

Right choice for ultimate yield

LSIS strives to maximize customers' profit in gratitude of choosing us for your partner.

Programmable Logic Controller

BACnet/IP I/F Module

XGT Series

User's Manual

XGL-BIPT



Safety Instructions

- Read this manual carefully before installing, wiring, operating, servicing or inspecting this equipment.
- Keep this manual within easy reach for quick reference.

LSIS

<http://www.lsis.com>

Safety Instructions

Before using the product ...

For your safety and effective operation, please read the safety instructions thoroughly before using the product.

- ▶ Safety Instructions should always be observed in order to prevent accident or risk with the safe and proper use the product.
- ▶ Instructions are divided into “Warning” and “Caution”, and the meaning of the terms is as follows.





This symbol indicates the possibility of serious injury or death if some applicable instruction is violated



This symbol indicates the possibility of severe or slight injury, and property damages if some applicable instruction is violated

Moreover, even classified events under its caution category may develop into serious accidents relying on situations. Therefore we strongly advise users to observe all precautions properly just like warnings.

- ▶ The marks displayed on the product and in the user’s manual have the following meanings.
 -  Be careful! Danger may be expected.
 -  Be careful! Electric shock may occur.
- ▶ The user’s manual even after read shall be kept available and accessible to any user of the product.

Safety Instructions

Safety Instructions for design process

Warning

- ▶ **Please install a protection circuit on the exterior of PLC so that the whole system may operate safely regardless of failures from external power or PLC.** Any abnormal output or operation from PLC may cause serious problems to safety in whole system.
 - Install protection units on the exterior of PLC like an interlock circuit that deals with opposite operations such as emergency stop, protection circuit, and forward/reverse rotation or install an interlock circuit that deals with high/low limit under its position controls.
 - If any system error (watch-dog timer error, module installation error, etc.) is detected during CPU operation in PLC, all output signals are designed to be turned off and stopped for safety. However, there are cases when output signals remain active due to device failures in Relay and TR which can't be detected. Thus, you are recommended to install an addition circuit to monitor the output status for those critical outputs which may cause significant problems.

- ▶ **Never overload more than rated current of output module nor allow to have a short circuit.** Over current for a long period time may cause a fire .

- ▶ **Never let the external power of the output circuit to be on earlier than PLC power,** which may cause accidents from abnormal output or operation.

- ▶ **Please install interlock circuits in the sequence program for safe operations in the system when exchange data with PLC or modify operation modes using a computer or other external equipments**
Read specific instructions thoroughly when conducting control operations with PLC.

Safety Instructions

Safety Instructions for design process

Caution

- ▶ **I/O signal or communication line shall be wired at least 100mm away from a high-voltage cable or power line.** Fail to follow this instruction may cause malfunctions from noise

Safety Instructions on installation process

Caution

- ▶ **Use PLC only in the environment specified in PLC manual or general standard of data sheet.** If not, electric shock, fire, abnormal operation of the product may be caused.
- ▶ **Before install or remove the module, be sure PLC power is off.** If not, electric shock or damage on the product may be caused.
- ▶ **Be sure that every module is securely attached after adding a module or an extension connector.** If the product is installed loosely or incorrectly, abnormal operation, error or dropping may be caused. In addition, contact failures under poor cable installation will be causing malfunctions as well.
- ▶ **Be sure that screws get tighten securely under vibrating environments.** Fail to do so will put the product under direct vibrations which will cause electric shock, fire and abnormal operation.
- ▶ **Do not come in contact with conducting parts in each module,** which may cause electric shock, malfunctions or abnormal operation.

Safety Instructions

Safety Instructions for wiring process

Warning

- ▶ **Prior to wiring works, make sure that every power is turned off.** If not, electric shock or damage on the product may be caused.
- ▶ **After wiring process is done, make sure that terminal covers are installed properly before its use.** Fail to install the cover may cause electric shocks.

Caution

- ▶ **Check rated voltages and terminal arrangements in each product prior to its wiring process.** Applying incorrect voltages other than rated voltages and misarrangement among terminals may cause fire or malfunctions.
- ▶ **Secure terminal screws tightly applying with specified torque.** If the screws get loose, short circuit, fire or abnormal operation may be caused. Securing screws too tightly will cause damages to the module or malfunctions, short circuit, and dropping.
- *
 - ▶ **Be sure to earth to the ground using Class 3 wires for FG terminals which is exclusively used for PLC.** If the terminals not grounded correctly, abnormal operation or electric shock may be caused.
 - ▶ **Don't let any foreign materials such as wiring waste inside the module while wiring,** which may cause fire, damage on the product or abnormal operation.
 - ▶ **Make sure that pressed terminals get tighten following the specified torque. External connector type shall be pressed or soldered using proper equipments.**

Safety Instructions

Safety Instructions for test-operation and maintenance

Warning

- ▶ **Don't touch the terminal when powered.** Electric shock or abnormal operation may occur.
- ▶ **Prior to cleaning or tightening the terminal screws, let all the external power off including PLC power.** If not, electric shock or abnormal operation may occur.
- ▶ **Don't let the battery recharged, disassembled, heated, short or soldered.** Heat, explosion or ignition may cause injuries or fire.

Caution

- ▶ **Do not make modifications or disassemble each module.** Fire, electric shock or abnormal operation may occur.
- ▶ **Prior to installing or disassembling the module, let all the external power off including PLC power.** If not, electric shock or abnormal operation may occur.
- ▶ **Keep any wireless equipment such as walkie-talkie or cell phones at least 30cm away from PLC.** If not, abnormal operation may be caused.
- ▶ **When making a modification on programs or using run to modify functions under PLC operations, read and comprehend all contents in the manual fully.** Mismanagement will cause damages to products and accidents.
- ▶ **Avoid any physical impact to the battery and prevent it from dropping as well.** Damages to battery may cause leakage from its fluid. When battery was dropped or exposed under strong impact, never reuse the battery again. Moreover skilled workers are needed when exchanging batteries.

Safety Instructions

Safety Instructions for waste disposal

 **Caution**

- ▶ **Product or battery waste shall be processed as industrial waste.**
The waste may discharge toxic materials or explode itself.

Revision History

Version	Data	Remark	Page
V 1.0	'14.05	First Edition	-
V 1.1	'15.01	XG5000 V4.0 UI Updated	-

※ The number of User's manual is indicated right part of the back cover.

Copyright © 2014 LSIS Co., Ltd All Rights Reserved.

Congratulations on purchasing PLC of LSIS Co.,Ltd.

Before use, make sure to carefully read and understand the User's Manual about the functions, performances, installation and programming of the product you purchased in order for correct use and importantly, let the end user and maintenance administrator to be provided with the User's Manual.

The User's Manual describes the product.

If necessary, you may refer to the following description and order accordingly.

In addition, you may connect our website (<http://www.lsis.biz/>) and download the information as a PDF file.

Relevant User's Manuals

Title	Description	Manual number
XG5000 User's Manual (for XGK, XGB)	XG5000 software user manual describing online function such as programming, print, monitoring, debugging by using XGK, XGB CPU	10310000512
XG5000 User's Manual (for XGI, XGR)	XG5000 software user manual describing online function such as programming, print, monitoring, debugging by using XGI, XGR CPU	10310000834
XGK/XGB Instructions & Programming User's Manual	User's manual for programming to explain how to use instructions that are used PLC system with XGK, XGB CPU.	10310000510
XGI/XGR Instructions & Programming User's Manual	User's manual for programming to explain how to use instructions that are used PLC system with XGI, XGR CPU.	10310000833
XGK CPU User's Manual (XGK- CPUA/CPUE/CPUH/CPUS/CPUU)	XGK-CPUA/CPUE/CPUH/CPUS/CPUU user manual describing about XGK CPU module, power module, base, IO module, specification of extension cable and system configuration, EMC standard	10310000508
XGI CPU User's Manual (XGI-CPUU)	XGI-CPUU user manual describing about XGK CPU module, power module, base, IO module, specification of extension cable and system configuration, EMC standard	10310000832
XGR redundant series User's Manual	XGR-CPUU user manual describing about XGR CPU module, power module, extension drive, base, IO module, specification of extension cable and system configuration, EMC standard	10310000694

Current user manual of XGL-BIPT is written based on the following version.

Related OS version list

Product name	OS version
XGK-CPUU, CPUH, CPUA, CPUS, CPUE	V4.2
XGI-CPUU/D, CPUU, CPUH, CPUS, CPUE	V3.8
XGR-CPUH/F, CPUH/T, CPUH/S	V2.6
XG5000	V4.0

© Contents ©

Chapter 1 Overview

1.1 Overview-----	1-1
1.2 Features-----	1-2
1.3 Product Configuration-----	1-3
1.3.1 Module name indication-----	1-3
1.3.2 Number of units installed by CPU-----	1-3
1.4 Software to use the product-----	1-4
1.4.1 Software check point-----	1-4
1.4.2 XG5000 -----	1-4
1.4.3 Check of version-----	1-5

Chapter 2 Product Specifications

2.1 General Specifications-----	2-1
2.2 Performance Specifications-----	2-2
2.3 Designations of Parts-----	2-3
2.4 Cable Specifications-----	2-5

Chapter 3 Installation and Test Operation

3.1 Installation Environment -----	3-1
3.2 Precautions for Handling-----	3-2
3.3 Operation Sequence-----	3-3
3.4 I/O Assignment and Device Information-----	3-4
3.4.1 I/O assignment -----	3-4
3.5 Installation of the product -----	3-9
3.6 Precaution -----	3-11

Chapter 4 System Configuration

4.1 Available System Configuration -----	4-1
--	-----

Chapter 5 Communication Parameter

5.1 Overview -----	5-1
5.1.1 XGL-BIPT Profile -----	5-1
5.1.2 Communication Service -----	5-1
5.2 ID Allocation of Input / Output Modules -----	5-2
5.2.1 Input / output Modules possible to support -----	5-2
5.2.2 Object ID allocation method of input / output modules -----	5-3
5.2.3 Object ID mapping of input/ output modules -----	5-3
5.3 Installation and Execution of Software -----	5-6

Contents

5.3.1 XG5000 installation	5-6
5.3.2 USB device driver installation(Installation in windows XP)	5-9
5.3.3 Confirmation of installed USB device driver	5-12
5.4 Communication Module Registration	5-18
5.4.1 Off-line registration of BACnet I/F module	5-18
5.4.2 Online registration of BACnet I/F module	5-20
5.4.3 How to read the parameter saved in the PLC	5-22
5.4.4 BACnet/IP I/F Module setting method	5-23
5.4.5 Menu bar and shortcut of XG5000	5-24

Chapter 6 P2P Service

6.1 Overview	6-1
6.2 Service Settings	6-2
6.2.1 Module settings	6-2
6.3 Start of the operation	6-6
6.3.1 XG5000 settings	6-6
6.4 Status Information by service	6-8
6.4.1 System diagnosis to P2P service	6-8

Chapter 7 Diagnosis

7.1 System diagnosis	7-1
7.2 Communication Module Information	7-3
7.3 Status by Service	7-4
7.4 Media Information	7-6
7.5 Ping Test	7-7
7.6 Auto scan	7-8
7.6.1 WHO-is Service	7-8
7.6.2 WHO-has Service	7-8
7.7 Device Communication Control	7-10
7.8 Troubleshooting	7-11
7.8.1 Identification through LED of the communication module	7-11
7.8.2 Identification of abnormalities of the muddle through XG5000	7-11
7.8.3 Identification of module abnormalities by system log	7-11
7.9 Remote Communication Control	7-13
7.9.1 Introduction	7-13
7.9.2 Setting and Connection	7-14

Appendix

A.1 Definition of Terms	A-1
A.2 Flag List	A-5
A.2.1 Special Relays List (F)	A-5
A.2.2 Communication Relays List (L)	A-12
A.3 Dimension	A-13

Chapter 1 Overview

1.1 Overview

This User Manual provides guidance for BACnet/IP I/F Module (hereafter referred to as "BIPT Module" in this manual), a XGT PLC System network. BACnet refers to a standard communication protocol named ANSI/ASHRAE Standard 135-1995, jointly employed and supported by American National Standard Institute (ANSI) and American Society of Heating, Refrigerating and Air-conditioning Engineers (ASHRAE). BACnet is an application protocol which uses Ethernet, UDP/IP, MS/TP or ARCnet as its medium: among them, XGL-BIPT module provides BACnet/IP which uses UDP/IP as its medium. PLC Digital I/O and Analog I/O module can be accessed using object, and a solution is provided to control PLC through BACnet communication in the BAS system along with XGT-InfoU.

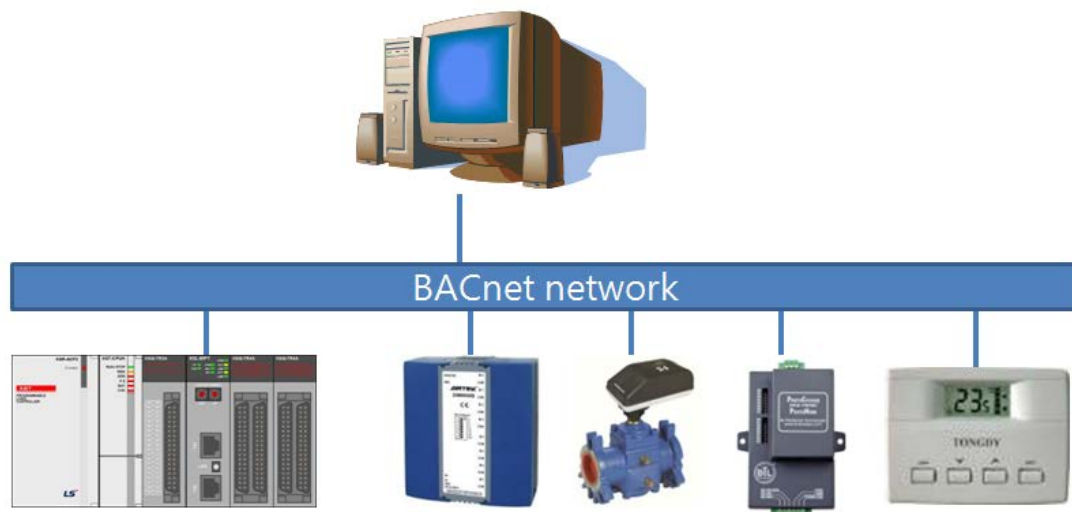

Please refer to the user manuals below for programming.

- XG5000 User Manual
- XGK Command List
- XGK User Manual
- XGI Command List
- XGI User Manual
- XGR Command List
- XGR User Manual

Please take note of the following requirement for system configuration.

- XGT PLC XG5000 Programming Tool: V4.00 or above

1.2 Features

Features of XGT BACnet/IP I/F Module are provided below.

(1) Device Profile: B-ASC + Client Function

Device Profile	B-ASC + Client
Data Sharing	DS-RP-A,B DS-RPM-A,B DS-WP-A,B DS-WPM-A,B
Device & Network Management	DM-DDB-B DM-DOB-B DM-DCC-A,B

* Reference 5.1.1 XGL-BIPT Profile and BACnet Interoperability Building Blocks (BIBB's)

(2) Compatibility: compatible with ANSI/ASHRAE 135-1995

(3) Provides 100BASE-TX media, and supports 100Mbps/Full Duplex.

(4) Up to 24 modules can be equipped per CPU module, and can be installed on main base or expanded base. However, they can be installed only on main base in XGR system.

(5) With its internal switch function, it requires no switch or HUB and it reduces wiring and provides installation flexibility.

(6) Makes cable works easier with its auto cross-over function.

(7) Provides various diagnosis functions and status information for modules and networks.

- ▶ Communication module status
- ▶ Communication service (P2P, Server) status
- ▶ Provides the type of transmitted/received packet of the communication module, as well as data volume (capable of predicting network load)
- ▶ Ping Test
- ▶ Autoscan function, which provides connected BACnet/IP module inside the network
- ▶ DCC(DeviceCommunicationControl) function, which controls communication of BACnet device
- ▶ Identification of main events logged in the communication module

1.3 Product Configuration

1.3.1 Module name indication

This section describes product configuration of XGT BACnet/IP I/F module

Model name	Content	Remarks
XGL-BIPT	Electrical 2-port BACnet/IP module	Category 5 or higher

1.3.2 Number of units installed by CPU

Up to 24 XGT BACnet/IP I/F modules can be installed on either main base or expanded base. Please install the modules on the main base to gain their maximum performance. The table below shows available services for different CPU's. Please consider the number of communication modules when applying them during system configuration.

Segment	XGK					XGI					XGR		
	CPUH	CPUU	CPUA	CPUS	CPUE	CPUU	CPUH	CPUS	CPUE	CPUU/D	CPUH/T	CPUH/F	CPUH/S
Number of P2P use modules(maximum)	8 units												
Maximum number of modules(server use modules included)	24 units												

1.4 Software to use the product

Sections below introduce key programming tools and other production software for using BIPT module Please apply the following explanations to the system for more accurate application of programs and communication.

1.4.1 Software check point

Segment	Component product	Communication setting tool
XGL-BIPT	Communication module for XGT	XG5000

Note

- 1) The program above is currently available for download at the web site. If you don't have any access to the internet, please visit our agency nearest from you and ask for the installation CD-ROM for the programs.
Internet Web Address : <http://www.lsis.com>
- 2) You can use RS-232C port and USB of the CPU module to program XG5000. Please see the XGT catalogue product list for the type name of the cable used (USB-301A, K1C-050A).

1.4.2 XG5000

XG5000 is communication module software that provides such functions as default parameter settings for operation of all communication modules including BACnet I/F, frame writing and module/network diagnosis.

The figure below shows the initial screen of XG5000.

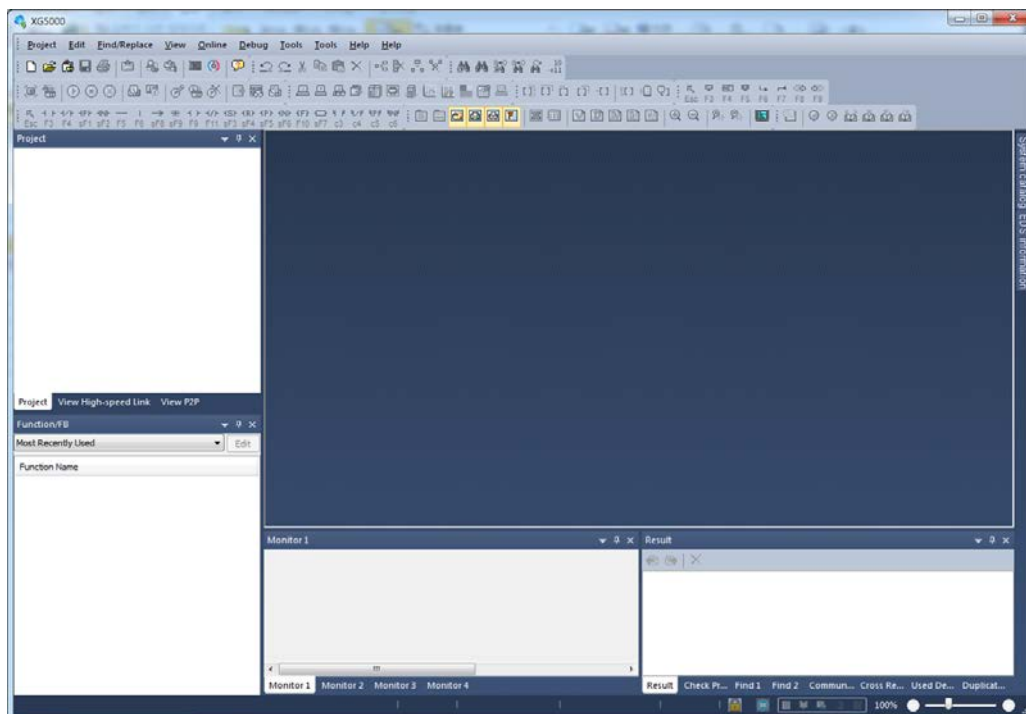

[Figure 1.4.1] XG5000 Initial Screen

1.4.3 Check of version

Before using XGT BACnet/IP I/F module, please identify the version of the module.

1) Identification through XG5000

You can read the information of a communication module by directly connecting to the module on-line.

If interface with CPU is normal, the information shown in the figure can be obtained.

- (1) Run XG5000.
- (2) Connect with the CPU, using on-line connection.
- (3) Once connected with the CPU, run XG5000 diagnosis.
- (4) Place the mouse cursor on the communication module on the system diagnosis screen of the on-line menu.
- (5) Double-click or right-click on the communication module to choose the detailed information of the communication module.

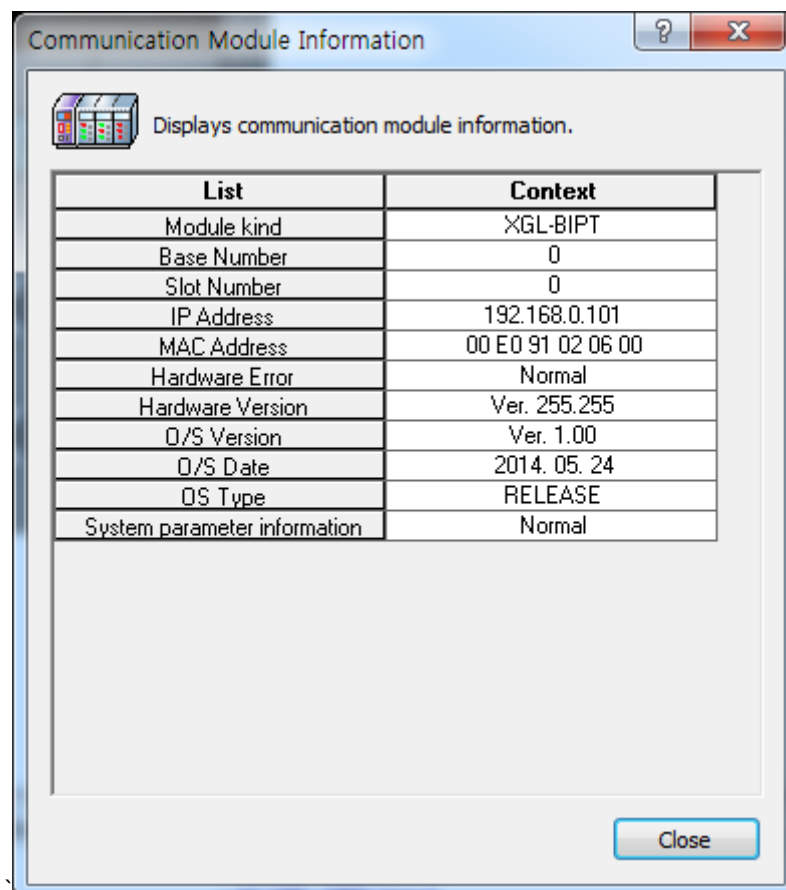

[Figure 1.4.2] Version identification of module through XG5000

2) Identification of version through case label of the product

The outside of the case for each communication module has the module's production information attached on it. If there is no external connection device for the PC and on-line verification is not possible, you can detach the module to verify the version indicated on the label.

The label is attached on the back side of the product, and it indicates the type name and version information of the product.

Chapter 2 Product Specifications

2.1 General Specifications

General specifications of XGT series are as shown in Table 2.1.

No.	Items	Specification	Reference				
1	Ambient Temp.	0 ~ 55 °C					
2	Storage Temp.	-25 ~ +70 °C					
3	Ambient humidity	5 ~ 95%RH (Non-condensing)					
4	Storage humidity	5 ~ 95%RH (Non-condensing)					
5	Vibration Immunity	Occasional vibration			-	10 times each direction (X, Y and Z)	IEC61131-2
		Frequency	Acceleration	Pulse width			
		$5 \leq f < 8.4\text{Hz}$	-	3.5mm			
		$8.4 \leq f \leq 150\text{Hz}$	$9.8\text{m/s}^2(1\text{G})$	-			
		Continuous vibration					
		Frequency	Acceleration	Pulse width			
		$5 \leq f < 8.4\text{Hz}$	-	1.75mm			
		$8.4 \leq f \leq 150\text{Hz}$	$4.9\text{m/s}^2(0.5\text{G})$	-			
6	Shocks Immunity	<ul style="list-style-type: none"> • Peak acceleration : $147\text{ m/s}^2(15\text{G})$ • Duration : 11ms • Pulse wave type : Half-sine (3 times each direction per each axis) 	IEC61131-2				
7	Noise Immunity	Square wave impulse noise	AC: $\pm 1,500\text{V}$ DC: $\pm 900\text{V}$	LSIS internal test spec.			
		Electrostatic discharge	4.0kV (Contact discharge)	IEC61131-2 IEC61000-4-2			
		Radiated electromagnetic field noise	80 ~ 1000 MHz, 10V/m	IEC61131-2, IEC61000-4-3			
		Fast transient /Burst noise	Classification Voltage	Power supply 2kV	Digital/Analog Input/Output, Communication Interface 1kV	IEC61131-2 IEC61000-4-4	
8	Operation ambience	Free from corrosive gases and excessive dust					
9	Altitude	Less than 2,000m					
10	Pollution degree	Less than 2					
11	Cooling method	Air-cooling					

[Table 2.1] General Specifications

Notes

- 1) IEC(International Electro technical Commission).
: An international nongovernmental organization which promotes internationally cooperated standardization in electric/electronic fields, publishes international standards and manages applicable estimation system related with.
- 2) Pollution level
: An index indicating pollution level of the operating environment which decides insulation performance of the devices. Generally, Pollution level 2 indicates the state that only non-conductive pollution occurs generally. However, this state contains temporary conduction due to dew produced.

2.2 Performance Specifications

The following describes system configuration specifications according to the media of BACnet/IP I/F module.

Please refer to the table below for system configuration.

Communication load is classified load by media interrupt per second at media of BACnet I/F module and transmission load (by Link I/F) that send to the BACnet I/F module from CPU module. If exceed the media interrupt load that BACnet I/F module is guaranteed, It may operate abnormally. Please configure the network system that you can block the DDOS attack by malicious purposes or ARP based attacks.

Please set the P2P parameters that sending next request after complete the basic request of P2P communication and response process. It may operate abnormally in same conditional flag.

	Item	Specification
Transmission standards	Transmission speed	100Mbps
	Transmission method	Base band
	Maximum extension distance between nodes	100m
	Maximum size of protocol	1,536 bytes
	Communication access method	CSMA/CD
	Frame error check method	$CRC\ 32 = X^{32} + X^{26} + X^{23} + \dots + X^2 + X + 1$
	Maximum number of units installed	24 units
Service	Service type	P2P/Server
	Maximum communication data	1,400 bytes
	Support object(Server)	Device Object Binary Input Object Binary Output Object Analog Input Object Analog Output Object
	Diagnostic function	Communication module information Service status information Media information Ping test Auto scan DCC(Device communication control) System log
Basic standards	External dimensions(mm)	98(H) X 27(W) X 90(D)
	Current consumption(mA)	400
	Weight(g)	102

[Table 2.2] Performance specifications

2.3 Designations of Parts

Names of each part of the PLC are as follows.

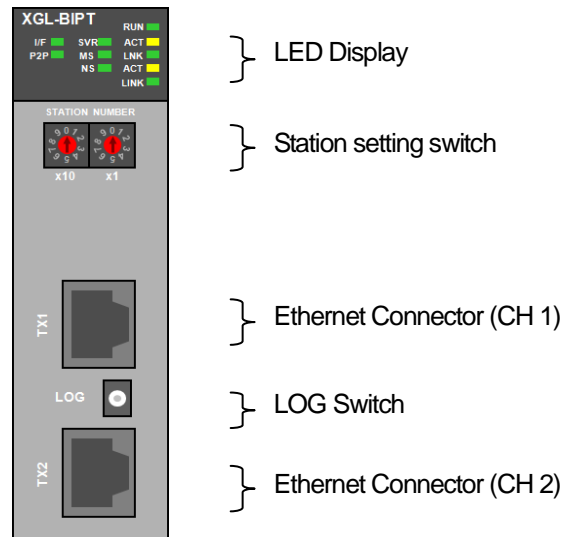

[Figure 2.3] Front view of PLC module

► LED names and contents

Silk indication	LED status	Contents
RUN	Light-on	Power ON and normal operation of the module
	Light-off	Power OFF and abnormal operation of the module
I/F	On-and-off light	In normal I/F with CPU
	Light-on/Light-off	Abnormal operation of I/F with CPU
P2P	Light-on	When setting P2P service
	Light-off	When releasing P2P service
SVR	Light-on	When connected to external clients
	Light-off	When there is no external client connections
MS	Green light-on	In normal operation
	Green light-on-and-off	When device configuration is not complete
	Red light-on-and-off	When wrong settings or recoverable errors occur
	Red light-on	In case non-recoverable error occurs
NS	Red and green light-on-and-off	In self-diagnosis
	Green light-on	BACnet Network Enable status(DCC)
	Red light on-and-off	In case a duplicate ID address is detected
nACT	Red light-on	BACnet Network Disable status(DCC)
	On-and-off light	When transmitting and receiving frames(n=1,2)
nLNK	Light-on	When the network link is formed(n=1,2)
	Light-off	When no network link is formed(n=1,2)

► Log switch

In case there is a need to read log in communication module and store the log, it is stored from the memory area to flash area by pressing it for more than one second. The memory area log is removed when power is turned on again, and flash area log is maintained even when power is turned on again.

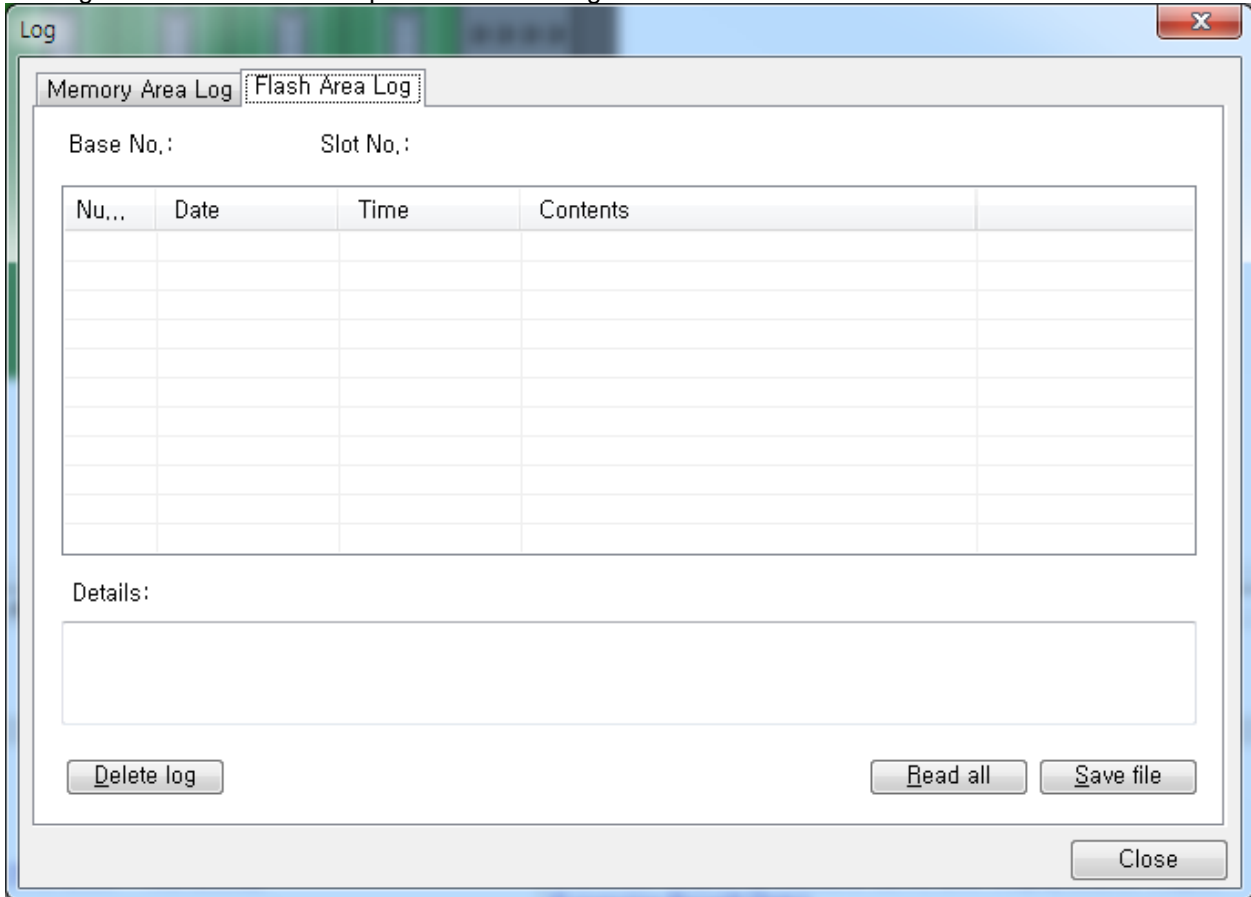

[Figure 2.4] Front view of module for PLC

2.4 Cable Specifications

2.4.1 UTP cable

UTP cable is classified into 3 types based on the following criteria.

- ▶ Shield: classified into 3 (UTP, FTP, STP)
- ▶ Frequency band used: classified into 7 (Cat. 1~7)
- ▶ Classification by flame retardant grade: 4 types(CMX, CM, CMR, CMP)

1) Type of cables (shield)

Classification	Details	Purpose
UTP (or U.UTP)	High speed data transmission Unshielded cable	Max. 200MHz Phonetic+Data+Low grade of video signal
FTP (or S.UTP)	Shielded cable core only. * Shield material: AL/Plastic complex foil or Copper Braid	Max.100MHz Electronic impediment (EMI) and electric stability considered Phonetic+Data+Low grade of video signal
STP (or S.STP)	Double-shielded cable Shielded core and Individually Pair cable * Pair Shielded material: AL/Plastic complex foil * Core Shielded material: AL/Plastic complex foil or Copper Braid	Max. 500MHz Phonetic+Data+Video signal Substitute for 75Ω coaxial cable

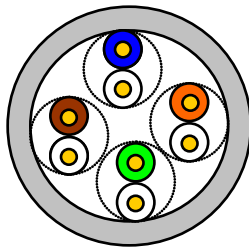

UTP

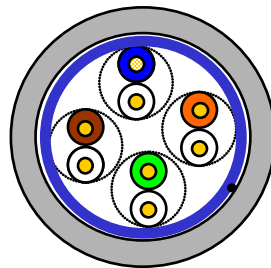

FTP

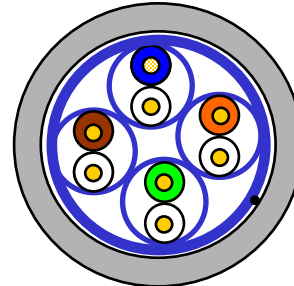

STP

Notes

1) UTP : Unshielded Twisted Paired Copper Cable

FTP : (Overall) Foiled Twisted Paired Copper Cable

STP : (Overall) Shielded(and Shielded Individually Pair)Twisted Paired Copper Cable

2) Patch Cable(or Patch Cord)

Conductor composed of stranded cable instead of solid conductor may be used to increase the flexibility of UTP 4-pair cable. And surface specification and materials used is Un-coated AWG 24 (7/0203A).

In other words, the diameter of a single cable is 0.203mm, and this cable is of 1+6 structure as standardized with annealed copper cable.

Chapter 2 Product Specifications

2) Classification based on frequency used

Classification	Frequency used (MHz)	Transmission Speed (Mbps)	Purpose
Category 1	Phonetic Frequency	1	Phone network (2-Pair)
Category 2	4	4	Multi-Pair communication cable
Category 3	16	16	Phone network + Computer network
Category 4	20	20	1) Computer network transmission speed Up 2) Low-loss communication cable
Category 5 and Enhanced Category 5	100	100	1) Digital Phone network + Computer network 2) Low-loss, broadband cable

Notes

- 1) Presently classified items are Category 3, 5, Enhanced Cat.5 and Cat.6 inside and outside of the country, where Category 4 has been replaced by Category 5 and Category 7 is being under development all over the world as STP structure.

3) Classification by flame retardant grade (based on UL certification)

Segment	Heat capacity	Time	Combustion length	Smoke suppression	Remarks
CMP	88(kW)	20 minutes	73m/min or less	Regulated	<ul style="list-style-type: none"> • For ceiling laid without duct • Plenum Cable • UL 910 (Plenum Test)
CMR	150(kW)	30 minutes	3.6m or less	Non-regulated	<ul style="list-style-type: none"> • Vertical laying-type • Non-Plenum Cable • UL 1666(Riser Test)
CM	21(kW)	20 minutes	2.4m or less	Non-regulated	<ul style="list-style-type: none"> • General-type • Non-Plenum Cable • UL 1581(VTFT Test)
CMX	1(kW)	1 minute	0.5m or less	Non-regulated	<ul style="list-style-type: none"> • Limited use • Non-Plenum Cable • UL 1581 (VW-1 Test)

Note

- 1) There is CMG in the grade between CM and CMR, but it is not commonly applied in LAN Cable such as UTP Cable.

4) Example (CTP-LAN5) of Category 5 twisted-pair cable (UTP)

Item	Unit		Value
Conductor resistance(Max)	Ω/km		93.5
Insulation resistance(Min)	$\text{M}\Omega\text{-km}$		2,500
Voltage endurance	V/min		AC 500
Characteristic impedance	$\Omega(1\sim 100\text{MHz})$		100 ± 15
Attenuation	dB/100m or less	10MHz	6.5
		16MHz	8.2
		20MHz	9.3
Near-end crosstalk Attenuation	dB/100m or less	10MHz	47
		16MHz	44
		20MHz	42

Chapter 3 Installation and Test Operation

3.1 Installation Environment

This product is of high reliance regardless of installation environment. However, for the sake of reliance and stability of the system, please pay attention to those precautions described below.

- (1) Environmental Conditions
 - (a) To be installed on the control panel waterproof and dustproof.
 - (b) No continuous impact or vibration shall be expected.
 - (c) Not to be exposed to the direct sunlight.
 - (d) No dew shall be caused by rapid temperature change.
 - (e) Ambient temperature shall be kept 0-55°C.

- (2) Installation Work
 - (a) No wiring waste is allowed inside PLC when wiring or drilling screw holes.
 - (b) To be installed on a good location to work on.
 - (c) Don't let it installed on the same panel as a high-voltage device is on.
 - (d) Let it kept at least 50 mm away from duct or near-by module.
 - (e) To be grounded in an agreeable place free from noise.

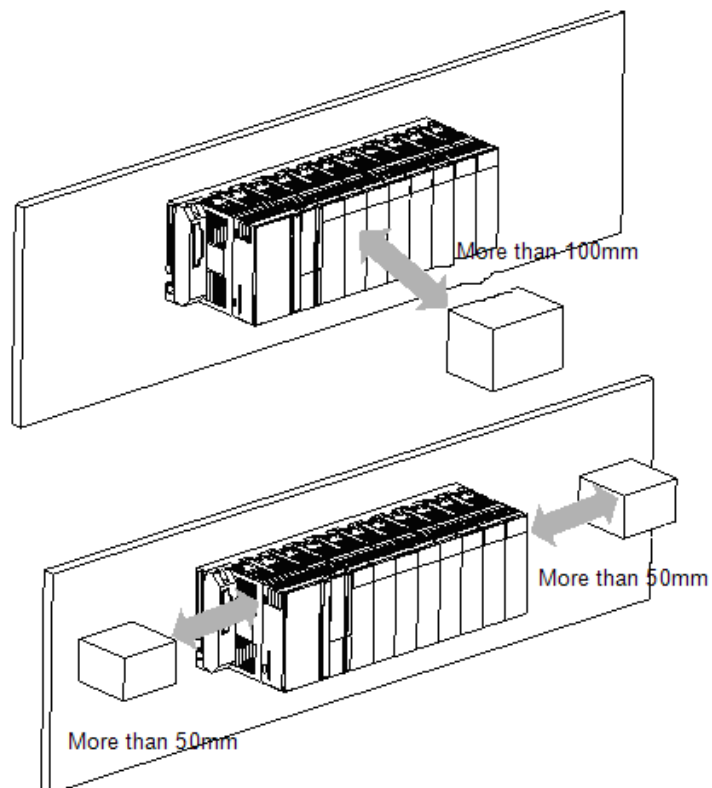

3.2 Precaution for Handling

The system configuration with RAPIEnet I/F module shall be performed under the following precautions.

- (1) Don't let it dropped or shocked hard.
- (2) Don't remove PCB from the case. It will cause abnormal operation.
- (3) Don't let any foreign materials including wiring waste inside the top of the module when wiring.
- (4) Get rid of foreign materials if any.
- (5) Don't install or remove the module while powered on.
- (6) Use standard cable only and let it installed within the maximum distance specified.
- (7) Let the communication cable free from the surge and inductive noise generated by or from the alternating current.
- (8) Don't let wiring too close to hot device and material or in direct contact with oil for long, which will cause damage or abnormal operation due to short-circuit.
- (9) For wiring with pipes, the pipes need grounding.

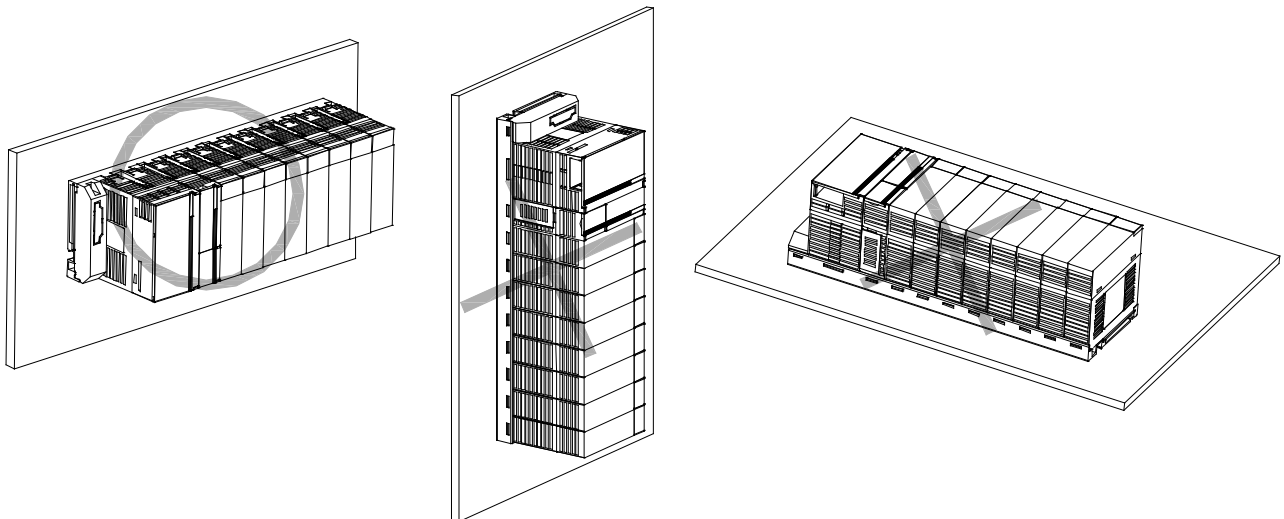

3.3 Operation Sequence

The sequence of the product from installation to operation will be described below. After the product installation is complete, install and configure the system to be operated as specified in the following sequence.

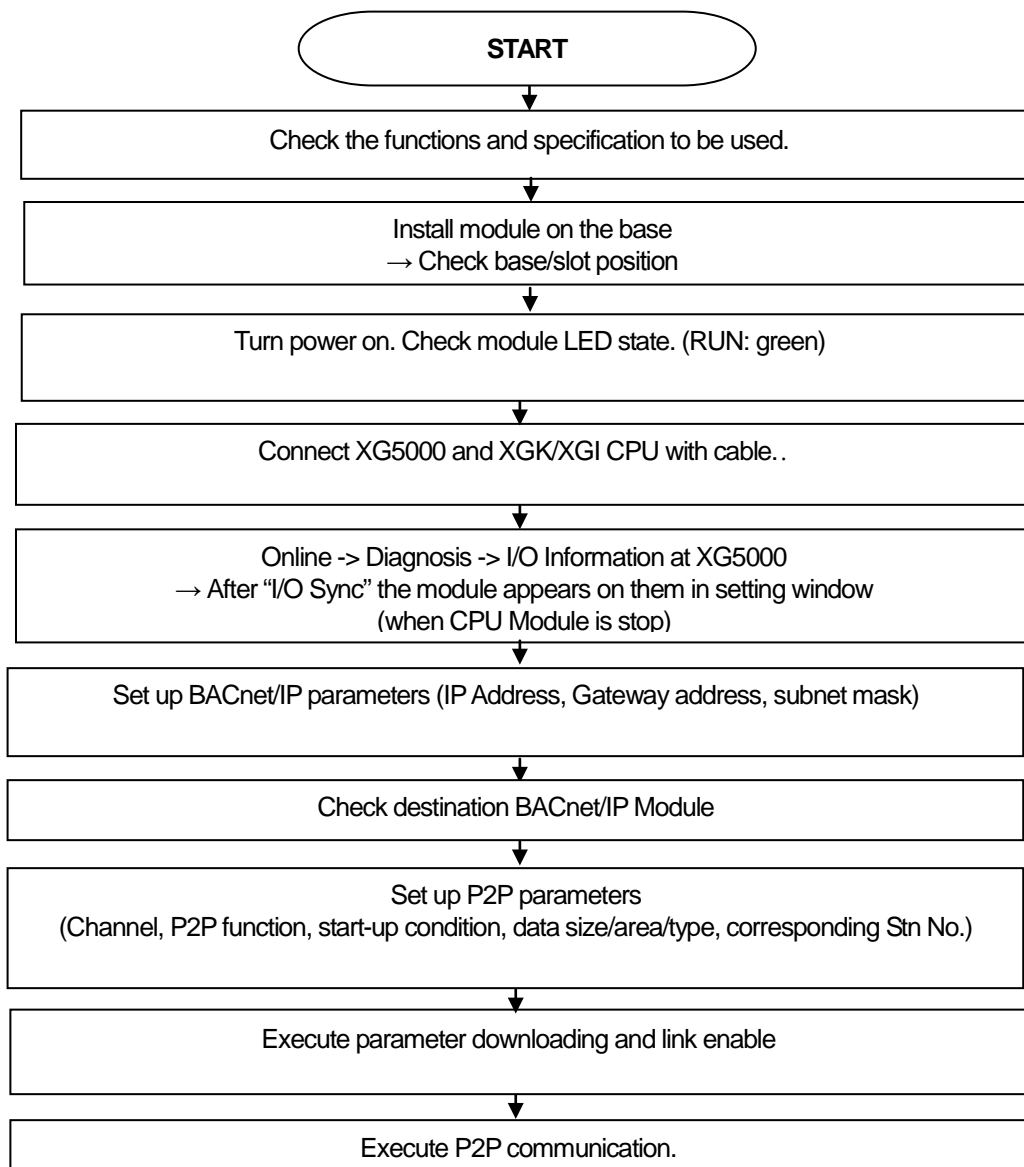

3.4 I/O Assignment and Device Information

3.4.1 I/O assignment

(1) Using XGK CPU

(a) Configuration method of basic system

The features of Basic system consisted by connecting the main base and expanded base by a cable are as follows. The number of stages of expanded base is limited according to the CPU type and the allocation method of I/O No. is available to select the fixed type and variable type according to the setting of basic parameter.

Classification	XGK-CPUE	XGK-CPUS	XGK-CPUA	XGK-CPUH	XGK-CPUU
Max. expanded stages	1stage	3 stages	3 stages	7 stages	7 stages
Max. no. of I/O Module install	24 Modules	48 Modules	48 Modules	96 Modules	96 Modules
Max. I/O point	1,536 points	3,072 points	3,072 points	6,144 points	6,144 points
Max. extended distance	15m				

(b) Allocation of I/O number (Fixed type)

- 1) Each slot of base is allocated by 64 points regardless module installation and type.
- 2) For one base, I/O no. of 16 slots is allocated. That is, the start no. of No.1 base becomes P0640. (refer to Ch2.3.2)
- 3) The example of I/O no. of 12 slot base is as below.

Slot No.		0	1	2	3	4	5	6	7	8	9	10	11
P W R	C	I	I	I	I	O	O	O	O	I	O	O	O
	P	1	1	3	6	1	3	3	6	3	1	3	3
	U	6	6	2	4	6	2	2	4	2	6	2	2

P3F P7F P11FP15FP19FP23FP27FP31FP35FP39FP43FP47F

(c) Allocation of I/O no. (Variable type)

- 1) If assigned installation module by I/O parameter, the assigned point is allocated.
- 2) The slot not assigned by I/O parameter shall be allocated automatically according to actual installation slot.
- 3) The slot not assigned by I/O parameter shall be allocated automatically according to actual installation slot (8 point module shall be allocated by 16 point.)
- 4) The empty slot not assigned by I/O parameter shall be processed by 16 point.
- 5) Available to assign the point only by I/O parameter without module assignment.
- 6) The slot installed by special module or communication module is allocated by 16 point.
- 7) The example of I/O no. of 12 Slot base is as below.

Slot No.		0	1	2	3	4	5	6	7	8	9	10	11
P W R	C	I	I	I	I	O	O	O	O	I	O	O	O
	P	1	1	3	6	1	3	3	6	3	1	3	3
	U	6	6	2	4	6	2	2	4	2	6	2	2

P0F P1F P3F P7F P8F P10FP12FP16FP18FP19FP21FP23F

- (d) Maximum configuration
 - 1) Max. configuration of basic system (fixed point)

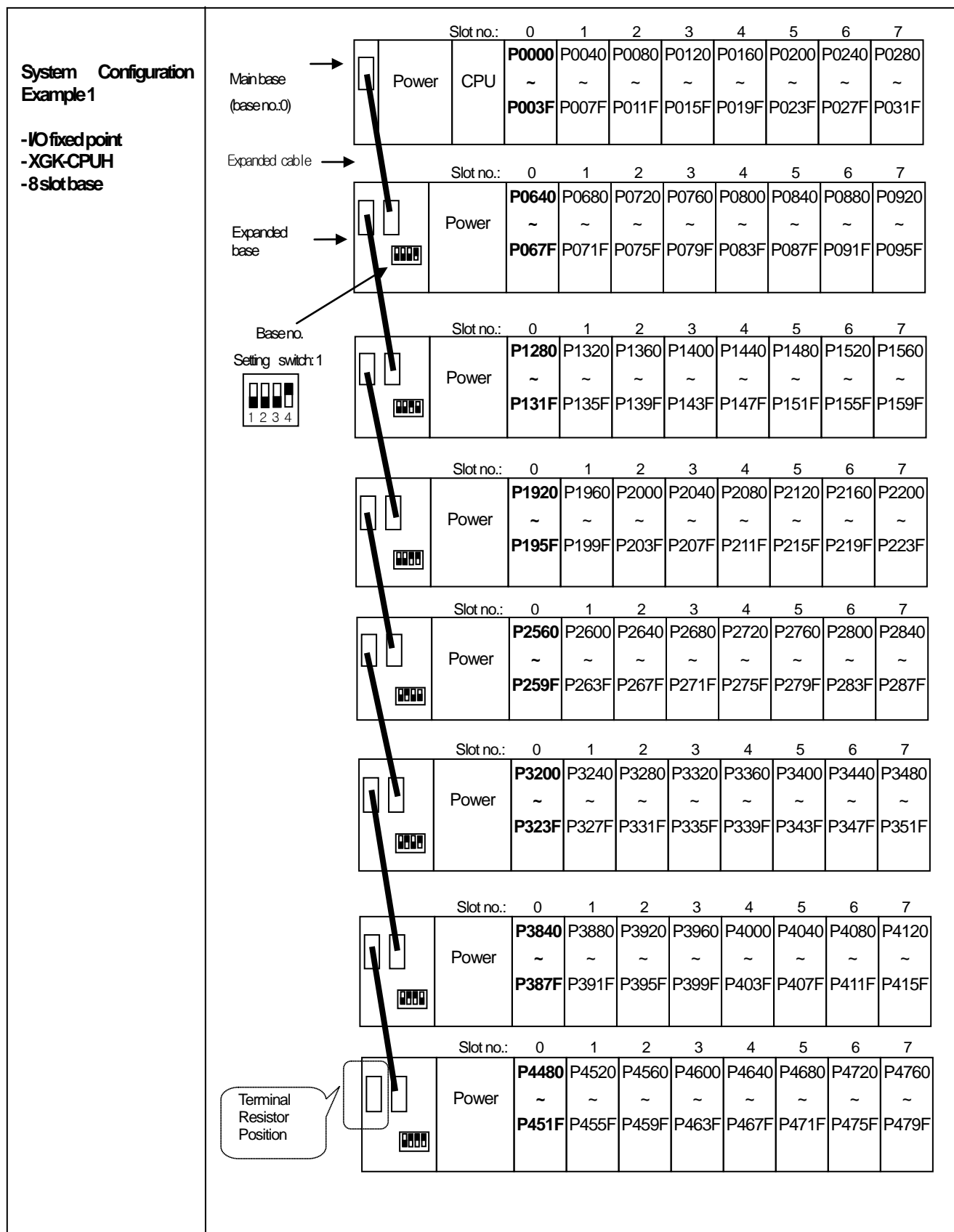

Chapter 3 Installation and Test Operation

2) Max. configuration of basic system (variable point)

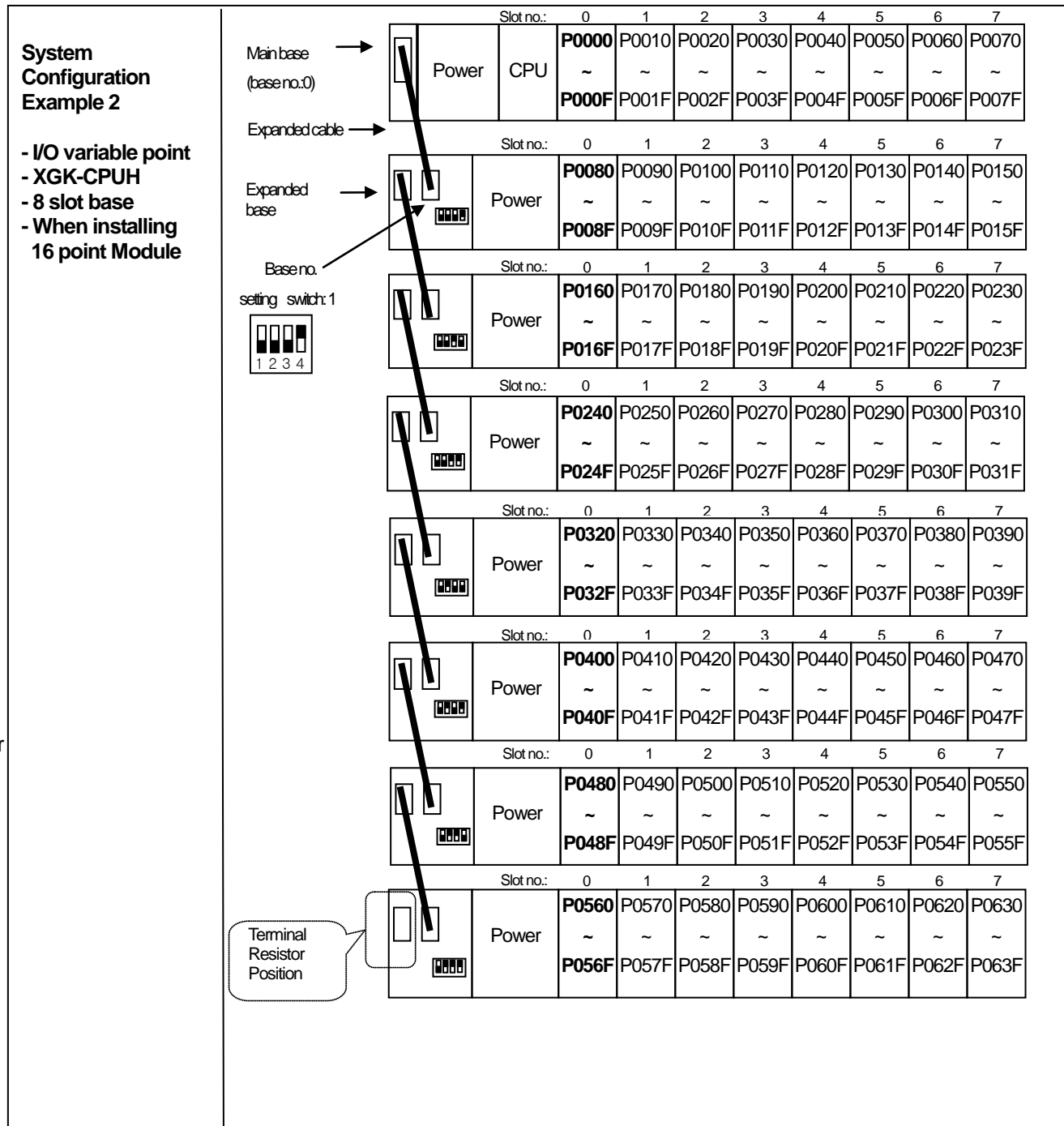

(2) Using XGI CPU

(a) Basic system configuration

Classification	XGI-CPUH, CPUU, CPUU/D	XGI-CPUS	XGI-CPUE																										
Max. extension stage	7 stages	3 stages	1 stage																										
Max. number of I/O module extension mounted	96 modules	48 modules	24 modules																										
Max. I/O contact number	6,144 points	3,072 points	1,536 points																										
Max. extension distance	15m																												
	<ul style="list-style-type: none"> I/O number is constantly allocated to 64 points per slot of the base. Each slot of the base is allocated with 64 points, irrespectively of module mounted or its type. The position on which a special module is mounted or the number is not limited. Unlike digital I/O module, a special module is not allocated for any constant I/O number. A special module is controlled by the exclusive function block and automatically allocated for the memory. For instance, the I/O number of 12 slot base is allocated as follows. <table style="margin-left: 40px; border-collapse: collapse;"> <tr> <td style="padding-right: 10px;">Slot no.</td> <td style="padding-right: 10px;">0</td> <td style="padding-right: 10px;">1</td> <td style="padding-right: 10px;">2</td> <td style="padding-right: 10px;">3</td> <td style="padding-right: 10px;">4</td> <td style="padding-right: 10px;">5</td> <td style="padding-right: 10px;">6</td> <td style="padding-right: 10px;">7</td> <td style="padding-right: 10px;">8</td> <td style="padding-right: 10px;">9</td> <td style="padding-right: 10px;">10</td> </tr> <tr> <td style="border: 1px solid black; padding: 2px;">Po wer</td> <td style="border: 1px solid black; padding: 2px;">C P U</td> <td style="border: 1px solid black; padding: 2px;">I 1 6</td> <td style="border: 1px solid black; padding: 2px;">I 1 6</td> <td style="border: 1px solid black; padding: 2px;">I 3 2</td> <td style="border: 1px solid black; padding: 2px;">I 6 4</td> <td style="border: 1px solid black; padding: 2px;">O 1 6</td> <td style="border: 1px solid black; padding: 2px;">O 3 2</td> <td style="border: 1px solid black; padding: 2px;">O 3 2</td> <td style="border: 1px solid black; padding: 2px;">O 6 4</td> <td style="border: 1px solid black; padding: 2px;">I 3 2</td> <td style="border: 1px solid black; padding: 2px;">O 1 6</td> <td style="border: 1px solid black; padding: 2px;">O 3 2</td> <td style="border: 1px solid black; padding: 2px;">O 3 2</td> </tr> </table> <div style="margin-left: 100px; margin-top: 10px;"> <p style="margin-left: 40px;">Base no. 1</p> </div>			Slot no.	0	1	2	3	4	5	6	7	8	9	10	Po wer	C P U	I 1 6	I 1 6	I 3 2	I 6 4	O 1 6	O 3 2	O 3 2	O 6 4	I 3 2	O 1 6	O 3 2	O 3 2
Slot no.	0	1	2	3	4	5	6	7	8	9	10																		
Po wer	C P U	I 1 6	I 1 6	I 3 2	I 6 4	O 1 6	O 3 2	O 3 2	O 6 4	I 3 2	O 1 6	O 3 2	O 3 2																

Remark

- 1) The basis base has its base number as '0' and the extension base has a switch to set the base number.
- 2) Operation starts as long as the module type set as I/O parameter and the actually mounted module type coincide.

Chapter 3 Installation and Test Operation

(b) Max. system configuration

System Configuration
Example 2

- XGI-CPUU
- 8 slot base
- When installing 16 point Module

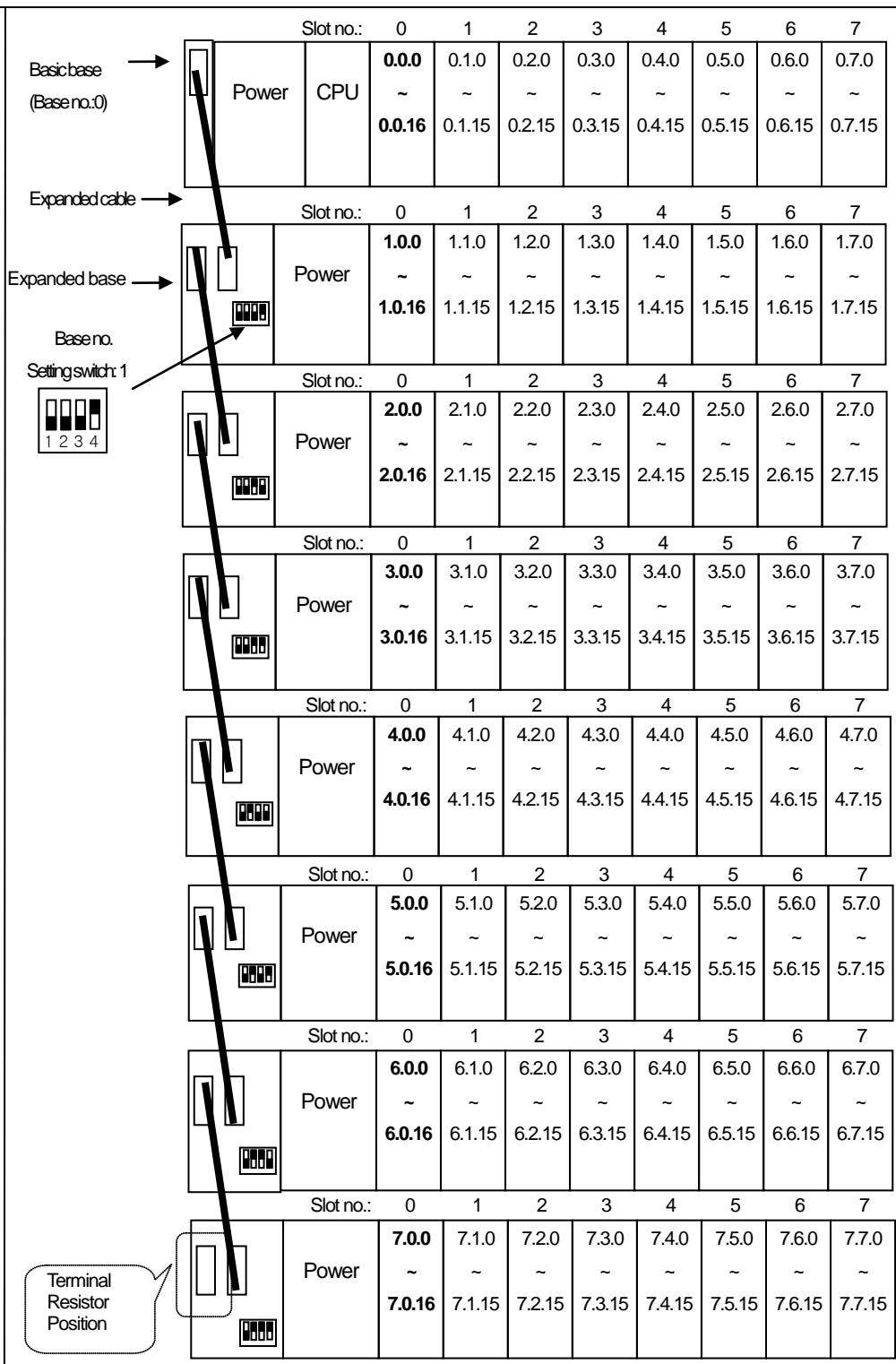

3.5 Installation of the Product

3.5.1 XGL-BIPT installation

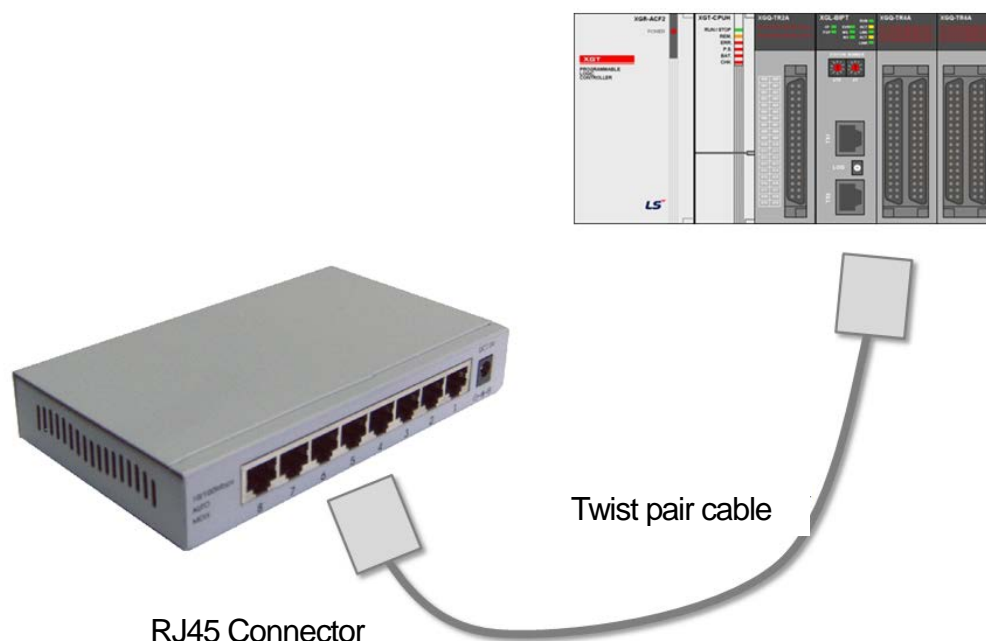

[Figure 3.6.1] 100BASE-TX Installation

The maximum length of 100BASE-TX segment is 100m (distance between modules)

Straight cables or crass cables are used.

You can reduce the time required for link connection by using cross cables to connect the communication modules.

Pin number	Signal	Straight cable between modules	1:1 Cross cable
1	TD+	1-1	1-3
2	TD-	2-2	2-6
3	RD+	3-3	3-1
6	RD-	6-6	6-2
4,5,7,8	Unused	-	-

Note

[Note 1] The structure of 100BASE-TX cables is vulnerable against noises from outside. Therefore, when twisting the cables, you need to twist the lines of Pin 1 and Pin 2 (TD+ and TD-, respectively) together and twist the lines of Pin 3 and Pin 6 (RD+ and RD-, respectively) to make wires reinforced against outside noises.

[Note 2] Please consult with experts for cable making and terminations.

Chapter 3 Installation and Test Operation

1) How to install UTP

- (1) For reliable 100Mbps signal transmission using UTP cable, patch cord, line cord, patch panel and DVO (Data Voice Outlet) should all have characteristics that satisfy EIA/TIA-568A, which is a category 5 spec.
- (2) In a cross-connect system, the length of patch cord must not exceed 7 meters. If the cord is more than 7m long, the excess should be deducted from the length permitted for Horizontal Distribution System, which is 90m.
- (3) In a work station, the length of line cord must not exceed 3 meters. If the cord is more than 3m long, the excess should be deducted from the length permitted for Horizontal Distribution System, which is 90m.
- (4) When wiring patch panel with DVO, the twisted pair loosening of UTP cable should not exceed the following standard.
- (5) Maximum twisted pair loosening : Category 5 : 13mm, Category 3 : 26mm
- (6) Jumper wires should be used for DC cross-connect system, and the loosening of twisted pair pitch should not exceed the standard above. In particular, it should be noted that severely bending the cable leads to damage as well as separation between pairs.
- (7) Maximum curvature radius : 4Pair cable : 4 times the external diameter
25Pair cable or above: 10 times the external diameter
- (8) When wiring, the maximum tensile strength must not exceed 110N (11.3Kgf) (in case of 4pairs).
- (9) Jumper wire and patch cord should be slightly loosely wired. Tight wiring may reduce their category 5 characteristics. Please take caution not to stress the cables when using tie-wraps.
- (10) Please maintain proper distances between EMI sources and UTP cables, when installing UTP cables.

The table below provides proper distances under various conditions.

Conditions	Minimum separation distance		
	Less than 2.0KVA	2.5 KVA	More than 5.0KVA
Unshielded power line or electrical equipment is open or close to non-metallic pipes	127mm	305mm	610mm
Unshielded power line or electrical equipment is close to the buried metal pipes	64mm	152mm	305mm
Power line in the buried metal pipe(or equivalent shielding) is close to the buried metal pipes	-	76mm	152mm

Note

- 1) Additional calculation is required if the voltage is more than 480V or the power rating is more than 5KVA.

3.6 Precaution

3.6.1 Precautions for system configuration

- 1) When using P2P services including the module in this manual, each station must have a different IP address from all the other stations.
- 2) Please use communication cables with designated specifications. Using other cables may cause severe communication problems.
- 3) Check for cable disconnection or short before installation.
- 4) Please tighten the communication cable connector so that the cable connection is securely fixed.
- 5) Incomplete connection causes severe communication problems.
- 6) When connecting communication cables over long distances, please separate the cables from power lines or inductive noise.
- 7) If the LED shows abnormal behaviors, please see Chapter 10 of this manual (Troubleshooting) to verify and solve the issue. Please contact the A/S/ center if the abnormal operation continues.

Chapter 4 System Configuration

BACnet/IP I/F module can be installed without regard to XGT CPU module. The maximum number of units installed is 24, which includes basic base and expanded base (XGR system is restricted by a main base). Among them, 8 units can be used as P2P service, and all 24 units are available when used as a server.

As for the communication system using this module, a variety of configurations are possible depending on applications. This chapter describes the case where system configuration is possible and the example that shows system configuration is impossible by the field of application.

4.1 Available System Configuration

XGL-BIPT module can be connected to BACnet Network using client/server, XGL-BIPT module is used as BACnet server, and sub-device can be controlled by being connected with PLC dedicated communication.

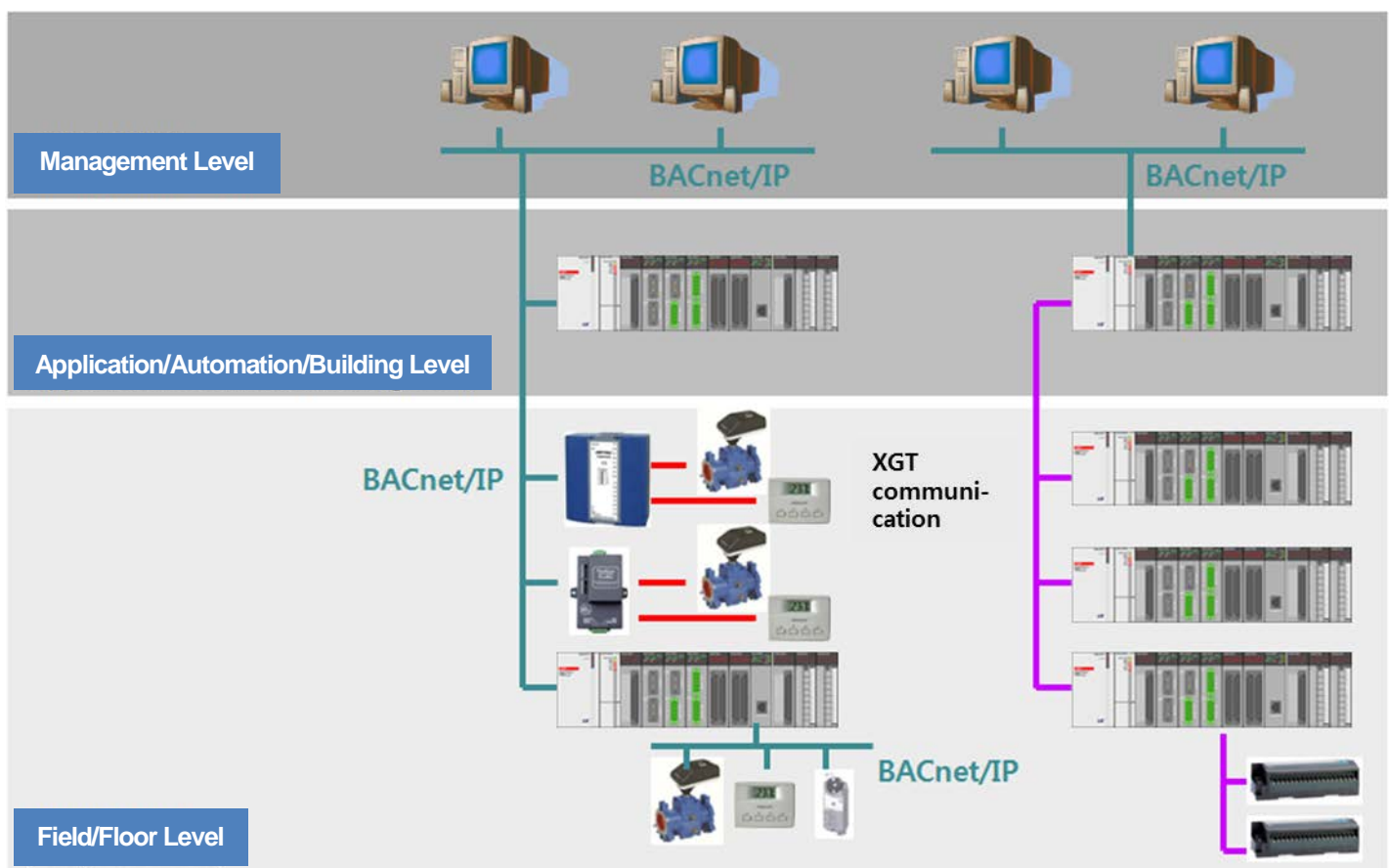

Chapter5 Communication Parameter

5.1 Overview

BACnet's communication method is based on the client-server model. A BACnet device consists of more than one object specified by ASHRAE, with each object having its properties including the ID and name. With such services as ReadProperty and WriteProperty, you can read property values of a certain object or change them. The XGL-BIPT module operates the BACnet/IP Client using P2P service. You can access the XGL-BIPT module from an external client using the server function,

5.1.1 XGL-BIPT Profile

The communication module of XGL-BIPT is B-ASC, one of device profiles specified by BACnet, with Client added to the profile. Functions supported by the profile are shown in the table.

Interoperability	BACnet Interoperability Building Blocks(BIBBs)			
	Client Side		Server Side	
Data Sharing(DS)	ReadProperty-A ReadPropertyMultiple-A WriteProperty-A WritePropertyMultiple-A	DS-RP-A DS-RPM-A DS-WP-A DS-WPM-A	ReadProperty-B ReadPropertyMultiple-B WriteProperty-B WritePropertyMultiple-B	DS-RP-B DS-RPM-B DS-WP-B DS-WPM-B
Device & Network management(DM)	Dynamic Device Binding-A Dynamic Object Binding-A DeviceCommunicationControl-A	DM-DDB-A DM-DOB-A DM-DCC-A	Dynamic Device Binding-B Dynamic Object Binding-B DeviceCommunicationControl-B	DM-DDB-B DM-DOB-B DM-DCC-B

- 1) Client: the subject requesting information
- 2) Server: the subject providing information as per the request
- 3) ReadProperty, WriteProperty: services used for reading or writing the value of one of the object's properties.
- 4) ReadPropertyMultiple, WritePropertyMultiple: services used for reading or writing the values of a number of the object's properties. The XGL-BIPT module is capable of sending multiple messages (up to 4) and the server is capable of processing up to 80 messages.
- 5) Dynamic Device Binding: refers to Who-is and I-am services in BACnet
- 6) Dynamic Object Binding: refers to Who-has and I-have services in BACnet.

5.1.2 Communication Service

In the XGL-BIPT module, the BACnet client is provided using P2P service. As for the server, objects are automatically generated for service, without special configuration except for the IP address.

The parameters below should be registered through XG5000 for the P2P service. When the preset time arrives, you can view the date through XG5000 by sending the request to the relevant server and receiving a response from it.

Parameters for P2P Communication

- 1) IP Address: IP address of the client and the server to communicate with
- 2) Operation Condition: the time to send the request
- 3) Service Type: Read or Write(automatic multiple encoding, in accordance with the number of requested parameters)
- 4) Object & Property: types of object and property of the relevant server

5.2 ID Allocation of Input / Output Modules

BACnet objects provided by BIPT communication module are Analog Input, Analog Output, Binary Input, and Binary Output. Analog Input object corresponds to Analog Input Module, Analog Output object corresponds to Analog Output Module, Binary Input object corresponds to Digital Input Module, and Binary Output Object corresponds to Digital Output Module. In order to control input/output modules using the BACnet protocol, you should access the input/output modules in use using the object ID. This Chapter explains the types of input/output modules supported by BIPT module, and how ID's of each object are allocated.

5.2.1 Input / output Modules possible to support

Input Output Modules that can be supported by the BIPT are as follows

1) Analog Module

Category	Sub-category	Channel/Axis	Module name
Input module	ADV(voltage-type)	8	XGF-AV8A
	ADI(current-type)	8	XGF-AC8A
		4	XGF-AC4H
	AD(insulation-type)	4	XGF-AW4S
		4	XFG-AD4S
		16	XGF-AD16A
		8	XGF-AD8A
Output module	DAV(voltage-type)	4	XGF-DV4A
		8	XGF-DV8A
	DAI(current-type)	4	XGF-DC4A
		8	XGF-DC8A
		4	XGF-DC4H
	DA(insulation-type)	4	XGF-DV4S
		4	XGF-DC4S
Input / Output modules	ADA(mixed-type)	4/2	XGF-AH6A

2) Digital Module

Category	Sub-category	Number of contacts	Module name
Input module	DC 24V	8	XGI-D21A
		16	XGI-D22A/B
		32	XGI-D24A/B
		64	XGI-D28A/B
	AC 110V	16	XGI-A12A
AC 220V	8	XGI-A21A/C	
Output module	RERAY	8	XGQ-RY1A
		16	XGQ-RY2A/B
	TR	8	XGQ-TR1C
		16	XGQ-TR2A/B
		32	XGQ-TR4A/B
		64	XGQ-TR8A/B
	SSR	16	XGQ-SS2A
Input / Output modules	DC 24V/TR	16/16	XGH-DT4A

5.2.2 Object ID allocation method of input / output modules

In order to control input / output modules through BACnet protocol, ID's should be allocated to BACnet objects corresponding to input / output modules. 32 ID's per slot are allocated to analog input modules or output modules, and 64 ID's per slot are allocated to digital input modules or output modules.

Object ID's are allocated to each slot as fixed values. 32 ID's per slot are allocated to analog input modules or output modules, and 64 ID's per slot are allocated to digital input modules or output modules. 32 object ID's are allocated to input and output of analog input / output (mixed mode) modules, respectively, and 64 ID's are allocated to input and output of digital input / output (mixed mode) modules, respectively.

1) Analog Input Module: 32 ID's per slot are allocated to analog input modules. Since same objects within a device may not have the same ID, ID's are sequentially allocated based on the base number and slot number.

(1) Analog Input Object ID

- ID of the starting object of the relevant slot = Index * 32 (Index = base number * 16 + slot number)
- ID of the last object of the relevant slot = ID of the starting object of the relevant slot + 31

2) Analog Output Module: It equal Analog Input Module.

(1) Analog Output Object ID

- Id of the starting object of the relevant slot = Index * 32 (Index = base number * 16 + slot number)
- Id of the last object of the relevant slot = Id of the starting object of the relevant slot + 31

3) Analog Input / Output Module: 32 object ID's are allocated to input and output of analog input / output (mixed mode) modules. ID's are allocated in the same way as analog input module, analog output module above.

4) Digital Input Module: 64 binary object ID's are allocated to each slot of digital input module. Since same objects within a device may not have the same ID, ID's are sequentially allocated based on the base number and slot number.

(1) Binary Input Object ID

- Id of the starting object of the relevant slot = Index * 64 (Index = base number * 16 + slot number)
- Id of the last object of the relevant slot = Id of the starting object of the relevant slot + 63

5) Digital Input Module: ID's are allocated in the same way as digital input module.

(1) Binary Output Object ID

- Id of the starting object of the relevant slot = Index * 64 (Index = base number * 16 + slot number)
- Id of the last object of the relevant slot = Id of the starting object of the relevant slot + 63

6) Digital Input / Output Module: 64 object ID's are allocated to input and output of analog input / output (mixed mode) modules. ID's are allocated in the same way as digital input module, digital output module above.

5.2.3 Object ID mapping of input/ output modules

In order to access the data of channels or contact points of input / output module, each corresponding channel or contact point should be mapped with the allocated Object ID. Explained below is object ID mapping for different types of modules.

1) Analog Input Module:

(1) Model Type: all input modules

(2) Object ID's of analog input module corresponding to the number of channels are sequentially mapped, starting from the object ID that is the starting object ID + 2. The figure below shows a case with 4 channels. As shown in the figure below, the data corresponding to a channel may be accessed through object ID.

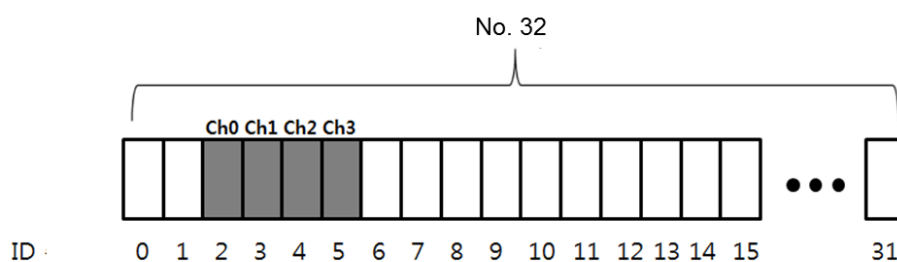

Chapter 5 Communication parameter

2) Analog Output Module:

(1) Module Type : all output modules

(2) Object ID's of analog output module corresponding to the number of channels are sequentially mapped, starting from the object ID that is the starting object ID + 3. The figure below shows a case with 8 channels. As shown in the figure below, the data corresponding to a channel may be accessed through object ID.

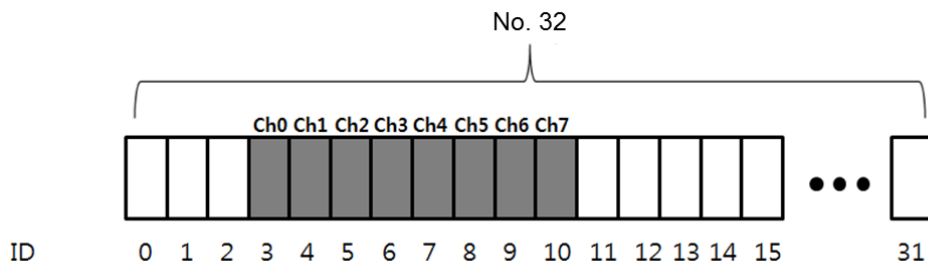

3) Analog Input / Output(mixed mode) Module:

(1) Model Type: XGF-AH6A

(2) 32 object ID's for input and output, respectively, are allocated to analog input / output(mixed mode) module. XGF-AH6A consists of 4 channel outputs and 2 channel inputs. Analog input object ID's corresponding to the number of contact points are sequentially mapped starting from the object ID that is the starting object ID allocated to the slot + 2. Analog output object ID's corresponding to the number of contact points are sequentially mapped starting from the object ID that is the starting object ID allocated to the slot + 9. The figure below shows a case of XGF-AH6A.

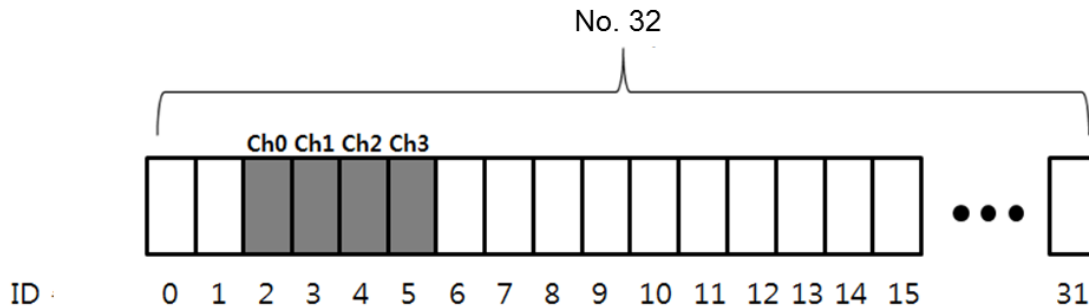

Analog Input Object ID Mapping

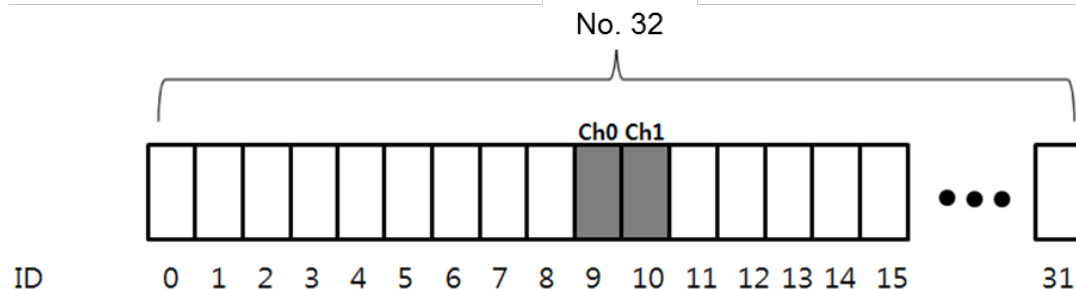

Analog Output Object ID Mapping

4) Digital Input / Output Module

(1) Model Type: all digital input or output modules

(2) As for digital input module or output module, ID's corresponding to the number of contact points are sequentially mapped starting from the starting object ID allocated to the relevant slot. The figure below shows a case with 8 channels. As shown in the figure below, the data corresponding to a channel may be accessed through object ID.

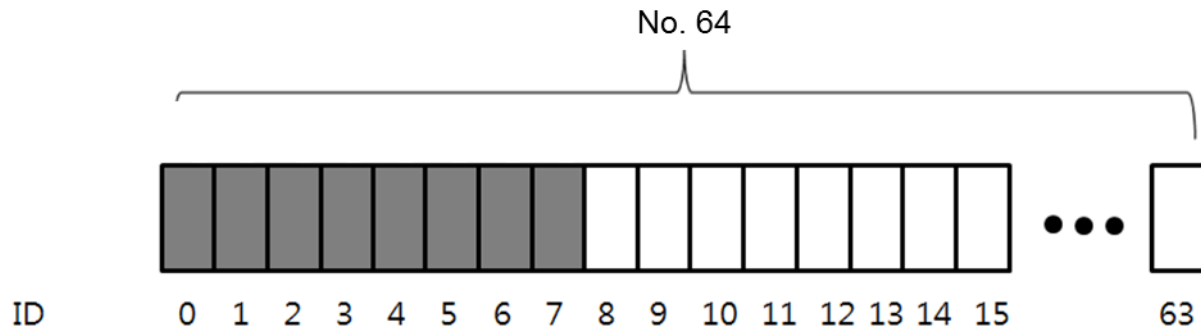

5) Digital Input / Output(mixed mode) Module

(1) Model Type: XGH-DT4A

(2) 64 object ID's for input and output, respectively, are allocated to digital input / output(mixed mode) module. XGH-DT4A consists of 16 input contact points and 16 output contact points. Binary input object ID's corresponding to the number of contact points are sequentially mapped starting from the starting object ID allocated to the slot. Binary Output object ID's corresponding to the number of contact points are sequentially mapped starting from the object ID that is the starting object ID + 16. The figure below shows a case of XGH-DT4A.

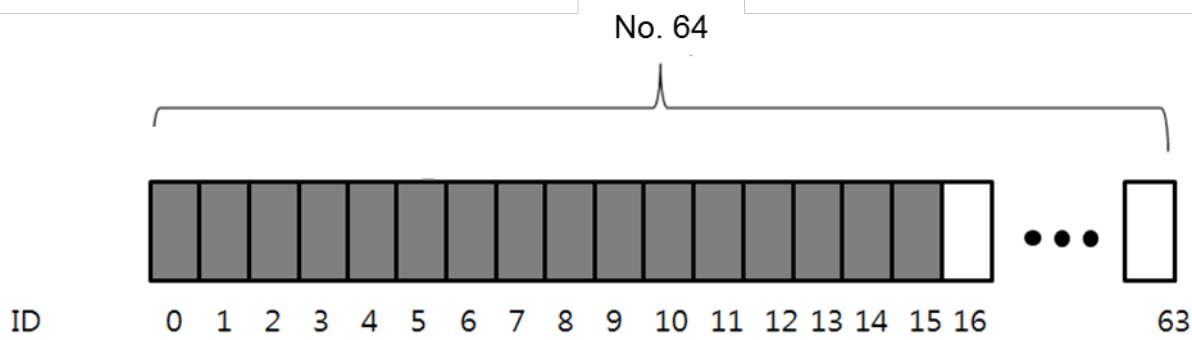

Binary Input Object ID Mapping

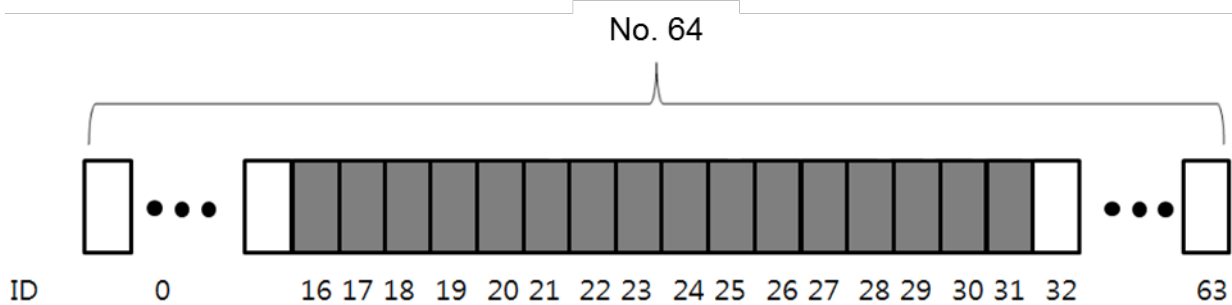

Binary Output Object ID Mapping

5.3 Installation and Execution of Software

In order to use the XG5000 software, you need to install the XG5000.
The system specifications required for the execution are as follows.

- (1) Personal Computer and Memory
 - A set of computer with Pentium and higher CPU and 128MB and more memory.
- (2) COM Port
 - RS-232C serial port or USB port is necessary.
- (3) Hard Disk
 - At least, 100MB and more space is necessary.
- (4) Mouse
 - Mouse to connect with the computer is necessary.
- (5) Monitor
 - Monitor should have 1024 x 768 and higher resolution.
- (6) Windows
 - Compatible with Windows 2000/XP. However, XG5000 may be shut down if several applications including other programs are executed in Windows 98/ME, due to limited memory. Please execute XG5000, based on Windows 2000 or XP.

5.3.1 XG5000 Installation

- (1) Execute the installation file.
- (2) Installation Wizard will prepare for installation as below.

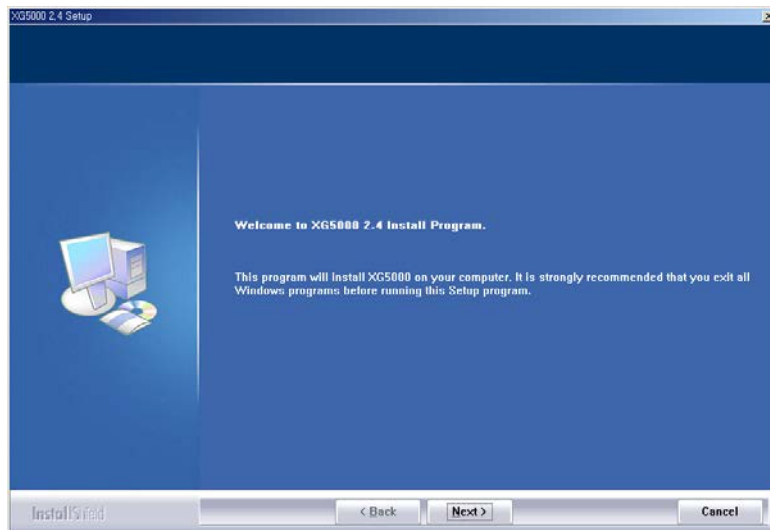

- (3) Click [Next] button, and it shows License Agreement message.
- (4) Read carefully and press [Yes]
- (5) Enter your name and company name and then click [Next] button.

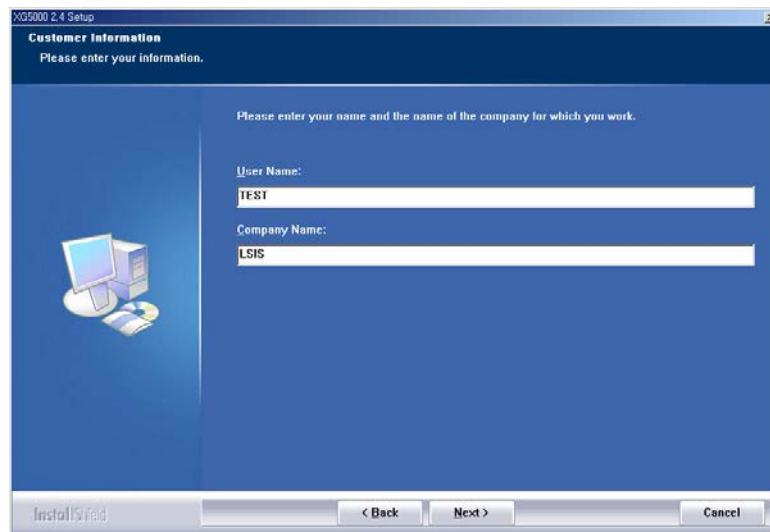

(6) Select a folder to install XG5000 into. If you want to change the folder, click Browse... button and make or select a new folder. XG5000 needs about 30M Bytes of installation space in hard disk, which will ask you to select a disk with enough capacity. If the installation space is not enough, a warning message will be displayed to make the following progress unavailable

(7) After a folder is selected, click [Next] button.

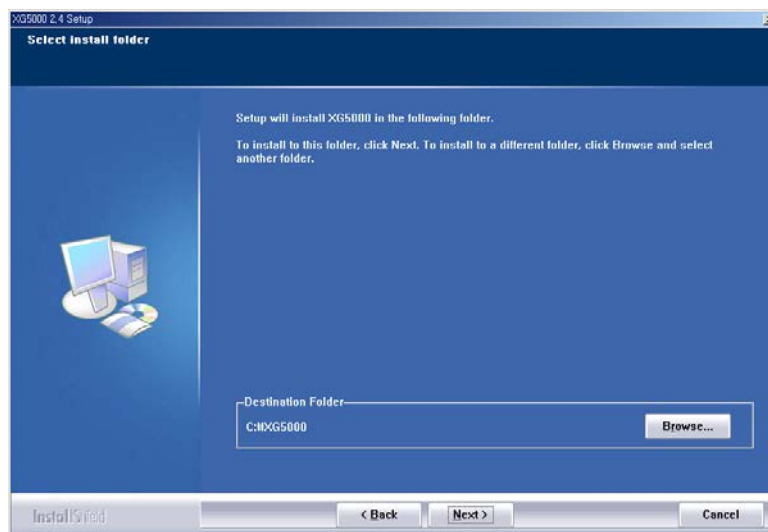

(8) Check installation folder and click [Next] button.

Chapter 5 Communication parameter

(9) Installation will be started as shown below.

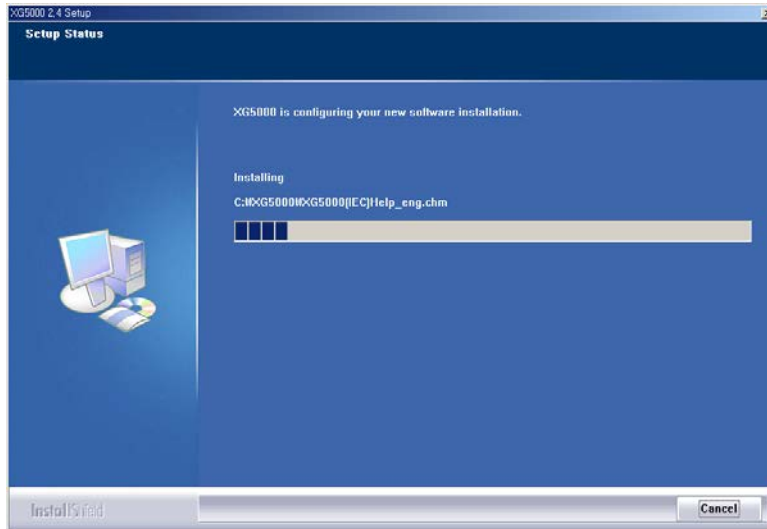

(10) Wait a second for the installation to be complete.

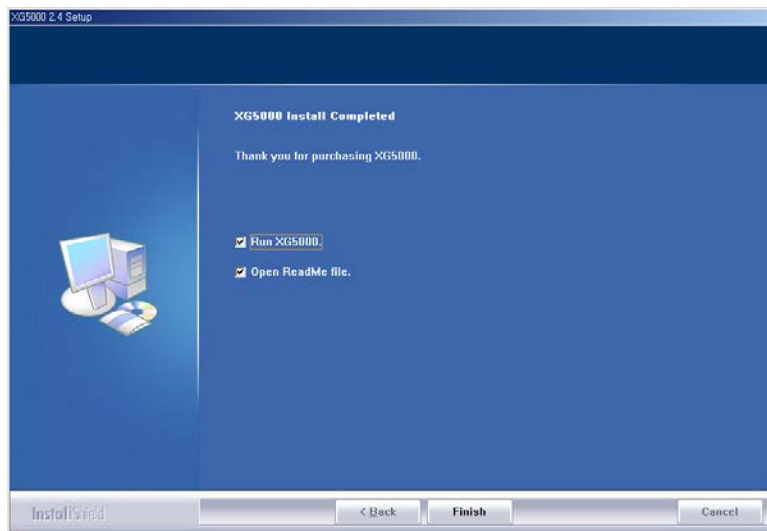

5.3.2 USB device driver installation(Installation in windows XP)

- (1) Ensure that Drivers folder is created in the folder where XG5000 is installed, and there are 2 driver files of **GmUSB.D.sys** and **GmUSB.D.inf** in the Drivers folder. If there is no folder or driver file, reinstall XG5000.
- (2) Turn PLC Power on and connect USB connector with PC. If connection is established, Find New Hardware Wizard Dialog Box will be displayed to ask you to install the device driver



- (3) From the options of Find New Hardware Wizard Dialog Box, select "Installation from a list or specific location (Advanced)" and click [Next] to continue.

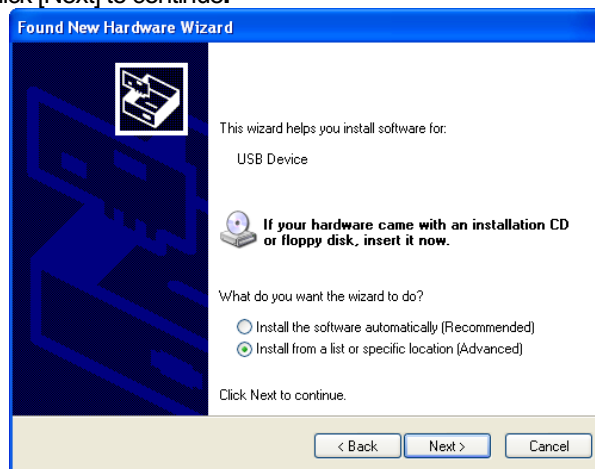

- (4) Among driver searching options, select "Search for the best driver in these locations" and check "Include this location in the search".

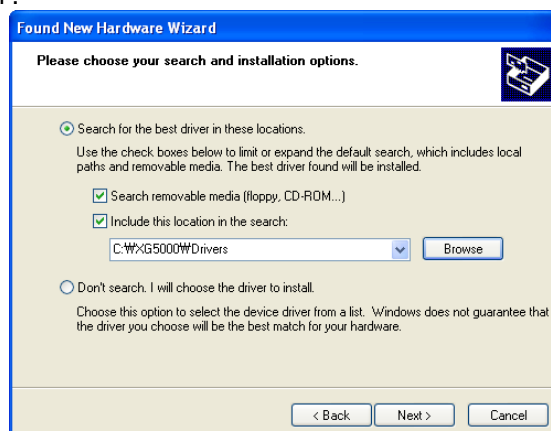

Chapter 5 Communication parameter

(5) Click [Browse] button. On Browse Folder Dialog Box, select Drivers' folder where XG5000 is installed.

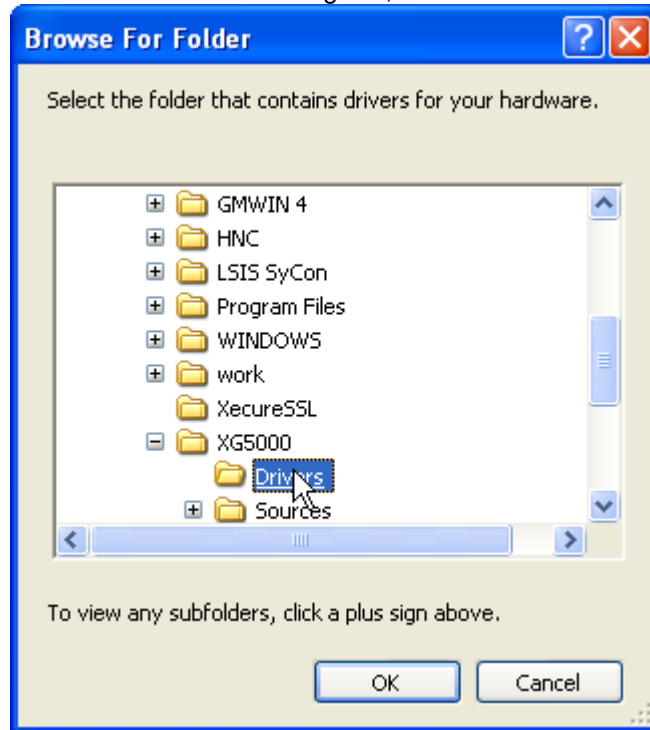

(6) Click [OK] button. Then, a computer starts searching for the driver files in the selected folder.

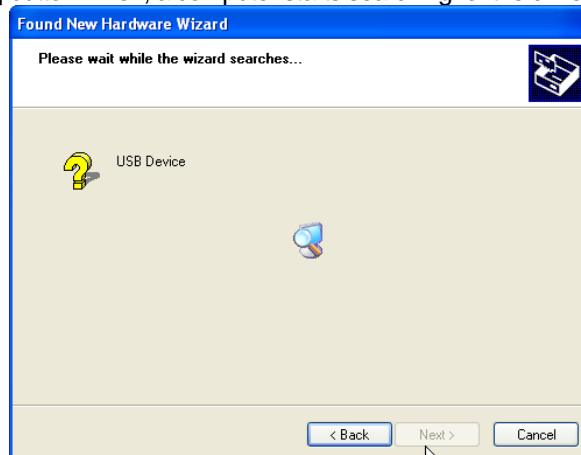

(7) If the computer found the most suitable device driver, you will be asked to decide to install the selected device driver.

Since USB device driver operated stably based on Windows OS, you may click [Continue Anyway] button.

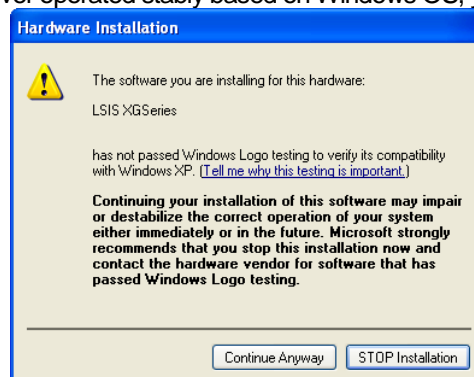

- (8) If the device driver has been installed completely, the Installation Complete Dialog Box will be displayed as follows. Click [Finish] button to end the installation of the driver.

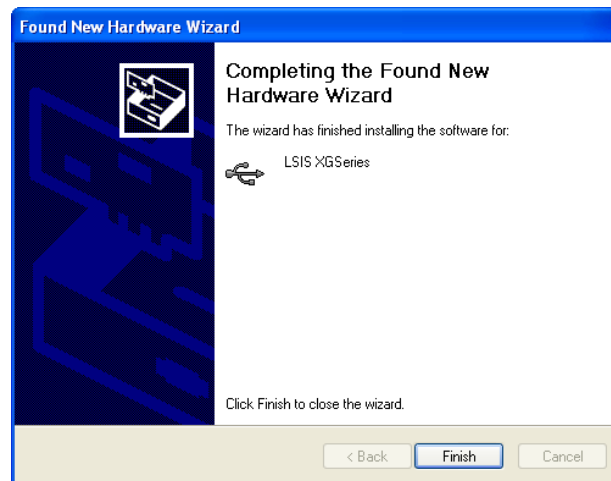

Note

If XG5000 is installed on Windows XP for the first time, it needs USB device driver installation as an additional step. USB device driver shall be also installed as described below. If your OS is Windows 2000, XG5000 will be installed with USB device driver automatically. However, in case of Windows XP, the driver shall be additionally installed.

5.3.3 Confirmation of installed USB device driver

If USB connection is not available, check the installation status of the device driver as follows

- (1) Click the right button of the mouse with the cursor on [My Computer] icon on the background screen, and select [Manage] on the menu.

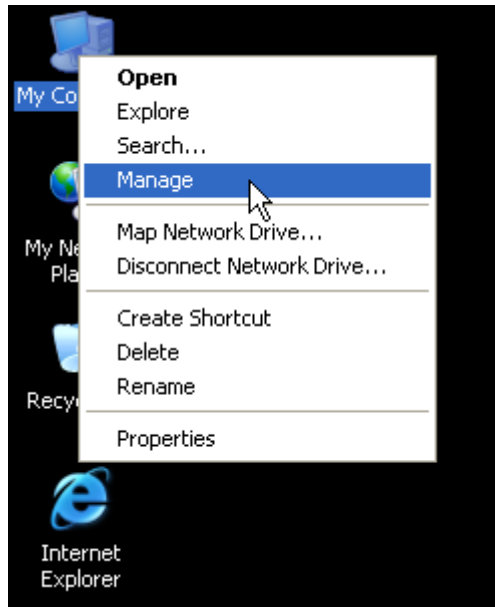

- (2) Computer Management Dialog Box will be displayed as shown in the figure below. On the left tree list of Dialog Box, click [Computer Management (Local)]-[System Tools]-[Device Manager] in regular order. The items displayed on the right list may be different according to devices installed on the computer.

(a) Normal case

The USB device driver for XGT PLC has been installed successfully, if the list [LSIS XG Series] appears with the figure under [Universal Serial Bus Controller].

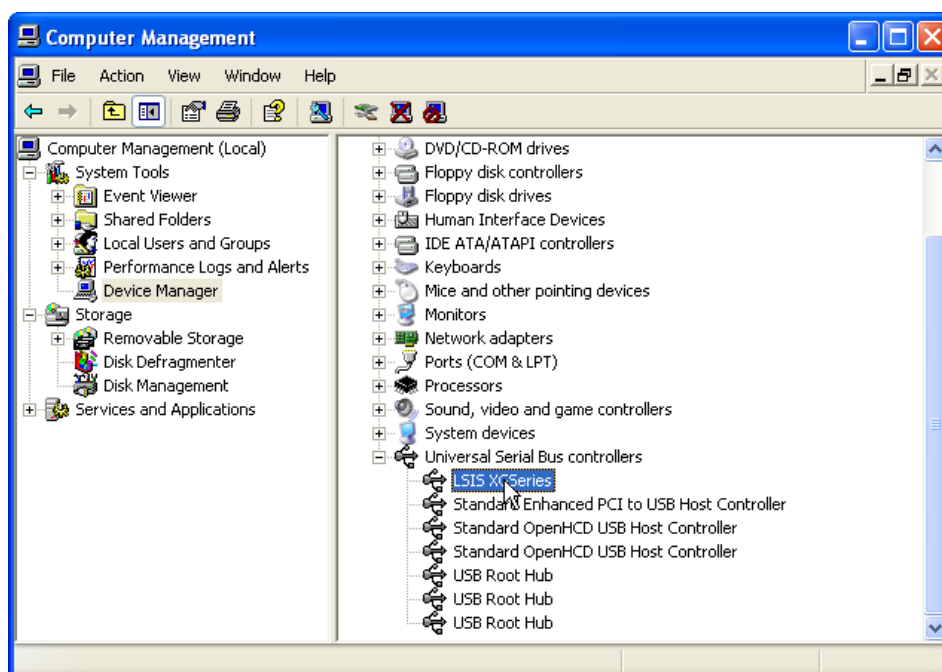

(b) Abnormal case

The device driver has not been installed successfully, if the following figure is displayed.

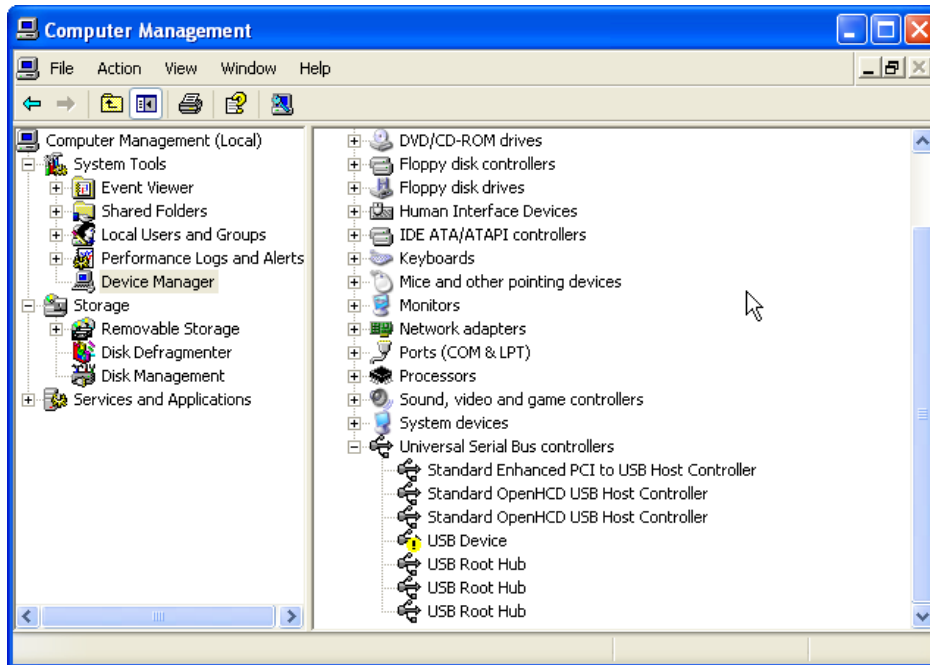

If the USB driver for XGT PLC is not installed successfully, reinstall the USB driver for XGT PLC in the following steps.

[Steps]

- (1) On the device driver with the icon with an exclamation mark, click the right button of the mouse. Select [Update Driver] on the menu.

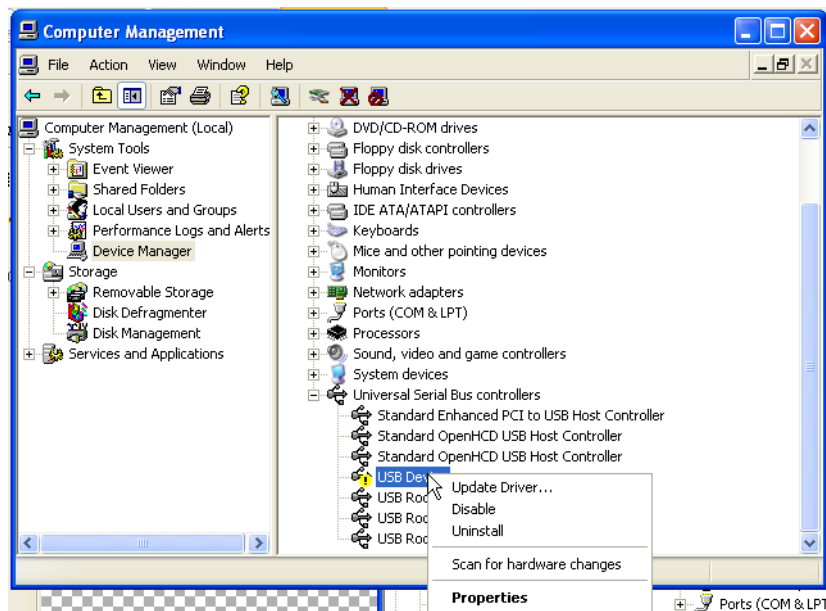

Chapter 5 Communication parameter

- (2) H/W Update Wizard Dialog Box will appear. Select the option “Installation from a list or specific location (Advanced)” and click [Next]. The next sequence is manually the same as in Installation of Device Driver.

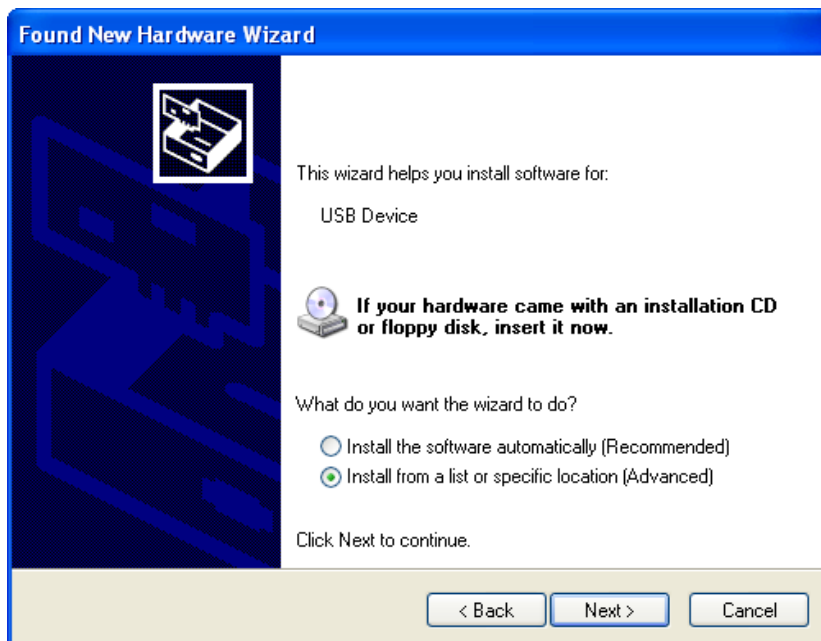

If the USB driver for XGT PLC is not installed successfully, reinstall the USB driver for XGT PLC in the following steps

[Steps]

- (1) If the device driver has been installed incorrectly or in error, execute H/W Update Wizard. Select the option “Installation from a list or specific location (Advanced)” and click [Next].

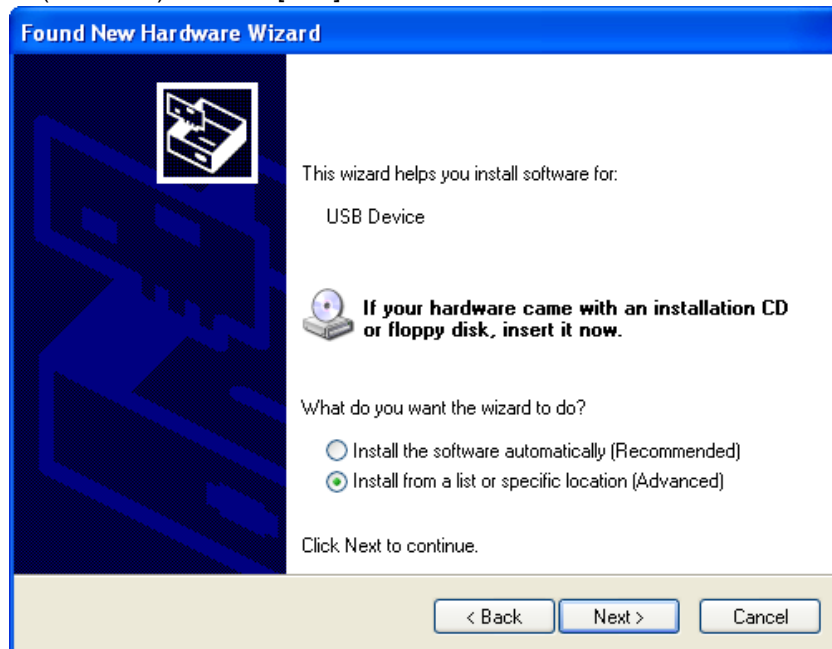

(2) On search and installation options, select [Don't Search. I will choose the driver to install.] and click [Next]

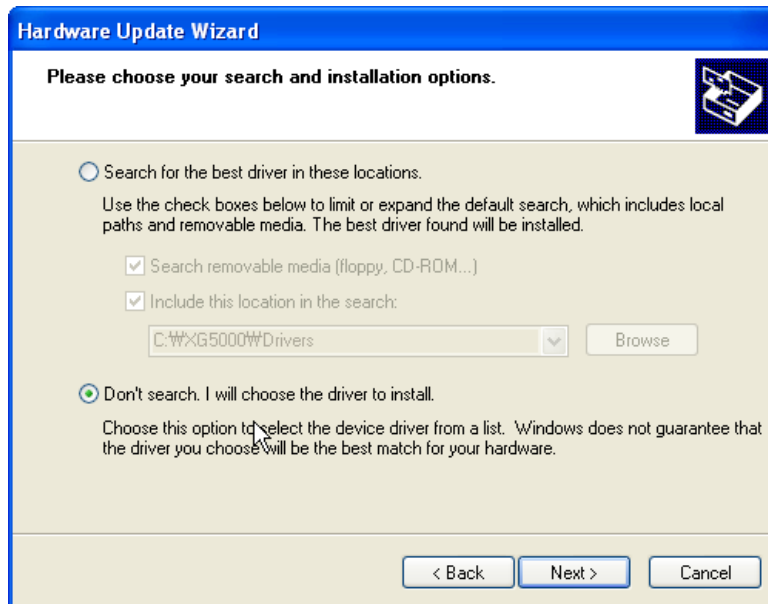

(3) Click [Have Disk...] on the Dialog Box below

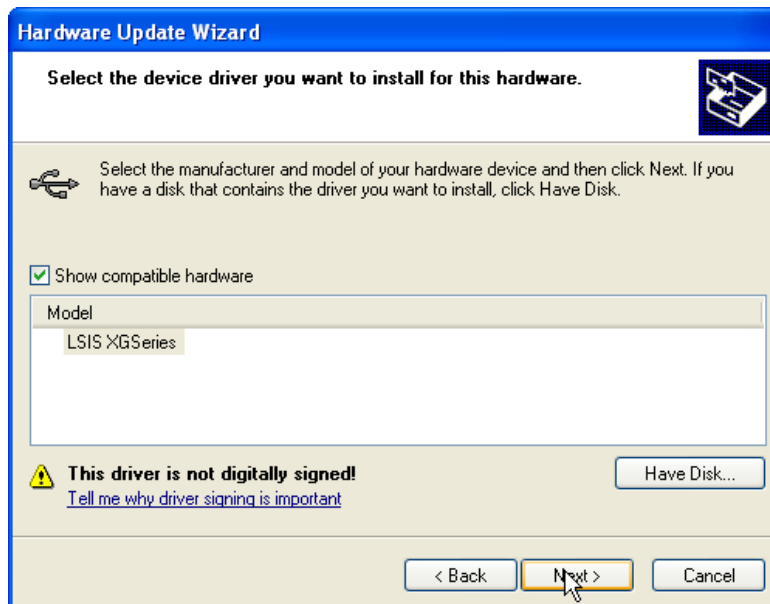

Chapter 5 Communication parameter

(4) If Installation Dialog Box is displayed on the disk, click [Browse] button.

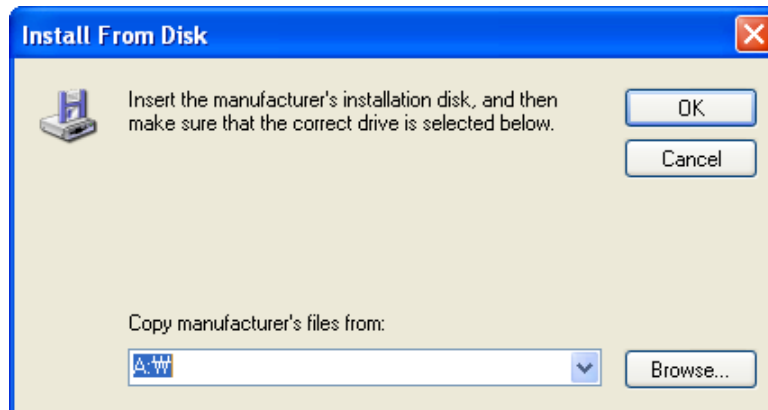

(5) From the Browse File Dialog Box, move to the folder XG5000 is installed in. Select drivers folder to display GmUSBD.inf file. With this file selected, click [Open] button.

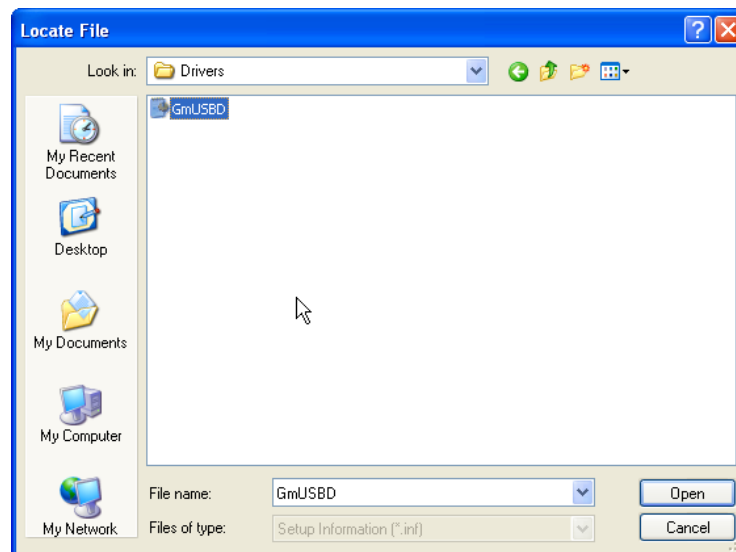

(6) On the item of 'Copy manufacturer's files from', a directory with the file of the device driver will be displayed. Click [OK] button

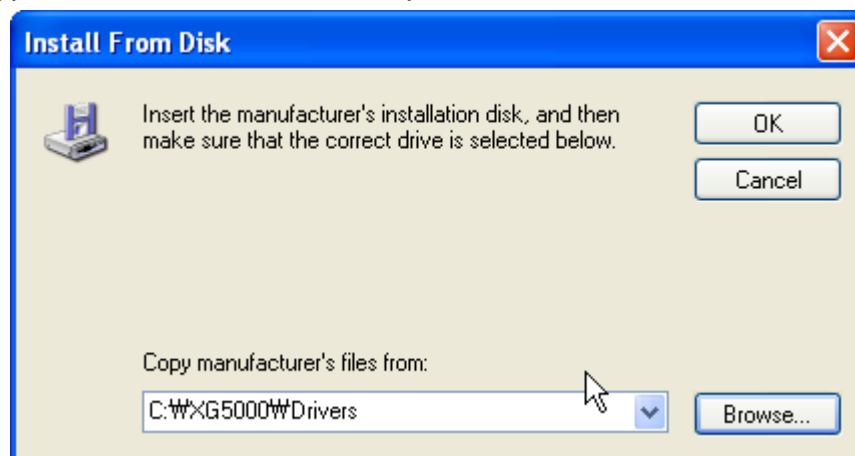

- (7) On 'Show compatible hardware' list of the device driver Select Dialog Box, select "LSIS XGSeries" driver and then click [Next] button

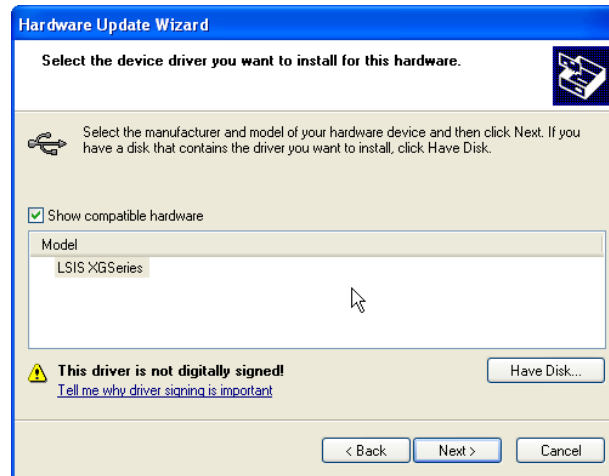

- (8) Hardware Installation Dialog Box will appear. Click [Continue Anyway] to go on with the installation

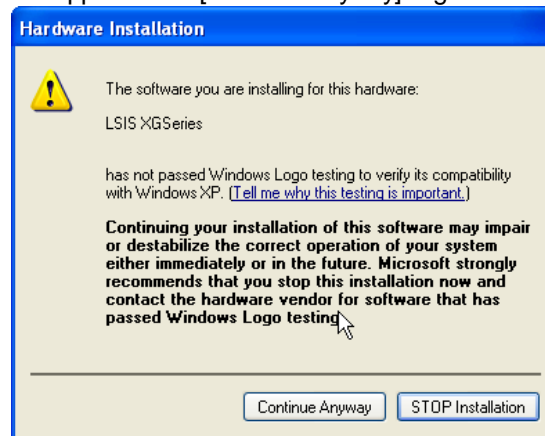

- (9) Completing the Hardware Update Dialog Box will appear. Click [Finish] button to end the installation of the driver



5.4 Communication Module Registration

In order to use BACnet I/F module, communication parameters shall be specified in XG5000. And for system setting of BACnet I/F module positioned at an optional place, its applicable module shall be registered in XG5000. How to register the optionally positioned BACnet I/F module depends on On/Off line status as described below.

5.4.1 Off-line registration of BACnet I/F module

This method is used when the user writes the parameter related with communication about communication module that is not connected with PLC.

- (1) Execute the XG5000 and select [File]-[New File] or click the icon ().

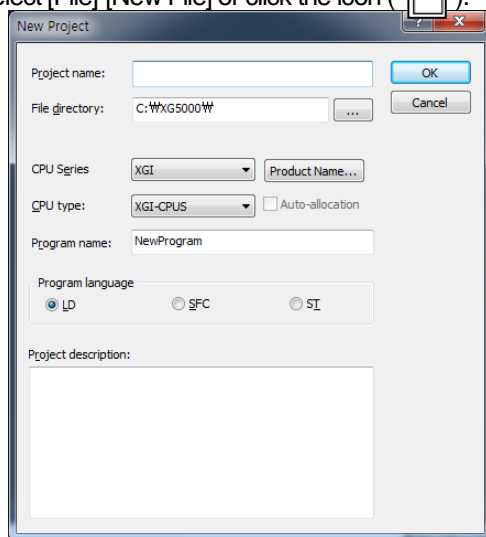

- (2) Input the project name, file location and PLC type the user is using.

- (3) If you want to register the communication module without connect to XGT, using “Communication module settings” window. In case of mount the BACnet I/F module at base 0 - slot 2, set in project window as follows.
 a) Right click the “Unspecified Network” in project tree. Then select the [Add Item]-[Communication module].

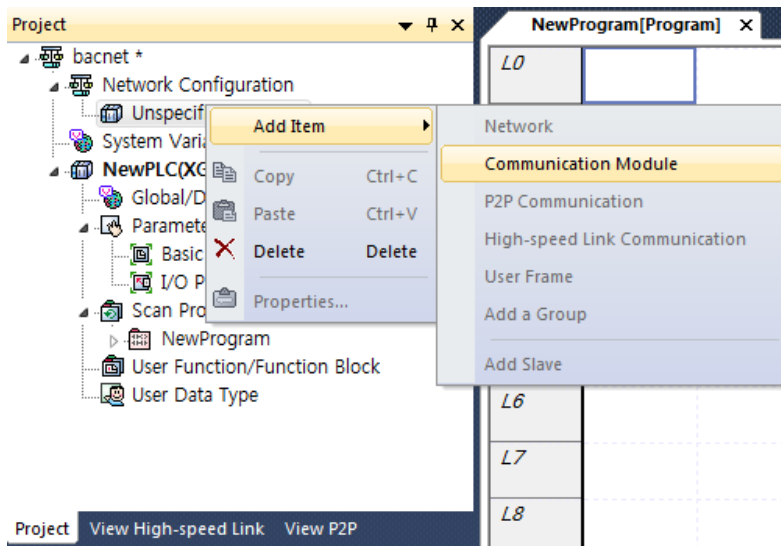

b) Click "Add Module" in "Select communication module" window.

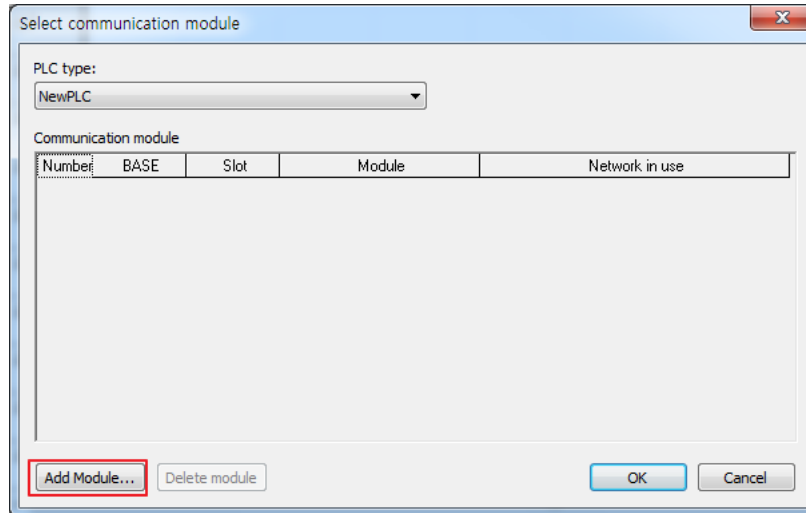

c) Set the communication module type, base number and slot number in "Communication Module Settings" window.

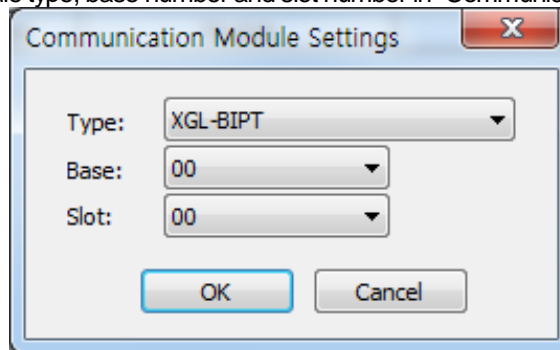

Screen that BACnet I/F module mounted in slot3 of base 0 is as follows.

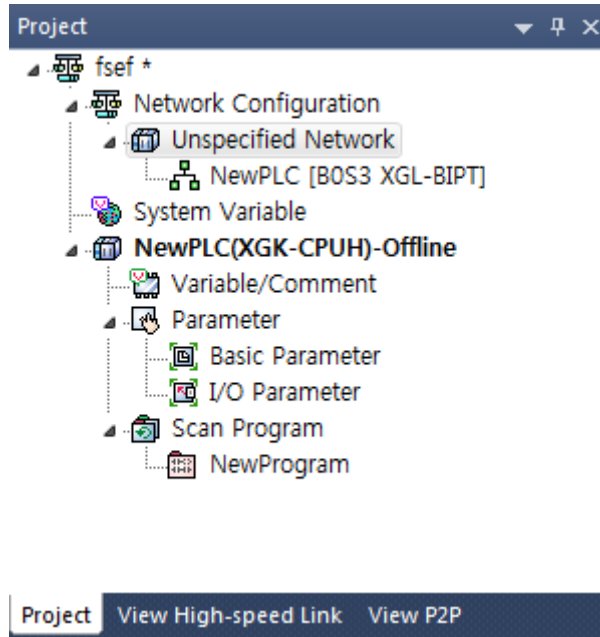

5.4.2 Online registration of BACnet I/F module

Step (1), (2) of off-line registration is same and the next step is as follows.

- (1) Input the project name, file location and PLC type the user is using.
- (2) If connection fails, check the connection status. Select [Online] – [Connection settings] or click the icon (). There are many connection types (RS-232C, USB, Ethernet and modem) and depths (Local, Remote 1, Remote 2).

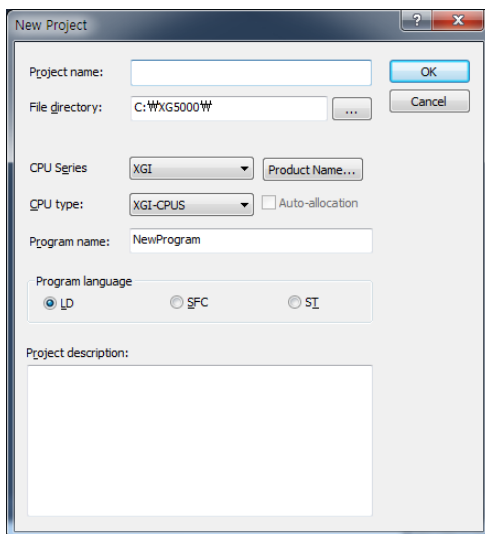

- (3) If connection succeeds, lower menu of online is activated.
- (4) In order to check the currently mounted modules, select [Online] – [Read IO Information] or click the icon (). Then all currently mounted communication modules in the basic and extension bases are searched and shown in the Project window.
- (5) If previous information of mounted module is different with currently mounted PLC information, the following message shows to check.

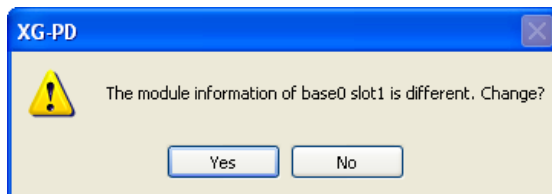

(6) The list of the mounted communication module shows in the Project window.

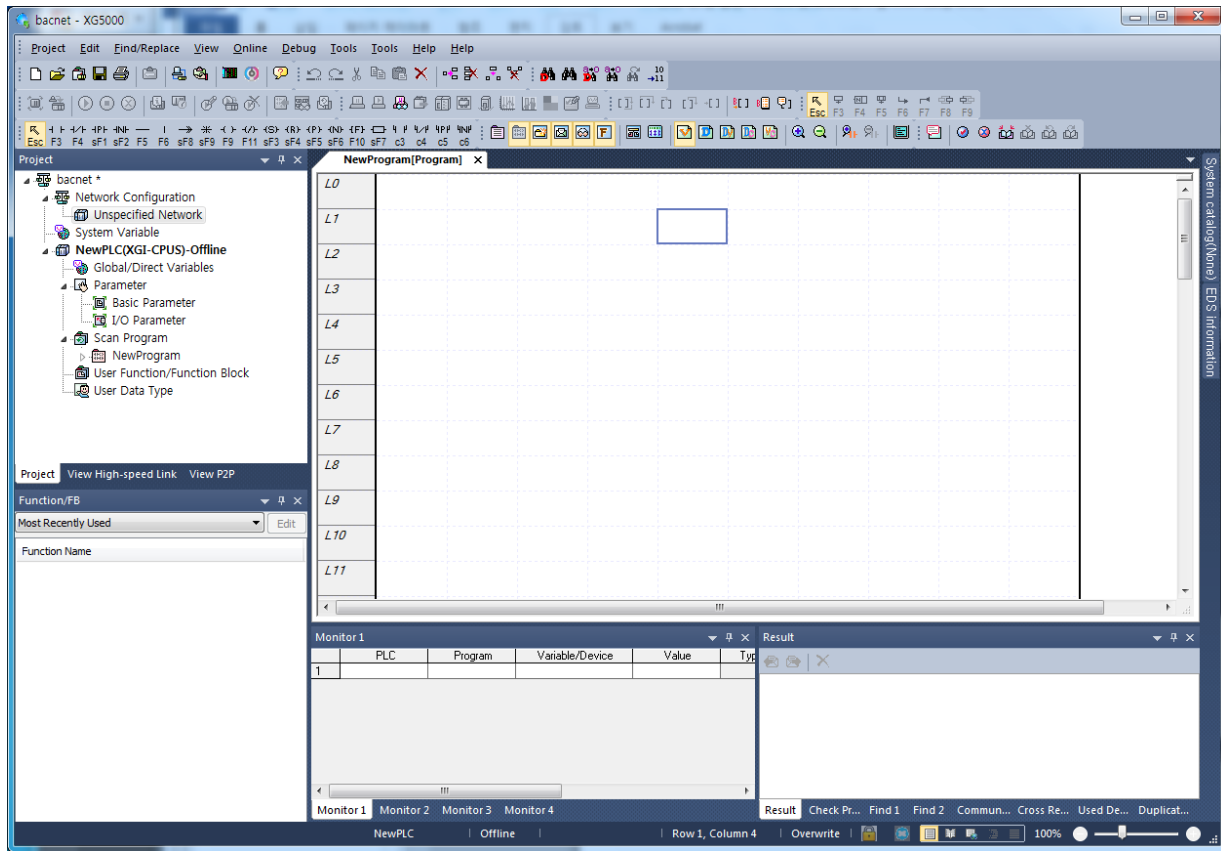

Chapter 5 Communication parameter

5.4.3 How to read the parameter saved in the PLC

To read the parameter saved in the PLC, follow the below sequence.

- (1) Select the 'Open from PLC'.

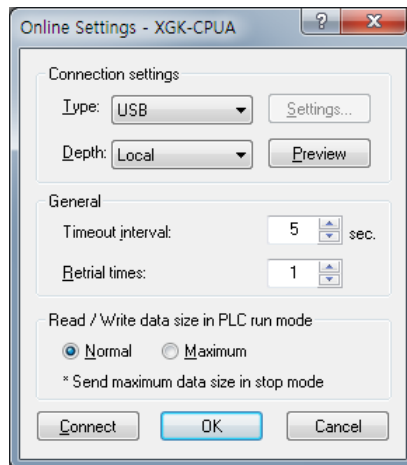

- (2) The user can check the setting value of standard settings and P2P saved in the PLC.

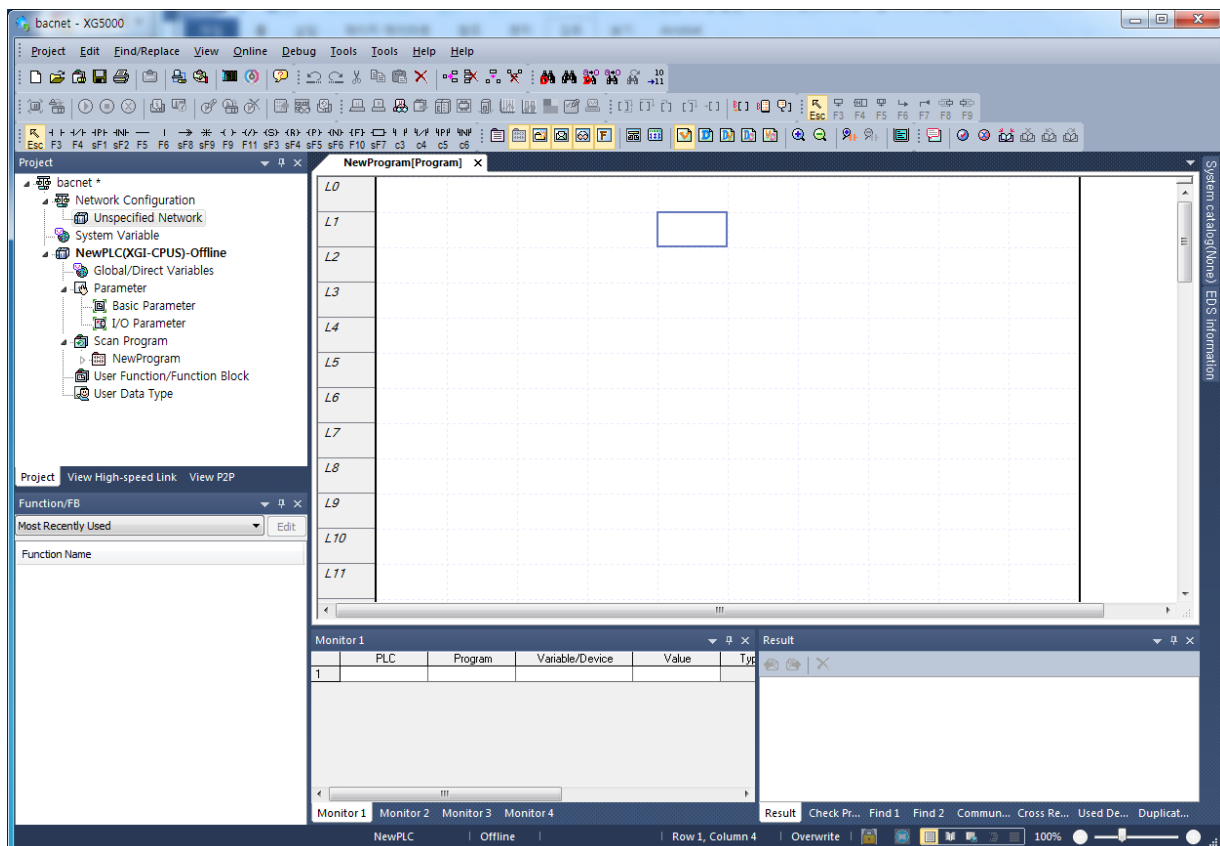

5.4.4 Module setting method

To use BACnet/IP I/F module, set as the following steps

1) Execution sequence

(1) Direct input in project window

[Online] – [Project Window], Double-clicks the slot number which is mounted BACnet/IP I/F module. Communication module setting window is appeared on the main window.

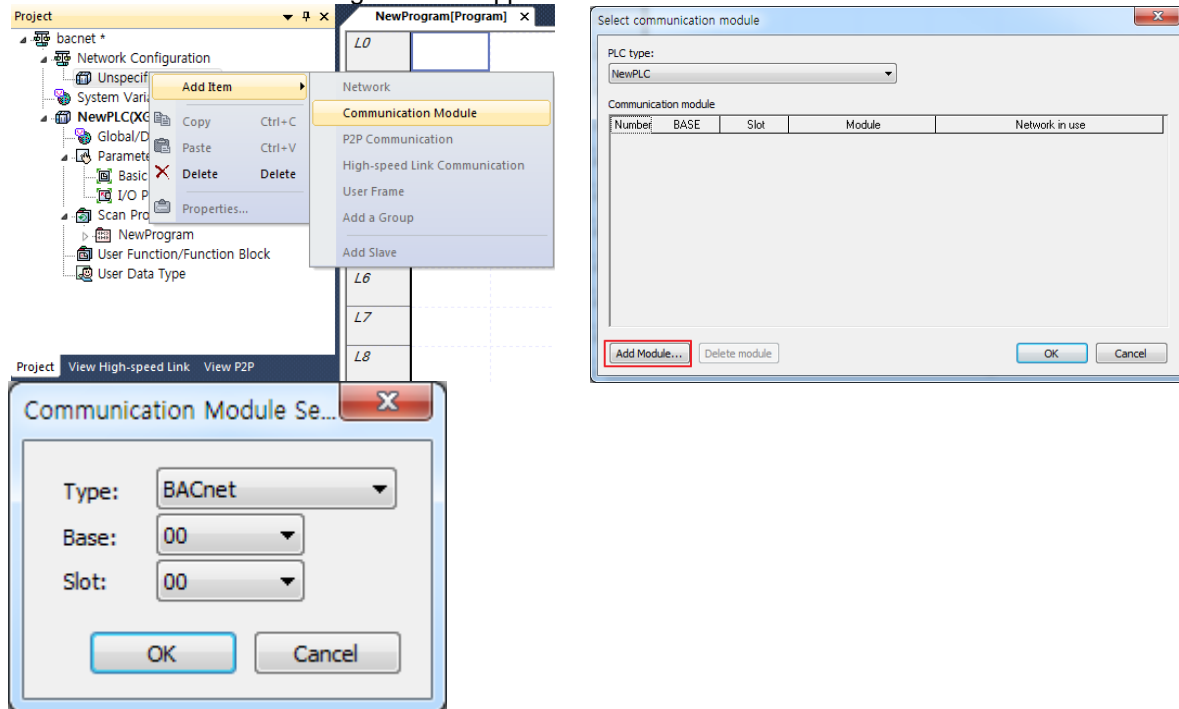

(2) Read I/O Information

Read the IO information of the currently mounted modules by [Online]-[Read IO Information] after connection.

2) Checking the operation

(1) Select [Online]-[Communication module setting]-[System Diagnosis] or click the icon ().

(2) Click the right button at the relevant module and click the 'Detailed Module Information' or 'Status By Service' to check the communication.

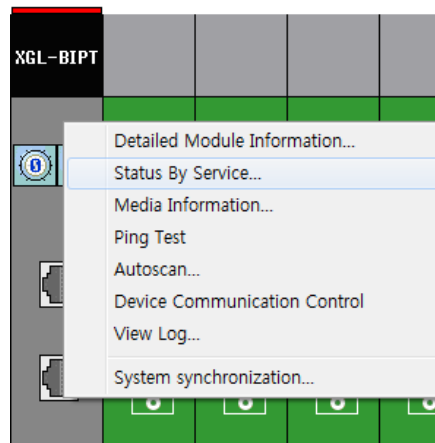









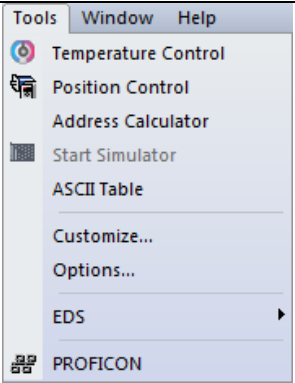

Chapter 5 Communication parameter

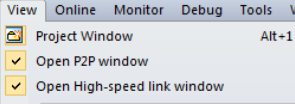
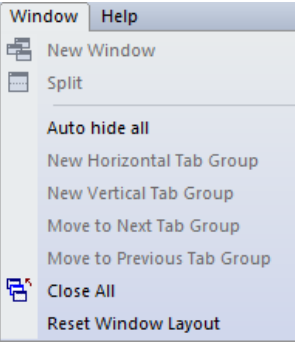
5.4.5 Menu bar and shortcut of XG5000

The following is menu bar and short cut of XG5000. (The other menu, please refer to the XG5000 User's manual).

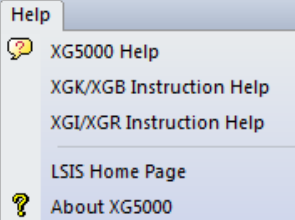
Menu bar	Menu	Icon	Description
Project	New Project		Create a new project.
	Open Project		Open the existing project.
	Open from PLC		Upload the project and program stored in PLC.
	Open KGLWIN File		Open the project file for KGLWIN.
	Open GMWIN File		Open the project file for GMWIN.
	Save Project		Save the project.
	Save As	-	Save the project as a different name.
	Close Project		Close the project.
	Save As Binary		Saved as the binary file that cannot show the details of the project.
	Write Binary to PLC		Write the binary file with the PLC. You cannot see the details of the project.
	Add Item		Add Item to Project
	Import from File		Import the item from the file to the project
	Export to File		Save the selected items included opened project as separated file.
	Save Variable Names to File		Save variable names to file for using other programs.
	Save EtherNet/IP Tags to file		Register EtherNet/IP tag and save the established EtherNet/IP tag list to the file.
	Compare Project		Compare two projects stored in PC and displays its result.
	Print		Print the active window's details.
	Preview	-	Previously display the screen to be printed.
	Print Project	-	Select the project item to print
	Print Setup	-	Set the printer options.
Edit	Undo		Cancel the edit on Program Edit Window to recover its previous status.
	Redo		Recover the edit cancelled above.
	Cut		Copy the selected block to clipboard and delete the block.
	Copy		Copy the selected block to the clipboard.
	Paste		Copy from the clipboard onto Edit Window.
	Delete		Delete the selected block or items.
	Register Module Variable Comments		Network variable automatic registration
	Read Only Mode		
Online	Connect		Connect with PLC
	Connection Setting		Specify the connection method.
	Change Mode		Change the mode of connected PLC
	Read		Read parameter/program/comment from PLC.
	Write		Write parameter/program/comment on PLC.
	Compare with PLC		Compare the project with project saved in PLC
	Set Flash Memory	-	Shows the window for setting up the flash memory.
	Control Redundancy		Control the redundancy PLC.
	Communication module setting		Set about communication module
	Diagnosis		

		Reset/Clear		Reset the PLC or delete the data
Tools		Temperature Control		Execute the XG-TCON tool.
		Position Control		Execute the XG-PM tool.
		Address Calculator		Open Address calculator
		Start Simulator		Start simulator
		ASCII Table		Open ASCII Table
		Customize		Open customize windows
		Options	-	Open XG5000 option windows
		EDS		Manage EDS file
		PROFICON		Open PROFICON
		View		Project Window
Open P2P window	-			Open P2P window to XG5000
Open High-speed link window	-			Open HS window to XG5000
...	-			The Following description, please refer to the XG5000 user's guide.
Window		New Window		Open a new window on the active window.
		Split		Divide the active window.
		Auto hide all		Hide all windows automatically except current windw
		New Horizontal Tab Group		Arrays the several windows belonging to XG5000 with the horizontal tab
		New Vertical Tab Group		Arrays the several windows belonging to XG5000 with the vertical tab.
		Move to Next Tab Group		Move to the next tab group.
		Move to Previous Tab Group		Move to the previous tab group.
		Close All		Close all windows belonging to XG5000.
		Reset Window Layout	-	Reset the default layout of the project.
		Help		Help
LSIS Home Page				Connect to LSIS Home Page via the Internet.
About XG5000				Shows XG5000 information.

Chapter 6 P2P Service

6.1 Overview

A BACnet device consists of more than one object, which has a number of properties. The read / write services of data sharing defined by the BACnet specification refers to the function of reading and writing these properties.

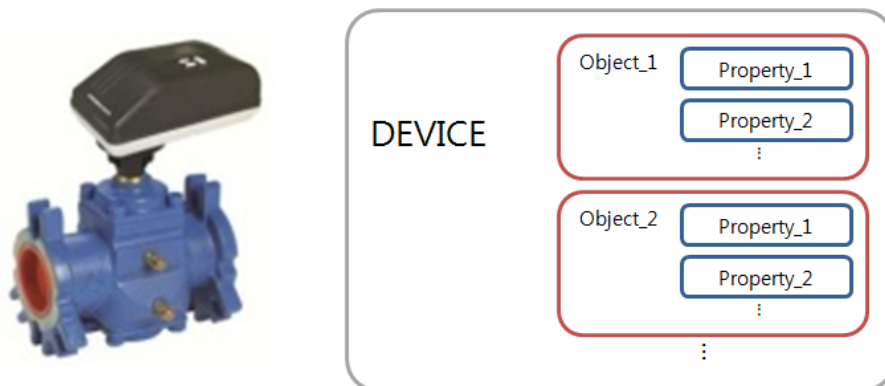

In BACnet, communication is provided based on the client-server model, and corresponds to the company's P2P service. You can communicate with the relevant server by configuring the P2P parameters of XG5000. The server's objects and properties are set based on the IO modules currently installed in PLC, without having to perform additional configuration.

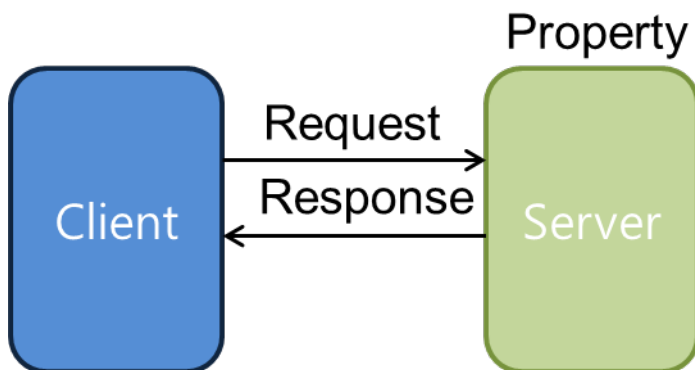

This section describes the types of P2P provided to users, as well as how to use them. The following table shows the programming sequence using P2P.

XG5000	
①	Connection with CPU. Communication module Registration
↓P2P parameter setting	
②	Registration of up to 64 channels
↓Online(parameter writing)	
③	Parameter download
↓Online(Link enable)	
④	P2P Enable

6.2 Service Settings

6.2.1 Module settings

After setting communication module and basic parameters using XG5000, you can start configuration by dragging the EDS file of the country that you want to communicate with.

1) Communication Module Setting and Basic Parameter Setting

Right click on “Unspecified Network” in project tree and select [Add Item]-[Communication Module].

Click “Add module” in “Select communication module” window.

Set communication module type, base number and slot number in “Communication Module Setting” window.

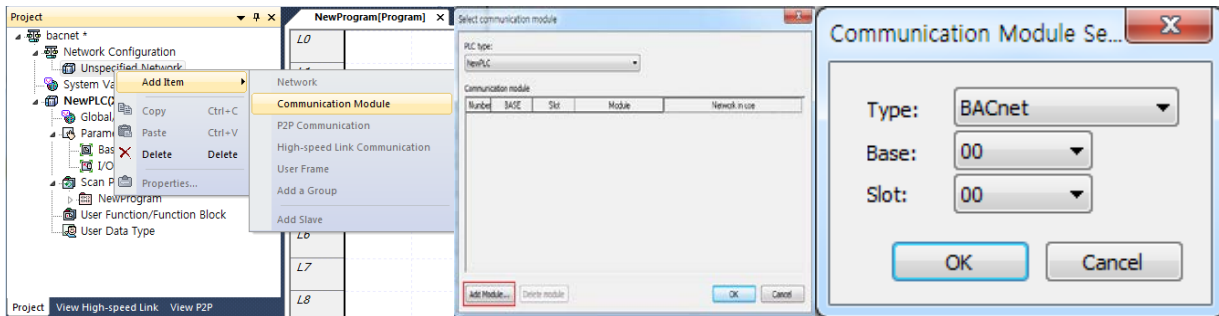

Figure 1 Communication Module Setting

Configure basic parameters by double-clicking the communication module.

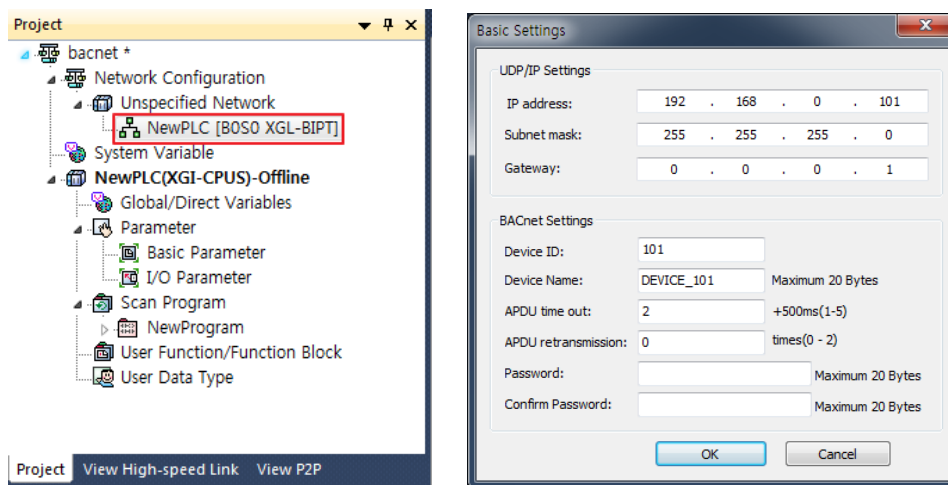
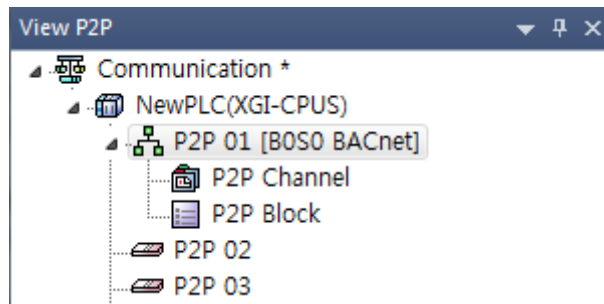

Figure 2 Basic Parameter Setting

2) You should choose P2P communication service for BACnet client communication. Register to a P2P service for P2P communication service.



[Figure 3] P2P Service Registration

After registration, you should configure the channel for the BACnet device to connect with. The channel information required is the IP address and device ID of the relevant device. You can also add descriptions.

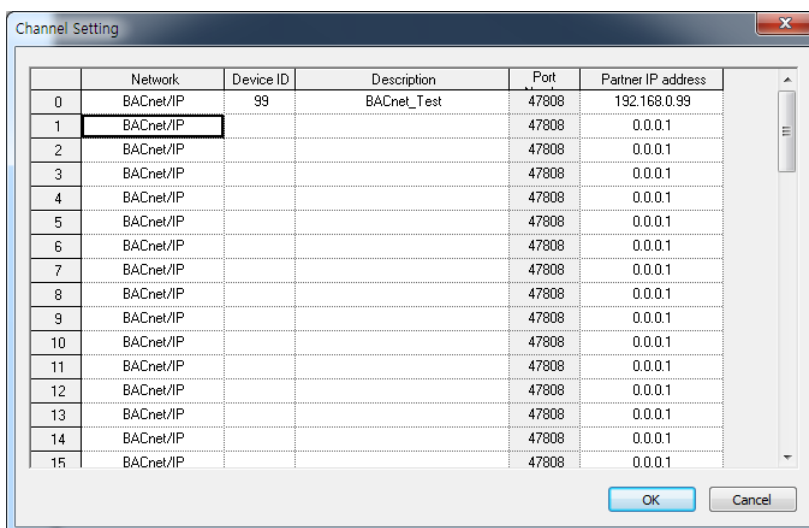

[Figure 4] P2P Channel Information

Once P2P channel information is set, you can begin block editing. In case of blocks, communication with BACnet server is configured in a more detailed way.

Index	Channel	Start-up conditions	Service	Data type	The number of variables	Detailed settings	Variable setting contents
0	0	%MX0	READ	BIT	1	Setting	Number :1 READ1:Binary Output Object, Present_Value, SAVE1:%MX2, OBJECTID:99, SIZE:1
1						Setting	
2						Setting	

[Figure 5] P2P Block Information

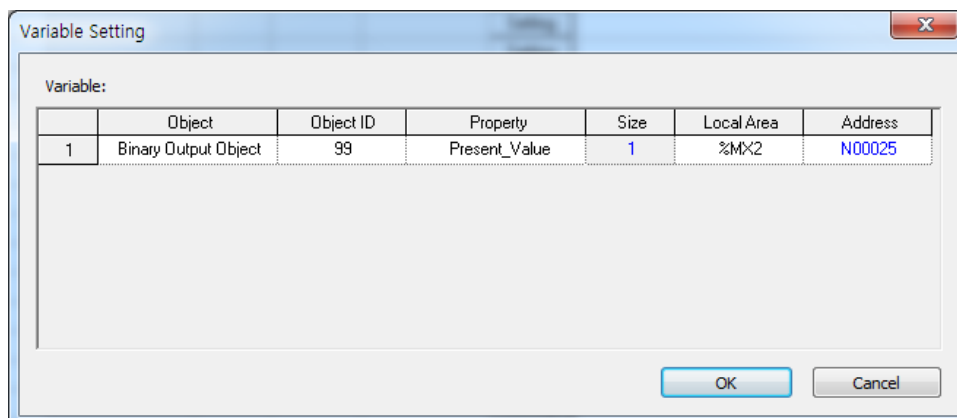

[Figure 5] P2P Block Detailed Configuration

- Channel: shows BACnet server to connect with.
- Start-up conditions: defines the timing of sending the message.
- Service: choose either Read or Write.
- Data type: sets the data type to communicate.
- Number of variables: sets the number of variables to communicate.
- Object, object ID, property: you can enter the object and property information of BACnet server to communicate with.

- In order to directly access (read/write) the CPU module memory device of BIPT server module, objects for exclusive use by LSIS have been added.

Object	Code	Remarks
LSIS-P-Device	768	P device area
LSIS-M-Device	769	M device area
LSIS-K-Device	770	K device area
LSIS-F-Device	771	F device area
LSIS-U-Device	772	U device area
LSIS-T-Device	773	T device area
LSIS-C-Device	774	C device area
LSIS-L-Device	775	L device area
LSIS-N-Device	776	N device area
LSIS-D-Device	777	D device area
LSIS-R-Device	778	R device area
LSIS-ZR-Device	779	ZR device area
LSIS-W-Device	780	W device area
LSIS-I-Device	781	I device area
LSIS-Q-Device	782	Q device area

3) Write Parameter

Choose 'parameter write' on-line. Check your P2P at the parameter write screen, and then click 'Confirm'.

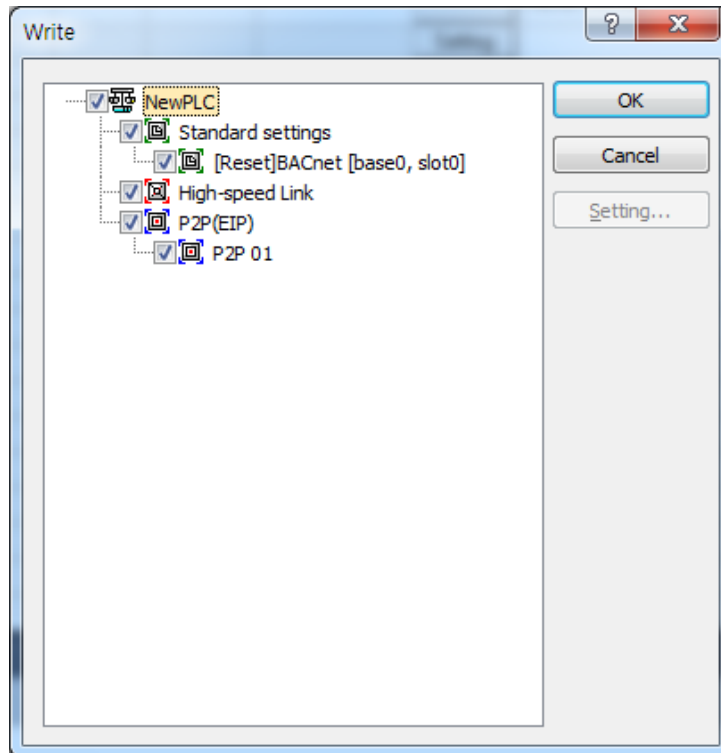

[Figure 6] Write Parameter

4) Read Parameter

Choose 'parameter read' on-line. Here, you can read the configured parameter by checking the relevant parameter and then clicking the 'Confirm' button.

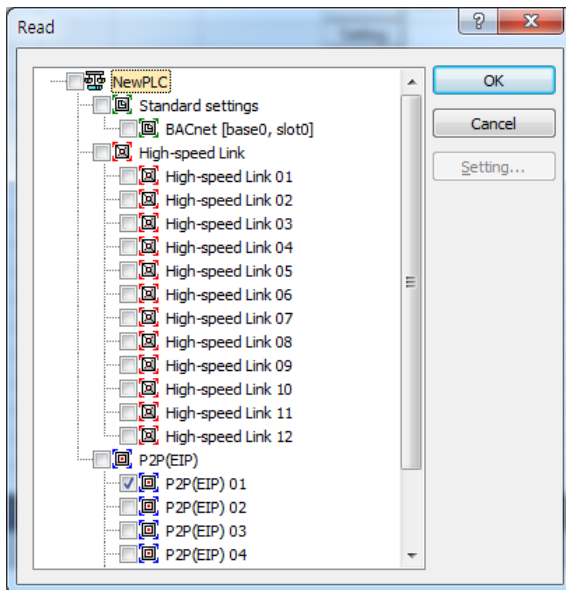

[Figure 7] Read Parameter

5) P2P Information

As P2P information is provided to users using user keywords, you can use the information in the program.

P2P Flag Types

	PLC	Program	Variable/Device	Value	Type	Device/Variable	Comment
1	NewPLC	<GLOBAL>	_P2P1_NDR00	10	BOOL	%LX10000	Service is normal in P2P 1-block 00
2	NewPLC	<GLOBAL>	_P2P1_ERR00	10	BOOL	%LX10001	Service is error in P2P 1-block 00
3	NewPLC	<GLOBAL>	_P2P1_STATUS00	HEX	WORD	%LW626	Error code in P2P 1-block 00
4	NewPLC	<GLOBAL>	_P2P1_SVCCNT00	10	UINT	%LW627	Normal service count in P2P 1-block 00
5	NewPLC	<GLOBAL>	_P2P1_ERRCNT00	10	UINT	%LW629	Error service count in P2P 1-block 00

[Figure 8] P2P Flag Information

6.3 Start of the Operation

6.3.1 XG5000 settings

1) Connection settings

- (1) Select Online → Connection Settings or click the () icon.
- (2) Select the connection option appropriate for the user environment, and click 'Connect.'

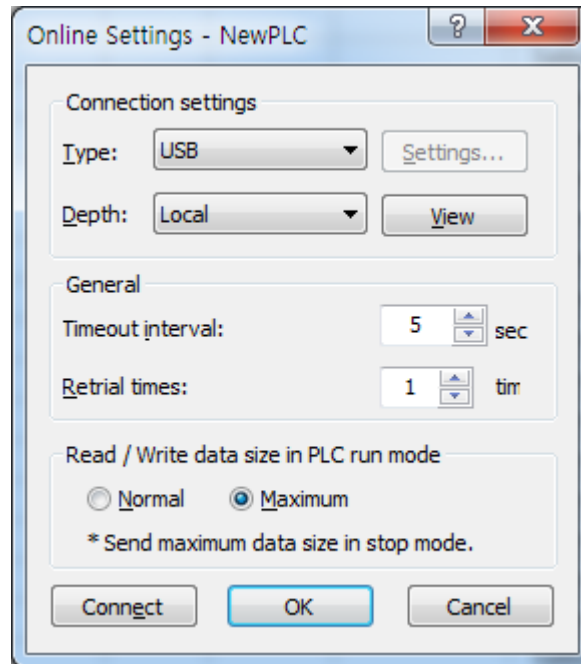

[Figure 9] Connection Settings

2) Read I/O Information

Select Online → Read I/O Information or click the () icon to read the information of the module currently installed in the base.

3) Link Enable

- (1) Select Online → Link Enable or click the () icon.
- (2) Check the P2P for which configuration is complete, and click 'Write.'

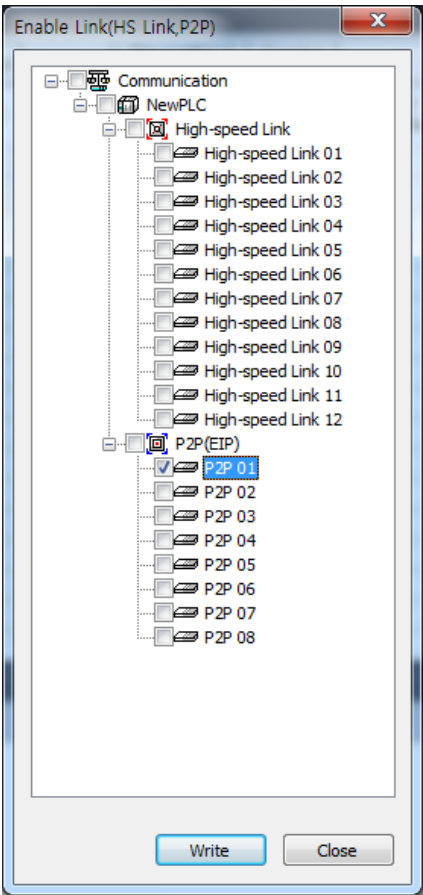

[Figure 10] Link Enable

4) Operation Confirmation.

- (1) Select Online → System Diagnosis or click the () icon.
- (2) Click the relevant module, and right click on frame monitoring or service statuses to see if communication is being performed normally.

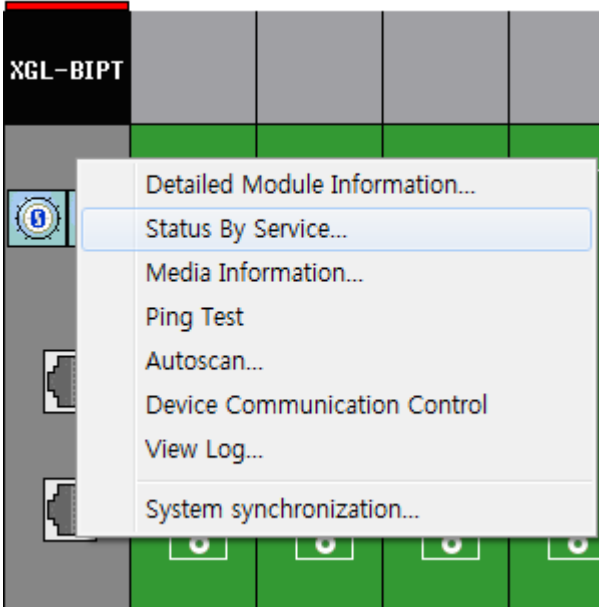

[Figure 11] System Diagnosis Menu

6.4 Status Information by Service

Using XG5000, you can view status information of each service, including P2P-related data or server-related data.

6.4.1 System diagnosis to P2P service

- 1) Select XG5000 → 'Connect' → 'Online' → 'Communication module setting' → 'System Diagnosis.'

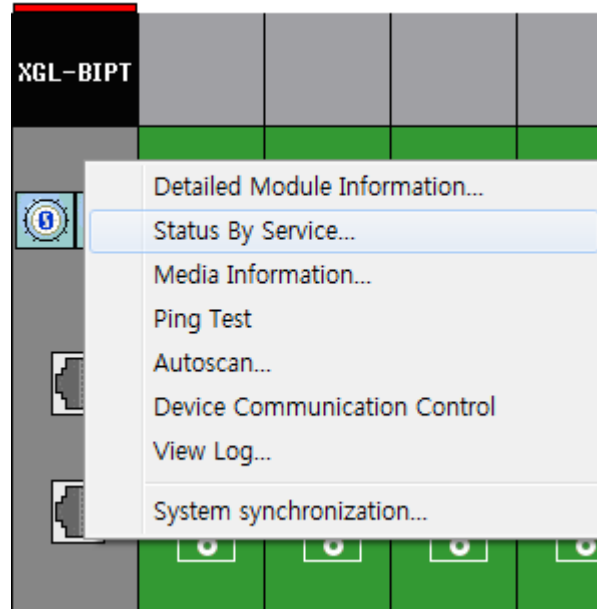

[Figure 12] System Diagnosis Screen

- 2) Put the mouse cursor on XGL-BIPT and right click on the information you want, then you will be able to view the information as shown below.

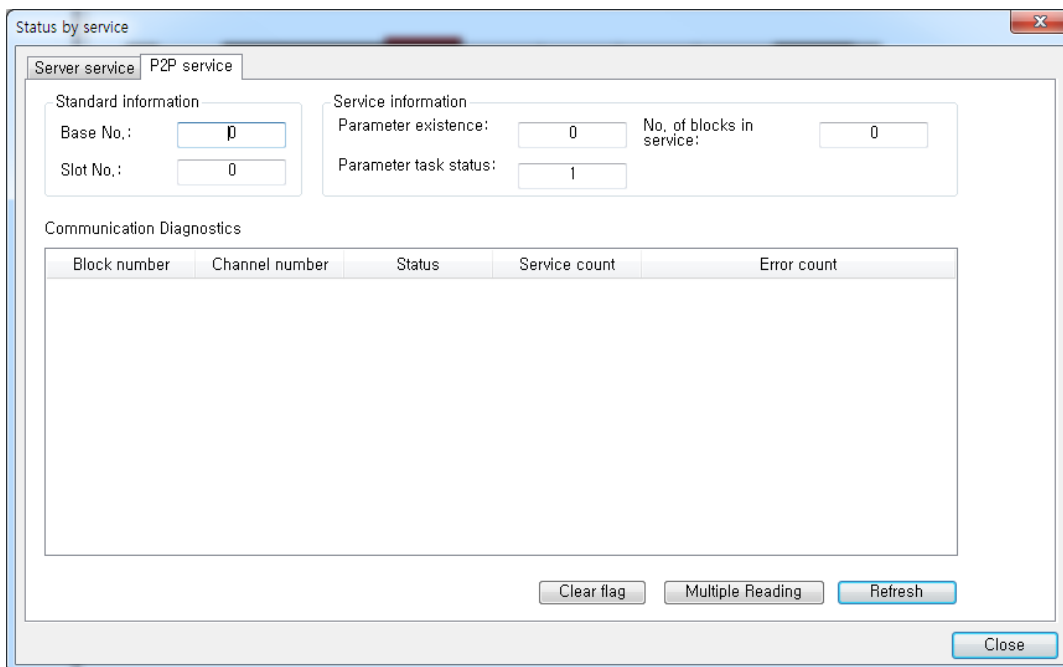

[Figure 13] System Diagnosis – P2P Service

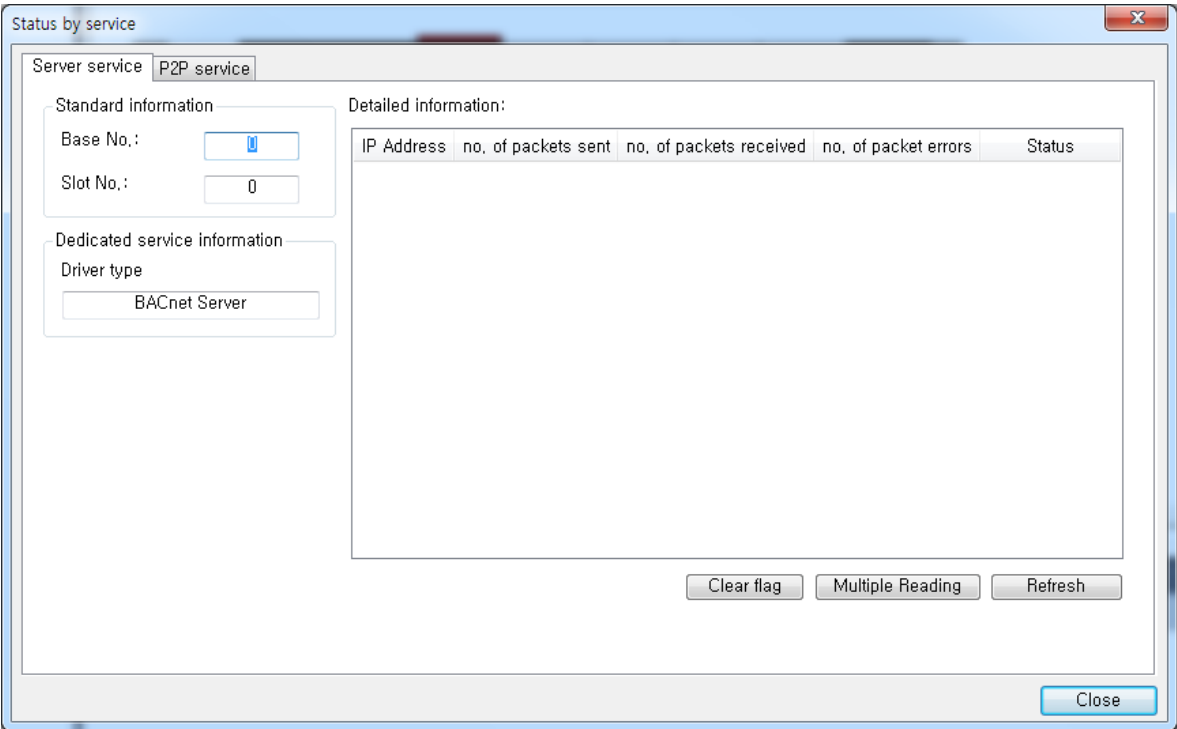

[Figure 14] System Diagnosis – Server service

Chapter 7 Diagnosis

This chapter explains how to verify the status of systems, modules and networks, and how to download the O/S. System composition and status of BACnet I/F module can be verified following the procedure below.

7.1 System Diagnosis

This method is used to verify the status of BACnet I/F module and system. On the XG5000 screen, click 'Online' → 'Connect' to connect to PLC, and then click 'Online' → 'Communication module setting' → 'System Diagnosis.' It will open the system diagnosis screen for local system as shown in [Figure 7.1.1], and a module information window will open beneath the system diagnosis screen as shown in [Figure 7.1.2].

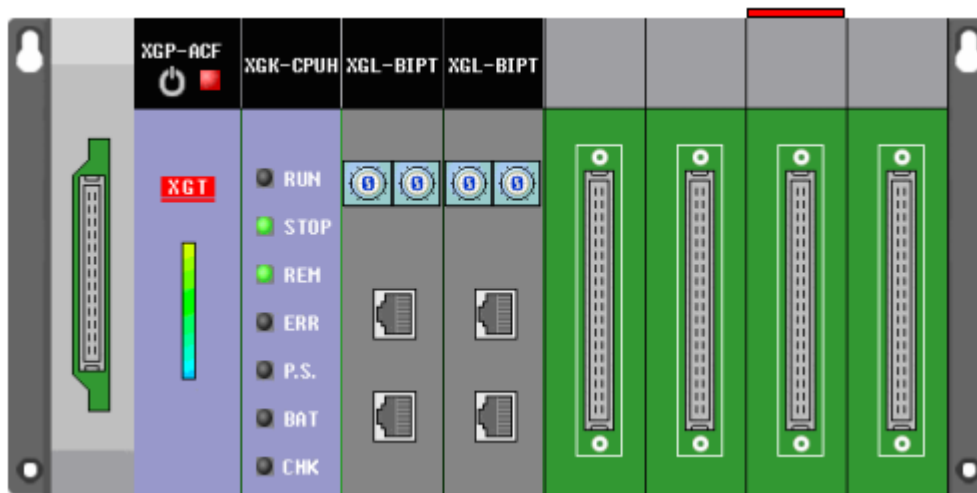

[Figure 7.1.1] System Diagnosis Screen

System information	Allocation information - Fixed	Comment
<ul style="list-style-type: none"> Base 0 : XGB-M06A Power : XGP-ACF CPU : XGI-CPUH Slot 0 : XGL-BIPT Slot 1 : XGL-BIPT Slot 2 : Empty slot Slot 3 : Empty slot Slot 4 : Empty slot Slot 5 : Empty slot 		Main Base(6 Slots) AC100~240V Input Standard CPU Module(I/O: Maximum 3,072 Points) BACnet Module BACnet Module

[Figure 7.1.2] Module Information Window

If an augmenting base is connected, click 'augmenting base' in the module window to open the system diagnosis screen for the augmenting base. [Figure 7.1.1] and [Figure 7.1.2] above show a main base system diagnosis screen for a system consisting of main base and augmenting base. You can view the augmenting base diagnosis screen for the said system shown in [Figure 7.1.3] by clicking on 'Base 1' in [Figure 7.1.2].

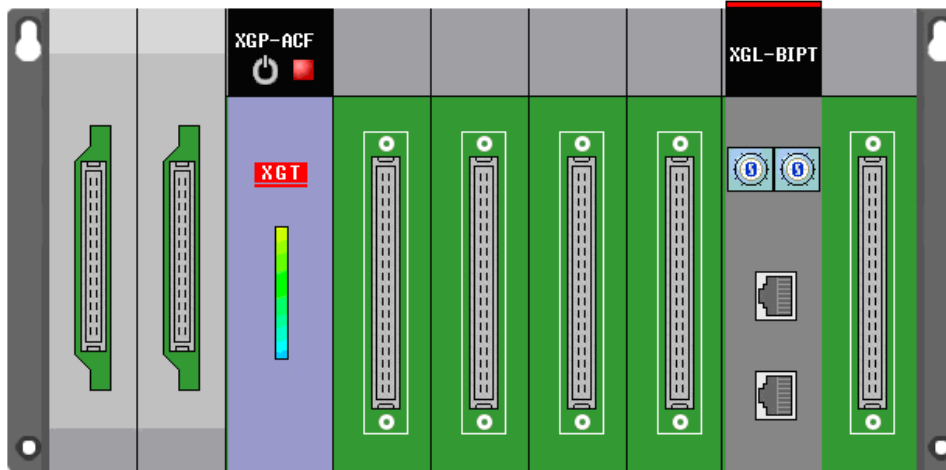

[Figure 7.1.3] System Diagnosis Screen for Augmenting base

System information	Assigns Information - Fixed Location	Comment
<ul style="list-style-type: none"> Base 0 : XGB-M06A <ul style="list-style-type: none"> Power: XGP-ACF CPU: XGI-CPUS Slot 0: XGL-BIPT Slot 1: Empty slot Slot 2: Empty slot Slot 3: Empty slot Slot 4: Empty slot Slot 5: Empty slot Base 1 : XGB-E06A <ul style="list-style-type: none"> Power: XGP-ACF Slot 0: Empty slot Slot 1: Empty slot Slot 2: Empty slot Slot 3: Empty slot Slot 4: XGL-BIPT Slot 5: Empty slot 		<p>Main Base(6 Slots) AC100~240V Input Standard CPU Module(I/O: Maximum 3,072 Points) BACnet Module</p> <p>Expansion Base(6 Slots) AC100~240V Input</p> <p>BACnet Module</p>

[Figure 7.1.4] Module Information Window for Augmenting base

7.2 Communication Module Information

This screen shows basic information of BACnet I/F module. On the system diagnosis screen, right-click on the BACnet I/F module of which communication module information you want to view. Then select 'Communication Module Information' to open the communication module information screen as shown in [Figure 7.2.1].

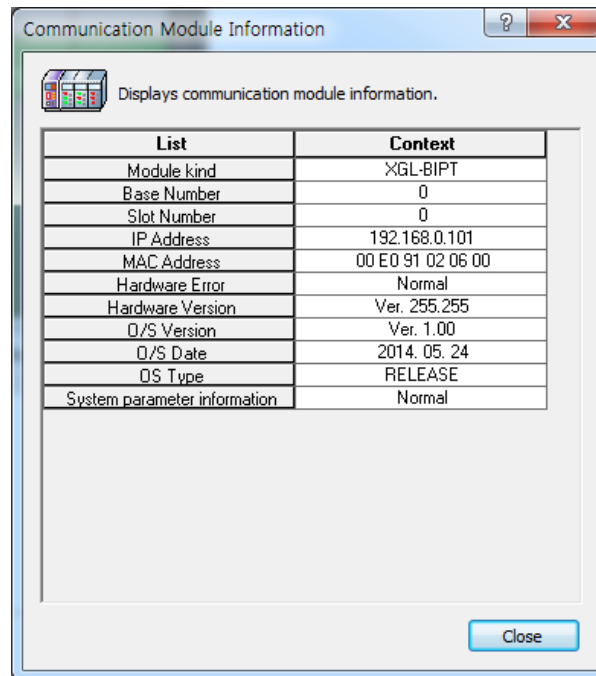

[Figure 7.2.1] Communication Module Information Screen

Segment	Contents
Type of communication module	Displays the type of module(XGL-BIPT)
Base number	Display the base location of the module installed
Slot number	Display the slot location of the module installed
IP address	Displays IP address set in the module
MAC address	Displays MAC address set in the module
Hardware error status	Displays error status of the hardware
Hardware version	Display the version of the hardware (deletion needs to be reviewed)
OS version	Displays the version of module OS
OS date	Displays the date of module OS
OS type	Displays the type of module OS
System parameter information	Displays default parameter settings

7.3 Status by Service

This screen shows service status of BACnet I/F module. It shows P2P service and server information.

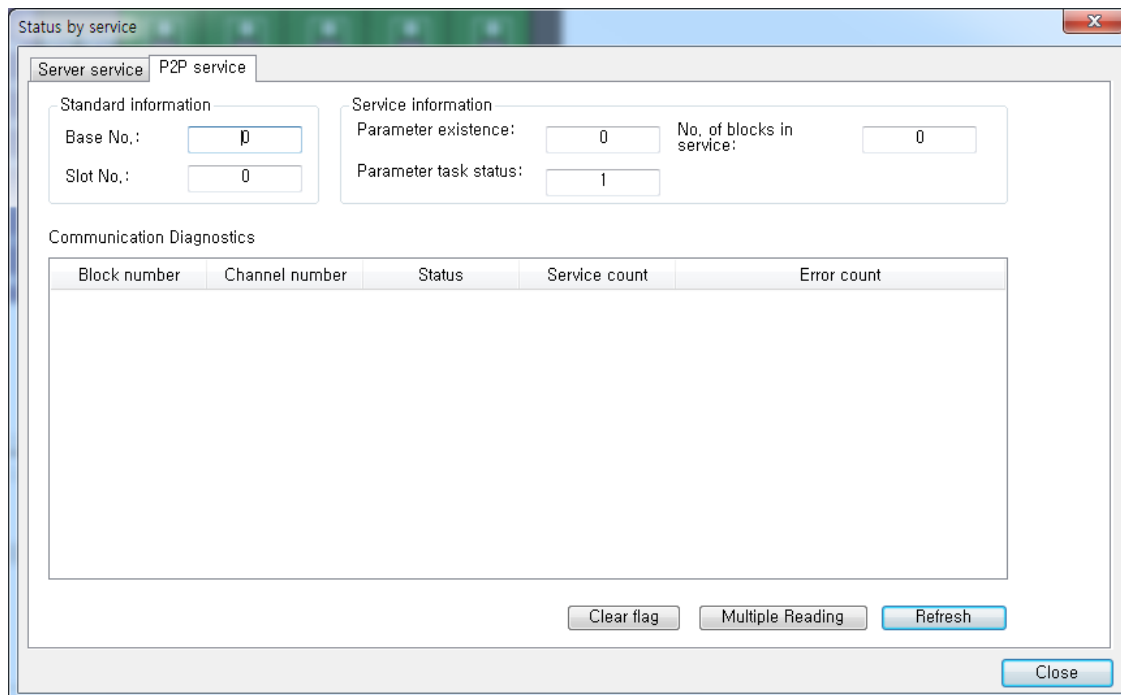
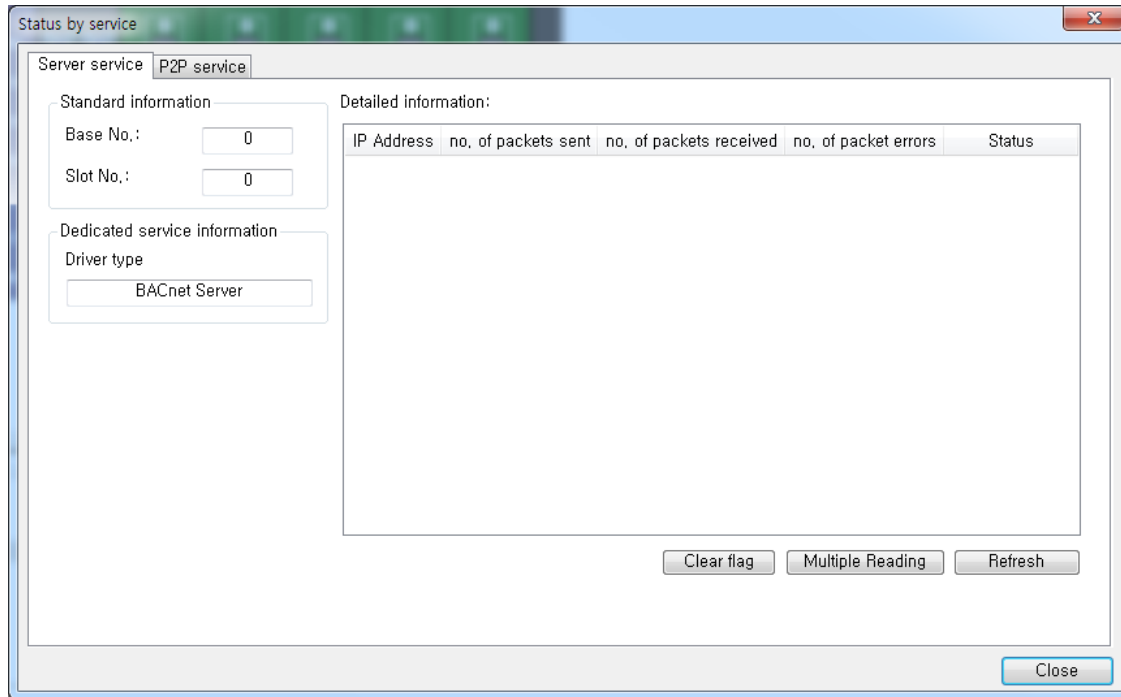

[Figure 7.3.1] Status Screen for each Service

The tables below describe the items shown in P2P service information.

Item	Contents
Block number	Displays index number of the block being serviced
Channel number	Displays channel number of the block being serviced
Block status	Displays status of the block being serviced
Service status	Displays the number of services per second of the block being serviced
Service count	Displays the number of service accumulations of the block being serviced
Error count	Displays the number of error accumulations of the block being serviced

The tables below describe the items shown in server service information.

Item	Contents
IP address	Displays IP addresses of clients connected to the server
Message type	Displays BACnet message type
Number of received packets	Displays the number of requested messages
Number of transmitted packets	Displays the number of response messages
Number of error packets	Displays the number of messages in which errors occur
Status	Displays the server operating status

7.4 Media Information

Select 'Media Information' from the diagnosis information of XG5000: it will show the information on transmitted/received frames in such categories as service, media, packet type, etc.

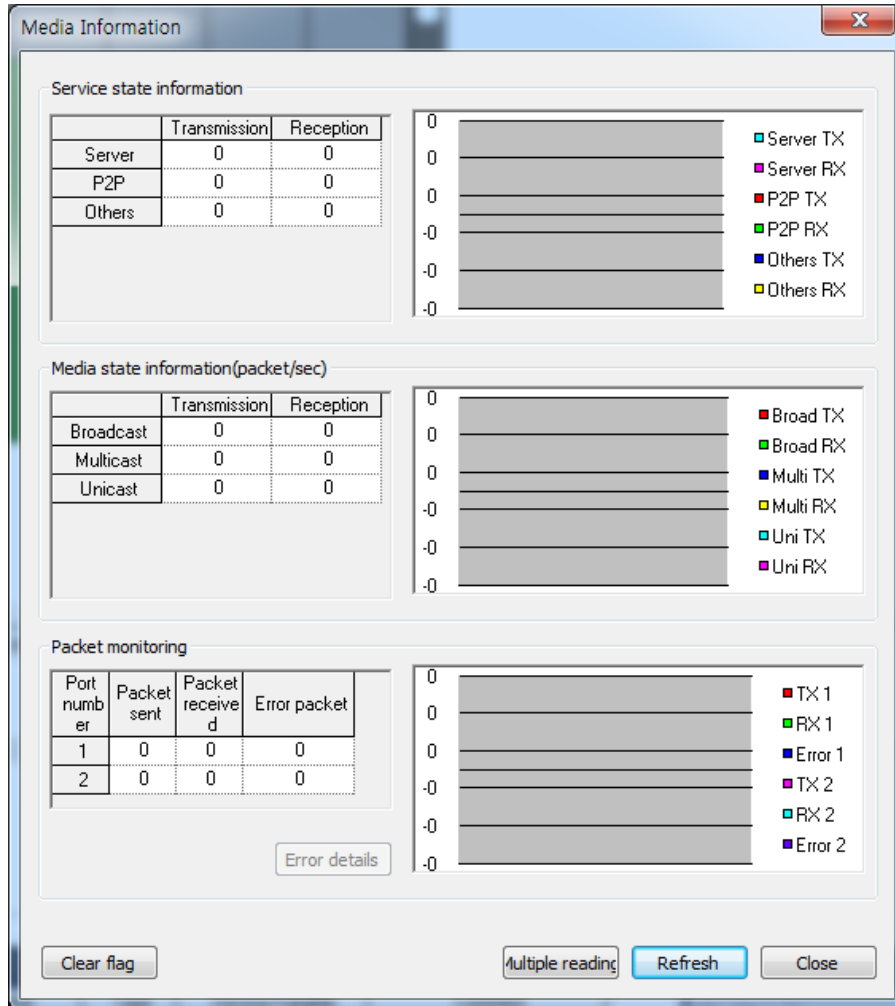

[Figure 7.4.1] Media Information Screen

7.5 Ping Test

You can perform ping test at the selected module. You can configure the IP Address, number of configurations and timeouts. The result will be shown on a message window.

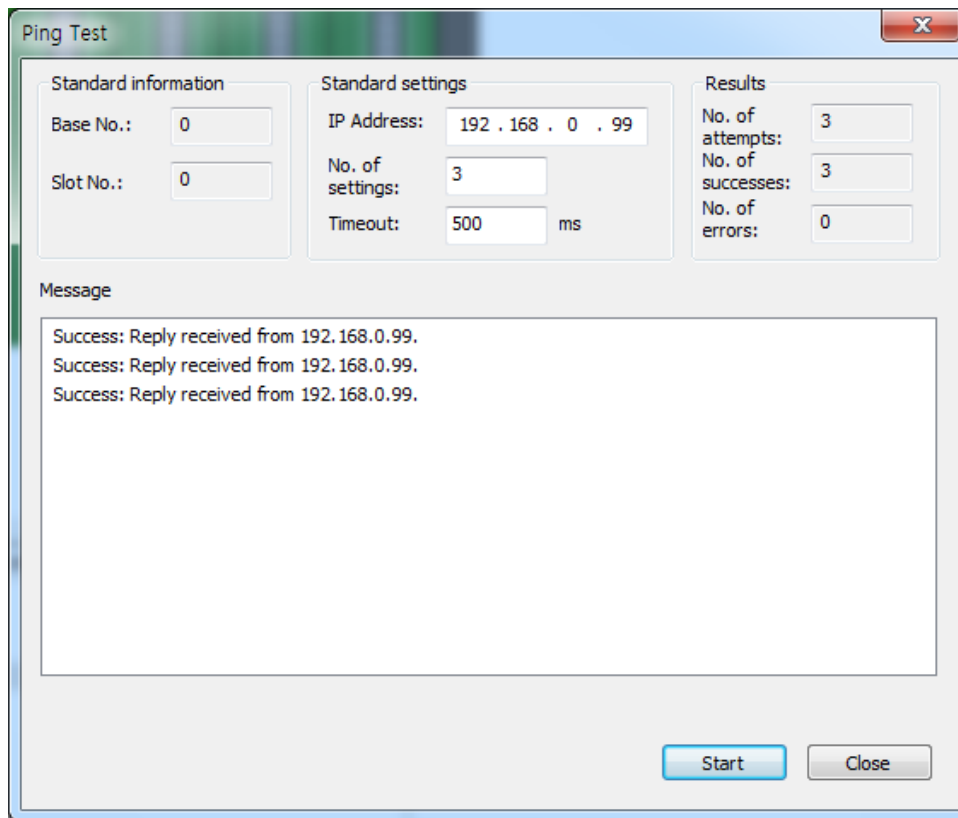

The screenshot shows a 'Ping Test' dialog box with three main sections: 'Standard information', 'Standard settings', and 'Results'. Below these is a 'Message' area and two buttons: 'Start' and 'Close'.

Section	Field	Value
Standard information	Base No.:	0
	Slot No.:	0
Standard settings	IP Address:	192 . 168 . 0 . 99
	No. of settings:	3
	Timeout:	500 ms
Results	No. of attempts:	3
	No. of successes:	3
	No. of errors:	0

Message

```
Success: Reply received from 192.168.0.99.  
Success: Reply received from 192.168.0.99.  
Success: Reply received from 192.168.0.99.
```

[Figure 7.5.1] Ping Test

7.6 Auto Scan

This screen shows the information of BACnet devices connected to BACnet network system connected with BACnet module. You can scan within a certain range defined using Who-is and Who-has of BACnet

7.6.1 Who-is Service

This shows IP address and device ID of connected BACnet devices. You can configure the range of Object ID's you want indicated.

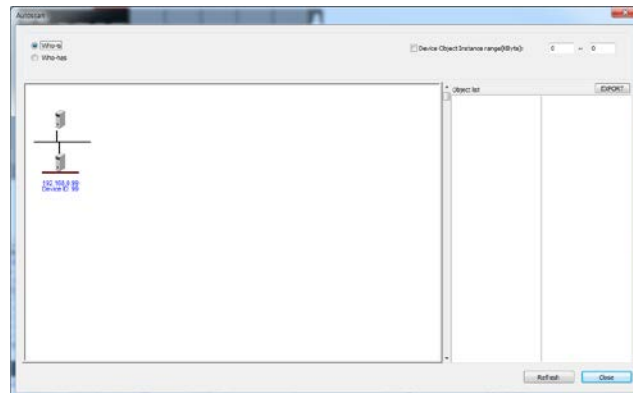

[Figure 7.6.1] Auto Scan Screen

7.6.2 Who-has Service

This shows BACnet devices after filtering them with object ID or name of connected BACnet devices.

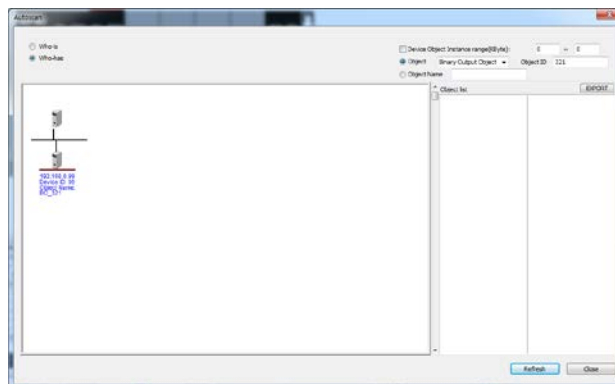

[Figure 7.6.2] Auto Scan Screen (filtered by Object ID)

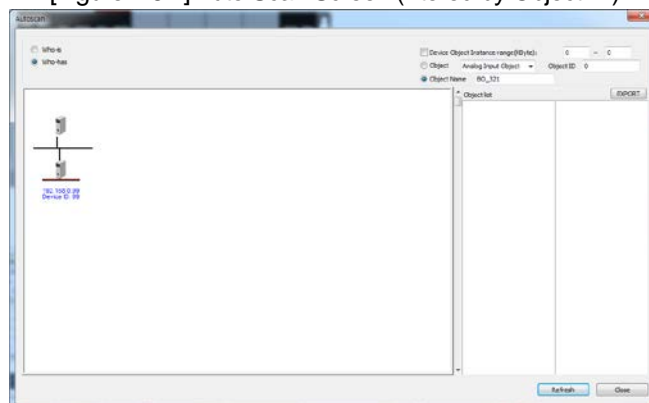

[Figure 7.6.3] Auto Scan Screen (filtered by Object Name)

7.7 Device Communication Control

You can enable or disable with a BACnet device. You can also select the duration of the relevant order (by minutes), or make requests using password.

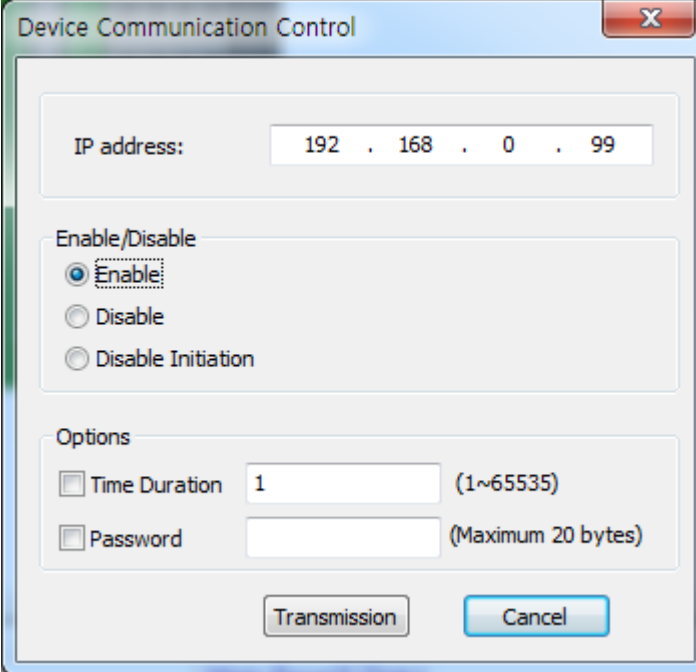

The screenshot shows a dialog box titled "Device Communication Control" with a close button (X) in the top right corner. The dialog contains the following fields and options:

- IP address:** A text field containing "192 . 168 . 0 . 99".
- Enable/Disable:** A section with three radio buttons: "Enable" (selected), "Disable", and "Disable Initiation".
- Options:** A section with two checkboxes:
 - Time Duration: A text field containing "1" with "(1~65535)" to its right.
 - Password: A text field with "(Maximum 20 bytes)" to its right.
- Buttons:** "Transmission" and "Cancel" buttons at the bottom.

[Figure 7.7.1] Auto Scan Screen

7.8 Troubleshooting

This section explains the cause and solutions for malfunctions or errors which may occur while operating the system. Abnormalities and details of the abnormalities of BACnet I/F module can be verified following the procedure below. Abnormality of a module should be verified in the order provided in this trouble shooting section. Do not Repair or dismantle the device on your own.

7.8.1 Identification through LED of the communication module

This method checks the conditions of communication modules by looking at the lights-on status of the LED for identification of the abnormal operation of the module

1) Indication of Abnormal Operation

You can verify the module's condition by looking at the LED placed on the front side of the BACnet I/F module.

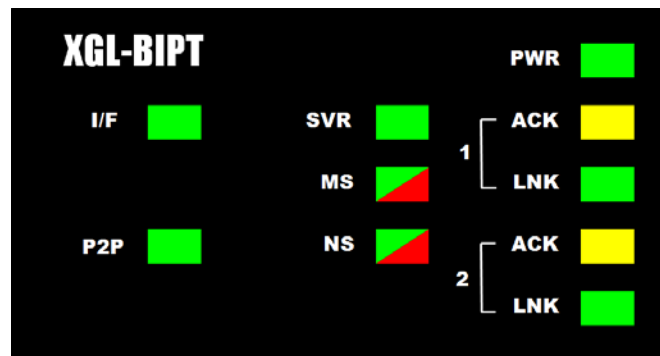

[Figure 7.8.1] BACnet I/F LED

LED content	Error content	Steps that need to be taken
RUN	Light-off after inputting module power	1) Poor installation of BACnet/IP communication module - Check if DC 5V power supply of power module is normally operated - Check if communication module is properly installed in the base 2) Warranty service request
I/F	Stop during on-and-off light operation	1) Check if CPU and communication module is properly installed 2) Warranty service request
P2P	Light-off during command service	1) Check if command input is properly made 2) Check if connection is properly made 3) Check link enable of the menu is on
SVR	Light-off during server operation	1) Check if the connection with clients is properly made
MS	Red light-on-and-off	1) Check default settings and power-on reset
	Red light-on	1) Power-on reset 2) Warranty service request
NS	Red light-on-and-off	1) IP Address reset(The same IP address found)
	Red light-on	1) Check if BACnet communication is enabled
ACT	Light-off during normal communication	1) Check transmission and reception parameters 2) Check if the connection is properly made
LNK	Light-off during normal communication	1) Check if cable is properly connected to the port 2) Check if the other module is normally operated

7.8.2 Identification of abnormalities of the muddle through XG5000

You can perform a brief monitoring to check for abnormalities of the communication module using XG5000 program. Insert the RS-232C or the USB connector into the iCPU module, and then select 'Online' → 'Diagnosis' → 'PLC Error/Warnings' in XG5000 to view the result.

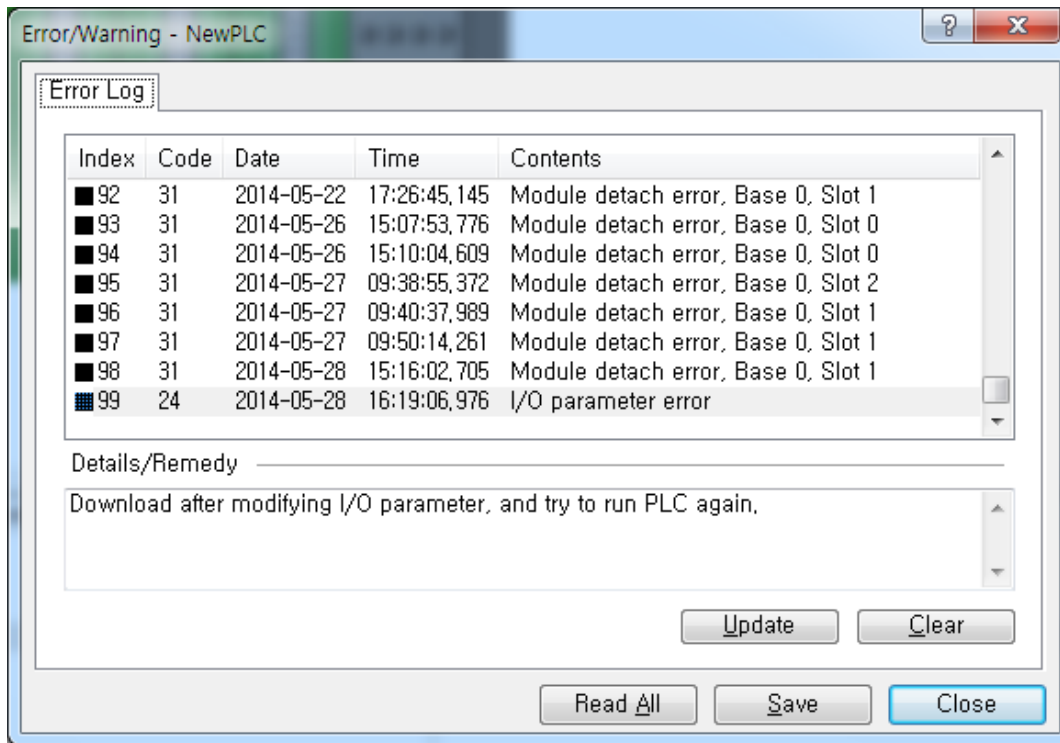

[Figure 7.8.2] PLC History Monitoring

In case of hardware error or CPU interface error, they are usually indicated by abnormal behaviors of the LED placed on the communication module. Using the program, however, you can view brief status information on the module's status.

As shown in [Figure 7.7.2], you can view the error/warnings information through PLC history from the [Online] menu of XG5000, and find solutions for the issue by consulting the contents of "Details and Measures."

7.8.3 Identification of module abnormalities by system log

You can perform a brief monitoring to check for abnormalities of the communication module using XG5000 program. Insert the RS-232C or the USB connector into the CPU module, then right-click on BACnet I/F module on the 'System Diagnosis' screen of XG5000. Then select 'System Log' to open the log screen.

1) Memory Area Log

You can check for errors or service performance.

[Figure 7.8.3] show the memory area log screen in 'System Log.'

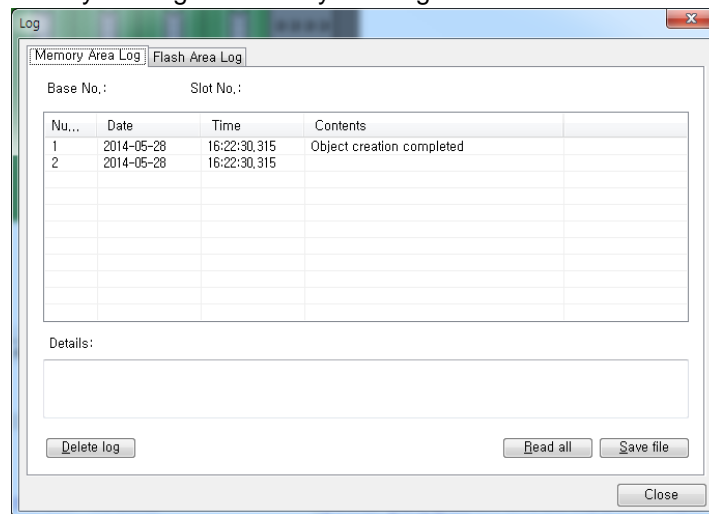

[Figure 7.8.3] Memory Area Log Screen in 'System Log'

In case of such events as error or service performance, you can verify their date, time and details.

2) Flash Area Log

In cases where errors or service performance cannot be verified using XG5000, when saving the contents of the current memory area log in flash, you can automatically save the memory area log into the flash by pressing the log switch on the front side of the BACnet I/F module.

[Figure 7.8.4] shows the flash area log screen in 'System Log.'

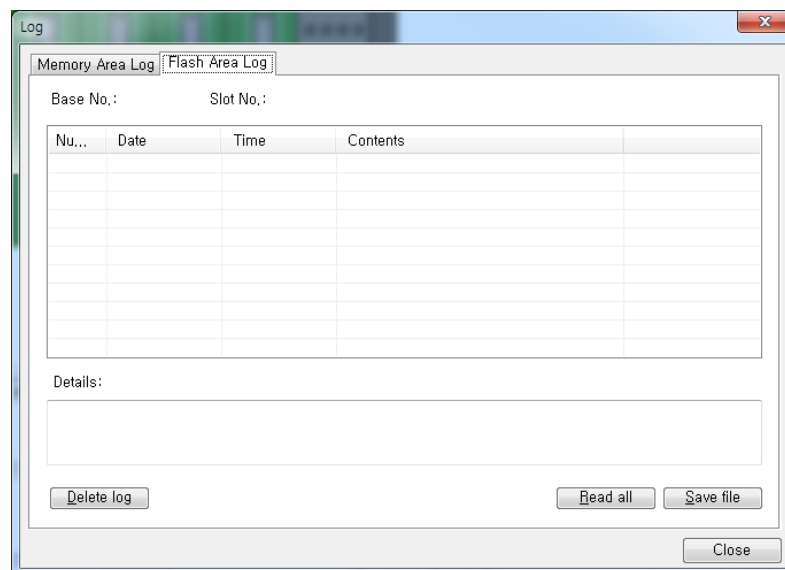

[Figure 7.8.4] Flash Area Log Screen in 'System Log'

Appendix

A.1 Definition of Terms

1. IEEE 802.3

IEEE 802.3 specifies standards for CSMA/CD based Ethernet. Exactly it is a LAN based on CSMA/CD (Carrier Sense Multiple Access with Collision Detection) Ethernet designed by IEEE 802.3 group, which is classified into detailed projects as specified below;

- A) IEEE P802.3 - 10G Base T study Group
- B) IEEE P802.3ah - Ethernet in the First Mile Task Force
- C) IEEE P802.3ak - 10G Base-CX4 Task Force

※ Ethernet and IEEE 802.3 are standardized at RFC894 and RFC1042 so each should process another frame.

2. ARP (Address Resolution Protocol)

Protocol to search for MAC address by means of correspondent IP address on the Ethernet LAN

3. Bridge

A device used to connect two networks so to be operated as one network. Bridge is used not only to connect two different types of networks but also to divide one big network into two small networks in order to increase the performance

4. Client

A user of the network service, or a computer or program (mainly the one requesting services) using other computer's resource.

5. CSMA/CD(Carrier Sense Multiple Access with Collision Detection)

Each client checks if there is any sign prior to transmission of data to the network (Carrier Sense) and then sends its data when the network is empty. At this time, all the clients have the equal right to send (Multiple Access). If two or more clients send data, collision may occur. The client who detects the collision tries to send again in a specific time.

6. DNS (Domain Name System)

A method used to convert alphabetic Domain Name on the Internet to its identical Internet number (namely, IP address)

7. Dot Address

Shows IP address of '100.100.100.100', where each figure is displayed in decimal with 1 byte occupied respectively for 4 bytes in total.

8. E-mail Address

The address of the user with login account for the specific machine connected via the Internet. Usually user's ID @ domain name (machine name) is assigned. In other words, it will be like hjjee@microsoft.com, where @ is called as 'at' displayed with shift+2 pressed on the keyboard.

The letters at the back of @ are for the domain name of specific company (school, institute,..) connected with the Internet, and the letters in front of @ are for the user ID registered in the machine. The last letters of the domain name are for the highest level. USA generally uses the following abbreviation as specified below, and Korea uses .kr to stand for Korea. .com : usually for companies) / .edu : usually for educational organizations such as universities. / .ac(academy) is mostly used in Korea / .gov : for governmental organizations. For example, nasa.gov is for NASA (government) / .mil : military related sites. For example, af.mil is for USA air force (military)/ .org : private organizations / .au : Australia / .uk : the United Kingdom / .ca : Canada / .kr : Korea / .jp : Japan / .fr : France / .tw : Taiwan, etc.

9. Ethernet

A representative LAN connection system (IEEE 802.3) developed by Xerox, Intel and DEC of America which can send about 10Mbps and use the packet of 1.5kB. Since Ethernet can allow various types of computers to be connected as one via the network, it has been called a pronoun of LAN as a universal standard with various products available, not limited to some specific companies.

10. FTP (File Transfer Protocol)

An application program used to transfer files between computers among application programs providing TCP/IP protocol. If an account is allowed to the computer to log in, fast log in the computer is available wherever the computer is so to copy files.

11. Gateway

Software/Hardware used to translate for two different protocols to work together, which is equivalent to the gateway necessary to exchange information with the different system.

12. Header

Part of the packet including self station No., correspondent station No. and error checking area.

13. HTML

Hypertext Markup Language, standard language of WWW. In other words, it is a language system to prepare Hypertext documents. The document made of HTML can be viewed through the web browser

14. HTTP

Hypertext Transfer Protocol, standard protocol of WWW. It is a protocol supporting the hypermedia system.

15. ICMP (Internet Control Message Protocol)

An extended protocol of IP address used to create error messages and test packets to control the Internet.

16. IP (Internet Protocol)

Protocol of network layers for the Internet

17. IP Address

Address of respective computers on the Internet made of figures binary of 32 bits (4 bytes) to distinguish the applicable machine on the Internet. Classified into 2 sections, network distinguishing address and host distinguishing address. The network address and the host address is respectively divided into class A, B and C based on the bits allotted. IP address since it shall be unique all over the world, shall be decided not optionally but as assigned by NIC(Network Information Center) of the applicable district when joining the Internet. In Korea, KRNIC(Korea Network Information Center) is in charge of this work. Ex.) 165.244.149.190

18. ISO (International Organization for Standardization)

A subsidiary organization of UN, establishing and managing the international standards.

19. LAN (Local Area Network)

Called also as local area communication network or district information communication network, which allows lots of computers to exchange data with each other as connected though communication cable within a limited area such as in an office or a building

20. MAC (Medium Access Control)

A method used to decide which device should use the network during given time on the broadcast network

21. Node

Each computer connected with the network is called Node

22. Packet

A package of data which is the basic unit used to send through the network. Usually the package is made of several tens or hundreds of bytes with the header attached in front to which its destination and other necessary information are added

23. PORT number

Used to classify the applications on TCP/UDP.

Ex.) 21/tcp : Telet

24. PPP (Point-to-Point Protocol)

Phone communication protocol which allows packet transmission in connecting with the Internet. In other words, normal phone cable and modem can be used for the computer to connect through TCP/IP with this most general Internet protocol.

Similar to SLIP, however with modern communication protocol factors such as error detection and data compression, it demonstrates more excellent performance than SLIP.

25. Protocol

Contains regulations related with mutual information transmission method between computers connected with each other through the network. The protocol may specify detailed interface between machines in Low level (for example, which bit/byte should go out through the line) or high level of message exchange regulations as files are transferred through the Internet.

26. Router

A device used to transfer the data packet between the networks. It sends the data packet to its final destination, waits if the network is congested, or decides which LAN is good to connect to at the LAN junction. Namely, it is a special computer/software used to control the two or more networks connected.

27. Server

The side which passively responds to the client's request and shares its resources.

28. TCP (Transmission Control Protocol)

A transport layer protocol for the Internet

- Data Tx/Rx through connection
- Multiplexing
- Transmission reliable
- Emergent data transmission supported

29. TCP/IP (Transmission Control Protocol/Internet Protocol)

Transmission protocol used for communication among different kinds of computers, which makes the communication available between general PC and medium host, IBM PC and MAC, and medium or large-sized different types of computer. It is also used as a general term for information transmission protocol between computer networks including FTP, Telnet, SMTP, etc. TCP divides data into packets to send through IP and the packets sent will be united back together through TCP.

30. Near-end crosstalk

Near-end crosstalk affecting other near line is one of the disturbances made by electric or magnetic field of communication signal. Near-end crosstalk causes that some part of communication contents of other line may be heard in one line. Phenomenon made by near-end crosstalk is called Electro-magnetic interference (EMI). This can be occurred in network line or small circuit in the computer or audio device.

Appendix

A.2 Flag List

A.2.1 Special Relays List (F)

Device 1	Device 2	Type	Variable	Function	Description
F0000		DWORD	_SYS_STATE	Mode & Status	PLC mode & run status displayed.
	F00000	BIT	_RUN	RUN	RUN status.
	F00001	BIT	_STOP	STOP	STOP status.
	F00002	BIT	_ERROR	ERROR	ERROR status.
	F00003	BIT	_DEBUG	DEBUG	DEBUG status.
	F00004	BIT	_LOCAL_CON	Local control	Local control mode.
	F00005	BIT	_MODBUS_CON	Modbus mode	Modbus control mode.
	F00006	BIT	_REMOTE_CON	Remote mode	Remote control mode.
	F00008	BIT	_RUN_EDIT_ST	Modification during run	Program being downloaded during run.
	F00009	BIT	_RUN_EDIT_CHK	Modification during run	Modification in progress during run.
	F0000A	BIT	_RUN_EDIT_DONE	Modification complete during run	Modification complete during run.
	F0000B	BIT	_RUN_EDIT_END	Modification complete during run	Modification complete during run.
	F0000C	BIT	_CMOD_KEY	Run Mode	Run Mode changed by key.
	F0000D	BIT	_CMOD_LPADT	Run Mode	Run Mode changed by local PADT.
	F0000E	BIT	_CMOD_RPADT	Run Mode	Run Mode changed by remote PADT.
	F0000F	BIT	_CMOD_RLINK	Run Mode	Run Mode changed by remote communication module.
	F00010	BIT	_FORCE_IN	Compulsory input	Compulsory input status.
	F00011	BIT	_FORCE_OUT	Compulsory output	Compulsory output status.
	F00012	BIT	_SKIP_ON	I/O SKIP	I/O SKIP being executed.
	F00013	BIT	_EMASK_ON	Error mask	Error mask being executed.
	F00014	BIT	_MON_ON	Monitor	Monitor being executed.
	F00015	BIT	_USTOP_ON	STOP	Stopped by STOP function
	F00016	BIT	_ESTOP_ON	ESTOP	Stopped by ESTOP function.
	F00017	BIT	_CONPILE_MODE	Compiling	Compile being performed.
	F00018	BIT	_INIT_RUN	Initializing	Initialization task being performed.
	F0001C	BIT	_PB1	Program code 1	Program code 1 selected.
	F0001D	BIT	_PB2	Program code 2	Program code 2 selected.
	F0001E	BIT	_CB1	Compile code 1	Compile code 1 selected.
F0001F	BIT	_CB2	Compile code 2	Compile code 2 selected.	

Appendix

Device 1	Device 2	Type	Variable	Function	Description
F0002		DWORD	_CNF_ER	System error	Serious error in system reported.
	F00020	BIT	_CPU_ER	CPU error	CPU configuration error found.
	F00021	BIT	_IO_TYER	Module type error	Module type not identical.
	F00022	BIT	_IO_DEER	Module installation error	Module displaced.
	F00023	BIT	_FUSE_ER	Fuse error	Fuse blown.
	F00024	BIT	_IO_RWER	Module I/O error	Module I/O error found.
	F00025	BIT	_IP_IFER	Module interface error	Error found in Special/communication module interface.
	F00026	BIT	_ANNUM_ER	External equipment Error	Serious error detected in external equipment.
	F00028	BIT	_BPRM_ER	Basic parameter	Basic parameter abnormal.
	F00029	BIT	_IOPRM_ER	IO parameter	IO configuration parameter abnormal.
	F0002A	BIT	_SPPRM_ER	Special module parameter	Special module parameter abnormal.
	F0002B	BIT	_CPPRM_ER	Communication module parameter	Communication module parameter abnormal.
	F0002C	BIT	_PGM_ER	Program error	Program error found.
	F0002D	BIT	_CODE_ER	Code error	Program code error found.
	F0002E	BIT	_SWDT_ER	System watch-dog	System watch-dog active.
	F0002F	BIT	_BASE_POWER_ER	Power error	Base power abnormal.
F00030	BIT	_WDT_ER	Scan watch-dog	Scan watch-dog active.	
F0004		DWORD	_CNF_WAR	System warning	Slight error in system reported.
	F00040	BIT	_RTC_ER	RTC error	RTC data abnormal.
	F00041	BIT	_DBCK_ER	Back-up error	Data back-up error found.
	F00042	BIT	_HBCK_ER	Restart error	Hot restart unavailable.
	F00043	BIT	_ABSD_ER	Run error stop	Stopped due to abnormal run.
	F00044	BIT	_TASK_ER	Task impact	Task being impacted.
	F00045	BIT	_BAT_ER	Battery error	Battery status abnormal.
	F00046	BIT	_ANNUM_WAR	External equipment error	Slight error detected in external equipment.
	F00047	BIT	_LOG_FULL	Memory full	Log memory full
	F00048	BIT	_HS_WAR1	HS link 1	HS link – parameter 1 error
	F00049	BIT	_HS_WAR2	HS link 2	HS link – parameter 2 error
	F0004A	BIT	_HS_WAR3	HS link 3	HS link – parameter 3 error
	F0004B	BIT	_HS_WAR4	HS link 4	HS link – parameter 4 error
	F0004C	BIT	_HS_WAR5	HS link 5	HS link – parameter 5 error
	F0004D	BIT	_HS_WAR6	HS link 6	HS link – parameter 6 error
F0004E	BIT	_HS_WAR7	HS link 7	HS link – parameter 7 error	

Appendix

Device 1	Device 2	Type	Variable	Function	Description
F0004	F0004F	BIT	_HS_WAR8	HS link 8	HS link – parameter 8 error
	F00050	BIT	_HS_WAR9	HS link 9	HS link – parameter 9 error
	F00051	BIT	_HS_WAR10	HS link 10	HS link – parameter 10 error
	F00052	BIT	_HS_WAR11	HS link 11	HS link - parameter11 error
	F00053	BIT	_HS_WAR12	HS link 12	HS link - parameter12 error
	F00054	BIT	_P2P_WAR1	P2P parameter 1	P2P - parameter1 error
	F00055	BIT	_P2P_WAR2	P2P parameter 2	P2P – parameter2 error
	F00056	BIT	_P2P_WAR3	P2P parameter 3	P2P – parameter3 error
	F00057	BIT	_P2P_WAR4	P2P parameter 4	P2P – parameter4 error
	F00058	BIT	_P2P_WAR5	P2P parameter 5	P2P – parameter5 error
	F00059	BIT	_P2P_WAR6	P2P parameter 6	P2P – parameter6 error
	F0005A	BIT	_P2P_WAR7	P2P parameter 7	P2P – parameter7 error
	F0005B	BIT	_P2P_WAR8	P2P parameter 8	P2P – parameter8 error
	F0005C	BIT	_CONSTANT_ER	Fixed cycle error	Fixed cycle error
F0009		WORD	_USER_F	User contact point	Timer available for user.
	F00090	BIT	_T20MS	20ms	CLOCK of 20ms cycle.
	F00091	BIT	_T100MS	100ms	CLOCK of 100ms cycle.
	F00092	BIT	_T200MS	200ms	CLOCK of 200ms cycle.
	F00093	BIT	_T1S	1s	CLOCK of 1s cycle.
	F00094	BIT	_T2S	2s	CLOCK of 2s cycle.
	F00095	BIT	_T10S	10s	CLOCK of 10s cycle.
	F00096	BIT	_T20S	20s	CLOCK of 20s cycle.
	F00097	BIT	_T60S	60s	CLOCK of 60s cycle.
	F00099	BIT	_ON	Always ON	Bit always ON.
	F0009A	BIT	_OFF	Always OFF	Bit always OFF
	F0009B	BIT	_1ON	1 scan ON	Bit only ON for the first scan.
	F0009C	BIT	_1OFF	1 scan OFF	Bit only OFF for the first scan.
	F0009D	BIT	_STOG	Reverse	Every scan reversed.
F0010		WORD	_USER_CLK	User CLOCK	CLOCK available to set by user.
	F00100	BIT	_USR_CLK0	Repeat specific scan	ON/OFF CLOCK 0 for specific scan
	F00101	BIT	_USR_CLK1	Repeat specific scan	ON/OFF CLOCK 1 for specific scan
	F00102	BIT	_USR_CLK2	Repeat specific scan	ON/OFF CLOCK 2 for specific scan
	F00103	BIT	_USR_CLK3	Repeat specific scan	ON/OFF CLOCK 3 for specific scan
	F00104	BIT	_USR_CLK4	Repeat specific scan	ON/OFF CLOCK 4 for specific scan
	F00105	BIT	_USR_CLK5	Repeat specific scan	ON/OFF CLOCK 5 for specific scan
	F00106	BIT	_USR_CLK6	Repeat specific scan	ON/OFF CLOCK 6 for specific scan
F00107	BIT	_USR_CLK7	Repeat specific scan	ON/OFF CLOCK 7 for specific scan	

Appendix

Device 1	Device 2	Type	Variable	Function	Description
F0011		WORD	_LOGIC_RESULT	Logic result	Logic result displayed.
	F00110	BIT	_LER	Calculation error	ON for 1 scan if calculation in error.
	F00111	BIT	_ZERO	Zero flag	ON if calculation result is 0.
	F00112	BIT	_CARRY	Carry flag	ON if Carry found during calculation.
	F00113	BIT	_ALL_OFF	Whole output OFF	ON if all output OFF
	F00115	BIT	_LER_LATCH	Calculation error latch	ON kept if calculation in error.
F0012		WORD	_CMP_RESULT	Compared result	Compared result displayed.
	F00120	BIT	_LT	LT flag	ON if "less than"
	F00121	BIT	_LTE	LTE flag	ON if "less than or equal"
	F00122	BIT	_EQU	EQU flag	ON if "equal"
	F00123	BIT	_GT	GT flag	ON if "greater than"
	F00124	BIT	_GTE	GTE flag	ON if "greater than or equal"
	F00125	BIT	_NEQ	NEQ flag	ON if "not equal"
F0013		WORD	_AC_F_CNT	Inspected power cut	Number of inspected power-cuts displayed.
F0014		WORD	_FALS_NUM	FALS No.	FALS No. displayed.
F0015		WORD	_PUTGET_ERR0	PUT/GET error 0	Main base PUT / GET error
F0016		WORD	_PUTGET_ERR1	PUT/GET error 1	Added base step 1 PUT / GET error
F0017		WORD	_PUTGET_ERR2	PUT/GET error 2	Added base step 2 PUT / GET error
F0018		WORD	_PUTGET_ERR3	PUT/GET error 3	Added base step 3 PUT / GET error
F0019		WORD	_PUTGET_ERR4	PUT/GET error 4	Added base step 4 PUT / GET error
F0020		WORD	_PUTGET_ERR5	PUT/GET error 5	Added base step 5 PUT / GET error
F0021		WORD	_PUTGET_ERR6	PUT/GET error 6	Added base step 6 PUT / GET error
F0022		WORD	_PUTGET_ERR7	PUT/GET error 7	Added base step 7 PUT / GET error
F0023		WORD	_PUTGET_NDR0	PUT/GET complete 0	Main base PUT / GET complete
F0024		WORD	_PUTGET_NDR1	PUT/GET complete 1	Added base step 1 PUT / GET complete
F0025		WORD	_PUTGET_NDR2	PUT/GET complete 2	Added base step 2 PUT / GET complete
F0026		WORD	_PUTGET_NDR3	PUT/GET complete 3	Added base step 3 PUT / GET complete
F0027		WORD	_PUTGET_NDR4	PUT/GET complete 4	Added base step 4 PUT / GET complete
F0028		WORD	_PUTGET_NDR5	PUT/GET complete 5	Added base step 5 PUT / GET complete
F0029		WORD	_PUTGET_NDR6	PUT/GET complete 6	Added base step 6 PUT / GET complete
F0030		WORD	_PUTGET_NDR7	PUT/GET complete 7	Added base step 7 PUT / GET complete
F0044		WORD	_CPU_TYPE	CPU type	Information on CPU type displayed.
F0045		WORD	_CPU_VER	CPU version	CPU version displayed.
F0046		DWORD	_OS_VER	OS version	OS version displayed.
F0048		DWORD	_OS_DATE	OS date	OS released date displayed.

Appendix

Device 1	Device 2	Type	Variable	Function	Description
F0050		WORD	_SCAN_MAX	Max. scan time	Max. scan time displayed
F0051		WORD	_SCAN_MIN	Min. scan time	Min. scan time displayed
F0052		WORD	_SCAN_CUR	Present scan time	Present scan time displayed.
F0053		WORD	_MON_YEAR	Month / Year	PLC's time information (Month/Year)
F0054		WORD	_TIME_DAY	Hour / Date	PLC's time information (Hour/Date)
F0055		WORD	_SEC_MIN	Second / Minute	PLC's time information (Second/Minute)
F0056		WORD	_HUND_WK	100 years / Day	PLC's time information (100 years/Day)
F0057		WORD	_FPU_INFO	FPU calculation result	Floating decimal calculation result displayed.
	F00570	BIT	_FPU_LFLAG_I	Incorrect error latch	Latched if in incorrect error.
	F00571	BIT	_FPU_LFLAG_U	Underflow latch	Latched if underflow found.
	F00572	BIT	_FPU_LFLAG_O	Overflow latch	Latched if overflow found.
	F00573	BIT	_FPU_LFLAG_Z	Latch divided by 0	Latched if divided by 0.
	F00574	BIT	_FPU_LFLAG_V	Invalid calculation latch	Latched if invalid calculation.
	F0057A	BIT	_FPU_FLAG_I	Incorrect error	Reported if incorrect error found.
	F0057B	BIT	_FPU_FLAG_U	Underflow	Reported if underflow found.
	F0057C	BIT	_FPU_FLAG_O	Overflow	Reported if overflow found.
	F0057D	BIT	_FPU_FLAG_Z	Division by 0	Reported if divided by 0.
	F0057E	BIT	_FPU_FLAG_V	Invalid calculation	Reported if calculation invalid.
F0057F	BIT	_FPU_FLAG_E	Irregular value input	Reported if irregular value input.	
F0058		DWORD	_ERR_STEP	Error step	Error step saved.
F0060		DWORD	_REF_COUNT	Refresh	Increased when module refresh executed.
F0062		DWORD	_REF_OK_CNT	Refresh OK	Increased if module refresh normal
F0064		DWORD	_REF_NG_CNT	Refresh NG	Increased if module refresh abnormal.
F0066		DWORD	_REF_LIM_CNT	Refresh LIMIT	Increased if module refresh abnormal (TIME OUT).
F0068		DWORD	_REF_ERR_CNT	Refresh ERROR	Increased if module refresh abnormal.
F0070		DWORD	_MOD_RD_ERR_CNT	Module READ ERROR	Increased if module reads 1 word abnormally.
F0072		DWORD	_MOD_WR_ERR_CNT	Module WRITE ERROR	Increased if module writes 1 word abnormally.
F0074		DWORD	_CA_CNT	Block service	Increased if module's block data serviced
F0076		DWORD	_CA_LIM_CNT	Block service LIMIT	Increased if module's block data service abnormal.
F0078		DWORD	_CA_ERR_CNT	Block service ERROR	Increased if module's block data service abnormal.
F0080		DWORD	_BUF_FULL_CNT	Buffer FULL	Increased if CPU's internal buffer is FULL.
F0082		DWORD	_PUT_CNT	PUT count	Increased if PUT executed.
F0084		DWORD	_GET_CNT	GET count	Increased if GET executed.
F0086		DWORD	_KEY	Present key	Local key's present status displayed.
F0088		DWORD	_KEY_PREV	Previous key	Local key's previous status displayed.

Appendix

Device 1	Device 2	Type	Variable	Function	Description
F0090		WORD	_IO_TYER_N	Discordant slot	Slot number with discordant module type displayed.
F0091		WORD	_IO_DEER_N	Displaced slot	Slot number with displaced module displayed.
F0092		WORD	_FUSE_ER_N	Fuse blown slot	Slot number with fuse blown displayed.
F0093		WORD	_IO_RWER_N	RW error slot	Slot number with module Read/Write error displayed.
F0094		WORD	_IP_IFER_N	IF error slot	Slot number with module interface error displayed.
F0096		WORD	_IO_TYER0	Module type 0 error	Main base module type error.
F0097		WORD	_IO_TYER1	Module type 1 error	Added base step 1 module type error.
F0098		WORD	_IO_TYER2	Module type 2 error	Added base step 2 module type error.
F0099		WORD	_IO_TYER3	Module type 3 error	Added base step 3 module type error.
F0100		WORD	_IO_TYER4	Module type 4 error	Added base step 4 module type error.
F0101		WORD	_IO_TYER5	Module type 5 error	Added base step 5 module type error
F0102		WORD	_IO_TYER6	Module type 6 error	Added base step 6 module type error
F0103		WORD	_IO_TYER7	Module type 7 error	Added base step 7 module type error
F0104		WORD	_IO_DEER0	Module installation 0 error	Main base module installation error
F0105		WORD	_IO_DEER1	Module installation 1 error	Added base step 1 module installation error
F0106		WORD	_IO_DEER2	Module installation 2 error	Added base step 2 module installation error
F0107		WORD	_IO_DEER3	Module installation 3 error	Added base step 3 module installation error
F0108		WORD	_IO_DEER4	Module installation 4 error	Added base step 4 module installation error
F0109		WORD	_IO_DEER5	Module installation 5 error	Added base step 5 module installation error
F0110		WORD	_IO_DEER6	Module installation 6 error	Added base step 6 module installation error
F0111		WORD	_IO_DEER7	Module installation 7 error	Added base step 7 module installation error
F0112		WORD	_FUSE_ER0	Fuse blown 0 error	Main base Fuse blown error
F0113		WORD	_FUSE_ER1	Fuse blown 1 error	Added base step 1 Fuse blown error
F0114		WORD	_FUSE_ER2	Fuse blown 2 error	Added base step 2 Fuse blown error
F0115		WORD	_FUSE_ER3	Fuse blown 3 error	Added base step 3 Fuse blown error
F0116		WORD	_FUSE_ER4	Fuse blown 4 error	Added base step 4 Fuse blown error
F0117		WORD	_FUSE_ER5	Fuse blown 5 error	Added base step 5 Fuse blown error
F0118		WORD	_FUSE_ER6	Fuse blown 6 error	Added base step 6 Fuse blown error
F0119		WORD	_FUSE_ER7	Fuse blown 7 error	Added base step 7 Fuse blown error
F0120		WORD	_IO_RWER0	Module RW 0 error	Main base module Read/Write error
F0121		WORD	_IO_RWER1	Module RW 1 error	Added base step 1 module Read/Write error
F0122		WORD	_IO_RWER2	Module RW 2 error	Added base step 2 module Read/Write error
F0123		WORD	_IO_RWER3	Module RW 3 error	Added base step 3 module Read/Write error
F0124		WORD	_IO_RWER4	Module RW 4 error	Added base step 4 module Read/Write error
F0125		WORD	_IO_RWER5	Module RW 5 error	Added base step 5 module Read/Write error
F0126		WORD	_IO_RWER6	Module RW 6 error	Added base step 6 module Read/Write error
F0127		WORD	_IO_RWER7	Module RW 7 error	Added base step 7 module Read/Write error

Appendix

Device 1	Device 2	Type	Variable	Function	Description
F0128		WORD	_IO_IFER_0	Module IF 0 error	Main base module interface error
F0129		WORD	_IO_IFER_1	Module IF 1 error	Added base step 1 module interface error
F0130		WORD	_IO_IFER_2	Module IF 2 error	Added base step 2 module interface error
F0131		WORD	_IO_IFER_3	Module IF 3 error	Added base step 3 module interface error
F0132		WORD	_IO_IFER_4	Module IF 4 error	Added base step 4 module interface error
F0133		WORD	_IO_IFER_5	Module IF 5 error	Added base step 5 module interface error
F0134		WORD	_IO_IFER_6	Module IF 6 error	Added base step 6 module interface error
F0135		WORD	_IO_IFER_7	Module IF 7 error	Added base step 7 module interface error
F0136		WORD	_RTC_DATE	RTC date	RTC's present date
F0137		WORD	_RTC_WEEK	RTC day	RTC's present day of the week
F0138		DWORD	_RTC_TOD	RTC time	RTC's present time (ms unit)
F0140		DWORD	_AC_FAIL_CNT	Power-cut times	Power-cut times saved.
F0142		DWORD	_ERR_HIS_CNT	Errors found	Number of found errors saved.
F0144		DWORD	_MOD_HIS_CNT	Mode conversion times	Mode conversion times saved.
F0146		DWORD	_SYS_HIS_CNT	History updated times	System's history updated times saved.
F0148		DWORD	_LOG_ROTATE	Log rotate	Log rotate information saved.
F0150		WORD	_BASE_INFO0	Slot information 0	Main base slot information
F0151		WORD	_BASE_INFO1	Slot information 1	Added base step 1 slot information
F0152		WORD	_BASE_INFO2	Slot information 2	Added base step 2 slot information
F0153		WORD	_BASE_INFO3	Slot information 3	Added base step 3 slot information
F0154		WORD	_BASE_INFO4	Slot information 4	Added base step 4 slot information
F0155		WORD	_BASE_INFO5	Slot information 5	Added base step 5 slot information
F0156		WORD	_BASE_INFO6	Slot information 6	Added base step 6 slot information
F0157		WORD	_BASE_INFO7	Slot information 7	Added base step 7 slot information
F0158		WORD	_RBANK_NUM	Used block number	Presently used block number
F0159		WORD	_RBLOCK_STATE	Flash status	Flash block status
F0160		DWORD	_RBLOCK_RD_FLAG	Flash Read	ON when reading Flash N block data.
F0162		DWORD	_RBLOCK_WR_FLAG	Flash Write	ON when writing Flash N block data.
F0164		DWORD	_RBLOCK_ER_FLAG	Flash error	Error found during Flash N block service.
F1024		WORD	_USER_WRITE_F	Available contact	Contact point available in program
	F10240	BIT	_RTC_WR	RTC RW	Data Write & Read in RTC
	F10241	BIT	_SCAN_WR	Scan WR	Scan value initialization
	F10242	BIT	_CHK_ANC_ERR	Detect external serious error	Detection of serious error in external equipment requested.
	F10243	BIT	_CHK_ANC_WAR	Detect external slight error	Detection of slight error in external equipment requested.
F1025		WORD	_USER_STAUS_F	User contact point	User contact point
	F10250	BIT	_INIT_DONE	Initialization complete	Initialization complete displayed.
F1026		WORD	_ANC_ERR	External serious error information	Serious error information in external equipment displayed.
F1027		WORD	_ANC_WAR	External slight error information	Slight error information in external equipment displayed.
F1034		WORD	_MON_YEAR_DT	Month / Year	Time information data (Month/Year)
F1035		WORD	_TIME_DAY_DT	Hour / Date	Time information data (Hour/Date)
F1036		WORD	_SEC_MIN_DT	Second / Minute	Time information data (Second/Minute)
F1037		WORD	_HUND_WK_DT	100 years / Day	Time information data (100 years/Day)

A.2.2 Communication Relays List (L)

1) Special register for data link

* P2P parameters : 1~8, P2P block : 0~63

No.	Keyword	Type	Detail	Description
L006250	_P2P1_NDR00	Bit	P2P parameter No.1, block No.00 service is completed normally	P2P parameter No.1, block No.0 service is completed normally
L006251	_P2P1_ERR00	Bit	P2P parameter No.1, block No.00 service is completed abnormally	P2P parameter No.1, block No.0 service is completed abnormally
L00626	_P2P1_STATUS00	Word	Error code if P2P parameter No.1, block No.00 service is completed abnormally	Displays Error code if P2P parameter No.1, block No.0 service is completed abnormally
L00627	_P2P1_SVCCNT00	DWord	P2P parameter No.1, block No.00 service normal execution times	Displays P2P parameter No.1, block No.0 service normal execution times
L00629	_P2P1_ERRCNT00	DWord	P2P parameter No.1, block No.00 service abnormal execution times	Displays P2P parameter No.1, block No.0 service abnormal execution times
L006310	_P2P1_NDR01	Bit	P2P parameter No.1, block No.01 service is completed normally	P2P parameter No.1, block No.1 service is completed normally
L006311	_P2P1_ERR01	Bit	P2P parameter No.1, block No.01 service is completed abnormally	P2P parameter No.1, block No.1 service is completed abnormally
L00632	_P2P1_STATUS01	Word	Error code if P2P parameter No.1, block No.01 service is completed abnormally	Displays error code if P2P parameter No.1, block No.1 service is completed abnormally
L00633	_P2P1_SVCCNT01	DWord	P2P parameter No.1, block No.01 service normal execution times	Displays P2P parameter No.1, block No.1 service normal execution times
L00635	_P2P1_ERRCNT01	DWord	P2P parameter No.1, block No.01 service abnormal execution times	Displays P2P parameter No.1, block No.1 service abnormal execution times

[Table 2] List of communication flags based on P2P service setting

A.3 Dimension

Unit : mm

- XGL-BIPT

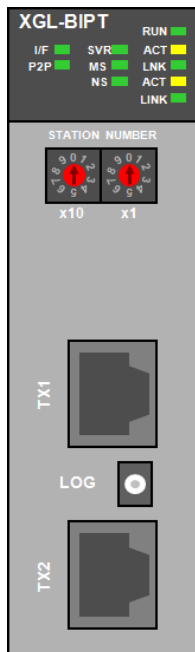
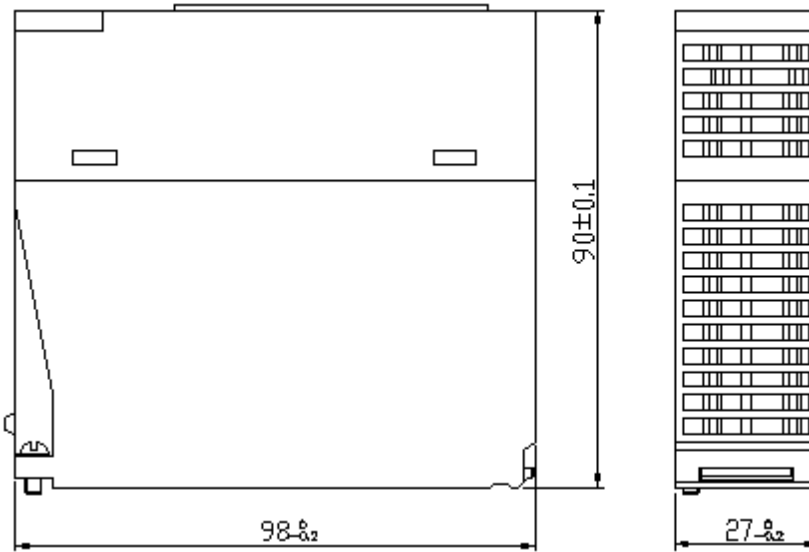

Warranty

1. Warranty Period

The product you purchased will be guaranteed for 18 months from the date of manufacturing.

2. Scope of Warranty

Any trouble or defect occurring for the above-mentioned period will be partially replaced or repaired. However, please note the following cases will be excluded from the scope of warranty.

- (1) Any trouble attributable to unreasonable condition, environment or handling otherwise specified in the manual,
- (2) Any trouble attributable to others' products,
- (3) If the product is modified or repaired in any other place not designated by the company,
- (4) Due to unintended purposes
- (5) Owing to the reasons unexpected at the level of the contemporary science and technology when delivered.
- (6) Not attributable to the company; for instance, natural disasters or fire

3. Since the above warranty is limited to PLC unit only, make sure to use the product considering the safety for system configuration or applications.

Environmental Policy

LSIS Co., Ltd supports and observes the environmental policy as below.

Environmental Management

LSIS considers the environmental preservation as the preferential management subject and every staff of LSIS use the reasonable endeavors for the pleasurable environmental preservation of the earth.

About Disposal

LSIS' PLC unit is designed to protect the environment. For the disposal, separate aluminum, iron and synthetic resin (cover) from the product as they are reusable.



www.lsis.com

LSIS

10310001362

■ **HEAD OFFICE**

LS Tower, 127, LS-ro, Dongan-gu, Anyang-si, Gyeonggi-Do, 431-848, Korea
 Tel : (82-2)2034-4870/Fax : 82-2-2034-4648 E-mail : cshwang@lsis.biz
 -**Southeast Asia** +82-2-2034-4888 cshwang@lsis.com (Charles Hwang)
 -**Europe** +82-2-2034-4676 sukyong@lsis.com (Brian Choi)
 -**Turkey/Israel/CIS** +82-2-2034-4879 dkimc@lsis.com (Daniel Kim)
 -**Oceania** +82-2-2034-4394 kacho@lsis.com (Kendra Cho)
 -**North/Latin America** +82-2-2034-4286 hkchung@lsis.com (Hank Raul Chung)
 -**Southwest Asia/Africa** +82-2-2034-4467 myleed@lsis.com (Henry Lee)
 -**Middle East** +971-4-886-5360 khchoi1@lsis.com (Lambert Choi)

■ **LSIS(Shanghai) Co., Ltd. /CHINA**

32nd Room 1~4, 32/F, Great Wall Building, No.3000 North Zhongshan Road,
 Putuo District, Shanghai, P.R. China
 Tel : 86-21-5237-9977(609) Fax : 86-21-5237-7189

■ **LSIS(Dalian) Co., Ltd. /CHINA**

No. 15, Liaohexi 3-Road, Economic and Technical Development zone, Dalian,
 P.R. China
 Tel : 86-411-8731-7542 Fax : 86-411-8730-7560 E-Mail : dskim@lsis.com

■ **LSIS(Wuxi) Co., Ltd./CHINA**

102-A, National High & New Tech Industrial Development Area, Wuxi, Jiangsu,
 P.R. China
 Tel : 86-510-8534-6666 Fax : 86-510-8534-4078 E-Mail : sojin@lsis.com

■ **LS Hukai Electric(Hubei) Co., Ltd./CHINA**

No. 100, Tanjiahe Road, Dianjun District, Yichang City, Hubei Province, P.R. China
 Tel : 86-717-667-7536 Fax : 86-717-667-7222 E-Mail : jaewoongh@lsis.com

■ **LS-VINA Industrial Systems Co., Ltd./VIETNAM**

Room 1311, 13th, M3-M4 Building 91 Nguyen Chi Thanh street, Hanoi, Vietnam
 Tel : 84-4-6275-8055 Fax : 86-21-5237-7189

■ **LSIS(ME) FZE/U.A.E.**

LOB 19-205, JAFZA View Tower, Jebel Ali Free Zone, Dubai, United Arab Emirates
 Tel : 971-4-886-5360 Fax : 971-4-886-5361 E-Mail : shunlee@lsis.com

■ **LSIS Europe B.V./NETHERLANDS**

1st. Floor, Tupolevlaan 48, 1119NZ, Schiphol-Rijk, The Netherlands
 Tel : 31-20-654-1420 Fax : 31-20-654-1429 E-Mail : htha@lsis.com

■ **LSIS Japan Co., Ltd./JAPAN**

16th, Higashi-Kan, Akasaka Twin Tower, 2-17-22, Akasaka, Minato-ku, Tokyo, Japan
 Tel : 81-3-3582-9128 Fax : 81-3-3582-2667 E-Mail : jschuna@lsis.com

■ **LSIS USA Inc./U.S.A**

2000 Millbrook Drive, Lincolnshire, Chicago, IL 60069, United States of America
 Tel : 847-941-8240 Fax : 847-941-8259 E-Mail : ybleeb@lsis.com

■ **LSIS Gurgaon Office/INDIA**

109 First Floor, Park Central, Sector-30, Gurgaon- 122 002, Haryana, India
 Tel : +0091-124-493-0070 Fax : 91-1244-930-066 E-Mail : hwyim@lsis.com

※ LSIS constantly endeavors to improve its product so that information in this manual is subject to change without notice.

© LSIS Co., Ltd. 2014 All Rights Reserved.