

**IDEC SmartRelay – The Intelligent Choice**



**Increase your versatility with a new remote display**

Look around. IDEC SmartRelays are in everything from lighting controls to ice-making machines and grocery store misters. Proving reliable time after time, these intelligent logic modules are the ideal controller for simple automation tasks. A new fifth-generation of SmartRelays offer functions to give you even more flexibility and convenience. Advances include extended memory, a brighter display with higher LCD contrast, improved analog and high-speed inputs, an external text display, and upgraded programming software.

With an ever changing market and tough competition, you need an edge to stay on top. SmartRelay has a new HMI text display panel to do just that! This economical interface lets you make quick adjustments, while at the same time making it easy to spot and troubleshoot failures using built-in operator functions and diagnostics. So why wait? Make the smart choice, IDEC SmartRelay!

**Industrial Facility Systems**



- Conveyor systems
- Elevator controls
- Exhaust and filtering systems
- Automatic food dispensing machines
- Water treatment and irrigation systems
- Motor, pump and valve controls

**Housing and Building Management**



- Lighting controls (outside and inside)
- Door and gate controls
- Heating and cooling systems
- Shutter, sun blind and awning controls
- Water and sprinkler systems
- Ventilation systems

**Unique Solutions**



- Solar-electric systems
- Marine systems
- Extreme environmental conditions
- Display panels and traffic light controls
- Energy management

**Monitoring Systems**



- Access controls
- Alarm systems
- Limit level monitoring
- Parking Lot monitoring
- Baggage control

[www.IDEC.com/smartrelay](http://www.IDEC.com/smartrelay)

OI Touchscreens

PLCs

Automation Software

Power Supplies

Sensors

Communication

Barriers

**New Faster Inputs**

FL1E can support up to four 5KHz high-speed inputs. You have the option of configuring inputs I3, I4, I5 and I6 as fast counter inputs to give you even more flexibility.

**Universal Voltages**

Available in 12/24V DC for solar and vehicle applications, and 24V AC/DC for building automation, as well as 100-240V AC/DC, SmartRelay can be used for a wide variety of applications.

**DIN Rail or Surface Mountable**

**New Controllable Backlit LCD Display**

FL1E SmartRelays have a built-in LCD display with a brighter, higher contrast screen you can adjust to your own preference. System status — input, output, analog values, timers and counters — can be monitored through the 4x12 LCD screen or you can display a predefined message with up to 48 characters (chosen from 103 special character types). Non-LCD versions are also available.

**New Built-in Analog Inputs**

Each SmartRelay is equipped with 8 digital inputs that can be used for your applications. New in the FL1E 12/24VDC and 24VDC models are four built-in analog inputs. Inputs I1, I2, I7, and I8 can now be configured to accept 0-10V analog signals. Using expansion modules, you can utilize a maximum of 24 digital and 8 analog inputs.

**New Memory Cartridges**

Three memory cartridges are now available for FL1E: Violet, Green and Brown! Violet is a 32K high-capacity, removable program memory card. Green is a battery card that supports a Real Time Clock power supply for up to two years. Brown is a combined memory/battery card.

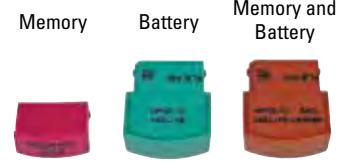

**Operational Control Buttons**

Program with just the push of a button! SmartRelay control buttons can be used to program, modify and change preset parameters. The four cursor keys can also be configured as inputs as needed.

**Digital Outputs**

IDEC SmartRelays are equipped with four relay outputs rated at 10A/pt. Using digital expansion modules; you can configure a maximum of sixteen outputs.

**New 50% More Memory**

FL1E SmartRelays offer an expanded program memory of 200 function blocks! This is a 50% increase compared to the existing FL1D series.

**EEPROM Memory**

With IDEC SmartRelays, your program is stored in a non-volatile EEPROM Memory.

**New Extended Retentive Data Memory**

Extended memory gives you up to 250 bytes of retentive data memory. More than 4 times that of FL1D!

**New Arithmetic Functions**

Analog Math function blocks allow basic arithmetic operations such as addition, subtraction, multiplication, and division.

**Password Protection**

Concerned about your program being copied or altered? IDEC SmartRelays keep you safe with a unique password protection scheme allowing end users to access certain parameters without seeing or modifying the actual program.

**Additional text display**

For the first time ever, you can connect an external text display to your SmartRelay, making it easy for you to monitor, view and troubleshoot from outside your panel. Turn to page 7 to learn more!

**Quality**

IDEC has built a reputation based on providing high-quality, dependable products you can trust, and our SmartRelays are no exception. Each model is cULus listed, CE certified, EMC compliant, FM approved for Class 1 Div 2 hazardous locations, C-tick compliant, Lloyds Registered and ABS approved.



IO Touchscreens

PLCs

Automation Software

Power Supplies

Sensors

Communication

Barriers

Part Numbers

OI Touchscreens

Base Modules – with LCD

Style	Part Number	Voltage	Input Signal	Input	Output	With Clock
	FL1E-H12RCE	12/24V DC	DC I1, I2, I7 and I8 are used for digital/analog	PNP	Relay	Yes
	FL1E-H12SND	24V DC			Transistor Source	
	FL1E-H12RCA	24V AC/DC	AC/DC	PNP/NPN	Relay	Yes
	FL1E-H12RCC	100-240V AC/DC				

PLCs

Base Modules – without LCD

Style	Part Number	Voltage	Input Signal	Input	Output	With Clock
	FL1E-B12RCE	12/24V DC	DC I1, I2, I7 and I8 are used for digital/analog	PNP	Relay	Yes
	FL1E-B12RCA	24V AC/DC				
	FL1E-B12RCC	100-240V AC/DC	AC/DC	PNP	Relay	Yes

Automation Software

Text Message Display

Style	Part Number	Rated Voltage	Description
	FL1E-RD1	12 VDC, 24 VAC/DC	FL1E Text Display Panel

Power Supplies

Digital I/O Expansion Modules

- 8-pt expansion module (4 in/4 out)
- Max. 4 digital expansion modules

Style	Part Number	Total I/O	Input Power	Input	Output
	FL1B-M08B2R2	8 (4 in/ 4 out)	12/24V DC	DC	Relay
	FL1B-M08B1S2		24V DC		Transistor Sink
	FL1B-M08C2R2		100-240V AC/DC	AC/DC	Relay
	FL1B-M08D2R2		24V AC/DC		

Sensors

Communication

Barriers

**Analog I/O Expansion Modules**

- 2-pt Analog input module
- 2-pt Analog output module
- 10-bit resolution
- Max. 4 analog input modules and 1 analog output module

Style	Part Number	Total I/O	Input Power	Input	Output
	FL1B-J2B2	2 (2 in/0 Out)	12/24V DC	0-10V, 4-20mA	—
	FL1D-K2BM2	2 (0 in/2 Out)	24V DC	—	0-10V, 4-20mA

**AS-Interface Communication Module**

- The AS-Interface communication module provides optimum solutions for decentralized controls and savings in installation space and wiring
- Virtual I/O points: 4 inputs, 4 outputs

Style	Part Number	Module	Input Power	Total I/O
	FL1B-CAS2	AS-Interface Communication Module	30V DC	Input: 4 points Output: 4 points

**Starter Kits**

IDEC SmartRelay Starter Kit is an economical and ideal solution for first time IDEC SmartRelay users

- Package includes a base module, WindLGC programming software, USB programming cable, simulator switch (DC models only) and a user’s manual



**Starter Kits**

Part Number	Description
SMARTSTART-BAC-E	FL1E-B12RCC, WindLGC software and programming cable
SMARTSTART-BDC-E	FL1E-B12RCE, WindLGC software, programming cable, and simulator switch
SMARTSTART-HAC-E	FL1E-H12RCC, WindLGC software and programming cable
SMARTSTART-HDC-E	FL1E-H12RCE, WindLGC software, programming cable, and simulator switch

**Accessories**

Part Number	Description
FL9Y-LP1CDW	WindLGC 6.0 programming software
FL1E-PC2	SmartRelay USB programming cable
FL1E-PM4	FL1E SmartRelay memory cartridge
FL1E-PB1	FL1E SmartRelay battery cartridge
FL1E-PG1	FL1E SmartRelay memory and battery combination cartridge
FL9Y-B1090-0	FL1E SmartRelay user’s manual
FL1B-Y1371-SW8	8-pt simulator switch, used with 12-24VDC, 24VDC base module only



WindLGC Software  
FL9Y-LP1CDW

I/O Touchscreens

PLCs

Automation Software

Power Supplies

Sensors

Communication

Barriers

## WindLGC

## Programming Software

WindLGC is the exclusive programming software for the IDEC SmartRelay using Windows®. Edit, save, and print out your programs.

**Key features:**

- Ladder programming
- Online Monitor
- Program Comparison
- Time Simulation
- Simplified connection of the functions
- Programs can be saved in PDF or JPG format

Just click the function blocks you need and link function blocks for easy wiring. Devise complicated circuits using the convenient functions of WindLGC.

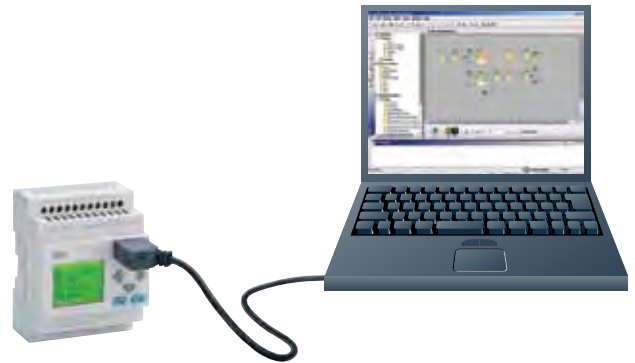
**Part Number**

Part Number	Description
FL9Y-LP1CDW	WindLGC programming software for IDEC SmartRelay

**WindLGC system requirements:**

- OS: Windows95/98/ME/NT/2000/XP/Vista and Windows 7
- CPU recommendation: Pentium 266MHz or higher
- Memory: 64MB or more
- RAM recommendation: 128MB
- Hard disk space: 90MB or more for installing WindLGC software.
- Monitor Recommendation: Display more than 800 x 600 dots and 256 colors
- Free download service, if upgrading from WindLGC Version 3.0 to Version 5.0, available at [www.idec.com/usa](http://www.idec.com/usa)

**Program Comparison****Simulation Mode/Online Monitor****Ladder Programming**

For more information, see the Automation Software section.  
Visit [www.IDEC.com/downloads](http://www.IDEC.com/downloads) for free upgrades or a free demo version.

Specifications

Base Modules

Style	with LCD Display	FL1E-H12SND	FL1E-H12RCE	FL1E-H12RCA	FL1E-H12RCC	
	without Display	—	FL1E-B12RCE	FL1E-B12RCA	FL1E-B12RCC	
Power Supply	Rated Power Voltage	24V DC	12/24V DC	24V AC/DC	100 to 240V AC/DC	
	Allowable Voltage Range	20.4 to 28.8V DC	10.8 to 28.8V DC	20.4 to 26.4V AC, 20.4 to 28.8V DC	85 to 265V AC, 100 to 253V DC	
	Rated Frequency	—	—	47 to 63Hz	47 to 63Hz	
	Current Draw	40 to 75mA (24V DC)	60 to 175mA (12V DC) 40 to 100mA (24V DC)	76 to 182mA (24V AC) 40 to 100mA (24V DC)	25 to 40mA (100V AC), 20 to 30mA (240V AC) 10 to 25mA (100V DC), 6 to 15mA (240V DC)	
	Allowable Momentary Power Interruption	—	2ms (Typ.) (12V DC) 5ms (Typ.) (24V DC)	5ms (Typ.) (24V AC/DC)	10ms (Typ.) (100V AC/DC) 20ms (Typ.) (240V AC/DC)	
	Power Consumption	0.7 to 1.3W (24V DC)	0.3 to 1.7W (12V DC) 0.4 to 1.8W (24V DC)	0.9 to 2.7VA (24V AC) 0.4 to 1.8W (24V DC)	1.1 to 4.6VA (100V AC), 2.4 to 6.0VA (240V AC) 0.5 to 2.9W (100V DC), 1.2 to 3.6W (240V DC)	
	Reverse Polarity Protection	Yes	Yes	—	—	
Clock	Backup Duration	—	80 hours (25°C) <sup>1</sup>	80 hours (25°C) <sup>1</sup>	80 hours (25°C) <sup>1</sup>	
	Clock Accuracy	—	±2 sec/day maximum	±2 sec/day maximum	±2 sec/day maximum	
Input	Input Signal	DC		AC/DC	AC/DC	
	Input Points	8 (I1 to I8)		8 (I1 to I8)	8 (I1 to I8)	
	Analog Input Points	4 (I1, I2, I7, I8)		—	—	
	High-speed Input <sup>2</sup>	4 (I3, I4, I5, I6), 5Khz maximum		—	—	
	Analog	Input Range	0 to 10V DC (max. rated input: 28.8V DC)		—	—
		Input Error	±1.5 (of full scale)		—	—
		Input Resolution	10 bits (0 to 1000)		—	—
		Allowable Voltage Range	0 to 28.8V DC		—	—
	Input Impedance	Digital Input	3.5kΩ		4.8kΩ	840kΩ
		Analog Input	72kΩ		—	—
	Isolation	—	—	—	—	
	Operating Range	OFF Voltage	< 5V DC		< 5V AC/DC	< 40V AC, < 30V DC
		ON Voltage	≥ 12V DC		≥ 12V AC/DC	≥ 79V AC, ≥ 79V DC
		OFF Current	< 0.85mA (I1 to I6), < 0.05mA (I1, I2, I7, I8)		< 1.0mA	< 0.03mA
ON Current		≥ 2mA (I3 to I6) ≥ 0.15mA (I1, I2, I7, I8)	≥ 1.5mA (I3 to I6) ≥ 0.1mA (I1, I2, I7, I8)	≥ 2.5mA	≥ 0.08mA, 100V AC: 50ms (Typ.)	
Turn ON Time	1.5ms (Typ.) ≤ 1.0ms (I3, I6)		1.5ms (Typ.)	100V AC: 50ms (Typ.), 240V AC: 30ms (Typ.) 100V DC: 25ms (Typ.) 240V DC: 15ms (Typ.)		
Turn OFF Time	1.5ms (Typ.) ≤ 1.0ms (I3, I6)		15ms (Typ.)	100V AC: 65ms (Typ.), 240V AC: 105ms (Typ.) 100V DC: 95ms (Typ.), 240V DC: 125ms (Typ.)		
Wire Length	100m <sup>3</sup>		100m <sup>3</sup>	100m		



1. Two year backup duration (typ.) when battery cartridge or memory/battery cartridge used.
2. When selecting frequency trigger function and up/down counter function.
3. 10m when connected to analog input (twisted pair cable).

Specifications can't on next page.

01 Touchscreens

PLCs

Automation Software

Power Supplies

Sensors

Communication

Barriers

Specifications con't

Style	with LCD Display	FL1E-H12SND	FL1E-H12RCE	FL1E-H12RCA	FL1E-H12RCC
	without Display	—	FL1E-B12RCE	FL1E-B12RCA	FL1E-B12RCC
Output	Output	Transistor source		Relay	
	Output Points/ Contact Configuration	4 points (separate)		4NO contacts	
	Isolation	—		Isolated	
	Dielectric Strength (between power/input terminals and output terminals)	—		2500V AC, 1 minute, 500V DC, 1 minute	
	Output Voltage	External power voltage		—	
	Maximum Load Current	0.3A		Resistive load: 10A at 12/24V AC/DC, 10A at 100/120V AC, 10A at 230/240V AC Inductive load: 2A at 12/24V AC/DC, 3A at 100/120V AC, 3A at 230/240V AC	
	Surge Current	—		30A maximum	
	Short-circuit Protection	Built-in current limiting resistor: Approx. 1A		External fuse required: 16A maximum	
	Minimum Switching Load	—	10mA, 2V DC	10mA, 12V DC	
	Initial Contact Resistance	—		100 mΩ maximum (at 1A, 24V DC)	
	Mechanical Life	—		10 million operations (no load, 10Hz)	
	Electrical Life	—		100,000 operations (rated resistive load) 1800 operations/hour	
Switching Rate	Mechanical Load	—		10Hz	
	Electrical Load	10Hz		—	
	Resistive Load/Lamp Load <sup>1</sup>	10Hz		2Hz	
	Inductive Load	0.5Hz		0.5Hz	

1. For fluorescent lamps, if the inrush current exceeds the allowable value, use an appropriate relay.

General

Style	Specification	Standard
Operating Temperature	Horizontal Mounting	0 to 55°C
	Vertical Mounting	0 to 55°C
Storage/Transportation Temperature	-40 to +70°C (no freezing)	—
Relative Humidity	10 to 95% RH (no condensation)	IEC60068-2-30
Atmospheric Pressure	795 to 1080 hPa	—
Operating Condition	No corrosive gas	—
Degree of Protection	IP20	—
Vibration Resistance	5 to 8.4Hz, amplitude 3.5mm 8.4 to 150Hz, acceleration 9.8m/s <sup>2</sup>	IEC60068-2-6
Shock Resistance	147m/s <sup>2</sup>	IEC60068-2-27
Drop Test	0.3m	IEC60068-2-31
Drop Test (packaged)	1m	IEC60068-2-32
Emission	Class B Group <sup>1</sup>	EN55011
Electrostatic Discharge	8kV air discharge, 6kV contact discharge <sup>2</sup>	IEC61000-4-2
Radiation Field Immunity	Field Strength: 1V/m and 10V/m	IEC61000-4-3
Burst Pulses	2kV (power line), 1kV (I/O signal line) <sup>3</sup>	IEC61000-4-4
Energy Carriers Single Pulse (Surge) <sup>4</sup> (FL1E-H12RCC, FL1E-B12RCC only)	1kV (power line) normal 2kV (power line) common	IEC61000-4-5
Communication Cable	0.5 to 2.5mm <sup>2</sup> (one wire), 0.5 to 1.5mm <sup>2</sup> (two wires)	—
Terminal Style	Finger-safe type <sup>5</sup>	—

Text Display

Part Number	FL1E-RD1	
Keyboard Display	Membrane keypad with 10 keys, FSTN-Graphic Display with 128 x 64 (columns x rows), LED backlight	
Power Supply	Input Voltage	24V AC/DC, 12V DC
	Allowable Voltage Range	20.4 to 26.4V AC, 10.2 to 28.8V DC
	Rated Frequency	47 to 63Hz
	Current Draw	30 to 55mA (24V DC)
Power Consumption	12V DC	65mA
	24V DC	40mA
	24V AC	90mA
Data Transmission Rate	19200 baud	
LCD Display	Backlight lifetime <sup>1</sup>	20,000 hours
	Display lifetime <sup>2</sup>	50,000 hours
Weight	220g	

Connect the text display and the base module using the text display cable (2.5m). The text display cable can be extended up to 10m using an extension cable (D-sub 9-pin).

- Backlight durability is the number of hours it takes for the light to become 50% of the original brightness.
- Display durability is calculated under ordinary operating and storage conditions: room temperature, normal humidity below 65% RH, and not subjected to direct sunlight.

- Class A for AS-Interface communication module.
- 8kV (air discharge), 4kV (contact discharge) for AS-Interface communication module.
- 1kV (criteria A), 2kV (criteria B) for AS-Interface communication module.

- For protection against surge noise on DC power supply types (FL1E-H12RCE/B12RCE, FL1E-H12SND, FL1E-H12RCA/B12RCA), use surge absorbers, noise cut transformers, or noise filters. Use of surge protection device (DEHN + SOHNE GmbH + Co. VVT AD 24 Part No. 918 402) is recommended.
- Tightening torque 0.4 to 0.5 N-m.

Expansion I/O Module

Expansion I/O Module Model Number		FL1B-M08B1S2	FL1B-M08B2R2	FL1B-M08D2R2	FL1B-M08C2R2	FL1B-J2B2	FL1D-K2BM2	
Power Supply	Rated Power Voltage	24V DC	12/24V DC	24V AC/DC	100 to 240V AC/DC	12/24V DC	24V DC	
	Allowable Voltage Range	20.4 to 28.8V DC	10.8 to 28.8V DC	20.4 to 26.4V AC 20.4 to 28.8V DC	85 to 265V AC 100 to 253V DC	10.8 to 28.8V DC	20.4 to 28.8V DC	
	Rated Frequency	—	—	50/60Hz (47 to 63Hz)	50/60Hz (47 to 63Hz)	—	—	
	Current Draw	30 to 45mA	30 to 140mA (12V DC) 20 to 75mA (24V DC)	40 to 110mA (24V AC) 20 to 75mA (24V DC)	10 to 30mA (100V AC) 10 to 20mA (240V AC) 5 to 15mA (100V DC) 5 to 10mA (240V DC)	25 to 50mA	25 to 50mA	
	Allowable Momentary Power Interruption	—	2ms (Typ.) (12V DC) 5ms (Typ.) (24V DC)	5ms (Typ.) (24V AC/DC)	10ms (Typ.) (100V AC/DC) 20ms (Typ.) (240V AC/DC)	2ms (Typ.) (12V AC/DC) 5ms (Typ.) (24V AC/DC)	5ms (Typ.)	
	Power Consumption	0.8 to 1.1W	0.3 to 1.7W (12V DC) 0.4 to 1.8W (24V DC)	0.9 to 2.7VA (24V AC) 0.4 to 1.8W (24V DC)	1.1 to 3.5VA (100V AC) 2.4 to 4.8VA (240V AC) 0.5 to 1.8W (100V DC) 1.2 to 2.4W (240V DC)	0.3 to 0.6W (12V DC) 0.6 to 1.2W (24V DC)	0.6 to 1.2W (24V DC)	
	Reverse Polarity Protection	Yes	Yes	—	—	Yes	Yes	
Input	Input Signal	DC input	DC input	AC/DC input	AC/DC input	Analog input	—	
	Input Points	4	4	4	4	—	—	
	Isolation	—	—	—	—	—	—	
	Allowable Voltage Range	0 to 28.8V DC	0 to 28.8V DC	0 to 26.4V AC 0 to 28.8V DC	0 to 265V AC 0 to 253V DC	—	—	
	Operating Range	OFF Voltage	< 5V DC	< 5V DC	< 5V AC/DC	< 40V AC < 30V DC	—	—
		ON Voltage	≥ 12V DC	≥ 8.5V DC	≥ 12V AC/DC	≥ 79V AC ≥ 79V DC	—	—
		OFF Current	< 0.85mA	< 0.85mA	< 1.0mA	< 0.03mA	—	—
		ON Current	≥ 2mA	≥ 1.5mA	≥ 2.5mA	≥ 0.08mA	—	—
	Turn ON Time	1.5ms (Typ.)	1.5ms (Typ.)	1.5ms (Typ.)	100V AC: 50ms (Typ.) 240V AC: 30ms (Typ.) 100V DC: 25ms (Typ.) 240V DC: 15ms (Typ.)	—	—	
	Turn OFF Time	1.5ms (Typ.)	1.5ms (Typ.)	1.5ms (Typ.)	100V AC: 65ms (Typ.) 240V AC: 105ms (Typ.) 100V DC: 95ms (Typ.) 240V DC: 125ms (Typ.)	—	—	
	Analog Input Points	—	—	—	—	2	—	
	Analog Input Range	—	—	—	—	0 to 10V (max. rated input: 28.8V) 0 to 20mA (max. rated input: 40mA)	—	
Digital Resolution	—	—	—	—	10 bits (0 to 1000)	—		
Input Error	—	—	—	—	±1.5% (of full scale)	—		
Input Impedance	—	—	—	—	76kΩ (0 to 10V) 155 to 250Ω (0 to 20mA)	—		
Sampling Cycle	—	—	—	—	50ms	—		

Expansion I/O Module Specifications con't on next page.

OT Touchscreens

PLCs

Automation Software

Power Supplies

Sensors

Communication

Barriers



## Expansion I/O Module, con't

Expansion I/O Module Model Number		FL1B-M08B1S2	FL1B-M08B2R2	FL1B-M08D2R2	FL1B-M08C2R2	FL1B-J2B2	FL1D-K2BM2
Output	Wire Length	100 m	100 m	100 m	100 m	10 m (twisted-pair shielded cable)	—
	Output	Transistor source	Relay	Relay	Relay	—	Analog
	Output Points/ Contact Configuration	4 points (separate)	4NO contacts	4NO contacts	4NO contacts	—	—
	Isolation	—	Isolated	Isolated	Isolated	—	—
	Dielectric Strength (between power/input terminals and output terminals)	—	2500V AC, 1 minute 500V DC, 1 minute	2500V AC, 1 minute 500V DC, 1 minute	2500V AC, 1 minute 500V DC, 1 minute	—	—
	Output Voltage	External power voltage (20.4 to 28.8V DC)	—	—	—	—	—
	Maximum Load Current	0.3A	Resistive load 5A at 12/24V AC/DC 5A at 100/120V AC 5A at 230/240V AC Inductive load 2A at 12/24V AC/DC 3A at 100/120V AC 3A at 230/240V AC	Resistive load 5A at 12/24V AC/DC 5A at 100/120V AC 5A at 230/240V AC Inductive load 2A at 12/24V AC/DC 3A at 100/120V AC 3A at 230/240V AC	Resistive load 5A at 12/24V AC/DC 5A at 100/120V AC 5A at 230/240V AC Inductive load 2A at 12/24V AC/DC 3A at 100/120V AC 3A at 230/240V AC	—	—
	Short-circuit Protection	Built-in current limiting resistor: Approx. 1A	External fuse required: 16A maximum	External fuse required: 16A maximum	External fuse required: 16A maximum	—	Yes
	Minimum Switching Load	—	10mA, 12V DC	10mA, 12V DC	10mA, 12V DC	—	—
	Initial Contact Resistance	—	100 mΩ maximum (at 1A, 24V DC)	100 mΩ maximum (at 1A, 24V DC)	100 mΩ maximum (at 1A, 24V DC)	—	—
	Mechanical Life	—	10 million operations (no load, 10Hz)	10 million operations (no load, 10Hz)	10 million operations (no load, 10Hz)	—	—
	Electrical Life	—	100,000 operations (rated resistive load) 1800 operations/hour	100,000 operations (rated resistive load) 1800 operations/hour	100,000 operations (rated resistive load) 1800 operations/hour	—	—
	Analog Output Points	—	—	—	—	—	2
	Analog Output Range	—	—	—	—	—	0 to 10V, 4-20mA
	Digital Resolution	—	—	—	—	—	10 bits (0 to 1000V)
	Output Error	—	—	—	—	—	±2.5% (of full scale)
Output Impedance	—	—	—	—	—	5kΩ	
Analog Value Conversion Interval	—	—	—	—	—	50ms	
Wire Length	—	—	—	—	—	10 m (twisted-pair shielded cable)	
Switching Rate	Mechanical Load	—	10Hz	10Hz	10Hz	—	—
	Electrical Load	10Hz	—	—	—	—	—
	Resistive Load/Lamp Load	10Hz	2Hz	2Hz	2Hz	—	—
	Inductive Load	0.5Hz	0.5Hz	0.5Hz	0.5Hz	—	—

General

Item	Specification	Standard
Operating Temperature	Horizontal Mounting	0 to 55°C
	Vertical Mounting	0 to 55°C
Storage/Transportation Temperature	-40 to +70°C <sup>1</sup>	—
Relative Humidity	10 to 95% RH <sup>2</sup>	IEC60068-2-30
Atmospheric Pressure	795 to 1080 hPa	—
Operating Condition	No corrosive gas	—
Degree of Protection	IP20	—
Vibration Resistance	5 to 9Hz, amplitude 3.5mm 9 to 150Hz, acceleration 9.8m/s <sup>2</sup> (1G)	IEC60068-2-6
Shock Resistance	147m/s <sup>2</sup> (15G)	IEC60068-2-27
Drop Test	50mm	IEC60068-2-31
Drop Test (packaged)	1m	IEC60068-2-32
Emission	Class B Group 1 <sup>3</sup>	EN55011
Electrostatic Discharge	8kV air discharge 6kV contact discharge <sup>4</sup>	IEC61000-4-2
Electromagnetic Fields	10V/m	IEC61000-4-3
Burst Pulses	2kV (power line) 1kV (I/O signal line) <sup>5</sup>	IEC61000-4-4
Energy Carriers Single Pulse (Surge) <sup>6</sup> (FL1B-H12RCC, FL1B-B12RCC only)	1kV (power line) normal 2kV (power line) common	IEC61000-4-5
Communication Cable	0.5 to 2.5mm <sup>2</sup> (one wire) 0.5 to 1.5mm <sup>2</sup> (two wires)	—
Terminal Style	Finger-safe type <sup>7</sup>	—

- 1. No freezing
- 2. No condensation
- 3. Class A for AS-Interface communication module
- 4. 8kV (air discharge), 4kV (contact discharge) for AS-Interface communication module
- 5. 1kV (criteria A), 2kV (criteria B) for AS-Interface communication module
- 6. For protection against surge noise on DC power supply types (FL1D-H12RCE/B12RCE, FL1D-H12SND, FL1D-H12RCA/B12RCA), use surge absorbers, noise cut transformers, or noise filters.
- 7. Tightening torque 0.4 to 0.5 N·m

AS-Interface Communication Module

Specifications

Module Type	AS-Interface slave module
Slave Type	Standard
Profile	I/O code: 7
	ID code: F
	ID2 code: F
Input/Output	Virtual input: 4
	Virtual output: 4
AS-Interface Voltage	30V DC (26.5 to 31.6V DC)
Current Draw	70 mA maximum (AS-Interface)

I/O Allocation

Input		Output	
AS-Interface	SmartRelay	SmartRelay	AS-Interface
Output Data Bit D0	Input In	Output Qm	Input Data Bit D0
Output Data Bit D1	Input In+1	Output Qm+1	Input Data Bit D1
Output Data Bit D2	Input In+2	Output Qm+2	Input Data Bit D2
Output Data Bit D3	Input In+3	Output Qm+3	Input Data Bit D3

- 1. I/O point numbers “n” and “m” of the SmartRelay are automatically allocated by the base module according to the mounted position of the AS-Interface communication module.
- 2. AS-Interface communication module is IP20 terminal type.
- 3. AS-Interface cable is connected to the terminal block.

I/O Touchscreens

PLCs

Automation Software

Power Supplies

Sensors

Communication

Barriers

01 Touchscreens

PLCs

Automation Software

Power Supplies

Sensors

Communication

Barriers

Dimensions (mm)

Base Module

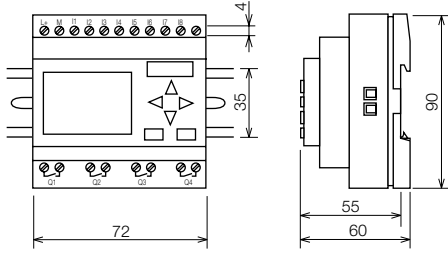

Expansion I/O Module, Communication Module

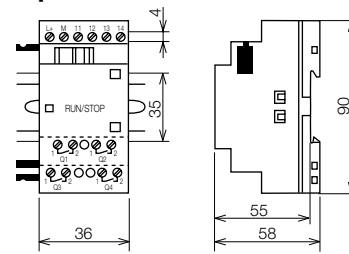

Mounting Hole Layout (Using Mounting Slides)

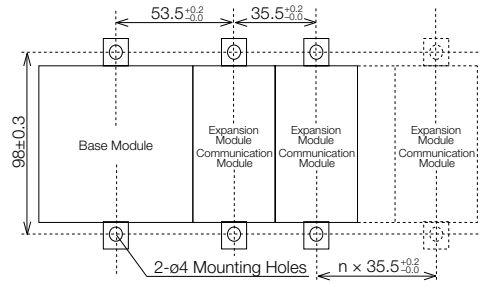

Text Display

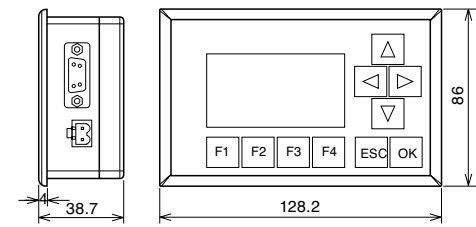

Installation

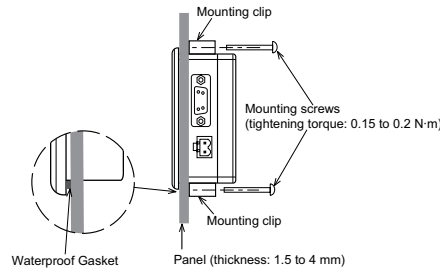

Mounting Hole Layout

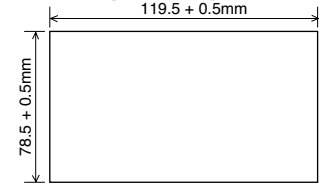

# Mouser Electronics

Authorized Distributor

Click to View Pricing, Inventory, Delivery & Lifecycle Information:

## IDEC:

[SMARTSTART-HAC-E](#) [SMARTSTART-HDC-E](#) [FL1E-PC2](#) [FL1B-M08C2R2](#) [FL1B-M08B2R2](#) [FL1B-M08D2R2](#)  
[FL1D-K2BM2](#) [FL1B-CAS2](#) [FL1B-CL1C12](#) [FL1B-J2B2](#) [FL1B-M08B1S2](#) [FL1B-PSP1](#) [FL1E-RDC1](#) [FL1E-B12RCA](#)  
[FL1E-B12RCC](#) [SMARTSTART-HAC](#) [SMARTSTART-HAC-B](#) [FL1E-H12SND](#) [FL1E-KW1](#) [FL1E-PB1](#) [FL1E-PG1](#)  
[FL1B-H12SND](#) [FL1D-B12RCA](#) [FL1D-B12RCC](#) [FL1D-B12RCE](#) [FL1D-H12RCA](#) [FL1D-H12RCC](#) [SMARTSTART-HDC-](#)  
[B](#) [SMARTSTART-HDC-C](#) [SMARTSTART-HDC-D](#) [FL1B-H12RCA](#) [FL1B-H12RCC](#) [FL1B-H12RCE](#) [SMARTSTART-](#)  
[BDC-B](#) [SMARTSTART-BDC-C](#) [SMARTSTART-BDC-D](#) [SMARTSTART-HAC-C](#) [SMARTSTART-HAC-D](#)  
[SMARTSTART-HDC](#) [FL1B-B12RCE](#) [FL1B-CASC12](#) [SMARTSTART-BAC](#) [SMARTSTART-BAC-B](#) [SMARTSTART-](#)  
[BAC-C](#) [SMARTSTART-BAC-D](#) [SMARTSTART-BAC-E](#) [FL1D-H12RCE](#) [FL1D-H12SND](#) [FL1D-K2B2](#) [FL1B-B12RCA](#)  
[FL1B-B12RCC](#) [FL1B-Y1371-SW8](#) [SMARTSTART-BAC-EU](#) [SMARTSTART-BDC-E](#) [SMARTSTART-BDC-EU](#)  
[SMARTSTART-HAC-EU](#) [SMARTSTART-HDC-EU](#)