

Catalog
ST 70

Edition
2022

SIMATIC

Products for Totally Integrated Automation

[siemens.com/tia](https://www.siemens.com/tia)

Related catalogs

SIMATIC HMI / PC-based Automation

ST 80/ST PC

Human Machine Interface Systems
PC-based Automation

PDF (E86060-K4680-A101-C9-7600)



SITRAIN

Digital Industry Academy

www.siemens.com/sitrain



SIMATIC

ST PCS 7

SIMATIC PCS 7 Process Control System
Vol. 1: System components

E86060-K4678-A111-C8-7600



Siemens TIA Selection Tool

for the selection, configuration and ordering of
TIA products and devices

www.siemens.com/tst



Industrial Communication

SCALANCE network components and
SIMATIC CPs

www.siemens.com/industrial-communication/mall



Industry Mall

Information and Ordering Platform
on the Internet:

www.siemens.com/industrymall

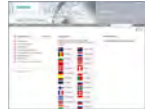

SIMATIC

ST 400

SIMATIC S7-400 advanced controller

PDF (E86060-K4678-A151-A1-7600)



Contact

Your personal contact can be found in our
Contacts Database at:

www.siemens.com/automation-contact



SITOP

SITOP
Power Supply

KT 10.1

E86060-D4001-A510-E0



TIA Selection Tool – quick, easy, smart configuration

For you to get the most out of our portfolio quickly and easily.

Do you always need the optimum configuration for planning your project?

For your application we offer the TIA Selection Tool to support all project planners, beginners and experts alike.

No detailed portfolio knowledge is necessary.

TIA Selection Tool is available for download as a free desktop version or a cloud variant.

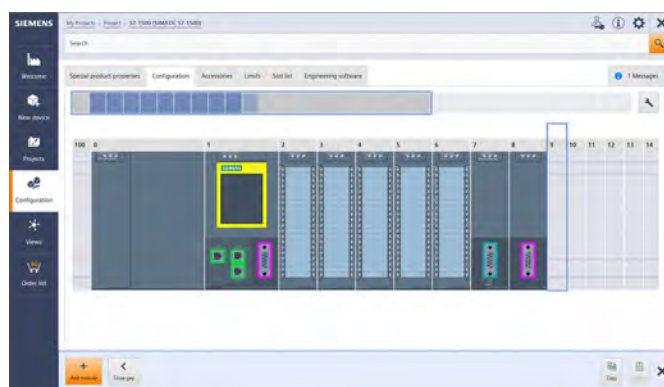

Your Advantages

Quick

- Configure a complete project with just a few entries – without a manual, without special knowledge
- Import and export of hardware configuration to TIA Portal or other systems
- Ideal visualization of the projects to be configured

Easy

- Tool download either as desktop version or web-based cloud version
- Technically always up-to-date about product portfolio and innovative approaches
- Highly flexible, secure, cross-team work in the cloud
- Direct ordering in the Siemens Industry Mall

Smart

- Smart selection wizard for error-free configuration and ordering
- Configuration options can be tested and simulated in advance
- Library for archiving sample configurations

The TIA Selection Tool is a completely paperless solution.

Download it now:

www.siemens.com/tst

For more
information,
scan the
QR code



Products for Totally Integrated Automation

SIMATIC



Catalog ST 70 · 2022

Supersedes:
Catalog ST 70 · 2021

Refer to the Industry Mall for current updates of
this catalog:
www.siemens.com/industrymall

© Siemens 2022

Introduction	1
LOGO! logic module	2
SIMATIC S7-1200 Basic Controllers	3
SIMATIC S7-1500 Advanced Controllers	4
SIMATIC S7-300 Advanced Controllers	5
SIMATIC S7-400 Advanced Controllers	6
Distributed Controllers	7
Software Controllers	8
Drive Controllers	9
I/O systems	10
SIMATIC control systems	11
Software for SIMATIC Controllers	12
SIMATIC programming devices	13
Products for specific requirements	14
Overviews	15
Supplementary components	16
Appendix	17



The products and systems described in this catalog are manufactured/distributed under application of a certified quality management system in accordance with DIN EN ISO 9001 (Certified Registration No. 1323QM-15). The certificate is recognized by all IQNet countries.

Introduction



1/2

**Totally Integrated Automation –
Integration³**

Totally Integrated Automation – Integration³

Working together to advance automation

Sustainably advancing the world of industry: That's long been the driving force behind new developments at Siemens – even 25 years ago, when Totally Integrated Automation (TIA) was introduced. At that time, TIA represented a totally new method of automation that had a lasting impact on automation technology overall. A fundamental element of TIA is consistency based on integrated automation. That's why every element in the portfolio has identical core characteristics to ensure that they will work together perfectly.

Data transparency through OT/IT integration

Of course, the industry and the associated demands on automation have undergone major changes. We are now in the throes of the fourth industrial revolution, and factories are generating huge volumes of data. This data is the key to optimization and competitiveness, but at the same time the amount of data and the variety of data sources are rapidly growing. That's why it is a major challenge to get the most out of the data to meet increasingly refined customer demands, right down to flexible production of single-unit batches.

Data transparency and data quality both have to be good in order to meet these requirements, which is why the integrated approach has been further refined. TIA still represents maximum consistency, harmonizing all components and competencies and ensuring communication between all of these elements. Rather than being confined to the field, this now takes place at all levels through to corporate management level, with a broad scope in place for innovations that are already being thought into today and integrated step-by-step. The result is known as "Integration³."

This advance is being achieved through consistent data management, global standards, standardized interfaces, and openness from OT (Operational Technology) to IT (Information Technology). At the production level, in the OT area in other words, sensors and actuators generate a lot of data to enable automation tasks to be performed. And the IT area involves a vast amount of information, by definition. The added value and the basis for new business models lie in combining these two environments so that information from both areas can be used simultaneously. Thanks to an end-to-end range of TIA products – from Simatic controllers to Sinamics frequency converters and Simotics motors and the associated fieldbuses – Siemens offers an infrastructure built up over many years that can gather all information originating in OT. This means that the data are already available in most systems. To communicate with the IT area, Siemens relies on the open standard OPC UA, which not only offers connectivity but also defines standards for data structure with its OPC UA companion specifications. These specifications are easy to implement in TIA Portal using drag-and-drop.

Flexible and secure from field to cloud

If the basis for communication is provided and the data are available in the right structure, there are multiple opportunities for integration. The machines can be connected to the MES system, or the production data can be transmitted directly to the cloud. The next milestone in OT/IT integration is edge computing. This involves shifting IT technologies to the manufacturing area, where Edge devices have so much computing power that they can run specific applications and orchestrate communication with other parts of the factory. Industrial Edge allows you to evaluate



and analyze all data at the machine, or to preprocess it quickly and instantly. The optimized data points can then be transmitted to the cloud more quickly. That creates new opportunities for users, including centrally installing updates or AI applications for predictive maintenance. Specific services also support users throughout the lifecycle of their machines to reveal hidden potential.

Solutions for the future

The Totally Integrated Automation approach is Siemens' way of not only responding to change but actively shaping it. Innovations such as artificial intelligence (AI) are already being gradually integrated, and more solutions for the future are being developed. But to use AI applications safely and beneficially in industry, it is essential for machine learning to work in tandem with software, hardware, the appropriate IT infrastructure, and domain and automation expertise. Entirely new opportunities for optimization will come with anomaly recognition or preventive maintenance, from autonomous handling of unfamiliar objects to improved availability and quality assurance. ■

› [siemens.com/tia](https://www.siemens.com/tia)

Highlights

- **Maximum data transparency** thanks to consistency, global standards, and uniform interfaces at all levels
- **New business models thanks to OT/IT integration** with OPC UA, cloud connectivity, and edge connections
- Future-proofing thanks to the **integration of innovations** such as artificial intelligence

Future-proof to enter new dimensions

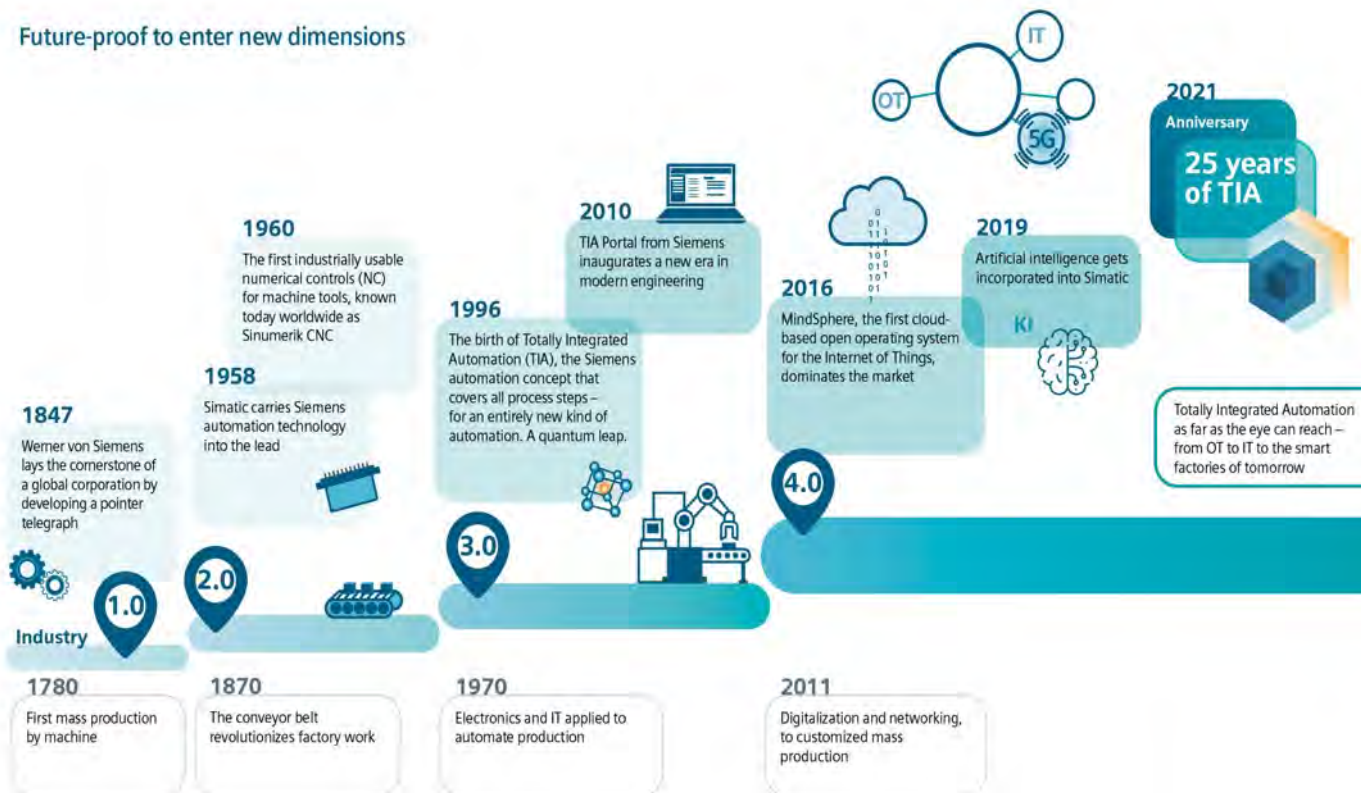

LOGO! logic module



2/2	Introduction
2/3	LOGO! basic and expansion modules
2/3	LOGO! basic modules with display
2/5	LOGO! basic modules without display
2/7	LOGO! expansion modules
2/13	SIPLUS LOGO! basic modules with display
2/16	SIPLUS LOGO! basic modules without display
2/19	SIPLUS LOGO! expansion modules
2/24	LOGO! communications modules
2/24	Introduction
2/25	LOGO! CMK2000 communications module
2/26	LOGO! CIM (Communication Interface Module)
2/27	LOGO! CSM unmanaged
2/30	LOGO! CMR (wireless communication)
2/36	LOGO!Power
2/36	Introduction
2/37	1-phase, 5 V DC
2/40	1-phase, 12 V DC
2/43	1-phase, 15 V DC
2/46	1-phase, 24 V DC
2/50	SIPLUS LOGO!Power
2/52	LOGO! software
2/53	LOGO! Starter Kits
2/54	LOGO! accessories
2/54	LOGO!Contact switching module
2/55	LOGO! mounting kit
2/56	System cabling for SIMATIC S7-1500 IO (25 mm), ET 200SP, S7-1200 and LOGO!

LOGO! logic module

Introduction

LOGO! logic module

Overview



LOGO! logic module

- The compact, easy-to-use and low-cost solution for simple control tasks
- Compact, easy to operate, universally applicable without accessories
- "All in one": Integrated display and operator panel
- 36 different functions can be connected at the press of a button or by means of PC software; up to 130 times
- LOGO! 8: 38/43 different functions can be linked at the press of a button or using PC software; up to 200/400 times
- Functions are easy to change at the press of a button. No more time-consuming rewiring

SIPLUS LOGO!

- The controller for use in the toughest environmental conditions
- With extended temperature range from -40/-25 °C to +70 °C
- Suitable for exposure to environmental substances (harmful gas atmosphere)
- Condensation permissible
- With the proven PLC technology of LOGO!
- Easy to handle, program, maintain, and service
- Ideal for use in automotive engineering, environmental engineering, mining, chemical plants, material handling, food industry, etc.

Accessories:

- The front panel mounting kit also allows simple and reliable installation of the logic modules in front panels; IP65 protection is thus possible.
- In order to ensure dependable operation of SIPLUS devices supplied by the battery in conjunction with combustion engines, it is necessary to put in a SIPLUS upmiter upstream device between the battery and the SIPLUS LOGO!.

For more information, please go to:

<http://www.siemens.com/siplus-extreme>

General technical specifications SIPLUS LOGO!

Ambient temperature range	-40/-25 ... +70 °C
Conformal coating	Coating of the printed circuit boards and the electronic components
Technical data	The technical data of the standard product applies except for the ambient conditions.

Ambient conditions

Extended range of environmental conditions	
<ul style="list-style-type: none"> • with reference to ambient temperature, air pressure and altitude 	Tmin ... Tmax at 1080 hPa ... 795 hPa (-1000 m ... +2000 m) // Tmin ... (Tmax - 10K) at 795 hPa ... 658 hPa (+2000 m ... +3500 m) // Tmin ... (Tmax - 20K) at 658 hPa ... 540 hPa (+3500 m ... +5000 m) 0° C
<ul style="list-style-type: none"> • At cold restart, min. 	0° C
Relative humidity	
<ul style="list-style-type: none"> • with condensation, max. 	100 %; RH incl. bedewing/frost (no commissioning in bedewed state)
Resistance	
<ul style="list-style-type: none"> • to biologically active substances/ compliance with EN 60721-3-3 	Yes; Class 3B2 mold and fungal spores (except fauna); the supplied plug covers must remain in place on the unused interfaces during operation.
<ul style="list-style-type: none"> • to chemically active substances/ compliance with EN 60721-3-3 	Yes; Class 3C4 (RH < 75%) incl. salt spray in accordance with EN 60068-2-52 (severity 3); the supplied plug covers must remain in place on the unused interfaces during operation.
<ul style="list-style-type: none"> • to mechanically active substances, compliance with EN 60721-3-3 	Yes; Class 3S4 incl. sand, dust; the supplied plug covers must remain in place on unused interfaces during operation.

Overview



- The space-saving basic variants
- Interface for the connection of expansion modules, up to 24 digital inputs, 20 digital outputs, 8 analog inputs and 8 analog outputs can be addressed
- All basic units with integrated web server
- Enclosure width 72 mm (4 U)
- All basic units with Ethernet interface for communication with LOGO! 8, LOGO! TDE, SIMATIC Controllers, SIMATIC Panels and PCs
- Use of standard micro SD cards

2

Ordering data

LOGO! 8 logic module

LOGO! 24CE

Supply voltage 24 V DC, 8 digital inputs 24 V DC, of which 4 can be used in analog mode (0 to 10 V), 4 digital outputs 24 V DC, 0.3 A, integrated time switch, Ethernet interface; 400 function blocks can be interlinked, modular expansion capability

Article No.

6ED1052-1CC08-0BA1

LOGO! 12/24RCE

Supply voltage 12...24 V DC, 8 digital inputs 12/24 V DC, of which 4 can be used in analog mode (0 to 10 V) 4 relay outputs 10 A, integrated time switch, Ethernet interface; 400 function blocks can be interlinked, modular expansion capability

6ED1052-1MD08-0BA1

LOGO! 24RCE

Supply voltage 24 V AC/DC, 8 digital inputs 24 V AC/DC, 4 relay outputs 10 A, integrated time switch, Ethernet interface; 400 function blocks can be interlinked, modular expansion capability

6ED1052-1HB08-0BA1

LOGO! 230RCE

Supply voltage 115...230 V AC/DC, 8 digital inputs 115...230 V AC/DC, 4 relay outputs 10 A, integrated time switch, Ethernet interface; 400 function blocks can be interlinked, modular expansion capability

6ED1052-1FB08-0BA1

Accessories

LOGO! 8 text display HMI

6-line text display, can be connected to all LOGO! 8 variants with and without display, with 2 Ethernet interfaces; incl. installation accessories. Requires additional 12 V DC or 24 V AC/DC power supply

Article No.

6ED1055-4MH08-0BA1

LOGO!Soft Comfort V8

For programming on the PC in LAD/FBD; executes on Windows 8, 7, XP, Linux and Mac OSX; on DVD

6ED1058-0BA08-0YA1

LOGO! Starter Kits

In TANOS Box, with LOGO! Soft Comfort V8, WinCC Basic, Ethernet cable

LOGO! Starter Kit 12/24 RCE

With LOGO! 12/24 RCE, power supply, screwdriver, in Systainer

6ED1057-3BA01-0AA8

LOGO! Starter Kit 130 RCE

With LOGO! 230 RCE, power supply, screwdriver, in Systainer

6ED1057-3BA03-0AA8

LOGO! Starter Kit 12/24 V

With LOGO! 12/24 RCEO, LOGO! TD, power supply, screwdriver, in Systainer

6ED1057-3BA11-0AA8

LOGO! 8 KP300 Basic Starter Kit

With LOGO! 12/24RCE, LOGO! Power 24 V 1.3 A, KP300 Basic mono PN

6AV2132-0HA00-0AA1

LOGO! 8 KTP400 Basic Starter Kit

With LOGO! 12/24RCE, LOGO! Power 24 V 1.3 A, KTP400 Basic

6AV2132-0KA00-0AA1

LOGO! 8 KTP700 Basic Starter Kit

With LOGO! 12/24RCE, LOGO! Power 24 V 1.3 A, KTP700 Basic

6AV2132-3GB00-0AA1

Front panel mounting kit

Width 4 U, with keys

6AG1057-1AA00-0AA3

Width 8 U, with keys

6AG1057-1AA00-0AA2

LOGO! logic module

LOGO! basic and expansion modules

LOGO! basic modules with display

Technical specifications

Article number	6ED1052-1CC08-0BA1 LOGO! 24CE, 8DI(4AI)/4DO, 400 Blocks	6ED1052-1MD08-0BA1 LOGO!12/24RCE, 8DI(4AI)/4DO, 400 Blocks	6ED1052-1HB08-0BA1 LOGO! 24RCE, 8DI/4DO, 400 Blocks	6ED1052-1FB08-0BA1 LOGO!230RCE, 8DI/4DO, 400 Blocks
Display				
with display	Yes	Yes	Yes	Yes
Installation type/mounting				
Mounting	on 35 mm DIN rail, 4 spacing units wide	on 35 mm DIN rail, 4 spacing units wide	on 35 mm DIN rail, 4 spacing units wide	on 35 mm DIN rail, 4 spacing units wide
Supply voltage				
Rated value (DC)				
• 12 V DC		Yes		
• 24 V DC	Yes	Yes	Yes	
• 115 V DC				Yes
• 230 V DC				Yes; 240 V DC
Rated value (AC)				
• 24 V AC			Yes	
• 115 V AC				Yes
• 230 V AC				Yes; 240 V AC
Time of day				
Time switching clocks				
• Number	400; Max. 400, function-specific	400; Max. 400, function-specific	400; Max. 400, function-specific	400; Max. 400, function-specific
• Power reserve	480 h	480 h	480 h	480 h
Digital inputs				
Number of digital inputs	8; Of which 4 can be used in analog mode (0 to 10 V)	8; Of which 4 can be used in analog mode (0 to 10 V)	8	8
Digital outputs				
Number of digital outputs	4; Transistor	4; Relays	4; Relays	4; Relays
Short-circuit protection	Yes; electrical (1 A)	No; external fusing necessary	No; external fusing necessary	No; external fusing necessary
Output current				
• for signal "I" permissible range for 0 to 55 °C, max.	0.3 A	10 A		
Relay outputs				
Switching capacity of contacts				
- with inductive load, max.		3 A	3 A	3 A
- with resistive load, max.		10 A	10 A	10 A
EMC				
Emission of radio interference acc. to EN 55 011				
• Limit class B, for use in residential areas	Yes; Radio interference suppression according to EN55011, Limit Value Class B	Yes; Radio interference suppression according to EN55011, Limit Value Class B	Yes; Radio interference suppression according to EN55011, Limit Value Class B	Yes; Radio interference suppression according to EN55011, Limit Value Class B
Standards, approvals, certificates				
CE mark	Yes	Yes	Yes	Yes
CSA approval	Yes	Yes	Yes	Yes
UL approval	Yes	Yes	Yes	Yes
FM approval	Yes	Yes	Yes	Yes
developed in accordance with IEC 61131	Yes	Yes	Yes	Yes
according to VDE 0631	Yes	Yes	Yes	Yes
Marine approval	Yes	Yes	Yes	Yes
Ambient conditions				
Ambient temperature during operation				
• min.	-20 °C; No condensation	-20 °C; No condensation	-20 °C; No condensation	-20 °C; No condensation
• max.	55 °C	55 °C	55 °C	55 °C
Altitude during operation relating to sea level				
• Ambient air temperature-barometric pressure-altitude	Tmin ... Tmax at 1 080 hPa ... 795 hPa (-1 000 m ... +2 000 m)	Tmin ... Tmax at 1 080 hPa ... 795 hPa (-1 000 m ... +2 000 m)	Tmin ... Tmax at 1 080 hPa ... 795 hPa (-1 000 m ... +2 000 m)	Tmin ... Tmax at 1 080 hPa ... 795 hPa (-1 000 m ... +2 000 m)
Dimensions				
Width	71.5 mm	71.5 mm	71.5 mm	71.5 mm
Height	90 mm	90 mm	90 mm	90 mm
Depth	60 mm	60 mm	60 mm	60 mm

Overview



- Basic versions optimized for costs
- Interface for the connection of expansion modules, up to 24 digital inputs, 20 digital outputs, 8 analog inputs and 8 analog outputs can be addressed
- With connection option for LOGO! TDE text display
- All basic units with integrated web server
- Enclosure width 72 mm (4 U)
- All basic units with Ethernet interface for communication with LOGO! 8, LOGO! TDE, SIMATIC Controllers, SIMATIC Panels and PCs
- Use of standard micro SD cards

2

Ordering data

Article No.

Article No.

LOGO! 8 logic module

24 V DC supply voltage, 8 digital inputs 24 V DC, of which 4 can be used in analog mode (0 to 10 V), 4 digital outputs 24 V DC, 0.3 A, integral time switch, Ethernet interface; without display and keyboard; 400 function blocks can be interlinked, modular expansion capability

6ED1052-2CC08-0BA1

LOGO! 12/24RCEo logic module

12...24 V DC supply voltage, 8 digital inputs 12...24 V DC, of which 4 can be used in analog mode (0 to 10 V), 4 relay outputs 10 A, integrated time switch, Ethernet interface; without display and keyboard; 400 function blocks can be interlinked, modular expansion capability

6ED1052-2MD08-0BA1

LOGO! 24RCEo logic module

24 V AC/DC supply voltage, 8 digital inputs 24 V AC/DC, 4 relay outputs 10 A, integral time switch; Ethernet interface; without display or keyboard; 400 function blocks can be interlinked, modular expansion capability

6ED1052-2HB08-0BA1

LOGO! 230RCEo logic module

115...230 V AC/DC supply voltage, 8 digital inputs 115...230 V AC/DC, 4 relay outputs 10 A, integral time switch; Ethernet interface; without display or keyboard; 400 function blocks can be interlinked, modular expansion capability

6ED1052-2FB08-0BA1

Accessories

LOGO! TDE Text Display

6-line text display, can be connected to all LOGO! 8 variants with and without display, with 2 Ethernet interfaces; incl. installation accessories. Requires additional 12 V DC or 24 V AC/DC power supply

6ED1055-4MH08-0BA1

LOGO!Soft Comfort V8

For programming on the PC in LAD/FBD; executes on Windows 8, 7, XP, Linux and Mac OSX; on DVD

6ED1058-0BA08-0YA1

LOGO! Starter Kits

In TANOS Box, with LOGO! Soft Comfort V8, WinCC Basic, Ethernet cable

LOGO! Starter Kit 12/24RCE

With LOGO! 12/24RCE, power supply, screwdriver, in Systainer

6ED1057-3BA01-0AA8

LOGO! Starter Kit 130 RCE

With LOGO! 230 RCE, power supply, screwdriver, in Systainer

6ED1057-3BA03-0AA8

LOGO! Starter Kit 12/24V

With LOGO! 12/24RCEO, LOGO! TD, power supply, screwdriver, in Systainer

6ED1057-3BA11-0AA8

LOGO! 8 KP300 Basic Starter Kit

With LOGO! 12/24RCE, LOGO! Power 24 V 1.3 A, KP300 Basic mono PN

6AV2132-0HA00-0AA1

LOGO! 8 KTP400 Basic Starter Kit

With LOGO! 12/24RCE, LOGO! Power 24 V 1.3 A, KTP400 Basic

6AV2132-0KA00-0AA1

LOGO! 8 KTP700 Basic Starter Kit

With LOGO! 12/24RCE, LOGO! Power 24 V 1.3 A, KTP700 Basic

6AV2132-3GB00-0AA1

LOGO! logic module

LOGO! basic and expansion modules

LOGO! basic modules without display**Technical specifications**

Article number	6ED1052-2CC08-0BA1 LOGO! 24CEO, 8DI(4AI)/4DO, 400 Blocks	6ED1052-2MD08-0BA1 LOGO!12/24RCEO, 8DI(4AI)/4DO,400 Blocks	6ED1052-2HB08-0BA1 LOGO! 24RCEO, 8DI/4DO, 400 Blocks	6ED1052-2FB08-0BA1 LOGO!230RCEO, 8DI/4DO,400 Blocks
Installation type/mounting				
Mounting	on 35 mm DIN rail, 4 spacing units wide	on 35 mm DIN rail, 4 spacing units wide	on 35 mm DIN rail, 4 spacing units wide	on 35 mm DIN rail, 4 spacing units wide
Supply voltage				
Rated value (DC)		Yes	Yes	Yes
<ul style="list-style-type: none"> • 12 V DC • 24 V DC • 115 V DC • 230 V DC 	Yes	Yes	Yes	Yes
Rated value (AC)			Yes	Yes
<ul style="list-style-type: none"> • 24 V AC • 115 V AC • 230 V AC 				Yes Yes; 240 V AC
Time of day				
Time switching clocks				
• Number	400; Max. 400, function-specific	400; Max. 400, function-specific	400; Max. 400, function-specific	400; Max. 400, function-specific
• Power reserve	480 h	480 h		480 h
Digital inputs				
Number of digital inputs	8; Of which 4 can be used in analog mode (0 to 10 V)	8; Of which 4 can be used in analog mode (0 to 10 V)	8	8
Digital outputs				
Number of digital outputs	4; Transistor	4; Relays	4; Relays	4; Relays
Short-circuit protection	Yes; electrical (1 A)	No; external fusing necessary	No; external fusing necessary	No; external fusing necessary
Output current				
• for signal "I" permissible range for 0 to 55 °C, max.	0.3 A	10 A		
Relay outputs				
Switching capacity of contacts				
- with inductive load, max.		3 A	3 A	3 A
- with resistive load, max.		10 A	10 A	10 A
EMC				
Emission of radio interference acc. to EN 55 011				
• Limit class B, for use in residential areas	Yes; Radio interference suppression according to EN55011, Limit Value Class B	Yes; Radio interference suppression according to EN55011, Limit Value Class B	Yes; Radio interference suppression according to EN55011, Limit Value Class B	Yes; Radio interference suppression according to EN55011, Limit Value Class B
Standards, approvals, certificates				
CE mark	Yes	Yes	Yes	Yes
CSA approval	Yes	Yes	Yes	Yes
UL approval	Yes	Yes	Yes	Yes
FM approval	Yes	Yes	Yes	Yes
developed in accordance with IEC 61131	Yes	Yes	Yes	Yes
according to VDE 0631	Yes	Yes	Yes	Yes
Marine approval	Yes	Yes	Yes	Yes
Ambient conditions				
Ambient temperature during operation				
• min.	-20 °C; No condensation	-20 °C; No condensation	-20 °C; No condensation	-20 °C; No condensation
• max.	55 °C	55 °C	55 °C	55 °C
Altitude during operation relating to sea level				
• Ambient air temperature-barometric pressure-altitude	Tmin ... Tmax at 1 080 hPa ... 795 hPa (-1 000 m ... +2 000 m)	Tmin ... Tmax at 1 080 hPa ... 795 hPa (-1 000 m ... +2 000 m)	Tmin ... Tmax at 1 080 hPa ... 795 hPa (-1 000 m ... +2 000 m)	Tmin ... Tmax at 1 080 hPa ... 795 hPa (-1 000 m ... +2 000 m)
Dimensions				
Width	71.5 mm	71.5 mm	71.5 mm	71.5 mm
Height	90 mm	90 mm	90 mm	90 mm
Depth	60 mm	60 mm	60 mm	60 mm

Overview

- Expansion modules for connection to LOGO! Modular
- With digital inputs and outputs, analog inputs, or analog outputs

2

Ordering data
Article No.
Article No.
LOGO! 8 expansion modules
LOGO! DM8 24

24 V DC supply voltage,
4 digital inputs 24 V DC,
4 digital outputs 24 V DC, 0.3 A

6ED1055-1CB00-0BA2
LOGO! DM16 24

24 V DC supply voltage,
8 digital inputs 24 V DC,
8 digital outputs 24 V DC, 0.3 A

6ED1055-1CB10-0BA2
LOGO! DM8 12/24R

12...24 V DC supply voltage,
4 digital inputs 12...24 V DC,
4 relay outputs 5 A

6ED1055-1MB00-0BA2
LOGO! DM8 24R

24 V AC/DC supply voltage,
4 digital inputs 24 V AC/DC,
4 relay outputs 5 A

6ED1055-1HB00-0BA2
LOGO! DM16 24R

24 V DC supply voltage,
8 digital inputs 24 V DC,
8 relay outputs 5 A

6ED1055-1NB10-0BA2
LOGO! DM8 230R

115...230 V AC/DC supply voltage,
4 digital inputs 115...230 V AC/DC,
4 relay outputs 5 A

6ED1055-1FB00-0BA2
LOGO! DM16 230R

115...230 V AC/DC supply voltage,
8 digital inputs 115...230 V AC/DC,
8 relay outputs 5 A

6ED1055-1FB10-0BA2
LOGO! AM2

12...24 V DC supply voltage,
2 analog inputs 0 to 10 V or
0 to 20 mA, resolution 10 bits

6ED1055-1MA00-0BA2
LOGO! AM2 PT 100

12...24 V DC supply voltage,
2 analog inputs Pt100,
temperature range
-50 °C to 200 °C

6ED1055-1MD00-0BA2
LOGO! AM2 AQ

24 V DC supply voltage,
2 analog outputs 0 to 10 V,
0/4 to 20 mA

6ED1055-1MM00-0BA2
Accessories for LOGO! 8
LOGO!Soft Comfort V8

For programming on the PC in
LAD/FBD; executes on
Windows 8, 7, XP, Linux and
Mac OSX; on DVD

6ED1058-0BA08-0YA1

LOGO! logic module

LOGO! basic and expansion modules

LOGO! expansion modules

Technical specifications

Article number	6ED1055-1CB00-0BA2	6ED1055-1HB00-0BA2	6ED1055-1MB00-0BA2	6ED1055-1FB00-0BA2
	LOGO! DM8 24 Exp. mod., 4DI/4DO	LOGO! DM8 24R Exp. mod. 2 U, 4DI/4DO	LOGO! DM8 12/24R Exp. mod. 2 U, 4DI/DO	LOGO! DM8 230R Exp. mod. 2 U, 4DI/4DO
Installation type/mounting				
Mounting	on 35 mm DIN rail, 2 spacing units wide	on 35 mm DIN rail, 2 spacing units wide	on 35 mm DIN rail, 2 spacing units wide	on 35 mm DIN rail, 2 spacing units wide
Supply voltage				
Rated value (DC)			Yes	
• 12 V DC	Yes	Yes	Yes	
• 24 V DC				Yes
• 115 V DC				Yes
• 230 V DC				
Rated value (AC)		Yes		Yes
• 24 V AC				Yes
• 115 V AC				Yes
• 230 V AC				
Line frequency				
• permissible range, lower limit		47 Hz		47 Hz
• permissible range, upper limit		63 Hz		63 Hz
Digital inputs				
Number of digital inputs	4	4	4	4
Input voltage				
• Type of input voltage	DC	AC/DC	DC	AC/DC
• for signal "0"	< 5 V DC	< 5 V AC/DC	< 5 V DC	< 40 V AC, < 30 V DC
• for signal "1"	> 12 V DC	> 12 V AC/DC	> 8.5 V	> 79 V AC, > 79 V DC
Input current				
• for signal "0", max. (permissible quiescent current)	0.88 mA	1.1 mA	0.88 mA	0.06 mA; 0.05 mA with AC, 0.06 mA with DC
• for signal "1", typ.	2.1 mA	2.63 mA	1.5 mA	0.13 mA
Input delay (for rated value of input voltage)				
for standard inputs				
- at "0" to "1", max.	1.5 ms	1.5 ms	1.5 ms	40 ms
- at "1" to "0", max.	1.5 ms	15 ms	1.5 ms	75 ms
Digital outputs				
Number of digital outputs	4	4; Relays	4; Relays	4; Relays
Short-circuit protection	Yes	No	No	No
Controlling a digital input		Yes	Yes	Yes
Switching capacity of the outputs				
• on lamp load, max.		1 000 W	1 000 W	1 000 W; 500 W at 115V AC
Parallel switching of two outputs				
• for uprating	No	No	No	No
Switching frequency				
• with resistive load, max.	10 Hz	2 Hz	2 Hz	2 Hz
• with inductive load, max.	0.5 Hz	0.5 Hz	0.5 Hz	0.5 Hz
• mechanical, max.		10 Hz	10 Hz	10 Hz
Relay outputs				
Switching capacity of contacts				
- with inductive load, max.		3 A	3 A	3 A
- with resistive load, max.		5 A	5 A	5 A
EMC				
Emission of radio interference acc. to EN 55 011				
• Limit class B, for use in residential areas	Yes	Yes	Yes	Yes
Degree and class of protection				
IP degree of protection	IP20	IP20	IP20	IP20

Technical specifications

Article number	6ED1055-1CB00-0BA2 LOGO! DM8 24 Exp. mod., 4DI/4DO	6ED1055-1HB00-0BA2 LOGO! DM8 24R Exp. mod. 2 U, 4DI/4DO	6ED1055-1MB00-0BA2 LOGO! DM8 12/24R Exp. mod. 2 U, 4DI/DO	6ED1055-1FB00-0BA2 LOGO! DM8 230R Exp. mod. 2 U, 4DI/4DO
Standards, approvals, certificates				
CE mark	Yes	Yes	Yes	Yes
CSA approval	Yes	Yes	Yes	Yes
UL approval	Yes	Yes	Yes	Yes
FM approval	Yes	Yes	Yes	Yes
developed in accordance with IEC 61131	Yes	Yes	Yes	Yes
according to VDE 0631	Yes	Yes		Yes
Marine approval	Yes	Yes	Yes	Yes
Ambient conditions				
Ambient temperature during operation				
• min.	0 °C; ES03 and higher: -20 °C	0 °C; ES03 and higher: -20 °C	0 °C; ES03 and higher: -20 °C	0 °C; ES03 and higher: -20 °C
• max.	55 °C	55 °C	55 °C	55 °C
Dimensions				
Width	35.5 mm	35.5 mm	35.5 mm	35.5 mm
Height	90 mm	90 mm	90 mm	90 mm
Depth	58 mm	58 mm	58 mm	58 mm
<hr/>				
Article number	6ED1055-1CB10-0BA2 LOGO! DM16 24 Exp. mod., 4 U, 8DI/8DO	6ED1055-1NB10-0BA2 LOGO! DM16 24R Exp. mod. 4 U, 8DI/8DO	6ED1055-1FB10-0BA2 LOGO! DM16 230R Exp. mod. 4 U, 8DI/8DO	
Installation type/mounting				
Mounting	on 35 mm DIN rail, 4 spacing units wide	on 35 mm DIN rail, 4 spacing units wide	on 35 mm DIN rail, 4 spacing units wide	
Supply voltage				
Rated value (DC)	Yes	Yes	Yes Yes	
• 24 V DC				
• 115 V DC				
Rated value (AC)	No	No	Yes Yes	
• 24 V AC				
• 115 V AC				
• 230 V AC			Yes Yes	
Line frequency				
• permissible range, lower limit			47 Hz	
• permissible range, upper limit			63 Hz	
Digital inputs				
Number of digital inputs	8	8	8	
Input voltage				
• Type of input voltage	DC	DC	AC/DC	
• for signal *0*	< 5 V DC	< 5 V DC	< 40 V AC, < 30 V DC	
• for signal *1*	> 12 V DC	> 12 V DC	> 79 V AC, > 79 V DC	
Input current				
• for signal *0*, max. (permissible quiescent current)	0.85 mA	0.85 mA	0.06 mA; 0.05 mA with AC, 0.06 mA with DC	
• for signal *1*, typ.	2 mA	2 mA	0.13 mA	
Input delay (for rated value of input voltage)				
for standard inputs				
- at *0* to *1*, max.	1.5 ms	1.5 ms	40 ms	
- at *1* to *0*, max.	1.5 ms	1.5 ms	75 ms	

LOGO! logic module

LOGO! basic and expansion modules

LOGO! expansion modules**Technical specifications**

Article number	6ED1055-1CB10-0BA2 LOGO! DM16 24 Exp. mod., 4 U, 8DI/8DO	6ED1055-1NB10-0BA2 LOGO! DM16 24R Exp. mod. 4 U, 8DI/8DO	6ED1055-1FB10-0BA2 LOGO! DM16 230R Exp. mod. 4 U, 8DI/8DO
Digital outputs			
Number of digital outputs	8	8; Relays	8; Relays
Short-circuit protection	Yes	No	No
Controlling a digital input		Yes	Yes
Switching capacity of the outputs			
• on lamp load, max.		1 000 W	1 000 W; 500 W at 115V AC
Parallel switching of two outputs			
• for uprating	No	No	No
Switching frequency			
• with resistive load, max.	10 Hz	2 Hz	2 Hz
• with inductive load, max.	0.5 Hz	0.5 Hz	0.5 Hz
• mechanical, max.		10 Hz	10 Hz
Relay outputs			
Switching capacity of contacts			
- with inductive load, max.		3 A	3 A
- with resistive load, max.		5 A	5 A
EMC			
Emission of radio interference acc. to EN 55 011			
• Limit class B, for use in residential areas	Yes	Yes	Yes
Degree and class of protection			
IP degree of protection	IP20	IP20	IP20
Standards, approvals, certificates			
CE mark	Yes	Yes	Yes
CSA approval	Yes	Yes	Yes
UL approval	Yes	Yes	Yes
FM approval	Yes	Yes	Yes
developed in accordance with IEC 61131	Yes	Yes	Yes
according to VDE 0631	Yes	Yes	Yes
Marine approval	Yes	Yes	Yes
Ambient conditions			
Ambient temperature during operation			
• min.	0 °C; ES03 and higher: -20 °C	0 °C; ES03 and higher: -20 °C	0 °C; ES03 and higher: -20 °C
• max.	55 °C	55 °C	55 °C
Dimensions			
Width	71.5 mm	71.5 mm	71.5 mm
Height	90 mm	90 mm	90 mm
Depth	58 mm	58 mm	58 mm

Technical specifications

Article number	6ED1055-1MA00-0BA2	6ED1055-1MD00-0BA2
	LOGO! AM2 Exp. mod., 12/24V, 2AI,	LOGO! AM2 RDT, 2AI, -50..+200DECR/C
Installation type/mounting		
Mounting	on 35 mm DIN rail, 2 spacing units wide	on 35 mm DIN rail, 2 spacing units wide
Supply voltage		
Rated value (DC)		
• 12 V DC	Yes; 10.8 V DC to 28.8 V DC	Yes; 10.8 V DC to 28.8 V DC
• 24 V DC	Yes; 10.8 V DC to 28.8 V DC	Yes; 10.8 V DC to 28.8 V DC
Analog inputs		
Number of analog inputs	2	2; 2 or 3 wire connection
Input ranges		
• Voltage	Yes	No
• Current	Yes	No
• Resistance thermometer	No	Yes; For PT100/PT1000 sensors
Input ranges (rated values), voltages		
• 0 to +10 V	Yes	No
Input ranges (rated values), currents		
• 0 to 20 mA	Yes; 0 mA or 4 mA to 20 mA	No
Input ranges (rated values), resistance thermometer		
• Pt 100	No	Yes
EMC		
Emission of radio interference acc. to EN 55 011		
• Limit class B, for use in residential areas	Yes	Yes
Degree and class of protection		
IP degree of protection	IP20	IP20
Standards, approvals, certificates		
CE mark	Yes	Yes
CSA approval	Yes	Yes
UL approval	Yes	Yes
FM approval	Yes	Yes
developed in accordance with IEC 61131	Yes	Yes
according to VDE 0631	Yes	
Marine approval	Yes	Yes
Ambient conditions		
Ambient temperature during operation		
• min.	0 °C; ES03 and higher: -20 °C	0 °C; ES03 and higher: -20 °C
• max.	55 °C	55 °C
Dimensions		
Width	35.5 mm	35.5 mm
Height	90 mm	90 mm
Depth	58 mm	58 mm

LOGO! logic module

LOGO! basic and expansion modules

LOGO! expansion modules**Technical specifications**

Article number	6ED1055-1MM00-0BA2 LOGO! AM2 AQ, 2AQ, 0-10V, 0/4-20mA
Installation type/mounting	
Mounting	on 35 mm DIN rail, 2 spacing units wide
Supply voltage	
Rated value (DC)	24 V
Analog outputs	
Number of analog outputs	2
Output ranges, voltage	
• 0 to 10 V	Yes
Output ranges, current	
• 0 to 20 mA	Yes
• 4 mA to 20 mA	Yes
EMC	
Emission of radio interference acc. to EN 55 011	
• Limit class B, for use in residential areas	Yes
Degree and class of protection	
IP degree of protection	IP20

Article number	6ED1055-1MM00-0BA2 LOGO! AM2 AQ, 2AQ, 0-10V, 0/4-20mA
Standards, approvals, certificates	
CE mark	Yes
CSA approval	Yes
UL approval	Yes
FM approval	Yes
developed in accordance with IEC 61131	Yes
according to VDE 0631	Yes
Marine approval	Yes
Ambient conditions	
Ambient temperature during operation	
• min.	0 °C; ES03 and higher: -20 °C
• max.	55 °C
Dimensions	
Width	35.5 mm
Height	90 mm
Depth	58 mm

2

Overview



- The space-saving basic variants
- Interface for connecting expansion modules, up to 24 digital inputs, 20 (16) digital outputs, 8 analog inputs and 8 (2) analog outputs can be addressed
- With connection option for LOGO! TD text display (can be connected to all LOGO! 0BA6 and 0BA7 basic variants); LOGO! TDE can be connected to LOGO! 8 or higher

New for LOGO! 8

- All basic units with integrated web server
- Same enclosure width as LOGO! 0BA6 (4 U)
- All basic units with Ethernet interface for communication with LOGO!, SIMATIC Controllers, SIMATIC Panel and PC
- Use of standard micro SD cards

LOGO! 0BA7 versions:

- Ethernet interface for communication with SIMATIC Controllers, SIMATIC Panel and PC
- Networking of max. 8 LOGO! devices
- Use of standard SD card or SIMATIC Memory Card

Note:

SIPLUS LOGO! 6/7 versions are not compatible with SIPLUS LOGO! 8.

SIPLUS extreme products are based on SIMATIC standard products. The contents listed here were taken from the corresponding standard products. SIPLUS extreme-specific information was added.

Ordering data

Article No.

SIPLUS LOGO! 8 logic module

SIPLUS LOGO! 24CE

24 V DC supply voltage,
8 digital inputs 24 V DC,
of which 4 can be used in
analog mode (0 to 10 V),
4 digital outputs 24 V DC, 0.3 A,
integrated time switch
Ethernet interface;
400 function blocks can be
interlinked, modular expansion
capability

Extended temperature range and
exposure to environmental
substances

6AG1052-1CC08-7BA1

SIPLUS LOGO! 12/24RCE

12...24 V DC supply voltage,
8 digital inputs 12/24 V DC,
of which 4 can be used in analog
mode (0 to 10 V),
4 relay outputs 10 A,
integrated time switch,
Ethernet interface;
400 function blocks can be
interlinked, modular expansion
capability

Extended temperature range and
exposure to environmental
substances

6AG1052-1MD08-7BA1

SIPLUS LOGO! 24RCE

24 V AC/DC supply voltage,
8 digital inputs 24 V AC/DC,
4 relay outputs 10 A,
integrated time switch,
Ethernet interface;
400 function blocks can be
interlinked, modular expansion
capability

Extended temperature range and
exposure to environmental
substances

6AG1052-1HB08-7BA1

SIPLUS LOGO! 230RCE

115...230 V AC/DC supply voltage,
8 digital inputs 115...230 V AC/DC,
4 relay outputs 10 A,
integrated time switch,
Ethernet interface;
400 function blocks can be
interlinked, modular expansion
capability

Extended temperature range and
exposure to environmental
substances

6AG1052-1FB08-7BA1

Accessories

SIPLUS LOGO! TDE

(Extended temperature range
-25 ... +60 °C (start-up -20 °C) and
exposure to environmental
substances)

6-line text display, can be
connected to all LOGO!
8 variants with and without display,
with 2 Ethernet interfaces; incl.
installation accessories.
Requires additional 12 V DC or 24 V
AC/DC power supply

6AG1055-4MH08-2BA1

LOGO!Soft Comfort V8

For programming on the PC in
LAD/FBD; executes on
Windows 8, 7, XP, Linux and
Mac OSX; on DVD

6ED1058-0BA08-0YA1

Front panel mounting kit

Width 8 U, with keys

6AG1057-1AA00-0AA2

LOGO! logic module

LOGO! basic and expansion modules

SIPLUS LOGO! basic modules with display**Technical specifications**

Article number	6AG1052-1CC08-7BA1	6AG1052-1MD08-7BA1	6AG1052-1FB08-7BA1	6AG1052-1HB08-7BA1
Based on	6ED1052-1CC08-0BA1	6ED1052-1MD08-0BA1	6ED1052-1FB08-0BA1	6ED1052-1HB08-0BA1
	SIPLUS LOGO! 24CE	SIPLUS LOGO! 12/24RCE	SIPLUS LOGO! 230RCE	SIPLUS LOGO! 24RCE
Ambient conditions				
Ambient temperature during operation				
• min.	-25 °C; = Tmin; Startup @ -20 °C	-25 °C; = Tmin; Startup @ -20 °C	-25 °C; = Tmin; Startup @ -20 °C	-25 °C; = Tmin; Startup @ -20 °C
• max.	60 °C; = Tmax	60 °C; Tmax; Tmax > +55 °C max. load 1 A per relay or max. load 3 A per relay and half the number of DIs (no adjacent points)	60 °C; Tmax; Tmax > +55 °C max. load 1 A per relay	70 °C; Tmax; Tmax > +55 °C max. load 1 A per relay or max. load 3 A per relay and half the number of DIs (no adjacent points)
• At cold restart, min.	-20 °C; incl. condensation / frost permitted (no commissioning under condensation conditions)	-20 °C; incl. condensation / frost permitted (no commissioning under condensation conditions)	-20 °C; incl. condensation / frost permitted (no commissioning under condensation conditions)	-20 °C; incl. condensation / frost permitted (no commissioning under condensation conditions)
Altitude during operation relating to sea level				
• Installation altitude above sea level, max.	5 000 m	5 000 m	2 000 m	5 000 m
• Ambient air temperature-barometric pressure-altitude	Tmin ... Tmax at 1 140 hPa ... 795 hPa (-1 000 m ... +2 000 m) // Tmin ... (Tmax - 10 K) at 795 hPa ... 658 hPa (+2 000 m ... +3 500 m) // Tmin ... (Tmax -20 K) at 658 hPa ... 540 hPa (+3 500 m ... +5 000 m)	Tmin ... Tmax at 1 140 hPa ... 795 hPa (-1 000 m ... +2 000 m) // Tmin ... (Tmax - 10 K) at 795 hPa ... 658 hPa (+2 000 m ... +3 500 m) // Tmin ... (Tmax -20 K) at 658 hPa ... 540 hPa (+3 500 m ... +5 000 m)	Tmin ... Tmax at 1 140 hPa ... 795 hPa (-1 000 m ... +2 000 m)	Tmin ... Tmax at 1 140 hPa ... 795 hPa (-1 000 m ... +2 000 m) // Tmin ... (Tmax - 10 K) at 795 hPa ... 658 hPa (+2 000 m ... +3 500 m) // Tmin ... (Tmax -20 K) at 658 hPa ... 540 hPa (+3 500 m ... +5 000 m)
Relative humidity				
• With condensation, tested in accordance with IEC 60068-2-38, max.	100 %; RH incl. condensation / frost (no commissioning in bedewed state), horizontal installation	100 %; RH incl. condensation / frost (no commissioning in bedewed state), horizontal installation	100 %; RH incl. condensation / frost (no commissioning in bedewed state), horizontal installation	100 %; RH incl. condensation / frost (no commissioning in bedewed state), horizontal installation
Resistance				
Coolants and lubricants				
- Resistant to commercially available coolants and lubricants	Yes; Incl. diesel and oil droplets in the air	Yes; Incl. diesel and oil droplets in the air	Yes; Incl. diesel and oil droplets in the air	Yes; Incl. diesel and oil droplets in the air
Use in stationary industrial systems				
- to biologically active substances according to EN 60721-3-3	Yes; Class 3B2 mold, fungus and dry rot spores (with the exception of fauna); Class 3B3 on request	Yes; Class 3B2 mold, fungus and dry rot spores (with the exception of fauna); Class 3B3 on request	Yes; Class 3B2 mold, fungus and dry rot spores (with the exception of fauna); Class 3B3 on request	Yes; Class 3B2 mold, fungus and dry rot spores (with the exception of fauna); Class 3B3 on request
- to chemically active substances according to EN 60721-3-3	Yes; Class 3C4 (RH < 75 %) incl. salt spray acc. to EN 60068-2-52 (severity degree 3); *	Yes; Class 3C4 (RH < 75 %) incl. salt spray acc. to EN 60068-2-52 (severity degree 3); *	Yes; Class 3C4 (RH < 75 %) incl. salt spray acc. to EN 60068-2-52 (severity degree 3); *	Yes; Class 3C4 (RH < 75 %) incl. salt spray acc. to EN 60068-2-52 (severity degree 3); *
- to mechanically active substances according to EN 60721-3-3	Yes; Class 3S4 incl. sand, dust, *	Yes; Class 3S4 incl. sand, dust, *	Yes; Class 3S4 incl. sand, dust, *	Yes; Class 3S4 incl. sand, dust, *
Use on ships/at sea				
- to biologically active substances according to EN 60721-3-6	Yes; Class 6B2 mold and fungal spores (excluding fauna); Class 6B3 on request	Yes; Class 6B2 mold and fungal spores (excluding fauna); Class 6B3 on request	Yes; Class 6B2 mold and fungal spores (excluding fauna); Class 6B3 on request	Yes; Class 6B2 mold and fungal spores (excluding fauna); Class 6B3 on request
- to chemically active substances according to EN 60721-3-6	Yes; Class 6C3 (RH < 75 %) incl. salt spray acc. to EN 60068-2-52 (severity degree 3); *	Yes; Class 6C3 (RH < 75 %) incl. salt spray acc. to EN 60068-2-52 (severity degree 3); *	Yes; Class 6C3 (RH < 75 %) incl. salt spray acc. to EN 60068-2-52 (severity degree 3); *	Yes; Class 6C3 (RH < 75 %) incl. salt spray acc. to EN 60068-2-52 (severity degree 3); *
- to mechanically active substances according to EN 60721-3-6	Yes; Class 6S3 incl. sand, dust; *	Yes; Class 6S3 incl. sand, dust; *	Yes; Class 6S3 incl. sand, dust; *	Yes; Class 6S3 incl. sand, dust; *

Technical specifications

Article number	6AG1052-1CC08-7BA1	6AG1052-1MD08-7BA1	6AG1052-1FB08-7BA1	6AG1052-1HB08-7BA1
Based on	6ED1052-1CC08-0BA1 SIPLUS LOGO! 24CE	6ED1052-1MD08-0BA1 SIPLUS LOGO! 12/24RCE	6ED1052-1FB08-0BA1 SIPLUS LOGO! 230RCE	6ED1052-1HB08-0BA1 SIPLUS LOGO! 24RCE
Usage in industrial process technology				
- Against chemically active substances acc. to EN 60654-4	Yes; Class 3 (excluding trichlorethylene)	Yes; Class 3 (excluding trichlorethylene)	Yes; Class 3 (excluding trichlorethylene)	Yes; Class 3 (excluding trichlorethylene)
- Environmental conditions for process, measuring and control systems acc. to ANSI/ISA-71.04	Yes; Level GX group A/B (excluding trichlorethylene; harmful gas concentrations up to the limits of EN 60721-3-3 class 3C4 permissible); level LC3 (salt spray) and level LB3 (oil)	Yes; Level GX group A/B (excluding trichlorethylene; harmful gas concentrations up to the limits of EN 60721-3-3 class 3C4 permissible); level LC3 (salt spray) and level LB3 (oil)	Yes; Level GX group A/B (excluding trichlorethylene; harmful gas concentrations up to the limits of EN 60721-3-3 class 3C4 permissible); level LC3 (salt spray) and level LB3 (oil)	Yes; Level GX group A/B (excluding trichlorethylene; harmful gas concentrations up to the limits of EN 60721-3-3 class 3C4 permissible); level LC3 (salt spray) and level LB3 (oil)
Remark				
- Note regarding classification of environmental conditions acc. to EN 60721, EN 60654-4 and ANSI/ISA-71.04	* The supplied plug covers must remain in place over the unused interfaces during operation!	* The supplied plug covers must remain in place over the unused interfaces during operation!	* The supplied plug covers must remain in place over the unused interfaces during operation!	* The supplied plug covers must remain in place over the unused interfaces during operation!
Conformal coating				
• Coatings for printed circuit board assemblies acc. to EN 61086	Yes; Class 2 for high reliability	Yes; Class 2 for high reliability	Yes; Class 2 for high reliability	Yes; Class 2 for high reliability
• Protection against fouling acc. to EN 60664-3	Yes; Type 1 protection	Yes; Type 1 protection	Yes; Type 1 protection	Yes; Type 1 protection
• Military testing according to MIL-I-46058C, Amendment 7	Yes; Discoloration of coating possible during service life	Yes; Discoloration of coating possible during service life	Yes; Discoloration of coating possible during service life	Yes; Discoloration of coating possible during service life
• Qualification and Performance of Electrical Insulating Compound for Printed Board Assemblies according to IPC-CC-830A	Yes; Conformal coating, Class A	Yes; Conformal coating, Class A	Yes; Conformal coating, Class A	Yes; Conformal coating, Class A

LOGO! logic module

LOGO! basic and expansion modules

SIPLUS LOGO! basic modules without display

Overview



- Basic versions optimized for costs
- Interface for connecting expansion modules, up to 24 digital inputs, 16 (20) digital outputs, 8 analog inputs and 2 (8) analog outputs can be addressed
- With connection option for LOGO! TD text display (can be connected to all LOGO! 0BA6 basic variants)

New for SIPLUS LOGO! 8

- All basic units with integrated web server
- Same enclosure width as LOGO! 0BA6 (4 U)
- All basic units with Ethernet interface for communication with LOGO!, SIMATIC Controllers, SIMATIC Panel and PC
- Use of standard micro SD cards

Note:

SIPLUS LOGO! 6 versions are not compatible with SIPLUS LOGO! 8.

SIPLUS extreme products are based on SIMATIC standard products. The contents listed here were taken from the corresponding standard products. SIPLUS extreme-specific information was added.

Ordering data

Article No.

SIPLUS LOGO! 8 logic module

SIPLUS LOGO! 24CEo

24 V DC supply voltage
8 digital inputs 24 V DC, of which 4 can be used in analog mode (0 to 10 V)
4 digital outputs 24 V DC, 0.3 A,
Integrated time switch
Ethernet interface;
without display and keyboard
400 function blocks can be interlinked, modular expansion capability
Extended temperature range and exposure to environmental substances

6AG1052-2CC08-7BA1

SIPLUS LOGO! 230RCEo

115...230 V AC/DC supply voltage
8 digital inputs 115...230 V AC/DC
4 relay outputs 10 A
Integrated time switch
Ethernet interface;
without display or keyboard
400 function blocks can be interlinked, modular expansion capability
Extended temperature range and exposure to environmental substances

6AG1052-2FB08-7BA1

SIPLUS LOGO! 24RCEo

24 V AC/DC supply voltage,
8 digital inputs 24 V AC/DC,
4 relay outputs 10 A,
integrated time switch,
Ethernet interface;
without display or keyboard;
400 function blocks can be interlinked, modular expansion capability
Extended temperature range and exposure to environmental substances

6AG1052-2HB08-7BA1

SIPLUS LOGO! 12/24RCEo

12...24 V DC supply voltage
8 digital inputs 12...24 V DC, of which 4 can be used in analog mode (0 to 10 V)
4 relay outputs 10 A
Integrated time switch
Ethernet interface;
without display and keyboard
400 function blocks can be interlinked, modular expansion capability
Extended temperature range and exposure to environmental substances

6AG1052-2MD08-7BA1

Accessories

SIPLUS LOGO! TDE

(Extended temperature range -25 ... +60 °C (start-up -20 °C) and exposure to environmental substances)

6-line text display, can be connected to all LOGO!
8 variants with and without display, with 2 Ethernet interfaces;
incl. installation accessories.
Requires additional 12 V DC or 24 V AC/DC power supply

6AG1055-4MH08-2BA1

LOGO!Soft Comfort V8

For programming on the PC in LAD/FBD; executes on Windows 8, 7, XP, Linux and Mac OSX; on DVD

6ED1058-0BA08-0YA1

Front panel mounting kit

Width 8 U, with keys

6AG1057-1AA00-0AA2

Technical specifications

Article number	6AG1052-2CC08-7BA1	6AG1052-2MD08-7BA1	6AG1052-2HB08-7BA1	6AG1052-2FB08-7BA1
Based on	6ED1052-2CC08-0BA1 SIPLUS LOGO! 24CEO	6ED1052-2MD08-0BA1 SIPLUS LOGO! 12/24RCEO	6ED1052-2HB08-0BA1 SIPLUS LOGO! 24RCEO (AC)	6ED1052-2FB08-0BA1 SIPLUS LOGO! 230RCEO
Ambient conditions				
Ambient temperature during operation				
• min.	-40 °C; = Tmin; Startup @ -25 °C	-40 °C; = Tmin; Startup @ -25 °C	-40 °C; = Tmin; Startup @ -25 °C	-40 °C; = Tmin; Startup @ -25 °C
• max.	70 °C; Tmax; Tmax > +55 °C max. load 0.2 A per output	70 °C; Tmax; Tmax > +55 °C max. load 1 A per relay or max. load 3 A per relay and half the number of DIs (no adjacent points)	70 °C; Tmax; Tmax > +55 °C max. load 1 A per relay or max. load 3 A per relay and half the number of DIs (no adjacent points)	70 °C; Tmax; Tmax > +55 °C max. load 1 A per relay
• At cold restart, min.	-25 °C; incl. condensation / frost permitted (no commissioning under condensation conditions)	-25 °C; incl. condensation / frost permitted (no commissioning under condensation conditions)	-25 °C; incl. condensation / frost permitted (no commissioning under condensation conditions)	-25 °C; incl. condensation / frost permitted (no commissioning under condensation conditions)
Altitude during operation relating to sea level				
• Installation altitude above sea level, max.	5 000 m	5 000 m	5 000 m	2 000 m
• Ambient air temperature-barometric pressure-altitude	Tmin ... Tmax at 1 140 hPa ... 795 hPa (-1 000 m ... +2 000 m) // Tmin ... (Tmax - 10 K) at 795 hPa ... 658 hPa (+2 000 m ... +3 500 m) // Tmin ... (Tmax -20 K) at 658 hPa ... 540 hPa (+3 500 m ... +5 000 m)	Tmin ... Tmax at 1 140 hPa ... 795 hPa (-1 000 m ... +2 000 m) // Tmin ... (Tmax - 10 K) at 795 hPa ... 658 hPa (+2 000 m ... +3 500 m) // Tmin ... (Tmax -20 K) at 658 hPa ... 540 hPa (+3 500 m ... +5 000 m)	Tmin ... Tmax at 1 140 hPa ... 795 hPa (-1 000 m ... +2 000 m) // Tmin ... (Tmax - 10 K) at 795 hPa ... 658 hPa (+2 000 m ... +3 500 m) // Tmin ... (Tmax -20 K) at 658 hPa ... 540 hPa (+3 500 m ... +5 000 m)	Tmin ... Tmax at 1 140 hPa ... 795 hPa (-1 000 m ... +2 000 m)
Relative humidity				
• With condensation, tested in accordance with IEC 60068-2-38, max.	100 %; RH incl. condensation / frost (no commissioning in bedewed state), horizontal installation	100 %; RH incl. condensation / frost (no commissioning in bedewed state), horizontal installation	100 %; RH incl. condensation / frost (no commissioning in bedewed state), horizontal installation	100 %; RH incl. condensation / frost (no commissioning in bedewed state), horizontal installation
Resistance				
Coolants and lubricants				
- Resistant to commercially available coolants and lubricants	Yes; Incl. diesel and oil droplets in the air	Yes; Incl. diesel and oil droplets in the air	Yes; Incl. diesel and oil droplets in the air	Yes; Incl. diesel and oil droplets in the air
Use in stationary industrial systems				
- to biologically active substances according to EN 60721-3-3	Yes; Class 3B2 mold, fungus and dry rot spores (with the exception of fauna); Class 3B3 on request	Yes; Class 3B2 mold, fungus and dry rot spores (with the exception of fauna); Class 3B3 on request	Yes; Class 3B2 mold, fungus and dry rot spores (with the exception of fauna); Class 3B3 on request	Yes; Class 3B2 mold, fungus and dry rot spores (with the exception of fauna); Class 3B3 on request
- to chemically active substances according to EN 60721-3-3	Yes; Class 3C4 (RH < 75 %) incl. salt spray acc. to EN 60068-2-52 (severity degree 3); *	Yes; Class 3C4 (RH < 75 %) incl. salt spray acc. to EN 60068-2-52 (severity degree 3); *	Yes; Class 3C4 (RH < 75 %) incl. salt spray acc. to EN 60068-2-52 (severity degree 3); *	Yes; Class 3C4 (RH < 75 %) incl. salt spray acc. to EN 60068-2-52 (severity degree 3); *
- to mechanically active substances according to EN 60721-3-3	Yes; Class 3S4 incl. sand, dust, *	Yes; Class 3S4 incl. sand, dust, *	Yes; Class 3S4 incl. sand, dust, *	Yes; Class 3S4 incl. sand, dust, *
Use on ships/at sea				
- to biologically active substances according to EN 60721-3-6	Yes; Class 6B2 mold and fungal spores (excluding fauna); Class 6B3 on request	Yes; Class 6B2 mold and fungal spores (excluding fauna); Class 6B3 on request	Yes; Class 6B2 mold and fungal spores (excluding fauna); Class 6B3 on request	Yes; Class 6B2 mold and fungal spores (excluding fauna); Class 6B3 on request
- to chemically active substances according to EN 60721-3-6	Yes; Class 6C3 (RH < 75 %) incl. salt spray acc. to EN 60068-2-52 (severity degree 3); *	Yes; Class 6C3 (RH < 75 %) incl. salt spray acc. to EN 60068-2-52 (severity degree 3); *	Yes; Class 6C3 (RH < 75 %) incl. salt spray acc. to EN 60068-2-52 (severity degree 3); *	Yes; Class 6C3 (RH < 75 %) incl. salt spray acc. to EN 60068-2-52 (severity degree 3); *
- to mechanically active substances according to EN 60721-3-6	Yes; Class 6S3 incl. sand, dust; *	Yes; Class 6S3 incl. sand, dust; *	Yes; Class 6S3 incl. sand, dust; *	Yes; Class 6S3 incl. sand, dust; *

LOGO! logic module

LOGO! basic and expansion modules

SIPLUS LOGO! basic modules without display**Technical specifications**

Article number	6AG1052-2CC08-7BA1	6AG1052-2MD08-7BA1	6AG1052-2HB08-7BA1	6AG1052-2FB08-7BA1
Based on	6ED1052-2CC08-0BA1 SIPLUS LOGO! 24CEO	6ED1052-2MD08-0BA1 SIPLUS LOGO! 12/24RCEO	6ED1052-2HB08-0BA1 SIPLUS LOGO! 24RCEO (AC)	6ED1052-2FB08-0BA1 SIPLUS LOGO! 230RCEO
Usage in industrial process technology				
- Against chemically active substances acc. to EN 60654-4	Yes; Class 3 (excluding trichlorethylene)	Yes; Class 3 (excluding trichlorethylene)	Yes; Class 3 (excluding trichlorethylene)	Yes; Class 3 (excluding trichlorethylene)
- Environmental conditions for process, measuring and control systems acc. to ANSI/ISA-71.04	Yes; Level GX group A/B (excluding trichlorethylene; harmful gas concentrations up to the limits of EN 60721-3-3 class 3C4 permissible); level LC3 (salt spray) and level LB3 (oil)	Yes; Level GX group A/B (excluding trichlorethylene; harmful gas concentrations up to the limits of EN 60721-3-3 class 3C4 permissible); level LC3 (salt spray) and level LB3 (oil)	Yes; Level GX group A/B (excluding trichlorethylene; harmful gas concentrations up to the limits of EN 60721-3-3 class 3C4 permissible); level LC3 (salt spray) and level LB3 (oil)	Yes; Level GX group A/B (excluding trichlorethylene; harmful gas concentrations up to the limits of EN 60721-3-3 class 3C4 permissible); level LC3 (salt spray) and level LB3 (oil)
Remark				
- Note regarding classification of environmental conditions acc. to EN 60721, EN 60654-4 and ANSI/ISA-71.04	* The supplied plug covers must remain in place over the unused interfaces during operation!	* The supplied plug covers must remain in place over the unused interfaces during operation!	* The supplied plug covers must remain in place over the unused interfaces during operation!	* The supplied plug covers must remain in place over the unused interfaces during operation!
Conformal coating				
• Coatings for printed circuit board assemblies acc. to EN 61086	Yes; Class 2 for high reliability	Yes; Class 2 for high reliability	Yes; Class 2 for high reliability	Yes; Class 2 for high reliability
• Protection against fouling acc. to EN 60664-3	Yes; Type 1 protection	Yes; Type 1 protection	Yes; Type 1 protection	Yes; Type 1 protection
• Military testing according to MIL-I-46058C, Amendment 7	Yes; Discoloration of coating possible during service life	Yes; Discoloration of coating possible during service life	Yes; Discoloration of coating possible during service life	Yes; Discoloration of coating possible during service life
• Qualification and Performance of Electrical Insulating Compound for Printed Board Assemblies according to IPC-CC-830A	Yes; Conformal coating, Class A	Yes; Conformal coating, Class A	Yes; Conformal coating, Class A	Yes; Conformal coating, Class A

Overview



- Expansion modules for connection to LOGO! Modular
- With digital inputs and outputs, analog inputs, or analog outputs

Note:

SIPLUS LOGO! 6 versions are not compatible with SIPLUS LOGO! 8.

SIPLUS extreme products are based on SIMATIC standard products. The contents listed here were adopted from the respective standard products. SIPLUS extreme specific information was added.

Ordering data

Article No.

SIPLUS LOGO! 8 expansion modules	
SIPLUS LOGO! DM8 24 24 V DC supply voltage, 4 digital inputs 24 V DC, 4 digital outputs 24 V DC, 0.3 A Extended temperature range and exposure to environmental substances	6AG1055-1CB00-7BA2
SIPLUS LOGO! DM8 230R 115...230 V AC/DC supply voltage, 4 digital inputs 115...230 V AC/DC, 4 relay outputs 5 A Extended temperature range and exposure to environmental substances	6AG1055-1FB00-7BA2
SIPLUS LOGO! DM8 24R 24 V AC/DC supply voltage, 4 digital inputs 24 V AC/DC, 4 relay outputs 5 A Extended temperature range and exposure to environmental substances	6AG1055-1HB00-7BA2
SIPLUS LOGO! AM2 12...24 V DC supply voltage, 2 analog inputs 0 to 10 V or 0 to 20 mA, 10-bit resolution Extended temperature range and exposure to environmental substances	6AG1055-1MA00-7BA2
SIPLUS LOGO! DM8 12/24R 12...24 V DC supply voltage, 4 digital inputs 12...24 V DC, 4 relay outputs 5 A Extended temperature range and exposure to environmental substances	6AG1055-1MB00-7BA2
LOGO! AM2 RTD 12...24 V DC supply voltage, 2 analog inputs Pt100, temperature range -50 °C to 200 °C Extended temperature range and exposure to environmental substances	6AG1055-1MD00-7BA2
SIPLUS LOGO! AM2 AQ 24 V DC supply voltage, 2 analog outputs 0 to 10 V, 0/4 to 20 mA Extended temperature range and exposure to environmental substances	6AG1055-1MM00-7BA2
SIPLUS LOGO! DM16 24R 24 V DC supply voltage, 8 digital inputs 24 V DC, 8 relay outputs 5 A Extended temperature range and exposure to environmental substances	6AG1055-1NB10-7BA2
Accessories	
LOGO!Soft Comfort V8 For programming on the PC in LAD/FBD; executes on Windows 8, 7, XP, Linux and Mac OSX; on DVD	6ED1058-0BA08-0YA1
Front panel mounting kit Width 8 U, with keys	6AG1057-1AA00-0AA2

LOGO! logic module

LOGO! basic and expansion modules

SIPLUS LOGO! expansion modules**Technical specifications**

Article number	6AG1055-1CB00-7BA2	6AG1055-1HB00-7BA2	6AG1055-1MB00-7BA2
Based on	6ED1055-1CB00-0BA2 SIPLUS LOGO! DM8 24 V8	6ED1055-1HB00-0BA2 SIPLUS LOGO! DM8 24R V8	6ED1055-1MB00-0BA2 SIPLUS LOGO! DM8 12/24R V8
Ambient conditions			
Ambient temperature during operation			
• min.	-40 °C; = Tmin; Startup @ -25 °C	-40 °C; = Tmin; Startup @ -25 °C	-40 °C; = Tmin; Startup @ -25 °C
• max.	70 °C; Tmax; Tmax > +55 °C max. load 0.2 A per output	70 °C; = Tmax; Tmax > +55 °C max. load 3 A per relay or max. total current 10 A	70 °C; = Tmax; Tmax > +55 °C max. load 3 A per relay or max. total current 10 A
• At cold restart, min.	-25 °C; incl. condensation / frost permitted (no commissioning under condensation conditions)	-25 °C; incl. condensation / frost permitted (no commissioning under condensation conditions)	-25 °C; incl. condensation / frost permitted (no commissioning under condensation conditions)
Altitude during operation relating to sea level			
• Installation altitude above sea level, max.	5 000 m	5 000 m	5 000 m
• Ambient air temperature-barometric pressure-altitude	Tmin ... Tmax at 1 140 hPa ... 795 hPa (-1 000 m ... +2 000 m) // Tmin ... (Tmax - 10 K) at 795 hPa ... 658 hPa (+2 000 m ... +3 500 m) // Tmin ... (Tmax -20 K) at 658 hPa ... 540 hPa (+3 500 m ... +5 000 m)	Tmin ... Tmax at 1 140 hPa ... 795 hPa (-1 000 m ... +2 000 m) // Tmin ... (Tmax - 10 K) at 795 hPa ... 658 hPa (+2 000 m ... +3 500 m) // Tmin ... (Tmax -20 K) at 658 hPa ... 540 hPa (+3 500 m ... +5 000 m)	Tmin ... Tmax at 1 140 hPa ... 795 hPa (-1 000 m ... +2 000 m) // Tmin ... (Tmax - 10 K) at 795 hPa ... 658 hPa (+2 000 m ... +3 500 m) // Tmin ... (Tmax -20 K) at 658 hPa ... 540 hPa (+3 500 m ... +5 000 m)
Relative humidity			
• With condensation, tested in accordance with IEC 60068-2-38, max.	100 %; RH incl. condensation / frost (no commissioning in bedewed state), horizontal installation	100 %; RH incl. condensation / frost (no commissioning in bedewed state), horizontal installation	100 %; RH incl. condensation / frost (no commissioning in bedewed state), horizontal installation
Resistance			
Coolants and lubricants			
- Resistant to commercially available coolants and lubricants	Yes; Incl. diesel and oil droplets in the air	Yes; Incl. diesel and oil droplets in the air	Yes; Incl. diesel and oil droplets in the air
Use in stationary industrial systems			
- to biologically active substances according to EN 60721-3-3	Yes; Class 3B2 mold, fungus and dry rot spores (with the exception of fauna); Class 3B3 on request	Yes; Class 3B2 mold, fungus and dry rot spores (with the exception of fauna); Class 3B3 on request	Yes; Class 3B2 mold, fungus and dry rot spores (with the exception of fauna); Class 3B3 on request
- to chemically active substances according to EN 60721-3-3	Yes; Class 3C4 (RH < 75 %) incl. salt spray acc. to EN 60068-2-52 (severity degree 3); *	Yes; Class 3C4 (RH < 75 %) incl. salt spray acc. to EN 60068-2-52 (severity degree 3); *	Yes; Class 3C4 (RH < 75 %) incl. salt spray acc. to EN 60068-2-52 (severity degree 3); *
- to mechanically active substances according to EN 60721-3-3	Yes; Class 3S4 incl. sand, dust, *	Yes; Class 3S4 incl. sand, dust, *	Yes; Class 3S4 incl. sand, dust, *
Use on ships/at sea			
- to biologically active substances according to EN 60721-3-6	Yes; Class 6B2 mold and fungal spores (excluding fauna); Class 6B3 on request	Yes; Class 6B2 mold and fungal spores (excluding fauna); Class 6B3 on request	Yes; Class 6B2 mold and fungal spores (excluding fauna); Class 6B3 on request
- to chemically active substances according to EN 60721-3-6	Yes; Class 6C3 (RH < 75 %) incl. salt spray acc. to EN 60068-2-52 (severity degree 3); *	Yes; Class 6C3 (RH < 75 %) incl. salt spray acc. to EN 60068-2-52 (severity degree 3); *	Yes; Class 6C3 (RH < 75 %) incl. salt spray acc. to EN 60068-2-52 (severity degree 3); *
- to mechanically active substances according to EN 60721-3-6	Yes; Class 6S3 incl. sand, dust; *	Yes; Class 6S3 incl. sand, dust; *	Yes; Class 6S3 incl. sand, dust; *
Usage in industrial process technology			
- Against chemically active substances acc. to EN 60654-4	Yes; Class 3 (excluding trichlorethylene)	Yes; Class 3 (excluding trichlorethylene)	Yes; Class 3 (excluding trichlorethylene)
- Environmental conditions for process, measuring and control systems acc. to ANSI/ISA-71.04	Yes; Level GX group A/B (excluding trichlorethylene; harmful gas concentrations up to the limits of EN 60721-3-3 class 3C4 permissible); level LC3 (salt spray) and level LB3 (oil)	Yes; Level GX group A/B (excluding trichlorethylene; harmful gas concentrations up to the limits of EN 60721-3-3 class 3C4 permissible); level LC3 (salt spray) and level LB3 (oil)	Yes; Level GX group A/B (excluding trichlorethylene; harmful gas concentrations up to the limits of EN 60721-3-3 class 3C4 permissible); level LC3 (salt spray) and level LB3 (oil)
Remark			
- Note regarding classification of environmental conditions acc. to EN 60721, EN 60654-4 and ANSI/ISA-71.04	* The supplied plug covers must remain in place over the unused interfaces during operation!	* The supplied plug covers must remain in place over the unused interfaces during operation!	* The supplied plug covers must remain in place over the unused interfaces during operation!

Technical specifications

Article number	6AG1055-1CB00-7BA2	6AG1055-1HB00-7BA2	6AG1055-1MB00-7BA2
Based on	6ED1055-1CB00-0BA2 SIPLUS LOGO! DM8 24 V8	6ED1055-1HB00-0BA2 SIPLUS LOGO! DM8 24R V8	6ED1055-1MB00-0BA2 SIPLUS LOGO! DM8 12/24R V8
Conformal coating			
<ul style="list-style-type: none"> Coatings for printed circuit board assemblies acc. to EN 61086 Protection against fouling acc. to EN 60664-3 Military testing according to MIL-I-46058C, Amendment 7 Qualification and Performance of Electrical Insulating Compound for Printed Board Assemblies according to IPC-CC-830A 	Yes; Class 2 for high reliability	Yes; Class 2 for high reliability	Yes; Class 2 for high reliability
	Yes; Type 1 protection	Yes; Type 1 protection	Yes; Type 1 protection
	Yes; Discoloration of coating possible during service life	Yes; Discoloration of coating possible during service life	Yes; Discoloration of coating possible during service life
	Yes; Conformal coating, Class A	Yes; Conformal coating, Class A	Yes; Conformal coating, Class A
Article number	6AG1055-1FB00-7BA2	6AG1055-1NB10-7BA2	
Based on	6ED1055-1FB00-0BA2 SIPLUS LOGO! DM8 230R V8	6ED1055-1NB10-0BA2 SIPLUS LOGO! DM16 24R V8	
Ambient conditions			
Ambient temperature during operation			
<ul style="list-style-type: none"> min. max. At cold restart, min. 	-40 °C; = Tmin; Startup @ -25 °C 70 °C; = Tmax; Tmax > +55 °C max. load 3 A per relay or max. total current 10 A -25 °C; incl. condensation / frost permitted (no commissioning under condensation conditions)	-40 °C; = Tmin; Startup @ -25 °C 70 °C; = Tmax; Tmax > +55 °C max. load 3 A per relay -25 °C; incl. condensation / frost permitted (no commissioning under condensation conditions)	
Altitude during operation relating to sea level			
<ul style="list-style-type: none"> Installation altitude above sea level, max. Ambient air temperature-barometric pressure-altitude 	2 000 m Tmin ... Tmax at 1 140 hPa ... 795 hPa (-1 000 m ... +2 000 m)	5 000 m Tmin ... Tmax at 1 140 hPa ... 795 hPa (-1 000 m ... +2 000 m) // Tmin ... (Tmax - 10 K) at 795 hPa ... 658 hPa (+2 000 m ... +3 500 m) // Tmin ... (Tmax -20 K) at 658 hPa ... 540 hPa (+3 500 m ... +5 000 m)	
Relative humidity			
<ul style="list-style-type: none"> With condensation, tested in accordance with IEC 60068-2-38, max. 	100 %; RH incl. condensation / frost (no commissioning in bedewed state), horizontal installation	100 %; RH incl. condensation / frost (no commissioning in bedewed state), horizontal installation	
Resistance			
Coolants and lubricants			
<ul style="list-style-type: none"> Resistant to commercially available coolants and lubricants 	Yes; Incl. diesel and oil droplets in the air	Yes; Incl. diesel and oil droplets in the air	
Use in stationary industrial systems			
<ul style="list-style-type: none"> to biologically active substances according to EN 60721-3-3 to chemically active substances according to EN 60721-3-3 to mechanically active substances according to EN 60721-3-3 	Yes; Class 3B2 mold, fungus and dry rot spores (with the exception of fauna); Class 3B3 on request Yes; Class 3C4 (RH < 75 %) incl. salt spray acc. to EN 60068-2-52 (severity degree 3); * Yes; Class 3S4 incl. sand, dust, *	Yes; Class 3B2 mold, fungus and dry rot spores (with the exception of fauna); Class 3B3 on request Yes; Class 3C4 (RH < 75 %) incl. salt spray acc. to EN 60068-2-52 (severity degree 3); * Yes; Class 3S4 incl. sand, dust, *	
Use on ships/at sea			
<ul style="list-style-type: none"> to biologically active substances according to EN 60721-3-6 to chemically active substances according to EN 60721-3-6 to mechanically active substances according to EN 60721-3-6 	Yes; Class 6B2 mold and fungal spores (excluding fauna); Class 6B3 on request Yes; Class 6C3 (RH < 75 %) incl. salt spray acc. to EN 60068-2-52 (severity degree 3); * Yes; Class 6S3 incl. sand, dust; *	Yes; Class 6B2 mold and fungal spores (excluding fauna); Class 6B3 on request Yes; Class 6C3 (RH < 75 %) incl. salt spray acc. to EN 60068-2-52 (severity degree 3); * Yes; Class 6S3 incl. sand, dust; *	
Usage in industrial process technology			
<ul style="list-style-type: none"> Against chemically active substances acc. to EN 60654-4 Environmental conditions for process, measuring and control systems acc. to ANSI/ISA-71.04 	Yes; Class 3 (excluding trichlorethylene) Yes; Level GX group A/B (excluding trichlorethylene; harmful gas concentrations up to the limits of EN 60721-3-3 class 3C4 permissible); level LC3 (salt spray) and level LB3 (oil)	Yes; Class 3 (excluding trichlorethylene) Yes; Level GX group A/B (excluding trichlorethylene; harmful gas concentrations up to the limits of EN 60721-3-3 class 3C4 permissible); level LC3 (salt spray) and level LB3 (oil)	
Remark			
<ul style="list-style-type: none"> Note regarding classification of environmental conditions acc. to EN 60721, EN 60654-4 and ANSI/ISA-71.04 	* The supplied plug covers must remain in place over the unused interfaces during operation!	* The supplied plug covers must remain in place over the unused interfaces during operation!	

LOGO! logic module

LOGO! basic and expansion modules

SIPLUS LOGO! expansion modules**Technical specifications**

Article number	6AG1055-1FB00-7BA2	6AG1055-1NB10-7BA2
Based on	6ED1055-1FB00-0BA2 SIPLUS LOGO! DM8 230R V8	6ED1055-1NB10-0BA2 SIPLUS LOGO! DM16 24R V8
Conformal coating		
<ul style="list-style-type: none"> Coatings for printed circuit board assemblies acc. to EN 61086 Protection against fouling acc. to EN 60664-3 Military testing according to MIL-I-46058C, Amendment 7 Qualification and Performance of Electrical Insulating Compound for Printed Board Assemblies according to IPC-CC-830A 	<ul style="list-style-type: none"> Yes; Class 2 for high reliability Yes; Type 1 protection Yes; Discoloration of coating possible during service life Yes; Conformal coating, Class A 	<ul style="list-style-type: none"> Yes; Class 2 for high reliability Yes; Type 1 protection Yes; Discoloration of coating possible during service life Yes; Conformal coating, Class A
Article number	6AG1055-1MA00-7BA2	6AG1055-1MD00-7BA2
Based on	6ED1055-1MA00-0BA2 SIPLUS LOGO! AM2 V8	6ED1055-1MD00-0BA2 SIPLUS LOGO! AM2 RTD
Ambient conditions		
Ambient temperature during operation		
<ul style="list-style-type: none"> min. max. At cold restart, min. 	<ul style="list-style-type: none"> -40 °C; = Tmin; Startup @ -25 °C 70 °C; = Tmax -25 °C; incl. condensation / frost permitted (no commissioning under condensation conditions) 	<ul style="list-style-type: none"> -40 °C; = Tmin; Startup @ -25 °C 70 °C; = Tmax -25 °C; incl. condensation / frost permitted (no commissioning under condensation conditions)
Altitude during operation relating to sea level		
<ul style="list-style-type: none"> Installation altitude above sea level, max. Ambient air temperature-barometric pressure-altitude 	<ul style="list-style-type: none"> 5 000 m Tmin ... Tmax at 1 140 hPa ... 795 hPa (-1 000 m ... +2 000 m) // Tmin ... (Tmax - 10 K) at 795 hPa ... 658 hPa (+2 000 m ... +3 500 m) // Tmin ... (Tmax -20 K) at 658 hPa ... 540 hPa (+3 500 m ... +5 000 m) 	<ul style="list-style-type: none"> 5 000 m Tmin ... Tmax at 1 140 hPa ... 795 hPa (-1 000 m ... +2 000 m) // Tmin ... (Tmax - 10 K) at 795 hPa ... 658 hPa (+2 000 m ... +3 500 m) // Tmin ... (Tmax -20 K) at 658 hPa ... 540 hPa (+3 500 m ... +5 000 m)
Relative humidity		
<ul style="list-style-type: none"> With condensation, tested in accordance with IEC 60068-2-38, max. 	100 %; RH incl. condensation / frost (no commissioning in bedewed state), horizontal installation	100 %; RH incl. condensation / frost (no commissioning in bedewed state), horizontal installation
Resistance		
Coolants and lubricants		
<ul style="list-style-type: none"> Resistant to commercially available coolants and lubricants 	Yes; Incl. diesel and oil droplets in the air	Yes; Incl. diesel and oil droplets in the air
Use in stationary industrial systems		
<ul style="list-style-type: none"> to biologically active substances according to EN 60721-3-3 to chemically active substances according to EN 60721-3-3 to mechanically active substances according to EN 60721-3-3 	<ul style="list-style-type: none"> Yes; Class 3B2 mold, fungus and dry rot spores (with the exception of fauna); Class 3B3 on request Yes; Class 3C4 (RH < 75 %) incl. salt spray acc. to EN 60068-2-52 (severity degree 3); * Yes; Class 3S4 incl. sand, dust, * 	<ul style="list-style-type: none"> Yes; Class 3B2 mold, fungus and dry rot spores (with the exception of fauna); Class 3B3 on request Yes; Class 3C4 (RH < 75 %) incl. salt spray acc. to EN 60068-2-52 (severity degree 3); * Yes; Class 3S4 incl. sand, dust, *
Use on ships/at sea		
<ul style="list-style-type: none"> to biologically active substances according to EN 60721-3-6 to chemically active substances according to EN 60721-3-6 to mechanically active substances according to EN 60721-3-6 	<ul style="list-style-type: none"> Yes; Class 6B2 mold and fungal spores (excluding fauna); Class 6B3 on request Yes; Class 6C3 (RH < 75 %) incl. salt spray acc. to EN 60068-2-52 (severity degree 3); * Yes; Class 6S3 incl. sand, dust; * 	<ul style="list-style-type: none"> Yes; Class 6B2 mold and fungal spores (excluding fauna); Class 6B3 on request Yes; Class 6C3 (RH < 75 %) incl. salt spray acc. to EN 60068-2-52 (severity degree 3); * Yes; Class 6S3 incl. sand, dust; *
Usage in industrial process technology		
<ul style="list-style-type: none"> Against chemically active substances acc. to EN 60654-4 Environmental conditions for process, measuring and control systems acc. to ANSI/ISA-71.04 	<ul style="list-style-type: none"> Yes; Class 3 (excluding trichlorethylene) Yes; Level GX group A/B (excluding trichlorethylene; harmful gas concentrations up to the limits of EN 60721-3-3 class 3C4 permissible); level LC3 (salt spray) and level LB3 (oil) 	<ul style="list-style-type: none"> Yes; Class 3 (excluding trichlorethylene) Yes; Level GX group A/B (excluding trichlorethylene; harmful gas concentrations up to the limits of EN 60721-3-3 class 3C4 permissible); level LC3 (salt spray) and level LB3 (oil)
Remark		
<ul style="list-style-type: none"> Note regarding classification of environmental conditions acc. to EN 60721, EN 60654-4 and ANSI/ISA-71.04 	* The supplied plug covers must remain in place over the unused interfaces during operation!	* The supplied plug covers must remain in place over the unused interfaces during operation!

Technical specifications

Article number	6AG1055-1MA00-7BA2	6AG1055-1MD00-7BA2	
Based on	6ED1055-1MA00-0BA2 SIPLUS LOGO! AM2 V8	6ED1055-1MD00-0BA2 SIPLUS LOGO! AM2 RTD	
Conformal coating			
<ul style="list-style-type: none"> Coatings for printed circuit board assemblies acc. to EN 61086 Protection against fouling acc. to EN 60664-3 Military testing according to MIL-I-46058C, Amendment 7 Qualification and Performance of Electrical Insulating Compound for Printed Board Assemblies according to IPC-CC-830A 	<ul style="list-style-type: none"> Yes; Class 2 for high reliability Yes; Type 1 protection Yes; Discoloration of coating possible during service life Yes; Conformal coating, Class A 	<ul style="list-style-type: none"> Yes; Class 2 for high reliability Yes; Type 1 protection Yes; Discoloration of coating possible during service life Yes; Conformal coating, Class A 	
Article number	6AG1055-1MM00-7BA2	Article number	6AG1055-1MM00-7BA2
Based on	6ED1055-1MM00-0BA2 SIPLUS LOGO! AM2 AQ V8	Based on	6ED1055-1MM00-0BA2 SIPLUS LOGO! AM2 AQ V8
Ambient conditions		Usage in industrial process technology	
Ambient temperature during operation		<ul style="list-style-type: none"> Against chemically active substances acc. to EN 60654-4 Environmental conditions for process, measuring and control systems acc. to ANSI/ISA-71.04 	<ul style="list-style-type: none"> Yes; Class 3 (excluding trichlorethylene) Yes; Level GX group A/B (excluding trichlorethylene; harmful gas concentrations up to the limits of EN 60721-3-3 class 3C4 permissible); level LC3 (salt spray) and level LB3 (oil)
<ul style="list-style-type: none"> min. max. At cold restart, min. 	<ul style="list-style-type: none"> -40 °C; = Tmin; Startup @ -25 °C 70 °C; = Tmax -25 °C; incl. condensation / frost permitted (no commissioning under condensation conditions) 	Remark	<ul style="list-style-type: none"> Note regarding classification of environmental conditions acc. to EN 60721, EN 60654-4 and ANSI/ISA-71.04
Altitude during operation relating to sea level		Conformal coating	
<ul style="list-style-type: none"> Installation altitude above sea level, max. Ambient air temperature-barometric pressure-altitude 	<ul style="list-style-type: none"> 5 000 m Tmin ... Tmax at 1 140 hPa ... 795 hPa (-1 000 m ... +2 000 m) // Tmin ... (Tmax - 10 K) at 795 hPa ... 658 hPa (+2 000 m ... +3 500 m) // Tmin ... (Tmax -20 K) at 658 hPa ... 540 hPa (+3 500 m ... +5 000 m) 	<ul style="list-style-type: none"> Coatings for printed circuit board assemblies acc. to EN 61086 Protection against fouling acc. to EN 60664-3 Military testing according to MIL-I-46058C, Amendment 7 Qualification and Performance of Electrical Insulating Compound for Printed Board Assemblies according to IPC-CC-830A 	<ul style="list-style-type: none"> Yes; Class 2 for high reliability Yes; Type 1 protection Yes; Discoloration of coating possible during service life Yes; Conformal coating, Class A
Relative humidity			
<ul style="list-style-type: none"> With condensation, tested in accordance with IEC 60068-2-38, max. 	<ul style="list-style-type: none"> 100 %; RH incl. condensation / frost (no commissioning in bedewed state), horizontal installation 		
Resistance			
Coolants and lubricants			
<ul style="list-style-type: none"> Resistant to commercially available coolants and lubricants 	<ul style="list-style-type: none"> Yes; Incl. diesel and oil droplets in the air 		
Use in stationary industrial systems			
<ul style="list-style-type: none"> to biologically active substances according to EN 60721-3-3 to chemically active substances according to EN 60721-3-3 to mechanically active substances according to EN 60721-3-3 	<ul style="list-style-type: none"> Yes; Class 3B2 mold, fungus and dry rot spores (with the exception of fauna); Class 3B3 on request Yes; Class 3C4 (RH < 75 %) incl. salt spray acc. to EN 60068-2-52 (severity degree 3); * Yes; Class 3S4 incl. sand, dust, * 		
Use on ships/at sea			
<ul style="list-style-type: none"> to biologically active substances according to EN 60721-3-6 to chemically active substances according to EN 60721-3-6 to mechanically active substances according to EN 60721-3-6 	<ul style="list-style-type: none"> Yes; Class 6B2 mold and fungal spores (excluding fauna); Class 6B3 on request Yes; Class 6C3 (RH < 75 %) incl. salt spray acc. to EN 60068-2-52 (severity degree 3); * Yes; Class 6S3 incl. sand, dust; * 		

LOGO! logic module

LOGO! communications modules

Introduction

Overview

2



- Communications modules for connecting LOGO! Modular to different bus systems.

Note on compatibility:

Communications module	Can be used with:
LOGO! CMK2000 communications module	LOGO! ...0BA8
LOGO! CIM	LOGO! 8
LOGO! CSM 12/24	LOGO! ...0BA7/...0BA8
LOGO! CSM 230	LOGO! ...0BA7
LOGO! CMR2020	LOGO! ...0BA8
LOGO! CMR2040	LOGO! ...0BA8

Overview

- Expansion module for LOGO! 8 basic versions
- For integrating LOGO! 8 in KNX installations
- With 24 digital inputs, 20 digital outputs as well as 8 analog inputs and outputs for processing process signals via KNX.

Ordering data
Article No.
LOGO! CMK2000 communications module
6BK1700-0BA20-0AA0

For integrating LOGO! 8 in the KNX building system bus, max. 50 communication objects can be configured;
 RJ45 port for Ethernet;
 supply voltage 24 V DC/40 mA

Technical specifications

Article number	6BK1700-0BA20-0AA0 LOGO! CMK2000
General information	
Firmware version	
• FW update possible	Yes
Installation type/mounting	
Mounting	on 35 mm DIN rail, 4 spacing units wide
Supply voltage	
Rated value (DC)	24 V
Input current	
Current consumption, max.	0.04 A
Power loss	
Power loss, max.	1.1 W
Memory	
Flash	Yes
Time of day	
Clock synchronization	
• supported	Yes

Article number	6BK1700-0BA20-0AA0 LOGO! CMK2000
Interfaces	
Number of industrial Ethernet interfaces	1; Ethernet, 1 port, RJ45
Number of other interfaces	1; EIB/KNX
Transmission rate, max.	100 Mbit/s over Ethernet, 9 600 bit/s over KNX
Design of plug-in connection	KNX terminal 0.6 mm ² - 1.0 mm ²
Protocols	
EIB/KNX	Yes
Web server	
• supported	Yes
communication functions / header	
S7 basic communication	
• supported	No
LOGO! communication	
• supported	Yes
Interrupts/diagnostics/status information	
Diagnostics indication LED	
• RUN/STOP LED	Yes
EMC	
Emission of radio interference acc. to EN 55 011	
• Limit class B, for use in residential areas	Yes; In accordance with EN 61000-6-3
Degree and class of protection	
IP degree of protection	IP20
Standards, approvals, certificates	
CE mark	Yes
CSA approval	Yes
UL approval	Yes
cULus	Yes
FM approval	No
RCM (formerly C-TICK)	No
KC approval	Yes
EAC (formerly Gost-R) according to VDE 0631	Yes
Marine approval	No
Ambient conditions	
Ambient temperature during operation	
• min.	0 °C
• max.	55 °C
Relative humidity	
• Operation, max.	95 %
connection method / header	
Design of electrical connection for supply voltage	2 screw-type terminals: L+, M 0.5 mm ² - 2.5 mm ² Screw-type terminal: FE 0.5 mm ² ... 6.0 mm ²
Dimensions	
Width	71.5 mm; 4TE
Height	90 mm
Depth	58.5 mm
Weights	
Weight, approx.	0.14 kg

LOGO! logic module

LOGO! communications modules

LOGO! CIM (Communication Interface Module)

Overview



- Expansion module for LOGO! 8 basic versions
- For transmitting and receiving SMS and transmission of data from LOGO! 8.3 basic units to the AWS Cloud
- The built-in ModbusRTU interface supports ModbusRTU participants with RS232, RS485 and RS422 interface
- With an integrated GNSS receiver for tracking and transmitting the position

Note

For wireless operation, the following additional components are required (not included in the scope of delivery of LOGO! CIM):

- Wireless engine
- Antennas
- Antenna connecting cable between wireless engine and antenna port (the corresponding products are recommended in the documentation)
- SIM card with activated data transmission

Ordering data

Article No.

Communications module LOGO! CIM (Communication Interface Module)

For transmitting and receiving SMS and transmission of data to the AWS Cloud

6ED1055-5MC08-0BA1

Technical specifications

Article number	6ED1055-5MC08-0BA1 LOGO! CIM
General information	
Firmware version	V1.0.0
• FW update possible	Yes
Installation type/mounting	
Mounting	on 35 mm DIN rail, 4 spacing units wide
Supply voltage	
Rated value (DC)	24 V; 12 V DC, 12/24 V AC/DC
• 12 V DC	Yes
• 24 V DC	Yes
Rated value (AC)	
• 24 V AC	No
Input current	
Current consumption, max.	1 A

Article number	6ED1055-5MC08-0BA1 LOGO! CIM
Memory	
Flash	Yes; 2 MB NOR flash
Time of day	
Clock synchronization	
• supported	Yes
Interfaces	
Number of industrial Ethernet interfaces	4; 4 ports (switch)
Number of other interfaces	1; mini PCIe interface for 4G module
Protocols	
Web server	
• supported	Yes
communication functions / header	
S7 basic communication	
• supported	Yes
LOGO! communication	
• supported	Yes
Interrupts/diagnostics/status information	
Diagnostics indication LED	
• RUN/STOP LED	Yes
EMC	
Emission of radio interference acc. to EN 55 011	
• Limit class B, for use in residential areas	Yes
Standards, approvals, certificates	
CE mark	Yes
UL approval	Yes
cULus	Yes
FM approval	Yes
RCM (formerly C-TICK)	Yes
KC approval	Yes
EAC (formerly Gost-R)	Yes
developed in accordance with IEC 61131	Yes
according to VDE 0631	No
Marine approval	No
Ambient conditions	
Ambient temperature during operation	
• min.	-20 °C
• max.	55 °C
Relative humidity	
• Operation, max.	95 %; no condensation
Dimensions	
Width	71.5 mm
Height	90 mm
Depth	58.5 mm; without antenna sockets
Weights	
Weight, approx.	200 g

Overview

The module is used to connect a LOGO! and up to three other nodes to an Industrial Ethernet network with 10/100 Mbps in an electrical linear, tree or star topology.

The essential features of the LOGO! CSM are:

- Unmanaged 4-port switch, of which one port is on the front for easy diagnostics access
- Two versions for the voltage ranges 12/24 V DC or 230 V AC/DC
- Problem-free connection using four RJ45 standard connectors
- Space-saving, optimized for connection to LOGO!
- Low-cost solution for implementing small, local Ethernet networks
- Stand-alone use for networking any Ethernet devices

Ordering data
Article No.
LOGO! CSM compact switch modules

Unmanaged switch for connection of one LOGO! and up to three further nodes on Industrial Ethernet with 10/100 Mbps; 4 x RJ45 ports; LED diagnostics, LOGO! module

- **LOGO! CSM12/24**
external 12 V DC or 24 V DC power supply, for LOGO! ... 0BA7/... 0BA8

6GK7177-1MA20-0AA0

- **LOGO! CSM230**
external 115 ... 240 V AC power supply, for LOGO! ... 0BA7

6GK7177-1FA10-0AA0
Accessories
IE TP cord RJ45/RJ45

TP cable 4 x 2 with 2 RJ45 plugs

- 0.5 m
- 1 m
- 2 m
- 6 m
- 10 m

6XV1870-3QE50
6XV1870-3QH10
6XV1870-3QH20
6XV1870-3QH60
6XV1870-3QN10
IE FC outlet RJ45

For connection of Industrial Ethernet FC cables and TP cords; graduated prices for 10 and 50 units or more

6GK1901-1FC00-0AA0

LOGO! logic module

LOGO! communications modules

LOGO! CSM unmanaged**Technical specifications**

Article number	6GK7177-1FA10-0AA0	6GK7177-1MA20-0AA0
product type designation	LOGO! CSM 230	LOGO! CSM 12/24
transfer rate		
transfer rate	10 Mbit/s, 100 Mbit/s	10 Mbit/s, 100 Mbit/s
interfaces for communication integrated		
number of electrical connections		
• for network components or terminal equipment	4	4
number of 100 Mbit/s SC ports		
• for multimode	0	0
number of 1000 Mbit/s LC ports		
• for multimode	0	0
• for single mode (LD)	0	0
interfaces other		
number of electrical connections		
• for power supply	1	1
type of electrical connection		
• for power supply	3-pole terminal block	3-pole terminal block
supply voltage, current consumption, power loss		
type of voltage 1 of the supply voltage	DC	DC
• supply voltage 1 rated value	230 V	24 V
• power loss [W] 1 rated value		1.5 W
• supply voltage 1 rated value	100 ... 240 V	10.2 ... 30.2 V
• consumed current 1 maximum	0.02 A	0.15 A
• type of electrical connection 1 for power supply	3-pole terminal block	3-pole terminal block
• product component 1 fusing at power supply input	Yes	Yes
type of voltage 2 of the supply voltage		
• supply voltage 2 rated value	100 ... 240 V	
ambient conditions		
ambient temperature		
• during operation	0 ... 55 °C	0 ... 55 °C
• during storage	-40 ... +70 °C	-40 ... +70 °C
• during transport	-40 ... +70 °C	-40 ... +70 °C
relative humidity		
• at 25 °C without condensation during operation maximum	90 %	90 %
protection class IP	IP20	IP20
design, dimensions and weights		
design	LOGO! module	LOGO! module
width	72 mm	71.5 mm
height	90 mm	90 mm
depth	55 mm	58.2 mm
net weight	0.155 kg	0.15 kg
fastening method		
• 35 mm top hat DIN rail mounting	Yes	Yes
• wall mounting	Yes	Yes
• S7-300 rail mounting	No	No
• S7-1500 rail mounting	No	No

Technical specifications

Article number	6GK7177-1FA10-0AA0	6GK7177-1MA20-0AA0
product type designation	LOGO! CSM 230	LOGO! CSM 12/24
product functions management, configuration, engineering		
product function		
• multiport mirroring	No	No
product function switch-managed	No	No
standards, specifications, approvals		
standard		
• for FM	FM3600 and 3611: CL. I, Div2, Group A,B,C,D T4, CL I, Zone 2, Group IIC, T4, Ta=55°C	
• for safety from CSA and UL	UL60079-0, UL60079-15, CSA C22.2	UL 508, CSA C22.2 No. 142
reference code		
• acc. to IEC 81346-2	KF	KF
• according to IEC 81346-2:2019	KFE	KFE
standards, specifications, approvals CE		
certificate of suitability CE marking	Yes	Yes
standards, specifications, approvals hazardous environments		
standard for hazardous zone	no	ATEX: EN 60079-0 : 2009, EN 60079-15 :2010 (Directive 94/9/EC), IECEx: IEC 60079-0 :2011, IEC 60079-15 :2010
• from CSA and UL		Haz-Loc ANSI/ISA 12.12.01: CL. I, Div2, Group A,B,C,D T4, CL I, Zone 2, Group IIC, T4, Ta=55°C
certificate of suitability		
• CCC for hazardous zone according to GB standard		Yes
standards, specifications, approvals other		
certificate of suitability		
• C-Tick	Yes	Yes
• KC approval	No	No
standards, specifications, approvals marine classification		
Marine classification association		
• American Bureau of Shipping Europe Ltd. (ABS)	No	No
• French marine classification society (BV)	No	No
• Det Norske Veritas (DNV)	No	No
• Germanische Lloyd (GL)	No	No
• Lloyds Register of Shipping (LRS)	No	No
• Nippon Kaiji Kyokai (NK)	No	No
• Polski Rejestr Statkow (PRS)	No	No

LOGO! logic module

LOGO! communications modules

LOGO! CMR (wireless communication)

Overview



LOGO! CMR in combination with the LOGO! logic module is a cost-efficient communication system suitable for monitoring and controlling distributed plants and systems via text message or email.

LOGO! CMR can send text messages or emails to predefined mobile network numbers as well as receive text messages from predefined mobile network numbers.

Sending a text message/email can be initiated by events in the LOGO! basic module as well as by the two digital alarm inputs of the LOGO! CMR. The values in the LOGO! logic module can be directly influenced by receiving a text message.

The LOGO! CMR offers convenient commissioning and diagnostics in web-based management via local and/or secure remote access.

The two digital outputs can also be switched remotely by incoming text messages/emails.

LOGO! CMR determines the current position of the module based on the GPS signal received by the GPS antenna. In addition, the LOGO! 8 logic module can be time-synchronized by means of the time included in the GPS signal. Determination of time by means of an NTP server or from the data of the mobile network provider offers more options for synchronization of the LOGO! BM with the current time of day.

Product version:

- LOGO! CMR2020 for use in GSM/GPRS mobile wireless networks
- LOGO! CMR2040 for use in LTE mobile wireless networks

Warning! The country-specific mobile network approvals must be observed:

DE: <http://www.siemens.de/mobilfunkzulassungen>

EN: <http://www.siemens.com/mobilenetwork-approvals>

Ordering data

Article No.

Communications module radio LOGO! CMR

Communications modules for connection of LOGO! 8 to GSM/GPRS or LTE network;
1x RJ45 port for Industrial Ethernet connection;
2x digital input;
2x digital output;
read/write access to LOGO! tags;
possible to send/receive text messages;
GPS position detection;
time-of-day synchronization/forwarding with real-time clock;
configuration and diagnostics per web interface;
Note country approvals:
www.siemens.com/mobilenetwork-approvals

LOGO! CMR2020

For connecting LOGO! 8 to a GSM/GPRS network

6GK7142-7BX00-0AX0

LOGO! CMR2040

For connecting LOGO! 8 to an LTE network

6GK7142-7EX00-0AX0

Accessories

Mobile wireless antennas

ANT794-4MR

For indoor and outdoor use;
5 m connecting cable permanently connected to antenna;
SMA plug; incl. mounting bracket, screws, wall anchors

6NH9860-1AA00

ANT896-4MA

Rod antenna for direct mounting on device; SMA male connector

6GK5896-4MA00-0AA3

ANT896-4ME

Cylinder-shaped antenna for remote installation, e.g. on a control cabinet;
N-Connect female connector

6GK5896-4ME00-0AA0

GPS antenna

ANT895-6ML

GPS/Glonass antenna for remote installation indoor and outdoor, magnet or screw mounting, 30 cm cable with N-Connect female connector

6GK5895-6ML00-0AA0

Antenna adapter cable

N-Connect/SMA male/male flexible connecting cable, pre-assembled, connecting cable;
suitable for 0 ... 6 GHz, IP68

- 0.3 m
- 1 m
- 2 m
- 5 m

6XV1875-5LE30
6XV1875-5LH10
6XV1875-5LH20
6XV1875-5LH50

Ordering data	Article No.	Article No.	
IWLAN RCoax/ antenna N-Connect male/male flexible connection cable Flexible connecting cable for connecting an RCoax cable or antenna to a SCALANCE W-700 access point with N-Connect connectors; pre-assembled with two N-Connect male plugs; suitable from 0 ... 6 GHz, IP68 <ul style="list-style-type: none"> • 1 m • 2 m • 5 m • 10 m 	6XV1875-5AH10 6XV1875-5AH20 6XV1875-5AH50 6XV1875-5AN10	Stainless steel enclosure in IP68 degree of protection Stainless steel enclosure in IP68 degree of protection; suitable for SIMATIC RTU3030C; temperature range -60 to +135 °C; matte surface; cover with Pin Torx screws and padlock 7 cable openings and opening for mobile wireless antenna prepared; please order the needed quantity of cable glands and sealing plugs separately	6NH3112-3BA00-1XX1
Cabinet bushing IWLAN RCOAX N-Connect/ N-Connect female/female panel feedthrough; Control cabinet feedthrough for wall thickness max. 4.5 mm; 2.4 GHz and 5 GHz, suitable from 0 ... 6 GHz, IP67	6GK5798-2PP00-2AA6	Aluminum enclosure in IP68 degree of protection Aluminum enclosure in IP68 degree of protection; suitable for SIMATIC RTU3030C; temperature range -40 to +80 °C; cover with Pin Torx screws; 7 cable openings and opening for mobile wireless antenna prepared; please order the needed quantity of cable glands and sealing plugs separately	6NH3112-3BA00-1XX3
Lightning protector LP798-2N Lightning protector with N/N female/female connection for ANT 790 antennas, IP67 (-40 to +85 °C), frequency range: 0 ... 6 GHz	6GK5798-2LP00-2AA6	Cable gland PG16 F for IP68 enclosure Cable gland, M16, IP68, -40 to +100 °C; nickel-plated brass; suitable for enclosure with article numbers 6NH3112-3BA00-1x X1 and 6NH3112-3BA00-1x X3 pack quantity = 2 units	6NH3112-3BA00-1XX4
Patch cable IE TP cord RJ45/RJ45 TP cable 4 x 2 with 2 RJ45 plugs <ul style="list-style-type: none"> • 0.5 m • 1 m • 2 m • 6 m • 10 m 	6XV1870-3QE50 6XV1870-3QH10 6XV1870-3QH20 6XV1870-3QH60 6XV1870-3QN10	Sealing plug M16 for IP68 enclosure Sealing plug, M16, IP68, -40 to +100 °C; nickel-plated brass; suitable for enclosure with article numbers 6NH3112-3BA00-1x X1 and 6NH3112-3BA00-1x X3, pack quantity = 2 units	6NH3112-3BA00-1XX5
IE FC RJ45 outlet For connection of Industrial Ethernet FC cables and TP cords; graded prices from 10 and 50 units	6GK1901-1FC00-0AA0		
LOGO! CSM12/24 Compact Switch Module for connecting a LOGO! (...0BA7/...0BA8) and up to 3 additional nodes to Industrial Ethernet; 12/24 V DC power supply	6GK7177-1MA20-0AA0		
LOGO! CSM230 Compact Switch Module for connecting a LOGO! (... 0BA7) and up to 3 additional nodes to Industrial Ethernet 115 ... 240 V AC/DC power supply	6GK7177-1FA10-0AA0		

LOGO! logic module

LOGO! communications modules

LOGO! CMR (wireless communication)**Technical specifications**

Article number	6GK7142-7BX00-0AX0	6GK7142-7EX00-0AX0
Product type designation	CMR2020	CMR2040
transfer rate		
transfer rate		
• at the 1st interface	10 ... 100 Mbit/s	10 ... 100 Mbit/s
• for GPRS transmission		
- with downlink maximum	80 kbit/s	85.6 kbit/s
- with uplink maximum	40 kbit/s	85.6 kbit/s
• for LTE transmission		
- with downlink maximum		100 Mbit/s
- with uplink maximum		50 Mbit/s
interfaces		
number of interfaces acc. to Industrial Ethernet	1	1
number of electrical connections		
• at the 1st interface acc. to Industrial Ethernet	1	1
• for external antenna(s)	2	2
• for power supply	1	1
number of slots		
• for SIM cards	1	1
• for memory cards	1	1
type of electrical connection		
• at the 1st interface acc. to Industrial Ethernet	RJ45 port	RJ45 port
type of electrical connection		
• for external antenna(s)	SMA socket (50 ohms)	SMA socket (50 ohms)
• for power supply	3-pole terminal block	3-pole terminal block
type of antenna		
• at connection 1 connectable	GPS Antenna	GPS Antenna
• at connection 2 connectable	Mobile radio antenna (GPRS/GSM)	Mobile radio antenna (GPRS/GSM, UMTS, LTE)
wire length of antenna wire maximum	15 m	15 m
slot version		
• for SIM card	Standard	Standard
• of the memory card	microSD	microSD
storage capacity of the memory card maximum	32 Gbyte	32 Gbyte
performance class of the memory card minimum necessary	Class 6	Class 6
type of file system type of file system	FAT32	FAT32
signal inputs/outputs		
number of electrical connections for digital input signals	2	2
type of electrical connection for digital input signals	3 pole terminal block	3 pole terminal block
digital input version	not galvanically isolated, not debounced	not galvanically isolated, not debounced
input voltage at digital input		
• with signal <0> at DC	0 ... 5 V	0 ... 5 V
• for signal <1> at DC	8.5 ... 24 V	8.5 ... 24 V
input current at digital input for signal <1> maximum	5.5 mA	5.5 mA
number of electrical connections for digital output signals	2	2

Technical specifications

Article number	6GK7142-7BX00-0AX0	6GK7142-7EX00-0AX0
Product type designation	CMR2020	CMR2040
type of electrical connection for digital output signals	3 pole terminal block	3 pole terminal block
digital output version	transistor, not potential seperated	transistor, not potential seperated
output voltage at digital output		
• for signal <1>	12 ... 24 V; Value of the actual supply voltage	12 ... 24 V; Value of the actual supply voltage
• for signal <0>	0 ... 5 V	0 ... 5 V
output current at digital output for signal <1> maximum	0.3 A	0.3 A
wireless technology		
type of mobile wireless service		
• is supported SMS	Yes	Yes
• is supported GPRS	Yes	Yes
• note	GPRS (Multislot Class 10, Mobile Station Class B)	LTE
type of wireless network is supported		
• GSM	Yes	Yes
• UMTS	No	Yes
• LTE	No	Yes
operating frequency for GSM transmission	operating frequency for GSM transmission 850 MHz, operating frequency for GSM transmission 900 MHz, operating frequency for GSM transmission 1800 MHz, operating frequency for GSM transmission 1900 MHz	operating frequency for GSM transmission 900 MHz, operating frequency for GSM transmission 1800 MHz
operating frequency with UMTS transmission		operating frequency with UMTS transmission 850 MHz, operating frequency with UMTS transmission 900 MHz, operating frequency with UMTS transmission 2100 MHz
operating frequency for LTE transmission		operating frequency for LTE transmission 800 MHz, operating frequency for LTE transmission 1800 MHz, operating frequency for LTE transmission 2600 MHz
supply voltage, current consumption, power loss		
type of voltage of the supply voltage	DC	DC
supply voltage external	12 ... 24 V	12 ... 24 V
supply voltage external at DC	12 ... 24 V	12 ... 24 V
supply voltage for GPS antenna maximum	3.8 V; at 5 mA: 3,575 V / at 10 mA: 3,35 V / at 15 mA: 3,125 V	3.8 V; at 5 mA: 3,575 V / at 10 mA: 3,35 V / at 15 mA: 3,125 V
relative positive tolerance at DC at 24 V	20 %	20 %
relative negative tolerance at DC at 12 V	10 %	10 %
consumed current		
• from external supply voltage at DC at 12 V maximum	0.25 A	0.25 A
• from external supply voltage at DC at 24 V maximum	0.125 A	0.125 A
output current for GPS antenna maximum	15 mA	15 mA
power loss [W]	3 W	3 W
ambient conditions		
ambient temperature		
• during operation	-20 ... +70 °C	-20 ... +70 °C
• during storage	-40 ... +85 °C	-40 ... +85 °C
• during transport	-40 ... +85 °C	-40 ... +85 °C
relative humidity		
• at 25 °C without condensation during operation maximum	95 %	95 %
protection class IP	IP20	IP20

LOGO! logic module

LOGO! communications modules

LOGO! CMR (wireless communication)**Technical specifications**

Article number	6GK7142-7BX00-0AX0	6GK7142-7EX00-0AX0
Product type designation	CMR2020	CMR2040
design, dimensions and weights		
module format	Compact module, for rail mounting	Compact module, for rail mounting
width	71.5 mm	71.5 mm
height	90 mm	90 mm
depth	58.2 mm	58.2 mm
net weight	0.16 kg	0.16 kg
fastening method		
• 35 mm top hat DIN rail mounting	Yes	Yes
• wall mounting	Yes	Yes
product features, product functions, product components general		
product function		
• DynDNS client	Yes	Yes
• no-ip.com client	Yes	Yes
performance data		
number of possible connections to the LOGO! logic module	1	1
number of users/telephone numbers/email addresses definable maximum	20	20
number of user groups definable maximum	10	10
number of signals for monitoring or device control definable maximum	32	32
number of events for monitoring definable maximum	32	32
number of actions definable maximum	32	32
number of assignments definable maximum	32	32
number of alias SMS commands definable maximum	20	20
number of constants definable maximum	10	10
performance data IT functions		
number of possible connections		
• as server by means of HTTP maximum	2	2
• as server by means of HTTPS maximum	2; http and https can be combined (max. number of 2 connections cannot be exceeded). Max. one connection via https is possible on the mobile wireless interface.	2; http and https can be combined (max. number of 2 connections cannot be exceeded). Max. one connection via https is possible on the mobile wireless interface.
• as email client maximum	1	1
number of free texts for emails and SMS maximum	20	20
number of characters per free text for emails or SMS maximum	160	160
performance data teleservice		
product function		
• remote firmware update	Yes	Yes
• remote configuration	Yes	Yes
product functions management, configuration, engineering		
configuration software		
• required	Web interface	Web interface
product functions diagnostics		
product function web-based diagnostics	Yes	Yes

Technical specifications

Article number	6GK7142-7BX00-0AX0	6GK7142-7EX00-0AX0
Product type designation	CMR2020	CMR2040
product functions security		
operating mode Virtual Private Network (VPN)	Yes; Open VPN Server in PSK mode	Yes; Open VPN Server in PSK mode
product function with VPN connection	OpenVPN PSK	OpenVPN PSK
type of encryption algorithms with VPN connection	AES-128 CBC	AES-128 CBC
type of authentication with Virtual Private Network PSK	Yes	Yes
type of hashing algorithms with VPN connection	SHA-256	SHA-256
number of possible connections with VPN connection	1	1
product function		
• password protection for Web applications	Yes	Yes
• password protection for VPN	Yes	Yes
• encrypted data transmission	Yes	Yes
• switch-off of non-required services	Yes	Yes
• log file for unauthorized access	Yes	Yes
product functions time		
product function pass on time synchronization	Yes	Yes
accuracy of the hardware real time clock per day maximum	7.5 s	7.5 s
time synchronization		
• from NTP-server	Yes	Yes
• from GPS-signal	Yes	Yes
• from mobile network provider	Yes	Yes
• PC	Yes	Yes
• manual setting	Yes	Yes
product functions position detection		
product function		
• position detection with GPS	Yes	Yes
• pass on position data	Yes	Yes
standards, specifications, approvals hazardous environments		
certificate of suitability CCC for hazardous zone according to GB standard	Yes	Yes

LOGO! logic module

LOGO!Power

Introduction

Overview

2

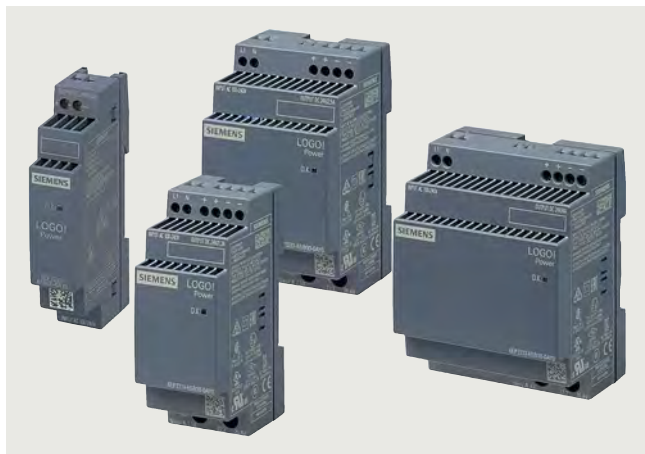

The flat power supply unit for distribution boards

Small. Clever. LOGO!Power: Thanks to its stepped profile design, the LOGO! 8 product line is ideally suited for installation in small distribution boards. The 12 V and 24 V versions are ideal for supplying LOGO! controllers with the corresponding voltage input. The high level of efficiency across the entire load range as well as the low no-load losses result in lower overall energy consumption. Greater convenience when commissioning and servicing thanks to the integrated current monitor. The extended ambient temperature range from -25 °C to +70 °C enables a host of additional applications.

To further increase 24 V availability, the 24 V LOGO!Power power supplies can be combined with the **buffer module BUF1200**, **DC UPS**, **redundancy** and **selectivity modules**.

This powerhouse can be used in any industry: e.g. in building technology applications for light and heating controllers or for access control systems. LOGO!Power is also well-suited for use in industrial automation, such as in packaging machine, machine tool, conveyor belt or sorting system applications.

Product highlights of the product line

- Low width
with minimum of 18 mm to maximum of 72 mm, thus requiring very little space in the control cabinet or distribution board
- High energy efficiency
with efficiency levels of up to 90% over the entire performance range and ERP-compliant no-load losses of < 0.3 W
- Global use
due to operating temperature range from -25 °C to +70 °C and international certificates
- Supply
of NEC Class 2 electric circuits with limited output current (100 VA)
- Load monitoring via current monitor
using real-time measurement of the output current without disconnecting the cable, i.e. without interrupting the DC supply
- Flexible mounting
with top hat DIN rail or wall mounting in different installation positions
- Flexible operation
in all standard 1-phase supply networks thanks to wide-range input of 100 ... 240 V AC without switchover and operation on DC networks with 110 ... 300 V DC
- Reliability
due to problem-free connection of loads with high inrush currents thanks to power reserve during startup as well as constant current in the event of overload

Overall width	18 mm	36 mm	54 mm	72 mm
24 V	0.6 A	1.3 A	2.5 A	4.0 A
12 V	0.9 A	1.9 A	4.5 A	
5 V		3.0 A	6.3 A	
15 V		1.9 A	4.0 A	

Overview



Thanks to its stepped profile design, the LOGO!Power product line is ideally suited for installation in small distribution boards. The stabilized power supplies with wide-range input are available with an output voltage of 5 V in two performance classes.

Product highlights

- 1-phase, 5 V DC/ 3 A and 6.3 A
- Wide-range input, input voltage 100 ... 240 V AC (85 ... 264 V), 110 ... 300 V DC
- Narrow unit with 36 mm or 54 mm width and overall depth of 53 mm in LOGO! design
- Up to 80% efficiency
- Integrated current monitor: Actual output current measurement directly at the power supply unit
- cULus, cURus, NEC class 2, ABS, DNV GL certifications

Ordering data

LOGO!Power 1-phase, 5 V DC/3 A

Stabilized power supply
 Input: 100 ... 240 V AC
 (110 ... 300 V AC)
 Output: 5 V DC/3 A

Article No.

6EP3310-6SB00-0AY0

Article No.

LOGO!Power 1-phase, 5 V DC/6.3 A

Stabilized power supply
 Input: 100 ... 240 V AC
 (110 ... 300 V AC)
 Output: 5 V DC/6.3 A

6EP3311-6SB00-0AY0

Technical specifications

Article number	6EP3310-6SB00-0AY0	6EP3311-6SB00-0AY0
Product	LOGO!Power	LOGO!Power
Power supply, type	5 V/3 A	5 V/6.3 A
Input		
Input	1-phase AC or DC	1-phase AC or DC
Rated voltage value $V_{in rated}$	100 ... 240 V	100 ... 240 V
Voltage range AC input voltage	85 ... 264 V	85 ... 264 V
• at DC	110 ... 300 V	110 ... 300 V
Wide-range input	Yes	Yes
Overvoltage resistance	300 V AC for 1 s	300 V AC for 1 s
Mains buffering	at $V_{in} = 187$ V	at $V_{in} = 187$ V
Mains buffering at $I_{out rated, min.}$	40 ms; at $V_{in} = 187$ V	40 ms; at $V_{in} = 187$ V
Rated line frequency 1	50 Hz	50 Hz
Rated line frequency 2	60 Hz	60 Hz
Rated line range input current	47 ... 63 Hz	47 ... 63 Hz
• at rated input voltage 120 V	0.36 A	0.71 A
• at rated input voltage 230 V	0.22 A	0.37 A
Switch-on current limiting (+25 °C), max.	26 A	50 A
I^2t , max.	0.8 A ² ·s	3 A ² ·s
Built-in incoming fuse	internal	internal
Protection in the mains power input (IEC 898)	Recommended miniature circuit breaker: from 6 A characteristic B or from 2 A characteristic C	Recommended miniature circuit breaker: from 10 A characteristic B or from 6 A characteristic C

LOGO! logic module

LOGO!Power

1-phase, 5 V DC

Technical specifications

Article number	6EP3310-6SB00-0AY0	6EP3311-6SB00-0AY0
Product	LOGO!Power	LOGO!Power
Power supply, type	5 V/3 A	5 V/6.3 A
Output		
Output	Controlled, isolated DC voltage	Controlled, isolated DC voltage
Rated voltage V_{out} DC output voltage	5 V	5 V
• at output 1 at DC rated value	5 V	5 V
Total tolerance, static ±	3 %	3 %
Static mains compensation, approx.	0.1 %	0.1 %
Static load balancing, approx.	0.1 %	0.1 %
Residual ripple peak-peak, max.	100 mV	100 mV
Residual ripple peak-peak, typ.	30 mV	30 mV
Spikes peak-peak, max. (bandwidth: 20 MHz)	100 mV	100 mV
Spikes peak-peak, typ. (bandwidth: 20 MHz)	50 mV	50 mV
Adjustment range	4.6 ... 5.4 V	4.6 ... 5.4 V
product function output voltage adjustable	Yes	Yes
Output voltage setting	via potentiometer	via potentiometer
Status display	Green LED for output voltage OK	Green LED for output voltage OK
On/off behavior	No overshoot of V_{out} (soft start)	No overshoot of V_{out} (soft start)
Startup delay, max.	0.5 s	0.5 s
Voltage rise, typ.	100 ms	100 ms
Rated current value I _{out} rated	3 A	6.3 A
Current range	0 ... 3 A	0 ... 6.3 A
• Note	+55 ... +70 °C: Derating 2%/K	+55 ... +70 °C: Derating 2%/K
supplied active power typical	15 W	31.5 W
Parallel switching for enhanced performance	Yes	Yes
Numbers of parallel switchable units for enhanced performance	2	2
Efficiency		
Efficiency at V_{out} rated, I_{out} rated, approx.	76 %	80 %
Power loss at V_{out} rated, I_{out} rated, approx.	5 W	8 W
power loss [W] during no-load operation maximum	0.3 W	0.3 W
Closed-loop control		
Dynamic mains compensation (V_{in} rated ±15 %), max.	0.2 %	0.2 %
Dynamic load smoothing (I_{out} : 10/90/10 %), U_{out} ± typ.	5 %	7 %
Load step setting time 10 to 90%, typ.	1 ms	1 ms
Load step setting time 90 to 10%, typ.	1 ms	1 ms
Protection and monitoring		
Output overvoltage protection	Yes, according to EN 60950-1	Yes, according to EN 60950-1
Current limitation, typ.	3.8 A	8.2 A
property of the output short-circuit proof	Yes	Yes
Short-circuit protection	Constant current characteristic	Constant current characteristic
enduring short circuit current RMS value		
• maximum	3.8 A	8.2 A
overcurrent overload capability in normal operation	overload capability 150% I_{out} rated typ. 200 ms	overload capability 150% I_{out} rated typ. 200 ms
Overload/short-circuit indicator	-	-
measuring point for output current	50 mV = 3 A	50 mV = 6.3 A
overcurrent overload capability when switching on	150% I_{out} rated typ. 200 ms	150% I_{out} rated typ. 200 ms

Technical specifications

Article number	6EP3310-6SB00-0AY0	6EP3311-6SB00-0AY0
Product	LOGO!Power	LOGO!Power
Power supply, type	5 V/3 A	5 V/6.3 A
Safety		
galvanic isolation between input and output	Yes	Yes
galvanic isolation	Safety extra-low output voltage U_{out} acc. to EN 60950-1 and EN 50178	Safety extra-low output voltage U_{out} acc. to EN 60950-1 and EN 50178
operating resource protection class	Class II (without protective conductor)	Class II (without protective conductor)
protection class IP	IP20	IP20
Approvals		
certificate of suitability		
CE marking	Yes	Yes
CSA approval	Yes; cULus-Listed (UL 508, CSA C22.2 No. 107.1), File E197259; cURus-Recognized (UL 60950, CSA C22.2 No. 60950), File E151273, NEC class 2 (acc. to UL 1310)	Yes; cULus-Listed (UL 508, CSA C22.2 No. 107.1), File E197259; cURus-Recognized (UL 60950, CSA C22.2 No. 60950), File E151273
cCSAus, Class 1, Division 2	No	No
ATEX	No	No
IECEX	No	No
NEC Class 2	Yes	No
type of certification CB-certificate	Yes	Yes
EAC approval	Yes	Yes
shipbuilding approval	ABS, BV, DNV GL, LRS	ABS, BV, DNV GL, LRS
EMC		
for emitted interference	EN 55022 Class B	EN 55022 Class B
for mains harmonics limitation	not applicable	not applicable
for interference immunity	EN 61000-6-2	EN 61000-6-2
environmental conditions		
ambient temperature		
• during operation	-25 ... +70 °C; with natural convection	-25 ... +70 °C; with natural convection
• during transport	-40 ... +85 °C	-40 ... +85 °C
• during storage	-40 ... +85 °C	-40 ... +85 °C
Humidity class acc. to IEC 60721	Climate class 3K3, 5 ... 95% no condensation	Climate class 3K3, 5 ... 95% no condensation
Mechanics		
type of electrical connection	screw-type terminals	screw-type terminals
• at input	L, N: 1 screw terminal each for 0.5 ... 2.5 mm ² single-core/finely stranded	L, N: 1 screw terminal each for 0.5 ... 2.5 mm ² single-core/finely stranded
• at output	+, -: 1 screw terminal each for 0.5 ... 2.5 mm ²	+, -: 1 screw terminal each for 0.5 ... 2.5 mm ²
• for auxiliary contacts	-	-
width of the enclosure	36 mm	54 mm
height of the enclosure	90 mm	90 mm
depth of the enclosure	53 mm	53 mm
required spacing		
• top	20 mm	20 mm
• bottom	20 mm	20 mm
• left	0 mm	0 mm
• right	0 mm	0 mm
net weight	0.12 kg	0.2 kg
product feature of the enclosure housing can be lined up	Yes	Yes
fastening method	Snaps onto DIN rail EN 60715 35x7.5/15, direct mounting in different mounting positions	Snaps onto DIN rail EN 60715 35x7.5/15, direct mounting in different mounting positions
MTBF at 40 °C	2 931 709 h	2 654 280 h
other information	Specifications at rated input voltage and ambient temperature +25 °C (unless otherwise specified)	Specifications at rated input voltage and ambient temperature +25 °C (unless otherwise specified)

LOGO! logic module

LOGO!Power

1-phase, 12 V DC**Overview**

2



Thanks to its stepped profile design, the LOGO!Power product line is ideally suited for installation in small distribution boards. The stabilized power supplies with wide-range input are available with an output voltage of 12 V in three performance classes. The 12 V versions are ideal for supplying LOGO! PLCs with the corresponding voltage input.

Product highlights

- 1-phase, 12 V DC/ 0.9 A, 1.9 A and 4.5 A
- Wide-range input, input voltage 100 ... 240 V AC (85 ... 264 V), 110 ... 300 V DC
- Narrow unit with width of 18 mm, 36 mm or 54 mm and overall depth of 53 mm in LOGO! design
- Up to 87.1% efficiency
- Integrated current monitor: Actual output current measurement directly at the power supply unit (for devices at least 36 mm wide)
- cULus, cURus, NEC class 2, ABS, DNV GL certifications

Ordering data**Article No.****Article No.****LOGO!Power 1-phase, 12 V DC/0.9 A**

Stabilized power supply
Input: 100 ... 240 V AC
(110 ... 300 V DC)
Output: 12 V DC/0.9 A

6EP3320-6SB00-0AY0**LOGO!Power 1-phase, 12 V DC/1.9 A**

Stabilized power supply
Input: 100 ... 240 V AC
(110 ... 300 V DC)
Output: 12 V DC/1.9 A

6EP3321-6SB00-0AY0**LOGO!Power 1-phase, 12 V DC/4.5 A**

Stabilized power supply
Input: 100 ... 240 V AC
(110 ... 300 V DC)
Output: 12 V DC/4.5 A

6EP3322-6SB00-0AY0**Add-on modules****SITOP redundancy modules RED1200**

For more information, visit:
<https://www.siemens.com/sitop-redundancy/mall>

Technical specifications

Article number	6EP3320-6SB00-0AY0	6EP3321-6SB00-0AY0	6EP3322-6SB00-0AY0
Product	LOGO!Power	LOGO!Power	LOGO!Power
Power supply, type	12 V/0.9 A	12 V/1.9 A	12 V/4.5 A
Input			
Input	1-phase AC or DC	1-phase AC or DC	1-phase AC or DC
Rated voltage value $V_{in rated}$	100 ... 240 V	100 ... 240 V	100 ... 240 V
Voltage range AC input voltage	85 ... 264 V	85 ... 264 V	85 ... 264 V
• at DC	110 ... 300 V	110 ... 300 V	110 ... 300 V
Wide-range input	Yes	Yes	Yes
Overvoltage resistance	300 V AC for 1 s	300 V AC for 1 s	300 V AC for 1 s
Mains buffering	at $V_{in} = 187$ V	at $V_{in} = 187$ V	at $V_{in} = 187$ V
Mains buffering at $I_{out rated}$, min.	40 ms; at $V_{in} = 187$ V	40 ms; at $V_{in} = 187$ V	40 ms; at $V_{in} = 187$ V
Rated line frequency 1	50 Hz	50 Hz	50 Hz
Rated line frequency 2	60 Hz	60 Hz	60 Hz
Rated line range	47 ... 63 Hz	47 ... 63 Hz	47 ... 63 Hz
input current			
• at rated input voltage 120 V	0.3 A	0.53 A	1.13 A
• at rated input voltage 230 V	0.2 A	0.3 A	0.61 A
Switch-on current limiting (+25 °C), max.	20 A	25 A	50 A
I^2t , max.	0.8 A ² ·s	0.8 A ² ·s	3 A ² ·s
Built-in incoming fuse	internal	internal	internal
Protection in the mains power input (IEC 898)	Recommended miniature circuit breaker: from 6 A characteristic B or from 2 A characteristic C	Recommended miniature circuit breaker: from 6 A characteristic B or from 2 A characteristic C	Recommended miniature circuit breaker: from 10 A characteristic B or from 6 A characteristic C

Technical specifications

Article number	6EP3320-6SB00-0AY0	6EP3321-6SB00-0AY0	6EP3322-6SB00-0AY0
Product	LOGO!Power	LOGO!Power	LOGO!Power
Power supply, type	12 V/0.9 A	12 V/1.9 A	12 V/4.5 A
Output			
Output	Controlled, isolated DC voltage	Controlled, isolated DC voltage	Controlled, isolated DC voltage
Rated voltage V_{out} DC output voltage	12 V	12 V	12 V
• at output 1 at DC rated value	12 V	12 V	12 V
Total tolerance, static ±	3 %	3 %	3 %
Static mains compensation, approx.	0.1 %	0.1 %	0.1 %
Static load balancing, approx.	0.1 %	0.1 %	0.1 %
Residual ripple peak-peak, max.	200 mV	200 mV	200 mV
Residual ripple peak-peak, typ.	30 mV	30 mV	30 mV
Spikes peak-peak, max. (bandwidth: 20 MHz)	300 mV	300 mV	300 mV
Spikes peak-peak, typ. (bandwidth: 20 MHz)	50 mV	50 mV	50 mV
Adjustment range		10.5 ... 16.1 V	10.5 ... 16.1 V
product function output voltage adjustable	No	Yes	Yes
Output voltage setting		via potentiometer	via potentiometer
Status display	Green LED for output voltage OK	Green LED for output voltage OK	Green LED for output voltage OK
On/off behavior	No overshoot of V_{out} (soft start)	No overshoot of V_{out} (soft start)	No overshoot of V_{out} (soft start)
Startup delay, max.	0.5 s	0.5 s	0.5 s
Voltage rise, typ.	100 ms	100 ms	100 ms
Rated current value $I_{out rated}$	0.9 A	1.9 A	4.5 A
Current range	0 ... 0.9 A	0 ... 1.9 A	0 ... 4.5 A
• Note	+55 ... +70 °C: Derating 2%/K	+55 ... +70 °C: Derating 2%/K	+55 ... +70 °C: Derating 2%/K
supplied active power typical	10.8 W	22.8 W	54 W
Parallel switching for enhanced performance	No	Yes	Yes
Numbers of parallel switchable units for enhanced performance		2	2
Efficiency			
Efficiency at $V_{out rated}$, $I_{out rated}$, approx.	78 %	81 %	87.1 %
Power loss at $V_{out rated}$, $I_{out rated}$, approx.	3 W	5 W	8 W
power loss [W] during no-load operation maximum	0.3 W	0.3 W	0.3 W
Closed-loop control			
Dynamic mains compensation ($V_{in rated} \pm 15\%$), max.	0.2 %	0.2 %	0.2 %
Dynamic load smoothing (I_{out} : 10/90/10 %), $U_{out} \pm$ typ.	3 %	2 %	4 %
Load step setting time 10 to 90%, typ.	1 ms	1 ms	1 ms
Load step setting time 90 to 10%, typ.	1 ms	1 ms	1 ms
Protection and monitoring			
Output overvoltage protection	Yes, according to EN 60950-1	Yes, according to EN 60950-1	Yes, according to EN 60950-1
Current limitation, typ.	1.3 A	2.5 A	5 A
property of the output short-circuit proof	Yes	Yes	Yes
Short-circuit protection enduring short circuit current RMS value	Constant current characteristic	Constant current characteristic	Constant current characteristic
• maximum	1.3 A	2.5 A	5 A
overcurrent overload capability in normal operation	overload capability 150% $I_{out rated}$ typ. 200 ms	overload capability 150% $I_{out rated}$ typ. 200 ms	overload capability 150% $I_{out rated}$ typ. 200 ms
Overload/short-circuit indicator	-	-	-
measuring point for output current		50 mV = ^ 1.9 A	50 mV = ^ 4.5 A
overcurrent overload capability when switching on	150% $I_{out rated}$ typ. 200 ms	150% $I_{out rated}$ typ. 200 ms	150% $I_{out rated}$ typ. 200 ms

LOGO! logic module

LOGO!Power

1-phase, 12 V DC

Technical specifications

Article number	6EP3320-6SB00-0AY0	6EP3321-6SB00-0AY0	6EP3322-6SB00-0AY0
Product	LOGO!Power	LOGO!Power	LOGO!Power
Power supply, type	12 V/0.9 A	12 V/1.9 A	12 V/4.5 A
Safety			
Primary/secondary isolation galvanic isolation	Yes Safety extra-low output voltage U_{out} acc. to EN 60950-1 and EN 50178 Class II (without protective conductor) IP20	Yes Safety extra-low output voltage U_{out} acc. to EN 60950-1 and EN 50178 Class II (without protective conductor) IP20	Yes Safety extra-low output voltage U_{out} acc. to EN 60950-1 and EN 50178 Class II (without protective conductor) IP20
Protection class Degree of protection (EN 60529)	IP20	IP20	IP20
Approvals			
certificate of suitability CE mark UL/cUL (CSA) approval	Yes Yes; cULus-Listed (UL 508, CSA C22.2 No. 107.1), File E197259; cURus-Recognized (UL 60950, CSA C22.2 No. 60950), File E151273, NEC class 2 (acc. to UL 1310)	Yes Yes; cULus-Listed (UL 508, CSA C22.2 No. 107.1), File E197259; cURus-Recognized (UL 60950, CSA C22.2 No. 60950), File E151273, NEC class 2 (acc. to UL 1310)	Yes Yes; cULus-Listed (UL 508, CSA C22.2 No. 107.1), File E197259; cURus-Recognized (UL 60950, CSA C22.2 No. 60950), File E151273, NEC class 2 (acc. to UL 1310)
cCSAus, Class 1, Division 2 ATEX	No No	No No	No No
certificate of suitability IECEX	No	No	No
NEC Class 2 ULhazloc approval	Yes No	Yes No	No No
FM registration	No	No	No
type of certification CB-certificate certificate of suitability	Yes	Yes	Yes
EAC approval	Yes	Yes	Yes
certificate of suitability shipbuilding approval shipbuilding approval	Yes ABS, BV, DNV GL, LRS	Yes ABS, BV, DNV GL, LRS	Yes ABS, BV, DNV GL, LRS
EMC			
standard for emitted interference for mains harmonics limitation for interference immunity	EN 55022 Class B not applicable EN 61000-6-2	EN 55022 Class B not applicable EN 61000-6-2	EN 55022 Class B not applicable EN 61000-6-2
environmental conditions			
ambient temperature • during operation • during transport • during storage	-25 ... +70 °C; with natural convection -40 ... +85 °C -40 ... +85 °C	-25 ... +70 °C; with natural convection -40 ... +85 °C -40 ... +85 °C	-25 ... +70 °C; with natural convection -40 ... +85 °C -40 ... +85 °C
Humidity class according to EN 60721	Climate class 3K3, 5 ... 95% no condensation	Climate class 3K3, 5 ... 95% no condensation	Climate class 3K3, 5 ... 95% no condensation
Mechanics			
Connection technology	screw-type terminals	screw-type terminals	screw-type terminals
Connections			
• Supply input	L, N: 1 screw terminal each for 0.5 ... 2.5 mm ² single-core/ finely stranded	L, N: 1 screw terminal each for 0.5 ... 2.5 mm ² single-core/ finely stranded	L, N: 1 screw terminal each for 0.5 ... 2.5 mm ² single-core/ finely stranded
• Output	+, -: 1 screw terminal each for 0.5 ... 2.5 mm ²	+, -: 1 screw terminal each for 0.5 ... 2.5 mm ²	+, -: 1 screw terminal each for 0.5 ... 2.5 mm ²
• Auxiliary	-	-	-
width of the enclosure	18 mm	36 mm	54 mm
height of the enclosure	90 mm	90 mm	90 mm
depth of the enclosure	53 mm	53 mm	53 mm
required spacing			
• top	20 mm	20 mm	20 mm
• bottom	20 mm	20 mm	20 mm
• left	0 mm	0 mm	0 mm
• right	0 mm	0 mm	0 mm
Weight, approx.	0.07 kg	0.12 kg	0.2 kg
product feature of the enclosure housing can be lined up	Yes	Yes	Yes
Installation	Snaps onto DIN rail EN 60715 35x7.5/15, direct mounting in different mounting positions 3 793 080 h Specifications at rated input voltage and ambient temperature +25 °C (unless otherwise specified)	Snaps onto DIN rail EN 60715 35x7.5/15, direct mounting in different mounting positions 2 938 542 h Specifications at rated input voltage and ambient temperature +25 °C (unless otherwise specified)	Snaps onto DIN rail EN 60715 35x7.5/15, direct mounting in different mounting positions 2 566 680 h Specifications at rated input voltage and ambient temperature +25 °C (unless otherwise specified)
MTBF at 40 °C other information			

Overview



Thanks to its stepped profile design, the LOGO!Power product line is ideally suited for installation in small distribution boards. The stabilized power supplies with a wide-range input are available with an output voltage of 15 V in two performance classes.

Product highlights

- 1-phase, 15 V DC/ 1.9 A and 4.0 A
- Wide-range input, input voltage 100 ... 240 V AC (85 ... 264 V), 110 ... 300 V DC
- Narrow unit with 36 mm or 54 mm width and overall depth of 53 mm in LOGO! design
- Up to 88.4% efficiency
- Integrated current monitor: Actual output current measurement directly at the power supply unit
- cULus, cURus, NEC class 2, ABS, BV, DNV GL, LRS certifications

2

Ordering data

LOGO!Power 1-phase, 15 V DC/1.9 A

Stabilized power supply
 Input: 100 ... 240 V AC
 (110 ... 300 V DC)
 Output: 15 V DC/1.9 A

Article No.

6EP3321-6SB10-0AY0

LOGO!Power 1-phase, 15 V DC/4 A

Stabilized power supply
 Input: 100 ... 240 V AC
 (110 ... 300 V DC)
 Output: 15 V DC/4 A

6EP3322-6SB10-0AY0

Article No.

Add-on modules

SITOP redundancy modules RED1200

For more information, visit:
<https://www.siemens.com/sitop-redundancy/mall>

Technical specifications

Article number	6EP3321-6SB10-0AY0	6EP3322-6SB10-0AY0
Product	LOGO!Power	LOGO!Power
Power supply, type	15 V/1.9 A	15 V/4 A
Input		
Input	1-phase AC or DC	1-phase AC or DC
Rated voltage value $V_{in rated}$	100 ... 240 V	100 ... 240 V
Voltage range AC input voltage	85 ... 264 V	85 ... 264 V
• at DC	110 ... 300 V	110 ... 300 V
Wide-range input	Yes	Yes
Overvoltage resistance	300 V AC for 1 s	300 V AC for 1 s
Mains buffering	at $V_{in} = 187 V$	at $V_{in} = 187 V$
Mains buffering at $I_{out rated, min.}$	40 ms; at $V_{in} = 187 V$	40 ms; at $V_{in} = 187 V$
Rated line frequency 1	50 Hz	50 Hz
Rated line frequency 2	60 Hz	60 Hz
Rated line range input current	47 ... 63 Hz	47 ... 63 Hz
• at rated input voltage 120 V	0.63 A	1.24 A
• at rated input voltage 230 V	0.33 A	0.68 A
Switch-on current limiting (+25 °C), max.	25 A	55 A
$I^2t, max.$	0.8 A ² ·s	3 A ² ·s
Built-in incoming fuse	internal	internal
Protection in the mains power input (IEC 898)	Recommended miniature circuit breaker: from 6 A characteristic B or from 2 A characteristic C	Recommended miniature circuit breaker: from 10 A characteristic B or from 6 A characteristic C

LOGO! logic module

LOGO!Power

1-phase, 15 V DC

Technical specifications

Article number	6EP3321-6SB10-0AY0	6EP3322-6SB10-0AY0
Product	LOGO!Power	LOGO!Power
Power supply, type	15 V/1.9 A	15 V/4 A
Output		
Output	Controlled, isolated DC voltage	Controlled, isolated DC voltage
Rated voltage V_{out} DC output voltage	15 V	15 V
• at output 1 at DC rated value	15 V	15 V
Total tolerance, static ±	3 %	3 %
Static mains compensation, approx.	0.1 %	0.1 %
Static load balancing, approx.	0.1 %	0.1 %
Residual ripple peak-peak, max.	200 mV	200 mV
Residual ripple peak-peak, typ.	30 mV	30 mV
Spikes peak-peak, max. (bandwidth: 20 MHz)	300 mV	300 mV
Spikes peak-peak, typ. (bandwidth: 20 MHz)	50 mV	50 mV
Adjustment range	10.5 ... 16.1 V	10.5 ... 16.1 V
product function output voltage adjustable	Yes	Yes
Output voltage setting	via potentiometer	via potentiometer
Status display	Green LED for output voltage OK	Green LED for output voltage OK
On/off behavior	No overshoot of V_{out} (soft start)	No overshoot of V_{out} (soft start)
Startup delay, max.	0.5 s	0.5 s
Voltage rise, typ.	100 ms	100 ms
Rated current value $I_{out rated}$	1.9 A	4 A
Current range	0 ... 1.9 A	0 ... 4 A
• Note	+55 ... +70 °C: Derating 2%/K	+55 ... +70 °C: Derating 2%/K
supplied active power typical	28.5 W	60 W
Parallel switching for enhanced performance	Yes	Yes
Numbers of parallel switchable units for enhanced performance	2	2
Efficiency		
Efficiency at $V_{out rated}$, $I_{out rated}$, approx.	83 %	88.4 %
Power loss at $V_{out rated}$, $I_{out rated}$, approx.	6 W	8 W
power loss [W] during no-load operation maximum	0.3 W	0.3 W
Closed-loop control		
Dynamic mains compensation ($V_{in rated} \pm 15\%$), max.	0.2 %	0.2 %
Dynamic load smoothing (I_{out} : 10/90/10 %), $U_{out} \pm$ typ.	2 %	3 %
Load step setting time 10 to 90%, typ.	1 ms	1 ms
Load step setting time 90 to 10%, typ.	1 ms	1 ms
Protection and monitoring		
Output overvoltage protection	Yes, according to EN 60950-1	Yes, according to EN 60950-1
Current limitation, typ.	2.5 A	5 A
property of the output short-circuit proof	Yes	Yes
Short-circuit protection	Constant current characteristic	Constant current characteristic
enduring short circuit current RMS value		
• maximum	2.5 A	5 A
overcurrent overload capability in normal operation	overload capability 150% $I_{out rated}$ typ. 200 ms	overload capability 150% $I_{out rated}$ typ. 200 ms
Overload/short-circuit indicator	-	-
measuring point for output current	50 mV $\hat{=}$ 1.9 A	45 mV $\hat{=}$ 4 A
overcurrent overload capability when switching on	150% $I_{out rated}$ typ. 200 ms	150% $I_{out rated}$ typ. 200 ms

Technical specifications

Article number	6EP3321-6SB10-0AY0	6EP3322-6SB10-0AY0
Product	LOGO!Power	LOGO!Power
Power supply, type	15 V/1.9 A	15 V/4 A
Safety		
galvanic isolation between input and output	Yes	Yes
galvanic isolation	Safety extra-low output voltage U_{out} acc. to EN 60950-1 and EN 50178	Safety extra-low output voltage U_{out} acc. to EN 60950-1 and EN 50178
operating resource protection class	Class II (without protective conductor)	Class II (without protective conductor)
protection class IP	IP20	IP20
Approvals		
certificate of suitability	Yes	Yes
CE mark	Yes	Yes
UL/cUL (CSA) approval	Yes; cULus-Listed (UL 508, CSA C22.2 No. 107.1), File E197259; cURus-Recognized (UL 60950, CSA C22.2 No. 60950), File E151273, NEC class 2 (acc. to UL 1310)	Yes; cULus-Listed (UL 508, CSA C22.2 No. 107.1), File E197259; cURus-Recognized (UL 60950, CSA C22.2 No. 60950), File E151273, NEC class 2 (acc. to UL 1310)
cCSAus, Class 1, Division 2	No	No
ATEX	No	No
certificate of suitability	No	No
IECEX	No	No
NEC Class 2	Yes	Yes
ULhazloc approval	No	No
FM registration	No	No
type of certification CB-certificate	Yes	Yes
certificate of suitability	Yes	Yes
EAC approval	Yes	Yes
certificate of suitability shipbuilding approval	Yes	Yes
shipbuilding approval	ABS, BV, DNV GL, LRS	ABS, BV, DNV GL, LRS
EMC		
Emitted interference	EN 55022 Class B	EN 55022 Class B
Supply harmonics limitation	not applicable	not applicable
Noise immunity	EN 61000-6-2	EN 61000-6-2
environmental conditions		
ambient temperature		
• during operation	-25 ... +70 °C; with natural convection	-25 ... +70 °C; with natural convection
• during transport	-40 ... +85 °C	-40 ... +85 °C
• during storage	-40 ... +85 °C	-40 ... +85 °C
Humidity class according to EN 60721	Climate class 3K3, 5 ... 95% no condensation	Climate class 3K3, 5 ... 95% no condensation
Mechanics		
Connection technology	screw-type terminals	screw-type terminals
Connections		
• Supply input	L, N: 1 screw terminal each for 0.5 ... 2.5 mm ² single-core/finely stranded	L, N: 1 screw terminal each for 0.5 ... 2.5 mm ² single-core/finely stranded
• Output	+, -: 1 screw terminal each for 0.5 ... 2.5 mm ²	+, -: 1 screw terminal each for 0.5 ... 2.5 mm ²
• Auxiliary	-	-
width of the enclosure	36 mm	54 mm
height of the enclosure	90 mm	90 mm
depth of the enclosure	53 mm	53 mm
required spacing		
• top	20 mm	20 mm
• bottom	20 mm	20 mm
• left	0 mm	0 mm
• right	0 mm	0 mm
Weight, approx.	0.12 kg	0.2 kg
product feature of the enclosure housing can be lined up	Yes	Yes
Installation	Snaps onto DIN rail EN 60715 35x7.5/15, direct mounting in different mounting positions	Snaps onto DIN rail EN 60715 35x7.5/15, direct mounting in different mounting positions
MTBF at 40 °C	2 938 542 h	2 566 680 h
other information	Specifications at rated input voltage and ambient temperature +25 °C (unless otherwise specified)	Specifications at rated input voltage and ambient temperature +25 °C (unless otherwise specified)

LOGO! logic module

LOGO!Power

1-phase, 24 V DC**Overview**

Thanks to its stepped profile design, the LOGO!Power product line is ideally suited for installation in small distribution boards. The stabilized power supplies with wide-range input are available with an output voltage of 24 V in four performance classes. The 24 V versions are ideal for supplying LOGO! PLCs with the corresponding voltage input.

To further increase the 24 V availability, the LOGO!Power power supply units can be combined with **DC UPS**, **redundancy** and **selectivity modules**.

Product highlights

- 1-phase, 24 V DC/ 0.6 A, 1.3 A, 2.5 A and 4.0 A
- Input voltage 100 ... 240 V AC (85 ... 264 V), 110 ... 300 V DC
- Narrow unit with width of 18 mm, 36 mm, 54 mm or 72 mm and overall depth of 53 mm in LOGO! design
- Up to 90% efficiency
- Integrated current monitor: Actual output current measurement directly at the power supply unit (for devices at least 36 mm wide)
- cULus, cURus, NEC class 2, ABS, BV, DNV GL, LRS certifications

Ordering data**Article No.****LOGO!Power 1-phase, 24 V DC/0.6 A**

Stabilized power supply
Input: 100 ... 240 V AC
(110 ... 300 V DC)
Output: 24 V DC/0.6 A

6EP3330-6SB00-0AY0**LOGO!Power 1-phase, 24 V DC/1.3 A**

Stabilized power supply
Input: 100 ... 240 V AC
(110 ... 300 V DC)
Output: 24 V DC/1.3 A

6EP3331-6SB00-0AY0**LOGO!Power 1-phase, 24 V DC/2.5 A**

Stabilized power supply
Input: 100 ... 240 V AC
(110 ... 300 V DC)
Output: 24 V DC/2.5 A

6EP3332-6SB00-0AY0**LOGO!Power 1-phase, 24 V DC/4 A**

Stabilized power supply
Input: 100 ... 240 V AC
(110 ... 300 V DC)
Output: 24 V DC/4 A

6EP3333-6SB00-0AY0**LOGO!Power Ex 1-phase, 24 V DC/4 A**

Stabilized power supply
Input: 100 ... 240 V AC
(110 ... 300 V DC)
Output: 24 V DC/4 A

6EP3333-6SC00-0AY0**Add-on modules****SITOP redundancy modules**

For more information, visit:
<https://www.siemens.com/sitop-redundancy/mall>

SITOP selectivity modules

For more information, visit:
<https://www.siemens.com/sitop-selectivity/mall>

SITOP buffer module BUF1200

For more information, visit:
<https://www.siemens.com/sitop-buffering/mall>

DC UPS modules**SITOP DC UPS**

For more information, visit:
<https://www.siemens.com/sitop-ups/mall>

Technical specifications

Article number	6EP3330-6SB00-0AY0	6EP3331-6SB00-0AY0	6EP3332-6SB00-0AY0	6EP3333-6SB00-0AY0	6EP3333-6SC00-0AY0
Product	LOGO!Power	LOGO!Power	LOGO!Power	LOGO!Power	LOGO!Power EX
Power supply, type	24 V/0.6 A	24 V/1.3 A	24 V/2.5 A	24 V/4 A	24 V/4 A
Input					
Input	1-phase AC or DC	1-phase AC or DC	1-phase AC or DC	1-phase AC or DC	1-phase AC or DC
Rated voltage value $V_{in rated}$	100 ... 240 V	100 ... 240 V	100 ... 240 V	100 ... 240 V	100 ... 240 V
Voltage range AC input voltage	85 ... 264 V	85 ... 264 V	85 ... 264 V	85 ... 264 V	85 ... 264 V
• at DC	110 ... 300 V	110 ... 300 V	110 ... 300 V	110 ... 300 V	110 ... 300 V
Wide-range input	Yes	Yes	Yes	Yes	Yes
Overvoltage resistance	300 V AC for 1 s	300 V AC for 1 s	300 V AC for 1 s	300 V AC for 1 s	300 V AC for 1 s
Mains buffering	at $V_{in} = 187$ V	at $V_{in} = 187$ V	at $V_{in} = 187$ V	at $V_{in} = 187$ V	at $V_{in} = 187$ V
Mains buffering at $I_{out rated, min.}$	40 ms; at $V_{in} = 187$ V	40 ms; at $V_{in} = 187$ V	40 ms; at $V_{in} = 187$ V	40 ms; at $V_{in} = 187$ V	40 ms; at $V_{in} = 187$ V
Rated line frequency 1	50 Hz	50 Hz	50 Hz	50 Hz	50 Hz
Rated line frequency 2	60 Hz	60 Hz	60 Hz	60 Hz	60 Hz
Rated line range input current	47 ... 63 Hz	47 ... 63 Hz	47 ... 63 Hz	47 ... 63 Hz	47 ... 63 Hz
• at rated input voltage 120 V	0.3 A	0.7 A	1.22 A	1.95 A	1.95 A
• at rated input voltage 230 V	0.2 A	0.35 A	0.66 A	0.97 A	0.97 A
Switch-on current limiting (+25 °C), max.	20 A	25 A	52 A	31 A	31 A
I^2t , max.	0.8 A ² ·s	0.8 A ² ·s	3 A ² ·s	2.5 A ² ·s	2.5 A ² ·s
Built-in incoming fuse	internal	internal	internal	internal	internal
Protection in the mains power input (IEC 898)	Recommended miniature circuit breaker: from 6 A characteristic B or from 2 A characteristic C	Recommended miniature circuit breaker: from 6 A characteristic B or from 2 A characteristic C	Recommended miniature circuit breaker: from 10 A characteristic B or from 6 A characteristic C	Recommended miniature circuit breaker: from 10 A characteristic B or from 6 A characteristic C	Recommended miniature circuit breaker: from 10 A characteristic B or from 6 A characteristic C
Output					
Output	Controlled, isolated DC voltage	Controlled, isolated DC voltage	Controlled, isolated DC voltage	Controlled, isolated DC voltage	Controlled, isolated DC voltage
Rated voltage $V_{out DC}$	24 V	24 V	24 V	24 V	24 V
output voltage					
• at output 1 at DC rated value	24 V	24 V	24 V	24 V	24 V
Total tolerance, static ±	3 %	3 %	3 %	3 %	3 %
Static mains compensation, approx.	0.1 %	0.1 %	0.1 %	0.1 %	0.1 %
Static load balancing, approx.	0.1 %	0.1 %	0.1 %	0.1 %	0.1 %
Residual ripple peak-peak, max.	200 mV	200 mV	200 mV	200 mV	200 mV
Residual ripple peak-peak, typ.	30 mV	30 mV	30 mV	30 mV	30 mV
Spikes peak-peak, max. (bandwidth: 20 MHz)	300 mV	300 mV	300 mV	300 mV	300 mV
Spikes peak-peak, typ. (bandwidth: 20 MHz)	50 mV	50 mV	50 mV	50 mV	50 mV
Adjustment range		22.2 ... 26.4 V	22.2 ... 26.4 V	22.2 ... 26.4 V	22.2 ... 26.4 V
product function output voltage adjustable	No	Yes	Yes	Yes	Yes
Output voltage setting		via potentiometer	via potentiometer	via potentiometer	via potentiometer
Status display	Green LED for output voltage OK	Green LED for output voltage OK	Green LED for output voltage OK	Green LED for output voltage OK	Green LED for output voltage OK
On/off behavior	No overshoot of Vout (soft start)	No overshoot of Vout (soft start)	No overshoot of Vout (soft start)	No overshoot of Vout (soft start)	No overshoot of Vout (soft start)
Startup delay, max.	0.5 s	0.5 s	0.5 s	0.5 s	0.5 s
Voltage rise, typ.	100 ms	100 ms	100 ms	100 ms	100 ms
Rated current value $I_{out rated}$	0.6 A	1.3 A	2.5 A	4 A	4 A
Current range	0 ... 0.6 A;	0 ... 1.3 A;	0 ... 2.5 A;	0 ... 4 A;	0 ... 4 A;
• Note	+55 ... +70 °C: Derating 2%/K	+55 ... +70 °C: Derating 2%/K	+55 ... +70 °C: Derating 2%/K	+55 ... +70 °C: Derating 2%/K	+55 ... +70 °C: Derating 2%/K
supplied active power typical	14.4 W	31.2 W	60 W	96 W	96 W
Parallel switching for enhanced performance	No	Yes	Yes	Yes	Yes
Numbers of parallel switchable units for enhanced performance		2	2	2	

LOGO! logic module

LOGO!Power

1-phase, 24 V DC

Technical specifications

Article number	6EP3330-6SB00-0AY0	6EP3331-6SB00-0AY0	6EP3332-6SB00-0AY0	6EP3333-6SB00-0AY0	6EP3333-6SC00-0AY0
Product	LOGO!Power	LOGO!Power	LOGO!Power	LOGO!Power	LOGO!Power EX
Power supply, type	24 V/0.6 A	24 V/1.3 A	24 V/2.5 A	24 V/4 A	24 V/4 A
Efficiency					
Efficiency at $V_{out\ rated}$, $I_{out\ rated}$, approx.	81 %	86 %	90 %	89 %	89 %
Power loss at $V_{out\ rated}$, $I_{out\ rated}$, approx.	3 W	5 W	7 W	12 W	12 W
power loss [W] during no-load operation maximum	0.3 W	0.3 W	0.3 W	0.3 W	0.3 W
Closed-loop control					
Dynamic mains compensation ($V_{in\ rated} \pm 15\%$), max.	0.2 %	0.2 %	0.2 %	0.2 %	0.2 %
Dynamic load smoothing (I_{out} : 10/90/10 %), $U_{out} \pm$ typ.	2 %	1 %	2 %	2 %	2 %
Load step setting time 10 to 90%, typ.	1 ms	1 ms	1 ms	1 ms	1 ms
Load step setting time 90 to 10%, typ.	1 ms	1 ms	1 ms	1 ms	1 ms
Protection and monitoring					
Output overvoltage protection	Yes, according to EN 60950-1	Yes, according to EN 60950-1	Yes, according to EN 60950-1	Yes, according to EN 60950-1	Yes, according to EN 60950-1
Current limitation, typ.	0.8 A	1.7 A	3.2 A	5 A	5 A
property of the output short-circuit proof	Yes	Yes	Yes	Yes	Yes
Short-circuit protection	Constant current characteristic	Constant current characteristic	Constant current characteristic	Constant current characteristic	Constant current characteristic
enduring short circuit current RMS value					
• maximum	0.8 A	1.7 A	3.2 A	5 A	5 A
overcurrent overload capability in normal operation	overload capability 150% $I_{out\ rated}$ typ. 200 ms	overload capability 150% $I_{out\ rated}$ typ. 200 ms	overload capability 150% $I_{out\ rated}$ typ. 200 ms	overload capability 150% $I_{out\ rated}$ typ. 200 ms	overload capability 150% $I_{out\ rated}$ typ. 200 ms
Overload/short-circuit indicator	-	-	-	-	-
measuring point for output current		50 mV = ^ 1.3 A	50 mV = ^ 2.5 A	50 mV = ^ 4 A	50 mV = ^ 4 A
overcurrent overload capability when switching on	150% $I_{out\ rated}$ typ. 200 ms	150% $I_{out\ rated}$ typ. 200 ms	150% $I_{out\ rated}$ typ. 200 ms	150% $I_{out\ rated}$ typ. 200 ms	150% $I_{out\ rated}$ typ. 200 ms
Safety					
galvanic isolation between input and output	Yes	Yes	Yes	Yes	Yes
galvanic isolation	Safety extra-low output voltage U_{out} acc. to EN 60950-1 and EN 50178	Safety extra-low output voltage U_{out} acc. to EN 60950-1 and EN 50178	Safety extra-low output voltage U_{out} acc. to EN 60950-1 and EN 50178	Safety extra-low output voltage U_{out} acc. to EN 60950-1 and EN 50178	Safety extra-low output voltage U_{out} acc. to EN 60950-1 and EN 50178
operating resource protection class	Class II (without protective conductor)	Class II (without protective conductor)	Class II (without protective conductor)	Class II (without protective conductor)	Class II (without protective conductor)
protection class IP	IP20	IP20	IP20	IP20	IP20
Approvals					
certificate of suitability					
CE marking	Yes	Yes	Yes	Yes	Yes
UL/cUL (CSA) approval	Yes; cULus-Listed (UL 508, CSA C22.2 No. 107.1), File E197259; cURus-Recognized (UL 60950, CSA C22.2 No. 60950), File E151273, NEC class 2 (acc. to UL 1310)	Yes; cULus-Listed (UL 508, CSA C22.2 No. 107.1), File E197259; cURus-Recognized (UL 60950, CSA C22.2 No. 60950), File E151273, NEC class 2 (acc. to UL 1310)	Yes; cULus-Listed (UL 508, CSA C22.2 No. 107.1), File E197259; cURus-Recognized (UL 60950, CSA C22.2 No. 60950), File E151273, NEC class 2 (acc. to UL 1310)	Yes; cULus-Listed (UL 508, CSA C22.2 No. 107.1), File E197259; cURus-Recognized (UL 60950, CSA C22.2 No. 60950), File E151273	No
cCSAus, Class 1, Division 2	No	No	No	No	No
ATEX	No	No	No	No	Yes
certificate of suitability					
IECEX	No	No	No	No	Yes
NEC Class 2	Yes	Yes	Yes	No	No
ULhazloc approval	No	No	No	No	No
FM registration	No	No	No	No	Yes
type of certification CB-certificate	Yes	Yes	Yes	Yes	
certificate of suitability					
EAC approval	Yes	Yes	Yes	Yes	
certificate of suitability shipbuilding approval	Yes	Yes	Yes	Yes	No

Technical specifications

Article number	6EP3330-6SB00-0AY0	6EP3331-6SB00-0AY0	6EP3332-6SB00-0AY0	6EP3333-6SB00-0AY0	6EP3333-6SC00-0AY0
Product	LOGO!Power	LOGO!Power	LOGO!Power	LOGO!Power	LOGO!Power EX
Power supply, type	24 V/0.6 A	24 V/1.3 A	24 V/2.5 A	24 V/4 A	24 V/4 A
shipbuilding approval	ABS, BV, DNV GL, LRS	ABS, BV, DNV GL, LRS	ABS, BV, DNV GL, LRS	ABS, BV, DNV GL, LRS	available soon
EMC					
Emitted interference	EN 55022 Class B	EN 55022 Class B	EN 55022 Class B	EN 55022 Class B	EN 55022 Class B
Supply harmonics limitation	not applicable	not applicable	not applicable	EN 61000-3-2	EN 61000-3-2
Noise immunity	EN 61000-6-2	EN 61000-6-2	EN 61000-6-2	EN 61000-6-2	EN 61000-6-2
environmental conditions					
ambient temperature					
• during operation	-25 ... +70 °C;	-25 ... +70 °C;	-25 ... +70 °C;	-25 ... +70 °C;	-25 ... +70 °C;
- Note	with natural convection	with natural convection	with natural convection	with natural convection	with natural convection
• during transport	-40 ... +85 °C	-40 ... +85 °C	-40 ... +85 °C	-40 ... +85 °C	-40 ... +85 °C
• during storage	-40 ... +85 °C	-40 ... +85 °C	-40 ... +85 °C	-40 ... +85 °C	-40 ... +85 °C
Humidity class acc. to IEC 60721	Climate class 3K3, 5 ... 95% no condensation	Climate class 3K3, 5 ... 95% no condensation	Climate class 3K3, 5 ... 95% no condensation	Climate class 3K3, 5 ... 95% no condensation	Climate class 3K3, 5 ... 95% no condensation
Mechanics					
type of electrical connection	screw-type terminals	screw-type terminals	screw-type terminals	screw-type terminals	screw-type terminals
• at input	L, N: 1 screw terminal each for 0.5 ... 2.5 mm ² single-core/finely stranded	L, N: 1 screw terminal each for 0.5 ... 2.5 mm ² single-core/finely stranded	L, N: 1 screw terminal each for 0.5 ... 2.5 mm ² single-core/finely stranded	L, N: 1 screw terminal each for 0.5 ... 2.5 mm ² single-core/finely stranded	L, N: 1 screw terminal each for 0.5 ... 2.5 mm ² single-core/finely stranded
• at output	+, -: 1 screw terminal each for 0.5 ... 2.5 mm ²	+, -: 1 screw terminal each for 0.5 ... 2.5 mm ²	+, -: 1 screw terminal each for 0.5 ... 2.5 mm ²	+, -: 1 screw terminal each for 0.5 ... 2.5 mm ²	+, -: 1 screw terminal each for 0.5 ... 2.5 mm ²
• for auxiliary contacts	-	-	-	-	-
width of the enclosure	18 mm	36 mm	54 mm	72 mm	72 mm
height of the enclosure	90 mm	90 mm	90 mm	90 mm	90 mm
depth of the enclosure	53 mm	53 mm	53 mm	53 mm	53 mm
required spacing					
• top	20 mm	20 mm	20 mm	20 mm	20 mm
• bottom	20 mm	20 mm	20 mm	20 mm	20 mm
• left	0 mm	0 mm	0 mm	0 mm	0 mm
• right	0 mm	0 mm	0 mm	0 mm	0 mm
net weight	0.07 kg	0.12 kg	0.2 kg	0.29 kg	0.29 kg
product feature of the enclosure housing can be lined up	Yes	Yes	Yes	Yes	Yes
fastening method	Snaps onto DIN rail EN 60715 35x7.5/15, direct mounting in different mounting positions	Snaps onto DIN rail EN 60715 35x7.5/15, direct mounting in different mounting positions	Snaps onto DIN rail EN 60715 35x7.5/15, direct mounting in different mounting positions	Snaps onto DIN rail EN 60715 35x7.5/15, direct mounting in different mounting positions	Snaps onto DIN rail EN 60715 35x7.5/15, direct mounting in different mounting positions
MTBF at 40 °C	4 415 040 h	3 094 996 h	2 864 520 h	2 391 480 h	2 391 480 h
other information	Specifications at rated input voltage and ambient temperature +25 °C (unless otherwise specified)	Specifications at rated input voltage and ambient temperature +25 °C (unless otherwise specified)	Specifications at rated input voltage and ambient temperature +25 °C (unless otherwise specified)	Specifications at rated input voltage and ambient temperature +25 °C (unless otherwise specified)	Specifications at rated input voltage and ambient temperature +25 °C (unless otherwise specified)

LOGO! logic module

SIPLUS LOGO!Power

SIPLUS LOGO!Power

Overview



Thanks to its stepped profile design, the SIPLUS LOGO!Power product family is ideally suited for low installation depths, such as in miniature distribution boards. The stabilized power supplies with a wide-range input of 100 ... 240 V AC (85 ... 264 V) and 110 ... 300 V DC are available with an output voltage of 24 V in four performance classes. The 24 V versions are ideal for supplying SIPLUS LOGO! PLCs with the corresponding voltage input. The high level of efficiency across the entire load range as well as the low no-load losses result in lower overall energy consumption. Greater convenience when commissioning and servicing thanks to integrated current monitor (for devices at least 36 mm wide). The extended temperature range enables a host of additional applications.

Main product highlights

- 24 V DC / 0.6 A, 1.3 A, 2.5 A and 4.0 A
- Narrow unit with width of 18 mm, 36 mm, 54 mm or 72 mm and overall depth of 53 mm in LOGO! design
- Flexible mounting: top hat DIN rail or wall mounting in a range of installation positions
- Higher energy efficiency: up to 90% efficiency over the entire load range as well as no-load power losses of < 0.3 W
- Integrated current monitor: Actual output current measurement directly at the power supply unit (for devices at least 36 mm wide)
- Global use: International certifications such as UL, CSA, FM or ATEX

Ordering data

Article No.

SIPLUS LOGO!Power 24 V 1.3 A

6AG1331-6SB00-7AY0

Extended temperature range and exposure to environmental substances

Input 100 ... 240 V AC
Output 24 V DC, 1.3 A

SIPLUS LOGO!Power 24 V 2.5 A

6AG1332-6SB00-7AY0

Extended temperature range and exposure to environmental substances

Input 100 ... 240 V AC
Output 24 V DC, 2.5 A

SIPLUS LOGO!Power 24 V 4 A

6AG1333-6SB00-7AY0

Extended temperature range and exposure to environmental substances

Input 100 ... 240 V AC
Output 24 V DC, 4 A

Technical specifications

Article number	6AG1331-6SB00-7AY0	6AG1332-6SB00-7AY0	6AG1333-6SB00-7AY0
Based on	6EP3331-6SB00-0AY0	6EP3332-6SB00-0AY0	6EP3333-6SB00-0AY0
Product	SIPLUS LOGO!Power	SIPLUS LOGO!Power	SIPLUS LOGO!Power
Power supply, type	24 V/1.3 A	24 V/2.5 A	24 V/4 A
environmental conditions			
ambient temperature			
in horizontal mounting position during operation	-40; Startup @ -25 °C ... +70 °C; with natural convection	-40; Startup @ -25 °C ... +70 °C; with natural convection	-40; Startup @ -25 °C ... +70 °C; with natural convection
during storage and transport	-40 ... +85 °C	-40 ... +85 °C	-40 ... +85 °C
installation altitude at height above sea level maximum	6 000 m	6 000 m	6 000 m
ambient condition relating to ambient temperature - air pressure - installation altitude	In case of operation at altitudes of 2000 - 6000 m above sea level: Output power derating of -7.5 %/1000 m or reduction of the ambient temperature by 5 K/1000 m	In case of operation at altitudes of 2000 - 6000 m above sea level: Output power derating of -7.5 %/1000 m or reduction of the ambient temperature by 5 K/1000 m	In case of operation at altitudes of 2000 - 6000 m above sea level: Output power derating of -7.5 %/1000 m or reduction of the ambient temperature by 5 K/1000 m
relative humidity with condensation acc. to IEC 60068-2-38 maximum	100 %; RH incl. condensation/frost (no commissioning if condensation is present), horizontal installation	100 %; RH incl. condensation/frost (no commissioning if condensation is present), horizontal installation	100 %; RH incl. condensation/frost (no commissioning if condensation is present), horizontal installation
chemical resistance to commercially available cooling lubricants	Yes; incl. diesel and oil droplets in the air	Yes; incl. diesel and oil droplets in the air	Yes; incl. diesel and oil droplets in the air
resistance to biologically active substances conformity acc. to EN 60721-3-3	Yes; Class 3B2 mold, fungal, sponge spores (except fauna); class 3B3 upon request	Yes; Class 3B2 mold, fungal, sponge spores (except fauna); class 3B3 upon request	Yes; Class 3B2 mold, fungal, sponge spores (except fauna); class 3B3 upon request
resistance to chemically active substances conformity acc. to EN 60721-3-3	Yes; Class 3C4 (RH < 75%) incl. salt spray acc. to EN 60068-2-52 (severity level 3)	Yes; Class 3C4 (RH < 75%) incl. salt spray acc. to EN 60068-2-52 (severity level 3)	Yes; Class 3C4 (RH < 75%) incl. salt spray acc. to EN 60068-2-52 (severity level 3)
resistance to mechanically active substances conformity acc. to EN 60721-3-3	Yes; Class 3S4 incl. sand, dust	Yes; Class 3S4 incl. sand, dust	Yes; Class 3S4 incl. sand, dust
resistance to biologically active substances conformity acc. to EN 60721-3-6	Yes; Class 6B2 mold, fungal, sponge spores (except fauna)	Yes; Class 6B2 mold, fungal, sponge spores (except fauna)	Yes; Class 6B2 mold, fungal, sponge spores (except fauna)
resistance to chemically active substances conformity acc. to EN 60721-3-6	Yes; Class 6C3 (RH < 75%) incl. salt spray acc. to EN 60068-2-52 (severity level 3)	Yes; Class 6C3 (RH < 75%) incl. salt spray acc. to EN 60068-2-52 (severity level 3)	Yes; Class 6C3 (RH < 75%) incl. salt spray acc. to EN 60068-2-52 (severity level 3)
resistance to mechanically active substances conformity acc. to EN 60721-3-6	Yes; Class 6S3 incl. sand, dust	Yes; Class 6S3 incl. sand, dust	Yes; Class 6S3 incl. sand, dust
coating for equipped printed circuit board acc. to EN 61086	Yes; Class 2 for high availability	Yes; Class 2 for high availability	Yes; Class 2 for high availability
type of coating protection against pollution according to EN 60664-3	Yes; Type 1 protection	Yes; Type 1 protection	Yes; Type 1 protection
type of test of the coating acc. to MIL-I-46058C	Yes; Discoloration of the coating during service life possible	Yes; Discoloration of the coating during service life possible	Yes; Discoloration of the coating during service life possible
product conformity of the coating Qualification and Performance of Electrical Insulating Compound for Printed Board Assemblies acc. to IPC-CC-830A	Yes; Conformal Coating, Class A	Yes; Conformal Coating, Class A	Yes; Conformal Coating, Class A

LOGO! logic module

LOGO! software

LOGO! software

Overview

2

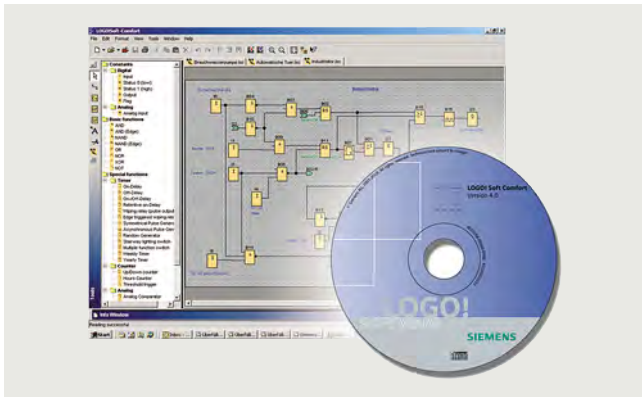

- The user-friendly software for generating switching programs on the PC for single-user mode and network mode
- Generation of switching programs in a function block diagram (FBD) or ladder logic (LAD)
- Furthermore, testing, simulation, online testing and archiving of the switching programs
- Professional documentation with the help of various comment and print functions

Minimum system requirements

Windows XP (32-bit), 7 (32/64-bit) or 8 (32/64-bit)

- PC Pentium IV.
- 150 MB free disk capacity.
- 256 MB RAM.
- SVGA graphics card with minimum resolution 800 x 600 (256 colors).
- DVD-ROM

Mac OS X

- Mac OS X 10.4

Linux

- Tested with SUSE Linux 11.3 SP2, kernel 3.0.76
- Runs on all Linux distributions on which Java 2 runs.
- Please refer to your relevant Linux distribution for the necessary hardware requirements.

Ordering data

LOGO!Soft Comfort V8

for programming on the PC in LAD/FBD; executes on Windows 8, 7, XP, Linux and Mac OSX; on DVD

Article No.

6ED1058-0BA08-0YA1

Overview

There are now six LOGO! 8 Starter Kits for price-conscious beginners – each individually configured for the specific requirements.

- LOGO! Starter Kit 12/24RCE;
With LOGO! 12/24RCE, power supply, screwdriver, in Systainer
- LOGO! Starter Kit 130 RCE;
With LOGO! 230RCE, power supply, screwdriver, in Systainer
- LOGO! Starter Kit 12/24 V;
With LOGO! 12/24RCEO, LOGO! TD, power supply, screwdriver, in Systainer
- LOGO! 8 KP300 Basic Starter Kit;
With LOGO! 12/24RCE, LOGO! Power 24 V 1.3 A, KP300 Basic mono PN
- LOGO! 8 KTP400 Basic Starter Kit;
With LOGO! 12/24RCE, LOGO! Power 24 V 1.3 A, KTP400 Basic
- LOGO! 8 KTP700 Basic Starter Kit;
With LOGO! 12/24RCE, LOGO! Power 24 V 1.3 A, KTP700 Basic

With these low-cost complete packages, users can familiarize themselves quickly and easily with the advantages and possibilities of the logic module. LOGO! has been used successfully for many years in industry and trade throughout the world. It solves switching and control tasks conveniently and cost-effectively.

Ordering data
Article No.
LOGO! Starter Kits

In TANOS Box, with LOGO! Soft Comfort V8, WinCC Basic, Ethernet cable

LOGO! Starter Kit 12/24RCE
6ED1057-3BA01-0AA8

With LOGO! 12/24RCE, power supply, screwdriver, in Systainer

LOGO! Starter Kit 130 RCE
6ED1057-3BA03-0AA8

With LOGO! 230RCE, power supply, screwdriver, in Systainer

LOGO! Starter Kit 12/24 V
6ED1057-3BA11-0AA8

With LOGO! 12/24RCEO, LOGO! TD, power supply, screwdriver, in Systainer

LOGO! 8 KP300 Basic Starter Kit
6AV2132-0HA00-0AA1

With LOGO! 12/24RCE, LOGO! Power 24 V 1.3 A, KP300 Basic mono PN

LOGO! 8 KTP400 Basic Starter Kit
6AV2132-0KA00-0AA1

With LOGO! 12/24RCE, LOGO! Power 24 V 1.3 A, KTP400 Basic

LOGO! 8 KTP700 Basic Starter Kit
6AV2132-3GB00-0AA1

With LOGO! 12/24RCE, LOGO! Power 24 V 1.3 A, KTP700 Basic

LOGO! logic module

LOGO! accessories

LOGO!Contact switching module**Overview**

2



- Switching module for the direct switching of resistive loads and motors

Ordering data**LOGO!Contact**

Switching module for direct switching of resistive loads up to 20 A and motors up to 4 kW

Switching voltage 24 V

Switching voltage 230 V

Article No.**6ED1057-4CA00-0AA0****6ED1057-4EA00-0AA0****Technical specifications**

Article number	6ED1057-4CA00-0AA0	6ED1057-4EA00-0AA0
	LOGO! Contact Mod., DC 24V, 3NO/1NC	LOGO! Contact Mod., AC 230V,3NO/1NC
Supply voltage		
Rated value (DC)	Yes	
• 24 V DC		
Rated value (AC)		Yes
• 230 V AC		
Standards, approvals, certificates		
CE mark	Yes	Yes
Ambient conditions		
Ambient temperature during operation		
• min.	-25 °C	-25 °C
• max.	55 °C	55 °C
Dimensions		
Width	36 mm	36 mm
Height	72 mm	72 mm
Depth	55 mm	55 mm
Weights		
Weight, approx.	160 g	160 g

Overview



LOGO! and SIPLUS LOGO! are designed for quick and easy mounting on top hat DIN rails. With the mounting kit, these devices can also be easily and safely installed in front panels. If the supplied washer and seals are used, the devices are reliably protected against harsh environmental conditions up to the IP65 degree of protection.

Ordering data

Front panel mounting kit

Width 4 U, with keys

Width 8 U, with keys

Article No.

6AG1057-1AA00-0AA3

6AG1057-1AA00-0AA2

LOGO! logic module

LOGO! accessories

System cabling for SIMATIC S7-1500 IO (25 mm), ET 200SP, S7-1200 and LOGO!

Overview

2

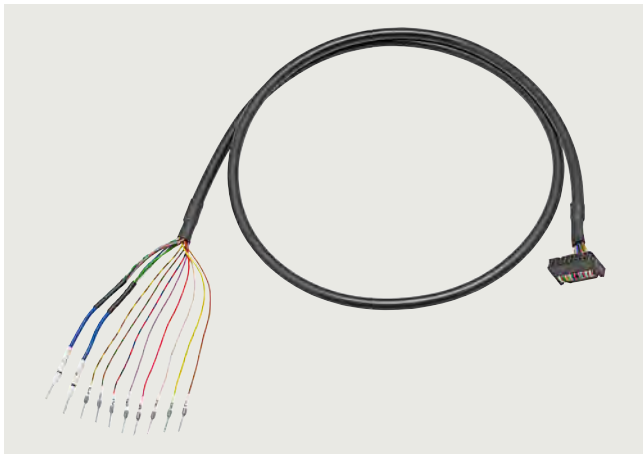

SIMATIC TOP connect universal connecting cable

The wiring of the

- SIMATIC S7-1500 IO (25 mm)
- SIMATIC ET 200SP
- SIMATIC S7-1200
- LOGO!

with the sensors/actuators is a significant factor with respect to time/cost overhead during configuration, control cabinet design, procurement and ease of servicing. The SIMATIC TOP connect system cabling makes connection easy, fast and secure.

Design

The unshielded universal connection cable is offered for a wide range of control cabinet concepts.

It comprises:

- 16-pin round cable with a core cross-section of 0.14 mm^2 , pre-assembled with wire end ferrules for connection to the controller:
 - Labeled with "0" ... "7" for the control inputs/outputs
 - Labeled with "M" for mass
 - Labeled with "L+" for 24 V DC potential
- 16-pin ID (insulation displacement) connector for connection to the SIMATIC TOP connect connection modules for 8 I/Os:
 - 3-wire connection using the appropriate connection module for quick, error-free wiring
 - Galvanic isolation and adaptation using a coupling relay for easy implementation of potential groups in the system
 - High output current (up to 4 A), even for higher switching frequencies, using an optocoupler module (overload and short-circuit proof)
 - Implementation of isolating terminals using switch modules enabling individual signals to be measured
 - Channel-wise protection of I/Os using a fuse module with a thermal fuse

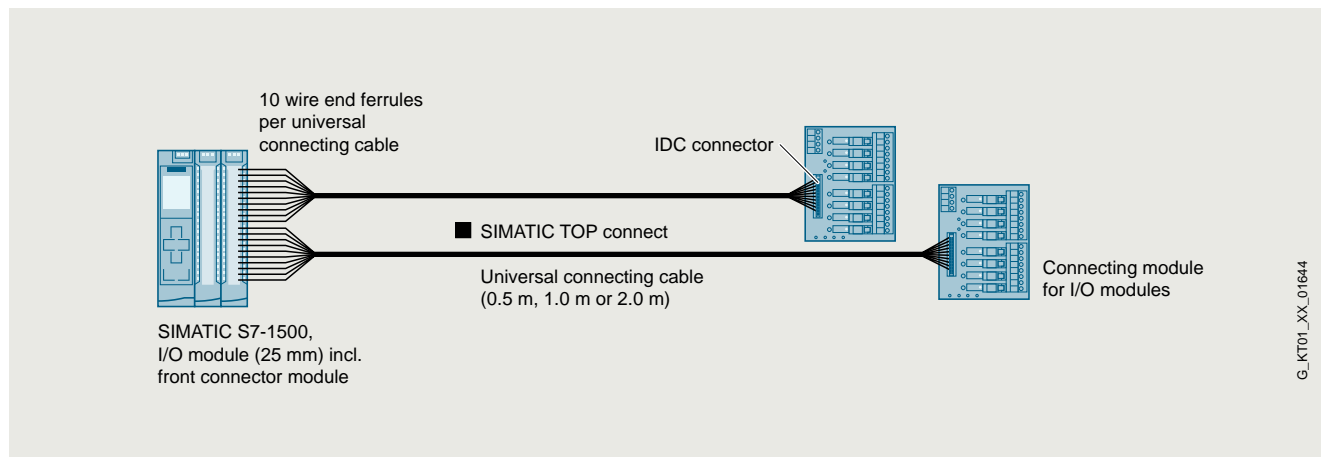

SIMATIC TOP connect universal connection cable

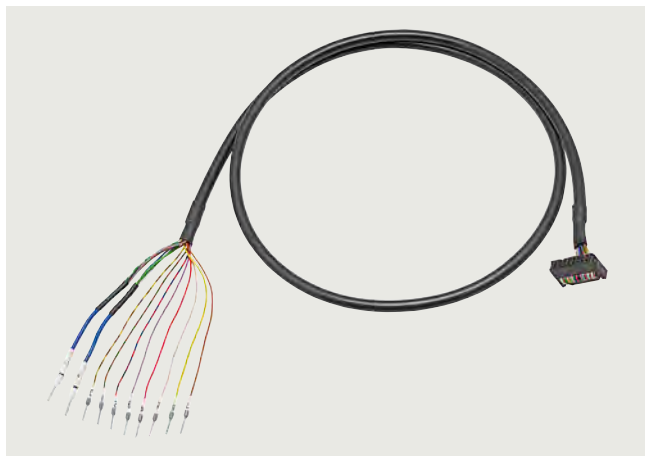
Overview Universal connecting cable

SIMATIC TOP connect universal connecting cable

The universal connecting cable constitutes the link between the standard connection of the SIMATIC S7-1500 IO (25 mm), SIMATIC ET 200SP, SIMATIC S7-1200 or LOGO! and the SIMATIC TOP connect terminal module. It transmits 8 signals and the supply voltage. The connecting cable is available in lengths of 0.5 m / 1.0 m / 2.0 m. the maximum technically feasible length is 30 m.

Ordering data
Article No.

**Universal connecting cable for
SIMATIC S7-1500 IO (25 mm),
SIMATIC ET 200SP,
SIMATIC S7-1200 and LOGO!**

16 x 0.14 mm² unshielded

- 0.5 m
- 1.0 m
- 2.0 m

6ES7923-0BA50-0FB0
6ES7923-0BB00-0FB0
6ES7923-0BC00-0FB0

Overview Connection modules

The connection modules are used instead of conventional terminal blocks and act as the interface between the PLC and signals from the field. All digital modules with 8 I/Os can be used.

Ordering data
Article No.
Connection module TP1

For 1-wire connection, for 16-pin connecting cables

- Push-in terminals without LEDs
- Screw-type terminals without LEDs
- Push-in terminals with LEDs
- Screw-type terminals with LEDs

6ES7924-0AA20-0AC0
6ES7924-0AA20-0AA0
6ES7924-0AA20-0BC0
6ES7924-0AA20-0BA0

Connection module TP3

For 3-wire connection, for 16-pin connecting cables

- Push-in terminals without LEDs
- Screw-type terminals without LEDs
- Push-in terminals with LEDs
- Screw-type terminals with LEDs
- Push-in terminals with LEDs and one isolating terminal per channel
- Screw-type terminals with LEDs and one isolating terminal per channel
- Push-in terminals with LEDs and fuse per channel
- Screw-type terminals with LEDs and fuse per channel

6ES7924-0CA20-0AC0
6ES7924-0CA20-0AA0
6ES7924-0CA20-0BC0
6ES7924-0CA20-0BA0
6ES7924-0CH20-0BC0
6ES7924-0CH20-0BA0
6ES7924-0CL20-0BC0
6ES7924-0CL20-0BA0

Connection module TPRo

Relay module for 8 outputs, relay as normally open contact

- Push-in terminals with LEDs
- Screw-type terminals with LEDs

6ES7924-0BD20-0BC0
6ES7924-0BD20-0BA0

Connection module TPRi

Relay module for 8 inputs (230 V AC), relay as normally open contact

- Push-in terminals with LEDs
- Screw-type terminals with LEDs

6ES7924-0BE20-0BC0
6ES7924-0BE20-0BA0

Connection module TPRi

Relay module for 8 inputs (110 V AC), relay as normally open contact

- Push-in terminals with LEDs
- Screw-type terminals with LEDs

6ES7924-0BG20-0BC0
6ES7924-0BG20-0BA0

Connection module TPOo

Optocoupler module for 8 outputs (max. 24 V DC/4 A)

- Push-in terminals with LEDs
- Screw-type terminals with LEDs

6ES7924-0BF20-0BC0
6ES7924-0BF20-0BA0

LOGO! logic module

Notes

2

SIMATIC S7-1200 Basic Controllers



3/2	Introduction		
3/2	S7-1200		
3/4	Central processing units		
3/4	<u>Standard CPUs</u>		
3/4	CPU 1211C		
3/8	CPU 1212C		
3/12	CPU 1214C		
3/16	CPU 1215C		
3/20	CPU 1217C		
3/23	<u>SIPLUS standard CPUs</u>		
3/23	SIPLUS CPU 1212C		
3/28	SIPLUS CPU 1214C		
3/35	SIPLUS CPU 1215C		
3/41	<u>Fail-safe CPUs</u>		
3/47	SIPLUS fail-safe CPUs		
3/50	I/O modules		
3/50	<u>Digital modules</u>		
3/50	SM 1221 digital input modules		
3/52	SB 1221 digital input modules		
3/54	SM 1222 digital output modules		
3/57	SB 1222 digital output modules		
3/59	SM 1223 digital input/output modules		
3/63	SB 1223 digital input/output modules		
3/65	<u>SIPLUS digital modules</u>		
3/65	SIPLUS SM 1221 digital input modules		
3/67	SIPLUS SB 1221 digital input modules		
3/69	SIPLUS SM 1222 digital output modules		
3/74	SIPLUS SB 1222 digital output modules		
3/76	SIPLUS SM 1223 digital input/output modules		
3/81	SIPLUS SB 1223 digital input/output modules		
3/83	<u>Analog modules</u>		
3/83	SM 1231 analog input modules		
3/86	SB 1231 analog input modules		
3/87	SM 1232 analog output modules		
3/89	SB 1232 analog output modules		
3/90	SM 1234 analog input/output modules		
3/92	SM 1231 thermocouple module		
3/94	SB 1231 thermocouple signal board		
3/95	SM 1231 RTD signal module		
3/98	SB 1231 RTD signal board		
3/99	SM 1238 Energy Meter 480 V AC analog input modules		
3/101	<u>SIPLUS analog modules</u>		
3/101	SIPLUS SM 1231 analog input modules		
3/103	SIPLUS SM 1232 analog output modules		
3/105	SIPLUS SB 1232 analog output modules		
3/107	SIPLUS SM 1234 analog input/output modules		
3/109	SIPLUS SM 1231 thermocouple module		
3/111	SIPLUS RTD SM 1231 signal module		
3/113	SIPLUS RTD SB 1231 signal board		
3/114	<u>Special modules</u>		
3/114	SM 1278 4xIO-Link master		
3/115	SIPLUS SM 1278 4xIO-Link master		
3/117	SIPLUS CMS1200 SM 1281 Condition Monitoring		
	<u>Special modules (continued)</u>		
3/119	SIM 1274 simulator module		
3/120	BB 1297 battery board		
3/121	SIWAREX WP231 weighing module		
3/124	SIWAREX WP241 weighing module		
3/126	SIWAREX WP251 weighing module		
3/129	<u>Communication</u>		
3/129	CM 1241 communications module		
3/131	CB 1241 RS485 communication board		
3/132	CM 1242-5		
3/134	AS-Interface communication		
3/134	- CM 1243-2 AS-i Master		
3/136	- DCM 1271 data decoupling module		
3/138	CM 1243-5		
3/140	CSM 1277 unmanaged		
3/142	CP 1243-1		
3/144	CP 1243-7 LTE		
3/147	CP 1243-8 IRC		
3/150	SIMATIC RF120C		
3/152	<u>SIPLUS communication</u>		
3/152	SIPLUS CM 1241 communications modules		
3/154	SIPLUS CB 1241 RS485 communication board		
3/155	SIPLUS CM 1242-5 communications modules		
3/156	SIPLUS CM 1243-2 communications modules		
3/157	SIPLUS CM 1243-5 communications modules		
3/159	SIPLUS CP 1243-1 communications modules		
3/161	SIPLUS NET CSM 1277		
3/162	<u>Connection system</u>		
3/162	System cabling for SIMATIC S7-1500 IO (25 mm), ET 200SP, S7-1200 and LOGO!		
3/164	<u>Fail-safe I/O modules</u>		
3/164	SM 1226 fail-safe digital input		
3/166	SM 1226 fail-safe digital output		
3/168	SM 1226 fail-safe relay output		
3/170	<u>SIPLUS Fail-safe digital inputs and outputs</u>		
3/170	SIPLUS SM 1226 fail-safe digital input		
3/171	SIPLUS SM 1226 fail-safe digital output		
3/172	SIPLUS SM 1226 fail-safe relay output		
3/173	Power supplies		
3/173	1-phase, 24 V DC (for S7-1200)		
3/175	SIPLUS power supplies		
3/175	1-phase, 24 V DC (for SIPLUS S7-1200)		
3/177	Operator control and monitoring		
3/177	Basic Panels		
3/178	Comfort Panels		
3/179	SIPLUS operator control and monitoring		
3/179	SIPLUS Basic Panels (2nd Generation)		
3/182	SIPLUS Basic Panels (1st Generation)		
3/184	SIPLUS Comfort Panels Standard		
3/189	Starter kits		
3/190	Add-on products from third-party manufacturers		
3/190	SIMATIC S7-1200 CM CANopen		

SIMATIC S7-1200 Basic Controllers

Introduction

S7-1200

Overview

3



SIMATIC S7-1200 Controllers are the intelligent choice for compact automation solutions with integrated I/Os, communication functions and technology functions for automation tasks in the lower to middle performance range. They are available in standard and fail-safe versions.

The scalable SIMATIC S7-1200 Controllers have integrated inputs and outputs as well as communication options and allow modular expansion. Digital and analog input and output modules as well as different communications and special modules enable flexible adaptation to the relevant automation task.

Technical specifications

General technical specifications of SIMATIC S7-1200	
Degree of protection	IP20 acc. to IEC 529
Ambient temperature	
• Operation (95% humidity)	
- Horizontal installation	-20 ... +60 °C
- Vertical installation	-20 ... +50 °C
• Transportation and storage	-40 ... +70 °C
- With 95% humidity	25 ... 55 °C
Insulation	
• 5/24 V DC circuits	500 V AC test voltage
• 115/230 V AC circuits to ground	1500 V AC test voltage
• 115/230 V AC circuits to 115/230 V AC circuits	1500 V AC test voltage
• 230 V AC circuits to 5/24 V DC circuits	1500 V AC test voltage
• 115 V AC circuits to 5/24 V DC circuits	1500 V AC test voltage
Electromagnetic compatibility	Requirements of the EMC directive
• Noise immunity acc. to EN 50082-2	Test acc. to: IEC 801-2, IEC 801-3, IEC 801-4, EN 50141, EN 50204, IEC 801-5, VDE 0160
• Emitted interference acc. to EN 50081-1 and EN 50081-2	Test according to EN 55011, Class A, Group 1
Mechanical strength	
• Vibrations, test acc. to / tested with	IEC 68, Part 2-6: 10 ... 57 Hz; constant amplitude 0.3 mm; 58 ... 150 Hz; constant acceleration 1 g (mounted on DIN rail) or 2 g (mounted in switchboard); mode of vibration: frequency sweeps with a sweep rate of 1 octave/minute; duration of vibration: 10 frequency sweeps per axis in each direction of the three mutually perpendicular axes
• Shocks, test acc. to / tested with	IEC 68, Part 2-27/half-sine: magnitude of shock 15 g (peak value), duration 11 ms, 6 shocks in each of the three mutually perpendicular axes

General technical data of SIPLUS S7-1200	
Ambient temperature range	-40/-25/-20 ... +55/+60/+70 °C
Conformal coating	Coating of the printed circuit boards and the electronic components
Technical specifications	The technical specifications of the standard product apply except for the ambient conditions.

Ambient conditions

Extended range of environmental conditions	
• with reference to ambient temperature, air pressure and altitude	Tmin ... Tmax at 1080 hPa ... 795 hPa (-1000 m ... +2000 m) // Tmin ... (Tmax - 10K) at 795 hPa ... 658 hPa (+2000 m ... +3500 m) // Tmin ... (Tmax - 20K) at 658 hPa ... 540 hPa (+3500 m ... +5000 m)
• At cold restart, min.	0° C
Relative humidity	
• with condensation, max.	100 %; RH incl. bedewing/frost (no commissioning in bedewed state)
Resistance	
• to biologically active substances/compliance with EN 60721-3-3	Yes; Class 3B2 mold and fungal spores (except fauna); the supplied plug covers must remain in place on the unused interfaces during operation.
• to chemically active substances/compliance with EN 60721-3-3	Yes; Class 3C4 (RH < 75%) incl. salt spray in accordance with EN 60068-2-52 (severity 3); the supplied plug covers must remain in place on the unused interfaces during operation.
• to mechanically active substances, compliance with EN 60721-3-3	Yes; Class 3S4 incl. sand, dust; the supplied plug covers must remain in place on unused interfaces during operation.

SIMATIC S7-1200 Basic Controllers

Central processing units
Standard CPUs

CPU 1211C

Overview



- Controller for intro to S7
- Expandable by:
 - 1 signal board (SB), battery board (BB) or communication board (CB)
 - Max. 3 communications modules (CM)

Ordering data

CPU 1211C

Compact CPU, AC/DC/relay;
Integrated program/
data memory 50 KB,
load memory 1 MB;
Wide-range power supply
85 ... 264 V AC;
Boolean execution times
0.1 µs per operation;
6 digital inputs,
4 digital outputs (relays),
2 analog inputs;
Expandable by up to
3 communications modules and
1 signal board/communication
board;
Digital inputs can be used as HSC
at 100 kHz

Article No.

6ES7211-1BE40-0XB0

Compact CPU, DC/DC/DC;
Integrated program/data memory
50 KB, load memory 1 MB;
Supply voltage 24 V DC;
Boolean execution times
0.1 µs per operation;
6 digital inputs,
4 digital outputs,
2 analog inputs;
Expandable by up to
3 communications modules and
1 signal board/communication
board;
Digital inputs can be used as HSC
at 100 kHz,
24 V DC digital outputs can be
used as pulse outputs (PTO) or
pulse-width modulated outputs
(PWM) at 100 kHz

6ES7211-1AE40-0XB0

Compact CPU, DC/DC/relay;
Integrated program/data memory
50 KB, load memory 1 MB;
Supply voltage 24 V DC;
Boolean execution times
0.1 µs per operation;
6 digital inputs,
4 digital outputs (relays),
2 analog inputs;
Expandable by up to
3 communications modules and
1 signal board/communication
board;
Digital inputs can be used as HSC
at 100 kHz

6ES7211-1HE40-0XB0

Article No.

SB 1221 signal board

4 inputs, 5 V DC, 200 kHz
4 inputs, 24 V DC, 200 kHz

6ES7221-3AD30-0XB0

6ES7221-3BD30-0XB0

SB 1222 signal board

4 outputs, 5 V DC, 0.1 A, 200 kHz
4 outputs, 24 V DC, 0.1 A, 200 kHz

6ES7222-1AD30-0XB0

6ES7222-1BD30-0XB0

SB 1223 signal board

2 inputs, 24 V DC,
IEC type 1 current sinking;
2 x 24 V DC transistor outputs,
0.5 A, 5 W;
can be used as HSC at
up to 30 kHz

6ES7223-0BD30-0XB0

2 inputs, 5 V DC, 200 kHz
2 outputs 5 V DC, 0.1 A, 200 kHz

6ES7223-3AD30-0XB0

2 inputs, 24 V DC, 200 kHz
2 outputs 24 V DC, 0.1 A, 200 kHz

6ES7223-3BD30-0XB0

SB 1231 signal board

1 analog input, ±10 V with
12 bits or 0 ... 20 mA with 11 bits

6ES7231-4HA30-0XB0

SB 1231 thermocouple signal board

1 input +/- 80 mV, resolution
15 bits + sign,
thermocouples type J, K

6ES7231-5QA30-0XB0

SB 1231 RTD signal board

1 input for resistance temperature
sensors Pt 100, Pt 200, Pt 500,
Pt 1000, resolution 15 bits + sign

6ES7231-5PA30-0XB0

SB 1232 signal board

1 analog output, ±10 V with 12 bits
or 0 to 20 mA with 11 bits

6ES7232-4HA30-0XB0

CB 1241 RS485 Communication Board

For point-to-point connection,
with 1 RS485 interface

6ES7241-1CH30-1XB0

Ordering data	Article No.	Ordering data	Article No.
BB1297 battery board For long-term backup of real-time clock, can be plugged into the signal board slot; battery (CR1025) is not included in scope of supply	6ES7297-0AX30-0XA0	RJ45 cable grip 4 units per pack Single port	6ES7290-3AA30-0XA0
Digital input simulator Simulator Module SIM 1274 (optional) 8 input switches, for CPU 1211C / CPU 1212C	6ES7274-1XF30-0XA0	Front flap set (spare part) For CPU 1211C/1212C	6ES7291-1AA30-0XA0
Analog input simulator Simulator Module SIM 1274 (optional) 2 potentiometers	6ES7274-1XA30-0XA0	STEP 7 Professional / Basic V17 Target system: SIMATIC S7-1200, S7-1500, S7-300, S7-400, WinAC Requirement: Windows 10 (64-bit) • Windows 10 Professional Version 1909, 2004, 20H2 • Windows 10 Enterprise Version 1909, 2004, 20H2 • Windows 10 IoT Enterprise 2016 LTSC • Windows 10 IoT Enterprise 2019 LTSC Windows Server (64-bit) • Windows Server 2016 Standard (full installation) • Windows Server 2019 Standard (full installation) Type of delivery: 9 languages: de, en, zh included, fr, sp, it, ru, jp, kr as download STEP 7 Professional V17, floating license STEP 7 Professional V17, floating license, software download including license key ¹⁾ Email address required for delivery STEP 7 Basic V17, floating license STEP 7 Basic V17, floating license, software download including license key ¹⁾ Email address required for delivery	
SIMATIC Memory Card (optional) 4 MB 12 MB 24 MB 256 MB 2 GB 32 GB	6ES7954-8LC03-0AA0 6ES7954-8LE03-0AA0 6ES7954-8LF03-0AA0 6ES7954-8LL03-0AA0 6ES7954-8LP03-0AA0 6ES7954-8LT03-0AA0		
Terminal block (spare part) For CPU 1211C AC/DC/relay • For DI, 14-pin, tin-coated, coded; 4 units - Screw-type system - Push-in system • For DO, 8-pin, tin-coated, coded; 4 units - Screw-type system - Push-in system • For AI, 3-pin, gold-plated; 4 units - Screw-type system - Push-in system For CPU 1211C DC/DC/DC • For DI, 14-pin, tin-coated; 4 units - Screw-type system - Push-in system • For DO, 8-pin, tin-coated; 4 units - Screw-type system - Push-in system • For AI, 3-pin, gold-plated; 4 units - Screw-type system - Push-in system For CPU 1211C DC/DC/relay • For DI, 14-pin, tin-coated; 4 units - Screw-type system - Push-in system • For DO, 8-pin, tin-coated, coded; 4 units - Screw-type system - Push-in system • For AI, 3-pin, gold-plated; 4 units - Screw-type system - Push-in system	6ES7292-1AP40-0XA0 6ES7292-2AP40-0XA0 6ES7292-1AH40-0XA0 6ES7292-2AH40-0XA0 6ES7292-1BC30-0XA0 6ES7292-2BC30-0XA0 6ES7292-1AP30-0XA0 6ES7292-2AP30-0XA0 6ES7292-1AH30-0XA0 6ES7292-2AH30-0XA0 6ES7292-1BC30-0XA0 6ES7292-2BC30-0XA0 6ES7292-1AP30-0XA0 6ES7292-2AP30-0XA0 6ES7292-1AH40-0XA0 6ES7292-2AH40-0XA0 6ES7292-1BC30-0XA0 6ES7292-2BC30-0XA0	6ES7822-1AA07-0YA5 6ES7822-1AE07-0YA5 6ES7822-0AA07-0YA5 6ES7822-0AE07-0YA5	

¹⁾ For up-to-date information and download availability, see: <http://www.siemens.com/tia-online-software-delivery>

SIMATIC S7-1200 Basic Controllers

Central processing units
Standard CPUs

CPU 1211C

Technical specifications

Article number	6ES7211-1HE40-0XB0 CPU 1211C, DC/DC/Relay, 6DI/4DO/2AI	6ES7211-1BE40-0XB0 CPU 1211C, AC/DC/Relay, 6DI/4DO/2AI	6ES7211-1AE40-0XB0 CPU 1211C, DC/DC/DC, 6DI/4DO/2AI
General information			
Product type designation	CPU 1211C DC/DC/relay	CPU 1211C AC/DC/relay	CPU 1211C DC/DC/DC
Engineering with			
• Programming package	STEP 7 V17 or higher	STEP 7 V17 or higher	STEP 7 V17 or higher
Supply voltage			
Rated value (DC)	Yes	Yes	Yes
• 24 V DC			
Rated value (AC)			
• 120 V AC	Yes	Yes	
• 230 V AC	Yes	Yes	
Encoder supply			
24 V encoder supply			
• 24 V	L+ minus 4 V DC min.	20.4 to 28.8V	L+ minus 4 V DC min.
Memory			
Work memory			
• integrated	50 kbyte	50 kbyte	50 kbyte
Load memory			
• integrated	1 Mbyte with SIMATIC memory card	1 Mbyte with SIMATIC memory card	1 Mbyte with SIMATIC memory card
• Plug-in (SIMATIC Memory Card), max.			
Backup			
• without battery	Yes	Yes	Yes
CPU processing times			
for bit operations, typ.	0.08 µs; / instruction	0.08 µs; / instruction	0.08 µs; / instruction
for word operations, typ.	1.7 µs; / instruction	1.7 µs; / instruction	1.7 µs; / instruction
for floating point arithmetic, typ.	2.3 µs; / instruction	2.3 µs; / instruction	2.3 µs; / instruction
Data areas and their retentivity			
Flag			
• Size, max.	4 kbyte; Size of bit memory address area	4 kbyte; Size of bit memory address area	4 kbyte; Size of bit memory address area
Address area			
Process image			
• Inputs, adjustable	1 kbyte	1 kbyte	1 kbyte
• Outputs, adjustable	1 kbyte	1 kbyte	1 kbyte
Time of day			
Clock			
• Hardware clock (real-time)	Yes	Yes	Yes
Digital inputs			
Number of digital inputs	6; Integrated	6; Integrated	6; Integrated
• of which inputs usable for technological functions	6; HSC (High Speed Counting)	6; HSC (High Speed Counting)	6; HSC (High Speed Counting)
Digital outputs			
Number of digital outputs	4; Relays	4; Relays	4
• of which high-speed outputs			4; 100 kHz Pulse Train Output
Analog inputs			
Number of analog inputs	2	2	2
Input ranges			
• Voltage	Yes	Yes	Yes
Analog outputs			
Number of analog outputs	0	0	0
1. Interface			
Interface type	PROFINET	PROFINET	PROFINET
Protocols			
• PROFINET IO Controller	Yes	Yes	Yes
• PROFINET IO Device	Yes	Yes	Yes
• SIMATIC communication	Yes	Yes	Yes
• Open IE communication	Yes; Optionally also encrypted	Yes; Optionally also encrypted	Yes; Optionally also encrypted
• Web server	Yes	Yes	Yes
• Media redundancy	No	No	No

Technical specifications

Article number	6ES7211-1HE40-0XB0 CPU 1211C, DC/DC/Relay, 6DI/4DO/2AI	6ES7211-1BE40-0XB0 CPU 1211C, AC/DC/Relay, 6DI/4DO/2AI	6ES7211-1AE40-0XB0 CPU 1211C, DC/DC/DC, 6DI/4DO/2AI
Protocols			
Open IE communication			
• TCP/IP	Yes	Yes	Yes
• ISO-on-TCP (RFC1006)	Yes	Yes	Yes
• UDP	Yes	Yes	Yes
Web server			
• supported	Yes	Yes	Yes
OPC UA			
• OPC UA Server	Yes; data access (read, write, subscribe), method call, runtime license required	Yes; data access (read, write, subscribe), method call, runtime license required	Yes; Data access (read, write, subscribe), runtime license required
communication functions / header			
S7 communication			
• supported	Yes	Yes	Yes
Number of connections			
• overall	PG Connections: 4 reserved / 4 max; HMI Connections: 12 reserved / 18 max; S7 Connections: 8 reserved / 14 max; Open User Connections: 8 reserved / 14 max; Web Connections: 2 reserved / 30 max; OPC UA Connections: 0 reserved / 10 max; Total Connections: 34 reserved / 64 max	PG Connections: 4 reserved / 4 max; HMI Connections: 12 reserved / 18 max; S7 Connections: 8 reserved / 14 max; Open User Connections: 8 reserved / 14 max; Web Connections: 2 reserved / 30 max; OPC UA Connections: 0 reserved / 10 max; Total Connections: 34 reserved / 64 max	PG Connections: 4 reserved / 4 max; HMI Connections: 12 reserved / 18 max; S7 Connections: 8 reserved / 14 max; Open User Connections: 8 reserved / 14 max; Web Connections: 2 reserved / 30 max; OPC UA Connections: 0 reserved / 10 max; Total Connections: 34 reserved / 64 max
Integrated Functions			
Counter			
• Number of counters	6	6	6
• Counting frequency, max.	100 kHz	100 kHz	100 kHz
Frequency measurement	Yes	Yes	Yes
controlled positioning	Yes	Yes	Yes
Number of position-controlled positioning axes, max.	8	8	8
Number of positioning axes via pulse-direction interface	Up to 4 with SB 1222	Up to 4 with SB 1222	4; With integrated outputs
PID controller	Yes	Yes	Yes
Number of alarm inputs	4	4	4
Number of pulse outputs			4
Limit frequency (pulse)			100 kHz
Ambient conditions			
Ambient temperature during operation			
• min.	-20 °C	-20 °C	-20 °C
• max.	60 °C	60 °C	60 °C
Pollutant concentrations			
• SO ₂ at RH < 60% without condensation	SO ₂ : < 0.5 ppm; H ₂ S: < 0.1 ppm; RH < 60% condensation-free	SO ₂ : < 0.5 ppm; H ₂ S: < 0.1 ppm; RH < 60% condensation-free	SO ₂ : < 0.5 ppm; H ₂ S: < 0.1 ppm; RH < 60% condensation-free
configuration / header			
configuration / programming / header			
Programming language			
- LAD	Yes	Yes	Yes
- FBD	Yes	Yes	Yes
- SCL	Yes	Yes	Yes
Dimensions			
Width	90 mm	90 mm	90 mm
Height	100 mm	100 mm	100 mm
Depth	75 mm	75 mm	75 mm
Weights			
Weight, approx.	380 g	420 g	370 g

SIMATIC S7-1200 Basic Controllers

Central processing units
Standard CPUs

CPU 1212C

Overview



- Controller for intro to S7 with basic expansion options
- Expandable by:
 - 1 signal board (SB), battery board (BB) or communication board (CB)
 - 2 signal modules (SM)
 - Max. 3 communications modules (CM)

Ordering data

CPU 1212C

Compact CPU, AC/DC/relay;
Integrated program/data memory
75 KB, load memory 2 MB;
Wide-range power supply
85 ... 264 V AC;
Boolean execution times
0.1 µs per operation;
8 digital inputs,
6 digital outputs (relays),
2 analog inputs;
Expandable by up to
3 communications modules,
2 signal modules and 1 signal
board/communication board;
Digital inputs can be used as HSC
at 100 kHz

Article No.

6ES7212-1BE40-0XB0

Compact CPU, DC/DC/DC;
Integrated program/data memory
75 KB, load memory 2 MB;
Supply voltage 24 V DC;
Boolean execution times
0.1 µs per operation;
8 digital inputs,
6 digital outputs,
2 analog inputs;
Expandable by up to
3 communications modules,
2 signal modules, and 1 signal
board/communication board;
Digital inputs can be used as HSC
at 100 kHz,
24 V DC digital outputs can be
used as pulse outputs (PTO) or
pulse-width modulated outputs
(PWM) at 100 kHz

6ES7212-1AE40-0XB0

Compact CPU, DC/DC/relay;
Integrated program/
data memory 75 KB,
load memory 2 MB;
Supply voltage 24 V DC;
Boolean execution times
0.1 µs per operation;
8 digital inputs,
6 digital outputs (relays),
2 analog inputs;
Expandable by up to
3 communications modules,
2 signal modules, and 1 signal
board/communication board;
Digital inputs can be used as HSC
at 100 kHz

6ES7212-1HE40-0XB0

Article No.

SB 1221 signal board

4 inputs, 5 V DC, 200 kHz

6ES7221-3AD30-0XB0

4 inputs, 24 V DC, 200 kHz

6ES7221-3BD30-0XB0

SB 1222 signal board

4 outputs, 5 V DC, 0.1 A, 200 kHz

6ES7222-1AD30-0XB0

4 outputs, 24 V DC, 0.1 A, 200 kHz

6ES7222-1BD30-0XB0

SB 1223 signal board

2 inputs, 24 V DC,
IEC type 1 current sinking;
2 x 24 V DC transistor outputs,
0.5 A, 5 W;
can be used as HSC at up to 30 kHz

6ES7223-0BD30-0XB0

2 inputs, 5 V DC, 200 kHz
2 outputs 5 V DC, 0.1 A, 200 kHz

6ES7223-3AD30-0XB0

2 inputs, 24 V DC, 200 kHz
2 outputs 24 V DC, 0.1 A, 200 kHz

6ES7223-3BD30-0XB0

SB 1231 signal board

6ES7231-4HA30-0XB0

1 analog input, ±10 V with
12 bits or 0 ... 20 mA with 11 bits

SB 1231 thermocouple signal board

6ES7231-5QA30-0XB0

1 input +/- 80 mV,
resolution 15 bits + sign,
thermocouples type J, K

SB 1231 RTD signal board

6ES7231-5PA30-0XB0

1 input for resistance temperature
sensors Pt 100, Pt 200, Pt 500,
Pt 1000, resolution 15 bits + sign

SB 1232 signal board

6ES7232-4HA30-0XB0

1 analog output, ±10 V with 12 bits
or 0 to 20 mA with 11 bits

CB 1241 RS485 Communication Board

6ES7241-1CH30-1XB0

For point-to-point connection,
with 1 RS485 interface

BB1297 battery board

6ES7297-0AX30-0XA0

For long-term backup of
real-time clock, can be plugged
into the signal board slot;
battery (CR1025) is not included
in scope of supply

Ordering data	Article No.	Article No.	
Digital input simulator Simulator Module SIM 1274 (optional) 8 input switches, for CPU 1211C / CPU 1212C	6ES7274-1XF30-0XA0		
Analog input simulator Simulator Module SIM 1274 (optional) 2 potentiometers	6ES7274-1XA30-0XA0		
SIMATIC Memory Card (optional) 4 MB 12 MB 24 MB 256 MB 2 GB 32 GB	6ES7954-8LC03-0AA0 6ES7954-8LE03-0AA0 6ES7954-8LF03-0AA0 6ES7954-8LL03-0AA0 6ES7954-8LP03-0AA0 6ES7954-8LT03-0AA0		
Extension cable for two-tier configuration For connecting digital/analog signal modules; length 2 m	6ES7290-6AA30-0XA0		
Starter Kit CPU 1212C AC/DC/relay Complete offer SIMATIC S7-1200, starter box, comprising: CPU 1212C AC/DC/relay, simulator, STEP 7 BASIC, manual CD, SIMATIC OPC UA S7-1200 Basic Runtime license, info material, in Systainer	6ES7212-1BE34-4YB0		
SIMATIC S7-1200 + KP300 Basic Starter Kit Consisting of: CPU 1212C AC/DC/relay, HMI KP300 Basic mono PN, input simulator, STEP 7 Basic, manual CD, SIMATIC OPC UA S7-1200 Basic Runtime license, Systainer	6AV6651-7HA02-3AA4		
SIMATIC S7-1200 + KTP400 Basic Starter Kit Consisting of: CPU 1212C AC/DC/relay, HMI KTP400 Basic, input simulator, STEP 7 Basic, manual CD, SIMATIC OPC UA S7-1200 Basic Runtime license, Systainer	6AV6651-7KA02-3AA4		
SIMATIC S7-1200 + KTP700 Basic Starter Kit Consisting of: CPU 1212C AC/DC/relay, HMI KTP700 Basic, input simulator, STEP 7 Basic, manual CD, SIMATIC OPC UA S7-1200 Basic Runtime license, Systainer	6AV6651-7DA02-3AA4		
Terminal block (spare part) For CPU 1212C AC/DC/relay <ul style="list-style-type: none"> For DI, 14-pin, tin-coated, coded; 4 units <ul style="list-style-type: none"> Screw-type system Push-in system For DO, 8-pin, tin-coated, coded; 4 units <ul style="list-style-type: none"> Screw-type system Push-in system 	6ES7292-1AP40-0XA0 6ES7292-2AP40-0XA0 6ES7292-1AH40-0XA0 6ES7292-2AH40-0XA0	Terminal block (spare part) (cont.) <ul style="list-style-type: none"> For AI, 3-pin, gold-plated; 4 units <ul style="list-style-type: none"> Screw-type system Push-in system For CPU 1212C DC/DC/DC <ul style="list-style-type: none"> For DI, 14-pin, tin-coated; 4 units <ul style="list-style-type: none"> Screw-type system Push-in system For DO, 8-pin, tin-coated; 4 units <ul style="list-style-type: none"> Screw-type system Push-in system For AI, 3-pin, gold-plated; 4 units <ul style="list-style-type: none"> Screw-type system Push-in system For CPU 1212C DC/DC/relay <ul style="list-style-type: none"> For DI, 14-pin, tin-coated; 4 units <ul style="list-style-type: none"> Screw-type system Push-in system For DO, 8-pin, tin-coated, coded; 4 units <ul style="list-style-type: none"> Screw-type system Push-in system For AI, 3-pin, gold-plated; 4 units <ul style="list-style-type: none"> Screw-type system Push-in system 	6ES7292-1BC30-0XA0 6ES7292-2BC30-0XA0 6ES7292-1AP30-0XA0 6ES7292-2AP30-0XA0 6ES7292-1AH30-0XA0 6ES7292-2AH30-0XA0 6ES7292-1BC30-0XA0 6ES7292-2BC30-0XA0 6ES7292-1AP30-0XA0 6ES7292-2AP30-0XA0 6ES7292-1AH40-0XA0 6ES7292-2AH40-0XA0 6ES7292-1BC30-0XA0 6ES7292-2BC30-0XA0
RJ45 cable grip 4 units per pack Single port		6ES7290-3AA30-0XA0	
Front flap set (spare part) For CPU 1211C/1212C		6ES7291-1AA30-0XA0	
STEP 7 Professional / Basic 17 Target system: SIMATIC S7-1200, S7-1500, S7-300, S7-400, WinAC Requirement: Windows 10 (64-bit) <ul style="list-style-type: none"> Windows 10 Professional Version 1909, 2004, 20H2 Windows 10 Enterprise Version 1909, 2004, 20H2 Windows 10 IoT Enterprise 2016 LTSC Windows 10 IoT Enterprise 2019 LTSC Windows Server (64-bit) <ul style="list-style-type: none"> Windows Server 2016 Standard (full installation) Windows Server 2019 Standard (full installation) Type of delivery: 9 languages: de, en, zh included, fr, sp, it, ru, jp, kr as download STEP 7 Professional V17, floating license STEP 7 Professional V17, floating license, software download including license key ¹⁾ Email address required for delivery STEP 7 Basic V17, floating license STEP 7 Basic V17, floating license, software download including license key ¹⁾ Email address required for delivery		6ES7822-1AA07-0YA5 6ES7822-1AE07-0YA5 6ES7822-0AA07-0YA5 6ES7822-0AE07-0YA5	

¹⁾ For up-to-date information and download availability, see:
<http://www.siemens.com/tia-online-software-delivery>

SIMATIC S7-1200 Basic Controllers

Central processing units
Standard CPUs

CPU 1212C

Technical specifications

Article number	6ES7212-1AE40-0XB0 CPU 1212C, DC/DC/DC, 8DI/6DO/2AI	6ES7212-1BE40-0XB0 CPU 1212C, AC/DC/Relay, 8DI/6DO/2AI	6ES7212-1HE40-0XB0 CPU 1212C, DC/DC/Relay, 8DI/6DO/2AI
General information			
Product type designation	CPU 1212C DC/DC/DC	CPU 1212C AC/DC/relay	CPU 1212C DC/DC/relay
Engineering with			
• Programming package	STEP 7 V17 or higher	STEP 7 V17 or higher	STEP 7 V17 or higher
Supply voltage			
Rated value (DC)	Yes	Yes	Yes
• 24 V DC			
Rated value (AC)			
• 120 V AC	Yes	Yes	
• 230 V AC	Yes	Yes	
Encoder supply			
24 V encoder supply			
• 24 V	L+ minus 4 V DC min.	20.4 to 28.8V	L+ minus 4 V DC min.
Memory			
Work memory			
• integrated	75 kbyte	75 kbyte	75 kbyte
Load memory			
• integrated	2 Mbyte	2 Mbyte	2 Mbyte
• Plug-in (SIMATIC Memory Card), max.	with SIMATIC memory card	with SIMATIC memory card	with SIMATIC memory card
Backup			
• without battery	Yes	Yes	Yes
CPU processing times			
for bit operations, typ.	0.08 µs; / instruction	0.08 µs; / instruction	0.08 µs; / instruction
for word operations, typ.	1.7 µs; / instruction	1.7 µs; / instruction	1.7 µs; / instruction
for floating point arithmetic, typ.	2.3 µs; / instruction	2.3 µs; / instruction	2.3 µs; / instruction
Data areas and their retentivity			
Flag			
• Size, max.	4 kbyte; Size of bit memory address area	4 kbyte; Size of bit memory address area	4 kbyte; Size of bit memory address area
Address area			
Process image			
• Inputs, adjustable	1 kbyte	1 kbyte	1 kbyte
• Outputs, adjustable	1 kbyte	1 kbyte	1 kbyte
Time of day			
Clock			
• Hardware clock (real-time)	Yes	Yes	Yes
Digital inputs			
Number of digital inputs	8; Integrated	8; Integrated	8; Integrated
• of which inputs usable for technological functions	6; HSC (High Speed Counting)	6; HSC (High Speed Counting)	6; HSC (High Speed Counting)
Digital outputs			
Number of digital outputs	6	6; Relays	6; Relays
• of which high-speed outputs	4; 100 kHz Pulse Train Output		
Analog inputs			
Number of analog inputs	2	2	2
Input ranges			
• Voltage	Yes	Yes	Yes
Analog outputs			
Number of analog outputs	0	0	0
1. Interface			
Interface type	PROFINET	PROFINET	PROFINET
Protocols			
• PROFINET IO Controller	Yes	Yes	Yes
• PROFINET IO Device	Yes	Yes	Yes
• SIMATIC communication	Yes	Yes	Yes
• Open IE communication	Yes; Optionally also encrypted	Yes; Optionally also encrypted	Yes; Optionally also encrypted
• Web server	Yes	Yes	Yes
• Media redundancy	No	No	No

Technical specifications

Article number	6ES7212-1AE40-0XB0 CPU 1212C, DC/DC/DC, 8DI/6DO/2AI	6ES7212-1BE40-0XB0 CPU 1212C, AC/DC/Relay, 8DI/6DO/2AI	6ES7212-1HE40-0XB0 CPU 1212C, DC/DC/Relay, 8DI/6DO/2AI
Protocols			
Open IE communication			
• TCP/IP	Yes	Yes	Yes
• ISO-on-TCP (RFC1006)	Yes	Yes	Yes
• UDP	Yes	Yes	Yes
Web server			
• supported	Yes	Yes	Yes
OPC UA			
• OPC UA Server	Yes; data access (read, write, subscribe), method call, runtime license required	Yes; data access (read, write, subscribe), method call, runtime license required	Yes; data access (read, write, subscribe), method call, runtime license required
communication functions / header			
S7 communication			
• supported	Yes	Yes	Yes
Number of connections			
• overall	PG Connections: 4 reserved / 4 max; HMI Connections: 12 reserved / 18 max; S7 Connections: 8 reserved / 14 max; Open User Connections: 8 reserved / 14 max; Web Connections: 2 reserved / 30 max; OPC UA Connections: 0 reserved / 10 max; Total Connections: 34 reserved / 64 max	PG Connections: 4 reserved / 4 max; HMI Connections: 12 reserved / 18 max; S7 Connections: 8 reserved / 14 max; Open User Connections: 8 reserved / 14 max; Web Connections: 2 reserved / 30 max; OPC UA Connections: 0 reserved / 10 max; Total Connections: 34 reserved / 64 max	PG Connections: 4 reserved / 4 max; HMI Connections: 12 reserved / 18 max; S7 Connections: 8 reserved / 14 max; Open User Connections: 8 reserved / 14 max; Web Connections: 2 reserved / 30 max; OPC UA Connections: 0 reserved / 10 max; Total Connections: 34 reserved / 64 max
Integrated Functions			
Counter			
• Number of counters	6	6	6
• Counting frequency, max.	100 kHz	100 kHz	100 kHz
Frequency measurement	Yes	Yes	Yes
controlled positioning	Yes	Yes	Yes
Number of position-controlled positioning axes, max.	8	8	8
Number of positioning axes via pulse-direction interface	4; With integrated outputs	Up to 4 with SB 1222	Up to 4 with SB 1222
PID controller	Yes	Yes	Yes
Number of alarm inputs	4	4	4
Number of pulse outputs	4		
Limit frequency (pulse)	100 kHz		
Ambient conditions			
Ambient temperature during operation			
• min.	-20 °C	-20 °C	-20 °C
• max.	60 °C; Number of simultaneously activated inputs or outputs 4 or 3 (no adjacent points) at 60 °C horizontal or 50 °C vertical, 8 or 6 at 55 °C horizontal or 45 °C vertical	60 °C; Number of simultaneously activated inputs or outputs 4 or 3 (no adjacent points) at 60 °C horizontal or 50 °C vertical, 8 or 6 at 55 °C horizontal or 45 °C vertical	60 °C; Number of simultaneously activated inputs or outputs 4 or 3 (no adjacent points) at 60 °C horizontal or 50 °C vertical, 8 or 6 at 55 °C horizontal or 45 °C vertical
Pollutant concentrations			
• SO ₂ at RH < 60% without condensation	SO ₂ : < 0.5 ppm; H ₂ S: < 0.1 ppm; RH < 60% condensation-free	SO ₂ : < 0.5 ppm; H ₂ S: < 0.1 ppm; RH < 60% condensation-free	SO ₂ : < 0.5 ppm; H ₂ S: < 0.1 ppm; RH < 60% condensation-free
configuration / header			
configuration / programming / header			
Programming language			
- LAD	Yes	Yes	Yes
- FBD	Yes	Yes	Yes
- SCL	Yes	Yes	Yes
Dimensions			
Width	90 mm	90 mm	90 mm
Height	100 mm	100 mm	100 mm
Depth	75 mm	75 mm	75 mm
Weights			
Weight, approx.	370 g	425 g	385 g

SIMATIC S7-1200 Basic Controllers

Central processing units
Standard CPUs

CPU 1214C

Overview



- Controller for intro to S7 with flexible expansion options
- Expandable by:
 - 1 signal board (SB), battery board (BB) or communication board (CB)
 - 8 signal modules (SM)
 - Max. 3 communication modules (CM)

Ordering data

CPU 1214C

Compact CPU, AC/DC/relay;

Integrated program/data memory 100 KB, load memory 2 MB;
Wide-range power supply 85 ... 264 V AC;
Boolean execution times 0.1 μ s per operation;
14 digital inputs, 10 digital outputs (relays), 2 analog inputs;
Expandable by up to 3 communications modules, 8 signal modules and 1 signal board/communication board;
Digital inputs can be used as HSC at 100 kHz

Article No.

6ES7214-1BG40-0XB0

Compact CPU, DC/DC/DC;

Integrated program/data memory 100 KB, load memory 2 MB;
Supply voltage 24 V DC;
Boolean execution times 0.1 μ s per operation;
14 digital inputs, 10 digital outputs, 2 analog inputs;
Expandable by up to 3 communications modules, 8 signal modules, and 1 signal board/communication board;
Digital inputs can be used as HSC at 100 kHz,
24 V DC digital outputs can be used as pulse outputs (PTO) or pulse-width modulated outputs (PWM) at 100 kHz

6ES7214-1AG40-0XB0

Compact CPU, DC/DC/relay;

Integrated program/data memory 100 KB, load memory 2 MB;
Supply voltage 24 V DC;
Boolean execution times 0.1 μ s per operation;
14 digital inputs, 10 digital outputs (relays), 2 analog inputs;
Expandable by up to 3 communications modules, 8 signal modules, and 1 signal board/communication board;
Digital inputs can be used as HSC at 100 kHz

6ES7214-1HG40-0XB0

Article No.

SB 1221 signal board

4 inputs, 5 V DC, 200 kHz
4 inputs, 24 V DC, 200 kHz

6ES7221-3AD30-0XB0

6ES7221-3BD30-0XB0

SB 1222 signal board

4 outputs, 5 V DC, 0.1 A, 200 kHz
4 outputs, 24 V DC, 0.1 A, 200 kHz

6ES7222-1AD30-0XB0

6ES7222-1BD30-0XB0

SB 1223 signal board

2 inputs, 24 V DC, IEC type 1 current sinking;
2 x 24 V DC transistor outputs, 0.5 A, 5 W;
can be used as HSC at up to 30 kHz

6ES7223-0BD30-0XB0

2 inputs, 5 V DC, 200 kHz
2 outputs 5 V DC, 0.1 A, 200 kHz

6ES7223-3AD30-0XB0

6ES7223-3BD30-0XB0

SB 1231 signal board

1 analog input, ± 10 V with 12 bits or 0 ... 20 mA with 11 bits

6ES7231-4HA30-0XB0

SB 1231 thermocouple signal board

1 input +/- 80 mV, resolution 15 bits + sign, thermocouples type J, K

6ES7231-5QA30-0XB0

SB 1231 RTD signal board

1 input for resistance temperature sensors Pt 100, Pt 200, Pt 500, Pt 1000, resolution 15 bits + sign

6ES7231-5PA30-0XB0

SB 1232 signal board

1 analog output, ± 10 V with 12 bits or 0 to 20 mA with 11 bits

6ES7232-4HA30-0XB0

CB 1241 RS485 Communication Board

For point-to-point connection, with 1 RS485 interface

6ES7241-1CH30-1XB0

BB1297 battery board

For long-term backup of real-time clock, can be plugged into the signal board slot; battery (CR1025) is not included in scope of supply

6ES7297-0AX30-0XA0

Ordering data	Article No.	Ordering data	Article No.
Digital input simulator Simulator Module SIM 1274 (optional) 14 input switches, for CPU 1214C/1215C	6ES7274-1XH30-0XA0	RJ45 cable grip 4 units per pack Single port	6ES7290-3AA30-0XA0
Analog input simulator Simulator Module SIM 1274 (optional) 2 potentiometers	6ES7274-1XA30-0XA0	Front flap set (spare part) For CPU 1214C	6ES7291-1AB30-0XA0
SIMATIC Memory Card (optional) 4 MB 12 MB 24 MB 256 MB 2 GB 32 GB	6ES7954-8LC03-0AA0 6ES7954-8LE03-0AA0 6ES7954-8LF03-0AA0 6ES7954-8LL03-0AA0 6ES7954-8LP03-0AA0 6ES7954-8LT03-0AA0	STEP 7 Professional / Basic V17 Target system: SIMATIC S7-1200, S7-1500, S7-300, S7-400, WinAC Requirement: Windows 10 (64-bit) • Windows 10 Professional Version 1909, 2004, 20H2 • Windows 10 Enterprise Version 1909, 2004, 20H2 • Windows 10 IoT Enterprise 2016 LTSC • Windows 10 IoT Enterprise 2019 LTSC Windows Server (64-bit) • Windows Server 2016 Standard (full installation) • Windows Server 2019 Standard (full installation) Type of delivery: 9 languages: de, en, zh included, fr, sp, it, ru, jp, kr as download STEP 7 Professional V17, floating license STEP 7 Professional V17, floating license, software download including license key ¹⁾ Email address required for delivery STEP 7 Basic V17, floating license STEP 7 Basic V17, floating license, software download including license key ¹⁾ Email address required for delivery	6ES7822-1AA07-0YA5 6ES7822-1AE07-0YA5 6ES7822-0AA07-0YA5 6ES7822-0AE07-0YA5
Extension cable for two-tier configuration For connecting digital/analog signal modules; length 2 m	6ES7290-6AA30-0XA0		
Terminal block (spare part) For CPU 1214C AC/DC/relay • For DI, 20-pin, tin-coated, coded; 4 units - Screw-type system - Push-in system • For DO, 12-pin, tin-coated, coded; 4 units - Screw-type system - Push-in system • For AI, 3-pin, gold-plated; 4 units - Screw-type system - Push-in system For CPU 1214C DC/DC/DC • For DI, 20-pin, tin-coated; 4 units - Screw-type system - Push-in system • For DO, 12-pin, tin-coated; 4 units - Screw-type system - Push-in system • For AI, 3-pin, gold-plated; 4 units - Screw-type system - Push-in system For CPU 1214C DC/DC/relay • For DI, 20-pin, tin-coated; 4 units - Screw-type system - Push-in system • For DO, 12-pin, tin-coated, coded; 4 units - Screw-type system - Push-in system • For AI, 3-pin, gold-plated; 4 units - Screw-type system - Push-in system	6ES7292-1AV40-0XA0 6ES7292-2AV40-0XA0 6ES7292-1AM40-0XA0 6ES7292-2AM40-0XA0 6ES7292-1BC30-0XA0 6ES7292-2BC30-0XA0 6ES7292-1AV30-0XA0 6ES7292-2AV30-0XA0 6ES7292-1AM30-0XA0 6ES7292-2AM30-0XA0 6ES7292-1BC30-0XA0 6ES7292-2BC30-0XA0 6ES7292-1AV30-0XA0 6ES7292-2AV30-0XA0 6ES7292-1AM40-0XA0 6ES7292-2AM40-0XA0 6ES7292-1BC30-0XA0 6ES7292-2BC30-0XA0		

¹⁾ For up-to-date information and download availability, see:
<http://www.siemens.com/tia-online-software-delivery>

SIMATIC S7-1200 Basic Controllers

Central processing units
Standard CPUs

CPU 1214C

Technical specifications

Article number	6ES7214-1BG40-0XB0 CPU 1214C, AC/DC/Relay, 14DI/10DO/2AI	6ES7214-1AG40-0XB0 CPU 1214C, DC/DC/DC, 14DI/10DO/2AI	6ES7214-1HG40-0XB0 CPU 1214C, DC/DC/Relay, 14DI/10DO/2AI
General information			
Product type designation	CPU 1214C AC/DC/relay	CPU 1214C DC/DC/DC	CPU 1214C DC/DC/relay
Engineering with			
• Programming package	STEP 7 V17 or higher	STEP 7 V17 or higher	STEP 7 V17 or higher
Supply voltage			
Rated value (DC)		Yes	Yes
• 24 V DC			
Rated value (AC)	Yes		
• 120 V AC	Yes		
• 230 V AC	Yes		
Encoder supply			
24 V encoder supply			
• 24 V	20.4 to 28.8V	L+ minus 4 V DC min.	L+ minus 4 V DC min.
Memory			
Work memory			
• integrated	100 kbyte	100 kbyte	100 kbyte
Load memory			
• integrated	4 Mbyte with SIMATIC memory card	4 Mbyte with SIMATIC memory card	4 Mbyte with SIMATIC memory card
• Plug-in (SIMATIC Memory Card), max.			
Backup			
• without battery	Yes	Yes	Yes
CPU processing times			
for bit operations, typ.	0.08 µs; / instruction	0.08 µs; / instruction	0.08 µs; / instruction
for word operations, typ.	1.7 µs; / instruction	1.7 µs; / instruction	1.7 µs; / instruction
for floating point arithmetic, typ.	2.3 µs; / instruction	2.3 µs; / instruction	2.3 µs; / instruction
Data areas and their retentivity			
Flag			
• Size, max.	8 kbyte; Size of bit memory address area	8 kbyte; Size of bit memory address area	8 kbyte; Size of bit memory address area
Address area			
Process image			
• Inputs, adjustable	1 kbyte	1 kbyte	1 kbyte
• Outputs, adjustable	1 kbyte	1 kbyte	1 kbyte
Time of day			
Clock			
• Hardware clock (real-time)	Yes	Yes	Yes
Digital inputs			
Number of digital inputs	14; Integrated	14; Integrated	14; Integrated
• of which inputs usable for technological functions	6; HSC (High Speed Counting)	6; HSC (High Speed Counting)	6; HSC (High Speed Counting)
Digital outputs			
Number of digital outputs	10; Relays	10	10; Relays
• of which high-speed outputs		4; 100 kHz Pulse Train Output	
Analog inputs			
Number of analog inputs	2	2	2
Input ranges			
• Voltage	Yes	Yes	Yes
Analog outputs			
Number of analog outputs	0	0	0
1. Interface			
Interface type	PROFINET	PROFINET	PROFINET
Protocols			
• PROFINET IO Controller	Yes	Yes	Yes
• PROFINET IO Device	Yes	Yes	Yes
• SIMATIC communication	Yes	Yes	Yes
• Open IE communication	Yes; Optionally also encrypted	Yes; Optionally also encrypted	Yes; Optionally also encrypted
• Web server	Yes	Yes	Yes
• Media redundancy	No	No	No

Technical specifications

Article number	6ES7214-1BG40-0XB0 CPU 1214C, AC/DC/Relay, 14DI/10DO/2AI	6ES7214-1AG40-0XB0 CPU 1214C, DC/DC/DC, 14DI/10DO/2AI	6ES7214-1HG40-0XB0 CPU 1214C, DC/DC/Relay, 14DI/10DO/2AI
Protocols			
Open IE communication			
• TCP/IP	Yes	Yes	Yes
• ISO-on-TCP (RFC1006)	Yes	Yes	Yes
• UDP	Yes	Yes	Yes
Web server			
• supported	Yes	Yes	Yes
OPC UA			
• OPC UA Server	Yes; data access (read, write, subscribe), method call, runtime license required	Yes; data access (read, write, subscribe), method call, runtime license required	Yes; data access (read, write, subscribe), method call, runtime license required
communication functions / header			
S7 communication			
• supported	Yes	Yes	Yes
Number of connections			
• overall	PG Connections: 4 reserved / 4 max; HMI Connections: 12 reserved / 18 max; S7 Connections: 8 reserved / 14 max; Open User Connections: 8 reserved / 14 max; Web Connections: 2 reserved / 30 max; OPC UA Connections: 0 reserved / 10 max; Total Connections: 34 reserved / 64 max	PG Connections: 4 reserved / 4 max; HMI Connections: 12 reserved / 18 max; S7 Connections: 8 reserved / 14 max; Open User Connections: 8 reserved / 14 max; Web Connections: 2 reserved / 30 max; OPC UA Connections: 0 reserved / 10 max; Total Connections: 34 reserved / 64 max	PG Connections: 4 reserved / 4 max; HMI Connections: 12 reserved / 18 max; S7 Connections: 8 reserved / 14 max; Open User Connections: 8 reserved / 14 max; Web Connections: 2 reserved / 30 max; OPC UA Connections: 0 reserved / 10 max; Total Connections: 34 reserved / 64 max
Integrated Functions			
Counter			
• Number of counters	6	6	6
• Counting frequency, max.	100 kHz	100 kHz	100 kHz
Frequency measurement	Yes	Yes	Yes
controlled positioning	Yes	Yes	Yes
Number of position-controlled positioning axes, max.	8	8	8
Number of positioning axes via pulse-direction interface	Up to 4 with SB 1222	4; With integrated outputs	Up to 4 with SB 1222
PID controller	Yes	Yes	Yes
Number of alarm inputs	4	4	4
Number of pulse outputs		4	
Limit frequency (pulse)		100 kHz	
Ambient conditions			
Ambient temperature during operation			
• min.	-20 °C	-20 °C	-20 °C
• max.	60 °C; Number of simultaneously activated inputs or outputs 7 or 5 (no adjacent points) at 60 °C horizontal or 50 °C vertical, 14 or 10 at 55 °C horizontal or 45 °C vertical	60 °C; Number of simultaneously activated inputs or outputs 7 or 5 (no adjacent points) a t 60 °C horizontal or 50 °C vertical, 14 or 10 at 55 °C horizontal or 45 °C vertical	60 °C; Number of simultaneously activated inputs or outputs 7 or 5 (no adjacent points) at 60 °C horizontal or 50 °C vertical, 14 or 10 at 55 °C horizontal or 45 °C vertical
Pollutant concentrations			
• SO ₂ at RH < 60% without condensation	SO ₂ : < 0.5 ppm; H ₂ S: < 0.1 ppm; RH < 60% condensation-free	SO ₂ : < 0.5 ppm; H ₂ S: < 0.1 ppm; RH < 60% condensation-free	SO ₂ : < 0.5 ppm; H ₂ S: < 0.1 ppm; RH < 60% condensation-free
configuration / header			
configuration / programming / header			
Programming language			
- LAD	Yes	Yes	Yes
- FBD	Yes	Yes	Yes
- SCL	Yes	Yes	Yes
Dimensions			
Width	110 mm	110 mm	110 mm
Height	100 mm	100 mm	100 mm
Depth	75 mm	75 mm	75 mm
Weights			
Weight, approx.	455 g	415 g	435 g

SIMATIC S7-1200 Basic Controllers

Central processing units
Standard CPUs

CPU 1215C

Overview



- Powerful controller with enhanced networking option
- Expandable by:
 - 1 signal board (SB), battery board (BB) or communication board (CB)
 - 8 signal modules (SM)
 - Max. 3 communications modules (CM)

Ordering data

CPU 1215C

Compact CPU, AC/DC/relay;
Integrated program/
data memory 125 KB,
load memory 4 MB;
Wide-range power supply
85 ... 264 V AC;
Boolean execution times
0.085 µs per operation;
14 digital inputs,
10 digital outputs (relays),
2 analog inputs,
2 analog outputs;
Expandable by up to
3 communications modules,
8 signal modules and 1 signal
board/communication board;
Digital inputs can be used as HSC
at 100 kHz

Article No.

6ES7215-1BG40-0XB0

Compact CPU, DC/DC/DC;
Integrated program/
data memory 125 KB,
load memory 4 MB;
Supply voltage 24 V DC;
Boolean execution times
0.085 µs per operation;
14 digital inputs,
10 digital outputs,
2 analog inputs,
2 analog outputs;
Expandable by up to
3 communications modules,
8 signal modules, and 1 signal
board/communication board;
Digital inputs can be used as HSC
at 100 kHz,
24 V DC digital outputs can be
used as pulse outputs (PTO) or
pulse-width modulated outputs
(PWM) at 100 kHz

6ES7215-1AG40-0XB0

Compact CPU, DC/DC/relay;
Integrated program/
data memory 125 KB,
load memory 4 MB;
Supply voltage 24 V DC;
Boolean execution times
0.085 µs per operation;
14 digital inputs,
10 digital outputs (relays),
2 analog inputs,
2 analog outputs;
Expandable by up to
3 communications modules,
8 signal modules, and 1 signal
board/communication board;
Digital inputs can be used as HSC
at 100 kHz

6ES7215-1HG40-0XB0

Article No.

SB 1221 signal board

4 inputs, 5 V DC, 200 kHz
4 inputs, 24 V DC, 200 kHz

6ES7221-3AD30-0XB0

6ES7221-3BD30-0XB0

SB 1222 signal board

4 outputs, 5 V DC, 0.1 A, 200 kHz
4 outputs, 24 V DC, 0.1 A, 200 kHz

6ES7222-1AD30-0XB0

6ES7222-1BD30-0XB0

SB 1223 signal board

2 inputs, 24 V DC,
IEC type 1 current sinking;
2 x 24 V DC transistor outputs,
0.5 A, 5 W;
can be used as HSC at up to 30 kHz

6ES7223-0BD30-0XB0

2 inputs, 5 V DC, 200 kHz
2 outputs 5 V DC, 0.1 A, 200 kHz

6ES7223-3AD30-0XB0

2 inputs, 24 V DC, 200 kHz
2 outputs 24 V DC, 0.1 A, 200 kHz

6ES7223-3BD30-0XB0

SB 1231 signal board

1 analog input, ±10 V with
12 bits or 0 ... 20 mA with 11 bits

6ES7231-4HA30-0XB0

SB 1231 thermocouple signal board

1 input +/- 80 mV,
resolution 15 bits + sign,
thermocouples type J, K

6ES7231-5QA30-0XB0

SB 1231 RTD signal board

1 input for resistance temperature
sensors Pt 100, Pt 200, Pt 500,
Pt 1000, resolution 15 bits + sign

6ES7231-5PA30-0XB0

SB 1232 signal board

1 analog output, ±10 V with
12 bits or 0 to 20 mA with 11 bits

6ES7232-4HA30-0XB0

CB 1241 RS485 Communication Board

For point-to-point connection,
with 1 RS485 interface

6ES7241-1CH30-1XB0

Ordering data	Article No.	Ordering data	Article No.
BB 1297 battery board For long-term backup of real-time clock; can be plugged into the signal board slot; battery (CR1025) is not included	6ES7297-0AX30-0XA0	Front flap set (spare part) For CPU 1215C	6ES7291-1AC30-0XA0
Digital input simulator Simulator Module SIM 1274 (optional) 14 input switches, for CPU 1214C/1215C	6ES7274-1XH30-0XA0	RJ45 cable grip 4 units per pack	6ES7290-3AB30-0XA0
Analog input simulator Simulator Module SIM 1274 (optional) 2 potentiometers	6ES7274-1XA30-0XA0	STEP 7 Professional / Basic V17 Target system: SIMATIC S7-1200, S7-1500, S7-300, S7-400, WinAC Requirement: Windows 10 (64-bit) • Windows 10 Professional Version 1909, 2004, 20H2 • Windows 10 Enterprise Version 1909, 2004, 20H2 • Windows 10 IoT Enterprise 2016 LTSB • Windows 10 IoT Enterprise 2019 LTSC Windows Server (64-bit) • Windows Server 2016 Standard (full installation) • Windows Server 2019 Standard (full installation) Type of delivery: 9 languages: de, en, zh included, fr, sp, it, ru, jp, kr as download	
SIMATIC Memory Card (optional) 4 MB	6ES7954-8LC03-0AA0	STEP 7 Professional V17, floating license	6ES7822-1AA07-0YA5
12 MB	6ES7954-8LE03-0AA0	STEP 7 Professional V17, floating license, software download including license key ¹⁾	6ES7822-1AE07-0YA5
24 MB	6ES7954-8LF03-0AA0	Email address required for delivery	
256 MB	6ES7954-8LL03-0AA0	STEP 7 Basic V17, floating license	6ES7822-0AA07-0YA5
2 GB	6ES7954-8LP03-0AA0	STEP 7 Basic V17, floating license, software download including license key ¹⁾	6ES7822-0AE07-0YA5
32 GB	6ES7954-8LT03-0AA0	Email address required for delivery	
Extension cable for two-tier configuration For connecting digital/analog signal modules; length 2 m	6ES7290-6AA30-0XA0		
Terminal block (spare part) For CPU 1215C AC/DC/relay • For DI, 20-pin, tin-coated, coded; 4 units - Screw-type system - Push-in system • For DO, 12-pin, tin-coated, coded; 4 units - Screw-type system - Push-in system • For analog signals, 6-pin, gold-plated; 4 units - Screw-type system - Push-in system For CPU 1215C DC/DC/DC • For DI, 20-pin, tin-coated; 4 units - Screw-type system - Push-in system • For DO, 12-pin, tin-coated, coded; 4 units - Screw-type system - Push-in system • For analog signals, 6-pin, gold-plated; 4 units - Screw-type system - Push-in system For CPU 1215C DC/DC/relay • For DI, 20-pin, tin-coated; 4 units - Screw-type system - Push-in system • For DO, 12-pin, tin-coated, coded; 4 units - Screw-type system - Push-in system • For analog signals, 6-pin, gold-plated; 4 units - Screw-type system - Push-in system	6ES7292-1AV40-0XA0 6ES7292-2AV40-0XA0 6ES7292-1AM40-0XA0 6ES7292-2AM40-0XA0 6ES7292-1BF30-0XB0 6ES7292-2BF30-0XB0 6ES7292-1AV30-0XA0 6ES7292-2AV30-0XA0 6ES7292-1AM30-0XA0 6ES7292-2AM30-0XA0 6ES7292-1BF30-0XB0 6ES7292-2BF30-0XB0 6ES7292-1AV30-0XA0 6ES7292-2AV30-0XA0 6ES7292-1AM40-0XA0 6ES7292-2AM40-0XA0 6ES7292-1BF30-0XB0 6ES7292-2BF30-0XB0		

¹⁾ For up-to-date information and download availability, see: <http://www.siemens.com/tia-online-software-delivery>

SIMATIC S7-1200 Basic Controllers

Central processing units
Standard CPUs

CPU 1215C

Technical specifications

Article number	6ES7215-1AG40-0XB0 CPU 1215C, DC/DC/DC, 14DI/10DO/2AI/2AO	6ES7215-1BG40-0XB0 CPU 1215C, AC/DC/RLY, 14DI/10DO/2AI/2AO	6ES7215-1HG40-0XB0 CPU 1215C, DC/DC/RLY, 14DI/10DO/2AI/2AO
General information			
Product type designation	CPU 1215C DC/DC/DC	CPU 1215C AC/DC/relay	CPU 1215C DC/DC/relay
Engineering with			
• Programming package	STEP 7 V17 or higher	STEP 7 V17 or higher	STEP 7 V17 or higher
Supply voltage			
Rated value (DC)	Yes		Yes
• 24 V DC			
Rated value (AC)		Yes	
• 120 V AC		Yes	
• 230 V AC		Yes	
Encoder supply			
24 V encoder supply			
• 24 V	L+ minus 4 V DC min.	20.4 to 28.8V	L+ minus 4 V DC min.
Memory			
Work memory			
• integrated	125 kbyte	125 kbyte	125 kbyte
Load memory			
• integrated	4 Mbyte	4 Mbyte	4 Mbyte
• Plug-in (SIMATIC Memory Card), max.	with SIMATIC memory card	with SIMATIC memory card	with SIMATIC memory card
Backup			
• without battery	Yes	Yes	Yes
CPU processing times			
for bit operations, typ.	0.08 µs; / instruction	0.08 µs; / instruction	0.08 µs; / instruction
for word operations, typ.	1.7 µs; / instruction	1.7 µs; / instruction	1.7 µs; / instruction
for floating point arithmetic, typ.	2.3 µs; / instruction	2.3 µs; / instruction	2.3 µs; / instruction
Data areas and their retentivity			
Flag			
• Size, max.	8 kbyte; Size of bit memory address area	8 kbyte; Size of bit memory address area	8 kbyte; Size of bit memory address area
Address area			
Process image			
• Inputs, adjustable	1 kbyte	1 kbyte	1 kbyte
• Outputs, adjustable	1 kbyte	1 kbyte	1 kbyte
Time of day			
Clock			
• Hardware clock (real-time)	Yes	Yes	Yes
Digital inputs			
Number of digital inputs	14; Integrated	14; Integrated	14; Integrated
• of which inputs usable for technological functions	6; HSC (High Speed Counting)	6; HSC (High Speed Counting)	6; HSC (High Speed Counting)
Digital outputs			
Number of digital outputs	10	10; Relays	10; Relays
• of which high-speed outputs	4; 100 kHz Pulse Train Output		
Analog inputs			
Number of analog inputs	2	2	2
Input ranges			
• Voltage	Yes	Yes	Yes
Analog outputs			
Number of analog outputs	2	2	2
Output ranges, current			
• 0 to 20 mA	Yes	Yes	Yes
1. Interface			
Interface type	PROFINET	PROFINET	PROFINET
Protocols			
• PROFINET IO Controller	Yes	Yes	Yes
• PROFINET IO Device	Yes	Yes	Yes
• SIMATIC communication	Yes	Yes	Yes
• Open IE communication	Yes; Optionally also encrypted	Yes; Optionally also encrypted	Yes; Optionally also encrypted
• Web server	Yes	Yes	Yes
• Media redundancy	Yes	Yes	Yes

Technical specifications

Article number	6ES7215-1AG40-0XB0	6ES7215-1BG40-0XB0	6ES7215-1HG40-0XB0
	CPU 1215C, DC/DC/DC, 14DI/10DO/2AI/2AO	CPU 1215C, AC/DC/RLY, 14DI/10DO/2AI/2AO	CPU 1215C, DC/DC/RLY, 14DI/10DO/2AI/2AO
Protocols			
Open IE communication			
• TCP/IP	Yes	Yes	Yes
• ISO-on-TCP (RFC1006)	Yes	Yes	Yes
• UDP	Yes	Yes	Yes
Web server			
• supported	Yes	Yes	Yes
OPC UA			
• OPC UA Server	Yes; data access (read, write, subscribe), method call, runtime license required	Yes; data access (read, write, subscribe), method call, runtime license required	Yes; data access (read, write, subscribe), method call, runtime license required
communication functions / header			
S7 communication			
• supported	Yes	Yes	Yes
Number of connections			
• overall	PG Connections: 4 reserved / 4 max; HMI Connections: 12 reserved / 18 max; S7 Connections: 8 reserved / 14 max; Open User Connections: 8 reserved / 14 max; Web Connections: 2 reserved / 30 max; OPC UA Connections: 0 reserved / 10 max; Total Connections: 34 reserved / 64 max	PG Connections: 4 reserved / 4 max; HMI Connections: 12 reserved / 18 max; S7 Connections: 8 reserved / 14 max; Open User Connections: 8 reserved / 14 max; Web Connections: 2 reserved / 30 max; OPC UA Connections: 0 reserved / 10 max; Total Connections: 34 reserved / 64 max	PG Connections: 4 reserved / 4 max; HMI Connections: 12 reserved / 18 max; S7 Connections: 8 reserved / 14 max; Open User Connections: 8 reserved / 14 max; Web Connections: 2 reserved / 30 max; OPC UA Connections: 0 reserved / 10 max; Total Connections: 34 reserved / 64 max
Integrated Functions			
Counter			
• Number of counters	6	6	6
• Counting frequency, max.	100 kHz	100 kHz	100 kHz
Frequency measurement	Yes	Yes	Yes
controlled positioning	Yes	Yes	Yes
Number of position-controlled positioning axes, max.	8	8	8
Number of positioning axes via pulse-direction interface	4; With integrated outputs	Up to 4 with SB 1222	Up to 4 with SB 1222
PID controller	Yes	Yes	Yes
Number of alarm inputs	4	4	4
Number of pulse outputs	4		
Limit frequency (pulse)	100 kHz		
Ambient conditions			
Ambient temperature during operation			
• min.	-20 °C	-20 °C	-20 °C
• max.	60 °C; Number of simultaneously activated inputs or outputs 7 or 5 (no adjacent points) at 60 °C horizontal or 50 °C vertical, 14 or 10 at 55 °C horizontal or 45 °C vertical	60 °C; Number of simultaneously activated inputs or outputs 7 or 5 (no adjacent points) at 60 °C horizontal or 50 °C vertical, 14 or 10 at 55 °C horizontal or 45 °C vertical	60 °C; Number of simultaneously activated inputs or outputs 7 or 5 (no adjacent points) at 60 °C horizontal or 50 °C vertical, 14 or 10 at 55 °C horizontal or 45 °C vertical
Pollutant concentrations			
• SO ₂ at RH < 60% without condensation	SO ₂ : < 0.5 ppm; H ₂ S: < 0.1 ppm; RH < 60% condensation-free	SO ₂ : < 0.5 ppm; H ₂ S: < 0.1 ppm; RH < 60% condensation-free	SO ₂ : < 0.5 ppm; H ₂ S: < 0.1 ppm; RH < 60% condensation-free
configuration / header			
configuration / programming / header			
Programming language			
- LAD	Yes	Yes	Yes
- FBD	Yes	Yes	Yes
- SCL	Yes	Yes	Yes
Dimensions			
Width	130 mm	130 mm	130 mm
Height	100 mm	100 mm	100 mm
Depth	75 mm	75 mm	75 mm
Weights			
Weight, approx.	500 g	550 g	585 g

SIMATIC S7-1200 Basic Controllers

Central processing units
Standard CPUs

CPU 1217C

Overview



- Powerful controller for extremely fast signal processing
- Expandable by:
 - 1 signal board (SB), battery board (BB) or communication board (CB)
 - 8 signal modules (SM)
 - Max. 3 communications modules (CM)

Ordering data

CPU 1217C

Compact CPU, DC/DC/DC;
Integrated program/
data memory 150 KB,
load memory 4 MB;
Supply voltage 24 V DC;
Boolean execution times
0.085 μ s per operation;
14 digital inputs (10 digital
24 V DC inputs, 4 digital
1.5 V DC differential inputs),
10 digital outputs (6 digital
24 V DC outputs, 4 digital
1.5 V DC differential outputs),
2 analog inputs,
2 analog outputs;
Expandable by up to
3 communications modules,
8 signal modules, and 1 signal
board/communication board;
Digital inputs can be used as HSC
at 1 MHz,
24 V DC digital outputs can be
used as pulse outputs (PTO) or
pulse-width modulated outputs
(PWM) at 100 kHz

Article No.

6ES7217-1AG40-0XB0

SB 1221 signal board

4 inputs, 5 V DC, 200 kHz
4 inputs, 24 V DC, 200 kHz

6ES7221-3AD30-0XB0

6ES7221-3BD30-0XB0

SB 1222 signal board

4 outputs, 5 V DC, 0.1 A, 200 kHz
4 outputs, 24 V DC, 0.1 A, 200 kHz

6ES7222-1AD30-0XB0

6ES7222-1BD30-0XB0

SB 1223 signal board

2 inputs, 24 V DC,
IEC type 1 current sinking;
2 x 24 V DC transistor outputs,
0.5 A, 5 W;
can be used as HSC at up to 30 kHz

6ES7223-0BD30-0XB0

2 inputs, 5 V DC, 200 kHz
2 outputs 5 V DC, 0.1 A, 200 kHz

6ES7223-3AD30-0XB0

2 inputs, 24 V DC, 200 kHz
2 outputs 24 V DC, 0.1 A, 200 kHz

6ES7223-3BD30-0XB0

Article No.

SB 1231 signal board

1 analog input, ± 10 V with 12 bits or
0 ... 20 mA with 11 bits

6ES7231-4HA30-0XB0

SB 1231 thermocouple signal board

1 input +/- 80 mV,
resolution 15 bits + sign,
thermocouples type J, K

6ES7231-5QA30-0XB0

SB 1231 RTD signal board

1 input for resistance temperature
sensors Pt 100, Pt 200, Pt 500,
Pt 1000, resolution 15 bits + sign

6ES7231-5PA30-0XB0

SB 1232 signal board

1 analog output, ± 10 V with
12 bits or 0 to 20 mA with 11 bits

6ES7232-4HA30-0XB0

CB 1241 RS485 Communication Board

For point-to-point connection,
with 1 RS485 interface

6ES7241-1CH30-1XB0

BB 1297 battery board

For long-term backup of real-time
clock; can be plugged into the
signal board slot;
battery (CR1025) is not included

6ES7297-0AX30-0XA0

Ordering data	Article No.	Article No.
Digital input simulator Simulator Module SIM 1274 (optional) 14 input switches, for CPU 1217C	6ES7274-1XK30-0XA0	STEP 7 Professional / Basic V17 Target system: SIMATIC S7-1200, S7-1500, S7-300, S7-400, WinAC Requirement: Windows 10 (64-bit) <ul style="list-style-type: none"> Windows 10 Professional Version 1909, 2004, 20H2 Windows 10 Enterprise Version 1909, 2004, 20H2 Windows 10 IoT Enterprise 2016 LTSB Windows 10 IoT Enterprise 2019 LTSC Windows Server (64-bit) <ul style="list-style-type: none"> Windows Server 2016 Standard (full installation) Windows Server 2019 Standard (full installation) Type of delivery: 9 languages: de, en, zh included, fr, sp, it, ru, jp, kr as download STEP 7 Professional V17, floating license STEP 7 Professional V17, floating license, software download including license key ¹⁾ Email address required for delivery STEP 7 Basic V17, floating license STEP 7 Basic V17, floating license, software download including license key ¹⁾ Email address required for delivery
Analog input simulator Simulator Module SIM 1274 (optional) 2 potentiometers	6ES7274-1XA30-0XA0	
SIMATIC Memory Card (optional) 4 MB 12 MB 24 MB 256 MB 2 GB 32 GB	6ES7954-8LC03-0AA0 6ES7954-8LE03-0AA0 6ES7954-8LF03-0AA0 6ES7954-8LL03-0AA0 6ES7954-8LP03-0AA0 6ES7954-8LT03-0AA0	
Extension cable for two-tier configuration For connecting digital/ analog signal modules; length 2 m	6ES7290-6AA30-0XA0	
Terminal block (spare part) For CPU 1217C <ul style="list-style-type: none"> For DI, 10-pin, tin-coated; 4 units <ul style="list-style-type: none"> Screw-type system - Push-in system For DI, 16-pin, tin-coated; 4 units <ul style="list-style-type: none"> Screw-type system - Push-in system For DO, 18-pin, tin-coated; 4 units <ul style="list-style-type: none"> Screw-type system - Push-in system For analog signals, 6-pin, gold-plated; 4 units <ul style="list-style-type: none"> Screw-type system - Push-in system 	6ES7292-1AK30-0XA0 6ES7292-2AK30-0XA0 6ES7292-1AR30-0XA0 6ES7292-2AR30-0XA0 6ES7292-1AT30-0XA0 6ES7292-2AT30-0XA0 6ES7292-1BF30-0XB0 6ES7292-2BF30-0XB0	
Front flap set (spare part) For CPU 1217C	6ES7291-1AD30-0XA0	
RJ45 cable grip 4 units per pack Dual port	6ES7290-3AB30-0XA0	

¹⁾ For up-to-date information and download availability, see:
<http://www.siemens.com/tia-online-software-delivery>

SIMATIC S7-1200 Basic Controllers

Central processing units
Standard CPUs

CPU 1217C

Technical specifications

Article number	6ES7217-1AG40-0XB0 CPU 1217C, DC/DC/DC, 14DI/10DQ/2AI/2AQ
General information	
Product type designation	CPU 1217C DC/DC/DC
Engineering with	
• Programming package	STEP 7 V17 or higher
Supply voltage	
Rated value (DC)	
• 24 V DC	Yes
Encoder supply	
24 V encoder supply	
• 24 V	L+ minus 4 V DC min.
Memory	
Work memory	
• integrated	150 kbyte
Load memory	
• integrated	4 Mbyte
• Plug-in (SIMATIC Memory Card), max.	with SIMATIC memory card
Backup	
• without battery	Yes
CPU processing times	
for bit operations, typ.	0.08 µs; / instruction
for word operations, typ.	1.7 µs; / instruction
for floating point arithmetic, typ.	2.3 µs; / Operation
Data areas and their retentivity	
Flag	
• Size, max.	8 kbyte; Size of bit memory address area
Address area	
Process image	
• Inputs, adjustable	1 kbyte
• Outputs, adjustable	1 kbyte
Time of day	
Clock	
• Hardware clock (real-time)	Yes
Digital inputs	
Number of digital inputs	14; Integrated
• of which inputs usable for technological functions	6; HSC (High Speed Counting)
Digital outputs	
Number of digital outputs	10
• of which high-speed outputs	4; 100 kHz Pulse Train Output
Analog inputs	
Number of analog inputs	2
Input ranges	
• Voltage	Yes
Analog outputs	
Number of analog outputs	2
Output ranges, current	
• 0 to 20 mA	Yes
1. Interface	
Interface type	PROFINET
Protocols	
• PROFINET IO Controller	Yes
• PROFINET IO Device	Yes
• SIMATIC communication	Yes
• Open IE communication	Yes; Optionally also encrypted
• Web server	Yes
• Media redundancy	Yes

Article number	6ES7217-1AG40-0XB0 CPU 1217C, DC/DC/DC, 14DI/10DQ/2AI/2AQ
Protocols	
Open IE communication	
• TCP/IP	Yes
• ISO-on-TCP (RFC1006)	Yes
• UDP	Yes
Web server	
• supported	Yes
OPC UA	
• OPC UA Server	Yes; data access (read, write, subscribe), method call, runtime license required
communication functions / header	
S7 communication	
• supported	Yes
Number of connections	
• overall	PG Connections: 4 reserved / 4 max; HMI Connections: 12 reserved / 18 max; S7 Connections: 8 reserved / 14 max; Open User Connections: 8 reserved / 14 max; Web Connections: 2 reserved / 30 max; OPC UA Connections: 0 reserved / 10 max; Total Connections: 34 reserved / 64 max
Integrated Functions	
Counter	
• Number of counters	6
• Counting frequency, max.	1 MHz
Frequency measurement	Yes
controlled positioning	Yes
Number of position-controlled positioning axes, max.	8
Number of positioning axes via pulse-direction interface	4; With integrated outputs
PID controller	Yes
Number of alarm inputs	4
Number of pulse outputs	4
Limit frequency (pulse)	1 MHz
Ambient conditions	
Ambient temperature during operation	
• min.	-20 °C
• max.	60 °C; Number of simultaneously activated inputs or outputs 7 or 5 (no adjacent points) at 60 °C horizontal or 50 °C vertical, 14 or 10 at 55 °C horizontal or 45 °C vertical
Pollutant concentrations	
• SO ₂ at RH < 60% without condensation	SO ₂ : < 0.5 ppm; H ₂ S: < 0.1 ppm; RH < 60% condensation-free
configuration / header	
configuration / programming / header	
Programming language	
- LAD	Yes
- FBD	Yes
- SCL	Yes
Dimensions	
Width	150 mm
Height	100 mm
Depth	75 mm
Weights	
Weight, approx.	530 g

Overview

- The superior compact solution
- With 14 integral input/outputs
- Expandable with:
 - 1 signal board (SB) or communication board (CB);
not possible with: 6AG1212-1AE40-2XB0, 6AG1212-1BE40-2XB0, 6AG1212-1HE40-2XB0
 - 2 signal modules (SM)
 - Max. 3 communication modules (CM)

Note:

SIPLUS extreme products are based on SIMATIC standard products. The contents listed here were taken from the respective standard products. SIPLUS extreme-specific information was added.

Ordering data**Article No.****Article No.****SIPLUS CPU 1212C compact CPU, AC/DC/relay**

(Extended temperature range and exposure to media)

Integrated program/data memory 75 KB, load memory 1 MB;
Wide-range power supply 85 ... 264 V AC;
Boolean execution times 0.1 µs per operation;
8 digital inputs, 6 digital outputs (relays), 2 analog inputs;
Expandable by up to 3 communication modules, 2 signal modules and 1 signal board/communication board;
Digital inputs can be used as HSC at 100 kHz

- For areas with extreme exposure to media (conformal coating); ambient temperature -20 ... +60 °C
- For areas with extreme exposure to media (conformal coating); ambient temperature -40 ... +70 °C

6AG1212-1BE40-4XB0**6AG1212-1BE40-2XB0****SIPLUS CPU 1212C compact CPU, DC/DC/DC**

(Extended temperature range and exposure to media)

Integrated program/data memory 75 KB, load memory 1 MB;
Power supply 24 V DC;
Boolean execution times 0.1 µs per operation;
8 digital inputs, 6 digital outputs, 2 analog inputs;
Expandable by up to 3 communication modules, 2 signal modules, and 1 signal board/communication board;
Digital inputs can be used as HSC at 100 kHz,
24 V DC digital outputs can be used as pulse outputs (PTO) or pulse-width modulated outputs (PWM) at 100 kHz

- For areas with extreme exposure to media (conformal coating); ambient temperature -20 ... +60 °C
- For areas with extreme exposure to media (conformal coating); ambient temperature -40 ... +70 °C

6AG1212-1AE40-4XB0**6AG1212-1AE40-2XB0**

SIMATIC S7-1200 Basic Controllers

Central processing units
SIPLUS standard CPUs

SIPLUS CPU 1212C

Ordering data

Article No.

Article No.

SIPLUS CPU 1212C

compact CPU, DC/DC/relay

(Extended temperature range and exposure to media)

Integrated program/
data memory 75 KB,
load memory 1 MB;
Power supply 24 V DC;
Boolean execution times
0.1 µs per operation;
8 digital inputs,
6 digital outputs (relays),
2 analog inputs;
Expandable by up to
3 communication modules,
2 signal modules, and 1 signal
board/communication board;
Digital inputs can be used as HSC
at 100 kHz

- For areas with extreme exposure to media (conformal coating); ambient temperature -20 ... +60 °C
- For areas with extreme exposure to media (conformal coating); ambient temperature -40 ... +70 °C

6AG1212-1HE40-4XB0

6AG1212-1HE40-2XB0

Accessories

SIPLUS SB 1221 digital input signal board

(Extended temperature range and exposure to media; cannot be used with 6AG1212-1.....-2XB0)

4 inputs, 5 V DC, 200 kHz, sourcing

6AG1221-3AD30-5XB0

4 inputs, 24 V DC, 200 kHz, sourcing

6AG1221-3BD30-5XB0

SIPLUS SB 1222 digital output signal board

(Extended temperature range and exposure to media; cannot be used with 6AG1212-1.....-2XB0)

4 outputs, 5 V DC, 0.1 A, 200 kHz

6AG1222-1AD30-5XB0

4 outputs, 24 V DC, 0.1 A, 200 kHz

6AG1222-1BD30-5XB0

SIPLUS SB 1223 digital input/output signal board

(Extended temperature range and exposure to media; cannot be used with 6AG1212-1.....-2XB0)

2 inputs, 24 V DC,
IEC type 1 current sinking;
2 transistor outputs 24 V DC,
0.5 A, 5 W;
can be used as HSC at
up to 30 kHz

- Suitable for areas with extreme exposure to media (conformal coating)
- Ambient temperature -25 ... +55 °C

2 inputs, 5 V DC, 200 kHz
2 outputs 5 V DC, 0.1 A, 200 kHz

6AG1223-0BD30-4XB0

6AG1223-0BD30-5XB0

6AG1223-3AD30-5XB0

6AG1223-3BD30-5XB0

SIPLUS SB 1232 analog output signal board

(Extended temperature range and exposure to media; cannot be used with 6AG1212-1.....-2XB0)

Ambient temperature range
-25 ... +55 °C

1 analog output, ±10 V with 12 bits
or 0 ... 20 mA with 11 bits

6AG1232-4HA30-5XB0

Ambient temperature range
0 ... +55 °C

1 analog output, ±10 V with 12 bits
or 0 ... 20 mA with 11 bits

6AG1232-4HA30-4XB0

SIPLUS CB 1241 RS 485 communication board

(Extended temperature range and exposure to media; cannot be used with 6AG1212-1.....-2XB0)

For point-to-point connection,
with 1 RS 485 interface

6AG1241-1CH30-5XB1

Additional accessories

See SIMATIC S7-1200
CPU 1212C, page 3/9

Technical specifications

Article number	6AG1212-1AE40-4XB0	6AG1212-1AE40-2XB0
Based on	6ES7212-1AE40-0XB0	6ES7212-1AE40-0XB0
	SIPLUS S7-1200 CPU 1212C DC/DC/DC	SIPLUS S7-1200 CPU 1212C DC/DC/DC
Ambient conditions		
Ambient temperature during operation		
<ul style="list-style-type: none"> min. max. 	-20 °C; = Tmin (incl. condensation/frost); start-up @ 0 °C 60 °C; Number of simultaneously activated inputs or outputs 4 or 3 (no adjacent points) at 60 °C horizontal or 50 °C vertical, 8 or 6 at 55 °C horizontal or 45 °C vertical	-40 °C; = Tmin (incl. condensation/frost); start-up @ -25 °C 70 °C; = Tmax; Tmax > +55 °C number of simultaneously switched-on digital inputs 4, digital outputs 3, analog inputs 2 (no adjacent points) with horizontal mounting position; Tmax > +60 °C number of simultaneously switched-on digital inputs 3, digital outputs 2, analog inputs 0 (no adjacent points) with horizontal mounting position
<ul style="list-style-type: none"> At cold restart, min. 	0 °C	-25 °C
Altitude during operation relating to sea level		
<ul style="list-style-type: none"> Installation altitude above sea level, max. Ambient air temperature-barometric pressure-altitude 	5 000 m Tmin ... Tmax at 1 140 hPa ... 795 hPa (-1 000 m ... +2 000 m) // Tmin ... (Tmax - 10 K) at 795 hPa ... 658 hPa (+2 000 m ... +3 500 m) // Tmin ... (Tmax -20 K) at 658 hPa ... 540 hPa (+3 500 m ... +5 000 m)	5 000 m Tmin ... Tmax at 1 140 hPa ... 795 hPa (-1 000 m ... +2 000 m) // Tmin ... (Tmax - 10 K) at 795 hPa ... 658 hPa (+2 000 m ... +3 500 m) // Tmin ... (Tmax -20 K) at 658 hPa ... 540 hPa (+3 500 m ... +5 000 m)
Relative humidity		
<ul style="list-style-type: none"> With condensation, tested in accordance with IEC 60068-2-38, max. 	100 %; RH incl. condensation/frost (no commissioning under condensation conditions)	100 %; RH incl. condensation/frost (no commissioning under condensation conditions)
Resistance		
Coolants and lubricants		
<ul style="list-style-type: none"> Resistant to commercially available coolants and lubricants 	Yes; Incl. diesel and oil droplets in the air	Yes; Incl. diesel and oil droplets in the air
Use in stationary industrial systems		
<ul style="list-style-type: none"> to biologically active substances according to EN 60721-3-3 to chemically active substances according to EN 60721-3-3 to mechanically active substances according to EN 60721-3-3 	Yes; Class 3B2 mold, fungus and dry rot spores (with the exception of fauna); Class 3B3 on request Yes; Class 3C4 (RH < 75 %) incl. salt spray acc. to EN 60068-2-52 (severity degree 3); * Yes; Class 3S4 incl. sand, dust, *	Yes; Class 3B2 mold, fungus and dry rot spores (with the exception of fauna); Class 3B3 on request Yes; Class 3C4 (RH < 75 %) incl. salt spray acc. to EN 60068-2-52 (severity degree 3); * Yes; Class 3S4 incl. sand, dust, *
Use on ships/at sea		
<ul style="list-style-type: none"> to biologically active substances according to EN 60721-3-6 to chemically active substances according to EN 60721-3-6 to mechanically active substances according to EN 60721-3-6 	Yes; Class 6B2 mold and fungal spores (excluding fauna); Class 6B3 on request Yes; Class 6C3 (RH < 75 %) incl. salt spray acc. to EN 60068-2-52 (severity degree 3); * Yes; Class 6S3 incl. sand, dust; *	Yes; Class 6B2 mold and fungal spores (excluding fauna); Class 6B3 on request Yes; Class 6C3 (RH < 75 %) incl. salt spray acc. to EN 60068-2-52 (severity degree 3); * Yes; Class 6S3 incl. sand, dust; *
Usage in industrial process technology		
<ul style="list-style-type: none"> Against chemically active substances acc. to EN 60654-4 Environmental conditions for process, measuring and control systems acc. to ANSI/ISA-71.04 	Yes; Class 3 (excluding trichlorethylene) Yes; Level GX group A/B (excluding trichlorethylene; harmful gas concentrations up to the limits of EN 60721-3-3 class 3C4 permissible); level LC3 (salt spray) and level LB3 (oil)	Yes; Class 3 (excluding trichlorethylene) Yes; Level GX group A/B (excluding trichlorethylene; harmful gas concentrations up to the limits of EN 60721-3-3 class 3C4 permissible); level LC3 (salt spray) and level LB3 (oil)
Remark		
<ul style="list-style-type: none"> Note regarding classification of environmental conditions acc. to EN 60721, EN 60654-4 and ANSI/ISA-71.04 	* The supplied plug covers must remain in place over the unused interfaces during operation!	* The supplied plug covers must remain in place over the unused interfaces during operation!
Conformal coating		
<ul style="list-style-type: none"> Coatings for printed circuit board assemblies acc. to EN 61086 Protection against fouling acc. to EN 60664-3 Military testing according to MIL-I-46058C, Amendment 7 Qualification and Performance of Electrical Insulating Compound for Printed Board Assemblies according to IPC-CC-830A 	Yes; Class 2 for high reliability Yes; Type 1 protection Yes; Discoloration of coating possible during service life Yes; Conformal coating, Class A	Yes; Class 2 for high reliability Yes; Type 1 protection Yes; Discoloration of coating possible during service life Yes; Conformal coating, Class A

SIMATIC S7-1200 Basic Controllers

Central processing units
SIPLUS standard CPUs

SIPLUS CPU 1212C

Technical specifications

Article number	6AG1212-1BE40-4XB0	6AG1212-1BE40-2XB0
Based on	6ES7212-1BE40-0XB0 SIPLUS S7-1200 CPU 1212C AC/DC/RLY	6ES7212-1BE40-0XB0 SIPLUS S7-1200 CPU 1212C AC/DC/RLY
Ambient conditions		
Ambient temperature during operation		
<ul style="list-style-type: none"> min. max. 	-20 °C; = Tmin; Startup @ 0 °C 60 °C; Number of simultaneously activated inputs or outputs 4 or 3 (no adjacent points) at 60 °C horizontal or 50 °C vertical, 8 or 6 at 55 °C horizontal or 45 °C vertical	-40 °C; = Tmin; Startup @ -25 °C 70 °C; = Tmax; Tmax > +55 °C number of simultaneously switched-on digital inputs 4, digital outputs 3, analog inputs 2 (no adjacent points) with horizontal mounting position; Tmax > +60 °C number of simultaneously switched-on digital inputs 3, digital outputs 2, analog inputs 0 (no adjacent points) with horizontal mounting position
<ul style="list-style-type: none"> At cold restart, min. 	0 °C	-25 °C
Altitude during operation relating to sea level		
<ul style="list-style-type: none"> Installation altitude above sea level, max. Ambient air temperature-barometric pressure-altitude 	2 000 m Tmin ... Tmax at 1 140 hPa ... 795 hPa (-1 000 m ... +2 000 m) // Tmin ... (Tmax - 10 K) at 795 hPa ... 658 hPa (+2 000 m ... +3 500 m) // Tmin ... (Tmax - 20 K) at 658 hPa ... 540 hPa (+3 500 m ... +5 000 m); above 2 000 m max. 132 V AC	2 000 m Tmin ... Tmax at 1 140 hPa ... 795 hPa (-1 000 m ... +2 000 m) // Tmin ... (Tmax - 10 K) at 795 hPa ... 658 hPa (+2 000 m ... +3 500 m) // Tmin ... (Tmax - 20 K) at 658 hPa ... 540 hPa (+3 500 m ... +5 000 m); above 2 000 m max. 132 V AC
Relative humidity		
<ul style="list-style-type: none"> With condensation, tested in accordance with IEC 60068-2-38, max. 	100 %; RH incl. condensation/frost (no commissioning under condensation conditions)	100 %; RH incl. condensation/frost (no commissioning under condensation conditions)
Resistance		
Coolants and lubricants		
<ul style="list-style-type: none"> Resistant to commercially available coolants and lubricants 	Yes; Incl. diesel and oil droplets in the air	Yes; Incl. diesel and oil droplets in the air
Use in stationary industrial systems		
<ul style="list-style-type: none"> to biologically active substances according to EN 60721-3-3 to chemically active substances according to EN 60721-3-3 to mechanically active substances according to EN 60721-3-3 	Yes; Class 3B2 mold, fungus and dry rot spores (with the exception of fauna); Class 3B3 on request Yes; Class 3C4 (RH < 75 %) incl. salt spray acc. to EN 60068-2-52 (severity degree 3); * Yes; Class 3S4 incl. sand, dust, *	Yes; Class 3B2 mold, fungus and dry rot spores (with the exception of fauna); Class 3B3 on request Yes; Class 3C4 (RH < 75 %) incl. salt spray acc. to EN 60068-2-52 (severity degree 3); * Yes; Class 3S4 incl. sand, dust, *
Use on ships/at sea		
<ul style="list-style-type: none"> to biologically active substances according to EN 60721-3-6 to chemically active substances according to EN 60721-3-6 to mechanically active substances according to EN 60721-3-6 	Yes; Class 6B2 mold and fungal spores (excluding fauna); Class 6B3 on request Yes; Class 6C3 (RH < 75 %) incl. salt spray acc. to EN 60068-2-52 (severity degree 3); * Yes; Class 6S3 incl. sand, dust; *	Yes; Class 6B2 mold and fungal spores (excluding fauna); Class 6B3 on request Yes; Class 6C3 (RH < 75 %) incl. salt spray acc. to EN 60068-2-52 (severity degree 3); * Yes; Class 6S3 incl. sand, dust; *
Usage in industrial process technology		
<ul style="list-style-type: none"> Against chemically active substances acc. to EN 60654-4 Environmental conditions for process, measuring and control systems acc. to ANSI/ISA-71.04 	Yes; Class 3 (excluding trichlorethylene) Yes; Level GX group A/B (excluding trichlorethylene; harmful gas concentrations up to the limits of EN 60721-3-3 class 3C4 permissible); level LC3 (salt spray) and level LB3 (oil)	Yes; Class 3 (excluding trichlorethylene) Yes; Level GX group A/B (excluding trichlorethylene; harmful gas concentrations up to the limits of EN 60721-3-3 class 3C4 permissible); level LC3 (salt spray) and level LB3 (oil)
Remark		
<ul style="list-style-type: none"> Note regarding classification of environmental conditions acc. to EN 60721, EN 60654-4 and ANSI/ISA-71.04 	* The supplied plug covers must remain in place over the unused interfaces during operation!	* The supplied plug covers must remain in place over the unused interfaces during operation!
Conformal coating		
<ul style="list-style-type: none"> Coatings for printed circuit board assemblies acc. to EN 61086 Protection against fouling acc. to EN 60664-3 Military testing according to MIL-I-46058C, Amendment 7 Qualification and Performance of Electrical Insulating Compound for Printed Board Assemblies according to IPC-CC-830A 	Yes; Class 2 for high reliability Yes; Type 1 protection Yes; Discoloration of coating possible during service life Yes; Conformal coating, Class A	Yes; Class 2 for high reliability Yes; Type 1 protection Yes; Discoloration of coating possible during service life Yes; Conformal coating, Class A

Technical specifications

Article number	6AG1212-1HE40-4XB0	6AG1212-1HE40-2XB0
Based on	6ES7212-1HE40-0XB0 SIPLUS S7-1200 CPU 1212C DC/DC/RLY	6ES7212-1HE40-0XB0 SIPLUS S7-1200 CPU 1212C DC/DC/RLY
Ambient conditions		
Ambient temperature during operation		
<ul style="list-style-type: none"> min. max. 	-20 °C; = Tmin; Startup @ 0 °C 60 °C; Number of simultaneously activated inputs or outputs 4 or 3 (no adjacent points) at 60 °C horizontal or 50 °C vertical, 8 or 6 at 55 °C horizontal or 45 °C vertical	-40 °C; = Tmin; Startup @ -25 °C 70 °C; = Tmax; Tmax > +55 °C number of simultaneously switched-on digital inputs 4, digital outputs 3, analog inputs 2 (no adjacent points) with horizontal mounting position; Tmax > +60 °C number of simultaneously switched-on digital inputs 3, digital outputs 2, analog inputs 0 (no adjacent points) with horizontal mounting position
<ul style="list-style-type: none"> At cold restart, min. 	0 °C	-25 °C
Altitude during operation relating to sea level		
<ul style="list-style-type: none"> Installation altitude above sea level, max. Ambient air temperature-barometric pressure-altitude 	2 000 m Tmin ... Tmax at 1 140 hPa ... 795 hPa (-1 000 m ... +2 000 m) // Tmin ... (Tmax - 10 K) at 795 hPa ... 658 hPa (+2 000 m ... +3 500 m) // Tmin ... (Tmax - 20 K) at 658 hPa ... 540 hPa (+3 500 m ... +5 000 m); above 2 000 m max. 132 V AC	2 000 m Tmin ... Tmax at 1 140 hPa ... 795 hPa (-1 000 m ... +2 000 m) // Tmin ... (Tmax - 10 K) at 795 hPa ... 658 hPa (+2 000 m ... +3 500 m) // Tmin ... (Tmax - 20 K) at 658 hPa ... 540 hPa (+3 500 m ... +5 000 m); above 2 000 m max. 132 V AC
Relative humidity		
<ul style="list-style-type: none"> With condensation, tested in accordance with IEC 60068-2-38, max. 	100 %; RH incl. condensation/frost (no commissioning under condensation conditions)	100 %; RH incl. condensation/frost (no commissioning under condensation conditions)
Resistance		
Coolants and lubricants		
<ul style="list-style-type: none"> Resistant to commercially available coolants and lubricants 	Yes; Incl. diesel and oil droplets in the air	Yes; Incl. diesel and oil droplets in the air
Use in stationary industrial systems		
<ul style="list-style-type: none"> to biologically active substances according to EN 60721-3-3 to chemically active substances according to EN 60721-3-3 to mechanically active substances according to EN 60721-3-3 	Yes; Class 3B2 mold, fungus and dry rot spores (with the exception of fauna); Class 3B3 on request Yes; Class 3C4 (RH < 75 %) incl. salt spray acc. to EN 60068-2-52 (severity degree 3); * Yes; Class 3S4 incl. sand, dust, *	Yes; Class 3B2 mold, fungus and dry rot spores (with the exception of fauna); Class 3B3 on request Yes; Class 3C4 (RH < 75 %) incl. salt spray acc. to EN 60068-2-52 (severity degree 3); * Yes; Class 3S4 incl. sand, dust, *
Use on ships/at sea		
<ul style="list-style-type: none"> to biologically active substances according to EN 60721-3-6 to chemically active substances according to EN 60721-3-6 to mechanically active substances according to EN 60721-3-6 	Yes; Class 6B2 mold and fungal spores (excluding fauna); Class 6B3 on request Yes; Class 6C3 (RH < 75 %) incl. salt spray acc. to EN 60068-2-52 (severity degree 3); * Yes; Class 6S3 incl. sand, dust; *	Yes; Class 6B2 mold and fungal spores (excluding fauna); Class 6B3 on request Yes; Class 6C3 (RH < 75 %) incl. salt spray acc. to EN 60068-2-52 (severity degree 3); * Yes; Class 6S3 incl. sand, dust; *
Usage in industrial process technology		
<ul style="list-style-type: none"> Against chemically active substances acc. to EN 60654-4 Environmental conditions for process, measuring and control systems acc. to ANSI/ISA-71.04 	Yes; Class 3 (excluding trichlorethylene) Yes; Level GX group A/B (excluding trichlorethylene; harmful gas concentrations up to the limits of EN 60721-3-3 class 3C4 permissible); level LC3 (salt spray) and level LB3 (oil)	Yes; Class 3 (excluding trichlorethylene) Yes; Level GX group A/B (excluding trichlorethylene; harmful gas concentrations up to the limits of EN 60721-3-3 class 3C4 permissible); level LC3 (salt spray) and level LB3 (oil)
Remark		
<ul style="list-style-type: none"> Note regarding classification of environmental conditions acc. to EN 60721, EN 60654-4 and ANSI/ISA-71.04 	* The supplied plug covers must remain in place over the unused interfaces during operation!	* The supplied plug covers must remain in place over the unused interfaces during operation!
Conformal coating		
<ul style="list-style-type: none"> Coatings for printed circuit board assemblies acc. to EN 61086 Protection against fouling acc. to EN 60664-3 Military testing according to MIL-I-46058C, Amendment 7 Qualification and Performance of Electrical Insulating Compound for Printed Board Assemblies according to IPC-CC-830A 	Yes; Class 2 for high reliability Yes; Type 1 protection Yes; Discoloration of coating possible during service life Yes; Conformal coating, Class A	Yes; Class 2 for high reliability Yes; Type 1 protection Yes; Discoloration of coating possible during service life Yes; Conformal coating, Class A

SIMATIC S7-1200 Basic Controllers

Central processing units
SIPLUS standard CPUs

SIPLUS CPU 1214C

Overview



- The compact high-performance CPU
- With 24 integrated I/Os
- Expandable with:
 - 1 signal board (SB) or communication board (CB);
not possible with: 6AG1214-1AG40-2XB0, 6AG1214-1BG40-2XB0, 6AG1214-1HG40-2XB0
 - 8 signal modules (SM)
 - Max. 3 communication modules (CM)

Note:

SIPLUS extreme products are based on SIMATIC standard products. The contents listed here were taken from the respective standard products. SIPLUS extreme-specific information was added.

Ordering data

Article No.

Article No.

SIPLUS CPU 1214C compact CPU, AC/DC/relay

(Extended temperature range and exposure to media)

Integrated program/data memory 100 KB, load memory 2 MB;
Wide-range power supply 85 ... 264 V AC;
Boolean execution times 0.1 µs per operation;
14 digital inputs, 10 digital outputs (relays), 2 analog inputs;
Expandable by up to 3 communication modules, 8 signal modules and 1 signal board/communication board;
Digital inputs can be used as HSC at 100 kHz

- For areas with extreme exposure to media (conformal coating); ambient temperature -20 ... +60 °C
- For areas with extreme exposure to media (conformal coating); ambient temperature -40 ... +60 °C
- For areas with extreme exposure to media (conformal coating); ambient temperature -40 ... +70 °C

6AG1214-1BG40-4XB0

6AG1214-1BG40-5XB0

6AG1214-1BG40-2XB0

SIPLUS CPU 1214C compact CPU, DC/DC/DC

(Extended temperature range and exposure to media)

Integrated program/data memory 100 KB, load memory 2 MB;
Power supply 24 V DC;
Boolean execution times 0.1 µs per operation;
14 digital inputs, 10 digital outputs, 2 analog inputs;
expandable by up to 3 communication modules, 8 signal modules, and 1 signal board/communication board;
Digital inputs can be used as HSC at 100 kHz,
24 V DC digital outputs can be used as pulse outputs (PTO) or pulse-width modulated outputs (PWM) at 100 kHz

- For areas with extreme exposure to media (conformal coating); ambient temperature -20 ... +60 °C
- For areas with extreme exposure to media (conformal coating); ambient temperature -40 ... +60 °C
- For areas with extreme exposure to media (conformal coating); ambient temperature -40 ... +70 °C

6AG1214-1AG40-4XB0

6AG1214-1AG40-5XB0

6AG1214-1AG40-2XB0

Ordering data	Article No.	Article No.	
<p>SIPLUS CPU 1214C compact CPU, DC/DC/relay</p> <p>(Extended temperature range and exposure to media)</p> <p>Integrated program/ data memory 100 KB, load memory 2 MB; Power supply 24 V DC; Boolean execution times 0.1 µs per operation; 14 digital inputs, 10 digital outputs (relays), 2 analog inputs; Expandable by up to 3 communication modules, 8 signal modules, and 1 signal board/communication board; Digital inputs can be used as HSC at 100 kHz</p> <ul style="list-style-type: none"> For areas with extreme exposure to media (conformal coating); ambient temperature -20 ... +60 °C For areas with extreme exposure to media (conformal coating); ambient temperature -40 ... +60 °C For areas with extreme exposure to media (conformal coating); ambient temperature -40 ... +70 °C 	<p>6AG1214-1HG40-4XB0</p> <p>6AG1214-1HG40-5XB0</p> <p>6AG1214-1HG40-2XB0</p>	<p>SIPLUS SB 1223 digital input/output signal board</p> <p>(Extended temperature range and exposure to media; cannot be used with 6AG1214-1.....-2XB0)</p> <p>2 inputs, 24 V DC, IEC type 1 current sinking; 2 transistor outputs 24 V DC, 0.5 A, 5 W; can be used as HSC at up to 30 kHz</p> <ul style="list-style-type: none"> Suitable for areas with extreme exposure to media (conformal coating) Ambient temperature -25 ... +55 °C <p>2 inputs, 5 V DC, 200 kHz 2 outputs 5 V DC, 0.1 A, 200 kHz</p> <p>2 inputs, 24 V DC, 200 kHz 2 outputs 24 V DC, 0.1 A, 200 kHz</p> <p>SIPLUS SB 1232 analog output signal board</p> <p>(Extended temperature range and exposure to media; cannot be used with 6AG1214-1.....-2XB0)</p> <p><u>Ambient temperature range</u> -25 ... +55 °C</p> <p>1 analog output, ±10 V with 12 bits or 0 ... 20 mA with 11 bits</p> <p><u>Ambient temperature range</u> 0 ... +55 °C</p> <p>1 analog output, ±10 V with 12 bits or 0 ... 20 mA with 11 bits</p> <p>SIPLUS CB 1241 RS 485 communication board</p> <p>(Extended temperature range and exposure to media; cannot be used with 6AG1214-1.....-2XB0)</p> <p>For point-to-point connection, with 1 RS 485 interface</p> <p>Additional accessories</p>	<p>6AG1223-0BD30-4XB0</p> <p>6AG1223-0BD30-5XB0</p> <p>6AG1223-3AD30-5XB0</p> <p>6AG1223-3BD30-5XB0</p> <p>6AG1232-4HA30-5XB0</p> <p>6AG1232-4HA30-4XB0</p> <p>6AG1241-1CH30-5XB1</p> <p>See SIMATIC S7-1200 CPU 1214C, page 3/13</p>
<p>Accessories</p> <p>SIPLUS SB 1221 digital input signal board</p> <p>(Extended temperature range and exposure to media; cannot be used with 6AG1214-1.....-2XB0)</p> <p>4 inputs, 5 V DC, 200 kHz, sourcing</p> <p>4 inputs, 24 V DC, 200 kHz, sourcing</p> <p>SIPLUS SB 1222 digital output signal board</p> <p>(Extended temperature range and exposure to media; cannot be used with 6AG1214-1.....-2XB0)</p> <p>4 outputs, 5 V DC, 0.1 A, 200 kHz</p> <p>4 outputs, 24 V DC, 0.1 A, 200 kHz</p>	<p>6AG1221-3AD30-5XB0</p> <p>6AG1221-3BD30-5XB0</p> <p>6AG1222-1AD30-5XB0</p> <p>6AG1222-1BD30-5XB0</p>		

SIMATIC S7-1200 Basic Controllers

Central processing units
SIPLUS standard CPUs

SIPLUS CPU 1214C

Technical specifications

Article number	6AG1214-1AG40-4XB0	6AG1214-1AG40-5XB0	6AG1214-1AG40-2XB0
Based on	6ES7214-1AG40-0XB0	6ES7214-1AG40-0XB0	6ES7214-1AG40-0XB0
	SIPLUS S7-1200 CPU 1214C DC/DC/DC	SIPLUS S7-1200 CPU 1214C DC/DC/DC	SIPLUS S7-1200 CPU 1214C DC/DC/DC
Ambient conditions			
Ambient temperature during operation			
• min.	-20 °C; = Tmin; Startup @ 0 °C	-40 °C; = Tmin (incl. condensation/frost); start-up @ -25 °C	-40 °C; = Tmin (incl. condensation/frost); start-up @ -25 °C
• max.	60 °C; Number of simultaneously activated inputs or outputs 7 or 5 (no adjacent points) at 60 °C horizontal or 50 °C vertical, 14 or 10 at 55 °C horizontal or 45 °C vertical	60 °C; = Tmax; Tmax > +55 °C number of simultaneously switched-on digital inputs 7, digital outputs 5, analog inputs 2 (no adjacent points) with horizontal mounting position	70 °C; = Tmax; Tmax > +55 °C number of simultaneously switched-on digital inputs 7, digital outputs 5, analog inputs 2 (no adjacent points) with horizontal mounting position; Tmax > +60 °C number of simultaneously switched-on digital inputs 7, digital outputs 5, analog inputs 1 (no adjacent points) with horizontal mounting position
• At cold restart, min.	0 °C	-25 °C	-25 °C
Altitude during operation relating to sea level			
• Installation altitude above sea level, max.	5 000 m	5 000 m	5 000 m
• Ambient air temperature-barometric pressure-altitude	Tmin ... Tmax at 1 140 hPa ... 795 hPa (-1 000 m ... +2 000 m) // Tmin ... (Tmax - 10 K) at 795 hPa ... 658 hPa (+2 000 m ... +3 500 m) // Tmin ... (Tmax -20 K) at 658 hPa ... 540 hPa (+3 500 m ... +5 000 m)	Tmin ... Tmax at 1 140 hPa ... 795 hPa (-1 000 m ... +2 000 m) // Tmin ... (Tmax - 10 K) at 795 hPa ... 658 hPa (+2 000 m ... +3 500 m) // Tmin ... (Tmax -20 K) at 658 hPa ... 540 hPa (+3 500 m ... +5 000 m)	Tmin ... Tmax at 1 140 hPa ... 795 hPa (-1 000 m ... +2 000 m) // Tmin ... (Tmax - 10 K) at 795 hPa ... 658 hPa (+2 000 m ... +3 500 m) // Tmin ... (Tmax -20 K) at 658 hPa ... 540 hPa (+3 500 m ... +5 000 m)
Relative humidity			
• With condensation, tested in accordance with IEC 60068-2-38, max.	100 %; RH incl. condensation/frost (no commissioning under condensation conditions)	100 %; RH incl. condensation/frost (no commissioning under condensation conditions)	100 %; RH incl. condensation/frost (no commissioning under condensation conditions)
Resistance			
Coolants and lubricants			
- Resistant to commercially available coolants and lubricants	Yes; Incl. diesel and oil droplets in the air	Yes; Incl. diesel and oil droplets in the air	Yes; Incl. diesel and oil droplets in the air
Use in stationary industrial systems			
- to biologically active substances according to EN 60721-3-3	Yes; Class 3B2 mold, fungus and dry rot spores (with the exception of fauna); Class 3B3 on request	Yes; Class 3B2 mold, fungus and dry rot spores (with the exception of fauna); Class 3B3 on request	Yes; Class 3B2 mold, fungus and dry rot spores (with the exception of fauna); Class 3B3 on request
- to chemically active substances according to EN 60721-3-3	Yes; Class 3C4 (RH < 75 %) incl. salt spray acc. to EN 60068-2-52 (severity degree 3); *	Yes; Class 3C4 (RH < 75 %) incl. salt spray acc. to EN 60068-2-52 (severity degree 3); *	Yes; Class 3C4 (RH < 75 %) incl. salt spray acc. to EN 60068-2-52 (severity degree 3); *
- to mechanically active substances according to EN 60721-3-3	Yes; Class 3S4 incl. sand, dust, *	Yes; Class 3S4 incl. sand, dust, *	Yes; Class 3S4 incl. sand, dust, *
Use on ships/at sea			
- to biologically active substances according to EN 60721-3-6	Yes; Class 6B2 mold and fungal spores (excluding fauna); Class 6B3 on request	Yes; Class 6B2 mold and fungal spores (excluding fauna); Class 6B3 on request	Yes; Class 6B2 mold and fungal spores (excluding fauna); Class 6B3 on request
- to chemically active substances according to EN 60721-3-6	Yes; Class 6C3 (RH < 75 %) incl. salt spray acc. to EN 60068-2-52 (severity degree 3); *	Yes; Class 6C3 (RH < 75 %) incl. salt spray acc. to EN 60068-2-52 (severity degree 3); *	Yes; Class 6C3 (RH < 75 %) incl. salt spray acc. to EN 60068-2-52 (severity degree 3); *
- to mechanically active substances according to EN 60721-3-6	Yes; Class 6S3 incl. sand, dust; *	Yes; Class 6S3 incl. sand, dust; *	Yes; Class 6S3 incl. sand, dust; *

Technical specifications

Article number	6AG1214-1AG40-4XB0	6AG1214-1AG40-5XB0	6AG1214-1AG40-2XB0
Based on	6ES7214-1AG40-0XB0 SIPLUS S7-1200 CPU 1214C DC/DC/DC	6ES7214-1AG40-0XB0 SIPLUS S7-1200 CPU 1214C DC/DC/DC	6ES7214-1AG40-0XB0 SIPLUS S7-1200 CPU 1214C DC/DC/DC
Usage in industrial process technology	Yes; Class 3 (excluding trichlorethylene)	Yes; Class 3 (excluding trichlorethylene)	Yes; Class 3 (excluding trichlorethylene)
- Against chemically active substances acc. to EN 60654-4	Yes; Level GX group A/B (excluding trichlorethylene; harmful gas concentrations up to the limits of EN 60721-3-3 class 3C4 permissible); level LC3 (salt spray) and level LB3 (oil)	Yes; Level GX group A/B (excluding trichlorethylene; harmful gas concentrations up to the limits of EN 60721-3-3 class 3C4 permissible); level LC3 (salt spray) and level LB3 (oil)	Yes; Level GX group A/B (excluding trichlorethylene; harmful gas concentrations up to the limits of EN 60721-3-3 class 3C4 permissible); level LC3 (salt spray) and level LB3 (oil)
- Environmental conditions for process, measuring and control systems acc. to ANSI/ISA-71.04			
Remark	* The supplied plug covers must remain in place over the unused interfaces during operation!	* The supplied plug covers must remain in place over the unused interfaces during operation!	* The supplied plug covers must remain in place over the unused interfaces during operation!
- Note regarding classification of environmental conditions acc. to EN 60721, EN 60654-4 and ANSI/ISA-71.04			
Conformal coating	Yes; Class 2 for high reliability	Yes; Class 2 for high reliability	Yes; Class 2 for high reliability
• Coatings for printed circuit board assemblies acc. to EN 61086	Yes; Type 1 protection	Yes; Type 1 protection	Yes; Type 1 protection
• Protection against fouling acc. to EN 60664-3	Yes; Discoloration of coating possible during service life	Yes; Discoloration of coating possible during service life	Yes; Discoloration of coating possible during service life
• Military testing according to MIL-I-46058C, Amendment 7	Yes; Conformal coating, Class A	Yes; Conformal coating, Class A	Yes; Conformal coating, Class A
• Qualification and Performance of Electrical Insulating Compound for Printed Board Assemblies according to IPC-CC-830A			
Article number	6AG1214-1BG40-4XB0	6AG1214-1BG40-5XB0	6AG1214-1BG40-2XB0
Based on	6ES7214-1BG40-0XB0 SIPLUS S7-1200 CPU 1214C AC/DC/RLY	6ES7214-1BG40-0XB0 SIPLUS S7-1200 CPU 1214C AC/DC/RLY	6ES7214-1BG40-0XB0 SIPLUS S7-1200 CPU 1214C AC/DC/RLY
Ambient conditions			
Ambient temperature during operation			
• min.	-20 °C; = Tmin (incl. condensation/frost); start-up @ 0 °C	-40 °C; = Tmin (incl. condensation/frost); start-up @ -25 °C	-40 °C; = Tmin (incl. condensation/frost); start-up @ -25 °C
• max.	60 °C; = Tmax	60 °C; = Tmax; Tmax > +55 °C number of simultaneously switched-on digital inputs 7, digital outputs 5, analog inputs 2 (no adjacent points) with horizontal mounting position	70 °C; = Tmax; Tmax > +55 °C number of simultaneously switched-on digital inputs 7, digital outputs 5, analog inputs 2 (no adjacent points) with horizontal mounting position; Tmax > +60 °C number of simultaneously switched-on digital inputs 7, digital outputs 5, analog inputs 1 (no adjacent points) with horizontal mounting position
• At cold restart, min.	0 °C	-25 °C	-25 °C
Altitude during operation relating to sea level			
• Installation altitude above sea level, max.	2 000 m	2 000 m	2 000 m
• Ambient air temperature-barometric pressure-altitude	Tmin ... Tmax at 1 140 hPa ... 795 hPa (-1 000 m ... +2 000 m) // Tmin ... (Tmax - 10 K) at 795 hPa ... 658 hPa (+2 000 m ... +3 500 m) // Tmin ... (Tmax - 20 K) at 658 hPa ... 540 hPa (+3 500 m ... +5 000 m); above 2 000 m max. 132 V AC	Tmin ... Tmax at 1 140 hPa ... 795 hPa (-1 000 m ... +2 000 m) // Tmin ... (Tmax - 10 K) at 795 hPa ... 658 hPa (+2 000 m ... +3 500 m) // Tmin ... (Tmax - 20 K) at 658 hPa ... 540 hPa (+3 500 m ... +5 000 m); above 2 000 m max. 132 V AC	Tmin ... Tmax at 1 140 hPa ... 795 hPa (-1 000 m ... +2 000 m) // Tmin ... (Tmax - 10 K) at 795 hPa ... 658 hPa (+2 000 m ... +3 500 m) // Tmin ... (Tmax - 20 K) at 658 hPa ... 540 hPa (+3 500 m ... +5 000 m); above 2 000 m max. 132 V AC
Relative humidity			
• With condensation, tested in accordance with IEC 60068-2-38, max.	100 %; RH incl. condensation/frost (no commissioning under condensation conditions)	100 %; RH incl. condensation/frost (no commissioning under condensation conditions)	100 %; RH incl. condensation/frost (no commissioning under condensation conditions)

SIMATIC S7-1200 Basic Controllers

Central processing units
SIPLUS standard CPUs

SIPLUS CPU 1214C

Technical specifications

Article number	6AG1214-1BG40-4XB0	6AG1214-1BG40-5XB0	6AG1214-1BG40-2XB0
Based on	6ES7214-1BG40-0XB0 SIPLUS S7-1200 CPU 1214C AC/DC/RLY	6ES7214-1BG40-0XB0 SIPLUS S7-1200 CPU 1214C AC/DC/RLY	6ES7214-1BG40-0XB0 SIPLUS S7-1200 CPU 1214C AC/DC/RLY
Resistance			
Coolants and lubricants			
- Resistant to commercially available coolants and lubricants	Yes; Incl. diesel and oil droplets in the air	Yes; Incl. diesel and oil droplets in the air	Yes; Incl. diesel and oil droplets in the air
Use in stationary industrial systems			
- to biologically active substances according to EN 60721-3-3	Yes; Class 3B2 mold, fungus and dry rot spores (with the exception of fauna); Class 3B3 on request	Yes; Class 3B2 mold, fungus and dry rot spores (with the exception of fauna); Class 3B3 on request	Yes; Class 3B2 mold, fungus and dry rot spores (with the exception of fauna); Class 3B3 on request
- to chemically active substances according to EN 60721-3-3	Yes; Class 3C4 (RH < 75 %) incl. salt spray acc. to EN 60068-2-52 (severity degree 3); *	Yes; Class 3C4 (RH < 75 %) incl. salt spray acc. to EN 60068-2-52 (severity degree 3); *	Yes; Class 3C4 (RH < 75 %) incl. salt spray acc. to EN 60068-2-52 (severity degree 3); *
- to mechanically active substances according to EN 60721-3-3	Yes; Class 3S4 incl. sand, dust, *	Yes; Class 3S4 incl. sand, dust, *	Yes; Class 3S4 incl. sand, dust, *
Use on ships/at sea			
- to biologically active substances according to EN 60721-3-6	Yes; Class 6B2 mold and fungal spores (excluding fauna); Class 6B3 on request	Yes; Class 6B2 mold and fungal spores (excluding fauna); Class 6B3 on request	Yes; Class 6B2 mold and fungal spores (excluding fauna); Class 6B3 on request
- to chemically active substances according to EN 60721-3-6	Yes; Class 6C3 (RH < 75 %) incl. salt spray acc. to EN 60068-2-52 (severity degree 3); *	Yes; Class 6C3 (RH < 75 %) incl. salt spray acc. to EN 60068-2-52 (severity degree 3); *	Yes; Class 6C3 (RH < 75 %) incl. salt spray acc. to EN 60068-2-52 (severity degree 3); *
- to mechanically active substances according to EN 60721-3-6	Yes; Class 6S3 incl. sand, dust; *	Yes; Class 6S3 incl. sand, dust; *	Yes; Class 6S3 incl. sand, dust; *
Usage in industrial process technology			
- Against chemically active substances acc. to EN 60654-4	Yes; Class 3 (excluding trichlorethylene)	Yes; Class 3 (excluding trichlorethylene)	Yes; Class 3 (excluding trichlorethylene)
- Environmental conditions for process, measuring and control systems acc. to ANSI/ISA-71.04	Yes; Level GX group A/B (excluding trichlorethylene; harmful gas concentrations up to the limits of EN 60721-3-3 class 3C4 permissible); level LC3 (salt spray) and level LB3 (oil)	Yes; Level GX group A/B (excluding trichlorethylene; harmful gas concentrations up to the limits of EN 60721-3-3 class 3C4 permissible); level LC3 (salt spray) and level LB3 (oil)	Yes; Level GX group A/B (excluding trichlorethylene; harmful gas concentrations up to the limits of EN 60721-3-3 class 3C4 permissible); level LC3 (salt spray) and level LB3 (oil)
Remark			
- Note regarding classification of environmental conditions acc. to EN 60721, EN 60654-4 and ANSI/ISA-71.04	* The supplied plug covers must remain in place over the unused interfaces during operation!	* The supplied plug covers must remain in place over the unused interfaces during operation!	* The supplied plug covers must remain in place over the unused interfaces during operation!
Conformal coating			
• Coatings for printed circuit board assemblies acc. to EN 61086	Yes; Class 2 for high reliability	Yes; Class 2 for high reliability	Yes; Class 2 for high reliability
• Protection against fouling acc. to EN 60664-3	Yes; Type 1 protection	Yes; Type 1 protection	Yes; Type 1 protection
• Military testing according to MIL-I-46058C, Amendment 7	Yes; Discoloration of coating possible during service life	Yes; Discoloration of coating possible during service life	Yes; Discoloration of coating possible during service life
• Qualification and Performance of Electrical Insulating Compound for Printed Board Assemblies according to IPC-CC-830A	Yes; Conformal coating, Class A	Yes; Conformal coating, Class A	Yes; Conformal coating, Class A

Technical specifications

Article number	6AG1214-1HG40-4XB0	6AG1214-1HG40-5XB0	6AG1214-1HG40-2XB0
Based on	6ES7214-1HG40-0XB0 SIPLUS S7-1200 CPU 1214C DC/DC/RLY	6ES7214-1HG40-0XB0 SIPLUS S7-1200 CPU 1214C DC/DC/RLY	6ES7214-1HG40-0XB0 SIPLUS S7-1200 CPU 1214C DC/DC/RLY
Ambient conditions			
Ambient temperature during operation			
• min.	-20 °C; = Tmin (incl. condensation/frost); start-up @ 0 °C	-40 °C; = Tmin (incl. condensation/frost); start-up @ -25 °C	-40 °C; = Tmin (incl. condensation/frost); start-up @ -25 °C
• max.	60 °C; Number of simultaneously activated inputs or outputs 7 or 5 (no adjacent points) at 60 °C horizontal or 50 °C vertical, 14 or 10 at 55 °C horizontal or 45 °C vertical	60 °C; = Tmax; Tmax > +55 °C number of simultaneously switched-on digital inputs 7, digital outputs 5, analog inputs 2 (no adjacent points) with horizontal mounting position	70 °C; = Tmax; Tmax > +55 °C number of simultaneously switched-on digital inputs 7, digital outputs 5, analog inputs 2 (no adjacent points) with horizontal mounting position; Tmax > +60 °C number of simultaneously switched-on digital inputs 7, digital outputs 5, analog inputs 1 (no adjacent points) with horizontal mounting position
• At cold restart, min.	0 °C	-25 °C	-25 °C
Altitude during operation relating to sea level			
• Installation altitude above sea level, max.	2 000 m	2 000 m	2 000 m
• Ambient air temperature-barometric pressure-altitude	Tmin ... Tmax at 1 140 hPa ... 795 hPa (-1 000 m ... +2 000 m) // Tmin ... (Tmax - 10 K) at 795 hPa ... 658 hPa (+2 000 m ... +3 500 m) // Tmin ... (Tmax - 20 K) at 658 hPa ... 540 hPa (+3 500 m ... +5 000 m); above 2 000 m max. 132 V AC	Tmin ... Tmax at 1 140 hPa ... 795 hPa (-1 000 m ... +2 000 m) // Tmin ... (Tmax - 10 K) at 795 hPa ... 658 hPa (+2 000 m ... +3 500 m) // Tmin ... (Tmax - 20 K) at 658 hPa ... 540 hPa (+3 500 m ... +5 000 m); above 2 000 m max. 132 V AC	Tmin ... Tmax at 1 140 hPa ... 795 hPa (-1 000 m ... +2 000 m) // Tmin ... (Tmax - 10 K) at 795 hPa ... 658 hPa (+2 000 m ... +3 500 m) // Tmin ... (Tmax - 20 K) at 658 hPa ... 540 hPa (+3 500 m ... +5 000 m); above 2 000 m max. 132 V AC
Relative humidity			
• With condensation, tested in accordance with IEC 60068-2-38, max.	100 %; RH incl. condensation/frost (no commissioning under condensation conditions)	100 %; RH incl. condensation/frost (no commissioning under condensation conditions)	100 %; RH incl. condensation/frost (no commissioning under condensation conditions)
Resistance			
Coolants and lubricants			
- Resistant to commercially available coolants and lubricants	Yes; Incl. diesel and oil droplets in the air	Yes; Incl. diesel and oil droplets in the air	Yes; Incl. diesel and oil droplets in the air
Use in stationary industrial systems			
- to biologically active substances according to EN 60721-3-3	Yes; Class 3B2 mold, fungus and dry rot spores (with the exception of fauna); Class 3B3 on request	Yes; Class 3B2 mold, fungus and dry rot spores (with the exception of fauna); Class 3B3 on request	Yes; Class 3B2 mold, fungus and dry rot spores (with the exception of fauna); Class 3B3 on request
- to chemically active substances according to EN 60721-3-3	Yes; Class 3C4 (RH < 75 %) incl. salt spray acc. to EN 60068-2-52 (severity degree 3); *	Yes; Class 3C4 (RH < 75 %) incl. salt spray acc. to EN 60068-2-52 (severity degree 3); *	Yes; Class 3C4 (RH < 75 %) incl. salt spray acc. to EN 60068-2-52 (severity degree 3); *
- to mechanically active substances according to EN 60721-3-3	Yes; Class 3S4 incl. sand, dust, *	Yes; Class 3S4 incl. sand, dust, *	Yes; Class 3S4 incl. sand, dust, *
Use on ships/at sea			
- to biologically active substances according to EN 60721-3-6	Yes; Class 6B2 mold and fungal spores (excluding fauna); Class 6B3 on request	Yes; Class 6B2 mold and fungal spores (excluding fauna); Class 6B3 on request	Yes; Class 6B2 mold and fungal spores (excluding fauna); Class 6B3 on request
- to chemically active substances according to EN 60721-3-6	Yes; Class 6C3 (RH < 75 %) incl. salt spray acc. to EN 60068-2-52 (severity degree 3); *	Yes; Class 6C3 (RH < 75 %) incl. salt spray acc. to EN 60068-2-52 (severity degree 3); *	Yes; Class 6C3 (RH < 75 %) incl. salt spray acc. to EN 60068-2-52 (severity degree 3); *
- to mechanically active substances according to EN 60721-3-6	Yes; Class 6S3 incl. sand, dust; *	Yes; Class 6S3 incl. sand, dust; *	Yes; Class 6S3 incl. sand, dust; *

SIMATIC S7-1200 Basic Controllers

Central processing units
SIPLUS standard CPUs

SIPLUS CPU 1214C

Technical specifications

Article number	6AG1214-1HG40-4XB0	6AG1214-1HG40-5XB0	6AG1214-1HG40-2XB0
Based on	6ES7214-1HG40-0XB0 SIPLUS S7-1200 CPU 1214C DC/DC/RLY	6ES7214-1HG40-0XB0 SIPLUS S7-1200 CPU 1214C DC/DC/RLY	6ES7214-1HG40-0XB0 SIPLUS S7-1200 CPU 1214C DC/DC/RLY
Usage in industrial process technology	<ul style="list-style-type: none"> - Against chemically active substances acc. to EN 60654-4 - Environmental conditions for process, measuring and control systems acc. to ANSI/ISA-71.04 	<ul style="list-style-type: none"> Yes; Class 3 (excluding trichlorethylene) Yes; Level GX group A/B (excluding trichlorethylene; harmful gas concentrations up to the limits of EN 60721-3-3 class 3C4 permissible); level LC3 (salt spray) and level LB3 (oil) 	<ul style="list-style-type: none"> Yes; Class 3 (excluding trichlorethylene) Yes; Level GX group A/B (excluding trichlorethylene; harmful gas concentrations up to the limits of EN 60721-3-3 class 3C4 permissible); level LC3 (salt spray) and level LB3 (oil)
Remark	<ul style="list-style-type: none"> - Note regarding classification of environmental conditions acc. to EN 60721, EN 60654-4 and ANSI/ISA-71.04 	* The supplied plug covers must remain in place over the unused interfaces during operation!	* The supplied plug covers must remain in place over the unused interfaces during operation!
Conformal coating	<ul style="list-style-type: none"> • Coatings for printed circuit board assemblies acc. to EN 61086 • Protection against fouling acc. to EN 60664-3 • Military testing according to MIL-I-46058C, Amendment 7 • Qualification and Performance of Electrical Insulating Compound for Printed Board Assemblies according to IPC-CC-830A 	<ul style="list-style-type: none"> Yes; Class 2 for high reliability Yes; Type 1 protection Yes; Discoloration of coating possible during service life Yes; Conformal coating, Class A 	<ul style="list-style-type: none"> Yes; Class 2 for high reliability Yes; Type 1 protection Yes; Discoloration of coating possible during service life Yes; Conformal coating, Class A

Overview

- The compact high-performance CPU
- With 24 integrated I/Os
- Expandable with:
 - 1 signal board (SB) or communication board (CB);
not possible with: 6AG1215-1AG40-2XB0, 6AG1215-1BG40-2XB0, 6AG1215-1HG40-2XB0
 - 8 signal modules (SM)
 - Max. 3 communication modules (CM)

Note:

SIPLUS extreme products are based on SIMATIC standard products. The contents listed here were taken from the respective standard products. SIPLUS extreme-specific information was added.

Ordering data**Article No.****Article No.****SIPLUS CPU 1215C compact CPU, AC/DC/relay**

(Extended temperature range and exposure to media)

- Integrated program and data memory 125 KB, load memory 4 MB; wide-range power supply 85 ... 264 V AC; Boolean execution times 0.085 µs per operation; 14 digital inputs, 10 digital outputs (relay), 2 analog inputs, 2 analog outputs; expandable by up to 3 communication modules, 8 signal modules and 1 signal board/communication board; digital inputs usable as HSC with 100 kHz
- For areas with extreme exposure to media (conformal coating); ambient temperature -20 ... +60 °C
 - For areas with extreme exposure to media (conformal coating); ambient temperature -40 ... +60 °C
 - For areas with extreme exposure to media (conformal coating); ambient temperature -40 ... +70 °C

6AG1215-1BG40-4XB0**6AG1215-1BG40-5XB0****6AG1215-1BG40-2XB0****SIPLUS CPU 1215C compact CPU, DC/DC/DC**

(Extended temperature range and exposure to media)

- Integrated program and data memory 125 KB, load memory 4 MB; power supply 24 V DC; Boolean execution times 0.085 µs per operation; 14 digital inputs, 10 digital outputs, 2 analog inputs, 2 analog outputs; expandable by up to 3 communication modules, 8 signal modules and 1 signal board/communication board; digital inputs usable as HSC with 100 kHz; 24 V DC digital outputs usable as pulse outputs (PTO) or pulse-width-modulated outputs (PWM) with 100 kHz
- For areas with extreme exposure to media (conformal coating); ambient temperature -20 ... +60 °C
 - For areas with extreme exposure to media (conformal coating); ambient temperature -40 ... +60 °C
 - For areas with extreme exposure to media (conformal coating); ambient temperature -40 ... +70 °C

6AG1215-1AG40-4XB0**6AG1215-1AG40-5XB0****6AG1215-1AG40-2XB0**

SIMATIC S7-1200 Basic Controllers

Central processing units
SIPLUS standard CPUs

SIPLUS CPU 1215C

Ordering data

SIPLUS CPU 1215C

compact CPU, DC/DC/relay

(Extended temperature range and exposure to media)

Integrated program and data memory 125 KB, load memory 4 MB; power supply 24 V DC; Boolean execution times 0.085 µs per operation; 14 digital inputs, 10 digital outputs (relay), 2 analog inputs, 2 analog outputs; expandable by up to 3 communication modules, 8 signal modules and 1 signal board/communication board; digital inputs usable as HSC with 100 kHz

- For areas with extreme exposure to media (conformal coating); ambient temperature -20 ... +60 °C
- For areas with extreme exposure to media (conformal coating); ambient temperature -40 ... +60 °C
- For areas with extreme exposure to media (conformal coating); ambient temperature -40 ... +70 °C

Accessories

SIPLUS SB 1221 digital input signal board

(Extended temperature range and exposure to media; cannot be used with 6AG1215-1.....-2XB0)

4 inputs, 5 V DC, 200 kHz, sourcing
4 inputs, 24 V DC, 200 kHz, sourcing

SIPLUS SB 1222 digital output signal board

(Extended temperature range and exposure to media; cannot be used with 6AG1215-1.....-2XB0)

4 outputs, 5 V DC, 0.1 A, 200 kHz
4 outputs, 24 V DC, 0.1 A, 200 kHz

Article No.

6AG1215-1HG40-4XB0

6AG1215-1HG40-5XB0

6AG1215-1HG40-2XB0

6AG1221-3AD30-5XB0

6AG1221-3BD30-5XB0

6AG1222-1AD30-5XB0

6AG1222-1BD30-5XB0

Article No.

SIPLUS SB 1223 digital input/output signal board

(Extended temperature range and exposure to media; cannot be used with 6AG1215-1.....-2XB0)

2 inputs, 24 V DC, IEC type 1 current sinking; 2 transistor outputs 24 V DC, 0.5 A, 5 W; can be used as HSC at up to 30 kHz

- Suitable for areas with extreme exposure to media (conformal coating)
- Ambient temperature -25 ... +55 °C

2 inputs, 5 V DC, 200 kHz
2 outputs 5 V DC, 0.1 A, 200 kHz

2 inputs, 24 V DC, 200 kHz
2 outputs 24 V DC, 0.1 A, 200 kHz

SIPLUS SB 1232 analog output signal board

(Extended temperature range and exposure to media; cannot be used with 6AG1215-1.....-2XB0)

Ambient temperature range
-25 ... +55 °C

1 analog output, ±10 V with 12 bits or 0 ... 20 mA with 11 bits

Ambient temperature range
0 ... +55 °C

1 analog output, ±10 V with 12 bits or 0 ... 20 mA with 11 bits

SIPLUS CB 1241 RS 485 communication board

(Extended temperature range and exposure to media; cannot be used with 6AG1215-1.....-2XB0)

for point-to-point connection, with 1 RS 485 interface

Additional accessories

6AG1223-0BD30-4XB0

6AG1223-0BD30-5XB0

6AG1223-3AD30-5XB0

6AG1223-3BD30-5XB0

6AG1232-4HA30-5XB0

6AG1232-4HA30-4XB0

6AG1241-1CH30-5XB1

See SIMATIC S7-1200 CPU 1215C, page 3/17

Technical specifications

Article number	6AG1215-1AG40-4XB0	6AG1215-1AG40-5XB0	6AG1215-1AG40-2XB0
Based on	6ES7215-1AG40-0XB0	6ES7215-1AG40-0XB0	6ES7215-1AG40-0XB0
	SIPLUS S7-1200 CPU 1215C DC/DC/DC	SIPLUS S7-1200 CPU 1215C DC/DC/DC	SIPLUS S7-1200 CPU 1215C DC/DC/DC
Ambient conditions			
Ambient temperature during operation			
• min.	-20 °C; = Tmin (incl. condensation/frost); start-up @ 0 °C	-40 °C; = Tmin (incl. condensation/frost); start-up @ -25 °C	-40 °C; = Tmin (incl. condensation/frost); start-up @ -25 °C
• max.	60 °C; Number of simultaneously activated inputs or outputs 7 or 5 (no adjacent points) at 60 °C horizontal or 50 °C vertical, 14 or 10 at 55 °C horizontal or 45 °C vertical	60 °C; = Tmax; Tmax > +55 °C number of simultaneously switched-on digital inputs 7, digital outputs 5, analog inputs 2, analog outputs 2 (no adjacent points) with horizontal mounting position	70 °C; = Tmax; Tmax > +55 °C number of simultaneously switched-on digital inputs 7, digital outputs 5, analog inputs 2, analog outputs 2 (no adjacent points) with horizontal mounting position; Tmax > +60 °C number of simultaneously switched-on digital inputs 7, digital outputs 5, analog inputs 1, analog outputs 1 (no adjacent points) with horizontal mounting position
• At cold restart, min.	0 °C	-25 °C	-25 °C
Altitude during operation relating to sea level			
• Installation altitude above sea level, max.	5 000 m	5 000 m	5 000 m
• Ambient air temperature-barometric pressure-altitude	Tmin ... Tmax at 1 140 hPa ... 795 hPa (-1 000 m ... +2 000 m) // Tmin ... (Tmax - 10 K) at 795 hPa ... 658 hPa (+2 000 m ... +3 500 m) // Tmin ... (Tmax -20 K) at 658 hPa ... 540 hPa (+3 500 m ... +5 000 m)	Tmin ... Tmax at 1 140 hPa ... 795 hPa (-1 000 m ... +2 000 m) // Tmin ... (Tmax - 10 K) at 795 hPa ... 658 hPa (+2 000 m ... +3 500 m) // Tmin ... (Tmax -20 K) at 658 hPa ... 540 hPa (+3 500 m ... +5 000 m)	Tmin ... Tmax at 1 140 hPa ... 795 hPa (-1 000 m ... +2 000 m) // Tmin ... (Tmax - 10 K) at 795 hPa ... 658 hPa (+2 000 m ... +3 500 m) // Tmin ... (Tmax -20 K) at 658 hPa ... 540 hPa (+3 500 m ... +5 000 m)
Relative humidity			
• With condensation, tested in accordance with IEC 60068-2-38, max.	100 %; RH incl. condensation/frost (no commissioning under condensation conditions)	100 %; RH incl. condensation/frost (no commissioning under condensation conditions)	100 %; RH incl. condensation/frost (no commissioning under condensation conditions)
Resistance			
Coolants and lubricants			
- Resistant to commercially available coolants and lubricants	Yes; Incl. diesel and oil droplets in the air	Yes; Incl. diesel and oil droplets in the air	Yes; Incl. diesel and oil droplets in the air
Use in stationary industrial systems			
- to biologically active substances according to EN 60721-3-3	Yes; Class 3B2 mold, fungus and dry rot spores (with the exception of fauna); Class 3B3 on request	Yes; Class 3B2 mold, fungus and dry rot spores (with the exception of fauna); Class 3B3 on request	Yes; Class 3B2 mold, fungus and dry rot spores (with the exception of fauna); Class 3B3 on request
- to chemically active substances according to EN 60721-3-3	Yes; Class 3C4 (RH < 75 %) incl. salt spray acc. to EN 60068-2-52 (severity degree 3); *	Yes; Class 3C4 (RH < 75 %) incl. salt spray acc. to EN 60068-2-52 (severity degree 3); *	Yes; Class 3C4 (RH < 75 %) incl. salt spray acc. to EN 60068-2-52 (severity degree 3); *
- to mechanically active substances according to EN 60721-3-3	Yes; Class 3S4 incl. sand, dust, *	Yes; Class 3S4 incl. sand, dust, *	Yes; Class 3S4 incl. sand, dust, *
Use on ships/at sea			
- to biologically active substances according to EN 60721-3-6	Yes; Class 6B2 mold and fungal spores (excluding fauna); Class 6B3 on request	Yes; Class 6B2 mold and fungal spores (excluding fauna); Class 6B3 on request	Yes; Class 6B2 mold and fungal spores (excluding fauna); Class 6B3 on request
- to chemically active substances according to EN 60721-3-6	Yes; Class 6C3 (RH < 75 %) incl. salt spray acc. to EN 60068-2-52 (severity degree 3); *	Yes; Class 6C3 (RH < 75 %) incl. salt spray acc. to EN 60068-2-52 (severity degree 3); *	Yes; Class 6C3 (RH < 75 %) incl. salt spray acc. to EN 60068-2-52 (severity degree 3); *
- to mechanically active substances according to EN 60721-3-6	Yes; Class 6S3 incl. sand, dust; *	Yes; Class 6S3 incl. sand, dust; *	Yes; Class 6S3 incl. sand, dust; *
Usage in industrial process technology			
- Against chemically active substances acc. to EN 60654-4	Yes; Class 3 (excluding trichlorethylene)	Yes; Class 3 (excluding trichlorethylene)	Yes; Class 3 (excluding trichlorethylene)
- Environmental conditions for process, measuring and control systems acc. to ANSI/ISA-71.04	Yes; Level GX group A/B (excluding trichlorethylene; harmful gas concentrations up to the limits of EN 60721-3-3 class 3C4 permissible); level LC3 (salt spray) and level LB3 (oil)	Yes; Level GX group A/B (excluding trichlorethylene; harmful gas concentrations up to the limits of EN 60721-3-3 class 3C4 permissible); level LC3 (salt spray) and level LB3 (oil)	Yes; Level GX group A/B (excluding trichlorethylene; harmful gas concentrations up to the limits of EN 60721-3-3 class 3C4 permissible); level LC3 (salt spray) and level LB3 (oil)
Remark			
- Note regarding classification of environmental conditions acc. to EN 60721, EN 60654-4 and ANSI/ISA-71.04	* The supplied plug covers must remain in place over the unused interfaces during operation!	* The supplied plug covers must remain in place over the unused interfaces during operation!	* The supplied plug covers must remain in place over the unused interfaces during operation!

SIMATIC S7-1200 Basic Controllers

Central processing units
SIPLUS standard CPUs

SIPLUS CPU 1215C

Technical specifications

Article number	6AG1215-1AG40-4XB0	6AG1215-1AG40-5XB0	6AG1215-1AG40-2XB0
Based on	6ES7215-1AG40-0XB0 SIPLUS S7-1200 CPU 1215C DC/DC/DC	6ES7215-1AG40-0XB0 SIPLUS S7-1200 CPU 1215C DC/DC/DC	6ES7215-1AG40-0XB0 SIPLUS S7-1200 CPU 1215C DC/DC/DC
Conformal coating			
<ul style="list-style-type: none"> Coatings for printed circuit board assemblies acc. to EN 61086 Protection against fouling acc. to EN 60664-3 Military testing according to MIL-I-46058C, Amendment 7 Qualification and Performance of Electrical Insulating Compound for Printed Board Assemblies according to IPC-CC-830A 	<ul style="list-style-type: none"> Yes; Class 2 for high reliability Yes; Type 1 protection Yes; Discoloration of coating possible during service life Yes; Conformal coating, Class A 	<ul style="list-style-type: none"> Yes; Class 2 for high reliability Yes; Type 1 protection Yes; Discoloration of coating possible during service life Yes; Conformal coating, Class A 	<ul style="list-style-type: none"> Yes; Class 2 for high reliability Yes; Type 1 protection Yes; Discoloration of coating possible during service life Yes; Conformal coating, Class A
Article number	6AG1215-1BG40-4XB0	6AG1215-1BG40-5XB0	6AG1215-1BG40-2XB0
Based on	6ES7215-1BG40-0XB0 SIPLUS S7-1200 CPU 1215C AC/DC/RLY	6ES7215-1BG40-0XB0 SIPLUS S7-1200 CPU 1215C AC/DC/RLY	6ES7215-1BG40-0XB0 SIPLUS S7-1200 CPU 1215C AC/DC/RLY
Ambient conditions			
Ambient temperature during operation			
<ul style="list-style-type: none"> min. max. At cold restart, min. 	<ul style="list-style-type: none"> -20 °C; = Tmin (incl. condensation/frost); start-up @ 0 °C 60 °C; Number of simultaneously activated inputs or outputs 7 or 5 (no adjacent points) at 60 °C horizontal or 50 °C vertical, 14 or 10 at 55 °C horizontal or 45 °C vertical 0 °C 	<ul style="list-style-type: none"> -40 °C; = Tmin (incl. condensation/frost); start-up @ -25 °C 60 °C; = Tmax; Tmax > +55 °C number of simultaneously switched-on digital inputs 7, digital outputs 5, analog inputs 2, analog outputs 2 (no adjacent points) with horizontal mounting position -25 °C 	<ul style="list-style-type: none"> -40 °C; = Tmin (incl. condensation/frost); start-up @ -25 °C 70 °C; = Tmax; Tmax > +55 °C number of simultaneously switched-on digital inputs 7, digital outputs 5, analog inputs 2, analog outputs 2 (no adjacent points) with horizontal mounting position; Tmax > +60 °C number of simultaneously switched-on digital inputs 7, digital outputs 5, analog inputs 1, analog outputs 1 (no adjacent points) with horizontal mounting position -25 °C
Altitude during operation relating to sea level			
<ul style="list-style-type: none"> Installation altitude above sea level, max. Ambient air temperature-barometric pressure-altitude 	<ul style="list-style-type: none"> 2 000 m Tmin ... Tmax at 1 140 hPa ... 795 hPa (-1 000 m ... +2 000 m) // Tmin ... (Tmax - 10 K) at 795 hPa ... 658 hPa (+2 000 m ... +3 500 m) // Tmin ... (Tmax - 20 K) at 658 hPa ... 540 hPa (+3 500 m ... +5 000 m); above 2 000 m max. 132 V AC 	<ul style="list-style-type: none"> 2 000 m Tmin ... Tmax at 1 140 hPa ... 795 hPa (-1 000 m ... +2 000 m) // Tmin ... (Tmax - 10 K) at 795 hPa ... 658 hPa (+2 000 m ... +3 500 m) // Tmin ... (Tmax - 20 K) at 658 hPa ... 540 hPa (+3 500 m ... +5 000 m); above 2 000 m max. 132 V AC 	<ul style="list-style-type: none"> 2 000 m Tmin ... Tmax at 1 140 hPa ... 795 hPa (-1 000 m ... +2 000 m) // Tmin ... (Tmax - 10 K) at 795 hPa ... 658 hPa (+2 000 m ... +3 500 m) // Tmin ... (Tmax - 20 K) at 658 hPa ... 540 hPa (+3 500 m ... +5 000 m); above 2 000 m max. 132 V AC
Relative humidity			
<ul style="list-style-type: none"> With condensation, tested in accordance with IEC 60068-2-38, max. 	100 %; RH incl. condensation/frost (no commissioning under condensation conditions)	100 %; RH incl. condensation/frost (no commissioning under condensation conditions)	100 %; RH incl. condensation/frost (no commissioning under condensation conditions)
Resistance			
Coolants and lubricants			
<ul style="list-style-type: none"> Resistant to commercially available coolants and lubricants 	Yes; Incl. diesel and oil droplets in the air	Yes; Incl. diesel and oil droplets in the air	Yes; Incl. diesel and oil droplets in the air
Use in stationary industrial systems			
<ul style="list-style-type: none"> to biologically active substances according to EN 60721-3-3 to chemically active substances according to EN 60721-3-3 to mechanically active substances according to EN 60721-3-3 	<ul style="list-style-type: none"> Yes; Class 3B2 mold, fungus and dry rot spores (with the exception of fauna); Class 3B3 on request Yes; Class 3C4 (RH < 75 %) incl. salt spray acc. to EN 60068-2-52 (severity degree 3); * Yes; Class 3S4 incl. sand, dust, * 	<ul style="list-style-type: none"> Yes; Class 3B2 mold, fungus and dry rot spores (with the exception of fauna); Class 3B3 on request Yes; Class 3C4 (RH < 75 %) incl. salt spray acc. to EN 60068-2-52 (severity degree 3); * Yes; Class 3S4 incl. sand, dust, * 	<ul style="list-style-type: none"> Yes; Class 3B2 mold, fungus and dry rot spores (with the exception of fauna); Class 3B3 on request Yes; Class 3C4 (RH < 75 %) incl. salt spray acc. to EN 60068-2-52 (severity degree 3); * Yes; Class 3S4 incl. sand, dust, *

Technical specifications

Article number	6AG1215-1BG40-4XB0	6AG1215-1BG40-5XB0	6AG1215-1BG40-2XB0
Based on	6ES7215-1BG40-0XB0 SIPLUS S7-1200 CPU 1215C AC/DC/RLY	6ES7215-1BG40-0XB0 SIPLUS S7-1200 CPU 1215C AC/DC/RLY	6ES7215-1BG40-0XB0 SIPLUS S7-1200 CPU 1215C AC/DC/RLY
Use on ships/at sea			
- to biologically active substances according to EN 60721-3-6	Yes; Class 6B2 mold and fungal spores (excluding fauna); Class 6B3 on request	Yes; Class 6B2 mold and fungal spores (excluding fauna); Class 6B3 on request	Yes; Class 6B2 mold and fungal spores (excluding fauna); Class 6B3 on request
- to chemically active substances according to EN 60721-3-6	Yes; Class 6C3 (RH < 75 %) incl. salt spray acc. to EN 60068-2-52 (severity degree 3); *	Yes; Class 6C3 (RH < 75 %) incl. salt spray acc. to EN 60068-2-52 (severity degree 3); *	Yes; Class 6C3 (RH < 75 %) incl. salt spray acc. to EN 60068-2-52 (severity degree 3); *
- to mechanically active substances according to EN 60721-3-6	Yes; Class 6S3 incl. sand, dust; *	Yes; Class 6S3 incl. sand, dust; *	Yes; Class 6S3 incl. sand, dust; *
Usage in industrial process technology			
- Against chemically active substances acc. to EN 60654-4	Yes; Class 3 (excluding trichlorethylene)	Yes; Class 3 (excluding trichlorethylene)	Yes; Class 3 (excluding trichlorethylene)
- Environmental conditions for process, measuring and control systems acc. to ANSI/ISA-71.04	Yes; Level GX group A/B (excluding trichlorethylene; harmful gas concentrations up to the limits of EN 60721-3-3 class 3C4 permissible); level LC3 (salt spray) and level LB3 (oil)	Yes; Level GX group A/B (excluding trichlorethylene; harmful gas concentrations up to the limits of EN 60721-3-3 class 3C4 permissible); level LC3 (salt spray) and level LB3 (oil)	Yes; Level GX group A/B (excluding trichlorethylene; harmful gas concentrations up to the limits of EN 60721-3-3 class 3C4 permissible); level LC3 (salt spray) and level LB3 (oil)
Remark			
- Note regarding classification of environmental conditions acc. to EN 60721, EN 60654-4 and ANSI/ISA-71.04	* The supplied plug covers must remain in place over the unused interfaces during operation!	* The supplied plug covers must remain in place over the unused interfaces during operation!	* The supplied plug covers must remain in place over the unused interfaces during operation!
Conformal coating			
• Coatings for printed circuit board assemblies acc. to EN 61086	Yes; Class 2 for high reliability	Yes; Class 2 for high reliability	Yes; Class 2 for high reliability
• Protection against fouling acc. to EN 60664-3	Yes; Type 1 protection	Yes; Type 1 protection	Yes; Type 1 protection
• Military testing according to MIL-I-46058C, Amendment 7	Yes; Discoloration of coating possible during service life	Yes; Discoloration of coating possible during service life	Yes; Discoloration of coating possible during service life
• Qualification and Performance of Electrical Insulating Compound for Printed Board Assemblies according to IPC-CC-830A	Yes; Conformal coating, Class A	Yes; Conformal coating, Class A	Yes; Conformal coating, Class A
Article number	6AG1215-1HG40-4XB0	6AG1215-1HG40-5XB0	6AG1215-1HG40-2XB0
Based on	6ES7215-1HG40-0XB0 SIPLUS S7-1200 CPU 1215C DC/DC/RLY	6ES7215-1HG40-0XB0 SIPLUS S7-1200 CPU 1215C DC/DC/RLY	6ES7215-1HG40-0XB0 SIPLUS S7-1200 CPU 1215C DC/DC/RLY
Ambient conditions			
Ambient temperature during operation			
• min.	-20 °C; = Tmin (incl. condensation/frost); start-up @ 0 °C	-40 °C; = Tmin (incl. condensation/frost); start-up @ -25 °C	-40 °C; = Tmin (incl. condensation/frost); start-up @ -25 °C
• max.	60 °C; Number of simultaneously activated inputs or outputs 7 or 5 (no adjacent points) at 60 °C horizontal or 50 °C vertical, 14 or 10 at 55 °C horizontal or 45 °C vertical	60 °C; = Tmax; Tmax > +55 °C number of simultaneously switched-on digital inputs 7, digital outputs 5, analog inputs 2, analog outputs 2 (no adjacent points) with horizontal mounting position	70 °C; = Tmax; Tmax > +55 °C number of simultaneously switched-on digital inputs 7, digital outputs 5, analog inputs 2, analog outputs 2 (no adjacent points) with horizontal mounting position; Tmax > +60 °C number of simultaneously switched-on digital inputs 7, digital outputs 5, analog inputs 1, analog outputs 1 (no adjacent points) with horizontal mounting position
• At cold restart, min.	0 °C	-25 °C	-25 °C
Altitude during operation relating to sea level			
• Installation altitude above sea level, max.	2 000 m	2 000 m	2 000 m
• Ambient air temperature-barometric pressure-altitude	Tmin ... Tmax at 1 140 hPa ... 795 hPa (-1 000 m ... +2 000 m) // Tmin ... (Tmax - 10 K) at 795 hPa ... 658 hPa (+2 000 m ... +3 500 m) // Tmin ... (Tmax - 20 K) at 658 hPa ... 540 hPa (+3 500 m ... +5 000 m); above 2 000 m max. 132 V AC	Tmin ... Tmax at 1 140 hPa ... 795 hPa (-1 000 m ... +2 000 m) // Tmin ... (Tmax - 10 K) at 795 hPa ... 658 hPa (+2 000 m ... +3 500 m) // Tmin ... (Tmax - 20 K) at 658 hPa ... 540 hPa (+3 500 m ... +5 000 m); above 2 000 m max. 132 V AC	Tmin ... Tmax at 1 140 hPa ... 795 hPa (-1 000 m ... +2 000 m) // Tmin ... (Tmax - 10 K) at 795 hPa ... 658 hPa (+2 000 m ... +3 500 m) // Tmin ... (Tmax - 20 K) at 658 hPa ... 540 hPa (+3 500 m ... +5 000 m); above 2 000 m max. 132 V AC

SIMATIC S7-1200 Basic Controllers

Central processing units
SIPLUS standard CPUs

SIPLUS CPU 1215C

Technical specifications

Article number	6AG1215-1HG40-4XB0	6AG1215-1HG40-5XB0	6AG1215-1HG40-2XB0
Based on	6ES7215-1HG40-0XB0 SIPLUS S7-1200 CPU 1215C DC/DC/RLY	6ES7215-1HG40-0XB0 SIPLUS S7-1200 CPU 1215C DC/DC/RLY	6ES7215-1HG40-0XB0 SIPLUS S7-1200 CPU 1215C DC/DC/RLY
Relative humidity			
<ul style="list-style-type: none"> With condensation, tested in accordance with IEC 60068-2-38, max. 	100 %; RH incl. condensation/frost (no commissioning under condensation conditions)	100 %; RH incl. condensation/frost (no commissioning under condensation conditions)	100 %; RH incl. condensation/frost (no commissioning under condensation conditions)
Resistance			
Coolants and lubricants			
<ul style="list-style-type: none"> Resistant to commercially available coolants and lubricants 	Yes; Incl. diesel and oil droplets in the air	Yes; Incl. diesel and oil droplets in the air	Yes; Incl. diesel and oil droplets in the air
Use in stationary industrial systems			
<ul style="list-style-type: none"> to biologically active substances according to EN 60721-3-3 to chemically active substances according to EN 60721-3-3 to mechanically active substances according to EN 60721-3-3 	Yes; Class 3B2 mold, fungus and dry rot spores (with the exception of fauna); Class 3B3 on request Yes; Class 3C4 (RH < 75 %) incl. salt spray acc. to EN 60068-2-52 (severity degree 3); * Yes; Class 3S4 incl. sand, dust, *	Yes; Class 3B2 mold, fungus and dry rot spores (with the exception of fauna); Class 3B3 on request Yes; Class 3C4 (RH < 75 %) incl. salt spray acc. to EN 60068-2-52 (severity degree 3); * Yes; Class 3S4 incl. sand, dust, *	Yes; Class 3B2 mold, fungus and dry rot spores (with the exception of fauna); Class 3B3 on request Yes; Class 3C4 (RH < 75 %) incl. salt spray acc. to EN 60068-2-52 (severity degree 3); * Yes; Class 3S4 incl. sand, dust, *
Use on ships/at sea			
<ul style="list-style-type: none"> to biologically active substances according to EN 60721-3-6 to chemically active substances according to EN 60721-3-6 to mechanically active substances according to EN 60721-3-6 	Yes; Class 6B2 mold and fungal spores (excluding fauna); Class 6B3 on request Yes; Class 6C3 (RH < 75 %) incl. salt spray acc. to EN 60068-2-52 (severity degree 3); * Yes; Class 6S3 incl. sand, dust; *	Yes; Class 6B2 mold and fungal spores (excluding fauna); Class 6B3 on request Yes; Class 6C3 (RH < 75 %) incl. salt spray acc. to EN 60068-2-52 (severity degree 3); * Yes; Class 6S3 incl. sand, dust; *	Yes; Class 6B2 mold and fungal spores (excluding fauna); Class 6B3 on request Yes; Class 6C3 (RH < 75 %) incl. salt spray acc. to EN 60068-2-52 (severity degree 3); * Yes; Class 6S3 incl. sand, dust; *
Usage in industrial process technology			
<ul style="list-style-type: none"> Against chemically active substances acc. to EN 60654-4 Environmental conditions for process, measuring and control systems acc. to ANSI/ISA-71.04 	Yes; Class 3 (excluding trichlorethylene) Yes; Level GX group A/B (excluding trichlorethylene; harmful gas concentrations up to the limits of EN 60721-3-3 class 3C4 permissible); level LC3 (salt spray) and level LB3 (oil)	Yes; Class 3 (excluding trichlorethylene) Yes; Level GX group A/B (excluding trichlorethylene; harmful gas concentrations up to the limits of EN 60721-3-3 class 3C4 permissible); level LC3 (salt spray) and level LB3 (oil)	Yes; Class 3 (excluding trichlorethylene) Yes; Level GX group A/B (excluding trichlorethylene; harmful gas concentrations up to the limits of EN 60721-3-3 class 3C4 permissible); level LC3 (salt spray) and level LB3 (oil)
Remark			
<ul style="list-style-type: none"> Note regarding classification of environmental conditions acc. to EN 60721, EN 60654-4 and ANSI/ISA-71.04 	* The supplied plug covers must remain in place over the unused interfaces during operation!	* The supplied plug covers must remain in place over the unused interfaces during operation!	* The supplied plug covers must remain in place over the unused interfaces during operation!
Conformal coating			
<ul style="list-style-type: none"> Coatings for printed circuit board assemblies acc. to EN 61086 Protection against fouling acc. to EN 60664-3 Military testing according to MIL-I-46058C, Amendment 7 Qualification and Performance of Electrical Insulating Compound for Printed Board Assemblies according to IPC-CC-830A 	Yes; Class 2 for high reliability Yes; Type 1 protection Yes; Discoloration of coating possible during service life Yes; Conformal coating, Class A	Yes; Class 2 for high reliability Yes; Type 1 protection Yes; Discoloration of coating possible during service life Yes; Conformal coating, Class A	Yes; Class 2 for high reliability Yes; Type 1 protection Yes; Discoloration of coating possible during service life Yes; Conformal coating, Class A

Overview



The fail-safe SIMATIC S7-1200 Controllers are based on the S7-1200 standard CPUs and offer additional safety-related functions.

They can be used for safety-oriented tasks according to IEC 61508 up to SIL 3 and ISO 13849-1 up to PL e.

Safety-related programs are created in the TIA Portal. The STEP 7 Safety engineering tool offers commands, operations and blocks for safety-related programs in the LAD and FBD languages. To this end, there is a library with pre-configured, TÜV-approved blocks for safety-related functions.

- Standard controller with integrated safety functions:
 - Standardized and convenient diagnostic functions for standard and safety
 - Uniform symbols, data consistency, ...
- Modular system with scalable range of CPUs and expandable I/O quantity structure:
 - One engineering for standard and fail-safe automation
 - Use of the standard I/O modules together with the fail-safe I/O modules in the central system
 - Integrated standard PROFINET functionalities for PROFINET controllers and PROFINET iDevice services
 - Connection of distributed standard I/O via field bus such as PROFINET or PROFIBUS
 - F-library certified by the German Technical Inspectorate (TÜV) for all common safety functions
 - Free programming of the safety logic using FBD and LAD
 - Standard-compliant printout of the F-program
- One integrated engineering for both standard and safety from S7-1200 to S7-300/400/1500 and WinAC RTX F:
 - STEP 7 Safety Basic for easy engineering of the CPU 1200 FC
 - STEP 7 Safety Advanced for the entire fail-safe SIMATIC S7 portfolio
- Integrated system diagnosis of the CPUs, for standard and safety:
 - Consistent plain text display of system diagnostic information in the TIA Portal, HMI and web server
 - Messages are updated even if the CPU is in STOP state
 - System diagnostics integrated in the CPU firmware. Configuration by user not required
 - The diagnostics is automatically updated on configuration changes.
- 2 fail-safe compact controllers with graded performances in the versions DC/DC/DC and DC/DC/relay

Characteristics	CPU 1212 FC	CPU 1214 FC	CPU 1215 FC
Variants	DC/DC/DC, DC/DC/relay	DC/DC/DC, DC/DC/relay	DC/DC/DC, DC/DC/relay
Main memory, integrated	100 KB	125 KB	150 KB
Load memory, integrated	2 MB	4 MB	4 MB
Memory card	SIMATIC Memory Card (optional)	SIMATIC Memory Card (optional)	SIMATIC Memory Card (optional)
Standard digital inputs/outputs, integrated	8/6	14/10	14/10
Standard analog inputs, integrated	2	2	2
Standard analog outputs, integrated	-	-	2
Process image	1024 bytes for inputs, 1024 bytes for outputs	1024 bytes for inputs, 1024 bytes for outputs	1024 bytes for inputs, 1024 bytes for outputs
Expansion by signal board	Max. 1	Max. 1	Max. 1
Expansion by signal modules	Max. 2	Max. 8	Max. 8
Expansion by communication modules	Max. 3	Max. 3	Max. 3

SIMATIC S7-1200 Basic Controllers

Central processing units

Fail-safe CPUs

Ordering data

Article No.

Article No.

CPU 1212FC

Fail-safe compact CPU, DC/DC/DC;

integrated program/
data memory 100 KB,
load memory 2 MB;
supply voltage 24 V DC;
Boolean execution times
0.085 µs per operation;
8 digital inputs,
6 digital outputs,
2 analog inputs;
expandable by up to
3 communications modules,
2 signal modules, and 1 signal
board/communication board;
digital inputs can be used as HSC
at 100 kHz,
24 V DC digital outputs can be
used as pulse outputs (PTO) or
pulse-width modulated outputs
(PWM) at 100 kHz

6ES7212-1AF40-0XB0

Fail-safe compact CPU, DC/DC/relay;

integrated program/
data memory 125 KB,
load memory 2 MB;
supply voltage 24 V DC;
Boolean execution times
0.085 µs per operation;
8 digital inputs,
6 digital outputs (relays),
2 analog inputs;
expandable by up to
3 communications modules,
2 signal modules, and 1 signal
board/communication board;
digital inputs can be used as HSC
at 100 kHz

6ES7212-1HF40-0XB0

CPU 1214FC

Fail-safe compact CPU, DC/DC/DC;

integrated program/
data memory 125 KB,
load memory 4 MB;
supply voltage 24 V DC;
Boolean execution times
0.085 µs per operation;
14 digital inputs,
10 digital outputs,
2 analog inputs;
expandable by up to
3 communications modules,
8 signal modules, and 1 signal
board/communication board;
digital inputs can be used as HSC
at 100 kHz,
24 V DC digital outputs can be
used as pulse outputs (PTO) or
pulse-width modulated outputs
(PWM) at 100 kHz

6ES7214-1AF40-0XB0

Fail-safe compact CPU, DC/DC/relay;

integrated program/
data memory 125 KB,
load memory 4 MB;
supply voltage 24 V DC;
Boolean execution times
0.085 µs per operation;
14 digital inputs,
10 digital outputs (relays),
2 analog inputs;
expandable by up to
3 communications modules,
8 signal modules, and 1 signal
board/communication board;
digital inputs can be used as HSC
at 100 kHz

6ES7214-1HF40-0XB0

CPU 1215FC

Fail-safe compact CPU, DC/DC/DC;

integrated program/
data memory 150 KB,
load memory 4 MB;
supply voltage 24 V DC;
Boolean execution times
0.085 µs per operation;
14 digital inputs,
10 digital outputs,
2 analog inputs;
2 analog outputs;
expandable by up to
3 communications modules,
8 signal modules, and 1 signal
board/communication board;
digital inputs can be used as HSC
at 100 kHz,
24 V DC digital outputs can be
used as pulse outputs (PTO) or
pulse-width modulated outputs
(PWM) at 100 kHz

6ES7215-1AF40-0XB0

Fail-safe compact CPU, DC/DC/relay;

integrated program/
data memory 150 KB,
load memory 4 MB;
supply voltage 24 V DC;
Boolean execution times
0.085 µs per operation;
14 digital inputs,
10 digital outputs (relays),
2 analog inputs;
2 analog outputs;
expandable by up to
3 communications modules,
8 signal modules, and 1 signal
board/communication board;
Digital inputs can be used as HSC
at 100 kHz

6ES7215-1HF40-0XB0

Accessories

SIMATIC S7-1200 Fail-Safe Starter Kit

With CPU 1212 FC DC/DC/relay;
also includes:
F-digital input SM 1226
16 x 24 V DC, F-digital output
SM 1226 4 x 24 V DC,
input simulator, STEP 7 Basic
and STEP 7 Safety Basic V16,
SIMATIC OPC UA S7-1200 Basic,
info material; in Systainer

6ES7212-1HF41-4YB1

With CPU 1214 FC DC/DC/relay;
also includes:
F-digital input SM 1226
16 x 24 V DC, F-digital output
SM 1226 4 x 24 V DC,
input simulator, STEP 7 Safety
Basic, SIMATIC OPC UA S7-1200
Basic, info material; in Systainer

6ES7212-1HF42-4YB1

Simulator (optional)

14 incoming circuit breakers

6ES7274-1XH30-0XA0

SIMATIC Memory Card (optional)

4 MB

6ES7954-8LC03-0AA0

12 MB

6ES7954-8LE03-0AA0

24 MB

6ES7954-8LF03-0AA0

256 MB

6ES7954-8LL03-0AA0

2 GB

6ES7954-8LP03-0AA0

32 GB

6ES7954-8LT03-0AA0

Ordering data	Article No.	Article No.
Extension cable for two-tier configuration For connecting digital/analog signal modules; length 2 m	6ES7290-6AA30-0XA0	
Terminal block (spare part) For CPU 1214FC, DC/DC/DC <ul style="list-style-type: none"> For DI, with 20 screws, tin-coated; 4 units For DO, with 12 screws, tin-coated; 4 units For AI, with 3 screws, gold-plated; 4 units For CPU 1214FC, DC/DC/relay <ul style="list-style-type: none"> For DI, with 20 screws, tin-coated; 4 units For DO, with 12 screws, tin-coated, coded; 4 units For AI, with 3 screws, gold-plated; 4 units For CPU 1215FC, DC/DC/DC <ul style="list-style-type: none"> For DI, with 20 screws, tin-coated; 4 units For DO, with 12 screws, tin-coated; 4 units For AI, with 6 screws, gold-plated; 4 units For CPU 1215FC, DC/DC/relay <ul style="list-style-type: none"> For DI, with 20 screws, tin-coated; 4 units For DO, with 12 screws, tin-coated, coded; 4 units For AI, with 6 screws, gold-plated; 4 units 	6ES7292-1AV30-0XA0 6ES7292-1AM30-0XA0 6ES7292-1BC30-0XA0 6ES7292-1AV30-0XA0 6ES7292-1AM40-0XA0 6ES7292-1BC30-0XA0 6ES7292-1AV30-0XA0 6ES7292-1AM30-0XA0 6ES7292-1BF30-0XB0 6ES7292-1AV30-0XA0 6ES7292-1AM40-0XA0 6ES7292-1BF30-0XB0	STEP 7 Safety Advanced V17 Task: Engineering tool for configuring and programming fail-safe user programs for SIMATIC S7-1200 FC, S7-1500F, S7-1500F Software Controller, S7-300F, S7-400F, WinAC RTX F, ET 200SP F Controller and the fail-safe ET 200SP, ET 200MP, ET 200S, ET 200M, ET 200iSP, ET 200pro and ET 200eco I/O Requirement: STEP 7 Professional V17 Note: As of TIA Portal V16, the SIMATIC STEP 7 Safety software is an integral component of the SIMATIC STEP 7 product setup. The functionality of SIMATIC STEP 7 Safety is activated by means of the license key supplied in each case. Floating license for 1 user; license key on USB flash drive 6ES7833-1FA17-0YA5 Floating license for 1 user; license key for download ¹⁾ ; Email address required for delivery 6ES7833-1FA17-0YH5
Front flap set (spare part) For CPU 1214FC For CPU 1215FC	6ES7291-1AB30-0XA0 6ES7291-1AC30-0XA0	
RJ45 cable grip 4 units per pack Single port Dual port	6ES7290-3AA30-0XA0 6ES7290-3AB30-0XA0	STEP 7 Safety Basic V17 Task: Engineering tool for configuring fail-safe user programs for SIMATIC S7-1200 FC Requirement: STEP 7 Basic V17 and higher Note: As of TIA Portal V16, the SIMATIC STEP 7 Safety software is an integral component of the SIMATIC STEP 7 product setup. The functionality of SIMATIC STEP 7 Safety is activated by means of the license key supplied in each case. Floating license for 1 user; license key on USB flash drive 6ES7833-1FB17-0YA5 Floating license for 1 user; license key for download ¹⁾ ; email address required for delivery 6ES7833-1FB17-0YH5

¹⁾ For up-to-date information and download availability, see: <http://www.siemens.com/tia-online-software-delivery>

SIMATIC S7-1200 Basic Controllers

Central processing units

Fail-safe CPUs

Technical specifications

Article number	6ES7212-1AF40-0XB0	6ES7212-1HF40-0XB0	6ES7214-1AF40-0XB0	6ES7214-1HF40-0XB0	6ES7215-1AF40-0XB0	6ES7215-1HF40-0XB0
	CPU 1212FC, DC/DC/DC, 8DI/6DO/2AI	CPU 1212FC, DC/DC/Relay, 8DI/6DO/2AI	CPU 1214 FC, DC/DC/DC, 14DI/10DO/2AI	CPU 1214 FC, DC/DC/Relay, 14DI/10DO/2AI	CPU 1215 FC, DC/DC/DC, 14DI/10DO/2AI/2AO	CPU 1215 FC, DC/DC/RLY, 14DI/10DO/2AI/2AO
General information						
Product type designation	CPU 1212FC DC/DC/DC	CPU 1212FC DC/DC/relay	CPU 1214FC DC/DC/DC	CPU 1214FC DC/DC/Relay	CPU 1215FC DC/DC/DC	CPU 1215FC DC/DC/relay
Engineering with						
• Programming package	STEP 7 V17 or higher	STEP 7 V17 or higher	STEP 7 V17 or higher	STEP 7 V17 or higher	STEP 7 V17 or higher	STEP 7 V17 or higher
Supply voltage						
Rated value (DC)						
• 24 V DC	Yes	Yes	Yes	Yes	Yes	Yes
Encoder supply						
24 V encoder supply						
• 24 V	L+ minus 4 V DC min.	L+ minus 4 V DC min.	L+ minus 4 V DC min.	L+ minus 4 V DC min.	L+ minus 4 V DC min.	L+ minus 4 V DC min.
Memory						
Work memory						
• integrated	100 kbyte	100 kbyte	125 kbyte	125 kbyte	150 kbyte	150 kbyte
Load memory						
• integrated	2 Mbyte	2 Mbyte	4 Mbyte	4 Mbyte	4 Mbyte	4 Mbyte
• Plug-in (SIMATIC Memory Card), max.	with SIMATIC memory card	with SIMATIC memory card	with SIMATIC memory card	with SIMATIC memory card	with SIMATIC memory card	with SIMATIC memory card
Backup						
• without battery	Yes	Yes	Yes	Yes	Yes	Yes
CPU processing times						
for bit operations, typ.	0.08 µs; / instruction	0.08 µs; / instruction	0.08 µs; / instruction	0.08 µs; / instruction	0.08 µs; / instruction	0.08 µs; / instruction
for word operations, typ.	1.7 µs; / instruction	1.7 µs; / instruction	1.7 µs; / instruction	1.7 µs; / instruction	1.7 µs; / instruction	1.7 µs; / instruction
for floating point arithmetic, typ.	2.3 µs; / instruction	2.3 µs; / instruction	2.3 µs; / instruction	2.3 µs; / instruction	2.3 µs; / instruction	2.3 µs; / instruction
Data areas and their retentivity						
Flag						
• Size, max.	4 kbyte; Size of bit memory address area	4 kbyte; Size of bit memory address area	8 kbyte; Size of bit memory address area	8 kbyte; Size of bit memory address area	8 kbyte; Size of bit memory address area	8 kbyte; Size of bit memory address area
Address area						
Process image						
• Inputs, adjustable	1 kbyte	1 kbyte	1 kbyte	1 kbyte	1 kbyte	1 kbyte
• Outputs, adjustable	1 kbyte	1 kbyte	1 kbyte	1 kbyte	1 kbyte	1 kbyte
Time of day						
Clock						
• Hardware clock (real-time)	Yes	Yes	Yes	Yes	Yes	Yes
Digital inputs						
Number of digital inputs	8; Integrated	8; Integrated	14; Integrated	14; Integrated	14; Integrated	14; Integrated
• of which inputs usable for technological functions	4; HSC (High Speed Counting)	4; HSC (High Speed Counting)	6; HSC (High Speed Counting)	6; HSC (High Speed Counting)	6; HSC (High Speed Counting)	6; HSC (High Speed Counting)
Digital outputs						
Number of digital outputs	6	6; Relays	10	10; Relays	10	10; Relays
• of which high-speed outputs	4; 100 kHz Pulse Train Output		4; 100 kHz Pulse Train Output		4; 100 kHz Pulse Train Output	
Analog inputs						
Number of analog inputs	2	2	2	2	2	2
Input ranges						
• Voltage	Yes	Yes	Yes	Yes	Yes	Yes
Analog outputs						
Number of analog outputs	0	0	0	0	2	2
Output ranges, current						
• 0 to 20 mA					Yes	Yes

Technical specifications

Article number	6ES7212-1AF40-0XB0	6ES7212-1HF40-0XB0	6ES7214-1AF40-0XB0	6ES7214-1HF40-0XB0	6ES7215-1AF40-0XB0	6ES7215-1HF40-0XB0
	CPU 1212FC, DC/DC/DC, 8DI/6DO/2AI	CPU 1212FC, DC/DC/Relay, 8DI/6DO/2AI	CPU 1214 FC, DC/DC/DC, 14DI/10DO/2AI	CPU 1214 FC, DC/DC/Relay, 14DI/10DO/2AI	CPU 1215 FC, DC/DC/DC, 14DI/10DO/2AI/2AO	CPU 1215 FC, DC/DC/RLY, 14DI/10DO/2AI/2AO
1. Interface						
Interface type	PROFINET	PROFINET	PROFINET	PROFINET	PROFINET	PROFINET
Protocols						
• PROFINET IO Controller	Yes	Yes	Yes	Yes	Yes	Yes
• PROFINET IO Device	Yes	Yes	Yes	Yes	Yes	Yes
• SIMATIC communication	Yes	Yes	Yes	Yes	Yes	Yes
• Open IE communication	Yes; Optionally also encrypted	Yes; Optionally also encrypted	Yes; Optionally also encrypted	Yes; Optionally also encrypted	Yes; Optionally also encrypted	Yes; Optionally also encrypted
• Web server	Yes	Yes	Yes	Yes	Yes	Yes
• Media redundancy	No	No	No	No	Yes; as MRP client	Yes
Protocols						
Open IE communication						
• TCP/IP	Yes	Yes	Yes	Yes	Yes	Yes
• ISO-on-TCP (RFC1006)	Yes	Yes	Yes	Yes	Yes	Yes
• UDP	Yes	Yes	Yes	Yes	Yes	Yes
Web server						
• supported	Yes	Yes	Yes	Yes	Yes	Yes
OPC UA						
• OPC UA Server	Yes; data access (read, write, subscribe), method call, runtime license required	Yes; data access (read, write, subscribe), method call, runtime license required	Yes; data access (read, write, subscribe), method call, runtime license required	Yes; data access (read, write, subscribe), method call, runtime license required	Yes; data access (read, write, subscribe), method call, runtime license required	Yes; data access (read, write, subscribe), method call, runtime license required
communication functions / header						
S7 communication						
• supported	Yes	Yes	Yes	Yes	Yes	Yes
Number of connections						
• overall	PG Connections: 4 reserved / 4 max; HMI Connections: 12 reserved / 18 max; S7 Connections: 8 reserved / 14 max; Open User Connections: 8 reserved / 14 max; Web Connections: 2 reserved / 30 max; OPC UA Connections: 0 reserved / 10 max; Total Connections: 34 reserved / 64 max	PG Connections: 4 reserved / 4 max; HMI Connections: 12 reserved / 18 max; S7 Connections: 8 reserved / 14 max; Open User Connections: 8 reserved / 14 max; Web Connections: 2 reserved / 30 max; OPC UA Connections: 0 reserved / 10 max; Total Connections: 34 reserved / 64 max	PG Connections: 4 reserved / 4 max; HMI Connections: 12 reserved / 18 max; S7 Connections: 8 reserved / 14 max; Open User Connections: 8 reserved / 14 max; Web Connections: 2 reserved / 30 max; OPC UA Connections: 0 reserved / 10 max; Total Connections: 34 reserved / 64 max	PG Connections: 4 reserved / 4 max; HMI Connections: 12 reserved / 18 max; S7 Connections: 8 reserved / 14 max; Open User Connections: 8 reserved / 14 max; Web Connections: 2 reserved / 30 max; OPC UA Connections: 0 reserved / 10 max; Total Connections: 34 reserved / 64 max	PG Connections: 4 reserved / 4 max; HMI Connections: 12 reserved / 18 max; S7 Connections: 8 reserved / 14 max; Open User Connections: 8 reserved / 14 max; Web Connections: 2 reserved / 30 max; OPC UA Connections: 0 reserved / 10 max; Total Connections: 34 reserved / 64 max	PG Connections: 4 reserved / 4 max; HMI Connections: 12 reserved / 18 max; S7 Connections: 8 reserved / 14 max; Open User Connections: 8 reserved / 14 max; Web Connections: 2 reserved / 30 max; OPC UA Connections: 0 reserved / 10 max; Total Connections: 34 reserved / 64 max
Integrated Functions						
Counter						
• Number of counters	6	6	6	6	6	6
• Counting frequency, max.	100 kHz	100 kHz	100 kHz	100 kHz	100 kHz	100 kHz
Frequency measurement						
controlled positioning	Yes	Yes	Yes	Yes	Yes	Yes
Number of position-controlled positioning axes, max.	8	8	8	8	8	8
Number of positioning axes via pulse-direction interface	Up to 4 with SB 1222	Up to 4 with SB 1222	4; With integrated outputs	Up to 4 with SB 1222	4; With integrated outputs	Up to 4 with SB 1222
PID controller	Yes	Yes	Yes	Yes	Yes	Yes
Number of alarm inputs	4	4	4	4	4	4
Number of pulse outputs	4	4	4	4	4	4
Limit frequency (pulse)	100 kHz	100 kHz	100 kHz	100 kHz	100 kHz	100 kHz

SIMATIC S7-1200 Basic Controllers

Central processing units

Fail-safe CPUs

Technical specifications

Article number	6ES7212-1AF40-0XB0	6ES7212-1HF40-0XB0	6ES7214-1AF40-0XB0	6ES7214-1HF40-0XB0	6ES7215-1AF40-0XB0	6ES7215-1HF40-0XB0
	CPU 1212FC, DC/DC/DC, 8DI/6DO/2AI	CPU 1212FC, DC/DC/Relay, 8DI/6DO/2AI	CPU 1214 FC, DC/DC/DC, 14DI/10DO/2AI	CPU 1214 FC, DC/DC/Relay, 14DI/10DO/2AI	CPU 1215 FC, DC/DC/DC, 14DI/10DO/2AI/2AO	CPU 1215 FC, DC/DC/RLY, 14DI/10DO/2AI/2AO
Ambient conditions						
Ambient temperature during operation						
• min.	0 °C	0 °C	0 °C	0 °C	0 °C	0 °C
• max.	55 °C; Number of simultaneously activated inputs or outputs 4 or 3 (no adjacent points) at 60 °C horizontal or 50 °C vertical, 8 or 6 at 55 °C horizontal or 45 °C vertical	55 °C; Number of simultaneously activated inputs or outputs 4 or 3 (no adjacent points) at 60 °C horizontal or 50 °C vertical, 8 or 6 at 55 °C horizontal or 45 °C vertical	55 °C; Number of simultaneously activated inputs or outputs 4 or 3 (no adjacent points) at 60 °C horizontal or 50 °C vertical, 8 or 6 at 55 °C horizontal or 45 °C vertical	55 °C; Number of simultaneously activated inputs or outputs 4 or 3 (no adjacent points) at 60 °C horizontal or 50 °C vertical, 8 or 6 at 55 °C horizontal or 45 °C vertical	55 °C; Number of simultaneously activated inputs or outputs 4 or 3 (no adjacent points) at 60 °C horizontal or 50 °C vertical, 8 or 6 at 55 °C horizontal or 45 °C vertical	55 °C; Number of simultaneously activated inputs or outputs 4 or 3 (no adjacent points) at 60 °C horizontal or 50 °C vertical, 8 or 6 at 55 °C horizontal or 45 °C vertical
Pollutant concentrations						
• SO ₂ at RH < 60% without condensation	SO ₂ : < 0.5 ppm; H ₂ S: < 0.1 ppm; RH < 60% condensation-free	SO ₂ : < 0.5 ppm; H ₂ S: < 0.1 ppm; RH < 60% condensation-free	SO ₂ : < 0.5 ppm; H ₂ S: < 0.1 ppm; RH < 60% condensation-free	SO ₂ : < 0.5 ppm; H ₂ S: < 0.1 ppm; RH < 60% condensation-free	SO ₂ : < 0.5 ppm; H ₂ S: < 0.1 ppm; RH < 60% condensation-free	SO ₂ : < 0.5 ppm; H ₂ S: < 0.1 ppm; RH < 60% condensation-free
configuration / header						
configuration / programming / header						
Programming language						
- LAD	Yes; incl. failsafe	Yes; incl. failsafe	Yes; incl. failsafe	Yes; incl. failsafe	Yes; incl. failsafe	Yes; incl. failsafe
- FBD	Yes; incl. failsafe	Yes; incl. failsafe	Yes; incl. failsafe	Yes; incl. failsafe	Yes; incl. failsafe	Yes; incl. failsafe
- SCL	Yes	Yes	Yes	Yes	Yes	Yes
Dimensions						
Width	90 mm	90 mm	110 mm	110 mm	130 mm	130 mm
Height	100 mm	100 mm	100 mm	100 mm	100 mm	100 mm
Depth	75 mm	75 mm	75 mm	75 mm	75 mm	75 mm
Weights						
Weight, approx.	370 g	385 g	415 g	435 g	500 g	585 g

Overview



The fail-safe SIPLUS S7-1200 Controllers are based on the SIPLUS S7-1200 standard CPUs and offer additional safety-related functions.

They can be used for safety-oriented tasks according to IEC 61508 up to SIL 3 and ISO 13849-1 up to PL e.

Safety-related programs are created in the TIA Portal engineering framework. The STEP 7 Safety engineering tool offers commands, operations and blocks for safety-related programs in the LAD and FBD languages. To this end, there is a library with pre-configured blocks for safety-related functions certified by the German Technical Inspectorate (TÜV).

- Standard controller with integrated safety functions:
 - Standardized and convenient diagnostic functions for standard and safety
 - Uniform symbols, data consistency, ...
- Modular system with scalable range of CPUs and expandable I/O quantity structure:
 - One engineering for standard and fail-safe automation
 - Use of the standard I/O modules together with the fail-safe I/O modules in the central system
 - Integrated standard PROFINET functionalities for PROFINET controllers and PROFINET iDevice services
 - Connection of distributed standard I/O via fieldbus such as PROFINET or PROFIBUS
 - TÜV-approved F-library for all common safety functions
 - Free programming of the safety logic using FBD and LAD
 - Standard-compliant printout of the F-program
- One integrated engineering for both standard and safety from S7-1200 to S7-300/400/1500 and WinAC RTX F:
 - STEP 7 Safety Basic for easy engineering of the CPU 1200 FC
 - STEP 7 Safety Advanced for the entire fail-safe SIMATIC S7 portfolio
- Integrated system diagnosis of the CPUs, for standard and safety:
 - Consistent plain text display of system diagnostic information in the TIA Portal, HMI and web server
 - Messages are updated even if the CPU is in STOP state
 - System diagnostics integrated in the CPU firmware. Configuration by user not required
 - The diagnostics is automatically updated on configuration changes.
- 2 fail-safe compact controllers with graded performances in the versions DC/DC/DC and DC/DC/relay

Characteristics	SIPLUS CPU 1214 FC	SIPLUS CPU 1215 FC
Variants	DC/DC/DC, DC/DC/relay	DC/DC/DC
Work memory, integrated	125 KB	150 KB
Load memory, integrated	4 MB	4 MB
Memory card	SIMATIC Memory Card (optional)	SIMATIC Memory Card (optional)
Standard digital inputs/outputs, integrated	14/10	14/10
Standard analog inputs, integrated	2	2
Standard analog outputs, integrated	-	2
Process image	1024 bytes for inputs, 1024 bytes for outputs	1024 bytes for inputs, 1024 bytes for outputs
Expansion by signal board	Max. 1	Max. 1
Expansion by signal modules	Max. 8	Max. 8
Expansion by communication modules	Max. 3	Max. 3

Note:

SIPLUS extreme products are based on SIMATIC standard products. The contents listed here were taken from the respective standard products. SIPLUS extreme-specific information was added.

SIMATIC S7-1200 Basic Controllers

Central processing units

SIPLUS fail-safe CPUs

Ordering data

Article No.

Article No.

CPU 1214 FC

(Extended temperature range and exposure to media)

Fail-safe compact CPU, DC/DC/DC;

Integrated program/ data memory 125 KB, load memory 4 MB; supply voltage 24 V DC; Boolean execution times 0.085 µs per operation; 14 digital inputs, 10 digital outputs, 2 analog inputs; expandable by up to 3 communication modules, 8 signal modules, and 1 signal board/communication board; digital inputs can be used as HSC at 100 kHz, 24 V DC digital outputs can be used as pulse outputs (PTO) or pulse-width modulated outputs (PWM) at 100 kHz

6AG1214-1AF40-5XB0

Fail-safe compact CPU, DC/DC/relay

Integrated program/ data memory 125 KB, load memory 4 MB; power supply 24 V DC Boolean execution times 0.085 µs per operation 14 digital inputs, 10 digital outputs (relays) 2 analog inputs Expandable by up to 3 communication modules, 8 signal modules, and 1 signal board/communication board Digital inputs can be used as HSC at 100 kHz

6AG1214-1HF40-5XB0

CPU 1215 FC

(Extended temperature range and exposure to media)

Fail-safe compact CPU, DC/DC/DC

Integrated program/ data memory 150 KB, load memory 4 MB Power supply 24 V DC Boolean execution times 0.085 µs per operation 14 digital inputs, 10 digital outputs 2 analog inputs; 2 analog outputs Expandable by up to 3 communication modules, 8 signal modules, and 1 signal board/communication board Digital inputs can be used as HSC at 100 kHz 24 V DC digital outputs can be used as pulse outputs (PTO) or pulse-width modulated outputs (PWM) at 100 kHz

6AG1215-1AF40-5XB0

Accessories

See SIMATIC CPU 121x FC, page 3/42

Technical specifications

Article number	6AG1214-1AF40-5XB0	6AG1214-1HF40-5XB0	6AG1215-1AF40-5XB0
Based on	6ES7214-1AF40-0XB0	6ES7214-1HF40-0XB0	6ES7215-1AF40-0XB0
	SIPLUS S7-1200 CPU 1214FC DC/DC/DC	SIPLUS S7-1200 CPU 1214FC DC/DC/RLY	SIPLUS S7-1200 CPU 1215FC DC/DC/DC
Ambient conditions			
Ambient temperature during operation			
• min.	-25 °C; = Tmin	-25 °C; = Tmin	-25 °C; = Tmin
• max.	55 °C; = Tmax	55 °C; = Tmax	55 °C; = Tmax
Altitude during operation relating to sea level			
• Installation altitude above sea level, max.	2 000 m	2 000 m	2 000 m
• Ambient air temperature-barometric pressure-altitude	Tmin ... Tmax at 1 140 hPa ... 795 hPa (-1 000 m ... +2 000 m)	Tmin ... Tmax at 1 140 hPa ... 795 hPa (-1 000 m ... +2 000 m)	Tmin ... Tmax at 1 140 hPa ... 795 hPa (-1 000 m ... +2 000 m)
Relative humidity			
• With condensation, tested in accordance with IEC 60068-2-38, max.	100 %; RH incl. condensation/frost (no commissioning under condensation conditions)	100 %; RH incl. condensation/frost (no commissioning under condensation conditions)	100 %; incl. condensation / frost permitted (no commissioning under condensation conditions)
Resistance			
Coolants and lubricants			
- Resistant to commercially available coolants and lubricants	Yes	Yes	Yes
Use in stationary industrial systems			
- to biologically active substances according to EN 60721-3-3	Yes; Class 3B2 mold, fungus and dry rot spores (with the exception of fauna); Class 3B3 on request	Yes; Class 3B2 mold, fungus and dry rot spores (with the exception of fauna); Class 3B3 on request	Yes; Class 3B2 mold, fungus and dry rot spores (with the exception of fauna); Class 3B3 on request
- to chemically active substances according to EN 60721-3-3	Yes; Class 3C4 (RH < 75 %) incl. salt spray acc. to EN 60068-2-52 (severity degree 3); *	Yes; Class 3C4 (RH < 75 %) incl. salt spray acc. to EN 60068-2-52 (severity degree 3); *	Yes; Class 3C4 (RH < 75 %) incl. salt spray acc. to EN 60068-2-52 (severity degree 3); *
- to mechanically active substances according to EN 60721-3-3	Yes; Class 3S4 incl. sand, dust, *	Yes; Class 3S4 incl. sand, dust, *	Yes; Class 3S4 incl. sand, dust, *
Use on ships/at sea			
- to biologically active substances according to EN 60721-3-6	Yes; Class 6B2 mold and fungal spores (excluding fauna); Class 6B3 on request	Yes; Class 6B2 mold and fungal spores (excluding fauna); Class 6B3 on request	Yes; Class 6B2 mold and fungal spores (excluding fauna); Class 6B3 on request
- to chemically active substances according to EN 60721-3-6	Yes; Class 6C3 (RH < 75 %) incl. salt spray acc. to EN 60068-2-52 (severity degree 3); *	Yes; Class 6C3 (RH < 75 %) incl. salt spray acc. to EN 60068-2-52 (severity degree 3); *	Yes; Class 6C3 (RH < 75 %) incl. salt spray acc. to EN 60068-2-52 (severity degree 3); *
- to mechanically active substances according to EN 60721-3-6	Yes; Class 6S3 incl. sand, dust; *	Yes; Class 6S3 incl. sand, dust; *	Yes; Class 6S3 incl. sand, dust; *
Usage in industrial process technology			
- Against chemically active substances acc. to EN 60654-4	Yes; Class 3 (excluding trichlorethylene)	Yes; Class 3 (excluding trichlorethylene)	Yes; Class 3 (excluding trichlorethylene)
- Environmental conditions for process, measuring and control systems acc. to ANSI/ISA-71.04	Yes; Level GX group A/B (excluding trichlorethylene; harmful gas concentrations up to the limits of EN 60721-3-3 class 3C4 permissible); level LC3 (salt spray) and level LB3 (oil)	Yes; Level GX group A/B (excluding trichlorethylene; harmful gas concentrations up to the limits of EN 60721-3-3 class 3C4 permissible); level LC3 (salt spray) and level LB3 (oil)	Yes; Level GX group A/B (excluding trichlorethylene; harmful gas concentrations up to the limits of EN 60721-3-3 class 3C4 permissible); level LC3 (salt spray) and level LB3 (oil)
Remark			
- Note regarding classification of environmental conditions acc. to EN 60721, EN 60654-4 and ANSI/ISA-71.04	* The supplied plug covers must remain in place over the unused interfaces during operation!	* The supplied plug covers must remain in place over the unused interfaces during operation!	* The supplied plug covers must remain in place over the unused interfaces during operation!
Conformal coating			
• Coatings for printed circuit board assemblies acc. to EN 61086	Yes; Class 2 for high reliability	Yes; Class 2 for high reliability	Yes; Class 2 for high reliability
• Protection against fouling acc. to EN 60664-3	Yes; Type 1 protection	Yes; Type 1 protection	Yes; Type 1 protection
• Military testing according to MIL-I-46058C, Amendment 7	Yes; Discoloration of coating possible during service life	Yes; Discoloration of coating possible during service life	Yes; Discoloration of coating possible during service life
• Qualification and Performance of Electrical Insulating Compound for Printed Board Assemblies according to IPC-CC-830A	Yes; Conformal coating, Class A	Yes; Conformal coating, Class A	Yes; Conformal coating, Class A

SIMATIC S7-1200 Basic Controllers

I/O modules

Digital modules

SM 1221 digital input modules

Overview



- Digital inputs as supplement to the integral I/O of the CPUs
- For flexible adaptation of the controller to the relevant task
- For subsequent expansion of the system with additional inputs

Ordering data

Article No.

SM 1221 digital input signal module

8 inputs, 24 V DC, isolated, current sourcing/sinking

6ES7221-1BF32-0XB0

16 inputs, 24 V DC, isolated, current sourcing/sinking

6ES7221-1BH32-0XB0

Extension cable for two-tier configuration

For connecting digital/analog signal modules; length 2 m

6ES7290-6AA30-0XA0

Terminal block (spare part)

For 6ES7221-1BF32-0XB0, 6ES7221-1BH32-0XB0

- 7-pin, tin-coated; 4 units

- Screw-type system

- Push-in system

6ES7292-1AG30-0XA0

6ES7292-2AG30-0XA0

Front flap set (spare part)

For modules with a width of 45 mm

6ES7291-1BA30-0XA0

Technical specifications

Article number	6ES7221-1BF32-0XB0	6ES7221-1BH32-0XB0
	Digital Input SM 1221, 8DI, 24V DC	Digital Input SM 1221, 16DI, 24V DC
General information		
Product type designation	SM 1221, DI 8x24 V DC	SM 1221, DI 16x24 V DC
Supply voltage		
Rated value (DC)	24 V	24 V
Input current		
from backplane bus 5 V DC, max.	105 mA	130 mA
Digital inputs		
• from load voltage L+ (without load), max.	4 mA; per channel	4 mA; per channel
output voltage / header		
supply voltage of the transmitters / header		
• present	Yes	Yes
Digital inputs		
Number of digital inputs	8	16
• in groups of	2	4
Input characteristic curve in accordance with IEC 61131, type 1	Yes	Yes
Number of simultaneously controllable inputs		
all mounting positions		
- up to 40 °C, max.	8	16
horizontal installation		
- up to 40 °C, max.	8	16
- up to 50 °C, max.	8	16
vertical installation		
- up to 40 °C, max.	8	16
Input voltage		
• Rated value (DC)	24 V	24 V
• for signal "0"	5 V DC at 1 mA	5 V DC at 1 mA
• for signal "1"	15 V DC at 2.5 mA	15 V DC at 2.5 mA

Technical specifications

Article number	6ES7221-1BF32-0XB0	6ES7221-1BH32-0XB0
	Digital Input SM 1221, 8DI, 24V DC	Digital Input SM 1221, 16DI, 24V DC
Input current		
• for signal "0", max. (permissible quiescent current)	1 mA	1 mA
• for signal "1", min.	2.5 mA	2.5 mA
• for signal "1", typ.	4 mA	4 mA
Input delay (for rated value of input voltage)		
for standard inputs		
- parameterizable	Yes; 0.2 ms, 0.4 ms, 0.8 ms, 1.6 ms, 3.2 ms, 6.4 ms and 12.8 ms, selectable in groups of four	Yes; 0.2 ms, 0.4 ms, 0.8 ms, 1.6 ms, 3.2 ms, 6.4 ms and 12.8 ms, selectable in groups of four
for interrupt inputs		
- parameterizable	Yes	Yes
Interrupts/diagnostics/status information		
Alarms		
• Diagnostic alarm	Yes	Yes
Diagnostics indication LED		
• for status of the inputs	Yes	Yes
Potential separation		
Potential separation digital inputs		
• between the channels, in groups of	2	4
Degree and class of protection		
IP degree of protection	IP20	IP20
Standards, approvals, certificates		
CE mark	Yes	Yes
CSA approval	Yes	Yes
UL approval	Yes	Yes
cULus	Yes	Yes
FM approval	Yes	Yes
RCM (formerly C-TICK)	Yes	Yes
KC approval	Yes	Yes
Marine approval	Yes	Yes
Ambient conditions		
Ambient temperature during operation		
• min.	-20 °C	-20 °C
• max.	60 °C	60 °C
connection method / header		
required front connector	Yes	Yes
Mechanics/material		
Enclosure material (front)		
• Plastic	Yes	Yes
Dimensions		
Width	45 mm	45 mm
Height	100 mm	100 mm
Depth	75 mm	75 mm
Weights		
Weight, approx.	170 g	210 g

SIMATIC S7-1200 Basic Controllers

I/O modules

Digital modules

SB 1221 digital input modules

Overview



- Digital inputs as a supplement to the integral I/O of SIMATIC S7-1200 CPUs
- Can be plugged directly into the CPU

Ordering data

Article No.

SB 1221 Signal Board digital input modules

4 inputs, 5 V DC, 200 kHz, sourcing

6ES7221-3AD30-0XB0

4 inputs, 24 V DC, 200 kHz, sourcing

6ES7221-3BD30-0XB0

Terminal block (spare part)

for Signal Board

with 6 screws, gold-plated; 4 pcs.

6ES7292-1BF30-0XA0

Technical specifications

Article number	6ES7221-3AD30-0XB0	6ES7221-3BD30-0XB0
	Signal Board SB 1221, 4 DI 5VDC 200KHz	Signal Board SB 1221, 4 DI 24VDC 200KHz
General information		
Product type designation	SB 1221, DI 4x5 V DC 200 kHz	SB 1221, DI 4x24 V DC 200 kHz
Input current		
from backplane bus 5 V DC, typ.	40 mA	40 mA
Digital inputs		
Number of digital inputs	4; Current-sourcing	4; Current-sourcing
• in groups of	4	4
Input voltage		
• Type of input voltage	DC	DC
• Rated value (DC)	5 V	24 V
• for signal *0*	(L+ minus 1.0 V DC) ... L+ (2.2 ... 0 mA)	(L+ minus 5.0 V DC) ... L+ (1.4 ... 0 mA)
• for signal *1*	0 V ... (L+ minus 2.0 V DC (20 ... 5.1 mA))	0 V ... (L+ minus 10 V DC (10 ... 2.9 mA))
Input current		
• for signal *0*, max. (permissible quiescent current)	2.2 mA	1.4 mA
• for signal *1*, min.	5.1 mA	2.9 mA
• for signal *1*, typ.	15 mA	7 mA
Input delay (for rated value of input voltage)		
for standard inputs		
- parameterizable	Yes; 0.1 / 0.2 / 0.4 / 0.8 / 1.6 / 3.2 / 6.4 / 10.0 / 12.8 / 20.0 μs; 0.05 / 0.1 / 0.2 / 0.4 / 0.8 / 1.6 / 3.2 / 6.4 / 10.0 / 12.8 / 20.0 ms	Yes; 0.1 / 0.2 / 0.4 / 0.8 / 1.6 / 3.2 / 6.4 / 10.0 / 12.8 / 20.0 μs; 0.05 / 0.1 / 0.2 / 0.4 / 0.8 / 1.6 / 3.2 / 6.4 / 10.0 / 12.8 / 20.0 ms
for interrupt inputs		
- parameterizable	Yes	Yes
for technological functions		
- parameterizable	Yes	Yes
Interrupts/diagnostics/status information		
Diagnostics indication LED		
• for status of the inputs	Yes	Yes

Technical specifications

Article number	6ES7221-3AD30-0XB0	6ES7221-3BD30-0XB0
	Signal Board SB 1221, 4 DI 5VDC 200KHz	Signal Board SB 1221, 4 DI 24VDC 200KHz
Standards, approvals, certificates		
CE mark	Yes	Yes
CSA approval	Yes	Yes
UL approval	Yes	Yes
cULus	Yes	Yes
FM approval	Yes	Yes
RCM (formerly C-TICK)	Yes	Yes
KC approval	Yes	Yes
Marine approval	Yes	Yes
Ambient conditions		
Ambient temperature during operation		
• min.	-20 °C	-20 °C
• max.	60 °C	60 °C
Mechanics/material		
Enclosure material (front)		
• Plastic	Yes	Yes
Dimensions		
Width	38 mm	38 mm
Height	62 mm	62 mm
Depth	21 mm	21 mm
Weights		
Weight, approx.	35 g	35 g

SIMATIC S7-1200 Basic Controllers

I/O modules

Digital modules

SM 1222 digital output modules

Overview



- Digital outputs as supplement to the integral I/O of the CPUs
- For flexible adaptation of the controller to the relevant task
- For subsequent expansion of the system with additional outputs

Ordering data

Article No.

SM 1222 digital output signal module

8 outputs, 24 V DC; 0.5 A, 5 W, isolated

6ES7222-1BF32-0XB0

16 outputs, 24 V DC; 0.5 A, 5 W, isolated

6ES7222-1BH32-0XB0

16 outputs, 24 V DC; 0.5 A, 5 W, isolated, sourcing output

6ES7222-1BH32-1XB0

8 relay outputs, 5 ... 30 V DC / 5 ... 250 V AC, 2 A, 30 W DC / 200 W AC

6ES7222-1HF32-0XB0

8 relay outputs, changeover contact, 5 ... 30 V DC / 5 ... 250 V AC, 2 A, 30 W DC / 200 W AC

6ES7222-1XF32-0XB0

16 relay outputs, 5 ... 30 V DC / 5 ... 250 V AC, 2 A, 30 W DC / 200 W AC

6ES7222-1HH32-0XB0

Extension cable for two-tier configuration

6ES7290-6AA30-0XA0

For connecting digital/analog signal modules; length 2 m

Terminal block (spare part)

For 6ES7222-1BF32-0XB0, 6ES7222-1BH32-0XB0

- 7-pin, tin-coated; 4 units

- Screw-type system
- Push-in system

6ES7292-1AG30-0XA0
6ES7292-2AG30-0XA0

For 6ES7222-1HF32-0XB0

- 7-pin, tin-coated, left coded; 4 units

- Screw-type system
- Push-in system

6ES7292-1AG40-0XA1
6ES7292-2AG40-0XA1

For 6ES7222-1HH32-0XB0

- 7-pin, tin-coated, right coded; 4 units

- Screw-type system
- Push-in system

6ES7292-1AG40-0XA0
6ES7292-2AG40-0XA0

For 6ES7222-1XF32-0XB0

- 11-pin, tin-coated, right coded; 4 units

- Screw-type system
- Push-in system

6ES7292-1AL40-0XA0
6ES7292-2AL40-0XA0

Front flap set (spare part)

For modules with a width of 45 mm

6ES7291-1BA30-0XA0

For modules with a width of 70 mm

6ES7291-1BB30-0XA0

Technical specifications

Article number	6ES7222-1BF32-0XB0	6ES7222-1BH32-0XB0	6ES7222-1BH32-1XB0	6ES7222-1HF32-0XB0	6ES7222-1HH32-0XB0	6ES7222-1XF32-0XB0
	Digital Output SM1222, 8 DO, 24V DC	Digital Output SM1222, 16 DO, 24V DC	Digital Output SM1222, 16DO, 24V DC sink	Digital Output SM 1222, 8 DO, Relay	Digital Output SM1222, 16 DO, Relay	Digital Output SM 1222, 8 DO, Changeover
General information						
Product type designation	SM 1222, DQ 8x24 V DC/0.5 A	SM 1222, DQ 16x24 V DC/0.5 A	SM 1222, DO 16x 24 V DC/0.5 A Sink	SM 1222, DQ 8x relay/2 A	SM 1222, DQ 16x relay/2 A	SM 1222, DQ 8x relay/2 A
Input current						
from backplane bus 5 V DC, max.	120 mA	140 mA	140 mA	120 mA	135 mA	140 mA
Digital outputs						
• from load voltage L+, max.				11 mA/relay coil	11 mA/relay coil	16.7 mA/relay coil
Digital outputs						
Number of digital outputs	8	16	16	8	16	8
• in groups of	1	1	1	2	1	1
Current-sinking			Yes			
Short-circuit protection	No; to be provided externally	No; to be provided externally	No; to be provided externally	No; to be provided externally	No; to be provided externally	No; to be provided externally
Limitation of inductive shutdown voltage to	typ. (L+) -48 V	typ. (L+) -48 V	Typ 45 V			
Switching capacity of the outputs						
• with resistive load, max.	0.5 A	0.5 A	0.5 A	2 A	2 A	2 A
• on lamp load, max.	5 W	5 W	5 W	30 W with DC, 200 W with AC	30 W with DC, 200 W with AC	30 W with DC, 200 W with AC
Output voltage						
• Rated value (DC)	24 V	24 V	24 V	5 V DC to 30 V DC	5 V DC to 30 V DC	5 V DC to 30 V DC
• Rated value (AC)				5 V AC to 250 V AC	5 V AC to 250 V AC	5 V AC to 250 V AC
• for signal "0", max.	0.1 V; with 10 kOhm load	0.1 V; with 10 kOhm load	L+ minus 0.75 V DC with 10k Load			
• for signal "1", min.	20 V DC	20 V DC	0.5 V			
Output current						
• for signal "1" rated value	0.5 A	0.5 A	0.5 A	2 A	2 A	2 A
• for signal "0" residual current, max.	10 µA	10 µA	75 µA			
Output delay with resistive load						
• "0" to "1", max.	50 µs	50 µs	20 µs	10 ms	10 ms	10 ms
• "1" to "0", max.	200 µs	200 µs	350 µs	10 ms	10 ms	10 ms
Total current of the outputs (per group)						
horizontal installation						
- up to 50 °C, max.	4 A; Current per mass	8 A; Current per mass	8 A; Current per mass	10 A; Current per mass	10 A; Current per mass	2 A; Current per mass
Relay outputs						
• Number of relay outputs				8	16	8
• Rated supply voltage of relay coil L+ (DC)				24 V	24 V	24 V
• Number of operating cycles, max.				mechanically 10 million, at rated load voltage 100 000	mechanically 10 million, at rated load voltage 100 000	mechanically 10 million, at rated load voltage 100 000
Switching capacity of contacts						
- with inductive load, max.	0.5 A	0.5 A	0.5 A	2 A	2 A	2 A
- on lamp load, max.	5 W	5 W	5 W	30 W with DC, 200 W with AC	30 W with DC, 200 W with AC	30 W with DC, 200 W with AC
- with resistive load, max.	0.5 A	0.5 A	0.5 A	2 A	2 A	2 A

SIMATIC S7-1200 Basic Controllers

I/O modules

Digital modules

SM 1222 digital output modules

Technical specifications

Article number	6ES7222-1BF32-0XB0	6ES7222-1BH32-0XB0	6ES7222-1BH32-1XB0	6ES7222-1HF32-0XB0	6ES7222-1HH32-0XB0	6ES7222-1XF32-0XB0
	Digital Output SM1222, 8 DO, 24V DC	Digital Output SM1222, 16 DO, 24V DC	Digital Output SM1222, 16DO, 24V DC sink	Digital Output SM 1222, 8 DO, Relay	Digital Output SM1222, 16 DO, Relay	Digital Output SM 1222, 8 DO, Changeover
Interrupts/diagnostics/status information						
Alarms						
• Diagnostic alarm	Yes	Yes	Yes	Yes	Yes	Yes
Diagnostics indication LED						
• for status of the outputs	Yes	Yes	Yes	Yes	Yes	Yes
Potential separation						
Potential separation digital outputs						
• between the channels				Relays	Relays	Relays
• between the channels, in groups of	1	1	1	2	4	1
• between the channels and backplane bus	500 V AC	500 V AC	500 V AC	1 500 V AC for 1 minute	1 500 V AC for 1 minute	1 500 V AC for 1 minute
Degree and class of protection						
IP degree of protection	IP20	IP20	IP20	IP20	IP20	IP20
Standards, approvals, certificates						
CE mark	Yes	Yes	Yes	Yes	Yes	Yes
CSA approval	Yes	Yes	Yes	Yes	Yes	Yes
UL approval	Yes	Yes	Yes	Yes	Yes	Yes
cULus	Yes	Yes	Yes	Yes	Yes	Yes
FM approval	Yes	Yes	Yes	Yes	Yes	Yes
RCM (formerly C-TICK)	Yes	Yes	Yes	Yes	Yes	Yes
KC approval	Yes	Yes	Yes	Yes	Yes	Yes
Marine approval	Yes	Yes	Yes	Yes	Yes	Yes
Ambient conditions						
Ambient temperature during operation						
• min.	-20 °C	-20 °C	-20 °C	-20 °C	-20 °C	-20 °C
• max.	60 °C	60 °C	60 °C	60 °C	60 °C; Number of simultaneously activated outputs: 8 (no adjacent points) at 60 °C horizontal or 50 °C vertical, 16 at 55 °C horizontal or 45 °C vertical	60 °C; Number of simultaneously activated outputs: 4 (no adjacent points) at 60 °C horizontal or 50 °C vertical, 8 at 55 °C horizontal or 45 °C vertical
connection method / header						
required front connector	Yes	Yes	Yes	Yes	Yes	Yes
Mechanics/material						
Enclosure material (front)						
• Plastic	Yes	Yes	Yes	Yes	Yes	Yes
Dimensions						
Width	45 mm	45 mm	45 mm	45 mm	45 mm	70 mm
Height	100 mm	100 mm	100 mm	100 mm	100 mm	100 mm
Depth	75 mm	75 mm	75 mm	75 mm	75 mm	75 mm
Weights						
Weight, approx.	180 g	220 g	220 g	190 g	260 g	310 g

Overview



- Digital outputs as a supplement to the integral I/O of SIMATIC S7-1200 CPUs
- Can be plugged directly into the CPU

Ordering data

Article No.

**SB 1222 Signal Board
digital output modules**

4 outputs, 5 V DC, 0.1 A, 200 kHz

6ES7222-1AD30-0XB0

4 outputs, 24 V DC, 0.1 A, 200 kHz

6ES7222-1BD30-0XB0**Terminal block (spare part)**

for Signal Board

with 6 screws, gold-plated; 4 pcs.

6ES7292-1BF30-0XA0

SIMATIC S7-1200 Basic Controllers

I/O modules

Digital modules

SB 1222 digital output modules

Technical specifications

Article number	6ES7222-1AD30-0XB0 Signal Board SB1222, 4 DQ 5VDC 200KHz	6ES7222-1BD30-0XB0 Signal Board SB1222, 4 DQ 24VDC 200KHz
General information		
Product type designation	SB 1222, DQ 4x5 V DC 200 kHz	SB 1222, DQ 4x24 V DC 200 kHz
Input current		
from backplane bus 5 V DC, typ.	35 mA	35 mA
Digital outputs		
Number of digital outputs	4; MOSFET, solid-state (current-sinking/current-sourcing)	4; MOSFET, solid-state (current-sinking/current-sourcing)
• in groups of	4	4
Short-circuit protection	No	No
Switching capacity of the outputs		
• with resistive load, max.	0.1 A	0.1 A
Load resistance range		
• upper limit	7 Ω	11 Ω
Output voltage		
• Rated value (DC)	5 V	24 V
• for signal "0", max.	0.2 V	1 V; with 10 kOhm load
• for signal "1", min.	L+ minus 0.7 V DC	L+ (-1.5 V)
• for signal "1", max.	6 V	
Output current		
• for signal "1" permissible range, max.	0.1 A	0.1 A
Interrupts/diagnostics/ status information		
Diagnostics indication LED		
• for status of the outputs	Yes	Yes
Standards, approvals, certificates		
CE mark	Yes	Yes
CSA approval	Yes	Yes
UL approval	Yes	Yes
cULus	Yes	Yes
FM approval	Yes	Yes
RCM (formerly C-TICK)	Yes	Yes
KC approval	Yes	Yes
Marine approval	Yes	Yes
Ambient conditions		
Ambient temperature during operation		
• min.	-20 °C	-20 °C
• max.	60 °C	60 °C
Mechanics/material		
Enclosure material (front)		
• Plastic	Yes	Yes
Dimensions		
Width	38 mm	38 mm
Height	62 mm	62 mm
Depth	21 mm	21 mm
Weights		
Weight, approx.	35 g	35 g

Overview



- Digital inputs and outputs as supplement to the integral I/O of the CPUs
- For flexible adaptation of the controller to the relevant task
- For subsequent expansion of the system with additional inputs and outputs

Ordering data

Article No.

SM 1223 digital input/output signal module

8 inputs, 24 V DC,
IEC type 1 current sinking;
8 x 24 V DC transistor outputs,
0.5 A, 5 W

6ES7223-1BH32-0XB0

16 inputs, 24 V DC,
IEC type 1 current sinking;
16 x 24 V DC transistor outputs,
0.5 A, 5 W

6ES7223-1BL32-0XB0

16 inputs, 24 V DC,
IEC type 1 current sinking;
16 x 24 V DC transistor outputs,
0.5 A, 5 W, sourcing output

6ES7223-1BL32-1XB0

8 inputs, 24 V DC,
IEC type 1 current sinking;
8 relay outputs,
5 ... 30 V DC/5 ... 250 V AC, 2 A,
30 W DC/200 W AC

6ES7223-1PH32-0XB0

16 inputs, 24 V DC,
IEC type 1 current sinking;
16 relay outputs,
5 ... 30 V DC/5 ... 250 V AC, 2 A,
30 W DC/200 W AC

6ES7223-1PL32-0XB0

8 inputs, 120/230 V AC;
8 relay outputs,
5 ... 30 V DC/5 ... 250 V AC, 2 A,
30 W DC/200 W AC

6ES7223-1QH32-0XB0

Extension cable for two-tier configuration

For connecting digital/analog signal modules; length 2 m

6ES7290-6AA30-0XA0

Terminal block (spare part)

For 6ES7223-1BH32-0XB0

- 7-pin, tin-coated; 4 units
 - Screw-type system
 - Push-in system

6ES7292-1AG30-0XA0
6ES7292-2AG30-0XA0

For 6ES7223-1BL32-0XB0

- 11-pin, tin-coated; 4 units
 - Screw-type system
 - Push-in system

6ES7292-1AL30-0XA0
6ES7292-2AL30-0XA0

For 6ES7223-1PH32-0XB0

- 7-pin, tin-coated; 4 units
 - Screw-type system
 - Push-in system
- 7-pin, tin-coated, right coded; 4 units
 - Screw-type system
 - Push-in system

6ES7292-1AG30-0XA0
6ES7292-2AG30-0XA06ES7292-1AG40-0XA0
6ES7292-2AG40-0XA0

For 6ES7223-1PL32-0XB0

- 11-pin, tin-coated; 4 units
 - Screw-type system
 - Push-in system
- 11-pin, tin-coated, coded; 4 units
 - Screw-type system
 - Push-in system

6ES7292-1AL30-0XA0
6ES7292-2AL30-0XA06ES7292-1AL40-0XA0
6ES7292-2AL40-0XA0

For 6ES7223-1QH32-0XB0

- 7-pin, tin-coated, right coded; 4 units
 - Screw-type system
 - Push-in system

6ES7292-1AG40-0XA0
6ES7292-2AG40-0XA0**Front flap set (spare part)**

For modules with a width of 45 mm

6ES7291-1BA30-0XA0

For modules with a width of 70 mm

6ES7291-1BB30-0XA0

SIMATIC S7-1200 Basic Controllers

I/O modules

Digital modules

SM 1223 digital input/output modules

Technical specifications

Article number	6ES7223-1BH32-0XB0	6ES7223-1BL32-0XB0	6ES7223-1BL32-1XB0	6ES7223-1PH32-0XB0	6ES7223-1PL32-0XB0	6ES7223-1QH32-0XB0
	Digital I/O SM 1223, 8 DI/8 DO	Digital I/O SM 1223, 16DI/16DO	Digital I/O SM 1223, 16DI/16DO sink	Digital I/O SM 1223, 8DI/8DO	Digital I/O SM 1223, 16DI/16DO	Digital I/O SM 1223, 8DI AC/8DO Rly
General information						
Product type designation	SM 1223, DI 8x24 V DC, DQ 8x24 V DC	SM 1223, DI 16x24 V DC, DQ 16x24 V DC	SM 1223, DI 16x24 V DC, DO 16x 24 V DC Sink	SM 1223, DI 8x24 V DC, DQ 8x relay	SM 1223, DI 16x24 V DC, DQ 16x relay	SM 1223, DI 8x120/230 V AC, DQ 8x relay
Supply voltage						
Rated value (DC)	24 V	24 V	24 V	24 V	24 V	24 V
Input current						
from backplane bus 5 V DC, max.	145 mA	185 mA	185 mA	145 mA	180 mA	120 mA
Digital inputs						
• from load voltage L+ (without load), max.	4 mA; per channel	4 mA; per channel	4 mA; per channel	4 mA/input 11 mA/relay	4 mA/input 11 mA/relay	
output voltage / header						
supply voltage of the transmitters / header						
• present	Yes	Yes	Yes	Yes	Yes	Yes
Digital inputs						
Number of digital inputs	8	16	16	8	16	8
• in groups of	2	2	2	2	2	4
Input characteristic curve in accordance with IEC 61131, type 1	Yes	Yes	Yes	Yes	Yes	Yes
Number of simultaneously controllable inputs						
all mounting positions						
- up to 40 °C, max.	8	16	16	8	16	8
horizontal installation						
- up to 40 °C, max.	8	16	16	8	16	8
- up to 50 °C, max.	8	16	16	8	16	8
vertical installation						
- up to 40 °C, max.	8	16	16	8	16	8
Input voltage						
• Type of input voltage	DC	DC	DC	DC	DC	AC
• Rated value (DC)	24 V	24 V	24 V	24 V	24 V	
• Rated value (AC)						120/230 V AC
• for signal *0*	5 V DC at 1 mA	5 V DC at 1 mA	5 V DC at 1 mA	5 V DC at 1 mA	5 V DC at 1 mA	20 V AC at 1 mA
• for signal *1*	15 V DC at 2.5 mA	15 V DC at 2.5 mA	15 V DC at 2.5 mA	15 V DC at 2.5 mA	15 V DC at 2.5 mA	79 V AC at 2.5 mA
Input current						
• for signal *0*, max. (permissible quiescent current)	1 mA	1 mA	1 mA	1 mA	1 mA	1 mA
• for signal *1*, min.	2.5 mA	2.5 mA	2.5 mA	2.5 mA	2.5 mA	2.5 mA
• for signal *1*, typ.	4 mA	4 mA	4 mA	4 mA	4 mA	9 mA
Input delay (for rated value of input voltage)						
for standard inputs						
- parameterizable	Yes; 0.2 ms, 0.4 ms, 0.8 ms, 1.6 ms, 3.2 ms, 6.4 ms and 12.8 ms, selectable in groups of four	Yes; 0.2 ms, 0.4 ms, 0.8 ms, 1.6 ms, 3.2 ms, 6.4 ms and 12.8 ms, selectable in groups of four	Yes; 0.2 ms, 0.4 ms, 0.8 ms, 1.6 ms, 3.2 ms, 6.4 ms and 12.8 ms, selectable in groups of four	Yes; 0.2 ms, 0.4 ms, 0.8 ms, 1.6 ms, 3.2 ms, 6.4 ms and 12.8 ms, selectable in groups of four	Yes; 0.2 ms, 0.4 ms, 0.8 ms, 1.6 ms, 3.2 ms, 6.4 ms and 12.8 ms, selectable in groups of four	Yes; 0.2 ms, 0.4 ms, 0.8 ms, 1.6 ms, 3.2 ms, 6.4 ms and 12.8 ms, selectable in groups of four
for interrupt inputs						
- parameterizable	Yes	Yes	Yes	Yes	Yes	Yes

Technical specifications

Article number	6ES7223-1BH32-0XB0	6ES7223-1BL32-0XB0	6ES7223-1BL32-1XB0	6ES7223-1PH32-0XB0	6ES7223-1PL32-0XB0	6ES7223-1QH32-0XB0
	Digital I/O SM 1223, 8 DI/8 DO	Digital I/O SM 1223, 16DI/16DO	Digital I/O SM 1223, 16DI/16DO sink	Digital I/O SM 1223, 8DI/8DO	Digital I/O SM 1223, 16DI/16DO	Digital I/O SM 1223, 8DI AC/8DO Rly
Digital outputs						
Number of digital outputs	8	16	16; Transistor current sinking	8	16	8
• in groups of	1	1	1	2	4	4
Short-circuit protection	No; to be provided externally	No; to be provided externally	Yes; 1 to 3.5 A	No; to be provided externally	No; to be provided externally	No; to be provided externally
Limitation of inductive shutdown voltage to	L+ (-48 V)	L+ (-48 V)	Typ 45 V			
Switching capacity of the outputs						
• with resistive load, max.	0.5 A	0.5 A	0.5 A	2 A	2 A	2 A
• on lamp load, max.	5 W	5 W	5 W	30 W with DC, 200 W with AC	30 W with DC, 200 W with AC	30 W with DC, 200 W with AC
Output voltage						
• Rated value (DC)	24 V	24 V	24 V	5 V DC to 30 V DC	5 V DC to 30 V DC	5 V DC to 30 V DC
• Rated value (AC)				5 V AC to 250 V AC	5 V AC to 250 V AC	5 V AC to 250 V AC
• for signal "0", max.	0.1 V; with 10 kOhm load	0.1 V; with 10 kOhm load	L+ minus 0.75 V DC with 10k Load			
• for signal "1", min.	20 V DC	20 V DC	0,5 V			
Output current						
• for signal "1" rated value	0.5 A	0.5 A	0.5 A	2 A	2 A	2 A
• for signal "0" residual current, max.	10 µA	10 µA	75 µA			
Output delay with resistive load						
• "0" to "1", max.	50 µs	50 µs	20 µs	10 ms	10 ms	10 ms
• "1" to "0", max.	200 µs	200 µs	350 µs	10 ms	10 ms	10 ms
Total current of the outputs (per group)						
horizontal installation						
- up to 50 °C, max.	4 A; Current per mass	8 A; Current per mass	8 A; Current per mass	10 A; Current per mass	8 A; Current per mass	8 A; Current per mass
Relay outputs						
• Number of relay outputs				8	16	8
• Rated supply voltage of relay coil L+ (DC)				24 V	24 V	24 V
• Number of operating cycles, max.				mechanically 10 million, at rated load voltage 100 000	mechanically 10 million, at rated load voltage 100 000	mechanically 10 million, at rated load voltage 100 000
Switching capacity of contacts						
- with inductive load, max.		0.5 A	0.5 A	2 A	2 A	2 A
- on lamp load, max.		5 W	5 W	30 W with DC, 200 W with AC	30 W with DC, 200 W with AC	30 W with DC, 200 W with AC
- with resistive load, max.		0.5 A	0.5 A	2 A	2 A	2 A
Interrupts/diagnostics/ status information						
Alarms						
• Diagnostic alarm	Yes	Yes	Yes	Yes	Yes	Yes
Diagnostics indication LED						
• for status of the inputs	Yes	Yes	Yes	Yes	Yes	Yes
• for status of the outputs	Yes	Yes	Yes	Yes	Yes	Yes

SIMATIC S7-1200 Basic Controllers

I/O modules

Digital modules

SM 1223 digital input/output modules

Technical specifications

Article number	6ES7223-1BH32-0XB0	6ES7223-1BL32-0XB0	6ES7223-1BL32-1XB0	6ES7223-1PH32-0XB0	6ES7223-1PL32-0XB0	6ES7223-1QH32-0XB0
Digital I/O SM 1223, 8 DI/8 DO	Digital I/O SM 1223, 16DI/16DO	Digital I/O SM 1223, 16DI/16DO	Digital I/O SM 1223, 16DI/16DO sink	Digital I/O SM 1223, 8DI/8DO	Digital I/O SM 1223, 16DI/16DO	Digital I/O SM 1223, 8DI AC/8DO Rly
Potential separation						
Potential separation digital inputs						
• between the channels, in groups of	2	2	2	2	2	2
Potential separation digital outputs						
• between the channels				Relays	Relays	Relays
• between the channels, in groups of	1	1	1	2	4	2
• between the channels and backplane bus	500 V AC	500 V AC	500 V AC	1 500 V AC for 1 minute	1 500 V AC for 1 minute	1 500 V AC for 1 minute
Degree and class of protection						
IP degree of protection	IP20	IP20	IP20	IP20	IP20	IP20
Standards, approvals, certificates						
CE mark	Yes	Yes	Yes	Yes	Yes	Yes
CSA approval	Yes	Yes	Yes	Yes	Yes	Yes
UL approval	Yes	Yes	Yes	Yes	Yes	Yes
cULus	Yes	Yes	Yes	Yes	Yes	Yes
FM approval	Yes	Yes	Yes	Yes	Yes	Yes
RCM (formerly C-TICK)	Yes	Yes	Yes	Yes	Yes	Yes
KC approval	Yes	Yes	Yes	Yes	Yes	Yes
Marine approval	Yes	Yes	Yes	Yes	Yes	Yes
Ambient conditions						
Ambient temperature during operation						
• min.	-20 °C	-20 °C	-20 °C	-20 °C	-20 °C	-20 °C
• max.	60 °C	60 °C	60 °C	60 °C	60 °C; Number of simultaneously activated outputs: 8 (no adjacent points) at 60 °C horizontal or 50 °C vertical, 16 at 55 °C horizontal or 45 °C vertical	60 °C; Number of simultaneously activated outputs: 4 (no adjacent points) at 60 °C horizontal or 50 °C vertical, 8 at 55 °C horizontal or 45 °C vertical
connection method / header						
required front connector	Yes	Yes	Yes	Yes	Yes	Yes
Mechanics/material						
Enclosure material (front)						
• Plastic	Yes	Yes	Yes	Yes	Yes	Yes
Dimensions						
Width	45 mm	70 mm	70 mm	45 mm	70 mm	45 mm
Height	100 mm	100 mm	100 mm	100 mm	100 mm	100 mm
Depth	75 mm	75 mm	75 mm	75 mm	75 mm	75 mm
Weights						
Weight, approx.	210 g	310 g	310 g	230 g	350 g	230 g

Overview



- Digital inputs and outputs as supplement to the integral I/O of the SIMATIC S7-1200 CPUs
- Can be plugged direct into the CPU

Ordering data

Article No.

SB 1223 digital input/output signal board

2 inputs, 24 V DC,
IEC type 1 current sinking;
2 x 24 V DC transistor outputs,
0.5 A, 5 W;
can be used as HSC at
up to 30 kHz

6ES7223-0BD30-0XB0

2 inputs, 5 V DC, 200 kHz
2 outputs 5 V DC, 0.1 A, 200 kHz

6ES7223-3AD30-0XB0

2 inputs, 24 V DC, 200 kHz
2 outputs 24 V DC, 0.1 A, 200 kHz

6ES7223-3BD30-0XB0**Terminal block (spare part)**

for signal board
with 6 screws, gold-plated; 4 pcs.

6ES7292-1BF30-0XA0

Technical specifications

Article number	6ES7223-0BD30-0XB0 Signal Board SB1223, 2 DI/2 DO	6ES7223-3AD30-0XB0 Signal Board SB 1223, 2DI/2DO 5V 200kHz	6ES7223-3BD30-0XB0 Signal Board SB 1223, 2DI/2DO 24V 200kHz
General information			
Product type designation	SB 1223, DI 2x24 V DC/ DO 2x24 V DC	SB 1223, DI 2x5 V DC/ DO 2x5 V DC 200 kHz	SB 1223, DI 2x24 V DC/ DO 2x24 V DC 200 kHz
Input current			
from backplane bus 5 V DC, typ.	50 mA	35 mA	35 mA
output voltage / header			
supply voltage of the transmitters / header			
• Supply current, max.	4 mA; per channel		
Digital inputs			
Number of digital inputs	2; Current-sinking	2; Current-sourcing	2; Current-sourcing
• in groups of	1	2	2
Input characteristic curve in accordance with IEC 61131, type 1	Yes		
Number of simultaneously controllable inputs			
all mounting positions			
- up to 40 °C, max.	2		2
Input voltage			
• Type of input voltage	DC	DC	DC
• Rated value (DC)	24 V	5 V	24 V
• for signal "0"	0 to 5 V	(L+ minus 1.0 V DC) ... L+	(L+ minus 5.0 V DC) ... L+
• for signal "1"	+15 to +30 V	0 V ... (L+ minus 2.0 V DC)	0 V ... (L+ minus 10 V DC)
Input current			
• for signal "0", max. (permissible quiescent current)	1 mA	2.2 mA	1.4 mA
• for signal "1", min.		5.1 mA	2.9 mA
• for signal "1", typ.	7 mA	15 mA	7 mA
Input delay (for rated value of input voltage)			
for standard inputs			
- parameterizable	Yes; 0.2 ms, 0.4 ms, 0.8 ms, 1.6 ms, 3.2 ms, 6.4 ms and 12.8 ms, selectable in groups of four	Yes; 0.1 / 0.2 / 0.4 / 0.8 / 1.6 / 3.2 / 6.4 / 10.0 / 12.8 / 20.0 μs; 0.05 / 0.1 / 0.2 / 0.4 / 0.8 / 1.6 / 3.2 / 6.4 / 10.0 / 12.8 / 20.0 ms	Yes; 0.1 / 0.2 / 0.4 / 0.8 / 1.6 / 3.2 / 6.4 / 10.0 / 12.8 / 20.0 μs; 0.05 / 0.1 / 0.2 / 0.4 / 0.8 / 1.6 / 3.2 / 6.4 / 10.0 / 12.8 / 20.0 ms
for interrupt inputs			
- parameterizable	Yes	Yes	Yes
for technological functions			
- parameterizable	Yes	Yes	Yes

SIMATIC S7-1200 Basic Controllers

I/O modules

Digital modules

SB 1223 digital input/output modules

Technical specifications

Article number	6ES7223-0BD30-0XB0 Signal Board SB1223, 2 DI/2 DO	6ES7223-3AD30-0XB0 Signal Board SB 1223, 2DI/2DQ 5V 200KHz	6ES7223-3BD30-0XB0 Signal Board SB 1223, 2DI/2DQ 24V 200KHz
Digital outputs			
Number of digital outputs	2; MOSFET, solid-state (current-sinking/current-sourcing)	2; MOSFET, solid-state (current-sinking/current-sourcing)	2; MOSFET, solid-state (current-sinking/current-sourcing)
• in groups of	1	2	2
Short-circuit protection	No	No	No
Switching capacity of the outputs			
• with resistive load, max.	0.5 A	0.1 A	0.1 A
• on lamp load, max.	5 W		
Load resistance range			
• upper limit	0.6 Ω	7 Ω	
Output voltage			
• Rated value (DC)	24 V	5 V	24 V
• for signal "0", max.	0.1 V; with 10 kOhm load	0.2 V	1 V
• for signal "1", min.	20 V	L+ minus 0.7 V DC	L+ (-1.5 V)
• for signal "1", max.		6 V	
Output current			
• for signal "1" permissible range, max.	0.5 A	0.1 A	0.1 A
• for signal "0" residual current, max.	10 μA		
Interrupts/diagnostics/status information			
Alarms	Yes		
Diagnostics function	Yes		
Diagnostics indication LED			
• for status of the inputs	Yes	Yes	Yes
• for status of the outputs	Yes	Yes	Yes
Standards, approvals, certificates			
CE mark	Yes	Yes	Yes
CSA approval	Yes	Yes	Yes
UL approval	Yes	Yes	Yes
cULus	Yes	Yes	Yes
FM approval	Yes	Yes	Yes
RCM (formerly C-TICK)	Yes	Yes	Yes
KC approval	Yes	Yes	Yes
Marine approval	Yes	Yes	Yes
Ambient conditions			
Ambient temperature during operation			
• min.	-20 °C	-20 °C	-20 °C
• max.	60 °C	60 °C	60 °C
Mechanics/material			
Enclosure material (front)			
• Plastic	Yes	Yes	Yes
Dimensions			
Width	38 mm	38 mm	38 mm
Height	62 mm	62 mm	62 mm
Depth	21 mm	21 mm	21 mm
Weights			
Weight, approx.	40 g	35 g	35 g

Overview



- Digital inputs as supplement to the integral I/O of the CPUs
- For flexible adaptation of the controller to the corresponding task
- For subsequent expansion of the system with additional inputs
- From +60 °C to +70 °C, max. 50% of the inputs can be controlled simultaneously

Note:

SIPLUS extreme products are based on SIMATIC standard products. The contents listed here were taken from the respective standard products. SIPLUS extreme-specific information was added.

Ordering data

Article No.

SIPLUS SM 1221 digital input signal module

(Extended temperature range and exposure to media)

8 inputs, 24 V DC, isolated, current sourcing/sinking

- Suitable for areas with extreme exposure to media (conformal coating)
- -25 ... +70 °C, from +60 ... +70 °C number of simultaneously controllable inputs and outputs max. 50 %

16 inputs, 24 V DC, isolated, current sourcing/sinking

- Suitable for areas with extreme exposure to media (conformal coating)
- -25 ... +70 °C, from +60 ... +70 °C number of simultaneously controllable inputs and outputs max. 50 %

Accessories

6AG1221-1BF32-4XB0

6AG1221-1BF32-2XB0

6AG1221-1BH32-4XB0

6AG1221-1BH32-2XB0

See SIMATIC S7-1200 SM 1221 digital input modules, page 3/50

Technical specifications

Article number	6AG1221-1BF32-2XB0	6AG1221-1BF32-4XB0	6AG1221-1BH32-2XB0	6AG1221-1BH32-4XB0
Based on	6ES7221-1BF32-0XB0 SIPLUS S7-1200 SM 1221 8DI	6ES7221-1BF32-0XB0 SIPLUS S7-1200 SM 1221 8DI	6ES7221-1BH32-0XB0 SIPLUS S7-1200 SM 1221 16DI	6ES7221-1BH32-0XB0 SIPLUS S7-1200 SM 1221 16DI
Ambient conditions				
Ambient temperature during operation				
• min.	-40 °C; = Tmin (incl. condensation/frost); start-up @ -25 °C	-20 °C; = Tmin (incl. condensation/frost); start-up @ 0 °C	-40 °C; = Tmin (incl. condensation/frost); start-up @ -25 °C	-20 °C; = Tmin (incl. condensation/frost); start-up @ 0 °C
• max.	70 °C; = Tmax; Tmax > +60 °C number of simultaneously activated inputs 4 (no adjacent points) for horizontal mounting position	60 °C; = Tmax	70 °C; = Tmax; Tmax > +60 °C number of simultaneously activated inputs 8 (no adjacent points) for horizontal mounting position	60 °C; = Tmax
• At cold restart, min.	-25 °C	0 °C	-25 °C	0 °C
Altitude during operation relating to sea level				
• Installation altitude above sea level, max.	5 000 m	5 000 m	5 000 m	5 000 m
• Ambient air temperature-barometric pressure-altitude	Tmin ... Tmax at 1 140 hPa ... 795 hPa (-1 000 m ... +2 000 m) // Tmin ... (Tmax - 10 K) at 795 hPa ... 658 hPa (+2 000 m ... +3 500 m) // Tmin ... (Tmax -20 K) at 658 hPa ... 540 hPa (+3 500 m ... +5 000 m)	Tmin ... Tmax at 1 140 hPa ... 795 hPa (-1 000 m ... +2 000 m) // Tmin ... (Tmax - 10 K) at 795 hPa ... 658 hPa (+2 000 m ... +3 500 m) // Tmin ... (Tmax -20 K) at 658 hPa ... 540 hPa (+3 500 m ... +5 000 m)	Tmin ... Tmax at 1 140 hPa ... 795 hPa (-1 000 m ... +2 000 m) // Tmin ... (Tmax - 10 K) at 795 hPa ... 658 hPa (+2 000 m ... +3 500 m) // Tmin ... (Tmax -20 K) at 658 hPa ... 540 hPa (+3 500 m ... +5 000 m)	Tmin ... Tmax at 1 140 hPa ... 795 hPa (-1 000 m ... +2 000 m) // Tmin ... (Tmax - 10 K) at 795 hPa ... 658 hPa (+2 000 m ... +3 500 m) // Tmin ... (Tmax -20 K) at 658 hPa ... 540 hPa (+3 500 m ... +5 000 m)
Relative humidity				
• With condensation, tested in accordance with IEC 60068-2-38, max.	100 %; RH incl. condensation/frost (no commissioning under condensation conditions)	100 %; RH incl. condensation/frost (no commissioning under condensation conditions)	100 %; RH incl. condensation/frost (no commissioning under condensation conditions)	100 %; RH incl. condensation/frost (no commissioning under condensation conditions)

SIMATIC S7-1200 Basic Controllers

I/O modules

SIPLUS digital modules

SIPLUS SM 1221 digital input modules

Technical specifications

Article number	6AG1221-1BF32-2XB0	6AG1221-1BF32-4XB0	6AG1221-1BH32-2XB0	6AG1221-1BH32-4XB0
Based on	6ES7221-1BF32-0XB0 SIPLUS S7-1200 SM 1221 8DI	6ES7221-1BF32-0XB0 SIPLUS S7-1200 SM 1221 8DI	6ES7221-1BH32-0XB0 SIPLUS S7-1200 SM 1221 16DI	6ES7221-1BH32-0XB0 SIPLUS S7-1200 SM 1221 16DI
Resistance				
Coolants and lubricants				
- Resistant to commercially available coolants and lubricants	Yes	Yes	Yes	Yes
Use in stationary industrial systems				
- to biologically active substances according to EN 60721-3-3	Yes; Class 3B2 mold, fungus and dry rot spores (with the exception of fauna); Class 3B3 on request	Yes; Class 3B2 mold, fungus and dry rot spores (with the exception of fauna); Class 3B3 on request	Yes; Class 3B2 mold, fungus and dry rot spores (with the exception of fauna); Class 3B3 on request	Yes; Class 3B2 mold, fungus and dry rot spores (with the exception of fauna); Class 3B3 on request
- to chemically active substances according to EN 60721-3-3	Yes; Class 3C4 (RH < 75 %) incl. salt spray acc. to EN 60068-2-52 (severity degree 3); *	Yes; Class 3C4 (RH < 75 %) incl. salt spray acc. to EN 60068-2-52 (severity degree 3); *	Yes; Class 3C4 (RH < 75 %) incl. salt spray acc. to EN 60068-2-52 (severity degree 3); *	Yes; Class 3C4 (RH < 75 %) incl. salt spray acc. to EN 60068-2-52 (severity degree 3); *
- to mechanically active substances according to EN 60721-3-3	Yes; Class 3S4 incl. sand, dust; *	Yes; Class 3S4 incl. sand, dust; *	Yes; Class 3S4 incl. sand, dust; *	Yes; Class 3S4 incl. sand, dust; *
Use on ships/at sea				
- to biologically active substances according to EN 60721-3-6	Yes; Class 6B2 mold and fungal spores (excluding fauna); Class 6B3 on request	Yes; Class 6B2 mold and fungal spores (excluding fauna); Class 6B3 on request	Yes; Class 6B2 mold and fungal spores (excluding fauna); Class 6B3 on request	Yes; Class 6B2 mold and fungal spores (excluding fauna); Class 6B3 on request
- to chemically active substances according to EN 60721-3-6	Yes; Class 6C3 (RH < 75 %) incl. salt spray acc. to EN 60068-2-52 (severity degree 3); *	Yes; Class 6C3 (RH < 75 %) incl. salt spray acc. to EN 60068-2-52 (severity degree 3); *	Yes; Class 6C3 (RH < 75 %) incl. salt spray acc. to EN 60068-2-52 (severity degree 3); *	Yes; Class 6C3 (RH < 75 %) incl. salt spray acc. to EN 60068-2-52 (severity degree 3); *
- to mechanically active substances according to EN 60721-3-6	Yes; Class 6S3 incl. sand, dust; *	Yes; Class 6S3 incl. sand, dust; *	Yes; Class 6S3 incl. sand, dust; *	Yes; Class 6S3 incl. sand, dust; *
Usage in industrial process technology				
- Against chemically active substances acc. to EN 60654-4	Yes; Class 3 (excluding trichlorethylene)	Yes; Class 3 (excluding trichlorethylene)	Yes; Class 3 (excluding trichlorethylene)	Yes; Class 3 (excluding trichlorethylene)
- Environmental conditions for process, measuring and control systems acc. to ANSI/ISA-71.04	Yes; Level GX group A/B (excluding trichlorethylene; harmful gas concentrations up to the limits of EN 60721-3-3 class 3C4 permissible); level LC3 (salt spray) and level LB3 (oil)	Yes; Level GX group A/B (excluding trichlorethylene; harmful gas concentrations up to the limits of EN 60721-3-3 class 3C4 permissible); level LC3 (salt spray) and level LB3 (oil)	Yes; Level GX group A/B (excluding trichlorethylene; harmful gas concentrations up to the limits of EN 60721-3-3 class 3C4 permissible); level LC3 (salt spray) and level LB3 (oil)	Yes; Level GX group A/B (excluding trichlorethylene; harmful gas concentrations up to the limits of EN 60721-3-3 class 3C4 permissible); level LC3 (salt spray) and level LB3 (oil)
Remark				
- Note regarding classification of environmental conditions acc. to EN 60721, EN 60654-4 and ANSI/ISA-71.04	* The supplied plug covers must remain in place over the unused interfaces during operation!	* The supplied plug covers must remain in place over the unused interfaces during operation!	* The supplied plug covers must remain in place over the unused interfaces during operation!	* The supplied plug covers must remain in place over the unused interfaces during operation!
Conformal coating				
• Coatings for printed circuit board assemblies acc. to EN 61086	Yes; Class 2 for high reliability	Yes; Class 2 for high reliability	Yes; Class 2 for high reliability	Yes; Class 2 for high reliability
• Protection against fouling acc. to EN 60664-3	Yes; Type 1 protection	Yes; Type 1 protection	Yes; Type 1 protection	Yes; Type 1 protection
• Military testing according to MIL-I-46058C, Amendment 7	Yes; Discoloration of coating possible during service life	Yes; Discoloration of coating possible during service life	Yes; Discoloration of coating possible during service life	Yes; Discoloration of coating possible during service life
• Qualification and Performance of Electrical Insulating Compound for Printed Board Assemblies according to IPC-CC-830A	Yes; Conformal coating, Class A	Yes; Conformal coating, Class A	Yes; Conformal coating, Class A	Yes; Conformal coating, Class A

Overview



- Digital inputs as a supplement to the integral I/O of SIMATIC S7-1200 CPUs
- Can be plugged directly into the CPU

Note:

SIPLUS extreme products are based on SIMATIC standard products. The contents listed here were taken from the respective standard products. SIPLUS extreme-specific information was added.

Ordering data

Article No.

SIPLUS SB 1221 digital input signal board

(extended temperature range and exposure to media)

4 inputs, 5 V DC, 200 kHz, sourcing

6AG1221-3AD30-5XB0

4 inputs, 24 V DC, 200 kHz, sourcing

6AG1221-3BD30-5XB0

Accessories

See SIMATIC S7-1200 SB 1221 digital input modules, page 3/52

3

Technical specifications

Article number	6AG1221-3AD30-5XB0	6AG1221-3BD30-5XB0
Based on	6ES7221-3AD30-0XB0 SIPLUS S7-1200 SB 1221 4DI 5VDC	6ES7221-3BD30-0XB0 SIPLUS S7-1200 SB 1221 4DI 24VDC
Ambient conditions		
Ambient temperature during operation		
• min.	-40 °C; = Tmin (incl. condensation/frost); start-up @ -25 °C	-40 °C; = Tmin (incl. condensation/frost); start-up @ -25 °C
• max.	60 °C; = Tmax	60 °C; = Tmax
Altitude during operation relating to sea level		
• Installation altitude above sea level, max.	5 000 m	5 000 m
• Ambient air temperature-barometric pressure-altitude	Tmin ... Tmax at 1 140 hPa ... 795 hPa (-1 000 m ... +2 000 m) // Tmin ... (Tmax - 10 K) at 795 hPa ... 658 hPa (+2 000 m ... +3 500 m) // Tmin ... (Tmax -20 K) at 658 hPa ... 540 hPa (+3 500 m ... +5 000 m)	Tmin ... Tmax at 1 140 hPa ... 795 hPa (-1 000 m ... +2 000 m) // Tmin ... (Tmax - 10 K) at 795 hPa ... 658 hPa (+2 000 m ... +3 500 m) // Tmin ... (Tmax -20 K) at 658 hPa ... 540 hPa (+3 500 m ... +5 000 m)
Relative humidity		
• With condensation, tested in accordance with IEC 60068-2-38, max.	100 %; RH incl. condensation / frost (no commissioning in bedewed state), horizontal installation	100 %; RH incl. condensation / frost (no commissioning in bedewed state), horizontal installation
Resistance		
Coolants and lubricants		
- Resistant to commercially available coolants and lubricants	Yes; Incl. diesel and oil droplets in the air	Yes; Incl. diesel and oil droplets in the air
Use in stationary industrial systems		
- to biologically active substances according to EN 60721-3-3	Yes; Class 3B2 mold, fungus and dry rot spores (with the exception of fauna); Class 3B3 on request	Yes; Class 3B2 mold, fungus and dry rot spores (with the exception of fauna); Class 3B3 on request
- to chemically active substances according to EN 60721-3-3	Yes; Class 3C4 (RH < 75 %) incl. salt spray acc. to EN 60068-2-52 (severity degree 3); *	Yes; Class 3C4 (RH < 75 %) incl. salt spray acc. to EN 60068-2-52 (severity degree 3); *
- to mechanically active substances according to EN 60721-3-3	Yes; Class 3S4 incl. sand, dust, *	Yes; Class 3S4 incl. sand, dust, *

SIMATIC S7-1200 Basic Controllers

I/O modules

SIPLUS digital modules

SIPLUS SB 1221 digital input modules**Technical specifications**

Article number	6AG1221-3AD30-5XB0	6AG1221-3BD30-5XB0
Based on	6ES7221-3AD30-0XB0 SIPLUS S7-1200 SB 1221 4DI 5VDC	6ES7221-3BD30-0XB0 SIPLUS S7-1200 SB 1221 4DI 24VDC
Use on ships/at sea		
- to biologically active substances according to EN 60721-3-6	Yes; Class 6B2 mold and fungal spores (excluding fauna); Class 6B3 on request	Yes; Class 6B2 mold and fungal spores (excluding fauna); Class 6B3 on request
- to chemically active substances according to EN 60721-3-6	Yes; Class 6C3 (RH < 75 %) incl. salt spray acc. to EN 60068-2-52 (severity degree 3); *	Yes; Class 6C3 (RH < 75 %) incl. salt spray acc. to EN 60068-2-52 (severity degree 3); *
- to mechanically active substances according to EN 60721-3-6	Yes; Class 6S3 incl. sand, dust; *	Yes; Class 6S3 incl. sand, dust; *
Usage in industrial process technology		
- Against chemically active substances acc. to EN 60654-4	Yes; Class 3 (excluding trichlorethylene)	Yes; Class 3 (excluding trichlorethylene)
- Environmental conditions for process, measuring and control systems acc. to ANSI/ISA-71.04	Yes; Level GX group A/B (excluding trichlorethylene; harmful gas concentrations up to the limits of EN 60721-3-3 class 3C4 permissible); level LC3 (salt spray) and level LB3 (oil)	Yes; Level GX group A/B (excluding trichlorethylene; harmful gas concentrations up to the limits of EN 60721-3-3 class 3C4 permissible); level LC3 (salt spray) and level LB3 (oil)
Remark		
- Note regarding classification of environmental conditions acc. to EN 60721, EN 60654-4 and ANSI/ISA-71.04	* The supplied plug covers must remain in place over the unused interfaces during operation!	* The supplied plug covers must remain in place over the unused interfaces during operation!
Conformal coating		
• Coatings for printed circuit board assemblies acc. to EN 61086	Yes; Class 2 for high reliability	Yes; Class 2 for high reliability
• Protection against fouling acc. to EN 60664-3	Yes; Type 1 protection	Yes; Type 1 protection
• Military testing according to MIL-I-46058C, Amendment 7	Yes; Discoloration of coating possible during service life	Yes; Discoloration of coating possible during service life
• Qualification and Performance of Electrical Insulating Compound for Printed Board Assemblies according to IPC-CC-830A	Yes; Conformal coating, Class A	Yes; Conformal coating, Class A

Overview



- Digital outputs as a supplement to the integral I/O of the CPUs
- For flexible adaptation of the controller to the corresponding task
- For subsequent expansion of the system with additional outputs
- From +60 °C to +70 °C, max. 50% of the inputs can be controlled simultaneously

Note:

SIPLUS extreme products are based on SIMATIC standard products. The contents listed here were taken from the respective standard products. SIPLUS extreme-specific information was added.

Ordering data

Article No.

SIPLUS SM 1222 digital output signal module

(Extended temperature range and exposure to media)

8 outputs, 24 V DC; 0.5 A, 5 W, isolated

- For areas with exceptional exposure to media (conformal coating)
- -25 ... +70 °C, from +60 ... +70°C number of simultaneously controllable inputs and outputs max. 50%

6AG1222-1BF32-4XB0**6AG1222-1BF32-2XB0**

16 outputs, 24 V DC; 0.5 A, 5 W, isolated

- For areas with exceptional exposure to media (conformal coating)
- -25 ... +70 °C, from +60 ... +70°C number of simultaneously controllable inputs and outputs max. 50%

6AG1222-1BH32-4XB0**6AG1222-1BH32-2XB0**

8 outputs, 5 ... 30 V DC / 5 ... 250 V AC, relay 2 A, 30 W DC/200 W AC

- For areas with exceptional exposure to media (conformal coating)
- -25 ... +70 °C, from +60 ... +70°C number of simultaneously controllable inputs and outputs max. 50%

6AG1222-1HF32-4XB0**6AG1222-1HF32-2XB0**

8 relay outputs, changeover contact, 5 ... 30 V DC / 5 ... 250 V AC, 2 A, 30 W DC / 200 W AC

- For areas with exceptional exposure to media (conformal coating)
- -40 ... +70 °C, from +60 ... +70°C number of simultaneously controllable inputs and outputs max. 50%

6AG1222-1XF32-4XB0**6AG1222-1XF32-2XB0**

16 outputs, 5 ... 30 V DC / 5 ... 250 V AC, relay 2 A, 30 W DC/200 W AC

- For areas with exceptional exposure to media (conformal coating)
- -25 ... +70 °C, from +60 ... +70°C number of simultaneously controllable inputs and outputs max. 50%

6AG1222-1HH32-4XB0**6AG1222-1HH32-2XB0****Accessories**

See SIMATIC S7-1200 SM 1222 digital output module, page 3/54

SIMATIC S7-1200 Basic Controllers

I/O modules

SIPLUS digital modules

SIPLUS SM 1222 digital output modules

Technical specifications

Article number	6AG1222-1BF32-2XB0	6AG1222-1BF32-4XB0	6AG1222-1BH32-2XB0	6AG1222-1BH32-4XB0
Based on	6ES7222-1BF32-0XB0 SIPLUS S7-1200 SM 1222 8DQ	6ES7222-1BF32-0XB0 SIPLUS S7-1200 SM 1222 8DQ	6ES7222-1BH32-0XB0 SIPLUS S7-1200 SM 1222 16DQ	6ES7222-1BH32-0XB0 SIPLUS S7-1200 SM 1222 16DQ
Ambient conditions				
Ambient temperature during operation				
• min.	-40 °C; = Tmin (incl. condensation/frost); start-up @ -25 °C	-20 °C; = Tmin (incl. condensation/frost); start-up @ 0 °C	-40 °C; = Tmin (incl. condensation/frost); start-up @ -25 °C	-20 °C; = Tmin (incl. condensation/frost); start-up @ 0 °C
• max.	70 °C; = Tmax; Tmax > +60 °C number of simultaneously activated outputs 4 (no adjacent points) for horizontal mounting position	60 °C; = Tmax	70 °C; = Tmax; Tmax > +60 °C number of simultaneously activated outputs 8 (no adjacent points) for horizontal mounting position	60 °C; = Tmax
• At cold restart, min.	-25 °C	0 °C	-25 °C	0 °C
Altitude during operation relating to sea level				
• Installation altitude above sea level, max.	5 000 m	5 000 m	5 000 m	5 000 m
• Ambient air temperature-barometric pressure-altitude	Tmin ... Tmax at 1 140 hPa ... 795 hPa (-1 000 m ... +2 000 m) // Tmin ... (Tmax - 10 K) at 795 hPa ... 658 hPa (+2 000 m ... +3 500 m) // Tmin ... (Tmax -20 K) at 658 hPa ... 540 hPa (+3 500 m ... +5 000 m)	Tmin ... Tmax at 1 140 hPa ... 795 hPa (-1 000 m ... +2 000 m) // Tmin ... (Tmax - 10 K) at 795 hPa ... 658 hPa (+2 000 m ... +3 500 m) // Tmin ... (Tmax -20 K) at 658 hPa ... 540 hPa (+3 500 m ... +5 000 m)	Tmin ... Tmax at 1 140 hPa ... 795 hPa (-1 000 m ... +2 000 m) // Tmin ... (Tmax - 10 K) at 795 hPa ... 658 hPa (+2 000 m ... +3 500 m) // Tmin ... (Tmax -20 K) at 658 hPa ... 540 hPa (+3 500 m ... +5 000 m)	Tmin ... Tmax at 1 140 hPa ... 795 hPa (-1 000 m ... +2 000 m) // Tmin ... (Tmax - 10 K) at 795 hPa ... 658 hPa (+2 000 m ... +3 500 m) // Tmin ... (Tmax -20 K) at 658 hPa ... 540 hPa (+3 500 m ... +5 000 m)
Relative humidity				
• With condensation, tested in accordance with IEC 60068-2-38, max.	100 %; RH incl. condensation/frost (no commissioning under condensation conditions)	100 %; RH incl. condensation/frost (no commissioning under condensation conditions)	100 %; RH incl. condensation/frost (no commissioning under condensation conditions)	100 %; RH incl. condensation/frost (no commissioning under condensation conditions)
Resistance				
Coolants and lubricants				
- Resistant to commercially available coolants and lubricants	Yes; Incl. diesel and oil droplets in the air	Yes; Incl. diesel and oil droplets in the air	Yes; Incl. diesel and oil droplets in the air	Yes; Incl. diesel and oil droplets in the air
Use in stationary industrial systems				
- to biologically active substances according to EN 60721-3-3	Yes; Class 3B2 mold, fungus and dry rot spores (with the exception of fauna); Class 3B3 on request	Yes; Class 3B2 mold, fungus and dry rot spores (with the exception of fauna); Class 3B3 on request	Yes; Class 3B2 mold, fungus and dry rot spores (with the exception of fauna); Class 3B3 on request	Yes; Class 3B2 mold, fungus and dry rot spores (with the exception of fauna); Class 3B3 on request
- to chemically active substances according to EN 60721-3-3	Yes; Class 3C4 (RH < 75 %) incl. salt spray acc. to EN 60068-2-52 (severity degree 3); *	Yes; Class 3C4 (RH < 75 %) incl. salt spray acc. to EN 60068-2-52 (severity degree 3); *	Yes; Class 3C4 (RH < 75 %) incl. salt spray acc. to EN 60068-2-52 (severity degree 3); *	Yes; Class 3C4 (RH < 75 %) incl. salt spray acc. to EN 60068-2-52 (severity degree 3); *
- to mechanically active substances according to EN 60721-3-3	Yes; Class 3S4 incl. sand, dust, *	Yes; Class 3S4 incl. sand, dust, *	Yes; Class 3S4 incl. sand, dust, *	Yes; Class 3S4 incl. sand, dust, *
Use on ships/at sea				
- to biologically active substances according to EN 60721-3-6	Yes; Class 6B2 mold and fungal spores (excluding fauna); Class 6B3 on request	Yes; Class 6B2 mold and fungal spores (excluding fauna); Class 6B3 on request	Yes; Class 6B2 mold and fungal spores (excluding fauna); Class 6B3 on request	Yes; Class 6B2 mold and fungal spores (excluding fauna); Class 6B3 on request
- to chemically active substances according to EN 60721-3-6	Yes; Class 6C3 (RH < 75 %) incl. salt spray acc. to EN 60068-2-52 (severity degree 3); *	Yes; Class 6C3 (RH < 75 %) incl. salt spray acc. to EN 60068-2-52 (severity degree 3); *	Yes; Class 6C3 (RH < 75 %) incl. salt spray acc. to EN 60068-2-52 (severity degree 3); *	Yes; Class 6C3 (RH < 75 %) incl. salt spray acc. to EN 60068-2-52 (severity degree 3); *
- to mechanically active substances according to EN 60721-3-6	Yes; Class 6S3 incl. sand, dust; *	Yes; Class 6S3 incl. sand, dust; *	Yes; Class 6S3 incl. sand, dust; *	Yes; Class 6S3 incl. sand, dust; *

Technical specifications

Article number	6AG1222-1BF32-2XB0	6AG1222-1BF32-4XB0	6AG1222-1BH32-2XB0	6AG1222-1BH32-4XB0
Based on	6ES7222-1BF32-0XB0 SIPLUS S7-1200 SM 1222 8DQ	6ES7222-1BF32-0XB0 SIPLUS S7-1200 SM 1222 8DQ	6ES7222-1BH32-0XB0 SIPLUS S7-1200 SM 1222 16DQ	6ES7222-1BH32-0XB0 SIPLUS S7-1200 SM 1222 16DQ
Usage in industrial process technology	<ul style="list-style-type: none"> Against chemically active substances acc. to EN 60654-4 Environmental conditions for process, measuring and control systems acc. to ANSI/ISA-71.04 	<ul style="list-style-type: none"> Against chemically active substances acc. to EN 60654-4 Environmental conditions for process, measuring and control systems acc. to ANSI/ISA-71.04 	<ul style="list-style-type: none"> Against chemically active substances acc. to EN 60654-4 Environmental conditions for process, measuring and control systems acc. to ANSI/ISA-71.04 	<ul style="list-style-type: none"> Against chemically active substances acc. to EN 60654-4 Environmental conditions for process, measuring and control systems acc. to ANSI/ISA-71.04
Remark	* The supplied plug covers must remain in place over the unused interfaces during operation!	* The supplied plug covers must remain in place over the unused interfaces during operation!	* The supplied plug covers must remain in place over the unused interfaces during operation!	* The supplied plug covers must remain in place over the unused interfaces during operation!
Conformal coating	<ul style="list-style-type: none"> Coatings for printed circuit board assemblies acc. to EN 61086 Protection against fouling acc. to EN 60664-3 Military testing according to MIL-I-46058C, Amendment 7 Qualification and Performance of Electrical Insulating Compound for Printed Board Assemblies according to IPC-CC-830A 	<ul style="list-style-type: none"> Coatings for printed circuit board assemblies acc. to EN 61086 Protection against fouling acc. to EN 60664-3 Military testing according to MIL-I-46058C, Amendment 7 Qualification and Performance of Electrical Insulating Compound for Printed Board Assemblies according to IPC-CC-830A 	<ul style="list-style-type: none"> Coatings for printed circuit board assemblies acc. to EN 61086 Protection against fouling acc. to EN 60664-3 Military testing according to MIL-I-46058C, Amendment 7 Qualification and Performance of Electrical Insulating Compound for Printed Board Assemblies according to IPC-CC-830A 	<ul style="list-style-type: none"> Coatings for printed circuit board assemblies acc. to EN 61086 Protection against fouling acc. to EN 60664-3 Military testing according to MIL-I-46058C, Amendment 7 Qualification and Performance of Electrical Insulating Compound for Printed Board Assemblies according to IPC-CC-830A
Article number	6AG1222-1HF32-2XB0	6AG1222-1HF32-4XB0	6AG1222-1XF32-2XB0	6AG1222-1XF32-4XB0
Based on	6ES7222-1HF32-0XB0 SIPLUS S7-1200 SM 1222 8DQ RLY	6ES7222-1HF32-0XB0 SIPLUS S7-1200 SM 1222 8DQ RLY	6ES7222-1XF32-0XB0 SIPLUS S7-1200 SM 1222 8DQ RLY	6ES7222-1XF32-0XB0 SIPLUS S7-1200 SM 1222 8DQ RLY
Ambient conditions				
Ambient temperature during operation				
• min.	-40 °C; = Tmin (incl. condensation/frost); start-up @ -25 °C	-20 °C; = Tmin (incl. condensation/frost); start-up @ 0 °C	-40 °C; = Tmin (incl. condensation/frost); start-up @ -25 °C	-20 °C; = Tmin (incl. condensation/frost); start-up @ 0 °C
• max.	70 °C; = Tmax; Tmax > +60 °C number of simultaneously activated outputs 4 (no adjacent points) for horizontal mounting position	60 °C; = Tmax	70 °C; = Tmax; Tmax > +60 °C number of simultaneously activated outputs 4 (no adjacent points) for horizontal mounting position	60 °C; = Tmax
• At cold restart, min.	-25 °C	0 °C	-25 °C	0 °C
Altitude during operation relating to sea level				
• Installation altitude above sea level, max.	2 000 m	2 000 m	2 000 m	2 000 m
• Ambient air temperature-barometric pressure-altitude	Tmin ... Tmax at 1 140 hPa ... 795 hPa (-1 000 m ... +2 000 m) // Tmin ... (Tmax - 10 K) at 795 hPa ... 658 hPa (+2 000 m ... +3 500 m) // Tmin ... (Tmax - 20 K) at 658 hPa ... 540 hPa (+3 500 m ... +5 000 m); above 2 000 m max. 132 V AC	Tmin ... Tmax at 1 140 hPa ... 795 hPa (-1 000 m ... +2 000 m) // Tmin ... (Tmax - 10 K) at 795 hPa ... 658 hPa (+2 000 m ... +3 500 m) // Tmin ... (Tmax - 20 K) at 658 hPa ... 540 hPa (+3 500 m ... +5 000 m); above 2 000 m max. 132 V AC	Tmin ... Tmax at 1 140 hPa ... 795 hPa (-1 000 m ... +2 000 m) // Tmin ... (Tmax - 10 K) at 795 hPa ... 658 hPa (+2 000 m ... +3 500 m) // Tmin ... (Tmax - 20 K) at 658 hPa ... 540 hPa (+3 500 m ... +5 000 m); above 2 000 m max. 132 V AC	Tmin ... Tmax at 1 140 hPa ... 795 hPa (-1 000 m ... +2 000 m) // Tmin ... (Tmax - 10 K) at 795 hPa ... 658 hPa (+2 000 m ... +3 500 m) // Tmin ... (Tmax - 20 K) at 658 hPa ... 540 hPa (+3 500 m ... +5 000 m); above 2 000 m max. 132 V AC
Relative humidity				
• With condensation, tested in accordance with IEC 60068-2-38, max.	100 %; RH incl. condensation/frost (no commissioning under condensation conditions)	100 %; RH incl. condensation/frost (no commissioning under condensation conditions)	100 %; RH incl. condensation/frost (no commissioning under condensation conditions)	100 %; RH incl. condensation/frost (no commissioning under condensation conditions)
Resistance				
Coolants and lubricants				
- Resistant to commercially available coolants and lubricants	Yes; Incl. diesel and oil droplets in the air	Yes; Incl. diesel and oil droplets in the air	Yes; Incl. diesel and oil droplets in the air	Yes; Incl. diesel and oil droplets in the air

SIMATIC S7-1200 Basic Controllers

I/O modules

SIPLUS digital modules

SIPLUS SM 1222 digital output modules

Technical specifications

Article number	6AG1222-1HF32-2XB0	6AG1222-1HF32-4XB0	6AG1222-1XF32-2XB0	6AG1222-1XF32-4XB0
Based on	6ES7222-1HF32-0XB0 SIPLUS S7-1200 SM 1222 8DQ RLY	6ES7222-1HF32-0XB0 SIPLUS S7-1200 SM 1222 8DQ RLY	6ES7222-1XF32-0XB0 SIPLUS S7-1200 SM 1222 8DQ RLY	6ES7222-1XF32-0XB0 SIPLUS S7-1200 SM 1222 8DQ RLY
Use in stationary industrial systems				
- to biologically active substances according to EN 60721-3-3	Yes; Class 3B2 mold, fungus and dry rot spores (with the exception of fauna); Class 3B3 on request	Yes; Class 3B2 mold, fungus and dry rot spores (with the exception of fauna); Class 3B3 on request	Yes; Class 3B2 mold, fungus and dry rot spores (with the exception of fauna); Class 3B3 on request	Yes; Class 3B2 mold, fungus and dry rot spores (with the exception of fauna); Class 3B3 on request
- to chemically active substances according to EN 60721-3-3	Yes; Class 3C4 (RH < 75 %) incl. salt spray acc. to EN 60068-2-52 (severity degree 3); *	Yes; Class 3C4 (RH < 75 %) incl. salt spray acc. to EN 60068-2-52 (severity degree 3); *	Yes; Class 3C4 (RH < 75 %) incl. salt spray acc. to EN 60068-2-52 (severity degree 3); *	Yes; Class 3C4 (RH < 75 %) incl. salt spray acc. to EN 60068-2-52 (severity degree 3); *
- to mechanically active substances according to EN 60721-3-3	Yes; Class 3S4 incl. sand, dust; *	Yes; Class 3S4 incl. sand, dust; *	Yes; Class 3S4 incl. sand, dust; *	Yes; Class 3S4 incl. sand, dust; *
Use on ships/at sea				
- to biologically active substances according to EN 60721-3-6	Yes; Class 6B2 mold and fungal spores (excluding fauna); Class 6B3 on request	Yes; Class 6B2 mold and fungal spores (excluding fauna); Class 6B3 on request	Yes; Class 6B2 mold and fungal spores (excluding fauna); Class 6B3 on request	Yes; Class 6B2 mold and fungal spores (excluding fauna); Class 6B3 on request
- to chemically active substances according to EN 60721-3-6	Yes; Class 6C3 (RH < 75 %) incl. salt spray acc. to EN 60068-2-52 (severity degree 3); *	Yes; Class 6C3 (RH < 75 %) incl. salt spray acc. to EN 60068-2-52 (severity degree 3); *	Yes; Class 6C3 (RH < 75 %) incl. salt spray acc. to EN 60068-2-52 (severity degree 3); *	Yes; Class 6C3 (RH < 75 %) incl. salt spray acc. to EN 60068-2-52 (severity degree 3); *
- to mechanically active substances according to EN 60721-3-6	Yes; Class 6S3 incl. sand, dust; *	Yes; Class 6S3 incl. sand, dust; *	Yes; Class 6S3 incl. sand, dust; *	Yes; Class 6S3 incl. sand, dust; *
Usage in industrial process technology				
- Against chemically active substances acc. to EN 60654-4	Yes; Class 3 (excluding trichlorethylene)	Yes; Class 3 (excluding trichlorethylene)	Yes; Class 3 (excluding trichlorethylene)	Yes; Class 3 (excluding trichlorethylene)
- Environmental conditions for process, measuring and control systems acc. to ANSI/ISA-71.04	Yes; Level GX group A/B (excluding trichlorethylene; harmful gas concentrations up to the limits of EN 60721-3-3 class 3C4 permissible); level LC3 (salt spray) and level LB3 (oil)	Yes; Level GX group A/B (excluding trichlorethylene; harmful gas concentrations up to the limits of EN 60721-3-3 class 3C4 permissible); level LC3 (salt spray) and level LB3 (oil)	Yes; Level GX group A/B (excluding trichlorethylene; harmful gas concentrations up to the limits of EN 60721-3-3 class 3C4 permissible); level LC3 (salt spray) and level LB3 (oil)	Yes; Level GX group A/B (excluding trichlorethylene; harmful gas concentrations up to the limits of EN 60721-3-3 class 3C4 permissible); level LC3 (salt spray) and level LB3 (oil)
Remark				
- Note regarding classification of environmental conditions acc. to EN 60721, EN 60654-4 and ANSI/ISA-71.04	* The supplied plug covers must remain in place over the unused interfaces during operation!	* The supplied plug covers must remain in place over the unused interfaces during operation!	* The supplied plug covers must remain in place over the unused interfaces during operation!	* The supplied plug covers must remain in place over the unused interfaces during operation!
Conformal coating				
• Coatings for printed circuit board assemblies acc. to EN 61086	Yes; Class 2 for high reliability	Yes; Class 2 for high reliability	Yes; Class 2 for high reliability	Yes; Class 2 for high reliability
• Protection against fouling acc. to EN 60664-3	Yes; Type 1 protection	Yes; Type 1 protection	Yes; Type 1 protection	Yes; Type 1 protection
• Military testing according to MIL-I-46058C, Amendment 7	Yes; Discoloration of coating possible during service life	Yes; Discoloration of coating possible during service life	Yes; Discoloration of coating possible during service life	Yes; Discoloration of coating possible during service life
• Qualification and Performance of Electrical Insulating Compound for Printed Board Assemblies according to IPC-CC-830A	Yes; Conformal coating, Class A	Yes; Conformal coating, Class A	Yes; Conformal coating, Class A	Yes; Conformal coating, Class A

Technical specifications

Article number	6AG1222-1HH32-2XB0	6AG1222-1HH32-4XB0
Based on	6ES7222-1HH32-0XB0 SIPLUS S7-1200 SM 1222 16DQ RLY	6ES7222-1HH32-0XB0 SIPLUS S7-1200 SM 1222 16DQ RLY
Ambient conditions		
Ambient temperature during operation		
<ul style="list-style-type: none"> min. max. At cold restart, min. 	-40 °C; = Tmin (incl. condensation/frost); start-up @ -25 °C 70 °C; = Tmax; Tmax > +60 °C number of simultaneously activated outputs 8 (no adjacent points) for horizontal mounting position -25 °C	-20 °C; = Tmin (incl. condensation/frost); start-up @ 0 °C 60 °C; = Tmax 0 °C
Altitude during operation relating to sea level		
<ul style="list-style-type: none"> Installation altitude above sea level, max. Ambient air temperature-barometric pressure-altitude 	2 000 m Tmin ... Tmax at 1 140 hPa ... 795 hPa (-1 000 m ... +2 000 m) // Tmin ... (Tmax - 10 K) at 795 hPa ... 658 hPa (+2 000 m ... +3 500 m) // Tmin ... (Tmax - 20 K) at 658 hPa ... 540 hPa (+3 500 m ... +5 000 m); above 2 000 m max. 132 V AC	2 000 m Tmin ... Tmax at 1 140 hPa ... 795 hPa (-1 000 m ... +2 000 m) // Tmin ... (Tmax - 10 K) at 795 hPa ... 658 hPa (+2 000 m ... +3 500 m) // Tmin ... (Tmax - 20 K) at 658 hPa ... 540 hPa (+3 500 m ... +5 000 m); above 2 000 m max. 132 V AC
Relative humidity		
<ul style="list-style-type: none"> With condensation, tested in accordance with IEC 60068-2-38, max. 	100 %; RH incl. condensation/frost (no commissioning under condensation conditions)	100 %; RH incl. condensation/frost (no commissioning under condensation conditions)
Resistance		
Coolants and lubricants		
<ul style="list-style-type: none"> Resistant to commercially available coolants and lubricants 	Yes; Incl. diesel and oil droplets in the air	Yes; Incl. diesel and oil droplets in the air
Use in stationary industrial systems		
<ul style="list-style-type: none"> to biologically active substances according to EN 60721-3-3 to chemically active substances according to EN 60721-3-3 to mechanically active substances according to EN 60721-3-3 	Yes; Class 3B2 mold, fungus and dry rot spores (with the exception of fauna); Class 3B3 on request Yes; Class 3C4 (RH < 75 %) incl. salt spray acc. to EN 60068-2-52 (severity degree 3); * Yes; Class 3S4 incl. sand, dust, *	Yes; Class 3B2 mold, fungus and dry rot spores (with the exception of fauna); Class 3B3 on request Yes; Class 3C4 (RH < 75 %) incl. salt spray acc. to EN 60068-2-52 (severity degree 3); * Yes; Class 3S4 incl. sand, dust, *
Use on ships/at sea		
<ul style="list-style-type: none"> to biologically active substances according to EN 60721-3-6 to chemically active substances according to EN 60721-3-6 to mechanically active substances according to EN 60721-3-6 	Yes; Class 6B2 mold and fungal spores (excluding fauna); Class 6B3 on request Yes; Class 6C3 (RH < 75 %) incl. salt spray acc. to EN 60068-2-52 (severity degree 3); * Yes; Class 6S3 incl. sand, dust; *	Yes; Class 6B2 mold and fungal spores (excluding fauna); Class 6B3 on request Yes; Class 6C3 (RH < 75 %) incl. salt spray acc. to EN 60068-2-52 (severity degree 3); * Yes; Class 6S3 incl. sand, dust; *
Usage in industrial process technology		
<ul style="list-style-type: none"> Against chemically active substances acc. to EN 60654-4 Environmental conditions for process, measuring and control systems acc. to ANSI/ISA-71.04 	Yes; Class 3 (excluding trichlorethylene) Yes; Level GX group A/B (excluding trichlorethylene; harmful gas concentrations up to the limits of EN 60721-3-3 class 3C4 permissible); level LC3 (salt spray) and level LB3 (oil)	Yes; Class 3 (excluding trichlorethylene) Yes; Level GX group A/B (excluding trichlorethylene; harmful gas concentrations up to the limits of EN 60721-3-3 class 3C4 permissible); level LC3 (salt spray) and level LB3 (oil)
Remark		
<ul style="list-style-type: none"> Note regarding classification of environmental conditions acc. to EN 60721, EN 60654-4 and ANSI/ISA-71.04 	* The supplied plug covers must remain in place over the unused interfaces during operation!	* The supplied plug covers must remain in place over the unused interfaces during operation!
Conformal coating		
<ul style="list-style-type: none"> Coatings for printed circuit board assemblies acc. to EN 61086 Protection against fouling acc. to EN 60664-3 Military testing according to MIL-I-46058C, Amendment 7 Qualification and Performance of Electrical Insulating Compound for Printed Board Assemblies according to IPC-CC-830A 	Yes; Class 2 for high reliability Yes; Type 1 protection Yes; Discoloration of coating possible during service life Yes; Conformal coating, Class A	Yes; Class 2 for high reliability Yes; Type 1 protection Yes; Discoloration of coating possible during service life Yes; Conformal coating, Class A

SIMATIC S7-1200 Basic Controllers

I/O modules

SIPLUS digital modules

SIPLUS SB 1222 digital output modules

Overview



- Digital outputs as a supplement to the integral I/O of the CPUs
- For flexible adaptation of the controller to the respective task
- For subsequent expansion of the system with additional outputs
- Can be plugged directly into the CPU
- From +60 °C to +70 °C, max. 50% of the inputs can be controlled simultaneously

Note:

SIPLUS extreme products are based on SIMATIC standard products. The contents listed here were taken from the respective standard products. SIPLUS extreme specific information was added.

Ordering data

SIPLUS SB 1222 digital output signal board

(Extended temperature range and exposure to media)

4 outputs, 5 V DC, 0.1 A, 200 kHz

4 outputs, 24 V DC, 0.1 A, 200 kHz

Accessories

Article No.

6AG1222-1AD30-5XB0

6AG1222-1BD30-5XB0

See SIMATIC S7-1200 SB 1222 digital output modules, page 3/57

Technical specifications

Article number	6AG1222-1AD30-5XB0	6AG1222-1BD30-5XB0
Based on	6ES7222-1AD30-0XB0 SIPLUS S7-1200 SB 1222 4DQ 5VDC	6ES7222-1BD30-0XB0 SIPLUS S7-1200 SB 1222 4DQ 24VDC
Ambient conditions		
Ambient temperature during operation		
• min.	-40 °C; = Tmin (incl. condensation/frost); start-up @ -25 °C	-40 °C; = Tmin (incl. condensation/frost); start-up @ -25 °C
• max.	60 °C; = Tmax	60 °C; = Tmax
Altitude during operation relating to sea level		
• Installation altitude above sea level, max.	5 000 m	5 000 m
• Ambient air temperature-barometric pressure-altitude	Tmin ... Tmax at 1 140 hPa ... 795 hPa (-1 000 m ... +2 000 m) // Tmin ... (Tmax - 10 K) at 795 hPa ... 658 hPa (+2 000 m ... +3 500 m) // Tmin ... (Tmax -20 K) at 658 hPa ... 540 hPa (+3 500 m ... +5 000 m)	Tmin ... Tmax at 1 140 hPa ... 795 hPa (-1 000 m ... +2 000 m) // Tmin ... (Tmax - 10 K) at 795 hPa ... 658 hPa (+2 000 m ... +3 500 m) // Tmin ... (Tmax -20 K) at 658 hPa ... 540 hPa (+3 500 m ... +5 000 m)
Relative humidity		
• With condensation, tested in accordance with IEC 60068-2-38, max.	100 %; RH incl. condensation / frost (no commissioning in bedewed state), horizontal installation	100 %; RH incl. condensation / frost (no commissioning in bedewed state), horizontal installation
Resistance		
Coolants and lubricants		
- Resistant to commercially available coolants and lubricants	Yes; Incl. diesel and oil droplets in the air	Yes; Incl. diesel and oil droplets in the air
Use in stationary industrial systems		
- to biologically active substances according to EN 60721-3-3	Yes; Class 3B2 mold, fungus and dry rot spores (with the exception of fauna); Class 3B3 on request	Yes; Class 3B2 mold, fungus and dry rot spores (with the exception of fauna); Class 3B3 on request
- to chemically active substances according to EN 60721-3-3	Yes; Class 3C4 (RH < 75 %) incl. salt spray acc. to EN 60068-2-52 (severity degree 3); *	Yes; Class 3C4 (RH < 75 %) incl. salt spray acc. to EN 60068-2-52 (severity degree 3); *
- to mechanically active substances according to EN 60721-3-3	Yes; Class 3S4 incl. sand, dust, *	Yes; Class 3S4 incl. sand, dust, *
Use on ships/at sea		
- to biologically active substances according to EN 60721-3-6	Yes; Class 6B2 mold and fungal spores (excluding fauna); Class 6B3 on request	Yes; Class 6B2 mold and fungal spores (excluding fauna); Class 6B3 on request
- to chemically active substances according to EN 60721-3-6	Yes; Class 6C3 (RH < 75 %) incl. salt spray acc. to EN 60068-2-52 (severity degree 3); *	Yes; Class 6C3 (RH < 75 %) incl. salt spray acc. to EN 60068-2-52 (severity degree 3); *
- to mechanically active substances according to EN 60721-3-6	Yes; Class 6S3 incl. sand, dust; *	Yes; Class 6S3 incl. sand, dust; *
Usage in industrial process technology		
- Against chemically active substances acc. to EN 60654-4	Yes; Class 3 (excluding trichlorethylene)	Yes; Class 3 (excluding trichlorethylene)
- Environmental conditions for process, measuring and control systems acc. to ANSI/ISA-71.04	Yes; Level GX group A/B (excluding trichlorethylene; harmful gas concentrations up to the limits of EN 60721-3-3 class 3C4 permissible); level LC3 (salt spray) and level LB3 (oil)	Yes; Level GX group A/B (excluding trichlorethylene; harmful gas concentrations up to the limits of EN 60721-3-3 class 3C4 permissible); level LC3 (salt spray) and level LB3 (oil)
Remark		
- Note regarding classification of environmental conditions acc. to EN 60721, EN 60654-4 and ANSI/ISA-71.04	* The supplied plug covers must remain in place over the unused interfaces during operation!	* The supplied plug covers must remain in place over the unused interfaces during operation!
Conformal coating		
• Coatings for printed circuit board assemblies acc. to EN 61086	Yes; Class 2 for high reliability	Yes; Class 2 for high reliability
• Protection against fouling acc. to EN 60664-3	Yes; Type 1 protection	Yes; Type 1 protection
• Military testing according to MIL-I-46058C, Amendment 7	Yes; Discoloration of coating possible during service life	Yes; Discoloration of coating possible during service life
• Qualification and Performance of Electrical Insulating Compound for Printed Board Assemblies according to IPC-CC-830A	Yes; Conformal coating, Class A	Yes; Conformal coating, Class A

SIMATIC S7-1200 Basic Controllers

I/O modules

SIPLUS digital modules

SIPLUS SM 1223 digital input/output modules**Overview**

- Digital inputs and outputs as supplement to the integral I/O of the CPUs
- For flexible adaptation of the controller to the corresponding task
- For subsequent expansion of the system with additional inputs and outputs
- From +60 °C to +70 °C, max. 50% of the inputs can be controlled simultaneously

Note:

SIPLUS extreme products are based on SIMATIC standard products. The contents listed here were taken from the respective standard products. SIPLUS extreme-specific information was added.

Ordering data**Article No.****SIPLUS SM 1223 digital input/output signal module**

(Extended temperature range and exposure to media)

8 inputs, 24 V DC,
IEC type 1 current sinking;
8 x 24 V DC transistor outputs,
0.5 A, 5 W

- For areas with exceptional exposure to media (conformal coating)
- -25 ... +70 °C, from +60 ... +70 °C number of simultaneously controllable inputs and outputs max. 50 %

6AG1223-1BH32-4XB0**6AG1223-1BH32-2XB0**

16 inputs, 24 V DC,
IEC type 1 current sinking;
16 x 24 V DC transistor outputs,
0.5 A, 5 W

- For areas with exceptional exposure to media (conformal coating)
- -25 ... +70 °C, from +60 ... +70 °C number of simultaneously controllable inputs and outputs max. 50 %

6AG1223-1BL32-4XB0**6AG1223-1BL32-2XB0**

8 inputs, 24 V DC,
IEC type 1 current sinking;
8 relay outputs,
5 ... 30 V DC / 5 ... 250 V AC, 2 A,
30 W DC / 200 W AC

- For areas with exceptional exposure to media (conformal coating)
- -25 ... +70 °C, from +60 ... +70 °C number of simultaneously controllable inputs and outputs max. 50 %

6AG1223-1PH32-4XB0**6AG1223-1PH32-2XB0**

16 inputs, 24 V DC,
IEC type 1 current sinking;
16 relay outputs,
5 ... 30 V DC / 5 ... 250 V AC, 2 A,
30 W DC / 200 W AC

- For areas with exceptional exposure to media (conformal coating)
- -25 ... +70 °C, from +60 ... +70 °C number of simultaneously controllable inputs and outputs max. 50 %

6AG1223-1PL32-4XB0**6AG1223-1PL32-2XB0**

8 inputs, 120/230 V AC;
8 relay outputs,
5 ... 30 V DC / 5 ... 250 V AC, 2 A,
30 W DC / 200 W AC

- For areas with exceptional exposure to media (conformal coating)

6AG1223-1QH32-4XB0

-40 ... +70 °C, from +60 ... +70 °C
number of simultaneously controllable inputs and outputs
max. 50%

6AG1223-1QH32-2XB0**Accessories**

See SIMATIC S7-1200
SM 1223 digital input/output
modules, page 3/59

Technical specifications

Article number	6AG1223-1BH32-2XB0	6AG1223-1BH32-4XB0	6AG1223-1PH32-2XB0	6AG1223-1PH32-4XB0
Based on	6ES7223-1BH32-0XB0 SIPLUS S7-1200 SM 1223 8DI/8DQ	6ES7223-1BH32-0XB0 SIPLUS S7-1200 SM 1223 8DI/8DQ	6ES7223-1PH32-0XB0 SIPLUS S7-1200 SM 1223 8DI/8DQ RLY	6ES7223-1PH32-0XB0 SIPLUS S7-1200 SM 1223 8DI/8DQ RLY
Ambient conditions				
Ambient temperature during operation				
• min.	-40 °C; = Tmin (incl. condensation/frost); start-up @ -25 °C	-20 °C; = Tmin (incl. condensation/frost); start-up @ 0 °C	-40 °C; = Tmin (incl. condensation/frost); start-up @ -25 °C	-20 °C; = Tmin (incl. condensation/frost); start-up @ 0 °C
• max.	70 °C; = Tmax; Tmax > +60 °C number of simultaneously activated outputs 4, inputs 4 (no adjacent points) for horizontal mounting position	60 °C; = Tmax	70 °C; = Tmax; Tmax > +60 °C number of simultaneously activated outputs 4, inputs 4 (no adjacent points) for horizontal mounting position	60 °C; = Tmax
• At cold restart, min.	-25 °C	0 °C	-25 °C	0 °C
Altitude during operation relating to sea level				
• Installation altitude above sea level, max.	5 000 m	5 000 m	2 000 m	2 000 m
• Ambient air temperature-barometric pressure-altitude	Tmin ... Tmax at 1 140 hPa ... 795 hPa (-1 000 m ... +2 000 m) // Tmin ... (Tmax - 10 K) at 795 hPa ... 658 hPa (+2 000 m ... +3 500 m) // Tmin ... (Tmax - 20 K) at 658 hPa ... 540 hPa (+3 500 m ... +5 000 m)	Tmin ... Tmax at 1 140 hPa ... 795 hPa (-1 000 m ... +2 000 m) // Tmin ... (Tmax - 10 K) at 795 hPa ... 658 hPa (+2 000 m ... +3 500 m) // Tmin ... (Tmax - 20 K) at 658 hPa ... 540 hPa (+3 500 m ... +5 000 m)	Tmin ... Tmax at 1 140 hPa ... 795 hPa (-1 000 m ... +2 000 m) // Tmin ... (Tmax - 10 K) at 795 hPa ... 658 hPa (+2 000 m ... +3 500 m) // Tmin ... (Tmax - 20 K) at 658 hPa ... 540 hPa (+3 500 m ... +5 000 m); above 2 000 m max. 132 V AC	Tmin ... Tmax at 1 140 hPa ... 795 hPa (-1 000 m ... +2 000 m) // Tmin ... (Tmax - 10 K) at 795 hPa ... 658 hPa (+2 000 m ... +3 500 m) // Tmin ... (Tmax - 20 K) at 658 hPa ... 540 hPa (+3 500 m ... +5 000 m); above 2 000 m max. 132 V AC
Relative humidity				
• With condensation, tested in accordance with IEC 60068-2-38, max.	100 %; RH incl. condensation/frost (no commissioning under condensation conditions)	100 %; RH incl. condensation/frost (no commissioning under condensation conditions)	100 %; RH incl. condensation/frost (no commissioning under condensation conditions)	100 %; RH incl. condensation/frost (no commissioning under condensation conditions)
Resistance				
Coolants and lubricants				
- Resistant to commercially available coolants and lubricants	Yes	Yes	Yes	Yes
Use in stationary industrial systems				
- to biologically active substances according to EN 60721-3-3	Yes; Class 3B2 mold, fungus and dry rot spores (with the exception of fauna); Class 3B3 on request	Yes; Class 3B2 mold, fungus and dry rot spores (with the exception of fauna); Class 3B3 on request	Yes; Class 3B2 mold, fungus and dry rot spores (with the exception of fauna); Class 3B3 on request	Yes; Class 3B2 mold, fungus and dry rot spores (with the exception of fauna); Class 3B3 on request
- to chemically active substances according to EN 60721-3-3	Yes; Class 3C4 (RH < 75 %) incl. salt spray acc. to EN 60068-2-52 (severity degree 3); *	Yes; Class 3C4 (RH < 75 %) incl. salt spray acc. to EN 60068-2-52 (severity degree 3); *	Yes; Class 3C4 (RH < 75 %) incl. salt spray acc. to EN 60068-2-52 (severity degree 3); *	Yes; Class 3C4 (RH < 75 %) incl. salt spray acc. to EN 60068-2-52 (severity degree 3); *
- to mechanically active substances according to EN 60721-3-3	Yes; Class 3S4 incl. sand, dust; *	Yes; Class 3S4 incl. sand, dust; *	Yes; Class 3S4 incl. sand, dust; *	Yes; Class 3S4 incl. sand, dust; *
Use on ships/at sea				
- to biologically active substances according to EN 60721-3-6	Yes; Class 6B2 mold and fungal spores (excluding fauna); Class 6B3 on request	Yes; Class 6B2 mold and fungal spores (excluding fauna); Class 6B3 on request	Yes; Class 6B2 mold and fungal spores (excluding fauna); Class 6B3 on request	Yes; Class 6B2 mold and fungal spores (excluding fauna); Class 6B3 on request
- to chemically active substances according to EN 60721-3-6	Yes; Class 6C3 (RH < 75 %) incl. salt spray acc. to EN 60068-2-52 (severity degree 3); *	Yes; Class 6C3 (RH < 75 %) incl. salt spray acc. to EN 60068-2-52 (severity degree 3); *	Yes; Class 6C3 (RH < 75 %) incl. salt spray acc. to EN 60068-2-52 (severity degree 3); *	Yes; Class 6C3 (RH < 75 %) incl. salt spray acc. to EN 60068-2-52 (severity degree 3); *
- to mechanically active substances according to EN 60721-3-6	Yes; Class 6S3 incl. sand, dust; *	Yes; Class 6S3 incl. sand, dust; *	Yes; Class 6S3 incl. sand, dust; *	Yes; Class 6S3 incl. sand, dust; *

SIMATIC S7-1200 Basic Controllers

I/O modules

SIPLUS digital modules

SIPLUS SM 1223 digital input/output modules

Technical specifications

Article number	6AG1223-1BH32-2XB0	6AG1223-1BH32-4XB0	6AG1223-1PH32-2XB0	6AG1223-1PH32-4XB0
Based on	6ES7223-1BH32-0XB0 SIPLUS S7-1200 SM 1223 8DI/8DQ	6ES7223-1BH32-0XB0 SIPLUS S7-1200 SM 1223 8DI/8DQ	6ES7223-1PH32-0XB0 SIPLUS S7-1200 SM 1223 8DI/8DQ RLY	6ES7223-1PH32-0XB0 SIPLUS S7-1200 SM 1223 8DI/8DQ RLY
Usage in industrial process technology	<ul style="list-style-type: none"> Against chemically active substances acc. to EN 60654-4 Environmental conditions for process, measuring and control systems acc. to ANSI/ISA-71.04 	<ul style="list-style-type: none"> Against chemically active substances acc. to EN 60654-4 Environmental conditions for process, measuring and control systems acc. to ANSI/ISA-71.04 	<ul style="list-style-type: none"> Against chemically active substances acc. to EN 60654-4 Environmental conditions for process, measuring and control systems acc. to ANSI/ISA-71.04 	<ul style="list-style-type: none"> Against chemically active substances acc. to EN 60654-4 Environmental conditions for process, measuring and control systems acc. to ANSI/ISA-71.04
Remark	<ul style="list-style-type: none"> Note regarding classification of environmental conditions acc. to EN 60721, EN 60654-4 and ANSI/ISA-71.04 	<ul style="list-style-type: none"> Note regarding classification of environmental conditions acc. to EN 60721, EN 60654-4 and ANSI/ISA-71.04 	<ul style="list-style-type: none"> Note regarding classification of environmental conditions acc. to EN 60721, EN 60654-4 and ANSI/ISA-71.04 	<ul style="list-style-type: none"> Note regarding classification of environmental conditions acc. to EN 60721, EN 60654-4 and ANSI/ISA-71.04
Conformal coating	<ul style="list-style-type: none"> Coatings for printed circuit board assemblies acc. to EN 61086 Protection against fouling acc. to EN 60664-3 Military testing according to MIL-I-46058C, Amendment 7 Qualification and Performance of Electrical Insulating Compound for Printed Board Assemblies according to IPC-CC-830A 	<ul style="list-style-type: none"> Coatings for printed circuit board assemblies acc. to EN 61086 Protection against fouling acc. to EN 60664-3 Military testing according to MIL-I-46058C, Amendment 7 Qualification and Performance of Electrical Insulating Compound for Printed Board Assemblies according to IPC-CC-830A 	<ul style="list-style-type: none"> Coatings for printed circuit board assemblies acc. to EN 61086 Protection against fouling acc. to EN 60664-3 Military testing according to MIL-I-46058C, Amendment 7 Qualification and Performance of Electrical Insulating Compound for Printed Board Assemblies according to IPC-CC-830A 	<ul style="list-style-type: none"> Coatings for printed circuit board assemblies acc. to EN 61086 Protection against fouling acc. to EN 60664-3 Military testing according to MIL-I-46058C, Amendment 7 Qualification and Performance of Electrical Insulating Compound for Printed Board Assemblies according to IPC-CC-830A
Article number	6AG1223-1PL32-2XB0	6AG1223-1PL32-4XB0	6AG1223-1BL32-2XB0	6AG1223-1BL32-4XB0
Based on	6ES7223-1PL32-0XB0 SIPLUS S7-1200 SM 1223 16DI/16DQ RLY	6ES7223-1PL32-0XB0 SIPLUS S7-1200 SM 1223 16DI/16DQ RLY	6ES7223-1BL32-0XB0 SIPLUS S7-1200 SM 1223 16DI/16DQ	6ES7223-1BL32-0XB0 SIPLUS S7-1200 SM 1223 16DI/16DQ
Ambient conditions				
Ambient temperature during operation				
• min.	-40 °C; = Tmin (incl. condensation/frost); start-up @ -25 °C	-20 °C; = Tmin (incl. condensation/frost); start-up @ 0 °C	-40 °C; = Tmin (incl. condensation/frost); start-up @ -25 °C	-20 °C; = Tmin (incl. condensation/frost); start-up @ 0 °C
• max.	70 °C; = Tmax; Tmax > +60 °C number of simultaneously activated outputs 8, inputs 8 (no adjacent points) for horizontal mounting position	60 °C; = Tmax	70 °C; = Tmax; Tmax > +60 °C number of simultaneously activated outputs 8, inputs 8 (no adjacent points) for horizontal mounting position	60 °C; = Tmax
• At cold restart, min.	-25 °C	0 °C	-25 °C	0 °C
Altitude during operation relating to sea level				
• Installation altitude above sea level, max.	2 000 m	2 000 m	5 000 m	5 000 m
• Ambient air temperature-barometric pressure-altitude	Tmin ... Tmax at 1 140 hPa ... 795 hPa (-1 000 m ... +2 000 m) // Tmin ... (Tmax - 10 K) at 795 hPa ... 658 hPa (+2 000 m ... +3 500 m) // Tmin ... (Tmax - 20 K) at 658 hPa ... 540 hPa (+3 500 m ... +5 000 m); above 2 000 m max. 132 V AC	Tmin ... Tmax at 1 140 hPa ... 795 hPa (-1 000 m ... +2 000 m) // Tmin ... (Tmax - 10 K) at 795 hPa ... 658 hPa (+2 000 m ... +3 500 m) // Tmin ... (Tmax - 20 K) at 658 hPa ... 540 hPa (+3 500 m ... +5 000 m); above 2 000 m max. 132 V AC	Tmin ... Tmax at 1 140 hPa ... 795 hPa (-1 000 m ... +2 000 m) // Tmin ... (Tmax - 10 K) at 795 hPa ... 658 hPa (+2 000 m ... +3 500 m) // Tmin ... (Tmax - 20 K) at 658 hPa ... 540 hPa (+3 500 m ... +5 000 m)	Tmin ... Tmax at 1 140 hPa ... 795 hPa (-1 000 m ... +2 000 m) // Tmin ... (Tmax - 10 K) at 795 hPa ... 658 hPa (+2 000 m ... +3 500 m) // Tmin ... (Tmax - 20 K) at 658 hPa ... 540 hPa (+3 500 m ... +5 000 m)
Relative humidity				
• With condensation, tested in accordance with IEC 60068-2-38, max.	100 %; RH incl. condensation/frost (no commissioning under condensation conditions)	100 %; RH incl. condensation/frost (no commissioning under condensation conditions)	100 %; RH incl. condensation/frost (no commissioning under condensation conditions)	100 %; RH incl. condensation/frost (no commissioning under condensation conditions)
Resistance				
Coolants and lubricants				
• Resistant to commercially available coolants and lubricants	Yes	Yes	Yes	Yes

Technical specifications

Article number	6AG1223-1PL32-2XB0	6AG1223-1PL32-4XB0	6AG1223-1BL32-2XB0	6AG1223-1BL32-4XB0
Based on	6ES7223-1PL32-0XB0 SIPLUS S7-1200 SM 1223 16DI/16DQ RLY	6ES7223-1PL32-0XB0 SIPLUS S7-1200 SM 1223 16DI/16DQ RLY	6ES7223-1BL32-0XB0 SIPLUS S7-1200 SM 1223 16DI/16DQ	6ES7223-1BL32-0XB0 SIPLUS S7-1200 SM 1223 16DI/16DQ
Use in stationary industrial systems				
- to biologically active substances according to EN 60721-3-3	Yes; Class 3B2 mold, fungus and dry rot spores (with the exception of fauna); Class 3B3 on request	Yes; Class 3B2 mold, fungus and dry rot spores (with the exception of fauna); Class 3B3 on request	Yes; Class 3B2 mold, fungus and dry rot spores (with the exception of fauna); Class 3B3 on request	Yes; Class 3B2 mold, fungus and dry rot spores (with the exception of fauna); Class 3B3 on request
- to chemically active substances according to EN 60721-3-3	Yes; Class 3C4 (RH < 75 %) incl. salt spray acc. to EN 60068-2-52 (severity degree 3); *	Yes; Class 3C4 (RH < 75 %) incl. salt spray acc. to EN 60068-2-52 (severity degree 3); *	Yes; Class 3C4 (RH < 75 %) incl. salt spray acc. to EN 60068-2-52 (severity degree 3); *	Yes; Class 3C4 (RH < 75 %) incl. salt spray acc. to EN 60068-2-52 (severity degree 3); *
- to mechanically active substances according to EN 60721-3-3	Yes; Class 3S4 incl. sand, dust; *	Yes; Class 3S4 incl. sand, dust; *	Yes; Class 3S4 incl. sand, dust; *	Yes; Class 3S4 incl. sand, dust; *
Use on ships/at sea				
- to biologically active substances according to EN 60721-3-6	Yes; Class 6B2 mold and fungal spores (excluding fauna); Class 6B3 on request	Yes; Class 6B2 mold and fungal spores (excluding fauna); Class 6B3 on request	Yes; Class 6B2 mold and fungal spores (excluding fauna); Class 6B3 on request	Yes; Class 6B2 mold and fungal spores (excluding fauna); Class 6B3 on request
- to chemically active substances according to EN 60721-3-6	Yes; Class 6C3 (RH < 75 %) incl. salt spray acc. to EN 60068-2-52 (severity degree 3); *	Yes; Class 6C3 (RH < 75 %) incl. salt spray acc. to EN 60068-2-52 (severity degree 3); *	Yes; Class 6C3 (RH < 75 %) incl. salt spray acc. to EN 60068-2-52 (severity degree 3); *	Yes; Class 6C3 (RH < 75 %) incl. salt spray acc. to EN 60068-2-52 (severity degree 3); *
- to mechanically active substances according to EN 60721-3-6	Yes; Class 6S3 incl. sand, dust; *	Yes; Class 6S3 incl. sand, dust; *	Yes; Class 6S3 incl. sand, dust; *	Yes; Class 6S3 incl. sand, dust; *
Usage in industrial process technology				
- Against chemically active substances acc. to EN 60654-4	Yes; Class 3 (excluding trichlorethylene)	Yes; Class 3 (excluding trichlorethylene)	Yes; Class 3 (excluding trichlorethylene)	Yes; Class 3 (excluding trichlorethylene)
- Environmental conditions for process, measuring and control systems acc. to ANSI/ISA-71.04	Yes; Level GX group A/B (excluding trichlorethylene; harmful gas concentrations up to the limits of EN 60721-3-3 class 3C4 permissible); level LC3 (salt spray) and level LB3 (oil)	Yes; Level GX group A/B (excluding trichlorethylene; harmful gas concentrations up to the limits of EN 60721-3-3 class 3C4 permissible); level LC3 (salt spray) and level LB3 (oil)	Yes; Level GX group A/B (excluding trichlorethylene; harmful gas concentrations up to the limits of EN 60721-3-3 class 3C4 permissible); level LC3 (salt spray) and level LB3 (oil)	Yes; Level GX group A/B (excluding trichlorethylene; harmful gas concentrations up to the limits of EN 60721-3-3 class 3C4 permissible); level LC3 (salt spray) and level LB3 (oil)
Remark				
- Note regarding classification of environmental conditions acc. to EN 60721, EN 60654-4 and ANSI/ISA-71.04	* The supplied plug covers must remain in place over the unused interfaces during operation!	* The supplied plug covers must remain in place over the unused interfaces during operation!	* The supplied plug covers must remain in place over the unused interfaces during operation!	* The supplied plug covers must remain in place over the unused interfaces during operation!
Conformal coating				
• Coatings for printed circuit board assemblies acc. to EN 61086	Yes; Class 2 for high reliability	Yes; Class 2 for high reliability	Yes; Class 2 for high reliability	Yes; Class 2 for high reliability
• Protection against fouling acc. to EN 60664-3	Yes; Type 1 protection	Yes; Type 1 protection	Yes; Type 1 protection	Yes; Type 1 protection
• Military testing according to MIL-I-46058C, Amendment 7	Yes; Discoloration of coating possible during service life	Yes; Discoloration of coating possible during service life	Yes; Discoloration of coating possible during service life	Yes; Discoloration of coating possible during service life
• Qualification and Performance of Electrical Insulating Compound for Printed Board Assemblies according to IPC-CC-830A	Yes; Conformal coating, Class A	Yes; Conformal coating, Class A	Yes; Conformal coating, Class A	Yes; Conformal coating, Class A

SIMATIC S7-1200 Basic Controllers

I/O modules

SIPLUS digital modules

SIPLUS SM 1223 digital input/output modules

Technical specifications

Article number	6AG1223-1QH32-2XB0	6AG1223-1QH32-4XB0
Based on	6ES7223-1QH32-0XB0 SIPLUS S7-1200 SM 1223 8DI AC/8DQ RLY	6ES7223-1QH32-0XB0 SIPLUS S7-1200 SM 1223 8DI AC/8DQ RLY
Ambient conditions		
Ambient temperature during operation		
<ul style="list-style-type: none"> min. max. 	-40 °C; = Tmin (incl. condensation/frost); start-up @ -25 °C 70 °C; = Tmax; Tmax > +60 °C number of simultaneously activated outputs 4, inputs 4 (no adjacent points) for horizontal mounting position	-20 °C; = Tmin (incl. condensation/frost); start-up @ 0 °C 60 °C; = Tmax
Altitude during operation relating to sea level		
<ul style="list-style-type: none"> Installation altitude above sea level, max. Ambient air temperature-barometric pressure-altitude 	5 000 m Tmin ... Tmax at 1 080 hPa ... 795 hPa (-1 000 m ... +2 000 m) // Tmin ... (Tmax - 10 K) at 795 hPa ... 658 hPa (+2 000 m ... +3 500 m) // Tmin ... (Tmax - 20 K) at 658 hPa ... 540 hPa (+3 500 m ... +5 000 m)	Tmin ... Tmax at 1 080 hPa ... 795 hPa (-1 000 m ... +2 000 m) // Tmin ... (Tmax - 10 K) at 795 hPa ... 658 hPa (+2 000 m ... +3 500 m) // Tmin ... (Tmax - 20 K) at 658 hPa ... 540 hPa (+3 500 m ... +5 000 m)
Relative humidity		
<ul style="list-style-type: none"> With condensation, tested in accordance with IEC 60068-2-38, max. 	100 %; RH incl. condensation/frost (no commissioning under condensation conditions)	100 %; RH incl. condensation/frost (no commissioning under condensation conditions)
Resistance		
Coolants and lubricants		
<ul style="list-style-type: none"> Resistant to commercially available coolants and lubricants 	Yes; Incl. diesel and oil droplets in the air	Yes; Incl. diesel and oil droplets in the air
Use in stationary industrial systems		
<ul style="list-style-type: none"> to biologically active substances according to EN 60721-3-3 to chemically active substances according to EN 60721-3-3 to mechanically active substances according to EN 60721-3-3 	Yes; Class 3B2 mold, fungus and dry rot spores (with the exception of fauna); Class 3B3 on request Yes; Class 3C4 (RH < 75 %) incl. salt spray acc. to EN 60068-2-52 (severity degree 3); * Yes; Class 3S4 incl. sand, dust, *	Yes; Class 3B2 mold, fungus and dry rot spores (with the exception of fauna); Class 3B3 on request Yes; Class 3C4 (RH < 75 %) incl. salt spray acc. to EN 60068-2-52 (severity degree 3); * Yes; Class 3S4 incl. sand, dust, *
Use on ships/at sea		
<ul style="list-style-type: none"> to biologically active substances according to EN 60721-3-6 to chemically active substances according to EN 60721-3-6 to mechanically active substances according to EN 60721-3-6 	Yes; Class 6B2 mold and fungal spores (excluding fauna); Class 6B3 on request Yes; Class 6C3 (RH < 75 %) incl. salt spray acc. to EN 60068-2-52 (severity degree 3); * Yes; Class 6S3 incl. sand, dust; *	Yes; Class 6B2 mold and fungal spores (excluding fauna); Class 6B3 on request Yes; Class 6C3 (RH < 75 %) incl. salt spray acc. to EN 60068-2-52 (severity degree 3); * Yes; Class 6S3 incl. sand, dust; *
Usage in industrial process technology		
<ul style="list-style-type: none"> Against chemically active substances acc. to EN 60654-4 Environmental conditions for process, measuring and control systems acc. to ANSI/ISA-71.04 	Yes; Class 3 (excluding trichlorethylene) Yes; Level GX group A/B (excluding trichlorethylene; harmful gas concentrations up to the limits of EN 60721-3-3 class 3C4 permissible); level LC3 (salt spray) and level LB3 (oil)	Yes; Class 3 (excluding trichlorethylene) Yes; Level GX group A/B (excluding trichlorethylene; harmful gas concentrations up to the limits of EN 60721-3-3 class 3C4 permissible); level LC3 (salt spray) and level LB3 (oil)
Remark		
<ul style="list-style-type: none"> Note regarding classification of environmental conditions acc. to EN 60721, EN 60654-4 and ANSI/ISA-71.04 	* The supplied plug covers must remain in place over the unused interfaces during operation!	* The supplied plug covers must remain in place over the unused interfaces during operation!
Conformal coating		
<ul style="list-style-type: none"> Coatings for printed circuit board assemblies acc. to EN 61086 Protection against fouling acc. to EN 60664-3 Military testing according to MIL-I-46058C, Amendment 7 Qualification and Performance of Electrical Insulating Compound for Printed Board Assemblies according to IPC-CC-830A 	Yes; Class 2 for high reliability Yes; Type 1 protection Yes; Discoloration of coating possible during service life Yes; Conformal coating, Class A	Yes; Class 2 for high reliability Yes; Type 1 protection Yes; Discoloration of coating possible during service life Yes; Conformal coating, Class A

Overview



- Digital inputs and outputs as supplement to the integral I/O of the SIPLUS S7-1200 CPUs
- Can be plugged directly into the CPU (cannot be used for +70 °C version)

Note:

SIPLUS extreme products are based on SIMATIC standard products. The contents listed here were taken from the respective standard products. SIPLUS extreme-specific information was added.

Ordering data

Article No.

SIPLUS SB 1223 digital input/output signal board

(Extended temperature range and exposure to media)

2 inputs, 24 V DC,
IEC type 1 current sinking;
2 x 24 V DC transistor outputs,
0.5 A, 5 W;
can be used as HSC at
up to 30 kHz

- Suitable for areas with extreme exposure to media (conformal coating)
- Ambient temperature
-25 ... +55 °C

2 inputs, 5 V DC, 200 kHz
2 outputs 5 V DC, 0.1 A, 200 kHz

2 inputs, 24 V DC, 200 kHz
2 outputs 24 V DC, 0.1 A, 200 kHz

Accessories

6AG1223-0BD30-4XB0

6AG1223-0BD30-5XB0

6AG1223-3AD30-5XB0

6AG1223-3BD30-5XB0

See SIMATIC S7-1200
SB 1223 digital input/output modules,
page 3/63

3

Technical specifications

Article number	6AG1223-0BD30-4XB0	6AG1223-0BD30-5XB0	6AG1223-3AD30-5XB0	6AG1223-3BD30-5XB0
Based on	6ES7223-0BD30-0XB0	6ES7223-0BD30-0XB0	6ES7223-3AD30-0XB0	6ES7223-3BD30-0XB0
	SIPLUS S7-1200 SB 1223 2DI/2DQ 24VDC	SIPLUS S7-1200 SB 1223 2DI/2DQ 24VDC	SIPLUS S7-1200 SB 1223 2DI/2DQ 5VDC	SIPLUS S7-1200 SB 1223 2DI/2DQ, 24VDC
Ambient conditions				
Ambient temperature during operation				
• min.	-20 °C; = Tmin (incl. condensation/frost)	-40 °C; = Tmin (incl. condensation/frost); start-up @ -25 °C	-40 °C; = Tmin (incl. condensation/frost); start-up @ -25 °C	-40 °C; = Tmin (incl. condensation/frost); start-up @ -25 °C
• max.	60 °C; = Tmax	60 °C; = Tmax	60 °C; = Tmax	60 °C; = Tmax
Altitude during operation relating to sea level				
• Installation altitude above sea level, max.	5 000 m	5 000 m	5 000 m	5 000 m
• Ambient air temperature-barometric pressure-altitude	Tmin ... Tmax at 1 140 hPa ... 795 hPa (-1 000 m ... +2 000 m) // Tmin ... (Tmax - 10 K) at 795 hPa ... 658 hPa (+2 000 m ... +3 500 m) // Tmin ... (Tmax -20 K) at 658 hPa ... 540 hPa (+3 500 m ... +5 000 m)	Tmin ... Tmax at 1 140 hPa ... 795 hPa (-1 000 m ... +2 000 m) // Tmin ... (Tmax - 10 K) at 795 hPa ... 658 hPa (+2 000 m ... +3 500 m) // Tmin ... (Tmax -20 K) at 658 hPa ... 540 hPa (+3 500 m ... +5 000 m)	Tmin ... Tmax at 1 140 hPa ... 795 hPa (-1 000 m ... +2 000 m) // Tmin ... (Tmax - 10 K) at 795 hPa ... 658 hPa (+2 000 m ... +3 500 m) // Tmin ... (Tmax -20 K) at 658 hPa ... 540 hPa (+3 500 m ... +5 000 m)	Tmin ... Tmax at 1 140 hPa ... 795 hPa (-1 000 m ... +2 000 m) // Tmin ... (Tmax - 10 K) at 795 hPa ... 658 hPa (+2 000 m ... +3 500 m) // Tmin ... (Tmax -20 K) at 658 hPa ... 540 hPa (+3 500 m ... +5 000 m)
Relative humidity				
• With condensation, tested in accordance with IEC 60068-2-38, max.	100 %; RH incl. condensation/frost permitted (no commissioning in bedewed state)	100 %; RH incl. condensation / frost (no commissioning in bedewed state), horizontal installation	100 %; RH incl. condensation / frost (no commissioning in bedewed state), horizontal installation	100 %; RH incl. condensation / frost (no commissioning in bedewed state), horizontal installation

SIMATIC S7-1200 Basic Controllers

I/O modules

SIPLUS digital modules

SIPLUS SB 1223 digital input/output modules

Technical specifications

Article number	6AG1223-0BD30-4XB0	6AG1223-0BD30-5XB0	6AG1223-3AD30-5XB0	6AG1223-3BD30-5XB0
Based on	6ES7223-0BD30-0XB0 SIPLUS S7-1200 SB 1223 2DI/2DQ 24VDC	6ES7223-0BD30-0XB0 SIPLUS S7-1200 SB 1223 2DI/2DQ 24VDC	6ES7223-3AD30-0XB0 SIPLUS S7-1200 SB 1223 2DI/2DQ 5VDC	6ES7223-3BD30-0XB0 SIPLUS S7-1200 SB 1223 2DI/2DQ, 24VDC
Resistance				
Coolants and lubricants				
- Resistant to commercially available coolants and lubricants	Yes; Incl. diesel and oil droplets in the air	Yes; Incl. diesel and oil droplets in the air	Yes; Incl. diesel and oil droplets in the air	Yes; Incl. diesel and oil droplets in the air
Use in stationary industrial systems				
- to biologically active substances according to EN 60721-3-3	Yes; Class 3B2 mold, fungus and dry rot spores (with the exception of fauna); Class 3B3 on request	Yes; Class 3B2 mold, fungus and dry rot spores (with the exception of fauna); Class 3B3 on request	Yes; Class 3B2 mold, fungus and dry rot spores (with the exception of fauna); Class 3B3 on request	Yes; Class 3B2 mold, fungus and dry rot spores (with the exception of fauna); Class 3B3 on request
- to chemically active substances according to EN 60721-3-3	Yes; Class 3C4 (RH < 75 %) incl. salt spray acc. to EN 60068-2-52 (severity degree 3); *	Yes; Class 3C4 (RH < 75 %) incl. salt spray acc. to EN 60068-2-52 (severity degree 3); *	Yes; Class 3C4 (RH < 75 %) incl. salt spray acc. to EN 60068-2-52 (severity degree 3); *	Yes; Class 3C4 (RH < 75 %) incl. salt spray acc. to EN 60068-2-52 (severity degree 3); *
- to mechanically active substances according to EN 60721-3-3	Yes; Class 3S4 incl. sand, dust; *	Yes; Class 3S4 incl. sand, dust; *	Yes; Class 3S4 incl. sand, dust; *	Yes; Class 3S4 incl. sand, dust; *
Use on ships/at sea				
- to biologically active substances according to EN 60721-3-6	Yes; Class 6B2 mold and fungal spores (excluding fauna); Class 6B3 on request	Yes; Class 6B2 mold and fungal spores (excluding fauna); Class 6B3 on request	Yes; Class 6B2 mold and fungal spores (excluding fauna); Class 6B3 on request	Yes; Class 6B2 mold and fungal spores (excluding fauna); Class 6B3 on request
- to chemically active substances according to EN 60721-3-6	Yes; Class 6C3 (RH < 75 %) incl. salt spray acc. to EN 60068-2-52 (severity degree 3); *	Yes; Class 6C3 (RH < 75 %) incl. salt spray acc. to EN 60068-2-52 (severity degree 3); *	Yes; Class 6C3 (RH < 75 %) incl. salt spray acc. to EN 60068-2-52 (severity degree 3); *	Yes; Class 6C3 (RH < 75 %) incl. salt spray acc. to EN 60068-2-52 (severity degree 3); *
- to mechanically active substances according to EN 60721-3-6	Yes; Class 6S3 incl. sand, dust; *	Yes; Class 6S3 incl. sand, dust; *	Yes; Class 6S3 incl. sand, dust; *	Yes; Class 6S3 incl. sand, dust; *
Usage in industrial process technology				
- Against chemically active substances acc. to EN 60654-4	Yes; Class 3 (excluding trichlorethylene)	Yes; Class 3 (excluding trichlorethylene)	Yes; Class 3 (excluding trichlorethylene)	Yes; Class 3 (excluding trichlorethylene)
- Environmental conditions for process, measuring and control systems acc. to ANSI/ISA-71.04	Yes; Level GX group A/B (excluding trichlorethylene; harmful gas concentrations up to the limits of EN 60721-3-3 class 3C4 permissible); level LC3 (salt spray) and level LB3 (oil)	Yes; Level GX group A/B (excluding trichlorethylene; harmful gas concentrations up to the limits of EN 60721-3-3 class 3C4 permissible); level LC3 (salt spray) and level LB3 (oil)	Yes; Level GX group A/B (excluding trichlorethylene; harmful gas concentrations up to the limits of EN 60721-3-3 class 3C4 permissible); level LC3 (salt spray) and level LB3 (oil)	Yes; Level GX group A/B (excluding trichlorethylene; harmful gas concentrations up to the limits of EN 60721-3-3 class 3C4 permissible); level LC3 (salt spray) and level LB3 (oil)
Remark				
- Note regarding classification of environmental conditions acc. to EN 60721, EN 60654-4 and ANSI/ISA-71.04	* The supplied plug covers must remain in place over the unused interfaces during operation!	* The supplied plug covers must remain in place over the unused interfaces during operation!	* The supplied plug covers must remain in place over the unused interfaces during operation!	* The supplied plug covers must remain in place over the unused interfaces during operation!
Conformal coating				
• Coatings for printed circuit board assemblies acc. to EN 61086	Yes; Class 2 for high reliability	Yes; Class 2 for high reliability	Yes; Class 2 for high reliability	Yes; Class 2 for high reliability
• Protection against fouling acc. to EN 60664-3	Yes; Type 1 protection	Yes; Type 1 protection	Yes; Type 1 protection	Yes; Type 1 protection
• Military testing according to MIL-I-46058C, Amendment 7	Yes; Discoloration of coating possible during service life	Yes; Discoloration of coating possible during service life	Yes; Discoloration of coating possible during service life	Yes; Discoloration of coating possible during service life
• Qualification and Performance of Electrical Insulating Compound for Printed Board Assemblies according to IPC-CC-830A	Yes; Conformal coating, Class A	Yes; Conformal coating, Class A	Yes; Conformal coating, Class A	Yes; Conformal coating, Class A

Overview



- Analog inputs for SIMATIC S7-1200
- Extremely short conversion times
- For the connection of analog sensors without additional amplifiers
- For solving even more complex automation tasks

Ordering data

Article No.

SM 1231 analog input signal module

4 analog inputs, $\pm 10V$, $\pm 5V$, $\pm 2.5V$, or 0 ... 20 mA, 16 bits

6ES7231-5ND32-0XB0

4 analog inputs, $\pm 10V$, $\pm 5V$, $\pm 2.5V$, or 0 ... 20 mA, 12 bits + sign

6ES7231-4HD32-0XB0

8 analog inputs, $\pm 10V$, $\pm 5V$, $\pm 2.5V$, or 0 ... 20 mA, 12 bits + sign

6ES7231-4HF32-0XB0

Extension cable for two-tier configuration

6ES7290-6AA30-0XA0

For connecting digital/analog signal modules; length 2 m

Terminal block (spare part)

For 6ES7231-5ND32-0XB0,
6ES7231-4HD32-0XB0,
6ES7231-4HF32-0XB0

- 7-pin, gold-plated; 4 units
- Screw-type system
- Push-in system

6ES7292-1BG30-0XA0

6ES7292-2BG30-0XA0

Front flap set (spare part)

For modules with a width of 45 mm

6ES7291-1BA30-0XA0

Technical specifications

Article number	6ES7231-4HD32-0XB0	6ES7231-4HF32-0XB0	6ES7231-5ND32-0XB0
	Analog Input SM 1231, 4AI	Analog Input SM 1231, 8AI	Analog Input SM 1231, 4AI 16bit
General information			
Product type designation	SM 1231, AI 4x13 bit	SM 1231, AI 8x13 bit	SM 1231, AI 4x16 bit
Supply voltage			
Rated value (DC)	24 V	24 V	24 V
Input current			
Current consumption, typ.	45 mA	45 mA	65 mA
from backplane bus 5 V DC, typ.	80 mA	90 mA	80 mA
Analog inputs			
Number of analog inputs	4; Current or voltage differential inputs	8; Current or voltage differential inputs	4; Current or voltage differential inputs
permissible input voltage for voltage input (destruction limit), max.	35 V	35 V	$\pm 35 V$
permissible input current for current input (destruction limit), max.	40 mA	40 mA	40 mA
Cycle time (all channels) max.	625 μs	625 μs	100 μs
Input ranges			
• Voltage	Yes; $\pm 10V$, $\pm 5V$, $\pm 2.5V$	Yes; $\pm 10V$, $\pm 5V$, $\pm 2.5V$	Yes; $\pm 10V$, $\pm 5V$, $\pm 2.5V$ or $\pm 1.25V$
• Current	Yes; 4 to 20 mA, 0 to 20 mA	Yes; 4 to 20 mA, 0 to 20 mA	Yes; 4 to 20 mA, 0 to 20 mA
• Thermocouple	No	No	No
• Resistance thermometer	No	No	No
• Resistance	No	Yes	No
Input ranges (rated values), voltages			
• -1.25 V to +1.25 V			Yes
• -10 V to +10 V	Yes	Yes	Yes
• -2.5 V to +2.5 V	Yes	Yes	Yes
• -5 V to +5 V	Yes	Yes	Yes
Input ranges (rated values), currents			
• 0 to 20 mA	Yes	Yes	Yes
• 4 mA to 20 mA	Yes	Yes	Yes
Thermocouple (TC)			
Temperature compensation		No	
- parameterizable			

SIMATIC S7-1200 Basic Controllers

I/O modules

Analog modules

SM 1231 analog input modules

Technical specifications

Article number	6ES7231-4HD32-0XB0 Analog Input SM 1231, 4AI	6ES7231-4HF32-0XB0 Analog Input SM 1231, 8AI	6ES7231-5ND32-0XB0 Analog Input SM 1231, 4AI 16bit
Analog value generation for the inputs			
Integration and conversion time/resolution per channel			
<ul style="list-style-type: none"> Resolution with overrange (bit including sign), max. 	12 bit; + sign	12 bit; + sign	15 bit; + sign
<ul style="list-style-type: none"> Integration time, parameterizable 	Yes	Yes	Yes
<ul style="list-style-type: none"> Interference voltage suppression for interference frequency f_1 in Hz 	40 dB, DC to 60 V for interference frequency 50 / 60 Hz	40 dB, DC to 60 V for interference frequency 50 / 60 Hz	40 dB, DC to 60 V for interference frequency 50 / 60 Hz
Smoothing of measured values			
<ul style="list-style-type: none"> parameterizable 	Yes	Yes	Yes
Errors/accuracies			
Temperature error (relative to input range), (+/-)	25 °C \pm 0.1%, to 55 °C \pm 0.2% total measurement range	25 °C \pm 0.1%, to 55 °C \pm 0.2% total measurement range	25 °C \pm 0.1% / \pm 0.3% total measurement range
Basic error limit (operational limit at 25 °C)			
<ul style="list-style-type: none"> Voltage, relative to input range, (+/-) 	0.1 %	0.1 %	0.1 %
<ul style="list-style-type: none"> Current, relative to input range, (+/-) 	0.1 %	0.1 %	0.1 %
Interference voltage suppression for $f = n \times (f_1 \pm 1 \%)$, $f_1 =$ interference frequency			
<ul style="list-style-type: none"> Common mode voltage, max. 	12 V	12 V	12 V
Interrupts/diagnostics/status information			
Alarms	Yes	Yes	Yes
Diagnostics function	Yes	Yes	Yes
Alarms			
<ul style="list-style-type: none"> Diagnostic alarm 	Yes	Yes	Yes
Diagnoses			
<ul style="list-style-type: none"> Monitoring the supply voltage 	Yes	Yes	Yes
<ul style="list-style-type: none"> Wire-break 	Yes	Yes	Yes
Diagnostics indication LED			
<ul style="list-style-type: none"> for status of the inputs 	Yes	Yes	Yes
<ul style="list-style-type: none"> for maintenance 	Yes	Yes	Yes
Degree and class of protection			
IP degree of protection	IP20	IP20	IP20
Standards, approvals, certificates			
CE mark	Yes	Yes	Yes
CSA approval	Yes	Yes	Yes
UL approval	Yes	Yes	Yes
cULus	Yes	Yes	Yes
FM approval	Yes	Yes	Yes
RCM (formerly C-TICK)	Yes	Yes	Yes
KC approval	Yes	Yes	Yes
Marine approval	Yes	Yes	Yes

Technical specifications

Article number	6ES7231-4HD32-0XB0	6ES7231-4HF32-0XB0	6ES7231-5ND32-0XB0
	Analog Input SM 1231, 4AI	Analog Input SM 1231, 8AI	Analog Input SM 1231, 4AI 16bit
Ambient conditions			
Ambient temperature during operation			
• min.	-20 °C	-20 °C	-20 °C
• max.	60 °C	60 °C	60 °C
Pollutant concentrations			
• SO ₂ at RH < 60% without condensation	SO ₂ : < 0.5 ppm; H ₂ S: < 0.1 ppm; RH < 60% condensation-free	SO ₂ : < 0.5 ppm; H ₂ S: < 0.1 ppm; RH < 60% condensation-free	SO ₂ : < 0.5 ppm; H ₂ S: < 0.1 ppm; RH < 60% condensation-free
connection method / header			
required front connector	Yes	Yes	Yes
Mechanics/material			
Enclosure material (front)			
• Plastic	Yes	Yes	Yes
Dimensions			
Width	45 mm	45 mm	45 mm
Height	100 mm	100 mm	100 mm
Depth	75 mm	75 mm	75 mm
Weights			
Weight, approx.	180 g	180 g	180 g

SIMATIC S7-1200 Basic Controllers

I/O modules

Analog modules

SB 1231 analog input modules

Overview

- Analog input for SIMATIC S7-1200
- Extremely short conversion times
- For the connection of analog sensors without additional amplifiers
- For solving even more complex automation tasks
- Can be plugged directly into the CPU

Ordering data

Article No.

SB 1231 signal board analog input module

1 analog input, ± 10 V with 12 bits or 0 ... 20 mA with 11 bits

6ES7231-4HA30-0XB0

Terminal block (spare part)

for signal board
with 6 screws, gold-plated; 4 pcs.

6ES7292-1BF30-0XA0

Technical specifications

Article number	6ES7231-4HA30-0XB0 Signal Board SB 1231, 1 AI
General information	
Product type designation	SB 1231, AI 1x12 bit
Supply voltage	
Rated value (DC)	24 V
Input current	
from backplane bus 5 V DC, typ.	55 mA
Analog inputs	
Number of analog inputs	1; Current or voltage differential inputs
permissible input voltage for current input (destruction limit), max.	± 35 V
permissible input voltage for voltage input (destruction limit), max.	35 V
permissible input current for voltage input (destruction limit), max.	40 mA
permissible input current for current input (destruction limit), max.	40 mA
Cycle time (all channels) max.	156.25 μ s; 400 Hz suppression
Input ranges	
• Voltage	Yes; ± 10 V, ± 5 V, ± 2.5 V
• Current	Yes; 0 to 20 mA
• Thermocouple	No
• Resistance thermometer	No
• Resistance	No
Input ranges (rated values), voltages	
• -10 V to +10 V	Yes
• -2.5 V to +2.5 V	Yes
• -5 V to +5 V	Yes
Input ranges (rated values), currents	
• 0 to 20 mA	Yes
Analog outputs	
Number of analog outputs	0
Cable length	
• shielded, max.	100 m; shielded, twisted pair
Analog value generation for the inputs	
Integration and conversion time/resolution per channel	
• Resolution with overrange (bit including sign), max.	11 bit; + sign
• Integration time, parameterizable	Yes
• Interference voltage suppression for interference frequency f1 in Hz	40 dB, DC to 60 Hz
Smoothing of measured values	
• parameterizable	Yes

Article number	6ES7231-4HA30-0XB0 Signal Board SB 1231, 1 AI
Errors/accuracies	
Temperature error (relative to input range), (+/-)	25 °C $\pm 0.3\%$, to 55 °C $\pm 0.6\%$ total measurement range
Interrupts/diagnostics/status information	
Alarms	Yes
Diagnostics function	Yes
Alarms	
• Diagnostic alarm	Yes
Diagnoses	
• Wire-break	No
Diagnostics indication LED	
• for status of the inputs	Yes
• for maintenance	Yes
Standards, approvals, certificates	
CE mark	Yes
CSA approval	Yes
UL approval	Yes
cULus	Yes
FM approval	Yes
RCM (formerly C-TICK)	Yes
KC approval	Yes
Marine approval	Yes
Ambient conditions	
Ambient temperature during operation	
• min.	-20 °C
• max.	60 °C
Pollutant concentrations	
• SO ₂ at RH < 60% without condensation	SO ₂ : < 0.5 ppm; H ₂ S: < 0.1 ppm; RH < 60% condensation-free
connection method / header	
required front connector	Yes
Mechanics/material	
Enclosure material (front)	
• Plastic	Yes
Dimensions	
Width	38 mm
Height	62 mm
Depth	21 mm
Weights	
Weight, approx.	35 g

Overview



- Analog outputs for SIMATIC S7-1200
- Extremely short conversion times
- For connecting analog actuators without additional amplifiers
- For solving even more complex automation tasks

Ordering data

Article No.

SM 1232 analog output signal module

2 analog outputs, ± 10 V with 14 bits or 0 ... 20 mA with 13 bits

6ES7232-4HB32-0XB0

4 analog outputs, ± 10 V with 14 bits or 0 ... 20 mA with 13 bits

6ES7232-4HD32-0XB0**Terminal block (spare part)**

For 6ES7232-4HB32-0XB0, 6ES7232-4HD32-0XB0

- 7-pin, gold-plated; 4 units
 - Screw-type system
 - Push-in system

6ES7292-1BG30-0XA0**6ES7292-2BG30-0XA0****Extension cable for two-tier configuration**

For connecting digital/analog signal modules; length 2 m

6ES7290-6AA30-0XA0**Front flap set (spare part)**

For modules with a width of 45 mm

6ES7291-1BA30-0XA0

Technical specifications

Article number	6ES7232-4HB32-0XB0 Analog Output SM 1232, 2AO	6ES7232-4HD32-0XB0 Analog Output SM 1232, 4AO
General information		
Product type designation	SM 1232, AQ 2x14 bit	SM 1232, AQ 4x14 bit
Supply voltage		
Rated value (DC)	24 V	24 V
Input current		
Current consumption, typ.	45 mA	45 mA
from backplane bus 5 V DC, typ.	80 mA	80 mA
Analog outputs		
Number of analog outputs	2; Current or voltage	4; Current or voltage
Output ranges, voltage		
• -10 V to +10 V	Yes	Yes
Output ranges, current		
• 0 to 20 mA	Yes	Yes
Load impedance (in rated range of output)		
• with voltage outputs, min.	1 000 Ω	1 000 Ω
• with current outputs, max.	600 Ω	600 Ω
Cable length		
• shielded, max.	100 m; shielded, twisted pair	100 m; shielded, twisted pair
Analog value generation for the outputs		
Integration and conversion time/resolution per channel		
• Resolution with overrange (bit including sign), max.	14 bit; Voltage: 14 bit; Current : 13 bit	14 bit; Voltage: 14 bit; Current : 13 bit
Errors/accuracies		
Temperature error (relative to output range), (+/-)	25 °C $\pm 0.3\%$, to 55 °C $\pm 0.6\%$ total measurement range	25 °C $\pm 0.3\%$, to 55 °C $\pm 0.6\%$ total measurement range
Basic error limit (operational limit at 25 °C)		
• Voltage, relative to output range, (+/-)	0.3 %	0.3 %
• Current, relative to output range, (+/-)	0.3 %	0.3 %
Interference voltage suppression for $f = n \times (f_1 \pm 1 \%)$, $f_1 =$ interference frequency		
• Common mode voltage, max.	12 V	12 V

SIMATIC S7-1200 Basic Controllers

I/O modules

Analog modules

SM 1232 analog output modules**Technical specifications**

Article number	6ES7232-4HB32-0XB0	6ES7232-4HD32-0XB0
	Analog Output SM 1232, 2AO	Analog Output SM 1232, 4AO
Interrupts/diagnostics/status information		
Alarms	Yes	Yes
Diagnostics function	Yes	Yes
Alarms		
• Diagnostic alarm	Yes	Yes
Diagnoses		
• Monitoring the supply voltage	Yes	Yes
• Wire-break	Yes	Yes
• Short-circuit	Yes	Yes
Diagnostics indication LED		
• for status of the outputs	Yes	Yes
• for maintenance	Yes	Yes
Degree and class of protection		
IP degree of protection	IP20	IP20
Standards, approvals, certificates		
CE mark	Yes	Yes
CSA approval	Yes	Yes
UL approval	Yes	Yes
cULus	Yes	Yes
FM approval	Yes	Yes
RCM (formerly C-TICK)	Yes	Yes
KC approval	Yes	Yes
Marine approval	Yes	Yes
Ambient conditions		
Ambient temperature during operation		
• min.	-20 °C	-20 °C
• max.	60 °C	60 °C
Pollutant concentrations		
• SO ₂ at RH < 60% without condensation	SO ₂ : < 0.5 ppm; H ₂ S: < 0.1 ppm; RH < 60% condensation-free	SO ₂ : < 0.5 ppm; H ₂ S: < 0.1 ppm; RH < 60% condensation-free
connection method / header		
required front connector	Yes	Yes
Mechanics/material		
Enclosure material (front)		
• Plastic	Yes	Yes
Dimensions		
Width	45 mm	45 mm
Height	100 mm	100 mm
Depth	75 mm	75 mm
Weights		
Weight, approx.	180 g	180 g

Overview



- Analog output for SIMATIC S7-1200
- Can be plugged directly into the CPU

Ordering data

Article No.

SB 1232 analog output signal board

1 analog output, ± 10 V with 12 bits or 0 ... 20 mA with 11 bits

6ES7232-4HA30-0XB0**Terminal block (spare part)**

for signal board
with 6 screws, gold-plated; 4 pcs.

6ES7292-1BF30-0XA0

Technical specifications

Article number	6ES7232-4HA30-0XB0 Signal Board SB 1232, 1 AO
General information	
Product type designation	SB 1232, AQ 1x12 bit
Input current	
from backplane bus 5 V DC, typ.	15 mA
output voltage / header	
supply voltage of the transmitters / header	
• Supply current, max.	25 mA
Analog inputs	
Number of analog inputs	0
Analog outputs	
Number of analog outputs	1
Cycle time (all channels) max.	Voltage: 300 μ S (R), 750 μ S (1 uF) Current: 600 ms (1 mH); 2 ms (10 mH)
Output ranges, voltage	
• -10 V to +10 V	Yes
Output ranges, current	
• 0 to 20 mA	Yes
Load impedance (in rated range of output)	
• with voltage outputs, min.	1 000 Ω
• with current outputs, max.	600 Ω
Cable length	
• shielded, max.	100 m; shielded, twisted pair
Analog value generation for the outputs	
Conversion principle	Differential
Integration and conversion time/resolution per channel	
• Resolution with overrange (bit including sign), max.	12 bit
Errors/accuracies	
Temperature error (relative to output range), (+/-)	25 °C $\pm 0.5\%$, to 55 °C $\pm 1\%$

Article number	6ES7232-4HA30-0XB0 Signal Board SB 1232, 1 AO
Interrupts/diagnostics/status information	
Alarms	Yes
Diagnostics function	Yes
Diagnostics indication LED	
• for status of the outputs	Yes
Standards, approvals, certificates	
CE mark	Yes
CSA approval	Yes
UL approval	Yes
cULus	Yes
FM approval	Yes
RCM (formerly C-TICK)	Yes
KC approval	Yes
Marine approval	Yes
Ambient conditions	
Ambient temperature during operation	
• min.	-20 °C
• max.	60 °C
Pollutant concentrations	
• SO ₂ at RH < 60% without condensation	SO ₂ : < 0.5 ppm; H ₂ S: < 0.1 ppm; RH < 60% condensation-free
Mechanics/material	
Enclosure material (front)	
• Plastic	Yes
Dimensions	
Width	38 mm
Height	62 mm
Depth	21 mm
Weights	
Weight, approx.	40 g

SIMATIC S7-1200 Basic Controllers

I/O modules

Analog modules

SM 1234 analog input/output modules

Overview



- Analog inputs and outputs for the SIMATIC S7-1200
- Extremely short conversion times
- For connecting analog actuators and sensors without additional amplifiers
- For solving even more complex automation tasks

Ordering data

Article No.

SM 1234 analog input/output signal module

4 analog inputs, ± 10 V, ± 5 V, ± 2.5 V, or 0 ... 20 mA, 12 bits + sign;
2 analog outputs, ± 10 V with 14 bits or 0 ... 20 mA with 13 bits

6ES7234-4HE32-0XB0

Terminal block (spare part)

For 6ES7234-4HE32-0XB0

- 7-pin, gold-plated; 4 units
 - Screw-type system
 - Push-in system

6ES7292-1BG30-0XA0
6ES7292-2BG30-0XA0

Extension cable for two-tier configuration

For connecting digital/analog signal modules; length 2 m

6ES7290-6AA30-0XA0

Front flap set (spare part)

For modules with a width of 45 mm

6ES7291-1BA30-0XA0

Technical specifications

Article number	6ES7234-4HE32-0XB0
	Analog I/O SM 1234, 4AI/2AO
General information	
Product type designation	SM 1234, AI 4x13 bit/AQ 2x14 bit
Supply voltage	
Rated value (DC)	24 V
Input current	
Current consumption, typ.	60 mA
from backplane bus 5 V DC, typ.	80 mA
Analog inputs	
Number of analog inputs	4; Current or voltage differential inputs
permissible input voltage for voltage input (destruction limit), max.	35 V
permissible input current for current input (destruction limit), max.	40 mA
Cycle time (all channels) max.	625 μ s
Input ranges	
• Voltage	Yes; ± 10 V, ± 5 V, ± 2.5 V
• Current	Yes; 4 to 20 mA, 0 to 20 mA
Input ranges (rated values), voltages	
• -10 V to +10 V	Yes
• -2.5 V to +2.5 V	Yes
• -5 V to +5 V	Yes
Input ranges (rated values), currents	
• 0 to 20 mA	Yes
• 4 mA to 20 mA	Yes

Article number	6ES7234-4HE32-0XB0
	Analog I/O SM 1234, 4AI/2AO
Analog outputs	
Number of analog outputs	2; Current or voltage
Output ranges, voltage	
• -10 V to +10 V	Yes
Output ranges, current	
• 0 to 20 mA	Yes
• 4 mA to 20 mA	Yes
Load impedance (in rated range of output)	
• with voltage outputs, min.	1 000 Ω
• with current outputs, max.	600 Ω
Cable length	
• shielded, max.	100 m; shielded, twisted pair
Analog value generation for the inputs	
Integration and conversion time/resolution per channel	
• Resolution with overrange (bit including sign), max.	12 bit; + sign
• Integration time, parameterizable	Yes
• Interference voltage suppression for interference frequency f1 in Hz	40 dB, DC to 60 V for interference frequency 50 / 60 Hz
Smoothing of measured values	
• parameterizable	Yes
Analog value generation for the outputs	
Integration and conversion time/resolution per channel	
• Resolution with overrange (bit including sign), max.	14 bit; Voltage: 14 bit; Current : 13 bit

Technical specifications

Article number	6ES7234-4HE32-0XB0 Analog I/O SM 1234, 4AI/2AO
Errors/accuracies	
Temperature error (relative to input range), (+/-)	25 °C ±0.1%, to 55 °C ±0.2% total measurement range
Temperature error (relative to output range), (+/-)	25 °C ±0.3%, to 55 °C ±0.6% total measurement range
Basic error limit (operational limit at 25 °C)	
• Voltage, relative to input range, (+/-)	0.1 %
• Current, relative to input range, (+/-)	0.1 %
• Voltage, relative to output range, (+/-)	0.3 %
• Current, relative to output range, (+/-)	0.3 %
Interference voltage suppression for $f = n \times (f1 \pm 1 \%)$, $f1 =$ interference frequency	
• Common mode voltage, max.	12 V
Interrupts/diagnostics/status information	
Alarms	Yes
Diagnostics function	Yes
Alarms	
• Diagnostic alarm	Yes
Diagnoses	
• Monitoring the supply voltage	Yes
• Wire-break	Yes
• Short-circuit	Yes
Diagnostics indication LED	
• for status of the inputs	Yes
• for status of the outputs	Yes
• for maintenance	Yes
Potential separation	
Potential separation analog outputs	
• between the channels and the power supply of the electronics	No

Article number	6ES7234-4HE32-0XB0 Analog I/O SM 1234, 4AI/2AO
Degree and class of protection	
IP degree of protection	IP20
Standards, approvals, certificates	
CE mark	Yes
CSA approval	Yes
UL approval	Yes
cULus	Yes
FM approval	Yes
RCM (formerly C-TICK)	Yes
KC approval	Yes
Marine approval	Yes
Ambient conditions	
Ambient temperature during operation	
• min.	-20 °C
• max.	60 °C
Pollutant concentrations	
• SO ₂ at RH < 60% without condensation	SO ₂ : < 0.5 ppm; H ₂ S: < 0.1 ppm; RH < 60% condensation-free
connection method / header	
required front connector	Yes
Mechanics/material	
Enclosure material (front)	
• Plastic	Yes
Dimensions	
Width	45 mm
Height	100 mm
Depth	75 mm
Weights	
Weight, approx.	220 g

SIMATIC S7-1200 Basic Controllers

I/O modules

Analog modules

SM 1231 thermocouple module

Overview

- For the convenient recording of temperatures with great accuracy
- 7 common thermocouple types can be used
- Also for the measurement of analog signals with a low level (± 80 mV)
- Can easily be retrofitted to existing plant

Ordering data

Ordering data	Article No.	Article No.
SM 1231 thermocouple module		
4 inputs +/- 80 mV, resolution 15 bits + sign, thermocouple types J, K, S, T, R, E, N	6ES7231-5QD32-0XB0	
8 inputs +/- 80 mV, resolution 15 bits + sign, thermocouple types J, K, T, E, R, S, N, C, TXK/XK(L)	6ES7231-5QF32-0XB0	
		Accessories
		Terminal block (spare part)
		For 6ES7231-5QD32-0XB0, 6ES7231-5QF32-0XB0
		• 7-pin, gold-plated; 4 units
		- Screw-type system
		- Push-in system
		6ES7292-1BG30-0XA0
		6ES7292-2BG30-0XA0
		Extension cable for two-tier configuration
		For connecting digital/analog signal modules; length 2 m
		6ES7290-6AA30-0XA0
		Front flap set (spare part)
		For modules with a width of 45 mm
		6ES7291-1BA30-0XA0

Technical specifications

Article number	6ES7231-5QD32-0XB0	6ES7231-5QF32-0XB0
	S7-1200, analog Input SM 1231 TC, 4 AI	S7-1200, analog Input SM 1231 TC, 8 AI
General information		
Product type designation	SM 1231, AI 4x16 bit TC	SM 1231, AI 8x16 bit TC
Supply voltage		
Rated value (DC)	24 V	24 V
Input current		
Current consumption, typ. from backplane bus 5 V DC, typ.	40 mA 80 mA	40 mA 80 mA
Analog inputs		
Number of analog inputs	4; Thermocouples	8; Thermocouples
permissible input voltage for voltage input (destruction limit), max.	± 35 V	± 35 V
Technical unit for temperature measurement adjustable	Degrees Celsius/degrees Fahrenheit	Degrees Celsius/degrees Fahrenheit
Input ranges		
• Voltage	Yes	Yes
• Current	No	No
• Thermocouple	Yes; J, K, T, E, R, S, N, C, TXK/XK(L); voltage range: ± 80 mV	Yes; J, K, T, E, R & S, B, N, C, TXK/XK(L); voltage range: ± 80 mV
• Resistance thermometer	No	No
• Resistance	No	No
Input ranges (rated values), voltages		
• -80 mV to +80 mV	Yes	Yes
Input ranges (rated values), thermocouples		
• Type B	Yes	Yes
• Type C	Yes	Yes
• Type E	Yes	Yes
• Type J	Yes	Yes
• Type K	Yes	Yes
• Type N	Yes	Yes
• Type R	Yes	Yes
• Type S	Yes	Yes
• Type T	Yes	Yes
• Type TXK/TXK(L) to GOST	Yes	Yes
Thermocouple (TC)		
Temperature compensation		
- parameterizable	No	No

Technical specifications

Article number	6ES7231-5QD32-0XB0	6ES7231-5QF32-0XB0
	S7-1200, analog Input SM 1231 TC, 4 AI	S7-1200, analog Input SM 1231 TC, 8 AI
Analog value generation for the inputs		
Integration and conversion time/resolution per channel		
• Resolution with overrange (bit including sign), max.	15 bit; + sign	15 bit; + sign
• Integration time, parameterizable	No	No
• Interference voltage suppression for interference frequency f1 in Hz	85 dB at 50 / 60 / 400 Hz	85 dB at 50 / 60 / 400 Hz
Smoothing of measured values		
• parameterizable	Yes	Yes
Errors/accuracies		
Temperature error (relative to input range), (+/-)	25 °C ±0.1%, to 55 °C ±0.2% total measurement range	25 °C ±0.1%, to 55 °C ±0.2% total measurement range
Repeat accuracy in steady state at 25 °C (relative to output range), (+/-)	0.5 %	0.5 %
Interference voltage suppression for $f = n \times (f1 \pm 1 \%)$, f1 = interference frequency		
• Common mode interference, min.	120 dB	120 dB
Interrupts/diagnostics/status information		
Alarms	Yes	Yes
Diagnostics function	Yes; Can be read out	Yes; Can be read out
Alarms		
• Diagnostic alarm	Yes	Yes
Diagnoses		
• Monitoring the supply voltage	Yes	Yes
• Wire-break	Yes	Yes
Diagnostics indication LED		
• for status of the inputs	Yes	Yes
• for maintenance	Yes	Yes
Degree and class of protection		
IP degree of protection	IP20	IP20
Standards, approvals, certificates		
CE mark	Yes	Yes
CSA approval	Yes	Yes
UL approval	Yes	Yes
cULus	Yes	Yes
FM approval	Yes	Yes
RCM (formerly C-TICK)	Yes	Yes
KC approval	Yes	Yes
Marine approval	Yes	Yes
Ambient conditions		
Ambient temperature during operation		
• min.	-20 °C	-20 °C
• max.	60 °C	60 °C
Pollutant concentrations		
• SO ₂ at RH < 60% without condensation	SO ₂ : < 0.5 ppm; H ₂ S: < 0.1 ppm; RH < 60% condensation-free	SO ₂ : < 0.5 ppm; H ₂ S: < 0.1 ppm; RH < 60% condensation-free
connection method / header		
required front connector	Yes	Yes
Mechanics/material		
Enclosure material (front)		
• Plastic	Yes	Yes
Dimensions		
Width	45 mm	45 mm
Height	100 mm	100 mm
Depth	75 mm	75 mm
Weights		
Weight, approx.	180 g	220 g

SIMATIC S7-1200 Basic Controllers

I/O modules

Analog modules

SB 1231 thermocouple signal board

Overview

- For the convenient recording of temperatures with great accuracy
- 1 input with 16-bit resolution
- Common thermocouple types can be used
- Also for the measurement of analog signals with a low level (± 80 mV)
- Can easily be retrofitted to existing plant
- Can be plugged directly into the CPU

Ordering data

Article No.

SB 1231 thermocouple signal board

1 input +/- 80 mV,
resolution 15 bits + sign,
thermocouples type J, K

6ES7231-5QA30-0XB0

Accessories

Terminal block (spare part)

for signal board
with 6 screws, gold-plated; 4 pcs.

6ES7292-1BF30-0XA0

Technical specifications

Article number	6ES7231-5QA30-0XB0 Signal Board SB 1231 TC, 1 AI
General information	
Product type designation	SB 1231, AI 1x16 bit TC
Supply voltage	
Rated value (DC)	24 V
Input current	
Current consumption, typ.	5 mA
from backplane bus 5 V DC, typ.	20 mA
Analog inputs	
Number of analog inputs	1; Thermocouples
permissible input voltage for current input (destruction limit), max.	± 35 V
permissible input voltage for voltage input (destruction limit), max.	± 35 V
Technical unit for temperature measurement adjustable	Degrees Celsius/degrees Fahrenheit
Input ranges	
• Voltage	Yes
• Current	No
• Thermocouple	Yes; J, K, T, E, R & S, B, N, C, TXK/XK(L); voltage range: ± 80 mV
• Resistance thermometer	No
• Resistance	No
Input ranges (rated values), voltages	
• -80 mV to +80 mV	Yes
Input ranges (rated values), thermocouples	
• Type J	Yes
• Type K	Yes
Thermocouple (TC)	
Temperature compensation	
- parameterizable	No
Analog outputs	
Number of analog outputs	0
Cable length	
• shielded, max.	100 m; shielded, twisted pair
Analog value generation for the inputs	
Integration and conversion time/resolution per channel	
• Resolution with overrange (bit including sign), max.	15 bit; + sign
• Integration time, parameterizable	No
• Interference voltage suppression for interference frequency f_1 in Hz	85 dB at 10 / 50 / 60 / 400 Hz
Smoothing of measured values	
• parameterizable	Yes

Article number	6ES7231-5QA30-0XB0 Signal Board SB 1231 TC, 1 AI
Errors/accuracies	
Temperature error (relative to input range), (+/-)	25 °C $\pm 0.1\%$, to 55 °C $\pm 0.2\%$ total measurement range
Repeat accuracy in steady state at 25 °C (relative to output range), (+/-)	0.5 %
Interference voltage suppression for $f = n \times (f_1 \pm 1 \%)$, $f_1 =$ interference frequency	
• Common mode interference, min.	120 dB
Interrupts/diagnostics/status information	
Alarms	Yes
Diagnostics function	Yes; Can be read out
Alarms	
• Diagnostic alarm	Yes
Diagnoses	
• Wire-break	Yes
Diagnostics indication LED	
• for status of the inputs	Yes
• for maintenance	Yes
Standards, approvals, certificates	
CE mark	Yes
CSA approval	Yes
UL approval	Yes
cULus	Yes
FM approval	Yes
RCM (formerly C-TICK)	Yes
KC approval	Yes
Marine approval	Yes
Ambient conditions	
Ambient temperature during operation	
• min.	-20 °C
• max.	60 °C
Pollutant concentrations	
• SO ₂ at RH < 60% without condensation	SO ₂ : < 0.5 ppm; H ₂ S: < 0.1 ppm; RH < 60% condensation-free
connection method / header	
required front connector	Yes
Mechanics/material	
Enclosure material (front)	
• Plastic	Yes
Dimensions	
Width	38 mm
Height	62 mm
Depth	21 mm
Weights	
Weight, approx.	35 g

Overview

- For the convenient recording of temperatures with great accuracy
- 4 inputs
- Most popular resistance temperature sensors can be used
- Can easily be retrofitted to existing installation

Ordering data

Ordering data	Article No.	Article No.
SM 1231 RTD signal module		
4 inputs for resistance temperature sensors Pt10/50/100/200/500/1000, Ni100/120/200/500/1000, Cu10/50/100, LG-Ni1000; resistance 150/300/600 ohms, resolution 15 bits + sign	6ES7231-5PD32-0XB0	
8 inputs for resistance temperature sensors Pt10/50/100/200/500/1000, Ni100/120/200/500/1000, Cu10/50/100, LG-Ni1000; resistance 150/300/600 ohms, resolution 15 bits + sign	6ES7231-5PF32-0XB0	
		Accessories
		Terminal block (spare part)
		For 6ES7231-5PD32-0XB0
		• 7-pin, gold-plated; 4 units
		- Screw-type system
		- Push-in system
		6ES7292-1BG30-0XA0
		6ES7292-2BG30-0XA0
		For 6ES7231-5PF32-0XB0
		• 11-pin, gold-plated; 4 units
		- Screw-type system
		- Push-in system
		6ES7292-1BL30-0XA0
		6ES7292-2BL30-0XA0
		Extension cable for two-tier configuration
		for connecting digital/analog signal modules; length 2 m
		6ES7290-6AA30-0XA0
		Front flap set (spare part)
		For modules with a width of 45 mm
		6ES7291-1BA30-0XA0
		For modules with a width of 70 mm
		6ES7291-1BB30-0XA0

Technical specifications

Article number	6ES7231-5PD32-0XB0	6ES7231-5PF32-0XB0
	S7-1200, analog Input SM 1231 RTD, 4 AI	S7-1200, analog Input SM 1231 RTD, 8 AI
General information		
Product type designation	SM 1231, AI 4x16 bit RTD	SM 1231, AI 8x16 bit RTD
Supply voltage		
Rated value (DC)	24 V	24 V
Input current		
Current consumption, typ.	40 mA	40 mA
from backplane bus 5 V DC, typ.	80 mA	80 mA
Analog inputs		
Number of analog inputs	4; Resistance thermometer	8; Resistance thermometer
permissible input voltage for voltage input (destruction limit), max.	±35 V	±35 V
Technical unit for temperature measurement adjustable	Degrees Celsius/degrees Fahrenheit	Degrees Celsius/degrees Fahrenheit
Input ranges		
• Voltage	No	No
• Current	No	No
• Thermocouple	No	No
• Resistance thermometer	Yes; Resistance-type transmitter: Pt10, Pt50, Pt100, Pt200, Pt500, Pt1000, Ni100, Ni120, Ni200, Ni500, Ni1000, Cu10, Cu50, Cu100, LG-Ni1000	Yes; Resistance-type transmitter: Pt10, Pt50, Pt100, Pt200, Pt500, Pt1000, Ni100, Ni120, Ni200, Ni500, Ni1000, Cu10, Cu50, Cu100, LG-Ni1000
• Resistance	Yes; 150 Ω, 300 Ω, 600 Ω	Yes; 150 Ω, 300 Ω, 600 Ω

SIMATIC S7-1200 Basic Controllers

I/O modules

Analog modules

SM 1231 RTD signal module

Technical specifications

Article number	6ES7231-5PD32-0XB0	6ES7231-5PF32-0XB0
	S7-1200, analog Input SM 1231 RTD, 4 AI	S7-1200, analog Input SM 1231 RTD, 8 AI
Input ranges (rated values), resistance thermometer		
• Cu 10	Yes	Yes
• Ni 100	Yes	Yes
• Ni 1000	Yes	Yes
• LG-Ni 1000	Yes	Yes
• Ni 120	Yes	Yes
• Ni 200	Yes	Yes
• Ni 500	Yes	Yes
• Pt 100	Yes	Yes
• Pt 1000	Yes	Yes
• Pt 200	Yes	Yes
• Pt 500	Yes	Yes
Input ranges (rated values), resistors		
• 0 to 150 ohms	Yes	Yes
• 0 to 300 ohms	Yes	Yes
• 0 to 600 ohms	Yes	Yes
Thermocouple (TC)		
Temperature compensation		
- parameterizable	No	No
Analog value generation for the inputs		
Integration and conversion time/resolution per channel		
• Resolution with overrange (bit including sign), max.	15 bit; + sign	15 bit; + sign
• Integration time, parameterizable	No	No
• Interference voltage suppression for interference frequency f1 in Hz	85 dB at 50 / 60 / 400 Hz	85 dB at 50 / 60 / 400 Hz
Errors/accuracies		
Temperature error (relative to input range), (+/-)	25 °C ±0.1%, to 55 °C ±0.2% total measurement range	25 °C ±0.1%, to 55 °C ±0.2% total measurement range
Repeat accuracy in steady state at 25 °C (relative to output range), (+/-)	0.05 %	0.05 %
Interference voltage suppression for $f = n \times (f1 \pm 1 \%)$, f1 = interference frequency		
• Common mode interference, min.	120 dB	120 dB
Interrupts/diagnostics/status information		
Alarms	Yes	Yes
Diagnostics function	Yes; Can be read out	Yes; Can be read out
Alarms		
• Diagnostic alarm	Yes	Yes
Diagnoses		
• Monitoring the supply voltage	Yes	Yes
• Wire-break	Yes	Yes
Diagnostics indication LED		
• for status of the inputs	Yes	Yes
• for maintenance	Yes	Yes
Degree and class of protection		
IP degree of protection	IP20	IP20

Technical specifications

Article number	6ES7231-5PD32-0XB0	6ES7231-5PF32-0XB0
	S7-1200, analog Input SM 1231 RTD, 4 AI	S7-1200, analog Input SM 1231 RTD, 8 AI
Standards, approvals, certificates		
CE mark	Yes	Yes
CSA approval	Yes	Yes
UL approval	Yes	Yes
cULus	Yes	Yes
FM approval	Yes	Yes
RCM (formerly C-TICK)	Yes	Yes
KC approval	Yes	Yes
Marine approval	Yes	Yes
Ambient conditions		
Ambient temperature during operation		
• min.	-20 °C	-20 °C
• max.	60 °C	60 °C
Pollutant concentrations		
• SO ₂ at RH < 60% without condensation	SO ₂ : < 0.5 ppm; H ₂ S: < 0.1 ppm; RH < 60% condensation-free	SO ₂ : < 0.5 ppm; H ₂ S: < 0.1 ppm; RH < 60% condensation-free
connection method / header		
required front connector	Yes	Yes
Mechanics/material		
Enclosure material (front)		
• Plastic	Yes	Yes
Dimensions		
Width	45 mm	70 mm
Height	100 mm	100 mm
Depth	75 mm	75 mm
Weights		
Weight, approx.	220 g	220 g

SIMATIC S7-1200 Basic Controllers

I/O modules

Analog modules

SB 1231 RTD signal board

Overview

- For the convenient recording of temperatures with great accuracy
- 1 input with 16-bit resolution
- Common resistance-type temperature sensors can be used
- Can easily be retrofitted to existing plant
- Can be plugged directly into the CPU

Ordering data

Article No.

RTD signal board SB 1231

6ES7231-5PA30-0XB0

1 input for resistance temperature sensors Pt 100, Pt 200, Pt 500, Pt 1000, resolution 15 bits + sign

Accessories

Terminal block (spare part)

for signal board
with 6 screws, gold-plated; 4 pcs.

6ES7292-1BF30-0XA0

Technical specifications

Article number	6ES7231-5PA30-0XB0 Signal Board SB 1231 RTD
General information	
Product type designation	SB 1231, AI 1x16 bit RTD
Supply voltage	
Rated value (DC)	24 V
Input current	
Current consumption, typ.	5 mA
from backplane bus 5 V DC, typ.	20 mA
Analog inputs	
Number of analog inputs	1; Resistance thermometer
permissible input voltage for current input (destruction limit), max.	±35 V
Technical unit for temperature measurement adjustable	Degrees Celsius/degrees Fahrenheit
Input ranges	
• Voltage	Yes
• Current	No
• Thermocouple	No
• Resistance thermometer	Yes; Platinum (Pt)
• Resistance	Yes; 150 Ω, 300 Ω, 600 Ω
Input ranges (rated values), resistance thermometer	
• Pt 100	Yes
• Pt 1000	Yes
• Pt 200	Yes
• Pt 500	Yes
Input ranges (rated values), resistors	
• 0 to 150 ohms	Yes
• 0 to 300 ohms	Yes
• 0 to 600 ohms	Yes
Thermocouple (TC)	
Temperature compensation	
- parameterizable	No
Analog outputs	
Number of analog outputs	0
Cable length	
• shielded, max.	100 m; shielded, twisted pair
Analog value generation for the inputs	
Integration and conversion time/resolution per channel	
• Resolution with overrange (bit including sign), max.	15 bit; + sign
• Integration time, parameterizable	No
• Interference voltage suppression for interference frequency f1 in Hz	85 dB at 10 / 50 / 60 / 400 Hz

Article number	6ES7231-5PA30-0XB0 Signal Board SB 1231 RTD
Errors/accuracies	
Temperature error (relative to input range), (+/-)	25 °C ±0.1%, to 55 °C ±0.2% total measurement range
Repeat accuracy in steady state at 25 °C (relative to output range), (+/-)	0.05 %
Interference voltage suppression for $f = n \times (f1 \pm 1 \%)$, f1 = interference frequency	
• Common mode interference, min.	120 dB
Interrupts/diagnostics/status information	
Alarms	Yes
Diagnostics function	Yes; Can be read out
Alarms	
• Diagnostic alarm	Yes
Diagnoses	
• Wire-break	Yes
Diagnostics indication LED	
• for status of the inputs	Yes
• for maintenance	Yes
Standards, approvals, certificates	
CE mark	Yes
CSA approval	Yes
UL approval	Yes
cULus	Yes
FM approval	Yes
RCM (formerly C-TICK)	Yes
KC approval	Yes
Marine approval	Yes
Ambient conditions	
Ambient temperature during operation	
• min.	-20 °C
• max.	60 °C
Pollutant concentrations	
• SO ₂ at RH < 60% without condensation	SO ₂ : < 0.5 ppm; H ₂ S: < 0.1 ppm; RH < 60% condensation-free
connection method / header	
required front connector	Yes
Mechanics/material	
Enclosure material (front)	
• Plastic	Yes
Dimensions	
Width	38 mm
Height	62 mm
Depth	21 mm
Weights	
Weight, approx.	35 g

SM 1238 Energy Meter 480 V AC analog input modules

Overview

- Energy management based on SIMATIC S7-1200
- Data acquisition of electrical characteristics in 1 and 3-phase networks up to 480 V AC
- Direct connection of voltage inputs
- Current measurement performed by 1 A and 5 A current transformers
- Can be used in TN and TT networks
- Data backup of measurement data in the event of a power failure

Ordering data

Article No.

SM 1238 Energy Meter 480 V AC analog input module

Energy measurement module for data acquisition in 1 and 3-phase networks (TN, TT) up to 480 V AC; current range: 1 A, 5 A; recording of voltage, current, phase angles, power ratings, energy values, frequencies; with channel diagnostics

6ES7238-5XA32-0XB0

Extension cable for two-tier configuration

For connecting digital/analog signal modules; length 2 m

6ES7290-6AA30-0XA0

Terminal block (spare part)

- For voltage input (top), 7-pin, tin-coated, coded in middle
 - Screw-type system
 - Push-in system

6ES7292-1AG40-0XA2
6ES7292-2AG40-0XA2

For current input (bottom), 7-pin, tin-coated

- Screw-type system
- Push-in system

6ES7292-1AG30-0XA0
6ES7292-2AG30-0XA0**Front flap set (spare part)**

For modules with a width of 45 mm

6ES7291-1BA30-0XA0

Technical specifications

Article number	6ES7238-5XA32-0XB0
	SM 1238 Energy Meter 480V AC
General information	
Product type designation	SM 1238, AI energy meter 480 V AC
Product function	
• Voltage measurement	Yes
- with voltage transformer	Yes
• Current measurement	Yes
- without current transformer	No
- with current transformer	Yes
• Energy measurement	Yes
• Frequency measurement	Yes
• Power measurement	Yes
• Active power measurement	Yes
• Reactive power measurement	Yes
• I&M data	Yes; I&M 0
• Isochronous mode	No
Engineering with	
• STEP 7 TIA Portal configurable/integrated from version	V13 SP1
Operating mode	
• cyclic measurement	Yes
• acyclic measurement	Yes
• Acyclic measured value access	Yes
• Fixed measured value sets	Yes
• Freely definable measured value sets	No

Article number	6ES7238-5XA32-0XB0
	SM 1238 Energy Meter 480V AC
Installation type/mounting	
Mounting position	Horizontal, vertical
Supply voltage	
Design of the power supply	from CPU
Type of supply voltage	DC
Input current	
Current consumption, max.	180 mA
Analog inputs	
Cycle time (all channels), typ.	50 ms; Time for consistent update of all measured and calculated values (cyclic and acyclic data)
Interrupts/diagnostics/status information	
Alarms	
• Diagnostic alarm	Yes
• Limit value alarm	Yes
• Hardware interrupt	No
Diagnostics indication LED	
• Monitoring of the supply voltage (PWR-LED)	Yes
• Channel status display	Yes; green LED
• for channel diagnostics	Yes; red Fn LED
• for module diagnostics	Yes; green/red DIAG LED

SIMATIC S7-1200 Basic Controllers

I/O modules

Analog modules

SM 1238 Energy Meter 480 V AC analog input modules

Technical specifications

Article number	6ES7238-5XA32-0XB0 SM 1238 Energy Meter 480V AC
Integrated Functions	
Measuring functions	
• Measuring procedure for voltage measurement	TRMS
• Measuring procedure for current measurement	TRMS
• Type of measured value acquisition	seamless
• Curve shape of voltage	Sinusoidal or distorted
• Buffering of measured variables	Yes
• Parameter length	74 byte
• Bandwidth of measured value acquisition	2 kHz; Harmonics: 39 / 50 Hz, 32 / 60 Hz
Measuring range	
- Frequency measurement, min.	45 Hz
- Frequency measurement, max.	65 Hz
Measuring inputs for voltage	
- Measurable line voltage between phase and neutral conductor	277 V
- Measurable line voltage between the line conductors	480 V
- Measurable line voltage between phase and neutral conductor, min.	0 V
- Measurable line voltage between phase and neutral conductor, max.	293 V
- Measurable line voltage between the line conductors, min.	0 V
- Measurable line voltage between the line conductors, max.	508 V
- Internal resistance line conductor and neutral conductor	3.4 MΩ
- Power consumption per phase	20 mW
- Impulse voltage resistance 1,2/50μs	1 kV
- Measurement category for voltage measurement in accordance with IEC 61010-2-030	CAT II; CAT III in case of guaranteed protection level of 1.5 kV
Measuring inputs for current	
- measurable relative current (AC), min.	1 %; Relative to the secondary rated current 5 A
- measurable relative current (AC), max.	100 %; Relative to the secondary rated current 5 A
- Continuous current with AC, maximum permissible	5 A
- Apparent power consumption per phase for measuring range 5 A	0.6 VA
- Rated value short-time withstand current restricted to 1 s	100 A
- Input resistance measuring range 0 to 5 A	25 mΩ; At the terminal
- Surge strength	10 A; for 1 minute
- Zero point suppression	Parameterizable: 2 ... 250 mA, default 50 mA

Article number	6ES7238-5XA32-0XB0 SM 1238 Energy Meter 480V AC
Accuracy class according to IEC 61557-12	
- Measured variable voltage	0,2
- Measured variable current	0,2
- Measured variable apparent power	0.5
- Measured variable active power	0.5
- Measured variable reactive power	1
- Measured variable power factor	0.5
- Measured variable active energy	0.5
- Measured variable reactive energy	1
- Measured variable neutral current	0.5; calculated
- Measured variable phase angle	± 1 °; not covered by IEC 61557-12
- Measured variable frequency	0.05
Potential separation	
Potential separation channels	
• between the channels and backplane bus	Yes; 3 700V AC (type test) CAT III
Standards, approvals, certificates	
CE mark	Yes
CSA approval	Yes
UL approval	Yes
cULus	Yes
FM approval	Yes
RCM (formerly C-TICK)	Yes
KC approval	Yes
Marine approval	Yes
Dimensions	
Width	45 mm
Height	100 mm
Depth	75 mm
Weights	
Weight, approx.	165 g
Other	
Data for selecting a current transformer	
• Burden power current transformer x/1A, min.	As a function of cable length and cross section, see device manual
• Burden power current transformer x/5A, min.	As a function of cable length and cross section, see device manual

Overview



- Analog inputs for SIPLUS S7-1200
- With extremely short conversion times
- For connecting analog actuators and sensors without additional amplifiers
- Even solves more complex automation tasks
- From +60 °C to +70 °C, max. 50% of the inputs can be controlled simultaneously

Note:

SIPLUS extreme products are based on SIMATIC standard products. The contents listed here were taken from the respective standard products. SIPLUS extreme-specific information was added.

Ordering data

Article No.

SIPLUS SM 1231 analog input signal module

(Extended temperature range and exposure to media)

Ambient temperature range
0 ... +55 °C

4 analog inputs, ±10 V, ±5 V, ±2.5 V, or 0 ... 20 mA, 16-bit

4 analog inputs ±10 V, ±5 V, ±2.5 V, or 0 ... 20 mA; 12-bit + sign

8 analog inputs, ±10 V, ±5 V, ±2.5 V, or 0 ... 20 mA, 12-bit + sign

Accessories**6AG1231-5ND32-4XB0****6AG1231-4HD32-4XB0****6AG1231-4HF32-4XB0**

See SIMATIC S7-1200 SM 1231 analog input modules, page 3/83

Technical specifications

Article number	6AG1231-4HD32-4XB0	6AG1231-4HF32-4XB0	6AG1231-5ND32-4XB0
Based on	6ES7231-4HD32-0XB0	6ES7231-4HF32-0XB0	6ES7231-5ND32-0XB0
	SIPLUS S7-1200 SM 1231 4AI 13Bit	SIPLUS S7-1200 SM 1231 8AI 13Bit	SIPLUS S7-1200 SM 1231 4AI 16Bit
Ambient conditions			
Ambient temperature during operation			
• min.	-20 °C; = Tmin (incl. condensation/frost); start-up @ 0 °C	-20 °C; = Tmin (incl. condensation/frost); start-up @ 0 °C	-20 °C; = Tmin (incl. condensation/frost); start-up @ 0 °C
• max.	60 °C; = Tmax	60 °C; = Tmax	60 °C; = Tmax
Altitude during operation relating to sea level			
• Installation altitude above sea level, max.	5 000 m	5 000 m	5 000 m
• Ambient air temperature-barometric pressure-altitude	Tmin ... Tmax at 1 140 hPa ... 795 hPa (-1 000 m ... +2 000 m) // Tmin ... (Tmax - 10 K) at 795 hPa ... 658 hPa (+2 000 m ... +3 500 m) // Tmin ... (Tmax -20 K) at 658 hPa ... 540 hPa (+3 500 m ... +5 000 m)	Tmin ... Tmax at 1 140 hPa ... 795 hPa (-1 000 m ... +2 000 m) // Tmin ... (Tmax - 10 K) at 795 hPa ... 658 hPa (+2 000 m ... +3 500 m) // Tmin ... (Tmax -20 K) at 658 hPa ... 540 hPa (+3 500 m ... +5 000 m)	Tmin ... Tmax at 1 140 hPa ... 795 hPa (-1 000 m ... +2 000 m) // Tmin ... (Tmax - 10 K) at 795 hPa ... 658 hPa (+2 000 m ... +3 500 m) // Tmin ... (Tmax -20 K) at 658 hPa ... 540 hPa (+3 500 m ... +5 000 m)
Relative humidity			
• With condensation, tested in accordance with IEC 60068-2-38, max.	100 %; RH incl. condensation/frost (no commissioning under condensation conditions)	100 %; RH incl. condensation/frost (no commissioning under condensation conditions)	100 %; RH incl. condensation/frost (no commissioning under condensation conditions)

SIMATIC S7-1200 Basic Controllers

I/O modules

SIPLUS analog modules

SIPLUS SM 1231 analog input modules

Technical specifications

Article number	6AG1231-4HD32-4XB0	6AG1231-4HF32-4XB0	6AG1231-5ND32-4XB0
Based on	6ES7231-4HD32-0XB0	6ES7231-4HF32-0XB0	6ES7231-5ND32-0XB0
	SIPLUS S7-1200 SM 1231 4AI 13Bit	SIPLUS S7-1200 SM 1231 8AI 13Bit	SIPLUS S7-1200 SM 1231 4AI 16Bit
Resistance			
Coolants and lubricants			
- Resistant to commercially available coolants and lubricants	Yes; Incl. diesel and oil droplets in the air	Yes; Incl. diesel and oil droplets in the air	Yes; Incl. diesel and oil droplets in the air
Use in stationary industrial systems			
- to biologically active substances according to EN 60721-3-3	Yes; Class 3B2 mold, fungus and dry rot spores (with the exception of fauna); Class 3B3 on request	Yes; Class 3B2 mold, fungus and dry rot spores (with the exception of fauna); Class 3B3 on request	Yes; Class 3B2 mold, fungus and dry rot spores (with the exception of fauna); Class 3B3 on request
- to chemically active substances according to EN 60721-3-3	Yes; Class 3C4 (RH < 75 %) incl. salt spray acc. to EN 60068-2-52 (severity degree 3); *	Yes; Class 3C4 (RH < 75 %) incl. salt spray acc. to EN 60068-2-52 (severity degree 3); *	Yes; Class 3C4 (RH < 75 %) incl. salt spray acc. to EN 60068-2-52 (severity degree 3); *
- to mechanically active substances according to EN 60721-3-3	Yes; Class 3S4 incl. sand, dust, *	Yes; Class 3S4 incl. sand, dust, *	Yes; Class 3S4 incl. sand, dust, *
Use on ships/at sea			
- to biologically active substances according to EN 60721-3-6	Yes; Class 6B2 mold and fungal spores (excluding fauna); Class 6B3 on request	Yes; Class 6B2 mold and fungal spores (excluding fauna); Class 6B3 on request	Yes; Class 6B2 mold and fungal spores (excluding fauna); Class 6B3 on request
- to chemically active substances according to EN 60721-3-6	Yes; Class 6C3 (RH < 75 %) incl. salt spray acc. to EN 60068-2-52 (severity degree 3); *	Yes; Class 6C3 (RH < 75 %) incl. salt spray acc. to EN 60068-2-52 (severity degree 3); *	Yes; Class 6C3 (RH < 75 %) incl. salt spray acc. to EN 60068-2-52 (severity degree 3); *
- to mechanically active substances according to EN 60721-3-6	Yes; Class 6S3 incl. sand, dust; *	Yes; Class 6S3 incl. sand, dust; *	Yes; Class 6S3 incl. sand, dust; *
Usage in industrial process technology			
- Against chemically active substances acc. to EN 60654-4	Yes; Class 3 (excluding trichlorethylene)	Yes; Class 3 (excluding trichlorethylene)	Yes; Class 3 (excluding trichlorethylene)
- Environmental conditions for process, measuring and control systems acc. to ANSI/ISA-71.04	Yes; Level GX group A/B (excluding trichlorethylene; harmful gas concentrations up to the limits of EN 60721-3-3 class 3C4 permissible); level LC3 (salt spray) and level LB3 (oil)	Yes; Level GX group A/B (excluding trichlorethylene; harmful gas concentrations up to the limits of EN 60721-3-3 class 3C4 permissible); level LC3 (salt spray) and level LB3 (oil)	Yes; Level GX group A/B (excluding trichlorethylene; harmful gas concentrations up to the limits of EN 60721-3-3 class 3C4 permissible); level LC3 (salt spray) and level LB3 (oil)
Remark			
- Note regarding classification of environmental conditions acc. to EN 60721, EN 60654-4 and ANSI/ISA-71.04	* The supplied plug covers must remain in place over the unused interfaces during operation!	* The supplied plug covers must remain in place over the unused interfaces during operation!	* The supplied plug covers must remain in place over the unused interfaces during operation!
Conformal coating			
• Coatings for printed circuit board assemblies acc. to EN 61086	Yes; Class 2 for high reliability	Yes; Class 2 for high reliability	Yes; Class 2 for high reliability
• Protection against fouling acc. to EN 60664-3	Yes; Type 1 protection	Yes; Type 1 protection	Yes; Type 1 protection
• Military testing according to MIL-I-46058C, Amendment 7	Yes; Discoloration of coating possible during service life	Yes; Discoloration of coating possible during service life	Yes; Discoloration of coating possible during service life
• Qualification and Performance of Electrical Insulating Compound for Printed Board Assemblies according to IPC-CC-830A	Yes; Conformal coating, Class A	Yes; Conformal coating, Class A	Yes; Conformal coating, Class A

Overview



- Analog outputs for SIPLUS S7-1200
- With extremely short conversion times
- For connecting analog actuators without additional amplifiers
- Even solves more complex automation tasks
- From +60 °C to +70 °C, max. 50% of the outputs can be controlled simultaneously

Note:

SIPLUS extreme products are based on SIMATIC standard products. The contents listed here were taken from the respective standard products. SIPLUS extreme-specific information was added.

Ordering data

Article No.

SIPLUS SM 1232 analog output signal module

(Extended temperature range and exposure to media)

Ambient temperature range
-20 ... +60 °C

2 analog outputs, ±10 V with 14-bit or 0 ... 20 mA with 13-bit

4 analog outputs, ±10 V with 14-bit or 0 ... 20 mA with 13-bit

Ambient temperature range
-40 ... +70 °C

4 analog outputs, ±10 V with 14-bit or 0 ... 20 mA with 13-bit

Accessories**6AG1232-4HB32-4XB0****6AG1232-4HD32-4XB0****6AG1232-4HD32-2XB0**

See SIMATIC S7-1200 SM 1232 analog output modules, page 3/87

Technical specifications

Article number	6AG1232-4HB32-4XB0	6AG1232-4HD32-2XB0	6AG1232-4HD32-4XB0
Based on	6ES7232-4HB32-0XB0	6ES7232-4HD32-0XB0	6ES7232-4HD32-0XB0
	SIPLUS S7-1200 SM 1232 2AQ 13Bit	SIPLUS S7-1200 SM 1232 4AQ 14Bit	SIPLUS S7-1200 SM 1232 4AQ 14Bit
Ambient conditions			
Ambient temperature during operation			
• min.	-20 °C; = Tmin (incl. condensation/frost); start-up @ 0 °C	-40 °C; = Tmin (incl. condensation/frost); start-up @ -25 °C	-20 °C; = Tmin (incl. condensation/frost); start-up @ 0 °C
• max.	60 °C; = Tmax	70 °C; = Tmax	60 °C; = Tmax
Altitude during operation relating to sea level			
• Installation altitude above sea level, max.	5 000 m	5 000 m	5 000 m
• Ambient air temperature-barometric pressure-altitude	Tmin ... Tmax at 1 140 hPa ... 795 hPa (-1 000 m ... +2 000 m) // Tmin ... (Tmax - 10 K) at 795 hPa ... 658 hPa (+2 000 m ... +3 500 m) // Tmin ... (Tmax -20 K) at 658 hPa ... 540 hPa (+3 500 m ... +5 000 m)	Tmin ... Tmax at 1 140 hPa ... 795 hPa (-1 000 m ... +2 000 m) // Tmin ... (Tmax - 10 K) at 795 hPa ... 658 hPa (+2 000 m ... +3 500 m) // Tmin ... (Tmax -20 K) at 658 hPa ... 540 hPa (+3 500 m ... +5 000 m)	Tmin ... Tmax at 1 140 hPa ... 795 hPa (-1 000 m ... +2 000 m) // Tmin ... (Tmax - 10 K) at 795 hPa ... 658 hPa (+2 000 m ... +3 500 m) // Tmin ... (Tmax -20 K) at 658 hPa ... 540 hPa (+3 500 m ... +5 000 m)
Relative humidity			
• With condensation, tested in accordance with IEC 60068-2-38, max.	100 %; RH incl. condensation/frost (no commissioning under condensation conditions)	100 %; RH incl. condensation/frost (no commissioning under condensation conditions)	100 %; RH incl. condensation/frost (no commissioning under condensation conditions)

SIMATIC S7-1200 Basic Controllers

I/O modules

SIPLUS analog modules

SIPLUS SM 1232 analog output modules**Technical specifications**

Article number	6AG1232-4HB32-4XB0	6AG1232-4HD32-2XB0	6AG1232-4HD32-4XB0
Based on	6ES7232-4HB32-0XB0	6ES7232-4HD32-0XB0	6ES7232-4HD32-0XB0
	SIPLUS S7-1200 SM 1232 2AQ 13Bit	SIPLUS S7-1200 SM 1232 4AQ 14Bit	SIPLUS S7-1200 SM 1232 4AQ 14Bit
Resistance			
Coolants and lubricants			
- Resistant to commercially available coolants and lubricants	Yes; Incl. diesel and oil droplets in the air	Yes; Incl. diesel and oil droplets in the air	Yes; Incl. diesel and oil droplets in the air
Use in stationary industrial systems			
- to biologically active substances according to EN 60721-3-3	Yes; Class 3B2 mold, fungus and dry rot spores (with the exception of fauna); Class 3B3 on request	Yes; Class 3B2 mold, fungus and dry rot spores (with the exception of fauna); Class 3B3 on request	Yes; Class 3B2 mold, fungus and dry rot spores (with the exception of fauna); Class 3B3 on request
- to chemically active substances according to EN 60721-3-3	Yes; Class 3C4 (RH < 75 %) incl. salt spray acc. to EN 60068-2-52 (severity degree 3); *	Yes; Class 3C4 (RH < 75 %) incl. salt spray acc. to EN 60068-2-52 (severity degree 3); *	Yes; Class 3C4 (RH < 75 %) incl. salt spray acc. to EN 60068-2-52 (severity degree 3); *
- to mechanically active substances according to EN 60721-3-3	Yes; Class 3S4 incl. sand, dust, *	Yes; Class 3S4 incl. sand, dust, *	Yes; Class 3S4 incl. sand, dust, *
Use on ships/at sea			
- to biologically active substances according to EN 60721-3-6	Yes; Class 6B2 mold and fungal spores (excluding fauna); Class 6B3 on request	Yes; Class 6B2 mold and fungal spores (excluding fauna); Class 6B3 on request	Yes; Class 6B2 mold and fungal spores (excluding fauna); Class 6B3 on request
- to chemically active substances according to EN 60721-3-6	Yes; Class 6C3 (RH < 75 %) incl. salt spray acc. to EN 60068-2-52 (severity degree 3); *	Yes; Class 6C3 (RH < 75 %) incl. salt spray acc. to EN 60068-2-52 (severity degree 3); *	Yes; Class 6C3 (RH < 75 %) incl. salt spray acc. to EN 60068-2-52 (severity degree 3); *
- to mechanically active substances according to EN 60721-3-6	Yes; Class 6S3 incl. sand, dust; *	Yes; Class 6S3 incl. sand, dust; *	Yes; Class 6S3 incl. sand, dust; *
Usage in industrial process technology			
- Against chemically active substances acc. to EN 60654-4	Yes; Class 3 (excluding trichlorethylene)	Yes; Class 3 (excluding trichlorethylene)	Yes; Class 3 (excluding trichlorethylene)
- Environmental conditions for process, measuring and control systems acc. to ANSI/ISA-71.04	Yes; Level GX group A/B (excluding trichlorethylene; harmful gas concentrations up to the limits of EN 60721-3-3 class 3C4 permissible); level LC3 (salt spray) and level LB3 (oil)	Yes; Level GX group A/B (excluding trichlorethylene; harmful gas concentrations up to the limits of EN 60721-3-3 class 3C4 permissible); level LC3 (salt spray) and level LB3 (oil)	Yes; Level GX group A/B (excluding trichlorethylene; harmful gas concentrations up to the limits of EN 60721-3-3 class 3C4 permissible); level LC3 (salt spray) and level LB3 (oil)
Remark			
- Note regarding classification of environmental conditions acc. to EN 60721, EN 60654-4 and ANSI/ISA-71.04	* The supplied plug covers must remain in place over the unused interfaces during operation!	* The supplied plug covers must remain in place over the unused interfaces during operation!	* The supplied plug covers must remain in place over the unused interfaces during operation!
Conformal coating			
• Coatings for printed circuit board assemblies acc. to EN 61086	Yes; Class 2 for high reliability	Yes; Class 2 for high reliability	Yes; Class 2 for high reliability
• Protection against fouling acc. to EN 60664-3	Yes; Type 1 protection	Yes; Type 1 protection	Yes; Type 1 protection
• Military testing according to MIL-I-46058C, Amendment 7	Yes; Discoloration of coating possible during service life	Yes; Discoloration of coating possible during service life	Yes; Discoloration of coating possible during service life
• Qualification and Performance of Electrical Insulating Compound for Printed Board Assemblies according to IPC-CC-830A	Yes; Conformal coating, Class A	Yes; Conformal coating, Class A	Yes; Conformal coating, Class A

Overview



- Analog output for SIPLUS S7-1200
- Can be plugged directly into the CPU (cannot be used for +70 °C version)

Note:

SIPLUS extreme products are based on SIMATIC standard products. The contents listed here were taken from the respective standard products. SIPLUS extreme-specific information was added.

Ordering data

Article No.

SIPLUS SB 1232 analog output signal board

(Extended temperature range and exposure to media)

Ambient temperature range
-25 ... +55 °C

1 analog output, ±10 V with 12 bits or 0 ... 20 mA with 11 bits

Ambient temperature range
0 ... +55 °C

1 analog output, ±10 V with 12 bits or 0 ... 20 mA with 11 bits

Accessories**6AG1232-4HA30-5XB0****6AG1232-4HA30-4XB0**

See SIMATIC S7-1200 SB 1232 analog output modules, page 3/89

3

Technical specifications

Article number	6AG1232-4HA30-4XB0	6AG1232-4HA30-5XB0
Based on	6ES7232-4HA30-0XB0 SIPLUS S7-1200 SB 1232 1AQ	6ES7232-4HA30-0XB0 SIPLUS S7-1200 SB 1232 1AQ
Ambient conditions		
Ambient temperature during operation		
• min.	-20 °C; = Tmin (incl. condensation/frost)	-40 °C; = Tmin (incl. condensation/frost); start-up @ -25 °C
• max.	60 °C; = Tmax	60 °C; = Tmax
Altitude during operation relating to sea level		
• Installation altitude above sea level, max.	5 000 m	5 000 m
• Ambient air temperature-barometric pressure-altitude	Tmin ... Tmax at 1 140 hPa ... 795 hPa (-1 000 m ... +2 000 m) // Tmin ... (Tmax - 10 K) at 795 hPa ... 658 hPa (+2 000 m ... +3 500 m) // Tmin ... (Tmax -20 K) at 658 hPa ... 540 hPa (+3 500 m ... +5 000 m)	Tmin ... Tmax at 1 140 hPa ... 795 hPa (-1 000 m ... +2 000 m) // Tmin ... (Tmax - 10 K) at 795 hPa ... 658 hPa (+2 000 m ... +3 500 m) // Tmin ... (Tmax -20 K) at 658 hPa ... 540 hPa (+3 500 m ... +5 000 m)
Relative humidity		
• With condensation, tested in accordance with IEC 60068-2-38, max.	100 %; RH incl. condensation/frost (no commissioning under condensation conditions)	100 %; RH incl. condensation/frost (no commissioning under condensation conditions)
Resistance		
Coolants and lubricants		
- Resistant to commercially available coolants and lubricants	Yes; Incl. diesel and oil droplets in the air	Yes; Incl. diesel and oil droplets in the air
Use in stationary industrial systems		
- to biologically active substances according to EN 60721-3-3	Yes; Class 3B2 mold, fungus and dry rot spores (with the exception of fauna); Class 3B3 on request	Yes; Class 3B2 mold, fungus and dry rot spores (with the exception of fauna); Class 3B3 on request
- to chemically active substances according to EN 60721-3-3	Yes; Class 3C4 (RH < 75 %) incl. salt spray acc. to EN 60068-2-52 (severity degree 3); *	Yes; Class 3C4 (RH < 75 %) incl. salt spray acc. to EN 60068-2-52 (severity degree 3); *
- to mechanically active substances according to EN 60721-3-3	Yes; Class 3S4 incl. sand, dust, *	Yes; Class 3S4 incl. sand, dust, *
Use on ships/at sea		
- to biologically active substances according to EN 60721-3-6	Yes; Class 6B2 mold and fungal spores (excluding fauna); Class 6B3 on request	Yes; Class 6B2 mold and fungal spores (excluding fauna); Class 6B3 on request
- to chemically active substances according to EN 60721-3-6	Yes; Class 6C3 (RH < 75 %) incl. salt spray acc. to EN 60068-2-52 (severity degree 3); *	Yes; Class 6C3 (RH < 75 %) incl. salt spray acc. to EN 60068-2-52 (severity degree 3); *
- to mechanically active substances according to EN 60721-3-6	Yes; Class 6S3 incl. sand, dust; *	Yes; Class 6S3 incl. sand, dust; *

SIMATIC S7-1200 Basic Controllers

I/O modules

SIPLUS analog modules

SIPLUS SB 1232 analog output modules**Technical specifications**

Article number	6AG1232-4HA30-4XB0	6AG1232-4HA30-5XB0
Based on	6ES7232-4HA30-0XB0 SIPLUS S7-1200 SB 1232 1AQ	6ES7232-4HA30-0XB0 SIPLUS S7-1200 SB 1232 1AQ
Usage in industrial process technology		
- Against chemically active substances acc. to EN 60654-4	Yes; Class 3 (excluding trichlorethylene)	Yes; Class 3 (excluding trichlorethylene)
- Environmental conditions for process, measuring and control systems acc. to ANSI/ISA-71.04	Yes; Level GX group A/B (excluding trichlorethylene; harmful gas concentrations up to the limits of EN 60721-3-3 class 3C4 permissible); level LC3 (salt spray) and level LB3 (oil)	Yes; Level GX group A/B (excluding trichlorethylene; harmful gas concentrations up to the limits of EN 60721-3-3 class 3C4 permissible); level LC3 (salt spray) and level LB3 (oil)
Remark		
- Note regarding classification of environmental conditions acc. to EN 60721, EN 60654-4 and ANSI/ISA-71.04	* The supplied plug covers must remain in place over the unused interfaces during operation!	* The supplied plug covers must remain in place over the unused interfaces during operation!
Conformal coating		
• Coatings for printed circuit board assemblies acc. to EN 61086	Yes; Class 2 for high reliability	Yes; Class 2 for high reliability
• Protection against fouling acc. to EN 60664-3	Yes; Type 1 protection	Yes; Type 1 protection
• Military testing according to MIL-I-46058C, Amendment 7	Yes; Discoloration of coating possible during service life	Yes; Discoloration of coating possible during service life
• Qualification and Performance of Electrical Insulating Compound for Printed Board Assemblies according to IPC-CC-830A	Yes; Conformal coating, Class A	Yes; Conformal coating, Class A

Overview



- Analog inputs and outputs for SIPLUS S7-1200
- With extremely short conversion times
- For connecting analog actuators and sensors without additional amplifiers
- Even solves more complex automation tasks
- From +60 °C to +70 °C, max. 50% of the inputs and outputs can be controlled simultaneously

Note:

SIPLUS extreme products are based on SIMATIC standard products. The contents listed here were taken from the respective standard products. SIPLUS extreme-specific information was added.

Ordering data

SIPLUS SM 1234 analog input/output signal module

(Extended temperature range and exposure to media)

Ambient temperature range
-25 ... +70 °C,

from +60 ... +70 °C number of simultaneously controllable inputs and outputs max. 50%

4 analog inputs, ±10 V, ±5 V, ±2.5 V, or 0 ... 20 mA, 12-bit + sign;
2 analog outputs, ±10 V with 14-bit or 0 ... 20 mA with 13-bit

Ambient temperature range
0 ... +55 °C

4 analog inputs, ±10 V, ±5 V, ±2.5 V, or 0 ... 20 mA, 12-bit + sign;
2 analog outputs, ±10 V with 14-bit or 0 ... 20 mA with 13-bit

Accessories

Article No.

6AG1234-4HE32-2XB0**6AG1234-4HE32-4XB0**

See SIMATIC S7-1200 SM 1234 analog input/output modules, page 3/90

Technical specifications

Article number	6AG1234-4HE32-2XB0	6AG1234-4HE32-4XB0
Based on	6ES7234-4HE32-0XB0 SIPLUS S7-1200 SM 1234 4AI/2AQ	6ES7234-4HE32-0XB0 SIPLUS S7-1200 SM 1234 4AI/2AQ
Ambient conditions		
Ambient temperature during operation		
• min.	-40 °C; = Tmin (incl. condensation/frost); start-up @ -25 °C	-20 °C; = Tmin (incl. condensation/frost); start-up @ 0 °C
• max.	70 °C; = Tmax; Tmax > +60 °C number of simultaneously used outputs 1, inputs 2 (no adjacent points) for horizontal mounting position	60 °C; = Tmax
Altitude during operation relating to sea level		
• Installation altitude above sea level, max.	5 000 m	5 000 m
• Ambient air temperature-barometric pressure-altitude	Tmin ... Tmax at 1 140 hPa ... 795 hPa (-1 000 m ... +2 000 m) // Tmin ... (Tmax - 10 K) at 795 hPa ... 658 hPa (+2 000 m ... +3 500 m) // Tmin ... (Tmax -20 K) at 658 hPa ... 540 hPa (+3 500 m ... +5 000 m)	Tmin ... Tmax at 1 140 hPa ... 795 hPa (-1 000 m ... +2 000 m) // Tmin ... (Tmax - 10 K) at 795 hPa ... 658 hPa (+2 000 m ... +3 500 m) // Tmin ... (Tmax -20 K) at 658 hPa ... 540 hPa (+3 500 m ... +5 000 m)
Relative humidity		
• With condensation, tested in accordance with IEC 60068-2-38, max.	100 %; RH incl. condensation/frost (no commissioning under condensation conditions)	100 %; RH incl. condensation/frost (no commissioning under condensation conditions)

SIMATIC S7-1200 Basic Controllers

I/O modules

SIPLUS analog modules

SIPLUS SM 1234 analog input/output modules**Technical specifications**

Article number	6AG1234-4HE32-2XB0	6AG1234-4HE32-4XB0
Based on	6ES7234-4HE32-0XB0 SIPLUS S7-1200 SM 1234 4AI/2AQ	6ES7234-4HE32-0XB0 SIPLUS S7-1200 SM 1234 4AI/2AQ
Resistance		
Coolants and lubricants		
- Resistant to commercially available coolants and lubricants	Yes; Incl. diesel and oil droplets in the air	Yes; Incl. diesel and oil droplets in the air
Use in stationary industrial systems		
- to biologically active substances according to EN 60721-3-3	Yes; Class 3B2 mold, fungus and dry rot spores (with the exception of fauna); Class 3B3 on request	Yes; Class 3B2 mold, fungus and dry rot spores (with the exception of fauna); Class 3B3 on request
- to chemically active substances according to EN 60721-3-3	Yes; Class 3C4 (RH < 75 %) incl. salt spray acc. to EN 60068-2-52 (severity degree 3); *	Yes; Class 3C4 (RH < 75 %) incl. salt spray acc. to EN 60068-2-52 (severity degree 3); *
- to mechanically active substances according to EN 60721-3-3	Yes; Class 3S4 incl. sand, dust, *	Yes; Class 3S4 incl. sand, dust, *
Use on ships/at sea		
- to biologically active substances according to EN 60721-3-6	Yes; Class 6B2 mold and fungal spores (excluding fauna); Class 6B3 on request	Yes; Class 6B2 mold and fungal spores (excluding fauna); Class 6B3 on request
- to chemically active substances according to EN 60721-3-6	Yes; Class 6C3 (RH < 75 %) incl. salt spray acc. to EN 60068-2-52 (severity degree 3); *	Yes; Class 6C3 (RH < 75 %) incl. salt spray acc. to EN 60068-2-52 (severity degree 3); *
- to mechanically active substances according to EN 60721-3-6	Yes; Class 6S3 incl. sand, dust; *	Yes; Class 6S3 incl. sand, dust; *
Usage in industrial process technology		
- Against chemically active substances acc. to EN 60654-4	Yes; Class 3 (excluding trichlorethylene)	Yes; Class 3 (excluding trichlorethylene)
- Environmental conditions for process, measuring and control systems acc. to ANSI/ISA-71.04	Yes; Level GX group A/B (excluding trichlorethylene; harmful gas concentrations up to the limits of EN 60721-3-3 class 3C4 permissible); level LC3 (salt spray) and level LB3 (oil)	Yes; Level GX group A/B (excluding trichlorethylene; harmful gas concentrations up to the limits of EN 60721-3-3 class 3C4 permissible); level LC3 (salt spray) and level LB3 (oil)
Remark		
- Note regarding classification of environmental conditions acc. to EN 60721, EN 60654-4 and ANSI/ISA-71.04	* The supplied plug covers must remain in place over the unused interfaces during operation!	* The supplied plug covers must remain in place over the unused interfaces during operation!
Conformal coating		
• Coatings for printed circuit board assemblies acc. to EN 61086	Yes; Class 2 for high reliability	Yes; Class 2 for high reliability
• Protection against fouling acc. to EN 60664-3	Yes; Type 1 protection	Yes; Type 1 protection
• Military testing according to MIL-I-46058C, Amendment 7	Yes; Discoloration of coating possible during service life	Yes; Discoloration of coating possible during service life
• Qualification and Performance of Electrical Insulating Compound for Printed Board Assemblies according to IPC-CC-830A	Yes; Conformal coating, Class A	Yes; Conformal coating, Class A

Overview

- For the convenient recording of temperatures with great accuracy
- 7 common thermocouple types can be used
- Also for the measurement of analog signals with a low level (± 80 mV)
- Can easily be retrofitted to existing plant

Note:

SIPLUS extreme products are based on SIMATIC standard products. The contents listed here were taken from the respective standard products. SIPLUS extreme specific information was added.

Ordering data**Article No.****SIPLUS SM 1231 thermocouple module**

(Extended temperature range and exposure to environmental substances)

Ambient temperature range
-40 ... +70 °C

8 inputs +/- 80 mV, resolution 15-bit + sign, thermocouple types J, K, T, E, R, S, N, C, TXK/XK(L)

4 inputs +/- 80 mV, resolution 15-bit + sign, thermocouple types J, K, T, E, R, S, N, C, TXK/XK(L)

Accessories**6AG1231-5QF32-4XB0****6AG1231-5QD32-4XB0**

See SIMATIC S7-1200 SM 1231 thermocouple module, page 3/92

Technical specifications

Article number	6AG1231-5QF32-4XB0	6AG1231-5QD32-4XB0
Based on	6ES7231-5QF32-0XB0 SIPLUS S7-1200 SM 1231 8AI TC 16Bit	6ES7231-5QD32-0XB0 SIPLUS S7-1200 SM 1231 4AI TC 16Bit
Ambient conditions		
Ambient temperature during operation		
• min.	-20 °C; = Tmin (incl. condensation/frost); start-up @ 0 °C	-20 °C; = Tmin (incl. condensation/frost); start-up @ 0 °C
• max.	60 °C; = Tmax	60 °C; = Tmax
Altitude during operation relating to sea level		
• Installation altitude above sea level, max.	5 000 m	5 000 m
• Ambient air temperature-barometric pressure-altitude	Tmin ... Tmax at 1 140 hPa ... 795 hPa (-1 000 m ... +2 000 m) // Tmin ... (Tmax - 10 K) at 795 hPa ... 658 hPa (+2 000 m ... +3 500 m) // Tmin ... (Tmax -20 K) at 658 hPa ... 540 hPa (+3 500 m ... +5 000 m)	Tmin ... Tmax at 1 140 hPa ... 795 hPa (-1 000 m ... +2 000 m) // Tmin ... (Tmax - 10 K) at 795 hPa ... 658 hPa (+2 000 m ... +3 500 m) // Tmin ... (Tmax -20 K) at 658 hPa ... 540 hPa (+3 500 m ... +5 000 m)
Relative humidity		
• With condensation, tested in accordance with IEC 60068-2-38, max.	100 %; RH incl. condensation/frost (no commissioning under condensation conditions)	100 %; RH incl. condensation/frost (no commissioning under condensation conditions)
Resistance		
Coolants and lubricants		
- Resistant to commercially available coolants and lubricants	Yes; Incl. diesel and oil droplets in the air	Yes; Incl. diesel and oil droplets in the air
Use in stationary industrial systems		
- to biologically active substances according to EN 60721-3-3	Yes; Class 3B2 mold, fungus and dry rot spores (with the exception of fauna); Class 3B3 on request	Yes; Class 3B2 mold, fungus and dry rot spores (with the exception of fauna); Class 3B3 on request
- to chemically active substances according to EN 60721-3-3	Yes; Class 3C4 (RH < 75 %) incl. salt spray acc. to EN 60068-2-52 (severity degree 3); *	Yes; Class 3C4 (RH < 75 %) incl. salt spray acc. to EN 60068-2-52 (severity degree 3); *
- to mechanically active substances according to EN 60721-3-3	Yes; Class 3S4 incl. sand, dust, *	Yes; Class 3S4 incl. sand, dust, *
Use on ships/at sea		
- to biologically active substances according to EN 60721-3-6	Yes; Class 6B2 mold and fungal spores (excluding fauna); Class 6B3 on request	Yes; Class 6B2 mold and fungal spores (excluding fauna); Class 6B3 on request
- to chemically active substances according to EN 60721-3-6	Yes; Class 6C3 (RH < 75 %) incl. salt spray acc. to EN 60068-2-52 (severity degree 3); *	Yes; Class 6C3 (RH < 75 %) incl. salt spray acc. to EN 60068-2-52 (severity degree 3); *
- to mechanically active substances according to EN 60721-3-6	Yes; Class 6S3 incl. sand, dust; *	Yes; Class 6S3 incl. sand, dust; *

SIMATIC S7-1200 Basic Controllers

I/O modules

SIPLUS analog modules

SIPLUS SM 1231 thermocouple module**Technical specifications**

Article number	6AG1231-5QF32-4XB0	6AG1231-5QD32-4XB0
Based on	6ES7231-5QF32-0XB0 SIPLUS S7-1200 SM 1231 8AI TC 16Bit	6ES7231-5QD32-0XB0 SIPLUS S7-1200 SM 1231 4AI TC 16Bit
Usage in industrial process technology		
- Against chemically active substances acc. to EN 60654-4	Yes; Class 3 (excluding trichlorethylene)	Yes; Class 3 (excluding trichlorethylene)
- Environmental conditions for process, measuring and control systems acc. to ANSI/ISA-71.04	Yes; Level GX group A/B (excluding trichlorethylene; harmful gas concentrations up to the limits of EN 60721-3-3 class 3C4 permissible); level LC3 (salt spray) and level LB3 (oil)	Yes; Level GX group A/B (excluding trichlorethylene; harmful gas concentrations up to the limits of EN 60721-3-3 class 3C4 permissible); level LC3 (salt spray) and level LB3 (oil)
Remark		
- Note regarding classification of environmental conditions acc. to EN 60721, EN 60654-4 and ANSI/ISA-71.04	* The supplied plug covers must remain in place over the unused interfaces during operation!	* The supplied plug covers must remain in place over the unused interfaces during operation!
Conformal coating		
• Coatings for printed circuit board assemblies acc. to EN 61086	Yes; Class 2 for high reliability	Yes; Class 2 for high reliability
• Protection against fouling acc. to EN 60664-3	Yes; Type 1 protection	Yes; Type 1 protection
• Military testing according to MIL-I-46058C, Amendment 7	Yes; Discoloration of coating possible during service life	Yes; Discoloration of coating possible during service life
• Qualification and Performance of Electrical Insulating Compound for Printed Board Assemblies according to IPC-CC-830A	Yes; Conformal coating, Class A	Yes; Conformal coating, Class A

Overview

- For the convenient recording of temperatures with great accuracy
- 4 inputs
- Most popular resistance temperature detectors can be used
- Can easily be retrofitted to existing plant

Note:

SIPLUS extreme products are based on SIMATIC standard products. The contents listed here were taken from the respective standard products. SIPLUS extreme specific information was added.

Ordering data**Article No.****SIPLUS RTD SM 1231 signal module**

(Extended temperature range and exposure to media)

4 inputs for resistance temperature detectors
Pt10/50/100/200/500/1000,
Ni100/120/200/500/1000,
Cu10/50/100, LG-Ni1000;
resistance 150/300/600 Ohm,
resolution 15-bit + sign

- For areas with extreme exposure to media (conformal coating); ambient temperature -20 ... +60 °C
- For areas with extreme exposure to media (conformal coating); ambient temperature -40 ... +70 °C

6AG1231-5PD32-4XB0**6AG1231-5PD32-2XB0**

8 inputs for resistance temperature detectors
Pt10/50/100/200/500/1000,
Ni100/120/200/500/1000,
Cu10/50/100, LG-Ni1000;
resistance 150/300/600 Ohm,
resolution 15-bit + sign

- For areas with extreme exposure to media (conformal coating); ambient temperature -20 ... +60 °C
- For areas with extreme exposure to media (conformal coating); ambient temperature -40 ... +70 °C

6AG1231-5PF32-4XB0**6AG1231-5PF32-2XB0****Accessories**

See SIMATIC S7-1200 RTD SM 1231 signal module, page 3/95

Technical specifications

Article number	6AG1231-5PD32-4XB0	6AG1231-5PD32-2XB0	6AG1231-5PF32-4XB0	6AG1231-5PF32-2XB0
Based on	6ES7231-5PD32-0XB0 SIPLUS S7-1200 SM 1231 4AI RTD 16Bit	6ES7231-5PD32-0XB0 SIPLUS S7-1200 SM 1231 4AI RTD 16Bit	6ES7231-5PF32-0XB0 SIPLUS S7-1200 SM 1231 8AI RTD 16Bit	6ES7231-5PF32-0XB0 SIPLUS S7-1200 SM 1231 8AI RTD 16Bit
Ambient conditions				
Ambient temperature during operation				
• min.	-20 °C; = Tmin (incl. condensation/frost); start-up @ 0 °C	-40 °C; = Tmin (incl. condensation/frost); start-up @ -25 °C	-20 °C; = Tmin (incl. condensation/frost); start-up @ 0 °C	-40 °C; = Tmin (incl. condensation/frost); start-up @ -25 °C
• max.	60 °C; = Tmax	70 °C; = Tmax	60 °C; = Tmax	70 °C; = Tmax
Altitude during operation relating to sea level				
• Installation altitude above sea level, max.	5 000 m	5 000 m	5 000 m	5 000 m
• Ambient air temperature-barometric pressure-altitude	Tmin ... Tmax at 1 140 hPa ... 795 hPa (-1 000 m ... +2 000 m) // Tmin ... (Tmax - 10 K) at 795 hPa ... 658 hPa (+2 000 m ... +3 500 m) // Tmin ... (Tmax -20 K) at 658 hPa ... 540 hPa (+3 500 m ... +5 000 m)	Tmin ... Tmax at 1 140 hPa ... 795 hPa (-1 000 m ... +2 000 m) // Tmin ... (Tmax - 10 K) at 795 hPa ... 658 hPa (+2 000 m ... +3 500 m) // Tmin ... (Tmax -20 K) at 658 hPa ... 540 hPa (+3 500 m ... +5 000 m)	Tmin ... Tmax at 1 140 hPa ... 795 hPa (-1 000 m ... +2 000 m) // Tmin ... (Tmax - 10 K) at 795 hPa ... 658 hPa (+2 000 m ... +3 500 m) // Tmin ... (Tmax -20 K) at 658 hPa ... 540 hPa (+3 500 m ... +5 000 m)	Tmin ... Tmax at 1 140 hPa ... 795 hPa (-1 000 m ... +2 000 m) // Tmin ... (Tmax - 10 K) at 795 hPa ... 658 hPa (+2 000 m ... +3 500 m) // Tmin ... (Tmax -20 K) at 658 hPa ... 540 hPa (+3 500 m ... +5 000 m)
Relative humidity				
• With condensation, tested in accordance with IEC 60068-2-38, max.	100 %; RH incl. condensation/frost (no commissioning under condensation conditions)	100 %; RH incl. condensation/frost (no commissioning under condensation conditions)	100 %; RH incl. condensation/frost (no commissioning under condensation conditions)	100 %; RH incl. condensation/frost (no commissioning under condensation conditions)
Resistance				
Coolants and lubricants				
- Resistant to commercially available coolants and lubricants	Yes; Incl. diesel and oil droplets in the air	Yes; Incl. diesel and oil droplets in the air	Yes; Incl. diesel and oil droplets in the air	Yes; Incl. diesel and oil droplets in the air

SIMATIC S7-1200 Basic Controllers

I/O modules

SIPLUS analog modules

SIPLUS RTD SM 1231 signal module

Technical specifications

Article number	6AG1231-5PD32-4XB0	6AG1231-5PD32-2XB0	6AG1231-5PF32-4XB0	6AG1231-5PF32-2XB0
Based on	6ES7231-5PD32-0XB0 SIPLUS S7-1200 SM 1231 4AI RTD 16Bit	6ES7231-5PD32-0XB0 SIPLUS S7-1200 SM 1231 4AI RTD 16Bit	6ES7231-5PF32-0XB0 SIPLUS S7-1200 SM 1231 8AI RTD 16Bit	6ES7231-5PF32-0XB0 SIPLUS S7-1200 SM 1231 8AI RTD 16Bit
Use in stationary industrial systems				
- to biologically active substances according to EN 60721-3-3	Yes; Class 3B2 mold, fungus and dry rot spores (with the exception of fauna); Class 3B3 on request	Yes; Class 3B2 mold, fungus and dry rot spores (with the exception of fauna); Class 3B3 on request	Yes; Class 3B2 mold, fungus and dry rot spores (with the exception of fauna); Class 3B3 on request	Yes; Class 3B2 mold, fungus and dry rot spores (with the exception of fauna); Class 3B3 on request
- to chemically active substances according to EN 60721-3-3	Yes; Class 3C4 (RH < 75 %) incl. salt spray acc. to EN 60068-2-52 (severity degree 3); *	Yes; Class 3C4 (RH < 75 %) incl. salt spray acc. to EN 60068-2-52 (severity degree 3); *	Yes; Class 3C4 (RH < 75 %) incl. salt spray acc. to EN 60068-2-52 (severity degree 3); *	Yes; Class 3C4 (RH < 75 %) incl. salt spray acc. to EN 60068-2-52 (severity degree 3); *
- to mechanically active substances according to EN 60721-3-3	Yes; Class 3S4 incl. sand, dust; *	Yes; Class 3S4 incl. sand, dust; *	Yes; Class 3S4 incl. sand, dust; *	Yes; Class 3S4 incl. sand, dust; *
Use on ships/at sea				
- to biologically active substances according to EN 60721-3-6	Yes; Class 6B2 mold and fungal spores (excluding fauna); Class 6B3 on request	Yes; Class 6B2 mold and fungal spores (excluding fauna); Class 6B3 on request	Yes; Class 6B2 mold and fungal spores (excluding fauna); Class 6B3 on request	Yes; Class 6B2 mold and fungal spores (excluding fauna); Class 6B3 on request
- to chemically active substances according to EN 60721-3-6	Yes; Class 6C3 (RH < 75 %) incl. salt spray acc. to EN 60068-2-52 (severity degree 3); *	Yes; Class 6C3 (RH < 75 %) incl. salt spray acc. to EN 60068-2-52 (severity degree 3); *	Yes; Class 6C3 (RH < 75 %) incl. salt spray acc. to EN 60068-2-52 (severity degree 3); *	Yes; Class 6C3 (RH < 75 %) incl. salt spray acc. to EN 60068-2-52 (severity degree 3); *
- to mechanically active substances according to EN 60721-3-6	Yes; Class 6S3 incl. sand, dust; *	Yes; Class 6S3 incl. sand, dust; *	Yes; Class 6S3 incl. sand, dust; *	Yes; Class 6S3 incl. sand, dust; *
Usage in industrial process technology				
- Against chemically active substances acc. to EN 60654-4	Yes; Class 3 (excluding trichlorethylene)	Yes; Class 3 (excluding trichlorethylene)	Yes; Class 3 (excluding trichlorethylene)	Yes; Class 3 (excluding trichlorethylene)
- Environmental conditions for process, measuring and control systems acc. to ANSI/ISA-71.04	Yes; Level GX group A/B (excluding trichlorethylene; harmful gas concentrations up to the limits of EN 60721-3-3 class 3C4 permissible); level LC3 (salt spray) and level LB3 (oil)	Yes; Level GX group A/B (excluding trichlorethylene; harmful gas concentrations up to the limits of EN 60721-3-3 class 3C4 permissible); level LC3 (salt spray) and level LB3 (oil)	Yes; Level GX group A/B (excluding trichlorethylene; harmful gas concentrations up to the limits of EN 60721-3-3 class 3C4 permissible); level LC3 (salt spray) and level LB3 (oil)	Yes; Level GX group A/B (excluding trichlorethylene; harmful gas concentrations up to the limits of EN 60721-3-3 class 3C4 permissible); level LC3 (salt spray) and level LB3 (oil)
Remark				
- Note regarding classification of environmental conditions acc. to EN 60721, EN 60654-4 and ANSI/ISA-71.04	* The supplied plug covers must remain in place over the unused interfaces during operation!	* The supplied plug covers must remain in place over the unused interfaces during operation!	* The supplied plug covers must remain in place over the unused interfaces during operation!	* The supplied plug covers must remain in place over the unused interfaces during operation!
Conformal coating				
• Coatings for printed circuit board assemblies acc. to EN 61086	Yes; Class 2 for high reliability	Yes; Class 2 for high reliability	Yes; Class 2 for high reliability	Yes; Class 2 for high reliability
• Protection against fouling acc. to EN 60664-3	Yes; Type 1 protection	Yes; Type 1 protection	Yes; Type 1 protection	Yes; Type 1 protection
• Military testing according to MIL-I-46058C, Amendment 7	Yes; Discoloration of coating possible during service life	Yes; Discoloration of coating possible during service life	Yes; Discoloration of coating possible during service life	Yes; Discoloration of coating possible during service life
• Qualification and Performance of Electrical Insulating Compound for Printed Board Assemblies according to IPC-CC-830A	Yes; Conformal coating, Class A	Yes; Conformal coating, Class A	Yes; Conformal coating, Class A	Yes; Conformal coating, Class A

Overview

- For the convenient recording of temperatures with great accuracy
- 1 input with 16-bit resolution
- Common resistance-type temperature detectors can be used
- Can easily be retrofitted to existing plant
- Can be plugged directly into the CPU

Note:

SIPLUS extreme products are based on SIMATIC standard products. The contents listed here were taken from the respective standard products. SIPLUS extreme specific information was added.

Ordering data

Article No.

SIPLUS RTD SB 1231 signal board

(Extended temperature range and exposure to media)

1 input for resistance temperature sensors
Pt 100, Pt 200, Pt 500, Pt 1000,
resolution 15-bit + sign

Accessories

6AG1231-5PA30-5XB0

See SIMATIC S7-1200
RTD SB 1231 signal board,
page 3/98

Technical specifications

Article number	6AG1231-5PA30-5XB0
Based on	6ES7231-5PA30-0XB0 SIPLUS S7-1200 SB 1231 1AI RTD
Ambient conditions	...
Ambient temperature during operation	
• min.	-40 °C; = Tmin (incl. condensation/frost); start-up @ -25 °C
• max.	60 °C; = Tmax
Altitude during operation relating to sea level	
• Installation altitude above sea level, max.	5 000 m
• Ambient air temperature-barometric pressure-altitude	Tmin ... Tmax at 1 140 hPa ... 795 hPa (-1 000 m ... +2 000 m) // Tmin ... (Tmax - 10 K) at 795 hPa ... 658 hPa (+2 000 m ... +3 500 m) // Tmin ... (Tmax -20 K) at 658 hPa ... 540 hPa (+3 500 m ... +5 000 m)
Relative humidity	
• With condensation, tested in accordance with IEC 60068-2-38, max.	100 %; RH incl. condensation / frost (no commissioning in bedewed state), horizontal installation
Resistance	
Coolants and lubricants	
- Resistant to commercially available coolants and lubricants	Yes; Incl. diesel and oil droplets in the air
Use in stationary industrial systems	
- to biologically active substances according to EN 60721-3-3	Yes; Class 3B2 mold, fungus and dry rot spores (with the exception of fauna); Class 3B3 on request
- to chemically active substances according to EN 60721-3-3	Yes; Class 3C4 (RH < 75 %) incl. salt spray acc. to EN 60068-2-52 (severity degree 3); *
- to mechanically active substances according to EN 60721-3-3	Yes; Class 3S4 incl. sand, dust, *

Article number	6AG1231-5PA30-5XB0
Based on	6ES7231-5PA30-0XB0 SIPLUS S7-1200 SB 1231 1AI RTD
Use on ships/at sea	
- to biologically active substances according to EN 60721-3-6	Yes; Class 6B2 mold and fungal spores (excluding fauna); Class 6B3 on request
- to chemically active substances according to EN 60721-3-6	Yes; Class 6C3 (RH < 75 %) incl. salt spray acc. to EN 60068-2-52 (severity degree 3); *
- to mechanically active substances according to EN 60721-3-6	Yes; Class 6S3 incl. sand, dust; *
Usage in industrial process technology	
- Against chemically active substances acc. to EN 60654-4	Yes; Class 3 (excluding trichlorethylene)
- Environmental conditions for process, measuring and control systems acc. to ANSI/ISA-71.04	Yes; Level GX group A/B (excluding trichlorethylene; harmful gas concentrations up to the limits of EN 60721-3-3 class 3C4 permissible); level LC3 (salt spray) and level LB3 (oil)
Remark	
- Note regarding classification of environmental conditions acc. to EN 60721, EN 60654-4 and ANSI/ISA-71.04	* The supplied plug covers must remain in place over the unused interfaces during operation!
Conformal coating	
• Coatings for printed circuit board assemblies acc. to EN 61086	Yes; Class 2 for high reliability
• Protection against fouling acc. to EN 60664-3	Yes; Type 1 protection
• Military testing according to MIL-I-46058C, Amendment 7	Yes; Discoloration of coating possible during service life
• Qualification and Performance of Electrical Insulating Compound for Printed Board Assemblies according to IPC-CC-830A	Yes; Conformal coating, Class A

SIMATIC S7-1200 Basic Controllers

I/O modules

Special modules

SM 1278 4xIO-Link master

Overview



- Module for connecting up to 4 IO-Link devices according to IO Link Specification V1.1. The IO-Link parameters are configured using the Port Configuration Tool (PCT), version V3.2 and higher.

Ordering data

Article No.

SM 1278 4xIO-Link-Master signal module

6ES7278-4BD32-0XB0

for the connection of up to 4 IO-Link devices according to IO Link Specification V1.1

Terminal block (spare part)

- 7-pin, tin-coated; 4 units
 - Screw-type system
 - Push-in system

6ES7292-1AG30-0XA0
6ES7292-2AG30-0XA0

Technical specifications

Article number	6ES7278-4BD32-0XB0 S7-1200, SM1278, 4 X IO-Link Master
General information	
Product type designation	SM 1278 4xIO-Link master
Supply voltage	
Rated value (DC)	24 V
Interrupts/diagnostics/ status information	
Diagnostics function	Yes
Degree and class of protection	
IP degree of protection	IP20
Standards, approvals, certificates	
CE mark	Yes
CSA approval	Yes
UL approval	Yes
cULus	Yes
FM approval	Yes
RCM (formerly C-TICK)	Yes
KC approval	Yes
Marine approval	Yes

Article number	6ES7278-4BD32-0XB0 S7-1200, SM1278, 4 X IO-Link Master
Ambient conditions	
Ambient temperature during operation	
• min.	-20 °C
• max.	60 °C
connection method / header	
required front connector	Yes
Mechanics/material	
Enclosure material (front)	Yes
• Plastic	Yes
Dimensions	
Width	45 mm
Height	100 mm
Depth	75 mm
Weights	
Weight, approx.	150 g

Overview



- Module for connecting up to 4 IO-Link devices according to IO Link Specification V1.1. The IO-Link parameters are configured using the Port Configuration Tool (PCT), version V3.2 and higher.

Note:

SIPLUS extreme products are based on SIMATIC standard products. The contents listed here were taken from the respective standard products. SIPLUS extreme-specific information was added.

Ordering data

Article No.

SIPLUS SM 1278 4xIO-Link master signal module

(Extended temperature range and exposure to media)

- For areas with extreme exposure to media (conformal coating)
- -25 ... +70 °C, from +60 ... +70 °C number of simultaneously controllable inputs and outputs max. 50%

6AG1278-4BD32-4XB0**6AG1278-4BD32-2XB0**

3

Technical specifications

Article number	6AG1278-4BD32-2XB0	6AG1278-4BD32-4XB0
Based on	6ES7278-4BD32-0XB0 SIPLUS S7-1200 SM 1278 IO-Link Master	6ES7278-4BD32-0XB0 SIPLUS S7-1200 SM 1278 IO-Link Master
Ambient conditions		
Ambient temperature during operation		
• min.	-40 °C; = Tmin (incl. condensation/frost); start-up @ -25 °C	-20 °C; = Tmin (incl. condensation/frost); start-up @ 0 °C
• max.	70 °C; = Tmax	60 °C; = Tmax
• At cold restart, min.	-25 °C	0 °C
Altitude during operation relating to sea level		
• Installation altitude above sea level, max.	5 000 m	5 000 m
• Ambient air temperature-barometric pressure-altitude	Tmin ... Tmax at 1 140 hPa ... 795 hPa (-1 000 m ... +2 000 m) // Tmin ... (Tmax - 10 K) at 795 hPa ... 658 hPa (+2 000 m ... +3 500 m) // Tmin ... (Tmax -20 K) at 658 hPa ... 540 hPa (+3 500 m ... +5 000 m)	Tmin ... Tmax at 1 140 hPa ... 795 hPa (-1 000 m ... +2 000 m) // Tmin ... (Tmax - 10 K) at 795 hPa ... 658 hPa (+2 000 m ... +3 500 m) // Tmin ... (Tmax -20 K) at 658 hPa ... 540 hPa (+3 500 m ... +5 000 m)
Relative humidity		
• With condensation, tested in accordance with IEC 60068-2-38, max.	100 %; RH incl. condensation/frost (no commissioning under condensation conditions)	100 %; RH incl. condensation/frost (no commissioning under condensation conditions)
Resistance		
Coolants and lubricants		
- Resistant to commercially available coolants and lubricants	Yes; Incl. diesel and oil droplets in the air	Yes; Incl. diesel and oil droplets in the air
Use in stationary industrial systems		
- to biologically active substances according to EN 60721-3-3	Yes; Class 3B2 mold, fungus and dry rot spores (with the exception of fauna); Class 3B3 on request	Yes; Class 3B2 mold, fungus and dry rot spores (with the exception of fauna); Class 3B3 on request
- to chemically active substances according to EN 60721-3-3	Yes; Class 3C4 (RH < 75 %) incl. salt spray acc. to EN 60068-2-52 (severity degree 3); *	Yes; Class 3C4 (RH < 75 %) incl. salt spray acc. to EN 60068-2-52 (severity degree 3); *
- to mechanically active substances according to EN 60721-3-3	Yes; Class 3S4 incl. sand, dust, *	Yes; Class 3S4 incl. sand, dust, *

SIMATIC S7-1200 Basic Controllers

I/O modules

Special modules

SIPLUS SM 1278 4xIO-Link master**Technical specifications**

Article number	6AG1278-4BD32-2XB0	6AG1278-4BD32-4XB0
Based on	6ES7278-4BD32-0XB0 SIPLUS S7-1200 SM 1278 IO-Link Master	6ES7278-4BD32-0XB0 SIPLUS S7-1200 SM 1278 IO-Link Master
Use on ships/at sea		
- to biologically active substances according to EN 60721-3-6	Yes; Class 6B2 mold and fungal spores (excluding fauna); Class 6B3 on request	Yes; Class 6B2 mold and fungal spores (excluding fauna); Class 6B3 on request
- to chemically active substances according to EN 60721-3-6	Yes; Class 6C3 (RH < 75 %) incl. salt spray acc. to EN 60068-2-52 (severity degree 3); *	Yes; Class 6C3 (RH < 75 %) incl. salt spray acc. to EN 60068-2-52 (severity degree 3); *
- to mechanically active substances according to EN 60721-3-6	Yes; Class 6S3 incl. sand, dust; *	Yes; Class 6S3 incl. sand, dust; *
Usage in industrial process technology		
- Against chemically active substances acc. to EN 60654-4	Yes; Class 3 (excluding trichlorethylene)	Yes; Class 3 (excluding trichlorethylene)
- Environmental conditions for process, measuring and control systems acc. to ANSI/ISA-71.04	Yes; Level GX group A/B (excluding trichlorethylene; harmful gas concentrations up to the limits of EN 60721-3-3 class 3C4 permissible); level LC3 (salt spray) and level LB3 (oil)	Yes; Level GX group A/B (excluding trichlorethylene; harmful gas concentrations up to the limits of EN 60721-3-3 class 3C4 permissible); level LC3 (salt spray) and level LB3 (oil)
Remark		
- Note regarding classification of environmental conditions acc. to EN 60721, EN 60654-4 and ANSI/ISA-71.04	* The supplied plug covers must remain in place over the unused interfaces during operation!	* The supplied plug covers must remain in place over the unused interfaces during operation!
Conformal coating		
• Coatings for printed circuit board assemblies acc. to EN 61086	Yes; Class 2 for high reliability	Yes; Class 2 for high reliability
• Protection against fouling acc. to EN 60664-3	Yes; Type 1 protection	Yes; Type 1 protection
• Military testing according to MIL-I-46058C, Amendment 7	Yes; Discoloration of coating possible during service life	Yes; Discoloration of coating possible during service life
• Qualification and Performance of Electrical Insulating Compound for Printed Board Assemblies according to IPC-CC-830A	Yes; Conformal coating, Class A	Yes; Conformal coating, Class A

Overview



SIPLUS CMS1200 SM 1281 Condition Monitoring forms part of SIMATIC S7-1200 and is used for the:

- Monitoring of motors, generators, pumps, fans, or other mechanical components
- Recording and analysis of vibrations
- Expansion capability of up to 7 modules

Ordering data

Article No.

SIPLUS CMS1200 SM 1281 Condition Monitoring**6AT8007-1AA10-0AA0**

Module for SIMATIC S7-1200 for monitoring vibrations in mechanical components based on characteristic values and frequency-selective analysis functions.

SIPLUS CMS1200 Ready to use Bundle**6AT8007-1AA30-0AA0**

Consisting of:

- SM1281 Condition Monitoring
- SM1281 Shield clamp set
- S7-1214C CPU
- S7-1200 Battery Board
- Memory card with TIA project

SIPLUS CMS1200 X-Tools Bundle**6AT8007-1AA31-0AA0**

Consisting of:

- SM1281 Condition Monitoring
- SM1281 Shield clamp set
- X-Tools Professional V05.00
- X-Tool Analysis library V05.00

Accessories**SIPLUS CMS1200 SM 1281 Shield clamp set****6AT8007-1AA20-0AA0**

For EMC-compliant connection of signal and encoder cables to SIPLUS CMS1200 SM 1281 Condition Monitoring.

SIPLUS CMS VIB-SENSOR

Piezoelectric sensor for connection to SIPLUS CMS1200 SM 1281 Condition Monitoring.

SIPLUS CMS VIB-Sensor S01, frequency range 0,5 Hz to 15 kHz; measuring range 50G; sensitivity 100 mV/G (+/-10 %); MIL connector on top

6AT8002-4AB00

SIPLUS CMS VIB-Sensor S02, frequency range 1 Hz to 15 kHz; measuring range 500G; sensitivity 10 mV/G (+/-10 %); MIL connector on top

6AT8008-2AA00-0AA0

SIPLUS CMS VIB-Sensor S03, frequency range 0,2 Hz to 3 kHz; measuring range 10G; sensitivity 500 mV/G (+/-10 %); MIL connector on top

6AT8008-2AA02-0AA0**SIPLUS CMS CABLE-MIL**

For connection of VIB-SENSOR S01, S02 and S03 vibration sensor to SIPLUS CMS1200 SM 1281 Condition Monitoring.

SIPLUS CMS CABLE-MIL-300; length 3 m

6AT8002-4AC03

SIPLUS CMS CABLE-MIL-1000; length 10 m

6AT8002-4AC10

SIPLUS CMS CABLE-MIL-3000; length 30 m

6AT8008-2BA12-0AA0

SIMATIC S7-1200 Basic Controllers

I/O modules

Special modules

SIPLUS CMS1200 SM 1281 Condition Monitoring

Technical specifications

Article number	6AT8007-1AA10-0AA0 SM1281_Condition_Monitoring
General information	
Product type designation	SM1281
Product description	S7-1200 module for the monitoring of vibrations on mechanical components based on parameters and frequency-selective analysis functions
Installation type/mounting	
Mounting type	Rail or wall mounting
Mounting position	Horizontal, vertical
Recommended mounting position	Horizontal
Supply voltage	
Type of supply voltage	DC
Rated value (DC)	24 V
permissible range, lower limit (DC)	20.4 V
permissible range, upper limit (DC)	28.8 V
Input current	
Current consumption, typ.	200 mA
Current consumption, max.	250 mA
from backplane bus 5 V DC, typ.	80 mA
from backplane bus 5 V DC, max.	85 mA
Power loss	
Power loss, typ.	4.8 W
Memory	
Total memory capacity	1 Gbyte
Hardware configuration	
Design of hardware configuration	Modular, up to 7 modules per CPU
Speed input	
Number of speed inputs	1
Input voltage	
• 24 V DC digital	Yes
Sensor input	
Number of IEPE sensor inputs	4
Sampling frequency, max.	46 875 Hz
Interfaces	
Type of data transmission	Export of raw data as WAV file for further analysis (e.g. using CMS X-Tools) can be downloaded via browser/FTP, online data transfer to CMS X-Tools
Ethernet interface	Yes
Protocols	
Bus communication	Yes
Web server	
• HTTP	Yes
Interrupts/diagnostics/status information	
Alarms	
• Diagnostic alarm	Yes
Diagnostics indication LED	
• for status of the inputs	Yes
• for maintenance	Yes
• Status indicator digital input (green)	No

Article number	6AT8007-1AA10-0AA0 SM1281_Condition_Monitoring
Integrated Functions	
Monitoring functions	
• Monitoring of the sensor inputs	Yes; Cable break and short-circuit
• Vibration characteristic monitoring via RMS value of the vibration speed	Yes
• Vibration characteristic monitoring via RMS value of the vibration acceleration	Yes
• Vibration characteristic monitoring via diagnostic characteristic value	Yes
• Frequency-selective monitoring via vibration speed spectrum	Yes
• Frequency-selective monitoring via vibration acceleration spectrum	Yes
• Frequency-selective monitoring via envelope curve analysis	Yes
Measuring functions	
• Physical measuring principle	Vibration acceleration
Measuring range	
- Measurement range vibration frequency, min.	0.1 Hz
- Measurement range vibration frequency, max.	10 000 Hz
Standards, approvals, certificates	
Certificate of suitability	CE
Ambient conditions	
Free fall	
• Fall height, max.	0.3 m; five times, in product package
Software	
Browser software required	Web browser Mozilla Firefox (ESR31) or Microsoft Internet Explorer (10/11)
Connection method	
required front connector	Yes
Design of electrical connection	Screw connection
Mechanics/material	
Material of housing	Plastic: polycarbonate, abbreviation: PC- GF 10 FR
Dimensions	
Width	70 mm
Height	112 mm
Depth	75 mm
Weights	
Weight, approx.	260 g

3

Overview

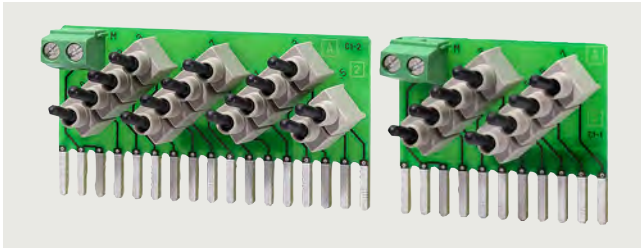

- Simulator module for program testing during commissioning and ongoing operation
- Simulation of 8 or 14 inputs

Ordering data

Article No.

**Digital input simulator
SIM 1274 simulator module**

with 8 input switches,
for CPU 1211C/1212C

6ES7274-1XF30-0XA0

with 14 input switches,
for CPU 1214C/1215C

6ES7274-1XH30-0XA0

with 14 input switches,
for CPU 1217C

6ES7274-1XK30-0XA0

**Analog input simulator
SIM 1274 simulator module**

2 potentiometers

6ES7274-1XA30-0XA0

Technical specifications

Article number	6ES7274-1XF30-0XA0	6ES7274-1XH30-0XA0
	S7-1200 Simulator Module SIM1274, 8 Inp	S7-1200 Simulator Module SIM1274, 14 Inp
General information		
Product type designation	SIM 1274, 8DI	SIM 1274, 14 DI
Supply voltage		
Rated value (DC)	24 V	24 V
Digital inputs		
Number of digital inputs	8	14
Digital outputs		
Number of digital outputs	0	0
Degree and class of protection		
IP degree of protection	IP20	IP20
Dimensions		
Width	43 mm	67 mm
Height	35 mm	35 mm
Depth	23 mm	23 mm

SIMATIC S7-1200 Basic Controllers

I/O modules

Special modules

BB 1297 battery board**Overview**

- Battery board for extending the power reserve for the S7-1200 real-time clock

Ordering data**Article No.****BB 1297 battery board****6ES7297-0AX30-0XA0**

For long-term backup of real-time clock; can be plugged into the signal board slot of an S7-1200 CPU in FW version 3.0 or higher; battery (CR 1025) is not included

Terminal block (spare part)

For signal board
with 6 screws, gold-plated; 4 units

6ES7292-1BF30-0XA0**Technical specifications**

Article number	6ES7297-0AX30-0XA0 Battery Board BB 1297 f. CPU 12xx
General information	
Product type designation	BB 1297
Interrupts/diagnostics/status information	
Alarms	Yes
Diagnostics function	Yes
Diagnostics indication LED	
• for maintenance	Yes; The maintenance LED (MAINT) of the PLC signals that the battery needs to be replaced.
Standards, approvals, certificates	
CE mark	Yes
CSA approval	Yes
FM approval	Yes
RCM (formerly C-TICK)	Yes
Marine approval	Yes

Article number	6ES7297-0AX30-0XA0 Battery Board BB 1297 f. CPU 12xx
Ambient conditions	
Free fall	
• Fall height, max.	0.3 m; five times, in product package
Ambient temperature during operation	
• min.	-20 °C
• max.	60 °C
Ambient temperature during storage/transportation	
• min.	-40 °C
• max.	70 °C
Air pressure acc. to IEC 60068-2-13	
• Operation, min.	795 hPa
• Operation, max.	1 080 hPa
• Storage/transport, min.	660 hPa
• Storage/transport, max.	1 080 hPa
Relative humidity	
• Operation at 25 °C without condensation, max.	95 %
Mechanics/material	
Enclosure material (front)	
• Plastic	Yes
Dimensions	
Width	38 mm
Height	62 mm
Depth	21 mm
Weights	
Weight, approx.	40 g

Overview



SIWAREX WP231 is a versatile, legal for trade weighing module for all simple weighing and force measuring tasks. The compact module is easy to install in the SIMATIC S7-1200 automation system. It can also be operated without a SIMATIC CPU.

3

Ordering data

Ordering data	Article No.	Ordering data	Article No.
SIWAREX WP231 weighing module Single-channel, legal-for-trade, for NAWI non-automatic weighing instruments (e.g. platform scales or hopper scales) with analog load cells (1–4 mV/V), 1 x LC, 4 x DQ, 4 x DI, 1 x AQ, 1 RS 485, Ethernet port.	7MH4960-2AA01	SIWATOOL V4 & V7 Service and commissioning software for SIWAREX weighing modules	7MH4900-1AK01
SIWAREX S7-1200 Equipment Manual Available in a range of languages Free download on the Internet at: http://www.siemens.com/weighing/documentation		Calibration set for SIWAREX WP2xx Valid for SIWAREX WP231 and SIWAREX WP251. For verification of up to 3 scales, comprising: <ul style="list-style-type: none"> • 3 x inscription foils for ID label • 1 x protective film • 3 x calibration protection plates • Guidelines for verification, certificates and approvals, editable label, SIWAREX WP 	7MH4960-0AY10
SIWAREX WP231 "Ready-for-use" Complete software package for non-automatic weighing instrument (for S7-1200 and a directly connected operator panel). Free download on the Internet at: http://www.siemens.com/weighing/documentation		Ethernet cable patch cord 2 m (7 ft) For connecting SIWAREX WP231 to a PC (SIWATOOL), SIMATIC CPU, panel, etc.	6XV1850-2GH20
SIWAREX WP231 "Ready-for-use - legal-for-trade" Software package for non-automatic weighing instruments for S7-1200 requiring official calibration. Free download on the Internet at: http://www.siemens.com/weighing/documentation		Remote display (optional) The digital remote displays can be connected directly to the SIWAREX WP231 via the RS 485 interface. Suitable remote display: S102 Siebert Industrieelektronik GmbH PO Box 1180 D-66565 Eppelborn Tel.: +49 6806/980-0 Fax: +49 6806/980-999 Internet: https://www.siebert-group.com/en/ Detailed information is available from the manufacturer.	
Software SecureDisplay Software for a legal trade display on Windows CE-based Panel. SIMATIC Basic and Key Panels are excluded. Free download on the Internet at: http://www.siemens.com/weighing/documentation			

SIMATIC S7-1200 Basic Controllers

I/O modules

Special modules

SIWAREX WP231 weighing module

Ordering data

Article No.

Accessories

SIWAREX JB junction box, aluminum housing

7MH5001-0AA20

For connecting up to 4 load cells in parallel, and for connecting multiple junction boxes.

SIWAREX JB junction box, stainless steel housing

7MH5001-0AA00

For connecting up to 4 load cells in parallel.

SIWAREX JB junction box, stainless steel housing (ATEX)

7MH5001-0AA01

For parallel connection of up to 4 load cells (for zone allocation, see manual or type-examination certificate).

SIWAREX DB digital terminal box

7MH5001-0AD20

For enhanced diagnostic and monitoring options in conjunction with SIWAREX WP electronics

SIWAREX IS Ex interface

For intrinsically safe connection of load cells. With ATEX approval (not UL/FM). Suitable for SIWAREX electronic weighing systems. Compatibility of load cells must be checked separately.

- Short-circuit current < 199 mA DC
- Short-circuit current < 137 mA DC

7MH4710-5BA
7MH4710-5CA

Article No.

Cable (optional)

Cable Li2Y 1 × 2 × 0.75 ST + 2 × (2 × 0.34 ST) – CY

For connecting SIWAREX electronic weighing systems to junction box (JB), extension box (EB) and Ex interface or between two EBs. For permanent installation. Occasional bending is possible.

External diameter:
approx. 10.8 mm (0.43 inch)

Permissible ambient temperature
-40 ... +80 °C (-40 ... +176 °F)

Sold by the meter.

- Sheath color: orange
- For hazardous atmospheres. Sheath color: blue.

7MH4702-8AG
7MH4702-8AF

Ground terminal for connecting the load cell cable shield to the grounded DIN rail

6ES5728-8MA11

Commissioning

Commissioning charge for one static scale with SIWAREX module

9LA1110-8SN50-0AA0

(Flat charge for travel and setup must be ordered separately)

Scope:

- Recording of data
- Checking of mechanical installation of the scale
- Checking of electrical wiring and function
- Static adjustment of the scale

Requirements:

- Mechanical design functional
- Modules electrically wired and tested
- Calibration weights available
- Free access to scale

Flat charge for travel and setup in Germany

9LA1110-8RA10-0AA0

Technical specifications

SIWAREX WP231		SIWAREX WP231	
Integration in automation systems		Load cells	Full-bridge strain gauges in 4-wire or 6-wire system
S7-1200	SIMATIC S7-1200 system bus	Load cell powering	
Operator panel and/or automation systems from other vendors	Via Ethernet (Modbus TCP/IP) or RS 485 (Modbus RTU)	Supply voltage (regulated via feedback)	4.85 V DC
Communication interfaces	<ul style="list-style-type: none"> • SIMATIC S7-1200 backplane bus • RS 485 (Modbus RTU, Siebert remote display) • Ethernet (SIWATOOL V7, Modbus TCP/IP) • Analog output 0/4 - 20 mA • 4 × digital outputs 24 V DC, floating, short-circuit proof • 4 × digital inputs 24 V DC, floating 	Permissible load resistance	
Commissioning options	<ul style="list-style-type: none"> • Using SIWATOOL V7 • Using function block in SIMATIC S7-1200 CPU / Touch Panel • Using Modbus TCP/IP • Using Modbus RTU 	<ul style="list-style-type: none"> • R_{Lmin} • R_{Lmax} 	<ul style="list-style-type: none"> > 40 Ω < 4 100 Ω
Measuring accuracy		With SIWAREX IS Ex interface	
EC type approval as non-automatic weighing instrument, trade class III	3000 d \geq 0.5 μ V/e	<ul style="list-style-type: none"> • R_{Lmin} • R_{Lmax} 	<ul style="list-style-type: none"> > 50 Ω < 4 100 Ω
Error limit according to DIN 1319-1 of full-scale value at 20 °C \pm 10 K (68 °F \pm 10 K)	0.05%	Load cell characteristic	1 ... 4 mV/V
Internal resolution	Up to \pm 4 million parts	Permissible range of the measurement signal (with 4 mV/V sensors)	-21.3 ... +21.3 mV
Measuring frequency	100 / 120 Hz	Max. distance of load cells	500 m (229.66 ft)
Digital filter	Variable adjustable low-pass and average filter	Connection to load cells in Ex zone 1	Optionally via SIWAREX IS Ex interface (compatibility of the load cells must be checked)
Typical applications	<ul style="list-style-type: none"> • Non-automatic weighing instruments • Force measurements • Fill-level monitoring • Belt tension monitors 	Approvals/certificates	<ul style="list-style-type: none"> • ATEX Zone 2 • UL • EAC • KCC • RCM • OIML R76 • Type approval 2009/23/EC (NAWI)
Weighing functions		Calibration approval	EC type approval OIML R76
Weight values	<ul style="list-style-type: none"> • Gross • Net • Tare 	Auxiliary power supply	
Limit values	<ul style="list-style-type: none"> • 2 × min/max • Empty 	Rated voltage	24 V DC
Zeroing	Per command	Max. power consumption	200 mA
Tare	Per command	Max. power consumption SIMATIC Bus	3 mA
Tare specification	Per command	IP degree of protection to EN 60529; IEC 60529	IP20
		Climatic requirements	
		$T_{min(IND)} \dots T_{max(IND)}$ (operating temperature)	
		• Vertical installation	-10 ... +40 °C (14 ... 104 °F)
		• Horizontal installation	-10 ... +55 °C (14 ... 131 °F)
		EMC requirements	According to EN 45501
		Dimensions	70 × 75 × 100 mm (2.76 × 2.95 × 3.94 inch)

SIMATIC S7-1200 Basic Controllers

I/O modules

Special modules

SIWAREX WP241 weighing module

Overview



SIWAREX WP241 is a flexible weighing module for belt scales. The compact module is easy to install in the SIMATIC S7-1200 automation system. It can also be operated as a stand-alone module, i.e. without a SIMATIC CPU.

Ordering data

SIWAREX WP241 weighing module

Single-channel, for belt scales with analog load cells / full-bridge strain gauges (1 - 4 mV/V), 1 × LC, 4 × DQ, 4 × DI, 1 × AQ, 1 × RS 485, Ethernet port.

SIWAREX S7-1200 Equipment Manual

Available in a range of languages

Free download on the Internet at: <http://www.siemens.com/weighing/documentation>

SIWAREX WP241 "Ready-for-use"

Complete software package for belt scale (for S7-1200 and a directly connected operator panel)

Free download on the Internet at: <http://www.siemens.com/weighing/documentation>

SIWATOOL V4 & V7

Service and commissioning software for SIWAREX weighing modules

Ethernet cable patch cord 2 m (7 ft)

For connecting SIWAREX WP241 to a PC (SIWATOOL), SIMATIC CPU, panel, etc.

Article No.

7MH4960-4AA01

7MH4900-1AK01

6XV1850-2GH20

Article No.

Accessories

SIWAREX JB junction box, aluminum housing

For connecting up to 4 load cells in parallel, and for connecting multiple junction boxes.

SIWAREX JB junction box, stainless steel housing

For connecting up to 4 load cells in parallel.

SIWAREX JB junction box, stainless steel housing (ATEX)

For parallel connection of up to 4 load cells (for zone allocation, see manual or type-examination certificate).

SIWAREX IS Ex interface

For intrinsically safe connection of load cells. With ATEX approval (not UL/FM). Suitable for SIWAREX electronic weighing systems. Compatibility of load cells must be checked separately.

- Short-circuit current < 199 mA DC
- Short-circuit current < 137 mA DC

Cable (optional)

Cable Li2Y 1 × 2 × 0.75 ST + 2 × (2 × 0.34 ST) – CY

For connecting SIWAREX electronic weighing systems to junction box (JB), extension box (EB) and Ex interface or between two EBs. For permanent installation. Occasional bending is possible.

External diameter: approx. 10.8 mm (0.43 inch)

Permissible ambient temperature -40 ... +80 °C (-40 ... +176 °F)

Sold by the meter.

- Sheath color: orange
- For hazardous atmospheres. Sheath color: blue.

Ground terminal for connecting the load cell cable shield to the grounded DIN rail

7MH5001-0AA20

7MH5001-0AA00

7MH5001-0AA01

7MH4710-5BA
7MH4710-5CA7MH4702-8AG
7MH4702-8AF

6ES5728-8MA11

Ordering data	Article No.	Article No.
Commissioning		
Commissioning charge for one belt scale with SIWAREX module	9LA1110-8SM50-0AA0	
(Flat charge for travel and setup must be ordered separately)		
Scope:		
• Recording of data		
• Checking of mechanical installation of the scale		
• Checking of electrical wiring and function		
• Dynamic adjustment of the scale		
Requirements:		
• Mechanical design functional		
• Modules electrically wired and tested		
• Calibration weights available		
• Free access to scale		
		Flat charge for travel and setup in Germany
		9LA1110-8RA10-0AA0

Technical specifications

SIWAREX WP241		SIWAREX WP241	
Integration in automation systems		Load cells	Full-bridge strain gauges in 4-wire or 6-wire system
S7-1200	SIMATIC S7-1200 system bus	Load cell powering	
Operator panel and/or automation systems from other vendors	Via Ethernet (Modbus TCP/IP) or RS 485 (Modbus RTU)	Supply voltage (regulated via feedback)	4.85 V DC
Communication interfaces	<ul style="list-style-type: none"> • SIMATIC S7-1200 backplane bus • RS 485 (Modbus RTU) • Ethernet (SIWATOOL V7, Modbus TCP/IP) • Analog output 0/4 - 20 mA • 4 × digital outputs, 24 V DC, floating, short-circuit proof • 4 × digital inputs 24 V DC, floating 	Permissible load resistance	
Commissioning options	<ul style="list-style-type: none"> • Using SIWATOOL V7 • Using function block in SIMATIC S7-1200 CPU / Touch Panel • Using Modbus TCP/IP • Using Modbus RTU 	<ul style="list-style-type: none"> • R_{Lmin} • R_{Lmax} 	<ul style="list-style-type: none"> > 40 Ω < 4 100 Ω
Measuring accuracy		With SIWAREX IS Ex interface	
Error limit according to DIN 1319-1 of full-scale value at 20 °C ± 10 K (68 °F ± 10 K)	0.05%	<ul style="list-style-type: none"> • R_{Lmin} • R_{Lmax} 	<ul style="list-style-type: none"> > 50 Ω < 4 100 Ω
Internal resolution	Up to ± 4 million parts	Load cell characteristic	1 ... 4 mV/V
Measuring frequency	100 / 120 Hz	Permissible measurement signal range	-21.3 ... +21.3 mV
Digital filter	Separate, variable adjustable low-pass and average filter for loading and speed	Max. distance of load cells	500 m (229.66 ft)
Filter for conveyor load	Low-pass filter (limit frequency 0.05 ... 50 Hz)	Connection to load cells in Ex zone 1	Optionally via SIWAREX IS Ex interface (compatibility of the load cells must be checked)
Filter for belt speed	Low-pass filter (limit frequency 0.05 ... 50 Hz)	Approvals/certificates	<ul style="list-style-type: none"> • ATEX Zone 2 • UL • EAC • KCC • RCM
Weighing functions		Auxiliary power supply	
Readout data	<ul style="list-style-type: none"> • Weight • Belt load • Material flow rate • Accumulated total • Main total • Free totals 1 ... 4 • Belt speed 	Rated voltage	24 V DC
Limits (min/max)	<ul style="list-style-type: none"> • Belt load • Material flow rate • Belt speed 	Max. power consumption	200 mA
		Max. power consumption SIMATIC Bus	3 mA
		IP degree of protection to EN 60529; IEC 60529	IP20
		Climatic requirements	
		$T_{min(IND)} \dots T_{max(IND)}$ (operating temperature)	
		• Vertical installation	-10 ... +40 °C (14 ... 104 °F)
		• Horizontal installation	-10 ... +55 °C (14 ... 131 °F)
		EMC requirements	According to EN 45501
		Dimensions	70 × 75 × 100 mm (2.76 × 2.95 × 3.94 inch)

SIMATIC S7-1200 Basic Controllers

I/O modules

Special modules

SIWAREX WP251 weighing module**Overview**

SIWAREX WP251 is a flexible weighing module for dosing and filling processes. The compact module can be installed seamlessly in the SIMATIC S7-1200 automation system. It can also be used without a SIMATIC CPU in stand-alone mode.

Ordering data**Article No.****Article No.****SIWAREX WP251 weighing module****7MH4960-6AA01**

Single-channel, legal-for-trade, for automatic dosing and filling scales (AGFI, ACI, NAWI) with analog load cells / full-bridge strain gauges (1 - 4 mV/V), 1 × LC, 4 × DQ, 4 × DI, 1 × AQ, 1 × RS 485, Ethernet port.

SIWAREX WP251 Equipment Manual

Available in a range of languages

Free download on the Internet at: <http://www.siemens.com/weighing/documentation>

SIWAREX WP251 "Ready-for-use"

Free download on the Internet at: <http://www.siemens.com/weighing/documentation>

SIWATOOL V4 & V7**7MH4900-1AK01**

Service and commissioning software for SIWAREX weighing modules

Calibration set for SIWAREX WP2xx**7MH4960-0AY10**

Valid for SIWAREX WP231 and SIWAREX WP251.

For verification of up to 3 scales, comprising:

- 3 × inscription foils for ID label
- 1 × protective film
- 3 × calibration protection plates
- Guidelines for verification, certificates and approvals, editable label, SIWAREX WP

Ethernet cable patch cord 2 m (7 ft)**6XV1850-2GH20**

For connecting SIWAREX WP251 to a PC (SIWATOOL), SIMATIC CPU, panel, etc.

Remote display (optional)

The digital remote displays can be connected directly to the SIWAREX WP251 via the RS 485 interface

Suitable remote display: S102

Siebert Industrieelektronik GmbH
PO Box 1180
D-66565 Eppelborn
Tel.: +49 6806/980-0
Fax: +49 6806/980-999

Internet: <https://www.siebert-group.com/en/>

Detailed information is available from the manufacturer.

Ordering data	Article No.	Commissioning	Article No.
Accessories		Commissioning charge for one static scale with SIWAREX module	9LA1110-8SN50-0AA0
SIWAREX JB junction box, aluminum housing For connecting up to 4 load cells in parallel, and for connecting multiple junction boxes.	7MH5001-0AA20	(Flat charge for travel and setup must be ordered separately)	
SIWAREX JB junction box, stainless steel housing For connecting up to 4 load cells in parallel.	7MH5001-0AA00	Scope: • Recording of data • Checking of mechanical installation of the scale • Checking of electrical wiring and function • Static adjustment of the scale	
SIWAREX JB junction box, stainless steel housing (ATEX) For parallel connection of up to 4 load cells (for zone allocation, see manual or type-examination certificate).	7MH5001-0AA01	Requirements: • Mechanical design functional • Modules electrically wired and tested • Calibration weights available • Free access to scale	
SIWAREX IS Ex interface For intrinsically safe connection of load cells. With ATEX approval (not UL/FM). Suitable for SIWAREX electronic weighing systems. Compatibility of load cells must be checked separately. • Short-circuit current < 199 mA DC • Short-circuit current < 137 mA DC	7MH4710-5BA 7MH4710-5CA	Flat charge for travel and setup in Germany	9LA1110-8RA10-0AA0
Cable (optional)			
Cable Li2Y 1 x 2 x 0.75 ST + 2 x (2 x 0.34 ST) – CY For connecting SIWAREX electronic weighing systems to junction box (JB), extension box (EB) and Ex interface or between two EBs. For permanent installation. Occasional bending is possible. External diameter: approx. 10.8 mm (0.43 inch) Permissible ambient temperature -40 ... +80 °C (-40 ... +176 °F) Sold by the meter. • Sheath color: orange • For hazardous atmospheres. Sheath color: blue.	7MH4702-8AG 7MH4702-8AF		
Ground terminal for connecting the load cell cable shield to the grounded DIN rail	6ES5728-8MA11		

SIMATIC S7-1200 Basic Controllers

I/O modules

Special modules

SIWAREX WP251 weighing module

Technical specifications

SIWAREX WP251	
Weighing modes	<ul style="list-style-type: none"> Non automatic weighing instrument (NAWI) (filling + removal) (legal-for-trade in accordance with OIML R76) Catchweighing instrument (CWI) (filling + removal) (legal-for-trade in accordance with OIML R51) Gravimetric filling instrument (GFI) (legal-for-trade in accordance with OIML R61) Discontinuous totalizing automatic weighing instrument (DTI) - (legal-for-trade in accordance with OIML R107)
Integration in automation systems	
S7-1200	SIMATIC S7-1200 system bus
Operator panel and/or automation systems from other vendors	Via Ethernet (Modbus TCP/IP) or RS 485 (Modbus RTU)
Ports	<ul style="list-style-type: none"> 1 x SIMATIC S7-1200 system bus 1 x Ethernet (SIWATOOL and Modbus TCP/IP) 1 x RS 485 (Modbus RTU or remote display) 1 x analog output (0/4 - 20 mA) 4 x digital inputs (24 V DC, floating) 4 x digital outputs (24 V DC, floating, short-circuit proof)
Functions	<ul style="list-style-type: none"> 3 limits Tare Tare specification Zeroing Zero adjustment Statistics Automatic correction of the shut-off points Internal protocol memory for 550 000 entries Trace function for signal analysis Internal restore point Stand-alone mode or SIMATIC S7-1200 integrated
Parameter assignment	<ul style="list-style-type: none"> Full access using function block in SIMATIC S7-1200 Full access using Modbus TCP/IP Full access using Modbus RTU
Remote display	
Connection	Via RS 485
Scale adjustment	PC software SIWATOOL (Ethernet), S7-1200 function block and touch panel or directly connected operator panel (Modbus)
Measuring accuracy	
Error limit according to DIN 1319-1 of full-scale value at 20 °C ± 10 K (68 °F ± 10 K)	0.05%
Internal resolution	Up to ± 4 million parts

SIWAREX WP251	
Number of measurements/second	100 or 120 (selectable)
Filter	<ul style="list-style-type: none"> Low-pass filter 0.1 ... 50 Hz Average value filter
Load cells	Strain gauges in 4-wire or 6-wire system
Load cell powering	
Supply voltage (regulated via feedback)	4.85 V DC
Permissible load resistance	<ul style="list-style-type: none"> R_{Lmin} > 40 Ω R_{Lmax} < 4 100 Ω
With SIWAREX IS Ex interface	<ul style="list-style-type: none"> R_{Lmin} > 50 Ω R_{Lmax} < 4 100 Ω
Load cell characteristic	1 ... 4 mV/V
Permissible range of the measurement signal (with 4 mV/V sensors)	-21.3 ... +21.3 mV
Max. distance of load cells	500 m (229.66 ft)
Connection to load cells in Ex zone 1	Optionally via SIWAREX IS Ex interface
Certificates	<ul style="list-style-type: none"> ATEX Zone 2 UL KCC EAC RCM
Calibration approvals	<ul style="list-style-type: none"> EU type-examination certificate 2014/31/EU (NAWI) according to OIML R76 EU type-examination certificate 2014/32/EU (MID) according to OIML R61 and OIML R51 EU type-examination certificates 2014/32/EU (MID) according to OIML R107
Auxiliary power supply	
Rated voltage	24 V DC
Max. power consumption	200 mA
Max. power consumption SIMATIC Bus	3 mA
IP degree of protection to EN 60529; IEC 60529	IP20
Climatic requirements	
$T_{min(IND)} \dots T_{max(IND)}$ (operating temperature)	
• Vertical installation	-10 ... +40 °C (14 ... 104 °F)
• Horizontal installation	-10 ... +55 °C (14 ... 131 °F)
EMC requirements	According to EN 45501
Dimensions	70 × 75 × 100 mm (2.76 × 2.95 × 3.94 inch)

Overview



- For quick, high-performance serial data exchange via point-to-point connection
- Implemented protocols: ASCII, USS drive protocol, Modbus RTU, 3964(R)
- Additional protocols can also be loaded
- Simple parameterization with STEP 7 Basic

Ordering data

Article No.

CM 1241 communications module

Communications module for point-to-point connection, with one RS 422/485 interface

6ES7241-1CH32-0XB0

Communications module for point-to-point connection, with one RS 232 interface

6ES7241-1AH32-0XB0**Accessories****Front flap set (spare part)**

For communications modules

6ES7291-1CC30-0XA0

Technical specifications

Article number	6ES7241-1CH32-0XB0	6ES7241-1AH32-0XB0
	Communication Module CM 1241, RS422/485	Communication Module CM 1241, RS232
General information		
Product type designation	CM 1241 RS 422 / 485	CM 1241 RS 232
Supply voltage		
Rated value (DC)	24 V	24 V
Input current		
Current consumption, max.	220 mA; From backplane bus 5 V DC	200 mA; From backplane bus 5 V DC
Interfaces		
Interfaces/bus type	RS 422 / 485 (X.27)	RS 232C (V.24)
Number of interfaces	1	1
Point-to-point connection		
• Cable length, max.	1 000 m	10 m
Integrated protocol driver		
- Freeport	Yes	Yes
- ASCII	Yes; Available as library function	Yes; Available as library function
- Modbus RTU master	Yes	Yes
- MODBUS RTU slave	Yes	Yes
- USS	Yes; Available as library function	

SIMATIC S7-1200 Basic Controllers

I/O modules

Communication

CM 1241 communications module

Technical specifications

Article number	6ES7241-1CH32-0XB0 Communication Module CM 1241, RS422/485	6ES7241-1AH32-0XB0 Communication Module CM 1241, RS232
Protocols		
Integrated protocols		
Freeport		
- Telegram length, max.	1 kbyte	1 kbyte
- Bits per character	7 or 8	7 or 8
- Number of stop bits	1 (Standard), 2	1 (Standard), 2
- Parity	No parity (standard); even, uneven, mark (parity bit always 1); space (parity bit always 0)	No parity (standard); even, uneven, mark (parity bit always 1); space (parity bit always 0)
3964 (R)		
- Telegram length, max.	1 kbyte	1 kbyte
- Bits per character	7 or 8	7 or 8
- Number of stop bits	1 (Standard), 2	1 (Standard), 2
- Parity	No parity (standard); even, uneven, mark (parity bit always 1); space (parity bit always 0)	No parity (standard); even, uneven, mark (parity bit always 1); space (parity bit always 0)
Modbus RTU master		
- Address area	1 through 49 999 (Standard Modbus addressing)	1 through 49 999 (Standard Modbus addressing)
- Number of slaves, max.	247; slave numbers 1 through 247, per MODBUS network segment maximum 32 devices, additional repeaters needed to expand the network to maximum configuration	247; slave numbers 1 through 247, per MODBUS network segment maximum 32 devices, additional repeaters needed to expand the network to maximum configuration
MODBUS RTU slave		
- Address area	1 through 49 999 (Standard Modbus addressing)	1 through 49 999 (Standard Modbus addressing)
Interrupts/diagnostics/status information		
Diagnostics function	Yes	Yes
Diagnostics indication LED		
• for status of the outputs	Yes	Yes
Degree and class of protection		
IP degree of protection	IP20	IP20
Standards, approvals, certificates		
CE mark	Yes	Yes
CSA approval	Yes	Yes
UL approval	Yes	Yes
cULus	Yes	Yes
FM approval	Yes	Yes
RCM (formerly C-TICK)	Yes	Yes
KC approval	Yes	Yes
Marine approval	Yes	Yes
Ambient conditions		
Ambient temperature during operation		
• min.	-20 °C	-20 °C
• max.	60 °C	60 °C
Dimensions		
Width	30 mm	30 mm
Height	100 mm	100 mm
Depth	75 mm	75 mm
Weights		
Weight, approx.	155 g	150 g

Overview

- For fast, high-performance serial data exchange via point-to-point connection
- Implemented protocols: ASCII, USS drive protocol, Modbus RTU
- Additional protocols can be loaded later
- Simple parameterization with STEP 7 Basic
- Can be plugged directly into the CPU

Ordering data

Article No.

CB 1241 RS485 communication board

for point-to-point connection, with 1 RS485 interface

6ES7241-1CH30-1XB0

Accessories

Terminal block (spare part)

for signal board
with 6 screws, gold-plated; 4 pcs.

6ES7292-1BF30-0XA0

Technical specifications

Article number	6ES7241-1CH30-1XB0 Communication Board CB 1241, RS485
General information	
Product type designation	CB 1241 RS 485
Input current	
from backplane bus 5 V DC, typ.	50 mA
Interfaces	
Point-to-point connection	
• Cable length, max.	1 000 m
Integrated protocol driver	
- Freeport	Yes
- ASCII	Yes; Available as library function
- Modbus RTU master	Yes
- MODBUS RTU slave	Yes
- USS	Yes; Available as library function
Protocols	
Integrated protocols	
Freeport	
- Telegram length, max.	1 kbyte
- Bits per character	7 or 8
- Number of stop bits	1 (Standard), 2
- Parity	No parity (standard); even, uneven, mark (parity bit always 1); space (parity bit always 0)
3964 (R)	
- Telegram length, max.	1 kbyte
- Bits per character	7 or 8
- Number of stop bits	1 (Standard), 2
- Parity	No parity (standard); even, uneven, mark (parity bit always 1); space (parity bit always 0)
Modbus RTU master	
- Address area	1 through 49 999 (Standard Modbus addressing)
- Number of slaves, max.	247; slave numbers 1 through 247, per MODBUS network segment maximum 32 devices, additional repeaters needed to expand the network to maximum configuration
MODBUS RTU slave	
- Address area	1 through 49 999 (Standard Modbus addressing)

Article number	6ES7241-1CH30-1XB0 Communication Board CB 1241, RS485
Interrupts/diagnostics/status information	
Diagnostics function	Yes
Degree and class of protection	
IP degree of protection	IP20
Standards, approvals, certificates	
CE mark	Yes
CSA approval	Yes
UL approval	Yes
cULus	Yes
FM approval	Yes
RCM (formerly C-TICK)	Yes
KC approval	Yes
Marine approval	Yes
Ambient conditions	
Ambient temperature during operation	
• min.	-20 °C
• max.	60 °C
Mechanics/material	
Enclosure material (front)	
• Plastic	Yes
Dimensions	
Width	38 mm
Height	62 mm
Depth	21 mm
Weights	
Weight, approx.	40 g

SIMATIC S7-1200 Basic Controllers

I/O modules

Communication

CM 1242-5**Overview**

DP-M	DP-S	FMS	PG/OP	S7
	●			

The CM 1242-5 communication module is used to connect a SIMATIC S7-1200 to PROFIBUS as a DP slave and has the following characteristics:

- PROFIBUS DPV1 slave in accordance with IEC 61158
- Module replacement without PG supported
- Power is supplied via the backplane bus so that no extra cabling is required
- Support of all standard baud rates from 9.6 kbps to 12 Mbps
- Compact industry-standard enclosure in S7-1200 design for mounting on a DIN rail
- Fast commissioning thanks to easy configuration using STEP 7 without additional programming overhead

The CM 1242-5 is intended for use in factory automation. Low-cost PROFIBUS-based automation solutions can be created on the basis of the SIMATIC S7-1200 for optimal production.

Ordering data**Article No.****CM 1242-5 communication module**

Communication module for electrical connection of SIMATIC S7-1200 to PROFIBUS as a DP slave module

6GK7242-5DX30-0XE0**Accessories****PROFIBUS FastConnect RS485 connection plug**

With 90° cable outlet; insulation displacement technology, max. transmission rate 12 Mbps

- Without programming device interface
- With programming device interface

6ES7972-0BA52-0XA0**6ES7972-0BB52-0XA0****PROFIBUS FC standard cable**

2-core bus cable, shielded, special design for fast mounting, sold by the meter; delivery unit: max. 1 000 m, minimum order quantity 20 m, sold by the meter

6XV1830-0EH10**PROFIBUS FastConnect stripping tool**

Stripping tool for fast stripping of the PROFIBUS FastConnect bus cable

6GK1905-6AA00**PROFIBUS bus terminal 12M**

Bus terminal for connection of PROFIBUS nodes up to 12 Mbps with connecting cable

6GK1500-0AA10

Technical specifications

Article number	6GK7242-5DX30-0XE0
product type designation	CM 1242-5
transfer rate	
transfer rate	
• at the 1st interface acc. to PROFIBUS	9.6 kbit/s ... 12 Mbit/s
interfaces	
number of interfaces acc. to Industrial Ethernet	0
number of electrical connections	
• at the 1st interface acc. to PROFIBUS	1
• for power supply	0
type of electrical connection	
• at the 1st interface acc. to PROFIBUS	9-pin Sub-D socket (RS485)
supply voltage, current consumption, power loss	
type of voltage of the supply voltage	DC
supply voltage 1 from backplane bus	5 V
consumed current	
• from backplane bus at DC at 5 V typical	0.15 A
power loss [W]	0.75 W
ambient conditions	
ambient temperature	
• for vertical installation during operation	0 ... 45 °C
• for horizontally arranged busbars during operation	0 ... 55 °C
• during storage	-40 ... +70 °C
• during transport	-40 ... +70 °C
relative humidity	
• at 25 °C without condensation during operation maximum	95 %
protection class IP	IP20

Article number	6GK7242-5DX30-0XE0
product type designation	CM 1242-5
design, dimensions and weights	
module format	Compact module S7-1200 single width
width	30 mm
height	100 mm
depth	75 mm
net weight	0.115 kg
fastening method	
• 35 mm top hat DIN rail mounting	Yes
• S7-300 rail mounting	No
• wall mounting	Yes
product features, product functions, product components general	
number of units	
• per CPU maximum	3
performance data PROFIBUS DP	
service as DP slave	
• DPV0	Yes
• DPV1	Yes
data volume	
• of the address range of the inputs as DP slave total	240 byte
• of the address range of the outputs as DP slave total	240 byte
performance data telecontrol	
protocol is supported	
• TCP/IP	No
product functions management, configuration, engineering	
configuration software	
• required	STEP 7 Basic/Professional
standards, specifications, approvals hazardous environments	
certificate of suitability CCC for hazardous zone according to GB standard	Yes

SIMATIC S7-1200 Basic Controllers

I/O modules

Communication

AS-Interface communication > CM 1243-2 AS-i Master

Overview



CM 1243-2 communications module for S7-1200

More information

Manuals

see <https://support.industry.siemens.com/cs/ww/en/ps/15750/man>

AS-Interface I/O modules and other AS-Interface system components
see catalog IC 10 <https://www.siemens.com/ic10>

More information see <https://www.siemens.com/as-interface>

The CM 1243-2 communications module is the AS-Interface master for the SIMATIC S7-1200 and has the following features:

- Connection of up to 62 AS-Interface slaves
- Integrated analog value transmission
- Supports all AS-Interface master functions in accordance with the AS-Interface specification V3.0
- Indication of the operating state on the front of the device displayed via LED
- Display of operating mode, AS-Interface voltage faults, configuration faults and peripheral faults via LED behind the front panel
- Compact enclosure in the design of the SIMATIC S7-1200
- Suitable for AS-Interface with 30 V voltage and for AS-i Power 24 V: A standard 24 V power supply unit can be used in combination with the optional DCM 1271 data decoupling module.
- Configuration and diagnostics via the TIA Portal

Design

The CM 1243-2 communications module is positioned to the left of the S7-1200 CPU and linked to the S7-1200 via lateral contacts.

It has:

- Terminals for two AS-i cables (internally jumpered) via two screw terminals
- One terminal for connection to the functional ground
- LEDs for indication of the operating state and fault statuses of the connected slaves

The screw terminals (included in scope of supply) can be removed to facilitate installation.

Function

The CM 1243-2 supports all specified functions of the AS-Interface specification V3.0.

The values of the digital AS-i slaves can be activated via the process image of the S7-1200. During configuration of the slaves in the TIA Portal, the values of the analog AS-i slaves can also be accessed directly in the process image.

If required, master calls can be performed with the data record interface, e.g. read/write parameters, read/write configuration.

Changeover of the operating mode, automatic application of the slave configuration and the re-addressing of a connected AS-i slave can be implemented via the control panel of the CM 1243-2 in the TIA Portal.

The optional DCM 1271 data decoupling module (see page 3/137) has an integrated detection unit for detecting ground faults on the AS-Interface cable. The integrated overload protection also disconnects the AS-Interface cable if the drive current required exceeds 4 A. For more information on DCM 1271, see page 3/136.

Notes on security

In order to protect plants, systems, machines and networks against cyber threats, it is necessary to implement – and continuously maintain – a holistic, state-of-the-art industrial security concept. Siemens products and solutions represent only one component of such a concept.

For more information about the subject of Industrial Security, see <http://www.siemens.com/industrialsecurity>.

Configuration

The TIA Portal enables user-friendly configuration and diagnostics of the AS-Interface master and any connected slaves.

When operated on a S7-1200 CPU with firmware version V4.0 or higher, the firmware version V1.1 (or higher) is required for the CM 1243-2.

Benefits

- More flexibility and versatility in the use of SIMATIC S7-1200 as the result of a significant increase in the number of digital and analog inputs/outputs available
- Very easy configuration and diagnostics of the AS-Interface via the TIA Portal
- Simple operation with AS-Interface power supply unit (see <https://mall.industry.siemens.com/mall/en/WWW/Catalog/Products/8200165?tree=CatalogTree>) possible without restrictions.
- Alternatively: No need for the AS-i power supply unit with AS-i Power24V. The AS-Interface cable is supplied through an existing 24 V DC PELV power supply unit. For decoupling, the AS-i DCM 1271 data decoupling module is required, see "Accessories" and page 3/136.
- LEDs for indication of fault statuses for fast diagnostics
- Monitoring of AS-Interface voltage facilitates diagnostics

Application

The CM 1243-2 is the AS-Interface master connection for the 12x CPUs of the SIMATIC S7-1200. Through connection to AS-Interface, the number of digital inputs and outputs available for the S7-1200 is greatly increased (max. 496 DI/496 DQ on the AS-Interface per CM).

The integrated analog value processing also makes the analog values available at the AS-Interface for the S7-1200. Up to 31 analog slaves with a standard address (each with up to four channels) or up to 62 analog slaves with an A/B address (each with up to two channels) are possible per CM.

Operating conditions

- The CM 1243-2 communications module exchanges data with the S7-1200 CPU with a cycle time of 10 ms.
- The AS-i cycle time depends on the AS-i bus capacity and is up to 5 ms in the case of 31 slave addresses; for more information, see manual AS-i Master CM 1243-2 and AS-i DCM 1271 data decoupling module, <https://support.industry.siemens.com/cs/ww/en/view/57358958>.
- For calculation of the maximum switching frequency at inputs/outputs of AS-i slaves, these cycle times and the runtime of the user program must be added up.

Ordering data**Article No.****CM 1243-2 communications module 3RK7243-2AA30-0XB0**

- AS-Interface master for SIMATIC S7-1200
- Corresponds to AS-Interface specification V3.0
- With screw terminals, removable terminals (included in the scope of supply)
- Dimensions (W x H x D) mm: 30 x 100 x 75

Note:

The CM 1243-2 communications module is available as a SIPLUS version under Article No. 6AG1243-2AA30-7XB0 in the extended temperature range (from -25 to +70 °C) and for use in harsh environmental conditions (coated according to environment standard IEC 60721).

For more information, see page 3/156.

Accessories**DCM 1271 data decoupling module 3RK7271-1AA30-0AA0**

- Max. current: 1 x 4 A
- With screw terminals, removable terminals (included in the scope of supply)
- Dimensions (W x H x D) mm: 30 x 100 x 75

Screw terminals (spare part)

- With screw terminals, 5-pole
For AS-i Master CM 1243-2 and AS-i DCM 1271 data decoupling module **3RK1901-3MA00**
- With screw terminals, 3-pole
For AS-i DCM 1271 data decoupling module for connecting the power supply unit **3RK1901-3MB00**

AS-Interface addressing unit V3.0 3RK1904-2AB02

- For AS-Interface modules and sensors and actuators with integrated AS-Interface according to AS-i specification V3.0
- For setting the AS-i address of standard slaves, and slaves with extended addressing mode (A/B slaves)
- With input/output test function and many other commissioning functions
- Battery operation with four type AA batteries (IEC LR6, NEDA 15)
- Degree of protection IP40
- Dimensions (W x H x D) mm: 84 x 195 x 35
- Scope of supply:
 - Addressing unit with four batteries
 - Addressing cable, with M12 plug to addressing plug (hollow plug), length 1.5 m

SIMATIC S7-1200 Basic Controllers

I/O modules

Communication

AS-Interface communication > DCM 1271 data decoupling module

Overview



DCM 1271 data decoupling module for SIMATIC S7-1200

More information

Manual for AS-i Master CM 1234-2 and AS-i DCM 1271 data decoupling module, see <https://support.industry.siemens.com/cs/ww/en/view/57358958>

More information on AS-i Power24V, see <https://support.industry.siemens.com/cs/ww/en/view/26250840>

AS-Interface I/O modules and other AS-Interface system components see catalog IC 10 <https://www.siemens.com/ic10>

More information see <https://www.siemens.com/as-interface>

With the aid of the DCM 1271 data decoupling module, the AS-Interface network can also be supplied with 24 V DC or 30 V DC from a standard power supply unit and the transmission of data and power can be implemented on one cable.

The DCM 1271 data decoupling module has the same type of enclosure as an S7-1200 module and can therefore be perfectly combined with the AS-i Master CM 1243-2.

The DCM 1271 data decoupling module has no connection to the backplane bus of the SIMATIC S7-1200 and is therefore not counted as a communications module for the calculation of the maximum configuration.

Features of the DCM 1271 data decoupling module

- Design: S7-1200, width 30 mm, degree of protection IP20
- Detachable terminals (included in scope of supply)
- Single data decoupling
- Supply of several AS-i networks with a single power supply unit
- Operation with 24 V DC or 30 V DC, grounded or non-grounded
- Current limiting at 4 A
- Integrated ground-fault detection
- Diagnostic LEDs for ground faults and overloads
- Signaling contact for ground-fault detection

Ground-fault detection

The integrated ground-fault detection functions with grounded and non-grounded power supply: The connection of negative pole and ground (upstream from the data decoupling module) customary with 24 V DC power supplies is permitted. A ground fault to the negative or positive pole on the AS-Interface network (behind the data decoupling module) is identified and signaled via LED and a transistor output.

Benefits

- An existing standard power supply unit with 24 V DC or 30 V DC can be used for supplying AS-i networks
- The AS-Interface system can also be used in tightly budgeted applications because no AS-Interface power supply unit needs to be purchased
- Applications benefit in addition from the advantages of a modern bus system:
 - High level of standardization
 - Additional diagnostics and maintenance information
 - Faster commissioning

Application

The AS-Interface data decoupling module is designed for AS-Interface networks with 30 V or 24 V supply (AS-i Power24V).

Operation of an AS-i network with the data decoupling module and a 30 V standard power supply unit is technically equivalent to the use of an AS-Interface power supply unit and offers the service-proven features of AS-Interface for all applications.

AS-i Power24V uses a 24 V power supply unit in conjunction with a data decoupling module and is particularly suitable for

- Compact machines using AS-Interface input/output modules
- Applications in the control cabinet for AS-Interface integration of SIRIUS 3RT2 contactors using 3RA27 function modules

Note:

The power supply units must comply with the ES1 (IEC 62368-1) or PELV (Protective Extra Low Voltage)/SELV (Safety Extra Low Voltage) standards, have a residual ripple of < 250 mV_{pp}, and must limit the output voltage to a maximum of 40 V in the event of a fault.

We recommend

- SITOP power supplies, see <https://mall.industry.siemens.com/mall/en/WW/Catalog/Products/10244081?tree=CatalogTree> or catalog KT 10.1, <https://support.industry.siemens.com/cs/ww/en/view/109745655>
- PSN130S 30 V power supply units, see <https://mall.industry.siemens.com/mall/en/WW/Catalog/Products/10174512?tree=CatalogTree>.

Note on AS-i Power24V:

The length of an AS-i Power24V network is restricted to 50 m in order to limit the voltage drop along the cable.

AS-i masters, AS-i slaves and the sensors and actuators supplied through the AS-i cable must be designed for the reduced voltage. Sensors and actuators for the standard voltage range of 10 to 30 V can be supplied with sufficient voltage.

Please also observe the requirements specified in "AS-i Power24V" for the operation of an AS-i Power24V network, see <https://mall.industry.siemens.com/mall/en/WW/Catalog/Products/10057530?tree=CatalogTree>.

More information on AS-i Power24V, see System Manual for AS-Interface, <https://support.industry.siemens.com/cs/ww/en/view/26250840>.

AS-Interface communication > DCM 1271 data decoupling module

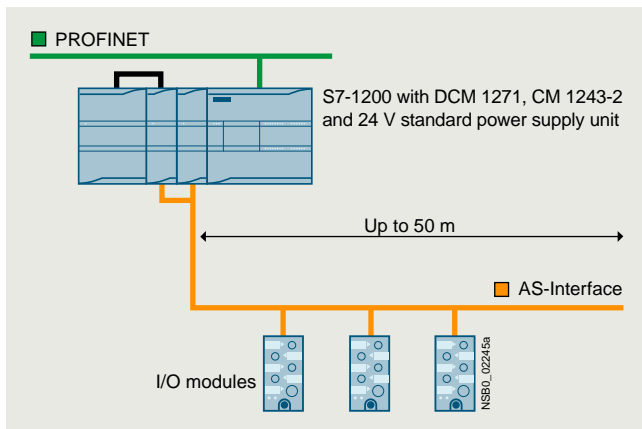

Configuration of an AS-i Power24V network with AS-Interface DCM 1271 data decoupling module

Ordering data

Article No.

DCM 1271 data decoupling module**3RK7271-1AA30-0AA0**

- Max. current: 1 x 4 A
- With screw terminals, removable terminals (included in the scope of supply)
- Dimensions (W x H x D) mm: 30 x 100 x 75

Accessories**Screw terminals (spare part)**

- With screw terminals, 5-pole
For AS-i Master CM 1243-2 and AS-i DCM 1271 data decoupling module
- With screw terminals, 3-pole
For AS-i DCM 1271 data decoupling module for connecting the power supply unit

3RK1901-3MA00**3RK1901-3MB00****CM 1243-2 communications module****3RK7243-2AA30-0XB0**

- AS-Interface master for SIMATIC S7-1200
- Corresponds to AS-Interface specification V3.0
- With screw terminals, removable terminals (included in the scope of supply)
- Dimensions (W x H x D) mm: 30 x 100 x 75

SIMATIC S7-1200 Basic Controllers

I/O modules

Communication

CM 1243-5

Overview



DP-M	DP-S	FMS	PG/OP	S7
●			●	●

The CM 1243-5 communication module is used to connect a SIMATIC S7-1200 to PROFIBUS as a DP master and has the following characteristics:

- PROFIBUS DPV1 master in accordance with IEC 61158
- Support of up to 16 PROFIBUS DP slaves
- Communication with other S7 controllers based on S7 communication
- Allows programming devices and operator panels with PROFIBUS interfaces to be connected to the SIMATIC S7-1200
- Module replacement without PG supported
- Support of all standard baud rates from 9.6 kbps to 12 Mbps
- Compact industrial enclosure in SIMATIC S7-1200 design for mounting on a DIN rail
- Fast commissioning thanks to easy configuration using STEP 7 without additional programming overhead

The CM 1243-5 is intended for use in factory automation. Low-cost PROFIBUS-based automation solutions can be created on the basis of the SIMATIC S7-1200 for optimal production.

Ordering data

Article No.

CM 1243-5 communications module

Communications module for electrical connection of SIMATIC S7-1200 to PROFIBUS as a DPV1 master

6GK7243-5DX30-0XE0

Accessories

PROFIBUS FastConnect RS485 connection plug

With 90° cable outlet; insulation displacement technology, max. transmission rate 12 Mbps

- Without programming device interface
- With programming device interface

6ES7972-0BA52-0XA0

6ES7972-0BB52-0XA0

PROFIBUS FC standard cable

2-wire bus cable, shielded, special design for fast mounting, delivery unit: max. 1 000 m, minimum order quantity 20 m, sold by the meter

6XV1830-0EH10

PROFIBUS FastConnect stripping tool

Stripping tool for fast stripping of the PROFIBUS FastConnect bus cable

6GK1905-6AA00

PROFIBUS bus terminal 12M

Bus terminal for connection of PROFIBUS nodes up to 12 Mbps with connecting cable

6GK1500-0AA10

Technical specifications

Article number	6GK7243-5DX30-0XE0
product type designation	CM 1243-5
transfer rate	
transfer rate	
• at the 1st interface acc. to PROFIBUS	9.6 kbit/s ... 12 Mbit/s
interfaces	
number of interfaces acc. to Industrial Ethernet	0
number of electrical connections	
• at the 1st interface acc. to PROFIBUS	1
• for power supply	1
type of electrical connection	
• at the 1st interface acc. to PROFIBUS	9-pin Sub-D socket (RS485)
• for power supply	3-pole terminal block
supply voltage, current consumption, power loss	
type of voltage of the supply voltage	DC
supply voltage external	24 V
supply voltage external at DC rated value	24 V
relative positive tolerance at DC at 24 V	20 %
relative negative tolerance at DC at 24 V	20 %
consumed current	
• from external supply voltage at DC at 24 V typical	0.1 A
power loss [W]	2.4 W
ambient conditions	
ambient temperature	
• for vertical installation during operation	0 ... 45 °C
• for horizontally arranged busbars during operation	0 ... 55 °C
• during storage	-40 ... +70 °C
• during transport	-40 ... +70 °C
relative humidity	
• at 25 °C without condensation during operation maximum	95 %
protection class IP	IP20
design, dimensions and weights	
module format	Compact module S7-1200 single width
width	30 mm
height	100 mm
depth	75 mm
net weight	0.134 kg
fastening method	
• 35 mm top hat DIN rail mounting	Yes
• S7-300 rail mounting	No
• wall mounting	Yes

Article number	6GK7243-5DX30-0XE0
product type designation	CM 1243-5
product features, product functions, product components general	
number of units	
• per CPU maximum	3
performance data PROFIBUS DP	
service as DP master	
• DPV1	Yes
number of DP slaves	
• on DP master operable	32
data volume	
• of the address range of the inputs as DP master total	512 byte
• of the address range of the outputs as DP master total	512 byte
• of the address range of the inputs per DP slave	244 byte
• of the address range of the outputs per DP slave	244 byte
• of the address range of the diagnostic data per DP slave	240 byte
service as DP slave	
• DPV0	No
• DPV1	No
performance data S7 communication	
number of possible connections for S7 communication	
• maximum	8; max. 4 connections to other S7 stations
• with PG connections maximum	1
• with PG/OP connections maximum	3
performance data multi-protocol mode	
number of active connections with multi-protocol mode	
• without DP maximum	8
• with DP maximum	8
performance data telecontrol	
protocol is supported	
• TCP/IP	No
product functions management, configuration, engineering	
configuration software	
• required	STEP 7 Basic/Professional
standards, specifications, approvals hazardous environments	
certificate of suitability CCC for hazardous zone according to GB standard	Yes

SIMATIC S7-1200 Basic Controllers

I/O modules

Communication

CSM 1277 unmanaged**Overview**

- Unmanaged switch for connecting a SIMATIC S7-1200 to an Industrial Ethernet network with a line, tree or star topology
- Multiplication of Ethernet interfaces on a SIMATIC S7-1200 for additional connection of up to three programming devices, operator controls, and further Ethernet nodes
- Simple, space-saving mounting on the SIMATIC S7-1200 DIN rail
- Low-cost solution for implementing small, local Ethernet networks
- Connection without any problems using RJ45 standard plug connectors
- Simple and fast status display via LEDs on the device
- Integral autocrossover function permits use of uncrossed connecting cables

Ordering data**Article No.****CSM 1277 compact switch module**

Unmanaged switch for connecting a SIMATIC S7-1200 and up to three further nodes to Industrial Ethernet with 10/100 Mbps; 4 x RJ45 ports; external 24 V DC power supply, diagnostics on LEDs, S7-1200 module including electronic manual on CD-ROM

6GK7277-1AA10-0AA0**SIPLUS NET CSM 1277 compact switch module**

Unmanaged switch for connection of SIPLUS S7-1200 and up to three further stations to Industrial Ethernet with 10/100 Mbps; 4 x RJ45 ports; external 24 V DC power supply, LED diagnostics, S7-1200 module including electronic manual on CD-ROM

6AG1277-1AA10-4AA0**Accessories****IE FC TP trailing cable 2 x 2 (Type C)**

4-core, shielded TP installation cable for connection to IE FC outlet RJ45/ IE FC RJ45 plug 180/90 for use as trailing cable; PROFINET-compatible; with UL approval; sold by the meter; max. delivery unit 1 000 m, minimum order quantity 20 m

6XV1840-3AH10**IE FC RJ45 plug 180 2 x 2**

RJ45 plug connector for Industrial Ethernet with a rugged metal housing and integrated insulation displacement contacts for connecting Industrial Ethernet FC installation cables; 180° cable outlet; for network components and CPs/CPUs with Industrial Ethernet interface

- 1 pack = 1 unit
- 1 pack = 10 units
- 1 pack = 50 units

6GK1901-1BB10-2AA0
6GK1901-1BB10-2AB0
6GK1901-1BB10-2AE0

IE FC outlet RJ45

For connection of Industrial Ethernet FC cables and TP cords; graduated prices for 10 and 50 units or more

6GK1901-1FC00-0AA0**IE TP cord RJ45/RJ45**

- TP cord pre-assembled with 2 RJ45 plug connectors; length: 0.5 m
- TP cable 4 x 2 with 2 RJ45 plug connectors; length: 0.5 m

6XV1850-2GE50**6XV1870-3QE50**

Technical specifications

Article number	6GK7277-1AA10-0AA0
product type designation	SCALANCE CSM 1277
transfer rate	
transfer rate	10 Mbit/s, 100 Mbit/s
interfaces for communication integrated	
number of electrical connections	4
• for network components or terminal equipment	
number of 100 Mbit/s SC ports	0
• for multimode	
number of 1000 Mbit/s LC ports	0
• for multimode	
• for single mode (LD)	0
interfaces other	
number of electrical connections	
• for power supply	1
type of electrical connection	
• for power supply	3-pole terminal block
supply voltage, current consumption, power loss	
type of voltage 1 of the supply voltage	DC
• supply voltage 1 rated value	24 V
• power loss [W] 1 rated value	1.6 W
• supply voltage 1 rated value	19.2 ... 28.8 V
• consumed current 1 maximum	0.07 A
• type of electrical connection 1 for power supply	3-pole terminal block
• product component 1 fusing at power supply input	Yes
• fuse protection type 1 at input for supply voltage	0.5 A / 60 V
ambient conditions	
ambient temperature	
• during operation	0 ... 60 °C
• during storage	-40 ... +70 °C
• during transport	-40 ... +70 °C
relative humidity	
• at 25 °C without condensation during operation maximum	95 %
protection class IP	IP20
design, dimensions and weights	
design	SIMATIC S7-1200 device design
width	45 mm
height	100 mm
depth	75 mm
net weight	0.15 kg
fastening method	
• 35 mm top hat DIN rail mounting	Yes
• wall mounting	Yes
• S7-300 rail mounting	No
• S7-1500 rail mounting	No

Article number	6GK7277-1AA10-0AA0
product functions management, configuration, engineering	
product function	
• multiport mirroring	No
product function switch-managed	No
product functions redundancy	
product function	
• Parallel Redundancy Protocol (PRP)/operation in the PRP-network	Yes
• Parallel Redundancy Protocol (PRP)/Redundant Network Access (RNA)	No
standards, specifications, approvals	
standard	
• for FM	FM3611: Class 1, Division 2, Group A, B, C, D / T., CL.1, Zone 2, GP. IIC, T. Ta
• for safety from CSA and UL	UL 508, CSA C22.2 No. 142
• for emitted interference	EN 61000-6-4 (Class A)
• for interference immunity	EN 61000-6-2
MTBF	273 y
reference code	
• acc. to IEC 81346-2	KF
• according to IEC 81346-2:2019	KFE
standards, specifications, approvals CE	
certificate of suitability CE marking	Yes
standards, specifications, approvals hazardous environments	
standard for hazardous zone	EN 600079-15:2005, EN 600079-0:2006, II 3 G Ex nA II T4, KEMA 08 ATEX 0003 X
certificate of suitability	
• CCC for hazardous zone according to GB standard	Yes
standards, specifications, approvals other	
certificate of suitability	EN 61000-6-2, EN 61000-6-4
• C-Tick	Yes
• KC approval	No
standards, specifications, approvals marine classification	
Marine classification association	
• American Bureau of Shipping Europe Ltd. (ABS)	Yes
• French marine classification society (BV)	Yes
• Det Norske Veritas (DNV)	Yes
• Germanische Lloyd (GL)	No
• Lloyds Register of Shipping (LRS)	Yes
• Nippon Kaiji Kyokai (NK)	Yes
• Polski Rejestr Statkow (PRS)	No
• Royal Institution of Naval Architects (RINA)	No

More information

Selection tool:

To support the selection of SCALANCE network components, the TIA selection tool is available at:

<http://www.siemens.com/tst>

SIMATIC S7-1200 Basic Controllers

I/O modules

Communication

CP 1243-1**Overview**

The CP 1243-1 communications processor is used for connecting the SIMATIC S7-1200 to telecontrol centers via remote networks and telecontrol protocols (DNP3, IEC 60870-5-104, TeleControl Basic), and for safe communication via IP-based networks.

The CP has the following features:

- Ethernet-based connection to TeleControl Server Basic, e.g. via internet
- Data transfer of measured values, control variables, or alarms optimized for telecontrol systems
- Automatic sending of alert emails
- Data buffering of up to 64 000 values ensures a secure database even with temporary connection failures
- Secure communication via VPN connections based on IPsec
- Access protection via stateful inspection firewall
- Support of SINEMA Remote Connect with autoconfiguration
- Clearly laid out LED signaling for fast and easy diagnostics
- Compact industrial enclosure in S7-1200 design for mounting on a DIN rail
- Fast commissioning thanks to easy configuration using STEP 7

Ordering data**Article No.****CP 1243-1 communications processor**

CP 1243-1 communications processor for connecting SIMATIC S7-1200 as an additional Ethernet interface and for connection to control centers via telecontrol protocols (DNP3, IEC 60870, TeleControl Basic), security (firewall, VPN)

6GK7243-1BX30-0XE0**Accessories****CSM 1277 compact switch module**

Unmanaged switch for connecting a SIMATIC S7-1200 and up to three further nodes to Industrial Ethernet with 10/100 Mbps; 4 x RJ45 ports; external 24 V DC power supply, LED diagnostics, S7-1200 module including electronic device manual on CD-ROM

6GK7277-1AA10-0AA0**IE FC RJ45 plugs**

RJ45 connectors for Industrial Ethernet with a rugged metal enclosure and integrated insulation displacement contacts for connecting Industrial Ethernet FC installation cables

IE FC RJ45 plug 180

180° cable outlet; for network components and CPs/CPUs with Industrial Ethernet interface

- 1 pack = 1 unit
- 1 pack = 10 units
- 1 pack = 50 units

6GK1901-1BB10-2AA0
6GK1901-1BB10-2AB0
6GK1901-1BB10-2AE0

IE FC TP standard cable GP 2 x 2 (Type A)

4-core, shielded TP installation cable for connection to IE FC outlet RJ45/IE F RJ45 plug; PROFINET-compatible; with UL approval; sold by the meter; max. length 1 000 m, minimum order quantity 20 m

6XV1840-2AH10**IE FC stripping tool**

Pre-adjusted stripping tool for fast stripping of Industrial Ethernet FC cables

6GK1901-1GA00**Technical specifications**

Article number	6GK7243-1BX30-0XE0
product type designation	CP 1243-1
transfer rate	
transfer rate	
• at the 1st interface	10 ... 100 Mbit/s
interfaces	
number of interfaces acc. to Industrial Ethernet	1
number of electrical connections	
• at the 1st interface acc. to Industrial Ethernet	1
• for power supply	0
type of electrical connection	
• at the 1st interface acc. to Industrial Ethernet	RJ45 port

Article number	6GK7243-1BX30-0XE0
product type designation	CP 1243-1
supply voltage, current consumption, power loss	
type of voltage of the supply voltage	DC
supply voltage 1 from backplane bus	5 V
consumed current	
• from backplane bus at DC at 5 V typical	0.25 A
power loss [W]	1.25 W

Technical specifications

Article number	6GK7243-1BX30-0XE0
product type designation	CP 1243-1
ambient conditions	
ambient temperature	
• for vertical installation during operation	-20 ... +60 °C
• for horizontally arranged busbars during operation	-20 ... +70 °C
• during storage	-40 ... +70 °C
• during transport	-40 ... +70 °C
relative humidity	
• at 25 °C without condensation during operation maximum	95 %
protection class IP	IP20
design, dimensions and weights	
module format	Compact module S7-1200 single width
width	30 mm
height	110 mm
depth	75 mm
net weight	0.122 kg
fastening method	
• 35 mm top hat DIN rail mounting	Yes
• wall mounting	Yes
product features, product functions, product components general	
number of units	
• per CPU maximum	3
performance data open communication	
number of possible connections for open communication	
• by means of T blocks maximum	like CPU
performance data S7 communication	
number of possible connections for S7 communication	
• maximum	like CPU
performance data IT functions	
number of possible connections	
• as email client maximum	1
performance data telecontrol	
suitability for use	
• node station	No
• substation	Yes
• TIM control center	No
control center connection	For use with TeleControl Server Basic, WinCC and PCS7
• by means of a permanent connection	supported
• note	Connection to SCADA system via Telecontrol Server Basic and Standard Telecontrol protocols
protocol is supported	
• DNP3	Yes
• IEC 60870-5	Yes
product function data buffering if connection is aborted	Yes; 64,000 events
number of data points per station maximum	500
number of stations for direct communication with Telecontrol Server Basic	
• in send direction maximum	3
• in receive direction maximum	15

Article number	6GK7243-1BX30-0XE0
product type designation	CP 1243-1
performance data teleservice	
diagnostics function online diagnostics with SIMATIC STEP 7	Yes
product function	
• program download with SIMATIC STEP 7	Yes
• remote firmware update	Yes
product functions management, configuration, engineering	
configuration software	
• required	STEP 7 Basic/Professional
product functions diagnostics	
product function web-based diagnostics	Yes
product functions security	
firewall version	stateful inspection
product function with VPN connection	IPsec, SINEMA RC
type of encryption algorithms with VPN connection	AES-256, AES-192, AES-128, 3DES-168
type of authentication procedure with VPN connection	Preshared key (PSK), X.509v3 certificates
type of hashing algorithms with VPN connection	MD5, SHA-1, SHA-2
number of possible connections with VPN connection	8
product function	
• password protection for Web applications	No
• password protection for teleservice access	No
• encrypted data transmission	Yes
• ACL - IP-based	No
• ACL - IP-based for PLC/routing	No
• switch-off of non-required services	Yes
• blocking of communication via physical ports	No
• log file for unauthorized access	No
product functions time	
protocol is supported	
• NTP	Yes
• NTP (secure)	Yes
time synchronization	
• from NTP-server	Yes
• from control center	Yes
standards, specifications, approvals hazardous environments	
certificate of suitability CCC for hazardous zone according to GB standard	Yes

SIMATIC S7-1200 Basic Controllers

I/O modules

Communication

CP 1243-7 LTE

Overview



CP 1243-7 LTE is used to connect the S7-1200 to a mobile wireless 4th Generation LTE (Long Term Evolution) network. The increased data rates compared to GPRS and widespread introduction of LTE open up new areas of application. The CP1243-7 is characterized by the following properties:

- 1 connection to LTE (4G) mobile wireless network (various versions for EU and North America)
- Integration into telecontrol applications via IEC60870-5-104, DNP3 or Telecontrol Server Basic
- Data transfer of measured values, control variables, or alarms optimized for telecontrol systems
- Operation with fixed IP addresses and dynamic IP addresses with standard cellular phone contract
- Time synchronization based on NTP (Network Time Protocol)
- "On-demand" connection setup via voice call or SMS
- Sending and receiving of SMS
- Teleservice access with STEP 7 to substations via mobile wireless networks
- Compact industrial enclosure in S7-1200 design for mounting on a DIN rail
- Temperature range in operation: -20°C to +70°C
- Top hat DIN rail mounting
- Diagnostics LEDs (overall status and details)
- Integrated security functions (VPN and firewall)
- Access to the CPU web server
- Fast commissioning due to simplified configuration with STEP 7
- Data buffering of up to 64 000 values ensures a secure database even with temporary connection failures
- Support of SINEMA Remote Connect with autoconfiguration

Ordering data

CP 1243-7 LTE communication processor

Communication processor for connecting SIMATIC S7-1200 to TeleControl Server Basic via LTE mobile wireless network

- **CP 1243-7 LTE EU**
Frequencies in European band: 700, 1 700 MHz

Frequencies in European band: 700, 1 700 MHz

- **CP 1243-7 LTE US**
Frequencies in North American band: 800, 1 800, 2 600 MHz

Accessories

ANT794-4MR antenna

Omnidirectional antenna for GSM (2G), UMTS (3G) and LTE (4G) networks; omnidirectional; weatherproof for indoor and outdoor use; 5 m cable with fixed connection to antenna; SMA connector; including mounting bracket, screws, wall plugs

Article No.

6GK7243-7KX30-0XE0

6GK7243-7SX30-0XE0

6NH9860-1AA00

Technical specifications

Article number	6GK7243-7KX30-0XE0	6GK7243-7SX30-0XE0
product type designation	CP 1243-7 LTE EU	CP 1243-7 LTE US
transfer rate		
transfer rate		
• for LTE transmission		
- with downlink maximum	42 Mbit/s	42 Mbit/s
- with uplink maximum	5.76 Mbit/s	5.76 Mbit/s
interfaces		
number of interfaces acc. to Industrial Ethernet	0	0
number of electrical connections		
• for external antenna(s)	1	1
• for power supply	1	1
number of slots		
• for SIM cards	1	1
type of electrical connection		
• for external antenna(s)	SMA socket (50 ohms)	SMA socket (50 ohms)
• for power supply slot version	3-pole terminal block	3-pole terminal block
• for SIM card	Standard	Standard
wireless technology		
type of mobile wireless service		
• is supported SMS	Yes	Yes
• is supported GPRS	Yes	Yes
• note	GPRS (Multislot Class 10)	GPRS (Multislot Class 10)
type of wireless network is supported		
• GSM	Yes	Yes
• UMTS	Yes	Yes
• LTE	Yes	Yes
operating frequency		
• 850 MHz		Yes
• 1900 MHz		Yes
operating frequency for GSM transmission	operating frequency for GSM transmission 900 MHz, operating frequency for GSM transmission 1800 MHz	
operating frequency with UMTS transmission	operating frequency with UMTS transmission 900 MHz, operating frequency with UMTS transmission 2100 MHz	
operating frequency for LTE transmission	operating frequency for LTE transmission 800 MHz, operating frequency for LTE transmission 1800 MHz, operating frequency for LTE transmission 2600 MHz	operating frequency for LTE transmission 700 MHz, operating frequency for LTE transmission 1700 MHz

Article number	6GK7243-7KX30-0XE0	6GK7243-7SX30-0XE0
product type designation	CP 1243-7 LTE EU	CP 1243-7 LTE US
supply voltage, current consumption, power loss		
type of voltage of the supply voltage	DC	DC
supply voltage external	24 V	24 V
supply voltage external at DC rated value	24 V	24 V
relative positive tolerance at DC at 24 V	20 %	20 %
relative negative tolerance at DC at 24 V	20 %	20 %
consumed current		
• from external supply voltage at DC at 24 V typical	0.1 A	0.1 A
• from external supply voltage at DC at 24 V maximum	0.22 A	0.22 A
ambient conditions		
ambient temperature		
• for vertical installation during operation	-20 ... +60 °C	-20 ... +60 °C
• for horizontally arranged busbars during operation	-20 ... +70 °C	-20 ... +70 °C
• during storage	-40 ... +70 °C	-40 ... +70 °C
• during transport	-40 ... +70 °C	-40 ... +70 °C
relative humidity		
• at 25 °C without condensation during operation maximum	95 %	95 %
protection class IP	IP20	IP20
design, dimensions and weights		
module format	Compact module S7-1200 single width	Compact module S7-1200 single width
width	30 mm	30 mm
height	100 mm	100 mm
depth	75 mm	75 mm
net weight	0.133 kg	0.133 kg
fastening method		
• 35 mm top hat DIN rail mounting	Yes	Yes
• S7-300 rail mounting	No	No
• wall mounting	Yes	Yes
product features, product functions, product components general		
number of units		
• per CPU maximum	3	3

SIMATIC S7-1200 Basic Controllers

I/O modules

Communication

CP 1243-7 LTE

Technical specifications

Article number	6GK7243-7KX30-0XE0	6GK7243-7SX30-0XE0
product type designation	CP 1243-7 LTE EU	CP 1243-7 LTE US
performance data		
number of users/telephone numbers definable maximum	10	10
performance data open communication		
number of possible connections for open communication		
• by means of T blocks maximum	like CPU	like CPU
performance data IT functions		
number of possible connections		
• as email client maximum	1	1
performance data telecontrol		
suitability for use		
• substation	Yes	Yes
control center connection	Telecontrol Server Basic	Telecontrol Server Basic
• by means of a permanent connection	supported	supported
• by means of demand-oriented connection	supported	supported
• note	Connection to SCADA system using OPC interface	Connection to SCADA system using OPC interface
protocol is supported		
• DNP3	Yes	Yes
• IEC 60870-5	Yes	Yes
product function data buffering if connection is aborted	Yes; 64,000 events	Yes; 64,000 events
number of stations for direct communication with Telecontrol Server Basic		
• in send direction maximum	3	3
• in receive direction maximum	15	15
performance data teleservice		
diagnostics function online diagnostics with SIMATIC STEP 7	Yes	Yes
product function		
• program download with SIMATIC STEP 7	Yes	Yes
• remote firmware update	Yes	Yes

Article number	6GK7243-7KX30-0XE0	6GK7243-7SX30-0XE0
product type designation	CP 1243-7 LTE EU	CP 1243-7 LTE US
product functions management, configuration, engineering		
configuration software		
• required	STEP 7 Basic/Professional	STEP 7 Basic/Professional
product functions diagnostics		
product function web-based diagnostics	Yes	Yes
product functions security		
firewall version	stateful inspection	stateful inspection
product function with VPN connection	IPsec, SINEMA RC	IPsec, SINEMA RC
type of encryption algorithms with VPN connection	AES-256, AES-192, AES-128, 3DES-168, DES-56	AES-256, AES-192, AES-128, 3DES-168, DES-56
type of authentication procedure with VPN connection	Preshared key (PSK), X.509v3 certificates	Preshared key (PSK), X.509v3 certificates
type of hashing algorithms with VPN connection	MD5, SHA-1	MD5, SHA-1
number of possible connections with VPN connection	1	1
product function		
• password protection for teleservice access	Yes	Yes
• encrypted data transmission	Yes	Yes
product functions time		
protocol is supported		
• NTP	Yes	Yes
time synchronization		
• from control center	Yes	Yes
standards, specifications, approvals hazardous environments		
certificate of suitability CCC for hazardous zone according to GB standard	Yes	Yes

3

Overview



The CP 1243-8 IRC (Industrial Remote Communication) communications processor is used for connecting a SIMATIC S7-1200 via the SINAUT ST7 telecontrol protocol to higher-level ST7 stations or to an ST7 control center. The CP 1243-8 IRC (as of HW2 and firmware V3.0) also offers connection to a DNP3 or IEC-capable control center via a corresponding open DNP3 or IEC 60870-5-104 telecontrol protocol. The CP 1243-8 IRC (as of HW2 and firmware V3.0) also offers connection to a DNP3 or IEC-capable control center via a corresponding open DNP3 or IEC 60870-5-104 telecontrol protocol.

The CP has the following features:

- Support for telecontrol protocol SINAUT ST7, DNP3, IEC 60870-5-104
- Two WAN connections for selecting the communication paths:
 - Ethernet-based connection: RJ45 port on the module for connecting external routers, e.g. SCALANCE M
 - Additional connection configurable via plug-in TS modules
- Both WAN interfaces can also be operated simultaneously: Route redundancy
- Data transfer of measured values, control variables, or alarms optimized for telecontrol systems
- Automatic transmission of alarms per email or text message
- Time synchronization based on NTP (Network Time Protocol) or via the SINAUT system
- Data buffering of up to 16,000 data frames prevents data loss in the event of temporary connection failures
- Secure communication via VPN connections based on IPsec
- Access protection via Stateful Inspection Firewall
- Support of SINEMA Remote Connect with autoconfiguration
- Fast and simple diagnostics via clear LED indicators, STEP 7 and web browser
- Compact industrial enclosure in S7-1200 design for mounting on a DIN rail

The integrated Ethernet interface and the option of using the TS modules provide flexible connection options for the CP. The following TS modules are available:

- TS module RS232
- TS module MODEM
- TS module ISDN

Ordering data

Article No.

CP 1243-8 IRC communications processor
6GK7243-8RX30-0XE0

Communications processor for connecting a SIMATIC S7-1200 via the SINAUT ST7 Telecontrol protocol to higher-level ST7 stations or to an ST7 control center, or a DNP3 or IEC-capable control center via a corresponding DNP3 or IEC 60870-5-104 open Telecontrol protocols

Accessories
SINAUT Engineering Software V5.5 + SP3
6NH7997-0CA55-0AA0

On CD, consisting of:

- SINAUT ST7/DNP3 configuration and diagnostic software for STEP 7 V5.6
- SINAUT TD7 block library
- Electronic manual in German and English

SINAUT engineering software V5.5 Upgrade from V5.0, V5.1, V5.2, V5.3 or V5.4
6NH7997-0CA55-0GA0
TeleService module

Connection to TS Adapter IE Basic/Advanced or CP 1243-8 IRC.
Power supply via TS Adapter IE Basic/Advanced or CP 1243-8 IRC.

TS module RS232
6ES7972-0MS00-0XA0
TS module MODEM
6ES7972-0MM00-0XA0
CSM 1277 compact switch module
6GK7277-1AA10-0AA0

Unmanaged switch for connecting a SIMATIC S7-1200 and up to three further nodes to Industrial Ethernet with 10/100 Mbps; 4 x RJ45 ports; external 24 V DC power supply, LED diagnostics, S7-1200 module including electronic device manual on CD-ROM

- 1) Please note country approvals under: <http://www.siemens.com/mobilenetwork-approvals>.

SIMATIC S7-1200 Basic Controllers

I/O modules

Communication

CP 1243-8 IRC

Technical specifications

Article number	6GK7243-8RX30-0XE0
product type designation	CP 1243-8 IRC
transfer rate	
transfer rate	
• at the 1st interface	10 ... 100 Mbit/s
• at the 2nd interface	0.3 ... 115.2 kbit/s
interfaces	
number of interfaces acc. to Industrial Ethernet	1
number of electrical connections	
• at the 1st interface acc. to Industrial Ethernet	1
• for power supply	1
type of electrical connection	
• at the 1st interface acc. to Industrial Ethernet	RJ45 port
type of electrical connection	
• at interface 2 for external data transmission	Interface to the TS Module
• for power supply	3-pole terminal block
supply voltage, current consumption, power loss	
type of voltage of the supply voltage	DC
supply voltage 1 from backplane bus	5 V
supply voltage external	24 V
supply voltage external	19.2 ... 28.8 V
supply voltage external at DC rated value	24 V
supply voltage external at DC rated value	19.2 ... 28.8 V
consumed current	
• from backplane bus at DC at 5 V typical	0.25 A
• from external supply voltage at DC at 24 V typical	0.1 A
power loss [W]	2.4 W; 1.25 W from S7-1200 backplane without TS module. 2.4 W from 24 V DC external with TS module
ambient conditions	
ambient temperature	
• for vertical installation during operation	-20 ... +60 °C
• for horizontally arranged busbars during operation	-20 ... +70 °C
• during storage	-40 ... -70 °C
• during transport	-40 ... +70 °C
relative humidity	
• at 25 °C without condensation during operation maximum	95 %
protection class IP	IP20

Article number	6GK7243-8RX30-0XE0
product type designation	CP 1243-8 IRC
design, dimensions and weights	
module format	Compact module S7-1200 single width
width	30 mm
height	110 mm
depth	75 mm
net weight	0.122 kg
fastening method	
• 35 mm top hat DIN rail mounting	Yes
• S7-300 rail mounting	No
• wall mounting	Yes
product features, product functions, product components general	
number of units	
• per CPU maximum	1
• note	One CP pluggable on left side of CPU, one TS Module pluggable left side of CP.
performance data open communication	
number of possible connections for open communication	
• by means of T blocks maximum	like CPU
performance data S7 communication	
number of possible connections for S7 communication	
• maximum	Configured S7-Connection for S7-Communication
• with PG connections maximum	2
• with OP connections maximum	1
service	
• SINAUT ST7 via S7 communication	Yes
performance data IT functions	
number of possible connections	
• as email client maximum	1

3

Technical specifications

Article number	6GK7243-8RX30-0XE0
product type designation	CP 1243-8 IRC
performance data telecontrol	
suitability for use	No
• node station	Yes
• substation	No
• TIM control center	Ethernet and TS Module can be operated in parallel
• note	
control center connection	control center with ST7 function supported
• by means of a permanent connection	
protocol is supported	
• DNP3	Yes
• IEC 60870-5	Yes
• SINAUT ST7 protocol	Yes
product function data buffering if connection is aborted	Yes; DNP3, IEC60870-5: 64000 events, SINAUT ST7: 16000 telegrams
number of data points per station maximum	500
transmission format	
• for SINAUT ST7 protocol with multi-master polling 10-bit	Yes
• for SINAUT ST7 protocol with polling or spontaneous 10-bit or 11-bit	Yes
operating mode for scanning of data transmission	
• with dedicated line/radio link with SINAUT ST7 protocol	Polling
• with dial-up network with SINAUT ST7 protocol	spontaneous
hamming distance	
• for SINAUT ST7 protocol	4
performance data teleservice	
diagnostics function online diagnostics with SIMATIC STEP 7 product function	Yes
• program download with SIMATIC STEP 7	Yes
• remote firmware update	Yes
product functions management, configuration, engineering	
protocol is supported	
• SNMP v3	Yes
• DCP	Yes
configuration software	
• required	SINAUT ES V5.5 and STEP7 V13 SP1 or higher
• for PG configuring required SINAUT ST7 configuration software for PG	Yes

Article number	6GK7243-8RX30-0XE0
product type designation	CP 1243-8 IRC
product functions diagnostics	
product function web-based diagnostics	Yes
product functions security	
firewall version	stateful inspection
operating mode Virtual Private Network (VPN)	Yes
product function with VPN connection	IPsec, SINEMA RC
type of encryption algorithms with VPN connection	AES-256, AES-192, AES-128, 3DES-168, DES-56
type of authentication procedure with VPN connection	Preshared key (PSK), X.509v3 certificates
type of hashing algorithms with VPN connection	MD5, SHA-1
number of possible connections with VPN connection	8
product function	
• password protection for teleservice access	No
• encrypted data transmission	Yes
• MSC client via GPRS modem with MSC capability	Yes
protocol	
• is supported MSC protocol	Yes
• with Virtual Private Network MSC is supported	TCP/IP
key length for MSC with Virtual Private Network	128 bit
number of possible connections	
• as MSC client with VPN connection	1
• as MSC server with VPN connection	0
product functions time	
protocol is supported	
• NTP	Yes
time synchronization	
• from NTP-server	Yes
• from control center	Yes
standards, specifications, approvals hazardous environments	
certificate of suitability CCC for hazardous zone according to GB standard	Yes
accessories	
accessories	TS Module RS232 or TS Module MODEM

SIMATIC S7-1200 Basic Controllers

I/O modules

Communication

SIMATIC RF120C**Overview**

The SIMATIC RF120C is a communications module for connecting the SIMATIC identification systems directly to the SIMATIC S7-1200. The readers of the RF200/300/1000 RFID systems as well as the MV300/400/500 optical readers can be operated on the SIMATIC RF120C.

Integration into the TIA Portal and the uniform plug-in connection systems permit fast and simple commissioning.

Ordering data**Article No.****SIMATIC RF120C communications module**

Integrated in the S7-1200 PLC for connection of a reader

6GT2002-0LA00**Accessories for all readers****Reader cable for SIMATIC RF200 / RF300 / MV400**

PUR material, trailable, straight reader connector

2 m

6GT2091-4LH20

5 m

6GT2091-4LH50

10 m

6GT2091-4LN10**Connecting cable for SIMATIC RF1000**

Prefabricated RS232, between RF1040R or RF1070R and RF120C; black, length 2 m

6GT2891-6UH20**Connecting cable for SIMATIC MV320**

Pre-assembled, between RF120C and MV320, coiled, length 5 m, usable length 1.6 to 4 m

6GT2191-1BH50**Accessories for extended use****Extension cable for all readers**

PUR material, trailable.

2 m, straight plug

6GT2891-4FH20

5 m, straight plug

6GT2891-4FH50

10 m, straight plug

6GT2891-4FN10

20 m, straight plug

6GT2891-4FN20

50 m, straight plug

6GT2891-4FN50

2 m, plug angled at reader

6GT2891-4JH20

5 m, plug angled at reader

6GT2891-4JH50

10 m, plug angled at reader

6GT2891-4JN10

Technical specifications

Article number	6GT2002-0LA00
product type designation	RF120C communication module
transfer rate	
transfer rate at the point-to-point connection serial maximum	115.2 kbit/s
interfaces	
design of the interface for point-to-point connection	RS422/RS232
number of readers connectable	1
type of electrical connection	
• of the backplane bus	S7-1200 backplane bus
• for supply voltage	Screw terminals
design of the interface to the reader for communication	sub-D, 9-pin, female
mechanical data	
material	Xantar MX 1094
color	Ti-grey 24L01
tightening torque of the screw for securing the equipment maximum	0.45 N·m
supply voltage, current consumption, power loss	
supply voltage	
• at DC rated value	24 V
• at DC	20 ... 30 V
consumed current at DC at 24 V	
• without connected devices typical	0.03 A
• with connected devices maximum	1 A
ambient conditions	
ambient temperature	
• during operation	0 ... 55 °C
• during storage	-40 ... +70 °C
• during transport	-40 ... +70 °C
protection class IP	IP20
shock resistance	According to IEC 61131-2
shock acceleration	300 m/s ²
vibrational acceleration	100 m/s ²

Article number	6GT2002-0LA00
product type designation	RF120C communication module
design, dimensions and weights	
width	30 mm
height	100 mm
depth	75 mm
net weight	0.15 kg
fastening method	S7-1200 rack
wire length for RS 422 interface maximum	1 000 m
product features, product functions, product components general	
display version	4 LEDs for reader connection, 1 LED for device status
product function addressable transponder file handler	No
protocol is supported	
• S7 communication	Yes
product functions management, configuration, engineering	
type of programming	ID profile, library with functions
type of computer-switched communication	acyclic communication
standards, specifications, approvals	
certificate of suitability	CE, FCC, cULus, KCC, C-Tick, FM
certificate of suitability	
• IECEX	Yes
• for IECEX as marking	Ex: II 3G Ex nAA IIC T4 Gc
MTBF	196 y

SIMATIC S7-1200 Basic Controllers

I/O modules

SIPLUS communication

SIPLUS CM 1241 communications modules

Overview



- For fast, high-performance serial data exchange via point-to-point coupling
- Implemented protocols: ASCII, USS drive protocol, Modbus RTU
- Additional protocols can also be loaded
- Simple parameterization with STEP 7 Basic

Note:

SIPLUS extreme products are based on SIMATIC standard products. The contents listed here were taken from the respective standard products. SIPLUS extreme-specific information was added.

Ordering data

Article No.

SIPLUS CM 1241 communications module

(Extended temperature range and exposure to environmental substances)

Ambient temperature
-40 ... +70° C

Communications module for point-to-point connection, with one RS232 interface

6AG1241-1AH32-2XB0

Communications module for point-to-point connection, with one RS 485 interface

6AG1241-1CH32-2XB0

Suitable for areas with extreme exposure to media (conformal coating)

Communications module for point-to-point connection, with one RS232 interface

6AG1241-1AH32-4XB0

Communications module for point-to-point connection, with one RS 485 interface

6AG1241-1CH32-4XB0

Accessories

See SIMATIC S7-1200 CM 1241 communications module, page 3/129

Technical specifications

Article number	6AG1241-1AH32-4XB0	6AG1241-1AH32-2XB0	6AG1241-1CH32-4XB0	6AG1241-1CH32-2XB0
Based on	6ES7241-1AH32-0XB0 SIPLUS S7-1200 CM 1241 RS232	6ES7241-1AH32-0XB0 SIPLUS S7-1200 CM1241 RS232	6ES7241-1CH32-0XB0 SIPLUS S7-1200 CM 1241 RS422/485	6ES7241-1CH32-0XB0 SIPLUS S7-1200 CM 1241 RS422/485
Ambient conditions				
Ambient temperature during operation				
• min.	-20 °C; = Tmin (incl. condensation/frost); start-up @ -25 °C	-40 °C; = Tmin (incl. condensation/frost); start-up @ -25 °C	-20 °C; = Tmin (incl. condensation/frost); start-up @ 0 °C	-40 °C; = Tmin (incl. condensation/frost); start-up @ -25 °C
• max.	60 °C; = Tmax	70 °C; = Tmax	60 °C; = Tmax	70 °C; Tmax > 60 °C, derating: Max. one module may be configured; this module must be the last module on the CM bus; minimum clearance on the left side of at least 45 mm
Altitude during operation relating to sea level				
• Installation altitude above sea level, max.	5 000 m	5 000 m	5 000 m	5 000 m
• Ambient air temperature-barometric pressure-altitude	Tmin ... Tmax at 1 140 hPa ... 795 hPa (-1 000 m ... +2 000 m) // Tmin ... (Tmax - 10 K) at 795 hPa ... 658 hPa (+2 000 m ... +3 500 m) // Tmin ... (Tmax -20 K) at 658 hPa ... 540 hPa (+3 500 m ... +5 000 m)	Tmin ... Tmax at 1 140 hPa ... 795 hPa (-1 000 m ... +2 000 m) // Tmin ... (Tmax - 10 K) at 795 hPa ... 658 hPa (+2 000 m ... +3 500 m) // Tmin ... (Tmax -20 K) at 658 hPa ... 540 hPa (+3 500 m ... +5 000 m)	Tmin ... Tmax at 1 140 hPa ... 795 hPa (-1 000 m ... +2 000 m) // Tmin ... (Tmax - 10 K) at 795 hPa ... 658 hPa (+2 000 m ... +3 500 m) // Tmin ... (Tmax -20 K) at 658 hPa ... 540 hPa (+3 500 m ... +5 000 m)	Tmin ... Tmax at 1 140 hPa ... 795 hPa (-1 000 m ... +2 000 m) // Tmin ... (Tmax - 10 K) at 795 hPa ... 658 hPa (+2 000 m ... +3 500 m) // Tmin ... (Tmax -20 K) at 658 hPa ... 540 hPa (+3 500 m ... +5 000 m)
Relative humidity				
• With condensation, tested in accordance with IEC 60068-2-38, max.	100 %; RH incl. condensation/frost (no commissioning under condensation conditions)	100 %; RH incl. condensation/frost (no commissioning under condensation conditions)	100 %; RH incl. condensation/frost (no commissioning under condensation conditions)	100 %; RH incl. condensation/frost (no commissioning under condensation conditions)
Resistance				
Coolants and lubricants				
- Resistant to commercially available coolants and lubricants	Yes; Incl. diesel and oil droplets in the air	Yes; Incl. diesel and oil droplets in the air	Yes; Incl. diesel and oil droplets in the air	Yes; Incl. diesel and oil droplets in the air

Technical specifications

Article number	6AG1241-1AH32-4XB0	6AG1241-1AH32-2XB0	6AG1241-1CH32-4XB0	6AG1241-1CH32-2XB0
Based on	6ES7241-1AH32-0XB0 SIPLUS S7-1200 CM 1241 RS232	6ES7241-1AH32-0XB0 SIPLUS S7-1200 CM1241 RS232	6ES7241-1CH32-0XB0 SIPLUS S7-1200 CM 1241 RS422/485	6ES7241-1CH32-0XB0 SIPLUS S7-1200 CM 1241 RS422/485
Use in stationary industrial systems				
- to biologically active substances according to EN 60721-3-3	Yes; Class 3B2 mold, fungus and dry rot spores (with the exception of fauna); Class 3B3 on request	Yes; Class 3B2 mold, fungus and dry rot spores (with the exception of fauna); Class 3B3 on request	Yes; Class 3B2 mold, fungus and dry rot spores (with the exception of fauna); Class 3B3 on request	Yes; Class 3B2 mold, fungus and dry rot spores (with the exception of fauna); Class 3B3 on request
- to chemically active substances according to EN 60721-3-3	Yes; Class 3C4 (RH < 75 %) incl. salt spray acc. to EN 60068-2-52 (severity degree 3); *	Yes; Class 3C4 (RH < 75 %) incl. salt spray acc. to EN 60068-2-52 (severity degree 3); *	Yes; Class 3C4 (RH < 75 %) incl. salt spray acc. to EN 60068-2-52 (severity degree 3); *	Yes; Class 3C4 (RH < 75 %) incl. salt spray acc. to EN 60068-2-52 (severity degree 3); *
- to mechanically active substances according to EN 60721-3-3	Yes; Class 3S4 incl. sand, dust; *	Yes; Class 3S4 incl. sand, dust; *	Yes; Class 3S4 incl. sand, dust; *	Yes; Class 3S4 incl. sand, dust; *
Use on ships/at sea				
- to biologically active substances according to EN 60721-3-6	Yes; Class 6B2 mold and fungal spores (excluding fauna); Class 6B3 on request	Yes; Class 6B2 mold and fungal spores (excluding fauna); Class 6B3 on request	Yes; Class 6B2 mold and fungal spores (excluding fauna); Class 6B3 on request	Yes; Class 6B2 mold and fungal spores (excluding fauna); Class 6B3 on request
- to chemically active substances according to EN 60721-3-6	Yes; Class 6C3 (RH < 75 %) incl. salt spray acc. to EN 60068-2-52 (severity degree 3); *	Yes; Class 6C3 (RH < 75 %) incl. salt spray acc. to EN 60068-2-52 (severity degree 3); *	Yes; Class 6C3 (RH < 75 %) incl. salt spray acc. to EN 60068-2-52 (severity degree 3); *	Yes; Class 6C3 (RH < 75 %) incl. salt spray acc. to EN 60068-2-52 (severity degree 3); *
- to mechanically active substances according to EN 60721-3-6	Yes; Class 6S3 incl. sand, dust; *	Yes; Class 6S3 incl. sand, dust; *	Yes; Class 6S3 incl. sand, dust; *	Yes; Class 6S3 incl. sand, dust; *
Usage in industrial process technology				
- Against chemically active substances acc. to EN 60654-4	Yes; Class 3 (excluding trichlorethylene)	Yes; Class 3 (excluding trichlorethylene)	Yes; Class 3 (excluding trichlorethylene)	Yes; Class 3 (excluding trichlorethylene)
- Environmental conditions for process, measuring and control systems acc. to ANSI/ISA-71.04	Yes; Level GX group A/B (excluding trichlorethylene; harmful gas concentrations up to the limits of EN 60721-3-3 class 3C4 permissible); level LC3 (salt spray) and level LB3 (oil)	Yes; Level GX group A/B (excluding trichlorethylene; harmful gas concentrations up to the limits of EN 60721-3-3 class 3C4 permissible); level LC3 (salt spray) and level LB3 (oil)	Yes; Level GX group A/B (excluding trichlorethylene; harmful gas concentrations up to the limits of EN 60721-3-3 class 3C4 permissible); level LC3 (salt spray) and level LB3 (oil)	Yes; Level GX group A/B (excluding trichlorethylene; harmful gas concentrations up to the limits of EN 60721-3-3 class 3C4 permissible); level LC3 (salt spray) and level LB3 (oil)
Remark				
- Note regarding classification of environmental conditions acc. to EN 60721, EN 60654-4 and ANSI/ISA-71.04	* The supplied plug covers must remain in place over the unused interfaces during operation!	* The supplied plug covers must remain in place over the unused interfaces during operation!	* The supplied plug covers must remain in place over the unused interfaces during operation!	* The supplied plug covers must remain in place over the unused interfaces during operation!
Conformal coating				
• Coatings for printed circuit board assemblies acc. to EN 61086	Yes; Class 2 for high reliability	Yes; Class 2 for high reliability	Yes; Class 2 for high reliability	Yes; Class 2 for high reliability
• Protection against fouling acc. to EN 60664-3	Yes; Type 1 protection	Yes; Type 1 protection	Yes; Type 1 protection	Yes; Type 1 protection
• Military testing according to MIL-I-46058C, Amendment 7	Yes; Discoloration of coating possible during service life	Yes; Discoloration of coating possible during service life	Yes; Discoloration of coating possible during service life	Yes; Discoloration of coating possible during service life
• Qualification and Performance of Electrical Insulating Compound for Printed Board Assemblies according to IPC-CC-830A	Yes; Conformal coating, Class A	Yes; Conformal coating, Class A	Yes; Conformal coating, Class A	Yes; Conformal coating, Class A

SIMATIC S7-1200 Basic Controllers

I/O modules

SIPLUS communication

SIPLUS CB 1241 RS485 communication board

Overview

- For fast, high-performance serial data exchange via point-to-point connection
- Implemented protocols: ASCII, USS drive protocol, Modbus RTU
- Additional protocols can be loaded later
- Simple parameterization with STEP 7 Basic
- Can be plugged directly into the CPU

Note:

SIPLUS extreme products are based on SIMATIC standard products. The contents listed here were taken from the respective standard products. SIPLUS extreme-specific information was added.

Ordering data

SIPLUS CB 1241 RS485 communication board

for point-to-point connection, with 1 RS485 interface

Accessories

Article No.

6AG1241-1CH30-5XB1

See SIMATIC CB 1241 RS485 communication board, page 3/131

Technical specifications

Article number	6AG1241-1CH30-5XB1
Based on	6ES7241-1CH30-1XB1 SIPLUS S7-1200 CB 1241 RS485
General information	
Product type designation	CB 1241 RS 485
Input current	
from backplane bus 5 V DC, typ.	50 mA
Alarms/diagnostics/status information	
Diagnostic indicator	Yes
Diagnostic indicator LED	
• For status of the outputs	Yes
Ambient conditions	
Ambient temperature during operation	
• min.	-40 °C; = Tmin (incl. condensation/frost); start-up @ -25 °C
• max.	60 °C; = Tmax
Altitude during operation relating to sea level	
• Installation altitude above sea level, max.	5 000 m
• Ambient air temperature-barometric pressure-altitude	Tmin ... Tmax at 1 140 hPa ... 795 hPa (-1 000 m ... +2 000 m) // Tmin ... (Tmax - 10 K) at 795 hPa ... 658 hPa (+2 000 m ... +3 500 m) // Tmin ... (Tmax -20 K) at 658 hPa ... 540 hPa (+3 500 m ... +5 000 m)
Relative humidity	
• With condensation, tested in accordance with IEC 60068-2-38, max.	100 %; RH incl. condensation/frost (no commissioning under condensation conditions)
Resistance	
Coolants and lubricants	
- Resistant to commercially available coolants and lubricants	Yes; Incl. diesel and oil droplets in the air
Use in stationary industrial systems	
- to biologically active substances according to EN 60721-3-3	Yes; Class 3B2 mold, fungus and dry rot spores (with the exception of fauna); Class 3B3 on request
- to chemically active substances according to EN 60721-3-3	Yes; Class 3C4 (RH < 75 %) incl. salt spray acc. to EN 60068-2-52 (severity degree 3); *
- to mechanically active substances according to EN 60721-3-3	Yes; Class 3S4 incl. sand, dust, *

Article number	6AG1241-1CH30-5XB1
Based on	6ES7241-1CH30-1XB1 SIPLUS S7-1200 CB 1241 RS485
Use on ships/at sea	
- to biologically active substances according to EN 60721-3-6	Yes; Class 6B2 mold and fungal spores (excluding fauna); Class 6B3 on request
- to chemically active substances according to EN 60721-3-6	Yes; Class 6C3 (RH < 75 %) incl. salt spray acc. to EN 60068-2-52 (severity degree 3); *
- to mechanically active substances according to EN 60721-3-6	Yes; Class 6S3 incl. sand, dust; *
Usage in industrial process technology	
- Against chemically active substances acc. to EN 60654-4	Yes; Class 3 (excluding trichlorethylene)
- Environmental conditions for process, measuring and control systems acc. to ANSI/ISA-71.04	Yes; Level GX group A/B (excluding trichlorethylene; harmful gas concentrations up to the limits of EN 60721-3-3 class 3C4 permissible); level LC3 (salt spray) and level LB3 (oil)
Remark	
- Note regarding classification of environmental conditions acc. to EN 60721, EN 60654-4 and ANSI/ISA-71.04	* The supplied plug covers must remain in place over the unused interfaces during operation!
Conformal coating	
• Coatings for printed circuit board assemblies acc. to EN 61086	Yes; Class 2 for high reliability
• Protection against fouling acc. to EN 60664-3	Yes; Type 1 protection
• Military testing according to MIL-I-46058C, Amendment 7	Yes; Discoloration of coating possible during service life
• Qualification and Performance of Electrical Insulating Compound for Printed Board Assemblies according to IPC-CC-830A	Yes; Conformal coating, Class A
Mechanics/material	
Enclosure material (front)	
• Plastic	Yes
Dimensions	
Width	38 mm
Height	62 mm
Depth	21 mm
Weights	
Weight, approx.	40 g

Overview



DP-M	DP-S	FMS	PG/OP	S7
	●			

The SIPLUS CM 1242-5 communication module is used to connect a SIPLUS S7-1200 controller to PROFIBUS as a DP slave and has the following characteristics:

- PROFIBUS DPV1 slave in accordance with IEC 61158
- Module replacement without PG supported
- Power is supplied via the backplane bus so that no extra cabling is required
- Support of all standard baud rates from 9.6 kbps to 12 Mbps
- Compact industry-standard enclosure in S7-1200 design for mounting on a DIN rail
- Fast commissioning thanks to easy configuration using STEP 7 without additional programming overhead

The CM 1242-5 is intended for use in factory automation. Low-cost PROFIBUS-based automation solutions can be created on the basis of S7-1200 for optimal production.

Technical specifications

Article number	6AG1242-5DX30-2XE0
Based on product type designation	6GK7242-5DX30-0XE0 SIPLUS S7-1200 CM 1242-5
ambient conditions	
ambient temperature	
• for vertical installation during operation	-25 ... +45 °C
• for horizontally arranged busbars during operation	-25 ... +55 °C
• during storage	-40 ... +70 °C
• during transport	-40 ... +70 °C
installation altitude at height above sea level maximum	5 000 m
ambient condition relating to ambient temperature - air pressure - installation altitude	Tmin ... Tmax at 1 140 hPa ... 795 hPa (-1 000 m ... +2 000 m) // Tmin ... (Tmax - 10 K) at 795 hPa ... 658 hPa (+2 000 m ... +3 500 m) // Tmin ... (Tmax - 20 K) at 658 hPa ... 540 hPa (+3 500 m ... +5 000 m)
relative humidity	
• with condensation acc. to IEC 60068-2-38 maximum	100 %; RH including condensation/frost (no commissioning when condensation is present), horizontal installation
chemical resistance to commercially available cooling lubricants	Yes; incl. airborne diesel and oil droplets
resistance to biologically active substances	
• conformity acc. to EN 60721-3-3	Yes; Class 3B2 mold and fungal spores (excluding fauna), Class 3B3 on request
• conformity acc. to EN 60721-3-6	Yes; Class 6B2 mold, fungal and dry rot spores (excluding fauna)
resistance to chemically active substances	
• conformity acc. to EN 60721-3-3	Yes; Class 3C4 (RH < 75 %) incl. salt spray in accordance with EN 60068-2-52 (Severity 3). The supplied plug covers must remain in place on the unused interfaces during operation.
• conformity acc. to EN 60721-3-6	Yes
resistance to mechanically active substances	
• conformity acc. to EN 60721-3-3	Yes; Class 3S4 incl. sand, dust. The supplied plug covers must remain in place over the unused interfaces during operation.
• conformity acc. to EN 60721-3-6	Yes; Class 6S3 incl. sand, dust. The supplied plug covers must remain in place over the unused interfaces during operation.
coating for equipped printed circuit board acc. to EN 61086	Yes; Class 2 for high availability
type of coating protection against pollution according to EN 60664-3	Yes; Protection of the type 1
type of test of the coating acc. to MIL-I-46058C	Yes; Coating discoloration during service life possible
product conformity of the coating Qualification and Performance of Electrical Insulating Compound for Printed Board Assemblies acc. to IPC-CC-830A	Yes; Conformal coating, class A
protection class IP	IP20

Ordering data

Article No.

SIPLUS CM 1242-5 communications module

(Extended temperature range and exposure to environmental substances)

Communications module for electrical connection of SIMATIC S7-1200 to PROFIBUS as a DPV1 slave

6AG1242-5DX30-2XE0

Accessories

See SIMATIC S7-1200 CM 1242-5 communications module, page 3/132

SIMATIC S7-1200 Basic Controllers

I/O modules

SIPLUS communication

SIPLUS CM 1243-2 communications modules

Overview



The CM 1243-2 communications module is the AS-Interface master for the SIMATIC S7-1200 and has the following features:

- As many as 62 AS-Interface slaves can be connected
- Integrated analog value transmission
- Supports all AS-Interface master functions according to the AS-Interface Specification V3.0
- Indication of the operating state on the front of the device via LED
- Indication of operating mode, AS-Interface voltage faults, configuration faults and I/O faults via LEDs behind the front panel
- Compact enclosure in the design of the SIMATIC S7-1200
- Suitable for AS-Interface with 30 V voltage and AS-i Power24V: In combination with the optional DCM 1271 data decoupling module, a standard 24 V power supply unit can be used
- Configuration and diagnostics via the TIA Portal

Installation

The CM 1243-2 communications module is positioned to the left of the S7-1200 CPU and linked to the S7-1200 via lateral contacts.

It incorporates:

- Terminals for two AS-i cables (internally jumpered) via two screw terminals each
- One terminal for connection to the functional ground
- LEDs for indication of the operating state and fault statuses of the connected slaves

The screw terminals (included in the scope of supply) can be removed to facilitate installation

Function

The CM 1243-2 supports all specified functions of the AS-Interface Specification V3.0.

The values of the digital AS-i slaves can be addressed via the process image of the S7-1200. During configuration of the slaves in the TIA Portal, the values of the analog AS-i slaves can also be accessed directly in the process image.

It is also possible to exchange all data of the AS-i master and the connected AS-i slaves with the S7-1200 via the data record interface.

Changeover of the operating mode, automatic application of the slave configuration and the re-addressing of a connected AS-i slave can be implemented via the control panel of the CM 1243-2 in the TIA Portal.

The optional DCM 1271 data decoupling unit (see page 3/136) has an integrated detection unit for detecting ground faults on the AS-Interface cable. The integrated overload protection also disconnects the AS-Interface cable if the drive current required exceeds 4 A. For more information on DCM 1271, see page 3/136.

Notes on security

In order to protect plants, systems, machines and networks against cyber threats, it is necessary to implement – and continuously maintain – a holistic, state-of-the-art industrial security concept. Siemens' products and solutions can constitute an integral element of such a concept.

For more information about industrial security, please visit <http://www.siemens.com/industrialsecurity>

Configuration

To configure CM 1243-2, you require STEP 7 V11 + SP2 or higher.

For STEP 7 V11 + SP2 or higher, the additional Hardware Support Package for CM 1243-2 is required. This is available from the Industry Online Support Portal, see <https://support.industry.siemens.com/cs/ww/en/view/72341852>.

The software enables user-friendly configuration and diagnostics of the AS-i master and any connected slaves.

Note:

SIPLUS extreme products are based on SIMATIC standard products. The contents listed here were taken from the respective standard products. SIPLUS extreme-specific information was added.

Ordering data	Article No.
SIPLUS CM 1243-2 communications module (Extended temperature range and exposure to environmental substances) <ul style="list-style-type: none"> • AS-Interface master for SIMATIC S7-1200 • Corresponds to AS-Interface Specification V3.0 • With screw terminals, removable terminals (included in the scope of supply) • Dimensions (W × H × D/ mm) 30 × 100 × 75 	6AG1243-2AA30-7XB0
Accessories	See S7-1200 CM 1243-2 communications module, page 3/135

Overview

DP-M	DP-S	FMS	PG/OP	S7
●			●	●

The CM 1243-5 communication module is used to connect a SIMATIC S7-1200 controller to PROFIBUS as a DP master and has the following characteristics:

- PROFIBUS DPV1 master in accordance with IEC 61158
- Support of up to 16 PROFIBUS DP slaves
- Communication with other S7 controllers based on S7 communication
- Allows the connection of programming devices and operator panels with a PROFIBUS interface to S7-1200
- Module replacement without PG supported
- Support of all standard baud rates from 9.6 kbps to 12 Mbps
- Compact industry-standard enclosure in S7-1200 design for mounting on a DIN rail
- Fast commissioning thanks to easy configuration using STEP 7 without additional programming overhead

The CM 1243-5 is intended for use in factory automation. Low-cost PROFIBUS-based automation solutions can be created on the basis of S7-1200 for optimal production.

Note:

SIPLUS extreme products are based on SIMATIC standard products. The contents listed here were taken from the respective standard products. SIPLUS extreme-specific information was added.

Ordering data**Article No.****SIPLUS CM 1243-5 communications module**

(Extended temperature range and exposure to environmental substances)

Communications module for electrical connection of SIMATIC S7-1200 to PROFIBUS as a DPV1 master

6AG1243-5DX30-2XE0**Accessories**

See SIMATIC S7-1200 CM 1243-5 communications module, page 3/138

SIMATIC S7-1200 Basic Controllers

I/O modules

SIPLUS communication

SIPLUS CM 1243-5 communications modules**Technical specifications**

Article number	6AG1243-5DX30-2XE0	Article number	6AG1243-5DX30-2XE0
Based on	6GK7243-5DX30-0XE0	Based on	6GK7243-5DX30-0XE0
product type designation	SIPLUS S7-1200 CM 1243-5	product type designation	SIPLUS S7-1200 CM 1243-5
ambient conditions		resistance to chemically active substances	
ambient temperature			
• for vertical installation during operation	-25 ... +45 °C	• conformity acc. to EN 60721-3-3	Yes; Class 3C4 (RH < 75 %) incl. salt spray in accordance with EN 60068-2-52 (Severity 3). The supplied plug covers must remain in place on the unused interfaces during operation.
• for horizontally arranged busbars during operation	-25 ... +55 °C		Yes
• during storage	-40 ... +70 °C	• conformity acc. to EN 60721-3-6	Yes; Class 3S4 incl. sand, dust. The supplied plug covers must remain in place over the unused interfaces during operation.
• during transport	-40 ... +70 °C		Yes; Class 6S3 incl. sand, dust. The supplied plug covers must remain in place over the unused interfaces during operation.
installation altitude at height above sea level maximum	5 000 m	resistance to mechanically active substances	
ambient condition relating to ambient temperature - air pressure - installation altitude	Tmin ... Tmax at 1 140 hPa ... 795 hPa (-1 000 m ... +2 000 m) // Tmin ... (Tmax - 10 K) at 795 hPa ... 658 hPa (+2 000 m ... +3 500 m) // Tmin ... (Tmax - 20 K) at 658 hPa ... 540 hPa (+3 500 m ... +5 000 m)	• conformity acc. to EN 60721-3-3	Yes; Class 3S4 incl. sand, dust. The supplied plug covers must remain in place over the unused interfaces during operation.
relative humidity		• conformity acc. to EN 60721-3-6	Yes; Class 6S3 incl. sand, dust. The supplied plug covers must remain in place over the unused interfaces during operation.
• with condensation acc. to IEC 60068-2-38 maximum	100 %; RH including condensation/frost (no commissioning when condensation is present), horizontal installation	coating for equipped printed circuit board acc. to EN 61086	Yes; Class 2 for high availability
chemical resistance to commercially available cooling lubricants	Yes; incl. airborne diesel and oil droplets	type of coating protection against pollution according to EN 60664-3	Yes; Protection of the type 1
resistance to biologically active substances		type of test of the coating acc. to MIL-I-46058C	Yes; Coating discoloration during service life possible
• conformity acc. to EN 60721-3-3	Yes; Class 3B2 mold and fungal spores (excluding fauna), Class 3B3 on request	product conformity of the coating Qualification and Performance of Electrical Insulating Compound for Printed Board Assemblies acc. to IPC-CC-830A	Yes; Conformal coating, class A
• conformity acc. to EN 60721-3-6	Yes; Class 6B2 mold, fungal and dry rot spores (excluding fauna)	protection class IP	IP20

Overview

The CP 1243-1 communications processor is used for connecting the SIMATIC S7-1200 to telecontrol centers via remote networks and telecontrol protocols (DNP3, IEC 60870-5-104, TeleControl Basic), and for safe communication via IP-based networks.

The CP has the following features:

- Ethernet-based connection to TeleControl Server Basic, e.g. via internet
- Data transfer of measured values, control variables, or alarms optimized for telecontrol systems
- Automatic sending of alert emails
- Data buffering of up to 64,000 values ensures a secure database even with temporary connection failures
- Secure communication via VPN connections based on IPsec
- Access protection via Stateful Inspection Firewall
- Support of SINEMA Remote Connect with autoconfiguration
- Clearly laid out LED signaling for fast and easy diagnostics
- Compact industrial enclosure in S7-1200 design for mounting on a standard DIN rail
- Fast commissioning thanks to easy configuration using STEP 7

Note:

SIPLUS extreme products are based on SIMATIC standard products. The contents listed here were taken from the respective standard products. SIPLUS extreme-specific information was added.

Ordering data**Article No.****SIPLUS CP 1243-1 communications module**

(Extended temperature range and exposure to environmental substances)

Communications processor for connecting SIMATIC S7-1200 as an additional Ethernet interface and for connection to control centers via telecontrol protocols (DNP3, IEC 60870, TeleControl Basic), security (firewall, VPN)

6AG1243-1BX30-2AX0**Accessories**

See SIMATIC S7-1200 CP 1243-1 communications processor, page 3/142

SIMATIC S7-1200 Basic Controllers

I/O modules

SIPLUS communication

SIPLUS CP 1243-1 communications modules

Technical specifications

Article number	6AG1243-1BX30-2AX0	Article number	6AG1243-1BX30-2AX0
Based on	6GK7243-1BX30-0XE0	Based on	6GK7243-1BX30-0XE0
product type designation	SIPLUS S7-1200 CP 1243-1	product type designation	SIPLUS S7-1200 CP 1243-1
ambient conditions		ambient conditions	
ambient temperature		resistance to chemically active substances	
• for vertical installation during operation	-40 ... +60 °C	• conformity acc. to EN 60721-3-3	Yes; Class 3C4 (RH < 75 %) incl. salt spray in accordance with EN 60068-2-52 (Severity 3). The supplied plug covers must remain in place on the unused interfaces during operation.
• for horizontally arranged busbars during operation	-40 ... +70 °C		Yes
• during storage	-40 ... +70 °C	• conformity acc. to EN 60721-3-6	Yes; Class 3S4 incl. sand, dust. The supplied plug covers must remain in place over the unused interfaces during operation.
• during transport	-40 ... +70 °C	resistance to mechanically active substances	
installation altitude at height above sea level maximum	5 000 m	• conformity acc. to EN 60721-3-3	Yes; Class 3S4 incl. sand, dust. The supplied plug covers must remain in place over the unused interfaces during operation.
ambient condition relating to ambient temperature - air pressure - installation altitude	Tmin ... Tmax at 1 140 hPa ... 795 hPa (-1 000 m ... +2 000 m) // Tmin ... (Tmax - 10 K) at 795 hPa ... 658 hPa (+2 000 m ... +3 500 m) // Tmin ... (Tmax - 20 K) at 658 hPa ... 540 hPa (+3 500 m ... +5 000 m)	• conformity acc. to EN 60721-3-6	Yes; Class 6S3 incl. sand, dust. The supplied plug covers must remain in place over the unused interfaces during operation.
relative humidity		coating for equipped printed circuit board acc. to EN 61086	Yes; Class 2 for high availability
• with condensation acc. to IEC 60068-2-38 maximum	100 %; RH including condensation/frost (no commissioning when condensation is present), horizontal installation	type of coating protection against pollution according to EN 60664-3	Yes; Protection of the type 1
chemical resistance to commercially available cooling lubricants	Yes; incl. airborne diesel and oil droplets	type of test of the coating acc. to MIL-I-46058C	Yes; Coating discoloration during service life possible
resistance to biologically active substances		product conformity of the coating Qualification and Performance of Electrical Insulating Compound for Printed Board Assemblies acc. to IPC-CC-830A	Yes; Conformal coating, class A
• conformity acc. to EN 60721-3-3	Yes; Class 3B2 mold and fungal spores (excluding fauna), Class 3B3 on request	protection class IP	IP20
• conformity acc. to EN 60721-3-6	Yes; Class 6B2 mold, fungal and dry rot spores (excluding fauna)		

Overview

- Unmanaged switch for connecting a SIPLUS S7-1200 controller to an Industrial Ethernet network with a line, tree or star topology
- Multiplication of Ethernet interfaces on a SIPLUS S7-1200 controller for additional connection of up to three programming devices, operator controls, and further Ethernet nodes
- Simple, space-saving mounting on the SIPLUS S7-1200 mounting rail
- Low-cost solution for implementing small, local Ethernet networks
- Problem-free connection using RJ45 plugs
- Simple and fast status display via LEDs on the device
- Integral autocrossover function permits use of uncrossed connecting cables

Note:

SIPLUS extreme products are based on SIMATIC standard products. The contents listed here were taken from the respective standard products. SIPLUS extreme-specific information was added.

SIPLUS NET CSM 1277	
Article No.	6AG1277-1AA10-4AA0
Article No. based on	6GK7277-1AA10-0AA0
Ambient temperature range	0 ... +60 °C

Ordering data**SIPLUS NET CSM 1277 compact switch module**

(Extended temperature range and exposure to media)

Unmanaged switch for connecting a SIPLUS S7-1200 controller and up to three further nodes to Industrial Ethernet with 10/100 Mbps; 4 x RJ45 ports; external 24 V DC power supply, LED diagnostics, S7-1200 module including electronic device manual on CD-ROM

Accessories**Article No.****6AG1277-1AA10-4AA0**

See CSM 1277 unmanaged, page 3/140

SIMATIC S7-1200 Basic Controllers

I/O modules

Connection system

System cabling for SIMATIC S7-1500 IO (25 mm), ET 200SP, S7-1200 and LOGO!

Overview

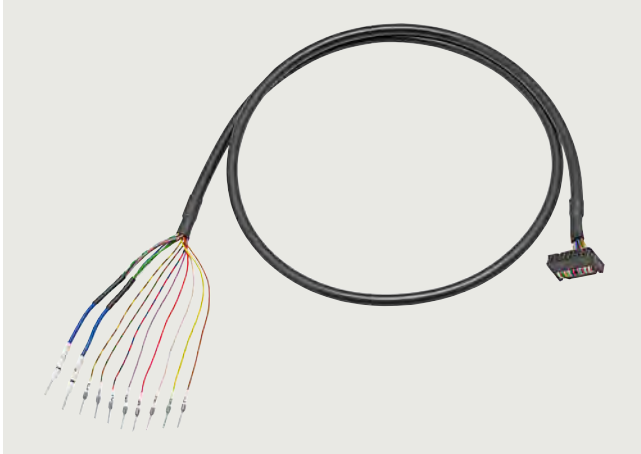

SIMATIC TOP connect universal connecting cable

The wiring of the

- SIMATIC S7-1500 IO (25 mm)
- SIMATIC ET 200SP
- SIMATIC S7-1200
- LOGO!

with the sensors/actuators is a significant factor with respect to time/cost overhead during configuration, control cabinet design, procurement and ease of servicing. The SIMATIC TOP connect system cabling makes connection easy, fast and secure.

Design

The unshielded universal connection cable is offered for a wide range of control cabinet concepts.

It comprises:

- 16-pin round cable with a core cross-section of 0.14 mm^2 , pre-assembled with wire end ferrules for connection to the controller:
 - Labeled with "0" ... "7" for the control inputs/outputs
 - Labeled with "M" for mass
 - Labeled with "L+" for 24 V DC potential
- 16-pin ID (insulation displacement) connector for connection to the SIMATIC TOP connect connection modules for 8 I/Os:
 - 3-wire connection using the appropriate connection module for quick, error-free wiring
 - Galvanic isolation and adaptation using a coupling relay for easy implementation of potential groups in the system
 - High output current (up to 4 A), even for higher switching frequencies, using an optocoupler module (overload and short-circuit proof)
 - Implementation of isolating terminals using switch modules enabling individual signals to be measured
 - Channel-wise protection of I/Os using a fuse module with a thermal fuse

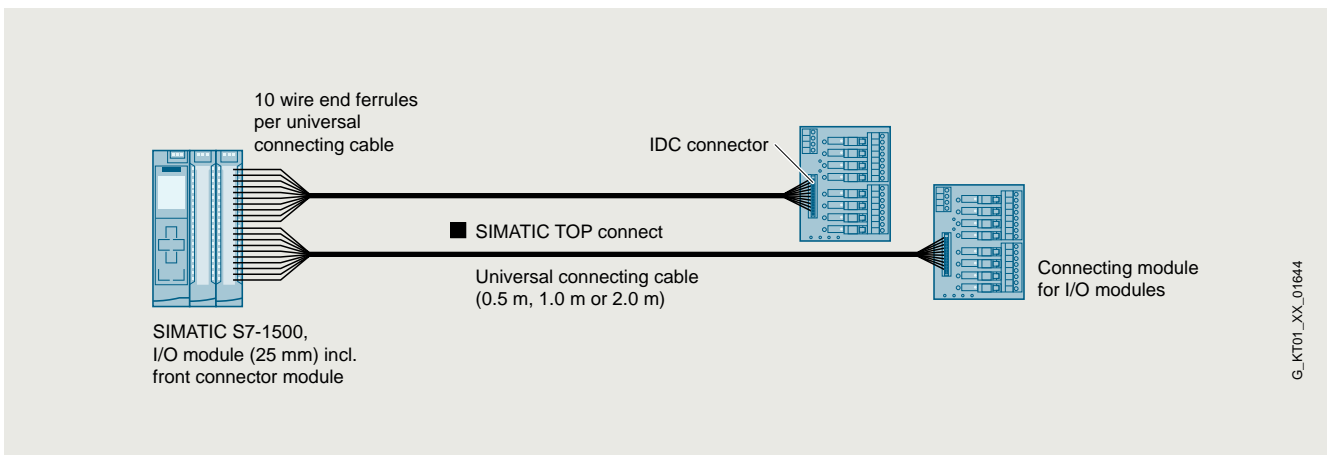

SIMATIC TOP connect universal connection cable

System cabling for SIMATIC S7-1500 IO (25 mm), ET 200SP, S7-1200 and LOGO!

Overview Universal connecting cable

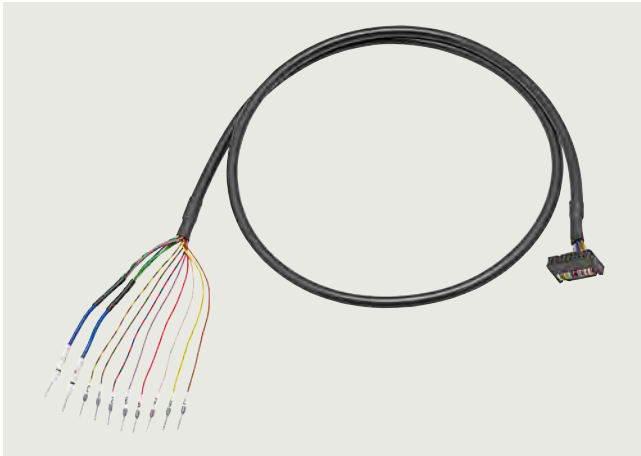

SIMATIC TOP connect universal connecting cable

The universal connecting cable constitutes the link between the standard connection of the SIMATIC S7-1500 IO (25 mm), SIMATIC ET 200SP, SIMATIC S7-1200 or LOGO! and the SIMATIC TOP connect terminal module. It transmits 8 signals and the supply voltage. The connecting cable is available in lengths of 0.5 m / 1.0 m / 2.0 m. the maximum technically feasible length is 30 m.

Ordering data

Article No.

Universal connecting cables for
SIMATIC S7-1500 IO (25 mm),
SIMATIC ET 200SP,
SIMATIC S7-1200 and LOGO!

16 x 0.14 mm² unshielded

- 0.5 m
- 1.0 m
- 2.0 m

6ES7923-0BA50-0FB0
6ES7923-0BB00-0FB0
6ES7923-0BC00-0FB0

Overview Connection modules

The connection modules are used instead of conventional terminal blocks and act as the interface between the PLC and signals from the field. All digital modules with 8 I/Os can be used.

Ordering data

Article No.

Connection module TP1

For 1-wire connection,
for 16-pin connecting cables

- Push-in terminals without LEDs
- Screw-type terminals without LEDs
- Push-in terminals with LEDs
- Screw-type terminals with LEDs

6ES7924-0AA20-0AC0
6ES7924-0AA20-0AA0
6ES7924-0AA20-0BC0
6ES7924-0AA20-0BA0

Connection module TP3

For 3-wire connection, for 16-pin
connecting cables

- Push-in terminals without LEDs
- Screw-type terminals without LEDs
- Push-in terminals with LEDs
- Screw-type terminals with LEDs
- Push-in terminals with LEDs and one isolating terminal per channel
- Screw-type terminals with LEDs and one isolating terminal per channel
- Push-in terminals with LEDs and fuse per channel
- Screw-type terminals with LEDs and fuse per channel

6ES7924-0CA20-0AC0
6ES7924-0CA20-0AA0
6ES7924-0CA20-0BC0
6ES7924-0CA20-0BA0
6ES7924-0CH20-0BC0
6ES7924-0CH20-0BA0
6ES7924-0CL20-0BC0
6ES7924-0CL20-0BA0

Connection module TPRo

Relay module for 8 outputs,
relay as normally open contact

- Push-in terminals with LEDs
- Screw-type terminals with LEDs

6ES7924-0BD20-0BC0
6ES7924-0BD20-0BA0

Connection module TPRi

Relay module for 8 inputs
(230 V AC), relay as normally
open contact

- Push-in terminals with LEDs
- Screw-type terminals with LEDs

6ES7924-0BE20-0BC0
6ES7924-0BE20-0BA0

Connection module TPRi

Relay module for 8 inputs
(110 V AC), relay as normally
open contact

- Push-in terminals with LEDs
- Screw-type terminals with LEDs

6ES7924-0BG20-0BC0
6ES7924-0BG20-0BA0

Connection module TPOo

Optocoupler module for 8 outputs
(max. 24 V DC/4 A)

- Push-in terminals with LEDs
- Screw-type terminals with LEDs

6ES7924-0BF20-0BC0
6ES7924-0BF20-0BA0

SIMATIC S7-1200 Basic Controllers

I/O modules

Fail-safe I/O modules

SM 1226 fail-safe digital input**Overview**

- Digital inputs as supplement to the integral I/O of the CPUs
- Integrated into the overall automation for the implementation of safety-related requirements
- With integrated safety functions
- Communication with fail-safe CPUs via PROFIsafe mechanisms
- For flexible adaptation of the controller to the corresponding task
- For subsequent expansion of the system with additional inputs
- Operable exclusively in the central system

Ordering data**Article No.****SM 1226 fail-safe digital input signal module****6ES7226-6BA32-0XB0**

16 inputs, 24 V DC (SIL 2/category 3/PL d) or 8 inputs 24 V DC (SIL 3/category 3 or category 4/PL e) or a combination of both

Accessories**Terminal block (spare part)**

With 11 screws, tin-coated; 4 units

6ES7292-1AL30-0XA0**Front flap set (spare part)**

For modules with a width of 70 mm

6ES7291-1BB30-0XA0**STEP 7 Safety Advanced V17****Task:**

Engineering tool for configuring and programming fail-safe user programs for SIMATIC S7-1200 FC, S7-1500F, S7-1500F Software Controller, S7-300F, S7-400F, WinAC RTX F, ET 200SP F Controller and the fail-safe ET 200SP, ET 200MP, ET 200S, ET 200M, ET 200iSP, ET 200pro and ET 200eco I/O

Requirement:

STEP 7 Professional V17

Note:

As of TIA Portal V16, the SIMATIC STEP 7 Safety software is an integral component of the SIMATIC STEP 7 product setup. The functionality of SIMATIC STEP 7 Safety is activated by means of the license key supplied in each case.

Floating license for 1 user; license key on USB flash drive

6ES7833-1FA17-0YA5

Floating license for 1 user; license key for download¹⁾; email address required for delivery

6ES7833-1FA17-0YH5**STEP 7 Safety Basic V17****Task:**

Engineering tool for configuring fail-safe user programs for SIMATIC S7-1200 FC

Requirement:

STEP 7 Basic V17 and higher

Note:

As of TIA Portal V16, the SIMATIC STEP 7 Safety software is an integral component of the SIMATIC STEP 7 product setup. The functionality of SIMATIC STEP 7 Safety is activated by means of the license key supplied in each case.

Floating license for 1 user; license key on USB flash drive

6ES7833-1FB17-0YA5

Floating license for 1 user; license key for download¹⁾; email address required for delivery

6ES7833-1FB17-0YH5

¹⁾ For up-to-date information and download availability, see: <http://www.siemens.com/tia-online-software-delivery>

Technical specifications

Article number	6ES7226-6BA32-0XB0 Digital Input SM 1226, F-DI 16x 24VDC
General information	
Product type designation	SM 1226, F-DI 16x24 V DC
Supply voltage	
Rated value (DC)	24 V
Input current	
from backplane bus 5 V DC, max.	155 mA; Current consumption (SM Bus, 5 V DC): 155 mA
Digital inputs	
<ul style="list-style-type: none"> from load voltage L+ (without load), max. 	130 mA; 130 mA + 6 mA / input used + any Vs1/Vs2 current used
Digital inputs	
Number of digital inputs	16; 16 (1oo1) or 8 (1oo2); Note: You can individually assign each pair of inputs "a.x" and "b.x" as a single (1oo2)-channel or as 2 separate (1oo1)-channels
Number of simultaneously controllable inputs	
horizontal installation - up to 50 °C, max.	16; 16 inputs at 55 °C horizontal
vertical installation - up to 40 °C, max.	16; 16 inputs at 45 °C vertical
Input voltage	
<ul style="list-style-type: none"> for signal *0* for signal *1* 	-30 V DC to +5 V DC 15 V DC to 30 V DC
Input current	
<ul style="list-style-type: none"> for signal *0*, max. (permissible quiescent current) for signal *1*, typ. 	0.5 mA 5 mA
Input delay (for rated value of input voltage)	
for standard inputs - parameterizable	Yes; 0.8 / 1.6 / 3.2 / 6.4 / 12.8 ms
Interrupts/diagnostics/ status information	
Diagnostics indication LED	
<ul style="list-style-type: none"> for status of the inputs 	Yes

Article number	6ES7226-6BA32-0XB0 Digital Input SM 1226, F-DI 16x 24VDC
Degree and class of protection	
IP degree of protection	IP20
Standards, approvals, certificates	
CE mark	Yes
cULus	Yes
FM approval	Yes
Highest safety class achievable in safety mode	
<ul style="list-style-type: none"> Performance level according to ISO 13849-1 SIL acc. to IEC 61508 	1-channel, Category 3, PL d; 2-channel, Category 3 or 4, PL e SIL 2 (single-channel), SIL 3 (two-channel)
Ambient conditions	
Ambient temperature during operation	
<ul style="list-style-type: none"> min. max. 	0 °C 55 °C
Mechanics/material	
Enclosure material (front)	
<ul style="list-style-type: none"> Plastic 	Yes
Dimensions	
Width	70 mm
Height	100 mm
Depth	75 mm
Weights	
Weight, approx.	250 g

SIMATIC S7-1200 Basic Controllers

I/O modules

Fail-safe I/O modules

SM 1226 fail-safe digital output**Overview**

- Digital outputs as a supplement to the integral I/O of the CPUs
- Integrated into the overall automation for the implementation of safety-related requirements
- With integrated safety functions
- Communication with fail-safe CPUs via PROFIsafe mechanisms
- For flexible adaptation of the controller to the corresponding task
- For subsequent expansion of the system with additional outputs
- Operable exclusively in the central system

Ordering data**Article No.****SM 1226 fail-safe digital output signal module****6ES7226-6DA32-0XB0**

4 outputs; 24 V DC, current sourcing/sinking

Accessories**Terminal block (spare part)**

With 11 screws, tin-coated; 4 units

6ES7292-1AL30-0XA0**Front flap set (spare part)**

For modules with a width of 70 mm

6ES7291-1BB30-0XA0**STEP 7 Safety Advanced V17****Task:**

Engineering tool for configuring and programming fail-safe user programs for SIMATIC S7-1200 FC, S7-1500F, S7-1500F Software Controller, S7-300F, S7-400F, WinAC RTX F, ET 200SP F Controller and the fail-safe I/O ET 200SP, ET 200MP, ET 200S, ET 200M, ET 200iSP, ET 200pro and ET 200eco

Requirement:

STEP 7 Professional V17

Note:

As of TIA Portal V16, the SIMATIC STEP 7 Safety software is an integral component of the SIMATIC STEP 7 product setup. The functionality of SIMATIC STEP 7 Safety is activated by means of the license key supplied in each case.

Floating license for 1 user;
license key on USB flash drive

6ES7833-1FA17-0YA5

Floating license for 1 user;
license key for download¹⁾;
Email address required for delivery

6ES7833-1FA17-0YH5**STEP 7 Safety Basic V17****Task:**

Engineering tool for configuring fail-safe user programs for SIMATIC S7-1200 FC

Requirement:

STEP 7 Basic V17 and higher

Note:

As of TIA Portal V16, the SIMATIC STEP 7 Safety software is an integral component of the SIMATIC STEP 7 product setup. The functionality of SIMATIC STEP 7 Safety is activated by means of the license key supplied in each case.

Floating license for 1 user;
license key on USB flash drive

6ES7833-1FB17-0YA5

Floating license for 1 user;
license key for download¹⁾;
email address required for delivery

6ES7833-1FB17-0YH5

¹⁾ For up-to-date information and download availability, see:
<http://www.siemens.com/tia-online-software-delivery>

Technical specifications

Article number	6ES7226-6DA32-0XB0 Digital Output SM 1226, F-DQ 4x 24VDC
General information	
Product type designation	SM 1226 F-DQ 4x 24 VDC
Input current	
from backplane bus 5 V DC, max.	125 mA
Digital outputs	
• from load voltage L+, max.	170 mA
Digital outputs	
Number of digital outputs	4
• in groups of	1
Short-circuit protection	Yes
Switching capacity of the outputs	
• with resistive load, max.	30 Hz
• on lamp load, max.	10 Hz
Output voltage	
• Rated value (DC)	24 V
Output current	
• for signal "1" rated value	2 A
• for signal "0" residual current, max.	P-switch: 0.5 mA, maximum; M-switch: 0.5 mA, maximum
Interrupts/diagnostics/ status information	
Diagnostics indication LED	
• for status of the outputs	Yes
Degree and class of protection	
IP degree of protection	IP20

Article number	6ES7226-6DA32-0XB0 Digital Output SM 1226, F-DQ 4x 24VDC
Standards, approvals, certificates	
CE mark	Yes
cULus	Yes
FM approval	Yes
Highest safety class achievable in safety mode	
• Performance level according to ISO 13849-1	Category 4, PL e
• SIL acc. to IEC 61508	SIL 3
Ambient conditions	
Ambient temperature during operation	
• min.	0 °C
• max.	55 °C
Mechanics/material	
Enclosure material (front)	
• Plastic	Yes
Dimensions	
Width	70 mm
Height	100 mm
Depth	75 mm
Weights	
Weight, approx.	270 g

SIMATIC S7-1200 Basic Controllers

I/O modules

Fail-safe I/O modules

SM 1226 fail-safe relay output**Overview**

- Relay outputs as a supplement to the integral I/O of the CPUs
- Integrated into the overall automation for the implementation of safety-related requirements
- With integrated safety functions
- Communication with fail-safe CPUs via PROFIsafe mechanisms
- For flexible adaptation of the controller to the corresponding task
- For subsequent expansion of the system with additional outputs
- Operable exclusively in the central system

Ordering data**Article No.****SM 1226 fail-safe relay output signal module****6ES7226-6RA32-0XB0**

2 relay outputs

Accessories**Terminal block (spare part)**

With 11 screws, tin-coated, coded; 4 units

6ES7292-1AL40-0XA0**Front flap set (spare part)**

For modules with a width of 70 mm

6ES7291-1BB30-0XA0**STEP 7 Safety Advanced V17****Task:**

Engineering tool for configuring and programming fail-safe user programs for SIMATIC S7-1200 FC, S7-1500F, S7-1500F Software Controller, S7-300F, S7-400F, WinAC RTX F, ET 200SP F Controller and the fail-safe I/O ET 200SP, ET 200MP, ET 200S, ET 200M, ET 200iSP, ET 200pro and ET 200eco

Requirement:

STEP 7 Professional V17

Note:

As of TIA Portal V16, the SIMATIC STEP 7 Safety software is an integral component of the SIMATIC STEP 7 product setup. The functionality of SIMATIC STEP 7 Safety is activated by means of the license key supplied in each case.

Floating license for 1 user; license key on USB flash drive

6ES7833-1FA17-0YA5

Floating license for 1 user; license key for download¹⁾; email address required for delivery

6ES7833-1FA17-0YH5**STEP 7 Safety Basic V17****Task:**

Engineering tool for configuring fail-safe user programs for SIMATIC S7-1200 FC

Requirement:

STEP 7 Basic V17 and higher

Note:

As of TIA Portal V16, the SIMATIC STEP 7 Safety software is an integral component of the SIMATIC STEP 7 product setup. The functionality of SIMATIC STEP 7 Safety is activated by means of the license key supplied in each case.

Floating license for 1 user; license key on USB flash drive

6ES7833-1FB17-0YA5

Floating license for 1 user; license key for download¹⁾; email address required for delivery

6ES7833-1FB17-0YH5

¹⁾ For up-to-date information and download availability, see: <http://www.siemens.com/tia-online-software-delivery>

Technical specifications

Article number	6ES7226-6RA32-0XB0 Digital Output SM 1226, F-DQ 2x Relay
General information	
Product type designation	SM 1226, F-DQ 2x relay/5 A
Input current	
from backplane bus 5 V DC, max.	120 mA
Digital outputs	
• from load voltage L+, max.	300 mA
Digital outputs	
Number of digital outputs	2
Short-circuit protection	No
Output voltage	
• Rated value (DC)	5 V DC to 30 V DC
• Rated value (AC)	5 V AC to 250 V AC
Relay outputs	
• Number of relay outputs	2; 2 circuits per output
Switching capacity of contacts	
- with inductive load, max.	0.1 Hz, accordance with IEC 60947-5-1, DC-13; 2 Hz, accordance with IEC 60947-5-1, AC-15
- with resistive load, max.	2 Hz
Interrupts/diagnostics/ status information	
Diagnostics indication LED	
• for status of the outputs	Yes
Degree and class of protection	
IP degree of protection	IP20

Article number	6ES7226-6RA32-0XB0 Digital Output SM 1226, F-DQ 2x Relay
Standards, approvals, certificates	
CE mark	Yes
cULus	Yes
FM approval	Yes
Highest safety class achievable in safety mode	
• Performance level according to ISO 13849-1	Category 4, PL e
• SIL acc. to IEC 61508	SIL 3
Ambient conditions	
Ambient temperature during operation	
• min.	0 °C
• max.	55 °C
Mechanics/material	
Enclosure material (front)	
• Plastic	Yes
Dimensions	
Width	70 mm
Height	100 mm
Depth	75 mm
Weights	
Weight, approx.	300 g

SIMATIC S7-1200 Basic Controllers

I/O modules

SIPLUS Fail-safe digital inputs and outputs

SIPLUS SM 1226 fail-safe digital input**Overview**

- Digital inputs as supplement to the integral I/O of the CPUs
- Integrated into the overall automation for the implementation of safety-related requirements
- With integrated safety functions
- Communication with fail-safe CPUs via PROFIsafe mechanisms
- For flexible adaptation of the controller to the corresponding task
- For subsequent expansion of the system with additional inputs
- Operable exclusively in the central system

Note

SIPLUS extreme products are based on SIMATIC standard products. The contents listed here were taken from the respective standard products. SIPLUS extreme-specific information was added.

Ordering data**Article No.****SIPLUS SM 1226 fail-safe digital input signal module****6AG1226-6BA32-5XB0**

(Extended temperature range and environmental stress)

16 inputs, 24 V DC (SIL 2/category 3/PL d) or 8 inputs 24 V DC (SIL 3/category 3 or category 4/PL e) or a combination of both

Accessories

See SIMATIC SM 1226 fail-safe digital input signal module, page 3/164

Technical specifications

Article number	6AG1226-6BA32-5XB0
Based on	6ES7226-6BA32-0XB0 SIPLUS S7-1200 SM 1226 F-DI 16x24VDC
Ambient conditions	
Ambient temperature during operation	
• min.	-25 °C; = Tmin
• max.	55 °C; = Tmax
Altitude during operation relating to sea level	
• Installation altitude above sea level, max.	2 000 m
• Ambient air temperature-barometric pressure-altitude	Tmin ... Tmax at 1 140 hPa ... 795 hPa (-1 000 m ... +2 000 m)
Relative humidity	
• With condensation, tested in accordance with IEC 60068-2-38, max.	100 %; RH incl. condensation/frost (no commissioning under condensation conditions)
Resistance	
Coolants and lubricants	
- Resistant to commercially available coolants and lubricants	Yes
Use in stationary industrial systems	
- to biologically active substances according to EN 60721-3-3	Yes; Class 3B2 mold, fungus and dry rot spores (with the exception of fauna); Class 3B3 on request
- to chemically active substances according to EN 60721-3-3	Yes; Class 3C4 (RH < 75 %) incl. salt spray acc. to EN 60068-2-52 (severity degree 3); *
- to mechanically active substances according to EN 60721-3-3	Yes; Class 3S4 incl. sand, dust; *
Use on ships/at sea	
- to biologically active substances according to EN 60721-3-6	Yes; Class 6B2 mold and fungal spores (excluding fauna); Class 6B3 on request
- to chemically active substances according to EN 60721-3-6	Yes; Class 6C3 (RH < 75 %) incl. salt spray acc. to EN 60068-2-52 (severity degree 3); *
- to mechanically active substances according to EN 60721-3-6	Yes; Class 6S3 incl. sand, dust; *
Usage in industrial process technology	
- Against chemically active substances acc. to EN 60654-4	Yes; Class 3 (excluding trichlorethylene)
- Environmental conditions for process, measuring and control systems acc. to ANSI/ISA-71.04	Yes; Level GX group A/B (excluding trichlorethylene; harmful gas concentrations up to the limits of EN 60721-3-3 class 3C4 permissible); level LC3 (salt spray) and level LB3 (oil)
Remark	
- Note regarding classification of environmental conditions acc. to EN 60721, EN 60654-4 and ANSI/ISA-71.04	* The supplied plug covers must remain in place over the unused interfaces during operation!
Conformal coating	
• Coatings for printed circuit board assemblies acc. to EN 61086	Yes; Class 2 for high reliability
• Protection against fouling acc. to EN 60664-3	Yes; Type 1 protection
• Military testing according to MIL-I-46058C, Amendment 7	Yes; Discoloration of coating possible during service life
• Qualification and Performance of Electrical Insulating Compound for Printed Board Assemblies according to IPC-CC-830A	Yes; Conformal coating, Class A

SIMATIC S7-1200 Basic Controllers

I/O modules

SIPLUS Fail-safe digital inputs and outputs

SIPLUS SM 1226 fail-safe digital output

Overview



- Digital outputs as a supplement to the integral I/O of the CPUs
- Integrated into the overall automation for the implementation of safety-related requirements
- With integrated safety functions
- Communication with fail-safe CPUs via PROFIsafe mechanisms
- For flexible adaptation of the controller to the corresponding task
- For subsequent expansion of the system with additional outputs
- Operable exclusively in the central system

Note

SIPLUS extreme products are based on SIMATIC standard products. The contents listed here were taken from the corresponding standard products. SIPLUS extreme-specific information was added.

Ordering data

SIPLUS SM 1226 fail-safe digital output module

4 outputs; 24 V DC, current sourcing/sinking

Accessories

Article No.

6AG1226-6DA32-5XB0

See SIMATIC SM 1226 fail-safe digital output signal module, page 3/166

Technical specifications

Article number	6AG1226-6DA32-5XB0
Based on	6ES7226-6DA32-0XB0 SIPLUS S7-1200 SM 1226 F-DQ 4x24VDC
Ambient conditions	
Ambient temperature during operation	
• min.	-25 °C; = Tmin
• max.	55 °C; = Tmax
Altitude during operation relating to sea level	
• Installation altitude above sea level, max.	2 000 m
• Ambient air temperature-barometric pressure-altitude	Tmin ... Tmax at 1 140 hPa ... 795 hPa (-1 000 m ... +2 000 m)
Relative humidity	
• With condensation, tested in accordance with IEC 60068-2-38, max.	100 %; RH incl. condensation/frost (no commissioning under condensation conditions)
Resistance	
Coolants and lubricants	
- Resistant to commercially available coolants and lubricants	Yes
Use in stationary industrial systems	
- to biologically active substances according to EN 60721-3-3	Yes; Class 3B2 mold, fungus and dry rot spores (with the exception of fauna); Class 3B3 on request
- to chemically active substances according to EN 60721-3-3	Yes; Class 3C4 (RH < 75 %) incl. salt spray acc. to EN 60068-2-52 (severity degree 3); *
- to mechanically active substances according to EN 60721-3-3	Yes; Class 3S4 incl. sand, dust; *
Use on ships/at sea	
- to biologically active substances according to EN 60721-3-6	Yes; Class 6B2 mold and fungal spores (excluding fauna); Class 6B3 on request
- to chemically active substances according to EN 60721-3-6	Yes; Class 6C3 (RH < 75 %) incl. salt spray acc. to EN 60068-2-52 (severity degree 3); *
- to mechanically active substances according to EN 60721-3-6	Yes; Class 6S3 incl. sand, dust; *
Usage in industrial process technology	
- Against chemically active substances acc. to EN 60654-4	Yes; Class 3 (excluding trichlorethylene)
- Environmental conditions for process, measuring and control systems acc. to ANSI/ISA-71.04	Yes; Level GX group A/B (excluding trichlorethylene; harmful gas concentrations up to the limits of EN 60721-3-3 class 3C4 permissible); level LC3 (salt spray) and level LB3 (oil)
Remark	
- Note regarding classification of environmental conditions acc. to EN 60721, EN 60654-4 and ANSI/ISA-71.04	* The supplied plug covers must remain in place over the unused interfaces during operation!
Conformal coating	
• Coatings for printed circuit board assemblies acc. to EN 61086	Yes; Class 2 for high reliability
• Protection against fouling acc. to EN 60664-3	Yes; Type 1 protection
• Military testing according to MIL-I-46058C, Amendment 7	Yes; Discoloration of coating possible during service life
• Qualification and Performance of Electrical Insulating Compound for Printed Board Assemblies according to IPC-CC-830A	Yes; Conformal coating, Class A

SIMATIC S7-1200 Basic Controllers

I/O modules

SIPLUS Fail-safe digital inputs and outputs

SIPLUS SM 1226 fail-safe relay output**Overview**

- Relay outputs as a supplement to the integral I/O of the CPUs
- Integrated into the overall automation for the implementation of safety-related requirements
- With integrated safety functions
- Communication with fail-safe CPUs via PROFIsafe mechanisms
- For flexible adaptation of the controller to the corresponding task
- For subsequent expansion of the system with additional outputs
- Operable exclusively in the central system

Note

SIPLUS extreme products are based on SIMATIC standard products. The contents listed here were taken from the corresponding standard products. SIPLUS extreme-specific information was added.

Ordering data**Article No.****SIPLUS SM 1226 fail-safe relay output signal module****6AG1226-6RA32-5XB0**

2 relay outputs

Accessories

See SIMATIC SM 1226 fail-safe relay output signal module, page 3/168

Technical specifications

Article number	6AG1226-6RA32-5XB0
Based on	6ES7226-6RA32-0XB0 SIPLUS S7-1200 SM 1226 F-DQ 2xRelay
Ambient conditions	
Ambient temperature during operation	
• min.	-25 °C; = Tmin
• max.	55 °C; = Tmax
Altitude during operation relating to sea level	
• Installation altitude above sea level, max.	2 000 m
• Ambient air temperature-barometric pressure-altitude	Tmin ... Tmax at 1 140 hPa ... 795 hPa (-1 000 m ... +2 000 m)
Relative humidity	
• With condensation, tested in accordance with IEC 60068-2-38, max.	100 %; RH incl. condensation/frost (no commissioning under condensation conditions)
Resistance	
Coolants and lubricants	
- Resistant to commercially available coolants and lubricants	Yes
Use in stationary industrial systems	
- to biologically active substances according to EN 60721-3-3	Yes; Class 3B2 mold, fungus and dry rot spores (with the exception of fauna); Class 3B3 on request
- to chemically active substances according to EN 60721-3-3	Yes; Class 3C4 (RH < 75 %) incl. salt spray acc. to EN 60068-2-52 (severity degree 3); *
- to mechanically active substances according to EN 60721-3-3	Yes; Class 3S4 incl. sand, dust; *
Use on ships/at sea	
- to biologically active substances according to EN 60721-3-6	Yes; Class 6B2 mold and fungal spores (excluding fauna); Class 6B3 on request
- to chemically active substances according to EN 60721-3-6	Yes; Class 6C3 (RH < 75 %) incl. salt spray acc. to EN 60068-2-52 (severity degree 3); *
- to mechanically active substances according to EN 60721-3-6	Yes; Class 6S3 incl. sand, dust; *
Usage in industrial process technology	
- Against chemically active substances acc. to EN 60654-4	Yes; Class 3 (excluding trichlorethylene)
- Environmental conditions for process, measuring and control systems acc. to ANSI/ISA-71.04	Yes; Level GX group A/B (excluding trichlorethylene; harmful gas concentrations up to the limits of EN 60721-3-3 class 3C4 permissible); level LC3 (salt spray) and level LB3 (oil)
Remark	
- Note regarding classification of environmental conditions acc. to EN 60721, EN 60654-4 and ANSI/ISA-71.04	* The supplied plug covers must remain in place over the unused interfaces during operation!
Conformal coating	
• Coatings for printed circuit board assemblies acc. to EN 61086	Yes; Class 2 for high reliability
• Protection against fouling acc. to EN 60664-3	Yes; Type 1 protection
• Military testing according to MIL-I-46058C, Amendment 7	Yes; Discoloration of coating possible during service life
• Qualification and Performance of Electrical Insulating Compound for Printed Board Assemblies according to IPC-CC-830A	Yes; Conformal coating, Class A

Overview



In terms of design and functionality, the SIMATIC PM 1207 single-phase load power supply (PM = power module) with automatic range selection of the input voltage is an optimal match to the SIMATIC S7-1200 PLC. It provides the supply to CPUs with 24 V input as well as to signal modules, and to 24 V loads connected to the modules. Comprehensive certifications such as UL and DNV GL enable universal use.

Ordering data

Article No.

SIMATIC S7-1200 PM 1207

6EP1332-1SH71

Input: 120/230 V AC
Output: 24 V DC/2.5 A

Technical specifications

Article number	6EP1332-1SH71
Product	S7-1200 PM1207
Power supply, type	24 V/2.5 A
Input	
type of the power supply network	1-phase AC
supply voltage at AC	
• initial value	Automatic range selection
supply voltage	
• 1 at AC rated value	120 V
• 2 at AC rated value	230 V
input voltage	
• 1 at AC	85 ... 132 V
• 2 at AC	176 ... 264 V
design of input wide range input	No
overvoltage overload capability	$2.3 \times V_{in \text{ rated}}$, 1.3 ms
operating condition of the mains buffering	at $V_{in} = 93/187 \text{ V}$
buffering time for rated value of the output current in the event of power failure minimum	20 ms
operating condition of the mains buffering	at $V_{in} = 93/187 \text{ V}$
line frequency	
• 1 rated value	50 Hz
• 2 rated value	60 Hz
line frequency	47 ... 63 Hz
input current	
• at rated input voltage 120 V	1.2 A
• at rated input voltage 230 V	0.67 A
current limitation of inrush current at 25 °C maximum	13 A
duration of inrush current limiting at 25 °C	
• maximum	3 ms
I ² t value maximum	0.5 A ² ·s
fuse protection type	T 3,15 A/250 V (not accessible)
• in the feeder	Recommended miniature circuit breaker: 16 A characteristic B or 10 A characteristic C
Output	
voltage curve at output	Controlled, isolated DC voltage
output voltage at DC rated value	24 V
output voltage	
• at output 1 at DC rated value	24 V
relative overall tolerance of the voltage	3 %
relative control precision of the output voltage	
• on slow fluctuation of input voltage	0.1 %
• on slow fluctuation of ohm loading	0.2 %
residual ripple	
• maximum	150 mV
voltage peak	
• maximum	240 mV
product function output voltage adjustable	No
type of output voltage setting	-
display version for normal operation	Green LED for 24 V OK
behavior of the output voltage when switching on	No overshoot of V_{out} (soft start)
response delay maximum	6 s; 2 s at 230 V, 6 s at 120 V
voltage increase time of the output voltage	
• typical	10 ms
output current	
• rated value	2.5 A

SIMATIC S7-1200 Basic Controllers

Power supplies

1-phase, 24 V DC (for S7-1200)

Technical specifications

Article number	6EP1332-1SH71
Product	S7-1200 PM1207
Power supply, type	24 V/2.5 A
<ul style="list-style-type: none"> rated range 	0 ... 2.5 A
supplied active power typical	60 W
short-term overload current	
<ul style="list-style-type: none"> on short-circuiting during the start-up typical 	6 A
<ul style="list-style-type: none"> at short-circuit during operation typical 	6 A
duration of overloading capability for excess current	
<ul style="list-style-type: none"> on short-circuiting during the start-up 	100 ms
<ul style="list-style-type: none"> at short-circuit during operation 	100 ms
product feature	
<ul style="list-style-type: none"> bridging of equipment 	Yes
number of parallel-switched equipment resources for increasing the power	2
Efficiency	
efficiency in percent	83 %
power loss [W]	
<ul style="list-style-type: none"> at rated output voltage for rated value of the output current typical 	12 W
Closed-loop control	
relative control precision of the output voltage with rapid fluctuation of the input voltage by +/- 15% typical	0.3 %
relative control precision of the output voltage load step of resistive load 50/100/50 % typical	3 %
setting time	
<ul style="list-style-type: none"> load step 50 to 100% typical 	5 ms
<ul style="list-style-type: none"> load step 100 to 50% typical 	5 ms
setting time	
<ul style="list-style-type: none"> maximum 	5 ms
Protection and monitoring	
design of the overvoltage protection	< 33 V
response value current limitation typical	2.65 A
property of the output short-circuit proof	Yes
design of short-circuit protection enduring short circuit current RMS value	Constant current characteristic
<ul style="list-style-type: none"> typical 	2.7 A
display version for overload and short circuit	-
Safety	
galvanic isolation between input and output	Yes
galvanic isolation	Safety extra-low output voltage U_{out} acc. to EN 60950-1 and EN 50178
operating resource protection class	Class I
leakage current	
<ul style="list-style-type: none"> maximum 	3.5 mA
protection class IP	IP20

Article number	6EP1332-1SH71
Product	S7-1200 PM1207
Power supply, type	24 V/2.5 A
Approvals	
certificate of suitability	
<ul style="list-style-type: none"> CE marking UL/cUL (CSA) approval 	Yes Yes; cULus-Listed (UL 508, CSA C22.2 No. 107.1), File E197259; cURus-Recognized (UL 60950-1, CSA C22.2 No. 60950-1) File E151273
<ul style="list-style-type: none"> cCSAus, Class 1, Division 2 ATEX 	No Yes; ATEX (EX) II 3G Ex nA nC IIC T4 Gc
<ul style="list-style-type: none"> NEC Class 2 FM registration 	No Yes; Class I, Div. 2, Group ABCD, T4
type of certification CB-certificate	Yes
<ul style="list-style-type: none"> EAC approval 	Yes
shipbuilding approval	ABS, BV, DNV GL, LRS, NK
EMC	
standard	
<ul style="list-style-type: none"> for emitted interference for mains harmonics limitation for interference immunity 	EN 55022 Class B not applicable EN 61000-6-2
environmental conditions	
ambient temperature	
<ul style="list-style-type: none"> during operation during transport during storage 	0 ... 60 °C; with natural convection -40 ... +85 °C -40 ... +85 °C
environmental category acc. to IEC 60721	Climate class 3K3, 5 ... 95% no condensation
Mechanics	
type of electrical connection	screw-type terminals
<ul style="list-style-type: none"> at input 	L, N, PE: 1 screw terminal each for 0.5 ... 2.5 mm ²
<ul style="list-style-type: none"> at output 	L+, M: 2 screw terminals each for 0.5 ... 2.5 mm ²
<ul style="list-style-type: none"> for auxiliary contacts 	-
width of the enclosure	70 mm
height of the enclosure	100 mm
depth of the enclosure	75 mm
required spacing	
<ul style="list-style-type: none"> top bottom left right 	20 mm 20 mm 0 mm 0 mm
net weight	0.3 kg
product feature of the enclosure housing can be lined up	Yes
fastening method	Snaps onto DIN rail EN 60715 35x7.5/15, wall mounting
MTBF at 40 °C	1 492 537 h
other information	Specifications at rated input voltage and ambient temperature +25 °C (unless otherwise specified)

Overview



- Stabilized power supply for SIPLUS S7-1200
- In the S7-1200 design
- Input 120/230 V AC, output 24 V DC, 2.5 A (derating: 1.5 A above 60 °C)

Note:

SIPLUS extreme products are based on SIMATIC standard products. The contents listed here were taken from the respective standard products. SIPLUS extreme-specific information was added.

SIPLUS power supply PM 1207

Article No.	6AG1332-1SH71-4AA0	6AG1332-1SH71-7AA0
Article No. based on	6EP1332-1SH71	
Ambient temperature range	0 ... +60° C	-40 ... +70° C
Conformal coating	Coating of the printed circuit boards and the electronic components	
Technical specifications	The technical data of the standard product applies except for the ambient conditions.	
Ambient conditions		
Relative humidity	100%, condensation/frost permissible. No commissioning if condensation present.	
Biologically active substances, compliance with EN 60721-3-3	Class 3B2 mold and fungal spores (excluding fauna). The supplied plug covers must remain in place over the unused interfaces during operation!	
Chemically active substances, compliance with EN 60721-3-3	Class 3C4 incl. salt spray in accordance with EN60068-2-52 (degree of severity 3). The supplied plug covers must remain in place over the unused interfaces during operation!	
Mechanically active substances, compliance with EN 60721-3-3	Class 3S4 incl. sand, dust. The supplied plug covers must remain in place over the unused interfaces during operation!	
Air pressure (depending on the highest positive temperature range specified)	1 080 ... 795 hPa (-1 000 ... +2 000 m) see ambient temperature range 795 ... 658 hPa (+2 000 ... +3 500 m) derating 10 K 658 ... 540 hPa (+3 500 ... +5 000 m) derating 20 K	

For technical documentation on SIPLUS, see:
<http://www.siemens.com/siplus-extreme>

SIMATIC S7-1200 Basic Controllers

SIPLUS power supplies

1-phase, 24 V DC (for SIPLUS S7-1200)**Ordering data****Article No.****SIPLUS S7-1200 PM 1207
power supply**

(Extended temperature range and exposure to media)

Input 120/230 V AC,
output 24 V DC, 2.5 A;
derating from +55 °C to +70 °C
to 1.2 A output currentAmbient temperature
-25 ... +70 °CAmbient temperature
0 ... +60 °C**6AG1332-1SH71-7AA0****6AG1332-1SH71-4AA0****Technical specifications**

	SIPLUS PM 1207
Article No.	6AG1332-1SH71-7AA0 6AG1332-1SH71-4AA0
Article No. based on	6EP1332-1SH71
Input voltage, nominal value	120/230 V AC (auto-switching)
• Range	85 ... 132 V/176 ... 264 V AC
Mains buffering	> 20 ms (at 93/187 V)
Line frequency, nominal	50/60 Hz
• Range	47 ... 63 Hz
Input current, nominal value	1.2/0.67 A
• Inrush current (25 °C)	< 13 A
• Recommended circuit-breaker	16 A Charact. B, 10 A Charact. C
Output voltage, nominal value	24 V DC
• Tolerance	± 3%
• Residual ripple	< 150 mVpp
• Adjustment	No
Output current, nominal value	2.5 A (derating: 1.5 A above 60 °C)
Efficiency at nominal values, approx.	83%
Parallel operation	Yes, 2 units
Electronic short-circuit protection	Yes, automatic restart
Radio interference suppression (EN 55022)	Class B
Operating display	Green LED for "24 V o.k."
Supply-harmonics limitation (EN 61000-3-2)	Not applicable
Degree of protection (EN 60529)	IP20
Protection class	Class 1
Electric isolation	SELV acc. to EN 60950 and EN 50178
Ambient temperature	0 ... +60 °C -40 ... +70 °C
Transport and storage temperature	-40 ... +85 °C
Installation	DIN rail EN 60715 35x7.5/15
Dimensions (W x H x D) in mm	70 x 100 x 75
Weight, approx.	0.3 kg
Certifications	CE

Overview**Basic Panels 2nd Generation**

With their fully developed HMI basic functions, SIMATIC HMI Basic Panels 2nd Generation are the ideal entry-level series for simple HMI applications.

The device family offers panels with 4", 7", 9" and 12" displays, as well as combined key and touch operation.

The innovative high-resolution widescreen displays with 64 000 colors are also suitable for upright installation, and they can be dimmed down to 100%. The innovative operator interface with improved usability opens up a diverse range of options thanks to new controls and graphics. The new USB interface enables the connection of keyboard, mouse or barcode scanner, and supports the simple archiving of data on a USB flash drive as well as the manual backup and restoring of the complete panel.

The integrated Ethernet or RS 485/422 interface (version-specific) enables simple connection to the controller.

<http://www.siemens.com/basic-panels>

Ordering data**Article No.****SIMATIC HMI Basic Panels (2nd Generation)****Key and touch devices****SIMATIC HMI KTP400 Basic****6AV2123-2DB03-0AX0**

Key/touch operation;
4" TFT widescreen display,
65 536 colors,
PROFINET interface

SIMATIC HMI TP400 Basic Keyless**6AV2143-6DB00-0AA0**

Touch screen operation;
4" TFT widescreen display,
65 536 colors,
PROFINET interface

SIMATIC HMI KTP700 Basic**6AV2123-2GB03-0AX0**

Key/touch operation;
7" TFT display, 65 536 colors,
PROFINET interface

SIMATIC HMI KTP700 Basic DP**6AV2123-2GA03-0AX0**

Key/touch operation;
7" TFT display, 65 536 colors,
PROFIBUS interface

SIMATIC HMI TP700 Basic Keyless**6AV2143-6GB00-0AA0**

Touch screen operation;
7" TFT display, 65 536 colors,
PROFINET interface

SIMATIC HMI KTP900 Basic**6AV2123-2JB03-0AX0**

Key/touch operation;
9" TFT display, 65 536 colors,
PROFINET interface

SIMATIC HMI TP900 Basic Keyless**6AV2143-6JB00-0AA0**

Touch screen operation;
9" TFT display, 65 536 colors,
PROFINET interface

SIMATIC HMI KTP1200 Basic**6AV2123-2MB03-0AX0**

Key/touch operation;
12" TFT display, 65 536 colors,
PROFINET interface

SIMATIC HMI KTP1200 Basic DP**6AV2123-2MA03-0AX0**

Key/touch operation;
12" TFT display, 65 536 colors,
PROFIBUS interface

Starter kits**Starter kit LOGO! + KP300 Basic mono PN****6AV2132-0HA00-0AA1****Starter kit LOGO! + KTP400 Basic****6AV2132-0KA00-0AA1****Starter kit LOGO! + KTP700 Basic****6AV2132-3GB00-0AA1**

Starter kits with a LOGO! consist of:

- the respective
SIMATIC HMI Basic Panel
SIMATIC HMI KP300 Basic
mono PN
SIMATIC HMI KTP400 Basic
SIMATIC HMI KTP700 Basic
- LOGO! 12/24 RCE
- LOGO! POWER 24 V 1.3 A
- LOGO! SOFT COMFORT V7
- WINCC BASIC (TIA Portal)
- Ethernet CAT5 cable, 2 m

Documentation

You can find the Equipment Manual for the Basic Panels on the Internet at:

<http://support.automation.siemens.com>

Accessories

See catalog ST 80/ST PC or Industry Mall

SIMATIC S7-1200 Basic Controllers

Operator control and monitoring
Comfort Panels

Comfort Panels Standard devices

Overview



SIMATIC HMI Comfort Panels - Standard devices

- Excellent HMI functionality for demanding applications
- Widescreen TFT displays with 4", 7", 9", 12", 15", 19" and 22" diagonals (all 16 million colors) with up to 40% more visualization area as compared to the predecessor devices
- Integrated high-end functionality with archives, scripts, PDF/Word/Excel viewer, Internet Explorer, Media Player and Web Server
- Dimmable displays from 0 to 100% via PROFlenergy, via the HMI project or via a controller
- Modern industrial design, cast aluminum fronts for 7" upwards
- Upright installation for all touch devices
- Data security in the event of a power failure for the device and for the SIMATIC HMI Memory Card
- Innovative service and commissioning concept
- Maximum performance with short screen refresh times
- Suitable for extremely harsh industrial environments thanks to extended approvals such as ATEX 2/22 and marine approvals
- All versions can be used as an OPC UA client or as a server
- Key-operated devices with LED in every function key and new text input mechanism, similar to the keypads of mobile phones
- All keys have a service life of 2 million operations
- Configuring with the WinCC engineering software of the TIA Portal engineering framework

Note:

A 7" and a 15" Comfort Outdoor version are available. These devices have been specially designed for outdoor applications in difficult environments. Best display quality, even under sunlight, UV-resistant fronts and much more.

For more information, please go to:

<http://www.siemens.com/comfort-panels>

Ordering data

Article No.

SIMATIC HMI Comfort Panels	
Key and touch devices	
SIMATIC HMI KTP400 Comfort Key/touch operation; 4" widescreen display	6AV2124-2DC01-0AX0
Touch devices	
SIMATIC HMI TP700 Comfort Touch operation; 7" widescreen display	6AV2124-0GC01-0AX0
SIMATIC HMI TP900 Comfort Touch operation; 9" widescreen display	6AV2124-0JC01-0AX0
SIMATIC HMI TP1200 Comfort Touch operation; 12" widescreen display	6AV2124-0MC01-0AX0
SIMATIC HMI TP1500 Comfort Touch operation; 15" widescreen display	6AV2124-0QC02-0AX1
SIMATIC HMI TP1900 Comfort Touch operation; 19" widescreen display	6AV2124-0UC02-0AX1
SIMATIC HMI TP2200 Comfort Touch operation; 22" widescreen display	6AV2124-0XC02-0AX1
Key devices	
SIMATIC HMI KP400 Comfort Key operation; 4" widescreen display	6AV2124-1DC01-0AX0
SIMATIC HMI KP700 Comfort Key operation; 7" widescreen display	6AV2124-1GC01-0AX0
SIMATIC HMI KP900 Comfort Key operation; 9" widescreen display	6AV2124-1JC01-0AX0
SIMATIC HMI KP1200 Comfort Key operation; 12" widescreen display	6AV2124-1MC01-0AX0
SIMATIC HMI KP1500 Comfort Key operation; 15" widescreen display	6AV2124-1QC02-0AX1
Accessories	See catalog ST 80/ST PC or Industry Mall

Overview



With their fully developed HMI basic functions, 2nd Generation SIPLUS Basic Panels are the ideal entry-level series for simple HMI applications.

The device family offers panels with 4", 7", 9" and 12" displays, as well as combined key and touch operation.

The innovative high-resolution widescreen displays with 64 000 colors are also suitable for upright installation, and they can be dimmed down to 100%. The innovative operator interface with improved usability opens up a diverse range of options thanks to new controls and graphics. The new USB interface enables the connection of keyboard, mouse or barcode scanner, and supports the simple archiving of data on a USB flash drive.

The integrated Ethernet or RS 485/422 interface (version-specific) enables simple connection to the controller.

Note:

SIPLUS extreme products are based on SIMATIC standard products. The contents listed here were taken from the respective standard products. SIPLUS extreme-specific information was added.

Technical documentation on SIPLUS can be found here: <http://www.siemens.com/siplus-extreme>

Ordering data

Article No.

SIPLUS HMI Basic Panels, Key and Touch

SIPLUS HMI KTP400 Basic

6AG1123-2DB03-2AX0

For areas with extreme exposure to environmental substances (conformal coating); ambient temperature -20 ... +60 °C

SIPLUS HMI KTP700 Basic

6AG1123-2GB03-2AX0

For areas with extreme exposure to environmental substances (conformal coating); ambient temperature -20 ... +50 °C

SIPLUS HMI KTP700 Basic DP

6AG1123-2GA03-2AX0

For areas with extreme exposure to environmental substances (conformal coating); ambient temperature -20 ... +50 °C

SIPLUS HMI KTP900 Basic

6AG1123-2JB03-2AX0

For areas with extreme exposure to environmental substances (conformal coating); ambient temperature -20 ... +50 °C

SIPLUS HMI KTP1200 Basic

6AG1123-2MB03-2AX0

For areas with extreme exposure to environmental substances (conformal coating); ambient temperature -10 ... +50 °C

SIPLUS HMI KTP1200 Basic DP

6AG1123-2MA03-2AX0

For areas with extreme exposure to environmental substances (conformal coating); ambient temperature -10 ... +50 °C

Accessories

See catalog ST 80/ST PC or Industry Mall

Technical specifications

Article number	6AG1123-2DB03-2AX0	6AG1123-2GB03-2AX0	6AG1123-2GA03-2AX0
Based on	6AV2123-2DB03-0AX0 SIPLUS HMI KTP400 BASIC	6AV2123-2GB03-0AX0 SIPLUS HMI KTP700 BASIC	6AV2123-2GA03-0AX0 SIPLUS HMI KTP700 BASIC DP
Ambient conditions			
Suited for indoor use		Yes	Yes
Suited for outdoor use		No	No
Ambient temperature during operation			
Operation (vertical installation)			
- For vertical installation, min.	-20 °C; = Tmin	-20 °C	-20 °C; = Tmin
- For vertical installation, max.	60 °C; = Tmax	50 °C	50 °C
Altitude during operation relating to sea level			
• Installation altitude above sea level, max.	5 000 m	5 000 m	5 000 m
• Ambient air temperature-barometric pressure-altitude	Tmin ... Tmax at 1 140 hPa ... 795 hPa (-1 000 m ... +2 000 m) // Tmin ... (Tmax - 10 K) at 795 hPa ... 658 hPa (+2 000 m ... +3 500 m) // Tmin ... (Tmax -20 K) at 658 hPa ... 540 hPa (+3 500 m ... +5 000 m)	Tmin ... Tmax at 1 140 hPa ... 795 hPa (-1 000 m ... +2 000 m) // Tmin ... (Tmax - 10 K) at 795 hPa ... 658 hPa (+2 000 m ... +3 500 m) // Tmin ... (Tmax -20 K) at 658 hPa ... 540 hPa (+3 500 m ... +5 000 m)	Tmin ... Tmax at 1 140 hPa ... 795 hPa (-1 000 m ... +2 000 m) // Tmin ... (Tmax - 10 K) at 795 hPa ... 658 hPa (+2 000 m ... +3 500 m) // Tmin ... (Tmax -20 K) at 658 hPa ... 540 hPa (+3 500 m ... +5 000 m)
Relative humidity			
• With condensation, tested in accordance with IEC 60068-2-38, max.	100 %; RH incl. condensation/frost (no commissioning under condensation conditions)	100 %; RH incl. condensation/frost (no commissioning under condensation conditions)	100 %; RH incl. condensation/frost (no commissioning when condensation present), vertical mounting position

SIMATIC S7-1200 Basic Controllers

SIPLUS operator control and monitoring

SIPLUS Basic Panels (2nd Generation)

Technical specifications

Article number	6AG1123-2DB03-2AX0	6AG1123-2GB03-2AX0	6AG1123-2GA03-2AX0
Based on	6AV2123-2DB03-0AX0 SIPLUS HMI KTP400 BASIC	6AV2123-2GB03-0AX0 SIPLUS HMI KTP700 BASIC	6AV2123-2GA03-0AX0 SIPLUS HMI KTP700 BASIC DP
Resistance			
Coolants and lubricants			
- Resistant to commercially available coolants and lubricants	Yes; Incl. diesel and oil droplets in the air	Yes; Incl. diesel and oil droplets in the air	Yes; Incl. diesel and oil droplets in the air
Use in stationary industrial systems			
- to biologically active substances according to EN 60721-3-3	Yes; Class 3B2 mold, fungus and dry rot spores (with the exception of fauna); Class 3B3 on request	Yes; Class 3B2 mold, fungus and dry rot spores (with the exception of fauna); Class 3B3 on request	Yes; Class 3B2 mold, fungus and dry rot spores (with the exception of fauna); Class 3B3 on request
- to chemically active substances according to EN 60721-3-3	Yes; Class 3C4 (RH < 75 %) incl. salt spray acc. to EN 60068-2-52 (severity degree 3); *	Yes; Class 3C4 (RH < 75 %) incl. salt spray acc. to EN 60068-2-52 (severity degree 3); *	Yes; Class 3C4 (RH < 75 %) incl. salt spray acc. to EN 60068-2-52 (severity degree 3); *
- to mechanically active substances according to EN 60721-3-3	Yes; Class 3S4 incl. sand, dust, *	Yes; Class 3S4 incl. sand, dust, *	Yes; Class 3S4 incl. sand, dust, *
Use on ships/at sea			
- to biologically active substances according to EN 60721-3-6	Yes; Class 6B2 mold and fungal spores (excluding fauna); Class 6B3 on request	Yes; Class 6B2 mold and fungal spores (excluding fauna); Class 6B3 on request	Yes; Class 6B2 mold and fungal spores (excluding fauna); Class 6B3 on request
- to chemically active substances according to EN 60721-3-6	Yes; Class 6C3 (RH < 75 %) incl. salt spray acc. to EN 60068-2-52 (severity degree 3); *	Yes; Class 6C3 (RH < 75 %) incl. salt spray acc. to EN 60068-2-52 (severity degree 3); *	Yes; Class 6C3 (RH < 75 %) incl. salt spray acc. to EN 60068-2-52 (severity degree 3); *
- to mechanically active substances according to EN 60721-3-6	Yes; Class 6S3 incl. sand, dust; *	Yes; Class 6S3 incl. sand, dust; *	Yes; Class 6S3 incl. sand, dust; *
Usage in industrial process technology			
- Against chemically active substances acc. to EN 60654-4	Yes; Class 3 (excluding trichlorethylene)	Yes; Class 3 (excluding trichlorethylene)	Yes; Class 3 (excluding trichlorethylene)
- Environmental conditions for process, measuring and control systems acc. to ANSI/ISA-71.04	Yes; Level GX group A/B (excluding trichlorethylene; harmful gas concentrations up to the limits of EN 60721-3-3 class 3C4 permissible); level LC3 (salt spray) and level LB3 (oil)	Yes; Level GX group A/B (excluding trichlorethylene; harmful gas concentrations up to the limits of EN 60721-3-3 class 3C4 permissible); level LC3 (salt spray) and level LB3 (oil)	Yes; Level GX group A/B (excluding trichlorethylene; harmful gas concentrations up to the limits of EN 60721-3-3 class 3C4 permissible); level LC3 (salt spray) and level LB3 (oil)
Remark			
- Note regarding classification of environmental conditions acc. to EN 60721, EN 60654-4 and ANSI/ISA-71.04	* The supplied plug covers must remain in place over the unused interfaces during operation!	* The supplied plug covers must remain in place over the unused interfaces during operation!	* The supplied plug covers must remain in place over the unused interfaces during operation!
Conformal coating			
• Coatings for printed circuit board assemblies acc. to EN 61086	Yes; Class 2 for high reliability	Yes; Class 2 for high reliability	Yes; Class 2 for high reliability
• Protection against fouling acc. to EN 60664-3	Yes; Type 1 protection	Yes; Type 1 protection	Yes; Type 1 protection
• Military testing according to MIL-I-46058C, Amendment 7	Yes; Discoloration of coating possible during service life	Yes; Discoloration of coating possible during service life	Yes; Discoloration of coating possible during service life
• Qualification and Performance of Electrical Insulating Compound for Printed Board Assemblies according to IPC-CC-830A	Yes; Conformal coating, Class A	Yes; Conformal coating, Class A	Yes; Conformal coating, Class A
Article number	6AG1123-2JB03-2AX0	6AG1123-2MB03-2AX0	6AG1123-2MA03-2AX0
Based on	6AV2123-2JB03-0AX0 SIPLUS HMI KTP900 BASIC	6AV2123-2MB03-0AX0 SIPLUS HMI KTP1200 BASIC	6AV2123-2MA03-0AX0 SIPLUS HMI KTP1200 BASIC DP
Ambient conditions			
Suited for indoor use	Yes	Yes	Yes
Suited for outdoor use	No	No	No
Ambient temperature during operation			
Operation (vertical installation)			
- For vertical installation, min.	-20 °C	-10 °C; = Tmin	-10 °C; = Tmin
- For vertical installation, max.	50 °C	50 °C	50 °C

SIMATIC S7-1200 Basic Controllers

SIPLUS operator control and monitoring

SIPLUS Basic Panels (2nd Generation)

3

Technical specifications

Article number	6AG1123-2JB03-2AX0	6AG1123-2MB03-2AX0	6AG1123-2MA03-2AX0
Based on	6AV2123-2JB03-0AX0	6AV2123-2MB03-0AX0	6AV2123-2MA03-0AX0
	SIPLUS HMI KTP900 BASIC	SIPLUS HMI KTP1200 BASIC	SIPLUS HMI KTP1200 BASIC DP
Altitude during operation relating to sea level			
<ul style="list-style-type: none"> Installation altitude above sea level, max. Ambient air temperature-barometric pressure-altitude 	5 000 m Tmin ... Tmax at 1 140 hPa ... 795 hPa (-1 000 m ... +2 000 m) // Tmin ... (Tmax - 10 K) at 795 hPa ... 658 hPa (+2 000 m ... +3 500 m) // Tmin ... (Tmax -20 K) at 658 hPa ... 540 hPa (+3 500 m ... +5 000 m)	5 000 m Tmin ... Tmax at 1 140 hPa ... 795 hPa (-1 000 m ... +2 000 m) // Tmin ... (Tmax - 10 K) at 795 hPa ... 658 hPa (+2 000 m ... +3 500 m) // Tmin ... (Tmax -20 K) at 658 hPa ... 540 hPa (+3 500 m ... +5 000 m)	5 000 m Tmin ... Tmax at 1 140 hPa ... 795 hPa (-1 000 m ... +2 000 m) // Tmin ... (Tmax - 10 K) at 795 hPa ... 658 hPa (+2 000 m ... +3 500 m) // Tmin ... (Tmax -20 K) at 658 hPa ... 540 hPa (+3 500 m ... +5 000 m)
Relative humidity			
<ul style="list-style-type: none"> With condensation, tested in accordance with IEC 60068-2-38, max. 	100 %; RH incl. condensation/frost (no commissioning under condensation conditions)	100 %; RH incl. condensation / frost (no commissioning in bedewed state), horizontal installation	100 %; RH incl. condensation/frost (no commissioning when condensation present), vertical mounting position
Resistance			
Coolants and lubricants			
<ul style="list-style-type: none"> Resistant to commercially available coolants and lubricants 	Yes; Incl. diesel and oil droplets in the air	Yes; Incl. diesel and oil droplets in the air	Yes; Incl. diesel and oil droplets in the air
Use in stationary industrial systems			
<ul style="list-style-type: none"> to biologically active substances according to EN 60721-3-3 to chemically active substances according to EN 60721-3-3 to mechanically active substances according to EN 60721-3-3 	Yes; Class 3B2 mold, fungus and dry rot spores (with the exception of fauna); Class 3B3 on request Yes; Class 3C4 (RH < 75 %) incl. salt spray acc. to EN 60068-2-52 (severity degree 3); * Yes; Class 3S4 incl. sand, dust, *	Yes; Class 3B2 mold, fungus and dry rot spores (with the exception of fauna); Class 3B3 on request Yes; Class 3C4 (RH < 75 %) incl. salt spray acc. to EN 60068-2-52 (severity degree 3); * Yes; Class 3S4 incl. sand, dust, *	Yes; Class 3B2 mold, fungus and dry rot spores (with the exception of fauna); Class 3B3 on request Yes; Class 3C4 (RH < 75 %) incl. salt spray acc. to EN 60068-2-52 (severity degree 3); * Yes; Class 3S4 incl. sand, dust, *
Use on ships/at sea			
<ul style="list-style-type: none"> to biologically active substances according to EN 60721-3-6 to chemically active substances according to EN 60721-3-6 to mechanically active substances according to EN 60721-3-6 	Yes; Class 6B2 mold and fungal spores (excluding fauna); Class 6B3 on request Yes; Class 6C3 (RH < 75 %) incl. salt spray acc. to EN 60068-2-52 (severity degree 3); * Yes; Class 6S3 incl. sand, dust; *	Yes; Class 6B2 mold and fungal spores (excluding fauna); Class 6B3 on request Yes; Class 6C3 (RH < 75 %) incl. salt spray acc. to EN 60068-2-52 (severity degree 3); * Yes; Class 6S3 incl. sand, dust; *	Yes; Class 6B2 mold and fungal spores (excluding fauna); Class 6B3 on request Yes; Class 6C3 (RH < 75 %) incl. salt spray acc. to EN 60068-2-52 (severity degree 3); * Yes; Class 6S3 incl. sand, dust; *
Usage in industrial process technology			
<ul style="list-style-type: none"> Against chemically active substances acc. to EN 60654-4 Environmental conditions for process, measuring and control systems acc. to ANSI/ISA-71.04 	Yes; Class 3 (excluding trichlorethylene) Yes; Level GX group A/B (excluding trichlorethylene; harmful gas concentrations up to the limits of EN 60721-3-3 class 3C4 permissible); level LC3 (salt spray) and level LB3 (oil)	Yes; Class 3 (excluding trichlorethylene) Yes; Level GX group A/B (excluding trichlorethylene; harmful gas concentrations up to the limits of EN 60721-3-3 class 3C4 permissible); level LC3 (salt spray) and level LB3 (oil)	Yes; Class 3 (excluding trichlorethylene) Yes; Level GX group A/B (excluding trichlorethylene; harmful gas concentrations up to the limits of EN 60721-3-3 class 3C4 permissible); level LC3 (salt spray) and level LB3 (oil)
Remark			
<ul style="list-style-type: none"> Note regarding classification of environmental conditions acc. to EN 60721, EN 60654-4 and ANSI/ISA-71.04 	* The supplied plug covers must remain in place over the unused interfaces during operation!	* The supplied plug covers must remain in place over the unused interfaces during operation!	* The supplied plug covers must remain in place over the unused interfaces during operation!
Conformal coating			
<ul style="list-style-type: none"> Coatings for printed circuit board assemblies acc. to EN 61086 Protection against fouling acc. to EN 60664-3 Military testing according to MIL-I-46058C, Amendment 7 Qualification and Performance of Electrical Insulating Compound for Printed Board Assemblies according to IPC-CC-830A 	Yes; Class 2 for high reliability Yes; Type 1 protection Yes; Discoloration of coating possible during service life Yes; Conformal coating, Class A	Yes; Class 2 for high reliability Yes; Type 1 protection Yes; Discoloration of coating possible during service life Yes; Conformal coating, Class A	Yes; Class 2 for high reliability Yes; Type 1 protection Yes; Discoloration of coating possible during service life Yes; Conformal coating, Class A

SIMATIC S7-1200 Basic Controllers

SIPLUS operator control and monitoring

SIPLUS Basic Panels (1st Generation)

Overview



- Ideal entry-level series of 3.8" to 15" for operating and monitoring compact machines and systems
- Clear process representation through the use of full-graphic displays
- Intuitive operation via touch and tactile function keys
- Equipped with all the necessary basic functions such as reporting, recipe management, curve representation, vector graphics, and language selection
- Easy connection to the controller via integrated Ethernet interface or a separate version with RS 485/422

Note:

SIPLUS extreme products are based on SIMATIC standard products. The contents listed here were taken from the respective standard products. SIPLUS extreme-specific information was added.

Technical documentation on SIPLUS can be found here:
<http://www.siemens.com/siplus-extreme>

Ordering data

SIPLUS HMI KP300 Basic mono PN

For areas with extreme exposure to environmental substances (conformal coating); ambient temperature -15 ... +60 °C

Accessories

Article No.

6AG1647-0AH11-2AX0

See catalog ST 80/ST PC or Industry Mall

SIMATIC S7-1200 Basic Controllers

SIPLUS operator control and monitoring

SIPLUS Basic Panels (1st Generation)

Technical specifications

Article number	6AG1647-0AH11-2AX0
Based on	6AV6647-0AH11-3AX0 SIPLUS HMI KP300 BASIC MONO PN 3,6"
Ambient conditions	
Suited for indoor use	Yes
Suited for outdoor use	No
Ambient temperature during operation	
Operation (vertical installation)	
- For vertical installation, min.	-25 °C
- For vertical installation, max.	60 °C
Altitude during operation relating to sea level	
• Installation altitude above sea level, max.	5 000 m
• Ambient air temperature-barometric pressure-altitude	Tmin ... Tmax at 1 140 hPa ... 795 hPa (-1 000 m ... +2 000 m) // Tmin ... (Tmax - 10 K) at 795 hPa ... 658 hPa (+2 000 m ... +3 500 m) // Tmin ... (Tmax -20 K) at 658 hPa ... 540 hPa (+3 500 m ... +5 000 m)
Relative humidity	
• With condensation, tested in accordance with IEC 60068-2-38, max.	100 %; RH incl. condensation/frost (no commissioning under condensation conditions)
Resistance	
Coolants and lubricants	
- Resistant to commercially available coolants and lubricants	Yes; Incl. diesel and oil droplets in the air
Use in stationary industrial systems	
- to biologically active substances according to EN 60721-3-3	Yes; Class 3B2 mold, fungus and dry rot spores (with the exception of fauna); Class 3B3 on request
- to chemically active substances according to EN 60721-3-3	Yes; Class 3C4 (RH < 75 %) incl. salt spray acc. to EN 60068-2-52 (severity degree 3); *
- to mechanically active substances according to EN 60721-3-3	Yes; Class 3S4 incl. sand, dust, *

Article number	6AG1647-0AH11-2AX0
Based on	6AV6647-0AH11-3AX0 SIPLUS HMI KP300 BASIC MONO PN 3,6"
Use on ships/at sea	
- to biologically active substances according to EN 60721-3-6	Yes; Class 6B2 mold and fungal spores (excluding fauna); Class 6B3 on request
- to chemically active substances according to EN 60721-3-6	Yes; Class 6C3 (RH < 75 %) incl. salt spray acc. to EN 60068-2-52 (severity degree 3); *
- to mechanically active substances according to EN 60721-3-6	Yes; Class 6S3 incl. sand, dust; *
Usage in industrial process technology	
- Against chemically active substances acc. to EN 60654-4	Yes; Class 3 (excluding trichlorethylene)
- Environmental conditions for process, measuring and control systems acc. to ANSI/ISA-71.04	Yes; Level GX group A/B (excluding trichlorethylene; harmful gas concentrations up to the limits of EN 60721-3-3 class 3C4 permissible); level LC3 (salt spray) and level LB3 (oil)
Remark	
- Note regarding classification of environmental conditions acc. to EN 60721, EN 60654-4 and ANSI/ISA-71.04	* The supplied plug covers must remain in place over the unused interfaces during operation!
Conformal coating	
• Coatings for printed circuit board assemblies acc. to EN 61086	Yes; Class 2 for high reliability
• Protection against fouling acc. to EN 60664-3	Yes; Type 1 protection
• Military testing according to MIL-I-46058C, Amendment 7	Yes; Discoloration of coating possible during service life
• Qualification and Performance of Electrical Insulating Compound for Printed Board Assemblies according to IPC-CC-830A	Yes; Conformal coating, Class A

SIMATIC S7-1200 Basic Controllers

SIPLUS operator control and monitoring

SIPLUS Comfort Panels Standard

Overview



- Excellent HMI functionality for demanding applications
- Widescreen TFT displays with 4", 7", 9", 12", 15", 19" and 22" diagonals (all 16 million colors) with up to 40% more visualization area as compared to the predecessor devices
- Integrated high-end functionality with archives, scripts, PDF/Word/Excel viewer, Internet Explorer, Media Player
- Dimmable displays from 0 to 100% via PROFIenergy, via the HMI project or via a controller
- Modern industrial design, cast aluminum fronts for 7" upwards
- Upright installation for all touch devices
- Optimal selection option: seven touch and five key versions are available
- Data security in the event of a power failure for the device and for the SIMATIC HMI Memory Card
- Innovative service and commissioning concept through second SD card (automatic backup)
- Easy project transfer via standard cable (standard Ethernet cable, standard USB cable)
- Maximum performance with short screen refresh times
- Suitable for extremely harsh industrial environments thanks to extended approvals such as ATEX 2/22
- Wide range of communication options: PROFIBUS and PROFINET onboard; 2x PROFINET with integrated switch for 7" models or larger; plus 1 additional PROFINET with Gigabit support for 15" models or larger
- All variants can be used as an OPC UA client or as an OPC DA server
- Key-operated devices with LED in every function key and new text input mechanism, similar to the keypads of mobile phones
- Key-operated devices with stamped keys for optimum tactile feedback
- All keys have a service life of 2 million operations
- Configuring with the WinCC engineering software of the TIA Portal

Note:

SIPLUS extreme products are based on SIMATIC standard products. The contents listed here were taken from the respective standard products. SIPLUS extreme-specific information was added.

Ordering data

Article No.

SIPLUS HMI Comfort Panels, Keys and Touch	
SIPLUS HMI KTP400 Comfort	6AG1124-2DC01-4AX0
SIPLUS HMI Comfort Panels, Touch	
SIPLUS HMI TP700 Comfort	6AG1124-0GC01-4AX0
SIPLUS HMI TP900 Comfort	6AG1124-0JC01-4AX0
SIPLUS HMI TP1200 Comfort	6AG1124-0MC01-4AX0
SIPLUS HMI TP1500 Comfort	6AG1124-0QC02-4AX1
SIPLUS HMI TP1900 Comfort	6AG1124-0UC02-4AX1
SIPLUS HMI TP2200 Comfort	6AG1124-0XC02-4AX1
SIPLUS HMI Comfort Panels, Keys	
SIPLUS HMI KP400 Comfort	6AG1124-1DC01-4AX0
SIPLUS HMI KP700 Comfort	6AG1124-1GC01-4AX0
SIPLUS HMI KP900 Comfort	6AG1124-1JC01-4AX0
SIPLUS HMI KP1200 Comfort	6AG1124-1MC01-4AX0
SIPLUS HMI KP1500 Comfort	6AG1124-1QC02-4AX1
Accessories	See catalog ST 80/ST PC or Industry Mall

Technical specifications

Article number	6AG1124-2DC01-4AX0	6AG1124-0GC01-4AX0	6AG1124-0JC01-4AX0	6AG1124-0MC01-4AX0
Based on	6AV2124-2DC01-0AX0 SIPLUS HMI KTP400 COMFORT	6AV2124-0GC01-0AX0 SIPLUS HMI TP700 COMFORT	6AV2124-0JC01-0AX0 SIPLUS HMI TP900 COMFORT	6AV2124-0MC01-0AX0 SIPLUS HMI TP1200 COMFORT
Ambient conditions				
Suited for indoor use	Yes	Yes	Yes	Yes
Suited for outdoor use	No	No	No	No
Ambient temperature during operation				
Operation (vertical installation)				
- For vertical installation, min.	0 °C; = Tmin	0 °C; = Tmin	0 °C; = Tmin	0 °C; = Tmin
- For vertical installation, max.	50 °C; = Tmax	50 °C; = Tmax	50 °C; = Tmax	50 °C; = Tmax
Altitude during operation relating to sea level				
• Installation altitude above sea level, max.	5 000 m	5 000 m	5 000 m	5 000 m
• Ambient air temperature-barometric pressure-altitude	Tmin ... Tmax at 1 140 hPa ... 795 hPa (-1 000 m ... +2 000 m) // Tmin ... (Tmax - 10 K) at 795 hPa ... 658 hPa (+2 000 m ... +3 500 m) // Tmin ... (Tmax -20 K) at 658 hPa ... 540 hPa (+3 500 m ... +5 000 m)	Tmin ... Tmax at 1 140 hPa ... 795 hPa (-1 000 m ... +2 000 m) // Tmin ... (Tmax - 10 K) at 795 hPa ... 658 hPa (+2 000 m ... +3 500 m) // Tmin ... (Tmax -20 K) at 658 hPa ... 540 hPa (+3 500 m ... +5 000 m)	Tmin ... Tmax at 1 140 hPa ... 795 hPa (-1 000 m ... +2 000 m) // Tmin ... (Tmax - 10 K) at 795 hPa ... 658 hPa (+2 000 m ... +3 500 m) // Tmin ... (Tmax -20 K) at 658 hPa ... 540 hPa (+3 500 m ... +5 000 m)	Tmin ... Tmax at 1 140 hPa ... 795 hPa (-1 000 m ... +2 000 m) // Tmin ... (Tmax - 10 K) at 795 hPa ... 658 hPa (+2 000 m ... +3 500 m) // Tmin ... (Tmax -20 K) at 658 hPa ... 540 hPa (+3 500 m ... +5 000 m)
Relative humidity				
• With condensation, tested in accordance with IEC 60068-2-38, max.	100 %; RH incl. condensation/frost (no commissioning under condensation conditions)	100 %; RH incl. condensation/frost (no commissioning under condensation conditions)	100 %; RH incl. condensation/frost (no commissioning under condensation conditions)	100 %; RH incl. condensation/frost (no commissioning under condensation conditions)
Resistance				
Coolants and lubricants				
- Resistant to commercially available coolants and lubricants	Yes; Incl. diesel and oil droplets in the air	Yes; Incl. diesel and oil droplets in the air	Yes; Incl. diesel and oil droplets in the air	Yes; Incl. diesel and oil droplets in the air
Use in stationary industrial systems				
- to biologically active substances according to EN 60721-3-3	Yes; Class 3B2 mold, fungus and dry rot spores (with the exception of fauna); Class 3B3 on request	Yes; Class 3B2 mold, fungus and dry rot spores (with the exception of fauna); Class 3B3 on request	Yes; Class 3B2 mold, fungus and dry rot spores (with the exception of fauna); Class 3B3 on request	Yes; Class 3B2 mold, fungus and dry rot spores (with the exception of fauna); Class 3B3 on request
- to chemically active substances according to EN 60721-3-3	Yes; Class 3C4 (RH < 75 %) incl. salt spray acc. to EN 60068-2-52 (severity degree 3); *	Yes; Class 3C4 (RH < 75 %) incl. salt spray acc. to EN 60068-2-52 (severity degree 3); *	Yes; Class 3C4 (RH < 75 %) incl. salt spray acc. to EN 60068-2-52 (severity degree 3); *	Yes; Class 3C4 (RH < 75 %) incl. salt spray acc. to EN 60068-2-52 (severity degree 3); *
- to mechanically active substances according to EN 60721-3-3	Yes; Class 3S4 incl. sand, dust, *	Yes; Class 3S4 incl. sand, dust, *	Yes; Class 3S4 incl. sand, dust, *	Yes; Class 3S4 incl. sand, dust, *
Use on ships/at sea				
- to biologically active substances according to EN 60721-3-6	Yes; Class 6B2 mold and fungal spores (excluding fauna); Class 6B3 on request	Yes; Class 6B2 mold and fungal spores (excluding fauna); Class 6B3 on request	Yes; Class 6B2 mold and fungal spores (excluding fauna); Class 6B3 on request	Yes; Class 6B2 mold and fungal spores (excluding fauna); Class 6B3 on request
- to chemically active substances according to EN 60721-3-6	Yes; Class 6C3 (RH < 75 %) incl. salt spray acc. to EN 60068-2-52 (severity degree 3); *	Yes; Class 6C3 (RH < 75 %) incl. salt spray acc. to EN 60068-2-52 (severity degree 3); *	Yes; Class 6C3 (RH < 75 %) incl. salt spray acc. to EN 60068-2-52 (severity degree 3); *	Yes; Class 6C3 (RH < 75 %) incl. salt spray acc. to EN 60068-2-52 (severity degree 3); *
- to mechanically active substances according to EN 60721-3-6	Yes; Class 6S3 incl. sand, dust; *	Yes; Class 6S3 incl. sand, dust; *	Yes; Class 6S3 incl. sand, dust; *	Yes; Class 6S3 incl. sand, dust; *
Usage in industrial process technology				
- Against chemically active substances acc. to EN 60654-4	Yes; Class 3 (excluding trichlorethylene)	Yes; Class 3 (excluding trichlorethylene)	Yes; Class 3 (excluding trichlorethylene)	Yes; Class 3 (excluding trichlorethylene)
- Environmental conditions for process, measuring and control systems acc. to ANSI/ISA-71.04	Yes; Level GX group A/B (excluding trichlorethylene; harmful gas concentrations up to the limits of EN 60721-3-3 class 3C4 permissible); level LC3 (salt spray) and level LB3 (oil)	Yes; Level GX group A/B (excluding trichlorethylene; harmful gas concentrations up to the limits of EN 60721-3-3 class 3C4 permissible); level LC3 (salt spray) and level LB3 (oil)	Yes; Level GX group A/B (excluding trichlorethylene; harmful gas concentrations up to the limits of EN 60721-3-3 class 3C4 permissible); level LC3 (salt spray) and level LB3 (oil)	Yes; Level GX group A/B (excluding trichlorethylene; harmful gas concentrations up to the limits of EN 60721-3-3 class 3C4 permissible); level LC3 (salt spray) and level LB3 (oil)
Remark				
- Note regarding classification of environmental conditions acc. to EN 60721, EN 60654-4 and ANSI/ISA-71.04	* The supplied plug covers must remain in place over the unused interfaces during operation!	* The supplied plug covers must remain in place over the unused interfaces during operation!	* The supplied plug covers must remain in place over the unused interfaces during operation!	* The supplied plug covers must remain in place over the unused interfaces during operation!

SIMATIC S7-1200 Basic Controllers

SIPLUS operator control and monitoring

SIPLUS Comfort Panels Standard

Technical specifications

Article number	6AG1124-2DC01-4AX0	6AG1124-0GC01-4AX0	6AG1124-0JC01-4AX0	6AG1124-0MC01-4AX0	
Based on	6AV2124-2DC01-0AX0 SIPLUS HMI KTP400 COMFORT	6AV2124-0GC01-0AX0 SIPLUS HMI TP700 COMFORT	6AV2124-0JC01-0AX0 SIPLUS HMI TP900 COMFORT	6AV2124-0MC01-0AX0 SIPLUS HMI TP1200 COMFORT	
Conformal coating					
• Coatings for printed circuit board assemblies acc. to EN 61086	Yes; Class 2 for high reliability	Yes; Class 2 for high reliability	Yes; Class 2 for high reliability	Yes; Class 2 for high reliability	
• Protection against fouling acc. to EN 60664-3	Yes; Type 1 protection	Yes; Type 1 protection	Yes; Type 1 protection	Yes; Type 1 protection	
• Military testing according to MIL-I-46058C, Amendment 7	Yes; Discoloration of coating possible during service life	Yes; Discoloration of coating possible during service life	Yes; Discoloration of coating possible during service life	Yes; Discoloration of coating possible during service life	
• Qualification and Performance of Electrical Insulating Compound for Printed Board Assemblies according to IPC-CC-830A	Yes; Conformal coating, Class A	Yes; Conformal coating, Class A	Yes; Conformal coating, Class A	Yes; Conformal coating, Class A	
Article number	6AG1124-1DC01-4AX0	6AG1124-1GC01-4AX0	6AG1124-1JC01-4AX0	6AG1124-1MC01-4AX0	6AG1124-1QC02-4AX1
Based on	6AV224-1DC01-0AX0 SIPLUS HMI KP400 COMFORT	6AV2124-1GC01-0AX0 SIPLUS HMI KP700 COMFORT	6AV2124-1JC01-0AX0 SIPLUS HMI KP900 COMFORT	6AV2124-1MC01-0AX0 SIPLUS HMI KP1200 COMFORT	6AV2124-1QC02-0AX1 SIPLUS HMI KP1500 Comfort
Ambient conditions					
Suited for indoor use	Yes	Yes	Yes	Yes	Yes
Suited for outdoor use	No	No	No	No	No
Ambient temperature during operation					
Operation (vertical installation)					
- For vertical installation, min.	0 °C; = Tmin	0 °C; = Tmin	0 °C; = Tmin	0 °C; = Tmin	0 °C
- For vertical installation, max.	50 °C; = Tmax	50 °C; = Tmax	50 °C; = Tmax	50 °C; = Tmax	50 °C; (55 °C, see entry ID: 64847814)
Altitude during operation relating to sea level					
• Installation altitude above sea level, max.	5 000 m	5 000 m	5 000 m	5 000 m	5 000 m
• Ambient air temperature-barometric pressure-altitude	Tmin ... Tmax at 1 140 hPa ... 795 hPa (-1 000 m ... +2 000 m) // Tmin ... (Tmax - 10 K) at 795 hPa ... 658 hPa (+2 000 m ... +3 500 m) // Tmin ... (Tmax -20 K) at 658 hPa ... 540 hPa (+3 500 m ... +5 000 m)	Tmin ... Tmax at 1 140 hPa ... 795 hPa (-1 000 m ... +2 000 m) // Tmin ... (Tmax - 10 K) at 795 hPa ... 658 hPa (+2 000 m ... +3 500 m) // Tmin ... (Tmax -20 K) at 658 hPa ... 540 hPa (+3 500 m ... +5 000 m)	Tmin ... Tmax at 1 140 hPa ... 795 hPa (-1 000 m ... +2 000 m) // Tmin ... (Tmax - 10 K) at 795 hPa ... 658 hPa (+2 000 m ... +3 500 m) // Tmin ... (Tmax -20 K) at 658 hPa ... 540 hPa (+3 500 m ... +5 000 m)	Tmin ... Tmax at 1 140 hPa ... 795 hPa (-1 000 m ... +2 000 m) // Tmin ... (Tmax - 10 K) at 795 hPa ... 658 hPa (+2 000 m ... +3 500 m) // Tmin ... (Tmax -20 K) at 658 hPa ... 540 hPa (+3 500 m ... +5 000 m)	Tmin ... Tmax at 1 080 hPa ... 795 hPa (-1 000 m ... +2 000 m) // Tmin ... (Tmax - 10 K) at 795 hPa ... 658 hPa (+2 000 m ... +3 500 m) // Tmin ... (Tmax - 20 K) at 658 hPa ... 540 hPa (+3 500 m ... +5 000 m)
Relative humidity					
• With condensation, tested in accordance with IEC 60068-2-38, max.	100 %; RH incl. condensation/frost (no commissioning under condensation conditions)	100 %; RH incl. condensation/frost (no commissioning under condensation conditions)	100 %; RH incl. condensation/frost (no commissioning under condensation conditions)	100 %; RH incl. condensation/frost (no commissioning under condensation conditions)	100 %; RH incl. condensation/frost (no commissioning under condensation conditions)
Resistance					
Coolants and lubricants					
- Resistant to commercially available coolants and lubricants	Yes; Incl. diesel and oil droplets in the air	Yes; Incl. diesel and oil droplets in the air	Yes; Incl. diesel and oil droplets in the air	Yes; Incl. diesel and oil droplets in the air	Yes; Incl. diesel and oil droplets in the air
Use in stationary industrial systems					
- to biologically active substances according to EN 60721-3-3	Yes; Class 3B2 mold, fungus and dry rot spores (with the exception of fauna); Class 3B3 on request	Yes; Class 3B2 mold, fungus and dry rot spores (with the exception of fauna); Class 3B3 on request	Yes; Class 3B2 mold, fungus and dry rot spores (with the exception of fauna); Class 3B3 on request	Yes; Class 3B2 mold, fungus and dry rot spores (with the exception of fauna); Class 3B3 on request	Yes; Class 3B2 mold, fungus and dry rot spores (with the exception of fauna); Class 3B3 on request
- to chemically active substances according to EN 60721-3-3	Yes; Class 3C4 (RH < 75 %) incl. salt spray acc. to EN 60068-2-52 (severity degree 3); *	Yes; Class 3C4 (RH < 75 %) incl. salt spray acc. to EN 60068-2-52 (severity degree 3); *	Yes; Class 3C4 (RH < 75 %) incl. salt spray acc. to EN 60068-2-52 (severity degree 3); *	Yes; Class 3C4 (RH < 75 %) incl. salt spray acc. to EN 60068-2-52 (severity degree 3); *	Yes; Class 3C4 (RH < 75 %) incl. salt spray acc. to EN 60068-2-52 (severity degree 3); *
- to mechanically active substances according to EN 60721-3-3	Yes; Class 3S4 incl. sand, dust, *	Yes; Class 3S4 incl. sand, dust, *	Yes; Class 3S4 incl. sand, dust, *	Yes; Class 3S4 incl. sand, dust, *	Yes; Class 3S4 incl. sand, dust, *

SIMATIC S7-1200 Basic Controllers

SIPLUS operator control and monitoring

SIPLUS Comfort Panels Standard

3

Technical specifications

Article number	6AG1124-1DC01-4AX0	6AG1124-1GC01-4AX0	6AG1124-1JC01-4AX0	6AG1124-1MC01-4AX0	6AG1124-1QC02-4AX1
Based on	6AV224-1DC01-0AX0	6AV2124-1GC01-0AX0	6AV2124-1JC01-0AX0	6AV2124-1MC01-0AX0	6AV2124-1QC02-0AX1
	SIPLUS HMI KP400 COMFORT	SIPLUS HMI KP700 COMFORT	SIPLUS HMI KP900 COMFORT	SIPLUS HMI KP1200 COMFORT	SIPLUS HMI KP1500 Comfort
Use on ships/at sea					
- to biologically active substances according to EN 60721-3-6	Yes; Class 6B2 mold and fungal spores (excluding fauna); Class 6B3 on request	Yes; Class 6B2 mold and fungal spores (excluding fauna); Class 6B3 on request	Yes; Class 6B2 mold and fungal spores (excluding fauna); Class 6B3 on request	Yes; Class 6B2 mold and fungal spores (excluding fauna); Class 6B3 on request	Yes; Class 6B2 mold and fungal spores (excluding fauna); Class 6B3 on request
- to chemically active substances according to EN 60721-3-6	Yes; Class 6C3 (RH < 75 %) incl. salt spray acc. to EN 60068-2-52 (severity degree 3); *	Yes; Class 6C3 (RH < 75 %) incl. salt spray acc. to EN 60068-2-52 (severity degree 3); *	Yes; Class 6C3 (RH < 75 %) incl. salt spray acc. to EN 60068-2-52 (severity degree 3); *	Yes; Class 6C3 (RH < 75 %) incl. salt spray acc. to EN 60068-2-52 (severity degree 3); *	Yes; Class 6C3 (RH < 75 %) incl. salt spray acc. to EN 60068-2-52 (severity degree 3); *
- to mechanically active substances according to EN 60721-3-6	Yes; Class 6S3 incl. sand, dust; *	Yes; Class 6S3 incl. sand, dust; *	Yes; Class 6S3 incl. sand, dust; *	Yes; Class 6S3 incl. sand, dust; *	Yes; Class 6S3 incl. sand, dust; *
Usage in industrial process technology					
- Against chemically active substances acc. to EN 60654-4	Yes; Class 3 (excluding trichlorethylene)	Yes; Class 3 (excluding trichlorethylene)	Yes; Class 3 (excluding trichlorethylene)	Yes; Class 3 (excluding trichlorethylene)	Yes; Class 3 (excluding trichlorethylene)
- Environmental conditions for process, measuring and control systems acc. to ANSI/ISA-71.04	Yes; Level GX group A/B (excluding trichlorethylene; harmful gas concentrations up to the limits of EN 60721-3-3 class 3C4 permissible); level LC3 (salt spray) and level LB3 (oil)	Yes; Level GX group A/B (excluding trichlorethylene; harmful gas concentrations up to the limits of EN 60721-3-3 class 3C4 permissible); level LC3 (salt spray) and level LB3 (oil)	Yes; Level GX group A/B (excluding trichlorethylene; harmful gas concentrations up to the limits of EN 60721-3-3 class 3C4 permissible); level LC3 (salt spray) and level LB3 (oil)	Yes; Level GX group A/B (excluding trichlorethylene; harmful gas concentrations up to the limits of EN 60721-3-3 class 3C4 permissible); level LC3 (salt spray) and level LB3 (oil)	Yes; Level GX group A/B (excluding trichlorethylene; harmful gas concentrations up to the limits of EN 60721-3-3 class 3C4 permissible); level LC3 (salt spray) and level LB3 (oil)
Remark					
- Note regarding classification of environmental conditions acc. to EN 60721, EN 60654-4 and ANSI/ISA-71.04	* The supplied plug covers must remain in place over the unused interfaces during operation!	* The supplied plug covers must remain in place over the unused interfaces during operation!	* The supplied plug covers must remain in place over the unused interfaces during operation!	* The supplied plug covers must remain in place over the unused interfaces during operation!	* The supplied plug covers must remain in place over the unused interfaces during operation!
Conformal coating					
• Coatings for printed circuit board assemblies acc. to EN 61086	Yes; Class 2 for high reliability	Yes; Class 2 for high reliability	Yes; Class 2 for high reliability	Yes; Class 2 for high reliability	Yes; Class 2 for high reliability
• Protection against fouling acc. to EN 60664-3	Yes; Type 1 protection	Yes; Type 1 protection	Yes; Type 1 protection	Yes; Type 1 protection	Yes; Type 1 protection
• Military testing according to MIL-I-46058C, Amendment 7	Yes; Discoloration of coating possible during service life	Yes; Discoloration of coating possible during service life	Yes; Discoloration of coating possible during service life	Yes; Discoloration of coating possible during service life	Yes; Discoloration of coating possible during service life
• Qualification and Performance of Electrical Insulating Compound for Printed Board Assemblies according to IPC-CC-830A	Yes; Conformal coating, Class A	Yes; Conformal coating, Class A	Yes; Conformal coating, Class A	Yes; Conformal coating, Class A	Yes; Conformal coating, Class A
Article number	6AG1124-0QC02-4AX1		6AG1124-0UC02-4AX1		6AG1124-0XC02-4AX1
Based on	6AV2124-0QC02-0AX1		6AV2124-0UC02-0AX1		6AV2124-0XC02-0AX1
	SIPLUS HMI TP1500 Comfort		SIPLUS HMI TP1900 Comfort		SIPLUS HMI TP2200 Comfort
Ambient conditions					
Suited for indoor use	Yes		Yes		Yes
Suited for outdoor use	No		No		No
Ambient temperature during operation					
Operation (vertical installation)					
- For vertical installation, min.	0 °C		0 °C; = Tmin		0 °C; = Tmin
- For vertical installation, max.	50 °C; (55 °C, see entry ID: 64847814)		45 °C; = Tmax		45 °C; = Tmax

SIMATIC S7-1200 Basic Controllers

SIPLUS operator control and monitoring

SIPLUS Comfort Panels Standard

Technical specifications

Article number	6AG1124-0QC02-4AX1	6AG1124-0UC02-4AX1	6AG1124-0XC02-4AX1
Based on	6AV2124-0QC02-0AX1 SIPLUS HMI TP1500 Comfort	6AV2124-0UC02-0AX1 SIPLUS HMI TP1900 Comfort	6AV2124-0XC02-0AX1 SIPLUS HMI TP2200 Comfort
Altitude during operation relating to sea level			
<ul style="list-style-type: none"> Installation altitude above sea level, max. Ambient air temperature-barometric pressure-altitude 	5 000 m Tmin ... Tmax at 1 140 hPa ... 795 hPa (-1 000 m ... +2 000 m) // Tmin ... (Tmax - 10 K) at 795 hPa ... 658 hPa (+2 000 m ... +3 500 m) // Tmin ... (Tmax -20 K) at 658 hPa ... 540 hPa (+3 500 m ... +5 000 m)	5 000 m Tmin ... Tmax at 1 140 hPa ... 795 hPa (-1 000 m ... +2 000 m) // Tmin ... (Tmax - 10 K) at 795 hPa ... 658 hPa (+2 000 m ... +3 500 m) // Tmin ... (Tmax -20 K) at 658 hPa ... 540 hPa (+3 500 m ... +5 000 m)	5 000 m Tmin ... Tmax at 1 080 hPa ... 795 hPa (-1 000 m ... +2 000 m) // Tmin ... (Tmax - 10 K) at 795 hPa ... 658 hPa (+2 000 m ... +3 500 m) // Tmin ... (Tmax - 20 K) at 658 hPa ... 540 hPa (+3 500 m ... +5 000 m)
Relative humidity			
<ul style="list-style-type: none"> With condensation, tested in accordance with IEC 60068-2-38, max. 	100 %; RH incl. condensation/frost (no commissioning under condensation conditions)	100 %; RH incl. condensation/frost (no commissioning under condensation conditions)	100 %; RH incl. condensation/frost (no commissioning under condensation conditions)
Resistance			
Coolants and lubricants			
<ul style="list-style-type: none"> Resistant to commercially available coolants and lubricants 	Yes; Incl. diesel and oil droplets in the air	Yes; Incl. diesel and oil droplets in the air	Yes; Incl. diesel and oil droplets in the air
Use in stationary industrial systems			
<ul style="list-style-type: none"> to biologically active substances according to EN 60721-3-3 to chemically active substances according to EN 60721-3-3 to mechanically active substances according to EN 60721-3-3 	Yes; Class 3B2 mold, fungus and dry rot spores (with the exception of fauna); Class 3B3 on request Yes; Class 3C4 (RH < 75 %) incl. salt spray acc. to EN 60068-2-52 (severity degree 3); * Yes; Class 3S4 incl. sand, dust, *	Yes; Class 3B2 mold, fungus and dry rot spores (with the exception of fauna); Class 3B3 on request Yes; Class 3C4 (RH < 75 %) incl. salt spray acc. to EN 60068-2-52 (severity degree 3); * Yes; Class 3S4 incl. sand, dust, *	Yes; Class 3B2 mold, fungus and dry rot spores (with the exception of fauna); Class 3B3 on request Yes; Class 3C4 (RH < 75 %) incl. salt spray acc. to EN 60068-2-52 (severity degree 3); * Yes; Class 3S4 incl. sand, dust, *
Use on ships/at sea			
<ul style="list-style-type: none"> to biologically active substances according to EN 60721-3-6 to chemically active substances according to EN 60721-3-6 to mechanically active substances according to EN 60721-3-6 	Yes; Class 6B2 mold and fungal spores (excluding fauna); Class 6B3 on request Yes; Class 6C3 (RH < 75 %) incl. salt spray acc. to EN 60068-2-52 (severity degree 3); * Yes; Class 6S3 incl. sand, dust; *	Yes; Class 6B2 mold and fungal spores (excluding fauna); Class 6B3 on request Yes; Class 6C3 (RH < 75 %) incl. salt spray acc. to EN 60068-2-52 (severity degree 3); * Yes; Class 6S3 incl. sand, dust; *	Yes; Class 6B2 mold and fungal spores (excluding fauna); Class 6B3 on request Yes; Class 6C3 (RH < 75 %) incl. salt spray acc. to EN 60068-2-52 (severity degree 3); * Yes; Class 6S3 incl. sand, dust; *
Usage in industrial process technology			
<ul style="list-style-type: none"> Against chemically active substances acc. to EN 60654-4 Environmental conditions for process, measuring and control systems acc. to ANSI/ISA-71.04 	Yes; Class 3 (excluding trichlorethylene) Yes; Level GX group A/B (excluding trichlorethylene; harmful gas concentrations up to the limits of EN 60721-3-3 class 3C4 permissible); level LC3 (salt spray) and level LB3 (oil)	Yes; Class 3 (excluding trichlorethylene) Yes; Level GX group A/B (excluding trichlorethylene; harmful gas concentrations up to the limits of EN 60721-3-3 class 3C4 permissible); level LC3 (salt spray) and level LB3 (oil)	Yes; Class 3 (excluding trichlorethylene) Yes; Level GX group A/B (excluding trichlorethylene; harmful gas concentrations up to the limits of EN 60721-3-3 class 3C4 permissible); level LC3 (salt spray) and level LB3 (oil)
Remark			
<ul style="list-style-type: none"> Note regarding classification of environmental conditions acc. to EN 60721, EN 60654-4 and ANSI/ISA-71.04 	* The supplied plug covers must remain in place over the unused interfaces during operation!	* The supplied plug covers must remain in place over the unused interfaces during operation!	* The supplied plug covers must remain in place over the unused interfaces during operation!
Conformal coating			
<ul style="list-style-type: none"> Coatings for printed circuit board assemblies acc. to EN 61086 Protection against fouling acc. to EN 60664-3 Military testing according to MIL-I-46058C, Amendment 7 Qualification and Performance of Electrical Insulating Compound for Printed Board Assemblies according to IPC-CC-830A 	Yes; Class 2 for high reliability Yes; Type 1 protection Yes; Discoloration of coating possible during service life Yes; Conformal coating, Class A	Yes; Class 2 for high reliability Yes; Type 1 protection Yes; Discoloration of coating possible during service life Yes; Conformal coating, Class A	Yes; Class 2 for high reliability Yes; Type 1 protection Yes; Discoloration of coating possible during service life Yes; Conformal coating, Class A

Overview

SIMATIC S7-1200 Starter Kits make it quick and easy to implement simple automation tasks. The various packages allow flexible and efficient implementation of different tasks, from engineering with the TIA Portal, to the integration of HMI Panels, all the way to solutions for fail-safe applications.

The following are available:

- Starter Kit CPU 1212C AC/DC/relay;
Complete offer SIMATIC S7-1200, starter box, consisting of:
CPU 1212C AC/DC/relay, simulator, STEP 7 BASIC, manual CD, SIMATIC OPC UA S7-1200 Basic Runtime license, info material, in Systainer
- SIMATIC S7-1200 + KP300 Basic Starter Kit;
Consisting of:
CPU 1212C AC/DC/relay, HMI KP300 Basic mono PN, input simulator, STEP 7 Basic, manual CD, SIMATIC OPC UA S7-1200 Basic Runtime license, Systainer
- SIMATIC S7-1200 + KTP400 Basic Starter Kit;
Consisting of:
CPU 1212C AC/DC/relay, HMI KTP400 Basic, input simulator, STEP 7 Basic, manual CD, SIMATIC OPC UA S7-1200 Basic Runtime license, Systainer
- SIMATIC S7-1200 + KTP700 Basic Starter Kit;
Consisting of:
CPU 1212C AC/DC/relay, HMI KTP700 Basic, input simulator, STEP 7 Basic, manual CD, SIMATIC OPC UA S7-1200 Basic Runtime license, Systainer
- SIMATIC S7-1200 Fail-Safe Starter Kit
- With CPU 1212 FC DC/DC/relay;
also includes:
F-digital input SM 1226 16 x 24 V DC,
F-digital output SM 1226 4 x 24 V DC, input simulator, STEP 7 Basic and STEP 7 Safety Basic V16, SIMATIC OPC UA S7-1200 Basic, info material; in Systainer
- With CPU 1214 FC DC/DC/relay;
also includes:
F-digital input SM 1226 16 x 24 V DC,
F-digital output SM 1226 4 x 24 V DC, input simulator, STEP 7 Safety Basic, SIMATIC OPC UA S7-1200 Basic, info material; in Systainer

Ordering data

Article No.

Starter Kit CPU 1212C AC/DC/relay

Complete offer SIMATIC S7-1200, starter box, consisting of:
CPU 1212C AC/DC/relay, simulator, STEP 7 BASIC, manual CD, SIMATIC OPC UA S7-1200 Basic Runtime license, info material, in Systainer

6ES7212-1BE34-4YB0

SIMATIC S7-1200 + KP300 Basic Starter Kit

Consisting of:
CPU 1212C AC/DC/relay, HMI KP300 Basic mono PN, input simulator, STEP 7 Basic, manual CD, SIMATIC OPC UA S7-1200 Basic Runtime license, Systainer

6AV6651-7HA02-3AA4

SIMATIC S7-1200 + KTP400 Basic Starter Kit

Consisting of:
CPU 1212C AC/DC/relay, HMI KTP400 Basic, input simulator, STEP 7 Basic, manual CD, SIMATIC OPC UA S7-1200 Basic Runtime license, Systainer

6AV6651-7KA02-3AA4

SIMATIC S7-1200 + KTP700 Basic Starter Kit

Consisting of:
CPU 1212C AC/DC/relay, HMI KTP700 Basic, input simulator, STEP 7 Basic, manual CD, SIMATIC OPC UA S7-1200 Basic Runtime license, Systainer

6AV6651-7DA02-3AA4

SIMATIC S7-1200 Fail-Safe Starter Kit

With CPU 1212 FC DC/DC/relay;
also includes:
F-digital input SM 1226 16 x 24 V DC,
F-digital output SM 1226 4 x 24 V DC, input simulator, STEP 7 Basic and STEP 7 Safety Basic V16, SIMATIC OPC UA S7-1200 Basic, info material; in Systainer

6ES7212-1HF41-4YB1

With CPU 1214 FC DC/DC/relay;
also includes:
F-digital input SM 1226 16 x 24 V DC,
F-digital output SM 1226 4 x 24 V DC, input simulator, STEP 7 Safety Basic, SIMATIC OPC UA S7-1200 Basic, info material; in Systainer

6ES7212-1HF42-4YB1

SIMATIC S7-1200 Basic Controllers

Add-on products from third-party manufacturers

SIMATIC S7-1200 CM CANopen

Overview



Note

The CM CANopen module is an HMS Industrial Networks product and can only be obtained through HMS.

The following description contains information on supplementary products that are manufactured and marketed, not by Siemens, but by third-parties outside the Siemens group ("external companies"). These external companies organize the manufacture, sale and delivery of their products independently. Their own terms and conditions of business and delivery apply.

Responsibility for these supplementary products and for the associated information presented here rests exclusively with the respective external company. Unless compulsory by law, Siemens assumes no liability and makes no guarantee for supplemental products of external companies. Please refer also to the note on "Exemption from liability/Use of hyperlinks" (see "More information").

Overview

An interface module is available for operating the SIMATIC S7-1200 on CANopen. It can be used together with system and IO components of the S7-1200 automation system.

CiA and CANopen are registered Community Trademarks of CAN in Automation e.V.

Application

CANopen is a widely used industrial bus system and can be used for a variety of different applications. The module allows simple and cost-effective connection of CANopen applications to SIMATIC.

- Control of hydraulic valves/axes in vehicles
- Control of motors in packaging machines or conveyors
- Capturing of angular encoder positions in wind turbines
- Capturing of control devices on machines, e.g. joysticks
- Capturing the measured data of path encoders, inclinometers or angular encoders, e.g. for tower cranes and gantry cranes

The CM CANopen module has the following properties:

- Interface module for CANopen (master/slave) for SIMATIC S7-1200
- Connection of up to 16 CANopen slave stations in the master mode
- 256 bytes of input data and 256 bytes of output data per module
- Connection of up to 3 modules per CPU
- 3 LEDs for module, network and I/O status diagnostics
- Possible integration of the module into the hardware catalog of the TIA Portal configuration suite
- Supports Transparent CAN 2.0A for processing customer-specific protocols
- CANopen implementation according to communication profiles CiA 301 Rev. 4.2 and CiA 302 Rev. 4.1 (master)

More information

The CANopen bus can be configured via any commercially available CANopen configuration tool. HMS Industrial Networks also supplies suitable "CM CANopen Configuration Studio" software with the product. The configuration is saved directly on the module by means of a USB connection. Routing via PROFIBUS/PROFINET is not possible.

Preprogrammed function blocks are available for easier PLC programming in the TIA Portal.

For more information, please contact HMS Industrial Networks directly:

<http://www.ixxat.com/cm-canopen>

Ordering and Support

Please note that ordering and support for the module are exclusively carried out via HMS Industrial Networks. Please contact HMS Industrial Networks directly should you have any questions concerning this module. The relevant contact details can be found on the Internet at

<http://www.ixxat.com/cm-canopen>

Exemption from liability/Use of hyperlinks

Siemens has prepared this description with great care. It is not possible, however, for Siemens to verify that the data supplied by external companies is complete, correct or up to date. The possibility that individual items of information might be incorrect, incomplete, or not up-to-date cannot therefore be ruled out. Unless compulsory by law, Siemens accepts no liability for the usability of the data or of the product for the user per se.

This article contains third-party Web addresses. Siemens is not responsible for the contents of these Web sites, nor does Siemens adopt these Web sites and their contents, as Siemens does not control the presented information and cannot be held responsible for the content and information they contain. You therefore use these links at your own risk.

SIMATIC S7-1500 Advanced Controllers



4/2	Introduction	4/193	<u>Connection system</u>
4/2	S7-1500	4/193	Front connectors
4/6	Central processing units	4/194	System cabling for SIMATIC S7-1500 and ET 200MP
4/6	Standard CPUs	4/195	- Fully modular connection
4/23	SIPLUS standard CPUs	4/199	- Flexible connection
4/30	Compact CPUs	4/200	System cabling for SIMATIC S7-1500 IO (25 mm), ET 200SP, S7-1200 and LOGO!
4/36	Fail-safe CPUs	4/202	<u>Fail-safe I/O modules</u>
4/54	SIPLUS fail-safe CPUs	4/202	Digital F-input modules
4/60	Redundant CPUs	4/204	Digital F-output modules
4/67	SIPLUS redundant CPUs	4/206	<u>SIPLUS F-digital/analog modules</u>
4/70	Technology CPUs	4/206	SIPLUS digital F-input modules
		4/207	SIPLUS digital F-output modules
4/90	I/O modules	4/208	Power supplies
4/90	<u>Digital modules</u>	4/208	1-phase, 24 V DC (for S7-1500 and ET200MP)
4/90	SM 521 digital input modules	4/211	System power supplies
4/97	SM 522 digital output modules	4/213	SIPLUS power supplies
4/108	SM 523 digital input/output modules	4/213	1-phase, 24 V DC (for S7-1500 and ET200MP)
4/112	<u>SIPLUS digital modules</u>	4/214	SIPLUS system power supplies
4/112	SIPLUS SM 521 digital input modules	4/216	Operator control and monitoring
4/115	SIPLUS SM 522 digital output modules	4/216	<u>Basic Panels</u>
4/119	<u>Analog modules</u>	4/216	Standard devices 2nd Generation
4/119	SM 531 analog input modules	4/217	<u>Comfort Panels</u>
4/131	SM 532 analog output modules	4/217	SIMATIC HMI Unified Comfort Panels Standard
4/135	SM 534 analog input/output modules	4/220	Comfort Panels Standard devices
4/139	<u>SIPLUS analog modules</u>	4/221	SIPLUS Operator control and monitoring
4/139	SIPLUS SM 531 analog input modules	4/221	SIPLUS Basic Panels (2nd Generation)
4/141	SIPLUS SM 532 analog output modules	4/224	SIPLUS Basic Panels (1st Generation)
4/143	<u>Technology modules</u>	4/226	SIPLUS Comfort Panels Standard
4/143	TM Count 2x24V counter module	4/231	Starter kits
4/146	TM PosInput 2 counter and position detection module	4/232	Accessories
4/149	TM Timer DIDQ 16x24V time-based IO module	4/232	DIN rail
4/152	TM PTO 4 interface module for PTO (Pulse Train Output)	4/233	Labeling sheets
4/154	SIWAREX WP521 / WP522 ST	4/234	Spare parts
4/157	<u>SIPLUS technology modules</u>		
4/157	SIPLUS TM Count 2x24V counter module		
4/158	SIPLUS TM PosInput 2 position detection module		
4/159	<u>Communication</u>		
4/159	CM PtP		
4/162	CM 8xIO-Link		
4/164	CM 1542-5		
4/166	CP 1542-5		
4/168	CM 1542-1		
4/171	CP 1543-1		
4/174	CP 1545-1		
4/177	TIM 1531 IRC (for S7-1500)		
4/181	SCALANCE W774 RJ45 for the control cabinet		
4/185	SCALANCE W734 RJ45 for the control cabinet		
4/189	<u>SIPLUS communication</u>		
4/189	SIPLUS CM PtP		
4/191	SIPLUS NET CM 1542-5		
4/192	SIPLUS NET CP 1543-1		

SIMATIC S7-1500 Advanced Controllers

Introduction

S7-1500

Overview



With its extended ambient conditions, the SIMATIC S7-1500 can be used almost anywhere. Many controllers can be operated in a temperature range from -25°C to $+60^{\circ}\text{C}$ and at altitudes up to 5 000 m as standard. A wide range of SIPLUS Controllers is available for requirements beyond this.

The SIMATIC S7-1500 is

- a modular, scalable, and universally usable system in IP20 degree of protection
- the system solution for a variety of automation applications in discrete automation
- maximum performance combined with excellent usability
- configurable in the Totally Integrated Automation Portal with STEP 7 Professional V12 or higher

Performance

- Increase in performance through
 - Faster command execution
 - Language extensions
 - New data types
 - Faster backplane bus
 - Optimized code generation
- Powerful communication:
 - PROFINET IO (2-port switch) as standard interface; from CPU 1515-2 PN, one or more additional integrated PROFINET interfaces, e.g. for network separation, for connecting further PROFINET devices or for high-speed communication as an I-Device
 - OPC UA server (data access) and client as runtime option for the easy connection of SIMATIC S7-1500 to non-Siemens devices/systems
 - Expandable with communications modules for bus systems and point-to-point connection

Integrated technology

- Motion Control integrated without additional modules:
 - Standardized blocks (PLCopen) for connection of analog and PROFIdrive-capable drives
 - The Motion Control functionality supports speed axes, positioning axes, relative synchronous operation (synchronizing without specification of the synchronized position), as well as external encoders, output cams and probes.
 - Extended Motion Control functions such as absolute synchronous operation (synchronizing with specification of the synchronized position), camming and functions for controlling kinematics are also integrated in the technology CPUs.
- Comprehensive trace functions for all CPU tags for real-time diagnostics and sporadic error detection; for effective commissioning and quick optimization of drives and controls
- Comprehensive control functionalities:
 - e.g. easily configurable blocks for automatic optimization of the control parameters for optimum control quality
- Additional functions through available technology modules:
 - e.g. high-speed counting, position detection, or measurement functions for signals up to 1 MHz

Safety Integrated

- Protection of personnel and machinery – within the framework of an integrated complete system
- Fail-safe SIMATIC S7-1500(T)F Controllers for processing standard and safety programs on the same controller. The fail-safe and standard user programs are created in the TIA Portal with the same editors; fail-safe data, for example, can therefore be evaluated like standard data in the standard user program. Due to this integration the system benefits and the comprehensive functionality of SIMATIC are also available for fail-safe applications.

Overview

Redundant systems



CPU 1513R-1 PN, CPU 1515R-2 PN

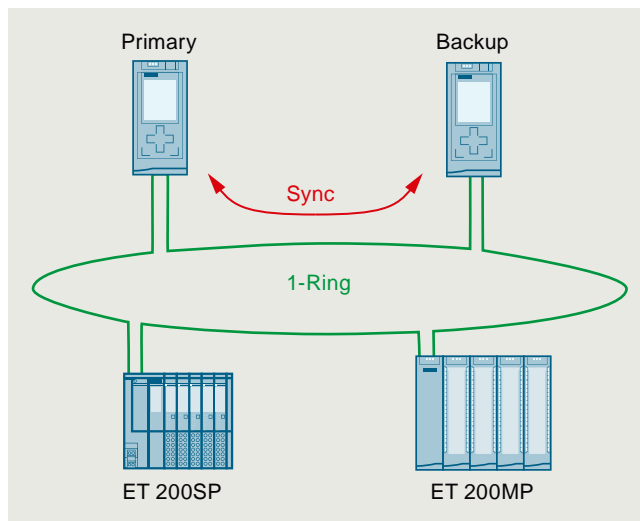

SIMATIC S7-1500R mode of operation



CPU 1517H-3 PN/FO

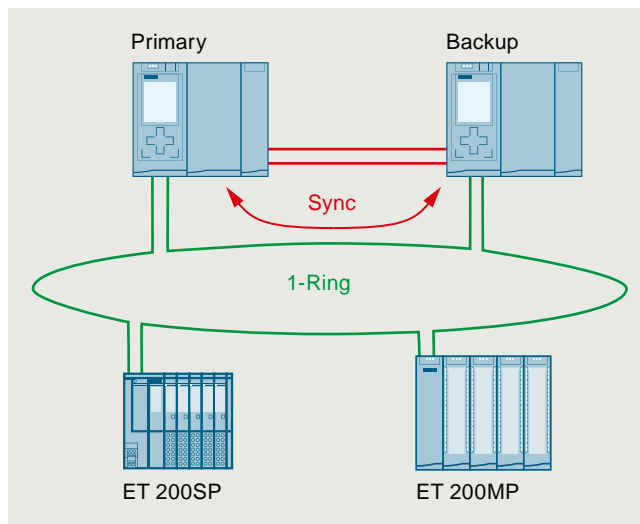

SIMATIC S7-1500H mode of operation

- Redundant S7-1500R/H CPUs for applications where availability of the PLC is crucial.
- Both CPUs are connected with the I/O stations via a PROFINET IO ring. Synchronization for the S7-1500R is via this ring, or via separate FOC synchronization cables for the S7-1500H. In the event of a CPU failure, the back-up CPU automatically assumes control of the process. No data is lost and the process can be continued extremely quickly. The PROFINET IO ring ensures that all nodes remain accessible in the event of a fieldbus interruption.
- The engineering corresponds to that of a standard CPU. The TIA Portal and redundant CPUs handle the synchronization of the programs and data. All without any additional overhead for the user.

SIMATIC S7-1500 Advanced Controllers

Introduction

S7-1500

Overview

Security Integrated

- Password-based know-how protection against unauthorized read-out and modification of program blocks
- Copy protection for greater protection against unauthorized copying of program blocks:
With copy protection, individual blocks on the SIMATIC Memory Card can be tied to its serial number so that the block can only be run if the configured memory card is inserted into the CPU.
- Rights concept with four different authorization levels: Different access rights can be assigned to various user groups. The new protection level 4 makes it possible to also restrict communication to HMI devices.
- Improved manipulation protection:
Changed or unauthorized transfers of engineering data are detected by the controller.
- For use of an Ethernet CP (CP 1543-1):
 - Additional access protection by means of a firewall
 - Establishment of secure VPN connections

Design and handling

- CPUs with display for plain text information (display simulator tool on the Internet):
 - Information about article numbers, firmware version, and the serial number of all connected modules can be displayed
 - Setting the IP address of the CPU and additional network settings possible directly on site, without programming device on the display
 - Display of occurring error messages directly as plain text message, meaning reduction in downtime
- Uniform front connectors for all modules and integrated potential bridges for flexible potential group formation simplify stock keeping and reduce wiring effort
- Integrated top hat DIN rail in the S7-1500 DIN rail: quick and easy installation of supplementary components such as miniature circuit breakers, relays, etc.
- Central expansion with signal modules: for flexible adaptation to any application
- System cabling for digital signal modules: for fast and clearly arranged connecting to sensors and actuators in the field and simple wiring inside the control cabinet
- Power supply:
 - Load power supply modules (PMs) for supplying the module with 24 V
 - Power supply modules to supply power to the internal module electronics via the backplane bus
 - System power supply modules for retentively storing the entire work memory on the controller
- Distributed expansion:
 - Use of up to 30 signal modules, communications modules, and technology modules via the PROFINET IM 155-5 interface module for the ET 200MP I/O system
 - No difference in terms of handling and system functions in central and distributed operation

Integrated system diagnostics

- Integrated system diagnostics for CPUs, activated by default:
 - Consistent plain text display of system diagnostic information in the display, TIA Portal, HMI, and web server, even for drive messages. Messages are updated even if the CPU is in STOP state.
 - System diagnostics integrated in the CPU firmware. Configuration by user not required. The diagnostics is automatically updated on configuration changes.

Support of SIMATIC ProDiag S7-1500

- ProDiag is a concept for the easy creation of machine and plant diagnostics. It increases availability and supports with fault analysis and elimination on-site.

Datalog (archives) and recipes

- SIMATIC Memory Card:
 - Plug-in load memory
 - Permits firmware updates
 - Storage option for STEP 7 projects (including comments and symbols), additional documentation, or csv/ASCII files (for recipes and archives)
 - Easy access to plant-relevant operating data and configuration data with Office tools via the SD card reader (two-way data exchange from and to the PLC)
- Integrated web server:
 - Easy access to plant-relevant operating data and configuration data, Motion Control diagnostics and display of trace recordings via a web browser

Approvals

The SIMATIC S7-1500 complies with the following national and international standards:

- cULus approval
- cULus HazLoc approval
- FM approval
- ATEX approval (only for 24 V; not for 230 V)
- CE
- RCM (formerly C-Tick)
- KCC
- IECEx (24 V only; not for 230 V)
- EN 61000-6-4
- EN 60068-2-1/-2/-6/-14/-27/-30/-32
- EN 61131-2

You can find the marine approvals available for the S7-1500 on the Internet (SIMATIC Customer Support):

<http://www.siemens.com/automation/support>

The S7-1500 system is also suitable for operating at elevations up to 5000 m. You can find a list of all currently approved modules here:

<https://support.industry.siemens.com/cs/ww/en/view/109763260>

Technical specifications

General technical specifications of SIMATIC S7-1500

Degree of protection	IP20 acc. to IEC 60 529
Ambient temperature	0...60 °C (display: at an operating temperature of typ. 50 °C, the display is switched off.)
• Horizontal installation	
• Vertical installation	0... 40 °C (display: at an operating temperature of typ. 40 °C, the display is switched off.)
Relative humidity	10 %...95 %, no condensation
Atmospheric pressure	From 1080 to 795 hPa (corresponds to an altitude of -1000 to +2000 m)
Insulation	
• < 50 V	707 V DC test voltage (type test)
• < 150 V	2200 V DC test voltage
• < 250 V	2500 V DC test voltage
Electromagnetic compatibility	Requirements of the EMC directive; interference immunity according to IEC 61000-6-2
• Pulse-shaped disturbance variables	Test according to: Electrostatic discharge according to IEC 61000-4-2, burst pulses according to IEC 61000-4-4, energy single pulse (surge) according to IEC 61000-4-5,
• Sinusoidal disturbance variables	Test according to: HF irradiation according to IEC 61000-4-3, HF decoupling according to IEC 61000-4-6
• Emission of radio frequency interference	Requirements of the EMC directive; interference emission according to EN 61000-6-4 Interference emission according to 61000-6-4 Interference emission of electromagnetic fields according to EN 61000-6-4
Mechanical stress	
• Vibrations	Testing according to EN 60068-2-6 Tested with: 5 Hz ≤ f ≤ 8.4 Hz, constant amplitude 7 mm; 9 Hz ≤ f ≤ 150 Hz, constant acceleration 2 g; duration of vibration: 10 frequency passes per axis in each direction of the 3 mutually perpendicular axes
• Shock	Testing according to EN 60068-2-27 Tested with: Half-wave: strength of shock 15 g peak value, 11 ms duration; shock direction: 3 shocks each in ± direction in each of the 3 mutually vertical axes

General technical data of SIPLUS S7-1500

Ambient temperature range	-40/-25/-20 ... +55/60/70 °C
Conformal coating	Coating of the printed circuit boards and the electronic components
Technical specifications	The technical data of the standard product applies except for the ambient conditions.
Ambient conditions	
Extended range of ambient conditions	
• with reference to ambient temperature, air pressure and altitude	Tmin ... Tmax at 1080 hPa ... 795 hPa (-1000 m ... +2000 m) // Tmin ... (Tmax - 10K) at 795 hPa ... 658 hPa (+2000 m ... +3500 m) // Tmin ... (Tmax - 20K) at 658 hPa ... 540 hPa (+3500 m ... +5000 m)
• at cold restart, min.	0° C
Relative humidity	
• with condensation, max.	100 %; RH incl. bedewing/frost (no commissioning in bedewed state)
Resistance	
• to biologically active substances/compliance with EN 60721-3-3	Yes; Class 3B2 mold and fungal spores (except fauna); the supplied plug covers must remain in place on the unused interfaces during operation.
• to chemically active substances/compliance with EN 60721-3-3	Yes; Class 3C4 (RH < 75%) incl. salt spray in accordance with EN 60068-2-52 (severity 3); the supplied plug covers must remain in place on the unused interfaces during operation.
• to mechanically active substances, compliance with EN 60721-3-3	Yes; Class 3S4 incl. sand, dust; the supplied plug covers must remain in place on unused interfaces during operation.

SIMATIC S7-1500 Advanced Controllers

Central processing units

Standard CPUs

Overview CPU 1511-1 PN



- Entry-level CPU in the S7-1500 Controller product range
- Suitable for applications with medium requirements for program scope and processing speed
- Used as central controller in production lines with central and distributed I/O
- PROFINET IO IRT interface with 2-port switch
- PROFINET IO controller for operating distributed I/O on PROFINET
- PROFINET I-Device for connecting the CPU as an intelligent PROFINET device under a SIMATIC or non-Siemens PROFINET IO controller
- OPC UA server and client as runtime option for the easy connection of SIMATIC S7-1500 to non-Siemens devices/systems with the functions:
 - OPC UA Data Access
 - OPC UA Security
 - OPC UA Methods Call, Support
 - OPC UA Companion Specifications
 - OPC UA Alarms & Conditions
- Central and distributed isochronous mode
- Integrated Motion Control functionalities for controlling speed-controlled and positioning axes, support for external encoders, output cams/cam tracks and probes
- Integrated web server for diagnostics with the option of creating user-defined web pages

Note:

SIMATIC Memory Card required for operation of the CPU

Overview CPU 1513-1 PN



- The CPU for applications with medium requirements for program/data storage in the S7-1500 Controller product range
- Medium to high processing speed for binary and floating-point arithmetic
- Used as central controller in production lines with central and distributed I/O
- PROFINET IO IRT interface with 2-port switch
- PROFINET IO controller for operating distributed I/O on PROFINET
- PROFINET I-Device for connecting the CPU as an intelligent PROFINET device under a SIMATIC or non-Siemens PROFINET IO controller
- OPC UA server and client as runtime option for the easy connection of SIMATIC S7-1500 to non-Siemens devices/systems with the functions:
 - OPC UA Data Access
 - OPC UA Security
 - OPC UA Methods Call
 - Support of OPC UA Companion specifications
 - OPC UA Alarms & Conditions
- Central and distributed isochronous mode
- Integrated Motion Control functionalities for controlling speed-controlled and positioning axes, support for external encoders, output cams/cam tracks and probes
- Integrated web server for diagnostics with the option of creating user-defined web pages

Note:

SIMATIC Memory Card required for operation of the CPU

Overview CPU 1515-2 PN



- The CPU for applications with medium to high requirements for program/data storage in the S7-1500 Controller product range
- Medium to high processing speed for binary and floating-point arithmetic
- Used as central PLC in production lines with central and distributed I/O
- PROFINET IO IRT interface with 2-port switch
- PROFINET IO controller for operating distributed I/O on PROFINET
- PROFINET I-Device for connecting the CPU as an intelligent PROFINET device under a SIMATIC or non-Siemens PROFINET IO controller
- Additional PROFINET interface with separate IP address for network separation, for connecting further PROFINET IO RT devices, or for high-speed communication as an I-Device
- OPC UA Server and Client as runtime option for the easy connection of SIMATIC S7-1500 to non-Siemens devices/systems with the functions:
 - OPC UA Data Access
 - OPC UA Security
 - OPC UA Methods Call
 - Support of OPC UA Companion specifications
 - OPC UA Alarms & Conditions
- Central and distributed isochronous mode
- Integrated Motion Control functionalities for controlling speed-controlled and positioning axes, precise position gearing between axes, support for external encoders, output cams/cam tracks and measuring inputs
- Integrated web server for diagnostics with the option of creating user-defined web pages

Note:

SIMATIC Memory Card required for operation of the CPU

Overview CPU 1516-3 PN/DP



- The CPU with a large program and data memory in the S7-1500 Controller product range for applications with high requirements regarding program scope and networking.
- High processing speed for binary and floating-point arithmetic
- Used as central PLC in production lines with central and distributed I/O
- PROFINET IO IRT interface with 2-port switch
- PROFINET IO controller for operating distributed I/O on PROFINET.
- PROFINET I-Device for connecting the CPU as an intelligent PROFINET device under a SIMATIC or non-Siemens PROFINET IO controller
- Additional PROFINET interface with separate IP address for network separation, for connecting further PROFINET IO RT devices, or for high-speed communication as an I-Device
- PROFIBUS DP master interface
- UA server and client as runtime option for easy connection of the SIMATIC S7-1500 to non-Siemens devices/systems with the functions:
 - OPC UA Data Access
 - OPC UA Security
 - OPC UA Methods Call
 - Support of OPC UA Companion specifications
 - OPC UA Alarms & Conditions
- Central and distributed isochronous mode on PROFIBUS and PROFINET
- Integrated Motion Control functionalities for controlling speed-controlled and positioning axes, support for external encoders, output cams/cam tracks and measuring inputs
- Integrated web server for diagnostics with the option of creating user-defined web pages

Note:

SIMATIC Memory Card required for operation of the CPU

SIMATIC S7-1500 Advanced Controllers

Central processing units

Standard CPUs

Overview CPU 1517-3 PN/DP



- The CPU with a very large program and data memory in the S7-1500 Controller product range for applications with high requirements regarding program scope and networking.
- High processing speed for binary and floating-point arithmetic
- For cross-industry automation tasks in series machine, special machine and plant construction
- Used as central PLC in production lines with central and distributed I/O
- PROFINET IO IRT interface with 2-port switch
- PROFINET IO controller for operating distributed I/O on PROFINET.
- PROFINET I-Device for connecting the CPU as an intelligent PROFINET device under a SIMATIC or non-Siemens PROFINET IO controller
- Additional PROFINET interface with separate IP address for network separation, for connecting further PROFINET IO RT devices, or for high-speed communication as an I-Device
- PROFIBUS DP master interface
- OPC UA Server and Client as runtime option for the easy connection of SIMATIC S7-1500 to non-Siemens devices/systems with the functions:
 - OPC UA Data Access
 - OPC UA Security
 - OPC UA Methods Call
 - Support of OPC UA Companion specifications
 - OPC UA Alarms & Conditions
- Central and distributed isochronous mode on PROFIBUS and PROFINET
- Integrated Motion Control functionalities for controlling speed-controlled and positioning axes, support for external encoders, precise position gearing between axes, output cams/cam tracks and probes
- Integrated web server for diagnostics with the option of creating user-defined web pages

Note:

SIMATIC Memory Card required for operation of the CPU.

Overview CPU 1518-4 PN/DP



- The CPU with a very large program and data memory in the S7-1500 Controller product range for demanding applications with extremely high requirements regarding program scope, performance and networking
- Extremely high processing speed for binary and floating-point arithmetic
- For cross-industry automation tasks in series machine, special machine and plant construction
- Used as central PLC in production lines with central and distributed I/O
- PROFINET IO IRT interface with 2-port switch
- PROFINET IO controller for operating distributed I/O on PROFINET.
- PROFINET I-Device for connecting the CPU as an intelligent PROFINET device under a SIMATIC or non-Siemens PROFINET IO controller
- Two additional PROFINET interfaces with separate IP address; for network separation. The PROFINET interface X2 can be used for connecting additional PROFINET IO RT devices or for fast communication as an I-Device. The PROFINET interface X3 facilitates data transfer at a speed of 1 Gbps.
- PROFIBUS DP master interface
- OPC UA Server and Client as runtime option for the easy connection of SIMATIC S7-1500 to non-Siemens devices/systems with the functions:
 - OPC UA Data Access
 - OPC UA Security
 - OPC UA Methods Call
 - Support of OPC UA Companion specifications
 - OPC UA Alarms & Conditions
- Central and distributed isochronous mode on PROFIBUS and PROFINET
- Integrated Motion Control functionalities for controlling speed-controlled and positioning axes, support for external encoders, precise position gearing between axes, output cams/cam tracks and probes
- Integrated web server for diagnostics with the option of creating user-defined web pages

Note:

SIMATIC Memory Card required for operation of the CPU

Overview CPU 1518-4 PN/DP MFP



- The CPU with a very large program and data memory in the S7-1500 Controller product range for demanding applications with extremely high requirements regarding program scope, performance and networking
- Extremely high processing speed for binary and floating-point arithmetic
- For cross-industry automation tasks in series machine, special machine and plant construction
- C/C++ functions can be called and executed in the CPU runtime.
- In parallel to the CPU Runtime, there is an additional C/C++ runtime, in which call-independent, i.e. stand-alone, C/C++ applications can be executed.
- Used as central PLC in production lines with central and distributed I/O
- PROFINET IO IRT interface with 2-port switch
- PROFINET IO controller for operating distributed I/O on PROFINET
- PROFINET I-Device for connecting the CPU as an intelligent PROFINET device under a SIMATIC or non-Siemens PROFINET IO controller
- Two additional PROFINET interfaces with separate IP addresses for network separation:
The PROFINET interface X2 can be used for connecting additional PROFINET IO RT devices or for fast communication as an I-Device. The PROFINET interface X3 facilitates data transfer at a speed of 1 Gbps.
- PROFIBUS DP master interface
- OPC UA Server and Client as runtime option for the easy connection of SIMATIC S7-1500 to non-Siemens devices/systems with the functions:
 - OPC UA Data Access
 - OPC UA Security
 - OPC UA Methods Call
 - Support of OPC UA Companion specifications
 - OPC UA Alarms & Conditions
- Central and distributed isochronous mode on PROFIBUS and PROFINET
- Integrated Motion Control functionalities for controlling speed-controlled and positioning axes, support for external encoders, gearing between axes, output cams/cam tracks and probes
- Integrated web server for diagnostics with the option of creating user-defined web pages

Multi-functional platform

With the multi-functional platform (MFP), more functionality can be accommodated in a module. The computing power of the CPU 1518-4 PN/DP MFP allows the merging of previously separate applications on a common platform while continuing to meet the high S7-1500 demands with regard to maintenance and ruggedness.

This means that, in addition to the control function, it is also possible to process typical PC applications on the multi-functional platform, e.g. tasks that:

- require high-level language programming,
- are developed based on models, or
- have to be solved via databases.

Thus, in addition to the option of running C/C++ code in the standard STEP 7 program, the CPU 1518-4 PN/DP MFP multi-functional platform provides an additional second independent runtime environment in order to execute C/C++ applications in parallel to the STEP 7 program if required. Control-independent applications, e.g. protocol converters, database applications and others, can be created in C/C++. This simplifies the creation or reuse of customer-specific, high-level language applications. The CPU 1518-4 PN/DP MFP has the quantity structure and functionality of a CPU 1518-4 PN/DP with regard to the control unit. In addition to the user program created with STEP 7 in the TIA Portal, C/C++ functions formulated via the SIMATIC ODK 1500S can be integrated into the standard user program. By using SIMATIC ODK 1500S (ODK - Open Development Kit), higher-level programming language mechanisms, such as object orientation, can also be utilized. Furthermore, with the SIMATIC Target 1500S™ engineering package for Simulink®, it is also possible to integrate complex Simulink models to take advantage of the model-based development using MATLAB and Simulink®.

Note

SIMATIC Memory Card required for operation of the CPU.

SIMATIC S7-1500 Advanced Controllers

Central processing units

Standard CPUs

Ordering data	Article No.	Ordering data	Article No.
CPU 1511-1 PN 150 KB work memory for program, 1 MB for data, PROFINET IRT interface with 2-port switch; SIMATIC Memory Card required	6ES7511-1AK02-0AB0	PE connection element for 2 000 mm DIN rail 20 units	6ES7590-5AA00-0AA0
CPU 1513-1 PN 300 KB work memory for program, 1.5 MB for data, PROFINET IRT interface with 2-port switch; SIMATIC Memory Card required	6ES7513-1AL02-0AB0	System power supply For supplying the backplane bus of the S7-1500 Controller	
CPU 1515-2 PN 500 KB work memory for program, 3 MB for data, PROFINET IRT interface with 2-port switch, PROFINET RT interface; SIMATIC Memory Card required	6ES7515-2AM02-0AB0	24 V DC input voltage, power 25 W 24/48/60 V DC input voltage, power 60 W 24/48/60 V DC input voltage, power 60 W, buffering functionality	6ES7505-0KA00-0AB0 6ES7505-0RA00-0AB0 6ES7505-0RB00-0AB0
CPU 1516-3 PN/DP 1 MB work memory for program, 5 MB for data, PROFINET IRT interface with 2-port switch, PROFINET RT interface, PROFIBUS interface; SIMATIC Memory Card required	6ES7516-3AN02-0AB0	120/230 V AC input voltage, power 60 W Power plug With coding element for power supply module; spare part, 10 units	6ES7507-0RA00-0AB0 6ES7590-8AA00-0AA0
CPU 1517-3 PN/DP 2 MB work memory for program, 8 MB for data, PROFINET IRT interface with 2-port switch, PROFINET RT interface, PROFIBUS interface; SIMATIC Memory Card required	6ES7517-3AP00-0AB0	Load current supply 24 V DC/3 A 24 V DC/8 A	6EP1332-4BA00 6EP1333-4BA00
CPU 1518-4 PN/DP 4 MB work memory for program, 20 MB for data, PROFINET IRT interface with 2-port switch, PROFINET RT interface, Ethernet interface, PROFIBUS interface; SIMATIC Memory Card required	6ES7518-4AP00-0AB0	Power supply connector Spare part; for connecting the 24 V DC supply voltage <ul style="list-style-type: none"> With push-in terminals 	6ES7193-4JB00-0AA0
CPU 1518-4 PN/DP MFP CPU 1518-4 PN/DP MFP, including C/C++ Runtime and OPC UA Runtime license	6ES7518-4AX00-1AC0	PROFIBUS FastConnect RS485 bus connector with 90° cable outlet With insulation displacement, max. transfer rate 12 Mbps Without programming device interface, grounding via control cabinet contact surface; 1 unit With programming device interface, grounding via control cabinet contact surface; 1 unit	6ES7972-0BA70-0XA0 6ES7972-0BB70-0XA0
Accessories		PROFIBUS FC standard cable GP Standard type with special design for quick mounting, 2-wire, shielded; sold by the meter; max. delivery unit 1 000 m, minimum order quantity 20 m	6XV1830-0EH10
SIMATIC Memory Card		PROFIBUS FC robust cable 2-wire, shielded; sold by the meter; max. delivery unit 1 000 m, minimum order quantity 20 m	6XV1830-0JH10
4 MB	6ES7954-8LC03-0AA0	PROFIBUS FC flexible cable 2-wire, shielded; sold by the meter; max. delivery unit 1 000 m, minimum order quantity 20 m	6XV1831-2K
12 MB	6ES7954-8LE03-0AA0	PROFIBUS FC trailing cable 2-wire, shielded; sold by the meter; max. delivery unit 1 000 m, minimum order quantity 20 m	
24 MB	6ES7954-8LF03-0AA0	Sheath color: Petrol	6XV1830-3EH10
256 MB	6ES7954-8LL03-0AA0	Sheath color: Violet	6XV1831-2L
2 GB, also for CPU 1518-4 PN/DP MFP	6ES7954-8LP03-0AA0	PROFIBUS FC food cable 2-wire, shielded; sold by the meter; max. delivery unit 1 000 m, minimum order quantity 20 m	6XV1830-0GH10
32 GB, also for CPU 1518-4 PN/DP MFP	6ES7954-8LT03-0AA0		
SIMATIC S7-1500 DIN rail			
Fixed lengths, with grounding elements <ul style="list-style-type: none"> 160 mm 245 mm 482 mm 530 mm 830 mm 	6ES7590-1AB60-0AA0 6ES7590-1AC40-0AA0 6ES7590-1AE80-0AA0 6ES7590-1AF30-0AA0 6ES7590-1AJ30-0AA0		
For cutting to length by customer, without drill holes; grounding elements must be ordered separately <ul style="list-style-type: none"> 2 000 mm 	6ES7590-1BC00-0AA0		

Ordering data	Article No.	Article No.
PROFIBUS FC ground cable 2-wire, shielded; sold by the meter; max. delivery unit 1 000 m, minimum order quantity 20 m	6XV1830-3FH10	Display module 70 mm For CPU 1515-2 PN, CPU 1516-3 PN/DP, CPU 1515F-2 PN and CPU 1516F-3 PN/DP; spare part
PROFIBUS FC FRNC cable GP 2-wire, shielded, flame-retardant, with copolymer protective jacket FRNC; sold by the meter; max. delivery unit 1 000 m, minimum order quantity 20 m	6XV1830-0LH10	Display For CPU 1517-3 PN/DP, CPU 1517F-3 PN/DP, CPU 1518-4 PN/DP, CPU 1518F-4 PN/DP, CPU 1518-4 PN/DP MFP and CPU 1518F-4 PN/DP MFP; spare part
PROFIBUS FastConnect stripping tool Pre-adjusted stripping tool for fast stripping of PROFIBUS FastConnect bus cables	6GK1905-6AA00	Cover 35 mm For CPU1511-1 PN, CPU1513-1 PN, CPU1511F-1 PN, CPU1513F-1 PN, CPU 1511C-1 PN and CPU 1512C-1 PN; spare part
IE FC RJ45 plugs RJ45 plug connector for Industrial Ethernet with a rugged metal enclosure and integrated insulation displacement contacts for connecting Industrial Ethernet FC installation cables		Cover 70 mm For CPU 1515-2 PN, CPU 1516-3 PN/DP, CPU 1515F-2 PN and CPU 1516F-3 PN/DP; spare part
IE FC RJ45 plug 180 180° cable outlet 1 unit 10 units 50 units	6GK1901-1BB10-2AA0 6GK1901-1BB10-2AB0 6GK1901-1BB10-2AE0	Front cover for PROFIBUS DP interface For CPU 1517-3 PN/DP, CPU 1518-4 PN/DP, CPU 1518-4 PN/DP ODK and CPU 1518-4 PN/DP MFP; spare part
IE FC TP standard cable GP 2x2 4-wire, shielded TP installation cable for connection to IE FC RJ45 outlet/IE FC RJ45 plug; PROFINET-compatible; with UL approval; sold by the meter; max. delivery unit 1 000 m, minimum order quantity 20 m	6XV1840-2AH10	SIMATIC S7-1500 Starter Kit Consisting of CPU 1511C-1 PN, SIMATIC Memory Card 4 MB, 160 mm DIN rail, front connector, STEP 7 Professional 365-day license, SIMATIC ProDiag 1500, SIMATIC OPC UA S7-1500 Small, PM 1507 24 V/3 A power supply, Ethernet cable, documentation
IE FC TP trailing cable 2 x 2 (type C) 4-wire, shielded TP installation cable for connection to IE FC RJ45 outlet/IE FC RJ45 plug 180/90 for use as trailing cable; PROFINET-compatible; with UL approval; sold by the meter; max. delivery unit 1 000 m, minimum order quantity 20 m	6XV1840-3AH10	STEP 7 Professional V17 Target system: SIMATIC S7-1200, S7-1500, S7-300, S7-400, WinAC Requirement: Windows 10 (64-bit) <ul style="list-style-type: none"> Windows 10 Professional Version 1909, 2004, 20H2 Windows 10 Enterprise Version 1909, 2004, 20H2 Windows 10 IoT Enterprise 2016 LTSC Windows 10 IoT Enterprise 2019 LTSC Windows Server (64-bit) <ul style="list-style-type: none"> Windows Server 2016 Standard (full installation) Windows Server 2019 Standard (full installation) Type of delivery: 9 languages: de, en, zh included, fr, es, it, ru, jp, kr as download
IE FC TP marine cable 2 x 2 (type B) 4-wire, shielded TP installation cable for connection to IE FC RJ45 outlet/IE FC RJ45 plug 180/90 with marine approval; sold by the meter; max. delivery unit 1 000 m, minimum order quantity 20 m	6XV1840-4AH10	STEP 7 Professional V17, floating license 6ES7822-1AA07-0YA5 STEP 7 Professional V17, floating license, software download including license key ¹⁾ 6ES7822-1AE07-0YA5 Email address required for delivery
IE FC stripping tool Pre-adjusted stripping tool for fast stripping of Industrial Ethernet FC cables	6GK1901-1GA00	
Display module 35 mm For CPU1511-1 PN, CPU1513-1 PN, CPU1511F-1 PN, CPU1513F-1 PN, CPU 1511C-1 PN and CPU 1512C-1 PN; spare part	6ES7591-1AB00-0AA0	

¹⁾ For up-to-date information and download availability, see: <http://www.siemens.com/tia-online-software-delivery>

SIMATIC S7-1500 Advanced Controllers

Central processing units

Standard CPUs

Ordering data

SIMATIC ODK 1500S

Open Development Kit V2.5 for support in developing high-level language applications for SIMATIC S7-1500 Advanced Controllers; supplied on DVD, license key (floating license) on USB flash drive

Open Development Kit V2.5 for support in developing high-level language applications for SIMATIC S7-1500 Advanced Controllers; software download including license key (floating license) ¹⁾

Email address required for delivery

Article No.

6ES7806-2CD03-0YA0

6ES7806-2CD03-0YG0

Article No.

SIMATIC Target for Simulink V5.0

Download incl. license key ¹⁾

Email address required for delivery

Upgrade of SIMATIC Target 1500S for Simulink V2.0...V4.0 to V5.0, download incl. license key ¹⁾

Email address required for delivery

SIMATIC Target + ODK 1500S bundle

Download incl. license key ¹⁾

Email address required for delivery

SIMATIC Manual Collection

Electronic manuals on DVD, multi-language: LOGO!, SIMADYN, SIMATIC Bus Components, SIMATIC C7, SIMATIC Distributed I/O, SIMATIC HMI, SIMATIC Sensors, SIMATIC NET, SIMATIC PC-based Automation, SIMATIC PCS 7, SIMATIC PG/PC, SIMATIC S7, SIMATIC Software, SIMATIC TDC

SIMATIC Manual Collection update service for 1 year

Current Manual Collection DVD and the three subsequent updates

¹⁾ For up-to-date information and download availability, see: <http://www.siemens.com/tia-online-software-delivery>

Technical specifications

Article number	6ES7511-1AK02-0AB0	6ES7513-1AL02-0AB0	6ES7515-2AM02-0AB0	6ES7516-3AN02-0AB0
	CPU 1511-1 PN, 150KB Program, 1MB Data	CPU 1513-1 PN, 300KB Prog., 1.5MB Data	CPU 1515-2 PN, 500KB Prog., 3MB Data	CPU 1516-3 PN/DP, 1MB Prog., 5MB Data
General information				
Product type designation	CPU 1511-1 PN	CPU 1513-1 PN	CPU 1515-2 PN	CPU 1516-3 PN/DP
Engineering with				
• STEP 7 TIA Portal configurable/integrated from version	V17 (FW V2.9) / V15 (FW V2.5) or higher; with older TIA Portal versions configurable as 6ES7511-1AK01-0AB0	V17 (FW V2.9) / V15 (FW V2.5) or higher; with older TIA Portal versions configurable as 6ES7513-1AL01-0AB0	V17 (FW V2.9) / V16 (FW V2.8) or higher; with older TIA Portal versions configurable as 6ES7515-2AM01-0AB0	V17 (FW V2.9) / V16 (FW V2.8) or higher; with older TIA Portal versions configurable as 6ES7516-3AN01-0AB0
Display				
Screen diagonal [cm]	3.45 cm	3.45 cm	6.1 cm	6.1 cm
Supply voltage				
Rated value (DC)	24 V	24 V	24 V	24 V
Memory				
Work memory				
• integrated (for program)	150 kbyte	300 kbyte	500 kbyte	1 Mbyte
• integrated (for data)	1 Mbyte	1.5 Mbyte	3 Mbyte	5 Mbyte
Load memory				
• Plug-in (SIMATIC Memory Card), max.	32 Gbyte	32 Gbyte	32 Gbyte	32 Gbyte
CPU processing times				
for bit operations, typ.	60 ns	40 ns	30 ns	10 ns
for word operations, typ.	72 ns	48 ns	36 ns	12 ns
for fixed point arithmetic, typ.	96 ns	64 ns	48 ns	16 ns
for floating point arithmetic, typ.	384 ns	256 ns	192 ns	64 ns

Technical specifications

Article number	6ES7511-1AK02-0AB0 CPU 1511-1 PN, 150KB Program, 1MB Data	6ES7513-1AL02-0AB0 CPU 1513-1 PN, 300KB Prog., 1,5MB Data	6ES7515-2AM02-0AB0 CPU 1515-2 PN, 500KB Prog., 3MB Data	6ES7516-3AN02-0AB0 CPU 1516-3 PN/DP, 1MB Prog., 5MB Data
Counters, timers and their retentivity				
S7 counter				
• Number	2 048	2 048	2 048	2 048
IEC counter				
• Number	Any (only limited by the main memory)	Any (only limited by the main memory)	Any (only limited by the main memory)	Any (only limited by the main memory)
S7 times				
• Number	2 048	2 048	2 048	2 048
IEC timer				
• Number	Any (only limited by the main memory)	Any (only limited by the main memory)	Any (only limited by the main memory)	Any (only limited by the main memory)
Data areas and their retentivity				
Flag				
• Size, max.	16 kbyte	16 kbyte	16 kbyte	16 kbyte
Address area				
I/O address area				
• Inputs	32 kbyte; All inputs are in the process image	32 kbyte; All inputs are in the process image	32 kbyte; All inputs are in the process image	32 kbyte; All inputs are in the process image
• Outputs	32 kbyte; All outputs are in the process image	32 kbyte; All outputs are in the process image	32 kbyte; All outputs are in the process image	32 kbyte; All outputs are in the process image
Time of day				
Clock				
• Type	Hardware clock	Hardware clock	Hardware clock	Hardware clock
1. Interface				
Interface types				
• RJ 45 (Ethernet)	Yes; X1	Yes; X1	Yes; X1	Yes; X1
• Number of ports	2	2	2	2
• integrated switch	Yes	Yes	Yes	Yes
Protocols				
• IP protocol	Yes; IPv4	Yes; IPv4	Yes; IPv4	Yes; IPv4
• PROFINET IO Controller	Yes	Yes	Yes	Yes
• PROFINET IO Device	Yes	Yes	Yes	Yes
• SIMATIC communication	Yes	Yes	Yes	Yes
• Open IE communication	Yes; Optionally also encrypted	Yes; Optionally also encrypted	Yes; Optionally also encrypted	Yes; Optionally also encrypted
• Web server	Yes	Yes	Yes	Yes
• Media redundancy	Yes	Yes	Yes	Yes

SIMATIC S7-1500 Advanced Controllers

Central processing units

Standard CPUs

Technical specifications

Article number	6ES7511-1AK02-0AB0 CPU 1511-1 PN, 150KB Program, 1MB Data	6ES7513-1AL02-0AB0 CPU 1513-1 PN, 300KB Prog., 1,5MB Data	6ES7515-2AM02-0AB0 CPU 1515-2 PN, 500KB Prog., 3MB Data	6ES7516-3AN02-0AB0 CPU 1516-3 PN/DP, 1MB Prog., 5MB Data
PROFINET IO Controller				
Services				
- PG/OP communication	Yes	Yes	Yes	Yes
- Isochronous mode	Yes	Yes	Yes	Yes
- Direct data exchange	Yes; Requirement: IRT and isochronous mode (MRPD optional)	Yes; Requirement: IRT and isochronous mode (MRPD optional)	Yes; Requirement: IRT and isochronous mode (MRPD optional)	Yes; Requirement: IRT and isochronous mode (MRPD optional)
- IRT	Yes	Yes	Yes	Yes
- PROFinergy	Yes; per user program	Yes; per user program	Yes; per user program	Yes; per user program
- Prioritized startup	Yes; Max. 32 PROFINET devices	Yes; Max. 32 PROFINET devices	Yes; Max. 32 PROFINET devices	Yes; Max. 32 PROFINET devices
- Number of connectable IO Devices, max.	128; In total, up to 256 distributed I/O devices can be connected via AS-i, PROFIBUS or PROFINET	128; In total, up to 512 distributed I/O devices can be connected via AS-i, PROFIBUS or PROFINET	256; In total, up to 1 000 distributed I/O devices can be connected via AS-i, PROFIBUS or PROFINET	256; In total, up to 1 000 distributed I/O devices can be connected via AS-i, PROFIBUS or PROFINET
- Of which IO devices with IRT, max.	64	64	64	64
- Number of connectable IO Devices for RT, max.	128	128	256	256
- of which in line, max.	128	128	256	256
- Number of IO Devices that can be simultaneously activated/ deactivated, max.	8; in total across all interfaces	8; in total across all interfaces	8; in total across all interfaces	8; in total across all interfaces
- Number of IO Devices per tool, max.	8	8	8	8
- Updating times	The minimum value of the update time also depends on communication share set for PROFINET IO, on the number of IO devices, and on the quantity of configured user data	The minimum value of the update time also depends on communication share set for PROFINET IO, on the number of IO devices, and on the quantity of configured user data	The minimum value of the update time also depends on communication share set for PROFINET IO, on the number of IO devices, and on the quantity of configured user data	The minimum value of the update time also depends on communication share set for PROFINET IO, on the number of IO devices, and on the quantity of configured user data
PROFINET IO Device				
Services				
- PG/OP communication	Yes	Yes	Yes	Yes
- Isochronous mode	No	No	No	No
- IRT	Yes	Yes	Yes	Yes
- PROFinergy	Yes; per user program	Yes; per user program	Yes; per user program	Yes; per user program
- Shared device	Yes	Yes	Yes	Yes
- Number of IO Controllers with shared device, max.	4	4	4	4
- activation/deactivation of I-devices	Yes; per user program	Yes; per user program	Yes; per user program	Yes; per user program
- Asset management record	Yes; per user program	Yes; per user program	Yes; per user program	Yes; per user program
2. Interface				
Interface types				
• RJ 45 (Ethernet)			Yes; X2	Yes; X2
• Number of ports			1	1
• integrated switch			No	No
Protocols				
• IP protocol			Yes; IPv4	Yes; IPv4
• PROFINET IO Controller			Yes	Yes
• PROFINET IO Device			Yes	Yes
• SIMATIC communication			Yes	Yes
• Open IE communication			Yes; Optionally also encrypted	Yes; Optionally also encrypted
• Web server			Yes	Yes
• Media redundancy			No	No

SIMATIC S7-1500 Advanced Controllers

Central processing units

Standard CPUs

Technical specifications

Article number	6ES7511-1AK02-0AB0	6ES7513-1AL02-0AB0	6ES7515-2AM02-0AB0	6ES7516-3AN02-0AB0
	CPU 1511-1 PN, 150KB Program, 1MB Data	CPU 1513-1 PN, 300KB Prog., 1,5MB Data	CPU 1515-2 PN, 500KB Prog., 3MB Data	CPU 1516-3 PN/DP, 1MB Prog., 5MB Data
PROFINET IO Controller				
Services				
- PG/OP communication			Yes	Yes
- Isochronous mode			No	No
- Direct data exchange			No	No
- IRT			No	No
- PROFlenergy			Yes; per user program	Yes; per user program
- Prioritized startup			No	No
- Number of connectable IO Devices, max.			32; In total, up to 1 000 distributed I/O devices can be connected via AS-i, PROFIBUS or PROFINET	32; In total, up to 1 000 distributed I/O devices can be connected via AS-i, PROFIBUS or PROFINET
- Number of connectable IO Devices for RT, max.			32	32
- of which in line, max.			32	32
- Number of IO Devices that can be simultaneously activated/deactivated, max.			8; in total across all interfaces	8; in total across all interfaces
- Number of IO Devices per tool, max.			8	8
- Updating times			The minimum value of the update time also depends on communication share set for PROFINET IO, on the number of IO devices, and on the quantity of configured user data	The minimum value of the update time also depends on communication share set for PROFINET IO, on the number of IO devices, and on the quantity of configured user data
PROFINET IO Device				
Services				
- PG/OP communication			Yes	Yes
- Isochronous mode			No	No
- IRT			No	No
- PROFlenergy			Yes; per user program	Yes; per user program
- Prioritized startup			No	No
- Shared device			Yes	Yes
- Number of IO Controllers with shared device, max.			4	4
- activation/deactivation of I-devices			Yes; per user program	Yes; per user program
- Asset management record			Yes; per user program	Yes; per user program
3. Interface				
Interface types				
• RS 485				Yes; X3
• Number of ports				1
Protocols				
• PROFIBUS DP master				Yes
• PROFIBUS DP slave				No
• SIMATIC communication				Yes
PROFIBUS DP master				
• Number of DP slaves, max.				125; In total, up to 1 000 distributed I/O devices can be connected via AS-i, PROFIBUS or PROFINET

SIMATIC S7-1500 Advanced Controllers

Central processing units

Standard CPUs

Technical specifications

Article number	6ES7511-1AK02-0AB0 CPU 1511-1 PN, 150KB Program, 1MB Data	6ES7513-1AL02-0AB0 CPU 1513-1 PN, 300KB Prog., 1,5MB Data	6ES7515-2AM02-0AB0 CPU 1515-2 PN, 500KB Prog., 3MB Data	6ES7516-3AN02-0AB0 CPU 1516-3 PN/DP, 1MB Prog., 5MB Data
Protocols				
Number of connections				
• Number of connections, max.	96; via integrated interfaces of the CPU and connected CPs / CMs	128; via integrated interfaces of the CPU and connected CPs / CMs	192; via integrated interfaces of the CPU and connected CPs / CMs	256; via integrated interfaces of the CPU and connected CPs / CMs
Redundancy mode				
Media redundancy				
- Media redundancy	only via 1st interface (X1)	only via 1st interface (X1)	only via 1st interface (X1)	only via 1st interface (X1)
- MRP	Yes; MRP Automanager according to IEC 62439-2 Edition 2.0, MRP Manager; MRP Client	Yes; MRP Automanager according to IEC 62439-2 Edition 2.0, MRP Manager; MRP Client	Yes; MRP Automanager according to IEC 62439-2 Edition 2.0, MRP Manager; MRP Client	Yes; MRP Automanager according to IEC 62439-2 Edition 2.0, MRP Manager; MRP Client
- MRP interconnection, supported	Yes; as MRP ring node according to IEC 62439-2 Edition 3.0	Yes; as MRP ring node according to IEC 62439-2 Edition 3.0	Yes; as MRP ring node according to IEC 62439-2 Edition 3.0	Yes; as MRP ring node according to IEC 62439-2 Edition 3.0
- MRPD	Yes; Requirement: IRT	Yes; Requirement: IRT	Yes; Requirement: IRT	Yes; Requirement: IRT
- Switchover time on line break, typ.	200 ms; For MRP, bumpless for MRPD	200 ms; For MRP, bumpless for MRPD	200 ms; For MRP, bumpless for MRPD	200 ms; For MRP, bumpless for MRPD
- Number of stations in the ring, max.	50	50	50	50
SIMATIC communication				
• S7 routing	Yes	Yes	Yes	Yes
OPC UA				
• OPC UA Client	Yes	Yes	Yes	Yes
• OPC UA Server	Yes; Data access (read, write, subscribe), method call, custom address space	Yes; Data access (read, write, subscribe), method call, custom address space	Yes; Data access (read, write, subscribe), method call, custom address space	Yes; Data access (read, write, subscribe), method call, custom address space
• Alarms and Conditions	Yes	Yes	Yes	Yes
Supported technology objects				
Motion Control	Yes; Note: The number of technology objects affects the cycle time of the PLC program; selection guide via the TIA Selection Tool	Yes; Note: The number of technology objects affects the cycle time of the PLC program; selection guide via the TIA Selection Tool	Yes; Note: The number of technology objects affects the cycle time of the PLC program; selection guide via the TIA Selection Tool	Yes; Note: The number of technology objects affects the cycle time of the PLC program; selection guide via the TIA Selection Tool
• Number of available Motion Control resources for technology objects	800	800	2 400	2 400
• Required Motion Control resources				
- per speed-controlled axis	40	40	40	40
- per positioning axis	80	80	80	80
- per synchronous axis	160	160	160	160
- per external encoder	80	80	80	80
- per output cam	20	20	20	20
- per cam track	160	160	160	160
- per probe	40	40	40	40
Controller				
• PID_Compact	Yes; Universal PID controller with integrated optimization	Yes; Universal PID controller with integrated optimization	Yes; Universal PID controller with integrated optimization	Yes; Universal PID controller with integrated optimization
• PID_3Step	Yes; PID controller with integrated optimization for valves	Yes; PID controller with integrated optimization for valves	Yes; PID controller with integrated optimization for valves	Yes; PID controller with integrated optimization for valves
• PID-Temp	Yes; PID controller with integrated optimization for temperature	Yes; PID controller with integrated optimization for temperature	Yes; PID controller with integrated optimization for temperature	Yes; PID controller with integrated optimization for temperature
Counting and measuring				
• High-speed counter	Yes	Yes	Yes	Yes

Technical specifications

Article number	6ES7511-1AK02-0AB0 CPU 1511-1 PN, 150KB Program, 1MB Data	6ES7513-1AL02-0AB0 CPU 1513-1 PN, 300KB Prog., 1,5MB Data	6ES7515-2AM02-0AB0 CPU 1515-2 PN, 500KB Prog., 3MB Data	6ES7516-3AN02-0AB0 CPU 1516-3 PN/DP, 1MB Prog., 5MB Data
Ambient conditions				
Ambient temperature during operation				
• horizontal installation, min.	-25 °C; No condensation	-25 °C; No condensation	-25 °C; No condensation	-25 °C; No condensation
• horizontal installation, max.	60 °C; Display: 50 °C, at an operating temperature of typically 50 °C, the display is switched off	60 °C; Display: 50 °C, at an operating temperature of typically 50 °C, the display is switched off	60 °C; Display: 50 °C, at an operating temperature of typically 50 °C, the display is switched off	60 °C; Display: 50 °C, at an operating temperature of typically 50 °C, the display is switched off
• vertical installation, min.	-25 °C; No condensation	-25 °C; No condensation	-25 °C; No condensation	-25 °C; No condensation
• vertical installation, max.	40 °C; Display: 40 °C, at an operating temperature of typically 40 °C, the display is switched off	40 °C; Display: 40 °C, at an operating temperature of typically 40 °C, the display is switched off	40 °C; Display: 40 °C, at an operating temperature of typically 40 °C, the display is switched off	40 °C; Display: 40 °C, at an operating temperature of typically 40 °C, the display is switched off
Altitude during operation relating to sea level				
• Installation altitude above sea level, max.	5 000 m; Restrictions for installation altitudes > 2 000 m, see manual	5 000 m; Restrictions for installation altitudes > 2 000 m, see manual	5 000 m; Restrictions for installation altitudes > 2 000 m, see manual	5 000 m; Restrictions for installation altitudes > 2 000 m, see manual
Configuration				
Programming				
Programming language				
- LAD	Yes	Yes	Yes	Yes
- FBD	Yes	Yes	Yes	Yes
- STL	Yes	Yes	Yes	Yes
- SCL	Yes	Yes	Yes	Yes
- GRAPH	Yes	Yes	Yes	Yes
Know-how protection				
• User program protection/password protection	Yes	Yes	Yes	Yes
• Copy protection	Yes	Yes	Yes	Yes
• Block protection	Yes	Yes	Yes	Yes
Access protection				
• protection of confidential configuration data	Yes	Yes	Yes	Yes
• Password for display	Yes	Yes	Yes	Yes
• Protection level: Write protection	Yes	Yes	Yes	Yes
• Protection level: Read/write protection	Yes	Yes	Yes	Yes
• Protection level: Complete protection	Yes	Yes	Yes	Yes
Dimensions				
Width	35 mm	35 mm	70 mm	70 mm
Height	147 mm	147 mm	147 mm	147 mm
Depth	129 mm	129 mm	129 mm	129 mm
Weights				
Weight, approx.	405 g	405 g	830 g	845 g
Article number	6ES7517-3AP00-0AB0 CPU 1517-3 PN/DP, 2MB Prog./8MB Data	6ES7518-4AP00-0AB0 CPU 1518-4 PN/DP, 6 MB Prog., 60MB Data	6ES7518-4AX00-1AC0 CPU 1518-4 PN/DP MFP + C/C++ RT + OPC UA	
General information				
Product type designation	CPU 1517-3 PN/DP	CPU 1518-4 PN/DP	CPU 1518-4 PN/DP MFP	
Engineering with				
• STEP 7 TIA Portal configurable/integrated from version	V17 (FW V2.9) / V13 Update 3 (FW V1.6) or higher	V17 (FW V2.9) / V13 (FW V1.5) or higher	V17 (FW V2.9) / V15 (FW V2.5) or higher	
Display				
Screen diagonal [cm]	6.1 cm	6.1 cm	6.1 cm	
Supply voltage				
Rated value (DC)	24 V	24 V	24 V	

SIMATIC S7-1500 Advanced Controllers

Central processing units

Standard CPUs

Technical specifications

Article number	6ES7517-3AP00-0AB0 CPU 1517-3 PN/DP, 2MB Prog./8MB Data	6ES7518-4AP00-0AB0 CPU 1518-4 PN/DP, 6 MB Prog., 60MB Data	6ES7518-4AX00-1AC0 CPU 1518-4 PN/DP MFP + C/C++ RT + OPC UA
Memory			
Work memory			
<ul style="list-style-type: none"> integrated (for program) integrated (for data) integrated (for CPU function library of CPU Runtime) 	2 Mbyte 8 Mbyte	6 Mbyte 60 Mbyte	6 Mbyte 60 Mbyte 50 Mbyte; Note: The "CPU function library of the CPU" are C/C++ blocks for the user program that were created using the SIMATIC ODK 1500S or Target 1500S.
Working memory for additional functions			
<ul style="list-style-type: none"> Integrated (for C/C++ Runtime application) available (for Linux runtime application) 			1 024 Mbyte 1 Gbyte
Load memory			
<ul style="list-style-type: none"> Plug-in (SIMATIC Memory Card), max. 	32 Gbyte	32 Gbyte	32 Gbyte; the memory card must have at least 2 GB of space on it
CPU processing times			
for bit operations, typ.	2 ns	1 ns	1 ns
for word operations, typ.	3 ns	2 ns	2 ns
for fixed point arithmetic, typ.	3 ns	2 ns	2 ns
for floating point arithmetic, typ.	12 ns	6 ns	6 ns
Counters, timers and their retentivity			
S7 counter			
<ul style="list-style-type: none"> Number 	2 048	2 048	2 048
IEC counter			
<ul style="list-style-type: none"> Number 	Any (only limited by the main memory)	Any (only limited by the main memory)	Any (only limited by the main memory)
S7 times			
<ul style="list-style-type: none"> Number 	2 048	2 048	2 048
IEC timer			
<ul style="list-style-type: none"> Number 	Any (only limited by the main memory)	Any (only limited by the main memory)	Any (only limited by the main memory)
Data areas and their retentivity			
Flag			
<ul style="list-style-type: none"> Size, max. 	16 kbyte	16 kbyte	16 kbyte
Address area			
I/O address area			
<ul style="list-style-type: none"> Inputs Outputs 	32 kbyte; All inputs are in the process image 32 kbyte; All outputs are in the process image	32 kbyte; All inputs are in the process image 32 kbyte; All outputs are in the process image	32 kbyte; All inputs are in the process image 32 kbyte; All outputs are in the process image
Time of day			
Clock			
<ul style="list-style-type: none"> Type 	Hardware clock	Hardware clock	Hardware clock
1. Interface			
Interface types			
<ul style="list-style-type: none"> RJ 45 (Ethernet) Number of ports integrated switch 	Yes; X1 2 Yes	Yes; X1 2 Yes	Yes; X1 2 Yes
Protocols			
<ul style="list-style-type: none"> IP protocol PROFINET IO Controller PROFINET IO Device SIMATIC communication Open IE communication Web server Media redundancy 	Yes; IPv4 Yes Yes Yes Yes; Optionally also encrypted Yes Yes	Yes; IPv4 Yes Yes Yes Yes; Optionally also encrypted Yes Yes	Yes; IPv4 Yes Yes Yes Yes; Optionally also encrypted Yes Yes

Technical specifications

Article number	6ES7517-3AP00-0AB0	6ES7518-4AP00-0AB0	6ES7518-4AX00-1AC0
	CPU 1517-3 PN/DP, 2MB Prog./8MB Data	CPU 1518-4 PN/DP, 6 MB Prog., 60MB Data	CPU 1518-4 PN/DP MFP + C/C++ RT + OPC UA
PROFINET IO Controller			
Services			
- PG/OP communication	Yes	Yes	Yes
- Isochronous mode	Yes	Yes	Yes
- Direct data exchange	Yes; Requirement: IRT and isochronous mode (MRPD optional)	Yes; Requirement: IRT and isochronous mode (MRPD optional)	Yes; Requirement: IRT and isochronous mode (MRPD optional)
- IRT	Yes	Yes	Yes
- PROFlenergy	Yes; per user program	Yes; per user program	Yes; per user program
- Prioritized startup	Yes; Max. 32 PROFINET devices	Yes; Max. 32 PROFINET devices	Yes; Max. 32 PROFINET devices
- Number of connectable IO Devices, max.	512; In total, up to 1 000 distributed I/O devices can be connected via AS-i, PROFIBUS or PROFINET	512; In total, up to 1 000 distributed I/O devices can be connected via AS-i, PROFIBUS or PROFINET	512; In total, up to 1 000 distributed I/O devices can be connected via AS-i, PROFIBUS or PROFINET
- Of which IO devices with IRT, max.	64	64	64
- Number of connectable IO Devices for RT, max.	512	512	512
- of which in line, max.	512	512	512
- Number of IO Devices that can be simultaneously activated/deactivated, max.	8; in total across all interfaces	8; in total across all interfaces	8; in total across all interfaces
- Number of IO Devices per tool, max.	8	8	8
- Updating times	The minimum value of the update time also depends on communication share set for PROFINET IO, on the number of IO devices, and on the quantity of configured user data	The minimum value of the update time also depends on communication share set for PROFINET IO, on the number of IO devices, and on the quantity of configured user data	The minimum value of the update time also depends on communication share set for PROFINET IO, on the number of IO devices, and on the quantity of configured user data
PROFINET IO Device			
Services			
- PG/OP communication	Yes	Yes	Yes
- Isochronous mode	No	No	No
- IRT	Yes	Yes; Minimum send cycle of 250 µs	Yes; Minimum send cycle of 250 µs
- PROFlenergy	Yes; per user program	Yes; per user program	Yes; per user program
- Shared device	Yes	Yes	Yes
- Number of IO Controllers with shared device, max.	4	4	4
- activation/deactivation of I-devices	Yes; per user program	Yes; per user program	Yes; per user program
- Asset management record	Yes; per user program	Yes; per user program	Yes; per user program
2. Interface			
Interface types			
• RJ 45 (Ethernet)	Yes; X2	Yes; X2	Yes; X2
• Number of ports	1	1	1
• integrated switch	No	No	No
Protocols			
• IP protocol	Yes; IPv4	Yes; IPv4	Yes; IPv4
• PROFINET IO Controller	Yes	Yes	Yes
• PROFINET IO Device	Yes	Yes	Yes
• SIMATIC communication	Yes	Yes	Yes
• Open IE communication	Yes; Optionally also encrypted	Yes; Optionally also encrypted	Yes; Optionally also encrypted
• Web server	Yes	Yes	Yes
• Media redundancy	No	No	No

SIMATIC S7-1500 Advanced Controllers

Central processing units

Standard CPUs

Technical specifications

Article number	6ES7517-3AP00-0AB0	6ES7518-4AP00-0AB0	6ES7518-4AX00-1AC0
	CPU 1517-3 PN/DP, 2MB Prog./8MB Data	CPU 1518-4 PN/DP, 6 MB Prog., 60MB Data	CPU 1518-4 PN/DP MFP + C/C++ RT + OPC UA
PROFINET IO Controller			
Services			
- PG/OP communication	Yes	Yes	Yes
- Isochronous mode	No	No	No
- Direct data exchange	No	No	No
- IRT	No	No	No
- PROFlenergy	Yes; per user program	Yes; per user program	Yes; per user program
- Prioritized startup	No	No	No
- Number of connectable IO Devices, max.	128; In total, up to 1 000 distributed I/O devices can be connected via AS-i, PROFIBUS or PROFINET	128; In total, up to 1 000 distributed I/O devices can be connected via AS-i, PROFIBUS or PROFINET	128; In total, up to 1 000 distributed I/O devices can be connected via AS-i, PROFIBUS or PROFINET
- Number of connectable IO Devices for RT, max.	128	128	128
- of which in line, max.	128	128	128
- Number of IO Devices that can be simultaneously activated/deactivated, max.	8; in total across all interfaces	8; in total across all interfaces	8; in total across all interfaces
- Number of IO Devices per tool, max.	8	8	8
- Updating times	The minimum value of the update time also depends on communication share set for PROFINET IO, on the number of IO devices, and on the quantity of configured user data	The minimum value of the update time also depends on communication share set for PROFINET IO, on the number of IO devices, and on the quantity of configured user data	The minimum value of the update time also depends on communication share set for PROFINET IO, on the number of IO devices, and on the quantity of configured user data
PROFINET IO Device			
Services			
- PG/OP communication	Yes	Yes	Yes
- Isochronous mode	No	No	No
- IRT	No	No	No
- PROFlenergy	Yes; per user program	Yes; per user program	Yes; per user program
- Prioritized startup	No	No	No
- Shared device	Yes	Yes	Yes
- Number of IO Controllers with shared device, max.	4	4	4
- activation/deactivation of I-devices	Yes; per user program	Yes; per user program	Yes; per user program
- Asset management record	Yes; per user program	Yes; per user program	Yes; per user program
3. Interface			
Interface types			
• RJ 45 (Ethernet)	Yes; X3	Yes; X3	Yes; X3
• RS 485			
• Number of ports	1	1	1; C/C++ Runtime can also be reached via this port
• integrated switch		No	No
Protocols			
• IP protocol		Yes; IPv4	Yes; IPv4
• PROFINET IO Controller		No	No
• PROFINET IO Device		No	No
• PROFIBUS DP master	Yes		
• PROFIBUS DP slave	No		
• SIMATIC communication	Yes	Yes	Yes
• Open IE communication		Yes	Yes
• Web server		Yes	Yes
PROFIBUS DP master			
• Number of DP slaves, max.	125; In total, up to 1 000 distributed I/O devices can be connected via AS-i, PROFIBUS or PROFINET		

SIMATIC S7-1500 Advanced Controllers

Central processing units

Standard CPUs

4

Technical specifications

Article number	6ES7517-3AP00-0AB0	6ES7518-4AP00-0AB0	6ES7518-4AX00-1AC0
	CPU 1517-3 PN/DP, 2MB Prog./8MB Data	CPU 1518-4 PN/DP, 6 MB Prog., 60MB Data	CPU 1518-4 PN/DP MFP + C/C++ RT + OPC UA
4. Interface			
Interface types			
<ul style="list-style-type: none"> RS 485 Number of ports 		Yes; X4 1	Yes; X4 1
Protocols			
<ul style="list-style-type: none"> PROFIBUS DP master PROFIBUS DP slave SIMATIC communication 		Yes No Yes	Yes No Yes
PROFIBUS DP master			
<ul style="list-style-type: none"> Number of DP slaves, max. 		125; In total, up to 1 000 distributed I/O devices can be connected via AS-i, PROFIBUS or PROFINET	125; In total, up to 1 000 distributed I/O devices can be connected via AS-i, PROFIBUS or PROFINET
Protocols			
Number of connections			
<ul style="list-style-type: none"> Number of connections, max. 	320; via integrated interfaces of the CPU and connected CPs / CMs	384; via integrated interfaces of the CPU and connected CPs / CMs	384; via integrated interfaces of the CPU and connected CPs / CMs
Redundancy mode			
Media redundancy			
<ul style="list-style-type: none"> Media redundancy MRP MRP interconnection, supported MRPD Switchover time on line break, typ. Number of stations in the ring, max. 	only via 1st interface (X1) Yes; MRP Automanager according to IEC 62439-2 Edition 2.0, MRP Manager; MRP Client Yes; as MRP ring node according to IEC 62439-2 Edition 3.0 Yes; Requirement: IRT 200 ms; For MRP, bumpless for MRPD 50	only via 1st interface (X1) Yes; MRP Automanager according to IEC 62439-2 Edition 2.0, MRP Manager; MRP Client Yes; as MRP ring node according to IEC 62439-2 Edition 3.0 Yes; Requirement: IRT 200 ms; For MRP, bumpless for MRPD 50	only via 1st interface (X1) Yes; MRP Automanager according to IEC 62439-2 Edition 2.0, MRP Manager; MRP Client Yes; as MRP ring node according to IEC 62439-2 Edition 3.0 Yes; Requirement: IRT 200 ms; For MRP, bumpless for MRPD 50
SIMATIC communication			
<ul style="list-style-type: none"> S7 routing 	Yes	Yes	Yes
OPC UA			
<ul style="list-style-type: none"> OPC UA Client OPC UA Server Alarms and Conditions 	Yes Yes; Data access (read, write, subscribe), method call, custom address space Yes	Yes Yes; Data access (read, write, subscribe), method call, custom address space Yes	Yes Yes; Data access (read, write, subscribe), method call, custom address space Yes
Supported technology objects			
Motion Control	Yes; Note: The number of technology objects affects the cycle time of the PLC program; selection guide via the TIA Selection Tool	Yes; Note: The number of technology objects affects the cycle time of the PLC program; selection guide via the TIA Selection Tool	Yes; Note: The number of technology objects affects the cycle time of the PLC program; selection guide via the TIA Selection Tool
<ul style="list-style-type: none"> Number of available Motion Control resources for technology objects Required Motion Control resources <ul style="list-style-type: none"> per speed-controlled axis per positioning axis per synchronous axis per external encoder per output cam per cam track per probe 	10 240 40 80 160 80 20 160 40	15 360 40 80 160 80 20 160 40	15 360 40 80 160 80 20 160 40
Controller			
<ul style="list-style-type: none"> PID_Compact PID_3Step PID-Temp 	Yes; Universal PID controller with integrated optimization Yes; PID controller with integrated optimization for valves Yes; PID controller with integrated optimization for temperature	Yes; Universal PID controller with integrated optimization Yes; PID controller with integrated optimization for valves Yes; PID controller with integrated optimization for temperature	Yes; Universal PID controller with integrated optimization Yes; PID controller with integrated optimization for valves Yes; PID controller with integrated optimization for temperature
Counting and measuring			
<ul style="list-style-type: none"> High-speed counter 	Yes	Yes	Yes

SIMATIC S7-1500 Advanced Controllers

Central processing units

Standard CPUs

Technical specifications

Article number	6ES7517-3AP00-0AB0 CPU 1517-3 PN/DP, 2MB Prog./8MB Data	6ES7518-4AP00-0AB0 CPU 1518-4 PN/DP, 6 MB Prog., 60MB Data	6ES7518-4AX00-1AC0 CPU 1518-4 PN/DP MFP + C/C++ RT + OPC UA
Ambient conditions			
Ambient temperature during operation			
• horizontal installation, min.	0 °C	0 °C	0 °C
• horizontal installation, max.	60 °C; Display: 50 °C, at an operating temperature of typically 50 °C, the display is switched off	60 °C; Display: 50 °C, at an operating temperature of typically 50 °C, the display is switched off	60 °C; Display: 50 °C, at an operating temperature of typically 50 °C, the display is switched off
• vertical installation, min.	0 °C	0 °C	0 °C
• vertical installation, max.	40 °C; Display: 40 °C, at an operating temperature of typically 40 °C, the display is switched off	40 °C; Display: 40 °C, at an operating temperature of typically 40 °C, the display is switched off	40 °C; Display: 40 °C, at an operating temperature of typically 40 °C, the display is switched off
Altitude during operation relating to sea level			
• Installation altitude above sea level, max.	5 000 m; Restrictions for installation altitudes > 2 000 m, see manual	5 000 m; Restrictions for installation altitudes > 2 000 m, see manual	5 000 m; Restrictions for installation altitudes > 2 000 m, see manual
Configuration			
Programming			
Programming language			
- LAD	Yes	Yes	Yes
- FBD	Yes	Yes	Yes
- STL	Yes	Yes	Yes
- SCL	Yes	Yes	Yes
- GRAPH	Yes	Yes	Yes
Know-how protection			
• User program protection/password protection	Yes	Yes	Yes
• Copy protection	Yes	Yes	Yes
• Block protection	Yes	Yes	Yes
Access protection			
• protection of confidential configuration data	Yes	Yes	Yes
• Password for display	Yes	Yes	Yes
• Protection level: Write protection	Yes	Yes	Yes
• Protection level: Read/write protection	Yes	Yes	Yes
• Protection level: Complete protection	Yes	Yes	Yes
Open Development interfaces			
• Size of ODK SO file, max.			9.8 Mbyte
Dimensions			
Width	175 mm	175 mm	175 mm
Height	147 mm	147 mm	147 mm
Depth	129 mm	129 mm	129 mm
Weights			
Weight, approx.	1 978 g	1 988 g	2 117 g

Overview SIPLUS CPU 1511-1 PN



- Entry-level CPU in the S7-1500 Controller product range
- Suitable for applications with medium requirements for program scope and processing speed
- Used as central controller in production lines with central and distributed I/O
- PROFINET IO IRT interface with 2-port switch
- PROFINET IO controller for operating distributed I/O on PROFINET
- PROFINET I-Device for connecting the CPU as an intelligent PROFINET device under a SIMATIC or non-Siemens PROFINET IO controller
- OPC UA server and client as runtime option for the easy connection of SIMATIC S7-1500 to non-Siemens devices/ systems with the functions:
 - OPC UA Data Access
 - OPC UA Security
 - OPC UA Methods Call, Support
 - OPC UA Companion Specifications
- Central and distributed isochronous mode
- Integrated Motion Control functionalities for controlling speed-controlled and positioning axes, support for external encoders, output cams/cam tracks and probes
- Integrated web server for diagnostics with the option of creating user-defined web pages
- SIMATIC Memory Card required for operation of the CPU

Note:

SIPLUS extreme products are based on SIMATIC standard products. The contents listed here were taken from the corresponding standard products. SIPLUS extreme-specific information was added.

Overview SIPLUS CPU 1513-1 PN



- The CPU for applications with medium/high requirements for program/data storage in the S7-1500 Controller product range
- High processing speed for binary and floating-point arithmetic
- Used as central controller in production lines with central and distributed I/O
- PROFINET IO IRT interface with 2-port switch
- PROFINET IO controller for operating distributed I/O on PROFINET
- PROFINET I-Device for connecting the CPU as an intelligent PROFINET device under a SIMATIC or non-Siemens PROFINET IO controller
- OPC UA server and client as runtime option for the easy connection of SIPLUS S7-1500 to non-Siemens devices/ systems with the functions:
 - OPC UA Data Access
 - OPC UA Security
 - OPC UA Methods Call, Support
 - OPC UA Companion Specifications
- Central and distributed isochronous mode
- Integrated Motion Control functionalities for controlling speed-controlled and positioning axes, support for external encoders, output cams/cam tracks and probes
- Integrated web server for diagnostics with the option of creating user-defined web pages
- SIMATIC Memory Card required for operation of the CPU

Note:

SIPLUS extreme products are based on SIMATIC standard products. The contents listed here were taken from the corresponding standard products. SIPLUS extreme-specific information was added.

SIMATIC S7-1500 Advanced Controllers

Central processing units

SIPLUS standard CPUs

Overview SIPLUS CPU 1516-3 PN/DP



- The CPU with large program and data memory in the S7-1500 controller product range for applications with high program scope requirements.
- High processing speed for binary and floating-point arithmetic
- Used as central PLC in production lines with central and distributed I/O
- PROFINET IO IRT interface with 2-port switch
- Additional PROFINET interface with separate IP address
- PROFINET IO controller for operating distributed I/O on PROFINET.
- PROFINET I-Device for connecting the CPU as an intelligent PROFINET device under a SIMATIC or non-Siemens PROFINET IO controller.
- PROFIBUS DP master interface
- Isochronous mode on PROFIBUS and PROFINET
- SIMATIC Memory Card required for operation of the CPU

Note:

SIPLUS extreme products are based on SIMATIC standard products. The contents listed here were taken from the respective standard products. SIPLUS extreme-specific information was added.

Overview SIPLUS CPU 1518-4 PN/DP



- The CPU with a very large program and data memory in the S7-1500 controller product range for demanding applications with extremely high requirements regarding program scope, performance and networking
- Extremely high processing speed for binary and floating-point arithmetic
- For cross-industry automation tasks in series machines, special machines and plant construction
- Used as central PLC in production lines with central and distributed I/O
- PROFINET IO IRT interface with 2-port switch
- Two additional PROFINET interfaces with separate IP address
- PROFINET IO controller for operating distributed I/O on PROFINET.
- PROFINET I-Device for connecting the CPU as an intelligent PROFINET device under a SIMATIC or non-Siemens PROFINET IO controller.
- PROFIBUS DP master interface
- Isochronous mode on PROFIBUS and PROFINET
- Integrated motion control functionalities for controlling speed-controlled and positioning axes, support for external encoders
- Integrated web server with the option of creating user-defined web pages

SIMATIC Memory Card required for operation of the CPU

Note:

SIPLUS extreme products are based on SIMATIC standard products. The contents listed here were taken from the respective standard products. SIPLUS extreme-specific information was added.

Overview SIPLUS CPU 1518-4 PN/DP MFP



- CPU with an extremely large program and data memory in the S7-1500 Controller product range for demanding applications with demanding requirements regarding program scope, performance and networking
- Extremely high processing speed for binary and floating-point arithmetic
- For cross-industry automation tasks in series machine, special machine and plant construction
- C/C++ functions can be called and executed in the CPU runtime.
- In parallel to the CPU runtime, there is an additional C/C++ runtime, in which call-independent, i.e. stand-alone, C/C++ applications can be executed.
- Used as central controller in production lines with central and distributed I/O
- PROFINET IO IRT interface with 2-port switch
- PROFINET IO controller for operating distributed I/O on PROFINET
- PROFINET I-Device for connecting the CPU as an intelligent PROFINET device under a SIMATIC or non-Siemens PROFINET IO controller
- Two additional PROFINET interfaces with separate IP addresses for network separation:
The PROFINET interface X2 can be used for connecting additional PROFINET IO RT devices or for fast communication as an I-Device. The PROFINET interface X3 facilitates data transfer at a speed of 1 Gbps.
- PROFIBUS DP master interface
- OPC UA server (Data Access) as runtime option for the easy connection of SIMATIC S7-1500 to third-party devices/systems
- Isochronous mode on PROFIBUS and PROFINET
- Integrated Motion Control functionalities for controlling speed-controlled and positioning axes, support for external encoders, gearing between axes, output cams/cam tracks and probes
- Integrated web server for diagnostics with the option of creating user-defined web pages

Multi-functional platform

With the multi-functional platform (MFP), more functionality can be accommodated in a module. The computing power of the CPU 1518-4 PN/DP MFP allows the merging of previously separate applications on a common platform, and continues to meet the high demands of the S7-1500 in respect of ease of maintenance and ruggedness.

This means that, in addition to the control function, it is also possible to process typical PC applications on the multi-functional platform, e.g. tasks that:

- require high-level language programming,
- are developed based on models, or
- have to be solved via databases.

Thus, in addition to the option of running C/C++ code in the standard STEP 7 program, the CPU 1518-4 PN/DP MFP multi-functional platform provides an additional second independent runtime environment in order to execute C/C++ applications in parallel to the STEP 7 program if required. Control-independent applications, e.g. protocol converters, database applications and others, can be created in C/C++.

This simplifies the creation or reuse of customer-specific, high-level language applications. The CPU 1518-4 PN/DP MFP has the quantity structure and functionality of a CPU 1518-4 PN/DP with regard to the control unit. In addition to the user program created with STEP 7 in the TIA Portal, C/C++ functions formulated via the SIMATIC ODK 1500S can be integrated into the standard user program. By using SIMATIC ODK 1500S (ODK - Open Development Kit), higher-level programming language mechanisms, such as object orientation, can also be utilized. Furthermore, with the SIMATIC Target 1500S™ engineering package for Simulink®, it is also possible to integrate complex Simulink models to take advantage of the model-based development using MATLAB and Simulink®.

Note

SIMATIC Memory Card required for operation of the CPU.

SIPLUS extreme products are based on SIMATIC standard products. The contents listed here were taken from the corresponding standard products. SIPLUS extreme-specific information was added.

SIMATIC S7-1500 Advanced Controllers

Central processing units

SIPLUS standard CPUs

Ordering data

Article No.

Article No.

SIPLUS CPU 1511-1 PN

(extended temperature range and exposure to environmental substances)

150 KB work memory for program, 1 MB for data, PROFINET IRT interface with 2-port switch; SIMATIC Memory Card required

Temperature range -40 ... +60 °C

6AG1511-1AK02-2AB0

Temperature range -40 ... +70 °C

6AG1511-1AK02-7AB0

SIPLUS CPU 1513-1 PN

(extended temperature range and exposure to environmental substances)

300 KB work memory for program, 1.5 MB for data, PROFINET IRT interface with 2-port switch; SIMATIC Memory Card required

Temperature range -40 ... +60 °C

6AG1513-1AL02-2AB0

Temperature range -40 ... +70 °C

6AG1513-1AL02-7AB0

SIPLUS CPU 1516-3 PN/DP

(extended temperature range and exposure to environmental substances)

1 MB work memory for program, 5 MB for data, PROFINET IRT interface with 2-port switch, PROFINET RT interface, PROFIBUS interface; SIMATIC Memory Card required

Temperature range -40 ... +60 °C

6AG1516-3AN02-2AB0

Temperature range -40 ... +70 °C

6AG1516-3AN02-7AB0

SIPLUS CPU 1518-4 PN/DP

6AG1518-4AP00-4AB0

(Exposure to environmental substances)

3 MB work memory for program, 10 MB for data, PROFINET IRT interface with 2-port switch, PROFINET RT interface, Ethernet interface, PROFIBUS interface; SIMATIC Memory Card required

SIPLUS CPU 1518-4 PN/DP MFP

(Exposure to environmental substances)

4 MB work memory for program, 20 MB for data, 50 MB for CPU function library in the CPU Runtime, 500 MB for C/C++ runtime application, PROFINET IRT interface with 2-port switch, PROFINET RT interface, Ethernet interface, PROFIBUS interface; C/C++ runtime and OPC UA runtime license included; SIMATIC Memory Card required

6AG1518-4AX00-4AC0

Accessories

System power supply

(extended temperature range and exposure to environmental substances)

24 V DC input voltage, power 25 W

6AG1505-0KA00-7AB0

24/48/60 V DC input voltage, power 60 W

6AG1505-0RA00-7AB0

120/230 V AC input voltage, power 60 W

6AG1507-0RA00-7AB0

Load current supply

(extended temperature range and exposure to environmental substances)

24 V DC/3 A

6AG1332-4BA00-7AA0

24 V DC/8 A

6AG1333-4BA00-7AA0

Display

(extended temperature range and exposure to environmental substances)

For SIPLUS CPU 1511-1 PN and CPU 1513-1 PN; spare part

6AG1591-1AB00-2AA0

For SIPLUS CPU 1516-3 PN/DP, 6AG1516-3AN01-2AB0; spare part

6AG1591-1BA01-2AA0

For SIPLUS CPU 1516-3 PN/DP, 6AG1516-3AN02-7AB0; spare part

6AG1591-1BB00-2AA0

For SIPLUS CPU 1518-4 PN/DP and SIPLUS CPU 1518-4 PN/DP; spare part

6AG1591-1BA02-2AA0

Other accessories

See SIMATIC S7-1500, standard CPUs, Page 4/10

Technical specifications

Article number	6AG1511-1AK02-2AB0	6AG1511-1AK02-7AB0	6AG1513-1AL02-2AB0	6AG1513-1AL02-7AB0
Based on	6ES7511-1AK02-0AB0	6ES7511-1AK02-0AB0	6ES7513-1AL02-0AB0	6ES7513-1AL02-0AB0
	SIPLUS S7-1500 CPU 1511-1 PN	SIPLUS S7-1500 CPU 1511-1 PN	SIPLUS S7-1500 CPU 1513-1 PN	SIPLUS S7-1500 CPU 1513-1 PN
Ambient conditions				
Ambient temperature during operation				
• horizontal installation, min.	-40 °C; = Tmin (incl. condensation/frost)	-40 °C; = Tmin (incl. condensation/frost)	-40 °C; = Tmin (incl. condensation/frost)	-40 °C; = Tmin (incl. condensation/frost)
• horizontal installation, max.	60 °C; Display: 50 °C, at an operating temperature of typically 50 °C, the display is switched off	70 °C; Display: 50 °C, at an operating temperature of typically 50 °C, the display is switched off	60 °C; Display: 50 °C, at an operating temperature of typically 50 °C, the display is switched off	70 °C; Display: 50 °C, at an operating temperature of typically 50 °C, the display is switched off
• vertical installation, min.	-40 °C; = Tmin (incl. condensation/frost)	-40 °C; = Tmin (incl. condensation/frost)	-40 °C; = Tmin (incl. condensation/frost)	-40 °C; = Tmin (incl. condensation/frost)
• vertical installation, max.	40 °C; Display: 40 °C, at an operating temperature of typically 40 °C, the display is switched off	40 °C; Display: 40 °C, at an operating temperature of typically 40 °C, the display is switched off	40 °C; Display: 40 °C, at an operating temperature of typically 40 °C, the display is switched off	40 °C; Display: 40 °C, at an operating temperature of typically 40 °C, the display is switched off
Altitude during operation relating to sea level				
• Installation altitude above sea level, max.	5 000 m; Restrictions for installation altitudes > 2 000 m, see manual	5 000 m; Restrictions for installation altitudes > 2 000 m, see manual	5 000 m; Restrictions for installation altitudes > 2 000 m, see manual	5 000 m; Restrictions for installation altitudes > 2 000 m, see manual
• Ambient air temperature-barometric pressure-altitude	Restrictions for installation altitudes > 2 000 m, see entry ID: 109763260	Restrictions for installation altitudes > 2 000 m, see entry ID: 109763260	Restrictions for installation altitudes > 2 000 m, see entry ID: 109763260	Restrictions for installation altitudes > 2 000 m, see entry ID: 109763260
Relative humidity				
• With condensation, tested in accordance with IEC 60068-2-38, max.	100 %; RH incl. condensation / frost (no commissioning in bedewed state), horizontal installation	100 %; RH incl. condensation / frost (no commissioning in bedewed state), horizontal installation	100 %; RH incl. condensation / frost (no commissioning in bedewed state), horizontal installation	100 %; RH incl. condensation / frost (no commissioning in bedewed state), horizontal installation
Resistance				
Coolants and lubricants				
- Resistant to commercially available coolants and lubricants	Yes; Incl. diesel and oil droplets in the air	Yes; Incl. diesel and oil droplets in the air	Yes; Incl. diesel and oil droplets in the air	Yes; Incl. diesel and oil droplets in the air
Use in stationary industrial systems				
- to biologically active substances according to EN 60721-3-3	Yes; Class 3B2 mold, fungus and dry rot spores (with the exception of fauna); Class 3B3 on request	Yes; Class 3B2 mold, fungus and dry rot spores (with the exception of fauna); Class 3B3 on request	Yes; Class 3B2 mold, fungus and dry rot spores (with the exception of fauna); Class 3B3 on request	Yes; Class 3B2 mold, fungus and dry rot spores (with the exception of fauna); Class 3B3 on request
- to chemically active substances according to EN 60721-3-3	Yes; Class 3C4 (RH < 75 %) incl. salt spray acc. to EN 60068-2-52 (severity degree 3); *	Yes; Class 3C4 (RH < 75 %) incl. salt spray acc. to EN 60068-2-52 (severity degree 3); *	Yes; Class 3C4 (RH < 75 %) incl. salt spray acc. to EN 60068-2-52 (severity degree 3); *	Yes; Class 3C4 (RH < 75 %) incl. salt spray acc. to EN 60068-2-52 (severity degree 3); *
- to mechanically active substances according to EN 60721-3-3	Yes; Class 3S4 incl. sand, dust; *	Yes; Class 3S4 incl. sand, dust; *	Yes; Class 3S4 incl. sand, dust; *	Yes; Class 3S4 incl. sand, dust; *
Use on ships/at sea				
- to biologically active substances according to EN 60721-3-6	Yes; Class 6B2 mold, fungal and dry rot spores (excluding fauna)	Yes; Class 6B2 mold, fungal and dry rot spores (excluding fauna)	Yes; Class 6B2 mold, fungal and dry rot spores (excluding fauna)	Yes; Class 6B2 mold, fungal and dry rot spores (excluding fauna)
- to chemically active substances according to EN 60721-3-6	Yes; Class 6C3 (RH < 75 %) incl. salt spray acc. to EN 60068-2-52 (severity degree 3); *	Yes; Class 6C3 (RH < 75 %) incl. salt spray acc. to EN 60068-2-52 (severity degree 3); *	Yes; Class 6C3 (RH < 75 %) incl. salt spray acc. to EN 60068-2-52 (severity degree 3); *	Yes; Class 6C3 (RH < 75 %) incl. salt spray acc. to EN 60068-2-52 (severity degree 3); *
- to mechanically active substances according to EN 60721-3-6	Yes; Class 6S3 incl. sand, dust; *	Yes; Class 6S3 incl. sand, dust; *	Yes; Class 6S3 incl. sand, dust; *	Yes; Class 6S3 incl. sand, dust; *

SIMATIC S7-1500 Advanced Controllers

Central processing units

SIPLUS standard CPUs

Technical specifications

Article number	6AG1511-1AK02-2AB0	6AG1511-1AK02-7AB0	6AG1513-1AL02-2AB0	6AG1513-1AL02-7AB0
Based on	6ES7511-1AK02-0AB0 SIPLUS S7-1500 CPU 1511-1 PN	6ES7511-1AK02-0AB0 SIPLUS S7-1500 CPU 1511-1 PN	6ES7513-1AL02-0AB0 SIPLUS S7-1500 CPU 1513-1 PN	6ES7513-1AL02-0AB0 SIPLUS S7-1500 CPU 1513-1 PN
Usage in industrial process technology	<ul style="list-style-type: none"> - Against chemically active substances acc. to EN 60654-4 - Environmental conditions for process, measuring and control systems acc. to ANSI/ISA-71.04 	<ul style="list-style-type: none"> - Against chemically active substances acc. to EN 60654-4 - Environmental conditions for process, measuring and control systems acc. to ANSI/ISA-71.04 	<ul style="list-style-type: none"> - Against chemically active substances acc. to EN 60654-4 - Environmental conditions for process, measuring and control systems acc. to ANSI/ISA-71.04 	<ul style="list-style-type: none"> - Against chemically active substances acc. to EN 60654-4 - Environmental conditions for process, measuring and control systems acc. to ANSI/ISA-71.04
Remark	* The supplied plug covers must remain in place over the unused interfaces during operation!	* The supplied plug covers must remain in place over the unused interfaces during operation!	* The supplied plug covers must remain in place over the unused interfaces during operation!	* The supplied plug covers must remain in place over the unused interfaces during operation!
Conformal coating	<ul style="list-style-type: none"> • Coatings for printed circuit board assemblies acc. to EN 61086 • Protection against fouling acc. to EN 60664-3 • Military testing according to MIL-I-46058C, Amendment 7 • Qualification and Performance of Electrical Insulating Compound for Printed Board Assemblies according to IPC-CC-830A 	<ul style="list-style-type: none"> • Coatings for printed circuit board assemblies acc. to EN 61086 • Protection against fouling acc. to EN 60664-3 • Military testing according to MIL-I-46058C, Amendment 7 • Qualification and Performance of Electrical Insulating Compound for Printed Board Assemblies according to IPC-CC-830A 	<ul style="list-style-type: none"> • Coatings for printed circuit board assemblies acc. to EN 61086 • Protection against fouling acc. to EN 60664-3 • Military testing according to MIL-I-46058C, Amendment 7 • Qualification and Performance of Electrical Insulating Compound for Printed Board Assemblies according to IPC-CC-830A 	<ul style="list-style-type: none"> • Coatings for printed circuit board assemblies acc. to EN 61086 • Protection against fouling acc. to EN 60664-3 • Military testing according to MIL-I-46058C, Amendment 7 • Qualification and Performance of Electrical Insulating Compound for Printed Board Assemblies according to IPC-CC-830A
Article number	6AG1516-3AN02-2AB0	6AG1516-3AN02-7AB0	6AG1518-4AP00-4AB0	6AG1518-4AX00-4AC0
Based on	6ES7516-3AN02-0AB0 SIPLUS S7-1500 CPU 1516-3 PN/DP	6ES7516-3AN02-0AB0 SIPLUS S7-1500 CPU 1516-3 PN/DP	6ES7518-4AP00-0AB0 SIPLUS S7-1500 CPU 1518-4 PN/DP	6ES7518-4AX00-1AC0 SIPLUS S7-1500 CPU 1518-4 PN/DP MFP
Ambient conditions				
Ambient temperature during operation				
• horizontal installation, min.	-40 °C; = Tmin (incl. condensation/frost)	-40 °C; = Tmin (incl. condensation/frost)	0 °C; = Tmin (incl. condensation/frost)	0 °C; = Tmin (incl. condensation/frost)
• horizontal installation, max.	60 °C; = Tmax; display: 50 °C, the display is switched off at an operating temperature of typically 50 °C	70 °C; = Tmax; display: 50 °C, the display is switched off at an operating temperature of typically 50 °C	60 °C; Display: 50 °C, at an operating temperature of typically 50 °C, the display is switched off	60 °C; Display: 50 °C, at an operating temperature of typically 50 °C, the display is switched off
• vertical installation, min.	-40 °C; = Tmin	-40 °C; = Tmin	0 °C; = Tmin	0 °C; = Tmin
• vertical installation, max.	40 °C; = Tmax; display: 40 °C, at an operating temperature of typically 40 °C, the display is switched off	40 °C; = Tmax; display: 40 °C, at an operating temperature of typically 40 °C, the display is switched off	40 °C; Display: 40 °C, at an operating temperature of typically 40 °C, the display is switched off	40 °C; Display: 40 °C, at an operating temperature of typically 40 °C, the display is switched off
Altitude during operation relating to sea level				
• Installation altitude above sea level, max.	5 000 m; Restrictions for installation altitudes > 2 000 m, see manual	5 000 m; Restrictions for installation altitudes > 2 000 m, see manual	5 000 m	5 000 m
• Ambient air temperature-barometric pressure-altitude	Restrictions for installation altitudes > 2 000 m, see entry ID: 109763260	Restrictions for installation altitudes > 2 000 m, see entry ID: 109763260	Tmin ... Tmax at 1 140 hPa ... 795 hPa (-1 000 m ... +2 000 m) // Tmin ... (Tmax - 10 K) at 795 hPa ... 658 hPa (+2 000 m ... +3 500 m) // Tmin ... (Tmax -20 K) at 658 hPa ... 540 hPa (+3 500 m ... +5 000 m)	Tmin ... Tmax at 1 140 hPa ... 795 hPa (-1 000 m ... +2 000 m) // Tmin ... (Tmax - 10 K) at 795 hPa ... 658 hPa (+2 000 m ... +3 500 m) // Tmin ... (Tmax -20 K) at 658 hPa ... 540 hPa (+3 500 m ... +5 000 m)
Relative humidity				
• With condensation, tested in accordance with IEC 60068-2-38, max.	100 %; RH incl. condensation / frost (no commissioning in bedewed state), horizontal installation	100 %; RH incl. condensation / frost (no commissioning in bedewed state), horizontal installation	100 %; RH incl. condensation/frost (no commissioning under condensation conditions)	100 %; incl. condensation / frost permitted (no commissioning under condensation conditions)

Technical specifications

Article number	6AG1516-3AN02-2AB0	6AG1516-3AN02-7AB0	6AG1518-4AP00-4AB0	6AG1518-4AX00-4AC0
Based on	6ES7516-3AN02-0AB0 SIPLUS S7-1500 CPU 1516-3 PN/DP	6ES7516-3AN02-0AB0 SIPLUS S7-1500 CPU 1516-3 PN/DP	6ES7518-4AP00-0AB0 SIPLUS S7-1500 CPU 1518-4 PN/DP	6ES7518-4AX00-1AC0 SIPLUS S7-1500 CPU 1518-4 PN/DP MFP
Resistance				
Coolants and lubricants				
- Resistant to commercially available coolants and lubricants	Yes; Incl. diesel and oil droplets in the air	Yes; Incl. diesel and oil droplets in the air	Yes; Incl. diesel and oil droplets in the air	Yes; Incl. diesel and oil droplets in the air
Use in stationary industrial systems				
- to biologically active substances according to EN 60721-3-3	Yes; Class 3B2 mold, fungus and dry rot spores (with the exception of fauna); Class 3B3 on request	Yes; Class 3B2 mold, fungus and dry rot spores (with the exception of fauna); Class 3B3 on request	Yes; Class 3B2 mold, fungus and dry rot spores (with the exception of fauna); Class 3B3 on request	Yes; Class 3B2 mold, fungus and dry rot spores (with the exception of fauna); Class 3B3 on request
- to chemically active substances according to EN 60721-3-3	Yes; Class 3C4 (RH < 75 %) incl. salt spray acc. to EN 60068-2-52 (severity degree 3); *	Yes; Class 3C4 (RH < 75 %) incl. salt spray acc. to EN 60068-2-52 (severity degree 3); *	Yes; Class 3C4 (RH < 75 %) incl. salt spray acc. to EN 60068-2-52 (severity degree 3); *	Yes; Class 3C4 (RH < 75 %) incl. salt spray acc. to EN 60068-2-52 (severity degree 3); *
- to mechanically active substances according to EN 60721-3-3	Yes; Class 3S4 incl. sand, dust; *	Yes; Class 3S4 incl. sand, dust; *	Yes; Class 3S4 incl. sand, dust; *	Yes; Class 3S4 incl. sand, dust; *
Use on ships/at sea				
- to biologically active substances according to EN 60721-3-6	Yes; Class 6B2 mold, fungal and dry rot spores (excluding fauna)	Yes; Class 6B2 mold, fungal and dry rot spores (excluding fauna)	Yes; Class 6B2 mold and fungal spores (excluding fauna); Class 6B3 on request	Yes; Class 6B2 mold and fungal spores (excluding fauna); Class 6B3 on request
- to chemically active substances according to EN 60721-3-6	Yes; Class 6C3 (RH < 75 %) incl. salt spray acc. to EN 60068-2-52 (severity degree 3); *	Yes; Class 6C3 (RH < 75 %) incl. salt spray acc. to EN 60068-2-52 (severity degree 3); *	Yes; Class 6C3 (RH < 75 %) incl. salt spray acc. to EN 60068-2-52 (severity degree 3); *	Yes; Class 6C3 (RH < 75 %) incl. salt spray acc. to EN 60068-2-52 (severity degree 3); *
- to mechanically active substances according to EN 60721-3-6	Yes; Class 6S3 incl. sand, dust; *	Yes; Class 6S3 incl. sand, dust; *	Yes; Class 6S3 incl. sand, dust; *	Yes; Class 6S3 incl. sand, dust; *
Usage in industrial process technology				
- Against chemically active substances acc. to EN 60654-4	Yes; Class 3 (excluding trichlorethylene)	Yes; Class 3 (excluding trichlorethylene)	Yes; Class 3 (excluding trichlorethylene)	Yes; Class 3 (excluding trichlorethylene)
- Environmental conditions for process, measuring and control systems acc. to ANSI/ISA-71.04	Yes; Level GX group A/B (excluding trichlorethylene; harmful gas concentrations up to the limits of EN 60721-3-3 class 3C4 permissible); level LC3 (salt spray) and level LB3 (oil)	Yes; Level GX group A/B (excluding trichlorethylene; harmful gas concentrations up to the limits of EN 60721-3-3 class 3C4 permissible); level LC3 (salt spray) and level LB3 (oil)	Yes; Level GX group A/B (excluding trichlorethylene; harmful gas concentrations up to the limits of EN 60721-3-3 class 3C4 permissible); level LC3 (salt spray) and level LB3 (oil)	Yes; Level GX group A/B (excluding trichlorethylene; harmful gas concentrations up to the limits of EN 60721-3-3 class 3C4 permissible); level LC3 (salt spray) and level LB3 (oil)
Remark				
- Note regarding classification of environmental conditions acc. to EN 60721, EN 60654-4 and ANSI/ISA-71.04	* The supplied plug covers must remain in place over the unused interfaces during operation!	* The supplied plug covers must remain in place over the unused interfaces during operation!	* The supplied plug covers must remain in place over the unused interfaces during operation!	* The supplied plug covers must remain in place over the unused interfaces during operation!
Conformal coating				
• Coatings for printed circuit board assemblies acc. to EN 61086	Yes; Class 2 for high reliability	Yes; Class 2 for high reliability	Yes; Class 2 for high reliability	Yes; Class 2 for high reliability
• Protection against fouling acc. to EN 60664-3	Yes; Type 1 protection	Yes; Type 1 protection	Yes; Type 1 protection	Yes; Type 1 protection
• Military testing according to MIL-I-46058C, Amendment 7	Yes; Discoloration of coating possible during service life	Yes; Discoloration of coating possible during service life	Yes; Discoloration of coating possible during service life	Yes; Discoloration of coating possible during service life
• Qualification and Performance of Electrical Insulating Compound for Printed Board Assemblies according to IPC-CC-830A	Yes; Conformal coating, Class A	Yes; Conformal coating, Class A	Yes; Conformal coating, Class A	Yes; Conformal coating, Class A

SIMATIC S7-1500 Advanced Controllers

Central processing units

Compact CPUs

Overview CPU 1511C-1 PN



- The compact CPU with integral digital and analog inputs and outputs in the product spectrum of the S7-1500 Controllers
- With integrated technological functions, e.g. high-speed counter (HSC), frequency measurement, period duration measurement or stepper motor control, pulse width modulation, frequency output
- Suitable for applications with medium requirements for program scope and processing speed
- Used as central PLC in production lines with central and distributed I/O
- PROFINET IO IRT interface with 2-port switch
- PROFINET IO controller for operating distributed I/O on PROFINET
- PROFINET I-Device for connecting the CPU as an intelligent PROFINET device under a SIMATIC or non-Siemens PROFINET IO controller
- OPC UA Server and Client as runtime option for the easy connection of SIMATIC S7-1500 to non-Siemens devices/systems with the functions:
 - OPC UA Data Access
 - OPC UA Security
 - OPC UA Methods Call
 - Support of OPC UA Companion specifications
 - OPC UA Alarms & Conditions
- Isochronous mode (distributed)
- Integrated Motion Control functionalities for controlling speed-controlled and positioning axes, support for external encoders, output cams/cam tracks and probes
- Integrated web server for diagnostics with the option of creating user-defined web pages

Note

SIMATIC Memory Card required for operation of the CPU.

Overview CPU 1512C-1 PN



- The compact CPU with integral digital and analog inputs and outputs in the product spectrum of the S7-1500 Controllers
- With integrated technological functions, e.g. high-speed counter (HSC), frequency measurement, period duration measurement or stepper motor control, pulse width modulation, frequency output
- Suitable for applications with medium requirements for program scope and processing speed
- Used as central PLC in production lines with central and distributed I/O
- PROFINET IO IRT interface with 2-port switch
- PROFINET IO controller for operating distributed I/O on PROFINET
- PROFINET I-Device for connecting the CPU as an intelligent PROFINET device under a SIMATIC or non-Siemens PROFINET IO controller
- OPC UA Server and Client as runtime option for the easy connection of SIMATIC S7-1500 to non-Siemens devices/systems with the functions:
 - OPC UA Data Access
 - OPC UA Security
 - OPC UA Methods Call
 - Support of OPC UA Companion specifications
 - OPC UA Alarms & Conditions
- Isochronous mode (distributed)
- Integrated Motion Control functionalities for controlling speed-controlled and positioning axes, support for external encoders, output cams/cam tracks and probes
- Integrated web server for diagnostics with the option of creating user-defined web pages

Note

SIMATIC Memory Card required for operation of the CPU.

Ordering data	Article No.	Ordering data	Article No.
CPU 1511C-1 PN 175 KB work memory for program, 1 MB for data, 16 digital inputs, 16 digital outputs, 5 analog inputs, 2 analog outputs, 6 high-speed counters, PROFINET IRT interface with 2-port switch, SIMATIC Memory Card required	6ES7511-1CK01-0AB0	System power supply For supplying the backplane bus of the S7-1500 Controller 24 V DC input voltage, power 25 W 24/48/60 V DC input voltage, power 60 W 24/48/60 V DC input voltage, power 60 W, buffering functionality 120/230 V AC input voltage, power 60 W	6ES7505-0KA00-0AB0 6ES7505-0RA00-0AB0 6ES7505-0RB00-0AB0 6ES7507-0RA00-0AB0
CPU 1512C-1 PN 250 KB work memory for program, 1 MB for data, 32 digital inputs, 32 digital outputs, 5 analog inputs, 2 analog outputs, 6 high-speed counters, PROFINET IRT interface with 2-port switch, SIMATIC Memory Card required	6ES7512-1CK01-0AB0	Power plug With coding element for power supply module; spare part, 10 units	6ES7590-8AA00-0AA0
Accessories SIMATIC Memory Card 4 MB 12 MB 24 MB 256 MB 2 GB 32 GB	6ES7954-8LC03-0AA0 6ES7954-8LE03-0AA0 6ES7954-8LF03-0AA0 6ES7954-8LL03-0AA0 6ES7954-8LP03-0AA0 6ES7954-8LT03-0AA0	Load current supply 24 V DC/3 A 24 V DC/8 A	6EP1332-4BA00 6EP1333-4BA00
Front connectors For 25 mm modules; including cable ties and individual labeling strips; push-in terminal 40-pin; spare part	6ES7592-1BM00-0XA0	Power supply connector Spare part; for connecting the 24 V DC supply voltage • With push-in terminals	6ES7193-4JB00-0AA0
Shielding set I/O For 25 mm modules; infeed element, shielding bracket, and shield terminal; 4 units, spare part (one shield set supplied with the module).	6ES7590-5CA10-0XA0	IE FC RJ45 plugs RJ45 plug connector for Industrial Ethernet with a rugged metal enclosure and integrated insulation displacement contacts for connecting Industrial Ethernet FC installation cables	
Shield terminal element 10 units; spare part	6ES7590-5BA00-0AA0	IE FC RJ45 plug 180 180° cable outlet 1 unit 10 units 50 units	6GK1901-1BB10-2AA0 6GK1901-1BB10-2AB0 6GK1901-1BB10-2AE0
SIMATIC S7-1500 DIN rail Fixed lengths, with grounding elements • 160 mm • 245 mm • 482 mm • 530 mm • 830 mm For cutting to length by customer, without drill holes; grounding elements must be ordered separately • 2 000 mm	6ES7590-1AB60-0AA0 6ES7590-1AC40-0AA0 6ES7590-1AE80-0AA0 6ES7590-1AF30-0AA0 6ES7590-1AJ30-0AA0 6ES7590-1BC00-0AA0	IE FC TP standard cable GP 2x2 4-wire, shielded TP installation cable for connection to IE FC RJ45 outlet/IE FC RJ45 plug; PROFINET-compatible; with UL approval; sold by the meter; max. delivery unit 1 000 m, minimum order quantity 20 m	6XV1840-2AH10
PE connection element for 2 000 mm DIN rail 20 units	6ES7590-5AA00-0AA0	IE FC TP trailing cable 2 x 2 (type C) 4-wire, shielded TP installation cable for connection to IE FC RJ45 outlet/IE FC RJ45 plug 180/90 for use as trailing cable; PROFINET-compatible; with UL approval; sold by the meter; max. delivery unit 1 000 m, minimum order quantity 20 m	6XV1840-3AH10
		IE FC TP marine cable 2 x 2 (type B) 4-wire, shielded TP installation cable for connection to IE FC RJ45 outlet/IE FC RJ45 plug 180/90 with marine approval; sold by the meter; max. delivery unit 1 000 m, minimum order quantity 20 m	6XV1840-4AH10
		IE FC stripping tool Pre-adjusted stripping tool for fast stripping of Industrial Ethernet FC cables	6GK1901-1GA00

SIMATIC S7-1500 Advanced Controllers

Central processing units

Compact CPUs

4

Ordering data	Article No.	Article No.
Display module 35 mm For CPU 1511-1 PN, CPU 1513-1 PN, CPU 1511F-1 PN, CPU 1513F-1 PN, CPU 1511C-1 PN and CPU 1512C-1 PN; spare part	6ES7591-1AB00-0AA0	
Cover 35 mm For CPU 1511-1 PN, CPU 1513-1 PN, CPU 1511F-1 PN, CPU 1513F-1 PN, CPU 1511C-1 PN and CPU 1512C-1 PN; spare part	6ES7591-4AB00-0AA0	
SIMATIC S7-1500 Starter Kit Consisting of CPU 1511C-1 PN, SIMATIC Memory Card 4 MB, 160 mm DIN rail, front connector, STEP 7 Professional 365-day license, SIMATIC ProDiag 1500, SIMATIC OPC UA S7-1500 Small, PM 1507 24 V/3 A power supply, Ethernet cable, documentation	6ES7511-1CK03-4YB5	
		STEP 7 Professional V17 Target system: SIMATIC S7-1200, S7-1500, S7-300, S7-400, WinAC Requirement: Windows 10 (64-bit) <ul style="list-style-type: none"> Windows 10 Professional Version 1909, 2004, 20H2 Windows 10 Enterprise Version 1909, 2004, 20H2 Windows 10 IoT Enterprise 2016 LTSC Windows 10 IoT Enterprise 2019 LTSC Windows Server (64-bit) <ul style="list-style-type: none"> Windows Server 2016 Standard (full installation) Windows Server 2019 Standard (full installation) Type of delivery: 9 languages: de, en, zh included, fr, es, it, ru, jp, kr as download STEP 7 Professional V17, floating license STEP 7 Professional V17, floating license, software download including license key ¹⁾ Email address required for delivery
		6ES7822-1AA07-0YA5
		6ES7822-1AE07-0YA5
		SIMATIC Manual Collection Electronic manuals on DVD, multi-language: LOGO!, SIMADYN, SIMATIC Bus Components, SIMATIC C7, SIMATIC Distributed I/O, SIMATIC HMI, SIMATIC Sensors, SIMATIC NET, SIMATIC PC-based Automation, SIMATIC PCS 7, SIMATIC PG/PC, SIMATIC S7, SIMATIC Software, SIMATIC TDC
		6ES7998-8XC01-8YE0
		SIMATIC Manual Collection update service for 1 year Current Manual Collection DVD and the three subsequent updates
		6ES7998-8XC01-8YE2

¹⁾ For up-to-date information and download availability, see: <http://www.siemens.com/tia-online-software-delivery>

Technical specifications

Article number	6ES7511-1CK01-0AB0	6ES7512-1CK01-0AB0
	CPU 1511C-1 PN, 175 KB Prog, 1 MB Data	CPU 1512C-1 PN, 250 KB Prog, 1 MB Data
General information		
Product type designation	CPU 1511C-1 PN	CPU 1512C-1 PN
Engineering with		
<ul style="list-style-type: none"> STEP 7 TIA Portal configurable/integrated from version 	V17 (FW V2.9) / V15 (FW V2.5) or higher; with older TIA Portal versions configurable as 6ES7511-1CK00-0AB0	V17 (FW V2.9) / V15 (FW V2.5) or higher; with older TIA Portal versions configurable as 6ES7512-1CK00-0AB0
Display		
Screen diagonal [cm]	3.45 cm	3.45 cm
Supply voltage		
Rated value (DC)	24 V	24 V
Memory		
Work memory		
<ul style="list-style-type: none"> integrated (for program) integrated (for data) 	175 kbyte 1 Mbyte	250 kbyte 1 Mbyte
Load memory		
<ul style="list-style-type: none"> Plug-in (SIMATIC Memory Card), max. 	32 Gbyte	32 Gbyte

Technical specifications

Article number	6ES7511-1CK01-0AB0 CPU 1511C-1 PN, 175 KB Prog, 1 MB Data	6ES7512-1CK01-0AB0 CPU 1512C-1 PN, 250 KB Prog, 1 MB Data
CPU processing times		
for bit operations, typ.	60 ns	48 ns
for word operations, typ.	72 ns	58 ns
for fixed point arithmetic, typ.	96 ns	77 ns
for floating point arithmetic, typ.	384 ns	307 ns
Counters, timers and their retentivity		
S7 counter		
• Number	2 048	2 048
IEC counter		
• Number	Any (only limited by the main memory)	Any (only limited by the main memory)
S7 times		
• Number	2 048	2 048
IEC timer		
• Number	Any (only limited by the main memory)	Any (only limited by the main memory)
Data areas and their retentivity		
Flag		
• Size, max.	16 kbyte	16 kbyte
Address area		
I/O address area		
• Inputs	32 kbyte; All inputs are in the process image	32 kbyte; All inputs are in the process image
• Outputs	32 kbyte; All outputs are in the process image	32 kbyte; All outputs are in the process image
Time of day		
Clock		
• Type	Hardware clock	Hardware clock
Digital inputs		
integrated channels (DI)	16	32
Digital outputs		
integrated channels (DO)	16	32
Short-circuit protection	Yes; electronic/thermal	Yes; electronic/thermal
Analog outputs		
integrated channels (AO)	2	2
1. Interface		
Interface types		
• RJ 45 (Ethernet)	Yes; X1	Yes; X1
• Number of ports	2	2
• integrated switch	Yes	Yes
Protocols		
• IP protocol	Yes; IPv4	Yes; IPv4
• PROFINET IO Controller	Yes	Yes
• PROFINET IO Device	Yes	Yes
• SIMATIC communication	Yes	Yes
• Open IE communication	Yes; Optionally also encrypted	Yes; Optionally also encrypted
• Web server	Yes	Yes
• Media redundancy	Yes	Yes

SIMATIC S7-1500 Advanced Controllers

Central processing units

Compact CPUs

Technical specifications

Article number	6ES7511-1CK01-0AB0 CPU 1511C-1 PN, 175 KB Prog, 1 MB Data	6ES7512-1CK01-0AB0 CPU 1512C-1 PN, 250 KB Prog, 1 MB Data
PROFINET IO Controller		
Services		
- PG/OP communication	Yes	Yes
- Isochronous mode	Yes	Yes
- Direct data exchange	Yes; Requirement: IRT and isochronous mode (MRPD optional)	Yes; Requirement: IRT and isochronous mode (MRPD optional)
- IRT	Yes	Yes
- PROFlenergy	Yes; per user program	Yes; per user program
- Prioritized startup	Yes; Max. 32 PROFINET devices	Yes; Max. 32 PROFINET devices
- Number of connectable IO Devices, max.	128; In total, up to 256 distributed I/O devices can be connected via AS-i, PROFIBUS or PROFINET	128; In total, up to 256 distributed I/O devices can be connected via AS-i, PROFIBUS or PROFINET
- Of which IO devices with IRT, max.	64	64
- Number of connectable IO Devices for RT, max.	128	128
- of which in line, max.	128	128
- Number of IO Devices that can be simultaneously activated/deactivated, max.	8; in total across all interfaces	8; in total across all interfaces
- Number of IO Devices per tool, max.	8	8
- Updating times	The minimum value of the update time also depends on communication share set for PROFINET IO, on the number of IO devices, and on the quantity of configured user data	The minimum value of the update time also depends on communication share set for PROFINET IO, on the number of IO devices, and on the quantity of configured user data
PROFINET IO Device		
Services		
- PG/OP communication	Yes	Yes
- Isochronous mode	No	No
- IRT	Yes	Yes
- PROFlenergy	Yes; per user program	Yes; per user program
- Shared device	Yes	Yes
- Number of IO Controllers with shared device, max.	4	4
- activation/deactivation of I-devices	Yes; per user program	Yes; per user program
- Asset management record	Yes; per user program	Yes; per user program
Protocols		
Number of connections		
• Number of connections, max.	96; via integrated interfaces of the CPU and connected CPs / CMs	128; via integrated interfaces of the CPU and connected CPs / CMs
Redundancy mode		
Media redundancy		
- Media redundancy	only via 1st interface (X1)	only via 1st interface (X1)
- MRP	Yes; MRP Automanager according to IEC 62439-2 Edition 2.0, MRP Manager; MRP Client	Yes; MRP Automanager according to IEC 62439-2 Edition 2.0, MRP Manager; MRP Client
- MRP interconnection, supported	Yes; as MRP ring node according to IEC 62439-2 Edition 3.0	Yes; as MRP ring node according to IEC 62439-2 Edition 3.0
- MRPD	Yes; Requirement: IRT	Yes; Requirement: IRT
- Switchover time on line break, typ.	200 ms; For MRP, bumpless for MRPD	200 ms; For MRP, bumpless for MRPD
- Number of stations in the ring, max.	50	50
SIMATIC communication		
• S7 routing	Yes	Yes
OPC UA		
• OPC UA Client	Yes	Yes
• OPC UA Server	Yes; Data access (read, write, subscribe), method call, custom address space	Yes; Data access (read, write, subscribe), method call, custom address space
• Alarms and Conditions	Yes	Yes

Technical specifications

Article number	6ES7511-1CK01-0AB0 CPU 1511C-1 PN, 175 KB Prog, 1 MB Data	6ES7512-1CK01-0AB0 CPU 1512C-1 PN, 250 KB Prog, 1 MB Data
Supported technology objects		
Motion Control	Yes; Note: The number of technology objects affects the cycle time of the PLC program; selection guide via the TIA Selection Tool	Yes; Note: The number of technology objects affects the cycle time of the PLC program; selection guide via the TIA Selection Tool
• Number of available Motion Control resources for technology objects	800	800
• Required Motion Control resources		
- per speed-controlled axis	40	40
- per positioning axis	80	80
- per synchronous axis	160	160
- per external encoder	80	80
- per output cam	20	20
- per cam track	160	160
- per probe	40	40
Controller		
• PID_Compact	Yes; Universal PID controller with integrated optimization	Yes; Universal PID controller with integrated optimization
• PID_3Step	Yes; PID controller with integrated optimization for valves	Yes; PID controller with integrated optimization for valves
• PID-Temp	Yes; PID controller with integrated optimization for temperature	Yes; PID controller with integrated optimization for temperature
Counting and measuring		
• High-speed counter	Yes	Yes
Ambient conditions		
Ambient temperature during operation		
• horizontal installation, min.	-25 °C; No condensation	-25 °C; No condensation
• horizontal installation, max.	60 °C; note derating data for onboard I/O in the manual. Display: 50 °C, at an operating temperature of typically 50 °C, the display is switched off	60 °C; note derating data for onboard I/O in the manual. Display: 50 °C, at an operating temperature of typically 50 °C, the display is switched off
• vertical installation, min.	-25 °C; No condensation	-25 °C; No condensation
• vertical installation, max.	40 °C; note derating data for onboard I/O in the manual. Display: 40 °C, at an operating temperature of typically 40 °C, the display is switched off	40 °C; note derating data for onboard I/O in the manual. Display: 40 °C, at an operating temperature of typically 40 °C, the display is switched off
Altitude during operation relating to sea level		
• Installation altitude above sea level, max.	5 000 m; Restrictions for installation altitudes > 2 000 m, see manual	5 000 m; Restrictions for installation altitudes > 2 000 m, see manual
Configuration		
Programming		
Programming language		
- LAD	Yes	Yes
- FBD	Yes	Yes
- STL	Yes	Yes
- SCL	Yes	Yes
- GRAPH	Yes	Yes
Know-how protection		
• User program protection/ password protection	Yes	Yes
• Copy protection	Yes	Yes
• Block protection	Yes	Yes
Access protection		
• protection of confidential configuration data	Yes	Yes
• Password for display	Yes	Yes
• Protection level: Write protection	Yes	Yes
• Protection level: Read/write protection	Yes	Yes
• Protection level: Complete protection	Yes	Yes
Dimensions		
Width	85 mm	110 mm
Height	147 mm	147 mm
Depth	129 mm	129 mm
Weights		
Weight, approx.	1 050 g	1 360 g

SIMATIC S7-1500 Advanced Controllers

Central processing units

Fail-safe CPUs

Overview CPU 1511F-1 PN



- Entry-level CPU in the S7-1500F Controller product range
- Can be used for safety functions up to SIL 3 according to IEC 61508 and up to PLe according to ISO 13849
- Suitable for standard and fail-safe applications with medium requirements for program scope and processing speed
- Used as central controller in production lines with central and distributed I/O
- Supports PROFIsafe in centralized and distributed configurations
- PROFINET IO IRT interface with 2-port switch
- PROFINET IO controller for operating distributed I/O on PROFINET
- PROFINET I-Device for connecting the CPU as an intelligent PROFINET device under a SIMATIC or non-Siemens PROFINET I/O controller
- Isochronous mode

Note:

SIMATIC Memory Card required for operation of the CPU

Overview CPU 1513F-1 PN



- The CPU for standard and fail-safe applications with medium/high requirements for program/data storage in the S7-1500 Controller product range
- Can be used for safety functions up to SIL 3 according to IEC 61508 and up to PLe according to ISO 13849
- High processing speed for binary and floating-point arithmetic
- Used as central PLC in production lines with central and distributed I/O
- Supports PROFIsafe in centralized and distributed configuration
- PROFINET IO IRT interface with 2-port switch
- PROFINET IO controller for operating distributed I/O on PROFINET
- PROFINET I-Device for connecting the CPU as an intelligent PROFINET device under a SIMATIC or non-Siemens PROFINET I/O controller
- Isochronous mode

Note:

SIMATIC Memory Card required for operation of the CPU

Overview CPU 1515F-2 PN



- The CPU for applications with medium to high requirements for program/data storage in the S7-1500 Controller product range
- Can be used for safety functions up to SIL 3 according to IEC 61508 and up to PL e according to ISO 13849
- Medium to high processing speed for binary and floating-point arithmetic
- Used as central controller in production lines with central and distributed I/O
- Supports PROFIsafe in centralized and distributed configurations
- PROFINET IO IRT interface with 2-port switch
- Additional PROFINET interface with separate IP address
- PROFINET IO controller for operating distributed I/O on PROFINET
- PROFINET I-Device for connecting the CPU as an intelligent PROFINET device under a SIMATIC or non-Siemens PROFINET IO controller
- Isochronous mode
- Integrated Motion Control functionalities for controlling speed-controlled and positioning axes, support for external encoders
- Integrated web server with the option of creating user-defined web pages

Note:

SIMATIC Memory Card required for operation of the CPU

Overview CPU 1516F-3 PN/DP



- The CPU with a large program and data memory in the S7-1500 Controller product range for fail-safe applications with high requirements regarding program scope and networking.
- Can be used for failsafe functions up to SIL 3 according to IEC 61508 and up to PLe according to ISO 13849.
- High processing speed for binary and floating-point arithmetic
- Used as central controller in production lines with central and distributed I/O
- Supports PROFIsafe in centralized and distributed configuration.
- PROFINET IO IRT interface with 2-port switch.
- Additional PROFINET interface with separate IP address.
- PROFINET IO controller for operating distributed I/O on PROFINET.
- PROFINET I-Device for connecting the CPU as an intelligent PROFINET device under a SIMATIC or non-Siemens PROFINET IO controller.
- PROFIBUS DP master interface.
- Isochronous mode on PROFIBUS and PROFINET.
- Integrated Motion Control functionalities for controlling speed-controlled and positioning axes, support for external encoders.
- Integrated web server with the option of creating user-defined web pages.

Note:

SIMATIC Memory Card required for operation of the CPU

SIMATIC S7-1500 Advanced Controllers

Central processing units

Fail-safe CPUs

Overview CPU 1517F-3 PN/DP



- The CPU with a very large program and data memory in the S7-1500 Controller product range for fail-safe applications with high requirements regarding program scope and networking.
- Can be used for safety functions up to SIL 3 according to IEC 61508 and up to PL e according to ISO 13849
- High processing speed for binary and floating-point arithmetic
- For cross-industry automation tasks in series machine, special machine and plant construction
- Used as central controller in production lines with central and distributed I/O
- Supports PROFIsafe in centralized and distributed configurations
- PROFINET IO IRT interface with 2-port switch
- Additional PROFINET interface with separate IP address
- PROFINET IO controller for operating distributed I/O on PROFINET.
- PROFINET I-Device for connecting the CPU as an intelligent PROFINET device under a SIMATIC or non-Siemens PROFINET IO controller.
- PROFIBUS DP master interface
- Isochronous mode on PROFIBUS and PROFINET
- Integrated Motion Control functionalities for controlling speed-controlled and positioning axes, support for external encoders, positionally precise gearing between axes
- Integrated web server with the option of creating user-defined web pages

Note:

SIMATIC Memory Card required for operation of the CPU

Overview CPU 1518F-4 PN/DP



- The CPU with a very large program and data memory in the S7-1500 Controller product range for fail-safe applications with highest requirements regarding program scope and networking.
- Can be used for failsafe functions up to SIL 3 according to IEC 61508 and up to PLe according to ISO 13849.
- Extremely high processing speed for binary and floating-point arithmetic.
- For cross-industry automation tasks in series machine, special machine and plant construction
- Used as central controller in production lines with central and distributed I/O
- Supports PROFIsafe in centralized and distributed configuration.
- PROFINET IO IRT interface with 2-port switch.
- Two additional PROFINET interfaces with separate IP addresses.
- PROFINET IO controller for operating distributed I/O on PROFINET.
- PROFINET I-Device for connecting the CPU as an intelligent PROFINET device under a SIMATIC or non-Siemens PROFINET IO controller.
- PROFIBUS DP master interface.
- Isochronous mode on PROFIBUS and PROFINET.
- Integrated Motion Control functionalities for controlling speed-controlled and positioning axes, support for external encoders
- Integrated web server with the option of creating user-defined web pages.

Note:

SIMATIC Memory Card required for operation of the CPU.

Overview CPU 1518F-4 PN/DP MFP



- CPU with an extremely large program and data memory in the S7-1500 Controller product range for demanding standard and fail-safe applications with demanding requirements regarding program scope, performance and networking
- Can be used for safety functions up to SIL 3 according to IEC 61508 and up to PL e according to ISO 13849
- Extremely high processing speed for binary and floating-point arithmetic
- For cross-industry automation tasks in series machine, special machine and plant construction
- C/C++ functions can be called and executed in the CPU runtime.
- In parallel to the CPU runtime, there is an additional C/C++ runtime, in which call-independent, i.e. stand-alone, C/C++ applications can be executed.
- Used as central controller in production lines with central and distributed I/O
- Supports PROFIsafe in centralized and distributed configurations
- PROFINET IO IRT interface with 2-port switch
- PROFINET IO controller for operating distributed I/O on PROFINET
- PROFINET I-Device for connecting the CPU as an intelligent PROFINET device under a SIMATIC or non-Siemens PROFINET IO controller
- Two additional PROFINET interfaces with separate IP addresses for network separation:
The PROFINET interface X2 can be used for connecting additional PROFINET IO RT devices or for fast communication as an I-Device. The PROFINET interface X3 facilitates data transfer at a speed of 1 Gbps.
- PROFIBUS DP master interface
- OPC UA server (data access) as runtime option for easy connection of the SIMATIC S7-1500 to non-Siemens devices/systems
- Isochronous mode on PROFIBUS and PROFINET
- Integrated Motion Control functionalities for controlling speed-controlled and positioning axes, support for external encoders, gearing between axes, output cams/cam tracks and probes
- Integrated web server for diagnostics with the option of creating user-defined web pages

Multi-functional platform

With the multi-functional platform (MFP), more functionality can be accommodated in a module. The computing power of the CPU 1518F-4 PN/DP MFP allows the merging of previously separate applications on a common platform while continuing to meet the high S7-1500 demands with regard to maintenance and ruggedness.

This means that, in addition to the control function, it is also possible to process typical PC applications on the multi-functional platform, e.g. tasks that:

- require high-level language programming,
- are developed based on models, or
- have to be solved via databases.

Besides the option of running C/C++ code in the standard STEP 7 program, the multi-functional platform CPU 1518F-4 PN/DP MFP thus provides an additional second independent runtime environment which facilitates execution of C/C++ applications in parallel to the STEP 7 program if required.

Control-independent applications, e.g. protocol converters, database applications and others, can be created in C/C++. This simplifies the creation or reuse of customer-specific, high-level language applications.

The CPU 1518F-4 PN/DP MFP has the quantity structure and functionality of a CPU 1518F-4 PN/DP with regard to the control part. In addition to the user program created with STEP 7 in the TIA Portal, C/C++ functions formulated via the SIMATIC ODK 1500S can be integrated into the standard user program.

By using SIMATIC ODK 1500S (ODK - Open Development Kit), higher-level programming language mechanisms, such as object orientation, can also be utilized.

Furthermore, with the SIMATIC Target 1500S™ engineering package for Simulink®, it is also possible to integrate complex Simulink models to take advantage of the model-based development using MATLAB and Simulink®.

Note

SIMATIC Memory Card required for operation of the CPU.

SIMATIC S7-1500 Advanced Controllers

Central processing units

Fail-safe CPUs

Ordering data

Article No.

CPU 1511F-1 PN

6ES7511-1FK02-0AB0

Fail-safe CPU,
230 KB work memory for
program, 1 MB for data,
PROFINET IRT interface
with 2-port switch;
SIMATIC Memory Card required

CPU 1513F-1 PN

6ES7513-1FL02-0AB0

Fail-safe CPU,
450 KB work memory for
program, 1.5 MB for data,
PROFINET IRT interface
with 2-port switch;
SIMATIC Memory Card required

CPU 1515F-2 PN

6ES7515-2FM02-0AB0

Fail-safe CPU,
750 KB work memory for
program, 3 MB for data,
PROFINET IRT interface
with 2-port switch;
PROFINET RT interface;
SIMATIC Memory Card required

CPU 1516F-3 PN/DP

6ES7516-3FN02-0AB0

Fail-safe CPU,
1.5 MB work memory for
program, 5 MB for data,
PROFINET IRT interface
with 2-port switch,
PROFINET RT interface,
PROFIBUS interface;
SIMATIC Memory Card required

CPU 1517F-3 PN/DP

6ES7517-3FP00-0AB0

Fail-safe CPU,
3 MB work memory for
program, 8 MB for data,
PROFINET IRT interface
with 2-port switch,
PROFINET RT interface,
PROFIBUS interface;
SIMATIC Memory Card required

CPU 1518F-4 PN/DP

6ES7518-4FP00-0AB0

Fail-safe CPU,
6 MB work memory for
program, 20 MB for data,
PROFINET IRT interface
with 2-port switch,
PROFINET RT interface,
Ethernet interface,
PROFIBUS interface;
SIMATIC Memory Card required

CPU 1518F-4 PN/DP MFP

6ES7518-4FX00-1AC0

CPU 1518F-4 PN/DP MFP,
including C/C++ Runtime and
OPC UA Runtime license

Accessories

SIMATIC Memory Card

4 MB

6ES7954-8LC03-0AA0

12 MB

6ES7954-8LE03-0AA0

24 MB

6ES7954-8LF03-0AA0

256 MB

6ES7954-8LL03-0AA0

2 GB, also for CPU 1518F-4
PN/DP MFP

6ES7954-8LP03-0AA0

32 GB, also for CPU 1518F-4
PN/DP MFP

6ES7954-8LT03-0AA0

SIMATIC S7-1500 DIN rail

Fixed lengths, with grounding
elements

- 160 mm
- 245 mm
- 482 mm
- 530 mm
- 830 mm

6ES7590-1AB60-0AA0

6ES7590-1AC40-0AA0

6ES7590-1AE80-0AA0

6ES7590-1AF30-0AA0

6ES7590-1AJ30-0AA0

For cutting to length by customer,
without drill holes; grounding
elements must be ordered
separately

- 2 000 mm

6ES7590-1BC00-0AA0

PE connection element for 2 000 mm DIN rail

6ES7590-5AA00-0AA0

20 units

System power supply

For supplying
the backplane bus of
the S7-1500 Controller

24 V DC input voltage,
power 25 W

6ES7505-0KA00-0AB0

24/48/60 V DC input voltage,
power 60 W

6ES7505-0RA00-0AB0

24/48/60 V DC input voltage,
power 60 W, buffering functionality

6ES7505-0RB00-0AB0

120/230 V AC input voltage,
power 60 W

6ES7507-0RA00-0AB0

Power plug

6ES7590-8AA00-0AA0

With coding element for
power supply module;
spare part, 10 units

Load current supply

24 V DC/3 A

6EP1332-4BA00

24 V DC/8 A

6EP1333-4BA00

Power supply connector

Spare part; for connecting
the 24 V DC supply voltage
• With push-in terminals

6ES7193-4JB00-0AA0

Ordering data	Article No.	Article No.	
PROFIBUS FastConnect RS485 bus connector with 90° cable outlet With insulation displacement terminals, max. transfer rate 12 Mbps Without programming device interface, grounding via control cabinet contact surface; 1 unit With programming device interface, grounding via control cabinet contact surface; 1 unit	6ES7972-0BA70-0XA0 6ES7972-0BB70-0XA0	IE FC TP standard cable GP 2x2 4-wire, shielded TP installation cable for connection to IE FC RJ45 outlet/IE FC RJ45 plug; PROFINET-compatible; with UL approval; sold by the meter; max. delivery unit 1 000 m, minimum order quantity 20 m	6XV1840-2AH10
PROFIBUS FC standard cable GP Standard type with special design for quick mounting, 2-wire, shielded; sold by the meter; max. delivery unit 1 000 m, minimum order quantity 20 m	6XV1830-0EH10	IE FC TP trailing cable 2 x 2 (type C) 4-wire, shielded TP installation cable for connection to IE FC RJ45 outlet/IE FC RJ45 plug 180/90 for use as trailing cable; PROFINET-compatible; with UL approval; sold by the meter; max. delivery unit 1 000 m, minimum order quantity 20 m	6XV1840-3AH10
PROFIBUS FC robust cable 2-wire, shielded; sold by the meter; max. delivery unit 1 000 m, minimum order quantity 20 m	6XV1830-0JH10	IE FC TP marine cable 2 x 2 (type B) 4-wire, shielded TP installation cable for connection to IE FC RJ45 outlet/IE FC RJ45 plug 180/90 with marine approval; sold by the meter; max. delivery unit 1 000 m, minimum order quantity 20 m	6XV1840-4AH10
PROFIBUS FC flexible cable 2-wire, shielded; sold by the meter; max. delivery unit 1 000 m, minimum order quantity 20 m	6XV1831-2K	IE FC stripping tool Pre-adjusted stripping tool for fast stripping of Industrial Ethernet FC cables	6GK1901-1GA00
PROFIBUS FC trailing cable 2-wire, shielded; sold by the meter; max. delivery unit 1 000 m, minimum order quantity 20 m Sheath color: Petrol Sheath color: Violet	6XV1830-3EH10 6XV1831-2L	Display module 35 mm For CPU 1511-1 PN, CPU 1513-1 PN, CPU 1511F-1 PN, CPU 1513F-1 PN, CPU 1511C-1 PN and CPU 1512C-1 PN; spare part	6ES7591-1AB00-0AA0
PROFIBUS FC food cable 2-wire, shielded; sold by the meter; max. delivery unit 1 000 m, minimum order quantity 20 m	6XV1830-0GH10	Display module 70 mm For CPU 1515-2 PN, CPU 1516-3 PN/DP, CPU 1515F-2 PN and CPU 1516F-3 PN/DP; spare part	6ES7591-1BB00-0AA0
PROFIBUS FC ground cable 2-wire, shielded; sold by the meter; max. delivery unit 1 000 m, minimum order quantity 20 m	6XV1830-3FH10	Display For CPU 1517-3 PN/DP, CPU 1517F-3 PN/DP, CPU 1518-4 PN/DP, CPU 1518F-4 PN/DP, CPU 1518-4 PN/DP MFP and CPU 1518F-4 PN/DP MFP; spare part	6ES7591-1BA02-0AA0
PROFIBUS FC FRNC cable GP 2-wire, shielded, flame-retardant, with copolymer protective jacket FRNC; sold by the meter; max. delivery unit 1 000 m, minimum order quantity 20 m	6XV1830-0LH10	Cover 35 mm For CPU 1511-1 PN, CPU 1513-1 PN, CPU 1511F-1 PN, CPU 1513F-1 PN, CPU 1511C-1 PN and CPU 1512C-1 PN; spare part	6ES7591-4AB00-0AA0
PROFIBUS FastConnect stripping tool Pre-adjusted stripping tool for fast stripping of PROFIBUS FastConnect bus cables	6GK1905-6AA00	Cover 70 mm For CPU 1515-2 PN, CPU 1516-3 PN/DP, CPU 1515F-2 PN and CPU 1516F-3 PN/DP; spare part	6ES7591-4BB00-0AA0
IE FC RJ45 plugs RJ45 plug connector for Industrial Ethernet with a rugged metal enclosure and integrated insulation displacement contacts for connecting Industrial Ethernet FC installation cables		Front cover for PROFIBUS DP interface For CPU 1517-3 PN/DP, CPU 1518-4 PN/DP, CPU 1518-4 PN/DP ODK and CPU 1518-4 PN/DP MFP; spare part	6ES7591-8AA00-0AA0
IE FC RJ45 plug 180 180° cable outlet 1 unit 10 units 50 units	6GK1901-1BB10-2AA0 6GK1901-1BB10-2AB0 6GK1901-1BB10-2AE0		

SIMATIC S7-1500 Advanced Controllers

Central processing units

Fail-safe CPUs

4

Ordering data

Article No.

SIMATIC S7-1500 Starter Kit

Consisting of CPU 1511C-1 PN, SIMATIC Memory Card 4 MB, 160 mm DIN rail, front connector, STEP 7 Professional 365-day license, SIMATIC ProDiag 1500, SIMATIC OPC UA S7-1500 Small, PM 1507 24 V/3 A power supply, Ethernet cable, documentation

6ES7511-1CK03-4YB5

STEP 7 Professional V17

Target system:
SIMATIC S7-1200, S7-1500, S7-300, S7-400, WinAC

Requirement:

Windows 10 (64-bit)

- Windows 10 Professional Version 1909, 2004, 20H2
- Windows 10 Enterprise Version 1909, 2004, 20H2
- Windows 10 IoT Enterprise 2016 LTSB
- Windows 10 IoT Enterprise 2019 LTSC

Windows Server (64-bit)

- Windows Server 2016 Standard (full installation)
- Windows Server 2019 Standard (full installation)

Type of delivery:

9 languages: de, en, zh included, fr, es, it, ru, jp, kr as download

STEP 7 Professional V17, floating license

6ES7822-1AA07-0YA5

STEP 7 Professional V17, floating license, software download including license key ¹⁾

6ES7822-1AE07-0YA5

Email address required for delivery

STEP 7 Safety Advanced V17

Task:

Engineering tool for configuring and programming fail-safe user programs for SIMATIC S7-1200 FC, S7-1500F, S7-1500F Software Controller, S7-300F, S7-400F, WinAC RTX F, ET 200SP F Controller and the fail-safe I/O ET 200SP, ET 200MP, ET 200S, ET 200M, ET 200iSP, ET 200pro and ET 200eco

Requirement:

STEP 7 Professional V17

Note:

As of TIA Portal V16, the SIMATIC STEP 7 Safety software is an integral component of the SIMATIC STEP 7 product setup. The functionality of SIMATIC STEP 7 Safety is activated by means of the license key supplied in each case.

Floating license for 1 user; license key on USB flash drive

6ES7833-1FA17-0YA5

Floating license for 1 user; license key for download²⁾; email address required for delivery

6ES7833-1FA17-0YH5

Article No.

SIMATIC ODK 1500S

Open Development Kit V2.5 for support in developing high-level language applications for SIMATIC S7-1500 Advanced Controllers; supplied on DVD, license key (floating license) on USB flash drive

6ES7806-2CD03-0YA0

Open Development Kit V2.5 for support in developing high-level language applications for SIMATIC S7-1500 Advanced Controllers; software download including license key (floating license) ¹⁾

6ES7806-2CD03-0YG0

Email address required for delivery

SIMATIC Target for Simulink V5.0

Download incl. license key ¹⁾

6ES7823-1BE04-0YA5

Email address required for delivery

Upgrade of SIMATIC Target 1500S for Simulink V2.0...V4.0 to V5.0, download incl. license key ¹⁾

6ES7823-1BE04-0YE5

Email address required for delivery

SIMATIC Target + ODK 1500S bundle

6ES7823-1BE14-0YA0

Download incl. license key ¹⁾

Email address required for delivery

SIMATIC Manual Collection

6ES7998-8XC01-8YE0

Electronic manuals on DVD, multi-language: LOGO!, SIMADYN, SIMATIC Bus Components, SIMATIC C7, SIMATIC Distributed I/O, SIMATIC HMI, SIMATIC Sensors, SIMATIC NET, SIMATIC PC-based Automation, SIMATIC PCS 7, SIMATIC PG/PC, SIMATIC S7, SIMATIC Software, SIMATIC TDC

SIMATIC Manual Collection update service for 1 year

6ES7998-8XC01-8YE2

Current Manual Collection DVD and the three subsequent updates

¹⁾ For up-to-date information and download availability, see: <http://www.siemens.com/tia-online-software-delivery>

Technical specifications

Article number	6ES7511-1FK02-0AB0 CPU 1511F-1 PN, 225KB prog., 1MB data	6ES7513-1FL02-0AB0 CPU 1513F-1 PN, 450KB Prog., 1,5MB data	6ES7515-2FM02-0AB0 CPU 1515F-2 PN, 750KB Prog., 3MB Data	6ES7516-3FN02-0AB0 CPU 1516F-3 PN/DP, 1,5MB Prog., 5MB Data
General information				
Product type designation	CPU 1511F-1 PN	CPU 1513F-1 PN	CPU 1515F-2 PN	CPU 1516F-3 PN/DP
Engineering with				
• STEP 7 TIA Portal configurable/ integrated from version	V17 (FW V2.9) / V15 (FW V2.5) or higher; with older TIA Portal versions configurable as 6ES7511-1FK01-0AB0	V17 (FW V2.9) / V15 (FW V2.5) or higher; with older TIA Portal versions configurable as 6ES7513-1FL01-0AB0	V17 (FW V2.9) / V16 (FW V2.8) or higher; with older TIA Portal versions configurable as 6ES7515-2FM01-0AB0	V17 (FW V2.9) / V16 (FW V2.8) or higher; with older TIA Portal versions configurable as 6ES7516-3FN01-0AB0
Display				
Screen diagonal [cm]	3.45 cm	3.45 cm	6.1 cm	6.1 cm
Supply voltage				
Rated value (DC)	24 V	24 V	24 V	24 V
Memory				
Work memory				
• integrated (for program)	225 kbyte	450 kbyte	750 kbyte	1.5 Mbyte
• integrated (for data)	1 Mbyte	1.5 Mbyte	3 Mbyte	5 Mbyte
Load memory				
• Plug-in (SIMATIC Memory Card), max.	32 Gbyte	32 Gbyte	32 Gbyte	32 Gbyte
CPU processing times				
for bit operations, typ.	60 ns	40 ns	30 ns	10 ns
for word operations, typ.	72 ns	48 ns	36 ns	12 ns
for fixed point arithmetic, typ.	96 ns	64 ns	48 ns	16 ns
for floating point arithmetic, typ.	384 ns	256 ns	192 ns	64 ns
Counters, timers and their retentivity				
S7 counter				
• Number	2 048	2 048	2 048	2 048
IEC counter				
• Number	Any (only limited by the main memory)	Any (only limited by the main memory)	Any (only limited by the main memory)	Any (only limited by the main memory)
S7 times				
• Number	2 048	2 048	2 048	2 048
IEC timer				
• Number	Any (only limited by the main memory)	Any (only limited by the main memory)	Any (only limited by the main memory)	Any (only limited by the main memory)
Data areas and their retentivity				
Flag				
• Size, max.	16 kbyte	16 kbyte	16 kbyte	16 kbyte
Address area				
I/O address area				
• Inputs	32 kbyte; All inputs are in the process image	32 kbyte; All inputs are in the process image	32 kbyte; All inputs are in the process image	32 kbyte; All inputs are in the process image
• Outputs	32 kbyte; All outputs are in the process image	32 kbyte; All outputs are in the process image	32 kbyte; All outputs are in the process image	32 kbyte; All outputs are in the process image
Time of day				
Clock				
• Type	Hardware clock	Hardware clock	Hardware clock	Hardware clock
1. Interface				
Interface types				
• RJ 45 (Ethernet)	Yes; X1	Yes; X1	Yes; X1	Yes; X1
• Number of ports	2	2	2	2
• integrated switch	Yes	Yes	Yes	Yes
Protocols				
• IP protocol	Yes; IPv4	Yes; IPv4	Yes; IPv4	Yes; IPv4
• PROFINET IO Controller	Yes	Yes	Yes	Yes
• PROFINET IO Device	Yes	Yes	Yes	Yes
• SIMATIC communication	Yes	Yes	Yes	Yes
• Open IE communication	Yes; Optionally also encrypted	Yes; Optionally also encrypted	Yes; Optionally also encrypted	Yes; Optionally also encrypted
• Web server	Yes	Yes	Yes	Yes
• Media redundancy	Yes; MRP Automanager according to IEC 62439-2 Edition 2.0	Yes; MRP Automanager according to IEC 62439-2 Edition 2.0	Yes; MRP Automanager according to IEC 62439-2 Edition 2.0	Yes; MRP Automanager according to IEC 62439-2 Edition 2.0

SIMATIC S7-1500 Advanced Controllers

Central processing units

Fail-safe CPUs

Technical specifications

Article number	6ES7511-1FK02-0AB0 CPU 1511F-1 PN, 225KB prog, 1MB data	6ES7513-1FL02-0AB0 CPU 1513F-1 PN, 450KB Prog., 1,5MB data	6ES7515-2FM02-0AB0 CPU 1515F-2 PN, 750KB Prog., 3MB Data	6ES7516-3FN02-0AB0 CPU 1516F-3 PN/DP, 1,5MB Prog, 5MB Data
PROFINET IO Controller				
Services				
- PG/OP communication	Yes	Yes	Yes	Yes
- Isochronous mode	Yes	Yes	Yes	Yes
- Direct data exchange	Yes; Requirement: IRT and isochronous mode (MRPD optional)	Yes; Requirement: IRT and isochronous mode (MRPD optional)	Yes; Requirement: IRT and isochronous mode (MRPD optional)	Yes; Requirement: IRT and isochronous mode (MRPD optional)
- IRT	Yes	Yes	Yes	Yes
- PROFinergy	Yes; per user program	Yes; per user program	Yes; per user program	Yes; per user program
- Prioritized startup	Yes; Max. 32 PROFINET devices	Yes; Max. 32 PROFINET devices	Yes; Max. 32 PROFINET devices	Yes; Max. 32 PROFINET devices
- Number of connectable IO Devices, max.	128; In total, up to 256 distributed I/O devices can be connected via AS-i, PROFIBUS or PROFINET	128; In total, up to 512 distributed I/O devices can be connected via AS-i, PROFIBUS or PROFINET	256; In total, up to 1 000 distributed I/O devices can be connected via AS-i, PROFIBUS or PROFINET	256; In total, up to 1 000 distributed I/O devices can be connected via AS-i, PROFIBUS or PROFINET
- Of which IO devices with IRT, max.	64	64	64	64
- Number of connectable IO Devices for RT, max.	128	128	256	256
- of which in line, max.	128	128	256	256
- Number of IO Devices that can be simultaneously activated/ deactivated, max.	8; in total across all interfaces	8; in total across all interfaces	8; in total across all interfaces	8; in total across all interfaces
- Number of IO Devices per tool, max.	8	8	8	8
- Updating times	The minimum value of the update time also depends on communication share set for PROFINET IO, on the number of IO devices, and on the quantity of configured user data	The minimum value of the update time also depends on communication share set for PROFINET IO, on the number of IO devices, and on the quantity of configured user data	The minimum value of the update time also depends on communication share set for PROFINET IO, on the number of IO devices, and on the quantity of configured user data	The minimum value of the update time also depends on communication share set for PROFINET IO, on the number of IO devices, and on the quantity of configured user data
PROFINET IO Device				
Services				
- PG/OP communication	Yes	Yes	Yes	Yes
- Isochronous mode	No	No	No	No
- IRT	Yes	Yes	Yes	Yes
- PROFinergy	Yes; per user program	Yes; per user program	Yes; per user program	Yes; per user program
- Shared device	Yes	Yes	Yes	Yes
- Number of IO Controllers with shared device, max.	4	4	4	4
- activation/deactivation of I-devices	Yes; per user program	Yes; per user program	Yes; per user program	Yes; per user program
- Asset management record	Yes; per user program	Yes; per user program	Yes; per user program	Yes; per user program
2. Interface				
Interface types				
• RJ 45 (Ethernet)			Yes; X2	Yes; X2
• Number of ports			1	1
• integrated switch			No	No
Protocols				
• IP protocol			Yes; IPv4	Yes; IPv4
• PROFINET IO Controller			Yes	Yes
• PROFINET IO Device			Yes	Yes
• SIMATIC communication			Yes	Yes
• Open IE communication			Yes; Optionally also encrypted	Yes; Optionally also encrypted
• Web server			Yes	Yes
• Media redundancy			No	No

SIMATIC S7-1500 Advanced Controllers

Central processing units

Fail-safe CPUs

Technical specifications

Article number	6ES7511-1FK02-0AB0	6ES7513-1FL02-0AB0	6ES7515-2FM02-0AB0	6ES7516-3FN02-0AB0
	CPU 1511F-1 PN, 225KB prog, 1MB data	CPU 1513F-1 PN, 450KB Prog., 1,5MB data	CPU 1515F-2 PN, 750KB Prog., 3MB Data	CPU 1516F-3 PN/DP, 1,5MB Prog, 5MB Data
PROFINET IO Controller				
Services				
- PG/OP communication			Yes	Yes
- Isochronous mode			No	No
- Direct data exchange			No	No
- IRT			No	No
- PROFlenergy			Yes; per user program	Yes; per user program
- Prioritized startup			No	No
- Number of connectable IO Devices, max.			32; In total, up to 1 000 distributed I/O devices can be connected via AS-i, PROFIBUS or PROFINET	32; In total, up to 1 000 distributed I/O devices can be connected via AS-i, PROFIBUS or PROFINET
- Number of connectable IO Devices for RT, max.			32	32
- of which in line, max.			32	32
- Number of IO Devices that can be simultaneously activated/ deactivated, max.			8; in total across all interfaces	8; in total across all interfaces
- Number of IO Devices per tool, max.			8	8
- Updating times			The minimum value of the update time also depends on communication share set for PROFINET IO, on the number of IO devices, and on the quantity of configured user data	The minimum value of the update time also depends on communication share set for PROFINET IO, on the number of IO devices, and on the quantity of configured user data
PROFINET IO Device				
Services				
- PG/OP communication			Yes	Yes
- Isochronous mode			No	No
- IRT			No	No
- PROFlenergy			Yes; per user program	Yes; per user program
- Prioritized startup			No	No
- Shared device			Yes	Yes
- Number of IO Controllers with shared device, max.			4	4
- activation/deactivation of I-devices			Yes; per user program	Yes; per user program
- Asset management record			Yes; per user program	Yes; per user program
3. Interface				
Interface types				
• RS 485				Yes; X3
• Number of ports				1
Protocols				
• PROFIBUS DP master				Yes
• PROFIBUS DP slave				No
• SIMATIC communication				Yes

SIMATIC S7-1500 Advanced Controllers

Central processing units

Fail-safe CPUs

Technical specifications

Article number	6ES7511-1FK02-0AB0 CPU 1511F-1 PN, 225KB prog., 1MB data	6ES7513-1FL02-0AB0 CPU 1513F-1 PN, 450KB Prog., 1,5MB data	6ES7515-2FM02-0AB0 CPU 1515F-2 PN, 750KB Prog., 3MB Data	6ES7516-3FN02-0AB0 CPU 1516F-3 PN/DP, 1,5MB Prog., 5MB Data
Protocols				
Number of connections				
• Number of connections, max.	96; via integrated interfaces of the CPU and connected CPs / CMs	128; via integrated interfaces of the CPU and connected CPs / CMs	192; via integrated interfaces of the CPU and connected CPs / CMs	256; via integrated interfaces of the CPU and connected CPs / CMs
Redundancy mode				
Media redundancy				
- Media redundancy	only via 1st interface (X1)	Yes; only via 1st interface (X1)	only via 1st interface (X1)	Yes; only via 1st interface (X1)
- MRP	Yes; MRP Automanager according to IEC 62439-2 Edition 2.0, MRP Manager; MRP Client	Yes; MRP Automanager according to IEC 62439-2 Edition 2.0, MRP Manager; MRP Client	Yes; MRP Automanager according to IEC 62439-2 Edition 2.0, MRP Manager; MRP Client	Yes; MRP Automanager according to IEC 62439-2 Edition 2.0, MRP Manager; MRP Client
- MRP interconnection, supported	Yes; as MRP ring node according to IEC 62439-2 Edition 3.0	Yes; as MRP ring node according to IEC 62439-2 Edition 3.0	Yes; as MRP ring node according to IEC 62439-2 Edition 3.0	Yes; as MRP ring node according to IEC 62439-2 Edition 3.0
- MRPD	Yes; Requirement: IRT	Yes; Requirement: IRT	Yes; Requirement: IRT	Yes; Requirement: IRT
- Switchover time on line break, typ.	200 ms; For MRP, bumpless for MRPD	200 ms; For MRP, bumpless for MRPD	200 ms; For MRP, bumpless for MRPD	200 ms; For MRP, bumpless for MRPD
- Number of stations in the ring, max.	50	50	50	50
SIMATIC communication				
• S7 routing	Yes	Yes	Yes	Yes
OPC UA				
• OPC UA Client	Yes	Yes	Yes	Yes
• OPC UA Server	Yes; Data access (read, write, subscribe), method call, custom address space	Yes; Data access (read, write, subscribe), method call, custom address space	Yes; Data access (read, write, subscribe), method call, custom address space	Yes; Data access (read, write, subscribe), method call, custom address space
• Alarms and Conditions		Yes		
Supported technology objects				
Motion Control	Yes; Note: The number of technology objects affects the cycle time of the PLC program; selection guide via the TIA Selection Tool	Yes; Note: The number of technology objects affects the cycle time of the PLC program; selection guide via the TIA Selection Tool	Yes; Note: The number of technology objects affects the cycle time of the PLC program; selection guide via the TIA Selection Tool	Yes; Note: The number of technology objects affects the cycle time of the PLC program; selection guide via the TIA Selection Tool
• Number of available Motion Control resources for technology objects	800	800	2 400	2 400
• Required Motion Control resources				
- per speed-controlled axis	40	40	40	40
- per positioning axis	80	80	80	80
- per synchronous axis	160	160	160	160
- per external encoder	80	80	80	80
- per output cam	20	20	20	20
- per cam track	160	160	160	160
- per probe	40	40	40	40
Controller				
• PID_Compact	Yes; Universal PID controller with integrated optimization	Yes; Universal PID controller with integrated optimization	Yes; Universal PID controller with integrated optimization	Yes; Universal PID controller with integrated optimization
• PID_3Step	Yes; PID controller with integrated optimization for valves	Yes; PID controller with integrated optimization for valves	Yes; PID controller with integrated optimization for valves	Yes; PID controller with integrated optimization for valves
• PID-Temp	Yes; PID controller with integrated optimization for temperature	Yes; PID controller with integrated optimization for temperature	Yes; PID controller with integrated optimization for temperature	Yes; PID controller with integrated optimization for temperature
Counting and measuring				
• High-speed counter	Yes	Yes	Yes	Yes

Technical specifications

Article number	6ES7511-1FK02-0AB0 CPU 1511F-1 PN, 225KB prog, 1MB data	6ES7513-1FL02-0AB0 CPU 1513F-1 PN, 450KB Prog., 1,5MB data	6ES7515-2FM02-0AB0 CPU 1515F-2 PN, 750KB Prog., 3MB Data	6ES7516-3FN02-0AB0 CPU 1516F-3 PN/DP, 1,5MB Prog, 5MB Data
Standards, approvals, certificates				
Highest safety class achievable in safety mode				
Probability of failure (for service life of 20 years and repair time of 100 hours)				
- Low demand mode: PFDavg in accordance with SIL3	< 2.00E-05	< 2.00E-05	< 2.00E-05	< 2.00E-05
- High demand/continuous mode: PFH in accordance with SIL3	< 1.00E-09	< 1.00E-09	< 1.00E-09	< 1.00E-09
Ambient conditions				
Ambient temperature during operation				
• horizontal installation, min.	-25 °C; No condensation	-25 °C; No condensation	-25 °C; No condensation	-25 °C; No condensation
• horizontal installation, max.	60 °C; Display: 50 °C, at an operating temperature of typically 50 °C, the display is switched off	60 °C; Display: 50 °C, at an operating temperature of typically 50 °C, the display is switched off	60 °C; Display: 50 °C, at an operating temperature of typically 50 °C, the display is switched off	60 °C; Display: 50 °C, at an operating temperature of typically 50 °C, the display is switched off
• vertical installation, min.	-25 °C; No condensation	-25 °C; No condensation	-25 °C; No condensation	-25 °C; No condensation
• vertical installation, max.	40 °C; Display: 40 °C, at an operating temperature of typically 40 °C, the display is switched off	40 °C; Display: 40 °C, at an operating temperature of typically 40 °C, the display is switched off	40 °C; Display: 40 °C, at an operating temperature of typically 40 °C, the display is switched off	40 °C; Display: 40 °C, at an operating temperature of typically 40 °C, the display is switched off
Altitude during operation relating to sea level				
• Installation altitude above sea level, max.	5 000 m; Restrictions for installation altitudes > 2 000 m, see manual	5 000 m; Restrictions for installation altitudes > 2 000 m, see manual	5 000 m; Restrictions for installation altitudes > 2 000 m, see manual	5 000 m; Restrictions for installation altitudes > 2 000 m, see manual
Configuration				
Programming				
Programming language				
- LAD	Yes; incl. failsafe	Yes; incl. failsafe	Yes; incl. failsafe	Yes; incl. failsafe
- FBD	Yes; incl. failsafe	Yes; incl. failsafe	Yes; incl. failsafe	Yes; incl. failsafe
- STL	Yes	Yes	Yes	Yes
- SCL	Yes	Yes	Yes	Yes
- GRAPH	Yes	Yes	Yes	Yes
Know-how protection				
• User program protection/password protection	Yes	Yes	Yes	Yes
• Copy protection	Yes	Yes	Yes	Yes
• Block protection	Yes	Yes	Yes	Yes
Access protection				
• Password for display	Yes	Yes	Yes	Yes
• Protection level: Write protection	Yes; Specific write protection both for Standard and for Failsafe	Yes; Specific write protection both for Standard and for Failsafe	Yes; Specific write protection both for Standard and for Failsafe	Yes; Specific write protection both for Standard and for Failsafe
• Protection level: Read/write protection	Yes	Yes	Yes	Yes
• Protection level: Write protection for Failsafe	Yes	Yes	Yes	Yes
• Protection level: Complete protection	Yes	Yes	Yes	Yes
Dimensions				
Width	35 mm	35 mm	70 mm	70 mm
Height	147 mm	147 mm	147 mm	147 mm
Depth	129 mm	129 mm	129 mm	129 mm
Weights				
Weight, approx.	405 g	405 g	830 g	845 g

SIMATIC S7-1500 Advanced Controllers

Central processing units

Fail-safe CPUs

Technical specifications

Article number	6ES7517-3FP00-0AB0 CPU 1517F-3 PN/DP, 3MB Prog., 8MB Data	6ES7518-4FP00-0AB0 CPU 1518F-4 PN/DP, 9 MB Prog., 60MB Data	6ES7518-4FX00-1AC0 CPU 1518F-4 PN/DP MFP + C/C++ RT +OPC UA
General information			
Product type designation	CPU 1517F-3PN/DP	CPU 1518F-4PN/DP	CPU 1518F-4 PN/DP MFP
Engineering with			
<ul style="list-style-type: none"> STEP 7 TIA Portal configurable/ integrated from version 	V17 (FW V2.9) / V13 Update 3 (FW V1.6) or higher	V17 (FW V2.9) / V13 (FW V1.5) or higher	V17 (FW V2.9) / V15 (FW V2.5) or higher
Display			
Screen diagonal [cm]	6.1 cm	6.1 cm	6.1 cm
Supply voltage			
Rated value (DC)	24 V	24 V	24 V
Memory			
Work memory			
<ul style="list-style-type: none"> integrated (for program) integrated (for data) integrated (for CPU function library of CPU Runtime) 	3 Mbyte 8 Mbyte	9 Mbyte 60 Mbyte	9 Mbyte 60 Mbyte 50 Mbyte; Note: The "CPU function library of the CPU" are C/C++ blocks for the user program that were created using the SIMATIC ODK 1500S or Target 1500S.
Working memory for additional functions			
<ul style="list-style-type: none"> Integrated (for C/C++ Runtime application) available (for Linux runtime application) 			512 Mbyte 1 Gbyte
Load memory			
<ul style="list-style-type: none"> Plug-in (SIMATIC Memory Card), max. 	32 Gbyte	32 Gbyte	32 Gbyte; the memory card must have at least 2 GB of space on it
CPU processing times			
for bit operations, typ.	2 ns	1 ns	1 ns
for word operations, typ.	3 ns	2 ns	2 ns
for fixed point arithmetic, typ.	3 ns	2 ns	2 ns
for floating point arithmetic, typ.	12 ns	6 ns	6 ns
Counters, timers and their retentivity			
S7 counter			
<ul style="list-style-type: none"> Number 	2 048	2 048	2 048
IEC counter			
<ul style="list-style-type: none"> Number 	Any (only limited by the main memory)	Any (only limited by the main memory)	Any (only limited by the main memory)
S7 times			
<ul style="list-style-type: none"> Number 	2 048	2 048	2 048
IEC timer			
<ul style="list-style-type: none"> Number 	Any (only limited by the main memory)	Any (only limited by the main memory)	Any (only limited by the main memory)
Data areas and their retentivity			
Flag			
<ul style="list-style-type: none"> Size, max. 	16 kbyte	16 kbyte	16 kbyte
Address area			
I/O address area			
<ul style="list-style-type: none"> Inputs Outputs 	32 kbyte; All inputs are in the process image 32 kbyte; All outputs are in the process image	32 kbyte; All inputs are in the process image 32 kbyte; All outputs are in the process image	32 kbyte; All inputs are in the process image 32 kbyte; All outputs are in the process image
Time of day			
Clock			
<ul style="list-style-type: none"> Type 	Hardware clock	Hardware clock	Hardware clock

Technical specifications

Article number	6ES7517-3FP00-0AB0 CPU 1517F-3 PN/DP, 3MB Prog., 8MB Data	6ES7518-4FP00-0AB0 CPU 1518F-4 PN/DP, 9 MB Prog., 60MB Data	6ES7518-4FX00-1AC0 CPU 1518F-4 PN/DP MFP + C/C++ RT +OPC UA
1. Interface			
Interface types			
• RJ 45 (Ethernet)	Yes; X1	Yes; X1	Yes; X1
• Number of ports	2	2	2
• integrated switch	Yes	Yes	Yes
Protocols			
• IP protocol	Yes; IPv4	Yes; IPv4	Yes; IPv4
• PROFINET IO Controller	Yes	Yes	Yes
• PROFINET IO Device	Yes	Yes	Yes
• SIMATIC communication	Yes	Yes	Yes
• Open IE communication	Yes; Optionally also encrypted	Yes; Optionally also encrypted	Yes; Optionally also encrypted
• Web server	Yes	Yes	Yes
• Media redundancy	Yes; MRP Automanager according to IEC 62439-2 Edition 2.0	Yes; MRP Automanager according to IEC 62439-2 Edition 2.0	Yes; MRP Automanager according to IEC 62439-2 Edition 2.0
PROFINET IO Controller			
Services			
- PG/OP communication	Yes	Yes	Yes
- Isochronous mode	Yes	Yes	Yes
- Direct data exchange	Yes; Requirement: IRT and isochronous mode (MRPD optional)	Yes; Requirement: IRT and isochronous mode (MRPD optional)	Yes; Requirement: IRT and isochronous mode (MRPD optional)
- IRT	Yes	Yes	Yes
- PROFIenergy	Yes; per user program	Yes; per user program	Yes; per user program
- Prioritized startup	Yes; Max. 32 PROFINET devices	Yes; Max. 32 PROFINET devices	Yes; Max. 32 PROFINET devices
- Number of connectable IO Devices, max.	512; In total, up to 1 000 distributed I/O devices can be connected via AS-i, PROFIBUS or PROFINET	512; In total, up to 1 000 distributed I/O devices can be connected via AS-i, PROFIBUS or PROFINET	512; In total, up to 1 000 distributed I/O devices can be connected via AS-i, PROFIBUS or PROFINET
- Of which IO devices with IRT, max.	64	64	64
- Number of connectable IO Devices for RT, max.	512	512	512
- of which in line, max.	512	512	512
- Number of IO Devices that can be simultaneously activated/deactivated, max.	8; in total across all interfaces	8; in total across all interfaces	8; in total across all interfaces
- Number of IO Devices per tool, max.	8	8	8
- Updating times	The minimum value of the update time also depends on communication share set for PROFINET IO, on the number of IO devices, and on the quantity of configured user data	The minimum value of the update time also depends on communication share set for PROFINET IO, on the number of IO devices, and on the quantity of configured user data	The minimum value of the update time also depends on communication share set for PROFINET IO, on the number of IO devices, and on the quantity of configured user data
PROFINET IO Device			
Services			
- PG/OP communication	Yes	Yes	Yes
- Isochronous mode	No	No	No
- IRT	Yes	Yes; Minimum send cycle of 250 µs	Yes; Minimum send cycle of 250 µs
- PROFIenergy	Yes; per user program	Yes; per user program	Yes; per user program
- Shared device	Yes	Yes	Yes
- Number of IO Controllers with shared device, max.	4	4	4
- activation/deactivation of I-devices	Yes; per user program	Yes; per user program	Yes; per user program
- Asset management record	Yes; per user program	Yes; per user program	Yes; per user program

SIMATIC S7-1500 Advanced Controllers

Central processing units

Fail-safe CPUs

Technical specifications

Article number	6ES7517-3FP00-0AB0 CPU 1517F-3 PN/DP, 3MB Prog., 8MB Data	6ES7518-4FP00-0AB0 CPU 1518F-4 PN/DP, 9 MB Prog., 60MB Data	6ES7518-4FX00-1AC0 CPU 1518F-4 PN/DP MFP + C/C++ RT +OPC UA
2. Interface			
Interface types			
• RJ 45 (Ethernet)	Yes; X2	Yes; X2	Yes; X2
• Number of ports	1	1	1
• integrated switch	No	No	No
Protocols			
• IP protocol	Yes; IPv4	Yes; IPv4	Yes; IPv4
• PROFINET IO Controller	Yes	Yes	Yes
• PROFINET IO Device	Yes	Yes	Yes
• SIMATIC communication	Yes	Yes	Yes
• Open IE communication	Yes; Optionally also encrypted	Yes; Optionally also encrypted	Yes; Optionally also encrypted
• Web server	Yes	Yes	Yes
• Media redundancy	No	No	No
PROFINET IO Controller			
Services			
- PG/OP communication	Yes	Yes	Yes
- Isochronous mode	No	No	No
- Direct data exchange	No	No	No
- IRT	No	No	No
- PROFlenergy	Yes; per user program	Yes; per user program	Yes; per user program
- Prioritized startup	No	No	No
- Number of connectable I/O Devices, max.	128; In total, up to 1 000 distributed I/O devices can be connected via AS-i, PROFIBUS or PROFINET	128; In total, up to 1 000 distributed I/O devices can be connected via AS-i, PROFIBUS or PROFINET	128; In total, up to 1 000 distributed I/O devices can be connected via AS-i, PROFIBUS or PROFINET
- Number of connectable I/O Devices for RT, max.	128	128	128
- of which in line, max.	128	128	128
- Number of IO Devices that can be simultaneously activated/deactivated, max.	8; in total across all interfaces	8; in total across all interfaces	8; in total across all interfaces
- Number of IO Devices per tool, max.	8	8	8
- Updating times	The minimum value of the update time also depends on communication share set for PROFINET IO, on the number of IO devices, and on the quantity of configured user data	The minimum value of the update time also depends on communication share set for PROFINET IO, on the number of IO devices, and on the quantity of configured user data	The minimum value of the update time also depends on communication share set for PROFINET IO, on the number of IO devices, and on the quantity of configured user data
PROFINET IO Device			
Services			
- PG/OP communication	Yes	Yes	Yes
- Isochronous mode	No	No	No
- IRT	No	No	No
- PROFlenergy	Yes; per user program	Yes; per user program	Yes; per user program
- Prioritized startup	No	No	No
- Shared device	Yes	Yes	Yes
- Number of IO Controllers with shared device, max.	4	4	4
- activation/deactivation of I-devices	Yes; per user program	Yes; per user program	Yes; per user program
- Asset management record	Yes; per user program	Yes; per user program	Yes; per user program

Technical specifications

Article number	6ES7517-3FP00-0AB0 CPU 1517F-3 PN/DP, 3MB Prog., 8MB Data	6ES7518-4FP00-0AB0 CPU 1518F-4 PN/DP, 9 MB Prog., 60MB Data	6ES7518-4FX00-1AC0 CPU 1518F-4 PN/DP MFP + C/C++ RT +OPC UA
3. Interface			
Interface types			
<ul style="list-style-type: none"> • RJ 45 (Ethernet) • RS 485 • Number of ports 	Yes; X3 1	Yes; X3 1	Yes; X3 1; C/C++ Runtime can also be reached via this port
<ul style="list-style-type: none"> • integrated switch 		No	No
Protocols			
<ul style="list-style-type: none"> • IP protocol • PROFINET IO Controller • PROFINET IO Device • PROFIBUS DP master • PROFIBUS DP slave • SIMATIC communication • Open IE communication • Web server 	Yes No Yes	Yes; IPv4 No No Yes Yes Yes	Yes; IPv4 No No Yes Yes Yes
PROFIBUS DP master			
<ul style="list-style-type: none"> • Number of DP slaves, max. 	125; In total, up to 1 000 distributed I/O devices can be connected via PROFIBUS or PROFINET		
4. Interface			
Interface types			
<ul style="list-style-type: none"> • RS 485 • Number of ports 		Yes; X4 1	Yes; X4 1
Protocols			
<ul style="list-style-type: none"> • PROFIBUS DP master • PROFIBUS DP slave • SIMATIC communication 		Yes No Yes	Yes No Yes
PROFIBUS DP master			
<ul style="list-style-type: none"> • Number of DP slaves, max. 		125; In total, up to 1 000 distributed I/O devices can be connected via AS-i, PROFIBUS or PROFINET	125; In total, up to 1 000 distributed I/O devices can be connected via AS-i, PROFIBUS or PROFINET
Protocols			
Number of connections			
<ul style="list-style-type: none"> • Number of connections, max. 	320; via integrated interfaces of the CPU and connected CPs / CMs	384; via integrated interfaces of the CPU and connected CPs / CMs	384; via integrated interfaces of the CPU and connected CPs / CMs
Redundancy mode			
Media redundancy			
<ul style="list-style-type: none"> - Media redundancy - MRP - MRP interconnection, supported - MRPD - Switchover time on line break, typ. - Number of stations in the ring, max. 	only via 1st interface (X1) Yes; as MRP redundancy manager and/or MRP client Yes; as ring node according to IEC 62439-2 Edition 2.0 Yes; Requirement: IRT 200 ms; For MRP, bumpless for MRPD 50	only via 1st interface (X1) Yes; as MRP redundancy manager and/or MRP client Yes; as ring node according to IEC 62439-2 Edition 2.0 Yes; Requirement: IRT 200 ms; For MRP, bumpless for MRPD 50	only via 1st interface (X1) Yes; as MRP redundancy manager and/or MRP client Yes; as ring node according to IEC 62439-2 Edition 2.0 Yes; Requirement: IRT 200 ms; For MRP, bumpless for MRPD 50
SIMATIC communication			
<ul style="list-style-type: none"> • S7 routing 	Yes	Yes	Yes
OPC UA			
<ul style="list-style-type: none"> • OPC UA Client • OPC UA Server 	Yes Yes; Data access (read, write, subscribe), method call, custom address space	Yes Yes; Data access (read, write, subscribe), method call, custom address space	Yes Yes; Data access (read, write, subscribe), method call, custom address space
<ul style="list-style-type: none"> • Alarms and Conditions 			Yes

SIMATIC S7-1500 Advanced Controllers

Central processing units

Fail-safe CPUs

Technical specifications

Article number	6ES7517-3FP00-0AB0 CPU 1517F-3 PN/DP, 3MB Prog., 8MB Data	6ES7518-4FP00-0AB0 CPU 1518F-4 PN/DP, 9 MB Prog., 60MB Data	6ES7518-4FX00-1AC0 CPU 1518F-4 PN/DP MFP + C/C++ RT +OPC UA
Supported technology objects			
Motion Control	Yes; Note: The number of technology objects affects the cycle time of the PLC program; selection guide via the TIA Selection Tool	Yes; Note: The number of technology objects affects the cycle time of the PLC program; selection guide via the TIA Selection Tool	Yes; Note: The number of technology objects affects the cycle time of the PLC program; selection guide via the TIA Selection Tool
• Number of available Motion Control resources for technology objects	10 240	15 360	15 360
• Required Motion Control resources			
- per speed-controlled axis	40	40	40
- per positioning axis	80	80	80
- per synchronous axis	160	160	160
- per external encoder	80	80	80
- per output cam	20	20	20
- per cam track	160	160	160
- per probe	40	40	40
Controller			
• PID_Compact	Yes; Universal PID controller with integrated optimization	Yes; Universal PID controller with integrated optimization	Yes; Universal PID controller with integrated optimization
• PID_3Step	Yes; PID controller with integrated optimization for valves	Yes; PID controller with integrated optimization for valves	Yes; PID controller with integrated optimization for valves
• PID-Temp	Yes; PID controller with integrated optimization for temperature	Yes; PID controller with integrated optimization for temperature	Yes; PID controller with integrated optimization for temperature
Counting and measuring			
• High-speed counter	Yes	Yes	Yes
Standards, approvals, certificates			
Highest safety class achievable in safety mode			
Probability of failure (for service life of 20 years and repair time of 100 hours)			
- Low demand mode: PFDavg in accordance with SIL3	< 2.00E-05	< 2.00E-05	< 2.00E-05
- High demand/continuous mode: PFH in accordance with SIL3	< 1.00E-09	< 1.00E-09	< 1.00E-09
Ambient conditions			
Ambient temperature during operation			
• horizontal installation, min.	0 °C	0 °C	0 °C
• horizontal installation, max.	60 °C; Display: 50 °C, at an operating temperature of typically 50 °C, the display is switched off	60 °C; Display: 50 °C, at an operating temperature of typically 50 °C, the display is switched off	60 °C; Display: 50 °C, at an operating temperature of typically 50 °C, the display is switched off
• vertical installation, min.	0 °C	0 °C	0 °C
• vertical installation, max.	40 °C; Display: 40 °C, at an operating temperature of typically 40 °C, the display is switched off	40 °C; Display: 40 °C, at an operating temperature of typically 40 °C, the display is switched off	40 °C; Display: 40 °C, at an operating temperature of typically 40 °C, the display is switched off
Altitude during operation relating to sea level			
• Installation altitude above sea level, max.	5 000 m; Restrictions for installation altitudes > 2 000 m, see manual	5 000 m; Restrictions for installation altitudes > 2 000 m, see manual	5 000 m; Restrictions for installation altitudes > 2 000 m, see manual

Technical specifications

Article number	6ES7517-3FP00-0AB0 CPU 1517F-3 PN/DP, 3MB Prog., 8MB Data	6ES7518-4FP00-0AB0 CPU 1518F-4 PN/DP, 9 MB Prog., 60MB Data	6ES7518-4FX00-1AC0 CPU 1518F-4 PN/DP MFP + C/C++ RT +OPC UA
Configuration			
Programming			
Programming language			
- LAD	Yes; incl. failsafe	Yes; incl. failsafe	Yes
- FBD	Yes; incl. failsafe	Yes; incl. failsafe	Yes
- STL	Yes	Yes	Yes
- SCL	Yes	Yes	Yes
- GRAPH	Yes	Yes	Yes
Know-how protection			
• User program protection/ password protection	Yes	Yes	Yes
• Copy protection	Yes	Yes	Yes
• Block protection	Yes	Yes	Yes
Access protection			
• Password for display	Yes	Yes	Yes
• Protection level: Write protection	Yes; Specific write protection both for Standard and for Failsafe	Yes; Specific write protection both for Standard and for Failsafe	Yes
• Protection level: Read/write protection	Yes	Yes	Yes
• Protection level: Write protection for Failsafe		Yes	
• Protection level: Complete protection	Yes	Yes	Yes
Open Development interfaces			
• Size of ODK SO file, max.			9.8 Mbyte
Dimensions			
Width	175 mm	175 mm	175 mm
Height	147 mm	147 mm	147 mm
Depth	129 mm	129 mm	129 mm
Weights			
Weight, approx.	1 978 g	1 988 g	2 117 g

SIMATIC S7-1500 Advanced Controllers

Central processing units

SIPLUS fail-safe CPUs

Overview SIPLUS CPU 1511F-1 PN



- Entry-level CPU in the SIPLUS S7-1500F Controller product range
- Can be used for safety functions up to SIL 3 according to IEC 61508 and up to PL e according to ISO 13849
- Suitable for standard and fail-safe applications with medium requirements for program scope and processing speed
- Used as central PLC in production lines with central and distributed I/O
- Supports PROFIsafe in centralized and distributed configurations
- PROFINET IO IRT interface with 2-port switch
- PROFINET IO controller for operating distributed I/O on PROFINET
- PROFINET I-Device for connecting the CPU as an intelligent PROFINET device under a SIMATIC or non-Siemens PROFINET IO controller
- Isochronous mode

Note:

SIMATIC Memory Card required for operation of the CPU.

SIPLUS extreme products are based on SIMATIC standard products. The contents listed here were taken from the corresponding standard products. SIPLUS extreme-specific information was added.

Overview SIPLUS CPU 1513F-1 PN



- The CPU for standard and fail-safe applications with medium/high requirements for program/data storage in the SIPLUS S7-1500 Controller product range
- High processing speed for binary and floating-point arithmetic
- Used as central PLC in production lines with central and distributed I/O
- Supports PROFIsafe in centralized and distributed configurations
- PROFINET IO IRT interface with 2-port switch
- PROFINET IO controller for operating distributed I/O on PROFINET
- PROFINET I-Device for connecting the CPU as an intelligent PROFINET device under a SIMATIC or non-Siemens PROFINET IO controller
- Isochronous mode

Note:

SIMATIC Memory Card required for operation of the CPU.

SIPLUS extreme products are based on SIMATIC standard products. The contents listed here were taken from the corresponding standard products. SIPLUS extreme-specific information was added.

Overview SIPLUS CPU 1515F-2 PN



- The CPU for applications with medium to high requirements for program/data storage in the S7-1500 Controller product range
- Can be used for safety functions up to SIL 3 according to IEC 61508 and up to PL e according to ISO 13849.
- Medium to high processing speed for binary and floating-point arithmetic
- Used as central controller in production lines with central and distributed I/O
- Supports PROFIsafe in centralized and distributed configuration.
- PROFINET IO IRT interface with 2-port switch
- Additional PROFINET interface with separate IP address
- PROFINET IO controller for operating distributed I/O on PROFINET
- PROFINET I-Device for connecting the CPU as an intelligent PROFINET device under a SIMATIC or non-Siemens PROFINET IO controller
- Isochronous mode
- Integrated Motion Control functionalities for controlling speed-controlled and positioning axes, support for external encoders
- Integrated web server with the option of creating user-defined web pages

Note:

SIMATIC Memory Card required for operation of the CPU.

SIPLUS extreme products are based on SIMATIC standard products. The contents listed here were taken from the corresponding standard products. SIPLUS extreme-specific information was added.

Overview SIPLUS CPU 1516F-3 PN/DP



- The CPU with a large program and data memory in the SIPLUS S7-1500 Controller product range for fail-safe applications with high requirements regarding program scope and networking.
- Can be used for failsafe functions up to SIL 3 according to IEC 61508 and up to PLe according to ISO 13849
- High processing speed for binary and floating-point arithmetic
- Used as central controller in production lines with central and distributed I/O
- Supports PROFIsafe in centralized and distributed configurations
- PROFINET IO IRT interface with 2-port switch.
- Additional PROFINET interface with separate IP address.
- PROFINET IO controller for operating distributed I/O on PROFINET.
- PROFINET I-Device for connecting the CPU as an intelligent PROFINET device under a SIMATIC or non-Siemens PROFINET IO controller.
- PROFIBUS DP master interface.
- Isochronous mode on PROFIBUS and PROFINET.
- Integrated Motion Control functionalities for controlling speed-controlled and positioning axes, support for external encoders.
- Integrated web server with the option of creating user-defined web pages.

Note:

SIMATIC Memory Card required for operation of the CPU

SIPLUS extreme products are based on SIMATIC standard products. The contents listed here were taken from the corresponding standard products. SIPLUS extreme-specific information was added.

SIMATIC S7-1500 Advanced Controllers

Central processing units

SIPLUS fail-safe CPUs

Overview SIPLUS CPU 1518F-4 PN/DP



- The CPU with a very large program and data memory in the SIPLUS S7-1500 Controller product range for fail-safe applications with highest requirements regarding program scope, performance and networking.
- Can be used for failsafe functions up to SIL 3 according to IEC 61508 and up to PLe according to ISO 13849.
- Extremely high processing speed for binary and floating-point arithmetic.
- For cross-industry automation tasks in series machine, special machine and plant construction
- Used as central controller in production lines with central and distributed I/O
- Supports PROFIsafe in centralized and distributed configuration.
- PROFINET IO IRT interface with 2-port switch.
- Two additional PROFINET interfaces with separate IP addresses.
- PROFINET IO controller for operating distributed I/O on PROFINET.
- PROFINET I-Device for connecting the CPU as an intelligent PROFINET device under a SIMATIC or non-Siemens PROFINET IO controller.
- PROFIBUS DP master interface.
- Isochronous mode on PROFIBUS and PROFINET.
- Integrated Motion Control functionalities for controlling speed-controlled and positioning axes, support for external encoders
- Integrated web server with the option of creating user-defined web pages.

Note:

SIMATIC Memory Card required for operation of the CPU.

SIPLUS extreme products are based on SIMATIC standard products. The contents listed here were taken from the corresponding standard products. SIPLUS extreme-specific information was added.

SIMATIC S7-1500 Advanced Controllers

Central processing units

SIPLUS fail-safe CPUs

4

Ordering data	Article No.	Accessories	Article No.
SIPLUS CPU 1511F-1 PN (extended temperature range and exposure to environmental substances) Fail-safe central processing unit with work memory 225 KB for program, 1 MB for data, 1st interface: PROFINET IRT with 2-port switch; SIMATIC Memory Card required Temperature range -25 ... +60 °C	6AG1511-1FK02-2AB0	System power supply (extended temperature range and exposure to environmental substances) For supplying the backplane bus of the S7-1500 PLC 24 V DC input voltage, power 25 W 24/48/60 V DC input voltage, power 60 W 120/230 V AC input voltage, power 60 W	6AG1505-0KA00-7AB0 6AG1505-0RA00-7AB0 6AG1507-0RA00-7AB0
SIPLUS CPU 1513F-1 PN (extended temperature range and exposure to environmental substances) Fail-safe CPU, 450 KB work memory for program, 1.5 MB for data, PROFINET IRT interface with 2-port switch; SIMATIC Memory Card required	6AG1513-1FL02-2AB0	Load current supply (extended temperature range and exposure to environmental substances) 24 V DC/3 A 24 V DC/8 A	6AG1332-4BA00-7AA0 6AG1333-4BA00-7AA0
SIPLUS CPU 1515F-2 PN (extended temperature range and exposure to environmental substances) Fail-safe CPU, 750 KB work memory for program, 3 MB for data, PROFINET IRT interface with 2-port switch; PROFINET RT interface; SIMATIC Memory Card required	6AG1515-2FM02-2AB0	Display (extended temperature range and exposure to environmental substances) For SIPLUS CPU 1511-1 PN; spare part For SIPLUS CPU 1513F-1 PN; spare part For SIPLUS CPU 1515F-2 PN, CPU 1516F-3 PN/DP and CPU 1518-4F PN/DP; spare part For SIPLUS CPU 1518-4F PN/DP; spare part	6AG1591-1AA01-2AA0 6AG1591-1AB00-2AA0 6AG1591-1BB00-2AA0 6AG1591-1BA02-2AA0
SIPLUS CPU 1516F-3 PN/DP (extended temperature range and exposure to environmental substances) Fail-safe CPU, 1.5 MB work memory for program, 5 MB for data, PROFINET IRT interface with 2-port switch, PROFINET RT interface, PROFIBUS interface; SIMATIC Memory Card required	6AG1516-3FN02-2AB0	Other accessories See SIMATIC S7-1500, fail-safe CPUs, page 4/40	
CPU 1518F-4 PN/DP (Exposure to environmental substances) Fail-safe CPU, 6 MB work memory for program, 20 MB for data, PROFINET IRT interface with 2-port switch, PROFINET RT interface, Ethernet interface, PROFIBUS interface; SIMATIC Memory Card required	6AG1518-4FP00-4AB0		

SIMATIC S7-1500 Advanced Controllers

Central processing units

SIPLUS fail-safe CPUs

Technical specifications

Article number	6AG1511-1FK02-2AB0	6AG1513-1FL02-2AB0	6AG1515-2FM02-2AB0	6AG1516-3FN02-2AB0	6AG1518-4FP00-4AB0
Based on	6ES7511-1FK02-0AB0	6ES7513-1FL02-0AB0	6ES7515-2FM02-0AB0	6ES7516-3FN02-0AB0	6ES7518-4FP00-0AB0
	SIPLUS S7-1500 CPU 1511F-1 PN	SIPLUS S7-1500 CPU 1513F-1 PN	SIPLUS S7-1500 CPU 1515F-2 PN	SIPLUS S7-1500 CPU 1516F-3 PN/DP	SIPLUS S7-1500 CPU 1518F-4 PN/DP
Ambient conditions					
Ambient temperature during operation					
• horizontal installation, min.	-25 °C; = Tmin (incl. condensation/frost)	-25 °C; = Tmin (incl. condensation/frost)	-40 °C; = Tmin (incl. condensation/frost)	-40 °C; = Tmin (incl. condensation/frost)	0 °C
• horizontal installation, max.	60 °C; = Tmax; display: 50 °C, the display is switched off at an operating temperature of typically 50 °C	60 °C; = Tmax; display: 50 °C, the display is switched off at an operating temperature of typically 50 °C	60 °C; = Tmax; display: 50 °C, the display is switched off at an operating temperature of typically 50 °C	60 °C; = Tmax; display: 50 °C, the display is switched off at an operating temperature of typically 50 °C	60 °C; Display: 50 °C, at an operating temperature of typically 50 °C, the display is switched off
• vertical installation, min.	-25 °C; = Tmin (incl. condensation/frost)	-25 °C; = Tmin (incl. condensation/frost)	-40 °C; = Tmin	-40 °C; = Tmin	0 °C
• vertical installation, max.	40 °C; Display: 40 °C, at an operating temperature of typically 40 °C, the display is switched off	40 °C; Display: 40 °C, at an operating temperature of typically 40 °C, the display is switched off	40 °C; = Tmax; display: 40 °C, at an operating temperature of typically 40 °C, the display is switched off	40 °C; = Tmax; display: 40 °C, at an operating temperature of typically 40 °C, the display is switched off	40 °C; Display: 40 °C, at an operating temperature of typically 40 °C, the display is switched off
Altitude during operation relating to sea level					
• Installation altitude above sea level, max.	5 000 m; Restrictions for installation altitudes > 2 000 m, see manual	5 000 m; Restrictions for installation altitudes > 2 000 m, see manual	5 000 m; Restrictions for installation altitudes > 2 000 m, see manual	5 000 m; Restrictions for installation altitudes > 2 000 m, see manual	5 000 m
• Ambient air temperature-barometric pressure-altitude	Restrictions for installation altitudes > 2 000 m, see entry ID: 109763260	Restrictions for installation altitudes > 2 000 m, see entry ID: 109763260	Restrictions for installation altitudes > 2 000 m, see entry ID: 109763260	Restrictions for installation altitudes > 2 000 m, see entry ID: 109763260	Restrictions for installation altitudes > 2 000 m, see entry ID: 109763260
Relative humidity					
• With condensation, tested in accordance with IEC 60068-2-38, max.	100 %; RH incl. condensation / frost (no commissioning in bedewed state), horizontal installation	100 %; RH incl. condensation / frost (no commissioning in bedewed state), horizontal installation	100 %; RH incl. condensation / frost (no commissioning in bedewed state), horizontal installation	100 %; RH incl. condensation / frost (no commissioning in bedewed state), horizontal installation	100 %; RH incl. condensation/frost (no commissioning under condensation conditions)
Resistance					
Coolants and lubricants					
- Resistant to commercially available coolants and lubricants	Yes; Incl. diesel and oil droplets in the air	Yes; Incl. diesel and oil droplets in the air	Yes; Incl. diesel and oil droplets in the air	Yes; Incl. diesel and oil droplets in the air	Yes; Incl. diesel and oil droplets in the air
Use in stationary industrial systems					
- to biologically active substances according to EN 60721-3-3	Yes; Class 3B2 mold, fungus and dry rot spores (with the exception of fauna); Class 3B3 on request	Yes; Class 3B2 mold, fungus and dry rot spores (with the exception of fauna); Class 3B3 on request	Yes; Class 3B2 mold, fungus and dry rot spores (with the exception of fauna); Class 3B3 on request	Yes; Class 3B2 mold, fungus and dry rot spores (with the exception of fauna); Class 3B3 on request	Yes; Class 3B2 mold, fungus and dry rot spores (with the exception of fauna); Class 3B3 on request
- to chemically active substances according to EN 60721-3-3	Yes; Class 3C4 (RH < 75 %) incl. salt spray acc. to EN 60068-2-52 (severity degree 3); *	Yes; Class 3C4 (RH < 75 %) incl. salt spray acc. to EN 60068-2-52 (severity degree 3); *	Yes; Class 3C4 (RH < 75 %) incl. salt spray acc. to EN 60068-2-52 (severity degree 3); *	Yes; Class 3C4 (RH < 75 %) incl. salt spray acc. to EN 60068-2-52 (severity degree 3); *	Yes; Class 3C4 (RH < 75 %) incl. salt spray acc. to EN 60068-2-52 (severity degree 3); *
- to mechanically active substances according to EN 60721-3-3	Yes; Class 3S4 incl. sand, dust, *	Yes; Class 3S4 incl. sand, dust, *	Yes; Class 3S4 incl. sand, dust, *	Yes; Class 3S4 incl. sand, dust, *	Yes; Class 3S4 incl. sand, dust, *
Use on ships/at sea					
- to biologically active substances according to EN 60721-3-6	Yes; Class 6B2 mold, fungal and dry rot spores (excluding fauna)	Yes; Class 6B2 mold, fungal and dry rot spores (excluding fauna)	Yes; Class 6B2 mold, fungal and dry rot spores (excluding fauna)	Yes; Class 6B2 mold, fungal and dry rot spores (excluding fauna)	Yes; Class 6B2 mold and fungal spores (excluding fauna); Class 6B3 on request
- to chemically active substances according to EN 60721-3-6	Yes; Class 6C3 (RH < 75 %) incl. salt spray acc. to EN 60068-2-52 (severity degree 3); *	Yes; Class 6C3 (RH < 75 %) incl. salt spray acc. to EN 60068-2-52 (severity degree 3); *	Yes; Class 6C3 (RH < 75 %) incl. salt spray acc. to EN 60068-2-52 (severity degree 3); *	Yes; Class 6C3 (RH < 75 %) incl. salt spray acc. to EN 60068-2-52 (severity degree 3); *	Yes; Class 6C3 (RH < 75 %) incl. salt spray acc. to EN 60068-2-52 (severity degree 3); *
- to mechanically active substances according to EN 60721-3-6	Yes; Class 6S3 incl. sand, dust; *	Yes; Class 6S3 incl. sand, dust; *	Yes; Class 6S3 incl. sand, dust; *	Yes; Class 6S3 incl. sand, dust; *	Yes; Class 6S3 incl. sand, dust; *

SIMATIC S7-1500 Advanced Controllers

Central processing units

SIPLUS fail-safe CPUs

Technical specifications

Article number	6AG1511-1FK02-2AB0	6AG1513-1FL02-2AB0	6AG1515-2FM02-2AB0	6AG1516-3FN02-2AB0	6AG1518-4FP00-4AB0
Based on	6ES7511-1FK02-0AB0 SIPLUS S7-1500 CPU 1511F-1 PN	6ES7513-1FL02-0AB0 SIPLUS S7-1500 CPU 1513F-1 PN	6ES7515-2FM02-0AB0 SIPLUS S7-1500 CPU 1515F-2 PN	6ES7516-3FN02-0AB0 SIPLUS S7-1500 CPU 1516F-3 PN/DP	6ES7518-4FP00-0AB0 SIPLUS S7-1500 CPU 1518F-4 PN/DP
Usage in industrial process technology					
- Against chemically active substances acc. to EN 60654-4	Yes; Class 3 (excluding trichlorethylene)	Yes; Class 3 (excluding trichlorethylene)	Yes; Class 3 (excluding trichlorethylene)	Yes; Class 3 (excluding trichlorethylene)	Yes; Class 3 (excluding trichlorethylene)
- Environmental conditions for process, measuring and control systems acc. to ANSI/ISA-71.04	Yes; Level GX group A/B (excluding trichlorethylene; harmful gas concentrations up to the limits of EN 60721-3-3 class 3C4 permissible); level LC3 (salt spray) and level LB3 (oil)	Yes; Level GX group A/B (excluding trichlorethylene; harmful gas concentrations up to the limits of EN 60721-3-3 class 3C4 permissible); level LC3 (salt spray) and level LB3 (oil)	Yes; Level GX group A/B (excluding trichlorethylene; harmful gas concentrations up to the limits of EN 60721-3-3 class 3C4 permissible); level LC3 (salt spray) and level LB3 (oil)	Yes; Level GX group A/B (excluding trichlorethylene; harmful gas concentrations up to the limits of EN 60721-3-3 class 3C4 permissible); level LC3 (salt spray) and level LB3 (oil)	Yes; Level GX group A/B (excluding trichlorethylene; harmful gas concentrations up to the limits of EN 60721-3-3 class 3C4 permissible); level LC3 (salt spray) and level LB3 (oil)
Remark					
- Note regarding classification of environmental conditions acc. to EN 60721, EN 60654-4 and ANSI/ISA-71.04	* The supplied plug covers must remain in place over the unused interfaces during operation!	* The supplied plug covers must remain in place over the unused interfaces during operation!	* The supplied plug covers must remain in place over the unused interfaces during operation!	* The supplied plug covers must remain in place over the unused interfaces during operation!	* The supplied plug covers must remain in place over the unused interfaces during operation!
Conformal coating					
• Coatings for printed circuit board assemblies acc. to EN 61086	Yes; Class 2 for high reliability	Yes; Class 2 for high reliability	Yes; Class 2 for high reliability	Yes; Class 2 for high reliability	Yes; Class 2 for high reliability
• Protection against fouling acc. to EN 60664-3	Yes; Type 1 protection	Yes; Type 1 protection	Yes; Type 1 protection	Yes; Type 1 protection	Yes; Type 1 protection
• Military testing according to MIL-I-46058C, Amendment 7	Yes; Discoloration of coating possible during service life	Yes; Discoloration of coating possible during service life	Yes; Discoloration of coating possible during service life	Yes; Discoloration of coating possible during service life	Yes; Discoloration of coating possible during service life
• Qualification and Performance of Electrical Insulating Compound for Printed Board Assemblies according to IPC-CC-830A	Yes; Conformal coating, Class A	Yes; Conformal coating, Class A	Yes; Conformal coating, Class A	Yes; Conformal coating, Class A	Yes; Conformal coating, Class A

SIMATIC S7-1500 Advanced Controllers

Central processing units

Redundant CPUs

Overview CPU 1513R-1 PN



- The CPU for applications with medium requirements for program scope and processing speed, and increased requirements for availability.
- High processing speed for binary and floating-point arithmetic
- Used as the central controller in production lines with distributed I/O
- PROFINET IO RT interface with 2-port switch
- PROFINET IO controller for operating distributed I/O on PROFINET

Note:

SIMATIC Memory Card required for operation of the CPU

Overview CPU 1517H-3 PN



- The CPU for applications with high requirements for availability, very high requirements for program scope and networking, and very high requirements for processing speed.
- High processing speed for binary and floating-point arithmetic
- Used as central controller with distributed I/O
- PROFINET IO RT interface with 2-port switch
- Additional PROFINET interface with separate IP address
- PROFINET IO controller for operating distributed I/O on PROFINET

Note:

SIMATIC Memory Card required for operation of the CPU

Overview CPU 1515R-2 PN



- The CPU for applications with medium/high requirements for program scope, networking and processing speed, and with increased requirements for availability.
- High processing speed for binary and floating-point arithmetic
- Used as central controller with distributed I/O
- PROFINET IO RT interface with 2-port switch
- Additional PROFINET interface with separate IP address
- PROFINET IO controller for operating distributed I/O on PROFINET

Note:

SIMATIC Memory Card required for operation of the CPU

Overview CPU 1518HF-4 PN



- The CPU for applications with high availability requirements, also in connection with functional safety requirements
- Can be used for safety functions up to SIL 3 according to IEC 61508 and up to PLE according to ISO 13849
- A very large program data memory enables the realization of extensive applications.
- High processing speed for binary and floating-point arithmetic
- Used as central PLC with distributed I/O
- Supports PROFIsafe in distributed configurations
- PROFINET IO RT interface with 2-port switch
- Two additional PROFINET interfaces with separate IP addresses
- PROFINET IO controller for operating distributed I/O on PROFINET

Note:

SIMATIC Memory Card required for operation of the CPU

Ordering data

CPU 1513R-1 PN

SIMATIC S7-1500R CPU, 300 KB work memory for program, 1.5 MB for data, PROFINET RT interface with 2-port switch; SIMATIC Memory Card required

Article No.

6ES7513-1RL00-0AB0

CPU 1515R-2 PN

SIMATIC S7-1500R CPU, 450 KB work memory for program, 3 MB for data, PROFINET RT interface with 2-port switch, PROFINET interface; SIMATIC Memory Card required

6ES7515-2RM00-0AB0

CPU 1517H-3 PN

SIMATIC S7-1500H CPU, 2 MB work memory for program, 8 MB for data, 1st PROFINET RT interface with 2-port switch, 2nd PROFINET interface, 3rd interface synchronization, command times for bit operations 4 ns; SIMATIC Memory Card required

6ES7517-3HP00-0AB0

SIMATIC S7-1500H CPU 1517H System Bundle

Comprising 2 CPUs 517H-3 PN, 4 synchronization modules up to 10 m, 2 FOC synchronization cables (1 m)

6ES7500-0HP00-0AB0

CPU 1518HF-4 PN

SIMATIC S7-1500H CPU, 9 MB work memory for program, 60 MB for data, 1st PROFINET RT interface with 2-port switch, 2nd PROFINET interface, 3rd PROFINET interface, 4th/5th interface synchronization, command times for bit operations 4 ns; SIMATIC Memory Card required

6ES7518-4JP00-0AB0

SIMATIC S7-1500HF CPU 1518HF System Bundle

Comprising 2 CPUs 518HF-4 PN, 4 synchronization modules up to 10 m, 2 FOC synchronization cables (1 m)

6ES7 500-0JP00-0AB0

Accessories

Synchronization modules

For patch cable FOC up to 10 m

6ES7960-1CB00-0AA5

For routing cable FOC up to 10 km

6ES7960-1FB00-0AA5

Synchronization connecting cables FOC for S7-1500H

Length 1 m

6ES7960-1BB00-5AA5

Length 2 m

6ES7960-1BC00-5AA5

Length 10 m

6ES7960-1CB00-5AA5

SIMATIC Memory Card

4 MB

6ES7954-8LC03-0AA0

12 MB

6ES7954-8LE03-0AA0

24 MB

6ES7954-8LF03-0AA0

256 MB

6ES7954-8LL03-0AA0

2 GB

6ES7954-8LP03-0AA0

32 GB

6ES7954-8LT03-0AA0

SIMATIC S7-1500 DIN rail

Fixed lengths, with grounding elements

- 160 mm
- 245 mm
- 482 mm
- 530 mm
- 830 mm

6ES7590-1AB60-0AA0

6ES7590-1AC40-0AA0

6ES7590-1AE80-0AA0

6ES7590-1AF30-0AA0

6ES7590-1AJ30-0AA0

For cutting to length by customer, without drill holes; grounding elements must be ordered separately

- 2 000 mm

6ES7590-1BC00-0AA0

PE connection element for 2 000 mm DIN rail

6ES7590-5AA00-0AA0

20 units

6ES7590-5AA00-0AA0

SIMATIC S7-1500 Advanced Controllers

Central processing units

Redundant CPUs

Ordering data	Article No.	Ordering data	Article No.
System power supply For supplying the backplane bus of the S7-1500 Controller 24 V DC input voltage, power 25 W 24/48/60 V DC input voltage, power 60 W 24/48/60 V DC input voltage, power 60 W, buffering functionality 120/230 V AC input voltage, power 60 W	6ES7505-0KA00-0AB0 6ES7505-0RA00-0AB0 6ES7505-0RB00-0AB0 6ES7507-0RA00-0AB0	IE FC stripping tool Pre-adjusted stripping tool for fast stripping of Industrial Ethernet FC cables	6GK1901-1GA00
Power plug With coding element for power supply module; spare part, 10 units	6ES7590-8AA00-0AA0	Display For CPU 1511-1 PN, CPU 1511F-1 PN, CPU 1513-1 PN, CPU 1513F-1 PN, CPU 1513R-1 PN; spare part For CPU 1515-2 PN, CPU 1515F-2 PN, CPU 1515R-2 PN, CPU 1516-3 PN/DP, CPU 1516F-3 PN/DP, CPU 1517-3 PN/DP, CPU 1517H-3 PN, CPU 1517F-3 PN/DP, CPU 1518-4 PN/DP, CPU 1518F-4 PN/DP, CPU 1518-4 PN/DP ODK, CPU 1518F-4 PN/DP ODK and CPU 1518HF-4 PN; spare part	6ES7591-1AA01-0AA0 6ES7591-1BA02-0AA0
Load current supply 24 V DC/3 A 24 V DC/8 A	6EP1332-4BA00 6EP1333-4BA00	STEP 7 Professional V17 (required for S7-1500R/H) Target system: SIMATIC S7-1200, S7-1500, S7-300, S7-400, WinAC Requirement: Windows 10 (64-bit) <ul style="list-style-type: none"> Windows 10 Professional Version 1909, 2004, 20H2 Windows 10 Enterprise Version 1909, 2004, 20H2 Windows 10 IoT Enterprise 2016 LTSC Windows 10 IoT Enterprise 2019 LTSC Windows Server (64-bit) <ul style="list-style-type: none"> Windows Server 2016 Standard (full installation) Windows Server 2019 Standard (full installation) Type of delivery: 9 languages: de, en, zh included, fr, es, it, ru, jp, kr as download	
Power supply connector Spare part; for connecting the 24 V DC supply voltage <ul style="list-style-type: none"> With push-in terminals 	6ES7193-4JB00-0AA0	STEP 7 Professional V17, floating license STEP 7 Professional V17, floating license, software download including license key ¹⁾	6ES7822-1AA07-0YA5 6ES7822-1AE07-0YA5
IE FC RJ45 plugs RJ45 plug connector for Industrial Ethernet with a rugged metal enclosure and integrated insulation displacement contacts for connecting Industrial Ethernet FC installation cables		SIMATIC Manual Collection Electronic manuals on DVD, multi-language: LOGO!, SIMADYN, SIMATIC Bus Components, SIMATIC C7, SIMATIC Distributed I/O, SIMATIC HMI, SIMATIC Sensors, SIMATIC NET, SIMATIC PC-based Automation, SIMATIC PCS 7, SIMATIC PG/PC, SIMATIC S7, SIMATIC Software, SIMATIC TDC	6ES7998-8XC01-8YE0
IE FC RJ45 plug 180 180° cable outlet 1 unit 10 units 50 units	6GK1901-1BB10-2AA0 6GK1901-1BB10-2AB0 6GK1901-1BB10-2AE0	SIMATIC Manual Collection update service for 1 year Current Manual Collection DVD and the three subsequent updates	6ES7998-8XC01-8YE2
IE FC TP standard cable GP 2x2 4-wire, shielded TP installation cable for connection to IE FC RJ45 outlet/ IE FC RJ45 plug; PROFINET-compatible; with UL approval; sold by the meter; max. delivery unit 1 000 m, minimum order quantity 20 m	6XV1840-2AH10		
IE FC TP trailing cable 2 x 2 (type C) 4-wire, shielded TP installation cable for connection to IE FC RJ45 outlet/ IE FC RJ45 plug 180/90 for use as trailing cable; PROFINET-compatible; with UL approval; sold by the meter; max. delivery unit 1 000 m, minimum order quantity 20 m	6XV1840-3AH10		
IE FC TP marine cable 2 x 2 (type B) 4-wire, shielded TP installation cable for connection to IE FC RJ45 outlet/ IE FC RJ45 plug 180/90 with marine approval; sold by the meter; max. delivery unit 1 000 m, minimum order quantity 20 m	6XV1840-4AH10		

¹⁾ For up-to-date information and download availability, see: <http://www.siemens.com/tia-online-software-delivery>

Technical specifications

Article number	6ES7513-1RL00-0AB0 CPU 1513R-1 PN, 300KB program/1,5MB data	6ES7515-2RM00-0AB0 CPU 1515R-2 PN, 500KB program/ 3MB data	6ES7517-3HP00-0AB0 CPU 1517H-3 PN, 2MB program/8MB data	6ES7518-4JP00-0AB0 CPU 1518HF-4 PN, 9MB program/60MB data
General information				
Product type designation	CPU 1513R-1 PN	CPU 1515R-2 PN	CPU 1517H-3 PN	CPU 1518HF-4PN
Engineering with				
• STEP 7 TIA Portal configurable/ integrated from version	V17 (FW V2.9) / V16 (FW V2.8) / V15.1 (FW V2.6)	V17 (FW V2.9) / V16 (FW V2.8) / V15.1 (FW V2.6)	V17 (FW V2.9) / V16 (FW V2.8) / V15.1 (FW V2.6)	V17
Display				
Screen diagonal [cm]	3.45 cm	6.1 cm	6.1 cm	6.1 cm
Supply voltage				
Rated value (DC)	24 V	24 V	24 V	24 V
Memory				
Work memory				
• integrated (for program)	300 kbyte	500 kbyte	2 Mbyte	9 Mbyte
• integrated (for data)	1.5 Mbyte	3 Mbyte	8 Mbyte	60 Mbyte
Load memory				
• Plug-in (SIMATIC Memory Card), max.	32 Gbyte	32 Gbyte	32 Gbyte	32 Gbyte
CPU processing times				
for bit operations, typ.	80 ns	60 ns	4 ns	4 ns
for word operations, typ.	96 ns	72 ns	6 ns	6 ns
for fixed point arithmetic, typ.	128 ns	96 ns	6 ns	6 ns
for floating point arithmetic, typ.	512 ns	384 ns	24 ns	24 ns
Counters, timers and their retentivity				
S7 counter				
• Number	2 048	2 048	2 048	2 048
IEC counter				
• Number	Any (only limited by the main memory)	Any (only limited by the main memory)	Any (only limited by the main memory)	Any (only limited by the main memory)
S7 times				
• Number	2 048	2 048	2 048	2 048
IEC timer				
• Number	Any (only limited by the main memory)	Any (only limited by the main memory)	Any (only limited by the main memory)	Any (only limited by the main memory)
Data areas and their retentivity				
Flag				
• Size, max.	16 kbyte	16 kbyte	16 kbyte	16 kbyte
Address area				
I/O address area				
• Inputs	32 kbyte; All inputs are in the process image	32 kbyte; All inputs are in the process image	32 kbyte; All inputs are in the process image	32 kbyte; All inputs are in the process image
• Outputs	32 kbyte; All outputs are in the process image	32 kbyte; All outputs are in the process image	32 kbyte; All outputs are in the process image	32 kbyte; All outputs are in the process image
Time of day				
Clock				
• Type	Hardware clock	Hardware clock	Hardware clock	Hardware clock
1. Interface				
Interface types				
• RJ 45 (Ethernet)	Yes; X1	Yes; X1	Yes; X1	Yes; X1
• Number of ports	2	2	2	2
• integrated switch	Yes	Yes	Yes	Yes
Protocols				
• IP protocol	Yes; IPv4	Yes; IPv4	Yes; IPv4	Yes; IPv4
• PROFINET IO Controller	Yes	Yes	Yes	Yes
• PROFINET IO Device	No	No	No	No
• SIMATIC communication	Yes; Only Server	Yes; Only Server	Yes; Only Server	Yes; Only Server
• Open IE communication	Yes	Yes	Yes	Yes
• Web server	No	No	No	No
• Media redundancy	Yes	Yes	Yes	Yes

SIMATIC S7-1500 Advanced Controllers

Central processing units

Redundant CPUs

Technical specifications

Article number	6ES7513-1RL00-0AB0	6ES7515-2RM00-0AB0	6ES7517-3HP00-0AB0	6ES7518-4JP00-0AB0
	CPU 1513R-1 PN, 300KB program/1,5MB data	CPU 1515R-2 PN, 500KB program/ 3MB data	CPU 1517H-3 PN, 2MB program/8MB data	CPU 1518HF-4 PN, 9MB program/60MB data
PROFINET IO Controller				
Services				
- PG/OP communication	Yes	Yes	Yes	Yes
- Isochronous mode	No	No	No	No
- IRT	No	No	No	No
- PROFinergy	Yes	Yes	Yes	Yes; per user program
- Number of connectable IO Devices, max.	64	64	256	256
- Updating times		The minimum value of the update time also depends on communication share set for PROFINET IO, on the number of IO devices, and on the quantity of configured user data		
2. Interface				
Interface types				
• RJ 45 (Ethernet)		Yes; X2	Yes; X2	Yes; X2
• Number of ports		1	1	1
• integrated switch		No	No	No
Protocols				
• IP protocol		Yes; IPv4	Yes; IPv4	Yes; IPv4
• PROFINET IO Controller		No	No	No
• PROFINET IO Device		No	No	No
• SIMATIC communication		Yes; Only Server	Yes; Only Server	Yes; Only Server
• Open IE communication		Yes	Yes	Yes
• Web server		No	No	No
• Media redundancy		No	No	No
3. Interface				
Interface type			Pluggable synchronization submodule (FO)	
Plug-in interface modules			Synchronization module 6ES7960-1CB00-0AA5 or 6ES7960-1FB00-0AA5	
Interface types				
• RJ 45 (Ethernet)				Yes; X3
• Number of ports				1
• integrated switch				No
Protocols				
• IP protocol				Yes; IPv4
• SIMATIC communication				Yes; Only Server
• Open IE communication				Yes
4. Interface				
Interface type			Pluggable synchronization submodule (FO)	Pluggable synchronization submodule (FO)
Plug-in interface modules			Synchronization module 6ES7960-1CB00-0AA5 or 6ES7960-1FB00-0AA5	Synchronization module 6ES7960-1CB00-0AA5 or 6ES7960-1FB00-0AA5

Technical specifications

Article number	6ES7513-1RL00-0AB0	6ES7515-2RM00-0AB0	6ES7517-3HP00-0AB0	6ES7518-4JP00-0AB0
	CPU 1513R-1 PN, 300KB program/1,5MB data	CPU 1515R-2 PN, 500KB program/ 3MB data	CPU 1517H-3 PN, 2MB program/8MB data	CPU 1518HF-4 PN, 9MB program/60MB data
Protocols				
Number of connections				
• Number of connections, max.	88	108	288	320
Redundancy mode				
Media redundancy				
- Media redundancy				only via 1st interface (X1)
- MRP	Yes; MRP Automanager according to IEC 62439-2 Edition 2.0	Yes; MRP Automanager according to IEC 62439-2 Edition 2.0	Yes; MRP Automanager according to IEC 62439-2 Edition 2.0	Yes; MRP Automanager according to IEC 62439-2 Edition 2.0
- MRP interconnection, supported	Yes; as MRP ring node according to IEC 62439-2 Edition 3.0	Yes; as MRP ring node according to IEC 62439-2 Edition 3.0	Yes; as MRP ring node according to IEC 62439-2 Edition 3.0	Yes; as MRP ring node according to IEC 62439-2 Edition 3.0
- MRPD	No	No	No	No
- Switchover time on line break, typ.	200 ms; PROFINET MRP	200 ms; PROFINET MRP	200 ms; PROFINET MRP	200 ms; PROFINET MRP
- Number of stations in the ring, max.	50; Only 16 are recommended, however	50; Only 16 are recommended, however	50	50
SIMATIC communication				
• S7 routing	No	Yes	Yes	Yes
OPC UA				
• OPC UA Client	No	No	No	No
• OPC UA Server	No	No	No	No
Supported technology objects				
Motion Control	No	No	No	No
Controller				
• PID_Compact	Yes; Universal PID controller with integrated optimization	Yes; Universal PID controller with integrated optimization	Yes; Universal PID controller with integrated optimization	Yes; Universal PID controller with integrated optimization
• PID_3Step	Yes; PID controller with integrated optimization for valves	Yes; PID controller with integrated optimization for valves	Yes; PID controller with integrated optimization for valves	Yes; PID controller with integrated optimization for valves
• PID-Temp	Yes; PID controller with integrated optimization for temperature	Yes; PID controller with integrated optimization for temperature	Yes; PID controller with integrated optimization for temperature	Yes; PID controller with integrated optimization for temperature
Counting and measuring	Yes	Yes	Yes	Yes
• High-speed counter	No	No	No	No
Standards, approvals, certificates				
Highest safety class achievable in safety mode				
Probability of failure (for service life of 20 years and repair time of 100 hours)				
- Low demand mode: PFDavg in accordance with SIL3				< 2.00E-05
- High demand/continuous mode: PFH in accordance with SIL3				< 1.00E-09
Ambient conditions				
Ambient temperature during operation				
• horizontal installation, min.	0 °C	0 °C	0 °C	0 °C
• horizontal installation, max.	60 °C; Display: 50 °C, at an operating temperature of typically 50 °C, the display is switched off	60 °C; Display: 50 °C, at an operating temperature of typically 50 °C, the display is switched off	60 °C; Display: 50 °C, at an operating temperature of typically 50 °C, the display is switched off	60 °C; Display: 50 °C, at an operating temperature of typically 50 °C, the display is switched off
• vertical installation, min.	0 °C	0 °C	0 °C	0 °C
• vertical installation, max.	40 °C; Display: 40 °C, at an operating temperature of typically 40 °C, the display is switched off	40 °C; Display: 40 °C, at an operating temperature of typically 40 °C, the display is switched off	40 °C; Display: 40 °C, at an operating temperature of typically 40 °C, the display is switched off	40 °C; Display: 40 °C, at an operating temperature of typically 40 °C, the display is switched off
Altitude during operation relating to sea level				
• Installation altitude above sea level, max.	5 000 m; Restrictions for installation altitudes > 2 000 m, see manual	5 000 m; Restrictions for installation altitudes > 2 000 m, see manual	5 000 m; Restrictions for installation altitudes > 2 000 m, see manual	5 000 m; Restrictions for installation altitudes > 2 000 m, see manual

SIMATIC S7-1500 Advanced Controllers

Central processing units

Redundant CPUs

Technical specifications

Article number	6ES7513-1RL00-0AB0 CPU 1513R-1 PN, 300KB program/1,5MB data	6ES7515-2RM00-0AB0 CPU 1515R-2 PN, 500KB program/ 3MB data	6ES7517-3HP00-0AB0 CPU 1517H-3 PN, 2MB program/8MB data	6ES7518-4JP00-0AB0 CPU 1518HF-4 PN, 9MB program/60MB data
Configuration				
Programming				
Programming language				
- LAD	Yes	Yes	Yes	Yes; incl. failsafe
- FBD	Yes	Yes	Yes	Yes; incl. failsafe
- STL	Yes	Yes	Yes	Yes
- SCL	Yes	Yes	Yes	Yes
- CFC	No	No	No	
- GRAPH	Yes	Yes	Yes	Yes
Know-how protection				
• User program protection/password protection	Yes	Yes	Yes	Yes
• Copy protection	No	No	No	No
• Block protection	Yes	Yes	Yes	Yes
Access protection				
• protection of confidential configuration data	Yes	Yes	Yes	Yes
• Password for display	Yes	Yes	Yes	Yes
• Protection level: Write protection	Yes	Yes	Yes	Yes
• Protection level: Read/write protection	Yes	Yes	Yes	Yes
• Protection level: Write protection for Failsafe				Yes
• Protection level: Complete protection	Yes	Yes	Yes	Yes
Dimensions				
Width	35 mm	70 mm	210 mm	210 mm
Height	147 mm	147 mm	147 mm	147 mm
Depth	129 mm	129 mm	129 mm	129 mm
Weights				
Weight, approx.	430 g	830 g	2 119 g; Interface modules: 2x 18 g	

SIMATIC S7-1500 Advanced Controllers

Central processing units

SIPLUS redundant CPUs

Overview SIPLUS CPU 1515R-2 PN



- The CPU for applications with medium/high requirements for program scope, networking and processing speed, and with increased requirements for availability.
- High processing speed for binary and floating-point arithmetic
- Used as central PLC with distributed I/O
- PROFINET IO RT interface with 2-port switch
- Additional PROFINET interface with separate IP address
- PROFINET IO controller for operating distributed I/O on PROFINET

Note:

SIMATIC Memory Card required for operation of the CPU

SIPLUS extreme products are based on SIMATIC standard products. The contents listed here were taken from the corresponding standard products. SIPLUS extreme-specific information was added.

Overview SIPLUS CPU 1517H-3 PN



- The CPU for applications with high requirements for availability, very high requirements for program scope and networking, and very high requirements for processing speed.
- High processing speed for binary and floating-point arithmetic
- Used as central PLC with distributed I/O
- PROFINET IO RT interface with 2-port switch
- Additional PROFINET interface with separate IP address
- PROFINET IO controller for operating distributed I/O on PROFINET

Note:

SIMATIC Memory Card required for operation of the CPU.

SIPLUS extreme products are based on SIMATIC standard products. The contents listed here were taken from the corresponding standard products. SIPLUS extreme-specific information was added.

SIMATIC S7-1500 Advanced Controllers

Central processing units

SIPLUS redundant CPUs

Ordering data

Article No.

SIPLUS CPU 1515R-2 PN

(extended temperature range and exposure to media)

SIPLUS S7-1500R CPU, 500 KB work memory for program, 3 MB for data, PROFINET RT interface with 2-port switch, PROFINET interface; SIMATIC Memory Card required

6AG1515-2RM00-7AB0

SIPLUS CPU 1517H-3 PN

(extended temperature range and exposure to media)

SIPLUS S7-1500H CPU, 2 MB work memory for program, 8 MB for data, 1st PROFINET RT interface with 2-port switch, 2nd PROFINET RT interface, 3rd interface synchronization, command times for bit operations 4 ns; SIMATIC Memory Card required

6AG1517-3HP00-4AB0

SIPLUS S7-1500 CPU 1517H System Bundle

(extended temperature range and exposure to media)

Comprising
2 SIPLUS CPU 1517H-3 PN,
4 SIPLUS synchronization modules up to 10 m,
2 FOC synchronization cables (1 m);
without memory card

6AG1500-0HP00-4AB0

Article No.

Accessories

Synchronization modules

(extended temperature range and exposure to media)

- For patch cable FOC up to 10 m
- For routing cable FOC up to 10 km

6AG1960-1CB00-4AA5

6AG1960-1FB00-4AA5

System power supply

(extended temperature range and exposure to media)

For supplying the backplane bus of the S7-1500 PLC

24 V DC input voltage, power 25 W

6AG1505-0KA00-7AB0

24/48/60 V DC input voltage, power 60 W

6AG1505-0RA00-7AB0

120/230 V AC input voltage, power 60 W

6AG1507-0RA00-7AB0

Load current supply

(extended temperature range and exposure to media)

24 V DC/3 A

6AG1332-4BA00-7AA0

24 V DC/8 A

6AG1333-4BA00-7AA0

Display

6AG1591-1BA02-2AA0

(extended temperature range and exposure to media)

For SIPLUS CPU 1515R-2 PN/DP and CPU 1517H-3 PN; spare part

Other accessories

See SIMATIC S7-1500, CPU 1515R-2 PN, page 4/61

Technical specifications

Article number	6AG1515-2RM00-7AB0	6AG1517-3HP00-4AB0
Based on	6ES7515-2RM00-0AB0	6ES7517-3HP00-0AB0
	SIPLUS S7-1500 CPU 1515R-2 PN	SIPLUS S7-1500 CPU 1517H-3 PN
Ambient conditions		
Ambient temperature during operation		
<ul style="list-style-type: none"> horizontal installation, min. horizontal installation, max. vertical installation, min. vertical installation, max. 	-40 °C; = Tmin (incl. condensation/frost); start-up @ -20 °C 70 °C; Display: 50 °C, at an operating temperature of typically 50 °C, the display is switched off -40 °C; = Tmin (incl. condensation/frost); start-up @ -20 °C 40 °C; Display: 40 °C, at an operating temperature of typically 40 °C, the display is switched off	0 °C; = Tmin 60 °C; = Tmax; display: 50 °C, the display is switched off at an operating temperature of typically 50 °C 0 °C; = Tmin 40 °C; Display: 40 °C, at an operating temperature of typically 40 °C, the display is switched off
Altitude during operation relating to sea level		
<ul style="list-style-type: none"> Installation altitude above sea level, max. Ambient air temperature-barometric pressure-altitude 	5 000 m; Restrictions for installation altitudes > 2 000 m, see manual Restrictions for installation altitudes > 2 000 m, see entry ID: 109763260	5 000 m Tmin ... Tmax at 1 140 hPa ... 795 hPa (-1 000 m ... +2 000 m) // Tmin ... (Tmax - 10 K) at 795 hPa ... 658 hPa (+2 000 m ... +3 500 m) // Tmin ... (Tmax -20 K) at 658 hPa ... 540 hPa (+3 500 m ... +5 000 m)
Relative humidity		
<ul style="list-style-type: none"> With condensation, tested in accordance with IEC 60068-2-38, max. 	100 %; RH incl. condensation / frost (no commissioning in bedewed state), horizontal installation	100 %; RH incl. condensation / frost (no commissioning in bedewed state), horizontal installation
Resistance		
Coolants and lubricants		
<ul style="list-style-type: none"> Resistant to commercially available coolants and lubricants 	Yes; Incl. diesel and oil droplets in the air	Yes; Incl. diesel and oil droplets in the air
Use in stationary industrial systems		
<ul style="list-style-type: none"> to biologically active substances according to EN 60721-3-3 to chemically active substances according to EN 60721-3-3 to mechanically active substances according to EN 60721-3-3 	Yes; Class 3B2 mold, fungus and dry rot spores (with the exception of fauna); Class 3B3 on request Yes; Class 3C4 (RH < 75 %) incl. salt spray acc. to EN 60068-2-52 (severity degree 3); * Yes; Class 3S4 incl. sand, dust, *	Yes; Class 3B2 mold, fungus and dry rot spores (with the exception of fauna); Class 3B3 on request Yes; Class 3C4 (RH < 75 %) incl. salt spray acc. to EN 60068-2-52 (severity degree 3); * Yes; Class 3S4 incl. sand, dust, *
Use on ships/at sea		
<ul style="list-style-type: none"> to biologically active substances according to EN 60721-3-6 to chemically active substances according to EN 60721-3-6 to mechanically active substances according to EN 60721-3-6 	Yes; Class 6B2 mold, fungal and dry rot spores (excluding fauna) Yes; Class 6C3 (RH < 75 %) incl. salt spray acc. to EN 60068-2-52 (severity degree 3); * Yes; Class 6S3 incl. sand, dust; *	Yes; Class 6B2 mold, fungal and dry rot spores (excluding fauna) Yes; Class 6C3 (RH < 75 %) incl. salt spray acc. to EN 60068-2-52 (severity degree 3); * Yes; Class 6S3 incl. sand, dust; *
Usage in industrial process technology		
<ul style="list-style-type: none"> Against chemically active substances acc. to EN 60654-4 Environmental conditions for process, measuring and control systems acc. to ANSI/ISA-71.04 	Yes; Class 3 (excluding trichlorethylene) Yes; Level GX group A/B (excluding trichlorethylene; harmful gas concentrations up to the limits of EN 60721-3-3 class 3C4 permissible); level LC3 (salt spray) and level LB3 (oil)	
Remark		
<ul style="list-style-type: none"> Note regarding classification of environmental conditions acc. to EN 60721, EN 60654-4 and ANSI/ISA-71.04 	* The supplied plug covers must remain in place over the unused interfaces during operation!	* The supplied plug covers must remain in place over the unused interfaces during operation!
Conformal coating		
<ul style="list-style-type: none"> Coatings for printed circuit board assemblies acc. to EN 61086 Protection against fouling acc. to EN 60664-3 Military testing according to MIL-I-46058C, Amendment 7 Qualification and Performance of Electrical Insulating Compound for Printed Board Assemblies according to IPC-CC-830A 	Yes; Class 2 for high reliability Yes; Type 1 protection Yes; Discoloration of coating possible during service life Yes; Conformal coating, Class A	Yes; Class 2 for high reliability Yes; Type 1 protection Yes; Discoloration of coating possible during service life Yes; Conformal coating, Class A

SIMATIC S7-1500 Advanced Controllers

Central processing units

Technology CPUs

Overview CPU 1511T-1 PN



- Entry-level CPU in the S7-1500T Controller product range
- Suitable for applications with medium requirements for program scope and processing speed
- Used as central PLC in production lines with central and distributed I/O
- PROFINET IO IRT interface with 2-port switch
- PROFINET IO controller for operating distributed I/O on PROFINET
- PROFINET I-Device for connecting the CPU as an intelligent PROFINET device under a SIMATIC or non-Siemens PROFINET IO controller
- OPC UA Server and Client as runtime option for the easy connection of SIMATIC S7-1500 to non-Siemens devices/systems with the functions:
 - OPC UA Data Access
 - OPC UA Security
 - OPC UA Methods Call
 - Support of OPC UA Companion specifications.
- Central and distributed isochronous mode
- Integrated Motion Control functionalities for controlling speed-controlled, positioning and synchronized axes (gearing and camming), support for external encoders, output cams/cam tracks and probes.

Technology object for controlling kinematics with up to 4 interpolating axes, e.g. Cartesian portal, delta picker, roller picker, articulated arm, cylindrical robot, tripod picker and SCARA.

User-defined kinematics are also supported.
- Cross-PLC synchronous operation for synchronization of multiple SIMATIC S7-1500T Controllers
- Integrated web server for diagnostics with the option of creating user-defined web pages

Note

SIMATIC Memory Card required for operation of the CPU

Overview CPU 1511TF-1 PN



- Entry-level CPU in the S7-1500T Controller product range
- Suitable for standard and fail-safe applications with medium requirements for program scope and processing speed
- Used as central PLC in production lines with central and distributed I/O
- Can be used for safety functions up to SIL 3 according to IEC 61508 and up to PLe according to ISO 13849
- PROFINET IO IRT interface with 2-port switch
- PROFINET IO controller for operating distributed I/O on PROFINET
- PROFINET I-Device for connecting the CPU as an intelligent PROFINET device under a SIMATIC or non-Siemens PROFINET IO controller
- OPC UA Server and Client as runtime option for the easy connection of SIMATIC S7-1500 to non-Siemens devices/systems with the functions:
 - OPC UA Data Access
 - OPC UA Security
 - OPC UA Methods Call
 - Support of OPC UA Companion specifications.
- Central and distributed isochronous mode
- Integrated Motion Control functionalities for controlling speed-controlled, positioning and synchronized axes (gearing and camming), support for external encoders, output cams/cam tracks and probes.

Technology object for controlling kinematics with up to 4 interpolating axes, e.g. Cartesian portal, delta picker, roller picker, articulated arm, cylindrical robot, tripod picker and SCARA.

User-defined kinematics are also supported.
- Cross-PLC synchronous operation for synchronization of multiple SIMATIC S7-1500T Controllers
- Integrated web server for diagnostics with the option of creating user-defined web pages

Note

SIMATIC Memory Card required for operation of the CPU.

Overview CPU 1515T-2 PN



- The CPU for applications with medium to high requirements regarding program/data storage in the S7-1500T Controller product range
- Medium to high processing speed for binary and floating-point arithmetic
- Used as central PLC in production lines with central and distributed I/O
- PROFINET IO IRT interface with 2-port switch
- PROFINET IO controller for operating distributed I/O on PROFINET
- PROFINET I-Device for connecting the CPU as an intelligent PROFINET device under a SIMATIC or non-Siemens PROFINET IO controller
- Additional PROFINET interface with separate IP address for network separation, for connecting further PROFINET IO RT devices, or for high-speed communication as an I-Device
- OPC UA Server and Client as runtime option for the easy connection of SIMATIC S7-1500 to non-Siemens devices/systems with the functions:
 - OPC UA Data Access
 - OPC UA Security
 - OPC UA Methods Call
 - Support of OPC UA Companion specifications.
- Central and distributed isochronous mode
- Integrated Motion Control functionalities for controlling speed-controlled, positioning and synchronized axes (gearing and camming), support for external encoders, output cams/cam tracks and probes. Technology object for controlling kinematics with up to 4 interpolating axes, e.g. Cartesian portal, delta picker, roller picker, articulated arm, cylindrical robot, tripod picker and SCARA. User-defined kinematics are also supported.
- Cross-PLC synchronous operation for synchronization of multiple SIMATIC S7-1500T Controllers
- Integrated web server for diagnostics with the option of creating user-defined web pages

Note

SIMATIC Memory Card required for operation of the CPU.

Overview CPU 1515TF-2 PN



- The CPU for standard and fail-safe applications with medium to high requirements regarding program/data storage in the S7-1500T Controller product range
- Medium to high processing speed for binary and floating-point arithmetic
- Used as central PLC in production lines with central and distributed I/O
- Can be used for safety functions up to SIL 3 according to IEC 61508 and up to PLe according to ISO 13849
- PROFINET IO IRT interface with 2-port switch
- PROFINET IO controller for operating distributed I/O on PROFINET
- PROFINET I-Device for connecting the CPU as an intelligent PROFINET device under a SIMATIC or non-Siemens PROFINET IO controller
- Additional PROFINET interface with separate IP address for network separation, for connecting further PROFINET IO RT devices, or for high-speed communication as an I-Device
- OPC UA Server and Client as runtime option for the easy connection of SIMATIC S7-1500 to non-Siemens devices/systems with the functions:
 - OPC UA Data Access
 - OPC UA Security
 - OPC UA Methods Call
 - Support of OPC UA Companion specifications.
- Isochronous mode centrally and distributed
- Integrated Motion Control functionalities for controlling speed-controlled, positioning and synchronized axes (gearing and camming), support for external encoders, output cams/cam tracks and probes. Technology object for controlling kinematics with up to 4 interpolating axes, e.g. Cartesian portal, delta picker, roller picker, articulated arm, cylindrical robot, tripod picker and SCARA. User-defined kinematics are also supported.
- Cross-PLC synchronous operation for synchronization of multiple SIMATIC S7-1500T Controllers
- Integrated web server for diagnostics with the option of creating user-defined web pages

Note

SIMATIC Memory Card required for operation of the CPU.

SIMATIC S7-1500 Advanced Controllers

Central processing units

Technology CPUs

Overview CPU 1516T-3 PN/DP



- The CPU with a large program and data memory in the S7-1500 Controller product range for applications with high requirements regarding program scope and networking.
- High processing speed for binary and floating-point arithmetic
- For cross-industry automation tasks in series machine, special machine and plant construction
- Used as central PLC in production lines with central and distributed I/O
- PROFINET IO IRT interface with 2-port switch
- PROFINET IO controller for operating distributed I/O on PROFINET.
- PROFINET I-Device for connecting the CPU as an intelligent PROFINET device under a SIMATIC or non-Siemens PROFINET IO controller
- Additional PROFINET interface with separate IP address for network separation, for connecting further PROFINET IO RT devices, or for high-speed communication as an I-Device
- PROFIBUS DP master interface
- OPC UA Server and Client as runtime option for the easy connection of SIMATIC S7-1500 to non-Siemens devices/systems with the functions:
 - OPC UA Data Access
 - OPC UA Security
 - OPC UA Methods Call
 - Support of OPC UA Companion specifications.
- Central and distributed isochronous mode on PROFIBUS and PROFINET
- Integrated Motion Control functionalities for controlling speed-controlled, positioning and synchronized axes (gearing and camming), support for external encoders, output cams/cam tracks and probes. Technology object for controlling kinematics with up to 4 interpolating axes, e.g. Cartesian portal, delta picker, roller picker, articulated arm, cylindrical robot, tripod picker and SCARA. User-defined kinematics are also supported.
- Cross-PLC synchronous operation for synchronization of multiple SIMATIC S7-1500T Controllers
- Integrated web server for diagnostics with the option of creating user-defined web pages

Note

SIMATIC Memory Card required for operation of the CPU.

Overview CPU 1516TF-3 PN/DP



- The CPU with a large program and data memory in the S7-1500 Controller product range for standard and fail-safe applications with high requirements regarding program scope and networking.
- Can be used for safety functions up to SIL 3 according to IEC 61508 and up to PLe according to ISO 13849
- High processing speed for binary and floating-point arithmetic
- For cross-industry automation tasks in series machine, special machine and plant construction
- Used as central PLC in production lines with central and distributed I/O
- PROFINET IO IRT interface with 2-port switch
- PROFINET IO controller for operating distributed I/O on PROFINET
- PROFINET I-Device for connecting the CPU as an intelligent PROFINET device under a SIMATIC or non-Siemens PROFINET IO controller
- Additional PROFINET interface with separate IP address for network separation, for connecting further PROFINET IO RT devices, or for high-speed communication as an I-Device
- PROFIBUS DP master interface
- OPC UA Server and Client as runtime option for the easy connection of SIMATIC S7-1500 to non-Siemens devices/systems with the functions:
 - OPC UA Data Access
 - OPC UA Security
 - OPC UA Methods Call
 - Support of OPC UA Companion specifications.
- Central and distributed isochronous mode on PROFIBUS and PROFINET
- Integrated Motion Control functionalities for controlling speed-controlled, positioning and synchronized axes (gearing and camming), support for external encoders, output cams/cam tracks and probes. Technology object for controlling kinematics with up to 4 interpolating axes, e.g. Cartesian portal, delta picker, roller picker, articulated arm, cylindrical robot, tripod picker and SCARA. User-defined kinematics are also supported.
- Cross-PLC synchronous operation for synchronization of multiple SIMATIC S7-1500T Controllers
- Integrated web server for diagnostics with the option of creating user-defined web pages

Note

SIMATIC Memory Card required for operation of the CPU.

Overview CPU 1517T-3 PN/DP



- The CPU with a very large program and data memory in the S7-1500 Controller product range for applications with high requirements regarding program scope and networking.
- High processing speed for binary and floating-point arithmetic
- For cross-industry automation tasks in series machine, special machine and plant construction
- Used as central PLC in production lines with central and distributed I/O
- PROFINET IO IRT interface with 2-port switch
- PROFINET IO controller for operating distributed I/O on PROFINET.
- PROFINET I-Device for connecting the CPU as an intelligent PROFINET device under a SIMATIC or non-Siemens PROFINET IO controller
- Additional PROFINET interface with separate IP address for network separation, for connecting further PROFINET IO RT devices, or for high-speed communication as an I-Device
- PROFIBUS DP master interface
- OPC UA Server and Client as runtime option for the easy connection of SIMATIC S7-1500 to non-Siemens devices/systems with the functions:
 - OPC UA Data Access
 - OPC UA Security
 - OPC UA Methods Call
 - Support of OPC UA Companion specifications.
- Central and distributed isochronous mode on PROFIBUS and PROFINET
- Integrated Motion Control functionalities for controlling speed-controlled, positioning and synchronized axes (gearing and camming), support for external encoders, output cams/cam tracks and probes. Technology object for controlling kinematics with up to 4 interpolating axes, e.g. Cartesian portal, delta picker, roller picker, articulated arm, cylindrical robot, tripod picker and SCARA. User-defined kinematics are also supported.
- Cross-PLC synchronous operation for synchronization of multiple SIMATIC S7-1500T Controllers
- Integrated web server for diagnostics with the option of creating user-defined web pages

Note

SIMATIC Memory Card required for operation of the CPU.

Overview CPU 1517TF-3 PN/DP



- The CPU with a very large program and data memory in the S7-1500 Controller product range for fail-safe applications with high requirements regarding program scope and networking.
- Can be used for safety functions up to SIL 3 according to IEC 61508 and up to PLe according to ISO 13849
- High processing speed for binary and floating-point arithmetic
- For cross-industry automation tasks in series machine, special machine and plant construction
- Used as central PLC in production lines with central and distributed I/O
- PROFINET IO IRT interface with 2-port switch
- PROFINET IO controller for operating distributed I/O on PROFINET.
- PROFINET I-Device for connecting the CPU as an intelligent PROFINET device under a SIMATIC or non-Siemens PROFINET IO controller
- Additional PROFINET interface with separate IP address for network separation, for connecting further PROFINET IO RT devices, or for high-speed communication as an I-Device
- PROFIBUS DP master interface
- OPC UA Server and Client as runtime option for the easy connection of SIMATIC S7-1500 to non-Siemens devices/systems with the functions:
 - OPC UA Data Access
 - OPC UA Security
 - OPC UA Methods Call
 - Support of OPC UA Companion specifications.
- Central and distributed isochronous mode on PROFIBUS and PROFINET
- Integrated Motion Control functionalities for controlling speed-controlled, positioning and synchronized axes (gearing and camming), support for external encoders, output cams/cam tracks and probes. Technology object for controlling kinematics with up to 4 interpolating axes, e.g. Cartesian portal, delta picker, roller picker, articulated arm, cylindrical robot, tripod picker and SCARA. User-defined kinematics are also supported.
- Cross-PLC synchronous operation for synchronization of multiple SIMATIC S7-1500T Controllers
- Integrated web server for diagnostics with the option of creating user-defined web pages

Note

SIMATIC Memory Card required for operation of the CPU.

SIMATIC S7-1500 Advanced Controllers

Central processing units

Technology CPUs

Overview CPU 1518T-4 PN/DP



- The CPU with a very large program and data memory in the S7-1500 Controller product range for applications with high requirements regarding program scope and networking.
- High processing speed for binary and floating-point arithmetic
- For cross-industry automation tasks in series machine, special machine and plant construction
- Used as central PLC in production lines with central and distributed I/O
- PROFINET IO IRT interface with 2-port switch
- PROFINET IO controller for operating distributed I/O on PROFINET
- PROFINET I-Device for connecting the CPU as an intelligent PROFINET device under a SIMATIC or non-Siemens PROFINET IO controller
- Additional PROFINET interface with separate IP address for network separation, for connecting further PROFINET IO RT devices, or for high-speed communication as an I-Device
- PROFIBUS DP master interface
- OPC UA Server and Client as runtime option for the easy connection of SIMATIC S7-1500 to non-Siemens devices/systems with the functions:
 - OPC UA Data Access
 - OPC UA Security
 - OPC UA Methods Call
 - Support of OPC UA Companion specifications.
- Central and distributed isochronous mode on PROFIBUS and PROFINET
- Integrated Motion Control functionalities for controlling speed-controlled, positioning and synchronized axes (gearing and camming), support for external encoders, output cams/cam tracks and probes. Technology object for controlling kinematics with up to 4 interpolating axes, e.g. Cartesian portal, delta picker, roller picker, articulated arm, cylindrical robot, tripod picker and SCARA. User-defined kinematics are also supported.
- Cross-PLC synchronous operation for synchronization of multiple SIMATIC S7-1500T Controllers
- Integrated web server for diagnostics with the option of creating user-defined web pages

Note

SIMATIC Memory Card required for operation of the CPU.

Overview CPU 1518TF-4 PN/DP



- The CPU with a very large program and data memory in the S7-1500 Controller product range for fail-safe applications with high requirements regarding program scope and networking.
- Can be used for safety functions up to SIL 3 according to IEC 61508 and up to PLe according to ISO 13849
- High processing speed for binary and floating-point arithmetic
- For cross-industry automation tasks in series machine, special machine and plant construction
- Used as central PLC in production lines with central and distributed I/O
- PROFINET IO IRT interface with 2-port switch
- PROFINET IO controller for operating distributed I/O on PROFINET
- PROFINET I-Device for connecting the CPU as an intelligent PROFINET device under a SIMATIC or non-Siemens PROFINET IO controller
- Additional PROFINET interface with separate IP address for network separation, for connecting further PROFINET IO RT devices, or for high-speed communication as an I-Device
- PROFIBUS DP master interface
- OPC UA Server and Client as runtime option for the easy connection of SIMATIC S7-1500 to non-Siemens devices/systems with the functions:
 - OPC UA Data Access
 - OPC UA Security
 - OPC UA Methods Call
 - Support of OPC UA Companion specifications.
- Central and distributed isochronous mode on PROFIBUS and PROFINET
- Integrated Motion Control functionalities for controlling speed-controlled, positioning and synchronized axes (gearing and camming), support for external encoders, output cams/cam tracks and probes. Technology object for controlling kinematics with up to 4 interpolating axes, e.g. Cartesian portal, delta picker, roller picker, articulated arm, cylindrical robot, tripod picker and SCARA. User-defined kinematics are also supported.
- Cross-PLC synchronous operation for synchronization of multiple SIMATIC S7-1500T Controllers
- Integrated web server for diagnostics with the option of creating user-defined web pages

Note

SIMATIC Memory Card required for operation of the CPU.

Ordering data	Article No.	Article No.
CPU 1511T-1 PN 225 KB work memory for program, 1 MB for data, PROFINET IRT interface with 2-port switch; SIMATIC Memory Card required	6ES7511-1TK01-0AB0	Accessories SIMATIC Memory Card 4 MB 6ES7954-8LC03-0AA0 12 MB 6ES7954-8LE03-0AA0 24 MB 6ES7954-8LF03-0AA0 256 MB 6ES7954-8LL03-0AA0 2 GB 6ES7954-8LP03-0AA0 32 GB 6ES7954-8LT03-0AA0 SIMATIC S7-1500 DIN rail Fixed lengths, with grounding elements <ul style="list-style-type: none"> • 160 mm 6ES7590-1AB60-0AA0 • 245 mm 6ES7590-1AC40-0AA0 • 482 mm 6ES7590-1AE80-0AA0 • 530 mm 6ES7590-1AF30-0AA0 • 830 mm 6ES7590-1AJ30-0AA0 For cutting to length by customer, without drill holes; grounding elements must be ordered separately <ul style="list-style-type: none"> • 2 000 mm 6ES7590-1BC00-0AA0 PE connection element for 2 000 mm DIN rail 20 units 6ES7590-5AA00-0AA0 System power supply For supplying the backplane bus of the S7-1500 Controller 24 V DC input voltage, power 25 W 6ES7505-0KA00-0AB0 24/48/60 V DC input voltage, power 60 W 6ES7505-0RA00-0AB0 24/48/60 V DC input voltage, power 60 W, buffering functionality 6ES7505-0RB00-0AB0 120/230 V AC input voltage, power 60 W 6ES7507-0RA00-0AB0 Power plug With coding element for power supply module; spare part, 10 units 6ES7590-8AA00-0AA0 Load current supply 24 V DC/3 A 6EP1332-4BA00 24 V DC/8 A 6EP1333-4BA00 Power supply connector Spare part; for connecting the 24 V DC supply voltage <ul style="list-style-type: none"> • With push-in terminals 6ES7193-4JB00-0AA0 PROFIBUS FastConnect RS485 bus connector with 90° cable outlet With insulation displacement terminals, max. transfer rate 12 Mbps Without programming device interface, grounding via control cabinet contact surface; 1 unit 6ES7972-0BA70-0XA0 With programming device interface, grounding via control cabinet contact surface; 1 unit 6ES7972-0BB70-0XA0 PROFIBUS FC standard cable GP Standard type with special design for quick mounting, 2-wire, shielded; sold by the meter; max. delivery unit 1 000 m, minimum order quantity 20 m 6XV1830-0EH10
CPU 1511TF-1 PN 225 KB work memory for program, 1 MB for data, PROFINET IRT interface with 2-port switch; SIMATIC Memory Card required	6ES7511-1UK01-0AB0	
CPU 1515T-2 PN 750 KB work memory for program, 3 MB for data, PROFINET IRT interface with 2-port switch, Ethernet interface; SIMATIC Memory Card required	6ES7515-2TM01-0AB0	
CPU 1515TF-2 PN 750 KB work memory for program, 3 MB for data, PROFINET IRT interface with 2-port switch, Ethernet interface; SIMATIC Memory Card required	6ES7515-2UM01-0AB0	
CPU 1516T-3 PN/DP 1.5 MB work memory for program, 5 MB for data, PROFINET IRT interface with 2-port switch, Ethernet interface, PROFIBUS interface; SIMATIC Memory Card required	6ES7516-3TN00-0AB0	
CPU 1516TF-3 PN/DP 1.5 MB work memory for program, 5 MB for data, PROFINET IRT interface with 2-port switch, Ethernet interface, PROFIBUS interface; SIMATIC Memory Card required	6ES7516-3UN00-0AB0	
CPU 1517T-3 PN/DP 3 MB work memory for program, 8 MB for data, PROFINET IRT interface with 2-port switch, Ethernet interface, PROFIBUS interface; SIMATIC Memory Card required	6ES7517-3TP00-0AB0	
CPU 1517TF-3 PN/DP 3 MB work memory for program, 8 MB for data, PROFINET IRT interface with 2-port switch, Ethernet interface, PROFIBUS interface; SIMATIC Memory Card required	6ES7517-3UP00-0AB0	
CPU 1518T-4 PN/DP 9 MB work memory for program, 60 MB for data, PROFINET IRT interface with 2-port switch, Ethernet interface, PROFIBUS interface; SIMATIC Memory Card required	6ES7518-4TP00-0AB0	
CPU 1518TF-4 PN/DP 9 MB work memory for program, 60 MB for data, PROFINET IRT interface with 2-port switch, Ethernet interface, PROFIBUS interface; SIMATIC Memory Card required	6ES7518-4UP00-0AB0	

SIMATIC S7-1500 Advanced Controllers

Central processing units

Technology CPUs

Ordering data	Article No.	Article No.
PROFIBUS FC robust cable 2-wire, shielded; sold by the meter; max. delivery unit 1 000 m, minimum order quantity 20 m	6XV1830-0JH10	IE FC TP trailing cable 2 x 2 (type C) 4-wire, shielded TP installation cable for connection to IE FC RJ45 outlet/IE FC RJ45 plug 180/90 for use as trailing cable; PROFINET-compatible; with UL approval; sold by the meter; max. delivery unit 1 000 m, minimum order quantity 20 m
PROFIBUS FC flexible cable 2-wire, shielded; sold by the meter; max. delivery unit 1 000 m, minimum order quantity 20 m	6XV1831-2K	
PROFIBUS FC trailing cable 2-wire, shielded; sold by the meter; max. delivery unit 1 000 m, minimum order quantity 20 m Sheath color: Petrol Sheath color: Violet	6XV1830-3EH10 6XV1831-2L	IE FC TP marine cable 2 x 2 (type B) 4-wire, shielded TP installation cable for connection to IE FC RJ45 outlet/IE FC RJ45 plug 180/90 with marine approval; sold by the meter; max. delivery unit 1 000 m, minimum order quantity 20 m
PROFIBUS FC food cable 2-wire, shielded; sold by the meter; max. delivery unit 1 000 m, minimum order quantity 20 m	6XV1830-0GH10	
PROFIBUS FC ground cable 2-wire, shielded; sold by the meter; max. delivery unit 1 000 m, minimum order quantity 20 m	6XV1830-3FH10	IE FC stripping tool 6GK1901-1GA00 Pre-adjusted stripping tool for fast stripping of Industrial Ethernet FC cables
PROFIBUS FC FRNC cable GP 2-wire, shielded, flame-retardant, with copolymer protective jacket FRNC; sold by the meter; max. delivery unit 1 000 m, minimum order quantity 20 m	6XV1830-0LH10	
PROFIBUS FastConnect stripping tool Pre-adjusted stripping tool for fast stripping of PROFIBUS FastConnect bus cables	6GK1905-6AA00	Display For CPU 1511T-1 PN and CPU 1511TF-1 PN; spare part For CPU 1515T-2 PN, CPU 515TF-2 PN, CPU 1516T-3 PN/DP, CPU 1516TF-3 PN/DP, CPU 1517T-3 PN/DP, CPU 1517TF-3 PN/DP, CPU 1518T-4 PN/DP and CPU 1518TF-4 PN/DP; spare part
IE FC RJ45 plugs RJ45 plug connector for Industrial Ethernet with a rugged metal enclosure and integrated insulation displacement contacts for connecting Industrial Ethernet FC installation cables		
IE FC RJ45 plug 180 180° cable outlet 1 unit 10 units 50 units	6GK1901-1BB10-2AA0 6GK1901-1BB10-2AB0 6GK1901-1BB10-2AE0	Front cover for PROFIBUS DP interface 6ES7591-8AA00-0AA0 For CPU 1516T-3 PN/DP, CPU 1516TF-3 PN/DP, CPU 1517T-3 PN/DP, CPU 1517TF-3 PN/DP, CPU 1518T-4 PN/DP and CPU 1518TF-4 PN/DP; spare part
IE FC TP standard cable GP 2x2 4-wire, shielded TP installation cable for connection to IE FC RJ45 outlet/IE FC RJ45 plug; PROFINET-compatible; with UL approval; sold by the meter; max. delivery unit 1 000 m, minimum order quantity 20 m	6XV1840-2AH10	
		SIMATIC S7-1500T Starter Kit 6ES7511-1TK03-4YB5 Consisting of CPU 1511T-1 PN, SIMATIC Memory Card 4 MB, 160 mm DIN rail, front connector, STEP 7 Professional 365-day license, SIMATIC ProDiag 1500, SIMATIC OPC UA S7-1500 Small, PM 1507 24 V/3 A power supply, Ethernet cable, documentation

Ordering data	Article No.	Article No.	
STEP 7 Professional V17 Target system: SIMATIC S7-1200, S7-1500, S7-300, S7-400, WinAC Requirement: Windows 10 (64-bit) <ul style="list-style-type: none"> Windows 10 Professional Version 1909, 2004, 20H2 Windows 10 Enterprise Version 1909, 2004, 20H2 Windows 10 IoT Enterprise 2016 LTSB Windows 10 IoT Enterprise 2019 LTSC Windows Server (64-bit) <ul style="list-style-type: none"> Windows Server 2016 Standard (full installation) Windows Server 2019 Standard (full installation) Type of delivery: 9 languages: de, en, zh included, fr, es, it, ru, jp, kr as download STEP 7 Professional V17, floating license STEP 7 Professional V17, floating license, software download including license key ¹⁾ Email address required for delivery	6ES7822-1AA07-0YA5 6ES7822-1AE07-0YA5	STEP 7 Safety Advanced V17 Task: Engineering tool for configuring and programming fail-safe user programs for SIMATIC S7-1200 FC, S7-1500F, S7-1500F Software Controller, S7-300F, S7-400F, WinAC RTX F, ET 200SP F Controller and the fail-safe ET 200SP, ET 200MP, ET 200S, ET 200M, ET 200iSP, ET 200pro and ET 200eco I/O Requirement: STEP 7 Professional V17 Note: As of TIA Portal V16, the SIMATIC STEP 7 Safety software is an integral component of the SIMATIC STEP 7 product setup. The functionality of SIMATIC STEP 7 Safety is activated by means of the license key supplied in each case. Floating license for 1 user; license key on USB flash drive Floating license for 1 user, license key for download ¹⁾ ; email address required for delivery SIMATIC Manual Collection Electronic manuals on DVD, multi-language: LOGO!, SIMADYN, SIMATIC Bus Components, SIMATIC C7, SIMATIC Distributed I/O, SIMATIC HMI, SIMATIC Sensors, SIMATIC NET, SIMATIC PC-based Automation, SIMATIC PCS 7, SIMATIC PG/PC, SIMATIC S7, SIMATIC Software, SIMATIC TDC SIMATIC Manual Collection update service for 1 year Current Manual Collection DVD and the three subsequent updates	6ES7833-1FA17-0YA5 6ES7833-1FA17-0YH5 6ES7998-8XC01-8YE0 6ES7998-8XC01-8YE2

¹⁾ For up-to-date information and download availability, see: <http://www.siemens.com/tia-online-software-delivery>

Technical specifications

Article number	6ES7511-1TK01-0AB0	6ES7515-2TM01-0AB0	6ES7516-3TN00-0AB0	6ES7517-3TP00-0AB0	6ES7518-4TP00-0AB0
	CPU 1511T-1 PN, 225KB progr., 1MB data	CPU 1515T-2 PN, 750KB progr, 3MB data	CPU 1516T-3 PN/DP, 1.5MB prog./5MB data	CPU 1517T-3 PN/DP, 3MB prog./8MB data	CPU 1518T-4 PN/DP, 9MB Prog., 60MB data
General information					
Product type designation	CPU 1511T-1 PN	CPU 1515T-2 PN	CPU 1516T-3 PN/DP	CPU 1517T-3 PN/DP	CPU 1518T-4 PN/DP
Engineering with					
• STEP 7 TIA Portal configurable/integrated from version	V17 (FW V2.9) / V14 (FW V2.0) or higher	V17 (FW V2.9) / V14 (FW V2.0) or higher	V17 (FW V2.9) / V15 (FW V2.5) or higher	V17 (FW V2.9) / V14 (FW V2.0) or higher	V17 (FW V2.9) / V17 (FW V2.9) or higher
Display					
Screen diagonal [cm]	3.45 cm	6.1 cm	6.1 cm	6.1 cm	6.1 cm
Supply voltage					
Rated value (DC)	24 V	24 V	24 V	24 V	24 V
Memory					
Work memory					
• integrated (for program)	225 kbyte	750 kbyte	1.5 Mbyte	3 Mbyte	9 Mbyte
• integrated (for data)	1 Mbyte	3 Mbyte	5 Mbyte	8 Mbyte	60 Mbyte
Load memory					
• Plug-in (SIMATIC Memory Card), max.	32 Gbyte	32 Gbyte	32 Gbyte	32 Gbyte	32 Gbyte

SIMATIC S7-1500 Advanced Controllers

Central processing units

Technology CPUs

Technical specifications

Article number	6ES7511-1TK01-0AB0 CPU 1511T-1 PN, 225KB progr., 1MB data	6ES7515-2TM01-0AB0 CPU 1515T-2 PN, 750KB progr, 3MB data	6ES7516-3TN00-0AB0 CPU 1516T-3 PN/DP, 1.5MB prog./5MB data	6ES7517-3TP00-0AB0 CPU 1517T-3 PN/DP, 3MB prog./8MB data	6ES7518-4TP00-0AB0 CPU 1518T-4 PN/DP, 9MB Prog., 60MB data
CPU processing times					
for bit operations, typ.	60 ns	30 ns	10 ns	2 ns	1 ns
for word operations, typ.	72 ns	36 ns	12 ns	3 ns	2 ns
for fixed point arithmetic, typ.	96 ns	48 ns	16 ns	3 ns	2 ns
for floating point arithmetic, typ.	384 ns	192 ns	64 ns	12 ns	6 ns
Counters, timers and their retentivity					
S7 counter					
• Number	2 048	2 048	2 048	2 048	2 048
IEC counter					
• Number	Any (only limited by the main memory)	Any (only limited by the main memory)	Any (only limited by the main memory)	Any (only limited by the main memory)	Any (only limited by the main memory)
S7 times					
• Number	2 048	2 048	2 048	2 048	2 048
IEC timer					
• Number	Any (only limited by the main memory)	Any (only limited by the main memory)	Any (only limited by the main memory)	Any (only limited by the main memory)	Any (only limited by the main memory)
Data areas and their retentivity					
Flag					
• Size, max.	16 kbyte	16 kbyte	16 kbyte	16 kbyte	16 kbyte
Address area					
I/O address area					
• Inputs	32 kbyte; All inputs are in the process image	32 kbyte; All inputs are in the process image	32 kbyte; All inputs are in the process image	32 kbyte; All inputs are in the process image	32 kbyte; All inputs are in the process image
• Outputs	32 kbyte; All outputs are in the process image	32 kbyte; All outputs are in the process image	32 kbyte; All outputs are in the process image	32 kbyte; All outputs are in the process image	32 kbyte; All outputs are in the process image
Time of day					
Clock					
• Type	Hardware clock	Hardware clock	Hardware clock	Hardware clock	Hardware clock
1. Interface					
Interface types					
• RJ 45 (Ethernet)	Yes; X1	Yes; X1	Yes; X1	Yes; X1	Yes; X1
• Number of ports	2	2	2	2	2
• integrated switch	Yes	Yes	Yes	Yes	Yes
Protocols					
• IP protocol	Yes; IPv4	Yes; IPv4	Yes; IPv4	Yes; IPv4	Yes; IPv4
• PROFINET IO Controller	Yes	Yes	Yes	Yes	Yes
• PROFINET IO Device	Yes	Yes	Yes	Yes	Yes
• SIMATIC communication	Yes	Yes	Yes	Yes	Yes
• Open IE communication	Yes; Optionally also encrypted	Yes; Optionally also encrypted	Yes; Optionally also encrypted	Yes; Optionally also encrypted	Yes; Optionally also encrypted
• Web server	Yes	Yes	Yes	Yes	Yes
• Media redundancy	Yes	Yes	Yes	Yes	Yes

Technical specifications

Article number	6ES7511-1TK01-0AB0	6ES7515-2TM01-0AB0	6ES7516-3TN00-0AB0	6ES7517-3TP00-0AB0	6ES7518-4TP00-0AB0
	CPU 1511T-1 PN, 225KB progr., 1MB data	CPU 1515T-2 PN, 750KB progr, 3MB data	CPU 1516T-3 PN/DP, 1.5MB prog./5MB data	CPU 1517T-3 PN/DP, 3MB prog./8MB data	CPU 1518T-4 PN/DP, 9MB Prog., 60MB data
PROFINET IO Controller					
Services					
- PG/OP communication	Yes	Yes	Yes	Yes	Yes
- Isochronous mode	Yes	Yes	Yes	Yes	Yes
- Direct data exchange	Yes; Requirement: IRT and isochronous mode (MRPD optional)	Yes; Requirement: IRT and isochronous mode (MRPD optional)	Yes; Requirement: IRT and isochronous mode (MRPD optional)	Yes; Requirement: IRT and isochronous mode (MRPD optional)	Yes; Requirement: IRT and isochronous mode (MRPD optional)
- IRT	Yes	Yes	Yes	Yes	Yes
- PROFinergy	Yes; per user program	Yes; per user program	Yes; per user program	Yes; per user program	Yes; per user program
- Prioritized startup	Yes; Max. 32 PROFINET devices	Yes; Max. 32 PROFINET devices	Yes; Max. 32 PROFINET devices	Yes; Max. 32 PROFINET devices	Yes; Max. 32 PROFINET devices
- Number of connectable IO Devices, max.	128; In total, up to 256 distributed I/O devices can be connected via AS-i, PROFIBUS or PROFINET	256; In total, up to 1 000 distributed I/O devices can be connected via AS-i, PROFIBUS or PROFINET	256; In total, up to 1 000 distributed I/O devices can be connected via AS-i, PROFIBUS or PROFINET	512; In total, up to 1 000 distributed I/O devices can be connected via AS-i, PROFIBUS or PROFINET	512; In total, up to 1 000 distributed I/O devices can be connected via AS-i, PROFIBUS or PROFINET
- Of which IO devices with IRT, max.	64	64	64	64	64
- Number of connectable IO Devices for RT, max.	128	256	256	512	512
- of which in line, max.	128	256	256	512	512
- Number of IO Devices that can be simultaneously activated/deactivated, max.	8; in total across all interfaces	8; in total across all interfaces	8; in total across all interfaces	8; in total across all interfaces	8; in total across all interfaces
- Number of IO Devices per tool, max.	8	8	8	8	8
- Updating times	The minimum value of the update time also depends on communication share set for PROFINET IO, on the number of IO devices, and on the quantity of configured user data	The minimum value of the update time also depends on communication share set for PROFINET IO, on the number of IO devices, and on the quantity of configured user data	The minimum value of the update time also depends on communication share set for PROFINET IO, on the number of IO devices, and on the quantity of configured user data	The minimum value of the update time also depends on communication share set for PROFINET IO, on the number of IO devices, and on the quantity of configured user data	The minimum value of the update time also depends on communication share set for PROFINET IO, on the number of IO devices, and on the quantity of configured user data
PROFINET IO Device					
Services					
- PG/OP communication	Yes	Yes	Yes	Yes	Yes
- Isochronous mode	No	No	No	No	No
- IRT	Yes	Yes	Yes	Yes	Yes; Minimum send cycle of 250 µs
- PROFinergy	Yes; per user program	Yes; per user program	Yes; per user program	Yes; per user program	Yes; per user program
- Shared device	Yes	Yes	Yes	Yes	Yes
- Number of IO Controllers with shared device, max.	4	4	4	4	4
- activation/deactivation of I-devices	Yes; per user program	Yes; per user program	Yes; per user program	Yes; per user program	Yes; per user program
- Asset management record	Yes; per user program	Yes; per user program	Yes; per user program	Yes; per user program	Yes; per user program
2. Interface					
Interface types					
• RJ 45 (Ethernet)		Yes; X2	Yes; X2	Yes; X2	Yes; X2
• Number of ports		1	1	1	1
• integrated switch		No	No	No	No
Protocols					
• IP protocol		Yes; IPv4	Yes; IPv4	Yes; IPv4	Yes; IPv4
• PROFINET IO Controller		Yes	Yes	Yes	Yes
• PROFINET IO Device		Yes	Yes	Yes	Yes
• SIMATIC communication		Yes	Yes	Yes	Yes
• Open IE communication		Yes; Optionally also encrypted	Yes; Optionally also encrypted	Yes; Optionally also encrypted	Yes; Optionally also encrypted
• Web server		Yes	Yes	Yes	Yes
• Media redundancy		No	No	No	No

SIMATIC S7-1500 Advanced Controllers

Central processing units

Technology CPUs

Technical specifications

Article number	6ES7511-1TK01-0AB0	6ES7515-2TM01-0AB0	6ES7516-3TN00-0AB0	6ES7517-3TP00-0AB0	6ES7518-4TP00-0AB0
	CPU 1511T-1 PN, 225KB progr., 1MB data	CPU 1515T-2 PN, 750KB progr, 3MB data	CPU 1516T-3 PN/DP, 1.5MB prog./5MB data	CPU 1517T-3 PN/DP, 3MB prog./8MB data	CPU 1518T-4 PN/DP, 9MB Prog., 60MB data
PROFINET IO Controller					
Services					
- PG/OP communication		Yes	Yes	Yes	Yes
- Isochronous mode		No	No	No	No
- Direct data exchange		No	No	No	No
- IRT		No	No	No	No
- PROFinergy		Yes; per user program	Yes; per user program	Yes; per user program	Yes; per user program
- Prioritized startup		No	No	No	No
- Number of connectable IO Devices, max.		32; In total, up to 1 000 distributed I/O devices can be connected via AS-i, PROFIBUS or PROFINET	32; In total, up to 1 000 distributed I/O devices can be connected via AS-i, PROFIBUS or PROFINET	128; In total, up to 1 000 distributed I/O devices can be connected via AS-i, PROFIBUS or PROFINET	128; In total, up to 1 000 distributed I/O devices can be connected via AS-i, PROFIBUS or PROFINET
- Number of connectable IO Devices for RT, max.		32	32	128	128
- of which in line, max.		32	32	128	128
- Number of IO Devices that can be simultaneously activated/deactivated, max.		8; in total across all interfaces	8; in total across all interfaces	8; in total across all interfaces	8; in total across all interfaces
- Number of IO Devices per tool, max.		8	8	8	8
- Updating times		The minimum value of the update time also depends on communication share set for PROFINET IO, on the number of IO devices, and on the quantity of configured user data	The minimum value of the update time also depends on communication share set for PROFINET IO, on the number of IO devices, and on the quantity of configured user data	The minimum value of the update time also depends on communication share set for PROFINET IO, on the number of IO devices, and on the quantity of configured user data	The minimum value of the update time also depends on communication share set for PROFINET IO, on the number of IO devices, and on the quantity of configured user data
PROFINET IO Device					
Services					
- PG/OP communication		Yes	Yes	Yes	Yes
- Isochronous mode		No	No	No	No
- IRT		No	No	No	No
- PROFinergy		Yes; per user program	Yes; per user program	Yes; per user program	Yes; per user program
- Prioritized startup		No	No	No	No
- Shared device		Yes	Yes	Yes	Yes
- Number of IO Controllers with shared device, max.		4	4	4	4
- activation/deactivation of I-devices		Yes; per user program	Yes; per user program	Yes; per user program	Yes; per user program
- Asset management record		Yes; per user program	Yes; per user program	Yes; per user program	Yes; per user program
3. Interface					
Interface types					
• RJ 45 (Ethernet)					Yes; X3
• RS 485			Yes; X3	Yes; X3	
• Number of ports			1	1	1
• integrated switch					No

Technical specifications

Article number	6ES7511-1TK01-0AB0	6ES7515-2TM01-0AB0	6ES7516-3TN00-0AB0	6ES7517-3TP00-0AB0	6ES7518-4TP00-0AB0
	CPU 1511T-1 PN, 225KB progr., 1MB data	CPU 1515T-2 PN, 750KB progr, 3MB data	CPU 1516T-3 PN/DP, 1.5MB prog./5MB data	CPU 1517T-3 PN/DP, 3MB prog./8MB data	CPU 1518T-4 PN/DP, 9MB Prog., 60MB data
Protocols					
<ul style="list-style-type: none"> IP protocol PROFINET IO Controller PROFINET IO Device PROFIBUS DP master PROFIBUS DP slave SIMATIC communication Open IE communication Web server 			Yes	Yes	Yes
PROFIBUS DP master					
<ul style="list-style-type: none"> Number of DP slaves, max. 			125; In total, up to 1 000 distributed I/O devices can be connected via AS-i, PROFIBUS or PROFINET	125; In total, up to 1 000 distributed I/O devices can be connected via AS-i, PROFIBUS or PROFINET	
4. Interface					
Interface types					
<ul style="list-style-type: none"> RS 485 Number of ports 					Yes; X4 1
Protocols					
<ul style="list-style-type: none"> PROFIBUS DP master PROFIBUS DP slave SIMATIC communication 					Yes No Yes
PROFIBUS DP master					
<ul style="list-style-type: none"> Number of DP slaves, max. 					125; In total, up to 1 000 distributed I/O devices can be connected via AS-i, PROFIBUS or PROFINET
Protocols					
Number of connections					
<ul style="list-style-type: none"> Number of connections, max. 	96; via integrated interfaces of the CPU and connected CPs / CMs	192; via integrated interfaces of the CPU and connected CPs / CMs	256; via integrated interfaces of the CPU and connected CPs / CMs	320; via integrated interfaces of the CPU and connected CPs / CMs	384; via integrated interfaces of the CPU and connected CPs / CMs
Redundancy mode					
Media redundancy					
- Media redundancy	only via 1st interface (X1)	only via 1st interface (X1)	only via 1st interface (X1)	only via 1st interface (X1)	only via 1st interface (X1)
- MRP	Yes; MRP Automanager according to IEC 62439-2 Edition 2.0, MRP Manager; MRP Client	Yes; MRP Automanager according to IEC 62439-2 Edition 2.0, MRP Manager; MRP Client	Yes; MRP Automanager according to IEC 62439-2 Edition 2.0, MRP Manager; MRP Client	Yes; MRP Automanager according to IEC 62439-2 Edition 2.0, MRP Manager; MRP Client	Yes; MRP Automanager according to IEC 62439-2 Edition 2.0, MRP Manager; MRP Client
- MRP interconnection, supported	Yes; as MRP ring node according to IEC 62439-2 Edition 3.0	Yes; as MRP ring node according to IEC 62439-2 Edition 3.0	Yes; as MRP ring node according to IEC 62439-2 Edition 3.0	Yes; as MRP ring node according to IEC 62439-2 Edition 3.0	Yes; as MRP ring node according to IEC 62439-2 Edition 3.0
- MRPD	Yes; Requirement: IRT	Yes; Requirement: IRT	Yes; Requirement: IRT	Yes; Requirement: IRT	Yes; Requirement: IRT
- Switchover time on line break, typ.	200 ms; For MRP, bumpless for MRPD	200 ms; For MRP, bumpless for MRPD	200 ms; For MRP, bumpless for MRPD	200 ms; For MRP, bumpless for MRPD	200 ms; For MRP, bumpless for MRPD
- Number of stations in the ring, max.	50	50	50	50	50
SIMATIC communication					
<ul style="list-style-type: none"> S7 routing 	Yes	Yes	Yes	Yes	Yes

SIMATIC S7-1500 Advanced Controllers

Central processing units

Technology CPUs

Technical specifications

Article number	6ES7511-1TK01-0AB0	6ES7515-2TM01-0AB0	6ES7516-3TN00-0AB0	6ES7517-3TP00-0AB0	6ES7518-4TP00-0AB0
	CPU 1511T-1 PN, 225KB progr., 1MB data	CPU 1515T-2 PN, 750KB progr, 3MB data	CPU 1516T-3 PN/DP, 1.5MB prog./5MB data	CPU 1517T-3 PN/DP, 3MB prog./8MB data	CPU 1518T-4 PN/DP, 9MB Prog., 60MB data
OPC UA					
• OPC UA Client	Yes	Yes	Yes	Yes	Yes
• OPC UA Server	Yes; Data access (read, write, subscribe), method call, custom address space	Yes; Data access (read, write, subscribe), method call, custom address space	Yes; Data access (read, write, subscribe), method call, custom address space	Yes; Data access (read, write, subscribe), method call, custom address space	Yes; Data access (read, write, subscribe), method call, custom address space
• Alarms and Conditions	Yes	Yes	Yes	Yes	Yes
Supported technology objects					
Motion Control	Yes; Note: The number of technology objects affects the cycle time of the PLC program; selection guide via the TIA Selection Tool	Yes; Note: The number of technology objects affects the cycle time of the PLC program; selection guide via the TIA Selection Tool	Yes; Note: The number of technology objects affects the cycle time of the PLC program; selection guide via the TIA Selection Tool	Yes; Note: The number of technology objects affects the cycle time of the PLC program; selection guide via the TIA Selection Tool	Yes; Note: The number of technology objects affects the cycle time of the PLC program; selection guide via the TIA Selection Tool
• Number of available Motion Control resources for technology objects	800	2 400	6 400	10 240	15 360
• Required Motion Control resources					
- per speed-controlled axis	40	40	40	40	40
- per positioning axis	80	80	80	80	80
- per synchronous axis	160	160	160	160	160
- per external encoder	80	80	80	80	80
- per output cam	20	20	20	20	20
- per cam track	160	160	160	160	160
- per probe	40	40	40	40	40
• Number of available Extended Motion Control resources for technology objects	40	120	192	256	512
• Required Extended Motion Control resources					
- per cam (1 000 points and 50 segments)	2	2	2	2	2
- per cam (10 000 points and 50 segments)	20	20	20	20	20
- for each set of kinematics	30	30	30	30	30
- Per leading axis proxy	3	3	3	3	3
Controller					
• PID_Compact	Yes; Universal PID controller with integrated optimization	Yes; Universal PID controller with integrated optimization	Yes; Universal PID controller with integrated optimization	Yes; Universal PID controller with integrated optimization	Yes; Universal PID controller with integrated optimization
• PID_3Step	Yes; PID controller with integrated optimization for valves	Yes; PID controller with integrated optimization for valves	Yes; PID controller with integrated optimization for valves	Yes; PID controller with integrated optimization for valves	Yes; PID controller with integrated optimization for valves
• PID-Temp	Yes; PID controller with integrated optimization for temperature	Yes; PID controller with integrated optimization for temperature	Yes; PID controller with integrated optimization for temperature	Yes; PID controller with integrated optimization for temperature	Yes; PID controller with integrated optimization for temperature
Counting and measuring					
• High-speed counter	Yes	Yes	Yes	Yes	Yes
Ambient conditions					
Ambient temperature during operation					
• horizontal installation, min.	0 °C	0 °C	0 °C	0 °C	0 °C
• horizontal installation, max.	60 °C; Display: 50 °C, at an operating temperature of typically 50 °C, the display is switched off	60 °C; Display: 50 °C, at an operating temperature of typically 50 °C, the display is switched off	60 °C; Display: 50 °C, at an operating temperature of typically 50 °C, the display is switched off	60 °C; Display: 50 °C, at an operating temperature of typically 50 °C, the display is switched off	60 °C; Display: 50 °C, at an operating temperature of typically 50 °C, the display is switched off
• vertical installation, min.	0 °C	0 °C	0 °C	0 °C	0 °C
• vertical installation, max.	40 °C; Display: 40 °C, at an operating temperature of typically 40 °C, the display is switched off	40 °C; Display: 40 °C, at an operating temperature of typically 40 °C, the display is switched off	40 °C; Display: 40 °C, at an operating temperature of typically 40 °C, the display is switched off	40 °C; Display: 40 °C, at an operating temperature of typically 40 °C, the display is switched off	40 °C; Display: 40 °C, at an operating temperature of typically 40 °C, the display is switched off

Technical specifications

Article number	6ES7511-1TK01-0AB0	6ES7515-2TM01-0AB0	6ES7516-3TN00-0AB0	6ES7517-3TP00-0AB0	6ES7518-4TP00-0AB0
	CPU 1511T-1 PN, 225KB progr., 1MB data	CPU 1515T-2 PN, 750KB progr, 3MB data	CPU 1516T-3 PN/DP, 1.5MB prog./5MB data	CPU 1517T-3 PN/DP, 3MB prog./8MB data	CPU 1518T-4 PN/DP, 9MB Prog., 60MB data
Altitude during operation relating to sea level					
<ul style="list-style-type: none"> Installation altitude above sea level, max. 	5 000 m; Restrictions for installation altitudes > 2 000 m, see manual	5 000 m; Restrictions for installation altitudes > 2 000 m, see manual	5 000 m; Restrictions for installation altitudes > 2 000 m, see manual	5 000 m; Restrictions for installation altitudes > 2 000 m, see manual	5 000 m; Restrictions for installation altitudes > 2 000 m, see manual
Configuration					
Programming					
Programming language					
- LAD	Yes	Yes	Yes	Yes	Yes
- FBD	Yes	Yes	Yes	Yes	Yes
- STL	Yes	Yes	Yes	Yes	Yes
- SCL	Yes	Yes	Yes	Yes	Yes
- GRAPH	Yes	Yes	Yes	Yes	Yes
Know-how protection					
<ul style="list-style-type: none"> User program protection/password protection Copy protection Block protection 	Yes	Yes	Yes	Yes	Yes
Access protection					
<ul style="list-style-type: none"> protection of confidential configuration data Password for display Protection level: Write protection Protection level: Read/write protection Protection level: Complete protection 	Yes	Yes	Yes	Yes	Yes
Dimensions					
Width	35 mm	70 mm	175 mm	175 mm	175 mm
Height	147 mm	147 mm	147 mm	147 mm	147 mm
Depth	129 mm	129 mm	129 mm	129 mm	129 mm
Weights					
Weight, approx.	430 g	830 g	1 978 g	1 978 g	1 988 g
Article number	6ES7511-1UK01-0AB0	6ES7515-2UM01-0AB0	6ES7516-3UN00-0AB0	6ES7517-3UP00-0AB0	6ES7518-4UP00-0AB0
	CPU 1511TF-1 PN, 225KB progr., 1MB data	CPU 1515TF-2 PN, 750KB progr, 3MB data	CPU 1516TF-3 PN/DP, 1.5MB prog./5MB data	CPU 1517TF-3 PN/DP, 3MB prog., 8MB data	CPU 1518TF-4 PN/DP, 9MB Prog, 60MB data
General information					
Product type designation	CPU 1511TF-1 PN	CPU 1515TF-2 PN	CPU 1516TF-3 PN/DP	CPU 1517TF-3 PN/DP	CPU 1518TF-4 PN/DP
Engineering with					
<ul style="list-style-type: none"> STEP 7 TIA Portal configurable/ integrated from version 	V17 (FW V2.9) / V14 (FW V2.0) or higher	V17 (FW V2.9) / V14 (FW V2.1) or higher	V17 (FW V2.9) / V15 (FW V2.5) or higher	V17 (FW V2.9) / V14 (FW V2.0) or higher	V17 (FW V2.9) / V17 (FW V2.9) or higher
Display					
Screen diagonal [cm]	3.45 cm	6.1 cm	6.1 cm	6.1 cm	6.1 cm
Supply voltage					
Rated value (DC)	24 V	24 V	24 V	24 V	24 V
Memory					
Work memory					
<ul style="list-style-type: none"> integrated (for program) integrated (for data) 	225 kbyte 1 Mbyte	750 kbyte 3 Mbyte	1.5 Mbyte 5 Mbyte	3 Mbyte 8 Mbyte	9 Mbyte 60 Mbyte
Load memory					
<ul style="list-style-type: none"> Plug-in (SIMATIC Memory Card), max. 	32 Gbyte	32 Gbyte	32 Gbyte	32 Gbyte	32 Gbyte

SIMATIC S7-1500 Advanced Controllers

Central processing units

Technology CPUs

Technical specifications

Article number	6ES7511-1UK01-0AB0	6ES7515-2UM01-0AB0	6ES7516-3UN00-0AB0	6ES7517-3UP00-0AB0	6ES7518-4UP00-0AB0
	CPU 1511TF-1 PN, 225KB progr., 1MB data	CPU 1515TF-2 PN, 750KB progr, 3MB data	CPU 1516TF-3 PN/DP, 1.5MB prog./5MB data	CPU 1517TF-3 PN/DP, 3MB prog., 8MB data	CPU 1518TF-4 PN/DP, 9MB Prog, 60MB data
CPU processing times					
for bit operations, typ.	60 ns	30 ns	10 ns	2 ns	1 ns
for word operations, typ.	72 ns	36 ns	12 ns	3 ns	2 ns
for fixed point arithmetic, typ.	96 ns	48 ns	16 ns	3 ns	2 ns
for floating point arithmetic, typ.	384 ns	192 ns	64 ns	12 ns	6 ns
Counters, timers and their retentivity					
S7 counter					
• Number	2 048	2 048	2 048	2 048	2 048
IEC counter					
• Number	Any (only limited by the main memory)	Any (only limited by the main memory)	Any (only limited by the main memory)	Any (only limited by the main memory)	Any (only limited by the main memory)
S7 times					
• Number	2 048	2 048	2 048	2 048	2 048
IEC timer					
• Number	Any (only limited by the main memory)	Any (only limited by the main memory)	Any (only limited by the main memory)	Any (only limited by the main memory)	Any (only limited by the main memory)
Data areas and their retentivity					
Flag					
• Size, max.	16 kbyte	16 kbyte	16 kbyte	16 kbyte	16 kbyte
Address area					
I/O address area					
• Inputs	32 kbyte; All inputs are in the process image	32 kbyte; All inputs are in the process image	32 kbyte; All inputs are in the process image	32 kbyte; All inputs are in the process image	32 kbyte; All inputs are in the process image
• Outputs	32 kbyte; All outputs are in the process image	32 kbyte; All outputs are in the process image	32 kbyte; All outputs are in the process image	32 kbyte; All outputs are in the process image	32 kbyte; All outputs are in the process image
Time of day					
Clock					
• Type	Hardware clock	Hardware clock	Hardware clock	Hardware clock	Hardware clock
1. Interface					
Interface types					
• RJ 45 (Ethernet)	Yes; X1	Yes; X1	Yes; X1	Yes; X1	Yes; X1
• Number of ports	2	2	2	2	2
• integrated switch	Yes	Yes	Yes	Yes	Yes
Protocols					
• IP protocol	Yes; IPv4	Yes; IPv4	Yes; IPv4	Yes; IPv4	Yes; IPv4
• PROFINET IO Controller	Yes	Yes	Yes	Yes	Yes
• PROFINET IO Device	Yes	Yes	Yes	Yes	Yes
• SIMATIC communication	Yes	Yes	Yes	Yes	Yes
• Open IE communication	Yes; Optionally also encrypted	Yes; Optionally also encrypted	Yes; Optionally also encrypted	Yes; Optionally also encrypted	Yes; Optionally also encrypted
• Web server	Yes	Yes	Yes	Yes	Yes
• Media redundancy	Yes	Yes	Yes	Yes	Yes

Technical specifications

Article number	6ES7511-1UK01-0AB0 CPU 1511TF-1 PN, 225KB progr., 1MB data	6ES7515-2UM01-0AB0 CPU 1515TF-2 PN, 750KB progr, 3MB data	6ES7516-3UN00-0AB0 CPU 1516TF-3 PN/DP, 1.5MB prog./5MB data	6ES7517-3UP00-0AB0 CPU 1517TF-3 PN/DP, 3MB progr., 8MB data	6ES7518-4UP00-0AB0 CPU 1518TF-4 PN/DP, 9MB Prog, 60MB data
PROFINET IO Controller					
Services					
- PG/OP communication	Yes	Yes	Yes	Yes	Yes
- Isochronous mode	Yes	Yes	Yes	Yes	Yes
- Direct data exchange	Yes; Requirement: IRT and isochronous mode (MRPD optional)	Yes; Requirement: IRT and isochronous mode (MRPD optional)	Yes; Requirement: IRT and isochronous mode (MRPD optional)	Yes; Requirement: IRT and isochronous mode (MRPD optional)	Yes; Requirement: IRT and isochronous mode (MRPD optional)
- IRT	Yes	Yes	Yes	Yes	Yes
- PROFinergy	Yes; per user program	Yes; per user program	Yes; per user program	Yes; per user program	Yes; per user program
- Prioritized startup	Yes; Max. 32 PROFINET devices	Yes; Max. 32 PROFINET devices	Yes; Max. 32 PROFINET devices	Yes; Max. 32 PROFINET devices	Yes; Max. 32 PROFINET devices
- Number of connectable IO Devices, max.	128; In total, up to 256 distributed I/O devices can be connected via AS-i, PROFIBUS or PROFINET	256; In total, up to 1 000 distributed I/O devices can be connected via AS-i, PROFIBUS or PROFINET	256; In total, up to 1 000 distributed I/O devices can be connected via AS-i, PROFIBUS or PROFINET	512; In total, up to 1 000 distributed I/O devices can be connected via AS-i, PROFIBUS or PROFINET	512; In total, up to 1 000 distributed I/O devices can be connected via AS-i, PROFIBUS or PROFINET
- Of which IO devices with IRT, max.	64	64	64	64	64
- Number of connectable IO Devices for RT, max.	128	256	256	512	512
- of which in line, max.	128	256	256	512	512
- Number of IO Devices that can be simultaneously activated/deactivated, max.	8; in total across all interfaces	8; in total across all interfaces	8; in total across all interfaces	8; in total across all interfaces	8; in total across all interfaces
- Number of IO Devices per tool, max.	8	8	8	8	8
- Updating times	The minimum value of the update time also depends on communication share set for PROFINET IO, on the number of IO devices, and on the quantity of configured user data	The minimum value of the update time also depends on communication share set for PROFINET IO, on the number of IO devices, and on the quantity of configured user data	The minimum value of the update time also depends on communication share set for PROFINET IO, on the number of IO devices, and on the quantity of configured user data	The minimum value of the update time also depends on communication share set for PROFINET IO, on the number of IO devices, and on the quantity of configured user data	The minimum value of the update time also depends on communication share set for PROFINET IO, on the number of IO devices, and on the quantity of configured user data
PROFINET IO Device					
Services					
- PG/OP communication	Yes	Yes	Yes	Yes	Yes
- Isochronous mode	No	No	No	No	No
- IRT	Yes	Yes	Yes	Yes	Yes; Minimum send cycle of 250 µs
- PROFinergy	Yes; per user program	Yes; per user program	Yes; per user program	Yes; per user program	Yes; per user program
- Shared device	Yes	Yes	Yes	Yes	Yes
- Number of IO Controllers with shared device, max.	4	4	4	4	4
- activation/deactivation of I-devices	Yes; per user program	Yes; per user program	Yes; per user program	Yes; per user program	Yes; per user program
- Asset management record	Yes; per user program	Yes; per user program	Yes; per user program	Yes; per user program	Yes; per user program
2. Interface					
Interface types					
• RJ 45 (Ethernet)		Yes; X2	Yes; X2	Yes; X2	Yes; X2
• Number of ports		1	1	1	1
• integrated switch		No	No	No	No
Protocols					
• IP protocol		Yes; IPv4	Yes; IPv4	Yes; IPv4	Yes; IPv4
• PROFINET IO Controller		Yes	Yes	Yes	Yes
• PROFINET IO Device		Yes	Yes	Yes	Yes
• SIMATIC communication		Yes	Yes	Yes	Yes
• Open IE communication		Yes; Optionally also encrypted	Yes; Optionally also encrypted	Yes; Optionally also encrypted	Yes; Optionally also encrypted
• Web server		Yes	Yes	Yes	Yes
• Media redundancy		No	No	No	No

SIMATIC S7-1500 Advanced Controllers

Central processing units

Technology CPUs

Technical specifications

Article number	6ES7511-1UK01-0AB0	6ES7515-2UM01-0AB0	6ES7516-3UN00-0AB0	6ES7517-3UP00-0AB0	6ES7518-4UP00-0AB0
	CPU 1511TF-1 PN, 225KB progr., 1MB data	CPU 1515TF-2 PN, 750KB progr, 3MB data	CPU 1516TF-3 PN/DP, 1.5MB prog./5MB data	CPU 1517TF-3 PN/DP, 3MB prog., 8MB data	CPU 1518TF-4 PN/DP, 9MB Prog, 60MB data
PROFINET IO Controller					
Services					
- PG/OP communication		Yes	Yes	Yes	Yes
- Isochronous mode		No	No	No	No
- Direct data exchange		No	No	No	No
- IRT		No	No	No	No
- PROFinergy		Yes; per user program	Yes; per user program	Yes; per user program	Yes; per user program
- Prioritized startup		No	No	No	No
- Number of connectable IO Devices, max.		32; In total, up to 1 000 distributed I/O devices can be connected via AS-i, PROFIBUS or PROFINET	32; In total, up to 1 000 distributed I/O devices can be connected via AS-i, PROFIBUS or PROFINET	128; In total, up to 1 000 distributed I/O devices can be connected via AS-i, PROFIBUS or PROFINET	128; In total, up to 1 000 distributed I/O devices can be connected via AS-i, PROFIBUS or PROFINET
- Number of connectable IO Devices for RT, max.		32	32	128	128
- of which in line, max.		32	32	128	128
- Number of IO Devices that can be simultaneously activated/deactivated, max.		8; in total across all interfaces	8; in total across all interfaces	8; in total across all interfaces	8; in total across all interfaces
- Number of IO Devices per tool, max.		8	8	8	8
- Updating times		The minimum value of the update time also depends on communication share set for PROFINET IO, on the number of IO devices, and on the quantity of configured user data	The minimum value of the update time also depends on communication share set for PROFINET IO, on the number of IO devices, and on the quantity of configured user data	The minimum value of the update time also depends on communication share set for PROFINET IO, on the number of IO devices, and on the quantity of configured user data	The minimum value of the update time also depends on communication share set for PROFINET IO, on the number of IO devices, and on the quantity of configured user data
PROFINET IO Device					
Services					
- PG/OP communication		Yes	Yes	Yes	Yes
- Isochronous mode		No	No	No	No
- IRT		No	No	No	No
- PROFinergy		Yes; per user program	Yes; per user program	Yes; per user program	Yes; per user program
- Prioritized startup		No	No	No	No
- Shared device		Yes	Yes	Yes	Yes
- Number of IO Controllers with shared device, max.		4	4	4	4
- activation/deactivation of I-devices		Yes; per user program	Yes; per user program	Yes; per user program	Yes; per user program
- Asset management record		Yes; per user program	Yes; per user program	Yes; per user program	Yes; per user program
3. Interface					
Interface types					
• RJ 45 (Ethernet)					Yes; X3
• RS 485			Yes; X3	Yes; X3	
• Number of ports			1	1	1
• integrated switch					No
Protocols					
• IP protocol					Yes; IPv4
• PROFINET IO Controller					No
• PROFINET IO Device					No
• PROFIBUS DP master			Yes	Yes	
• PROFIBUS DP slave			No	No	
• SIMATIC communication			Yes	Yes	Yes
• Open IE communication					Yes
• Web server					Yes

Technical specifications

Article number	6ES7511-1UK01-0AB0	6ES7515-2UM01-0AB0	6ES7516-3UN00-0AB0	6ES7517-3UP00-0AB0	6ES7518-4UP00-0AB0
	CPU 1511TF-1 PN, 225KB progr., 1MB data	CPU 1515TF-2 PN, 750KB progr, 3MB data	CPU 1516TF-3 PN/DP, 1.5MB prog./5MB data	CPU 1517TF-3 PN/DP, 3MB prog., 8MB data	CPU 1518TF-4 PN/DP, 9MB Prog, 60MB data
PROFIBUS DP master					
• Number of DP slaves, max.			125; In total, up to 1 000 distributed I/O devices can be connected via AS-i, PROFIBUS or PROFINET	125; In total, up to 1 000 distributed I/O devices can be connected via AS-i, PROFIBUS or PROFINET	
4. Interface					
Interface types					
• RS 485					Yes; X4
• Number of ports					1
Protocols					
• PROFIBUS DP master					Yes
• PROFIBUS DP slave					No
• SIMATIC communication					Yes
PROFIBUS DP master					
• Number of DP slaves, max.					125; In total, up to 1 000 distributed I/O devices can be connected via AS-i, PROFIBUS or PROFINET
Protocols					
Number of connections					
• Number of connections, max.	96; via integrated interfaces of the CPU and connected CPs / CMs	192; via integrated interfaces of the CPU and connected CPs / CMs	256; via integrated interfaces of the CPU and connected CPs / CMs	320; via integrated interfaces of the CPU and connected CPs / CMs	384; via integrated interfaces of the CPU and connected CPs / CMs
Redundancy mode					
Media redundancy					
- Media redundancy	only via 1st interface (X1)	only via 1st interface (X1)	only via 1st interface (X1)	only via 1st interface (X1)	only via 1st interface (X1)
- MRP	Yes; MRP Automanager according to IEC 62439-2 Edition 2.0, MRP Manager; MRP Client	Yes; MRP Automanager according to IEC 62439-2 Edition 2.0, MRP Manager; MRP Client	Yes; MRP Automanager according to IEC 62439-2 Edition 2.0, MRP Manager; MRP Client	Yes; MRP Automanager according to IEC 62439-2 Edition 2.0, MRP Manager; MRP Client	Yes; MRP Automanager according to IEC 62439-2 Edition 2.0, MRP Manager; MRP Client
- MRP interconnection, supported	Yes; as MRP ring node according to IEC 62439-2 Edition 3.0	Yes; as MRP ring node according to IEC 62439-2 Edition 3.0	Yes; as MRP ring node according to IEC 62439-2 Edition 3.0	Yes; as MRP ring node according to IEC 62439-2 Edition 3.0	Yes; as MRP ring node according to IEC 62439-2 Edition 3.0
- MRPD	Yes; Requirement: IRT	Yes; Requirement: IRT	Yes; Requirement: IRT	Yes; Requirement: IRT	Yes; Requirement: IRT
- Switchover time on line break, typ.	200 ms; For MRP, bumpless for MRPD	200 ms; For MRP, bumpless for MRPD	200 ms; For MRP, bumpless for MRPD	200 ms; For MRP, bumpless for MRPD	200 ms; For MRP, bumpless for MRPD
- Number of stations in the ring, max.	50	50	50	50	50
SIMATIC communication					
• S7 routing	Yes	Yes	Yes	Yes	Yes
OPC UA					
• OPC UA Client	Yes	Yes	Yes	Yes	Yes
• OPC UA Server	Yes; Data access (read, write, subscribe), method call, custom address space	Yes; Data access (read, write, subscribe), method call, custom address space	Yes; Data access (read, write, subscribe), method call, custom address space	Yes; Data access (read, write, subscribe), method call, custom address space	Yes; Data access (read, write, subscribe), method call, custom address space
• Alarms and Conditions	Yes	Yes	Yes	Yes	Yes

SIMATIC S7-1500 Advanced Controllers

Central processing units

Technology CPUs

Technical specifications

Article number	6ES7511-1UK01-0AB0	6ES7515-2UM01-0AB0	6ES7516-3UN00-0AB0	6ES7517-3UP00-0AB0	6ES7518-4UP00-0AB0
	CPU 1511TF-1 PN, 225KB progr., 1MB data	CPU 1515TF-2 PN, 750KB progr, 3MB data	CPU 1516TF-3 PN/DP, 1.5MB prog./5MB data	CPU 1517TF-3 PN/DP, 3MB prog., 8MB data	CPU 1518TF-4 PN/DP, 9MB Prog, 60MB data
Supported technology objects					
Motion Control	Yes; Note: The number of technology objects affects the cycle time of the PLC program; selection guide via the TIA Selection Tool	Yes; Note: The number of technology objects affects the cycle time of the PLC program; selection guide via the TIA Selection Tool	Yes; Note: The number of technology objects affects the cycle time of the PLC program; selection guide via the TIA Selection Tool	Yes; Note: The number of technology objects affects the cycle time of the PLC program; selection guide via the TIA Selection Tool	Yes; Note: The number of technology objects affects the cycle time of the PLC program; selection guide via the TIA Selection Tool
• Number of available Motion Control resources for technology objects	800	2 400	6 400	10 240	15 360
• Required Motion Control resources					
- per speed-controlled axis	40	40	40	40	40
- per positioning axis	80	80	80	80	80
- per synchronous axis	160	160	160	160	160
- per external encoder	80	80	80	80	80
- per output cam	20	20	20	20	20
- per cam track	160	160	160	160	160
- per probe	40	40	40	40	40
• Number of available Extended Motion Control resources for technology objects	40	120	192	256	512
• Required Extended Motion Control resources					
- per cam (1 000 points and 50 segments)	2	2	2	2	2
- per cam (10 000 points and 50 segments)	20	20	20	20	20
- for each set of kinematics	30	30	30	30	30
- Per leading axis proxy	3	3	3	3	3
Controller					
• PID_Compact	Yes; Universal PID controller with integrated optimization	Yes; Universal PID controller with integrated optimization	Yes; Universal PID controller with integrated optimization	Yes; Universal PID controller with integrated optimization	Yes; Universal PID controller with integrated optimization
• PID_3Step	Yes; PID controller with integrated optimization for valves	Yes; PID controller with integrated optimization for valves	Yes; PID controller with integrated optimization for valves	Yes; PID controller with integrated optimization for valves	Yes; PID controller with integrated optimization for valves
• PID-Temp	Yes; PID controller with integrated optimization for temperature	Yes; PID controller with integrated optimization for temperature	Yes; PID controller with integrated optimization for temperature	Yes; PID controller with integrated optimization for temperature	Yes; PID controller with integrated optimization for temperature
Counting and measuring					
• High-speed counter	Yes	Yes	Yes	Yes	Yes
Standards, approvals, certificates					
Highest safety class achievable in safety mode					
Probability of failure (for service life of 20 years and repair time of 100 hours)					
- Low demand mode: PFDavg in accordance with SIL3	< 2.00E-05	< 2.00E-05	< 2.00E-05	< 2.00E-05	< 2.00E-05
- High demand/continuous mode: PFH in accordance with SIL3	< 1.00E-09	< 1.00E-09	< 1.00E-09 1/h	< 1.00E-09 1/h	< 1.00E-09

Technical specifications

Article number	6ES7511-1UK01-0AB0	6ES7515-2UM01-0AB0	6ES7516-3UN00-0AB0	6ES7517-3UP00-0AB0	6ES7518-4UP00-0AB0
	CPU 1511TF-1 PN, 225KB progr., 1MB data	CPU 1515TF-2 PN, 750KB progr, 3MB data	CPU 1516TF-3 PN/DP, 1.5MB prog./5MB data	CPU 1517TF-3 PN/DP, 3MB progr., 8MB data	CPU 1518TF-4 PN/DP, 9MB Prog, 60MB data
Ambient conditions					
Ambient temperature during operation					
• horizontal installation, min.	0 °C	0 °C	0 °C	0 °C	0 °C
• horizontal installation, max.	60 °C; Display: 50 °C, at an operating temperature of typically 50 °C, the display is switched off	60 °C; Display: 50 °C, at an operating temperature of typically 50 °C, the display is switched off	60 °C; Display: 50 °C, at an operating temperature of typically 50 °C, the display is switched off	60 °C; Display: 50 °C, at an operating temperature of typically 50 °C, the display is switched off	60 °C; Display: 50 °C, at an operating temperature of typically 50 °C, the display is switched off
• vertical installation, min.	0 °C	0 °C	0 °C	0 °C	0 °C
• vertical installation, max.	40 °C; Display: 40 °C, at an operating temperature of typically 40 °C, the display is switched off	40 °C; Display: 40 °C, at an operating temperature of typically 40 °C, the display is switched off	40 °C; Display: 40 °C, at an operating temperature of typically 40 °C, the display is switched off	40 °C; Display: 40 °C, at an operating temperature of typically 40 °C, the display is switched off	40 °C; Display: 40 °C, at an operating temperature of typically 40 °C, the display is switched off
Altitude during operation relating to sea level					
• Installation altitude above sea level, max.	5 000 m; Restrictions for installation altitudes > 2 000 m, see manual	5 000 m; Restrictions for installation altitudes > 2 000 m, see manual	3 000 m; Restrictions for installation altitudes > 2 000 m, see manual	3 000 m; Restrictions for installation altitudes > 2 000 m, see manual	3 000 m; Restrictions for installation altitudes > 2 000 m, see manual
Configuration					
Programming					
Programming language					
- LAD	Yes; incl. failsafe	Yes; incl. failsafe	Yes; incl. failsafe	Yes; incl. failsafe	Yes; incl. failsafe
- FBD	Yes; incl. failsafe	Yes; incl. failsafe	Yes; incl. failsafe	Yes; incl. failsafe	Yes; incl. failsafe
- STL	Yes	Yes	Yes	Yes	Yes
- SCL	Yes	Yes	Yes	Yes	Yes
- GRAPH	Yes	Yes	Yes	Yes	Yes
Know-how protection					
• User program protection/password protection	Yes	Yes	Yes	Yes	Yes
• Copy protection	Yes	Yes	Yes	Yes	Yes
• Block protection	Yes	Yes	Yes	Yes	Yes
Access protection					
• protection of confidential configuration data	Yes	Yes	Yes	Yes	Yes
• Password for display	Yes	Yes	Yes	Yes	Yes
• Protection level: Write protection	Yes; Specific write protection both for Standard and for Failsafe	Yes; Specific write protection both for Standard and for Failsafe	Yes; Specific write protection both for Standard and for Failsafe	Yes; Specific write protection both for Standard and for Failsafe	Yes; Specific write protection both for Standard and for Failsafe
• Protection level: Read/write protection	Yes	Yes	Yes	Yes	Yes
• Protection level: Write protection for Failsafe	Yes	Yes	Yes	Yes	Yes
• Protection level: Complete protection	Yes	Yes	Yes	Yes	Yes
Dimensions					
Width	35 mm	70 mm	175 mm	175 mm	175 mm
Height	147 mm	147 mm	147 mm	147 mm	147 mm
Depth	129 mm	129 mm	129 mm	129 mm	129 mm
Weights					
Weight, approx.	430 g	830 g	1 978 g	1 978 g	1 988 g

SIMATIC S7-1500 Advanced Controllers

I/O modules

Digital modules

SM 521 digital input modules

Overview



- 16, 32 and 64-channel digital input modules
- Sinking and sourcing input versions available
- Module for recording NAMUR signals
- For flexible adaptation of the PLC to the corresponding task
- For subsequent expansion of the system with additional inputs
- 35 mm wide modules with parameters and diagnostic functions
- 25 mm wide modules for use in tight spaces: particularly economical, without parameters or diagnostic functions

Ordering data

SM 521 digital input modules

Module width 35 mm

16 inputs, 24 V DC
High Feature, isolated,
parameterizable diagnostics and
hardware interrupts

6ES7521-1BH00-0AB0

32 inputs, 24 V DC
High Feature, isolated,
parameterizable diagnostics and
hardware interrupts

6ES7521-1BL00-0AB0

16 inputs, 24 V DC
High Speed, isolated,
parameterizable diagnostics and
hardware interrupts

6ES7521-7BH00-0AB0

64 inputs, 24 V DC Basic,
source-sinking input,
input delay 3.2 ms; cables and
terminal blocks can be ordered
separately (SIMATIC TOP connect)

6ES7521-1BP00-0AA0

16 inputs, 24 V DC basic,
isolated,
input delay 3.2 ms

6ES7521-1BH50-0AA0

16 inputs, 230 V AC basic,
isolated,
input delay 20 ms

6ES7521-1FH00-0AA0

16 inputs, 24 ... 125 V UC
High Feature, input delay
0.05 ... 20 ms, parameterizable
diagnostics and hardware
interrupts

6ES7521-7EH00-0AB0

16 inputs to record
NAMUR signals (8.2 V DC),
2 potential groups,
input delay
0.05 ... 20 ms, parameterizable
diagnostics and hardware
interrupts

6ES7521-7TH00-0AB0

Module width 25 mm; front connector (push-in) included in scope of delivery

16 inputs, 24 V DC basic, isolated

6ES7521-1BH10-0AA0

32 inputs, 24 V DC basic, isolated

6ES7521-1BL10-0AA0

Accessories

Front connectors

For 35 mm modules (not 64-channel);
including four potential bridges,
cable ties and individual labeling
strips, 40-pin

- Screw terminals
- Push-in

6ES7592-1AM00-0XB0
6ES7592-1BM00-0XB0

Article No.

Front connectors

For 25 mm modules;
including cable ties and
individual labeling strips;
push-in terminal 40-pin;
spare part

6ES7592-1BM00-0XA0

Potential bridges for front connectors

For 35 mm modules;
20 pieces; spare part

6ES7592-3AA00-0AA0

DIN A4 labeling sheets

For 35 mm modules;
10 sheets with 10
labeling strips each
for I/O modules;
perforated, Al gray

6ES7592-2AX00-0AA0

For 25 mm modules;
10 sheets with 20
labeling strips each
for I/O modules;
perforated, Al gray

6ES7592-1AX00-0AA0

U connector

5 units; spare part

6ES7590-0AA00-0AA0

Universal front door for I/O modules

For 35 mm modules;
5 front doors;
with 5 labeling strips on the front
and 5 cabling diagrams per front
door; spare part

6ES7528-0AA00-7AA0

For 25 mm modules;
5 front doors;
with 5 labeling strips on the front
and 5 cabling diagrams per front
door; spare part

6ES7528-0AA00-0AA0

SIMATIC Manual Collection

Electronic manuals on
DVD, multi-language:
LOGO!, SIMADYN, SIMATIC
Bus Components, SIMATIC C7,
SIMATIC Distributed I/O,
SIMATIC HMI, SIMATIC Sensors,
SIMATIC NET, SIMATIC PC-based
Automation, SIMATIC PCS 7,
SIMATIC PG/PC, SIMATIC S7,
SIMATIC Software, SIMATIC TDC

6ES7998-8XC01-8YE0

SIMATIC Manual Collection update service for 1 year

Current Manual Collection DVD and
the three subsequent updates

6ES7998-8XC01-8YE2

Technical specifications

Article number	6ES7521-1BH00-0AB0 S7-1500, DI 16x24VDC HF	6ES7521-1BL00-0AB0 S7-1500, DI 32x24VDC HF	6ES7521-7BH00-0AB0 S7-1500, DI 16x24VDC HS	6ES7521-1BH50-0AA0 S7-1500, DI 16x24VDC SRC BA	6ES7521-1FH00-0AA0 S7-1500, DI 16x230VAC BA	6ES7521-1BP00-0AA0 S7-1500, DI 64x24VDC SNK/SRC BA
General information						
Product type designation	DI 16x24VDC HF	DI 32x24VDC HF	DI 16x24 V DC HS	DI 16x24VDC SRC BA	DI 16x230VAC BA	DI 64x24VDC BA
Product function						
• Isochronous mode	Yes	Yes	Yes	No	No	No
• Prioritized startup	Yes	Yes	Yes	Yes	Yes	No
Engineering with						
• STEP 7 TIA Portal configurable/ integrated from version	V13 SP1 / -	V13 SP1 / -	STEP 7 V17 or higher	V12 / V12	V12 / V12	V16 with HSP 0319 / V17
• STEP 7 configurable/integrated from version	V5.5 SP3 / -	V5.5 SP3 / -	V5.5 SP3 / -	V5.5 SP3 / -	V5.5 SP3 / -	V5.5 SP3 / -
• PROFIBUS from GSD version/ GSD revision	V1.0 / V5.1	V1.0 / V5.1	V1.0 / V5.1	V1.0 / V5.1	V1.0 / V5.1	V1.0 / V5.1
• PROFINET from GSD version/ GSD revision	V2.3 / -	V2.3 / -	V2.3 / -	V2.3 / -	V2.3 / -	V2.35 / -
Operating mode						
• DI	Yes	Yes	Yes	Yes	Yes	Yes
• Counter	Yes	Yes	Yes	No	No	No
• Oversampling	No	No	Yes			No
• MSI	Yes	Yes	Yes	Yes	Yes	Yes
Supply voltage						
Rated value (DC)	24 V	24 V	24 V			
Reverse polarity protection	Yes	Yes	Yes			
Encoder supply						
Number of outputs			16; 2x 24 V DC			
Short-circuit protection			Yes			
24 V encoder supply						
• 24 V			Yes			
• Short-circuit protection			Yes; Per group, electronic			
• Output current, max.			150 mA; per group			
Digital inputs						
Number of digital inputs	16	32	16	16	16	64
Digital inputs, parameterizable	Yes	Yes	Yes	No	No	No
Source/sink input	P-reading	P-reading	P-reading	Sourcing	P-reading	Yes
Input characteristic curve in accordance with IEC 61131, type 1			Yes		Yes	
Input characteristic curve in accordance with IEC 61131, type 2						
Input characteristic curve in accordance with IEC 61131, type 3	Yes	Yes		Yes		Yes
Pulse extension			Yes; 0.05 s, 0.1 s, 0.2 s, 0.5 s, 1 s, 2 s			
Edge evaluation			Yes; Positive edge, negative edge			
Signal change flutter			Yes; 2 to 32 signal changes			
Flutter observation window			Yes; 0.5 s, 1 s to 100 s in 1-s steps			
Number of simultaneously controllable inputs						
• Number of simultaneously controllable inputs						64; see additional description in the manual
Digital input functions, parameterizable						
• Gate start/stop	Yes	Yes	Yes; software/ hardware gate			
• Freely usable digital input	Yes	Yes	Yes			
• Digital input with oversampling			Yes			

SIMATIC S7-1500 Advanced Controllers

I/O modules

Digital modules

SM 521 digital input modules

Technical specifications

Article number	6ES7521-1BH00-0AB0 S7-1500, DI 16x24VDC HF	6ES7521-1BL00-0AB0 S7-1500, DI 32x24VDC HF	6ES7521-7BH00-0AB0 S7-1500, DI 16x24VDC HS	6ES7521-1BH50-0AA0 S7-1500, DI 16x24VDC SRC BA	6ES7521-1FH00-0AA0 S7-1500, DI 16x230VAC BA	6ES7521-1BP00-0AA0 S7-1500, DI 64x24VDC SNK/SRC BA
Input voltage						
• Rated value (DC)	24 V	24 V	24 V	24 V		24 V
• Rated value (AC)					230 V; 120/230 V AC, 50/60 Hz	
• for signal "0"	-30 to +5 V	-30 to +5 V	-30 to +5 V	-5 to +30V	0V AC to 40V AC	-5 ... +5 V (reference potential is COM)
• for signal "1"	+11 to +30V	+11 to +30V	+11 to +30V	-11 to -30V	79V AC to 264V AC	-11 ... -30 V; +11 ... +30 V (reference potential is COM)
Input current						
• for signal "1", typ.	2.5 mA	2.5 mA	9 mA	4.5 mA	11 mA; At 230 V AC and 5.5 mA at 120 V AC	2.7 mA
Input delay (for rated value of input voltage) for standard inputs						
- parameterizable	Yes; 0.05/0.1/0.4/ 1.6/3.2/12.8/ 20 ms	Yes; 0.05/0.1/0.4/ 1.6/3.2/12.8/ 20 ms	Yes; 0.05/0.1/0.4/ 0.8/1.6/3.2/ 12.8/20 ms	No	No	No
for interrupt inputs						
- parameterizable	Yes	Yes	Yes	No	No	No
for technological functions						
- parameterizable	Yes	Yes	Yes	No	No	No
Encoder						
Connectable encoders						
• 2-wire sensor	Yes	Yes	Yes	Yes	Yes	Yes
- permissible quiescent current (2-wire sensor), max.	1.5 mA	1.5 mA	2 mA	1.5 mA	2 mA	1.5 mA
Isochronous mode						
Filtering and processing time (TCI), min.	80 µs; At 50 µs filter time	80 µs; At 50 µs filter time	60 µs; At 50 µs filter time			
Bus cycle time (TDP), min.	250 µs	250 µs	250 µs			
Interrupts/diagnostics/ status information						
Diagnostics function	Yes	Yes	Yes	No	No	No
Alarms						
• Diagnostic alarm	Yes	Yes	Yes	No	No	No
• Hardware interrupt	Yes	Yes	Yes	No	No	No
Diagnoses						
• Monitoring the supply voltage	Yes	Yes	Yes	No	No	No
• Monitoring of encoder power supply			Yes; short-circuit			
• Wire-break	Yes; to I < 350 µA	Yes; to I < 350 µA	Yes; to I < 350 µA	No	No	No
• Short-circuit	No	No	No	No	No	No
• Group error						No
Diagnostics indication LED						
• RUN LED	Yes; green LED	Yes; green LED	Yes; green LED	Yes; green LED	Yes; green LED	Yes; green LED
• ERROR LED	Yes; red LED	Yes; red LED	Yes; red LED	Yes; red LED	Yes; red LED	Yes; red LED
• MAINT LED						No
• Monitoring of the supply voltage (PWR-LED)	Yes; green LED	Yes; green LED	Yes; green LED	No	No	Yes; via SIMATIC TOP connect connection module
• Channel status display	Yes; green LED	Yes; green LED	Yes; green LED	Yes; green LED	Yes; green LED	Yes; via SIMATIC TOP connect connection module
• for channel diagnostics	Yes; red LED	Yes; red LED	Yes; red LED	No	No	No
• for module diagnostics	Yes; red LED	Yes; red LED	Yes; red LED	No	Yes; red LED	No

Technical specifications

Article number	6ES7521-1BH00-0AB0	6ES7521-1BL00-0AB0	6ES7521-7BH00-0AB0	6ES7521-1BH50-0AA0	6ES7521-1FH00-0AA0	6ES7521-1BP00-0AA0
	S7-1500, DI 16x24VDC HF	S7-1500, DI 32x24VDC HF	S7-1500, DI 16x24VDC HS	S7-1500, DI 16x24VDC SRC BA	S7-1500, DI 16x230VAC BA	S7-1500, DI 64x24VDC SNK/SRC BA
Potential separation						
Potential separation channels						
• between the channels and backplane bus	Yes	Yes	Yes	Yes	Yes	Yes
Standards, approvals, certificates						
Suitable for safety functions	No	No	No	No	No	No
Ambient conditions						
Ambient temperature during operation						
• horizontal installation, min.	-30 °C; From FS05	-30 °C; From FS05	-30 °C	0 °C	0 °C	-30 °C
• horizontal installation, max.	60 °C	60 °C	60 °C	60 °C	60 °C	60 °C
• vertical installation, min.	-30 °C; From FS05	-30 °C; From FS05	-30 °C	0 °C	0 °C	-30 °C
• vertical installation, max.	40 °C	40 °C	40 °C	40 °C	40 °C	40 °C
Altitude during operation relating to sea level						
• Installation altitude above sea level, max.	5 000 m; Restrictions for installation altitudes > 2 000 m, see manual	5 000 m; Restrictions for installation altitudes > 2 000 m, see manual	5 000 m; Restrictions for installation altitudes > 2 000 m, see manual	5 000 m; Restrictions for installation altitudes > 2 000 m, see manual		5 000 m
Dimensions						
Width	35 mm	35 mm	35 mm	35 mm	35 mm	35 mm
Height	147 mm	147 mm	147 mm	147 mm	147 mm	147 mm
Depth	129 mm	129 mm	129 mm	129 mm	129 mm	129 mm
Weights						
Weight, approx.	240 g	260 g	240 g	230 g	300 g	250 g
Other						
Note:						Please order cable and connection modules separately

Article number	6ES7521-7EH00-0AB0	6ES7521-7TH00-0AB0
	S7-1500, DI 16 x 24...125V UC HF	S7-1500, DI 16xNAMUR HF
General information		
Product type designation	DI 16x24 ... 125 V UC HF	DI 16xNAMUR HF
Product function		
• Isochronous mode	No	Yes
• Prioritized startup	Yes	Yes
Engineering with		
• STEP 7 TIA Portal configurable/integrated from version	V13 SP1 / -	STEP 7 V17 or higher
• STEP 7 configurable/integrated from version	V5.5 SP3 / -	V5.5 SP3 / -
• PROFIBUS from GSD version/GSD revision	V1.0 / V5.1	V1.0 / V5.1
• PROFINET from GSD version/GSD revision	V2.3 / -	V2.3 / -
Operating mode		
• DI	Yes	Yes
• Counter	No	Yes
• Oversampling	No	No
• MSI	Yes	Yes
Supply voltage		
Rated value (DC)		24 V
Reverse polarity protection		Yes
Encoder supply		
Number of outputs		16; 2x 8.2 V DC
Short-circuit protection		Yes

SIMATIC S7-1500 Advanced Controllers

I/O modules

Digital modules

SM 521 digital input modules

Technical specifications

Article number	6ES7521-7EH00-0AB0 S7-1500, DI 16 x 24...125V UC HF	6ES7521-7TH00-0AB0 S7-1500, DI 16XNAMUR HF
NAMUR encoder supply		
<ul style="list-style-type: none"> • 8,2 V • Short-circuit protection • Output current, max. • Output current per module, max. 		Yes Yes; Per group, electronic 100 mA; per group 200 mA
Digital inputs		
Number of digital inputs	16	16; NAMUR
Digital inputs, parameterizable	Yes	Yes
Source/sink input	Yes	P-reading
Input characteristic curve in accordance with IEC 61131, type 3	Yes; At 24 V DC	
Pulse extension		Yes
Digital input functions, parameterizable		
<ul style="list-style-type: none"> • Gate start/stop • Freely usable digital input 		Yes; software/hardware gate Yes
Input voltage		
<ul style="list-style-type: none"> • Rated value (DC) • Rated value (AC) • for signal "0" • for signal "1" 	24 V; 48 V, 125 V 24 V; 48 V, 125 V (50 - 60 Hz) -5 ... +5 V +11 ... +146 V	8.2 V
Input current		
<ul style="list-style-type: none"> • for signal "1", typ. for NAMUR encoders <ul style="list-style-type: none"> - for signal "0", min. - for signal "0", max. - for signal "1", min. - for signal "1", max. 	3 mA; At 24 V DC	10 mA 0.35 mA 1.2 mA 2.1 mA 10 mA
Input delay (for rated value of input voltage) for standard inputs		
- parameterizable	Yes; 0.05 / 0.1 / 0.4 / 1.6 / 3.2 / 12.8 / 20 ms parameterizable with DC, 20 ms fixed with AC	Yes; 0.05 / 0.1 / 0.4 / 1.6 / 3.2 / 12.8 / 20 ms
for interrupt inputs		
- parameterizable	Yes	Yes
for technological functions		
- parameterizable	No	Yes
Encoder		
Connectable encoders		
<ul style="list-style-type: none"> • 2-wire sensor - permissible quiescent current (2-wire sensor), max. 	Yes 1.5 mA	Yes 1.2 mA
Isochronous mode		
Filtering and processing time (TCI), min.		60 µs; At 50 µs filter time
Bus cycle time (TDP), min.		250 µs
Interrupts/diagnostics/status information		
Diagnostics function	Yes	Yes
Alarms		
<ul style="list-style-type: none"> • Diagnostic alarm • Hardware interrupt 	Yes Yes	Yes Yes
Diagnoses		
<ul style="list-style-type: none"> • Monitoring the supply voltage • Wire-break • Short-circuit 	No Yes; To I < 550 µA No	Yes Yes; to I < 350 µA No

Technical specifications

Article number	6ES7521-7EH00-0AB0 S7-1500, DI 16 x 24...125V UC HF	6ES7521-7TH00-0AB0 S7-1500, DI 16XNAMUR HF
Diagnostics indication LED		
• RUN LED	Yes; green LED	Yes; green LED
• ERROR LED	Yes; red LED	Yes; red LED
• Monitoring of the supply voltage (PWR-LED)	No	Yes; green LED
• Channel status display	Yes; green LED	Yes; green LED
• for channel diagnostics	Yes; red LED	Yes; red LED
• for module diagnostics	Yes; red LED	Yes; red LED
Potential separation		
Potential separation channels		
• between the channels and backplane bus	Yes	Yes
Standards, approvals, certificates		
Suitable for safety functions	No	No
Ambient conditions		
Ambient temperature during operation		
• horizontal installation, min.	0 °C	-30 °C
• horizontal installation, max.	60 °C	60 °C
• vertical installation, min.	0 °C	-30 °C
• vertical installation, max.	40 °C	40 °C
Altitude during operation relating to sea level		
• Installation altitude above sea level, max.		5 000 m; Restrictions for installation altitudes > 2 000 m, see manual
Dimensions		
Width	35 mm	35 mm
Height	147 mm	147 mm
Depth	129 mm	129 mm
Weights		
Weight, approx.	240 g	240 g
Article number	6ES7521-1BH10-0AA0 S7-1500, DI 16x24VDC BA	6ES7521-1BL10-0AA0 S7-1500, DI 32x24VDC BA
General information		
Product type designation	DI 16 x 24 V DC BA	DI 32x24VDC BA
Product function		
• Isochronous mode	No	No
• Prioritized startup	Yes	Yes
Engineering with		
• STEP 7 TIA Portal configurable/integrated from version	V13 / V13	V13 / V13
• STEP 7 configurable/integrated from version	V5.5 SP3 / -	V5.5 SP3 / -
• PROFIBUS from GSD version/GSD revision	V1.0 / V5.1	V1.0 / V5.1
• PROFINET from GSD version/GSD revision	V2.3 / -	V2.3 / -
Operating mode		
• DI	Yes	Yes
• Counter	No	No
• MSI	Yes	Yes
Supply voltage		
Rated value (DC)	24 V	24 V
Digital inputs		
Number of digital inputs	16	32
Digital inputs, parameterizable	No	No
Source/sink input	P-reading	P-reading
Input characteristic curve in accordance with IEC 61131, type 3	Yes	Yes
Input voltage		
• Rated value (DC)	24 V	24 V
• for signal "0"	-30 to +5 V	-30 to +5 V

SIMATIC S7-1500 Advanced Controllers

I/O modules

Digital modules

SM 521 digital input modules

Technical specifications

Article number	6ES7521-1BH10-0AA0	6ES7521-1BL10-0AA0
	S7-1500, DI 16x24VDC BA	S7-1500, DI 32x24VDC BA
• for signal *1*	+11 to +30V	+11 to +30V
Input current		
• for signal *1*, typ.	2.7 mA	2.7 mA
Input delay (for rated value of input voltage)		
for standard inputs		
- parameterizable	No	No
for interrupt inputs		
- parameterizable	No	No
for technological functions		
- parameterizable	No	No
Encoder		
Connectable encoders		
• 2-wire sensor	Yes	Yes
- permissible quiescent current (2-wire sensor), max.	1.5 mA	1.5 mA
Interrupts/diagnostics/status information		
Diagnostics function	No	No
Alarms		
• Diagnostic alarm	No	No
• Hardware interrupt	No	No
Diagnoses		
• Monitoring the supply voltage	No	No
• Wire-break	No	No
• Short-circuit	No	No
Diagnostics indication LED		
• RUN LED	Yes; green LED	Yes; green LED
• ERROR LED	Yes; red LED	Yes; red LED
• Monitoring of the supply voltage (PWR-LED)	No	No
• Channel status display	Yes; green LED	Yes; green LED
• for channel diagnostics	No	No
• for module diagnostics	No	No
Potential separation		
Potential separation channels		
• between the channels and backplane bus	Yes	Yes
Standards, approvals, certificates		
Suitable for safety functions	No	No
Ambient conditions		
Ambient temperature during operation		
• horizontal installation, min.	-30 °C; from FS04	-30 °C; from FS04
• horizontal installation, max.	60 °C	60 °C
• vertical installation, min.	-30 °C; from FS04	-30 °C; from FS04
• vertical installation, max.	40 °C	40 °C
Altitude during operation relating to sea level		
• Installation altitude above sea level, max.	5 000 m; Restrictions for installation altitudes > 2 000 m, see manual	5 000 m; Restrictions for installation altitudes > 2 000 m, see manual
Dimensions		
Width	25 mm	25 mm
Height	147 mm	147 mm
Depth	129 mm	129 mm
Weights		
Weight, approx.	230 g	260 g
Other		
Note:	Supplied incl. 40-pole push-in front connectors	Supplied incl. 40-pole push-in front connectors

Overview



- 8, 32, 16 and 64-channel digital output modules
- Sinking and sourcing output versions available
- For flexible adaptation of the PLC to the corresponding task
- For subsequent expansion of the system with additional outputs
- High Feature modules with parameters and diagnostic functions
- 25 mm wide modules for use in tight spaces: particularly economical, without parameters or diagnostic functions

4

Ordering data

SM 522 digital output modules

Module width 35 mm

8 outputs, 24 V DC,
2 A High Feature, isolated

6ES7522-1BF00-0AB0

16 outputs, 24 V DC,
0.5 A High Feature, isolated

6ES7522-1BH01-0AB0

32 outputs, 24 V DC,
0.5 A High Feature, isolated

6ES7522-1BL01-0AB0

64 outputs, 24 V DC;
0.3A Basic; sinking output;
cables and terminal blocks
can be ordered separately
(SIMATIC TOP connect)

6ES7522-1BP00-0AA0

64 outputs, 24 V DC;
0.3A Basic; sourcing;
cables and terminal blocks
can be ordered separately
(SIMATIC TOP connect)

6ES7522-1BP50-0AA0

8 relay outputs, 230 V AC,
5 A Standard

6ES7522-5HF00-0AB0

16 relay outputs, 230 V AC,
2 A Standard

6ES7522-5HH00-0AB0

8 outputs (triac), 230 V AC,
2 A Standard

6ES7522-5FF00-0AB0

16 outputs (triac), 230 V AC,
1 A Standard

6ES7522-5FH00-0AB0

16 outputs, 24 ... 48 V UC,
125 V DC, 0.5 A Standard, isolated

6ES7522-5EH00-0AB0

Module width 25 mm;
front connector (push-in)
included in scope of delivery

16 outputs, 24 V DC,
0.5 A Basic, isolated

6ES7 522-1BH10-0AA0

32 outputs, 24 V DC,
0.5 A Basic, isolated

6ES7 522-1BL10-0AA0

Accessories

Front connector

For 35 mm modules
(not 64-channel);
including four potential bridges,
cable ties and individual
labeling strips, 40-pin

- Screw terminals
- Push-in

6ES7592-1AM00-0XB0

6ES7592-1BM00-0XB0

For 25 mm modules;
including cable ties and
individual labeling strips;
push-in terminal 40-pin;
spare part

6ES7592-1BM00-0XA0

Potential bridges for front connectors

Article No.

6ES7592-3AA00-0AA0

For 35 mm modules;
20 pieces; spare part

DIN A4 labeling sheets

For 35 mm modules;
10 sheets with
10 labeling strips each for
I/O modules;
perforated, Al gray

6ES7592-2AX00-0AA0

For 25 mm modules;
10 sheets with
20 labeling strips each for
I/O modules;
perforated, Al gray

6ES7592-1AX00-0AA0

U connector

6ES7590-0AA00-0AA0

5 units; spare part

Universal front door for I/O modules

For 35 mm modules;
5 front doors;
with 5 labeling strips on the front
and 5 cabling diagrams per front
door; spare part

6ES7528-0AA00-7AA0

For 25 mm modules;
5 front doors;
with 5 labeling strips on the front
and 5 cabling diagrams per front
door; spare part

6ES7528-0AA00-0AA0

SIMATIC Manual Collection

6ES7998-8XC01-8YE0

Electronic manuals on
DVD, multi-language:
LOGO!, SIMADYN, SIMATIC
bus components, SIMATIC C7,
SIMATIC distributed I/O,
SIMATIC HMI, SIMATIC Sensors,
SIMATIC NET, SIMATIC PC-based
Automation, SIMATIC PCS 7,
SIMATIC PG/PC, SIMATIC S7,
SIMATIC Software, SIMATIC TDC

SIMATIC Manual Collection update service for 1 year

6ES7998-8XC01-8YE2

Current Manual Collection DVD and
the three subsequent updates

SIMATIC S7-1500 Advanced Controllers

I/O modules

Digital modules

SM 522 digital output modules

Technical specifications

Article number	6ES7522-1BH01-0AB0 S7-1500, DQ 16x24V DC/0.5A HF	6ES7522-1BL01-0AB0 S7-1500, DQ 32x24VDC/0.5A HF	6ES7522-1BF00-0AB0 S7-1500, DQ 8x24VDC/2A HF	6ES7522-5EH00-0AB0 S7-1500, DQ 16x24...48VUC/ 125VDC/0.5A ST
General information				
Product type designation	DQ 16x24VDC/0.5A HF	DQ 32x24VDC/0.5A HF	DQ 8x24VDC/2A HF	DQ 16x24 ... 48 V UC/ 125 V DC/0.5 A ST
Product function				
• Isochronous mode	Yes	Yes	No	No
• Prioritized startup	Yes	Yes	Yes	Yes
Engineering with				
• STEP 7 TIA Portal configurable/ integrated from version	V13 SP1 / -	V13 SP1 / -	V13 SP1 / -	V13 SP1 / -
• STEP 7 configurable/integrated from version	V5.5 SP3 / -	V5.5 SP3 / -	V5.5 SP3 / -	V5.5 SP3 / -
• PROFIBUS from GSD version/ GSD revision	V1.0 / V5.1	V1.0 / V5.1	V1.0 / V5.1	V1.0 / V5.1
• PROFINET from GSD version/ GSD revision	V2.3 / -	V2.3 / -	V2.3 / -	V2.3 / -
Operating mode				
• DQ	Yes	Yes	Yes	Yes
• DQ with energy-saving function	No	No	Yes; with an application	No
• PWM	No	No	Yes; FS02 and FW V2.1.0 or higher; two outputs can be operated with max. 500 Hz PWM	No
• Cam control (switching at comparison values)	No	No	No	No
• Oversampling	No	No	No	No
• MSO	Yes	Yes	Yes	Yes
• Integrated operating cycle counter	Yes	Yes	Yes	No
Supply voltage				
Rated value (DC)	24 V	24 V	24 V	
Reverse polarity protection	Yes; through internal protection with 7 A per group	Yes; through internal protection with 7 A per group	Yes; through internal protection with 10 A per group	
Digital outputs				
Type of digital output	Transistor	Transistor	Transistor	Transistor
Number of digital outputs	16	32	8	16
Current-sinking				Yes
Current-sourcing	Yes	Yes	Yes	Yes
Digital outputs, parameterizable	Yes	Yes	Yes	Yes
Short-circuit protection	Yes; Clocked electronically	Yes; Clocked electronically	Yes	
Limitation of inductive shutdown voltage to	L+ (-53 V)	L+ (-53 V)	-17 V	200 V (suppressor diode)
Controlling a digital input	Yes	Yes	Yes	Yes
Digital output functions, parameterizable				
• Freely usable digital output			Yes	
• PWM output			Yes; FS02 and FW V2.1.0 or higher	
- Number, max.			2	
Switching capacity of the outputs				
• with resistive load, max.	0.5 A	0.5 A		0.5 A
• on lamp load, max.	5 W	5 W	10 W	40 W; At 125 V DC, 10 W at 48 V UC, 5 W at 24 V UC
Load resistance range				
• lower limit	48 Ω	48 Ω	12 Ω	
• upper limit	12 kΩ	12 kΩ	4 kΩ	
Output voltage				
• for signal "1", min.	L+ (-0.8 V)	L+ (-0.8 V)	L+ (-0.8 V)	L+ (-1.0 V)
Output current				
• for signal "1" rated value	0.5 A	0.5 A	2 A	0.5 A
• for signal "0" residual current, max.	0.5 mA	0.5 mA	0.5 mA	

Technical specifications

Article number	6ES7522-1BH01-0AB0 S7-1500, DQ 16x24V DC/0.5A HF	6ES7522-1BL01-0AB0 S7-1500, DQ 32x24VDC/0.5A HF	6ES7522-1BF00-0AB0 S7-1500, DQ 8x24VDC/2A HF	6ES7522-5EH00-0AB0 S7-1500, DQ 16x24...48VUC/ 125VDC/0.5A ST
Output delay with resistive load				
• "0" to "1", typ.			80 µs	
• "0" to "1", max.	100 µs	100 µs	100 µs	5 ms
• "1" to "0", typ.			300 µs	
• "1" to "0", max.	500 µs	500 µs	500 µs	5 ms
Parallel switching of two outputs				
• for logic links	Yes	Yes	Yes	Yes
• for uprating	No	No	No	No
• for redundant control of a load	Yes	Yes	Yes	Yes
Switching frequency				
• with resistive load, max.	100 Hz	100 Hz	100 Hz; With PWM operation: 500 Hz	25 Hz
• with inductive load, max.	0.5 Hz; According to IEC 60947-5-1, DC-13	0.5 Hz; According to IEC 60947-5-1, DC-13	0.5 Hz; According to IEC 60947-5-1, DC-13; max. 500 Hz with PWM operation only with external circuit; see additional description in the manual	0.5 Hz
• on lamp load, max.	10 Hz	10 Hz	10 Hz	10 Hz
Total current of the outputs				
• Current per channel, max.	0.5 A; see additional description in the manual	0.5 A; see additional description in the manual	2 A; see additional description in the manual	0.5 A
• Current per group, max.	4 A; see additional description in the manual	4 A; see additional description in the manual	8 A; see additional description in the manual	0.5 A
• Current per module, max.	8 A; see additional description in the manual	16 A; see additional description in the manual	16 A; see additional description in the manual	8 A
Isochronous mode				
Execution and activation time (TCO), min.	70 µs	70 µs		
Bus cycle time (TDP), min.	250 µs	250 µs		
Interrupts/diagnostics/ status information				
Diagnostics function	Yes	Yes	Yes	No
Substitute values connectable	Yes	Yes	Yes	Yes
Alarms				
• Diagnostic alarm	Yes	Yes	Yes	No
• Maintenance interrupt	Yes	Yes	Yes	No
Diagnoses				
• Monitoring the supply voltage	Yes	Yes	Yes	No
• Wire-break	Yes	Yes	No	No
• Short-circuit	Yes	Yes	Yes	No
• Group error	Yes	Yes	Yes	
Diagnostics indication LED				
• RUN LED	Yes; green LED	Yes; green LED	Yes; green LED	Yes; green LED
• ERROR LED	Yes; red LED	Yes; red LED	Yes; red LED	Yes; red LED
• MAINT LED	Yes; Yellow LED	Yes; Yellow LED	Yes; Yellow LED	
• Monitoring of the supply voltage (PWR-LED)	Yes; green LED	Yes; green LED	Yes; green LED	No
• Channel status display	Yes; green LED	Yes; green LED	Yes; green LED	Yes; green LED
• for channel diagnostics	Yes; red LED	Yes; red LED	Yes; red LED	No
• for module diagnostics	Yes; red LED	Yes; red LED	Yes; red LED	Yes; red LED
Potential separation				
Potential separation channels				
• between the channels and backplane bus	Yes	Yes	Yes	Yes

SIMATIC S7-1500 Advanced Controllers

I/O modules

Digital modules

SM 522 digital output modules

Technical specifications

Article number	6ES7522-1BH01-0AB0 S7-1500, DQ 16x24V DC/0.5A HF	6ES7522-1BL01-0AB0 S7-1500, DQ 32x24VDC/0.5A HF	6ES7522-1BF00-0AB0 S7-1500, DQ 8x24VDC/2A HF	6ES7522-5EH00-0AB0 S7-1500, DQ 16x24...48VUC/ 125VDC/0.5A ST
Standards, approvals, certificates				
Suitable for safety functions	No	No	No	No
Suitable for safety-related tripping of standard modules	Yes; From FS02	Yes; From FS02	Yes; From FS03	Yes; From FS02
Highest safety class achievable for safety-related tripping of standard modules				
• Performance level according to ISO 13849-1	PL d	PL d	PL d	PL d
• Category according to ISO 13849-1	Cat. 3	Cat. 3	Cat. 3	Cat. 3
• SIL acc. to IEC 62061	SIL 2	SIL 2	SIL 2	SIL 2
Ambient conditions				
Ambient temperature during operation				
• horizontal installation, min.	-30 °C; From FS03	-30 °C; From FS03		0 °C
• horizontal installation, max.	60 °C	60 °C		60 °C
• vertical installation, min.	-30 °C; From FS03	-30 °C; From FS03		0 °C
• vertical installation, max.	40 °C	40 °C		40 °C
Altitude during operation relating to sea level				
• Installation altitude above sea level, max.	5 000 m; Restrictions for installation altitudes > 2 000 m, see manual	5 000 m; Restrictions for installation altitudes > 2 000 m, see manual	5 000 m; Restrictions for installation altitudes > 2 000 m, see manual	
Dimensions				
Width	35 mm	35 mm	35 mm	35 mm
Height	147 mm	147 mm	147 mm	147 mm
Depth	129 mm	129 mm	129 mm	129 mm
Weights				
Weight, approx.	230 g	280 g	240 g	230 g
<hr/>				
Article number	6ES7522-5HF00-0AB0 S7-1500, DQ 8x230VAC/5A ST (Relay)	6ES7522-5HH00-0AB0 S7-1500, DQ 16x230VAC/2A ST (Relay)	6ES7522-5FF00-0AB0 S7-1500, DQ 8x230VAC/2A ST (Triac)	6ES7522-5FH00-0AB0 S7-1500, DQ 16x230VAC/1A ST (Triac)
General information				
Product type designation	DQ 8x230 V AC/5 A ST (relay)	DQ 16x 230 V AC/2 A ST (relay)	DQ 8x230 V AC/2A ST (triac)	DQ 16x230VAC/1A ST (Triac)
Product function				
• Isochronous mode	No	No	No	No
• Prioritized startup	Yes	Yes	Yes	Yes
Engineering with				
• STEP 7 TIA Portal configurable/integrated from version	V12 / V12	V13 SP1 / -	V12 / V12	V13 SP1 / -
• STEP 7 configurable/integrated from version	V5.5 SP3 / -	V5.5 SP3 / -	V5.5 SP3 / -	V5.5 SP3 / -
• PROFIBUS from GSD version/GSD revision	V1.0 / V5.1	V1.0 / V5.1	V1.0 / V5.1	V1.0 / V5.1
• PROFINET from GSD version/GSD revision	V2.3 / -	V2.3 / -	V2.3 / -	V2.3 / -
Operating mode				
• DQ	Yes	Yes	Yes	Yes
• DQ with energy-saving function	No	No	No	No
• PWM	No	No	No	No
• Oversampling	No	No	No	No
• MSO	Yes	Yes	Yes	Yes
• Integrated operating cycle counter	Yes; FW V2.1.0 or higher	Yes; FW V1.1.0 or higher	Yes; FW V2.2.0 or higher	Yes; FW V1.2.0 or higher
Supply voltage				
Rated value (DC)	24 V	24 V		
Reverse polarity protection	Yes	Yes		

Technical specifications

Article number	6ES7522-5HF00-0AB0	6ES7522-5HH00-0AB0	6ES7522-5FF00-0AB0	6ES7522-5FH00-0AB0
	S7-1500, DQ 8x230VAC/5A ST (Relay)	S7-1500, DQ 16x230VAC/2A ST (Relay)	S7-1500, DQ 8x230VAC/2A ST (Triac)	S7-1500, DQ 16x230VAC/1A ST (Triac)
Digital outputs				
Type of digital output	Relays	Relays	Triac	Triac
Number of digital outputs	8	16	8	16
Current-sinking	Yes	Yes		Yes
Current-sourcing	Yes	Yes	Yes	Yes
Digital outputs, parameterizable	Yes	Yes	Yes	Yes
Short-circuit protection	No	No	No	No
Controlling a digital input	Yes; possible	Yes		
Size of motor starters according to NEMA, max.	5	5	5	4
Switching capacity of the outputs				
• with resistive load, max.			2 A	1 A
• on lamp load, max.	1 500 W; 10 000 operating cycles	50 W (230 V AC), 5 W (24 V DC)	50 W	50 W
• Low energy/fluorescent lamps with electronic control gear	10x 58 W (25 000 operating cycles)			
• Fluorescent tubes, conventionally compensated	1x 58 W (25 000 operating cycles)			
• Fluorescent tubes, uncompensated	10x 58 W (25 000 operating cycles)			
Output voltage				
• for signal "1", min.			L1 (-1.5 V) at maximum output current; L1 (-8.5 V) at minimum output current	L1 (-1.5 V) at maximum output current; L1 (-8.5 V) at minimum output current
Output current				
• for signal "1" rated value	5 A	2 A	2 A	1 A
• for signal "0" residual current, max.	0 A	0 A	2 mA	2 mA
Output delay with resistive load				
• "0" to "1", max.			1 AC cycle	1 AC cycle
• "1" to "0", max.			1 AC cycle	1 AC cycle
Parallel switching of two outputs				
• for logic links	Yes	Yes	No	No
• for uprating	No	No	No	No
• for redundant control of a load	Yes	Yes	Yes	Yes
Switching frequency				
• with resistive load, max.	2 Hz	1 Hz	10 Hz	10 Hz
• with inductive load, max.	0.5 Hz	0.5 Hz	0.5 Hz	0.5 Hz
• on lamp load, max.	2 Hz	1 Hz	1 Hz	1 Hz
Total current of the outputs				
• Current per channel, max.	8 A; see additional description in the manual	2 A; see additional description in the manual	2 A; see additional description in the manual	1 A; see additional description in the manual
• Current per group, max.	8 A; see additional description in the manual	4 A; see additional description in the manual	2 A; see additional description in the manual	2 A; see additional description in the manual
• Current per module, max.	64 A; see additional description in the manual	32 A; see additional description in the manual	10 A; see additional description in the manual	10 A; see additional description in the manual

SIMATIC S7-1500 Advanced Controllers

I/O modules

Digital modules

SM 522 digital output modules

Technical specifications

Article number	6ES7522-5HF00-0AB0	6ES7522-5HH00-0AB0	6ES7522-5FF00-0AB0	6ES7522-5FH00-0AB0
	S7-1500, DQ 8x230VAC/5A ST (Relay)	S7-1500, DQ 16x230VAC/2A ST (Relay)	S7-1500, DQ 8x230VAC/2A ST (Triac)	S7-1500, DQ 16x230VAC/1A ST (Triac)
Relay outputs				
• Number of relay outputs	8	16		
• Rated supply voltage of relay coil L+ (DC)	24 V	24 V		
• Current consumption of relays (coil current of all relays), typ.	80 mA	150 mA		
• external protection for relay outputs	With miniature circuit breaker with characteristic B for: cos φ 1.0: 600 A cos φ 0.5 ... 0.7: 900 A with 8 A Diazed fuse: 1 000 A	Miniature circuit breaker B10 / B16		
• Contact connection (internal)	No	No		
• Number of operating cycles, max.	4 000 000; see additional description in the manual	see additional description in the manual		
• Relay approved acc. to UL 508	Yes; 250 V AC/5 A g.p.; 120 V AC TV-4 tungsten; A300, R300	No		
Switching capacity of contacts				
- with inductive load, max.	see additional description in the manual	2 A; see additional description in the manual		
- with resistive load, max.	see additional description in the manual	2 A; see additional description in the manual		
Interrupts/diagnostics/status information				
Diagnostics function	Yes		No	No
Substitute values connectable	Yes	Yes	Yes	Yes
Alarms				
• Diagnostic alarm	Yes	Yes	No	No
• Maintenance interrupt		Yes	Yes; maintenance alarm for switching cycle counter	Yes; maintenance alarm for switching cycle counter
Diagnoses				
• Monitoring the supply voltage	Yes	Yes	No	No
• Wire-break	No	No	No	No
• Short-circuit	No	No	No	No
Diagnostics indication LED				
• RUN LED	Yes; green LED	Yes; green LED	Yes; green LED	Yes; green LED
• ERROR LED	Yes; red LED	Yes; red LED	Yes; red LED	Yes; red LED
• MAINT LED	Yes; Yellow LED	Yes; Yellow LED		
• Monitoring of the supply voltage (PWR-LED)	Yes; green LED	Yes; green LED	No	No
• Channel status display	Yes; green LED	Yes; green LED	Yes; green LED	Yes; green LED
• for channel diagnostics	No	No	No	No
• for module diagnostics	Yes; red LED	Yes; red LED	Yes; red LED	Yes; red LED
Potential separation				
Potential separation channels				
• between the channels and backplane bus	Yes	Yes	Yes	Yes
Standards, approvals, certificates				
Suitable for safety functions	No	No	No	No
Suitable for safety-related tripping of standard modules	Yes; From FS03	Yes; From FS02		
Highest safety class achievable for safety-related tripping of standard modules				
• Performance level according to ISO 13849-1	PL c	PL c		
• Category according to ISO 13849-1	Cat. 2	Cat. 2		

Technical specifications

Article number	6ES7522-5HF00-0AB0	6ES7522-5HH00-0AB0	6ES7522-5FF00-0AB0	6ES7522-5FH00-0AB0
	S7-1500, DQ 8x230VAC/5A ST (Relay)	S7-1500, DQ 16x230VAC/2A ST (Relay)	S7-1500, DQ 8x230VAC/2A ST (Triac)	S7-1500, DQ 16x230VAC/1A ST (Triac)
Ambient conditions				
Ambient temperature during operation				
• horizontal installation, min.	-30 °C; From FS03	-25 °C; From FS02	0 °C	0 °C
• horizontal installation, max.	60 °C	60 °C	60 °C	60 °C
• vertical installation, min.	-30 °C; From FS03	-25 °C; From FS02	0 °C	0 °C
• vertical installation, max.	40 °C	40 °C	40 °C	40 °C
Dimensions				
Width	35 mm	35 mm	35 mm	35 mm
Height	147 mm	147 mm	147 mm	147 mm
Depth	129 mm	129 mm	129 mm	129 mm
Weights				
Weight, approx.	350 g	350 g	290 g	310 g
<hr/>				
Article number	6ES7522-1BP00-0AA0	6ES7522-1BP50-0AA0		
	S7-1500, DQ 64x24VDC/0.3A BA	S7-1500, DQ 64x24VDC/0.3A SNK BA		
General information				
Product type designation	DQ 64x24VDC/0.3A BA	DQ 64x24VDC/0.3A SNK BA		
Product function				
• Isochronous mode	No	No		
• Prioritized startup	No	No		
Engineering with				
• STEP 7 TIA Portal configurable/ integrated from version	V16 with HSP 0319 / V17	V16 with HSP 0319 / V17		
• STEP 7 configurable/integrated from version	V5.5 SP3 / -	V5.5 SP3 / -		
• PROFIBUS from GSD version/ GSD revision	V1.0 / V5.1	V1.0 / V5.1		
• PROFINET from GSD version/ GSD revision	V2.35 / -	V2.35 / -		
Operating mode				
• DQ	Yes	Yes		
• DQ with energy-saving function	No	No		
• PWM	No	No		
• Cam control (switching at comparison values)	No	No		
• Oversampling	No	No		
• MSO	Yes	Yes		
• Integrated operating cycle counter	No	No		
Supply voltage				
Rated value (DC)	24 V	24 V		
Reverse polarity protection	Yes; through internal protection with 7 A per group	Yes; Through internal protection with 4 A per group		
Digital outputs				
Type of digital output	Transistor	Transistor		
Number of digital outputs	64	64		
Current-sinking	No	Yes		
Current-sourcing	Yes	No		
Digital outputs, parameterizable	No	No		
Short-circuit protection	Yes	No; external fusing necessary, max. 4 A per group, tripping characteristic type B or C		
Limitation of inductive shutdown voltage to	L+ (-53 V)	L+ (-53 V)		
Controlling a digital input	Yes	Yes		
Switching capacity of the outputs				
• with resistive load, max.	0.3 A	0.3 A		
• on lamp load, max.	5 W	5 W		
Load resistance range				
• lower limit	80 Ω	80 Ω		
• upper limit	10 kΩ	10 kΩ		

SIMATIC S7-1500 Advanced Controllers

I/O modules

Digital modules

SM 522 digital output modules

Technical specifications

Article number	6ES7522-1BP00-0AA0 S7-1500, DQ 64x24VDC/0.3A BA	6ES7522-1BP50-0AA0 S7-1500, DQ 64x24VDC/0.3A SNK BA
Output voltage		
• for signal "1", min.	L+ (-0.8 V)	M+ (0.5 V)
Output current		
• for signal "1" rated value	0.3 A	0.3 A
• for signal "0" residual current, max.	0.5 mA	0.5 mA
Output delay with resistive load		
• "0" to "1", max.	100 µs	100 µs
• "1" to "0", max.	500 µs	500 µs
Parallel switching of two outputs		
• for logic links	Yes	Yes
• for uprating	No	No
• for redundant control of a load	Yes	Yes
Switching frequency		
• with resistive load, max.	100 Hz	100 Hz
• with inductive load, max.	0.5 Hz; According to IEC 60947-5-1, DC-13	0.5 Hz; According to IEC 60947-5-1, DC-13
• on lamp load, max.	10 Hz	10 Hz
Total current of the outputs		
• Current per channel, max.	0.3 A	0.3 A
• Current per group, max.	2 A	2 A
• Current per module, max.	8 A	8 A
Total current of the outputs (per module)		
horizontal installation		
- up to 60 °C, max.	8 A	8 A
vertical installation		
- up to 40 °C, max.	8 A	8 A
Interrupts/diagnostics/status information		
Diagnostics function	No	No
Substitute values connectable	No	No
Alarms		
• Diagnostic alarm	No	No
• Maintenance interrupt	No	No
Diagnoses		
• Monitoring the supply voltage	No	No
• Wire-break	No	No
• Short-circuit	No	No
• Group error	No	No
Diagnostics indication LED		
• RUN LED	Yes; green LED	Yes; green LED
• ERROR LED	Yes; red LED	Yes; red LED
• MAINT LED	No	No
• Monitoring of the supply voltage (PWR-LED)	Yes; via SIMATIC TOP connect connection module	Yes; via SIMATIC TOP connect connection module
• Channel status display	Yes; via SIMATIC TOP connect connection module	Yes; via SIMATIC TOP connect connection module
• for channel diagnostics	No	No
• for module diagnostics	No	No
Potential separation		
Potential separation channels		
• between the channels and backplane bus	Yes	Yes

Technical specifications

Article number	6ES7522-1BP00-0AA0 S7-1500, DQ 64x24VDC/0.3A BA	6ES7522-1BP50-0AA0 S7-1500, DQ 64x24VDC/0.3A SNK BA
Standards, approvals, certificates		
Suitable for safety functions	No	No
Suitable for safety-related tripping of standard modules	Yes; From FS01	No
Highest safety class achievable for safety-related tripping of standard modules		
• Performance level according to ISO 13849-1	PL d	
• Category according to ISO 13849-1	Cat. 3	
• SIL acc. to IEC 62061	SIL 2	
Ambient conditions		
Ambient temperature during operation		
• horizontal installation, min.	-30 °C	-30 °C
• horizontal installation, max.	60 °C	60 °C
• vertical installation, min.	-30 °C	-30 °C
• vertical installation, max.	40 °C	40 °C
Altitude during operation relating to sea level		
• Installation altitude above sea level, max.	5 000 m	5 000 m
Dimensions		
Width	35 mm	35 mm
Height	147 mm	147 mm
Depth	129 mm	129 mm
Weights		
Weight, approx.	270 g	270 g
Other		
Note:	Please order cable and connection modules separately	Please order cable and connection modules separately
Article number	6ES7522-1BH10-0AA0 S7-1500, DQ 16x24VDC/0.5A BA	6ES7522-1BL10-0AA0 S7-1500, DQ 32x24VDC/0.5A BA
General information		
Product type designation	DQ 16x24VDC/0.5A BA	DQ 32x24VDC/0.5A BA
Product function		
• Isochronous mode	No	No
• Prioritized startup	Yes	Yes
Engineering with		
• STEP 7 TIA Portal configurable/integrated from version	V13 / V13	V13 / V13
• STEP 7 configurable/integrated from version	V5.5 SP3 / -	V5.5 SP3 / -
• PROFIBUS from GSD version/GSD revision	V1.0 / V5.1	V1.0 / V5.1
• PROFINET from GSD version/GSD revision	V2.3 / -	V2.3 / -
Operating mode		
• DQ	Yes	Yes
• DQ with energy-saving function	No	No
• PWM	No	No
• Oversampling	No	No
• MSO	Yes	Yes
Supply voltage		
Rated value (DC)	24 V	24 V
Reverse polarity protection	Yes; through internal protection with 7 A per group	Yes; through internal protection with 7 A per group

SIMATIC S7-1500 Advanced Controllers

I/O modules

Digital modules

SM 522 digital output modules

Technical specifications

Article number	6ES7522-1BH10-0AA0 S7-1500, DQ 16x24VDC/0.5A BA	6ES7522-1BL10-0AA0 S7-1500, DQ 32x24VDC/0.5A BA
Digital outputs		
Type of digital output	Transistor	Transistor
Number of digital outputs	16	32
Current-sourcing	Yes	Yes
Digital outputs, parameterizable	No	No
Short-circuit protection	Yes	Yes
Limitation of inductive shutdown voltage to	L+ (-53 V)	L+ (-53 V)
Controlling a digital input	Yes	Yes
Switching capacity of the outputs		
• with resistive load, max.	0.5 A	0.5 A
• on lamp load, max.	5 W	5 W
Load resistance range		
• lower limit	48 Ω	48 Ω
• upper limit	12 kΩ	12 kΩ
Output voltage		
• for signal "1", min.	L+ (-0.8 V)	L+ (-0.8 V)
Output current		
• for signal "1" rated value	0.5 A	0.5 A
• for signal "0" residual current, max.	0.5 mA	0.5 mA
Output delay with resistive load		
• "0" to "1", max.	100 μs	100 μs
• "1" to "0", max.	500 μs	500 μs
Parallel switching of two outputs		
• for logic links	Yes	Yes
• for uprating	No	No
• for redundant control of a load	Yes	Yes
Switching frequency		
• with resistive load, max.	100 Hz	100 Hz
• with inductive load, max.	0.5 Hz; According to IEC 60947-5-1, DC-13	0.5 Hz; According to IEC 60947-5-1, DC-13
• on lamp load, max.	10 Hz	10 Hz
Total current of the outputs		
• Current per channel, max.	0.5 A; see additional description in the manual	0.5 A; see additional description in the manual
• Current per group, max.	4 A; see additional description in the manual	4 A; see additional description in the manual
• Current per module, max.	8 A; see additional description in the manual	16 A; see additional description in the manual
Interrupts/diagnostics/ status information		
Diagnostics function	No	No
Substitute values connectable	No	No
Alarms		
• Diagnostic alarm	No	No
• Maintenance interrupt	No	No
Diagnoses		
• Monitoring the supply voltage	No	No
• Wire-break	No	No
• Short-circuit	No	No
• Group error	No	No
Diagnostics indication LED		
• RUN LED	Yes; green LED	Yes; green LED
• ERROR LED	Yes; red LED	Yes; red LED
• Monitoring of the supply voltage (PWR-LED)	Yes; green LED	Yes; green LED
• Channel status display	Yes; green LED	Yes; green LED
• for channel diagnostics	No	No
• for module diagnostics	No	No

Technical specifications

Article number	6ES7522-1BH10-0AA0 S7-1500, DQ 16x24VDC/0.5A BA	6ES7522-1BL10-0AA0 S7-1500, DQ 32x24VDC/0.5A BA
Potential separation		
Potential separation channels • between the channels and backplane bus	Yes	Yes
Standards, approvals, certificates		
Suitable for safety functions	No	No
Suitable for safety-related tripping of standard modules	Yes; From FS02	Yes; From FS02
Highest safety class achievable for safety-related tripping of standard modules		
• Performance level according to ISO 13849-1	PL d	PL d
• Category according to ISO 13849-1	Cat. 3	Cat. 3
• SIL acc. to IEC 62061	SIL 2	SIL 2
Ambient conditions		
ambient temperature during operation		
• horizontal installation, min.	-30 °C; from FS04	-30 °C; from FS04
• horizontal installation, max.	60 °C	60 °C
• vertical installation, min.	-30 °C; from FS04	-30 °C; from FS04
• vertical installation, max.	40 °C	40 °C
Altitude during operation relating to sea level		
• Installation altitude above sea level, max.	5 000 m; Restrictions for installation altitudes > 2 000 m, see manual	5 000 m; Restrictions for installation altitudes > 2 000 m, see manual
Dimensions		
Width	25 mm	25 mm
Height	147 mm	147 mm
Depth	129 mm	129 mm
Weights		
Weight, approx.	230 g	280 g
Other		
Note:	Supplied incl. 40-pole push-in front connectors	Supplied incl. 40-pole push-in front connectors

SIMATIC S7-1500 Advanced Controllers

I/O modules

Digital modules

SM 523 digital input/output modules

Overview



- 16 digital inputs and 16 digital outputs (25 mm wide)
- 32 digital inputs, sinking/sourcing / 32 digital outputs, sourcing (35 mm wide)
- For flexible adaptation of the PLC to the corresponding task
- For subsequent expansion of the system with additional inputs and outputs
- For use in the tightest spaces: particularly economical, without parameters or diagnostic functions

4

Ordering data

SM 523 digital input/output module

Module width 35 mm

32 inputs, 24 V DC Basic, source-sinking input, input delay 3.2 ms, input type 3 (IEC 61131); 32 outputs, 24 V DC / 0.3 A Basic, sourcing

Module width 25 mm; front connector (push-in) included in scope of delivery

16 inputs, 24 V DC, isolated; 16 outputs, 24 V DC; 0.5 A, isolated

Accessories

Front connector

For 25 mm modules; including cable ties and individual labeling strips; push-in terminal 40-pin; spare part

DIN A4 labeling sheets

For 25 mm modules; 10 sheets with 20 labeling strips each for I/O modules; perforated, Al gray

Article No.

6ES7523-1BP50-0AA0

6ES7523-1BL00-0AA0

6ES7592-1BM00-0XA0

6ES7592-1AX00-0AA0

Article No.

U connector

5 units; spare part

Universal front door for I/O modules

For 25 mm modules; 5 front doors; with 5 labeling strips on the front and 5 cabling diagrams per front door; spare part

SIMATIC Manual Collection

Electronic manuals on DVD, multi-language: LOGO!, SIMADYN, SIMATIC bus components, SIMATIC C7, SIMATIC distributed I/O, SIMATIC HMI, SIMATIC Sensors, SIMATIC NET, SIMATIC PC-based Automation, SIMATIC PCS 7, SIMATIC PG/PC, SIMATIC S7, SIMATIC Software, SIMATIC TDC

SIMATIC Manual Collection update service for 1 year

Current Manual Collection DVD and the three subsequent updates

6ES7590-0AA00-0AA0

6ES7528-0AA00-0AA0

6ES7998-8XC01-8YE0

6ES7998-8XC01-8YE2

Technical specifications

Article number	6ES7523-1BL00-0AA0 S7-1500, DI 16x24VDC/DQ 16x24VDC/0.5A BA	6ES7523-1BP50-0AA0 S7-1500, DI 32x24VDC/DQ 32x24VDC/0.3A BA
General information		
Product type designation	DI 16x24VDC / DQ16x24VDC/0.5A BA	DI 32 x 24 V DC / DQ 32 x 24 V DC/0.3A SNK BA
Product function		
• Isochronous mode	No	No
• Prioritized startup	Yes	No
Engineering with		
• STEP 7 TIA Portal configurable/ integrated from version	V13 / V13	V16 with HSP 0319 / V17
• STEP 7 configurable/integrated from version	V5.5 SP3 / -	V5.5 SP3 / -
• PROFIBUS from GSD version/ GSD revision	V1.0 / V5.1	V1.0 / V5.1
• PROFINET from GSD version/ GSD revision	V2.3 / -	V2.35 / -
Operating mode		
• DI	Yes	Yes
• Counter	No	No
• DQ	Yes	Yes
• DQ with energy-saving function	No	No
• PWM	No	No
• Cam control (switching at comparison values)	No	No
• Oversampling	No	No
• MSI	Yes	Yes
• MSO	Yes	Yes
• Integrated operating cycle counter	No	No
Supply voltage		
Rated value (DC)	24 V	24 V
Reverse polarity protection	Yes; through internal protection with 7 A per group	Yes; Through internal protection with 4 A per group
Digital inputs		
Number of digital inputs	16	32
Digital inputs, parameterizable	No	No
Source/sink input	P-reading	Yes
Input characteristic curve in accordance with IEC 61131, type 3	Yes	Yes
Number of simultaneously controllable inputs		
• Number of simultaneously controllable inputs		32
horizontal installation		
- up to 60 °C, max.		32
vertical installation		
- up to 40 °C, max.		16
Input voltage		
• Rated value (DC)	24 V	24 V
• for signal *0*	-30 to +5 V	-5 ... +5 V (reference potential is COM)
• for signal *1*	+11 to +30V	-11 ... -30 V; +11 ... +30 V (reference potential is COM)
Input current		
• for signal *1*, typ.	2.7 mA	2.7 mA
Input delay (for rated value of input voltage) for standard inputs		
- parameterizable	No	No
for interrupt inputs		
- parameterizable	No	No
for technological functions		
- parameterizable		No

SIMATIC S7-1500 Advanced Controllers

I/O modules

Digital modules

SM 523 digital input/output modules

Technical specifications

Article number	6ES7523-1BL00-0AA0	6ES7523-1BP50-0AA0
	S7-1500, DI 16x24VDC/DQ 16x24VDC/0.5A BA	S7-1500, DI 32x24VDC/DQ 32x24VDC/0.3A BA
Digital outputs		
Type of digital output	Transistor	Transistor
Number of digital outputs	16	32
Current-sinking		Yes
Current-sourcing	Yes	No
Digital outputs, parameterizable	No	No
Short-circuit protection	Yes	No; external fusing necessary, max. 4 A per group, tripping characteristic type B or C
Limitation of inductive shutdown voltage to	L+ (-53 V)	L+ (-53 V)
Controlling a digital input	Yes	Yes
Switching capacity of the outputs		
• with resistive load, max.	0.5 A	0.3 A
• on lamp load, max.	5 W	5 W
Load resistance range		
• lower limit	48 Ω	80 Ω
• upper limit	12 kΩ	10 kΩ
Output voltage		
• for signal "1", min.	L+ (-0.8 V)	M+ (0.5 V)
Output current		
• for signal "1" rated value	0.5 A	0.3 A
• for signal "0" residual current, max.	0.5 mA	0.5 mA
Output delay with resistive load		
• "0" to "1", max.	100 μs	100 μs
• "1" to "0", max.	500 μs	500 μs
Parallel switching of two outputs		
• for logic links	Yes	Yes
• for uprating	No	No
• for redundant control of a load	Yes	Yes
Switching frequency		
• with resistive load, max.	100 Hz	100 Hz
• with inductive load, max.	0.5 Hz	0.5 Hz; According to IEC 60947-5-1, DC-13
• on lamp load, max.	10 Hz	10 Hz
Total current of the outputs		
• Current per channel, max.	0.5 A; see additional description in the manual	0.3 A
• Current per group, max.	4 A; see additional description in the manual	2 A
• Current per module, max.	8 A; see additional description in the manual	4 A
Total current of the outputs (per module)		
horizontal installation - up to 60 °C, max.		4 A
vertical installation - up to 40 °C, max.		4 A
Encoder		
Connectable encoders		
• 2-wire sensor	Yes	Yes
- permissible quiescent current (2-wire sensor), max.	1.5 mA	1.5 mA

Technical specifications

Article number	6ES7523-1BL00-0AA0	6ES7523-1BP50-0AA0
	S7-1500, DI 16x24VDC/DQ 16x24VDC/0.5A BA	S7-1500, DI 32x24VDC/DQ 32x24VDC/0.3A BA
Interrupts/diagnostics/status information		
Diagnostics function	No	No
Substitute values connectable	No	No
Alarms		
• Diagnostic alarm	No	No
• Maintenance interrupt	No	No
• Hardware interrupt	No	No
Diagnoses		
• Monitoring the supply voltage	No	No
• Wire-break	No	No
• Short-circuit	No	No
• Group error	No	No
Diagnostics indication LED		
• RUN LED	Yes; green LED	Yes; green LED
• ERROR LED	Yes; red LED	Yes; red LED
• MAINT LED	No	No
• Monitoring of the supply voltage (PWR-LED)	Yes; green LED	Yes; via SIMATIC TOP connect connection module
• Channel status display	Yes; green LED	Yes; via SIMATIC TOP connect connection module
• for channel diagnostics	No	No
• for module diagnostics	No	No
Potential separation		
Potential separation channels		
• between the channels and backplane bus	Yes	Yes
Standards, approvals, certificates		
Suitable for safety-related tripping of standard modules	Yes; From FS03	
Highest safety class achievable for safety-related tripping of standard modules		
• Performance level according to ISO 13849-1	PL d	
• Category according to ISO 13849-1	Cat. 3	
• SIL acc. to IEC 62061	SIL 2	
Ambient conditions		
Ambient temperature during operation		
• horizontal installation, min.	-30 °C; from FS04	-30 °C
• horizontal installation, max.	60 °C	60 °C
• vertical installation, min.	-30 °C; from FS04	-30 °C
• vertical installation, max.	40 °C	40 °C
Altitude during operation relating to sea level		
• Installation altitude above sea level, max.	5 000 m; Restrictions for installation altitudes > 2 000 m, see manual	5 000 m
Dimensions		
Width	25 mm	35 mm
Height	147 mm	147 mm
Depth	129 mm	129 mm
Weights		
Weight, approx.	280 g	250 g
Other		
Note:	Supplied incl. 40-pole push-in front connectors	Please order cable and connection modules separately

SIMATIC S7-1500 Advanced Controllers

I/O modules

SIPLUS digital modules

SIPLUS SM 521 digital input modules

Overview



- 16 and 32-channel digital input modules
- For flexible adaptation of the controller to the corresponding task
- For subsequent expansion of the system with additional inputs

Note:

SIPLUS extreme products are based on SIMATIC standard products. The contents listed here were taken from the respective standard products. SIPLUS extreme-specific information was added.

Ordering data

SIPLUS SM 521 digital input modules

(Extended temperature range and exposure to environmental substances)

16 inputs, 24 V DC, isolated, parameterizable diagnostics and hardware interrupts

32 inputs, 24 V DC, isolated, parameterizable diagnostics and hardware interrupts

16 inputs, 24 V DC, isolated, input delay 3.2 ms

16 inputs, 230 V AC, isolated, input delay 20 ms

16 inputs, 48 ... 125 V UC, input delay 0.05 ... 20 ms, parameterizable diagnostics and hardware interrupts

Accessories

Article No.

6AG1521-1BH00-7AB0

6AG1521-1BL00-7AB0

6AG1521-1BH50-7AA0

6AG1521-1FH00-7AA0

6AG1521-7EH00-7AB0

See SIMATIC S7-1500 SM 521 digital input modules, page 4/90

Technical specifications

Article number	6AG1521-1BH00-7AB0	6AG1521-1BL00-7AB0	6AG1521-1BH50-7AA0	6AG1521-1FH00-7AA0	6AG1521-7EH00-7AB0
Based on	6ES7521-1BH00-0AB0 SIPLUS S7-1500 DI 16x24VDC HF	6ES7521-1BL00-0AB0 SIPLUS S7-1500 DI 32x24VDC HF	6ES7521-1BH50-0AA0 SIPLUS S7-1500 DI 16x24VDC SRC BA	6ES7521-1FH00-0AA0 SIPLUS S7-1500 DI 16x230VAC BA	6ES7521-7EH00-0AB0 SIPLUS S7-1500 DI 48VUC/125VDC HF
Ambient conditions					
Ambient temperature during operation					
• horizontal installation, min.	-40 °C; = Tmin (incl. condensation/frost)	-40 °C; = Tmin (incl. condensation/frost)	-40 °C; = Tmin (incl. condensation/frost)	-40 °C; = Tmin (incl. condensation/frost)	-40 °C; = Tmin (incl. condensation/frost)
• horizontal installation, max.	70 °C; = Tmax	70 °C; = Tmax; > +60 °C number of simultaneously controllable inputs max. 16	70 °C; = Tmax; > +60 °C number of simultaneously controllable inputs max. 8	70 °C; = Tmax; > +60 °C number of simultaneously controllable inputs max. 8	70 °C; = Tmax; see Derating BasedOn (e.g. manual), additionally Tmax > 60 °C max. 4 inputs (no adjacent points)
• vertical installation, min.	-40 °C; = Tmin	-40 °C; = Tmin	-40 °C; = Tmin	-40 °C; = Tmin	
• vertical installation, max.	40 °C; = Tmax	40 °C; = Tmax	40 °C; = Tmax	40 °C; = Tmax	
Altitude during operation relating to sea level					
• Installation altitude above sea level, max.	5 000 m	5 000 m	5 000 m	2 000 m	2 000 m
• Ambient air temperature-barometric pressure-altitude	Tmin ... Tmax at 1 140 hPa ... 795 hPa (-1 000 m ... +2 000 m) // Tmin ... (Tmax - 10 K) at 795 hPa ... 658 hPa (+2 000 m ... +3 500 m) // Tmin ... (Tmax -20 K) at 658 hPa ... 540 hPa (+3 500 m ... +5 000 m)	Tmin ... Tmax at 1 140 hPa ... 795 hPa (-1 000 m ... +2 000 m) // Tmin ... (Tmax - 10 K) at 795 hPa ... 658 hPa (+2 000 m ... +3 500 m) // Tmin ... (Tmax -20 K) at 658 hPa ... 540 hPa (+3 500 m ... +5 000 m)	Tmin ... Tmax at 1 140 hPa ... 795 hPa (-1 000 m ... +2 000 m) // Tmin ... (Tmax - 10 K) at 795 hPa ... 658 hPa (+2 000 m ... +3 500 m) // Tmin ... (Tmax -20 K) at 658 hPa ... 540 hPa (+3 500 m ... +5 000 m)	Tmin ... Tmax at 1 140 hPa ... 795 hPa (-1 000 m ... +2 000 m)	Tmin ... Tmax at 1 140 hPa ... 795 hPa (-1 000 m ... +2 000 m)

Technical specifications

Article number	6AG1521-1BH00-7AB0	6AG1521-1BL00-7AB0	6AG1521-1BH50-7AA0	6AG1521-1FH00-7AA0	6AG1521-7EH00-7AB0
Based on	6ES7521-1BH00-0AB0 SIPLUS S7-1500 DI 16x24VDC HF	6ES7521-1BL00-0AB0 SIPLUS S7-1500 DI 32x24VDC HF	6ES7521-1BH50-0AA0 SIPLUS S7-1500 DI 16x24VDC SRC BA	6ES7521-1FH00-0AA0 SIPLUS S7-1500 DI 16x230VAC BA	6ES7521-7EH00-0AB0 SIPLUS S7-1500 DI 48VUC/125VDC HF
Relative humidity					
• With condensation, tested in accordance with IEC 60068-2-38, max.	100 %; RH incl. condensation/frost (no commissioning under condensation conditions)	100 %; RH incl. condensation/frost (no commissioning under condensation conditions)	100 %; RH incl. condensation/frost (no commissioning under condensation conditions)	100 %; RH incl. condensation/frost (no commissioning under condensation conditions)	100 %; RH incl. condensation / frost (no commissioning in bedewed state), horizontal installation
Resistance					
Coolants and lubricants					
- Resistant to commercially available coolants and lubricants	Yes; Incl. diesel and oil droplets in the air	Yes; Incl. diesel and oil droplets in the air	Yes; Incl. diesel and oil droplets in the air	Yes; Incl. diesel and oil droplets in the air	Yes; Incl. diesel and oil droplets in the air
Use in stationary industrial systems					
- to biologically active substances according to EN 60721-3-3	Yes; Class 3B2 mold, fungus and dry rot spores (with the exception of fauna); Class 3B3 on request	Yes; Class 3B2 mold, fungus and dry rot spores (with the exception of fauna); Class 3B3 on request	Yes; Class 3B2 mold, fungus and dry rot spores (with the exception of fauna); Class 3B3 on request	Yes; Class 3B2 mold, fungus and dry rot spores (with the exception of fauna); Class 3B3 on request	Yes; Class 3B2 mold, fungus and dry rot spores (with the exception of fauna); Class 3B3 on request
- to chemically active substances according to EN 60721-3-3	Yes; Class 3C4 (RH < 75 %) incl. salt spray acc. to EN 60068-2-52 (severity degree 3); *	Yes; Class 3C4 (RH < 75 %) incl. salt spray acc. to EN 60068-2-52 (severity degree 3); *	Yes; Class 3C4 (RH < 75 %) incl. salt spray acc. to EN 60068-2-52 (severity degree 3); *	Yes; Class 3C4 (RH < 75 %) incl. salt spray acc. to EN 60068-2-52 (severity degree 3); *	Yes; Class 3C4 (RH < 75 %) incl. salt spray acc. to EN 60068-2-52 (severity degree 3); *
- to mechanically active substances according to EN 60721-3-3	Yes; Class 3S4 incl. sand, dust, *	Yes; Class 3S4 incl. sand, dust, *	Yes; Class 3S4 incl. sand, dust, *	Yes; Class 3S4 incl. sand, dust, *	Yes; Class 3S4 incl. sand, dust, *
Use on ships/at sea					
- to biologically active substances according to EN 60721-3-6	Yes; Class 6B2 mold and fungal spores (excluding fauna); Class 6B3 on request	Yes; Class 6B2 mold and fungal spores (excluding fauna); Class 6B3 on request	Yes; Class 6B2 mold and fungal spores (excluding fauna); Class 6B3 on request	Yes; Class 6B2 mold and fungal spores (excluding fauna); Class 6B3 on request	Yes; Class 6B2 mold and fungal spores (excluding fauna); Class 6B3 on request
- to chemically active substances according to EN 60721-3-6	Yes; Class 6C3 (RH < 75 %) incl. salt spray acc. to EN 60068-2-52 (severity degree 3); *	Yes; Class 6C3 (RH < 75 %) incl. salt spray acc. to EN 60068-2-52 (severity degree 3); *	Yes; Class 6C3 (RH < 75 %) incl. salt spray acc. to EN 60068-2-52 (severity degree 3); *	Yes; Class 6C3 (RH < 75 %) incl. salt spray acc. to EN 60068-2-52 (severity degree 3); *	Yes; Class 6C3 (RH < 75 %) incl. salt spray acc. to EN 60068-2-52 (severity degree 3); *
- to mechanically active substances according to EN 60721-3-6	Yes; Class 6S3 incl. sand, dust; *	Yes; Class 6S3 incl. sand, dust; *	Yes; Class 6S3 incl. sand, dust; *	Yes; Class 6S3 incl. sand, dust; *	Yes; Class 6S3 incl. sand, dust; *

SIMATIC S7-1500 Advanced Controllers

I/O modules

SIPLUS digital modules

SIPLUS SM 521 digital input modules

Technical specifications

Article number	6AG1521-1BH00-7AB0	6AG1521-1BL00-7AB0	6AG1521-1BH50-7AA0	6AG1521-1FH00-7AA0	6AG1521-7EH00-7AB0
Based on	6ES7521-1BH00-0AB0 SIPLUS S7-1500 DI 16x24VDC HF	6ES7521-1BL00-0AB0 SIPLUS S7-1500 DI 32x24VDC HF	6ES7521-1BH50-0AA0 SIPLUS S7-1500 DI 16x24VDC SRC BA	6ES7521-1FH00-0AA0 SIPLUS S7-1500 DI 16x230VAC BA	6ES7521-7EH00-0AB0 SIPLUS S7-1500 DI 48VUC/125VDC HF
Usage in industrial process technology					
- Against chemically active substances acc. to EN 60654-4	Yes; Class 3 (excluding trichlorethylene)	Yes; Class 3 (excluding trichlorethylene)	Yes; Class 3 (excluding trichlorethylene)	Yes; Class 3 (excluding trichlorethylene)	Yes; Class 3 (excluding trichlorethylene)
- Environmental conditions for process, measuring and control systems acc. to ANSI/ISA-71.04	Yes; Level GX group A/B (excluding trichlorethylene; harmful gas concentrations up to the limits of EN 60721-3-3 class 3C4 permissible); level LC3 (salt spray) and level LB3 (oil)	Yes; Level GX group A/B (excluding trichlorethylene; harmful gas concentrations up to the limits of EN 60721-3-3 class 3C4 permissible); level LC3 (salt spray) and level LB3 (oil)	Yes; Level GX group A/B (excluding trichlorethylene; harmful gas concentrations up to the limits of EN 60721-3-3 class 3C4 permissible); level LC3 (salt spray) and level LB3 (oil)	Yes; Level GX group A/B (excluding trichlorethylene; harmful gas concentrations up to the limits of EN 60721-3-3 class 3C4 permissible); level LC3 (salt spray) and level LB3 (oil)	Yes; Level GX group A/B (excluding trichlorethylene; harmful gas concentrations up to the limits of EN 60721-3-3 class 3C4 permissible); level LC3 (salt spray) and level LB3 (oil)
Remark					
- Note regarding classification of environmental conditions acc. to EN 60721, EN 60654-4 and ANSI/ISA-71.04	* The supplied plug covers must remain in place over the unused interfaces during operation!	* The supplied plug covers must remain in place over the unused interfaces during operation!	* The supplied plug covers must remain in place over the unused interfaces during operation!	* The supplied plug covers must remain in place over the unused interfaces during operation!	* The supplied plug covers must remain in place over the unused interfaces during operation!
Conformal coating					
• Coatings for printed circuit board assemblies acc. to EN 61086	Yes; Class 2 for high reliability	Yes; Class 2 for high reliability	Yes; Class 2 for high reliability	Yes; Class 2 for high reliability	Yes; Class 2 for high reliability
• Protection against fouling acc. to EN 60664-3	Yes; Type 1 protection	Yes; Type 1 protection	Yes; Type 1 protection	Yes; Type 1 protection	Yes; Type 1 protection
• Military testing according to MIL-I-46058C, Amendment 7	Yes; Discoloration of coating possible during service life	Yes; Discoloration of coating possible during service life	Yes; Discoloration of coating possible during service life	Yes; Discoloration of coating possible during service life	Yes; Discoloration of coating possible during service life
• Qualification and Performance of Electrical Insulating Compound for Printed Board Assemblies according to IPC-CC-830A	Yes; Conformal coating, Class A	Yes; Conformal coating, Class A	Yes; Conformal coating, Class A	Yes; Conformal coating, Class A	Yes; Conformal coating, Class A

Overview



- 8, 16 and 32-channel digital output modules
- For flexible adaptation of the controller to the corresponding task
- For subsequent expansion of the system with additional outputs

Note:

SIPLUS extreme products are based on SIMATIC standard products. The contents listed here were taken from the respective standard products. SIPLUS extreme-specific information has been added.

Ordering data

Article No.

SIPLUS SM 522 digital output modules

(Extended temperature range and exposure to environmental substances)

- 8 outputs, 24 V DC; 2 A, isolated
- 16 outputs, 24 V DC; 0.5 A, isolated
- 32 outputs, 24 V DC; 0.5 A, isolated
- 8 relay outputs, 230 V AC, 5 A
- 16 relay outputs, 230 V AC, 2 A
- 8 outputs (triac), 230 V AC, 2 A
- 16 outputs (triac), 230 V AC, 1 A
- 16 outputs, 24 ... 48 V UC, 125 V DC, 0.5 A, isolated

6AG1522-1BF00-7AB0**6AG1522-1BH01-7AB0****6AG1522-1BL01-7AB0****6AG1522-5HF00-2AB0****6AG1522-5HH00-7AB0****6AG1522-5FF00-7AB0****6AG1522-5FH00-7AB0****6AG1522-5EH00-7AB0****Accessories**

See SIMATIC S7-1500 SM 522 digital output modules, page 4/97

Technical specifications

Article number	6AG1522-1BF00-7AB0	6AG1522-1BH01-7AB0	6AG1522-1BL01-7AB0	6AG1522-5EH00-7AB0
Based on	6ES7522-1BF00-0AB0 SIPLUS S7-1500 DQ 8x24VDC/2A HF	6ES7522-1BH01-0AB0 SIPLUS S7-1500 DQ 16x24VDC/0.5A HF	6ES7522-1BL01-0AB0 SIPLUS S7-1500 DQ 32x24VDC/0.5A HF	6ES7522-5EH00-0AB0 SIPLUS S7-1500 DQ 16x48VUC/125VDC ST
Ambient conditions				
Ambient temperature during operation				
• horizontal installation, min.	-40 °C; = Tmin (incl. condensation/frost)	-40 °C; = Tmin (incl. condensation/frost)	-40 °C; = Tmin (incl. condensation/frost)	-40 °C; = Tmin (incl. condensation/frost)
• horizontal installation, max.	70 °C; = Tmax; > +60 °C Number of simultaneously controllable outputs max. 8x 0.5 A, max. total current per group 2 A	70 °C; = Tmax; see Derating BasedOn (e.g. manual), additionally Tmax > 60 °C max. aggregate current 2 A per group	70 °C; = Tmax; see Derating BasedOn (e.g. manual), additionally Tmax > 60 °C max. aggregate current 2 A per group	70 °C; = Tmax; > +60 °C max. 0.25 A per output
• vertical installation, min.	-40 °C; = Tmin			
• vertical installation, max.	40 °C; = Tmax			
Altitude during operation relating to sea level				
• Installation altitude above sea level, max.	5 000 m	5 000 m	5 000 m	2 000 m
• Ambient air temperature-barometric pressure-altitude	Tmin ... Tmax at 1 140 hPa ... 795 hPa (-1 000 m ... +2 000 m) // Tmin ... (Tmax - 10 K) at 795 hPa ... 658 hPa (+2 000 m ... +3 500 m) // Tmin ... (Tmax -20 K) at 658 hPa ... 540 hPa (+3 500 m ... +5 000 m)	Tmin ... Tmax at 1 140 hPa ... 795 hPa (-1 000 m ... +2 000 m) // Tmin ... (Tmax - 10 K) at 795 hPa ... 658 hPa (+2 000 m ... +3 500 m) // Tmin ... (Tmax -20 K) at 658 hPa ... 540 hPa (+3 500 m ... +5 000 m)	Tmin ... Tmax at 1 140 hPa ... 795 hPa (-1 000 m ... +2 000 m) // Tmin ... (Tmax - 10 K) at 795 hPa ... 658 hPa (+2 000 m ... +3 500 m) // Tmin ... (Tmax -20 K) at 658 hPa ... 540 hPa (+3 500 m ... +5 000 m)	Tmin ... Tmax at 1 140 hPa ... 795 hPa (-1 000 m ... +2 000 m)
Relative humidity				
• With condensation, tested in accordance with IEC 60068-2-38, max.	100 %; RH incl. condensation/frost (no commissioning under condensation conditions)	100 %; RH incl. condensation / frost (no commissioning in bedewed state), horizontal installation	100 %; RH incl. condensation / frost (no commissioning in bedewed state), horizontal installation	100 %; RH incl. condensation / frost (no commissioning in bedewed state), horizontal installation
Resistance				
Coolants and lubricants				
- Resistant to commercially available coolants and lubricants	Yes; Incl. diesel and oil droplets in the air	Yes; Incl. diesel and oil droplets in the air	Yes; Incl. diesel and oil droplets in the air	Yes; Incl. diesel and oil droplets in the air

SIMATIC S7-1500 Advanced Controllers

I/O modules

SIPLUS digital modules

SIPLUS SM 522 digital output modules

Technical specifications

Article number	6AG1522-1BF00-7AB0	6AG1522-1BH01-7AB0	6AG1522-1BL01-7AB0	6AG1522-5EH00-7AB0
Based on	6ES7522-1BF00-0AB0 SIPLUS S7-1500 DQ 8x24VDC/2A HF	6ES7522-1BH01-0AB0 SIPLUS S7-1500 DQ 16x24VDC/0.5A HF	6ES7522-1BL01-0AB0 SIPLUS S7-1500 DQ 32x24VDC/0.5A HF	6ES7522-5EH00-0AB0 SIPLUS S7-1500 DQ 16x48VUC/125VDC ST
Use in stationary industrial systems				
- to biologically active substances according to EN 60721-3-3	Yes; Class 3B2 mold, fungus and dry rot spores (with the exception of fauna); Class 3B3 on request	Yes; Class 3B2 mold, fungus and dry rot spores (with the exception of fauna); Class 3B3 on request	Yes; Class 3B2 mold, fungus and dry rot spores (with the exception of fauna); Class 3B3 on request	Yes; Class 3B2 mold, fungus and dry rot spores (with the exception of fauna); Class 3B3 on request
- to chemically active substances according to EN 60721-3-3	Yes; Class 3C4 (RH < 75 %) incl. salt spray acc. to EN 60068-2-52 (severity degree 3); *	Yes; Class 3C4 (RH < 75 %) incl. salt spray acc. to EN 60068-2-52 (severity degree 3); *	Yes; Class 3C4 (RH < 75 %) incl. salt spray acc. to EN 60068-2-52 (severity degree 3); *	Yes; Class 3C4 (RH < 75 %) incl. salt spray acc. to EN 60068-2-52 (severity degree 3); *
- to mechanically active substances according to EN 60721-3-3	Yes; Class 3S4 incl. sand, dust; *	Yes; Class 3S4 incl. sand, dust; *	Yes; Class 3S4 incl. sand, dust; *	Yes; Class 3S4 incl. sand, dust; *
Use on ships/at sea				
- to biologically active substances according to EN 60721-3-6	Yes; Class 6B2 mold and fungal spores (excluding fauna); Class 6B3 on request	Yes; Class 6B2 mold and fungal spores (excluding fauna); Class 6B3 on request	Yes; Class 6B2 mold and fungal spores (excluding fauna); Class 6B3 on request	Yes; Class 6B2 mold and fungal spores (excluding fauna); Class 6B3 on request
- to chemically active substances according to EN 60721-3-6	Yes; Class 6C3 (RH < 75 %) incl. salt spray acc. to EN 60068-2-52 (severity degree 3); *	Yes; Class 6C3 (RH < 75 %) incl. salt spray acc. to EN 60068-2-52 (severity degree 3); *	Yes; Class 6C3 (RH < 75 %) incl. salt spray acc. to EN 60068-2-52 (severity degree 3); *	Yes; Class 6C3 (RH < 75 %) incl. salt spray acc. to EN 60068-2-52 (severity degree 3); *
- to mechanically active substances according to EN 60721-3-6	Yes; Class 6S3 incl. sand, dust; *	Yes; Class 6S3 incl. sand, dust; *	Yes; Class 6S3 incl. sand, dust; *	Yes; Class 6S3 incl. sand, dust; *
Usage in industrial process technology				
- Against chemically active substances acc. to EN 60654-4	Yes; Class 3 (excluding trichlorethylene)	Yes; Class 3 (excluding trichlorethylene)	Yes; Class 3 (excluding trichlorethylene)	Yes; Class 3 (excluding trichlorethylene)
- Environmental conditions for process, measuring and control systems acc. to ANSI/ISA-71.04	Yes; Level GX group A/B (excluding trichlorethylene; harmful gas concentrations up to the limits of EN 60721-3-3 class 3C4 permissible); level LC3 (salt spray) and level LB3 (oil)	Yes; Level GX group A/B (excluding trichlorethylene; harmful gas concentrations up to the limits of EN 60721-3-3 class 3C4 permissible); level LC3 (salt spray) and level LB3 (oil)	Yes; Level GX group A/B (excluding trichlorethylene; harmful gas concentrations up to the limits of EN 60721-3-3 class 3C4 permissible); level LC3 (salt spray) and level LB3 (oil)	Yes; Level GX group A/B (excluding trichlorethylene; harmful gas concentrations up to the limits of EN 60721-3-3 class 3C4 permissible); level LC3 (salt spray) and level LB3 (oil)
Remark				
- Note regarding classification of environmental conditions acc. to EN 60721, EN 60654-4 and ANSI/ISA-71.04	* The supplied plug covers must remain in place over the unused interfaces during operation!	* The supplied plug covers must remain in place over the unused interfaces during operation!	* The supplied plug covers must remain in place over the unused interfaces during operation!	* The supplied plug covers must remain in place over the unused interfaces during operation!
Conformal coating				
• Coatings for printed circuit board assemblies acc. to EN 61086	Yes; Class 2 for high reliability	Yes; Class 2 for high reliability	Yes; Class 2 for high reliability	Yes; Class 2 for high reliability
• Protection against fouling acc. to EN 60664-3	Yes; Type 1 protection	Yes; Type 1 protection	Yes; Type 1 protection	Yes; Type 1 protection
• Military testing according to MIL-I-46058C, Amendment 7	Yes; Discoloration of coating possible during service life	Yes; Discoloration of coating possible during service life	Yes; Discoloration of coating possible during service life	Yes; Discoloration of coating possible during service life
• Qualification and Performance of Electrical Insulating Compound for Printed Board Assemblies according to IPC-CC-830A	Yes; Conformal coating, Class A	Yes; Conformal coating, Class A	Yes; Conformal coating, Class A	Yes; Conformal coating, Class A

Technical specifications

Article number	6AG1522-5HH00-7AB0	6AG1522-5HF00-2AB0	6AG1522-5FF00-7AB0	6AG1522-5FH00-7AB0
Based on	6ES7522-5HH00-0AB0 SIPLUS S7-1500 DQ 16x230VAC 2A RLY	6ES7522-5HF00-0AB0 SIPLUS S7-1500 DQ 8x230VAC/5A ST (RELAY)	6ES7522-5FF00-0AB0 SIPLUS S7-1500 DQ 8x230VAC/2A ST (TRIAC)	6ES7522-5FH00-0AB0 SIPLUS S7-1500 DQ 16x230VAC 1A ST TRIAC
Ambient conditions				
Ambient temperature during operation				
• horizontal installation, min.	-40 °C; = Tmin (incl. condensation/frost); start-up @ -25 °C	-25 °C; = Tmin (incl. condensation/frost)	-40 °C; = Tmin (incl. condensation/frost)	-40 °C; = Tmin (incl. condensation/frost); start-up @ -25 °C
• horizontal installation, max.	70 °C; = Tmax; see Derating BasedOn (e.g. manual), additionally Tmax > 60 °C max. 8 outputs (no adjacent points)	60 °C; = Tmax	70 °C; = Tmax; > +60 °C number of simultaneously controllable outputs max. 8x 0.25 A, max. total current 2 A	70 °C; = Tmax; see Derating BasedOn (e.g. manual), additionally Tmax > 60 °C max. 4 A aggregate current per module, max. 0.25 A per output
• vertical installation, min.	-40 °C; = Tmin; Startup @ -25 °C	-25 °C; = Tmin	-40 °C; = Tmin	-40 °C; = Tmin; Startup @ -25 °C
• vertical installation, max.	40 °C	40 °C; = Tmax	40 °C; = Tmax	60 °C
Altitude during operation relating to sea level				
• Installation altitude above sea level, max.	2 000 m	2 000 m	2 000 m	2 000 m
• Ambient air temperature-barometric pressure-altitude	Tmin ... Tmax at 1 140 hPa ... 795 hPa (-1 000 m ... +2 000 m)	Tmin ... Tmax at 1 140 hPa ... 795 hPa (-1 000 m ... +2 000 m)	Tmin ... Tmax at 1 140 hPa ... 795 hPa (-1 000 m ... +2 000 m)	Tmin ... Tmax at 1 140 hPa ... 795 hPa (-1 000 m ... +2 000 m)
Relative humidity				
• With condensation, tested in accordance with IEC 60068-2-38, max.	100 %; RH incl. condensation / frost (no commissioning in bedewed state), horizontal installation	100 %; RH incl. condensation/frost (no commissioning under condensation conditions)	100 %; RH incl. condensation/frost (no commissioning under condensation conditions)	100 %; RH incl. condensation / frost (no commissioning in bedewed state), horizontal installation
Resistance				
Coolants and lubricants				
- Resistant to commercially available coolants and lubricants	Yes; Incl. diesel and oil droplets in the air	Yes; Incl. diesel and oil droplets in the air	Yes; Incl. diesel and oil droplets in the air	Yes; Incl. diesel and oil droplets in the air
Use in stationary industrial systems				
- to biologically active substances according to EN 60721-3-3	Yes; Class 3B2 mold, fungus and dry rot spores (with the exception of fauna); Class 3B3 on request	Yes; Class 3B2 mold, fungus and dry rot spores (with the exception of fauna); Class 3B3 on request	Yes; Class 3B2 mold, fungus and dry rot spores (with the exception of fauna); Class 3B3 on request	Yes; Class 3B2 mold, fungus and dry rot spores (with the exception of fauna); Class 3B3 on request
- to chemically active substances according to EN 60721-3-3	Yes; Class 3C4 (RH < 75 %) incl. salt spray acc. to EN 60068-2-52 (severity degree 3); *	Yes; Class 3C4 (RH < 75 %) incl. salt spray acc. to EN 60068-2-52 (severity degree 3); *	Yes; Class 3C4 (RH < 75 %) incl. salt spray acc. to EN 60068-2-52 (severity degree 3); *	Yes; Class 3C4 (RH < 75 %) incl. salt spray acc. to EN 60068-2-52 (severity degree 3); *
- to mechanically active substances according to EN 60721-3-3	Yes; Class 3S4 incl. sand, dust; *	Yes; Class 3S4 incl. sand, dust; *	Yes; Class 3S4 incl. sand, dust; *	Yes; Class 3S4 incl. sand, dust; *
Use on ships/at sea				
- to biologically active substances according to EN 60721-3-6	Yes; Class 6B2 mold and fungal spores (excluding fauna); Class 6B3 on request	Yes; Class 6B2 mold and fungal spores (excluding fauna); Class 6B3 on request	Yes; Class 6B2 mold and fungal spores (excluding fauna); Class 6B3 on request	Yes; Class 6B2 mold and fungal spores (excluding fauna); Class 6B3 on request
- to chemically active substances according to EN 60721-3-6	Yes; Class 6C3 (RH < 75 %) incl. salt spray acc. to EN 60068-2-52 (severity degree 3); *	Yes; Class 6C3 (RH < 75 %) incl. salt spray acc. to EN 60068-2-52 (severity degree 3); *	Yes; Class 6C3 (RH < 75 %) incl. salt spray acc. to EN 60068-2-52 (severity degree 3); *	Yes; Class 6C3 (RH < 75 %) incl. salt spray acc. to EN 60068-2-52 (severity degree 3); *
- to mechanically active substances according to EN 60721-3-6	Yes; Class 6S3 incl. sand, dust; *	Yes; Class 6S3 incl. sand, dust; *	Yes; Class 6S3 incl. sand, dust; *	Yes; Class 6S3 incl. sand, dust; *

SIMATIC S7-1500 Advanced Controllers

I/O modules

SIPLUS digital modules

SIPLUS SM 522 digital output modules

Technical specifications

Article number	6AG1522-5HH00-7AB0	6AG1522-5HF00-2AB0	6AG1522-5FF00-7AB0	6AG1522-5FH00-7AB0
Based on	6ES7522-5HH00-0AB0 SIPLUS S7-1500 DQ 16x230VAC 2A RLY	6ES7522-5HF00-0AB0 SIPLUS S7-1500 DQ 8x230VAC/5A ST (RELAY)	6ES7522-5FF00-0AB0 SIPLUS S7-1500 DQ 8x230VAC/2A ST (TRIAC)	6ES7522-5FH00-0AB0 SIPLUS S7-1500 DQ 16x230VAC 1A ST TRIAC
Usage in industrial process technology				
- Against chemically active substances acc. to EN 60654-4	Yes; Class 3 (excluding trichlorethylene)	Yes; Class 3 (excluding trichlorethylene)	Yes; Class 3 (excluding trichlorethylene)	Yes; Class 3 (excluding trichlorethylene)
- Environmental conditions for process, measuring and control systems acc. to ANSI/ISA-71.04	Yes; Level GX group A/B (excluding trichlorethylene; harmful gas concentrations up to the limits of EN 60721-3-3 class 3C4 permissible); level LC3 (salt spray) and level LB3 (oil)	Yes; Level GX group A/B (excluding trichlorethylene; harmful gas concentrations up to the limits of EN 60721-3-3 class 3C4 permissible); level LC3 (salt spray) and level LB3 (oil)	Yes; Level GX group A/B (excluding trichlorethylene; harmful gas concentrations up to the limits of EN 60721-3-3 class 3C4 permissible); level LC3 (salt spray) and level LB3 (oil)	Yes; Level GX group A/B (excluding trichlorethylene; harmful gas concentrations up to the limits of EN 60721-3-3 class 3C4 permissible); level LC3 (salt spray) and level LB3 (oil)
Remark				
- Note regarding classification of environmental conditions acc. to EN 60721, EN 60654-4 and ANSI/ISA-71.04	* The supplied plug covers must remain in place over the unused interfaces during operation!	* The supplied plug covers must remain in place over the unused interfaces during operation!	* The supplied plug covers must remain in place over the unused interfaces during operation!	* The supplied plug covers must remain in place over the unused interfaces during operation!
Conformal coating				
• Coatings for printed circuit board assemblies acc. to EN 61086	Yes; Class 2 for high reliability	Yes; Class 2 for high reliability	Yes; Class 2 for high reliability	Yes; Class 2 for high reliability
• Protection against fouling acc. to EN 60664-3	Yes; Type 1 protection	Yes; Type 1 protection	Yes; Type 1 protection	Yes; Type 1 protection
• Military testing according to MIL-I-46058C, Amendment 7	Yes; Discoloration of coating possible during service life	Yes; Discoloration of coating possible during service life	Yes; Discoloration of coating possible during service life	Yes; Discoloration of coating possible during service life
• Qualification and Performance of Electrical Insulating Compound for Printed Board Assemblies according to IPC-CC-830A	Yes; Conformal coating, Class A	Yes; Conformal coating, Class A	Yes; Conformal coating, Class A	Yes; Conformal coating, Class A

Overview



- 4, 8 or 16-channel analog input modules
- Optionally with extremely short conversion times
- For the connection of analog sensors without additional amplifiers
- Even solves more complex automation tasks

Ordering data

SM 531 analog input modules

4 x U/I/RTD/TC
4 analog inputs, ± 10 V, ± 5 V, ± 2.5 V, ± 1 V, ± 500 mV, ± 250 mV, ± 80 mV, ± 50 mV, 1 ... 5 V, 0/4 ... 20 mA, ± 20 mA, thermocouples type B, E, J, K, N, R, S, T, resistance thermometers Ni 100, Ni 1000, LG-Ni 1000, Pt100, Pt1000, Pt250, Pt500, resistors 0 ... 150/300/600/6000 ohms; 16 bits; incl. infeed element, shield bracket, shield terminal, labeling strips, U connector, printed front door

Article No.

6ES7531-7QD00-0AB0

8 x U/I/R/RTD/
8 analog inputs ± 1 V, ± 10 V, ± 5 V, ± 50 mV, ± 500 mV, 1 ... 5 V, 0/4 ... 20 mA, ± 20 mA, resistance thermometers Ni 100, Ni 1000, LG-Ni 1000, Pt100, Pt1000, resistors 0 ... 600/6000 ohms, PTC; 16 bits; incl. infeed element, shield bracket, shield terminal, labeling strips, U connector, printed front door

6ES7531-7QF00-0AB0

8 x U/I HS
8 analog inputs, ± 10 V, ± 5 V, 1 ... 5 V or 0/4 ... 20 mA, ± 20 mA, 16 bits + sign; incl. infeed element, shield bracket, shield terminal, labeling strips, U connector, printed front door

6ES7531-7NF10-0AB0

8 x U/I/RTD/TC
8 analog inputs ± 10 V, ± 5 V, ± 2.5 V, ± 1 V, ± 500 mV, ± 250 mV, ± 80 mV, ± 50 mV, 1 ... 5 V, 0/4 ... 20 mA, ± 20 mA, thermocouples type B, E, J, K, N, R, S, T, resistance thermometers Ni 100, Ni 1000, LG-Ni 1000, Pt100, Pt1000, Pt250, Pt500, resistors 0 ... 150/300/600/6000 ohms; 16 bits; incl. infeed element, shield bracket, shield terminal, labeling strips, U connector, printed front door

6ES7531-7KF00-0AB0

Article No.

8 x U/I HF
8 analog inputs, ± 10 V, ± 5 V, 1 ... 5 V or 0/4 ... 20 mA, ± 20 mA, 16 bits + sign; incl. infeed element, shield bracket, shield terminal, labeling strips, U connector, printed front door

6ES7531-7NF00-0AB0

8 x U/R/RTD/TC
8 analog inputs, ± 1 V, ± 500 mV, ± 250 mV, ± 80 mV, ± 50 mV, ± 25 mV; thermocouples type B, E, J, K, N, R, S, T, TXK/TXK(L) according to GOST; resistance thermometers Cu 10, Cu 50, Cu 100, Ni 10, Ni 100, Ni 120, Ni 200, Ni 500, Ni 1000, LG-Ni 1000, Pt10, Pt50, Pt100, Pt200, Pt500, Pt1000; resistors 0...150/300/600/6000 ohms, PTC; 16 bits; incl. infeed element, shield bracket, shield terminal, labeling strips, U connector, printed front door

6ES7531-7PF00-0AB0

16 x U BA
16 analog inputs 1 ... 5 V, ± 1 V, ± 5 V, ± 10 V, 16-bit resolution, accuracy 0.5%, 16 channels in groups of 16, 4 V DC common mode voltage, diagnostics, hardware interrupts; delivery including infeed element, shield bracket and shield terminal: Order front connectors (screw terminals or push-in) separately

6ES7531-7LH00-0AB0

16 x I BA
16 analog inputs 0/4 ... 20 mA, ± 20 mA, 16-bit resolution, accuracy 0.5%, 16 channels in groups of 16, 4 V DC common mode voltage, diagnostics, hardware interrupts; delivery including infeed element, shield bracket and shield terminal: Order front connectors (screw terminals or push-in) separately

6ES7531-7MH00-0AB0

SIMATIC S7-1500 Advanced Controllers

I/O modules

Analog modules

SM 531 analog input modules

Ordering data	Article No.	Ordering data	Article No.
Accessories		Shielding set I/O	
Front connectors		For 35 mm modules; infeed element, shield bracket, and shield terminal; 5 units, spare part (one shield set supplied with the module).	6ES7590-5CA00-0AA0
For 35 mm modules; including four potential bridges, cable ties and individual labeling strips, 40-pin		For 25 mm modules; infeed element, shield bracket, and shield terminal; 4 units, spare part (one shield set supplied with the module).	6ES7590-5CA10-0XA0
• Screw terminals	6ES7592-1AM00-0XB0	Shield terminal element	6ES7590-5BA00-0AA0
• Push-in	6ES7592-1BM00-0XB0	10 units; spare part	
For 25 mm modules; including cable ties and individual labeling strips; push-in terminal 40-pin; spare part	6ES7592-1BM00-0XA0	SIMATIC Manual Collection	6ES7998-8XC01-8YE0
DIN A4 labeling sheets		Electronic manuals on DVD, multilingual: LOGO!, SIMADYN, SIMATIC bus components, SIMATIC C7, SIMATIC TDC	
For 35 mm modules; 10 sheets with 10 labeling strips each for I/O modules; perforated, Al gray	6ES7592-2AX00-0AA0	SIMATIC Manual Collection update service for 1 year	6ES7998-8XC01-8YE2
For 25 mm modules; 10 sheets with 20 labeling strips each for I/O modules; perforated, Al gray	6ES7592-1AX00-0AA0	Current Manual Collection DVD and the three subsequent updates	
U connector	6ES7590-0AA00-0AA0		
5 units; spare part			
Universal front door for I/O modules			
For 35 mm modules; 5 front doors; with 5 labeling strips (front) and 5 cabling diagrams per front door; spare part	6ES7528-0AA00-7AA0		
For 25 mm modules; 5 front doors; with 5 labeling strips (front) and 5 cabling diagrams per front door; spare part	6ES7528-0AA00-0AA0		

Technical specifications

Article number	6ES7531-7QD00-0AB0	6ES7531-7QF00-0AB0	6ES7531-7KF00-0AB0	6ES7531-7NF10-0AB0	6ES7531-7NF00-0AB0
	S7-1500, AI 4xU/I/RTD/TC ST	S7-1500, AI 8xU/I/R/RTD BA	S7-1500, AI 8xU/I/RTD/TC ST	S7-1500, AI 8xU/I HS	S7-1500, AI 8xU/I HF
General information					
Product type designation	AI 4xU/I/RTD/TC ST	AI 8xU/I/R/RTD BA	AI 8xU/I/RTD/TC ST	AI 8xU/I HS	AI 8xU/I HF
Product function					
• Isochronous mode	No	No	No	Yes	No
• Prioritized startup	No	No	No	Yes	Yes
• Measuring range scalable	No	No	No	No	No
• Scalable measured values	No	No	No	No	Yes
• Adjustment of measuring range	No	No	No	No	Yes
Engineering with					
• STEP 7 TIA Portal configurable/integrated from version	V13 / V13.0.2	V15.1 / V16	V12 / V12	V14 / -	V14 / -
• STEP 7 configurable/integrated from version	V5.5 SP3 / -	V5.5 SP3 / -	V5.5 SP3 / -	V5.5 SP3 / -	V5.5 SP3 / -
• PROFIBUS from GSD version/GSD revision	V1.0 / V5.1	V1.0 / V5.1	V1.0 / V5.1	V1.0 / V5.1	V1.0 / V5.1
• PROFINET from GSD version/GSD revision	V2.3 / -	V2.3 / -	V2.3 / -	V2.3 / -	V2.3 / -
Operating mode					
• Oversampling	No	No	No	Yes	No
• MSI	Yes	Yes	Yes	Yes	Yes

Technical specifications

Article number	6ES7531-7QD00-0AB0 S7-1500, AI 4xU/I/RTD/TC ST	6ES7531-7QF00-0AB0 S7-1500, AI 8xU/I/R/RTD BA	6ES7531-7KF00-0AB0 S7-1500, AI 8xU/I/RTD/TC ST	6ES7531-7NF10-0AB0 S7-1500, AI 8xU/I HS	6ES7531-7NF00-0AB0 S7-1500, AI 8xU/I HF
Supply voltage					
Rated value (DC)	24 V		24 V	24 V	24 V
Reverse polarity protection	Yes		Yes	Yes	Yes
Analog inputs					
Number of analog inputs	4	8	8	8	8
• For current measurement	4	8	8	8	8
• For voltage measurement	4	8	8	8	8
• For resistance/resistance thermometer measurement	2	8	4		
• For thermocouple measurement	4		8		
permissible input voltage for voltage input (destruction limit), max.	28.8 V	12 V; 12 V continuous, 30 V for max. 1 s	28.8 V	28.8 V	28.8 V
permissible input current for current input (destruction limit), max.	40 mA	40 mA	40 mA	40 mA	40 mA
Constant measurement current for resistance-type transmitter, typ.	150 Ohm, 300 Ohm, 600 Ohm, Pt100, Pt200, Ni100: 1.25 mA; 6 000 Ohm, Pt500, Pt1000, Ni1000, LG-Ni1000: 0.625 mA; PTC: 0.472 mA	230 ... 370 µA	150 Ohm, 300 Ohm, 600 Ohm, Pt100, Pt200, Ni100: 1.25 mA; 6 000 Ohm, Pt500, Pt1000, Ni1000, LG-Ni1000: 0.625 mA; PTC: 0.472 mA		
Technical unit for temperature measurement adjustable	Yes; °C/°F/K	Yes; °C/°F/K	Yes; °C/°F/K		
Analog input with oversampling	No				
Standardization of measured values	No				
Input ranges (rated values), voltages					
• 0 to +5 V	No	No	No	No	No
• 0 to +10 V	No	No	No	No	No
• 1 V to 5 V	Yes	Yes	Yes	Yes	Yes
• -1 V to +1 V	Yes	Yes	Yes		
• -10 V to +10 V	Yes	Yes	Yes	Yes	Yes
• -2.5 V to +2.5 V	Yes	No	Yes	No	Yes
• -25 mV to +25 mV	No	No	No	No	No
• -250 mV to +250 mV	Yes	No	Yes	No	No
• -5 V to +5 V	Yes	Yes	Yes	Yes	Yes
• -50 mV to +50 mV	Yes	Yes	Yes	No	No
• -500 mV to +500 mV	Yes	Yes	Yes	No	No
• -80 mV to +80 mV	Yes	No	Yes	No	No
Input ranges (rated values), currents					
• 0 to 10 mA		No			
• 0 to 20 mA	Yes	Yes	Yes	Yes	Yes
• -20 mA to +20 mA	Yes	Yes	Yes	Yes	Yes
• 4 mA to 20 mA	Yes	Yes	Yes	Yes	Yes
Input ranges (rated values), thermocouples					
• Type B	Yes	No	Yes	No	No
• Type C	No	No	No	No	No
• Type E	Yes	No	Yes	No	No
• Type J	Yes	No	Yes	No	No
• Type K	Yes	No	Yes	No	No
• Type L	No	No	No	No	No
• Type N	Yes	No	Yes	No	No
• Type R	Yes	No	Yes	No	No
• Type S	Yes	No	Yes	No	No
• Type T	Yes	No	Yes	No	No
• Type U	No	No			
• Type TXK/TXK(L) to GOST	No	No	No	No	No

SIMATIC S7-1500 Advanced Controllers

I/O modules

Analog modules

SM 531 analog input modules

Technical specifications

Article number	6ES7531-7QD00-0AB0 S7-1500, AI 4xU/I/RTD/TC ST	6ES7531-7QF00-0AB0 S7-1500, AI 8xU/I/R/RTD BA	6ES7531-7KF00-0AB0 S7-1500, AI 8xU/I/RTD/TC ST	6ES7531-7NF10-0AB0 S7-1500, AI 8xU/I HS	6ES7531-7NF00-0AB0 S7-1500, AI 8xU/I HF
Input ranges (rated values), resistance thermometer					
• Cu 10	No	No	No	No	No
• Cu 10 according to GOST	No	No	No	No	No
• Cu 50	No	No	No	No	No
• Cu 50 according to GOST	No	No	No	No	No
• Cu 100	No	No	No	No	No
• Cu 100 according to GOST	No	No	No	No	No
• Ni 10	No	No	No	No	No
• Ni 10 according to GOST	No	No	No	No	No
• Ni 100	Yes; Standard/climate	Yes; Standard/climate	Yes; Standard/climate	No	No
• Ni 100 according to GOST	No	No	No	No	No
• Ni 1000	Yes; Standard/climate	Yes; Standard/climate	Yes; Standard/climate	No	No
• Ni 1000 according to GOST	No	No	No	No	No
• LG-Ni 1000	Yes; Standard/climate	Yes; Standard/climate	Yes; Standard/climate	No	No
• Ni 120	No	No	No	No	No
• Ni 120 according to GOST	No	No	No	No	No
• Ni 200	No	No	No	No	No
• Ni 200 according to GOST	No	No	No	No	No
• Ni 500	No	No	No	No	No
• Ni 500 according to GOST	No	No	No	No	No
• Pt 10	No	No	No	No	No
• Pt 10 according to GOST	No	No	No	No	No
• Pt 50	No	No	No	No	No
• Pt 50 according to GOST	No	No	No	No	No
• Pt 100	Yes; Standard/climate	Yes; Standard/climate	Yes; Standard/climate	No	No
• Pt 100 according to GOST	No	No	No	No	No
• Pt 1000	Yes; Standard/climate	Yes; Standard/climate	Yes; Standard/climate	No	No
• Pt 1000 according to GOST	No	No	No	No	No
• Pt 200	Yes; Standard/climate	No	Yes; Standard/climate	No	No
• Pt 200 according to GOST	No	No	No	No	No
• Pt 500	Yes; Standard/climate	No	Yes; Standard/climate	No	No
• Pt 500 according to GOST	No	No	No	No	No
Input ranges (rated values), resistors					
• 0 to 150 ohms	Yes	No	Yes	No	No
• 0 to 300 ohms	Yes	No	Yes	No	No
• 0 to 600 ohms	Yes	Yes	Yes	No	No
• 0 to 3000 ohms	No	No	No	No	No
• 0 to 6000 ohms	Yes	Yes	Yes	No	No
• PTC	Yes	Yes	Yes	No	No
Thermocouple (TC)					
Temperature compensation					
- parameterizable	Yes		Yes		
Cable length					
• shielded, max.	800 m; for U/I, 200 m for R/RTD, 50 m for TC	200 m; 50 m at 50 mV	800 m; for U/I, 200 m for R/RTD, 50 m for TC	800 m	800 m

Technical specifications

Article number	6ES7531-7QD00-0AB0 S7-1500, AI 4xU/I/RTD/TC ST	6ES7531-7QF00-0AB0 S7-1500, AI 8xU/I/R/RTD BA	6ES7531-7KF00-0AB0 S7-1500, AI 8xU/I/RTD/TC ST	6ES7531-7NF10-0AB0 S7-1500, AI 8xU/I HS	6ES7531-7NF00-0AB0 S7-1500, AI 8xU/I HF
Analog value generation for the inputs					
Integration and conversion time/resolution per channel					
<ul style="list-style-type: none"> Resolution with overrange (bit including sign), max. 	16 bit	16 bit	16 bit	16 bit	24 bit; When using the function "Scaling of the measured values" or "Measuring range adaptation" (32 bit REAL format); 16 bit when using the S7 format (16 bit INTEGER)
<ul style="list-style-type: none"> Integration time, parameterizable 	Yes	Yes	Yes		Yes
<ul style="list-style-type: none"> Integration time (ms) 	2,5 / 16,67 / 20 / 100 ms	2,5 / 16,67 / 20 / 100 ms	2,5 / 16,67 / 20 / 100 ms		Fast mode: 2,5 / 16,67 / 20 / 100 ms, standard mode: 7,5 / 50 / 60 / 300 ms
<ul style="list-style-type: none"> Basic conversion time, including integration time (ms) 	9 / 23 / 27 / 107 ms	10 / 24 / 27 / 107 ms	9 / 23 / 27 / 107 ms		Fast mode: 4 / 18 / 22 / 102 ms; Standard mode: 9 / 52 / 62 / 302 ms
<ul style="list-style-type: none"> - additional conversion time for resistance measurement 	150 ohm, 300 ohm, 600 ohm, Pt100, Pt200, Ni100: 2 ms, 6000 ohm, Pt500, Pt1000, Ni1000, LG-Ni1000, PTC: 4 ms	8 ms	150 ohm, 300 ohm, 600 ohm, Pt100, Pt200, Ni100: 2 ms, 6000 ohm, Pt500, Pt1000, Ni1000, LG-Ni1000, PTC: 4 ms		
<ul style="list-style-type: none"> Interference voltage suppression for interference frequency f_1 in Hz 	400 / 60 / 50 / 10	400 / 60 / 50 / 10 Hz	400 / 60 / 50 / 10 Hz		400 / 60 / 50 / 10 Hz
<ul style="list-style-type: none"> Basic execution time of the module (all channels released) 					Corresponds to the channel with the highest basic conversion time
<ul style="list-style-type: none"> Basic execution time of the module (all channels released) 				62.5 μ s; independent of number of activated channels	
Smoothing of measured values					
<ul style="list-style-type: none"> parameterizable 	Yes	Yes	Yes	Yes	Yes
Encoder					
Connection of signal encoders					
<ul style="list-style-type: none"> for voltage measurement 	Yes	Yes	Yes	Yes	Yes
<ul style="list-style-type: none"> for current measurement as 2-wire transducer 	Yes	Yes; with external supply	Yes	Yes	Yes; with external transmitter supply
<ul style="list-style-type: none"> - Burden of 2-wire transmitter, max. 	820 Ω		820 Ω	820 Ω	
<ul style="list-style-type: none"> for current measurement as 4-wire transducer 	Yes	Yes	Yes	Yes	Yes
<ul style="list-style-type: none"> for resistance measurement with two-wire connection 	Yes; Only for PTC	Yes; Only for PTC	Yes; Only for PTC	No	No
<ul style="list-style-type: none"> for resistance measurement with three-wire connection 	Yes; All measuring ranges except PTC; internal compensation of the cable resistances	Yes; All measuring ranges except PTC; internal compensation of the cable resistances	Yes; All measuring ranges except PTC; internal compensation of the cable resistances	No	No
<ul style="list-style-type: none"> for resistance measurement with four-wire connection 	Yes; All measuring ranges except PTC		Yes; All measuring ranges except PTC	No	No

SIMATIC S7-1500 Advanced Controllers

I/O modules

Analog modules

SM 531 analog input modules

Technical specifications

Article number	6ES7531-7QD00-0AB0	6ES7531-7QF00-0AB0	6ES7531-7KF00-0AB0	6ES7531-7NF10-0AB0	6ES7531-7NF00-0AB0
	S7-1500, AI 4xU/I/RTD/TC ST	S7-1500, AI 8xU/I/R/RTD BA	S7-1500, AI 8xU/I/RTD/TC ST	S7-1500, AI 8xU/I HS	S7-1500, AI 8xU/I HF
Errors/accuracies					
Basic error limit (operational limit at 25 °C)					
• Voltage, relative to input range, (+/-)	0.1 %	0.3 %	0.1 %	0.2 %	0.05 %
• Current, relative to input range, (+/-)	0.1 %	0.3 %	0.1 %	0.2 %	0.05 %
• Resistance, relative to input range, (+/-)	0.1 %	0.3 %	0.1 %		
• Resistance thermometer, relative to input range, (+/-)	0.1 %; Ptxxx standard: ±0.7 K, Ptxxx climate: ±0.2 K, Nixxx standard: ±0.3 K, Nixxx climate: ±0.15 K	Ptxxx Standard: ±1.0 K, Ptxxx Climate: ±0.5 K, Nixxx Standard: ±0.5 K, Nixxx Climate: ±0.5 K	Ptxxx standard: ±0.7 K, Ptxxx climate: ±0.2 K, Nixxx standard: ±0.3 K, Nixxx climate: ±0.15 K		
• Thermocouple, relative to input range, (+/-)	0.1 %; Type B: > 600 °C ±1.7 K, type E: > -200 °C ±0.7 K, type J: > -210 °C ±0.8 K, type K: > -200 °C ±1.2 K, type N: > -200 °C ±1.2 K, type R: > 0 °C ±1.9 K, type S: > 0 °C ±1.9 K, type T: > -200 °C ±0.8 K		Type B: > 600 °C ±1.7 K, type E: > -200 °C ±0.7 K, type J: > -210 °C ±0.8 K, type K: > -200 °C ±1.2 K, type N: > -200 °C ±1.2 K, type R: > 0 °C ±1.9 K, type S: > 0 °C ±1.9 K, type T: > -200 °C ±0.8 K		
Interference voltage suppression for $f = n \times (f1 \pm 1 \%)$, $f1 =$ interference frequency					
• Series mode interference (peak value of interference < rated value of input range), min.	40 dB	40 dB	40 dB		80 dB; in the Standard operating mode, 40 dB in the Fast operating mode
• Common mode voltage, max.	10 V	4 V	10 V	10 V	60 V DC/30 V AC
• Common mode interference, min.	60 dB	60 dB	60 dB	50 dB at 400 Hz; 60 dB at 60 / 50 / 10 Hz	80 dB
Isochronous mode					
Filtering and processing time (TCI), min.				80 µs	
Bus cycle time (TDP), min.				250 µs	
Interrupts/diagnostics/status information					
Diagnostics function	Yes	Yes	Yes	Yes	Yes
Alarms					
• Diagnostic alarm	Yes	Yes	Yes	Yes	Yes
• Limit value alarm	Yes; two upper and two lower limit values in each case	Yes; two upper and two lower limit values in each case	Yes; two upper and two lower limit values in each case	Yes; two upper and two lower limit values in each case	Yes; two upper and two lower limit values in each case
Diagnoses					
• Monitoring the supply voltage	Yes	No	Yes	Yes	Yes
• Wire-break	Yes; Only for 1 to 5 V, 4 to 20 mA, TC, R, and RTD	Yes; Only for 1 ... 5 V, 4 ... 20 mA, R, and RTD	Yes; Only for 1 to 5 V, 4 to 20 mA, TC, R, and RTD	Yes; only for 1 ... 5 V and 4 ... 20 mA	Yes; only for 1 ... 5 V and 4 ... 20 mA
• Short-circuit		No			
• Group error		No			
• Overflow/underflow	Yes	Yes	Yes	Yes	Yes
Diagnostics indication LED					
• RUN LED	Yes; green LED	Yes; green LED	Yes; green LED	Yes; green LED	Yes; green LED
• ERROR LED	Yes; red LED	Yes; red LED	Yes; red LED	Yes; red LED	Yes; red LED
• MAINT LED		No			
• Monitoring of the supply voltage (PWR-LED)	Yes; green LED	No	Yes; green LED	Yes; green LED	Yes; green LED
• Channel status display	Yes; green LED	Yes; green LED	Yes; green LED	Yes; green LED	Yes; green LED
• for channel diagnostics	Yes; red LED	Yes; red LED	Yes; red LED	Yes; red LED	Yes; red LED
• for module diagnostics	Yes; red LED	Yes; red LED	Yes; red LED	Yes; red LED	Yes; red LED

Technical specifications

Article number	6ES7531-7QD00-0AB0	6ES7531-7QF00-0AB0	6ES7531-7KF00-0AB0	6ES7531-7NF10-0AB0	6ES7531-7NF00-0AB0
	S7-1500, AI 4xU/I/RTD/TC ST	S7-1500, AI 8xU/I/R/RTD BA	S7-1500, AI 8xU/I/RTD/TC ST	S7-1500, AI 8xU/I HS	S7-1500, AI 8xU/I HF
Potential separation					
Potential separation channels					
• between the channels and backplane bus	Yes	Yes	Yes	Yes	Yes
Standards, approvals, certificates					
Suitable for applications according to AMS 2750			Yes; Declaration of Conformity, see online support entry 109757262		
Suitable for applications according to CQI-9			Yes; Based on AMS 2750 E		
Ambient conditions					
Ambient temperature during operation					
• horizontal installation, min.	-25 °C; From FS03	0 °C	0 °C	-25 °C; From FS02	-30 °C; From FS02
• horizontal installation, max.	60 °C	60 °C	60 °C	60 °C	60 °C
• vertical installation, min.	-25 °C; From FS03	0 °C	0 °C	-25 °C; From FS02	-30 °C; From FS02
• vertical installation, max.	40 °C	40 °C	40 °C	40 °C	40 °C
Altitude during operation relating to sea level					
• Installation altitude above sea level, max.	5 000 m; Restrictions for installation altitudes > 2 000 m, see manual	5 000 m; Restrictions for installation altitudes > 2 000 m, see manual	5 000 m; Restrictions for installation altitudes > 2 000 m, see manual	5 000 m; Restrictions for installation altitudes > 2 000 m, see manual	
Dimensions					
Width	25 mm	35 mm	35 mm	35 mm	35 mm
Height	147 mm	147 mm	147 mm	147 mm	147 mm
Depth	129 mm	129 mm	129 mm	129 mm	129 mm
Weights					
Weight, approx.	210 g	250 g	310 g	300 g	280 g
Other					
Note:	Supplied incl. 40-pole push-in front connectors. Additional basic error and noise for integration time = 2.5 ms: Voltage: ±250 mV (±0.02%), ±80 mV (±0.05%), ±50 mV (±0.05%); resistance: 150 Ohms (±0.02%); resistance thermometer: Pt100 climate: ±0.08 K, Ni100 climate: ±0.08 K; thermoelement: Type B, R, S: ±3 K, type E, J, K, N, T: ±1 K		Additional basic error and noise for integration time = 2.5 ms: Voltage: ±250 mV (±0.02%), ±80 mV (±0.05%), ±50 mV (±0.05%); resistance: 150 ohms ±0.02%; resistance thermometer: Pt100 climate: ±0.08 K, Ni100 climate: ±0.08 K; thermocouple: Type B, R, S: ±3 K, type E, J, K, N, T: ±1 K		

SIMATIC S7-1500 Advanced Controllers

I/O modules

Analog modules

SM 531 analog input modules

Technical specifications

Article number	6ES7531-7LH00-0AB0 S7-1500, AI 16xU BA	6ES7531-7MH00-0AB0 S7-1500, AI 16xI BA
General information		
Product type designation	AI 16xU BA	AI 16xI BA
Product function		
• Isochronous mode	No	No
• Prioritized startup	No	No
• Measuring range scalable	No	No
• Scalable measured values	No	No
• Adjustment of measuring range	No	No
Engineering with		
• STEP 7 TIA Portal configurable/ integrated from version	V16 with HSP 312 / V17	V16 with HSP 312 / V17
• STEP 7 configurable/integrated from version	V5.5 SP3 / -	V5.5 SP3 / -
• PROFIBUS from GSD version/ GSD revision	V1.0 / V5.1	V1.0 / V5.1
• PROFINET from GSD version/ GSD revision	V2.3 / -	V2.3 / -
Operating mode		
• Oversampling	No	No
• MSI	Yes	Yes
Analog inputs		
Number of analog inputs	16	16
• For current measurement		16
• For voltage measurement	16	
permissible input voltage for voltage input (destruction limit), max.	12 V; 12 V continuous, 30 V for max. 1 s	
permissible input current for current input (destruction limit), max.		40 mA
Input ranges (rated values), voltages		
• 0 to +5 V	No	
• 0 to +10 V	No	
• 1 V to 5 V	Yes	
• -1 V to +1 V	Yes	
• -10 V to +10 V	Yes	
• -2.5 V to +2.5 V	No	
• -25 mV to +25 mV	No	
• -250 mV to +250 mV	No	
• -5 V to +5 V	Yes	
• -50 mV to +50 mV	No	
• -500 mV to +500 mV	No	
• -80 mV to +80 mV	No	
Input ranges (rated values), currents		
• 0 to 10 mA		No
• 0 to 20 mA		Yes
• -20 mA to +20 mA		Yes
• 4 mA to 20 mA		Yes
Cable length		
• shielded, max.	200 m	800 m

Technical specifications

Article number	6ES7531-7LH00-0AB0 S7-1500, AI 16xU BA	6ES7531-7MH00-0AB0 S7-1500, AI 16xI BA
Analog value generation for the inputs		
Integration and conversion time/resolution per channel		
• Resolution with overrange (bit including sign), max.	16 bit	16 bit
• Integration time, parameterizable	Yes	Yes
• Integration time (ms)	2,5 / 16,67 / 20 / 100 ms	2,5 / 16,67 / 20 / 100 ms
• Basic conversion time, including integration time (ms)	10 / 24 / 27 / 107 ms	10 / 24 / 27 / 107 ms
• Interference voltage suppression for interference frequency f1 in Hz	400 / 60 / 50 / 10 Hz	400 / 60 / 50 / 10 Hz
Smoothing of measured values		
• parameterizable	Yes	Yes
Encoder		
Connection of signal encoders		
• for voltage measurement	Yes	No
• for current measurement as 2-wire transducer		Yes; with external supply
• for current measurement as 4-wire transducer		Yes
• for resistance measurement with two-wire connection		No
• for resistance measurement with three-wire connection		No
• for resistance measurement with four-wire connection		No
Errors/accuracies		
Basic error limit (operational limit at 25 °C)		
• Voltage, relative to input range, (+/-)	0.3 %	
• Current, relative to input range, (+/-)		0.3 %
Interference voltage suppression for $f = n \times (f1 \pm 1 \%)$, f1 = interference frequency		
• Series mode interference (peak value of interference < rated value of input range), min.	40 dB	40 dB
• Common mode voltage, max.	4 V	4 V
• Common mode interference, min.	60 dB	60 dB
Interrupts/diagnostics/status information		
Diagnostics function	Yes	Yes
Alarms		
• Diagnostic alarm	Yes	Yes
• Limit value alarm	Yes; two upper and two lower limit values in each case	Yes; two upper and two lower limit values in each case
Diagnoses		
• Monitoring the supply voltage	No	No
• Wire-break	Yes; Only for 1 ... 5 V	Yes; Only for 4 ... 20 mA
• Short-circuit	No	No
• Group error	No	No
• Overflow/underflow	Yes	Yes
Diagnostics indication LED		
• RUN LED	Yes; green LED	Yes; green LED
• ERROR LED	Yes; red LED	Yes; red LED
• MAINT LED	No	No
• Monitoring of the supply voltage (PWR-LED)	No	No
• Channel status display	Yes; green LED	Yes; green LED
• for channel diagnostics	Yes; red LED	Yes; red LED
• for module diagnostics	Yes; red LED	Yes; red LED

SIMATIC S7-1500 Advanced Controllers

I/O modules

Analog modules

SM 531 analog input modules

Technical specifications

Article number	6ES7531-7LH00-0AB0 S7-1500, AI 16xU BA	6ES7531-7MH00-0AB0 S7-1500, AI 16xI BA
Potential separation		
Potential separation channels		
• between the channels and backplane bus	Yes	Yes
Ambient conditions		
Ambient temperature during operation		
• horizontal installation, min.	-30 °C	-30 °C
• horizontal installation, max.	60 °C	60 °C
• vertical installation, min.	-30 °C	-30 °C
• vertical installation, max.	40 °C	40 °C
Altitude during operation relating to sea level		
• Installation altitude above sea level, max.	5 000 m; Restrictions for installation altitudes > 2 000 m, see manual	5 000 m; Restrictions for installation altitudes > 2 000 m, see manual
Dimensions		
Width	35 mm	35 mm
Height	147 mm	147 mm
Depth	129 mm	129 mm
Weights		
Weight, approx.	250 g	250 g

Article number	6ES7531-7PF00-0AB0 S7-1500, AI 8 X U/R/RTD/TC HF
General information	
Product type designation	AI 8xU/R/RTD/TC HF
Product function	
• Isochronous mode	No
• Prioritized startup	Yes
• Measuring range scalable	Yes
• Scalable measured values	No
• Adjustment of measuring range	No
Engineering with	
• STEP 7 TIA Portal configurable/integrated from version	V14 / -
• STEP 7 configurable/integrated from version	V5.5 SP3 / -
• PROFIBUS from GSD version/GSD revision	V1.0 / V5.1
• PROFINET from GSD version/GSD revision	V2.3 / -
Operating mode	
• Oversampling	No
• MSI	Yes
Supply voltage	
Rated value (DC)	24 V
Reverse polarity protection	Yes
Analog inputs	
Number of analog inputs	8; Plus one additional RTD (reference) channel
• For voltage measurement	8; Plus one additional RTD (reference) channel
• For resistance/resistance thermometer measurement	8; Plus one additional RTD (reference) channel
• For thermocouple measurement	8; Plus one additional RTD (reference) channel
permissible input voltage for voltage input (destruction limit), max.	20 V

Article number	6ES7531-7PF00-0AB0 S7-1500, AI 8 X U/R/RTD/TC HF
Constant measurement current for resistance-type transmitter, typ.	150 Ohm, 300 Ohm, 600 Ohm, Cu10, Cu50, Cu100, Ni10, Ni100, Ni120, Ni200, Pt10, Pt50, Pt100, Pt200 climate: 1 mA; 6 kOhm, Ni500, Ni1000, LG-Ni1000, Pt200 standard, Pt500, Pt1000, PTC: 0.25 mA
Technical unit for temperature measurement adjustable	Yes; °C/°F/K
Input ranges (rated values), voltages	
• 0 to +5 V	No
• 0 to +10 V	No
• 1 V to 5 V	No
• -1 V to +1 V	Yes
• -10 V to +10 V	No
• -2.5 V to +2.5 V	No
• -25 mV to +25 mV	Yes
• -250 mV to +250 mV	Yes
• -5 V to +5 V	No
• -50 mV to +50 mV	Yes
• -500 mV to +500 mV	Yes
• -80 mV to +80 mV	Yes
Input ranges (rated values), currents	
• 0 to 20 mA	No
• -20 mA to +20 mA	No
• 4 mA to 20 mA	No
Input ranges (rated values), thermocouples	
• Type B	Yes
• Type C	Yes
• Type E	Yes
• Type J	Yes
• Type K	Yes
• Type L	No
• Type N	Yes
• Type R	Yes
• Type S	Yes
• Type T	Yes
• Type TXK/TXK(L) to GOST	Yes

Technical specifications

Article number	6ES7531-7PF00-0AB0 S7-1500, AI 8 X U/R/RTD/TC HF
Input ranges (rated values), resistance thermometer	
• Cu 10	Yes; Standard/climate
• Cu 10 according to GOST	Yes; Standard/climate
• Cu 50	Yes; Standard/climate
• Cu 50 according to GOST	Yes; Standard/climate
• Cu 100	Yes; Standard/climate
• Cu 100 according to GOST	Yes; Standard/climate
• Ni 10	Yes; Standard/climate
• Ni 10 according to GOST	Yes; Standard/climate
• Ni 100	Yes; Standard/climate
• Ni 100 according to GOST	Yes; Standard/climate
• Ni 1000	Yes; Standard/climate
• Ni 1000 according to GOST	Yes; Standard/climate
• LG-Ni 1000	Yes; Standard/climate
• Ni 120	Yes; Standard/climate
• Ni 120 according to GOST	Yes; Standard/climate
• Ni 200	Yes; Standard/climate
• Ni 200 according to GOST	Yes; Standard/climate
• Ni 500	Yes; Standard/climate
• Ni 500 according to GOST	Yes; Standard/climate
• Pt 10	Yes; Standard/climate
• Pt 10 according to GOST	Yes; Standard/climate
• Pt 50	Yes; Standard/climate
• Pt 50 according to GOST	Yes; Standard/climate
• Pt 100	Yes; Standard/climate
• Pt 100 according to GOST	Yes; Standard/climate
• Pt 1000	Yes; Standard/climate
• Pt 1000 according to GOST	Yes; Standard/climate
• Pt 200	Yes; Standard/climate
• Pt 200 according to GOST	Yes; Standard/climate
• Pt 500	Yes; Standard/climate
• Pt 500 according to GOST	Yes; Standard/climate
Input ranges (rated values), resistors	
• 0 to 150 ohms	Yes
• 0 to 300 ohms	Yes
• 0 to 600 ohms	Yes
• 0 to 3000 ohms	No
• 0 to 6000 ohms	Yes
• PTC	Yes
Thermocouple (TC)	
Temperature compensation	
- parameterizable	Yes
Cable length	
• shielded, max.	800 m; at U; 200 m at R/RTD/TC

Article number	6ES7531-7PF00-0AB0 S7-1500, AI 8 X U/R/RTD/TC HF
Analog value generation for the inputs	
Integration and conversion time/resolution per channel	
• Resolution with overrange (bit including sign), max.	21 bit; For measuring mode RTC and TC when using the function "Scalable temperature measuring range" (32 bit REAL format); 16 bit for measuring mode R and U; 16 bit for all measuring modes when using the S7 format (16 bit INTEGER)
• Integration time, parameterizable	Yes
• Integration time (ms)	Fast mode: 2.5 / 16.67 / 20 / 100 ms, standard mode: 7.5 / 50 / 60 / 300 ms
• Basic conversion time, including integration time (ms)	Fast mode: 4 / 18 / 22 / 102 ms; Standard mode: 9 / 52 / 62 / 302 ms
• Interference voltage suppression for interference frequency f1 in Hz	400 / 60 / 50 / 10 Hz
• Basic execution time of the module (all channels released)	Corresponds to the channel with the highest basic conversion time
Smoothing of measured values	
• parameterizable	Yes
Encoder	
Connection of signal encoders	
• for voltage measurement	Yes
• for current measurement as 2-wire transducer	No
• for current measurement as 4-wire transducer	No
• for resistance measurement with two-wire connection	Yes
• for resistance measurement with three-wire connection	Yes; All measuring ranges except PTC; internal compensation of the cable resistances
• for resistance measurement with four-wire connection	Yes; All measuring ranges except PTC
Errors/accuracies	
Basic error limit (operational limit at 25 °C)	
• Voltage, relative to input range, (+/-)	0.05 %
• Resistance, relative to input range, (+/-)	0.05 %
• Resistance thermometer, relative to input range, (+/-)	Cuxxx Standard: ±0.3 K, Cuxxx Klima: ±0.2 K, Ptxxx Standard: ±0.5 K, Ptxxx Klima: ±0.2 K, Nixxx Standard: ±0.3 K, Nixxx Klima: ±0.15 K
• Thermocouple, relative to input range, (+/-)	Type B: > 600 °C ±1 K, Type E: > -200 °C ±0.5 K, Type J: > -210 °C ±0.5 K, Type K: > -200 °C ±1 K, Type N: > -200 °C ±1 K, Type R: > 0 °C ±1 K, Type S: > 0 °C ±1 K, Type T: > -200 °C ±0.5 K, Type C: ±2 K, Type TXK/TXK(L): ±0.5 K
Interference voltage suppression for f = n x (f1 +/- 1 %), f1 = interference frequency	
• Series mode interference (peak value of interference < rated value of input range), min.	80 dB; in the Standard operating mode, 40 dB in the Fast operating mode
• Common mode voltage, max.	60 V DC/30 V AC
• Common mode interference, min.	80 dB

SIMATIC S7-1500 Advanced Controllers

I/O modules

Analog modules

SM 531 analog input modules

Technical specifications

Article number	6ES7531-7PF00-0AB0 S7-1500, AI 8 X U/R/RTD/TC HF
Interrupts/diagnostics/status information	
Diagnostics function	Yes
Alarms	
• Diagnostic alarm	Yes
• Limit value alarm	Yes; two upper and two lower limit values in each case
Diagnoses	
• Monitoring the supply voltage	Yes
• Wire-break	Yes; Only with TC, R, RTD
• Overflow/underflow	Yes
Diagnostics indication LED	
• RUN LED	Yes; green LED
• ERROR LED	Yes; red LED
• Monitoring of the supply voltage (PWR-LED)	Yes; green LED
• Channel status display	Yes; green LED
• for channel diagnostics	Yes; red LED
• for module diagnostics	Yes; red LED
Potential separation	
Potential separation channels	
• between the channels and backplane bus	Yes

Article number	6ES7531-7PF00-0AB0 S7-1500, AI 8 X U/R/RTD/TC HF
Standards, approvals, certificates	
Suitable for applications according to AMS 2750	Yes; Declaration of Conformity, see online support entry 109757262
Suitable for applications according to CQI-9	Yes; Based on AMS 2750 E
Ambient conditions	
Ambient temperature during operation	
• horizontal installation, min.	0 °C
• horizontal installation, max.	60 °C
• vertical installation, min.	0 °C
• vertical installation, max.	40 °C
Dimensions	
Width	35 mm
Height	147 mm
Depth	129 mm
Weights	
Weight, approx.	290 g
Other	
Note:	for the R/RDT three-wire measurement, the conductor compensation is made alternating with the measurement; this then requires two module cycles for a measured value

4

Overview



- 2, 4 and 8-channel analog output modules
- Optionally with extremely short conversion times
- For connecting analog actuators without additional amplifiers
- Even solves more complex automation tasks

Ordering data

SM 532 analog output modules

Module width 25 mm

2 x U/I ST; 2 analog outputs, ± 10 V, 1 ... 5 V, 0 ... 10 V or ± 20 mA, 0/4 ... 20 mA, 16-bit; incl. infeed element, shield bracket, shield terminal, labeling strips, U connector, printed front door

6ES7532-5NB00-0AB0

Module width 35 mm

4 x U/I ST; 4 analog outputs, ± 10 V, 1 ... 5 V, 0 ... 10 V or ± 20 mA, 0/4 ... 20 mA, 16-bit; incl. infeed element, shield bracket, shield terminal, labeling strips, U connector, printed front door

6ES7532-5HD00-0AB0

8 x U/I HF; 8 analog outputs, ± 10 V, 1 ... 5 V, 0 ... 10 V or ± 20 mA, 0/4 ... 20 mA, 16-bit; incl. infeed element, shield bracket, shield terminal, labeling strips, U connector, printed front door

6ES7532-5HF00-0AB0

4 x U/I HF; 4 analog outputs, ± 10 V, 1 ... 5 V, 0 ... 10 V or ± 20 mA, 0/4 ... 20 mA, 16-bit; incl. infeed element, shield bracket, shield terminal, labeling strips, U connector, printed front door

6ES7532-5ND00-0AB0

Accessories

Front connectors

For 35 mm modules; including four potential bridges, cable ties and individual labeling strips, 40-pin

- Screw terminals
- Push-in

6ES7592-1AM00-0XB0

6ES7592-1BM00-0XB0

For 25 mm modules; including cable ties and individual labeling strips; push-in terminal 40-pin; spare part

6ES7592-1BM00-0XA0

Article No.

DIN A4 labeling sheets

For 35 mm modules; 10 sheets with 10 labeling strips each for I/O modules; perforated, Al gray

6ES7592-2AX00-0AA0

For 25 mm modules; 10 sheets with 20 labeling strips each for I/O modules; perforated, Al gray

6ES7592-1AX00-0AA0

U connector

5 units; spare part

6ES7590-0AA00-0AA0

Universal front door for I/O modules

For 35 mm modules; 5 front doors; with 5 labeling strips (front) and 5 cabling diagrams per front door; spare part

6ES7528-0AA00-7AA0

For 25 mm modules; 5 front doors; with 5 labeling strips (front) and 5 cabling diagrams per front door; spare part

6ES7528-0AA00-0AA0

Shielding set I/O

For 35 mm modules; infeed element, shield bracket, and shield terminal; 5 units, spare part (one shield set supplied with the module).

6ES7590-5CA00-0AA0

For 25 mm modules; infeed element, shield bracket, and shield terminal; 4 units, spare part (one shield set supplied with the module).

6ES7590-5CA10-0XA0

Shield terminal element

10 units; spare part

6ES7590-5BA00-0AA0

SIMATIC Manual Collection

Electronic manuals on DVD, multi-language: LOGO!, SIMADYN, SIMATIC bus components, SIMATIC C7, SIMATIC distributed I/O, SIMATIC HMI, SIMATIC Sensors, SIMATIC NET, SIMATIC PC-based Automation, SIMATIC PCS 7, SIMATIC PG/PC, SIMATIC S7, SIMATIC software, SIMATIC TDC

6ES7998-8XC01-8YE0

SIMATIC Manual Collection update service for 1 year

Current "Manual Collection" DVD and the three subsequent updates

6ES7998-8XC01-8YE2

SIMATIC S7-1500 Advanced Controllers

I/O modules

Analog modules

SM 532 analog output modules

Technical specifications

Article number	6ES7532-5NB00-0AB0 S7-1500, AQ 2xU/I ST	6ES7532-5HD00-0AB0 S7-1500, AQ 4xU/I ST	6ES7532-5HF00-0AB0 S7-1500, AQ 8xU/I HS	6ES7532-5ND00-0AB0 S7-1500, AQ 4xU/I HF
General information				
Product type designation	AQ 2xU/I ST	AQ 4xU/I ST	AQ 8xU/I HS	AQ 4xU/I HF
Product function				
• Isochronous mode	No	No	Yes	Yes
• Prioritized startup	No	No	No	Yes
• Output range scalable	No	No	No	
Engineering with				
• STEP 7 TIA Portal configurable/ integrated from version	V13 / V13.0.2	V12 / V12	V14 / -	V14 / -
• STEP 7 configurable/integrated from version	V5.5 SP3 / -	V5.5 SP3 / -	V5.5 SP3 / -	V5.5 SP3 / -
• PROFIBUS from GSD version/ GSD revision	V1.0 / V5.1	V1.0 / V5.1	V1.0 / V5.1	V1.0 / V5.1
• PROFINET from GSD version/ GSD revision	V2.3 / -	V2.3 / -	V2.3 / -	V2.3 / -
Operating mode				
• Oversampling	No	No	Yes	No
• MSO	Yes	Yes	Yes	Yes
Supply voltage				
Rated value (DC)	24 V	24 V	24 V	24 V
Reverse polarity protection	Yes	Yes	Yes	Yes
Analog outputs				
Number of analog outputs	2	4	8	4
Cycle time (all channels), min.	3.2 ms; independent of number of activated channels	3.2 ms; independent of number of activated channels	125 µs; independent of number of activated channels	125 µs; independent of number of activated channels
Output ranges, voltage				
• 0 to 10 V	Yes	Yes	Yes	Yes
• 1 V to 5 V	Yes	Yes	Yes	Yes
• -5 V to +5 V	No	No	No	No
• -10 V to +10 V	Yes	Yes	Yes	Yes
Output ranges, current				
• 0 to 20 mA	Yes	Yes	Yes	Yes
• -20 mA to +20 mA	Yes	Yes	Yes	Yes
• 4 mA to 20 mA	Yes	Yes	Yes	Yes
Connection of actuators				
• for voltage output two-wire connection	Yes	Yes	Yes	Yes
• for voltage output four-wire connection	Yes	Yes	Yes	Yes
• for current output two-wire connection	Yes	Yes	Yes	Yes
Load impedance (in rated range of output)				
• with voltage outputs, min.	1 kΩ; 0.5 kΩhm at 1 to 5 V	1 kΩ; 0.5 kΩhm at 1 to 5 V	1 kΩ	1 kΩ; 0.5 kΩhm at 1 to 5 V
• with voltage outputs, capacitive load, max.	1 µF	1 µF	100 nF	1 µF
• with current outputs, max.	750 Ω	750 Ω	500 Ω	750 Ω
• with current outputs, inductive load, max.	10 mH	10 mH	1 mH	10 mH
Cable length				
• shielded, max.	800 m; for current, 200 m for voltage	800 m; for current, 200 m for voltage	200 m	800 m; for current, 200 m for voltage

Technical specifications

Article number	6ES7532-5NB00-0AB0 S7-1500, AQ 2xU/I ST	6ES7532-5HD00-0AB0 S7-1500, AQ 4xU/I ST	6ES7532-5HF00-0AB0 S7-1500, AQ 8xU/I HS	6ES7532-5ND00-0AB0 S7-1500, AQ 4xU/I HF
Analog value generation for the outputs				
Integration and conversion time/resolution per channel				
• Resolution with overrange (bit including sign), max.	16 bit	16 bit	16 bit	16 bit
• Conversion time (per channel)	0.5 ms	0.5 ms	50 µs; independent of number of activated channels	125 µs; independent of number of activated channels
Settling time				
• for resistive load	1.5 ms	1.5 ms	30 µs; see additional description in the manual	0.2 ms; see additional description in the manual
• for capacitive load	2.5 ms	2.5 ms	100 µs; see additional description in the manual	1.8 ms; see additional description in the manual
• for inductive load	2.5 ms	2.5 ms	100 µs; see additional description in the manual	2 ms; see additional description in the manual
Errors/accuracies				
Basic error limit (operational limit at 25 °C)				
• Voltage, relative to output range, (+/-)	0.2 %	0.2 %	0.2 %	0.06 %
• Current, relative to output range, (+/-)	0.2 %	0.2 %	0.2 %	0.1 %
Isochronous mode				
Execution and activation time (TCO), min.			100 µs	100 µs
Bus cycle time (TDP), min.			250 µs	250 µs
Interrupts/diagnostics/status information				
Diagnostics function	Yes	Yes	Yes	Yes
Substitute values connectable	Yes	Yes	Yes	Yes
Alarms				
• Diagnostic alarm	Yes	Yes	Yes	Yes
Diagnoses				
• Monitoring the supply voltage	Yes	Yes	Yes	Yes
• Wire-break	Yes; Only for output type "current"	Yes; Only for output type "current"	Yes; Only for output type "current"	Yes; Only for output type "current"
• Short-circuit	Yes; Only for output type "voltage"	Yes; Only for output type "voltage"	Yes; Only for output type "voltage"	Yes; Only for output type "voltage"
• Overflow/underflow	Yes	Yes	Yes	Yes
Diagnostics indication LED				
• RUN LED	Yes; green LED	Yes; green LED	Yes; green LED	Yes; green LED
• ERROR LED	Yes; red LED	Yes; red LED	Yes; red LED	Yes; red LED
• Monitoring of the supply voltage (PWR-LED)	Yes; green LED	Yes; green LED	Yes; green LED	Yes; green LED
• Channel status display	Yes; green LED	Yes; green LED	Yes; green LED	Yes; green LED
• for channel diagnostics	Yes; red LED	Yes; red LED	Yes; red LED	Yes; red LED
• for module diagnostics	Yes; red LED	Yes; red LED	Yes; red LED	Yes; red LED
Potential separation				
Potential separation channels				
• between the channels and backplane bus	Yes	Yes	Yes	Yes

SIMATIC S7-1500 Advanced Controllers

I/O modules

Analog modules

SM 532 analog output modules**Technical specifications**

Article number	6ES7532-5NB00-0AB0 S7-1500, AQ 2xU/I ST	6ES7532-5HD00-0AB0 S7-1500, AQ 4xU/I ST	6ES7532-5HF00-0AB0 S7-1500, AQ 8xU/I HS	6ES7532-5ND00-0AB0 S7-1500, AQ 4xU/I HF
Standards, approvals, certificates				
Suitable for safety-related tripping of standard modules	Yes; From FS02	Yes; From FS05	Yes; from FS04	Yes; From FS03
Highest safety class achievable for safety-related tripping of standard modules				
• Performance level according to ISO 13849-1	PL d	PL d	PL d	PL d
• Category according to ISO 13849-1	Cat. 3	Cat. 3	Cat. 3	Cat. 3
• SIL acc. to IEC 62061	SIL 2	SIL 2	SIL 2	SIL 2
Ambient conditions				
Ambient temperature during operation				
• horizontal installation, min.		-30 °C; From FS06	-30 °C; From FS03	-25 °C; From FS02
• horizontal installation, max.		60 °C	60 °C	60 °C
• vertical installation, min.		-30 °C; From FS06	-30 °C; From FS03	-25 °C; From FS02
• vertical installation, max.		40 °C	40 °C	40 °C
Altitude during operation relating to sea level				
• Installation altitude above sea level, max.	5 000 m; Restrictions for installation altitudes > 2 000 m, see manual	5 000 m; Restrictions for installation altitudes > 2 000 m, see manual	5 000 m; Restrictions for installation altitudes > 2 000 m, see manual	
Dimensions				
Width	25 mm	35 mm	35 mm	35 mm
Height	147 mm	147 mm	147 mm	147 mm
Depth	129 mm	129 mm	129 mm	129 mm
Weights				
Weight, approx.	200 g	310 g	325 g	300 g
Other				
Note:	Supplied incl. 40-pole push-in front connectors			

Overview



- 4 analog inputs/ 2 analog outputs
- For flexible adaptation of the PLC to the corresponding task
- For subsequent expansion of the system with additional inputs and outputs
- For use in the tightest spaces

Ordering data

SM 534 analog input/output module

Module width 25 mm

4 analog inputs
 ± 10 V, ± 5 V, ± 2.5 V, ± 1 V, ± 500 mV,
 ± 250 mV, ± 80 mV, ± 50 mV, 1 ... 5 V,
 0/4 ... 20 mA, ± 20 mA,
 thermocouples
 type B, E, J, K, N, R, S, T,
 resistance thermometers
 Ni 100, Ni 1000, LG-Ni 1000,
 Pt 100, Pt 1000, Pt 250, Pt 500,
 resistors
 0...150/300/600/6000 ohms,
 16 bits;
 2 analog outputs,
 ± 10 V, 1 ... 5 V, 0 ... 10 V or
 ± 20 mA, 0/4 ... 20 mA, 16 bits;
 incl. infeed element,
 shield bracket, shield terminal,
 labeling strips, U connector,
 printed front door

Accessories**Front connectors**

For 25 mm modules;
 including cable ties and
 individual labeling strips;
 push-in terminal 40-pin;
 spare part

DIN A4 labeling sheets

For 25 mm modules;
 10 sheets with
 20 labeling strips each for
 I/O modules; perforated,
 Al gray

U connector

5 units; spare part

Article No.

6ES7534-7QE00-0AB0

6ES7592-1BM00-0XA0

6ES7592-1AX00-0AA0

6ES7590-0AA00-0AA0

Article No.

Universal front door for I/O modules

For 25 mm modules;
 5 front doors;
 with 5 labeling strips (front)
 and 5 cabling diagrams per
 front door; spare part

Shielding set I/O

For 25 mm modules;
 infeed element, shield bracket,
 and shield terminal; 4 units,
 spare part (one shield set supplied
 with the module).

Shield terminal element

10 units; spare part

SIMATIC Manual Collection

Electronic manuals on
 DVD, multi-language:
 LOGO!, SIMADYN, SIMATIC
 bus components, SIMATIC C7,
 SIMATIC distributed I/O,
 SIMATIC HMI, SIMATIC Sensors,
 SIMATIC NET, SIMATIC PC-based
 Automation, SIMATIC PCS 7,
 SIMATIC PG/PC, SIMATIC S7,
 SIMATIC software, SIMATIC TDC

SIMATIC Manual Collection update service for 1 year

Current "Manual Collection" DVD
 and the three subsequent updates

6ES7528-0AA00-0AA0

6ES7590-5CA10-0XA0

6ES7590-5BA00-0AA0

6ES7998-8XC01-8YE0

6ES7998-8XC01-8YE2

SIMATIC S7-1500 Advanced Controllers

I/O modules

Analog modules

SM 534 analog input/output modules

Technical specifications

Article number	6ES7534-7QE00-0AB0 S7-1500, AI 4x U/I/RTD/TC/AQ 2x U/I ST
General information	
Product type designation	AI 4xU/I/RTD/TC /AQ 2xU/I ST
Product function	
• Isochronous mode	No
• Prioritized startup	No
• Measuring range scalable	No
• Scalable measured values	No
• Adjustment of measuring range	No
• Output range scalable	No
Engineering with	
• STEP 7 TIA Portal configurable/ integrated from version	V13 / V13.0.2
• STEP 7 configurable/integrated from version	V5.5 SP3 / -
• PROFIBUS from GSD version/ GSD revision	V1.0 / V5.1
• PROFINET from GSD version/ GSD revision	V2.3 / -
Operating mode	
• Oversampling	No
• MSI	Yes
• MSO	Yes
Supply voltage	
Rated value (DC)	24 V
Reverse polarity protection	Yes
Analog inputs	
Number of analog inputs	4
• For current measurement	4
• For voltage measurement	4
• For resistance/resistance thermometer measurement	2
• For thermocouple measurement	4
permissible input voltage for voltage input (destruction limit), max.	28.8 V
permissible input current for current input (destruction limit), max.	40 mA
Constant measurement current for resistance-type transmitter, typ.	150 Ohm, 300 Ohm, 600 Ohm, Pt100, Pt200, Ni100: 1.25 mA; 6 000 Ohm, Pt500, Pt1000, Ni1000, LG-Ni1000: 0.625 mA; PTC: 0.472 mA
Technical unit for temperature measurement adjustable	Yes; °C/°F/K
Analog input with oversampling	No
Standardization of measured values	No
Input ranges (rated values), voltages	
• 0 to +5 V	No
• 0 to +10 V	No
• 1 V to 5 V	Yes
• -1 V to +1 V	Yes
• -10 V to +10 V	Yes
• -2.5 V to +2.5 V	Yes
• -25 mV to +25 mV	No
• -250 mV to +250 mV	Yes
• -5 V to +5 V	Yes
• -50 mV to +50 mV	Yes
• -500 mV to +500 mV	Yes
• -80 mV to +80 mV	Yes

Article number	6ES7534-7QE00-0AB0 S7-1500, AI 4x U/I/RTD/TC/AQ 2x U/I ST
Input ranges (rated values), currents	
• 0 to 20 mA	Yes
• -20 mA to +20 mA	Yes
• 4 mA to 20 mA	Yes
Input ranges (rated values), thermocouples	
• Type B	Yes
• Type C	No
• Type E	Yes
• Type J	Yes
• Type K	Yes
• Type L	No
• Type N	Yes
• Type R	Yes
• Type S	Yes
• Type T	Yes
• Type U	No
• Type TXK/TXK(L) to GOST	No
Input ranges (rated values), resistance thermometer	
• Cu 10	No
• Cu 10 according to GOST	No
• Cu 50	No
• Cu 50 according to GOST	No
• Cu 100	No
• Cu 100 according to GOST	No
• Ni 10	No
• Ni 10 according to GOST	No
• Ni 100	Yes; Standard/climate
• Ni 100 according to GOST	No
• Ni 1000	Yes; Standard/climate
• Ni 1000 according to GOST	No
• LG-Ni 1000	Yes; Standard/climate
• Ni 120	No
• Ni 120 according to GOST	No
• Ni 200	No
• Ni 200 according to GOST	No
• Ni 500	No
• Ni 500 according to GOST	No
• Pt 10	No
• Pt 10 according to GOST	No
• Pt 50	No
• Pt 50 according to GOST	No
• Pt 100	Yes; Standard/climate
• Pt 100 according to GOST	No
• Pt 1000	Yes; Standard/climate
• Pt 1000 according to GOST	No
• Pt 200	Yes; Standard/climate
• Pt 200 according to GOST	No
• Pt 500	Yes; Standard/climate
• Pt 500 according to GOST	No

Technical specifications

Article number	6ES7534-7QE00-0AB0 S7-1500, AI 4x U/I/RTD/TC/AQ 2x U/I ST
Input ranges (rated values), resistors	
• 0 to 150 ohms	Yes
• 0 to 300 ohms	Yes
• 0 to 600 ohms	Yes
• 0 to 3000 ohms	No
• 0 to 6000 ohms	Yes
• PTC	Yes
Thermocouple (TC)	
Temperature compensation	
- parameterizable	Yes
Cable length	
• shielded, max.	800 m; for U/I, 200 m for R/RTD, 50 m for TC
Analog outputs	
Number of analog outputs	2
Cycle time (all channels), min.	3.2 ms; ±0.5 ms, regardless of the number of activated channels
Output ranges, voltage	
• 0 to 10 V	Yes
• 1 V to 5 V	Yes
• -5 V to +5 V	No
• -10 V to +10 V	Yes
Output ranges, current	
• 0 to 20 mA	Yes
• -20 mA to +20 mA	Yes
• 4 mA to 20 mA	Yes
Connection of actuators	
• for voltage output two-wire connection	Yes
• for voltage output four-wire connection	Yes
• for current output two-wire connection	Yes
Load impedance (in rated range of output)	
• with voltage outputs, min.	1 kΩ; 0.5 kΩhm at 1 to 5 V
• with voltage outputs, capacitive load, max.	1 μF
• with current outputs, max.	750 Ω
• with current outputs, inductive load, max.	10 mH
Cable length	
• shielded, max.	800 m; for current, 200 m for voltage

Article number	6ES7534-7QE00-0AB0 S7-1500, AI 4x U/I/RTD/TC/AQ 2x U/I ST
Analog value generation for the inputs	
Integration and conversion time/resolution per channel	
• Resolution with overrange (bit including sign), max.	16 bit
• Integration time, parameterizable	Yes
• Integration time (ms)	2.5 / 16.67 / 20 / 100 ms
• Basic conversion time, including integration time (ms)	9 / 23 / 27 / 107 ms
- additional conversion time for resistance measurement	150 ohm, 300 ohm, 600 ohm, Pt100, Pt200, Ni100: 2 ms, 6000 ohm, Pt500, Pt1000, Ni1000, LG-Ni1000, PTC: 4 ms
• Interference voltage suppression for interference frequency f1 in Hz	400 / 60 / 50 / 10
Smoothing of measured values	
• parameterizable	Yes
Analog value generation for the outputs	
Integration and conversion time/resolution per channel	
• Resolution with overrange (bit including sign), max.	16 bit
• Conversion time (per channel)	0.5 ms
Settling time	
• for resistive load	1.5 ms
• for capacitive load	2.5 ms
• for inductive load	2.5 ms
Encoder	
Connection of signal encoders	
• for voltage measurement	Yes
• for current measurement as 2-wire transducer	Yes
- Burden of 2-wire transmitter, max.	820 Ω
• for current measurement as 4-wire transducer	Yes
• for resistance measurement with two-wire connection	Yes; Only for PTC
• for resistance measurement with three-wire connection	Yes; All measuring ranges except PTC; internal compensation of the cable resistances
• for resistance measurement with four-wire connection	Yes; All measuring ranges except PTC

SIMATIC S7-1500 Advanced Controllers

I/O modules

Analog modules

SM 534 analog input/output modules

Technical specifications

Article number	6ES7534-7QE00-0AB0 S7-1500, AI 4x U/I/RTD/TC/AQ 2x U/I ST
Errors/accuracies	
Basic error limit (operational limit at 25 °C)	
• Voltage, relative to input range, (+/-)	0.1 %
• Current, relative to input range, (+/-)	0.1 %
• Resistance, relative to input range, (+/-)	0.1 %
• Resistance thermometer, relative to input range, (+/-)	0.1 %; Ptxxx standard: ± 0.7 K, Ptxxx climate: ± 0.2 K, Nixxx standard: ± 0.3 K, Nixxx climate: ± 0.15 K
• Thermocouple, relative to input range, (+/-)	0.1 %; Type B: > 600 °C ± 1.7 K, type E: > -200 °C ± 0.7 K, type J: > -210 °C ± 0.8 K, type K: > -200 °C ± 1.2 K, type N: > -200 °C ± 1.2 K, type R: > 0 °C ± 1.9 K, type S: > 0 °C ± 1.9 K, type T: > -200 °C ± 0.8 K
• Voltage, relative to output range, (+/-)	0.2 %
• Current, relative to output range, (+/-)	0.2 %
Interference voltage suppression for $f = n \times (f1 \pm 1 \%)$, $f1 =$ interference frequency	
• Series mode interference (peak value of interference < rated value of input range), min.	40 dB
• Common mode voltage, max.	10 V
• Common mode interference, min.	60 dB
Interrupts/diagnostics/status information	
Diagnostics function	Yes
Substitute values connectable	Yes
Alarms	
• Diagnostic alarm	Yes
• Limit value alarm	Yes; two upper and two lower limit values in each case
Diagnoses	
• Monitoring the supply voltage	Yes
• Wire-break	Yes; only for input type 1 ... 5 V, 4 ... 20 mA, TC, R, RTD and output type current
• Short-circuit	Yes; Only for output type "voltage"
• Overflow/underflow	Yes
Diagnostics indication LED	
• RUN LED	Yes; green LED
• ERROR LED	Yes; red LED
• Monitoring of the supply voltage (PWR-LED)	Yes; green LED
• Channel status display	Yes; green LED
• for channel diagnostics	Yes; red LED
• for module diagnostics	Yes; red LED

Article number	6ES7534-7QE00-0AB0 S7-1500, AI 4x U/I/RTD/TC/AQ 2x U/I ST
Potential separation	
Potential separation analog inputs	
• between the channels and backplane bus	Yes
Potential separation analog outputs	
• between the channels and backplane bus	Yes
Ambient conditions	
Ambient temperature during operation	
• horizontal installation, min.	0 °C
• horizontal installation, max.	60 °C
• vertical installation, min.	0 °C
• vertical installation, max.	40 °C
Altitude during operation relating to sea level	
• Installation altitude above sea level, max.	5 000 m; Restrictions for installation altitudes > 2 000 m, see manual
Dimensions	
Width	25 mm
Height	147 mm
Depth	129 mm
Weights	
Weight, approx.	250 g
Other	
Note:	Supplied incl. 40-pole push-in front connectors. Additional basic error and noise for integration time = 2.5 ms: Voltage: ± 250 mV ($\pm 0.02\%$), ± 80 mV ($\pm 0.05\%$), ± 50 mV ($\pm 0.05\%$); resistance: 150 Ohms ($\pm 0.02\%$); resistance thermometer: Pt100 climate: ± 0.08 K, Ni100 climate: ± 0.08 K; thermoelement: Type B, R, S: ± 3 K, type E, J, K, N, T: ± 1 K

Overview



- 8-channel analog input modules
- Optionally with extremely short conversion times
- For the connection of analog sensors without additional amplifiers
- Even solves more complex automation tasks

Note:

SIPLUS extreme products are based on SIMATIC standard products. The contents listed here were taken from the respective standard products. SIPLUS extreme-specific information was added.

Ordering data

Article No.

SIPLUS SM 531 analog input modules

(Extended temperature range and exposure to environmental substances)

8 analog inputs,
±10 V, ±5 V, 1 ... 5 V or
0/4 ... 20 mA, ±20 mA,
16 bits + sign; incl. infeed element,
shielding bracket, shield terminal,
labeling strips, U connector,
printed front door

6AG1531-7NF10-7AB0

8 analog inputs
±10 V, ±5 V, ±2.5 V, ±1 V, ±500 mV,
±250 mV, ±80 mV, ±50 mV, 1 ... 5 V,
0/4 ... 20 mA, ±20 mA,
thermocouples
type B, E, J, K, N, R, S, T,
resistance thermometers
Ni 100, Ni 1000, LG-Ni 1000,
Pt 100, Pt 1000, Pt 250, Pt 500,
resistors
0...150/300/600/6000 ohms, 16 bits

6AG1531-7KF00-7AB0

8 analog inputs,
±10 V, ±5 V, 1 ... 5 V or
0/4 ... 20 mA, ±20 mA,
16 bits + sign; including infeed
element, shielding bracket,
shield terminal, labeling strips,
U connector, printed front door

6AG1531-7NF00-7AB0

8 analog inputs,
±1 V, ±500 mV, ±250 mV, ±80 mV,
±50 mV, ±25 mV;
thermocouples
type B, E, J, K, N, R, S, T,
TXK/TXK(L) according to GOST;
resistance thermometers
Cu 10, Cu 50, Cu 100, Ni 10,
Ni 100, Ni 120, Ni 200, Ni 500,
Ni 1000, LG-Ni 1000, Pt10, Pt50,
Pt100, Pt200, Pt500, Pt1000;
resistors
0...150/300/600/6 000 ohms,
PTC; 16 bit; incl. infeed element,
shield bracket, shield terminal,
labeling strips, U connector,
printed front door

6AG1531-7PF00-4AB0**Accessories**

See SIMATIC S7-1500
SM 531 analog input modules,
page 4/120

Technical specifications

Article number	6AG1531-7NF10-7AB0	6AG1531-7KF00-7AB0	6AG1531-7NF00-7AB0	6AG1531-7PF00-4AB0
Based on	6ES7531-7NF10-0AB0	6ES7531-7KF00-0AB0	6ES7531-7NF00-0AB0	6ES7531-7PF00-0AB0
	SIPLUS S7-1500 AI 8xU/I HS	SIPLUS S7-1500 AI 8xU/I/RTD/TC ST	SIPLUS S7-1500 AI 8xU/I HF	SIPLUS S7-1500 AI 8xU/R/RTD/TC HF
Ambient conditions				
Ambient temperature during operation				
• horizontal installation, min.	-40 °C; = Tmin (incl. condensation/frost)	-40 °C; = Tmin (incl. condensation/frost)	-40 °C; = Tmin (incl. condensation/frost)	0 °C; = Tmin (incl. condensation/frost)
• horizontal installation, max.	70 °C; = Tmax	70 °C; = Tmax	70 °C; = Tmax	60 °C; = Tmax
• vertical installation, min.	-40 °C; = Tmin	-40 °C; = Tmin	-40 °C; = Tmin	0 °C; = Tmin
• vertical installation, max.	40 °C; = Tmax	40 °C; = Tmax	40 °C; = Tmax	40 °C; = Tmax
Altitude during operation relating to sea level				
• Installation altitude above sea level, max.	5 000 m	5 000 m	5 000 m	5 000 m
• Ambient air temperature-barometric pressure-altitude	Tmin ... Tmax at 1 140 hPa ... 795 hPa (-1 000 m ... +2 000 m) // Tmin ... (Tmax - 10 K) at 795 hPa ... 658 hPa (+2 000 m ... +3 500 m) // Tmin ... (Tmax -20 K) at 658 hPa ... 540 hPa (+3 500 m ... +5 000 m)	Tmin ... Tmax at 1 140 hPa ... 795 hPa (-1 000 m ... +2 000 m) // Tmin ... (Tmax - 10 K) at 795 hPa ... 658 hPa (+2 000 m ... +3 500 m) // Tmin ... (Tmax -20 K) at 658 hPa ... 540 hPa (+3 500 m ... +5 000 m)	Tmin ... Tmax at 1 140 hPa ... 795 hPa (-1 000 m ... +2 000 m) // Tmin ... (Tmax - 10 K) at 795 hPa ... 658 hPa (+2 000 m ... +3 500 m) // Tmin ... (Tmax -20 K) at 658 hPa ... 540 hPa (+3 500 m ... +5 000 m)	Tmin ... Tmax at 1 140 hPa ... 795 hPa (-1 000 m ... +2 000 m) // Tmin ... (Tmax - 10 K) at 795 hPa ... 658 hPa (+2 000 m ... +3 500 m) // Tmin ... (Tmax -20 K) at 658 hPa ... 540 hPa (+3 500 m ... +5 000 m)

SIMATIC S7-1500 Advanced Controllers

I/O modules

SIPLUS analog modules

SIPLUS SM 531 analog input modules

Technical specifications

Article number	6AG1531-7NF10-7AB0	6AG1531-7KF00-7AB0	6AG1531-7NF00-7AB0	6AG1531-7PF00-4AB0
Based on	6ES7531-7NF10-0AB0 SIPLUS S7-1500 AI 8xU/I HS	6ES7531-7KF00-0AB0 SIPLUS S7-1500 AI 8xU/I/RTD/TC ST	6ES7531-7NF00-0AB0 SIPLUS S7-1500 AI 8xU/I HF	6ES7531-7PF00-0AB0 SIPLUS S7-1500 AI 8xU/R/RTD/TC HF
Relative humidity				
<ul style="list-style-type: none"> With condensation, tested in accordance with IEC 60068-2-38, max. 	100 %; RH incl. condensation/frost (no commissioning under condensation conditions)	100 %; RH incl. condensation/frost (no commissioning under condensation conditions)	100 %; RH incl. condensation / frost (no commissioning in bedewed state), horizontal installation	100 %; RH incl. condensation / frost (no commissioning in bedewed state), horizontal installation
Resistance				
Coolants and lubricants				
- Resistant to commercially available coolants and lubricants	Yes; Incl. diesel and oil droplets in the air	Yes; Incl. diesel and oil droplets in the air	Yes; Incl. diesel and oil droplets in the air	Yes; Incl. diesel and oil droplets in the air
Use in stationary industrial systems				
- to biologically active substances according to EN 60721-3-3	Yes; Class 3B2 mold, fungus and dry rot spores (with the exception of fauna); Class 3B3 on request	Yes; Class 3B2 mold, fungus and dry rot spores (with the exception of fauna); Class 3B3 on request	Yes; Class 3B2 mold, fungus and dry rot spores (with the exception of fauna); Class 3B3 on request	Yes; Class 3B2 mold, fungus and dry rot spores (with the exception of fauna); Class 3B3 on request
- to chemically active substances according to EN 60721-3-3	Yes; Class 3C4 (RH < 75 %) incl. salt spray acc. to EN 60068-2-52 (severity degree 3); *	Yes; Class 3C4 (RH < 75 %) incl. salt spray acc. to EN 60068-2-52 (severity degree 3); *	Yes; Class 3C4 (RH < 75 %) incl. salt spray acc. to EN 60068-2-52 (severity degree 3); *	Yes; Class 3C4 (RH < 75 %) incl. salt spray acc. to EN 60068-2-52 (severity degree 3); *
- to mechanically active substances according to EN 60721-3-3	Yes; Class 3S4 incl. sand, dust; *	Yes; Class 3S4 incl. sand, dust; *	Yes; Class 3S4 incl. sand, dust; *	Yes; Class 3S4 incl. sand, dust; *
Use on ships/at sea				
- to biologically active substances according to EN 60721-3-6	Yes; Class 6B2 mold and fungal spores (excluding fauna); Class 6B3 on request	Yes; Class 6B2 mold and fungal spores (excluding fauna); Class 6B3 on request	Yes; Class 6B2 mold and fungal spores (excluding fauna); Class 6B3 on request	Yes; Class 6B2 mold and fungal spores (excluding fauna); Class 6B3 on request
- to chemically active substances according to EN 60721-3-6	Yes; Class 6C3 (RH < 75 %) incl. salt spray acc. to EN 60068-2-52 (severity degree 3); *	Yes; Class 6C3 (RH < 75 %) incl. salt spray acc. to EN 60068-2-52 (severity degree 3); *	Yes; Class 6C3 (RH < 75 %) incl. salt spray acc. to EN 60068-2-52 (severity degree 3); *	Yes; Class 6C3 (RH < 75 %) incl. salt spray acc. to EN 60068-2-52 (severity degree 3); *
- to mechanically active substances according to EN 60721-3-6	Yes; Class 6S3 incl. sand, dust; *	Yes; Class 6S3 incl. sand, dust; *	Yes; Class 6S3 incl. sand, dust; *	Yes; Class 6S3 incl. sand, dust; *
Usage in industrial process technology				
- Against chemically active substances acc. to EN 60654-4	Yes; Class 3 (excluding trichlorethylene)	Yes; Class 3 (excluding trichlorethylene)	Yes; Class 3 (excluding trichlorethylene)	Yes; Class 3 (excluding trichlorethylene)
- Environmental conditions for process, measuring and control systems acc. to ANSI/ISA-71.04	Yes; Level GX group A/B (excluding trichlorethylene; harmful gas concentrations up to the limits of EN 60721-3-3 class 3C4 permissible); level LC3 (salt spray) and level LB3 (oil)	Yes; Level GX group A/B (excluding trichlorethylene; harmful gas concentrations up to the limits of EN 60721-3-3 class 3C4 permissible); level LC3 (salt spray) and level LB3 (oil)	Yes; Level GX group A/B (excluding trichlorethylene; harmful gas concentrations up to the limits of EN 60721-3-3 class 3C4 permissible); level LC3 (salt spray) and level LB3 (oil)	Yes; Level GX group A/B (excluding trichlorethylene; harmful gas concentrations up to the limits of EN 60721-3-3 class 3C4 permissible); level LC3 (salt spray) and level LB3 (oil)
Remark				
- Note regarding classification of environmental conditions acc. to EN 60721, EN 60654-4 and ANSI/ISA-71.04	* The supplied plug covers must remain in place over the unused interfaces during operation!	* The supplied plug covers must remain in place over the unused interfaces during operation!	* The supplied plug covers must remain in place over the unused interfaces during operation!	* The supplied plug covers must remain in place over the unused interfaces during operation!
Conformal coating				
<ul style="list-style-type: none"> Coatings for printed circuit board assemblies acc. to EN 61086 Protection against fouling acc. to EN 60664-3 Military testing according to MIL-I-46058C, Amendment 7 Qualification and Performance of Electrical Insulating Compound for Printed Board Assemblies according to IPC-CC-830A 	Yes; Class 2 for high reliability Yes; Type 1 protection Yes; Discoloration of coating possible during service life Yes; Conformal coating, Class A	Yes; Class 2 for high reliability Yes; Type 1 protection Yes; Discoloration of coating possible during service life Yes; Conformal coating, Class A	Yes; Class 2 for high reliability Yes; Type 1 protection Yes; Discoloration of coating possible during service life Yes; Conformal coating, Class A	Yes; Class 2 for high reliability Yes; Type 1 protection Yes; Discoloration of coating possible during service life Yes; Conformal coating, Class A

Overview



- 4 and 8-channel analog output modules
- Optionally with extremely short conversion times
- For connecting analog actuators without additional amplifiers
- Even solves more complex automation tasks

Note:

SIPLUS extreme products are based on SIMATIC standard products. The contents listed here were taken from the respective standard products. SIPLUS extreme-specific information was added.

Ordering data

Article No.

SIPLUS SM 532 analog output modules

(Extended temperature range and exposure to media)

4 analog outputs,
±10 V, 1 ... 5 V, 0 ... 10 V or
±20 mA, 0/4 ... 20 mA, 16-bit

6AG1532-5HD00-7AB0

8 analog outputs,
±10 V, 1 ... 5 V, 0 ... 10 V or
±20 mA, 0/4 ... 20 mA, 16-bit;
incl. infeed element, shield clamp,
shield terminal, labeling strips,
U connector, printed front door

6AG1532-5HF00-7AB0**Accessories**

See SIMATIC S7-1500
SM 532 analog output modules,
page 4/131

Technical specifications

Article number	6AG1532-5HD00-7AB0	6AG1532-5HF00-7AB0
Based on	6ES7532-5HD00-0AB0 SIPLUS S7-1500 AQ 4xU/I ST	6ES7532-5HF00-0AB0 SIPLUS S7-1500 AQ 8xU/I HS
Ambient conditions		
Ambient temperature during operation		
• horizontal installation, min.	-40 °C; = Tmin (incl. condensation/frost)	-40 °C; = Tmin (incl. condensation/frost); start-up @ -25 °C
• horizontal installation, max.	70 °C; = Tmax	70 °C; = Tmax; > +60 °C max. 4x ±10 V permissible
• vertical installation, min.	-40 °C; = Tmin	-40 °C; = Tmin; Startup @ -25 °C
• vertical installation, max.	40 °C; = Tmax	40 °C; = Tmax
Altitude during operation relating to sea level		
• Installation altitude above sea level, max.	5 000 m	5 000 m
• Ambient air temperature-barometric pressure-altitude	Tmin ... Tmax at 1 140 hPa ... 795 hPa (-1 000 m ... +2 000 m) // Tmin ... (Tmax - 10 K) at 795 hPa ... 658 hPa (+2 000 m ... +3 500 m) // Tmin ... (Tmax -20 K) at 658 hPa ... 540 hPa (+3 500 m ... +5 000 m)	Tmin ... Tmax at 1 140 hPa ... 795 hPa (-1 000 m ... +2 000 m) // Tmin ... (Tmax - 10 K) at 795 hPa ... 658 hPa (+2 000 m ... +3 500 m) // Tmin ... (Tmax -20 K) at 658 hPa ... 540 hPa (+3 500 m ... +5 000 m)
Relative humidity		
• With condensation, tested in accordance with IEC 60068-2-38, max.	100 %; RH incl. condensation/frost (no commissioning under condensation conditions)	100 %; RH incl. condensation/frost (no commissioning under condensation conditions)

SIMATIC S7-1500 Advanced Controllers

I/O modules

SIPLUS analog modules

SIPLUS SM 532 analog output modules

Technical specifications

Article number	6AG1532-5HD00-7AB0	6AG1532-5HF00-7AB0
Based on	6ES7532-5HD00-0AB0 SIPLUS S7-1500 AQ 4xU/I ST	6ES7532-5HF00-0AB0 SIPLUS S7-1500 AQ 8xU/I HS
Resistance		
Coolants and lubricants		
- Resistant to commercially available coolants and lubricants	Yes; Incl. diesel and oil droplets in the air	Yes; Incl. diesel and oil droplets in the air
Use in stationary industrial systems		
- to biologically active substances according to EN 60721-3-3	Yes; Class 3B2 mold, fungus and dry rot spores (with the exception of fauna); Class 3B3 on request	Yes; Class 3B2 mold, fungus and dry rot spores (with the exception of fauna); Class 3B3 on request
- to chemically active substances according to EN 60721-3-3	Yes; Class 3C4 (RH < 75 %) incl. salt spray acc. to EN 60068-2-52 (severity degree 3); *	Yes; Class 3C4 (RH < 75 %) incl. salt spray acc. to EN 60068-2-52 (severity degree 3); *
- to mechanically active substances according to EN 60721-3-3	Yes; Class 3S4 incl. sand, dust, *	Yes; Class 3S4 incl. sand, dust, *
Use on ships/at sea		
- to biologically active substances according to EN 60721-3-6	Yes; Class 6B2 mold and fungal spores (excluding fauna); Class 6B3 on request	Yes; Class 6B2 mold and fungal spores (excluding fauna); Class 6B3 on request
- to chemically active substances according to EN 60721-3-6	Yes; Class 6C3 (RH < 75 %) incl. salt spray acc. to EN 60068-2-52 (severity degree 3); *	Yes; Class 6C3 (RH < 75 %) incl. salt spray acc. to EN 60068-2-52 (severity degree 3); *
- to mechanically active substances according to EN 60721-3-6	Yes; Class 6S3 incl. sand, dust; *	Yes; Class 6S3 incl. sand, dust; *
Usage in industrial process technology		
- Against chemically active substances acc. to EN 60654-4	Yes; Class 3 (excluding trichlorethylene)	Yes; Class 3 (excluding trichlorethylene)
- Environmental conditions for process, measuring and control systems acc. to ANSI/ISA-71.04	Yes; Level GX group A/B (excluding trichlorethylene; harmful gas concentrations up to the limits of EN 60721-3-3 class 3C4 permissible); level LC3 (salt spray) and level LB3 (oil)	Yes; Level GX group A/B (excluding trichlorethylene; harmful gas concentrations up to the limits of EN 60721-3-3 class 3C4 permissible); level LC3 (salt spray) and level LB3 (oil)
Remark		
- Note regarding classification of environmental conditions acc. to EN 60721, EN 60654-4 and ANSI/ISA-71.04	* The supplied plug covers must remain in place over the unused interfaces during operation!	* The supplied plug covers must remain in place over the unused interfaces during operation!
Conformal coating		
• Coatings for printed circuit board assemblies acc. to EN 61086	Yes; Class 2 for high reliability	Yes; Class 2 for high reliability
• Protection against fouling acc. to EN 60664-3	Yes; Type 1 protection	Yes; Type 1 protection
• Military testing according to MIL-I-46058C, Amendment 7	Yes; Discoloration of coating possible during service life	Yes; Discoloration of coating possible during service life
• Qualification and Performance of Electrical Insulating Compound for Printed Board Assemblies according to IPC-CC-830A	Yes; Conformal coating, Class A	Yes; Conformal coating, Class A

Overview



- 2-channel high-speed counter module
- With comprehensive parameterization options for an optimum adaptation to the task and reduction of control load
- Speed and time period measuring
- Storage and comparison functions
- Connection of 24 V encoders

Ordering data

TM Count 2x24V counter module

With 2 channels, max. 200 kHz; for 24 V encoder

Accessories

Front connector

For 35 mm modules; including four potential bridges, cable ties and individual labeling strips, 40-pin

- Screw terminals
- Push-in

DIN A4 labeling sheets

10 sheets with 10 labeling strips each for I/O modules; perforated, Al grey

U connector

5 units; spare part

Universal front door for I/O modules

5 front doors; with 5 labeling strips (front) and 5 cabling diagrams per front door; spare part

Article No.

6ES7550-1AA01-0AB0

6ES7592-1AM00-0XB0

6ES7592-1BM00-0XB0

6ES7592-2AX00-0AA0

6ES7590-0AA00-0AA0

6ES7528-0AA00-7AA0

Article No.

Shielding set I/O

Infeed element, shield clamp, and shield terminal; 5 units, spare part

Shield terminal element

10 units; spare part

SIMATIC Manual Collection

Electronic manuals on DVD, multi-language: LOGO!, SIMADYN, SIMATIC bus components, SIMATIC C7, SIMATIC distributed I/O, SIMATIC HMI, SIMATIC Sensors, SIMATIC NET, SIMATIC PC-based Automation, SIMATIC PCS 7, SIMATIC PG/PC, SIMATIC S7, SIMATIC Software, SIMATIC TDC

SIMATIC Manual Collection update service for 1 year

Current Manual Collection DVD and the three subsequent updates

6ES7590-5CA00-0AA0

6ES7590-5BA00-0AA0

6ES7998-8XC01-8YE0

6ES7998-8XC01-8YE2

Technical specifications

Article number	6ES7550-1AA01-0AB0 S7-1500, TM Count 2x24V
General information	
Product type designation	TM Count 2x24V
Product function	
• I&M data	Yes; I&M0 to I&M3
• Isochronous mode	Yes
Engineering with	
• STEP 7 TIA Portal configurable/integrated from version	V16 with HSP 0332 / V17
• PROFIBUS from GSD version/GSD revision	GSD Revision 5
• PROFINET from GSD version/GSD revision	V2.3 / -

Article number	6ES7550-1AA01-0AB0 S7-1500, TM Count 2x24V
Installation type/mounting	
Rail mounting	Yes; S7-1500 mounting rail
Supply voltage	
Load voltage L+	
• Rated value (DC)	24 V
• Reverse polarity protection	Yes
Encoder supply	
Number of outputs	1; A common 24V encoder supply for both channels
24 V encoder supply	
• 24 V	Yes; L+ (-0.8 V)
• Short-circuit protection	Yes
• Output current, max.	1 A; total current of all encoders/channels

SIMATIC S7-1500 Advanced Controllers

I/O modules

Technology modules

TM Count 2x24V counter module

Technical specifications

Article number	6ES7550-1AA01-0AB0 S7-1500, TM Count 2x24V
Digital inputs	
Number of digital inputs	6; 3 per channel
Digital inputs, parameterizable	Yes
Input characteristic curve in accordance with IEC 61131, type 3	Yes
Digital input functions, parameterizable	
• Gate start/stop	Yes
• Capture	Yes
• Synchronization	Yes
• Freely usable digital input	Yes
Input voltage	
• Type of input voltage	DC
• Rated value (DC)	24 V
• for signal "0"	-5 ... +5 V
• for signal "1"	+11 to +30V
• permissible voltage at input, min.	-30 V; -5 V continuous, -30 V brief reverse polarity protection
• permissible voltage at input, max.	30 V
Input current	
• for signal "1", typ.	2.5 mA
Input delay (for rated value of input voltage) for standard inputs	
- parameterizable	Yes; none / 0.05 / 0.1 / 0.4 / 0.8 / 1.6 / 3.2 / 12.8 / 20 ms
- at "0" to "1", min.	6 µs; for parameterization "none"
- at "1" to "0", min.	6 µs; for parameterization "none"
for technological functions	
- parameterizable	Yes
Digital outputs	
Type of digital output	Transistor
Number of digital outputs	4; 2 per channel
Digital outputs, parameterizable	Yes
Short-circuit protection	Yes; electronic/thermal
Limitation of inductive shutdown voltage to	L+ (-53 V)
Controlling a digital input	Yes
Digital output functions, parameterizable	
• Switching tripped by comparison values	Yes
• Freely usable digital output	Yes
Switching capacity of the outputs	
• with resistive load, max.	0.5 A; Per digital output
• on lamp load, max.	5 W
Load resistance range	
• lower limit	48 Ω
• upper limit	12 kΩ
Output voltage	
• Type of output voltage	DC
• for signal "1", min.	23.2 V; L+ (-0.8 V)
Output current	
• for signal "1" rated value	0.5 A; Per digital output
• for signal "0" residual current, max.	0.5 mA
Output delay with resistive load	
• "0" to "1", max.	50 µs
• "1" to "0", max.	50 µs

Article number	6ES7550-1AA01-0AB0 S7-1500, TM Count 2x24V
Switching frequency	
• with resistive load, max.	10 kHz
• with inductive load, max.	0.5 Hz; Acc. to IEC 60947-5-1, DC-13; observe derating curve
• on lamp load, max.	10 Hz
Total current of the outputs	
• Current per module, max.	2 A
Encoder	
Connectable encoders	
• 2-wire sensor	Yes
- permissible quiescent current (2-wire sensor), max.	1.5 mA
Encoder signals, incremental encoder (asymmetrical)	
• Input voltage	24 V
• Input frequency, max.	200 kHz
• Counting frequency, max.	800 kHz; with quadruple evaluation
• Cable length, shielded, max.	600 m; depending on input frequency, encoder and cable quality; max. 50 m at 200 kHz
• Signal filter, parameterizable	Yes
• Incremental encoder with A/B tracks, 90° phase offset	Yes
• Incremental encoder with A/B tracks, 90° phase offset and zero track	Yes
• pulse encoder	Yes
• pulse encoder with direction	Yes
• pulse encoder with one impulse signal per count direction	Yes
Encoder signal 24 V	
- permissible voltage at input, min.	-30 V
- permissible voltage at input, max.	30 V
Interface types	
• Source/sink input	Yes
• Input characteristic curve in accordance with IEC 61131, type 3	Yes
Interrupts/diagnostics/status information	
Alarms	
• Diagnostic alarm	Yes
• Hardware interrupt	Yes
Diagnoses	
• Monitoring the supply voltage	Yes
• Wire-break	Yes
• Short-circuit	Yes
• A/B transition error at incremental encoder	Yes
Diagnostics indication LED	
• RUN LED	Yes; green LED
• ERROR LED	Yes; red LED
• MAINT LED	Yes; Yellow LED
• Monitoring of the supply voltage (PWR-LED)	Yes; green LED
• Channel status display	Yes; green LED
• for channel diagnostics	Yes; red LED

Technical specifications

Article number	6ES7550-1AA01-0AB0 S7-1500, TM Count 2x24V
Integrated Functions	
Counter	Yes
• Number of counters	2
• Counting frequency, max.	800 kHz; with quadruple evaluation
Fast mode	Yes
Counting functions	
• Can be used with TO High_Speed_Counter	Yes
• Continuous counting	Yes
• Counter response parameterizable	Yes
• Hardware gate via digital input	Yes
• Software gate	Yes
• Event-controlled stop	Yes
• Synchronization via digital input	Yes
• Counting range, parameterizable	Yes
Comparator	
- Number of comparators	2; Per channel
- Direction dependency	Yes
- Can be changed from user program	Yes
Position detection	
• Incremental acquisition	Yes
• Suitable for S7-1500 Motion Control	Yes
• suitable for SIMOTION	Yes
Measuring functions	
• Measuring time, parameterizable	Yes
• Dynamic measurement period adjustment	Yes
• Number of thresholds, parameterizable	2
Measuring range	
- Frequency measurement, min.	0.04 Hz
- Frequency measurement, max.	800 kHz
- Cycle duration measurement, min.	1.25 µs
- Cycle duration measurement, max.	25 s
Accuracy	
- Frequency measurement	100 ppm; depending on measuring interval and signal evaluation
- Cycle duration measurement	100 ppm; depending on measuring interval and signal evaluation
- Velocity measurement	100 ppm; depending on measuring interval and signal evaluation

Article number	6ES7550-1AA01-0AB0 S7-1500, TM Count 2x24V
Potential separation	
Potential separation channels	
• between the channels and backplane bus	Yes
Ambient conditions	
Ambient temperature during operation	
• horizontal installation, min.	-30 °C
• horizontal installation, max.	60 °C; Please note derating for inductive loads
• vertical installation, min.	-30 °C
• vertical installation, max.	40 °C; Please note derating for inductive loads
Altitude during operation relating to sea level	
• Installation altitude above sea level, max.	5 000 m; restrictions for installation altitudes > 2 000 m, see ET 200MP system manual
Decentralized operation	
to SIMATIC S7-300	Yes
to SIMATIC S7-400	Yes
to SIMATIC S7-1200	Yes
to SIMATIC S7-1500	Yes
to standard PROFIBUS master	Yes
to standard PROFINET controller	Yes
Dimensions	
Width	35 mm
Height	147 mm
Depth	129 mm
Weights	
Weight, approx.	250 g

SIMATIC S7-1500 Advanced Controllers

I/O modules

Technology modules

TM PosInput 2 counter and position detection module

Overview



- 2-channel counter and position detection module with RS 422 interface
- Extensive parameterization options for optimum task-specific adaptation
- Reduces load on controller due to preprocessing on the module
- Position detection with incremental and SSI absolute encoders
- Speed and time period measuring
- Storage and comparison functions
- Connection of encoders with RS 422 signals or 5V-TTL signals

Ordering data

TM PosInput 2 counter and position detection module

With 2 channels, max. 1 MHz counting frequency; for SSI encoders and incremental encoders with RS 422 or 5V TTL interface

Accessories

Front connector

For 35 mm modules; including four potential bridges, cable ties and individual labeling strips, 40-pin

- Screw terminals
- Push-in

DIN A4 labeling sheets

10 sheets with 10 labeling strips each for I/O modules; perforated, AI grey

U connector

5 units; spare part

Universal front door for I/O modules

5 front doors; with 5 labeling strips (front) and 5 cabling diagrams per front door; spare part

Article No.

6ES7551-1AB00-0AB0

6ES7592-1AM00-0XB0

6ES7592-1BM00-0XB0

6ES7592-2AX00-0AA0

6ES7590-0AA00-0AA0

6ES7528-0AA00-7AA0

Article No.

Shielding set I/O

Infeed element, shield clamp, and shield terminal; 5 units, spare part

Shield terminal element

10 units; spare part

SIMATIC Manual Collection

Electronic manuals on DVD, multi-language: LOGO!, SIMADYN, SIMATIC bus components, SIMATIC C7, SIMATIC distributed I/O, SIMATIC HMI, SIMATIC Sensors, SIMATIC NET, SIMATIC PC-based Automation, SIMATIC PCS 7, SIMATIC PG/PC, SIMATIC S7, SIMATIC Software, SIMATIC TDC

SIMATIC Manual Collection update service for 1 year

Current Manual Collection DVD and the three subsequent updates

6ES7590-5CA00-0AA0

6ES7590-5BA00-0AA0

6ES7998-8XC01-8YE0

6ES7998-8XC01-8YE2

Technical specifications

Article number	6ES7551-1AB00-0AB0 S7-1500, TM Posinput 2
General information	
Product type designation	TM PosInput 2
Product function	
• I&M data	Yes; I&M0 to I&M3
• Isochronous mode	Yes
Engineering with	
• STEP 7 TIA Portal configurable/integrated from version	V12 (FW V1.0) ... V15 (FW V1.3)/ V12 (FW V1.0), V13 (FW V1.1)
• PROFIBUS from GSD version/ GSD revision	GSD Revision 5
• PROFINET from GSD version/ GSD revision	V2.3 / -

Article number	6ES7551-1AB00-0AB0 S7-1500, TM Posinput 2
Installation type/mounting	
Rail mounting	Yes; S7-1500 mounting rail
Supply voltage	
Load voltage L+	
• Rated value (DC)	24 V
• Reverse polarity protection	Yes
Encoder supply	
Number of outputs	4; One 5V and 24V encoder supply per channel
5 V encoder supply	
• 5 V	Yes; 5.2 V ±2 %
• Short-circuit protection	Yes
• Output current, max.	300 mA; Per channel

Technical specifications

Article number	6ES7551-1AB00-0AB0 S7-1500, TM Posinput 2
24 V encoder supply	
• 24 V	Yes; L+ (-0.8 V)
• Short-circuit protection	Yes
• Output current, max.	300 mA; Per channel
Digital inputs	
Number of digital inputs	4; 2 per channel
Digital inputs, parameterizable	Yes
Input characteristic curve in accordance with IEC 61131, type 3	Yes
Digital input functions, parameterizable	
• Gate start/stop	Yes; only for pulse and incremental encoders
• Capture	Yes
• Synchronization	Yes; only for pulse and incremental encoders
• Freely usable digital input	Yes
Input voltage	
• Type of input voltage	DC
• Rated value (DC)	24 V
• for signal "0"	-5 ... +5 V
• for signal "1"	+11 to +30V
• permissible voltage at input, min.	-30 V; -5 V continuous, -30 V brief reverse polarity protection
• permissible voltage at input, max.	30 V
Input current	
• for signal "1", typ.	2.5 mA
Input delay (for rated value of input voltage) for standard inputs	
- parameterizable	Yes; none / 0.05 / 0.1 / 0.4 / 0.8 / 1.6 / 3.2 / 12.8 / 20 ms
- at "0" to "1", min.	6 µs; for parameterization "none"
- at "1" to "0", min.	6 µs; for parameterization "none"
for technological functions	
- parameterizable	Yes
Digital outputs	
Type of digital output	Transistor
Number of digital outputs	4; 2 per channel
Digital outputs, parameterizable	Yes
Short-circuit protection	Yes; electronic/thermal
Limitation of inductive shutdown voltage to	L+ (-33 V)
Controlling a digital input	Yes
Digital output functions, parameterizable	
• Switching tripped by comparison values	Yes
• Freely usable digital output	Yes
Switching capacity of the outputs	
• with resistive load, max.	0.5 A; Per digital output
• on lamp load, max.	5 W
Load resistance range	
• lower limit	48 Ω
• upper limit	12 kΩ
Output voltage	
• Type of output voltage	DC
• for signal "1", min.	23.2 V; L+ (-0.8 V)
Output current	
• for signal "1" rated value	0.5 A; Per digital output
• for signal "0" residual current, max.	0.5 mA

Article number	6ES7551-1AB00-0AB0 S7-1500, TM Posinput 2
Output delay with resistive load	
• "0" to "1", max.	50 µs
• "1" to "0", max.	50 µs
Switching frequency	
• with resistive load, max.	10 kHz
• with inductive load, max.	0.5 Hz; Acc. to IEC 60947-5-1, DC-13; observe derating curve
• on lamp load, max.	10 Hz
Total current of the outputs	
• Current per module, max.	2 A
Encoder	
Encoder signals, incremental encoder (symmetrical)	
• Input voltage	RS 422
• Input frequency, max.	1 MHz
• Counting frequency, max.	4 MHz; with quadruple evaluation
• Cable length, shielded, max.	32 m; at 1 MHz
• Signal filter, parameterizable	Yes
• Incremental encoder with A/B tracks, 90° phase offset	Yes
• Incremental encoder with A/B tracks, 90° phase offset and zero track	Yes
• pulse encoder	Yes
• Pulse encoder with direction	Yes
• pulse encoder with one impulse signal per count direction	Yes
Encoder signals, incremental encoder (asymmetrical)	
• Input voltage	5 V TTL (push-pull encoders only)
• Input frequency, max.	1 MHz
• Counting frequency, max.	4 MHz; with quadruple evaluation
• Signal filter, parameterizable	Yes
• Incremental encoder with A/B tracks, 90° phase offset	Yes
• Incremental encoder with A/B tracks, 90° phase offset and zero track	Yes
• pulse encoder	Yes
• pulse encoder with direction	Yes
• pulse encoder with one impulse signal per count direction	Yes
Encoder signals, absolute encoder (SSI)	
• Input signal	to RS-422
• Telegram length, parameterizable	10 ... 40 bit
• Clock frequency, max.	2 MHz; 125 kHz, 250 kHz, 500 kHz, 1 MHz, 1.5 MHz or 2 MHz
• Binary code	Yes
• Gray code	Yes
• Cable length, shielded, max.	320 m; Cable length, RS-422 SSI absolute encoders, Siemens type 6FX2001-5, 24 V supply: 125 kHz, 320 meters shielded, max.; 250 kHz, 160 meters shielded, max.; 500 kHz, 60 meters shielded, max.; 1 MHz, 20 meters shielded, max. 1.5 MHz, 10 meters shielded, max.; 2 MHz, 8 meters shielded, max.
• Parity bit, parameterizable	Yes
• Monoflop time	16, 32, 48, 64 µs & automatic
• Multiturn	Yes
• Singleturn	Yes
Interface types	
• TTL 5 V	Yes; push-pull encoders only
• RS 422	Yes

SIMATIC S7-1500 Advanced Controllers

I/O modules

Technology modules

TM Posinput 2 counter and position detection module

Technical specifications

Article number	6ES7551-1AB00-0AB0 S7-1500, TM Posinput 2
Isochronous mode	
Filtering and processing time (TCI), min.	130 µs; only for pulse and incremental encoders
Bus cycle time (TDP), min.	250 µs
Interrupts/diagnostics/status information	
Alarms	
• Diagnostic alarm	Yes
• Hardware interrupt	Yes
Diagnoses	
• Monitoring the supply voltage	Yes
• Wire-break	Yes
• Short-circuit	Yes
• A/B transition error at incremental encoder	Yes
• Telegram error at SSI encoder	Yes
Diagnostics indication LED	
• RUN LED	Yes; green LED
• ERROR LED	Yes; red LED
• MAINT LED	Yes; Yellow LED
• Monitoring of the supply voltage (PWR-LED)	Yes; green LED
• Channel status display	Yes; green LED
• for channel diagnostics	Yes; red LED
Integrated Functions	
Counter	Yes
• Number of counters	2
• Counting frequency, max.	4 MHz; with quadruple evaluation
Counting functions	
• Can be used with TO High_Speed_Counter	Yes; only for pulse and incremental encoders
• Continuous counting	Yes
• Counter response parameterizable	Yes
• Hardware gate via digital input	Yes
• Software gate	Yes
• Event-controlled stop	Yes
• Synchronization via digital input	Yes
• Counting range, parameterizable	Yes
Comparator	
- Number of comparators	2; Per channel
- Direction dependency	Yes
- Can be changed from user program	Yes
Position detection	
• Incremental acquisition	Yes
• Absolute acquisition	Yes
• Suitable for S7-1500 Motion Control	Yes

Article number	6ES7551-1AB00-0AB0 S7-1500, TM Posinput 2
Measuring functions	
• Measuring time, parameterizable	Yes
• Dynamic measurement period adjustment	Yes
• Number of thresholds, parameterizable	2
Measuring range	
- Frequency measurement, min.	0.04 Hz
- Frequency measurement, max.	4 MHz
- Cycle duration measurement, min.	0.25 µs
- Cycle duration measurement, max.	25 s
Accuracy	
- Frequency measurement	100 ppm; depending on measuring interval and signal evaluation
- Cycle duration measurement	100 ppm; depending on measuring interval and signal evaluation
- Velocity measurement	100 ppm; depending on measuring interval and signal evaluation
Potential separation	
Potential separation channels	
• between the channels and backplane bus	Yes
Ambient conditions	
Ambient temperature during operation	
• horizontal installation, min.	0 °C
• horizontal installation, max.	60 °C; Please note derating for inductive loads
• vertical installation, min.	0 °C
• vertical installation, max.	40 °C; Please note derating for inductive loads
Altitude during operation relating to sea level	
• Installation altitude above sea level, max.	5 000 m; restrictions for installation altitudes > 2 000 m, see ET 200MP system manual
Decentralized operation	
to SIMATIC S7-300	Yes
to SIMATIC S7-400	Yes
to SIMATIC S7-1200	Yes
to SIMATIC S7-1500	Yes
to standard PROFIBUS master	Yes; FW V1.1 and higher
to standard PROFINET controller	Yes
Dimensions	
Width	35 mm
Height	147 mm
Depth	129 mm
Weights	
Weight, approx.	325 g

4

Overview



- 8 digital inputs, 16 digital outputs, of which up to 16 can be used in different configurations as technological, time-controlled channels
- Inputs for detecting the input edges with μs accuracy
- Outputs for outputting switching signals with μs accuracy
- 32x oversampling
- PWM output
- Counter function
- Outputs can be switched between 0.5 A standard and especially fast 0.1 A high-speed operation

Ordering data

Article No.

TM Timer DIDQ 16x24V time-based IO module	6ES7552-1AA00-0AB0
Max. 16 time-controlled inputs or outputs	
Accessories	
Front connector	
For 35 mm modules; including four potential bridges, cable ties and individual labeling strips, 40-pin	
<ul style="list-style-type: none"> • Screw terminals • Push-in 	6ES7592-1AM00-0XB0 6ES7592-1BM00-0XB0
DIN A4 labeling sheets	6ES7592-2AX00-0AA0
10 sheets with 10 labeling strips each for I/O modules; perforated, Al grey	
U connector	6ES7590-0AA00-0AA0
5 units; spare part	
Universal front door for I/O modules	6ES7528-0AA00-7AA0
5 front doors; with 5 labeling strips (front) and 5 cabling diagrams per front door; spare part	
Shielding set I/O	6ES7590-5CA00-0AA0
Infeed element, shield bracket, and shield terminal; 5 units, spare part:	
Note: Only shield bracket and shield terminal are required for the TM Timer DIDQ 16x24V	
Shield terminal element	6ES7590-5BA00-0AA0
10 units; spare part	
SIMATIC Manual Collection	6ES7998-8XC01-8YE0
Electronic manuals on DVD, multi-language: LOGO!, SIMADYN, SIMATIC bus components, SIMATIC C7, SIMATIC distributed I/O, SIMATIC HMI, SIMATIC Sensors, SIMATIC NET, SIMATIC PC-based Automation, SIMATIC PCS 7, SIMATIC PG/PC, SIMATIC S7, SIMATIC Software, SIMATIC TDC	
SIMATIC Manual Collection update service for 1 year	6ES7998-8XC01-8YE2
Current Manual Collection DVD and the three subsequent updates	

SIMATIC S7-1500 Advanced Controllers

I/O modules

Technology modules

TM Timer DIDQ 16x24V time-based IO module

Technical specifications

Article number	6ES7552-1AA00-0AB0 S7-1500, TM Timer DIDQ 16x24V
General information	
Product type designation	TM Timer DIDQ 16x24V
Product function	
• I&M data	Yes; I&M 0
• Isochronous mode	Yes
Engineering with	
• STEP 7 TIA Portal configurable/ integrated from version	V13 Update 3
Installation type/mounting	
Rail mounting	Yes; S7-1500 mounting rail
Supply voltage	
Load voltage 1L+	
• Rated value (DC)	24 V
• Reverse polarity protection	Yes; against destruction
Load voltage 2L+	
• Rated value (DC)	24 V
• Reverse polarity protection	Yes; against destruction
Encoder supply	
Number of outputs	8; max. depending on parameterization
24 V encoder supply	
• 24 V	Yes; L+ (-0.8 V)
• Short-circuit protection	Yes
• Output current, max.	1.2 A; Total current of all encoders / channels, max. 0.5 A per output
Digital inputs	
Number of digital inputs	8; max. depending on parameterization
• in groups of	8
Digital inputs, parameterizable	Yes
Input characteristic curve in accordance with IEC 61131, type 3	Yes
Digital input functions, parameterizable	
• Digital input with time stamp - Number, max.	Yes 8
• Counter - Number, max.	Yes 4
• Counter for incremental encoder - Number, max.	Yes 4
• Digital input with oversampling - Number, max.	Yes 8
• HW enable for digital input - Number, max.	Yes 4
• HW enable for digital output - Number, max.	Yes 4
Input voltage	
• Type of input voltage	DC
• Rated value (DC)	24 V
• for signal "0"	-5 ... +5 V
• for signal "1"	+11 to +30V
• permissible voltage at input, min.	-30 V; -5 V continuous, -30 V brief reverse polarity protection
• permissible voltage at input, max.	30 V
Input current	
• for signal "1", typ.	2.5 mA

Article number	6ES7552-1AA00-0AB0 S7-1500, TM Timer DIDQ 16x24V
Input delay (for rated value of input voltage)	
• Minimum pulse width for program reactions	3 µs for parameterization "none"
for standard inputs	
- parameterizable	Yes; none / 0.05 / 0.1 / 0.4 / 0.8 ms
- at "0" to "1", min.	4 µs; for parameterization "none"
- at "1" to "0", min.	4 µs; for parameterization "none"
Digital outputs	
Type of digital output	Transistor
Number of digital outputs	16; max. depending on parameterization
• in groups of	8
Digital outputs, parameterizable	Yes
Short-circuit protection	Yes; electronic/thermal
Limitation of inductive shutdown voltage to	-0.8 V
Controlling a digital input	Yes
Digital output functions, parameterizable	
• Digital output with time stamp	Yes
- Number, max.	16
• PWM output	Yes
- Number, max.	16
• Digital output with oversampling	Yes
- Number, max.	16
Switching capacity of the outputs	
• with resistive load, max.	0.5 A; 0.1 A with High Speed output
• on lamp load, max.	5 W; 1 W with High Speed output
Load resistance range	
• lower limit	48 Ω; 240 ohm with High Speed output
• upper limit	12 kΩ
Output voltage	
• Type of output voltage	DC
• for signal "0", max.	1 V; With High Speed output
• for signal "1", min.	23.2 V; L+ (-0.8 V)
Output current	
• for signal "1" rated value	0.5 A; 0.1 A with High Speed output, observe derating
• for signal "0" residual current, max.	0.5 mA
Output delay with resistive load	
• "0" to "1", max.	1 µs; With High Speed output, 5 µs with Standard output
• "1" to "0", max.	1 µs; With High Speed output, 6 µs with Standard output
Switching frequency	
• with resistive load, max.	10 kHz
• on lamp load, max.	10 Hz
Total current of the outputs	
• Current per group, max.	4 A
• Current per module, max.	8 A; Observe derating

Technical specifications

Article number	6ES7552-1AA00-0AB0 S7-1500, TM Timer DIDQ 16x24V
Encoder	
Connectable encoders	
• Incremental encoder (asymmetrical)	Yes
• 24 V initiator	Yes
• 2-wire sensor	Yes
- permissible quiescent current (2-wire sensor), max.	1.5 mA
Encoder signals, incremental encoder (asymmetrical)	
• Input voltage	24 V
• Input frequency, max.	50 kHz
• Counting frequency, max.	200 kHz; with quadruple evaluation
• Cable length, shielded, max.	600 m; Depending on input frequency, encoder and cable quality; max. 200 m at 50 kHz
• Incremental encoder with A/B tracks, 90° phase offset	Yes
• pulse encoder	Yes
Encoder signal 24 V	
- permissible voltage at input, min.	-30 V
- permissible voltage at input, max.	30 V
Interface types	
• Input characteristic curve in accordance with IEC 61131, type 3	Yes
Isochronous mode	
Bus cycle time (TDP), min.	250 µs
Interrupts/diagnostics/status information	
Diagnostics function	Yes
Substitute values connectable	Yes
Alarms	
• Diagnostic alarm	Yes
Diagnoses	
• Monitoring the supply voltage	Yes
• Short-circuit	Yes
Diagnostics indication LED	
• RUN LED	Yes; green LED
• ERROR LED	Yes; red LED
• MAINT LED	Yes; yellow LED
• Monitoring of the supply voltage (PWR-LED)	Yes; green LED
• Channel status display	Yes; green LED
• for channel diagnostics	Yes; red LED

Article number	6ES7552-1AA00-0AB0 S7-1500, TM Timer DIDQ 16x24V
Integrated Functions	
Counter	Yes
• Number of counters	4
• Counting frequency, max.	200 kHz; with quadruple evaluation
Counting functions	
• Continuous counting	Yes
Position detection	
• Incremental acquisition	Yes
Potential separation	
Potential separation channels	
• between the channels and backplane bus	Yes
Ambient conditions	
Ambient temperature during operation	
• horizontal installation, min.	0 °C
• horizontal installation, max.	60 °C
• vertical installation, min.	0 °C
• vertical installation, max.	40 °C; Observe derating
Altitude during operation relating to sea level	
• Installation altitude above sea level, max.	5 000 m; restrictions for installation altitudes > 2 000 m, see ET 200MP system manual
Decentralized operation to SIMATIC S7-1500	
	Yes
Dimensions	
Width	35 mm
Height	147 mm
Depth	129 mm
Weights	
Weight, approx.	320 g

SIMATIC S7-1500 Advanced Controllers

I/O modules

Technology modules

TM PTO 4 interface module for PTO (Pulse Train Output)

Overview

- 4-channel interface module for PTO (Pulse Train Output)
- 3 signal interfaces can be configured for speed and direction:
 - 24 V asymmetrical up to 200 kHz
 - RS422, 5 V symmetrical up to 1 MHz
 - TTL 5 V asymmetrical up to 200 kHz
- 3 signal types can be configured:
 - Pulse and direction
 - Pulses for forward movement and pulses for backwards movement
 - 2 phase-shifted signals, with simple or quadruple evaluation
- Supported technology objects:
 - Speed controlled axis (S7-1500, S7-1500T)
 - Positioning axis (S7-1200, S7-1500, S7-1500T)
 - Synchronous axis (S7-1500, S7-1500T)
 - Probe (S7-1500, S7-1500T)

Ordering data

Ordering data	Article No.	Ordering data	Article No.
TM PTO 4 interface module for stepper drives 4 Pulse Train Output PTO channels; PTO: 24 V or RS422; 2 DQ PTO, 2 DI 24 V, 1 DIQ 24 V per channel	6ES7553-1AA00-0AB0	Universal front door for I/O modules 5 front doors; with 5 labeling strips (front) and 5 cabling diagrams per front door; spare part	6ES7528-0AA00-7AA0
Accessories		Shielding set I/O Infeed element, shield clamp, and shield terminal; 5 units, spare part	6ES7590-5CA00-0AA0
Front connector For 35 mm modules; including four potential bridges, cable ties and individual labeling strips, 40-pin		Shield terminal element 10 units; spare part	6ES7590-5BA00-0AA0
• Screw terminals • Push-in	6ES7592-1AM00-0XB0 6ES7592-1BM00-0XB0	SIMATIC Manual Collection SIMATIC Manual Collection on DVD in 5 languages, all manuals for S7-1200/1500/200/300/400, LOGO!, SIMATIC DP, PC, PG, STEP 7, Engineering SW, Runtime SW, PCS 7, SIMATIC HMI, SIMATIC NET, SIMATIC IDENT	6ES7998-8XC01-8YE0
DIN A4 labeling sheets 10 sheets with 10 labeling strips each for I/O modules; perforated, Al grey	6ES7592-2AX00-0AA0	SIMATIC Manual Collection update service for 1 year Current Manual Collection DVD and the three subsequent updates	6ES7998-8XC01-8YE2
U connector 5 units; spare part	6ES7590-0AA00-0AA0		

Technical specifications

Article number	6ES7553-1AA00-0AB0 S7-1500, TM PTO4	Article number	6ES7553-1AA00-0AB0 S7-1500, TM PTO4
General information		Digital inputs	
Product type designation	TM PTO 4	Number of digital inputs	12; 3 per channel, of which 1 DIQ
Number of channels	4; Axes	Digital inputs, parameterizable	Yes
Product function		Input characteristic curve in accordance with IEC 61131, type 3	Yes
• I&M data	Yes; I&M0 to I&M3	Digital input functions, parameterizable	
• Isochronous mode	Yes	• Synchronization	Yes
Engineering with		Input voltage	
• STEP 7 TIA Portal configurable/integrated from version	STEP 7 V14 or higher	• Type of input voltage	DC
• STEP 7 configurable/integrated from version	V5.5 SP3 with GSD file / -	• Rated value (DC)	24 V
• PROFINET from GSD version/GSD revision	GSDML V2.32	• for signal "0"	-5 ... +5 V
Installation type/mounting		• for signal "1"	+11 to +30V
Rail mounting	Yes; S7-1500 mounting rail	• permissible voltage at input, min.	-5 V
Supply voltage		• permissible voltage at input, max.	30 V
Load voltage L+		Input current	
• Rated value (DC)	24 V	• for signal "1", typ.	2.5 mA
• Reverse polarity protection	Yes		

TM PTO 4 interface module for PTO (Pulse Train Output)

Technical specifications

Article number	6ES7553-1AA00-0AB0 S7-1500, TM PTO4
Input delay (for rated value of input voltage)	
for standard inputs	
- parameterizable	Yes; none / 0.05 / 0.1 / 0.4 / 0.8 / 1.6 / 3.2 / 12.8 / 20 ms
- at "0" to "1", min.	4 µs; for parameterization "none"
- at "1" to "0", min.	4 µs; for parameterization "none"
for technological functions	
- parameterizable	Yes
Digital outputs	
Number of digital outputs	12; 3 per channel, of which 1 DIQ
Digital outputs, parameterizable	Yes
Short-circuit protection	Yes; electronic/thermal
Controlling a digital input	Yes
Digital output functions, parameterizable	
• PTO (pulse train output) signal interface	
- 24 V asymmetrical	Yes
- RS 422 symmetrical	Yes
- TTL (5 V) asymmetrical	Yes
• PTO (pulse train output) signal type	
- Pulse and direction	Yes
- Count up, count down	Yes
- Incremental encoder (A, B phase shift)	Yes
- Incremental encoder (A, B phase shift, quadruple)	Yes
Switching capacity of the outputs	
• with resistive load, max.	0.1 A; 0.5 A for DIQn.2
• on lamp load, max.	1 W; 5 W for DIQn.2
Load resistance range	
• lower limit	240 Ω; 48 ohms for DIQn.2
• upper limit	12 kΩ
Output voltage	
• Type of output voltage	DC
• for signal "1", min.	23.2 V; L+ (-0.8 V), L+ (-1.3 V) for DIQn.2
Output current	
• for signal "1" rated value	0.1 A; 0.5 A for DIQn.2
• for signal "0" residual current, max.	0.5 mA
Output delay with resistive load	
• "0" to "1", typ.	1 µs; 28 µs for DIQn.2
• "1" to "0", typ.	1 µs; 25 µs for DIQn.2
Switching frequency	
• with resistive load, max.	1 kHz; For DIQn.2
• with inductive load, max.	0.5 Hz; According to IEC 60947-5-1, DC-13, for DIQn.2
• on lamp load, max.	10 Hz; For DIQn.2
• For signal interface 24 V asymmetrical	200 kHz; With DQn.0 and DQn.1
• For signal interface RS 422 symmetrical	1 MHz
• For signal interface TTL (5 V) asymmetrical	200 kHz

Article number	6ES7553-1AA00-0AB0 S7-1500, TM PTO4
Isochronous mode	
Bus cycle time (TDP), min.	250 µs; 375 µs if all 4 channels are used
Interrupts/diagnostics/status information	
Diagnostics function	Yes
Alarms	
• Diagnostic alarm	Yes
Diagnoses	
• Monitoring the supply voltage	Yes
• Short-circuit	Yes; Thermal overload protection
• Group error	Yes
Diagnostics indication LED	
• RUN LED	Yes; green LED
• ERROR LED	Yes; red LED
• MAINT LED	Yes; yellow LED
• Monitoring of the supply voltage (PWR-LED)	Yes; green LED
• Channel status display	Yes; green LED
• for channel diagnostics	Yes; red LED
Potential separation	
Potential separation channels	
• between the channels and backplane bus	Yes
Ambient conditions	
Ambient temperature during operation	
• horizontal installation, min.	0 °C
• horizontal installation, max.	60 °C; Observe derating
• vertical installation, min.	0 °C
• vertical installation, max.	40 °C; Observe derating
Altitude during operation relating to sea level	
• Installation altitude above sea level, max.	5 000 m; restrictions for installation altitudes > 2 000 m, see ET 200MP system manual
Decentralized operation	
to SIMATIC S7-300	Yes; Via control and feedback interface
to SIMATIC S7-400	Yes; Via control and feedback interface
to SIMATIC S7-1200	Yes
to SIMATIC S7-1500	Yes
to standard PROFINET controller	Yes; Via control and feedback interface
Dimensions	
Width	35 mm
Height	147 mm
Depth	129 mm
Weights	
Weight, approx.	300 g

SIMATIC S7-1500 Advanced Controllers

I/O modules

Technology modules

SIWAREX WP521 / WP522 ST

Overview



SIWAREX WP521 ST



SIWAREX WP522 ST

SIWAREX WP521 ST / WP522 ST (ST = Standard) are versatile weighing modules for the SIMATIC S7-1500 Advanced Controller family. With these electronic weighing systems, simple weighing applications, such as platform or hopper scales, can be seamlessly integrated into the S7-1500 automation environment.

Ordering data

Article No.

Article No.

Weighing module TM SIWAREX WP521 ST

Single-channel, for platform scales or hopper scales with analog load cells (1 - 4 mV/V), 1 x LC, 4 x DQ, 3 x DI, 1 x RS 485, Ethernet port, including shielding set.

7MH4980-1AA01

Weighing module TM SIWAREX WP522 ST

Two-channel, for two separate platform scales or hopper scales with analog load cells (1 - 4 mV/V), per channel 1 x LC, 4 x DQ, 3 x DI, 1 x RS 485, Ethernet port, including shielding set.

7MH4980-2AA01

SIMATIC S7-1500, front connector with screw-type terminals

40-pin, for 35 mm wide modules, including 4 jumper links and cable ties

6ES7592-1AM00-0XB0

SIMATIC S7-1500, front connector with push-in technology

40-pin, for 35 mm wide modules, including 4 jumper links and cable ties

6ES7592-1BM00-0XB0

SIWATOOL V4 & V7

Service and commissioning software for SIWAREX weighing modules

7MH4900-1AK01

Ethernet cable patch cord 2 m (7 ft)

For connecting SIWAREX WP52x ST to a PC (SIWATOOL V7 or Modbus TCP/IP)

6XV1850-2GH20

Remote display (optional)

The digital remote displays can be connected directly to the SIWAREX WP231 via the RS 485 interface.

Suitable remote display: S102
Siebert Industrieelektronik GmbH
PO Box 1180
D-66565 Eppelborn
Tel.: +49 6806/980-0
Fax: +49 6806/980-999

<https://www.siebert-group.com/en/>

Detailed information is available from the manufacturer.

Ordering data	Article No.	Commissioning	Article No.
Accessories		Commissioning charge for one static scale with SIWAREX module	9LA1110-8SN50-0AA0
SIWAREX JB junction box, aluminum housing For connecting up to 4 load cells in parallel, and for connecting multiple junction boxes.	7MH5001-0AA20	(Flat charge for travel and setup must be ordered separately)	
SIWAREX JB junction box, stainless steel housing For connecting up to 4 load cells in parallel.	7MH5001-0AA00	Scope: • Recording of data • Checking of mechanical installation of the scale • Checking of electrical wiring and function • Static adjustment of the scale	
SIWAREX JB junction box, stainless steel housing (ATEX) For parallel connection of up to 4 load cells (for zone allocation, see manual or type-examination certificate).	7MH5001-0AA01	Requirements: • Mechanical design functional • Modules electrically wired and tested • Calibration weights available • Free access to scale	
SIWAREX IS Ex interface For intrinsically safe connection of load cells. With ATEX approval (not UL/FM). Suitable for SIWAREX electronic weighing systems. Compatibility of load cells must be checked separately. • Short-circuit current < 199 mA DC • Short-circuit current < 137 mA DC	7MH4710-5BA 7MH4710-5CA	Flat charge for travel and setup in Germany	9LA1110-8RA10-0AA0
Cable (optional)			
Cable Li2Y 1 x 2 x 0.75 ST + 2 x (2 x 0.34 ST) – CY For connecting SIWAREX electronic weighing systems to junction box (JB), extension box (EB) and Ex interface or between two EBs. For permanent installation. Occasional bending is possible. External diameter: approx. 10.8 mm (0.43 inch) Permissible ambient temperature -40 ... +80 °C (-40 ... +176 °F) Sold by the meter. • Sheath color: orange • For hazardous atmospheres. Sheath color: blue.	7MH4702-8AG 7MH4702-8AF		

Technical specifications

SIWAREX WP521 ST / WP522 ST		SIWAREX WP521 ST / WP522 ST	
Weighing modes	<ul style="list-style-type: none"> Non-automatic scales, e.g. platform and hopper scales 	Parameter assignment	<ul style="list-style-type: none"> Using function block in SIMATIC S7-1500 and HMI Using SIWATOOL V7 Using Modbus TCP/IP Using Modbus RTU
Ports	<ul style="list-style-type: none"> 1 x SIMATIC S7-1500 system bus 1 x Ethernet (SIWATOOL, Modbus TCP/IP) 1 x RS 485 per channel (Modbus RTU or remote display) 3 x digital inputs per channel (24 V DC) 4 x digital outputs (24 V DC short-circuit proof) per channel 	Remote display (see accessories)	
Functions	<ul style="list-style-type: none"> 3 limits Zeroing Tare Tare specification Zero adjustment Trace function for signal analysis Internal restore point SIMATIC S7-1500 integrated and/or stand-alone operation 	Connection	Via RS 485
		Display	Additional display for weight value
		Measuring accuracy	
		Error limit according to DIN 1319-1 of full-scale value at 20 °C ± 10 K (68 °F ± 10 K)	0.05%
		Internal resolution	Up to ± 4 million parts
		Number of measurements/second	100 or 120 (selectable)
		Filter	<ul style="list-style-type: none"> Low-pass filter 0.05 ... 50 Hz Average value filter

SIMATIC S7-1500 Advanced Controllers

I/O modules

Technology modules

SIWAREX WP521 / WP522 ST**Technical specifications**

SIWAREX WP521 ST / WP522 ST	
Weighing functions	
Weight values	<ul style="list-style-type: none"> • Gross • Net • Tare
Limit values	<ul style="list-style-type: none"> • 2 × min/max • 1 × empty
Zeroing	Per command
Tare	Per command
Tare specification	Per command
Compatible sensors	Analog load cells / full-bridge strain gauges (1-4 mV/V) in 4-wire or 6-wire system
Load cell powering	
Supply voltage (regulated via feedback)	4.85 V DC
Permissible load resistance	<ul style="list-style-type: none"> • R_{Lmin} > 40 Ω • R_{Lmax} < 4 100 Ω
With SIWAREX IS Ex interface	<ul style="list-style-type: none"> • R_{Lmin} > 50 Ω • R_{Lmax} < 4 100 Ω
Load cell characteristic	1 ... 4 mV/V
Permissible range of the measurement signal (with 4 mV/V sensors)	-21.3 ... +21.3 mV
Max. distance of load cells	800 m (2 624 ft)
Connection to load cells in Ex zone 1	Optionally via SIWAREX IS Ex interface

SIWAREX WP521 ST / WP522 ST	
Certificates	<ul style="list-style-type: none"> • ATEX Zone 2 • UL • KCC • EAC • RCM • FM • IECEx
Auxiliary power supply	
Rated voltage	24 V DC
Max. power consumption WP521 ST / WP522 ST	120 mA / 200 mA
Max. power consumption SIMATIC Bus	35 mA @ 15 V
IP degree of protection to EN 60529; IEC 60529	IP20
Climatic requirements	
$T_{min(IND)} \dots T_{max(IND)}$ (operating temperature)	
• Horizontal installation	-10 ... +60 °C (14 ... 140 °F)
• Vertical installation	-10 ... +40 °C (14 ... 104 °F)
EMC requirements	According to IEC 61000-6-2:2004; IEC 61000-6-4:2007+A1:2011
Dimensions (W × H × D)	35 × 147 × 129 mm (1.38 × 5.79 × 5.08 inch)

SIMATIC S7-1500 Advanced Controllers

I/O modules

SIPLUS technology modules

SIPLUS TM Count 2x24V counter module

Overview

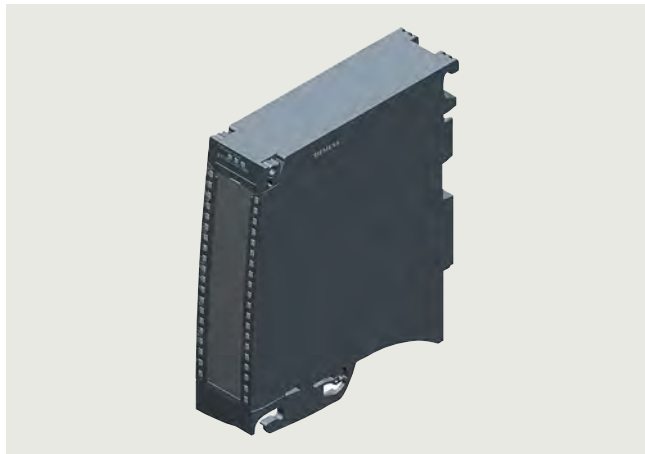

- 2-channel high-speed counter module
- With comprehensive parameterization options for an optimum adaptation to the task and reduction of control load
- Speed and time period measuring
- Storage and comparison functions
- Connection of 24 V encoders

Note:

SIPLUS extreme products are based on SIMATIC standard products. The contents listed here were taken from the respective standard products. SIPLUS extreme-specific information was added.

Ordering data

Ordering data	Article No.
SIPLUS TM Count 2x24V counter module (Extended temperature range and exposure to environmental substances) With 2 channels, max. 200 kHz; for 24 V encoder	6AG1550-1AA01-7AB0
Accessories	See SIMATIC S7-1500, TM Count 2x24V counter module, page 4/143

Technical specifications

Article number	6AG1550-1AA01-7AB0
Based on	6ES7550-1AA01-0AB0 SIPLUS S7-1500 TM COUNT 2X24V
Ambient conditions	
Ambient temperature during operation	
• horizontal installation, min.	-40 °C; = Tmin (incl. condensation/frost)
• horizontal installation, max.	70 °C; = Tmax
• vertical installation, min.	-40 °C; = Tmin (incl. condensation/frost)
• vertical installation, max.	40 °C; = Tmax

Article number	6AG1550-1AA01-7AB0
Based on	6ES7550-1AA01-0AB0 SIPLUS S7-1500 TM COUNT 2X24V
Altitude during operation relating to sea level	
• Installation altitude above sea level, max.	5 000 m
• Ambient air temperature-barometric pressure-altitude	Tmin ... Tmax at 1 140 hPa ... 795 hPa (-1 000 m ... +2 000 m) // Tmin ... (Tmax - 10 K) at 795 hPa ... 658 hPa (+2 000 m ... +3 500 m) // Tmin ... (Tmax -20 K) at 658 hPa ... 540 hPa (+3 500 m ... +5 000 m)
Relative humidity	
• With condensation, tested in accordance with IEC 60068-2-38, max.	100 %; RH incl. condensation/frost (no commissioning under condensation conditions)
Resistance	
Coolants and lubricants	
- Resistant to commercially available coolants and lubricants	Yes; Incl. diesel and oil droplets in the air
Use in stationary industrial systems	
- to biologically active substances according to EN 60721-3-3	Yes; Class 3B2 mold, fungus and dry rot spores (with the exception of fauna); Class 3B3 on request
- to chemically active substances according to EN 60721-3-3	Yes; Class 3C4 (RH < 75 %) incl. salt spray acc. to EN 60068-2-52 (severity degree 3); *
- to mechanically active substances according to EN 60721-3-3	Yes; Class 3S4 incl. sand, dust, *
Use on ships/at sea	
- to biologically active substances according to EN 60721-3-6	Yes; Class 6B2 mold and fungal spores (excluding fauna); Class 6B3 on request
- to chemically active substances according to EN 60721-3-6	Yes; Class 6C3 (RH < 75 %) incl. salt spray acc. to EN 60068-2-52 (severity degree 3); *
- to mechanically active substances according to EN 60721-3-6	Yes; Class 6S3 incl. sand, dust; *
Usage in industrial process technology	
- Against chemically active substances acc. to EN 60654-4	Yes; Class 3 (excluding trichlorethylene)
- Environmental conditions for process, measuring and control systems acc. to ANSI/ISA-71.04	Yes; Level GX group A/B (excluding trichlorethylene; harmful gas concentrations up to the limits of EN 60721-3-3 class 3C4 permissible); level LC3 (salt spray) and level LB3 (oil)
Remark	
- Note regarding classification of environmental conditions acc. to EN 60721, EN 60654-4 and ANSI/ISA-71.04	* The supplied plug covers must remain in place over the unused interfaces during operation!
Conformal coating	
• Coatings for printed circuit board assemblies acc. to EN 61086	Yes; Class 2 for high reliability
• Protection against fouling acc. to EN 60664-3	Yes; Type 1 protection
• Military testing according to MIL-I-46058C, Amendment 7	Yes; Discoloration of coating possible during service life
• Qualification and Performance of Electrical Insulating Compound for Printed Board Assemblies according to IPC-CC-830A	Yes; Conformal coating, Class A

SIMATIC S7-1500 Advanced Controllers

I/O modules

SIPLUS technology modules

SIPLUS TM PosInput 2 position detection module

Overview



- 2-channel counter and position detection module with RS422 interface
- Comprehensive parameterization options for optimum adaptation to the task
- Offloading of controller through preprocessing on the module
- Position detection with incremental and SSI absolute-value encoders
- Speed and time period measuring
- Storage and comparison functions
- Connection of encoders with RS422 signals or 5 V TTL signals

Note:

SIPLUS extreme products are based on SIMATIC standard products. The contents listed here were taken from the respective standard products. SIPLUS extreme-specific information was added.

Ordering data

Ordering data	Article No.
SIPLUS TM PosInput 2 counter and positioning module (extended temperature range and medial exposure) With 2 channels, max. 1 MHz counter frequency; for SSI and incremental encoders with RS422 or 5 V TTL interface	6AG1551-1AB00-7AB0
Accessories	See SIMATIC S7-1500, TM PosInput 2 counter and positioning module, page 4/146

Technical specifications

Article number	6AG1551-1AB00-7AB0
Based on	6ES7551-1AB00-0AB0 SIPLUS S7-1500 TM POSINPUT 2
Ambient conditions	
Ambient temperature during operation	
• horizontal installation, min.	-40 °C; = Tmin (incl. condensation/frost); start-up @ -25 °C
• horizontal installation, max.	70 °C; Please note derating for inductive loads
• vertical installation, min.	0 °C
• vertical installation, max.	40 °C; Please note derating for inductive loads

Article number	6AG1551-1AB00-7AB0
Based on	6ES7551-1AB00-0AB0 SIPLUS S7-1500 TM POSINPUT 2
Altitude during operation relating to sea level	
<ul style="list-style-type: none"> • Installation altitude above sea level, max. • Ambient air temperature-barometric pressure-altitude 	5 000 m Tmin ... Tmax at 1 140 hPa ... 795 hPa (-1 000 m ... +2 000 m) // Tmin ... (Tmax - 10 K) at 795 hPa ... 658 hPa (+2 000 m ... +3 500 m) // Tmin ... (Tmax -20 K) at 658 hPa ... 540 hPa (+3 500 m ... +5 000 m)
Relative humidity	
<ul style="list-style-type: none"> • With condensation, tested in accordance with IEC 60068-2-38, max. 	100 %; RH incl. condensation / frost (no commissioning in bedewed state), horizontal installation
Resistance	
Coolants and lubricants	
<ul style="list-style-type: none"> - Resistant to commercially available coolants and lubricants 	Yes; Incl. diesel and oil droplets in the air
Use in stationary industrial systems	
<ul style="list-style-type: none"> - to biologically active substances according to EN 60721-3-3 - to chemically active substances according to EN 60721-3-3 - to mechanically active substances according to EN 60721-3-3 	Yes; Class 3B2 mold, fungus and dry rot spores (with the exception of fauna); Class 3B3 on request Yes; Class 3C4 (RH < 75 %) incl. salt spray acc. to EN 60068-2-52 (severity degree 3); * Yes; Class 3S4 incl. sand, dust; *
Use on ships/at sea	
<ul style="list-style-type: none"> - to biologically active substances according to EN 60721-3-6 - to chemically active substances according to EN 60721-3-6 - to mechanically active substances according to EN 60721-3-6 	Yes; Class 6B2 mold and fungal spores (excluding fauna); Class 6B3 on request Yes; Class 6C3 (RH < 75 %) incl. salt spray acc. to EN 60068-2-52 (severity degree 3); * Yes; Class 6S3 incl. sand, dust; *
Usage in industrial process technology	
<ul style="list-style-type: none"> - Against chemically active substances acc. to EN 60654-4 - Environmental conditions for process, measuring and control systems acc. to ANSI/ISA-71.04 	Yes; Class 3 (excluding trichlorethylene) Yes; Level GX group A/B (excluding trichlorethylene; harmful gas concentrations up to the limits of EN 60721-3-3 class 3C4 permissible); level LC3 (salt spray) and level LB3 (oil)
Remark	
<ul style="list-style-type: none"> - Note regarding classification of environmental conditions acc. to EN 60721, EN 60654-4 and ANSI/ISA-71.04 	* The supplied plug covers must remain in place over the unused interfaces during operation!
Conformal coating	
<ul style="list-style-type: none"> • Coatings for printed circuit board assemblies acc. to EN 61086 • Protection against fouling acc. to EN 60664-3 • Military testing according to MIL-I-46058C, Amendment 7 • Qualification and Performance of Electrical Insulating Compound for Printed Board Assemblies according to IPC-CC-830A 	Yes; Class 2 for high reliability Yes; Type 1 protection Yes; Discoloration of coating possible during service life Yes; Conformal coating, Class A

Overview



- Modules for serial communication connections, scaled according to interface types, protocols, and performance
- 4 versions with different physical transmission characteristics:
 - RS 232C, max. 19.2 Kbps
 - RS 232C, max. 115.2 Kbps
 - RS 422/RS 485, max. 19.2 Kbps
 - RS 422/RS 485, max. 115.2 Kbps
- Protocols supported
 - Freeport: User-parameterizable telegram format for universal communication
 - 3964(R) for improved transmission reliability
 - Modbus RTU Master
 - Modbus RTU Slave
 - USS, implemented through instructions

Ordering data

Ordering data	Article No.	Ordering data	Article No.
CM PtP RS 232 BA communications module Basic communications module with one RS 232 interface, Freeport, 3964(R) and USS protocols, 9-pin D-sub connector, max. 19.2 Kbps	6ES7540-1AD00-0AA0	Accessories RS 232 connecting cable For linking to SIMATIC S7 5 m 10 m 15 m	6ES7902-1AB00-0AA0 6ES7902-1AC00-0AA0 6ES7902-1AD00-0AA0
CM PtP RS 232 HF communications module High Feature communications module with one RS 232 interface, Freeport, 3964(R), USS and Modbus RTU protocols, 9-pin D-sub connector, max. 115.2 Kbps	6ES7541-1AD00-0AB0	RS 422/485 connecting cable For linking to SIMATIC S7 5 m 10 m 50 m	6ES7902-3AB00-0AA0 6ES7902-3AC00-0AA0 6ES7902-3AG00-0AA0
CM PtP RS422/485 BA communications module Basic communications module with one RS 422/485 interface, Freeport, 3964(R) and USS protocols, 15-pin sub D socket, max. 19.2 Kbps	6ES7540-1AB00-0AA0	SIMATIC Manual Collection Electronic manuals on DVD, multi-language: LOGO!, SIMADYN, SIMATIC bus components, SIMATIC C7, SIMATIC distributed I/O, SIMATIC HMI, SIMATIC Sensors, SIMATIC NET, SIMATIC PC-based Automation, SIMATIC PCS 7, SIMATIC PG/PC, SIMATIC S7, SIMATIC Software, SIMATIC TDC	6ES7998-8XC01-8YE0
CM PtP RS422/485 HF communications module High Feature communications module with one RS 422/485 interface, Freeport, 3964(R), USS and Modbus RTU protocols, 15-pin sub D socket, max. 115.2 Kbps	6ES7541-1AB00-0AB0	SIMATIC Manual Collection update service for 1 year Current Manual Collection DVD and the three subsequent updates	6ES7998-8XC01-8YE2

SIMATIC S7-1500 Advanced Controllers

I/O modules

Communication

CM PtP

Technical specifications

Article number	6ES7540-1AD00-0AA0 S7-1500, CM PTP RS232 BA	6ES7541-1AD00-0AB0 S7-1500, CM PTP RS232 HF	6ES7540-1AB00-0AA0 S7-1500, CM PTP RS422/485 BA	6ES7541-1AB00-0AB0 S7-1500, CM PTP RS422/485 HF
General information				
Product type designation	CM PtP RS 232 BA	CM PTP RS 232 HF	CM PtP RS 422 / 485 BA	CM PTP RS 422 / 485 HF
Product function				
• I&M data	Yes; I&M 0	Yes; I&M 0	Yes; I&M 0	Yes; I&M 0
• Fast startup	Yes	Yes	Yes	Yes
Engineering with				
• STEP 7 TIA Portal configurable/integrated from version	V12 / V12	V12 / V12	V12 / V12	V12 / V12
• STEP 7 configurable/integrated from version	V5.5 SP2 with GSD file	V5.5 SP2 with GSD file	V5.5 SP2 with GSD file	V5.5 SP2 with GSD file
• PROFIBUS from GSD version/GSD revision	- / -	- / -	- / -	- / -
• PROFINET from GSD version/GSD revision	V2.3	V2.3 / -	V2.3	V2.3 / -
Installation type/mounting				
Rail mounting	Yes; S7-1500 mounting rail	Yes; S7-1500 mounting rail	Yes; S7-1500 mounting rail	Yes; S7-1500 mounting rail
Interface types				
RS 232				
• Transmission rate, max.	19.2 Kbps	115.2 Kbps		
• Cable length, max.	15 m	15 m		
• RS 232 auxiliary signals	RTS, CTS, DTR, DSR, RI, DCD	RTS, CTS, DTR, DSR, RI, DCD		
RS 485				
• Transmission rate, max.			19.2 Kbps	115.2 Kbps
• Cable length, max.			1 200 m	1 200 m
RS 422				
• Transmission rate, max.			19.2 Kbps	115.2 Kbps
• Cable length, max.			1 200 m	1 200 m
• 4-wire full duplex connection			Yes	Yes
• 4-wire multipoint connection			No	No
Protocols				
Integrated protocols				
Freepoint				
- Telegram length, max.	1 kbyte	4 kbyte	1 kbyte	4 kbyte
- Bits per character	7 or 8	7 or 8	7 or 8	7 or 8
- Number of stop bits	1 or 2 bit	1 or 2 bit	1 or 2 bit	1 or 2 bit
- Parity	None, even, odd, always 1, always 0, any	None, even, odd, always 1, always 0, any	None, even, odd, always 1, always 0, any	None, even, odd, always 1, always 0, any
3964 (R)				
- Telegram length, max.	1 kbyte	4 kbyte	1 kbyte	4 kbyte
- Bits per character	7 or 8	7 or 8	7 or 8	7 or 8
- Number of stop bits	1 or 2 bit	1 or 2 bit	1 or 2 bit	1 or 2 bit
- Parity	None, even, odd, always 1, always 0, any	None, even, odd, always 1, always 0, any	None, even, odd, always 1, always 0, any	None, even, odd, always 1, always 0, any
Modbus RTU master				
- Address area		1 to 247, extended 1 to 65535		1 to 247, extended 1 to 65535
- Number of slaves, max.		1		32
MODBUS RTU slave				
- Address area		1 to 247, extended 1 to 65535		1 to 247, extended 1 to 65535
Telegram buffer				
• Buffer memory for telegrams	2 kbyte	8 kbyte	2 kbyte	8 kbyte
• Number of telegrams which can be buffered	255	255	255	255

Technical specifications

Article number	6ES7540-1AD00-0AA0 S7-1500, CM PTP RS232 BA	6ES7541-1AD00-0AB0 S7-1500, CM PTP RS232 HF	6ES7540-1AB00-0AA0 S7-1500, CM PTP RS422/485 BA	6ES7541-1AB00-0AB0 S7-1500, CM PTP RS422/485 HF
Interrupts/diagnostics/status information				
Diagnostics function	Yes	Yes	Yes	Yes
Alarms				
• Diagnostic alarm	Yes	Yes	Yes	Yes
• Hardware interrupt	No	No	No	No
Diagnoses				
• Wire-break	Yes	Yes	Yes	Yes
Diagnostics indication LED				
• RUN LED	Yes; green LED	Yes; green LED	Yes; green LED	Yes; green LED
• ERROR LED	Yes; red LED	Yes; red LED	Yes; red LED	Yes; red LED
• Receive RxD	Yes; Yellow LED	Yes; Yellow LED	Yes; Yellow LED	Yes; Yellow LED
• Transmit TxD	Yes; Yellow LED	Yes; Yellow LED	Yes; Yellow LED	Yes; Yellow LED
Potential separation				
between backplane bus and interface	Yes	Yes	Yes	Yes
Ambient conditions				
Ambient temperature during operation				
• horizontal installation, min.	0 °C	0 °C	0 °C	0 °C
• horizontal installation, max.	60 °C	60 °C	60 °C	60 °C
• vertical installation, min.	0 °C	0 °C	0 °C	0 °C
• vertical installation, max.	40 °C	40 °C	40 °C	40 °C
Altitude during operation relating to sea level				
• Installation altitude above sea level, max.	5 000 m; restrictions for installation altitudes > 2 000 m, see ET 200MP system manual	5 000 m; restrictions for installation altitudes > 2 000 m, see ET 200MP system manual	5 000 m; restrictions for installation altitudes > 2 000 m, see ET 200MP system manual	5 000 m; restrictions for installation altitudes > 2 000 m, see ET 200MP system manual
Decentralized operation				
to SIMATIC S7-300	Yes	Yes	Yes	Yes
to SIMATIC S7-400	Yes	Yes	Yes	Yes
to SIMATIC S7-1500	Yes	Yes	Yes	Yes
to standard PROFINET controller	Yes	Yes	Yes	Yes
Dimensions				
Width	35 mm	35 mm	35 mm	35 mm
Height	147 mm	147 mm	147 mm	147 mm
Depth	127 mm	127 mm	127 mm	127 mm
Weights				
Weight, approx.	0.22 kg	0.22 kg	0.22 kg	0.22 kg

SIMATIC S7-1500 Advanced Controllers

I/O modules

Communication

CM 8xIO-Link

Overview



- Communication module for connecting up to 8 IO-Link devices (three-wire connection) or 8 standard sensors
- Can be used directly downstream of an S7-1500 CPU or distributed in ET 200MP via PROFINET or PROFIBUS
- Powerful diagnostics functions facilitate preventive maintenance to avoid plant standstills
- Easy replacement of sensors/actuators without time-consuming parameter assignment

Ordering data

Article No.

Ordering data	Article No.
CM 8xIO-Link communication module Communication module for connecting up to 8 IO-Link devices (three-wire connection) or 8 standard sensors	6ES7547-1JF00-0AB0
SIMATIC Manual Collection Electronic manuals on DVD, multilingual: LOGO!, SIMADYN, SIMATIC bus components, SIMATIC C7, SIMATIC TDC	6ES7998-8XC01-8YE0
SIMATIC Manual Collection update service for 1 year Current "Manual Collection" DVD and the three subsequent updates	6ES7998-8XC01-8YE2

Technical specifications

Article number	6ES7547-1JF00-0AB0 S7-1500, CM 8xIO-Link
General information	
Product type designation	CM 8xIO-Link
Product function	
• I&M data	Yes; I&M0 to I&M3
Engineering with	
• STEP 7 TIA Portal configurable/integrated from version	V15.1 with HSP 274
• STEP 7 configurable/integrated from version	Configurable via GSD file
• PROFIBUS from GSD version/GSD revision	GSD as of Revision 5
• PROFINET from GSD version/GSD revision	GSDML V2.34
Supply voltage	
Rated value (DC)	24 V
Reverse polarity protection	Yes
Encoder supply	
Number of outputs	8
Output current	
• Rated value	1 A; 4 A total current per module
24 V encoder supply	
• Short-circuit protection	Yes; per channel, electronic
IO-Link	
Number of ports	8
• of which simultaneously controllable	8
IO-Link protocol 1.0	Yes
IO-Link protocol 1.1	Yes
Cycle time, min.	2 ms
Size of process data, input per port	33 byte; max.
Size of process data, input per module	240 byte; max.
Size of process data, output per port	32 byte; max.
Size of process data, output per module	240 byte; max.
Memory size for device parameter	2 kbyte; for each port
Master backup	Yes
Configuration without S7-PCT	Yes
Cable length unshielded, max.	20 m
Operating modes	
• IO-Link	Yes
• DI	Yes
• DQ	No
Time Based IO	
- TIO IO-Link IN	No
- TIO IO-Link OUT	No
- TIO IO-Link IN/OUT	No
Connection of IO-Link devices	
• Port type A	Yes
• Port type B	Yes; 24 V DC via external terminal

Technical specifications

Article number	6ES7547-1JF00-0AB0 S7-1500, CM 8xIO-Link
Interrupts/diagnostics/ status information	
Alarms	
• Diagnostic alarm	Yes; The port diagnosis is available in the IO-Link mode only.
Diagnoses	
• Monitoring the supply voltage	Yes
• Wire-break	Yes
• Short-circuit	Yes
• Group error	Yes
Diagnostics indication LED	
• Monitoring of the supply voltage (PWR-LED)	Yes; green LED
• Channel status display	Yes; green LED
• for channel diagnostics	Yes; red LED
• for module diagnostics	Yes; red LED
Potential separation	
Potential separation channels	
• between the channels and backplane bus	Yes

Article number	6ES7547-1JF00-0AB0 S7-1500, CM 8xIO-Link
Ambient conditions	
Ambient temperature during operation	
• horizontal installation, min.	-30 °C; From FS05
• horizontal installation, max.	60 °C; Observe derating
• vertical installation, min.	-30 °C; From FS05
• vertical installation, max.	40 °C; Observe derating
Altitude during operation relating to sea level	
• Installation altitude above sea level, max.	5 000 m; Restrictions for installation altitudes > 2 000 m, see manual
Dimensions	
Width	35 mm
Height	147 mm
Depth	129 mm

SIMATIC S7-1500 Advanced Controllers

I/O modules

Communication

CM 1542-5

Overview



DP-M	DP-S	FMS	PG/OP	S7
●	●		●	●

The CM 1542-5 communications module expands the SIMATIC S7-1500 PLC to include a PROFIBUS connection for communication with lower-level PROFIBUS devices in bandwidths from 9.6 kbps to 12 Mbps. The module can also be used to implement separate PROFIBUS lines, in other words, to control a number of different field devices via a number of PROFIBUS segments. The CM 1542-5 assumes all communication tasks, thus reducing the CPU workload.

The CM 1542-5 is suitable for S7 communication as well as for conventional PROFIBUS communication. This makes it possible to establish communication between the S7-1500 PLC and other devices, for example those from the SIMATIC S7-300/400 range.

- PROFIBUS DP master or DP slave with electrical interface for connecting the SIMATIC S7-1500 to PROFIBUS at up to 12 Mbps (including 45.45 kbps)
- Communication services:
 - PROFIBUS DP
 - PG/OP communication
 - S7 communication
 - Open user communication (SEND/RECEIVE) via FDL
- Time synchronization
- Simple programming and configuration over PROFIBUS
- Cross-network PG communication using S7 routing
- Module replacement without a PG
- Data record routing (PROFIBUS DP)
- Adding or modifying distributed I/O during operation

Ordering data

Article No.

CM 1542-5 communications module

Communications module for electrical connection of SIMATIC S7-1500 to PROFIBUS as DP master or DP slave; S7 and PG/OP communication, data record routing, time synchronization, diagnostics

6GK7542-5DX00-0XE0

Accessories

PROFIBUS FastConnect RS485 connection plug

With 90° cable outlet; insulation displacement technology, max. transmission rate 12 Mbps

- Without programming device interface
- With programming device interface

6ES7972-0BA52-0XA0

6ES7972-0BB52-0XA0

PROFIBUS FC standard cable

2-core bus cable, shielded, special design for fast mounting, delivery unit: max. 1 000 m, minimum order quantity 20 m, sold by the meter

6XV1830-0EH10

PROFIBUS FastConnect stripping tool

Stripping tool for fast stripping of the PROFIBUS FastConnect bus cable

6GK1905-6AA00

PROFIBUS bus terminal 12M

Bus terminal for connection of PROFIBUS nodes up to 12 Mbps with connecting cable

6GK1500-0AA10

Note:

You can find order data for software for communication with PC systems in the Industry Mall under System interfaces – Software overview

Technical specifications

Article number	6GK7542-5DX00-0XE0
product type designation	CM 1542-5
transfer rate	
transfer rate	
• at the 1st interface acc. to PROFIBUS	9.6 Kbps ... 12 Mbit/s
interfaces	
number of interfaces acc. to Industrial Ethernet	0
number of electrical connections	
• at the 1st interface acc. to PROFIBUS	1
type of electrical connection	
• at the 1st interface acc. to PROFIBUS	9-pin Sub-D socket (RS485)
supply voltage, current consumption, power loss	
type of voltage of the supply voltage	DC
supply voltage 1 from backplane bus	15 V
relative symmetrical tolerance at DC	
• at 15 V	3 %
consumed current	
• from backplane bus at DC at 15 V typical	0.2 A
power loss [W]	3 W

Technical specifications

Article number	6GK7542-5DX00-0XE0
product type designation	CM 1542-5
ambient conditions	
ambient temperature	
• for vertical installation during operation	0 ... 40 °C
• for horizontally arranged busbars during operation	0 ... 60 °C
• during storage	-40 ... +70 °C
• during transport	-40 ... +70 °C
relative humidity	
• at 25 °C without condensation during operation maximum	95 %
protection class IP	IP20
design, dimensions and weights	
module format	Compact module S7-1500 single width
width	35 mm
height	142 mm
depth	129 mm
net weight	0.4 kg
fastening method	
• S7-1500 rail mounting	Yes
product features, product functions, product components general	
number of units	
• per CPU maximum	8
• note	depending on CPU type
performance data open communication	
number of possible connections for open communication by means of SEND/RECEIVE blocks maximum	30
• as user data per connection for open communication by means of SEND/RECEIVE blocks maximum	240 byte
performance data PROFIBUS DP	
service as DP master	
• DPV1	Yes
number of DP slaves	
• on DP master operable	125
data volume	
• of the address range of the inputs as DP master total	8 192 byte
• of the address range of the outputs as DP master total	8 192 byte
• of the address range of the inputs per DP slave	244 byte
• of the address range of the outputs per DP slave	244 byte
service as DP slave	
• DPV0	Yes
• DPV1	Yes
data volume	
• of the address range of the inputs as DP slave total	240 byte
• of the address range of the outputs as DP slave total	240 byte

Article number	6GK7542-5DX00-0XE0
product type designation	CM 1542-5
performance data S7 communication	
number of possible connections for S7 communication	
• maximum	48; depending on the system upper limit
performance data multi-protocol mode	
number of active connections with multi-protocol mode	48
performance data telecontrol	
protocol is supported	
• TCP/IP	No
product functions management, configuration, engineering	
configuration software	
• required	STEP 7 Professional V12 (TIA Portal) or higher
identification & maintenance function	
• I&M0 - device-specific information	Yes
• I&M1 - higher level designation/location designation	Yes
product functions diagnostics	
product function web-based diagnostics	Yes; via S7-1500 CPU
product functions time	
product function pass on time synchronization	Yes
standards, specifications, approvals hazardous environments	
certificate of suitability CCC for hazardous zone according to GB standard	Yes

SIMATIC S7-1500 Advanced Controllers

I/O modules

Communication

CP 1542-5**Overview**

DP-M	DP-S	FMS	PG/OP	S7/S5	
●	●		●		

The CP 1542-5 communications processor expands the SIMATIC S7-1500 PLC to include a PROFIBUS connection for communication with lower-level PROFIBUS devices in bandwidths from 9.6 kbps to 12 Mbps. This CPU allows the implementation of separate PROFIBUS lines, in other words the control of multiple field devices over multiple PROFIBUS segments. The CP 1542-5 handles all communication tasks, thus reducing the CPU load.

- PROFIBUS DP master or DP slave with electrical interface for connecting the SIMATIC S7-1500 to PROFIBUS at up to 12 Mbps (including 45.45 kbps)

Communication services:

- PROFIBUS DP
- PG/OP communication
- Time synchronization
- Simple programming and configuration over PROFIBUS
- Cross-network PG communication using S7 routing
- Module replacement without a PG

Ordering data**Article No.****CP 1542-5 communications processor**

Communications module for electrical connection of SIMATIC S7-1500 to PROFIBUS as DP master or DP slave; PG/OP communication, time synchronization, diagnostics; smaller quantity structure

6GK7542-5FX00-0XE0**Accessories****PROFIBUS FastConnect RS 485 connection plug**

With 90° cable outlet; insulation displacement technology, max. transmission rate 12 Mbps

- Without programming device interface
- With programming device interface

6ES7972-0BA52-0XA0**6ES7972-0BB52-0XA0****PROFIBUS FC Standard Cable**

2-core bus cable, shielded, special design for fast mounting, delivery unit: max. 1000 m, minimum order quantity 20 m, sold by the meter

6XV1830-0EH10**PROFIBUS FastConnect Stripping Tool**

Stripping tool for fast stripping of the PROFIBUS FastConnect bus cable

6GK1905-6AA00**PROFIBUS bus terminal 12M**

Bus terminal for connection of PROFIBUS stations for up to 12 Mbps with connecting cable

6GK1500-0AA10**Note:**

You can find order information for software for communication with PC systems in the Industry Mall under System interfaces – Software overview.

Technical specifications

Article number	6GK7542-5FX00-0XE0
product type designation	CP 1542-5
transfer rate	
transfer rate	
• at the 1st interface acc. to PROFIBUS	9.6 Kbps ... 12 Mbit/s
interfaces	
number of interfaces acc. to Industrial Ethernet	0
number of electrical connections	
• at the 1st interface acc. to PROFIBUS	1
type of electrical connection	
• at the 1st interface acc. to PROFIBUS	9-pin Sub-D socket (RS485)
supply voltage, current consumption, power loss	
type of voltage of the supply voltage	DC
supply voltage 1 from backplane bus	15 V
relative symmetrical tolerance at DC	
• at 15 V	3 %
consumed current	
• from backplane bus at DC at 15 V typical	0.1 A
power loss [W]	1.5 W
ambient conditions	
ambient temperature	
• for vertical installation during operation	0 ... 40 °C
• for horizontally arranged busbars during operation	0 ... 60 °C
• during storage	-40 ... +70 °C
• during transport	-40 ... +70 °C
relative humidity	
• at 25 °C without condensation during operation maximum	95 %
protection class IP	IP20
design, dimensions and weights	
module format	Compact module S7-1500 single width
width	35 mm
height	142 mm
depth	129 mm
net weight	0.27 kg
fastening method	
• S7-1500 rail mounting	Yes
product features, product functions, product components general	
number of units	
• per CPU maximum	8
• note	depending on CPU type

Article number	6GK7542-5FX00-0XE0
product type designation	CP 1542-5
performance data PROFIBUS DP	
service as DP master	
• DPV1	Yes
number of DP slaves	
• on DP master operable	32
data volume	
• of the address range of the inputs as DP master total	2 048 byte
• of the address range of the outputs as DP master total	2 048 byte
• of the address range of the inputs per DP slave	244 byte
• of the address range of the outputs per DP slave	244 byte
service as DP slave	
• DPV0	Yes
• DPV1	Yes
data volume	
• of the address range of the inputs as DP slave total	240 byte
• of the address range of the outputs as DP slave total	240 byte
performance data S7 communication	
number of possible connections for S7 communication	
• maximum	16; depending on the system upper limit
performance data multi-protocol mode	
number of active connections with multi-protocol mode	16
performance data telecontrol	
protocol is supported	
• TCP/IP	No
product functions management, configuration, engineering	
configuration software	
• required	STEP 7 Professional V12 SP1 (TIA Portal) or higher
identification & maintenance function	
• I&M0 - device-specific information	Yes
• I&M1 - higher level designation/ location designation	Yes
product functions diagnostics	
product function web-based diagnostics	Yes; via S7-1500 CPU
product functions time	
product function pass on time synchronization	Yes
standards, specifications, approvals hazardous environments	
certificate of suitability CCC for hazardous zone according to GB standard	Yes

SIMATIC S7-1500 Advanced Controllers

I/O modules

Communication

CM 1542-1**Overview**

ISO	TCP/ UDP	PN	MRP	IT	IP-R	PG/OP	S7/S5
	●	●	●	●	●	●	●

Communications module for connecting a SIMATIC S7-1500 to PROFINET networks as PROFINET IO controller or PROFINET IO device.

The CM 1542-1 supports the following communication services:

- PG/OP communication
- S7 communication
- Open communication (SEND/RECEIVE)
- PROFINET communication
- IT communication;
 - Web diagnostics by means of access to the web server of the S7-1500 system
 - Static IP routing with up to 1 Mbps via IPv4 to other CM 1543-1 / CM 1542-1 units in an S7-1500 station, e.g., for web server accesses without real-time capability.

Ordering data**Article No.****CM 1542-1****communications module**

For connecting SIMATIC S7-1500 to PROFINET IO, TCP/IP, ISO-on-TCP, UDP, S7 communication, IP broadcast/multicast, SNMPV1, time synchronization via NTP; 2 x RJ45 interface with 10/100 Mbps

6GK7542-1AX00-0XE0**Accessories****IE FC RJ45 plug 4 x 2**

RJ45 plug-in connector for Industrial Ethernet (10/100/1 000 Mbps) with a rugged metal enclosure and integrated insulation displacement contacts for connecting Industrial Ethernet FC installation cables; 180° cable outlet; for network components and CPs/CPUs with Industrial Ethernet interface

- 1 pack = 1 unit
- 1 pack = 10 units
- 1 pack = 50 units

6GK1901-1BB11-2AA0
6GK1901-1BB11-2AB0
6GK1901-1BB11-2AE0

IE FC TP standard cable GP 4 x 2

8-wire, shielded TP installation cable for connection to IE FC RJ45 modular outlet for universal applications; with UL approval; sold by the meter; max. delivery unit 1 000 m, minimum order quantity 20 m

- AWG22, for connection to IE FC RJ45 modular outlet
- AWG24, for connection to IE FC RJ45 plug 4 x 2

6XV1870-2E**6XV1878-2A****SCALANCE XC206-2SFP Industrial Ethernet switch**

Manageable Layer 2 IE switch; IEC 62443-4-2 certified; 6x 10/100 Mbps RJ45 ports; 2x 100/1 000 Mbps SFP; 1x console port

6GK5206-2BS00-2AC2

Technical specifications

Article number	6GK7542-1AX00-0XE0
product type designation	CM 1542-1
transfer rate	
transfer rate	
• at the 1st interface	10 ... 100 Mbit/s
interfaces	
number of interfaces acc. to Industrial Ethernet	1
number of electrical connections	
• at the 1st interface acc. to Industrial Ethernet	2
type of electrical connection	
• at the 1st interface acc. to Industrial Ethernet	RJ45 port
supply voltage, current consumption, power loss	
type of voltage of the supply voltage	DC
supply voltage 1 from backplane bus	15 V
relative symmetrical tolerance at DC	
• at 15 V	3 %
consumed current	
• from backplane bus at DC at 15 V typical	0.22 A
power loss [W]	3.3 W
ambient conditions	
ambient temperature	
• for vertical installation during operation	0 ... 40 °C
• for horizontally arranged busbars during operation	0 ... 60 °C
• during storage	-40 ... +70 °C
• during transport	-40 ... +70 °C
relative humidity	
• at 25 °C without condensation during operation maximum	95 %
protection class IP	IP20
design, dimensions and weights	
module format	Compact module S7-1500 single width
width	35 mm
height	142 mm
depth	129 mm
net weight	0.4 kg
fastening method	
• S7-1500 rail mounting	Yes
product features, product functions, product components general	
number of units	
• per CPU maximum	8
• note	depending on CPU type

Article number	6GK7542-1AX00-0XE0
product type designation	CM 1542-1
performance data open communication	
number of possible connections for open communication	
• by means of T blocks maximum	64; depending on the system upper limit
data volume	
• as user data per ISO on TCP connection for open communication by means of T blocks maximum	65 536 byte
number of Multicast stations	6
performance data S7 communication	
number of possible connections for S7 communication	
• maximum	64; depending on the system upper limit
performance data multi-protocol mode	
number of active connections with multi-protocol mode	64
performance data PROFINET communication as PN IO controller	
product function PROFINET IO controller	Yes
number of PN IO devices on PROFINET IO controller operable total	128
number of PN IO IRT devices on PROFINET IO controller operable	64
number of external PN IO lines with PROFINET per rack	10
data volume	
• as user data for input variables as PROFINET IO controller maximum	8 Kibyte
• as user data for output variables as PROFINET IO controller maximum	8 Kibyte
• as user data for input variables per PN IO device as PROFINET IO controller maximum	1 433 byte
• as user data for output variables per PN IO device as PROFINET IO controller maximum	1 433 byte
• as user data for input variables per PN IO device for each sub-module as PROFINET IO controller maximum	256 byte
• as user data for output variables per PN IO device for each sub-module as PROFINET IO controller maximum	256 byte

SIMATIC S7-1500 Advanced Controllers

I/O modules

Communication

CM 1542-1

Technical specifications

Article number	6GK7542-1AX00-0XE0
product type designation	CM 1542-1
performance data PROFINET communication as PN IO device	
product function PROFINET IO device	Yes
data volume	
• as user data for input variables as PROFINET IO device maximum	8 192 byte
• as user data for output variables as PROFINET IO device maximum	8 192 byte
• as user data for input variables for each sub-module as PROFINET IO device	256 byte
• as user data for output variables for each sub-module as PROFINET IO device	256 byte
• as user data for the consistency area for each sub-module	256 byte
number of submodules per PROFINET IO-Device	32
performance data telecontrol	
protocol is supported	
• TCP/IP	Yes
product functions management, configuration, engineering	
product function MIB support	Yes
protocol is supported	
• SNMP v1	Yes
• DCP	Yes
• LLDP	Yes
configuration software	
• required	STEP 7 Professional V14 (TIA Portal) or higher
identification & maintenance function	
• I&M0 - device-specific information	Yes
• I&M1 – higher level designation/location designation	Yes
product functions diagnostics	
product function web-based diagnostics	Yes; via S7-1500 CPU
product functions switch	
product feature switch	Yes
product function	
• switch-managed	No
• with IRT PROFINET IO switch	Yes
• configuration with STEP 7	Yes

Article number	6GK7542-1AX00-0XE0
product type designation	CM 1542-1
product functions routing	
service routing note	IP routing up to 1 Mbps
product function	
• static IP routing	Yes
• static IP routing IPv6	No
• dynamic IP routing	No
• dynamic IP routing IPv6	No
protocol is supported	
• RIP v1	No
• RIPv2	No
• RIPnG for IPv6	No
• OSPFv2	No
• OSPFv3 for IPv6	No
• VRRP	No
• VRRP for IPv6	No
• BGP	No
• PPP	No
• PPoE via DSL	No
product functions redundancy	
product function	
• ring redundancy	Yes
• redundancy manager	Yes
protocol is supported Media Redundancy Protocol (MRP)	Yes
product functions security	
product function	
• switch-off of non-required services	Yes
• blocking of communication via physical ports	No
• log file for unauthorized access	No
product functions time	
product function SICLOCK support	Yes
product function pass on time synchronization	Yes
protocol is supported	
• NTP	Yes
standards, specifications, approvals hazardous environments	
certificate of suitability CCC for hazardous zone according to GB standard	Yes

Overview



ISO	TCP/UDP	PN	MRP	IT	IP-R	PG/OP	S7/S5
●	●			●	●	●	●

The SIMATIC CP 1543-1 communications processor securely connects the SIMATIC S7-1500 PLC to Industrial Ethernet networks. By combining a variety of security features such as stateful packet inspection firewalls and VPNs, and data encryption protocols such as FTPS and SNMPv3, the communications processor protects individual S7-1500 stations or even entire automation cells against unauthorized access.

The CP can also be used for integrating the S7-1500 station into an IPv6-based network. All functions are configured by means of STEP 7 Professional V12 (TIA Portal) or higher.

The CP 1543-1 supports the following communications services:

- PG/OP communication
- S7 communication
- Open user communication (SEND/RECEIVE, FETCH/WRITE)
- IT communication
 - FTP functions (File Transfer Protocol FTP/FTPS) for file management and access to data blocks in the CPU (client and server function)
 - Access (read and write modes) to csv files stored on the memory card of the CPU via FTP(S)
 - Sending emails via SMTP or ESMTP with "SMTP-Auth" for authentication on an email server (also with IPv6)
 - Static IP routing with up to 1 Mbps via IPv4 to other CP 1543-1 / CM 1542-1 units in an S7-1500 system, e.g. for web server access without real-time capability
- Security Integrated
 - Stateful Packet Inspection Firewall
 - Secure communication via VPN (IPsec)
 - Network authentication according to IEEE 802.1X using the EAP methods MD5, TLS, PEAP, TTLS, MSCHAPv2 or PWD
- Protocols for secure communication
 - Secure access to the web server of the CPU via the HTTPS protocol
 - Secure file transfer using FTPS
 - Secure time of day transfer (NTP)
 - SNMPv3 for tap-proof transfer of network analysis information
 - Encrypted email communication via SMTPS (Port 587)
 - Secure open communication over TCP/IP
 - Connection to SINEMA Remote Connect via OpenVPN
- Integration of the S7-1500 into IPv6-based networks; An IPv6-compliant IP address can be used for the following communications services:
 - FETCH/WRITE access (CP as server)
 - FTP server mode
 - FTP client mode with addressing via program block
 - Email transfer with addressing via program block

Ordering data

Article No.

Article No.

CP 1543-1 communications processor

For connecting SIMATIC S7-1500 to Industrial Ethernet; TCP/IP, ISO, UDP, S7 communication, IP broadcast/multicast, security (VPN, firewall) diagnostics SNMPv1/v3, DHCP, FTP client/server, email, IPv4/IPv6, IEEE 802.1X (radius), time synchronization via NTP, 1x RJ45 (10/100/1 000 Mbps)

6GK7543-1AX00-0XE0

Accessories**IE FC RJ45 plug 180 2 x 2**

RJ45 plug-in connector for Industrial Ethernet with a rugged metal enclosure and integrated insulation displacement contacts for connecting Industrial Ethernet FC installation cables; with 180° cable outlet; for network components and CPs/CPUs with Industrial Ethernet interface

- 1 pack = 1 unit
- 1 pack = 10 units
- 1 pack = 50 units

6GK1901-1BB10-2AA0
6GK1901-1BB10-2AB0
6GK1901-1BB10-2AE0

IE FC RJ45 plug 4 x 2

RJ45 plug-in connector for Industrial Ethernet (10/100/1 000 Mbps) with a rugged metal enclosure and integrated insulation displacement contacts for connecting Industrial Ethernet FC installation cables; 180° cable outlet; for network components and CPs/CPUs with Industrial Ethernet interface

- 1 pack = 1 unit
- 1 pack = 10 units
- 1 pack = 50 units

6GK1901-1BB11-2AA0
6GK1901-1BB11-2AB0
6GK1901-1BB11-2AE0

IE FC TP standard cable GP 2 x 2 (type A)

4-wire, shielded TP installation cable for connection to IE FC RJ45 outlet/IE FC RJ45 plug; PROFINET-compatible; with UL approval; sold by the meter; max. delivery unit 1 000 m, minimum order quantity 20 m

6XV1840-2AH10

SIMATIC S7-1500 Advanced Controllers

I/O modules

Communication

CP 1543-1

Ordering data

IE FC TP standard cable GP 4 x 2

8-wire, shielded
TP installation cable for
connection to IE FC RJ45 modular
outlet for universal applications;
with UL approval;
sold by the meter;
max. delivery unit 1 000 m,
minimum order quantity 20 m

- AWG22, for connection to
IE FC RJ45 modular outlet
- AWG24, for connection to
IE FC RJ45 plug 4 x 2

6XV1870-2E

6XV1878-2A

IE FC stripping tool

Pre-adjusted stripping tool
for fast stripping of
Industrial Ethernet FC cables

6GK1901-1GA00

SCALANCE XC206-2SFP Industrial Ethernet switch

Manageable Layer 2 IE switch;
IEC 62443-4-2 certified;
6x 10/100 Mbps RJ45 ports;
2x 100/1 000 Mbps SFP;
1x console port

Article No.

6GK5206-2BS00-2AC2

Note:

You can find order data for software for communication with
PC systems in the Industry Mall under System interfaces -
Software overview.

Technical specifications

Article number	6GK7543-1AX00-0XE0
product type designation	CP 1543-1
transfer rate	
transfer rate	
• at the 1st interface	10 ... 1 000 Mbit/s
interfaces	
number of interfaces acc. to Industrial Ethernet	1
number of electrical connections	
• at the 1st interface acc. to Industrial Ethernet	1
type of electrical connection	
• at the 1st interface acc. to Industrial Ethernet	RJ45 port
supply voltage, current consumption, power loss	
type of voltage of the supply voltage	DC
supply voltage 1 from backplane bus	15 V
relative symmetrical tolerance at DC	
• at 15 V	3 %
consumed current	
• from backplane bus at DC at 15 V typical	0.35 A
power loss [W]	5.3 W
ambient conditions	
ambient temperature	
• for vertical installation during operation	0 ... 40 °C
• for horizontally arranged busbars during operation	0 ... 60 °C
• during storage	-40 ... +70 °C
• during transport	-40 ... +70 °C
relative humidity	
• at 25 °C without condensation during operation maximum	95 %
protection class IP	IP20

Article number	6GK7543-1AX00-0XE0
product type designation	CP 1543-1
design, dimensions and weights	
module format	Compact module S7-1500 single width
width	35 mm
height	142 mm
depth	129 mm
net weight	0.35 kg
fastening method	
• S7-1500 rail mounting	Yes
product features, product functions, product components general	
number of units	
• per CPU maximum	8
• note	depending on CPU type
performance data open communication	
number of possible connections for open communication	
• by means of T blocks maximum	118; depending on the system upper limit
data volume	
• as user data per ISO on TCP connection for open communication by means of T blocks maximum	65 536 byte
number of Multicast stations	118
performance data S7 communication	
number of possible connections for S7 communication	
• maximum	118; depending on the system upper limit
performance data multi-protocol mode	
number of active connections with multi-protocol mode	118

Technical specifications

Article number	6GK7543-1AX00-0XE0
product type designation	CP 1543-1
performance data IT functions	
number of possible connections	
• as client by means of FTP maximum	32
• as server by means of FTP maximum	16
number of possible connections	
• as server by means of HTTP maximum	4
• as email client maximum	1
data volume as user data for email maximum	64 Kibyte
performance data telecontrol	
protocol is supported	
• TCP/IP	Yes
product functions management, configuration, engineering	
product function MIB support	Yes
protocol is supported	
• SNMP v1	Yes
• DCP	Yes
• LLDP	No
configuration software	
• required	STEP 7 Professional V14 (TIA Portal) or higher
identification & maintenance function	
• I&MO - device-specific information	Yes
• I&M1 – higher level designation/location designation	Yes
product functions diagnostics	
product function web-based diagnostics	Yes; via S7-1500 CPU
product functions routing	
service routing note	IP routing up to 1 Mbps
product function	
• static IP routing	Yes
• static IP routing IPv6	No
• dynamic IP routing	No
• dynamic IP routing IPv6	No
protocol is supported	
• RIP v1	No
• RIPv2	No
• RIPnG for IPv6	No
• OSPFv2	No
• OSPFv3 for IPv6	No
• VRRP	No
• VRRP for IPv6	No
• BGP	No
• PPP	No
• PPOE via DSL	No

Article number	6GK7543-1AX00-0XE0
product type designation	CP 1543-1
product functions security	
firewall version	stateful inspection
product function with VPN connection	IPSec
type of encryption algorithms with VPN connection	AES-256, AES-192, AES-128, 3DES-168, DES-56
type of authentication procedure with VPN connection	Preshared key (PSK), X.509v3 certificates
type of hashing algorithms with VPN connection	MD5, SHA-1
number of possible connections with VPN connection	16
product function	
• IEEE 802.1x (radius)	Yes
• password protection for Web applications	No
• ACL - IP-based	No
• ACL - IP-based for PLC/routing	No
• switch-off of non-required services	Yes
• blocking of communication via physical ports	No
• log file for unauthorized access	Yes
product functions time	
product function SICLOCK support	Yes
product function pass on time synchronization	Yes
protocol is supported	
• NTP	Yes
standards, specifications, approvals hazardous environments	
certificate of suitability CCC for hazardous zone according to GB standard	Yes

SIMATIC S7-1500 Advanced Controllers

I/O modules

Communication

CP 1545-1

Overview



ISO	TCP/ UDP	PN	MRP	IT	IP-R	PG/OP	S7/S5
●	●			●	●	●	●

The SIMATIC CP 1545-1 communications processor securely connects the SIMATIC S7-1500 PLC to Industrial Ethernet networks. The new CloudConnect functionality enables easy and reliable transfer of all selected data from the SIMATIC S7-1500 to MindSphere, or a cloud solution that supports the standardized MQTT protocol, e.g. Microsoft Azure or IBM Cloud. The CP protects the SIMATIC S7-1500 station from unauthorized access with the integrated SPI (Stateful Packet Inspection) firewall. Data from cloud systems or MQTT brokers can also be received using the MQTT protocol.

The CloudConnect function of the CP 1545-1 is easy to configure with a few input screens in TIA Portal. First, all the parameters required for the different cloud platforms are specified. The data intended for the cloud is then selected from the tag management of the SIMATIC S7-1500 and saved as topics to be transferred with the corresponding trigger conditions.

All functions are configured using STEP 7 Professional V15.1 update 3 (TIA Portal) or higher. The CP 1545-1 supports the following communications services:

- PG/OP communication
- S7 communication
- Open user communication (SEND/RECEIVE, FETCH/WRITE)
- IT communication
 - MQTT Publish for transferring selected data to a cloud system or MQTT broker
 - MQTT Subscribe for receiving data from a cloud system or MQTT broker
 - FTP functions (File Transfer Protocol FTP/FTPS) for file management and access to data blocks in the CPU (client and server function)
 - Access (read and write modes) to csv files stored on the memory card of the CPU via FTP(S)
 - Sending emails via SMTP or ESMTP with "SMTP-Auth" for authentication on an email server (also with IPv6)
 - Static IP routing with up to 1 Mbps via IPv4 to other CP 1545-1 / CP 1543-1 / CM 1542-1 units in the S7-1500 system, e.g. for web server accesses without real-time capability
- Security Integrated
 - Stateful Packet Inspection Firewall
- Protocols for secure communication
 - Secure access to the web server of the CPU via the HTTPS protocol
 - Secure file transfer using FTPS
 - Secure time of day transfer (NTP)
 - SNMPv3 for tap-proof transfer of network analysis information
 - Encrypted email communication via SMTPS (Port 587)
 - Secure open communication over TCP/IP
- Integration of the S7-1500 into IPv6-based networks
 - An IPv6-compliant IP address can be used for the following communications services:
 - MQTT
 - FETCH/WRITE access (CP as server)
 - FTP server mode
 - FTP client mode with addressing via program block
 - Email transfer with addressing via program block

Ordering data

Article No.

CP 1545-1 communications processor

CP 1545-1 communications processor for connecting the SIMATIC S7-1500 to Industrial Ethernet; TCP/IP, UDP, S7 communication, security (firewall), SNMPv1/v3, DHCP, FTP client/server, email, IPv4/IPv6, time synchronization via NTP, connection to cloud systems via MQTT, 1x RJ45 (10/100/1 000 Mbps)

6GK7545-1GX00-0XE0

Note:

You can find order information for software for communication with PC systems in the Industry Mall under System interfaces – Software overview

Technical specifications

Article number	6GK7545-1GX00-0XE0
product type designation	CP 1545-1
transfer rate	
transfer rate	
• at the 1st interface	10 ... 1 000 Mbit/s
interfaces	
number of interfaces acc. to Industrial Ethernet	1
number of electrical connections	
• at the 1st interface acc. to Industrial Ethernet	1
type of electrical connection	
• at the 1st interface acc. to Industrial Ethernet	RJ45 port

Technical specifications

Article number	6GK7545-1GX00-0XE0
product type designation	CP 1545-1
supply voltage, current consumption, power loss	
type of voltage of the supply voltage	DC
supply voltage 1 from backplane bus	15 V
relative symmetrical tolerance at DC	
• at 15 V	3 %
consumed current	
• from backplane bus at DC at 15 V typical	0.3 A
power loss [W]	4.5 W
ambient conditions	
ambient temperature	
• for vertical installation during operation	0 ... 40 °C
• for horizontally arranged busbars during operation	0 ... 60 °C
• during storage	-40 ... +70 °C
• during transport	-40 ... +70 °C
relative humidity	
• at 25 °C without condensation during operation maximum	95 %
protection class IP	IP20
design, dimensions and weights	
module format	Compact module S7-1500 single width
width	35 mm
height	142 mm
depth	129 mm
net weight	0.32 kg
fastening method	
• S7-1500 rail mounting	Yes
product features, product functions, product components general	
number of units	
• per CPU maximum	8
• note	depending on CPU type
product functions cloud connectivity	
protocol is supported	
• Message Queuing Telemetry Transport (MQTT)	Yes
• Advanced Message Queuing Protocol (AMQP)	No
product function for cloud connectivity	
• trigger management	Yes
• time stamping	Yes
product feature for cloud connectivity buffered message frame memory	No
number of data points per device maximum	500

Article number	6GK7545-1GX00-0XE0
product type designation	CP 1545-1
performance data open communication	
number of possible connections for open communication	
• by means of T blocks maximum	118; depending on the system upper limit
data volume	
• as user data per ISO on TCP connection for open communication by means of T blocks maximum	65 536 byte
number of Multicast stations	118
performance data S7 communication	
number of possible connections for S7 communication	
• maximum	118; depending on the system upper limit
performance data multi-protocol mode	
number of active connections with multi-protocol mode	118
performance data IT functions	
number of possible connections	
• as client by means of FTP maximum	32
• as server by means of FTP maximum	16
number of possible connections	
• as server by means of HTTP maximum	4
• as email client maximum	1
data volume as user data for email maximum	64 Kibyte
performance data telecontrol	
protocol is supported	
• TCP/IP	Yes
product functions management, configuration, engineering	
product function MIB support	Yes
protocol is supported	
• SNMP v1	Yes
• SNMP v3	Yes
• DCP	Yes
• LLDP	Yes
configuration software	
• required	STEP 7 Professional V15.1 (TIA Portal) or higher
identification & maintenance function	
• I&M0 - device-specific information	Yes
• I&M1 - higher level designation/location designation	Yes

SIMATIC S7-1500 Advanced Controllers

I/O modules

Communication

CP 1545-1

Technical specifications

Article number	6GK7545-1GX00-0XE0
product type designation	CP 1545-1
product functions diagnostics	
product function web-based diagnostics	Yes; via S7-1500 CPU
product functions routing	
service routing note	IP routing up to 1 Mbps
product function	
• static IP routing	Yes
• static IP routing IPv6	No
• dynamic IP routing	No
• dynamic IP routing IPv6	No
protocol is supported	
• RIP v1	No
• RIPv2	No
• RIPnG for IPv6	No
• OSPFv2	No
• OSPFv3 for IPv6	No
• VRRP	No
• VRRP for IPv6	No
• BGP	No
• PPP	No
• PPoE via DSL	No
product functions security	
firewall version	stateful inspection
product function	
• password protection for Web applications	No
• ACL - IP-based	No
• ACL - IP-based for PLC/routing	No
• switch-off of non-required services	Yes
• blocking of communication via physical ports	No
• log file for unauthorized access	Yes

Article number	6GK7545-1GX00-0XE0
product type designation	CP 1545-1
product functions time	
product function SICLOCK support	No
product function pass on time synchronization	Yes
protocol is supported	
• NTP	Yes
standards, specifications, approvals hazardous environments	
certificate of suitability CCC for hazardous zone according to GB standard	Yes

4

Overview



- TIM 1531 IRC communications module for telecontrol applications with four interfaces as a stand-alone device for SIMATIC S7-1500 for use in wide area networks (WANs)
- For universal use in a station, node station and control center
- Communication either via the SINAUT ST7, IEC 60870-5-101/104 or DNP3 telecontrol protocols
- Operation via VPN (IPsec/OpenVPN) with additional SIMATIC NET components
- Wireless communication via mobile wireless routers, modems or radio devices
- Wired communication via Ethernet, Internet, 2/4 wire cables (SHDSL), dialup modems or dedicated line modem
- Frame buffer for seamless recording of data
- Support of redundant communication paths
- Simple configuration with STEP 7 Professional V15.1 (TIA Portal)

Ordering data

Ordering data	Article No.	Ordering data	Article No.
TIM 1531 IRC communications module TIM 1531 IRC communications module for SIMATIC S7-1500, S7-400, S7-300 with SINAUT ST7, DNP3 and IEC 60870-5-101/104 with three RJ45 interfaces for communication via IP-based networks (WAN/LAN) and an RS 232/RS 485 interface for communication via conventional WANs	6GK7543-1MX00-0XE0	SCALANCE M876-4 (EU) 4G router; for wireless IP communication of Ethernet-based programmable controllers via LTE (4G) mobile wireless optimized for use in Europe, VPN, firewall, NAT; 4-port switch; 2 x SMA antenna, MIMO technology; 1 x digital input, 1 x digital output; note country approvals.	6GK5876-4AA00-2BA2
Engineering Software STEP 7 Professional V16 <ul style="list-style-type: none"> • SIMATIC STEP 7 Professional V17 floating license • Upgrade SIMATIC STEP 7 Basic V11 ... V16 → V17 floating license 	6ES7822-1AA07-0YA5 6ES7822-0AA07-0YE5	SCALANCE M876-4 (NAM) 4G router (NAM); for wireless IP communication of Ethernet-based programmable controllers via LTE (4G) mobile wireless optimized for use in North America, VPN, firewall, NAT; 4-port switch; 2 x SMA antenna, MIMO technology; 1 x digital input, 1 x digital output; note country approvals.	6GK5876-4AA00-2DA2
Accessories		SCALANCE M826-2 SHDSL router For IP communication via the 2-wire and 4-wire cables of Ethernet-based automation devices; SHDSL topology: point-to-point, bonding, line bridge mode, routing mode with VPN, firewall, NAT; 4-port switch, 1x digital input, 1x digital output	6GK5826-2AB00-2AB2
DIN rail SIMATIC S7-1500, 160 mm DIN rail; incl. grounding screw, integrated DIN rail for mounting small items, such as terminals, relays	6ES7590-1AB60-0AA0		
SIMATIC Memory Card SIMATIC S7, Memory Card for S7-1x 00 CPU/SINAMICS, 3.3 V flash, 24 MB	6ES7954-8LF03-0AA0		

SIMATIC S7-1500 Advanced Controllers

I/O modules

Communication

TIM 1531 IRC (for S7-1500)

Ordering data

MD720 modem

GSM/GPRS, 2G mobile wireless modem with RS232 interface; for GSM services CSD, GPRS, SMS; Quadband GSM; AT command interface; note country-specific approvals! Autom. GPRS connection setup; including gender changer for RS 232/PPI adapter

Article No.

6NH9720-3AA01-0XX0

Connecting cable

With one end open for connecting a TIM (RS232) to a third-party modem or radio unit (RS232); cable length 2.5 m

6NH7701-4BN

Connecting cable

For connecting two TIMs via their RS232 interfaces without modems (null modem); cable length 6 m

6NH7701-0AR

SITOP compact 24 V/0.6 A

1-phase power supply with wide-range input 85 ... 264 V AC/110 ... 300 V DC, 24 V stabilized output voltage, 0.6 A nominal value of output current, slim design

Article No.

6EP1331-5BA00

SIMATIC PM 1507 24 V/3 A

Stabilized power supply for SIMATIC S7-1500 input: 120/230 V AC output: 24 V DC/3 A

6EP1332-4BA00

SIMATIC PM 1507 24 V/8 A

Stabilized power supply for SIMATIC S7-1500 input: 120/230 V AC output: 24 V DC/8 A

6EP1333-4BA00

- Output current 3 A
- Output current 8 A

6EP1333-4BA00

Note:

You will find ordering data for software for communicating with PC systems in the Industry Mall under System interfaces – Software overview

Technical specifications

Article number	6GK7543-1MX00-0XE0
product type designation	TIM 1531 IRC
transfer rate	
transfer rate	
• at the 1st interface	10 ... 1 000 Mbit/s
• at the 2nd interface	10 ... 100 Mbit/s
• at interface 3	10 ... 100 Mbit/s
• acc. to RS 232	300 ... 115 200 bit/s
interfaces	
number of interfaces acc. to Industrial Ethernet	3
number of electrical connections	
• for external data transmission acc. to RS 232	1
• for power supply	1
number of slots	
• for memory cards	1
type of electrical connection	
• of Industrial Ethernet interface	RJ45 port
type of electrical connection	
• at interface 1 for external data transmission	9 pin Sub-D-connector, RS232 switchable to RS485
• for power supply	2-pole plugable terminal block
slot version	
• of the memory card	SD 1.0, SD 1.1, SDHC, Siemens SMC
storage capacity of the memory card maximum	32 Gbyte

Article number	6GK7543-1MX00-0XE0
product type designation	TIM 1531 IRC
supply voltage, current consumption, power loss	
type of voltage of the supply voltage	DC
supply voltage	24 V
supply voltage	20.4 ... 28.8 V
supply voltage external at DC rated value	24 V
supply voltage external at DC rated value	20.4 ... 28.8 V
consumed current	
• from external supply voltage at DC at 24 V typical	0.15 A
• from external supply voltage at DC at 24 V maximum	0.3 A
power loss [W] with external supply voltage at 24 V DC	
• in update mode typical	3.9 W
• in communication mode typical	3.9 W
product extension optional backup battery	No

Technical specifications

Article number	6GK7543-1MX00-0XE0
product type designation	TIM 1531 IRC
ambient conditions	
ambient temperature	
• during operation	0 ... 70 °C
• for vertical installation during operation	0 ... 50 °C
• for horizontally arranged busbars during operation	0 ... 70 °C
• during storage	-40 ... +70 °C
• during transport	-40 ... +70 °C
relative humidity	
• at 25 °C without condensation during operation maximum	95 %
protection class IP	IP20
design, dimensions and weights	
module format	Compact module S7-1500 double-wide
width	70 mm
height	147 mm
depth	129 mm
net weight	0.525 kg
fastening method	
• 35 mm top hat DIN rail mounting	No
• S7-300 rail mounting	No
• S7-1500 rail mounting	Yes
product features, product functions, product components general	
product function	
• DynDNS client	No
number of units	
• note	Number of TIM per S7-1500: 1
wire length	
• with RS 232 interface maximum	6 m
• with RS 485 interface maximum	30 m
performance data S7 communication	
number of possible connections for S7 communication	
• maximum	132; only via LAN
• with PG connections maximum	4
• with PG/OP connections maximum	4
• with OP connections maximum	4
service	
• of SIMATIC communication as server	Yes
• SINAUT ST7 via S7 communication	Yes
• PG/OP communication	Yes

Article number	6GK7543-1MX00-0XE0
product type designation	TIM 1531 IRC
performance data IT functions	
number of possible connections	
• as server by means of HTTP maximum	2
• as server by means of HTTPS maximum	2; 2 per Ethernet interface
• as email client maximum	1
performance data telecontrol	
suitability for use	
• node station	Yes
• substation	Yes
• TIM control center	Yes
control center connection	Systems with ST7, DNP3 and IEC 60870-5-101/104 protocol
• by means of a permanent connection	Systems with ST7, DNP3 and IEC 60870-5-101/104 protocol
protocol is supported	
• DNP3	Yes
• IEC 60870-5	Yes
• SINAUT ST1 protocol	No
• SINAUT ST7 protocol	Yes
• Modbus RTU	No
product function data buffering if connection is aborted	Yes; 100000 data telegrams (ST7) or 250000 events (IEC 60870-5 / DNP3)
number of data points per station maximum	3 000
number of DNP3 masters	
• for Ethernet maximum	4
• with RS 232 interface maximum	4
product feature buffered message frame memory	Yes
transmission format	
• for SINAUT ST7 protocol with polling or spontaneous 10-bit or 11-bit	Yes
operating mode for scanning of data transmission	
• with dedicated line/radio link with SINAUT ST7 protocol	Polling, polling with time slot procedure
• with dial-up network with SINAUT ST7 protocol	spontaneous
hamming distance	
• for SINAUT ST7 protocol	4
performance data teleservice	
diagnostics function online diagnostics with SIMATIC STEP 7	Yes
product function	
• program download with SIMATIC STEP 7	Yes
• remote firmware update	Yes
• remote configuration	Yes

SIMATIC S7-1500 Advanced Controllers

I/O modules

Communication

TIM 1531 IRC (for S7-1500)

Technical specifications

Article number	6GK7543-1MX00-0XE0
product type designation	TIM 1531 IRC
product functions management, configuration, engineering	
product function MIB support protocol is supported	Yes
• SNMP v1	Yes
• SNMP v3	Yes
• DCP	Yes
• LLDP	Yes
configuration software	
• required	STEP 7 Professional V14 SP1 (TIA Portal) or higher
• for CPU configuring required SINAUT TD7 block library for CPU	No
• for PG configuring required SINAUT ST7 configuration software for PG	No
storage location of TIM configuration data	Flash or SD card of the TIM 1531 IRC
identification & maintenance function	
• I&M0 - device-specific information	Yes
• I&M1 - higher level designation/location designation	Yes
• I&M2 - installation date	Yes
• I&M3 - comment	Yes
product functions diagnostics	
product function web-based diagnostics	Yes
product functions routing	
service routing note	IP routing up to 1 Mbps
product function	
• static IP routing	Yes
• static IP routing IPv6	Yes
• dynamic IP routing	No
• dynamic IP routing IPv6	No
protocol is supported	
• RIP v1	No
• RIPv2	No
• RIPnG for IPv6	No
• OSPFv2	No
• OSPFv3 for IPv6	No
• VRRP	No
• VRRP for IPv6	No
• BGP	No
• PPP	No
• PPoE via DSL	No

Article number	6GK7543-1MX00-0XE0
product type designation	TIM 1531 IRC
product functions security	
product function	
• MSC client via GPRS modem with MSC capability	Yes
protocol	
• is supported MSC protocol	Yes
• with Virtual Private Network MSC is supported	TCP/IP
key length for MSC with Virtual Private Network	128 bit
number of possible connections	
• as MSC client with VPN connection	1
• as MSC server with VPN connection	127
product functions time	
product function SICLOCK support	No
product function pass on time synchronization	Yes
protocol is supported	
• NTP	Yes
• NTP (secure)	Yes
product component hardware real time clock	No
product feature hardware real time clock w. battery backup	No
time synchronization	
• from NTP-server	Yes
• from GPS-signal	No
• from control center	Yes
• from mobile network provider	No
• PC	No
• manual setting	No
product functions position detection	
product function	
• position detection with GPS	No
• pass on position data	No
standards, specifications, approvals hazardous environments	
certificate of suitability CCC for hazardous zone according to GB standard	Yes

4

Overview

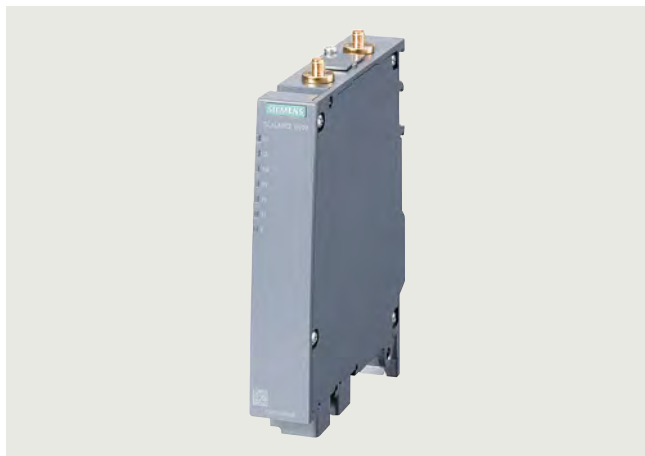

- Access points in SIMATIC S7-1500 design are suitable for applications where the device is to be mounted in the control cabinet

4

Ordering data

Ordering data	Article No.	Ordering data	Article No.
Access Points SCALANCE W774 IWLAN access points with built-in wireless interface for establishing wireless connections with iFeatures; wireless networks IEEE 802.11a/b/g/h/n at 2.4/5 GHz up to 300 Mbps; WPA2/AES; integrated 2-port switch; Power over Ethernet (PoE), IP30 degree of protection (-20°C to +60°C); scope of supply: Mounting hardware; 4-pin screw terminal for 24 V DC; manual on CD-ROM; English/German		IE FC RJ45 plug 180 2 x 2 RJ45 connector for Industrial Ethernet with a rugged metal enclosure and integrated insulation-displacement contacts for connecting Industrial Ethernet FC installation cables; with a 180° cable outlet; for network components and CPs/CPUs with Industrial Ethernet interface <ul style="list-style-type: none"> • 1 pack = 1 unit • 1 pack = 10 units • 1 pack = 50 units 	6GK1901-1BB10-2AA0 6GK1901-1BB10-2AB0 6GK1901-1BB10-2AE0
SCALANCE W774-1 RJ45 IWLAN Access Point with one built-in wireless interface <ul style="list-style-type: none"> • Country approvals for operation outside the USA • Country approvals for operation within the USA ¹⁾ • Country approvals for operation in Israel ¹⁾ 	6GK5774-1FX00-0AA0 6GK5774-1FX00-0AB0 6GK5774-1FX00-0AC0	IE FC Standard Cable GP 2 x 2 4-core, shielded TP installation cable for connection to IE FC outlet RJ45 plug / IE FC RJ45 plug; PROFINET-compliant; with UL approval; sold by the meter; max. delivery unit 1 000 m, minimum order quantity 20 m	6XV1840-2AH10
Accessories		IE FC Stripping Tool Pre-adjusted stripping tool for fast stripping of Industrial Ethernet FC cables	6GK1901-1GA00
KEY-PLUG W780 iFeatures Removable data storage medium for enabling additional iFeatures, for simple device replacement if a fault occurs and for storage of configuration data; can be used in SCALANCE W access points with PLUG compartment	6GK5907-8PA00	Antennas and miscellaneous IWLAN accessories	See Industry Mall, Industrial Wireless LAN/Accessories
C-PLUG Removable data storage medium for simple replacement of devices if a fault occurs; for storing configuration data; can be used in SIMATIC NET products with PLUG compartment	6GK1900-0AB10		

¹⁾ Please note country approvals under:
<http://www.siemens.com/wireless-approvals>

SIMATIC S7-1500 Advanced Controllers

I/O modules

Communication

SCALANCE W774 RJ45 for the control cabinet

Technical specifications

Article number	6GK5774-1FX00-0AA0 6GK5774-1FX00-0AB0 ¹⁾ 6GK5774-1FX00-0AC0 ²⁾
product type designation	W774-1 RJ45
transfer rate	
transfer rate	
• with WLAN maximum	300 Mbit/s
• for Industrial Ethernet	10 Mbit/s, 100 Mbit/s
transfer rate for Industrial Ethernet	
• minimum	10 Mbit/s
• maximum	100 Mbit/s
interfaces	
number of electrical connections	
• for network components or terminal equipment	2
• for power supply	1
• for redundant voltage supply	1
type of electrical connection	
• for network components or terminal equipment	RJ45 socket
• for power supply	4-pole screw terminal, PoE
design of the removable storage	
• C-PLUG	Yes
• KEY-PLUG	Yes
memory	
design of the removable storage	
• C-PLUG	Yes
• KEY-PLUG	Yes
interfaces wireless	
number of radio cards permanently installed	1
transmission mode for multiple input multiple output (MIMO)	2x2
number of spatial streams	2
number of electrical connections for external antenna(s)	2
type of electrical connection for external antenna(s)	R-SMA (socket)
product feature external antenna can be mounted directly on device	Yes
supply voltage, current consumption, power loss	
type of voltage of the supply voltage	DC
supply voltage	
• from Power-over-Ethernet acc. to IEEE802.3at for type 1 and IEEE802.3af	48 V
consumed current	
• at DC at 24 V typical	0.25 A
• with Power-over-Ethernet according to IEEE802.3at for type 1 and IEEE802.3af typical	0.125 A
power loss [W]	
• at DC at 24 V typical	6 W
• with Power-over-Ethernet according to IEEE802.3at for type 1 and IEEE802.3af typical	6 W
supply voltage 1	
• from terminal block	19.2 V
supply voltage 2	
• from terminal block	28.8 V

Article number	6GK5774-1FX00-0AA0 6GK5774-1FX00-0AB0 ¹⁾ 6GK5774-1FX00-0AC0 ²⁾
product type designation	W774-1 RJ45
ambient conditions	
ambient temperature	
• during operation	-20 ... +60 °C
• during storage	-40 ... +85 °C
• during transport	-40 ... +85 °C
relative humidity at 25 °C without condensation during operation maximum	97 %
ambient condition for operation	When used under hazardous conditions (Zone 2), the SCALANCE W774-1 RJ45 or W734-1 RJ45 product must be installed in an enclosure. To comply with EN 50021, this enclosure must meet the requirements of at least IP 54 in compliance with EN 60529.
protection class IP	IP30
design, dimensions and weights	
width	26 mm
height	156 mm
depth	127 mm
width of the enclosure without antenna	26 mm
height of the enclosure without antenna	147 mm
depth of the enclosure without antenna	127 mm
net weight	0.52 kg
fastening method	wall mounting only if flat mounted
• S7-300 rail mounting	Yes
• S7-1500 rail mounting	Yes
• 35 mm top hat DIN rail mounting	Yes
• wall mounting	Yes
radio frequencies	
operating frequency	
• for WLAN in 2.4 GHz frequency band	2.41 ... 2.48 GHz; depending on the country approvals
• for WLAN in 5 GHz frequency band	4.9 ... 5.8 GHz; depending on the country approvals
product features, product functions, product components general	
product function Access Point Mode	Yes
product function client Mode	Yes
number of SSIDs	4
product function	
• iPCF Access Point	Yes; Only in combination with the 'KEY-PLUG W780 iFeatures'
• iPCF client	Yes; Only in combination with the 'KEY-PLUG W740 iFeatures'
• iPCF-MC Access Point	No
• iPCF-MC client	Yes; Only in combination with the 'KEY-PLUG W740 iFeatures'
number of iPCF-capable radio modules	1
product function iREF	Yes; Only in combination with the 'KEY-PLUG W780 iFeatures' or 'KEY-PLUG W740 iFeatures'
number of iREF-capable radio modules	1
product function iPRP	Yes; In combination with the 'KEY-PLUG W780 iFeatures' only

¹⁾ Wireless approval in the USA

²⁾ Wireless approval in the Israel

Technical specifications

Article number	6GK5774-1FX00-0AA0 6GK5774-1FX00-0AB0 ¹⁾ 6GK5774-1FX00-0AC0 ²⁾
product type designation	W774-1 RJ45
product functions management, configuration, engineering	
number of manageable IP addresses in client	8
product function	
• CLI	Yes
• web-based management	Yes
• MIB support	Yes
• TRAPs via email	Yes
• configuration with STEP 7	Yes
• configuration with STEP 7 in the TIA Portal	Yes
• operation with IWLAN controller	No
• operation with Enterasys WLAN controller	No
• forced roaming on IP down with IWLAN	Yes
• forced roaming on link down with IWLAN	Yes
• WDS	Yes
protocol is supported	
• Address Resolution Protocol (ARP)	Yes
• ICMP	Yes
• Telnet	Yes
• HTTP	Yes
• HTTPS	Yes
• TFTP	Yes
• DCP	Yes
• LLDP	Yes
identification & maintenance function	
• I&M0 - device-specific information	Yes
• I&M1 – higher level designation/ location designation	Yes
product functions diagnostics	
product function	
• PROFINET IO diagnosis	Yes
• link check	No
• connection monitoring IP-Alive	No
• localization via Aeroscout	Yes
• SysLog	Yes
protocol is supported	
• SNMP v1	Yes
• SNMP v2	Yes
• SNMP v3	Yes

Article number	6GK5774-1FX00-0AA0 6GK5774-1FX00-0AB0 ¹⁾ 6GK5774-1FX00-0AC0 ²⁾
product type designation	W774-1 RJ45
product functions VLAN	
product function	
• function VLAN with IWLAN	Yes
product functions DHCP	
product function	
• DHCP client	Yes
• DHCP server	Yes
• DHCP Option 82	Yes
product functions redundancy	
protocol is supported	
• STP/RSTP	Yes
• MSTP	Yes
• RSTP	Yes
product functions security	
product function	
• ACL - MAC-based	Yes
• management security, ACL-IP based	Yes
• IEEE 802.1x (radius)	Yes
• NAT/NAPT	No
• access protection according to IEEE802.11i	Yes
• WPA/WPA2	Yes
• TKIP/AES	Yes
protocol is supported	
• SSH	Yes
• RADIUS	Yes
product functions time	
protocol is supported	
• NTP	Yes
• SNTP	Yes
• SIMATIC time synchronization (SIMATIC Time)	Yes

1) Wireless approval in the USA

2) Wireless approval in the Israel

SIMATIC S7-1500 Advanced Controllers

I/O modules

Communication

SCALANCE W774 RJ45 for the control cabinet**Technical specifications**

Article number	6GK5774-1FX00-0AA0 6GK5774-1FX00-0AB0 ¹⁾ 6GK5774-1FX00-0AC0 ²⁾
product type designation	W774-1 RJ45
standards, specifications, approvals	
standard	
• for FM	FM 3611: Class I, Division 2, Groups A,B,C,D, T4 / Class 1, Zone 2, Group IIC, T4
• for safety from CSA and UL certificate of suitability	UL 60950-1, CSA C22.2 No. 60950-1
• EC Declaration of Conformity	Yes
• CE marking	Yes
• C-Tick	Yes
• E1 approval	No
• railway application in accordance with EN 50155	No
• railway application in accordance with EN 50121-4	No
• NEMA TS2	No
• IEC 61375	No
• IEC 61850-3	No
• NEMA4X	No
• Power-over-Ethernet according IEEE802.3at for type 1 and IEEE802.3af	Yes
• Power-over-Ethernet according to IEEE802.3at for type 2	Yes
standard for wireless communication	
• IEEE 802.11a	Yes
• IEEE 802.11b	Yes
• IEEE 802.11e	Yes
• IEEE 802.11g	Yes
• IEEE 802.11h	Yes
• IEEE 802.11i	Yes
• IEEE 802.11n	Yes
wireless approval	You will find the current list of countries at: http://www.siemens.com/wireless-approvals

Article number	6GK5774-1FX00-0AA0 6GK5774-1FX00-0AB0 ¹⁾ 6GK5774-1FX00-0AC0 ²⁾
product type designation	W774-1 RJ45
standards, specifications, approvals marine classification	
Marine classification association	
• American Bureau of Shipping Europe Ltd. (ABS)	Yes
• French marine classification society (BV)	Yes
• DNV GL	Yes
• Korean Register of Shipping (KRS)	Yes
• Lloyds Register of Shipping (LRS)	Yes
• Nippon Kaiji Kyokai (NK)	Yes
• Polski Rejestr Statkow (PRS)	Yes
• Royal Institution of Naval Architects (RINA)	Yes
standards, specifications, approvals hazardous environments	
standard for hazardous zone	EN 60079-15:2005, EN 60079-0:2006, II 3 G Ex nA II T4 KEMA 07 ATEX 0145X
certificate of suitability CCC for hazardous zone according to GB standard	Yes
accessories	
accessories	24 V DC screw terminal included in scope of delivery

¹⁾ Wireless approval in the USA²⁾ Wireless approval in the Israel

Overview

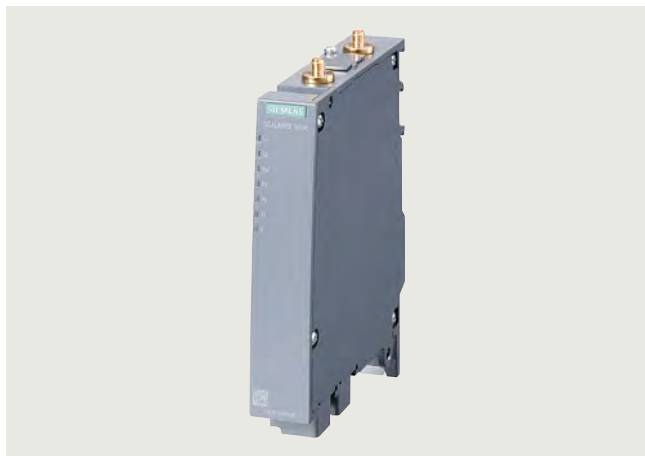

- Client modules in SIMATIC S7-1500 design are suitable for applications where the device is to be mounted in the control cabinet



ET 200MP station with SCALANCE W734 RJ45

Ordering data

SCALANCE W734 client modules

IWLAN Ethernet client modules with built-in wireless interface; wireless networks IEEE 802.11a/b/g/h/n at 2.4/5 GHz up to 300 Mbps; WPA2/AES; integrated 2-port switch; Power over Ethernet (PoE), IP30 degree of protection (-20 °C to +60 °C); scope of supply: Mounting hardware; 4-pin screw terminal for 24 V DC; manual on CD-ROM; English/German

SCALANCE W734-1 RJ45

For managing the radio link of up to eight devices with Industrial Ethernet connections;

- Country approvals for operation outside the USA
- Country approvals for operation within the USA ¹⁾

Accessories

KEY-PLUG W740 iFeatures

Removable data storage medium for enabling additional iFeatures, for simple device replacement in the event of a fault, and for storing configuration data; can be used in SCALANCE W client modules with a PLUG slot.

C-PLUG

Removable data storage medium for simple device replacement in the event of a fault; for storing configuration data; can be used in SIMATIC NET products with a PLUG slot

Article No.

6GK5734-1FX00-0AA0

6GK5734-1FX00-0AB0

6GK5907-4PA00

6GK1900-0AB10

Article No.

IE FC RJ45 plug 180 2 x 2

RJ45 connector for Industrial Ethernet with a rugged metal enclosure and integrated insulation-displacement contacts for connecting Industrial Ethernet FC installation cables; with a 180° cable outlet; for network components and CPs/CPUs with Industrial Ethernet interface

- 1 pack = 1 unit
- 1 pack = 10 units
- 1 pack = 50 units

6GK1901-1BB10-2AA0
6GK1901-1BB10-2AB0
6GK1901-1BB10-2AE0

IE FC standard cable GP 2 x 2

4-wire, shielded TP installation cable for connection to IE FC RJ45 outlet plug/IE FC RJ45 plug; PROFINET-compliant; with UL approval; sold by the meter; max. delivery unit 1 000 m, minimum order quantity 20 m

6XV1840-2AH10

IE FC stripping tool

Pre-adjusted stripping tool for fast stripping of Industrial Ethernet FC cables

6GK1901-1GA00

Antennas and miscellaneous IWLAN accessories

See Industry Mall, Industrial Wireless LAN/Accessories

¹⁾ Please note country approvals under: <http://www.siemens.com/wireless-approvals>

SIMATIC S7-1500 Advanced Controllers

I/O modules

Communication

SCALANCE W734 RJ45 for the control cabinet

Technical specifications

Article number	6GK5734-1FX00-0AA0 6GK5734-1FX00-0AB0 ¹⁾
product type designation	W734-1 RJ45
transfer rate	
transfer rate	
• with WLAN maximum	300 Mbit/s
• for Industrial Ethernet	10 Mbit/s, 100 Mbit/s
transfer rate for Industrial Ethernet	
• minimum	10 Mbit/s
• maximum	100 Mbit/s
interfaces	
number of electrical connections	
• for network components or terminal equipment	2
• for power supply	1
• for redundant voltage supply	1
type of electrical connection	
• for network components or terminal equipment	RJ45 socket
• for power supply	4-pole screw terminal, PoE
design of the removable storage	
• C-PLUG	Yes
• KEY-PLUG	Yes
memory	
design of the removable storage	
• C-PLUG	Yes
• KEY-PLUG	Yes
interfaces wireless	
number of radio cards permanently installed	1
transmission mode for multiple input multiple output (MIMO)	2x2
number of spatial streams	2
number of electrical connections for external antenna(s)	2
type of electrical connection for external antenna(s)	R-SMA (socket)
product feature external antenna can be mounted directly on device	Yes
supply voltage, current consumption, power loss	
type of voltage of the supply voltage	DC
supply voltage	
• from Power-over-Ethernet acc. to IEEE802.3at for type 1 and IEEE802.3af	48 V
consumed current	
• at DC at 24 V typical	0.25 A
• with Power-over-Ethernet according to IEEE802.3at for type 1 and IEEE802.3af typical	0.125 A
power loss [W]	
• at DC at 24 V typical	6 W
• with Power-over-Ethernet according to IEEE802.3at for type 1 and IEEE802.3af typical	6 W
supply voltage 1	
• from terminal block	19.2 V
supply voltage 2	
• from terminal block	28.8 V

Article number	6GK5734-1FX00-0AA0 6GK5734-1FX00-0AB0 ¹⁾
product type designation	W734-1 RJ45
ambient conditions	
ambient temperature	
• during operation	-20 ... +60 °C
• during storage	-40 ... +85 °C
• during transport	-40 ... +85 °C
relative humidity at 25 °C without condensation during operation maximum	95 %
ambient condition for operation	When used under hazardous conditions (Zone 2), the SCALANCE W774-1 RJ45 or W734-1 RJ45 product must be installed in an enclosure. To comply with EN 50021, this enclosure must meet the requirements of at least IP 54 in compliance with EN 60529.
protection class IP	IP30
design, dimensions and weights	
width	26 mm
height	156 mm
depth	127 mm
width of the enclosure without antenna	26 mm
height of the enclosure without antenna	147 mm
depth of the enclosure without antenna	127 mm
net weight	0.52 kg
fastening method	wall mounting only if flat mounted
• S7-300 rail mounting	Yes
• S7-1500 rail mounting	Yes
• 35 mm top hat DIN rail mounting	Yes
• wall mounting	Yes
radio frequencies	
operating frequency	
• for WLAN in 2.4 GHz frequency band	2.41 ... 2.48 GHz; depending on the country approvals
• for WLAN in 5 GHz frequency band	4.9 ... 5.8 GHz; depending on the country approvals
product features, product functions, product components general	
product function Access Point Mode	No
product function client Mode	Yes
product function	
• iPCF client	Yes; Only in combination with the 'KEY-PLUG W780 iFeatures' or 'KEY-PLUG W740 iFeatures'
• iPCF-MC client	Yes; Only in combination with 'KEY-PLUG W780 iFeatures' or 'KEY-PLUG W740 iFeatures'
number of iPCF-capable radio modules	1
product function iPRP	Yes; In combination with the 'KEY-PLUG W780 iFeatures' or 'KEY-PLUG W740 iFeatures' only

¹⁾ Wireless approval in the USA

Technical specifications

Article number	6GK5734-1FX00-0AA0 6GK5734-1FX00-0AB0 ¹⁾
product type designation	W734-1 RJ45
product functions management, configuration, engineering	
number of manageable IP addresses in client	8
product function	
• CLI	Yes
• web-based management	Yes
• MIB support	Yes
• TRAPs via email	Yes
• configuration with STEP 7	Yes
• configuration with STEP 7 in the TIA Portal	Yes
• WDS	No
protocol is supported	
• Address Resolution Protocol (ARP)	Yes
• ICMP	Yes
• Telnet	Yes
• HTTP	Yes
• HTTPS	Yes
• TFTP	Yes
• DCP	Yes
• LLDP	No
identification & maintenance function	
• I&M0 - device-specific information	Yes
• I&M1 – higher level designation/location designation	Yes
product functions diagnostics	
product function	
• PROFINET IO diagnosis	Yes
• link check	No
• connection monitoring IP-Alive	No
• SysLog	Yes
protocol is supported	
• SNMP v1	Yes
• SNMP v2	Yes
• SNMP v3	Yes
product functions VLAN	
product function	
• function VLAN with IWLAN	No
product functions DHCP	
product function	
• DHCP client	Yes
• DHCP server	Yes
• DHCP Option 82	Yes
product functions redundancy	
protocol is supported	
• STP/RSTP	Yes
• MSTP	Yes
• RSTP	Yes

Article number	6GK5734-1FX00-0AA0 6GK5734-1FX00-0AB0 ¹⁾
product type designation	W734-1 RJ45
product functions security	
product function	
• ACL - MAC-based	Yes
• management security, ACL-IP based	Yes
• IEEE 802.1x (radius)	Yes
• NAT/NAPT	Yes
• access protection according to IEEE802.11i	Yes
• WPA/WPA2	Yes
• TKIP/AES	Yes
protocol is supported	
• SSH	Yes
• RADIUS	Yes
product functions time	
protocol is supported	
• NTP	Yes
• SNTP	Yes
• SIMATIC time synchronization (SIMATIC Time)	Yes
standards, specifications, approvals	
standard	
• for FM	FM 3611: Class I, Division 2, Groups A,B,C,D, T4 / Class 1, Zone 2, Group IIC, T4 UL 60950-1, CSA C22.2 No. 60950-1
• for safety from CSA and UL certificate of suitability	
• EC Declaration of Conformity	Yes
• CE marking	Yes
• C-Tick	Yes
• E1 approval	No
• railway application in accordance with EN 50155	No
• NEMA TS2	No
• IEC 61375	No
• IEC 61850-3	No
• NEMA4X	No
• Power-over-Ethernet according to IEEE802.3at for type 1 and IEEE802.3af	Yes
• Power-over-Ethernet according to IEEE802.3at for type 2	Yes
standard for wireless communication	
• IEEE 802.11a	Yes
• IEEE 802.11b	Yes
• IEEE 802.11e	Yes
• IEEE 802.11g	Yes
• IEEE 802.11h	Yes
• IEEE 802.11i	Yes
• IEEE 802.11n	Yes
wireless approval	You will find the current list of countries at: http://www.siemens.com/wireless-approvals

¹⁾ Wireless approval in the USA

SIMATIC S7-1500 Advanced Controllers

I/O modules

Communication

SCALANCE W734 RJ45 for the control cabinet**Technical specifications**

Article number	6GK5734-1FX00-0AA0 6GK5734-1FX00-0AB0 ¹⁾
product type designation	W734-1 RJ45
standards, specifications, approvals marine classification	
Marine classification association	
• American Bureau of Shipping Europe Ltd. (ABS)	Yes
• French marine classification society (BV)	Yes
• DNV GL	Yes
• Korean Register of Shipping (KRS)	Yes
• Lloyds Register of Shipping (LRS)	Yes
• Nippon Kaiji Kyokai (NK)	Yes
• Polski Rejestr Statkow (PRS)	Yes
• Royal Institution of Naval Architects (RINA)	Yes

Article number	6GK5734-1FX00-0AA0 6GK5734-1FX00-0AB0 ¹⁾
product type designation	W734-1 RJ45
standards, specifications, approvals hazardous environments	
standard for hazardous zone	EN 60079-15:2005, EN 60079-0:2006, II 3 G Ex nA II T4 KEMA 07 ATEX 0145X
certificate of suitability CCC for hazardous zone according to GB standard	Yes
accessories	
accessories	24 V DC screw terminal included in scope of delivery

¹⁾ Wireless approval in the USA

Overview



- Modules for serial communication connections, scaled according to interface types, protocols, and performance
- 4 versions with different physical transmission characteristics:
 - RS 232C, max. 19.2 kbps
 - RS 232C, max. 115.2 kbps
 - RS 422/RS 485, max. 19.2 kbps
 - RS 422/RS 485, max. 115.2 kbps
- Protocols supported
 - Freeport: User-parameterizable telegram format for universal communication
 - 3964(R) for improved transmission reliability
 - Modbus RTU Master
 - Modbus RTU Slave
 - USS, implemented through instructions

Note:

SIPLUS extreme products are based on SIMATIC standard products. The contents listed here were taken from the respective standard products. SIPLUS extreme-specific information was added.

Ordering data

Article No.

SIPLUS CM PtP RS 232 BA communications module

(Extended temperature range and exposure to environmental substances)

Basic communications module with 1 interface RS 232, Freeport, 3964(R) and USS protocols, 9-pin D-sub connector, max. 19.2 Kbps

6AG1540-1AD00-7AA0

SIPLUS CM PtP RS 232 HF communications module

(Extended temperature range and exposure to environmental substances)

High Feature communications module with 1 interface RS 232, Freeport, 3964(R), USS and Modbus RTU protocols, 9-pin D-sub connector, max. 115.2 Kbps

6AG1541-1AD00-7AB0

SIPLUS CM PtP RS 422/485 BA communications module

(Extended temperature range and exposure to environmental substances)

Basic communications module with 1 interface RS 422/485, Freeport, 3964(R) and USS protocols, 15-pin sub D socket, max. 19.2 Kbps

6AG1540-1AB00-7AA0

SIPLUS CM PtP RS 422/485 HF communications module

(Extended temperature range and exposure to environmental substances)

High Feature communications module with 1 interface RS 422/485, Freeport, 3964(R), USS and Modbus RTU protocols, 15-pin sub D socket, max. 115.2 Kbps

6AG1541-1AB00-7AB0

Accessories

See SIMATIC S7-1500, CM PtP communications module, page 4/159

Technical specifications

Article number	6AG1540-1AD00-7AA0	6AG1541-1AD00-7AB0	6AG1540-1AB00-7AA0	6AG1541-1AB00-7AB0
Based on	6ES7540-1AD00-0AA0 SIPLUS S7-1500 CM PtP RS232 BA	6ES7541-1AD00-0AB0 SIPLUS S7-1500 CM PtP RS232 HF	6ES7540-1AB00-0AA0 SIPLUS S7-1500 CM PtP RS422/485 BA	6ES7541-1AB00-0AB0 SIPLUS S7-1500 CM PtP RS422/485 HF
Ambient conditions				
Ambient temperature during operation				
• horizontal installation, min.	-40 °C; = Tmin (incl. condensation/frost); start-up @ -25 °C	-40 °C; = Tmin (incl. condensation/frost); start-up @ -25 °C	-40 °C; = Tmin (incl. condensation/frost); start-up @ -25 °C	-40 °C; = Tmin (incl. condensation/frost); start-up @ -25 °C
• horizontal installation, max.	70 °C	70 °C	70 °C	70 °C
• vertical installation, min.	-40 °C; = Tmin; Startup @ -25 °C	-40 °C; = Tmin; Startup @ -25 °C	-40 °C; = Tmin; Startup @ -25 °C	-40 °C; = Tmin; Startup @ -25 °C
• vertical installation, max.	40 °C	40 °C	40 °C	40 °C
Altitude during operation relating to sea level				
• Installation altitude above sea level, max.	5 000 m	5 000 m	5 000 m	5 000 m
• Ambient air temperature-barometric pressure-altitude	Tmin ... Tmax at 1 140 hPa ... 795 hPa (-1 000 m ... +2 000 m) // Tmin ... (Tmax - 10 K) at 795 hPa ... 658 hPa (+2 000 m ... +3 500 m) // Tmin ... (Tmax -20 K) at 658 hPa ... 540 hPa (+3 500 m ... +5 000 m)	Tmin ... Tmax at 1 140 hPa ... 795 hPa (-1 000 m ... +2 000 m) // Tmin ... (Tmax - 10 K) at 795 hPa ... 658 hPa (+2 000 m ... +3 500 m) // Tmin ... (Tmax -20 K) at 658 hPa ... 540 hPa (+3 500 m ... +5 000 m)	Tmin ... Tmax at 1 140 hPa ... 795 hPa (-1 000 m ... +2 000 m) // Tmin ... (Tmax - 10 K) at 795 hPa ... 658 hPa (+2 000 m ... +3 500 m) // Tmin ... (Tmax -20 K) at 658 hPa ... 540 hPa (+3 500 m ... +5 000 m)	Tmin ... Tmax at 1 140 hPa ... 795 hPa (-1 000 m ... +2 000 m) // Tmin ... (Tmax - 10 K) at 795 hPa ... 658 hPa (+2 000 m ... +3 500 m) // Tmin ... (Tmax -20 K) at 658 hPa ... 540 hPa (+3 500 m ... +5 000 m)

SIMATIC S7-1500 Advanced Controllers

I/O modules

SIPLUS communication

SIPLUS CM PtP

Technical specifications

Article number	6AG1540-1AD00-7AA0	6AG1541-1AD00-7AB0	6AG1540-1AB00-7AA0	6AG1541-1AB00-7AB0
Based on	6ES7540-1AD00-0AA0 SIPLUS S7-1500 CM PtP RS232 BA	6ES7541-1AD00-0AB0 SIPLUS S7-1500 CM PtP RS232 HF	6ES7540-1AB00-0AA0 SIPLUS S7-1500 CM PtP RS422/485 BA	6ES7541-1AB00-0AB0 SIPLUS S7-1500 CM PtP RS422/485 HF
Relative humidity				
<ul style="list-style-type: none"> With condensation, tested in accordance with IEC 60068-2-38, max. 	100 %; RH incl. condensation/frost (no commissioning under condensation conditions)	100 %; RH incl. condensation/frost (no commissioning under condensation conditions)	100 %; RH incl. condensation/frost (no commissioning under condensation conditions)	100 %; RH incl. condensation/frost (no commissioning under condensation conditions)
Resistance				
Coolants and lubricants				
- Resistant to commercially available coolants and lubricants	Yes; Incl. diesel and oil droplets in the air	Yes; Incl. diesel and oil droplets in the air	Yes; Incl. diesel and oil droplets in the air	Yes; Incl. diesel and oil droplets in the air
Use in stationary industrial systems				
- to biologically active substances according to EN 60721-3-3	Yes; Class 3B2 mold, fungus and dry rot spores (with the exception of fauna); Class 3B3 on request	Yes; Class 3B2 mold, fungus and dry rot spores (with the exception of fauna); Class 3B3 on request	Yes; Class 3B2 mold, fungus and dry rot spores (with the exception of fauna); Class 3B3 on request	Yes; Class 3B2 mold, fungus and dry rot spores (with the exception of fauna); Class 3B3 on request
- to chemically active substances according to EN 60721-3-3	Yes; Class 3C4 (RH < 75 %) incl. salt spray acc. to EN 60068-2-52 (severity degree 3); *	Yes; Class 3C4 (RH < 75 %) incl. salt spray acc. to EN 60068-2-52 (severity degree 3); *	Yes; Class 3C4 (RH < 75 %) incl. salt spray acc. to EN 60068-2-52 (severity degree 3); *	Yes; Class 3C4 (RH < 75 %) incl. salt spray acc. to EN 60068-2-52 (severity degree 3); *
- to mechanically active substances according to EN 60721-3-3	Yes; Class 3S4 incl. sand, dust; *	Yes; Class 3S4 incl. sand, dust; *	Yes; Class 3S4 incl. sand, dust; *	Yes; Class 3S4 incl. sand, dust; *
Use on ships/at sea				
- to biologically active substances according to EN 60721-3-6	Yes; Class 6B2 mold and fungal spores (excluding fauna); Class 6B3 on request	Yes; Class 6B2 mold and fungal spores (excluding fauna); Class 6B3 on request	Yes; Class 6B2 mold and fungal spores (excluding fauna); Class 6B3 on request	Yes; Class 6B2 mold and fungal spores (excluding fauna); Class 6B3 on request
- to chemically active substances according to EN 60721-3-6	Yes; Class 6C3 (RH < 75 %) incl. salt spray acc. to EN 60068-2-52 (severity degree 3); *	Yes; Class 6C3 (RH < 75 %) incl. salt spray acc. to EN 60068-2-52 (severity degree 3); *	Yes; Class 6C3 (RH < 75 %) incl. salt spray acc. to EN 60068-2-52 (severity degree 3); *	Yes; Class 6C3 (RH < 75 %) incl. salt spray acc. to EN 60068-2-52 (severity degree 3); *
- to mechanically active substances according to EN 60721-3-6	Yes; Class 6S3 incl. sand, dust; *	Yes; Class 6S3 incl. sand, dust; *	Yes; Class 6S3 incl. sand, dust; *	Yes; Class 6S3 incl. sand, dust; *
Usage in industrial process technology				
- Against chemically active substances acc. to EN 60654-4	Yes; Class 3 (excluding trichlorethylene)	Yes; Class 3 (excluding trichlorethylene)	Yes; Class 3 (excluding trichlorethylene)	Yes; Class 3 (excluding trichlorethylene)
- Environmental conditions for process, measuring and control systems acc. to ANSI/ISA-71.04	Yes; Level GX group A/B (excluding trichlorethylene; harmful gas concentrations up to the limits of EN 60721-3-3 class 3C4 permissible); level LC3 (salt spray) and level LB3 (oil)	Yes; Level GX group A/B (excluding trichlorethylene; harmful gas concentrations up to the limits of EN 60721-3-3 class 3C4 permissible); level LC3 (salt spray) and level LB3 (oil)	Yes; Level GX group A/B (excluding trichlorethylene; harmful gas concentrations up to the limits of EN 60721-3-3 class 3C4 permissible); level LC3 (salt spray) and level LB3 (oil)	Yes; Level GX group A/B (excluding trichlorethylene; harmful gas concentrations up to the limits of EN 60721-3-3 class 3C4 permissible); level LC3 (salt spray) and level LB3 (oil)
Remark				
- Note regarding classification of environmental conditions acc. to EN 60721, EN 60654-4 and ANSI/ISA-71.04	* The supplied plug covers must remain in place over the unused interfaces during operation!	* The supplied plug covers must remain in place over the unused interfaces during operation!	* The supplied plug covers must remain in place over the unused interfaces during operation!	* The supplied plug covers must remain in place over the unused interfaces during operation!
Conformal coating				
<ul style="list-style-type: none"> Coatings for printed circuit board assemblies acc. to EN 61086 Protection against fouling acc. to EN 60664-3 Military testing according to MIL-I-46058C, Amendment 7 Qualification and Performance of Electrical Insulating Compound for Printed Board Assemblies according to IPC-CC-830A 	Yes; Class 2 for high reliability Yes; Type 1 protection Yes; Discoloration of coating possible during service life Yes; Conformal coating, Class A	Yes; Class 2 for high reliability Yes; Type 1 protection Yes; Discoloration of coating possible during service life Yes; Conformal coating, Class A	Yes; Class 2 for high reliability Yes; Type 1 protection Yes; Discoloration of coating possible during service life Yes; Conformal coating, Class A	Yes; Class 2 for high reliability Yes; Type 1 protection Yes; Discoloration of coating possible during service life Yes; Conformal coating, Class A

Overview



DP-M	DP-S	FMS	PG/OP	S7/S5	
●	●		●	●	

The CM 1542-5 communication module expands the SIMATIC S7-1500 controller to include a PROFIBUS connection for communication with lower-level PROFIBUS devices in bandwidths from 9.6 kbps to 12 Mbps. The module can also be used to implement separate PROFIBUS lines, in other words, to control a number of different field devices via a number of PROFIBUS segments. The CM 1542-5 handles all communication tasks, thus reducing the CPU load.

Apart from classic PROFIBUS communication, the CM 1542-5 is also suitable for S7 communication. This makes it possible to establish communication between the S7-1500 controller and other devices, for example those from the SIMATIC S7-300/400 range.

- PROFIBUS DP master or DP slave with electrical interface for connecting a SIMATIC S7-1500 to PROFIBUS at up to 12 Mbps (including 45.45 kbps)
- Communications services:
 - PROFIBUS DP
 - PG/OP communication
 - S7 communication
- Time synchronization
- Simple programming and configuration over PROFIBUS
- Cross-network PG communication using S7 routing
- Module replacement without a PG
- Data record routing (PROFIBUS DP)
- Adding or modifying distributed I/O during operation

Note:

SIPLUS extreme products are based on SIMATIC standard products. The contents listed here were taken from the respective standard products. SIPLUS extreme-specific information was added.

Ordering data

SIPLUS CM 1542-5 communication module

(extended temperature range and medial exposure)

Communication module for electrical connection of SIMATIC S7-1500 to PROFIBUS as a DP master or DP slave

Accessories

Article No.

6AG1542-5DX00-7XE0

See SIMATIC S7-1500, CM 1542-5 communication module, page 4/164

SIMATIC S7-1500 Advanced Controllers

I/O modules

SIPLUS communication

SIPLUS NET CP 1543-1

Overview



ISO	TCP/UDP	PN	MRP	IT	IP-R	PG/OP	S7/S5
●	●			●	●	●	●

The SIMATIC CP 1543-1 communications processor securely connects the new SIMATIC S7-1500 Controller to Industrial Ethernet networks. By combining a variety of security features such as an SPI (Stateful Packet Inspection) firewall, VPN and data encryption protocols such as FTPS and SNMPv3, the communications processor protects individual S7-1500 stations or even entire automation cells against unauthorized access.

The CP can also be used for linking the S7-1500 station into an IPv6-based network. All functions are configured by means of STEP 7 Professional V12 (TIA Portal) or higher.

The CP 1543-1 supports the following communications services:

- PG/OP communication
- S7 communication
- Open communication (SEND/RECEIVE, FETCH/WRITE)
- IT communication
 - FTP functions (File Transfer Protocol FTP/FTPS) for file management and access to data blocks in the CPU (client and server function)
 - Sending emails via SMTP or ESMTP with "SMTP-Auth" for authentication on an email server (also with IPv6)
- Security functions
 - Stateful Packet Inspection (layers 3 and 4) firewall
 - Secure communication via VPN (IPsec)
 - Secure access to the web server of the CPU via the HTTPS protocol
 - Secure file transfer using FTPS
 - Secure transfer of the time of day (NTP)
 - SNMPv3 for tap-proof transfer of network analysis information
- Integration of an S7-1500 into IPv6-based networks; An IPv6-compliant IP address can be used for the following communication services:
 - FETCH/WRITE access (CP as server)
 - FTP server mode
 - FTP client mode with addressing by program block
 - Email transfer with addressing by program block

Note

SIPLUS extreme products are based on SIMATIC standard products. The contents listed here were taken from the corresponding standard products. SIPLUS extreme-specific information was added.

Ordering data

Article No.

SIPLUS NET CP 1543-1 communications processor

6AG1543-1AX00-2XE0

(Extended temperature range and exposure to media)

For connection of SIMATIC S7-1500 to Industrial Ethernet via TCP/IP, ISO and UDP and Security functions; 1 x RJ45 interface with 10/100/1000 Mbps; electronic manual on DVD

Accessories

See SIMATIC S7-1500, CP 1543-1 communications processor, page 4/171

Overview



- Uniform, 40-pin front connector, suitable for SIMATIC S7-1500 I/O modules
- Versions for 25 mm wide or 35 mm wide modules
- With screw-type or push-in terminals
- Connectable core cross-sections: 0.25 mm² to 1.5 mm² (AWG 24 to 16)
- Front connector for 35 mm modules to be ordered separately; front connector for 25 mm modules included in scope of supply of modules

Design

- 40 terminals, arranged in two rows, numbered consecutively from 1 to 40
- Direct assignment of terminal to LED and labeling simplifies wiring, commissioning, and troubleshooting
- Holders for four potential bridges for simple and flexible creation of potential groups; four units are supplied with the front connector (optionally available as spare parts in packs of 20)
- Integrated shielding concept for analog modules and technology modules; allows space-saving installation without tools and ensures high ruggedness and EMC stability; components supplied with analog modules
- Cable ties for mechanical fixing of the cable bundle and for strain relief; 1 unit supplied with front connector

Ordering data

Article No.

Front connectors

For 35 mm modules; including four potential bridges, cable ties and individual labeling strips, 40-pin

- Screw terminals
- Push-in

6ES7592-1AM00-0XB0**6ES7592-1BM00-0XB0**

For 25 mm modules; including cable ties and individual labeling strips; push-in, 40-pin; spare part

6ES7592-1BM00-0XA0**Potential bridges for front connectors**

For 35 mm modules; 20 pieces; spare part

6ES7592-3AA00-0AA0

SIMATIC S7-1500 Advanced Controllers

I/O modules

Connection system

System cabling for SIMATIC S7-1500 and ET 200MP

Overview



With two cabling systems, SIMATIC TOP connect ensures efficient wiring of the input and output module of the SIMATIC S7-1500 (35 mm unit): Fully modular connection for fast and clearly arranged connecting to sensors and actuators in the field, and flexible connection for simple wiring inside the control cabinet.

With the TIA Selection Tool, you can select suitable system cabling for the individual I/O modules with a simple mouse click. Suitable components for the respective I/O module are always offered. These can be transferred to the order list and then ordered in the Industry Mall.

Further information can be found on the Internet at

<http://www.siemens.com/tia-selection-tool>

Design

Two cabling variants are available for a wide range of control cabinet concepts:

Fully modular connection

The system consists of:

- Front connector module
- Connecting cable
- Connection modules in the following versions: Basic module, signal module and function module

Connection errors are thus practically excluded and installation overhead is significantly reduced. Systematic connection of the SIMATIC system. The assembly work for the connecting cables is drastically reduced thanks to the use of pre-assembled cables sold by the meter.

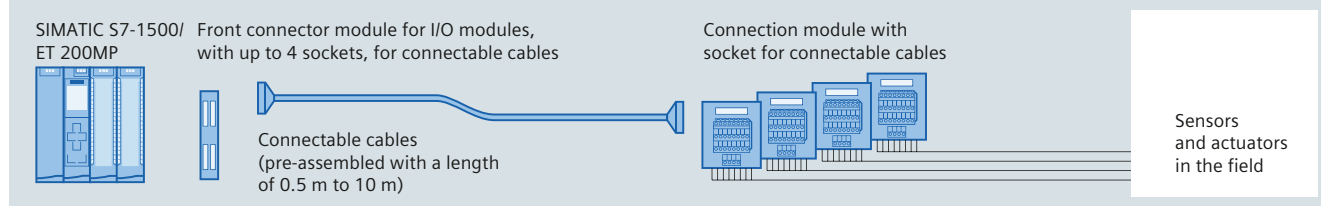

SIMATIC TOP connect for S7-1500/ET 200MP, fully modular connection

Flexible connection

Flexible connection with front connectors is available with 20 (Pin1 – 20) or 40 wired single cores.

These are available in lengths from 2.5 m to 10.0 m.

The single cores are available in different versions:

- Wire type H05V-K is used for industrial applications
- The UL/CSA-approved core is available for export to North America
- The halogen-free version is used where low smoke gas density in the event of fire is required, e.g. in building automation

The blue wires are numbered sequentially and can be routed direct to each element in the control cabinet. The numbering of the single cores corresponds to the coding of the front connector contacts.

In comparison to conventional single wiring, there is a cost saving of 50% for assembly, since the single cores that have already been checked on the connector are fixed.

Thus no complex pre-assembly of up to two times 20 single cores per module is necessary.

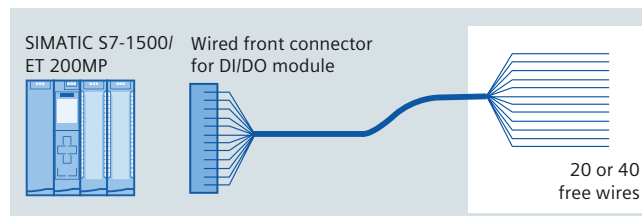

SIMATIC TOP connect for S7-1500/ET 200MP, flexible connection

Overview



The fully modular connection for connecting to the digital I/O modules of the SIMATIC S7-1500 or ET 200MP (35 mm design) consists of modified front connectors, called front connector modules, pre-assembled connecting cables of various lengths, and connection modules. Suitable components can be selected for the application in question and joined by means of simple plug-in connections. The connection modules are used instead of conventional terminal blocks and act as the interface to the sensors and actuators.

4

Benefits

- Front connector module, connecting cable and connection module are easy to plug in
- Fast, low-cost wiring
- In the case of digital signals, the supply voltage can be connected to the front connector module or the connection module
- Reduction in wiring errors, clear control cabinet wiring
- Byte-by-byte, or four-byte distribution of the signals in the case of digital signals
- Each component can be replaced individually
- Use of pre-assembled cables possible

Design

Front connector module

Modified front connectors, called front connector modules, are available for connecting to the I/O modules (35 mm design). These are plugged into the I/O module to be wired instead of the front connector. The front connector modules are available in many different versions for digital I/O modules, analog I/O modules and for the 24 V, 2-ampère module. The connecting cables are plugged into these front connector modules.

Connecting cable

There are different versions of the connecting cable.

As a pre-assembled 16-pole or 50-pole round cable (shielded or unshielded) it is available in lengths up to 10 m.

When pre-assembled, there are one or two connectors in insulation displacement method (female ribbon connectors) at both ends of the cable.

The connecting cable connects the front connector module with the connection module.

As a pre-assembled round cable (unshielded) with a 40-pole plug on the side of the I/O module (64-channel) and a 50-pole plug for the connection to the connection module (4-byte version). The cable connectors are designed with the insulation displacement method.

Connection module

The system has both digital and analog connection modules for connecting the I/O signals. These are snapped onto the DIN rail. The connection modules with basic or signal functionality are available in 1-byte or 4-byte versions.

Connection modules are available for two different connection methods: with push-in or screw-type terminals. The potential can be fed in at the connection module or at the front connector module.

If other voltage or power levels are required in the field, the connection module for TPRO or TPOo output signals is used. For the TPRO connection module, relays are used for the implementation. For the TPOo connection module, optocouplers are used for the implementation. This converts the 24 V DC output signal simply and reliably to another voltage or power level. If 230 V AC or 110 V AC input signals have to be transmitted to the PLC in the field, a connection module with relay TPRi is available that simply converts the 230/110 V AC signal to 24 V DC. This means that there is always the same voltage level on the module side.

Use with optocouplers for the TPRO relay modules

If higher switching frequencies of the relay terminal module are required for the output signals, the relay can simply be replaced with an optocoupler (note technical specifications) in order to increase the switching frequency.

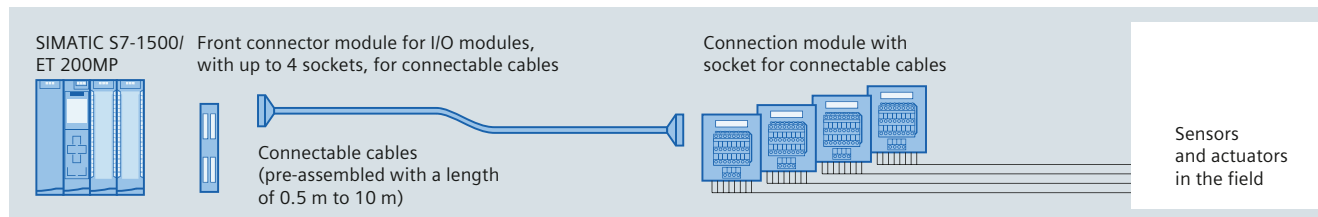

SIMATIC TOP connect for S7-1500/ET 200MP, fully modular connection

SIMATIC S7-1500 Advanced Controllers

I/O modules

Connection system

System cabling for SIMATIC S7-1500 and ET 200MP > Fully modular connection

Ordering data

Article No.

Article No.

Front connector module ¹⁾

Front connector module for digital modules for the connection of 16-pole connecting cables

Power supply via

- Push-in
- Screw terminals

6ES7921-5AH20-0AA0
6ES7921-5AB20-0AA0

Front connector module for digital modules for the connection of 50-pole connecting cables

Power supply via

- Push-in
- Screw terminals

6ES7921-5CH20-0AA0
6ES7921-5CB20-0AA0

Front connector module for 2 A digital output modules for the connection of 16-pole connecting cables

Power supply via

- Push-in
- Screw terminals

6ES7921-5AJ00-0AA0
6ES7921-5AD00-0AA0

Front connector module for analog modules for the connection of 16-pole connecting cables

6ES7921-5AK20-0AA0

Front connector module for analog modules for the connection of 50-pole connecting cables

6ES7921-5CK20-0AA0

¹⁾ The terminal assignment of these front connector modules is unique and the dimensional drawings are shown in the Equipment Manual of SIMATIC TOP connect for S7-1500 and ET 200MP. The equipment manual is available as a download from Customer Support with the following ID: 95924607.

Connecting cables

Connecting cables for SIMATIC S7-1500

Pre-assembled round cable

16-pin, 0.14 mm²

Unshielded

- 0.5 m
- 1.0 m
- 1.5 m
- 2.0 m
- 2.5 m
- 3.0 m
- 4.0 m
- 5.0 m
- 6.5 m
- 8.0 m
- 10.0 m

6ES7923-0BA50-0CB0
6ES7923-0BB00-0CB0
6ES7923-0BB50-0CB0
6ES7923-0BC00-0CB0
6ES7923-0BC50-0CB0
6ES7923-0BD00-0CB0
6ES7923-0BE00-0CB0
6ES7923-0BF00-0CB0
6ES7923-0BG50-0CB0
6ES7923-0BJ00-0CB0
6ES7923-0CB00-0CB0

Shielded

- 1.0 m
- 2.0 m
- 2.5 m
- 3.0 m
- 4.0 m
- 5.0 m
- 6.5 m
- 8.0 m
- 10.0 m

6ES7923-0BB00-0DB0
6ES7923-0BC00-0DB0
6ES7923-0BC50-0DB0
6ES7923-0BD00-0DB0
6ES7923-0BE00-0DB0
6ES7923-0BF00-0DB0
6ES7923-0BG50-0DB0
6ES7923-0BJ00-0DB0
6ES7923-0CB00-0DB0

Version 4 x 16 to 1 x 50-pin, 0.14 mm²

Unshielded

- 0.5 m
- 1.0 m
- 1.5 m
- 2.0 m
- 2.5 m
- 3.0 m
- 4.0 m
- 5.0 m
- 6.5 m
- 8.0 m
- 10.0 m

6ES7923-5BA50-0EB0
6ES7923-5BB00-0EB0
6ES7923-5BB50-0EB0
6ES7923-5BC00-0EB0
6ES7923-5BC50-0EB0
6ES7923-5BD00-0EB0
6ES7923-5BE00-0EB0
6ES7923-5BF00-0EB0
6ES7923-5BG50-0EB0
6ES7923-5BJ00-0EB0
6ES7923-5CB00-0EB0

Pre-assembled round cable

50-pin, 0.14 mm²

Unshielded

- 0.5 m
- 1.0 m
- 1.5 m
- 2.0 m
- 2.5 m
- 3.0 m
- 4.0 m
- 5.0 m
- 6.5 m
- 8.0 m
- 10.0 m

6ES7923-5BA50-0CB0
6ES7923-5BB00-0CB0
6ES7923-5BB50-0CB0
6ES7923-5BC00-0CB0
6ES7923-5BC50-0CB0
6ES7923-5BD00-0CB0
6ES7923-5BE00-0CB0
6ES7923-5BF00-0CB0
6ES7923-5BG50-0CB0
6ES7923-5BJ00-0CB0
6ES7923-5CB00-0CB0

Shielded

- 1.0 m
- 2.0 m
- 2.5 m
- 3.0 m
- 4.0 m
- 5.0 m
- 6.5 m
- 8.0 m
- 10.0 m

6ES7923-5BB00-0DB0
6ES7923-5BC00-0DB0
6ES7923-5BC50-0DB0
6ES7923-5BD00-0DB0
6ES7923-5BE00-0DB0
6ES7923-5BF00-0DB0
6ES7923-5BG50-0DB0
6ES7923-5BJ00-0DB0
6ES7923-5CB00-0DB0

Version 1 x 40-pin to 1 x 50-pin, 0.14 mm²

Unshielded

- 1.0 m
- 2.0 m
- 2.5 m
- 3.0 m

6ES7923-5BB00-0GB0
6ES7923-5BC00-0GB0
6ES7923-5BC50-0GB0
6ES7923-5BD00-0GB0

Ordering data

Article No.

Article No.

Connection modules**Connection module TP1**

For 1-wire connection, for 16-pin connecting cables

- Push-in terminals without LEDs
- Screw-type terminals without LEDs
- Push-in terminals with LEDs
- Screw-type terminals with LEDs

6ES7924-0AA20-0AC0
6ES7924-0AA20-0AA0
6ES7924-0AA20-0BC0
6ES7924-0AA20-0BA0

For 1-wire connection, for 50-pin connecting cables

- Push-in terminals without LEDs
- Screw-type terminals without LEDs
- Push-in terminals with LEDs
- Screw-type terminals with LEDs
- Push-in terminals, sourcing input, with LEDs
- Screw-type terminals, sourcing input, with LEDs
- Push-in terminals, mid-point conductor signal, with LEDs
- Screw-type terminals, mid-point conductor signal, with LEDs

6ES7924-2AA20-0AC0
6ES7924-2AA20-0AA0
6ES7924-2AA20-0BC0
6ES7924-2AA20-0BA0
6ES7924-2AK20-0BC0
6ES7924-2AK20-0BA0
6ES7924-2AM20-0BC0
6ES7924-2AM20-0BA0

Connection module TP3

For 3-wire connection, for 16-pin connecting cables

- Push-in terminals without LEDs
- Screw-type terminals without LEDs
- Push-in terminals with LEDs
- Screw-type terminals with LEDs
- Push-in terminals with LEDs and one isolating terminal per channel
- Screw-type terminals with LEDs and one isolating terminal per channel
- Push-in terminals with LEDs and fuse per channel
- Screw-type terminals with LEDs and fuse per channel

6ES7924-0CA20-0AC0
6ES7924-0CA20-0AA0
6ES7924-0CA20-0BC0
6ES7924-0CA20-0BA0
6ES7924-0CH20-0BC0
6ES7924-0CH20-0BA0
6ES7924-0CL20-0BC0
6ES7924-0CL20-0BA0

For 3-wire connection, for 50-pin connecting cables

- Push-in terminals without LEDs
- Screw-type terminals without LEDs
- Push-in terminals with LEDs
- Screw-type terminals with LEDs

6ES7924-2CA20-0AC0
6ES7924-2CA20-0AA0
6ES7924-2CA20-0BC0
6ES7924-2CA20-0BA0

Connection module TPPro

Relay module for 8 outputs, relay as normally open contact

- Push-in terminals with LEDs
- Screw-type terminals with LEDs

6ES7924-0BD20-0BC0
6ES7924-0BD20-0BA0

Connection module TPRI

Relay module for 8 inputs (110 V AC), relay as normally open contact

- Push-in terminals with LEDs
- Screw-type terminals with LEDs

6ES7924-0BG20-0BC0
6ES7924-0BG20-0BA0

Connection module TPRI

Relay module for 8 inputs (230 V AC), relay as normally open contact

- Push-in terminals with LEDs
- Screw-type terminals with LEDs

6ES7924-0BE20-0BC0
6ES7924-0BE20-0BA0

Connection module TPOo

Optocoupler module for 8 outputs (max. 24 V DC/4 A)

- Push-in terminals with LEDs
- Screw-type terminals with LEDs

6ES7924-0BF20-0BC0
6ES7924-0BF20-0BA0

Connection module for digital output modules 2 A

Connection module TP2

- Push-in terminals without LEDs
- Screw-type terminals without LEDs

6ES7924-0BB20-0AC0
6ES7924-0BB20-0AA0

Connection module for analog modules

Connection module TPA, 16-pin

- Push-in terminals without LEDs
- Screw-type terminals without LEDs

6ES7924-0CC20-0AC0
6ES7924-0CC20-0AA0

Connection module TPA, 50-pin

- Push-in terminals without LEDs
- Screw-type terminals without LEDs

6ES7924-2CC20-0AC0
6ES7924-2CC20-0AA0

Accessories**Shield plate for analog connection module**

PU = 4 units (for connection of 15-pin connecting cable)

6ES7928-1AA20-4AA0

PU = 4 units (for connection of 15-pin connecting cable)

6ES7928-1BA20-4AA0

Shield connection clamp

For shield plate at SIMATIC end, PU = 10 units

6ES7590-5BA00-0AA0

For shield plate at field end, 2 x 2 ... 6 mm

6ES7390-5AB00-0AA0

For shield plate at field end, 3 ... 8 mm

6ES7390-5BA00-0AA0

For shield plate at field end, 4 ... 13 mm

6ES7390-5CA00-0AA0

SIMATIC S7-1500 Advanced Controllers

I/O modules

Connection system

System cabling for SIMATIC S7-1500 and ET 200MP > Fully modular connection**Technical specifications Front connector modules**

Rated operating voltage	24 V DC
Max. permissible operating voltage	60 V DC
Max. permissible continuous current • per connector pin	1 A
Max. permissible total current	2 A/byte
Permissible ambient temperature	0 to +60 °C
Test voltage	0.5 kV, 50 Hz, 60 sec.
Clearance and creepage distances	IEC 664 (1980), IEC 664 A (1981), in accordance with DIN VDE 0110 (01.89), overvoltage class II, pollution degree 2

Wiring rules for the front connector modules**SIMATIC TOP connect front connector module,
connection for potential infeed**

	Push-in	Screw terminals
	Modules up to 4 connections	
Connectable cable cross-sections		
• Solid conductors	No	
• Flexible cables with/without wire end ferrule	0.25 to 1.5 mm ²	
Number of cables per connection	1 or a combination of 2 wires up to 1.5 mm ² (total) in a common wire end ferrule	
Max. diameter of the cable insulation	3.1 mm	
Stripped length of the cables		
• Without insulating collar	6 mm	
• With insulating collar	-	
Wire end ferrules according to DIN 46228		
• Without insulating collar	Form A; 5 to 7 mm long	
• With insulating collar 0.25 to 1.0 mm ²	-	
• With insulating collar 1.5 mm ²	-	
Blade width of the screwdriver	3.5 mm (cylindrical design)	
Tightening torque for connecting the cables	-	0.4 Nm to 0.7 Nm

Technical specifications Connecting cable

Technical specifications of connecting cable from SIMATIC S7 to connection module	
Operating voltage	60 V DC
Continuous current per signal conductor	1 A
Max. total current	4 A/byte
Operating temperature	0 to +60 °C
Outer diameter of pre-assembled round cable in mm unshielded/shielded (16-pole)	Approx. 6.5/7.0

Overview



Flexible connection of the cabling system consists of a S7-1500 front connector which has the 20 or 40 single cores already in place and which directly connects the I/O modules (35 mm design) with the sensors and actuators inside the control cabinet. With a cross-section of 0.5 square mm, the single wires are also suitable for higher currents and are available in different lengths and versions: as H05V-K cores (PVC insulation), H05Z-K (halogen-free insulation) or with UL/CSA certified cores. The halogen-free version has a low smoke gas density in the event of a fire and is thus particularly well suited for use in buildings.

Can be used for SIMATIC S7-1500 and ET 200MP digital modules (24 V DC, 35 mm design)

The front connectors with single cores replace the SIMATIC standard connectors

- 6ES7592-1AM00-0XB0 and 6ES7592-1BM00-0XB0

Technical specifications

Front connector with single cores for 16 channels (pins 1-20)

Rated operating voltage	24 V DC
Permissible continuous current with simultaneous load of all cores, max.	1.5 A
Permissible ambient temperature	0 to 60 °C
Core type	H05V-K, UL 1007/1569; CSA TR64, or halogen-free
Number of single cores	20
Core cross-section	0.5 mm ² ; Cu
Bundle diameter in mm	approx. 15
Wire color	Blue, RAL 5010
Designation of cores	Numbered from 1 to 20 (front connector contact = core number)
Assembly	Screw contacts

Front connector with single cores for 32 channels (pins 1-40)

Rated operating voltage	24 V DC
Permissible continuous current with simultaneous load of all cores, max.	1.5 A
Permissible ambient temperature	0 to 60 °C
Core type	H05V-K, UL 1007/1569; CSA TR64, or halogen-free
Number of single cores	40
Core cross-section	0.5 mm ² ; Cu
Bundle diameter in mm	approx. 17
Wire color	Blue, RAL 5010
Designation of cores	Numbered from 1 to 40 (front connector contact = core number)
Assembly	Screw contacts

Ordering data

Article No.

Front connector with single cores for 32 channels (pins 1-40)

Core type H05V-K (0.5 mm² with screw connection)

- 2.5 m
- 3.2 m
- 5.0 m
- 6.5 m
- 8.0 m
- 10.0 m

6ES7922-5BC50-0AC0
6ES7922-5BD20-0AC0
6ES7922-5BF00-0AC0
6ES7922-5BG50-0AC0
6ES7922-5BJ00-0AC0
6ES7922-5CB00-0AC0

Core type H05Z-K, halogen-free (0.5 mm² with screw connection)

- 2.5 m
- 3.2 m
- 5.0 m
- 6.5 m
- 8.0 m
- 10.0 m

6ES7922-5BC50-0HC0
6ES7922-5BD20-0HC0
6ES7922-5BF00-0HC0
6ES7922-5BG50-0HC0
6ES7922-5BJ00-0HC0
6ES7922-5CB00-0HC0

Core type UL/CSA-certified (0.5 mm² with screw connection)

- 3.2 m
- 5.0 m
- 6.5 m

6ES7922-5BD20-0UC0
6ES7922-5BF00-0UC0
6ES7922-5BG50-0UC0

Front connector with single cores for 16 channels (pins 1-20)

Core type H05V-K (0.5 mm² with screw connection)

- 2.5 m
- 3.2 m
- 5.0 m
- 6.5 m
- 8.0 m
- 10.0 m

6ES7922-5BC50-0AB0
6ES7922-5BD20-0AB0
6ES7922-5BF00-0AB0
6ES7922-5BG50-0AB0
6ES7922-5BJ00-0AB0
6ES7922-5CB00-0AB0

Core type H05Z-K, halogen-free (0.5 mm² with screw connection)

- 2.5 m
- 3.2 m
- 5.0 m
- 6.5 m
- 8.0 m
- 10.0 m

6ES7922-5BC50-0HB0
6ES7922-5BD20-0HB0
6ES7922-5BF00-0HB0
6ES7922-5BG50-0HB0
6ES7922-5BJ00-0HB0
6ES7922-5CB00-0HB0

Core type UL/CSA-certified (0.5 mm² with screw connection)

- 3.2 m
- 5.0 m
- 6.5 m

6ES7922-5BD20-0UB0
6ES7922-5BF00-0UB0
6ES7922-5BG50-0UB0

SIMATIC S7-1500 Advanced Controllers

I/O modules

Connection system

System cabling for SIMATIC S7-1500 IO (25 mm), ET 200SP, S7-1200 and LOGO!

Overview

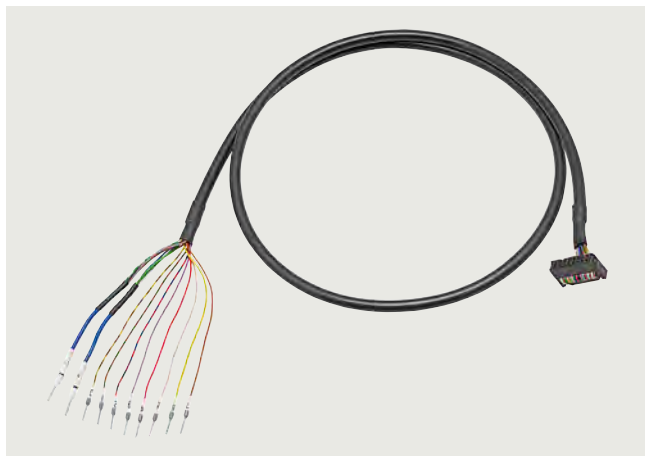

SIMATIC TOP connect universal connecting cable

The wiring of the

- SIMATIC S7-1500 IO (25 mm)
- SIMATIC ET 200SP
- SIMATIC S7-1200
- LOGO!

with the sensors/actuators is a significant factor with respect to time/cost overhead during configuration, control cabinet design, procurement and ease of servicing. The SIMATIC TOP connect system cabling makes connection easy, fast and secure.

Design

The unshielded universal connection cable is offered for a wide range of control cabinet concepts.

It comprises:

- 16-pin round cable with a core cross-section of 0.14 mm², pre-assembled with wire end ferrules for connection to the controller:
 - Labeled with "0" ... "7" for the control inputs/outputs
 - Labeled with "M" for mass
 - Labeled with "L+" for 24 V DC potential

- 16-pin ID (insulation displacement) connector for connection to the SIMATIC TOP connect connection modules for 8 I/Os:
 - 3-wire connection using the appropriate connection module for quick, error-free wiring
 - Galvanic isolation and adaptation using a coupling relay for easy implementation of potential groups in the system
 - High output current (up to 4 A), even for higher switching frequencies, using an optocoupler module (overload and short-circuit proof)
 - Implementation of isolating terminals using switch modules enabling individual signals to be measured
 - Channel-wise protection of I/Os using a fuse module with a thermal fuse

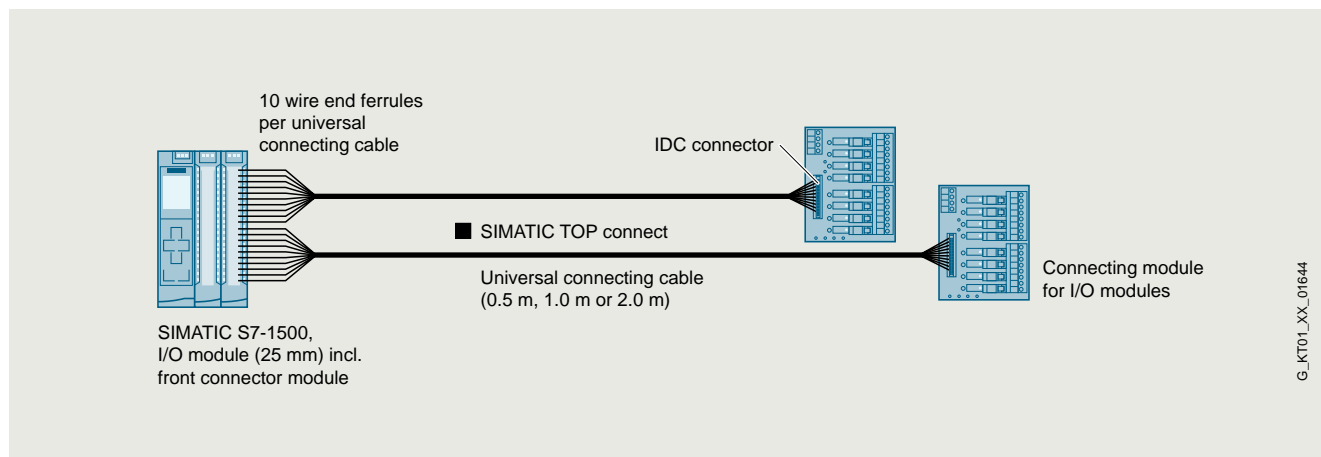

SIMATIC TOP connect universal connection cable

System cabling for SIMATIC S7-1500 IO (25 mm), ET 200SP, S7-1200 and LOGO!

Overview Universal connecting cable

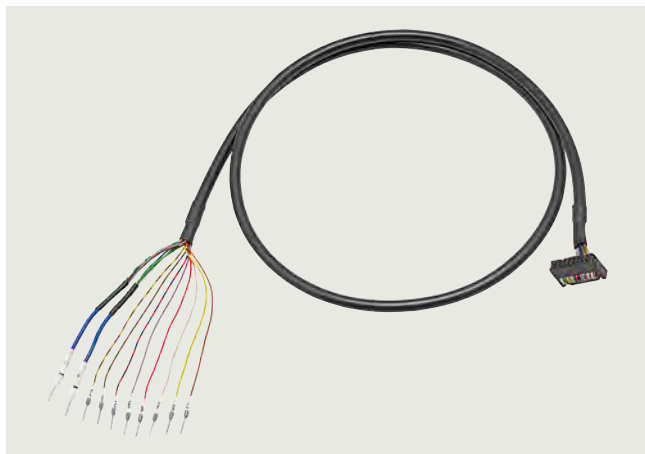

SIMATIC TOP connect universal connecting cable

The universal connecting cable constitutes the link between the standard connection of the SIMATIC S7-1500 IO (25 mm), SIMATIC ET 200SP, SIMATIC S7-1200 or LOGO! and the SIMATIC TOP connect terminal module. It transmits 8 signals and the supply voltage. The connecting cable is available in lengths of 0.5 m / 1.0 m / 2.0 m. the maximum technically feasible length is 30 m.

Ordering data

Article No.

Universal connecting cable for
SIMATIC S7-1500 IO (25 mm),
SIMATIC ET 200SP,
SIMATIC S7-1200 and LOGO!

16 x 0.14 mm² unshielded

- 0.5 m
- 1.0 m
- 2.0 m

6ES7923-0BA50-0FB0
6ES7923-0BB00-0FB0
6ES7923-0BC00-0FB0

Overview Connection modules

The connection modules are used instead of conventional terminal blocks and act as the interface between the PLC and signals from the field. All digital modules with 8 I/Os can be used.

Ordering data

Article No.

Connection module TP1

For 1-wire connection,
for 16-pin connecting cables

- Push-in terminals without LEDs
- Screw-type terminals without LEDs
- Push-in terminals with LEDs
- Screw-type terminals with LEDs

6ES7924-0AA20-0AC0
6ES7924-0AA20-0AA0
6ES7924-0AA20-0BC0
6ES7924-0AA20-0BA0

Connection module TP3

For 3-wire connection, for 16-pin
connecting cables

- Push-in terminals without LEDs
- Screw-type terminals without LEDs
- Push-in terminals with LEDs
- Screw-type terminals with LEDs
- Push-in terminals with LEDs and one isolating terminal per channel
- Screw-type terminals with LEDs and one isolating terminal per channel
- Push-in terminals with LEDs and fuse per channel
- Screw-type terminals with LEDs and fuse per channel

6ES7924-0CA20-0AC0
6ES7924-0CA20-0AA0
6ES7924-0CA20-0BC0
6ES7924-0CA20-0BA0
6ES7924-0CH20-0BC0
6ES7924-0CH20-0BA0
6ES7924-0CL20-0BC0
6ES7924-0CL20-0BA0

Connection module TPRo

Relay module for 8 outputs,
relay as normally open contact

- Push-in terminals with LEDs
- Screw-type terminals with LEDs

6ES7924-0BD20-0BC0
6ES7924-0BD20-0BA0

Connection module TPRi

Relay module for 8 inputs (230 V AC),
relay as normally open contact

- Push-in terminals with LEDs
- Screw-type terminals with LEDs

6ES7924-0BE20-0BC0
6ES7924-0BE20-0BA0

Connection module TPRi

Relay module for 8 inputs
(110 V AC), relay as normally
open contact

- Push-in terminals with LEDs
- Screw-type terminals with LEDs

6ES7924-0BG20-0BC0
6ES7924-0BG20-0BA0

Connection module TPOo

Optocoupler module for 8 outputs
(max. 24 V DC/4 A)

- Push-in terminals with LEDs
- Screw-type terminals with LEDs

6ES7924-0BF20-0BC0
6ES7924-0BF20-0BA0

SIMATIC S7-1500 Advanced Controllers

I/O modules

Fail-safe I/O modules

Digital F-input modules

Overview



Fail-safe digital input module: F-DI 16x24VDC PROFISAFE

Important properties:

- 16-channel fail-safe digital input module for ET 200MP/S7-1500
- For fail-safe reading of sensor information (1 or 2 channels)
- Provides integral discrepancy evaluation for 2-out-of-2 signals
- 4 internal sensor supplies (incl. test function) onboard
- Certified up to SIL 3 (IEC 61508), PL e (ISO 13849)
- LED display for error, operation, supply voltage and status
- Clear module labeling
 - Plain text identification of the module type
 - Complete Article No.
 - 2D matrix code (order and serial number)
 - Connection diagram
 - Hardware and firmware version
- Optional labeling accessories
 - Labeling sheets, yellow
- The modules support PROFIsafe in both PROFIBUS and PROFINET configurations. Can be used with all fail-safe SIMATIC S7-1500 F-CPU's in the central configuration, as well as ET 200MP distributed I/O with all other SIMATIC S7 F-CPU's.

Ordering data

	Article No.
F-digital input module 16 inputs, 24 V DC, PROFISAFE	6ES7526-1BH00-0AB0
Accessories	
Coding elements E-coding element type F for ET 200MP module F-DI/F-DQ; 5 units, spare part	6ES7592-6EF00-1AA0
Front connector Incl. four potential bridges, cable ties and individual labeling strips, 40-pin • Screw terminals • Push-in	6ES7592-1AM00-0XB0 6ES7592-1BM00-0XB0
DIN A4 labeling sheets For 35-mm F-modules; 10 sheets with 10 labeling strips each for I/O modules; perforated, yellow	6ES7592-2CX00-0AA0
U connector 5 units; spare part	6ES7590-0AA00-0AA0
Front door for F-I/O modules 5 front doors; with 5 labeling strips (front) and 5 cabling diagrams per front door; spare part	6ES7528-0AA10-7AA0

Article No.

STEP 7 Safety Advanced V17

Task:
Engineering tool for configuring and programming fail-safe user programs for SIMATIC S7-1200 FC, S7-1500F, S7-1500F Software Controller, S7-300F, S7-400F, WinAC RTX F, ET 200SP F Controller and the fail-safe I/O ET 200SP, ET 200MP, ET 200S, ET 200M, ET 200iSP, ET 200pro and ET 200eco

Requirement:
STEP 7 Professional V17

Note:

As of TIA Portal V16, the SIMATIC STEP 7 Safety software is an integral component of the SIMATIC STEP 7 product setup. The functionality of SIMATIC STEP 7 Safety is activated by means of the license key supplied in each case.

Floating license for 1 user; license key on USB flash drive

Floating license for 1 user; license key for download¹⁾; Email address required for delivery

6ES7833-1FA17-0YA5

6ES7833-1FA17-0YH5

¹⁾ For up-to-date information and download availability, see: <http://www.siemens.com/tia-online-software-delivery>

Ordering data	Article No.
S7 Distributed Safety V5.4 SP5 Update 2 programming tool Task: Configuration software for configuring fail-safe user programs for SIMATIC S7-300F, S7-400F, WinAC RTX F, ET 200S, ET 200M, ET 200iSP, ET 200pro, ET 200eco, ET 200SP Requirement: Windows 7 SP1 (64-bit), Windows 10 Professional/Enterprise (64-bit), Windows Server 2008 R2 SP1 (64-bit), Windows Server 2012 R2 (64-bit), Windows Server 2016 (64-bit); STEP 7 as of V5.5 SP1; Please also consider the operating systems that have been released for the used STEP 7 version Floating license for 1 user; software and documentation on DVD; license key on USB flash drive Floating license for 1 user; software, documentation and license key for download ¹⁾ ; Email address required for delivery	6ES7833-1FC02-0YA5 6ES7833-1FC02-0YH5

¹⁾ For up-to-date information and download availability, see: <http://www.siemens.com/tia-online-software-delivery>

Technical specifications	
Article number	6ES7526-1BH00-0AB0 ET 200MP, F-DI 16X24VDC
General information	
Product type designation	F-DI 16x24VDC
Engineering with	
• STEP 7 TIA Portal configurable/integrated from version	V13 SP1 with HSP 0086
Operating mode	
• DI	Yes
Supply voltage	
Rated value (DC)	24 V
Reverse polarity protection	Yes
Encoder supply	
Number of outputs	4
Short-circuit protection	Yes; Electronic (response threshold 0.7 A to 1.8 A)
24 V encoder supply	
• 24 V	Yes; min. L+ (-1.5 V)
• Short-circuit protection	Yes
• Output current, max.	300 mA; Max. 100 mA when mounted vertically
Digital inputs	
Number of digital inputs	16
Source/sink input	Yes; P-reading
Input characteristic curve in accordance with IEC 61131, type 1	Yes
Input voltage	
• Rated value (DC)	24 V
• for signal "0"	-30 to +5 V
• for signal "1"	+15 to +30 V
Input current	
• for signal "1", typ.	3.7 mA
Input delay (for rated value of input voltage)	
for standard inputs	
- parameterizable	Yes

Article number	6ES7526-1BH00-0AB0 ET 200MP, F-DI 16X24VDC
Interrupts/diagnostics/status information	
Diagnostics function	Yes
Alarms	
• Diagnostic alarm	Yes
• Hardware interrupt	No
Diagnoses	
• Monitoring the supply voltage	Yes
• Wire-break	No
• Short-circuit	Yes
• Group error	Yes
Diagnostics indication LED	
• RUN LED	Yes; green LED
• ERROR LED	Yes; red LED
• Channel status display	Yes; green LED
• for channel diagnostics	Yes; red LED
• for module diagnostics	Yes; red LED
Potential separation	
Potential separation channels	
• between the channels and backplane bus	Yes
Standards, approvals, certificates	
Suitable for safety functions	Yes
Highest safety class achievable in safety mode	
• Performance level according to ISO 13849-1	PLe
• SIL acc. to IEC 61508	SIL 3
Ambient conditions	
Ambient temperature during operation	
• horizontal installation, min.	0 °C
• horizontal installation, max.	60 °C
• vertical installation, min.	0 °C
• vertical installation, max.	40 °C
Dimensions	
Width	35 mm
Height	147 mm
Depth	129 mm
Weights	
Weight, approx.	280 g

SIMATIC S7-1500 Advanced Controllers

I/O modules

Fail-safe I/O modules

Digital F-output modules

Overview



Digital fail-safe output module:
F-DQ 8x24VDC 2A PPM PROFISAFE

Important features:

- 8-channel digital fail-safe output module for ET 200MP/S7-1500
- Fail-safe 2-channel activation (parameterizable PM/PP switching) of actuators
- Actuators can be controlled up to 2 A
- Certified up to SIL 3 (IEC 61508), PL e (ISO 13849)
- LED display for error, operation, supply voltage and status
- Clear module labeling
 - Plain text identification of the module type
 - Complete Article No.
 - 2D matrix code (order and serial number)
 - Connection diagram
 - Hardware and firmware version
- Optional labeling accessories
 - Labeling sheets, yellow
- The module supports PROFIsafe in both PROFIBUS and PROFINET configurations.
- Can be used with all fail-safe SIMATIC S7-1500 F-CPU's in the central configuration, as well as ET 200MP distributed I/O with all other SIMATIC S7 F-CPU's.

Ordering data

Article No.

F-digital output module

8 outputs, 24 V DC, 2 A, PROFISAFE, switching to P/M potential

6ES7526-2BF00-0AB0

Accessories

Coding elements

E-coding element type F for ET 200MP module F-DI/F-DQ; 5 units, spare part

6ES7592-6EF00-1AA0

Front connector

Incl. four potential bridges, cable ties and individual labeling strips, 40-pin

- Screw terminals
- Push-in

6ES7592-1AM00-0XB0
6ES7592-1BM00-0XB0

DIN A4 labeling sheets

For 35-mm F-modules; 10 sheets with 10 labeling strips each for I/O modules; perforated, yellow

6ES7592-2CX00-0AA0

U connector

5 units; spare part

6ES7590-0AA00-0AA0

Front door for F-I/O modules

5 front doors; with 5 labeling strips (front) and 5 cabling diagrams per front door; spare part

6ES7528-0AA10-7AA0

Article No.

STEP 7 Safety Advanced V17

Task:

Engineering tool for configuring and programming fail-safe user programs for SIMATIC S7-1200 FC, S7-1500F, S7-1500F Software Controller, S7-300F, S7-400F, WinAC RTX F, ET 200SP F Controller and the fail-safe I/O ET 200SP, ET 200MP, ET 200S, ET 200M, ET 200iSP, ET 200pro and ET 200eco

Requirement:

STEP 7 Professional V17

Note:

As of TIA Portal V16, the SIMATIC STEP 7 Safety software is an integral component of the SIMATIC STEP 7 product setup. The functionality of SIMATIC STEP 7 Safety is activated by means of the license key supplied in each case.

Floating license for 1 user; license key on USB flash drive

6ES7833-1FA17-0YA5

Floating license for 1 user; license key for download¹⁾; Email address required for delivery

6ES7833-1FA17-0YH5

¹⁾ For up-to-date information and download availability, see: <http://www.siemens.com/tia-online-software-delivery>

Ordering data	Article No.
S7 Distributed Safety V5.4 SP5 Update 2 programming tool Task: Configuration software for configuring fail-safe user programs for SIMATIC S7-300F, S7-400F, WinAC RTX F, ET 200S, ET 200M, ET 200iSP, ET 200pro, ET 200eco, ET 200SP Requirement: Windows 7 SP1 (64-bit), Windows 10 Professional/Enterprise (64-bit), Windows Server 2008 R2 SP1 (64-bit), Windows Server 2012 R2 (64-bit), Windows Server 2016 (64-bit); STEP 7 as of V5.5 SP1; Please also consider the operating systems that have been released for the used STEP 7 version Floating license for 1 user; software and documentation on DVD; license key on USB flash drive Floating license for 1 user; software, documentation and license key for download ¹⁾ ; Email address required for delivery	6ES7833-1FC02-0YA5 6ES7833-1FC02-0YH5

1) For up-to-date information and download availability, see: <http://www.siemens.com/tia-online-software-delivery>

Technical specifications

Article number	6ES7526-2BF00-0AB0 ET 200MP, F-DQ 8x24VDC 2A PPM
General information	
Product type designation	F-DQ 8x24VDC/2A PPM
Engineering with	
• STEP 7 TIA Portal configurable/integrated from version	V13 SP1 with HSP 0086
Operating mode	
• DQ	Yes
Supply voltage	
Rated value (DC)	24 V
Reverse polarity protection	Yes
Digital outputs	
Number of digital outputs	8
Current-sinking	Yes
Current-sourcing	Yes
Short-circuit protection	Yes
Open-circuit detection	Yes
Overload protection	Yes
Limitation of inductive shutdown voltage to	PM-switching: -24 V + (-47 V), PP-switching: -24 V
Switching capacity of the outputs	
• with resistive load, max.	2 A
• on lamp load, max.	10 W
Load resistance range	
• lower limit	12 Ω
• upper limit	2 000 Ω
Output voltage	
• for signal *1*, min.	24 V; L+ (-0.5 V)
Output current	
• for signal *1* rated value	2 A
• for signal *0* residual current, max.	0.5 mA; Current-sourcing, or current sourcing and sinking switches individually, current sinking: max. 1 mA

Article number	6ES7526-2BF00-0AB0 ET 200MP, F-DQ 8x24VDC 2A PPM
Switching frequency	
• with resistive load, max.	30 Hz
• with inductive load, max.	0.1 Hz
• on lamp load, max.	10 Hz
Total current of the outputs	
• Current per channel, max.	2 A
Total current of the outputs (per module)	
horizontal installation	
- up to 40 °C, max.	16 A
- up to 60 °C, max.	8 A
vertical installation	
- up to 40 °C, max.	8 A
Interrupts/diagnostics/status information	
Diagnostics function	Yes
Substitute values connectable	No
Alarms	
• Diagnostic alarm	Yes
Diagnoses	
• Monitoring the supply voltage	Yes
• Wire-break	Yes
• Short-circuit	Yes
• Group error	Yes
Diagnostics indication LED	
• RUN LED	Yes; green LED
• ERROR LED	Yes; red LED
• Monitoring of the supply voltage (PWR-LED)	Yes
• Channel status display	Yes; green LED
• for channel diagnostics	Yes; red LED
• for module diagnostics	Yes; red LED
Potential separation	
Potential separation channels	
• between the channels and backplane bus	Yes
Standards, approvals, certificates	
Suitable for safety functions	Yes
Highest safety class achievable in safety mode	
• Performance level according to ISO 13849-1	PLe
• SIL acc. to IEC 61508	SIL 3
Ambient conditions	
Ambient temperature during operation	
• horizontal installation, min.	0 °C
• horizontal installation, max.	60 °C
• vertical installation, min.	0 °C
• vertical installation, max.	40 °C
Dimensions	
Width	35 mm
Height	147 mm
Depth	129 mm
Weights	
Weight, approx.	300 g

SIMATIC S7-1500 Advanced Controllers

I/O modules

SIPLUS F-digital/analog modules

SIPLUS digital F-input modules

Overview



SIPLUS digital fail-safe input module: F-DI 16x24 V DC

Important properties:

- 16-channel fail-safe digital input module for ET 200MP/S7-1500
- For fail-safe reading of sensor information (1 or 2 channels)
- Provides integral discrepancy evaluation for 2-out-of-2 signals
- 4 internal sensor supplies (incl. test function) onboard
- Certified up to SIL 3 (IEC 61508), PL e (ISO 13849)
- LED display for error, operation, supply voltage and status
- Clear module labeling
 - Plain text identification of the module type
 - Complete Article No.
 - 2D matrix code (order and serial number)
 - Connection diagram
 - Hardware and firmware version
- Optional labeling accessories
 - Labeling sheets, yellow
- The modules support PROFIsafe in both PROFIBUS and PROFINET configurations. Can be used with all fail-safe SIMATIC S7-1500 F-CPUs in the central configuration, as well as ET 200MP distributed I/O with all other SIMATIC S7 F-CPUs.

Note:

SIPLUS extreme products are based on SIMATIC standard products. The contents listed here were taken from the corresponding standard products. SIPLUS extreme-specific information was added.

Ordering data

Article No.

SIPLUS F-digital input module	
16 inputs, 24 V DC, PROFISAFE	6AG1526-1BH00-2AB0
Accessories	
Coding elements	6AG1592-6EF00-2AA0
E-coding element type F for SIPLUS ET 200MP modules F-DI/F-DQ; 5 units, spare part	
Other accessories	See SIMATIC S7-1500 F-digital input modules, page 4/202

Technical specifications

Article number	6AG1526-1BH00-2AB0
Based on	6ES7526-1BH00-0AB0 SIPLUS S7-1500 F-DI 16x24VDC
Ambient conditions	
Ambient temperature during operation	
• horizontal installation, min.	-30 °C; = Tmin (incl. condensation/frost)
• horizontal installation, max.	60 °C; = Tmax
• vertical installation, min.	-30 °C; = Tmin
• vertical installation, max.	40 °C; = Tmax
Altitude during operation relating to sea level	
• Installation altitude above sea level, max.	2 000 m
• Ambient air temperature-barometric pressure-altitude	Tmin ... Tmax at 1 140 hPa ... 795 hPa (-1 000 m ... +2 000 m)
Relative humidity	
• With condensation, tested in accordance with IEC 60068-2-38, max.	100 %; RH incl. condensation/frost (no commissioning under condensation conditions)
Resistance	
Coolants and lubricants	
- Resistant to commercially available coolants and lubricants	Yes; Incl. diesel and oil droplets in the air
Use in stationary industrial systems	
- to biologically active substances according to EN 60721-3-3	Yes; Class 3B2 mold, fungus and dry rot spores (with the exception of fauna); Class 3B3 on request
- to chemically active substances according to EN 60721-3-3	Yes; Class 3C4 (RH < 75 %) incl. salt spray acc. to EN 60068-2-52 (severity degree 3); *
- to mechanically active substances according to EN 60721-3-3	Yes; Class 3S4 incl. sand, dust; *
Use on ships/at sea	
- to biologically active substances according to EN 60721-3-6	Yes; Class 6B2 mold and fungal spores (excluding fauna); Class 6B3 on request
- to chemically active substances according to EN 60721-3-6	Yes; Class 6C3 (RH < 75 %) incl. salt spray acc. to EN 60068-2-52 (severity degree 3); *
- to mechanically active substances according to EN 60721-3-6	Yes; Class 6S3 incl. sand, dust; *
Usage in industrial process technology	
- Against chemically active substances acc. to EN 60654-4	Yes; Class 3 (excluding trichlorethylene)
- Environmental conditions for process, measuring and control systems acc. to ANSI/ISA-71.04	Yes; Level GX group A/B (excluding trichlorethylene; harmful gas concentrations up to the limits of EN 60721-3-3 class 3C4 permissible); level LC3 (salt spray) and level LB3 (oil)
Remark	
- Note regarding classification of environmental conditions acc. to EN 60721, EN 60654-4 and ANSI/ISA-71.04	* The supplied plug covers must remain in place over the unused interfaces during operation!
Conformal coating	
• Coatings for printed circuit board assemblies acc. to EN 61086	Yes; Class 2 for high reliability
• Protection against fouling acc. to EN 60664-3	Yes; Type 1 protection
• Military testing according to MIL-I-46058C, Amendment 7	Yes; Discoloration of coating possible during service life
• Qualification and Performance of Electrical Insulating Compound for Printed Board Assemblies according to IPC-CC-830A	Yes; Conformal coating, Class A

Overview



SIPLUS digital fail-safe output module:
F-DQ 8x24 V DC 2 A PPM

Important properties:

- 8-channel digital fail-safe output module for ET 200MP/S7-1500
- Fail-safe 2-channel activation (parameterizable PM/PP switching) of actuators
- Actuators can be controlled up to 2 A
- Certified up to SIL 3 (IEC 61508), PL e (ISO 13849)
- LED display for error, operation, supply voltage and status
- Clear module labeling
 - Plain text identification of the module type
 - Complete Article No.
 - 2D matrix code (article and serial number)
 - Connection diagram
 - Hardware and firmware version
- Optional labeling accessories
 - Labeling sheets, yellow
- The module supports PROFIsafe in both PROFIBUS and PROFINET configurations.
- Can be used with all fail-safe SIMATIC S7-1500 F-CPU's in the central configuration, as well as ET 200MP distributed I/O with all other SIMATIC S7 F-CPU's.

Note:

SIPLUS extreme products are based on SIMATIC standard products. The contents listed here were taken from the respective standard products. SIPLUS extreme-specific information was added.

Ordering data

SIPLUS F-digital output module

8 outputs, 24 V DC, 2 A, PROFISAFE, switching to P/M potential

Article No.

6AG1526-2BF00-2AB0

Accessories

Coding elements

E-coding element type F for SIPLUS ET 200MP modules F-DI/F-DQ; 5 units, spare part

6AG1592-6EF00-2AA0

Other accessories

See SIMATIC S7-1500 F-digital output modules, page 4/204

Technical specifications

Article number	6AG1526-2BF00-2AB0
Based on	6ES7526-2BF00-0AB0 SIPLUS S7-1500 F-DQ 8x24VDC/2A
Ambient conditions	
Ambient temperature during operation	
• horizontal installation, min.	-30 °C; = Tmin (incl. condensation/frost)
• horizontal installation, max.	60 °C; = Tmax
• vertical installation, min.	-30 °C; = Tmin
• vertical installation, max.	40 °C; = Tmax
Altitude during operation relating to sea level	
• Installation altitude above sea level, max.	2 000 m
• Ambient air temperature-barometric pressure-altitude	Tmin ... Tmax at 1 140 hPa ... 795 hPa (-1 000 m ... +2 000 m)
Relative humidity	
• With condensation, tested in accordance with IEC 60068-2-38, max.	100 %; RH incl. condensation/frost (no commissioning under condensation conditions)
Resistance	
Coolants and lubricants	
- Resistant to commercially available coolants and lubricants	Yes; Incl. diesel and oil droplets in the air
Use in stationary industrial systems	
- to biologically active substances according to EN 60721-3-3	Yes; Class 3B2 mold, fungus and dry rot spores (with the exception of fauna); Class 3B3 on request
- to chemically active substances according to EN 60721-3-3	Yes; Class 3C4 (RH < 75 %) incl. salt spray acc. to EN 60068-2-52 (severity degree 3); *
- to mechanically active substances according to EN 60721-3-3	Yes; Class 3S4 incl. sand, dust; *
Use on ships/at sea	
- to biologically active substances according to EN 60721-3-6	Yes; Class 6B2 mold and fungal spores (excluding fauna); Class 6B3 on request
- to chemically active substances according to EN 60721-3-6	Yes; Class 6C3 (RH < 75 %) incl. salt spray acc. to EN 60068-2-52 (severity degree 3); *
- to mechanically active substances according to EN 60721-3-6	Yes; Class 6S3 incl. sand, dust; *
Usage in industrial process technology	
- Against chemically active substances acc. to EN 60654-4	Yes; Class 3 (excluding trichlorethylene)
- Environmental conditions for process, measuring and control systems acc. to ANSI/ISA-71.04	Yes; Level GX group A/B (excluding trichlorethylene; harmful gas concentrations up to the limits of EN 60721-3-3 class 3C4 permissible); level LC3 (salt spray) and level LB3 (oil)
Remark	
- Note regarding classification of environmental conditions acc. to EN 60721, EN 60654-4 and ANSI/ISA-71.04	* The supplied plug covers must remain in place over the unused interfaces during operation!
Conformal coating	
• Coatings for printed circuit board assemblies acc. to EN 61086	Yes; Class 2 for high reliability
• Protection against fouling acc. to EN 60664-3	Yes; Type 1 protection
• Military testing according to MIL-I-46058C, Amendment 7	Yes; Discoloration of coating possible during service life
• Qualification and Performance of Electrical Insulating Compound for Printed Board Assemblies according to IPC-CC-830A	Yes; Conformal coating, Class A

SIMATIC S7-1500 Advanced Controllers

Power supplies

1-phase, 24 V DC (for S7-1500 and ET200MP)

Overview



The design and functionality of the SIMATIC PM 1507 single-phase load power supply (PM = power module) with automatic range selection of the input voltage makes it an optimal match to the SIMATIC S7-1500 PLC. It supplies the S7-1500 system components such as CPU, system power supply (PS), I/O circuits of the input and output modules and, if necessary, the sensors and actuators with 24 V DC.

Ordering data

Article No.

SIMATIC PM 1507

Stabilized power supply for SIMATIC S7-1500
Input: 120/230 V AC
Output: 24 V DC/3 A

6EP1332-4BA00

SIMATIC PM 1507

Stabilized power supply for SIMATIC S7-1500
Input: 120/230 V AC
Output: 24 V DC/8 A

6EP1333-4BA00

Accessories

Power plug

With coding element for power supply module; spare part, 10 units per packing unit

6ES7590-8AA00-0AA0

Top hat DIN rail adapter

For adapting S7-1500 DIN rails on low or flat top hat DIN rails, as pre-assembled in control cabinets and terminal boxes, for example. An adapter must be positioned every 25 cm. Including mounting hardware. 10 units per packing unit

6ES7590-6AA00-0AA0

Technical specifications

Article number	6EP1332-4BA00	6EP1333-4BA00
Product	S7-1500 PM1507	S7-1500 PM1507
Power supply, type	24 V/3 A	24 V/8 A
Input		
Input	1-phase AC	1-phase AC
• Note	Automatic range selection	Automatic range selection
supply voltage		
• 1 at AC rated value	120 V	120 V
• 2 at AC rated value	230 V	230 V
input voltage		
• 1 at AC	85 ... 132 V	85 ... 132 V
• 2 at AC	170 ... 264 V	170 ... 264 V
Wide-range input	No	No
Overvoltage resistance	2.3 × Vin rated, 1.3 ms	2.3 × Vin rated, 1.3 ms
Mains buffering	at Vin = 93/187 V	at Vin = 93/187 V
Mains buffering at Iout rated, min.	20 ms; at Vin = 93/187 V	20 ms; at Vin = 93/187 V
Rated line frequency 1	50 Hz	50 Hz
Rated line frequency 2	60 Hz	60 Hz
Rated line range	45 ... 65 Hz	45 ... 65 Hz
input current		
• at rated input voltage 120 V	1.4 A	3.7 A
• at rated input voltage 230 V	0.8 A	1.7 A
Switch-on current limiting (+25 °C), max.	23 A	62 A
duration of inrush current limiting at 25 °C		
• maximum	3 ms	3 ms
I ² t, max.	1.3 A ² ·s	12 A ² ·s
Built-in incoming fuse	T 3,15 A/250 V (not accessible)	T 6.3 A/250 V (not accessible)
Protection in the mains power input (IEC 898)	Recommended miniature circuit breaker: 10 A characteristic B or 6 A characteristic C	Recommended miniature circuit breaker: 16 A characteristic B or 10 A characteristic C

Technical specifications

Article number	6EP1332-4BA00	6EP1333-4BA00
Product	S7-1500 PM1507	S7-1500 PM1507
Power supply, type	24 V/3 A	24 V/8 A
Output		
Output	Controlled, isolated DC voltage	Controlled, isolated DC voltage
Rated voltage U_{out} DC	24 V	24 V
• output voltage at output 1 at DC rated value	24 V	24 V
Total tolerance, static \pm	1 %	1 %
Static mains compensation, approx.	0.1 %	0.1 %
Static load balancing, approx.	0.1 %	0.1 %
Residual ripple peak-peak, max.	50 mV	50 mV
Spikes peak-peak, max. (bandwidth: 20 MHz)	150 mV	150 mV
product function output voltage adjustable	No	No
Status display	LED green for 24 V OK; LED red for error; LED yellow for stand-by	LED green for 24 V OK; LED red for error; LED yellow for stand-by
On/off behavior	No overshoot of V_{out} (soft start)	No overshoot of V_{out} (soft start)
Startup delay, max.	1.5 s	1.5 s
Voltage rise, typ.	10 ms	10 ms
Rated current value I_{out} rated	3 A	8 A
Current range	0 ... 3 A	0 ... 8 A
supplied active power typical	72 W	192 W
short-term overload current		
• on short-circuiting during the start-up typical	12 A	35 A
• at short-circuit during operation typical	12 A	35 A
duration of overloading capability for excess current		
• on short-circuiting during the start-up	70 ms	70 ms
• at short-circuit during operation	70 ms	70 ms
Parallel switching for enhanced performance	Yes	Yes
Numbers of parallel switchable units for enhanced performance	2	2
Efficiency		
Efficiency at U_{out} rated, I_{out} rated, approx.	87 %	90 %
Power loss at U_{out} rated, I_{out} rated, approx.	11 W	21 W
Closed-loop control		
Dynamic mains compensation (U_{in} rated ± 15 %), max.	0.1 %	0.1 %
Dynamic load smoothing (I_{out} : 50/100/50 %), $U_{out} \pm$ typ.	1 %	2 %
Dynamic load smoothing (I_{out} : 10/90/10 %), $U_{out} \pm$ typ.	3 %	3 %
Load step setting time 10 to 90%, typ.	5 ms	5 ms
Load step setting time 90 to 10%, typ.	5 ms	5 ms
setting time maximum	5 ms	5 ms
Protection and monitoring		
Output overvoltage protection	Additional control loop, limitation (closed loop control) at < 28.8 V	Additional control loop, limitation (closed loop control) at < 28.8 V
Current limitation	3.15 ... 3.6 A	8.4 ... 9.6 A
Current limitation, typ.	3.4 A	9 A
property of the output short-circuit proof	Yes	Yes
Short-circuit protection	Electronic shutdown, automatic restart	Electronic shutdown, automatic restart
Overload/short-circuit indicator	-	-
Safety		
Primary/secondary isolation galvanic isolation	Yes	Yes
Protection class	Safety extra-low output voltage U_{out} acc. to EN 60950-1 and EN 50178 and EN 61131-2	Safety extra-low output voltage U_{out} acc. to EN 60950-1 and EN 50178 and EN 61131-2
leakage current	Class I	Class I
• maximum	3.5 mA	3.5 mA
• typical	0.4 mA	1.3 mA
Degree of protection (EN 60529)	IP20	IP20

SIMATIC S7-1500 Advanced Controllers

Power supplies

1-phase, 24 V DC (for S7-1500 and ET200MP)

Technical specifications

Article number	6EP1332-4BA00	6EP1333-4BA00
Product	S7-1500 PM1507	S7-1500 PM1507
Power supply, type	24 V/3 A	24 V/8 A
Approvals		
certificate of suitability		
• CE marking	Yes	Yes
• UL/cUL (CSA) approval	Yes; cULus-Listed (UL 508, CSA C22.2 No. 142), File E143289	Yes; cULus-Listed (UL 508, CSA C22.2 No. 142), File E143289
• cCSAus, Class 1, Division 2	No	No
• ATEX	Yes; ATEX (EX) II 3G Ex nA nC IIC T4 Gc	Yes; ATEX (EX) II 3G Ex nA nC IIC T3 Gc
certificate of suitability		
• relating to ATEX	IECEX Ex nA nC IIC T4 Gc; ATEX (EX) II 3G Ex nA nC IIC T4 Gc; cULus (ANSI/ISA 12.12.01, CSA C22.2 No.213) Class I, Div. 2, Group ABCD, T4, File E330455	IECEX Ex nA nC IIC T3 Gc; ATEX (EX) II 3G Ex nA nC IIC T3 Gc; cULus (ANSI/ISA 12.12.01, CSA C22.2 No.213) Class I, Div. 2, Group ABCD, T3, File E330455
• IECEX	Yes; IECEX Ex nA nC IIC T4 Gc	Yes; IECEX Ex nA nC IIC T3 Gc
• NEC Class 2	No	No
• ULhazloc approval	Yes	Yes
• FM registration	Yes; Class I, Div. 2, Group ABCD, T4	Yes; Class I, Div. 2, Group ABCD, T4
type of certification CB-certificate	Yes	Yes
certificate of suitability		
• EAC approval	Yes	Yes
certificate of suitability shipbuilding approval	Yes	Yes
shipbuilding approval	ABS, BV, DNV GL	ABS, BV, DNV GL
Marine classification association		
• American Bureau of Shipping Europe Ltd. (ABS)	Yes	Yes
• French marine classification society (BV)	Yes	Yes
• DNV GL	Yes	Yes
• Lloyds Register of Shipping (LRS)	No	No
• Nippon Kaiji Kyokai (NK)	No	No
EMC		
Emitted interference	EN 55022 Class B	EN 55022 Class B
Supply harmonics limitation	EN 61000-3-2	EN 61000-3-2
Noise immunity	EN 61000-6-2	EN 61000-6-2
environmental conditions		
ambient temperature		
• during operation	0 ... 60 °C	0 ... 60 °C
- Note	with natural convection	with natural convection
• during transport	-40 ... +85 °C	-40 ... +85 °C
• during storage	-40 ... +85 °C	-40 ... +85 °C
Humidity class according to EN 60721	Climate class 3K3, 5 ... 95% no condensation	Climate class 3K3, 5 ... 95% no condensation
Mechanics		
Connection technology	Screw-/spring clamp connection	Screw-/spring clamp connection
Connections		
• Supply input	L, N, PE: 1 screw terminal each for 0.5 ... 2.5 mm ²	L, N, PE: 1 screw terminal each for 0.5 ... 2.5 mm ²
• Output	L+, M: 2 spring-loaded terminals each for 0.5 to 2.5 mm ²	L+, M: 2 spring-loaded terminals each for 0.5 to 2.5 mm ²
product function		
• removable terminal at input	Yes	Yes
• removable terminal at output	Yes	Yes
width of the enclosure	50 mm	75 mm
height of the enclosure	147 mm	147 mm
depth of the enclosure	129 mm	129 mm
required spacing		
• top	40 mm	40 mm
• bottom	40 mm	40 mm
• left	0 mm	0 mm
• right	0 mm	0 mm
Weight, approx.	0.45 kg	0.74 kg
product feature of the enclosure housing can be lined up	Yes	Yes
Installation	Can be mounted onto S7-1500 rail	Can be mounted onto S7-1500 rail
MTBF at 40 °C	1 611 993 h	1 362 918 h
other information	Specifications at rated input voltage and ambient temperature +25 °C (unless otherwise specified)	Specifications at rated input voltage and ambient temperature +25 °C (unless otherwise specified)

Overview



- System power supplies for SIMATIC S7-1500
- For conversion of AC or DC line voltages to the operating voltages required for the internal electronics
- 25 or 60 W output power
- Can be used for S7-1500 or ET 200MP
- Engineering and configuration via STEP 7 V12 and higher (PS 60W 24/48/60V DC HF: from STEP 7 V14 SP1)
- In addition with PS 60W 24/48/60V DC HF: Retentive storage of CPU work memory (data) for all S7-1500 CPUs

Ordering data

Article No.

System power supply

For supplying the backplane bus of the S7-1500 Controller

24 V DC input voltage, power 25 W

6ES7505-0KA00-0AB0

24/48/60 V DC input voltage, power 60 W

6ES7505-0RA00-0AB0

24/48/60 V DC input voltage, power 60 W, buffering functionality

6ES7505-0RB00-0AB0

120/230 V AC input voltage, power 60 W

6ES7507-0RA00-0AB0

Accessories

SIMATIC S7-1500 DIN rail

Fixed lengths, with grounding elements

- 160 mm
- 245 mm
- 482 mm
- 530 mm
- 830 mm

6ES7590-1AB60-0AA0
6ES7590-1AC40-0AA0
6ES7590-1AE80-0AA0
6ES7590-1AF30-0AA0
6ES7590-1AJ30-0AA0

For cutting to length by customer, without drill holes; grounding elements must be ordered separately

- 2 000 mm

6ES7590-1BC00-0AA0

PE connection element for 2 000 mm DIN rail

6ES7590-5AA00-0AA0

Spare part, 20 units

Power plug

6ES7590-8AA00-0AA0

With coding element for power supply module; spare part, 10 units

Technical specifications

Article number	6ES7505-0KA00-0AB0	6ES7505-0RA00-0AB0	6ES7505-0RB00-0AB0	6ES7507-0RA00-0AB0
	S7-1500, PS 25W 24V DC	S7-1500, PS 60W 24/48/60V DC	S7-1500, PS 60W 24/48/60V DC HF	S7-1500, PS 60W 120/230V AC/DC
General information				
Product type designation	PS 25W 24VDC	PS 60 W 24/48/60 V DC	PS 60 W 24/48/60 V DC HF	PS 60 W 120/230 V AC/DC
Engineering with				
• STEP 7 TIA Portal configurable/integrated from version	V12 / V12	V12 / V12	V14 SP1	V12 / V12
• STEP 7 configurable/integrated from version	V5.5 SP3 or higher	V5.5 SP3 or higher		V5.5 SP3 or higher
Installation type/mounting				
Rail mounting		Yes		Yes
Supply voltage				
Rated value (DC)	24 V	24 V / 48 V / 60 V	24 V / 48 V / 60 V	120 V / 230 V
Rated value (AC)				120 V / 230 V
Reverse polarity protection	Yes	Yes	Yes	
Short-circuit protection	Yes	Yes	Yes	Yes
Line frequency				
• Rated value 50 Hz				Yes
• permissible range, lower limit				47 Hz
• permissible range, upper limit				63 Hz
Mains buffering				
• Mains/voltage failure stored energy time	20 ms	20 ms	20 ms	20 ms

SIMATIC S7-1500 Advanced Controllers

Power supplies

System power supplies

Technical specifications

Article number	6ES7505-0KA00-0AB0 S7-1500, PS 25W 24V DC	6ES7505-0RA00-0AB0 S7-1500, PS 60W 24/48/60V DC	6ES7505-0RB00-0AB0 S7-1500, PS 60W 24/48/60V DC HF	6ES7507-0RA00-0AB0 S7-1500, PS 60W 120/230V AC/DC
Input current				
Rated value at 24 V DC	1.3 A	3 A	3 A	
Rated value at 48 V DC		1.5 A	1.5 A	
Rated value at 60 V DC		1.2 A	1.2 A	
Rated value at 120 V DC				0.6 A
Rated value at 230 V DC				0.3 A
Rated value at 120 V AC				0.6 A
Rated value at 230 V AC				0.34 A
Inrush current, max.			≤ 8 A for t ≤ 1 s	
Output current				
Short-circuit protection	Yes	Yes	Yes	Yes
Power				
Infeed power to the backplane bus	25 W	60 W	60 W	60 W
Power loss				
Power loss at nominal rating conditions	6.2 W	12 W	12 W	12 W
Interrupts/diagnostics/status information				
Status indicator	Yes	Yes	Yes	Yes
Potential separation				
primary/secondary	Yes	Yes; Electrical isolation for 230 V AC (reinforced isolation)		Yes
EMC				
Interference immunity against voltage surge				
<ul style="list-style-type: none"> Interference immunity on supply lines acc. to IEC 61000-4-5 	Yes; ±1 kV (acc. to IEC 61000-4-5; 1995; surge symm.), ±2 kV (acc. to IEC 61000-4-5; 1995; surge asymm.), no external protective circuit required	Yes; ±1 kV (acc. to IEC 61000-4-5; 1995; surge symm.), ±2 kV (acc. to IEC 61000-4-5; 1995; surge asymm.), no external protective circuit required	Yes; ±1 kV (acc. to IEC 61000-4-5; 1995; surge symm.), ±2 kV (acc. to IEC 61000-4-5; 1995; surge asymm.), no external protective circuit required	Yes; ±1 kV (acc. to IEC 61000-4-5; 1995; surge symm.), ±2 kV (acc. to IEC 61000-4-5; 1995; surge asymm.), no external protective circuit required
Degree and class of protection				
Equipment protection class	III, with protective conductor	I, with protective conductor	I, with protective conductor	I, with protective conductor
Ambient conditions				
Altitude during operation relating to sea level				
<ul style="list-style-type: none"> Installation altitude above sea level, max. 	5 000 m; Restrictions for installation altitudes > 2 000 m, see manual			
Dimensions				
Width	35 mm	70 mm	105 mm	70 mm
Height	147 mm	147 mm	147 mm	147 mm
Depth	129 mm	129 mm	129 mm	129 mm
Weights				
Weight, approx.	350 g	600 g	865 g	600 g

SIMATIC S7-1500 Advanced Controllers

SIPLUS power supplies

1-phase, 24 V DC (for S7-1500 and ET200MP)

Overview



The design and functionality of the SIMATIC PM 1507 single-phase load power supply (PM = power module) with automatic range selection of the input voltage makes it an optimal match to the SIMATIC S7-1500 PLC. It supplies the S7-1500 system components such as CPU, system power supply (PS), I/O circuits of the input and output modules and, if necessary, the sensors and actuators with 24 V DC.

Note

SIPLUS extreme products are based on Siemens standard products. The contents listed here were taken from the respective standard products. SIPLUS extreme specific information was added.

4

SIPLUS S7-1500 PM 1507

Article No.	6AG1332-4BA00-7AA0	6AG1333-4BA00-7AA0
Article number based on	6EP1332-4BA00	6EP1333-4BA00
Ambient temperature range	-40 ... +70 °C	
Conformal coating	Coating of the printed circuit boards and the electronic components	
Technical specifications	The technical specifications of the standard product apply, except for the ambient conditions.	
Ambient conditions		
Extended range of environmental conditions		
• with reference to ambient temperature, air pressure and altitude	Tmin ... Tmax at 1080 hPa ... 795 hPa (-1000 m ... +2000 m) // Tmin ... (Tmax - 10K) at 795 hPa ... 658 hPa (+2000 m ... +3500 m) // Tmin ... (Tmax - 20K) at 658 hPa ... 540 hPa (+3500 m ... +5000 m)	
Relative humidity		
• with condensation, max.	100 %; RH incl. bedewing/frost (no commissioning in bedewed state)	
Resistance		
• to biologically active substances/compliance with EN 60721-3-3	Yes; Class 3B2 mold and fungal spores (except fauna); the supplied plug covers must remain in place on the unused interfaces during operation.	
• to chemically active substances/compliance with EN 60721-3-3	Yes; Class 3C4 (RH < 75%) incl. salt spray in accordance with EN 60068-2-52 (severity 3); the supplied plug covers must remain in place on the unused interfaces during operation.	
• to mechanically active substances, compliance with EN 60721-3-3	Yes; Class 3S4 incl. sand, dust; the supplied plug covers must remain in place on unused interfaces during operation.	

Ordering data

SIPLUS S7-1500 PM 1507

(Extended temperature range and exposure to media)

Input 120/230 V AC,
output 24 V DC, 3 A

Input 120/230 V AC,
output 24 V DC, 8 A

Article No.

6AG1332-4BA00-7AA0

6AG1333-4BA00-7AA0

Article No.

Accessories

See power supplies,
page 4/208

SIMATIC S7-1500 Advanced Controllers

SIPLUS power supplies

SIPLUS system power supplies

Overview



- System power supplies for the SIMATIC S7-1500
- For conversion of AC or DC line voltages to the operating voltages required for the internal electronics
- 25 or 60 W output power
- Can be used for S7-1500 or ET 200MP
- Engineering and configuration via STEP 7 V12

Note:

SIPLUS extreme products are based on SIMATIC standard products. The contents listed here were taken from the respective standard products. SIPLUS extreme-specific information was added.

Ordering data

Article No.

SIPLUS S7-1500 system power supply

(Extended temperature range and exposure to environmental substances)

For supplying the backplane bus of the S7-1500 Controller

24 V DC input voltage, power 25 W

24/48/60 V DC input voltage, power 60 W

120/230 V AC input voltage, power 60 W

Accessories

6AG1505-0KA00-7AB0

6AG1505-0RA00-7AB0

6AG1507-0RA00-7AB0

See SIMATIC S7-1500, system power supplies, page 4/211

Technical specifications

Article number	6AG1505-0KA00-7AB0	6AG1505-0RA00-7AB0	6AG1507-0RA00-7AB0
Based on	6ES7505-0KA00-0AB0 SIPLUS S7-1500 PS 1505 25W 24VDC	6ES7505-0RA00-0AB0 SIPLUS S7-1500 PS 1505 60W 24VDC	6ES7507-0RA00-0AB0 SIPLUS S7-1500 PS 1507 60W 230VAC
Ambient conditions			
Ambient temperature during operation			
• min.	-40 °C; = Tmin (incl. condensation/frost); start-up @ -25 °C	-40 °C; = Tmin (incl. condensation/frost); start-up @ -25 °C	-40 °C; = Tmin (incl. condensation/frost); start-up @ -25 °C
• max.	70 °C; = Tmax; for vertical mounting position Tmax = +40 °C	70 °C; = Tmax; > +60 °C max. power input 30 W; for vertical mounting position Tmax = +40 °C	70 °C; = Tmax; for vertical mounting position Tmax = +40 °C
Altitude during operation relating to sea level			
• Installation altitude above sea level, max.	5 000 m	5 000 m	2 000 m
• Ambient air temperature-barometric pressure-altitude	Tmin ... Tmax at 1 140 hPa ... 795 hPa (-1 000 m ... +2 000 m) // Tmin ... (Tmax - 10 K) at 795 hPa ... 658 hPa (+2 000 m ... +3 500 m) // Tmin ... (Tmax -20 K) at 658 hPa ... 540 hPa (+3 500 m ... +5 000 m)	Tmin ... Tmax at 1 140 hPa ... 795 hPa (-1 000 m ... +2 000 m) // Tmin ... (Tmax - 10 K) at 795 hPa ... 658 hPa (+2 000 m ... +3 500 m) // Tmin ... (Tmax -20 K) at 658 hPa ... 540 hPa (+3 500 m ... +5 000 m)	Tmin ... Tmax at 1 140 hPa ... 795 hPa (-1 000 m ... +2 000 m)
Relative humidity			
• With condensation, tested in accordance with IEC 60068-2-38, max.	100 %; RH incl. condensation/frost (no commissioning under condensation conditions)	100 %; RH incl. condensation/frost (no commissioning under condensation conditions)	100 %; RH incl. condensation/frost (no commissioning under condensation conditions)

Technical specifications

Article number	6AG1505-0KA00-7AB0	6AG1505-0RA00-7AB0	6AG1507-0RA00-7AB0
Based on	6ES7505-0KA00-0AB0	6ES7505-0RA00-0AB0	6ES7507-0RA00-0AB0
	SIPLUS S7-1500 PS 1505 25W 24VDC	SIPLUS S7-1500 PS 1505 60W 24VDC	SIPLUS S7-1500 PS 1507 60W 230VAC
Resistance			
Coolants and lubricants			
- Resistant to commercially available coolants and lubricants	Yes; Incl. diesel and oil droplets in the air	Yes; Incl. diesel and oil droplets in the air	Yes; Incl. diesel and oil droplets in the air
Use in stationary industrial systems			
- to biologically active substances according to EN 60721-3-3	Yes; Class 3B2 mold, fungus and dry rot spores (with the exception of fauna); Class 3B3 on request	Yes; Class 3B2 mold, fungus and dry rot spores (with the exception of fauna); Class 3B3 on request	Yes; Class 3B2 mold, fungus and dry rot spores (with the exception of fauna); Class 3B3 on request
- to chemically active substances according to EN 60721-3-3	Yes; Class 3C4 (RH < 75 %) incl. salt spray acc. to EN 60068-2-52 (severity degree 3); *	Yes; Class 3C4 (RH < 75 %) incl. salt spray acc. to EN 60068-2-52 (severity degree 3); *	Yes; Class 3C4 (RH < 75 %) incl. salt spray acc. to EN 60068-2-52 (severity degree 3); *
- to mechanically active substances according to EN 60721-3-3	Yes; Class 3S4 incl. sand, dust, *	Yes; Class 3S4 incl. sand, dust, *	Yes; Class 3S4 incl. sand, dust, *
Use on ships/at sea			
- to biologically active substances according to EN 60721-3-6	Yes; Class 6B2 mold and fungal spores (excluding fauna); Class 6B3 on request	Yes; Class 6B2 mold and fungal spores (excluding fauna); Class 6B3 on request	Yes; Class 6B2 mold and fungal spores (excluding fauna); Class 6B3 on request
- to chemically active substances according to EN 60721-3-6	Yes; Class 6C3 (RH < 75 %) incl. salt spray acc. to EN 60068-2-52 (severity degree 3); *	Yes; Class 6C3 (RH < 75 %) incl. salt spray acc. to EN 60068-2-52 (severity degree 3); *	Yes; Class 6C3 (RH < 75 %) incl. salt spray acc. to EN 60068-2-52 (severity degree 3); *
- to mechanically active substances according to EN 60721-3-6	Yes; Class 6S3 incl. sand, dust; *	Yes; Class 6S3 incl. sand, dust; *	Yes; Class 6S3 incl. sand, dust; *
Usage in industrial process technology			
- Against chemically active substances acc. to EN 60654-4	Yes; Class 3 (excluding trichlorethylene)	Yes; Class 3 (excluding trichlorethylene)	Yes; Class 3 (excluding trichlorethylene)
- Environmental conditions for process, measuring and control systems acc. to ANSI/ISA-71.04	Yes; Level GX group A/B (excluding trichlorethylene; harmful gas concentrations up to the limits of EN 60721-3-3 class 3C4 permissible); level LC3 (salt spray) and level LB3 (oil)	Yes; Level GX group A/B (excluding trichlorethylene; harmful gas concentrations up to the limits of EN 60721-3-3 class 3C4 permissible); level LC3 (salt spray) and level LB3 (oil)	Yes; Level GX group A/B (excluding trichlorethylene; harmful gas concentrations up to the limits of EN 60721-3-3 class 3C4 permissible); level LC3 (salt spray) and level LB3 (oil)
Remark			
- Note regarding classification of environmental conditions acc. to EN 60721, EN 60654-4 and ANSI/ISA-71.04	* The supplied plug covers must remain in place over the unused interfaces during operation!	* The supplied plug covers must remain in place over the unused interfaces during operation!	* The supplied plug covers must remain in place over the unused interfaces during operation!
Conformal coating			
• Coatings for printed circuit board assemblies acc. to EN 61086	Yes; Class 2 for high reliability	Yes; Class 2 for high reliability	Yes; Class 2 for high reliability
• Protection against fouling acc. to EN 60664-3	Yes; Type 1 protection	Yes; Type 1 protection	Yes; Type 1 protection
• Military testing according to MIL-I-46058C, Amendment 7	Yes; Discoloration of coating possible during service life	Yes; Discoloration of coating possible during service life	Yes; Discoloration of coating possible during service life
• Qualification and Performance of Electrical Insulating Compound for Printed Board Assemblies according to IPC-CC-830A	Yes; Conformal coating, Class A	Yes; Conformal coating, Class A	Yes; Conformal coating, Class A

SIMATIC S7-1500 Advanced Controllers

Operator control and monitoring
Basic Panels

Standard devices 2nd Generation

Overview



Basic Panels 2nd Generation

With their fully developed HMI basic functions, SIMATIC HMI Basic Panels 2nd Generation are the ideal entry-level series for simple HMI applications.

The device family offers panels with 4", 7", 9" and 12" displays, as well as combined key and touch operation.

The innovative high-resolution widescreen displays with 64 000 colors are also suitable for upright installation, and they can be dimmed down to 100%. The innovative operator interface with improved usability opens up a diverse range of options thanks to new controls and graphics. The new USB interface enables the connection of keyboard, mouse or barcode scanner, and supports the simple archiving of data on a USB flash drive as well as the manual backup and restoring of the complete panel.

The integrated Ethernet or RS 485/422 interface (version-specific) enables simple connection to the controller.

<http://www.siemens.com/basic-panels>

Ordering data

Article No.

SIMATIC HMI Basic Panels (2nd Generation)

Key and touch devices

SIMATIC HMI KTP400 Basic

6AV2123-2DB03-0AX0

Key/touch operation;
4" TFT widescreen display,
65 536 colors, PROFINET interface

SIMATIC HMI TP400 Basic Keyless

6AV2143-6DB00-0AA0

Touch screen operation;
4" TFT widescreen display,
65 536 colors, PROFINET interface

SIMATIC HMI KTP700 Basic

6AV2123-2GB03-0AX0

Key/touch operation;
7" TFT display, 65 536 colors,
PROFINET interface

SIMATIC HMI KTP700 Basic DP

6AV2123-2GA03-0AX0

Key/touch operation;
7" TFT display, 65 536 colors,
PROFIBUS interface

SIMATIC HMI TP700 Basic Keyless

6AV2143-6GB00-0AA0

Touch screen operation;
7" TFT display, 65 536 colors,
PROFINET interface

SIMATIC HMI KTP900 Basic

6AV2123-2JB03-0AX0

Key/touch operation;
9" TFT display, 65 536 colors,
PROFINET interface

SIMATIC HMI TP900 Basic Keyless

6AV2143-6JB00-0AA0

Touch screen operation;
9" TFT display, 65 536 colors,
PROFINET interface

SIMATIC HMI KTP1200 Basic

6AV2123-2MB03-0AX0

Key/touch operation;
12" TFT display, 65 536 colors,
PROFINET interface

SIMATIC HMI KTP1200 Basic DP

6AV2123-2MA03-0AX0

Key/touch operation;
12" TFT display, 65 536 colors,
PROFIBUS interface

Starter kits

Starter kit LOGO! + KP300 Basic mono PN

6AV2132-0HA00-0AA1

Starter kit LOGO! + KTP400 Basic

6AV2132-0KA00-0AA1

Starter kit LOGO! + KTP700 Basic

6AV2132-3GB00-0AA1

Starter kits with a LOGO!
consist of:

- the respective
SIMATIC HMI Basic Panel
SIMATIC HMI KP300 Basic mono
PN
SIMATIC HMI KTP400 Basic
SIMATIC HMI KTP700 Basic
- LOGO! 12/24 RCE
- LOGO! POWER 24 V 1,3 A
- LOGO! SOFT COMFORT V7
- WINCC BASIC (TIA Portal)
- Ethernet CAT5 cable, 2 m

Documentation

You can find the Equipment
Manual for the Basic Panels
on the Internet at:

<http://support.automation.siemens.com>

Accessories

See catalog ST 80/ST PC
or Industry Mall

Overview

SIMATIC HMI MTP2200 Unified Comfort Panel Standard design front view

SIMATIC HMI Unified Comfort Panels - standard devices

SIMATIC HMI Unified Comfort Panels consist of six different devices with varying display sizes.

All devices come with the same number of hardware interfaces and the same functionality – just select the perfect device for your needs based on the screen size.

Each Unified Comfort Panel is available in the standard design with Siemens and SIMATIC HMI branding and a silver-colored aluminum frame.

All Unified Comfort Panels come with integrated Edge functionality.

Siemens Industrial Edge can be used in two different ways:

- Device-managed Edge
- Centrally-managed Edge (planned)

SIMATIC HMI Unified Comfort Panels can also be ordered with a neutral design. Starter kits are available for standard design devices.

Note:

The technical specifications of the neutral design devices correspond to the technical specifications of the devices with standard design.

Ordering data**Article No.****Article No.****Touch devices for SIMATIC HMI Unified Comfort Panels****Standard design****SIMATIC HMI MTP700 Unified Comfort Panel**

7" widescreen TFT display, touch operation, 16 million colors, PROFINET interface, configurable as of WinCC Unified Comfort V16

- Contains open source SW which is provided free of charge
See enclosed Blu-Ray
- With additional certifications for explosion-proof areas and for use in shipbuilding (see technical specifications). Contains open source SW, which is provided free of charge
See enclosed DVD

6AV2128-3GB06-0AX0**6AV2128-3GB06-0AX1****SIMATIC HMI MTP1000 Unified Comfort Panel**

10.1" widescreen TFT display, touch operation, 16 million colors, PROFINET interface, configurable as of WinCC Unified Comfort V16

- Contains open source SW which is provided free of charge
See enclosed Blu-Ray
- With additional certifications for explosion-proof areas and for use in shipbuilding (see technical specifications). Contains open source SW, which is provided free of charge
See enclosed DVD

6AV2128-3KB06-0AX0**6AV2128-3KB06-0AX1****SIMATIC HMI MTP1200 Unified Comfort Panel**

12.1" widescreen TFT display, touch operation, 16 million colors, PROFINET interface, configurable as of WinCC Unified Comfort V16

- Contains open source SW which is provided free of charge
See enclosed Blu-Ray
- With additional certifications for explosion-proof areas and for use in shipbuilding (see technical specifications). Contains open source SW, which is provided free of charge
See enclosed DVD

6AV2128-3MB06-0AX0**6AV2128-3MB06-0AX1****SIMATIC HMI MTP1500 Unified Comfort Panel**

15.6" widescreen TFT display, touch operation, 16 million colors, PROFINET interface, configurable as of WinCC Unified Comfort V16

- Contains open source SW which is provided free of charge
See enclosed Blu-Ray
- With additional certifications for explosion-proof areas and for use in shipbuilding (see technical specifications). Contains open source SW, which is provided free of charge
See enclosed DVD

6AV2128-3QB06-0AX0**6AV2128-3QB06-0AX1**

SIMATIC S7-1500 Advanced Controllers

Operator control and monitoring
Comfort Panels

SIMATIC HMI Unified Comfort Panels Standard

Ordering data

Article No.

Article No.

SIMATIC HMI MTP1900 Unified Comfort Panel

18.5" widescreen TFT display, touch operation, 16 million colors, PROFINET interface, configurable as of WinCC Unified Comfort V16

- Contains open source SW which is provided free of charge See enclosed Blu-Ray
- With additional certifications for explosion-proof areas and for use in shipbuilding (see technical specifications). Contains open source SW, which is provided free of charge See enclosed DVD

6AV2128-3UB06-0AX0

6AV2128-3UB06-0AX1

SIMATIC HMI MTP2200 Unified Comfort Panel

21.5" widescreen TFT display, touch operation, 16 million colors, PROFINET interface, configurable as of WinCC Unified Comfort V16

- Contains open source SW which is provided free of charge See enclosed Blu-Ray
- With additional certifications for explosion-proof areas and for use in shipbuilding (see technical specifications). Contains open source SW, which is provided free of charge See enclosed DVD

6AV2128-3XB06-0AX0

6AV2128-3XB06-0AX1

Neutral design

SIMATIC HMI MTP700 Unified Comfort Panel

Neutral, touch operation; 7" widescreen TFT display, 16 million colors, PROFINET interface, configurable as of WinCC Unified Comfort V16

- Contains open source SW which is provided free of charge See enclosed Blu-Ray
- With additional certifications for explosion-proof areas and for use in shipbuilding (see technical specifications). Contains open source SW, which is provided free of charge See enclosed DVD

6AV2128-3GB36-0AX0

6AV2128-3GB36-0AX1

SIMATIC HMI MTP1000 Unified Comfort Panel

Neutral, touch operation, 10.1" widescreen TFT display, 16 million colors, PROFINET interface, configurable as of WinCC Unified Comfort V16

- Contains open source SW which is provided free of charge See enclosed Blu-Ray
- With additional certifications for explosion-proof areas and for use in shipbuilding (see technical specifications). Contains open source SW, which is provided free of charge See enclosed DVD

6AV2128-3KB36-0AX0

6AV2128-3KB36-0AX1

SIMATIC HMI MTP1200 Unified Comfort Panel

Neutral, touch operation, 12.1" widescreen TFT display, 16 million colors, PROFINET interface, configurable as of WinCC Unified Comfort V16

- Contains open source SW which is provided free of charge See enclosed Blu-Ray
- With additional certifications for explosion-proof areas and for use in shipbuilding (see technical specifications). Contains open source SW, which is provided free of charge See enclosed DVD

6AV2128-3MB36-0AX0

6AV2128-3MB36-0AX1

SIMATIC HMI MTP1500 Unified Comfort Panel

Neutral, touch operation, 15.6" widescreen TFT display, 16 million colors, PROFINET interface, configurable as of WinCC Unified Comfort V16

- Contains open source SW which is provided free of charge See enclosed Blu-Ray
- With additional certifications for explosion-proof areas and for use in shipbuilding (see technical specifications). Contains open source SW, which is provided free of charge See enclosed DVD

6AV2128-3QB36-0AX0

6AV2128-3QB36-0AX1

SIMATIC HMI MTP1900 Unified Comfort Panel

Neutral, touch operation, 18.5" widescreen TFT display, 16 million colors, PROFINET interface, configurable as of WinCC Unified Comfort V16

- Contains open source SW which is provided free of charge See enclosed Blu-Ray
- With additional certifications for explosion-proof areas and for use in shipbuilding (see technical specifications). Contains open source SW, which is provided free of charge See enclosed DVD

6AV2128-3UB36-0AX0

6AV2128-3UB36-0AX1

SIMATIC HMI MTP2200 Unified Comfort Panel

Neutral, touch operation, 21.5" widescreen TFT display, 16 million colors, PROFINET interface, configurable as of WinCC Unified Comfort V16

- Contains open source SW which is provided free of charge See enclosed Blu-Ray
- With additional certifications for explosion-proof areas and for use in shipbuilding (see technical specifications). Contains open source SW, which is provided free of charge See enclosed DVD

6AV2128-3XB36-0AX0

6AV2128-3XB36-0AX1

SIMATIC S7-1500 Advanced ControllersOperator control and monitoring
Comfort Panels**SIMATIC HMI Unified Comfort Panels Standard**

Ordering data	Article No.		Article No.
Starter kits		SIMATIC HMI MTP1500 Unified Comfort	6AV2128-3QB06-0AP0
Standard design		SIMATIC HMI MTP1900 Unified Comfort	6AV2128-3UB06-0AP0
Each consisting of:		SIMATIC HMI MTP2200 Unified Comfort	6AV2128-3XB06-0AP0
• The corresponding Unified Comfort Panel		Software	
• WinCC Unified Comfort (TIA Portal)		EDGE Runtime for SIMATIC Unified Comfort	6AV2170-2BA00-0AA0
• EDGE Runtime license		Runtime software, single license, license key for download, without software and documentation, Class A, email address required for delivery	
• Industrial Ethernet cable, for test purposes			
• SIMATIC SD Card Indoor 32 GB			
• 5 protective films			
SIMATIC HMI MTP700 Unified Comfort	6AV2128-3GB06-0AP0		
SIMATIC HMI MTP1000 Unified Comfort	6AV2128-3KB06-0AP0		
SIMATIC HMI MTP1200 Unified Comfort	6AV2128-3MB06-0AP0		

SIMATIC S7-1500 Advanced Controllers

Operator control and monitoring
Comfort Panels

Comfort Panels Standard devices

Overview



SIMATIC HMI Comfort Panels - Standard devices

- Excellent HMI functionality for demanding applications
- Widescreen TFT displays with 4", 7", 9", 12", 15", 19" and 22" diagonals (all 16 million colors) with up to 40% more visualization area as compared to the predecessor devices
- Integrated high-end functionality with archives, scripts, PDF/Word/Excel viewer, Internet Explorer, Media Player and Web Server
- Dimmable displays from 0 to 100% via PROFlenergy, via the HMI project or via a controller
- Modern industrial design, cast aluminum fronts for 7" upwards
- Upright installation for all touch devices
- Data security in the event of a power failure for the device and for the SIMATIC HMI memory card
- Innovative service and commissioning concept
- Maximum performance with short screen refresh times
- Suitable for extremely harsh industrial environments thanks to extended approvals such as ATEX 2/22 and marine approvals
- All versions can be used as an OPC UA client or as a server
- Key-operated devices with LED in every function key and new text input mechanism, similar to the keypads of mobile phones
- All keys have a service life of 2 million operations
- Configuring with the WinCC engineering software of the TIA Portal engineering framework

Note:

A 7" and a 15" Comfort Outdoor version are available. These devices have been specially designed for outdoor applications in difficult environments. Best display quality, even under sunlight, UV-resistant fronts and much more.

For more information, please go to:

<http://www.siemens.com/comfort-panels>

Ordering data

Article No.

Ordering data	Article No.
SIMATIC HMI Comfort Panels	
Key and touch devices	
SIMATIC HMI KTP400 Comfort Key/touch operation; 4" widescreen display	6AV2124-2DC01-0AX0
Touch devices	
SIMATIC HMI TP700 Comfort Touch operation; 7" widescreen display	6AV2124-0GC01-0AX0
SIMATIC HMI TP900 Comfort Touch operation; 9" widescreen display	6AV2124-0JC01-0AX0
SIMATIC HMI TP1200 Comfort Touch operation; 12" widescreen display	6AV2124-0MC01-0AX0
SIMATIC HMI TP1500 Comfort Touch operation; 15" widescreen display	6AV2124-0QC02-0AX1
SIMATIC HMI TP1900 Comfort Touch operation; 19" widescreen display	6AV2124-0UC02-0AX1
SIMATIC HMI TP2200 Comfort Touch operation; 22" widescreen display	6AV2124-0XC02-0AX1
Key devices	
SIMATIC HMI KP400 Comfort Key operation; 4" widescreen display	6AV2124-1DC01-0AX0
SIMATIC HMI KP700 Comfort Key operation; 7" widescreen display	6AV2124-1GC01-0AX0
SIMATIC HMI KP900 Comfort Key operation; 9" widescreen display	6AV2124-1JC01-0AX0
SIMATIC HMI KP1200 Comfort Key operation; 12" widescreen display	6AV2124-1MC01-0AX0
SIMATIC HMI KP1500 Comfort Key operation; 15" widescreen display	6AV2124-1QC02-0AX1
Accessories	See catalog ST 80/ST PC or Industry Mall

SIMATIC S7-1500 Advanced Controllers

SIPLUS Operator control and monitoring

SIPLUS Basic Panels (2nd Generation)

Overview



With their fully developed HMI basic functions, 2nd Generation SIPLUS Basic Panels are the ideal entry-level series for simple HMI applications.

The device family offers panels with 4", 7", 9" and 12" displays, as well as combined key and touch operation.

The innovative high-resolution widescreen displays with 64 000 colors are also suitable for upright installation, and they can be dimmed down to 100%. The innovative operator interface with improved usability opens up a diverse range of options thanks to new controls and graphics. The new USB interface enables the connection of keyboard, mouse or barcode scanner, and supports the simple archiving of data on a USB flash drive.

The integrated Ethernet or RS 485/422 interface (version-specific) enables simple connection to the controller.

Note:

SIPLUS extreme products are based on SIMATIC standard products. The contents listed here were taken from the respective standard products. SIPLUS extreme-specific information was added.

Technical documentation on SIPLUS can be found here:
<http://www.siemens.com/siplus-extreme>

Ordering data

Article No.

SIPLUS HMI Basic Panels, Key and Touch

SIPLUS HMI KTP400 Basic

6AG1123-2DB03-2AX0

For areas with extreme exposure to environmental substances (conformal coating); ambient temperature -20 ... +60 °C

SIPLUS HMI KTP700 Basic

6AG1123-2GB03-2AX0

For areas with extreme exposure to environmental substances (conformal coating); ambient temperature -20 ... +50 °C

SIPLUS HMI KTP700 Basic DP

6AG1123-2GA03-2AX0

For areas with extreme exposure to environmental substances (conformal coating); ambient temperature -20 ... +50 °C

SIPLUS HMI KTP900 Basic

6AG1123-2JB03-2AX0

For areas with extreme exposure to environmental substances (conformal coating); ambient temperature -20 ... +50 °C

SIPLUS HMI KTP1200 Basic

6AG1123-2MB03-2AX0

For areas with extreme exposure to environmental substances (conformal coating); ambient temperature -10 ... +50 °C

SIPLUS HMI KTP1200 Basic DP

6AG1123-2MA03-2AX0

For areas with extreme exposure to environmental substances (conformal coating); ambient temperature -10 ... +50 °C

Accessories

See catalog ST 80/ST PC or Industry Mall

Technical specifications

Article number	6AG1123-2DB03-2AX0	6AG1123-2GB03-2AX0	6AG1123-2GA03-2AX0
Based on	6AV2123-2DB03-0AX0 SIPLUS HMI KTP400 Basic	6AV2123-2GB03-0AX0 SIPLUS HMI KTP700 Basic	6AV2123-2GA03-0AX0 SIPLUS HMI KTP700 Basic DP
General information			
Ambient conditions			
Suited for indoor use		Yes	Yes
Suited for outdoor use		No	No
Ambient temperature during operation			
Operation (vertical installation)			
- For vertical installation, min.	-20 °C; = Tmin	-20 °C	-20 °C; = Tmin
- For vertical installation, max.	60 °C; = Tmax	50 °C	50 °C
Altitude during operation relating to sea level			
• Installation altitude above sea level, max.	5 000 m	5 000 m	5 000 m
• Ambient air temperature-barometric pressure-altitude	Tmin ... Tmax at 1 140 hPa ... 795 hPa (-1 000 m ... +2 000 m) // Tmin ... (Tmax - 10 K) at 795 hPa ... 658 hPa (+2 000 m ... +3 500 m) // Tmin ... (Tmax -20 K) at 658 hPa ... 540 hPa (+3 500 m ... +5 000 m)	Tmin ... Tmax at 1 140 hPa ... 795 hPa (-1 000 m ... +2 000 m) // Tmin ... (Tmax - 10 K) at 795 hPa ... 658 hPa (+2 000 m ... +3 500 m) // Tmin ... (Tmax -20 K) at 658 hPa ... 540 hPa (+3 500 m ... +5 000 m)	Tmin ... Tmax at 1 140 hPa ... 795 hPa (-1 000 m ... +2 000 m) // Tmin ... (Tmax - 10 K) at 795 hPa ... 658 hPa (+2 000 m ... +3 500 m) // Tmin ... (Tmax -20 K) at 658 hPa ... 540 hPa (+3 500 m ... +5 000 m)
Relative humidity			
• With condensation, tested in accordance with IEC 60068-2-38, max.	100 %; RH incl. condensation/frost (no commissioning under condensation conditions)	100 %; RH incl. condensation/frost (no commissioning under condensation conditions)	100 %; RH incl. condensation/frost (no commissioning when condensation present), vertical mounting position

SIMATIC S7-1500 Advanced Controllers

SIPLUS Operator control and monitoring

SIPLUS Basic Panels (2nd Generation)

Technical specifications

Article number	6AG1123-2DB03-2AX0	6AG1123-2GB03-2AX0	6AG1123-2GA03-2AX0
Based on	6AV2123-2DB03-0AX0 SIPLUS HMI KTP400 Basic	6AV2123-2GB03-0AX0 SIPLUS HMI KTP700 Basic	6AV2123-2GA03-0AX0 SIPLUS HMI KTP700 Basic DP
Resistance			
Coolants and lubricants			
- Resistant to commercially available coolants and lubricants	Yes; Incl. diesel and oil droplets in the air	Yes; Incl. diesel and oil droplets in the air	Yes; Incl. diesel and oil droplets in the air
Use in stationary industrial systems			
- to biologically active substances according to EN 60721-3-3	Yes; Class 3B2 mold, fungus and dry rot spores (with the exception of fauna); Class 3B3 on request	Yes; Class 3B2 mold, fungus and dry rot spores (with the exception of fauna); Class 3B3 on request	Yes; Class 3B2 mold, fungus and dry rot spores (with the exception of fauna); Class 3B3 on request
- to chemically active substances according to EN 60721-3-3	Yes; Class 3C4 (RH < 75 %) incl. salt spray acc. to EN 60068-2-52 (severity degree 3); *	Yes; Class 3C4 (RH < 75 %) incl. salt spray acc. to EN 60068-2-52 (severity degree 3); *	Yes; Class 3C4 (RH < 75 %) incl. salt spray acc. to EN 60068-2-52 (severity degree 3); *
- to mechanically active substances according to EN 60721-3-3	Yes; Class 3S4 incl. sand, dust, *	Yes; Class 3S4 incl. sand, dust, *	Yes; Class 3S4 incl. sand, dust, *
Use on ships/at sea			
- to biologically active substances according to EN 60721-3-6	Yes; Class 6B2 mold and fungal spores (excluding fauna); Class 6B3 on request	Yes; Class 6B2 mold and fungal spores (excluding fauna); Class 6B3 on request	Yes; Class 6B2 mold and fungal spores (excluding fauna); Class 6B3 on request
- to chemically active substances according to EN 60721-3-6	Yes; Class 6C3 (RH < 75 %) incl. salt spray acc. to EN 60068-2-52 (severity degree 3); *	Yes; Class 6C3 (RH < 75 %) incl. salt spray acc. to EN 60068-2-52 (severity degree 3); *	Yes; Class 6C3 (RH < 75 %) incl. salt spray acc. to EN 60068-2-52 (severity degree 3); *
- to mechanically active substances according to EN 60721-3-6	Yes; Class 6S3 incl. sand, dust; *	Yes; Class 6S3 incl. sand, dust; *	Yes; Class 6S3 incl. sand, dust; *
Usage in industrial process technology			
- Against chemically active substances acc. to EN 60654-4	Yes; Class 3 (excluding trichlorethylene)	Yes; Class 3 (excluding trichlorethylene)	Yes; Class 3 (excluding trichlorethylene)
- Environmental conditions for process, measuring and control systems acc. to ANSI/ISA-71.04	Yes; Level GX group A/B (excluding trichlorethylene; harmful gas concentrations up to the limits of EN 60721-3-3 class 3C4 permissible); level LC3 (salt spray) and level LB3 (oil)	Yes; Level GX group A/B (excluding trichlorethylene; harmful gas concentrations up to the limits of EN 60721-3-3 class 3C4 permissible); level LC3 (salt spray) and level LB3 (oil)	Yes; Level GX group A/B (excluding trichlorethylene; harmful gas concentrations up to the limits of EN 60721-3-3 class 3C4 permissible); level LC3 (salt spray) and level LB3 (oil)
Remark			
- Note regarding classification of environmental conditions acc. to EN 60721, EN 60654-4 and ANSI/ISA-71.04	* The supplied plug covers must remain in place over the unused interfaces during operation!	* The supplied plug covers must remain in place over the unused interfaces during operation!	* The supplied plug covers must remain in place over the unused interfaces during operation!
Conformal coating			
• Coatings for printed circuit board assemblies acc. to EN 61086	Yes; Class 2 for high reliability	Yes; Class 2 for high reliability	Yes; Class 2 for high reliability
• Protection against fouling acc. to EN 60664-3	Yes; Type 1 protection	Yes; Type 1 protection	Yes; Type 1 protection
• Military testing according to MIL-I-46058C, Amendment 7	Yes; Discoloration of coating possible during service life	Yes; Discoloration of coating possible during service life	Yes; Discoloration of coating possible during service life
• Qualification and Performance of Electrical Insulating Compound for Printed Board Assemblies according to IPC-CC-830A	Yes; Conformal coating, Class A	Yes; Conformal coating, Class A	Yes; Conformal coating, Class A
Article number	6AG1123-2JB03-2AX0	6AG1123-2MB03-2AX0	6AG1123-2MA03-2AX0
Based on	6AV2123-2JB03-0AX0 SIPLUS HMI KTP900 Basic	6AV2123-2MB03-0AX0 SIPLUS HMI KTP1200 Basic	6AV2123-2MA03-0AX0 SIPLUS HMI KTP1200 Basic DP
Ambient conditions			
Suited for indoor use	Yes	Yes	Yes
Suited for outdoor use	No	No	No
Ambient temperature during operation			
Operation (vertical installation)			
- For vertical installation, min.	-20 °C	-10 °C; = Tmin	-10 °C; = Tmin
- For vertical installation, max.	50 °C	50 °C	50 °C

Technical specifications

Article number	6AG1123-2JB03-2AX0	6AG1123-2MB03-2AX0	6AG1123-2MA03-2AX0
Based on	6AV2123-2JB03-0AX0	6AV2123-2MB03-0AX0	6AV2123-2MA03-0AX0
	SIPLUS HMI KTP900 Basic	SIPLUS HMI KTP1200 Basic	SIPLUS HMI KTP1200 Basic DP
Altitude during operation relating to sea level <ul style="list-style-type: none"> Installation altitude above sea level, max. Ambient air temperature-barometric pressure-altitude 	5 000 m Tmin ... Tmax at 1 140 hPa ... 795 hPa (-1 000 m ... +2 000 m) // Tmin ... (Tmax - 10 K) at 795 hPa ... 658 hPa (+2 000 m ... +3 500 m) // Tmin ... (Tmax -20 K) at 658 hPa ... 540 hPa (+3 500 m ... +5 000 m)	5 000 m Tmin ... Tmax at 1 140 hPa ... 795 hPa (-1 000 m ... +2 000 m) // Tmin ... (Tmax - 10 K) at 795 hPa ... 658 hPa (+2 000 m ... +3 500 m) // Tmin ... (Tmax -20 K) at 658 hPa ... 540 hPa (+3 500 m ... +5 000 m)	5 000 m Tmin ... Tmax at 1 140 hPa ... 795 hPa (-1 000 m ... +2 000 m) // Tmin ... (Tmax - 10 K) at 795 hPa ... 658 hPa (+2 000 m ... +3 500 m) // Tmin ... (Tmax -20 K) at 658 hPa ... 540 hPa (+3 500 m ... +5 000 m)
Relative humidity <ul style="list-style-type: none"> With condensation, tested in accordance with IEC 60068-2-38, max. 	100 %; RH incl. condensation/frost (no commissioning under condensation conditions)	100 %; RH incl. condensation / frost (no commissioning in bedewed state), horizontal installation	100 %; RH incl. condensation/frost (no commissioning when condensation present), vertical mounting position
Resistance			
Coolants and lubricants <ul style="list-style-type: none"> Resistant to commercially available coolants and lubricants 	Yes; Incl. diesel and oil droplets in the air	Yes; Incl. diesel and oil droplets in the air	Yes; Incl. diesel and oil droplets in the air
Use in stationary industrial systems <ul style="list-style-type: none"> to biologically active substances according to EN 60721-3-3 to chemically active substances according to EN 60721-3-3 to mechanically active substances according to EN 60721-3-3 	Yes; Class 3B2 mold, fungus and dry rot spores (with the exception of fauna); Class 3B3 on request Yes; Class 3C4 (RH < 75 %) incl. salt spray acc. to EN 60068-2-52 (severity degree 3); * Yes; Class 3S4 incl. sand, dust, *	Yes; Class 3B2 mold, fungus and dry rot spores (with the exception of fauna); Class 3B3 on request Yes; Class 3C4 (RH < 75 %) incl. salt spray acc. to EN 60068-2-52 (severity degree 3); * Yes; Class 3S4 incl. sand, dust, *	Yes; Class 3B2 mold, fungus and dry rot spores (with the exception of fauna); Class 3B3 on request Yes; Class 3C4 (RH < 75 %) incl. salt spray acc. to EN 60068-2-52 (severity degree 3); * Yes; Class 3S4 incl. sand, dust, *
Use on ships/at sea <ul style="list-style-type: none"> to biologically active substances according to EN 60721-3-6 to chemically active substances according to EN 60721-3-6 to mechanically active substances according to EN 60721-3-6 	Yes; Class 6B2 mold and fungal spores (excluding fauna); Class 6B3 on request Yes; Class 6C3 (RH < 75 %) incl. salt spray acc. to EN 60068-2-52 (severity degree 3); * Yes; Class 6S3 incl. sand, dust; *	Yes; Class 6B2 mold and fungal spores (excluding fauna); Class 6B3 on request Yes; Class 6C3 (RH < 75 %) incl. salt spray acc. to EN 60068-2-52 (severity degree 3); * Yes; Class 6S3 incl. sand, dust; *	Yes; Class 6B2 mold and fungal spores (excluding fauna); Class 6B3 on request Yes; Class 6C3 (RH < 75 %) incl. salt spray acc. to EN 60068-2-52 (severity degree 3); * Yes; Class 6S3 incl. sand, dust; *
Usage in industrial process technology <ul style="list-style-type: none"> Against chemically active substances acc. to EN 60654-4 Environmental conditions for process, measuring and control systems acc. to ANSI/ISA-71.04 	Yes; Class 3 (excluding trichlorethylene) Yes; Level GX group A/B (excluding trichlorethylene; harmful gas concentrations up to the limits of EN 60721-3-3 class 3C4 permissible); level LC3 (salt spray) and level LB3 (oil)	Yes; Class 3 (excluding trichlorethylene) Yes; Level GX group A/B (excluding trichlorethylene; harmful gas concentrations up to the limits of EN 60721-3-3 class 3C4 permissible); level LC3 (salt spray) and level LB3 (oil)	Yes; Class 3 (excluding trichlorethylene) Yes; Level GX group A/B (excluding trichlorethylene; harmful gas concentrations up to the limits of EN 60721-3-3 class 3C4 permissible); level LC3 (salt spray) and level LB3 (oil)
Remark <ul style="list-style-type: none"> Note regarding classification of environmental conditions acc. to EN 60721, EN 60654-4 and ANSI/ISA-71.04 	* The supplied plug covers must remain in place over the unused interfaces during operation!	* The supplied plug covers must remain in place over the unused interfaces during operation!	* The supplied plug covers must remain in place over the unused interfaces during operation!
Conformal coating <ul style="list-style-type: none"> Coatings for printed circuit board assemblies acc. to EN 61086 Protection against fouling acc. to EN 60664-3 Military testing according to MIL-I-46058C, Amendment 7 Qualification and Performance of Electrical Insulating Compound for Printed Board Assemblies according to IPC-CC-830A 	Yes; Class 2 for high reliability Yes; Type 1 protection Yes; Discoloration of coating possible during service life Yes; Conformal coating, Class A	Yes; Class 2 for high reliability Yes; Type 1 protection Yes; Discoloration of coating possible during service life Yes; Conformal coating, Class A	Yes; Class 2 for high reliability Yes; Type 1 protection Yes; Discoloration of coating possible during service life Yes; Conformal coating, Class A

SIMATIC S7-1500 Advanced Controllers

SIPLUS Operator control and monitoring

SIPLUS Basic Panels (1st Generation)

Overview



- Ideal entry-level series of 3.8" to 15" for operating and monitoring compact machines and systems
- Clear process representation through the use of full-graphic displays
- Intuitive operation via touch and tactile function keys
- Equipped with all the necessary basic functions such as reporting, recipe management, curve representation, vector graphics, and language selection
- Easy connection to the controller via integrated Ethernet interface or a separate version with RS 485/422

Note:

SIPLUS extreme products are based on SIMATIC standard products. The contents listed here were taken from the respective standard products. SIPLUS extreme-specific information was added.

Technical documentation on SIPLUS can be found here:
<http://www.siemens.com/siplus-extreme>

Ordering data

Article No.

SIPLUS HMI Basic Panels

SIPLUS HMI KP300 Basic mono PN

For areas with extreme exposure to environmental substances (conformal coating); ambient temperature -15 ... +60 °C

Accessories

6AG1647-0AH11-2AX0

See catalog ST 80/ST PC or Industry Mall

Technical specifications

Article number	6AG1647-0AH11-2AX0
Based on	6AV6647-0AH11-3AX0 SIPLUS HMI KP300 Basic Mono PN 3,6"
Ambient conditions	
Suited for indoor use	Yes
Suited for outdoor use	No
Ambient temperature during operation	
Operation (vertical installation)	
- For vertical installation, min.	-25 °C
- For vertical installation, max.	60 °C
Altitude during operation relating to sea level	
• Installation altitude above sea level, max.	5 000 m
• Ambient air temperature-barometric pressure-altitude	Tmin ... Tmax at 1 140 hPa ... 795 hPa (-1 000 m ... +2 000 m) // Tmin ... (Tmax - 10 K) at 795 hPa ... 658 hPa (+2 000 m ... +3 500 m) // Tmin ... (Tmax -20 K) at 658 hPa ... 540 hPa (+3 500 m ... +5 000 m)
Relative humidity	
• With condensation, tested in accordance with IEC 60068-2-38, max.	100 %; RH incl. condensation/frost (no commissioning under condensation conditions)

Article number	6AG1647-0AH11-2AX0
Based on	6AV6647-0AH11-3AX0 SIPLUS HMI KP300 Basic Mono PN 3,6"
Resistance	
Coolants and lubricants	
- Resistant to commercially available coolants and lubricants	Yes; Incl. diesel and oil droplets in the air
Use in stationary industrial systems	
- to biologically active substances according to EN 60721-3-3	Yes; Class 3B2 mold, fungus and dry rot spores (with the exception of fauna); Class 3B3 on request
- to chemically active substances according to EN 60721-3-3	Yes; Class 3C4 (RH < 75 %) incl. salt spray acc. to EN 60068-2-52 (severity degree 3); *
- to mechanically active substances according to EN 60721-3-3	Yes; Class 3S4 incl. sand, dust, *
Use on ships/at sea	
- to biologically active substances according to EN 60721-3-6	Yes; Class 6B2 mold and fungal spores (excluding fauna); Class 6B3 on request
- to chemically active substances according to EN 60721-3-6	Yes; Class 6C3 (RH < 75 %) incl. salt spray acc. to EN 60068-2-52 (severity degree 3); *
- to mechanically active substances according to EN 60721-3-6	Yes; Class 6S3 incl. sand, dust; *

SIMATIC S7-1500 Advanced Controllers

SIPLUS Operator control and monitoring

SIPLUS Basic Panels (1st Generation)

Technical specifications

Article number	6AG1647-0AH11-2AX0
Based on	6AV6647-0AH11-3AX0 SIPLUS HMI KP300 Basic Mono PN 3,6"
Usage in industrial process technology	
- Against chemically active substances acc. to EN 60654-4	Yes; Class 3 (excluding trichlorethylene)
- Environmental conditions for process, measuring and control systems acc. to ANSI/ISA-71.04	Yes; Level GX group A/B (excluding trichlorethylene; harmful gas concentrations up to the limits of EN 60721-3-3 class 3C4 permissible); level LC3 (salt spray) and level LB3 (oil)
Remark	
- Note regarding classification of environmental conditions acc. to EN 60721, EN 60654-4 and ANSI/ISA-71.04	* The supplied plug covers must remain in place over the unused interfaces during operation!

Article number	6AG1647-0AH11-2AX0
Based on	6AV6647-0AH11-3AX0 SIPLUS HMI KP300 Basic Mono PN 3,6"
Conformal coating	
• Coatings for printed circuit board assemblies acc. to EN 61086	Yes; Class 2 for high reliability
• Protection against fouling acc. to EN 60664-3	Yes; Type 1 protection
• Military testing according to MIL-I-46058C, Amendment 7	Yes; Discoloration of coating possible during service life
• Qualification and Performance of Electrical Insulating Compound for Printed Board Assemblies according to IPC-CC-830A	Yes; Conformal coating, Class A

SIMATIC S7-1500 Advanced Controllers

SIPLUS Operator control and monitoring

SIPLUS Comfort Panels Standard

Overview



- Excellent HMI functionality for demanding applications
- Widescreen TFT displays with 4", 7", 9", 12", 15", 19" and 22" diagonals (all 16 million colors) with up to 40% more visualization area as compared to the predecessor devices
- Integrated high-end functionality with archives, scripts, PDF/Word/Excel viewer, Internet Explorer, Media Player
- Dimmable displays from 0 to 100% via PROFlenergy, via the HMI project or via a controller
- Modern industrial design, cast aluminum fronts for 7" upwards
- Upright installation for all touch devices
- Optimal selection option: seven touch and five key versions are available

- Data security in the event of a power failure for the device and for the SIMATIC HMI memory card
- Innovative service and commissioning concept through second SD card (automatic backup)
- Easy project transfer via standard cable (standard Ethernet cable, standard USB cable)
- Maximum performance with short screen refresh times
- Suitable for extremely harsh industrial environments thanks to extended approvals such as ATEX 2/22
- Wide range of communication options: PROFIBUS and PROFINET onboard; 2x PROFINET with integrated switch for 7" models or larger; plus 1 additional PROFINET with Gigabit support for 15" models or larger
- All variants can be used as an OPC UA client or as an OPC DA server
- Key-operated devices with LED in every function key and new text input mechanism, similar to the keypads of mobile phones
- Key-operated devices with stamped keys for optimum tactile feedback
- All keys have a service life of 2 million operations
- Configuring with the WinCC engineering software of the TIA Portal

Note:

SIPLUS extreme products are based on SIMATIC standard products. The contents listed here were taken from the respective standard products. SIPLUS extreme-specific information was added.

Ordering data

Article No.

SIPLUS HMI Comfort Panels, Keys and Touch	
SIPLUS HMI KTP400 Comfort	6AG1124-2DC01-4AX0
SIPLUS HMI Comfort Panels, Touch	
SIPLUS HMI TP700 Comfort	6AG1124-0GC01-4AX0
SIPLUS HMI TP900 Comfort	6AG1124-0JC01-4AX0
SIPLUS HMI TP1200 Comfort	6AG1124-0MC01-4AX0
SIPLUS HMI TP1500 Comfort	6AG1124-0QC02-4AX1
SIPLUS HMI TP1900 Comfort	6AG1124-0UC02-4AX1
SIPLUS HMI TP2200 Comfort	6AG1124-0XC02-4AX1

Article No.

SIPLUS HMI Comfort Panels, Keys	
SIPLUS HMI KP400 Comfort	6AG1124-1DC01-4AX0
SIPLUS HMI KP700 Comfort	6AG1124-1GC01-4AX0
SIPLUS HMI KP900 Comfort	6AG1124-1JC01-4AX0
SIPLUS HMI KP1200 Comfort	6AG1124-1MC01-4AX0
SIPLUS HMI KP1500 Comfort	6AG1124-1QC02-4AX1
Accessories	See catalog ST 80/ST PC or Industry Mall

Technical specifications

Article number	6AG1124-2DC01-4AX0	6AG1124-0GC01-4AX0	6AG1124-0JC01-4AX0	6AG1124-0MC01-4AX0
Based on	6AV2124-2DC01-0AX0 SIPLUS HMI KTP400 Comfort	6AV2124-0GC01-0AX0 SIPLUS HMI TP700 Comfort	6AV2124-0JC01-0AX0 SIPLUS HMI TP900 Comfort	6AV2124-0MC01-0AX0 SIPLUS HMI TP1200 Comfort
Ambient conditions				
Suited for indoor use	Yes	Yes	Yes	Yes
Suited for outdoor use	No	No	No	No
Ambient temperature during operation				
Operation (vertical installation)				
- For vertical installation, min.	0 °C; = Tmin	0 °C; = Tmin	0 °C; = Tmin	0 °C; = Tmin
- For vertical installation, max.	50 °C; = Tmax	50 °C; = Tmax	50 °C; = Tmax	50 °C; = Tmax
Altitude during operation relating to sea level				
• Installation altitude above sea level, max.	5 000 m	5 000 m	5 000 m	5 000 m
• Ambient air temperature-barometric pressure-altitude	Tmin ... Tmax at 1 140 hPa ... 795 hPa (-1 000 m ... +2 000 m) // Tmin ... (Tmax - 10 K) at 795 hPa ... 658 hPa (+2 000 m ... +3 500 m) // Tmin ... (Tmax -20 K) at 658 hPa ... 540 hPa (+3 500 m ... +5 000 m)	Tmin ... Tmax at 1 140 hPa ... 795 hPa (-1 000 m ... +2 000 m) // Tmin ... (Tmax - 10 K) at 795 hPa ... 658 hPa (+2 000 m ... +3 500 m) // Tmin ... (Tmax -20 K) at 658 hPa ... 540 hPa (+3 500 m ... +5 000 m)	Tmin ... Tmax at 1 140 hPa ... 795 hPa (-1 000 m ... +2 000 m) // Tmin ... (Tmax - 10 K) at 795 hPa ... 658 hPa (+2 000 m ... +3 500 m) // Tmin ... (Tmax -20 K) at 658 hPa ... 540 hPa (+3 500 m ... +5 000 m)	Tmin ... Tmax at 1 140 hPa ... 795 hPa (-1 000 m ... +2 000 m) // Tmin ... (Tmax - 10 K) at 795 hPa ... 658 hPa (+2 000 m ... +3 500 m) // Tmin ... (Tmax -20 K) at 658 hPa ... 540 hPa (+3 500 m ... +5 000 m)
Relative humidity				
• With condensation, tested in accordance with IEC 60068-2-38, max.	100 %; RH incl. condensation/frost (no commissioning under condensation conditions)	100 %; RH incl. condensation/frost (no commissioning under condensation conditions)	100 %; RH incl. condensation/frost (no commissioning under condensation conditions)	100 %; RH incl. condensation/frost (no commissioning under condensation conditions)
Resistance				
Coolants and lubricants				
- Resistant to commercially available coolants and lubricants	Yes; Incl. diesel and oil droplets in the air	Yes; Incl. diesel and oil droplets in the air	Yes; Incl. diesel and oil droplets in the air	Yes; Incl. diesel and oil droplets in the air
Use in stationary industrial systems				
- to biologically active substances according to EN 60721-3-3	Yes; Class 3B2 mold, fungus and dry rot spores (with the exception of fauna); Class 3B3 on request	Yes; Class 3B2 mold, fungus and dry rot spores (with the exception of fauna); Class 3B3 on request	Yes; Class 3B2 mold, fungus and dry rot spores (with the exception of fauna); Class 3B3 on request	Yes; Class 3B2 mold, fungus and dry rot spores (with the exception of fauna); Class 3B3 on request
- to chemically active substances according to EN 60721-3-3	Yes; Class 3C4 (RH < 75 %) incl. salt spray acc. to EN 60068-2-52 (severity degree 3); *	Yes; Class 3C4 (RH < 75 %) incl. salt spray acc. to EN 60068-2-52 (severity degree 3); *	Yes; Class 3C4 (RH < 75 %) incl. salt spray acc. to EN 60068-2-52 (severity degree 3); *	Yes; Class 3C4 (RH < 75 %) incl. salt spray acc. to EN 60068-2-52 (severity degree 3); *
- to mechanically active substances according to EN 60721-3-3	Yes; Class 3S4 incl. sand, dust, *	Yes; Class 3S4 incl. sand, dust, *	Yes; Class 3S4 incl. sand, dust, *	Yes; Class 3S4 incl. sand, dust, *
Use on ships/at sea				
- to biologically active substances according to EN 60721-3-6	Yes; Class 6B2 mold and fungal spores (excluding fauna); Class 6B3 on request	Yes; Class 6B2 mold and fungal spores (excluding fauna); Class 6B3 on request	Yes; Class 6B2 mold and fungal spores (excluding fauna); Class 6B3 on request	Yes; Class 6B2 mold and fungal spores (excluding fauna); Class 6B3 on request
- to chemically active substances according to EN 60721-3-6	Yes; Class 6C3 (RH < 75 %) incl. salt spray acc. to EN 60068-2-52 (severity degree 3); *	Yes; Class 6C3 (RH < 75 %) incl. salt spray acc. to EN 60068-2-52 (severity degree 3); *	Yes; Class 6C3 (RH < 75 %) incl. salt spray acc. to EN 60068-2-52 (severity degree 3); *	Yes; Class 6C3 (RH < 75 %) incl. salt spray acc. to EN 60068-2-52 (severity degree 3); *
- to mechanically active substances according to EN 60721-3-6	Yes; Class 6S3 incl. sand, dust; *	Yes; Class 6S3 incl. sand, dust; *	Yes; Class 6S3 incl. sand, dust; *	Yes; Class 6S3 incl. sand, dust; *
Usage in industrial process technology				
- Against chemically active substances acc. to EN 60654-4	Yes; Class 3 (excluding trichlorethylene)	Yes; Class 3 (excluding trichlorethylene)	Yes; Class 3 (excluding trichlorethylene)	Yes; Class 3 (excluding trichlorethylene)
- Environmental conditions for process, measuring and control systems acc. to ANSI/ISA-71.04	Yes; Level GX group A/B (excluding trichlorethylene; harmful gas concentrations up to the limits of EN 60721-3-3 class 3C4 permissible); level LC3 (salt spray) and level LB3 (oil)	Yes; Level GX group A/B (excluding trichlorethylene; harmful gas concentrations up to the limits of EN 60721-3-3 class 3C4 permissible); level LC3 (salt spray) and level LB3 (oil)	Yes; Level GX group A/B (excluding trichlorethylene; harmful gas concentrations up to the limits of EN 60721-3-3 class 3C4 permissible); level LC3 (salt spray) and level LB3 (oil)	Yes; Level GX group A/B (excluding trichlorethylene; harmful gas concentrations up to the limits of EN 60721-3-3 class 3C4 permissible); level LC3 (salt spray) and level LB3 (oil)
Remark				
- Note regarding classification of environmental conditions acc. to EN 60721, EN 60654-4 and ANSI/ISA-71.04	* The supplied plug covers must remain in place over the unused interfaces during operation!	* The supplied plug covers must remain in place over the unused interfaces during operation!	* The supplied plug covers must remain in place over the unused interfaces during operation!	* The supplied plug covers must remain in place over the unused interfaces during operation!

SIMATIC S7-1500 Advanced Controllers

SIPLUS Operator control and monitoring

SIPLUS Comfort Panels Standard

Technical specifications

Article number	6AG1124-2DC01-4AX0	6AG1124-0GC01-4AX0	6AG1124-0JC01-4AX0	6AG1124-0MC01-4AX0	
Based on	6AV2124-2DC01-0AX0 SIPLUS HMI KTP400 Comfort	6AV2124-0GC01-0AX0 SIPLUS HMI TP700 Comfort	6AV2124-0JC01-0AX0 SIPLUS HMI TP900 Comfort	6AV2124-0MC01-0AX0 SIPLUS HMI TP1200 Comfort	
Conformal coating					
<ul style="list-style-type: none"> Coatings for printed circuit board assemblies acc. to EN 61086 Protection against fouling acc. to EN 60664-3 Military testing according to MIL-I-46058C, Amendment 7 Qualification and Performance of Electrical Insulating Compound for Printed Board Assemblies according to IPC-CC-830A 	Yes; Class 2 for high reliability	Yes; Class 2 for high reliability	Yes; Class 2 for high reliability	Yes; Class 2 for high reliability	
	Yes; Type 1 protection	Yes; Type 1 protection	Yes; Type 1 protection	Yes; Type 1 protection	
	Yes; Discoloration of coating possible during service life	Yes; Discoloration of coating possible during service life	Yes; Discoloration of coating possible during service life	Yes; Discoloration of coating possible during service life	
	Yes; Conformal coating, Class A	Yes; Conformal coating, Class A	Yes; Conformal coating, Class A	Yes; Conformal coating, Class A	
Article number	6AG1124-1DC01-4AX0	6AG1124-1GC01-4AX0	6AG1124-1JC01-4AX0	6AG1124-1MC01-4AX0	6AG1124-1QC02-4AX1
Based on	6AV224-1DC01-0AX0 SIPLUS HMI KP400 Comfort	6AV2124-1GC01-0AX0 SIPLUS HMI KP700 Comfort	6AV2124-1JC01-0AX0 SIPLUS HMI KP900 Comfort	6AV2124-1MC01-0AX0 SIPLUS HMI KP1200 Comfort	6AV2124-1QC02-0AX1 SIPLUS HMI KP1500 Comfort
Ambient conditions					
Suited for indoor use	Yes	Yes	Yes	Yes	Yes
Suited for outdoor use	No	No	No	No	No
Ambient temperature during operation					
Operation (vertical installation)					
- For vertical installation, min.	0 °C; = Tmin	0 °C; = Tmin	0 °C; = Tmin	0 °C; = Tmin	0 °C
- For vertical installation, max.	50 °C; = Tmax	50 °C; = Tmax	50 °C; = Tmax	50 °C; = Tmax	50 °C; (55 °C, see entry ID: 64847814)
Altitude during operation relating to sea level					
• Installation altitude above sea level, max.	5 000 m	5 000 m	5 000 m	5 000 m	5 000 m
• Ambient air temperature-barometric pressure-altitude	Tmin ... Tmax at 1 140 hPa ... 795 hPa (-1 000 m ... +2 000 m) // Tmin ... (Tmax - 10 K) at 795 hPa ... 658 hPa (+2 000 m ... +3 500 m) // Tmin ... (Tmax - 20 K) at 658 hPa ... 540 hPa (+3 500 m ... +5 000 m)	Tmin ... Tmax at 1 140 hPa ... 795 hPa (-1 000 m ... +2 000 m) // Tmin ... (Tmax - 10 K) at 795 hPa ... 658 hPa (+2 000 m ... +3 500 m) // Tmin ... (Tmax - 20 K) at 658 hPa ... 540 hPa (+3 500 m ... +5 000 m)	Tmin ... Tmax at 1 140 hPa ... 795 hPa (-1 000 m ... +2 000 m) // Tmin ... (Tmax - 10 K) at 795 hPa ... 658 hPa (+2 000 m ... +3 500 m) // Tmin ... (Tmax - 20 K) at 658 hPa ... 540 hPa (+3 500 m ... +5 000 m)	Tmin ... Tmax at 1 140 hPa ... 795 hPa (-1 000 m ... +2 000 m) // Tmin ... (Tmax - 10 K) at 795 hPa ... 658 hPa (+2 000 m ... +3 500 m) // Tmin ... (Tmax - 20 K) at 658 hPa ... 540 hPa (+3 500 m ... +5 000 m)	Tmin ... Tmax at 1 080 hPa ... 795 hPa (-1 000 m ... +2 000 m) // Tmin ... (Tmax - 10 K) at 795 hPa ... 658 hPa (+2 000 m ... +3 500 m) // Tmin ... (Tmax - 20 K) at 658 hPa ... 540 hPa (+3 500 m ... +5 000 m)
Relative humidity					
• With condensation, tested in accordance with IEC 60068-2-38, max.	100 %; RH incl. condensation/frost (no commissioning under condensation conditions)	100 %; RH incl. condensation/frost (no commissioning under condensation conditions)	100 %; RH incl. condensation/frost (no commissioning under condensation conditions)	100 %; RH incl. condensation/frost (no commissioning under condensation conditions)	100 %; RH incl. condensation/frost (no commissioning under condensation conditions)
Resistance					
Coolants and lubricants					
- Resistant to commercially available coolants and lubricants	Yes; Incl. diesel and oil droplets in the air	Yes; Incl. diesel and oil droplets in the air	Yes; Incl. diesel and oil droplets in the air	Yes; Incl. diesel and oil droplets in the air	Yes; Incl. diesel and oil droplets in the air
Use in stationary industrial systems					
- to biologically active substances according to EN 60721-3-3	Yes; Class 3B2 mold, fungus and dry rot spores (with the exception of fauna); Class 3B3 on request	Yes; Class 3B2 mold, fungus and dry rot spores (with the exception of fauna); Class 3B3 on request	Yes; Class 3B2 mold, fungus and dry rot spores (with the exception of fauna); Class 3B3 on request	Yes; Class 3B2 mold, fungus and dry rot spores (with the exception of fauna); Class 3B3 on request	Yes; Class 3B2 mold, fungus and dry rot spores (with the exception of fauna); Class 3B3 on request
- to chemically active substances according to EN 60721-3-3	Yes; Class 3C4 (RH < 75 %) incl. salt spray acc. to EN 60068-2-52 (severity degree 3); *	Yes; Class 3C4 (RH < 75 %) incl. salt spray acc. to EN 60068-2-52 (severity degree 3); *	Yes; Class 3C4 (RH < 75 %) incl. salt spray acc. to EN 60068-2-52 (severity degree 3); *	Yes; Class 3C4 (RH < 75 %) incl. salt spray acc. to EN 60068-2-52 (severity degree 3); *	Yes; Class 3C4 (RH < 75 %) incl. salt spray acc. to EN 60068-2-52 (severity degree 3); *
- to mechanically active substances according to EN 60721-3-3	Yes; Class 3S4 incl. sand, dust, *	Yes; Class 3S4 incl. sand, dust, *	Yes; Class 3S4 incl. sand, dust, *	Yes; Class 3S4 incl. sand, dust, *	Yes; Class 3S4 incl. sand, dust, *

Technical specifications

Article number	6AG1124-1DC01-4AX0	6AG1124-1GC01-4AX0	6AG1124-1JC01-4AX0	6AG1124-1MC01-4AX0	6AG1124-1QC02-4AX1
Based on	6AV224-1DC01-0AX0 SIPLUS HMI KP400 Comfort	6AV2124-1GC01-0AX0 SIPLUS HMI KP700 Comfort	6AV2124-1JC01-0AX0 SIPLUS HMI KP900 Comfort	6AV2124-1MC01-0AX0 SIPLUS HMI KP1200 Comfort	6AV2124-1QC02-0AX1 SIPLUS HMI KP1500 Comfort
Use on ships/at sea					
- to biologically active substances according to EN 60721-3-6	Yes; Class 6B2 mold and fungal spores (excluding fauna); Class 6B3 on request	Yes; Class 6B2 mold and fungal spores (excluding fauna); Class 6B3 on request	Yes; Class 6B2 mold and fungal spores (excluding fauna); Class 6B3 on request	Yes; Class 6B2 mold and fungal spores (excluding fauna); Class 6B3 on request	Yes; Class 6B2 mold and fungal spores (excluding fauna); Class 6B3 on request
- to chemically active substances according to EN 60721-3-6	Yes; Class 6C3 (RH < 75 %) incl. salt spray acc. to EN 60068-2-52 (severity degree 3); *	Yes; Class 6C3 (RH < 75 %) incl. salt spray acc. to EN 60068-2-52 (severity degree 3); *	Yes; Class 6C3 (RH < 75 %) incl. salt spray acc. to EN 60068-2-52 (severity degree 3); *	Yes; Class 6C3 (RH < 75 %) incl. salt spray acc. to EN 60068-2-52 (severity degree 3); *	Yes; Class 6C3 (RH < 75 %) incl. salt spray acc. to EN 60068-2-52 (severity degree 3); *
- to mechanically active substances according to EN 60721-3-6	Yes; Class 6S3 incl. sand, dust; *	Yes; Class 6S3 incl. sand, dust; *	Yes; Class 6S3 incl. sand, dust; *	Yes; Class 6S3 incl. sand, dust; *	Yes; Class 6S3 incl. sand, dust; *
Usage in industrial process technology					
- Against chemically active substances acc. to EN 60654-4	Yes; Class 3 (excluding trichlorethylene)	Yes; Class 3 (excluding trichlorethylene)	Yes; Class 3 (excluding trichlorethylene)	Yes; Class 3 (excluding trichlorethylene)	Yes; Class 3 (excluding trichlorethylene)
- Environmental conditions for process, measuring and control systems acc. to ANSI/ISA-71.04	Yes; Level GX group A/B (excluding trichlorethylene; harmful gas concentrations up to the limits of EN 60721-3-3 class 3C4 permissible); level LC3 (salt spray) and level LB3 (oil)	Yes; Level GX group A/B (excluding trichlorethylene; harmful gas concentrations up to the limits of EN 60721-3-3 class 3C4 permissible); level LC3 (salt spray) and level LB3 (oil)	Yes; Level GX group A/B (excluding trichlorethylene; harmful gas concentrations up to the limits of EN 60721-3-3 class 3C4 permissible); level LC3 (salt spray) and level LB3 (oil)	Yes; Level GX group A/B (excluding trichlorethylene; harmful gas concentrations up to the limits of EN 60721-3-3 class 3C4 permissible); level LC3 (salt spray) and level LB3 (oil)	Yes; Level GX group A/B (excluding trichlorethylene; harmful gas concentrations up to the limits of EN 60721-3-3 class 3C4 permissible); level LC3 (salt spray) and level LB3 (oil)
Remark					
- Note regarding classification of environmental conditions acc. to EN 60721, EN 60654-4 and ANSI/ISA-71.04	* The supplied plug covers must remain in place over the unused interfaces during operation!	* The supplied plug covers must remain in place over the unused interfaces during operation!	* The supplied plug covers must remain in place over the unused interfaces during operation!	* The supplied plug covers must remain in place over the unused interfaces during operation!	* The supplied plug covers must remain in place over the unused interfaces during operation!
Conformal coating					
• Coatings for printed circuit board assemblies acc. to EN 61086	Yes; Class 2 for high reliability	Yes; Class 2 for high reliability	Yes; Class 2 for high reliability	Yes; Class 2 for high reliability	Yes; Class 2 for high reliability
• Protection against fouling acc. to EN 60664-3	Yes; Type 1 protection	Yes; Type 1 protection	Yes; Type 1 protection	Yes; Type 1 protection	Yes; Type 1 protection
• Military testing according to MIL-I-46058C, Amendment 7	Yes; Discoloration of coating possible during service life	Yes; Discoloration of coating possible during service life	Yes; Discoloration of coating possible during service life	Yes; Discoloration of coating possible during service life	Yes; Discoloration of coating possible during service life
• Qualification and Performance of Electrical Insulating Compound for Printed Board Assemblies according to IPC-CC-830A	Yes; Conformal coating, Class A	Yes; Conformal coating, Class A	Yes; Conformal coating, Class A	Yes; Conformal coating, Class A	Yes; Conformal coating, Class A
Article number	6AG1124-0QC02-4AX1		6AG1124-0UC02-4AX1		6AG1124-0XC02-4AX1
Based on	6AV2124-0QC02-0AX1 SIPLUS HMI TP1500 Comfort		6AV2124-0UC02-0AX1 SIPLUS HMI TP1900 Comfort		6AV2124-0XC02-0AX1 SIPLUS HMI TP2200 Comfort
Ambient conditions					
Suited for indoor use	Yes		Yes		Yes
Suited for outdoor use	No		No		No
Ambient temperature during operation					
Operation (vertical installation)					
- For vertical installation, min.	0 °C		0 °C; = Tmin		0 °C; = Tmin
- For vertical installation, max.	50 °C; (55 °C, see entry ID: 64847814)		45 °C; = Tmax		45 °C; = Tmax

SIMATIC S7-1500 Advanced Controllers

SIPLUS Operator control and monitoring

SIPLUS Comfort Panels Standard

Technical specifications

Article number	6AG1124-0QC02-4AX1	6AG1124-0UC02-4AX1	6AG1124-0XC02-4AX1
Based on	6AV2124-0QC02-0AX1 SIPLUS HMI TP1500 Comfort	6AV2124-0UC02-0AX1 SIPLUS HMI TP1900 Comfort	6AV2124-0XC02-0AX1 SIPLUS HMI TP2200 Comfort
Altitude during operation relating to sea level			
<ul style="list-style-type: none"> Installation altitude above sea level, max. Ambient air temperature-barometric pressure-altitude 	5 000 m Tmin ... Tmax at 1 140 hPa ... 795 hPa (-1 000 m ... +2 000 m) // Tmin ... (Tmax - 10 K) at 795 hPa ... 658 hPa (+2 000 m ... +3 500 m) // Tmin ... (Tmax -20 K) at 658 hPa ... 540 hPa (+3 500 m ... +5 000 m)	5 000 m Tmin ... Tmax at 1 140 hPa ... 795 hPa (-1 000 m ... +2 000 m) // Tmin ... (Tmax - 10 K) at 795 hPa ... 658 hPa (+2 000 m ... +3 500 m) // Tmin ... (Tmax -20 K) at 658 hPa ... 540 hPa (+3 500 m ... +5 000 m)	5 000 m Tmin ... Tmax at 1 080 hPa ... 795 hPa (-1 000 m ... +2 000 m) // Tmin ... (Tmax - 10 K) at 795 hPa ... 658 hPa (+2 000 m ... +3 500 m) // Tmin ... (Tmax - 20 K) at 658 hPa ... 540 hPa (+3 500 m ... +5 000 m)
Relative humidity			
<ul style="list-style-type: none"> With condensation, tested in accordance with IEC 60068-2-38, max. 	100 %; RH incl. condensation/frost (no commissioning under condensation conditions)	100 %; RH incl. condensation/frost (no commissioning under condensation conditions)	100 %; RH incl. condensation/frost (no commissioning under condensation conditions)
Resistance			
Coolants and lubricants			
<ul style="list-style-type: none"> Resistant to commercially available coolants and lubricants 	Yes; Incl. diesel and oil droplets in the air	Yes; Incl. diesel and oil droplets in the air	Yes; Incl. diesel and oil droplets in the air
Use in stationary industrial systems			
<ul style="list-style-type: none"> to biologically active substances according to EN 60721-3-3 to chemically active substances according to EN 60721-3-3 to mechanically active substances according to EN 60721-3-3 	Yes; Class 3B2 mold, fungus and dry rot spores (with the exception of fauna); Class 3B3 on request Yes; Class 3C4 (RH < 75 %) incl. salt spray acc. to EN 60068-2-52 (severity degree 3); * Yes; Class 3S4 incl. sand, dust, *	Yes; Class 3B2 mold, fungus and dry rot spores (with the exception of fauna); Class 3B3 on request Yes; Class 3C4 (RH < 75 %) incl. salt spray acc. to EN 60068-2-52 (severity degree 3); * Yes; Class 3S4 incl. sand, dust, *	Yes; Class 3B2 mold, fungus and dry rot spores (with the exception of fauna); Class 3B3 on request Yes; Class 3C4 (RH < 75 %) incl. salt spray acc. to EN 60068-2-52 (severity degree 3); * Yes; Class 3S4 incl. sand, dust, *
Use on ships/at sea			
<ul style="list-style-type: none"> to biologically active substances according to EN 60721-3-6 to chemically active substances according to EN 60721-3-6 to mechanically active substances according to EN 60721-3-6 	Yes; Class 6B2 mold and fungal spores (excluding fauna); Class 6B3 on request Yes; Class 6C3 (RH < 75 %) incl. salt spray acc. to EN 60068-2-52 (severity degree 3); * Yes; Class 6S3 incl. sand, dust; *	Yes; Class 6B2 mold and fungal spores (excluding fauna); Class 6B3 on request Yes; Class 6C3 (RH < 75 %) incl. salt spray acc. to EN 60068-2-52 (severity degree 3); * Yes; Class 6S3 incl. sand, dust; *	Yes; Class 6B2 mold and fungal spores (excluding fauna); Class 6B3 on request Yes; Class 6C3 (RH < 75 %) incl. salt spray acc. to EN 60068-2-52 (severity degree 3); * Yes; Class 6S3 incl. sand, dust; *
Usage in industrial process technology			
<ul style="list-style-type: none"> Against chemically active substances acc. to EN 60654-4 Environmental conditions for process, measuring and control systems acc. to ANSI/ISA-71.04 	Yes; Class 3 (excluding trichlorethylene) Yes; Level GX group A/B (excluding trichlorethylene; harmful gas concentrations up to the limits of EN 60721-3-3 class 3C4 permissible); level LC3 (salt spray) and level LB3 (oil)	Yes; Class 3 (excluding trichlorethylene) Yes; Level GX group A/B (excluding trichlorethylene; harmful gas concentrations up to the limits of EN 60721-3-3 class 3C4 permissible); level LC3 (salt spray) and level LB3 (oil)	Yes; Class 3 (excluding trichlorethylene) Yes; Level GX group A/B (excluding trichlorethylene; harmful gas concentrations up to the limits of EN 60721-3-3 class 3C4 permissible); level LC3 (salt spray) and level LB3 (oil)
Remark			
<ul style="list-style-type: none"> Note regarding classification of environmental conditions acc. to EN 60721, EN 60654-4 and ANSI/ISA-71.04 	* The supplied plug covers must remain in place over the unused interfaces during operation!	* The supplied plug covers must remain in place over the unused interfaces during operation!	* The supplied plug covers must remain in place over the unused interfaces during operation!
Conformal coating			
<ul style="list-style-type: none"> Coatings for printed circuit board assemblies acc. to EN 61086 Protection against fouling acc. to EN 60664-3 Military testing according to MIL-I-46058C, Amendment 7 Qualification and Performance of Electrical Insulating Compound for Printed Board Assemblies according to IPC-CC-830A 	Yes; Class 2 for high reliability Yes; Type 1 protection Yes; Discoloration of coating possible during service life Yes; Conformal coating, Class A	Yes; Class 2 for high reliability Yes; Type 1 protection Yes; Discoloration of coating possible during service life Yes; Conformal coating, Class A	Yes; Class 2 for high reliability Yes; Type 1 protection Yes; Discoloration of coating possible during service life Yes; Conformal coating, Class A

Overview

Everything for a simple way to get started: SIMATIC S7-1500 Starter kits enable you to configure, mount, wire and use the PLC in quick and easy steps.

The following starter kits are available:

- SIMATIC S7-1500 Starter Kit;
Consisting of CPU 1511C-1 PN, SIMATIC Memory Card 4 MB, 160 mm DIN rail, front connector, STEP 7 Professional 365-day license, SIMATIC ProDiag 1500, SIMATIC OPC UA S7-1500 Small, PM 1507 24 V/3 A power supply, Ethernet cable, documentation
- SIMATIC S7-1500T Starter Kit;
Consisting of CPU 1511T-1 PN, SIMATIC Memory Card 4 MB, 160 mm DIN rail, front connector, STEP 7 Professional 365-day license, SIMATIC ProDiag 1500, SIMATIC OPC UA S7-1500 Small, PM 1507 24 V/3 A power supply, Ethernet cable, documentation

Current anniversary edition 60 years of SIMATIC

In 2018, Siemens celebrated 60 years of SIMATIC. To mark this occasion, every SIMATIC S7-1500 Starter Kit is expanded by TIA Portal options. In addition to STEP 7 Professional, the licenses for the option packages SIMATIC ProDiag S7-1500 for 250 supervisions and SIMATIC OPC UA S7-1500 Small for secure, reliable, manufacturer-and platform-independent communication are included.

Ordering data

Article No.

SIMATIC S7-1500 Starter Kit

Consisting of CPU 1511C-1 PN, SIMATIC Memory Card 4 MB, 160 mm DIN rail, front connector, STEP 7 Professional 365-day license, SIMATIC ProDiag 1500, SIMATIC OPC UA S7-1500 Small, PM 1507 24 V/3 A power supply, Ethernet cable, documentation

6ES7511-1CK03-4YB5

SIMATIC S7-1500T Starter Kit

Consisting of CPU 1511T-1 PN, SIMATIC Memory Card 4 MB, 160 mm DIN rail, front connector, STEP 7 Professional 365-day license, SIMATIC ProDiag 1500, SIMATIC OPC UA S7-1500 Small, PM 1507 24 V/3 A power supply, Ethernet cable, documentation

6ES7511-1TK03-4YB5

SIMATIC S7-1500 Advanced Controllers

Accessories

DIN rail

Overview



- Aluminum DIN rail for mounting the SIMATIC S7-1500 or ET 200MP
- With integrated top hat DIN rail for snapping on a wide range of standard components
- Attachment of modules with a single screw
- Installation by screwing to the control cabinet wall
- Entire length of rail can be used
- Can also be mounted on low or flat top hat DIN rails, e.g. in control cabinets and terminals boxes, using top hat DIN rail adapter

Ordering data

Article No.

SIMATIC S7-1500 DIN rail

Fixed lengths, with grounding elements

- 160 mm
- 245 mm
- 482 mm
- 530 mm
- 830 mm

6ES7590-1AB60-0AA0
6ES7590-1AC40-0AA0
6ES7590-1AE80-0AA0
6ES7590-1AF30-0AA0
6ES7590-1AJ30-0AA0

For cutting to length by customer, without drill holes; grounding elements must be ordered separately

- 2 000 mm

6ES7590-1BC00-0AA0

PE connection element for 2 000 mm DIN rail

20 units

6ES7590-5AA00-0AA0

Top hat DIN rail adapter

For adapting S7-1500 DIN rails on low or flat top hat DIN rails, as pre-assembled in control cabinets and terminal boxes, for example. An adapter must be placed every 25 cm. Including mounting hardware. 10 units per packaging unit

6ES7590-6AA00-0AA0

SIMATIC Manual Collection

Electronic manuals on DVD, multi-language: LOGO!, SIMADYN, SIMATIC bus components, SIMATIC C7, SIMATIC distributed I/O, SIMATIC HMI, SIMATIC Sensors, SIMATIC NET, SIMATIC PC-based Automation, SIMATIC PCS 7, SIMATIC PG/PC, SIMATIC S7, SIMATIC Software, SIMATIC TDC

6ES7998-8XC01-8YE0

SIMATIC Manual Collection update service for 1 year

Current Manual Collection DVD and the three subsequent updates

6ES7998-8XC01-8YE2

Overview

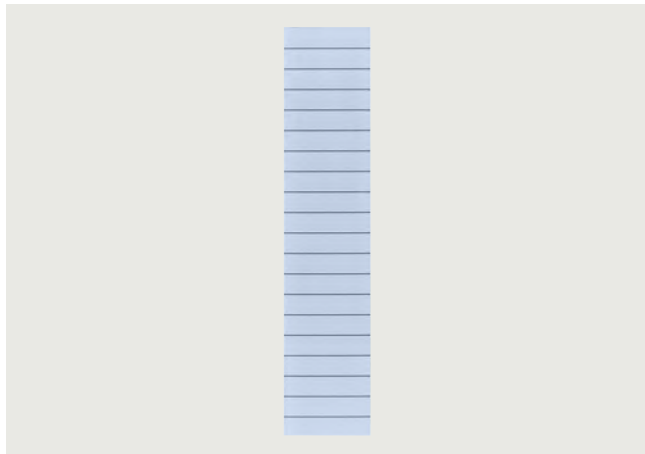

- Film sheets for the application-specific, automatic labeling of SIMATIC S7-1500 I/O modules using standard laser printers
- Direct printing possible from the TIA Portal
 - No double entry of symbols and/or addresses
 - Saves time and avoids typing errors
- Plain color films, tear-resistant, dirt-repellent
- Simple handling:
 - Perforated labeling sheets in DIN A4 format for easy separation of the labeling strips.
 - Detached strips can be inserted directly into the I/O modules.
- Different colors to differentiate module types; yellow reserved for fail-safe systems

Ordering data

Article No.

DIN A4 labeling sheet

For 35 mm module;
10 sheets with
10 labeling strips each for
I/O modules; perforated, Al gray

6ES7592-2AX00-0AA0

For 25 mm modules;
10 sheets with
20 labeling strips each for
I/O modules; perforated, Al gray

6ES7592-1AX00-0AA0

SIMATIC Manual Collection

Electronic manuals on
DVD, multi-language:
LOGO!, SIMADYN, SIMATIC
bus components, SIMATIC C7,
SIMATIC distributed I/O,
SIMATIC HMI, SIMATIC Sensors,
SIMATIC NET, SIMATIC PC-based
Automation, SIMATIC PCS 7,
SIMATIC PG/PC, SIMATIC S7,
SIMATIC Software, SIMATIC TDC

6ES7998-8XC01-8YE0

SIMATIC Manual Collection update service for 1 year

Current Manual Collection DVD and
the three subsequent updates

6ES7998-8XC01-8YE2

SIMATIC S7-1500 Advanced Controllers

Accessories

Spare parts

Overview

Front doors



- Versions:
 - Universal front doors for digital and analog I/O modules
 - Universal front doors for the interface module IM155-5 PN ST
- Included in the scope of supply of the respective modules. Can be ordered as a spare part in a set consisting of five universal (unlabeled) front doors.
- Front doors for I/O modules: Universal labeling sheets and cabling diagrams are included. Cabling diagrams can be detached from perforated sheets and inserted inside the door.

U connector



- To interconnect the modules (self-assembling backplane bus)
- Implementation of a rugged, interference-free station setup through
 - Consistent separation of supply voltage of modules and data signals
 - Fully shielded, gold-plated contacts for the data bus
- Included in the scope of supply of each module. Available as spare part in sets of 5.

Shielding



- Components for implementing the integrated S7-1500 shielding concept:
 - 24 V DC infeed element for supplying the analog module: strict separation of infeed and analog signals ensures high EMC stability.
 - Shield bracket for insertion in the front connector: allows a low-impedance connection and optimally dissipates interference.
 - Universal shield terminal: connects the cable shield with the shield bracket and is simultaneously used for mechanical fixing.
- Included in the scope of supply of the analog modules. Available as a spare part in two versions:
 - Shielding set, comprising infeed element, shield bracket, and shield terminal (pack of 5 units each)
 - Individual shield terminals (pack of 20)
- No tool required for assembly/disassembly

Ordering data	Article No.		Article No.
Universal front door for IM 155-5 PN ST 5 front doors; spare part	6ES7528-0AA70-7AA0		
Universal front door for I/O modules 5 front doors; with 5 labeling strips (front) and 5 cabling diagrams per front door; spare part <ul style="list-style-type: none"> For 35 mm modules For 25 mm modules 	6ES7528-0AA00-7AA0 6ES7528-0AA00-0AA0	SIMATIC Manual Collection Electronic manuals on DVD, multi-language: LOGO!, SIMADYN, SIMATIC bus components, SIMATIC C7, SIMATIC distributed I/O, SIMATIC HMI, SIMATIC Sensors, SIMATIC NET, SIMATIC PC-based Automation, SIMATIC PCS 7, SIMATIC PG/PC, SIMATIC S7, SIMATIC Software, SIMATIC TDC	6ES7998-8XC01-8YE0
U connector 5 units; spare part	6ES7590-0AA00-0AA0		
Shielding set I/O Infeed element, shield clamp, and shield terminal; 5 units, spare part <ul style="list-style-type: none"> For 35 mm modules For 25 mm modules 	6ES7590-5CA00-0AA0 6ES7590-5CA10-0XA0	SIMATIC Manual Collection update service for 1 year Current Manual Collection DVD and the three subsequent updates	6ES7998-8XC01-8YE2
Shield terminal element 10 units; spare part	6ES7590-5BA00-0AA0		

SIMATIC S7-1500 Advanced Controllers

Notes

4

SIMATIC S7-300 Advanced Controllers



5/3	Introduction	5/135	Function modules
5/3	S7-300/S7-300F, SIPLUS S7-300	5/135	FM 350-1 counter module
5/5	Central processing units	5/137	FM 350-2 counter module
5/5	Standard CPUs	5/139	FM 351 positioning module
5/15	SIPLUS S7-300 standard CPUs	5/141	FM 352 cam controllers
5/20	Compact CPUs	5/143	FM 352-5 high-speed Boolean processor
5/30	SIPLUS S7-300 compact CPUs	5/147	FM 355 controller module
5/37	Fail-safe CPUs	5/151	FM 355-2 temperature controller module
5/44	SIPLUS S7-300 fail-safe CPUs	5/155	SM 338 POS input module
5/50	Technology CPUs	5/157	SIWAREX U weighing module
5/56	I/O modules	5/160	SIWAREX FTA weighing module
5/56	<u>Digital modules</u>	5/163	SIWAREX FTC weighing module
5/56	SM 321 digital input modules	5/166	<u>SIPLUS S7-300 function modules</u>
5/61	SM 322 digital output modules	5/166	SIPLUS S7-300 FM 350-1
5/66	SM 323/SM 327 digital input/output modules	5/168	SIPLUS S7-300 FM 350-2
5/69	<u>SIPLUS S7-300 digital modules</u>	5/170	SIPLUS SIWAREX U
5/69	SIPLUS S7-300 SM 321	5/172	SIPLUS SIWAREX FTA
5/73	SIPLUS S7-300 SM 322	5/174	<u>Communication</u>
5/78	SIPLUS S7-300 SM 323	5/174	CP 340
5/80	<u>Analog modules</u>	5/176	CP 341
5/80	SM 331 analog input modules	5/178	Loadable drivers for CP 441-2 and CP 341
5/88	SM 332 analog output modules	5/180	CP 343-2P/CP 343-2
5/91	SM 334 analog input/output modules	5/182	CP 342-5
5/95	<u>SIPLUS S7-300 analog modules</u>	5/184	CP 343-5
5/95	SIPLUS S7-300 SM 331	5/186	CP 343-1 Lean
5/99	SIPLUS S7-300 SM 332	5/189	CP 343-1
5/102	SIPLUS S7-300 SM 334	5/192	CP 343-1 Advanced
5/104	<u>F-digital/analog modules</u>	5/196	CSM 377 unmanaged
5/104	SM 326 F-digital input modules - Safety Integrated	5/198	TIM 3V-IE (for S7-300)
5/107	SM 326 F-digital output modules - Safety Integrated	5/201	TIM 3V-IE Advanced (for S7-300)
5/110	SM 336 F-analog input modules - Safety Integrated	5/204	TIM 4R-IE (for S7-300/-400/PC)
5/112	Safety protector	5/207	TIM 3V-IE DNP3 (for S7-300)
5/113	<u>SIPLUS S7-300 F-digital/analog modules</u>	5/209	TIM 4R-IE DNP3 (for S7-300/-400)
5/113	SIPLUS S7-300 SM 326 - Safety Integrated	5/211	ASM 475
5/116	SIPLUS S7-300 SM 326 - Safety Integrated	5/213	<u>SIPLUS S7-300 communication</u>
5/119	SIPLUS S7-300 SM 336 - Safety Integrated	5/213	SIPLUS S7-300 CP 340
5/121	SIPLUS S7-300 safety protector	5/215	SIPLUS S7-300 CP 341
5/122	<u>Ex digital modules</u>	5/217	SIPLUS CP 342-5
5/122	Ex digital input modules	5/218	SIPLUS S7-300 CP 343-1 Lean
5/124	Ex digital output modules	5/220	SIPLUS S7-300 CP 343-1
5/126	<u>SIPLUS S7-300 Ex digital modules</u>	5/222	SIPLUS S7-300 CP 343-1 Advanced
5/126	SIPLUS S7-300 Ex digital input modules	5/225	SIPLUS TIM 3V-IE for WAN and Ethernet
5/128	<u>Ex analog modules</u>	5/227	SIPLUS TIM 4R-IE for WAN and Ethernet
5/128	Ex analog input modules	5/229	SIPLUS TIM 3V-IE DNP3
5/131	Ex analog output modules	5/231	SIPLUS TIM 4R-IE DNP3
5/133	<u>SIPLUS S7-300 Ex analog modules</u>		
5/133	SIPLUS S7-300 Ex analog input modules		

SIMATIC S7-300 Advanced Controllers



5/233	<u>Special modules</u>
5/233	SM 374 simulator
5/234	DM 370 dummy module
5/235	<u>SIPLUS S7-300 special modules</u>
5/235	SIPLUS S7-300 DM 370
5/236	<u>Connection system</u>
5/236	Front connectors
5/237	System cabling for SIMATIC S7-300 and ET 200M
5/238	- Fully modular connection
5/242	- Front connector with single wires
5/243	- Front connectors with crimp connections

5/244	Power supplies
5/244	1-phase, 24 V DC (for S7-300 and ET200M)
5/248	SIPLUS power supplies
5/248	1-phase, 24 V DC (for S7-300 and ET200M)
5/250	Interface modules
5/250	IM 360/361/365 interface modules
5/251	SIPLUS interface modules
5/251	SIPLUS S7-300 IM 365
5/252	Accessories
5/252	DIN rail
5/252	Labeling sheets

Overview



S7-300

- The modular mini PLC system for the low and mid-performance ranges
- With comprehensive range of modules for optimum adaptation to the automation task
- Flexible use through simple implementation of distributed structures and versatile networking
- User-friendly handling and uncomplicated design without a fan
- Can be expanded without problems when the tasks increase
- Powerful thanks to a range of integrated functions

S7-300F

- Fail-safe automation system for plants with increased safety requirements for production technology
- Based on S7-300
- Additional ET 200S and ET 200M distributed I/O stations complete with safety-related modules can be connected
- Safety-related communication via PROFIBUS DP with PROFIsafe profile
- Standard modules can be used in addition for non-safety-relevant applications

Availability

As part of our established product portfolio, the SIMATIC S7-300/ET 200M system families will generally be available until 2023. Following the product phase-out declaration, products will be available as spare parts for another ten years.

Technical specifications

General technical specifications of SIMATIC S7-300	
Degree of protection	IP20 according to IEC 60 529
Ambient temperature	<ul style="list-style-type: none"> • For horizontal installation 0 to 60 °C • For vertical installation 0 to 40 °C
Relative humidity	10 to 95%, non-condensing, corresponds to relative humidity (RH), stress level 2 acc. to IEC 61131, Part 2
Air pressure	From 1080 to 795 hPa (corresponds to an altitude of -1000 to +2000 m)
Insulation	<ul style="list-style-type: none"> • < 50 V 500 V DC test voltage • < 150 V 2500 V DC test voltage • < 250 V 4000 V DC test voltage
Electromagnetic compatibility	<p>Requirements of the EMC directive; interference immunity according to IEC 61000-6-2</p> <ul style="list-style-type: none"> • Pulse-shaped disturbance variables Test according to: Electrostatic discharge according to IEC 61000-4-2, burst pulses according to IEC 61000-4-4, energy single pulse (surge) according to IEC 61000-4-5, • Sinusoidal disturbance variables Test according to: HF irradiation according to IEC 61000-4-3, HF decoupling according to IEC 61000-4-6 • Emission of radio interference Interference emission according to EN 50081-2 <p>Test according to: Emitted interference of electromagnetic fields according to EN 55016: Limit value class A, (measured at a distance of 10 m) Interference emission via AC mains according to EN 55011: Limit value class A, Group 1</p>
Mechanical strength	<ul style="list-style-type: none"> • Vibrations <p>Frequency range $10 \text{ Hz} \leq f \leq 58 \text{ Hz}$</p> <ul style="list-style-type: none"> • Continuous: 0.0375 mm amplitude • Occasionally 0.75 mm amplitude <p>Frequency range $58 \text{ Hz} \leq f \leq 150 \text{ Hz}$</p> <ul style="list-style-type: none"> • Continuous: 0.5 g constant acceleration • Occasionally 1 g constant acceleration <p>Testing according to IEC 60068-2-6 Tested with: $5 \text{ Hz} \leq f \leq 9 \text{ Hz}$, constant amplitude 3.5 mm; $9 \text{ Hz} \leq f \leq 150 \text{ Hz}$, constant acceleration 1 g; Duration of oscillation: 10 frequency passes per axis in each direction of the 3 mutually perpendicular axes Testing according to IEC 60068-2-27 Tested with: Half-sine wave: strength of shock 15 g peak value, 11 ms duration; Shock direction: 3 shocks each in \pm direction in each of the 3 mutually vertical axes</p>
	<ul style="list-style-type: none"> • Shock

SIMATIC S7-300 Advanced Controllers

Introduction

S7-300/S7-300F, SIPLUS S7-300

Technical specifications

General technical data of SIPLUS S7-300

Ambient temperature range	-40/-25 ... +60/70 °C
Conformal coating	Coating of the printed circuit boards and the electronic components
Technical data	The technical data of the standard product applies except for the environmental conditions.

Ambient conditions

Extended range of environmental conditions	
<ul style="list-style-type: none"> with reference to ambient temperature, air pressure and altitude 	Tmin ... Tmax at 1080 hPa ... 795 hPa (-1000 m ... +2000 m) // Tmin ... (Tmax - 10K) at 795 hPa ... 658 hPa (+2000 m ... +3500 m) // Tmin ... (Tmax - 20K) at 658 hPa ... 540 hPa (+3500 m ... +5000 m)
<ul style="list-style-type: none"> At cold restart, min. 	0° C
Relative humidity	
<ul style="list-style-type: none"> with condensation, max. 	100 %; RH incl. bedewing/frost (no commissioning in bedewed state)
Resistance	
<ul style="list-style-type: none"> to biologically active substances/compliance with EN 60721-3-3 	Yes; Class 3B2 mold and fungal spores (except fauna); the supplied plug covers must remain in place on the unused interfaces during operation.
<ul style="list-style-type: none"> to chemically active substances/compliance with EN 60721-3-3 	Yes; Class 3C4 (RH < 75%) incl. salt spray in accordance with EN 60068-2-52 (severity 3); the supplied plug covers must remain in place on the unused interfaces during operation.
<ul style="list-style-type: none"> to mechanically active substances, compliance with EN 60721-3-3 	Yes; Class 3S4 incl. sand, dust; the supplied plug covers must remain in place on unused interfaces during operation.

Overview CPU 312



- The entry level CPU in Totally Integrated Automation (TIA)
- For smaller applications with moderate processing performance requirements

SIMATIC Micro Memory Card required for operation of CPU.

Overview CPU 314



- For plants with medium program scope requirements
- High processing power in binary and floating-point arithmetic

SIMATIC Micro Memory Card required for operation of CPU.

Overview CPU 315-2 DP



- The CPU with medium to large program memory and quantity structures for optional use of SIMATIC engineering tools
- High processing power in binary and floating-point arithmetic
- Used as central controller in production lines with central and distributed I/O
- PROFIBUS DP master/slave interface
- For comprehensive I/O expansion
- For configuring distributed I/O structures
- Isochronous mode on PROFIBUS

SIMATIC Micro Memory Card required for operation of CPU.

SIMATIC S7-300 Advanced Controllers

Central processing units

Standard CPUs

Overview CPU 315-2 PN/DP



- The CPU with mid-range program memory and quantity frameworks
- High processing power in binary and floating-point arithmetic
- Used as central controller in production lines with central and distributed I/O
- PROFINET interface with 2-port switch
- PROFINET IO controller for operating distributed I/O on PROFINET
- PROFINET I-Device for connecting the CPU as an intelligent PROFINET device under a SIMATIC or non-Siemens PROFINET IO controller
- Component-based Automation (CBA) on PROFINET
- PROFINET proxy for intelligent devices on PROFIBUS DP in Component-based Automation (CBA)
- Integrated web server with the option of creating user-defined web pages
- Combined MPI/PROFIBUS DP master/slave interface
- Isochronous mode on PROFIBUS and PROFINET

SIMATIC Micro Memory Card required for operation of CPU.

Overview CPU 317-2 DP



- The CPU with a large program memory and quantity framework for demanding applications
- For cross-industry automation tasks in series machine, special machine and plant construction
- Used as central controller in production lines with central and distributed I/O
- High processing power in binary and floating-point arithmetic
- 2 PROFIBUS DP master/slave interfaces
- For comprehensive I/O expansion
- For configuring distributed I/O structures
- Isochronous mode on PROFIBUS
- Optionally supports the use of SIMATIC engineering tools

SIMATIC Micro Memory Card required for operation of CPU.

Overview CPU 317-2 PN/DP



- The CPU with a large program memory and quantity framework for demanding applications
 - For cross-industry automation tasks in series machine, special machine and plant construction
 - Used as central controller in production lines with central and distributed I/O
 - High processing power in binary and floating-point arithmetic
 - PROFINET interface with 2-port switch
 - PROFINET I/O Controller for operating distributed I/O on PROFINET
 - PROFINET I-Device for connecting the CPU as intelligent PROFINET device under a SIMATIC or third-party PROFINET I/O Controller
 - Distributed intelligence in Component Based Automation (CBA) on PROFINET
 - PROFINET proxy for intelligent devices on PROFIBUS DP in Component Based Automation (CBA)
 - Integrated web server with the option of creating user-defined web pages
 - Combined MPI/PROFIBUS DP master/slave interface
 - Isochronous mode on PROFIBUS and PROFINET
 - Optionally supports the use of SIMATIC engineering tools
- SIMATIC Micro Memory Card required for operation of CPU.

Overview CPU 319-3 PN/DP



- The CPU with high command processing performance, large program memory and quantity framework for demanding applications
 - For cross-industry automation tasks in series machine, special machine and plant construction
 - Used as central controller in production lines with central and distributed I/O on PROFIBUS and PROFINET
 - PROFINET I/O controller for operating distributed I/O on PROFINET
 - PROFINET I-Device for connecting the CPU as intelligent PROFINET device under a SIMATIC or non-Siemens PROFINET I/O controller
 - PROFINET interface with 2-port switch
 - Isochronous mode on PROFIBUS or PROFINET
 - Integrated web server with the option of creating user-defined web pages
 - Distributed intelligence in Component Based Automation (CBA) on PROFINET
 - PROFINET proxy for intelligent devices on PROFIBUS DP in Component Based Automation (CBA)
 - Optionally supports the use of SIMATIC engineering tools
- SIMATIC Micro Memory Card required for operation of the CPU.

SIMATIC S7-300 Advanced Controllers

Central processing units

Standard CPUs

Ordering data	Article No.	Article No.
CPU 312 32 KB work memory, supply voltage 24 V DC, MPI; MMC required	6ES7312-1AE14-0AB0	SIMATIC Manual Collection Electronic manuals on DVD, multi-language: LOGO!, SIMADYN, SIMATIC Bus Components, SIMATIC C7, SIMATIC Distributed I/O, SIMATIC HMI, SIMATIC Sensors, SIMATIC NET, SIMATIC PC-based Automation, SIMATIC PCS 7, SIMATIC PG/PC, SIMATIC S7, SIMATIC Software, SIMATIC TDC
CPU 314 128 KB work memory, supply voltage 24 V DC, MPI; MMC required	6ES7314-1AG14-0AB0	SIMATIC Manual Collection update service for 1 year Current Manual Collection DVD and the three subsequent updates
CPU 315-2 DP 256 KB work memory, supply voltage 24 V DC, MPI, PROFIBUS DP master/slave interface; MMC required	6ES7315-2AH14-0AB0	Power supply connector 10 units, spare part
CPU 315-2 PN/DP 384 KB work memory, 24 V DC supply voltage, combined MPI/PROFIBUS DP master/slave interface, Ethernet/PROFINET interface with 2-port switch; MMC required	6ES7315-2EH14-0AB0	USB A2 PC adapter For connecting a programming device/PC or notebook to PROFIBUS or MPI; USB cable included in scope of delivery
CPU 317-2 DP 1 MB work memory, supply voltage 24 V DC, MPI, PROFIBUS DP master/slave interface; MMC required	6ES7317-2AK14-0AB0	PROFIBUS bus components PROFIBUS DP RS 485 bus connector • With 90° cable outlet, max. transfer rate 12 Mbps - Without programming device interface - With programming device interface • With 90° cable outlet for FastConnect connection system, max. transfer rate 12 Mbps - Without programming device interface, 1 unit - Without programming device interface, 100 units - With programming device interface, 1 unit - With programming device interface, 100 units • With axial cable outlet for SIMATIC OP, for connecting to PPI, MPI, PROFIBUS
CPU 317-2 PN/DP 1 MB work memory, 24 V DC supply voltage, combined MPI/PROFIBUS DP master/slave interface, Ethernet/PROFINET interface with 2-port switch; MMC required	6ES7317-2EK14-0AB0	PROFIBUS FastConnect bus cable Standard type with special design for quick mounting, 2-wire, shielded, sold by the meter, max. delivery unit 1 000 m, minimum order quantity 20 m
CPU 319-3 PN/DP 2 MB work memory, 24 V DC supply voltage, combined MPI/PROFIBUS DP master/slave interface, PROFIBUS DP master/slave interface, Ethernet/PROFINET interface with 2-port switch; MMC required	6ES7318-3EL01-0AB0	RS 485 repeater for PROFIBUS Transmission rate up to 12 Mbps; 24 V DC; IP20 enclosure
SIMATIC Micro Memory Card 64 KB 128 KB 512 KB 2 MB 4 MB 8 MB	6ES7953-8LF31-0AA0 6ES7953-8LG31-0AA0 6ES7953-8LJ31-0AA0 6ES7953-8LL31-0AA0 6ES7953-8LM32-0AA0 6ES7953-8LP31-0AA0	
MPI cable For connection of SIMATIC S7 and PG via MPI; length 5 m	6ES7901-0BF00-0AA0	
Slot number plates	6ES7912-0AA00-0AA0	

Ordering data	Article No.	Article No.
PROFINET bus components		
IE FC TP standard cable GP 2x2 4-wire, shielded TP installation cable for connection to IE FC RJ45 outlet/IE FC RJ45 plug; PROFINET-compatible; with UL approval; Sold by the meter	6XV1840-2AH10	
FO standard cable GP (50/125) Standard cable, splittable, UL approval, sold by the meter	6XV1873-2A	
SCALANCE X204-2 Industrial Ethernet Switch Industrial Ethernet switches with integrated SNMP access, web diagnostics, copper cable diagnostics and PROFINET diagnostics for configuring line, star and ring topologies; four 10/100 Mbps RJ45 ports and two FO ports	6GK5204-2BB10-2AA3	
Compact Switch Module CSM 377 Unmanaged switch for connecting SIMATIC S7-300, ET 200M and up to three other stations to Industrial Ethernet with 10/100 Mbps; 4 x RJ45 ports; external 24 V DC power supply, LED diagnostics, S7-300 module including electronic Equipment Manual on CD-ROM	6GK7377-1AA00-0AA0	
		IE FC RJ45 plugs RJ45 plug connector for Industrial Ethernet with a rugged metal enclosure and integrated insulation displacement contacts for connecting Industrial Ethernet FC installation cables
		IE FC RJ45 plug 145 145° cable outlet 1 unit 10 units 50 units
		IE FC RJ45 plug 180 180° cable outlet 1 unit 10 units 50 units
		PROFIBUS/PROFINET bus components For establishing MPI/PROFIBUS/PROFINET communication
		See Industry Mall
		6GK1901-1BB30-0AA0 6GK1901-1BB30-0AB0 6GK1901-1BB30-0AE0
		6GK1901-1BB10-2AA0 6GK1901-1BB10-2AB0 6GK1901-1BB10-2AE0

Technical specifications

Article number	6ES7312-1AE14-0AB0	6ES7314-1AG14-0AB0	6ES7315-2AH14-0AB0	6ES7315-2EH14-0AB0
	CPU312, 32KB	CPU314, 128 KB	CPU315-2DP, 256 KB	CPU315-2 PN/DP, 384 KB
General information				
Product function				
• Isochronous mode			Yes	Yes; Via PROFIBUS DP or PROFINET interface
Engineering with				
• Programming package	STEP 7 V5.5 + SP1 or higher or STEP 7 V5.2 + SP1 or higher with HSP 218	STEP 7 V5.5 + SP1 or higher or STEP 7 V5.2 + SP1 or higher with HSP 218	STEP 7 V5.5 + SP1 or higher or STEP 7 V5.2 + SP1 or higher with HSP 218	STEP 7 V5.5 or higher
Supply voltage				
Rated value (DC)	24 V	24 V	24 V	24 V
Memory				
Work memory				
• integrated	32 kbyte	128 kbyte	256 kbyte	384 kbyte
• expandable	No	No	No	No
Load memory				
• Plug-in (MMC), max.	8 Mbyte	8 Mbyte	8 Mbyte	8 Mbyte
CPU processing times				
for bit operations, typ.	0.1 µs	0.06 µs	0.05 µs	0.05 µs
for word operations, typ.	0.24 µs	0.12 µs	0.09 µs	0.09 µs
for fixed point arithmetic, typ.	0.32 µs	0.16 µs	0.12 µs	0.12 µs
for floating point arithmetic, typ.	1.1 µs	0.59 µs	0.45 µs	0.45 µs

SIMATIC S7-300 Advanced Controllers

Central processing units

Standard CPUs

Technical specifications

Article number	6ES7312-1AE14-0AB0 CPU312, 32KB	6ES7314-1AG14-0AB0 CPU314, 128 KB	6ES7315-2AH14-0AB0 CPU315-2DP, 256 KB	6ES7315-2EH14-0AB0 CPU315-2 PN/DP, 384 KB
Counters, timers and their retentivity				
S7 counter				
• Number	256	256	256	256
IEC counter				
• present	Yes	Yes	Yes	Yes
S7 times				
• Number	256	256	256	256
IEC timer				
• present	Yes	Yes	Yes	Yes
Data areas and their retentivity				
Flag				
• Size, max.	256 byte	256 byte	2 048 byte	2 048 byte
Address area				
I/O address area				
• Inputs	1 024 byte	1 024 byte	2 048 byte	2 048 byte
• Outputs	1 024 byte	1 024 byte	2 048 byte	2 048 byte
Process image				
• Inputs, adjustable	1 024 byte	1 024 byte	2 048 byte	2 048 byte
• Outputs, adjustable	1 024 byte	1 024 byte	2 048 byte	2 048 byte
Time of day				
Clock				
• Hardware clock (real-time)		Yes	Yes	Yes
• Software clock	Yes			
Operating hours counter				
• Number	1	1	1	1
1. Interface				
Interface type	Integrated RS 485 interface	Integrated RS 485 interface	Integrated RS 485 interface	Integrated RS 485 interface
Interface types				
• RS 485	Yes	Yes	Yes	Yes
Protocols				
• MPI	Yes	Yes	Yes	Yes
• PROFIBUS DP master	No	No	No	Yes
• PROFIBUS DP slave	No	No	No	Yes
• Point-to-point connection	No	No	No	No
PROFIBUS DP master				
• Number of DP slaves, max.				124
2. Interface				
Interface type			Integrated RS 485 interface	PROFINET
Interface types				
• RJ 45 (Ethernet)				Yes
• RS 485			Yes	
• Number of ports				2
Protocols				
• MPI			No	No
• PROFINET IO Controller				Yes; Also simultaneously with IO-Device functionality
• PROFINET IO Device				Yes; Also simultaneously with IO Controller functionality
• PROFINET CBA				Yes
• PROFIBUS DP master			Yes	No
• PROFIBUS DP slave			Yes	No
PROFIBUS DP master				
• Number of DP slaves, max.			124; Per station	

Technical specifications

Article number	6ES7312-1AE14-0AB0 CPU312, 32KB	6ES7314-1AG14-0AB0 CPU314, 128 KB	6ES7315-2AH14-0AB0 CPU315-2DP, 256 KB	6ES7315-2EH14-0AB0 CPU315-2 PN/DP, 384 KB
PROFINET IO Controller				
Services				
- Number of connectable IO Devices, max.				128
- Of which IO devices with IRT, max.				64
- Number of IO Devices with IRT and the option "high flexibility"				128
- Number of connectable IO Devices for RT, max.				128
Protocols				
Open IE communication				
• TCP/IP				Yes; via integrated PROFINET interface and loadable FBs
- Number of connections, max.				8
• ISO-on-TCP (RFC1006)				Yes; via integrated PROFINET interface and loadable FBs
- Number of connections, max.				8
• UDP				Yes; via integrated PROFINET interface and loadable FBs
- Number of connections, max.				8
Web server				
• supported				Yes
Communication functions				
PG/OP communication	Yes	Yes	Yes	Yes
Data record routing	No	No	Yes	Yes
Global data communication				
• supported	Yes	Yes	Yes	Yes
S7 basic communication				
• supported	Yes	Yes	Yes	Yes
S7 communication				
• supported	Yes	Yes	Yes	Yes
S5 compatible communication				
• supported	Yes; via CP and loadable FC	Yes; via CP and loadable FC	Yes; via CP and loadable FC	Yes; via CP and loadable FC
Number of connections				
• overall	6	12	16	16
Ambient conditions				
Ambient temperature during operation				
• min.	0 °C	0 °C	0 °C	0 °C
• max.	60 °C	60 °C	60 °C	60 °C
Configuration				
Programming				
Programming language				
- LAD	Yes	Yes	Yes	Yes
- FBD	Yes	Yes	Yes	Yes
- STL	Yes	Yes	Yes	Yes
- SCL	Yes	Yes	Yes	Yes
- CFC		Yes	Yes	Yes
- GRAPH	Yes	Yes	Yes	Yes
- HiGraph®	Yes	Yes	Yes	Yes
Know-how protection				
• User program protection/ password protection	Yes	Yes	Yes	Yes
• Block encryption	Yes; With S7 block Privacy	Yes; With S7 block Privacy	Yes; With S7 block Privacy	Yes; With S7 block Privacy
Dimensions				
Width	40 mm	40 mm	40 mm	40 mm
Height	125 mm	125 mm	125 mm	125 mm
Depth	130 mm	130 mm	130 mm	130 mm
Weights				
Weight, approx.	270 g	280 g	290 g	340 g

SIMATIC S7-300 Advanced Controllers

Central processing units

Standard CPUs

Technical specifications

Article number	6ES7317-2AK14-0AB0 CPU317-2 DP, 1 MB	6ES7317-2EK14-0AB0 CPU317-2 PN/DP, 1 MB	6ES7318-3EL01-0AB0 CPU319-3 PN/DP, 2 MB
General information			
Product function			
• Isochronous mode		Yes; Via PROFIBUS DP or PROFINET interface	Yes; Via 2nd PROFIBUS DP or PROFINET interface
Engineering with			
• Programming package	STEP 7 as of V5.5 + SP1 or STEP 7 V5.2 + SP1 or higher with HSP 202	STEP 7 V5.5 or higher	STEP 7 V5.5 or higher
Supply voltage			
Rated value (DC)	24 V	24 V	24 V
Memory			
Work memory			
• integrated	1 024 kbyte	1 024 kbyte	2 048 kbyte
• expandable	No	No	No
Load memory			
• Plug-in (MMC), max.	8 Mbyte	8 Mbyte	8 Mbyte
CPU processing times			
for bit operations, typ.	0.025 µs	0.025 µs	0.004 µs
for word operations, typ.	0.03 µs	0.03 µs	0.01 µs
for fixed point arithmetic, typ.	0.04 µs	0.04 µs	0.01 µs
for floating point arithmetic, typ.	0.16 µs	0.16 µs	0.04 µs
Counters, timers and their retentivity			
S7 counter			
• Number	512	512	2 048
IEC counter			
• present	Yes	Yes	Yes
S7 times			
• Number	512	512	2 048
IEC timer			
• present	Yes	Yes	Yes
Data areas and their retentivity			
Flag			
• Size, max.	4 096 byte	4 096 byte	8 192 byte
Address area			
I/O address area			
• Inputs	8 192 byte	8 192 byte	8 192 byte
• Outputs	8 192 byte	8 192 byte	8 192 byte
Process image			
• Inputs, adjustable	8 192 byte	8 192 byte	8 192 byte
• Outputs, adjustable	8 192 byte	8 192 byte	8 192 byte
Time of day			
Clock			
• Hardware clock (real-time)	Yes	Yes	Yes
Operating hours counter			
• Number	4	4	4
1. Interface			
Interface type	Integrated RS 485 interface	Integrated RS 485 interface	Integrated RS 485 interface
Interface types			
• RS 485	Yes	Yes	Yes
Protocols			
• MPI	Yes	Yes	Yes
• PROFIBUS DP master	Yes	Yes	Yes
• PROFIBUS DP slave	Yes; A DP slave at both interfaces simultaneously is not possible	Yes	Yes; A DP slave at both interfaces simultaneously is not possible
• Point-to-point connection	No	No	No
PROFIBUS DP master			
• Number of DP slaves, max.	124	124	124

Technical specifications

Article number	6ES7317-2AK14-0AB0 CPU317-2 DP, 1 MB	6ES7317-2EK14-0AB0 CPU317-2 PN/DP, 1 MB	6ES7318-3EL01-0AB0 CPU319-3 PN/DP, 2 MB
2. Interface			
Interface type	Integrated RS 485 interface	PROFINET	Integrated RS 485 interface
Interface types			
<ul style="list-style-type: none"> • RJ 45 (Ethernet) • RS 485 • Number of ports 	Yes	Yes 2	Yes
Protocols			
<ul style="list-style-type: none"> • MPI • PROFINET IO Controller • PROFINET IO Device • PROFINET CBA • PROFIBUS DP master • PROFIBUS DP slave 	No Yes Yes; A DP slave at both interfaces simultaneously is not possible	No Yes; Also simultaneously with IO-Device functionality Yes; Also simultaneously with IO Controller functionality Yes No No	No No No No Yes Yes; A DP slave at both interfaces simultaneously is not possible
PROFIBUS DP master			
<ul style="list-style-type: none"> • Number of DP slaves, max. 	124		124
PROFINET IO Controller			
Services			
<ul style="list-style-type: none"> - Number of connectable IO Devices, max. - Of which IO devices with IRT, max. - Number of IO Devices with IRT and the option "high flexibility" - Number of connectable IO Devices for RT, max. 		128 64 128 128	
3. Interface			
Interface type			PROFINET
Interface types			
<ul style="list-style-type: none"> • RJ 45 (Ethernet) • Number of ports 			Yes 2
Protocols			
<ul style="list-style-type: none"> • MPI • PROFINET IO Controller • PROFINET IO Device • PROFINET CBA • PROFIBUS DP master • PROFIBUS DP slave 			No Yes; Also simultaneously with I-Device functionality Yes; Also simultaneously with IO Controller functionality Yes No No
PROFINET IO Controller			
Services			
<ul style="list-style-type: none"> - Number of connectable IO Devices, max. - Of which IO devices with IRT, max. - Number of IO Devices with IRT and the option "high flexibility" - Number of connectable IO Devices for RT, max. 			256 64 256 256
Protocols			
Open IE communication			
<ul style="list-style-type: none"> • TCP/IP - Number of connections, max. • ISO-on-TCP (RFC1006) - Number of connections, max. • UDP - Number of connections, max. 		Yes; via integrated PROFINET interface and loadable FBs 16 Yes; via integrated PROFINET interface and loadable FBs 16 Yes; via integrated PROFINET interface and loadable FBs 16	Yes; via integrated PROFINET interface and loadable FBs 32 Yes; via integrated PROFINET interface and loadable FBs 32 Yes; via integrated PROFINET interface and loadable FBs 32
Web server			
<ul style="list-style-type: none"> • supported 		Yes	Yes

SIMATIC S7-300 Advanced Controllers

Central processing units

Standard CPUs

Technical specifications

Article number	6ES7317-2AK14-0AB0 CPU317-2 DP, 1 MB	6ES7317-2EK14-0AB0 CPU317-2 PN/DP, 1 MB	6ES7318-3EL01-0AB0 CPU319-3 PN/DP, 2 MB
Communication functions			
PG/OP communication	Yes	Yes	Yes
Data record routing	Yes	Yes	Yes
Global data communication			
• supported	Yes	Yes	Yes
S7 basic communication			
• supported	Yes	Yes	Yes
S7 communication			
• supported	Yes	Yes	Yes
S5 compatible communication			
• supported	Yes; via CP and loadable FC	Yes; via CP and loadable FC	Yes; via CP and loadable FC
Number of connections			
• overall	32	32	32
Ambient conditions			
Ambient temperature during operation			
• min.	0 °C	0 °C	0 °C
• max.	60 °C	60 °C	60 °C
Configuration			
Programming			
Programming language			
- LAD	Yes	Yes	Yes
- FBD	Yes	Yes	Yes
- STL	Yes	Yes	Yes
- SCL	Yes	Yes	Yes
- CFC	Yes	Yes	Yes
- GRAPH	Yes	Yes	Yes
- HiGraph®	Yes	Yes	Yes
Know-how protection			
• User program protection/ password protection	Yes	Yes	Yes
• Block encryption	Yes; With S7 block Privacy	Yes; With S7 block Privacy	Yes; With S7 block Privacy
Dimensions			
Width	40 mm	40 mm	120 mm
Height	125 mm	125 mm	125 mm
Depth	130 mm	130 mm	130 mm
Weights			
Weight, approx.	360 g	340 g	1 250 g

Overview SIPLUS S7-300 CPU 314



- For plants with medium requirements on the program scope
- High processing performance in binary and floating-point arithmetic

SIAMATIC Micro Memory Card required for operation of CPU.

Note:

SIPLUS extreme products are based on SIMATIC standard products. The contents listed here were taken from the respective standard products. SIPLUS extreme-specific information was added.

Overview SIPLUS S7-300 CPU 315-2 DP



- The CPU with medium to large program memory and quantity structures for optional use of SIMATIC engineering tools
- High processing performance in binary and floating-point arithmetic
- PROFIBUS DP master/slave interface
- For comprehensive I/O expansion
- For configuring distributed I/O structures

SIAMATIC Micro Memory Card required for operation of CPU.

Note:

SIPLUS extreme products are based on SIMATIC standard products. The contents listed here were taken from the respective standard products. SIPLUS extreme-specific information was added.

SIMATIC S7-300 Advanced Controllers

Central processing units

SIPLUS S7-300 standard CPUs

Overview SIPLUS S7-300 CPU 315-2 PN/DP



- The CPU with medium-sized program memory and quantity frameworks
- High processing performance in binary and floating-point arithmetic
- Used as central controller in production lines with central and distributed I/O
- Component Based Automation (CBA) on PROFINET
- PROFINET proxy for intelligent devices on PROFIBUS DP in Component Based Automation (CBA)
- PROFINET IO Controller for operating distributed I/O on PROFINET
- PROFINET interface with 2-port switch
- Combined MPI/PROFIBUS DP master/slave interface
- Isochronous mode on PROFIBUS

SIMATIC Micro Memory Card required for operation of CPU.

Note:

SIPLUS extreme products are based on SIMATIC standard products. The contents listed here were taken from the respective standard products. SIPLUS extreme-specific information was added.

Overview SIPLUS S7-300 CPU 317-2 PN/DP



- The CPU with a large program memory and quantity framework for demanding applications
- Distributed intelligence in Component Based Automation (CBA) on PROFINET
- PROFINET proxy for intelligent devices on PROFIBUS DP in Component Based Automation (CBA)
- PROFINET I/O Controller for operating distributed I/O on PROFINET
- For cross-industry automation tasks in series machine, special machine and plant construction
- Used as central controller in production lines with central and distributed I/O
- For comprehensive I/O expansion
- For configuring distributed I/O structures
- High processing performance in binary and floating-point arithmetic
- Combined MPI/PROFIBUS DP master/slave interface
- Optionally supports the use of SIMATIC engineering tools

SIMATIC Micro Memory Card required for operation of CPU.

Note:

SIPLUS extreme products are based on SIMATIC standard products. The contents listed here were taken from the respective standard products. SIPLUS extreme-specific information was added.

Ordering data	Article No.	Article No.
SIPLUS S7-300 CPU 314 <i>For industrial applications with extended ambient conditions</i> CPU, 128 KB work memory, supply voltage 24 V DC, MPI; MMC required Extended temperature range and exposure to media	6AG1314-1AG14-7AB0	<i>For communication within the application</i> PROFIBUS DP RS 485 bus connector (Extended temperature range and exposure to environmental substances) With 90° cable outlet, max. transfer rate 12 Mbps <ul style="list-style-type: none"> • Without PG interface • With PG interface With angled cable outlet, max. transmission rate 12 Mbps <ul style="list-style-type: none"> • Without PG interface • With PG interface With insulation displacement terminals, max. transfer rate 12 Mbps <ul style="list-style-type: none"> • With programming device interface, grounding via control cabinet cover (Extended temperature range) With axial cable outlet for SIMATIC OP, for connecting to PPI, MPI, PROFIBUS
SIPLUS S7-300 CPU 315-2 DP <i>For industrial applications with extended ambient conditions</i> CPU, 256 KB work memory, supply voltage 24 V DC, MPI, PROFIBUS DP master/slave interface; MMC required Extended temperature range and exposure to media	6AG1315-2AH14-7AB0	6AG1972-0BA12-2XA0 6AG1972-0BB12-2XA0 6AG1972-0BA42-7XA0 6AG1972-0BB42-7XA0 6AG1972-0BB70-7XA0 6AG1500-0EA02-2AA0
SIPLUS S7-300 CPU 315-2 PN/DP <i>For industrial applications with extended ambient conditions</i> CPU, 384 KB work memory, supply voltage 24 V DC, combined MPI/PROFIBUS DP master/slave interface, Ethernet/PROFINET interface with 2-port switch; MMC required Extended temperature range and exposure to media	6AG1315-2EH14-7AB0	IE FC RJ45 plug 180 (Extended temperature range and exposure to environmental substances) 180° cable outlet <ul style="list-style-type: none"> • 1 unit
SIPLUS S7-300 CPU 317-2 PN/DP <i>For industrial applications with extended ambient conditions</i> CPU, 1 MB work memory, supply voltage 24 V DC, combined MPI/PROFIBUS DP master/slave interface, Ethernet/PROFINET interface; MMC required Extended temperature range and exposure to media	6AG1317-2EK14-7AB0	SIPLUS SCALANCE XC-200 Industrial Ethernet Switches Industrial Ethernet switches with integrated SNMP access, web diagnostics, copper cable diagnostics and PROFINET diagnostics for configuring line, star and ring topologies; with integrated redundancy manager; incl. operating instructions, Industrial Ethernet network manual and configuration software on CD-ROM Extended temperature range and exposure to media Switches with PROFINET delivery state <ul style="list-style-type: none"> • SIPLUS SCALANCE XC206-2 (ST/BFOC) with six RJ45 ports 10/100 Mbps and two ST/BFOC ports 100 Mbps
Accessories <i>Mandatory</i> SIMATIC Micro Memory Card 64 KB 128 KB 512 KB 2 MB 4 MB 8 MB	6ES7953-8LF31-0AA0 6ES7953-8LG31-0AA0 6ES7953-8LJ31-0AA0 6ES7953-8LL31-0AA0 6ES7953-8LM32-0AA0 6ES7953-8LP31-0AA0	PROFIBUS FastConnect bus cable Standard type with special design for quick mounting, 2-wire, shielded, sold by the meter, max. delivery unit 1 000 m, minimum order quantity 20 m RS 485 repeater for PROFIBUS (Extended temperature range and exposure to environmental substances) Transmission rate up to 12 Mbps; 24 V DC; IP20 enclosure IE FC TP standard cable GP 2x2 4-wire, shielded TP installation cable for connection to IE FC RJ45 outlet/ IE FC RJ45 plug; PROFINET-compatible; with UL approval; Sold by the meter FO standard cable GP (50/125)
		6AG1901-1BB10-7AA0 6AG1206-2BB00-7AC2 6XV1830-0EH10 6AG1972-0AA02-7XA0 6XV1840-2AH10 6XV1873-2A

SIMATIC S7-300 Advanced Controllers

Central processing units

SIPLUS S7-300 standard CPUs

Ordering data	Article No.	Documentation	Article No.
Standard cable, splittable, UL approval, sold by the meter <i>For commissioning</i>			
MPI cable For connection of SIMATIC S7 and programming device via MPI; length 5 m	6ES7901-0BF00-0AA0	SIMATIC Manual Collection Electronic manuals on DVD, multi-language: LOGO!, SIMADYN, SIMATIC bus components, SIMATIC C7, SIMATIC distributed I/O, SIMATIC HMI, SIMATIC Sensors, SIMATIC NET, SIMATIC PC-based Automation, SIMATIC PCS 7, SIMATIC PG/PC, SIMATIC S7, SIMATIC Software, SIMATIC TDC	6ES7998-8XC01-8YE0
USB A2 PC adapter For connecting a programming device/PC or Notebook to PROFIBUS or MPI; USB cable included in scope of delivery	6GK1571-0BA00-0AA0		
<i>Consumables</i>			
Power supply connector 10 units, spare part	6ES7391-1AA00-0AA0	SIMATIC Manual Collection update service for 1 year Current Manual Collection DVD and the three subsequent updates	6ES7998-8XC01-8YE2
Slot number plates	6ES7912-0AA00-0AA0		

Technical specifications

Article number	6AG1314-1AG14-7AB0	6AG1315-2AH14-7AB0
Based on	6ES7314-1AG14-0AB0 SIPLUS S7-300 CPU314	6ES7315-2AH14-0AB0 SIPLUS S7-300 CPU 315-2DP
Ambient conditions		
Ambient temperature during operation		
• min.	-25 °C; = Tmin	-25 °C; = Tmin
• max.	70 °C; = Tmax; 60 °C @ UL/cUL, ATEX and FM use	70 °C; = Tmax; 60 °C @ UL/cUL, ATEX and FM use
Altitude during operation relating to sea level		
• Installation altitude above sea level, max.	5 000 m	5 000 m
• Ambient air temperature-barometric pressure-altitude	Tmin ... Tmax at 1 140 hPa ... 795 hPa (-1 000 m ... +2 000 m) // Tmin ... (Tmax - 10 K) at 795 hPa ... 658 hPa (+2 000 m ... +3 500 m) // Tmin ... (Tmax -20 K) at 658 hPa ... 540 hPa (+3 500 m ... +5 000 m)	Tmin ... Tmax at 1 140 hPa ... 795 hPa (-1 000 m ... +2 000 m) // Tmin ... (Tmax - 10 K) at 795 hPa ... 658 hPa (+2 000 m ... +3 500 m) // Tmin ... (Tmax -20 K) at 658 hPa ... 540 hPa (+3 500 m ... +5 000 m)
Relative humidity		
• With condensation, tested in accordance with IEC 60068-2-38, max.	100 %; RH incl. condensation/frost (no commissioning under condensation conditions)	100 %; RH incl. condensation/frost (no commissioning under condensation conditions)
Resistance		
Use in stationary industrial systems		
- to biologically active substances according to EN 60721-3-3	Yes; Class 3B2 mold, fungus and dry rot spores (with the exception of fauna); Class 3B3 on request	Yes; Class 3B2 mold, fungus and dry rot spores (with the exception of fauna); Class 3B3 on request
- to chemically active substances according to EN 60721-3-3	Yes; Class 3C4 (RH < 75 %) incl. salt spray acc. to EN 60068-2-52 (severity degree 3); *	Yes; Class 3C4 (RH < 75 %) incl. salt spray acc. to EN 60068-2-52 (severity degree 3); *
- to mechanically active substances according to EN 60721-3-3	Yes; Class 3S4 incl. sand, dust, *	Yes; Class 3S4 incl. sand, dust, *
Use on ships/at sea		
- to biologically active substances according to EN 60721-3-6	Yes; Class 6B2 mold and fungal spores (excluding fauna); Class 6B3 on request	Yes; Class 6B2 mold and fungal spores (excluding fauna); Class 6B3 on request
- to chemically active substances according to EN 60721-3-6	Yes; Class 6C3 (RH < 75 %) incl. salt spray acc. to EN 60068-2-52 (severity degree 3); *	Yes; Class 6C3 (RH < 75 %) incl. salt spray acc. to EN 60068-2-52 (severity degree 3); *
- to mechanically active substances according to EN 60721-3-6	Yes; Class 6S3 incl. sand, dust; *	Yes; Class 6S3 incl. sand, dust; *
Usage in industrial process technology		
- Against chemically active substances acc. to EN 60654-4	Yes; Class 3 (excluding trichlorethylene)	Yes; Class 3 (excluding trichlorethylene)
- Environmental conditions for process, measuring and control systems acc. to ANSI/ISA-71.04	Yes; Level GX group A/B (excluding trichlorethylene; harmful gas concentrations up to the limits of EN 60721-3-3 class 3C4 permissible); level LC3 (salt spray) and level LB3 (oil)	Yes; Level GX group A/B (excluding trichlorethylene; harmful gas concentrations up to the limits of EN 60721-3-3 class 3C4 permissible); level LC3 (salt spray) and level LB3 (oil)
Remark		
- Note regarding classification of environmental conditions acc. to EN 60721, EN 60654-4 and ANSI/ISA-71.04	* The supplied plug covers must remain in place over the unused interfaces during operation!	* The supplied plug covers must remain in place over the unused interfaces during operation!

Technical specifications

Article number	6AG1315-2EH14-7AB0	6AG1317-2EK14-7AB0
Based on	6ES7315-2EH14-0AB0 SIPLUS S7-300 CPU315-2PN/DP	6ES7317-2EK14-0AB0 SIPLUS S7-300 CPU317-2PN/DP
Ambient conditions		
Ambient temperature during operation		
• min.	-25 °C; = Tmin	-25 °C; = Tmin
• max.	70 °C; = Tmax; 60 °C @ UL/cUL, ATEX and FM use	70 °C; = Tmax; @ 60°C for UL/ATEX/FM use
Altitude during operation relating to sea level		
• Installation altitude above sea level, max.	5 000 m	5 000 m
• Ambient air temperature-barometric pressure-altitude	Tmin ... Tmax at 1 140 hPa ... 795 hPa (-1 000 m ... +2 000 m) // Tmin ... (Tmax - 10 K) at 795 hPa ... 658 hPa (+2 000 m ... +3 500 m) // Tmin ... (Tmax -20 K) at 658 hPa ... 540 hPa (+3 500 m ... +5 000 m)	Tmin ... Tmax at 1 140 hPa ... 795 hPa (-1 000 m ... +2 000 m) // Tmin ... (Tmax - 10 K) at 795 hPa ... 658 hPa (+2 000 m ... +3 500 m) // Tmin ... (Tmax -20 K) at 658 hPa ... 540 hPa (+3 500 m ... +5 000 m)
Relative humidity		
• With condensation, tested in accordance with IEC 60068-2-38, max.	100 %; RH incl. condensation/frost (no commissioning under condensation conditions)	100 %; RH incl. condensation/frost (no commissioning under condensation conditions)
Resistance		
Use in stationary industrial systems		
- to biologically active substances according to EN 60721-3-3	Yes; Class 3B2 mold, fungus and dry rot spores (with the exception of fauna); Class 3B3 on request	Yes; Class 3B2 mold, fungus and dry rot spores (with the exception of fauna); Class 3B3 on request
- to chemically active substances according to EN 60721-3-3	Yes; Class 3C4 (RH < 75 %) incl. salt spray acc. to EN 60068-2-52 (severity degree 3); *	Yes; Class 3C4 (RH < 75 %) incl. salt spray acc. to EN 60068-2-52 (severity degree 3); *
- to mechanically active substances according to EN 60721-3-3	Yes; Class 3S4 incl. sand, dust, *	Yes; Class 3S4 incl. sand, dust, *
Use on ships/at sea		
- to biologically active substances according to EN 60721-3-6	Yes; Class 6B2 mold and fungal spores (excluding fauna); Class 6B3 on request	Yes; Class 6B2 mold and fungal spores (excluding fauna); Class 6B3 on request
- to chemically active substances according to EN 60721-3-6	Yes; Class 6C3 (RH < 75 %) incl. salt spray acc. to EN 60068-2-52 (severity degree 3); *	Yes; Class 6C3 (RH < 75 %) incl. salt spray acc. to EN 60068-2-52 (severity degree 3); *
- to mechanically active substances according to EN 60721-3-6	Yes; Class 6S3 incl. sand, dust; *	Yes; Class 6S3 incl. sand, dust; *
Usage in industrial process technology		
- Against chemically active substances acc. to EN 60654-4	Yes; Class 3 (excluding trichlorethylene)	Yes; Class 3 (excluding trichlorethylene)
- Environmental conditions for process, measuring and control systems acc. to ANSI/ISA-71.04	Yes; Level GX group A/B (excluding trichlorethylene; harmful gas concentrations up to the limits of EN 60721-3-3 class 3C4 permissible); level LC3 (salt spray) and level LB3 (oil)	Yes; Level GX group A/B (excluding trichlorethylene; harmful gas concentrations up to the limits of EN 60721-3-3 class 3C4 permissible); level LC3 (salt spray) and level LB3 (oil)
Remark		
- Note regarding classification of environmental conditions acc. to EN 60721, EN 60654-4 and ANSI/ISA-71.04	* The supplied plug covers must remain in place over the unused interfaces during operation!	* The supplied plug covers must remain in place over the unused interfaces during operation!

SIMATIC S7-300 Advanced Controllers

Central processing units

Compact CPUs

Overview CPU 312C



- The compact CPU with integral digital inputs/outputs
 - For small applications with increased processing performance requirements
 - With technological functions
- SIMATIC Micro Memory Card required for operation of CPU.

Overview CPU 313C-2 PtP



- The compact CPU with integrated digital inputs/outputs as well as second serial interface
 - For plants with high processing performance and response time requirements
 - With technological functions
- SIMATIC Micro Memory Card required for operation of the CPU.

Overview CPU 313C



- The compact CPU with integral digital and analog inputs/outputs
 - For plants with high processing performance and response time requirements
 - With technological functions
- SIMATIC Micro Memory Card required for operation of the CPU.

Overview CPU 313C-2 DP



- The compact CPU with integral digital inputs/outputs and PROFIBUS DP master/slave interface
 - For plants with high processing performance and response time requirements
 - With technological functions
 - For tasks with special functions
 - For connecting distributed I/Os
- SIMATIC Micro Memory Card required for operation of CPU.

Overview CPU 314C-2 PtP



- The compact CPU with integrated digital and analog inputs/outputs as well as second serial interface
- For plants with high processing performance and response time requirements
- With technological functions

SIMATIC Micro Memory Card required for operation of the CPU.

Overview CPU 314C-2 DP



- The compact CPU with integral digital and analog inputs/outputs and PROFIBUS DP master/slave interface
- With technological functions
- For plants with high processing performance and response time requirements
- For connecting distributed I/Os

SIMATIC Micro Memory Card required for operation of the CPU.

Overview CPU 314C-2 PN/DP



- The compact CPU with integral digital and analog inputs/outputs and technological functions
- High processing performance in binary and floating-point arithmetic
- For connecting distributed I/O via PROFIBUS and PROFINET
- Combined MPI/PROFIBUS DP master/slave interface
- PROFINET interface with 2-port switch
- PROFINET IO controller for operating distributed I/O on PROFINET
- PROFINET I-Device for connecting the CPU as an intelligent PROFINET device under a SIMATIC or non-Siemens PROFINET IO controller
- Component-based Automation (CBA) on PROFINET
- PROFINET proxy for intelligent devices on PROFIBUS DP in Component-based Automation (CBA)
- Integrated web server with the option of creating user-defined web pages
- Isochronous mode on PROFINET

SIMATIC Micro Memory Card required for operation of CPU.

SIMATIC S7-300 Advanced Controllers

Central processing units

Compact CPUs

Ordering data

CPU 312C

Compact CPU, 64 KB work memory, 24 V DC supply voltage, 10 DI/6 DQ integrated, integrated functions, MPI; including slot number labels; MMC required

6ES7312-5BF04-0AB0

CPU 313C

Compact CPU, 128 KB work memory, 24 V DC supply voltage, 24 DI/16 DQ, 4 AI/2 AQ integrated, integrated functions, MPI; MMC required

6ES7313-5BG04-0AB0

CPU 313C-2 PtP

Compact CPU, 128 KB work memory, 24 V DC supply voltage, 16 DI/16 DQ integrated, integrated functions, MPI, RS 422/485 interface; MMC required

6ES7313-6BG04-0AB0

CPU 313C-2 DP

Compact CPU, 128 KB work memory, 24 V DC supply voltage, 16 DI/16 DQ integrated, integrated functions, MPI, PROFIBUS DP master/slave interface; MMC required

6ES7313-6CG04-0AB0

CPU 314C-2 PtP

Compact CPU, 192 KB work memory, 24 V DC supply voltage, 24DI/16DQ/4AI/2AQ integrated, integrated functions, MPI, RS 422/485 interface; MMC required

6ES7314-6BH04-0AB0

CPU 314C-2 DP

Compact CPU, 192 KB work memory, 24 V DC supply voltage, 24 DI/16 DQ/4 AI/2 AQ integrated, integrated functions, MPI, PROFIBUS DP master/slave interface; MMC required

6ES7314-6CH04-0AB0

CPU 314C-2 PN/DP

Compact CPU, 192 KB work memory, 24 V DC supply voltage, 24 DI/16 DQ/4 AI/2 AQ integrated, integrated functions, MPI, PROFIBUS DP master/slave interface; PROFINET IO controller/I-Device interface, MMC required

6ES7314-6EH04-0AB0

SIMATIC Micro Memory Card

64 KB

6ES7953-8LF31-0AA0

128 KB

6ES7953-8LG31-0AA0

512 KB

6ES7953-8LJ31-0AA0

2 MB

6ES7953-8LL31-0AA0

4 MB

6ES7953-8LM32-0AA0

8 MB

6ES7953-8LP31-0AA0

MPI cable

For connection of SIMATIC S7 and PG via MPI; length 5 m

6ES7901-0BF00-0AA0

Point-to-point link cable

For connection to CPU 31xC-2 PtP

5 m

6ES7902-3AB00-0AA0

10 m

6ES7902-3AC00-0AA0

50 m

6ES7902-3AG00-0AA0

Front connector (1 unit)

For compact CPUs

40-pin, with screw connections

- 1 unit
- 100 units

6ES7392-1AM00-0AA0

6ES7392-1AM00-1AB0

40-pin, with spring-loaded contacts

- 1 unit
- 100 units

6ES7392-1BM01-0AA0

6ES7392-1BM01-1AB0

SIMATIC TOP connect

See page 5/237; for information about which components can be used for the respective module, see Industry Mall

Front door, elevated design

For compact CPUs; for connecting 1.3 mm²/16 AWG wires; cabling diagram and labeling strips in petrol

6ES7328-7AA20-0AA0

Slot number plates

6ES7912-0AA00-0AA0

SIMATIC Manual Collection

Electronic manuals on DVD, multi-language: LOGO!, SIMADYN, SIMATIC Bus Components, SIMATIC C7, SIMATIC Distributed I/O, SIMATIC HMI, SIMATIC Sensors, SIMATIC NET, SIMATIC PC-based Automation, SIMATIC PCS 7, SIMATIC PG/PC, SIMATIC S7, SIMATIC Software, SIMATIC TDC

6ES7998-8XC01-8YE0

SIMATIC Manual Collection update service for 1 year

Current Manual Collection DVD and the three subsequent updates

6ES7998-8XC01-8YE2

Power supply connector

10 units, spare part

6ES7391-1AA00-0AA0

Labeling strips

10 units, spare part

6ES7392-2XX00-0AA0

Label cover

10 units, spare part

6ES7392-2XY00-0AA0

Labeling sheets for machine inscription

For modules with 40-pin front connector, DIN A4, for printing with laser printer; 10 units

Petrol

6ES7392-2AX10-0AA0

Light beige

6ES7392-2BX10-0AA0

Yellow

6ES7392-2CX10-0AA0

Red

6ES7392-2DX10-0AA0

USB A2 PC adapter

For connecting a programming device/PC or notebook to PROFIBUS or MPI; USB cable included in scope of delivery

6GK1571-0BA00-0AA0

Ordering data	Article No.	Article No.
PROFIBUS DP RS 485 bus connector <ul style="list-style-type: none"> With 90° cable outlet, max. transfer rate 12 Mbps - Without programming device interface - With programming device interface 	6ES7972-0BA12-0XA0 6ES7972-0BB12-0XA0	6GK5204-2BB10-2AA3 Industrial Ethernet switches with integrated SNMP access, web diagnostics, copper cable diagnostics and PROFINET diagnostics for configuring line, star and ring topologies; four 10/100 Mbps RJ45 ports and two FO ports Compact Switch Module CSM 377 Unmanaged switch for connecting SIMATIC S7-300, ET 200M and up to three other stations to Industrial Ethernet with 10/100 Mbps; 4 x RJ45 ports; external 24 V DC power supply, LED diagnostics, S7-300 module incl. electronic Equipment Manual on CD-ROM IE FC RJ45 plugs RJ45 plug connector for Industrial Ethernet with a rugged metal enclosure and integrated insulation displacement contacts for connecting Industrial Ethernet FC installation cables IE FC RJ45 plug 180 180° cable outlet 1 unit 10 units 50 units PROFIBUS/PROFINET bus components For establishing MPI/PROFIBUS/PROFINET communication
<ul style="list-style-type: none"> With 90° cable outlet for FastConnect connection system, max. transfer rate 12 Mbps - Without programming device interface, 1 unit - Without programming device interface, 100 units - With programming device interface, 1 unit - With programming device interface, 100 units 	6ES7972-0BA52-0XA0 6ES7972-0BA52-0XB0 6ES7972-0BB52-0XA0 6ES7972-0BB52-0XB0	
<ul style="list-style-type: none"> With axial cable outlet for SIMATIC OP, for connecting to PPI, MPI, PROFIBUS 	6GK1500-0EA02	
PROFIBUS FastConnect bus cable Standard type with special design for quick mounting, 2-wire, shielded, sold by the meter, max. delivery unit 1 000 m, minimum order quantity 20 m	6XV1830-0EH10	
RS 485 repeater for PROFIBUS Transmission rate up to 12 Mbps; 24 V DC; IP20 enclosure	6ES7972-0AA02-0XA0	
PROFINET bus components		
IE FC TP standard cable GP 2x2 4-wire, shielded TP installation cable for connection to IE FC RJ45 outlet/IE FC RJ45 plug; PROFINET-compatible; with UL approval; Sold by the meter: Max. delivery unit 1000 m Minimum order quantity 20 m	6XV1840-2AH10	
FO standard cable GP (50/125) Standard cable, splittable, UL approval, sold by the meter Max. delivery unit 1000 m Minimum order quantity 20 m	6XV1873-2A	

SIMATIC S7-300 Advanced Controllers

Central processing units

Compact CPUs

Technical specifications

Article number	6ES7312-5BF04-0AB0	6ES7313-5BG04-0AB0	6ES7313-6BG04-0AB0	6ES7313-6CG04-0AB0
	CPU312C, 10DI/6DO, 64 KB	CPU313C, 24DI/16DO/ 5AI/2AO, 128 KB	CPU313C-2 PTP, 16DI/16DO, 128 KB	CPU313C-2 DP, 16DI/16DO, 128 KB
General information				
Engineering with				
• Programming package	STEP 7 V5.5 + SP1 or higher or STEP 7 V5.3 + SP2 or higher with HSP 203	STEP 7 V5.5 + SP1 or higher or STEP 7 V5.3 + SP2 or higher with HSP 203	STEP 7 as of V5.5 + SP1 or STEP 7 V5.3 + SP2 or higher with HSP 204	STEP 7 V5.5 + SP1 or higher or STEP 7 V5.3 + SP2 or higher with HSP 203
Supply voltage				
Rated value (DC)	24 V	24 V	24 V	24 V
Memory				
Work memory				
• integrated	64 kbyte	128 kbyte	128 kbyte	128 kbyte
• expandable	No	No	No	No
Load memory				
• Plug-in (MMC), max.	8 Mbyte	8 Mbyte	8 Mbyte	8 Mbyte
CPU processing times				
for bit operations, typ.	0.1 µs	0.07 µs	0.07 µs	0.07 µs
for word operations, typ.	0.24 µs	0.15 µs	0.15 µs	0.15 µs
for fixed point arithmetic, typ.	0.32 µs	0.2 µs	0.2 µs	0.2 µs
for floating point arithmetic, typ.	1.1 µs	0.72 µs	0.72 µs	0.72 µs
Counters, timers and their retentivity				
S7 counter				
• Number	256	256	256	256
IEC counter				
• present	Yes	Yes	Yes	Yes
S7 times				
• Number	256	256	256	256
IEC timer				
• present	Yes	Yes	Yes	Yes
Data areas and their retentivity				
Flag				
• Size, max.	256 byte	256 byte	256 byte	256 byte
Address area				
I/O address area				
• Inputs	1 024 byte	1 024 byte	1 024 byte	2 048 byte
• Outputs	1 024 byte	1 024 byte	1 024 byte	2 048 byte
Process image				
• Inputs, adjustable	1 024 byte	1 024 byte	1 024 byte	2 048 byte
• Outputs, adjustable	1 024 byte	1 024 byte	1 024 byte	2 048 byte
Time of day				
Clock				
• Hardware clock (real-time)		Yes	Yes	Yes
• Software clock	Yes			
Operating hours counter				
• Number	1	1	1	1
Digital inputs				
integrated channels (DI)	10	24	16	16
Digital outputs				
integrated channels (DO)	6	16	16	16
Analog inputs				
integrated channels (AI)	0	5; 4x current/voltage, 1x resistance	0	0
Input ranges				
• Voltage		Yes; ±10 V / 100 kΩ; 0 V to 10 V / 100 kΩ		
• Current		Yes; ±20 mA / 100 Ω; 0 mA to 20 mA / 100 Ω; 4 mA to 20 mA / 100 Ω		
• Resistance thermometer		Yes; Pt 100 / 10 MΩ		
• Resistance		Yes; 0 Ω to 600 Ω / 10 MΩ		

Technical specifications

Article number	6ES7312-5BF04-0AB0	6ES7313-5BG04-0AB0	6ES7313-6BG04-0AB0	6ES7313-6CG04-0AB0
	CPU312C, 10DI/6DO, 64 KB	CPU313C, 24DI/16DO/ 5AI/2AO, 128 KB	CPU313C-2 PTP, 16DI/16DO, 128 KB	CPU313C-2 DP, 16DI/16DO, 128 KB
Analog outputs				
integrated channels (AO)	0	2	0	0
Output ranges, voltage				
• 0 to 10 V		Yes		
• -10 V to +10 V		Yes		
Output ranges, current				
• 0 to 20 mA		Yes		
• -20 mA to +20 mA		Yes		
• 4 mA to 20 mA		Yes		
1. Interface				
Interface type	Integrated RS 485 interface	Integrated RS 485 interface	Integrated RS 485 interface	Integrated RS 485 interface
Interface types				
• RS 485	Yes	Yes		Yes
Protocols				
• MPI	Yes	Yes	Yes	Yes
• PROFIBUS DP master	No	No	No	No
• PROFIBUS DP slave	No	No	No	No
• Point-to-point connection	No	No	No	No
2. Interface				
Interface type			Integrated RS 422/ 485 interface	Integrated RS 485 interface
Interface types				
• RS 485			Yes; RS 422 / 485 (X.27)	Yes
Protocols				
• MPI			No	No
• PROFINET IO Controller			No	No
• PROFINET IO Device			No	No
• PROFINET CBA			No	No
• PROFIBUS DP master			No	Yes
• PROFIBUS DP slave			No	Yes
PROFIBUS DP master				
• Number of DP slaves, max.				124
Communication functions				
PG/OP communication	Yes	Yes	Yes	Yes
Data record routing	No	No	No	Yes
Global data communication				
• supported	Yes	Yes	Yes	Yes
S7 basic communication				
• supported	Yes	Yes	Yes; Server	Yes
S7 communication				
• supported	Yes	Yes	Yes	Yes
S5 compatible communication				
• supported	Yes; via CP and loadable FC	Yes; via CP and loadable FC	Yes; via CP and loadable FC	Yes; via CP and loadable FC
Number of connections				
• overall	6	8	8	8
Integrated Functions				
Counter				
• Number of counters	2; See "Technological Functions" manual	3; See "Technological Functions" manual	3; See "Technological Functions" manual	3; See "Technological Functions" manual
• Counting frequency, max.	10 kHz	30 kHz	30 kHz	30 kHz
Frequency measurement	Yes	Yes	Yes	Yes
• Number of frequency meters	2; up to 10 kHz (see "Technological Functions" manual)	3; up to 30 kHz (see "Technological Functions" manual)	3; up to 30 kHz (see "Technological Functions" manual)	3; up to 30 kHz (see "Technological Functions" manual)
controlled positioning	No	No	No	No
integrated function blocks (closed-loop control)	No	Yes; PID controller (see "Technological Functions" manual)	Yes; PID controller (see "Technological Functions" manual)	Yes; PID controller (see "Technological Functions" manual)
PID controller	No	Yes	Yes	Yes
Number of pulse outputs	2; Pulse width modulation up to 2.5 kHz (see "Technological Functions" Manual)	3; Pulse width modulation up to 2.5 kHz (see "Technological Functions" Manual)	3; Pulse width modulation up to 2.5 kHz (see "Technological Functions" Manual)	3; Pulse width modulation up to 2.5 kHz (see "Technological Functions" Manual)
Limit frequency (pulse)	2.5 kHz	2.5 kHz	2.5 kHz	2.5 kHz

SIMATIC S7-300 Advanced Controllers

Central processing units

Compact CPUs

Technical specifications

Article number	6ES7312-5BF04-0AB0	6ES7313-5BG04-0AB0	6ES7313-6BG04-0AB0	6ES7313-6CG04-0AB0
	CPU312C, 10DI/6DO, 64 KB	CPU313C, 24DI/16DO/ 5AI/2AO, 128 KB	CPU313C-2 PTP, 16DI/16DO, 128 KB	CPU313C-2 DP, 16DI/16DO, 128 KB
Ambient conditions				
Ambient temperature during operation				
• min.	0 °C	0 °C	0 °C	0 °C
• max.	60 °C	60 °C	60 °C	60 °C
Configuration				
Programming				
Programming language				
- LAD	Yes	Yes	Yes	Yes
- FBD	Yes	Yes	Yes	Yes
- STL	Yes	Yes	Yes	Yes
- SCL	Yes	Yes	Yes	Yes
- CFC	Yes	Yes	Yes	Yes
- GRAPH	Yes	Yes	Yes	Yes
- HiGraph®	Yes	Yes	Yes	Yes
Know-how protection				
• User program protection/ password protection	Yes	Yes	Yes	Yes
• Block encryption	Yes; With S7 block Privacy	Yes; With S7 block Privacy	Yes; With S7 block Privacy	Yes; With S7 block Privacy
Dimensions				
Width	80 mm	120 mm	80 mm	80 mm
Height	125 mm	125 mm	125 mm	125 mm
Depth	130 mm	130 mm	130 mm	130 mm
Weights				
Weight, approx.	410 g	660 g	500 g	500 g

Article number	6ES7314-6BH04-0AB0	6ES7314-6CH04-0AB0	6ES7314-6EH04-0AB0
	CPU314C-2PTP, 24DI/16DO/5AI/2AO, 192 KB	CPU314C-2DP, 24DI/16DO/5AI/2AO, 192 KB	CPU314C-2PN/DP, 24DI/16DO/4AI/2AO, 192KB
General information			
Product function			
• Isochronous mode			Yes; For PROFINET only
Engineering with			
• Programming package	STEP 7 as of V5.5 + SP1 or STEP 7 V5.3 + SP2 or higher with HSP 204	STEP 7 V5.5 + SP1 or higher or STEP 7 V5.3 + SP2 or higher with HSP 203	STEP 7 V5.5 or higher with HSP 191
Supply voltage			
Rated value (DC)	24 V	24 V	24 V
Memory			
Work memory			
• integrated	192 kbyte	192 kbyte	192 kbyte
• expandable	No	No	No
Load memory			
• Plug-in (MMC), max.	8 Mbyte	8 Mbyte	8 Mbyte
CPU processing times			
for bit operations, typ.	0.06 µs	0.06 µs	0.06 µs
for word operations, typ.	0.12 µs	0.12 µs	0.12 µs
for fixed point arithmetic, typ.	0.16 µs	0.16 µs	0.16 µs
for floating point arithmetic, typ.	0.59 µs	0.59 µs	0.59 µs
Counters, timers and their retentivity			
S7 counter			
• Number	256	256	256
IEC counter			
• present	Yes	Yes	Yes
S7 times			
• Number	256	256	256
IEC timer			
• present	Yes	Yes	Yes

Technical specifications

Article number	6ES7314-6BH04-0AB0 CPU314C-2PTP, 24DI/16DO/5AI/2AO, 192 KB	6ES7314-6CH04-0AB0 CPU314C-2DP, 24DI/16DO/5AI/2AO, 192 KB	6ES7314-6EH04-0AB0 CPU314C-2PN/DP, 24DI/16DO/4AI/2AO, 192KB
Data areas and their retentivity			
Flag			
• Size, max.	256 byte	256 byte	256 byte
Address area			
I/O address area			
• Inputs	1 024 byte	2 048 byte	2 048 byte
• Outputs	1 024 byte	2 048 byte	2 048 byte
Process image			
• Inputs, adjustable	1 024 byte	2 048 byte	2 048 byte
• Outputs, adjustable	1 024 byte	2 048 byte	2 048 byte
Time of day			
Clock			
• Hardware clock (real-time)	Yes	Yes	Yes
Operating hours counter			
• Number	1	1	1
Digital inputs			
integrated channels (DI)	24	24	24
Digital outputs			
integrated channels (DO)	16	16	16
Analog inputs			
integrated channels (AI)	5; 4x current/voltage, 1x resistance	5; 4x current/voltage, 1x resistance	5; 4x current/voltage, 1x resistance
Input ranges			
• Voltage	Yes; $\pm 10\text{ V} / 100\text{ k}\Omega$; 0 V to 10 V / 100 k Ω	Yes; $\pm 10\text{ V} / 100\text{ k}\Omega$; 0 V to 10 V / 100 k Ω	Yes; $\pm 10\text{ V} / 100\text{ k}\Omega$; 0 V to 10 V / 100 k Ω
• Current	Yes; $\pm 20\text{ mA} / 100\ \Omega$; 0 mA to 20 mA / 100 Ω ; 4 mA to 20 mA / 100 Ω	Yes; $\pm 20\text{ mA} / 100\ \Omega$; 0 mA to 20 mA / 100 Ω ; 4 mA to 20 mA / 100 Ω	Yes; $\pm 20\text{ mA} / 100\ \Omega$; 0 mA to 20 mA / 100 Ω ; 4 mA to 20 mA / 100 Ω
• Resistance thermometer	Yes; Pt 100 / 10 M Ω	Yes; Pt 100 / 10 M Ω	Yes; Pt 100 / 10 M Ω
• Resistance	Yes; 0 Ω to 600 Ω / 10 M Ω	Yes; 0 Ω to 600 Ω / 10 M Ω	Yes; 0 Ω to 600 Ω / 10 M Ω
Analog outputs			
integrated channels (AO)	2	2	2
Output ranges, voltage			
• 0 to 10 V	Yes	Yes	Yes
• -10 V to +10 V	Yes	Yes	Yes
Output ranges, current			
• 0 to 20 mA	Yes	Yes	Yes
• -20 mA to +20 mA	Yes	Yes	Yes
• 4 mA to 20 mA	Yes	Yes	Yes
1. Interface			
Interface type	Integrated RS 485 interface	Integrated RS 485 interface	Integrated RS 485 interface
Interface types			
• RS 485	Yes	Yes	Yes
Protocols			
• MPI	Yes	Yes	Yes
• PROFIBUS DP master	No	No	Yes
• PROFIBUS DP slave	No	No	Yes
• Point-to-point connection	No	No	No
PROFIBUS DP master			
• Number of DP slaves, max.			124

SIMATIC S7-300 Advanced Controllers

Central processing units

Compact CPUs

Technical specifications

Article number	6ES7314-6BH04-0AB0 CPU314C-2PTP, 24DI/16DO/5AI/2AO, 192 KB	6ES7314-6CH04-0AB0 CPU314C-2DP, 24DI/16DO/5AI/2AO, 192 KB	6ES7314-6EH04-0AB0 CPU314C-2PN/DP, 24DI/16DO/4AI/2AO, 192KB
2. Interface			
Interface type	Integrated RS 422/ 485 interface	Integrated RS 485 interface	PROFINET
Interface types			
• RJ 45 (Ethernet)			Yes
• RS 485	Yes; RS 422 / 485 (X.27)	Yes	
• Number of ports			2
Protocols			
• MPI	No	No	No
• PROFINET IO Controller	No	No	Yes; Also simultaneously with IO-Device functionality
• PROFINET IO Device	No	No	Yes; Also simultaneously with IO Controller functionality
• PROFINET CBA	No	No	Yes
• PROFIBUS DP master	No	Yes	No
• PROFIBUS DP slave	No	Yes	No
PROFIBUS DP master			
• Number of DP slaves, max.		124	
PROFINET IO Controller			
Services			
- Number of connectable IO Devices, max.			128
- Of which IO devices with IRT, max.			64
- Number of IO Devices with IRT and the option "high flexibility"			128
- Number of connectable IO Devices for RT, max.			128
Protocols			
Open IE communication			
• TCP/IP			Yes; via integrated PROFINET interface and loadable FBs
- Number of connections, max.			8
• ISO-on-TCP (RFC1006)			Yes; via integrated PROFINET interface and loadable FBs
- Number of connections, max.			8
• UDP			Yes; via integrated PROFINET interface and loadable FBs
- Number of connections, max.			8
Web server			
• supported			Yes
Communication functions			
PG/OP communication	Yes	Yes	Yes
Data record routing	No	Yes	Yes
Global data communication			
• supported	Yes	Yes	Yes
S7 basic communication			
• supported	Yes	Yes	Yes
S7 communication			
• supported	Yes	Yes	Yes
S5 compatible communication			
• supported	Yes; via CP and loadable FC	Yes; via CP and loadable FC	Yes; via CP and loadable FC
Number of connections			
• overall	12	12	12

Technical specifications

Article number	6ES7314-6BH04-0AB0 CPU314C-2PTP, 24DI/16DO/5AI/2AO, 192 KB	6ES7314-6CH04-0AB0 CPU314C-2DP, 24DI/16DO/5AI/2AO, 192 KB	6ES7314-6EH04-0AB0 CPU314C-2PN/DP, 24DI/16DO/4AI/2AO, 192KB
Integrated Functions			
Counter			
• Number of counters	4; See "Technological Functions" manual	4; See "Technological Functions" manual	4; See "Technological Functions" manual
• Counting frequency, max.	60 kHz	60 kHz	60 kHz
Frequency measurement	Yes	Yes	Yes
• Number of frequency meters	4; up to 60 kHz (see "Technological Functions" manual)	4; up to 60 kHz (see "Technological Functions" manual)	4; up to 60 kHz (see "Technological Functions" manual)
controlled positioning	Yes	Yes	Yes
integrated function blocks (closed-loop control)	Yes; PID controller (see "Technological Functions" manual)	Yes; PID controller (see "Technological Functions" manual)	Yes; PID controller (see "Technological Functions" manual)
PID controller	Yes	Yes	Yes
Number of pulse outputs	4; Pulse width modulation up to 2.5 kHz (see "Technological Functions" Manual)	4; Pulse width modulation up to 2.5 kHz (see "Technological Functions" Manual)	4; Pulse width modulation up to 2.5 kHz (see "Technological Functions" Manual)
Limit frequency (pulse)	2.5 kHz	2.5 kHz	2.5 kHz
Ambient conditions			
Ambient temperature during operation			
• min.	0 °C	0 °C	0 °C
• max.	60 °C	60 °C	60 °C
Configuration			
Programming			
Programming language			
- LAD	Yes	Yes	Yes
- FBD	Yes	Yes	Yes
- STL	Yes	Yes	Yes
- SCL	Yes	Yes	Yes
- CFC	Yes	Yes	Yes
- GRAPH	Yes	Yes	Yes
- HiGraph®	Yes	Yes	Yes
Know-how protection			
• User program protection/ password protection	Yes	Yes	Yes
• Block encryption	Yes; With S7 block Privacy	Yes; With S7 block Privacy	Yes; With S7 block Privacy
Dimensions			
Width	120 mm	120 mm	120 mm
Height	125 mm	125 mm	125 mm
Depth	130 mm	130 mm	130 mm
Weights			
Weight, approx.	680 g	680 g	730 g

SIMATIC S7-300 Advanced Controllers

Central processing units

SIPLUS S7-300 compact CPUs

Overview SIPLUS S7-300 CPU 312C



- The compact CPU with integral digital inputs/outputs
- For small applications with increased processing performance requirements
- With technological functions

Micro Memory Card required for operation of CPU.

Note:

SIPLUS extreme products are based on SIMATIC standard products. The contents listed here were taken from the respective standard products. SIPLUS extreme-specific information was added.

Overview SIPLUS S7-300 CPU 313C-2 DP



- The compact CPU with integral digital inputs/outputs and PROFIBUS DP master/slave interface
- With technological functions
- For tasks with special functions
- For connecting distributed I/O

Micro Memory Card required for operation of CPU.

Note:

SIPLUS extreme products are based on SIMATIC standard products. The contents listed here were taken from the respective standard products. SIPLUS extreme-specific information was added.

Overview SIPLUS S7-300 CPU 313C



- The compact CPU with integrated digital and analog inputs/outputs
- For plants with high processing performance and response time requirements
- With technological functions

Micro Memory Card required for operation of CPU.

Note:

SIPLUS extreme products are based on SIMATIC standard products. The contents listed here were taken from the corresponding standard products. SIPLUS extreme-specific information was added.

Overview SIPLUS S7-300 CPU 314C-2 PtP



- The compact CPU with integrated digital and analog inputs/outputs as well as second serial interface
- For plants with high processing performance and response time requirements
- With technological functions

SIMATIC Micro Memory Card required for operation of CPU.

Note:

SIPLUS extreme products are based on SIMATIC standard products. The contents listed here were taken from the respective standard products. SIPLUS extreme-specific information was added.

SIMATIC S7-300 Advanced Controllers

Central processing units

SIPLUS S7-300 compact CPUs

Overview SIPLUS S7-300 CPU 314C-2 DP



- The compact CPU with integral digital and analog inputs/outputs and PROFIBUS DP master/slave interface
- With technological functions
- For tasks with special functions
- For connecting distributed I/O

Micro Memory Card required for operation of CPU.

Note:

SIPLUS extreme products are based on SIMATIC standard products. The contents listed here were taken from the respective standard products. SIPLUS extreme-specific information was added.

Overview SIPLUS S7-300 CPU 314C-2 PN/DP



- The compact CPU with integral digital and analog inputs/outputs and technological functions
- High processing performance in binary and floating-point arithmetic
- For connecting distributed I/O via PROFIBUS and PROFINET
- Combined MPI/PROFIBUS DP master/slave interface
- PROFINET interface with 2-port switch
- PROFINET IO controller for operating distributed I/O on PROFINET
- PROFINET I-Device for connecting the CPU as intelligent PROFINET device under a SIMATIC or non-Siemens PROFINET I/O controller
- Component based Automation (CBA) on PROFINET
- PROFINET proxy for intelligent devices on PROFIBUS DP in Component based Automation (CBA)
- Integrated Web server with the option of creating user-defined web pages
- Isochronous mode on PROFINET

SIMATIC Micro Memory Card required for operation of CPU.

Note:

SIPLUS extreme products are based on SIMATIC standard products. The contents listed here were taken from the respective standard products. SIPLUS extreme-specific information was added.

SIMATIC S7-300 Advanced Controllers

Central processing units

SIPLUS S7-300 compact CPUs

Ordering data

Article No.

Article No.

SIPLUS S7-300 CPU 312C

For industrial applications with extended ambient conditions

Compact CPU, 64 KB work memory, supply voltage 24 V DC, 10 DI/6 DO integrated, integrated functions, MPI; including slot number labels; MMC required

Extended temperature range and exposure to media

6AG1312-5BF04-7AB0

SIPLUS S7-300 CPU 313C

For industrial applications with extended ambient conditions

Compact CPU, 128 KB work memory, 24 V DC supply voltage, 24 DI/16 DQ, 4 AI/2 AQ integrated, integrated functions, MPI; MMC required

Extended temperature range and exposure to media

6AG1313-5BG04-7AB0

SIPLUS S7-300 CPU 313C-2 DP

For industrial applications with extended ambient conditions

Compact CPU, 128 KB work memory, supply voltage 24 V DC, 16 DI/16 DO integrated, integrated functions, MPI, PROFIBUS DP master/slave interface; MMC required

Extended temperature range and exposure to media

6AG1313-6CG04-7AB0

SIPLUS S7-300 CPU 314C-2 PIP

For industrial applications with extended ambient conditions

Compact CPU, 192 KB work memory, 24 V DC supply voltage, 24DI/16DQ/4AI/2AQ integrated, integrated functions, MPI, RS 422/485 interface; MMC required

Extended temperature range and exposure to media

6AG1314-6BH04-7AB0

SIPLUS S7-300 CPU 314C-2 DP

For industrial applications with extended ambient conditions

Compact CPU, 192 KB work memory, 24 V DC supply voltage, 24 DI/16 DQ/4 AI/2 AQ integrated, integrated functions, MPI, PROFIBUS DP master/slave interface; MMC required

Extended temperature range and exposure to media

6AG1314-6CH04-7AB0

SIPLUS S7-300 CPU 314C-2 PN/DP

For industrial applications with extended ambient conditions

Compact CPU, 192 KB work memory, 24 V DC supply voltage, 24 DI/16 DQ/4 AI/2 AQ integrated, integrated functions, MPI, PROFIBUS DP master/slave interface; PROFINET IO controller/I-Device interface, MMC required

Extended temperature range and exposure to media

6AG1314-6EH04-7AB0

Accessories

Mandatory

SIMATIC Micro Memory Card

64 KB

6ES7953-8LF31-0AA0

128 KB

6ES7953-8LG31-0AA0

512 KB

6ES7953-8LJ31-0AA0

2 MB

6ES7953-8LL31-0AA0

4 MB

6ES7953-8LM32-0AA0

8 MB

6ES7953-8LP31-0AA0

Front connector (1 unit)

For compact CPUs

40-pin, with spring-loaded contacts

- 1 unit
- 100 units

6ES7392-1BM01-0AA0

6ES7392-1BM01-1AB0

For communication within the application

PROFIBUS DP RS 485 bus connector

(extended temperature range and exposure to media)

With 90° cable outlet, max. transfer rate 12 Mbps

- Without programming device interface
- With programming device interface

6AG1972-0BA12-2XA0

6AG1972-0BB12-2XA0

With angled cable outlet, max. transmission rate 12 Mbps

- Without programming device interface
- With programming device interface

6AG1972-0BA42-7XA0

6AG1972-0BB42-7XA0

(Extended temperature range)

With axial cable outlet for SIMATIC OP, for connecting to PPI, MPI, PROFIBUS

6AG1500-0EA02-2AA0

IE FC RJ45 plug 180

(extended temperature range and exposure to media)

- 180° cable outlet
- 1 unit

6AG1901-1BB10-7AA0

SIMATIC S7-300 Advanced Controllers

Central processing units

SIPLUS S7-300 compact CPUs

5

Ordering data	Article No.	Article No.
Industrial Ethernet Switches SIPLUS SCALANCE XC-200 Industrial Ethernet switches with integrated SNMP access, web diagnostics, copper cable diagnostics and PROFINET diagnostics for configuring line, star and ring topologies; with integrated redundancy manager; incl. operating instructions, Industrial Ethernet network manual and configuration software on CD-ROM Extended temperature range and exposure to media Switches with PROFINET delivery state • SIPLUS SCALANCE XC206-2 (ST/BFOC) with six RJ45 ports 10/100 Mbps and two ST/BFOC ports 100 Mbps	6AG1206-2BB00-7AC2	<i>For commissioning</i> MPI cable For connection of SIMATIC S7 and programming device via MPI; length 5 m USB A2 PC adapter For connecting a programming device/PC or Notebook to PROFIBUS or MPI; USB cable included in scope of delivery <i>Consumables</i> Front door, elevated design For compact CPUs; for connecting 1.3 mm ² /16 AWG wires; wiring diagram and labeling strips in petrol Power supply connector 10 units, spare part Slot number plates Labeling strips 10 units, spare part Label cover 10 units, spare part Labeling sheets for machine inscription For modules with 40-pin front connector, DIN A4, for printing with laser printer; 10 units Petrol 6ES7392-2AX10-0AA0 Light beige 6ES7392-2BX10-0AA0 Yellow 6ES7392-2CX10-0AA0 Red 6ES7392-2DX10-0AA0 <i>Documentation</i> SIMATIC Manual Collection Electronic manuals on DVD, multi-language: LOGO!, SIMADYN, SIMATIC bus components, SIMATIC C7, SIMATIC Distributed I/O, SIMATIC HMI, SIMATIC Sensors, SIMATIC NET, SIMATIC PC-based Automation, SIMATIC PCS 7, SIMATIC PG/PC, SIMATIC S7, SIMATIC Software, SIMATIC TDC SIMATIC Manual Collection update service for 1 year Current Manual Collection DVD and the three subsequent updates
PROFIBUS FastConnect bus cable Standard type with special design for quick mounting, 2-wire, shielded, sold by the meter, max. delivery unit 1 000 m, minimum order quantity 20 m	6XV1830-0EH10	
IE FC TP standard cable GP 2x2 4-wire, shielded TP installation cable for connection to IE FC RJ45 outlet/ IE FC RJ45 plug; PROFINET-compatible; with UL approval; Sold by the meter: Max. delivery unit 1000 m Minimum order quantity 20 m	6XV1840-2AH10	
FO standard cable GP (50/125) Standard cable, splittable, UL approval, sold by the meter: max. delivery unit 1 000 m minimum order quantity 20 m	6XV1873-2A	
RS 485 repeater for PROFIBUS (extended temperature range and exposure to media) Transmission rate up to 12 Mbps; 24 V DC; IP20 enclosure	6AG1972-0AA02-7XA0	
Point-to-point link cable For connection to CPU 31xC-2 PtP 5 m 10 m 50 m	6ES7902-3AB00-0AA0 6ES7902-3AC00-0AA0 6ES7902-3AG00-0AA0	

SIMATIC S7-300 Advanced Controllers

Central processing units

SIPLUS S7-300 compact CPUs

Technical specifications

Article number	6AG1312-5BF04-7AB0	6AG1313-5BG04-7AB0
Based on	6ES7312-5BF04-0AB0 SIPLUS S7-300 CPU312C	6ES7313-5BG04-0AB0 SIPLUS S7-300 CPU313C
Ambient conditions		
Ambient temperature during operation		
• min.	-25 °C; = Tmin	-25 °C; = Tmin
• max.	70 °C; = Tmax; 60 °C @ UL/cUL, ATEX and FM use	70 °C; = Tmax; 60 °C @ UL/cUL, ATEX and FM use
Altitude during operation relating to sea level		
• Installation altitude above sea level, max.	5 000 m	5 000 m
• Ambient air temperature-barometric pressure-altitude	Tmin ... Tmax at 1 140 hPa ... 795 hPa (-1 000 m ... +2 000 m) // Tmin ... (Tmax - 10 K) at 795 hPa ... 658 hPa (+2 000 m ... +3 500 m) // Tmin ... (Tmax -20 K) at 658 hPa ... 540 hPa (+3 500 m ... +5 000 m)	Tmin ... Tmax at 1 140 hPa ... 795 hPa (-1 000 m ... +2 000 m) // Tmin ... (Tmax - 10 K) at 795 hPa ... 658 hPa (+2 000 m ... +3 500 m) // Tmin ... (Tmax -20 K) at 658 hPa ... 540 hPa (+3 500 m ... +5 000 m)
Relative humidity		
• With condensation, tested in accordance with IEC 60068-2-38, max.	100 %; RH incl. condensation/frost (no commissioning under condensation conditions)	100 %; RH incl. condensation/frost (no commissioning under condensation conditions)
Resistance		
Use in stationary industrial systems		
- to biologically active substances according to EN 60721-3-3	Yes; Class 3B2 mold, fungus and dry rot spores (with the exception of fauna); Class 3B3 on request	Yes; Class 3B2 mold, fungus and dry rot spores (with the exception of fauna); Class 3B3 on request
- to chemically active substances according to EN 60721-3-3	Yes; Class 3C4 (RH < 75 %) incl. salt spray acc. to EN 60068-2-52 (severity degree 3); *	Yes; Class 3C4 (RH < 75 %) incl. salt spray acc. to EN 60068-2-52 (severity degree 3); *
- to mechanically active substances according to EN 60721-3-3	Yes; Class 3S4 incl. sand, dust, *	Yes; Class 3S4 incl. sand, dust, *
Use on ships/at sea		
- to biologically active substances according to EN 60721-3-6	Yes; Class 6B2 mold and fungal spores (excluding fauna); Class 6B3 on request	Yes; Class 6B2 mold and fungal spores (excluding fauna); Class 6B3 on request
- to chemically active substances according to EN 60721-3-6	Yes; Class 6C3 (RH < 75 %) incl. salt spray acc. to EN 60068-2-52 (severity degree 3); *	Yes; Class 6C3 (RH < 75 %) incl. salt spray acc. to EN 60068-2-52 (severity degree 3); *
- to mechanically active substances according to EN 60721-3-6	Yes; Class 6S3 incl. sand, dust; *	Yes; Class 6S3 incl. sand, dust; *
Usage in industrial process technology		
- Against chemically active substances acc. to EN 60654-4	Yes; Class 3 (excluding trichlorethylene)	Yes; Class 3 (excluding trichlorethylene)
- Environmental conditions for process, measuring and control systems acc. to ANSI/ISA-71.04	Yes; Level GX group A/B (excluding trichlorethylene; harmful gas concentrations up to the limits of EN 60721-3-3 class 3C4 permissible); level LC3 (salt spray) and level LB3 (oil)	Yes; Level GX group A/B (excluding trichlorethylene; harmful gas concentrations up to the limits of EN 60721-3-3 class 3C4 permissible); level LC3 (salt spray) and level LB3 (oil)
Remark		
- Note regarding classification of environmental conditions acc. to EN 60721, EN 60654-4 and ANSI/ISA-71.04	* The supplied plug covers must remain in place over the unused interfaces during operation!	* The supplied plug covers must remain in place over the unused interfaces during operation!

Technical specifications

Article number	6AG1313-6CG04-7AB0	6AG1314-6BH04-7AB0
Based on	6ES7313-6CG04-0AB0 SIPLUS S7-300 CPU313C-2DP	6ES7314-6BH04-0AB0 SIPLUS S7-300 CPU314C-2 PTP
Ambient conditions		
Ambient temperature during operation		
• min.	-25 °C; = Tmin	-25 °C; = Tmin
• max.	70 °C; = Tmax; 60 °C @ UL/cUL, ATEX and FM use	70 °C; = Tmax; 60 °C @ UL/cUL, ATEX and FM use
Altitude during operation relating to sea level		
• Installation altitude above sea level, max.	5 000 m	5 000 m
• Ambient air temperature-barometric pressure-altitude	Tmin ... Tmax at 1 140 hPa ... 795 hPa (-1 000 m ... +2 000 m) // Tmin ... (Tmax - 10 K) at 795 hPa ... 658 hPa (+2 000 m ... +3 500 m) // Tmin ... (Tmax -20 K) at 658 hPa ... 540 hPa (+3 500 m ... +5 000 m)	Tmin ... Tmax at 1 140 hPa ... 795 hPa (-1 000 m ... +2 000 m) // Tmin ... (Tmax - 10 K) at 795 hPa ... 658 hPa (+2 000 m ... +3 500 m) // Tmin ... (Tmax -20 K) at 658 hPa ... 540 hPa (+3 500 m ... +5 000 m)
Relative humidity		
• With condensation, tested in accordance with IEC 60068-2-38, max.	100 %; RH incl. condensation/frost (no commissioning under condensation conditions)	100 %; RH incl. condensation/frost (no commissioning under condensation conditions)
Resistance		
Use in stationary industrial systems		
- to biologically active substances according to EN 60721-3-3	Yes; Class 3B2 mold, fungus and dry rot spores (with the exception of fauna); Class 3B3 on request	Yes; Class 3B2 mold, fungus and dry rot spores (with the exception of fauna); Class 3B3 on request
- to chemically active substances according to EN 60721-3-3	Yes; Class 3C4 (RH < 75 %) incl. salt spray acc. to EN 60068-2-52 (severity degree 3); *	Yes; Class 3C4 (RH < 75 %) incl. salt spray acc. to EN 60068-2-52 (severity degree 3); *
- to mechanically active substances according to EN 60721-3-3	Yes; Class 3S4 incl. sand, dust, *	Yes; Class 3S4 incl. sand, dust, *
Use on ships/at sea		
- to biologically active substances according to EN 60721-3-6	Yes; Class 6B2 mold and fungal spores (excluding fauna); Class 6B3 on request	Yes; Class 6B2 mold and fungal spores (excluding fauna); Class 6B3 on request
- to chemically active substances according to EN 60721-3-6	Yes; Class 6C3 (RH < 75 %) incl. salt spray acc. to EN 60068-2-52 (severity degree 3); *	Yes; Class 6C3 (RH < 75 %) incl. salt spray acc. to EN 60068-2-52 (severity degree 3); *
- to mechanically active substances according to EN 60721-3-6	Yes; Class 6S3 incl. sand, dust; *	Yes; Class 6S3 incl. sand, dust; *
Usage in industrial process technology		
- Against chemically active substances acc. to EN 60654-4	Yes; Class 3 (excluding trichlorethylene)	Yes; Class 3 (excluding trichlorethylene)
- Environmental conditions for process, measuring and control systems acc. to ANSI/ISA-71.04	Yes; Level GX group A/B (excluding trichlorethylene; harmful gas concentrations up to the limits of EN 60721-3-3 class 3C4 permissible); level LC3 (salt spray) and level LB3 (oil)	Yes; Level GX group A/B (excluding trichlorethylene; harmful gas concentrations up to the limits of EN 60721-3-3 class 3C4 permissible); level LC3 (salt spray) and level LB3 (oil)
Remark		
- Note regarding classification of environmental conditions acc. to EN 60721, EN 60654-4 and ANSI/ISA-71.04	* The supplied plug covers must remain in place over the unused interfaces during operation!	* The supplied plug covers must remain in place over the unused interfaces during operation!

SIMATIC S7-300 Advanced Controllers

Central processing units

SIPLUS S7-300 compact CPUs

Technical specifications

Article number	6AG1314-6CH04-7AB0	6AG1314-6EH04-7AB0
Based on	6ES7314-6CH04-0AB0 SIPLUS S7-300 CPU314C-2DP	6ES7314-6EH04-0AB0 SIPLUS S7-300 CPU314C-2PN/DP
Ambient conditions		
Ambient temperature during operation		
• min.	-25 °C; = Tmin	-25 °C; = Tmin
• max.	70 °C; = Tmax; 60 °C @ UL/cUL, ATEX and FM use	70 °C; = Tmax; @ 60°C for UL/ATEX/FM use
Altitude during operation relating to sea level		
• Installation altitude above sea level, max.	5 000 m	5 000 m
• Ambient air temperature-barometric pressure-altitude	Tmin ... Tmax at 1 140 hPa ... 795 hPa (-1 000 m ... +2 000 m) // Tmin ... (Tmax - 10 K) at 795 hPa ... 658 hPa (+2 000 m ... +3 500 m) // Tmin ... (Tmax -20 K) at 658 hPa ... 540 hPa (+3 500 m ... +5 000 m)	Tmin ... Tmax at 1 140 hPa ... 795 hPa (-1 000 m ... +2 000 m) // Tmin ... (Tmax - 10 K) at 795 hPa ... 658 hPa (+2 000 m ... +3 500 m) // Tmin ... (Tmax -20 K) at 658 hPa ... 540 hPa (+3 500 m ... +5 000 m)
Relative humidity		
• With condensation, tested in accordance with IEC 60068-2-38, max.	100 %; RH incl. condensation/frost (no commissioning under condensation conditions)	100 %; RH incl. condensation/frost (no commissioning under condensation conditions)
Resistance		
Use in stationary industrial systems		
- to biologically active substances according to EN 60721-3-3	Yes; Class 3B2 mold, fungus and dry rot spores (with the exception of fauna); Class 3B3 on request	Yes; Class 3B2 mold, fungus and dry rot spores (with the exception of fauna); Class 3B3 on request
- to chemically active substances according to EN 60721-3-3	Yes; Class 3C4 (RH < 75 %) incl. salt spray acc. to EN 60068-2-52 (severity degree 3); *	Yes; Class 3C4 (RH < 75 %) incl. salt spray acc. to EN 60068-2-52 (severity degree 3); *
- to mechanically active substances according to EN 60721-3-3	Yes; Class 3S4 incl. sand, dust, *	Yes; Class 3S4 incl. sand, dust, *
Use on ships/at sea		
- to biologically active substances according to EN 60721-3-6	Yes; Class 6B2 mold and fungal spores (excluding fauna); Class 6B3 on request	Yes; Class 6B2 mold and fungal spores (excluding fauna); Class 6B3 on request
- to chemically active substances according to EN 60721-3-6	Yes; Class 6C3 (RH < 75 %) incl. salt spray acc. to EN 60068-2-52 (severity degree 3); *	Yes; Class 6C3 (RH < 75 %) incl. salt spray acc. to EN 60068-2-52 (severity degree 3); *
- to mechanically active substances according to EN 60721-3-6	Yes; Class 6S3 incl. sand, dust; *	Yes; Class 6S3 incl. sand, dust; *
Usage in industrial process technology		
- Against chemically active substances acc. to EN 60654-4	Yes; Class 3 (excluding trichlorethylene)	Yes; Class 3 (excluding trichlorethylene)
- Environmental conditions for process, measuring and control systems acc. to ANSI/ISA-71.04	Yes; Level GX group A/B (excluding trichlorethylene; harmful gas concentrations up to the limits of EN 60721-3-3 class 3C4 permissible); level LC3 (salt spray) and level LB3 (oil)	Yes; Level GX group A/B (excluding trichlorethylene; harmful gas concentrations up to the limits of EN 60721-3-3 class 3C4 permissible); level LC3 (salt spray) and level LB3 (oil)
Remark		
- Note regarding classification of environmental conditions acc. to EN 60721, EN 60654-4 and ANSI/ISA-71.04	* The supplied plug covers must remain in place over the unused interfaces during operation!	* The supplied plug covers must remain in place over the unused interfaces during operation!

Overview CPU 315F-2 DP



- Based on the SIMATIC CPU 315-2 DP
- For constructing a fail-safe automation system for plants with increased safety requirements
- Complies with safety requirements to SIL 3 acc. to IEC 61508 and PL e acc. to ISO 13849.1
- Distributed fail-safe I/O modules can be connected locally via the integrated PROFIBUS DP interface (PROFIsafe)
- Fail-safe ET 200M I/O modules can also be centrally connected
- Central and distributed use of standard modules for non safety-oriented applications

SIMATIC Micro Memory Card required for operation of CPU.

Overview CPU 315F-2 PN/DP



- Based on CPU 315-2 PN/DP
- The CPU with medium-sized program memory and quantity structures for setting up a fail-safe automation system in plants with increased safety requirements
- Complies with safety requirements to SIL 3 acc. to IEC 61508 and PL e acc. to ISO 13849.1
- Distributed fail-safe I/O modules can be locally connected via the integrated PROFINET interface (PROFIsafe) and/or via the integrated PROFIBUS DP interface (PROFIsafe)
- Fail-safe ET 200M I/O modules can also be connected centrally

- Central and distributed use of standard modules for non safety-oriented applications
- Component Based Automation (CBA) on PROFINET
- PROFINET IO controller for operating distributed I/O on PROFINET
- PROFINET interface with 2-port switch
- PROFINET proxy for intelligent devices on PROFIBUS DP in Component Based Automation (CBA)

SIMATIC Micro Memory Card required for operation of CPU.

Overview CPU 317F-2 DP



- The fail-safe CPU with a large program memory and quantity framework for demanding applications
- For constructing a fail-safe automation system for plants with increased safety requirements
- Complies with safety requirements to SIL 3 acc. to IEC 61508 and PL e acc. to ISO 13849.1
- Fail-safe I/O modules can be connected in a distributed configuration to both integral PROFIBUS DP interfaces (PROFIsafe)
- Fail-safe ET 200M I/O modules can also be connected centrally
- Central and distributed use of standard modules for non safety-oriented applications

SIMATIC Micro Memory Card required for operation of CPU.

SIMATIC S7-300 Advanced Controllers

Central processing units

Fail-safe CPUs

Overview CPU 317F-2 PN/DP



- Based on CPU 317-2 PN/DP
- The fail-safe CPU with a large program memory and quantity framework for demanding applications; for setting up a fail-safe automation system in plants with increased safety requirements.
- Complies with safety requirements to SIL 3 acc. to IEC 61508 and PL e acc. to ISO 13849.1
- Distributed fail-safe I/O modules can be locally connected via the integrated PROFINET interface (PROFIsafe) and/or via the integrated PROFIBUS DP interface (PROFIsafe)
- Fail-safe ET 200M I/O modules can also be connected centrally
- Central and distributed use of standard modules for non safety-oriented applications
- Component-based Automation (CBA) on PROFINET
- PROFINET IO controller for operating distributed I/O on PROFINET
- PROFINET interface with 2-port switch
- PROFINET proxy for intelligent devices on PROFIBUS DP in Component-based Automation (CBA)

SIMATIC Micro Memory Card required for operation of CPU.

Overview CPU 319F-3 PN/DP



- The fail-safe CPU with high-performance command processing, large program memory and large quantity structure for demanding applications
- For constructing a fail-safe automation system for plants with increased safety requirements
- Complies with safety requirements to SIL 3 acc. to IEC 61508 and PL e acc. to 13849.1
- Distributed fail-safe I/O modules can be locally connected via the integrated PROFINET interface (PROFIsafe) and/or via the integrated PROFIBUS DP interface (PROFIsafe);
- Fail-safe ET 200M I/O modules can also be connected centrally
- Standard modules for non-safety-related applications can be operated centrally and locally
- Distributed intelligence in Component Based Automation (CBA) on PROFINET
- Isochronous mode on PROFIBUS
- PROFINET proxy for intelligent devices on PROFIBUS DP in Component Based Automation (CBA)

SIMATIC Micro Memory Card required for operation of CPU.

Ordering data	Article No.	Ordering data	Article No.
CPU 315F-2 DP CPU for SIMATIC S7-300F; 384 KB work memory, 24 V DC supply voltage, MPI, PROFIBUS DP master/slave interface, incl. slot number labels; MMC required	6ES7315-6FF04-0AB0	STEP 7 Safety Advanced V17 Task: Engineering tool for configuring and programming fail-safe user programs for SIMATIC S7-1200 FC, S7-1500F, S7-1500F Software Controller, S7-300F, S7-400F, WinAC RTX F, ET 200SP F Controller and the fail-safe ET 200SP, ET 200MP, ET 200S, ET 200M, ET 200iSP, ET 200pro and ET 200eco I/O Requirement: STEP 7 Professional V17 Note: As of TIA Portal V16, the SIMATIC STEP 7 Safety software is an integral component of the SIMATIC STEP 7 product setup. The functionality of SIMATIC STEP 7 Safety is activated by means of the license key supplied in each case. Floating license for 1 user; license key on USB flash drive Floating license for 1 user, license key for download ¹⁾ ; email address required for delivery	6ES7833-1FA17-0YA5 6ES7833-1FA17-0YH5
CPU 315F-2 PN/DP CPU for SIMATIC S7-300F; 512 KB work memory, 24 V DC supply voltage, MPI/PROFIBUS DP master/slave interface, Industrial Ethernet/PROFINET interface; incl. slot number labels; MMC required	6ES7315-2FJ14-0AB0	SIMATIC Micro Memory Card 64 KB 128 KB 512 KB 2 MB 4 MB 8 MB MPI cable For connection of SIMATIC S7 and PG via MPI; length 5 m	6ES7953-8LF31-0AA0 6ES7953-8LG31-0AA0 6ES7953-8LJ31-0AA0 6ES7953-8LL31-0AA0 6ES7953-8LM32-0AA0 6ES7953-8LP31-0AA0 6ES7901-0BF00-0AA0
CPU 317F-2 DP 1.5 MB work memory, supply voltage 24 V DC, MPI, PROFIBUS DP master/slave interface; MMC required	6ES7317-6FF04-0AB0	Slot number plates SIMATIC Manual Collection Electronic manuals on DVD, multi-language: LOGO!, SIMADYN, SIMATIC Bus Components, SIMATIC C7, SIMATIC Distributed I/O, SIMATIC HMI, SIMATIC Sensors, SIMATIC NET, SIMATIC PC-based Automation, SIMATIC PCS 7, SIMATIC PG/PC, SIMATIC S7, SIMATIC Software, SIMATIC TDC	6ES7912-0AA00-0AA0 6ES7998-8XC01-8YE0
CPU 317F-2 PN/DP 1.5 MB work memory, 24 V DC supply voltage; MPI/PROFIBUS DP master/slave interface; Industrial Ethernet/PROFINET interface; MMC required	6ES7317-2FK14-0AB0	SIMATIC Manual Collection update service for 1 year Current Manual Collection DVD and the three subsequent updates	6ES7998-8XC01-8YE2
CPU 319F-3 PN/DP 2.5 MB work memory, supply voltage 24 V DC, combined MPI/PROFIBUS DP master/slave interface, PROFIBUS DP master/slave interface, Ethernet/PROFINET interface; MMC required	6ES7318-3FL01-0AB0	Power supply connector 10 units, spare part	6ES7391-1AA00-0AA0
S7 Distributed Safety V5.4 SP5 Update 2 programming tool Task: Configuration software for configuring fail-safe user programs for SIMATIC S7-300F, S7-400F, WinAC RTX F, ET 200S, ET 200M, ET 200iSP, ET 200pro, ET 200eco, ET 200SP Requirement: Windows 7 SP1 (64-bit) Windows 10 Professional/Enterprise (64-bit) Windows Server 2008 R2 SP1 (64-bit) Windows Server 2012 R2 (64-bit), Windows Server 2016 (64-bit) STEP 7 from V5.5 SP1; Please also consider the operating systems that have been released for the used STEP 7 version Floating license for 1 user, software and documentation on DVD; license key on USB flash drive Floating license for 1 user; software, documentation and license key for download ¹⁾ ; email address required for delivery	6ES7833-1FC02-0YA5 6ES7833-1FC02-0YH5	USB A2 PC adapter For connecting a programming device/PC or notebook to PROFIBUS or MPI; USB cable included in scope of delivery	6GK1571-0BA00-0AA0
S7 Distributed Safety upgrade From V5.x to V5.4; floating license for 1 user, software and documentation on DVD; license key on USB flash drive	6ES7833-1FC02-0YE5		

¹⁾ For up-to-date information and download availability, see:
<http://www.siemens.com/tia-online-software-delivery>

SIMATIC S7-300 Advanced Controllers

Central processing units

Fail-safe CPUs

Ordering data	Article No.	Article No.
PROFIBUS bus components		
PROFIBUS DP RS 485 bus connector		
<ul style="list-style-type: none"> With 90° cable outlet, max. transfer rate 12 Mbps <ul style="list-style-type: none"> Without programming device interface With programming device interface With 90° cable outlet for FastConnect connection system, max. transfer rate 12 Mbps <ul style="list-style-type: none"> Without programming device interface, 1 unit Without programming device interface, 100 units With programming device interface, 1 unit With programming device interface, 100 units With axial cable outlet for SIMATIC OP, for connecting to PPI, MPI, PROFIBUS 	6ES7972-0BA12-0XA0 6ES7972-0BB12-0XA0 6ES7972-0BA52-0XA0 6ES7972-0BA52-0XB0 6ES7972-0BB52-0XA0 6ES7972-0BB52-0XB0 6GK1500-0EA02	
PROFIBUS FastConnect bus cable	6XV1830-0EH10	
Standard type with special design for quick mounting, 2-wire, shielded, sold by the meter, max. delivery unit 1 000 m, minimum order quantity 20 m		
RS 485 repeater for PROFIBUS	6ES7972-0AA02-0XA0	
Transmission rate up to 12 Mbps; 24 V DC; IP20 enclosure		
PROFINET bus components		
IE FC TP standard cable GP 2x2	6XV1840-2AH10	
4-wire, shielded TP installation cable for connection to IE FC RJ45 outlet/IE FC RJ45 plug; PROFINET-compatible; with UL approval; Sold by the meter		
FO standard cable GP (50/125)	6XV1873-2A	
Standard cable, splittable, UL approval, sold by the meter		
		SCALANCE X204-2 Industrial Ethernet Switch
		Industrial Ethernet switches with integrated SNMP access, web diagnostics, copper cable diagnostics and PROFINET diagnostics for configuring line, star and ring topologies; four 10/100 Mbps RJ45 ports and two FO ports
		Compact Switch Module CSM 377
		Unmanaged switch for connecting SIMATIC S7-300, ET 200M and up to three other stations to Industrial Ethernet with 10/100 Mbps; 4 x RJ45 ports; external 24 V DC power supply, LED diagnostics, S7-300 module including electronic Equipment Manual on CD-ROM
		IE FC RJ45 plugs
		RJ45 plug connector for Industrial Ethernet with a rugged metal enclosure and integrated insulation displacement contacts for connecting Industrial Ethernet FC installation cables
		IE FC RJ45 plug 145
		145° cable outlet
		1 unit
		10 units
		50 units
		IE FC RJ45 plug 180
		180° cable outlet
		1 unit
		10 units
		50 units
		PROFIBUS/PROFINET bus components
		For establishing MPI/PROFIBUS/PROFINET communication
		6GK5204-2BB10-2AA3
		6GK7377-1AA00-0AA0
		6GK1901-1BB30-0AA0
		6GK1901-1BB30-0AB0
		6GK1901-1BB30-0AE0
		6GK1901-1BB10-2AA0
		6GK1901-1BB10-2AB0
		6GK1901-1BB10-2AE0
		See Industry Mall

Technical specifications

Article number	6ES7315-6FF04-0AB0	6ES7315-2FJ14-0AB0	6ES7317-6FF04-0AB0	6ES7317-2FK14-0AB0	6ES7318-3FL01-0AB0
	CPU315F, 384KB	CPU315F-2 PN/DP, 512 KB	CPU317F-2DP, 1.5 MB	CPU317F-2 PN/DP, 1.5 MB	CPU319F-3 PN/DP, 2.5 MB
General information					
Product function					
<ul style="list-style-type: none"> Isochronous mode 	Yes	Yes; Via PROFIBUS DP or PROFINET interface		Yes; Via PROFIBUS DP or PROFINET interface	Yes; Via 2nd PROFIBUS DP or PROFINET interface
Engineering with					
<ul style="list-style-type: none"> Programming package 	STEP 7 V5.5 + SP1 or higher or STEP 7 V5.2 + SP1 or higher with HSP 218 + Distributed Safety	STEP 7 V5.5 or higher, Distributed Safety V5.4 SP4	STEP 7 V5.5 + SP1 or higher or STEP 7 V5.2 + SP1 or higher with HSP 202 + Distributed Safety	STEP 7 V5.5 or higher, Distributed Safety V5.4 SP4	STEP 7 V5.5 or higher, Distributed Safety V5.4 SP4
Supply voltage					
Rated value (DC)	24 V	24 V	24 V	24 V	24 V

Technical specifications

Article number	6ES7315-6FF04-0AB0	6ES7315-2FJ14-0AB0	6ES7317-6FF04-0AB0	6ES7317-2FK14-0AB0	6ES7318-3FL01-0AB0
	CPU315F, 384KB	CPU315F-2 PN/DP, 512 KB	CPU317F-2DP, 1.5 MB	CPU317F-2 PN/DP, 1.5 MB	CPU319F-3 PN/DP, 2.5 MB
Memory					
Work memory					
• integrated	384 kbyte	512 kbyte	1 536 kbyte	1 536 kbyte	2 560 kbyte
• expandable	No	No	No	No	No
Load memory					
• Plug-in (MMC), max.	8 Mbyte	8 Mbyte	8 Mbyte	8 Mbyte	8 Mbyte
CPU processing times					
for bit operations, typ.	0.05 µs	0.05 µs	0.025 µs	0.025 µs	0.004 µs
for word operations, typ.	0.09 µs	0.09 µs	0.03 µs	0.03 µs	0.01 µs
for fixed point arithmetic, typ.	0.12 µs	0.12 µs	0.04 µs	0.04 µs	0.01 µs
for floating point arithmetic, typ.	0.45 µs	0.45 µs	0.16 µs	0.16 µs	0.04 µs
Counters, timers and their retentivity					
S7 counter					
• Number	256	256	512	512	2 048
IEC counter					
• present	Yes	Yes	Yes	Yes	Yes
S7 times					
• Number	256	256	512	512	2 048
IEC timer					
• present	Yes	Yes	Yes	Yes	Yes
Data areas and their retentivity					
Flag					
• Size, max.	2 048 byte	2 048 byte	4 096 byte	4 096 byte	8 192 byte
Address area					
I/O address area					
• Inputs	2 048 byte	2 048 byte	8 192 byte	8 192 byte	8 192 byte
• Outputs	2 048 byte	2 048 byte	8 192 byte	8 192 byte	8 192 byte
Process image					
• Inputs, adjustable	2 048 byte	2 048 byte	8 192 byte	8 192 byte	8 192 byte
• Outputs, adjustable	2 048 byte	2 048 byte	8 192 byte	8 192 byte	8 192 byte
Time of day					
Clock					
• Hardware clock (real-time)	Yes	Yes	Yes	Yes	Yes
Operating hours counter					
• Number	1	1	4	4	4
1. Interface					
Interface type	Integrated RS 485 interface	Integrated RS 485 interface	Integrated RS 485 interface	Integrated RS 485 interface	Integrated RS 485 interface
Interface types					
• RS 485	Yes	Yes	Yes	Yes	Yes
Protocols					
• MPI	Yes	Yes	Yes	Yes	Yes
• PROFIBUS DP master	No	Yes	Yes	Yes	Yes
• PROFIBUS DP slave	No	Yes	Yes; A DP slave at both interfaces simultaneously is not possible	Yes	Yes; A DP slave at both interfaces simultaneously is not possible
• Point-to-point connection	No	No	No	No	No
PROFIBUS DP master					
• Number of DP slaves, max.		124	124	124	124

SIMATIC S7-300 Advanced Controllers

Central processing units

Fail-safe CPUs

Technical specifications

Article number	6ES7315-6FF04-0AB0	6ES7315-2FJ14-0AB0	6ES7317-6FF04-0AB0	6ES7317-2FK14-0AB0	6ES7318-3FL01-0AB0
	CPU315F, 384KB	CPU315F-2 PN/DP, 512 KB	CPU317F-2DP, 1.5 MB	CPU317F-2 PN/DP, 1.5 MB	CPU319F-3 PN/DP, 2.5 MB
2. Interface					
Interface type	Integrated RS 485 interface	PROFINET	Integrated RS 485 interface	PROFINET	Integrated RS 485 interface
Interface types					
<ul style="list-style-type: none"> • RJ 45 (Ethernet) • RS 485 • Number of ports 	Yes	Yes	Yes	Yes	Yes
Protocols					
<ul style="list-style-type: none"> • MPI • PROFINET IO Controller • PROFINET IO Device • PROFINET CBA • PROFIBUS DP master • PROFIBUS DP slave 	No	No Yes; Also simultaneously with IO-Device functionality Yes; Also simultaneously with IO Controller functionality	No	No Yes; Also simultaneously with IO-Device functionality Yes; Also simultaneously with IO Controller functionality	No No No Yes Yes; A DP slave at both interfaces simultaneously is not possible
PROFIBUS DP master					
• Number of DP slaves, max.	124; Per station		124		124
PROFINET IO Controller					
Services					
- Number of connectable IO Devices, max.		128		128	
- Of which IO devices with IRT, max.		64		64	
- Number of IO Devices with IRT and the option "high flexibility"		128		128	
- Number of connectable IO Devices for RT, max.		128		128	
3. Interface					
Interface type					PROFINET
Interface types					
<ul style="list-style-type: none"> • RJ 45 (Ethernet) • Number of ports 					Yes 2
Protocols					
<ul style="list-style-type: none"> • MPI • PROFINET IO Controller • PROFINET IO Device • PROFINET CBA • PROFIBUS DP master • PROFIBUS DP slave 					No Yes; Also simultaneously with I-Device functionality Yes; Also simultaneously with IO Controller functionality Yes No No
PROFINET IO Controller					
Services					
- Number of connectable IO Devices, max.					256
- Of which IO devices with IRT, max.					64
- Number of IO Devices with IRT and the option "high flexibility"					256
- Number of connectable IO Devices for RT, max.					256

Technical specifications

Article number	6ES7315-6FF04-0AB0	6ES7315-2FJ14-0AB0	6ES7317-6FF04-0AB0	6ES7317-2FK14-0AB0	6ES7318-3FL01-0AB0
	CPU315F, 384KB	CPU315F-2 PN/DP, 512 KB	CPU317F-2DP, 1.5 MB	CPU317F-2 PN/DP, 1.5 MB	CPU319F-3 PN/DP, 2.5 MB
Protocols					
Open IE communication					
• TCP/IP		Yes; via integrated PROFINET interface and loadable FBs		Yes; via integrated PROFINET interface and loadable FBs	Yes; via integrated PROFINET interface and loadable FBs
- Number of connections, max.		8		16	32
• ISO-on-TCP (RFC1006)		Yes; via integrated PROFINET interface and loadable FBs		Yes; via integrated PROFINET interface and loadable FBs	Yes; via integrated PROFINET interface and loadable FBs
- Number of connections, max.		8		16	32
• UDP		Yes; via integrated PROFINET interface and loadable FBs		Yes; via integrated PROFINET interface and loadable FBs	Yes; via integrated PROFINET interface and loadable FBs
- Number of connections, max.		8		16	32
Web server					
• supported		Yes; only read function		Yes	Yes
Communication functions					
PG/OP communication	Yes	Yes	Yes	Yes	Yes
Data record routing	Yes	Yes	Yes	Yes	Yes
Global data communication					
• supported	Yes	Yes	Yes	Yes	Yes
S7 basic communication					
• supported	Yes	Yes	Yes	Yes	Yes
S7 communication					
• supported	Yes	Yes	Yes	Yes	Yes
S5 compatible communication					
• supported	Yes; via CP and loadable FC	Yes; via CP and loadable FC	Yes; via CP and loadable FC	Yes; via CP and loadable FC	Yes; via CP and loadable FC
Number of connections					
• overall	16	16	32	32	32
Ambient conditions					
Ambient temperature during operation					
• min.	0 °C	0 °C	0 °C	0 °C	0 °C
• max.	60 °C	60 °C	60 °C	60 °C	60 °C
Configuration					
Programming					
Programming language					
- LAD	Yes	Yes	Yes	Yes	Yes
- FBD	Yes	Yes	Yes	Yes	Yes
- STL	Yes	Yes	Yes	Yes	Yes
- SCL	Yes	Yes	Yes	Yes	Yes
- CFC	Yes	Yes	Yes	Yes	Yes
- GRAPH	Yes	Yes	Yes	Yes	Yes
- HiGraph®	Yes	Yes	Yes	Yes	Yes
Know-how protection					
• User program protection/ password protection	Yes	Yes	Yes	Yes	Yes
• Block encryption	Yes; With S7 block Privacy	Yes; With S7 block Privacy	Yes; With S7 block Privacy	Yes; With S7 block Privacy	Yes; With S7 block Privacy
Dimensions					
Width	40 mm	40 mm	40 mm	40 mm	120 mm
Height	125 mm	125 mm	125 mm	125 mm	125 mm
Depth	130 mm	130 mm	130 mm	130 mm	130 mm
Weights					
Weight, approx.	290 g	340 g	360 g	340 g	1 250 g

SIMATIC S7-300 Advanced Controllers

Central processing units

SIPLUS S7-300 fail-safe CPUs

Overview SIPLUS S7-300 CPU 315F-2 DP



- For configuring a fail-safe automation system for plants with increased safety requirements
- Complies with safety requirements up to SIL 3 according to IEC 61508 and up to Cat. 4 according to EN 954-1
- Distributed fail-safe I/O modules can be connected through the integral PROFIBUS DP interface (PROFIsafe)
- Fail-safe ET 200M I/O modules are also centrally connectable
- The standard modules for non-safety applications can be operated both centrally and locally

Micro Memory Card required for operation of CPU.

Note:

SIPLUS extreme products are based on SIMATIC standard products. The contents listed here were taken from the respective standard products. SIPLUS extreme-specific information was added.

Overview SIPLUS S7-300 CPU 315F-2 PN/DP



- The CPU with a medium sized program memory and quantity structures to build a fail-safe automation system for plants with increased safety requirements
- Complies with safety requirements up to SIL 3 according to IEC 61508, PL e in accordance with ISO 13849 and up to Cat. 4 of EN 954-1
- The fail-safe I/O modules can be locally connected to the integrated PROFINET interface (PROFIsafe) and/or to the integrated PROFIBUS DP interface (PROFIsafe)
- Fail-safe ET 200M I/O modules are also centrally connectable
- The standard modules for non-safety applications can be operated both centrally and locally
- Component Based Automation (CBA) on PROFINET
- PROFINET IO controller for operating distributed I/O on PROFINET
- PROFINET interface with 2-port switch
- PROFINET proxy for intelligent devices on PROFIBUS DP in Component Based Automation (CBA)

Micro Memory Card required for operation of CPU.

Note:

SIPLUS extreme products are based on SIMATIC standard products. The contents listed here were taken from the respective standard products. SIPLUS extreme-specific information was added.

Overview SIPLUS S7-300 CPU 317F-2 DP



- The fail-safe CPU with a large program memory and quantity framework for demanding applications
- For configuring a fail-safe automation system for plants with increased safety requirements
- Complies with safety requirements up to SIL 3 according to IEC 61508 and up to Cat. 4 according to EN 954-1
- Fail-safe I/O modules can be connected in a distributed configuration to both integral PROFIBUS DP interfaces (PROFIsafe)
- Fail-safe ET 200M I/O modules are also centrally connectable
- The standard modules for non-safety applications can be operated both centrally and locally

Micro Memory Card required for operation of CPU.

Note:

SIPLUS extreme products are based on SIMATIC standard products. The contents listed here were taken from the respective standard products. SIPLUS extreme-specific information was added.

Overview SIPLUS S7-300 CPU 317F-2 PN/DP



- The failsafe CPU with a large program memory and quantity structures for demanding applications to build a fail-safe automation system for plants with increased safety requirements
- Complies with safety requirements up to SIL 3 according to IEC 61508, PL e in accordance with ISO 13849-1 and up to category 4 of EN 954-1
- The fail-safe I/O modules can be locally connected via the integrated PROFINET interface (PROFIsafe) and/or via the integrated PROFIBUS DP interface (PROFIsafe)
- Fail-safe ET 200M I/O modules are also centrally connectable
- The standard modules for non-safety applications can be operated both centrally and locally
- Component Based Automation (CBA) on PROFINET
- PROFINET IO Controller for operating distributed I/O on PROFINET
- PROFINET interface with 2-port switch
- PROFINET proxy for intelligent devices on PROFIBUS DP in Component Based Automation (CBA)

SIMATIC Micro Memory Card required for operation of CPU.

Note:

SIPLUS extreme products are based on SIMATIC standard products. The contents listed here were taken from the respective standard products. SIPLUS extreme-specific information was added.

SIMATIC S7-300 Advanced Controllers

Central processing units

SIPLUS S7-300 fail-safe CPUs

Ordering data

Article No.

Article No.

SIPLUS S7-300 CPU 315F-2 DP

For industrial applications with extended ambient conditions

CPU for SIPLUS S7-300F; 384 KB work memory, supply voltage 24 V DC, MPI, PROFIBUS DP master/slave interface; incl. slot number labels; MMC required

Extended temperature range and exposure to media

6AG1315-6FF04-2AB0

SIPLUS S7-300 CPU 315F-2 PN/DP

For industrial applications with extended ambient conditions

CPU for SIPLUS S7-300F; 512 KB work memory, supply voltage 24 V DC, MPI/PROFIBUS DP master/slave interface, Industrial Ethernet/PROFINET interface; incl. slot number labels

Extended temperature range and exposure to media

6AG1315-2FJ14-2AB0

SIPLUS S7-300 CPU 317F-2 DP

For industrial applications with extended ambient conditions

CPU for SIPLUS S7-300F, 1.5 MB work memory, supply voltage 24 V DC, MPI, PROFIBUS DP master/slave interface; MMC required

Extended temperature range and exposure to media

6AG1317-6FF04-2AB0

SIPLUS S7-300 CPU 317F-2 PN/DP

For industrial applications with extended ambient conditions

CPU for SIPLUS S7-300F, 1.5 MB work memory, supply voltage 24 V DC, MPI/PROFIBUS DP master/slave interface; Industrial Ethernet/PROFINET interface; MMC required

Extended temperature range and exposure to media

6AG1317-2FK14-2AB0

Accessories

Mandatory

SIMATIC Micro Memory Card

64 KB

6ES7953-8LF31-0AA0

128 KB

6ES7953-8LG31-0AA0

512 KB

6ES7953-8LJ31-0AA0

2 MB

6ES7953-8LL31-0AA0

4 MB

6ES7953-8LM32-0AA0

8 MB

6ES7953-8LP31-0AA0

For communication within the application

PROFIBUS DP RS 485 bus connector

(Extended temperature range and exposure to environmental substances)

With 90° cable outlet, max. transfer rate 12 Mbps

- Without PG interface
- With PG interface

6AG1972-0BA12-2XA0
6AG1972-0BB12-2XA0

With angled cable outlet, max. transmission rate 12 Mbps

- Without PG interface
- With PG interface

6AG1972-0BA42-7XA0
6AG1972-0BB42-7XA0

(Extended temperature range)

With axial cable outlet for SIMATIC OP, for connecting to PPI, MPI, PROFIBUS

6AG1500-0EA02-2AA0

RS 485 repeater for PROFIBUS

6AG1972-0AA02-7XA0

(Extended temperature range and exposure to environmental substances)

Transmission rate up to 12 Mbps; 24 V DC; IP20 enclosure

IE FC RJ45 plug 180

(Extended temperature range and exposure to environmental substances)

180° cable outlet

- 1 unit

6AG1901-1BB10-7AA0

SIPLUS SCALANCE XC-200 Industrial Ethernet Switches

Industrial Ethernet switches with integrated SNMP access, web diagnostics, copper cable diagnostics and PROFINET diagnostics for configuring line, star and ring topologies; with integrated redundancy manager; incl. operating instructions, Industrial Ethernet network manual and configuration software on CD-ROM

Extended temperature range and exposure to media

Switches with PROFINET delivery state

- **SIPLUS SCALANCE XC206-2 (ST/BFOC)**
with six RJ45 ports 10/100 Mbps and two ST/BFOC ports 100 Mbps

6AG1206-2BB00-7AC2

PROFIBUS FastConnect bus cable

6XV1830-0EH10

Standard type with special design for quick mounting, 2-wire, shielded, sold by the meter, max. delivery unit 1 000 m, minimum order quantity 20 m

IE FC TP standard cable GP 2x2

6XV1840-2AH10

4-wire, shielded TP installation cable for connection to IE FC RJ45 outlet/ IE FC RJ45 plug; PROFINET-compatible; with UL approval; Sold by the meter

FO standard cable GP (50/125)

6XV1873-2A

SIMATIC S7-300 Advanced Controllers

Central processing units

SIPLUS S7-300 fail-safe CPUs

Ordering data	Article No.	Ordering data	Article No.
<i>For commissioning</i>		<i>Consumables</i>	
MPI cable For connection of SIMATIC S7 and programming device via MPI; length 5 m	6ES7901-0BF00-0AA0	Power supply connector 10 units, spare part	6ES7391-1AA00-0AA0
USB A2 PC adapter For connecting a programming device/PC or Notebook to PROFIBUS or MPI; USB cable included in scope of delivery	6GK1571-0BA00-0AA0	Slot number plates	6ES7912-0AA00-0AA0
S7 Distributed Safety V5.4 SP5 Update 2 programming tool Task: Configuration software for configuring fail-safe user programs for SIMATIC S7-300F, S7-400F, WinAC RTX F, ET 200S, ET 200M, ET 200iSP, ET 200pro, ET 200eco, ET 200SP Requirement: Windows 7 SP1 (64-bit) Windows 10 Professional/Enterprise (64-bit) Windows Server 2008 R2 SP1 (64-bit) Windows Server 2012 R2 (64-bit), Windows Server 2016 (64-bit) STEP 7 from V5.5 SP1; Please also consider the operating systems that have been released for the used STEP 7 version Floating license for 1 user; software and documentation on DVD; license key on USB flash drive Floating license for 1 user, software, documentation and license key for download ¹⁾ ; Email address required for delivery	6ES7833-1FC02-0YA5 6ES7833-1FC02-0YH5	<i>Documentation</i> SIMATIC Manual Collection Electronic manuals on DVD, multi-language: LOGO!, SIMADYN, SIMATIC bus components, SIMATIC C7, SIMATIC distributed I/O, SIMATIC HMI, SIMATIC Sensors, SIMATIC NET, SIMATIC PC-based Automation, SIMATIC PCS 7, SIMATIC PG/PC, SIMATIC S7, SIMATIC Software, SIMATIC TDC	6ES7998-8XC01-8YE0
S7 Distributed Safety upgrade From V5.x to V5.4; floating license for 1 user; software and documentation on DVD; license key on USB flash drive	6ES7833-1FC02-0YE5	SIMATIC Manual Collection update service for 1 year Current Manual Collection DVD and the three subsequent updates	6ES7998-8XC01-8YE2
STEP 7 Safety Advanced V17 Task: Engineering tool for configuring and programming fail-safe user programs for SIMATIC S7-1200 FC, S7-1500F, S7-1500F Software Controller, S7-300F, S7-400F, WinAC RTX F, ET 200SP F Controller and the fail-safe ET 200SP, ET 200MP, ET 200S, ET 200M, ET 200iSP, ET 200pro and ET 200eco I/O Requirement: STEP 7 Professional V17 <u>Note:</u> As of TIA Portal V16, the SIMATIC STEP 7 Safety software is an integral component of the SIMATIC STEP 7 product setup. The functionality of SIMATIC STEP 7 Safety is activated by means of the license key supplied in each case. Floating license for 1 user; license key on USB flash drive Floating license for 1 user; license key for download ¹⁾ ; Email address required for delivery	6ES7833-1FA17-0YA5 6ES7833-1FA17-0YH5		

¹⁾ For up-to-date information and download availability, see: <http://www.siemens.com/tia-online-software-delivery>

SIMATIC S7-300 Advanced Controllers

Central processing units

SIPLUS S7-300 fail-safe CPUs

Technical specifications

Article number	6AG1315-6FF04-2AB0	6AG1315-2FJ14-2AB0
Based on	6ES7315-6FF04-0AB0	6ES7315-2FJ14-0AB0
	SIPLUS S7-300 CPU 315F-2DP	SIPLUS S7-300 CPU315F-2PN/DP
Ambient conditions		
Ambient temperature during operation		
• min.	-25 °C	-25 °C; = Tmin
• max.	60 °C	60 °C; = Tmax
Altitude during operation relating to sea level		
• Installation altitude above sea level, max.	2 000 m	2 000 m
• Ambient air temperature-barometric pressure-altitude	Tmin ... Tmax at 1 140 hPa ... 795 hPa (-1 000 m ... +2 000 m)	Tmin ... Tmax at 1 140 hPa ... 795 hPa (-1 000 m ... +2 000 m)
Relative humidity		
• With condensation, tested in accordance with IEC 60068-2-38, max.	100 %; RH incl. condensation/frost (no commissioning under condensation conditions)	100 %; RH incl. condensation/frost (no commissioning under condensation conditions)
Resistance		
Use in stationary industrial systems		
- to biologically active substances according to EN 60721-3-3	Yes; Class 3B2 mold, fungus and dry rot spores (with the exception of fauna); Class 3B3 on request	Yes; Class 3B2 mold, fungus and dry rot spores (with the exception of fauna); Class 3B3 on request
- to chemically active substances according to EN 60721-3-3	Yes; Class 3C4 (RH < 75 %) incl. salt spray acc. to EN 60068-2-52 (severity degree 3); *	Yes; Class 3C4 (RH < 75 %) incl. salt spray acc. to EN 60068-2-52 (severity degree 3); *
- to mechanically active substances according to EN 60721-3-3	Yes; Class 3S4 incl. sand, dust, *	Yes; Class 3S4 incl. sand, dust, *
Use on ships/at sea		
- to biologically active substances according to EN 60721-3-6	Yes; Class 6B2 mold and fungal spores (excluding fauna); Class 6B3 on request	Yes; Class 6B2 mold and fungal spores (excluding fauna); Class 6B3 on request
- to chemically active substances according to EN 60721-3-6	Yes; Class 6C3 (RH < 75 %) incl. salt spray acc. to EN 60068-2-52 (severity degree 3); *	Yes; Class 6C3 (RH < 75 %) incl. salt spray acc. to EN 60068-2-52 (severity degree 3); *
- to mechanically active substances according to EN 60721-3-6	Yes; Class 6S3 incl. sand, dust; *	Yes; Class 6S3 incl. sand, dust; *
Usage in industrial process technology		
- Against chemically active substances acc. to EN 60654-4	Yes; Class 3 (excluding trichlorethylene)	Yes; Class 3 (excluding trichlorethylene)
- Environmental conditions for process, measuring and control systems acc. to ANSI/ISA-71.04	Yes; Level GX group A/B (excluding trichlorethylene; harmful gas concentrations up to the limits of EN 60721-3-3 class 3C4 permissible); level LC3 (salt spray) and level LB3 (oil)	Yes; Level GX group A/B (excluding trichlorethylene; harmful gas concentrations up to the limits of EN 60721-3-3 class 3C4 permissible); level LC3 (salt spray) and level LB3 (oil)
Remark		
- Note regarding classification of environmental conditions acc. to EN 60721, EN 60654-4 and ANSI/ISA-71.04	* The supplied plug covers must remain in place over the unused interfaces during operation!	* The supplied plug covers must remain in place over the unused interfaces during operation!

Technical specifications

Article number	6AG1317-6FF04-2AB0	6AG1317-2FK14-2AB0
Based on	6ES7317-6FF04-0AB0	6ES7317-2FK14-0AB0
	SIPLUS S7-300 CPU317F-2DP	SIPLUS S7-300 CPU 317F-2PN/DP
Ambient conditions		
Ambient temperature during operation		
• min.	-25 °C; = Tmin	-25 °C; = Tmin
• max.	60 °C; = Tmax	60 °C; = Tmax
Altitude during operation relating to sea level		
• Installation altitude above sea level, max.	2 000 m	2 000 m
• Ambient air temperature-barometric pressure-altitude	Tmin ... Tmax at 1 140 hPa ... 795 hPa (-1 000 m ... +2 000 m)	Tmin ... Tmax at 1 140 hPa ... 795 hPa (-1 000 m ... +2 000 m)
Relative humidity		
• With condensation, tested in accordance with IEC 60068-2-38, max.	100 %; RH incl. condensation/frost (no commissioning under condensation conditions)	100 %; RH incl. condensation/frost (no commissioning under condensation conditions)
Resistance		
Use in stationary industrial systems		
- to biologically active substances according to EN 60721-3-3	Yes; Class 3B2 mold, fungus and dry rot spores (with the exception of fauna); Class 3B3 on request	Yes; Class 3B2 mold, fungus and dry rot spores (with the exception of fauna); Class 3B3 on request
- to chemically active substances according to EN 60721-3-3	Yes; Class 3C4 (RH < 75 %) incl. salt spray acc. to EN 60068-2-52 (severity degree 3); *	Yes; Class 3C4 (RH < 75 %) incl. salt spray acc. to EN 60068-2-52 (severity degree 3); *
- to mechanically active substances according to EN 60721-3-3	Yes; Class 3S4 incl. sand, dust, *	Yes; Class 3S4 incl. sand, dust, *
Use on ships/at sea		
- to biologically active substances according to EN 60721-3-6	Yes; Class 6B2 mold and fungal spores (excluding fauna); Class 6B3 on request	Yes; Class 6B2 mold and fungal spores (excluding fauna); Class 6B3 on request
- to chemically active substances according to EN 60721-3-6	Yes; Class 6C3 (RH < 75 %) incl. salt spray acc. to EN 60068-2-52 (severity degree 3); *	Yes; Class 6C3 (RH < 75 %) incl. salt spray acc. to EN 60068-2-52 (severity degree 3); *
- to mechanically active substances according to EN 60721-3-6	Yes; Class 6S3 incl. sand, dust; *	Yes; Class 6S3 incl. sand, dust; *
Usage in industrial process technology		
- Against chemically active substances acc. to EN 60654-4	Yes; Class 3 (excluding trichlorethylene)	Yes; Class 3 (excluding trichlorethylene)
- Environmental conditions for process, measuring and control systems acc. to ANSI/ISA-71.04	Yes; Level GX group A/B (excluding trichlorethylene; harmful gas concentrations up to the limits of EN 60721-3-3 class 3C4 permissible); level LC3 (salt spray) and level LB3 (oil)	Yes; Level GX group A/B (excluding trichlorethylene; harmful gas concentrations up to the limits of EN 60721-3-3 class 3C4 permissible); level LC3 (salt spray) and level LB3 (oil)
Remark		
- Note regarding classification of environmental conditions acc. to EN 60721, EN 60654-4 and ANSI/ISA-71.04	* The supplied plug covers must remain in place over the unused interfaces during operation!	* The supplied plug covers must remain in place over the unused interfaces during operation!

SIMATIC S7-300 Advanced Controllers

Central processing units

Technology CPUs

Overview CPU 315T-3 PN/DP



- SIMATIC CPU with integral technology/motion control functionality
- With full standard CPU 315-2 PN/DP functionality (except for CBA)
- For cross-industry automation tasks in series machine, special machine and plant construction
- Ideal for synchronized motion, such as coupling to a virtual/real master, gear synchronization, cam disk, path interpolation, or print mark compensation
- 3D path interpolation with different kinematics
- Position and pressure-regulated hydraulic axes
- Used as central controller in production lines with central and distributed I/O
- With integrated I/O for high-speed technology functions (e.g. camming, reference point acquisition)
- PROFIBUS DP (DRIVE) interface for isochronous connection of drive components
- PROFINET interface with 2-port switch
- PROFINET IO controller for operating distributed I/O on PROFINET
- One common S7 user program for control and motion control tasks (no additional programming language necessary for motion control)
- "S7 Technology" option package required (version V4.2 SP3 and higher)

SIMATIC Micro Memory Card (8 MB) required for operation of the CPU.

Overview CPU 317T-3 PN/DP



- SIMATIC CPU with integral technology/motion control functionality
- With full standard CPU 317-2 PN/DP functionality (except for CBA)
- For cross-industry automation tasks in series machine, special machine and plant construction
- Ideal for synchronized motion, such as coupling to a virtual/real master, gear synchronization, cam disk, path interpolation, or print mark compensation
- 3D path interpolation with different kinematics
- Position and pressure-regulated hydraulic axes
- Used as central controller in production lines with central and distributed I/O
- With integrated I/O for high-speed technology functions (e.g. camming, reference point acquisition)
- PROFIBUS DP (DRIVE) interface for isochronous connection of drive components
- PROFINET interface with 2-port switch
- PROFINET IO controller for operating distributed I/O on PROFINET
- One common S7 user program for control and motion control tasks (no additional programming language necessary for motion control)
- "S7 Technology" option package required (version V4.2 SP3 and higher)

SIMATIC Micro Memory Card (8 MB) required for operation of the CPU.

Overview CPU 317TF-3 PN/DP



- Fail-safe SIMATIC CPU 317TF-3 PN/DP with integral technology/motion control functionality
- Spare-part-compatible successor to the CPU 317TF-2 DP (Article No. 6ES7317-6TF14-0AB0)
- With full functionality of the standard CPU 317-2 PN/DP and CPU 317F-2 PN/DP (except for CBA)
- For cross-industry automation tasks in series machine, special machine and plant construction

- Ideal for synchronized motion, such as coupling to a virtual/real master, gear synchronization, cam disk, path interpolation, or print mark compensation
- 3D path interpolation with different kinematics
- Position and pressure-regulated hydraulic axes
- Used as central controller in production lines with central and distributed I/O
- With integrated I/O for high-speed technology functions (e.g. camming, reference point acquisition)
- PROFIBUS DP (DRIVE) interface for isochronous connection of drive components
- PROFINET interface with 2-port switch
- PROFINET IO controller for operating distributed I/O on PROFINET
- One common S7 user program for control and motion control tasks (no additional programming language necessary for motion control)
- "S7 Technology" option package required
- "S7 Distributed Safety" option package required (version V4.2 SP3 and higher)

SIMATIC Micro Memory Card (8 MB) required for operation of the CPU.

Ordering data

CPU 315T-3 PN/DP

384 KB work memory, 24 V DC supply voltage, MPI, PROFIBUS DP master/slave interface, PROFIBUS DP(DRIVE) interface, Ethernet/PROFINET interface with 2-port switch; with technology/Motion Control functions; MMC required

Article No.

6ES7315-7TJ10-0AB0

CPU 317T-3 PN/DP

1024 KB work memory, supply voltage 24 V DC, MPI, PROFIBUS DP master/slave interface, PROFIBUS DP(DRIVE) interface, Ethernet/PROFINET interface with 2-port switch; with technology/Motion Control functions; MMC required

6ES7317-7TK10-0AB0

CPU 317TF-3 PN/DP

1.5 MB work memory, 24 V DC supply voltage, MPI, PROFIBUS DP master/slave interface, PROFIBUS DP(DRIVE) interface, Ethernet/PROFINET interface with 2-port switch; with technology/Motion Control functions; MMC required

6ES7317-7UL10-0AB0

S7 Technology V4.2

Task:
Option package for configuring and programming technology tasks with SIMATIC S7 CPU 31xT and SIMATIC S7 CPU 317TF
Requirement:
STEP 7 V5.6 and higher
Type of delivery:
On DVD
Incl. documentation for CPU 31xT, CPU 317TF (included on DVD)

Floating license

Floating license for 1 user, license key download without software or documentation¹⁾; email address required for delivery

Article No.

6ES7864-1CC42-0YA5

6ES7864-1CC42-0XH5

¹⁾ For up-to-date information and download availability, see: <http://www.siemens.com/tia-online-software-delivery>

SIMATIC S7-300 Advanced Controllers

Central processing units

Technology CPUs

Ordering data

S7 Distributed Safety V5.4 SP5 Update 2 programming tool

Task:
Configuration software for configuring fail-safe user programs for SIMATIC S7-300F, S7-400F, WinAC RTX F, ET 200S, ET 200M, ET 200iSP, ET 200pro, ET 200eco, ET 200SP

Requirement:
Windows 7 SP1 (64-bit), Windows 10 Professional/Enterprise (64-bit), Windows Server 2008 R2 SP1 (64-bit), Windows Server 2012 R2 (64-bit), Windows Server 2016 (64-bit); STEP 7 from V5.5 SP1; Please also note the operating systems that have been released for the STEP 7 version used

Floating license for 1 user, software and documentation on DVD; license key on USB flash drive

Floating license for 1 user; software, documentation and license key for download¹⁾; email address required for delivery

Article No.

6ES7833-1FC02-0YA5

6ES7833-1FC02-0YH5

6ES7833-1FC02-0YE5

S7 Distributed Safety upgrade

From V5.x to V5.4; floating license for 1 user, software and documentation on DVD; license key on USB flash drive

6ES7833-1FC02-0YE5

SIMATIC Micro Memory Card

8 MB

6ES7953-8LP31-0AA0

MPI cable

For connection of SIMATIC S7 and PG via MPI; length 5 m

6ES7901-0BF00-0AA0

Front connectors

40-pin, with screw connections

- 1 unit
- 100 units

6ES7392-1AM00-0AA0

6ES7392-1AM00-1AB0

40-pin, with spring-loaded contacts

- 1 unit
- 100 units

6ES7392-1BM01-0AA0

6ES7392-1BM01-1AB0

Slot number plates

6ES7912-0AA00-0AA0

SIMATIC Manual Collection

Electronic manuals on DVD, multi-language: LOGO!, SIMADYN, SIMATIC Bus Components, SIMATIC C7, SIMATIC Distributed I/O, SIMATIC HMI, SIMATIC Sensors, SIMATIC NET, SIMATIC PC-based Automation, SIMATIC PCS 7, SIMATIC PG/PC, SIMATIC S7, SIMATIC Software, SIMATIC TDC

6ES7998-8XC01-8YE0

SIMATIC Manual Collection update service for 1 year

Current Manual Collection DVD and the three subsequent updates

6ES7998-8XC01-8YE2

Article No.

Power supply connector

10 units, spare part

6ES7391-1AA00-0AA0

Labeling strips

10 units, spare part

6ES7392-2XX00-0AA0

Label cover

10 units, spare part

6ES7392-2XY00-0AA0

Labeling sheets for machine inscription

For modules with 40-pin front connector, DIN A4, for printing with laser printer; 10 units

Petrol

6ES7392-2AX10-0AA0

Light beige

6ES7392-2BX10-0AA0

Yellow

6ES7392-2CX10-0AA0

Red

6ES7392-2DX10-0AA0

USB A2 PC adapter

For connecting a programming device/PC or notebook to PROFIBUS or MPI; USB cable included in scope of delivery

6GK1571-0BA00-0AA0

PROFIBUS bus components

PROFIBUS DP RS 485 bus connector

- With 90° cable outlet, max. transfer rate 12 Mbps
- Without programming device interface
- With programming device interface

6ES7972-0BA12-0XA0

6ES7972-0BB12-0XA0

- With 90° cable outlet for FastConnect connection system, max. transfer rate 12 Mbps
- Without programming device interface, 1 unit
- Without programming device interface, 100 units
- With programming device interface, 1 unit
- With programming device interface, 100 units

6ES7972-0BA52-0XA0

6ES7972-0BA52-0XB0

6ES7972-0BB52-0XA0

6ES7972-0BB52-0XB0

- With axial cable outlet for SIMATIC OP, for connecting to PPI, MPI, PROFIBUS

6GK1500-0EA02

PROFIBUS FastConnect bus cable

Standard type with special design for quick mounting, 2-wire, shielded, sold by the meter, max. delivery unit 1 000 m, minimum order quantity 20 m

6XV1830-0EH10

RS 485 repeater for PROFIBUS

Transmission rate up to 12 Mbps; 24 V DC; IP20 enclosure

6ES7972-0AA02-0XA0

¹⁾ For up-to-date information and download availability, see: <http://www.siemens.com/tia-online-software-delivery>

Ordering data	Article No.	Article No.
PROFINET bus components		
IE FC TP standard cable GP 2x2 4-wire, shielded TP installation cable for connection to IE FC RJ45 outlet /IE FC RJ45 plug; PROFINET-compatible; with UL approval; sold by the meter	6XV1840-2AH10	
FO standard cable GP (50/125) Standard cable, splittable, UL approval, sold by the meter	6XV1873-2A	
SCALANCE X204-2 Industrial Ethernet Switch Industrial Ethernet switches with integrated SNMP access, web diagnostics, copper cable diagnostics and PROFINET diagnostics for configuring line, star and ring topologies; four 10/100 Mbps RJ45 ports and two FO ports	6GK5204-2BB10-2AA3	
Compact Switch Module CSM 377 Unmanaged switch for connecting the SIMATIC S7-300, ET 200M and up to three other stations to Industrial Ethernet with 10/100 Mbps; 4 x RJ45 ports; external 24 V DC power supply, LED diagnostics, S7-300 module incl. electronic Equipment Manual on CD-ROM	6GK7377-1AA00-0AA0	
		IE FC RJ45 plugs RJ45 plug connector for Industrial Ethernet with a rugged metal enclosure and integrated insulation displacement contacts for connecting Industrial Ethernet FC installation cables
		IE FC RJ45 plug 180 180° cable outlet 1 unit 10 units 50 units
		PROFIBUS/PROFINET bus components For establishing MPI/PROFIBUS/PROFINET communication
		6GK1901-1BB10-2AA0 6GK1901-1BB10-2AB0 6GK1901-1BB10-2AE0 See Industry Mall

Technical specifications

Article number	6ES7315-7TJ10-0AB0 CPU315T-3 PN/DP, 384KB	6ES7317-7TK10-0AB0 CPU317T-3 PN/DP, 1024KB	6ES7317-7UL10-0AB0 CPU317TF-3 PN/DP, 1,5 MB
General information			
Product function			
• Isochronous mode	Yes; Via PROFIBUS DP or PROFINET interface	Yes; Via PROFIBUS DP or PROFINET interface	Yes; Via PROFIBUS DP or PROFINET interface
Engineering with			
• Programming package	STEP 7 V5.5 SP2 or higher and S7-Technology option package V4.2 SP3	STEP 7 V5.5 SP2 or higher and S7-Technology option package V4.2 SP3	STEP 7 V5.5 SP2 or higher; S7-Technology option package V4.2 SP3 or higher, Distributed Safety V5.4 SP5 or higher, S7-F Configuration Pack V5.5 SP10 or higher
Supply voltage			
Rated value (DC)	24 V	24 V	24 V
Memory			
Work memory			
• integrated	384 kbyte	1 024 kbyte	1 536 kbyte
• expandable	No	No	No
Load memory			
• Plug-in (MMC), max.	8 Mbyte	8 Mbyte	8 Mbyte
CPU processing times			
for bit operations, typ.	0.05 µs	0.025 µs	0.025 µs
for word operations, typ.	0.09 µs	0.03 µs	0.03 µs
for fixed point arithmetic, typ.	0.12 µs	0.04 µs	0.04 µs
for floating point arithmetic, typ.	0.45 µs	0.16 µs	0.16 µs
Counters, timers and their retentivity			
S7 counter			
• Number	256	512	512
IEC counter			
• present	Yes	Yes	Yes
S7 times			
• Number	256	512	512
IEC timer			
• present	Yes	Yes	Yes

SIMATIC S7-300 Advanced Controllers

Central processing units

Technology CPUs

Technical specifications

Article number	6ES7315-7TJ10-0AB0 CPU315T-3 PN/DP, 384KB	6ES7317-7TK10-0AB0 CPU317T-3 PN/DP, 1024KB	6ES7317-7UL10-0AB0 CPU317TF-3 PN/DP, 1,5 MB
Data areas and their retentivity			
Flag			
• Size, max.	2 048 byte	4 096 byte	4 096 byte
Address area			
I/O address area			
• Inputs	2 048 byte	8 192 byte	8 192 byte
• Outputs	2 048 byte	8 192 byte	8 192 byte
Process image			
• Inputs, adjustable	2 048 byte	8 192 byte	8 192 byte
• Outputs, adjustable	2 048 byte	8 192 byte	8 192 byte
Time of day			
Clock			
• Hardware clock (real-time)	Yes	Yes	Yes
Operating hours counter			
• Number	1	4	4
Digital outputs			
Integrated high-speed cams			
• Switching accuracy (+/-)	70 µs	70 µs	70 µs
1. Interface			
Interface type	Integrated RS 485 interface	Integrated RS 485 interface	Integrated RS 485 interface
Interface types			
• RS 485	Yes	Yes	Yes
Protocols			
• MPI	Yes	Yes	Yes
• PROFIBUS DP master	Yes	Yes	Yes
• PROFIBUS DP slave	Yes	Yes	Yes
• Point-to-point connection	No	No	No
PROFIBUS DP master			
• Number of DP slaves, max.	124	124	124
2. Interface			
Interface type	Integrated RS 485 interface	Integrated RS 485 interface	Integrated RS 485 interface
Interface types			
• RS 485	Yes	Yes	Yes
Protocols			
• MPI	No	No	No
• PROFIBUS DP master	Yes; DP(DRIVE)-Master	Yes; DP(DRIVE)-Master	Yes; DP(DRIVE)-Master
• PROFIBUS DP slave	No	No	No
PROFIBUS DP master			
• Number of DP slaves, max.	64	64	64
3. Interface			
Interface type	PROFINET	PROFINET	PROFINET
Interface types			
• RJ 45 (Ethernet)	Yes	Yes	Yes
• Number of ports	2	2	2
Protocols			
• MPI	No	No	No
• PROFINET IO Controller	Yes; Also simultaneously with IO-Device functionality	Yes; Also simultaneously with IO-Device functionality	Yes; Also simultaneously with IO-Device functionality
• PROFINET IO Device	Yes; Also simultaneously with IO Controller functionality	Yes; Also simultaneously with IO Controller functionality	Yes; Also simultaneously with IO Controller functionality
• PROFIBUS DP master	No	No	No
• PROFIBUS DP slave	No	No	No

Technical specifications

Article number	6ES7315-7TJ10-0AB0 CPU315T-3 PN/DP, 384KB	6ES7317-7TK10-0AB0 CPU317T-3 PN/DP, 1024KB	6ES7317-7UL10-0AB0 CPU317TF-3 PN/DP, 1,5 MB
PROFINET IO Controller			
Services			
- Number of connectable IO Devices, max.	128	128	128
- Of which IO devices with IRT, max.	64	64	64
- Number of connectable IO Devices for RT, max.	128	128	128
Protocols			
Open IE communication			
• TCP/IP	Yes; via integrated PROFINET interface and loadable FBs	Yes; via integrated PROFINET interface and loadable FBs	Yes; via integrated PROFINET interface and loadable FBs
- Number of connections, max.	8	16	16
• ISO-on-TCP (RFC1006)	Yes; via integrated PROFINET interface and loadable FBs	Yes; via integrated PROFINET interface and loadable FBs	Yes; via integrated PROFINET interface and loadable FBs
- Number of connections, max.	8	16	16
• UDP	Yes; via integrated PROFINET interface and loadable FBs	Yes; via integrated PROFINET interface and loadable FBs	Yes; via integrated PROFINET interface and loadable FBs
- Number of connections, max.	8	16	16
Web server			
• supported	Yes	Yes	Yes
Communication functions			
PG/OP communication	Yes	Yes	Yes
Data record routing	Yes	Yes	Yes
Global data communication			
• supported	Yes	Yes	Yes
S7 basic communication			
• supported	Yes	Yes	Yes
S7 communication			
• supported	Yes	Yes	Yes
S5 compatible communication			
• supported	Yes; via CP and loadable FC	Yes; via CP and loadable FC	Yes; via CP and loadable FC
Number of connections			
• overall	16	32	32
Ambient conditions			
Ambient temperature during operation			
• min.	0 °C	0 °C	0 °C
• max.	60 °C	60 °C	60 °C
Configuration			
Programming			
Programming language			
- LAD	Yes	Yes	Yes
- FBD	Yes	Yes	Yes
- STL	Yes	Yes	Yes
- SCL	Yes	Yes	Yes
- CFC	Yes	Yes	Yes
- GRAPH	Yes	Yes	Yes
- HiGraph®	Yes	Yes	Yes
Know-how protection			
• User program protection/ password protection	Yes	Yes	Yes
• Block encryption	Yes; With S7 block Privacy	Yes; With S7 block Privacy	Yes; With S7 block Privacy
Dimensions			
Width	120 mm	120 mm	120 mm
Height	125 mm	125 mm	125 mm
Depth	130 mm	130 mm	130 mm
Weights			
Weight, approx.	640 g	640 g	640 g

SIMATIC S7-300 Advanced Controllers

I/O modules

Digital modules

SM 321 digital input modules

Overview



- Digital inputs
- For connecting standard switches and two-wire proximity switches (BEROs)

5

Ordering data

SM 321 digital input modules

Incl. labeling strips, bus connector

16 inputs, 24 V DC

6ES7321-1BH02-0AA0

16 inputs, 24 V DC, sourcing input

6ES7321-1BH50-0AA0

32 inputs, 24 V DC

6ES7321-1BL00-0AA0

64 inputs, 24 V DC, source-sinking input

6ES7321-1BP00-0AA0

Note:

6ES7392-4...0-0AA0 connecting cable and 6ES7392-1.N00-0AA0 terminal blocks necessary.

16 inputs, 24 to 48 V DC

6ES7321-1CH00-0AA0

16 inputs, 48 to 125 V DC

6ES7321-1CH20-0AA0

16 inputs, 24 V DC, for isochronous mode

6ES7321-1BH10-0AA0

32 inputs, 120 V AC

6ES7321-1EL00-0AA0

8 inputs, 120/230 V AC

6ES7321-1FF01-0AA0

8 inputs, 120/230 V AC, single root

6ES7321-1FF10-0AA0

16 inputs, 120/230 V AC

6ES7321-1FH00-0AA0

16 inputs, 24 V DC, for isochronous mode, diagnostics-capable

6ES7321-7BH01-0AB0

Front connector

20-pin, with screw contacts

- 1 unit
- 100 units

6ES7392-1AJ00-0AA0

6ES7392-1AJ00-1AB0

20-pin, with spring-loaded contacts

- 1 unit
- 100 units

6ES7392-1BJ00-0AA0

6ES7392-1BJ00-1AB0

40-pin, with screw contacts

- 1 unit
- 100 units

6ES7392-1AM00-0AA0

6ES7392-1AM00-1AB0

40-pin, with spring-loaded contacts

- 1 unit
- 100 units

6ES7392-1BM01-0AA0

6ES7392-1BM01-1AB0

Article No.

S7-300 connecting cable

For 64-channel modules; 2 units

1 m

6ES7392-4BB00-0AA0

2.5 m

6ES7392-4BC50-0AA0

5 m

6ES7392-4BF00-0AA0

Terminal block

For 64-channel modules; 2 units

With screw contacts

6ES7392-1AN00-0AA0

With spring-loaded contacts

6ES7392-1BN00-0AA0

Front door, elevated design

6ES7328-0AA00-7AA0

e.g. for 32-channel modules; for connecting 1.3 mm²/16 AWG conductors; circuit diagram and nameplates in petrol

SIMATIC TOP connect

See page 5/237

Bus connectors

6ES7390-0AA00-0AA0

1 unit (spare part)

Labeling strips

10 units (spare part)

For modules with 20-pin front connector

6ES7392-2XX00-0AA0

For modules with 40-pin front connector

6ES7392-2XX10-0AA0

Label cover

10 units (spare part)

For modules with 20-pin front connector

6ES7392-2XY00-0AA0

For modules with 40-pin front connector

6ES7392-2XY10-0AA0

Ordering data

Labeling sheets for machine printing

For modules with 20-pin front connector, DIN A4, for printing with laser printer; 10 units

Petrol

6ES7392-2AX00-0AA0

Light beige

6ES7392-2BX00-0AA0

Yellow

6ES7392-2CX00-0AA0

Red

6ES7392-2DX00-0AA0

For modules with 40-pin front connector, DIN A4, for printing with laser printer; 10 units

Petrol

6ES7392-2AX10-0AA0

Light beige

6ES7392-2BX10-0AA0

Yellow

6ES7392-2CX10-0AA0

Red

6ES7392-2DX10-0AA0

SIMATIC Manual Collection

Electronic manuals on DVD, multi-language:
LOGO!, SIMADYN,
SIMATIC bus components,
SIMATIC C7, SIMATIC distributed I/O,
SIMATIC HMI, SIMATIC Sensors,
SIMATIC NET, SIMATIC PC-based
Automation, SIMATIC PCS 7,
SIMATIC PG/PC, SIMATIC S7,
SIMATIC Software, SIMATIC TDC

6ES7998-8XC01-8YE0

SIMATIC Manual Collection
update service for 1 year

Current Manual Collection DVD and the three subsequent updates

6ES7998-8XC01-8YE2

Technical specifications

Article number	6ES7321-1BH02-0AA0	6ES7321-1BH50-0AA0	6ES7321-1BL00-0AA0	6ES7321-1BP00-0AA0	6ES7321-1BH10-0AA0
	SM321, 16DI, DC24V	SM321, 16DI, DC24V, Source Input	SM321, 32DI, DC24V	SM321, 64 DI, DC 24V, 3MS, P/M reading	SM321, 16DI, DC24V, 0.05ms Input Delay.
Supply voltage					
Load voltage L+					
• Rated value (DC)	24 V	24 V	24 V	24 V	24 V
Input current					
from backplane bus 5 V DC, max.	10 mA	10 mA	15 mA	100 mA	110 mA
Power loss					
Power loss, typ.	3.5 W	3.5 W	6.5 W	7 W	3.8 W
Digital inputs					
Number of digital inputs	16	16	32	64	16
Input characteristic curve in accordance with IEC 61131, type 1	Yes	Yes	Yes	Yes	Yes
Input voltage					
• Type of input voltage	DC	DC	DC	DC	DC
• Rated value (DC)	24 V	24 V	24 V	24 V	24 V
• for signal "0"	-30 to +5 V	-5 to +30V	-30 to +5 V	-30 to +5 V	-30 to +5 V
• for signal "1"	13 to 30V	-13 to -30V	13 to 30V	13 to 30V	13 to 30V
Input current					
• for signal "1", typ.	7 mA	7 mA	7 mA	4.2 mA	7 mA
Input delay (for rated value of input voltage)					
for standard inputs					
- parameterizable	No	No	No	No	No
- at "0" to "1", min.	1.2 ms	1.2 ms	1.2 ms	1.2 ms	25 µs
- at "0" to "1", max.	4.8 ms	4.8 ms	4.8 ms	4.8 ms	75 µs
Cable length					
• shielded, max.	1 000 m	1 000 m	1 000 m	1 000 m	1 000 m

SIMATIC S7-300 Advanced Controllers

I/O modules

Digital modules

SM 321 digital input modules

Technical specifications

Article number	6ES7321-1BH02-0AA0	6ES7321-1BH50-0AA0	6ES7321-1BL00-0AA0	6ES7321-1BP00-0AA0	6ES7321-1BH10-0AA0
	SM321, 16DI, DC24V	SM321, 16DI, DC24V, Source Input	SM321, 32DI, DC24V	SM321, 64 DI, DC 24V, 3MS, P/M reading	SM321, 16DI, DC24V, 0.05ms Input Delay.
Encoder					
Connectable encoders					
• 2-wire sensor	Yes	Yes	Yes	No	Yes
- permissible quiescent current (2-wire sensor), max.	1.5 mA	1.5 mA	1.5 mA		1.5 mA
Interrupts/diagnostics/status information					
Alarms	No	No	No	No	No
Diagnostics function	No	No	No	No	No
Alarms					
• Diagnostic alarm	No	No	No	No	No
• Hardware interrupt	No	No	No	No	No
Connection method					
required front connector	20-pin	20-pin	40-pin	Cable: 6ES7392-4Bxx0-0AA0 terminal blocks: 6ES7392-1xN00-0AA0	20-pin
Dimensions					
Width	40 mm	40 mm	40 mm	40 mm	40 mm
Height	125 mm	125 mm	125 mm	125 mm	125 mm
Depth	120 mm	120 mm	120 mm	112 mm	120 mm
Weights					
Weight, approx.	200 g	200 g	260 g	230 g	200 g

Article number	6ES7321-7BH01-0AB0	6ES7321-1CH00-0AA0	6ES7321-1CH20-0AA0	6ES7321-1FH00-0AA0
	SM321, 16DI, 24V DC	SM321, 16 DI, AC/DC 24-48V, 1ch/common	SM321, 16DI, DC48-125V	SM321, 16 DI, 120/230V AC
Supply voltage				
Load voltage L+				
• Rated value (DC)	24 V	24 V	48 V	
Load voltage L1				
• Rated value (AC)		24 V		230 V; 120/230 V AC; all load voltages must have the same phase.
Input current				
from load voltage L+ (without load), max.	90 mA			
from backplane bus 5 V DC, max.	130 mA	100 mA	40 mA	29 mA
Encoder supply				
Number of outputs	2			
Output current				
• Rated value	120 mA			
Power loss				
Power loss, typ.	4 W	1.5 W; at 24 V; 2,8 W at 48 V	4.3 W	4.9 W
Digital inputs				
Number of digital inputs	16	16	16	16
Input characteristic curve in accordance with IEC 61131, type 1		Yes	Yes	Yes
Input characteristic curve in accordance with IEC 61131, type 2	Yes			
Input voltage				
• Type of input voltage	DC	AC/DC	DC	AC
• Rated value (DC)	24 V	24 V; DC 24 or 48 V	48 V; 48 V DC to 125 V DC	
• Rated value (AC)		24 V; 24 V AC or 48 V AC (0 ... 63 Hz)		230 V; 120/230 V AC (47 ... 63 Hz)
• for signal "0"	-30 to +5 V	-5V AC to +5V AC	-146 V DC to +15 V DC	0 to 40V
• for signal "1"	13 to 30V	14V AC to 60V AC	30 V DC to 146 V DC	79 to 264V
Input current				
• for signal "1", typ.	7 mA	2.7 mA	3.5 mA	6.5 mA; (120 V, 60 Hz), 16 mA (230 V, 50 Hz)

Technical specifications

Article number	6ES7321-7BH01-0AB0 SM321, 16DI, 24V DC	6ES7321-1CH00-0AA0 SM321, 16 DI, AC/DC 24-48V, 1ch/common	6ES7321-1CH20-0AA0 SM321, 16DI, DC48-125V	6ES7321-1FH00-0AA0 SM321, 16 DI, 120/230V AC
Input delay (for rated value of input voltage) for standard inputs				
- parameterizable	Yes; 0.1 / 0.5 / 3 / 15 / 20 ms	No	No	No
- at "0" to "1", min.		16 ms	0.1 ms	25 ms
- at "0" to "1", max.		16 ms	3.5 ms	25 ms
Cable length				
• shielded, max.	1 000 m	1 000 m	1 000 m	1 000 m
Encoder				
Connectable encoders				
• 2-wire sensor	Yes	Yes	Yes	Yes
- permissible quiescent current (2-wire sensor), max.	2 mA	1 mA	1 mA	2 mA
Interrupts/diagnostics/status information				
Alarms	Yes	No	No	No
Diagnostics function	Yes; Parameterizable	No	No	No
Alarms				
• Diagnostic alarm	Yes; Parameterizable	No	No	No
• Hardware interrupt	Yes; Parameterizable	No	No	No
Connection method				
required front connector	20-pin	40-pin	20-pin	20-pin
Dimensions				
Width	40 mm	40 mm	40 mm	40 mm
Height	125 mm	125 mm	125 mm	125 mm
Depth	120 mm	120 mm	120 mm	120 mm
Weights				
Weight, approx.	200 g	260 g	200 g	240 g
Article number	6ES7321-1EL00-0AA0 SM321, 32DI, AC120V	6ES7321-1FF01-0AA0 SM321, 8DI, AC120/230V	6ES7321-1FF10-0AA0 SM321, 8 DI, AC/DC 120/230V, 1ch/common	
Supply voltage				
Load voltage L1				
• Rated value (AC)	120 V	230 V; 120/230 V AC	230 V; 120/230 V AC; all load voltages must have the same phase.	
Input current				
from backplane bus 5 V DC, max.	16 mA	29 mA	100 mA	
Power loss				
Power loss, typ.	4 W	4.9 W	4.9 W	
Digital inputs				
Number of digital inputs	32	8	8	
Input characteristic curve in accordance with IEC 61131, type 1		Yes	Yes	
Input characteristic curve in accordance with IEC 61131, type 2	Yes			
Input voltage				
• Type of input voltage	AC	AC	AC	
• Rated value (AC)	120 V; 47 ... 63 Hz	230 V; 120/230 V AC (47 ... 63 Hz)	120 V; 120/230 V AC (47 ... 63 Hz)	
• for signal "0"	0 to 20V	0 to 40V	0 to 40V	
• for signal "1"	74 to 132V	79 to 264V	79 to 264V	
Input current				
• for signal "1", typ.	21 mA	6.5 mA; (120 V); 11 mA (230 V)	7.5 mA; (120 V); 17.3 mA (230 V)	
Input delay (for rated value of input voltage) for standard inputs				
- parameterizable	No	No	No	
- at "0" to "1", max.	15 ms	25 ms	25 ms	
Cable length				
• shielded, max.	1 000 m	1 000 m	1 000 m	

SIMATIC S7-300 Advanced Controllers

I/O modules

Digital modules

SM 321 digital input modules**Technical specifications**

Article number	6ES7321-1EL00-0AA0 SM321, 32DI, AC120V	6ES7321-1FF01-0AA0 SM321, 8DI, AC 120/230V	6ES7321-1FF10-0AA0 SM321, 8 DI, AC/DC 120/230V, 1ch/common
Encoder			
Connectable encoders			
• 2-wire sensor	Yes	Yes	Yes
- permissible quiescent current (2-wire sensor), max.	4 mA	2 mA	2 mA
Interrupts/diagnostics/ status information			
Alarms	No	No	No
Diagnostics function	No	No	No
Alarms			
• Diagnostic alarm	No	No	No
• Hardware interrupt	No	No	No
Connection method			
required front connector	40-pin	20-pin	40-pin
Dimensions			
Width	40 mm	40 mm	40 mm
Height	125 mm	125 mm	125 mm
Depth	120 mm	120 mm	120 mm
Weights			
Weight, approx.	300 g	240 g	240 g

Overview



- Digital outputs
- For connecting solenoid valves, contactors, small-power motors, lamps and motor starters

Ordering data

SM 322 digital output modules

Incl. labeling strips, bus connector

8 outputs, 24 V DC, 2 A

16 outputs, 24 V DC, 0.5 A

16 outputs, 24 V DC, 0.5 A, high speed

32 outputs, 24 V DC, 0.5 A

64 outputs, 24 V DC, 0.3 A

Note:

6ES7392-4...0-0AA0 connecting cable and 6ES7392-1.N00-0AA0 terminal blocks necessary.

64 outputs, 24 V DC, 0.3 A, sinking output

Note:

6ES7392-4...0-0AA0 connecting cable and 6ES7392-1.N00-0AA0 terminal blocks necessary.

8 outputs, 24 V DC, 0.5 A, diagnostics-capable

16 outputs, 24/48 V DC, 0.5 A

8 outputs, 48 to 125 V DC, 1.5 A

8 outputs, 120/230 V AC, 1 A

8 outputs, 120/230 V AC, 2 A

16 outputs, 120/230 V AC, 1 A

32 outputs, 120 V AC, 1 A

8 outputs, relay contacts, 2 A

8 outputs, relay contacts, 5 A

8 outputs, relay contacts, 5 A, with RC filter, overvoltage protection

16 outputs, relay contacts, 8 A

Article No.

6ES7322-1BF01-0AA0

6ES7322-1BH01-0AA0

6ES7322-1BH10-0AA0

6ES7322-1BL00-0AA0

6ES7322-1BP00-0AA0

6ES7322-1BP50-0AA0

6ES7322-8BF00-0AB0

6ES7322-5GH00-0AB0

6ES7322-1CF00-0AA0

6ES7322-1FF01-0AA0

6ES7322-5FF00-0AB0

6ES7322-1FH00-0AA0

6ES7322-1FL00-0AA0

6ES7322-1HF01-0AA0

6ES7322-1HF10-0AA0

6ES7322-5HF00-0AB0

6ES7322-1HH01-0AA0

Article No.

Front connector

20-pin, with screw contacts

- 1 unit
- 100 units

20-pin, with spring-loaded contacts

- 1 unit
- 100 units

40-pin, with screw contacts

- 1 unit
- 100 units

40-pin, with spring-loaded contacts

- 1 unit
- 100 units

S7-300 connecting cable

For 64-channel modules; 2 units

1 m

2.5 m

5 m

6ES7392-4BB00-0AA0

6ES7392-4BC50-0AA0

6ES7392-4BF00-0AA0

6ES7392-1AN00-0AA0

6ES7392-1BN00-0AA0

6ES7328-0AA00-7AA0

e.g. for 32-channel modules; for connecting 1.3 mm²/16 AWG conductors

SIMATIC TOP connect

See page 5/237

Bus connectors

1 unit (spare part)

Set of fuses for SM 322

10 fuses 8 A quick-response, 2 fuse holders; for 6ES7 322-1FF01-0AA0, 6ES7 322-1FH00-0AA0

10 fuses 6.3 A; for 6ES7 322-1CF00-0AA0

6ES7973-1HD00-0AA0

6ES7973-1GC00-0AA0

SIMATIC S7-300 Advanced Controllers

I/O modules

Digital modules

SM 322 digital output modules

Ordering data

Ordering data	Article No.	Ordering data	Article No.
Labeling strips 10 units (spare part) For modules with 20-pin front connector 6ES7392-2XX00-0AA0 For modules with 40-pin front connector 6ES7392-2XX10-0AA0		SIMATIC Manual Collection Electronic manuals on DVD, multi-language: LOGO!, SIMADYN, SIMATIC bus components, SIMATIC C7, SIMATIC distributed I/O, SIMATIC HMI, SIMATIC Sensors, SIMATIC NET, SIMATIC PC-based Automation, SIMATIC PCS 7, SIMATIC PG/PC, SIMATIC S7, SIMATIC Software, SIMATIC TDC	6ES7998-8XC01-8YE0
Label cover 10 units (spare part) For modules with 20-pin front connector 6ES7392-2XY00-0AA0 For modules with 40-pin front connector 6ES7392-2XY10-0AA0		SIMATIC Manual Collection update service for 1 year Current Manual Collection DVD and the three subsequent updates	6ES7998-8XC01-8YE2
Labeling sheets for machine printing For modules with 20-pin front connector, DIN A4, for printing with laser printer; 10 units Petrol 6ES7392-2AX00-0AA0 Light beige 6ES7392-2BX00-0AA0 Yellow 6ES7392-2CX00-0AA0 Red 6ES7392-2DX00-0AA0 For modules with 40-pin front connector, DIN A4, for printing with laser printer; 10 units Petrol 6ES7392-2AX10-0AA0 Light beige 6ES7392-2BX10-0AA0 Yellow 6ES7392-2CX10-0AA0 Red 6ES7392-2DX10-0AA0			

Technical specifications

Article number	6ES7322-1BH01-0AA0	6ES7322-1BH10-0AA0	6ES7322-1BL00-0AA0	6ES7322-1BP00-0AA0	6ES7322-1BP50-0AA0	6ES7322-8BF00-0AB0
	SM322, 16DO 24V DC, 0,5A	SM322 High Speed, 16DO 24V DC, 0,5A	SM322, 32DO 24V DC, 0,5A	SM322 64DA, DC24V, 0,3A P-write	SM322 64DO, DC24V, 0,3A M-write	SM322, 8DO, 24V DC, 0,5A
Supply voltage						
Load voltage L+						
• Rated value (DC)	24 V	24 V	24 V	24 V	24 V	24 V
Input current						
from load voltage L+ (without load), max.	80 mA	110 mA	160 mA	75 mA	75 mA	90 mA
from backplane bus 5 V DC, max.	80 mA	70 mA	110 mA	100 mA	100 mA	70 mA
Power loss						
Power loss, typ.	4.9 W	5 W	6.6 W	6 W	6 W	5 W
Digital outputs						
Number of digital outputs	16	16	32	64	64	8
Short-circuit protection	Yes; Electronic	Yes; Electronic	Yes; Electronic	Yes; Electronic	Yes; Electronic	Yes; Electronic
Limitation of inductive shutdown voltage to	L+ (-53 V)	L+ (-53 V)	L+ (-53 V)	L+ (-53 V)	M+ (45 V)	L+ (-45 V)
Switching capacity of the outputs						
• on lamp load, max.	5 W	5 W	5 W	5 W	5 W	5 W
Load resistance range						
• lower limit	48 Ω	48 Ω	48 Ω	80 Ω	80 Ω	48 Ω
• upper limit	4 kΩ	4 kΩ	4 kΩ	10 kΩ	10 kΩ	3 kΩ
Output voltage						
• for signal "1", min.	L+ (-0.8 V)	L+ (-0.8 V)	L+ (-0.8 V)	L+ (-0.5 V)	M+ (0.5 V)	L+ (-0.8 to -1.6 V)
Output current						
• for signal "1" rated value	0.5 A	0.5 A	0.5 A	0.3 A	0.3 A	0.5 A
• for signal "0" residual current, max.	0.5 mA	0.5 mA	0.5 mA	0.1 mA		0.5 mA

Technical specifications

Article number	6ES7322-1BH01-0AA0 SM322, 16DO 24V DC, 0,5A	6ES7322-1BH10-0AA0 SM322 High Speed, 16DO 24V DC, 0,5A	6ES7322-1BL00-0AA0 SM322, 32DO 24V DC, 0,5A	6ES7322-1BP00-0AA0 SM322 64DA, DC24V, 0,3A P-write	6ES7322-1BP50-0AA0 SM322 64DO, DC24V, 0,3A M-write	6ES7322-8BF00-0AB0 SM322, 8DO, 24V DC, 0,5A
Switching frequency						
• with resistive load, max.	100 Hz	1 000 Hz	100 Hz	100 Hz	100 Hz	100 Hz
• with inductive load, max.	0.5 Hz	0.5 Hz	0.5 Hz	0.5 Hz	0.5 Hz	2 Hz
• on lamp load, max.	10 Hz	10 Hz	10 Hz	10 Hz	10 Hz	10 Hz
Total current of the outputs (per group)						
horizontal installation						
- up to 40 °C, max.	4 A	4 A	4 A	1.6 A	1.6 A	4 A
- up to 60 °C, max.	3 A	3 A	3 A	1.2 A	1.2 A	3 A
vertical installation						
- up to 40 °C, max.	2 A	2 A	2 A	1.6 A	1.6 A	4 A
Cable length						
• shielded, max.	1 000 m	1 000 m	1 000 m	1 000 m	1 000 m	1 000 m
Interrupts/diagnostics/status information						
Alarms	No	No	No	No	No	
Diagnostics function	No	No	No	No	No	Yes; Parameterizable
Alarms						
• Diagnostic alarm	No	No	No	No	No	Yes; Parameterizable
Connection method						
required front connector	20-pin	20-pin	40-pin	Cable: 6ES7392-4Bxx0-0AA0 terminal blocks: 6ES7392-1xN00-0AA0	Cable: 6ES7392-4Bxx0-0AA0 terminal blocks: 6ES7392-1xN00-0AA0	20-pin
Dimensions						
Width	40 mm	40 mm	40 mm	40 mm	40 mm	40 mm
Height	125 mm	125 mm	125 mm	125 mm	125 mm	125 mm
Depth	120 mm	120 mm	120 mm	112 mm	112 mm	120 mm
Weights						
Weight, approx.	190 g	200 g	260 g	230 g	230 g	210 g
Article number	6ES7322-5GH00-0AB0 SM322, 16DO, AC/DC24-48V, 0,5A	6ES7322-1CF00-0AA0 SM322, 8DO, 48-125V DC, 1,5A	6ES7322-1BF01-0AA0 SM322, 8DO, 24V DC, 2A	6ES7322-1FF01-0AA0 SM322, 8DO, 120/230V AC, 1A	6ES7322-5FF00-0AB0 SM322, 8DO, AC120/230V, 2A	6ES7322-1FH00-0AA0 SM322, 16DO, 120/230V AC, 1A
Supply voltage						
Load voltage L+						
• Rated value (DC)	24 V; 24 / 48	48 V; 48 V DC to 125 V DC	24 V			
Load voltage L1						
• Rated value (AC)				230 V; 120/230 V AC	230 V; 120/230 V AC	230 V; 120/230 V AC
Input current						
from supply voltage L+, max.	200 mA					
from load voltage L+ (without load), max.		2 mA	60 mA			
from load voltage L1 (without load), max.				2 mA	2 mA	2 mA
from backplane bus 5 V DC, max.	100 mA	100 mA	40 mA	100 mA	100 mA	200 mA
Power loss						
Power loss, typ.	2.8 W	7.2 W	6.8 W	8.6 W	8.6 W	8.6 W
Digital outputs						
Number of digital outputs	16	8	8	8	8	16
Short-circuit protection	No; to be provided externally	Yes; Electronic	Yes; Electronic	Yes; Fuse 8 A, 250 V; per group	Yes; to be provided externally; fuse 3.15 A / 250 V, quick response	Yes; Fuse 8 A, 250 V; per group
Limitation of inductive shutdown voltage to		M (-1 V)	L+ (-48 V)			

SIMATIC S7-300 Advanced Controllers

I/O modules

Digital modules

SM 322 digital output modules

Technical specifications

Article number	6ES7322-5GH00-0AB0	6ES7322-1CF00-0AAA0	6ES7322-1BF01-0AAA0	6ES7322-1FF01-0AAA0	6ES7322-5FF00-0AB0	6ES7322-1FH00-0AAA0
	SM322, 16DO, AC/DC24-48V, 0,5A	SM322, 8DO, 48-125V DC, 1,5A	SM322, 8DO, 24V DC, 2A	SM322, 8DO, 120/230V AC, 1A	SM322, 8DO, AC120/230V, 2A	SM322, 16DO, 120/230V AC, 1A
Switching capacity of the outputs						
• on lamp load, max.	2.5 W	15 W; 15 W (48 V) or 40 W (125 V)	10 W	50 W	50 W	50 W
Load resistance range						
• lower limit			12 Ω			
• upper limit			4 kΩ			
Output voltage						
• for signal "1", min.	L+ (-0.25 V)	L+ (-1.2 V)	L+ (-0.8 V)	L1 (-1.5 V)	L1 (-8.5 V)	
Output current						
• for signal "1" rated value	0.5 A	1.5 A	2 A	2 A	2 A	1 A
• for signal "0" residual current, max.	10 μA	0.5 mA	0.5 mA	2 mA	2 mA	2 mA
Switching frequency						
• with resistive load, max.	10 Hz	25 Hz	100 Hz	10 Hz	10 Hz	10 Hz
• with inductive load, max.	0.5 Hz	0.5 Hz	0.5 Hz	0.5 Hz	0.5 Hz	0.5 Hz
• on lamp load, max.	0.5 Hz	10 Hz	10 Hz	1 Hz	1 Hz	1 Hz
Total current of the outputs (per group)						
horizontal installation						
- up to 40 °C, max.	0.5 A; 8 A per module	6 A	4 A	4 A	8 A	4 A
- up to 50 °C, max.		4 A				
- up to 60 °C, max.	0.5 A; 8 A per module	3 A	4 A	2 A	4 A	2 A
vertical installation						
- up to 40 °C, max.	0.5 A; 8 A per module	4 A	4 A	2 A	4 A	2 A
Cable length						
• shielded, max.	1 000 m	1 000 m	1 000 m	1 000 m	1 000 m	1 000 m
Interrupts/diagnostics/status information						
Alarms		No	No	No		
Diagnostics function	Yes; Parameterizable	No	No	Yes; Fuse blown or load voltage missing	Yes; Parameterizable	Yes; Fuse blown or load voltage missing
Alarms						
• Diagnostic alarm	Yes; Parameterizable	No	No	No	Yes; Parameterizable	No
Connection method						
required front connector	40-pin	20-pin	20-pin	20-pin	40-pin	20-pin
Dimensions						
Width	40 mm	40 mm	40 mm	40 mm	40 mm	40 mm
Height	125 mm	125 mm	125 mm	125 mm	125 mm	125 mm
Depth	120 mm	120 mm	120 mm	120 mm	120 mm	120 mm
Weights						
Weight, approx.	260 g	250 g	190 g	275 g	275 g	275 g

Article number	6ES7322-1FL00-0AAA0	6ES7322-1HF01-0AAA0	6ES7322-1HF10-0AAA0	6ES7322-5HF00-0AB0	6ES7322-1HH01-0AAA0
	SM322, 32DO, 120/230V AC, 1A	SM322, 8DA, 24V DC/2A or 230V AC/2A	SM322, 8DA, 24V DC/5A OR 230V AC/5A	SM322, 8DO Relay, 24VDC, 120-230V AC, 5A	SM322, 16DO Relay
Supply voltage					
Load voltage L+					
• Rated value (DC)		24 V	120 V	24 V	120 V
Load voltage L1					
• Rated value (AC)	120 V; 120/230 V AC		230 V	230 V	230 V
Input current					
from supply voltage L+, max.		160 mA	125 mA	160 mA	250 mA
from load voltage L1 (without load), max.	10 mA				
from backplane bus 5 V DC, max.	190 mA	40 mA	40 mA	100 mA	100 mA

Technical specifications

Article number	6ES7322-1FL00-0AA0	6ES7322-1HF01-0AA0	6ES7322-1HF10-0AA0	6ES7322-5HF00-0AB0	6ES7322-1HH01-0AA0
	SM322, 32DO, 120/230V AC, 1A	SM322, 8DA, 24V DC/2A or 230V AC/2A	SM322, 8DA, 24V DC/5A OR 230V AC/5A	SM322, 8DO Relay, 24VDC, 120-230V AC, 5A	SM322, 16DO Relay
Power loss					
Power loss, typ.	25 W	3.2 W	3.2 W	3.5 W	4.5 W
Digital outputs					
Number of digital outputs	32	8; Relays	8; Relays	8; Relays	16; Relays
Short-circuit protection	No	No	No; to be provided externally	No; to be provided externally	No
Switching capacity of the outputs					
• on lamp load, max.	50 W	50 W	1 500 W; 230 V AC	1 500 W; 230 V AC	50 W; 230 V AC
Output voltage					
• for signal "1", min.	L1 (-0.8 V)				
Output current					
• for signal "1" rated value	1 A	2 A	5 A	5 A	2 A
• for signal "0" residual current, max.	2 mA				
Switching frequency					
• with resistive load, max.	10 Hz	2 Hz	2 Hz	2 Hz	1 Hz
• with inductive load, max.	0.5 Hz	0.5 Hz	0.5 Hz	0.5 Hz	0.5 Hz
• on lamp load, max.	1 Hz	2 Hz	2 Hz	2 Hz	1 Hz
• mechanical, max.		10 Hz	10 Hz	10 Hz	10 Hz
Total current of the outputs (per group)					
horizontal installation					
- up to 40 °C, max.	4 A				
- up to 60 °C, max.	3 A		5 A	5 A	8 A
vertical installation					
- up to 40 °C, max.	4 A		5 A	5 A	8 A
Relay outputs					
• Rated supply voltage of relay coil L+ (DC)		24 V; 110 mA	24 V		24 V
• Contact connection (internal)		Yes; SIOV-CU4032 K275G	No	Yes; 330 Ohm, 0.1uF	No
• Number of operating cycles, max.		300 000; 230 V AC; 100 000; 120 V AC; 200 000; 24 V DC; 300 000 (at 2 A)	300 000; 300 000 (24 V DC, at 2 A); 200 000 (120 V AC, at 3 A); 100 000 (230 V AC, at 3 A)	100 000; 100 000 (24 V DC, at 5 A); 100 000 (230 V AC, at 5 A)	100 000; 50 000 (24 V DC, at 2 A); 700 000 (120 V AC, at 2 A); 100 000 (230 V AC, at 2 A)
Switching capacity of contacts					
- with inductive load, max.		2 A; 2 A (230 V AC), 2 A (24 V DC)	3 A; 3 A (230 V DC), 2 A (24 V AC)	5 A; 5 A (230 V DC), 5 A (24 V AC)	2 A; 2 A (230 V AC), 2 A (24 V DC)
- with resistive load, max.		2 A	8 A; 8 A (230 V DC), 5 A (24 V AC)	5 A; 5 A (230 V DC), 5 A (24 V AC)	2 A; 2 A (230 V AC), 2 A (24 V DC)
- Thermal continuous current, max.		3 A	8 A	5 A	2 A
Cable length					
• shielded, max.	1 000 m	1 000 m	1 000 m	1 000 m	1 000 m
Interrupts/diagnostics/status information					
Alarms	No	No	No	Yes	No
Diagnostics function	Yes; Fuse blown or load voltage missing	No	No	Yes; Parameterizable	No
Alarms					
• Diagnostic alarm	No	No	No	Yes; Parameterizable	No
Connection method					
required front connector	20-pin	20-pin	40-pin	40-pin	20-pin
Dimensions					
Width	80 mm	40 mm	40 mm	40 mm	40 mm
Height	125 mm	125 mm	125 mm	125 mm	125 mm
Depth	117 mm	120 mm	120 mm	120 mm	120 mm
Weights					
Weight, approx.	500 g	190 g	320 g	320 g	250 g

SIMATIC S7-300 Advanced Controllers

I/O modules

Digital modules

SM 323/SM 327 digital input/output modules**Overview**

- Digital inputs and outputs
- For connection of switches, 2-wire proximity switches (BEROs), solenoid valves, contactors, low-power motors, lamps and motor starters

5

Ordering data**Article No.****SM 323 digital input/output modules**

incl. labeling strips, bus connector

8 inputs, 8 outputs

6ES7323-1BH01-0AA0

16 inputs, 16 outputs

6ES7323-1BL00-0AA0**SM 327 digital input/output modules**

incl. labeling strips, bus connector

8 inputs, 8 inputs or outputs
(can be configured)**6ES7327-1BH00-0AB0****Front connector**

20-pin, with screw contacts

- 1 unit
- 100 units

6ES7392-1AJ00-0AA0
6ES7392-1AJ00-1AB0

20-pin, with spring-loaded contacts

- 1 unit
- 100 units

6ES7392-1BJ00-0AA0
6ES7392-1BJ00-1AB0

40-pin, with screw contacts

- 1 unit
- 100 units

6ES7392-1AM00-0AA0
6ES7392-1AM00-1AB0

40-pin, with spring-loaded contacts

- 1 unit
- 100 units

6ES7392-1BM01-0AA0
6ES7392-1BM01-1AB0**Front door, elevated design****6ES7328-0AA00-7AA0**e.g. for 32 channel modules;
enables connection of
1.3 mm²/16 AWG wires**SIMATIC TOP connect**

See page 5/237

Bus connectors**6ES7390-0AA00-0AA0**

1 unit (spare part)

Labeling strips

10 units (spare part)

for modules with 20-pin front
connector**6ES7392-2XX00-0AA0**for modules with 40-pin front
connector**6ES7392-2XX10-0AA0****Article No.****Label cover**

10 units (spare part)

for modules with 20-pin front
connector**6ES7392-2XY00-0AA0**for modules with 40-pin front
connector**6ES7392-2XY10-0AA0****Labeling sheets for machine
inscription**for modules with 20-pin front
connector, DIN A4, for printing with
laser printer; 10 units

petrol

6ES7392-2AX00-0AA0

light-beige

6ES7392-2BX00-0AA0

yellow

6ES7392-2CX00-0AA0

red

6ES7392-2DX00-0AA0for modules with 40-pin front
connector, DIN A4, for printing with
laser printer; 10 units

petrol

6ES7392-2AX10-0AA0

light-beige

6ES7392-2BX10-0AA0

yellow

6ES7392-2CX10-0AA0

red

6ES7392-2DX10-0AA0**SIMATIC Manual Collection****6ES7998-8XC01-8YE0**Electronic manuals on DVD,
multilingual:
LOGO!, SIMADYN,
SIMATIC bus components,
SIMATIC C7, SIMATIC distributed I/O,
SIMATIC HMI, SIMATIC Sensors,
SIMATIC NET, SIMATIC PC Based
Automation, SIMATIC PCS 7,
SIMATIC PG/PC, SIMATIC S7,
SIMATIC Software, SIMATIC TDC**SIMATIC Manual Collection
update service for 1 year****6ES7998-8XC01-8YE2**Current "Manual Collection" DVD
and the three subsequent updates

Technical specifications

Article number	6ES7323-1BH01-0AA0 SM323, 8DI/8DO, DC24V, 0,5A	6ES7323-1BL00-0AA0 SM323, 16DI/DO, DC24V, 0,5A	6ES7327-1BH00-0AB0 SM327, 8DI/8DX, DC24V, 0,5A
Supply voltage			
Load voltage L+			
• Rated value (DC)	24 V	24 V	24 V
Input current			
from load voltage L+ (without load), max.	40 mA	80 mA	20 mA
from backplane bus 5 V DC, max.	40 mA	80 mA	60 mA
Power loss			
Power loss, typ.	3.5 W	6.5 W	3 W
Digital inputs			
Number of digital inputs	8	16	8; 8 hard-wired, 8 others individually parameterizable
Input characteristic curve in accordance with IEC 61131, type 1	Yes	Yes	Yes
Input voltage			
• Type of input voltage	DC	DC	DC
• Rated value (DC)	24 V	24 V	24 V
• for signal "0"	-30 to +5 V	-30 to +5 V	-30 to +5 V
• for signal "1"	13 to 30V	13 to 30V	+15 to +30 V
Input current			
• for signal "1", typ.	7 mA	7 mA	6 mA
Input delay (for rated value of input voltage) for standard inputs			
- at "0" to "1", min.	1.2 ms	1.2 ms	1.2 ms
- at "0" to "1", max.	4.8 ms	4.8 ms	4.8 ms
Cable length			
• shielded, max.	1 000 m	1 000 m	1 000 m
Digital outputs			
Number of digital outputs	8	16	8; can also be parameterized individually as DI
Short-circuit protection	Yes	Yes	Yes
Limitation of inductive shutdown voltage to	L+ (-53 V)	L+ (-48 V)	L+ (-54 V)
Switching capacity of the outputs			
• on lamp load, max.	5 W	5 W	5 W
Load resistance range			
• lower limit	48 Ω	48 Ω	48 Ω
• upper limit	4 kΩ	4 kΩ	4 kΩ
Output voltage			
• for signal "1", min.	L+ (-0.8 V)	L+ (-0.8 V)	L+ (-1.5 V)
Output current			
• for signal "1" rated value	0.5 A	0.5 A	0.5 A
• for signal "0" residual current, max.	0.5 mA	0.5 mA	0.5 mA
Switching frequency			
• with resistive load, max.	100 Hz	100 Hz	100 Hz
• with inductive load, max.	0.5 Hz	0.5 Hz	0.5 Hz
• on lamp load, max.	10 Hz	100 Hz	10 Hz
Total current of the outputs (per group)			
horizontal installation			
- up to 40 °C, max.	4 A	4 A	4 A
- up to 60 °C, max.	4 A	3 A	3 A
vertical installation			
- up to 40 °C, max.	4 A	2 A	2 A
Cable length			
• shielded, max.	1 000 m	1 000 m	1 000 m

SIMATIC S7-300 Advanced Controllers

I/O modules

Digital modules

SM 323/SM 327 digital input/output modules**Technical specifications**

Article number	6ES7323-1BH01-0AA0	6ES7323-1BL00-0AA0	6ES7327-1BH00-0AB0
	SM323, 8DI/8DO, DC24V, 0,5A	SM323, 16DI/DO, DC24V, 0,5A	SM327, 8DI/8DX, DC24V, 0,5A
Encoder			
Connectable encoders			
• 2-wire sensor	Yes	Yes	Yes
- permissible quiescent current (2-wire sensor), max.	2 mA	1.5 mA	1.5 mA
Interrupts/diagnostics/status information			
Alarms	No	No	No
Diagnostics function	No	No	No
Connection method			
required front connector	20-pin	40-pin	20-pin
Dimensions			
Width	40 mm	40 mm	40 mm
Height	125 mm	125 mm	125 mm
Depth	120 mm	120 mm	120 mm
Weights			
Weight, approx.	220 g	260 g	200 g

5

Overview

- Digital inputs
- For connection of switches and 2-wire proximity switches (BEROs)

Note:

SIPLUS extreme products are based on SIMATIC standard products. The contents listed here were taken from the respective standard products. SIPLUS extreme-specific information was added.

Ordering data**Article No.****Article No.****SIPLUS S7-300 SM 321 digital input modules**

For industrial applications with extended ambient conditions

Extended temperature range and exposure to media

16 inputs, 24 V DC

6AG1321-1BH02-2AA0

32 inputs, 24 V DC

6AG1321-1BL00-2AA0

16 inputs, 48 to 120 V DC

6AG1321-1CH20-2AA0

8 inputs, 120/230 V AC

6AG1321-1FF01-2AA0

8 inputs, 120/230 V AC, single root

6AG1321-1FF10-7AA0

16 inputs, 120/230 V AC

6AG1321-1FH00-7AA0

16 inputs, 24 V DC, diagnostics-capable

6AG1321-7BH01-2AB0Exposure to media

16 inputs, NAMUR, redundant design possible

6AG1321-7TH00-4AB0

For rolling stock railway applications

Conforms to EN 50155

16 inputs, 24 V DC

6AG1321-1BH02-2AA0

32 inputs, 24 V DC

6AG1321-1BL00-2AA0

16 inputs, 48 to 120 V DC

6AG1321-1CH20-2AA0

8 inputs, 120/230 V AC

6AG1321-1FF01-2AA0

16 inputs, 24 V DC, diagnostics-capable

6AG1321-7BH01-2AB0**Accessories**Mandatory**Front connector**

20-pin, with spring-loaded contacts

- 1 unit
- 100 units

6ES7392-1BJ00-0AA0**6ES7392-1BJ00-1AB0**

40-pin, with spring-loaded contacts

- 1 unit
- 100 units

6ES7392-1BM01-0AA0**6ES7392-1BM01-1AB0**Consumables**Front door, elevated design****6ES7328-0AA00-7AA0**

E.g. for 32-channel modules; for connecting 1.3 mm²/16 AWG conductors; circuit diagram and nameplates in petrol

Bus connectors**6ES7390-0AA00-0AA0**

1 unit (spare part)

Labeling strips

10 units; spare part

For modules with 20-pin front connector

6ES7392-2XX00-0AA0

For modules with 40-pin front connector

6ES7392-2XX10-0AA0**Label cover**

10 units; spare part

For modules with 20-pin front connector

6ES7392-2XY00-0AA0

For modules with 40-pin front connector

6ES7392-2XY10-0AA0Documentation**SIMATIC Manual Collection****6ES7998-8XC01-8YE0**

Electronic manuals on DVD, multi-language: LOGO!, SIMADYN, SIMATIC bus components, SIMATIC C7, SIMATIC distributed I/O, SIMATIC HMI, SIMATIC Sensors, SIMATIC NET, SIMATIC PC Based Automation, SIMATIC PCS 7, SIMATIC PG/PC, SIMATIC S7, SIMATIC Software, SIMATIC TDC

SIMATIC Manual Collection update service for 1 year**6ES7998-8XC01-8YE2**

Current "Manual Collection" DVD and the three subsequent updates

SIMATIC S7-300 Advanced Controllers

I/O modules

SIPLUS S7-300 digital modules

SIPLUS S7-300 SM 321

Technical specifications

Article number	6AG1321-1BH02-2AA0	6AG1321-1BL00-2AA0	6AG1321-1CH20-2AA0	6AG1321-1FF01-2AA0	6AG1321-1FF10-7AA0
Based on	6ES7321-1BH02-0AA0 SIPLUS S7-300 SM 321 16DI/ DC 24 V	6ES7321-1BL00-0AA0 SIPLUS S7-300 SM 321 32DI/ DC 24 V	6ES7321-1CH20-0AA0 SIPLUS S7-300 SM 321 16DI/ DC 48-125 V	6ES7321-1FF01-0AA0 SIPLUS S7-300 SM 321 8DI 120/220 VAC	6ES7321-1FF10-0AA0 SIPLUS S7-300 SM 321 8DI
Ambient conditions					
Ambient temperature during operation					
• min.	-40 °C; = Tmin	-40 °C; = Tmin	-25 °C; = Tmin	-40 °C; = Tmin	-25 °C
• max.	70 °C; = Tmax; 60 °C @ UL/cUL, ATEX and FM use	70 °C; = Tmax; for use on railway vehicles according to EN50155, the rated temperature range -25 ... +55 °C (T1) or 60 °C @ UL/ULhaz/ATEX/FM use applies	70 °C; = Tmax; for use on railway vehicles according to EN50155, the rated temperature range -25 ... +55 °C (T1) or 60 °C @ UL/ULhaz/ATEX/FM use applies	70 °C; = Tmax; for use on railway vehicles according to EN50155, the rated temperature range -25 ... +55 °C (T1) or 60 °C @ UL/ULhaz/ATEX/FM use applies	70 °C; = Tmax; 60 °C @ UL/cUL, ATEX and FM use
Altitude during operation relating to sea level					
• Installation altitude above sea level, max.	5 000 m	5 000 m	2 000 m	2 000 m	5 000 m
• Ambient air temperature-barometric pressure-altitude	Tmin ... Tmax at 1 140 hPa ... 795 hPa (-1 000 m ... +2 000 m) // Tmin ... (Tmax - 10 K) at 795 hPa ... 658 hPa (+2 000 m ... +3 500 m) // Tmin ... (Tmax -20 K) at 658 hPa ... 540 hPa (+3 500 m ... +5 000 m)	Tmin ... Tmax at 1 140 hPa ... 795 hPa (-1 000 m ... +2 000 m) // Tmin ... (Tmax - 10 K) at 795 hPa ... 658 hPa (+2 000 m ... +3 500 m) // Tmin ... (Tmax -20 K) at 658 hPa ... 540 hPa (+3 500 m ... +5 000 m)	Tmin ... Tmax at 1 140 hPa ... 795 hPa (-1 000 m ... +2 000 m)	Tmin ... Tmax at 1 140 hPa ... 795 hPa (-1 000 m ... +2 000 m)	Tmin ... Tmax at 1 140 hPa ... 795 hPa (-1 000 m ... +2 000 m) // Tmin ... (Tmax - 10 K) at 795 hPa ... 658 hPa (+2 000 m ... +3 500 m) // Tmin ... (Tmax -20 K) at 658 hPa ... 540 hPa (+3 500 m ... +5 000 m)
Resistance					
Use in stationary industrial systems					
- to biologically active substances according to EN 60721-3-3	Yes; Class 3B2 mold, fungus and dry rot spores (with the exception of fauna); Class 3B3 on request	Yes; Class 3B2 mold, fungus and dry rot spores (with the exception of fauna); Class 3B3 on request	Yes; Class 3B2 mold, fungus and dry rot spores (with the exception of fauna); Class 3B3 on request	Yes; Class 3B2 mold, fungus and dry rot spores (with the exception of fauna); Class 3B3 on request	Yes; Class 3B2 mold, fungus and dry rot spores (with the exception of fauna); Class 3B3 on request
- to chemically active substances according to EN 60721-3-3	Yes; Class 3C4 (RH < 75 %) incl. salt spray acc. to EN 60068-2-52 (severity degree 3); *	Yes; Class 3C4 (RH < 75 %) incl. salt spray acc. to EN 60068-2-52 (severity degree 3); *	Yes; Class 3C4 (RH < 75 %) incl. salt spray acc. to EN 60068-2-52 (severity degree 3); *	Yes; Class 3C4 (RH < 75 %) incl. salt spray acc. to EN 60068-2-52 (severity degree 3); *	Yes; Class 3C4 (RH < 75 %) incl. salt spray acc. to EN 60068-2-52 (severity degree 3); *
- to mechanically active substances according to EN 60721-3-3	Yes; Class 3S4 incl. sand, dust, *	Yes; Class 3S4 incl. sand, dust, *	Yes; Class 3S4 incl. sand, dust, *	Yes; Class 3S4 incl. sand, dust, *	Yes; Class 3S4 incl. sand, dust, *
Use on land craft, rail vehicles and special-purpose vehicles					
- to biologically active substances according to EN 60721-3-5	Yes; Class 5B2 mold, fungus and dry rot spores (with the exception of fauna); Class 5B3 on request	Yes; Class 5B2 mold, fungus and dry rot spores (with the exception of fauna); Class 5B3 on request	Yes; Class 5B2 mold, fungus and dry rot spores (with the exception of fauna); Class 5B3 on request	Yes; Class 5B2 mold, fungus and dry rot spores (with the exception of fauna); Class 5B3 on request	Yes; Class 5B2 mold, fungus and dry rot spores (with the exception of fauna); Class 5B3 on request
- to chemically active substances according to EN 60721-3-5	Yes; Class 5C3 (RH < 75 %) incl. salt spray acc. to EN 50155 (ST2); *	Yes; Class 5C3 (RH < 75 %) incl. salt spray acc. to EN 50155 (ST2); *	Yes; Class 5C3 (RH < 75 %) incl. salt spray acc. to EN 50155 (ST2); *	Yes; Class 5C3 (RH < 75 %) incl. salt spray acc. to EN 50155 (ST2); *	Yes; Class 5C3 (RH < 75 %) incl. salt spray acc. to EN 50155 (ST2); *
- to mechanically active substances according to EN 60721-3-5	Yes; Class 5S3 incl. sand, dust; *	Yes; Class 5S3 incl. sand, dust; *	Yes; Class 5S3 incl. sand, dust; *	Yes; Class 5S3 incl. sand, dust; *	Yes; Class 5S3 incl. sand, dust; *

Technical specifications

Article number	6AG1321-1BH02-2AA0	6AG1321-1BL00-2AA0	6AG1321-1CH20-2AA0	6AG1321-1FF01-2AA0	6AG1321-1FF10-7AA0
Based on	6ES7321-1BH02-0AA0	6ES7321-1BL00-0AA0	6ES7321-1CH20-0AA0	6ES7321-1FF01-0AA0	6ES7321-1FF10-0AA0
	SIPLUS S7-300 SM 321 16DI/ DC 24 V	SIPLUS S7-300 SM 321 32DI/ DC 24 V	SIPLUS S7-300 SM 321 16DI/ DC 48-125 V	SIPLUS S7-300 SM 321 8DI 120/220 VAC	SIPLUS S7-300 SM 321 8DI
Use on ships/at sea					
- to biologically active substances according to EN 60721-3-6	Yes; Class 6B2 mold and fungal spores (excluding fauna); Class 6B3 on request	Yes; Class 6B2 mold and fungal spores (excluding fauna); Class 6B3 on request	Yes; Class 6B2 mold and fungal spores (excluding fauna); Class 6B3 on request	Yes; Class 6B2 mold and fungal spores (excluding fauna); Class 6B3 on request	Yes; Class 6B2 mold and fungal spores (excluding fauna); Class 6B3 on request
- to chemically active substances according to EN 60721-3-6	Yes; Class 6C3 (RH < 75 %) incl. salt spray acc. to EN 60068-2-52 (severity degree 3); *	Yes; Class 6C3 (RH < 75 %) incl. salt spray acc. to EN 60068-2-52 (severity degree 3); *	Yes; Class 6C3 (RH < 75 %) incl. salt spray acc. to EN 60068-2-52 (severity degree 3); *	Yes; Class 6C3 (RH < 75 %) incl. salt spray acc. to EN 60068-2-52 (severity degree 3); *	Yes; Class 6C3 (RH < 75 %) incl. salt spray acc. to EN 60068-2-52 (severity degree 3); *
- to mechanically active substances according to EN 60721-3-6	Yes; Class 6S3 incl. sand, dust; *	Yes; Class 6S3 incl. sand, dust; *	Yes; Class 6S3 incl. sand, dust; *	Yes; Class 6S3 incl. sand, dust; *	Yes; Class 6S3 incl. sand, dust; *
Usage in industrial process technology					
- Against chemically active substances acc. to EN 60654-4	Yes; Class 3 (excluding trichlorethylene)	Yes; Class 3 (excluding trichlorethylene)	Yes; Class 3 (excluding trichlorethylene)	Yes; Class 3 (excluding trichlorethylene)	Yes; Class 3 (excluding trichlorethylene)
- Environmental conditions for process, measuring and control systems acc. to ANSI/ISA-71.04	Yes; Level GX group A/B (excluding trichlorethylene; harmful gas concentrations up to the limits of EN 60721-3-3 class 3C4 permissible); level LC3 (salt spray) and level LB3 (oil)	Yes; Level GX group A/B (excluding trichlorethylene; harmful gas concentrations up to the limits of EN 60721-3-3 class 3C4 permissible); level LC3 (salt spray) and level LB3 (oil)	Yes; Level GX group A/B (excluding trichlorethylene; harmful gas concentrations up to the limits of EN 60721-3-3 class 3C4 permissible); level LC3 (salt spray) and level LB3 (oil)	Yes; Level GX group A/B (excluding trichlorethylene; harmful gas concentrations up to the limits of EN 60721-3-3 class 3C4 permissible); level LC3 (salt spray) and level LB3 (oil)	Yes; Level GX group A/B (excluding trichlorethylene; harmful gas concentrations up to the limits of EN 60721-3-3 class 3C4 permissible); level LC3 (salt spray) and level LB3 (oil)
Remark					
- Note regarding classification of environmental conditions acc. to EN 60721, EN 60654-4 and ANSI/ISA-71.04	* The supplied plug covers must remain in place over the unused interfaces during operation!	* The supplied plug covers must remain in place over the unused interfaces during operation!	* The supplied plug covers must remain in place over the unused interfaces during operation!	* The supplied plug covers must remain in place over the unused interfaces during operation!	* The supplied plug covers must remain in place over the unused interfaces during operation!

Article number	6AG1321-1FH00-7AA0	6AG1321-7BH01-2AB0	6AG1321-7TH00-4AB0
Based on	6ES7321-1FH00-0AA0	6ES7321-7BH01-0AB0	6ES7321-7TH00-0AB0
	SIPLUS S7-300 SM 321 16DI	SIPLUS S7-300 SM 321 16DI/ DC 24 V	SIPLUS PCS 7 SM321 16DE
Ambient conditions			
Ambient temperature during operation			
• min.	-40 °C; = Tmin	-25 °C; = Tmin	0 °C
• max.	70 °C; = Tmax; 60 °C @ UL/cUL, ATEX and FM use	70 °C; = Tmax; 60 °C @ UL/cUL, ATEX and FM use	60 °C
Altitude during operation relating to sea level			
• Installation altitude above sea level, max.	5 000 m	5 000 m	5 000 m
• Ambient air temperature-barometric pressure-altitude	Tmin ... Tmax at 1 140 hPa ... 795 hPa (-1 000 m ... +2 000 m) // Tmin ... (Tmax - 10 K) at 795 hPa ... 658 hPa (+2 000 m ... +3 500 m) // Tmin ... (Tmax -20 K) at 658 hPa ... 540 hPa (+3 500 m ... +5 000 m)	Tmin ... Tmax at 1 140 hPa ... 795 hPa (-1 000 m ... +2 000 m) // Tmin ... (Tmax - 10 K) at 795 hPa ... 658 hPa (+2 000 m ... +3 500 m) // Tmin ... (Tmax -20 K) at 658 hPa ... 540 hPa (+3 500 m ... +5 000 m)	Tmin ... Tmax at 1 140 hPa ... 795 hPa (-1 000 m ... +2 000 m) // Tmin ... (Tmax - 10 K) at 795 hPa ... 658 hPa (+2 000 m ... +3 500 m) // Tmin ... (Tmax -20 K) at 658 hPa ... 540 hPa (+3 500 m ... +5 000 m)

SIMATIC S7-300 Advanced Controllers

I/O modules

SIPLUS S7-300 digital modules

SIPLUS S7-300 SM 321

Technical specifications

Article number	6AG1321-1FH00-7AA0	6AG1321-7BH01-2AB0	6AG1321-7TH00-4AB0
Based on	6ES7321-1FH00-0AA0	6ES7321-7BH01-0AB0	6ES7321-7TH00-0AB0
	SIPLUS S7-300 SM 321 16DI	SIPLUS S7-300 SM 321 16DI/ DC 24 V	SIPLUS PCS 7 SM321 16DE
Resistance			
Use in stationary industrial systems			
- to biologically active substances according to EN 60721-3-3	Yes; Class 3B2 mold, fungus and dry rot spores (with the exception of fauna); Class 3B3 on request	Yes; Class 3B2 mold, fungus and dry rot spores (with the exception of fauna); Class 3B3 on request	Yes; Class 3B2 mold, fungus and dry rot spores (with the exception of fauna); Class 3B3 on request
- to chemically active substances according to EN 60721-3-3	Yes; Class 3C4 (RH < 75 %) incl. salt spray acc. to EN 60068-2-52 (severity degree 3); *	Yes; Class 3C4 (RH < 75 %) incl. salt spray acc. to EN 60068-2-52 (severity degree 3); *	Yes; Class 3C4 (RH < 75 %) incl. salt spray acc. to EN 60068-2-52 (severity degree 3); *
- to mechanically active substances according to EN 60721-3-3	Yes; Class 3S4 incl. sand, dust, *	Yes; Class 3S4 incl. sand, dust, *	Yes; Class 3S4 incl. sand, dust, *
Use on land craft, rail vehicles and special-purpose vehicles			
- to biologically active substances according to EN 60721-3-5		Yes; Class 5B2 mold, fungus and dry rot spores (with the exception of fauna); Class 5B3 on request	
- to chemically active substances according to EN 60721-3-5		Yes; Class 5C3 (RH < 75 %) incl. salt spray acc. to EN 50155 (ST2); *	
- to mechanically active substances according to EN 60721-3-5		Yes; Class 5S3 incl. sand, dust; *	
Use on ships/at sea			
- to biologically active substances according to EN 60721-3-6	Yes; Class 6B2 mold and fungal spores (excluding fauna); Class 6B3 on request	Yes; Class 6B2 mold and fungal spores (excluding fauna); Class 6B3 on request	Yes; Class 6B2 mold and fungal spores (excluding fauna); Class 6B3 on request
- to chemically active substances according to EN 60721-3-6	Yes; Class 6C3 (RH < 75 %) incl. salt spray acc. to EN 60068-2-52 (severity degree 3); *	Yes; Class 6C3 (RH < 75 %) incl. salt spray acc. to EN 60068-2-52 (severity degree 3); *	Yes; Class 6C3 (RH < 75 %) incl. salt spray acc. to EN 60068-2-52 (severity degree 3); *
- to mechanically active substances according to EN 60721-3-6	Yes; Class 6S3 incl. sand, dust; *	Yes; Class 6S3 incl. sand, dust; *	Yes; Class 6S3 incl. sand, dust; *
Usage in industrial process technology			
- Against chemically active substances acc. to EN 60654-4	Yes; Class 3 (excluding trichlorethylene)	Yes; Class 3 (excluding trichlorethylene)	Yes; Class 3 (excluding trichlorethylene)
- Environmental conditions for process, measuring and control systems acc. to ANSI/ISA-71.04	Yes; Level GX group A/B (excluding trichlorethylene; harmful gas concentrations up to the limits of EN 60721-3-3 class 3C4 permissible); level LC3 (salt spray) and level LB3 (oil)	Yes; Level GX group A/B (excluding trichlorethylene; harmful gas concentrations up to the limits of EN 60721-3-3 class 3C4 permissible); level LC3 (salt spray) and level LB3 (oil)	Yes; Level GX group A/B (excluding trichlorethylene; harmful gas concentrations up to the limits of EN 60721-3-3 class 3C4 permissible); level LC3 (salt spray) and level LB3 (oil)
Remark			
- Note regarding classification of environmental conditions acc. to EN 60721, EN 60654-4 and ANSI/ISA-71.04	* The supplied plug covers must remain in place over the unused interfaces during operation!	* The supplied plug covers must remain in place over the unused interfaces during operation!	* The supplied plug covers must remain in place over the unused interfaces during operation!

5

Overview



- Digital outputs
- For connecting solenoid valves, contactors, small-power motors, lamps and motor starters

Note:

SIPLUS extreme products are based on SIMATIC standard products. The contents listed here were taken from the respective standard products. SIPLUS extreme-specific information was added.

Ordering data

SIPLUS S7-300 SM 322 digital output modules

For industrial applications with extended ambient conditions

Extended temperature range and exposure to media

- 8 outputs, 24 V DC, 2 A
- 16 outputs, 24 V DC, 0.5 A
- 32 outputs, 24 V DC, 0.5 A
- 8 outputs, 48 to 125 V DC, 1.5 A
- 8 outputs, 120/230 V AC, 1 A
- 16 outputs, 120/230 V AC, 1 A
- 8 outputs, relay contacts, 5 A
- 16 outputs, relay contacts, 8 A
- 8 outputs, 24 V DC, 0.5 A, diagnostics-capable

Exposure to media

- 8 outputs, 120/230 V AC, 2 A
- 8 outputs, relay contacts, 5 A, with RC filter, overvoltage protection

For rolling stock railway applications

Conforms to EN 50155

- 16 outputs, 24 V DC, 0.5 A, high speed
- 32 outputs, 24 V DC, 0.5 A
- 8 outputs, relay contacts, 5 A
- 16 outputs, relay contacts, 8 A
- 8 outputs, 24 V DC, 0.5 A, diagnostics-capable

Accessories

Mandatory

Front connector

- 20-pin, with spring-loaded contacts
 - 1 unit
 - 100 units
- 40-pin, with spring-loaded contacts
 - 1 unit
 - 100 units

Article No.

- 6AG1322-1BF01-2XB0**
- 6AG1322-1BH01-2AA0**
- 6AG1322-1BL00-2AA0**
- 6AG1322-1CF00-7AA0**
- 6AG1322-1FF01-7AA0**
- 6AG1322-1FH00-7AA0**
- 6AG1322-1HF10-2AA0**
- 6AG1322-1HH01-2AA0**
- 6AG1322-8BF00-2AB0**

- 6AG1322-5FF00-4AB0**
- 6AG1322-5HF00-4AB0**

- 6AG1322-1BH01-2AA0**
- 6AG1322-1BL00-2AA0**
- 6AG1322-1HF10-2AA0**
- 6AG1322-1HH01-2AA0**
- 6AG1322-8BF00-2AB0**

- 6ES7392-1BJ00-0AA0**
- 6ES7392-1BJ00-1AB0**

- 6ES7392-1BM01-0AA0**
- 6ES7392-1BM01-1AB0**

Article No.

*Consumables***Front door, elevated design**

E.g. for 32-channel modules; for connecting 1.3 mm²/16 AWG conductors; circuit diagram and nameplates in petrol

6ES7328-0AA00-7AA0**Bus connectors**

1 unit (spare part)

6ES7390-0AA00-0AA0**Labeling strips**

10 units; spare part

For modules with 20-pin front connector

6ES7392-2XX00-0AA0

For modules with 40-pin front connector

6ES7392-2XX10-0AA0**Label cover**

10 units; spare part

For modules with 20-pin front connector

6ES7392-2XY00-0AA0

For modules with 40-pin front connector

6ES7392-2XY10-0AA0*Documentation***SIMATIC Manual Collection**

Electronic manuals on DVD, multi-language: LOGO!, SIMADYN, SIMATIC bus components, SIMATIC C7, SIMATIC distributed I/O, SIMATIC HMI, SIMATIC Sensors, SIMATIC NET, SIMATIC PC Based Automation, SIMATIC PCS 7, SIMATIC PG/PC, SIMATIC S7, SIMATIC Software, SIMATIC TDC

6ES7998-8XC01-8YE0**SIMATIC Manual Collection update service for 1 year**

Current "Manual Collection" DVD and the three subsequent updates

6ES7998-8XC01-8YE2

SIMATIC S7-300 Advanced Controllers

I/O modules

SIPLUS S7-300 digital modules

SIPLUS S7-300 SM 322

Technical specifications

Article number	6AG1322-1BF01-2XB0	6AG1322-8BF00-2AB0	6AG1322-1BH01-2AA0	6AG1322-1BL00-2AA0
Based on	6ES7322-1BF01-0XB0 SIPLUS S7-300 SM 322 8DO/ DC 24 V	6ES7322-8BF00-0AB0 SIPLUS S7-300 SM 322 8DO/ DC 24V	6ES7322-1BH01-0AA0 SIPLUS S7-300 SM 322 16DO DC24 V 0.5A	6ES7322-1BL00-0AA0 SIPLUS S7-300 SM 322 32DO
Ambient conditions				
Ambient temperature during operation				
• min.	-25 °C	-25 °C; = Tmin	-25 °C; = Tmin	-25 °C; = Tmin
• max.	70 °C; = Tmax; 60 °C @ UL/cUL use	70 °C; = Tmax; 60 °C @ UL/cUL use	70 °C; = Tmax; for use on railway vehicles according to EN50155, the rated temperature range -25 ... +55 °C (T1) or 60 °C @ UL/ULhaz/ATEX/FM use applies	70 °C; = Tmax; for use on railway vehicles according to EN50155, the rated temperature range -25 ... +55 °C (T1) or 60 °C @ UL/ULhaz/ATEX/FM use applies
Altitude during operation relating to sea level				
• Installation altitude above sea level, max.	5 000 m	5 000 m	5 000 m	5 000 m
• Ambient air temperature-barometric pressure-altitude	Tmin ... Tmax at 1 140 hPa ... 795 hPa (-1 000 m ... +2 000 m) // Tmin ... (Tmax - 10 K) at 795 hPa ... 658 hPa (+2 000 m ... +3 500 m) // Tmin ... (Tmax -20 K) at 658 hPa ... 540 hPa (+3 500 m ... +5 000 m)	Tmin ... Tmax at 1 140 hPa ... 795 hPa (-1 000 m ... +2 000 m) // Tmin ... (Tmax - 10 K) at 795 hPa ... 658 hPa (+2 000 m ... +3 500 m) // Tmin ... (Tmax -20 K) at 658 hPa ... 540 hPa (+3 500 m ... +5 000 m)	Tmin ... Tmax at 1 140 hPa ... 795 hPa (-1 000 m ... +2 000 m) // Tmin ... (Tmax - 10 K) at 795 hPa ... 658 hPa (+2 000 m ... +3 500 m) // Tmin ... (Tmax -20 K) at 658 hPa ... 540 hPa (+3 500 m ... +5 000 m)	Tmin ... Tmax at 1 140 hPa ... 795 hPa (-1 000 m ... +2 000 m) // Tmin ... (Tmax - 10 K) at 795 hPa ... 658 hPa (+2 000 m ... +3 500 m) // Tmin ... (Tmax -20 K) at 658 hPa ... 540 hPa (+3 500 m ... +5 000 m)
Resistance				
Use in stationary industrial systems				
- to biologically active substances according to EN 60721-3-3	Yes; Class 3B2 mold, fungus and dry rot spores (with the exception of fauna); Class 3B3 on request	Yes; Class 3B2 mold, fungus and dry rot spores (with the exception of fauna); Class 3B3 on request	Yes; Class 3B2 mold, fungus and dry rot spores (with the exception of fauna); Class 3B3 on request	Yes; Class 3B2 mold, fungus and dry rot spores (with the exception of fauna); Class 3B3 on request
- to chemically active substances according to EN 60721-3-3	Yes; Class 3C4 (RH < 75 %) incl. salt spray acc. to EN 60068-2-52 (severity degree 3); *	Yes; Class 3C4 (RH < 75 %) incl. salt spray acc. to EN 60068-2-52 (severity degree 3); *	Yes; Class 3C4 (RH < 75 %) incl. salt spray acc. to EN 60068-2-52 (severity degree 3); *	Yes; Class 3C4 (RH < 75 %) incl. salt spray acc. to EN 60068-2-52 (severity degree 3); *
- to mechanically active substances according to EN 60721-3-3	Yes; Class 3S4 incl. sand, dust; *	Yes; Class 3S4 incl. sand, dust; *	Yes; Class 3S4 incl. sand, dust; *	Yes; Class 3S4 incl. sand, dust; *
Use on land craft, rail vehicles and special-purpose vehicles				
- to biologically active substances according to EN 60721-3-5		Yes; Class 5B2 mold, fungus and dry rot spores (with the exception of fauna); Class 5B3 on request	Yes; Class 5B2 mold, fungus and dry rot spores (with the exception of fauna); Class 5B3 on request	Yes; Class 5B2 mold, fungus and dry rot spores (with the exception of fauna); Class 5B3 on request
- to chemically active substances according to EN 60721-3-5		Yes; Class 5C3 (RH < 75 %) incl. salt spray acc. to EN 50155 (ST2); *	Yes; Class 5C3 (RH < 75 %) incl. salt spray acc. to EN 50155 (ST2); *	Yes; Class 5C3 (RH < 75 %) incl. salt spray acc. to EN 50155 (ST2); *
- to mechanically active substances according to EN 60721-3-5		Yes; Class 5S3 incl. sand, dust; *	Yes; Class 5S3 incl. sand, dust; *	Yes; Class 5S3 incl. sand, dust; *
Use on ships/at sea				
- to biologically active substances according to EN 60721-3-6	Yes; Class 6B2 mold and fungal spores (excluding fauna); Class 6B3 on request	Yes; Class 6B2 mold and fungal spores (excluding fauna); Class 6B3 on request	Yes; Class 6B2 mold and fungal spores (excluding fauna); Class 6B3 on request	Yes; Class 6B2 mold and fungal spores (excluding fauna); Class 6B3 on request
- to chemically active substances according to EN 60721-3-6	Yes; Class 6C3 (RH < 75 %) incl. salt spray acc. to EN 60068-2-52 (severity degree 3); *	Yes; Class 6C3 (RH < 75 %) incl. salt spray acc. to EN 60068-2-52 (severity degree 3); *	Yes; Class 6C3 (RH < 75 %) incl. salt spray acc. to EN 60068-2-52 (severity degree 3); *	Yes; Class 6C3 (RH < 75 %) incl. salt spray acc. to EN 60068-2-52 (severity degree 3); *
- to mechanically active substances according to EN 60721-3-6	Yes; Class 6S3 incl. sand, dust; *	Yes; Class 6S3 incl. sand, dust; *	Yes; Class 6S3 incl. sand, dust; *	Yes; Class 6S3 incl. sand, dust; *

Technical specifications

Article number	6AG1322-1BF01-2XB0	6AG1322-8BF00-2AB0	6AG1322-1BH01-2AA0	6AG1322-1BL00-2AA0
Based on	6ES7322-1BF01-0XB0 SIPLUS S7-300 SM 322 8DO/ DC 24 V	6ES7322-8BF00-0AB0 SIPLUS S7-300 SM 322 8DO/ DC 24V	6ES7322-1BH01-0AA0 SIPLUS S7-300 SM 322 16DO DC24 V 0.5A	6ES7322-1BL00-0AA0 SIPLUS S7-300 SM 322 32DO
Usage in industrial process technology				
- Against chemically active substances acc. to EN 60654-4	Yes; Class 3 (excluding trichlorethylene)	Yes; Class 3 (excluding trichlorethylene)	Yes; Class 3 (excluding trichlorethylene)	Yes; Class 3 (excluding trichlorethylene)
- Environmental conditions for process, measuring and control systems acc. to ANSI/ISA-71.04	Yes; Level GX group A/B (excluding trichlorethylene; harmful gas concentrations up to the limits of EN 60721-3-3 class 3C4 permissible); level LC3 (salt spray) and level LB3 (oil)	Yes; Level GX group A/B (excluding trichlorethylene; harmful gas concentrations up to the limits of EN 60721-3-3 class 3C4 permissible); level LC3 (salt spray) and level LB3 (oil)	Yes; Level GX group A/B (excluding trichlorethylene; harmful gas concentrations up to the limits of EN 60721-3-3 class 3C4 permissible); level LC3 (salt spray) and level LB3 (oil)	Yes; Level GX group A/B (excluding trichlorethylene; harmful gas concentrations up to the limits of EN 60721-3-3 class 3C4 permissible); level LC3 (salt spray) and level LB3 (oil)
Remark				
- Note regarding classification of environmental conditions acc. to EN 60721, EN 60654-4 and ANSI/ISA-71.04	* The supplied plug covers must remain in place over the unused interfaces during operation!	* The supplied plug covers must remain in place over the unused interfaces during operation!	* The supplied plug covers must remain in place over the unused interfaces during operation!	* The supplied plug covers must remain in place over the unused interfaces during operation!
Article number	6AG1322-1CF00-7AA0	6AG1322-1HF10-2AA0	6AG1322-5HF00-4AB0	6AG1322-1FF01-7AA0
Based on	6ES7322-1CF00-0AA0 SIPLUS S7-300 SM 322 8DO/ DC 48-125 V	6ES7322-1HF10-0AA0 SIPLUS S7-300 SM 322 8DO/ RLY	6ES7322-5HF00-0AB0 SIPLUS S7-300 SM 322 8DO/ RLY	6ES7322-1FF01-0AA0 SIPLUS S7-300 SM 322 8DA/120/230VAC
Ambient conditions				
Ambient temperature during operation				
• min.	-25 °C	-25 °C; = Tmin	0 °C; = Tmin	-40 °C
• max.	70 °C; = Tmax; for use on railway vehicles according to EN50155, the rated temperature range -25 ... +55 °C (T1) or 60 °C @ UL/ULhaz/ATEX/FM use applies	60 °C	60 °C; = Tmax	70 °C; = Tmax; for use on railway vehicles according to EN 50155, the rated temperature range -25 ... +55 °C (T1) or 60 °C @ UL/UL hazardous use applies
Altitude during operation relating to sea level				
• Installation altitude above sea level, max.	2 000 m	2 000 m	2 000 m	2 000 m
• Ambient air temperature-barometric pressure-altitude	Tmin ... Tmax at 1 140 hPa ... 795 hPa (-1 000 m ... +2 000 m)	Tmin ... Tmax at 1 140 hPa ... 795 hPa (-1 000 m ... +2 000 m)	Tmin ... Tmax at 1 140 hPa ... 795 hPa (-1 000 m ... +2 000 m)	Tmin ... Tmax at 1 140 hPa ... 795 hPa (-1 000 m ... +2 000 m)
Resistance				
Use in stationary industrial systems				
- to biologically active substances according to EN 60721-3-3	Yes; Class 3B2 mold, fungus and dry rot spores (with the exception of fauna); Class 3B3 on request	Yes; Class 3B2 mold, fungus and dry rot spores (with the exception of fauna); Class 3B3 on request	Yes; Class 3B2 mold, fungus and dry rot spores (with the exception of fauna); Class 3B3 on request	Yes; Class 3B2 mold, fungus and dry rot spores (with the exception of fauna); Class 3B3 on request
- to chemically active substances according to EN 60721-3-3	Yes; Class 3C4 (RH < 75 %) incl. salt spray acc. to EN 60068-2-52 (severity degree 3); *	Yes; Class 3C4 (RH < 75 %) incl. salt spray acc. to EN 60068-2-52 (severity degree 3); *	Yes; Class 3C4 (RH < 75 %) incl. salt spray acc. to EN 60068-2-52 (severity degree 3); *	Yes; Class 3C4 (RH < 75 %) incl. salt spray acc. to EN 60068-2-52 (severity degree 3); *
- to mechanically active substances according to EN 60721-3-3	Yes; Class 3S4 incl. sand, dust, *	Yes; Class 3S4 incl. sand, dust, *	Yes; Class 3S4 incl. sand, dust, *	Yes; Class 3S4 incl. sand, dust, *
Use on land craft, rail vehicles and special-purpose vehicles				
- to biologically active substances according to EN 60721-3-5		Yes; Class 5B2 mold, fungus and dry rot spores (with the exception of fauna); Class 5B3 on request		
- to chemically active substances according to EN 60721-3-5		Yes; Class 5C3 (RH < 75 %) incl. salt spray acc. to EN 50155 (ST2); *		
- to mechanically active substances according to EN 60721-3-5		Yes; Class 5S3 incl. sand, dust, *		

SIMATIC S7-300 Advanced Controllers

I/O modules

SIPLUS S7-300 digital modules

SIPLUS S7-300 SM 322

Technical specifications

Article number	6AG1322-1CF00-7AA0	6AG1322-1HF10-2AA0	6AG1322-5HF00-4AB0	6AG1322-1FF01-7AA0
Based on	6ES7322-1CF00-0AA0 SIPLUS S7-300 SM 322 8DO/ DC 48-125 V	6ES7322-1HF10-0AA0 SIPLUS S7-300 SM 322 8DO/ RLY	6ES7322-5HF00-0AB0 SIPLUS S7-300 SM 322 8DO/ RLY	6ES7322-1FF01-0AA0 SIPLUS S7-300 SM 322 8DA/120/230VAC
Use on ships/at sea				
- to biologically active substances according to EN 60721-3-6	Yes; Class 6B2 mold and fungal spores (excluding fauna); Class 6B3 on request	Yes; Class 6B2 mold and fungal spores (excluding fauna); Class 6B3 on request	Yes; Class 6B2 mold and fungal spores (excluding fauna); Class 6B3 on request	Yes; Class 6B2 mold and fungal spores (excluding fauna); Class 6B3 on request
- to chemically active substances according to EN 60721-3-6	Yes; Class 6C3 (RH < 75 %) incl. salt spray acc. to EN 60068-2-52 (severity degree 3); *	Yes; Class 6C3 (RH < 75 %) incl. salt spray acc. to EN 60068-2-52 (severity degree 3); *	Yes; Class 6C3 (RH < 75 %) incl. salt spray acc. to EN 60068-2-52 (severity degree 3); *	Yes; Class 6C3 (RH < 75 %) incl. salt spray acc. to EN 60068-2-52 (severity degree 3); *
- to mechanically active substances according to EN 60721-3-6	Yes; Class 6S3 incl. sand, dust; *	Yes; Class 6S3 incl. sand, dust; *	Yes; Class 6S3 incl. sand, dust; *	Yes; Class 6S3 incl. sand, dust; *
Usage in industrial process technology				
- Against chemically active substances acc. to EN 60654-4	Yes; Class 3 (excluding trichlorethylene)	Yes; Class 3 (excluding trichlorethylene)	Yes; Class 3 (excluding trichlorethylene)	Yes; Class 3 (excluding trichlorethylene)
- Environmental conditions for process, measuring and control systems acc. to ANSI/ISA-71.04	Yes; Level GX group A/B (excluding trichlorethylene; harmful gas concentrations up to the limits of EN 60721-3-3 class 3C4 permissible); level LC3 (salt spray) and level LB3 (oil)	Yes; Level GX group A/B (excluding trichlorethylene; harmful gas concentrations up to the limits of EN 60721-3-3 class 3C4 permissible); level LC3 (salt spray) and level LB3 (oil)	Yes; Level GX group A/B (excluding trichlorethylene; harmful gas concentrations up to the limits of EN 60721-3-3 class 3C4 permissible); level LC3 (salt spray) and level LB3 (oil)	Yes; Level GX group A/B (excluding trichlorethylene; harmful gas concentrations up to the limits of EN 60721-3-3 class 3C4 permissible); level LC3 (salt spray) and level LB3 (oil)
Remark				
- Note regarding classification of environmental conditions acc. to EN 60721, EN 60654-4 and ANSI/ISA-71.04	* The supplied plug covers must remain in place over the unused interfaces during operation!	* The supplied plug covers must remain in place over the unused interfaces during operation!	* The supplied plug covers must remain in place over the unused interfaces during operation!	* The supplied plug covers must remain in place over the unused interfaces during operation!

Article number	6AG1322-5FF00-4AB0	6AG1322-1FH00-7AA0	6AG1322-1HH01-2AA0
Based on	6ES7322-5FF00-0AB0 SIPLUS S7-300 SM 322 8DO	6ES7322-1FH00-0AA0 SIPLUS S7-300 SM 322 16DO	6ES7322-1HH01-0AA0 SIPLUS S7-300 SM 322 16DO/ RLY
Ambient conditions			
Ambient temperature during operation			
• min.	0 °C; = Tmin	-40 °C; = Tmin	-40 °C; = Tmin
• max.	60 °C; = Tmax	70 °C; = Tmax; 60 °C @ UL/cUL, ATEX and FM use	70 °C; = Tmax; 60 °C @ UL/cUL, ATEX and FM use
Altitude during operation relating to sea level			
• Installation altitude above sea level, max.	5 000 m	5 000 m	2 000 m
• Ambient air temperature-barometric pressure-altitude	Tmin ... Tmax at 1 140 hPa ... 795 hPa (-1 000 m ... +2 000 m) // Tmin ... (Tmax - 10 K) at 795 hPa ... 658 hPa (+2 000 m ... +3 500 m) // Tmin ... (Tmax -20 K) at 658 hPa ... 540 hPa (+3 500 m ... +5 000 m)	Tmin ... Tmax at 1 140 hPa ... 795 hPa (-1 000 m ... +2 000 m) // Tmin ... (Tmax - 10 K) at 795 hPa ... 658 hPa (+2 000 m ... +3 500 m) // Tmin ... (Tmax -20 K) at 658 hPa ... 540 hPa (+3 500 m ... +5 000 m)	Tmin ... Tmax at 1 140 hPa ... 795 hPa (-1 000 m ... +2 000 m)

Technical specifications

Article number	6AG1322-5FF00-4AB0	6AG1322-1FH00-7AA0	6AG1322-1HH01-2AA0
Based on	6ES7322-5FF00-0AB0	6ES7322-1FH00-0AA0	6ES7322-1HH01-0AA0
	SIPLUS S7-300 SM 322 8DO	SIPLUS S7-300 SM 322 16DO	SIPLUS S7-300 SM 322 16DO/ RLY
Resistance			
Use in stationary industrial systems			
- to biologically active substances according to EN 60721-3-3	Yes; Class 3B2 mold, fungus and dry rot spores (with the exception of fauna); Class 3B3 on request	Yes; Class 3B2 mold, fungus and dry rot spores (with the exception of fauna); Class 3B3 on request	Yes; Class 3B2 mold, fungus and dry rot spores (with the exception of fauna); Class 3B3 on request
- to chemically active substances according to EN 60721-3-3	Yes; Class 3C4 (RH < 75 %) incl. salt spray acc. to EN 60068-2-52 (severity degree 3); *	Yes; Class 3C4 (RH < 75 %) incl. salt spray acc. to EN 60068-2-52 (severity degree 3); *	Yes; Class 3C4 (RH < 75 %) incl. salt spray acc. to EN 60068-2-52 (severity degree 3); *
- to mechanically active substances according to EN 60721-3-3	Yes; Class 3S4 incl. sand, dust, *	Yes; Class 3S4 incl. sand, dust, *	Yes; Class 3S4 incl. sand, dust, *
Use on land craft, rail vehicles and special-purpose vehicles			
- to biologically active substances according to EN 60721-3-5			Yes; Class 5B2 mold, fungus and dry rot spores (with the exception of fauna); Class 5B3 on request
- to chemically active substances according to EN 60721-3-5			Yes; Class 5C3 (RH < 75 %) incl. salt spray acc. to EN 50155 (ST2); *
- to mechanically active substances according to EN 60721-3-5			Yes; Class 5S3 incl. sand, dust; *
Use on ships/at sea			
- to biologically active substances according to EN 60721-3-6	Yes; Class 6B2 mold and fungal spores (excluding fauna); Class 6B3 on request	Yes; Class 6B2 mold and fungal spores (excluding fauna); Class 6B3 on request	Yes; Class 6B2 mold and fungal spores (excluding fauna); Class 6B3 on request
- to chemically active substances according to EN 60721-3-6	Yes; Class 6C3 (RH < 75 %) incl. salt spray acc. to EN 60068-2-52 (severity degree 3); *	Yes; Class 6C3 (RH < 75 %) incl. salt spray acc. to EN 60068-2-52 (severity degree 3); *	Yes; Class 6C3 (RH < 75 %) incl. salt spray acc. to EN 60068-2-52 (severity degree 3); *
- to mechanically active substances according to EN 60721-3-6	Yes; Class 6S3 incl. sand, dust; *	Yes; Class 6S3 incl. sand, dust; *	Yes; Class 6S3 incl. sand, dust; *
Usage in industrial process technology			
- Against chemically active substances acc. to EN 60654-4	Yes; Class 3 (excluding trichlorethylene)	Yes; Class 3 (excluding trichlorethylene)	Yes; Class 3 (excluding trichlorethylene)
- Environmental conditions for process, measuring and control systems acc. to ANSI/ISA-71.04	Yes; Level GX group A/B (excluding trichlorethylene; harmful gas concentrations up to the limits of EN 60721-3-3 class 3C4 permissible); level LC3 (salt spray) and level LB3 (oil)	Yes; Level GX group A/B (excluding trichlorethylene; harmful gas concentrations up to the limits of EN 60721-3-3 class 3C4 permissible); level LC3 (salt spray) and level LB3 (oil)	Yes; Level GX group A/B (excluding trichlorethylene; harmful gas concentrations up to the limits of EN 60721-3-3 class 3C4 permissible); level LC3 (salt spray) and level LB3 (oil)
Remark			
- Note regarding classification of environmental conditions acc. to EN 60721, EN 60654-4 and ANSI/ISA-71.04	* The supplied plug covers must remain in place over the unused interfaces during operation!	* The supplied plug covers must remain in place over the unused interfaces during operation!	* The supplied plug covers must remain in place over the unused interfaces during operation!

SIMATIC S7-300 Advanced Controllers

I/O modules

SIPLUS S7-300 digital modules

SIPLUS S7-300 SM 323

Overview



- Digital inputs and outputs
- For connection of switches, 2-wire proximity switches (BEROs), solenoid valves, contactors, low-power motors, lamps and motor starters

Note:

SIPLUS extreme products are based on SIMATIC standard products. The contents listed here were taken from the respective standard products. SIPLUS extreme-specific information was added.

5

Ordering data

Article No.

SIPLUS S7-300 SM 323 digital input/output module

For industrial applications with extended ambient conditions

Extended temperature range and exposure to media

8 inputs, 8 outputs

6AG1323-1BH01-2AA0

For rolling stock railway applications

Conforms to EN 50155

8 inputs, 8 outputs

6AG1323-1BH01-2AA0

Accessories

Mandatory

Front connector

20-pin, with spring-loaded contacts

- 1 unit
- 100 units

6ES7392-1BJ00-0AA0
6ES7392-1BJ00-1AB0

40-pin, with spring-loaded contacts

- 1 unit
- 100 units

6ES7392-1BM01-0AA0
6ES7392-1BM01-1AB0

Consumables

Front door, elevated design

E.g. for 32-channel modules; for connecting 1.3 mm²/16 AWG conductors; circuit diagram and nameplates in petrol

6ES7328-0AA00-7AA0

Bus connectors

1 unit (spare part)

6ES7390-0AA00-0AA0

Labeling strips

10 units; spare part

For modules with 20-pin front connector

6ES7392-2XX00-0AA0

For modules with 40-pin front connector

6ES7392-2XX10-0AA0

Label cover

10 units; spare part

For modules with 20-pin front connector

6ES7392-2XY00-0AA0

For modules with 40-pin front connector

6ES7392-2XY10-0AA0

Article No.

Documentation

SIMATIC Manual Collection

Electronic manuals on DVD, multi-language: LOGO!, SIMADYN, SIMATIC bus components, SIMATIC C7, SIMATIC distributed I/O, SIMATIC HMI, SIMATIC Sensors, SIMATIC NET, SIMATIC PC Based Automation, SIMATIC PCS 7, SIMATIC PG/PC, SIMATIC S7, SIMATIC Software, SIMATIC TDC

6ES7998-8XC01-8YE0

SIMATIC Manual Collection update service for 1 year

Current "Manual Collection" DVD and the three subsequent updates

6ES7998-8XC01-8YE2

Technical specifications

Article number	6AG1323-1BH01-2AA0
Based on	6ES7323-1BH01-0AA0 SIPLUS S7-300 SM 323 8DI/ 8DO
Ambient conditions	
Ambient temperature during operation	
• min.	-40 °C; = Tmin
• max.	70 °C; = Tmax; 60 °C @ UL/cUL, ATEX and FM use
Altitude during operation relating to sea level	
• Installation altitude above sea level, max.	5 000 m
• Ambient air temperature-barometric pressure-altitude	Tmin ... Tmax at 1 140 hPa ... 795 hPa (-1 000 m ... +2 000 m) // Tmin ... (Tmax - 10 K) at 795 hPa ... 658 hPa (+2 000 m ... +3 500 m) // Tmin ... (Tmax -20 K) at 658 hPa ... 540 hPa (+3 500 m ... +5 000 m)
Resistance	
Use in stationary industrial systems	
- to biologically active substances according to EN 60721-3-3	Yes; Class 3B2 mold, fungus and dry rot spores (with the exception of fauna); Class 3B3 on request
- to chemically active substances according to EN 60721-3-3	Yes; Class 3C4 (RH < 75 %) incl. salt spray acc. to EN 60068-2-52 (severity degree 3); *
- to mechanically active substances according to EN 60721-3-3	Yes; Class 3S4 incl. sand, dust, *
Use on land craft, rail vehicles and special-purpose vehicles	
- to biologically active substances according to EN 60721-3-5	Yes; Class 5B2 mold, fungus and dry rot spores (with the exception of fauna); Class 5B3 on request
- to chemically active substances according to EN 60721-3-5	Yes; Class 5C3 (RH < 75 %) incl. salt spray acc. to EN 50155 (ST2); *
- to mechanically active substances according to EN 60721-3-5	Yes; Class 5S3 incl. sand, dust; *

Article number	6AG1323-1BH01-2AA0
Based on	6ES7323-1BH01-0AA0 SIPLUS S7-300 SM 323 8DI/ 8DO
Use on ships/at sea	
- to biologically active substances according to EN 60721-3-6	Yes; Class 6B2 mold and fungal spores (excluding fauna); Class 6B3 on request
- to chemically active substances according to EN 60721-3-6	Yes; Class 6C3 (RH < 75 %) incl. salt spray acc. to EN 60068-2-52 (severity degree 3); *
- to mechanically active substances according to EN 60721-3-6	Yes; Class 6S3 incl. sand, dust; *
Usage in industrial process technology	
- Against chemically active substances acc. to EN 60654-4	Yes; Class 3 (excluding trichlorethylene)
- Environmental conditions for process, measuring and control systems acc. to ANSI/ISA-71.04	Yes; Level GX group A/B (excluding trichlorethylene; harmful gas concentrations up to the limits of EN 60721-3-3 class 3C4 permissible); level LC3 (salt spray) and level LB3 (oil)
Remark	
- Note regarding classification of environmental conditions acc. to EN 60721, EN 60654-4 and ANSI/ISA-71.04	* The supplied plug covers must remain in place over the unused interfaces during operation!

SIMATIC S7-300 Advanced Controllers

I/O modules

Analog modules

SM 331 analog input modules

Overview



- Analog inputs
- For connection of voltage and current sensors, thermocouples, resistors and resistance thermometers

5

Ordering data

SM 331 analog input modules

Including labeling strips, bus connector, measuring range modules

8 inputs, resolution 13 bits

6ES7331-1KF02-0AB0

8 inputs, resolution 9/12/14 bits

6ES7331-7KF02-0AB0

2 inputs, resolution 9/12/14 bits

6ES7331-7KB02-0AB0

8 inputs, enhanced resolution 16 bits

6ES7331-7NF00-0AB0

8 inputs, enhanced resolution 16 bits, 4-channel mode

6ES7331-7NF10-0AB0

8 inputs, resolution 14 bits, for isochronous mode

6ES7331-7HF01-0AB0

6 inputs, for thermal elements, resolution 16 bits

6ES7331-7PE10-0AB0

8 inputs, for thermal resistors

6ES7331-7PF01-0AB0

8 inputs, for thermoelements

6ES7331-7PF11-0AB0

Measuring range module for analog inputs

1 module for 2 analog inputs; 2 units (spare part)

6ES7974-0AA00-0AA0

Front connector

20-pin, with screw contacts

- 1 unit
- 100 units

6ES7392-1AJ00-0AA0
6ES7392-1AJ00-1AB0

20-pin, with spring-loaded contacts

- 1 unit
- 100 units

6ES7392-1BJ00-0AA0
6ES7392-1BJ00-1AB0

40-pin, with screw contacts

- 1 unit
- 100 units

6ES7392-1AM00-0AA0
6ES7392-1AM00-1AB0

40-pin, with spring-loaded contacts

- 1 unit
- 100 units

6ES7392-1BM01-0AA0
6ES7392-1BM01-1AB0

Front door, elevated design

6ES7328-0AA00-7AA0

e.g. for 32-channel modules; for connecting 1.3 mm²/16 AWG wires

SIMATIC TOP connect

See page 5/237

Article No.

Bus connectors

1 unit (spare part)

6ES7390-0AA00-0AA0

Shield connection element

80 mm wide, with 2 rows for 4 shield connection clamps each

6ES7390-5AA00-0AA0

Shield connection clamps

2 units

For 2 cables with 2 mm to 6 mm diameter

6ES7390-5AB00-0AA0

For 1 cable with 3 mm to 8 mm diameter

6ES7390-5BA00-0AA0

For 1 cable with 4 mm to 13 mm diameter

6ES7390-5CA00-0AA0

Label cover

10 units (spare part), for modules with 20-pin front connector

6ES7392-2XY00-0AA0

Labeling strips

10 units (spare part), for modules with 20-pin front connector

6ES7392-2XX00-0AA0

Labeling sheets for machine labeling

For modules with 20-pin front connector, DIN A4, for printing with laser printer; 10 units

Petrol

6ES7392-2AX00-0AA0

Light beige

6ES7392-2BX00-0AA0

Yellow

6ES7392-2CX00-0AA0

Red

6ES7392-2DX00-0AA0

For modules with 40-pin front connector, DIN A4, for printing with laser printer; 10 units

Petrol

6ES7392-2AX10-0AA0

Light beige

6ES7392-2BX10-0AA0

Yellow

6ES7392-2CX10-0AA0

Red

6ES7392-2DX10-0AA0

Ordering data

Article No.

Article No.

SIMATIC Manual Collection

Electronic manuals on DVD, multi-language:
LOGO!, SIMADYN,
SIMATIC bus components,
SIMATIC C7, SIMATIC distributed I/O,
SIMATIC HMI, SIMATIC Sensors,
SIMATIC NET, SIMATIC PC-based
Automation, SIMATIC PCS 7,
SIMATIC PG/PC, SIMATIC S7,
SIMATIC Software, SIMATIC TDC

6ES7998-8XC01-8YE0**SIMATIC Manual Collection
update service for 1 year**

Current Manual Collection DVD and
the three subsequent updates

6ES7998-8XC01-8YE2

Technical specifications

Article number	6ES7331-7KF02-0AB0 SM331, 8AI, 9/12/14Bit	6ES7331-7HF01-0AB0 SM331, 8AI, 14BIT, 0,052MS/channel	6ES7331-1KF02-0AB0 SM331, 8AI, 13bit	6ES7331-7KB02-0AB0 SM331, 2AI, 9/12/14Bit
Supply voltage				
Load voltage L+				
• Rated value (DC)	24 V	24 V		24 V
Input current				
from load voltage L+ (without load), max.	30 mA	50 mA		30 mA
from backplane bus 5 V DC, max.	50 mA	100 mA	90 mA	50 mA
Power loss				
Power loss, typ.	1 W	1.5 W	0.4 W	1 W
Analog inputs				
Number of analog inputs	8	8	8	2
• For resistance measurement	4		8	1
permissible input voltage for voltage input (destruction limit), max.	20 V; continuous; 75 V for max. 1 s (mark to space ratio 1:20)	20 V; 20 V DC permanent, 75 V DC for max. 1 s (duty factor 1:20)	30 V; 12 V continuous, 30 V for max. 1 s	20 V; continuous; 75 V for max. 1 s (mark to space ratio 1:20)
permissible input current for current input (destruction limit), max.	40 mA	40 mA	40 mA	40 mA
Input ranges (rated values), voltages				
• 0 to +10 V	No	No	Yes	No
• 1 V to 5 V	Yes	Yes	Yes	Yes
• 1 V to 10 V	No		No	No
• -1 V to +1 V	Yes	Yes	Yes	Yes
• -10 V to +10 V	Yes	Yes	Yes	Yes
• -2.5 V to +2.5 V	Yes		No	Yes
• -250 mV to +250 mV	Yes		No	Yes
• -5 V to +5 V	Yes	Yes	Yes	Yes
• -50 mV to +50 mV	No		Yes	No
• -500 mV to +500 mV	Yes	Yes	Yes	Yes
• -80 mV to +80 mV	Yes	Yes	No	Yes
Input ranges (rated values), currents				
• 0 to 20 mA	Yes	Yes	Yes	Yes
• -10 mA to +10 mA	Yes		No	Yes
• -20 mA to +20 mA	Yes	Yes	Yes	Yes
• -3.2 mA to +3.2 mA	Yes		No	Yes
• 4 mA to 20 mA	Yes	Yes	Yes	Yes

SIMATIC S7-300 Advanced Controllers

I/O modules

Analog modules

SM 331 analog input modules

Technical specifications

Article number	6ES7331-7KF02-0AB0 SM331, 8AI, 9/12/14Bit	6ES7331-7HF01-0AB0 SM331, 8AI, 14BIT, 0,052MS/channel	6ES7331-1KF02-0AB0 SM331, 8AI, 13bit	6ES7331-7KB02-0AB0 SM331, 2AI, 9/12/14Bit
Input ranges (rated values), thermocouples				
• Type B	No		No	No
• Type C	No		No	
• Type E	Yes		No	Yes
• Type J	Yes		No	Yes
• Type K	Yes		No	Yes
• Type L	Yes		No	No
• Type N	Yes		No	Yes
• Type R	No		No	No
• Type S	No		No	No
• Type T	No		No	No
• Type U	No		No	No
• Type TXK/TXK(L) to GOST	No		No	No
Input ranges (rated values), resistance thermometer				
• Cu 10	No		No	No
• Ni 100	Yes; Standard		Yes; Standard/climate	Yes
• Ni 1000	No		Yes	No
• LG-Ni 1000	No		Yes; Standard/climate	No
• Ni 120	No		No	No
• Ni 200	No		No	No
• Ni 500	No		No	No
• Pt 100	Yes; Standard		Yes; Standard/climate	Yes
• Pt 1000	No		No	No
• Pt 200	No		No	No
• Pt 500	No		No	No
Input ranges (rated values), resistors				
• 0 to 150 ohms	Yes		No	Yes
• 0 to 300 ohms	Yes		No	Yes
• 0 to 600 ohms	Yes		Yes	Yes
• 0 to 6000 ohms	No		Yes	No
Thermocouple (TC)				
Temperature compensation				
- parameterizable	Yes		No	Yes
- internal temperature compensation	Yes		No	Yes
- external temperature compensation with compensations socket	Yes		No	Yes
- for definable comparison point temperature	Yes			Yes
Characteristic linearization				
• parameterizable	Yes		Yes	Yes
- for thermocouples	Type E, J, K, L, N		No	Type E, J, K, L, N
- for resistance thermometer	Pt100 (standard, climatic range), Ni100 (standard, climatic range)		yes; Pt100 standard/air con.; Ni100 standard/air con.; Ni1000 standard/air con.; LG-Ni1000 standard/air con.	Pt100 (standard, climatic range), Ni100 (standard, climatic range)
Cable length				
• shielded, max.	200 m; 50 m at 80 mV and thermocouples	200 m	200 m; max. 50 m at 50 mV	200 m; 50 m at 80 mV and thermocouples
Analog value generation for the inputs				
Integration and conversion time/resolution per channel				
• Resolution with overrange (bit including sign), max.	15 bit; Unipolar: 9/12/12/14 bit; bipolar: 9 bit + sign/12 bit + sign/ 12 bit + sign/14 bit + sign	14 bit; Unipolar: 14 bit; bipolar: 13 bit + sign	13 bit	15 bit; Unipolar: 9/12/12/14 bit; bipolar: 9 bit + sign/12 bit + sign/ 12 bit + sign/14 bit + sign
• Integration time, parameterizable	Yes; 2,5 / 16,67 / 20 / 100 ms	Yes	Yes; 60 / 50 ms	Yes; 2,5 / 16,67 / 20 / 100 ms
• Basic conversion time (ms)	3 / 17 / 22 / 102 ms	52 µs per channel	66 / 55 ms	3 / 17 / 22 / 102 ms
• Interference voltage suppression for interference frequency f1 in Hz	400 / 60 / 50 / 10 Hz	none / 400 / 60 / 50 Hz	50 / 60 Hz	400 / 60 / 50 / 10 Hz

Technical specifications

Article number	6ES7331-7KF02-0AB0 SM331, 8AI, 9/12/14Bit	6ES7331-7HF01-0AB0 SM331, 8AI, 14BIT, 0,052MS/channel	6ES7331-1KF02-0AB0 SM331, 8AI, 13bit	6ES7331-7KB02-0AB0 SM331, 2AI, 9/12/14Bit
Encoder				
Connection of signal encoders				
• for voltage measurement	Yes		Yes	Yes
• for current measurement as 2-wire transducer	Yes	Yes	Yes; with external supply	Yes
• for current measurement as 4-wire transducer	Yes	Yes	Yes	Yes
• for resistance measurement with two-wire connection	Yes		Yes	Yes
• for resistance measurement with three-wire connection	Yes		Yes	Yes
• for resistance measurement with four-wire connection	Yes		Yes	Yes
Errors/accuracies				
Operational error limit in overall temperature range				
• Voltage, relative to input range, (+/-)	1 %; ±1% (80 mV); ±0.6% (250 mV to 1 000 mV); ±0.8% (2.5 V to 10 V)	0.4 %	0.6 %; ±0.6 % (±5 V, 10 V, 1 to 5 V, 0 to 10 V); ±0.5 % (±50 mV, 500 mV, 1 V)	1 %; ±1% (80 mV); ±0.6% (250 mV to 1 000 mV); ±0.8% (2.5 V to 10 V)
• Current, relative to input range, (+/-)	0.7 %; From 3.2 to 20 mA	0.3 %	0.5 %; ±20 mA, 0 to 20 mA, 4 to 20 mA	0.7 %; From 3.2 to 20 mA
• Resistance, relative to input range, (+/-)	0.7 %; 150, 300, 600 Ohm		0.5 %; 0 to 6 kohms, 0 to 600 kohms	0.7 %; 150, 300, 600 Ohm
• Resistance thermometer, relative to input range, (+/-)	0.7 %; ±0.7 % (Pt100/ Ni100); ±0.8 % (Pt100 climate)		1 Kelvin (Pt100, Ni100, climatic; Ni1000, LG-Ni1000, standard; Ni1000, LG-Ni1000, climatic); 1.2 Kelvin (Pt100, Ni100, standard)	0.7 %; ±0.7 % (Pt100/ Ni100); ±0.8 % (Pt100 climate)
• Thermocouple, relative to input range, (+/-)	1.1 %; Type E, J, K, L, N			1.1 %; Type E, J, K, L, N
Basic error limit (operational limit at 25 °C)				
• Voltage, relative to input range, (+/-)	0.6 %; ±0.4 % (250 mV to 1 000 mV); ±0.6 % (2.5 mV to 10 mV); ±0.7 % (80 mV)	0.25 %	0.4 %; 0.4% (±5 V, 10 V, 1 to 5 V, 0 to 10 V); 0.3% (±50 mV, 500 mV, 1 V)	0.6 %; ±0.6% (80 mV, 2.5 V to 10 V); ±0.4% (250 mV to 1 000 mV)
• Current, relative to input range, (+/-)	0.5 %; 3.2 to 20 mA	0.2 %	0.3 %; ±20 mA, 0 to 20 mA, 4 to 20 mA	0.5 %; 3.2 to 20 mA
• Resistance, relative to input range, (+/-)	0.5 %; 150, 300, 600 Ohm		0.3 %; 0 to 6 kohms, 0 to 600 kohms	0.5 %; 150, 300, 600 Ohm
• Resistance thermometer, relative to input range, (+/-)	0.6 %; ±0.5% (Pt100/ Ni100), ±0.6% (Pt100 climate)		1 Kelvin (Pt100, Ni100, standard); 0.8 Kelvin (Pt100, Ni100, climatic; Ni1000, LG-Ni1000, standard; Ni1000, LG-Ni1000, climatic)	0.6 %; ±0.5% (Pt100/ Ni100), ±0.6% (Pt100 climate)
• Thermocouple, relative to input range, (+/-)	0.7 %; Type E, N, J, K, L			0.7 %; Type E, N, J, K, L
Interrupts/diagnostics/status information				
Diagnostics function	Yes; Parameterizable	Yes	No	Yes; Parameterizable
Alarms				
• Diagnostic alarm	Yes; Parameterizable, channels 0 and 2	Yes; Parameterizable	No	Yes
• Limit value alarm	Yes; Parameterizable	Yes; Parameterizable, channels 0 and 2	No	Yes; Parameterizable, channel 0
Connection method				
required front connector	20-pin	20-pin	40-pin	20-pin
Dimensions				
Width	40 mm	40 mm	40 mm	40 mm
Height	125 mm	125 mm	125 mm	125 mm
Depth	117 mm	117 mm	117 mm	120 mm
Weights				
Weight, approx.	250 g	230 g	250 g	250 g

SIMATIC S7-300 Advanced Controllers

I/O modules

Analog modules

SM 331 analog input modules

Technical specifications

Article number	6ES7331-7PF01-0AB0	6ES7331-7PF11-0AB0	6ES7331-7PE10-0AB0	6ES7331-7NF00-0AB0	6ES7331-7NF10-0AB0
	SM331, 8AI, resistor, PT100/200/1000, ..	SM331, 8AI, 16BIT, Thermocouples	SM331, 6AI, 16bit, Thermocouple	SM331,8AI, +/-5/10V,1-5V, +/-20mA,0/4-20mA	SM331,8AI, +/-5/10V,1-5V, +/-20mA,0/4-20mA
Supply voltage					
Load voltage L+					
• Rated value (DC)	24 V	24 V	24 V		24 V
Input current					
from load voltage L+ (without load), max.	240 mA	240 mA	150 mA		200 mA
from backplane bus 5 V DC, max.	100 mA	100 mA	100 mA	130 mA	100 mA
Power loss					
Power loss, typ.	4.6 W	3 W	2.2 W	0.6 W	3 W
Analog inputs					
Number of analog inputs	8	8	6	8	8
• For resistance measurement	8				
permissible input voltage for voltage input (destruction limit), max.	75 V; 35 V continuous, 75 V for max. 1 s (mark to space ratio 1:20)	75 V; 20 V DC permanent, 75 V DC for max. 1 s (duty factor 1:20)	35 V; 35 V continuous, 75 V for max. 1 s (mark to space ratio 1:20)	50 V; Permanent	75 V; 35 V continuous, 75 V for max. 1 s (mark to space ratio 1:20)
permissible input current for current input (destruction limit), max.				32 mA	40 mA
Input ranges (rated values), voltages					
• 0 to +10 V	No	No	No	No	No
• 1 V to 5 V	No	No	No	Yes	Yes
• 1 V to 10 V	No	No	No	No	No
• -1 V to +1 V	No	No	Yes	No	No
• -10 V to +10 V	No	No	No	Yes	Yes
• -2.5 V to +2.5 V	No	No	No	No	No
• -250 mV to +250 mV	No	No	Yes	No	No
• -5 V to +5 V	No	No	No	Yes	Yes
• -50 mV to +50 mV	No	No	Yes	No	No
• -500 mV to +500 mV	No	No	Yes	No	No
• -80 mV to +80 mV	No	No	Yes	No	No
Input ranges (rated values), currents					
• 0 to 20 mA	No	No	No	Yes	Yes
• -10 mA to +10 mA	No	No	No	No	No
• -20 mA to +20 mA	No	No	No	Yes	Yes
• -3.2 mA to +3.2 mA	No	No	No	No	No
• 4 mA to 20 mA	No	No	No	Yes	Yes
Input ranges (rated values), thermocouples					
• Type B	No	Yes	Yes	No	No
• Type C	No	Yes	Yes	No	No
• Type E	No	Yes	Yes	No	No
• Type J	No	Yes	Yes	No	No
• Type K	No	Yes	Yes	No	No
• Type L	No	Yes	Yes	No	No
• Type N	No	Yes	Yes	No	No
• Type R	No	Yes	Yes	No	No
• Type S	No	Yes	Yes	No	No
• Type T	No	Yes	Yes	No	No
• Type U	No	Yes	Yes	No	No
• Type TXK/TXK(L) to GOST	No	Yes	Yes	No	No

Technical specifications

Article number	6ES7331-7PF01-0AB0	6ES7331-7PF11-0AB0	6ES7331-7PE10-0AB0	6ES7331-7NF00-0AB0	6ES7331-7NF10-0AB0
	SM331, 8AI, resistor, PT100/200/1000, ..	SM331, 8AI, 16BIT, Thermocouples	SM331, 6AI, 16bit, Thermocouple	SM331,8AI, +/-5/10V,1-5V, +/-20mA,0/4-20mA	SM331,8AI, +/-5/10V,1-5V, +/-20mA,0/4-20mA
Input ranges (rated values), resistance thermometer					
• Cu 10	Yes	No	No	No	No
• Ni 100	Yes	No	No	No	No
• Ni 1000	Yes	No	No	No	No
• LG-Ni 1000	Yes	No	No	No	No
• Ni 120	Yes	No	No	No	No
• Ni 200	Yes	No	No	No	No
• Ni 500	Yes	No	No	No	No
• Pt 100	Yes	No	No	No	No
• Pt 1000	Yes	No	No	No	No
• Pt 200	Yes	No	No	No	No
• Pt 500	Yes	No	No	No	No
Input ranges (rated values), resistors					
• 0 to 150 ohms	Yes	No	No	No	No
• 0 to 300 ohms	Yes	No	No	No	No
• 0 to 600 ohms	Yes	No	No	No	No
• 0 to 6000 ohms		No	No	No	No
Thermocouple (TC)					
Temperature compensation					
- parameterizable		Yes	Yes		
- internal temperature compensation		Yes	Yes		
- external temperature compensation with Pt100		Yes	Yes		
- external temperature compensation with compensations socket		Yes	Yes		
- for definable comparison point temperature		Yes	Yes		
Characteristic linearization					
• parameterizable	Yes	Yes	Yes		
- for thermocouples		Type B, E, J, K, L, N, R, S, T, U, C	Type B, E, J, K, L, N, R, S, T, U, C, TXK, XK(L)		
- for resistance thermometer	Pt100, Pt200, Pt500, Pt1000, Ni100, Ni120, Ni200, Ni500, Ni1000, Cu10; (standard/ climate)		No		
Cable length					
• shielded, max.	200 m	100 m	200 m	200 m	200 m
Analog value generation for the inputs					
Integration and conversion time/resolution per channel					
• Resolution with overrange (bit including sign), max.	16 bit; Two's complement	16 bit; Two's complement	16 bit; Two's complement	16 bit; Unipolar: 15/15/15/15 bit; bipolar: 15 bit + sign/15 bit + sign/15 bit + sign/15 bit + sign	16 bit; Unipolar: 15/15/15/15 bit; bipolar: 15 bit + sign/15 bit + sign/15 bit + sign
• Integration time, parameterizable	Yes	Yes	Yes	Yes; 10/ 16.67/ 20/ 100 ms	Yes; 23 / 72 / 83 / 95 ms
• Basic conversion time (ms)	up to 4 channels: 10 ms per module, over 5 channels: 190 ms per module, 8 channels: 80 ms	Up to 4 channels: 10 ms per module, 5 channels upwards: 190 ms per module	30 / 50 / 60 / 300 ms		10 ms (4-channel mode); 95/83/72/23 ms (8-channel mode)
• Integration time (ms)			10/ 16.67/ 20/ 100 ms		
• Interference voltage suppression for interference frequency f1 in Hz	400 / 60 / 50 Hz	400 / 60 / 50 Hz	10 / 50 / 60 / 400 Hz	400 / 60 / 50 / 10 Hz	400 / 60 / 50 Hz, combinations of 400, 60, 50 Hz

SIMATIC S7-300 Advanced Controllers

I/O modules

Analog modules

SM 331 analog input modules

Technical specifications

Article number	6ES7331-7PF01-0AB0	6ES7331-7PF11-0AB0	6ES7331-7PE10-0AB0	6ES7331-7NF00-0AB0	6ES7331-7NF10-0AB0
	SM331, 8AI, resistor, PT100/200/1000, ..	SM331, 8AI, 16BIT, Thermocouples	SM331, 6AI, 16bit, Thermocouple	SM331,8AI, +/-5/10V,1-5V, +/-20mA,0/4-20mA	SM331,8AI, +/-5/10V,1-5V, +/-20mA,0/4-20mA
Encoder					
Connection of signal encoders					
<ul style="list-style-type: none"> for voltage measurement for current measurement as 2-wire transducer 			Yes	Yes	Yes
<ul style="list-style-type: none"> for current measurement as 4-wire transducer 				Yes	Yes
<ul style="list-style-type: none"> for resistance measurement with two-wire connection 	Yes; without resistance correction				
<ul style="list-style-type: none"> for resistance measurement with three-wire connection 	Yes				
<ul style="list-style-type: none"> for resistance measurement with four-wire connection 	Yes				
Errors/accuracies					
Operational error limit in overall temperature range					
<ul style="list-style-type: none"> Voltage, relative to input range, (+/-) 		±1 K	Operating error at 0 ... 60 °C: ±0.12% @ ±25 mV, ±0.08% @ ±50 mV, ±0.6% @ ±80 mV, ±0.05% @ ±250 mV, ±0.05% @ 500 mV, ±0.05% @ ±1 V	0.1 %; At Ucm = 0 V or ±0.7 % at Ucm = 50 V	0.1 %
<ul style="list-style-type: none"> Current, relative to input range, (+/-) 				0.3 %; At Ucm = 0 V or ±0.9 % at Ucm = 50 V	0.1 %
<ul style="list-style-type: none"> Resistance, relative to input range, (+/-) 	0.1 %				
<ul style="list-style-type: none"> Resistance thermometer, relative to input range, (+/-) 	±1 K				
<ul style="list-style-type: none"> Thermocouple, relative to input range, (+/-) 		Type T: ±0.18%, Type U: ±0.15%, Type E: ±0.12%, Type J: ±0.12%, Type L: ±0.17%, Type K: ±0.15%, Type N: ±0.17%, Type R: ±0.08%, Type S: ±0.10%, Type B: ±0.13%, Type C: ±0.10%, TXK/XK(L): ±1.00% accuracy in the lower range of the characteristic curve	See manual for details		
Basic error limit (operational limit at 25 °C)					
<ul style="list-style-type: none"> Voltage, relative to input range, (+/-) Current, relative to input range, (+/-) 			See manual for details	0.05 % 0.05 %	0.05 % 0.05 %
<ul style="list-style-type: none"> Resistance, relative to input range, (+/-) 	0.05 %				
<ul style="list-style-type: none"> Resistance thermometer, relative to input range, (+/-) 	±0.5 K				

5

Technical specifications

Article number	6ES7331-7PF01-0AB0	6ES7331-7PF11-0AB0	6ES7331-7PE10-0AB0	6ES7331-7NF00-0AB0	6ES7331-7NF10-0AB0
	SM331, 8AI, resistor, PT100/200/1000, ..	SM331, 8AI, 16BIT, Thermocouples	SM331, 6AI, 16bit, Thermocouple	SM331,8AI, +/-5/10V,1-5V, +/-20mA,0/4-20mA	SM331,8AI, +/-5/10V,1-5V, +/-20mA,0/4-20mA
• Thermocouple, relative to input range, (+/-)		Type T: ±0.13%, Type U: ±0.08%, Type E: ±0.05%, Type J: ±0.04%, Type L: ±0.06%, Type K: ±0.04%, Type N: ±0.04%, Type R: ±0.03%, Type S: ±0.03%, Type B: ±0.05%, Type C: ±0.02%, TXK/XK(L): ±0.67 % accuracy in the lower range of the characteristic curve	See manual for details		
Interrupts/diagnostics/status information					
Diagnostics function	Yes; Parameterizable	Yes; Parameterizable	Yes; Parameterizable	Yes; Parameterizable	Yes; Parameterizable
Alarms					
• Diagnostic alarm	Yes; Parameterizable per group	Yes; Parameterizable per group	Yes; channel by channel	Yes; Parameterizable	Yes; Parameterizable
• Limit value alarm	Yes; Parameterizable	Yes; Parameterizable	Yes; Parameterizable	Yes; Parameterizable, channels 0 and 2	Yes; Parameterizable all channels (end of cycle interrupt is also supported across modules)
• Hardware interrupt	Yes; Parameterizable, channels 0 to 7	Yes; Parameterizable, channels 0 to 7	Yes; Parameterizable		Yes; Parameterizable, channels 0 to 7 (on exceeding limit value), at end of cycle
Connection method					
required front connector	40-pin	40-pin	40-pin	40-pin	40-pin
Dimensions					
Width	40 mm	40 mm	40 mm	40 mm	40 mm
Height	125 mm	125 mm	125 mm	125 mm	125 mm
Depth	120 mm	120 mm	120 mm	117 mm	117 mm
Weights					
Weight, approx.	272 g	272 g	272 g	272 g	272 g

SIMATIC S7-300 Advanced Controllers

I/O modules

Analog modules

SM 332 analog output modules

Overview



- Analog outputs
- For the connection of analog actuators

5

Ordering data

SM 332 analog output modules

Incl. labeling strips, bus connector

4 outputs, 11/12 bits

6ES7332-5HD01-0AB0

4 outputs, 16 bits

6ES7332-7ND02-0AB0

2 outputs, 11/12 bits

6ES7332-5HB01-0AB0

8 outputs, 11/12 bits

6ES7332-5HF00-0AB0

Front connector

20-pin, with screw contacts

- 1 unit
- 100 units

6ES7392-1AJ00-0AA0

6ES7392-1AJ00-1AB0

20-pin, with spring-loaded contacts

- 1 unit
- 100 units

6ES7392-1BJ00-0AA0

6ES7392-1BJ00-1AB0

40-pin, with screw contacts

- 1 unit
- 100 units

6ES7392-1AM00-0AA0

6ES7392-1AM00-1AB0

40-pin, with spring-loaded contacts

- 1 unit
- 100 units

6ES7392-1BM01-0AA0

6ES7392-1BM01-1AB0

Front door, elevated design

6ES7328-0AA00-7AA0

e.g. for 32-channel modules; for connecting 1.3 mm²/16 AWG wires

SIMATIC TOP connect

See page 5/237

Bus connectors

1 unit (spare part)

6ES7390-0AA00-0AA0

Shield connection element

6ES7390-5AA00-0AA0

80 mm wide, with 2 rows for 4 shield connection clamps each

Shield connection clamps

2 units

For 2 cables with 2 mm to 6 mm diameter

6ES7390-5AB00-0AA0

For 1 cable with 3 mm to 8 mm diameter

6ES7390-5BA00-0AA0

For 1 cable with 4 mm to 13 mm diameter

6ES7390-5CA00-0AA0

Article No.

Label cover

10 units (spare part), for modules with 20-pin front connector

6ES7392-2XY00-0AA0

Labeling strips

10 units (spare part), for modules with 20-pin front connector

6ES7392-2XX00-0AA0

Labeling sheets for machine labeling

For modules with 20-pin front connector, DIN A4, for printing with laser printer; 10 units

Petrol

6ES7392-2AX00-0AA0

Light beige

6ES7392-2BX00-0AA0

Yellow

6ES7392-2CX00-0AA0

Red

6ES7392-2DX00-0AA0

For modules with 40-pin front connector, DIN A4, for printing with laser printer; 10 units

Petrol

6ES7392-2AX10-0AA0

Light beige

6ES7392-2BX10-0AA0

Yellow

6ES7392-2CX10-0AA0

Red

6ES7392-2DX10-0AA0

SIMATIC Manual Collection

6ES7998-8XC01-8YE0

Electronic manuals on DVD, multi-language: LOGO!, SIMADYN, SIMATIC bus components, SIMATIC C7, SIMATIC distributed I/O, SIMATIC HMI, SIMATIC Sensors, SIMATIC NET, SIMATIC PC-based Automation, SIMATIC PCS 7, SIMATIC PG/PC, SIMATIC S7, SIMATIC Software, SIMATIC TDC

SIMATIC Manual Collection update service for 1 year

6ES7998-8XC01-8YE2

Current Manual Collection DVD and the three subsequent updates

Technical specifications

Article number	6ES7332-5HB01-0AB0 SM332, 2AA, U/I, 11/12Bit	6ES7332-5HD01-0AB0 SM332, 4AO, U/I, 11/12Bit	6ES7332-5HF00-0AB0 SM332, 8AA, U/I, 11/12Bit	6ES7332-7ND02-0AB0 SM332, 4AA, 0-10V, 0-5V, +/-10V,+/-20mA
Supply voltage				
Load voltage L+				
• Rated value (DC)	24 V	24 V	24 V	24 V
Input current				
from load voltage L+ (without load), max.	135 mA	240 mA	340 mA	290 mA
from backplane bus 5 V DC, max.	60 mA	60 mA	100 mA	120 mA
Power loss				
Power loss, typ.	3 W	3 W	6 W	3 W
Analog outputs				
Number of analog outputs	2	4	8	4; Isochronous mode
Voltage output, short-circuit protection	Yes	Yes	Yes	Yes
Voltage output, short-circuit current, max.	25 mA	25 mA	25 mA	40 mA
Current output, no-load voltage, max.	18 V	18 V	18 V	18 V
Output ranges, voltage				
• 0 to 10 V	Yes	Yes	Yes	Yes
• 1 V to 5 V	Yes	Yes	Yes	Yes
• -10 V to +10 V	Yes	Yes	Yes	Yes
Output ranges, current				
• 0 to 20 mA	Yes	Yes	Yes	Yes
• -20 mA to +20 mA	Yes	Yes	Yes	Yes
• 4 mA to 20 mA	Yes	Yes	Yes	Yes
Load impedance (in rated range of output)				
• with voltage outputs, min.	1 k Ω	1 k Ω	1 k Ω	1 k Ω
• with voltage outputs, capacitive load, max.	1 μ F	1 μ F	1 μ F	1 μ F
• with current outputs, max.	500 Ω	500 Ω	500 Ω	500 Ω
• with current outputs, inductive load, max.	10 mH	10 mH	10 mH	1 mH
Cable length				
• shielded, max.	200 m	200 m	200 m	200 m
Analog value generation for the outputs				
Integration and conversion time/resolution per channel				
• Resolution with overrange (bit including sign), max.	12 bit; ± 10 V, ± 20 mA, 4 mA to 20 mA, 1 V to 5 V: 11 bit + sign; 0 V to 10 V, 0 mA to 20 mA: 12 bit	12 bit; ± 10 V, ± 20 mA, 4 mA to 20 mA, 1 V to 5 V: 11 bit + sign; 0 V to 10 V, 0 mA to 20 mA: 12 bit	12 bit; ± 10 V, ± 20 mA, 4 mA to 20 mA, 1 V to 5 V: 11 bit + sign; 0 V to 10 V, 0 mA to 20 mA: 12 bit	16 bit
• Conversion time (per channel)	0.8 ms	0.8 ms	0.8 ms	200 μ s; in isochronous mode 640 μ s
Settling time				
• for resistive load	0.2 ms	0.2 ms	0.2 ms	0.2 ms
• for capacitive load	3.3 ms	3.3 ms	3.3 ms	3.3 ms
• for inductive load	0.5 ms; 0.5 ms (1 mH); 3.3 ms (10 mH)	0.5 ms; 0.5 ms (1 mH); 3.3 ms (10 mH)	0.5 ms; 0.5 ms (1 mH); 3.3 ms (10 mH)	0.5 ms

SIMATIC S7-300 Advanced Controllers

I/O modules

Analog modules

SM 332 analog output modules**Technical specifications**

Article number	6ES7332-5HB01-0AB0 SM332, 2AA, U/I, 11/12Bit	6ES7332-5HD01-0AB0 SM332, 4AO, U/I, 11/12Bit	6ES7332-5HF00-0AB0 SM332, 8AA, U/I, 11/12Bit	6ES7332-7ND02-0AB0 SM332, 4AA, 0-10V, 0-5V, +/-10V,+/-20mA
Errors/accuracies				
Operational error limit in overall temperature range				
• Voltage, relative to output range, (+/-)	0.5 %	0.5 %	0.5 %	0.12 %
• Current, relative to output range, (+/-)	0.6 %	0.6 %	0.6 %	0.18 %
Basic error limit (operational limit at 25 °C)				
• Voltage, relative to output range, (+/-)	0.4 %	0.4 %	0.4 %	0.02 %
• Current, relative to output range, (+/-)	0.5 %	0.5 %	0.5 %	0.02 %
Interrupts/diagnostics/status information				
Diagnostics function	Yes; Parameterizable	Yes; Parameterizable	Yes; Parameterizable	Yes; Parameterizable
Alarms				
• Diagnostic alarm	Yes; Parameterizable	Yes; Parameterizable	Yes; Parameterizable	Yes; Parameterizable
Connection method				
required front connector	20-pin	20-pin	40-pin	20-pin
Dimensions				
Width	40 mm	40 mm	40 mm	40 mm
Height	125 mm	125 mm	125 mm	125 mm
Depth	117 mm	117 mm	117 mm	117 mm
Weights				
Weight, approx.	220 g	220 g	272 g	220 g

5

Overview



- Analog inputs and outputs
- For the connection of analog sensors and actuators

Ordering data

SM 334 analog input/output modules

Incl. labeling strips, bus connector

4 inputs, 2 outputs

6ES7334-0CE01-0AA0

4 inputs, 2 outputs, resistance measurement, Pt 100

6ES7334-0KE00-0AB0**Front connector**

20-pin, with screw contacts

- 1 unit
- 100 units

6ES7392-1AJ00-0AA0**6ES7392-1AJ00-1AB0**

20-pin, with spring-loaded terminals

- 1 unit
- 100 units

6ES7392-1BJ00-0AA0**6ES7392-1BJ00-1AB0****Front door, elevated design****6ES7328-0AA00-7AA0**e.g. for 32-channel modules; for connecting 1.3 mm²/16 AWG wires**SIMATIC TOP connect**

See page 5/237

Bus connectors**6ES7390-0AA00-0AA0**

1 unit (spare part)

Shield connection element**6ES7390-5AA00-0AA0**

80 mm wide, with 2 rows for 4 shield connection clamps each

Shield connection clamps

2 units

For 2 cables with 2 mm to 6 mm diameter

6ES7390-5AB00-0AA0

For 1 cable with 3 mm to 8 mm diameter

6ES7390-5BA00-0AA0

For 1 cable with 4 mm to 13 mm diameter

6ES7390-5CA00-0AA0**Label cover**

10 units (spare part), for modules with 20-pin front connector

Article No.**6ES7392-2XY00-0AA0****Labeling strips**

10 units (spare part), for modules with 20-pin front connector

6ES7392-2XX00-0AA0**Labeling sheets for machine labeling**

For modules with 20-pin front connector, DIN A4, for printing with laser printer; 10 units

Petrol

6ES7392-2AX00-0AA0

Light beige

6ES7392-2BX00-0AA0

Yellow

6ES7392-2CX00-0AA0

Red

6ES7392-2DX00-0AA0**SIMATIC Manual Collection****6ES7998-8XC01-8YE0**

Electronic manuals on DVD, multilingual: LOGO!, SIMADYN, SIMATIC bus components, SIMATIC C7, SIMATIC distributed I/O, SIMATIC HMI, SIMATIC Sensors, SIMATIC NET, SIMATIC PC Based Automation, SIMATIC PCS 7, SIMATIC PG/PC, SIMATIC S7, SIMATIC Software, SIMATIC TDC

SIMATIC Manual Collection update service for 1 year**6ES7998-8XC01-8YE2**

Current "Manual Collection" DVD and the three subsequent updates

SIMATIC S7-300 Advanced Controllers

I/O modules

Analog modules

SM 334 analog input/output modules

Technical specifications

Article number	6ES7334-0CE01-0AA0 SM334, 4AI, 2AO, non isolated	6ES7334-0KE00-0AB0 SM334, 4AI/2AO, 0-10V f.PT100
Supply voltage		
Load voltage L+		
• Rated value (DC)	24 V	24 V
Input current		
from supply and load voltage L+ (without load), max.	110 mA	80 mA
from backplane bus 5 V DC, max.	55 mA	60 mA
Power loss		
Power loss, typ.	3 W	2 W
Analog inputs		
Number of analog inputs	4	4
• For voltage measurement	4	2
• For resistance measurement		4
permissible input voltage for voltage input (destruction limit), max.	20 V	20 V; continuous; 75 V for max. 1 s (mark to space ratio 1:20)
permissible input current for current input (destruction limit), max.	40 mA	
Cycle time (all channels) max.	5 ms	85 ms
Input ranges (rated values), voltages		
• 0 to +10 V	Yes	Yes
Input ranges (rated values), currents		
• 0 to 20 mA	Yes	
Input ranges (rated values), resistance thermometer		
• Pt 100		Yes; only climatic range
Input ranges (rated values), resistors		
• 0 to 10000 ohms		Yes
Characteristic linearization		
• parameterizable		Yes
- for resistance thermometer		Pt100 (climate)
Cable length		
• shielded, max.	200 m	100 m
Analog outputs		
Number of analog outputs	2	2
Voltage output, short-circuit protection	Yes	Yes
Voltage output, short-circuit current, max.	11 mA	30 mA
Current output, no-load voltage, max.	15 V	
Output ranges, voltage		
• 0 to 10 V	Yes	Yes
Output ranges, current		
• 0 to 20 mA	Yes	
Load impedance (in rated range of output)		
• with voltage outputs, min.	5 k Ω	2.5 k Ω
• with voltage outputs, capacitive load, max.	1 μ F	1 μ F
• with current outputs, max.	300 Ω	
• with current outputs, inductive load, max.	1 mH	
Cable length		
• shielded, max.	200 m	100 m

5

Technical specifications

Article number	6ES7334-0CE01-0AA0	6ES7334-0KE00-0AB0
	SM334, 4AI, 2AO, non isolated	SM334, 4AI/2AO, 0-10V f.PT100
Analog value generation for the inputs		
Integration and conversion time/resolution per channel		
• Resolution with overrange (bit including sign), max.	8 bit	12 bit
• Integration time, parameterizable	No	Yes
• Integration time (ms)		16,67 / 20 ms
• Interference voltage suppression for interference frequency f1 in Hz		50 / 60 Hz
Analog value generation for the outputs		
Integration and conversion time/resolution per channel		
• Resolution with overrange (bit including sign), max.	8 bit	12 bit
• Conversion time (per channel)	500 µs	500 µs
Settling time		
• for resistive load	0.3 ms	0.8 ms
• for capacitive load	3 ms	0.8 ms
• for inductive load	0.3 ms	
Encoder		
Connection of signal encoders		
• for voltage measurement	Yes	Yes
• for current measurement as 2-wire transducer	No	
• for current measurement as 4-wire transducer	Yes	
• for resistance measurement with two-wire connection		Yes
• for resistance measurement with three-wire connection		Yes
• for resistance measurement with four-wire connection		Yes
Errors/accuracies		
Operational error limit in overall temperature range		
• Voltage, relative to input range, (+/-)	0.9 %	0.7 %; 0 to 10V
• Current, relative to input range, (+/-)	0.8 %	
• Resistance, relative to input range, (+/-)		3.5 %; 10 kOhm
• Resistance thermometer, relative to input range, (+/-)		1 %
• Voltage, relative to output range, (+/-)	0.6 %	1 %
• Current, relative to output range, (+/-)	1 %	
Basic error limit (operational limit at 25 °C)		
• Voltage, relative to input range, (+/-)	0.7 %	0.5 %; 0 to 10V
• Current, relative to input range, (+/-)	0.6 %	
• Resistance, relative to input range, (+/-)		2.8 %; 10 kOhm
• Resistance thermometer, relative to input range, (+/-)		0.8 %
• Voltage, relative to output range, (+/-)	0.5 %	0.85 %
• Current, relative to output range, (+/-)	0.5 %	

SIMATIC S7-300 Advanced Controllers

I/O modules

Analog modules

SM 334 analog input/output modules**Technical specifications**

Article number	6ES7334-0CE01-0AA0	6ES7334-0KE00-0AB0
	SM334, 4AI, 2AO, non isolated	SM334, 4AI/2AO, 0-10V f.PT100
Interrupts/diagnostics/ status information		
Alarms	No	No
Diagnostics function	No	No
Connection method		
required front connector	20-pin	20-pin
Dimensions		
Width	40 mm	40 mm
Height	125 mm	125 mm
Depth	117 mm	117 mm
Weights		
Weight, approx.	285 g	200 g

Overview



- Analog inputs
- For connecting voltage sensors and current sensors, thermocouples, resistors and resistance thermometers

Note:

SIPLUS extreme products are based on SIMATIC standard products. The contents listed here were taken from the respective standard products. SIPLUS extreme specific information was added.

Ordering data

SIPLUS S7-300 SM 331 analog input modules

For industrial applications with extended ambient conditions

Extended temperature range and exposure to media

- 8 inputs, 13-bit resolution
- 2 inputs, 9/12/14-bit resolution
- 8 inputs, 9/12/14-bit resolution
- 8 inputs, enhanced 16-bit resolution
- 8 inputs, enhanced 16-bit resolution, 4-channel mode

Exposure to media

- 8 inputs, for thermal resistors
- 8 inputs, for thermocouples

For rolling stock railway applications

Conforms to EN 50155

- 8 inputs, 9/12/14-bit resolution
- 8 inputs, enhanced 16-bit resolution

Accessories*Mandatory***Front connector**

- 20-pin, with spring-loaded contacts
 - 1 unit
 - 100 units
- 40-pin, with spring-loaded contacts
 - 1 unit
 - 100 units

*Consumables***Front door, elevated design**

E.g. for 32-channel modules; for connecting 1.3 mm²/16 AWG conductors; circuit diagram and nameplates in petrol

Article No.

- 6AG1331-1KF02-7AB0
- 6AG1331-7KB02-2AB0
- 6AG1331-7KF02-2AB0
- 6AG1331-7NF00-2AB0
- 6AG1331-7NF10-2AB0
- 6AG1331-7PF01-4AB0
- 6AG1331-7PF11-4AB0
- 6AG1331-7KF02-2AB0
- 6AG1331-7NF00-2AB0

6ES7328-0AA00-7AA0

Article No.

Bus connectors

1 unit (spare part)

Labeling strips

10 units; spare part

For modules with 20-pin front connector

For modules with 40-pin front connector

Label cover

10 units; spare part

For modules with 20-pin front connector

For modules with 40-pin front connector

*Documentation***SIMATIC Manual Collection**

Electronic manuals on DVD, multi-language: LOGO!, SIMADYN, SIMATIC bus components, SIMATIC C7, SIMATIC distributed I/O, SIMATIC HMI, SIMATIC Sensors, SIMATIC NET, SIMATIC PC Based Automation, SIMATIC PCS 7, SIMATIC PG/PC, SIMATIC S7, SIMATIC Software, SIMATIC TDC

SIMATIC Manual Collection update service for 1 year

Current "Manual Collection" DVD and the three subsequent updates

6ES7390-0AA00-0AA0

6ES7392-2XX00-0AA0

6ES7392-2XX10-0AA0

6ES7392-2XY00-0AA0

6ES7392-2XY10-0AA0

6ES7998-8XC01-8YE0

6ES7998-8XC01-8YE2

SIMATIC S7-300 Advanced Controllers

I/O modules

SIPLUS S7-300 analog modules

SIPLUS S7-300 SM 331**Technical specifications**

Article number	6AG1331-1KF02-7AB0	6AG1331-7KB02-2AB0	6AG1331-7KF02-2AB0
Based on	6ES7331-1KF02-0AB0 SIPLUS S7-300 SM 331 8AI	6ES7331-7KB02-0AB0 SIPLUS S7-300 SM 331 2AI	6ES7331-7KF02-0AB0 SIPLUS S7-300 SM 331 8AI
Ambient conditions			
Ambient temperature during operation			
• min.	-25 °C	-25 °C; = Tmin	-25 °C; = Tmin
• max.	70 °C; = Tmax; 60 °C @ UL/cUL, ATEX and FM use	70 °C; = Tmax; 60 °C @ UL/cUL, ATEX and FM use	70 °C; = Tmax; for use on railway vehicles according to EN50155, the rated temperature range -25 ... +55 °C (T1) or 60 °C @ UL/ULhaz/ATEX/FM use applies
Altitude during operation relating to sea level			
• Installation altitude above sea level, max.	5 000 m	5 000 m	5 000 m
• Ambient air temperature-barometric pressure-altitude	Tmin ... Tmax at 1 140 hPa ... 795 hPa (-1 000 m ... +2 000 m) // Tmin ... (Tmax - 10 K) at 795 hPa ... 658 hPa (+2 000 m ... +3 500 m) // Tmin ... (Tmax -20 K) at 658 hPa ... 540 hPa (+3 500 m ... +5 000 m)	Tmin ... Tmax at 1 140 hPa ... 795 hPa (-1 000 m ... +2 000 m) // Tmin ... (Tmax - 10 K) at 795 hPa ... 658 hPa (+2 000 m ... +3 500 m) // Tmin ... (Tmax -20 K) at 658 hPa ... 540 hPa (+3 500 m ... +5 000 m)	Tmin ... Tmax at 1 140 hPa ... 795 hPa (-1 000 m ... +2 000 m) // Tmin ... (Tmax - 10 K) at 795 hPa ... 658 hPa (+2 000 m ... +3 500 m) // Tmin ... (Tmax -20 K) at 658 hPa ... 540 hPa (+3 500 m ... +5 000 m)
Resistance			
Use in stationary industrial systems			
- to biologically active substances according to EN 60721-3-3	Yes; Class 3B2 mold, fungus and dry rot spores (with the exception of fauna); Class 3B3 on request	Yes; Class 3B2 mold, fungus and dry rot spores (with the exception of fauna); Class 3B3 on request	Yes; Class 3B2 mold, fungus and dry rot spores (with the exception of fauna); Class 3B3 on request
- to chemically active substances according to EN 60721-3-3	Yes; Class 3C4 (RH < 75 %) incl. salt spray acc. to EN 60068-2-52 (severity degree 3); *	Yes; Class 3C4 (RH < 75 %) incl. salt spray acc. to EN 60068-2-52 (severity degree 3); *	Yes; Class 3C4 (RH < 75 %) incl. salt spray acc. to EN 60068-2-52 (severity degree 3); *
- to mechanically active substances according to EN 60721-3-3	Yes; Class 3S4 incl. sand, dust, *	Yes; Class 3S4 incl. sand, dust, *	Yes; Class 3S4 incl. sand, dust, *
Use on land craft, rail vehicles and special-purpose vehicles			
- to biologically active substances according to EN 60721-3-5			Yes; Class 5B2 mold, fungus and dry rot spores (with the exception of fauna); Class 5B3 on request
- to chemically active substances according to EN 60721-3-5			Yes; Class 5C3 (RH < 75 %) incl. salt spray acc. to EN 50155 (ST2); *
- to mechanically active substances according to EN 60721-3-5			Yes; Class 5S3 incl. sand, dust; *
Use on ships/at sea			
- to biologically active substances according to EN 60721-3-6	Yes; Class 6B2 mold and fungal spores (excluding fauna); Class 6B3 on request	Yes; Class 6B2 mold and fungal spores (excluding fauna); Class 6B3 on request	Yes; Class 6B2 mold and fungal spores (excluding fauna); Class 6B3 on request
- to chemically active substances according to EN 60721-3-6	Yes; Class 6C3 (RH < 75 %) incl. salt spray acc. to EN 60068-2-52 (severity degree 3); *	Yes; Class 6C3 (RH < 75 %) incl. salt spray acc. to EN 60068-2-52 (severity degree 3); *	Yes; Class 6C3 (RH < 75 %) incl. salt spray acc. to EN 60068-2-52 (severity degree 3); *
- to mechanically active substances according to EN 60721-3-6	Yes; Class 6S3 incl. sand, dust; *	Yes; Class 6S3 incl. sand, dust; *	Yes; Class 6S3 incl. sand, dust; *
Usage in industrial process technology			
- Against chemically active substances acc. to EN 60654-4	Yes; Class 3 (excluding trichlorethylene)	Yes; Class 3 (excluding trichlorethylene)	Yes; Class 3 (excluding trichlorethylene)
- Environmental conditions for process, measuring and control systems acc. to ANSI/ISA-71.04	Yes; Level GX group A/B (excluding trichlorethylene; harmful gas concentrations up to the limits of EN 60721-3-3 class 3C4 permissible); level LC3 (salt spray) and level LB3 (oil)	Yes; Level GX group A/B (excluding trichlorethylene; harmful gas concentrations up to the limits of EN 60721-3-3 class 3C4 permissible); level LC3 (salt spray) and level LB3 (oil)	Yes; Level GX group A/B (excluding trichlorethylene; harmful gas concentrations up to the limits of EN 60721-3-3 class 3C4 permissible); level LC3 (salt spray) and level LB3 (oil)
Remark			
- Note regarding classification of environmental conditions acc. to EN 60721, EN 60654-4 and ANSI/ISA-71.04	* The supplied plug covers must remain in place over the unused interfaces during operation!	* The supplied plug covers must remain in place over the unused interfaces during operation!	* The supplied plug covers must remain in place over the unused interfaces during operation!

Technical specifications

Article number	6AG1331-7NF00-2AB0	6AG1331-7NF10-2AB0	6AG1331-7PF01-4AB0	6AG1331-7PF11-4AB0
Based on	6ES7331-7NF00-0AB0 SIPLUS S7-300 SM 331 8AI - 40-pin	6ES7331-7NF10-0AB0 SIPLUS S7-300 SM 331 8AI - 40-pin	6ES7331-7PF01-0AB0 SIPLUS S7-300 SM 331 8AI - 40-pin	6ES7331-7PF11-0AB0 SIPLUS S7-300 SM 331 8AI - 40-pin
Ambient conditions				
Ambient temperature during operation				
• min.	-25 °C; = Tmin	-25 °C; = Tmin	0 °C; = Tmin	0 °C; = Tmin
• max.	70 °C; = Tmax; for use on railway vehicles according to EN 50155, the rated temperature range -25 ... +55 °C (T1) or 60 °C @ UL/UL hazardous use applies	60 °C; = Tmax	60 °C; = Tmax	60 °C; = Tmax
Altitude during operation relating to sea level				
• Installation altitude above sea level, max.	5 000 m	5 000 m	5 000 m	5 000 m
• Ambient air temperature-barometric pressure-altitude	Tmin ... Tmax at 1 140 hPa ... 795 hPa (-1 000 m ... +2 000 m) // Tmin ... (Tmax - 10 K) at 795 hPa ... 658 hPa (+2 000 m ... +3 500 m) // Tmin ... (Tmax -20 K) at 658 hPa ... 540 hPa (+3 500 m ... +5 000 m)	Tmin ... Tmax at 1 140 hPa ... 795 hPa (-1 000 m ... +2 000 m) // Tmin ... (Tmax - 10 K) at 795 hPa ... 658 hPa (+2 000 m ... +3 500 m) // Tmin ... (Tmax -20 K) at 658 hPa ... 540 hPa (+3 500 m ... +5 000 m)	Tmin ... Tmax at 1 140 hPa ... 795 hPa (-1 000 m ... +2 000 m) // Tmin ... (Tmax - 10 K) at 795 hPa ... 658 hPa (+2 000 m ... +3 500 m) // Tmin ... (Tmax -20 K) at 658 hPa ... 540 hPa (+3 500 m ... +5 000 m)	Tmin ... Tmax at 1 140 hPa ... 795 hPa (-1 000 m ... +2 000 m) // Tmin ... (Tmax - 10 K) at 795 hPa ... 658 hPa (+2 000 m ... +3 500 m) // Tmin ... (Tmax -20 K) at 658 hPa ... 540 hPa (+3 500 m ... +5 000 m)
Resistance				
Use in stationary industrial systems				
- to biologically active substances according to EN 60721-3-3	Yes; Class 3B2 mold, fungus and dry rot spores (with the exception of fauna); Class 3B3 on request	Yes; Class 3B2 mold, fungus and dry rot spores (with the exception of fauna); Class 3B3 on request	Yes; Class 3B2 mold, fungus and dry rot spores (with the exception of fauna); Class 3B3 on request	Yes; Class 3B2 mold, fungus and dry rot spores (with the exception of fauna); Class 3B3 on request
- to chemically active substances according to EN 60721-3-3	Yes; Class 3C4 (RH < 75 %) incl. salt spray acc. to EN 60068-2-52 (severity degree 3); *	Yes; Class 3C4 (RH < 75 %) incl. salt spray acc. to EN 60068-2-52 (severity degree 3); *	Yes; Class 3C4 (RH < 75 %) incl. salt spray acc. to EN 60068-2-52 (severity degree 3); *	Yes; Class 3C4 (RH < 75 %) incl. salt spray acc. to EN 60068-2-52 (severity degree 3); *
- to mechanically active substances according to EN 60721-3-3	Yes; Class 3S4 incl. sand, dust; *	Yes; Class 3S4 incl. sand, dust; *	Yes; Class 3S4 incl. sand, dust; *	Yes; Class 3S4 incl. sand, dust; *
Use on land craft, rail vehicles and special-purpose vehicles				
- to biologically active substances according to EN 60721-3-5	Yes; Class 5B2 mold, fungus and dry rot spores (with the exception of fauna); Class 5B3 on request	Yes; Class 5B2 mold, fungus and dry rot spores (with the exception of fauna); Class 5B3 on request	Yes; Class 5B2 mold, fungus and dry rot spores (with the exception of fauna); Class 5B3 on request	Yes; Class 5B2 mold, fungus and dry rot spores (with the exception of fauna); Class 5B3 on request
- to chemically active substances according to EN 60721-3-5	Yes; Class 5C3 (RH < 75 %) incl. salt spray acc. to EN 50155 (ST2); *	Yes; Class 5C3 (RH < 75 %) incl. salt spray acc. to EN 50155 (ST2); *	Yes; Class 5C3 (RH < 75 %) incl. salt spray acc. to EN 50155 (ST2); *	Yes; Class 5C3 (RH < 75 %) incl. salt spray acc. to EN 50155 (ST2); *
- to mechanically active substances according to EN 60721-3-5	Yes; Class 5S3 incl. sand, dust; *	Yes; Class 5S3 incl. sand, dust; *	Yes; Class 5S3 incl. sand, dust; *	Yes; Class 5S3 incl. sand, dust; *
Use on ships/at sea				
- to biologically active substances according to EN 60721-3-6	Yes; Class 6B2 mold and fungal spores (excluding fauna); Class 6B3 on request	Yes; Class 6B2 mold and fungal spores (excluding fauna); Class 6B3 on request	Yes; Class 6B2 mold and fungal spores (excluding fauna); Class 6B3 on request	Yes; Class 6B2 mold and fungal spores (excluding fauna); Class 6B3 on request
- to chemically active substances according to EN 60721-3-6	Yes; Class 6C3 (RH < 75 %) incl. salt spray acc. to EN 60068-2-52 (severity degree 3); *	Yes; Class 6C3 (RH < 75 %) incl. salt spray acc. to EN 60068-2-52 (severity degree 3); *	Yes; Class 6C3 (RH < 75 %) incl. salt spray acc. to EN 60068-2-52 (severity degree 3); *	Yes; Class 6C3 (RH < 75 %) incl. salt spray acc. to EN 60068-2-52 (severity degree 3); *
- to mechanically active substances according to EN 60721-3-6	Yes; Class 6S3 incl. sand, dust; *	Yes; Class 6S3 incl. sand, dust; *	Yes; Class 6S3 incl. sand, dust; *	Yes; Class 6S3 incl. sand, dust; *

SIMATIC S7-300 Advanced Controllers

I/O modules

SIPLUS S7-300 analog modules

SIPLUS S7-300 SM 331**Technical specifications**

Article number	6AG1331-7NF00-2AB0	6AG1331-7NF10-2AB0	6AG1331-7PF01-4AB0	6AG1331-7PF11-4AB0
Based on	6ES7331-7NF00-0AB0	6ES7331-7NF10-0AB0	6ES7331-7PF01-0AB0	6ES7331-7PF11-0AB0
	SIPLUS S7-300 SM 331 8AI - 40-pin	SIPLUS S7-300 SM 331 8AI - 40-pin	SIPLUS S7-300 SM 331 8AI - 40-pin	SIPLUS S7-300 SM 331 8AI - 40-pin
Usage in industrial process technology				
- Against chemically active substances acc. to EN 60654-4	Yes; Class 3 (excluding trichlorethylene)	Yes; Class 3 (excluding trichlorethylene)	Yes; Class 3 (excluding trichlorethylene)	Yes; Class 3 (excluding trichlorethylene)
- Environmental conditions for process, measuring and control systems acc. to ANSI/ISA-71.04	Yes; Level GX group A/B (excluding trichlorethylene; harmful gas concentrations up to the limits of EN 60721-3-3 class 3C4 permissible); level LC3 (salt spray) and level LB3 (oil)	Yes; Level GX group A/B (excluding trichlorethylene; harmful gas concentrations up to the limits of EN 60721-3-3 class 3C4 permissible); level LC3 (salt spray) and level LB3 (oil)	Yes; Level GX group A/B (excluding trichlorethylene; harmful gas concentrations up to the limits of EN 60721-3-3 class 3C4 permissible); level LC3 (salt spray) and level LB3 (oil)	Yes; Level GX group A/B (excluding trichlorethylene; harmful gas concentrations up to the limits of EN 60721-3-3 class 3C4 permissible); level LC3 (salt spray) and level LB3 (oil)
Remark				
- Note regarding classification of environmental conditions acc. to EN 60721, EN 60654-4 and ANSI/ISA-71.04	* The supplied plug covers must remain in place over the unused interfaces during operation!	* The supplied plug covers must remain in place over the unused interfaces during operation!	* The supplied plug covers must remain in place over the unused interfaces during operation!	* The supplied plug covers must remain in place over the unused interfaces during operation!

Overview

- Analog outputs
- For connection of analog actuators

Note:

SIPLUS extreme products are based on SIMATIC standard products. The contents listed here were taken from the respective standard products. SIPLUS extreme specific information was added.

Ordering data**Article No.****Article No.****SIPLUS S7-300 SM 332 analog output modules**

For industrial applications with particularly demanding ambient conditions

Extended temperature range and exposure to media

2 outputs, 11/12-bit

6AG1332-5HB01-2AB0

4 outputs, 11/12-bit

6AG1332-5HD01-7AB0

8 outputs, 11/12-bit

6AG1332-5HF00-2AB0

Exposure to media

4 outputs, 16-bit; only exposure to media

6AG1332-7ND02-4AB0

For rolling stock railway applications

Conforms to EN 50155

2 outputs, 11/12-bit

6AG1332-5HB01-2AB0**Accessories**

Mandatory

Front connector

20-pin, with spring-loaded contacts

- 1 unit
- 100 units

6ES7392-1BJ00-0AA0
6ES7392-1BJ00-1AB0

40-pin, with spring-loaded contacts

- 1 unit
- 100 units

6ES7392-1BM01-0AA0
6ES7392-1BM01-1AB0

Consumables

Front door, elevated design

E.g. for 32-channel modules; for connecting 1.3 mm²/16 AWG conductors; circuit diagram and nameplates in petrol

6ES7328-0AA00-7AA0**Bus connectors**

1 unit (spare part)

6ES7390-0AA00-0AA0**Labeling strips**

10 units; spare part

For modules with 20-pin front connector

6ES7392-2XX00-0AA0

For modules with 40-pin front connector

6ES7392-2XX10-0AA0**Label cover**

10 units; spare part

For modules with 20-pin front connector

6ES7392-2XY00-0AA0

For modules with 40-pin front connector

6ES7392-2XY10-0AA0

Documentation

SIMATIC Manual Collection

Electronic manuals on DVD, multi-language: LOGO!, SIMADYN, SIMATIC bus components, SIMATIC C7, SIMATIC distributed I/O, SIMATIC HMI, SIMATIC Sensors, SIMATIC NET, SIMATIC PC Based Automation, SIMATIC PCS 7, SIMATIC PG/PC, SIMATIC S7, SIMATIC Software, SIMATIC TDC

6ES7998-8XC01-8YE0

SIMATIC S7-300 Advanced Controllers

I/O modules

SIPLUS S7-300 analog modules

SIPLUS S7-300 SM 332

Technical specifications

Article number	6AG1332-5HD01-7AB0	6AG1332-7ND02-4AB0	6AG1332-5HB01-2AB0	6AG1332-5HF00-2AB0
Based on	6ES7332-5HD01-0AB0 SIPLUS S7-300 SM 332 4AO U/I	6ES7332-7ND02-0AB0 SIPLUS S7-300 SM 332 4AO	6ES7332-5HB01-0AB0 SIPLUS S7-300 SM 332 2AO	6ES7332-5HF00-0AB0 SIPLUS S7-300 SM 332 8AO - 40-pin
Ambient conditions				
Ambient temperature during operation				
• min.	-25 °C; = Tmin	0 °C; = Tmin	-25 °C; = Tmin	-25 °C
• max.	70 °C; = Tmax; 60 °C @ UL/cUL, ATEX and FM use	60 °C; = Tmax	70 °C; = Tmax; for use on railway vehicles according to EN50155, the rated temperature range -25 ... +55 °C (T1) or 60 °C @ UL/ULhaz/ATEX/FM use applies	70 °C; = Tmax; 60 °C @ UL/cUL, ATEX and FM use
Altitude during operation relating to sea level				
• Installation altitude above sea level, max.	5 000 m	5 000 m	5 000 m	5 000 m
• Ambient air temperature-barometric pressure-altitude	Tmin ... Tmax at 1 140 hPa ... 795 hPa (-1 000 m ... +2 000 m) // Tmin ... (Tmax - 10 K) at 795 hPa ... 658 hPa (+2 000 m ... +3 500 m) // Tmin ... (Tmax -20 K) at 658 hPa ... 540 hPa (+3 500 m ... +5 000 m)	Tmin ... Tmax at 1 140 hPa ... 795 hPa (-1 000 m ... +2 000 m) // Tmin ... (Tmax - 10 K) at 795 hPa ... 658 hPa (+2 000 m ... +3 500 m) // Tmin ... (Tmax -20 K) at 658 hPa ... 540 hPa (+3 500 m ... +5 000 m)	Tmin ... Tmax at 1 140 hPa ... 795 hPa (-1 000 m ... +2 000 m) // Tmin ... (Tmax - 10 K) at 795 hPa ... 658 hPa (+2 000 m ... +3 500 m) // Tmin ... (Tmax -20 K) at 658 hPa ... 540 hPa (+3 500 m ... +5 000 m)	Tmin ... Tmax at 1 140 hPa ... 795 hPa (-1 000 m ... +2 000 m) // Tmin ... (Tmax - 10 K) at 795 hPa ... 658 hPa (+2 000 m ... +3 500 m) // Tmin ... (Tmax -20 K) at 658 hPa ... 540 hPa (+3 500 m ... +5 000 m)
Resistance				
Use in stationary industrial systems				
- to biologically active substances according to EN 60721-3-3	Yes; Class 3B2 mold, fungus and dry rot spores (with the exception of fauna); Class 3B3 on request	Yes; Class 3B2 mold, fungus and dry rot spores (with the exception of fauna); Class 3B3 on request	Yes; Class 3B2 mold, fungus and dry rot spores (with the exception of fauna); Class 3B3 on request	Yes; Class 3B2 mold, fungus and dry rot spores (with the exception of fauna); Class 3B3 on request
- to chemically active substances according to EN 60721-3-3	Yes; Class 3C4 (RH < 75 %) incl. salt spray acc. to EN 60068-2-52 (severity degree 3); *	Yes; Class 3C4 (RH < 75 %) incl. salt spray acc. to EN 60068-2-52 (severity degree 3); *	Yes; Class 3C4 (RH < 75 %) incl. salt spray acc. to EN 60068-2-52 (severity degree 3); *	Yes; Class 3C4 (RH < 75 %) incl. salt spray acc. to EN 60068-2-52 (severity degree 3); *
- to mechanically active substances according to EN 60721-3-3	Yes; Class 3S4 incl. sand, dust; *	Yes; Class 3S4 incl. sand, dust; *	Yes; Class 3S4 incl. sand, dust; *	Yes; Class 3S4 incl. sand, dust; *
Use on land craft, rail vehicles and special-purpose vehicles				
- to biologically active substances according to EN 60721-3-5			Yes; Class 5B2 mold, fungus and dry rot spores (with the exception of fauna); Class 5B3 on request	
- to chemically active substances according to EN 60721-3-5			Yes; Class 5C3 (RH < 75 %) incl. salt spray acc. to EN 50155 (ST2); *	
- to mechanically active substances according to EN 60721-3-5			Yes; Class 5S3 incl. sand, dust; *	
Use on ships/at sea				
- to biologically active substances according to EN 60721-3-6	Yes; Class 6B2 mold and fungal spores (excluding fauna); Class 6B3 on request	Yes; Class 6B2 mold and fungal spores (excluding fauna); Class 6B3 on request	Yes; Class 6B2 mold and fungal spores (excluding fauna); Class 6B3 on request	Yes; Class 6B2 mold and fungal spores (excluding fauna); Class 6B3 on request
- to chemically active substances according to EN 60721-3-6	Yes; Class 6C3 (RH < 75 %) incl. salt spray acc. to EN 60068-2-52 (severity degree 3); *	Yes; Class 6C3 (RH < 75 %) incl. salt spray acc. to EN 60068-2-52 (severity degree 3); *	Yes; Class 6C3 (RH < 75 %) incl. salt spray acc. to EN 60068-2-52 (severity degree 3); *	Yes; Class 6C3 (RH < 75 %) incl. salt spray acc. to EN 60068-2-52 (severity degree 3); *
- to mechanically active substances according to EN 60721-3-6	Yes; Class 6S3 incl. sand, dust; *	Yes; Class 6S3 incl. sand, dust; *	Yes; Class 6S3 incl. sand, dust; *	Yes; Class 6S3 incl. sand, dust; *

Technical specifications

Article number	6AG1332-5HD01-7AB0	6AG1332-7ND02-4AB0	6AG1332-5HB01-2AB0	6AG1332-5HF00-2AB0
Based on	6ES7332-5HD01-0AB0 SIPLUS S7-300 SM 332 4AO U/I	6ES7332-7ND02-0AB0 SIPLUS S7-300 SM 332 4AO	6ES7332-5HB01-0AB0 SIPLUS S7-300 SM 332 2AO	6ES7332-5HF00-0AB0 SIPLUS S7-300 SM 332 8AO - 40-pin
Usage in industrial process technology				
- Against chemically active substances acc. to EN 60654-4	Yes; Class 3 (excluding trichlorethylene)	Yes; Class 3 (excluding trichlorethylene)	Yes; Class 3 (excluding trichlorethylene)	Yes; Class 3 (excluding trichlorethylene)
- Environmental conditions for process, measuring and control systems acc. to ANSI/ISA-71.04	Yes; Level GX group A/B (excluding trichlorethylene; harmful gas concentrations up to the limits of EN 60721-3-3 class 3C4 permissible); level LC3 (salt spray) and level LB3 (oil)	Yes; Level GX group A/B (excluding trichlorethylene; harmful gas concentrations up to the limits of EN 60721-3-3 class 3C4 permissible); level LC3 (salt spray) and level LB3 (oil)	Yes; Level GX group A/B (excluding trichlorethylene; harmful gas concentrations up to the limits of EN 60721-3-3 class 3C4 permissible); level LC3 (salt spray) and level LB3 (oil)	Yes; Level GX group A/B (excluding trichlorethylene; harmful gas concentrations up to the limits of EN 60721-3-3 class 3C4 permissible); level LC3 (salt spray) and level LB3 (oil)
Remark				
- Note regarding classification of environmental conditions acc. to EN 60721, EN 60654-4 and ANSI/ISA-71.04	* The supplied plug covers must remain in place over the unused interfaces during operation!	* The supplied plug covers must remain in place over the unused interfaces during operation!	* The supplied plug covers must remain in place over the unused interfaces during operation!	* The supplied plug covers must remain in place over the unused interfaces during operation!

SIMATIC S7-300 Advanced Controllers

I/O modules

SIPLUS S7-300 analog modules

SIPLUS S7-300 SM 334**Overview**

- Analog inputs and outputs
- For connection of analog sensors and actuators

Note:

SIPLUS extreme products are based on SIMATIC standard products. The contents listed here were taken from the respective standard products. SIPLUS extreme specific information was added.

5

Ordering data**Article No.****SIPLUS S7-300 SM 334
analog input/output modules**

For industrial applications with extended ambient conditions

Extended temperature range and exposure to media

4 inputs, 2 outputs; resistance measurement, Pt 100

6AG1334-0KE00-7AB0**Accessories**

Mandatory

Front connector

20-pin, with spring-loaded contacts

- 1 unit
- 100 units

**6ES7392-1BJ00-0AA0
6ES7392-1BJ00-1AB0**

40-pin, with spring-loaded contacts

- 1 unit
- 100 units

**6ES7392-1BM01-0AA0
6ES7392-1BM01-1AB0**

Consumables

Front door, elevated design

E.g. for 32-channel modules; for connecting 1.3 mm²/16 AWG conductors; circuit diagram and nameplates in petrol

6ES7328-0AA00-7AA0**Bus connectors**

1 unit (spare part)

6ES7390-0AA00-0AA0**Article No.****Labeling strips**

10 units; spare part

For modules with 20-pin front connector

6ES7392-2XX00-0AA0

For modules with 40-pin front connector

6ES7392-2XX10-0AA0**Label cover**

10 units; spare part

For modules with 20-pin front connector

6ES7392-2XY00-0AA0

For modules with 40-pin front connector

6ES7392-2XY10-0AA0

Documentation

SIMATIC Manual Collection

Electronic manuals on DVD, multi-language:
LOGO!, SIMADYN,
SIMATIC bus components,
SIMATIC C7, SIMATIC distributed I/O,
SIMATIC HMI, SIMATIC Sensors,
SIMATIC NET, SIMATIC PC Based
Automation, SIMATIC PCS 7,
SIMATIC PG/PC, SIMATIC S7,
SIMATIC Software, SIMATIC TDC

6ES7998-8XC01-8YE0**SIMATIC Manual Collection
update service for 1 year**

Current "Manual Collection" DVD and the three subsequent updates

6ES7998-8XC01-8YE2

Technical specifications

Article number	6AG1334-0KE00-7AB0
Based on	6ES7334-0KE00-0AB0 SIPLUS S7-300 SM 334 4AI/ 2AO
Ambient conditions	
Ambient temperature during operation	
• min.	-25 °C; = Tmin
• max.	70 °C; = Tmax; 60 °C @ UL/cUL, ATEX and FM use
Altitude during operation relating to sea level	
• Installation altitude above sea level, max.	5 000 m
• Ambient air temperature-barometric pressure-altitude	Tmin ... Tmax at 1 140 hPa ... 795 hPa (-1 000 m ... +2 000 m) // Tmin ... (Tmax - 10 K) at 795 hPa ... 658 hPa (+2 000 m ... +3 500 m) // Tmin ... (Tmax -20 K) at 658 hPa ... 540 hPa (+3 500 m ... +5 000 m)
Resistance	
Use in stationary industrial systems	
- to biologically active substances according to EN 60721-3-3	Yes; Class 3B2 mold, fungus and dry rot spores (with the exception of fauna); Class 3B3 on request
- to chemically active substances according to EN 60721-3-3	Yes; Class 3C4 (RH < 75 %) incl. salt spray acc. to EN 60068-2-52 (severity degree 3); *
- to mechanically active substances according to EN 60721-3-3	Yes; Class 3S4 incl. sand, dust, *

Article number	6AG1334-0KE00-7AB0
Based on	6ES7334-0KE00-0AB0 SIPLUS S7-300 SM 334 4AI/ 2AO
Use on ships/at sea	
- to biologically active substances according to EN 60721-3-6	Yes; Class 6B2 mold and fungal spores (excluding fauna); Class 6B3 on request
- to chemically active substances according to EN 60721-3-6	Yes; Class 6C3 (RH < 75 %) incl. salt spray acc. to EN 60068-2-52 (severity degree 3); *
- to mechanically active substances according to EN 60721-3-6	Yes; Class 6S3 incl. sand, dust; *
Usage in industrial process technology	
- Against chemically active substances acc. to EN 60654-4	Yes; Class 3 (excluding trichlorethylene)
- Environmental conditions for process, measuring and control systems acc. to ANSI/ISA-71.04	Yes; Level GX group A/B (excluding trichlorethylene; harmful gas concentrations up to the limits of EN 60721-3-3 class 3C4 permissible); level LC3 (salt spray) and level LB3 (oil)
Remark	
- Note regarding classification of environmental conditions acc. to EN 60721, EN 60654-4 and ANSI/ISA-71.04	* The supplied plug covers must remain in place over the unused interfaces during operation!

SIMATIC S7-300 Advanced Controllers

I/O modules

F-digital/analog modules

SM 326 F-digital input modules - Safety Integrated**Overview**

- Digital inputs for the fail-safe SIMATIC S7 systems
- For connecting:
 - Switches and 2-wire proximity switches
 - Sensors according to NAMUR and mechanical contacts, also for signals from hazardous areas
- With integral safety functions for fail-safe operation
- Can be used in fail-safe operation
 - Centrally: with S7-31xF-2 DP
 - Distributed in ET 200M: with SIMATIC IM 151-7 F-CPU, S7-31xF-2 DP, S7-416F-2 and S7-400F/FH
- In standard operation can be used in the same way as S7-300 modules

Ordering data**Article No.****SM 326 F-digital input module**

24 inputs, 24 V DC

6ES7326-1BK02-0AB0

8 inputs, 24 V DC, NAMUR

6ES7326-1RF01-0AB0**S7 Distributed Safety V5.4 SP5 Update 2 programming tool****Task:**

Configuration software for configuring fail-safe user programs for SIMATIC S7-300F, S7-400F, WinAC RTX F, ET 200S, ET 200M, ET 200iSP, ET 200pro, ET 200eco, ET 200SP

Requirement:

Windows 7 SP1 (64-bit), Windows 10 Professional/Enterprise (64-bit), Windows Server 2008 R2 SP1 (64-bit), Windows Server 2012 R2 (64-bit), Windows Server 2016 (64-bit); STEP 7 as of V5.5 SP1; Please also consider the operating systems that have been released for the used STEP 7 version

Floating license for 1 user; software and documentation on DVD; license key on USB flash drive

6ES7833-1FC02-0YA5

Floating license for 1 user; software, documentation and license key for download¹⁾; Email address required for delivery

6ES7833-1FC02-0YH5**S7 Distributed Safety upgrade**

From V5.x to V5.4; floating license for 1 user; software and documentation on DVD; license key on USB flash drive

6ES7833-1FC02-0YE5**Article No.****STEP 7 Safety Advanced V17****Task:**

Engineering tool for configuring and programming fail-safe user programs for SIMATIC S7-1200 FC, S7-1500F, S7-1500F Software Controller, S7-300F, S7-400F, WinAC RTX F, ET 200SP F Controller and the fail-safe I/O ET 200SP, ET 200MP, ET 200S, ET 200M, ET 200iSP, ET 200pro and ET 200eco

Requirement:

STEP 7 Professional V17

Note:

As of TIA Portal V16, the SIMATIC STEP 7 Safety software is an integral component of the SIMATIC STEP 7 product setup. The functionality of SIMATIC STEP 7 Safety is activated by means of the license key supplied in each case.

Floating license for 1 user; license key on USB flash drive

6ES7833-1FA17-0YA5

Floating license for 1 user; license key for download¹⁾; Email address required for delivery

6ES7833-1FA17-0YH5

¹⁾ For up-to-date information and download availability, see: <http://www.siemens.com/tia-online-software-delivery>

Ordering data	Article No.	Article No.
DIN rail for active bus modules For max. 5 active bus modules for hot swapping function <ul style="list-style-type: none"> Length: 483 mm (19") Length: 530 mm Length: 620 mm Length: 2 000 mm 	6ES7195-1GA00-0XA0 6ES7195-1GF30-0XA0 6ES7195-1GG30-0XA0 6ES7195-1GC00-0XA0	Labeling strips For F-modules (spare part); 10 units 6ES7392-2XX20-0AA0
Active bus module BM 1 x 80 for 1 module, 80 mm wide	6ES7195-7HC00-0XA0	Label cover For F-modules (spare part); 10 units 6ES7392-2XY20-0AA0
SITOP power supply module For ET 200M; 120/230 V AC, 24 V DC, 5 A; Type PS 307-1E	6ES7307-1EA01-0AA0	LK 393 cable guide For F-modules; L+ and M connections; 5 units 6ES7393-4AA10-0AA0
Front connector 40-pin, with screw contacts <ul style="list-style-type: none"> 1 unit 100 units 40-pin, with spring-loaded contacts <ul style="list-style-type: none"> 1 unit 100 units 	6ES7392-1AM00-0AA0 6ES7392-1AM00-1AB0 6ES7392-1BM01-0AA0 6ES7392-1BM01-1AB0	SIMATIC Manual Collection Electronic manuals on DVD, multi-language: LOGO!, SIMADYN, SIMATIC bus components, SIMATIC C7, SIMATIC distributed I/O, SIMATIC HMI, SIMATIC Sensors, SIMATIC NET, SIMATIC PC-based Automation, SIMATIC PCS 7, SIMATIC PG/PC, SIMATIC S7, SIMATIC Software, SIMATIC TDC 6ES7998-8XC01-8YE0
Front door, higher version, for F-modules For F-modules; for connecting 1.3 mm ² /16 AWG wires; wiring diagram and labels in yellow	6ES7328-7AA10-0AA0	SIMATIC Manual Collection update service for 1 year Current Manual Collection DVD and the three subsequent updates 6ES7998-8XC01-8YE2

Technical specifications

Article number	6ES7326-1RF01-0AB0	6ES7326-1BK02-0AB0
	SM326, 8DI, DC24V, failsafe	SM326, F-DI 24 X DC24V, failsafe
Supply voltage		
Rated value (DC)	24 V	24 V
Input current		
from load voltage L+ (without load), max.	160 mA	450 mA
from backplane bus 5 V DC, max.	90 mA	100 mA
Encoder supply		
Number of outputs	8	4; Isolated
Output current		
• Rated value		400 mA
Power loss		
Power loss, typ.	4.5 W	10 W
Digital inputs		
Number of digital inputs	8	24
Input voltage		
• Type of input voltage	DC	DC
• Rated value (DC)		24 V
• for signal "0"		-30 to +5 V
• for signal "1"		+11 to +30V
Input current		
• for signal "1", typ.	2.1 to 7 mA	10 mA
Input delay (for rated value of input voltage)		
for standard inputs		
- at "0" to "1", max.		3.4 ms
for NAMUR inputs		
- at "0" to "1", max.	1.2 to 3 ms	
- at "1" to "0", max.	1.2 to 3 ms	
Cable length		
• shielded, max.	200 m	200 m

SIMATIC S7-300 Advanced Controllers

I/O modules

F-digital/analog modules

SM 326 F-digital input modules - Safety Integrated**Technical specifications**

Article number	6ES7326-1RF01-0AB0 SM326, 8DI, DC24V, failsafe	6ES7326-1BK02-0AB0 SM326, F-DI 24 X DC24V, failsafe
Encoder		
Connectable encoders		
<ul style="list-style-type: none"> 2-wire sensor permissible quiescent current (2-wire sensor), max. 		Yes; if short-circuit test is deactivated 2 mA
Interrupts/diagnostics/ status information		
Diagnostics function		Yes
Alarms		
<ul style="list-style-type: none"> Diagnostic alarm 	Yes; Parameterizable	Yes
Ex(i) characteristics		
Module for Ex(i) protection	Yes	
maximum values for connecting terminals for gas group IIC		
<ul style="list-style-type: none"> U_o (no-load voltage), max. I_o (short-circuit current), max. P_o (power output), max. C_o (permissible external capacity), max. L_o (permissible external inductivity), max. U_m (voltage at non-intrinsically safe connecting terminals), max. 	10 V 13.9 mA 33.1 mW 3 µF 80 mH 60 V DC/30 V AC	
Standards, approvals, certificates		
Highest safety class achievable in safety mode		
<ul style="list-style-type: none"> acc. to DIN VDE 0801 acc. to EN 954 SIL acc. to IEC 61508 	Cat. 4 SIL 2 (single-channel), SIL 3 (two-channel)	AK 6 Cat. 4 SIL 3
Ambient conditions		
Ambient temperature during operation		
<ul style="list-style-type: none"> max. 	60 °C	
Connection method		
required front connector	1x 40-pin	40-pin
Dimensions		
Width	80 mm	80 mm
Height	125 mm	125 mm
Depth	120 mm	120 mm
Weights		
Weight, approx.	482 g	442 g

5

Overview



- Digital outputs for the fail-safe SIMATIC S7 systems
- Two versions (1 x switching to P/P potential, 1 x switching to P/M potential)
- For connecting solenoid valves, DC contactors and indicator lights
- With integral safety functions for fail-safe operation
- Can be used in fail-safe operation
 - Centrally: with S7-31xF DP, S7-31xF PN/DP
 - Distributed in ET 200M: with SIMATIC IM 151-7 F-CPU, S7-31xF-2 DP, S7-41xF-2 and S7-400F/FH

5

Ordering data

Ordering data	Article No.	Ordering data	Article No.
SM 326 F-digital output module		STEP 7 Safety Advanced V17	
10 outputs, 24 V DC, 2 A PP; width 40 mm	6ES7326-2BF10-0AB0	Task: Engineering tool for configuring and programming fail-safe user programs for SIMATIC S7-1200 FC, S7-1500F, S7-1500F Software Controller, S7-300F, S7-400F, WinAC RTX F, ET 200SP F Controller and the fail-safe I/O ET 200SP, ET 200MP, ET 200S, ET 200M, ET 200iSP, ET 200pro and ET 200eco	
8 outputs, 24 V DC, 2 A PM; width 80 mm	6ES7326-2BF41-0AB0	Requirement: STEP 7 Professional V17	
S7 Distributed Safety V5.4 SP5 Update 2 programming tool		Note: As of TIA Portal V16, the SIMATIC STEP 7 Safety software is an integral component of the SIMATIC STEP 7 product setup. The functionality of SIMATIC STEP 7 Safety is activated by means of the license key supplied in each case.	
Task: Configuration software for configuring fail-safe user programs for SIMATIC S7-300F, S7-400F, WinAC RTX F, ET 200S, ET 200M, ET 200iSP, ET 200pro, ET 200eco, ET 200SP		Floating license for 1 user; license key on USB flash drive	6ES7833-1FA17-0YA5
Requirement: Windows 7 SP1 (64-bit), Windows 10 Professional/Enterprise (64-bit), Windows Server 2008 R2 SP1 (64-bit), Windows Server 2012 R2 (64-bit), Windows Server 2016 (64-bit); STEP 7 as of V5.5 SP1; Please also consider the operating systems that have been released for the used STEP 7 version		Floating license for 1 user; license key for download ¹⁾ ; Email address required for delivery	6ES7833-1FA17-0YH5
Floating license for 1 user; software and documentation on DVD; license key on USB flash drive	6ES7833-1FC02-0YA5	DIN rail for active bus modules	
Floating license for 1 user; software, documentation and license key for download ¹⁾ ; Email address required for delivery	6ES7833-1FC02-0YH5	For max. 5 active bus modules, for function "Insertion and removal"	
S7 Distributed Safety upgrade		• Length: 483 mm (19")	6ES7195-1GA00-0XA0
From V5.x to V5.4; floating license for 1 user; software and documentation on DVD; license key on USB flash drive	6ES7833-1FC02-0YE5	• Length: 530 mm	6ES7195-1GF30-0XA0
		• Length: 620 mm	6ES7195-1GG30-0XA0
		• Length: 2 000 mm	6ES7195-1GC00-0XA0
		Active bus modules	
		BM 2 x 40 for accepting 2 I/O modules each 40 mm wide	6ES7195-7HB00-0XA0
		BM 1 x 80 for accepting 1 I/O module 80 mm wide	6ES7195-7HC00-0XA0

¹⁾ For up-to-date information and download availability, see:
<http://www.siemens.com/tia-online-software-delivery>

SIMATIC S7-300 Advanced Controllers

I/O modules

F-digital/analog modules

SM 326 F-digital output modules - Safety Integrated

Ordering data

SITOP power supply module

For ET 200M; 120/230 V AC,
24 V DC, 5 A; Type PS 307-1E

6ES7307-1EA01-0AA0

Front connector

40-pin, with screw contacts

- 1 unit
- 100 units

6ES7392-1AM00-0AA0
6ES7392-1AM00-1AB0

40-pin, with spring-loaded contacts

- 1 unit
- 100 units

6ES7392-1BM01-0AA0
6ES7392-1BM01-1AB0

Front door, higher version, for F-modules

For F-modules; for connecting
1.3 mm²/16 AWG wires; wiring
diagram and labels in yellow

6ES7328-7AA10-0AA0

Labeling strips

For F-modules (spare part), 10 units

6ES7392-2XX20-0AA0

Label cover

For F-modules (spare part), 10 units

6ES7392-2XY20-0AA0

LK 393 cable guide

For F-modules;
L+ and M connections, 5 units

Article No.

6ES7393-4AA10-0AA0

SIMATIC Manual Collection

Electronic manuals on DVD,
multi-language:
LOGO!, SIMADYN,
SIMATIC bus components,
SIMATIC C7, SIMATIC distributed I/O,
SIMATIC HMI, SIMATIC Sensors,
SIMATIC NET, SIMATIC PC-based
Automation, SIMATIC PCS 7,
SIMATIC PG/PC, SIMATIC S7,
SIMATIC Software, SIMATIC TDC

6ES7998-8XC01-8YE0

SIMATIC Manual Collection update service for 1 year

Current Manual Collection DVD and
the three subsequent updates

6ES7998-8XC01-8YE2

Technical specifications

Article number	6ES7326-2BF10-0AB0	6ES7326-2BF41-0AB0
	SM326, F-DO10XDC24V/2A PP, failsafe	SM 326, F-DO 8 X DC 24V/2A PM
Supply voltage		
Rated value (DC)	24 V; 1L+	24 V; 1L+
Load voltage L+		
• Rated value (DC)	24 V; 2L+, 3L+	24 V; 2L+, 3L+
Input current		
from supply voltage 1L+, max.	100 mA	75 mA
from load voltage 2L+ (without load), max.	100 mA	100 mA
from load voltage 3L+ (without load), max.	100 mA	100 mA
from backplane bus 5 V DC, max.	100 mA	100 mA
Power loss		
Power loss, typ.	6 W	12 W
Digital outputs		
Number of digital outputs	10	8
Short-circuit protection	Yes	Yes
Limitation of inductive shutdown voltage to		L+ (-33 V)
Switching capacity of the outputs		
• on lamp load, max.	5 W	5 W
Output voltage		
• for signal "1", min.	L+ (-1.0 V)	L+ (-1.0 V)
Output current		
• for signal "1" rated value	2 A	2 A
• for signal "0" residual current, max.	0.5 mA	0.5 mA
Switching frequency		
• with resistive load, max.	25 Hz	30 Hz
• with inductive load, max.	25 Hz	2 Hz
• on lamp load, max.	10 Hz	10 Hz

5

Technical specifications

Article number	6ES7326-2BF10-0AB0	6ES7326-2BF41-0AB0
	SM326, F-DO10XDC24V/2A PP, failsafe	SM 326, F-DO 8 X DC 24V/2A PM
Total current of the outputs (per group)		
horizontal installation		
- up to 40 °C, max.	10 A	7.5 A
- up to 60 °C, max.	6 A	5 A
vertical installation		
- up to 40 °C, max.	5 A	5 A
Cable length		
• shielded, max.	1 000 m	200 m; 200 m for SIL 3, AK 6, Cat 4
Interrupts/diagnostics/status information		
Alarms		
• Diagnostic alarm	Yes	Yes; Parameterizable
Standards, approvals, certificates		
Highest safety class achievable in safety mode		
• acc. to DIN VDE 0801	AK 5 and 6	
• acc. to EN 954	Cat. 4	Cat. 4
• SIL acc. to IEC 61508	SIL 3	SIL 3
Connection method		
required front connector	40-pin	40-pin
Dimensions		
Width	40 mm	80 mm
Height	125 mm	125 mm
Depth	120 mm	120 mm
Weights		
Weight, approx.	330 g	465 g

SIMATIC S7-300 Advanced Controllers

I/O modules

F-digital/analog modules

SM 336 F-analog input modules - Safety Integrated

Overview



- Analog inputs for fail-safe SIMATIC S7 systems
- Can be used in the ET 200M distributed I/O device with IM 153-2 HF as well as centrally with SIMATIC S7-31xF-2 DP
- Properties of the SM 336; F-AI 6 x 0/4 ... 20 mA HART:
 - 6 analog inputs with galvanic isolation between channels and backplane bus
 - Input ranges: 0 mA to 20 mA, 4 mA to 20 mA
 - Short-circuit-proof power supply of 2- or 4-wire transmitters via the module
 - External encoder supply possible
 - Can be used in safety mode
 - HART communication
 - Firmware update using HW Config
 - Identification data

Ordering data

Article No.

SM 336 F-analog input module

6 inputs, 15 bits, 0/4 ... 20 mA
HART

6ES7336-4GE00-0AB0

S7 Distributed Safety V5.4 SP5 Update 2 programming tool

Task:

Configuration software for configuring fail-safe user programs for SIMATIC S7-300F, S7-400F, WinAC RTX F, ET 200S, ET 200M, ET 200iSP, ET 200pro, ET 200eco, ET 200SP

Requirement:

Windows 7 SP1 (64-bit),
Windows 10 Professional/Enterprise (64-bit),
Windows Server 2008 R2 SP1 (64-bit),
Windows Server 2012 R2 (64-bit),
Windows Server 2016 (64-bit);
STEP 7 as of V5.5 SP1;
Please also consider the operating systems that have been released for the used STEP 7 version

Floating license for 1 user;
software and documentation on DVD; license key on USB flash drive

6ES7833-1FC02-0YA5

Floating license for 1 user; software, documentation and license key for download¹⁾;
Email address required for delivery

6ES7833-1FC02-0YH5

S7 Distributed Safety upgrade

From V5.x to V5.4; floating license for 1 user; software and documentation on DVD; license key on USB flash drive

6ES7833-1FC02-0YE5

Article No.

STEP 7 Safety Advanced V17

Task:

Engineering tool for configuring and programming fail-safe user programs for SIMATIC S7-1200 FC, S7-1500F, S7-1500F Software Controller, S7-300F, S7-400F, WinAC RTX F, ET 200SP F Controller and the fail-safe I/O ET 200SP, ET 200MP, ET 200S, ET 200M, ET 200iSP, ET 200pro and ET 200eco

Requirement:

STEP 7 Professional V17

Note:

As of TIA Portal V16, the SIMATIC STEP 7 Safety software is an integral component of the SIMATIC STEP 7 product setup. The functionality of SIMATIC STEP 7 Safety is activated by means of the license key supplied in each case.

Floating license for 1 user;
license key on USB flash drive

6ES7833-1FA17-0YA5

Floating license for 1 user;
license key for download¹⁾;
Email address required for delivery

6ES7833-1FA17-0YH5

DIN rail for active bus modules

For max. 5 active bus modules for hot swapping function

- Length: 483 mm
- Length: 530 mm
- Length: 620 mm
- Length: 2 000 mm

6ES7195-1GA00-0XA0

6ES7195-1GF30-0XA0

6ES7195-1GG30-0XA0

6ES7195-1GC00-0XA0

Active bus module BM 2x40

6ES7195-7HB00-0XA0

Bus module for accepting 2 I/O modules each 40 mm wide

¹⁾ For up-to-date information and download availability, see: <http://www.siemens.com/tia-online-software-delivery>

Ordering data	Article No.	Ordering data	Article No.
SITOP power supply module For ET 200M; 120/230 V AC, 24 V DC, 5 A; Type PS 307-1E	6ES7307-1EA01-0AA0	LK 393 cable guide For F-modules; L+ and M connections, 5 units	6ES7393-4AA10-0AA0
Front connector 20-pin, with screw contacts • 1 unit • 100 units 20-pin, with spring-loaded contacts • 1 unit • 100 units	6ES7392-1AJ00-0AA0 6ES7392-1AJ00-1AB0 6ES7392-1BJ00-0AA0 6ES7392-1BJ00-1AB0	SIMATIC Manual Collection Electronic manuals on DVD, multi-language: LOGO!, SIMADYN, SIMATIC bus components, SIMATIC C7, SIMATIC distributed I/O, SIMATIC HMI, SIMATIC Sensors, SIMATIC NET, SIMATIC PC-based Automation, SIMATIC PCS 7, SIMATIC PG/PC, SIMATIC S7, SIMATIC Software, SIMATIC TDC	6ES7998-8XC01-8YE0
Front door, higher version, for F-modules For F-modules; for connecting 1.3 mm ² /16 AWG wires; wiring diagram and labels in yellow	6ES7328-7AA10-0AA0	SIMATIC Manual Collection update service for 1 year Current Manual Collection DVD and the three subsequent updates	6ES7998-8XC01-8YE2
Labeling strips For F-modules (spare part), 10 units	6ES7392-2XX20-0AA0		
Label cover For F-modules (spare part), 10 units	6ES7392-2XY20-0AA0		

Technical specifications

Article number	6ES7336-4GE00-0AB0 SM 336, f.AI 6 X 0/4 ... 20mA HART
Supply voltage	
Rated value (DC)	24 V
Load voltage L+	
• Rated value (DC)	24 V
Input current	
From power supply L+, typ.	150 mA
from backplane bus 5 V DC, max.	90 mA
Power loss	
Power loss, typ.	4.5 W
Analog inputs	
Number of analog inputs	6
permissible input current for current input (destruction limit), max.	40 mA
Input ranges (rated values), currents	
• 0 to 20 mA	Yes
• 4 mA to 20 mA	Yes
Cable length	
• shielded, max.	1 000 m
Analog value generation for the inputs	
Integration and conversion time/resolution per channel	
• Resolution with overrange (bit including sign), max.	16 bit; 15 bit + sign
• Integration time (ms)	20 ms @ 50 Hz, 16.7 ms @ 60 Hz
• Interference voltage suppression for interference frequency f1 in Hz	f=n x (f1 ±0.5 %)
Encoder	
Connection of signal encoders	
• for current measurement as 2-wire transducer	Yes
• for current measurement as 4-wire transducer	Yes

Article number	6ES7336-4GE00-0AB0 SM 336, f.AI 6 X 0/4 ... 20mA HART
Errors/accuracies	
Operational error limit in overall temperature range	
• Current, relative to input range, (+/-)	0.2 %; 40 µA
Basic error limit (operational limit at 25 °C)	
• Current, relative to input range, (+/-)	0.1 %
Interrupts/diagnostics/ status information	
Diagnostics function	Yes
Alarms	
• Diagnostic alarm	Yes
Standards, approvals, certificates	
Highest safety class achievable in safety mode	
• acc. to EN 954	4
• SIL acc. to IEC 61508	SIL 3
Connection method	
required front connector	20-pin
Dimensions	
Width	40 mm
Height	125 mm
Depth	120 mm
Weights	
Weight, approx.	350 g

SIMATIC S7-300 Advanced Controllers

I/O modules

F-digital/analog modules

Safety protector

Overview



- Supports mixed operation of fail-safe signal modules in safety mode and S7-300 standard modules in an ET 200M distributed I/O device for achieving Cat. 4 or SIL 3.
- The safety protector is not required if the safety class or safety category to be achieved is less than SIL 3 or Cat. 4, respectively.

When Cat. 4/SIL 3 is required, the safety protector must be implemented in the following situations:

Application	Safety protector must be used
Central use after CPU 31xF-2 DP or CPU 31xF-2 PN/DP <ul style="list-style-type: none"> • Only fail-safe modules in the tier • Standard and fail-safe modules in the tier 	Yes, behind the CPU Yes, after the last standard module and before the first fail-safe module
Central use after CPU 31xF-2 DP or CPU 31xF-2 PN/DP in an expansion rack <ul style="list-style-type: none"> • Only fail-safe modules in the tier • Standard and fail-safe modules in the tier 	Yes, after the IM 36x Yes, after the last standard module and before the first fail-safe module
Distributed behind the IM 153-2 with copper connection <ul style="list-style-type: none"> • Only fail-safe modules in the station • Standard and fail-safe modules in the station 	Yes, after the IM 153-2 Yes, after the last standard module and before the first fail-safe module
Distributed behind the IM 153-2 with fiber-optic connection <ul style="list-style-type: none"> • Only fail-safe modules in the station • Standard and fail-safe modules in the station 	No Yes, after the last standard module and before the first fail-safe module

Ordering data

Article No.

Safety protector

For simultaneous operation of fail-safe and standard modules in ET 200M

6ES7195-7KF00-0XA0

Bus safety protector

For holding the safety protector in ET 200M

6ES7195-7HG00-0XA0

Technical specifications

Article number	6ES7195-7KF00-0XA0 Safety Protector betw. F- and Std-Mod.
General information	
Product type designation	Safety protector
Weights	
Weight, approx.	10 g

SIMATIC S7-300 Advanced Controllers

I/O modules

SIPLUS S7-300 F-digital/analog modules

SIPLUS S7-300 SM 326 - Safety Integrated

Overview



- Digital inputs for the fail-safe SIPLUS S7 systems
- For connecting:
 - Switches and 2-wire proximity switches
 - Sensors according to NAMUR and mechanical contacts, also for signals from hazardous areas
- With integral safety functions for fail-safe operation
- Can be used in fail-safe operation
 - Centrally: with S7-31xF-2 DP
 - Distributed in ET 200M: with SIMATIC IM 151-7 F-CPU, S7-31xF-2 DP, S7-416F-2 and S7-400F/FH
- In standard operation can be used in the same way as S7-300 modules

Note:

SIPLUS extreme products are based on SIMATIC standard products. The contents listed here were taken from the respective standard products. SIPLUS extreme-specific information was added.

5

Ordering data

SIPLUS S7-300 SM 326 F-digital input

For industrial applications with extended ambient conditions

Extended temperature range and exposure to media

24 inputs, 24 V DC, fail-safe, with diagnostics interrupt

6AG1326-1BK02-2AB0

8 inputs, 24 V DC, NAMUR, fail-safe

6AG1326-1RF01-4AB0

Accessories

Mandatory

Front connector

40-pin, with spring-loaded contacts

- 1 unit
- 100 units

6ES7392-1BM01-0AA0
6ES7392-1BM01-1AB0

Accessories for hot swapping function

Active bus module

BM 1 x 80 for 1 module, 80 mm wide

6AG1195-7HC00-2XA0

Article No.

Consumables

DIN rail for active bus modules

For max. 5 active bus modules for hot swapping function

- Length 483 mm (19")
- Length 530 mm
- Length 620 mm
- Length 2 000 mm

6ES7195-1GA00-0XA0
6ES7195-1GF30-0XA0
6ES7195-1GG30-0XA0
6ES7195-1GC00-0XA0

Front door, elevated design, for F-modules

6ES7328-7AA10-0AA0

For F-modules; for connecting 1.3 mm²/16 AWG wires; wiring diagram and labels in yellow

Labeling strips

For F-modules (spare part); 10 units

6ES7392-2XX20-0AA0

Label cover

For F-modules (spare part); 10 units

6ES7392-2XY20-0AA0

LK 393 cable guide

For F-modules; L+ and M connections; 5 units

6ES7393-4AA10-0AA0

SIMATIC S7-300 Advanced Controllers

I/O modules

SIPLUS S7-300 F-digital/analog modules

SIPLUS S7-300 SM 326 - Safety Integrated**Ordering data****Article No.****Article No.***Programming tools and documentation***S7 Distributed Safety V5.4 SP5 Update 2 programming tool**

Task:

Configuration software for configuring fail-safe user programs for SIMATIC S7-300F, S7-400F, WinAC RTX F, ET 200S, ET 200M, ET 200iSP, ET 200pro, ET 200eco, ET 200SP

Requirement:

Windows 7 SP1 (64-bit), Windows 10 Professional/Enterprise (64-bit), Windows Server 2008 R2 SP1 (64-bit), Windows Server 2012 R2 (64-bit), Windows Server 2016 (64-bit); STEP 7 as of V5.5 SP1; Please also consider the operating systems that have been released for the used STEP 7 version

Floating license for 1 user; software and documentation on DVD; license key on USB flash drive

Floating license for 1 user; software, documentation and license key for download¹⁾; email address required for delivery

6ES7833-1FC02-0YA5**6ES7833-1FC02-0YH5****S7 Distributed Safety upgrade**

From V5.x to V5.4; floating license for 1 user; software and documentation on DVD; license key on USB flash drive

6ES7833-1FC02-0YE5**STEP 7 Safety Advanced V17**

Task:

Engineering tool for configuring and programming fail-safe user programs for SIMATIC S7-1200 FC, S7-1500F, S7-1500F Software Controller, S7-300F, S7-400F, WinAC RTX F, ET 200SP F Controller and the fail-safe I/O ET 200SP, ET 200MP, ET 200S, ET 200M, ET 200iSP, ET 200pro and ET 200eco

Requirement:

STEP 7 Professional V17

Note:

As of TIA Portal V16, the SIMATIC STEP 7 Safety software is an integral component of the SIMATIC STEP 7 product setup. The functionality of SIMATIC STEP 7 Safety is activated by means of the license key supplied in each case.

Floating license for 1 user; license key on USB flash drive

6ES7833-1FA17-0YA5

Floating license for 1 user, license key for download¹⁾; email address required for delivery

6ES7833-1FA17-0YH5**SIMATIC Manual Collection**

Electronic manuals on DVD, multi-language: LOGO!, SIMADYN, SIMATIC bus components, SIMATIC C7, SIMATIC Distributed I/O, SIMATIC HMI, SIMATIC sensors, SIMATIC NET, SIMATIC PC-based Automation, SIMATIC PCS 7, SIMATIC PG/PC, SIMATIC S7, SIMATIC software, SIMATIC TDC

6ES7998-8XC01-8YE0**SIMATIC Manual Collection update service for 1 year**

Current Manual Collection DVD and the three subsequent updates

6ES7998-8XC01-8YE2

¹⁾ For up-to-date information and download availability, see: <http://www.siemens.com/tia-online-software-delivery>

Technical specifications

Article number	6AG1326-1BK02-2AB0	6AG1326-1RF01-4AB0
Based on	6ES7326-1BK02-0AB0	6ES7326-1RF01-0AB0
	SIPLUS S7-300 SM 326F DI24	SIPLUS S7-300 SM 326F DI8 NAMUR
Ambient conditions		
Ambient temperature during operation		
• min.	-25 °C; = Tmin	0 °C; = Tmin
• max.	60 °C; = Tmax; *+70 °C where forced convection with a minimum air velocity of 0.7 m/s through the modules and rated voltage of 24 V ±5 % are ensured. If in the course of maintenance or automatic diagnosis it is determined that the admissible specified parameters have been exceeded, the modules should be subjected to a proof test (function check) by the manufacturer.	60 °C; = Tmax
Altitude during operation relating to sea level		
• Installation altitude above sea level, max.	2 000 m	2 000 m
• Ambient air temperature-barometric pressure-altitude	Tmin ... Tmax at 1 140 hPa ... 795 hPa (-1 000 m ... +2 000 m)	Tmin ... Tmax at 1 140 hPa ... 795 hPa (-1 000 m ... +2 000 m)
Relative humidity		
• With condensation, tested in accordance with IEC 60068-2-38, max.	100 %; RH incl. condensation/frost (no commissioning under condensation conditions)	100 %; RH incl. condensation/frost (no commissioning under condensation conditions)
Resistance		
Use in stationary industrial systems		
- to biologically active substances according to EN 60721-3-3	Yes; Class 3B2 mold, fungus and dry rot spores (with the exception of fauna); Class 3B3 on request	Yes; Class 3B2 mold, fungus and dry rot spores (with the exception of fauna); Class 3B3 on request
- to chemically active substances according to EN 60721-3-3	Yes; Class 3C4 (RH < 75 %) incl. salt spray acc. to EN 60068-2-52 (severity degree 3); *	Yes; Class 3C4 (RH < 75 %) incl. salt spray acc. to EN 60068-2-52 (severity degree 3); *
- to mechanically active substances according to EN 60721-3-3	Yes; Class 3S4 incl. sand, dust, *	Yes; Class 3S4 incl. sand, dust, *
Use on ships/at sea		
- to biologically active substances according to EN 60721-3-6	Yes; Class 6B2 mold and fungal spores (excluding fauna); Class 6B3 on request	Yes; Class 6B2 mold and fungal spores (excluding fauna); Class 6B3 on request
- to chemically active substances according to EN 60721-3-6	Yes; Class 6C3 (RH < 75 %) incl. salt spray acc. to EN 60068-2-52 (severity degree 3); *	Yes; Class 6C3 (RH < 75 %) incl. salt spray acc. to EN 60068-2-52 (severity degree 3); *
- to mechanically active substances according to EN 60721-3-6	Yes; Class 6S3 incl. sand, dust; *	Yes; Class 6S3 incl. sand, dust; *
Usage in industrial process technology		
- Against chemically active substances acc. to EN 60654-4	Yes; Class 3 (excluding trichlorethylene)	Yes; Class 3 (excluding trichlorethylene)
- Environmental conditions for process, measuring and control systems acc. to ANSI/ISA-71.04	Yes; Level GX group A/B (excluding trichlorethylene; harmful gas concentrations up to the limits of EN 60721-3-3 class 3C4 permissible); level LC3 (salt spray) and level LB3 (oil)	Yes; Level GX group A/B (excluding trichlorethylene; harmful gas concentrations up to the limits of EN 60721-3-3 class 3C4 permissible); level LC3 (salt spray) and level LB3 (oil)
Remark		
- Note regarding classification of environmental conditions acc. to EN 60721, EN 60654-4 and ANSI/ISA-71.04	* The supplied plug covers must remain in place over the unused interfaces during operation!	* The supplied plug covers must remain in place over the unused interfaces during operation!

SIMATIC S7-300 Advanced Controllers

I/O modules

SIPLUS S7-300 F-digital/analog modules

SIPLUS S7-300 SM 326 - Safety Integrated**Overview**

- Digital outputs for the fail-safe SIMATIC S7 systems
- For connection of solenoid valves, DC contactors and indicator lights
- With integral safety functions for fail-safe operation
- Can be used in fail-safe mode
 - Centrally: with S7-31xF-2 DP
 - Distributed in ET 200M: with SIMATIC IM 151-7 F-CPU, S7-31xF-2 DP, S7-416F-2 and S7-400F/FH

Note:

SIPLUS extreme products are based on SIMATIC standard products. The contents listed here were taken from the respective standard products. SIPLUS extreme-specific information was added.

5

Ordering data**Article No.****SIPLUS S7-300 SM 326
F-digital output**

For industrial applications with extended ambient conditions

Extended temperature range and exposure to media

10 outputs, 24 V DC, 2 A, fail-safe

6AG1326-2BF10-2AB0

8 outputs, 24 V DC, 2 A, fail-safe, source-sinking output

6AG1326-2BF41-2AB0**Accessories**

Mandatory

Front connector

40-pin, with spring-loaded contacts

- 1 unit
- 100 units

6ES7392-1BM01-0AA0**6ES7392-1BM01-1AB0**

Accessories for hot swapping function

Active bus module

BM 2 x 40 for accepting 2 I/O modules, each 40 mm wide

6AG1195-7HB00-7XA0

BM 1 x 80 for 1 module, 80 mm wide

6AG1195-7HC00-2XA0**Article No.***Consumables***DIN rail for active bus modules**

For max. 5 active bus modules for hot swapping function

- Length 483 mm (19")
- Length 530 mm
- Length 620 mm
- Length 2 000 mm

6ES7195-1GA00-0XA0**6ES7195-1GF30-0XA0****6ES7195-1GG30-0XA0****6ES7195-1GC00-0XA0****Front door, elevated design, for F-modules****6ES7328-7AA10-0AA0**

For F-modules; for connecting 1.3 mm²/16 AWG wires; wiring diagram and labels in yellow

Labeling strips**6ES7392-2XX20-0AA0**

For F-modules (spare part); 10 units

Label cover**6ES7392-2XY20-0AA0**

For F-modules (spare part); 10 units

LK 393 cable guide**6ES7393-4AA10-0AA0**

For F-modules; L+ and M connections; 5 units

Ordering data	Article No.	Ordering data	Article No.
<p><i>Programming tools and documentation</i></p> <p>S7 Distributed Safety V5.4 SP5 Update 2 programming tool</p> <p>Task: Configuration software for configuring fail-safe user programs for SIMATIC S7-300F, S7-400F, WinAC RTX F, ET 200S, ET 200M, ET 200iSP, ET 200pro, ET 200eco, ET 200SP</p> <p>Requirement: Windows 7 SP1 (64-bit), Windows 10 Professional/Enterprise (64-bit), Windows Server 2008 R2 SP1 (64-bit), Windows Server 2012 R2 (64-bit), Windows Server 2016 (64-bit); STEP 7 as of V5.5 SP1; Please also consider the operating systems that have been released for the used STEP 7 version</p> <p>Floating license for 1 user; software and documentation on DVD; license key on USB flash drive</p> <p>Floating license for 1 user; software, documentation and license key for download¹⁾; email address required for delivery</p> <p>S7 Distributed Safety upgrade</p> <p>From V5.x to V5.4; floating license for 1 user; software and documentation on DVD; license key on USB flash drive</p>	<p>6ES7833-1FC02-0YA5</p> <p>6ES7833-1FC02-0YH5</p> <p>6ES7833-1FC02-0YE5</p>	<p>STEP 7 Safety Advanced V17</p> <p>Task: Engineering tool for configuring and programming fail-safe user programs for SIMATIC S7-1200 FC, S7-1500F, S7-1500F Software Controller, S7-300F, S7-400F, WinAC RTX F, ET 200SP F Controller and the fail-safe I/O ET 200SP, ET 200MP, ET 200S, ET 200M, ET 200iSP, ET 200pro and ET 200eco</p> <p>Requirement: STEP 7 Professional V17</p> <p><u>Note:</u> As of TIA Portal V17, the SIMATIC STEP 7 Safety software is an integral part of the SIMATIC STEP 7 product setup. The functionality of SIMATIC STEP 7 Safety is activated by means of the license key supplied in each case.</p> <p>Floating license for 1 user; license key on USB flash drive</p> <p>Floating license for 1 user, license key for download¹⁾; email address required for delivery</p> <p>SIMATIC Manual Collection</p> <p>Electronic manuals on DVD, multi-language: LOGO!, SIMADYN, SIMATIC bus components, SIMATIC C7, SIMATIC Distributed I/O, SIMATIC HMI, SIMATIC sensors, SIMATIC NET, SIMATIC PC-based Automation, SIMATIC PCS 7, SIMATIC PG/PC, SIMATIC S7, SIMATIC software, SIMATIC TDC</p> <p>SIMATIC Manual Collection update service for 1 year</p> <p>Current Manual Collection DVD and the three subsequent updates</p>	<p>6ES7833-1FA17-0YA5</p> <p>6ES7833-1FA17-0YH5</p> <p>6ES7998-8XC01-8YE0</p> <p>6ES7998-8XC01-8YE2</p>

¹⁾ For up-to-date information and download availability, see: <http://www.siemens.com/tia-online-software-delivery>

SIMATIC S7-300 Advanced Controllers

I/O modules

SIPLUS S7-300 F-digital/analog modules

SIPLUS S7-300 SM 326 - Safety Integrated**Technical specifications**

Article number	6AG1326-2BF10-2AB0	6AG1326-2BF41-2AB0
Based on	6ES7326-2BF10-0AB0 SIPLUS S7-300 SM 326F 10DO	6ES7326-2BF41-0AB0 SIPLUS S7-300 SM 326F 8DO
Ambient conditions		
Ambient temperature during operation		
• min.	-25 °C	-25 °C
• max.	60 °C; = T max; *+70 °C when forced convection at a minimum air speed of 0.3 m/s through the modules is ensured. If in the course of maintenance or automatic diagnosis it is determined that the admissible specified parameters have been exceeded, the modules should be subjected to a proof test (function check) by the manufacturer.	60 °C
Altitude during operation relating to sea level		
• Installation altitude above sea level, max.	2 000 m	2 000 m
• Ambient air temperature-barometric pressure-altitude	Tmin ... Tmax at 1 140 hPa ... 795 hPa (-1 000 m ... +2 000 m)	Tmin ... Tmax at 1 140 hPa ... 795 hPa (-1 000 m ... +2 000 m)
Relative humidity		
• With condensation, tested in accordance with IEC 60068-2-38, max.	100 %; RH incl. condensation/frost (no commissioning under condensation conditions)	100 %; RH incl. condensation/frost (no commissioning under condensation conditions)
Resistance		
Use in stationary industrial systems		
- to biologically active substances according to EN 60721-3-3	Yes; Class 3B2 mold, fungus and dry rot spores (with the exception of fauna); Class 3B3 on request	Yes; Class 3B2 mold, fungus and dry rot spores (with the exception of fauna); Class 3B3 on request
- to chemically active substances according to EN 60721-3-3	Yes; Class 3C4 (RH < 75 %) incl. salt spray acc. to EN 60068-2-52 (severity degree 3); *	Yes; Class 3C4 (RH < 75 %) incl. salt spray acc. to EN 60068-2-52 (severity degree 3); *
- to mechanically active substances according to EN 60721-3-3	Yes; Class 3S4 incl. sand, dust, *	Yes; Class 3S4 incl. sand, dust, *
Use on ships/at sea		
- to biologically active substances according to EN 60721-3-6	Yes; Class 6B2 mold and fungal spores (excluding fauna); Class 6B3 on request	Yes; Class 6B2 mold and fungal spores (excluding fauna); Class 6B3 on request
- to chemically active substances according to EN 60721-3-6	Yes; Class 6C3 (RH < 75 %) incl. salt spray acc. to EN 60068-2-52 (severity degree 3); *	Yes; Class 6C3 (RH < 75 %) incl. salt spray acc. to EN 60068-2-52 (severity degree 3); *
- to mechanically active substances according to EN 60721-3-6	Yes; Class 6S3 incl. sand, dust; *	Yes; Class 6S3 incl. sand, dust; *
Usage in industrial process technology		
- Against chemically active substances acc. to EN 60654-4	Yes; Class 3 (excluding trichlorethylene)	Yes; Class 3 (excluding trichlorethylene)
- Environmental conditions for process, measuring and control systems acc. to ANSI/ISA-71.04	Yes; Level GX group A/B (excluding trichlorethylene; harmful gas concentrations up to the limits of EN 60721-3-3 class 3C4 permissible); level LC3 (salt spray) and level LB3 (oil)	Yes; Level GX group A/B (excluding trichlorethylene; harmful gas concentrations up to the limits of EN 60721-3-3 class 3C4 permissible); level LC3 (salt spray) and level LB3 (oil)
Remark		
- Note regarding classification of environmental conditions acc. to EN 60721, EN 60654-4 and ANSI/ISA-71.04	* The supplied plug covers must remain in place over the unused interfaces during operation!	* The supplied plug covers must remain in place over the unused interfaces during operation!

SIMATIC S7-300 Advanced Controllers

I/O modules

SIPLUS S7-300 F-digital/analog modules

SIPLUS S7-300 SM 336 - Safety Integrated

Overview



- Analog inputs for fail-safe SIPLUS S7 systems
- Applicable in the ET 200M distributed I/O device with IM 153-2 HF as well as centrally with SIPLUS S7-31xF-2 DP
- Properties of the SM 336; F-AI 6 x 0/4 ... 20 mA HART:

- 6 analog inputs with galvanic isolation between channels and backplane bus
- Input ranges: 0 mA to 20 mA, 4 mA to 20 mA
- Short-circuit proof power supply of 2 or 4-wire transmitter via the module
- External encoder supply possible
- Applicable in safety mode
- HART communication
- Firmware update using HW Config
- Identification data
- Temperature range -25 ... +70 °C;
(+70 °C when ensuring a forced convection with a minimal air velocity of 0.3 m/s through the module. If a violation of the permissible, specified parameters is detected during maintenance or by automatic diagnostics, the modules must be proof-tested by the manufacturer. Without this measure the temperature range is -25...60°C)

Note:

SIPLUS extreme products are based on SIMATIC standard products. The contents listed here were taken from the respective standard products. SIPLUS extreme specific information was added.

5

Ordering data

SIPLUS S7-300 SM 336 F-analog input module

For industrial applications with extended ambient conditions

Extended temperature range and exposure to media

6 inputs, 15 bits,
0/4 ... 20 mA HART

6AG1336-4GE00-2AB0

Accessories

Mandatory

Front connector

20-pin, with spring-loaded contacts

- 1 unit
- 100 units

6ES7392-1BJ00-0AA0
6ES7392-1BJ00-1AB0

Accessories for hot swapping function

Active bus module

BM 2 x 40 for accepting
2 I/O modules, each 40 mm wide

6AG1195-7HB00-7XA0

Consumables

DIN rail for active bus modules

For max. 5 active bus modules for hot swapping function

- Length 483 mm (19")
- Length 530 mm
- Length 620 mm
- Length 2 000 mm

6ES7195-1GA00-0XA0
6ES7195-1GF30-0XA0
6ES7195-1GG30-0XA0
6ES7195-1GC00-0XA0

Front door, elevated design, for F-modules

For F-modules; for connecting
1.3 mm²/16 AWG wires; wiring
diagram and labels in yellow

6ES7328-7AA10-0AA0

Labeling strips

For F-modules (spare part); 10 units

6ES7392-2XX20-0AA0

Label cover

For F-modules (spare part); 10 units

6ES7392-2XY20-0AA0

LK 393 cable guide

For F-modules;
L+ and M connections; 5 units

6ES7393-4AA10-0AA0

Programming tools and documentation

S7 Distributed Safety V5.4 SP5 Update 2 programming tool

Task:
Configuration software for configuring fail-safe user programs for SIMATIC S7-300F, S7-400F, WinAC RTX F, ET 200S, ET 200M, ET 200iSP, ET 200pro, ET 200eco, ET 200SP

Requirement:

Windows 7 SP1 (64-bit),
Windows 10 Professional/Enterprise (64-bit),
Windows Server 2008 R2 SP1 (64-bit),
Windows Server 2012 R2 (64-bit),
Windows Server 2016 (64-bit);
STEP 7 as of V5.5 SP1;
Please also consider the operating systems that have been released for the used STEP 7 version

Floating license for 1 user;
software and documentation on
DVD; license key on USB flash drive

6ES7833-1FC02-0YA5

Floating license for 1 user; software,
documentation and license key for
download¹⁾;
email address required for delivery

6ES7833-1FC02-0YH5

¹⁾ For up-to-date information and download availability, see:
<http://www.siemens.com/tia-online-software-delivery>

SIMATIC S7-300 Advanced Controllers

I/O modules

SIPLUS S7-300 F-digital/analog modules

SIPLUS S7-300 SM 336 - Safety Integrated

Ordering data

Article No.

S7 Distributed Safety upgrade

From V5.x to V5.4; floating license for 1 user; software and documentation on DVD; license key on USB flash drive

6ES7833-1FC02-0YE5

STEP 7 Safety Advanced V17

Task:

Engineering tool for configuring and programming fail-safe user programs for SIMATIC S7-1200 FC, S7-1500F, S7-1500F Software Controller, S7-300F, S7-400F, WinAC RTX F, ET 200SP F Controller and the fail-safe I/O ET 200SP, ET 200MP, ET 200S, ET 200M, ET 200ISP, ET 200pro and ET 200eco

Requirement:

STEP 7 Professional V17

Note:

As of TIA Portal V16, the SIMATIC STEP 7 Safety software is an integral component of the SIMATIC STEP 7 product setup. The functionality of SIMATIC STEP 7 Safety is activated by means of the license key supplied in each case.

Floating license for 1 user; license key on USB flash drive

6ES7833-1FA17-0YA5

Floating license for 1 user; license key for download¹⁾; email address required for delivery

6ES7833-1FA17-0YH5

SIMATIC Manual Collection

6ES7998-8XC01-8YE0

Electronic manuals on DVD, multi-language: LOGO!, SIMADYN, SIMATIC bus components, SIMATIC C7, SIMATIC Distributed I/O, SIMATIC HMI, SIMATIC sensors, SIMATIC NET, SIMATIC PC-based Automation, SIMATIC PCS 7, SIMATIC PG/PC, SIMATIC S7, SIMATIC software, SIMATIC TDC

SIMATIC Manual Collection update service for 1 year

6ES7998-8XC01-8YE2

Current Manual Collection DVD and the three subsequent updates

Technical specifications

Article number

6AG1336-4GE00-2AB0

Based on

6ES7336-4GE00-0AB0

SIPLUS S7-300 SM336 F 6AI 15BIT

Ambient conditions

Ambient temperature during operation

- min. -25 °C; = Tmin; Startup @ -25 °C
- max. 60 °C; = Tmax; *+70 °C when forced convection at a minimum air speed of 0.3 m/s through the modules is ensured. If in the course of maintenance or automatic diagnosis it is determined that the admissible specified parameters have been exceeded, the modules should be subjected to a proof test (function check) by the manufacturer.

Altitude during operation relating to sea level

- Installation altitude above sea level, max. 2 000 m
- Ambient air temperature-barometric pressure-altitude Tmin ... Tmax at 1 140 hPa ... 795 hPa (-1 000 m ... +2 000 m)

Relative humidity

- With condensation, tested in accordance with IEC 60068-2-38, max. 100 %; RH incl. condensation/frost (no commissioning under condensation conditions)

Resistance

Use in stationary industrial systems

- to biologically active substances according to EN 60721-3-3 Yes; Class 3B2 mold, fungus and dry rot spores (with the exception of fauna); Class 3B3 on request
- to chemically active substances according to EN 60721-3-3 Yes; Class 3C4 (RH < 75 %) incl. salt spray acc. to EN 60068-2-52 (severity degree 3); *
- to mechanically active substances according to EN 60721-3-3 Yes; Class 3S4 incl. sand, dust, *

Use on ships/at sea

- to biologically active substances according to EN 60721-3-6 Yes; Class 6B2 mold and fungal spores (excluding fauna); Class 6B3 on request
- to chemically active substances according to EN 60721-3-6 Yes; Class 6C3 (RH < 75 %) incl. salt spray acc. to EN 60068-2-52 (severity degree 3); *
- to mechanically active substances according to EN 60721-3-6 Yes; Class 6S3 incl. sand, dust; *

Usage in industrial process technology

- Against chemically active substances acc. to EN 60654-4 Yes; Class 3 (excluding trichlorethylene)
- Environmental conditions for process, measuring and control systems acc. to ANSI/ISA-71.04 Yes; Level GX group A/B (excluding trichlorethylene; harmful gas concentrations up to the limits of EN 60721-3-3 class 3C4 permissible); level LC3 (salt spray) and level LB3 (oil)

Remark

- Note regarding classification of environmental conditions acc. to EN 60721, EN 60654-4 and ANSI/ISA-71.04 * The supplied plug covers must remain in place over the unused interfaces during operation!

¹⁾ For up-to-date information and download availability, see: <http://www.siemens.com/tia-online-software-delivery>

Overview



- Allows combined operation of fail-safe signal modules in safety mode and S7-300 standard modules in an ET 200M.
- The safety protector is not required if the safety class SIL 3 or safety category < Cat. 4 is to be achieved.

Note:

SIPLUS extreme products are based on SIMATIC standard products. The contents listed here were taken from the respective standard products. SIPLUS extreme specific information was added.

Ordering data

Article No.

SIPLUS F safety protector

For the simultaneous operation of fail-safe and standard modules in the same ET 200M

For industrial applications with extended ambient conditions

Extended temperature range and exposure to media

6AG1195-7KF00-2XA0

Accessories

SIPLUS ET 200M

bus safety protector F

For the simultaneous operation of fail-safe and standard modules in ET 200 M for the hot swapping function

Extended temperature range and exposure to media

6AG1195-7HG00-2XA0

Technical specifications

Article number	6AG1195-7KF00-2XA0
Based on	6ES7195-7KF00-0XA0 SIPLUS S7-300 safety protector
Ambient conditions	
Ambient temperature during operation	
• min.	-25 °C; = Tmin
• max.	60 °C; = Tmax
Ambient temperature during storage/transportation	
• min.	-40 °C
• max.	70 °C
Altitude during operation relating to sea level	
• Installation altitude above sea level, max.	2 000 m
• Ambient air temperature-barometric pressure-altitude	Tmin ... Tmax at 1 140 hPa ... 795 hPa (-1 000 m ... +2 000 m)
Relative humidity	
• With condensation, tested in accordance with IEC 60068-2-38, max.	100 %; RH incl. condensation/frost (no commissioning under condensation conditions)
Resistance	
Use in stationary industrial systems	
- to biologically active substances according to EN 60721-3-3	Yes; Class 3B2 mold, fungus and dry rot spores (with the exception of fauna); Class 3B3 on request
- to chemically active substances according to EN 60721-3-3	Yes; Class 3C4 (RH < 75 %) incl. salt spray acc. to EN 60068-2-52 (severity degree 3); *
- to mechanically active substances according to EN 60721-3-3	Yes; Class 3S4 incl. sand, dust, *
Use on ships/at sea	
- to biologically active substances according to EN 60721-3-6	Yes; Class 6B2 mold and fungal spores (excluding fauna); Class 6B3 on request
- to chemically active substances according to EN 60721-3-6	Yes; Class 6C3 (RH < 75 %) incl. salt spray acc. to EN 60068-2-52 (severity degree 3); *
- to mechanically active substances according to EN 60721-3-6	Yes; Class 6S3 incl. sand, dust; *
Usage in industrial process technology	
- Against chemically active substances acc. to EN 60654-4	Yes; Class 3 (excluding trichlorethylene)
- Environmental conditions for process, measuring and control systems acc. to ANSI/ISA-71.04	Yes; Level GX group A/B (excluding trichlorethylene; harmful gas concentrations up to the limits of EN 60721-3-3 class 3C4 permissible); level LC3 (salt spray) and level LB3 (oil)
Remark	
- Note regarding classification of environmental conditions acc. to EN 60721, EN 60654-4 and ANSI/ISA-71.04	* The supplied plug covers must remain in place over the unused interfaces during operation!

SIMATIC S7-300 Advanced Controllers

I/O modules

Ex digital modules

Ex digital input modules

Overview



- Digital inputs for signals from the Ex field
- For the connection of intrinsically safe digital equipment from the Ex field
- 4 DI NAMUR
- 4 digital inputs in 4 channel modules (single-channel isolation)
- Connectable encoder in accordance with EN 60947-5-6 and NAMUR, optionally with wired or unwired mechanical contacts
- Diagnostics and diagnostics alarm programmable

5

Ordering data

Ex digital input module

4 inputs, isolated, NAMUR

Article No.

6ES7321-7RD00-0AB0

Front connector

20-pin, with screw contacts

- 1 unit
- 100 units

6ES7392-1AJ00-0AA0
6ES7392-1AJ00-1AB0

Front door, elevated design

e.g. for 32 channel modules;
enables connection of
1.3 mm²/16 AWG wires

6ES7328-0AA00-7AA0

LK 393 cable guide

Mandatory for operation in
Ex-hazard areas

6ES7393-4AA00-0AA0

Labeling strips

10 units (spare part), for modules
with 20-pin front connector

6ES7392-2XX00-0AA0

Label cover

10 units (spare part), for modules
with 20-pin front connector

6ES7392-2XY00-0AA0

Labeling sheets for machine inscription

for modules with 20-pin front
connector, DIN A4, for printing with
laser printer; 10 units

petrol

6ES7392-2AX00-0AA0

light-beige

6ES7392-2BX00-0AA0

yellow

6ES7392-2CX00-0AA0

red

6ES7392-2DX00-0AA0

Article No.

SIMATIC Manual Collection

Electronic manuals on DVD,
multilingual:
LOGO!, SIMADYN,
SIMATIC bus components,
SIMATIC C7, SIMATIC distributed I/O,
SIMATIC HMI, SIMATIC Sensors,
SIMATIC NET, SIMATIC PC Based
Automation, SIMATIC PCS 7,
SIMATIC PG/PC, SIMATIC S7,
SIMATIC Software, SIMATIC TDC

6ES7998-8XC01-8YE0

SIMATIC Manual Collection update service for 1 year

Current "Manual Collection" DVD
and the three subsequent updates

6ES7998-8XC01-8YE2

Technical specifications

Article number	6ES7321-7RD00-0AB0 SM321, 4DI, DC24V, HAZARDOUS AREAS
Supply voltage	
Load voltage L+	
• Rated value (DC)	24 V
Input current	
from load voltage L+ (without load), max.	50 mA
from backplane bus 5 V DC, max.	80 mA
Power loss	
Power loss, typ.	1.1 W
Digital inputs	
Number of digital inputs	4
Number of NAMUR inputs	4
Input voltage	
• Type of input voltage	DC
• Rated value (DC)	8.2 V; from internal power circuit supply
Input current	
• on wire-break, max.	0.1 mA
• on short-circuit, max.	8.5 mA
for NAMUR encoders	
- for signal *0*, min.	0.35 mA
- for signal *0*, max.	1.2 mA
- for signal *1*, min.	2.1 mA
- for signal *1*, max.	7 mA
Input delay (for rated value of input voltage)	
• Input frequency (with a time delay of 0.1 ms), max.	2 kHz
for NAMUR inputs	
- parameterizable	Yes; 0.1 / 0.5 / 3 / 15 / 20 ms (plus 0.25 ms preparation time)
Encoder	
Connectable encoders	
• NAMUR encoder	Yes; Two-wire connection
Interrupts/diagnostics/status information	
Diagnostics function	Yes

Article number	6ES7321-7RD00-0AB0 SM321, 4DI, DC24V, HAZARDOUS AREAS
Ex(i) characteristics	
Module for Ex(i) protection	Yes
maximum values for connecting terminals for gas group IIC	
• U _o (no-load voltage), max.	10 V
• I _o (short-circuit current), max.	14.1 mA
• P _o (power output), max.	33.7 mW
• C _o (permissible external capacity), max.	3 µF
• L _o (permissible external inductivity), max.	100 mH
Standards, approvals, certificates	
Use in hazardous areas	
• ATEX marking	ATEX II 3 G (2) GD Ex nA [ib Gb] [ib IIIC Db] IIC T4 Gc
• FM marking	Class II, Division 2, Group A, B, C, D T4
• Test number PTB	Ex-96.D.2094X
Ambient conditions	
Ambient temperature during operation	
• max.	60 °C
Connection method	
required front connector	20-pin
Dimensions	
Width	40 mm
Height	125 mm
Depth	120 mm
Weights	
Weight, approx.	230 g

SIMATIC S7-300 Advanced Controllers

I/O modules

Ex digital modules

Ex digital output modules

Overview



- Digital outputs for signals from the Ex field
- For the connection of intrinsically safe digital equipment from the Ex field
- 4 DO 24 V DC/10mA or 4 DO 15 V DC/20 mA
- 4 digital outputs in 4 channel modules (single-channel isolation)
- Diagnostics and diagnostics alarm programmable
- Substitute value behavior programmable

5

Ordering data

Article No.

Ex digital output modules

4 outputs, isolated, 24 V DC, 10 mA

6ES7322-5SD00-0AB0

4 outputs, isolated, 15 V DC, 20 mA

6ES7322-5RD00-0AB0

Front connector

20-pin, with screw contacts

- 1 unit
- 100 units

6ES7392-1AJ00-0AA0

6ES7392-1AJ00-1AB0

Front door, elevated design

e.g. for 32 channel modules;
enables connection of
1.3 mm²/16 AWG wires

6ES7328-0AA00-7AA0

LK 393 cable guide

Mandatory for operation in
Ex-hazard areas

6ES7393-4AA00-0AA0

Labeling strips

10 units (spare part), for modules
with 20-pin front connector

6ES7392-2XX00-0AA0

Label cover

10 units (spare part), for modules
with 20-pin front connector

6ES7392-2XY00-0AA0

Labeling sheets for machine inscription

for modules with 40-pin front
connector, DIN A4, for printing with
laser printer; 10 units

petrol

6ES7392-2AX00-0AA0

light-beige

6ES7392-2BX00-0AA0

yellow

6ES7392-2CX00-0AA0

red

6ES7392-2DX00-0AA0

Article No.

SIMATIC Manual Collection

Electronic manuals on DVD,
multilingual:
LOGO!, SIMADYN,
SIMATIC bus components,
SIMATIC C7, SIMATIC distributed I/O,
SIMATIC HMI, SIMATIC Sensors,
SIMATIC NET, SIMATIC PC Based
Automation, SIMATIC PCS 7,
SIMATIC PG/PC, SIMATIC S7,
SIMATIC Software, SIMATIC TDC

6ES7998-8XC01-8YE0

SIMATIC Manual Collection update service for 1 year

Current "Manual Collection" DVD
and the three subsequent updates

6ES7998-8XC01-8YE2

Technical specifications

Article number	6ES7322-5SD00-0AB0 SM322, 4DO, 24V DC, 10MA, HAZARDOUS AREAS	6ES7322-5RD00-0AB0 SM322, 4DO, 15V DC, 20MA, HAZARDOUS AREAS
Supply voltage		
Load voltage L+		
• Rated value (DC)	24 V	24 V
Input current		
from load voltage L+ (without load), max.	160 mA	160 mA
from backplane bus 5 V DC, max.	85 mA	85 mA
Power loss		
Power loss, typ.	3 W	3 W
Digital outputs		
Number of digital outputs	4	4
Short-circuit protection	Yes; Electronic	Yes; Electronic
Load resistance range		
• upper limit	390 Ω; Two-wire connection	200 Ω; Two-wire connection
Output voltage		
• Rated value (DC)	24 V	15 V
Switching frequency		
• with resistive load, max.	100 Hz	100 Hz
Interrupts/diagnostics/ status information		
Diagnostics function	Yes	Yes
Ex(i) characteristics		
Module for Ex(i) protection	Yes	Yes
maximum values for connecting terminals for gas group IIC		
• U _o (no-load voltage), max.	25.2 V	15.75 V
• I _o (short-circuit current), max.	70 mA	85 mA
• P _o (power output), max.	440 mW	335 mW
• C _o (permissible external capacity), max.	90 nF	500 nF
• L _o (permissible external inductivity), max.	6.7 mH	5 mH
Standards, approvals, certificates		
Use in hazardous areas		
• ATEX marking	[EEx ib] IIC	[EEx ib] IIC
• FM marking	AIS CL.1, DIV 1, GP A, B, C, D; CL.I, DIV 2, GP A, B, C, D T4	AIS CL.1, DIV 1, GP A, B, C, D; CL.I, DIV 2, GP A, B, C, D T4
• Test number PTB	Ex-96.D.2093X	Ex-96.D.2102X
Ambient conditions		
Ambient temperature during operation		
• max.	60 °C	60 °C
Connection method		
required front connector	20-pin	20-pin
Dimensions		
Width	40 mm	40 mm
Height	125 mm	125 mm
Depth	120 mm	120 mm
Weights		
Weight, approx.	230 g	230 g

SIMATIC S7-300 Advanced Controllers

I/O modules

SIPLUS S7-300 Ex digital modules

SIPLUS S7-300 Ex digital input modules

Overview



- Digital inputs for signals from the Ex field
- For the connection of intrinsically safe digital equipment from the Ex field
- 4 DI NAMUR
- 4 digital inputs in 4 channel modules (single-channel isolation)
- Connectable encoder in accordance with EN 60947-5-6 and NAMUR, optionally with wired or unwired mechanical contacts
- Programmable diagnostics and diagnostic interrupt

Note:

SIPLUS extreme products are based on SIMATIC standard products. The contents listed here were taken from the respective standard products. SIPLUS extreme-specific information was added.

5

Ordering data

Article No.

SIPLUS S7-300 Ex digital input module

Exposure to media

4 inputs, isolated, NAMUR

6AG1321-7RD00-4AB0

Accessories

Mandatory

Front connector

20-pin, with spring-loaded contacts

- 1 unit
- 100 units

6ES7392-1BJ00-0AA0
6ES7392-1BJ00-1AB0

Consumables

DIN rail for active bus modules

For max. 5 active bus modules for hot swapping function

- Length 483 mm (19")
- Length 530 mm
- Length 620 mm
- Length 2000 mm

6ES7195-1GA00-0XA0
6ES7195-1GF30-0XA0
6ES7195-1GG30-0XA0
6ES7195-1GC00-0XA0

Front door, elevated design

6ES7328-0AA00-7AA0

E.g. for 32-channel modules; for connecting 1.3 mm²/16 AWG conductors; circuit diagram and nameplates in petrol

LK 393 cable guide

6ES7393-4AA00-0AA0

Mandatory for operation in hazardous areas

Labeling strips

6ES7392-2XX00-0AA0

10 units (spare part), for modules with 20-pin front connector

Label cover

6ES7392-2XY00-0AA0

10 units (spare part), for modules with 20-pin front connector

Article No.

Labeling sheets for machine inscription

For modules with 20-pin front connector, DIN A4, for printing with laser printer; 10 units

Petrol

6ES7392-2AX00-0AA0

Light beige

6ES7392-2BX00-0AA0

Yellow

6ES7392-2CX00-0AA0

Red

6ES7392-2DX00-0AA0

Documentation

SIMATIC Manual Collection

6ES7998-8XC01-8YE0

Electronic manuals on DVD, multi-language: LOGO!, SIMADYN, SIMATIC bus components, SIMATIC C7, SIMATIC distributed I/O, SIMATIC HMI, SIMATIC Sensors, SIMATIC NET, SIMATIC PC Based Automation, SIMATIC PCS 7, SIMATIC PG/PC, SIMATIC S7, SIMATIC Software, SIMATIC TDC

SIMATIC Manual Collection update service for 1 year

6ES7998-8XC01-8YE2

Current "Manual Collection" DVD and the three subsequent updates

Technical specifications

Article number	6AG1321-7RD00-4AB0	Article number	6AG1321-7RD00-4AB0
Based on	6ES7321-7RD00-0AB0 SIPLUS S7-300 SM 321 4DI NAMUR	Based on	6ES7321-7RD00-0AB0 SIPLUS S7-300 SM 321 4DI NAMUR
Ambient conditions		Resistance	
Ambient temperature during operation		Use in stationary industrial systems	
• min.	0 °C; = Tmin	- to biologically active substances according to EN 60721-3-3	Yes; Class 3B2 mold, fungus and dry rot spores (with the exception of fauna); Class 3B3 on request
• max.	60 °C; = Tmax	- to chemically active substances according to EN 60721-3-3	Yes; Class 3C4 (RH < 75 %) incl. salt spray acc. to EN 60068-2-52 (severity degree 3); *
Altitude during operation relating to sea level		- to mechanically active substances according to EN 60721-3-3	Yes; Class 3S4 incl. sand, dust, *
• Installation altitude above sea level, max.	5 000 m	Use on ships/at sea	
• Ambient air temperature-barometric pressure-altitude	Tmin ... Tmax at 1 140 hPa ... 795 hPa (-1 000 m ... +2 000 m) // Tmin ... (Tmax - 10 K) at 795 hPa ... 658 hPa (+2 000 m ... +3 500 m) // Tmin ... (Tmax -20 K) at 658 hPa ... 540 hPa (+3 500 m ... +5 000 m)	- to biologically active substances according to EN 60721-3-6	Yes; Class 6B2 mold and fungal spores (excluding fauna); Class 6B3 on request
Relative humidity		- to chemically active substances according to EN 60721-3-6	Yes; Class 6C3 (RH < 75 %) incl. salt spray acc. to EN 60068-2-52 (severity degree 3); *
• With condensation, tested in accordance with IEC 60068-2-38, max.	100 %; RH incl. condensation/frost (no commissioning under condensation conditions)	- to mechanically active substances according to EN 60721-3-6	Yes; Class 6S3 incl. sand, dust; *
		Usage in industrial process technology	
		- Against chemically active substances acc. to EN 60654-4	Yes; Class 3 (excluding trichlorethylene)
		- Environmental conditions for process, measuring and control systems acc. to ANSI/ISA-71.04	Yes; Level GX group A/B (excluding trichlorethylene; harmful gas concentrations up to the limits of EN 60721-3-3 class 3C4 permissible); level LC3 (salt spray) and level LB3 (oil)
		Remark	
		- Note regarding classification of environmental conditions acc. to EN 60721, EN 60654-4 and ANSI/ISA-71.04	* The supplied plug covers must remain in place over the unused interfaces during operation!

SIMATIC S7-300 Advanced Controllers

I/O modules

Ex analog modules

Ex analog input modules

Overview



- Analog inputs for signals from the Ex field
- For the connection of intrinsically safe analog equipment from the Ex field
- 8 or 4 analog inputs in 4 channel groups (single-channel isolation)
- Measurement type and range can be selected for each channel
- Diagnostics and diagnostics alarm programmable
- Programmable threshold alarm
- HART-compatible inputs (only 6ES7331-7RD00-0AB0)

5

Ordering data

Ex analog input modules

4 inputs, isolated, 0/4 to 20 mA, 15 bit

Article No.

6ES7331-7RD00-0AB0

8/4 inputs, isolated, for thermocouples and Pt100, Pt200, Ni100

6ES7331-7SF00-0AB0

Front connector

20-pin, with screw contacts

- 1 unit
- 100 units

6ES7392-1AJ00-0AA0
6ES7392-1AJ00-1AB0

Front door, elevated design

e.g. for 32 channel modules; enables connection of 1.3 mm²/16 AWG wires

6ES7328-0AA00-7AA0

LK 393 cable guide

Mandatory for operation in Ex-hazard areas

6ES7393-4AA00-0AA0

Labeling strips

10 units (spare part), for modules with 20-pin front connector

6ES7392-2XX00-0AA0

Label cover

10 units (spare part), for modules with 20-pin front connector

6ES7392-2XY00-0AA0

Labeling sheets for machine inscription

for modules with 20-pin front connector, DIN A4, for printing with laser printer; 10 units

petrol

6ES7392-2AX00-0AA0

light-beige

6ES7392-2BX00-0AA0

yellow

6ES7392-2CX00-0AA0

red

6ES7392-2DX00-0AA0

Article No.

SIMATIC Manual Collection

Electronic manuals on DVD, multilingual:
LOGO!, SIMADYN,
SIMATIC bus components,
SIMATIC C7, SIMATIC distributed I/O,
SIMATIC HMI, SIMATIC Sensors,
SIMATIC NET, SIMATIC PC Based
Automation, SIMATIC PCS 7,
SIMATIC PG/PC, SIMATIC S7,
SIMATIC Software, SIMATIC TDC

6ES7998-8XC01-8YE0

SIMATIC Manual Collection update service for 1 year

Current "Manual Collection" DVD and the three subsequent updates

6ES7998-8XC01-8YE2

Technical specifications

Article number	6ES7331-7RD00-0AB0 SM331, 4AI, 0/4-20MA, EX AREA	6ES7331-7SF00-0AB0 SM331, 8AI THERMO/4AI PT100, EX AREA
Supply voltage		
Load voltage L+		
• Rated value (DC)	24 V	24 V
Input current		
from load voltage L+ (without load), max.	250 mA	
from backplane bus 5 V DC, max.	60 mA	120 mA
Output voltage		
Supply voltage of the transmitters		
• Rated value (DC)	13 V; at 22 mA	
Power loss		
Power loss, typ.	3 W	0.6 W
Analog inputs		
Number of analog inputs	4	8; 8x thermocouples; 4x RTD thermoresistors
permissible input current for current input (destruction limit), max.	40 mA	
Input ranges (rated values), voltages		
• -1 V to +1 V		Yes
• -25 mV to +25 mV		Yes
• -250 mV to +250 mV		Yes
• -50 mV to +50 mV		Yes
• -500 mV to +500 mV		Yes
• -80 mV to +80 mV		Yes
Input ranges (rated values), currents		
• 0 to 20 mA	Yes	
• 4 mA to 20 mA	Yes	
Input ranges (rated values), thermocouples		
• Type B		Yes
• Type E		Yes
• Type J		Yes
• Type K		Yes
• Type L		Yes
• Type N		Yes
• Type R		Yes
• Type S		Yes
• Type T		Yes
• Type U		Yes
Input ranges (rated values), resistance thermometer		
• Ni 100		Yes
• Pt 100		Yes
• Pt 200		Yes
Cable length		
• shielded, max.	200 m	200 m; TC: 50 m
Analog value generation for the inputs		
Integration and conversion time/resolution per channel		
• Resolution with overrange (bit including sign), max.	16 bit; 10 bit to 15 bit + sign	16 bit; 10 bit to 15 bit + sign
• Integration time, parameterizable	Yes; 2.5 to 100 ms	Yes; 2.5 to 100 ms
• Interference voltage suppression for interference frequency f1 in Hz	10 to 400 Hz	10 to 400 Hz
Encoder		
Connection of signal encoders		
• for current measurement as 2-wire transducer	Yes	Yes
• for current measurement as 4-wire transducer	Yes	Yes

SIMATIC S7-300 Advanced Controllers

I/O modules

Ex analog modules

Ex analog input modules**Technical specifications**

Article number	6ES7331-7RD00-0AB0 SM331, 4AI, 0/4-20mA, EX AREA	6ES7331-7SF00-0AB0 SM331, 8AI THERMO/4AI PT100, EX AREA
Errors/accuracies		
Operational error limit in overall temperature range		
<ul style="list-style-type: none"> Current, relative to input range, (+/-) Resistance thermometer, relative to input range, (+/-) 	0.45 %	0.04 %; 0.09 to 0.04%
Basic error limit (operational limit at 25 °C)		
<ul style="list-style-type: none"> Current, relative to input range, (+/-) Resistance thermometer, relative to input range, (+/-) 	0.1 %	0.008 %; 0.018 ... 0.008%
Interrupts/diagnostics/status information		
Diagnostics function	Yes	Yes
Ex(i) characteristics		
Module for Ex(i) protection	Yes	Yes
maximum values for connecting terminals for gas group IIC		
<ul style="list-style-type: none"> U_o (no-load voltage), max. I_o (short-circuit current), max. P_o (power output), max. C_o (permissible external capacity), max. L_o (permissible external inductivity), max. 	25.2 V 68.5 mA 431 mW 90 nF 7.5 mH	5.9 V 28.8 mA 41.4 mW 43 µF 40 mH
Standards, approvals, certificates		
Use in hazardous areas		
<ul style="list-style-type: none"> ATEX marking FM marking Test number PTB 	ATEX II 3 G (2) GD Ex nA [ib Gb] [ib IIIC Db] IIC T4 Gc Class I, Division 2, Group A, B, C, D T4 Ex-96.D.2092X	ATEX II 3 G (2) GD Ex nA [ib Gb] [ib IIIC Db] IIC T4 Gc Class I, Division 2, Group A, B, C, D T4 Ex-96.D.2108X
Ambient conditions		
Ambient temperature during operation		
<ul style="list-style-type: none"> max. 	60 °C	60 °C
Connection method		
required front connector	20-pin	20-pin
Dimensions		
Width	40 mm	
Height	125 mm	
Depth	120 mm	
Weights		
Weight, approx.	290 g	210 g

5

Overview



- Analog outputs for signals from the Ex field
- For the connection of intrinsically safe analog equipment from the Ex field
- 4 analog outputs in 4 channel modules (single-channel isolation)
- Diagnostics and diagnostics alarm programmable

Ordering data

Ex analog output module

4 outputs, isolated, 0/4 to 20 mA

Article No.

6ES7332-5RD00-0AB0**Front connector**

20-pin, with screw contacts

- 1 unit
- 100 units

6ES7392-1AJ00-0AA0
6ES7392-1AJ00-1AB0
Front door, elevated designe.g. for 32 channel modules; enables connection of 1.3 mm²/16 AWG wires**6ES7328-0AA00-7AA0****LK 393 cable guide**

Mandatory for operation in hazardous areas

6ES7393-4AA00-0AA0**Labeling strips**

10 units (spare part), for modules with 20-pin front connector

6ES7392-2XX00-0AA0**Label cover**

10 units (spare part), for modules with 20-pin front connector

6ES7392-2XY00-0AA0**Labeling sheets for machine inscription**

For modules with 20-pin front connector, DIN A4, for printing with laser printer; 10 units

Petrol

6ES7392-2AX00-0AA0

Light beige

6ES7392-2BX00-0AA0

Yellow

6ES7392-2CX00-0AA0

Red

6ES7392-2DX00-0AA0

Article No.

SIMATIC Manual Collection

Electronic manuals on DVD, multilingual: LOGO!, SIMADYN, SIMATIC bus components, SIMATIC C7, SIMATIC distributed I/O, SIMATIC HMI, SIMATIC Sensors, SIMATIC NET, SIMATIC PC Based Automation, SIMATIC PCS 7, SIMATIC PG/PC, SIMATIC S7, SIMATIC Software, SIMATIC TDC

6ES7998-8XC01-8YE0**SIMATIC Manual Collection update service for 1 year**

Current "Manual Collection" DVD and the three subsequent updates

6ES7998-8XC01-8YE2

SIMATIC S7-300 Advanced Controllers

I/O modules

Ex analog modules

Ex analog output modules

Technical specifications

Article number	6ES7332-5RD00-0AB0 SM332, 4AO, 0/4-20MA, EX AREA
Supply voltage	
Load voltage L+	
• Rated value (DC)	24 V
Input current	
from load voltage L+ (without load), max.	200 mA
from backplane bus 5 V DC, max.	80 mA
Power loss	
Power loss, typ.	4 W
Analog outputs	
Number of analog outputs	4
Voltage output, short-circuit protection	Yes
Voltage output, short-circuit current, max.	70 mA
Current output, no-load voltage, max.	14 V
Output ranges, current	
• 0 to 20 mA	Yes
• 4 mA to 20 mA	Yes
Load impedance (in rated range of output)	
• with current outputs, max.	500 Ω
Cable length	
• shielded, max.	200 m
Analog value generation for the outputs	
Integration and conversion time/resolution per channel	
• Resolution with overrange (bit including sign), max.	15 bit
Errors/accuracies	
Operational error limit in overall temperature range	
• Current, relative to output range, (+/-)	0.55 %
Basic error limit (operational limit at 25 °C)	
• Current, relative to output range, (+/-)	0.2 %

Article number	6ES7332-5RD00-0AB0 SM332, 4AO, 0/4-20MA, EX AREA
Interrupts/diagnostics/status information	
Diagnostics function	Yes
Ex(i) characteristics	
Module for Ex(i) protection	Yes
maximum values for connecting terminals for gas group IIC	
• U _o (no-load voltage), max.	14 V
• I _o (short-circuit current), max.	70 mA
• P _o (power output), max.	440 mW
• C _o (permissible external capacity), max.	850 nF
• L _o (permissible external inductivity), max.	6.6 mH
Standards, approvals, certificates	
Use in hazardous areas	
• ATEX marking	[Ex ib] IIC
• FM marking	Class I, Division 2, Group A, B, C, D T4
• Test number PTB	Ex-96.D.2026X
Ambient conditions	
Ambient temperature during operation	
• max.	60 °C
Connection method	
required front connector	20-pin
Dimensions	
Width	40 mm
Height	125 mm
Depth	120 mm
Weights	
Weight, approx.	280 g

5

Overview

- Analog inputs for signals from the Ex field
- For the connection of intrinsically safe analog equipment from the Ex field
- 4 analog inputs in 4 channel groups (single-channel isolation)
- Measurement type and range can be selected for each channel
- Programmable diagnostics and diagnostic interrupt
- Programmable threshold alarm
- HART-compatible inputs (6AG1 331-7RD00-2AB0 only)

Note:

SIPLUS extreme products are based on SIMATIC standard products. The contents listed here were taken from the respective standard products. SIPLUS extreme-specific information was added.

Ordering data**SIPLUS S7-300
Ex analog input modules**

Extended temperature range and exposure to media

4 inputs, isolated, 0/4 to 20 mA, 15 bit

Exposure to media

8/4 inputs, isolated, for thermocouples and Pt100, Pt200, Ni100; medial exposure only

Accessories

Mandatory

Front connector

20-pin, with spring-loaded contacts

- 1 unit
- 100 units

Consumables

DIN rail for active bus modules

For max. 5 active bus modules for hot swapping function

- Length 483 mm (19")
- Length 530 mm
- Length 620 mm
- Length 2000 mm

Front door, elevated design

E.g. for 32-channel modules; for connecting 1.3 mm²/16 AWG conductors; circuit diagram and nameplates in petrol

LK 393 cable guide

Mandatory for operation in hazardous areas

Article No.

6AG1331-7RD00-2AB0

6AG1331-7SF00-4AB0

6ES7392-1BJ00-0AA0
6ES7392-1BJ00-1AB0

6ES7195-1GA00-0XA0
6ES7195-1GF30-0XA0
6ES7195-1GG30-0XA0
6ES7195-1GC00-0XA0

6ES7328-0AA00-7AA0

6ES7393-4AA00-0AA0

Article No.**Labeling strips**

10 units (spare part), for modules with 20-pin front connector

Label cover

10 units (spare part), for modules with 20-pin front connector

Labeling sheets for machine inscription

For modules with 20-pin front connector, DIN A4, for printing with laser printer; 10 units

Petrol

6ES7392-2AX00-0AA0

Light beige

6ES7392-2BX00-0AA0

Yellow

6ES7392-2CX00-0AA0

Red

6ES7392-2DX00-0AA0

Documentation

SIMATIC Manual Collection

6ES7998-8XC01-8YE0

Electronic manuals on DVD, multi-language: LOGO!, SIMADYN, SIMATIC bus components, SIMATIC C7, SIMATIC distributed I/O, SIMATIC HMI, SIMATIC Sensors, SIMATIC NET, SIMATIC PC Based Automation, SIMATIC PCS 7, SIMATIC PG/PC, SIMATIC S7, SIMATIC Software, SIMATIC TDC

SIMATIC Manual Collection update service for 1 year

6ES7998-8XC01-8YE2

Current "Manual Collection" DVD and the three subsequent updates

SIMATIC S7-300 Advanced Controllers

I/O modules

SIPLUS S7-300 Ex analog modules

SIPLUS S7-300 Ex analog input modules**Technical specifications**

Article number	6AG1331-7RD00-2AB0	6AG1331-7SF00-4AB0
Based on	6ES7331-7RD00-0AB0 SIPLUS S7-300 SM 331 4AI	6ES7331-7SF00-0AB0 SIPLUS S7-300 SM 331 AI 20-pin
Ambient conditions		
Ambient temperature during operation		
• min.	-25 °C; = Tmin	0 °C; = Tmin
• max.	60 °C; = Tmax; 60 °C @ UL/cUL, ATEX and FM use, 70 °C only 4 wire	60 °C; = Tmax
Altitude during operation relating to sea level		
• Installation altitude above sea level, max.	5 000 m	5 000 m
• Ambient air temperature-barometric pressure-altitude	Tmin ... Tmax at 1 140 hPa ... 795 hPa (-1 000 m ... +2 000 m) // Tmin ... (Tmax - 10 K) at 795 hPa ... 658 hPa (+2 000 m ... +3 500 m) // Tmin ... (Tmax -20 K) at 658 hPa ... 540 hPa (+3 500 m ... +5 000 m)	Tmin ... Tmax at 1 140 hPa ... 795 hPa (-1 000 m ... +2 000 m) // Tmin ... (Tmax - 10 K) at 795 hPa ... 658 hPa (+2 000 m ... +3 500 m) // Tmin ... (Tmax -20 K) at 658 hPa ... 540 hPa (+3 500 m ... +5 000 m)
Relative humidity		
• With condensation, tested in accordance with IEC 60068-2-38, max.	100 %; RH incl. condensation/frost (no commissioning under condensation conditions)	100 %; RH incl. condensation/frost (no commissioning under condensation conditions)
Resistance		
Use in stationary industrial systems		
- to biologically active substances according to EN 60721-3-3	Yes; Class 3B2 mold, fungus and dry rot spores (with the exception of fauna); Class 3B3 on request	Yes; Class 3B2 mold, fungus and dry rot spores (with the exception of fauna); Class 3B3 on request
- to chemically active substances according to EN 60721-3-3	Yes; Class 3C4 (RH < 75 %) incl. salt spray acc. to EN 60068-2-52 (severity degree 3); *	Yes; Class 3C4 (RH < 75 %) incl. salt spray acc. to EN 60068-2-52 (severity degree 3); *
- to mechanically active substances according to EN 60721-3-3	Yes; Class 3S4 incl. sand, dust, *	Yes; Class 3S4 incl. sand, dust, *
Use on ships/at sea		
- to biologically active substances according to EN 60721-3-6	Yes; Class 6B2 mold and fungal spores (excluding fauna); Class 6B3 on request	Yes; Class 6B2 mold and fungal spores (excluding fauna); Class 6B3 on request
- to chemically active substances according to EN 60721-3-6	Yes; Class 6C3 (RH < 75 %) incl. salt spray acc. to EN 60068-2-52 (severity degree 3); *	Yes; Class 6C3 (RH < 75 %) incl. salt spray acc. to EN 60068-2-52 (severity degree 3); *
- to mechanically active substances according to EN 60721-3-6	Yes; Class 6S3 incl. sand, dust; *	Yes; Class 6S3 incl. sand, dust; *
Usage in industrial process technology		
- Against chemically active substances acc. to EN 60654-4	Yes; Class 3 (excluding trichlorethylene)	Yes; Class 3 (excluding trichlorethylene)
- Environmental conditions for process, measuring and control systems acc. to ANSI/ISA-71.04	Yes; Level GX group A/B (excluding trichlorethylene; harmful gas concentrations up to the limits of EN 60721-3-3 class 3C4 permissible); level LC3 (salt spray) and level LB3 (oil)	Yes; Level GX group A/B (excluding trichlorethylene; harmful gas concentrations up to the limits of EN 60721-3-3 class 3C4 permissible); level LC3 (salt spray) and level LB3 (oil)
Remark		
- Note regarding classification of environmental conditions acc. to EN 60721, EN 60654-4 and ANSI/ISA-71.04	* The supplied plug covers must remain in place over the unused interfaces during operation!	* The supplied plug covers must remain in place over the unused interfaces during operation!

5

Overview



- One-channel intelligent counter module for simple counting tasks
- For direct connection of incremental encoders
- Comparison function with 2 specifiable comparison values
- Integrated digital outputs to output the response upon reaching the comparison value.
- Operating modes:
 - Continuous counting
 - One-shot counting
 - Periodic counting
- Special functions:
 - Set counter
 - Latch counter
- Start/stop counter with gate function

Note:

Incremental encoders and pre-assembled connecting cables for counting and positioning functions are offered under SIMODRIVE Sensor or Motion Connect 500.

<http://www.siemens.com/simatic-technology>

Ordering data

Ordering data	Article No.
FM 350-1 counter module With 1 channel, max. 500 kHz; for incremental encoder	6ES7350-1AH03-0AE0
Coding plug - Range card for analog inputs Spare part	6ES7974-0AA00-0AA0
Front connector 20-pin, with screw contacts • 1 unit • 100 units	6ES7392-1AJ00-0AA0 6ES7392-1AJ00-1AB0
20-pin, with spring-loaded contacts • 1 unit • 100 units	6ES7392-1BJ00-0AA0 6ES7392-1BJ00-1AB0
Bus connectors 1 unit (spare part)	6ES7390-0AA00-0AA0
Labeling strips 10 units (spare part)	6ES7392-2XX00-0AA0
Labeling sheets for machine inscription	See under "Accessories" page 5/252
Slot number label Spare part	6ES7912-0AA00-0AA0
Shield connection element 80 mm wide, with 2 rows of 4 terminals each	6ES7390-5AA00-0AA0
Shield connection clamps 2 units For 2 cables, diameter 2 mm to 6 mm	6ES7390-5AB00-0AA0
For 1 cable, diameter 3 mm to 8 mm	6ES7390-5BA00-0AA0
For 1 cable, diameter 4 mm to 13 mm	6ES7390-5CA00-0AA0
Connectable incremental encoders 6FX2 001-2...	Refer to the Industry Mall under SIMODRIVE Sensor or Motion Connect 500 (see also http://www.siemens.com/simatic-technology)

Signal cable	Article No.
Pre-assembled for HTL and TTL encoder, without D-sub connector, UL/DESINA Length code: 0 m 100 m 200 m	6FX5002-2CA12- ■ ■ ■ 0
0 m 10 m 20 m 30 m 40 m 50 m 60 m 70 m 80 m 90 m	1 2 3 A B C D E F G H J K
0 m 1 m 2 m 3 m 4 m 5 m 6 m 7 m 8 m 9 m	A B C D E F G H J K

SIMATIC S7-300 Advanced Controllers

I/O modules

Function modules

FM 350-1 counter module

Technical specifications

Article number	6ES7350-1AH03-0AE0 FM350-1, counter mod. up to 500KHZ
Supply voltage	
Auxiliary voltage 1L+, load voltage 2L+	
• Rated value (DC)	24 V
Input current	
from load voltage 1L+ (without load), max.	40 mA
from backplane bus 5 V DC, max.	160 mA
Encoder supply	
5 V encoder supply	
• 5 V	Yes; 5.2 V \pm 2 %
• Output current, max.	300 mA
24 V encoder supply	
• 24 V	Yes; 1L+ (-3 V)
• Output current, max.	400 mA
Power loss	
Power loss, typ.	4.5 W
Digital inputs	
Number of digital inputs	3
Functions	1 for gate start, 1 for gate stop, 1 for setting the counter
Input voltage	
• for signal "0"	-28.8 ... +5V
• for signal "1"	+11 to +28.8V
Input current	
• for signal "1", typ.	9 mA
Digital outputs	
Number of digital outputs	2
Short-circuit protection	Yes; Clocked electronically
Limitation of inductive shutdown voltage to	2L+ (-39 V)
Output voltage	
• for signal "0", max.	3 V
• for signal "1", min.	2L+ (-1,5 V)
Output current	
• for signal "1" rated value	0.5 A
• for signal "1" permissible range for 0 to 60 °C, min.	5 mA
• for signal "1" permissible range for 0 to 60 °C, max.	0.6 A

Article number	6ES7350-1AH03-0AE0 FM350-1, counter mod. up to 500KHZ
Encoder	
Connectable encoders	
• Incremental encoder (symmetrical)	Yes; With 2 pulse trains offset by 90°
• Incremental encoder (asymmetrical)	Yes
• 24 V initiator	Yes
• 24 V directional element	Yes; 1 pulse train, 1 direction level
Counter	
Number of counter inputs	1; 32 bit or \pm 31 bit
Counter input 5 V	
• Type	RS 422
• Terminating resistor	220 Ω
• Differential input voltage	1,3 V
• Counting frequency, max.	500 kHz
Counter input 24 V	
• Input voltage for signal "0"	-28.8 ... +5V
• Input voltage for signal "1"	+11 to +28.8V
• Input current for signal "1", typ.	9 mA
• Counting frequency, max.	200 kHz
• Minimum pulse width	2.5 μ s
Connection method	
required front connector	1x 20-pin
Dimensions	
Width	40 mm
Height	125 mm
Depth	120 mm
Weights	
Weight, approx.	250 g

5

Overview



- 8-channel intelligent counter module for universal counting and measuring
- To directly connect 24 V incremental encoders, direction sensors, initiators or NAMUR encoders
- Check function with preselectable set points (number depends on mode)
- Integrated digital outputs to output the response when the setpoint is reached
- Operating modes:
 - Continuous/single/periodic counting
 - Frequency/speed measurement
 - Cycle duration measurement
 - Dosing

Note:

Incremental encoder and pre-assembled connecting cables for counter and positioning function are offered under SIMODRIVE Sensor and Motion Connect 500.

<http://www.siemens.com/simatic-technology>

Ordering data

Ordering data	Article No.	Ordering data	Article No.
FM 350-2 counter module With 8 channels, max. 20 kHz; for 24 V incremental encoders and NAMUR encoders; incl. configuration package and electronic documentation on CD	6ES7350-2AH01-0AE0	Shield connection element 80 mm wide, with 2 rows for 4 terminals each	6ES7390-5AA00-0AA0
Front connector 40-pin, with screw contacts <ul style="list-style-type: none"> • 1 unit • 100 units 40-pin, with spring-loaded contacts <ul style="list-style-type: none"> • 1 unit • 100 units 	6ES7392-1AM00-0AA0 6ES7392-1AM00-1AB0 6ES7392-1BM01-0AA0 6ES7392-1BM01-1AB0	Terminal elements 2 units For 2 cables with 2 mm to 6 mm diameter For 1 cable with 3 mm to 8 mm diameter For 1 cable with 4 mm to 13 mm diameter	6ES7390-5AB00-0AA0 6ES7390-5BA00-0AA0 6ES7390-5CA00-0AA0
Bus connectors 1 unit (spare part)	6ES7390-0AA00-0AA0	Signal cable Pre-assembled for HTL and TTL encoder, without sub D connector, UL/DESINA Length code:	6FX5002-2CA12- ■■■ 0 See FM 350-1, page 5/135
Labeling strips 10 units (spare part)	6ES7392-2XX10-0AA0		
Labeling sheets for machine inscription	See under "Accessories" page 5/252		
Slot number label Spare part	6ES7912-0AA00-0AA0		

SIMATIC S7-300 Advanced Controllers

I/O modules

Function modules

FM 350-2 counter module

Technical specifications

Article number	6ES7350-2AH01-0AE0 FM350-2, Counter Mod., 8 Channels, 20KHz
Supply voltage	
Auxiliary voltage 1L+, load voltage 2L+	
• Rated value (DC)	24 V
Input current	
from load voltage L+ (without load), max.	150 mA
from backplane bus 5 V DC, max.	100 mA
Encoder supply	
NAMUR encoder supply	
• 8.2 V	Yes
• Short-circuit protection	Yes
• Output current, max.	200 mA
Power loss	
Power loss, typ.	10 W
Digital inputs	
Number of digital inputs	8
Number of NAMUR inputs	8
Functions	1 each for gate start/ gate stop
Input voltage	
• for signal *0*	-3 to +5V
• for signal *1*	11 to 30.2 V
Input current	
• for signal *0*, max. (permissible quiescent current)	2 mA
• for signal *1*, typ.	9 mA
for NAMUR encoders	
- for signal *0*, max.	1.2 mA
- for signal *1*, min.	2.1 mA
Input delay (for rated value of input voltage)	
• Input frequency, max.	20 kHz
for standard inputs	
- at *0* to *1*, max.	50 µs
for NAMUR inputs	
- at *0* to *1*, max.	50 µs
Cable length	
• shielded, max.	100 m
Digital outputs	
Number of digital outputs	8
Short-circuit protection	Yes
Limitation of inductive shutdown voltage to	L+ (-40 V)
Output voltage	
• for signal *1*, min.	L+ (-0.8 V)
Output current	
• for signal *1* rated value	0.5 A
• for signal *0* residual current, max.	0.5 mA
Switching frequency	
• with resistive load, max.	500 Hz
• with inductive load, max.	0.5 Hz

Article number	6ES7350-2AH01-0AE0 FM350-2, Counter Mod., 8 Channels, 20KHz
Total current of the outputs (per group)	
horizontal installation	
- up to 40 °C, max.	4 A
- up to 60 °C, max.	2 A
all other mounting positions	
- up to 40 °C, max.	2 A
Cable length	
• shielded, max.	600 m
Encoder	
Connectable encoders	
• Incremental encoder (asymmetrical)	Yes
• 24 V initiator	Yes
• 24 V directional element	Yes
• NAMUR encoder	Yes; to DIN 19 234
• 2-wire sensor	Yes
Interrupts/diagnostics/ status information	
Diagnostics function	Yes; Diagnostic information readable
Alarms	
• Diagnostic alarm	Yes; Parameterizable
• Hardware interrupt	Yes; Parameterizable
Counter	
Number of counter inputs	8; 32 bit or ±31 bit
Counter input 24 V	
• Input voltage for signal *0*	-3 to +5V
• Input voltage for signal *1*	11 to 30.2 V
• Input current for signal *1*, typ.	9 mA
• Counting frequency, max.	20 kHz; Incremental encoder: 10 kHz
Connection method	
required front connector	1x 40-pin
Dimensions	
Width	80 mm
Height	125 mm
Depth	120 mm
Weights	
Weight, approx.	460 g

5

Overview



- Two-channel positioning module for rapid-traverse/creep-speed drives
- 4 digital outputs per channel for motor control
- Incremental or synchro-serial position decoding

Note:

SIMODRIVE Sensor/Motion Connect 500 feature position-measuring systems and preassembled connecting cables for counting and positioning functions.

<http://www.siemens.com/simatic-technology>

Ordering data

Article No.

Signal cables

Preassembled for SSI absolute encoder, UL/DESINA

6FX50 2-2CC11-

Preassembled for TTL encoder 6FX2001-1, UL/DESINA

6FX50 2-2CD01-

Preassembled for TTL encoder 24 V, UL/DESINA

6FX50 2-2CD24-

Not crimped

0

Module end crimped, connector case supplied

1

Motor end crimped, connector case supplied

4

0 m

1

100 m

2

200 m

3

0 m

A

10 m

B

20 m

C

30 m

D

40 m

E

50 m

F

60 m

G

70 m

H

80 m

J

90 m

K

0 m

A

1 m

B

2 m

C

3 m

D

4 m

E

5 m

F

6 m

G

7 m

H

8 m

J

9 m

K

0,0 m

0

0,1 m

1

0,2 m

2

0,3 m

3

0,4 m

4

0,5 m

5

0,6 m

6

0,7 m

7

0,8 m

8

Ordering data

Article No.

FM 351 positioning module

6ES7351-1AH02-0AE0

For rapid traverse and creep speed drives

Front connectors

20-pin, with screw contacts

- 1 unit
- 100 units

6ES7392-1AJ00-0AA0

6ES7392-1AJ00-1AB0

20-pin, with spring-loaded contacts

- 1 unit
- 100 units

6ES7392-1BJ00-0AA0

6ES7392-1BJ00-1AB0

Bus connectors

6ES7390-0AA00-0AA0

1 unit (spare part)

Labeling strips

6ES7392-2XX00-0AA0

10 units (spare part)

Slot number label

6ES7912-0AA00-0AA0

Labeling sheets for machine inscription

See under "Accessories" page 5/252

Spare part

Shield connection element

6ES7390-5AA00-0AA0

80 mm wide, with 2 rows for 4 terminals each

Shield connection clamp

2 units

For 2 cables with 2 mm to 6 mm diameter

6ES7390-5AB00-0AA0

For 1 cable with 3 mm to 8 mm diameter

6ES7390-5BA00-0AA0

For 1 cable with 4 mm to 13 mm diameter

6ES7390-5CA00-0AA0

SIMATIC S7-300 Advanced Controllers

I/O modules

Function modules

FM 351 positioning module

Technical specifications

Article number	6ES7351-1AH02-0AE0 FM351 positioning Mod. rapid/creep Feed
Supply voltage	
Rated value (DC)	24 V
Load voltage L+	
• Rated value (DC)	24 V
Input current	
Current consumption, max.	350 mA
from backplane bus 5 V DC, max.	150 mA
Encoder supply	
5 V encoder supply	
• 5 V	Yes
• Output current, max.	350 mA
• Cable length, max.	32 m
24 V encoder supply	
• 24 V	Yes
• Output current, max.	400 mA; Per channel
• Cable length, max.	100 m
Power loss	
Power loss, typ.	7.9 W
Digital inputs	
Number of digital inputs	8
Functions	Reference cams, reversing cams, flying actual value setting, start/stop positioning
Input voltage	
• Rated value (DC)	24 V
• for signal *0*	-3 to +5V
• for signal *1*	+11 to +30V
Input current	
• for signal *0*, max. (permissible quiescent current)	2 mA
• for signal *1*, typ.	6 mA
Digital outputs	
Number of digital outputs	8
Functions	Rapid traverse, creep, run right, run left
Short-circuit protection	Yes
Output voltage	
• Rated value (DC)	24 V
• for signal *1*, min.	UP - 0.8 V
Output current	
• for signal *1* permissible range for 0 to 60 °C, min.	5 mA; with UPmax
• for signal *1* permissible range for 0 to 60 °C, max.	600 mA; with UPmax
• for signal *0* residual current, max.	0.5 mA

Article number	6ES7351-1AH02-0AE0 FM351 positioning Mod. rapid/creep Feed
Encoder	
Connectable encoders	
• Incremental encoder (symmetrical)	Yes
• Incremental encoder (asymmetrical)	Yes
• Absolute encoder (SSI)	Yes
• 2-wire sensor	Yes
- permissible quiescent current (2-wire sensor), max.	2 mA; on signal *0*, max. 2 mA; on signal *1*, max. 6 mA
Encoder signals, incremental encoder (symmetrical)	
• Trace mark signals	A, notA, B, notB
• Zero mark signal	N, notN
• Input voltage	5 V difference signal (phys. RS 422)
• Input frequency, max.	0.5 MHz
Encoder signals, incremental encoder (asymmetrical)	
• Trace mark signals	A, B
• Zero mark signal	N
• Input voltage	24 V
• Input frequency, max.	50 kHz; 50 kHz for 25 m cable length; 25 kHz for 100 m cable length
Encoder signals, absolute encoder (SSI)	
• Input signal	5 V difference signal (phys. RS 422)
• Data signal	DATA, notDATA
• Clock signal	CL, notCL
• Telegram length, parameterizable	13 or 25 bit
• Clock frequency, max.	1.5 MHz
• Gray code	Yes
• Cable length, shielded, max.	200 m; At max. 188 kHz
Ambient conditions	
Ambient temperature during operation	
• min.	0 °C
• max.	60 °C
Connection method	
required front connector	1x 20-pin
Dimensions	
Width	80 mm
Height	125 mm
Depth	120 mm
Weights	
Weight, approx.	550 g

5

Overview



- Extremely high-speed electronic cam controller
- Low-cost alternative to mechanical cam controllers
- 32 cam tracks, 13 onboard digital outputs for direct output of actions
- Incremental or synchro-serial position decoding

Note:

SIMODRIVE Sensor/Motion Connect 500 feature position-measuring systems and preassembled connecting cables for counting and positioning functions.

<http://www.siemens.com/simatic-technology>

Ordering data

Ordering data	Article No.
FM352 electronic cam controller	6ES7352-1AH02-0AE0
Front connectors	
20-pin, with screw contacts	
• 1 unit	6ES7392-1AJ00-0AA0
• 100 units	6ES7392-1AJ00-1AB0
20-pin, with spring-loaded contacts	
• 1 unit	6ES7392-1BJ00-0AA0
• 100 units	6ES7392-1BJ00-1AB0
Bus connectors	6ES7390-0AA00-0AA0
1 unit (spare part)	
Labeling strips	6ES7392-2XX00-0AA0
10 units (spare part)	
Labeling sheets for machine inscription	See under "Accessories" page 5/252
Slot number label	6ES7912-0AA00-0AA0
Spare part	
Shield connection element	6ES7390-5AA00-0AA0
80 mm wide, with 2 rows for 4 terminals each	
Shield connection clamps	
2 units	
For 2 cables with 2 mm to 6 mm diameter	6ES7390-5AB00-0AA0
For 1 cable with 3 mm to 8 mm diameter	6ES7390-5BA00-0AA0
For 1 cable with 4 mm to 13 mm diameter	6ES7390-5CA00-0AA0

Ordering data

Article No.

Signal cable

Pre-assembled for SSI absolute encoder, UL/DESINA

6FX50 ■ **2-2CC11-** ■ ■ ■ ■ ■

Pre-assembled for TTL encoder 6FX2001-1, UL/DESINA

6FX50 ■ **2-2CD01-** ■ ■ ■ ■ ■

Pre-assembled for TTL encoder 24 V, UL/DESINA

6FX50 ■ **2-2CD24-** ■ ■ ■ ■ ■

Not crimped

0

Module end crimped, connector case supplied

1

Motor end crimped, connector case supplied

4

0 m

1

100 m

2

200 m

3

0 m

A

10 m

B

20 m

C

30 m

D

40 m

E

50 m

F

60 m

G

70 m

H

80 m

J

90 m

K

0 m

A

1 m

B

2 m

C

3 m

D

4 m

E

5 m

F

6 m

G

7 m

H

8 m

J

9 m

K

0,0 m

0

0,1 m

1

0,2 m

2

0,3 m

3

0,4 m

4

0,5 m

5

0,6 m

6

0,7 m

7

0,8 m

8

SIMATIC S7-300 Advanced Controllers

I/O modules

Function modules

FM 352 cam controllers

Technical specifications

Article number	6ES7352-1AH02-0AE0 FM352 Electron. Cam-operated Control
Supply voltage	
Rated value (DC)	24 V
Input current	
from load voltage L+ (without load), max.	200 mA
from backplane bus 5 V DC, max.	100 mA
Encoder supply	
5 V encoder supply	
• 5 V	Yes
• Output current, max.	300 mA
• Cable length, max.	32 m
24 V encoder supply	
• 24 V	Yes
• Output current, max.	300 mA
• Cable length, max.	100 m
Power loss	
Power loss, typ.	8.1 W
Digital inputs	
Number of digital inputs	4
Functions	Reference point switch, set floating actual value/length measurement, brake release, enable track output no. 3
Input voltage	
• Rated value (DC)	24 V
• for signal *0*	-30 to +5 V
• for signal *1*	+11 to +30V
Input current	
• for signal *0*, max. (permissible quiescent current)	2 mA
• for signal *1*, typ.	9 mA
Digital outputs	
Number of digital outputs	13
Functions	Cam track
Short-circuit protection	Yes
Output voltage	
• Rated value (DC)	24 V
• for signal *1*, min.	UP - 0.8 V
Output current	
• for signal *1* permissible range for 0 to 60 °C, min.	5 mA; with UPmax
• for signal *1* permissible range for 0 to 60 °C, max.	600 mA; with UPmax
• for signal *0* residual current, max.	0.5 mA

Article number	6ES7352-1AH02-0AE0 FM352 Electron. Cam-operated Control
Encoder	
Connectable encoders	
• Incremental encoder (symmetrical)	Yes
• Incremental encoder (asymmetrical)	Yes
• Absolute encoder (SSI)	Yes
• 2-wire sensor	Yes
- permissible quiescent current (2-wire sensor), max.	2 mA
Encoder signals, incremental encoder (symmetrical)	
• Trace mark signals	A, notA, B, notB
• Zero mark signal	N, notN
• Input voltage	5 V difference signal (phys. RS 422)
• Input frequency, max.	1 MHz
Encoder signals, incremental encoder (asymmetrical)	
• Trace mark signals	A, B
• Zero mark signal	N
• Input voltage	24 V
• Input frequency, max.	50 kHz; 50 kHz for 25 m cable length; 25 kHz for 100 m cable length
Encoder signals, absolute encoder (SSI)	
• Data signal	DATA, notDATA
• Clock signal	CL, notCL
• Telegram length, parameterizable	13 or 25 bit
• Clock frequency, max.	1 MHz
• Gray code	Yes
• Cable length, shielded, max.	320 m; at max. 125 kHz
Ambient conditions	
Ambient temperature during operation	
• min.	0 °C
• max.	60 °C
Connection method	
required front connector	1x 20-pin
Dimensions	
Width	80 mm
Height	125 mm
Depth	120 mm
Weights	
Weight, approx.	550 g

5

Overview



- The FM 352-5 High Speed Boolean processor provides extremely fast binary control and also some of the fastest switching processes ever possible (cycle time: 1 µs).
- Programming is possible with LAD or FBD.
- The available set of statements comprises bit statements (partial statement set of STEP 7), timers, counters, frequency dividers, frequency generators, shift registers.
- 12 integral DI / 8 integral DO.
- 2 versions: sinking or sourcing digital outputs.
- 1 channel for connection of a 24-V incremental encoder, a 5-V incremental encoder (RS422) or an SSI absolute encoder.

Micro Memory Card required for use of the FM 352-5

Note:

Displacement measuring systems and precut/pre-assembled cables for counting and positioning functions are available under SIMODRIVE Sensor or Motion Connect 500.

<http://www.siemens.com/simatic-technology>

Ordering data

Article No.

FM 352-5 High Speed Boolean processor	
with digital outputs switching to M potential	6ES7352-5AH01-0AE0
with digital outputs switching to P potential	6ES7352-5AH11-0AE0
Micro Memory Card	
128 KB	6ES7953-8LG31-0AA0
512 KB	6ES7953-8LJ31-0AA0
2 MB	6ES7953-8LL31-0AA0
Front connector	
40-pin, with screw contacts	
• 1 unit	6ES7392-1AM00-0AA0
• 100 units	6ES7392-1AM00-1AB0
40-pin, with spring-loaded contacts	
• 1 unit	6ES7392-1BM01-0AA0
• 100 units	6ES7392-1BM01-1AB0
Signal cables	
To HTL and TTL encoders, preassembled, without D-sub connector	6FX5002-2CA12- ■ ■ ■ 0
To SSI absolute encoders 6FX2 001-5, preassembled, without D-sub connector	6FX5002-2CC12- ■ ■ ■ ■
Length code:	
0 m	1
100 m	2
200 m	3
0 m	A
10 m	B
20 m	C
30 m	D
40 m	E
50 m	F
60 m	G
70 m	H
80 m	J
90 m	K
0 m	A
1 m	B
2 m	C
3 m	D
4 m	E
5 m	F
6 m	G
7 m	H
8 m	J
9 m	K
0,0 m	0
0,1 m	1
0,2 m	2
0,3 m	3
0,4 m	4
0,5 m	5
0,6 m	6
0,7 m	7
0,8 m	8

SIMATIC S7-300 Advanced Controllers

I/O modules

Function modules

FM 352-5 high-speed Boolean processor

Technical specifications

Article number	6ES7352-5AH01-0AE0 FM 352-5, Boolean Processor 12DI/8DO	6ES7352-5AH11-0AE0 FM 352-5 PNP, Boolean Processor 12DI/8DO
Supply voltage		
Load voltage L+		
• Rated value (DC)	24 V	24 V
Input current		
from load voltage 1L+, max.	150 mA; typ. 60 mA	150 mA; typ. 60 mA
from load voltage 2L+ (without load), max.	200 mA; typ. 60 mA, DI/DO supply	200 mA; typ. 60 mA, DI/DO supply
from load voltage 3L+ (with encoder), max.	600 mA; typ. 80 mA plus encoder supply	600 mA; typ. 80 mA plus encoder supply
from load voltage 3L+ (without load), max.	200 mA; typ. 80 mA	200 mA; typ. 80 mA
from backplane bus 5 V DC, typ.	135 mA	135 mA
Encoder supply		
5 V encoder supply		
• 5 V	Yes	Yes
• Short-circuit protection	Yes; Electronic overload protection; no protection on applying a normal or counter voltage.	Yes; Electronic overload protection; no protection on applying a normal or counter voltage.
• Output current, max.	250 mA	250 mA
24 V encoder supply		
• 24 V	Yes	Yes
• Short-circuit protection	Yes; Overvoltage and overheating protection if overloaded; diagnostics if output reaches temperature limit; no protection on applying a normal or counter voltage	Yes; Overvoltage and overheating protection if overloaded; diagnostics if output reaches temperature limit; no protection on applying a normal or counter voltage
• Output current, max.	400 mA	400 mA
Power loss		
Power loss, typ.	6.5 W	6.5 W
Memory		
Type of memory	RAM	RAM
Memory size	128 kbyte; required for operation, MMC	128 kbyte; required for operation, MMC
Digital inputs		
Number of digital inputs	8; Standard and up to 12 with 24 V DC encoder inputs as digital inputs	8; Standard and up to 12 with 24 V DC encoder inputs as digital inputs
Input voltage		
• Rated value (DC)	24 V	24 V
• for signal "0"	-30 to +5 V	-30 to +5 V
• for signal "1"	+11 to +30V	+11 to +30V
Input current		
• for signal "0", max. (permissible quiescent current)	1.5 mA	1.5 mA
• for signal "1", typ.	3.8 mA	3.8 mA
Input delay (for rated value of input voltage)		
• Input frequency (with a time delay of 0.1 ms), max.	200 kHz	200 kHz
• programmable digital filter delay	None, 5 μs, 10 μs, 15 μs, 20 μs, 50 μs, 1.6 ms	None, 5 μs, 10 μs, 15 μs, 20 μs, 50 μs, 1.6 ms
• Minimum pulse width for program reactions	1 μs, 5 μs, 10 μs, 15 μs, 20 μs, 50 μs, 1.6 ms	1 μs, 5 μs, 10 μs, 15 μs, 20 μs, 50 μs, 1.6 ms
for standard inputs		
- at "0" to "1", max.	3 μs; typ. 1.5 μs	3 μs; typ. 1.5 μs
Cable length		
• shielded, max.	600 m	600 m

5

Technical specifications

Article number	6ES7352-5AH01-0AE0 FM 352-5, Boolean Processor 12DI/8DO	6ES7352-5AH11-0AE0 FM 352-5 PNP, Boolean Processor 12DI/8DO
Digital outputs		
Number of digital outputs	8	8
Current-sinking	Yes	No
Current-sourcing	No	Yes
Short-circuit protection	Yes; Overvoltage protection, thermal protection	Yes; Overvoltage protection, thermal protection
Limitation of inductive shutdown voltage to	2M -45 V typ., (-40 V to -55 V); comment: no protection against inductive kickback >55 mJ	2M -45 V typ., (-40 V to -55 V); comment: no protection against inductive kickback >55 mJ
Switching capacity of the outputs		
• on lamp load, max.	5 W	5 W
Output voltage		
• Rated value (DC)	24 V	24 V
• for signal *0*, max.	28.8 V	28.8 V
• for signal *1*, max.	0.5 V	0.5 V
Output current		
• for signal *1* rated value	0.5 A; At 60 °C	0.5 A; At 60 °C
• for signal *1* permissible range for 0 to 60 °C, min.	5 mA	5 mA
• for signal *1* permissible range for 0 to 60 °C, max.	600 mA	600 mA
• for signal *0* residual current, max.	1 mA	1 mA
Switching frequency		
• with resistive load, max.	100 kHz; 20 kHz at 0.5 A; 100 kHz at 0.25 A	100 kHz; 20 kHz at 0.5 A; 100 kHz at 0.25 A
• with inductive load, max.	2 Hz; 2 Hz at 0.5 A with external commutator diodes; 0.5 Hz at 0.5 A without external commutator diodes	2 Hz; 2 Hz at 0.5 A with external commutator diodes; 0.5 Hz at 0.5 A without external commutator diodes
• on lamp load, max.	10 Hz	10 Hz
Cable length		
• shielded, max.	600 m	600 m
Encoder		
Connectable encoders		
• Incremental encoder (symmetrical)	Yes	Yes
• Incremental encoder (asymmetrical)	Yes	Yes
• Absolute encoder (SSI)	Yes	Yes
• 2-wire sensor	Yes	Yes
- permissible quiescent current (2-wire sensor), max.	1.5 mA	1.5 mA
Encoder signals, incremental encoder (symmetrical)		
• Trace mark signals	A, notA, B, notB	A, notA, B, notB
• Zero mark signal	N, notN	N, notN
• Input voltage	5 V difference signal (phys. RS 422)	5 V difference signal (phys. RS 422)
• Input frequency, max.	500 kHz	500 kHz
• Cable length, shielded, max.	100 m; 100 m with 24 V supply and 500 kHz; 32 m with 5 V supply and 500 kHz	100 m; 100 m with 24 V supply and 500 kHz; 32 m with 5 V supply and 500 kHz
Encoder signals, incremental encoder (asymmetrical)		
• Trace mark signals	A, B	A, B
• Zero mark signal	N	N
• Input voltage	24 V	24 V
• Input frequency, max.	200 kHz	200 kHz
• Cable length, shielded, max.	50 m; Cable length, HTL incremental encoder, Siemens, type 6FX2001-4: 50 kHz, 25 m shielded, max., 25 kHz, 50 m shielded, max.	50 m; Cable length, HTL incremental encoder, Siemens, type 6FX2001-4: 50 kHz, 25 m shielded, max., 25 kHz, 50 m shielded, max.

SIMATIC S7-300 Advanced Controllers

I/O modules

Function modules

FM 352-5 high-speed Boolean processor

Technical specifications

Article number	6ES7352-5AH01-0AE0 FM 352-5, Boolean Processor 12DI/8DO	6ES7352-5AH11-0AE0 FM 352-5 PNP, Boolean Processor 12DI/8DO
Encoder signals, absolute encoder (SSI)		
• Data signal	DATA, notDATA	DATA, notDATA
• Clock signal	CK, notCK	CK, notCK
• Telegram length, parameterizable	13 or 25 bit	13 or 25 bit
• Clock frequency, max.	1 MHz; 125 kHz, 250 kHz, 500 kHz or 1 MHz	1 MHz; 125 kHz, 250 kHz, 500 kHz or 1 MHz
• Cable length, shielded, max.	320 m; At 125 kHz	320 m; At 125 kHz
• Monoflop time	settable: 16/32/48/64 µs	settable: 16/32/48/64 µs
• Listening mode	Yes; one or two stations	Yes; one or two stations
• Multiturn	Yes; 25 bit message frame	Yes; 25 bit message frame
Encoder signal evaluation		
• Counting direction, forward	Yes	Yes
• Counting direction, backward	Yes	Yes
Response times		
Input- to output response time	5 V input to 24 V output, 0 filter: 1 to 4 µs (typ.); 24 V input to 24 V output, 0 filter: 2 to 6 µs (typ.)	5 V input to 24 V output, 0 filter: 1 to 4 µs (typ.); 24 V input to 24 V output, 0 filter: 2 to 6 µs (typ.)
Interfaces		
Point-to-point connection		
• Updating times	PLC interface: 1.7 ms	PLC interface: 1.7 ms
Interrupts/diagnostics/ status information		
Alarms		
• Diagnostic alarm	Yes; 1L, 2L, 3L missing; MMC error; output overload (8); encoder supply overload; differential wire break; parameterization error; SSI message frame overflow	Yes; 1L, 2L, 3L missing; MMC error; output overload (8); encoder supply overload; differential wire break; parameterization error; SSI message frame overflow
• Hardware interrupt	Yes; 8 available; for generation by user program	Yes; 8 available; for generation by user program
Counter		
Counting range, description	Counting range (16-bit counters): -32 768 to 32 767 (user-specific within this range); counting range (32-bit counters): -2 147 483 648 to 2 147 483 647 (user-specific within this range)	Counting range (16-bit counters): -32 768 to 32 767 (user-specific within this range); counting range (32-bit counters): -2 147 483 648 to 2 147 483 647 (user-specific within this range)
Counting range, lower limit	-2 147 483 648	-2 147 483 648
Counting range, upper limit	2 147 483 647	2 147 483 647
Counting mode		
• Counting mode, individual	Yes	Yes
• Counting mode, continuous	Yes	Yes
• Counting mode, periodic	Yes	Yes
Ambient conditions		
Ambient temperature during operation		
• min.	0 °C	0 °C
• max.	60 °C	60 °C
Configuration		
Programming		
• Program cycle time (scan)	1 µs	1 µs
Connection method		
required front connector	1x 40-pin	1x 40-pin
Dimensions		
Width	80 mm	80 mm
Height	125 mm	125 mm
Depth	120 mm	120 mm
Weights		
Weight, approx.	434 g; Module weight: approx. 434 g (with 1L connection and without I/O connection or MMC); shipping weight: approx. 500 g (with bus and 1L connection and without I/O connection or MMC)	434 g; Module weight: approx. 434 g (with 1L connection and without I/O connection or MMC); shipping weight: approx. 500 g (with bus and 1L connection and without I/O connection or MMC)

Overview



- 4-channel closed-loop controller module for universal control tasks
- Can be used for temperature, pressure, flow and level controls
- Convenient online self-optimization for temperature controls
- Predefined controller structures
- 2 control algorithms
- 2 versions:
 - FM 355 C as continuous controller;
 - FM 355 S as step or pulse controller
- With 4 analog outputs (FM 355 C) or 8 digital outputs (FM 355 S) for direct control of the most common actuators
- Continuation of control mode also possible with CPU stop or failure

Ordering data

Article No.

FM 355 C controller module **6ES7355-0VH10-0AE0**

With 4 analog outputs for
4 continuous controllers

FM 355 S controller module **6ES7355-1VH10-0AE0**

With 8 digital outputs for
4 step or pulse controllers

Front connector

20-pin, with screw contacts

- 1 unit
- 100 units

6ES7392-1AJ00-0AA0
6ES7392-1AJ00-1AB0

20-pin, with spring-loaded contacts

- 1 unit
- 100 units

6ES7392-1BJ00-0AA0
6ES7392-1BJ00-1AB0

Bus connectors

1 unit (spare part)

6ES7390-0AA00-0AA0

Labeling strips

10 units (spare part)

6ES7392-2XX00-0AA0

Labeling sheets for machine inscription

See under "Accessories",
page 5/252

Slot number label

Spare part

6ES7912-0AA00-0AA0

Shield connection element

80 mm wide, with 2 rows for
4 terminals each

6ES7390-5AA00-0AA0

Shield connection clamps

2 units

For 2 cables with 2 mm to 6 mm
diameter

6ES7390-5AB00-0AA0

For 1 cable with 3 mm to 8 mm
diameter

6ES7390-5BA00-0AA0

For 1 cable with 4 mm to 13 mm
diameter

6ES7390-5CA00-0AA0

Technical specifications

Article number	6ES7355-0VH10-0AE0 Control unit FM355C, 4 chan.	6ES7355-1VH10-0AE0 Control unit FM355S, 4 chan.
Supply voltage		
Load voltage L+		
• Rated value (DC)	24 V	24 V
Input current		
from load voltage L+ (without load), max.	310 mA; Typ. 260 mA	270 mA; typ. 220 mA
from backplane bus 5 V DC, max.	75 mA; typ. 50 mA	75 mA; typ. 50 mA
Power loss		
Power loss, typ.	6.5 W	5.5 W
Digital inputs		
Number of digital inputs	8	8
Input characteristic curve in accordance with IEC 61131, type 2	Yes	Yes
Input voltage		
• Rated value (DC)	24 V	24 V
• for signal "0"	-3 to +5V	-3 to +5V
• for signal "1"	13 to 30V	13 to 30V
Input current		
• for signal "1", typ.	7 mA	7 mA
Cable length		
• shielded, max.	1 000 m	1 000 m

SIMATIC S7-300 Advanced Controllers

I/O modules

Function modules

FM 355 controller module

Technical specifications

Article number	6ES7355-0VH10-0AE0	6ES7355-1VH10-0AE0
	Control unit FM355C, 4 chan.	Control unit FM355S, 4 chan.
Digital outputs		
Number of digital outputs		8
Short-circuit protection		Yes; Electronic
Limitation of inductive shutdown voltage to		L+ (-1.5 V)
Switching capacity of the outputs		
• on lamp load, max.		5 W
Load resistance range		
• lower limit		240 Ω
• upper limit		4 kΩ
Output voltage		
• for signal *1*, min.		L+ (-2.5 V)
Output current		
• for signal *1* rated value		100 mA
• for signal *1* permissible range for 0 to 60 °C, min.		5 mA
• for signal *1* permissible range for 0 to 60 °C, max.		150 mA
• for signal *0* residual current, max.		0.5 mA
Switching frequency		
• with resistive load, max.		100 Hz
• with inductive load, max.		0.5 Hz
• on lamp load, max.		100 Hz
Total current of the outputs (per group)		
all mounting positions		
- up to 60 °C, max.		400 mA
Cable length		
• shielded, max.		1 000 m
Analog inputs		
Number of analog inputs	4	4
permissible input voltage for voltage input (destruction limit), max.	30 V	30 V
permissible input current for current input (destruction limit), max.	40 mA	40 mA
Input ranges (rated values), voltages		
• 0 to +10 V	Yes	Yes
• -1.75 V to +11.75 V	Yes	Yes
• -80 mV to +80 mV	Yes	Yes
Input ranges (rated values), currents		
• 0 to 20 mA	Yes	Yes
• 0 to 23.5 mA	Yes	Yes
• -3.5 mA to +23.5 mA	Yes	Yes
• 4 mA to 20 mA	Yes	Yes
Input ranges (rated values), thermocouples		
• Type B	Yes	Yes
• Type J	Yes	Yes
• Type K	Yes	Yes
• Type R	Yes	Yes
• Type S	Yes	Yes
Input ranges (rated values), resistance thermometer		
• Pt 100	Yes	Yes

Technical specifications

Article number	6ES7355-0VH10-0AE0	6ES7355-1VH10-0AE0
	Control unit FM355C, 4 chan.	Control unit FM355S, 4 chan.
Thermocouple (TC)		
Temperature compensation		
- internal temperature compensation	Yes	Yes
- external temperature compensation with Pt100	Yes	Yes
Characteristic linearization		
• parameterizable	Yes	Yes
- for thermocouples	Type B, J, K, R, S	Type B, J, K, R, S
- for resistance thermometer	Pt100 (standard)	Pt100 (standard)
Cable length		
• shielded, max.	200 m; 50 m at 80 mV and thermocouples	200 m; 50 m at 80 mV and thermocouples
Analog outputs		
Number of analog outputs	4	
Voltage output, short-circuit protection	Yes	
Voltage output, short-circuit current, max.	25 mA	
Current output, no-load voltage, max.	18 V	
Output ranges, voltage		
• 0 to 10 V	Yes	
• -10 V to +10 V	Yes	
Output ranges, current		
• 0 to 20 mA	Yes	
• 4 mA to 20 mA	Yes	
Connection of actuators		
• for voltage output two-wire connection	Yes	
• for current output two-wire connection	Yes	
Load impedance (in rated range of output)		
• with voltage outputs, min.	1 k Ω	
• with voltage outputs, capacitive load, max.	1 μ F	
• with current outputs, max.	500 Ω	
• with current outputs, inductive load, max.	1 mH	
Cable length		
• shielded, max.	200 m; 50 m at 80 mV and thermocouples	
Analog value generation for the inputs		
Integration and conversion time/resolution per channel		
• Resolution with overrange (bit including sign), max.	14 bit; 12 bit or 14 bit, parameterizable	14 bit; 12 bit or 14 bit, parameterizable
Analog value generation for the outputs		
Settling time		
• for resistive load	0.1 ms	
• for capacitive load	3.3 ms	
• for inductive load	0.5 ms	

SIMATIC S7-300 Advanced Controllers

I/O modules

Function modules

FM 355 controller module

Technical specifications

Article number	6ES7355-0VH10-0AE0	6ES7355-1VH10-0AE0
	Control unit FM355C, 4 chan.	Control unit FM355S, 4 chan.
Encoder		
Connection of signal encoders		
• for voltage measurement	Yes	Yes
• for current measurement as 4-wire transducer	Yes	Yes
Connectable encoders		
• 2-wire sensor	Yes	Yes
- permissible quiescent current (2-wire sensor), max.	1.5 mA	1.5 mA
Errors/accuracies		
Operational error limit in overall temperature range		
• Voltage, relative to input range, (+/-)	0.6 %; ± 0.6 to $\pm 1\%$	0.6 %; ± 0.6 to $\pm 1\%$
• Current, relative to input range, (+/-)	0.6 %; ± 0.6 to $\pm 1\%$	0.6 %; ± 0.6 to $\pm 1\%$
• Resistance thermometer, relative to input range, (+/-)	0.6 %; ± 0.6 to $\pm 1\%$	0.6 %; ± 0.6 to $\pm 1\%$
• Voltage, relative to output range, (+/-)	0.5 %	
• Current, relative to output range, (+/-)	0.6 %	
Basic error limit (operational limit at 25 °C)		
• Voltage, relative to input range, (+/-)	0.4 %; 80 mV: ± 0.6 %; 250 to 1 000 mV: ± 0.4 %; 2.5 to 10 V: ± 0.6 %; 3.2 to 20 mA: ± 0.5 %	0.4 %; 80 mV: ± 0.6 %; 250 to 1 000 mV: ± 0.4 %; 2.5 to 10 V: ± 0.6 %; 3.2 to 20 mA: ± 0.5 %
• Current, relative to input range, (+/-)	0.4 %; ± 0.4 to ± 0.6 %	0.4 %; ± 0.4 to ± 0.6 %
• Resistance thermometer, relative to input range, (+/-)	0.4 %; ± 0.4 to ± 0.6 %	0.4 %; ± 0.4 to ± 0.6 %
• Voltage, relative to output range, (+/-)	0.3 %	
• Current, relative to output range, (+/-)	0.5 %	
Interrupts/diagnostics/status information		
Substitute values connectable	Yes; Parameterizable	Yes; Parameterizable
Integrated Functions		
Control technology		
• Number of closed-loop controllers	4	4
Connection method		
required front connector	2x 20-pin	2x 20-pin
Dimensions		
Width	80 mm	80 mm
Height	125 mm	125 mm
Depth	120 mm	120 mm
Weights		
Weight, approx.	470 g	470 g

5

Overview



- 4-channel closed-loop controller module specifically for temperature controls
- Including integrated and easy-to-use online self-optimization
- Heating and cooling controllers as well as combined controllers with heating and active cooling function feasible
- Ready-to-use controller structures
- 2 versions:
 - FM 355-2 C as a continuous controller;
 - FM 355-2 S as step or pulse controllers
- With 4 analog outputs (FM 355-2 C) or 8 digital outputs (FM 355-2 S) to directly control the most common final control elements
- Continuation of control mode also possible with CPU stop or failure

Ordering data

Article No.

FM 355-2 C temperature controller module **6ES7355-2CH00-0AE0**

With 4 analog outputs for 4 continuous-action controllers

FM 355-2 S temperature controller module **6ES7355-2SH00-0AE0**

With 8 digital outputs for 4 step or pulse controllers

Front connector

20-pin, with screw contacts

- 1 unit
- 100 units

6ES7392-1AJ00-0AA0
6ES7392-1AJ00-1AB0

20-pin, with spring-loaded contacts

- 1 unit
- 100 units

6ES7392-1BJ00-0AA0
6ES7392-1BJ00-1AB0

Bus connectors

1 unit (spare part)

6ES7390-0AA00-0AA0

Labeling strips

10 units (spare part)

6ES7392-2XX00-0AA0

Labeling sheets for machine inscription

See under "Accessories", page 5/252

Slot number label

Spare part

6ES7912-0AA00-0AA0

Shield connection element

80 mm wide, with 2 rows for 4 terminals each

6ES7390-5AA00-0AA0

Shield connection clamps

2 units

For 2 cables with 2 mm to 6 mm diameter

6ES7390-5AB00-0AA0

For 1 cable with 3 mm to 8 mm diameter

6ES7390-5BA00-0AA0

For 1 cable with 4 mm to 13 mm diameter

6ES7390-5CA00-0AA0

Technical specifications

Article number	6ES7355-2CH00-0AE0	6ES7355-2SH00-0AE0
	TEMP.-Control unit FM355-2C, 4 chan.	TEMP.-Control unit FM355-2S, 4 chan.
Supply voltage		
Load voltage L+		
• Rated value (DC)	24 V	24 V
Input current		
from load voltage L+ (without load), max.	310 mA; Typ. 260 mA	270 mA; typ. 220 mA
from backplane bus 5 V DC, max.	75 mA; typ. 50 mA	75 mA; typ. 50 mA
Power loss		
Power loss, typ.	6.5 W	5.5 W
Digital inputs		
Number of digital inputs	8	8
Input characteristic curve in accordance with IEC 61131, type 2	Yes	Yes
Input voltage		
• Rated value (DC)	24 V	24 V
• for signal "0"	-3 to +5V	-3 to +5V
• for signal "1"	13 to 30V	13 to 30V
Input current		
• for signal "1", typ.	7 mA	7 mA
Cable length		
• shielded, max.	1 000 m	1 000 m

SIMATIC S7-300 Advanced Controllers

I/O modules

Function modules

FM 355-2 temperature controller module

Technical specifications

Article number	6ES7355-2CH00-0AE0 TEMP.-Control unit FM355-2C, 4 chan.	6ES7355-2SH00-0AE0 TEMP.-Control unit FM355-2S, 4 chan.
Digital outputs		
Number of digital outputs		8
Short-circuit protection		Yes; Electronic
Limitation of inductive shutdown voltage to		L+ (-1.5 V)
Switching capacity of the outputs		
• on lamp load, max.		5 W
Load resistance range		
• lower limit		240 Ω
• upper limit		4 kΩ
Output voltage		
• for signal *1*, min.		L+ (-2.5 V)
Output current		
• for signal *1* rated value		0.1 A
• for signal *1* permissible range for 0 to 60 °C, min.		5 mA
• for signal *1* permissible range for 0 to 60 °C, max.		150 mA
• for signal *0* residual current, max.		0.5 mA
Switching frequency		
• with resistive load, max.		100 Hz
• with inductive load, max.		0.5 Hz
• on lamp load, max.		100 Hz
Total current of the outputs (per group)		
all mounting positions		
- up to 60 °C, max.		400 mA
Cable length		
• shielded, max.		1 000 m
Analog inputs		
Number of analog inputs	4	4
permissible input voltage for voltage input (destruction limit), max.	20 V	20 V
permissible input current for current input (destruction limit), max.	40 mA	40 mA
Input ranges (rated values), voltages		
• 0 to +10 V	Yes	Yes
• -1.75 V to +11.75 V	Yes	Yes
Input ranges (rated values), currents		
• 0 to 20 mA	Yes	Yes
• 0 to 23.5 mA	Yes	Yes
• -3.5 mA to +23.5 mA	Yes	Yes
• 4 mA to 20 mA	Yes	Yes
Input ranges (rated values), thermocouples		
• Type B	Yes	Yes
• Type E	Yes	Yes
• Type J	Yes	Yes
• Type K	Yes	Yes
• Type R	Yes	Yes
• Type S	Yes	Yes
Input ranges (rated values), resistance thermometer		
• Pt 100	Yes	Yes

Technical specifications

Article number	6ES7355-2CH00-0AE0	6ES7355-2SH00-0AE0
	TEMP.-Control unit FM355-2C, 4 chan.	TEMP.-Control unit FM355-2S, 4 chan.
Thermocouple (TC)		
Temperature compensation		
- internal temperature compensation	Yes	Yes
- external temperature compensation with Pt100	Yes	Yes
Characteristic linearization		
• parameterizable	Yes	Yes
- for thermocouples	Type B, E, J, K, R, S	Type B, E, J, K, R, S
- for resistance thermometer	Pt100 (standard)	Pt100 (standard)
Cable length		
• shielded, max.	200 m; 50 m at 80 mV and thermocouples	200 m; 50 m at 80 mV and thermocouples
Analog outputs		
Number of analog outputs	4	
Voltage output, short-circuit protection	Yes	
Voltage output, short-circuit current, max.	25 mA	
Current output, no-load voltage, max.	18 V	
Output ranges, voltage		
• 0 to 10 V	Yes	
• -10 V to +10 V	Yes	
Output ranges, current		
• 0 to 20 mA	Yes	
• 4 mA to 20 mA	Yes	
Connection of actuators		
• for voltage output two-wire connection	Yes	
• for current output two-wire connection	Yes	
Load impedance (in rated range of output)		
• with voltage outputs, min.	1 k Ω	
• with voltage outputs, capacitive load, max.	1 μ F	
• with current outputs, max.	500 Ω	
• with current outputs, inductive load, max.	1 mH	
Cable length		
• shielded, max.	200 m; 50 m at 80 mV and thermocouples	
Analog value generation for the inputs		
Integration and conversion time/resolution per channel		
• Resolution with overrange (bit including sign), max.	14 bit	14 bit
Analog value generation for the outputs		
Settling time		
• for resistive load	0.1 ms	
• for capacitive load	3.3 ms	
• for inductive load	0.5 ms	

SIMATIC S7-300 Advanced Controllers

I/O modules

Function modules

FM 355-2 temperature controller module

Technical specifications

Article number	6ES7355-2CH00-0AE0	6ES7355-2SH00-0AE0
	TEMP.-Control unit FM355-2C, 4 chan.	TEMP.-Control unit FM355-2S, 4 chan.
Encoder		
Connection of signal encoders		
• for voltage measurement	Yes	Yes
• for current measurement as 4-wire transducer	Yes	Yes
Connectable encoders		
• 2-wire sensor	Yes	Yes
- permissible quiescent current (2-wire sensor), max.	1.5 mA	1.5 mA
Errors/accuracies		
Operational error limit in overall temperature range		
• Voltage, relative to input range, (+/-)	0.6 %; ± 0.6 to ± 0.7 %	0.06 %; ± 0.06 to ± 0.7 %
• Current, relative to input range, (+/-)	0.6 %; ± 0.6 to ± 0.7 %	0.06 %; ± 0.06 to ± 0.7 %
• Resistance thermometer, relative to input range, (+/-)	0.6 %; ± 0.6 to ± 0.7 %	0.06 %; ± 0.06 to ± 0.7 %
• Voltage, relative to output range, (+/-)	0.5 %	
• Current, relative to output range, (+/-)	0.6 %	
Basic error limit (operational limit at 25 °C)		
• Voltage, relative to input range, (+/-)	0.04 %; ± 0.04 to ± 0.5 %	0.04 %; ± 0.04 to ± 0.5 %
• Current, relative to input range, (+/-)	0.04 %; ± 0.04 to ± 0.5 %	0.04 %; ± 0.04 to ± 0.5 %
• Resistance thermometer, relative to input range, (+/-)	0.04 %; ± 0.04 to ± 0.5 %	0.04 %; ± 0.04 to ± 0.5 %
• Voltage, relative to output range, (+/-)	0.4 %	
• Current, relative to output range, (+/-)	0.5 %	
Interrupts/diagnostics/status information		
Substitute values connectable	Yes; Parameterizable	Yes; Parameterizable
Integrated Functions		
Control technology		
• Number of closed-loop controllers	4	4
Connection method		
required front connector	2x 20-pin	2x 20-pin
Dimensions		
Width	80 mm	80 mm
Height	125 mm	125 mm
Depth	120 mm	120 mm
Weights		
Weight, approx.	470 g	470 g

5

Overview



- Interface between max. 3 absolute-value sensors (SSI) and the CPU
- For provision of the displacement encoder values for further processing in STEP 7 programs
- Enables direct response of controller to encoder values in moving systems

Note:

Displacement measuring systems and precut/preassembled cables for counting and positioning functions are available under SIMODRIVE Sensor or Motion Connect 500.

<http://www.siemens.com/simatic-technology>

Ordering data

Article No.

Signal cable

Pre-assembled for SSI absolute encoder 6FX2001-5, without D-sub connector, UL/DESINA

6FX5002-2CC12-

0 m
100 m
200 m

1
2
3

0 m
10 m
20 m
30 m
40 m
50 m
60 m
70 m
80 m
90 m

A
B
C
D
E
F
G
H
J
K

0 m
1 m
2 m
3 m
4 m
5 m
6 m
7 m
8 m
9 m

A
B
C
D
E
F
G
H
J
K

0,0 m
0,1 m
0,2 m
0,3 m
0,4 m
0,5 m
0,6 m
0,7 m
0,8 m

0
1
2
3
4
5
6
7
8

Ordering data

Article No.

SM 338 POS input module

6ES7338-4BC01-0AB0

For position sensing with
3 SSI encoders

Front connector

20-pin, with screw contacts

- 1 unit
- 100 units

6ES7392-1AJ00-0AA0

6ES7392-1AJ00-1AB0

20-pin, with spring-loaded contacts

- 1 unit
- 100 units

6ES7392-1BJ00-0AA0

6ES7392-1BJ00-1AB0

Front door, elevated design

6ES7328-0AA00-7AA0

e.g. for 32-channel modules;
for connecting 1.3 mm²/
16 AWG conductors

SIMATIC Manual Collection

6ES7998-8XC01-8YE0

Electronic manuals on DVD,
multi-language:
LOGO!, SIMADYN,
SIMATIC bus components,
SIMATIC C7, SIMATIC Distributed I/O,
SIMATIC HMI, SIMATIC Sensors,
SIMATIC NET, SIMATIC PC-based
Automation, SIMATIC PCS 7,
SIMATIC PG/PC, SIMATIC S7,
SIMATIC Software, SIMATIC TDC

SIMATIC Manual Collection
update service for 1 year

6ES7998-8XC01-8YE2

Current Manual Collection DVD and
the three subsequent updates

SIMATIC S7-300 Advanced Controllers

I/O modules

Function modules

SM 338 POS input module**Technical specifications**

Article number	6ES7338-4BC01-0AB0 SM 338, f. 3 SSI encoders
Supply voltage	
Load voltage L+	
• Rated value (DC)	24 V
Input current	
from load voltage L+ (without load), max.	100 mA
from backplane bus 5 V DC, max.	160 mA
Encoder supply	
24 V encoder supply	
• 24 V	Yes; L+ (-0.8 V)
• Output current, max.	900 mA
Power loss	
Power loss, typ.	3 W
Digital inputs	
Input voltage	
• for signal *0*	-3 to +5V
• for signal *1*	11 to 30.2 V
Input current	
• for signal *0*, max. (permissible quiescent current)	2 mA
• for signal *1*, typ.	9 mA
Input delay (for rated value of input voltage) for standard inputs	
- at *0* to *1*, min.	300 µs
Cable length	
• shielded, max.	600 m

Article number	6ES7338-4BC01-0AB0 SM 338, f. 3 SSI encoders
Encoder	
Number of connectable encoders, max.	3
Connectable encoders	
• Absolute encoder (SSI)	Yes
• 2-wire sensor	Yes
Encoder signals, absolute encoder (SSI)	
• Cable length, shielded, max.	320 m; 320 m at 125 kHz; 160 m at 250 kHz; 60 m at 500 kHz; 20 m at 1 MHz
Interrupts/diagnostics/ status information	
Alarms	
• Diagnostic alarm	Yes
Connection method	
required front connector	20-pin
Dimensions	
Width	40 mm
Height	125 mm
Depth	120 mm
Weights	
Weight, approx.	235 g

5

Overview



SIWAREX U is a versatile weighing module for all simple weighing and force measuring tasks. The compact module can be integrated into SIMATIC automation systems without any problems. Complete data access is then possible via the SIMATIC.

5

Ordering data

Ordering data	Article No.
SIWAREX U For SIMATIC S7 and ET 200M, incl. bus connector, weight 0.3 kg (0.661 lb) Single-channel version ¹⁾ for connecting one scale Two-channel version ²⁾ for connecting two scales	 7MH4950-1AA01 7MH4950-2AA01
SIWATOOL V4 & V7 Service and commissioning software for SIWAREX weighing modules	7MH4900-1AK01
SIWAREX U configuration package for PCS 7, version 8.0 Suitable for 7MH4950-xAA01 <ul style="list-style-type: none"> • Function block for CFC • Faceplate • Manual 	7MH4950-3AK62
SIWAREX PCS 7 AddOn Library for PCS 7 V8.x and V9.0 <ul style="list-style-type: none"> • Supports PROFINET APL faceplates and function blocks for: <ul style="list-style-type: none"> • SIWAREX U • SIWAREX FTA • SIWAREX FTC_B (belt scale) • SIWAREX WP321 Classic faceplate and function block for: <ul style="list-style-type: none"> • SIWAREX FTC_L (Loss-in-weight) 	7MH4900-1AK61
SIWATOOL connection cable From SIWAREX U/CS with serial PC interface, for 9-pin PC interfaces (RS 232), length 3 m (9.84 ft)	7MH4607-8CA
Installation material (mandatory)	
20-pin front connector with screw contacts Required for each SIWAREX module	6ES7392-1AJ00-0AA0
Shield connection element Sufficient for two SIWAREX U modules	6ES7390-5AA00-0AA0

Ordering data	Article No.
Shield connection clamp Contents: 2 units (suitable for cable with diameter 4 ... 13 mm / 0.16 ... 0.51 inch) Note: One shield connection clamp is required for each of the following: <ul style="list-style-type: none"> • Scale connection • RS 485 interface • RS 232 interface 	6ES7390-5CA00-0AA0
S7 DIN rail <ul style="list-style-type: none"> • 160 mm (6.30 inch) • 480 mm (18.90 inch) • 530 mm (20.87 inch) • 830 mm (32.68 inch) • 2 000 mm (78.74 inch) 	6ES7390-1AB60-0AA0 6ES7390-1AE80-0AA0 6ES7390-1AF30-0AA0 6ES7390-1AJ30-0AA0 6ES7390-1BC00-0AA0
Accessories (optional)	
Labeling strips (10 units, spare part)	6ES7392-2XX00-0AA0
Remote displays (option) The digital remote displays can be connected directly to SIWAREX U through a TTY interface. The following remote displays can be used: S102, S302 Siebert Industrieelektronik GmbH PO Box 1180 D-66565 Eppelborn Tel.: +49 6806/980-0 Fax: +49 6806/980-999 Internet: https://www.siebert-group.com/en/ Detailed information is available from the manufacturer.	
SIWAREX JB junction box, aluminum housing For connecting up to 4 load cells in parallel, and for connecting multiple junction boxes.	7MH5001-0AA20

¹⁾ Compatible with 7MH4601-1AA01; supply of load cells changed to 6 V DC.

²⁾ Compatible with 7MH4601-1BA01; supply of load cells changed to 6 V DC.

SIMATIC S7-300 Advanced Controllers

I/O modules

Function modules

SIWAREX U weighing module**Ordering data****Article No.****SIWAREX JB junction box, stainless steel housing**

For connecting up to 4 load cells in parallel.

7MH5001-0AA00**SIWAREX JB junction box, stainless steel housing (ATEX)**

For parallel connection of up to 4 load cells (for zone allocation, see manual or type-examination certificate).

7MH5001-0AA01**SIWAREX IS Ex interface**

For intrinsically safe connection of load cells. With ATEX approval (not UL/FM). Suitable for SIWAREX electronic weighing systems. Compatibility of load cells must be checked separately.

- With short-circuit current < 199 mA DC
- With short-circuit current < 137 mA DC

7MH4710-5BA**7MH4710-5CA****Cable (optional)****Cable Li2Y 1 x 2 x 0.75 ST + 2 x (2 x 0.34 ST) – CY**

For connecting SIWAREX electronic weighing systems to junction box (JB), extension box (EB) and Ex interface or between two EBs. For permanent installation. Occasional bending is possible.

External diameter:
approx. 10.8 mm (0.43 inch)

Permissible ambient temperature
-40 ... +80 °C (-40 ... +176 °F)

Sold by the meter.

- Sheath color: orange
- For hazardous atmospheres. Sheath color: blue.

7MH4702-8AG**7MH4702-8AF****Article No.****Commissioning****Commissioning charge for one static scale with SIWAREX module**

(Flat charge for travel and setup must be ordered separately)

Scope:

- Recording of data
- Checking of mechanical installation of the scale
- Checking of electrical wiring and function
- Static adjustment of the scale

Requirements:

- Mechanical design functional
- Modules electrically wired and tested
- Calibration weights available
- Free access to scale

9LA1110-8SN50-0AA0**Flat charge for travel and setup in Germany****9LA1110-8RA10-0AA0****5**

Technical specifications

SIWAREX U	
Integration in automation systems	
<ul style="list-style-type: none"> S7-300 S7-1500 S7-400 (H) PCS 7 (H) Automation systems from other vendors Stand-alone (without SIMATIC CPU) 	Direct integration Through ET 200M Through ET 200M Through ET 200M Through ET 200M Possible with IM 153-1
Communication interfaces	<ul style="list-style-type: none"> SIMATIC S7 (P bus) RS 232 TTY
Connection of remote display (via serial TTY interface)	Gross, channel 1, 2 or default value 1, 2
Scale adjustment	Through SIMATIC (P bus) or PC using SIWATOOL U (RS 232)
Measuring properties	
Error limit according to DIN 1319-1 of full-scale value at 20 °C ± 10 K (68 °F ± 10 K)	0.05%
Internal resolution ADC	65 535
Data format weight values	2 bytes (fixed-point)
Number of measurements/second	50
Digital filter	0.05 ... 5 Hz (in 7 steps), mean value filter
Weighing functions	
Weight values	Gross
Limit values	2 (min./max.)
Zero-setting function	Per command
Load cells	Strain gauges in 4-wire or 6-wire system

SIWAREX U	
Load cell powering	
Supply voltage U_s (rated value)	6 V DC ¹⁾
Max. supply current	≤ 150 mA per channel
Permissible load resistance	<ul style="list-style-type: none"> R_{Lmin} > 40 Ω per channel R_{Lmax} < 4 010 Ω
With Ex(i) interface	<ul style="list-style-type: none"> R_{Lmin} > 87 Ω per channel R_{Lmax} < 4 010 Ω
Permissible load cell characteristic	Up to 4 mV/V
Max. distance of load cells	<ul style="list-style-type: none"> 500 m²⁾ 150/500 m for gas group IIC 500 m²⁾ for gas group IIB (see SIWAREX IS Manual)
Intrinsically-safe load cell powering	Optional (Ex interface) with SIWAREX IS
Auxiliary power supply	
Rated voltage	24 V DC
Max. power consumption	150 mA (single-channel) / 240 mA (dual-channel)
Current consumption on backplane bus	≤ 100 mA
Certification	ATEX 95, FM, cUL _{US} Haz. Loc.
IP degree of protection to EN 60529; IEC 60529	IP20
Climatic requirements	
T_{min} (IND) ... T_{max} (IND) (operating temperature)	
• Horizontal installation	0 ... +60 °C (32 ... 140 °F)
• Vertical installation	0 ... +40 °C (32 ... 104 °F)
EMC requirements	According to NAMUR NE21, Part 1; EN 61326
Dimensions	40 × 125 × 130 mm (1.58 × 4.92 × 5.12 inch)

¹⁾ Load cell supply changed to 6 V DC as compared to 7MH4601-1AA01 and 7MH4601-1BA01.

²⁾ Possible up to 1 000 m under certain conditions when using the recommended cable (accessories).

SIMATIC S7-300 Advanced Controllers

I/O modules

Function modules

SIWAREX FTA weighing module

Overview



SIWAREX FTA (Flexible Technology, Automatic Weighing Instrument) is a versatile and flexible weighing module for industrial use. It can be used in both non-automatic and automatic weighing operation, for example the production of mixtures, and for filling, loading, monitoring and bag filling.

It has the corresponding scale approvals and is also suitable for weighing systems requiring official calibration.

The SIWAREX FTA function module is integrated in SIMATIC S7/PCS 7 and uses the features of this modern automation system, such as integrated communication, diagnostics and configuration tools.

5

Ordering data

SIWAREX FTA

Legal-for-trade electronic weighing systems for automatic scales for S7-300 and ET 200M.
EC type approval 3 x 6000 d
Applications: Dosing, filling, bagging, loading.
Note: Observe approval conditions for applications requiring official calibration. We recommend using our calibration set and contacting our SIWAREX hotline.

Article No.

7MH4900-2AA01

SIPLUS FTA

SIPLUS FTA -10 ... +60 °C with conformal coating based on 7MH4900-2AA01
Legal-for-trade electronic weighing system for automatic scales for S7-300 and ET 200M.
EU type approval 3 x 6000 d
Applications: Dosing, filling, bagging, loading.
Note: Observe approval conditions for applications requiring official calibration. We recommend using our calibration set and contacting our SIWAREX hotline.

6AG1900-2AA01-4AA0

SIWAREX FTA Equipment Manual

Available in a range of languages
Free download on the Internet at: <http://www.siemens.com/weighing/documentation>.

SIWAREX FTA "Getting Started"

Sample software shows beginners how to program the scales in STEP 7.
Free download on the Internet at: <http://www.siemens.com/weighing/documentation>.

SIWATOOL V4 & V7

Service and commissioning software for SIWAREX weighing modules

7MH4900-1AK01

Article No.

Configuration package SIWAREX FTA for SIMATIC PCS 7, Version 8.0 on CD-ROM

- HSP hardware support package for integrating SIWAREX FTA/FTC in STEP 7
- Function block for CFC
- Faceplate
- Manual

7MH4900-2AK63

SIWAREX PCS 7 AddOn Library for PCS 7 V8.x and V9.0

- Supports PROFINET
- APL faceplates and function blocks for:
- SIWAREX U
 - SIWAREX FTA
 - SIWAREX FTC_B (belt scale)
 - SIWAREX WP321
- Classic faceplate and function block for:
- SIWAREX FTC_L (Loss-in-weight)

7MH4900-1AK61

Calibration set for SIWAREX FTA

For verification of up to 5 scales comprising:

- 3 x inscription foils for ID label
- 1 x protective film
- Guidelines for verification, verification certificates and approvals, editable label, SIWAREX FTA Equipment Manual on CD-ROM

7MH4900-2AY10

SIWATOOL connection cable

From SIWAREX FTA with serial PC interface, for 9-pin PC interfaces (RS 232)

- 2 m long (6.56 ft)
- 5 m long (16.40 ft)

7MH4702-8CA
7MH4702-8CB

Front connector, 40-pin

Required for each SIWAREX module

- With screw contacts
- With spring-loaded terminals

6ES7392-1AM00-0AA0
6ES7392-1BM01-0AA0

Ordering data	Article No.	Article No.
Shield connection element Sufficient for one SIWAREX FTA module	6ES7390-5AA00-0AA0	
Shield connection clamp Contents: 2 units (suitable for cable with diameter 4 ... 13 mm / 0.16 ... 0.51 inch) Note: One shield connection clamp is required for each of the following: <ul style="list-style-type: none"> • Scale connection • RS 485 interface • RS 232 interface 	6ES7390-5CA00-0AA0	
S7 DIN rail <ul style="list-style-type: none"> • 160 mm (6.30 inch) • 480 mm (18.90 inch) • 530 mm (20.87 inch) • 830 mm (32.68 inch) • 2 000 mm (78.74 inch) 	6ES7390-1AB60-0AA0 6ES7390-1AE80-0AA0 6ES7390-1AF30-0AA0 6ES7390-1AJ30-0AA0 6ES7390-1BC00-0AA0	
MMC memory For data logging up to 32 MB, only for legal-for-trade applications R76, R51 and R107	7MH4900-2AY21	
Remote displays (option) The Siebert S102 and S302 remote digital displays can be directly connected to the SIWAREX FTA via an RS 485 interface. Siebert Industrieelektronik GmbH PO Box 1180 D-66565 Eppelborn Tel.: +49 6806/980-0 Fax: +49 6806/980-999 Internet: https://www.siebert-group.com/en/ Detailed information is available from the manufacturer.		Ex interface SIWAREX IS For intrinsically safe connection of load cells. With ATEX approval (not UL/FM). Suitable for SIWAREX electronic weighing systems. Compatibility of load cells must be checked separately. <ul style="list-style-type: none"> • With short-circuit current < 199 mA DC • With short-circuit current < 137 mA DC
SIWAREX JB junction box, aluminum housing For connecting up to 4 load cells in parallel, and for connecting several junction boxes	7MH5001-0AA20	7MH4710-5BA
SIWAREX JB junction box, stainless steel housing For connecting up to 4 load cells in parallel.	7MH5001-0AA00	7MH4710-5CA
SIWAREX JB junction box, stainless steel housing (ATEX) For parallel connection of up to 4 load cells (for zone allocation, see manual or type-examination certificate).	7MH5001-0AA01	
		Cable (optional) Cable Li2Y 1 x 2 x 0.75 ST + 2 x (2 x 0.34 ST) – CY For connecting SIWAREX electronic weighing systems to junction box (JB), extension box (EB) and Ex interface or between two EBs. For permanent installation. Occasional bending is possible. External diameter: approx. 10.8 mm (0.43 inch) Permissible ambient temperature -40 ... +80 °C (-40 ... +176 °F) Sold by the meter. <ul style="list-style-type: none"> • Sheath color: orange • For hazardous atmospheres. Sheath color: blue.
		Commissioning Commissioning charge for one static scale with SIWAREX module (Flat charge for travel and setup must be ordered separately) Scope: <ul style="list-style-type: none"> • Recording of data • Checking of mechanical installation of the scale • Checking of electrical wiring and function • Static adjustment of the scale Requirements: <ul style="list-style-type: none"> • Mechanical design functional • Modules electrically wired and tested • Calibration weights available • Free access to scale
		Flat charge for travel and setup in Germany
		9LA1110-8SN50-0AA0
		9LA1110-8RA10-0AA0

SIMATIC S7-300 Advanced Controllers

I/O modules

Function modules

SIWAREX FTA weighing module

Technical specifications

SIWAREX FTA	
Use in automation systems	
S7-300	Directly or via ET 200M
S7-1500	Through ET 200M
S7-400 (H)	Through ET 200M
PCS 7 (H)	Through ET 200M
Communication interfaces	
S7	Through backplane bus
RS 232	For SIWATOOL or printer connection
RS 485	For remote display or digital load cell
Module parameterization	
	Using SIMATIC S7
	Using SIWATOOL FTA software (RS 232)
Measuring properties	
EC type approval as non automatic weighing instrument, trade class III	3 x 6 000 d ≥ 0.5 μV/e
Internal resolution	16 million parts
Internal/external updating rate	400/100 Hz
Several parameterizable digital filters	Critically dampened, Bessel, Butterworth (0.05 ... 20 Hz), mean-value filter
Weighing functions	
Non automatic weighing instrument	OIML R76
Automatic weighing machine	OIML R51, R61, R107
Load cells	
	Strain gauges in 4-wire or 6-wire system
3 characteristic value ranges	1, 2 or 4 mV/V
Load cell powering	
Supply voltage U_s (rated value)	10.3 V DC
Max. supply current	184 mA
Permissible load cell resistance	
• R_{Lmin}	> 56 Ω
• R_{Lmax}	> 87 Ω with Ex interface ≤ 4 010 Ω

SIWAREX FTA	
Max. distance of load cells	
When using the recommended cable:	
Standard	1 000 m (3 280 ft)
In hazardous area ¹⁾	
• For gases of group IIC	300 m (984 ft)
• For gases of group IIB	1000 m (3 280 ft)
Connection to load cells in Ex zone 1	Optionally via SIWAREX IS Ex interface
Ex approvals zone 2 and safety	ATEX 95, FM, cUL _{US} Haz. Loc.
Auxiliary power supply	
Rated voltage	24 V DC
Max. power consumption	500 mA
Current consumption on backplane bus	Typ. 55 mA
Inputs/outputs	
Digital inputs	7 DI electrically isolated
Digital outputs	8 DO electrically isolated
Counter input	Up to 10 kHz
Analog output	
• Current range	0/4 ... 20 mA
• Updating rate	100 Hz
Approvals	EC type approval (CE, OIML R76)
	EU type-examination certificate according to MID (OIML R51, R61, R107)
Degree of protection according to EN 60529; IEC 60529	IP20
Climatic requirements	
T_{min} (IND) ... T_{max} (IND) (operating temperature)	
• Horizontal installation	-10 ... 60 °C (14 ... 140 °F)
• Vertical installation	-10 ... 40 °C (14 ... 104 °F)
EMC requirements	EN 61326, EN 45501, NAMUR NE21, Part 1
Dimensions	80 × 125 × 130 mm (3.15 × 4.92 × 5.12 inch)
Weight	600 g (0.44 lb)

¹⁾ For further details, see Ex interface, type SIWAREX IS.

Overview



The SIWAREX FTC (Flexible Technology for Continuous Weighing) is a versatile and flexible weighing module for belt scales, loss-in-weight feeders and solids flowmeters. It can also be used to record weights and measure force. The SIWAREX FTC function module is integrated in SIMATIC S7/PCS 7 and uses the features of this modern automation system, such as integrated communication, diagnostics and configuration tools.

Ordering data

Ordering data	Article No.	Ordering data	Article No.
SIWAREX FTC Electronic weighing system for S7-300 and ET 200M. Applications: Belt scales, force measurement, loss-in-weight scales and solids flowmeters	7MH4900-3AA01	SIWATOOL V4 & V7 Service and commissioning software for SIWAREX weighing modules	7MH4900-1AK01
SIWAREX FTC_B Equipment Manual for belt scales Available in a range of languages Free download on the Internet at: http://www.siemens.com/weighing/documentation		SIWAREX PCS 7 AddOn Library for PCS7 V8.x and V9.0 • Supports PROFINET APL faceplates and function blocks for: • SIWAREX U • SIWAREX FTA • SIWAREX FTC_B (belt scale) • SIWAREX WP321	7MH4900-1AK61
SIWAREX FTC_L Equipment Manual for solids flowmeters and loss-in-weight scales Available in a range of languages Free download on the Internet at: http://www.siemens.com/weighing/documentation		Classic faceplate and function block for: • SIWAREX FTC_L (Loss-in-weight)	
SIWAREX FTC "Getting Started" for belt scales Sample software shows beginners how to program the scales in STEP 7 for belt scale mode Free download on the Internet at: http://www.siemens.com/weighing/documentation		SIWATOOL connection cable from SIWAREX FTC with serial PC interface, for 9-pin PC interfaces (RS 232) • 2 m long (6.56 ft) • 5 m long (16.40 ft)	7MH4702-8CA 7MH4702-8CB
SIWAREX FTC "Getting Started" for solids flowmeters Sample software shows beginners how to program the scales in STEP 7 for solids flowmeter mode Free download on the Internet at: http://www.siemens.com/weighing/documentation		40-pin front connector with screw contacts Required for each SIWAREX module • With screw contacts • With spring-loaded terminals	6ES7392-1AM00-0AA0 6ES7392-1BM01-0AA0
SIWAREX FTC "Getting Started" for loss-in-weight scales Sample software shows beginners how to program the scales in STEP 7 for loss-in-weight scale mode Free download on the Internet at: http://www.siemens.com/weighing/documentation		Shield connection element Sufficient for one SIWAREX FTC module	6ES7390-5AA00-0AA0
		Shield connection clamp Contents: 2 units (suitable for cable with diameter 4 ... 13 mm / 0.16 ... 0.51 inch) Note: One shield connection clamp is required for each of the following: • Scale connection • RS 485 interface • RS 232 interface	6ES7390-5CA00-0AA0

SIMATIC S7-300 Advanced Controllers

I/O modules

Function modules

SIWAREX FTC weighing module

Ordering data

Article No.

S7 DIN rail

- 160 mm (6.30 inch)
- 480 mm (18.90 inch)
- 530 mm (20.87 inch)
- 830 mm (32.68 inch)
- 2 000 mm (78.74 inch)

6ES7390-1AB60-0AA0
6ES7390-1AE80-0AA0
6ES7390-1AF30-0AA0
6ES7390-1AJ30-0AA0
6ES7390-1BC00-0AA0

MMC memory

For data logging up to 32 MB, only for legal-for-trade applications R76, R51 and R107

7MH4900-2AY21

Remote display (optional)

The Siebert S102 and S302 remote digital displays can be directly connected to the SIWAREX FTC via an RS 485 interface. (not suitable for belt scale mode)

Siebert Industrieelektronik GmbH
PO Box 1180
D-66565 Eppelborn
Tel.: +49 6806/980-0
Fax: +49 6806/980-999

Internet:
<https://www.siebert-group.com/en/>

Detailed information is available from the manufacturer.

SIWAREX JB junction box, aluminum housing

For connecting up to 4 load cells in parallel, and for connecting multiple junction boxes.

7MH5001-0AA20

SIWAREX JB junction box, stainless steel housing

For connecting up to 4 load cells in parallel.

7MH5001-0AA00

SIWAREX JB junction box, stainless steel housing (ATEX)

For parallel connection of up to 4 load cells (for zone allocation, see manual or type-examination certificate).

7MH5001-0AA01

Ex interface SIWAREX IS

For intrinsically safe connection of load cells. With ATEX approval (not UL/FM). Suitable for SIWAREX electronic weighing systems. Compatibility of load cells must be checked separately.

- With short-circuit current < 199 mA DC
- With short-circuit current < 137 mA DC

7MH4710-5BA

7MH4710-5CA

Article No.

Cable (optional)

Cable Li2Y 1 x 2 x 0.75 ST + 2 x (2 x 0.34 ST) – CY

For connecting SIWAREX electronic weighing systems to junction box (JB), extension box (EB) and Ex interface or between two EBs. For permanent installation. Occasional bending is possible.

External diameter:
approx. 10.8 mm (0.43 inch)

Permissible ambient temperature
-40 ... +80 °C (-40 ... +176 °F)

Sold by the meter.

- Sheath color: orange
- For hazardous atmospheres. Sheath color: blue.

7MH4702-8AG
7MH4702-8AF

Commissioning

Commissioning charge for one belt scale with SIWAREX module

9LA1110-8SM50-0AA0

(Flat charge for travel and setup must be ordered separately)

Scope:

- Recording of data
- Checking of mechanical installation of the scale
- Checking of electrical wiring and function
- Dynamic adjustment of the scale

Requirements:

- Mechanical design functional
- Modules electrically wired and tested
- Calibration weights available
- Free access to scale

Flat charge for travel and setup in Germany

9LA1110-8RA10-0AA0

Technical specifications

SIWAREX FTC	
Use in automation systems	
S7-300	Directly or via ET 200M
S7-1500	Through ET 200M
S7-400 (H)	Through ET 200M
PCS 7 (H)	Through ET 200M
Communication interfaces	
S7	Through backplane bus
RS 232	For SIWATOOL or printer connection
RS 485	For remote display or digital load cell
Module parameterization	
	Using SIMATIC S7
	Using SIWATOOL FTC software (RS 232)
Measuring properties	
Accuracy according to EN 45501	$3 \times 6\,000 d \geq 0.5 \mu\text{V/e}$
Internal resolution	+/- 8 million parts
Internal/external updating rate	400/100 Hz
Several parameterizable digital filters	Critically damped, Bessel, Butterworth (0.05 ... 20 Hz), mean-value filter
Weighing functions	<ul style="list-style-type: none"> • Non automatic weighing instrument, force measurement • Belt scale • Loss-in-weight scale • Solids flowmeters
Load cells	Strain gauges in 4-wire or 6-wire system
3 characteristic value ranges	1, 2 or 4 mV/V
Load cell powering	
Supply voltage U_s (rated value)	10.3 V DC
Max. supply current	184 mA
Permissible load cell resistance	
• $R_{L\min}$	$> 56 \Omega$
	$> 87 \Omega$ with Ex interface
• $R_{L\max}$	$\leq 4\,010 \Omega$

SIWAREX FTC	
Max. distance of load cells	
When using the recommended cable:	
Standard	1 000 m (3 280 ft)
In hazardous area ¹⁾	
• For gases of group IIC	300 m (984 ft)
• For gases of group IIB	1 000 m (3 280 ft)
Connection to load cells in Ex zone 1	Optionally via SIWAREX IS Ex interface
Ex approvals zone 2 and safety	ATEX 95, FM, cUL _{US} Haz. Loc.
Auxiliary power supply	
Rated voltage	24 V DC
Max. power consumption	500 mA
Current consumption on backplane bus	Typ. 55 mA
Inputs/outputs	
Digital inputs	7, electrically isolated
Digital outputs	8, electrically isolated
Counter input	Up to 10 kHz
Analog output	
• Current range	0/4 ... 20 mA
• Updating rate	100 Hz
Degree of protection according to EN 60529; IEC 60529	IP20
Climatic requirements	
T_{\min} (IND) ... T_{\max} (IND) (operating temperature)	
• Horizontal installation	-10 ... 60 °C (14 ... 140 °F)
• Vertical installation	-10 ... 40 °C (14 ... 104 °F)
EMC requirements	EN 61326, EN 45501, NAMUR NE21, Part 1
Dimensions	80 × 125 × 130 mm (3.15 × 4.92 × 5.12 inch)
Weight	600 g (0.44 lb)

¹⁾ For further details, see Ex interface, type SIWAREX IS.

SIMATIC S7-300 Advanced Controllers

I/O modules

SIPLUS S7-300 function modules

SIPLUS S7-300 FM 350-1**Overview**

- Single-channel, intelligent counter module for simple counting tasks
- For direct connection of incremental encoders
- Comparison function with 2 definable comparison values
- Integrated digital outputs for output of the response on reaching the comparison value
- Operating modes:
 - Continuous counting
 - Single counting
 - Periodic counting
- Special functions:
 - Set counter
 - Latch counter
- Start/stop counter by gate function

Note:

SIPLUS extreme products are based on SIMATIC standard products. The contents listed here were taken from the respective standard products. SIPLUS extreme-specific information was added.

Ordering data**Article No.****SIPLUS S7-300 FM 350-1 counter module**

With 1 channel, max. 500 kHz;
for incremental encoder

*For industrial applications with
extended ambient conditions*

Extended temperature range and
exposure to media

6AG1350-1AH03-2AE0**Accessories**

Mandatory

Front connector

20-pin, with spring-loaded contacts

- 1 unit
- 100 units

6ES7392-1BJ00-0AA0
6ES7392-1BJ00-1AB0

Consumables

Bus connectors

1 unit (spare part)

6ES7390-0AA00-0AA0**Shield connection element**

80 mm wide, with 2 rows for 4 shield
connection clamps each

6ES7390-5AA00-0AA0**Shield connection clamps**

2 units

For 1 cable,
diameter 3 mm to 8 mm

6ES7390-5BA00-0AA0

For 1 cable,
diameter 4 mm to 13 mm

6ES7390-5CA00-0AA0**Article No.****Label cover**

10 units (spare part), for modules
with 20-pin front connector

6ES7392-2XY00-0AA0**Labeling strips**

10 units (spare part), for modules
with 20-pin front connector

6ES7392-2XX00-0AA0**Slot number plates****6ES7912-0AA00-0AA0**

Documentation

SIMATIC Manual Collection

Electronic manuals on DVD,
multi-language:
LOGO!, SIMADYN,
SIMATIC bus components,
SIMATIC C7, SIMATIC Distributed I/O,
SIMATIC HMI, SIMATIC Sensors,
SIMATIC NET, SIMATIC PC-based
Automation, SIMATIC PCS 7,
SIMATIC PG/PC, SIMATIC S7,
SIMATIC Software, SIMATIC TDC

6ES7998-8XC01-8YE0**SIMATIC Manual Collection
update service for 1 year**

Current Manual Collection DVD and
the three subsequent updates

6ES7998-8XC01-8YE2

Technical specifications

Article number	6AG1350-1AH03-2AE0
Based on	6ES7350-1AH03-0AE0 SIPLUS S7-300 FM 350-1
Ambient conditions	
Ambient temperature during operation	
• min.	-25 °C; = Tmin
• max.	60 °C; = Tmax
Altitude during operation relating to sea level	
• Installation altitude above sea level, max.	5 000 m
• Ambient air temperature-barometric pressure-altitude	Tmin ... Tmax at 1 140 hPa ... 795 hPa (-1 000 m ... +2 000 m) // Tmin ... (Tmax - 10 K) at 795 hPa ... 658 hPa (+2 000 m ... +3 500 m) // Tmin ... (Tmax -20 K) at 658 hPa ... 540 hPa (+3 500 m ... +5 000 m)
Relative humidity	
• With condensation, tested in accordance with IEC 60068-2-38, max.	100 %; RH incl. condensation/frost (no commissioning under condensation conditions)
Resistance	
Use in stationary industrial systems	
- to biologically active substances according to EN 60721-3-3	Yes; Class 3B2 mold, fungus and dry rot spores (with the exception of fauna); Class 3B3 on request
- to chemically active substances according to EN 60721-3-3	Yes; Class 3C4 (RH < 75 %) incl. salt spray acc. to EN 60068-2-52 (severity degree 3); *
- to mechanically active substances according to EN 60721-3-3	Yes; Class 3S4 incl. sand, dust, *

Article number	6AG1350-1AH03-2AE0
Based on	6ES7350-1AH03-0AE0 SIPLUS S7-300 FM 350-1
Use on ships/at sea	
- to biologically active substances according to EN 60721-3-6	Yes; Class 6B2 mold and fungal spores (excluding fauna); Class 6B3 on request
- to chemically active substances according to EN 60721-3-6	Yes; Class 6C3 (RH < 75 %) incl. salt spray acc. to EN 60068-2-52 (severity degree 3); *
- to mechanically active substances according to EN 60721-3-6	Yes; Class 6S3 incl. sand, dust; *
Usage in industrial process technology	
- Against chemically active substances acc. to EN 60654-4	Yes; Class 3 (excluding trichlorethylene)
- Environmental conditions for process, measuring and control systems acc. to ANSI/ISA-71.04	Yes; Level GX group A/B (excluding trichlorethylene; harmful gas concentrations up to the limits of EN 60721-3-3 class 3C4 permissible); level LC3 (salt spray) and level LB3 (oil)
Remark	
- Note regarding classification of environmental conditions acc. to EN 60721, EN 60654-4 and ANSI/ISA-71.04	* The supplied plug covers must remain in place over the unused interfaces during operation!

SIMATIC S7-300 Advanced Controllers

I/O modules

SIPLUS S7-300 function modules

SIPLUS S7-300 FM 350-2**Overview**

- 8-channel intelligent counter module for universal counting and measuring tasks
- For the direct connection of 24 V incremental encoders, directional encoders, initiators or NAMUR encoders
- Comparison function with predefined comparison values (number depending on operating mode)
- Integrated digital outputs for output of the response on reaching the comparison value
- Operating modes:
 - Continuous / single / periodic counting
 - Frequency and speed control
 - Period measurement
 - Dosing

Note:

SIPLUS extreme products are based on SIMATIC standard products. The contents listed here were taken from the respective standard products. SIPLUS extreme specific information was added.

Ordering data**Article No.****SIPLUS S7-300 FM 350-2 counter module**

With 8 channels, max. 20 kHz; for 24 V incremental encoders and NAMUR encoders; includes configuration package and electronic documentation on CD

Exposure to media

6AG1350-2AH01-4AE0**Accessories***Mandatory***Front connector**

40-pin, with spring-loaded contacts

- 1 unit
- 100 units

6ES7392-1BM01-0AA0
6ES7392-1BM01-1AB0*Consumables***Bus connectors**

1 unit (spare part)

6ES7390-0AA00-0AA0**Shield connection clamps**

2 units

For 2 cables, diameter 2 mm to 6 mm

6ES7390-5AB00-0AA0

For 1 cable, diameter 3 mm to 8 mm

6ES7390-5BA00-0AA0

For 1 cable, diameter 4 mm to 13 mm

6ES7390-5CA00-0AA0**Article No.****Label cover**

10 units (spare part), for modules with 40-pin front connector

6ES7392-2XY10-0AA0**Labeling strips**

10 units (spare part), for modules with 40-pin front connector

6ES7392-2XX10-0AA0**Slot number plates****6ES7912-0AA00-0AA0***Documentation***SIMATIC Manual Collection**

Electronic manuals on DVD, multi-language: LOGO!, SIMADYN, SIMATIC bus components, SIMATIC C7, SIMATIC Distributed I/O, SIMATIC HMI, SIMATIC Sensors, SIMATIC NET, SIMATIC PC-based Automation, SIMATIC PCS 7, SIMATIC PG/PC, SIMATIC S7, SIMATIC Software, SIMATIC TDC

6ES7998-8XC01-8YE0**SIMATIC Manual Collection update service for 1 year**

Current Manual Collection DVD and the three subsequent updates

6ES7998-8XC01-8YE2

Technical specifications

Article number	6AG1350-2AH01-4AE0
Based on	6ES7350-2AH01-0AE0 SIPLUS S7-300 FM 350-2
Ambient conditions	
Ambient temperature during operation	
• min.	0 °C; = Tmin
• max.	60 °C; = Tmax
Altitude during operation relating to sea level	
• Installation altitude above sea level, max.	5 000 m
• Ambient air temperature-barometric pressure-altitude	Tmin ... Tmax at 1 140 hPa ... 795 hPa (-1 000 m ... +2 000 m) // Tmin ... (Tmax - 10 K) at 795 hPa ... 658 hPa (+2 000 m ... +3 500 m) // Tmin ... (Tmax -20 K) at 658 hPa ... 540 hPa (+3 500 m ... +5 000 m)
Relative humidity	
• With condensation, tested in accordance with IEC 60068-2-38, max.	100 %; RH incl. condensation/frost (no commissioning under condensation conditions)
Resistance	
Use in stationary industrial systems	
- to biologically active substances according to EN 60721-3-3	Yes; Class 3B2 mold, fungus and dry rot spores (with the exception of fauna); Class 3B3 on request
- to chemically active substances according to EN 60721-3-3	Yes; Class 3C4 (RH < 75 %) incl. salt spray acc. to EN 60068-2-52 (severity degree 3); *
- to mechanically active substances according to EN 60721-3-3	Yes; Class 3S4 incl. sand, dust, *

Article number	6AG1350-2AH01-4AE0
Based on	6ES7350-2AH01-0AE0 SIPLUS S7-300 FM 350-2
Use on ships/at sea	
- to biologically active substances according to EN 60721-3-6	Yes; Class 6B2 mold and fungal spores (excluding fauna); Class 6B3 on request
- to chemically active substances according to EN 60721-3-6	Yes; Class 6C3 (RH < 75 %) incl. salt spray acc. to EN 60068-2-52 (severity degree 3); *
- to mechanically active substances according to EN 60721-3-6	Yes; Class 6S3 incl. sand, dust; *
Usage in industrial process technology	
- Against chemically active substances acc. to EN 60654-4	Yes; Class 3 (excluding trichlorethylene)
- Environmental conditions for process, measuring and control systems acc. to ANSI/ISA-71.04	Yes; Level GX group A/B (excluding trichlorethylene; harmful gas concentrations up to the limits of EN 60721-3-3 class 3C4 permissible); level LC3 (salt spray) and level LB3 (oil)
Remark	
- Note regarding classification of environmental conditions acc. to EN 60721, EN 60654-4 and ANSI/ISA-71.04	* The supplied plug covers must remain in place over the unused interfaces during operation!

SIMATIC S7-300 Advanced Controllers

I/O modules

SIPLUS S7-300 function modules

SIPLUS SIWAREX U**Overview****SIPLUS SIWAREX U electronic weighing system**

SIPLUS SIWAREX U is a flexible weighing module for all simple weighing and force measuring tasks. The compact module can be integrated into SIPLUS automation systems without any problems.

Note:

SIPLUS extreme products are based on SIMATIC standard products. The contents listed here were taken from the respective standard products. SIPLUS extreme-specific information was added.

SIPLUS SIWAREX U electronic weighing system

Article No.	6AG1 950-2AA01-4AA0
Article No. based on	7MH4 950-2AA01
Range of ambient temperature	0 ... +60 °C
Conformal coating	Coating of the printed-circuit boards and the electronic components
Technical data	The technical data of the standard product applies except for the ambient conditions.
Ambient conditions	
Relative humidity	100%, condensation/frost permissible. No commissioning in bedewed state.

For technical documentation on SIPLUS, see:

<http://www.siemens.com/siplus-extreme>

Ordering data**SIPLUS SIWAREX U**

Electronic weighing system for SIPLUS S7 and ET 200M, incl. bus connector

Exposure to media

6AG1950-2AA01-4AA0

Accessories

Mandatory

Front connector

20-pin, with spring-loaded contacts

- 1 unit
- 100 units

6ES7392-1BJ00-0AA0
6ES7392-1BJ00-1AB0

Consumables

Bus connectors

1 unit (spare part)

6ES7390-0AA00-0AA0

Shield connection clamps

2 units

For 2 cables with 2 mm to 6 mm diameter

6ES7390-5AB00-0AA0

For 1 cable with 3 mm to 8 mm diameter

6ES7390-5BA00-0AA0

For 1 cable with 4 mm to 13 mm diameter

6ES7390-5CA00-0AA0

Article No.**Labeling strips**

10 units (spare part)

6ES7392-2XX00-0AA0

Label cover

10 units (spare part)

6ES7392-2XY00-0AA0

Slot number plates

6ES7912-0AA00-0AA0

SIWAREX JB junction box, aluminum housing

For connecting up to 4 load cells in parallel, and for connecting multiple junction boxes

7MH5001-0AA20

SIWAREX JB junction box, stainless steel housing

For connecting up to 4 load cells in parallel

7MH5001-0AA00

SIWAREX JB junction box, stainless steel housing (ATEX)

For parallel connection of up to 4 load cells (for zone allocation, see manual or type-examination certificate).

7MH5001-0AA01

Ex interface, type SIWAREX IS

With ATEX approval, but without UL and FM approvals, for intrinsically safe connection of load cells

Incl. Equipment Manual

Suitable for SIWAREX U, CS, MS, FTA, FTC and CF weighing modules

Approved for use in the EU

- With short-circuit current < 199 mA DC
- With short-circuit current < 137 mA DC

7MH4710-5BA

7MH4710-5CA

Ordering data	Article No.	Article No.
Cables (optional)		
Cable Li2Y 1 x 2 x 0.75 ST + 2 x (2 x 0.34 ST) – CY, orange sheath For connecting SIWAREX U, CS, MS, FTA, FTC and CF to the junction box (JB), extension box (EB) or Ex interface (Ex-I) or between two JB's; for fixed laying, occasional bending permitted, 10.8 mm (0.43 inch) outer diameter, for ambient temperature -40 ... +80 °C (-40 ... +176 °F)	7MH4702-8AG	<i>Configuration software</i> SIWATOOL V4 & V7 Service and commissioning software for SIWAREX weighing modules 7MH4900-1AK01
Cable Li2Y 1 x 2 x 0.75 ST + 2 x (2 x 0.34 ST) – CY, blue sheath For connecting the junction box (JB) or extension box (EB) in a potentially explosive atmosphere to the Ex interface (Ex I), for fixed laying, occasional bending permitted, blue PVC insulating sheath, approx. 10.8 mm (0.43 inch) outer diameter, for ambient temperature -40 ... +80 °C (-40 ... +176 °F)	7MH4702-8AF	SIWAREX U configuration package for PCS 7, version 8.0 Suitable for 7MH4950-xAA01 <ul style="list-style-type: none"> • Function block for the CFC chart • Faceplate • Manual 7MH4950-3AK62
		SIWAREX PCS 7 AddOn Library for PCS 7 V8.x and V9.0 <ul style="list-style-type: none"> • Supports PROFINET • APL faceplates and function blocks for: <ul style="list-style-type: none"> • Classic faceplate and function block for: <ul style="list-style-type: none"> - SIWAREX U - SIWAREX FTA - SIWAREX FTC_B (belt scales) - SIWAREX WP321 • Classic faceplate and function block for: <ul style="list-style-type: none"> - SIWAREX FTC_L (Loss-in-weight)
		<i>Documentation</i> SIMATIC Manual Collection Electronic manuals on DVD, multi-language: LOGO!, SIMADYN, SIMATIC bus components, SIMATIC C7, SIMATIC distributed I/O, SIMATIC HMI, SIMATIC Sensors, SIMATIC NET, SIMATIC PC-based Automation, SIMATIC PCS 7, SIMATIC PG/PC, SIMATIC S7, SIMATIC Software, SIMATIC TDC 6ES7998-8XC01-8YE0
		SIMATIC Manual Collection update service for 1 year Current Manual Collection DVD and the three subsequent updates 6ES7998-8XC01-8YE2

SIMATIC S7-300 Advanced Controllers

I/O modules

SIPLUS S7-300 function modules

SIPLUS SIWAREX FTA**Overview**

SIPLUS SIWAREX FTA (Flexible Technology, Automatic Weighing Instrument) is a versatile and flexible weighing module for industrial use. It can be used in both non-automatic and automatic weighing operation, for example the production of mixtures, and for filling, loading, monitoring and bag filling.

It has the corresponding scale approvals and is also suitable for legal-for-trade weighing systems.

The SIPLUS SIWAREX FTA function module is integrated in SIMATIC S7/PCS7 and uses the features of this modern automation system, such as integrated communication, diagnostics and configuration tools.

Note:

SIPLUS extreme products are based on SIMATIC standard products. The contents listed here were taken from the corresponding standard products. SIPLUS extreme specific information has been added.

SIPLUS SIWAREX FTA	
Article No.	6AG1900-2AA01-4AA0
Article No. based on	7MH4900-2AA01
Ambient temperature range	-25 ... +70 °C
Conformal coating	Coating of the printed circuit boards and the electronic components
Technical specifications	The technical specifications of the standard product apply, except for the ambient conditions.
Ambient conditions	
Relative humidity	100%, condensation/frost permissible. No commissioning under condensation conditions.
Biologically active substances, compliance with EN 60721-3-3	Class 3B2 mold, fungal and dry rot spores (excluding fauna). The supplied plug covers must remain in place over the unused interfaces during operation!
Chemically active substances, compliance with EN 60721-3-3	Class 3C4 incl. salt spray in accordance with EN60068-2-52 (degree of severity 3). The supplied plug covers must remain in place over the unused interfaces during operation!
Mechanically active substances, compliance with EN 60721-3-3	Class 3S4 incl. sand, dust. The supplied plug covers must remain in place over the unused interfaces during operation!

Ordering data**SIPLUS SIWAREX FTA**

Weighing electronics with official calibration capability for (automatic) scales for S7-300 and ET 200M EU type approval 3 x 6000 d Application areas: Proportioning, filling, bagging, loading. Notice: Observe approval conditions for applications with verification obligations. We recommend using our calibration set and contacting our SIWAREX hotline.

Exposure to media

Accessories*Mandatory***MMC memory**

For data recording up to 32 MB, only for R76, R51 and R107 applications with calibration capability

Front connector

40-pin

- With screw connections
- With spring-loaded contacts

Article No.**6AG1900-2AA01-4AA0****7MH4900-2AY21**

6ES7392-1AM00-0AA0
6ES7392-1BM01-1AB0

Article No.*Consumables***Bus connectors**

1 unit (spare part)

Shield connection clamps

2 units; one shield connection clamp each is required for the weighing instrument connection, RS 485 interface and RS 232 interface

For 1 cable, diameter 4 mm to 13 mm

Shield connection element

Sufficient for one SIWAREX FTA module

SIWAREX JB junction box, aluminum housing

For connecting up to 4 load cells in parallel, and for connecting multiple junction boxes

SIWAREX JB junction box, stainless steel housing

For connecting up to 4 load cells in parallel.

SIWAREX JB junction box, stainless steel housing (ATEX)

For parallel connection of up to 4 load cells (for zone allocation, see manual or type-examination certificate).

6ES7390-0AA00-0AA0**6ES7390-5CA00-0AA0****6ES7390-5AA00-0AA0****7MH5001-0AA20****7MH5001-0AA00****7MH5001-0AA01**

Ordering data	Article No.	Article No.	
<p>Ex interface, type SIWAREX IS</p> <p>For intrinsically safe connection of load cells. With ATEX approval (not UL/FM). Suitable for SIWAREX electronic weighing systems. Compatibility of the load cells must be checked separately.</p> <ul style="list-style-type: none"> • With short-circuit current < 199 mA DC • With short-circuit current < 137 mA DC 	<p>7MH4710-5BA</p> <p>7MH4710-5CA</p>	<p>Calibration set for SIWAREX FTA</p> <p>For verification of up to 5 scales, comprising:</p> <ul style="list-style-type: none"> • 3 x inscription foil for labeling • 1 x protective foil • Guidelines for verification, verification certificates and approvals, adaptable label, SIWAREX FTA Manual on CD-ROM 	<p>7MH4900-2AY10</p>
<p>Cables (optional)</p> <p>Cable Li2Y 1 x 2 x 0.75 ST + 2 x (2 x 0.34 ST) – CY, orange sheath</p> <p>For connecting SIWAREX electronic weighing systems to junction boxes (JB), extension boxes (EB) and Ex interface or between two JB's. For permanent installation. Occasional bending is permitted.</p> <p>Outer diameter: approx. 10.8 mm (0.43 inch)</p> <p>Permissible ambient temperature -40 ... +80 °C (-40 ... +176 °F)</p> <p>Sold by the meter</p> <p>Sheath color: orange</p> <p>For hazardous areas. Sheath color: blue</p>	<p>7MH4702-8AG</p> <p>7MH4702-8AF</p>	<p>SIWATOOL connection cable</p> <p>From SIWAREX FTA with serial PC interface, for 9-pin PC interfaces (RS 232)</p> <ul style="list-style-type: none"> • 2 m long (6.56 ft) • 5 m long (16.40 ft) <p><i>Documentation</i></p> <p>SIWAREX FTA Manual</p> <p>Available in a range of languages</p> <p>Free download from the Internet at: http://www.siemens.com/weighing/documentation</p> <p>SIWAREX FTA "Getting started"</p> <p>Sample software shows beginners how to program the scales in STEP 7.</p> <p>Free download on the Internet at: http://www.siemens.com/weighing/documentation</p>	<p>7MH4702-8CA</p> <p>7MH4702-8CB</p>
<p><i>Configuration software</i></p> <p>SIWATOOL V4 & V7</p> <p>Service and commissioning software for SIWAREX weighing modules</p>	<p>7MH4900-1AK01</p>	<p>SIMATIC Manual Collection</p> <p>Electronic manuals on DVD, multi-language: LOGO!, SIMADYN, SIMATIC bus components, SIMATIC C7, SIMATIC Distributed I/O, SIMATIC HMI, SIMATIC Sensors, SIMATIC NET, SIMATIC PC-based Automation, SIMATIC PCS 7, SIMATIC PG/PC, SIMATIC S7, SIMATIC Software, SIMATIC TDC</p>	<p>6ES7998-8XC01-8YE0</p>
<p>SIWAREX PCS 7 AddOn Library for PCS 7 V8.x and V9.0</p> <ul style="list-style-type: none"> • Supports PROFINET <p>APL faceplates and function blocks for:</p> <ul style="list-style-type: none"> • SIWAREX U • SIWAREX FTA • SIWAREX FTC_B (belt scales) • SIWAREX WP321 <p>Classic faceplate and function block for:</p> <ul style="list-style-type: none"> • SIWAREX FTC_L (loss in weight) 	<p>7MH4900-1AK61</p>	<p>SIMATIC Manual Collection update service for 1 year</p> <p>Current Manual Collection DVD and the three subsequent updates</p>	<p>6ES7998-8XC01-8YE2</p>

SIMATIC S7-300 Advanced Controllers

I/O modules

Communication

CP 340

Overview



- The economical complete solution for serial communication via point-to-point links.
- 3 versions with different transmission interfaces:
 - RS 232C (V.24)
 - 20 mA (TTY)
 - RS 422/RS 485 (X.27)
- Implemented protocols:
 - ASCII
 - 3964 (R) (not for RS 485)
 - Printer driver
- Simple parameterization via a parameterization tool integrated into STEP 7

Ordering data

Article No.

CP 340 communications module With one RS 232 C (V.24) interface	6ES7340-1AH02-0AE0
RS 232 connecting cable For linking to SIMATIC S7	
5 m	6ES7902-1AB00-0AA0
10 m	6ES7902-1AC00-0AA0
15 m	6ES7902-1AD00-0AA0
CP 340 communications module With one 20 mA (TTY) interface	6ES7340-1BH02-0AE0
20 mA (TTY) connecting cable For linking to SIMATIC S7	
5 m	6ES7902-2AB00-0AA0
10 m	6ES7902-2AC00-0AA0
50 m	6ES7902-2AG00-0AA0
CP 340 communications module With one RS 422/485 (X.27) interface	6ES7340-1CH02-0AE0
RS 422/485 connecting cable For linking to SIMATIC S7	
5 m	6ES7902-3AB00-0AA0
10 m	6ES7902-3AC00-0AA0
50 m	6ES7902-3AG00-0AA0

Technical specifications

Article number	6ES7340-1AH02-0AE0	6ES7340-1BH02-0AE0	6ES7340-1CH02-0AE0
	CP340 w. RS232C interface(V.24)	CP340 w. 20MA interface(TTY)	CP340 w. RS422/485 interface
General information			
Product type designation	CP 340	CP 340	CP 340
Supply voltage			
Rated value (DC)			
• 24 V DC	No; Power supply via backplane bus 5V	No; Power supply via backplane bus 5V	No; Power supply via backplane bus 5V
Input current			
from backplane bus 5 V DC, max.	165 mA	190 mA	165 mA
Power loss			
Power loss, typ.	0.6 W	0.85 W	0.6 W
Interfaces			
Interfaces/bus type	RS 232C (V.24)	20 mA (TTY)	RS 422 / 485 (X.27)
Number of interfaces	1; Isolated	1; Isolated	1; Isolated
Transmission rate, min.	2.4 kbit/s	2.4 kbit/s	2.4 kbit/s
Transmission rate, max.	19.2 kbit/s	19.2 kbit/s	19.2 kbit/s
Point-to-point connection			
• Cable length, max.	15 m	1 000 m; 100 m active, 1 000 m passive	1 200 m
• supported printers	HP-Deskjet, HP-Laserjet, IBM-Proprinter, user-defined	HP-Deskjet, HP-Laserjet, IBM-Proprinter, user-defined	HP-Deskjet, HP-Laserjet, IBM-Proprinter, user-defined
• Connector type	9-pin sub D connector	9-pin sub D socket	15-pin sub D socket
Integrated protocol driver			
- 3964 (R)	Yes	Yes	Yes
- ASCII	Yes	Yes	Yes
- RK 512	No	No	No
- customer-specific drivers reloadable	No	No	No
Telegram length, max.			
- 3964 (R)	1 024 byte	1 024 byte	1 024 byte
- ASCII	1 024 byte	1 024 byte	1 024 byte

Technical specifications

Article number	6ES7340-1AH02-0AE0 CP340 w. RS232C interface(V.24)	6ES7340-1BH02-0AE0 CP340 w. 20MA interface(TTY)	6ES7340-1CH02-0AE0 CP340 w. RS422/485 interface
Transmission rate, 20 mA (TTY) - with 3964 (R) protocol, max. - with ASCII protocol, max. - with printer driver, max.		19.2 kbit/s 9.6 kbit/s 9.6 kbit/s	
Transmission rate, RS 422/485 - with 3964 (R) protocol, max. - with ASCII protocol, max. - with printer driver, max.			19.2 kbit/s 9.6 kbit/s 9.6 kbit/s
Transmission speed, RS 232 - with 3964 (R) protocol, max. - with ASCII protocol, max. - with printer driver, max.	19.2 kbit/s 9.6 kbit/s 9.6 kbit/s		
Ambient conditions			
Ambient temperature during operation • min. • max.	0 °C 60 °C	0 °C 60 °C	0 °C 60 °C
Ambient temperature during storage/transportation • min. • max.	-40 °C 70 °C	-40 °C 70 °C	-40 °C 70 °C
Software			
Block • FB length in RAM, max.	2 700 byte; Data communication, sending and receiving	2 700 byte; Data communication, sending and receiving	2 700 byte; Data communication, sending and receiving
Connection method Design of electrical connection for supply voltage	Over backplane bus	Over backplane bus	Over backplane bus
Dimensions			
Width	40 mm	40 mm	40 mm
Height	125 mm	125 mm	125 mm
Depth	120 mm	120 mm	120 mm
Weights			
Weight, approx.	300 g	300 g	300 g

SIMATIC S7-300 Advanced Controllers

I/O modules

Communication

CP 341

Overview



- For quick, high-performance serial data exchange via point-to-point coupling
- 3 versions with different transmission physics:
 - RS 232C (V.24),
 - 20 mA (TTY),
 - RS 422/RS 485 (X.27)
- Implemented protocols: ASCII, 3964 (R), RK 512
- The following protocols can also be loaded: Modbus RTU
- Simple parameter assignment using tool integrated in STEP 7

Ordering data

Article No.

CP 341 communications module **6ES7341-1AH02-0AE0**

With one RS 232 C (V.24) interface

RS 232 connecting cable

For linking to SIMATIC S7

5 m

6ES7902-1AB00-0AA0

10 m

6ES7902-1AC00-0AA0

15 m

6ES7902-1AD00-0AA0

CP 341 communications module **6ES7341-1BH02-0AE0**

With one 20 mA (TTY) interface

20 mA (TTY) connecting cable

For linking to SIMATIC S7

5 m

6ES7902-2AB00-0AA0

10 m

6ES7902-2AC00-0AA0

50 m

6ES7902-2AG00-0AA0

CP 341 communications module **6ES7341-1CH02-0AE0**

With one RS 422/485 (X.27) interface

RS 422/485 connecting cable

For linking to SIMATIC S7

5 m

6ES7902-3AB00-0AA0

10 m

6ES7902-3AC00-0AA0

50 m

6ES7902-3AG00-0AA0

Loadable drivers for CP 341

Modbus master (RTU format)

- Single license
- Single license, without software or documentation

6ES7870-1AA01-0YA0

6ES7870-1AA01-0YA1

Modbus slave (RTU format)

- Single license
- Single license, without software or documentation

6ES7870-1AB01-0YA0

6ES7870-1AB01-0YA1

Technical specifications

Article number	6ES7341-1AH02-0AE0	6ES7341-1BH02-0AE0	6ES7341-1CH02-0AE0
	CP 341 RS232C (V.24)	CP341 20mA-Interface (TTY)	CP341 RS422/485-Interface
General information			
Product type designation	CP 341	CP 341	CP 341
Supply voltage			
Rated value (DC)			
• 24 V DC	Yes	Yes	Yes
Input current			
from supply voltage L+, max.	100 mA	100 mA	100 mA
from backplane bus 5 V DC, max.	70 mA	70 mA	70 mA
Power loss			
Power loss, typ.	1.6 W	1.6 W	1.6 W
Interfaces			
Interfaces/bus type	RS 232C (V.24)	20 mA (TTY)	RS 422 / 485 (X.27)
Number of interfaces	1; Isolated	1; Isolated	1; Isolated
Transmission rate, min.	0.3 kbit/s	0.3 kbit/s	0.3 kbit/s
Transmission rate, max.	115.2 kbit/s	19.2 kbit/s	115.2 kbit/s

Technical specifications

Article number	6ES7341-1AH02-0AE0 CP 341 RS232C (V.24)	6ES7341-1BH02-0AE0 CP341 20mA-Interface (TTY)	6ES7341-1CH02-0AE0 CP341 RS422/485-Interface
Point-to-point connection			
• Cable length, max.	15 m	1 000 m	1 200 m
• supported printers	Serial printers	Serial printers	Serial printers
• Connector type	9-pin sub D connector	9-pin sub D socket	15-pin sub D socket
Integrated protocol driver			
- 3964 (R)	Yes	Yes	Yes; not with RS 485
- ASCII	Yes	Yes	Yes
- RK 512	Yes	Yes	Yes; not with RS 485
Telegram length, max.			
- 3964 (R)	4 096 byte	4 096 byte	4 096 byte
- ASCII	4 096 byte	4 096 byte	4 096 byte
- RK 512	4 096 byte	4 096 byte	4 096 byte
Transmission rate, 20 mA (TTY)			
- with 3964 (R) protocol, max.		19.2 kbit/s	
- with ASCII protocol, max.		19.2 kbit/s	
- with printer driver, max.		19.2 kbit/s	
- with RK 512 protocol, max.		19.2 kbit/s	
Transmission rate, RS 422/485			
- with 3964 (R) protocol, max.			115.2 kbit/s
- with ASCII protocol, max.			115.2 kbit/s
- with printer driver, max.			115.2 kbit/s
- with RK 512 protocol, max.			115.2 kbit/s
Transmission speed, RS 232			
- with 3964 (R) protocol, max.	115.2 kbit/s		
- with ASCII protocol, max.	115.2 kbit/s		
- with printer driver, max.	115.2 kbit/s		
- with RK 512 protocol, max.	115.2 kbit/s		
Ambient conditions			
Ambient temperature during operation			
• min.	0 °C	0 °C	0 °C
• max.	60 °C	60 °C	60 °C
Ambient temperature during storage/transportation			
• min.	-40 °C	-40 °C	-40 °C
• max.	70 °C	70 °C	70 °C
Software			
Block			
• FB length in RAM, max.	6 100 byte; Data communication, sending and receiving	6 100 byte; Data communication, sending and receiving	6 100 byte; Data communication, sending and receiving
Connection method			
Design of electrical connection for supply voltage	3 screw-type terminals: L+, M, GND	3 screw-type terminals: L+, M, GND	3 screw-type terminals: L+, M, GND
Dimensions			
Width	40 mm	40 mm	40 mm
Height	125 mm	125 mm	125 mm
Depth	120 mm	120 mm	120 mm
Weights			
Weight, approx.	300 g	300 g	300 g

SIMATIC S7-300 Advanced Controllers

I/O modules

Communication

Loadable drivers for CP 441-2 and CP 341**Overview**

- Drivers for Modbus protocol with RTU message format; communication as master or slave
- Downloadable onto CP 341 and CP 441-2 (6ES7 441-2AA05-0AE0)

Ordering data**Article No.****Article No.****Modbus Master V3.1**

Task:
Communication via Modbus protocol with RTU format, SIMATIC S7 as master

Requirement:
CP 341 or CP 441-2;
STEP 7 V4.02 and higher

Type of delivery:
Driver program/documentation, English, German, French

Single license

6ES7870-1AA01-0YA0

Single license, without software or documentation

6ES7870-1AA01-0YA1**Modbus Slave V3.1**

Task:
Communication via Modbus protocol with RTU format, SIMATIC S7 as slave

Requirement:
CP 341 or CP 441-2;
STEP 7 V4.02 and higher

Type of delivery:
Driver program/documentation, English, German, French

Single license

6ES7870-1AB01-0YA0

Single license, without software or documentation

6ES7870-1AB01-0YA1**SIMATIC Manual Collection**

Electronic manuals on DVD, multi-language:
LOGO!, SIMADYN,
SIMATIC bus components,
SIMATIC C7, SIMATIC distributed I/O,
SIMATIC HMI, SIMATIC Sensors,
SIMATIC NET, SIMATIC PC-based
Automation, SIMATIC PCS 7,
SIMATIC PG/PC, SIMATIC S7,
SIMATIC Software, SIMATIC TDC

6ES7998-8XC01-8YE0**SIMATIC Manual Collection update service for 1 year**

Current Manual Collection DVD and the three subsequent updates

6ES7998-8XC01-8YE2

Technical specifications

Parameterization software	Loadable drivers for CP 441-2 and CP 341
Type of license	Simple license, copy license
Target system	SIMATIC CP 341, SIMATIC CP 441-2
Technical specifications	Modbus Master
Adjustable parameters	<ul style="list-style-type: none"> • Modbus protocol with RTU format • Master/slave coupling: SIMATIC S7 is master • Function codes implemented: 01, 02, 03, 04, 05, 06, 07, 08, 11, 12, 15, 16 • No V.24 control and signal lines • CRC polynomial: $x^{16} + x^{15} + x^2 + 1$ • Interfaces: TTY (20 mA); V.24 (RS 232 C); X.27 (RS 422/485) 2-wire or 4-wire • Receive mailbox specified on BRCV • Character delay time 3.5 characters or multiple thereof • Broadcast message possible • Transmission rate 300 bit/s up to 76800 bit/s (TTY up to 19200 bit/s) • Character frame • With/without RS 485 operation for 2-wire connections • With/without modem operation (ignore smudge characters) • Response monitoring time 100 ms to 25.5 s in steps of 100 ms • Factor for the character delay time 1-10 • Default setting of receive line when using the X.27 interface module

Adjustable parameters

Modbus slave
<ul style="list-style-type: none"> • Modbus protocol with RTU format • Master/slave coupling: SIMATIC S7 is slave • Function codes implemented: 01, 02, 03, 04, 05, 06, 08, 15, 16 • No V.24 control and signal line • CRC polynomial: $x^{16} + x^{15} + x^2 + 1$ • Interfaces: TTY (20 mA), V.24 (RS 232C), X.27 (RS 422/485) 2-wire or 4-wire • Communications FB 180, instance DB 180 (use of a multi-instance) • Conversion of the Modbus data address to S7 data areas. Data areas which can be processed: DB, bit memories, outputs, inputs, timers, counters • Character delay time 3.5 characters or multiple thereof • Transmission rate 300 bit/s up to 76800 bit/s (TTY up to 19200 bit/s) • Character frame • Slave address of CP (1 to 255) • With/without RS 485 operation for 2-wire connection • With/without modem operation (ignore smudge characters) • Factor for the character delay time 1-10 • Number of work DB (for FB processing) • Enabling of memory areas for writing by the master • Default setting of receive line when using the X.27 interface module • Conversion of Modbus addresses to S7 data areas

SIMATIC S7-300 Advanced Controllers

I/O modules

Communication

CP 343-2P/CP 343-2

Overview



CP 343-2P/CP 343-2

More information

Manuals,
see <https://support.industry.siemens.com/cs/ww/en/ps/15754/man>

For diagnostics during ongoing operation, diagnostics blocks with clearly arranged visualization on the SIMATIC HMI panel are available or can be downloaded free of charge via a web browser, see <https://support.industry.siemens.com/cs/ww/en/view/61892138>.

AS-Interface block library for SIMATIC PCS 7 for easy connection of AS-Interface to PCS 7, see <https://mall.industry.siemens.com/mall/en/WWW/Catalog/Products/10046725?tree=CatalogTree>

AS-Interface I/O modules and other AS-Interface system components see Catalog IC 10 <https://www.siemens.com/ic10>

More information see <https://www.siemens.com/as-interface>

The CP 343-2P communications processor is the AS-Interface master for the SIMATIC S7-300 and the ET 200M distributed I/O station, with user-friendly parameterizing options.

The CP 343-2 is the basic version of the module.

The CP 343-2P/CP 343-2 has the following characteristics:

- Connection of up to 62 AS-Interface slaves
- Integrated analog value transmission
- Supports all AS-Interface master functions according to the AS-Interface specification V3.0
- Status displays of operating states and indication of the readiness for operation of connected slaves by means of LEDs in the front panel
- Fault indications (including AS-Interface voltage errors, configuration errors) by means of LEDs on the front plate.
- Compact enclosure in the design of the SIMATIC S7-300
- Suitable for AS-Interface with 30 V voltage and AS-i Power24V
- Additionally for CP 343-2P: Supports the configuration of the AS-Interface network with STEP 7

Design

The CP 343-2P/CP 343-2 is connected like an I/O module to the S7-300. It has:

- Two terminal connections for connecting the AS-Interface cable directly.
- LEDs in the front panel for indicating the operating state and the readiness for operation of all connected and activated slaves
- Pushbuttons for switching over the master operating state and for adopting the existing ACTUAL configuration of the AS-i slave as the TARGET configuration

Function

The CP 343-2P/CP 343-2 support all specified functions of the AS-Interface specification V3.0.

The CP 343-2P/CP 343-2 each occupy 16 bytes in the I/O address area of the SIMATIC S7-300. The digital I/O data of the standard slaves and A slaves is saved in this area. The digital I/O data of the B slaves and the analog I/O data can be accessed with the S7 system functions for read/write data records.

If required, master calls can be performed with the command interface, e.g. read/write parameters, read/write configuration.

For more information, see <https://support.industry.siemens.com/cs/ww/en/view/51678777>.

Notes on security:

In order to protect plants, systems, machines and networks against cyber threats, it is necessary to implement – and continuously maintain – a holistic, state-of-the-art industrial security concept. Siemens products and solutions represent only one component of such a concept.

For more information about the subject of Industrial Security, see <http://www.siemens.com/industrialsecurity>.

Configuration

All connected AS-Interface slaves are configured at the press of a button. No further configuration of the CP is required.

Additionally for CP 343-2P

The CP 343-2P also supports configuring of the AS-Interface network with STEP 7. Specifying the AS-i configuration in HW-Config facilitates the setting of slave parameters and documentation of the plant. Uploading the ACTUAL configuration of an already configured AS-Interface network is also supported. The saved configuration cannot be overwritten at the press of a button and is therefore tamper-proof.

Benefits

- Shorter start-up times through simple configuration at the press of a button
- Design of flexible machine-related structures using the ET 200M distributed I/O system
- Enables diagnostics of the AS-Interface network
- Well suited also for complex applications thanks to connection options for 62 slaves and integral analog value processing
- Reduction of standstill and servicing times in the event of a fault thanks to the LED indicators:
 - Status of the AS-Interface network
 - Slaves connected and their readiness for operation
 - Monitoring of the AS-Interface voltage
- Lower costs for stock keeping and spare parts inventory because the CP can be used for the SIMATIC S7-300 and also for the ET 200M
- Additionally for CP 343-2P: Improved plant documentation and support for service assignments thanks to a description of the AS-Interface configuration in the STEP 7 project
- Simple operation with AS-Interface power supply unit (see <https://mall.industry.siemens.com/mall/en/WW/Catalog/Products/8200165?tree=CatalogTree>) possible without restrictions
- Alternatively: No need for the AS-i power supply unit with AS-i Power24V. The AS-Interface cable is powered through an existing 24 V DC PELV power supply unit. An S22.5 AS-i data decoupling module (e.g. 3RK1901-1DE12-1AA0) is required for the decoupling, see <https://mall.industry.siemens.com/mall/en/WW/Catalog/Products/10057533?tree=CatalogTree>.

Application

The CP 343-2P/CP 343-2 is the AS-Interface master connection for the SIMATIC S7-300 and the ET 200M.

Through connection to AS-Interface it is possible to access max. 248 DI/248 DQ per CP, using 62 A/B slaves with 4 DI/4 DQ each.

With the integrated analog value processing, it is easy to transmit analog signals. Up to 62 analog slaves with an A/B address (each with up to two channels) or up to 31 analog slaves with a standard address (each with up to four channels) are possible per CP.

The CP 343-2P is the further development of the CP 343-2 and contains its entire functionality. An existing STEP 7 user program for a CP 343-2 can thus be used without restrictions with a CP 343-2P. It is only in STEP 7 HW-Config that the two modules are configured differently, with the CP 343-2P offering additional options. This is why the CP 343-2P is recommended.

Ordering data**Article No.****CP 343-2P****communications processor**

- Device version with expanded configuration options for connection of SIMATIC S7-300 and ET 200M to AS-Interface
- Configuration of the AS-i network using the SET key or STEP 7
- Without front connector
- Corresponds to AS-Interface specification V3.0
- Dimensions (W x H x D) mm: 40 x 125 x 120

6GK7343-2AH11-0XA0**CP 343-2****communications processor**

- Basic version for connection of SIMATIC S7-300 and ET 200M to AS-Interface
- Configuration of the AS-i network using the SET key
- Without front connector
- Corresponds to AS-Interface specification V3.0
- Dimensions (W x H x D) mm: 40 x 125 x 120

6GK7343-2AH01-0XA0**Accessories****Front connector, 20-pin**

- With screw terminals
- With spring-loaded terminals

6ES7392-1AJ00-0AA0**6ES7392-1BJ00-0AA0****AS-Interface addressing unit V3.0**

- For AS-Interface modules and sensors and actuators with integrated AS-Interface according to AS-i specification V3.0
- For setting the AS-i address of standard slaves, and slaves with extended addressing mode (A/B slaves)
- With input/output test function and many other commissioning functions
- Battery operation with four type AA batteries (IEC LR6, NEDA 15)
- Degree of protection IP40
- Dimensions (W x H x D) mm: 84 x 195 x 35
- Scope of supply:
 - Addressing unit with four batteries
 - Addressing cable, with M12 plug to addressing plug (hollow plug), length 1.5 m

3RK1904-2AB02

SIMATIC S7-300 Advanced Controllers

I/O modules

Communication

CP 342-5

Overview



DP-M	DP-S	FMS	PG/OP	S7/S5	
●	●		●	●	

- PROFIBUS DP master or slave with electrical interface for connecting the SIMATIC S7-300 to PROFIBUS at up to 12 Mbps (including 45.45 Kbps)
- Communication services:
 - PROFIBUS DP
 - PG/OP communication (OP multiplexing)
 - S7 communication (client, server)
 - Open communication (SEND/RECEIVE)
- Easy configuration and programming over PROFIBUS
- Cross-network PG communication using S7 routing
- Modules can be replaced without the need for a PG

Ordering data

Article No.

CP 342-5 communications processor

6GK7342-5DA03-0XE0

Communications processor for electrical connection of SIMATIC S7-300 to PROFIBUS at up to 12 Mbps, with electronic manual on CD-ROM

Accessories

PROFIBUS FastConnect RS485 connection plug

With 90° cable outlet; insulation displacement technology, max. transmission rate 12 Mbps

- Without programming device interface **6ES7972-0BA52-0XA0**
- With programming device interface **6ES7972-0BB52-0XA0**

PROFIBUS bus connector IP20

With connection to PPI, MPI, PROFIBUS

- Without programming device interface **6ES7972-0BA12-0XA0**
- With programming device interface **6ES7972-0BB12-0XA0**

PROFIBUS FC standard cable

2-core bus cable, shielded, special design for fast mounting, delivery unit: max. 1 000 m, minimum order quantity 20 m, sold by the meter

6XV1830-0EH10

PROFIBUS bus terminal 12M

Bus terminal for connection of PROFIBUS nodes up to 12 Mbps with connecting cable

6GK1500-0AA10

SIMATIC S7-300 DM 370

Dummy module; used for module replacement

6ES7370-0AA01-0AA0

Technical specifications

Article number	6GK7342-5DA03-0XE0
product type designation	CP 342-5
transfer rate	
transfer rate	
• at the 1st interface acc. to PROFIBUS	9.6 kbit/s ... 12 Mbit/s
interfaces	
number of interfaces acc. to Industrial Ethernet	0
number of electrical connections	
• at the 1st interface acc. to PROFIBUS	1
• for power supply	1
type of electrical connection	
• at the 1st interface acc. to PROFIBUS	9-pin Sub-D socket (RS485)
• for power supply	4-pole terminal block

Article number	6GK7342-5DA03-0XE0
product type designation	CP 342-5
supply voltage, current consumption, power loss	
type of voltage of the supply voltage	DC
supply voltage 1 from backplane bus	5 V
supply voltage external	24 V
supply voltage external at DC rated value	24 V
relative positive tolerance at DC at 24 V	20 %
relative negative tolerance at DC at 24 V	15 %
consumed current	
• from backplane bus at DC at 5 V typical	0.15 A
• from external supply voltage at DC at 24 V typical	0.25 A
power loss [W]	6.75 W

Technical specifications

Article number	6GK7342-5DA03-0XE0
product type designation	CP 342-5
ambient conditions	
ambient temperature	
• during operation	0 ... 60 °C
• during storage	-40 ... +70 °C
• during transport	-40 ... +70 °C
relative humidity	
• at 25 °C without condensation during operation maximum	95 %
protection class IP	IP20
design, dimensions and weights	
module format	Compact module S7-300 single width
width	40 mm
height	125 mm
depth	120 mm
net weight	0.3 kg
product features, product functions, product components general	
number of units	
• per CPU maximum	4
performance data open communication	
number of possible connections for open communication by means of SEND/RECEIVE blocks maximum	16
data volume	
• as user data per connection for open communication by means of SEND/RECEIVE blocks maximum	240 byte

Article number	6GK7342-5DA03-0XE0
product type designation	CP 342-5
performance data PROFIBUS DP	
service as DP master	
• DPV0	Yes
number of DP slaves	
• on DP master operable	124
data volume	
• of the address range of the inputs as DP master total	2 160 byte
• of the address range of the outputs as DP master total	2 160 byte
• of the address range of the inputs per DP slave	244 byte
• of the address range of the outputs per DP slave	244 byte
• of the address range of the diagnostic data per DP slave	240 byte
service as DP slave	
• DPV0	Yes
data volume	
• of the address range of the inputs as DP slave total	240 byte
• of the address range of the outputs as DP slave total	240 byte
performance data S7 communication	
number of possible connections for S7 communication	
• maximum	16
performance data multi-protocol mode	
number of active connections with multi-protocol mode	
• without DP maximum	32
• with DP maximum	28
performance data telecontrol	
protocol is supported	
• TCP/IP	No
product functions management, configuration, engineering	
configuration software	
• required	STEP 7 V5.1 SP2 or higher / STEP 7 Professional V12 (TIA Portal) or higher
standards, specifications, approvals hazardous environments	
certificate of suitability CCC for hazardous zone according to GB standard	Yes

SIMATIC S7-300 Advanced Controllers

I/O modules

Communication

CP 343-5**Overview**

DP-M	DP-S	FMS	PG/OP	S7/S5	
		●	●	●	

Connection of SIMATIC S7-300 to PROFIBUS at up to 12 Mbps (including 45.45 Kbps)

- Communication services:
 - PG/OP communication
 - S7 communication
 - Open communication (SEND/RECEIVE)
 - PROFIBUS FMS
- Easy configuration and programming over PROFIBUS
- Can be easily integrated into the S7-300 system
- Cross-network PG communication using S7 routing
- Modules can be replaced without the need for a PG

Ordering data**Article No.**
CP 343-5 communications processor **6GK7343-5FA01-0XE0**

Communications processor for connection of S7-300 to PROFIBUS, FMS, open communication, PG/OP and S7 communication; with electronic manual on CD-ROM

Accessories**STEP 7 Version 5.7**

Target system:
SIMATIC S7-300/-400, SIMATIC C7

Requirements:
Windows 10 Professional/
Enterprise, Windows Server 2016,
Windows Server 2019

Type of delivery:
English, German, French, Spanish,
Italian; including license key on
USB flash drive,
with electronic documentation

Floating license on DVD

6ES7810-4CC12-0YA5

Floating license, download¹⁾;
software, license key and
documentation as download;
consignee email address required
for delivery

6ES7810-4CE12-0YB5

Rental license for 50 hours;
software and documentation on
DVD, license key on USB flash

6ES7810-4CC12-0YA6

Rental license for 50 hours,
download¹⁾; software, license key
and documentation as download;
consignee email address required
for delivery

6ES7810-4CE12-0YB6

Upgrade floating license
V5.3...5.6 to V5.7; on DVD

6ES7810-4CC12-0YE5

Upgrade floating license
V5.3...V5.6 to V5.7, download¹⁾;
software, license key and
documentation as download;
consignee email address required
for delivery

6ES7810-4CE12-0YE5

Trial license STEP 7 V5.7;
on DVD, runs for 21 days

6ES7810-4CC12-0YA7**PROFIBUS FastConnect RS485 bus connection plug**

With 90° cable outlet; insulation
displacement technology, max.
transfer rate 12 Mbit/s (1 unit)

- Without PG interface
- With PG interface

6ES7972-0BA52-0XA0**6ES7972-0BB52-0XA0****PROFIBUS bus connector IP20**

With connection to PPI, MPI,
PROFIBUS

- Without PG interface
- With PG interface

6ES7972-0BA12-0XA0**6ES7972-0BB12-0XA0****PROFIBUS bus terminal 12M****6GK1500-0AA10**

Bus terminal for connection of
PROFIBUS nodes at up to 12 Mbit/s
with connecting cable

SIMATIC S7-300 DM 370**6ES7370-0AA01-0AA0**

Dummy module; used for module
replacement

¹⁾ For up-to-date information and download availability, see:
<http://www.siemens.com/tia-online-software-delivery>

Technical specifications

Article number	6GK7343-5FA01-0XE0
product type designation	CP 343-5
transfer rate	
transfer rate	
• at the 1st interface acc. to PROFIBUS	9.6 kbit/s ... 12 Mbit/s
interfaces	
number of interfaces acc. to Industrial Ethernet	0
number of electrical connections	
• at the 1st interface acc. to PROFIBUS	1
• for power supply	1
type of electrical connection	
• at the 1st interface acc. to PROFIBUS	9-pin Sub-D socket (RS485)
• for power supply	4-pole terminal block
supply voltage, current consumption, power loss	
type of voltage of the supply voltage	DC
supply voltage 1 from backplane bus	5 V
supply voltage	24 V
supply voltage external	24 V
supply voltage external at DC rated value	24 V
relative positive tolerance at DC at 24 V	20 %
relative negative tolerance at DC at 24 V	15 %
consumed current	
• from backplane bus at DC at 5 V typical	0.15 A
• from external supply voltage at DC at 24 V typical	0.25 A
power loss [W]	5 W
ambient conditions	
ambient temperature	
• during operation	0 ... 60 °C
• during storage	-40 ... +70 °C
• during transport	-40 ... +70 °C
relative humidity	
• at 25 °C without condensation during operation maximum	95 %
protection class IP	IP20

Article number	6GK7343-5FA01-0XE0
product type designation	CP 343-5
design, dimensions and weights	
module format	Compact module S7-300 single width
width	40 mm
height	125 mm
depth	120 mm
net weight	0.3 kg
fastening method	
• S7-300 rail mounting	Yes
product features, product functions, product components general	
number of units	
• per CPU maximum	4
performance data open communication	
number of possible connections for open communication by means of SEND/RECEIVE blocks maximum data volume	16
• as user data per connection for open communication by means of SEND/RECEIVE blocks maximum	240 byte
performance data FMS functions	
number of possible connections for FMS connection maximum	16
data volume of the variables	
• for READ job maximum	237 byte
• for WRITE and REPORT job maximum	233 byte
number of variables	
• configurable from server to FMS partner	256
• loadable from server to FMS partner	256
performance data S7 communication	
number of possible connections for S7 communication	
• maximum	16
performance data multi-protocol mode	
number of active connections with multi-protocol mode	48
performance data telecontrol	
protocol is supported	
• TCP/IP	No
product functions management, configuration, engineering	
configuration software	
• required	STEP 7 V5.1 SP3 or higher and NCM S7 for PROFIBUS
standards, specifications, approvals hazardous environments	
certificate of suitability CCC for hazardous zone according to GB standard	Yes

SIMATIC S7-300 Advanced Controllers

I/O modules

Communication

CP 343-1 Lean**Overview**

ISO	TCP/UDP	PN	MRP	IT	IP-R	PG/OP	S7/S5
	●	●	●			●	●

Communications processor for connecting a SIMATIC S7-300 to Industrial Ethernet networks, also as PROFINET IO Device.

The CP supports:

- PG/OP communication
- S7 communication
- Open communication (SEND/RECEIVE)
- PROFINET communication

Ordering data**Article No.****CP 343-1 Lean communications processor****6GK7343-1CX10-0XE0**

For connecting SIMATIC S7-300 to Industrial Ethernet through TCP/IP and UDP, Multicast, S7 communication, open communication (SEND/RECEIVE), FETCH/WRITE, PROFINET IO Device, MRP, integrated 2-port switch ERTEC, comprehensive diagnostics facilities, module replacement without PG, SNMP, initial commissioning over LAN; with electronic manual on CD-ROM

Accessories**IE FC RJ45 Plug 145**

RJ45 plug connector 2 x 2 for Industrial Ethernet with a rugged metal enclosure and integrated insulation displacement contacts for connecting Industrial Ethernet FC installation cables; with 145° cable outlet

- 1 pack = 1 unit
- 1 pack = 10 units
- 1 pack = 50 units

6GK1901-1BB30-0AA0
6GK1901-1BB30-0AB0
6GK1901-1BB30-0AE0

IE FC TP Standard Cable GP 2 x 2 (Type A)**6XV1840-2AH10**

4-core, shielded TP installation cable for connection to IE FC Outlet RJ45/IE FC RJ45 Plug; PROFINET-compatible; with UL approval; sold by the meter; max. length 1000 m, minimum order quantity 20 m

IE FC Stripping Tool**6GK1901-1GA00**

Preadjusted stripping tool for fast stripping of the Industrial Ethernet FC cables

Compact Switch Module CSM 377**6GK7377-1AA00-0AA0**

Unmanaged switch for connection of a SIMATIC S7-300 CPU, ET 200M, and up to three further nodes to Industrial Ethernet operating at 10/100 Mbit/s; 4 x RJ45 ports; external 24 V DC power supply, LED diagnostics, S7-300 module including electronic manual on CD-ROM

Technical specifications

Article number	6GK7343-1CX10-0XE0
product type designation	CP 343-1 Lean
transfer rate	
transfer rate	
• at the 1st interface	10 ... 100 Mbit/s
interfaces	
number of interfaces acc. to Industrial Ethernet	2
number of electrical connections	
• at the 1st interface acc. to Industrial Ethernet	2
• for power supply	1
type of electrical connection	
• of Industrial Ethernet interface	RJ45 port
• at the 1st interface acc. to Industrial Ethernet	RJ45 port
type of electrical connection	
• for power supply	2-pole plugable terminal block
supply voltage, current consumption, power loss	
type of voltage of the supply voltage	DC
supply voltage 1 from backplane bus	5 V
supply voltage	24 V
supply voltage external	24 V
supply voltage external at DC rated value	24 V
relative positive tolerance at DC at 24 V	20 %
relative negative tolerance at DC at 24 V	15 %
consumed current	
• from backplane bus at DC at 5 V typical	0.2 A
• from external supply voltage at DC at 24 V typical	0.16 A
• from external supply voltage at DC at 24 V maximum	0.2 A
power loss [W]	5.8 W
ambient conditions	
ambient temperature	
• for vertical installation during operation	0 ... 40 °C
• for horizontally arranged busbars during operation	0 ... 60 °C
• during storage	-40 ... +70 °C
• during transport	-40 ... +70 °C
relative humidity	
• at 25 °C without condensation during operation maximum	95 %
protection class IP	IP20

Article number	6GK7343-1CX10-0XE0
product type designation	CP 343-1 Lean
design, dimensions and weights	
module format	Compact module S7-300 single width
width	40 mm
height	125 mm
depth	120 mm
net weight	0.22 kg
fastening method	
• S7-300 rail mounting	Yes
performance data open communication	
number of possible connections for open communication by means of SEND/RECEIVE blocks maximum	8
data volume	
• as user data per ISO on TCP connection for open communication by means of SEND/RECEIVE blocks maximum	8 Kibyte
• as user data per TCP connection for open communication by means of SEND/RECEIVE blocks maximum	8 Kibyte
• as user data per UDP connection for open IE communication by means of SEND/RECEIVE blocks maximum	2 Kibyte
number of Multicast stations	8
performance data S7 communication	
number of possible connections for S7 communication	
• maximum	4
service	
• of SIMATIC communication as server	Yes
performance data multi-protocol mode	
number of active connections with multi-protocol mode	12
performance data PROFINET communication as PN IO controller	
product function PROFINET IO controller	No

SIMATIC S7-300 Advanced Controllers

I/O modules

Communication

CP 343-1 Lean

Technical specifications

Article number	6GK7343-1CX10-0XE0
product type designation	CP 343-1 Lean
performance data PROFINET communication as PN IO device	
product function PROFINET IO device	Yes
data volume	
• as user data for input variables as PROFINET IO device maximum	512 byte
• as user data for output variables as PROFINET IO device maximum	512 byte
• as user data for input variables for each sub-module as PROFINET IO device	240 byte
• as user data for output variables for each sub-module as PROFINET IO device	240 byte
• as user data for the consistency area for each sub-module	240 byte
number of submodules per PROFINET IO-Device	32
performance data telecontrol	
protocol is supported	
• TCP/IP	Yes
product functions management, configuration, engineering	
product function MIB support	Yes
protocol is supported	
• SNMP v1	Yes
• DCP	Yes
• LLDP	Yes
configuration software	
• required	STEP 7 V5.4 or higher / STEP 7 Professional V11 (TIA Portal) or higher
identification & maintenance function	
• I&MO - device-specific information	Yes
• I&M1 – higher level designation/location designation	Yes

Article number	6GK7343-1CX10-0XE0
product type designation	CP 343-1 Lean
product functions diagnostics	
product function web-based diagnostics	Yes
product functions switch	
product feature switch	Yes
product function	
• switch-managed	No
• with IRT PROFINET IO switch	No
• configuration with STEP 7	Yes
product functions redundancy	
product function	
• ring redundancy	Yes
• redundancy manager	No
protocol is supported Media Redundancy Protocol (MRP)	Yes
product functions security	
product function	
• password protection for Web applications	No
• ACL - IP-based	Yes
• ACL - IP-based for PLC/routing	No
• switch-off of non-required services	Yes
• blocking of communication via physical ports	Yes
• log file for unauthorized access	No
product functions time	
product function SICLOCK support	Yes
product function pass on time synchronization	Yes
protocol is supported	
• NTP	Yes
standards, specifications, approvals hazardous environments	
certificate of suitability CCC for hazardous zone according to GB standard	Yes

5

Overview



ISO	TCP/UDP	PN	MRP	IT	IP-R	PG/OP	S7/S5
●	●	●	●			●	●

Communications processor for connecting a SIMATIC S7-300/SINUMERIK 840D powerline to Industrial Ethernet networks, also as PROFINET IO Controller or IO Device.

The CP supports:

- PG/OP communication
- S7 communication
- Open communication (SEND/RECEIVE)
- PROFINET communication

5

Ordering data

CP 343-1 communications processor

For connection of SIMATIC S7-300 to Industrial Ethernet over ISO and TCP/IP; PROFINET IO Controller or PROFINET IO Device, MRP, integrated 2-port switch ERTEC; S7 communication, open communication (SEND/RECEIVE), FETCH/WRITE, with and without RFC 1006, multicast, DHCP, CPU clock synchronization via SIMATIC procedure and NTP, diagnostics, SNMP, access protection through IP access list, initialization over LAN 10/100 Mbps; with electronic manual on DVD

Accessories**IE FC RJ45 plug 180 2 x 2**

RJ45 plug-in connector for Industrial Ethernet with a rugged metal enclosure and integrated insulation displacement contacts for connecting Industrial Ethernet FC installation cables; with 180° cable outlet; for network components and CPs/CPUs with Industrial Ethernet interface

- 1 pack = 1 unit
- 1 pack = 10 units
- 1 pack = 50 units

IE FC RJ45 plug 145

RJ45 plug connector 2 x 2 for Industrial Ethernet with a rugged metal enclosure and integrated insulation displacement contacts for connecting Industrial Ethernet FC installation cables; with 145° cable outlet

- 1 pack = 1 unit
- 1 pack = 10 units
- 1 pack = 50 units

Article No.

6GK7343-1EX30-0XE0

Article No.

IE FC TP standard cable GP 2 x 2 (type A)

4-wire, shielded TP installation cable for connection to IE FC RJ45 outlet/IE FC RJ45 plug; PROFINET-compatible; with UL approval; sold by the meter; max. delivery unit 1 000 m, minimum order quantity 20 m

IE FC stripping tool

Pre-adjusted stripping tool for fast stripping of Industrial Ethernet FC cables

Compact Switch Module CSM 377

Unmanaged switch for connection of a SIMATIC S7-300 CPU, ET 200M, and up to three further nodes to Industrial Ethernet operating at 10/100 Mbps; 4 x RJ45 ports; external 24 V DC power supply, LED diagnostics, S7-300 module including electronic Equipment Manual on CD-ROM

SCALANCE XC206-2SFP Industrial Ethernet switch

Manageable Layer 2 IE switch; IEC 62443-4-2 certified; 6x 10/100 Mbps RJ45 ports; 2x 100/1 000 Mbps SFP; 1x console port

6GK1901-1BB10-2AA0
6GK1901-1BB10-2AB0
6GK1901-1BB10-2AE0

6GK1901-1BB30-0AA0
6GK1901-1BB30-0AB0
6GK1901-1BB30-0AE0

6XV1840-2AH10

6GK1901-1GA00

6GK7377-1AA00-0AA0

6GK5206-2BS00-2AC2

SIMATIC S7-300 Advanced Controllers

I/O modules

Communication

CP 343-1

Technical specifications

Article number	6GK7343-1EX30-0XE0
product type designation	CP 343-1
transfer rate	
transfer rate	
• at the 1st interface	10 ... 100 Mbit/s
interfaces	
number of interfaces acc. to Industrial Ethernet	2
number of electrical connections	
• at the 1st interface acc. to Industrial Ethernet	2
• for power supply	1
type of electrical connection	
• of Industrial Ethernet interface	RJ45 port
• at the 1st interface acc. to Industrial Ethernet	RJ45 port
type of electrical connection	
• for power supply	2-pole pluggable terminal block
supply voltage, current consumption, power loss	
type of voltage of the supply voltage	DC
supply voltage 1 from backplane bus	5 V
supply voltage	24 V
supply voltage external	24 V
supply voltage external at DC rated value	24 V
relative positive tolerance at DC at 24 V	20 %
relative negative tolerance at DC at 24 V	15 %
consumed current	
• from backplane bus at DC at 5 V typical	0.2 A
• from external supply voltage at DC at 24 V typical	0.16 A
• from external supply voltage at DC at 24 V maximum	0.2 A
power loss [W]	5.8 W
ambient conditions	
ambient temperature	
• for vertical installation during operation	0 ... 40 °C
• for horizontally arranged busbars during operation	0 ... 60 °C
• during storage	-40 ... +70 °C
• during transport	-40 ... +70 °C
relative humidity	
• at 25 °C without condensation during operation maximum	95 %
protection class IP	IP20

Article number	6GK7343-1EX30-0XE0
product type designation	CP 343-1
design, dimensions and weights	
module format	Compact module S7-300 single width
width	40 mm
height	125 mm
depth	120 mm
net weight	0.22 kg
fastening method	
• S7-300 rail mounting	Yes
performance data open communication	
number of possible connections for open communication by means of SEND/RECEIVE blocks maximum data volume	16
• as user data per ISO connection for open communication by means of SEND/RECEIVE blocks maximum	8 Kibyte
• as user data per ISO on TCP connection for open communication by means of SEND/RECEIVE blocks maximum	8 Kibyte
• as user data per TCP connection for open communication by means of SEND/RECEIVE blocks maximum	8 Kibyte
• as user data per UDP connection for open IE communication by means of SEND/RECEIVE blocks maximum	2 Kibyte
number of Multicast stations	16
performance data S7 communication	
number of possible connections for S7 communication	
• maximum	16
performance data multi-protocol mode	
number of active connections with multi-protocol mode	32
performance data PROFINET communication as PN IO controller	
number of PN IO devices on PROFINET IO controller operable total	32
number of external PN IO lines with PROFINET per rack	1
data volume	
• as user data for input variables as PROFINET IO controller maximum	1 Kibyte
• as user data for output variables as PROFINET IO controller maximum	1 Kibyte
• as user data for input variables per PN IO device as PROFINET IO controller maximum	1 433 byte
• as user data for output variables per PN IO device as PROFINET IO controller maximum	1 433 byte
• as user data for input variables per PN IO device for each sub-module as PROFINET IO controller maximum	240 byte
• as user data for output variables per PN IO device for each sub-module as PROFINET IO controller maximum	240 byte

5

Technical specifications

Article number	6GK7343-1EX30-0XE0
product type designation	CP 343-1
performance data PROFINET communication as PN IO device	
product function PROFINET IO device	Yes
data volume	
• as user data for input variables as PROFINET IO device maximum	512 byte
• as user data for output variables as PROFINET IO device maximum	512 byte
• as user data for input variables for each sub-module as PROFINET IO device	240 byte
• as user data for output variables for each sub-module as PROFINET IO device	240 byte
• as user data for the consistency area for each sub-module	240 byte
number of submodules per PROFINET IO-Device	32
performance data telecontrol	
protocol is supported	
• TCP/IP	Yes
product functions management, configuration, engineering	
product function MIB support	Yes
protocol is supported	
• SNMP v1	Yes
• DCP	Yes
• LLDP	Yes
configuration software	
• required	STEP 7 V5.4 SP2 or higher / STEP 7 Professional V11 (TIA Portal) or higher
identification & maintenance function	
• I&MO - device-specific information	Yes
• I&M1 – higher level designation/location designation	Yes

Article number	6GK7343-1EX30-0XE0
product type designation	CP 343-1
product functions diagnostics	
product function web-based diagnostics	Yes
product functions switch	
product feature switch	Yes
product function	
• switch-managed	No
• with IRT PROFINET IO switch	Yes
• configuration with STEP 7	Yes
product functions redundancy	
product function	
• ring redundancy	Yes
• redundancy manager	No
protocol is supported Media Redundancy Protocol (MRP)	Yes
product functions security	
product function	
• password protection for Web applications	No
• ACL - IP-based	Yes
• ACL - IP-based for PLC/routing	No
• switch-off of non-required services	Yes
• blocking of communication via physical ports	Yes
• log file for unauthorized access	No
product functions time	
product function SICLOCK support	Yes
product function pass on time synchronization	Yes
protocol is supported	
• NTP	Yes
standards, specifications, approvals hazardous environments	
certificate of suitability CCC for hazardous zone according to GB standard	Yes

SIMATIC S7-300 Advanced Controllers

I/O modules

Communication

CP 343-1 Advanced

Overview



In addition, the CP 343-1 Advanced provides email functions and allows users to create their own Web pages - ideal support for maintenance and quality assurance. The Internet functions such as FTP even allow connection to the most diverse PC-based systems. This CP is therefore the bridge between the field level and the management level for the S7-300. The CP 343-1 Advanced connects seamlessly to the security structures of the office and IT world.

Note:

Critical restrictions to cyber security for CP 343-1 Advanced (6GK7343-1GX31-0XE0)

Parts of the CP firmware originate from third-party vendors who have discontinued maintenance for the supplied software components. Therefore, these components are no longer monitored for newly disclosed critical security vulnerabilities. For CPs purchased after June 2021, this means:

- Siemens can no longer ensure that the firmware does not contain any security-critical vulnerabilities.
- Siemens no longer publishes newly discovered security vulnerabilities as security advisories and no longer eliminates such vulnerabilities. This does not affect the functionality of the CP. It merely means that there is no longer any guarantee that the CP-secured networks are protected without restrictions. Siemens recommends the following measures:
 - Implement a state-of-the-art security concept for the entire plant. You can find more information here: <https://www.siemens.com/industrialsecurity>
 - Additionally secure the Internet access implemented via the CP using further security components, such as a SCALANCE S. In this case, the plant is adequately protected, even if there is a security-critical vulnerability in the CP.

ISO	TCP/UDP	PN	MRP	IT	IP-R	PG/OP	S7/S5
●	●	●	●	●	●	●	●

Communications processor for connecting the SIMATIC S7-300/SINUMERIK 840D powerline to Industrial Ethernet networks, also as PROFINET IO controller and IO device.

The CP supports:

- PG/OP communication
- S7 communication
- Open communication (SEND/RECEIVE)
- PROFINET communication
- IT communication
- Security functionality, firewall and VPN

Ordering data

Article No.

CP 343-1 Advanced communications processor

For connecting the SIMATIC S7-300 CPU to Industrial Ethernet;
1 x 10/100/1 000 Mbps;
2 x 10/100 Mbps (IE SWITCH);
RJ 45 ports; TCP; UDP; ISO;
PROFINET IO controller and device,
S7 communication (client + server);
open communication (SEND/RECEIVE); S7 routing;
IP configuration via DHCP/block;
extended web diagnostics;
time synchronization; IP Access Control List; IP routing; FTP; email;
PROFINET CBA; C-Plug

- With Security (Firewall + VPN) and PROFinergy (Controller + Device)

6GK7343-1GX31-0XE0

Accessories

IE FC RJ45 plug 180 2 x 2

RJ45 plug-in connector for Industrial Ethernet with a rugged metal enclosure and integrated insulation displacement contacts for connecting Industrial Ethernet FC installation cables; with 180° cable outlet; for network components and CPs/CPUs with Industrial Ethernet interface

- 1 pack = 1 unit
- 1 pack = 10 units
- 1 pack = 50 units

6GK1901-1BB10-2AA0
6GK1901-1BB10-2AB0
6GK1901-1BB10-2AE0

IE FC RJ45 plug 145

RJ45 plug connector 2 x 2 for Industrial Ethernet with a rugged metal enclosure and integrated insulation displacement contacts for connecting Industrial Ethernet FC installation cables; with 145° cable outlet

- 1 pack = 1 unit
- 1 pack = 10 units
- 1 pack = 50 units

6GK1901-1BB30-0AA0
6GK1901-1BB30-0AB0
6GK1901-1BB30-0AE0

IE FC RJ45 plug 4 x 2

RJ45 plug-in connector for Industrial Ethernet (10/100/1 000 Mbps) with a rugged metal enclosure and integrated insulation displacement contacts for connecting Industrial Ethernet FC installation cables; 180° cable outlet; for network components and CPs/CPUs with Industrial Ethernet interface

- 1 pack = 1 unit
- 1 pack = 10 units
- 1 pack = 50 units

6GK1901-1BB11-2AA0
6GK1901-1BB11-2AB0
6GK1901-1BB11-2AE0

IE FC TP standard cable GP 2 x 2 (type A)

4-wire, shielded TP installation cable for connection to IE FC RJ45 outlet/IE FC RJ45 plug; PROFINET-compatible; with UL approval; sold by the meter; max. delivery unit 1 000 m, minimum order quantity 20 m

6XV1840-2AH10

Ordering data	Article No.	Article No.
IE FC TP standard cable GP 4 x 2 8-wire, shielded TP installation cable for connection to IE FC RJ45 modular outlet for universal applications; with UL approval; sold by the meter; max. delivery unit 1 000 m, minimum order quantity 20 m <ul style="list-style-type: none"> • AWG22, for connection to IE FC RJ45 modular outlet • AWG24, for connection to IE FC RJ45 plug 4 x 2 	6XV1870-2E 6XV1878-2A	Compact Switch Module CSM 377 Unmanaged switch for connection of a SIMATIC S7-300 CPU, ET 200M, and up to three further nodes to Industrial Ethernet operating at 10/100 Mbps; 4 x RJ45 ports; external 24 V DC power supply, LED diagnostics, S7-300 module including electronic Equipment Manual on CD-ROM
IE FC stripping tool Pre-adjusted stripping tool for fast stripping of Industrial Ethernet FC cables	6GK1901-1GA00	SCALANCE XC206-2SFP Industrial Ethernet switch Manageable Layer 2 IE switch; IEC 62443-4-2 certified; 6x 10/100 Mbps RJ45 ports; 2x 100/1 000 Mbps SFP; 1x console port
		6GK7377-1AA00-0AA0 6GK5206-2BS00-2AC2

Technical specifications

Article number	6GK7343-1GX31-0XE0
product type designation	CP 343-1 Advanced
transfer rate	
transfer rate	
• at the 1st interface	10 ... 1 000 Mbit/s
• at the 2nd interface	10 ... 100 Mbit/s
interfaces	
number of interfaces acc. to Industrial Ethernet	3
number of electrical connections	
• at the 1st interface acc. to Industrial Ethernet	1
• at the 2nd interface acc. to Industrial Ethernet	2
• for power supply	1
type of electrical connection	
• at the 1st interface acc. to Industrial Ethernet	RJ45 port
• at the 2nd interface acc. to Industrial Ethernet	RJ45 port
type of electrical connection	
• for power supply	2-pole plugable terminal block
design of the removable storage	
• C-PLUG	Yes
supply voltage, current consumption, power loss	
type of voltage of the supply voltage	DC
supply voltage 1 from backplane bus	5 V
supply voltage external	24 V
supply voltage external at DC rated value	24 V
relative positive tolerance at DC at 24 V	20 %
relative negative tolerance at DC at 24 V	15 %
consumed current	
• from backplane bus at DC at 5 V typical	0.14 A
• from external supply voltage at DC at 24 V typical	0.48 A
• from external supply voltage at DC at 24 V maximum	0.62 A
power loss [W]	14.7 W

Article number	6GK7343-1GX31-0XE0
product type designation	CP 343-1 Advanced
ambient conditions	
ambient temperature	
• for vertical installation during operation	0 ... 40 °C
• for horizontally arranged busbars during operation	0 ... 60 °C
• during storage	-40 ... +70 °C
• during transport	-40 ... +70 °C
relative humidity	
• at 25 °C without condensation during operation maximum	95 %
protection class IP	IP20
design, dimensions and weights	
module format	Compact module
width	80 mm
height	125 mm
depth	120 mm
net weight	0.8 kg
fastening method	
• S7-300 rail mounting	Yes
performance data open communication	
number of possible connections for open communication by means of SEND/RECEIVE blocks maximum	16
data volume	
• as user data per ISO connection for open communication by means of SEND/RECEIVE blocks maximum	8 Kibyte
• as user data per ISO on TCP connection for open communication by means of SEND/RECEIVE blocks maximum	8 Kibyte
• as user data per TCP connection for open communication by means of SEND/RECEIVE blocks maximum	8 Kibyte
• as user data per UDP connection for open IE communication by means of SEND/RECEIVE blocks maximum	2 Kibyte
number of Multicast stations	16

SIMATIC S7-300 Advanced Controllers

I/O modules

Communication

CP 343-1 Advanced

Technical specifications

Article number	6GK7343-1GX31-0XE0
product type designation	CP 343-1 Advanced
performance data S7 communication	
number of possible connections for S7 communication	
• maximum	16
performance data multi-protocol mode	
number of active connections with multi-protocol mode	48
performance data IT functions	
number of possible connections	
• as client by means of FTP maximum	10
• as server by means of FTP maximum	2
number of possible connections	
• as server by means of HTTP maximum	4
• as email client maximum	1
data volume as user data for email maximum	8 Kibyte
storage capacity of the user memory	
• as flash memory file system	28 Mibyte
• as RAM	30 Mibyte
number of possible write cycles of the flash memory cells	100 000
performance data PROFINET communication as PN IO controller	
product function PROFINET IO controller	Yes
number of PN IO devices on PROFINET IO controller operable total	128
number of PN IO IRT devices on PROFINET IO controller operable	128
number of external PN IO lines with PROFINET per rack	1
data volume	
• as user data for input variables as PROFINET IO controller maximum	4 Kibyte
• as user data for output variables as PROFINET IO controller maximum	4 Kibyte
• as user data for input variables per PN IO device as PROFINET IO controller maximum	1 433 byte
• as user data for output variables per PN IO device as PROFINET IO controller maximum	1 433 byte
• as user data for input variables per PN IO device for each sub-module as PROFINET IO controller maximum	240 byte
• as user data for output variables per PN IO device for each sub-module as PROFINET IO controller maximum	240 byte

Article number	6GK7343-1GX31-0XE0
product type designation	CP 343-1 Advanced
performance data PROFINET communication as PN IO device	
product function PROFINET IO device	Yes
data volume	
• as user data for input variables as PROFINET IO device maximum	1 024 byte
• as user data for output variables as PROFINET IO device maximum	1 024 byte
• as user data for input variables for each sub-module as PROFINET IO device	240 byte
• as user data for output variables for each sub-module as PROFINET IO device	240 byte
• as user data for the consistency area for each sub-module	240 byte
number of submodules per PROFINET IO-Device	32
performance data PROFINET CBA	
number of remote connection partners with PROFINET CBA	64
number of connections with PROFINET CBA total	1 000
data volume	
• as user data for digital inputs with PROFINET CBA maximum	8 Kibyte
• as user data for digital outputs with PROFINET CBA maximum	8 Kibyte
• as user data for arrays and data types in the case of acyclic transmission with PROFINET CBA maximum	8 Kibyte
• as user data for arrays and data types with PROFINET CBA with cyclical transfer maximum	250 byte
• as user data for arrays and data types with PROFINET CBA in the case of local interconnection maximum	2 400 byte
performance data PROFINET CBA remote interconnection with acyclic transfer	
update time of the remote interconnections in the case of acyclic transmission with PROFINET CBA	100 ms
number of remote connections to input variables in the case of acyclic transmission with PROFINET CBA maximum	128
number of remote connections to output variables in the case of acyclic transmission with PROFINET CBA maximum	128
data volume	
• as user data for remote interconnections with input variables in the case of acyclic transmission with PROFINET CBA	8 Kibyte
• as user data for remote interconnections with output variables in the case of acyclic transmission with PROFINET CBA	8 Kibyte

5

Technical specifications

Article number	6GK7343-1GX31-0XE0
product type designation	CP 343-1 Advanced
performance data PROFINET CBA remote interconnection with cyclic transfer	
update time of the remote interconnections with cyclical transfer with PROFINET CBA	8 ms
number of remote connections to input variables with PROFINET CBA with cyclic transfer maximum	200
number of remote connections to output variables with cyclical transfer with PROFINET CBA maximum	200
data volume	
• as user data for remote interconnections with input variables with cyclical transfer with PROFINET CBA maximum	2 000 byte
• as user data for remote interconnections with output variables with cyclical transfer with PROFINET CBA maximum	2 000 byte
performance data PROFINET CBA HMI variables via PROFINET acyclic	
number of connectable HMI stations for HMI variables in the case of acyclic transmission with PROFINET CBA	3
update time of the HMI variables in the case of acyclic transmission with PROFINET CBA	500 ms
number of HMI variables in the case of acyclic transmission with PROFINET CBA maximum	200
data volume as user data for HMI variables in the case of acyclic transmission with PROFINET CBA maximum	8 Kibyte
performance data PROFINET CBA device-internal interconnections	
number of internal connections with PROFINET CBA maximum	256
data volume of the internal connections with PROFINET CBA maximum	2 400 byte
performance data PROFINET CBA interconnections to constants	
number of connections with constants with PROFINET CBA maximum	200
data volume as user data for interconnections with constants with PROFINET CBA maximum	4 096 byte
performance data PROFINET CBA PROFIBUS proxy functionality	
product function with PROFINET CBA PROFIBUS proxy functionality	No
performance data telecontrol	
protocol is supported	
• TCP/IP	Yes
product functions management, configuration, engineering	
product function MIB support	Yes

Article number	6GK7343-1GX31-0XE0
product type designation	CP 343-1 Advanced
protocol is supported	
• SNMP v1	Yes
• SNMP v3	Yes
• DCP	Yes
• LLDP	Yes
configuration software	
• required	STEP7 V5.5 SP2 HF1 or higher / STEP 7 Professional V12 (TIA Portal) or higher SIMATIC iMap V3.0 SP4 and higher
• for PROFINET CBA required identification & maintenance function	Yes
• I&M0 - device-specific information	Yes
• I&M1 – higher level designation/ location designation	Yes
product functions diagnostics	
product function web-based diagnostics	Yes
product functions switch	
product feature switch	Yes
product function	
• switch-managed	No
• with IRT PROFINET IO switch	Yes
• configuration with STEP 7	Yes
product functions redundancy	
product function	
• ring redundancy	Yes
• redundancy manager	Yes
protocol is supported Media Redundancy Protocol (MRP)	Yes
product functions security	
firewall version	stateful inspection
product function with VPN connection	IPSec
type of encryption algorithms with VPN connection	AES-256, AES-192, AES-128, 3DES-168, DES-56
type of authentication procedure with VPN connection	Preshared key (PSK), X.509v3 certificates
type of hashing algorithms with VPN connection	MD5, SHA-1
number of possible connections with VPN connection	32
product function	
• password protection for Web applications	Yes
• ACL - IP-based	Yes
• ACL - IP-based for PLC/routing	Yes
• switch-off of non-required services	Yes
• blocking of communication via physical ports	Yes
• log file for unauthorized access	No
product functions time	
product function SICLOCK support	Yes
product function pass on time synchronization	Yes
protocol is supported	
• NTP	Yes
standards, specifications, approvals hazardous environments	
certificate of suitability CCC for hazardous zone according to GB standard	Yes

SIMATIC S7-300 Advanced Controllers

I/O modules

Communication

CSM 377 unmanaged**Overview**

- Unmanaged switch for connecting a SIMATIC S7-300 with integral PROFINET interface or an Industrial Ethernet CP or SIMATIC ET 200M to an Industrial Ethernet in an electrical line, tree or star structure
- As many as three additional nodes can be connected
- As an unmanaged switch, the CSM 377 is used for integrating small machines into existing automation networks or for the stand-alone operation of the machines
- Simple, space-saving attachment to SIMATIC S7-300 DIN rail due to design as single-width module in SIMATIC S7-300 format
- Low-cost solution for implementing small, local Ethernet networks
- Rugged, industry-standard node connections with PROFINET-compliant RJ45 plug connectors that latch onto the enclosure to offer additional strain and bending relief

Ordering data**Article No.****Compact Switch Module CSM 377**

Unmanaged switch for connecting a SIMATIC S7-300, ET200 M and up to three further nodes to Industrial Ethernet with 10/100 Mbps; 4 x RJ45 ports; external 24 V DC power supply; diagnostics on LEDs; S7-300 module including electronic manual on CD-ROM

6GK7377-1AA00-0AA0**Accessories****IE FC TP Standard Cable GP 2 x 2 (Type A)**

4-core, shielded TP installation cable for connection to IE FC outlet RJ45/ IE FC RJ45 plug; PROFINET-compliant; with UL approval; sold by the meter; max. delivery unit 1 000 m, minimum order quantity 20 m

6XV1840-2AH10**IE FC RJ45 plug 180 2 x 2**

RJ45 plug connector for Industrial Ethernet with a rugged metal housing and integrated insulation displacement contacts for connecting Industrial Ethernet FC installation cables; 180° cable outlet; for network components and CPs/CPUs with Industrial Ethernet interface

- 1 pack = 1 unit
- 1 pack = 10 units
- 1 pack = 50 units

6GK1901-1BB10-2AA0
6GK1901-1BB10-2AB0
6GK1901-1BB10-2AE0

IE FC Stripping Tool

Pre-adjusted stripping tool for fast stripping of Industrial Ethernet FC cables

6GK1901-1GA00**Technical specifications**

Article number	6GK7377-1AA00-0AA0
product type designation	SCALANCE CSM 377
transfer rate	
transfer rate	10 Mbit/s, 100 Mbit/s
interfaces for communication integrated	
number of electrical connections	
• for network components or terminal equipment	4
number of 100 Mbit/s SC ports	
• for multimode	0
number of 1000 Mbit/s LC ports	
• for multimode	0
• for single mode (LD)	0
interfaces other	
number of electrical connections	
• for power supply	1
type of electrical connection	
• for power supply	2-pole terminal block

Article number	6GK7377-1AA00-0AA0
product type designation	SCALANCE CSM 377
supply voltage, current consumption, power loss	
type of voltage 1 of the supply voltage	DC
• supply voltage 1 rated value	24 V
• power loss [W] 1 rated value	1.6 W
• supply voltage 1 rated value	19.2 ... 28.8 V
• consumed current 1 maximum	0.07 A
• type of electrical connection 1 for power supply	2-pole terminal block
• product component 1 fusing at power supply input	Yes
• fuse protection type 1 at input for supply voltage	0.5 A / 60 V

Technical specifications

Article number	6GK7377-1AA00-0AA0
product type designation	SCALANCE CSM 377
ambient conditions	
ambient temperature	
• during operation	0 ... 60 °C
• during storage	-40 ... +70 °C
• during transport	-40 ... +70 °C
relative humidity	
• at 25 °C without condensation during operation maximum	95 %
protection class IP	IP20
design, dimensions and weights	
design	SIMATIC S7-300 device design
width	40 mm
height	125 mm
depth	118 mm
net weight	0.2 kg
fastening method	
• 35 mm top hat DIN rail mounting	No
• wall mounting	No
• S7-300 rail mounting	Yes
• S7-1500 rail mounting	No
product functions management, configuration, engineering	
product function	
• multipoint mirroring	No
product function switch-managed	No
product functions redundancy	
product function	
• Parallel Redundancy Protocol (PRP)/operation in the PRP-network	Yes
• Parallel Redundancy Protocol (PRP)/Redundant Network Access (RNA)	No

Article number	6GK7377-1AA00-0AA0
product type designation	SCALANCE CSM 377
standards, specifications, approvals	
standard	
• for FM	FM3611: Class 1, Division 2, Group A, B, C, D / T...; CL.1, Zone 2, GP. IIC, T.. Ta
• for safety from CSA and UL	UL 508, CSA C22.2 No. 142
• for emitted interference	EN 61000-6-4:2001
• for interference immunity	EN 61000-6-2:2001
MTBF	144 y
reference code	
• acc. to IEC 81346-2	KF
• according to IEC 81346-2:2019	KFE
standards, specifications, approvals CE	
certificate of suitability CE marking	Yes
standards, specifications, approvals hazardous environments	
standard for hazardous zone	EN 60079-15, II 3 G Ex nA II T...; KEMA 06 ATEX 0021 X
• from CSA and UL	UL 1604 and UL 2279-15 (Hazardous Location)
certificate of suitability	
• CCC for hazardous zone according to GB standard	Yes
standards, specifications, approvals other	
certificate of suitability	EN 61000-6-2:2001, EN 61000-6-4:2001
• C-Tick	Yes
• KC approval	No
standards, specifications, approvals marine classification	
Marine classification association	
• American Bureau of Shipping Europe Ltd. (ABS)	Yes
• French marine classification society (BV)	Yes
• Det Norske Veritas (DNV)	Yes
• Germanische Lloyd (GL)	No
• Lloyds Register of Shipping (LRS)	Yes
• Nippon Kaiji Kyokai (NK)	Yes
• Polski Rejestr Statkow (PRS)	No
• Royal Institution of Naval Architects (RINA)	No

SIMATIC S7-300 Advanced Controllers

I/O modules

Communication

TIM 3V-IE (for S7-300)**Overview**

- SINAUT communications module TIM for SIMATIC S7-300 for use in a wide area network (WAN)
- IP communication via secure VPN (virtual private network) using the Internet
- Wireless communication via mobile wireless routers or wireless devices
- Wired communication via Ethernet, DSL, dialup modems or dedicated line modem
- Complete migration of existing wireless, dedicated line and dial-up technology to IP-based network
- Frame buffer for seamless recording of data
- Simple configuration and operation without specialist IT knowledge

Ordering data**Article No.****Article No.****TIM 3V-IE communications module****6NH7800-3BA00**

With an RS 232 interface for SINAUT communication via a conventional WAN or an IP-based network (WAN or LAN)

SINAUT Engineering Software V5.5 + SP4**6NH7997-0CA55-0AA0**

On DVD, comprising

- SINAUT Engineering Software V5.5 for the PG
- SINAUT TD7 block library
- Electronic manual in German and English

Engineering Software STEP 7 Professional V17**6ES7822-1AA07-0YA5**

- SIMATIC STEP 7 Professional V17 floating license

- Upgrade SIMATIC STEP 7 Basic V11 ... V16 → V17 floating license

6ES7822-0AA07-0YE5**Accessories****IE FC TP Standard Cable GP 2 x 2 (Type A)****6XV1840-2AH10**

4-wire, shielded TP installation cable for connection to IE FC RJ45 outlet/IE FC RJ45 plug; PROFINET-compatible; with UL approval
Sold by the meter;
Max. delivery unit 1 000 m, minimum order quantity 20 m

IE FC RJ45 plug 180

RJ45 plug connector for Industrial Ethernet with a rugged metal enclosure and integrated insulation displacement contacts for connecting Industrial Ethernet FC installation cables; with 180° cable outlet; for network components and CPs/CPU with Industrial Ethernet interface

- 1 pack = 1 unit
- 1 pack = 10 units
- 1 pack = 50 units

6GK1901-1BB10-2AA0
6GK1901-1BB10-2AB0
6GK1901-1BB10-2AE0

IE FC Stripping Tool**6GK1901-1GA00**

Pre-adjusted stripping tool for fast stripping of Industrial Ethernet FC cables

Connecting cable**6NH7701-5AN**

For connecting a TIM (RS232) with the GSM modem MD720; also suitable for third-party modems or wireless devices with standard RS232 interface; Cable length 2.5 m

Connecting cable**6NH7701-4BN**

With one end open for connecting a TIM (RS 232) to a third-party modem or radio unit (RS 232); Cable length 2.5 m

Connecting cable**6NH7701-0AR**

For connecting two TIM modules via their RS 232 interface without modems ("null modem"); cable length 6 m

Technical specifications

Article number	6NH7800-3BA00
product type designation	TIM 3V-IE
transfer rate	
transfer rate	
• for Industrial Ethernet	10 ... 100 Mbit/s
• acc. to RS 232	50 ... 38 400 bit/s
interfaces	
number of interfaces acc. to Industrial Ethernet	1
number of electrical connections	
• for external data transmission acc. to RS 232	1
• for power supply	1
type of electrical connection	
• of Industrial Ethernet interface	RJ45 port
type of electrical connection	
• at interface 1 for external data transmission	9 pin Sub-D-connector (RS232)
• for power supply	2-pole plugable terminal block
design of the removable storage	
• C-PLUG	No
supply voltage, current consumption, power loss	
type of voltage of the supply voltage	DC
supply voltage	24 V
supply voltage	20.4 ... 28.8 V
supply voltage external at DC rated value	24 V
supply voltage external at DC rated value	20.4 ... 28.8 V
relative symmetrical tolerance at DC	
• at 5 V	5 %
relative positive tolerance at DC at 24 V	5 %
relative negative tolerance at DC at 24 V	5 %
consumed current	
• from backplane bus at DC at 24 V maximum	0.2 A
• from external supply voltage at DC at 24 V maximum	0.2 A
power loss [W]	5.8 W
product extension optional backup battery	No

Article number	6NH7800-3BA00
product type designation	TIM 3V-IE
ambient conditions	
ambient temperature	
• during operation	0 ... 60 °C
• during storage	-40 ... +70 °C
• during transport	-40 ... +70 °C
relative humidity	
• at 25 °C without condensation during operation maximum	95 %
protection class IP	IP20
design, dimensions and weights	
module format	Compact module S7-300 single width
width	40 mm
height	125 mm
depth	120 mm
net weight	0.25 kg
product features, product functions, product components general	
number of units	
• per CPU maximum	1
• note	Number of TIM per S7-300
wire length	
• with RS 232 interface maximum	6 m
performance data S7 communication	
number of possible connections for S7 communication	
• maximum	8
• with PG connections maximum	2
• with OP connections maximum	8
service	
• SINAUT ST7 via S7 communication	Yes
• PG/OP communication	Yes
performance data multi-protocol mode	
number of active connections with multi-protocol mode	12

SIMATIC S7-300 Advanced Controllers

I/O modules

Communication

TIM 3V-IE (for S7-300)

Technical specifications

Article number	6NH7800-3BA00
product type designation	TIM 3V-IE
performance data telecontrol	
suitability for use	
• node station	No
• substation	Yes
• TIM control center	No
• note	RS232 and Industrial Ethernet can not be operated in parallel
protocol is supported	
• DNP3	No
• SINAUT ST1 protocol	Yes
• SINAUT ST7 protocol	Yes
product function data buffering if connection is aborted	Yes; 16,000 data messages
storage capacity	
• of S7 CPU work memory for TD7onCPU mode data blocks on CPU required	20 Kibyte
• of S7 CPU work memory for TD7onTIM mode data blocks on TIM required	0 Kibyte
• note	TD7onCPU: at least 20 KB, actual requirement determined by data volume and functional scope TD7onTIM: 0 bytes in most favorable case
product feature buffered message frame memory	No
transmission format	
• for SINAUT ST1 protocol with polling 11 bit	Yes
• for SINAUT ST1 protocol with spontaneous 10-bit or 11-bit	Yes
• for SINAUT ST7 protocol with multi-master polling 10-bit	Yes
• for SINAUT ST7 protocol with polling or spontaneous 10-bit or 11-bit	Yes
operating mode for scanning of data transmission	
• with dedicated line/radio link with SINAUT ST1 protocol	Polling, polling with time slot procedure
• with dedicated line/radio link with SINAUT ST7 protocol	Polling, polling with time slot procedure, multi-master polling with time slot procedure
• with dial-up network with SINAUT ST1 protocol	spontaneous
• with dial-up network with SINAUT ST7 protocol	spontaneous
hamming distance	
• for SINAUT ST1 protocol	4
• for SINAUT ST7 protocol	4

Article number	6NH7800-3BA00
product type designation	TIM 3V-IE
product functions management, configuration, engineering	
configuration software	
• required	SINAUT ST7 ES
• for CPU configuring required SINAUT TD7 block library for CPU	Yes
• for PG configuring required SINAUT ST7 configuration software for PG	Yes
storage location of TIM configuration data	on the TIM
product functions security	
operating mode Virtual Private Network (VPN)	Yes; VPN operation as MSC client with MSC protocol and password protection only possible in conjunction with GPRS modem with MSC capability
type of authentication with Virtual Private Network PSK	Yes
product function	
• password protection for VPN	Yes
• MSC client via GPRS modem with MSC capability	Yes
protocol	
• is supported MSC protocol	No
key length for MSC with Virtual Private Network	128 bit
number of possible connections	
• as MSC client with VPN connection	1
• as MSC server with VPN connection	0
standards, specifications, approvals hazardous environments	
certificate of suitability CCC for hazardous zone according to GB standard	Yes

5

Overview

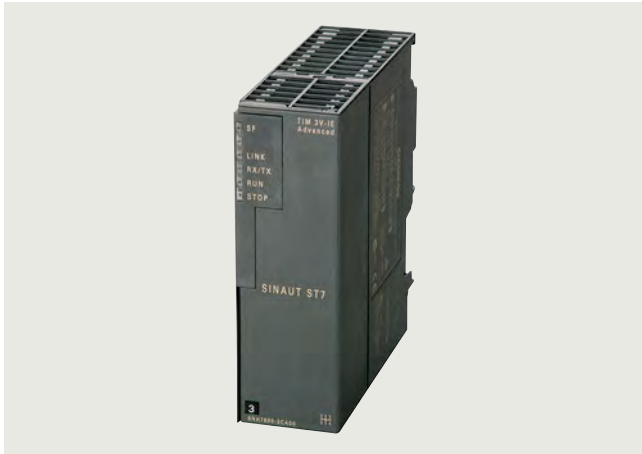

- SINAUT communications module TIM for SIMATIC S7-300 for use in wide area network (WAN) as station, node station, and control center
- IP communication via secure VPN (virtual private network) using the Internet
- Wireless communication via mobile wireless routers or wireless devices
- Wired communication via Ethernet, DSL, dialup modems or dedicated line modem
- Complete migration of existing wireless, dedicated line and dial-up technology to IP-based network
- Message frame memory for seamless recording of data and support of redundant communication paths
- Simple configuration and operation without specialist IT knowledge

5

Ordering data

Ordering data	Article No.	Ordering data	Article No.
TIM 3V-IE Advanced communications module With an RS 232 interface and an RJ45 interface for SINAUT communication via a conventional WAN and an IP-based network (WAN or LAN)	6NH7800-3CA00	IE FC RJ45 plug 180 RJ45 plug connector for Industrial Ethernet with a rugged metal enclosure and integrated insulation displacement contacts for connecting Industrial Ethernet FC installation cables; with 180° cable outlet; for network components and CPs/CPU with Industrial Ethernet interface	
Accessories SINAUT Engineering Software V5.5 + SP4 On DVD, comprising <ul style="list-style-type: none"> • SINAUT ST7 Engineering Software V5.5 + SP3 for the PG • SINAUT TD7 block library • Electronic manual in German and English 	6NH7997-0CA55-0AA0	<ul style="list-style-type: none"> • 1 pack = 1 unit • 1 pack = 10 units • 1 pack = 50 units 	6GK1901-1BB10-2AA0 6GK1901-1BB10-2AB0 6GK1901-1BB10-2AE0
SINAUT ST7 Engineering Software Update from Version V5.0x to V5.5 SINAUT Engineering Software V5.5 upgrade; for owners of SINAUT Engineering Software Version V5.0 or higher	6NH7997-0CA55-0GA0	IE FC Stripping Tool Pre-adjusted stripping tool for fast stripping of Industrial Ethernet FC cables	6GK1901-1GA00
Engineering Software STEP 7 Professional V17 <ul style="list-style-type: none"> • SIMATIC STEP 7 Professional V17 floating license • Upgrade SIMATIC STEP 7 Basic V11 ... V16 → V17 floating license 	6ES7822-1AA07-0YA5 6ES7822-0AA07-0YE5	Connecting cable For connecting a TIM (RS 232) with the GSM modem MD720-3; also suitable for third-party modems or radio equipment with standard RS 232 interface; Cable length 2.5 m	6NH7701-5AN
IE FC TP Standard Cable GP 2 x 2 (Type A) 4-wire, shielded TP installation cable for connection to IE FC RJ45 outlet/IE FC RJ45 plug; PROFINET-compatible; with UL approval Sold by the meter; Max. delivery unit 1 000 m, minimum order quantity 20 m	6XV1840-2AH10	Connecting cable With one end open for connecting a TIM (RS 232) to a third-party modem or radio unit (RS 232); Cable length 2.5 m	6NH7701-4BN
		Connecting cable For connecting two TIM modules via their RS 232 interface without modems ("null modem"). Cable length 6 m	6NH7701-0AR

SIMATIC S7-300 Advanced Controllers

I/O modules

Communication

TIM 3V-IE Advanced (for S7-300)

Technical specifications

Article number	6NH7800-3CA00
product type designation	TIM 3V-IE Advanced
transfer rate	
transfer rate	
• for Industrial Ethernet	10 ... 100 Mbit/s
• acc. to RS 232	50 ... 38 400 bit/s
interfaces	
number of interfaces acc. to Industrial Ethernet	1
number of electrical connections	
• for external data transmission acc. to RS 232	1
• for power supply	1
type of electrical connection	
• of Industrial Ethernet interface	RJ45 port
type of electrical connection	
• at interface 1 for external data transmission	9 pin Sub-D-connector (RS232)
• for power supply	2-pole plugable terminal block
design of the removable storage	
• C-PLUG	No
supply voltage, current consumption, power loss	
type of voltage of the supply voltage	DC
supply voltage	24 V
supply voltage	20.4 ... 28.8 V
supply voltage external at DC rated value	24 V
supply voltage external at DC rated value	20.4 ... 28.8 V
relative symmetrical tolerance at DC	
• at 5 V	5 %
relative positive tolerance at DC at 24 V	5 %
relative negative tolerance at DC at 24 V	5 %
consumed current	
• from backplane bus at DC at 24 V maximum	0.2 A
• from external supply voltage at DC at 24 V maximum	0.2 A
power loss [W]	5.8 W
product extension optional backup battery	No

Article number	6NH7800-3CA00
product type designation	TIM 3V-IE Advanced
ambient conditions	
ambient temperature	
• during operation	0 ... 60 °C
• during storage	-40 ... +70 °C
• during transport	-40 ... +70 °C
relative humidity	
• at 25 °C without condensation during operation maximum	95 %
protection class IP	IP20
design, dimensions and weights	
module format	Compact module S7-300 single width
width	40 mm
height	125 mm
depth	120 mm
net weight	0.25 kg
product features, product functions, product components general	
number of units	
• note	Number of TIMs per S7-300: multiple, number depends on the connection resources of the S7-300 CPU
wire length	
• with RS 232 interface maximum	6 m
performance data S7 communication	
number of possible connections for S7 communication	
• maximum	24
• with PG connections maximum	4
• with OP connections maximum	20
service	
• SINAUT ST7 via S7 communication	Yes
• PG/OP communication	Yes
performance data multi-protocol mode	
number of active connections with multi-protocol mode	24

5

Technical specifications

Article number	6NH7800-3CA00
product type designation	TIM 3V-IE Advanced
performance data telecontrol	
suitability for use	
• node station	Yes
• substation	Yes
• TIM control center	Yes
• note	RS232 and Industrial Ethernet can be operated in parallel
protocol is supported	
• DNP3	No
• SINAUT ST1 protocol	Yes
• SINAUT ST7 protocol	Yes
product function data buffering if connection is aborted	Yes; 32,000 data messages
storage capacity	
• of S7 CPU work memory for TD7onCPU mode data blocks on CPU required	20 Kibyte
• of S7 CPU work memory for TD7onTIM mode data blocks on TIM required	0 Kibyte
• note	TD7onCPU: at least 20 KB, actual requirement determined by data volume and functional scope TD7onTIM: 0 bytes in most favorable case
product feature buffered message frame memory	No
transmission format	
• for SINAUT ST1 protocol with polling 11 bit	Yes
• for SINAUT ST1 protocol with spontaneous 10-bit or 11-bit	Yes
• for SINAUT ST7 protocol with multi-master polling 10-bit	Yes
• for SINAUT ST7 protocol with polling or spontaneous 10-bit or 11-bit	Yes
operating mode for scanning of data transmission	
• with dedicated line/radio link with SINAUT ST1 protocol	Polling, polling with time slot procedure
• with dedicated line/radio link with SINAUT ST7 protocol	Polling, polling with time slot procedure, multi-master polling with time slot procedure
• with dial-up network with SINAUT ST1 protocol	spontaneous
• with dial-up network with SINAUT ST7 protocol	spontaneous
hamming distance	
• for SINAUT ST1 protocol	4
• for SINAUT ST7 protocol	4

Article number	6NH7800-3CA00
product type designation	TIM 3V-IE Advanced
product functions management, configuration, engineering	
configuration software	
• required	SINAUT ST7 ES
• for CPU configuring required SINAUT TD7 block library for CPU	Yes
• for PG configuring required SINAUT ST7 configuration software for PG	Yes
storage location of TIM configuration data	on the TIM
product functions security	
operating mode Virtual Private Network (VPN)	Yes
type of authentication with Virtual Private Network PSK	Yes
product function	
• password protection for VPN	Yes
• MSC client via GPRS modem with MSC capability	Yes
protocol	
• is supported MSC protocol	Yes
• with Virtual Private Network MSC is supported	TCP/IP
key length for MSC with Virtual Private Network	128 bit
number of possible connections	
• as MSC client with VPN connection	1
• as MSC server with VPN connection	0
standards, specifications, approvals hazardous environments	
certificate of suitability CCC for hazardous zone according to GB standard	Yes

SIMATIC S7-300 Advanced Controllers

I/O modules

Communication

TIM 4R-IE (for S7-300/-400/PC)

Overview



- SINAUT communications module TIM with four interfaces for SIMATIC S7-300 or as self-contained unit for the S7-400 for use in the wide area network (WAN)
- For universal use in a SINAUT station, node station and control center
- Internet communication via integrated MSC-VPN tunnel with direct connection to DSL router or operation via IPsec VPN with additional SIMATIC NET components
- Wireless communication via mobile wireless routers or wireless devices
- Wired communication via Ethernet, DSL, dialup modems or dedicated line modem
- Complete migration of existing wireless, dedicated line and dial-up technology to IP-based network
- Message frame memory for seamless recording of data and support of redundant communication paths
- Simple configuration and operation without specialist IT knowledge

Ordering data

TIM 4R-IE communications module

With two combined RS 232/RS 485 interfaces for SINAUT communication via conventional WANs and two RJ45 interfaces for SINAUT communication via IP-based networks (WAN or LAN)

Accessories

SINAUT Engineering Software V5.5 + SP4

On DVD, comprising

- SINAUT ST7 Engineering Software V5.5 + SP3 for the PG
- SINAUT TD7 block library
- Electronic manual in German and English

SINAUT ST7 Engineering Software Update from Version V5.0x to V5.5

SINAUT Engineering Software V5.5 upgrade; for owners of SINAUT Engineering Software Version V5.0 or higher

Engineering Software STEP 7 Professional V17

- SIMATIC STEP 7 Professional V17 floating license
- Upgrade SIMATIC STEP 7 Basic V11 ... V16 → V17 floating license

Backup battery

3.6 V/2.3 Ah for TIM 4R-IE

IE FC TP Standard Cable GP 2 x 2 (Type A)

4-wire, shielded TP installation cable for connection to IE FC RJ45 outlet/IE FC RJ45 plug; PROFINET-compatible; with UL approval
Sold by the meter;
Max. delivery unit 1 000 m, minimum order quantity 20 m

Article No.

6NH7800-4BA00

6NH7997-0CA55-0AA0

6NH7997-0CA55-0GA0

6ES7822-1AA07-0YA5

6ES7822-0AA07-0YE5

6ES7971-0BA00

6XV1840-2AH10

Article No.

IE FC RJ45 plug 180

RJ45 plug connector for Industrial Ethernet with a rugged metal enclosure and integrated insulation displacement contacts for connecting Industrial Ethernet FC installation cables; with 180° cable outlet; for network components and CPs/CPU with Industrial Ethernet interface

- 1 pack = 1 unit
- 1 pack = 10 units
- 1 pack = 50 units

6GK1901-1BB10-2AA0

6GK1901-1BB10-2AB0

6GK1901-1BB10-2AE0

IE FC Stripping Tool

Pre-adjusted stripping tool for fast stripping of Industrial Ethernet FC cables

6GK1901-1GA00

Connecting cable

For connecting a TIM (RS 232) with the GSM modem MD720-3; also suitable for third-party modems or radio equipment with standard RS 232 interface; Cable length 2.5 m

6NH7701-5AN

Connecting cable

With one end open for connecting a TIM (RS 232) to a third-party modem or radio unit (RS 232); Cable length 2.5 m

6NH7701-4BN

Connecting cable

For connecting two TIM modules via their RS 232 interface without modems ("null modem"). Cable length 6 m

6NH7701-0AR

SITOP compact 24 V/0.6 A

Single-phase power supply with wide-range input 85 ... 264 V AC/110 ... 300 V DC, stabilized output voltage 24 V, rated output current value 0.6 A, slim design

6EP1331-5BA00

Technical specifications

Article number	6NH7800-4BA00
product type designation	TIM 4R-IE
transfer rate	
transfer rate	
• for Industrial Ethernet	10 ... 100 Mbit/s
• acc. to RS 232	50 ... 38 400 bit/s
interfaces	
number of interfaces acc. to Industrial Ethernet	2
number of electrical connections	
• for external data transmission acc. to RS 232	2
• for power supply	1
type of electrical connection	
• of Industrial Ethernet interface	RJ45 port
type of electrical connection	
• at interface 1 for external data transmission	9 pin Sub-D-connector, RS232 switchable to RS485
• at interface 2 for external data transmission	9-pole D-sub connector, RS232 can be switched to RS485
• for power supply	2-pole pluggable terminal block
design of the removable storage	
• C-PLUG	Yes
supply voltage, current consumption, power loss	
type of voltage of the supply voltage	DC
supply voltage	24 V
supply voltage	20.4 ... 28.8 V
supply voltage external at DC rated value	24 V
supply voltage external at DC rated value	20.4 ... 28.8 V
consumed current	
• from backplane bus at DC at 24 V maximum	0.2 A
• from external supply voltage at DC at 24 V maximum	0.17 A
power loss [W]	4.6 W
product extension optional backup battery	Yes
type of battery	Lithium AA / 3.6 V / 2.3 Ah
backup current	
• typical	100 µA
• maximum	160 µA

Article number	6NH7800-4BA00
product type designation	TIM 4R-IE
ambient conditions	
ambient temperature	
• during operation	0 ... 60 °C
• during storage	-40 ... +70 °C
• during transport	-40 ... +70 °C
relative humidity	
• at 25 °C without condensation during operation maximum	95 %
protection class IP	IP20
design, dimensions and weights	
module format	Compact module S7-300 double width
width	80 mm
height	125 mm
depth	120 mm
net weight	0.4 kg
product features, product functions, product components general	
number of units	
• note	Number of TIM 4R-IE per S7-300/S7-400: multiple, number depends on the connection resources of the CPU
wire length	
• with RS 232 interface maximum	6 m
• with RS 485 interface maximum	30 m
performance data S7 communication	
number of possible connections for S7 communication	
• maximum	64
• with PG connections maximum	2
• with OP connections maximum	62
service	
• SINAUT ST7 via S7 communication	Yes
• PG/OP communication	Yes
performance data multi-protocol mode	
number of active connections with multi-protocol mode	128

SIMATIC S7-300 Advanced Controllers

I/O modules

Communication

TIM 4R-IE (for S7-300/-400/PC)

Technical specifications

Article number	6NH7800-4BA00
product type designation	TIM 4R-IE
performance data telecontrol	
suitability for use	
• node station	Yes
• substation	Yes
• TIM control center	Yes
protocol is supported	
• DNP3	No
• SINAUT ST1 protocol	Yes
• SINAUT ST7 protocol	Yes
product function data buffering if connection is aborted	Yes; 56,000 data messages
storage capacity	
• of S7 CPU work memory for TD7onCPU mode data blocks on CPU required	20 Kibyte
• of S7 CPU work memory for TD7onTIM mode data blocks on TIM required	0 Kibyte
• note	TD7onCPU: at least 20 KB, actual requirement determined by data volume and functional scope TD7onTIM: 0 bytes in most favorable case
product feature buffered message frame memory	Yes
transmission format	
• for SINAUT ST1 protocol with polling 11 bit	Yes
• for SINAUT ST1 protocol with spontaneous 10-bit or 11-bit	Yes
• for SINAUT ST7 protocol with multi-master polling 10-bit	Yes
• for SINAUT ST7 protocol with polling or spontaneous 10-bit or 11-bit	Yes
operating mode for scanning of data transmission	
• with dedicated line/radio link with SINAUT ST1 protocol	Polling, polling with time slot procedure
• with dedicated line/radio link with SINAUT ST7 protocol	Polling, polling with time slot procedure, multi-master polling with time slot procedure
• with dial-up network with SINAUT ST1 protocol	spontaneous
• with dial-up network with SINAUT ST7 protocol	spontaneous
hamming distance	
• for SINAUT ST1 protocol	4
• for SINAUT ST7 protocol	4

Article number	6NH7800-4BA00
product type designation	TIM 4R-IE
product functions management, configuration, engineering	
configuration software	
• required	SINAUT ST7 ES
• for CPU configuring required SINAUT TD7 block library for CPU	Yes
• for PG configuring required SINAUT ST7 configuration software for PG	Yes
storage location of TIM configuration data	on internal TIM flash memory, or on TIM in optional C-PLUG, or on MMC of the S7-300 CPU if TIM installed in S7-300 controller
product functions security	
operating mode Virtual Private Network (VPN)	Yes
type of authentication with Virtual Private Network PSK	Yes
product function	
• password protection for VPN	Yes
• MSC client via GPRS modem with MSC capability	Yes
protocol	
• is supported MSC protocol	Yes
• with Virtual Private Network MSC is supported	TCP/IP
key length for MSC with Virtual Private Network	128 bit
number of possible connections	
• as MSC client with VPN connection	1
• as MSC server with VPN connection	128
product functions time	
product component hardware real time clock	Yes
product feature hardware real time clock w. battery backup	Yes
accuracy of the hardware real time clock per day maximum	4 s
time synchronization	
• from NTP-server	Yes
standards, specifications, approvals hazardous environments	
certificate of suitability CCC for hazardous zone according to GB standard	Yes

5

Overview

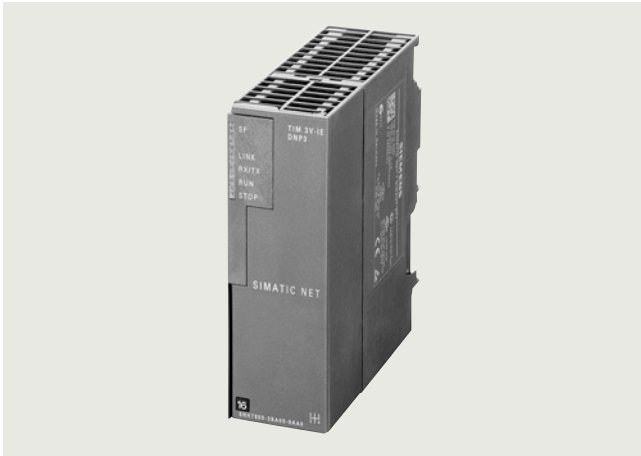

In a station for the S7-CPU, the communications module TIM 3V-IE DNP3 (TeleControl Interface Module) handles the data exchange with the assigned master system SIMATIC PCS 7 TeleControl V8.0 using the open DNP3 protocol. The module additionally supports master and node functionality.

- With the S7-300 housing, the module can be fully integrated into the S7-300 system
- The module has an RS232 interface for the connection of an external modem for data transmission via a conventional WAN or the connection of a Modbus RTU slave to an S7-300 system
- The RJ45 port is used for data transmission via IP-based networks

5

Ordering data

Ordering data	Article No.	Ordering data	Article No.
TIM 3V-IE DNP3 communications module With an RS 232 interface for SINAUT communication via a conventional WAN and an IP-based network (WAN or LAN)	6NH7803-3BA00-0AA0	IE FC RJ45 plug 180 RJ45 plug connector for Industrial Ethernet with a rugged metal housing and integrated insulation displacement contacts for connecting Industrial Ethernet FC installation cables; with 180° cable outlet; for network components and CPs/CPU's with Industrial Ethernet interface <ul style="list-style-type: none"> • 1 pack = 1 unit • 1 pack = 10 units • 1 pack = 50 units 	6GK1901-1BB10-2AA0 6GK1901-1BB10-2AB0 6GK1901-1BB10-2AE0
SINAUT Engineering Software V5.5 + SP4 On DVD, comprising <ul style="list-style-type: none"> • SINAUT ST7 Engineering Software V5.5 for the PG • SINAUT TD7 block library • Electronic manual in German and English 	6NH7997-0CA55-0AA0	IE FC Stripping Tool Pre-adjusted stripping tool for fast stripping of Industrial Ethernet FC cables	6GK1901-1GA00
SINAUT ST7 Engineering Software Update from Version V5.0x to V5.5 SINAUT Engineering Software V5.5 upgrade; for owners of SINAUT Engineering Software Version V5.0 or higher	6NH7997-0CA55-0GA0	Connecting cable For connecting a TIM (RS 232) with the GSM modem MD720-3; also suitable for third-party modems or radio equipment with standard RS 232 interface; Cable length 2.5 m	6NH7701-5AN
Accessories		Connecting cable With one end open for connecting a TIM (RS 232) to a third-party modem or radio unit (RS 232); Cable length 2.5 m	6NH7701-4BN
IE FC TP Standard Cable GP 2 x 2 (Type A) 4-wire, shielded TP installation cable for connection to IE FC RJ45 outlet/IE FC RJ45 plug; PROFINET-compatible; with UL approval Sold by the meter; Max. delivery unit 1 000 m, minimum order quantity 20 m	6XV1840-2AH10	Connecting cable For connecting two TIM modules via their RS 232 interface without modems ("null modem"). Cable length 6 m	6NH7701-0AR

SIMATIC S7-300 Advanced Controllers

I/O modules

Communication

TIM 3V-IE DNP3 (for S7-300)

Technical specifications

Article number	6NH7803-3BA00-0AA0
product type designation	TIM 3V-IE DNP3
transfer rate	
transfer rate	
• for Industrial Ethernet	10 ... 100 Mbit/s
• acc. to RS 232	9 600 ... 38 400 bit/s
interfaces	
number of interfaces acc. to Industrial Ethernet	1
number of electrical connections	
• for external data transmission acc. to RS 232	1
• for power supply	1
type of electrical connection	
• of Industrial Ethernet interface	RJ45 port
type of electrical connection	
• at interface 1 for external data transmission	9 pin Sub-D-connector (RS232)
• for power supply	2-pole pluggable terminal block
design of the removable storage	
• C-PLUG	No
supply voltage, current consumption, power loss	
type of voltage of the supply voltage	DC
supply voltage	24 V
supply voltage	20.4 ... 28.8 V
supply voltage external at DC rated value	24 V
supply voltage external at DC rated value	20.4 ... 28.8 V
consumed current	
• from backplane bus at DC at 24 V maximum	0.2 A
• from external supply voltage at DC at 24 V maximum	0.2 A
power loss [W]	5.8 W
product extension optional backup battery	No
ambient conditions	
ambient temperature	
• during operation	0 ... 60 °C
• during storage	-40 ... +70 °C
• during transport	-40 ... +70 °C
relative humidity	
• at 25 °C without condensation during operation maximum	95 %
protection class IP	IP20

Article number	6NH7803-3BA00-0AA0
product type designation	TIM 3V-IE DNP3
design, dimensions and weights	
module format	Compact module S7-300 single width
width	40 mm
height	125 mm
depth	120 mm
net weight	0.25 kg
product features, product functions, product components general	
number of units	
• note	Number of TIMs per S7-300: 1
wire length	
• with RS 232 interface maximum	6 m
performance data S7 communication	
number of possible connections for S7 communication	
• maximum	3; only via LAN
• with PG connections maximum	2
• with OP connections maximum	1
service	
• PG/OP communication	Yes
performance data telecontrol	
suitability for use	
• node station	Yes
• substation	Yes
• TIM control center	Yes
protocol is supported	
• DNP3	Yes
• SINAUT ST1 protocol	No
• SINAUT ST7 protocol	No
• Modbus RTU	Yes
product function data buffering if connection is aborted	Yes; 64,000 data points with one master
number of DNP3 masters	
• for Ethernet maximum	8
• with RS 232 interface maximum	1
number of Modbus RTU slaves maximum	1
product functions management, configuration, engineering	
configuration software	
• required	SINAUT ST7 ES
storage location of TIM configuration data	on the CPU or TIM
standards, specifications, approvals hazardous environments	
certificate of suitability CCC for hazardous zone according to GB standard	Yes

5

Overview



In a station for the S7-CPU, the communication module TIM 4R-IE DNP3 (TeleControl Interface Module) handles the data exchange with the assigned SIMATIC PCS7 TeleControl V8.0 master system using the open DNP3 protocol. In addition, the V3.0 module now also supports master and node functionality.

- With the double-width S7-300 housing, the module can be fully integrated into the S7-300 system
- Can be connected as a stand-alone module to a SIMATIC S7-400 and SIMATIC S7-400 H System
- Two RS 232/RS 485 interfaces support connection of an external modem for data transmission via a conventional WAN or of a Modbus RTU slave to an S7-300 system
- The module has two RJ45 interfaces for data transmission via IP-based networks
- By using physically separate connection paths, the module permits media redundancy without loss of data during the switchover

Ordering data

TIM 4R-IE DNP3 communications module

With two combined RS 232/RS 485 interfaces for SINAUT communication via conventional WANs and two RJ45 interfaces for SINAUT communication via IP-based networks (WAN or LAN)

Accessories**SINAUT Engineering Software V5.5 + SP4**

On DVD, comprising

- SINAUT ST7 Engineering Software V5.5 + SP3 for the PG
- SINAUT TD7 block library
- Electronic manual in German and English

SINAUT ST7 Engineering Software Update from Version V5.0x to V5.5

SINAUT Engineering Software V5.5 upgrade; for owners of SINAUT Engineering Software Version V5.0 or higher

Backup battery

3.6 V/2.3 Ah for TIM 4R-IE DNP3

IE FC TP Standard Cable GP 2 x 2 (Type A)

4-wire, shielded TP installation cable for connection to IE FC RJ45 outlet/IE FC RJ45 plug; PROFINET-compatible; with UL approval; sold by the meter; max. delivery unit 1 000 m, minimum order quantity 20 m

Article No.

6NH7803-4BA00-0AA0

6NH7997-0CA55-0AA0

6NH7997-0CA55-0GA0

6ES7971-0BA00

6XV1840-2AH10

Article No.

IE FC RJ45 plug 180

RJ45 plug connector for Industrial Ethernet with a rugged metal housing and integrated insulation displacement contacts for connecting Industrial Ethernet FC installation cables; with 180° cable outlet; for network components and CPs/CPU with Industrial Ethernet interface

- 1 pack = 1 unit
- 1 pack = 10 units
- 1 pack = 50 units

IE FC Stripping Tool

Pre-adjusted stripping tool for fast stripping of Industrial Ethernet FC cables

Connecting cable

For connecting a TIM (RS 232) with the GSM modem MD720-3; also suitable for third-party modems or radio equipment with standard RS 232 interface; Cable length 2.5 m

Connecting cable

With one end open for connecting a TIM (RS 232) to a third-party modem or radio unit (RS 232); Cable length 2.5 m

Connecting cable

For connecting two TIM modules via their RS 232 interface without modems ("null modem"). Cable length 6 m

SITOP compact 24 V/0.6 A

Single-phase power supply with wide-range input 85 to 264 V AC/110 to 300 V DC, stabilized output voltage 24 V, rated output current value 0.6 A, slim design

6GK1901-1BB10-2AA0

6GK1901-1BB10-2AB0

6GK1901-1BB10-2AE0

6GK1901-1GA00

6NH7701-5AN

6NH7701-4BN

6NH7701-0AR

6EP1331-5BA00

SIMATIC S7-300 Advanced Controllers

I/O modules

Communication

TIM 4R-IE DNP3 (for S7-300/-400)

Technical specifications

Article number	6NH7803-4BA00-0AA0
product type designation	TIM 4R-IE DNP3
transfer rate	
transfer rate	
• for Industrial Ethernet	10 ... 100 Mbit/s
• acc. to RS 232	9 600 ... 115 200 bit/s
interfaces	
number of interfaces acc. to Industrial Ethernet	2
number of electrical connections	
• for external data transmission acc. to RS 232	2
• for power supply	1
type of electrical connection	
• of Industrial Ethernet interface	RJ45 port
type of electrical connection	
• at interface 1 for external data transmission	9 pin Sub-D-connector, RS232 switchable to RS485
• at interface 2 for external data transmission	9-pole D-sub connector, RS232 can be switched to RS485
• for power supply	2-pole pluggable terminal block
design of the removable storage	
• C-PLUG	Yes
supply voltage, current consumption, power loss	
type of voltage of the supply voltage	DC
supply voltage	24 V
supply voltage	20.4 ... 28.8 V
supply voltage external at DC rated value	24 V
supply voltage external at DC rated value	20.4 ... 28.8 V
consumed current	
• from backplane bus at DC at 24 V maximum	0.2 A
• from external supply voltage at DC at 24 V maximum	0.17 A
power loss [W]	4.6 W
product extension optional backup battery	Yes
type of battery	Lithium AA / 3.6 V / 2.3 Ah
backup current	
• typical	100 µA
• maximum	160 µA
ambient conditions	
ambient temperature	
• during operation	0 ... 60 °C
• during storage	-40 ... +70 °C
• during transport	-40 ... +70 °C
relative humidity	
• at 25 °C without condensation during operation maximum	95 %
protection class IP	IP20

Article number	6NH7803-4BA00-0AA0
product type designation	TIM 4R-IE DNP3
design, dimensions and weights	
module format	Compact module S7-300 double width
width	80 mm
height	125 mm
depth	120 mm
net weight	0.4 kg
product features, product functions, product components general	
number of units	
• note	Number of TIMs per S7-300 / S7-400: 1
wire length	
• with RS 232 interface maximum	6 m
• with RS 485 interface maximum	30 m
performance data S7 communication	
number of possible connections for S7 communication	
• maximum	5; only via LAN
• with PG connections maximum	2
• with OP connections maximum	1
service	
• PG/OP communication	Yes
performance data telecontrol	
suitability for use	
• node station	Yes
• substation	Yes
• TIM control center protocol is supported	Yes
• DNP3	Yes
• SINAUT ST1 protocol	No
• SINAUT ST7 protocol	No
• Modbus RTU	Yes
product function data buffering if connection is aborted	Yes; 200,000 data points with one master
number of DNP3 masters	
• for Ethernet maximum	8
• with RS 232 interface maximum	1
number of Modbus RTU slaves maximum	1
product functions management, configuration, engineering	
configuration software	
• required	SINAUT ST7 ES
storage location of TIM configuration data	on the CPU or TIM
product functions time	
product component hardware real time clock	Yes
product feature hardware real time clock w. battery backup	Yes
accuracy of the hardware real time clock per day maximum	4 s
time synchronization	
• from NTP-server	Yes
standards, specifications, approvals hazardous environments	
certificate of suitability CCC for hazardous zone according to GB standard	Yes

5

Overview



The ASM 475 is a powerful communications module for connecting the MOBY D, SIMATIC RF200, RF300 and SIMATIC MV400, MV500 identification systems to the S7-300 and ET 200M.

Ordering data

Ordering data	Article No.
ASM 475 communications module For SIMATIC S7-300 and ET 200M, parameterizable	6GT2002-0GA10
Accessories	
Front connector (1 x per ASM 475) <ul style="list-style-type: none"> with screw terminals with spring-loaded terminals 	6ES7392-1AJ00-0AA0 6ES7392-1BJ00-0AA0
Shield connection element (80 mm wide for 2 x ASM 475)	6ES7390-5AA00-0AA0
Shield connection clamp (1 x per reader cable) SIMATIC RF200 / RF300 / MV400 connecting cable Pre-assembled, between ASM 475 and RF200 / RF300 / MV400, IP65, straight connector, PUR material, trailable, available in following lengths ¹⁾ :	6ES7390-5BA00-0AA0
2 m	6GT2891-4EH20
5 m	6GT2891-4EH50
Extension cable SIMATIC RF200 / RF300 / MV400, PUR material, trailable, straight connector	
2 m	6GT2891-4FH20
5 m	6GT2891-4FH50
10 m	6GT2891-4FN10
20 m	6GT2891-4FN20
50 m	6GT2891-4FN50

¹⁾ The connecting cables can be extended using RF300 connecting cables of type 6GT2891-4Fxxx. These connecting cables are available in the lengths 2 m, 5 m, 10 m, 20 m and 50 m.

Technical specifications

Article number	6GT2002-0GA10
product type designation	ASM 475 communication module
transfer rate	
transfer rate at the point-to-point connection serial maximum	115.2 kbit/s
interfaces	
design of the interface for point-to-point connection	RS422
number of readers connectable	2
type of electrical connection	
<ul style="list-style-type: none"> of the backplane bus of the PROFIBUS interface of Industrial Ethernet interface for supply voltage 	S7-300 backplane bus (according to the head module) (according to the head module) Screw-type or spring-loaded terminals
design of the interface to the reader for communication	Screw-type or spring-loaded terminals
mechanical data	
material	Noryl
color	anthracite
supply voltage, current consumption, power loss	
supply voltage	
<ul style="list-style-type: none"> at DC rated value at DC 	24 V 20 ... 30 V
consumed current at DC at 24 V	
<ul style="list-style-type: none"> without connected devices typical with connected devices maximum 	0.1 A 1 A
ambient conditions	
ambient temperature	
<ul style="list-style-type: none"> during operation during storage during transport 	0 ... 60 °C -40 ... +70 °C -40 ... +70 °C
protection class IP	IP20
shock resistance	According to IEC 61131-2
shock acceleration	150 m/s ²
vibrational acceleration	10 m/s ²
design, dimensions and weights	
width	40 mm
height	125 mm
depth	120 mm
net weight	0.2 kg
fastening method	S7-300 rack
wire length for RS 422 interface maximum	1 000 m

SIMATIC S7-300 Advanced Controllers

I/O modules

Communication

ASM 475**Technical specifications**

Article number	6GT2002-0GA10
product type designation	ASM 475 communication module
product features, product functions, product components general	
display version	4 LEDs per reader connection, 2 LEDs for device status
product function addressable transponder file handler	Yes
protocol is supported	
• S7 communication	Yes
product functions management, configuration, engineering	
type of parameterization	Object manager, GSD
type of programming	FB 45, FB 55, FC 56 (FC 45/55 with limited functionality)
type of computer-switched communication	acyclic communication

Article number	6GT2002-0GA10
product type designation	ASM 475 communication module
standards, specifications, approvals	
certificate of suitability	CE, FCC, UL/CSA
accessories	
accessories	Front connector with screw-type or spring-loaded terminals

5

Overview



- The low-cost, complete solution for serial communication over a point-to-point connection
- RS 232C (V.24) and RS 422/485 (X.27)
- Implemented protocols:
 - ASCII
 - 3964 (R) (not for RS 485)
 - Printer driver
- Simple parameterization using tool integrated in STEP 7

Note:

SIPLUS extreme products are based on SIMATIC standard products. The contents listed here were taken from the respective standard products. SIPLUS extreme specific information was added.

Ordering data

SIPLUS S7-300 CP 340 communications module

For industrial applications with extended ambient conditions

Extended temperature range and exposure to media

with 1 RS 232C (V.24) interface

with 1 RS 422/485 (X.27) interface

Article No.

6AG1340-1AH02-2AE0

6AG1340-1CH02-2AE0

Technical specifications

Article number	6AG1340-1AH02-2AE0	6AG1340-1CH02-2AE0
Based on	6ES7340-1AH02-0AE0 SIPLUS S7-300 CP 340 RS232	6ES7340-1CH02-0AE0 SIPLUS S7-300 CP 340 RS422/485
Ambient conditions		
Ambient temperature during operation		
• min.	-25 °C; = Tmin	-25 °C; = Tmin
• max.	70 °C; = Tmax; 60 °C @ UL/cUL, ATEX and FM use	60 °C; = Tmax
Ambient temperature during storage/transportation		
• min.	-40 °C	-40 °C
• max.	70 °C	70 °C
Altitude during operation relating to sea level		
• Installation altitude above sea level, max.	5 000 m	5 000 m
• Ambient air temperature-barometric pressure-altitude	Tmin ... Tmax at 1 140 hPa ... 795 hPa (-1 000 m ... +2 000 m) // Tmin ... (Tmax - 10 K) at 795 hPa ... 658 hPa (+2 000 m ... +3 500 m) // Tmin ... (Tmax -20 K) at 658 hPa ... 540 hPa (+3 500 m ... +5 000 m)	Tmin ... Tmax at 1 140 hPa ... 795 hPa (-1 000 m ... +2 000 m) // Tmin ... (Tmax - 10 K) at 795 hPa ... 658 hPa (+2 000 m ... +3 500 m) // Tmin ... (Tmax -20 K) at 658 hPa ... 540 hPa (+3 500 m ... +5 000 m)
Relative humidity		
• With condensation, tested in accordance with IEC 60068-2-38, max.	100 %; RH incl. condensation/frost (no commissioning under condensation conditions)	100 %; RH incl. condensation/frost (no commissioning under condensation conditions)

SIMATIC S7-300 Advanced Controllers

I/O modules

SIPLUS S7-300 communication

SIPLUS S7-300 CP 340**Technical specifications**

Article number	6AG1340-1AH02-2AE0	6AG1340-1CH02-2AE0
Based on	6ES7340-1AH02-0AE0 SIPLUS S7-300 CP 340 RS232	6ES7340-1CH02-0AE0 SIPLUS S7-300 CP 340 RS422/485
Resistance		
Use in stationary industrial systems		
- to biologically active substances according to EN 60721-3-3	Yes; Class 3B2 mold, fungus and dry rot spores (with the exception of fauna); Class 3B3 on request	Yes; Class 3B2 mold, fungus and dry rot spores (with the exception of fauna); Class 3B3 on request
- to chemically active substances according to EN 60721-3-3	Yes; Class 3C4 (RH < 75 %) incl. salt spray acc. to EN 60068-2-52 (severity degree 3); *	Yes; Class 3C4 (RH < 75 %) incl. salt spray acc. to EN 60068-2-52 (severity degree 3); *
- to mechanically active substances according to EN 60721-3-3	Yes; Class 3S4 incl. sand, dust, *	Yes; Class 3S4 incl. sand, dust, *
Use on ships/at sea		
- to biologically active substances according to EN 60721-3-6	Yes; Class 6B2 mold and fungal spores (excluding fauna); Class 6B3 on request	Yes; Class 6B2 mold and fungal spores (excluding fauna); Class 6B3 on request
- to chemically active substances according to EN 60721-3-6	Yes; Class 6C3 (RH < 75 %) incl. salt spray acc. to EN 60068-2-52 (severity degree 3); *	Yes; Class 6C3 (RH < 75 %) incl. salt spray acc. to EN 60068-2-52 (severity degree 3); *
- to mechanically active substances according to EN 60721-3-6	Yes; Class 6S3 incl. sand, dust; *	Yes; Class 6S3 incl. sand, dust; *
Usage in industrial process technology		
- Against chemically active substances acc. to EN 60654-4	Yes; Class 3 (excluding trichlorethylene)	Yes; Class 3 (excluding trichlorethylene)
- Environmental conditions for process, measuring and control systems acc. to ANSI/ISA-71.04	Yes; Level GX group A/B (excluding trichlorethylene; harmful gas concentrations up to the limits of EN 60721-3-3 class 3C4 permissible); level LC3 (salt spray) and level LB3 (oil)	Yes; Level GX group A/B (excluding trichlorethylene; harmful gas concentrations up to the limits of EN 60721-3-3 class 3C4 permissible); level LC3 (salt spray) and level LB3 (oil)
Remark		
- Note regarding classification of environmental conditions acc. to EN 60721, EN 60654-4 and ANSI/ISA-71.04	* The supplied plug covers must remain in place over the unused interfaces during operation!	* The supplied plug covers must remain in place over the unused interfaces during operation!

Overview



- For fast, high-performance serial data exchange via point-to-point coupling
- Two versions with different physical transmission characteristics:
 - RS 232C (V.24),
 - RS 422/RS 485 (X.27)
- Implemented protocols: ASCII, 3964 (R), RK 512, customized protocols (can be reloaded)
- Simple parameter assignment using tool integrated in STEP 7

Note:

SIPLUS extreme products are based on SIMATIC standard products. The contents listed here were taken from the respective standard products. SIPLUS extreme specific information was added.

Ordering data

Article No.

SIPLUS S7-300 CP 341 communications processor

For industrial applications with extended ambient conditions

Extended temperature range and exposure to media

with RS 232C interface (V.24)

6AG1341-1AH02-7AE0

with RS 422/485 (X.27) interface

6AG1341-1CH02-7AE0**Accessories****Modbus Master V3.1**

Task:

Communication via Modbus protocol with RTU format, SIMATIC S7 as master

Requirement:
CP 341 or CP 441-2; STEP 7 V4.02 and higher

Type of delivery:
Driver program/documentation, English, German, French

Single license

6ES7870-1AA01-0YA0

Single license, without software and documentation

6ES7870-1AA01-0YA1**Modbus Slave V3.1**

Task:

Communication via Modbus protocol with RTU format, SIMATIC S7 as slave

Requirement:
CP 341 or CP 441-2; STEP 7 V4.02 and higher

Type of delivery:
Driver program/documentation, English, German, French

Single license

6ES7870-1AB01-0YA0

Single license, without software and documentation

6ES7870-1AB01-0YA1

Technical specifications

Article number	6AG1341-1AH02-7AE0	6AG1341-1CH02-7AE0
Based on	6ES7341-1AH02-0AE0 SIPLUS S7-300 CP 341 RS232C	6ES7341-1CH02-0AE0 SIPLUS S7-300 CP 341 RS422/485
Ambient conditions		
Ambient temperature during operation		
• min.	-25 °C; = Tmin	-25 °C; = Tmin
• max.	70 °C; = Tmax; 60 °C @ UL/cUL, ATEX and FM use	70 °C; = Tmax; 60 °C @ UL/cUL, ATEX and FM use
Ambient temperature during storage/transportation		
• min.	-40 °C	-40 °C
• max.	70 °C	70 °C
Altitude during operation relating to sea level		
• Installation altitude above sea level, max.	5 000 m	5 000 m
• Ambient air temperature-barometric pressure-altitude	Tmin ... Tmax at 1 140 hPa ... 795 hPa (-1 000 m ... +2 000 m) // Tmin ... (Tmax - 10 K) at 795 hPa ... 658 hPa (+2 000 m ... +3 500 m) // Tmin ... (Tmax -20 K) at 658 hPa ... 540 hPa (+3 500 m ... +5 000 m)	Tmin ... Tmax at 1 140 hPa ... 795 hPa (-1 000 m ... +2 000 m) // Tmin ... (Tmax - 10 K) at 795 hPa ... 658 hPa (+2 000 m ... +3 500 m) // Tmin ... (Tmax -20 K) at 658 hPa ... 540 hPa (+3 500 m ... +5 000 m)
Relative humidity		
• With condensation, tested in accordance with IEC 60068-2-38, max.	100 %; RH incl. condensation/frost (no commissioning under condensation conditions)	100 %; RH incl. condensation/frost (no commissioning under condensation conditions)

SIMATIC S7-300 Advanced Controllers

I/O modules

SIPLUS S7-300 communication

SIPLUS S7-300 CP 341**Technical specifications**

Article number	6AG1341-1AH02-7AE0	6AG1341-1CH02-7AE0
Based on	6ES7341-1AH02-0AE0 SIPLUS S7-300 CP 341 RS232C	6ES7341-1CH02-0AE0 SIPLUS S7-300 CP 341 RS422/485
Resistance		
Use in stationary industrial systems		
- to biologically active substances according to EN 60721-3-3	Yes; Class 3B2 mold, fungus and dry rot spores (with the exception of fauna); Class 3B3 on request	Yes; Class 3B2 mold, fungus and dry rot spores (with the exception of fauna); Class 3B3 on request
- to chemically active substances according to EN 60721-3-3	Yes; Class 3C4 (RH < 75 %) incl. salt spray acc. to EN 60068-2-52 (severity degree 3); *	Yes; Class 3C4 (RH < 75 %) incl. salt spray acc. to EN 60068-2-52 (severity degree 3); *
- to mechanically active substances according to EN 60721-3-3	Yes; Class 3S4 incl. sand, dust, *	Yes; Class 3S4 incl. sand, dust, *
Use on ships/at sea		
- to biologically active substances according to EN 60721-3-6	Yes; Class 6B2 mold and fungal spores (excluding fauna); Class 6B3 on request	Yes; Class 6B2 mold and fungal spores (excluding fauna); Class 6B3 on request
- to chemically active substances according to EN 60721-3-6	Yes; Class 6C3 (RH < 75 %) incl. salt spray acc. to EN 60068-2-52 (severity degree 3); *	Yes; Class 6C3 (RH < 75 %) incl. salt spray acc. to EN 60068-2-52 (severity degree 3); *
- to mechanically active substances according to EN 60721-3-6	Yes; Class 6S3 incl. sand, dust; *	Yes; Class 6S3 incl. sand, dust; *
Usage in industrial process technology		
- Against chemically active substances acc. to EN 60654-4	Yes; Class 3 (excluding trichlorethylene)	Yes; Class 3 (excluding trichlorethylene)
- Environmental conditions for process, measuring and control systems acc. to ANSI/ISA-71.04	Yes; Level GX group A/B (excluding trichlorethylene; harmful gas concentrations up to the limits of EN 60721-3-3 class 3C4 permissible); level LC3 (salt spray) and level LB3 (oil)	Yes; Level GX group A/B (excluding trichlorethylene; harmful gas concentrations up to the limits of EN 60721-3-3 class 3C4 permissible); level LC3 (salt spray) and level LB3 (oil)
Remark		
- Note regarding classification of environmental conditions acc. to EN 60721, EN 60654-4 and ANSI/ISA-71.04	* The supplied plug covers must remain in place over the unused interfaces during operation!	* The supplied plug covers must remain in place over the unused interfaces during operation!

5

Overview



DP-M	DP-S	FMS	PG/OP	S7/S5
●	●		●	●

- PROFIBUS DP master or slave with electrical interface for connecting the SIMATIC S7-300 to PROFIBUS at up to 12 Mbps (including 45.45 Kbps)
- Communication services:
- PROFIBUS DP
- PG/OP communication (OP multiplexing)
- S7 communication (client, server)
- Open communication (SEND/RECEIVE)
- Easy configuring and programming via PROFIBUS
- Cross-network PG communication using S7 routing
- Modules can be replaced without a PG

Note:

SIPLUS extreme products are based on Siemens Industry standard products. The contents listed here were taken from the respective standard products. SIPLUS extreme-specific information was added.

Technical specifications

Article number	6AG1342-5DA03-7XE0
Based on product type designation	6GK7342-5DA03-0XE0 SIPLUS NET CP 342-5
ambient conditions	
ambient temperature	
• during operation	-25 ... +70 °C
• during storage	-40 ... +70 °C
• during transport	-40 ... +70 °C
installation altitude at height above sea level maximum	5 000 m
ambient condition relating to ambient temperature - air pressure - installation altitude	Tmin ... Tmax at 1 140 hPa ... 795 hPa (-1 000 m ... +2 000 m) // Tmin ... (Tmax - 10 K) at 795 hPa ... 658 hPa (+2 000 m ... +3 500 m) // Tmin ... (Tmax - 20 K) at 658 hPa ... 540 hPa (+3 500 m ... +5 000 m)
relative humidity	
• with condensation acc. to IEC 60068-2-38 maximum	100 %; RH including condensation/frost (no commissioning when condensation is present), horizontal installation
chemical resistance to commercially available cooling lubricants	Yes; incl. airborne diesel and oil droplets
resistance to biologically active substances	
• conformity acc. to EN 60721-3-3	Yes; Class 3B2 mold and fungal spores (excluding fauna), Class 3B3 on request
• conformity acc. to EN 60721-3-6	Yes; Class 6B2 mold, fungal and dry rot spores (excluding fauna)
resistance to chemically active substances	
• conformity acc. to EN 60721-3-3	Yes; Class 3C4 (RH < 75 %) incl. salt spray in accordance with EN 60068-2-52 (Severity 3). The supplied plug covers must remain in place on the unused interfaces during operation.
• conformity acc. to EN 60721-3-6	Yes
resistance to mechanically active substances	
• conformity acc. to EN 60721-3-3	Yes; Class 3S4 incl. sand, dust. The supplied plug covers must remain in place over the unused interfaces during operation.
• conformity acc. to EN 60721-3-6	Yes; Class 6S3 incl. sand, dust. The supplied plug covers must remain in place over the unused interfaces during operation.
coating for equipped printed circuit board acc. to EN 61086	Yes; Class 2 for high availability
type of coating protection against pollution according to EN 60664-3	Yes; Protection of the type 1
type of test of the coating acc. to MIL-I-46058C	Yes; Coating discoloration during service life possible
product conformity of the coating Qualification and Performance of Electrical Insulating Compound for Printed Board Assemblies acc. to IPC-CC-830A	Yes; Conformal coating, class A
protection class IP	IP20

Ordering data

Article No.

SIPLUS CP 342-5 communications processor

(Extended temperature range and exposure to environmental substances)

Communications processor for electrical connection of SIMATIC S7-300 to PROFIBUS at up to 12 Mbps, with electronic manual on CD-ROM

Ambient temperature range
-25 ... +70 °C

6AG1342-5DA03-7XE0

Accessories

See SIMATIC CP 342-5 communications processor, page 5/182

SIMATIC S7-300 Advanced Controllers

I/O modules

SIPLUS S7-300 communication

SIPLUS S7-300 CP 343-1 Lean

Overview



ISO	TCP/UDP	PN	MRP	IT	IP-R	PG/OP	S7/S5
	●	●	●			●	●

- Connection for the SIMATIC S7-300 to Industrial Ethernet (not for SINUMERIK)
 - 2 x RJ45 interface for 10/100 Mbps full/half duplex connection (with autosensing for automatic switchover and autocrossover function)
 - Integrated 2-port real-time switch ERTEC
 - Multi-protocol operation with TCP and UDP transport protocol and PROFINET IO
 - Keep Alive function
- Communications services:
 - Open communication (TCP/IP and UDP)
 - PG/OP communication
 - S7 communication (server)
 - PROFINET IO device
- Multicast for UDP
- Remote programming and initial commissioning is possible over Industrial Ethernet
- IT communication
 - Web function
- Integration into network management through SNMP
- Configuration with STEP 7
- Cross-network PG/OP communication by means of S7 routing
- Diagnostics possibilities in STEP 7 and via web browser

Note:

SIPLUS extreme products are based on SIMATIC standard products. The contents listed here were adopted from the respective standard products. SIPLUS extreme-specific information was added.

Ordering data

Article No.

SIPLUS CP 343-1 Lean communications processor

For connecting SIMATIC S7-300 to Industrial Ethernet through TCP/IP and UDP, Multicast, S7 communication, open communication (SEND/RECEIVE), FETCH/WRITE, PROFINET IO device, integral 2-port switch ERTEC, comprehensive diagnostics facilities, module replacement without programming device, SNMP, initial commissioning over LAN; with electronic manual on CD-ROM

For industrial applications with extended ambient conditions

Extended temperature range and exposure to environmental substances

6AG1343-1CX10-2XE0

Accessories

Consumables

IE FC RJ45 plug 180

(Extended temperature range and exposure to environmental substances)

180° cable outlet

- 1 unit

6AG1901-1BB10-7AA0

IE FC TP standard cable GP 2 x 2 (type A)

4-wire, shielded TP installation cable for connection to IE FC RJ45 outlet/IE FC RJ45 plug; PROFINET-compliant; with UL approval; sold by the meter; max. delivery unit 1 000 m, minimum order quantity 20 m

6XV1840-2AH10

IE FC stripping tool

Pre-adjusted stripping tool for fast stripping of Industrial Ethernet FC cables

6GK1901-1GA00

Programming tools

STEP 7 Version 5.7

See chapter 12

STEP 7 Professional V17

See chapter 12

SOFTNET S7 for Industrial Ethernet

Software for S7 and open communication, incl. OPC server, PG/OP communication, and NCM PC/STEP 7 Professional V12, runtime software, software and electronic manual on CD-ROM, license key on USB flash drive, Class A

See Industry Mall

Technical specifications

Article number	6AG1343-1CX10-2XE0
Based on	6GK7343-1CX10-0XE0
product type designation	SIPLUS NET CP343-1 LEAN
ambient conditions	
ambient temperature	
• for vertical installation during operation	-25 ... +40 °C
• for horizontally arranged busbars during operation	-25 ... +60 °C
• during storage	-40 ... +70 °C
• during transport	-40 ... +70 °C
installation altitude at height above sea level maximum	5 000 m
ambient condition relating to ambient temperature - air pressure - installation altitude	Tmin ... Tmax at 1 140 hPa ... 795 hPa (-1 000 m ... +2 000 m) // Tmin ... (Tmax - 10 K) at 795 hPa ... 658 hPa (+2 000 m ... +3 500 m) // Tmin ... (Tmax - 20 K) at 658 hPa ... 540 hPa (+3 500 m ... +5 000 m)
relative humidity	
• with condensation acc. to IEC 60068-2-38 maximum	100 %; RH including condensation/frost (no commissioning when condensation is present), horizontal installation
chemical resistance to commercially available cooling lubricants	Yes; incl. airborne diesel and oil droplets
resistance to biologically active substances	
• conformity acc. to EN 60721-3-3	Yes; Class 3B2 mold and fungal spores (excluding fauna), Class 3B3 on request
• conformity acc. to EN 60721-3-6	Yes; Class 6B2 mold, fungal and dry rot spores (excluding fauna)

Article number	6AG1343-1CX10-2XE0
Based on	6GK7343-1CX10-0XE0
product type designation	SIPLUS NET CP343-1 LEAN
resistance to chemically active substances	
• conformity acc. to EN 60721-3-3	Yes; Class 3C4 (RH < 75 %) incl. salt spray in accordance with EN 60068-2-52 (Severity 3). The supplied plug covers must remain in place on the unused interfaces during operation.
• conformity acc. to EN 60721-3-6	Yes
resistance to mechanically active substances	
• conformity acc. to EN 60721-3-3	Yes; Class 3S4 incl. sand, dust. The supplied plug covers must remain in place over the unused interfaces during operation.
• conformity acc. to EN 60721-3-6	Yes; Class 6S3 incl. sand, dust. The supplied plug covers must remain in place over the unused interfaces during operation.
coating for equipped printed circuit board acc. to EN 61086	Yes; Class 2 for high availability
type of coating protection against pollution according to EN 60664-3	Yes; Protection of the type 1
type of test of the coating acc. to MIL-I-46058C	Yes; Coating discoloration during service life possible
product conformity of the coating Qualification and Performance of Electrical Insulating Compound for Printed Board Assemblies acc. to IPC-CC-830A	Yes; Conformal coating, class A
protection class IP	IP20

SIMATIC S7-300 Advanced Controllers

I/O modules

SIPLUS S7-300 communication

SIPLUS S7-300 CP 343-1

Overview



ISO	TCP/UDP	PN	MRP	IT	IP-R	PG/OP	S7/S5
●	●	●	●			●	●

- The connection of SIMATIC S7-300/SINUMERIK 840D powerline to Industrial Ethernet
 - 2 x RJ45 interface for 10/100 Mbps full/half-duplex connection with autosensing/autonegotiation and autocrossover function
 - Integrated 2-port real-time switch ERTEC
 - Multi-protocol operation with ISO, TCP, UDP transport protocol and PROFINET IO
 - Adjustable keep-alive function

- Communications services:
 - Open communication (ISO, TCP/IP, and UDP)
 - PROFINET IO controller or PROFINET IO device
 - PG/OP communication: Cross-network by means of S7 routing
 - S7 communication (client, server, multiplexing)
- Media redundancy (MRP); within an Ethernet network with ring topology, the CP supports the media redundancy procedure MRP (V2.2 or higher).
- Multicast for UDP
- IP address assignment via DHCP, simple PC tool or via the user program (e.g. HMI)
- Access protection via configurable access list
- Remote programming and commissioning via Industrial Ethernet
- Configuration with STEP 7
- Automatic setting of CPU clock setting over Ethernet with NTP or SIMATIC procedure
- Web diagnostics
- Integration in network management systems via SNMP (MIB2 diagnostics information)
- Diagnostics possibilities in STEP 7 and via web browser

Note:

SIPLUS extreme products are based on SIMATIC standard products. The contents listed here were adopted from the respective standard products. SIPLUS extreme-specific information was added.

Ordering data

Article No.

SIPLUS S7-300 CP 343-1 communications processor

For connection of SIMATIC S7-300 to Industrial Ethernet over ISO and TCP/IP; PROFINET IO controller or PROFINET IO device, MRP, integrated 2-port switch ERTEC; S7 communication, open communication (SEND/RECEIVE), FETCH/WRITE, with and without RFC 1006, multicast, DHCP, CPU clock synchronization via SIMATIC procedure and NTP, diagnostics, SNMP, access protection through IP access list, initialization over LAN 10/100 Mbps; with electronic manual on DVD

For industrial applications with extended ambient conditions

Extended temperature range and exposure to environmental substances

6AG1343-1EX30-7XE0

Article No.

Accessories

Consumables

IE FC RJ45 plug 180

(Extended temperature range and exposure to environmental substances)

180° cable outlet

- 1 unit

6AG1901-1BB10-7AA0

C-PLUG

Removable data storage medium for simple replacement of devices in the event of a fault; for storing configuration or engineering and application data; can be used for SIMATIC NET products with C-PLUG slot, -40 ... +70 °C, exposure to environmental substances

6AG1900-0AB10-7AA0

IE FC TP standard cable GP 2 x 2 (type A)

4-wire, shielded TP installation cable for connection to IE FC RJ45 outlet/IE FC RJ45 plug; PROFINET-compliant; with UL approval; sold by the meter; max. delivery unit 1 000 m, minimum order quantity 20 m

6XV1840-2AH10

IE FC stripping tool

Pre-adjusted stripping tool for fast stripping of Industrial Ethernet FC cables

6GK1901-1GA00

Ordering data	Article No.	Article No.
<p><i>Communication within the application</i></p> <p>SIPLUS SCALANCE XC-200 Industrial Ethernet switches</p> <p>Industrial Ethernet switches with integrated SNMP access, web diagnostics, copper cable diagnostics and PROFINET diagnostics for configuring line, star and ring topologies; with integrated redundancy manager; incl. operating instructions, Industrial Ethernet network manual and configuration software on CD-ROM</p> <p>Extended temperature range and exposure to environmental substances</p> <p>Switches with PROFINET delivery state</p> <ul style="list-style-type: none"> • SIPLUS SCALANCE XC206-2 (ST/BFOC) with six RJ45 ports 10/100 Mbps and two ST/BFOC ports 100 Mbps 	6AG1206-2BB00-7AC2	<p><i>Programming tools</i></p> <p>STEP 7 Version 5.7 See chapter 12</p> <p>STEP 7 Professional V17 See chapter 12</p> <p>SOFTNET S7 for Industrial Ethernet See Industry Mall</p> <p>Software for S7 and open communication, incl. OPC server, PG/OP communication, and NCM PC/STEP 7 Professional V12, runtime software, software and electronic manual on CD-ROM, license key on USB flash drive, Class A</p>

Technical specifications		Technical specifications	
Article number	6AG1343-1EX30-7XE0	Article number	6AG1343-1EX30-7XE0
Based on	6GK7343-1EX30-0XE0	Based on	6GK7343-1EX30-0XE0
product type designation	SIPLUS NET CP 343-1	product type designation	SIPLUS NET CP 343-1
ambient conditions		resistance to chemically active substances	
ambient temperature		• conformity acc. to EN 60721-3-3	Yes; Class 3C4 (RH < 75 %) incl. salt spray in accordance with EN 60068-2-52 (Severity 3). The supplied plug covers must remain in place on the unused interfaces during operation.
• during operation	-25 ... +70 °C		Yes
• during storage	-40 ... +70 °C	• conformity acc. to EN 60721-3-6	Yes; Class 3S4 incl. sand, dust. The supplied plug covers must remain in place over the unused interfaces during operation.
• during transport	-40 ... +70 °C		Yes; Class 6S3 incl. sand, dust. The supplied plug covers must remain in place over the unused interfaces during operation.
installation altitude at height above sea level maximum	5 000 m	resistance to mechanically active substances	Yes; Class 2 for high availability
ambient condition relating to ambient temperature - air pressure - installation altitude	Tmin ... Tmax at 1 140 hPa ... 795 hPa (-1 000 m ... +2 000 m) // Tmin ... (Tmax - 10 K) at 795 hPa ... 658 hPa (+2 000 m ... +3 500 m) // Tmin ... (Tmax - 20 K) at 658 hPa ... 540 hPa (+3 500 m ... +5 000 m)	• conformity acc. to EN 60721-3-6	Yes; Protection of the type 1
relative humidity		coating for equipped printed circuit board acc. to EN 61086	Yes; Coating discoloration during service life possible
• with condensation acc. to IEC 60068-2-38 maximum	100 %; RH including condensation/frost (no commissioning when condensation is present), horizontal installation	type of coating protection against pollution according to EN 60664-3	Yes; Conformal coating, class A
chemical resistance to commercially available cooling lubricants	Yes; incl. airborne diesel and oil droplets	type of test of the coating acc. to MIL-I-46058C	
resistance to biologically active substances		product conformity of the coating Qualification and Performance of Electrical Insulating Compound for Printed Board Assemblies acc. to IPC-CC-830A	
• conformity acc. to EN 60721-3-3	Yes; Class 3B2 mold and fungal spores (excluding fauna), Class 3B3 on request	protection class IP	IP20
• conformity acc. to EN 60721-3-6	Yes; Class 6B2 mold, fungal and dry rot spores (excluding fauna)		

SIMATIC S7-300 Advanced Controllers

I/O modules

SIPLUS S7-300 communication

SIPLUS S7-300 CP 343-1 Advanced

Overview



ISO	TCP/UDP	PN	MRP	IT	IP-R	PG/OP	S7/S5
●	●	●	●	●	●	●	●

- The connection of SIMATIC S7-300/SINUMERIK 840D powerline to Industrial Ethernet
 - Multi-protocol operation with TCP and UDP transport protocol
 - Adjustable keep-alive function
- Two separate interfaces (integrated network separation):
 - Gigabit interface with one RJ45 port with 10/100/1 000 Mbps, full/half-duplex with auto-sensing capability
 - PROFINET interface with two RJ45 ports with 10/100 Mbps full/half-duplex with auto-sensing and auto-crossover functionality via integrated 2-port switch
- Communications services via both interfaces:
 - Open communication (TCP/IP and UDP): Multicast with UDP, including routing between both interfaces
 - PG/OP communication:
 - Cross-network by means of S7 routing
 - S7 communication (client, server, multiplexing) including routing between both interfaces
 - IT communication:
 - HTTP communication supports access to process data via own web pages;
 - e-mail client function, sending of e-mails directly from user program;
 - FTP communication supports program-controlled FTP client communication;
 - access to data blocks through FTP server

- Communications services via PROFINET interfaces:
 - PROFINET IO controller and IO device with real-time properties (RT and IRT)¹⁾
 - PROFINET CBA
 - IP address assignment via DHCP, simple PC tool or via program block (e.g. for HMI)
 - Configuration with STEP 7
- Media redundancy (MRP); within an Ethernet network with ring topology, the CP supports the media redundancy procedure MRP (V2.2 or higher).
- Access protection by means of configurable IP access list
- Module replacement without programming device; all information is stored on the C-PLUG (also file system for IT functions)
- Extensive diagnostic functions for all modules in the rack
- IT communication
 - Web function
 - E-mail function
 - FTP
- Integration into network management systems through the support of SNMP V1 MIB-II

- ¹⁾ possible combinations in parallel operation:
- IO controller with IRT and IO device with RT
 - IO controller with RT and IO device with IRT

Note:

SIPLUS extreme products are based on SIMATIC standard products. The contents listed here were adopted from the respective standard products. SIPLUS extreme-specific information was added.

Ordering data	Article No.	Article No.
<p>SIPLUS S7-300 CP 343-1 Advanced communications processor</p> <p>For connecting the SIMATIC S7-300 to Industrial Ethernet, PROFINET IO controller and IO Device with RT and IRT, MRP, PROFINET CBA, TCP/IP and UDP, S7 communication, open communication (SEND/RECEIVE), FETCH/WRITE with or without RFC 1006, diagnostics extensions, multicast, web server, HTML diagnostics, FTP server, FTP client, email client, CPU clock set via SIMATIC procedure and NTP, access protection via IP access list, SNMP, DHCP, initialization over LAN 10/100 Mbps; with electronic manual on DVD; C-PLUG included in scope of delivery</p> <p><i>For industrial applications with extended ambient conditions</i></p> <p>Exposure to environmental substances</p>	6AG1343-1GX31-4XE0	<p><i>Communication within the application</i></p> <p>SIPLUS SCALANCE XC-200 Industrial Ethernet switches</p> <p>Industrial Ethernet switches with integrated SNMP access, web diagnostics, copper cable diagnostics and PROFINET diagnostics for configuring line, star and ring topologies; with integrated redundancy manager; incl. operating instructions, Industrial Ethernet network manual and configuration software on CD-ROM</p> <p>Extended temperature range and exposure to environmental substances</p> <p>Switches with PROFINET delivery state</p> <p>• SIPLUS SCALANCE XC206-2 (ST/BFOC) with six RJ45 ports 10/100 Mbps and two ST/BFOC ports 100 Mbps</p>
<p>Accessories</p> <p><i>Consumables</i></p> <p>IE FC RJ45 plug 180</p> <p>(Extended temperature range and exposure to environmental substances)</p> <p>180° cable outlet</p> <p>• 1 unit</p>	6AG1901-1BB10-7AA0	<p><i>Programming tools</i></p> <p>STEP 7 Version 5.7</p> <p>See chapter 12</p>
<p>SIPLUS C-PLUG</p> <p>Removable data storage medium for simple replacement of devices in the event of a fault; for storing configuration or engineering and application data; can be used for SIMATIC NET products with C-PLUG slot, -40 ... +70 °C, exposure to environmental substances</p>	6AG1900-0AB10-7AA0	<p>STEP 7 Professional V17</p> <p>See chapter 12</p>
<p>IE FC TP standard cable GP 2 x 2 (type A)</p> <p>4-wire, shielded TP installation cable for connection to IE FC RJ45 outlet/IE FC RJ45 plug; PROFINET-compliant; with UL approval; sold by the meter; max. delivery unit 1 000 m, minimum order quantity 20 m</p>	6XV1840-2AH10	<p>SOFTNET S7 for Industrial Ethernet</p> <p>Software for S7 and open communication, incl. OPC server, PG/OP communication, and NCM PC/STEP 7 Professional V12, runtime software, software and electronic manual on CD-ROM, license key on USB flash drive, Class A</p> <p>See Industry Mall</p>
<p>IE FC TP standard cable GP 4 x 2</p> <p>8-wire, shielded TP installation cable for universal applications; with UL approval; sold by the meter; max. delivery unit 1 000 m, minimum order quantity 20 m</p> <p>• AWG22, for connection to IE FC RJ45 modular outlet</p> <p>• AWG24, for connecting to IE FC RJ45 Plug 4 x 2, IE FC M12 Plug PRO 4 x 2</p>	6XV1870-2E 6XV1878-2A	
<p>IE FC stripping tool</p> <p>Pre-adjusted stripping tool for fast stripping of Industrial Ethernet FC cables</p>	6GK1901-1GA00	

SIMATIC S7-300 Advanced Controllers

I/O modules

SIPLUS S7-300 communication

SIPLUS S7-300 CP 343-1 Advanced**Technical specifications**

Article number	6AG1343-1GX31-4XE0	Article number	6AG1343-1GX31-4XE0
Based on	6GK7343-1GX31-0XE0	Based on	6GK7343-1GX31-0XE0
product type designation	SIPLUS NET CP343-1 ADVANCED	product type designation	SIPLUS NET CP343-1 ADVANCED
ambient conditions		resistance to chemically active substances	
ambient temperature			
• for vertical installation during operation	0 ... 40 °C	• conformity acc. to EN 60721-3-3	Yes; Class 3C4 (RH < 75 %) incl. salt spray in accordance with EN 60068-2-52 (Severity 3). The supplied plug covers must remain in place on the unused interfaces during operation.
• for horizontally arranged busbars during operation	0 ... 60 °C		Yes
• during storage	-40 ... +70 °C	• conformity acc. to EN 60721-3-6	Yes; Class 3S4 incl. sand, dust. The supplied plug covers must remain in place over the unused interfaces during operation.
• during transport	-40 ... +70 °C		Yes; Class 6S3 incl. sand, dust. The supplied plug covers must remain in place over the unused interfaces during operation.
installation altitude at height above sea level maximum	5 000 m	resistance to mechanically active substances	
ambient condition relating to ambient temperature - air pressure - installation altitude	Tmin ... Tmax at 1 140 hPa ... 795 hPa (-1 000 m ... +2 000 m) // Tmin ... (Tmax - 10 K) at 795 hPa ... 658 hPa (+2 000 m ... +3 500 m) // Tmin ... (Tmax - 20 K) at 658 hPa ... 540 hPa (+3 500 m ... +5 000 m)	• conformity acc. to EN 60721-3-3	Yes; Class 3S4 incl. sand, dust. The supplied plug covers must remain in place over the unused interfaces during operation.
relative humidity			Yes; Class 2 for high availability
• with condensation acc. to IEC 60068-2-38 maximum	100 %; RH including condensation/frost (no commissioning when condensation is present), horizontal installation	coating for equipped printed circuit board acc. to EN 61086	Yes; Protection of the type 1
chemical resistance to commercially available cooling lubricants	Yes; incl. airborne diesel and oil droplets	type of coating protection against pollution according to EN 60664-3	Yes; Coating discoloration during service life possible
resistance to biologically active substances		type of test of the coating acc. to MIL-I-46058C	Yes; Conformal coating, class A
• conformity acc. to EN 60721-3-3	Yes; Class 3B2 mold and fungal spores (excluding fauna), Class 3B3 on request	product conformity of the coating Qualification and Performance of Electrical Insulating Compound for Printed Board Assemblies acc. to IPC-CC-830A	
• conformity acc. to EN 60721-3-6	Yes; Class 6B2 mold, fungal and dry rot spores (excluding fauna)	protection class IP	IP20

Overview



- SINAUT communication module SIPLUS TIM for SIMATIC S7-300 for use in a wide area network (WAN)
- IP communication via secure VPN (virtual private network) using the Internet
- Wireless communication via GPRS router, GPRS modem, or radio devices
- Wired communication via Ethernet, DSL, dialup modems or dedicated line modem
- Complete migration of existing wireless, dedicated line and dial-up technology to IP-based network
- Message frame memory for seamless recording of data
- Simple configuration and operation without specialist IT knowledge

Note:

SIPLUS extreme products are based on SIMATIC standard products. The contents listed here were adopted from the respective standard products. SIPLUS extreme-specific information was added.

Ordering data

Article No.

SIPLUS ST7 TIM 3V-IE communication module With an RS 232 interface for SINAUT communication via a conventional WAN or an IP-based network (WAN or LAN)	6AG1800-3BA00-7AA0
Accessories <i>Consumables</i>	
IE FC TP standard cable GP 2 x 2 (Type A) 4-wire, shielded TP installation cable for connection to IE FC outlet RJ45/IE FC RJ45 plug; PROFINET-compliant; with UL approval; sold by the meter; max. delivery unit 1000 m, minimum order quantity 20 m	6XV1840-2AH10
IE FC RJ45 plug 180 RJ45 plug connector for Industrial Ethernet with a rugged metal housing and integrated insulation displacement contacts for connecting Industrial Ethernet FC installation cables; with 180° cable outlet; for network components and CPs/CPUs with Industrial Ethernet interface <ul style="list-style-type: none"> • 1 pack = 1 unit, -40 ... +70 °C, exposure to media 	6AG1901-1BB10-7AA0
IE FC stripping tool Preadjusted stripping tool for fast stripping of Industrial Ethernet FC cables	6GK1901-1GA00

SIMATIC S7-300 Advanced Controllers

I/O modules

SIPLUS S7-300 communication

SIPLUS TIM 3V-IE for WAN and Ethernet**Technical specifications**

Article number	6AG1800-3BA00-7AA0	Article number	6AG1800-3BA00-7AA0
Based on	6NH7800-3BA00	Based on	6NH7800-3BA00
product type designation	SIPLUS SINAUT ST7, TIM 3V-IE	product type designation	SIPLUS SINAUT ST7, TIM 3V-IE
ambient conditions		resistance to chemically active substances	
ambient temperature		• conformity acc. to EN 60721-3-3	Yes; Class 3C4 (RH < 75 %) incl. salt spray in accordance with EN 60068-2-52 (Severity 3). The supplied plug covers must remain in place on the unused interfaces during operation.
• during operation	-25 ... +70 °C		Yes
• during storage	-40 ... +70 °C	• conformity acc. to EN 60721-3-6	Yes; Class 3S4 incl. sand, dust. The supplied plug covers must remain in place over the unused interfaces during operation.
• during transport	-40 ... +70 °C		Yes; Class 6S3 incl. sand, dust. The supplied plug covers must remain in place over the unused interfaces during operation.
installation altitude at height above sea level maximum	5 000 m	resistance to mechanically active substances	Yes; Class 2 for high availability
ambient condition relating to ambient temperature - air pressure - installation altitude	Tmin ... Tmax at 1 140 hPa ... 795 hPa (-1 000 m ... +2 000 m) // Tmin ... (Tmax - 10 K) at 795 hPa ... 658 hPa (+2 000 m ... +3 500 m) // Tmin ... (Tmax - 20 K) at 658 hPa ... 540 hPa (+3 500 m ... +5 000 m)	• conformity acc. to EN 60721-3-6	Yes; Protection of the type 1
relative humidity		coating for equipped printed circuit board acc. to EN 61086	Yes; Coating discoloration during service life possible
• with condensation acc. to IEC 60068-2-38 maximum	100 %; RH including condensation/frost (no commissioning when condensation is present), horizontal installation	type of coating protection against pollution according to EN 60664-3	Yes; Conformal coating, class A
chemical resistance to commercially available cooling lubricants	Yes; incl. airborne diesel and oil droplets	type of test of the coating acc. to MIL-I-46058C	
resistance to biologically active substances		product conformity of the coating Qualification and Performance of Electrical Insulating Compound for Printed Board Assemblies acc. to IPC-CC-830A	
• conformity acc. to EN 60721-3-3	Yes; Class 3B2 mold and fungal spores (excluding fauna), Class 3B3 on request	protection class IP	IP20
• conformity acc. to EN 60721-3-6	Yes; Class 6B2 mold, fungal and dry rot spores (excluding fauna)		

Overview



- SINAUT communication module SIPLUS TIM with four interfaces for SIMATIC S7-300 or as a self-contained device for S7-400 for use in a wide area network (WAN)
- For universal use in a SINAUT station, node station and control center
- Internet communication via integrated MSC-VPN tunnel with direct connection to DSL router or operation via IPsec VPN with additional SIMATIC NET components
- Wireless communication via GPRS router, GPRS modem, or radio devices
- Wired communication via Ethernet, DSL, dialup modems or dedicated line modem
- Complete migration of existing wireless, dedicated line and dial-up technology to IP-based network
- Message frame memory for seamless recording of data and support of redundant communication paths
- Simple configuration and operation without specialist IT knowledge

Note:

SIPLUS extreme products are based on SIMATIC standard products. The contents listed here were adopted from the respective standard products. SIPLUS extreme-specific information was added.

Ordering data

Article No.

SIPLUS ST7 TIM 4R-IE communication module With two combined RS 232/RS 485 interfaces for SINAUT communication via conventional WANs and two RJ45 interfaces for SINAUT communication via IP-based networks (WAN or LAN)	6AG1800-4BA00-7AA0
Accessories	
<i>Consumables</i>	
IE FC TP standard cable GP 2 x 2 (Type A) 4-wire, shielded TP installation cable for connection to IE FC outlet RJ45/IE FC RJ45 plug; PROFINET-compliant; with UL approval; sold by the meter; max. delivery unit 1000 m, minimum order quantity 20 m	6XV1840-2AH10
IE FC RJ45 plug 180 RJ45 plug connector for Industrial Ethernet with a rugged metal housing and integrated insulation displacement contacts for connecting Industrial Ethernet FC installation cables; with 180° cable outlet; for network components and CPs/CPU with Industrial Ethernet interface • 1 pack = 1 unit; -40 ... +70 °C, exposure to media	6AG1901-1BB10-7AA0
IE FC stripping tool Preadjusted stripping tool for fast stripping of Industrial Ethernet FC cables	6GK1901-1GA00

SIMATIC S7-300 Advanced Controllers

I/O modules

SIPLUS S7-300 communication

SIPLUS TIM 4R-IE for WAN and Ethernet**Technical specifications**

Article number	6AG1800-4BA00-7AA0	Article number	6AG1800-4BA00-7AA0
Based on	6NH7800-4BA00	Based on	6NH7800-4BA00
product type designation	SIPLUS SINAUT ST7, TIM 4R-IE	product type designation	SIPLUS SINAUT ST7, TIM 4R-IE
ambient conditions		resistance to chemically active substances	
ambient temperature		<ul style="list-style-type: none"> conformity acc. to EN 60721-3-3 	Yes; Class 3C4 (RH < 75 %) incl. salt spray in accordance with EN 60068-2-52 (Severity 3). The supplied plug covers must remain in place on the unused interfaces during operation.
<ul style="list-style-type: none"> during operation during storage during transport 	-25 ... +70 °C -40 ... +70 °C -40 ... +70 °C	<ul style="list-style-type: none"> conformity acc. to EN 60721-3-6 	Yes
installation altitude at height above sea level maximum	5 000 m	resistance to mechanically active substances	
ambient condition relating to ambient temperature - air pressure - installation altitude	Tmin ... Tmax at 1 140 hPa ... 795 hPa (-1 000 m ... +2 000 m) // Tmin ... (Tmax - 10 K) at 795 hPa ... 658 hPa (+2 000 m ... +3 500 m) // Tmin ... (Tmax - 20 K) at 658 hPa ... 540 hPa (+3 500 m ... +5 000 m)	<ul style="list-style-type: none"> conformity acc. to EN 60721-3-6 	Yes; Class 3S4 incl. sand, dust. The supplied plug covers must remain in place over the unused interfaces during operation.
relative humidity		<ul style="list-style-type: none"> conformity acc. to EN 60721-3-6 	Yes; Class 6S3 incl. sand, dust. The supplied plug covers must remain in place over the unused interfaces during operation.
<ul style="list-style-type: none"> with condensation acc. to IEC 60068-2-38 maximum 	100 %; RH including condensation/frost (no commissioning when condensation is present), horizontal installation	coating for equipped printed circuit board acc. to EN 61086	Yes; Class 2 for high availability
chemical resistance to commercially available cooling lubricants	Yes; incl. airborne diesel and oil droplets	type of coating protection against pollution according to EN 60664-3	Yes; Protection of the type 1
resistance to biologically active substances		type of test of the coating acc. to MIL-I-46058C	Yes; Coating discoloration during service life possible
<ul style="list-style-type: none"> conformity acc. to EN 60721-3-3 	Yes; Class 3B2 mold and fungal spores (excluding fauna), Class 3B3 on request	product conformity of the coating Qualification and Performance of Electrical Insulating Compound for Printed Board Assemblies acc. to IPC-CC-830A	Yes; Conformal coating, class A
<ul style="list-style-type: none"> conformity acc. to EN 60721-3-6 	Yes; Class 6B2 mold, fungal and dry rot spores (excluding fauna)	protection class IP	IP20

Overview



In a station for the S7-CPU, the new SIPLUS communication module TIM 3V-IE DNP3 V3.0 (TeleControl Interface Module) handles the data exchange with the assigned master system SIMATIC PCS 7 TeleControl V8.0 using the open DNP3 protocol. In addition, the V3.0 module now also supports master and node functionality.

- With the S7-300 housing, the module can be fully integrated into the S7-300 system
- The module has an RS232 interface for the connection of an external modem for data transmission via a conventional WAN or the connection of a Modbus RTU slave to an S7-300 system
- The RJ45 port is used for data transmission via IP-based networks

Note:

SIPLUS extreme products are based on SIMATIC standard products. The contents listed here were adopted from the respective standard products. SIPLUS extreme-specific information was added.

Ordering data

Article No.

SIPLUS TIM 3V-IE DNP3 communication module**6AG1803-3BA00-7AA0**

With an RS232 interface for SINAUT communication via a conventional WAN and an IP-based network (WAN or LAN)

Accessories*Consumables***IE FC TP standard cable GP 2 x 2 (Type A)****6XV1840-2AH10**

4-wire, shielded TP installation cable for connection to IE FC outlet RJ45/IE FC RJ45 plug; PROFINET-compliant; with UL approval; sold by the meter; max. delivery unit 1000 m, minimum order quantity 20 m

IE FC RJ45 plug 180

RJ45 plug-in connector for Industrial Ethernet with a rugged metal housing and integrated insulation displacement contacts for connecting Industrial Ethernet FC installation cables; with 180° cable outlet; for network components and CPs/CPUs with Industrial Ethernet interface

- 1 pack = 1 unit
- -40 ... +70 °C, exposure to media

6AG1901-1BB10-7AA0**IE FC stripping tool**

Preadjusted stripping tool for fast stripping of the Industrial Ethernet FC cables

6GK1901-1GA00

SIMATIC S7-300 Advanced Controllers

I/O modules

SIPLUS S7-300 communication

SIPLUS TIM 3V-IE DNP3**Technical specifications**

Article number	6AG1803-3BA00-7AA0	Article number	6AG1803-3BA00-7AA0
Based on	6NH7803-3BA00-0AA0	Based on	6NH7803-3BA00-0AA0
product type designation	SIPLUS NET TIM 3V-IE DNP3	product type designation	SIPLUS NET TIM 3V-IE DNP3
ambient conditions		resistance to chemically active substances	
ambient temperature			
• during operation	-25 ... +70 °C	• conformity acc. to EN 60721-3-3	Yes; Class 3C4 (RH < 75 %) incl. salt spray in accordance with EN 60068-2-52 (Severity 3). The supplied plug covers must remain in place on the unused interfaces during operation.
• during storage	-40 ... +70 °C		Yes
• during transport	-40 ... +70 °C		
installation altitude at height above sea level maximum	5 000 m	• conformity acc. to EN 60721-3-6	Yes; Class 3S4 incl. sand, dust. The supplied plug covers must remain in place over the unused interfaces during operation.
ambient condition relating to ambient temperature - air pressure - installation altitude	Tmin ... Tmax at 1 140 hPa ... 795 hPa (-1 000 m ... +2 000 m) // Tmin ... (Tmax - 10 K) at 795 hPa ... 658 hPa (+2 000 m ... +3 500 m) // Tmin ... (Tmax - 20 K) at 658 hPa ... 540 hPa (+3 500 m ... +5 000 m)	resistance to mechanically active substances	Yes; Class 6S3 incl. sand, dust. The supplied plug covers must remain in place over the unused interfaces during operation.
relative humidity		• conformity acc. to EN 60721-3-6	Yes; Class 6S3 incl. sand, dust. The supplied plug covers must remain in place over the unused interfaces during operation.
• with condensation acc. to IEC 60068-2-38 maximum	100 %; RH including condensation/frost (no commissioning when condensation is present), horizontal installation	coating for equipped printed circuit board acc. to EN 61086	Yes; Class 2 for high availability
chemical resistance to commercially available cooling lubricants	Yes; incl. airborne diesel and oil droplets	type of coating protection against pollution according to EN 60664-3	Yes; Protection of the type 1
resistance to biologically active substances		type of test of the coating acc. to MIL-I-46058C	Yes; Coating discoloration during service life possible
• conformity acc. to EN 60721-3-3	Yes; Class 3B2 mold and fungal spores (excluding fauna), Class 3B3 on request	product conformity of the coating Qualification and Performance of Electrical Insulating Compound for Printed Board Assemblies acc. to IPC-CC-830A	Yes; Conformal coating, class A
• conformity acc. to EN 60721-3-6	Yes; Class 6B2 mold, fungal and dry rot spores (excluding fauna)	protection class IP	IP20

Overview



In a station for the S7-CPU, the SIPLUS communication module TIM 4R-IE DNP3 (TeleControl Interface Module) handles the data exchange with the assigned SIMATIC PCS7 TeleControl V8.0 master system using the open DNP3 protocol. In addition, the V3.0 module now also supports master and node functionality.

- With the double-width S7-300 housing, the module can be fully integrated into the S7-300 system
- Can be connected as a stand-alone module to a SIMATIC S7-400 and SIMATIC S7-400 H System
- Two RS232/RS485 interfaces support connection of an external modem for data transmission via a conventional WAN or of a Modbus RTU slave to an S7-300 system
- The module has two RJ45 interfaces for data transmission via IP-based networks
- By using physically separate connection paths, the module permits media redundancy without loss of data during the switchover

Note:

SIPLUS extreme products are based on SIMATIC standard products. The contents listed here were adopted from the respective standard products. SIPLUS extreme-specific information was added.

Ordering data

Article No.

SIPLUS TIM 4R-IE DNP3 communication module With two combined RS 232/RS 485 interfaces for SINAUT communication via conventional WANs and two RJ45 interfaces for SINAUT communication via IP-based networks (WAN or LAN)	6AG1803-4BA00-7AA0
Accessories <i>Consumables</i>	
IE FC TP standard cable GP 2 x 2 (Type A) 4-wire, shielded TP installation cable for connection to IE FC outlet RJ45/IE FC RJ45 plug; PROFINET-compatible; with UL approval; sold by the meter; max. delivery unit 1000 m, minimum order quantity 20 m	6XV1840-2AH10
IE FC RJ45 plug 180 RJ45 plug-in connector for Industrial Ethernet with a rugged metal housing and integrated insulation displacement contacts for connecting Industrial Ethernet FC installation cables; with 180° cable outlet; for network components and CPs/CPU with Industrial Ethernet interface <ul style="list-style-type: none"> • 1 pack = 1 unit • -40 ... +70 °C, exposure to media 	6AG1901-1BB10-7AA0
IE FC stripping tool Preadjusted stripping tool for fast stripping of Industrial Ethernet FC cables	6GK1901-1GA00

SIMATIC S7-300 Advanced Controllers

I/O modules

SIPLUS S7-300 communication

SIPLUS TIM 4R-IE DNP3**Technical specifications**

Article number	6AG1803-4BA00-7AA0	Article number	6AG1803-4BA00-7AA0
Based on	6NH7803-4BA00-0AA0	Based on	6NH7803-4BA00-0AA0
product type designation	SIPLUS NET TIM 4R-IE DNP3	product type designation	SIPLUS NET TIM 4R-IE DNP3
ambient conditions		resistance to chemically active substances	
ambient temperature		• conformity acc. to EN 60721-3-3	Yes; Class 3C4 (RH < 75 %) incl. salt spray in accordance with EN 60068-2-52 (Severity 3). The supplied plug covers must remain in place on the unused interfaces during operation.
• during operation	-25 ... +70 °C		Yes
• during storage	-40 ... +70 °C	• conformity acc. to EN 60721-3-6	Yes; Class 3S4 incl. sand, dust. The supplied plug covers must remain in place over the unused interfaces during operation.
• during transport	-40 ... +70 °C		Yes; Class 6S3 incl. sand, dust. The supplied plug covers must remain in place over the unused interfaces during operation.
installation altitude at height above sea level maximum	5 000 m	resistance to mechanically active substances	Yes; Class 2 for high availability
ambient condition relating to ambient temperature - air pressure - installation altitude	Tmin ... Tmax at 1 140 hPa ... 795 hPa (-1 000 m ... +2 000 m) // Tmin ... (Tmax - 10 K) at 795 hPa ... 658 hPa (+2 000 m ... +3 500 m) // Tmin ... (Tmax - 20 K) at 658 hPa ... 540 hPa (+3 500 m ... +5 000 m)	• conformity acc. to EN 60721-3-3	Yes; Protection of the type 1
relative humidity	100 %; RH including condensation/frost (no commissioning when condensation is present), horizontal installation	• conformity acc. to EN 60721-3-6	Yes; Coating discoloration during service life possible
• with condensation acc. to IEC 60068-2-38 maximum		coating for equipped printed circuit board acc. to EN 61086	Yes; Conformal coating, class A
chemical resistance to commercially available cooling lubricants	Yes; incl. airborne diesel and oil droplets	type of coating protection against pollution according to EN 60664-3	
resistance to biologically active substances	Yes; incl. airborne diesel and oil droplets	type of test of the coating acc. to MIL-I-46058C	
• conformity acc. to EN 60721-3-3	Yes; Class 3B2 mold and fungal spores (excluding fauna), Class 3B3 on request	product conformity of the coating Qualification and Performance of Electrical Insulating Compound for Printed Board Assemblies acc. to IPC-CC-830A	
• conformity acc. to EN 60721-3-6	Yes; Class 6B2 mold, fungal and dry rot spores (excluding fauna)	protection class IP	IP20

Overview



- Simulator module for program testing during commissioning and ongoing operation
- For the simulation of sensor signals using switches
- For display of signal conditions on the outputs using LED
- Simulation of
 - 16 inputs or
 - 16 outputs or
 - 8 inputs and 8 outputs
- Function can be directly adjusted on the module using a screwdriver

Technical specifications

Article number	6ES7374-2XH01-0AA0 SM 374 Simulation unit 16E/16A
General information	
Product type designation	SM 374
Input current	
from backplane bus 5 V DC, max.	80 mA
Power loss	
Power loss, typ.	0.35 W
Digital inputs	
Number of digital inputs	16; Switch
Digital outputs	
Number of digital outputs	16; LEDs
Potential separation	
Potential separation digital inputs	
• between the channels and backplane bus	No
Potential separation digital outputs	
• between the channels and backplane bus	No
Dimensions	
Width	40 mm
Height	125 mm
Depth	120 mm
Weights	
Weight, approx.	190 g

Ordering data

Article No.

SM 374 simulator module incl. bus connectors, labeling strips	6ES7374-2XH01-0AA0
Bus connectors 1 unit, spare part	6ES7390-0AA00-0AA0
Labeling strips 10 units (spare part)	6ES7392-2XX00-0AA0
Label cover 10 units (spare part)	6ES7392-2XY00-0AA0
Labeling sheets for machine inscription for modules with 20-pin front connector, DIN A4, for printing with laser printer; 10 units	
petrol	6ES7392-2AX00-0AA0
light-beige	6ES7392-2BX00-0AA0
yellow	6ES7392-2CX00-0AA0
red	6ES7392-2DX00-0AA0

SIMATIC S7-300 Advanced Controllers

I/O modules

Special modules

DM 370 dummy module**Overview**

- Dummy module for reserving slots for non-parameterized signal modules
- Structure and address allocation is retained when replaced with a signal module

Technical specifications

Article number	6ES7370-0AA01-0AA0 DM 370 DUMMY module
General information	
Product type designation	DM 370
Input current	
from backplane bus 5 V DC, max.	5 mA
Power loss	
Power loss, max.	0.03 W
Digital inputs	
Number of digital inputs	0
Digital outputs	
Number of digital outputs	0
Dimensions	
Width	40 mm
Height	125 mm
Depth	120 mm
Weights	
Weight, approx.	180 g

Ordering data**Article No.**

DM 370 dummy module incl. bus connectors, labeling strips	6ES7370-0AA01-0AA0
Bus connectors 1 unit, spare part	6ES7390-0AA00-0AA0
Labeling strips 10 units (spare part)	6ES7392-2XX00-0AA0
Label cover 10 units (spare part)	6ES7392-2XY00-0AA0
Labeling sheets for machine inscription for modules with 20-pin front connector, DIN A4, for printing with laser printer; 10 units	
petrol	6ES7392-2AX00-0AA0
light-beige	6ES7392-2BX00-0AA0
yellow	6ES7392-2CX00-0AA0
red	6ES7392-2DX00-0AA0

Overview



- Dummy module for reserving slots for unconfigured signal modules
- Retention of design and address assignment when replacing with a signal module

Note:

SIPLUS extreme products are based on SIMATIC standard products. The contents listed here were taken from the respective standard products. SIPLUS extreme-specific information was added.

Ordering data

Article No.

Ordering data	Article No.
SIMATIC S7-300 DM 370 dummy module for use when replacing modules	
Extended temperature range and exposure to media	6AG1370-0AA01-7AA0
Accessories	
<i>Consumables</i>	
Bus connectors 1 unit (spare part)	6ES7390-0AA00-0AA0
Labeling strips 10 units (spare part) For modules with 20-pin front connector	6ES7392-2XX00-0AA0
Label cover 10 units (spare part) For modules with 20-pin front connector	6ES7392-2XY00-0AA0
Labeling sheets for machine printing For modules with 20-pin front connector, DIN A4, for printing with laser printer; 10 units	
Petrol	6ES7392-2AX00-0AA0
Light beige	6ES7392-2BX00-0AA0
Yellow	6ES7392-2CX00-0AA0
Red	6ES7392-2DX00-0AA0

Technical specifications

Article number	6AG1370-0AA01-7AA0
Based on	6ES7370-0AA01-0AA0 SIPLUS S7-300 Dummy-BG
Ambient conditions	
Ambient temperature during operation	
• min.	-40 °C; = Tmin
• max.	70 °C; = Tmax; 60 °C @ UL/cUL, ATEX and FM use
Altitude during operation relating to sea level	
• Installation altitude above sea level, max.	5 000 m
• Ambient air temperature-barometric pressure-altitude	Tmin ... Tmax at 1 140 hPa ... 795 hPa (-1 000 m ... +2 000 m) // Tmin ... (Tmax - 10 K) at 795 hPa ... 658 hPa (+2 000 m ... +3 500 m) // Tmin ... (Tmax -20 K) at 658 hPa ... 540 hPa (+3 500 m ... +5 000 m)
Relative humidity	
• With condensation, tested in accordance with IEC 60068-2-38, max.	100 %; RH incl. condensation/frost (no commissioning under condensation conditions)
Resistance	
Use in stationary industrial systems	
- to biologically active substances according to EN 60721-3-3	Yes; Class 3B2 mold, fungus and dry rot spores (with the exception of fauna); Class 3B3 on request
- to chemically active substances according to EN 60721-3-3	Yes; Class 3C4 (RH < 75 %) incl. salt spray acc. to EN 60068-2-52 (severity degree 3); *
- to mechanically active substances according to EN 60721-3-3	Yes; Class 3S4 incl. sand, dust, *
Use on ships/at sea	
- to biologically active substances according to EN 60721-3-6	Yes; Class 6B2 mold and fungal spores (excluding fauna); Class 6B3 on request
- to chemically active substances according to EN 60721-3-6	Yes; Class 6C3 (RH < 75 %) incl. salt spray acc. to EN 60068-2-52 (severity degree 3); *
- to mechanically active substances according to EN 60721-3-6	Yes; Class 6S3 incl. sand, dust; *
Usage in industrial process technology	
- Against chemically active substances acc. to EN 60654-4	Yes; Class 3 (excluding trichlorethylene)
- Environmental conditions for process, measuring and control systems acc. to ANSI/ISA-71.04	Yes; Level GX group A/B (excluding trichlorethylene; harmful gas concentrations up to the limits of EN 60721-3-3 class 3C4 permissible); level LC3 (salt spray) and level LB3 (oil)
Remark	
- Note regarding classification of environmental conditions acc. to EN 60721, EN 60654-4 and ANSI/ISA-71.04	* The supplied plug covers must remain in place over the unused interfaces during operation!

SIMATIC S7-300 Advanced Controllers

I/O modules

Connection system

Front connectors**Overview**

- For the simple and user-friendly connection of sensors and actuators to the S7-300 I/O modules
- For maintaining the wiring when replacing modules ("permanent wiring")
- With mechanical coding to avoid errors when replacing modules

Ordering data**Article No.****Front connectors**

20-pin, with screw contacts

- 1 unit
- 100 units

6ES7392-1AJ00-0AA0
6ES7392-1AJ00-1AB0

20-pin, with spring-loaded contacts

- 1 unit
- 100 units

6ES7392-1BJ00-0AA0
6ES7392-1BJ00-1AB0

40-pin, with screw contacts

- 1 unit
- 100 units

6ES7392-1AM00-0AA0
6ES7392-1AM00-1AB0

40-pin, with spring-loaded contacts

- 1 unit
- 100 units

6ES7392-1BM01-0AA0
6ES7392-1BM01-1AB0

Front door, elevated design**6ES7328-0AA00-7AA0**

e.g. for 32 channel modules;
 enables connection of
 1.3 mm²/16 AWG wires

Front door, higher version, for F-modules**6ES7328-7AA10-0AA0**

For F-modules; for connecting
 1.3 mm²/16 AWG wires; wiring
 diagram and labels in yellow

Overview

Wiring of SIMATIC S7 I/O modules with the sensors/actuators is a significant factor with respect to time/cost overhead, configuring, control cabinet installation, procurement and ease of service.

With SIMATIC TOP connect system cabling, it is simple and quick to establish a reliable connection for your SIMATIC S7-300 or ET 200M.

With the TIA Selection Tool, a mouse click is all that is required to configure the connection from the SIMATIC S7 module to the I/O. The program automatically checks for plausibility and generates a parts list for the selected connection components that can then be ordered in the Industry Mall.

More information can be found on the Internet at

<http://www.siemens.com/tia-selection-tool>

5**Design**

Two cabling variants are available for a wide range of control cabinet concepts:

Fully modular connection

Each component is individually inserted.

The system consists of:

- Front connector module
- Connecting cable
- Connection modules in the following versions: basic module, signal module and function module

Connection errors are thus practically excluded and installation overhead is minimized. Systematic connection of the SIMATIC system. The assembly work for the connecting cables is drastically reduced thanks to the use of pre-assembled cables sold by the meter.

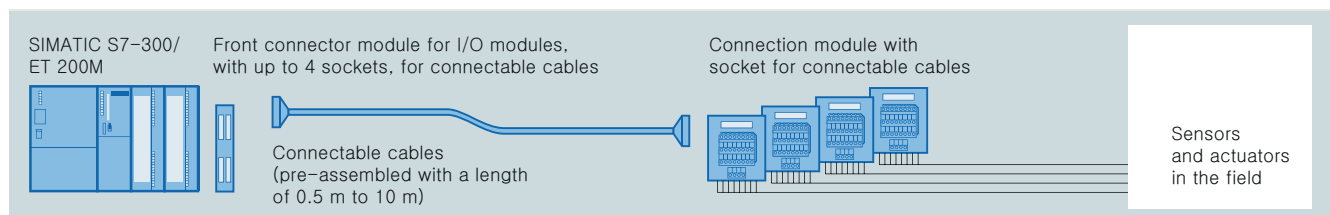

SIMATIC TOP connect for S7-300/ET 200M, fully modular connection

Flexible connection

Consisting of:

- Front connector with screw-type or crimp connection
- Front connector with fixed single cores
- Single cores also available with UL/CSA-certified cores

The blue wires are numbered sequentially and can be routed direct to each element in the control cabinet. The numbering of the single cores corresponds to the coding of the front connector contacts.

In comparison to conventional single wiring, there is a cost saving of 50% for assembly, since the single cores that have already been checked on the connector are fixed.

This eliminates the time-consuming assembly of up to 40 individual wires per module.

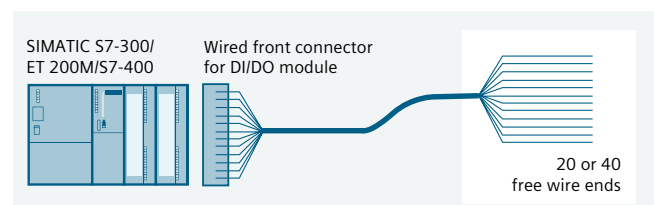

SIMATIC TOP connect for S7-300/ET 200M, flexible connection

SIMATIC S7-300 Advanced Controllers

I/O modules

Connection system

System cabling for SIMATIC S7-300 and ET 200M > Fully modular connection

Overview



The fully modular connection for connecting to the digital I/O modules of the SIMATIC S7-300 or ET 200M consists of modified front connectors, called front connector modules, preassembled connecting cables of various lengths, and terminal modules. Suitable components can be selected for the application in question and joined by means of simple plug-in connections. The terminal modules are used instead of conventional terminal blocks and act as the interface to the sensors and actuators.

5

Benefits

- Front connector module, connecting cable and terminal module are easy to plug in
- Fast, low-cost wiring
- For digital and analog signals, supply voltage can be connected to the front plug-in module or terminal module
- Reduction in wiring errors, clear control cabinet wiring
- Distribution of digital signals by byte or quadruple byte
- Each component can be replaced individually
- Pre-assembled cables can be used in different lengths

Design

Front connector module

Modified front connectors, called front connector modules, are available for connecting to the module. These are plugged into the module to be wired instead of the front connector. Many different front connector module versions, for digital I/O modules, 24 V 2-ampère modules or analog I/O modules. The connecting cables are plugged into these front connector modules.

Connecting cable

There are different versions of the connecting cable.

As a pre-assembled 16-pin or 50-pin round cable (shielded or unshielded) it is available in lengths up to 10 m.

When assembled, there are one or two insulation displacement connectors (female ribbon connectors) at both ends of the cable.

The connecting cable connects the front connector module with the terminal module.

Terminal module

The system has both digital and analog terminal modules for connecting the I/O signals. These are snapped onto the DIN rail. The terminal modules with basic or signal functionality are available in 1-byte or 4-byte versions.

Terminal modules are available for two different connection methods: with push-in or screw-type terminals. The potential can be fed in at the terminal module or at the front connector module.

If other voltage or power levels are required in the field, the terminal module for TPRo or TPOo output signals is used. For the TPRo terminal module, relays are used for the implementation. For the TPOo terminal module, optocouplers are used for the implementation. This converts the 24 V DC output signal simply and reliably to another voltage or power level. If 230 V AC or 110 V AC input signals have to be transmitted to the controller in the field, a terminal module with relay TPRI is available that simply converts the 230/110 V AC signal to 24 V DC. This means that there is always the same voltage level on the module side.

Use with optocouplers for the TPRo relay modules

If higher switching frequencies of the relay terminal module are required for the output signals, the relay can simply be replaced with an optocoupler (note technical specifications) in order to increase the switching frequency.

Shield plate

The shield plate is latched onto the terminal module for 3-core initiators or optionally onto the terminal module for analog signals and then snapped onto the DIN rail with the terminal module. With the shield connection clamps, optimal shield connection is achieved between the shielded round-sheath ribbon cable or the shielded field cables and the grounded DIN rail.

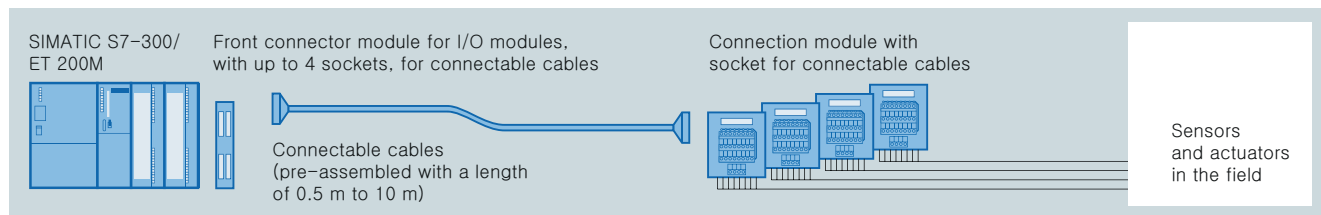

SIMATIC TOP connect for S7-300/ET200 M, fully modular connection

Ordering data**Front connector modules¹⁾**

Ordering data	Article No.
Front connector module (compact CPU 312C) Power supply via • Screw terminals	6ES7921-3AK20-0AA0
Front connector module (compact CPU 313C/314C-2PtP/314C-2DP), slot X1 Power supply via • Screw terminals	6ES7921-3AM20-0AA0
Front connector module (digital 2 x 8 I/O) Power supply via • Spring-loaded terminals • Screw terminals	6ES7921-3AA00-0AA0 6ES7921-3AB00-0AA0
Front connector module (digital 4 x 8 I/O) Power supply via • Spring-loaded terminals • Screw terminals	6ES7921-3AA20-0AA0 6ES7921-3AB20-0AA0

Ordering data	Article No.
Front connector module (1 x 8 outputs) for 2-ampere digital outputs Power supply via • Spring-loaded terminals • Screw terminals	6ES7921-3AC00-0AA0 6ES7921-3AD00-0AA0
Front connector module 20-pin (analog) Power supply via • Spring-loaded terminals • Screw terminals	6ES7921-3AF00-0AA0 6ES7921-3AG00-0AA0
Front connector module 40-pin (analog) Power supply via • Spring-loaded terminals • Screw terminals	6ES7921-3AF20-0AA0 6ES7921-3AG20-0AA0

¹⁾ The terminal assignments of these front connector modules are unambiguous, so dimension drawings can be omitted. The dimension drawings for these front connector modules can be found under "Wiring of S7-300 analog modules" in the Industry Mall.

Connecting cable

Ordering data	Article No.
Connecting cables for SIMATIC S7-300 Pre-assembled round cable 16-pin, 0.14 mm ² Unshielded • 0.5 m • 1.0 m • 1.5 m • 2.0 m • 2.5 m • 3.0 m • 4.0 m • 5.0 m • 6.5 m • 8.0 m • 10.0 m Shielded • 1.0 m • 2.0 m • 2.5 m • 3.0 m • 4.0 m • 5.0 m • 6.5 m • 8.0 m • 10.0 m	6ES7923-0BA50-0CB0 6ES7923-0BB00-0CB0 6ES7923-0BB50-0CB0 6ES7923-0BC00-0CB0 6ES7923-0BC50-0CB0 6ES7923-0BD00-0CB0 6ES7923-0BE00-0CB0 6ES7923-0BF00-0CB0 6ES7923-0BG50-0CB0 6ES7923-0BJ00-0CB0 6ES7923-0CB00-0CB0 6ES7923-0BB00-0DB0 6ES7923-0BC00-0DB0 6ES7923-0BC50-0DB0 6ES7923-0BD00-0DB0 6ES7923-0BE00-0DB0 6ES7923-0BF00-0DB0 6ES7923-0BG50-0DB0 6ES7923-0BJ00-0DB0 6ES7923-0CB00-0DB0

Ordering data	Article No.
Version 4 x 16 to 1 x 50-pin, 0.14 mm² Unshielded • 0.5 m • 1.0 m • 1.5 m • 2.0 m • 2.5 m • 3.0 m • 4.0 m • 5.0 m • 6.5 m • 8.0 m • 10.0 m	6ES7923-5BA50-0EB0 6ES7923-5BB00-0EB0 6ES7923-5BB50-0EB0 6ES7923-5BC00-0EB0 6ES7923-5BC50-0EB0 6ES7923-5BD00-0EB0 6ES7923-5BE00-0EB0 6ES7923-5BF00-0EB0 6ES7923-5BG50-0EB0 6ES7923-5BJ00-0EB0 6ES7923-5CB00-0EB0

SIMATIC S7-300 Advanced Controllers

I/O modules

Connection system

System cabling for SIMATIC S7-300 and ET 200M > Fully modular connection

Ordering data

Article No.

Article No.

Connection modules**Connection module TP1**

For 1-wire connection,
for 16-pin connecting cables

- Push-in terminals without LEDs
- Screw-type terminals without LEDs
- Push-in terminals with LEDs
- Screw-type terminals with LEDs

6ES7924-0AA20-0AC0
6ES7924-0AA20-0AA0

6ES7924-0AA20-0BC0
6ES7924-0AA20-0BA0

For 1-wire connection,
for 50-pin connecting cables

- Push-in terminals without LEDs
- Screw-type terminals without LEDs
- Push-in terminals with LEDs
- Screw-type terminals with LEDs

6ES7924-2AA20-0AC0
6ES7924-2AA20-0AA0

6ES7924-2AA20-0BC0
6ES7924-2AA20-0BA0

Connection module TP3

For 3-wire connection,
for 16-pin connecting cables

- Push-in terminals without LEDs
- Screw-type terminals without LEDs
- Push-in terminals with LEDs
- Screw-type terminals with LEDs
- Push-in terminals with LEDs and one isolating terminal per channel
- Screw-type terminals with LEDs and one isolating terminal per channel
- Push-in terminals with LEDs and fuse per channel
- Screw-type terminals with LEDs and fuse per channel

6ES7924-0CA20-0AC0
6ES7924-0CA20-0AA0

6ES7924-0CA20-0BC0
6ES7924-0CA20-0BA0
6ES7924-0CH20-0BC0

6ES7924-0CH20-0BA0

6ES7924-0CL20-0BC0

6ES7924-0CL20-0BA0

For 3-wire connection,
for 50-pin connecting cables

- Push-in terminals without LEDs
- Screw-type terminals without LEDs
- Push-in terminals with LEDs
- Screw-type terminals with LEDs

6ES7924-2CA20-0AC0
6ES7924-2CA20-0AA0

6ES7924-2CA20-0BC0
6ES7924-2CA20-0BA0

Connection module TPPro

Relay module for 8 outputs,
relay as normally open contact

- Push-in terminals with LEDs
- Screw-type terminals with LEDs

6ES7924-0BD20-0BC0
6ES7924-0BD20-0BA0

Connection module TPRI

Relay module for 8 inputs
(110 V AC), relay as normally
open contact

- Push-in terminals with LEDs
- Screw-type terminals with LEDs

6ES7924-0BG20-0BC0
6ES7924-0BG20-0BA0

Connection module TPRI

Relay module for 8 inputs
(230 V AC), relay as normally
open contact

- Push-in terminals with LEDs
- Screw-type terminals with LEDs

6ES7924-0BE20-0BC0
6ES7924-0BE20-0BA0

Connection module TPOo

Optocoupler module for 8 outputs
(max. 24 V DC/4 A)

- Push-in terminals with LEDs
- Screw-type terminals with LEDs

6ES7924-0BF20-0BC0
6ES7924-0BF20-0BA0

Connection module for digital output modules 2 A

Connection module TP2

- Push-in terminals without LEDs
- Screw-type terminals without LEDs

6ES7924-0BB20-0AC0
6ES7924-0BB20-0AA0

Connection module for analog modules

Connection module TPA

- Push-in terminals without LEDs
- Screw-type terminals without LEDs

6ES7924-0CC21-0AC0
6ES7924-0CC21-0AA0

Accessories**Shield plate for analog connection module**

PU = 4 units (for connection of
15-pin connecting cable)

6ES7928-1AA20-4AA0

Shield connection clamp

For shield plate at SIMATIC end,
PU = 10 units

6ES7590-5BA00-0AA0

For shield plate at field end,
2 x 2 ... 6 mm

6ES7390-5AB00-0AA0

For shield plate at field end,
3 ... 8 mm

6ES7390-5BA00-0AA0

For shield plate at field end,
4 ... 13 mm

6ES7390-5CA00-0AA0

Technical specifications front connector module

Technical data of front connector module	
Rated operating voltage	24 V DC
Max. permissible operating voltage	60 V DC
Max. permissible continuous current	1 A
• per connector pin	
Max. permissible summation current	4 A/byte
Permissible ambient temperature	0 to + 60°C
Test voltage	0.5 kV, 50 Hz, 60 sec.
Air gaps and creepage distances	IEC 664 (1980), IEC 664 A (1981), in accordance with DIN VDE 0110 (01.89), overvoltage class II, pollution degree 2

Wiring rules for front connector modules

Front connector module SIMATIC TOP connect, connection for potential infeed	
	Spring connection Screw connection
Modules up to 4 connections	
Connectable cable cross-sections	No
• solid cables	0,25 to 1.5 mm ²
• flexible cables with/without wire end ferrule	
Number of wires per connection	1 or a combination of 2 conductors up to 1.5 mm ² (total) in a common wire end ferrule
Max. diameter of the cable insulation	3.1 mm
Stripping length of the cables	6 mm
• without insulating collar	
• with insulating collar	-
Wire-end ferrules in acc. with DIN 46228	
• without insulating collar	Form A; 5 to 7 mm long
• with insulating collar	-
0.25 to 1.0 mm ²	
• with insulating collar 1.5 mm ²	-
Blade width of the screwdriver	3.5 mm (cylindrical shape)
Tightening torque for connecting the cables	- 0.4 to 0.7 Nm

Front connector module SIMATIC TOP connect, connection for potential infeed	
	Spring connection Screw connection
Modules up to 8 connections	
Connectable cable cross-sections	No
• solid cables	0.25 to 0.75 mm ²
• flexible cables with/without wire end ferrule	
Number of cables per connection	1 or a combination of 2 wires up to 0.75 mm ² (total) in a common wire end ferrule
Max. diameter of the cable insulation	2.0 mm
Stripping length of the cables	6 mm
• without insulating collar	
• with insulating collar	-
Wire-end ferrules in acc. with DIN 46228	
• without insulating collar	Form A; 5 to 7 mm long
• with insulating collar	-
0.25 to 1.0 mm ²	
• with insulating collar 1.5 mm ²	-
Blade width of the screwdriver	3.5 mm (cylindrical shape)
Tightening torque for connecting the cables	- 0.4 to 0.7 Nm

Technical specifications connecting cable

Technical specifications of connecting cable from SIMATIC S7 to connection module	
Operating voltage	60 V DC
Continuous current per signal conductor	1 A
Max. total current	4 A/byte
Operating temperature	0 to +60 °C
Outer diameter of pre-assembled round cable in mm unshielded/shielded (16-pole)	Approx. 6.5/7.0

SIMATIC S7-300 Advanced Controllers

I/O modules

Connection system

System cabling for SIMATIC S7-300 and ET 200M > Flexible connection > Front connector with single wires

Overview

Flexible connection enables fast, direct connection of the SIMATIC S7-300/ET 200 M input/output modules to the individual elements in the control cabinet.

Attached single cores reduce the wiring outlay.

Wire cross-sections of 0.5 mm^2 allow higher currents, too.

Technical specifications

Front connector with single cores for 16 channels	
Rated operating voltage	24 V DC
Permissible continuous current with simultaneous load of all wires, max.	1.5 A
Permissible ambient temperature	0 to 60 °C
Core type	H05V-K or with UL 1007/1569; CSA TR64
Number of single cores	20
Core cross-section	0.5 mm^2 ; Cu
Bundle diameter in mm	approx. 15
Core color	Blue, RAL 5010
Designation of cores	Numbered from 1 to 20 (front connector contact = core number)
Assembly	Screw-type or crimp contacts
Front connector with single cores for 32 channels	
Rated operating voltage	24 V DC
Permissible continuous current with simultaneous load of all wires, max.	1.5 A
Permissible ambient temperature	0 to 60 °C
Core type	H05V-K or with UL 1007/1569; CSA TR64
Number of single cores	40
Core cross-section	0.5 mm^2 ; Cu
Bundle diameter in mm	approx. 17
Core color	Blue, RAL 5010
Designation of cores	Numbered from 1 to 40 (front connector contact = core number)
Assembly	Screw-type or crimp contacts

Ordering data**Article No.****Front connector with single wires for 16-channel digital modules SIMATIC S7-300, 20 x 0.5 mm^2** **Core type H05V-K**Screw version

Packaging unit: 1 unit

Length:

- 2.5 m
- 3.2 m
- 5 m
- Custom lengths

6ES7922-3BC50-0AB0
6ES7922-3BD20-0AB0
6ES7922-3BF00-0AB0
 On request

Packaging unit: 5 units

Length:

- 2.5 m
- 3.2 m
- 5.0 m

6ES7922-3BC50-5AB0
6ES7922-3BD20-5AB0
6ES7922-3BF00-5AB0

Crimp version

Packaging unit: 1 unit

Length:

- 2.5 m
- 3.2 m
- 5.0 m
- Custom lengths

6ES7922-3BC50-0AF0
6ES7922-3BD20-0AF0
6ES7922-3BF00-0AF0
 On request

Core type UL/CSA-certifiedScrew version

Packaging unit: 1 unit

Length:

- 3.2 m
- 5.0 m

6ES7922-3BD20-0UB0
6ES7922-3BF00-0UB0

Front connector with single wires for 32-channel digital modules SIMATIC S7-300, 40 x 0.5 mm^2 **Core type H05V-K**Screw version

Packaging unit: 1 unit

Length:

- 2.5 m
- 3.2 m
- 5.0 m
- Custom lengths

6ES7922-3BC50-0AC0
6ES7922-3BD20-0AC0
6ES7922-3BF00-0AC0
 On request

Packaging unit: 5 units

Length:

- 2.5 m
- 3.2 m
- 5.0 m

6ES7922-3BC50-5AC0
6ES7922-3BD20-5AC0
6ES7922-3BF00-5AC0

Crimp version

Packaging unit: 1 unit

Length:

- 2.5 m
- 3.2 m
- 5.0 m
- Custom lengths

6ES7922-3BC50-0AG0
6ES7922-3BD20-0AG0
6ES7922-3BF00-0AG0
 On request

Core type UL/CSA-certifiedScrew version

Packaging unit: 1 unit

Length:

- 3.2 m
- 5.0 m

6ES7922-3BD20-0UC0
6ES7922-3BF00-0UC0

Design***The front connector is available in two versions:***

The 20-pin front connector comprises:

- 20 crimp contact connections for the wiring
- Strain relief for the cables
- Unlocking button for unlatching the front connector when replacing the module
- Receptacle for coding element attachment; there are two coding elements with attachments on the module. The attachments latch into the front connector when inserted for the first time.

The 40-pin front connector comprises:

- 40 crimp contact connections for the wiring
- Strain relief for the cables
- Locking screw for fixing and detaching the front connector when the module is replaced
- Receptacle for coding element attachment; there is one two coding element with attachment on the module. The attachment latches into the front connector when inserted for the first time.

Integration

Use of the 20-pole front connector with

- 16-channel signal modules
- Function modules
- CPU 312 IFM

Use of the 40-pole front connector with

- 32-channel signal modules
- Compact CPUs

Ordering data**Article No.****Front connector 20-pin, crimp version without crimp contacts**

Packing unit 100 units

6ES7921-3AH00-1AA0

Front connector 40-pin, crimp version without crimp contacts

Packing unit 100 units

6ES7921-3AH20-1AA0

Accessories**Crimp contacts for front connectors**

Packing unit 250 units

6XX3070

Crimping tool

For crimping the crimp contacts

6XX3071

SIMATIC S7-300 Advanced Controllers

Power supplies

1-phase, 24 V DC (for S7-300 and ET200M)

Overview



The design and functionality of the SIMATIC PS307 single-phase load power supply (system and load current supply) with automatic range switching of the input voltage are an optimal match to the SIMATIC S7-300 PLC. The supply to the CPU is quickly established by means of the connecting comb that is supplied with the system and load current supply. It is also possible to provide a 24 V supply to other S7-300 system components, input/output circuits of the input/output modules and, if necessary, the sensors and actuators. Comprehensive certifications such as UL and GL enable universal use (does not apply to outdoor use).

Ordering data

Article No.

PS307 load current supply, 2 A

6ES7307-1BA01-0AA0

incl. connecting comb
Input: 120/230 V AC
Output: 24 V DC/2 A

SIMATIC S7-300 Outdoor, 2 A

6ES7305-1BA80-0AA0

Stabilized power supply PS305
Input: 24 ... 110 V DC
Output: 24 V DC/2 A

PS307 load current supply, 5 A

6ES7307-1EA01-0AA0

incl. connecting comb
Input: 120/230 V AC
Output: 24 V DC/5 A

SIMATIC S7-300 Outdoor, 5 A

6ES7307-1EA80-0AA0

PS307 stabilized power supply
Input: 120/230 V AC
Output: 24 V DC/5 A

PS307 load current supply, 10 A

6ES7307-1KA02-0AA0

Input: 120/230 V AC
Output: 24 V DC/10 A

Accessories

SIMATIC S7-300 mounting adapter

6EP1971-1BA00

For snapping the new PS307 onto a 35 mm DIN rail (EN 60715)
Spare part

SIMATIC S7-300 mounting adapter

6ES7390-6BA00-0AA0

For snapping the PS307 onto a 35 mm DIN rail

Technical specifications

Article number	6ES7307-1BA01-0AA0	6ES7305-1BA80-0AA0	6ES7307-1EA01-0AA0	6ES7307-1EA80-0AA0	6ES7307-1KA02-0AA0
Product	PS 307	PS 305 Outdoor	PS 307	PS 307 Outdoor	PS 307
Power supply, type	24 V/2 A	24 V/2 A	24 V/5 A	24 V/5 A	24 V/10 A
Input					
type of the power supply network	1-phase AC	DC voltage	1-phase AC	1-phase AC	1-phase AC
supply voltage at AC					
• initial value	Automatic range selection		Automatic range selection	Set by means of selector switch on the device	Automatic range selection
supply voltage					
• 1 at AC rated value	120 V		120 V	120 V	120 V
• 2 at AC rated value	230 V		230 V	230 V	230 V
• at DC		24 ... 110 V			
input voltage					
• 1 at AC	85 ... 132 V		85 ... 132 V	93 ... 132 V	85 ... 132 V
• 2 at AC	170 ... 264 V		170 ... 264 V	187 ... 264 V	170 ... 264 V
• at DC		16.8 ... 138 V			
design of input wide range input	No	Yes	No	No	No
overvoltage overload capability	2.3 × Vin rated, 1.3 ms	154 V; 0.1 s	2.3 × Vin rated, 1.3 ms	2.3 × Vin rated, 1.3 ms	2.3 × Vin rated, 1.3 ms
operating condition of the mains buffering	at Vin = 93/187 V	at Vin rated	at Vin = 93/187 V	at Vin = 93/187 V	at Vin = 93/187 V
buffering time for rated value of the output current in the event of power failure minimum	20 ms	10 ms	20 ms	20 ms	20 ms
operating condition of the mains buffering	at Vin = 93/187 V	at Vin rated	at Vin = 93/187 V	at Vin = 93/187 V	at Vin = 93/187 V
line frequency					
• 1 rated value	50 Hz		50 Hz	50 Hz	50 Hz
• 2 rated value	60 Hz		60 Hz	60 Hz	60 Hz
line frequency	47 ... 63 Hz		47 ... 63 Hz	47 ... 63 Hz	47 ... 63 Hz
input current					
• at rated input voltage 120 V	0.9 A		2.3 A	2.1 A	4.2 A
• at rated input voltage 230 V	0.5 A		1.2 A	1.2 A	1.9 A
• at rated input voltage 24 V		2.4 A			
• at rated input voltage 110 V		0.6 A			
current limitation of inrush current at 25 °C maximum	22 A	20 A	20 A	45 A	55 A

SIMATIC S7-300 Advanced Controllers

Power supplies

1-phase, 24 V DC (for S7-300 and ET200M)

Technical specifications

Article number	6ES7307-1BA01-0AA0	6ES7305-1BA80-0AA0	6ES7307-1EA01-0AA0	6ES7307-1EA80-0AA0	6ES7307-1KA02-0AA0
Product	PS 307	PS 305 Outdoor	PS 307	PS 307 Outdoor	PS 307
Power supply, type	24 V/2 A	24 V/2 A	24 V/5 A	24 V/5 A	24 V/10 A
duration of inrush current limiting at 25 °C					
• maximum	3 ms	10 ms	3 ms	3 ms	3 ms
I ² t value maximum	1 A ² ·s	5 A ² ·s	1.2 A ² ·s	1.8 A ² ·s	3.3 A ² ·s
fuse protection type	T 1.6 A/250 V (not accessible)	T 6.3 A/250 V (not accessible)	T 3,15 A/250 V (not accessible)	T 3,15 A/250 V (not accessible)	T 6.3 A/250 V (not accessible)
• in the feeder	Recommended miniature circuit breaker: 3 A characteristic C	Recommended miniature circuit breaker: from 10 A characteristic C, suitable for DC	Recommended miniature circuit breaker: from 6 A characteristic C	Recommended miniature circuit breaker: from 10 A characteristic C or from 6 A characteristic D	Recommended miniature circuit breaker: from 10 A characteristic C
Output					
voltage curve at output	Controlled, isolated DC voltage	Controlled, isolated DC voltage	Controlled, isolated DC voltage	Controlled, isolated DC voltage	Controlled, isolated DC voltage
output voltage at DC rated value	24 V	24 V	24 V	24 V	24 V
output voltage					
• at output 1 at DC rated value	24 V	24 V	24 V	24 V	24 V
relative overall tolerance of the voltage	3 %	3 %	3 %	3 %	3 %
relative control precision of the output voltage					
• on slow fluctuation of input voltage	0.1 %	0.2 %	0.1 %	0.2 %	0.1 %
• on slow fluctuation of ohm loading	0.2 %	0.4 %	0.5 %	0.4 %	0.5 %
residual ripple					
• maximum	50 mV	150 mV	50 mV	150 mV	50 mV
• typical	5 mV	30 mV	10 mV	40 mV	15 mV
voltage peak					
• maximum	150 mV	240 mV	150 mV	240 mV	150 mV
• typical	20 mV	150 mV	20 mV	90 mV	60 mV
product function output voltage adjustable	No	No	No	No	No
type of output voltage setting	-	-	-	-	-
display version for normal operation	Green LED for 24 V OK	Green LED for 24 V OK	Green LED for 24 V OK	Green LED for 24 V OK	Green LED for 24 V OK
behavior of the output voltage when switching on	No overshoot of Vout (soft start)	No overshoot of Vout (soft start)	No overshoot of Vout (soft start)	No overshoot of Vout (soft start)	No overshoot of Vout (soft start)
response delay maximum	2 s	3 s	2 s	3 s	2 s
voltage increase time of the output voltage					
• typical	10 ms	5 ms	10 ms	100 ms	10 ms
output current					
• rated value	2 A	2 A	5 A	5 A	10 A
• rated range	0 ... 2 A	0 ... 3 A; 3 A up to +60°C at Vin > 24 V	0 ... 5 A	0 ... 5 A	0 ... 10 A
supplied active power typical	48 W	48 W	120 W	120 W	240 W
short-term overload current					
• on short-circuiting during the start-up typical	9 A	9 A	20 A	20 A	38 A
• at short-circuit during operation typical	9 A	9 A	20 A	20 A	38 A
duration of overloading capability for excess current					
• on short-circuiting during the start-up	90 ms	270 ms	100 ms	180 ms	80 ms
• at short-circuit during operation	90 ms	270 ms	100 ms	80 ms	80 ms
product feature					
• bridging of equipment	Yes	Yes	Yes	No	Yes
number of parallel-switched equipment resources for increasing the power	2	2			
Efficiency					
efficiency in percent	84 %	75 %	87 %	84 %	90 %
power loss [W]					
• at rated output voltage for rated value of the output current typical	9 W	16 W	18 W	23 W	27 W

SIMATIC S7-300 Advanced Controllers

Power supplies

1-phase, 24 V DC (for S7-300 and ET200M)

Technical specifications

Article number	6ES7307-1BA01-0AA0	6ES7305-1BA80-0AA0	6ES7307-1EA01-0AA0	6ES7307-1EA80-0AA0	6ES7307-1KA02-0AA0
Product	PS 307	PS 305 Outdoor	PS 307	PS 307 Outdoor	PS 307
Power supply, type	24 V/2 A	24 V/2 A	24 V/5 A	24 V/5 A	24 V/10 A
Closed-loop control					
relative control precision of the output voltage with rapid fluctuation of the input voltage by +/- 15% typical	0.1 %	0.3 %	0.1 %	0.3 %	0.1 %
relative control precision of the output voltage load step of resistive load 50/100/50 % typical	0.8 %	2.5 %	1 %	3 %	2 %
setting time					
• load step 50 to 100% typical	0.5 ms	2.5 ms	0.3 ms	0.2 ms	
• load step 100 to 50% typical	0.5 ms	2.5 ms	0.3 ms	0.2 ms	
setting time					
• maximum	1 ms	5 ms		5 ms	0.1 ms
Protection and monitoring					
design of the overvoltage protection	Additional control loop, shutdown at < 28.8 V, automatic restart	Additional control loop, shutdown at approx. 30 V, automatic restart	Additional control loop, shutdown at < 28.8 V, automatic restart	Additional control loop, shutdown at approx. 30 V, automatic restart	Additional control loop, shutdown at < 28.8 V, automatic restart
response value current limitation	2.2 ... 2.6 A	3.3 ... 3.9 A	5.5 ... 6.5 A	5.5 ... 6.5 A	11 ... 12 A
property of the output short-circuit proof	Yes	Yes	Yes	Yes	Yes
design of short-circuit protection	Electronic shutdown, automatic restart	Electronic shutdown, automatic restart	Electronic shutdown, automatic restart	Electronic shutdown, automatic restart	Electronic shutdown, automatic restart
enduring short circuit current RMS value					
• maximum	2 A	2 A	7 A	5 A	12 A
display version for overload and short circuit	-	-			-
Safety					
galvanic isolation between input and output	Yes	Yes	Yes	Yes	Yes
galvanic isolation	Safety extra-low output voltage Uout acc. to EN 60950-1 and EN 50178	Safety extra low output voltage Vout according to EN 60950-1 and EN 50178, creepage distances and clearances > 5 mm	Safety extra-low output voltage Uout acc. to EN 60950-1 and EN 50178	Safety extra low output voltage Vout according to EN 60950-1 and EN 50178, creepage distances and clearances > 5 mm	Safety extra-low output voltage Uout acc. to EN 60950-1 and EN 50178
operating resource protection class	Class I	Class I	Class I	Class I	Class I
leakage current					
• maximum	3.5 mA		3.5 mA	3.5 mA	3.5 mA
• typical	0.5 mA		0.5 mA	0.3 mA	0.6 mA
protection class IP	IP20	IP20	IP20	IP20	IP20
Approvals					
certificate of suitability					
• CE marking	Yes	Yes	Yes	Yes	Yes
• UL approval	Yes; cULus-Listed (UL 508, CSA C22.2 No. 142), File E143289	Yes; UL-Listed (UL 508), File E143289; CSA (CSA C22.2 No. 142)	Yes; cULus-Listed (UL 508, CSA C22.2 No. 142), File E143289	Yes; UL-Listed (UL 508), File E143289; CSA (CSA C22.2 No. 142)	Yes; cULus-Listed (UL 508, CSA C22.2 No. 142), File E143289
• CSA approval	Yes; cULus-Listed (UL 508, CSA C22.2 No. 142), File E143289	Yes; UL-Listed (UL 508), File E143289, CSA (CSA C22.2 No. 142)	Yes; cULus-Listed (UL 508, CSA C22.2 No. 142), File E143289	Yes; UL-Listed (UL 508), File E143289, CSA (CSA C22.2 No. 142)	Yes; cULus-Listed (UL 508, CSA C22.2 No. 142), File E143289
• cCSAus, Class 1, Division 2	No	No	No	No	No
• ATEX	Yes; ATEX (EX) II 3G Ex nA nC IIC T4 Gc	No	Yes; ATEX (EX) II 3G Ex nA nC IIC T3 Gc	No	Yes; ATEX (EX) II 3G Ex nA nC IIC T3 Gc
certificate of suitability					
• relating to ATEX	IECEX Ex nA nC IIC T4 Gc; ATEX (EX) II 3G Ex nA nC IIC T4 Gc; cULus (ANSI/ISA 12.12.01, CSA C22.2 No.213) Class I, Div. 2, Group ABCD, T4, File E330455		IECEX Ex nA nC IIC T3 Gc; ATEX (EX) II 3G Ex nA nC IIC T3 Gc; cULus (ANSI/ISA 12.12.01, CSA C22.2 No.213) Class I, Div. 2, Group ABCD, T4, File E330455		IECEX Ex nA nC IIC T3 Gc; ATEX (EX) II 3G Ex nA nC IIC T3 Gc; cULus (ANSI/ISA 12.12.01, CSA C22.2 No.213) Class I, Div. 2, Group ABCD, T4, File E330455
• IECEX	Yes; IECEX Ex nA nC IIC T4 Gc	No	Yes; IECEX Ex nA nC IIC T3 Gc	No	Yes; IECEX Ex nA nC IIC T3 Gc
• NEC Class 2	No	No	No	No	No
• ULhazloc approval	Yes	No	Yes	No	Yes
• FM registration	Yes; Class I, Div. 2, Group ABCD, T4	No	Yes; Class I, Div. 2, Group ABCD, T4	No	Yes; Class I, Div. 2, Group ABCD, T4
type of certification CB-certificate	No	No	No	No	No

Technical specifications

Article number	6ES7307-1BA01-0AA0	6ES7305-1BA80-0AA0	6ES7307-1EA01-0AA0	6ES7307-1EA80-0AA0	6ES7307-1KA02-0AA0
Product	PS 307	PS 305 Outdoor	PS 307	PS 307 Outdoor	PS 307
Power supply, type	24 V/2 A	24 V/2 A	24 V/5 A	24 V/5 A	24 V/10 A
certificate of suitability					
• EAC approval	Yes	Yes	Yes	Yes	Yes
certificate of suitability shipbuilding approval	Yes	No	Yes	No	Yes
shipbuilding approval	In S7-300 system	-	In S7-300 system	-	In S7-300 system
Marine classification association					
• American Bureau of Shipping Europe Ltd. (ABS)	No	No	No	No	No
• French marine classification society (BV)	No	No	No	No	No
• DNV GL	No	No	No	No	No
• Lloyds Register of Shipping (LRS)	No	No	No	No	No
• Nippon Kaiji Kyokai (NK)	No	No	No	No	No
EMC					
standard					
• for emitted interference	EN 55022 Class B	EN 55011 Class A	EN 55022 Class B	EN 55011 Class A	EN 55022 Class B
• for mains harmonics limitation	not applicable	not applicable	EN 61000-3-2	-	EN 61000-3-2
• for interference immunity	EN 61000-6-2	EN 61000-6-2	EN 61000-6-2	EN 61000-6-2	EN 61000-6-2
environmental conditions					
ambient temperature					
• during operation	0 ... 60 °C; with natural convection	-25 ... +70 °C; with natural convection	0 ... 60 °C; with natural convection	-25 ... +70 °C; with natural convection	0 ... 60 °C; with natural convection
• during transport	-40 ... +85 °C	-40 ... +85 °C	-40 ... +85 °C	-40 ... +85 °C	-40 ... +85 °C
• during storage	-40 ... +85 °C	-40 ... +85 °C	-40 ... +85 °C	-40 ... +85 °C	-40 ... +85 °C
environmental category acc. to IEC 60721	Climate class 3K3, 5 ... 95% no condensation	Climate class 3K5, transient condensation permitted	Climate class 3K3, 5 ... 95% no condensation	Climate class 3K5, transient condensation permitted	Climate class 3K3, 5 ... 95% no condensation
Mechanics					
type of electrical connection	screw-type terminals	screw-type terminals	screw-type terminals	screw-type terminals	screw-type terminals
• at input	L, N, PE: 1 screw terminal each for 0.5 ... 2.5 mm ² single-core/finely stranded	L+1, M1, PE: 1 screw terminal each for 0.5 ... 2.5 mm ² single-core/finely stranded	L, N, PE: 1 screw terminal each for 0.5 ... 2.5 mm ² single-core/finely stranded	L, N, PE: 1 screw terminal each for 0.5 ... 2.5 mm ² single-core/finely stranded	L, N, PE: 1 screw terminal each for 0.5 ... 2.5 mm ² single-core/finely stranded
• at output	L+, M: 2 screw terminals each for 0.5 ... 2.5 mm ²	L+, M: 3 screw terminals each for 0.5 ... 2.5 mm ²	L+, M: 3 screw terminals each for 0.5 ... 2.5 mm ²	L+, M: 3 screw terminals each for 0.5 ... 2.5 mm ²	L+, M: 4 screw terminals each for 0.5 ... 2.5 mm ²
• for auxiliary contacts	-	-	-	-	-
width of the enclosure	40 mm	80 mm	60 mm	80 mm	80 mm
height of the enclosure	125 mm	125 mm	125 mm	125 mm	125 mm
depth of the enclosure	120 mm	120 mm	120 mm	120 mm	120 mm
required spacing					
• top	40 mm	50 mm	40 mm	50 mm	40 mm
• bottom	40 mm	50 mm	40 mm	50 mm	40 mm
• left	0 mm	0 mm	0 mm	0 mm	0 mm
• right	0 mm	0 mm	0 mm	0 mm	0 mm
net weight	0.4 kg	0.57 kg	0.6 kg	0.57 kg	0.8 kg
product feature of the enclosure housing can be lined up	Yes	Yes	Yes	Yes	Yes
fastening method	Can be mounted onto S7 rail	Can be mounted onto S7 rail	Can be mounted onto S7 rail	Can be mounted onto S7 rail	Can be mounted onto S7 rail
mechanical accessories	Mounting adapter for standard mounting rail (6EP1971-1BA00)	Mounting adapter for standard mounting rail (6ES7390-6BA00-0AA0)	Mounting adapter for standard mounting rail (6EP1971-1BA00)	Mounting adapter for standard mounting rail (6ES7390-6BA00-0AA0)	Mounting adapter for standard mounting rail (6EP1971-1BA00)
MTBF at 40 °C	2 320 078 h	964 506 h	2 480 589 h	2 231 610 h	1 504 280 h
other information	Specifications at rated input voltage and ambient temperature +25 °C (unless otherwise specified)	Specifications at rated input voltage and ambient temperature +25 °C (unless otherwise specified)	Specifications at rated input voltage and ambient temperature +25 °C (unless otherwise specified)	Specifications at rated input voltage and ambient temperature +25 °C (unless otherwise specified)	Specifications at rated input voltage and ambient temperature +25 °C (unless otherwise specified)

SIMATIC S7-300 Advanced Controllers

SIPLUS power supplies

1-phase, 24 V DC (for S7-300 and ET200M)

Overview

The design and functionality of the SIPLUS PS 305 and PS 307 1-phase load power supplies (system and load current supply) with automatic range switchover of the input voltage are an optimal match for the SIMATIC S7-300 in design and functionality. By means of the connecting comb that is supplied with the system and load current supply, the supply to the CPU is quickly established. It is also possible to provide a 24 V supply to other S7-300 system components, input/output circuits of the input/output modules and, if necessary, the sensors and actuators. Comprehensive certifications, such as UL, ATEX or GL facilitate universal use (does not apply to outdoor use).

Note:

SIPLUS extreme products are based on Siemens standard products. The contents listed here were taken from the respective standard products. SIPLUS extreme-specific information was added.

Ordering data**Article No.****SIPLUS power supplies**

For industrial applications with extended ambient conditions

SIPLUS S7-300 PS 305**6AG1305-1BA80-2AA0**

(Extended temperature range and medial exposure)

Input: 24 ... 110 V DC
Output: 24 V DC/2 A

SIPLUS S7-300 PS 307 5 A**6AG1307-1EA01-7AA0**

(Extended temperature range and medial exposure)

Incl. connection bracket
120/230 V AC; 24 V DC
Output current 5 A
(dimensions 60 x 125 x 120)

SIPLUS S7-300 PS 307 10 A**6AG1307-1KA02-7AA0**

(Extended temperature range and medial exposure)

Incl. connection bracket
120/230 V AC; 24 V DC
Output current 10 A
(dimensions 80 x 125 x 120)

SIPLUS S7-300 PS 305**6AG1305-1BA80-2AA0**

For rolling stock railway applications

(Extended temperature range and medial exposure)

Input: 24 ... 110 V DC
Output: 24 V DC/2 A

Input: 24 ... 110 V DC
Output: 24 V DC/2 A

Accessories**SIMATIC S7-300 mounting adapter****6EP1971-1BA00**

For snapping the PS 307 onto a 35 mm DIN rail (EN 60715)

Spare part

SIMATIC S7-300 mounting adapter; for snapping the PS 307 onto 35 mm standard rails

6ES7390-6BA00-0AA0

Technical specifications

Article number	6AG1305-1BA80-2AA0	6AG1307-1EA01-7AA0	6AG1307-1KA02-7AA0
Based on	6ES7305-1BA80-0AA0 SIPLUS S7-300 PS 305 2A	6ES7307-1EA01-0AA0 SIPLUS S7-300 PS 307 5A	6ES7307-1KA02-0AA0 SIPLUS S7-300 PS 307 10 A
Ambient conditions			
Ambient temperature during operation			
<ul style="list-style-type: none"> • min. • max. 	-25 °C; = Tmin 70 °C; = Tmax; for use on railway vehicles according to EN 50155, the rated temperature range -25 ... +55 °C (T1) or 60 °C @ UL/UL hazardous use applies	-25 °C; = Tmin 70 °C; = Tmax; 60 °C @ UL/cUL, ATEX and FM use	-25 °C; = Tmin 70 °C; = Tmax; 60 °C @ UL/cUL, ATEX and FM use
Altitude during operation relating to sea level			
<ul style="list-style-type: none"> • Installation altitude above sea level, max. • Ambient air temperature-barometric pressure-altitude 	2 000 m Tmin ... Tmax at 1 140 hPa ... 795 hPa (-1 000 m ... +2 000 m) // Tmin ... (Tmax - 10 K) at 795 hPa ... 658 hPa (+2 000 m ... +3 500 m) // Tmin ... (Tmax - 20 K) at 658 hPa ... 540 hPa (+3 500 m ... +5 000 m); above 2 000 m max. 75 V DC	2 000 m Tmin ... Tmax at 1 140 hPa ... 795 hPa (-1 000 m ... +2 000 m) // Tmin ... (Tmax - 10 K) at 795 hPa ... 658 hPa (+2 000 m ... +3 500 m) // Tmin ... (Tmax - 20 K) at 658 hPa ... 540 hPa (+3 500 m ... +5 000 m); above 2 000 m max. 75 V DC	2 000 m Tmin ... Tmax at 1 140 hPa ... 795 hPa (-1 000 m ... +2 000 m) // Tmin ... (Tmax - 10 K) at 795 hPa ... 658 hPa (+2 000 m ... +3 500 m) // Tmin ... (Tmax - 20 K) at 658 hPa ... 540 hPa (+3 500 m ... +5 000 m); above 2 000 m max. 75 V DC
Relative humidity			
<ul style="list-style-type: none"> • With condensation, tested in accordance with IEC 60068-2-38, max. 	100 %; RH incl. condensation/frost (no commissioning under condensation conditions)	100 %; RH incl. condensation/frost (no commissioning under condensation conditions)	100 %; RH incl. condensation/frost (no commissioning under condensation conditions)
Resistance			
Use in stationary industrial systems			
<ul style="list-style-type: none"> - to biologically active substances according to EN 60721-3-3 - to chemically active substances according to EN 60721-3-3 - to mechanically active substances according to EN 60721-3-3 	Yes; Class 3B2 mold, fungus and dry rot spores (with the exception of fauna); Class 3B3 on request Yes; Class 3C4 (RH < 75 %) incl. salt spray acc. to EN 60068-2-52 (severity degree 3); * Yes; Class 3S4 incl. sand, dust, *	Yes; Class 3B2 mold, fungus and dry rot spores (with the exception of fauna); Class 3B3 on request Yes; Class 3C4 (RH < 75 %) incl. salt spray acc. to EN 60068-2-52 (severity degree 3); * Yes; Class 3S4 incl. sand, dust, *	Yes; Class 3B2 mold, fungus and dry rot spores (with the exception of fauna); Class 3B3 on request Yes; Class 3C4 (RH < 75 %) incl. salt spray acc. to EN 60068-2-52 (severity degree 3); * Yes; Class 3S4 incl. sand, dust, *
Use on land craft, rail vehicles and special-purpose vehicles			
<ul style="list-style-type: none"> - to biologically active substances according to EN 60721-3-5 - to chemically active substances according to EN 60721-3-5 - to mechanically active substances according to EN 60721-3-5 	Yes; Class 5B2 mold, fungus and dry rot spores (with the exception of fauna); Class 5B3 on request Yes; Class 5C3 (RH < 75 %) incl. salt spray acc. to EN 50155 (ST2); * Yes; Class 5S3 incl. sand, dust; *	Yes; Class 5B2 mold, fungus and dry rot spores (with the exception of fauna); Class 5B3 on request Yes; Class 5C3 (RH < 75 %) incl. salt spray acc. to EN 50155 (ST2); * Yes; Class 5S3 incl. sand, dust; *	Yes; Class 5B2 mold, fungus and dry rot spores (with the exception of fauna); Class 5B3 on request Yes; Class 5C3 (RH < 75 %) incl. salt spray acc. to EN 50155 (ST2); * Yes; Class 5S3 incl. sand, dust; *
Use on ships/at sea			
<ul style="list-style-type: none"> - to biologically active substances according to EN 60721-3-6 - to chemically active substances according to EN 60721-3-6 - to mechanically active substances according to EN 60721-3-6 	Yes; Class 6B2 mold and fungal spores (excluding fauna); Class 6B3 on request Yes; Class 6C3 (RH < 75 %) incl. salt spray acc. to EN 60068-2-52 (severity degree 3); * Yes; Class 6S3 incl. sand, dust; *	Yes; Class 6B2 mold and fungal spores (excluding fauna); Class 6B3 on request Yes; Class 6C3 (RH < 75 %) incl. salt spray acc. to EN 60068-2-52 (severity degree 3); * Yes; Class 6S3 incl. sand, dust; *	Yes; Class 6B2 mold and fungal spores (excluding fauna); Class 6B3 on request Yes; Class 6C3 (RH < 75 %) incl. salt spray acc. to EN 60068-2-52 (severity degree 3); * Yes; Class 6S3 incl. sand, dust; *
Usage in industrial process technology			
<ul style="list-style-type: none"> - Against chemically active substances acc. to EN 60654-4 - Environmental conditions for process, measuring and control systems acc. to ANSI/ISA-71.04 	Yes; Class 3 (excluding trichlorethylene) Yes; Level GX group A/B (excluding trichlorethylene; harmful gas concentrations up to the limits of EN 60721-3-3 class 3C4 permissible); level LC3 (salt spray) and level LB3 (oil)	Yes; Class 3 (excluding trichlorethylene) Yes; Level GX group A/B (excluding trichlorethylene; harmful gas concentrations up to the limits of EN 60721-3-3 class 3C4 permissible); level LC3 (salt spray) and level LB3 (oil)	Yes; Class 3 (excluding trichlorethylene) Yes; Level GX group A/B (excluding trichlorethylene; harmful gas concentrations up to the limits of EN 60721-3-3 class 3C4 permissible); level LC3 (salt spray) and level LB3 (oil)
Remark			
<ul style="list-style-type: none"> - Note regarding classification of environmental conditions acc. to EN 60721, EN 60654-4 and ANSI/ISA-71.04 	* The supplied plug covers must remain in place over the unused interfaces during operation!	* The supplied plug covers must remain in place over the unused interfaces during operation!	* The supplied plug covers must remain in place over the unused interfaces during operation!

SIMATIC S7-300 Advanced Controllers

Interface modules

IM 360/361/365 interface modules

Overview



- For connection of the SIMATIC S7-300 rack in multi-tier configurations
- IM 365:
For configuring central controllers and max. 1 expansion unit. Limited use of modules in the expansion unit (e.g. no CPs and FMs)
- IM 360/IM 361:
For configuring central controllers and max. 3 expansion units. Unlimited selection of modules in the expansion unit

Ordering data

Article No.

IM 360 interface module For expanding the S7-300 with max. 3 EUs; can be plugged into the CC	6ES7360-3AA01-0AA0
IM 361 interface module For expanding the S7-300 with max. 3 EUs; can be plugged into the EU	6ES7361-3CA01-0AA0
Connecting cable Between IM 360 and IM 361 or IM 361 and IM 361	
1 m	6ES7368-3BB01-0AA0
2.5 m	6ES7368-3BC51-0AA0
5 m	6ES7368-3BF01-0AA0
10 m	6ES7368-3CB01-0AA0
IM 365 interface module For expanding the S7-300 with max. 1 EU; 2 modules with permanent connecting cable (1 m)	6ES7365-0BA01-0AA0
SIMATIC Manual Collection Electronic manuals on DVD, multilingual: LOGO!, SIMADYN, SIMATIC bus components, SIMATIC C7, SIMATIC distributed I/O, SIMATIC HMI, SIMATIC Sensors, SIMATIC NET, SIMATIC PC Based Automation, SIMATIC PCS 7, SIMATIC PG/PC, SIMATIC S7, SIMATIC software, SIMATIC TDC	6ES7998-8XC01-8YE0
SIMATIC Manual Collection update service for 1 year Current "Manual Collection" DVD and the three subsequent updates	6ES7998-8XC01-8YE2

Technical specifications

Article number	6ES7360-3AA01-0AA0 Interf. mod. IM360 in CC, with K-BUS	6ES7361-3CA01-0AA0 IM 361 Interface Module in ER,with K-Bus	6ES7365-0BA01-0AA0 Interf. mod. IM365, w/o K-BUS
Supply voltage			
Rated value (DC)			
• 24 V DC		Yes	
Input current			
from supply voltage L+, max.		500 mA	
from backplane bus 5 V DC, max.	350 mA		100 mA
Power loss			
Power loss, typ.	2 W	5 W	0.5 W
Hardware configuration			
Number of interfaces per CPU, max.	1	3	1; 1 pair
Dimensions			
Width	40 mm	80 mm	40 mm
Height	125 mm	125 mm	125 mm
Depth	120 mm	120 mm	120 mm
Weights			
Weight, approx.	225 g	505 g	580 g

Overview



- SIPLUS IM 365:
For configuration of 1 central controller and max. 1 expansion unit

Note:

SIPLUS extreme products are based on SIMATIC standard products. The contents listed here were taken from the respective standard products. SIPLUS extreme specific information was added.

Ordering data

SIPLUS S7-300 IM 365 interface module

For expansion of S7-300 with max. 1 EU; 2 modules with permanent connecting cable (1 m)

Extended temperature range and exposure to media

Article No.

6AG1365-0BA01-2AA0

Technical specifications

Article number	6AG1365-0BA01-2AA0
Based on	6ES7365-0BA01-0AAA SIPLUS S7-300 IM 365
Ambient conditions	
Ambient temperature during operation	
• min.	-25 °C; = Tmin
• max.	60 °C; = Tmax
Ambient temperature during storage/transportation	
• min.	-40 °C
• max.	70 °C
Altitude during operation relating to sea level	
• Installation altitude above sea level, max.	5 000 m
• Ambient air temperature-barometric pressure-altitude	Tmin ... Tmax at 1 140 hPa ... 795 hPa (-1 000 m ... +2 000 m) // Tmin ... (Tmax - 10 K) at 795 hPa ... 658 hPa (+2 000 m ... +3 500 m) // Tmin ... (Tmax -20 K) at 658 hPa ... 540 hPa (+3 500 m ... +5 000 m)
Relative humidity	
• With condensation, tested in accordance with IEC 60068-2-38, max.	100 %; RH incl. condensation/frost (no commissioning under condensation conditions)
Resistance	
Use in stationary industrial systems	
- to biologically active substances according to EN 60721-3-3	Yes; Class 3B2 mold, fungus and dry rot spores (with the exception of fauna); Class 3B3 on request
- to chemically active substances according to EN 60721-3-3	Yes; Class 3C4 (RH < 75 %) incl. salt spray acc. to EN 60068-2-52 (severity degree 3); *
- to mechanically active substances according to EN 60721-3-3	Yes; Class 3S4 incl. sand, dust, *

Article number	6AG1365-0BA01-2AA0
Based on	6ES7365-0BA01-0AAA SIPLUS S7-300 IM 365
Use on land craft, rail vehicles and special-purpose vehicles	
- to biologically active substances according to EN 60721-3-5	Yes; Class 5B2 mold, fungus and dry rot spores (with the exception of fauna); Class 5B3 on request
- to chemically active substances according to EN 60721-3-5	Yes; Class 5C3 (RH < 75 %) incl. salt spray acc. to EN 50155 (ST2); *
- to mechanically active substances according to EN 60721-3-5	Yes; Class 5S3 incl. sand, dust; *
Use on ships/at sea	
- to biologically active substances according to EN 60721-3-6	Yes; Class 6B2 mold and fungal spores (excluding fauna); Class 6B3 on request
- to chemically active substances according to EN 60721-3-6	Yes; Class 6C3 (RH < 75 %) incl. salt spray acc. to EN 60068-2-52 (severity degree 3); *
- to mechanically active substances according to EN 60721-3-6	Yes; Class 6S3 incl. sand, dust; *
Usage in industrial process technology	
- Against chemically active substances acc. to EN 60654-4	Yes; Class 3 (excluding trichlorethylene)
- Environmental conditions for process, measuring and control systems acc. to ANSI/ISA-71.04	Yes; Level GX group A/B (excluding trichlorethylene; harmful gas concentrations up to the limits of EN 60721-3-3 class 3C4 permissible); level LC3 (salt spray) and level LB3 (oil)
Remark	
- Note regarding classification of environmental conditions acc. to EN 60721, EN 60654-4 and ANSI/ISA-71.04	* The supplied plug covers must remain in place over the unused interfaces during operation!

SIMATIC S7-300 Advanced Controllers

Accessories

DIN rail, Labeling sheets

Overview DIN rail



- The mechanical rack for SIMATIC S7-300
- For accommodating the modules
- Can be attached to walls

Ordering data

Article No.

DIN rail

160 mm
482 mm
530 mm
830 mm
2000 mm

6ES7390-1AB60-0AA0
6ES7390-1AE80-0AA0
6ES7390-1AF30-0AA0
6ES7390-1AJ30-0AA0
6ES7390-1BC00-0AA0

Overview

Labeling sheets

- Film sheets for the application-specific labeling of SIMATIC S7-300 I/O modules using standard laser printers
- Plain color films, tear-resistant, dirt-repellent
- Simple handling:
 - perforated labeling sheets in DIN A4 format for easy separation of the labeling strips.
 - the separated strips can be attached directly onto the I/O modules.
- Different colors to distinguish between different module types or preferred applications:
The labeling sheets are available in the following colors: petrol, light-beige, red, and yellow. Yellow is reserved for fail-safe systems.

Label cover

- Petrol-colored film
- For sealing and fixing of custom labeling strips on normal paper
- Accessories, 10 units

Ordering data

Article No.

Labeling sheets

for modules with 20-pin front connector, DIN A4, for printing with laser printer; 10 units

petrol

6ES7392-2AX00-0AA0

light-beige

6ES7392-2BX00-0AA0

yellow

6ES7392-2CX00-0AA0

red

6ES7392-2DX00-0AA0

for modules with 40-pin front connector, DIN A4, for printing with laser printer; 10 units

petrol

6ES7392-2AX10-0AA0

light-beige

6ES7392-2BX10-0AA0

yellow

6ES7392-2CX10-0AA0

red

6ES7392-2DX10-0AA0

Technical specifications

Labeling sheets for S7-300

Dimensions	DIN A4
Labeling strips per sheet, pre-perforated	10
Weight, approx.	0.1 kg

SIMATIC S7-400 Advanced Controllers



6/2

6/2

6/5

Overview

SIMATIC S7-400

I/O modules

SIMATIC S7-400 Advanced Controllers

Overview

SIMATIC S7-400

Overview

SIMATIC S7-400:
The powerful controller for system solutions in the manufacturing and process industries

Within the controller family, the SIMATIC S7-400 is designed for system solutions in the manufacturing and process automation industry.

- The modularly designed S7-400H can be flexibly adapted to your requirements. The redundant configuration further increases system availability.
- An additional protective coating (conformal coating) on the circuit board optimally protects the modules against external influences and makes them durable.
- The S7-400H stands out thanks to its long-term availability.
- Safety engineering, SIMATIC F-systems and standard automation can be integrated into a single automation system.
- The configuration of the distributed I/O of the S7-400 can be modified during operation. In addition signal modules can be removed and inserted while live (hot swapping). This makes it very easy to expand the system or replace modules in the event of a fault.
- Storage of the entire project data, including symbols and comments, on the CPU simplifies service and maintenance calls.



SIMATIC S7-400, CPU	412-5H ⁴⁾	414-5H ⁴⁾	416-5H ⁴⁾	417-5H ⁴⁾
Work memory	1 MB	4 MB	16 MB	32 MB
Processing times (ns)				
Bit/word/ fixed point/floating point	31.25/31.25/ 31.25/62.5	18.75/18.75/ 18.75/37.5	12.5/12.5/ 12.5/25	7.5/7.5/ 7.5/15
Timers/counters	2048/2048	2048/2048	2048/2048	2048/2048
Address ranges				
Digital inputs/outputs	65536 each	65536 each	131072 each	131072 each
Analog inputs/outputs	4096 each	4096 each	8192 each	8192 each
DP interfaces				
Number of MPI/DP interfaces	1	1	1	1
Number of DP interfaces	1	1	1	1
Number of DP slaves per MPI/DP	32	32	32	32
Number of DP slaves per DP	64	96	125	125
Plug-in interface modules	—	—	—	—
Data set gateway	●	●	●	●
PN interfaces				
Number of PN interfaces	1 (2 ports)	1 (2 ports)	1 (2 ports)	1 (2 ports)
PROFINET IO	●	●	●	●
PROFINET with IRT	—	—	—	—
PROFINET CBA	—	—	—	—
TCP/IP	●	●	●	●
UDP	●	●	●	●
Web server	—	—	—	—
ISO-on-TCP (RFC 1006)	●	●	●	●
Mounting dimensions				
W x H x D (mm)	50 x 290 x 219	50 x 290 x 219	50 x 290 x 219	50 x 290 x 219

— = cannot be used/not available
 ● = can be used/available

⁴⁾ also as SIPLUS extreme component for corrosive atmosphere/condensation

Overview

- The S7-400 is especially suitable for data-intensive tasks in the process industry. High processing speeds and deterministic response times guarantee short machine cycle times on high-speed machines in the manufacturing industry. The high-speed backplane bus of S7-400 ensures efficient linking of central I/O modules.
- The S7-400 is used preferably to coordinate complete plants and to control lower-level devices/stations; this is guaranteed by the high communication power and the integral interfaces.
- The performance is scalable thanks to a graded range of CPUs; Interfaces for the PROFIBUS/PROFINET connection ensure optimal connectivity.
- To further increase ruggedness and durability in the harsh everyday industrial environment, the S7-400 has a "G3" conformal coating.



SIMATIC S7-400, CPU	412-1 / 412-2	412-2 PN ⁴⁾	414-2 / 414-3	414-3 PN/DP ⁴⁾	416-2 / 416-3 ⁴⁾	416-3 PN/DP ⁴⁾	417-4 ⁴⁾
Work memory	512KB/ 1 ¹⁾ MB	1 MB	2/4 ²⁾ MB	4 MB	8/16 ³⁾ MB	16 MB	32 MB
Processing times (ns)							
Bit/word/ fixed point/floating point	31.25/31.25/ 31.25/62.5	31.25/31.25/ 31.25/62.5	18.75/18.75/ 18.75/37.5	18.75/18.75/ 18.75/37.5	12.5/12.5/ 12.5/25	12.5/12.5/ 12.5/25	7.5/7.5/ 7.5/15
Timers/counters	2048/2048	2048/2048	2048/2048	2048/2048	2048/2048	2048/2048	2048/2048
Address range							
Digital inputs/outputs	32768 each	32768 each	65536 each	65536 each	131072 each	131072 each	131072 each
Analog inputs/outputs	2048 each	2048 each	4096 each	4096 each	8192 each	8192 each	8192 each
DP interfaces							
Number of MPI/DP interfaces	1	1	1	1	1	1	1
Number of DP interfaces	— / 1 ¹⁾	—	1	—	1	1	1
Number of DP slaves per MPI/DP	32	32	32	32	32	32	32
Number of DP slaves per DP	64	—	96 each	125 each	125 each	125 each	125 each
Plug-in interface modules	—	—	— / 1 x DP ²⁾	1 x DP	— / 1 x DP ³⁾	1 x DP	2 x DP
Data set gateway	●	●	●	●	●	●	●
PN interfaces							
Number of PN interfaces	—	1 (2 ports)	—	1 (2 ports)	—	1 (2 ports)	—
PROFINET IO	—	●	—	●	—	●	—
PROFINET with IRT	—	●	—	●	—	●	—
PROFINET CBA	—	●	—	●	—	●	—
TCP/IP	—	●	—	●	—	●	—
UDP	—	●	—	●	—	●	—
Web server	—	●	—	●	—	●	—
ISO-on-TCP (RFC 1006)	—	●	—	●	—	●	—
Mounting dimensions							
W x H x D (mm)	25 x 290 x 219	25 x 290 x 219	25 x 290 x 219 50 x 290 x 219 ²⁾	50 x 290 x 219	25 x 290 x 219 50 x 290 x 219 ³⁾	50 x 290 x 219	50 x 290 x 219

— = cannot be used/not available
● = can be used/available

¹⁾ CPU 412-2

²⁾ CPU 414-3

³⁾ CPU 416-3

⁴⁾ also as SIPLUS extreme component for corrosive atmosphere/condensation

SIMATIC S7-400 Advanced Controllers

Overview

SIMATIC S7-400

Overview

- Safety engineering and standard automation can be integrated into a single S7-400.
- For demanding, safety-oriented automation in mechanical engineering with S7 Distributed Safety.
- Many S7-400 components are also available in a SIPLUS extreme version for extreme environmental conditions, e.g. for use where there is a corrosive atmosphere/condensation. For more detailed information, visit www.siemens.com/siplus-extreme

For more information, refer to:

www.siemens.com/simatic-s7-400

Detailed information on SIMATIC S7-400, see **Catalog ST 400** in the Siemens Industry Online Support:

www.siemens.com/industry-catalogs



SIMATIC S7-400, CPU	414F-3 PN/DP	416F-2	416F-3 PN/DP
Work memory	4 MB	8 MB	16 MB
Processing times (ns)			
Bit/word/ fixed point/floating point	18.75/18.75/ 18.75/37.5	12.5/12.5/ 12.5/25	12.5/12.5/ 12.5/25
Timers/counters	2048/2048	2048/2048	2048/2048
Address ranges			
Digital inputs/outputs	65536 each	131072 each	131072 each
Analog inputs/outputs	4096 each	8192 each	8192 each
DP interfaces			
Number of MPI/DP interfaces	1	1	1
Number of DP interfaces	1	1	1
Number of DP slaves per MPI/DP	32	32	32
Number of DP slaves per DP	125 each	125	125 each
Plug-in interface modules	1 x DP	—	1 x DP
Data set gateway	●	●	●
PN interfaces			
Number of PN interfaces	1 (2 ports)	—	1 (2 ports)
PROFINET IO	●	—	●
PROFINET with IRT	●	—	●
PROFINET CBA	●	—	●
TCP/IP	●	—	●
UDP	●	—	●
Web server	●	—	●
ISO-on-TCP (RFC 1006)	●	—	●
Mounting dimensions			
W x H x D (mm)	50 x 290 x 219	25 x 290 x 219	50 x 290 x 219

— = cannot be used/not available

● = can be used/available

Overview

Digital modules

SM 421 digital input module

Article No.



- Digital inputs for the SIMATIC S7-400
 - For connecting switches and 2-wire proximity switches (BEROs)
- Detailed information on SIMATIC S7-400, see **Catalog ST 400** in Siemens Industry Online Support: www.siemens.com/industry-catalogs

16 inputs, 24 V DC, with hardware/diagnostics interrupt

6ES7421-7BH01-0AB0

32 inputs, 24 V DC

6ES7421-1BL01-0AA0

32 inputs, 120 V UC

6ES7421-1EL00-0AA0

16 inputs, 120/230 V UC, inputs according to IEC 1131-2 Type 2

6ES7421-1FH20-0AA0

16 inputs, 24 to 60 V UC, with hardware/diagnostics interrupt

6ES7421-7DH00-0AB0

SM 422 digital output module

Article No.



- Digital outputs for the SIMATIC S7-400
 - For connecting solenoid valves, contactors, small-power motors, lamps and motor starters
- Detailed information on SIMATIC S7-400, see **Catalog ST 400** in Siemens Industry Online Support: www.siemens.com/industry-catalogs

16 outputs, 120/230 V AC, 2 A

6ES7422-1FH00-0AA0

6 outputs, relay contacts

6ES7422-1HH00-0AA0

16 outputs, 24 V DC, 2 A

6ES7422-1BH11-0AA0

32 outputs, 24 V DC, 0.5 A

6ES7422-1BL00-0AA0

32 outputs; 24 V DC, 0.5 A; with diagnostics

6ES7422-7BL00-0AB0

Analog modules

SM 431 analog input module

Article No.



- Analog inputs for the SIMATIC S7-400
 - For connecting voltage sensors and current sensors, thermocouples, resistors and resistance thermometers
 - Resolution 13 to 16 bit
- Detailed information on SIMATIC S7-400, see **Catalog ST 400** in Siemens Industry Online Support: www.siemens.com/industry-catalogs

16 inputs, non-floating, 13 bit

6ES7431-0HH00-0AB0

8 inputs, floating, 14 bit

6ES7431-1KF20-0AB0

8 inputs, floating, 13 bit

6ES7431-1KF00-0AB0

8 inputs, floating, 14 bit, with linearization

6ES7431-1KF10-0AB0

16 inputs, floating, 16 bit, hardware interrupt capability

6ES7431-7QH00-0AB0

8 inputs, floating, 16 bit, hardware interrupt capability, for thermocouples (I, U)

6ES7431-7KF00-0AB0

8 inputs, floating, 16 bit, hardware interrupt capability, for thermal resistors

6ES7431-7KF10-0AB0

SM 432 analog output module

Article No.



- Analog outputs for the SIMATIC S7-400
 - For connecting analog actuators
- Detailed information on SIMATIC S7-400, see **Catalog ST 400** in Siemens Industry Online Support: www.siemens.com/industry-catalogs

8 outputs, floating, 13 bit

6ES7432-1HF00-0AB0

SIMATIC S7-400 Advanced Controllers

Overview

I/O modules

Overview

Function modules

FM 450-1 counter module

Article No.



- Two-channel, intelligent counter module for simple counting tasks
- For direct connection of incremental encoders
- Comparison function with 2 definable comparison values
- Integrated digital outputs for outputting the reaction on reaching the comparison values

With 2 channels, max. 500 kHz; for incremental encoders

6ES7450-1AP01-0AE0

Detailed information on SIMATIC S7-400, see **Catalog ST 400** in Siemens Industry Online Support: www.siemens.com/industry-catalogs

FM 451 positioning module

Article No.



The three-channel FM 451 positioning module takes over the adjustment of mechanical axes for rapid traverse/creep speed drives. The module is designed for positioning adjusting and tooling axes, preferably with standard motors, controlled via contactors or frequency converters.

For rapid traverse and creep speed drives

6ES7451-3AL00-0AE0

- Three-channel positioning module for rapid traverse/creep speed drives
- 4 digital outputs per channel for motor control
- Incremental or synchronous-serial position feedback

Detailed information on SIMATIC S7-400, see **Catalog ST 400** in Siemens Industry Online Support: www.siemens.com/industry-catalogs

FM 452 cam controller

Article No.



- Very high-speed electronic cam controller
- Low-cost alternative to mechanical cam controllers
- 32 cam tracks, 16 onboard digital outputs for direct output of actions
- Incremental or synchronous-serial position feedback

Detailed information on SIMATIC S7-400, see **Catalog ST 400** in Siemens Industry Online Support: www.siemens.com/industry-catalogs

6ES7452-1AH00-0AE0

FM 453 positioning module

Article No.



The FM 453 is an intelligent, three-channel module designed for a wide range of positioning tasks using servo and/or stepper motors.

with 3 channels/axes

6ES7453-3AH00-0AE0

- It can be used for simple point-to-point positioning tasks as well as for complex traverse profiles with the most stringent demands for dynamic response, accuracy, and velocity.
- It is the ideal solution for positioning tasks in machines with high clock rates and for multi-axis machines.
- Up to 3 independent motors can be controlled

Detailed information on SIMATIC S7-400, see **Catalog ST 400** in Siemens Industry Online Support: www.siemens.com/industry-catalogs

Overview

Function modules

FM 455 controller module

Article No.



The FM 455 controller module is the intelligent 16-channel controller module for universal control tasks. It can be used, for example, for temperature control, pressure control, flow control or level control.

- Convenient online self-optimization for temperature controls
- Ready-to-use controller structures
- 2 control algorithms
- 2 versions:
 - FM 455 C as continuous controller
 - FM 455 S as step or pulse controller

- With 16 analog outputs (FM 455 C) or 32 digital outputs (FM 455 S) for actuators

Detailed information on SIMATIC S7-400, see **Catalog ST 400** in Siemens Industry Online Support:

www.siemens.com/industry-catalogs

With 16 analog outputs for 16 continuous controllers

6ES7455-0VS00-0AE0

With 32 digital outputs for 16 step or pulse controllers

6ES7455-1VS00-0AE0

SIMATIC S7-400 Advanced Controllers

Notes

6

Distributed Controllers

**7/2****based on ET 200SP**Standard CPUs

7/2 CPU 1510SP-1 PN

7/6 CPU 1512SP-1 PN

SIPLUS standard CPUs

7/10 SIPLUS CPU 1510SP-1 PN

7/12 SIPLUS CPU 1512SP-1 PN

Fail-safe CPUs

7/14 CPU 1510SP F-1 PN

7/18 CPU 1512SP F-1 PN

SIPLUS fail-safe CPUs

7/22 SIPLUS CPU 1510SP F-1 PN

7/24 SIPLUS CPU 1512SP F-1 PN

ET 200SP Open ControllersStandard CPUs

7/26 - CPU 1515SP PC2

Fail-safe CPUs

7/30 - CPU 1515SP PC2 F

Technology-CPUs

7/34 - CPU 1515SP PC2 T

7/38 - CPU 1515SP PC2 TF

SIPLUS ET 200SP Open ControllersSIPLUS standard CPUs

7/42 - SIPLUS CPU 1515SP PC2

SIPLUS fail-safe CPUs

7/45 - SIPLUS CPU 1515SP PC2 F

7/47**based on ET 200pro**Standard CPUs

7/47 IM 154-8 PN/DP CPU

7/51 CPU 1513pro-2 PN

7/55 CPU 1516pro-2 PN

Fail-safe CPUs

7/59 IM 154-8 F PN/DP CPU

7/64 CPU 1513pro F-2 PN

7/68 CPU 1516pro F-2 PN

Distributed Controllers

based on ET 200SP
Standard CPUs

CPU 1510SP-1 PN

Overview



- CPU 1510SP-1 PN for SIMATIC ET 200SP based on S7-1500 CPU 1511-1 PN
- For high-performance control solutions using ET 200SP
- Increase in availability of systems and machines
- PROFINET IO controller for up to 64 IO devices
- PROFINET I-Device for connecting the CPU as an intelligent PROFINET device with a SIMATIC or non-Siemens PROFINET IO controller
- PROFINET shared I-Device for 4 controllers
- PROFINET IO IRT interface with integrated 3-port switch
- Isochronous mode on PROFINET
- With multiple communication options: Programming device/OP communication, PROFINET IO, open IE communication (TCP, ISO-on-TCP and UDP), web server and S7 communication (with loadable FBs)
- OPC UA Server and Client (Data Access) as runtime option for easy connection of the SIMATIC ET 200SP to non-Siemens devices/systems
- Optional PROFIBUS DP master for 125 PROFIBUS DP slaves (with CM DP module 6ES7545-5DA00-0AB0)
- Optional PROFIBUS DP slave (with CM DP module 6ES7545-5DA00-0AB0)
- Configuration control (option handling)
- Integrated Motion Control functionalities for controlling speed-controlled and positioning axes, support for external encoders, output cams/cam tracks and probes

Note

SIMATIC Memory Card required for operation of the CPU. The BusAdapter is not included in scope of supply and is to be ordered separately.

Ordering data

Article No.

CPU 1510SP-1 PN	6ES7510-1DJ01-0AB0
100 KB work memory for program, 750 KB for data, PROFINET IO IRT interface; SIMATIC Memory Card required	
Accessories	
CM DP for ET 200SP CPU	6ES7545-5DA00-0AB0
PROFIBUS DP master/slave with electrical interface for connecting the ET 200SP CPUs to PROFIBUS at up to 12 Mbps	
SIMATIC Memory Card	
4 MB	6ES7954-8LC03-0AA0
12 MB	6ES7954-8LE03-0AA0
24 MB	6ES7954-8LF03-0AA0
256 MB	6ES7954-8LL03-0AA0
2 GB	6ES7954-8LP03-0AA0
32 GB	6ES7954-8LT03-0AA0
DIN rail, 35 mm	
• Length 483 mm for 19" cabinets	6ES710-8MA11
• Length 530 mm for 600 mm cabinets	6ES710-8MA21
• Length 830 mm for 900 mm cabinets	6ES710-8MA31
• Length 2 m	6ES710-8MA41
PE connection element for 2 000 mm DIN rail	6ES7590-5AA00-0AA0
BusAdapter BA 2xRJ45	6ES7193-6AR00-0AA0
BusAdapter BA 2xFC for increased vibration and EMC loads	6ES7193-6AF00-0AA0
BusAdapter BA 2xSCRJ	6ES7193-6AP00-0AA0
BusAdapter BA SCRJ/RJ45	6ES7193-6AP20-0AA0
BusAdapter BA SCRJ/FC	6ES7193-6AP40-0AA0
Equipment labeling plate	6ES7193-6LF30-0AW0
10 sheets of 16 labels	
Labeling strips	
500 labeling strips on roll, light gray, for inscription with thermal transfer roll printer	6ES7193-6LR10-0AA0
500 labeling strips on roll, yellow, for inscription with thermal transfer roll printer	6ES7193-6LR10-0AG0
1 000 labeling strips DIN A4, light gray, card, for inscription with laser printer	6ES7193-6LA10-0AA0
1 000 labeling strips DIN A4, yellow, card, for inscription with laser printer	6ES7193-6LA10-0AG0

Ordering data	Article No.	Ordering data	Article No.
IE FC RJ45 plugs RJ45 plug connector for Industrial Ethernet with a rugged metal enclosure and integrated insulation displacement contacts for connecting Industrial Ethernet FC installation cables		SIMATIC Manual Collection Electronic manuals on DVD, multi-language: LOGO!, SIMADYN, SIMATIC bus components, SIMATIC C7, SIMATIC Distributed I/O, SIMATIC HMI, SIMATIC sensors, SIMATIC NET, SIMATIC PC-based Automation, SIMATIC PCS 7, SIMATIC PG/PC, SIMATIC S7, SIMATIC software, SIMATIC TDC	6ES7998-8XC01-8YE0
IE FC RJ45 plug 90 90° cable outlet 1 unit 10 units 50 units	6GK1901-1BB20-2AA0 6GK1901-1BB20-2AB0 6GK1901-1BB20-2AE0	SIMATIC Manual Collection update service for 1 year Current Manual Collection DVD and the three subsequent updates	6ES7998-8XC01-8YE2
IE FC RJ45 plug 180 180° cable outlet 1 unit 10 units 50 units	6GK1901-1BB10-2AA0 6GK1901-1BB10-2AB0 6GK1901-1BB10-2AE0	STEP 7 Professional V17 Target system: SIMATIC S7-1200, S7-1500, S7-300, S7-400, WinAC Requirement: Windows 10 (64-bit) <ul style="list-style-type: none"> Windows 10 Professional Version 1909, 2004, 20H2 Windows 10 Enterprise Version 1909, 2004, 20H2 Windows 10 IoT Enterprise 2016 LTSC Windows 10 IoT Enterprise 2019 LTSC Windows Server (64-bit) <ul style="list-style-type: none"> Windows Server 2016 Standard (full installation) Windows Server 2019 Standard (full installation) Type of delivery: 9 languages: de, en, zh included, fr, sp, it, ru, jp, kr as download	
IE FC TP standard cable GP 2x2 4-wire, shielded TP installation cable for connection to IE FC RJ45 outlet/IE FC RJ45 plug; PROFINET-compatible; with UL approval; sold by the meter; max. delivery unit 1 000 m, minimum order quantity 20 m	6XV1840-2AH10	STEP 7 Professional V17, floating license STEP 7 Professional V17, floating license, software download including license key ¹⁾ Email address required for delivery	6ES7822-1AA07-0YA5 6ES7822-1AE07-0YA5
IE FC TP trailing cable 2 x 2 (type C) 4-wire, shielded TP installation cable for connection to IE FC RJ45 outlet/IE FC RJ45 plug 180/90 for use as trailing cable; PROFINET-compatible; with UL approval; sold by the meter; max. delivery unit 1 000 m, minimum order quantity 20 m	6XV1840-3AH10	Spare parts Power supply connector Spare part; for connecting the 24 V DC supply voltage <ul style="list-style-type: none"> With push-in terminals; 10 units 	
IE FC TP marine cable 2 x 2 (type B) 4-wire, shielded TP installation cable for connection to IE FC RJ45 outlet/IE FC RJ45 plug 180/90 with marine approval; sold by the meter; max. delivery unit 1 000 m, minimum order quantity 20 m	6XV1840-4AH10	Cover for BusAdapter interface 5 units	
IE FC stripping tool Pre-adjusted stripping tool for fast stripping of Industrial Ethernet FC cables	6GK1901-1GA00	Server module	
Manuals for ET 200SP distributed I/O system ET 200SP library: ET 200SP Manual Collection, comprising system manual, product information, and device manuals Manuals can be downloaded from the Internet as PDF files: http://www.siemens.com/simatic-docu			

¹⁾ For up-to-date information and download availability, see:
<http://www.siemens.com/tia-online-software-delivery>

Distributed Controllers

based on ET 200SP
Standard CPUs

CPU 1510SP-1 PN

Technical specifications

Article number	6ES7510-1DJ01-0AB0 CPU 1510SP-1 PN, 100KB Prog./750KB Data
General information	
Product type designation	CPU 1510SP-1 PN
Engineering with	
• STEP 7 TIA Portal configurable/integrated from version	V17 (FW V2.9) / V13 SP1 Update 4 (FW V1.8) or higher
Supply voltage	
Rated value (DC)	24 V
Memory	
Work memory	
• integrated (for program)	100 kbyte
• integrated (for data)	750 kbyte
Load memory	
• Plug-in (SIMATIC Memory Card), max.	32 Gbyte
CPU processing times	
for bit operations, typ.	72 ns
for word operations, typ.	86 ns
for fixed point arithmetic, typ.	115 ns
for floating point arithmetic, typ.	461 ns
Counters, timers and their retentivity	
S7 counter	
• Number	2 048
IEC counter	
• Number	Any (only limited by the main memory)
S7 times	
• Number	2 048
IEC timer	
• Number	Any (only limited by the main memory)
Data areas and their retentivity	
Flag	
• Size, max.	16 kbyte
Address area	
I/O address area	
• Inputs	32 kbyte; All inputs are in the process image
• Outputs	32 kbyte; All outputs are in the process image
Address space per module	
• Address space per module, max.	288 byte; For input and output data respectively
Address space per station	
• Address space per station, max.	2 560 byte; for central inputs and outputs; depending on configuration; 2 048 bytes for ET 200SP modules + 512 bytes for ET 200AL modules
Time of day	
Clock	
• Type	Hardware clock

Article number	6ES7510-1DJ01-0AB0 CPU 1510SP-1 PN, 100KB Prog./750KB Data
1. Interface	
Interface types	
• RJ 45 (Ethernet)	Yes; X1 P3; opt. X1 P1 and X1 P2 via BusAdapter BA 2x RJ45
• Number of ports	3; 1. integr. + 2. via BusAdapter
• integrated switch	Yes
• BusAdapter (PROFINET)	Yes; compatible BusAdapters: BA 2x RJ45, BA 2x FC, BA 2x M12
Protocols	
• IP protocol	Yes; IPv4
• PROFINET IO Controller	Yes
• PROFINET IO Device	Yes
• SIMATIC communication	Yes
• Open IE communication	Yes; Optionally also encrypted
• Web server	Yes
• Media redundancy	Yes; MRP Automanager according to IEC 62439-2 Edition 2.0
PROFINET IO Controller Services	
- PG/OP communication	Yes
- Isochronous mode	Yes
- Direct data exchange	Yes; Requirement: IRT and isochronous mode (MRPD optional)
- IRT	Yes
- PROFlenergy	Yes; per user program
- Prioritized startup	Yes; Max. 32 PROFINET devices
- Number of connectable IO Devices, max.	64; In total, up to 256 distributed I/O devices can be connected via AS-i, PROFIBUS or PROFINET
- Of which IO devices with IRT, max.	64
- Number of connectable IO Devices for RT, max.	64
- of which in line, max.	64
- Number of IO Devices that can be simultaneously activated/deactivated, max.	8; in total across all interfaces
- Number of IO Devices per tool, max.	8
- Updating times	The minimum value of the update time also depends on communication share set for PROFINET IO, on the number of IO devices, and on the quantity of configured user data
PROFINET IO Device Services	
- PG/OP communication	Yes
- Isochronous mode	No
- IRT	Yes
- PROFlenergy	Yes; per user program
- Shared device	Yes
- Number of IO Controllers with shared device, max.	4
- activation/deactivation of I-devices	Yes; per user program
- Asset management record	Yes; per user program

Technical specifications

Article number	6ES7510-1DJ01-0AB0 CPU 1510SP-1 PN, 100KB Prog./750KB Data
2. Interface	
Interface types	
• RS 485	Yes; Via CM DP module
• Number of ports	1
Protocols	
• PROFIBUS DP master	Yes
• PROFIBUS DP slave	Yes
• SIMATIC communication	Yes
PROFIBUS DP master	
• Number of DP slaves, max.	125; In total, up to 256 distributed I/O devices can be connected via AS-i, PROFIBUS or PROFINET
Protocols	
Number of connections	
• Number of connections, max.	96; via integrated interfaces of the CPU and connected CPs / CMs
Redundancy mode	
Media redundancy	
- Media redundancy	Yes; only via BusAdapter
- MRP	Yes; MRP Automanager according to IEC 62439-2 Edition 2.0, MRP Manager; MRP Client
- MRP interconnection, supported	Yes; as MRP ring node according to IEC 62439-2 Edition 3.0
- MRPD	Yes; Requirement: IRT
- Switchover time on line break, typ.	200 ms; For MRP, bumpless for MRPD
- Number of stations in the ring, max.	50
SIMATIC communication	
• S7 routing	Yes
OPC UA	
• OPC UA Client	Yes
• OPC UA Server	Yes; Data access (read, write, subscribe), method call, custom address space
• Alarms and Conditions	Yes
Supported technology objects	
Motion Control	Yes; Note: The number of technology objects affects the cycle time of the PLC program; selection guide via the TIA Selection Tool
• Number of available Motion Control resources for technology objects	800
• Required Motion Control resources	
- per speed-controlled axis	40
- per positioning axis	80
- per synchronous axis	160
- per external encoder	80
- per output cam	20
- per cam track	160
- per probe	40
Controller	
• PID_Compact	Yes; Universal PID controller with integrated optimization
• PID_3Step	Yes; PID controller with integrated optimization for valves
• PID-Temp	Yes; PID controller with integrated optimization for temperature
Counting and measuring	
• High-speed counter	Yes

Article number	6ES7510-1DJ01-0AB0 CPU 1510SP-1 PN, 100KB Prog./750KB Data
Ambient conditions	
Ambient temperature during operation	
• horizontal installation, min.	-25 °C; No condensation
• horizontal installation, max.	60 °C
• vertical installation, min.	-25 °C; No condensation
• vertical installation, max.	50 °C
Altitude during operation relating to sea level	
• Installation altitude above sea level, max.	5 000 m; Restrictions for installation altitudes > 2 000 m, see manual
Configuration	
Programming	
Programming language	
- LAD	Yes
- FBD	Yes
- STL	Yes
- SCL	Yes
- GRAPH	Yes
Know-how protection	
• User program protection/password protection	Yes
• Copy protection	Yes
• Block protection	Yes
Access protection	
• protection of confidential configuration data	Yes
• Protection level: Write protection	Yes
• Protection level: Read/write protection	Yes
• Protection level: Complete protection	Yes
Dimensions	
Width	100 mm
Height	117 mm
Depth	75 mm
Weights	
Weight, approx.	310 g

Distributed Controllers

based on ET 200SP
Standard CPUs

CPU 1512SP-1 PN

Overview



- CPU 1512SP-1 PN for SIMATIC ET 200SP based on S7-1500 CPU 1513-1 PN
- For applications with medium requirements in terms of program scope and processing speed, for distributed configurations via PROFINET IO or PROFIBUS DP.
- Increase in availability of systems and machines
- PROFINET IO controller for up to 128 IO devices
- PROFINET I-device for connecting the CPU as an intelligent PROFINET device with a SIMATIC or third-party PROFINET IO controller
- PROFINET shared I-device for 4 controllers
- PROFINET IO IRT interface with integrated 3-port switch
- Isochronous mode on PROFINET
- With multiple communication options: PG/OP communication, PROFINET IO, open IE communication (TCP, ISO-on-TCP and UDP), web server and S7 communication (with loadable FBs)
- OPC UA server and client (data access) as runtime option for easy connection of the SIMATIC ET 200SP to third-party devices/systems
- Optional PROFIBUS DP master for 125 PROFIBUS DP slaves (with CM DP module 6ES7545-5DA00-0AB0)
- Optional PROFIBUS DP slave (with CM DP module 6ES7545-5DA00-0AB0)
- Configuration control (option handling)
- Integrated motion control functionalities for controlling speed-controlled and positioning axes, support for external encoders, cams/cam tracks and probes

Note

SIMATIC Memory Card required for operation of the CPU. BusAdapter is not included in scope of delivery and is to be ordered separately.

Ordering data

Article No.

CPU 1512SP-1 PN 200 KB work memory for program, 1 MB for data, PROFINET IO IRT interface; SIMATIC Memory Card required	6ES7512-1DK01-0AB0
Accessories	
CM DP for ET 200SP CPU PROFIBUS DP master/slave with electrical interface for connecting the ET 200SP CPUs to PROFIBUS at up to 12 Mbps	6ES7545-5DA00-0AB0
SIMATIC Memory Card	
4 MB	6ES7954-8LC03-0AA0
12 MB	6ES7954-8LE03-0AA0
24 MB	6ES7954-8LF03-0AA0
256 MB	6ES7954-8LL03-0AA0
2 GB	6ES7954-8LP03-0AA0
32 GB	6ES7954-8LT03-0AA0
DIN rail, 35 mm	
• Length 483 mm for 19" cabinets	6ES5710-8MA11
• Length 530 mm for 600 mm cabinets	6ES5710-8MA21
• Length 830 mm for 900 mm cabinets	6ES5710-8MA31
• Length 2 m	6ES5710-8MA41
PE connection element for 2 000 mm DIN rail	6ES7590-5AA00-0AA0
BusAdapter BA 2xRJ45	6ES7193-6AR00-0AA0
BusAdapter BA 2xFC for increased vibration and EMC loads	6ES7193-6AF00-0AA0
BusAdapter BA 2xSCRJ	6ES7193-6AP00-0AA0
BusAdapter BA SCRJ/RJ45	6ES7193-6AP20-0AA0
BusAdapter BA SCRJ/FC	6ES7193-6AP40-0AA0
BusAdapter BA 2xLC	6ES7193-6AG00-0AA0
BusAdapter BA LC/RJ45	6ES7193-6AG20-0AA0
BusAdapter BA LC/FC	6ES7193-6AG40-0AA0
Equipment labeling plate	6ES7193-6LF30-0AW0
10 sheets of 16 labels	
Labeling strips	
500 labeling strips on roll, light gray, for inscription with thermal transfer roll printer	6ES7193-6LR10-0AA0
500 labeling strips on roll, yellow, for inscription with thermal transfer roll printer	6ES7193-6LR10-0AG0
1 000 labeling strips DIN A4, light gray, card, for inscription with laser printer	6ES7193-6LA10-0AA0
1 000 labeling strips DIN A4, yellow, card, for inscription with laser printer	6ES7193-6LA10-0AG0

Ordering data	Article No.	Ordering data	Article No.
IE FC RJ45 plugs RJ45 plug connector for Industrial Ethernet with a rugged metal enclosure and integrated insulation displacement contacts for connecting Industrial Ethernet FC installation cables		SIMATIC Manual Collection Electronic manuals on DVD, multi-language: LOGO!, SIMADYN, SIMATIC bus components, SIMATIC C7, SIMATIC Distributed I/O, SIMATIC HMI, SIMATIC sensors, SIMATIC NET, SIMATIC PC-based Automation, SIMATIC PCS 7, SIMATIC PG/PC, SIMATIC S7, SIMATIC software, SIMATIC TDC	6ES7998-8XC01-8YE0
IE FC RJ45 plug 90 90° cable outlet 1 unit 10 units 50 units	6GK1901-1BB20-2AA0 6GK1901-1BB20-2AB0 6GK1901-1BB20-2AE0	SIMATIC Manual Collection update service for 1 year Current Manual Collection DVD and the three subsequent updates	6ES7998-8XC01-8YE2
IE FC RJ45 plug 180 180° cable outlet 1 unit 10 units 50 units	6GK1901-1BB10-2AA0 6GK1901-1BB10-2AB0 6GK1901-1BB10-2AE0	STEP 7 Professional V17 Target system: SIMATIC S7-1200, S7-1500, S7-300, S7-400, WinAC Requirement: Windows 10 (64-bit) • Windows 10 Professional Version 1909, 2004, 20H2 • Windows 10 Enterprise Version 1909, 2004, 20H2 • Windows 10 IoT Enterprise 2016 LTSC • Windows 10 IoT Enterprise 2019 LTSC Windows Server (64-bit) • Windows Server 2016 Standard (full installation) • Windows Server 2019 Standard (full installation) Type of delivery: 9 languages: de, en, zh included, fr, sp, it, ru, jp, kr as download	
IE FC TP standard cable GP 2x2 4-wire, shielded TP installation cable for connection to IE FC RJ45 outlet/IE FC RJ45 plug; PROFINET-compatible; with UL approval; sold by the meter; max. delivery unit 1 000 m, minimum order quantity 20 m	6XV1840-2AH10	STEP 7 Professional V17, floating license STEP 7 Professional V17, floating license, software download including license key ¹⁾ Email address required for delivery	6ES7822-1AA07-0YA5 6ES7822-1AE07-0YA5
IE FC TP trailing cable 2 x 2 (type C) 4-wire, shielded TP installation cable for connection to IE FC RJ45 outlet/IE FC RJ45 plug 180/90 for use as trailing cable; PROFINET-compatible; with UL approval; sold by the meter; max. delivery unit 1 000 m, minimum order quantity 20 m	6XV1840-3AH10	Spare parts Power supply connector Spare part; for connecting the 24 V DC supply voltage • With push-in terminals; 10 units	
IE FC TP marine cable 2 x 2 (type B) 4-wire, shielded TP installation cable for connection to IE FC RJ45 outlet/IE FC RJ45 plug 180/90 with marine approval; sold by the meter; max. delivery unit 1 000 m, minimum order quantity 20 m	6XV1840-4AH10	Cover for BusAdapter interface 5 units	
IE FC stripping tool Pre-adjusted stripping tool for fast stripping of Industrial Ethernet FC cables	6GK1901-1GA00	Server module	
Manuals for ET 200SP distributed I/O system ET 200SP library: ET 200SP Manual Collection, comprising system manual, product information, and device manuals Manuals can be downloaded from the Internet as PDF files: http://www.siemens.com/simatic-docu			

¹⁾ For up-to-date information and download availability, see:
<http://www.siemens.com/tia-online-software-delivery>

Distributed Controllers

based on ET 200SP
Standard CPUs

CPU 1512SP-1 PN

Technical specifications

Article number	6ES7512-1DK01-0AB0 CPU 1512SP-1 PN, 200KB Prog./1MB Data
General information	
Product type designation	CPU 1512SP-1 PN
Engineering with	
• STEP 7 TIA Portal configurable/ integrated from version	V17 (FW V2.9) / V13 SP1 Update 4 (FW V1.8) or higher
Supply voltage	
Rated value (DC)	24 V
Memory	
Work memory	
• integrated (for program)	200 kbyte
• integrated (for data)	1 Mbyte
Load memory	
• Plug-in (SIMATIC Memory Card), max.	32 Gbyte
CPU processing times	
for bit operations, typ.	48 ns
for word operations, typ.	58 ns
for fixed point arithmetic, typ.	77 ns
for floating point arithmetic, typ.	307 ns
Counters, timers and their retentivity	
S7 counter	
• Number	2 048
IEC counter	
• Number	Any (only limited by the main memory)
S7 times	
• Number	2 048
IEC timer	
• Number	Any (only limited by the main memory)
Data areas and their retentivity	
Flag	
• Size, max.	16 kbyte
Address area	
I/O address area	
• Inputs	32 kbyte; All inputs are in the process image
• Outputs	32 kbyte; All outputs are in the process image
Address space per module	
• Address space per module, max.	288 byte; For input and output data respectively
Address space per station	
• Address space per station, max.	2 560 byte; for central inputs and outputs; depending on configuration; 2 048 bytes for ET 200SP modules + 512 bytes for ET 200AL modules
Time of day	
Clock	
• Type	Hardware clock

Article number	6ES7512-1DK01-0AB0 CPU 1512SP-1 PN, 200KB Prog./1MB Data
1. Interface	
Interface types	
• RJ 45 (Ethernet)	Yes; X1 P3; opt. X1 P1 and X1 P2 via BusAdapter BA 2x RJ45
• Number of ports	3; 1. integr. + 2. via BusAdapter
• integrated switch	Yes
• BusAdapter (PROFINET)	Yes; compatible BusAdapters: BA 2x RJ45, BA 2x M12, BA 2x FC, BA 2x LC, BA LC/RJ45, BA LC/FC, BA 2x SCRJ, BA SCRJ/RJ45, BA SCRJ/FC,
Protocols	
• IP protocol	Yes; IPv4
• PROFINET IO Controller	Yes
• PROFINET IO Device	Yes
• SIMATIC communication	Yes
• Open IE communication	Yes; Optionally also encrypted
• Web server	Yes
• Media redundancy	Yes; MRP Automanager according to IEC 62439-2 Edition 2.0
PROFINET IO Controller	
Services	
- PG/OP communication	Yes
- Isochronous mode	Yes
- Direct data exchange	Yes; Requirement: IRT and isochronous mode (MRPD optional)
- IRT	Yes
- PROFIenergy	Yes; per user program
- Prioritized startup	Yes; Max. 32 PROFINET devices
- Number of connectable IO Devices, max.	128; In total, up to 512 distributed I/O devices can be connected via AS-i, PROFIBUS or PROFINET
- Of which IO devices with IRT, max.	64
- Number of connectable IO Devices for RT, max.	128
- of which in line, max.	128
- Number of IO Devices that can be simultaneously activated/ deactivated, max.	8; in total across all interfaces
- Number of IO Devices per tool, max.	8
- Updating times	The minimum value of the update time also depends on communication share set for PROFINET IO, on the number of IO devices, and on the quantity of configured user data
PROFINET IO Device	
Services	
- PG/OP communication	Yes
- Isochronous mode	No
- IRT	Yes
- PROFIenergy	Yes; per user program
- Shared device	Yes
- Number of IO Controllers with shared device, max.	4
- activation/deactivation of I-devices	Yes; per user program
- Asset management record	Yes; per user program

Technical specifications

Article number	6ES7512-1DK01-0AB0 CPU 1512SP-1 PN, 200KB Prog./1MB Data
2. Interface	
Interface types	
• RS 485	Yes; Via CM DP module
• Number of ports	1
Protocols	
• PROFIBUS DP master	Yes
• PROFIBUS DP slave	Yes
• SIMATIC communication	Yes
PROFIBUS DP master	
• Number of DP slaves, max.	125; In total, up to 512 distributed I/O devices can be connected via AS-i, PROFIBUS or PROFINET
Protocols	
Number of connections	
• Number of connections, max.	128; via integrated interfaces of the CPU and connected CPs / CMs
Redundancy mode	
Media redundancy	
- Media redundancy	Yes; only via BusAdapter
- MRP	Yes; MRP Automanager according to IEC 62439-2 Edition 2.0, MRP Manager; MRP Client
- MRP interconnection, supported	Yes; as MRP ring node according to IEC 62439-2 Edition 3.0
- MRPD	Yes; Requirement: IRT
- Switchover time on line break, typ.	200 ms; For MRP, bumpless for MRPD
- Number of stations in the ring, max.	50
SIMATIC communication	
• S7 routing	Yes
OPC UA	
• OPC UA Client	Yes
• OPC UA Server	Yes; Data access (read, write, subscribe), method call, custom address space
• Alarms and Conditions	Yes
Supported technology objects	
Motion Control	Yes; Note: The number of technology objects affects the cycle time of the PLC program; selection guide via the TIA Selection Tool
• Number of available Motion Control resources for technology objects	800
• Required Motion Control resources	
- per speed-controlled axis	40
- per positioning axis	80
- per synchronous axis	160
- per external encoder	80
- per output cam	20
- per cam track	160
- per probe	40
Controller	
• PID_Compact	Yes; Universal PID controller with integrated optimization
• PID_3Step	Yes; PID controller with integrated optimization for valves
• PID-Temp	Yes; PID controller with integrated optimization for temperature
Counting and measuring	
• High-speed counter	Yes

Article number	6ES7512-1DK01-0AB0 CPU 1512SP-1 PN, 200KB Prog./1MB Data
Ambient conditions	
Ambient temperature during operation	
• horizontal installation, min.	-25 °C; No condensation
• horizontal installation, max.	60 °C
• vertical installation, min.	-25 °C; No condensation
• vertical installation, max.	50 °C
Altitude during operation relating to sea level	
• Installation altitude above sea level, max.	5 000 m; Restrictions for installation altitudes > 2 000 m, see manual
Configuration	
Programming	
Programming language	
- LAD	Yes
- FBD	Yes
- STL	Yes
- SCL	Yes
- GRAPH	Yes
Know-how protection	
• User program protection/password protection	Yes
• Copy protection	Yes
• Block protection	Yes
Access protection	
• protection of confidential configuration data	Yes
• Protection level: Write protection	Yes
• Protection level: Read/write protection	Yes
• Protection level: Complete protection	Yes
Dimensions	
Width	100 mm
Height	117 mm
Depth	75 mm
Weights	
Weight, approx.	310 g

Distributed Controllers

based on ET 200SP
SIPLUS standard CPUs

SIPLUS CPU 1510SP-1 PN

Overview



- SIPLUS CPU 1510SP-1 PN for SIPLUS ET 200SP based on SIPLUS-S7-1500 CPU 1511-1 PN
- For high-performance control solutions using ET 200SP
- Increase in availability of systems and machines
- PROFINET IO controller for up to 64 IO devices
- PROFINET I-Device for connecting the CPU as an intelligent PROFINET device with a SIMATIC or non-Siemens PROFINET I/O controller
- PROFINET shared I-Device for 4 controllers
- PROFINET IO IRT interface with integrated 3-port switch
- Isochronous mode on PROFINET
- With multiple communication options: PG/OP communication, PROFINET IO, open IE communication (TCP, ISO-on-TCP and UDP), web server and S7 communication (with loadable FBs)
- Optional PROFIBUS DP master for 125 PROFIBUS DP slaves (with CM DP module 6ES7545-5DA00-0AB0)
- Optional PROFIBUS DP slave (with CM DP module 6ES7545-5DA00-0AB0)
- Configuration control (option handling)
- Integrated motion control functionalities for controlling speed-controlled and positioning axes, support for external encoders

Note

SIMATIC Memory Card required for operation of the CPU.
The BusAdapter is not included in the scope of supply and is to be ordered separately.
No BusAdapter can be inserted with the variant for the temperature range -40...+70 °C.

SIPLUS extreme products are based on SIMATIC standard products. The contents listed here were taken from the respective standard products. SIPLUS extreme-specific information was added.

Ordering data

Article No.

SIPLUS CPU 1510SP-1 PN

(Extended temperature range and exposure to environmental substances)

Work memory 100 KB for program, 750 KB for data, PROFINET IO IRT interface; SIMATIC Memory Card required

Temperature range -40 ... +60 °C

6AG1510-1DJ01-2AB0

Temperature range -40 ... +70 °C; No BusAdapter can be inserted

6AG1510-1DJ01-7AB0

Accessories

BusAdapter BA 2xRJ45

(Extended temperature range and exposure to environmental substances)

6AG1193-6AR00-7AA0

BusAdapter BA 2xFC for increased vibration and EMC loads

(Extended temperature range and exposure to environmental substances)

6AG1193-6AF00-7AA0

IE FC RJ45 plugs

RJ45 plug connector for Industrial Ethernet with a rugged metal enclosure and integrated insulation displacement contacts for connecting Industrial Ethernet FC installation cables

IE FC RJ45 plug 180

(Extended temperature range and exposure to environmental substances)

180° cable outlet

1 unit

6AG1901-1BB10-7AA0

SIPLUS Mounting Kit ET 200SP

Mounting accessories for use with increased mechanical vibration and shock loads.
Not approved for SIPLUS CPU 6AG1510-1DJ01-7AB0 and BusAdapter BA 2xRJ45

6AG1193-6AA00-0AA0

Other accessories

See SIMATIC ET 200SP CPU 1510SP-1 PN, page 7/2

Technical specifications

Article number	6AG1510-1DJ01-2AB0	6AG1510-1DJ01-7AB0
Based on	6ES7510-1DJ01-0AB0 SIPLUS ET 200SP CPU 1510SP-1 PN	6ES7510-1DJ01-0AB0 SIPLUS ET 200SP CPU 1510SP-1 PN
Ambient conditions		
Ambient temperature during operation		
<ul style="list-style-type: none"> horizontal installation, min. horizontal installation, max. vertical installation, min. vertical installation, max. 	-40 °C; = Tmin (incl. condensation/frost) 60 °C; = Tmax -25 °C; = Tmin 50 °C; = Tmax	-40 °C; = Tmin (incl. condensation/frost) 70 °C; = Tmax -40 °C; = Tmin 50 °C; = Tmax
Altitude during operation relating to sea level		
<ul style="list-style-type: none"> Installation altitude above sea level, max. 	5 000 m; Restrictions for installation altitudes > 2 000 m, see manual	5 000 m; Restrictions for installation altitudes > 2 000 m, see manual
Relative humidity		
<ul style="list-style-type: none"> With condensation, tested in accordance with IEC 60068-2-38, max. 	100 %; RH incl. condensation / frost (no commissioning in bedewed state), horizontal installation	100 %; RH incl. condensation / frost (no commissioning in bedewed state), horizontal installation
Resistance		
Coolants and lubricants		
<ul style="list-style-type: none"> Resistant to commercially available coolants and lubricants 	Yes; Incl. diesel and oil droplets in the air	No
Use in stationary industrial systems		
<ul style="list-style-type: none"> to biologically active substances according to EN 60721-3-3 to chemically active substances according to EN 60721-3-3 to mechanically active substances according to EN 60721-3-3 Against mechanical environmental conditions acc. to EN 60721-3-3 	Yes; Class 3B2 mold, fungus and dry rot spores (with the exception of fauna); Class 3B3 on request Yes; Class 3C4 (RH < 75 %) incl. salt spray acc. to EN 60068-2-52 (severity degree 3); * Yes; Class 3S4 incl. sand, dust, * Yes; Class 3M8 using the SIPLUS Mounting Kit ET 200SP (6AG1193-6AA00-0AA0)	Yes; Class 3B2 mold, fungus and dry rot spores (with the exception of fauna); Class 3B3 on request Yes; Class 3C4 (RH < 75 %) incl. salt spray acc. to EN 60068-2-52 (severity degree 3); * Yes; Class 3S4 incl. sand, dust, *
Use on land craft, rail vehicles and special-purpose vehicles		
<ul style="list-style-type: none"> Against mechanical environmental conditions acc. to EN 60721-3-5 against mechanical environmental conditions in agriculture acc. to ISO 15003 	Yes; Class 5M2 using the SIPLUS Mounting Kit ET 200SP (6AG1193-6AA00-0AA0) Yes; level 1 (Location LE) using the SIPLUS Mounting Kit ET 200SP (6AG1193-6AA00-0AA0)	
Use on ships/at sea		
<ul style="list-style-type: none"> to biologically active substances according to EN 60721-3-6 to chemically active substances according to EN 60721-3-6 to mechanically active substances according to EN 60721-3-6 Against mechanical environmental conditions acc. to EN 60721-3-6 	Yes; Class 6B2 mold, fungal and dry rot spores (excluding fauna) Yes; Class 6C3 (RH < 75 %) incl. salt spray acc. to EN 60068-2-52 (severity degree 3); * Yes; Class 6S3 incl. sand, dust; * Yes; Class 6M4 using the SIPLUS Mounting Kit ET 200SP (6AG1193-6AA00-0AA0)	Yes; Class 6B2 mold, fungal and dry rot spores (excluding fauna) Yes; Class 6C3 (RH < 75 %) incl. salt spray acc. to EN 60068-2-52 (severity degree 3); * Yes; Class 6S3 incl. sand, dust (with the exception of oil droplets in the air); *
Usage in industrial process technology		
<ul style="list-style-type: none"> Against chemically active substances acc. to EN 60654-4 Environmental conditions for process, measuring and control systems acc. to ANSI/ISA-71.04 	Yes; Class 3 (excluding trichlorethylene) Yes; Level GX group A/B (excluding trichlorethylene; harmful gas concentrations up to the limits of EN 60721-3-3 class 3C4 permissible); level LC3 (salt spray) and level LB3 (oil)	Yes; Class 3 (excluding trichlorethylene) Yes; Level GX group A/B (excluding trichlorethylene; harmful gas concentrations up to the limits of EN 60721-3-3 class 3C4 permissible); level LC3 (salt spray) and level LB3 (oil)
Remark		
<ul style="list-style-type: none"> Note regarding classification of environmental conditions acc. to EN 60721, EN 60654-4 and ANSI/ISA-71.04 	* The supplied plug covers must remain in place over the unused interfaces during operation!	* The supplied plug covers must remain in place over the unused interfaces during operation!
Conformal coating		
<ul style="list-style-type: none"> Coatings for printed circuit board assemblies acc. to EN 61086 Protection against fouling acc. to EN 60664-3 Military testing according to MIL-I-46058C, Amendment 7 Qualification and Performance of Electrical Insulating Compound for Printed Board Assemblies according to IPC-CC-830A 	Yes; Class 2 for high reliability Yes; Type 1 protection Yes; Discoloration of coating possible during service life Yes; Conformal coating, Class A	Yes; Class 2 for high reliability Yes; Type 1 protection Yes; Discoloration of coating possible during service life Yes; Conformal coating, Class A

Distributed Controllers

based on ET 200SP
SIPLUS standard CPUs

SIPLUS CPU 1512SP-1 PN

Overview



- SIPLUS CPU 1512SP-1 PN for SIPLUS ET 200SP based on SIPLUS S7-1500 CPU 1513-1 PN
- For applications with medium requirements regarding the program scope and processing speed, for distributed setup via PROFINET IO or PROFIBUS DP.
- Increase in availability of systems and machines
- PROFINET IO controller for up to 128 IO devices
- PROFINET I-Device for connecting the CPU as an intelligent PROFINET device with a SIMATIC or non-Siemens PROFINET I/O controller
- PROFINET shared I-Device for 4 controllers
- PROFINET IO IRT interface with integrated 3-port switch
- Isochronous mode on PROFINET
- With multiple communication options: PG/OP communication, PROFINET IO, open IE communication (TCP, ISO-on-TCP and UDP), web server and S7 communication (with loadable FBs)
- Optional PROFIBUS DP master for 125 PROFIBUS DP slaves (with CM DP module 6ES7545-5DA00-0AB0)
- Optional PROFIBUS DP slave (with CM DP module 6ES7545-5DA00-0AB0)
- Configuration control (option handling)
- Integrated motion control functionalities for controlling speed-controlled and positioning axes, support for external encoders

Note

SIMATIC Memory Card required for operation of the CPU. BusAdapter is not included in scope of supply and is to be ordered separately.

No BusAdapter can be inserted with the variant for the temperature range -40...+70 °C.

SIPLUS extreme products are based on SIMATIC standard products. The contents listed here were taken from the respective standard products. SIPLUS extreme-specific information was added.

Ordering data

Article No.

SIPLUS CPU 1512SP-1 PN

(Extended temperature range and exposure to environmental substances)

Work memory 200 KB for program, 1 MB for data, PROFINET IO IRT interface; SIMATIC Memory Card required

Temperature range -40 ... +60 °C

6AG1512-1DK01-2AB0

Temperature range -40 ... +70 °C; No BusAdapter can be inserted

6AG1512-1DK01-7AB0

Accessories

BusAdapter BA 2xRJ45

6AG1193-6AR00-7AA0

(Extended temperature range and exposure to environmental substances)

BusAdapter BA 2xFC for increased vibration and EMC loads

6AG1193-6AF00-7AA0

(Extended temperature range and exposure to environmental substances)

IE FC RJ45 plugs

RJ45 plug connector for Industrial Ethernet with a rugged metal enclosure and integrated insulation displacement contacts for connecting Industrial Ethernet FC installation cables

IE FC RJ45 plug 180

180° cable outlet

1 unit

6AG1901-1BB10-7AA0

SIPLUS Mounting Kit ET 200SP

6AG1193-6AA00-0AA0

Mounting accessories for use with increased mechanical vibration and shock loads.

Not approved for SIPLUS CPU 6AG1512-1DK01-7AB0 and BusAdapter BA 2xRJ45

Other accessories

See SIMATIC ET 200SP, CPU 1512SP-1 PN, page 7/6

Technical specifications

Article number	6AG1512-1DK01-2AB0	6AG1512-1DK01-7AB0
Based on	6ES7512-1DK01-0AB0 SIPLUS ET 200SP CPU 1512SP-1 PN	6ES7512-1DK01-0AB0 SIPLUS ET 200SP CPU 1512SP-1 PN
Ambient conditions		
Ambient temperature during operation		
• horizontal installation, min.	-40 °C; = Tmin (incl. condensation/frost)	-40 °C; = Tmin (incl. condensation/frost)
• horizontal installation, max.	60 °C; = Tmax	70 °C; = Tmax
• vertical installation, min.	-40 °C; = Tmin	-40 °C; = Tmin
• vertical installation, max.	50 °C; = Tmax	50 °C; = Tmax
Altitude during operation relating to sea level		
• Installation altitude above sea level, max.	5 000 m; Restrictions for installation altitudes > 2 000 m, see manual	5 000 m; Restrictions for installation altitudes > 2 000 m, see manual
Relative humidity		
• With condensation, tested in accordance with IEC 60068-2-38, max.	100 %; RH incl. condensation / frost (no commissioning in bedewed state), horizontal installation	100 %; RH incl. condensation / frost (no commissioning in bedewed state), horizontal installation
Resistance		
Coolants and lubricants		
- Resistant to commercially available coolants and lubricants	Yes; Incl. diesel and oil droplets in the air	No
Use in stationary industrial systems		
- to biologically active substances according to EN 60721-3-3	Yes; Class 3B2 mold, fungus and dry rot spores (with the exception of fauna); Class 3B3 on request	Yes; Class 3B2 mold, fungus and dry rot spores (with the exception of fauna); Class 3B3 on request
- to chemically active substances according to EN 60721-3-3	Yes; Class 3C4 (RH < 75 %) incl. salt spray acc. to EN 60068-2-52 (severity degree 3); *	Yes; Class 3C4 (RH < 75 %) incl. salt spray acc. to EN 60068-2-52 (severity degree 3); *
- to mechanically active substances according to EN 60721-3-3	Yes; Class 3S4 incl. sand, dust, *	Yes; Class 3S4 incl. sand, dust, *
- Against mechanical environmental conditions acc. to EN 60721-3-3	Yes; Class 3M8 using the SIPLUS Mounting Kit ET 200SP (6AG1193-6AA00-0AA0)	
Use on land craft, rail vehicles and special-purpose vehicles		
- Against mechanical environmental conditions acc. to EN 60721-3-5	Yes; Class 5M2 using the SIPLUS Mounting Kit ET 200SP (6AG1193-6AA00-0AA0)	
- against mechanical environmental conditions in agriculture acc. to ISO 15003	Yes; level 1 (Location LE) using the SIPLUS Mounting Kit ET 200SP (6AG1193-6AA00-0AA0)	
Use on ships/at sea		
- to biologically active substances according to EN 60721-3-6	Yes; Class 6B2 mold, fungal and dry rot spores (excluding fauna)	Yes; Class 6B2 mold, fungal and dry rot spores (excluding fauna)
- to chemically active substances according to EN 60721-3-6	Yes; Class 6C3 (RH < 75 %) incl. salt spray acc. to EN 60068-2-52 (severity degree 3); *	Yes; Class 6C3 (RH < 75 %) incl. salt spray acc. to EN 60068-2-52 (severity degree 3); *
- to mechanically active substances according to EN 60721-3-6	Yes; Class 6S3 incl. sand, dust; *	Yes; Class 6S3 incl. sand, dust (with the exception of oil droplets in the air); *
- Against mechanical environmental conditions acc. to EN 60721-3-6	Yes; Class 6M4 using the SIPLUS Mounting Kit ET 200SP (6AG1193-6AA00-0AA0)	
Usage in industrial process technology		
- Against chemically active substances acc. to EN 60654-4	Yes; Class 3 (excluding trichlorethylene)	Yes; Class 3 (excluding trichlorethylene)
- Environmental conditions for process, measuring and control systems acc. to ANSI/ISA-71.04	Yes; Level GX group A/B (excluding trichlorethylene; harmful gas concentrations up to the limits of EN 60721-3-3 class 3C4 permissible); level LC3 (salt spray) and level LB3 (oil)	Yes; Level GX group A/B (excluding trichlorethylene; harmful gas concentrations up to the limits of EN 60721-3-3 class 3C4 permissible); level LC3 (salt spray) and level LB3 (oil)
Remark		
- Note regarding classification of environmental conditions acc. to EN 60721, EN 60654-4 and ANSI/ISA-71.04	* The supplied plug covers must remain in place over the unused interfaces during operation!	* The supplied plug covers must remain in place over the unused interfaces during operation!
Conformal coating		
• Coatings for printed circuit board assemblies acc. to EN 61086	Yes; Class 2 for high reliability	Yes; Class 2 for high reliability
• Protection against fouling acc. to EN 60664-3	Yes; Type 1 protection	Yes; Type 1 protection
• Military testing according to MIL-I-46058C, Amendment 7	Yes; Discoloration of coating possible during service life	Yes; Discoloration of coating possible during service life
• Qualification and Performance of Electrical Insulating Compound for Printed Board Assemblies according to IPC-CC-830A	Yes; Conformal coating, Class A	Yes; Conformal coating, Class A

Distributed Controllers

based on ET 200SP

Fail-safe CPUs

CPU 1510SP F-1 PN

Overview



- CPU 1510SP F-1 PN for SIMATIC ET 200SP based on S7-1500 CPU 1511F-1 PN
- For high-performance control solutions using ET 200SP
- Increase in availability of systems and machines
- Supports PROFIsafe in centralized and distributed configuration
- PROFINET IO controller for up to 64 IO devices
- PROFINET I-Device for connecting the CPU as an intelligent PROFINET device with a SIMATIC or non-Siemens PROFINET IO controller
- PROFINET shared I-Device for 4 controllers
- PROFINET IO IRT interface with integrated 3-port switch
- Isochronous mode on PROFINET
- With multiple communication options: Programming device/OP communication, PROFINET IO, open IE communication (TCP, ISO-on-TCP and UDP), web server and S7 communication (with loadable FBs)
- OPC UA Server and Client (Data Access) as runtime option for easy connection of the SIMATIC ET 200SP to non-Siemens devices/systems
- Optional PROFIBUS master for 125 PROFIBUS DP slaves (with CM DP module 6ES7545-5DA00-0AB0)
- Configuration control (option handling)
- Integrated Motion Control functionalities for controlling speed-controlled and positioning axes, support for external encoders

Note

SIMATIC Memory Card required for operation of the CPU.

The BusAdapter is not included in the scope of supply and must be ordered separately.

Ordering data

Article No.

CPU 1510SP F-1 PN **6ES7510-1SJ01-0AB0**

150 KB work memory for program,
750 KB for data,
PROFINET IO IRT interface;
SIMATIC Memory Card required

Accessories

CM DP for ET 200SP CPU **6ES7545-5DA00-0AB0**

PROFIBUS DP master/slave with electrical interface for connecting the ET 200SP CPUs to PROFIBUS at up to 12 Mbps

SIMATIC Memory Card

4 MB	6ES7954-8LC03-0AA0
12 MB	6ES7954-8LE03-0AA0
24 MB	6ES7954-8LF03-0AA0
256 MB	6ES7954-8LL03-0AA0
2 GB	6ES7954-8LP03-0AA0
32 GB	6ES7954-8LT03-0AA0

DIN rail, 35 mm

• Length 483 mm for 19" cabinets	6ES710-8MA11
• Length 530 mm for 600 mm cabinets	6ES710-8MA21
• Length 830 mm for 900 mm cabinets	6ES710-8MA31
• Length 2 m	6ES710-8MA41

PE connection element for 2 000 mm DIN rail **6ES7590-5AA00-0AA0**

BusAdapter BA 2xRJ45 **6ES7193-6AR00-0AA0**

BusAdapter BA 2xFC for increased vibration and EMC loads **6ES7193-6AF00-0AA0**

BusAdapter BA 2xSCRJ **6ES7193-6AP00-0AA0**

BusAdapter BA SCRJ/RJ45 **6ES7193-6AP20-0AA0**

BusAdapter BA SCRJ/FC **6ES7193-6AP40-0AA0**

Equipment labeling plate **6ES7193-6LF30-0AW0**

10 sheets of 16 labels

Labeling strips

500 labeling strips on roll, light gray, for inscription with thermal transfer roll printer **6ES7193-6LR10-0AA0**

500 labeling strips on roll, yellow, for inscription with thermal transfer roll printer **6ES7193-6LR10-0AG0**

1 000 labeling strips DIN A4, light gray, card, for inscription with laser printer **6ES7193-6LA10-0AA0**

1 000 labeling strips DIN A4, yellow, card, for inscription with laser printer **6ES7193-6LA10-0AG0**

IE FC RJ45 plugs

RJ45 plug connector for Industrial Ethernet with a rugged metal enclosure and integrated insulation displacement contacts for connecting Industrial Ethernet FC installation cables

IE FC RJ45 plug 90

90° cable outlet	
1 unit	6GK1901-1BB20-2AA0
10 units	6GK1901-1BB20-2AB0
50 units	6GK1901-1BB20-2AE0

Ordering data	Article No.	Article No.
IE FC RJ45 plug 180 180° cable outlet 1 unit 10 units 50 units	6GK1901-1BB10-2AA0 6GK1901-1BB10-2AB0 6GK1901-1BB10-2AE0	
IE FC TP standard cable GP 2x2 4-wire, shielded TP installation cable for connection to IE FC RJ45 outlet/IE FC RJ45 plug; PROFINET-compatible; with UL approval; sold by the meter; max. delivery unit 1 000 m, minimum order quantity 20 m	6XV1840-2AH10	
IE FC TP trailing cable 2 x 2 (type C) 4-wire, shielded TP installation cable for connection to IE FC RJ45 outlet/IE FC RJ45 plug 180/90 for use as trailing cable; PROFINET-compatible; with UL approval; sold by the meter; max. delivery unit 1 000 m, minimum order quantity 20 m	6XV1840-3AH10	
IE FC TP marine cable 2 x 2 (type B) 4-wire, shielded TP installation cable for connection to IE FC RJ45 outlet/IE FC RJ45 plug 180/90 with marine approval; sold by the meter; max. delivery unit 1 000 m, minimum order quantity 20 m	6XV1840-4AH10	
IE FC stripping tool Pre-adjusted stripping tool for fast stripping of Industrial Ethernet FC cables	6GK1901-1GA00	
Manuals for ET 200SP distributed I/O system ET 200SP library: ET 200SP Manual Collection, comprising system manual, product information, and device manuals Manuals can be downloaded from the Internet as PDF files: http://www.siemens.com/simatic-docu		
SIMATIC Manual Collection Electronic manuals on DVD, multi-language: LOGO!, SIMADYN, SIMATIC bus components, SIMATIC C7, SIMATIC Distributed I/O, SIMATIC HMI, SIMATIC sensors, SIMATIC NET, SIMATIC PC-based Automation, SIMATIC PCS 7, SIMATIC PG/PC, SIMATIC S7, SIMATIC software, SIMATIC TDC	6ES7998-8XC01-8YE0	
SIMATIC Manual Collection update service for 1 year Current Manual Collection DVD and the three subsequent updates	6ES7998-8XC01-8YE2	
		STEP 7 Professional V17 Target system: SIMATIC S7-1200, S7-1500, S7-300, S7-400, WinAC Requirement: Windows 10 (64-bit) <ul style="list-style-type: none"> Windows 10 Professional Version 1909, 2004, 20H2 Windows 10 Enterprise Version 1909, 2004, 20H2 Windows 10 IoT Enterprise 2016 LTSB Windows 10 IoT Enterprise 2019 LTSC Windows Server (64-bit) <ul style="list-style-type: none"> Windows Server 2016 Standard (full installation) Windows Server 2019 Standard (full installation) Type of delivery: 9 languages: de, en, zh included, fr, sp, it, ru, jp, kr as download STEP 7 Professional V17, floating license STEP 7 Professional V17, floating license, software download including license key ¹⁾ Email address required for delivery
		6ES7822-1AA07-0YA5 6ES7822-1AE07-0YA5
		STEP 7 Safety Advanced V17 Task: Engineering tool for configuring and programming fail-safe user programs for SIMATIC S7-1200 FC, S7-1500F, S7-1500F Software Controller, S7-300F, S7-400F, WinAC RTX F, ET 200SP F Controller and the fail-safe ET 200SP, ET 200MP, ET 200S, ET 200M, ET 200iSP, ET 200pro and ET 200eco I/O Requirement: STEP 7 Professional V17 Note: As of TIA Portal V16, the SIMATIC STEP 7 Safety software is an integral component of the SIMATIC STEP 7 product setup. The functionality of SIMATIC STEP 7 Safety is activated by means of the license key supplied in each case. Floating license for 1 user; license key on USB flash drive Floating license for 1 user; license key for download ¹⁾ ; Email address required for delivery
		6ES7833-1FA17-0YA5 6ES7833-1FA17-0YH5
		Spare parts
		Power supply connector Spare part; for connecting the 24 V DC supply voltage <ul style="list-style-type: none"> With push-in terminals; 10 units
		6ES7193-4JB00-0AA0
		Cover for BusAdapter interface 5 units
		6ES7591-3AA00-0AA0
		Server module
		6ES7193-6PA00-0AA0

¹⁾ For up-to-date information and download availability, see:
<http://www.siemens.com/tia-online-software-delivery>

Distributed Controllers

based on ET 200SP

Fail-safe CPUs

CPU 1510SP F-1 PN

Technical specifications

Article number	6ES7510-1SJ01-0AB0 CPU1510SP F-1 PN, 150KB Prog./750KB Data
General information	
Product type designation	CPU 1510SP F-1 PN
Engineering with	
• STEP 7 TIA Portal configurable/ integrated from version	V17 (FW V2.9) / V13 SP1 Update 4 (FW V1.8) or higher
Supply voltage	
Rated value (DC)	24 V
Memory	
Work memory	
• integrated (for program)	150 kbyte
• integrated (for data)	750 kbyte
Load memory	
• Plug-in (SIMATIC Memory Card), max.	32 Gbyte
CPU processing times	
for bit operations, typ.	72 ns
for word operations, typ.	86 ns
for fixed point arithmetic, typ.	115 ns
for floating point arithmetic, typ.	461 ns
Counters, timers and their retentivity	
S7 counter	
• Number	2 048
IEC counter	
• Number	Any (only limited by the main memory)
S7 times	
• Number	2 048
IEC timer	
• Number	Any (only limited by the main memory)
Data areas and their retentivity	
Flag	
• Size, max.	16 kbyte
Address area	
I/O address area	
• Inputs	32 kbyte; All inputs are in the process image
• Outputs	32 kbyte; All outputs are in the process image
Address space per module	
• Address space per module, max.	288 byte; For input and output data respectively
Address space per station	
• Address space per station, max.	2 560 byte; for central inputs and outputs; depending on configuration; 2 048 bytes for ET 200SP modules + 512 bytes for ET 200AL modules
Time of day	
Clock	
• Type	Hardware clock

Article number	6ES7510-1SJ01-0AB0 CPU1510SP F-1 PN, 150KB Prog./750KB Data
1. Interface	
Interface types	
• RJ 45 (Ethernet)	Yes; X1 P3; opt. X1 P1 and X1 P2 via BusAdapter BA 2x RJ45
• Number of ports	3; 1. integr. + 2. via BusAdapter
• integrated switch	Yes
• BusAdapter (PROFINET)	Yes; compatible BusAdapters: BA 2x RJ45, BA 2x FC, BA 2x M12
Protocols	
• IP protocol	Yes; IPv4
• PROFINET IO Controller	Yes
• PROFINET IO Device	Yes
• SIMATIC communication	Yes
• Open IE communication	Yes; Optionally also encrypted
• Web server	Yes
• Media redundancy	Yes; MRP Automanager according to IEC 62439-2 Edition 2.0
PROFINET IO Controller Services	
- PG/OP communication	Yes
- Isochronous mode	Yes
- Direct data exchange	Yes; Requirement: IRT and isochronous mode (MRPD optional)
- IRT	Yes
- PROFIenergy	Yes; per user program
- Prioritized startup	Yes; Max. 32 PROFINET devices
- Number of connectable IO Devices, max.	64; In total, up to 256 distributed I/O devices can be connected via AS-i, PROFIBUS or PROFINET
- Of which IO devices with IRT, max.	64
- Number of connectable IO Devices for RT, max.	64
- of which in line, max.	64
- Number of IO Devices that can be simultaneously activated/ deactivated, max.	8; in total across all interfaces
- Number of IO Devices per tool, max.	8
- Updating times	The minimum value of the update time also depends on communication share set for PROFINET IO, on the number of IO devices, and on the quantity of configured user data
PROFINET IO Device Services	
- PG/OP communication	Yes
- Isochronous mode	No
- IRT	Yes
- PROFIenergy	Yes; per user program
- Shared device	Yes
- Number of IO Controllers with shared device, max.	4
- activation/deactivation of I-devices	Yes; per user program
- Asset management record	Yes; per user program

Technical specifications

Article number	6ES7510-1SJ01-0AB0 CPU 1510SP F-1 PN, 150KB Prog./750KB Data
2. Interface	
Interface types	
• RS 485	Yes; Via CM DP module
• Number of ports	1
Protocols	
• PROFIBUS DP master	Yes
• PROFIBUS DP slave	Yes
• SIMATIC communication	Yes
PROFIBUS DP master	
• Number of DP slaves, max.	125; In total, up to 256 distributed I/O devices can be connected via AS-i, PROFIBUS or PROFINET
Protocols	
Number of connections	
• Number of connections, max.	96; via integrated interfaces of the CPU and connected CPs / CMs
Redundancy mode	
Media redundancy	
- Media redundancy	Yes; only via BusAdapter
- MRP	Yes; MRP Automanager according to IEC 62439-2 Edition 2.0, MRP Manager; MRP Client
- MRP interconnection, supported	Yes; as MRP ring node according to IEC 62439-2 Edition 3.0
- MRPD	Yes; Requirement: IRT
- Switchover time on line break, typ.	200 ms; For MRP, bumpless for MRPD
- Number of stations in the ring, max.	50
SIMATIC communication	
• S7 routing	Yes
OPC UA	
• OPC UA Client	Yes
• OPC UA Server	Yes; Data access (read, write, subscribe), method call, custom address space
• Alarms and Conditions	Yes
Supported technology objects	
Motion Control	Yes; Note: The number of technology objects affects the cycle time of the PLC program; selection guide via the TIA Selection Tool
• Number of available Motion Control resources for technology objects	800
• Required Motion Control resources	
- per speed-controlled axis	40
- per positioning axis	80
- per synchronous axis	160
- per external encoder	80
- per output cam	20
- per cam track	160
- per probe	40
Controller	
• PID_Compact	Yes; Universal PID controller with integrated optimization
• PID_3Step	Yes; PID controller with integrated optimization for valves
• PID-Temp	Yes; PID controller with integrated optimization for temperature
Counting and measuring	
• High-speed counter	Yes

Article number	6ES7510-1SJ01-0AB0 CPU 1510SP F-1 PN, 150KB Prog./750KB Data
Standards, approvals, certificates	
Highest safety class achievable in safety mode	
Probability of failure (for service life of 20 years and repair time of 100 hours)	
- Low demand mode: PFDavg in accordance with SIL3	< 2.00E-05
- High demand/continuous mode: PFH in accordance with SIL3	< 1.00E-09
Ambient conditions	
Ambient temperature during operation	
• horizontal installation, min.	-25 °C; No condensation
• horizontal installation, max.	60 °C
• vertical installation, min.	-25 °C; No condensation
• vertical installation, max.	50 °C
Altitude during operation relating to sea level	
• Installation altitude above sea level, max.	5 000 m; Restrictions for installation altitudes > 2 000 m, see manual
Configuration	
Programming	
Programming language	
- LAD	Yes; incl. failsafe
- FBD	Yes; incl. failsafe
- STL	Yes
- SCL	Yes
- GRAPH	Yes
Know-how protection	
• User program protection/ password protection	Yes
• Copy protection	Yes
• Block protection	Yes
Access protection	
• protection of confidential configuration data	Yes
• Protection level: Write protection	Yes
• Protection level: Read/write protection	Yes
• Protection level: Write protection for Failsafe	Yes
• Protection level: Complete protection	Yes
Dimensions	
Width	100 mm
Height	117 mm
Depth	75 mm
Weights	
Weight, approx.	310 g

Distributed Controllers

based on ET 200SP

Fail-safe CPUs

CPU 1512SP F-1 PN

Overview



- CPU 1512SP F-1 PN for SIMATIC ET 200SP based on S7-1500 CPU 1513F-1 PN
- For applications with medium requirements in terms of program scope and processing speed, for distributed configurations via PROFINET IO or PROFIBUS DP.
- Increase in availability of systems and machines
- Supports PROFI-safe in centralized and distributed configuration
- PROFINET IO controller for up to 128 IO devices
- PROFINET I-Device for connecting the CPU as an intelligent PROFINET device with a SIMATIC or non-Siemens PROFINET IO controller
- PROFINET shared I-Device for 4 controllers
- PROFINET IO IRT interface with integrated 3-port switch
- Isochronous mode on PROFINET
- With multiple communication options: Programming device/OP communication, PROFINET IO, open IE communication (TCP, ISO-on-TCP and UDP), web server and S7 communication (with loadable FBs)
- OPC UA Server and Client (Data Access) as runtime option for easy connection of the SIMATIC ET 200SP to non-Siemens devices/systems
- Optional PROFIBUS master for 125 PROFIBUS DP slaves (with CM DP module 6ES7545-5DA00-0AB0)
- Configuration control (option handling)
- Integrated Motion Control functionalities for controlling speed-controlled and positioning axes, support for external encoders

Note

SIMATIC Memory Card required for operation of the CPU.

The BusAdapter is not included in the scope of supply and must be ordered separately.

Ordering data

Article No.

CPU 1512SP F-1 PN **6ES7512-1SK01-0AB0**

300 KB work memory for program, 1 MB for data, PROFINET IO IRT interface, SIMATIC Memory Card required

Accessories

CM DP for ET 200SP CPU **6ES7545-5DA00-0AB0**

PROFIBUS DP master/slave with electrical interface for connecting the ET 200SP CPUs to PROFIBUS at up to 12 Mbps

SIMATIC Memory Card

4 MB	6ES7954-8LC03-0AA0
12 MB	6ES7954-8LE03-0AA0
24 MB	6ES7954-8LF03-0AA0
256 MB	6ES7954-8LL03-0AA0
2 GB	6ES7954-8LP03-0AA0
32 GB	6ES7954-8LT03-0AA0

DIN rail, 35 mm

- Length 483 mm for 19" cabinets **6ES710-8MA11**
- Length 530 mm for 600 mm cabinets **6ES710-8MA21**
- Length 830 mm for 900 mm cabinets **6ES710-8MA31**
- Length 2 m **6ES710-8MA41**

PE connection element for 2 000 mm DIN rail **6ES7590-5AA00-0AA0**

BusAdapter BA 2xRJ45 **6ES7193-6AR00-0AA0**

BusAdapter BA 2xFC for increased vibration and EMC loads **6ES7193-6AF00-0AA0**

BusAdapter BA 2xSCRJ **6ES7193-6AP00-0AA0**

BusAdapter BA SCRJ/RJ45 **6ES7193-6AP20-0AA0**

BusAdapter BA SCRJ/FC **6ES7193-6AP40-0AA0**

Equipment labeling plate **6ES7193-6LF30-0AW0**

10 sheets of 16 labels

Labeling strips

500 labeling strips on roll, light gray, for inscription with thermal transfer roll printer **6ES7193-6LR10-0AA0**

500 labeling strips on roll, yellow, for inscription with thermal transfer roll printer **6ES7193-6LR10-0AG0**

1 000 labeling strips DIN A4, light gray, card, for inscription with laser printer **6ES7193-6LA10-0AA0**

1 000 labeling strips DIN A4, yellow, card, for inscription with laser printer **6ES7193-6LA10-0AG0**

IE FC RJ45 plugs

RJ45 plug connector for Industrial Ethernet with a rugged metal enclosure and integrated insulation displacement contacts for connecting Industrial Ethernet FC installation cables

IE FC RJ45 plug 90

90° cable outlet	
1 unit	6GK1901-1BB20-2AA0
10 units	6GK1901-1BB20-2AB0
50 units	6GK1901-1BB20-2AE0

Ordering data	Article No.	Article No.
IE FC RJ45 plug 180 180° cable outlet 1 unit 10 units 50 units	6GK1901-1BB10-2AA0 6GK1901-1BB10-2AB0 6GK1901-1BB10-2AE0	
IE FC TP standard cable GP 2x2 4-wire, shielded TP installation cable for connection to IE FC RJ45 outlet/IE FC RJ45 plug; PROFINET-compatible; with UL approval; sold by the meter; max. delivery unit 1 000 m, minimum order quantity 20 m	6XV1840-2AH10	
IE FC TP trailing cable 2 x 2 (type C) 4-wire, shielded TP installation cable for connection to IE FC RJ45 outlet/IE FC RJ45 plug 180/90 for use as trailing cable; PROFINET-compatible; with UL approval; sold by the meter; max. delivery unit 1 000 m, minimum order quantity 20 m	6XV1840-3AH10	
IE FC TP marine cable 2 x 2 (type B) 4-wire, shielded TP installation cable for connection to IE FC RJ45 outlet/IE FC RJ45 plug 180/90 with marine approval; sold by the meter; max. delivery unit 1 000 m, minimum order quantity 20 m	6XV1840-4AH10	
IE FC stripping tool Pre-adjusted stripping tool for fast stripping of Industrial Ethernet FC cables	6GK1901-1GA00	
Manuals for ET 200SP distributed I/O system ET 200SP library: ET 200SP Manual Collection, comprising system manual, product information, and device manuals Manuals can be downloaded from the Internet as PDF files: http://www.siemens.com/simatic-docu		
SIMATIC Manual Collection Electronic manuals on DVD, multi-language: LOGO!, SIMADYN, SIMATIC bus components, SIMATIC C7, SIMATIC Distributed I/O, SIMATIC HMI, SIMATIC sensors, SIMATIC NET, SIMATIC PC-based Automation, SIMATIC PCS 7, SIMATIC PG/PC, SIMATIC S7, SIMATIC software, SIMATIC TDC	6ES7998-8XC01-8YE0	
SIMATIC Manual Collection update service for 1 year Current Manual Collection DVD and the three subsequent updates	6ES7998-8XC01-8YE2	
		STEP 7 Professional V17 Target system: SIMATIC S7-1200, S7-1500, S7-300, S7-400, WinAC Requirement: Windows 10 (64-bit) <ul style="list-style-type: none"> Windows 10 Professional Version 1909, 2004, 20H2 Windows 10 Enterprise Version 1909, 2004, 20H2 Windows 10 IoT Enterprise 2016 LTSB Windows 10 IoT Enterprise 2019 LTSC Windows Server (64-bit) <ul style="list-style-type: none"> Windows Server 2016 Standard (full installation) Windows Server 2019 Standard (full installation) Type of delivery: 9 languages: de, en, zh included, fr, sp, it, ru, jp, kr as download STEP 7 Professional V17, floating license STEP 7 Professional V17, floating license, software download including license key ¹⁾ Email address required for delivery
		6ES7822-1AA07-0YA5
		6ES7822-1AE07-0YA5
		STEP 7 Safety Advanced V17 Task: Engineering tool for configuring and programming fail-safe user programs for SIMATIC S7-1200 FC, S7-1500F, S7-1500F Software Controller, S7-300F, S7-400F, WinAC RTX F, ET 200SP F Controller and the fail-safe ET 200SP, ET 200MP, ET 200S, ET 200M, ET 200iSP, ET 200pro and ET 200eco I/O Requirement: STEP 7 Professional V17 Note: As of TIA Portal V16, the SIMATIC STEP 7 Safety software is an integral component of the SIMATIC STEP 7 product setup. The functionality of SIMATIC STEP 7 Safety is activated by means of the license key supplied in each case. Floating license for 1 user; license key on USB flash drive Floating license for 1 user; license key for download ¹⁾ ; Email address required for delivery
		6ES7833-1FA17-0YA5
		6ES7833-1FA17-0YH5
		Spare parts Power supply connector Spare part; for connecting the 24 V DC supply voltage <ul style="list-style-type: none"> With push-in terminals; 10 units
		6ES7193-4JB00-0AA0
		Cover for BusAdapter interface 5 units
		6ES7591-3AA00-0AA0
		Server module
		6ES7193-6PA00-0AA0

¹⁾ For up-to-date information and download availability, see:
<http://www.siemens.com/tia-online-software-delivery>

Distributed Controllers

based on ET 200SP

Fail-safe CPUs

CPU 1512SP F-1 PN

Technical specifications

Article number	6ES7512-1SK01-0AB0 CPU 1512SP F-1 PN, 300KB Prog./1MB Data
General information	
Product type designation	CPU 1512SP F-1 PN
Engineering with	
• STEP 7 TIA Portal configurable/ integrated from version	V17 (FW V2.9) / V13 SP1 Update 4 (FW V1.8) or higher
Supply voltage	
Rated value (DC)	24 V
Memory	
Work memory	
• integrated (for program)	300 kbyte
• integrated (for data)	1 Mbyte
Load memory	
• Plug-in (SIMATIC Memory Card), max.	32 Gbyte
CPU processing times	
for bit operations, typ.	48 ns
for word operations, typ.	58 ns
for fixed point arithmetic, typ.	77 ns
for floating point arithmetic, typ.	307 ns
Counters, timers and their retentivity	
S7 counter	
• Number	2 048
IEC counter	
• Number	Any (only limited by the main memory)
S7 times	
• Number	2 048
IEC timer	
• Number	Any (only limited by the main memory)
Data areas and their retentivity	
Flag	
• Size, max.	16 kbyte
Address area	
I/O address area	
• Inputs	32 kbyte; All inputs are in the process image
• Outputs	32 kbyte; All outputs are in the process image
Address space per module	
• Address space per module, max.	288 byte; For input and output data respectively
Address space per station	
• Address space per station, max.	2 560 byte; for central inputs and outputs; depending on configuration; 2 048 bytes for ET 200SP modules + 512 bytes for ET 200AL modules
Time of day	
Clock	
• Type	Hardware clock

Article number	6ES7512-1SK01-0AB0 CPU 1512SP F-1 PN, 300KB Prog./1MB Data
1. Interface	
Interface types	
• RJ 45 (Ethernet)	Yes; X1 P3; opt. X1 P1 and X1 P2 via BusAdapter BA 2x RJ45
• Number of ports	3; 1. integr. + 2. via BusAdapter
• integrated switch	Yes
• BusAdapter (PROFINET)	Yes; compatible BusAdapters: BA 2x RJ45, BA 2x FC, BA 2x M12
Protocols	
• IP protocol	Yes; IPv4
• PROFINET IO Controller	Yes
• PROFINET IO Device	Yes
• SIMATIC communication	Yes
• Open IE communication	Yes; Optionally also encrypted
• Web server	Yes
• Media redundancy	Yes; MRP Automanager according to IEC 62439-2 Edition 2.0
PROFINET IO Controller Services	
- PG/OP communication	Yes
- Isochronous mode	Yes
- Direct data exchange	Yes; Requirement: IRT and isochronous mode (MRPD optional)
- IRT	Yes
- PROFIenergy	Yes; per user program
- Prioritized startup	Yes; Max. 32 PROFINET devices
- Number of connectable IO Devices, max.	128; In total, up to 512 distributed I/O devices can be connected via AS-i, PROFIBUS or PROFINET
- Of which IO devices with IRT, max.	64
- Number of connectable IO Devices for RT, max.	128
- of which in line, max.	128
- Number of IO Devices that can be simultaneously activated/ deactivated, max.	8; in total across all interfaces
- Number of IO Devices per tool, max.	8
- Updating times	The minimum value of the update time also depends on communication share set for PROFINET IO, on the number of IO devices, and on the quantity of configured user data
PROFINET IO Device Services	
- PG/OP communication	Yes
- Isochronous mode	No
- IRT	Yes
- PROFIenergy	Yes; per user program
- Shared device	Yes
- Number of IO Controllers with shared device, max.	4
- activation/deactivation of I-devices	Yes; per user program
- Asset management record	Yes; per user program

Technical specifications

Article number	6ES7512-1SK01-0AB0 CPU 1512SP F-1 PN, 300KB Prog./1MB Data
2. Interface	
Interface types	
• RS 485	Yes; Via CM DP module
• Number of ports	1
Protocols	
• PROFIBUS DP master	Yes
• PROFIBUS DP slave	Yes
• SIMATIC communication	Yes
PROFIBUS DP master	
• Number of DP slaves, max.	125; In total, up to 512 distributed I/O devices can be connected via AS-i, PROFIBUS or PROFINET
Protocols	
Number of connections	
• Number of connections, max.	128; via integrated interfaces of the CPU and connected CPs / CMs
Redundancy mode	
Media redundancy	
- Media redundancy	Yes; only via BusAdapter
- MRP	Yes; MRP Automanager according to IEC 62439-2 Edition 2.0, MRP Manager; MRP Client
- MRP interconnection, supported	Yes; as MRP ring node according to IEC 62439-2 Edition 3.0
- MRPD	Yes; Requirement: IRT
- Switchover time on line break, typ.	200 ms; For MRP, bumpless for MRPD
- Number of stations in the ring, max.	50
SIMATIC communication	
• S7 routing	Yes
OPC UA	
• OPC UA Client	Yes
• OPC UA Server	Yes; Data access (read, write, subscribe), method call, custom address space
Supported technology objects	
Motion Control	Yes; Note: The number of technology objects affects the cycle time of the PLC program; selection guide via the TIA Selection Tool
• Number of available Motion Control resources for technology objects	800
• Required Motion Control resources	
- per speed-controlled axis	40
- per positioning axis	80
- per synchronous axis	160
- per external encoder	80
- per output cam	20
- per cam track	160
- per probe	40
Controller	
• PID_Compact	Yes; Universal PID controller with integrated optimization
• PID_3Step	Yes; PID controller with integrated optimization for valves
• PID-Temp	Yes; PID controller with integrated optimization for temperature
Counting and measuring	
• High-speed counter	Yes

Article number	6ES7512-1SK01-0AB0 CPU 1512SP F-1 PN, 300KB Prog./1MB Data
Standards, approvals, certificates	
Highest safety class achievable in safety mode	
Probability of failure (for service life of 20 years and repair time of 100 hours)	
- Low demand mode: PFDavg in accordance with SIL3	< 2.00E-05
- High demand/continuous mode: PFH in accordance with SIL3	< 1.00E-09
Ambient conditions	
Ambient temperature during operation	
• horizontal installation, min.	-25 °C; No condensation
• horizontal installation, max.	60 °C
• vertical installation, min.	-25 °C; No condensation
• vertical installation, max.	50 °C
Altitude during operation relating to sea level	
• Installation altitude above sea level, max.	5 000 m; Restrictions for installation altitudes > 2 000 m, see manual
Configuration	
Programming	
Programming language	
- LAD	Yes; incl. failsafe
- FBD	Yes; incl. failsafe
- STL	Yes
- SCL	Yes
- GRAPH	Yes
Know-how protection	
• User program protection/ password protection	Yes
• Copy protection	Yes
• Block protection	Yes
Access protection	
• protection of confidential configuration data	Yes
• Protection level: Write protection	Yes
• Protection level: Read/write protection	Yes
• Protection level: Write protection for Failsafe	Yes
• Protection level: Complete protection	Yes
Dimensions	
Width	100 mm
Height	117 mm
Depth	75 mm
Weights	
Weight, approx.	310 g

Distributed Controllers

based on ET 200SP
SIPLUS fail-safe CPUs

SIPLUS CPU 1510SP F-1 PN

Overview



- SIPLUS CPU 1510SP F-1 PN for SIPLUS ET 200SP based on S7-1500 CPU 1511F-1 PN
- For high-performance control solutions using ET 200SP
- Increase in availability of systems and machines
- Supports PROFIsafe in centralized and distributed configuration
- PROFINET IO controller for up to 64 IO devices
- PROFINET I-Device for connecting the CPU as an intelligent PROFINET device with a SIMATIC or non-Siemens PROFINET I/O controller
- PROFINET shared I-Device for 4 controllers
- PROFINET IO IRT interface with integrated 3-port switch
- Isochronous mode on PROFINET
- With multiple communication options: PG/OP communication, PROFINET IO, open IE communication (TCP, ISO-on-TCP and UDP), web server and S7 communication (with loadable FBs)
- Optional PROFIBUS master for 125 PROFIBUS DP slaves (with CM DP module 6ES7545-5DA00-0AB0)
- Configuration control (option handling)
- Integrated Motion Control functionalities for controlling speed-controlled and positioning axes, support for external encoders

Note

SIMATIC Memory Card required for operation of the CPU.

The BusAdapter is not included in the scope of supply and must be ordered separately.

SIPLUS extreme products are based on SIMATIC standard products. The contents listed here were taken from the corresponding standard products. SIPLUS extreme-specific information was added.

Ordering data

Article No.

SIPLUS CPU 1510SP F-1 PN

6AG1510-1SJ01-2AB0

(Extended temperature range and exposure to environmental substances)

Work memory 150 KB for program, 750 KB for data, PROFINET IO IRT interface; SIMATIC Memory Card required

Accessories

SIPLUS BusAdapter BA 2xRJ45

6AG1193-6AR00-7AA0

SIPLUS BusAdapter BA 2xFC

6AG1193-6AF00-7AA0

IE FC RJ45 plugs

RJ45 plug connector for Industrial Ethernet with a rugged metal enclosure and integrated insulation displacement contacts for connecting Industrial Ethernet FC installation cables

IE FC RJ45 plug 180

(Extended temperature range and exposure to environmental substances)

180° cable outlet

1 unit

6AG1901-1BB10-7AA0

SIPLUS Mounting Kit ET 200SP

6AG1193-6AA00-0AA0

Mounting accessories for use with increased mechanical vibration and shock loads. Not approved for SIPLUS BusAdapter BA 2xRJ45

Other accessories

See SIMATIC ET 200SP, CPU 1510 F-1 PN; page 7/14

Technical specifications

Article number	6AG1510-1SJ01-2AB0
Based on	6ES7510-1SJ01-0AB0 SIPLUS ET 200SP CPU 1510SP F-1 PN
Ambient conditions	
Ambient temperature during operation	
• horizontal installation, min.	-25 °C; = Tmin (incl. condensation/frost)
• horizontal installation, max.	60 °C; = Tmax
• vertical installation, min.	-25 °C; = Tmin
• vertical installation, max.	50 °C; = Tmax
Altitude during operation relating to sea level	
• Installation altitude above sea level, max.	5 000 m; Restrictions for installation altitudes > 2 000 m, see manual
Relative humidity	
• With condensation, tested in accordance with IEC 60068-2-38, max.	100 %; RH incl. condensation / frost (no commissioning in bedewed state), horizontal installation
Resistance	
Coolants and lubricants	
- Resistant to commercially available coolants and lubricants	Yes; Incl. diesel and oil droplets in the air
Use in stationary industrial systems	
- to biologically active substances according to EN 60721-3-3	Yes; Class 3B2 mold, fungus and dry rot spores (with the exception of fauna); Class 3B3 on request
- to chemically active substances according to EN 60721-3-3	Yes; Class 3C4 (RH < 75 %) incl. salt spray acc. to EN 60068-2-52 (severity degree 3); *
- to mechanically active substances according to EN 60721-3-3	Yes; Class 3S4 incl. sand, dust, *
- Against mechanical environmental conditions acc. to EN 60721-3-3	Yes; Class 3M8 using the SIPLUS Mounting Kit ET 200SP (6AG1193-6AA00-0AA0)
Use on ships/at sea	
- to biologically active substances according to EN 60721-3-6	Yes; Class 6B2 mold, fungal and dry rot spores (excluding fauna)
- to chemically active substances according to EN 60721-3-6	Yes; Class 6C3 (RH < 75 %) incl. salt spray acc. to EN 60068-2-52 (severity degree 3); *
- to mechanically active substances according to EN 60721-3-6	Yes; Class 6S3 incl. sand, dust; *
- Against mechanical environmental conditions acc. to EN 60721-3-6	Yes; Class 6M4 using the SIPLUS Mounting Kit ET 200SP (6AG1193-6AA00-0AA0)

Article number	6AG1510-1SJ01-2AB0
Based on	6ES7510-1SJ01-0AB0 SIPLUS ET 200SP CPU 1510SP F-1 PN
Usage in industrial process technology	
- Against chemically active substances acc. to EN 60654-4	Yes; Class 3 (excluding trichlorethylene)
- Environmental conditions for process, measuring and control systems acc. to ANSI/ISA-71.04	Yes; Level GX group A/B (excluding trichlorethylene; harmful gas concentrations up to the limits of EN 60721-3-3 class 3C4 permissible); level LC3 (salt spray) and level LB3 (oil)
Remark	
- Note regarding classification of environmental conditions acc. to EN 60721, EN 60654-4 and ANSI/ISA-71.04	* The supplied plug covers must remain in place over the unused interfaces during operation!
Conformal coating	
• Coatings for printed circuit board assemblies acc. to EN 61086	Yes; Class 2 for high reliability
• Protection against fouling acc. to EN 60664-3	Yes; Type 1 protection
• Military testing according to MIL-I-46058C, Amendment 7	Yes; Discoloration of coating possible during service life
• Qualification and Performance of Electrical Insulating Compound for Printed Board Assemblies according to IPC-CC-830A	Yes; Conformal coating, Class A

Distributed Controllers

based on ET 200SP
SIPLUS fail-safe CPUs

SIPLUS CPU 1512SP F-1 PN

Overview



- SIPLUS CPU 1512SP F-1 PN for SIPLUS ET 200SP based on S7-1500 CPU 1513F-1 PN
- For applications with medium requirements in terms of program scope and processing speed, for distributed configurations via PROFINET IO or PROFIBUS DP.
- Increase in availability of systems and machines
- Supports PROFIsafe in centralized and distributed configuration
- PROFINET IO controller for up to 128 IO devices
- PROFINET I-Device for connecting the CPU as an intelligent PROFINET device with a SIMATIC or non-Siemens PROFINET I/O controller
- PROFINET shared I-Device for 4 controllers
- PROFINET IO IRT interface with integrated 3-port switch
- Isochronous mode on PROFINET
- With multiple communication options: PG/OP communication, PROFINET IO, open IE communication (TCP, ISO-on-TCP and UDP), web server and S7 communication (with loadable FBs)
- Optional PROFIBUS master for 125 PROFIBUS DP slaves (with CM DP module 6ES7545-5DA00-0AB0)
- Configuration control (option handling)
- Integrated Motion Control functionalities for controlling speed-controlled and positioning axes, support for external encoders

Note

SIMATIC Memory Card required for operation of the CPU.

The BusAdapter is not included in the scope of supply and must be ordered separately.

SIPLUS extreme products are based on SIMATIC standard products. The contents listed here were taken from the corresponding standard products. SIPLUS extreme-specific information was added.

Ordering data

Article No.

SIPLUS CPU 1512SP F-1 PN

(Extended temperature range and exposure to environmental substances)

Work memory 300 KB for program, 1 MB for data, PROFINET IO IRT interface, SIMATIC Memory Card required

Temperature range -25...+60 °C

6AG1512-1SK01-2AB0

Temperature range -40...+70 °C; No BusAdapter can be inserted

6AG1512-1SK01-7AB0

Accessories

SIPLUS BusAdapter BA 2xRJ45

6AG1193-6AR00-7AA0

SIPLUS BusAdapter BA 2xFC

6AG1193-6AF00-7AA0

IE FC RJ45 plugs

RJ45 plug connector for Industrial Ethernet with a rugged metal enclosure and integrated insulation displacement contacts for connecting Industrial Ethernet FC installation cables

IE FC RJ45 plug 180

(Extended temperature range and exposure to environmental substances)

180° cable outlet

1 unit

6AG1901-1BB10-7AA0

SIPLUS Mounting Kit ET 200SP

6AG1193-6AA00-0AA0

Mounting accessories for use with increased mechanical vibration and shock loads. Not approved for SIPLUS BusAdapter 2xBA RJ45

Other accessories

See SIMATIC ET 200SP, CPU 1512 F-1 PN, page 7/18

Technical specifications

Article number	6AG1512-1SK01-2AB0	6AG1512-1SK01-7AB0
Based on	6ES7512-1SK01-0AB0 SIPLUS ET 200SP CPU 1512SP F-1 PN	6ES7512-1SK01-0AB0 SIPLUS ET 200SP CPU 1512SP F-1 PN
Ambient conditions		
Ambient temperature during operation		
• horizontal installation, min.	-25 °C; = Tmin (incl. condensation/frost)	-40 °C; = Tmin (incl. condensation/frost)
• horizontal installation, max.	60 °C; = Tmax	70 °C; = Tmax
• vertical installation, min.	-25 °C; = Tmin	-40 °C; = Tmin
• vertical installation, max.	50 °C; = Tmax	50 °C; = Tmax
Altitude during operation relating to sea level		
• Installation altitude above sea level, max.	5 000 m; Restrictions for installation altitudes > 2 000 m, see manual	5 000 m; Restrictions for installation altitudes > 2 000 m, see manual
Relative humidity		
• With condensation, tested in accordance with IEC 60068-2-38, max.	100 %; RH incl. condensation / frost (no commissioning in bedewed state), horizontal installation	100 %; RH incl. condensation / frost (no commissioning in bedewed state), horizontal installation
Resistance		
Coolants and lubricants		
- Resistant to commercially available coolants and lubricants	Yes; Incl. diesel and oil droplets in the air	No
Use in stationary industrial systems		
- to biologically active substances according to EN 60721-3-3	Yes; Class 3B2 mold, fungus and dry rot spores (with the exception of fauna); Class 3B3 on request	Yes; Class 3B2 mold, fungus and dry rot spores (with the exception of fauna); Class 3B3 on request
- to chemically active substances according to EN 60721-3-3	Yes; Class 3C4 (RH < 75 %) incl. salt spray acc. to EN 60068-2-52 (severity degree 3); *	Yes; Class 3C4 (RH < 75 %) incl. salt spray acc. to EN 60068-2-52 (severity degree 3); *
- to mechanically active substances according to EN 60721-3-3	Yes; Class 3S4 incl. sand, dust, *	Yes; Class 3S4 incl. sand, dust, *
- Against mechanical environmental conditions acc. to EN 60721-3-3	Yes; Class 3M8 using the SIPLUS Mounting Kit ET 200SP (6AG1193-6AA00-0AA0)	
Use on land craft, rail vehicles and special-purpose vehicles		
- Against mechanical environmental conditions acc. to EN 60721-3-5	Yes; Class 5M2 using the SIPLUS Mounting Kit ET 200SP (6AG1193-6AA00-0AA0)	
- against mechanical environmental conditions in agriculture acc. to ISO 15003	Yes; level 1 (Location LE) using the SIPLUS Mounting Kit ET 200SP (6AG1193-6AA00-0AA0)	
Use on ships/at sea		
- to biologically active substances according to EN 60721-3-6	Yes; Class 6B2 mold, fungal and dry rot spores (excluding fauna)	Yes; Class 6B2 mold, fungal and dry rot spores (excluding fauna)
- to chemically active substances according to EN 60721-3-6	Yes; Class 6C3 (RH < 75 %) incl. salt spray acc. to EN 60068-2-52 (severity degree 3); *	Yes; Class 6C3 (RH < 75 %) incl. salt spray acc. to EN 60068-2-52 (severity degree 3); *
- to mechanically active substances according to EN 60721-3-6	Yes; Class 6S3 incl. sand, dust; *	Yes; Class 6S3 incl. sand, dust (with the exception of oil droplets in the air); *
- Against mechanical environmental conditions acc. to EN 60721-3-6	Yes; Class 6M4 using the SIPLUS Mounting Kit ET 200SP (6AG1193-6AA00-0AA0)	
Usage in industrial process technology		
- Against chemically active substances acc. to EN 60654-4	Yes; Class 3 (excluding trichlorethylene)	Yes; Class 3 (excluding trichlorethylene)
- Environmental conditions for process, measuring and control systems acc. to ANSI/ISA-71.04	Yes; Level GX group A/B (excluding trichlorethylene; harmful gas concentrations up to the limits of EN 60721-3-3 class 3C4 permissible); level LC3 (salt spray) and level LB3 (oil)	Yes; Level GX group A/B (excluding trichlorethylene; harmful gas concentrations up to the limits of EN 60721-3-3 class 3C4 permissible); level LC3 (salt spray) and level LB3 (oil)
Remark		
- Note regarding classification of environmental conditions acc. to EN 60721, EN 60654-4 and ANSI/ISA-71.04	* The supplied plug covers must remain in place over the unused interfaces during operation!	* The supplied plug covers must remain in place over the unused interfaces during operation!
Conformal coating		
• Coatings for printed circuit board assemblies acc. to EN 61086	Yes; Class 2 for high reliability	Yes; Class 2 for high reliability
• Protection against fouling acc. to EN 60664-3	Yes; Type 1 protection	Yes; Type 1 protection
• Military testing according to MIL-I-46058C, Amendment 7	Yes; Discoloration of coating possible during service life	Yes; Discoloration of coating possible during service life
• Qualification and Performance of Electrical Insulating Compound for Printed Board Assemblies according to IPC-CC-830A	Yes; Conformal coating, Class A	Yes; Conformal coating, Class A

Distributed Controllers

based on ET 200SP

ET 200SP Open Controllers

Standard CPUs > CPU 1515SP PC2

Overview



ET 200SP Open Controller, CPU 1515SP PC2, combines robustness and compact dimensions with the flexibility of centralized or decentralized communication in the highest industrial functionality. Furthermore, the CPU offers the entire value added of the ET 200SP system, the S7-1500 Controller family and the TIA world together.

- Rugged, compact control system
- Combines the functions of an ET 200SP controller with those of a PC-based platform
- Turnkey all-in-one controller
- High performance automation tasks with the use of new generation Intel Quad Core processors
- Connects high-level language applications and processes high data volumes with support from SIMATIC ODK 1500S

7

Ordering data

SIMATIC ET 200SP Open Controller CPU 1515SP PC2 (+ HMI)

ET 200SP central module with Windows 10 IoT Enterprise 64-bit and pre-installed SIMATIC S7-1500 Software Controller (optionally with WinCC RT Advanced); 8 GB RAM, 128 GB CFast card

Type of delivery:
German, English, Chinese, Italian, French, Spanish

- CPU 1515SP PC2

With pre-installed WinCC RT Advanced

- CPU 1515SP PC2 + HMI 128PT
- CPU 1515SP PC2 + HMI 512PT
- CPU 1515SP PC2 + HMI 2048PT

Accessories

BusAdapter BA 2xRJ45 6ES7193-6AR00-0AA0

BusAdapter BA 2xFC 6ES7193-6AF00-0AA0

BusAdapter BA 2xSCRJ 6ES7193-6AP00-0AA0

BusAdapter BA SCRJ/RJ45 6ES7193-6AP20-0AA0

BusAdapter BA SCRJ/FC 6ES7193-6AP40-0AA0

For increased vibration and EMC loads

BusAdapter BA 2XLC 6ES7193-6AG00-0AA0

BusAdapter BA LC/RJ45 6ES7193-6AG20-0AA0

BusAdapter BA LC/FC 6ES7193-6AG40-0AA0

CM DP for ET 200SP CPU 6ES7545-5DA00-0AB0

PROFIBUS DP master with electrical interface for connecting the ET 200SP CPUs to PROFIBUS at up to 12 Mbps

Server module 6ES7193-6PA00-0AA0

Spare part

Power supply connector 6ES7193-4JB00-0AA0

Spare part; for connecting the 24 V DC supply voltage; with push-in terminals (10 units)

Article No.

6ES7677-2DB42-0GB0

6ES7677-2DB42-0GK0

6ES7677-2DB42-0GL0

6ES7677-2DB42-0GM0

6ES7193-6AG00-0AA0

6ES7193-6AG20-0AA0

6ES7193-6AG40-0AA0

6ES7545-5DA00-0AB0

6ES7193-6PA00-0AA0

6ES7193-4JB00-0AA0

Article No.

Equipment labeling plate

10 sheets of 16 labels

6ES7193-6LF30-0AW0

Labeling strips

500 labeling strips on roll, light gray, for inscription with thermal transfer roll printer

6ES7193-6LR10-0AA0

1 000 labeling strips DIN A4, light gray, card, for inscription with laser printer

6ES7193-6LA10-0AA0

STEP 7 Professional V17

Target system:
SIMATIC S7-1200, S7-1500, S7-300, S7-400, WinAC

Requirement:

- Windows 10 (64-bit)
- Windows 10 Professional Version 1909, 2004, 20H2
- Windows 10 Enterprise Version 1909, 2004, 20H2
- Windows 10 IoT Enterprise 2016 LTSC
- Windows 10 IoT Enterprise 2019 LTSC

- Windows Server (64-bit)
- Windows Server 2016 Standard (full installation)
- Windows Server 2019 Standard (full installation)

Type of delivery:
9 languages: de, en, zh included, fr, sp, it, ru, jp, kr as download

STEP 7 Professional V17, floating license

6ES7822-1AA07-0YA5

STEP 7 Professional V17, floating license, software download including license key ¹⁾

6ES7822-1AE07-0YA5

Email address required for delivery

¹⁾ For up-to-date information and download availability, see: <https://www.siemens.com/tia-online-software-delivery>

Ordering data

Article No.

SIMATIC ODK 1500S

Open Development Kit V2.5 for support in developing high-level language applications for SIMATIC S7-1500 Advanced Controllers; supplied on DVD, license key (floating license) on USB flash drive

6ES7806-2CD03-0YA0

Open Development Kit V2.5 for support in developing high-level language applications for SIMATIC S7-1500 Advanced Controllers; software download including license key (floating license) ¹⁾

6ES7806-2CD03-0YG0

Email address required for delivery

WinCC Advanced V17

Engineering software in the TIA Portal; in 6 languages: de, en, fr, es, it, zh; for configuring SIMATIC Panels, WinCC Runtime Advanced, WinCC Unified PC Runtime

6AV2102-0AA07-0AA5

- Floating license; software and documentation on DVD; license key on USB flash drive

- Floating license; software, documentation and license key for download ¹⁾; Email address required for delivery

6AV2102-0AA07-0AH5

Technical specifications

Article number	6ES7677-2DB42-0GB0 CPU1515SP PC2
General information	
Product type designation	CPU 1515SP PC2
Engineering with	
• STEP 7 TIA Portal configurable/integrated from version	V16
Installed software	
• Visualization	No
• Control	S7-1500 Software Controller CPU 1505SP
Supply voltage	
Rated value (DC)	24 V
Processor	
Processor type	Intel Atom E3940, 1.6 GHz, 4 cores
Memory	
Type of memory	DDR3L
Main memory	8 GB RAM
CFlash memory card	Yes; 128 GB flash memory
Work memory	
• integrated (for program)	1 Mbyte
• integrated (for data)	5 Mbyte
• integrated (for CPU function library of CPU Runtime)	20 Mbyte
Load memory	
• integrated (on PC mass storage)	320 Mbyte
CPU processing times	
for bit operations, typ.	10 ns
for word operations, typ.	12 ns
for fixed point arithmetic, typ.	16 ns
for floating point arithmetic, typ.	64 ns
Counters, timers and their retentivity	
S7 counter	
• Number	2 048
IEC counter	
• Number	Any (only limited by the main memory)
S7 times	
• Number	2 048
IEC timer	
• Number	Any (only limited by the main memory)
Data areas and their retentivity	
Flag	
• Size, max.	16 kbyte
Address area	
I/O address area	
• Inputs	32 kbyte; All inputs are in the process image
• Outputs	32 kbyte; All outputs are in the process image
Hardware configuration	
Integrated power supply	Yes
Time of day	
Clock	
• Type	Hardware clock
• Hardware clock (real-time)	Yes; Resolution: 1 s

¹⁾ For up-to-date information and download availability, see: <https://www.siemens.com/tia-online-software-delivery>

Distributed Controllers

based on ET 200SP

ET 200SP Open Controllers

Standard CPUs > CPU 1515SP PC2

Technical specifications

Article number	6ES7677-2DB42-0GB0 CPU1515SP PC2
Interfaces	
Number of industrial Ethernet interfaces	2
Number of RS 485 interfaces	1; Via CM DP module
Number of USB interfaces	4; 2x USB 2.0, 2x USB 3.0 on front side
Number of SD card slots	1
Video interfaces	
• Graphics interface	1x DisplayPort
1. Interface	
Interface type	PROFINET
automatic detection of transmission rate	Yes
Autonegotiation	Yes
Autocrossing	Yes
Number of connections	88
Interface types	
• RJ 45 (Ethernet)	Yes; Via BusAdapter BA 2x RJ45
- Transmission rate, max.	100 Mbit/s
- Industrial Ethernet status LED	Yes
• Number of ports	2
• integrated switch	Yes
• BusAdapter (PROFINET)	Yes; Compatible BusAdapter: BA 2x RJ45, BA 2x FC, BA 2x SCRJ (from FS03, V2.2), BA SCRJ / RJ45 (from FS03, V3.1), BA SCRJ / FC (from FS03, V3.1), BA 2x LC (from FS03, V3.3), BA LC / RJ45 (from FS03, V3.3), BA LC / FC (from FS03, V3.3)
Protocols	
• PROFINET IO Controller	Yes
• PROFINET IO Device	Yes
• SIMATIC communication	Yes
• Open IE communication	Yes
• Web server	Yes

Article number	6ES7677-2DB42-0GB0 CPU1515SP PC2
PROFINET IO Controller	
Services	
- Isochronous mode	Yes
- shortest clock pulse	500 µs
- IRT	Yes
- PROFINergy	Yes
- Prioritized startup	Yes; max. 32 PROFINET devices; if you want to use the "Prioritized startup" functionality in STEP 7 for the PROFINET interface of the CPU, the CPU and the device must be separated by means of a switch (e.g. SCALANCE X205)
- Number of connectable IO Devices, max.	128
- Of which IO devices with IRT, max.	64
- of which in line, max.	64
- Number of connectable IO Devices for RT, max.	128
- of which in line, max.	128
- Number of IO Devices that can be simultaneously activated/deactivated, max.	8
- IO Devices changing during operation (partner ports), supported	Yes
- Number of IO Devices per tool, max.	8
- Updating times	The minimum value of the update time also depends on communication share set for PROFINET IO, on the number of IO devices, and on the quantity of configured user data
Address area	
- Inputs, max.	8 kbyte
- Outputs, max.	8 kbyte
PROFINET IO Device	
Services	
- Isochronous mode	No
- shortest clock pulse	500 µs
- IRT	Yes
- PROFINergy	Yes
- Prioritized startup	Yes
- Shared device	Yes
- Number of IO Controllers with shared device, max.	4
- Asset management record	Yes
2. Interface	
Interface type	Integrated Ethernet interface
automatic detection of transmission rate	Yes
Autonegotiation	Yes
Autocrossing	Yes
Interface types	
• RJ 45 (Ethernet)	Yes; Integrated
- Transmission rate, max.	1 000 Mbit/s
- Industrial Ethernet status LED	No
• Number of ports	1

Technical specifications

Article number	6ES7677-2DB42-0GB0 CPU1515SP PC2
3. Interface	
Interface type	PROFIBUS with CM DP
Number of connections	44
Interface types	
• RS 485	Yes
Protocols	
• PROFIBUS DP master	Yes
• PROFIBUS DP slave	Yes
• SIMATIC communication	Yes
PROFIBUS DP master	
• Number of DP slaves, max.	125
Services	
- Equidistance	No
- Isochronous mode	No
Address area	
- Inputs, max.	8 kbyte
- Outputs, max.	8 kbyte
Protocols	
Number of connections	
• Number of connections, max.	88
Redundancy mode	
Media redundancy	
- MRP	Yes
- MRPD	Yes
- Switchover time on line break, typ.	200 ms
- Number of stations in the ring, max.	50
SIMATIC communication	
• S7 routing	Yes
OPC UA	
• OPC UA Client	Yes; From SW CPU 1505SP V2.6
• OPC UA Server	Yes; Data access (read, write, subscribe), runtime license required
Supported technology objects	
Motion Control	Yes
• Number of available Motion Control resources for technology objects	2 400
• Required Motion Control resources	
- per speed-controlled axis	40; per axis
- per positioning axis	80; per axis
- per synchronous axis	160; per axis
- per external encoder	80; per external encoder
- per output cam	20; per cam
- per cam track	160; per cam track
- per probe	40; per probe
Controller	
• PID_Compact	Yes; Universal PID controller with integrated optimization
• PID_3Step	Yes; PID controller with integrated optimization for valves
• PID-Temp	Yes; PID controller with integrated optimization for temperature
Counting and measuring	
• High-speed counter	Yes

Article number	6ES7677-2DB42-0GB0 CPU1515SP PC2
Ambient conditions	
Ambient temperature during operation	
• min.	-20 °C
• max.	Up to 60 °C with max. 32 ET 200SP modules; up to 55 °C with max. 64 ET 200SP modules
• horizontal installation, min.	-20 °C
• horizontal installation, max.	60 °C
• vertical installation, min.	-20 °C
• vertical installation, max.	50 °C; With max. 32 ET 200SP modules
Operating systems	
pre-installed operating system	Windows 10 IoT Enterprise 2016 LTSB, 64bit, MUI
Configuration	
Programming	
Programming language	
- LAD	Yes
- FBD	Yes
- STL	Yes
- SCL	Yes
- CFC	No
- GRAPH	Yes
Know-how protection	
• User program protection/ password protection	Yes
• Copy protection	Yes
• Block protection	Yes
Access protection	
• Protection level: Write protection	Yes
• Protection level: Read/write protection	Yes
• Protection level: Complete protection	Yes
Open Development interfaces	
• Size of ODK SO file, max.	5.8 Mbyte
Peripherals/Options	
SD card	Optionally for additional mass storage
Dimensions	
Width	160 mm
Height	117 mm
Depth	75 mm
Weights	
Weight, approx.	0.83 kg

Distributed Controllers

based on ET 200SP

ET 200SP Open Controllers

Fail-safe CPUs > CPU 1515SP PC2 F

Overview

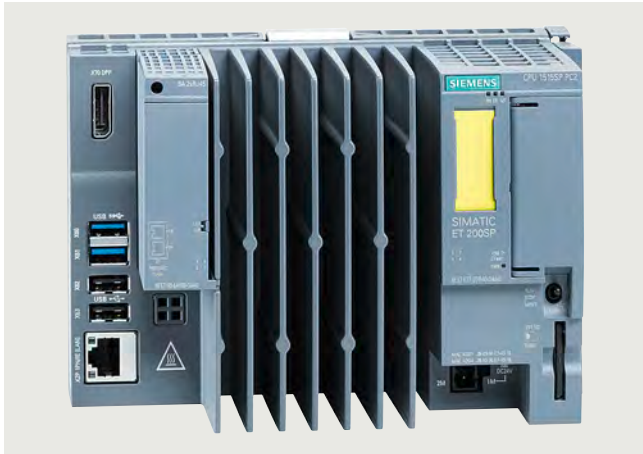

ET 200SP Open Controller, CPU 1515SP PC2 F, combines robustness and compact dimensions with the flexibility of centralized or decentralized communication in the highest industrial functionality. Furthermore, the CPU offers the entire value added of the ET 200SP system, the S7-1500 Controller family and the TIA world together.

- Rugged, compact control system
- Combines the functions of an ET 200SP controller with those of a PC-based platform
- Turnkey all-in-one controller
- Can be used up to safety class SIL3 (Safety Integrity Level) according to IEC 61508 2nd Edition or PL e (Performance Level) according to ISO 13849
- High performance automation tasks with the use of new generation Intel Quad Core processors
- Connects high-level language applications and processes high data volumes with support from SIMATIC ODK 1500S

7

Ordering data

Article No.

SIMATIC ET 200SP Open Controller CPU 1515SP PC2 F (+ HMI)

Fail-safe ET 200SP CPU with Windows 10 IoT Enterprise 64-bit and pre-installed SIMATIC S7-1500 Failsafe Software Controller (optionally with WinCC RT Advanced); 8 GB RAM, 128 GB CFast card;

Type of delivery:
German, English, Chinese, Italian, French, Spanish

- CPU 1515SP PC2 F

6ES7677-2SB42-0GB0

With pre-installed WinCC RT Advanced

- CPU 1515SP PC2 F + HMI 128PT
- CPU 1515SP PC2 F + HMI 512PT
- CPU 1515SP PC2 F + HMI 2048PT

6ES7677-2SB42-0GK0

6ES7677-2SB42-0GL0

6ES7677-2SB42-0GM0

Accessories

BusAdapter BA 2xRJ45

6ES7193-6AR00-0AA0

BusAdapter BA 2xFC

6ES7193-6AF00-0AA0

BusAdapter BA 2xSCRJ

6ES7193-6AP00-0AA0

BusAdapter BA SCRJ/RJ45

6ES7193-6AP20-0AA0

BusAdapter BA SCRJ/FC

6ES7193-6AP40-0AA0

For increased vibration and EMC loads

BusAdapter BA 2XLC

6ES7193-6AG00-0AA0

BusAdapter BA LC/RJ45

6ES7193-6AG20-0AA0

BusAdapter BA LC/FC

6ES7193-6AG40-0AA0

CM DP for ET 200SP CPU

6ES7545-5DA00-0AB0

PROFIBUS DP master with electrical interface for connecting the ET 200SP CPUs to PROFIBUS at up to 12 Mbps

Server module

6ES7193-6PA00-0AA0

Spare part

Power supply connector

6ES7193-4JB00-0AA0

Spare part; for connecting the 24 V DC supply voltage; with push-in terminals (10 units)

Article No.

Equipment labeling plate

6ES7193-6LF30-0AW0

10 sheets of 16 labels

Labeling strips

500 labeling strips on roll, light gray, for inscription with thermal transfer roll printer

6ES7193-6LR10-0AA0

1 000 labeling strips DIN A4, light gray, card, for inscription with laser printer

6ES7193-6LA10-0AA0

STEP 7 Professional V17

Target system:
SIMATIC S7-1200, S7-1500, S7-300, S7-400, WinAC

Requirement:

- Windows 10 (64-bit)
- Windows 10 Professional Version 1909, 2004, 20H2
 - Windows 10 Enterprise Version 1909, 2004, 20H2
 - Windows 10 IoT Enterprise 2016 LTSC
 - Windows 10 IoT Enterprise 2019 LTSC

- Windows Server (64-bit)
- Windows Server 2016 Standard (full installation)
 - Windows Server 2019 Standard (full installation)

Type of delivery:
9 languages: de, en, zh included, fr, sp, it, ru, jp, kr as download

STEP 7 Professional V17, floating license

6ES7822-1AA07-0YA5

STEP 7 Professional V17, floating license, software download including license key ¹⁾

6ES7822-1AE07-0YA5

Email address required for delivery

¹⁾ For up-to-date information and download availability, see: <http://www.siemens.com/tia-online-software-delivery>

Ordering data

Article No.

SIMATIC ODK 1500S

Open Development Kit V2.5 for support in developing high-level language applications for SIMATIC S7-1500 Advanced Controllers; supplied on DVD, license key (floating license) on USB flash drive

6ES7806-2CD03-0YA0

Open Development Kit V2.5 for support in developing high-level language applications for SIMATIC S7-1500 Advanced Controllers; software download including license key (floating license) ¹⁾

6ES7806-2CD03-0YG0

Email address required for delivery

WinCC Advanced V17

Engineering software in the TIA Portal; in 6 languages: de, en, fr, es, it, zh; for configuring SIMATIC Panels, WinCC Runtime Advanced, WinCC Unified PC Runtime

6AV2102-0AA07-0AA5

- Floating license; software and documentation on DVD; license key on USB flash drive

6AV2102-0AA07-0AH5

- Floating license; software, documentation and license key for download ¹⁾; Email address required for delivery

Technical specifications

Article number	6ES7677-2SB42-0GB0 CPU1515SP PC2 F
General information	
Product type designation	CPU 1515SP PC2 F
Engineering with	
• STEP 7 TIA Portal configurable/ integrated from version	V16
Installed software	
• Visualization	No
• Control	S7-1500 Software Controller CPU 1505SP F
Processor	
Processor type	Intel Atom E3940, 1.6 GHz, 4 cores
Memory	
Type of memory	DDR3L
Main memory	8 GB RAM
CFast memory card	Yes; 128 GB flash memory
Work memory	
• integrated (for program)	1.5 Mbyte
• integrated (for data)	5 Mbyte
• integrated (for CPU function library of CPU Runtime)	20 Mbyte
Load memory	
• integrated (on PC mass storage)	320 Mbyte
CPU processing times	
for bit operations, typ.	10 ns
for word operations, typ.	12 ns
for fixed point arithmetic, typ.	16 ns
for floating point arithmetic, typ.	64 ns
Counters, timers and their retentivity	
S7 counter	
• Number	2 048
IEC counter	
• Number	Any (only limited by the main memory)
S7 times	
• Number	2 048
IEC timer	
• Number	Any (only limited by the main memory)
Data areas and their retentivity	
Flag	
• Size, max.	16 kbyte
Address area	
I/O address area	
• Inputs	32 kbyte; All inputs are in the process image
• Outputs	32 kbyte; All outputs are in the process image
Hardware configuration	
Integrated power supply	Yes
Time of day	
Clock	
• Type	Hardware clock
• Hardware clock (real-time)	Yes; Resolution: 1 s
Interfaces	
Number of industrial Ethernet interfaces	2
Number of RS 485 interfaces	1; Via CM DP module
Number of USB interfaces	4; 2x USB 2.0, 2x USB 3.0 on front side
Number of SD card slots	1

¹⁾ For up-to-date information and download availability, see: <http://www.siemens.com/tia-online-software-delivery>

Distributed Controllers

based on ET 200SP

ET 200SP Open Controllers

Fail-safe CPUs > CPU 1515SP PC2 F

Technical specifications

Article number	6ES7677-2SB42-0GB0 CPU1515SP PC2 F
Video interfaces	
• Graphics interface	1x DisplayPort
1. Interface	
Interface type	PROFINET
automatic detection of transmission rate	Yes
Autonegotiation	Yes
Autocrossing	Yes
Number of connections	88
Interface types	
• RJ 45 (Ethernet)	Yes; Via BusAdapter BA 2x RJ45
- Transmission rate, max.	100 Mbit/s
- Industrial Ethernet status LED	Yes
• Number of ports	2
• integrated switch	Yes
• BusAdapter (PROFINET)	Yes; Compatible BusAdapter: BA 2x RJ45, BA 2x FC, BA 2x SCRJ (from FS03, V2.2), BA SCRJ / RJ45 (from FS03, V3.1), BA SCRJ / FC (from FS03, V3.1), BA 2x LC (from FS03, V3.3), BA LC / RJ45 (from FS03, V3.3), BA LC / FC (from FS03, V3.3)
Protocols	
• PROFINET IO Controller	Yes
• PROFINET IO Device	Yes
• SIMATIC communication	Yes
• Open IE communication	Yes
• Web server	Yes
PROFINET IO Controller	
Services	
- Isochronous mode	Yes
- shortest clock pulse	500 µs
- IRT	Yes
- Prioritized startup	Yes; Max. 32 PROFINET devices
- Number of connectable IO Devices, max.	128
- Of which IO devices with IRT, max.	64
- of which in line, max.	64
- Number of connectable IO Devices for RT, max.	128
- of which in line, max.	128
- Number of IO Devices that can be simultaneously activated/ deactivated, max.	8
- IO Devices changing during operation (partner ports), supported	Yes
- Number of IO Devices per tool, max.	8
- Updating times	The minimum value of the update time also depends on communication share set for PROFINET IO, on the number of IO devices, and on the quantity of configured user data
PROFINET IO Device	
Services	
- Isochronous mode	No
- IRT	Yes
- Prioritized startup	Yes
- Shared device	Yes
- Number of IO Controllers with shared device, max.	4

Article number	6ES7677-2SB42-0GB0 CPU1515SP PC2 F
2. Interface	
Interface type	Integrated Ethernet interface
automatic detection of transmission rate	Yes
Autonegotiation	Yes
Autocrossing	Yes
Interface types	
• RJ 45 (Ethernet)	Yes; Integrated
- Transmission rate, max.	1 000 Mbit/s
- Industrial Ethernet status LED	No
• Number of ports	1
3. Interface	
Interface type	PROFIBUS with CM DP
Number of connections	44
Interface types	
• RS 485	Yes
Protocols	
• PROFIBUS DP master	Yes
• PROFIBUS DP slave	Yes
• SIMATIC communication	Yes
PROFIBUS DP master	
• Number of DP slaves, max.	125
Services	
- Equidistance	No
- Isochronous mode	No
Protocols	
Number of connections	
• Number of connections, max.	88
Redundancy mode	
Media redundancy	
- MRP	Yes
- MRPD	Yes
- Switchover time on line break, typ.	200 ms
- Number of stations in the ring, max.	50
SIMATIC communication	
• S7 routing	Yes
OPC UA	
• OPC UA Client	Yes; Data access (read, write), method call
• OPC UA Server	Yes; Data access (read, write, subscribe), runtime license required

Technical specifications

Article number	6ES7677-2SB42-0GB0 CPU1515SP PC2 F
Supported technology objects	
Motion Control	Yes
• Number of available Motion Control resources for technology objects	2 400
• Required Motion Control resources	
- per speed-controlled axis	40; per axis
- per positioning axis	80; per axis
- per synchronous axis	160; per axis
- per external encoder	80; per external encoder
- per output cam	20; per cam
- per cam track	160; per cam track
- per probe	40; per probe
Controller	
• PID_Compact	Yes; Universal PID controller with integrated optimization
• PID_3Step	Yes; PID controller with integrated optimization for valves
• PID-Temp	Yes; PID controller with integrated optimization for temperature
Counting and measuring	
• High-speed counter	Yes
Standards, approvals, certificates	
Highest safety class achievable in safety mode	
• Performance level according to ISO 13849-1	PLe
• SIL acc. to IEC 61508	SIL 3
Probability of failure (for service life of 20 years and repair time of 100 hours)	
- Low demand mode: PFDavg in accordance with SIL3	< 2.00E-05
- High demand/continuous mode: PFH in accordance with SIL3	< 1.00E-09 1/h
Ambient conditions	
Ambient temperature during operation	
• min.	-20 °C
• max.	Up to 60 °C with max. 32 ET 200SP modules and 3x 100 mA USB load; up to 55 °C with max. 64 ET 200SP modules and 2x max. 500 mA and 1x max. 100 mA USB load
• horizontal installation, min.	-20 °C
• horizontal installation, max.	60 °C
• vertical installation, min.	-20 °C
• vertical installation, max.	50 °C; With max. 32 ET 200SP modules and 3x 100 mA USB load

Article number	6ES7677-2SB42-0GB0 CPU1515SP PC2 F
Operating systems	
pre-installed operating system	Windows 10 IoT Enterprise 2016 LTSB, 64bit, MUI
Configuration	
Programming	
Programming language	
- LAD	Yes; incl. failsafe
- FBD	Yes; incl. failsafe
- STL	Yes
- SCL	Yes
- CFC	No
- GRAPH	Yes
Know-how protection	
• User program protection/ password protection	Yes
• Copy protection	Yes
• Block protection	Yes
Access protection	
• Protection level: Write protection	Yes
• Protection level: Read/write protection	Yes
• Protection level: Complete protection	Yes
Open Development interfaces	
• Size of ODK SO file, max.	3.8 Mbyte
Peripherals/Options	
SD card	Optionally for additional mass storage
Dimensions	
Width	160 mm
Height	117 mm
Depth	75 mm
Weights	
Weight, approx.	0.83 kg

Distributed Controllers

based on ET 200SP

ET 200SP Open Controllers

Technology-CPU > CPU 1515SP PC2 T

Overview



ET 200SP Open Controller CPU 1515SP PC2 T combines robustness and compact dimensions with the flexibility of centralized or decentralized communication in the highest industrial functionality. Furthermore, the CPU offers the entire value added of the ET 200SP system, the S7-1500 controller family and the TIA world together.

- Rugged, compact control system
- Combines the functions of an ET 200SP controller with those of a PC-based platform
- Turnkey all-in-one controller
- High performance automation tasks with the use of new generation Intel Quad Core processors
- Connects high-level language applications and processes high data volumes with support from SIMATIC ODK 1500S

7

Ordering data

SIMATIC ET 200SP Open Controller CPU 1515SP PC2 T

ET 200SP central module with Windows 10 IoT Enterprise 64-bit and pre-installed SIMATIC S7-1500 Software Controller (with WinCC RT Advanced option); 8 GB RAM, 128 GB CFast card; with extended Motion Control functionality

Type of delivery:
German, English, Chinese, Italian, French, Spanish

- CPU 1515SP PC2 T

With pre-installed WinCC RT Advanced

- CPU 1515SP PC2 T + HMI 128PT
- CPU 1515SP PC2 T + HMI 512PT
- CPU 1515SP PC2 T + HMI 2048PT

Accessories

BusAdapter BA 2xRJ45 6ES7193-6AR00-0AA0

BusAdapter BA 2xFC 6ES7193-6AF00-0AA0

BusAdapter BA 2xSCRJ 6ES7193-6AP00-0AA0

BusAdapter BA SCRJ/RJ45 6ES7193-6AP20-0AA0

BusAdapter BA SCRJ/FC 6ES7193-6AP40-0AA0

For increased vibration and EMC loads

BusAdapter BA 2XLC 6ES7193-6AG00-0AA0

BusAdapter BA LC/RJ45 6ES7193-6AG20-0AA0

BusAdapter BA LC/FC 6ES7193-6AG40-0AA0

CM DP for ET 200SP CPU 6ES7545-5DA00-0AB0

PROFIBUS DP master with electrical interface for connecting the ET 200SP CPUs to PROFIBUS at up to 12 Mbps

Server module 6ES7193-6PA00-0AA0

Spare part

Power supply connector 6ES7193-4JB00-0AA0

Spare part; for connecting the 24 V DC supply voltage; with push-in terminals (10 units)

Article No.

6ES7677-2VB42-0GB0

6ES7677-2VB42-0GK0

6ES7677-2VB42-0GL0

6ES7677-2VB42-0GM0

6ES7193-6AG00-0AA0

6ES7193-6AG20-0AA0

6ES7193-6AG40-0AA0

6ES7545-5DA00-0AB0

6ES7193-6PA00-0AA0

6ES7193-4JB00-0AA0

Article No.

Equipment labeling plate

10 sheets of 16 labels

6ES7193-6LF30-0AW0

Labeling strips

500 labeling strips on roll, light gray, for inscription with thermal transfer roll printer

6ES7193-6LR10-0AA0

1 000 labeling strips DIN A4, light gray, card, for inscription with laser printer

6ES7193-6LA10-0AA0

STEP 7 Professional V17

Target system:
SIMATIC S7-1200, S7-1500, S7-300, S7-400, WinAC

Requirement:

- Windows 10 (64-bit)
- Windows 10 Professional Version 1909, 2004, 20H2
 - Windows 10 Enterprise Version 1909, 2004, 20H2
 - Windows 10 IoT Enterprise 2016 LTSC
 - Windows 10 IoT Enterprise 2019 LTSC

- Windows Server (64-bit)
- Windows Server 2016 Standard (full installation)
 - Windows Server 2019 Standard (full installation)

Type of delivery:
9 languages: de, en, zh included, fr, sp, it, ru, jp, kr as download

STEP 7 Professional V17, floating license

6ES7822-1AA07-0YA5

STEP 7 Professional V17, floating license, software download including license key ¹⁾

6ES7822-1AE07-0YA5

Email address required for delivery

¹⁾ For up-to-date information and download availability, see: <http://www.siemens.com/tia-online-software-delivery>

Ordering data	Article No.	Technical specifications	
<p>SIMATIC ODK 1500S</p> <p>Open Development Kit V2.5 for support in developing high-level language applications for SIMATIC S7-1500 Advanced Controllers; supplied on DVD, license key (floating license) on USB flash drive</p> <p>Open Development Kit V2.5 for support in developing high-level language applications for SIMATIC S7-1500 Advanced Controllers; software download including license key (floating license) ¹⁾ Email address required for delivery</p>	<p>6ES7806-2CD03-0YA0</p> <p>6ES7806-2CD03-0YG0</p>	<p>Article number</p> <p>6ES7677-2VB42-0GB0 CPU1515SP PC2 T</p>	
<p>WinCC Advanced V17</p> <p>Engineering software in the TIA Portal; in 6 languages: de, en, fr, es, it, zh; for configuring SIMATIC Panels, WinCC Runtime Advanced, WinCC Unified PC Runtime</p> <ul style="list-style-type: none"> Floating license; software and documentation on DVD; license key on USB flash drive Floating license; software, documentation and license key for download ¹⁾; Email address required for delivery 	<p>6AV2102-0AA07-0AA5</p> <p>6AV2102-0AA07-0AH5</p>	<p>General information</p> <p>Product type designation</p> <p>CPU 1515SP PC2 T</p>	
		<p>Engineering with</p> <ul style="list-style-type: none"> STEP 7 TIA Portal configurable/ integrated from version 	<p>STEP 7 V16 or higher</p>
		<p>Installed software</p> <ul style="list-style-type: none"> Visualization Control 	<p>No</p> <p>S7-1500 Software Controller CPU 1505SP T</p>
		<p>Processor</p> <p>Processor type</p>	<p>Intel Atom E3940, 1.6 GHz, 4 cores</p>
		<p>Memory</p> <p>Type of memory</p> <p>Main memory</p> <p>CFast memory card</p>	<p>DDR3L</p> <p>8 GB RAM</p> <p>Yes; 30 GB flash memory</p>
		<p>Work memory</p> <ul style="list-style-type: none"> integrated (for program) integrated (for data) integrated (for CPU function library of CPU Runtime) 	<p>1 Mbyte</p> <p>5 Mbyte</p> <p>20 Mbyte</p>
		<p>Load memory</p> <ul style="list-style-type: none"> integrated (on PC mass storage) 	<p>320 Mbyte</p>
		<p>CPU processing times</p> <p>for bit operations, typ.</p> <p>for word operations, typ.</p> <p>for fixed point arithmetic, typ.</p> <p>for floating point arithmetic, typ.</p>	<p>10 ns</p> <p>12 ns</p> <p>16 ns</p> <p>64 ns</p>
		<p>Counters, timers and their retentivity</p> <p>S7 counter</p> <ul style="list-style-type: none"> Number 	<p>2 048</p>
		<p>IEC counter</p> <ul style="list-style-type: none"> Number 	<p>Any (only limited by the main memory)</p>
		<p>S7 times</p> <ul style="list-style-type: none"> Number 	<p>2 048</p>
		<p>IEC timer</p> <ul style="list-style-type: none"> Number 	<p>Any (only limited by the main memory)</p>
		<p>Data areas and their retentivity</p> <p>Flag</p> <ul style="list-style-type: none"> Size, max. 	<p>16 kbyte</p>
		<p>Address area</p> <p>I/O address area</p> <ul style="list-style-type: none"> Inputs Outputs 	<p>32 kbyte; All inputs are in the process image</p> <p>32 kbyte; All outputs are in the process image</p>
		<p>Hardware configuration</p> <p>Integrated power supply</p>	<p>Yes</p>
		<p>Time of day</p> <p>Clock</p> <ul style="list-style-type: none"> Type Hardware clock (real-time) 	<p>Hardware clock</p> <p>Yes; Resolution: 1 s</p>
		<p>Interfaces</p> <p>Number of industrial Ethernet interfaces</p>	<p>2</p>
		<p>Number of RS 485 interfaces</p>	<p>1; Via CM DP module</p>
		<p>Number of USB interfaces</p>	<p>4; 2x USB 2.0, 2x USB 3.0 on front side</p>
		<p>Number of SD card slots</p>	<p>1</p>

¹⁾ For up-to-date information and download availability, see: <http://www.siemens.com/tia-online-software-delivery>

Distributed Controllers

based on ET 200SP

ET 200SP Open Controllers

Technology-CPU > CPU 1515SP PC2 T

Technical specifications

Article number	6ES7677-2VB42-0GB0 CPU1515SP PC2 T
Video interfaces	
• Graphics interface	1x DisplayPort
1. Interface	
Interface type	PROFINET
automatic detection of transmission rate	Yes
Autonegotiation	Yes
Autocrossing	Yes
Number of connections	88
Interface types	
• RJ 45 (Ethernet)	Yes; Via BusAdapter BA 2x RJ45
- Transmission rate, max.	100 Mbit/s
- Industrial Ethernet status LED	Yes
• Number of ports	2
• integrated switch	Yes
• BusAdapter (PROFINET)	Yes; Compatible BusAdapter: BA 2x RJ45, BA 2x FC, BA 2x SCRJ (from FS03, V2.2), BA SCRJ / RJ45 (from FS03, V3.1), BA SCRJ / FC (from FS03, V3.1), BA 2x LC (from FS03, V3.3), BA LC / RJ45 (from FS03, V3.3), BA LC / FC (from FS03, V3.3)
Protocols	
• PROFINET IO Controller	Yes
• PROFINET IO Device	Yes
• SIMATIC communication	Yes
• Open IE communication	Yes
• Web server	Yes
PROFINET IO Controller	
Services	
- Isochronous mode	Yes
- shortest clock pulse	500 µs
- IRT	Yes
- PROFIenergy	Yes
- Prioritized startup	Yes; max. 32 PROFINET devices; if you want to use the "Prioritized startup" functionality in STEP 7 for the PROFINET interface of the CPU, the CPU and the device must be separated by means of a switch (e.g. SCALANCE)
- Number of connectable IO Devices, max.	128
- Of which IO devices with IRT, max.	64
- of which in line, max.	64
- Number of connectable IO Devices for RT, max.	128
- of which in line, max.	128
- Number of IO Devices that can be simultaneously activated/deactivated, max.	8
- IO Devices changing during operation (partner ports), supported	Yes
- Number of IO Devices per tool, max.	8
- Updating times	The minimum value of the update time also depends on communication share set for PROFINET IO, on the number of IO devices, and on the quantity of configured user data
Address area	
- Inputs, max.	8 kbyte
- Outputs, max.	8 kbyte

Article number	6ES7677-2VB42-0GB0 CPU1515SP PC2 T
PROFINET IO Device	
Services	
- Isochronous mode	No
- shortest clock pulse	500 µs
- IRT	Yes
- PROFIenergy	Yes
- Prioritized startup	Yes
- Shared device	Yes
- Number of IO Controllers with shared device, max.	4
- Asset management record	Yes
2. Interface	
Interface type	Integrated Ethernet interface
automatic detection of transmission rate	Yes
Autonegotiation	Yes
Autocrossing	Yes
Interface types	
• RJ 45 (Ethernet)	Yes; Integrated
- Transmission rate, max.	1 000 Mbit/s
- Industrial Ethernet status LED	No
• Number of ports	1
3. Interface	
Interface type	PROFIBUS with CM DP
Number of connections	44
Interface types	
• RS 485	Yes
Protocols	
• PROFIBUS DP master	Yes
• PROFIBUS DP slave	Yes
• SIMATIC communication	Yes
PROFIBUS DP master	
• Number of DP slaves, max.	125
Services	
- Equidistance	No
- Isochronous mode	No
Address area	
- Inputs, max.	8 kbyte
- Outputs, max.	8 kbyte
Protocols	
Number of connections	
• Number of connections, max.	88
Redundancy mode	
Media redundancy	
- Switchover time on line break, typ.	200 ms
- Number of stations in the ring, max.	50
SIMATIC communication	
• S7 routing	Yes
OPC UA	
• OPC UA Client	Yes; From SW CPU 1505SP V2.6
• OPC UA Server	Yes; Data access (read, write, subscribe), runtime license required

Technical specifications

Article number	6ES7677-2VB42-0GB0 CPU1515SP PC2 T
Supported technology objects	
Motion Control	Yes
• Number of available Motion Control resources for technology objects	2 400
• Required Motion Control resources	
- per speed-controlled axis	40; per axis
- per positioning axis	80; per axis
- per synchronous axis	160; per axis
- per external encoder	80; per external encoder
- per output cam	20; per cam
- per cam track	160; per cam track
- per probe	40; per probe
• Number of available Extended Motion Control resources for technology objects	120
• Required Extended Motion Control resources	
- per cam (1 000 points and 50 segments)	2
- for each set of kinematics	30
- Per leading axis proxy	3
Controller	
• PID_Compact	Yes; Universal PID controller with integrated optimization
• PID_3Step	Yes; PID controller with integrated optimization for valves
• PID-Temp	Yes; PID controller with integrated optimization for temperature
Counting and measuring	
• High-speed counter	Yes
Ambient conditions	
Ambient temperature during operation	
• min.	-20 °C
• max.	Up to 60 °C with max. 32 ET 200SP modules; up to 55 °C with max. 64 ET 200SP modules
• horizontal installation, min.	-20 °C
• horizontal installation, max.	60 °C
• vertical installation, min.	-20 °C
• vertical installation, max.	50 °C; With max. 32 ET 200SP modules

Article number	6ES7677-2VB42-0GB0 CPU1515SP PC2 T
Operating systems	
pre-installed operating system	Windows 10 IoT Enterprise 2016 LTSB, 64bit, MUI
Configuration	
Programming	
Programming language	
- LAD	Yes
- FBD	Yes
- STL	Yes
- SCL	Yes
- CFC	No
- GRAPH	Yes
Know-how protection	
• User program protection/ password protection	Yes
• Copy protection	Yes
• Block protection	Yes
Access protection	
• Protection level: Write protection	Yes
• Protection level: Read/write protection	Yes
• Protection level: Complete protection	Yes
Open Development interfaces	
• Size of ODK SO file, max.	5.8 Mbyte
Peripherals/Options	
SD card	Optionally for additional mass storage
Dimensions	
Width	160 mm
Height	117 mm
Depth	75 mm
Weights	
Weight, approx.	0.83 kg

Distributed Controllers

based on ET 200SP

ET 200SP Open Controllers

Technology-CPU > CPU 1515SP PC2 TF

Overview

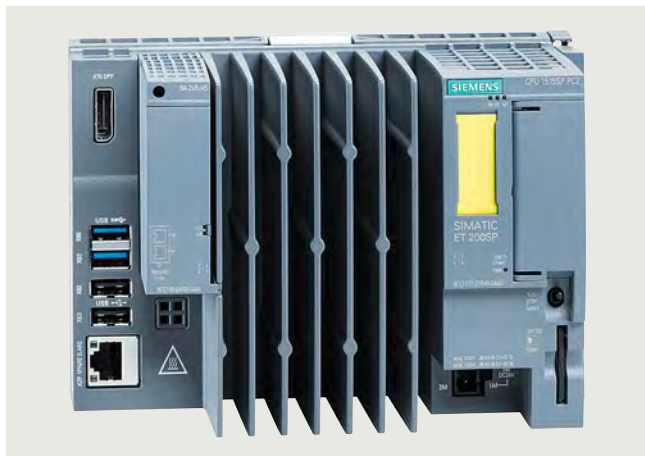

ET 200SP Open Controller, CPU 1515SP PC2 TF, combines robustness and compact dimensions with the flexibility of centralized or decentralized communication in the highest industrial functionality. Furthermore, the CPU offers the entire value added of the ET 200SP system, the S7-1500 Controller family and the TIA world together.

- Rugged, compact control system
- Combines the functions of an ET 200SP controller with those of a PC-based platform
- Turnkey all-in-one controller
- Can be used up to safety class SIL3 (Safety Integrity Level) according to IEC 61508 2nd Edition or PL e (Performance Level) according to ISO 13849
- High performance automation tasks with the use of new generation Intel Quad Core processors
- Connects high-level language applications and processes high data volumes with support from SIMATIC ODK 1500S

7

Ordering data

Article No.

SIMATIC ET 200SP Open Controller CPU 1515SP PC2 TF

Fail-safe ET 200SP central module with Windows 10 IoT Enterprise 64-bit and pre-installed fail-safe SIMATIC S7-1500 Software Controller (with WinCC RT Advanced option); 8 GB RAM, 128 GB CFAST card; with extended Motion Control functionality

Type of delivery:
German, English, Chinese, Italian, French, Spanish

- CPU 1515SP PC2 TF

6ES7677-2WB42-0GB0

With pre-installed WinCC RT Advanced

- CPU 1515SP PC2 TF + HMI 128PT
- CPU 1515SP PC2 TF + HMI 512PT
- CPU 1515SP PC2 TF + HMI 2048PT

6ES7677-2WB42-0GK0

6ES7677-2WB42-0GL0

6ES7677-2WB42-0GM0

Accessories

BusAdapter BA 2xRJ45

6ES7193-6AR00-0AA0

BusAdapter BA 2xFC

6ES7193-6AF00-0AA0

BusAdapter BA 2xSCRJ

6ES7193-6AP00-0AA0

BusAdapter BA SCRJ/RJ45

6ES7193-6AP20-0AA0

BusAdapter BA SCRJ/FC

6ES7193-6AP40-0AA0

For increased vibration and EMC loads

BusAdapter BA 2XLC

6ES7193-6AG00-0AA0

BusAdapter BA LC/RJ45

6ES7193-6AG20-0AA0

BusAdapter BA LC/FC

6ES7193-6AG40-0AA0

CM DP for ET 200SP CPU

6ES7545-5DA00-0AB0

PROFIBUS DP master with electrical interface for connecting the ET 200SP CPUs to PROFIBUS at up to 12 Mbps

Server module

6ES7193-6PA00-0AA0

Spare part

Article No.

Power supply connector

Spare part; for connecting the 24 V DC supply voltage; with push-in terminals (10 units)

6ES7193-4JB00-0AA0

Equipment labeling plate

10 sheets of 16 labels

6ES7193-6LF30-0AW0

Labeling strips

500 labeling strips on roll, light gray, for inscription with thermal transfer roll printer

6ES7193-6LR10-0AA0

1 000 labeling strips DIN A4, light gray, card, for inscription with laser printer

6ES7193-6LA10-0AA0

STEP 7 Professional V17

Target system:
SIMATIC S7-1200, S7-1500, S7-300, S7-400, WinAC

Requirement:

- Windows 10 (64-bit)
 - Windows 10 Professional Version 1909, 2004, 20H2
 - Windows 10 Enterprise Version 1909, 2004, 20H2
 - Windows 10 IoT Enterprise 2016 LTSC
 - Windows 10 IoT Enterprise 2019 LTSC

- Windows Server (64-bit)
 - Windows Server 2016 Standard (full installation)
 - Windows Server 2019 Standard (full installation)

Type of delivery:
9 languages: de, en, zh included, fr, sp, it, ru, jp, kr as download

STEP 7 Professional V17, floating license

6ES7822-1AA07-0YA5

STEP 7 Professional V17, floating license, software download including license key ¹⁾

6ES7822-1AE07-0YA5

Email address required for delivery

¹⁾ For up-to-date information and download availability, see: <http://www.siemens.com/tia-online-software-delivery>

Ordering data	Article No.	Technical specifications	
<p>SIMATIC ODK 1500S</p> <p>Open Development Kit V2.5 for support in developing high-level language applications for SIMATIC S7-1500 Advanced Controllers; supplied on DVD, license key (floating license) on USB flash drive</p> <p>Open Development Kit V2.5 for support in developing high-level language applications for SIMATIC S7-1500 Advanced Controllers; software download including license key (floating license) ¹⁾ Email address required for delivery</p>	<p>6ES7806-2CD03-0YA0</p> <p>6ES7806-2CD03-0YG0</p>	<p>Article number</p> <p>6ES7677-2WB42-0GB0 CPU1515SP PC2 TF</p>	
<p>WinCC Advanced V17</p> <p>Engineering software in the TIA Portal; in 6 languages: de, en, fr, es, it, zh; for configuring SIMATIC Panels, WinCC Runtime Advanced, WinCC Unified PC Runtime</p> <ul style="list-style-type: none"> Floating license; software and documentation on DVD; license key on USB flash drive Floating license; software, documentation and license key for download ¹⁾; Email address required for delivery 	<p>6AV2102-0AA07-0AA5</p> <p>6AV2102-0AA07-0AH5</p>	<p>General information</p> <p>Product type designation</p> <p>CPU 1515SP PC2 TF</p>	
		<p>Engineering with</p> <ul style="list-style-type: none"> STEP 7 TIA Portal configurable/ integrated from version 	<p>STEP 7 V16 or higher</p>
		<p>Installed software</p> <ul style="list-style-type: none"> Visualization Control 	<p>No</p> <p>S7-1500 Software Controller CPU 1505SP TF</p>
		<p>Processor</p> <p>Processor type</p>	<p>Intel Atom E3940, 1.6 GHz, 4 cores</p>
		<p>Memory</p> <p>Type of memory</p> <p>Main memory</p> <p>CFast memory card</p>	<p>DDR3L</p> <p>8 GB RAM</p> <p>Yes; 128 GB flash memory</p>
		<p>Work memory</p> <ul style="list-style-type: none"> integrated (for program) integrated (for data) integrated (for CPU function library of CPU Runtime) 	<p>1.5 Mbyte</p> <p>5 Mbyte</p> <p>20 Mbyte</p>
		<p>Load memory</p> <ul style="list-style-type: none"> integrated (on PC mass storage) 	<p>320 Mbyte</p>
		<p>CPU processing times</p> <p>for bit operations, typ.</p> <p>for word operations, typ.</p> <p>for fixed point arithmetic, typ.</p> <p>for floating point arithmetic, typ.</p>	<p>10 ns</p> <p>12 ns</p> <p>16 ns</p> <p>64 ns</p>
		<p>Counters, timers and their retentivity</p> <p>S7 counter</p> <ul style="list-style-type: none"> Number 	<p>2 048</p>
		<p>IEC counter</p> <ul style="list-style-type: none"> Number 	<p>Any (only limited by the main memory)</p>
		<p>S7 times</p> <ul style="list-style-type: none"> Number 	<p>2 048</p>
		<p>IEC timer</p> <ul style="list-style-type: none"> Number 	<p>Any (only limited by the main memory)</p>
		<p>Data areas and their retentivity</p> <p>Flag</p> <ul style="list-style-type: none"> Size, max. 	<p>16 kbyte</p>
		<p>Address area</p> <p>I/O address area</p> <ul style="list-style-type: none"> Inputs Outputs 	<p>32 kbyte; All inputs are in the process image</p> <p>32 kbyte; All outputs are in the process image</p>
		<p>Hardware configuration</p> <p>Integrated power supply</p>	<p>Yes</p>
		<p>Time of day</p> <p>Clock</p> <ul style="list-style-type: none"> Type Hardware clock (real-time) 	<p>Hardware clock</p> <p>Yes; Resolution: 1 s</p>
		<p>Interfaces</p> <p>Number of industrial Ethernet interfaces</p> <p>Number of RS 485 interfaces</p> <p>Number of USB interfaces</p> <p>Number of SD card slots</p>	<p>2</p> <p>1; Via CM DP module</p> <p>4; 2x USB 2.0, 2x USB 3.0 on front side</p> <p>1</p>

¹⁾ For up-to-date information and download availability, see: <http://www.siemens.com/tia-online-software-delivery>

Distributed Controllers

based on ET 200SP

ET 200SP Open Controllers

Technology-CPU > CPU 1515SP PC2 TF

Technical specifications

Article number	6ES7677-2WB42-0GB0 CPU1515SP PC2 TF
Video interfaces	
• Graphics interface	1x DisplayPort
1. Interface	
Interface type	PROFINET
automatic detection of transmission rate	Yes
Autonegotiation	Yes
Autocrossing	Yes
Number of connections	88
Interface types	
• RJ 45 (Ethernet)	Yes; Via BusAdapter BA 2x RJ45
- Transmission rate, max.	100 Mbit/s
- Industrial Ethernet status LED	Yes
• Number of ports	2
• integrated switch	Yes
• BusAdapter (PROFINET)	Yes; Compatible BusAdapter: BA 2x RJ45, BA 2x FC, BA 2x SCRJ (from FS03, V2.2), BA SCRJ / RJ45 (from FS03, V3.1), BA SCRJ / FC (from FS03, V3.1), BA 2x LC (from FS03, V3.3), BA LC / RJ45 (from FS03, V3.3), BA LC / FC (from FS03, V3.3)
Protocols	
• PROFINET IO Controller	Yes
• PROFINET IO Device	Yes
• SIMATIC communication	Yes
• Open IE communication	Yes
• Web server	Yes
PROFINET IO Controller	
Services	
- Isochronous mode	Yes
- shortest clock pulse	500 µs
- IRT	Yes
- PROFIenergy	Yes
- Prioritized startup	Yes
- Number of connectable IO Devices, max.	128
- Of which IO devices with IRT, max.	64
- of which in line, max.	64
- Number of connectable IO Devices for RT, max.	128
- of which in line, max.	128
- Number of IO Devices that can be simultaneously activated/deactivated, max.	8
- IO Devices changing during operation (partner ports), supported	Yes
- Number of IO Devices per tool, max.	8
- Updating times	The minimum value of the update time also depends on communication share set for PROFINET IO, on the number of IO devices, and on the quantity of configured user data
Address area	
- Inputs, max.	8 kbyte
- Outputs, max.	8 kbyte

Article number	6ES7677-2WB42-0GB0 CPU1515SP PC2 TF
PROFINET IO Device	
Services	
- Isochronous mode	No
- shortest clock pulse	500 µs
- IRT	Yes
- PROFIenergy	Yes
- Prioritized startup	Yes
- Shared device	Yes
- Number of IO Controllers with shared device, max.	4
- Asset management record	Yes
2. Interface	
Interface type	Integrated Ethernet interface
automatic detection of transmission rate	Yes
Autonegotiation	Yes
Autocrossing	Yes
Interface types	
• RJ 45 (Ethernet)	Yes; Integrated
- Transmission rate, max.	1 000 Mbit/s
- Industrial Ethernet status LED	No
• Number of ports	1
3. Interface	
Interface type	PROFIBUS with CM DP
Number of connections	44
Interface types	
• RS 485	Yes
Protocols	
• PROFIBUS DP master	Yes
• PROFIBUS DP slave	Yes
• SIMATIC communication	Yes
PROFIBUS DP master	
• Number of DP slaves, max.	125
Services	
- Equidistance	No
- Isochronous mode	No
Address area	
- Inputs, max.	8 kbyte
- Outputs, max.	8 kbyte
Protocols	
Number of connections	
• Number of connections, max.	88
Redundancy mode	
Media redundancy	
- Switchover time on line break, typ.	200 ms
- Number of stations in the ring, max.	50
SIMATIC communication	
• S7 routing	Yes
OPC UA	
• OPC UA Client	Yes; From SW CPU 1505SP V2.6
• OPC UA Server	Yes; Data access (read, write, subscribe), runtime license required

Technical specifications

Article number	6ES7677-2WB42-0GB0 CPU1515SP PC2 TF
Supported technology objects	
Motion Control	Yes
• Number of available Motion Control resources for technology objects	2 400
• Required Motion Control resources	
- per speed-controlled axis	40; per axis
- per positioning axis	80; per axis
- per synchronous axis	160; per axis
- per external encoder	80; per external encoder
- per output cam	20; per cam
- per cam track	160; per cam track
- per probe	40; per probe
• Number of available Extended Motion Control resources for technology objects	120
• Required Extended Motion Control resources	
- per cam (1 000 points and 50 segments)	2
- for each set of kinematics	30
- Per leading axis proxy	3
Controller	
• PID_Compact	Yes; Universal PID controller with integrated optimization
• PID_3Step	Yes; PID controller with integrated optimization for valves
• PID-Temp	Yes; PID controller with integrated optimization for temperature
Counting and measuring	
• High-speed counter	Yes
Standards, approvals, certificates	
Highest safety class achievable in safety mode	
• Performance level according to ISO 13849-1	PLe
• SIL acc. to IEC 61508	SIL 3
Probability of failure (for service life of 20 years and repair time of 100 hours)	
- Low demand mode: PFDavg in accordance with SIL3	< 2.00E-05
- High demand/continuous mode: PFH in accordance with SIL3	< 1.00E-09 1/h
Ambient conditions	
Ambient temperature during operation	
• min.	-20 °C
• max.	Up to 60 °C with max. 32 ET 200SP modules; up to 55 °C with max. 64 ET 200SP modules
• horizontal installation, min.	-20 °C
• horizontal installation, max.	60 °C
• vertical installation, min.	-20 °C
• vertical installation, max.	50 °C; With max. 32 ET 200SP modules

Article number	6ES7677-2WB42-0GB0 CPU1515SP PC2 TF
Operating systems	
pre-installed operating system	Windows 10 IoT Enterprise 2016 LTSB, 64bit, MUI
Configuration	
Programming	
Programming language	
- LAD	Yes; incl. failsafe
- FBD	Yes; incl. failsafe
- STL	Yes
- SCL	Yes
- CFC	No
- GRAPH	Yes
Know-how protection	
• User program protection/ password protection	Yes
• Copy protection	Yes
• Block protection	Yes
Access protection	
• Protection level: Write protection	Yes
• Protection level: Read/write protection	Yes
• Protection level: Complete protection	Yes
Open Development interfaces	
• Size of ODK SO file, max.	5.8 Mbyte
Peripherals/Options	
SD card	Optionally for additional mass storage
Dimensions	
Width	160 mm
Height	117 mm
Depth	75 mm
Weights	
Weight, approx.	0.83 kg

Distributed Controllers

based on ET 200SP

SIPLUS ET 200SP Open Controllers

SIPLUS standard CPUs > SIPLUS CPU 1515SP PC2

Overview



SIPLUS ET 200SP Open Controller, SIPLUS CPU 1515SP PC2, combines robustness and compact dimensions with the flexibility of centralized or decentralized communication in the highest industrial functionality. Furthermore, the CPU offers the entire value added of the SIPLUS ET 200SP system, the SIPLUS S7-1500 controller family and the TIA world together.

- Rugged, compact control system
- Combines the functions of a SIPLUS ET 200SP controller with those of a PC-based platform
- Turnkey all-in-one controller
- High performance automation tasks with the use of new generation Intel Quad Core processors
- Connects high-level language applications and processes high data volumes with support from SIMATIC ODK 1500S

Note

SIPLUS extreme products are based on SIMATIC standard products. The contents listed here were adopted from the respective standard products. SIPLUS extreme-specific information was added.

Ordering data

Article No.

SIPLUS ET 200SP Open Controller CPU 1515SP PC2

SIPLUS ET 200SP CPU with Windows 10 IoT Enterprise 64-bit and pre-installed SIMATIC S7-1500 Software Controller; 8 GB RAM, 30 GB CFast card

Type of delivery:
English, German, Chinese, Italian, French, Spanish

- SIPLUS ET 200SP CPU 1515SP PC2

For areas with exceptional exposure to environmental substances (conformal coating); ambient temperature -40 ... +60 °C

- SIPLUS ET 200SP CPU 1515SP PC2 Spare

Spare part, without CFast card

- SIPLUS ET 200SP CPU 1515SP PC2 L

8 GB RAM, 128 GB CFast card, Ready4Linux,

For areas with exceptional exposure to environmental substances (conformal coating); ambient temperature -40 ... +60 °C

Accessories

BusAdapter BA 2xRJ45

(Extended temperature range and exposure to environmental substances)

SIPLUS BA 2xFC BusAdapter

(Extended temperature range and exposure to environmental substances)

BusAdapter BA 2xSCRJ

(Extended temperature range and exposure to environmental substances)

BusAdapter BA 2xLC

(Extended temperature range and exposure to environmental substances)

SIPLUS Mounting Kit ET 200SP

Mounting accessories for use with increased mechanical vibration and shock loads. Not approved for SIPLUS BusAdapter BA 2xRJ45

Other accessories

6AG1677-2DB42-2GB0

6AG1677-2DB40-2AA0

6AG1677-2DB40-2GB0

6AG1193-6AR00-7AA0

6AG1193-6AF00-7AA0

6AG1193-6AP00-2AA0

6AG1193-6AG00-2AA0

6AG1193-6AA00-0AA0

See SIMATIC CPU 1515SP PC2, page 7/26

7

Technical specifications

Article number	6AG1677-2DB42-2GB0	6AG1677-2DB40-2AA0	6AG1677-2DB40-2GB0
Based on	6ES7677-2DB42-0GB0	6ES7677-2DB40-0AA0	6ES7677-2DB40-0GB0
	SIPLUS ET 200SP CPU 1515SP PC2	SIPLUS ET 200SP CPU 1515SP PC2	SIPLUS ET 200SP CPU 1515SP PC2 L
Ambient conditions			
Ambient temperature during operation			
• min.	-40 °C; = Tmin	-40 °C; = Tmin	-40 °C; = Tmin
• max.	Up to 60 °C with max. 32 ET 200SP modules; up to 55 °C with max. 64 ET 200SP modules	Up to 60 °C with max. 32 ET 200SP modules; up to 55 °C with max. 64 ET 200SP modules	Up to 60 °C with max. 32 ET 200SP modules; up to 55 °C with max. 64 ET 200SP modules
• horizontal installation, min.	-40 °C; = Tmin (incl. condensation/frost)	-40 °C; = Tmin (incl. condensation/frost)	-40 °C; = Tmin (incl. condensation/frost)
• horizontal installation, max.	60 °C; = Tmax	60 °C; = Tmax	60 °C; = Tmax
• vertical installation, min.	-40 °C; = Tmin	-40 °C; = Tmin	-40 °C; = Tmin
• vertical installation, max.	50 °C; = Tmax; with max. 32 ET 200SP modules	50 °C; = Tmax; with max. 32 ET 200SP modules	50 °C; = Tmax; with max. 32 ET 200SP modules
Altitude during operation relating to sea level			
• Installation altitude above sea level, max.	2 000 m	2 000 m	2 000 m
• Ambient air temperature-barometric pressure-altitude	Tmin ... Tmax at 1 140 hPa ... 795 hPa (-1 000 m ... +2 000 m)	Tmin ... Tmax at 1 140 hPa ... 795 hPa (-1 000 m ... +2 000 m)	Tmin ... Tmax at 1 140 hPa ... 795 hPa (-1 000 m ... +2 000 m)
Relative humidity			
• With condensation, tested in accordance with IEC 60068-2-38, max.	100 %; RH incl. condensation / frost (no commissioning in bedewed state), horizontal installation	100 %; RH incl. condensation / frost (no commissioning in bedewed state), horizontal installation	100 %; RH incl. condensation / frost (no commissioning in bedewed state), horizontal installation
Resistance			
Coolants and lubricants			
- Resistant to commercially available coolants and lubricants	Yes; Incl. diesel and oil droplets in the air	Yes; Incl. diesel and oil droplets in the air	Yes; Incl. diesel and oil droplets in the air
Use in stationary industrial systems			
- to biologically active substances according to EN 60721-3-3	Yes; Class 3B2 mold, fungus and dry rot spores (with the exception of fauna); Class 3B3 on request	Yes; Class 3B2 mold, fungus and dry rot spores (with the exception of fauna); Class 3B3 on request	Yes; Class 3B2 mold, fungus and dry rot spores (with the exception of fauna); Class 3B3 on request
- to chemically active substances according to EN 60721-3-3	Yes; Class 3C4 (RH < 75 %) incl. salt spray acc. to EN 60068-2-52 (severity degree 3); *	Yes; Class 3C4 (RH < 75 %) incl. salt spray acc. to EN 60068-2-52 (severity degree 3); *	Yes; Class 3C4 (RH < 75 %) incl. salt spray acc. to EN 60068-2-52 (severity degree 3); *
- to mechanically active substances according to EN 60721-3-3	Yes; Class 3S4 incl. sand, dust, *	Yes; Class 3S4 incl. sand, dust, *	Yes; Class 3S4 incl. sand, dust, *
- Against mechanical environmental conditions acc. to EN 60721-3-3	Yes; Class 3M8 using the SIPLUS Mounting Kit ET 200SP (6AG1193-6AA00-0AA0)	Yes; Class 3M8 using the SIPLUS Mounting Kit ET 200SP (6AG1193-6AA00-0AA0)	Yes; Class 3M8 using the SIPLUS Mounting Kit ET 200SP (6AG1193-6AA00-0AA0)
Use on ships/at sea			
- to biologically active substances according to EN 60721-3-6	Yes; Class 6B2 mold, fungal and dry rot spores (excluding fauna)	Yes; Class 6B2 mold, fungal and dry rot spores (excluding fauna)	Yes; Class 6B2 mold, fungal and dry rot spores (excluding fauna)
- to chemically active substances according to EN 60721-3-6	Yes; Class 6C3 (RH < 75 %) incl. salt spray acc. to EN 60068-2-52 (severity degree 3); *	Yes; Class 6C3 (RH < 75 %) incl. salt spray acc. to EN 60068-2-52 (severity degree 3); *	Yes; Class 6C3 (RH < 75 %) incl. salt spray acc. to EN 60068-2-52 (severity degree 3); *
- to mechanically active substances according to EN 60721-3-6	Yes; Class 6S3 incl. sand, dust; *	Yes; Class 6S3 incl. sand, dust; *	Yes; Class 6S3 incl. sand, dust; *
- Against mechanical environmental conditions acc. to EN 60721-3-6	Yes; Class 6M4 using the SIPLUS Mounting Kit ET 200SP (6AG1193-6AA00-0AA0)	Yes; Class 6M4 using the SIPLUS Mounting Kit ET 200SP (6AG1193-6AA00-0AA0)	Yes; Class 6M4 using the SIPLUS Mounting Kit ET 200SP (6AG1193-6AA00-0AA0)
Usage in industrial process technology			
- Against chemically active substances acc. to EN 60654-4	Yes; Class 3 (excluding trichlorethylene)	Yes; Class 3 (excluding trichlorethylene)	Yes; Class 3 (excluding trichlorethylene)
- Environmental conditions for process, measuring and control systems acc. to ANSI/ISA-71.04	Yes; Level GX group A/B (excluding trichlorethylene; harmful gas concentrations up to the limits of EN 60721-3-3 class 3C4 permissible); level LC3 (salt spray) and level LB3 (oil)	Yes; Level GX group A/B (excluding trichlorethylene; harmful gas concentrations up to the limits of EN 60721-3-3 class 3C4 permissible); level LC3 (salt spray) and level LB3 (oil)	Yes; Level GX group A/B (excluding trichlorethylene; harmful gas concentrations up to the limits of EN 60721-3-3 class 3C4 permissible); level LC3 (salt spray) and level LB3 (oil)
Remark			
- Note regarding classification of environmental conditions acc. to EN 60721, EN 60654-4 and ANSI/ISA-71.04	* The supplied plug covers must remain in place over the unused interfaces during operation!	* The supplied plug covers must remain in place over the unused interfaces during operation!	* The supplied plug covers must remain in place over the unused interfaces during operation!

Distributed Controllers

based on ET 200SP

SIPLUS ET 200SP Open Controllers

SIPLUS standard CPUs > SIPLUS CPU 1515SP PC2

Technical specifications

Article number	6AG1677-2DB42-2GB0	6AG1677-2DB40-2AA0	6AG1677-2DB40-2GB0
Based on	6ES7677-2DB42-0GB0	6ES7677-2DB40-0AA0	6ES7677-2DB40-0GB0
	SIPLUS ET 200SP CPU 1515SP PC2	SIPLUS ET 200SP CPU 1515SP PC2	SIPLUS ET 200SP CPU 1515SP PC2 L
Conformal coating			
• Coatings for printed circuit board assemblies acc. to EN 61086	Yes; Class 2 for high reliability	Yes; Class 2 for high reliability	Yes; Class 2 for high reliability
• Protection against fouling acc. to EN 60664-3	Yes; Type 1 protection	Yes; Type 1 protection	Yes; Type 1 protection
• Military testing according to MIL-I-46058C, Amendment 7	Yes; Discoloration of coating possible during service life	Yes; Discoloration of coating possible during service life	Yes; Discoloration of coating possible during service life
• Qualification and Performance of Electrical Insulating Compound for Printed Board Assemblies according to IPC-CC-830A	Yes; Conformal coating, Class A	Yes; Conformal coating, Class A	Yes; Conformal coating, Class A

Overview

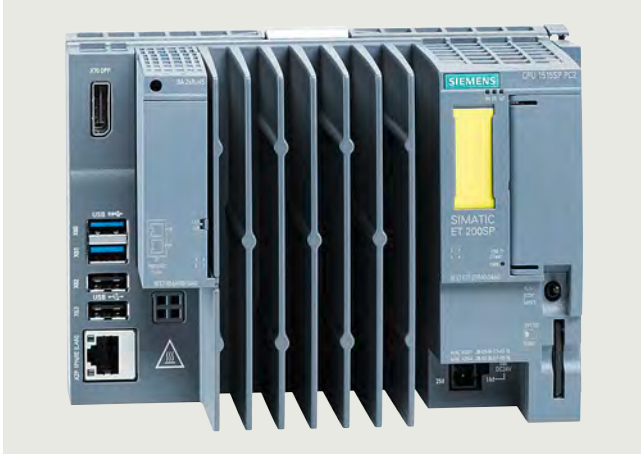

SIPLUS ET 200SP Open Controller, SIPLUS CPU 1515SP PC2 F, combines robustness and compact dimensions with the flexibility of centralized or decentralized communication in the highest industrial functionality. Furthermore, the CPU offers the entire value added of the SIPLUS ET 200SP system, the SIPLUS S7-1500 controller family and the TIA world together.

- Rugged, compact control system
- Combines the functions of a SIPLUS ET 200SP controller with those of a PC-based platform
- Turnkey all-in-one controller
- Can be used up to safety class SIL3 (Safety Integrity Level) according to IEC 61508 2nd Edition or PL e (Performance Level) according to ISO 13849
- High performance automation tasks with the use of new generation Intel Quad Core processors
- Connects high-level language applications and processes high data volumes with support from SIMATIC ODK 1500S

Note

SIPLUS extreme products are based on SIMATIC standard products. The contents listed here were taken from the respective standard products. SIPLUS extreme-specific information was added.

Ordering data

Article No.

SIPLUS ET 200SP Open Controller CPU 1515SP PC2 F

(Extended temperature range and exposure to environmental substances)

Fail-safe ET 200SP CPU with Windows 10 IoT Enterprise 64-bit and pre-installed SIMATIC S7-1500 Failsafe Software Controller (with WinCC RT Advanced option); 8 GB RAM, 30 GB CFast card;

Type of delivery:
English, German, Chinese, Italian, French, Spanish

- SIPLUS CPU 1515SP PC2 F

6AG1677-2SB42-2GB0

Accessories

BusAdapter BA 2xRJ45

(Extended temperature range and exposure to environmental substances)

6AG1193-6AR00-7AA0

SIPLUS BusAdapter BA 2xFC

(Extended temperature range and exposure to environmental substances)

6AG1193-6AF00-7AA0

BusAdapter BA 2xSCRJ

(Extended temperature range and exposure to environmental substances)

6AG1193-6AP00-2AA0

BusAdapter BA 2xLC

(Extended temperature range and exposure to environmental substances)

6AG1193-6AG00-2AA0

SIPLUS Mounting Kit ET 200SP

Mounting accessories for use with increased mechanical vibration and shock loads. Not approved for SIPLUS BusAdapter BA 2xRJ45

6AG1193-6AA00-0AA0

Other accessories

See SIMATIC CPU 1515SP PC2 F, page 7/30

Distributed Controllers

based on ET 200SP

SIPLUS ET 200SP Open Controllers

SIPLUS fail-safe CPUs > SIPLUS CPU 1515SP PC2 F

Technical specifications

Article number	6AG1677-2SB42-2GB0
Based on	6ES7677-2SB42-0GB0 SIPLUS ET 200SP CPU 1515SP PC2 F
Ambient conditions	
Ambient temperature during operation	
• min.	-40 °C; = Tmin
• max.	Up to 60 °C with max. 32 ET 200SP modules; up to 55 °C with max. 64 ET 200SP modules
• horizontal installation, min.	-40 °C; = Tmin (incl. condensation/frost)
• horizontal installation, max.	60 °C; = Tmax
• vertical installation, min.	-40 °C; = Tmin
• vertical installation, max.	50 °C; = Tmax; with max. 32 ET 200SP modules
Altitude during operation relating to sea level	
• Installation altitude above sea level, max.	2 000 m
• Ambient air temperature-barometric pressure-altitude	Tmin ... Tmax at 1 140 hPa ... 795 hPa (-1 000 m ... +2 000 m)
Relative humidity	
• With condensation, tested in accordance with IEC 60068-2-38, max.	100 %; RH incl. condensation / frost (no commissioning in bedewed state), horizontal installation
Resistance	
Coolants and lubricants	
- Resistant to commercially available coolants and lubricants	Yes; Incl. diesel and oil droplets in the air
Use in stationary industrial systems	
- to biologically active substances according to EN 60721-3-3	Yes; Class 3B2 mold, fungus and dry rot spores (with the exception of fauna); Class 3B3 on request
- to chemically active substances according to EN 60721-3-3	Yes; Class 3C4 (RH < 75 %) incl. salt spray acc. to EN 60068-2-52 (severity degree 3); *
- to mechanically active substances according to EN 60721-3-3	Yes; Class 3S4 incl. sand, dust, *
- Against mechanical environmental conditions acc. to EN 60721-3-3	Yes; Class 3M8 using the SIPLUS Mounting Kit ET 200SP (6AG1193-6AA00-0AA0)

Article number	6AG1677-2SB42-2GB0
Based on	6ES7677-2SB42-0GB0 SIPLUS ET 200SP CPU 1515SP PC2 F
Use on ships/at sea	
- to biologically active substances according to EN 60721-3-6	Yes; Class 6B2 mold, fungal and dry rot spores (excluding fauna)
- to chemically active substances according to EN 60721-3-6	Yes; Class 6C3 (RH < 75 %) incl. salt spray acc. to EN 60068-2-52 (severity degree 3); *
- to mechanically active substances according to EN 60721-3-6	Yes; Class 6S3 incl. sand, dust; *
- Against mechanical environmental conditions acc. to EN 60721-3-6	Yes; Class 6M4 using the SIPLUS Mounting Kit ET 200SP (6AG1193-6AA00-0AA0)
Usage in industrial process technology	
- Against chemically active substances acc. to EN 60654-4	Yes; Class 3 (excluding trichlorethylene)
- Environmental conditions for process, measuring and control systems acc. to ANSI/ISA-71.04	Yes; Level GX group A/B (excluding trichlorethylene; harmful gas concentrations up to the limits of EN 60721-3-3 class 3C4 permissible); level LC3 (salt spray) and level LB3 (oil)
Remark	
- Note regarding classification of environmental conditions acc. to EN 60721, EN 60654-4 and ANSI/ISA-71.04	* The supplied plug covers must remain in place over the unused interfaces during operation!
Conformal coating	
• Coatings for printed circuit board assemblies acc. to EN 61086	Yes; Class 2 for high reliability
• Protection against fouling acc. to EN 60664-3	Yes; Type 1 protection
• Military testing according to MIL-I-46058C, Amendment 7	Yes; Discoloration of coating possible during service life
• Qualification and Performance of Electrical Insulating Compound for Printed Board Assemblies according to IPC-CC-830A	Yes; Conformal coating, Class A

7

Overview

- CPU with PLC functionality equivalent to S7-315-2 PN/DP provides distributed intelligence for preprocessing
- Interface module for exchanging pre-processed I/O data between the ET 200pro and a higher-level master/IO controller via PROFIBUS DP/PROFINET IO
- PROFINET IO controller for operating distributed I/O on PROFINET
- Component-based Automation (CBA) on PROFINET
- PROFINET proxy for intelligent devices on PROFIBUS DP in Component-based Automation (CBA)
- PROFINET interface with 3-port switch
- Isochronous mode on PROFIBUS or PROFINET
- Integrated web server with the option of creating user-defined web pages
- CPU with PLC functionality equivalent to S7-315-2 PN/DP provides distributed intelligence for preprocessing
- Fast, simple and end-to-end programming of a system with modular programs via STEP 7
- Fail-safe IM 154-8F PN/DP CPU PROFIsafe available

Note

SIMATIC Micro Memory Card required for operation of CPU.

7

Ordering data	Article No.		Article No.
IM 154-8 PN/DP CPU interface module, V3.2 PROFINET IO controller for operating distributed I/Os on PROFINET, with integrated PLC functionality.	6ES7154-8AB01-0AB0	Industrial Ethernet FC RJ45 plug 180 RJ45 plug connector for Industrial Ethernet with a rugged metal enclosure and integrated insulation displacement contacts for connecting Industrial Ethernet FC installation cables; with 180° cable outlet	
Accessories		<ul style="list-style-type: none"> • 1 unit • 10 units • 50 units 	6GK1901-1BB10-2AA0 6GK1901-1BB10-2AB0 6GK1901-1BB10-2AE0
MMC 64 KB ¹⁾ For program backup.	6ES7953-8LF31-0AA0	Industrial Ethernet FastConnect installation cables <ul style="list-style-type: none"> • FastConnect standard cable • FastConnect trailing cable • FastConnect marine cable 	6XV1840-2AH10 6XV1840-3AH10 6XV1840-4AH10
MMC 128 KB ¹⁾ For program backup.	6ES7953-8LG31-0AA0	Industrial Ethernet FastConnect installation cables <ul style="list-style-type: none"> • IE FC TP trailing cable GP 2 x 2; sold by the meter, max. delivery unit 1 000 m; minimum order quantity 20 m. • IE TP torsion cable GP 2 x 2; sold by the meter, max. delivery unit 1 000 m; minimum order quantity 20 m. 	6XV1870-2D 6XV1870-2F
MMC 512 KB ¹⁾ For program backup.	6ES7953-8LJ31-0AA0	Industrial Ethernet FastConnect Stripping tool	6GK1901-1GA00
MMC 2 MB ¹⁾ For program backup and/or firmware updates.	6ES7953-8LL31-0AA0		
MMC 4 MB ¹⁾ For program backup.	6ES7953-8LM32-0AA0		
MMC 8 MB ¹⁾ For program backup.	6ES7953-8LP31-0AA0		
Connection module For CPU IM154-8 PN/DP, with 4 x M12 and 2 x 7/8", for connecting PROFINET and PROFIBUS DP.	6ES7194-4AN00-0AA0		

¹⁾ An MMC is essential for operating the CPU

Distributed Controllers

based on ET 200pro
Standard CPUs

IM 154-8 PN/DP CPU

Ordering data

Article No.

Article No.

IE connecting cable M12-180/M12-180

- Pre-assembled IE FC TP trailing cable GP 2 x 2 (PROFINET Type C) with two 4-pin M12 plugs (4-pin, D-coded), degree of protection IP65/IP67, in various lengths:
 - 0.3 m
 - 0.5 m
 - 1.0 m
 - 1.5 m
 - 2.0 m
 - 3.0 m
 - 5.0 m
 - 10 m
 - 15 m
- PROFINET M12 trailing connecting cable, pre-assembled at both ends with angled M12 plugs (pin), in various lengths:
 - 3.0 m
 - 5.0 m
 - 10 m
- PROFINET M12 trailing connecting cable, pre-assembled at one end with angled M12 plug (pin at one end, other end open), in various lengths:
 - 3.0 m
 - 5.0 m
 - 10 m

6XV1870-8AE30
6XV1870-8AE50
6XV1870-8AH10
6XV1870-8AH15
6XV1870-8AH20
6XV1870-8AH30
6XV1870-8AH50
6XV1870-8AN10
6XV1870-8AN15

3RK1902-2NB30
3RK1902-2NB50
3RK1902-2NC10

3RK1902-2HB30
3RK1902-2HB50
3RK1902-2HC10

IE FC M12 plug PRO

PROFINET M12 plug connector, D-coded with fast connection system, axial cable outlet.

- 1 unit
- 8 units
- PROFINET M12 plug connector, D-coded, angled.

6GK1901-0DB20-6AA0
6GK1901-0DB20-6AA8
3RK1902-2DA00

IE panel feedthrough

Cabinet feed-through for converting from the M12 connection system (D-coded, IP65/IP67) to the RJ45 connection system (IP20), 1 pack = 5 units.

6GK1901-0DM20-2AA5

7/8" connecting cable to power supply

- 5-wire, 5 x 1.5 mm², trailing, pre-assembled with two 7/8" plugs (axial cable outlet), 5-pin, up to 50 m, in various lengths:
 - 1.5 m
 - 2.0 m
 - 3.0 m
 - 5.0 m
 - 10 m
 - 15 m
 - Other special lengths with 90° or 180° cable outlet.
- Trailing power cable, 5 x 1.5 mm², pre-assembled at both ends with 7/8" angled connectors (socket at one end, pin at the other end), in various lengths:
 - 3.0 m
 - 5.0 m
 - 10 m
- Trailing power cable, 5 x 1.5 mm², pre-assembled at one end with 7/8" angled connector with female contact insert (socket at one end, other end open), in various lengths:
 - 3.0 m
 - 5.0 m
 - 10 m

6XV1822-5BH15
6XV1822-5BH20
6XV1822-5BH30
6XV1822-5BH50
6XV1822-5BN10
6XV1822-5BN15

See:
<http://support.automation.siemens.com/WWW/view/en/26999294>

3RK1902-3NB30
3RK1902-3NB50
3RK1902-3NC10

3RK1902-3GB30
3RK1902-3GB50
3RK1902-3GC10

Power line

5-wire, 5 x 1.5 mm², trailing type, sold by the meter, minimum order quantity 20 m, maximum order quantity 1 000 m.

6XV1830-8AH10

7/8" connection plug

For ET 200eco, with axial cable outlet

- With male contact insert, 5-pack
- With female contact insert, 5-pack
- Angled, with female contact insert, 1 unit
- Angled, with male contact insert, 1 unit

6GK1905-0FA00
6GK1905-0FB00
3RK1902-3DA00
3RK1902-3BA00

7/8" cover cap, 10 per pack

6ES7194-3JA00-0AA0

Twisted pair cables 4x2 with RJ45 plugs

0.5 m
1 m
2 m
6 m
10 m

6XV1870-3QE50
6XV1870-3QH10
6XV1870-3QH20
6XV1870-3QH60
6XV1870-3QN10

Crossed twisted pair cables 4x2 with RJ45 plugs

0.5 m
1 m
2 m
6 m
10 m

6XV1870-3RE50
6XV1870-3RH10
6XV1870-3RH20
6XV1870-3RH60
6XV1870-3RN10

Ordering data	Article No.	Ordering data	Article No.
M12 sealing cap For protection of unused M12 connections with ET 200pro	3RX9802-0AA00	PROFIBUS FC standard cable GP Standard type with special design for quick mounting, 2-wire, shielded. Sold by the meter; max. delivery unit 1 000 m, minimum order quantity 20 m.	6XV1830-0EH10
M12 sealing caps with female thread 5 units	6ES7194-4JD60-0AA0	PROFIBUS FC trailing cable 2-wire, shielded.	6XV1830-3EH10
PROFIBUS M12 connecting cable Pre-assembled, with two 5-pin M12 plugs/sockets, up to 100 m, in various lengths: 1.5 m 2.0 m 3.0 m 5.0 m 10 m 15 m Other special lengths with 90° or 180° cable outlet	6XV1830-3DH15 6XV1830-3DH20 6XV1830-3DH30 6XV1830-3DH50 6XV1830-3DN10 6XV1830-3DN15 See http://support.automation.siemens.com/WWW/view/en/26999294	PROFIBUS FC food cable 2-wire, shielded. Sold by the meter; max. delivery unit 1 000 m, minimum order quantity 20 m.	6XV1830-0GH10
M12 bus termination connector for PROFIBUS, female contact insert	6GK1905-0ED00	PROFIBUS FC robust cable 2-wire, shielded Sold by the meter; max. delivery unit 1 000 m, minimum order quantity 20 m.	6XV1830-0JH10
M12 bus termination connector for PROFIBUS, male contact insert	6GK1905-0EC00	PROFIBUS M12 connection plug 5-pin, B-coded, metal housing, 1 pack = 5 units. • Female contact insert	6GK1905-0EB00
M12 plug connector, axial outlet, with male contact insert	6GK1905-0EA00		

Technical specifications

Article number	6ES7154-8AB01-0AB0 ET 200pro: IM 154-8 PN/DP CPU, 384KB
General information	
Product function	
• Isochronous mode	Yes; Via PROFIBUS DP or PROFINET interface
Supply voltage	
Rated value (DC)	24 V
Memory	
Work memory	
• integrated	384 kbyte
• expandable	No
Load memory	
• Plug-in (MMC), max.	8 Mbyte
CPU processing times	
for bit operations, typ.	0.05 µs
for word operations, typ.	0.09 µs
for fixed point arithmetic, typ.	0.12 µs
for floating point arithmetic, typ.	0.45 µs
Counters, timers and their retentivity	
S7 counter	
• Number	256
IEC counter	
• present	Yes
S7 times	
• Number	256
IEC timer	
• present	Yes

Article number	6ES7154-8AB01-0AB0 ET 200pro: IM 154-8 PN/DP CPU, 384KB
Data areas and their retentivity	
Flag	
• Size, max.	2 048 byte
Address area	
I/O address area	
• Inputs	2 048 byte
• Outputs	2 048 byte
Process image	
• Inputs, adjustable	2 048 byte
• Outputs, adjustable	2 048 byte
Time of day	
Clock	
• Hardware clock (real-time)	Yes
Operating hours counter	
• Number	1
Interfaces	
Interfaces/bus type	1x MPI/PROFIBUS DP, 1x PROFINET (3 ports)
1. Interface	
Interface type	Integrated RS 485 interface
Interface types	
• RS 485	Yes
Protocols	
• MPI	Yes
• PROFIBUS DP master	Yes
• PROFIBUS DP slave	Yes
• Point-to-point connection	No
PROFIBUS DP master	
• Number of DP slaves, max.	124

Distributed Controllers

based on ET 200pro
Standard CPUs

IM 154-8 PN/DP CPU

Technical specifications

Article number	6ES7154-8AB01-0AB0 ET 200pro: IM 154-8 PN/DP CPU, 384KB
2. Interface	
Interface type	PROFINET
Interface types	
• Number of ports	3
Protocols	
• MPI	No
• PROFINET IO Controller	Yes; Also simultaneously with IO-Device functionality
• PROFINET IO Device	Yes; Also simultaneously with IO Controller functionality
• PROFINET CBA	Yes
• PROFIBUS DP master	No
• PROFIBUS DP slave	No
PROFINET IO Controller	
Services	
- Number of connectable IO Devices, max.	128
- Of which IO devices with IRT, max.	64
- Number of IO Devices with IRT and the option "high flexibility"	128
- Number of connectable IO Devices for RT, max.	128
Protocols	
SIMATIC communication	
• S7 routing	Yes
Open IE communication	
• TCP/IP	Yes; via integrated PROFINET interface and loadable FBs
- Number of connections, max.	8
• ISO-on-TCP (RFC1006)	Yes
- Number of connections, max.	8
• UDP	Yes
- Number of connections, max.	8
Web server	
• supported	Yes

Article number	6ES7154-8AB01-0AB0 ET 200pro: IM 154-8 PN/DP CPU, 384KB
Communication functions	
PG/OP communication	Yes
Global data communication	
• supported	Yes
S7 basic communication	
• supported	Yes
S7 communication	
• supported	Yes
Number of connections	
• overall	16
Degree and class of protection	
IP degree of protection	IP65/67
Configuration	
Programming	
Programming language	
- LAD	Yes
- FBD	Yes
- STL	Yes
- SCL	Yes
- CFC	Yes
- GRAPH	Yes
- HiGraph®	Yes
Know-how protection	
• User program protection/ password protection	Yes
• Block encryption	Yes; With S7 block Privacy
Dimensions	
Width	135 mm
Height	130 mm
Depth	65 mm; 60 mm without cover for RJ45 socket; 65 mm with cover for RJ45 socket
Weights	
Weight, approx.	720 g

7

Overview



- CPU 1513pro-2 PN for SIMATIC ET 200pro based on S7-1500 CPU 1513-1 PN
- For applications with medium requirements on the program scope and processing speed, for distributed setup via PROFINET IO.
- PROFINET IO controller for operating distributed I/O on PROFINET
- PROFINET I-Device for connecting the CPU as an intelligent PROFINET device with a SIMATIC or non-Siemens PROFINET IO controller
- PROFINET shared I-Device for 4 controllers
- PROFINET IO RT/IRT interface with integrated 3-port switch
- Additional PROFINET IO RT interface with separate IP address
- Isochronous mode on PROFINET
- Integrated motion control functionalities for controlling speed-controlled and positioning axes, support for external encoders, output cams/cam tracks and probes
- OPC UA server and client (data access) as runtime option for the easy connection of SIMATIC ET 200pro to non-Siemens devices/systems
- Integrated web server with the option of creating user-defined web pages

Note

SIMATIC Memory Card required for operation of the CPU.

Ordering data

Article No.

CPU 1513pro-2 PN**6ES7513-2PL00-0AB0**

300 KB work memory for program, 1.5 MB for data, PROFINET IO IRT interface, PROFINET IO RT interface, SIMATIC Memory Card required

Accessories**SIMATIC Memory Card**4 MB¹⁾**6ES7954-8LC03-0AA0**12 MB¹⁾**6ES7954-8LE03-0AA0**24 MB¹⁾**6ES7954-8LF03-0AA0**256 MB¹⁾**6ES7954-8LL03-0AA0**2 GB¹⁾**6ES7954-8LP03-0AA0**32 GB¹⁾**6ES7954-8LT03-0AA0****Connection module****6ES7194-4AP00-0AA0**

CM CPU 2PN M12 / 7/8";
With 3 x M12 and 2 x 7/8", for connecting 2 x PROFINET

Industrial Ethernet FC RJ45 plug 180

RJ45 plug connector for Industrial Ethernet with a rugged metal enclosure and integrated insulation displacement contacts for connecting Industrial Ethernet FC installation cables; with 180° cable outlet

- 1 unit
- 10 units
- 50 units

6GK1901-1BB10-2AA0
6GK1901-1BB10-2AB0
6GK1901-1BB10-2AE0

Industrial Ethernet FastConnect installation cables

- FastConnect standard cable
- FastConnect trailing cable
- FastConnect marine cable

6XV1840-2AH10
6XV1840-3AH10
6XV1840-4AH10

Industrial Ethernet FastConnect installation cables

- IE FC TP trailing cable GP 2 x 2; sold by the meter, max. delivery unit 1 000 m; minimum order quantity 20 m.
- IE TP torsion cable GP 2 x 2; sold by the meter, max. delivery unit 1 000 m; minimum order quantity 20 m.

6XV1870-2D**6XV1870-2F****Industrial Ethernet FastConnect**

Stripping tool

6GK1901-1GA00

¹⁾ An MMC is essential for operating the CPU

Distributed Controllers

based on ET 200pro
Standard CPUs

CPU 1513pro-2 PN

Ordering data

Article No.

Article No.

IE connecting cable M12-180/M12-180

- Pre-assembled
IE FC TP trailing cable GP 2 x 2 (PROFINET type C) with two 4-pin M12 plugs (D-coded), degree of protection IP65/IP67, in various lengths:
 - 0.3 m
 - 0.5 m
 - 1.0 m
 - 1.5 m
 - 2.0 m
 - 3.0 m
 - 5.0 m
 - 10 m
 - 15 m
- PROFINET M12 trailing connecting cable, pre-assembled at both ends with angled M12 plugs (male contact insert), in various lengths:
 - 3.0 m
 - 5.0 m
 - 10 m
- PROFINET M12 trailing connecting cable, pre-assembled at one end with angled M12 plug (male contact insert at one end, other end open), in various lengths:
 - 3.0 m
 - 5.0 m
 - 10 m

6XV1870-8AE30
6XV1870-8AE50
6XV1870-8AH10
6XV1870-8AH15
6XV1870-8AH20
6XV1870-8AH30
6XV1870-8AH50
6XV1870-8AN10
6XV1870-8AN15

3RK1902-2NB30
3RK1902-2NB50
3RK1902-2NC10

3RK1902-2HB30
3RK1902-2HB50
3RK1902-2HC10

IE FC M12 plug PRO

PROFINET M12 plug connector, D-coded with fast connection system, axial cable outlet.

- 1 unit
- 8 units
- PROFINET M12 plug connector, D-coded, angled.

6GK1901-0DB20-6AA0
6GK1901-0DB20-6AA8
3RK1902-2DA00

IE panel feedthrough

Cabinet feedthrough for converting from the M12 connection system (D-coded, IP65/IP67) to the RJ45 connection system (IP20), 1 pack = 5 units.

6GK1901-0DM20-2AA5

7/8" connecting cable to power supply

- 5-wire, 5 x 1.5 mm², trailing, pre-assembled with two 7/8" plugs (axial cable outlet), 5-pin, up to 50 m, in various lengths:
 - 1.5 m
 - 2.0 m
 - 3.0 m
 - 5.0 m
 - 10 m
 - 15 m
- Other special lengths with 90° or 180° cable outlet.

6XV1822-5BH15
6XV1822-5BH20
6XV1822-5BH30
6XV1822-5BH50
6XV1822-5BN10
6XV1822-5BN15

See

<http://support.automation.siemens.com/WW/view/en/26999294>

- Trailing power cable, 5 x 1.5 mm², pre-assembled at both ends with 7/8" angled plugs (female contact insert at one end, male contact insert at the other end), in various lengths:
 - 3.0 m
 - 5.0 m
 - 10 m
- Trailing power cable, 5 x 1.5 mm², pre-assembled at one end with 7/8" angled plug with female contact insert (female contact insert at one end, other end open), in various lengths:
 - 3.0 m
 - 5.0 m
 - 10 m

3RK1902-3NB30
3RK1902-3NB50
3RK1902-3NC10

3RK1902-3GB30
3RK1902-3GB50
3RK1902-3GC10

Power line

5-wire, 5 x 1.5 mm², trailing type, sold by the meter, minimum order quantity 20 m, maximum order quantity 1 000 m.

6XV1830-8AH10

7/8" connection plug

For ET 200eco, with axial cable outlet

- With male contact insert, 5-pack
- With female contact insert, 5-pack
- Angled, with female contact insert, 1 unit
- Angled, with male contact insert, 1 unit

6GK1905-0FA00
6GK1905-0FB00
3RK1902-3DA00

3RK1902-3BA00

7/8" cover cap, 10 per pack

6ES7194-3JA00-0AA0

Twisted pair cables 4x2 with RJ45 plugs

0.5 m
1 m
2 m
6 m
10 m

6XV1870-3QE50
6XV1870-3QH10
6XV1870-3QH20
6XV1870-3QH60
6XV1870-3QN10

Crossed twisted pair cables 4x2 with RJ45 plugs

0.5 m
1 m
2 m
6 m
10 m

6XV1870-3RE50
6XV1870-3RH10
6XV1870-3RH20
6XV1870-3RH60
6XV1870-3RN10

M12 sealing cap

For protection of unused M12 connections with ET 200pro

3RX9802-0AA00

M12 sealing caps with female thread

5 units

6ES7194-4JD60-0AA0

Technical specifications

Article number	6ES7513-2PL00-0AB0 ET 200pro: CPU 1513pro-2 PN
General information	
Product type designation	CPU 1513pro-2 PN
Engineering with	
• STEP 7 TIA Portal configurable/ integrated from version	V17 (FW V2.9) / V16 (FW V2.8) or higher
Supply voltage	
Rated value (DC)	24 V
Memory	
Work memory	
• integrated (for program)	300 kbyte
• integrated (for data)	1.5 Mbyte
Load memory	
• Plug-in (SIMATIC Memory Card), max.	32 Gbyte
CPU processing times	
for bit operations, typ.	40 ns
for word operations, typ.	48 ns
for fixed point arithmetic, typ.	64 ns
for floating point arithmetic, typ.	256 ns
Counters, timers and their retentivity	
S7 counter	
• Number	2 048
IEC counter	
• Number	Any (only limited by the main memory)
S7 times	
• Number	2 048
IEC timer	
• Number	Any (only limited by the main memory)
Data areas and their retentivity	
Flag	
• Size, max.	16 kbyte
Address area	
I/O address area	
• Inputs	32 kbyte; All inputs are in the process image
• Outputs	32 kbyte; All outputs are in the process image
Time of day	
Clock	
• Type	Hardware clock
1. Interface	
Interface types	
• RJ 45 (Ethernet)	Yes; X1 P3
• Number of ports	3; 2x M12 + 1x RJ45
• integrated switch	Yes
Protocols	
• IP protocol	Yes; IPv4
• PROFINET IO Controller	Yes
• PROFINET IO Device	Yes
• SIMATIC communication	Yes
• Open IE communication	Yes; Optionally also encrypted
• Web server	Yes
• Media redundancy	Yes; MRP Automanager according to IEC 62439-2 Edition 2.0

Article number	6ES7513-2PL00-0AB0 ET 200pro: CPU 1513pro-2 PN
PROFINET IO Controller	
Services	
- PG/OP communication	Yes
- Isochronous mode	Yes
- Direct data exchange	Yes; Requirement: IRT and isochronous mode (MRPD optional)
- IRT	Yes
- PROFINergy	Yes; per user program
- Prioritized startup	Yes; Max. 32 PROFINET devices
- Number of connectable IO Devices, max.	128; In total, up to 512 distributed I/O devices can be connected via AS-i, PROFIBUS or PROFINET
- Of which IO devices with IRT, max.	64
- Number of connectable IO Devices for RT, max.	128
- of which in line, max.	128
- Number of IO Devices that can be simultaneously activated/ deactivated, max.	8; in total across all interfaces
- Number of IO Devices per tool, max.	8
- Updating times	The minimum value of the update time also depends on communication share set for PROFINET IO, on the number of IO devices, and on the quantity of configured user data
PROFINET IO Device	
Services	
- PG/OP communication	Yes
- Isochronous mode	No
- IRT	Yes
- PROFINergy	Yes; per user program
- Prioritized startup	No
- Shared device	Yes
- Number of IO Controllers with shared device, max.	4
- activation/deactivation of I-devices	Yes; per user program
- Asset management record	Yes; per user program
2. Interface	
Interface types	
• RJ 45 (Ethernet)	No
• Number of ports	1; 1x M12
• integrated switch	No
Protocols	
• IP protocol	Yes; IPv4
• PROFINET IO Controller	Yes
• PROFINET IO Device	Yes
• SIMATIC communication	Yes
• Open IE communication	Yes; Optionally also encrypted
• Web server	Yes
• Media redundancy	No

Distributed Controllers

based on ET 200pro
Standard CPUs

CPU 1513pro-2 PN

Technical specifications

Article number	6ES7513-2PL00-0AB0 ET 200pro: CPU 1513pro-2 PN
PROFINET IO Controller	
Services	
- PG/OP communication	Yes
- Isochronous mode	No
- Direct data exchange	No
- IRT	No
- PROFINergy	Yes
- Prioritized startup	No
- Number of connectable IO Devices, max.	32; In total, up to 512 distributed I/O devices can be connected via AS-i, PROFIBUS or PROFINET
- Number of connectable IO Devices for RT, max.	32
- of which in line, max.	32
- Number of IO Devices that can be simultaneously activated/deactivated, max.	8; in total across all interfaces
- Number of IO Devices per tool, max.	8
- Updating times	The minimum value of the update time also depends on communication share set for PROFINET IO, on the number of IO devices, and on the quantity of configured user data
PROFINET IO Device	
Services	
- PG/OP communication	Yes
- Isochronous mode	No
- IRT	No
- PROFINergy	Yes; per user program
- Prioritized startup	No
- Shared device	Yes
- Number of IO Controllers with shared device, max.	4
- activation/deactivation of I-devices	Yes; per user program
- Asset management record	Yes; per user program
Protocols	
Number of connections	
• Number of connections, max.	128; Via integrated interfaces of the CPU
Redundancy mode	
Media redundancy	
- Media redundancy	Yes; only via 1st interface (X1)
- MRP	Yes; MRP Automanager according to IEC 62439-2 Edition 2.0, MRP Manager; MRP Client
- MRP interconnection, supported	Yes; as MRP ring node according to IEC 62439-2 Edition 3.0
- MRPD	Yes; Requirement: IRT
- Switchover time on line break, typ.	200 ms; For MRP, bumpless for MRPD
- Number of stations in the ring, max.	50
SIMATIC communication	
• S7 routing	Yes
OPC UA	
• OPC UA Client	Yes
• OPC UA Server	Yes; Data access (read, write, subscribe), method call, custom address space
• Alarms and Conditions	Yes

Article number	6ES7513-2PL00-0AB0 ET 200pro: CPU 1513pro-2 PN
Supported technology objects	
Motion Control	Yes; Note: The number of technology objects affects the cycle time of the PLC program; selection guide via the TIA Selection Tool
• Number of available Motion Control resources for technology objects	800
• Required Motion Control resources	
- per speed-controlled axis	40
- per positioning axis	80
- per synchronous axis	160
- per external encoder	80
- per output cam	20
- per cam track	160
- per probe	40
Controller	
• PID_Compact	Yes; Universal PID controller with integrated optimization
• PID_3Step	Yes; PID controller with integrated optimization for valves
• PID-Temp	Yes; PID controller with integrated optimization for temperature
Counting and measuring	
• High-speed counter	Yes
Ambient conditions	
Ambient temperature during operation	
• horizontal installation, min.	-25 °C
• horizontal installation, max.	55 °C
• vertical installation, min.	-25 °C
• vertical installation, max.	55 °C
Configuration	
Programming	
Programming language	
- LAD	Yes
- FBD	Yes
- STL	Yes
- SCL	Yes
- GRAPH	Yes
Know-how protection	
• User program protection/password protection	Yes
• Copy protection	Yes
• Block protection	Yes
Access protection	
• protection of confidential configuration data	Yes
• Protection level: Write protection	Yes
• Protection level: Read/write protection	Yes
• Protection level: Complete protection	Yes
Dimensions	
Width	135 mm
Height	130 mm
Depth	65 mm
Weights	
Weight, approx.	614 g

Overview



- CPU 1516pro-2 PN for SIMATIC ET 200pro based on S7-1500 CPU 1516-3 PN/DP
- For applications with high requirements on the program scope and processing speed, for distributed setup via PROFINET IO
- PROFINET IO controller for operating distributed I/O on PROFINET
- PROFINET I-Device for connecting the CPU as an intelligent PROFINET device with a SIMATIC or non-Siemens PROFINET IO controller
- PROFINET shared I-Device for 4 controllers
- PROFINET IO RT/IRT interface with integrated 3-port switch
- Additional PROFINET IO RT interface with separate IP address
- Isochronous mode on PROFINET
- Integrated Motion Control functionalities for controlling speed-controlled and positioning axes, support for external encoders, output cams/cam tracks and probes
- OPC UA Server and Client (Data Access) as runtime option for the easy connection of SIMATIC ET 200pro to non-Siemens devices/systems
- Integrated web server with the option of creating user-defined web pages

Note

SIMATIC Memory Card required for operation of the CPU

Ordering data

Article No.

CPU 1516pro-2 PN**6ES7516-2PN00-0AB0**

1 MB work memory for program, 5 MB for data, PROFINET IO IRT interface, PROFINET IO RT interface; SIMATIC Memory Card required

Accessories**SIMATIC Memory Card**4 MB¹⁾**6ES7954-8LC03-0AA0**12 MB¹⁾**6ES7954-8LE03-0AA0**24 MB¹⁾**6ES7954-8LF03-0AA0**256 MB¹⁾**6ES7954-8LL03-0AA0**2 GB¹⁾**6ES7954-8LP03-0AA0**32 GB¹⁾**6ES7954-8LT03-0AA0****Connection module****6ES7194-4AP00-0AA0**

CM CPU 2PN M12 / 7/8";
With 3 x M12 and 2 x 7/8", for connecting 2 x PROFINET

Industrial Ethernet FC RJ45 plug 180

RJ45 plug connector for Industrial Ethernet with a rugged metal enclosure and integrated insulation displacement contacts for connecting Industrial Ethernet FC installation cables; with 180° cable outlet

- 1 unit
- 10 units
- 50 units

6GK1901-1BB10-2AA0
6GK1901-1BB10-2AB0
6GK1901-1BB10-2AE0

Industrial Ethernet FastConnect installation cables

- FastConnect standard cable
- FastConnect trailing cable
- FastConnect marine cable

6XV1840-2AH10
6XV1840-3AH10
6XV1840-4AH10

Industrial Ethernet FastConnect installation cables

- IE FC TP trailing cable GP 2 x 2; sold by the meter, max. delivery unit 1 000 m; minimum order quantity 20 m.
- IE TP torsion cable GP 2 x 2; sold by the meter, max. delivery unit 1 000 m; minimum order quantity 20 m.

6XV1870-2D
6XV1870-2F

Industrial Ethernet FastConnect

Stripping tool

6GK1901-1GA00

¹⁾ An MMC is essential for operating the CPU

Distributed Controllers

based on ET 200pro
Standard CPUs

CPU 1516pro-2 PN

Ordering data

Article No.

Article No.

IE connecting cable M12-180/M12-180

- Pre-assembled
IE FC TP trailing cable GP 2 x 2 (PROFINET type C) with two 4-pin M12 plugs (4-pin, D-coded), degree of protection IP65/IP67, in various lengths:

- 0.3 m
- 0.5 m
- 1.0 m
- 1.5 m
- 2.0 m
- 3.0 m
- 5.0 m
- 10 m
- 15 m

6XV1870-8AE30
6XV1870-8AE50
6XV1870-8AH10
6XV1870-8AH15
6XV1870-8AH20
6XV1870-8AH30
6XV1870-8AH50
6XV1870-8AN10
6XV1870-8AN15

- PROFINET M12 trailing connecting cable, pre-assembled at both ends with angled M12 plugs (male contact insert), in various lengths:

- 3.0 m
- 5.0 m
- 10 m

3RK1902-2NB30
3RK1902-2NB50
3RK1902-2NC10

- PROFINET M12 trailing connecting cable, pre-assembled at one end with angled M12 plug (male contact insert at one end, other end open), in various lengths:

- 3.0 m
- 5.0 m
- 10 m

3RK1902-2HB30
3RK1902-2HB50
3RK1902-2HC10

IE FC M12 plug PRO

PROFINET M12 plug connector, D-coded with fast connection system, axial cable outlet.

- 1 unit
- 8 units
- PROFINET M12 plug connector, D-coded, angled.

6GK1901-0DB20-6AA0
6GK1901-0DB20-6AA8
3RK1902-2DA00

IE panel feedthrough

Cabinet feedthrough for converting from the M12 connection system (D-coded, IP65/IP67) to the RJ45 connection system (IP20), 1 pack = 5 units.

6GK1901-0DM20-2AA5

7/8" connecting cable to power supply

- 5-wire, 5 x 1.5 mm², trailing, pre-assembled with two 7/8" plugs (axial cable outlet), 5-pin, up to 50 m, in various lengths:

- 1.5 m
- 2.0 m
- 3.0 m
- 5.0 m
- 10 m
- 15 m

6XV1822-5BH15
6XV1822-5BH20
6XV1822-5BH30
6XV1822-5BH50
6XV1822-5BN10
6XV1822-5BN15

- Other special lengths with 90° or 180° cable outlet.

See
<http://support.automation.siemens.com/WW/view/en/26999294>

- Trailing power cable, 5 x 1.5 mm², pre-assembled at both ends with 7/8" angled plugs (female contact insert at one end, male contact insert at the other end), in various lengths:

- 3.0 m
- 5.0 m
- 10 m

3RK1902-3NB30
3RK1902-3NB50
3RK1902-3NC10

- Trailing power cable, 5 x 1.5 mm², pre-assembled at one end with 7/8" angled plug with female contact insert (female contact insert at one end, other end open), in various lengths:

- 3.0 m
- 5.0 m
- 10 m

3RK1902-3GB30
3RK1902-3GB50
3RK1902-3GC10

Power line

5-wire, 5 x 1.5 mm², trailing type, sold by the meter, minimum order quantity 20 m, maximum order quantity 1 000 m.

6XV1830-8AH10

7/8" connection plug

For ET 200eco, with axial cable outlet

- With male contact insert, 5-pack
- With female contact insert, 5-pack
- Angled, with female contact insert, 1 unit
- Angled, with male contact insert, 1 unit

6GK1905-0FA00
6GK1905-0FB00
3RK1902-3DA00
3RK1902-3BA00

7/8" cover cap, 10 per pack

6ES7194-3JA00-0AA0

Twisted pair cables 4x2 with RJ45 plugs

0.5 m
1 m
2 m
6 m
10 m

6XV1870-3QE50
6XV1870-3QH10
6XV1870-3QH20
6XV1870-3QH60
6XV1870-3QN10

Crossed twisted pair cables 4x2 with RJ45 plugs

0.5 m
1 m
2 m
6 m
10 m

6XV1870-3RE50
6XV1870-3RH10
6XV1870-3RH20
6XV1870-3RH60
6XV1870-3RN10

M12 sealing cap

For protection of unused M12 connections with ET 200pro

3RX9802-0AA00

M12 sealing caps with female thread

5 units

6ES7194-4JD60-0AA0

Technical specifications

Article number	6ES7516-2PN00-0AB0 ET 200pro: CPU 1516PRO-2 PN
General information	
Product type designation	CPU 1516pro-2 PN
Engineering with	
• STEP 7 TIA Portal configurable/ integrated from version	V17 (FW V2.9) / V14 (FW V2.0) or higher
Supply voltage	
Rated value (DC)	24 V
Memory	
Work memory	
• integrated (for program)	1 Mbyte
• integrated (for data)	5 Mbyte
Load memory	
• Plug-in (SIMATIC Memory Card), max.	32 Gbyte
CPU processing times	
for bit operations, typ.	10 ns
for word operations, typ.	12 ns
for fixed point arithmetic, typ.	16 ns
for floating point arithmetic, typ.	64 ns
Counters, timers and their retentivity	
S7 counter	
• Number	2 048
IEC counter	
• Number	Any (only limited by the main memory)
S7 times	
• Number	2 048
IEC timer	
• Number	Any (only limited by the main memory)
Data areas and their retentivity	
Flag	
• Size, max.	16 kbyte
Address area	
I/O address area	
• Inputs	32 kbyte; All inputs are in the process image
• Outputs	32 kbyte; All outputs are in the process image
Time of day	
Clock	
• Type	Hardware clock
1. Interface	
Interface types	
• RJ 45 (Ethernet)	Yes; X1 P3
• Number of ports	3; 2x M12 + 1x RJ45
• integrated switch	Yes
Protocols	
• IP protocol	Yes; IPv4
• PROFINET IO Controller	Yes
• PROFINET IO Device	Yes
• SIMATIC communication	Yes
• Open IE communication	Yes; Optionally also encrypted
• Web server	Yes
• Media redundancy	Yes; MRP Automanager according to IEC 62439-2 Edition 2.0

Article number	6ES7516-2PN00-0AB0 ET 200pro: CPU 1516PRO-2 PN
PROFINET IO Controller	
Services	
- PG/OP communication	Yes
- Isochronous mode	Yes
- Direct data exchange	Yes; Requirement: IRT and isochronous mode (MRPD optional)
- IRT	Yes
- PROFINergy	Yes; per user program
- Prioritized startup	Yes; Max. 32 PROFINET devices
- Number of connectable IO Devices, max.	256; In total, up to 1 000 distributed I/O devices can be connected via AS-i, PROFIBUS or PROFINET
- Of which IO devices with IRT, max.	64
- Number of connectable IO Devices for RT, max.	256
- of which in line, max.	256
- Number of IO Devices that can be simultaneously activated/ deactivated, max.	8; in total across all interfaces
- Number of IO Devices per tool, max.	8
- Updating times	The minimum value of the update time also depends on communication share set for PROFINET IO, on the number of IO devices, and on the quantity of configured user data
PROFINET IO Device	
Services	
- PG/OP communication	Yes
- Isochronous mode	No
- IRT	Yes
- PROFINergy	Yes; per user program
- Prioritized startup	No
- Shared device	Yes
- Number of IO Controllers with shared device, max.	4
- activation/deactivation of I-devices	Yes; per user program
- Asset management record	Yes; per user program
2. Interface	
Interface types	
• RJ 45 (Ethernet)	No
• Number of ports	1; 1x M12
• integrated switch	No
Protocols	
• IP protocol	Yes; IPv4
• PROFINET IO Controller	Yes
• PROFINET IO Device	Yes
• SIMATIC communication	Yes
• Open IE communication	Yes; Optionally also encrypted
• Web server	Yes
• Media redundancy	No

Distributed Controllers

based on ET 200pro
Standard CPUs

CPU 1516pro-2 PN

Technical specifications

Article number	6ES7516-2PN00-0AB0 ET 200pro: CPU 1516PRO-2 PN
PROFINET IO Controller	
Services	
- PG/OP communication	Yes
- Isochronous mode	No
- Direct data exchange	No
- IRT	No
- PROFINergy	Yes; per user program
- Prioritized startup	No
- Number of connectable IO Devices, max.	32; In total, up to 1 000 distributed I/O devices can be connected via AS-i, PROFIBUS or PROFINET
- Number of connectable IO Devices for RT, max.	32
- of which in line, max.	32
- Number of IO Devices that can be simultaneously activated/deactivated, max.	8; in total across all interfaces
- Number of IO Devices per tool, max.	8
- Updating times	The minimum value of the update time also depends on communication share set for PROFINET IO, on the number of IO devices, and on the quantity of configured user data
PROFINET IO Device	
Services	
- PG/OP communication	Yes
- Isochronous mode	No
- IRT	No
- PROFINergy	Yes; per user program
- Prioritized startup	No
- Shared device	Yes
- Number of IO Controllers with shared device, max.	4
- activation/deactivation of I-devices	Yes; per user program
- Asset management record	Yes; per user program
Protocols	
Number of connections	
• Number of connections, max.	128; Via integrated interfaces of the CPU
Redundancy mode	
Media redundancy	
- Media redundancy	Yes; only via 1st interface (X1)
- MRP	Yes; MRP Automanager according to IEC 62439-2 Edition 2.0, MRP Manager; MRP Client
- MRP interconnection, supported	Yes; as MRP ring node according to IEC 62439-2 Edition 3.0
- MRPD	Yes; Requirement: IRT
- Switchover time on line break, typ.	200 ms; For MRP, bumpless for MRPD
- Number of stations in the ring, max.	50
SIMATIC communication	
• S7 routing	Yes
OPC UA	
• OPC UA Client	Yes
• OPC UA Server	Yes; Data access (read, write, subscribe), method call, custom address space
• Alarms and Conditions	Yes

Article number	6ES7516-2PN00-0AB0 ET 200pro: CPU 1516PRO-2 PN
Supported technology objects	
Motion Control	Yes; Note: The number of technology objects affects the cycle time of the PLC program; selection guide via the TIA Selection Tool
• Number of available Motion Control resources for technology objects	2 400
• Required Motion Control resources	
- per speed-controlled axis	40
- per positioning axis	80
- per synchronous axis	160
- per external encoder	80
- per output cam	20
- per cam track	160
- per probe	40
Controller	
• PID_Compact	Yes; Universal PID controller with integrated optimization
• PID_3Step	Yes; PID controller with integrated optimization for valves
• PID-Temp	Yes; PID controller with integrated optimization for temperature
Counting and measuring	
• High-speed counter	Yes
Ambient conditions	
Ambient temperature during operation	
• horizontal installation, min.	-25 °C
• horizontal installation, max.	55 °C
• vertical installation, min.	-25 °C
• vertical installation, max.	55 °C
Configuration	
Programming	
Programming language	
- LAD	Yes
- FBD	Yes
- STL	Yes
- SCL	Yes
- GRAPH	Yes
Know-how protection	
• User program protection/ password protection	Yes
• Copy protection	Yes
• Block protection	Yes
Access protection	
• protection of confidential configuration data	Yes
• Protection level: Write protection	Yes
• Protection level: Read/write protection	Yes
• Protection level: Complete protection	Yes
Dimensions	
Width	135 mm
Height	130 mm
Depth	65 mm
Weights	
Weight, approx.	614 g

Overview



- Interface module for SIMATIC ET 200pro with integrated fail-safe CPU
- CPU with PLC functionality equivalent to CPU S7-315F PN/DP; with distributed intelligence for preprocessing
- For constructing a fail-safe automation system for plants with increased safety requirements
- Complies with safety requirements up to SIL 3 according to IEC 61508, IEC 62061 and PL e according to ISO 13849.1:2006
- For high-performance control solutions in ET 200pro
- Increase in availability of systems and machines
- Integral web server with the option of creating user-defined web pages
- Isochronous mode on PROFIBUS or PROFINET
- PROFINET IO controller for up to 128 IO devices
- PROFINET interface with integrated 3-port switch
- With multiple communication options: PG/OP communication, PROFINET IO, PROFINET CBA, open IE communication (TCP, ISO-on-TCP and UDP), web server and S7-communication (with loadable FBs)
- Fast, simple and end-to-end programming of a system with modular programs via STEP 7
- Compact SIMATIC Micro Memory Card (MMC)

Note:

SIMATIC Micro Memory Card required for operation of CPU.

Ordering data

Article No.

IM 154-8 F PN/DP CPU interface module, V3.2

Fail-safe PROFINET IO controller for operating distributed I/O on PROFINET, with integrated PLC functionality.

- 512 KB work memory
- 1.5 MB work memory

6ES7154-8FB01-0AB0
6ES7154-8FX00-0AB0

S7 Distributed Safety V5.4 SP5 Update 2 programming tool

Task:

Configuration software for configuring fail-safe user programs for SIMATIC S7-300F, S7-400F, WinAC RTX F, ET 200S, ET 200M, ET 200iSP, ET 200pro, ET 200eco, ET 200SP

Requirement:

Windows 7 SP1 (64-bit), Windows 10 Professional/Enterprise (64-bit), Windows Server 2008 R2 SP1 (64-bit), Windows Server 2012 R2 (64-bit), Windows Server 2016 (64-bit); STEP 7 from V5.5 SP1; Please also note the operating systems that have been released for the STEP 7 version used

Floating license for 1 user, software and documentation on DVD; license key on USB flash drive

6ES7833-1FC02-0YA5

Floating license for 1 user; software, documentation and license key for download¹⁾; email address required for delivery

6ES7833-1FC02-0YH5

S7 Distributed Safety upgrade

From V5.x to V5.4; floating license for 1 user, software and documentation on DVD; license key on USB flash drive

6ES7833-1FC02-0YE5

STEP 7 Safety Advanced V17

Task:

Engineering tool for configuring and programming fail-safe user programs for SIMATIC S7-1200 FC, S7-1500F, S7-1500F Software Controller, S7-300F, S7-400F, WinAC RTX F, ET 200SP F Controller and the fail-safe ET 200SP, ET 200MP, ET 200S, ET 200M, ET 200iSP, ET 200pro and ET 200eco I/O

Requirement:

STEP 7 Professional V17

Note:

As of TIA Portal V16, the SIMATIC STEP 7 Safety software is an integral component of the SIMATIC STEP 7 product setup. The functionality of SIMATIC STEP 7 Safety is activated by means of the license key supplied in each case.

Floating license for 1 user; license key on USB flash drive

6ES7833-1FA17-0YA5

Floating license for 1 user, license key for download¹⁾; email address required for delivery

6ES7833-1FA17-0YH5

¹⁾ For up-to-date information and download availability, see: <http://www.siemens.com/tia-online-software-delivery>

Distributed Controllers

based on ET 200pro

Fail-safe CPUs

IM 154-8 F PN/DP CPU

Ordering data

Article No.

Accessories	
SIMATIC Micro Memory Cards	
MMC 64 KB ²⁾	6ES7953-8LF31-0AA0
For program backup.	
MMC 128 KB ²⁾	6ES7953-8LG31-0AA0
For program backup.	
MMC 512 KB ²⁾	6ES7953-8LJ31-0AA0
For program backup.	
MMC 2 MB ²⁾	6ES7953-8LL31-0AA0
For program backup and/or firmware updates.	
MMC 4 MB ²⁾	6ES7953-8LM32-0AA0
For program backup.	
MMC 8 MB ²⁾	6ES7953-8LP31-0AA0
For program backup.	
Connection module	6ES7194-4AN00-0AA0
For CPU IM154-8 PN/DP, with 4 x M12 and 2 x 7/8", for connecting PROFINET and PROFIBUS DP.	
Industrial Ethernet FC RJ45 plug 90	
RJ45 plug connector for Industrial Ethernet with a rugged metal enclosure and integrated insulation displacement contacts for connecting Industrial Ethernet FC installation cables; with 90° cable outlet.	
<ul style="list-style-type: none"> • 1 unit • 10 units 	6GK1901-1BB20-2AA0 6GK1901-1BB20-2AB0
Industrial Ethernet FC RJ45 plug 180	
RJ45 plug connector for Industrial Ethernet with a rugged metal enclosure and integrated insulation displacement contacts for connecting Industrial Ethernet FC installation cables; with 180° cable outlet	
<ul style="list-style-type: none"> • 1 unit • 10 units • 50 units 	6GK1901-1BB10-2AA0 6GK1901-1BB10-2AB0 6GK1901-1BB10-2AE0
Industrial Ethernet FastConnect installation cables	
<ul style="list-style-type: none"> • FastConnect standard cable • FastConnect trailing cable • FastConnect marine cable 	6XV1840-2AH10 6XV1840-3AH10 6XV1840-4AH10

Article No.

Industrial Ethernet FastConnect installation cables	
<ul style="list-style-type: none"> • IE FC TP trailing cable GP 2 x 2; sold by the meter, max. delivery unit 1 000 m; minimum order quantity 20 m. • IE TP torsion cable GP 2 x 2; sold by the meter, max. delivery unit 1 000 m; minimum order quantity 20 m. 	6XV1870-2D 6XV1870-2F
Industrial Ethernet FastConnect Stripping tool	6GK1901-1GA00
IE connecting cable M12-180/M12-180	
<ul style="list-style-type: none"> • Pre-assembled IE FC TP trailing cable GP 2 x 2 (PROFINET type C) with two 4-pin M12 plugs (D-coded), degree of protection IP65/IP67, in various lengths: <ul style="list-style-type: none"> - 0.3 m - 0.5 m - 1.0 m - 1.5 m - 2.0 m - 3.0 m - 5.0 m - 10 m - 15 m • PROFINET M12 trailing connecting cable, pre-assembled at both ends with angled M12 plugs (pin), in various lengths: <ul style="list-style-type: none"> - 3.0 m - 5.0 m - 10 m • PROFINET M12 trailing connecting cable, pre-assembled at one end with angled M12 plug (pin at one end, other end open), in various lengths: <ul style="list-style-type: none"> - 3.0 m - 5.0 m - 10 m 	6XV1870-8AE30 6XV1870-8AE50 6XV1870-8AH10 6XV1870-8AH15 6XV1870-8AH20 6XV1870-8AH30 6XV1870-8AH50 6XV1870-8AN10 6XV1870-8AN15 3RK1902-2NB30 3RK1902-2NB50 3RK1902-2NC10 3RK1902-2HB30 3RK1902-2HB50 3RK1902-2HC10
IE FC M12 plug PRO	
PROFINET M12 plug connector, D-coded with fast connection system, axial cable outlet.	
<ul style="list-style-type: none"> • 1 unit • 8 units • PROFINET M12 plug connector, D-coded, angled 	6GK1901-0DB20-6AA0 6GK1901-0DB20-6AA8 3RK1902-2DA00
IE panel feedthrough	
Cabinet feedthrough for converting from the M12 connection system (D-coded, IP65/IP67) to the RJ45 connection system (IP20), 1 pack = 5 units	6GK1901-0DM20-2AA5

²⁾ An MMC is essential for operating the CPU

Ordering data	Article No.	Article No.	
7/8" connecting cable to power supply <ul style="list-style-type: none"> 5-wire, 5 x 1.5 mm², trailing, pre-assembled with two 7/8" plugs (axial cable outlet), 5-pin, up to 50 m, in various lengths: <ul style="list-style-type: none"> - 1.5 m - 2.0 m - 3.0 m - 5.0 m - 10 m - 15 m - Other special lengths with 90° or 180° cable outlet Trailing power cable, 5 x 1.5 mm², pre-assembled at both ends with 7/8" angled connectors (socket at one end, pin at the other end), in various lengths: <ul style="list-style-type: none"> - 3.0 m - 5.0 m - 10 m Trailing power cable, 5 x 1.5 mm², pre-assembled at one end with 7/8" angled plug with female contact insert (socket at one end, other end open), in various lengths: <ul style="list-style-type: none"> - 3.0 m - 5.0 m - 10 m 	6XV1822-5BH15 6XV1822-5BH20 6XV1822-5BH30 6XV1822-5BH50 6XV1822-5BN10 6XV1822-5BN15 See http://support.automation.siemens.com/WWW/view/en/26999294 3RK1902-3NB30 3RK1902-3NB50 3RK1902-3NC10 3RK1902-3GB30 3RK1902-3GB50 3RK1902-3GC10	M12 sealing cap For protection of unused M12 connections with ET 200pro M12 sealing caps with female thread 5 units PROFIBUS M12 connecting cable Pre-assembled, with two 5-pin M12 plugs/sockets, up to 100 m, in various lengths: <ul style="list-style-type: none"> 1.5 m 2.0 m 3.0 m 5.0 m 10 m 15 m Other special lengths with 90° or 180° cable outlet M12 bus termination connector for PROFIBUS, female contact insert M12 bus termination connector for PROFIBUS, male contact insert M12 plug connector, axial outlet, with male contact insert PROFIBUS FC standard cable GP Standard type with special design for quick mounting, 2-wire, shielded. Sold by the meter; max. delivery unit 1 000 m, minimum order quantity 20 m. PROFIBUS FC trailing cable 2-wire, shielded. PROFIBUS FC food cable 2-wire, shielded. Sold by the meter; max. delivery unit 1 000 m, minimum order quantity 20 m. PROFIBUS FC robust cable 2-wire, shielded. Sold by the meter; max. delivery unit 1 000 m, minimum order quantity 20 m. PROFIBUS M12 connection plug 5-pin, B-coded, metal housing, 1 pack = 5 units. • Female contact insert	3RX9802-0AA00 6ES7194-4JD60-0AA0 6XV1830-3DH15 6XV1830-3DH20 6XV1830-3DH30 6XV1830-3DH50 6XV1830-3DN10 6XV1830-3DN15 See http://support.automation.siemens.com/WWW/view/en/26999294 6GK1905-0ED00 6GK1905-0EC00 6GK1905-0EA00 6XV1830-0EH10 6XV1830-3EH10 6XV1830-0GH10 6XV1830-0JH10 6GK1905-0EB00
Power line 5-wire, 5 x 1.5 mm ² , trailing type, sold by the meter, minimum order quantity 20 m, maximum order quantity 1 000 m.	6XV1830-8AH10		
7/8" connection plug For ET 200eco, with axial cable outlet <ul style="list-style-type: none"> With male contact insert, 5-pack With female contact insert, 5-pack Angled, with female contact insert, 1 unit Angled, with male contact insert, 1 unit 7/8" cover cap, 10 per pack	6GK1905-0FA00 6GK1905-0FB00 3RK1902-3DA00 3RK1902-3BA00 6ES7194-3JA00-0AA0		
Twisted pair cables 4x2 with RJ45 plugs 0.5 m 1 m 2 m 6 m 10 m	6XV1870-3QE50 6XV1870-3QH10 6XV1870-3QH20 6XV1870-3QH60 6XV1870-3QN10		
Crossed twisted pair cables 4x2 with RJ45 plugs 0.5 m 1 m 2 m 6 m 10 m	6XV1870-3RE50 6XV1870-3RH10 6XV1870-3RH20 6XV1870-3RH60 6XV1870-3RN10		

Distributed Controllers

based on ET 200pro

Fail-safe CPUs

IM 154-8 F PN/DP CPU

Technical specifications

Article number	6ES7154-8FB01-0AB0 ET 200pro: IM 154-8F PN/DP CPU, 512KB	6ES7154-8FX00-0AB0 ET 200pro: IM 154-8FX PN/DP CPU, 1,5MB
General information		
Product function		
• Isochronous mode	Yes; Via PROFIBUS DP or PROFINET interface	Yes; Via PROFIBUS DP or PROFINET interface
Supply voltage		
Rated value (DC)	24 V	24 V
Memory		
Work memory		
• integrated	512 kbyte	1 536 kbyte
• expandable	No	No
Load memory		
• Plug-in (MMC), max.	8 Mbyte	8 Mbyte
CPU processing times		
for bit operations, typ.	0.05 µs	0.025 µs
for word operations, typ.	0.09 µs	0.03 µs
for fixed point arithmetic, typ.	0.12 µs	0.04 µs
for floating point arithmetic, typ.	0.45 µs	0.16 µs
Counters, timers and their retentivity		
S7 counter		
• Number	256	256
IEC counter		
• present	Yes	Yes
S7 times		
• Number	256	256
IEC timer		
• present	Yes	Yes
Data areas and their retentivity		
Flag		
• Size, max.	2 048 byte	2 048 byte
Address area		
I/O address area		
• Inputs	2 048 byte	2 048 byte
• Outputs	2 048 byte	2 048 byte
Process image		
• Inputs, adjustable	2 048 byte	2 048 byte
• Outputs, adjustable	2 048 byte	2 048 byte
Time of day		
Clock		
• Hardware clock (real-time)	Yes	Yes
Operating hours counter		
• Number	1	1
1. Interface		
Interface type	Integrated RS 485 interface	Integrated RS 485 interface
Interface types		
• RS 485	Yes	Yes
Protocols		
• MPI	Yes	Yes
• PROFIBUS DP master	Yes	Yes
• PROFIBUS DP slave	Yes	Yes
• Point-to-point connection	No	No
PROFIBUS DP master		
• Number of DP slaves, max.	124	124
2. Interface		
Interface type	PROFINET	PROFINET
Interface types		
• Number of ports	3	3

7

Technical specifications

Article number	6ES7154-8FB01-0AB0	6ES7154-8FX00-0AB0
	ET 200pro: IM 154-8F PN/DP CPU, 512KB	ET 200pro: IM 154-8FX PN/DP CPU, 1,5MB
Protocols		
• MPI	No	No
• PROFINET IO Controller	Yes; Also simultaneously with IO-Device functionality	Yes; Also simultaneously with IO-Device functionality
• PROFINET IO Device	Yes; Also simultaneously with IO Controller functionality	Yes; Also simultaneously with IO Controller functionality
• PROFINET CBA	Yes	Yes
• PROFIBUS DP master	No	No
• PROFIBUS DP slave	No	No
PROFINET IO Controller		
Services		
- Number of connectable IO Devices, max.	128	128
- Of which IO devices with IRT, max.	64	64
- Number of IO Devices with IRT and the option "high flexibility"	128	128
- Number of connectable IO Devices for RT, max.	128	128
Protocols		
SIMATIC communication		
• S7 routing	Yes	Yes
Open IE communication		
• TCP/IP	Yes; via integrated PROFINET interface and loadable FBs	Yes; via integrated PROFINET interface and loadable FBs
- Number of connections, max.	8	8
• ISO-on-TCP (RFC1006)	Yes	Yes
- Number of connections, max.	8	8
• UDP	Yes	Yes
- Number of connections, max.	8	8
Web server		
• supported	Yes	Yes
Communication functions		
PG/OP communication	Yes	Yes
Global data communication		
• supported	Yes	Yes
S7 basic communication		
• supported	Yes	Yes
S7 communication		
• supported	Yes	Yes
Number of connections		
• overall	16	16
Degree and class of protection		
IP degree of protection	IP65/67	IP65/67
Configuration		
Programming		
Programming language		
- LAD	Yes	Yes
- FBD	Yes	Yes
- STL	Yes	Yes
- SCL	Yes	Yes
- CFC	Yes	Yes
- GRAPH	Yes	Yes
- HiGraph®	Yes	Yes
Know-how protection		
• User program protection/ password protection	Yes	Yes
• Block encryption	Yes; With S7 block Privacy	Yes; With S7 block Privacy
Dimensions		
Width	135 mm	135 mm
Height	130 mm	130 mm
Depth	65 mm; 60 mm without cover for RJ45 socket; 65 mm with cover for RJ45 socket	65 mm; 60 mm without cover for RJ45 socket; 65 mm with cover for RJ45 socket
Weights		
Weight, approx.	720 g	720 g

Distributed Controllers

based on ET 200pro
Fail-safe CPUs

CPU 1513pro F-2 PN

Overview



- Fail-safe CPU 1513pro F-2 PN for SIMATIC ET 200pro based on S7-1500 CPU 1513F-1 PN
- For applications with medium requirements on the program scope and processing speed, for distributed setup via PROFINET IO.
- Can be used for safety functions up to SIL 3 according to IEC 61508 and up to PLe according to ISO 13849
- PROFINET IO controller for operating distributed I/O on PROFINET
- PROFINET I-Device for connecting the CPU as an intelligent PROFINET device with a SIMATIC or non-Siemens PROFINET IO controller
- PROFIsafe in centralized and distributed configurations
- PROFINET shared I-Device for 4 controllers
- PROFINET IO RT/IRT interface with integrated 3-port switch
- Additional PROFINET IO RT interface with separate IP address
- Isochronous mode on PROFINET
- Integrated motion control functionalities for controlling speed-controlled and positioning axes, support for external encoders
- OPC UA server and client (data access) as runtime option for the easy connection of SIMATIC ET 200pro to non-Siemens devices/systems
- Integrated web server with the option of creating user-defined web pages

Note

SIMATIC Memory Card required for operation of the CPU.

Ordering data

Article No.

CPU 1513pro F-2 PN

6ES7513-2GL00-0AB0

450 KB work memory for program, 1.5 MB for data, PROFINET IO IRT interface, PROFINET IO RT interface, SIMATIC Memory Card required

Accessories

SIMATIC Memory Card

4 MB ¹⁾	6ES7954-8LC03-0AA0
12 MB ¹⁾	6ES7954-8LE03-0AA0
24 MB ¹⁾	6ES7954-8LF03-0AA0
256 MB ¹⁾	6ES7954-8LL03-0AA0
2 GB ¹⁾	6ES7954-8LP03-0AA0
32 GB ¹⁾	6ES7954-8LT03-0AA0

Connection module

6ES7194-4AP00-0AA0

CM CPU 2PN M12 / 7/8";
With 3 x M12 and 2 x 7/8",
for connecting 2 x PROFINET

Industrial Ethernet FC RJ45 plug 180

RJ45 plug connector for Industrial Ethernet with a rugged metal enclosure and integrated insulation displacement contacts for connecting Industrial Ethernet FC installation cables; with 180° cable outlet

- 1 unit
- 10 units
- 50 units

6GK1901-1BB10-2AA0
6GK1901-1BB10-2AB0
6GK1901-1BB10-2AE0

Industrial Ethernet FastConnect installation cables

- FastConnect standard cable
- FastConnect trailing cable
- FastConnect marine cable

6XV1840-2AH10
6XV1840-3AH10
6XV1840-4AH10

Industrial Ethernet FastConnect installation cables

- IE FC TP trailing cable GP 2 x 2; sold by the meter, max. delivery unit 1 000 m; minimum order quantity 20 m.
- IE TP torsion cable GP 2 x 2; sold by the meter, max. delivery unit 1 000 m; minimum order quantity 20 m.

6XV1870-2D

6XV1870-2F

Industrial Ethernet FastConnect

Stripping tool

6GK1901-1GA00

¹⁾ An MMC is essential for operating the CPU

Ordering data	Article No.	Article No.
<p>IE connecting cable M12-180/M12-180</p> <p>Pre-assembled IE FC TP trailing cable GP 2 x 2 (PROFINET type C) with two 4-pin M12 plugs (4-pin, D-coded), degree of protection IP65/IP67, in various lengths:</p> <ul style="list-style-type: none"> • 0.3 m • 0.5 m • 1.0 m • 1.5 m • 2.0 m • 3.0 m • 5.0 m • 10 m • 15 m <p>PROFINET M12 trailing connecting cable, pre-assembled at both ends with angled M12 plugs (male contact insert), in various lengths:</p> <ul style="list-style-type: none"> • 3.0 m • 5.0 m • 10 m <p>PROFINET M12 trailing connecting cable, pre-assembled at one end with angled M12 plug (male contact insert at one end, other end open), in various lengths:</p> <ul style="list-style-type: none"> • 3.0 m • 5.0 m • 10 m 	<p>6XV1870-8AE30 6XV1870-8AE50 6XV1870-8AH10 6XV1870-8AH15 6XV1870-8AH20 6XV1870-8AH30 6XV1870-8AH50 6XV1870-8AN10 6XV1870-8AN15</p> <p>3RK1902-2NB30 3RK1902-2NB50 3RK1902-2NC10</p> <p>3RK1902-2HB30 3RK1902-2HB50 3RK1902-2HC10</p>	<p>Trailing power cable, 5 x 1.5 mm², pre-assembled at both ends with 7/8" angled plugs (female contact insert at one end, male contact insert at the other end), in various lengths:</p> <ul style="list-style-type: none"> • 3.0 m • 5.0 m • 10 m <p>Trailing power cable, 5 x 1.5 mm², pre-assembled at one end with 7/8" angled plug with female contact insert (female contact insert at one end, other end open), in various lengths:</p> <ul style="list-style-type: none"> • 3.0 m • 5.0 m • 10 m <p>Power line</p> <p>5-wire, 5 x 1.5 mm², trailing type, sold by the meter, minimum order quantity 20 m, maximum order quantity 1 000 m.</p> <p>7/8" connection plug</p> <p>For ET 200eco, with axial cable outlet</p> <ul style="list-style-type: none"> • With male contact insert, 5-pack • With female contact insert, 5-pack • Angled, with female contact insert, 1 unit • Angled, with male contact insert, 1 unit <p>7/8" cover cap, 10 per pack</p> <p>Twisted pair cables 4x2 with RJ45 plugs</p> <p>0.5 m 1 m 2 m 6 m 10 m</p> <p>Crossed twisted pair cables 4x2 with RJ45 plugs</p> <p>0.5 m 1 m 2 m 6 m 10 m</p> <p>M12 sealing cap</p> <p>For protection of unused M12 connections with ET 200pro</p> <p>M12 sealing caps with female thread</p> <p>5 units</p>
<p>IE FC M12 plug PRO</p> <p>PROFINET M12 plug connector, D-coded with fast connection system, axial cable outlet.</p> <ul style="list-style-type: none"> • 1 unit • 8 units • PROFINET M12 plug connector, D-coded, angled. 	<p>6GK1901-0DB20-6AA0 6GK1901-0DB20-6AA8 3RK1902-2DA00</p>	<p>6ES7194-3JA00-0AA0</p>
<p>IE panel feedthrough</p> <p>Cabinet feedthrough for converting from the M12 connection system (D-coded, IP65/IP67) to the RJ45 connection system (IP20), 1 pack = 5 units.</p>	<p>6GK1901-0DM20-2AA5</p>	
<p>7/8" connecting cable to power supply</p> <p>5-wire, 5 x 1.5 mm², trailing, pre-assembled with two 7/8" plugs (axial cable outlet), 5-pin, up to 50 m, in various lengths:</p> <ul style="list-style-type: none"> • 1.5 m • 2.0 m • 3.0 m • 5.0 m • 10 m • 15 m • Other special lengths with 90° or 180° cable outlet. 	<p>6XV1822-5BH15 6XV1822-5BH20 6XV1822-5BH30 6XV1822-5BH50 6XV1822-5BN10 6XV1822-5BN15</p> <p>See http://support.automation.siemens.com/WWW/view/en/26999294</p>	<p>6ES7194-4JD60-0AA0</p>

Distributed Controllers

based on ET 200pro

Fail-safe CPUs

CPU 1513pro F-2 PN

Technical specifications

Article number	6ES7513-2GL00-0AB0 ET 200pro: CPU 1513pro F-2 PN
General information	
Product type designation	CPU 1513pro F-2 PN
Engineering with	
• STEP 7 TIA Portal configurable/ integrated from version	V17 (FW V2.9) / V16 (FW V2.8) or higher
Supply voltage	
Rated value (DC)	24 V
Memory	
Work memory	
• integrated (for program)	450 kbyte
• integrated (for data)	1.5 Mbyte
Load memory	
• Plug-in (SIMATIC Memory Card), max.	32 Gbyte
CPU processing times	
for bit operations, typ.	40 ns
for word operations, typ.	48 ns
for fixed point arithmetic, typ.	64 ns
for floating point arithmetic, typ.	256 ns
Counters, timers and their retentivity	
S7 counter	
• Number	2 048
IEC counter	
• Number	Any (only limited by the main memory)
S7 times	
• Number	2 048
IEC timer	
• Number	Any (only limited by the main memory)
Data areas and their retentivity	
Flag	
• Size, max.	16 kbyte
Address area	
I/O address area	
• Inputs	32 kbyte; All inputs are in the process image
• Outputs	32 kbyte; All outputs are in the process image
Time of day	
Clock	
• Type	Hardware clock
1. Interface	
Interface types	
• RJ 45 (Ethernet)	Yes; X1 P3
• Number of ports	3; 2x M12 + 1x RJ45
• integrated switch	Yes
Protocols	
• IP protocol	Yes; IPv4
• PROFINET IO Controller	Yes
• PROFINET IO Device	Yes
• SIMATIC communication	Yes
• Open IE communication	Yes; Optionally also encrypted
• Web server	Yes
• Media redundancy	Yes; MRP Automanager according to IEC 62439-2 Edition 2.0

Article number	6ES7513-2GL00-0AB0 ET 200pro: CPU 1513pro F-2 PN
PROFINET IO Controller	
Services	
- PG/OP communication	Yes
- Isochronous mode	Yes
- Direct data exchange	Yes; Requirement: IRT and isochronous mode (MRPD optional)
- IRT	Yes
- PROFINergy	Yes; per user program
- Prioritized startup	Yes; Max. 32 PROFINET devices
- Number of connectable IO Devices, max.	128; In total, up to 512 distributed I/O devices can be connected via AS-i, PROFIBUS or PROFINET
- Of which IO devices with IRT, max.	64
- Number of connectable IO Devices for RT, max.	128
- of which in line, max.	128
- Number of IO Devices that can be simultaneously activated/deactivated, max.	8; in total across all interfaces
- Number of IO Devices per tool, max.	8
- Updating times	The minimum value of the update time also depends on communication share set for PROFINET IO, on the number of IO devices, and on the quantity of configured user data
PROFINET IO Device	
Services	
- PG/OP communication	Yes
- Isochronous mode	No
- IRT	Yes
- PROFINergy	Yes; per user program
- Prioritized startup	No
- Shared device	Yes
- Number of IO Controllers with shared device, max.	4
- activation/deactivation of I-devices	Yes; per user program
- Asset management record	Yes; per user program
2. Interface	
Interface types	
• RJ 45 (Ethernet)	No
• Number of ports	1; 1x M12
• integrated switch	No
Protocols	
• IP protocol	Yes; IPv4
• PROFINET IO Controller	Yes
• PROFINET IO Device	Yes
• SIMATIC communication	Yes
• Open IE communication	Yes; Optionally also encrypted
• Web server	Yes
• Media redundancy	No

Technical specifications

Article number	6ES7513-2GL00-0AB0 ET 200pro: CPU 1513pro F-2 PN
PROFINET IO Controller	
Services	
- PG/OP communication	Yes
- Isochronous mode	No
- Direct data exchange	No
- IRT	No
- PROFinergy	Yes
- Prioritized startup	No
- Number of connectable IO Devices, max.	32; In total, up to 512 distributed I/O devices can be connected via AS-i, PROFIBUS or PROFINET
- Number of connectable IO Devices for RT, max.	32
- of which in line, max.	32
- Number of IO Devices that can be simultaneously activated/deactivated, max.	8; in total across all interfaces
- Number of IO Devices per tool, max.	8
- Updating times	The minimum value of the update time also depends on communication share set for PROFINET IO, on the number of IO devices, and on the quantity of configured user data
PROFINET IO Device	
Services	
- PG/OP communication	Yes
- Isochronous mode	No
- IRT	No
- PROFinergy	Yes; per user program
- Prioritized startup	No
- Shared device	Yes
- Number of IO Controllers with shared device, max.	4
- activation/deactivation of I-devices	Yes; per user program
- Asset management record	Yes; per user program
Protocols	
Number of connections	
• Number of connections, max.	128; Via integrated interfaces of the CPU
Redundancy mode	
Media redundancy	
- Media redundancy	Yes; only via 1st interface (X1)
- MRP	Yes; MRP Automanager according to IEC 62439-2 Edition 2.0, MRP Manager; MRP Client
- MRP interconnection, supported	Yes; as MRP ring node according to IEC 62439-2 Edition 3.0
- MRPD	Yes; Requirement: IRT
- Switchover time on line break, typ.	200 ms; For MRP, bumpless for MRPD
- Number of stations in the ring, max.	50
SIMATIC communication	
• S7 routing	Yes
OPC UA	
• OPC UA Client	Yes
• OPC UA Server	Yes; Data access (read, write, subscribe), method call, custom address space
Supported technology objects	
Motion Control	Yes; Note: The number of technology objects affects the cycle time of the PLC program; selection guide via the TIA Selection Tool

Article number	6ES7513-2GL00-0AB0 ET 200pro: CPU 1513pro F-2 PN
• Number of available Motion Control resources for technology objects	800
• Required Motion Control resources	
- per speed-controlled axis	40
- per positioning axis	80
- per synchronous axis	160
- per external encoder	80
- per output cam	20
- per cam track	160
- per probe	40
Controller	
• PID_Compact	Yes; Universal PID controller with integrated optimization
• PID_3Step	Yes; PID controller with integrated optimization for valves
• PID-Temp	Yes; PID controller with integrated optimization for temperature
Counting and measuring	
• High-speed counter	Yes
Standards, approvals, certificates	
Highest safety class achievable in safety mode	
Probability of failure (for service life of 20 years and repair time of 100 hours)	
- Low demand mode: PFDavg in accordance with SIL3	< 2.00E-05
- High demand/continuous mode: PFH in accordance with SIL3	< 1.00E-09
Ambient conditions	
Ambient temperature during operation	
• horizontal installation, min.	-25 °C
• horizontal installation, max.	55 °C
• vertical installation, min.	-25 °C
• vertical installation, max.	55 °C
Configuration	
Programming	
Programming language	
- LAD	Yes; incl. failsafe
- FBD	Yes; incl. failsafe
- STL	Yes
- SCL	Yes
- GRAPH	Yes
Know-how protection	
• User program protection/ password protection	Yes
• Copy protection	Yes
• Block protection	Yes
Access protection	
• protection of confidential configuration data	Yes
• Protection level: Write protection	Yes
• Protection level: Read/write protection	Yes
• Protection level: Complete protection	Yes
Dimensions	
Width	135 mm
Height	130 mm
Depth	65 mm
Weights	
Weight, approx.	614 g

Distributed Controllers

based on ET 200pro
Fail-safe CPUs

CPU 1516pro F-2 PN

Overview



- Fail-safe CPU 1516pro F-2 PN for SIMATIC ET 200pro based on S7-1500 CPU 1516F-3 PN/DP
- For applications with high requirements on the program scope and processing speed, for distributed setup via PROFINET IO
- Can be used for safety functions up to SIL 3 according to IEC 61508 and up to PLe according to ISO 13849

- PROFINET IO controller for operating distributed I/O on PROFINET
- PROFINET I-Device for connecting the CPU as an intelligent PROFINET device with a SIMATIC or non-Siemens PROFINET IO controller
- Supports PROFIsafe in centralized and distributed configurations
- PROFINET shared I-Device for 4 controllers
- PROFINET IO RT/IRT interface with integrated 3-port switch
- Additional PROFINET IO RT interface with separate IP address
- Isochronous mode on PROFINET
- Integrated Motion Control functionalities for controlling speed-controlled and positioning axes, support for external encoders
- OPC UA Server and Client (Data Access) as runtime option for the easy connection of SIMATIC ET 200pro to non-Siemens devices/systems
- Integrated web server with the option of creating user-defined web pages

Note

SIMATIC Memory Card required for operation of the CPU.

Ordering data

Ordering data	Article No.
CPU 1516pro F-2 PN 1.5 MB work memory for program, 5 MB for data, PROFINET IO IRT interface, PROFINET IO RT interface; SIMATIC Memory Card required	6ES7516-2GN00-0AB0
Accessories	
SIMATIC Memory Card	
4 MB ¹⁾	6ES7954-8LC03-0AA0
12 MB ¹⁾	6ES7954-8LE03-0AA0
24 MB ¹⁾	6ES7954-8LF03-0AA0
256 MB ¹⁾	6ES7954-8LL03-0AA0
2 GB ¹⁾	6ES7954-8LP03-0AA0
32 GB ¹⁾	6ES7954-8LT03-0AA0
Connection module	6ES7194-4AP00-0AA0
CM CPU 2PN M12 / 7/8"; With 3 x M12 and 2 x 7/8", for connecting 2 x PROFINET	
Industrial Ethernet FC RJ45 plug 180	
RJ45 plug connector for Industrial Ethernet with a rugged metal enclosure and integrated insulation displacement contacts for connecting Industrial Ethernet FC installation cables; with 180° cable outlet	
• 1 unit	6GK1901-1BB10-2AA0
• 10 units	6GK1901-1BB10-2AB0
• 50 units	6GK1901-1BB10-2AE0
Industrial Ethernet FastConnect installation cables	
• FastConnect standard cable	6XV1840-2AH10
• FastConnect trailing cable	6XV1840-3AH10
• FastConnect marine cable	6XV1840-4AH10

Industrial Ethernet FastConnect installation cables

- IE FC TP trailing cable GP 2 x 2; sold by the meter, max. delivery unit 1 000 m; minimum order quantity 20 m.
- IE TP torsion cable GP 2 x 2; sold by the meter, max. delivery unit 1 000 m; minimum order quantity 20 m.

Industrial Ethernet FastConnect

Stripping Tool

6GK1901-1GA00

IE connecting cable M12-180/M12-180

Preassembled IE FC TP trailing cable GP 2 x 2 (PROFINET type C) with two 4-pin M12 plugs (4-pin, D-coded), degree of protection IP65/IP67, in various lengths:

- 0.3 m
- 0.5 m
- 1.0 m
- 1.5 m
- 2.0 m
- 3.0 m
- 5.0 m
- 10 m
- 15 m

6XV1870-8AE30
6XV1870-8AE50
6XV1870-8AH10
6XV1870-8AH15
6XV1870-8AH20
6XV1870-8AH30
6XV1870-8AH50
6XV1870-8AN10
6XV1870-8AN15

PROFINET M12 trailing connecting cable, preassembled at both ends with angled M12 plugs (male insert), in various lengths:

- 3.0 m
- 5.0 m
- 10 m

3RK1902-2NB30
3RK1902-2NB50
3RK1902-2NC10

¹⁾ An MMC is essential for operating the CPU

Ordering data	Article No.	Article No.
PROFINET M12 trailing connecting cable, preassembled at one end with angled M12 plug (male insert at one end, other end open), in various lengths: <ul style="list-style-type: none"> • 3.0 m • 5.0 m • 10 m 	3RK1902-2HB30 3RK1902-2HB50 3RK1902-2HC10	Trailing power cable, 5 x 1.5 mm ² , preassembled at one end with 7/8" angled connector with female contact insert (female contact insert at one end, other end open), in various lengths: <ul style="list-style-type: none"> • 3.0 m • 5.0 m • 10 m
IE FC M12 plug PRO PROFINET M12 plug connector, D-coded with fast connection system, axial cable outlet. <ul style="list-style-type: none"> • 1 unit • 8 units • PROFINET M12 plug connector, D-coded, angled.	6GK1901-0DB20-6AA0 6GK1901-0DB20-6AA8 3RK1902-2DA00	Power line 5-wire, 5 x 1.5 mm ² , trailing type, sold by the meter, minimum order quantity 20 m, maximum order quantity 1 000 m.
IE panel feedthrough Cabinet feedthrough for converting from the M12 connection system (D-coded, IP65/IP67) to the RJ45 connection system (IP20), 1 pack = 5 units.	6GK1901-0DM20-2AA5	7/8" connection plug For ET 200eco, with axial cable outlet <ul style="list-style-type: none"> • with male insert, 5-pack • with female contact insert, 5-pack • Angled, with female contact insert, 1 unit • Angled, with male insert, 1 unit 7/8" cover cap, 10 per pack
7/8" connecting cable to power supply 5-wire, 5 x 1.5 mm ² , trailing, preassembled with two 7/8" connectors (axial cable outlet), 5-pin, up to 50 m, in various lengths: <ul style="list-style-type: none"> • 1.5 m • 2.0 m • 3.0 m • 5.0 m • 10 m • 15 m • Other special lengths with 90° or 180° cable outlet. 	6XV1822-5BH15 6XV1822-5BH20 6XV1822-5BH30 6XV1822-5BH50 6XV1822-5BN10 6XV1822-5BN15 See http://support.automation.siemens.com/WWW/view/en/26999294	Twisted Pair cables 4x2 with RJ45 connectors 0.5 m 1 m 2 m 6 m 10 m
Trailing power cable, 5 x 1.5 mm ² , preassembled at both ends with 7/8" angled connectors (female contact insert at one end, male insert at the other end), in various lengths: <ul style="list-style-type: none"> • 3.0 m • 5.0 m • 10 m 	3RK1902-3NB30 3RK1902-3NB50 3RK1902-3NC10	Crossed Twisted Pair cables 4x2 with RJ45 connectors 0.5 m 1 m 2 m 6 m 10 m
		M12 sealing cap For protection of unused M12 connections with ET 200pro
		M12 sealing caps with female thread 5 units

Technical specifications

Article number	6ES7516-2GN00-0AB0 ET 200pro: CPU 1516PRO F-2 PN
General information	
Product type designation	CPU 1516pro F-2 PN
Engineering with	
• STEP 7 TIA Portal configurable/integrated from version	V17 (FW V2.9) / V14 (FW V2.0) or higher
Supply voltage	
Rated value (DC)	24 V
Memory	
Work memory	
• integrated (for program)	1.5 Mbyte
• integrated (for data)	5 Mbyte
Load memory	
• Plug-in (SIMATIC Memory Card), max.	32 Gbyte

Article number	6ES7516-2GN00-0AB0 ET 200pro: CPU 1516PRO F-2 PN
CPU processing times	
for bit operations, typ.	10 ns
for word operations, typ.	12 ns
for fixed point arithmetic, typ.	16 ns
for floating point arithmetic, typ.	64 ns
Counters, timers and their retentivity	
S7 counter	
• Number	2 048
IEC counter	
• Number	Any (only limited by the main memory)
S7 times	
• Number	2 048

Distributed Controllers

based on ET 200pro

Fail-safe CPUs

CPU 1516pro F-2 PN

Technical specifications

Article number	6ES7516-2GN00-0AB0 ET 200pro: CPU 1516PRO F-2 PN
IEC timer	
• Number	Any (only limited by the main memory)
Data areas and their retentivity	
Flag	
• Size, max.	16 kbyte
Address area	
I/O address area	
• Inputs	32 kbyte; All inputs are in the process image
• Outputs	32 kbyte; All outputs are in the process image
Time of day	
Clock	
• Type	Hardware clock
1. Interface	
Interface types	
• RJ 45 (Ethernet)	Yes; X1 P3
• Number of ports	3; 2x M12 + 1x RJ45
• integrated switch	Yes
Protocols	
• IP protocol	Yes; IPv4
• PROFINET IO Controller	Yes
• PROFINET IO Device	Yes
• SIMATIC communication	Yes
• Open IE communication	Yes; Optionally also encrypted
• Web server	Yes
• Media redundancy	Yes; MRP Automanager according to IEC 62439-2 Edition 2.0
PROFINET IO Controller	
Services	
- PG/OP communication	Yes
- Isochronous mode	Yes
- Direct data exchange	Yes; Requirement: IRT and isochronous mode (MRPD optional)
- IRT	Yes
- PROFlenergy	Yes; per user program
- Prioritized startup	Yes; Max. 32 PROFINET devices
- Number of connectable IO Devices, max.	256; In total, up to 1 000 distributed I/O devices can be connected via AS-i, PROFIBUS or PROFINET
- Of which IO devices with IRT, max.	64
- Number of connectable IO Devices for RT, max.	256
- of which in line, max.	256
- Number of IO Devices that can be simultaneously activated/deactivated, max.	8; in total across all interfaces
- Number of IO Devices per tool, max.	8
- Updating times	The minimum value of the update time also depends on communication share set for PROFINET IO, on the number of IO devices, and on the quantity of configured user data

Article number	6ES7516-2GN00-0AB0 ET 200pro: CPU 1516PRO F-2 PN
PROFINET IO Device	
Services	
- PG/OP communication	Yes
- Isochronous mode	No
- IRT	Yes
- PROFlenergy	Yes; per user program
- Prioritized startup	No
- Shared device	Yes
- Number of IO Controllers with shared device, max.	4
- activation/deactivation of I-devices	Yes; per user program
- Asset management record	Yes; per user program
2. Interface	
Interface types	
• RJ 45 (Ethernet)	No
• Number of ports	1; 1x M12
• integrated switch	No
Protocols	
• IP protocol	Yes; IPv4
• PROFINET IO Controller	Yes
• PROFINET IO Device	Yes
• SIMATIC communication	Yes
• Open IE communication	Yes; Optionally also encrypted
• Web server	Yes
• Media redundancy	No
PROFINET IO Controller	
Services	
- PG/OP communication	Yes
- Isochronous mode	No
- Direct data exchange	No
- IRT	No
- PROFlenergy	Yes; per user program
- Prioritized startup	No
- Number of connectable IO Devices, max.	32; In total, up to 1 000 distributed I/O devices can be connected via AS-i, PROFIBUS or PROFINET
- Number of connectable IO Devices for RT, max.	32
- of which in line, max.	32
- Number of IO Devices that can be simultaneously activated/deactivated, max.	8; in total across all interfaces
- Number of IO Devices per tool, max.	8
- Updating times	The minimum value of the update time also depends on communication share set for PROFINET IO, on the number of IO devices, and on the quantity of configured user data

Technical specifications

Article number	6ES7516-2GN00-0AB0 ET 200pro: CPU 1516PRO F-2 PN
PROFINET IO Device	
Services	
- PG/OP communication	Yes
- Isochronous mode	No
- IRT	No
- PROFlenergy	Yes; per user program
- Prioritized startup	No
- Shared device	Yes
- Number of IO Controllers with shared device, max.	4
- activation/deactivation of I-devices	Yes; per user program
- Asset management record	Yes; per user program
Protocols	
Number of connections	
• Number of connections, max.	128; Via integrated interfaces of the CPU
Redundancy mode	
Media redundancy	
- Media redundancy	Yes; only via 1st interface (X1)
- MRP	Yes; MRP Automanager according to IEC 62439-2 Edition 2.0, MRP Manager; MRP Client
- MRP interconnection, supported	Yes; as MRP ring node according to IEC 62439-2 Edition 3.0
- MRPD	Yes; Requirement: IRT
- Switchover time on line break, typ.	200 ms; For MRP, bumpless for MRPD
- Number of stations in the ring, max.	50
SIMATIC communication	
• S7 routing	Yes
OPC UA	
• OPC UA Client	Yes
• OPC UA Server	Yes; Data access (read, write, subscribe), method call, custom address space
• Alarms and Conditions	Yes
Supported technology objects	
Motion Control	Yes; Note: The number of technology objects affects the cycle time of the PLC program; selection guide via the TIA Selection Tool
• Number of available Motion Control resources for technology objects	800
• Required Motion Control resources	
- per speed-controlled axis	40
- per positioning axis	80
- per synchronous axis	160
- per external encoder	80
- per output cam	20
- per cam track	160
- per probe	40
Controller	
• PID_Compact	Yes; Universal PID controller with integrated optimization
• PID_3Step	Yes; PID controller with integrated optimization for valves
• PID-Temp	Yes; PID controller with integrated optimization for temperature
Counting and measuring	
• High-speed counter	Yes

Article number	6ES7516-2GN00-0AB0 ET 200pro: CPU 1516PRO F-2 PN
Standards, approvals, certificates	
Highest safety class achievable in safety mode	
Probability of failure (for service life of 20 years and repair time of 100 hours)	
- Low demand mode: PFDavg in accordance with SIL3	< 2.00E-05
- High demand/continuous mode: PFH in accordance with SIL3	< 1.00E-09
Ambient conditions	
Ambient temperature during operation	
• horizontal installation, min.	-25 °C
• horizontal installation, max.	55 °C
• vertical installation, min.	-25 °C
• vertical installation, max.	55 °C
Configuration	
Programming	
Programming language	
- LAD	Yes; incl. failsafe
- FBD	Yes; incl. failsafe
- STL	Yes
- SCL	Yes
- GRAPH	Yes
Know-how protection	
• User program protection/ password protection	Yes
• Copy protection	Yes
• Block protection	Yes
Access protection	
• protection of confidential configuration data	Yes
• Protection level: Write protection	Yes
• Protection level: Read/write protection	Yes
• Protection level: Complete protection	Yes
Dimensions	
Width	135 mm
Height	130 mm
Depth	65 mm
Weights	
Weight, approx.	614 g

Distributed Controllers

Notes

7

**8/2****SIMATIC S7-1500 Software Controllers**

8/2

Standard CPUs

8/2

CPU 1507S

8/6

CPU 1508S

8/10

Fail-safe CPUs

8/10

CPU 1507S F

8/14

CPU 1508S F

8/18

Add-on applications

8/18

ODK 1500S SQL driver

8/18

ODK 1500S XML Data Access driver

8/19

ODK 1500S FileServer

8/19

ODK 1500S SMX driver

8/19

ODK 1500S serial driver

Software Controllers

SIMATIC S7-1500 Software Controllers Standard CPUs

CPU 1507S

Overview

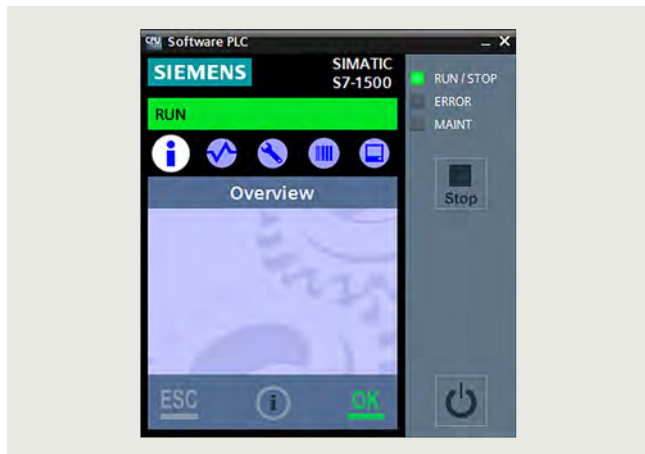

- Software Controller for implementing the functions of a SIMATIC S7-1500 Controller on a SIMATIC IPC
- For use as a PC-based controller in machines with distributed I/O via PROFINET and PROFIBUS
- For utilizing IPC onboard interfaces and PC plug-in cards for PROFINET and PROFIBUS connections
- Optimized for PC-based control tasks with the IPC427E Microbox PC and the IPC477E Panel PC
- Can also be used on the IPC227E, IPC627D, IPC627E and IPC827D Box PCs, the IPC277E, IPC677D and IPC677E Panel PCs, and the IPC647D, IPC647E, IPC847D and IPC847E Rack PCs
- Execution of functions and algorithms implemented with high-level languages under Windows (C/C++, C#, VB) and locally in the CPU 1507S (C/C++)
- Integrated Motion Control functionalities for controlling speed-controlled and positioning axes as well as synchronous operation, support for external encoders, precise position gearing between axes, output cams/cam tracks and probes
- Integrated web server for diagnostics with the option of creating user-defined web pages
- OPC UA server (data access) and client as runtime option for easy connection of the software controller to Windows applications or non-Siemens devices/systems

Ordering data

Article No.

SIMATIC S7-1500 Software Controller CPU 1507S

For implementing the function of an S7-1500 Controller on SIMATIC IPCs

Target system:

Optimized for PC-based control tasks with IPC427E Microbox PC and IPC477E Panel PC;

Can also be used with IPC277E Panel PC, IPC677D Panel PC, IPC677E Panel PC, IPC227E Box PC, IPC627D Box PC, IPC627E Box PC, IPC827D Box PC, IPC647D Rack PC, IPC647E Rack PC, IPC847D Rack PC, IPC847E Rack PC

Requirement:

Windows 7 /
Windows Embedded Standard 7 /
Windows 10 Enterprise;
for supported Windows 10 version, see technical specifications

Type of delivery:

English, German, Chinese,
Italian, French, Spanish

- Single license for one installation Software and documentation on DVD, license key on USB flash drive
- Single license for one installation; Software download including license key ¹⁾

6ES7672-7AC01-0YA0

6ES7672-7AC01-0YG0

Article No.

Accessories

SIMATIC IPC

- SIMATIC IPC427E Microbox PC
- SIMATIC IPC477E Panel PC
- SIMATIC IPC227E Nanobox PC
- SIMATIC IPC277E Panel PC
- SIMATIC IPC677D Panel PC
- SIMATIC IPC677E Panel PC
- SIMATIC IPC627D Box PC
- SIMATIC IPC627E Box PC
- SIMATIC IPC827D Box PC
- SIMATIC IPC647D Rack PC
- SIMATIC IPC647E Rack PC
- SIMATIC IPC847D Rack PC
- SIMATIC IPC847E Rack PC

6AG4141-.....
6AV7241-.....
6ES7647-8B.....
6AV7882-0...0-...0
6AV7260-.....
6AV7261-.....
6AG4131-2.....
6AG4131-3.....
6AG4132-2.....
6AG4112-2.....
6AG4112-3.....
6AG4114-2.....
6AG4114-3.....

CP 1625 communications processor

PCI Express x1 card for connecting PROFINET with IRT to the SIMATIC S7-1500 Software Controller

6ES7648-2CF10-1AA0

CP 5622 communications processor

PCI Express x1 card (32-bit) for connecting a programming device or PC to PROFIBUS

6GK1562-2AA00

CP 5623 communications processor

PCI Express x1 card (32-bit) for connection to PROFIBUS incl. DP-Base software with NCM PC; DP-RAM interface for DP master or DP slave, incl. PG and FDL protocols; single license for 1 installation, runtime software, software and electronic manual on CD-ROM, Class A; for operating system support see SIMATIC NET software en/de

6GK1562-3AA00

¹⁾ For up-to-date information and download availability, see: <http://www.siemens.com/tia-online-software-delivery>

Technical specifications

Article number	6ES7672-7AC01-0YA0 SIMATIC Software Controller CPU 1507S
General information	
Product type designation	CPU 1507S
Engineering with	
• STEP 7 TIA Portal configurable/ integrated from version	V17
Memory	
Work memory	
• integrated (for program)	5 Mbyte
• integrated (for data)	20 Mbyte
• integrated (for CPU function library of CPU Runtime)	50 Mbyte
Load memory	
• integrated (on PC mass storage)	320 Mbyte
CPU processing times	
for bit operations, typ.	1 ns; On IPC427E, Intel Xeon processor
for word operations, typ.	2 ns; On IPC427E, Intel Xeon processor
for fixed point arithmetic, typ.	2 ns; On IPC427E, Intel Xeon processor
for floating point arithmetic, typ.	2 ns; On IPC427E, Intel Xeon processor
Counters, timers and their retentivity	
S7 counter	
• Number	2 048
IEC counter	
• Number	Any (only limited by the main memory)
S7 times	
• Number	2 048
IEC timer	
• Number	Any (only limited by the main memory)
Data areas and their retentivity	
Flag	
• Size, max.	16 kbyte
Address area	
I/O address area	
• Inputs	32 kbyte
• Outputs	32 kbyte
Time of day	
Clock	
• Type	Software clock, synchronizable, no battery backup
Interfaces	
Number of interfaces	3
1. Interface	
Interface type	CP 1625
Number of connections	128
Interface types	
• RJ 45 (Ethernet)	Yes
- Transmission rate, max.	100 Mbit/s
- Industrial Ethernet status LED	Yes
• Number of ports	2
• integrated switch	Yes

Article number	6ES7672-7AC01-0YA0 SIMATIC Software Controller CPU 1507S
Protocols	
• PROFINET IO Controller	Yes
• PROFINET IO Device	Yes
• SIMATIC communication	Yes
• Open IE communication	Yes; Optionally also encrypted
• Web server	Yes
• Media redundancy	Yes; MRP Automanager according to IEC 62439-2 Edition 2.0
PROFINET IO Controller	
Services	
- Isochronous mode	Yes
- Direct data exchange	Yes; Requirement: IRT and isochronous mode (MRPD optional)
- shortest clock pulse	500 µs
- IRT	Yes
- PROFIenergy	Yes
- Prioritized startup	Yes; max. 32 PROFINET devices; if you want to use the "Prioritized startup" functionality in STEP7 for the PROFINET interface of the CPU, the CPU and the device must be separated by means of a switch (e.g. SCALANCE X205) or CP1625
- Number of connectable IO Devices, max.	256
- Of which IO devices with IRT, max.	64
- Number of connectable IO Devices for RT, max.	256
- of which in line, max.	256
- Number of IO Devices that can be simultaneously activated/ deactivated, max.	8
- IO Devices changing during operation (partner ports), supported	Yes; the CPU and changing IO devices must be separated by a switch (e.g. SCALANCE X205)
- Number of IO Devices per tool, max.	8
- Updating times	The minimum value of the update time also depends on communication share set for PROFINET IO, on the number of IO devices, and on the quantity of configured user data
Address area	
- Inputs, max.	8 kbyte
- Outputs, max.	8 kbyte
PROFINET IO Device	
Services	
- PG/OP communication	Yes
- Isochronous mode	No
- IRT	Yes
- PROFIenergy	Yes
- Prioritized startup	Yes; if you want to use the "Prioritized startup" functionality in STEP 7 for the PROFINET interface of the CPU, the CPU and the device must be separated by means of a switch (e.g. SCALANCE X205)
- Shared device	Yes
- Number of IO Controllers with shared device, max.	4
- Asset management record	Yes

Software Controllers

SIMATIC S7-1500 Software Controllers Standard CPUs

CPU 1507S

Technical specifications

Article number	6ES7672-7AC01-0YA0 SIMATIC Software Controller CPU 1507S
2. Interface	
Interface type	Onboard PROFINET / IE interface X2/X3 of the SIMATIC IPC, Intel Springville i210T
Number of connections via this interface	128
Interface types	
• RJ 45 (Ethernet)	Yes
- Transmission rate, max.	100 Mbit/s
- Industrial Ethernet status LED	Yes
• Number of ports	1
• integrated switch	No
Protocols	
• PROFINET IO Controller	Yes
• PROFINET IO Device	Yes
• SIMATIC communication	Yes
• Open IE communication	Yes
• Web server	Yes
• Media redundancy	No
PROFINET IO Controller	
Services	
- Isochronous mode	No
- IRT	No
- PROFinergy	Yes
- Prioritized startup	Yes; max. 32 PROFINET devices; if you want to use the "Prioritized startup" functionality in STEP 7 for the PROFINET interface of the CPU, the CPU and the device must be separated by means of a switch (e.g. SCALANCE X205)
- Number of connectable IO Devices for RT, max.	128
- of which in line, max.	128
- Number of IO Devices that can be simultaneously activated/deactivated, max.	8
- Number of IO Devices per tool, max.	8
- Updating times	The minimum value of the update time also depends on communication share set for PROFINET IO, on the number of IO devices, and on the quantity of configured user data
Address area	
- Inputs, max.	8 kbyte
- Outputs, max.	8 kbyte
PROFINET IO Device	
Services	
- Isochronous mode	No
- IRT	No
- PROFinergy	Yes
- Shared device	Yes
- Number of IO Controllers with shared device, max.	4
- Asset management record	Yes

Article number	6ES7672-7AC01-0YA0 SIMATIC Software Controller CPU 1507S
3. Interface	
Interface type	PROFIBUS with CP 5622, CP 5622 onboard
Number of connections	44
Interface types	
• RS 485	Yes
Protocols	
• PROFIBUS DP master	Yes
• PROFIBUS DP slave	No
• SIMATIC communication	Yes; no PG/STEP 7 connection possible
PROFIBUS DP master	
• Number of DP slaves, max.	64
Services	
- Equidistance	No
- Isochronous mode	No
Address area	
- Inputs, max.	8 kbyte
- Outputs, max.	8 kbyte
4. Interface	
Interface type	PROFIBUS with CP 5623
Number of connections	44
Interface types	
• RS 485	Yes
Protocols	
• PROFIBUS DP master	Yes
• PROFIBUS DP slave	No
• SIMATIC communication	Yes; no PG/STEP 7 connection possible
PROFIBUS DP master	
• Number of DP slaves, max.	125
Protocols	
Number of connections	
• Number of connections, max.	128
Redundancy mode	
Media redundancy	
- MRP	Yes
- MRPD	Yes; Requirement: IRT
- Switchover time on line break, typ.	200 ms; For MRP, bumpless for MRPD
- Number of stations in the ring, max.	50
SIMATIC communication	
• S7 routing	Yes
OPC UA	
• OPC UA Client	Yes; Data access (read, write), method call
• OPC UA Server	Yes; Data access (read, write, subscribe), method call, custom address space

Technical specifications

Article number	6ES7672-7AC01-0YA0 SIMATIC Software Controller CPU 1507S
Supported technology objects	
Motion Control	Yes; Note: The number of technology objects affects the cycle time of the PLC program; selection guide via the TIA Selection Tool or SIZER
• Number of available Motion Control resources for technology objects	4 800
• Required Motion Control resources	
- per speed-controlled axis	40
- per positioning axis	80
- per synchronous axis	160
- per external encoder	80
- per output cam	20
- per cam track	160
- per probe	40
Controller	
• PID_Compact	Yes; Universal PID controller with integrated optimization
• PID_3Step	Yes; PID controller with integrated optimization for valves
• PID-Temp	Yes; PID controller with integrated optimization for temperature
Counting and measuring	
• High-speed counter	Yes
Hardware requirement	
Hardware required	SIMATIC IPC2x7E, IPC4x7D/E, IPC6x7D/E, IPC8x7D/E
Processor	
• Single-core processor	No
• Single-core processor with hyper-threading	No
• Multi-core processor	Yes
• Multi-core processor with hyper-threading	Yes
• occupied cores	1; For multicore processors with activated Hyper-Threading, one complete physical core is reserved for the CPU 1507S
Memory	
• Work memory, min.	4 Gbyte
• Hard disk memory required for installation	720 Mbyte
• Temporary hard disk memory for installation	230 Mbyte
• Hard disk memory required at runtime	400 Mbyte

Article number	6ES7672-7AC01-0YA0 SIMATIC Software Controller CPU 1507S
Operating systems	
Runs under operating system	
• Windows 7	Yes; Professional, Enterprise, Ultimate (32 bit and 64 bit); Windows Embedded Standard 7 with delivery image of the SIMATIC IPC
• Windows 10	Yes; Windows 10 Enterprise 2016 LTSB, 64-bit, MUI on IPC2x7E, IPC4x7E, IPC6x7D, IPC8x7D; Windows 10 Enterprise 2019 LTSC 64-bit, MUI on IPC2x7E, IPC4x7E, IPC6x7E, IPC8x7E
Configuration / header	
Configuration / programming / header	
Programming language	
- LAD	Yes
- FBD	Yes
- STL	Yes
- SCL	Yes
- CFC	No
- GRAPH	Yes
Know-how protection	
• User program protection/password protection	Yes
• Copy protection	Yes
• Block protection	Yes
Access protection	
• Protection level: Write protection	Yes
• Protection level: Read/write protection	Yes
• Protection level: Complete protection	Yes
Open Development interfaces	
• Size of ODK SO file, max.	9.8 Mbyte

Software Controllers

SIMATIC S7-1500 Software Controllers Standard CPUs

CPU 1508S

Overview

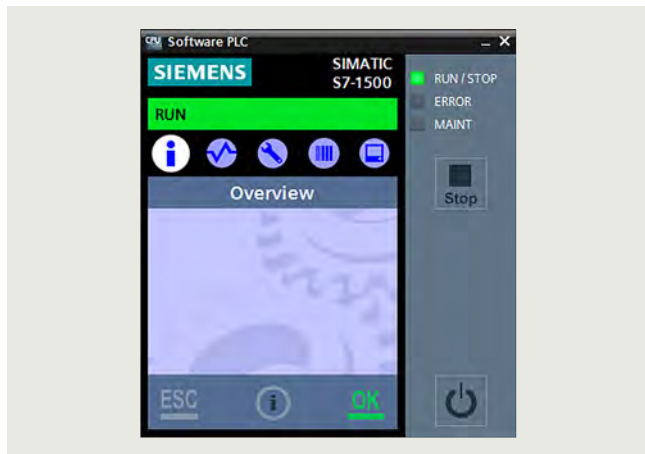

- Software Controller for implementing the functions of a SIMATIC S7-1500 Controller on a SIMATIC IPC
- For use with control applications with increased requirements for program and data memory
- For use as a PC-based controller in machines with distributed I/O via PROFINET and PROFIBUS
- For utilizing IPC onboard interfaces and PC plug-in cards for PROFINET and PROFIBUS connections
- Optimized for PC-based control tasks with the IPC627E Box PC, the IPC677E Panel PC, and the IPC647E and IPC847E Rack PCs
- Can also be used on the IPC427E, IPC627D and IPC827D Box PCs, the IPC477E and IPC677D Panel PCs, and the IPC647D and IPC847D Rack PCs
- Execution of functions and algorithms implemented with high-level languages under Windows (C/C++, C#, VB) and locally in the CPU 1508S (C/C++)
- Integrated Motion Control functionalities for controlling speed-controlled and positioning axes as well as synchronous operation, support for external encoders, precise position gearing between axes, output cams/cam tracks and probes
- OPC UA server (data access) and client as runtime option for easy connection of the software controller to Windows applications or non-Siemens devices/systems

Ordering data

Article No.

SIMATIC S7-1500 Software Controller CPU 1508S

For implementing the function of an S7-1500 Controller on SIMATIC IPCs

Target system:

Optimized for PC-based control tasks with Panel PC IPC677E, Box PC IPC627E, Rack PC IPC647E, Rack PC IPC847E; can also be used with Panel PC IPC477E, Panel PC IPC677D, Box PC IPC427E, Box PC IPC627D, Box PC IPC827D, Rack PC IPC647D, Rack PC IPC847D;

Requirement:

Windows 7 /
Windows Embedded Standard 7 /
Windows 10 (64-bit)

Type of delivery:

en, de, fr, it, es, zh

- Single license for one installation Software and documentation on DVD, license key on USB flash drive
- Single license for one installation; Software download including license key ¹⁾

6ES7672-8AC01-0YA0

6ES7672-8AC01-0YG0

Article No.

Accessories

SIMATIC IPC

- SIMATIC IPC427E Microbox PC
- SIMATIC IPC477E Panel PC
- SIMATIC IPC677D Panel PC
- SIMATIC IPC677E Panel PC
- SIMATIC IPC627D Box PC
- SIMATIC IPC627E Box PC
- SIMATIC IPC827D Box PC
- SIMATIC IPC647D Rack PC
- SIMATIC IPC647E Rack PC
- SIMATIC IPC847D Rack PC
- SIMATIC IPC847E Rack PC

For more information, see Catalog ST 80 / ST PC.

CP 1625 communications processor

PCI Express x1 card for connecting PROFINET with IRT to the SIMATIC S7-1500 Software Controller

CP 5622 communications processor

PCI Express x1 card (32-bit) for connecting a programming device or PC to PROFIBUS

CP 5623 communications processor

PCI Express x1 card (32-bit) for connection to PROFIBUS incl. DP-Base software with NCM PC; DP-RAM interface for DP master or DP slave, incl. PG and FDL protocols; single license for 1 installation, runtime software, software and electronic manual on CD-ROM, Class A; for operating system support see SIMATIC NET software en/de

6AG4141-.....-....
6AV7241-.....-....
6AV7260-.....-....
6AV7261-.....-....
6AG4131-2.....-....
6AG4131-3.....-....
6AG4132-2.....-....
6AG4112-2.....-....
6AG4112-3.....-....
6AG4114-2.....-....
6AG4114-3.....-....

6ES7648-2CF10-1AA0

6GK1562-2AA00

6GK1562-3AA00

¹⁾ For up-to-date information and download availability, see: <http://www.siemens.com/tia-online-software-delivery>

Technical specifications

Article number	6ES7672-8AC01-0YA0 SIMATIC Software Controller CPU 1508S
General information	
Product type designation	CPU 1508S
Engineering with	
• STEP 7 TIA Portal configurable/ integrated from version	V17
Memory	
Work memory	
• integrated (for program)	10 Mbyte
• integrated (for data)	100 Mbyte
• integrated (for CPU function library of CPU Runtime)	50 Mbyte
Load memory	
• integrated (on PC mass storage)	1 024 Mbyte
CPU processing times	
for bit operations, typ.	1 ns; On IPC427E, Intel Xeon processor
for word operations, typ.	2 ns; On IPC427E, Intel Xeon processor
for fixed point arithmetic, typ.	2 ns; On IPC427E, Intel Xeon processor
for floating point arithmetic, typ.	2 ns; On IPC427E, Intel Xeon processor
Counters, timers and their retentivity	
S7 counter	
• Number	2 048
IEC counter	
• Number	Any (only limited by the main memory)
S7 times	
• Number	2 048
IEC timer	
• Number	Any (only limited by the main memory)
Data areas and their retentivity	
Flag	
• Size, max.	16 kbyte
Address area	
I/O address area	
• Inputs	32 kbyte
• Outputs	32 kbyte
Time of day	
Clock	
• Type	Software clock, synchronizable, no battery backup
Interfaces	
Number of interfaces	3
1. Interface	
Interface type	CP 1625
Number of connections	192
Interface types	
• RJ 45 (Ethernet)	Yes
- Transmission rate, max.	100 Mbit/s
- Industrial Ethernet status LED	Yes
• Number of ports	2
• integrated switch	Yes
Protocols	
• IP protocol	Yes; IPv4
• PROFINET IO Controller	Yes
• PROFINET IO Device	Yes
• SIMATIC communication	Yes
• Open IE communication	Yes
• Web server	Yes

Article number	6ES7672-8AC01-0YA0 SIMATIC Software Controller CPU 1508S
PROFINET IO Controller	
Services	
- Isochronous mode	Yes
- Direct data exchange	Yes; Requirement: IRT and isochronous mode (MRPD optional)
- shortest clock pulse	500 µs
- IRT	Yes
- PROFIenergy	Yes
- Prioritized startup	Yes; max. 32 PROFINET devices; if you want to use the "Prioritized startup" functionality in STEP7 for the PROFINET interface of the CPU, the CPU and the device must be separated by means of a switch (e.g. SCALANCE X205) or CP1625
- Number of connectable IO Devices, max.	256; the maximal amount of supported devices on all interfaces (PN/PB) is 384 (256+128) in total; theoretically it should be 509 (256+128+125), but it is accepted to be limited to 384
- Of which IO devices with IRT, max.	64
- Number of connectable IO Devices for RT, max.	256
- of which in line, max.	256
- Number of IO Devices that can be simultaneously activated/deactivated, max.	8
- IO Devices changing during operation (partner ports), supported	Yes; the CPU and changing IO devices must be separated by a switch (e.g. SCALANCE X205)
- Number of IO Devices per tool, max.	8
- Updating times	The minimum value of the update time also depends on communication share set for PROFINET IO, on the number of IO devices, and on the quantity of configured user data
Address area	
- Inputs, max.	16 kbyte
- Outputs, max.	16 kbyte
PROFINET IO Device	
Services	
- Isochronous mode	No
- IRT	Yes
- PROFIenergy	Yes
- Prioritized startup	Yes
- Shared device	Yes
- Number of IO Controllers with shared device, max.	4
- Asset management record	Yes
2. Interface	
Interface type	Onboard PROFINET / IE interface X2 of the SIMATIC IPC, Intel Springville i210T
Number of connections via this interface	192
Interface types	
• RJ 45 (Ethernet)	Yes
- Transmission rate, max.	100 Mbit/s
- Industrial Ethernet status LED	Yes
• Number of ports	1
• integrated switch	No

Software Controllers

SIMATIC S7-1500 Software Controllers Standard CPUs

CPU 1508S

Technical specifications

Article number	6ES7672-8AC01-0YA0 SIMATIC Software Controller CPU 1508S
Protocols	
• IP protocol	Yes; IPv4
• PROFINET IO Controller	Yes
• PROFINET IO Device	Yes
• SIMATIC communication	Yes
• Open IE communication	Yes
• Web server	Yes
• Media redundancy	No
PROFINET IO Controller	
Services	
- Isochronous mode	No
- IRT	No
- PROFlenergy	Yes
- Prioritized startup	Yes; max. 32 PROFINET devices; if you want to use the "Prioritized startup" functionality in STEP 7 for the PROFINET interface of the CPU, the CPU and the device must be separated by means of a switch (e.g. SCALANCE X205)
- Number of connectable IO Devices for RT, max.	128; the maximal amount of supported devices on all interfaces (PN/PB) is 384 (256+128) in total; theoretically it should be 509 (256+128+125), but it is accepted to be limited to 384
- of which in line, max.	128
- Number of IO Devices that can be simultaneously activated/deactivated, max.	8
- Number of IO Devices per tool, max.	8
- Updating times	The minimum value of the update time also depends on communication share set for PROFINET IO, on the number of IO devices, and on the quantity of configured user data
Address area	
- Inputs, max.	8 kbyte
- Outputs, max.	8 kbyte
PROFINET IO Device	
Services	
- Isochronous mode	No
- IRT	No
- PROFlenergy	Yes
- Shared device	Yes
- Number of IO Controllers with shared device, max.	4
- Asset management record	Yes
3. Interface	
Interface type	PROFIBUS with CP 5622, CP 5622 onboard
Number of connections	44
Interface types	
• RS 485	Yes
Protocols	
• PROFIBUS DP master	Yes
• PROFIBUS DP slave	No
• SIMATIC communication	Yes; no PG/STEP 7 connection possible

Article number	6ES7672-8AC01-0YA0 SIMATIC Software Controller CPU 1508S
PROFIBUS DP master	
• Number of DP slaves, max.	64
Services	
- Equidistance	No
- Isochronous mode	No
Address area	
- Inputs, max.	8 kbyte
- Outputs, max.	8 kbyte
4. Interface	
Interface type	PROFIBUS with CP 5623
Number of connections	44
Interface types	
• RS 485	Yes
Protocols	
• PROFIBUS DP master	Yes
• PROFIBUS DP slave	No
• SIMATIC communication	Yes; no PG/STEP 7 connection possible
PROFIBUS DP master	
• Number of DP slaves, max.	125
Protocols	
Number of connections	
• Number of connections, max.	192
Redundancy mode	
Media redundancy	
- MRP	Yes
- MRPD	Yes; Requirement: IRT
- Switchover time on line break, typ.	200 ms; For MRP, bumpless for MRPD
- Number of stations in the ring, max.	50
SIMATIC communication	
• S7 routing	Yes
OPC UA	
• OPC UA Client	Yes; Data access (read, write), method call
• OPC UA Server	Yes; Data access (read, write, subscribe), method call, custom address space

Technical specifications

Article number	6ES7672-8AC01-0YA0 SIMATIC Software Controller CPU 1508S
Supported technology objects	
Motion Control	Yes; Note: The number of technology objects affects the cycle time of the PLC program; selection guide via the TIA Selection Tool or SIZER
• Number of available Motion Control resources for technology objects	4 800
• Required Motion Control resources	
- per speed-controlled axis	40
- per positioning axis	80
- per synchronous axis	160
- per external encoder	80
- per output cam	20
- per cam track	160
- per probe	40
Controller	
• PID_Compact	Yes; Universal PID controller with integrated optimization
• PID_3Step	Yes; PID controller with integrated optimization for valves
• PID-Temp	Yes; PID controller with integrated optimization for temperature
Counting and measuring	
• High-speed counter	Yes
Hardware requirement	
Hardware required	SIMATIC IPC4x7E, IPC6x7D/E, IPC8x7D/E
Processor	
• Single-core processor	No
• Single-core processor with hyper-threading	No
• Multi-core processor	Yes
• Multi-core processor with hyper-threading	Yes
• occupied cores	1; For multicore processors with activated Hyper-Threading, one complete physical core is reserved for the CPU 1507S
Memory	
• Work memory, min.	8 Gbyte
• Hard disk memory required for installation	720 Mbyte
• Temporary hard disk memory for installation	230 Mbyte
• Hard disk memory required at runtime	1 000 Mbyte

Article number	6ES7672-8AC01-0YA0 SIMATIC Software Controller CPU 1508S
Operating systems	
Runs under operating system	
• Windows 7	Yes; Professional, Enterprise, Ultimate (32 bit and 64 bit); Windows Embedded Standard 7 with delivery image of the SIMATIC IPC
• Windows 10	Yes; Windows 10 Enterprise 2016 LTSB, 64-bit, MUI on IPC2x7E, IPC4x7E, IPC6x7D, IPC8x7D; Windows 10 Enterprise 2019 LTSC 64-bit, MUI on IPC2x7E, IPC4x7E, IPC6x7E, IPC8x7E
Configuration / header	
Configuration / programming / header	
Programming language	
- LAD	Yes
- FBD	Yes
- STL	Yes
- SCL	Yes
- CFC	No
- GRAPH	Yes
Know-how protection	
• User program protection/password protection	Yes
• Copy protection	Yes
• Block protection	Yes
Access protection	
• Protection level: Write protection	Yes
• Protection level: Read/write protection	Yes
• Protection level: Complete protection	Yes
Open Development interfaces	
• Size of ODK SO file, max.	9.8 Mbyte

Software Controllers

SIMATIC S7-1500 Software Controllers Fail-safe CPUs

CPU 1507S F

Overview

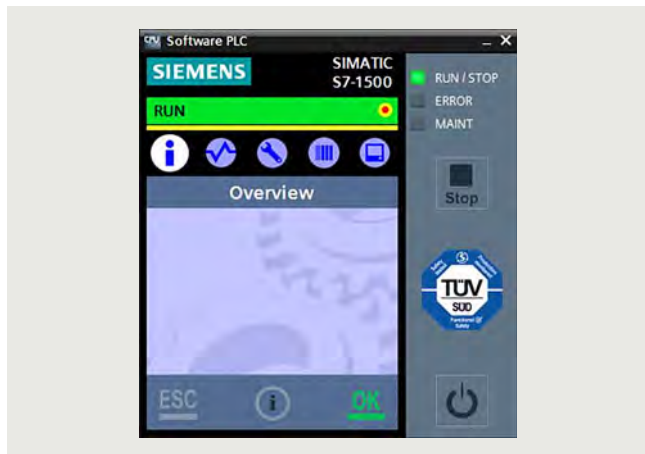

- Software Controller for implementing the functions of a SIMATIC S7-1500 Controller on a SIMATIC IPC
- For use as a PC-based controller in machines with distributed I/O via PROFINET and PROFIBUS
- For utilizing IPC onboard interfaces and PC plug-in cards for PROFINET and PROFIBUS connections
- Can be used for safety functions up to SIL 3 according to IEC 61508 and up to PL e according to ISO 13849

- Supports PROFIsafe in distributed configurations
- Optimized for PC-based control tasks with the IPC427E Microbox PC and the IPC477E Panel PC (requires configuration with NVRAM)
- Can also be used on IPC227E, IPC627D, IPC627E and IPC827D Box PCs, IPC277E, IPC677D and IPC677E Panel PCs, and IPC647E and IPC847E Rack PCs (configurations with NVRAM are required for the IPC227E, IPC427E, IPC627D, IPC827D, IPC277E, IPC477E and IPC677D PCs)
- Execution of functions and algorithms implemented with high-level languages under Windows (C/C++, C#, VB) and locally in the CPU 1507S F (C/C++)
- Integrated Motion Control functionalities for controlling speed-controlled and positioning axes as well as synchronous operation, support for external encoders, precise position gearing between axes, output cams/cam tracks and probes
- Integrated web server for diagnostics with the option of creating user-defined web pages
- OPC UA server (data access) and client as runtime option for easy connection of the software controller to Windows applications or non-Siemens devices/systems

Ordering data

Article No.

Software Controller CPU 1507S F

For implementing the function of a fail-safe S7-1500 Controller on SIMATIC IPCs

Target system:

Optimized for PC-based control tasks with IPC427E Microbox PC and IPC477E Panel PC;

Can also be used with IPC277E Panel PC, IPC677D Panel PC, IPC677E Panel PC, IPC227E Box PC, IPC627D Box PC, IPC627E Box PC, IPC827D Box PC, IPC647E Rack PC, IPC847E Rack PC

Requirement:

Windows 7 / Windows Embedded Standard 7 / Windows 10 Enterprise LTSB with MBR boot;

For supported Windows 10 versions, see Technical specifications

For the IPC227E, IPC427E, IPC627D, IPC827D, IPC277E, IPC477E and IPC677D, IPC configurations with NVRAM are required)

Type of delivery:

English, German, Chinese, Italian, French, Spanish

- Single license for one installation Software and documentation on DVD, license key on USB flash drive
- Single license for one installation; Software download including license key ¹⁾

6ES7672-7FC01-0YA0

6ES7672-7FC01-0YG0

Article No.

Accessories

SIMATIC IPC

- SIMATIC IPC227E Nanobox PC
- SIMATIC IPC427E Microbox PC
- SIMATIC IPC627D Box PC
- SIMATIC IPC627E Box PC
- SIMATIC IPC827D Box PC
- SIMATIC IPC277E Panel PC
- SIMATIC IPC477E Panel PC
- SIMATIC IPC677D Panel PC
- SIMATIC IPC677E Panel PC
- IPC647E Rack PC
- IPC847E Rack PC

6ES7647-8B...-....

6AG4141-.....-....

6AG4131-2.....-....

6AG4131-3.....-....

6AG4132-2.....-....

6AV7882-0...0-...0

6AV7241-.....-....

6AV7260-.....-....

6AV7261-.....-....

6AG4112-3.....-....

6AG4114-3.....-....

CP 1625

communications processor

PCI Express x1 card for connecting PROFINET with IRT to the SIMATIC S7-1500 Software Controller

6ES7648-2CF10-1AA0

CP 5622

communications processor

PCI Express x1 card (32-bit) for connecting a programming device or PC to PROFIBUS

6GK1562-2AA00

CP 5623

communications processor

PCI Express x1 card (32-bit) for connection to PROFIBUS incl. DP-Base software with NCM PC; DP-RAM interface for DP master or DP slave, incl. PG and FDL protocols; single license for 1 installation, runtime software, software and electronic manual on CD-ROM, Class A; for operating system support see SIMATIC NET software en/de

6GK1562-3AA00

¹⁾ For up-to-date information and download availability, see: <http://www.siemens.com/tia-online-software-delivery>

Technical specifications

Article number	6ES7672-7FC01-0YA0 SIMATIC Failsafe SW Ctrl CPU 1507S F
General information	
Product type designation	CPU 1507S F
Engineering with	
• STEP 7 TIA Portal configurable/ integrated from version	V17
Memory	
Work memory	
• integrated (for program)	7.5 Mbyte
• integrated (for data)	20 Mbyte
• integrated (for CPU function library of CPU Runtime)	50 Mbyte
Load memory	
• integrated (on PC mass storage)	320 Mbyte
CPU processing times	
for bit operations, typ.	1 ns; On IPC427E, Intel Xeon processor
for word operations, typ.	2 ns; On IPC427E, Intel Xeon processor
for fixed point arithmetic, typ.	2 ns; On IPC427E, Intel Xeon processor
for floating point arithmetic, typ.	2 ns; On IPC427E, Intel Xeon processor
Counters, timers and their retentivity	
S7 counter	
• Number	2 048
IEC counter	
• Number	Any (only limited by the main memory)
S7 times	
• Number	2 048
IEC timer	
• Number	Any (only limited by the main memory)
Data areas and their retentivity	
Flag	
• Size, max.	16 kbyte
Address area	
I/O address area	
• Inputs	32 kbyte
• Outputs	32 kbyte
Time of day	
Clock	
• Type	Software clock, synchronizable, no battery backup
Interfaces	
Number of interfaces	3
1. Interface	
Interface type	CP 1625
Number of connections	128
Interface types	
• RJ 45 (Ethernet)	Yes
- Transmission rate, max.	100 Mbit/s
- Industrial Ethernet status LED	Yes
• Number of ports	2
• integrated switch	Yes

Article number	6ES7672-7FC01-0YA0 SIMATIC Failsafe SW Ctrl CPU 1507S F
Protocols	
• PROFINET IO Controller	Yes
• PROFINET IO Device	Yes
• SIMATIC communication	Yes
• Open IE communication	Yes
• Web server	Yes
PROFINET IO Controller	
Services	
- Isochronous mode	Yes
- Direct data exchange	Yes; Requirement: IRT and isochronous mode (MRPD optional)
- shortest clock pulse	500 µs
- IRT	Yes
- PROFINergy	Yes
- Prioritized startup	Yes; max. 32 PROFINET devices; if you want to use the "Prioritized startup" functionality in STEP7 for the PROFINET interface of the CPU, the CPU and the device must be separated by means of a switch (e.g. SCALANCE X205) or CP1625
- Number of connectable IO Devices, max.	256
- Of which IO devices with IRT, max.	64
- Number of connectable IO Devices for RT, max.	256
- of which in line, max.	256
- Number of IO Devices that can be simultaneously activated/deactivated, max.	8
- IO Devices changing during operation (partner ports), supported	Yes; the CPU and changing IO devices must be separated by a switch (e.g. SCALANCE X205)
- Number of IO Devices per tool, max.	8
- Updating times	The minimum value of the update time also depends on communication share set for PROFINET IO, on the number of IO devices, and on the quantity of configured user data
Address area	
- Inputs, max.	8 kbyte
- Outputs, max.	8 kbyte
PROFINET IO Device	
Services	
- PG/OP communication	Yes
- Isochronous mode	No
- IRT	Yes
- PROFINergy	Yes
- Prioritized startup	Yes; if you want to use the "Prioritized startup" functionality in STEP 7 for the PROFINET interface of the CPU, the CPU and the device must be separated by means of a switch (e.g. SCALANCE X205)
- Shared device	Yes
- Number of IO Controllers with shared device, max.	4
- Asset management record	Yes

Software Controllers

SIMATIC S7-1500 Software Controllers Fail-safe CPUs

CPU 1507S F

Technical specifications

Article number	6ES7672-7FC01-0YA0 SIMATIC Failsafe SW Ctrl CPU 1507S F
2. Interface	
Interface type	Onboard PROFINET / IE interface X2/X3 of the SIMATIC IPC, Intel Springville i210T
Number of connections via this interface	128
Interface types	
• RJ 45 (Ethernet)	Yes
- Transmission rate, max.	100 Mbit/s
- Industrial Ethernet status LED	Yes
• Number of ports	1
• integrated switch	No
Protocols	
• PROFINET IO Controller	Yes
• PROFINET IO Device	Yes
• SIMATIC communication	Yes
• Open IE communication	Yes
• Web server	Yes
• Media redundancy	No
PROFINET IO Controller	
Services	
- Isochronous mode	No
- IRT	No
- PROFIenergy	Yes
- Prioritized startup	Yes; max. 32 PROFINET devices; if you want to use the "Prioritized startup" functionality in STEP 7 for the PROFINET interface of the CPU, the CPU and the device must be separated by means of a switch (e.g. SCALANCE X205)
- Number of connectable IO Devices for RT, max.	128
- of which in line, max.	128
- Number of IO Devices that can be simultaneously activated/deactivated, max.	8
- Number of IO Devices per tool, max.	8
- Updating times	The minimum value of the update time also depends on communication share set for PROFINET IO, on the number of IO devices, and on the quantity of configured user data
Address area	
- Inputs, max.	8 kbyte
- Outputs, max.	8 kbyte
PROFINET IO Device	
Services	
- Isochronous mode	No
- IRT	No
- PROFIenergy	Yes
- Shared device	Yes
- Number of IO Controllers with shared device, max.	4
- Asset management record	Yes

Article number	6ES7672-7FC01-0YA0 SIMATIC Failsafe SW Ctrl CPU 1507S F
3. Interface	
Interface type	PROFIBUS with CP 5622, CP 5622 onboard
Number of connections	44
Interface types	
• RS 485	Yes
Protocols	
• PROFIBUS DP master	Yes
• PROFIBUS DP slave	No
• SIMATIC communication	Yes; no PG/STEP 7 connection possible
PROFIBUS DP master	
• Number of DP slaves, max.	64
Services	
- Equidistance	No
- Isochronous mode	No
Address area	
- Inputs, max.	8 kbyte
- Outputs, max.	8 kbyte
4. Interface	
Interface type	PROFIBUS with CP 5623
Number of connections	44
Interface types	
• RS 485	Yes
Protocols	
• PROFIBUS DP master	Yes
• PROFIBUS DP slave	No
• SIMATIC communication	Yes; no PG/STEP 7 connection possible
PROFIBUS DP master	
• Number of DP slaves, max.	125
Protocols	
Number of connections	
• Number of connections, max.	128
Redundancy mode	
Media redundancy	
- MRP	Yes
- MRPD	Yes; Requirement: IRT
- Switchover time on line break, typ.	200 ms; For MRP, bumpless for MRPD
- Number of stations in the ring, max.	50
SIMATIC communication	
• S7 routing	Yes
OPC UA	
• OPC UA Client	Yes; Data access (read, write), method call
• OPC UA Server	Yes; Data access (read, write, subscribe), method call, custom address space

Technical specifications

Article number	6ES7672-7FC01-0YA0 SIMATIC Failsafe SW Ctrl CPU 1507S F
Supported technology objects	
Motion Control	Yes; Note: The number of technology objects affects the cycle time of the PLC program; selection guide via the TIA Selection Tool or SIZER
• Number of available Motion Control resources for technology objects	4 800
• Required Motion Control resources	
- per speed-controlled axis	40
- per positioning axis	80
- per synchronous axis	160
- per external encoder	80
- per output cam	20
- per cam track	160
- per probe	40
Controller	
• PID_Compact	Yes; Universal PID controller with integrated optimization
• PID_3Step	Yes; PID controller with integrated optimization for valves
• PID-Temp	Yes; PID controller with integrated optimization for temperature
Counting and measuring	
• High-speed counter	Yes
Standards, approvals, certificates	
Highest safety class achievable in safety mode	
• Performance level according to ISO 13849-1	PLe
• SIL acc. to IEC 61508	SIL 3
Probability of failure (for service life of 20 years and repair time of 100 hours)	
- Low demand mode: PFDavg in accordance with SIL3	< 2.00E-05
- High demand/continuous mode: PFH in accordance with SIL3	< 1.00E-09
Hardware requirement	
Hardware required	SIMATIC IPC2x7E, IPC4x7D/E, IPC627D, IPC677D, IPC827D: configurations with NVRAM required; IPC6x7E, IPC8x7E
Processor	
• Single-core processor	No
• Single-core processor with hyper-threading	No
• Multi-core processor	Yes
• Multi-core processor with hyper-threading	Yes
• occupied cores	1; For multicore processors with activated Hyper-Threading, one complete physical core is reserved for the CPU 1507S

Article number	6ES7672-7FC01-0YA0 SIMATIC Failsafe SW Ctrl CPU 1507S F
Memory	
• Work memory, min.	4 Gbyte
• Hard disk memory required for installation	720 Mbyte
• Temporary hard disk memory for installation	230 Mbyte
• Hard disk memory required at runtime	400 Mbyte
Operating systems	
Runs under operating system	
• Windows 7	Yes; Professional, Enterprise, Ultimate (32 bit and 64 bit); Windows Embedded Standard 7 with delivery image of the SIMATIC IPC
• Windows 10	Yes; Windows 10 Enterprise 2016 LTSB, 64-bit, MUI on IPC2x7E, IPC4x7E, IPC6x7D, IPC8x7D; Windows 10 Enterprise 2019 LTSC 64-bit, MUI on IPC2x7E, IPC4x7E, IPC6x7E, IPC8x7E
Configuration / header	
Configuration / programming / header	
Programming language	
- LAD	Yes; incl. failsafe
- FBD	Yes; incl. failsafe
- STL	Yes
- SCL	Yes
- CFC	No
- GRAPH	Yes
Know-how protection	
• User program protection/password protection	Yes
• Copy protection	Yes
• Block protection	Yes
Access protection	
• Protection level: Write protection	Yes
• Protection level: Read/write protection	Yes
• Protection level: Write protection for Failsafe	Yes
• Protection level: Complete protection	Yes
Open Development interfaces	
• Size of ODK SO file, max.	9.8 Mbyte

Software Controllers

SIMATIC S7-1500 Software Controllers Fail-safe CPUs

CPU 1508S F

Overview



- Software Controller for implementing the functions of a SIMATIC S7-1500 Controller on a SIMATIC IPC
- For use with control applications with increased requirements for program and data memory
- For use as a PC-based controller in machines with distributed I/O via PROFINET and PROFIBUS
- For utilizing IPC onboard interfaces and PC plug-in cards for PROFINET and PROFIBUS connections

- Can be used for safety functions up to SIL 3 according to IEC 61508 and up to PL e according to ISO 13849
- Supports PROFIsafe in distributed configurations
- Optimized for PC-based control tasks with the IPC627E Box PC, the IPC677E Panel PC, and the IPC647E and IPC847E Rack PCs
- Can also be used on the IPC427E, IPC627D and IPC827D Box PCs and the IPC477E and IPC677D Panel PCs (configuration with NVRAM required)
- Execution of functions and algorithms implemented with high-level languages under Windows (C/C++, C#, VB) and locally in the CPU 1508S F (C/C++)
- Integrated Motion Control functionalities for controlling speed-controlled and positioning axes as well as synchronous operation, support for external encoders, precise position gearing between axes, output cams/cam tracks and probes
- Integrated web server for diagnostics with the option of creating user-defined web pages
- OPC UA server (data access) and client as runtime option for easy connection of the software controller to Windows applications or non-Siemens devices/systems

Ordering data

Article No.

SIMATIC S7-1500 Software Controller CPU 1508S F

For implementing the function of a fail-safe S7-1500 Controller on SIMATIC IPCs (IPC configuration with NVRAM required)

Target system:

Optimized for PC-based control tasks with IPC677E Panel PC, IPC627E Box PC, IPC647E Rack PC, IPC847E Rack PC; Can also be used with IPC477E Panel PC, IPC677D Panel PC, IPC427E Box PC, IPC627D Box PC, IPC827D Box PC;

Requirement:

Windows 7 / Windows Embedded Standard 7 / Windows 10 (64-bit); for supported Windows 10 versions, see technical specifications.

On IPC477E, IPC677D, IPC427E, IPC627D and IPC827D, configurations with NVRAM are required

Type of delivery:

English, German, Chinese, Italian, French, Spanish

- Single license for one installation Software and documentation on DVD, license key on USB flash drive
- Single license for one installation; Software download including license key ¹⁾

6ES7672-8FC01-0YA0

6ES7672-8FC01-0YG0

Article No.

Accessories

SIMATIC IPC

- SIMATIC IPC427E Microbox PC
- SIMATIC IPC627E Box PC
- SIMATIC IPC627D Box PC
- SIMATIC IPC827D Box PC
- SIMATIC IPC477E Panel PC
- SIMATIC IPC677D Panel PC
- SIMATIC IPC677E Panel PC
- SIMATIC IPC647E Rack PC
- SIMATIC IPC847E Rack PC

For more information, see Catalog ST 80 / ST PC.

CP 1625 communications processor

PCI Express x1 card for connecting PROFINET with IRT to the SIMATIC S7-1500 Software Controller

CP 5622 communications processor

PCI Express x1 card (32-bit) for connecting a programming device or PC to PROFIBUS

CP 5623 communications processor

PCI Express x1 card (32-bit) for connection to PROFIBUS incl. DP-Base software with NCM PC; DP-RAM interface for DP master or DP slave, incl. PG and FDL protocols; single license for 1 installation, runtime software, software and electronic manual on CD-ROM, Class A; for operating system support see SIMATIC NET software en/de

6AG4141-.....-.....
6AG4131-3.....-.....
6AG4131-2.....-.....
6AG4132-2.....-.....
6AV7241-.....-.....
6AV7260-.....-.....
6AV7261-.....-.....
6AG4112-3.....-.....
6AG4114-3.....-.....

6ES7648-2CF10-1AA0

6GK1562-2AA00

6GK1562-3AA00

¹⁾ For up-to-date information and download availability, see: <http://www.siemens.com/tia-online-software-delivery>

Technical specifications

Article number	6ES7672-8FC01-0YA0 SIMATIC Failsafe SW Ctrl CPU 1508S F
General information	
Product type designation	CPU 1508S F
Engineering with	
• STEP 7 TIA Portal configurable/ integrated from version	V17
Memory	
Work memory	
• integrated (for program)	12.5 Mbyte
• integrated (for data)	100 Mbyte
• integrated (for CPU function library of CPU Runtime)	50 Mbyte
Load memory	
• integrated (on PC mass storage)	1 024 Mbyte
CPU processing times	
for bit operations, typ.	1 ns; On IPC427E, Intel Xeon processor
for word operations, typ.	2 ns; On IPC427E, Intel Xeon processor
for fixed point arithmetic, typ.	2 ns; On IPC427E, Intel Xeon processor
for floating point arithmetic, typ.	2 ns; On IPC427E, Intel Xeon processor
Counters, timers and their retentivity	
S7 counter	
• Number	2 048
IEC counter	
• Number	Any (only limited by the main memory)
S7 times	
• Number	2 048
IEC timer	
• Number	Any (only limited by the main memory)
Data areas and their retentivity	
Flag	
• Size, max.	16 kbyte
Address area	
I/O address area	
• Inputs	32 kbyte
• Outputs	32 kbyte
Time of day	
Clock	
• Type	Software clock, synchronizable, no battery backup
Interfaces	
Number of interfaces	3
1. Interface	
Interface type	CP 1625
Number of connections	192
Interface types	
• RJ 45 (Ethernet)	Yes
- Transmission rate, max.	100 Mbit/s
- Industrial Ethernet status LED	Yes
• Number of ports	2
• integrated switch	Yes

Article number	6ES7672-8FC01-0YA0 SIMATIC Failsafe SW Ctrl CPU 1508S F
Protocols	
• PROFINET IO Controller	Yes
• PROFINET IO Device	Yes
• SIMATIC communication	Yes
• Open IE communication	Yes
• Web server	Yes
PROFINET IO Controller	
Services	
- Isochronous mode	Yes
- Direct data exchange	Yes; Requirement: IRT and isochronous mode (MRPD optional)
- shortest clock pulse	500 µs
- IRT	Yes
- PROFIenergy	Yes
- Prioritized startup	Yes; max. 32 PROFINET devices; if you want to use the "Prioritized startup" functionality in STEP7 for the PROFINET interface of the CPU, the CPU and the device must be separated by means of a switch (e.g. SCALANCE X205) or CP1625
- Number of connectable IO Devices, max.	256; the maximal amount of supported devices on all interfaces (PN/PB) is 384 (256+128) in total; theoretically it should be 509 (256+128+125), but it is accepted to be limited to 384
- Of which IO devices with IRT, max.	64
- Number of connectable IO Devices for RT, max.	256
- of which in line, max.	256
- Number of IO Devices that can be simultaneously activated/ deactivated, max.	8
- IO Devices changing during operation (partner ports), supported	Yes; the CPU and changing IO devices must be separated by a switch (e.g. SCALANCE X205)
- Number of IO Devices per tool, max.	8
- Updating times	The minimum value of the update time also depends on communication share set for PROFINET IO, on the number of IO devices, and on the quantity of configured user data
Address area	
- Inputs, max.	16 kbyte
- Outputs, max.	16 kbyte
PROFINET IO Device	
Services	
- Isochronous mode	No
- IRT	Yes
- PROFIenergy	Yes
- Prioritized startup	Yes
- Shared device	Yes
- Number of IO Controllers with shared device, max.	4
- Asset management record	Yes

Software Controllers

SIMATIC S7-1500 Software Controllers

Fail-safe CPUs

CPU 1508S F

Technical specifications

Article number	6ES7672-8FC01-0YA0 SIMATIC Failsafe SW Ctrl CPU 1508S F
2. Interface	
Interface type	Onboard PROFINET / IE interface X2 of the SIMATIC IPC, Intel Springville i210T
Number of connections via this interface	192
Interface types	
• RJ 45 (Ethernet)	Yes
- Transmission rate, max.	100 Mbit/s
• Number of ports	1
• integrated switch	No
Protocols	
• PROFINET IO Controller	Yes
• PROFINET IO Device	Yes
• SIMATIC communication	Yes
• Open IE communication	Yes
• Web server	Yes
• Media redundancy	No
PROFINET IO Controller	
Services	
- Isochronous mode	No
- IRT	No
- PROFlenergy	Yes
- Prioritized startup	Yes; max. 32 PROFINET devices; if you want to use the "Prioritized startup" functionality in STEP 7 for the PROFINET interface of the CPU, the CPU and the device must be separated by means of a switch (e.g. SCALANCE X205)
- Number of connectable IO Devices for RT, max.	128; the maximal amount of supported devices on all interfaces (PN/PB) is 384 (256+128) in total; theoretically it should be 509 (256+128+125), but it is accepted to be limited to 384
- of which in line, max.	128
- Number of IO Devices that can be simultaneously activated/deactivated, max.	8
- Number of IO Devices per tool, max.	8
- Updating times	The minimum value of the update time also depends on communication share set for PROFINET IO, on the number of IO devices, and on the quantity of configured user data
Address area	
- Inputs, max.	8 kbyte
- Outputs, max.	8 kbyte
PROFINET IO Device	
Services	
- Isochronous mode	No
- IRT	No
- PROFlenergy	Yes
- Shared device	Yes
- Number of IO Controllers with shared device, max.	4
- Asset management record	Yes

Article number	6ES7672-8FC01-0YA0 SIMATIC Failsafe SW Ctrl CPU 1508S F
3. Interface	
Interface type	PROFIBUS with CP 5622, CP 5622 onboard
Number of connections	44
Protocols	
• PROFIBUS DP master	Yes
• PROFIBUS DP slave	No
• SIMATIC communication	Yes
PROFIBUS DP master	
• Number of DP slaves, max.	64
Services	
- Equidistance	No
- Isochronous mode	No
Address area	
- Inputs, max.	8 kbyte
- Outputs, max.	8 kbyte
4. Interface	
Interface type	PROFIBUS with CP 5623
Number of connections	44
Interface types	
• RS 485	Yes
Protocols	
• PROFIBUS DP master	Yes
• PROFIBUS DP slave	No
• SIMATIC communication	Yes; no PG/STEP 7 connection possible
PROFIBUS DP master	
• Number of DP slaves, max.	125
Protocols	
Number of connections	
• Number of connections, max.	192
Redundancy mode	
Media redundancy	
- MRP	Yes
- MRPD	Yes; Requirement: IRT
- Switchover time on line break, typ.	200 ms; For MRP, bumpless for MRPD
- Number of stations in the ring, max.	50
SIMATIC communication	
• S7 routing	Yes
OPC UA	
• OPC UA Client	Yes; Data access (read, write), method call
• OPC UA Server	Yes; Data access (read, write, subscribe), method call, custom address space

Technical specifications

Article number	6ES7672-8FC01-0YA0 SIMATIC Failsafe SW Ctrl CPU 1508S F
Supported technology objects	
Motion Control	Yes; Note: The number of technology objects affects the cycle time of the PLC program; selection guide via the TIA Selection Tool or SIZER
• Number of available Motion Control resources for technology objects	4 800
• Required Motion Control resources	
- per speed-controlled axis	40
- per positioning axis	80
- per synchronous axis	160
- per external encoder	80
- per output cam	20
- per cam track	160
- per probe	40
Controller	
• PID_Compact	Yes; Universal PID controller with integrated optimization
• PID_3Step	Yes; PID controller with integrated optimization for valves
• PID-Temp	Yes; PID controller with integrated optimization for temperature
Counting and measuring	
• High-speed counter	Yes
Standards, approvals, certificates	
Highest safety class achievable in safety mode	
• Performance level according to ISO 13849-1	PLe
• SIL acc. to IEC 61508	SIL 3
Probability of failure (for service life of 20 years and repair time of 100 hours)	
- Low demand mode: PFDavg in accordance with SIL3	< 2.00E-05
- High demand/continuous mode: PFH in accordance with SIL3	< 1.00E-09
Hardware requirement	
Hardware required	SIMATIC IPC4x7E, IPC627D, IPC677D, IPC827D, configurations with NVRAM required; IPC6x7E, IPC847E
Processor	
• Single-core processor	No
• Single-core processor with hyper-threading	No
• Multi-core processor	Yes
• Multi-core processor with hyper-threading	Yes
• occupied cores	1; For multicore processors with activated Hyper-Threading, one complete physical core is reserved for the CPU 1507S

Article number	6ES7672-8FC01-0YA0 SIMATIC Failsafe SW Ctrl CPU 1508S F
Memory	
• Work memory, min.	8 Gbyte
• Hard disk memory required for installation	720 Mbyte
• Temporary hard disk memory for installation	230 Mbyte
• Hard disk memory required at runtime	1 000 Mbyte
Operating systems	
Runs under operating system	
• Windows 7	Yes; Professional, Enterprise, Ultimate (32 bit and 64 bit); Windows Embedded Standard 7 with delivery image of the SIMATIC IPC
• Windows 10	Yes; Windows 10 Enterprise 2016 LTSB, 64-bit, MUI on IPC2x7E, IPC4x7E, IPC6x7D, IPC8x7D; Windows 10 Enterprise 2019 LTSC 64-bit, MUI on IPC2x7E, IPC4x7E, IPC6x7E, IPC8x7E
Configuration / header	
Configuration / programming / header	
Programming language	
- LAD	Yes; incl. failsafe
- FBD	Yes; incl. failsafe
- STL	Yes
- SCL	Yes
- CFC	No
- GRAPH	Yes
Know-how protection	
• User program protection/password protection	Yes
• Copy protection	Yes
• Block protection	Yes
Access protection	
• Protection level: Write protection	Yes
• Protection level: Read/write protection	Yes
• Protection level: Write protection for Failsafe	Yes
• Protection level: Complete protection	Yes
Open Development interfaces	
• Size of ODK SO file, max.	9.8 Mbyte

Software Controllers

SIMATIC S7-1500 Software Controllers

Add-on applications

ODK 1500S SQL driver, ODK 1500S XML Data Access driver

Overview ODK 1500S SQL driver

Note

This catalog entry contains non-binding information on a supplementary application software for the SIMATIC S7-1500 Software Controller and the SIMATIC ET 200SP Open Controller.

Overview

The ODK 1500S SQL driver enables direct access to an SQL database from the PLC program. In this case the database can be installed on the same computer as the S7-1500 Software Controller or in the network.

- Direct data exchange with SQL-based database by means of SQL commands from the PLC program
- Connection to SQL-based database on the same PC or to database servers in the network

Technical specifications

Supported SQL commands	<ul style="list-style-type: none"> • SELECT • INSERT • UPDATE • DELETE
Supported data types	All standard SQL data types
System requirements	SIMATIC IPC with S7-1500 Software Controller or SIMATIC ET 200SP Open Controller STEP 7 in the TIA Portal V13 SP1
<ul style="list-style-type: none"> • Runtime PC • Engineering 	

More information

If you are interested, please contact your sales representative:
<http://www.automation.siemens.com/partner/>

You can find Service and Support at:
<https://support.industry.siemens.com/cs/ww/en/view/109479140>

Overview ODK 1500S XML Data Access driver

Note

This catalog entry contains non-binding information about supplementary application software for the SIMATIC S7-1500 Software Controller and the SIMATIC ET 200SP Open Controller.

Overview

With the function blocks of the ODK 1500S XML Data Access driver it is possible to access specific information in XML files in the Windows file system from the PLC program.

XPath expressions are used for accessing XML file elements since they provide the highest possible flexibility for processing XML data. This means that extremely large XML files can be edited, too.

The driver offers the following functionality:

- XML data can be read into and processed in the PLC.
- XML data can be modified and written back to the XML file.

Technical specifications

System requirements	SIMATIC IPC with SIMATIC S7-1500 Software Controller or SIMATIC ET 200SP Open Controller STEP 7 in TIA Portal V13 SP1
<ul style="list-style-type: none"> • Runtime PC • Engineering 	

More information

If you are interested, please contact your sales representative:
<http://www.automation.siemens.com/partner/>

You can find Service and Support at:
<https://support.industry.siemens.com/cs/ww/en/view/109479496>

ODK 1500S FileServer, ODK 1500S SMX driver, ODK 1500S serial driver

Overview ODK 1500S FileServer

Note

This catalog entry contains non-binding information about supplementary application software for the SIMATIC S7-1500 Software Controller and the SIMATIC ET 200SP Open Controller.

Overview

The ODK 1500S FileServer enhances the SIMATIC S7-1500 Software Controller file function with an option enabling direct access to the Windows file system of the PC from the STEP 7 program.

The driver enables reading and writing of data blocks in/from files in structured form. Various file formats are supported.

There are also FBs available for handling files (e.g. renaming, deleting).

Technical specifications

Supported file formats	<ul style="list-style-type: none"> • CSV • ASCII • Windows-INI • XML ¹⁾ • Binary
System requirements	SIMATIC IPC with SIMATIC S7-1500 Software Controller or SIMATIC ET 200SP Open Controller STEP 7 in TIA Portal V13 SP1
<ul style="list-style-type: none"> • Runtime PC • Engineering 	

¹⁾ The XML format is predefined. A DB can be saved and read in as an XML file. It is not possible to parse any particular XML file.

More information

If you are interested, please contact your sales representative:
<http://www.automation.siemens.com/partner/>

You can find Service and Support at:
<https://support.industry.siemens.com/cs/ww/en/view/109479497>

Overview ODK 1500S SMX driver

Note

This catalog entry contains non-binding information about supplementary application software for the SIMATIC S7-1500 Software Controller and the SIMATIC ET 200SP Open Controller.

Overview

The ODK 1500S SMX driver permits access from a Windows user program to data of the PLC program. A shared memory which can be accessed by the PLC and user program is set up for this purpose. The ODK 1500S simplifies the changeover to the SIMATIC S7-1500 Software Controller of applications that previously used the SMX interface of the SIMATIC WinAC RTX.

More information

If you are interested, please contact your sales representative:
<http://www.automation.siemens.com/partner/>

You can find Service and Support at:
<https://support.industry.siemens.com/cs/ww/en/view/109741583>

Overview ODK 1500S serial driver

Note

This catalog entry contains non-binding information about supplementary application software for the SIMATIC S7-1500 Software Controller and the SIMATIC ET 200SP Open Controller.

Overview

The ODK 1500S serial driver enables serial communication from the STEP 7 user program via the integrated serial interface of a SIMATIC IPC or, depending on the application environment, via a USB-to-serial adapter. All serial interfaces of the PC are supported, which are addressed in Windows as COM n interface, e.g. RS232, RS422 or RS485.

More information

If you are interested, please contact your sales representative:
<http://www.automation.siemens.com/partner/>

You can find Service and Support at:
<https://support.industry.siemens.com/cs/ww/en/view/109479259>

Software Controllers

SIMATIC S7-1500 Software Controllers

Add-on applications

Notes

Drive Controllers

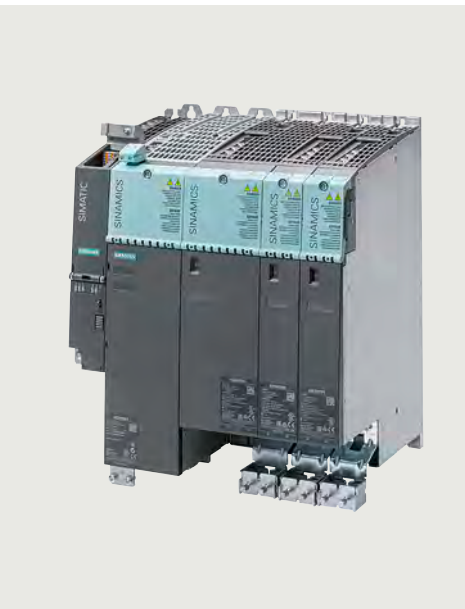

9/2

Introduction

9/3

Technology CPUs

9/3

CPU 1504D TF, CPU 1507D TF

Drive Controllers

Introduction

Drive Controllers

Overview

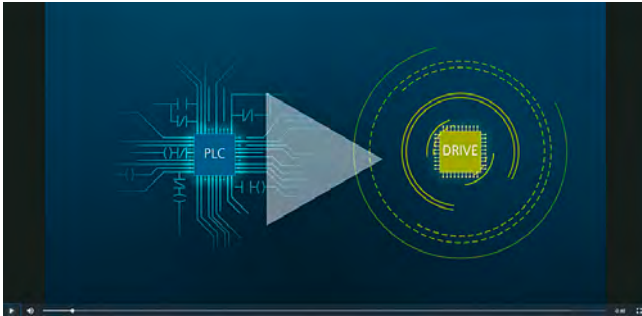

SIMATIC Drive Controller Video:
https://players.brightcove.net/1813624294001/70fecf0f-fbad-4fad-a077-d0e26af4d84c_default/index.html?videoId=6138318810001



The SIMATIC Drive Controller is available in two performance classes and meets even the most demanding Motion Control needs with the two fail-safe technology CPUs (CPU 1504D TF and CPU 1507D TF).

The fail-safe CPUs permit the processing of standard and safety programs on the same controller.

As technology CPUs, they also have extensive Motion Control functions such as:

- Speed and positioning axes
- Synchronous operation functions
 - Synchronizing with/without specifying the synchronization position
 - Actual value coupling
 - Shifting of the master value at following axis
 - Camming
 - Cross-PLC synchronous operation
- Cam
- Cyclic specification of the motion vector from the application (MotionIn interface)
- Kinematics
 - With up to 4 interpolating axes (e.g. cartesian portal, delta picker, roller picker, articulated arm, cylindrical robot, tripod picker and SCARA)
 - User-defined kinematics
- External encoders, output cams and measuring inputs

The extensive integrated interfaces and technology I/Os are consistently available in all performance classes and enable the efficient implementation of compact and modular automation solutions with Motion Control based on the SINAMICS S120 drive system.

Thanks to fast system response times, the SIMATIC Drive Controller is the ideal solution wherever axes with high configuration limits and the shortest cycle times for high machine cycle rates and optimum product quality through deterministic and reproducible machine behavior are required.

The SIMATIC Drive Controller is configured in TIA Portal V16 or higher with the SIMATIC STEP 7 Professional engineering software and SINAMICS Startdrive.

The SIMATIC Drive Controller can be extended with components from the modular SINAMICS S120 drive system and SIMATIC automation components such as HMI and I/O systems. Additional drive systems such as e.g. SINAMICS S210 or SINAMICS G can easily be integrated via PROFINET.

Overview CPU 1504D TF

CPU 1504D TF

- For standard and fail-safe applications with medium requirements for program scope and processing speed
- Ultra-compact due to the integration of fail-safe SIMATIC S7-1500 technology CPU, SINAMICS S120 drive control and technology I/Os in a single device
- Extensive integrated communication interfaces and technology I/Os for the efficient implementation of automation solutions with Motion Control
- Tried-and-tested engineering in TIA Portal

Overview CPU 1507D TF

CPU 1507D TF

- For standard and fail-safe applications with high to very high requirements for program scope and processing speed
- Ultra-compact due to the integration of fail-safe SIMATIC S7-1500 technology CPU, SINAMICS S120 drive control and technology I/Os in a single device
- Extensive integrated communication interfaces and technology I/Os for the efficient implementation of automation solutions with Motion Control
- Tried-and-tested engineering in TIA Portal

Ordering data
Article No.

SIMATIC S7-1500 Drive Controller CPU 1504D TF With SINAMICS S120 Integrated; Fail-safe technology CPU; Work memory: 2 MB for program, 4 MB for data; Interfaces: 12 DI, 16 DI/DQ, 4 DRIVE-CLIQ, 3 PROFINET; 3+1+1 ports, 1 PROFIBUS; SIMATIC Memory Card required	6ES7615-4DF10-0AB0
SIMATIC S7-1500 Drive Controller CPU 1507D TF With SINAMICS S120 Integrated; Fail-safe technology CPU; Work memory: 6 MB for program, 20 MB for data; Interfaces: 12 DI, 16 DI/DQ, 4 DRIVE-CLIQ, 3 PROFINET; 3+1+1 ports, 1 PROFIBUS; SIMATIC Memory Card required	6ES7615-7DF10-0AB0
Accessories SIMATIC Memory Card ¹⁾ <ul style="list-style-type: none"> • 4 MB • 12 MB • 24 MB • 256 MB • 2 GB • 32 GB 	6ES7954-8LC03-0AA0 6ES7954-8LE03-0AA0 6ES7954-8LF03-0AA0 6ES7954-8LL03-0AA0 6ES7954-8LP03-0AA0 6ES7954-8LT03-0AA0

Article No.

<i>Drive licenses for integrated drive control</i> Safety Integrated Extended Functions Certificate of License (CoL) for a SINAMICS S120 axis <ul style="list-style-type: none"> • CoL in paper form • CoL in electronic form³⁾ Email address required for delivery	6SL3074-0AA10-0AA0 6SL3074-0AA10-0AH0
Safety Integrated Advanced Functions Certificate of License (CoL) for a SINAMICS S120 axis <ul style="list-style-type: none"> • CoL in paper form • CoL in electronic form³⁾ Email address required for delivery	6SL3074-0AA20-0AA0 6SL3074-0AA20-0AH0
Cogging torque compensation Certificate of License (CoL) for a SINAMICS S120 axis <ul style="list-style-type: none"> • CoL in paper form • CoL in electronic form³⁾ Email address required for delivery	6SL3074-0AA15-0AA0 6SL3074-0AA15-0AH0

¹⁾ When using the integrated SINAMICS S120 drive control, a memory card size of at least 12 MB is recommended. A memory card size of at least 256 MB is required for firmware updates.

³⁾ For up-to-date information and download availability, see: <http://www.siemens.com/tia-online-software-delivery>

Drive Controllers

Technology CPUs

CPU 1504D TF, CPU 1507D TF

Ordering data

Advanced Position Control (APC)

Certificate of License (CoL) for a SINAMICS S120 axis

- CoL in paper form
- CoL in electronic form³⁾
Email address required for delivery

6SL3074-0AA05-0AA0
6SL3074-0AA05-0AH0

Advanced Synchronous Reluctance Control

Certificate of License (CoL) for a SINAMICS S120 axis

- CoL in paper form
- CoL in electronic form³⁾
Email address required for delivery

6SL3074-0AA06-0AA0
6SL3074-0AA06-0AH0

Technology Extension VIBX (Vibration Extinction)

Certificate of License (CoL) per SINAMICS Integrated

- CoL in paper form
- CoL in electronic form³⁾
Email address required for delivery

6SL3077-0AA00-5AB0
6SL3077-0AA00-5AH0

Technology Extension SERVOUP (Servo Coupling)

Certificate of License (CoL) per SINAMICS Integrated

- CoL in paper form
- CoL in electronic form³⁾
Email address required for delivery

6SL3077-0AA00-8AB0
6SL3077-0AA00-8AH0

DCB Extension Library

Certificate of License (CoL) per SINAMICS Integrated

- CoL in paper form
- CoL in electronic form³⁾
Email address required for delivery

6SL3077-0AA00-0AB0
6SL3077-0AA00-0AH0

For other SINAMICS licenses (controller parameter adaption, dynamic grid support and line droop control), see SIMATIC Drive Controller system manual

Control licenses

SIMATIC OPC UA S7-1500 Small

Required for CPU 1504D TF Single Runtime License

- License certificate for OPC UA Server (Data Access and OPC UA Client)
- Download incl. license certificate for OPC UA Server (Data Access and OPC UA Client)³⁾
Email address required for delivery

6ES7823-0BA00-1BA0

6ES7823-0BE00-1BA0

SIMATIC OPC UA S7-1500 Large

Required for CPU 1507D TF Single Runtime License

- License certificate for OPC UA Server (Data Access and OPC UA Client)
- Download incl. license certificate for OPC UA Server (Data Access and OPC UA Client)³⁾
Email address required for delivery

6ES7823-0BA00-1DA0

6ES7823-0BE00-1DA0

Accessories for PROFIBUS (interface X126)

PROFIBUS RS485 bus connector

With angular cable outlet (35°) with screw-type terminals, max. transmission rate 12 Mbps

- Without programming device/PC interface
- With programming device/PC interface

6ES7972-0BA42-0XA0

6ES7972-0BB42-0XA0

PROFIBUS FastConnect RS485 bus connector

With angular cable outlet (35°) with insulation displacement technology, max. transmission rate 12 Mbps

- Without programming device/PC interface
- With programming device/PC interface

6ES7972-0BA61-0XA0

6ES7972-0BB61-0XA0

FastConnect cables for PROFIBUS

(sold by the meter; max. delivery unit 1 000 m; minimum order quantity 20 m)

- FC standard cable GP
- FC robust cable
- FC flexible cable
- FC trailing cable, sheath color: Petrol
- FC trailing cable, sheath color: Violet
- FC food cable
- FC ground cable
- FC FRNC cable GP

6XV1830-0EH10

6XV1830-0JH10

6XV1831-2K

6XV1830-3EH10

6XV1831-2L

6XV1830-0GH10

6XV1830-3FH10

6XV1830-0LH10

Accessories for PROFINET (interface X150 and X160; X130 only up to 100 Mbps)

IE FC RJ45 plug 145

145° cable outlet (10/100 Mbps)

- 1 unit
- 10 units
- 50 units

6GK1901-1BB30-0AA0

6GK1901-1BB30-0AB0

6GK1901-1BB30-0AE0

FastConnect cables for Industrial Ethernet/PROFINET

(sold by the meter; max. delivery unit 1 000 m; minimum order quantity 20 m)

- IE FC standard cable GP 2x2
- IE FC flexible cable GP 2x2
- IE FC trailing cable GP 2x2
- IE FC trailing cable 2x2
- IE FC marine cable 2x2

6XV1840-2AH10

6XV1870-2B

6XV1870-2D

6XV1840-3AH10

6XV1840-4AH10

Accessories for PROFINET²⁾ (interface X130, for up to 1 000 Mbps)

IE FC RJ45 plug 180

180° cable outlet (10/100/1 000 Mbps)

- 1 unit
- 10 units
- 50 units

6GK1901-1BB11-2AA0

6GK1901-1BB11-2AB0

6GK1901-1BB11-2AE0

FastConnect cables for Industrial Ethernet/PROFINET

(sold by the meter; max. delivery unit 1 000 m; minimum order quantity 20 m)

- IE FC standard cable GP 4x2
- IE FC flexible cable GP 4x2

6XV1878-2A

6XV1878-2B

²⁾ The Ethernet interface X130 supports 10, 100 and 1 000 Mbps. For 1 000 Mbps, 8-wire cables (4x2) and the 180° FastConnect plug in 1 000 Mbps version must be used.

³⁾ For up-to-date information and download availability, see: <http://www.siemens.com/tia-online-software-delivery>

Ordering data	Article No.	Engineering software	Article No.
<i>Other accessories</i>			
PROFIBUS FastConnect stripping tool Pre-adjusted stripping tool for fast stripping of PROFIBUS FastConnect bus cables	6GK1905-6AA00	<p>The following engineering software is required for the SIMATIC Drive Controller:</p> <ul style="list-style-type: none"> STEP 7 Professional V17 for configuring control functionality STEP 7 Safety Advanced V17 for creating safety-related programs S7-PLCSIM Advanced V4.0 for simulation and validation of the control functionality SINAMICS Startdrive Basic V17⁴⁾ or SINAMICS Startdrive Advanced V17 for configuring the integrated drive control (SINAMICS Integrated) SINAMICS DCC V17 (option package for SINAMICS Startdrive) for the graphical configuration of control, computing and logic blocks 	<p>For ordering data for engineering software controllers, see catalog section 12. For ordering data for engineering software drive systems, see Industry Mall: https://www.siemens.com/industrymall</p>
IE FC stripping tool Pre-adjusted stripping tool for fast stripping of Industrial Ethernet FC cables	6GK1901-1GA00		
Dust protection blanking plugs For sealing unused DRIVE-CLiQ and PROFINET ports; blanking plug (50 units)	6SL3066-4CA00-0AA0		
<i>Spare parts</i>			
Bottom cover	6ES7615-0AC10-0AA0		
Top cover	6ES7615-0AC10-1AA0		
Spacer	6SL3064-1BB00-0AA0	<i>Documentation</i>	
Terminal Kit • 3 x I/O plug for X122/X132/X142 • 1 x 24 V plug for X124 • 5 x DRIVE-CLiQ blanking cover	6SL3064-2CB00-0AA0	SIMATIC Manual Collection Electronic manuals on DVD, multilingual	6ES7998-8XC01-8YE0
		SIMATIC Manual Collection Update service for 1 year Current Manual Collection DVD and the three subsequent updates	6ES7998-8XC01-8YE2

⁴⁾ The SINAMICS Startdrive Basic commissioning tool is available for free on the Internet at: <https://www.siemens.com/startdrive>

Technical specifications

Article number	6ES7615-4DF10-0AB0 SIMATIC Drive Controller, CPU 1504D TF	6ES7615-7DF10-0AB0 SIMATIC Drive Controller, CPU 1507D TF
General information		
Product type designation	CPU 1504D TF	CPU 1507D TF
Engineering with		
• STEP 7 TIA Portal configurable/integrated from version	V17 (FW V2.9) / V16 (FW V2.8) or higher	V17 (FW V2.9) / V16 (FW V2.8) or higher
Integrated drive control		
• Number of axes for servo control, max.	6	6
• Number of axes for vector control, max.	6	6
• Number of axes for V/f control, max.	12	12
• Remark	alternative control modes; drive control based on SINAMICS S120 CU320-2 (firmware version V5.x); functional subset compared to CU320-2: no free function blocks, ... ; for details, see the manual	alternative control modes; drive control based on SINAMICS S120 CU320-2 (firmware version V5.x); functional subset compared to CU320-2: no free function blocks, ... ; for details, see the manual
Supply voltage		
Rated value (DC)	24 V	24 V

Drive Controllers

Technology CPUs

CPU 1504D TF, CPU 1507D TF

Technical specifications

Article number	6ES7615-4DF10-0AB0 SIMATIC Drive Controller, CPU 1504D TF	6ES7615-7DF10-0AB0 SIMATIC Drive Controller, CPU 1507D TF
Memory		
Work memory		
• integrated (for program)	2 Mbyte	6 Mbyte
• integrated (for data)	4 Mbyte	20 Mbyte
Load memory		
• Plug-in (SIMATIC Memory Card), required	12 Mbyte; Recommended at least when integrated drive is used	12 Mbyte; Recommended at least when integrated drive is used
• Plug-in (SIMATIC Memory Card), max.	32 Gbyte	32 Gbyte
Counters, timers and their retentivity		
S7 counter		
• Number	2 048	2 048
IEC counter		
• Number	Any (only limited by the main memory)	Any (only limited by the main memory)
S7 times		
• Number	2 048	2 048
IEC timer		
• Number	Any (only limited by the main memory)	Any (only limited by the main memory)
Data areas and their retentivity		
Flag		
• Size, max.	16 kbyte	16 kbyte
Address area		
I/O address area		
• Inputs	32 kbyte; All inputs are in the process image	32 kbyte; All inputs are in the process image
• Outputs	32 kbyte; All outputs are in the process image	32 kbyte; All outputs are in the process image
Time of day		
Clock		
• Type	Hardware clock	Hardware clock
Digital inputs		
integrated channels (DI)	28; max. depending on parameterization	28; max. depending on parameterization
Digital outputs		
integrated channels (DO)	16; max. depending on parameterization	16; max. depending on parameterization
Digital outputs, parameterizable	Yes; 8 DI/DQ (X122/X132, SINAMICS Integrated) + 8 DI/DQ (X142, PLC)	Yes; 8 DI/DQ (X122/X132, SINAMICS Integrated) + 8 DI/DQ (X142, PLC)
Short-circuit protection	Yes; electronic/thermal	Yes; electronic/thermal
1. Interface		
Interface types		
• RJ 45 (Ethernet)	Yes; X150	Yes; X150
• Number of ports	3	3
• integrated switch	Yes	Yes
Protocols		
• IP protocol	Yes; IPv4	Yes; IPv4
• PROFINET IO Controller	Yes	Yes
• PROFINET IO Device	Yes	Yes
• SIMATIC communication	Yes	Yes
• Open IE communication	Yes; Optionally also encrypted	Yes; Optionally also encrypted
• Web server	Yes	Yes
• Media redundancy	Yes	Yes

Technical specifications

Article number	6ES7615-4DF10-0AB0 SIMATIC Drive Controller, CPU 1504D TF	6ES7615-7DF10-0AB0 SIMATIC Drive Controller, CPU 1507D TF
PROFINET IO Controller		
Services		
- PG/OP communication	Yes	Yes
- Isochronous mode	Yes	Yes
- Direct data exchange	Yes; Requirement: IRT and isochronous mode (MRPD optional)	Yes; Requirement: IRT and isochronous mode (MRPD optional)
- shortest clock pulse	500 µs	250 µs
- IRT	Yes	Yes
- PROFIenergy	Yes; per user program	Yes; per user program
- Prioritized startup	Yes; Max. 32 PROFINET devices	Yes; Max. 32 PROFINET devices
- Number of connectable IO Devices, max.	256; In total, up to 1 000 distributed I/O devices can be connected via AS-i, PROFIBUS or PROFINET	256; In total, up to 1 000 distributed I/O devices can be connected via AS-i, PROFIBUS or PROFINET
- Of which IO devices with IRT, max.	64	64
- Number of connectable IO Devices for RT, max.	256	256
- of which in line, max.	256	256
- Number of IO Devices that can be simultaneously activated/deactivated, max.	8; in total across all interfaces	8; in total across all interfaces
- Number of IO Devices per tool, max.	8	8
- Updating times	The minimum value of the update time also depends on communication share set for PROFINET IO, on the number of IO devices, and on the quantity of configured user data	The minimum value of the update time also depends on communication share set for PROFINET IO, on the number of IO devices, and on the quantity of configured user data
PROFINET IO Device		
Services		
- PG/OP communication	Yes	Yes
- Isochronous mode	No	No
- shortest clock pulse	500 µs	250 µs
- IRT	Yes	Yes
- PROFIenergy	Yes; per user program	Yes; per user program
- Shared device	Yes	Yes
- Number of IO Controllers with shared device, max.	4	4
- activation/deactivation of I-devices	Yes; per user program	Yes; per user program
- Asset management record	Yes; per user program	Yes; per user program
2. Interface		
Interface types		
• RJ 45 (Ethernet)	Yes; X160	Yes; X160
• Number of ports	1	1
• integrated switch	No	No
Protocols		
• IP protocol	Yes; IPv4	Yes; IPv4
• PROFINET IO Controller	Yes	Yes
• PROFINET IO Device	Yes	Yes
• SIMATIC communication	Yes	Yes
• Open IE communication	Yes; Optionally also encrypted	Yes; Optionally also encrypted
• Web server	Yes	Yes
• Media redundancy	No	No

Drive Controllers

Technology CPUs

CPU 1504D TF, CPU 1507D TF

Technical specifications

Article number	6ES7615-4DF10-0AB0 SIMATIC Drive Controller, CPU 1504D TF	6ES7615-7DF10-0AB0 SIMATIC Drive Controller, CPU 1507D TF
PROFINET IO Controller		
Services		
- PG/OP communication	Yes	Yes
- Isochronous mode	No	No
- Direct data exchange	No	No
- IRT	No	No
- PROFinergy	Yes; per user program	Yes; per user program
- Prioritized startup	No	No
- Number of connectable IO Devices, max.	128; In total, up to 1 000 distributed I/O devices can be connected via AS-i, PROFIBUS or PROFINET	128; In total, up to 1 000 distributed I/O devices can be connected via AS-i, PROFIBUS or PROFINET
- Number of connectable IO Devices for RT, max.	128	128
- of which in line, max.	128	128
- Number of IO Devices that can be simultaneously activated/deactivated, max.	8; in total across all interfaces	8; in total across all interfaces
- Number of IO Devices per tool, max.	8	8
- Updating times	The minimum value of the update time also depends on communication share set for PROFINET IO, on the number of IO devices, and on the quantity of configured user data	The minimum value of the update time also depends on communication share set for PROFINET IO, on the number of IO devices, and on the quantity of configured user data
PROFINET IO Device		
Services		
- PG/OP communication	Yes	Yes
- Isochronous mode	No	No
- IRT	No	No
- PROFinergy	Yes; per user program	Yes; per user program
- Prioritized startup	No	No
- Shared device	Yes	Yes
- Number of IO Controllers with shared device, max.	4	4
- activation/deactivation of I-devices	Yes; per user program	Yes; per user program
- Asset management record	Yes; per user program	Yes; per user program
3. Interface		
Interface types		
• RJ 45 (Ethernet)	Yes; X130	Yes; X130
• Number of ports	1	1
• integrated switch	No	No
Protocols		
• IP protocol	Yes; IPv4	Yes; IPv4
• PROFINET IO Controller	No	No
• PROFINET IO Device	No	No
• SIMATIC communication	Yes	Yes
• Open IE communication	Yes	Yes
• Web server	Yes	Yes
4. Interface		
Interface types		
• RS 485	Yes; X126	Yes; X126
• Number of ports	1	1
Protocols		
• PROFIBUS DP master	Yes	Yes
• PROFIBUS DP slave	No	No
• SIMATIC communication	Yes	Yes
PROFIBUS DP master		
• Number of DP slaves, max.	125; In total, up to 1 000 distributed I/O devices can be connected via AS-i, PROFIBUS or PROFINET	125; In total, up to 1 000 distributed I/O devices can be connected via AS-i, PROFIBUS or PROFINET

Technical specifications

Article number	6ES7615-4DF10-0AB0 SIMATIC Drive Controller, CPU 1504D TF	6ES7615-7DF10-0AB0 SIMATIC Drive Controller, CPU 1507D TF
Protocols		
Number of connections		
• Number of connections, max.	384; Via integrated interfaces of the CPU	384; Via integrated interfaces of the CPU
Redundancy mode		
Media redundancy		
- Media redundancy	only via interface X150	only via interface X150
- MRP	Yes; MRP Automanager according to IEC 62439-2 Edition 2.0, MRP Manager; MRP Client	Yes; MRP Automanager according to IEC 62439-2 Edition 2.0, MRP Manager; MRP Client
- MRP interconnection, supported	Yes; as MRP ring node according to IEC 62439-2 Edition 3.0	Yes; as MRP ring node according to IEC 62439-2 Edition 3.0
- MRPD	Yes; Requirement: IRT	Yes; Requirement: IRT
- Switchover time on line break, typ.	200 ms; For MRP, bumpless for MRPD	200 ms; For MRP, bumpless for MRPD
- Number of stations in the ring, max.	50	50
SIMATIC communication		
• S7 routing	Yes	Yes
OPC UA		
• OPC UA Client	Yes	Yes
• OPC UA Server	Yes; Data access (read, write, subscribe), method call, custom address space	Yes; Data access (read, write, subscribe), method call, custom address space
• Alarms and Conditions	Yes	Yes
Supported technology objects		
Motion Control	Yes; Note: The number of technology objects affects the cycle time of the PLC program; selection guide via the TIA Selection Tool	Yes; Note: The number of technology objects affects the cycle time of the PLC program; selection guide via the TIA Selection Tool
• Number of available Motion Control resources for technology objects	2 400	12 800
• Required Motion Control resources		
- per speed-controlled axis	40	40
- per positioning axis	80	80
- per synchronous axis	160	160
- per external encoder	80	80
- per output cam	20	20
- per cam track	160	160
- per probe	40	40
• Number of available Extended Motion Control resources for technology objects	120	420
• Required Extended Motion Control resources		
- per cam (1 000 points and 50 segments)	2	2
- per cam (10 000 points and 50 segments)	20	20
- for each set of kinematics	30	30
- Per leading axis proxy	3	3
Controller		
• PID_Compact	Yes; Universal PID controller with integrated optimization	Yes; Universal PID controller with integrated optimization
• PID_3Step	Yes; PID controller with integrated optimization for valves	Yes; PID controller with integrated optimization for valves
• PID-Temp	Yes; PID controller with integrated optimization for temperature	Yes; PID controller with integrated optimization for temperature
Counting and measuring		
• High-speed counter	Yes	Yes

Drive Controllers

Technology CPUs

CPU 1504D TF, CPU 1507D TF

Technical specifications

Article number	6ES7615-4DF10-0AB0 SIMATIC Drive Controller, CPU 1504D TF	6ES7615-7DF10-0AB0 SIMATIC Drive Controller, CPU 1507D TF
Standards, approvals, certificates		
Highest safety class achievable in safety mode		
Probability of failure (for service life of 20 years and repair time of 100 hours)		
- Low demand mode: PFDavg in accordance with SIL2	< 14.00E-04	< 14.00E-04
- Low demand mode: PFDavg in accordance with SIL3	< 2.00E-05 PLd (if exclusively F-CPU is used)	< 2.00E-05 PLd (if exclusively F-CPU is used)
- High demand/continuous mode: PFH in accordance with SIL2	< 14.00E-09	< 14.00E-09
- High demand/continuous mode: PFH in accordance with SIL3	if exclusively F-CPU is used: < 1.00E-09 (at a site altitude of up to 3000 m); < 2.00E-09 (at a site altitude of more than 3000 m and up to 4000 m)	if exclusively F-CPU is used: < 1.00E-09 (at a site altitude of up to 3000 m); < 2.00E-09 (at a site altitude of more than 3000 m and up to 4000 m)
Ambient conditions		
Ambient temperature during operation		
• min.	0 °C	0 °C
• max.	55 °C	55 °C
Altitude during operation relating to sea level		
• Installation altitude above sea level, max.	4 000 m; as of an altitude of 2000 m, the maximum ambient air temperature is reduced by 7 °C per 1000 m; see SINAMICS documentation for SINAMICS S120 drive components	4 000 m; as of an altitude of 2000 m, the maximum ambient air temperature is reduced by 7 °C per 1000 m; see SINAMICS documentation for SINAMICS S120 drive components
• Ambient air temperature-barometric pressure-altitude	Permissible air pressure: 620 hPa ... 1 060 hPa	Permissible air pressure: 620 hPa ... 1 060 hPa
Configuration / header		
Configuration / programming / header		
Programming language		
- LAD	Yes; incl. failsafe	Yes; incl. failsafe
- FBD	Yes; incl. failsafe	Yes; incl. failsafe
- STL	Yes	Yes
- SCL	Yes	Yes
- GRAPH	Yes	Yes
Know-how protection		
• User program protection/password protection	Yes	Yes
• Copy protection	Yes	Yes
• Block protection	Yes	Yes
Access protection		
• protection of confidential configuration data	Yes	Yes
• Protection level: Write protection	Yes	Yes
• Protection level: Read/write protection	Yes	Yes
• Protection level: Write protection for Failsafe	Yes	Yes
• Protection level: Complete protection	Yes	Yes
Dimensions		
Width	50 mm	50 mm
Height	300 mm	300 mm
Depth	226 mm; 270 mm with spacer (included in scope of supply)	226 mm; 270 mm with spacer (included in scope of supply)
Weights		
Weight, approx.	2 400 g	2 400 g
Other		
Note:	The SIMATIC Drive Controller deviates from the usual SIMATIC S7-1500 ambient conditions and specifications as well as the available approvals and certificates because of the drive design. For details, see the SIMATIC Drive Controller device and system manual. Operation is without fan.	The SIMATIC Drive Controller deviates from the usual SIMATIC S7-1500 ambient conditions and specifications as well as the available approvals and certificates because of the drive design. For details, see the SIMATIC Drive Controller device and system manual. Operation is without fan.

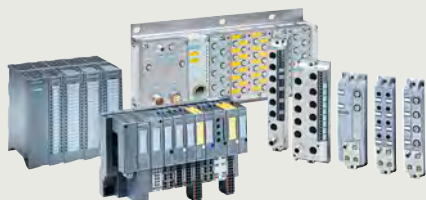

10/4	Introduction	10/171	- SCALANCE W722 RJ45 for the control cabinet
10/5	SIMATIC ET 200 systems for the control cabinet	10/174	- SCALANCE W721 RJ45 for the control cabinet
10/5	SIMATIC ET 200SP	10/177	- SIPLUS CM PtP serial interface
10/9	Interface modules	10/179	- SIPLUS CM 4x IO-Link
10/19	SIPLUS interface modules	10/181	- SIPLUS ET 200SP CM CAN
10/22	<u>I/O modules</u>	10/183	- SIPLUS CM DP for ET 200SP CPU
10/22	Digital input modules	10/185	Fail-safe I/O modules
10/32	Digital output modules	10/185	- Digital F-input modules
10/49	Analog input modules	10/188	- Digital F-output modules
10/69	Analog output modules	10/192	- Digital F-output module relay
10/77	SIPLUS digital inputs	10/194	- Analog F-input modules
10/81	SIPLUS digital outputs	10/198	- Special fail-safe modules
10/87	SIPLUS analog inputs	10/201	- Fail-safe technology modules
10/94	SIPLUS analog outputs	10/205	- SIPLUS digital F-input modules
10/98	Technology modules	10/208	- SIPLUS digital F-output modules
10/98	- TM Count 1x24V counter module	10/211	- SIPLUS digital F-output module relay
10/102	- TM PosInput 1 counter and position detection module	10/213	- SIPLUS analog F-input modules
10/106	- TM Timer DIDQ 10x24V time-based IO module	10/216	- SIPLUS special fail-safe modules
10/109	- TM Pulse 2x24V pulse output module	10/218	- Fail-safe communication
10/112	- TM StepDrive 24...48V/5A stepper motor control (Phytron Co.)	10/218	- F-CM AS-i Safety ST for SIMATIC ET 200SP
10/113	- F-TM ServoDrive HF	10/221	Ex I/O modules
10/115	- F-TM ServoDrive ST	10/222	ET 200SP motor starters
10/117	- F-TM StepDrive ST	10/231	<u>Pneumatics</u>
10/119	- SIMATIC ET 200SP ECC charging controllers	10/231	Valve terminal AirLINE SP type 8647 (Bürkert Co.)
10/125	- TM SIWAREX WP321 ST weighing module	10/232	<u>Power supplies</u>
10/128	- TM SIWAREX WP351 HF weighing module	10/232	1-phase, 24 V DC (for SIMATIC ET 200SP)
10/130	- SIPLUS TM Count 1x24V counter module	10/236	<u>BaseUnits</u>
10/132	- SIPLUS TM PosInput 1 counting and position detection module	10/242	<u>SIPLUS BaseUnits</u>
10/134	- SIPLUS TM timer DIDQ 10x24 V time-based IO module	10/250	<u>BusAdapters</u>
10/136	- SIPLUS TM Pulse 2x24V pulse output module	10/253	<u>SIPLUS BusAdapters</u>
10/138	- SIPLUS ET 200SP ECC charging controller	10/256	<u>Accessories</u>
10/140	- SIPLUS SIWAREX WP321		
10/142	Communication	10/258	SIMATIC ET 200SP HA
10/142	- CM PtP serial interface	10/259	Interface module
10/145	- CM 4x IO-Link	10/261	Digital I/O modules
10/149	- CM 1xDALI	10/268	Analog I/O modules
10/151	- CM CAN	10/275	Analog/digital module
10/153	- CM AS-i Master ST for SIMATIC ET 200SP	10/278	Fail-safe I/O-modules
10/157	- CM DP for ET 200SP CPU	10/279	Ex I/O modules
10/159	- CP 1542SP-1	10/288	Carrier modules
10/162	- CP 1543SP-1	10/291	Terminal blocks
10/165	- CP 1542SP-1 IRC	10/296	BusAdapter
10/168	- SCALANCE W761 RJ45 for the control cabinet	10/298	Additional I/O modules
		10/299	SIMATIC ET 200MP
		10/301	Interface modules
		10/301	IM 155-5 PN
		10/306	IM 155-5 DP
		10/308	SIPLUS IM 155-5 PN
		10/310	SIPLUS IM 155-5 DP
		10/311	I/O modules
		10/312	Active backplane bus

**10/314 SIMATIC ET 200M**

- 10/315 [Interface modules](#)
- 10/315 IM 153-1/153-2
- 10/318 IM 153-4 PN
- 10/321 SIPLUS ET 200M IM 153-1/153-2
- 10/324 SIPLUS ET 200M IM 153-4 PN IO
- 10/326 [I/O modules](#)
- 10/326 Digital modules, analog modules
- 10/327 Analog modules with HART
- 10/327 Analog input module with HART
- 10/329 Analog output module with HART
- 10/331 Ex-analog input module with HART
- 10/333 Ex-analog output module with HART
- 10/335 SIPLUS S7-300
analog input module with HART
- 10/336 SIPLUS S7-300
analog output module with HART
- 10/337 F-digital/analog modules,
Ex modules
- 10/338 Function modules
- 10/340 Special modules, Communication,
Power supplies

10/341 SIMATIC ET 200iSP

- 10/342 Power supply unit
- 10/344 Interface module
- 10/346 Digital electronic modules
- 10/353 Analog electronic modules
- 10/358 Safety-related electronic modules
- 10/362 Watchdog module
- 10/363 RS 485-iS coupler
- 10/365 Stainless steel wall enclosures

**10/366 SIMATIC ET 200 systems
without control cabinet****10/366 SIMATIC ET 200pro**

- 10/367 [Interface modules](#)
- 10/367 IM 154-1 and IM 154-2
- 10/370 IM 154-3 PN and IM 154-4 PN
- 10/374 [I/O modules](#)
- 10/374 Digital expansion modules
- 10/380 Analog expansion modules
- 10/386 [Communication](#)
- 10/386 IO-Link master modules
- 10/387 [Fail-safe expansion modules](#)
- 10/387 Fail-safe digital expansion modules
- 10/389 PM-E power module
- 10/391 PM-O power module output
- 10/392 ET 200pro pneumatic interface
- 10/394 RF170C
- 10/396 [Power supplies](#)
- 10/396 3-phase, 24 V DC (ET200pro PS, IP67)

- 10/398 ET 200pro motor starters
- 10/413 [SIMATIC ET 200pro FC-2
frequency converter](#)
- 10/416 [ET 200pro software](#)
- 10/416 Motor Starter ES
- 10/418 [Add-on products for ET 200pro](#)
- 10/418 EtherNet/IP interface module

10/419 SIMATIC ET 200AL

- 10/420 [Interface modules](#)
- 10/420 IM 157-1 DP
- 10/422 IM 157-1 PN
- 10/424 [I/O modules](#)
- 10/424 Digital I/O modules
- 10/431 Analog I/O modules
- 10/437 Fail-safe I/O modules
- 10/440 Communication
- CM IO-Link
- 10/442 IO-Link I/O modules
- 10/448 [Accessories](#)
- 10/448 Cables and connectors
- 10/464 Labels

10/465 SIMATIC ET 200eco PN

- 10/466 [I/O devices](#)
- 10/466 Digital I/O devices
- 10/484 Analog I/O devices
- 10/490 Fail-safe I/O device
- 10/493 IO-Link master
- 10/501 [Accessories](#)
- 10/501 Mounting rail, labels

10/502 IO systems for heating elements

- 10/503 [SIPLUS HCS4200 heating control system](#)
- 10/504 Rack
- 10/506 Central Interface Module (CIM)
- 10/509 Power Output Module (POM)
- 10/514 [SIPLUS HCS4300 heating control system](#)
- 10/515 Central Interface Module (CIM)
- 10/521 Power Output Module (POM)

**10/526 PROFIBUS components**10/526 Diagnostics

10/526 PROFIBUS DP diagnostic repeater

10/528 SIPLUS diagnostic repeater
for PROFIBUS10/530 PROFIBUS DP ASICs**10/532 PROFINET components**10/532 ERTEC Enhanced Real-Time Ethernet
Controller

10/534 Development kits

10/535 PROFINET drivers

**10/537 Network components for PROFIBUS
Electrical networks (RS 485)**

10/537 Active RS 485 terminating element

10/538 RS 485 repeater for PROFIBUS

10/539 SIPLUS DP active RS 485
terminating element

10/541 SIPLUS RS 485 repeater

10/543 Network transitions

10/543 PN/PN couplers

10/546 PN/CAN LINK

10/548 SIPLUS PN/CAN LINK

10/550 PN/J1939 LINK

10/552 PN/BACnet LINK

10/554 PN/M-Bus LINK

10/556 DP/DP couplers

10/557 SIMATIC CFU

10/559 SIMATIC CFU PA Edition

10/565 SIMATIC CFU DIQ Edition

10/570 BusAdapter

10/573 Accessories

I/O systems

Introduction

I/O systems

Overview



SIMATIC ET 200 offers the right solution for every application

With SIMATIC ET 200 a wide range of distributed I/O systems is available - for solutions in the control cabinet or without a control cabinet directly at the machine, as well as for applications in hazardous areas. The modular design makes it possible to scale and expand the ET 200 systems simply and in small stages. Already integrated add-on modules reduce costs and at the same time offer a widely diverse range of possible applications. You can choose from many different combination options: digital and analog inputs/outputs, intelligent modules with CPU functionality, safety systems, motor starters, pneumatic devices, frequency converters, as well as various different technology modules (e.g. for counting, positioning).

Communication over PROFINET and PROFIBUS, uniform engineering, transparent diagnostic possibilities as well as optimal interfacing to SIMATIC Controllers and HMI units prove the unique integration of Totally Integrated Automation.

PROFINET

PROFINET is the open, cross-vendor Industrial Ethernet standard (IEC 61158/61784) for automation.

Based on Industrial Ethernet, PROFINET enables direct communication between field devices (IO devices) and controllers (IO controllers), up to and including the solution of isochronous drive controls for Motion Control applications.

As PROFINET is based on Standard Ethernet according to IEEE 802.3, any devices from the field level to the management level can be connected.

In this way, PROFINET enables system-wide communication, supports plant-wide engineering and applies IT standards, such as web server or FTP, right down to field level. Tried and tested fieldbus systems, such as PROFIBUS or AS-Interface, can be easily integrated without any modification to the existing devices.

PROFIBUS

PROFIBUS is the international standard (IEC 61158/61784) for the field level. It is the only fieldbus to allow communication both in manufacturing applications and in process-oriented applications.

PROFIBUS is used to connect field devices, e.g. distributed I/O devices or drives, to automation systems such as SIMATIC S7, SIMOTION, SINUMERIK, or PCs.

PROFIBUS is standardized in accordance with IEC 61158 and is a powerful, open and rugged fieldbus system with short response times. PROFIBUS is available in different forms for various applications.

PROFIBUS DP (distributed I/O)

PROFIBUS DP is used for connecting distributed field devices, e.g. SIMATIC ET 200, or drives with extremely fast response times. PROFIBUS DP is used when sensors/actuators are distributed at the machine or in the plant (e.g. field level).

AS-Interface

AS-Interface is the international standard (IEC 62026/EN 50295) which, as an alternative to the cable harness, links especially cost-effective sensors and actuators by means of a two-wire line. This two-wire line is also used to supply the individual stations with power. This makes the AS-Interface the ideal partner for PROFINET and PROFIBUS DP. AS-i communications modules in ET 200SP enable the flexible combination of AS-Interface and distributed I/O. AS-Interface transmits standard data and safety data up to PL e / SIL 3 in the same AS-i network. AS-Interface is not only suitable for efficient transmission of digital and analog I/O signals but also ideal for the user-friendly connection of EMERGENCY STOP pushbuttons and protective doors.

IO-Link

The communication standard IO-Link permits the intelligent connection of sensors and switching devices to the control level. IO-Link facilitates the integration of all components in the control cabinet and on the field level - for maximum integration and seamless communication on the final meters to the process.

IO-Link solutions from Siemens ensure maximum precision and cost-effectiveness in any production system. IO-Link is completely integrated in Totally Integrated Automation (TIA) and offers many advantages.

- The open standard permits the networking of devices from different manufacturers
- Simple wiring facilitates the installation process
- Reduced wiring effort saves time and money during installation
- Efficient engineering facilitates configuration and commissioning
- High-speed diagnostics ensures short plant standstill times and high plant availability
- High process transparency permits, for example, efficient power management

Overview



SIMATIC ET 200SP video
https://players.brightcove.net/1813624294001/70fecf0f-fbad-4fad-a077-d0e26af4d84c_default/index.html?videoId=6140549987001

SIMATIC ET 200SP



The scalable SIMATIC ET 200SP I/O system is a highly flexible, modular I/O system with IP20 degree of protection. Via interface modules, it can exchange IO data of the connected I/O modules with a higher-level PLC. The following interface variants are available for this purpose:

- MultiFieldbus: IM155-6MF with the Ethernet-based protocols PROFINET, EtherNet/IP and Modbus TCP
- PROFINET: IM155-6PN
- PROFIBUS: IM155-6DP

Alternatively, as further head-end stations, various PLC, F-PLC and Open Controllers are available as compact S7-1500 Controllers (Distributed Controllers). ET 200SP components in SIPLUS version meet extreme requirements and have a high degree of robustness.

An extensive range of I/O modules, including fail-safe and Ex versions, enable the flexible connection of sensors and actuators:

- Digital input modules (DI), with color coding white
- Digital output modules (DO), with color coding black
- Analog input modules (AI), with color coding light blue
- Analog output modules (AO), with color coding dark blue
- Technology modules (TM), with color coding turquoise
- Communications modules (CM), with color coding light gray
- Special modules, with color coding mint green
- Motor starters as direct-on-line starters (DS) and reversing starters (RS), also as F-version in each case
- Pneumatics

Apart from the standard type of delivery in an individual package, selected I/O modules and BaseUnits are also available in a pack of 10 units. The pack of 10 units enables the amount of waste to be reduced considerably, as well as saving the time and cost of unpacking individual modules.

Compact design

- Modular configuration with up to 64 modules
- System-integrated, self-assembling potential groups, potential group supply without power module with infeed of supply voltage via light BaseUnits
- Small size and highly flexible due to the modular design and comprehensive product range
- Up to 16 channels per module
- Permanent wiring
- Hot swapping: Module replacement without tools in RUN
- Startup and operation with slot gaps (free spaces)

Flexible connection system

- Flexible fieldbus connection via BusAdapter (RJ45, FastConnect, plastic or glass fiber-optic cables), also as integrated media converter
- Push-in terminals for cross-sections up to 1.5 mm² with wire end ferrule, and up to 2.5 mm² without wire end ferrule
- BaseUnits for 1-wire or direct multi-wire connection
- PotDis module for system-integrated and space-saving provision of additional potential terminals
- Optimum accessibility for wiring due to spring release and measuring tap next to the conductor opening
- System-integrated, space-saving shielding for installation without tools



SIMATIC ET 200SP shielding video
https://players.brightcove.net/1813624294001/70fecf0f-fbad-4fad-a077-d0e26af4d84c_default/index.html?videoId=6196729280001

I/O systems

SIMATIC ET 200 systems for the control cabinet

SIMATIC ET 200SP

Overview

Safety Integrated

- Easy integration of fail-safe modules
- Easy F parameter assignment via software
- Group-by-group disconnection of non-fail-safe modules

High performance

- Isochronous PROFINET
- Internal data transfer with up to 100 Mbps
- Record analog values and output as of 50 µs
- Record digital values and output as of 1 µs

High-performance technology

- Modules for the functions Servodrive, Counting, Positioning, Weighing, Output cams, PWM, Force measurement, Flow measurement, etc.

Energy efficiency

- Energy meter for recording electrical variables
- System-integrated PROFIenergy with interval substitute values

Extended functions

- Configuration control: application-based adaptation of the actual configuration via user software (option handling)
- Time-based IO: time stamping of the signals to the µs
- MSI/MSO: Simultaneous access to I/O data from up to 4 PLCs
- MtM: Direct data exchange between IO modules (**M**odule-**t**o-**M**odule communication)
- Oversampling: n-fold acquisition or output of digital and analog signals within a PN cycle
- Adaptation of measuring range: increased resolution by adapting the measuring range to a limited section of a measuring range supported by the analog input module
- Scaling of measured values: permits the transmission of the analog value normalized to the required physical value as a REAL value (32-bit floating point)

Communication standards

- PROFINET IO
- EtherNet/IP
- Modbus TCP
- PROFIBUS DP V0/V1
- ET connection for connecting the ET 200AL (IP67)
- IO-Link V1.1
- CAN
- DALI
- AS-Interface
- Point-to-point (RS232, RS485, RS422)
- Freeport
- 3964(R)
- USS
- DMX
- Modbus RTU (master/slave)

CPU

- PROFINET connection with 3 ports
- IO controller and PN IO device
- Optional expansion as DP master/slave
- Also as fail-safe version and Open Controller

Labeling of I/O modules

- Meaningful labeling on the front of the I/O modules
 - Module type in plain text including function class, e.g. "DI 8x24VDC HF"
 - Article No.
 - 2D matrix code with article and serial number (with call via the "Industry Online Support" app, direct link to the support page of the module)
 - Hardware functional status and firmware version
 - Suitable BU type for the respective I/O module
 - Color code of the suitable color-coding label
 - Connection diagram
- Optionally expandable with
 - Labeling strips
 - Equipment labeling plate

Overview of ET 200SP components

Basic components	Function
CPU	The CPU: <ul style="list-style-type: none"> • Executes the user program • Is used as IO controller, I-Device on PROFINET IO, or as standalone CPU • Connects the ET 200SP with the IO devices or the IO controller • Exchanges data with the I/O modules via the backplane bus. Further functions of the CPU: <ul style="list-style-type: none"> • Communication via PROFIBUS DP (in combination with the CM DP communications module, the CPU can be used as DP master or slave) • Integrated web server • Integrated technology • Integrated trace functionality • Integrated system diagnostics • Integrated safety

Basic components	Function
Open Controller	As the first controller of this type, the SIMATIC ET 200SP Open Controller combines the functions of a PC-based software controller with visualization, PC applications and central I/Os (inputs/outputs) in a single, compact device. <ul style="list-style-type: none"> • All in one • High system availability • Compact and modular • Rugged • User-friendly design • Efficient engineering in TIA Portal
Interface modules with MultiFieldbus interface (IM 155-6MF)	The MF interface module: <ul style="list-style-type: none"> • Supports the three Ethernet protocols PROFINET IO, EtherNet IP and Modbus TCP • Is easy to configure via MultiFieldbus Configuration Tool (MFCT) • Connects ET 200SP with the IO controller • Exchanges data with the I/O modules via the backplane bus.

Overview

Basic components	Function
Interface modules for PROFINET IO (IM 155-6PN)	The interface module: <ul style="list-style-type: none"> • Is used as IO device on PROFINET IO • Connects ET 200SP with the IO controller • Exchanges data with the I/O modules via the backplane bus.
Interface module for PROFIBUS DP (IM 155-6DP)	The interface module: <ul style="list-style-type: none"> • Is used as DP slave on PROFIBUS DP • Connects ET 200SP with the DP master • Exchanges data with the I/O modules via the backplane bus.
SIMATIC BusAdapter (BA)	SIMATIC BusAdapters permit the free selection of the connection system and physical connection for head-end stations with PROFINET or MultiFieldbus interface. Various versions are available for the connection of copper cables or plastic and glass fiber-optic cables. Hybrid copper/fiber-optic versions are also available as integrated media converters. Cable length between 2 stations: 100 m (Cu), max. 50 m (POF), (PCF), max. 3 km (multi-mode glass FOC). For expanding the station with the I/O system ET 200AL via ET connection, the BA-Send BusAdapter is available
BaseUnit (BU)	The BaseUnits provide the electrical and mechanical connection for the ET 200SP components. <ul style="list-style-type: none"> • Bright BaseUnits permit a new potential group up to max. 10 A • Dark BaseUnits forward the self-assembling voltage busbars P1, P2 and AUX from the left to the right BaseUnit. • Suitable BaseUnits with 12 to 28 terminals are available for different connection systems (single or direct multi-conductor connection) and functions. • The I/O module is plugged onto the desired BaseUnit and determines the potential assignment of the terminals on the BaseUnit. • For expanding the station with the I/O system ET 200AL via ET connection, the BaseUnit BU-Send is available.

Basic components	Function
Potential distributor modules (PotDis BU, PotDis TB)	With the potential distributor modules for SIMATIC ET 200SP, additional potentials required within an ET 200SP station can be set up quickly and in a space-saving manner. Due to the free combinability of PotDis-BUs and PotDis-TBs, the potential distributor modules allow a large number of design variants and thus simple adaptation to individual needs. Within the station, existing potentials can be multiplied or even new potential groups can be formed. With 36 terminals per 15 mm width, the PotDis modules require very little space without compromising on the conductor cross-sections (maximum 2.5 mm ²). They allow the connection of voltages up to 48 V DC with a maximum current carrying capacity of 10 A, and with the PotDis TB-BR-W even up to 230 V AC/10 A as well as the possibility to connect a protective conductor.
I/O modules and fail-safe I/O modules	The I/O module determines the function at the terminals. The PLC detects the current process state via the connected sensors and triggers corresponding responses via the connected actuators. Some I/O modules feature extended functions, in part they are also designed as individual operating mode. I/O modules are divided into the following module types; the fail-safe versions are identified by a preceding 'F-' and a yellow module enclosure: <ul style="list-style-type: none"> • DI (digital input) • DQ (digital output) • AI (analog input) • AQ (analog output) • TM (technology modules) • CM (communications modules) • SM (special modules)
Protective cover (BU cover)	The ET 200SP system can be operated with any number of slot gaps (BU slot without I/O module). Applications for this include: <ul style="list-style-type: none"> • partial commissioning • prewired, and currently unequipped options To protect against damage, such slot gaps must be covered by a BU cover. Within the BU cover, an equipment labeling plate can be kept for the possible later use of an I/O module. Versions: <ul style="list-style-type: none"> • for BaseUnits with a width of 15 mm • for BaseUnits with a width of 20 mm

I/O systems

SIMATIC ET 200 systems for the control cabinet

SIMATIC ET 200SP

Overview

Basic components	Function
Server module	The server module concludes the setup of an ET 200SP station. On the server module there are holders for 3 spare fuses (5 × 20 mm). The server module is included in the scope of supply of all head-end stations.
DIN rail according to EN 60715	The DIN rail is the module rack of the ET 200SP I/O system. ET 200SP is mounted on the DIN rail.
Coding element	When plugging an I/O module onto a BaseUnit for the first time, the coding element moves from the I/O module to the BaseUnit. There it prevents the destruction of the ET 200SP components in the event of a subsequent module replacement with incorrectly selected I/O module. The coding element is available in two versions: <ul style="list-style-type: none"> • Mechanical coding element • Electronic coding element: additionally features an electronic, re-writable memory for the redundant storage of module-specific configuration data (e.g. F target address for fail-safe modules, parameter data for IO-Link master). Thus these data are automatically backed up during a module replacement.
System-integrated shield connection	The shield connection permits the connection of cable shields. Compared to external shield supports, the system offers the following advantages: <ul style="list-style-type: none"> • Quick installation without tools by plugging the shield connection element onto the BaseUnit • Automatic low-impedance connection to the functional ground (DIN rail) • Optimized EMC properties by separating the supply voltage lines from the signal cables by means of the shield connection element and short, unshielded cable lengths • Low space requirements
Labeling strips	Optionally, for system-specific marking the head-end stations and I/O modules can be equipped with labeling strips (13 × 31 mm). The labeling strips can be inscribed mechanically. Labeling strips are available in two versions in the colors light gray and yellow: <ul style="list-style-type: none"> • 500 strips on the roll, for printing on thermal-transfer printers. Core diameter 40 mm, external diameter 70 mm, width 62 mm. • 10 DIN A4 sheets with 100 strips each, card 180 g/mm², perforated, for printing with a laser printer direct from TIA Portal or via print templates.

Basic components	Function
Equipment labeling plate	Optionally, one equipment labeling plate each can be plugged onto head-end stations, BusAdapters, BaseUnits, potential distributor modules (PotDis BU and PotDis TB), and I/O modules. Equipment labeling plates are supplied in packs of 10 sheets with 16 labels each. The labels can be printed with thermal-transfer card printers or plotters, or stickers can be attached to them. Advantages compared to labels that are attached directly: <ul style="list-style-type: none"> • The inscription on the front is not covered • Simple label replacement when replacing a module • No parallax errors when marking the BaseUnits on the mounting plate The size of the inscribable area of the labels is 14.8 × 10.5 mm (W × H)
Color-coded labels	The I/O modules that are plugged onto the BaseUnits determine the potentials connected at the process terminals. The +/- potentials can optionally be identified using module-specific color-coded labels. The potentials of the AUX and add-on terminals as well as potential distributor modules can also be marked using color-coded labels. Color-coded labels are supplied in packs of 10 or 50 labels. Advantages of the color-coded labels: <ul style="list-style-type: none"> • Quick installation (one label for marking up to 16 terminals) • Avoidance of wiring errors • Simple detection of potentials during servicing

Overview



SIMATIC ET 200SP MultiFieldbus video
https://players.brightcove.net/1813624294001/70fecf0f-fbad-4fad-a077-d0e26af4d84c_default/index.html?videoId=6144272396001



Thanks to their wide scope of functions, the interface modules of the scalable SIMATIC ET 200SP I/O system, even in their basic versions, cover a wide range of applications. The basic functions of the interface modules include:

- Short data update times of typically 1 ms
- Single Hot Swap (withdrawing and insertion of an I/O module during operation without impairing the communication with the remaining modules)
- Operation with gaps (empty BaseUnits)
- Complete diagnostic support, extending to channel-by-channel diagnostics
- Configuration control / option handling (adaptation of the actual configuration via user program)
- Device replacement without programming device, with automatic re-initialization, with and without topological configuring
- I&M data 0 to 3 (electronic rating plate with non-volatile storage of plant data)
- Firmware update
- Pluggable 24 V DC supply connection
- Mains/voltage failure buffering time of at least 5 ms or 10 ms
- Labeling option via optional labeling strips and equipment labeling plates

When using PROFINET interface modules, the following basic functions are also included:

- Media redundancy (MRP)
- Integrated 2-port switch
- Freely selectable connection system (Standard function class and above) and physical connection (High Feature function class and above) by means of SIMATIC BusAdapters, also as system-integrated media converter from fiber-optic to copper cable. Can also be used for interface modules with MultiFieldbus interface.
- Reset button for simple return to factory settings without the need for programming device
- Automatic synchronization of the backplane bus to the PROFINET cycle to minimize the response time fluctuations (jitter)

Listed below is a short overview of the interface modules available for the ET 200SP, showing the essential differences. An up-to-date, clear and more precise comparison of functions of the different interface modules is offered by the TIA Selection Tool.

SIMATIC IM155-6DP High Feature with PROFIBUS connection

- Max. 32 I/O modules, also PROFIsafe modules with complete diagnostic support.
- Expansion option with max. 16 modules from the ET 200AL series using the BU-Send BaseUnit and the BA-Send BusAdapter
- Max. 244 bytes in each case for input and output data per module and per station
- Data update time: typ. 5 ms
- PROFIBUS connection via 9-pin SUB-D socket
- Package includes server module and PROFIBUS connector with PG socket

SIMATIC IM155-6PN Basic with PROFINET access

- Max. 12 I/O modules, no PROFIsafe modules, with complete diagnostic support
- Max. 32 bytes in each case for input and output data per module and per station
- Data update time: typ. 1 ms
- PROFINET connection via 2 integrated RJ45 sockets (integrated 2-port switch)
- Package includes server module

SIMATIC IM 155-6PN Standard with a PROFINET interface for SIMATIC BusAdapters

- Two types of delivery:
 - As package with IM155-6PN ST, with pre-assembled BA 2xRJ45 BusAdapter, including server module
 - As package with IM155-6PN ST, without BusAdapter, including server module
- Max. 32 I/O modules, also PROFIsafe modules, with complete diagnostic support
- Expansion option with max. 16 modules from the ET 200AL series using the BU-Send BaseUnit and the BA-Send BusAdapter
- Max. 256 bytes in each case for input and output data per module and max. 512 bytes per station (depending on configuration)
- Data update time: typ. 1 ms
- Selection of the type of connection of the PROFINET by means of SIMATIC BusAdapter (BusAdapter for copper cables only)

I/O systems

SIMATIC ET 200 systems for the control cabinet
SIMATIC ET 200SP

Interface modules > IM 155-6

Overview

SIMATIC IM155-6PN/2 High Feature, 2-port IM with one slot for SIMATIC BusAdapter

- Max. 64 I/O modules, also PROFIsafe modules, with complete diagnostic support
- Expansion option with max. 16 modules from the ET 200AL series using the BU-Send BaseUnit and the BA-Send BusAdapter
- Max. 288 bytes in each case for input and output data per module and max. 1440 bytes per station (depending on configuration)
- Fast data refresh time from 250 µs, also in isochronous mode
- S2 system redundancy
- Choice of connection type and physical connection of the PROFINET by means of SIMATIC BusAdapter. All BusAdapters with a connection for copper and/or fiber-optic cables can be used; BusAdapter must be ordered separately
- Package includes server module

SIMATIC IM155-6MF High Feature, MultiFieldbus IM with two slots for SIMATIC BusAdapters

Differences compared to the 2-port IM155-6PN/2 High Feature:

- Multi-protocol capability
Operation on Ethernet controllers via the PROFINET, EtherNet/IP and Modbus protocols
- Compatible with IM155-6MF High Feature (as of 6ES7155-6AU01-0CN0);
Exception: Isochronous mode and prioritized startup
- Shared device:
Simultaneous access from different controllers via different Ethernet protocols PROFINET, EtherNet/IP and Modbus TCP
- Local data links:
Deterministic, easy-to-configure data exchange between controllers, also via different Ethernet protocols PROFINET, EtherNet/IP and Modbus TCP

SIMATIC IM155-6PN/3 High Feature, 3-port IM with two slots for SIMATIC BusAdapter

Supplementary functions compared to 2-port IM155-6PN/2 High Feature:

- Second slot for SIMATIC BusAdapter, max. 3 ports can be used
- Local IO data coupling between up to 4 controllers

SIMATIC IM 155-6PN High Speed with a PROFINET interface for SIMATIC BusAdapters

- Max. 30 I/O modules, also PROFIsafe modules, with complete diagnostic support
- Max. 32 bytes in each case for input and output data per module and max. 968 bytes per station (depending on configuration)
- Fast data refresh time from isochronous mode from 125 µs
- Performance upgrade for PROFINET
- Choice of connection type and physical connection of the PROFINET by means of SIMATIC BusAdapter. All BusAdapters with a connection for copper and/or fiber-optic cables can be used; BusAdapter must be ordered separately
- Package includes server module

Ordering data	Article No.
IM155-6MF High Feature MultiFieldbus interface module 2-port IM with server module, without SIMATIC BusAdapter; PROFINET, EtherNet/IP and Modbus TCP	6ES7155-6MU00-0CN0
IM155-6PN Basic PROFINET interface module With server module; two integrated RJ45 sockets	6ES7155-6AR00-0AN0
IM155-6PN Standard PROFINET interface module With server module <ul style="list-style-type: none"> • With attached SIMATIC BA 2xRJ45 BusAdapter • Without SIMATIC BusAdapter 	6ES7155-6AA01-0BN0 6ES7155-6AU01-0BN0
IM155-6PN/2 High Feature PROFINET interface module 2-port IM with server module, without SIMATIC BusAdapter	6ES7155-6AU01-0CN0
IM155-6PN/3 High Feature PROFINET interface module 3-port IM with server module, without SIMATIC BusAdapter	6ES7155-6AU30-0CN0
IM155-6PN High Speed PROFINET interface module With server module, without SIMATIC BusAdapter	6ES7155-6AU00-0DN0
IM155-6DP High Feature PROFIBUS interface module With server module, with PROFIBUS plug with PG socket	6ES7155-6BA01-0CN0
Accessories	
Strain relief for the PROFINET cable System-integrated strain relief for High Feature PN interface modules (5 units)	6ES7193-6RA00-1AN0
SIMATIC BA 2xRJ45 BusAdapter For PROFINET interface modules, standard function class or above; max. cable length 50 m	6ES7193-6AR00-0AA0
SIMATIC BA 2xFC BusAdapter For PROFINET interface modules, standard function class or above; for increased vibration and EMC loads; max. cable length 50 m	6ES7193-6AF00-0AA0
BA 2xM12 BusAdapter For IM 155-6PN ST, HF; 2 x M12 push-pull sockets, D-coding, also suitable for standard M12. For PROFINET	6ES7193-6AM00-0AA0
SIMATIC BA 2xSCRJ BusAdapter For PROFINET interface modules from High Feature function class or above; fiber-optic cable connection for POF or PCF; for increased vibration and EMC load capacity; max. cable length 50 m (POF) or 100 m (PCF)	6ES7193-6AP00-0AA0

Ordering data	Article No.	Ordering data	Article No.
SIMATIC BA SCRJ/RJ45 BusAdapter For PROFINET interface modules from High Feature function class or above; with media converter FOC-Cu; for increased vibration and EMC loads; max. cable length 50 m (POF, copper) or 100 m (PCF)	6ES7193-6AP20-0AA0	Equipment labeling plate 10 sheets of 16 labels, for printing with thermal transfer card printer or plotter	6ES7193-6LF30-0AW0
SIMATIC BA SCRJ/FC BusAdapter For PROFINET interface modules from High Feature function class or above; with media converter FOC-Cu; for increased vibration and EMC loads; max. cable length 50 m (POF, copper) or 100 m (PCF)	6ES7193-6AP40-0AA0	DIN rail, 35 mm Length 483 mm for 19" cabinets Length 530 mm for 600 mm cabinets Length 830 mm for 900 mm cabinets Length 2 m	6ES5710-8MA11 6ES5710-8MA21 6ES5710-8MA31 6ES5710-8MA41
SIMATIC BA 2XLC BusAdapter For PROFINET interface modules from High Feature function class or above; with LC fiber-optic connection; for increased vibration and EMC load capacity; max. cable length 2 km	6ES7193-6AG00-0AA0	Manuals for ET 200SP distributed I/O system SIMATIC ET 200SP Manual Collection: PDF file with the following content: <ul style="list-style-type: none"> • Basic information System manual, product information, overview tables, correction information or manual supplements • Device-specific information Device manuals for the interface modules, PLC, OC and I/O modules, including fail-safe and motor starters • Comprehensive information Function manuals The ET 200SP Manual Collection can be downloaded from the Internet as a PDF file: https://support.industry.siemens.com/cs/ww/en/view/84133942	
SIMATIC BA LC/RJ45 BusAdapter For PROFINET interface modules from High Feature function class or above; with media converter FOC-Cu; for increased vibration and EMC loads; max. cable length 2 km (glass) or 50 m (copper)	6ES7193-6AG20-0AA0	SIMATIC Manual Collection Electronic manuals on DVD, multi-language: LOGO!, SIMADYN, SIMATIC bus components, SIMATIC C7, SIMATIC distributed I/O, SIMATIC HMI, SIMATIC Sensors, SIMATIC NET, SIMATIC PC-based Automation, SIMATIC PCS 7, SIMATIC PG/PC, SIMATIC S7, SIMATIC Software, SIMATIC TDC	6ES7998-8XC01-8YE0
SIMATIC BA LC/FC BusAdapter For PROFINET interface modules from High Feature function class or above; with media converter FOC-Cu; for increased vibration and EMC loads; max. cable length 2 km (glass) or 50 m (copper)	6ES7193-6AG40-0AA0	SIMATIC Manual Collection update service for 1 year Current Manual Collection DVD and the three subsequent updates	6ES7998-8XC01-8YE2
Station expansion with IP67 I/O system ET 200AL		Spare parts	
ET 200SP BA-Send 1 x FC BusAdapter	6ES7193-6AS00-0AA0	Server module Terminates an ET 200SP station; included in the scope of supply of the interface modules, CPUs and Open Controllers	6ES7193-6PA00-0AA0
BaseUnit BU-Send	6ES7193-6BN00-0NE0	Power supply connector for ET 200SP head-end stations (interface module, CPU and open controller) For connecting the 24 V DC supply voltage, push-in version; included in scope of supply of the head-end station with push-in terminals (10 units)	6ES7193-4JB00-0AA0
Other accessories			
Labeling strips 500 labeling strips on roll, light gray, for inscription with thermal transfer roll printer	6ES7193-6LR10-0AA0		
500 labeling strips on roll, yellow, for inscription with thermal transfer roll printer	6ES7193-6LR10-0AG0		
1 000 labeling strips DIN A4, light gray, card, perforated, for inscription with laser printer	6ES7193-6LA10-0AA0		
1 000 labeling strips DIN A4, yellow, card, perforated, for inscription with laser printer	6ES7193-6LA10-0AG0		

I/O systems

SIMATIC ET 200 systems for the control cabinet
SIMATIC ET 200SP

Interface modules > IM 155-6

Technical specifications

Article number	6ES7155-6MU00-0CN0 ET 200SP, IM155-6MF HF
General information	
Product type designation	IM 155-6 MF HF
Product function	
• I&M data	Yes; I&M0 to I&M3
• Module swapping during operation (hot swapping)	Yes; Multi-hot swapping
• Isochronous mode	No
• Tool changer	Yes; Docking station and docking unit
• Local coupling, IO data	No
• Local coupling, data records	No
Engineering with	
• STEP 7 TIA Portal configurable/integrated from version	via IM155-6PN/2 HF in compatibility mode
• STEP 7 configurable/integrated from version	via IM155-6PN/2 HF in compatibility mode
• PROFINET from GSD version/GSD revision	GSDML V2.3
• Multi Fieldbus Configuration Tool (MFCT)	V1.0 Update 2
Supply voltage	
Rated value (DC)	24 V
Reverse polarity protection	Yes
Address area	
Address space per station	
• Address space per station, max.	1 440 byte; Dependent on configuration
Hardware configuration	
Rack	
• Quantity of operable ET 200SP modules, max.	64
• Quantity of operable ET 200AL modules, max.	16
Submodules	
• Number of submodules per station, max.	256
Time stamping	
Accuracy	10 ms
Interfaces	
Number of PROFINET interfaces	1; 2 ports (switch)
1. Interface	
Interface types	
• Number of ports	2; via BusAdapter
• integrated switch	Yes
• BusAdapter (PROFINET)	Yes; compatible BusAdapters: BA 2x RJ45, BA 2x M12, BA 2x FC, BA 2x LC, BA LC/RJ45, BA LC/FC, BA 2x SCRJ, BA SCRJ/RJ45, BA SCRJ/FC,
Protocols	
• PROFINET IO Device	Yes
• Open IE communication	Yes
• Media redundancy	Yes; PROFINET MRP
Interface types	
RJ 45 (Ethernet)	
• Transmission procedure	PROFINET with 100 Mbit/s full duplex (100BASE-TX)
• 10 Mbps	No
• 100 Mbps	Yes; PROFINET with 100 Mbit/s full duplex (100BASE-TX)
• Autonegotiation	Yes
• Autocrossing	Yes

Article number	6ES7155-6MU00-0CN0 ET 200SP, IM155-6MF HF
Protocols	
Modbus TCP	Yes
Number of connections	
• Number of MtM communication relationships/connections, max.	16
PROFINET IO Device	
Services	
- IRT	No
- PROFIenergy	Yes
- Prioritized startup	No
- Shared device	No
Redundancy mode	
• PROFINET system redundancy (S2)	Yes; NAP S2
• H-Sync forwarding	Yes
Media redundancy	
- MRP	Yes
- MRPD	No
EtherNet/IP	
Services	
- CIP Implicit Messaging	Yes
- CIP Explicit Messaging	Yes
- CIP Safety	No
- Configuration control via Explicit Messaging	No
- Shared device	No
Updating times	
- Requested Packet Interval (RPI)	2 ms
Address area	
- Address space per module, max.	288 byte; (246 byte outputs / 288 byte inputs)
- ForwardOpen (Class1 & 32 bit Header)	500 byte; (246 byte outputs / 500 byte inputs)
- LargeForwardOpen (Class3)	4 002 byte
Connections	
- Number of rack connections	1
Modbus TCP	
Services	
- Read Holding Registers (Code=3)	Yes
- Write Multiple Registers (Code=16)	Yes
- Parameter change by master	Yes
- Modbus TCP Security Protocol	No
Address space per station	
- Address space per station, max.	500 byte; (246 byte outputs / 500 byte inputs)
- Access-consistent address space	250 byte; (246 byte outputs / 250 byte inputs)
Updating time	
- I/O request interval	2 ms
Connections	
- Number of connections per slave	9; (1x inputs / 2x outputs / 4x volatile registers / 2x Device Info)
Open IE communication	
• TCP/IP	Yes
• UDP	Yes
• SNMP	Yes
• LLDP	Yes
• ARP	Yes
• IGMP	Yes
• Multicast	Yes
• Broadcast	Yes
• IPv4	Yes

Technical specifications

Article number	6ES7155-6MU00-0CN0 ET 200SP, IM155-6MF HF
Interrupts/diagnostics/ status information	
Status indicator	Yes
Alarms	Yes
Diagnostics function	Yes
Diagnostics indication LED	
• RUN LED	Yes; green LED
• ERROR LED	Yes; red LED
• MAINT LED	Yes; Yellow LED
• Monitoring of the supply voltage (PWR-LED)	Yes; green PWR LED
• NS LED	Yes; green/red LED
• MS LED	Yes; green/red LED
• IO LED	Yes; red-green-yellow LED
• Connection display LINK TX/RX	Yes; 2x green link LEDs on BusAdapter
Standards, approvals, certificates	
Network loading class	3
Security level	According to Security Level 1 Test Cases V1.1.1

Article number	6ES7155-6MU00-0CN0 ET 200SP, IM155-6MF HF
Ambient conditions	
Ambient temperature during operation	
• horizontal installation, min.	-30 °C; No condensation
• horizontal installation, max.	60 °C
• vertical installation, min.	-30 °C; No condensation
• vertical installation, max.	50 °C
Altitude during operation relating to sea level	
• Installation altitude above sea level, max.	5 000 m; Restrictions for installation altitudes > 2 000 m, see manual
Connection method	
ET-Connection	
• via BU/BA Send	Yes; + 16 ET 200AL modules
Mechanics/material	
Strain relief	Yes; Optional
Dimensions	
Width	50 mm
Height	117 mm
Depth	74 mm
Weights	
Weight, approx.	120 g; without BusAdapter

Article number	6ES7155-6AR00-0AN0 ET 200SP, IM155-6PN Basic	6ES7155-6AA01-0BN0 ET 200SP, IM155-6PN ST incl. BA 2xRJ45	6ES7155-6AU01-0BN0 ET 200SP, IM155-6PN ST
General information			
Product type designation	IM 155-6 PN BA	IM 155-6 PN ST	IM 155-6 PN ST
Product function			
• I&M data	Yes; I&M0 to I&M3	Yes; I&M0 to I&M3	Yes; I&M0 to I&M3
• Module swapping during operation (hot swapping)	Yes; Single hot swapping	Yes; Single hot swapping	Yes; Single hot swapping
• Isochronous mode	No	No	No
Engineering with			
• STEP 7 TIA Portal configurable/ integrated from version	V13 SP1	V14	V14
• STEP 7 configurable/ integrated from version	V5.5 SP4 and higher	V5.5 SP4 and higher	V5.5 SP4 and higher
• PROFINET from GSD version/ GSD revision	V2.3 / -	V2.3 / -	V2.3 / -
Supply voltage			
Rated value (DC)	24 V	24 V	24 V
Reverse polarity protection	Yes	Yes	Yes
Short-circuit protection		Yes	Yes
Input current			
Current consumption (rated value)		450 mA	450 mA
Address area			
Address space per station			
• Address space per station, max.	32 byte; per input / output	512 byte; Dependent on configuration	512 byte; Dependent on configuration
Hardware configuration			
Rack			
• Quantity of operable ET 200SP modules, max.	12	32	32
• Quantity of operable ET 200AL modules, max.	0	16	16
Submodules			
• Number of submodules per station, max.		256	256
Interfaces			
Number of PROFINET interfaces	1; 2 ports (switch)	1; 2 ports (switch)	1; 2 ports (switch)

I/O systemsSIMATIC ET 200 systems for the control cabinet
SIMATIC ET 200SP**Interface modules > IM 155-6****Technical specifications**

Article number	6ES7155-6AR00-0AN0 ET 200SP, IM155-6PN Basic	6ES7155-6AA01-0BN0 ET 200SP, IM155-6PN ST incl. BA 2xRJ45	6ES7155-6AU01-0BN0 ET 200SP, IM155-6PN ST
1. Interface			
Interface types			
• RJ 45 (Ethernet)	Yes; 2 integrated RJ45 ports	Yes; Pre-assembled BusAdapter BA 2x RJ45	
• Number of ports	2	2	2
• integrated switch	Yes	Yes	Yes
• BusAdapter (PROFINET)	No	Yes; compatible BusAdapters: BA 2x RJ45, BA 2x FC, BA 2x M12	Yes; compatible BusAdapters: BA 2x RJ45, BA 2x FC, BA 2x M12
Protocols			
• PROFINET IO Device	Yes	Yes	Yes
• Open IE communication	Yes	Yes	Yes
• Media redundancy	Yes; PROFINET MRP	Yes; PROFINET MRP	Yes; PROFINET MRP
Interface types			
RJ 45 (Ethernet)			
• Transmission procedure	PROFINET with 100 Mbit/s full duplex (100BASE-TX)	PROFINET with 100 Mbit/s full duplex (100BASE-TX)	PROFINET with 100 Mbit/s full duplex (100BASE-TX)
• 10 Mbps	No		
• 100 Mbps	Yes; PROFINET with 100 Mbit/s full duplex (100BASE-TX)	Yes; PROFINET with 100 Mbit/s full duplex (100BASE-TX)	Yes; PROFINET with 100 Mbit/s full duplex (100BASE-TX)
• Autonegotiation	Yes	Yes	Yes
• Autocrossing	Yes	Yes	Yes
Protocols			
PROFINET IO Device			
Services			
- IRT	No	Yes; with send cycles of between 250 µs and 4 ms in increments of 125 µs	Yes; with send cycles of between 250 µs and 4 ms in increments of 125 µs
- PROFinergy	No	Yes	Yes
- Prioritized startup	No	Yes	Yes
- Shared device	No	Yes	Yes
- Number of IO Controllers with shared device, max.		2	2
Redundancy mode			
• PROFINET system redundancy (S2)	No	No	No
Media redundancy			
- MRP	Yes	Yes	Yes
- MRPD	No	No	No
Open IE communication			
• TCP/IP	Yes	Yes	Yes
• SNMP	Yes	Yes	Yes
• LLDP	Yes	Yes	Yes
Isochronous mode			
Equidistance	No		
Interrupts/diagnostics/ status information			
Status indicator	Yes	Yes	Yes
Alarms	Yes	Yes	Yes
Diagnostics function	Yes	Yes	Yes
Diagnostics indication LED			
• RUN LED	Yes; green LED	Yes; green LED	Yes; green LED
• ERROR LED	Yes; red LED	Yes; red LED	Yes; red LED
• MAINT LED	Yes; Yellow LED	Yes; Yellow LED	Yes; Yellow LED
• Monitoring of the supply voltage (PWR-LED)	Yes; green PWR LED	Yes; green PWR LED	Yes; green PWR LED
• Connection display LINK TX/RX	Yes; 2x green link LEDs on BusAdapter	Yes; 2x green link LEDs on BusAdapter	Yes; 2x green link LEDs on BusAdapter
Standards, approvals, certificates			
Network loading class	2	2	2
Security level		According to Security Level 1 Test Cases V1.1.1	According to Security Level 1 Test Cases V1.1.1

Technical specifications

Article number	6ES7155-6AR00-0AN0 ET 200SP, IM155-6PN Basic	6ES7155-6AA01-0BN0 ET 200SP, IM155-6PN ST incl. BA 2xRJ45	6ES7155-6AU01-0BN0 ET 200SP, IM155-6PN ST	
Ambient conditions				
Ambient temperature during operation				
• horizontal installation, min.	-30 °C	0 °C	0 °C	
• horizontal installation, max.	60 °C	60 °C	60 °C	
• vertical installation, min.	-30 °C	0 °C	0 °C	
• vertical installation, max.	50 °C	50 °C	50 °C	
Altitude during operation relating to sea level				
• Installation altitude above sea level, max.	5 000 m; Restrictions for installation altitudes > 2 000 m, see manual	5 000 m; Restrictions for installation altitudes > 2 000 m, see manual	5 000 m	
Connection method				
ET-Connection				
• via BU/BA Send	No	Yes; + 16 ET 200AL modules	Yes; + 16 ET 200AL modules	
Dimensions				
Width	35 mm	50 mm	50 mm	
Height	117 mm	117 mm	117 mm	
Depth	74 mm	74 mm	74 mm	
Weights				
Weight, approx.	125 g	190 g; IM 155-6 PN BA with 2x RJ45 ports and server module	147 g; without BusAdapter	
Article number	6ES7155-6AU01-0CNO ET 200SP, IM155-6PN/2 HF	6ES7155-6AU30-0CNO ET 200SP, IM155-6PN/3 HF	6ES7155-6AU00-0DNO ET 200SP, IM155-6PN HS	6ES7155-6BA01-0CNO ET 200SP, IM155-6DP HF incl. DP-Connect.
General information				
Product type designation	IM 155-6 PN/2 HF	IM 155-6 PN/3 HF	IM 155-6 PN HS	IM 155-6 DP HF
Product function				
• I&M data	Yes; I&M0 to I&M3	Yes; I&M0 to I&M3	Yes; I&M0 to I&M3	Yes; I&M0 to I&M3
• Module swapping during operation (hot swapping)	Yes; Multi-hot swapping	Yes; Multi-hot swapping	Yes; Multi-hot swapping	Yes; Multi-hot swapping
• Isochronous mode	Yes	Yes	Yes	No
• Tool changer	Yes; Docking station and docking unit	Yes; Docking station and docking unit		
• Local coupling, IO data	No	Yes		
- Number of coupling modules		16		
- Number of coupling submodules per module		4		
• Local coupling, data records	No	No		
Engineering with				
• STEP 7 TIA Portal configurable/ integrated from version	STEP 7 V15.1 or higher	V15.1	STEP 7 V14 or higher	V15 SP1
• STEP 7 configurable/ integrated from version	Configurable via GSD file	Configurable via GSD file	V5.5 SP4 and higher	As of V5.5 SP4, only up to FW V3.1
• PROFIBUS from GSD version/ GSD revision				One GSD file each, Revision 3 and 5 and higher
• PROFINET from GSD version/ GSD revision	GSDML V2.3	GSDML V2.3	- / V2.3	
Supply voltage				
Rated value (DC)	24 V	24 V	24 V	24 V
Reverse polarity protection	Yes	Yes	Yes	Yes
Input current				
Current consumption (rated value)		175 mA; At 24 V, 2 slots 2x RJ45 BusAdapter, no I/O modules		
Address area				
Address space per station				
• Address space per station, max.	1 440 byte; Dependent on configuration	1 440 byte; Dependent on configuration	968 byte; For input and output data respectively	244 byte; per input / output

I/O systemsSIMATIC ET 200 systems for the control cabinet
SIMATIC ET 200SP**Interface modules > IM 155-6****Technical specifications**

Article number	6ES7155-6AU01-0CNO ET 200SP, IM155-6PN/2 HF	6ES7155-6AU30-0CNO ET 200SP, IM155-6PN/3 HF	6ES7155-6AU00-0DNO ET 200SP, IM155-6PN HS	6ES7155-6BA01-0CNO ET 200SP, IM155-6DP HF incl. DP-Connect.
Hardware configuration				
Rack				
• Quantity of operable ET 200SP modules, max.	64	64	30	32
• Quantity of operable ET 200AL modules, max.	16	16	0	16
Submodules				
• Number of submodules per station, max.	256	256	125	
Time stamping				
Accuracy	10 ms			
Interfaces				
Number of PROFINET interfaces	1; 2 ports (switch)	1; 3 ports (switch)	1; 2 ports (switch)	
Number of PROFIBUS interfaces				1
1. Interface				
Interface types				
• RS 485				Yes
• Number of ports	2; via BusAdapter	3; Via 2 BusAdapter slots	2	
• integrated switch	Yes	Yes	Yes	
• BusAdapter (PROFINET)	Yes; compatible BusAdapters: BA 2x RJ45, BA 2x M12, BA 2x FC, BA 2x LC, BA LC/RJ45, BA LC/FC, BA 2x SCRJ, BA SCRJ/RJ45, BA SCRJ/FC,	Yes; Compatible BusAdapter: BA 2x RJ45, BA 2x FC, BA 2x SCRJ, BA SCRJ / RJ45, BA SCRJ / FC, BA 2x LC, BA LC / RJ45, BA LC / FC	Yes; Compatible BusAdapter: BA 2x RJ45, BA 2x FC, BA 2x SCRJ, BA SCRJ / RJ45, BA SCRJ / FC, BA 2x LC, BA LC / RJ45, BA LC / FC	
• Output current of the interface, max.				90 mA
Protocols				
• PROFINET IO Device	Yes	Yes	Yes	
• PROFIBUS DP slave				Yes
• Open IE communication	Yes	Yes	Yes	
• Media redundancy	Yes; PROFINET MRP	Yes; PROFINET MRP	Yes; As MRP or MRPD client; max. 50 or 30 devices in the ring	
Interface types				
RJ 45 (Ethernet)				
• Transmission procedure	PROFINET with 100 Mbit/s full duplex (100BASE-TX)	PROFINET with 100 Mbit/s full duplex (100BASE-TX)	PROFINET with 100 Mbit/s full duplex (100BASE-TX)	
• 10 Mbps	No	No	No	
• 100 Mbps	Yes; PROFINET with 100 Mbit/s full duplex (100BASE-TX)	Yes; PROFINET with 100 Mbit/s full duplex (100BASE-TX)	Yes; PROFINET with 100 Mbit/s full duplex (100BASE-TX)	
• Autonegotiation	Yes	Yes	Yes	
• Autocrossing	Yes	Yes	Yes	
RS 485				
• Transmission rate, max.				12 Mbit/s
Protocols				
Number of connections				
• Number of MtM communication relationships/connections, max.	16	16		
PROFINET IO Device				
Services				
- IRT	Yes; 250 µs, 500 µs, 1 ms, 2 ms, 4 ms additionally with IRT with high performance: 250 µs to 4 ms in 125 µs frame	Yes; 250 µs, 500 µs, 1 ms, 2 ms, 4 ms additionally with IRT with high performance: 250 µs to 4 ms in 125 µs frame	Yes; 125 µs, 250 µs, 500 µs, 1 ms, 2 ms, 4 ms additionally with IRT with high performance: 250 µs to 4 ms in 125 µs frame	
- PROFenergy	Yes	Yes	Yes	
- Prioritized startup	Yes	Yes	Yes	
- Shared device	Yes	Yes	Yes	
- Number of IO Controllers with shared device, max.	4	4	4	

Technical specifications

Article number	6ES7155-6AU01-0CNO ET 200SP, IM155-6PN/2 HF	6ES7155-6AU30-0CNO ET 200SP, IM155-6PN/3 HF	6ES7155-6AU00-0DNO ET 200SP, IM155-6PN HS	6ES7155-6BA01-0CNO ET 200SP, IM155-6DP HF incl. DP-Connect.
Redundancy mode				
• PROFINET system redundancy (S2)	Yes; NAP S2	Yes; NAP S2	No	
• Redundant PROFINET configuration (R1)		No		
• H-Sync forwarding	Yes	Yes		
Media redundancy				
- MRP	Yes	Yes	Yes	
- MRPD	No	No	Yes	
Open IE communication				
• TCP/IP	Yes	Yes	Yes	No
• SNMP	Yes	Yes	Yes	
• LLDP	Yes	Yes	Yes	
PROFIBUS DP				
Services				
- SYNC capability				Yes
- FREEZE capability				Yes
- DPV0				Yes
- DPV1				Yes
Isochronous mode				
Equidistance	Yes	Yes	Yes	
shortest clock pulse	250 µs	250 µs	125 µs	
max. cycle	4 ms	4 ms	4 ms	
Bus cycle time (TDP), min.	250 µs	250 µs	125 µs	
Interrupts/diagnostics/ status information				
Status indicator	Yes	Yes	Yes	Yes
Alarms	Yes	Yes	Yes	Yes
Diagnostics function	Yes	Yes	Yes	Yes
Diagnostics indication LED				
• RUN LED	Yes; green LED	Yes; green LED	Yes; green LED	Yes; green LED
• ERROR LED	Yes; red LED	Yes; red LED	Yes; red LED	Yes; red LED
• MAINT LED	Yes; Yellow LED	Yes; Yellow LED	Yes; Yellow LED	Yes; Yellow LED
• Monitoring of the supply voltage (PWR-LED)	Yes; green PWR LED	Yes; green PWR LED	Yes; green PWR LED	Yes; green PWR LED
• Connection display LINK TX/RX	Yes; 2x green link LEDs on BusAdapter	Yes; 2x green link LEDs on BusAdapter	Yes; 2x green link LEDs on BusAdapter	
• Connection display DP				Yes; green DP LED
Standards, approvals, certificates				
Network loading class	3	3	3	
Security level	According to Security Level 1 Test Cases V1.1.1	According to Security Level 1 Test Cases V1.1.1	According to Security Level 1 Test Cases V1.1.1	
Ambient conditions				
Ambient temperature during operation				
• horizontal installation, min.	-30 °C; No condensation	-30 °C	-25 °C; No condensation	-25 °C
• horizontal installation, max.	60 °C	60 °C	60 °C	60 °C
• vertical installation, min.	-30 °C; No condensation	-30 °C	-25 °C; No condensation	-25 °C
• vertical installation, max.	50 °C	50 °C	50 °C	50 °C
Altitude during operation relating to sea level				
• Installation altitude above sea level, max.	5 000 m; Restrictions for installation altitudes > 2 000 m, see manual	5 000 m; Restrictions for installation altitudes > 2 000 m, see manual	5 000 m; Restrictions for installation altitudes > 2 000 m, see manual	5 000 m; Restrictions for installation altitudes > 2 000 m, see manual

I/O systems

SIMATIC ET 200 systems for the control cabinet

SIMATIC ET 200SP

Interface modules > IM 155-6**Technical specifications**

Article number	6ES7155-6AU01-0CNO ET 200SP, IM155-6PN/2 HF	6ES7155-6AU30-0CNO ET 200SP, IM155-6PN/3 HF	6ES7155-6AU00-0DN0 ET 200SP, IM155-6PN HS	6ES7155-6BA01-0CNO ET 200SP, IM155-6DP HF incl. DP-Connect.
Connection method				
ET-Connection				
• via BU/BA Send	Yes; + 16 ET 200AL modules	Yes; + 16 ET 200AL modules	No	Yes; + 16 ET 200AL modules
Mechanics/material				
Strain relief	Yes; Optional	Yes; Optional		
Dimensions				
Width	50 mm	100 mm	50 mm	50 mm
Height	117 mm	117 mm	117 mm	117 mm
Depth	74 mm	74 mm	74 mm	74 mm
Weights				
Weight, approx.	120 g; without BusAdapter	220 g; without BusAdapter	147 g; without BusAdapter	150 g

Overview



- Interface modules for linking the I/O modules to a higher-level PLC with PROFINET or PROFIBUS
- Server module included in the scope of supply
- Station expansion with IP67 I/O system ET 200AL via ET-connection to BU-Send / BA-Send
- PROFINET bus connection
 - 2 ports for line configuration
 - PN connection selected via BusAdapter (ST, HF)
 - Two integrated RJ45 sockets (BA)
- PROFIBUS bus connection
 - 9-pin sub D socket
 - PROFIBUS connector included in scope of supply
 - Hot swapping (module replacement during operation)
 - Startup and operation with gaps
 - Dynamic re-parameterization in RUN mode
 - Configuration control (option handling)
 - Pluggable 24 V DC supply connector
 - Electronically readable rating plate (I&M data)

Note:

SIPLUS extreme products are based on SIMATIC standard products. The contents listed here were taken from the respective standard products. SIPLUS extreme-specific information was added.

Ordering data

Article No.

**SIPLUS PROFINET
IM155-6PN Standard interface
module**

(Extended temperature range and exposure to environmental substances)

IM 155-6PN ST, with server module and installed BusAdapter BA 2xRJ45, plus extended power failure backup time

6AG1155-6AA01-7BN0

IM 155-6PN HF, including server module, without BusAdapter, plus extended power failure backup time

6AG1155-6AU01-7BN0**SIPLUS interface module
High Feature**

(Extended temperature range and exposure to environmental substances)

IM 155-6DP HF, with server module, with multi-hot-swap, incl. PROFIBUS connector

6AG1155-6BA01-7CN0

IM 155-6PN HF, incl. server module, without BusAdapter

- Temperature range -40...+60 °C
- Temperature range -40...+70 °C

6AG1155-6AU01-2CN0**6AG1155-6AU01-7CN0****Accessories****SIPLUS Mounting Kit ET 200SP****6AG1193-6AA00-0AA0**

Mounting accessories for use with increased mechanical vibration and shock loads. Not approved for SIPLUS BusAdapter BA 2xRJ45

Other accessories

See SIMATIC ET 200SP, IM 155-6 interface module, page 10/10

I/O systems

SIMATIC ET 200 systems for the control cabinet
SIMATIC ET 200SP

Interface modules > SIPLUS interface modules

Technical specifications

Article number	6AG1155-6AA01-7BN0	6AG1155-6AU01-2CN0	6AG1155-6AU01-7CN0	6AG1155-6AU01-7BN0	6AG1155-6BA01-7CN0
Based on	6ES7155-6AA01-0BN0 SIPLUS ET 200SP IM155-6PN ST / BA	6ES7155-6AU01-0CN0 SIPLUS ET 200SP IM155-6PN HF	6ES7155-6AU01-0CN0 SIPLUS ET 200SP IM155-6PN HF	6ES7155-6AU01-0BN0 SIPLUS ET 200SP IM155-6PN ST	6ES7155-6BA01-0CN0 SIPLUS ET 200SP IM155-6DP HF
Ambient conditions					
Ambient temperature during operation					
• horizontal installation, min.	-40 °C; = Tmin (incl. condensation/frost)	-40 °C; = Tmin (incl. condensation/frost)	-40 °C; = Tmin (incl. condensation/frost)	-40 °C; = Tmin (incl. condensation/frost)	-40 °C; = Tmin (incl. condensation/frost)
• horizontal installation, max.	70 °C; = Tmax	60 °C; = Tmax	70 °C; = Tmax	70 °C; = Tmax	70 °C; = Tmax
• vertical installation, min.	-40 °C; = Tmin	-40 °C; = Tmin (incl. condensation/frost)	-40 °C; = Tmin (incl. condensation/frost)	-40 °C; = Tmin	-40 °C; = Tmin (incl. condensation/frost)
• vertical installation, max.	50 °C; = Tmax	50 °C; = Tmax	50 °C; = Tmax	50 °C; = Tmax	50 °C; = Tmax
Altitude during operation relating to sea level					
• Installation altitude above sea level, max.	5 000 m	5 000 m	5 000 m	5 000 m	5 000 m
• Ambient air temperature-barometric pressure-altitude	Tmin ... Tmax at 1 140 hPa ... 795 hPa (-1 000 m ... +2 000 m) // Tmin ... (Tmax - 10 K) at 795 hPa ... 658 hPa (+2 000 m ... +3 500 m) // Tmin ... (Tmax -20 K) at 658 hPa ... 540 hPa (+3 500 m ... +5 000 m)	Tmin ... Tmax at 1 140 hPa ... 795 hPa (-1 000 m ... +2 000 m) // Tmin ... (Tmax - 10 K) at 795 hPa ... 658 hPa (+2 000 m ... +3 500 m) // Tmin ... (Tmax -20 K) at 658 hPa ... 540 hPa (+3 500 m ... +5 000 m)	Tmin ... Tmax at 1 140 hPa ... 795 hPa (-1 000 m ... +2 000 m) // Tmin ... (Tmax - 10 K) at 795 hPa ... 658 hPa (+2 000 m ... +3 500 m) // Tmin ... (Tmax -20 K) at 658 hPa ... 540 hPa (+3 500 m ... +5 000 m)	Tmin ... Tmax at 1 140 hPa ... 795 hPa (-1 000 m ... +2 000 m) // Tmin ... (Tmax - 10 K) at 795 hPa ... 658 hPa (+2 000 m ... +3 500 m) // Tmin ... (Tmax -20 K) at 658 hPa ... 540 hPa (+3 500 m ... +5 000 m)	Tmin ... Tmax at 1 140 hPa ... 795 hPa (-1 000 m ... +2 000 m) // Tmin ... (Tmax - 10 K) at 795 hPa ... 658 hPa (+2 000 m ... +3 500 m) // Tmin ... (Tmax -20 K) at 658 hPa ... 540 hPa (+3 500 m ... +5 000 m)
Relative humidity					
• With condensation, tested in accordance with IEC 60068-2-38, max.	100 %; RH incl. condensation / frost (no commissioning in bedewed state), horizontal installation	100 %; RH incl. condensation / frost (no commissioning in bedewed state), horizontal installation	100 %; RH incl. condensation / frost (no commissioning in bedewed state), horizontal installation	100 %; RH incl. condensation / frost (no commissioning in bedewed state), horizontal installation	100 %; RH incl. condensation / frost (no commissioning in bedewed state), horizontal installation
Resistance					
Coolants and lubricants					
- Resistant to commercially available coolants and lubricants	Yes; Incl. diesel and oil droplets in the air	Yes; Incl. diesel and oil droplets in the air	Yes; Incl. diesel and oil droplets in the air	Yes; Incl. diesel and oil droplets in the air	Yes; Incl. diesel and oil droplets in the air
Use in stationary industrial systems					
- to biologically active substances according to EN 60721-3-3	Yes; Class 3B2 mold, fungus and dry rot spores (with the exception of fauna); Class 3B3 on request	Yes; Class 3B2 mold, fungus and dry rot spores (with the exception of fauna); Class 3B3 on request	Yes; Class 3B2 mold, fungus and dry rot spores (with the exception of fauna); Class 3B3 on request	Yes; Class 3B2 mold, fungus and dry rot spores (with the exception of fauna); Class 3B3 on request	Yes; Class 3B2 mold, fungus and dry rot spores (with the exception of fauna); Class 3B3 on request
- to chemically active substances according to EN 60721-3-3	Yes; Class 3C4 (RH < 75 %) incl. salt spray acc. to EN 60068-2-52 (severity degree 3); *	Yes; Class 3C4 (RH < 75 %) incl. salt spray acc. to EN 60068-2-52 (severity degree 3); *	Yes; Class 3C4 (RH < 75 %) incl. salt spray acc. to EN 60068-2-52 (severity degree 3); *	Yes; Class 3C4 (RH < 75 %) incl. salt spray acc. to EN 60068-2-52 (severity degree 3); *	Yes; Class 3C4 (RH < 75 %) incl. salt spray acc. to EN 60068-2-52 (severity degree 3); *
- to mechanically active substances according to EN 60721-3-3	Yes; Class 3S4 incl. sand, dust, *	Yes; Class 3S4 incl. sand, dust, *	Yes; Class 3S4 incl. sand, dust, *	Yes; Class 3S4 incl. sand, dust, *	Yes; Class 3S4 incl. sand, dust, *
- Against mechanical environmental conditions acc. to EN 60721-3-3	Yes; Class 3M8 using the SIPLUS Mounting Kit ET 200SP (6AG1193-6AA00-0AA0)	Yes; Class 3M8 using the SIPLUS Mounting Kit ET 200SP (6AG1193-6AA00-0AA0)	Yes; Class 3M8 using the SIPLUS Mounting Kit ET 200SP (6AG1193-6AA00-0AA0)	Yes; Class 3M8 using the SIPLUS Mounting Kit ET 200SP (6AG1193-6AA00-0AA0)	Yes; Class 3M8 using the SIPLUS Mounting Kit ET 200SP (6AG1193-6AA00-0AA0)

Technical specifications

Article number	6AG1155-6AA01-7BN0	6AG1155-6AU01-2CN0	6AG1155-6AU01-7CN0	6AG1155-6AU01-7BN0	6AG1155-6BA01-7CN0
Based on	6ES7155-6AA01-0BN0 SIPLUS ET 200SP IM155-6PN ST / BA	6ES7155-6AU01-0CN0 SIPLUS ET 200SP IM155-6PN HF	6ES7155-6AU01-0CN0 SIPLUS ET 200SP IM155-6PN HF	6ES7155-6AU01-0BN0 SIPLUS ET 200SP IM155-6PN ST	6ES7155-6BA01-0CN0 SIPLUS ET 200SP IM155-6DP HF
Use on ships/at sea					
- to biologically active substances according to EN 60721-3-6	Yes; Class 6B2 mold and fungal spores (excluding fauna); Class 6B3 on request	Yes; Class 6B2 mold, fungal and dry rot spores (excluding fauna)	Yes; Class 6B2 mold, fungal and dry rot spores (excluding fauna)	Yes; Class 6B2 mold and fungal spores (excluding fauna); Class 6B3 on request	Yes; Class 6B2 mold, fungal and dry rot spores (excluding fauna)
- to chemically active substances according to EN 60721-3-6	Yes; Class 6C3 (RH < 75 %) incl. salt spray acc. to EN 60068-2-52 (severity degree 3); *	Yes; Class 6C3 (RH < 75 %) incl. salt spray acc. to EN 60068-2-52 (severity degree 3); *	Yes; Class 6C3 (RH < 75 %) incl. salt spray acc. to EN 60068-2-52 (severity degree 3); *	Yes; Class 6C3 (RH < 75 %) incl. salt spray acc. to EN 60068-2-52 (severity degree 3); *	Yes; Class 6C3 (RH < 75 %) incl. salt spray acc. to EN 60068-2-52 (severity degree 3); *
- to mechanically active substances according to EN 60721-3-6	Yes; Class 6S3 incl. sand, dust; *	Yes; Class 6S3 incl. sand, dust; *	Yes; Class 6S3 incl. sand, dust; *	Yes; Class 6S3 incl. sand, dust; *	Yes; Class 6S3 incl. sand, dust; *
- Against mechanical environmental conditions acc. to EN 60721-3-6		Yes; Class 6M4 using the SIPLUS Mounting Kit ET 200SP (6AG1193-6AA00-0AA0)	Yes; Class 6M4 using the SIPLUS Mounting Kit ET 200SP (6AG1193-6AA00-0AA0)	Yes; Class 6M4 using the SIPLUS Mounting Kit ET 200SP (6AG1193-6AA00-0AA0)	Yes; Class 6M4 using the SIPLUS Mounting Kit ET 200SP (6AG1193-6AA00-0AA0)
Usage in industrial process technology					
- Against chemically active substances acc. to EN 60654-4	Yes; Class 3 (excluding trichlorethylene)	Yes; Class 3 (excluding trichlorethylene)	Yes; Class 3 (excluding trichlorethylene)	Yes; Class 3 (excluding trichlorethylene)	Yes; Class 3 (excluding trichlorethylene)
- Environmental conditions for process, measuring and control systems acc. to ANSI/ISA-71.04	Yes; Level GX group A/B (excluding trichlorethylene; harmful gas concentrations up to the limits of EN 60721-3-3 class 3C4 permissible); level LC3 (salt spray) and level LB3 (oil)	Yes; Level GX group A/B (excluding trichlorethylene; harmful gas concentrations up to the limits of EN 60721-3-3 class 3C4 permissible); level LC3 (salt spray) and level LB3 (oil)	Yes; Level GX group A/B (excluding trichlorethylene; harmful gas concentrations up to the limits of EN 60721-3-3 class 3C4 permissible); level LC3 (salt spray) and level LB3 (oil)	Yes; Level GX group A/B (excluding trichlorethylene; harmful gas concentrations up to the limits of EN 60721-3-3 class 3C4 permissible); level LC3 (salt spray) and level LB3 (oil)	Yes; Level GX group A/B (excluding trichlorethylene; harmful gas concentrations up to the limits of EN 60721-3-3 class 3C4 permissible); level LC3 (salt spray) and level LB3 (oil)
Remark					
- Note regarding classification of environmental conditions acc. to EN 60721, EN 60654-4 and ANSI/ISA-71.04	* The supplied plug covers must remain in place over the unused interfaces during operation!	* The supplied plug covers must remain in place over the unused interfaces during operation!	* The supplied plug covers must remain in place over the unused interfaces during operation!	* The supplied plug covers must remain in place over the unused interfaces during operation!	* The supplied plug covers must remain in place over the unused interfaces during operation!
Conformal coating					
• Coatings for printed circuit board assemblies acc. to EN 61086	Yes; Class 2 for high reliability	Yes; Class 2 for high reliability	Yes; Class 2 for high reliability	Yes; Class 2 for high reliability	Yes; Class 2 for high reliability
• Protection against fouling acc. to EN 60664-3	Yes; Type 1 protection	Yes; Type 1 protection	Yes; Type 1 protection	Yes; Type 1 protection	Yes; Type 1 protection
• Military testing according to MIL-I-46058C, Amendment 7	Yes; Discoloration of coating possible during service life	Yes; Discoloration of coating possible during service life	Yes; Discoloration of coating possible during service life	Yes; Discoloration of coating possible during service life	Yes; Discoloration of coating possible during service life
• Qualification and Performance of Electrical Insulating Compound for Printed Board Assemblies according to IPC-CC-830A	Yes; Conformal coating, Class A	Yes; Conformal coating, Class A	Yes; Conformal coating, Class A	Yes; Conformal coating, Class A	Yes; Conformal coating, Class A

I/O systems

SIMATIC ET 200 systems for the control cabinet
SIMATIC ET 200SP

I/O modules > Digital input modules

Overview



- 4, 8 and 16-channel digital input (DI) modules
- Apart from the standard type of delivery in an individual package, selected I/O modules and BaseUnits are also available in a pack of 10 units. The pack of 10 units enables the amount of waste to be reduced considerably, as well as saving the time and cost of unpacking individual modules.

For different requirements, the digital input modules offer:

- Function classes Basic, Standard, High Feature and High Speed as well as fail-safe DI (see "Fail-safe I/O modules")
- BaseUnits for single or multiple-conductor connection with automatic slot coding
- Potential distributor modules for system-integrated expansion with additional potential terminals
- Individual system-integrated potential group formation with self-assembling voltage busbars (a separate power module is no longer required for ET 200SP)

- Option of connecting sensors compliant with IEC 61131 type 1, 2 or 3 (module-dependent) for rated voltages of up to 24 V DC or 230 V AC
- PNP (sinking input) and NPN (sourcing input) versions
- Clear labeling on front of module
- LEDs for diagnostics, status, supply voltage and faults (e.g. wire break/short-circuit)
- Electronically readable and non-volatile writable rating plate (I&M data 0 to 3)
- Extended functions and additional operating modes in some cases
 - MSI operating mode (simultaneous reading of input data from as many as three other PLCs)
 - Counting operating mode (multi-channel counter for pulse generators with 32-bit counting width and up to 10 kHz counting frequency)
 - Oversampling operating mode (n-fold equidistant acquisition of digital values within one PN cycle for increasing the time resolution for slow CPU cycles)
 - Parameterizable input delay time
 - Isochronous mode (simultaneous equidistant reading of all input channels)
 - Hardware interrupts
 - Pulse stretching
 - Re-parameterization during operation
 - Firmware update
 - Diagnosis of wire break and short-circuit (on channel or module basis)
 - Value status (optional binary validity information of the input signal in the process image)
 - Supports the PROFlenergy profile
- Optional accessories
 - Labeling strips (film or card)
 - Equipment labeling plate
 - Color-coded label with module-specific CC code
 - Shielding terminal

A quick and clear comparison of the functions of the different DI modules is offered by the TIA Selection Tool.

Overview of digital input modules

Digital input	PU	Article No.	CC code	BU type
DI 16 x 24 V DC ST	1	6ES7131-6BH01-0BA0	CC00	A0
DI 16 x 24 V DC ST	10	6ES7131-6BH01-2BA0	CC00	A0
DI 8 x 24 V DC BA	1	6ES7131-6BF01-0AA0	CC01	A0
DI 8 x 24 V DC BA	10	6ES7131-6BF01-2AA0	CC01	A0
DI 8 x 24 V DC SRC BA	1	6ES7131-6BF61-0AA0	CC02	A0
DI 8 x 24 V DC ST	1	6ES7131-6BF01-0BA0	CC01	A0
DI 8 x 24 V DC ST	10	6ES7131-6BF01-2BA0	CC01	A0
DI 8 x 24 V DC HF	1	6ES7131-6BF00-0CA0	CC01	A0
DI 8 x 24 V DC HF	10	6ES7131-6BF00-2CA0	CC01	A0
DI 8 x NAMUR HF	1	6ES7131-6TF00-0CA0	CC01	A0
DI 8 x 24 V DC HS	1	6ES7131-6BF00-0DA0	CC01	A0
With three operating modes: • High-speed isochronous DI • 4 pulse counters, 32-bit, 10 kHz • Oversampling				
DI 4 x 120 ... 230 V AC ST	1	6ES7131-6FD01-0BB1	CC41	B1
DI 8 x 24 V AC ... 48 V UC	1	6ES7131-6CF00-0AU0	CC20	U0

Overview

Overview of BaseUnits

BaseUnit	PU	Article No.	CC codes for push-in terminals	CC codes for AUX terminals
BU type A0 • New potential group (light) • 16 push-in terminals • With 10 AUX terminals	1	6ES7193-6BP20-0DA0	CC00 to CC05	CC71 to CC73
BU type A0 • New potential group (light) • 16 push-in terminals • With 10 AUX terminals	10	6ES7193-6BP20-2DA0	CC00 to CC05	CC71 to CC73
BU type A0 • New potential group (light) • 16 push-in terminals • Without AUX terminals	1	6ES7193-6BP00-0DA0	CC00 to CC05	--
BU type A0 • New potential group (light) • 16 push-in terminals • Without AUX terminals	10	6ES7193-6BP00-2DA0	CC00 to CC05	--
BU type A0 • Forwarding of the potential group (dark) • 16 push-in terminals • With 10 AUX terminals	1	6ES7193-6BP20-0BA0	CC00 to CC05	CC71 to CC73
BU type A0 • Forwarding of the potential group (dark) • 16 push-in terminals • With 10 AUX terminals	10	6ES7193-6BP20-2BA0	CC00 to CC05	CC71 to CC73
BU type A0 • Forwarding of the potential group (dark) • 16 push-in terminals • Without AUX terminals	1	6ES7193-6BP00-0BA0	CC00 to CC05	--
BU type A0 • Forwarding of the potential group (dark) • 16 push-in terminals • Without AUX terminals	10	6ES7193-6BP00-2BA0	CC00 to CC05	--
BU type B1 • Forwarding of the potential group (dark) • 12 push-in terminals • 2 x 2 (1L, 2L, 1N, 2N) direct infeed module • Without AUX terminals	1	6ES7193-6BP20-0BB1	CC41	--
BU type B1 • Forwarding of the potential group (dark) • 12 push-in terminals • 2 x 2 (1L, 2L, 1N, 2N) direct infeed module • Without AUX terminals	10	6ES7193-6BP20-2BB1	CC41	--
BU type U0 • New potential group (light) • 16 push-in terminals • Without AUX terminals	1	6ES7193-6BP00-0DU0	CC00	--
BU type U0 • New potential group (light) • 16 push-in terminals • Without AUX terminals	10	6ES7193-6BP00-2DU0	CC00	--
BU type U0 • Forwarding of the potential group (dark) • 16 push-in terminals • Without AUX terminals	1	6ES7193-6BP00-0BU0	CC00	--
BU type U0 • Forwarding of the potential group (dark) • 16 push-in terminals • Without AUX terminals	10	6ES7193-6BP00-2BU0	CC00	--

I/O systems

SIMATIC ET 200 systems for the control cabinet
SIMATIC ET 200SP

I/O modules > Digital input modules

Overview of potential distributor modules

Potential distributor module	PU	Article No.	CC codes for push-in terminals
PotDis BU Type P1 (light), 17x P1 potential, 1x P2 potential, for starting a new potential group (max. 10 A)	1	6ES7193-6UP00-0DP1	CC00, CC62
PotDis BU Type P1 (dark), 17x P1 potential, 1x P2 potential, for continuing the potential group	1	6ES7193-6UP00-0BP1	CC00, CC62
PotDis BU Type P2 (light), 1x P1 potential, 17x P2 potential, for starting a new potential group (max. 10 A)	1	6ES7193-6UP00-0DP2	CC00, CC63
PotDis BU Type P2 (dark), 1x P1 potential, 17x P2 potential, for continuing the potential group	1	6ES7193-6UP00-0BP2	CC00, CC63
PotDis TB Type BR-W, 18x internally jumpered terminals, without reference to P1, P2 or AUX, (total current max. 10 A)	1	6ES7193-6TP00-0TP0	CC10 to CC13
PotDis TB Type P1-R, 18x P1 potential, (total current max. 10 A)	1	6ES7193-6TP00-0TP1	CC10, CC12
PotDis TB Type P2-B, 18x P2 potential, (total current max. 10 A)	1	6ES7193-6TP00-0TP2	CC10, CC13
PotDis TB Type n.c.-G, 18x n.c. (not connected) terminals, without reference to P1, P2 or AUX	1	6ES7193-6TP00-0TN0	CC10

Ordering data

Digital input modules

Delivery options:
Apart from the standard type of delivery in single-unit package, selected I/O modules and BaseUnits are also available in a pack of 10 units. The pack of 10 units enables the amount of waste to be reduced considerably, as well as saving the time and cost of unpacking individual modules.

The number of modules required is the number of modules ordered. The pack type is selected by selecting the article number. Packs of 10 can therefore only be ordered in integer multiples of 10.

Digital input module
DI 8x24VDC Basic, BU type A0, color code CC01

- Pack of 1 unit
- Pack of 10 units; to order a pack, please order this article number with an order quantity of 10

Digital input module
DI 8x24VDC Source Input, Basic, BU type A0, color code CC02; PU: 1 unit

6ES7131-6BF01-0AA0
6ES7131-6BF01-2AA0

6ES7131-6BF61-0AA0

Digital input module
DI 8x24VDC Standard, BU type A0, color code CC01

- Pack of 1 unit
- Pack of 10 units; to order a pack, please order this article number with an order quantity of 10

Digital input module
DI 16 x 24 V DC Standard, BU type A0, color code CC00

- Pack of 1 unit
- Pack of 10 units; to order a pack, please order this article number with an order quantity of 10

Digital input module
DI 8x24VDC High Feature, BU type A0, color code CC01, channel-specific diagnostics, isochronous mode, shared input (MSI); PU: 1 unit

- Pack of 1 unit
- Pack of 10 units; to order a pack, please order this article number with an order quantity of 10

Article No.

6ES7131-6BF01-0BA0
6ES7131-6BF01-2BA0

6ES7131-6BH01-0BA0
6ES7131-6BH01-2BA0

6ES7131-6BF00-0CA0
6ES7131-6BF00-2CA0

Ordering data	Article No.	Article No.
Digital input module DI 8x24VDC High Speed, BU type A0, color code CC01; 3 operating modes (fast isochronous DI, 4 pulse counters 32-bit 10 kHz, oversampling); PU: 1 unit	6ES7131-6BF00-0DA0	BU20-P12+A0+4B BU type B1; BaseUnit (dark) with 12 push-in terminals to the module; for continuing the potential group; 1 unit <ul style="list-style-type: none">• Pack of 1 unit• Pack of 10 units; to order a pack, please order this article number with an order quantity of 10
Digital input module DI 8xNAMUR High Feature, BU type A0, color code CC01; PU: 1 unit	6ES7131-6TF00-0CA0	
Digital input module DI 4x120VAC-230VAC Standard, BU type B1, color code CC41; PU: 1 unit	6ES7131-6FD01-0BB1	
Digital input module DI 8x24VAC-48VUC Basic, BU type U0, color code CC20, module diagnostics, PU: 1 unit	6ES7131-6CF00-0AU0	
Suitable BaseUnits		
BU15-P16+A10+2D BU type A0; BaseUnit (light) with 16 push-in terminals (1 ... 16) to the module and an additional 10 internally jumpered AUX terminals (1 A to 10 A); for starting a new potential group (max. 10 A) <ul style="list-style-type: none">• Pack of 1 unit• Pack of 10 units; to order a pack, please order this article number with an order quantity of 10	6ES7193-6BP20-0DA0 6ES7193-6BP20-2DA0	BU20-P16+A0+2D BU type U0; BaseUnit (light) with 16 push-in terminals to the module; for starting a new potential group (max. 10 A) <ul style="list-style-type: none">• Pack of 1 unit• Pack of 10 units; to order a pack, please order this article number with an order quantity of 10
BU15-P16+A0+2D BU type A0; BaseUnit (light) with 16 push-in terminals to the module; for starting a new potential group (max. 10 A) <ul style="list-style-type: none">• Pack of 1 unit• Pack of 10 units; to order a pack, please order this article number with an order quantity of 10	6ES7193-6BP00-0DA0 6ES7193-6BP00-2DA0	
BU15-P16+A10+2B BU type A0; BaseUnit (dark) with 16 push-in terminals (1 ... 16) to the module and an additional 10 internally jumpered UX terminals (1 A to 10 A); for continuing the potential group <ul style="list-style-type: none">• Pack of 1 unit• Pack of 10 units; to order a pack, please order this article number with an order quantity of 10	6ES7193-6BP20-0BA0 6ES7193-6BP20-2BA0	BU20-P16+A0+2B BU type U0; BaseUnit (dark) with 16 push-in terminals to the module; for continuing the potential group <ul style="list-style-type: none">• Pack of 1 unit• Pack of 10 units; to order a pack, please order this article number with an order quantity of 10
BU15-P16+A0+2B BU type A0; BaseUnit (dark) with 16 push-in terminals to the module; for continuing the potential group <ul style="list-style-type: none">• Pack of 1 unit• Pack of 10 units; to order a pack, please order this article number with an order quantity of 10	6ES7193-6BP00-0BA0 6ES7193-6BP00-2BA0	Potential distributor modules
		PotDis BU PotDis BU, Type P1 (light), 17x P1 potential, 1x P2 potential, for starting a new potential group (max. 10 A) PotDis BU, Type P1 (dark), 17x P1 potential, 1x P2 potential, for continuing the potential group PotDis BU, Type P2 (light), 1x P1 potential, 17x P2 potential, for starting a new potential group (max. 10 A) PotDis BU, Type P2 (dark), 1x P1 potential, 17x P2 potential, for continuing the potential group
		6ES7193-6UP00-ODP1 6ES7193-6UP00-OBP1 6ES7193-6UP00-ODP2 6ES7193-6UP00-OBP2
		PotDis TB PotDis TB, type BR-W, 18x internally jumpered terminals, without reference to P1, P2 or AUX, (total current max. 10 A) PotDis TB, type P1-R, 18x P1 potential, (total current max. 10 A) PotDis TB, type P2-B, 18x P2 potential, (total current max. 10 A) PotDis TB, type n.c.-G, 18x n.c. (not connected) terminals, without reference to P1, P2 or AUX
		6ES7193-6TP00-OTP0 6ES7193-6TP00-OTP1 6ES7193-6TP00-OTP2 6ES7193-6TP00-OTN0

I/O systems

SIMATIC ET 200 systems for the control cabinet
SIMATIC ET 200SP

I/O modules > Digital input modules

Ordering data

Article No.

Accessories

Equipment labeling plate

10 sheets of 16 labels,
for printing with thermal transfer
card printer or plotter

6ES7193-6LF30-0AW0

Labeling strips

500 labeling strips on roll,
light gray, for inscription with
thermal transfer roll printer

6ES7193-6LR10-0AA0

500 labeling strips on roll,
yellow, for inscription with thermal
transfer roll printer

6ES7193-6LR10-0AG0

1 000 labeling strips DIN A4,
light gray, card, perforated,
for inscription with laser printer

6ES7193-6LA10-0AA0

1 000 labeling strips DIN A4,
yellow, card, perforated,
for inscription with laser printer

6ES7193-6LA10-0AG0

BU cover

For covering empty slots (gaps);
5 units

- 15 mm wide
- 20 mm wide

6ES7133-6CV15-1AM0

6ES7133-6CV20-1AM0

Shield connection

5 shield supports and
5 shield terminals

6ES7193-6SC00-1AM0

Color-coded labels for 15 mm-wide BaseUnits

Color code CC00,
for 16 push-in terminals, BU type A0,
A1, gray (terminals 1 to 8),
red (terminals 9 to 16); 10 units

6ES7193-6CP00-2MA0

Color code CC01,
for 16 push-in terminals, BU type A0,
A1, gray (terminals 1 to 8),
red (terminals 9 to 16); 10 units

6ES7193-6CP01-2MA0

Color code CC01,
for 16 push-in terminals, BU type A0,
A1, gray (terminals 1 to 8),
red (terminals 9 to 16); 50 units

6ES7193-6CP01-4MA0

Color code CC02,
for 16 push-in terminals, BU type A0,
A1, gray (terminals 1 to 8),
blue (terminals 9 to 16); 10 units

6ES7193-6CP02-2MA0

Color code CC02,
for 16 push-in terminals, BU type A0,
A1, gray (terminals 1 to 8),
blue (terminals 9 to 16); 50 units

6ES7193-6CP02-4MA0

Color code CC71,
for 10 AUX terminals, BU type A0,
yellow/green (terminals 1 A to 10 A);
10 units

6ES7193-6CP71-2AA0

Color code CC72,
for 10 AUX terminals, BU type A0,
red (terminals 1 A to 10 A);
10 units

6ES7193-6CP72-2AA0

Color code CC73,
for 10 AUX terminals, BU type A0,
blue (terminals 1 A to 10 A);
10 units

6ES7193-6CP73-2AA0

Color code CC73,
for 10 AUX terminals, BU type A0,
blue (terminals 1 A to 10 A);
50 units

6ES7193-6CP73-4AA0

Color-coded labels for 20 mm-wide BaseUnits

Color code CC41,
for 16 push-in terminals, BU type B1,
gray (terminals 1 to 4),
red (terminals 5 to 8),
blue (terminals 9 to 12); 10 units

6ES7193-6CP41-2MB0

Color-coded labels for PotDis BU

Color code CC62,
for 16 push-in terminals,
PotDis BU type P1,
red (terminals 1 to 16); 10 units

6ES7193-6CP62-2MA0

Color code CC63,
for 16 push-in terminals,
PotDis BU type P2,
blue (terminals 1 to 16); 10 units

6ES7193-6CP63-2MA0

Color-coded labels for PotDis TB

Color code CC10,
for 18 push-in terminals,
PotDis TB,
gray (terminals 1 to 18); 10 units

6ES7193-6CP10-2MT0

Color code CC11,
for 18 push-in terminals,
PotDis TB,
yellow-green (terminals 1 to 18);
10 units

6ES7193-6CP11-2MT0

Color code CC12,
for 18 push-in terminals,
PotDis TB, type P1 and BR,
red (terminals 1 to 18); 10 units

6ES7193-6CP12-2MT0

Color code CC13,
for 18 push-in terminals,
PotDis TB, type P2 and BR,
blue (terminals 1 to 18); 10 units

6ES7193-6CP13-2MT0

Mechanical coding elements

For automatic coding of
I/O modules; spare part.
20 units

Type A

6ES7193-6KA00-3AA0

Type B

6ES7193-6KB00-3AA0

Type C

6ES7193-6KC00-3AA0

Type D

6ES7193-6KD00-3AA0

Technical specifications

Article number	6ES7131-6BF01-0AA0 ET 200SP, DI 8x 24V DC Basic, PU 1	6ES7131-6BF61-0AA0 ET 200SP, DI 8x 24V DC SRC BA	6ES7131-6BF01-0BA0 ET 200SP, DI 8x 24V DC ST, PU 1	6ES7131-6BH01-0BA0 ET 200SP, DI 16x 24V DC ST, PU 1
General information				
Product type designation	DI 8x24VDC BA	DI 8x24 VDC SRC BA	DI 8x24 VDC ST	DI 16x24VDC ST
Product function				
• Isochronous mode	No	No	No	No
Engineering with				
• STEP 7 TIA Portal configurable/ integrated from version	V14	V14	V14	V14
• STEP 7 configurable/ integrated from version	V5.5 SP3 / -	V5.5 SP3 / -	V5.5 SP3 or higher	V5.5 SP3
• PCS 7 configurable/ integrated from version			V8.1 SP1	V8.1 SP1
• PROFIBUS from GSD version/ GSD revision	One GSD file each, Revision 3 and 5 and higher	One GSD file each, Revision 3 and 5 and higher	One GSD file each, Revision 3 and 5 and higher	One GSD file each, Revision 3 and 5 and higher
• PROFINET from GSD version/ GSD revision	GSDML V2.3	GSDML V2.3	GSDML V2.3	GSDML V2.3
Operating mode				
• DI	Yes	Yes	Yes	Yes
• Counter	No	No	No	No
• Oversampling	No	No	No	No
• MSI	No	No	No	No
Supply voltage				
Rated value (DC)	24 V	24 V	24 V	24 V
Reverse polarity protection	Yes	Yes	Yes	Yes
Encoder supply				
Number of outputs	8		8	
Short-circuit protection	Yes; per module	No	Yes; per module	
24 V encoder supply				
• 24 V	Yes		Yes	No
• Short-circuit protection	Yes		Yes	
• Output current, max.			700 mA	
• Output current per channel, max.	700 mA		700 mA	
• Output current per module, max.	700 mA		700 mA	
Digital inputs				
Number of digital inputs	8	8	8	16
Digital inputs, parameterizable	Yes	Yes	Yes	Yes
Source/sink input	P-reading	Sourcing	P-reading	P-reading
Input characteristic curve in accordance with IEC 61131, type 1	Yes	Yes		
Input characteristic curve in accordance with IEC 61131, type 2	Yes			
Input characteristic curve in accordance with IEC 61131, type 3	Yes		Yes	Yes
Input voltage				
• Rated value (DC)	24 V	24 V	24 V	24 V
• for signal "0"	-30 to +5 V	30 V to -5 V (reference potential is L+)	-30 to +5 V	-30 to +5 V
• for signal "1"	+11 to +30V	-11 V to -30 V (reference potential is L+)	+11 to +30V	+11 to +30V
Input current				
• for signal "1", typ.	6.8 mA	6 mA	2.5 mA	2.5 mA
Input delay (for rated value of input voltage) for standard inputs				
- parameterizable	Yes; 0.05 / 0.1 / 0.4 / 0.8 / 1.6 / 3.2 / 12.8 / 20 ms (in each case + delay of 30 to 500 µs, depending on line length)	Yes; 0.05 / 0.1 / 0.4 / 0.8 / 1.6 / 3.2 / 12.8 / 20 ms (in each case + delay of 30 to 500 µs, depending on line length)	Yes; 0.05 / 0.1 / 0.4 / 0.8 / 1.6 / 3.2 / 12.8 / 20 ms (in each case + delay of 30 to 500 µs, depending on line length)	Yes; 0.05 / 0.1 / 0.4 / 0.8 / 1.6 / 3.2 / 12.8 / 20 ms (in each case + delay of 30 to 500 µs, depending on line length)

I/O systemsSIMATIC ET 200 systems for the control cabinet
SIMATIC ET 200SP**I/O modules > Digital input modules****Technical specifications**

Article number	6ES7131-6BF01-0AA0 ET 200SP, DI 8x 24V DC Basic, PU 1	6ES7131-6BF61-0AA0 ET 200SP, DI 8x 24V DC SRC BA	6ES7131-6BF01-0BA0 ET 200SP, DI 8x 24V DC ST, PU 1	6ES7131-6BH01-0BA0 ET 200SP, DI 16x 24V DC ST, PU 1
Encoder				
Connectable encoders				
• 2-wire sensor	Yes	Yes	Yes	Yes
- permissible quiescent current (2-wire sensor), max.	2 mA	1.5 mA	1.5 mA	1.5 mA
Interrupts/diagnostics/ status information				
Diagnostics function	Yes	Yes	Yes	Yes
Alarms				
• Diagnostic alarm	Yes	Yes	Yes	Yes
Diagnoses				
• Diagnostic information readable	Yes	Yes	Yes	Yes
• Monitoring the supply voltage	Yes	Yes	Yes	Yes
- parameterizable	Yes	Yes	Yes	Yes
• Monitoring of encoder power supply	No	No	Yes; Module-by-module, optional protective circuit for preventing wire-break diagnostics in the case of simple encoder contacts: 25 kOhm to 45 kOhm	No
• Wire-break	No	No	Yes; Module-wise	Yes; Module-by-module, optional protective circuit for preventing wire-break diagnostics in the case of simple encoder contacts: 25 kOhm to 45 kOhm
• Short-circuit	No	No	Yes; Module-wise	No
• Group error	Yes	Yes	Yes	Yes
Diagnostics indication LED				
• Monitoring of the supply voltage (PWR-LED)	Yes; green PWR LED	Yes; green PWR LED	Yes; green PWR LED	Yes; green PWR LED
• Channel status display	Yes; green LED	Yes; green LED	Yes; green LED	Yes; green LED
• for channel diagnostics	No	No	No	No
• for module diagnostics	Yes; green/red DIAG LED	Yes; green/red DIAG LED	Yes; green/red DIAG LED	Yes; green/red DIAG LED
Potential separation				
Potential separation channels				
• between the channels and backplane bus	Yes	Yes	Yes	Yes
Standards, approvals, certificates				
Suitable for safety functions	No	No	No	No
Ambient conditions				
Ambient temperature during operation				
• horizontal installation, min.	-30 °C; < 0 °C as of FS03	-30 °C; < 0 °C as of FS02	-30 °C; < 0 °C as of FS02	-30 °C; < 0 °C as of FS02
• horizontal installation, max.	60 °C	60 °C	60 °C	60 °C
• vertical installation, min.	-30 °C; < 0 °C as of FS03	-30 °C; < 0 °C as of FS02	-30 °C; < 0 °C as of FS02	-30 °C; < 0 °C as of FS02
• vertical installation, max.	50 °C	50 °C	50 °C	50 °C
Altitude during operation relating to sea level				
• Installation altitude above sea level, max.	5 000 m; Restrictions for installation altitudes > 2 000 m, see manual	5 000 m; Restrictions for installation altitudes > 2 000 m, see manual	5 000 m; Restrictions for installation altitudes > 2 000 m, see manual	5 000 m; Restrictions for installation altitudes > 2 000 m, see manual
Dimensions				
Width	15 mm	15 mm	15 mm	15 mm
Height	73 mm	73 mm	73 mm	73 mm
Depth	58 mm	58 mm	58 mm	58 mm
Weights				
Weight, approx.	28 g	28 g	28 g	28 g

Technical specifications

Article number	6ES7131-6BF00-0CA0 ET 200SP, DI 8x24VDC HF, PU 1	6ES7131-6BF00-0DA0 ET 200SP, DI 8x24VDC High Speed	6ES7131-6TF00-0CA0 ET 200SP, DI 8xNAMUR HF	6ES7131-6FD01-0BB1 ET 200SP, DI 4x 120...230VAC ST	6ES7131-6CF00-0AU0 ET 200SP, DI 8x 24VAC..48VUC BA, PU 1
General information					
Product type designation	DI 8x24 V DC HF	DI 8x24 V DC HS	DI 8xNAMUR HF	DI 4x120 ... 230 V AC ST	DI 8x24VAC/48VUC BA
Product function					
• Isochronous mode	Yes	Yes	No	No	No
Engineering with					
• STEP 7 TIA Portal configurable/ integrated from version	V13 SP1 / -	V13 SP1	V13 / V13	V14	V15
• STEP 7 configurable/ integrated from version	V5.5 / -	V5.5 SP3 / -	V5.5 SP3 / -	V5.5 SP3	V5.6
• PCS 7 configurable/ integrated from version	V8.1 SP1				
• PROFIBUS from GSD version/ GSD revision	One GSD file each, Revision 3 and 5 and higher	One GSD file each, Revision 3 and 5 and higher	GSD Revision 5	One GSD file each, Revision 3 and 5 and higher	One GSD file each, Revision 3 and 5 and higher
• PROFINET from GSD version/ GSD revision	GSDML V2.3	GSDML V2.3	GSDML V2.3	GSDML V2.3	GSDML V2.3
Operating mode					
• DI	Yes	Yes	Yes	Yes	Yes
• Counter	No	Yes	No	No	No
• Oversampling	No	Yes	No	No	No
• MSI	Yes	No	No	No	No
Supply voltage					
Rated value (DC)	24 V	24 V	24 V		48 V
Rated value (AC)				230 V	48 V; 24 V/48 V; 50 Hz/60 Hz
Reverse polarity protection	Yes	Yes	Yes	No	Yes
Encoder supply					
Number of outputs	8		8	4	8
Short-circuit protection	Yes		Yes	No; when using BU type B1, a fuse with 10 A tripping current must be provided	Yes; Per module, 5x 20 mm fuse, 2 A/250 V, quick-response, replaceable
Output current					
• up to 60 °C, max.				10 A	1 A
24 V encoder supply					
• 24 V	Yes	Yes	No		No
• Short-circuit protection	Yes; per channel, electronic	Yes; per module, electronic	No		
• Output current, max.		700 mA			
• Output current per channel, max.	700 mA				
• Output current per module, max.	700 mA				
Digital inputs					
Number of digital inputs	8	8	8; NAMUR	4	8
Digital inputs, parameterizable	Yes		Yes		
Source/sink input	P-reading	P-reading			P-reading
Input characteristic curve in accordance with IEC 61131, type 1					Yes
Input characteristic curve in accordance with IEC 61131, type 2					No
Input characteristic curve in accordance with IEC 61131, type 3	Yes			Yes	No
Pulse extension	Yes; Pulse duration from 4 µs	Yes	Yes; 0.5 s, 1 s, 2 s		No
• Length	2 s; 50 ms, 100 ms, 200 ms, 500 ms, 1 s, 2 s	2 s; 50 ms, 100 ms, 200 ms, 500 ms, 1 s, 2 s			
Edge evaluation	Yes; rising edge, falling edge, edge change		Yes; rising edge, falling edge, edge change		
Signal change flutter			Yes; 2 to 32 signal changes		
Flutter observation window			Yes; 0.5 s, 1 s to 100 s in 1-s steps		

I/O systemsSIMATIC ET 200 systems for the control cabinet
SIMATIC ET 200SP**I/O modules > Digital input modules****Technical specifications**

Article number	6ES7131-6BF00-0CA0 ET 200SP, DI 8x24VDC HF, PU 1	6ES7131-6BF00-0DA0 ET 200SP, DI 8x24VDC High Speed	6ES7131-6TF00-0CA0 ET 200SP, DI 8xNAMUR HF	6ES7131-6FD01-0BB1 ET 200SP, DI 4x 120...230VAC ST	6ES7131-6CF00-0AU0 ET 200SP, DI 8x 24VAC..48VUC BA, PU 1
Digital input functions, parameterizable					
<ul style="list-style-type: none"> • Gate start/stop • Freely usable digital input • Counter • Digital input with oversampling 		Yes			
Input voltage					
<ul style="list-style-type: none"> • Rated value (DC) • Rated value (AC) • for signal *0* • for signal *1* 	24 V	24 V	8.2 V	230 V 0V AC to 40V AC 74 V AC to 264 V AC	AC/DC < 10 V AC > 14 V, DC > 34 V
Input current					
<ul style="list-style-type: none"> • for signal *1*, typ. 	2.5 mA	6 mA		10.8 mA	3.5 mA
for 10 k switched contact					
<ul style="list-style-type: none"> - for signal *0* - for signal *1* 			0.35 to 1.2 mA 2.1 to 7 mA		
for unswitched contact					
<ul style="list-style-type: none"> - for signal *0*, max. (permissible quiescent current) - for signal *1* 			0.5 mA typ. 8 mA		
for NAMUR encoders					
<ul style="list-style-type: none"> - for signal *0*, min. - for signal *0*, max. - for signal *1*, min. - for signal *1*, max. 			0.35 mA 1.2 mA 2.1 mA 7 mA		
Input delay (for rated value of input voltage)					
<ul style="list-style-type: none"> • tolerated changeover time for changeover contacts 			300 ms		
for standard inputs					
<ul style="list-style-type: none"> - parameterizable 	Yes; 0.05 / 0.1 / 0.4 / 0.8 / 1.6 / 3.2 / 12.8 / 20 ms (in each case + delay of 30 to 500 µs, depending on line length)	Yes; none / 0.05 / 0.1 / 0.4 / 0.8 / 1.6 / 3.2 / 12.8 / 20 ms	No	No	No
for interrupt inputs					
<ul style="list-style-type: none"> - parameterizable 		Yes			
for technological functions					
<ul style="list-style-type: none"> - parameterizable 		Yes			
for NAMUR inputs					
<ul style="list-style-type: none"> - at *0* to *1*, max. - at *1* to *0*, max. 			12 ms 12 ms		
Encoder					
Connectable encoders					
<ul style="list-style-type: none"> • NAMUR encoder/changeover contact according to EN 60947 • Single contact / changeover contact unconnected • Single contact / changeover contact connected with 10 kΩ • 2-wire sensor - permissible quiescent current (2-wire sensor), max. 	Yes 1.5 mA	Yes 1.5 mA	Yes Yes Yes	Yes	Yes
Isochronous mode					
Filtering and processing time (TCI), min.	420 µs				
Bus cycle time (TDP), min.	500 µs	125 µs			

Technical specifications

Article number	6ES7131-6BF00-0CA0 ET 200SP, DI 8x24VDC HF, PU 1	6ES7131-6BF00-0DA0 ET 200SP, DI 8x24VDC High Speed	6ES7131-6TF00-0CA0 ET 200SP, DI 8xNAMUR HF	6ES7131-6FD01-0BB1 ET 200SP, DI 4x 120...230VAC ST	6ES7131-6CF00-0AU0 ET 200SP, DI 8x 24VAC..48VUC BA, PU 1
Interrupts/diagnostics/ status information					
Diagnostics function	Yes	Yes	Yes		Yes
Alarms					
• Diagnostic alarm	Yes; channel by channel	Yes	Yes; channel by channel	No	Yes
• Hardware interrupt	Yes; Parameterizable, channels 0 to 7	Yes	Yes; Parameterizable, channels 0 to 7	No	
Diagnoses					
• Diagnostic information readable	Yes	Yes	Yes		Yes
• Monitoring the supply voltage	Yes	Yes	Yes	No	Yes
- parameterizable	Yes	Yes	Yes		
• Monitoring of encoder power supply	Yes; channel by channel	Yes; Module-wise	No		Yes
• Wire-break	Yes; Channel by channel, optional protective circuit for preventing wire-break diagnostics in the case of simple encoder contacts: 25 kOhm to 45 kOhm	No	Yes; channel by channel	No	
• Short-circuit	Yes; channel by channel	Yes; Module-wise	Yes; channel by channel	No	
• Group error					Yes
Diagnostics indication LED					
• Monitoring of the supply voltage (PWR-LED)	Yes; green PWR LED	Yes; green PWR LED	Yes; green PWR LED	Yes; green PWR LED	Yes; green PWR LED
• Channel status display	Yes; green LED	Yes; green LED	Yes; green LED	Yes; green LED	Yes; green LED
• for channel diagnostics	Yes; red LED	No	Yes; red LED	No	No
• for module diagnostics	Yes; green/red DIAG LED	Yes; green/red DIAG LED	Yes; green/red DIAG LED	Yes; green/red DIAG LED	Yes; green/red DIAG LED
Potential separation					
Potential separation channels					
• between the channels and backplane bus	Yes	Yes	Yes	Yes	Yes
Standards, approvals, certificates					
Suitable for safety functions	No	No	No	No	No
Ambient conditions					
Ambient temperature during operation					
• horizontal installation, min.	-30 °C; < 0 °C as of FS07	-30 °C; < 0 °C as of FS04	-30 °C	-30 °C	-30 °C
• horizontal installation, max.	60 °C	60 °C	60 °C	60 °C	60 °C
• vertical installation, min.	-30 °C; < 0 °C as of FS07	-30 °C; < 0 °C as of FS04	-30 °C	-30 °C	-30 °C
• vertical installation, max.	50 °C	50 °C	50 °C	50 °C	50 °C
Altitude during operation relating to sea level					
• Installation altitude above sea level, max.	5 000 m; Restrictions for installation altitudes > 2 000 m, see manual	5 000 m; Restrictions for installation altitudes > 2 000 m, see manual	5 000 m; Restrictions for installation altitudes > 2 000 m, see manual	2 000 m; On request: Installation altitudes greater than 2 000 m	2 000 m; On request: Installation altitudes greater than 2 000 m
Dimensions					
Width	15 mm	15 mm	15 mm	20 mm	20 mm
Height	73 mm	73 mm	73 mm	73 mm	73 mm
Depth	58 mm	58 mm	58 mm	58 mm	58 mm
Weights					
Weight, approx.	28 g	28 g	32 g	36 g	40 g

I/O systems

SIMATIC ET 200 systems for the control cabinet
SIMATIC ET 200SP

I/O modules > Digital output modules

Overview



- 4, 8 and 16-channel digital output (DQ) modules
- Apart from the standard type of delivery in an individual package, selected I/O modules and BaseUnits are also available in a pack of 10 units. The pack of 10 units enables the amount of waste to be reduced considerably, as well as saving the time and cost of unpacking individual modules.

For different requirements, the digital output modules offer:

- Function classes Basic, Standard, High Feature and High Speed as well as fail-safe DQ (see "Fail-safe I/O modules")
- BaseUnits for single or multiple-conductor connection with automatic slot coding
- Potential distributor modules for system-integrated expansion with potential terminals
- Individual system-integrated potential group formation with self-assembling voltage busbars (a separate power module is no longer required for ET 200SP)
- Option of connecting actuators with rated load voltages of up to 120 V DC or 230 V AC and load currents of up to 5 A (depending on module)

- Relay modules
 - NO contact or changeover contact
 - for load or signal voltages (coupling relay)
 - with manual operation (as simulation module for inputs and outputs, jog mode for commissioning or emergency operation on failure of PLC)
- PNP (sourcing output) and NPN (sinking output) versions
- Clear labeling on front of module
- LEDs for diagnostics, status, supply voltage and faults
- Electronically readable and non-volatile writable rating plate (I&M data 0 to 3)
- Extended functions and additional operating modes in some cases
 - MSO operating mode (simultaneous reading of output data from as many as three other PLCs)
 - Pulse width modulation mode (output value as pulse-pause ratio of between 0.0% and 100.0% for controlling the output current)
 - Oversampling operating mode (n-fold equidistant output of digital values within a PN cycle for the precise time control of an output or a sequence of output values)
 - Isochronous mode (simultaneous equidistant output of all output channels)
 - Output of substitute value in the event of interruptions to communication (0, 1 or last value retained)
 - Re-parameterization during operation
 - Firmware update
 - Valve control (output signal does not switch automatically after a set pickup time to a current-saving PWM output)
 - Diagnosis of wire break and short-circuit (on channel or module basis)
 - Value status (optional binary validity information of the output signal in the process image)
 - Supports the PROFINET profile
- Optional accessories
 - Labeling strips (film or card)
 - Equipment labeling plate
 - Color-coded label with module-specific CC code
 - Shielding terminal

A quick and clear comparison of the functions of the different DQ modules is offered by the TIA Selection Tool.

Overview

Overview of digital output modules

Digital output	PU	Article No.	CC code	BU type
DQ 16 x 24 V DC/0.5 A BA	1	6ES7132-6BH00-0AA0	CC00	A0
DQ 16 x 24 V DC/0.5 A BA	10	6ES7132-6BH00-2AA0	CC00	A0
DQ 16 x 24 V DC/0.5 A ST	1	6ES7132-6BH01-0BA0	CC00	A0
DQ 16 x 24 V DC/0.5 A ST	10	6ES7132-6BH01-2BA0	CC00	A0
DQ 8 x 24 V DC/0.5 A SNK BA	1	6ES7132-6BF61-0AA0	CC01	A0
DQ 8 x 24 V DC/0.5 A BA	1	6ES7132-6BF01-0AA0	CC02	A0
DQ 8 x 24 V DC/0.5 A BA	10	6ES7132-6BF01-2AA0	CC02	A0
DQ 8 x 24 V DC/0.5 A ST	1	6ES7132-6BF01-0BA0	CC02	A0
DQ 8 x 24 V DC/0.5 A ST	10	6ES7132-6BF01-2BA0	CC02	A0
DQ 8 x 24 V DC/0.5 A HF	1	6ES7132-6BF00-0CA0	CC02	A0
DQ 8 x 24 V DC/0.5 A HF	10	6ES7132-6BF00-2CA0	CC02	A0
DQ 4 x 24 V DC/2 A ST	1	6ES7132-6BD20-0BA0	CC02	A0
DQ 4 x 24 V DC/2 A ST	10	6ES7132-6BD20-2BA0	CC02	A0
DQ 4 x 24 V DC/2 A HF	1	6ES7132-6BD20-0CA0	CC02	A0
DQ 4 x 24 V DC/2 A HS	1	6ES7132-6BD20-0DA0	CC02	A0
With three operating modes: • Fast isochronous DQ with valve control • Pulse width modulation • Oversampling				
DQ 4 x 24 ... 230 V AC/2 A ST	1	6ES7132-6FD00-0BB1	CC41	B0, B1
DQ 4 x 24 ... 230 V AC/2 A ST	10	6ES7132-6FD00-2BB1	CC41	B0, B1
DQ 4 x 24 ... 230 V AC/2 A HF	1	6ES7132-6FD00-0CU0	CC20	U0
With two operating modes: • DQ • PC: Power control via phase angle, half-wave or full-wave control				
RQ 4 x 24 V UC/2 A CO ST	1	6ES7132-6GD51-0BA0	--	A0
RQ 4 x 120 V DC-230 V AC/5 A NO ST	1	6ES7132-6HD01-0BB1	--	B0, B1
RQ 4 x 120 V DC-230 V AC/5 A NO ST	10	6ES7132-6HD01-2BB1	--	B0, B1
RQ MA 4 x 120 V DC ... 230 V AC/5 A NO ST	1	6ES7132-6MD00-0BB1	--	B0, B1

Overview of BaseUnits

BaseUnit	PU	Article No.	CC codes for push-in terminals	CC codes for AUX terminals
BU type A0 • New potential group (light) • 16 push-in terminals • With 10 AUX terminals	1	6ES7193-6BP20-0DA0	CC01 to CC05	CC71 to CC73
BU type A0 • New potential group (light) • 16 push-in terminals • With 10 AUX terminals	10	6ES7193-6BP20-2DA0	CC01 to CC05	CC71 to CC73
BU type A0 • New potential group (light) • 16 push-in terminals • Without AUX terminals	1	6ES7193-6BP00-0DA0	CC01 to CC05	--
BU type A0 • New potential group (light) • 16 push-in terminals • Without AUX terminals	10	6ES7193-6BP00-2DA0	CC01 to CC05	--
BU type A0 • Forwarding of the potential group (dark) • 16 push-in terminals • With 10 AUX terminals	1	6ES7193-6BP20-0BA0	CC01 to CC05	CC71 to CC73

I/O systems

SIMATIC ET 200 systems for the control cabinet

SIMATIC ET 200SP

I/O modules > Digital output modules**Overview**

BaseUnit	PU	Article No.	CC codes for push-in terminals	CC codes for AUX terminals
BU type A0 • Forwarding of the potential group (dark) • 16 push-in terminals • With 10 AUX terminals	10	6ES7193-6BP20-2BA0	CC01 to CC05	CC71 to CC73
BU type A0 • Forwarding of the potential group (dark) • 16 push-in terminals • Without AUX terminals	1	6ES7193-6BP00-0BA0	CC01 to CC05	--
BU type A0 • Forwarding of the potential group (dark) • 16 push-in terminals • Without AUX terminals	10	6ES7193-6BP00-2BA0	CC01 to CC05	--
BU type B0 • Forwarding of the potential group (dark) • 12 push-in terminals • With 4 AUX terminals	1	6ES7193-6BP20-0BB0	CC41	CC81 to CC83
BU type B0 • Forwarding of the potential group (dark) • 12 push-in terminals • With 4 AUX terminals	10	6ES7193-6BP20-0BB0	CC41	CC81 to CC83
BU type B1 • Forwarding of the potential group (dark) • 12 push-in terminals • 2 x 2 (1L, 2L, 1N, 2N) direct infeed module • Without AUX terminals	1	6ES7193-6BP20-0BB1	CC41	--
BU type B1 • Forwarding of the potential group (dark) • 12 push-in terminals • 2 x 2 (1L, 2L, 1N, 2N) direct infeed module • Without AUX terminals	10	6ES7193-6BP20-2BB1	CC41	--
BU type U0 • Forwarding of the potential group (dark) • 16 push-in terminals • Without AUX terminals	1	6ES7193-6BP00-0BU0	CC20	--
BU type U0 • Forwarding of the potential group (dark) • 16 push-in terminals • Without AUX terminals	10	6ES7193-6BP00-2BU0	CC20	--
BU type U0 • New potential group (light) • 16 push-in terminals • Without AUX terminals	1	6ES7193-6BP00-0DU0	CC20	--
BU type U0 • New potential group (light) • 16 push-in terminals • Without AUX terminals	10	6ES7193-6BP00-2DU0	CC20	--

Overview

Overview of potential distributor modules

Potential distributor module	PU	Article No.	CC codes for push-in terminals
PotDis BU Type P1 (light), 17x P1 potential, 1x P2 potential, for starting a new potential group (max. 10 A)	1	6ES7193-6UP00-0DP1	CC00, CC62
PotDis BU Type P1 (dark), 17x P1 potential, 1x P2 potential, for continuing the potential group	1	6ES7193-6UP00-0BP1	CC00, CC62
PotDis BU Type P2 (light), 1x P1 potential, 17x P2 potential, for starting a new potential group (max. 10 A)	1	6ES7193-6UP00-0DP2	CC00, CC63
PotDis BU Type P2 (dark), 1x P1 potential, 17x P2 potential, for continuing the potential group	1	6ES7193-6UP00-0BP2	CC00, CC63
PotDis TB Type BR-W, 18x internally jumpered terminals, without reference to P1, P2 or AUX, (total current max. 10 A)	1	6ES7193-6TP00-0TP0	CC10 to CC13
PotDis TB Type P1-R, 18x P1 potential, (total current max. 10 A)	1	6ES7193-6TP00-0TP1	CC10, CC12
PotDis TB Type P2-B, 18x P2 potential, (total current max. 10 A)	1	6ES7193-6TP00-0TP2	CC10, CC13
PotDis TB Type n.c.-G, 18x n.c. (not connected) terminals, without reference to P1, P2 or AUX	1	6ES7193-6TP00-0TN0	CC10

10

Ordering data

Digital output modules

Types of delivery:
Apart from the standard type of delivery in an individual package, selected I/O modules and BaseUnits are also available in a pack of 10 units. The pack of 10 units enables the amount of waste to be reduced considerably, as well as saving the time and cost of unpacking individual modules.

The number of modules required is the number of modules ordered. The pack type is selected by selecting the article number. Packs of 10 can therefore only be ordered in integer multiples of 10.

Digital output module
DQ 16x24VDC/0.5A Basic,
BU type A0, color code CC00

- Pack of 1 unit
- Pack of 10 units;
to order a pack, please order this article number with an order quantity of 10.

6ES7132-6BH00-0AA0
6ES7132-6BH00-2AA0

Digital output module
DQ 16x24VDC/0.5A Standard,
Source output (sourcing),
BU type A0, color code CC00

- Pack of 1 unit
- Pack of 10 units;
to order a pack, please order this article number with an order quantity of 10.

6ES7132-6BH01-0BA0
6ES7132-6BH01-2BA0

Digital output module
DQ 8x24VDC/0.5A Sink output,
Basic, BU type A0, color code CC01

- Pack of 1 unit

6ES7132-6BF61-0AA0

Digital output module
DQ 8x24VDC/0.5A Basic,
BU type A0, color code CC02

- Pack of 1 unit
- Pack of 10 units;
to order a pack, please order this article number with an order quantity of 10.

6ES7132-6BF01-0AA0
6ES7132-6BF01-2AA0

I/O systemsSIMATIC ET 200 systems for the control cabinet
SIMATIC ET 200SP**I/O modules > Digital output modules****Ordering data****Article No.****Article No.**

Digital output module
DQ 8x24VDC/0.5A Standard,
BU type A0, color code CC02

- Pack of 1 unit
- Pack of 10 units;
to order a pack, please order this
article number with an order
quantity of 10.

6ES7132-6BF01-0BA0
6ES7132-6BF01-2BA0

Digital output module
DQ 8x24VDC/0.5A High Feature,
BU type A0, color code CC02

- Pack of 1 unit
- Pack of 10 units;
to order a pack, please order this
article number with an order
quantity of 10.

6ES7132-6BF00-0CA0
6ES7132-6BF00-2CA0

Digital output module
DQ 4x24VDC/2A Standard,
BU type A0, color code CC02

- Pack of 1 unit
- Pack of 10 units;
to order a pack, please order this
article number with an order
quantity of 10.

6ES7132-6BD20-0BA0
6ES7132-6BD20-2BA0

Digital output module
DQ 4x24VDC/2A High Feature,
BU type A0, color code CC02,
channel-specific diagnostics,
isochronous mode,
shared output (MSO)

- Pack of 1 unit

6ES7132-6BD20-0CA0

Digital output module
DQ 4x24VDC/2A High Speed,
BU type A0, color code CC02,
3 operating modes
(fast isochronous DQ with valve
control, pulse width modulation,
oversampling)

- Pack of 1 unit

6ES7132-6BD20-0DA0

Digital output module
DQ 4x24VAC...230VAC/2A
Standard for BU type B1,
color code CC41

- Pack of 1 unit
- Pack of 10 units;
to order a pack, please order this
article number with an order
quantity of 10.

6ES7132-6FD00-0BB1
6ES7132-6FD00-2BB1

Digital output module
DQ 4x24VAC...230VAC/2A
High Feature for BU type U0,
color code CC20,
2 operating modes:
DQ and PC (power control via
phase angle, half-wave and
full-wave control)

- Pack of 1 unit

6ES7132-6FD00-0CU0

Signal relay module
RQ CO 4x24VUC/2A Standard,
changeover contact, BU type A0,
color code CC00

- Pack of 1 unit

6ES7132-6GD51-0BA0

Relay module
RQ NO 4x120VDC-230VAC/5A
Standard, NO contact,
BU type B0, B1

- Pack of 1 unit
- Pack of 10 units;
to order a pack, please order this
article number with an order
quantity of 10.

6ES7132-6HD01-0BB1
6ES7132-6HD01-2BB1

Relay module
RQ NO 4x120VDC-230VAC/5A
Standard, NO contact,
with manual operation,
BU type B0, B1

6ES7132-6MD00-0BB1

Relay module
RQ CO 3x120V DC..230VAC/5A
Standard, changeover contact,
floating, BU type U0,
color code CC20

6ES7132-6HC50-0BU0

Relay module
RQ COni 3x120V DC..230VAC/5A
Standard, changeover contact,
non-floating, BU type U0,
color code CC20

6ES7132-6HC70-0BU0

Suitable BaseUnits**BU15-P16+A10+2D**

BU type A0; BaseUnit (light)
with 16 push-in terminals (1 ... 16)
to the module and an additional
10 internally jumpered AUX
terminals (1 A to 10 A);
for starting a new potential group
(max. 10 A)

- Pack of 1 unit
- Pack of 10 units;
to order a pack, please order this
article number with an order
quantity of 10.

6ES7193-6BP20-0DA0
6ES7193-6BP20-2DA0

BU15-P16+A0+2D

BU type A0; BaseUnit (light)
with 16 push-in terminals to
the module;
for starting a new potential group
(max. 10 A)

- Pack of 1 unit
- Pack of 10 units;
to order a pack, please order this
article number with an order
quantity of 10.

6ES7193-6BP00-0DA0
6ES7193-6BP00-2DA0

BU15-P16+A10+2B

BU type A0; BaseUnit (dark)
with 16 push-in terminals (1 ... 16)
to the module and an additional
10 internally jumpered AUX
terminals (1 A to 10 A);
for continuing the potential group

- Pack of 1 unit
- Pack of 10 units;
to order a pack, please order this
article number with an order
quantity of 10.

6ES7193-6BP20-0BA0
6ES7193-6BP20-2BA0

BU15-P16+A0+2B

BU type A0; BaseUnit (dark)
with 16 push-in terminals to
the module; for continuing the
potential group

- Pack of 1 unit
- Pack of 10 units;
to order a pack, please order this
article number with an order
quantity of 10.

6ES7193-6BP00-0BA0
6ES7193-6BP00-2BA0

Ordering data	Article No.	Article No.
BU20-P12+A4+0B BU type B0; BaseUnit (dark) with 12 push-in terminals (1 ... 12) to the module and an additional 4 internally jumpered AUX terminals (1 A to 4 A); for continuing the potential group <ul style="list-style-type: none"> • Pack of 1 unit • Pack of 10 units; to order a pack, please order this article number with an order quantity of 10. 	6ES7193-6BP20-0BB0 6ES7193-6BP20-2BB0	PotDis TB PotDis TB, type BR-W, 18x internally jumpered terminals, without reference to P1, P2 or AUX, (total current max. 10 A) PotDis TB, type P1-R, 18x P1 potential, (total current max. 10 A) PotDis TB, type P2-B, 18x P2 potential, (total current max. 10 A) PotDis TB, type n.c.-G, 18x n.c. (not connected) terminals, without reference to P1, P2 or AUX Accessories Equipment labeling plate 10 sheets of 16 labels, for printing with thermal transfer card printer or plotter Labeling strips 500 labeling strips on roll, light gray, for inscription with thermal transfer roll printer 500 labeling strips on roll, yellow, for inscription with thermal transfer roll printer 1 000 labeling strips DIN A4, light gray, card, perforated, for inscription with laser printer 1 000 labeling strips DIN A4, yellow, card, perforated, for inscription with laser printer BU cover For covering empty slots (gaps); 5 units <ul style="list-style-type: none"> • 15 mm wide • 20 mm wide Shield connection 5 shield supports and 5 shield terminals Color-coded labels for 15 mm-wide BaseUnits Color code CC00, for 16 push-in terminals, BU type A0, A1, gray (terminals 1 to 8), red (terminals 9 to 16); 10 units Color code CC01, for 16 push-in terminals, BU type A0, A1, gray (terminals 1 to 8), red (terminals 9 to 16); 10 units Color code CC01, for 16 push-in terminals, BU type A0, A1, gray (terminals 1 to 8), red (terminals 9 to 16); 50 units Color code CC02, for 16 push-in terminals, BU type A0, A1, gray (terminals 1 to 8), blue (terminals 9 to 16); 10 units Color code CC02, for 16 push-in terminals, BU type A0, A1, gray (terminals 1 to 8), blue (terminals 9 to 16); 50 units Color code CC71, for 10 AUX terminals, BU type A0, yellow/green (terminals 1 A to 10 A); 10 units Color code CC72, for 10 AUX terminals, BU type A0, red (terminals 1 A to 10 A); 10 units
BU20-P12+A0+4B BU type B1; BaseUnit (dark) with 12 push-in terminals to the module; for continuing the potential group; PU: 1 unit <ul style="list-style-type: none"> • Pack of 1 unit • Pack of 10 units; to order a pack, please order this article number with an order quantity of 10. 	6ES7193-6BP20-0BB1 6ES7193-6BP20-2BB1	6ES7193-6TP00-0TP0 6ES7193-6TP00-0TP1 6ES7193-6TP00-0TP2 6ES7193-6TP00-0TN0
BU20-P16+A0+2D BU type U0; BaseUnit (light) with 16 push-in terminals to the module; for starting a new potential group (max. 10 A) <ul style="list-style-type: none"> • Pack of 1 unit • Pack of 10 units; to order a pack, please order this article number with an order quantity of 10. 	6ES7193-6BP00-0DU0 6ES7193-6BP00-2DU0	6ES7193-6LR10-0AA0 6ES7193-6LR10-0AG0 6ES7193-6LA10-0AA0 6ES7193-6LA10-0AG0
BU20-P16+A0+2B BU type U0; BaseUnit (dark) with 16 push-in terminals to the module; for continuing the potential group <ul style="list-style-type: none"> • Pack of 1 unit • Pack of 10 units; to order a pack, please order this article number with an order quantity of 10. 	6ES7193-6BP00-0BU0 6ES7193-6BP00-2BU0	6ES7133-6CV15-1AM0 6ES7133-6CV20-1AM0
Potential distributor modules PotDis BU PotDis BU, Type P1 (light), 17x P1 potential, 1x P2 potential, for starting a new potential group (max. 10 A) PotDis BU, Type P1 (dark), 17x P1 potential, 1x P2 potential, for continuing the potential group PotDis BU, Type P2 (light), 1x P1 potential, 17x P2 potential, for starting a new potential group (max. 10 A) PotDis BU, Type P2 (dark), 1x P1 potential, 17x P2 potential, for continuing the potential group	6ES7193-6UP00-0DP1 6ES7193-6UP00-0BP1 6ES7193-6UP00-0DP2 6ES7193-6UP00-0BP2	6ES7193-6SC00-1AM0
		6ES7193-6CP00-2MA0 6ES7193-6CP01-2MA0 6ES7193-6CP01-4MA0 6ES7193-6CP02-2MA0 6ES7193-6CP02-4MA0 6ES7193-6CP71-2AA0 6ES7193-6CP72-2AA0

I/O systems

SIMATIC ET 200 systems for the control cabinet
SIMATIC ET 200SP

I/O modules > Digital output modules

Ordering data	Article No.	Article No.
Color code CC73, for 10 AUX terminals, BU type A0, blue (terminals 1 A to 10 A); 10 units	6ES7193-6CP73-2AA0	Color-coded labels for PotDis TB Color code CC10, for 18 push-in terminals, PotDis TB, gray (terminals 1 to 18); 10 units
Color code CC73, for 10 AUX terminals, BU type A0, blue (terminals 1 A to 10 A); 50 units	6ES7193-6CP73-4AA0	6ES7193-6CP10-2MT0
Color-coded labels for 20 mm-wide BaseUnits		6ES7193-6CP11-2MT0
Color code CC41, for 16 push-in terminals, BU type B1, gray (terminals 1 to 4), red (terminals 5 to 8), blue (terminals 9 to 12); 10 units	6ES7193-6CP41-2MB0	6ES7193-6CP12-2MT0
Color code CC81, for 4 AUX terminals, BU type B0, yellow/green (terminals 1 A to 4 A); 10 units	6ES7193-6CP81-2AB0	6ES7193-6CP13-2MT0
Color code CC82, for 4 AUX terminals, BU type B0, red (terminals 1 A to 4 A); 10 units	6ES7193-6CP82-2AB0	Mechanical coding elements For automatic coding of I/O modules; spare part. 20 units
Color code CC83, for 4 AUX terminals, BU type B0, blue (terminals 1 A to 4 A); 10 units	6ES7193-6CP83-2AB0	Type A 6ES7193-6KA00-3AA0
Color-coded labels for PotDis BU		Type B 6ES7193-6KB00-3AA0
Color code CC62, for 16 push-in terminals, PotDis BU type P1, red (terminals 1 to 16); 10 units	6ES7193-6CP62-2MA0	Type C 6ES7193-6KC00-3AA0
Color code CC63, for 16 push-in terminals, PotDis BU type P2, blue (terminals 1 to 16); 10 units	6ES7193-6CP63-2MA0	Type D 6ES7193-6KD00-3AA0

Technical specifications

Article number	6ES7132-6BF61-0AA0	6ES7132-6BH00-0AA0	6ES7132-6BF01-0AA0	6ES7132-6BH01-0BA0	6ES7132-6BF01-0BA0
	ET 200SP, DQ 8x 24VDC/0,5A SINK BA, PU 1	ET 200SP, DQ 16x24VDC/0,5A BA, PU 1	ET 200SP, DQ 8x 24V DC/0,5A Basic, PU 1	ET 200SP, DQ 16x 24V DC/0,5A ST, PU 1	ET 200SP, DQ 8x 24V DC/0,5A ST, PU 1
General information					
Product type designation	DQ 8x24VDC/0,5A SNK BA	DQ 16x24VDC/0.5A BA	DQ 8x24VDC/0.5A BA	DQ 16x24VDC/0.5A ST	DQ 8x24VDC/0.5A ST
Product function					
• Isochronous mode	No	No	No	No	No
Engineering with					
• STEP 7 TIA Portal configurable/ integrated from version	V14	V14	V14	V14	V14
• STEP 7 configurable/ integrated from version	V5.5 SP3	STEP 7 V5.5 or higher	V5.5 SP3	V5.5 SP3	V5.5 SP3 or higher
• PCS 7 configurable/ integrated from version				V8.1 SP1	V8.1 SP1
• PROFIBUS from GSD version/ GSD revision	One GSD file each, Revision 3 and 5 and higher	One GSD file each, Revision 3 and 5 and higher	One GSD file each, Revision 3 and 5 and higher	One GSD file each, Revision 3 and 5 and higher	One GSD file each, Revision 3 and 5 and higher
• PROFINET from GSD version/ GSD revision	GSDML V2.3	GSDML V2.3	GSDML V2.3	GSDML V2.3	GSDML V2.3
Operating mode					
• DQ	Yes	Yes	Yes	Yes	Yes
• DQ with energy-saving function	No	No	No	No	No
• PWM	No	No	No	No	No
• Oversampling	No	No	No	No	No
• MSO	No	No	No	No	No

Overview

Article number	6ES7132-6BF61-0AA0 ET 200SP, DQ 8x 24VDC/0,5A SINK BA, PU 1	6ES7132-6BH00-0AA0 ET 200SP, DQ 16x24VDC/0,5A BA, PU 1	6ES7132-6BF01-0AA0 ET 200SP, DQ 8x 24V DC/0,5A Basic, PU 1	6ES7132-6BH01-0BA0 ET 200SP, DQ 16x 24V DC/0,5A ST, PU 1	6ES7132-6BF01-0BA0 ET 200SP, DQ 8x 24V DC/0,5A ST, PU 1
Supply voltage					
Rated value (DC)	24 V	24 V	24 V	24 V	24 V
Reverse polarity protection		Yes	Yes	Yes	Yes
Digital outputs					
Type of digital output	Source output (PNP, current-sourcing)	Source output (PNP, current-sourcing)	Source output (PNP, current-sourcing)	Source output (PNP, current-sourcing)	Source output (PNP, current-sourcing)
Number of digital outputs	8	16	8	16	8
Current-sinking	Yes	No		No	
Current-sourcing		Yes	Yes	Yes	Yes
Digital outputs, parameterizable	Yes	Yes	Yes	Yes	Yes
Short-circuit protection	Yes	Yes	Yes; per channel, electronic	Yes	Yes
Open-circuit detection		No		Yes	
Limitation of inductive shutdown voltage to	Typ. 47 V	Typ. L+ (-53 V)	Typ. L+ (-50 V)	Typ. L+ (-50 V)	Typ. L+ (-50 V)
Controlling a digital input	Yes	Yes	Yes	Yes	Yes
Switching capacity of the outputs					
• with resistive load, max.	0.5 A	0.5 A	0.5 A	0.5 A	0.5 A
• on lamp load, max.	5 W	5 W	5 W	5 W	5 W
Load resistance range					
• lower limit	48 Ω	48 Ω	48 Ω	48 Ω	48 Ω
• upper limit	3 400 Ω	100 kΩ	100 kΩ	12 kΩ	12 kΩ
Output voltage					
• for signal "1", min.					L+ (-0.8 V)
Output current					
• for signal "1" rated value	0.5 A	0.5 A	0.5 A	0.5 A	0.5 A
• for signal "0" residual current, max.	5 μA	30 μA	10 μA	0.1 mA	0.1 mA
Output delay with resistive load					
• "0" to "1", typ.		80 μs; at rated load		50 μs	
• "0" to "1", max.	300 μs	150 μs; at rated load	100 μs; at rated load		50 μs; at rated load
• "1" to "0", typ.		100 μs; at rated load		100 μs	
• "1" to "0", max.	600 μs	200 μs; at rated load	150 μs; at rated load		100 μs; at rated load
Parallel switching of two outputs					
• for uprating	No	No	No	No	No
• for redundant control of a load	Yes	Yes	Yes	Yes	Yes
Switching frequency					
• with resistive load, max.	100 Hz	100 Hz	100 Hz	100 Hz	100 Hz
• with inductive load, max.	0.5 Hz	2 Hz	2 Hz	2 Hz	2 Hz
• on lamp load, max.	10 Hz	10 Hz	10 Hz	10 Hz	10 Hz
Total current of the outputs					
• Current per channel, max.	0.5 A	0.5 A	0.5 A	0.5 A	0.5 A
• Current per module, max.	4 A	8 A	4 A	8 A	4 A
Total current of the outputs (per module)					
horizontal installation					
- up to 40 °C, max.				8 A	
- up to 50 °C, max.				6 A	
- up to 60 °C, max.	4 A	8 A	4 A	4 A	4 A
vertical installation					
- up to 30 °C, max.				8 A	
- up to 40 °C, max.				6 A	
- up to 50 °C, max.	4 A	8 A	4 A	4 A	4 A

I/O systems

SIMATIC ET 200 systems for the control cabinet

SIMATIC ET 200SP

I/O modules > Digital output modules

Technical specifications

Article number	6ES7132-6BF61-0AA0 ET 200SP, DQ 8x 24VDC/0,5A SINK BA, PU 1	6ES7132-6BH00-0AA0 ET 200SP, DQ 16x24VDC/0,5A BA, PU 1	6ES7132-6BF01-0AA0 ET 200SP, DQ 8x 24V DC/0,5A Basic, PU 1	6ES7132-6BH01-0BA0 ET 200SP, DQ 16x 24V DC/0,5A ST, PU 1	6ES7132-6BF01-0BA0 ET 200SP, DQ 8x 24V DC/0,5A ST, PU 1
Interrupts/diagnostics/ status information					
Diagnostics function	Yes	Yes	Yes	Yes	Yes
Substitute values connectable	Yes	Yes	Yes	Yes	Yes
Alarms					
• Diagnostic alarm	Yes	Yes	Yes	Yes	Yes
Diagnoses					
• Monitoring the supply voltage	Yes	Yes	Yes	Yes	Yes
• Wire-break	No	No	No	Yes; Module-wise	Yes; Module-wise
• Short-circuit	No	No	No		
• Short-circuit to M				Yes; Module-wise	Yes; Module-wise
• Short-circuit to L+				Yes; Module-wise	Yes; Module-wise
• Group error	Yes	Yes	Yes	Yes	Yes
Diagnostics indication LED					
• Monitoring of the supply voltage (PWR-LED)	Yes; green PWR LED	Yes; green PWR LED	Yes; green PWR LED	Yes; green PWR LED	Yes; green PWR LED
• Channel status display	Yes; green LED	Yes; green LED	Yes; green LED	Yes; green LED	Yes; green LED
• for channel diagnostics	No	No	No	No	No
• for module diagnostics	Yes; green/red DIAG LED	Yes; green/red DIAG LED	Yes; green/red DIAG LED	Yes; green/red DIAG LED	Yes; green/red DIAG LED
Potential separation					
Potential separation channels					
• between the channels and backplane bus	Yes	Yes	Yes	Yes	Yes
Standards, approvals, certificates					
Suitable for safety functions	No	No	No	No	No
Suitable for safety-related tripping of standard modules		No	Yes; see FAQ Entry ID: 39198632	Yes; see FAQ Entry ID: 39198632	Yes; see FAQ Entry ID: 39198632
Highest safety class achievable in safety mode					
• Performance level according to ISO 13849-1			PL d	PL d	PL d
• SIL acc. to IEC 61508			SIL 2	SIL 2	SIL 2
Ambient conditions					
Ambient temperature during operation					
• horizontal installation, min.	-25 °C	-30 °C	-30 °C; < 0 °C as of FS02	-30 °C; < 0 °C as of FS03	-30 °C; < 0 °C as of FS02
• horizontal installation, max.	60 °C	60 °C	60 °C	60 °C	60 °C
• vertical installation, min.	-25 °C	-30 °C	-30 °C; < 0 °C as of FS02	-30 °C; < 0 °C as of FS03	-30 °C; < 0 °C as of FS02
• vertical installation, max.	50 °C	50 °C	50 °C	50 °C	50 °C
Altitude during operation relating to sea level					
• Installation altitude above sea level, max.	5 000 m; Restrictions for installation altitudes > 2 000 m, see manual	5 000 m; Restrictions for installation altitudes > 2 000 m, see manual	5 000 m; Restrictions for installation altitudes > 2 000 m, see manual	5 000 m; Restrictions for installation altitudes > 2 000 m, see manual	5 000 m; R estrictions for installation altitudes > 2 000 m, see manual
Dimensions					
Width	15 mm	15 mm	15 mm	15 mm	15 mm
Height	73 mm	73 mm	73 mm	73 mm	73 mm
Depth	58 mm	58 mm	58 mm	58 mm	58 mm
Weights					
Weight, approx.	30 g	30 g	30 g	30 g	30 g

Overview

Article number	6ES7132-6BF00-0CA0 ET 200SP, DQ 8x24VDC/0,5A HF, PU 1	6ES7132-6BD20-0BA0 ET 200SP, DQ 4x24VDC/2A ST	6ES7132-6BD20-0CA0 ET 200SP, DQ 4x24VDC/2A HF	6ES7132-6BD20-0DA0 ET 200SP, DQ 4x24VDC/2A High Speed, PU 1	6ES7132-6FD00-0BB1 ET 200SP, DQ 4x24...230VAC/2A ST
General information					
Product type designation	DQ 8x24 V DC/0.5 A HF	DQ 4x24 V DC/2 A ST	DQ 4x DC 24 V/2 A HF	DQ 4x24 V DC/2 A HS	DQ 4x24 ... 230 V AC/2 A ST
Product function					
• Isochronous mode	Yes	No	Yes	Yes; Operating modes DQ and OVS only	No
Engineering with					
• STEP 7 TIA Portal configurable/ integrated from version	V13 SP1 / -	V11 SP2 / V13	V13 SP1 / -	STEP 7 V15.1 or higher	V13 / V13
• STEP 7 configurable/ integrated from version	V5.5 / -	V5.5 SP3 / -	V5.5 / -	via GSD as of V5.6 HF4	V5.5 SP3 / -
• PCS 7 configurable/ integrated from version	V8.1 SP1	V8.1 SP1			
• PROFIBUS from GSD version/ GSD revision	One GSD file each, Revision 3 and 5 and higher	GSD Revision 5	GSD Revision 5	One GSD file each, Revision 3 and 5 and higher	GSD Revision 5
• PROFINET from GSD version/ GSD revision	GSDML V2.3	GSDML V2.3	GSDML V2.3	GSDML V2.33	GSDML V2.3
Operating mode					
• DQ	Yes	Yes	Yes	Yes	Yes
• DQ with energy-saving function	No	No	No	Yes; Valve control	No
• PWM	No	No	No	Yes	No
• Cam control (switching at comparison values)				Yes; Via MtM (module-to-module communication)	
• Oversampling	No	No	No	Yes	No
• MSO	Yes	No	Yes	No	No
Supply voltage					
Rated value (DC)	24 V	24 V	24 V	24 V	
Rated value (AC)					230 V
Reverse polarity protection	Yes	Yes	Yes	Yes	
Digital outputs					
Type of digital output	Source output (PNP, current-sourcing)	Source output (PNP, current-sourcing)	Source output (PNP, current-sourcing)	Source output (PNP, current-sourcing)	Triac with zero point detection
Number of digital outputs	8	4	4	4	4
Current-sinking	No	No	No	No	No
Current-sourcing	Yes	Yes	Yes	Yes; Push-pull output	Yes
Digital outputs, parameterizable	Yes	Yes	Yes	Yes	No
Short-circuit protection	Yes	Yes	Yes	Yes	No; When using BU type B1, a miniature, quick-response fuse with 10 A tripping current must be provided
Limitation of inductive shutdown voltage to	Typ. L+ (-50 V)	Typ. L+ (-50 V)	L+ (-37 to 41V)	M (-1 V)	
Controlling a digital input	Yes	Yes	Yes; Minimum current consumption 7 mA	No	Yes
Size of motor starters according to NEMA, max.					5
Digital output functions, parameterizable					
• Switching tripped by comparison values				Yes	
- Number of cam tracks, max.				4	
• Freely usable digital output				Yes	
• PWM output				Yes	
- Number, max.				4	
• Digital output with oversampling				Yes	
- Number, max.				4	
Switching capacity of the outputs					
• with resistive load, max.	0.5 A	2 A	2 A	2 A	2 A
• on lamp load, max.	5 W	10 W	10 W	10 W	100 W

I/O systemsSIMATIC ET 200 systems for the control cabinet
SIMATIC ET 200SP**I/O modules > Digital output modules****Technical specifications**

Article number	6ES7132-6BF00-0CA0 ET 200SP, DQ 8x24VDC/0,5A HF, PU 1	6ES7132-6BD20-0BA0 ET 200SP, DQ 4x24VDC/2A ST	6ES7132-6BD20-0CA0 ET 200SP, DQ 4x24VDC/2A HF	6ES7132-6BD20-0DA0 ET 200SP, DQ 4x24VDC/2A High Speed, PU 1	6ES7132-6FD00-0BB1 ET 200SP, DQ 4x24...230VAC/2A ST
Load resistance range					
• lower limit	48 Ω	12 Ω	12 Ω	12 Ω	
• upper limit	12 kΩ	3 400 Ω	3 400 Ω	3 400 Ω	
Output voltage					
• for signal "1", min.					20.4 V
Output current					
• for signal "1" rated value	0.5 A	2 A	2 A	2 A	2 A
• for signal "0" residual current, max.	0.1 mA	0.1 mA	0.1 mA	0.1 mA	460 μA
Output delay with resistive load					
• "0" to "1", typ.	50 μs	50 μs	50 μs		
• "0" to "1", max.		50 μs		1 μs	10 ms
• "1" to "0", typ.	100 μs	100 μs	100 μs		
• "1" to "0", max.		100 μs		1 μs	10 ms
Parallel switching of two outputs					
• for logic links					No
• for uprating	No	No	No	No	No
• for redundant control of a load	Yes	Yes			Yes
Switching frequency					
• with resistive load, max.	100 Hz	100 Hz	100 Hz	5 kHz	10 Hz
• with inductive load, max.	2 Hz	2 Hz	2 Hz	5 kHz	0.5 Hz; Higher frequencies are possible, see Equipment Manual / Product Information
• on lamp load, max.	10 Hz	10 Hz	10 Hz	5 kHz	1 Hz
Total current of the outputs					
• Current per channel, max.	0.5 A	2 A	2 A	2 A	2 A
• Current per module, max.	4 A	8 A	8 A	8 A	8 A
Total current of the outputs (per module)					
horizontal installation					
- up to 30 °C, max.				8 A; DQ mode	
- up to 40 °C, max.		8 A	8 A	6.9 A; DQ mode	8 A
- up to 50 °C, max.		6 A	6 A	4.7 A; DQ mode	6 A
- up to 60 °C, max.	4 A	4 A	4 A	2.5 A; DQ mode	4 A
vertical installation					
- up to 30 °C, max.		8 A	8 A	7.2 A; DQ mode	8 A
- up to 40 °C, max.		6 A	6 A	5.6 A; DQ mode	6 A
- up to 50 °C, max.	4 A	4 A	4 A	4 A; DQ mode	4 A
- up to 60 °C, max.		4 A			
Isochronous mode					
Execution and activation time (TCO), min.	48 μs			40 μs	
Bus cycle time (TDP), min.	500 μs		500 μs	125 μs	
Interrupts/diagnostics/status information					
Diagnostics function	Yes	Yes	Yes	Yes	No
Substitute values connectable	Yes	Yes	Yes	Yes	Yes
Alarms					
• Diagnostic alarm	Yes	Yes	Yes	Yes	No
Diagnoses					
• Diagnostic information readable				Yes	
• Monitoring the supply voltage	Yes	Yes	Yes	Yes	No
• Wire-break	Yes; channel by channel	Yes; Module-wise	Yes; channel by channel	No	No
• Short-circuit	Yes; channel by channel	Yes; Module-wise	Yes; channel by channel	Yes; Module-wise	No
• Group error	Yes	Yes	Yes	Yes	Yes

Overview

Article number	6ES7132-6BF00-0CA0 ET 200SP, DQ 8x24VDC/0,5A HF, PU 1	6ES7132-6BD20-0BA0 ET 200SP, DQ 4x24VDC/2A ST	6ES7132-6BD20-0CA0 ET 200SP, DQ 4x24VDC/2A HF	6ES7132-6BD20-0DA0 ET 200SP, DQ 4x24VDC/2A High Speed, PU 1	6ES7132-6FD00-0BB1 ET 200SP, DQ 4x24...230VAC/2A ST
Diagnostics indication LED					
• Monitoring of the supply voltage (PWR-LED)	Yes; green PWR LED	Yes; green PWR LED	Yes; green PWR LED	Yes; green PWR LED	Yes; green PWR LED
• Channel status display	Yes; green LED	Yes; green LED	Yes; green LED	Yes; green LED	Yes; green LED
• for channel diagnostics	Yes; red LED	No	Yes; red LED	No	No
• for module diagnostics	Yes; green/red DIAG LED	Yes; green/red DIAG LED	Yes; green/red DIAG LED	Yes; green/red DIAG LED	Yes; green/red DIAG LED
Potential separation					
Potential separation channels					
• between the channels and backplane bus	Yes	Yes	Yes	Yes	Yes
Standards, approvals, certificates					
Suitable for safety functions	No	No	No	No	No
Suitable for safety-related tripping of standard modules	No; see FAQ Entry ID: 39198632	Yes; see FAQ Entry ID: 39198632	Yes; see FAQ Entry ID: 39198632	No	
Highest safety class achievable in safety mode					
• Performance level according to ISO 13849-1	PL d	PL d	PL d		
• SIL acc. to IEC 61508	SIL 2	SIL 2	SIL 2		
Ambient conditions					
Ambient temperature during operation					
• horizontal installation, min.	-30 °C; < 0 °C as of FS07	-30 °C; < 0 °C as of FS08	-30 °C; < 0 °C as of FS06	-30 °C	-30 °C
• horizontal installation, max.	60 °C	60 °C	60 °C	60 °C	60 °C
• vertical installation, min.	-30 °C; < 0 °C as of FS07	-30 °C; < 0 °C as of FS08	-30 °C; < 0 °C as of FS06	-30 °C	-30 °C
• vertical installation, max.	50 °C	50 °C	50 °C	50 °C	60 °C
Altitude during operation relating to sea level					
• Installation altitude above sea level, max.	5 000 m; Restrictions for installation altitudes > 2 000 m, see manual	5 000 m; Restrictions for installation altitudes > 2 000 m, see manual	5 000 m; Restrictions for installation altitudes > 2 000 m, see manual	5 000 m; Restrictions for installation altitudes > 2 000 m, see manual	2 000 m; On request: Installation altitudes greater than 2 000 m
Dimensions					
Width	15 mm	15 mm	15 mm	15 mm	20 mm
Height	73 mm	73 mm	73 mm	73 mm	73 mm
Depth	58 mm	58 mm	58 mm	58 mm	58 mm
Weights					
Weight, approx.	30 g	30 g	30 g	31 g	50 g
Article number	6ES7132-6FD00-0CU0 ET 200SP, DQ 4x24...230VAC/2A HF, PU 1	6ES7132-6GD51-0BA0 ET 200SP, RQ CO 4x 24V DC/2A ST, PU 1	6ES7132-6HD01-0BB1 ET 200SP, RQ NO 4x 120VDC...230VAC/5A, PU1	6ES7132-6MD00-0BB1 ET 200SP,RQ NO-mA 4x120VDC...230VAC/5A ST	
General information					
Product type designation	DQ 4x24 ... 230 V AC/2 A HF	RQ CO 4x24VDC/2A ST	RQ 4x120 VDC ... 230 VAC/ 5 A NO ST	RQ 4x120 V DC ... 230 V AC/ 5 A NO MA ST	
Product function					
• Isochronous mode	No	No	No		
Engineering with					
• STEP 7 TIA Portal configurable/ integrated from version	V14	V14	V14	V13 SP1	
• STEP 7 configurable/ integrated from version	STEP 7 V5.5 or higher	V5.5 SP3	V5.5 SP3	V5.5 SP3 / -	
• PCS 7 configurable/ integrated from version			V8.1 SP1		
• PROFIBUS from GSD version/ GSD revision	GSD as of Revision 5	One GSD file each, Revision 3 and 5 and higher	One GSD file each, Revision 3 and 5 and higher	One GSD file each, Revision 3 and 5 and higher	
• PROFINET from GSD version/ GSD revision	GSDML V2.3	GSDML V2.3	GSDML V2.3	GSDML V2.3	

I/O systems

SIMATIC ET 200 systems for the control cabinet

SIMATIC ET 200SP

I/O modules > Digital output modules**Technical specifications**

Article number	6ES7132-6FD00-0CU0 ET 200SP, DQ 4x24...230VAC/2A HF, PU 1	6ES7132-6GD51-0BA0 ET 200SP, RQ CO 4x 24V DC/2A ST, PU 1	6ES7132-6HD01-0BB1 ET 200SP, RQ NO 4x 120VDC..230VAC/5A, PU1	6ES7132-6MD00-0BB1 ET 200SP,RQ NO-mA 4x120VDC..230VAC/5A ST
Operating mode				
• DQ	Yes	Yes	Yes	Yes
• DQ with energy-saving function	Yes	No	No	No
• PWM	No	No	No	No
• Oversampling	No	No	No	No
• MSO	No	No	No	No
• Phase control	Yes; Control area: 8.5 ... 100% of the phase angle			
• Trailing-edge phase	No			
• Half-wave	Yes			
• Full-wave	Yes			
Supply voltage				
Rated value (DC)		24 V	24 V	24 V
Rated value (AC)	230 V; 47 ... 63 Hz, max. rate of change of frequency 1 mHz/s			
Reverse polarity protection		Yes	Yes	Yes
Digital outputs				
Type of digital output	Triac	Relays	Relays	Relays
Number of digital outputs	4	4	4	4
Current-sinking	No	Yes	Yes	
Current-sourcing	Yes	Yes	Yes	
Digital outputs, parameterizable	Yes	Yes	Yes	
Short-circuit protection	No; external fusing necessary	No	No	No
Open-circuit detection	Yes; channel by channel			
Overload protection	No; A miniature fuse with 10 tripping current and tripping characteristic "quick response" must be provided in the module supply			
Controlling a digital input	Yes			
Switching capacity of the outputs				
• with resistive load, max.	2 A; Max. 4 A, see additional description in manual			
• with inductive load, max.	2 A			
• on lamp load, max.	100 W; Tungsten rating in accordance with UL; for thermistors with higher power ratings, see the notes in the manual			
Output voltage				
• for signal "1", min.	20.4 V			
Output current				
• for signal "1" rated value	2 A			
• for signal "0" residual current, max.	3 mA			
Output delay with resistive load				
• "0" to "1", max.	40 ms; 2 AC cycles			
• "1" to "0", max.	20 ms; 1 AC cycle			
Parallel switching of two outputs				
• for logic links	No	Yes	Yes	
• for uprating	No	No	No	
• for redundant control of a load	Yes	Yes	Yes	

Overview

Article number	6ES7132-6FD00-0CU0 ET 200SP, DQ 4x24...230VAC/2A HF, PU 1	6ES7132-6GD51-0BA0 ET 200SP, RQ CO 4x 24V DC/2A ST, PU 1	6ES7132-6HD01-0BB1 ET 200SP, RQ NO 4x 120VDC...230VAC/5A, PU1	6ES7132-6MD00-0BB1 ET 200SP,RQ NO-mA 4x120VDC...230VAC/5A ST
Switching frequency				
• with resistive load, max.	10 Hz; Applies to DQ mode; limited by line frequency in PC mode	2 Hz	2 Hz	2 Hz
• with inductive load, max.			0.5 Hz	0.5 Hz
• with inductive load (acc. to IEC 60947-5-1, AC15), max.	10 Hz; Applies to DQ mode; limited by line frequency in PC mode			
• on lamp load, max.	1 Hz; Applies to DQ mode; limited by line frequency in PC mode		2 Hz	2 Hz
Total current of the outputs				
• Current per channel, max.	2 A; Max. 4 A, see additional description in manual	2 A	5 A	5 A
• Current per module, max.	8 A	8 A	20 A	20 A
Total current of the outputs (per module)				
horizontal installation				
- up to 40 °C, max.	8 A	8 A		
- up to 50 °C, max.	6 A	6 A	20 A	20 A
- up to 60 °C, max.	4 A	4 A	16 A	16 A
vertical installation				
- up to 30 °C, max.	8 A	8 A		
- up to 40 °C, max.	6 A	6 A	20 A	20 A
- up to 50 °C, max.	4 A	4 A	16 A	16 A
Relay outputs				
• Number of relay outputs		4	4	4
• Rated supply voltage of relay coil L+ (DC)		24 V	24 V	24 V
• Current consumption of relays (coil current of all relays), max.		40 mA	40 mA	40 mA
• external protection for relay outputs			Yes, with miniature fuse max. 6 A tripping current and quick-response tripping characteristic	Yes, with miniature fuse max. 6 A tripping current and quick-response tripping characteristic
• Number of operating cycles, max.		500 000	7 000 000; see additional description in the manual	7 000 000; see additional description in the manual
Switching capacity of contacts				
- with inductive load, max.			2 A; see additional description in the manual	2 A; see additional description in the manual
- with resistive load, max.		2 A	5 A; see additional description in the manual	5 A; see additional description in the manual
- Thermal continuous current, max.		2 A	5 A; Max. 1 385 VA, 150 W	5 A
- Switching current, min.		1 mA; 5 V DC	100 mA; 5 V DC	100 mA; 5 V DC
- Rated switching voltage (DC)		24 V	24 V DC to 120 V DC	24 V DC to 120 V DC
- Rated switching voltage (AC)		24 V	24V AC to 230V AC	24V AC to 230V AC
Interrupts/diagnostics/ status information				
Diagnostics function	Yes	Yes	Yes	Yes
Substitute values connectable	Yes	Yes	Yes	Yes
Alarms				
• Diagnostic alarm	Yes	Yes	Yes	Yes

I/O systems

SIMATIC ET 200 systems for the control cabinet
SIMATIC ET 200SP

I/O modules > Digital output modules

Technical specifications

Article number	6ES7132-6FD00-0CU0 ET 200SP, DQ 4x24..230VAC/2A HF, PU 1	6ES7132-6GD51-0BA0 ET 200SP, RQ CO 4x 24V DC/2A ST, PU 1	6ES7132-6HD01-0BB1 ET 200SP, RQ NO 4x 120VDC..230VAC/5A, PU1	6ES7132-6MD00-0BB1 ET 200SP,RQ NO-mA 4x120VDC..230VAC/5A ST
Diagnoses				
• Diagnostic information readable	Yes			
• Monitoring the supply voltage	Yes	Yes	Yes	Yes
• Wire-break	Yes; channel by channel	No	No	No
• Short-circuit	No	No	No	No
• Group error	Yes			Yes
Diagnoses indication LED				
• Monitoring of the supply voltage (PWR-LED)	Yes; green PWR LED	Yes; green PWR LED	Yes; green PWR LED	Yes; green PWR LED
• Channel status display	Yes; green LED	Yes; green LED	Yes; green LED	Yes; green LED
• for channel diagnostics	Yes; red Fn LED	No	No	No
• for module diagnostics	Yes; green/red DIAG LED	Yes; green/red DIAG LED	Yes; green/red DIAG LED	Yes; green/red DIAG LED
Potential separation				
Potential separation channels				
• between the channels and backplane bus	Yes	Yes	Yes	Yes
Standards, approvals, certificates				
Suitable for safety functions	No	No	No	No
Ambient conditions				
Ambient temperature during operation				
• horizontal installation, min.	-30 °C	-30 °C	-30 °C	-30 °C
• horizontal installation, max.	60 °C	60 °C	60 °C	60 °C
• vertical installation, min.	-30 °C	-30 °C	-30 °C	-30 °C
• vertical installation, max.	50 °C	50 °C	50 °C	50 °C
Altitude during operation relating to sea level				
• Installation altitude above sea level, max.	2 000 m; On request: Installation altitudes greater than 2 000 m	2 000 m; On request: Installation altitudes greater than 2 000 m	2 000 m; On request: Installation altitudes greater than 2 000 m	2 000 m; On request: Installation altitudes greater than 2 000 m
Dimensions				
Width	20 mm	15 mm	20 mm	20 mm
Height	73 mm	73 mm	73 mm	73 mm
Depth	58 mm	58 mm	58 mm	58 mm
Weights				
Weight, approx.	50 g	30 g	40 g	45 g
Article number	6ES7132-6HC50-0BU0 ET 200SP, RQ CO 3x120VDC.230VAC/5A ST	6ES7132-6HC70-0BU0 ET 200SP, RQ CO ni 3x120VDC.230VAC/5A ST		
General information				
Product type designation	RQ 3x120VDC-230VAC/5A CO ST	RQ 3x120VDC-230VAC/5A CO n.i. ST		
Product function				
• Isochronous mode	No	No		
Engineering with				
• STEP 7 TIA Portal configurable/ integrated from version	STEP 7 V16 or higher			
• STEP 7 configurable/ integrated from version	Configurable via GSD file			
• PROFIBUS from GSD version/ GSD revision	One GSD file each, Revision 3 and 5 and higher			
• PROFINET from GSD version/ GSD revision	GSDML V2.34			
Supply voltage				
Rated value (DC)	24 V	24 V		
Reverse polarity protection	Yes	Yes		

Overview

Article number	6ES7132-6HC50-0BU0 ET 200SP, RQ CO 3x120VDC.230VAC/5A ST	6ES7132-6HC70-0BU0 ET 200SP, RQ COi 3x120VDC.230VAC/5A ST
Digital outputs		
Type of digital output	Relays	Relays
Number of digital outputs	3	3
Current-sinking	Yes	Yes
Current-sourcing	Yes	Yes
Digital outputs, parameterizable	Yes	Yes
Short-circuit protection	No	No
Switching capacity of the outputs		
• with resistive load, max.	5 A; see additional description in the manual	5 A; see additional description in the manual
• with inductive load, max.	2 A; see additional description in the manual	2 A; see additional description in the manual
Parallel switching of two outputs		
• for logic links	Yes	Yes
• for uprating	No	No
• for redundant control of a load	Yes	Yes
Switching frequency		
• with resistive load, max.	2 Hz	2 Hz
• with inductive load, max.	0.5 Hz	0.5 Hz
• on lamp load, max.	2 Hz	2 Hz
Total current of the outputs		
• Current per channel, max.	5 A	5 A
• Current per module, max.	15 A	5 A
Total current of the outputs (per module)		
horizontal installation		
- up to 50 °C, max.	15 A	5 A
- up to 60 °C, max.	12 A; maximum channel current 4A	5 A
vertical installation		
- up to 40 °C, max.	15 A	5 A
- up to 50 °C, max.	12 A; maximum channel current 4A	5 A
Relay outputs		
• Number of relay outputs	3; changeover contact, isolated	3; Changeover contact, non-floating
• Rated supply voltage of relay coil L+ (DC)	24 V	24 V
• Current consumption of relays (coil current of all relays), max.	30 mA	40 mA
• external protection for relay outputs	yes, with miniature fuse max. 6.3 A tripping current, quick-response tripping characteristic and 1 500 A breaking capacity	yes, with miniature fuse max. 6.3 A tripping current, quick-response tripping characteristic and 1 500 A breaking capacity
• Number of operating cycles, max.	1 000 000; see additional description in the manual	1 000 000; see additional description in the manual
Switching capacity of contacts		
- with inductive load, max.	2 A; see additional description in the manual	2 A; see additional description in the manual
- with resistive load, max.	5 A; see additional description in the manual	5 A; see additional description in the manual
- Thermal continuous current, max.	5 A; Max. 1 385 VA, 150 W	5 A; Max. 1 385 VA, 150 W
- Switching current, min.	10 mA; 5 V DC	10 mA; 5 V DC
- Rated switching voltage (DC)	24 V DC to 120 V DC	24 V DC to 120 V DC
- Rated switching voltage (AC)	24V AC to 230V AC	24V AC to 230V AC
Interrupts/diagnostics/status information		
Diagnostics function	Yes	Yes
Substitute values connectable	Yes	Yes
Alarms		
• Diagnostic alarm	Yes	Yes

I/O systems

SIMATIC ET 200 systems for the control cabinet

SIMATIC ET 200SP

I/O modules > Digital output modules**Technical specifications**

Article number	6ES7132-6HC50-0BU0 ET 200SP, RQ CO 3x120VDC.230VAC/5A ST	6ES7132-6HC70-0BU0 ET 200SP, RQ COni 3x120VDC.230VAC/5A ST
Diagnoses		
• Monitoring the supply voltage	Yes	Yes
• Wire-break	No	No
• Short-circuit	No	No
Diagnostics indication LED		
• Monitoring of the supply voltage (PWR-LED)	Yes; green PWR LED	Yes; green PWR LED
• Channel status display	Yes; green LED	Yes; green LED
• for channel diagnostics	No	No
• for module diagnostics	Yes; green/red DIAG LED	Yes; green/red DIAG LED
Potential separation		
Potential separation channels		
• between the channels and backplane bus	Yes	Yes
Standards, approvals, certificates		
Suitable for safety functions	No	No
Ambient conditions		
Ambient temperature during operation		
• horizontal installation, min.	-30 °C	-30 °C
• horizontal installation, max.	60 °C	60 °C
• vertical installation, min.	-30 °C	-30 °C
• vertical installation, max.	50 °C	50 °C
Altitude during operation relating to sea level		
• Installation altitude above sea level, max.	2 000 m	2 000 m
Dimensions		
Width	20 mm	20 mm
Height	73 mm	73 mm
Depth	58 mm	58 mm
Weights		
Weight, approx.	40 g	40 g

Overview

Energy Meter HF module
for SIMATIC ET 200SP

Energy Meter HF module for SIMATIC ET 200SP video
https://players.brightcove.net/1813624294001/70fecf0f-fbad-4fad-a077-d0e26af4d84c_default/index.html?videoId=5848889024001



- 2, 4 and 8-channel analog input (AI) modules
- Apart from the standard type of delivery in an individual package, selected I/O modules and BaseUnits are also available in a pack of 10 units. The pack of 10 units enables the amount of waste to be reduced considerably, as well as saving the time and cost of unpacking individual modules.

For different requirements, the digital input modules offer:

- Function classes Basic, Standard, High Feature and High Speed
- BaseUnits for single or multiple-conductor connection with automatic slot coding
- Potential distributor modules for system-integrated expansion with potential terminals
- Individual system-integrated potential group formation with self-assembling voltage busbars (a separate power module is no longer required for ET 200SP)
- Option of connecting current, voltage and resistance sensors, as well as thermocouples
- Option of connecting force and torque sensors

- Energy Meter for recording up to 600 electrical variables
- Clear labeling on front of module
- LEDs for diagnostics, status, supply voltage and faults
- Electronically readable and non-volatile writable rating plate (I&M data 0 to 3)
- Extended functions and additional operating modes in some cases
 - MSI operating mode (simultaneous reading of input data from as many as three other controllers)
 - Oversampling operating mode (n-fold equidistant acquisition of analog values within one PN cycle for increasing the time resolution for slow CPU cycles)
 - Isochronous mode (simultaneous equidistant reading in of all analog values)
 - Scalable measuring range (adaptation of measuring range, increase of the 16-bit resolution by adapting the measuring range to a limited section)
 - Scaling of the measured values (transmission of the analog value normalized to the required physical value as a 32-bit floating point value)
 - Internal compensation of the line resistance for thermocouples by means of terminal temperature measurement in the BaseUnit for BU type A1
 - Internal compensation also for 2-conductor resistance test by means of adjustable line resistance
 - Calibration during runtime
 - Single-channel galvanic isolation
 - HART communication
 - Re-parameterization during operation
 - Firmware update
 - Diagnostics of wire break, short-circuit, overflow, underflow
 - Two upper and lower hardware interrupts in each case, interference frequency suppression, smoothing
 - Value status (optional binary validity information of the analog value status in the process image)
 - Supports the PROFlenergy profile
- Optional accessories
 - Labeling strips (film or card)
 - Equipment labeling plate
 - Color-coded label with module-specific CC code
 - Shield terminal

A quick and clear comparison of the functions of the AI modules is offered by the TIA Selection Tool.

I/O systemsSIMATIC ET 200 systems for the control cabinet
SIMATIC ET 200SP**I/O modules > Analog input modules****Overview**

Overview of analog input modules

Analog input	PU	Article No.	CC code	BU type
AI 8 x I 2/4-wire BA	1	6ES7134-6GF00-0AA1	CC01	A0, A1
AI 2 x U ST	1	6ES7134-6FB00-0BA1	CC00	A0, A1
AI 8 x U BA	1	6ES7134-6FF00-0AA1	CC02	A0, A1
AI 4 x U/I 2-wire ST	1	6ES7134-6HD00-0BA1	CC03	A0, A1
AI 4 x U/I 2-wire ST	10	6ES7134-6HD00-2BA1	CC03	A0, A1
AI 2 x I 2/4-wire ST	1	6ES7134-6GB00-0BA1	CC05	A0, A1
AI 4 x I 2/4-wire ST	1	6ES7134-6GD00-0BA1	CC03	A0, A1
AI 4 x I 2/4-wire ST	10	6ES7134-6GD00-2BA1	CC03	A0, A1
AI 4 x I 2-wire 4 ... 20 mA HART	1	6ES7134-6TD00-0CA1	CC03	A0, A1
AI 2 x U/I 2/4-wire HF	1	6ES7134-6HB00-0CA1	CC05	A0, A1
AI 2 x U/I 2/4-wire HS With two operating modes: • High-speed isochronous AI • Oversampling	1	6ES7134-6HB00-0DA1	CC00	A0, A1
AI 8 x RTD/TC 2-wire HF	1	6ES7134-6JF00-0CA1	CC00	A0, A1
AI 8 x RTD/TC 2-wire HF	10	6ES7134-6JF00-2CA1	CC00	A0, A1
AI 4 x RTD/TC 2/3/4-wire HF	1	6ES7134-6JD00-0CA1	CC00	A0, A1
AI 4 x RTD/TC 2/3/4-wire HF	10	6ES7134-6JD00-2CA1	CC00	A0, A1
AI 4 x TC High Speed	1	6ES7134-6JD00-0DA1	CC00	A0, A1
AI 2 x SG 4/6-wire High Speed	1	7MH4134-6LB00-0DA0	CC00	A0
AI Energy Meter CT ST	1	6ES7134-6PA01-0BU0	--	U0
AI Energy Meter RC ST	1	6ES7134-6PA21-0BU0	--	U0
AI Energy Meter CT HF	1	6ES7134-6PA01-0CU0	--	U0
AI Energy Meter RC HF	1	6ES7134-6PA21-0CU0	--	U0

Overview of BaseUnits

BaseUnit	PU	Article No.	CC codes for push-in terminals	CC codes for AUX terminals
BU type A0 • New potential group (light) • 16 push-in terminals • With 10 AUX terminals	1	6ES7193-6BP20-0DA0	CC01 to CC05	CC71 to CC73
BU type A0 • New potential group (light) • 16 push-in terminals • With 10 AUX terminals	10	6ES7193-6BP20-2DA0	CC01 to CC05	CC71 to CC73
BU type A0 • New potential group (light) • 16 push-in terminals • Without AUX terminals	1	6ES7193-6BP00-0DA0	CC01 to CC05	--
BU type A0 • New potential group (light) • 16 push-in terminals • Without AUX terminals	10	6ES7193-6BP00-2DA0	CC01 to CC05	--
BU type A0 • Forwarding of the potential group (dark) • 16 push-in terminals • With 10 AUX terminals	1	6ES7193-6BP20-0BA0	CC01 to CC05	CC71 to CC73
BU type A0 • Forwarding of the potential group (dark) • 16 push-in terminals • With 10 AUX terminals	10	6ES7193-6BP20-2BA0	CC01 to CC05	CC71 to CC73
BU type A0 • Forwarding of the potential group (dark) • 16 push-in terminals • Without AUX terminals	1	6ES7193-6BP00-0BA0	CC01 to CC05	--

Overview

BaseUnit	PU	Article No.	CC codes for push-in terminals	CC codes for AUX terminals
BU type A0 • Forwarding of the potential group (dark) • 16 push-in terminals • Without AUX terminals	10	6ES7193-6BP00-2BA0	CC01 to CC05	--
BU type A1 • New potential group (light) • With temperature sensor • 16 push-in terminals • With 2x5 additional terminals	1	6ES7193-6BP40-0DA1	CC01 to CC05	CC74
BU type A1 • New potential group (light) • With temperature sensor • 16 push-in terminals • Without 2x5 additional terminals	1	6ES7193-6BP00-0DA1	CC01 to CC05	--
BU type A1 • Forwarding of the potential group (dark) • With temperature sensor • 16 push-in terminals • With 2x5 additional terminals	1	6ES7193-6BP40-0BA1	CC01 to CC05	CC74
BU type A1 • Forwarding of the potential group (dark) • With temperature sensor • 16 push-in terminals • Without 2x5 additional terminals	1	6ES7193-6BP00-0BA1	CC01 to CC05	--
BU type U0 • New potential group (light) • 16 push-in terminals • Without AUX terminals	1	6ES7193-6BP00-0DU0	CC00	--
BU type U0 • New potential group (light) • 16 push-in terminals • Without AUX terminals	10	6ES7193-6BP00-2DU0	CC00	--
BU type U0 • Forwarding of the potential group (dark) • 16 push-in terminals • Without AUX terminals	1	6ES7193-6BP00-0BU0	CC00	--
BU type U0 • Forwarding of the potential group (dark) • 16 push-in terminals • Without AUX terminals	10	6ES7193-6BP00-2BU0	CC00	--

Overview of potential distributor modules

Potential distributor module	PU	Article No.	CC codes for push-in terminals
PotDis BU Type P1 (light), 17x P1 potential, 1x P2 potential, for starting a new potential group (max. 10 A)	1	6ES7193-6UP00-0DP1	CC00, CC62
PotDis BU Type P1 (dark), 17x P1 potential, 1x P2 potential, for continuing the potential group	1	6ES7193-6UP00-0BP1	CC00, CC62
PotDis BU Type P2 (light), 1x P1 potential, 17x P2 potential, for starting a new potential group (max. 10 A)	1	6ES7193-6UP00-0DP2	CC00, CC63

I/O systemsSIMATIC ET 200 systems for the control cabinet
SIMATIC ET 200SP**I/O modules > Analog input modules****Overview**

Potential distributor module	PU	Article No.	CC codes for push-in terminals
PotDis BU Type P2 (dark), 1x P1 potential, 17x P2 potential, for continuing the potential group	1	6ES7193-6UP00-0BP2	CC00, CC63
PotDis TB Type BR-W, 18x internally jumpered terminals, without reference to P1, P2 or AUX, (total current max. 10 A)	1	6ES7193-6TP00-0TP0	CC10 to CC13
PotDis TB Type P1-R, 18x P1 potential, (total current max. 10 A)	1	6ES7193-6TP00-0TP1	CC10, CC12
PotDis TB Type P2-B, 18x P2 potential, (total current max. 10 A)	1	6ES7193-6TP00-0TP2	CC10, CC13
PotDis TB Type n.c.-G, 18x n.c. (not connected) terminals, without reference to P1, P2 or AUX	1	6ES7193-6TP00-0TN0	CC10

Ordering data**Article No.****Article No.****Analog input modules**

Types of delivery:
Apart from the standard type of delivery in a single-unit package, selected I/O modules and BaseUnits are also available in a pack of 10 units. The pack of 10 units enables the amount of waste to be reduced considerably, as well as saving the time and cost of unpacking individual modules.

The number of modules required is the number of modules ordered. The pack type is selected by selecting the article number. Packs of 10 can therefore only be ordered in integer multiples of 10.

Analog input module
AI 8xI 2/4-wire BA, BU type A0 or A1, color code CC01

6ES7 134-6GF00-0AA1

Analog input module
AI 2xU ST, BU type A0 or A1, color code CC00

6ES7134-6FB00-0BA1

Analog input module
AI 8xU BA, BU type A0 or A1, color code CC02

6ES7 134-6FF00-0AA1

Analog input module
AI 4xU/I 2-wire Standard, BU type A0 or A1, color code CC03, 16-bit, ±0.3%

6ES7134-6HD01-0BA1
6ES7134-6HD01-2BA1

- Pack of 1 unit
- Pack of 10 units; to order a pack, please order this article number with an order quantity of 10.

Analog input module
AI 2xI 2/4-wire Standard, BU type A0 or A1, color code CC05, 16-bit

6ES7134-6GB00-0BA1

- Pack of 1 unit

Analog input module
AI 4xI 2/4-wire Standard, BU type A0 or A1, color code CC03, 16-bit, ±0.3%

- Pack of 1 unit
- Pack of 10 units; to order a pack, please order this article number with an order quantity of 10.

6ES7134-6GD01-0BA1
6ES7134-6GD01-2BA1

Analog input module
AI 4xI 2-wire 4 ... 20 mA HART, BU type A0 or A1, color code CC03

6ES7134-6TD00-0CA1

Analog input module
AI 2xU/I 2/4-wire High Feature, BU type A0 or A1, color code CC05, 16-bit, ±0.1%, independent channel galvanic isolation, isochronous mode above 1 ms

6ES7134-6HB00-0CA1

Analog input module
AI 2xU/I 2/4-wire High Speed, BU type A0 or A1, color code CC00, 16-bit, ±0.3%, isochronous mode above 250 µs, oversampling above 50 µs

6ES7134-6HB00-0DA1

Analog input module
AI 8xRTD/TC 2-wire High Feature, BU type A0 or A1, color code CC00, 16-bit, ±0.1%, scalable measuring range

- Pack of 1 unit
- Pack of 10 units; to order a pack, please order this article number with an order quantity of 10.

6ES7134-6JF00-0CA1
6ES7134-6JF00-2CA1

Analog input module
AI 4xRTD/TC 2/3/4-wire High Feature, BU type A0 or A1, color code CC00, 16-bit, ±0.1%, scalable measuring range

- Pack of 1 unit
- Pack of 10 units; to order a pack, please order this article number with an order quantity of 10.

6ES7134-6JD00-0CA1
6ES7134-6JD00-2CA1

Ordering data	Article No.	Article No.
Analog input module AI 4xTC High Speed, BU type A0 or A1, color code CC00, 16-bit, channel diagnostics	6ES7134-6JD00-0DA1	BU15-P16+A0+2B BU type A0; BaseUnit (dark) with 16 push-in terminals to the module; for continuing the potential group <ul style="list-style-type: none">• Pack of 1 unit• Pack of 10 units; to order a pack, please order this article number with an order quantity of 10.
Analog input module AI 2x SG, 4/6-wire High Speed, BU type A0, color code CC00, channel diagnostics, 28/16-bit, ±0.05%, for DMS full bridges; for connecting force and torque sensors	7MH4134-6LB00-0DA0	
Analog input module AI Energy Meter CT ST, BU type U0	6ES7134-6PA01-0BU0	Usable type A1 BaseUnits (temperature detection) BU15-P16+A0+12D/T BU type A1; BaseUnit (light) with 16 push-in terminals (1 ... 16) to the module and 2x5 internally jumpered additional terminals (1 B to 5 B and 1 C to 5 C); for starting a new potential group (max. 10 A)
Analog input module AI Energy Meter RC ST, BU type U0	6ES7134-6PA21-0BU0	
Analog input module AI Energy Meter CT HF, for 1 A or 5 A current transformers, with line analysis functions, channel diagnostics; BU type U0	6ES7134-6PA01-0CU0	BU15-P16+A0+2D/T BU type A1; BaseUnit (light) with 16 push-in terminals to the module; for starting a new potential group (max. 10 A)
Analog input module AI Energy Meter RC HF, for Rogowski coils or 333 mV current/voltage transformers, with line analysis functions, channel diagnostics; BU type U0	6ES7134-6PA21-0CU0	
Usable type A0 BaseUnits		BU15-P16+A0+12B/T BU type A1; BaseUnit (dark) with 16 push-in terminals (1 ... 16) to the module and 2x5 internally jumpered additional terminals (1 B to 5 B and 1 C to 5 C); for continuing the potential group
BU15-P16+A10+2D BU type A0; BaseUnit (light) with 16 push-in terminals (1 ... 16) to the module and an additional 10 internally jumpered AUX terminals (1 A to 10 A); for starting a new potential group (max. 10 A) <ul style="list-style-type: none">• Pack of 1 unit• Pack of 10 units; to order a pack, please order this article number with an order quantity of 10.	6ES7193-6BP20-0DA0 6ES7193-6BP20-2DA0	
BU15-P16+A0+2D BU type A0; BaseUnit (light) with 16 push-in terminals to the module; for starting a new potential group (max. 10 A) <ul style="list-style-type: none">• Pack of 1 unit• Pack of 10 units; to order a pack, please order this article number with an order quantity of 10.	6ES7193-6BP00-0DA0 6ES7193-6BP00-2DA0	BU15-P16+A0+2B/T BU type A1; BaseUnit (dark) with 16 push-in terminals to the module; for continuing the potential group Suitable type U0 BaseUnits BU20-P16+A0+2D BU type U0; BaseUnit (light) with 16 push-in terminals to the module; for starting a new potential group (max. 10 A) <ul style="list-style-type: none">• Pack of 1 unit• Pack of 10 units; to order a pack, please order this article number with an order quantity of 10.
BU15-P16+A10+2B BU type A0; BaseUnit (dark) with 16 push-in terminals (1 ... 16) to the module and an additional 10 internally jumpered AUX terminals (1 A to 10 A); for continuing the potential group <ul style="list-style-type: none">• Pack of 1 unit• Pack of 10 units; to order a pack, please order this article number with an order quantity of 10.	6ES7193-6BP20-0BA0 6ES7193-6BP20-2BA0	

I/O systemsSIMATIC ET 200 systems for the control cabinet
SIMATIC ET 200SP**I/O modules > Analog input modules****Ordering data****Article No.****Article No.****BU20-P16+A0+2B**

BU type U0; BaseUnit (dark) with 16 push-in terminals to the module; for continuing the potential group

- Pack of 1 unit
- Pack of 10 units; to order a pack, please order this article number with an order quantity of 10.

6ES7193-6BP00-0BU0
6ES7193-6BP00-2BU0

Potential distributor modules**PotDis BU**

PotDis BU, Type P1 (light), 17x P1 potential, 1x P2 potential, for starting a new potential group (max. 10 A)

6ES7193-6UP00-ODP1

PotDis BU, Type P1 (dark), 17x P1 potential, 1x P2 potential, for continuing the potential group

6ES7193-6UP00-OBP1

PotDis BU, Type P2 (light), 1x P1 potential, 17x P2 potential, for starting a new potential group (max. 10 A)

6ES7193-6UP00-ODP2

PotDis BU, Type P2 (dark), 1x P1 potential, 17x P2 potential, for continuing the potential group

6ES7193-6UP00-OBP2**PotDis TB**

PotDis TB, type BR-W, 18x internally jumpered terminals, without reference to P1, P2 or AUX, (total current max. 10 A)

6ES7193-6TP00-0TP0

PotDis TB, type P1-R, 18x P1 potential, (total current max. 10 A)

6ES7193-6TP00-0TP1

PotDis TB, type P2-B, 18x P2 potential, (total current max. 10 A)

6ES7193-6TP00-0TP2

PotDis TB, type n.c.-G, 18x n.c. (not connected) terminals, without reference to P1, P2 or AUX

6ES7193-6TP00-0TN0**Accessories****Equipment labeling plate**

10 sheets of 16 labels, for printing with thermal transfer card printer or plotter

6ES7193-6LF30-0AW0**Labeling strips**

500 labeling strips on roll, light gray, for inscription with thermal transfer roll printer

6ES7193-6LR10-0AA0

500 labeling strips on roll, yellow, for inscription with thermal transfer roll printer

6ES7193-6LR10-0AG0

1 000 labeling strips DIN A4, light gray, card, perforated, for inscription with laser printer

6ES7193-6LA10-0AA0

1 000 labeling strips DIN A4, yellow, card, perforated, for inscription with laser printer

6ES7193-6LA10-0AG0**BU cover**

For covering empty slots (gaps); 5 units

- 15 mm wide
- 20 mm wide

6ES7133-6CV15-1AM0
6ES7133-6CV20-1AM0

Shield connection

5 shield supports and 5 shield terminals

6ES7193-6SC00-1AM0**Color-coded labels**

Color code CC00, for 16 push-in terminals, BU type A0, A1, gray (terminals 1 to 8), red (terminals 9 to 16); 10 units

6ES7193-6CP00-2MA0

Color code CC01, for 16 push-in terminals, BU type A0, A1, gray (terminals 1 to 8), red (terminals 9 to 16); 10 units

6ES7193-6CP01-2MA0

Color code CC01, for 16 push-in terminals, BU type A0, A1, gray (terminals 1 to 8), red (terminals 9 to 16); 50 units

6ES7193-6CP01-4MA0

Color code CC02, for 16 push-in terminals, BU type A0, A1, gray (terminals 1 to 8), blue (terminals 9 to 16); 10 units

6ES7193-6CP02-2MA0

Color code CC02, for 16 push-in terminals, BU type A0, A1, gray (terminals 1 to 8), blue (terminals 9 to 16); 50 units

6ES7193-6CP02-4MA0

Color code CC03, for 16 push-in terminals, BU type A0, A1 gray (terminals 1 to 8), red (terminals 9 to 12), gray (terminals 13 to 16); 10 units

6ES7193-6CP03-2MA0

Color code CC05, for 16 push-in terminals, BU type A0, A1, gray (terminals 1 to 12), red (terminals 13 to 14), blue (terminals 15 to 16); 10 units

6ES7193-6CP05-2MA0

Color code CC71, for 10 AUX terminals, BU type A0, yellow/green (terminals 1 A to 10 A); 10 units

6ES7193-6CP71-2AA0

Color code CC72, for 10 AUX terminals, BU type A0, red (terminals 1 A to 10 A); 10 units

6ES7193-6CP72-2AA0

Color code CC73, for 10 AUX terminals, BU type A0, blue (terminals 1 A to 10 A); 10 units

6ES7193-6CP73-2AA0

Color code CC74, for 2x5 additional terminals, BU type A1, red (terminals 1B to 5B), blue (terminals 1C to 5C); 10 units

6ES7193-6CP74-2AA0**Color-coded labels for PotDis BU**

Color code CC62, for 16 push-in terminals, PotDis BU type P1, red (terminals 1 to 16); 10 units

6ES7193-6CP62-2MA0

Color code CC63, for 16 push-in terminals, PotDis BU type P2, blue (terminals 1 to 16); 10 units

6ES7193-6CP63-2MA0**Color-coded labels for PotDis TB**

Color code CC10, for 18 push-in terminals, PotDis TB, gray (terminals 1 to 18); 10 units

6ES7193-6CP10-2MT0

Color code CC11, for 18 push-in terminals, PotDis TB, yellow-green (terminals 1 to 18); 10 units

6ES7193-6CP11-2MT0

Ordering data	Article No.	Article No.
Color code CC12, for 18 push-in terminals, PotDis TB, type P1 and BR, red (terminals 1 to 18); 10 units	6ES7193-6CP12-2MT0	Mechanical coding elements For automatic coding of I/O modules; spare part. 20 units Type A Type B Type C Type D
Color code CC13, for 18 push-in terminals, PotDis TB, type P2 and BR, blue (terminals 1 to 18); 10 units	6ES7193-6CP13-2MT0	
		6ES7193-6KA00-3AA0 6ES7193-6KB00-3AA0 6ES7193-6KC00-3AA0 6ES7193-6KD00-3AA0

Technical specifications

Article number	6ES7134-6GF00-0AA1	6ES7134-6FB00-0BA1	6ES7134-6FF00-0AA1	6ES7134-6HD01-0BA1	6ES7134-6GB00-0BA1
	ET 200SP, AI 8xI 2-/4-Wire Basic	ET 200SP, AI 2xU Standard, PU 1	ET 200SP, AI 8xU Basic	ET 200SP, AI 4xU/I 2-Wire ST, PU 1	ET 200SP, AI 2xI 2-/4-Wire ST, PU 1
General information					
Product type designation	AI 8xI 2-/4-wire BA	AI 2xU ST	AI 8xU BA	AI 4x U/I 2-wire	AI 2xI 2-/4-wire ST
Product function					
• Isochronous mode	No	No	No	No	No
• Measuring range scalable	No	No	No	No	No
Engineering with					
• STEP 7 TIA Portal configurable/integrated from version	V13 SP1	V13 SP1	V13 SP1	V14 / -	V13 SP1
• STEP 7 configurable/integrated from version	V5.5 SP3 / -	V5.5 SP3 / -	V5.5 SP3 / -	V5.6 and higher	V5.5 SP3
• PCS 7 configurable/integrated from version				V8.1 SP1	
• PROFIBUS from GSD version/GSD revision	One GSD file each, Revision 3 and 5 and higher	One GSD file each, Revision 3 and 5 and higher	One GSD file each, Revision 3 and 5 and higher	One GSD file each, Revision 3 and 5 and higher	One GSD file each, Revision 3 and 5 and higher
• PROFINET from GSD version/GSD revision	GSDML V2.3	GSDML V2.3	GSDML V2.3	GSDML V2.3	V2.3 / -
Operating mode					
• Oversampling	No	No	No	No	No
• MSI	No	No	No	No	No
Supply voltage					
Rated value (DC)	24 V	24 V	24 V	24 V	24 V
Reverse polarity protection	Yes	Yes	Yes	Yes	Yes
Analog inputs					
Number of analog inputs	8; Single-ended	2	8; Single-ended	4; Differential inputs	2
• For current measurement	8				2
• For voltage measurement		2	8		
permissible input voltage for voltage input (destruction limit), max.		30 V	30 V	30 V	
permissible input current for current input (destruction limit), max.	50 mA			50 mA	50 mA
Cycle time (all channels), min.	1 ms; per channel	500 µs	1 ms; per channel	Sum of the basic conversion times and additional processing times (depending on the parameterization of the active channels)	500 µs
Input ranges (rated values), voltages					
• 0 to +10 V		Yes; 15 bit	Yes; 15 bit	Yes; 15 bit	
• 1 V to 5 V		Yes; 15 bit		Yes; 15 bit	
• -10 V to +10 V		Yes; 16 bit incl. sign	Yes; 16 bit incl. sign	Yes; 16 bit incl. sign	
• -5 V to +5 V		Yes; 16 bit incl. sign		Yes; 16 bit incl. sign	

I/O systems

SIMATIC ET 200 systems for the control cabinet
SIMATIC ET 200SP

I/O modules > Analog input modules

Technical specifications

Article number	6ES7134-6GF00-0AA1	6ES7134-6FB00-0BA1	6ES7134-6FF00-0AA1	6ES7134-6HD01-0BA1	6ES7134-6GB00-0BA1
	ET 200SP, AI 8xI 2-/4-Wire Basic	ET 200SP, AI 2xU Standard, PU 1	ET 200SP, AI 8xU Basic	ET 200SP, AI 4xU/I 2-Wire ST, PU 1	ET 200SP, AI 2xI 2-/4-Wire ST, PU 1
Input ranges (rated values), currents					
• 0 to 20 mA	Yes			Yes; 15 bit	Yes; 15 bit
• -20 mA to +20 mA	Yes				Yes; 16 bit incl. sign
• 4 mA to 20 mA	Yes			Yes; 15 bit	Yes; 15 bit
Cable length					
• shielded, max.	200 m	200 m	200 m	1 000 m; 200 m for voltage measurement	1 000 m
Analog value generation for the inputs					
Integration and conversion time/ resolution per channel					
• Resolution with overrange (bit including sign), max.	16 bit	16 bit	16 bit	16 bit	16 bit
• Integration time, parameterizable	Yes	Yes	Yes	Yes	Yes
• Interference voltage suppression for interference frequency f_1 in Hz	16.67 / 50 / 60 / 4 800 (16.67 / 50 / 60)	16.6 / 50 / 60 Hz / off	16.67 / 50 / 60 / 4 800 (16.67 / 50 / 60)	16.6 / 50 / 60 Hz	16.6 / 50 / 60 Hz / off
• Conversion time (per channel)	180 / 60 / 50 / 0.625 (67.5 / 22.5 / 18.75) ms	50 ms @ 60 Hz, 60 ms @ 50 Hz, 180 ms @ 16.6 Hz, 250 μ s without filter	180 / 60 / 50 / 0.625 (67.5 / 22.5 / 18.75) ms	180 / 60 / 50 ms	50 ms @ 60 Hz, 60 ms @ 50 Hz, 180 ms @ 16.6 Hz, 500 μ s without filter
Smoothing of measured values					
• Number of smoothing levels	4; None; 4/8/16 times	4	4; None; 4/8/16 times	4; None; 4/8/16 times	4
• parameterizable	Yes	Yes	Yes	Yes	Yes
Encoder					
Connection of signal encoders					
• for voltage measurement	No	Yes	Yes	Yes	
• for current measurement as 2-wire transducer	Yes			Yes	Yes
- Burden of 2-wire transmitter, max.	650 Ω			650 Ω	650 Ω
• for current measurement as 4-wire transducer	Yes		No	No	Yes
Errors/accuracies					
Basic error limit (operational limit at 25 °C)					
• Voltage, relative to input range, (+/-)		0.3 %	0.3 %	0.3 %	
• Current, relative to input range, (+/-)	0.3 %			0.3 %	0.3 %
Interference voltage suppression for $f = n \times (f_1 \pm 1 \%)$, $f_1 =$ interference frequency					
• Series mode interference (peak value of interference < rated value of input range), min.	70 dB; With conversion time 67.5 / 22.5 / 18.75 ms: 40 dB	70 dB	70 dB; With conversion time 67.5 / 22.5 / 18.75 ms: 40 dB	70 dB	70 dB
• Common mode voltage, max.		10 V		10 V	10 V
• Common mode interference, min.		90 dB		90 dB	90 dB
Interrupts/diagnostics/ status information					
Diagnostics function	Yes	Yes	Yes	Yes	Yes
Alarms					
• Diagnostic alarm	Yes	Yes	Yes	Yes	Yes
• Limit value alarm	No	No	No	No	No

Technical specifications

Article number	6ES7134-6GF00-0AA1 ET 200SP, AI 8xI 2-/4-Wire Basic	6ES7134-6FB00-0BA1 ET 200SP, AI 2xU Standard, PU 1	6ES7134-6FF00-0AA1 ET 200SP, AI 8xU Basic	6ES7134-6HD01-0BA1 ET 200SP, AI 4xU/I 2-Wire ST, PU 1	6ES7134-6GB00-0BA1 ET 200SP, AI 2xI 2-/4-Wire ST, PU 1
Diagnoses					
• Monitoring the supply voltage	Yes	Yes	Yes	Yes	Yes
• Wire-break	Yes; at 4 to 20 mA	No	No	Yes; at 4 to 20 mA	Yes; at 4 to 20 mA
• Short-circuit	Yes; Sensor supply to M; module by module	Yes; at 1 to 5 V	No	Yes; with 1 to 5 V or 2-wire mode: Short-circuit of the encoder supply to ground or of an input to the encoder supply	Yes; Short-circuit of the encoder supply
• Group error	Yes	Yes	Yes	Yes	Yes
• Overflow/underflow	Yes	Yes	Yes	Yes	Yes
Diagnostics indication LED					
• Monitoring of the supply voltage (PWR-LED)	Yes; green LED	Yes; green PWR LED	Yes; green PWR LED	Yes; green LED	Yes; green PWR LED
• Channel status display	Yes; green LED	Yes; green LED	Yes; green LED	Yes; green LED	Yes; green LED
• for channel diagnostics	No	No	No	No	No
• for module diagnostics	Yes; green/red DIAG LED	Yes; green/red DIAG LED	Yes; green/red DIAG LED	Yes; green/red LED	Yes; green/red DIAG LED
Potential separation					
Potential separation channels					
• between the channels and backplane bus	Yes	Yes	Yes	Yes	Yes
Standards, approvals, certificates					
Suitable for applications according to AMS 2750				Yes; Declaration of Conformity, see online support entry 109757262	
Suitable for applications according to CQI-9				Yes	
Ambient conditions					
Ambient temperature during operation					
• horizontal installation, min.	-30 °C; < 0 °C as of FS04	-30 °C; < 0 °C as of FS04	-30 °C; < 0 °C as of FS04	-30 °C; < 0 °C as of FS02	-30 °C; < 0 °C as of FS04
• horizontal installation, max.	60 °C	60 °C	60 °C	60 °C	60 °C
• vertical installation, min.	-30 °C; < 0 °C as of FS04	-30 °C; < 0 °C as of FS04	-30 °C; < 0 °C as of FS04	-30 °C; < 0 °C as of FS02	-30 °C; < 0 °C as of FS04
• vertical installation, max.	50 °C	50 °C	50 °C	50 °C	50 °C
Altitude during operation relating to sea level					
• Installation altitude above sea level, max.	5 000 m; Restrictions for installation altitudes > 2 000 m, see manual	5 000 m; Restrictions for installation altitudes > 2 000 m, see manual	5 000 m; Restrictions for installation altitudes > 2 000 m, see manual	5 000 m; Restrictions for installation altitudes > 2 000 m, see manual	5 000 m; Restrictions for installation altitudes > 2 000 m, see manual
Dimensions					
Width	15 mm	15 mm	15 mm	15 mm	15 mm
Height	73 mm	73 mm	73 mm	73 mm	73 mm
Depth	58 mm	58 mm	58 mm	58 mm	58 mm
Weights					
Weight, approx.	31 g	31 g	31 g	31 g	32 g

I/O systems

SIMATIC ET 200 systems for the control cabinet

SIMATIC ET 200SP

I/O modules > Analog input modules**Technical specifications**

Article number	6ES7134-6GD01-0BA1 ET 200SP, AI 4xI 2-/4-Wire ST, PU 1	6ES7134-6TD00-0CA1 ET 200SP, AI 4xI 2-WIRE 4...20MA HART	6ES7134-6HB00-0CA1 ET 200SP AI 2 X U/I 2-, 4-Wire HF	6ES7134-6HB00-0DA1 ET 200SP AI 2 X U/I 2-, 4-Wire HS
General information				
Product type designation	AI 4xI 2-/4-wire ST	AI 4xI 2-wire HART	AI 2xU/I 2-/4-wire HF	AI 2xU/I 2-/4-wire HS
Product function				
• Isochronous mode	No	No	Yes	Yes
• Measuring range scalable	No	No	No	No
• Scalable measured values				No
• Adjustment of measuring range				No
Engineering with				
• STEP 7 TIA Portal configurable/ integrated from version	V14 / -	V13 SP1	V13	V13 SP1
• STEP 7 configurable/ integrated from version	V5.6 and higher	V5.5 SP4 and higher	V5.5 / -	V5.5 SP3 / -
• PCS 7 configurable/ integrated from version	V8.1 SP1	V8.1 SP1	V8.1 SP1	
• PROFIBUS from GSD version/ GSD revision	One GSD file each, Revision 3 and 5 and higher	GSD Revision 5	One GSD file each, Revision 3 and 5 and higher	One GSD file each, Revision 3 and 5 and higher
• PROFINET from GSD version/ GSD revision	GSDML V2.3	GSDML V2.3	GSDML V2.3	GSDML V2.3
Operating mode				
• Oversampling	No	No	No	Yes; 2 channels per module
• MSI	No	No	Yes	No
Supply voltage				
Rated value (DC)	24 V	24 V	24 V	24 V
Reverse polarity protection	Yes	Yes	Yes	Yes
Analog inputs				
Number of analog inputs	4; Differential inputs	4; Differential inputs	2; Differential inputs	2; Differential inputs
• For current measurement		4	2	2
• For voltage measurement			2	2
permissible input voltage for voltage input (destruction limit), max.			30 V	30 V
permissible input current for current input (destruction limit), max.	50 mA	50 mA	50 mA	50 mA
Cycle time (all channels), min.	Sum of the basic conversion times and additional processing times (depending on the parameterization of the active channels)			125 µs
Analog input with oversampling			No	Yes
• Values per cycle, max.				16
• Resolution, min.				50 µs
Standardization of measured values			Yes	
Input ranges (rated values), voltages				
• 0 to +10 V			Yes; 15 bit	Yes; 15 bit
• 1 V to 5 V			Yes; 15 bit	Yes; 13 bit
• -10 V to +10 V			Yes; 16 bit incl. sign	Yes; 16 bit incl. sign
• -5 V to +5 V			Yes; 16 bit incl. sign	Yes; 15 bit incl. sign
Input ranges (rated values), currents				
• 0 to 20 mA	Yes; 16 bit incl. sign	No	Yes; 15 bit	Yes; 15 bit
• -20 mA to +20 mA	Yes	No	Yes; 16 bit incl. sign	Yes; 16 bit incl. sign
• 4 mA to 20 mA	Yes; 15 bit	Yes; 15 bit + sign	Yes; 15 bit	Yes; 14 bit
Cable length				
• shielded, max.	1 000 m	800 m	1 000 m; 200 m for voltage measurement	1 000 m; 200 m for voltage measurement

Technical specifications

Article number	6ES7134-6GD01-0BA1	6ES7134-6TD00-0CA1	6ES7134-6HB00-0CA1	6ES7134-6HB00-0DA1
	ET 200SP, AI 4XI 2-/4-Wire ST, PU 1	ET 200SP, AI 4XI 2-WIRE 4...20MA HART	ET 200SP AI 2 X U/I 2-, 4-Wire HF	ET 200SP AI 2 X U/I 2-, 4-Wire HS
Analog value generation for the inputs				
Integration and conversion time/resolution per channel				
• Resolution with overrange (bit including sign), max.	16 bit	16 bit	16 bit	16 bit
• Integration time, parameterizable	Yes	Yes; channel by channel	Yes	
• Integration time (ms)			67.5 / 22.5 / 18.75 / 10 / 5 / 2.5 / 1.25 / 0.625 ms	
• Basic conversion time, including integration time (ms)			68.03 / 22.83 / 19.03 / 10.28 / 5.23 / 2.68 / 1.43 / 0.730 ms	
• Interference voltage suppression for interference frequency f1 in Hz	16.6 / 50 / 60 Hz	10 / 50 / 60 Hz	16.6 / 50 / 60 / 300 / 600 / 1 200 / 2 400 / 4 800	No
• Conversion time (per channel)	180 / 60 / 50 ms		68.2 / 23 / 19.2 / 10.45 / 5.40 / 2.85 / 1.6 / 0.9 ms	10 µs
• Basic execution time of the module (all channels released)			1 ms	
Smoothing of measured values				
• Number of smoothing levels	4; None; 4/8/16 times	4; None; 4/8/16 times	6; none; 2-/4-/8-/16-/32-fold	7; none; 2-/4-/8-/16-/32-/64-fold
• parameterizable	Yes	Yes	Yes	Yes
Encoder				
Connection of signal encoders				
• for voltage measurement	No	No	Yes	Yes
• for current measurement as 2-wire transducer	Yes	Yes	Yes	Yes
- Burden of 2-wire transmitter, max.	650 Ω		650 Ω	650 Ω
• for current measurement as 4-wire transducer	Yes		Yes	Yes
Errors/accuracies				
Basic error limit (operational limit at 25 °C)				
• Voltage, relative to input range, (+/-)			0.05 %; 0.1 % at SFU 4.8 kHz	0.2 %
• Current, relative to input range, (+/-)	0.3 %	0.3 %	0.05 %; 0.1 % at SFU 4.8 kHz	0.2 %
Interference voltage suppression for f = n x (f1 +/- 1 %), f1 = interference frequency				
• Series mode interference (peak value of interference < rated value of input range), min.	70 dB	60 dB		
• Common mode voltage, max.	10 V		35 V	35 V
• Common mode interference, min.	90 dB		90 dB	90 dB
Isochronous mode				
Filtering and processing time (TCI), min.			800 µs	80 µs
Bus cycle time (TDP), min.			1 ms	125 µs; Starting from firmware Version V2.0.1
Interrupts/diagnostics/status information				
Diagnostics function	Yes	Yes	Yes	
Alarms				
• Diagnostic alarm	Yes	Yes	Yes	Yes
• Limit value alarm	No	Yes	Yes; two upper and two lower limit values in each case	Yes; two upper and two lower limit values in each case

I/O systems

SIMATIC ET 200 systems for the control cabinet
SIMATIC ET 200SP

I/O modules > Analog input modules

Technical specifications

Article number	6ES7134-6GD01-0BA1 ET 200SP, AI 4X1 2-/4-Wire ST, PU 1	6ES7134-6TD00-0CA1 ET 200SP, AI 4X1 2-WIRE 4...20MA HART	6ES7134-6HB00-0CA1 ET 200SP AI 2 X U/I 2-, 4-Wire HF	6ES7134-6HB00-0DA1 ET 200SP AI 2 X U/I 2-, 4-Wire HS
Diagnoses				
• Monitoring the supply voltage	Yes	Yes	Yes	Yes
• Wire-break	Yes; at 4 to 20 mA	Yes; channel by channel	Yes; Measuring range 4 to 20 mA only	Yes; channel-by-channel, at 4 to 20 mA only
• Short-circuit	Yes; 2-wire mode: Short-circuit of the encoder supply to ground or of an input to the encoder supply	Yes; Channel-by-channel, short-circuit of the encoder supply to ground or of an input to the encoder supply	Yes; channel-by-channel, at 1 to 5 V or for short-circuit in encoder supply	Yes; channel-by-channel, at 1 to 5 V or for current measuring ranges short- circuit in encoder supply
• Group error	Yes	Yes	Yes	Yes
• Overflow/underflow	Yes	Yes; channel by channel	Yes	Yes
Diagnostics indication LED				
• Monitoring of the supply voltage (PWR-LED)	Yes; green LED	Yes; green PWR LED	Yes; green PWR LED	Yes; green PWR LED
• Channel status display	Yes; green LED	Yes; green LED	Yes; green LED	Yes; green LED
• for channel diagnostics	No	Yes; red LED	Yes; red LED	Yes; red LED
• for module diagnostics	Yes; green/red LED	Yes; green/red DIAG LED	Yes; green/red DIAG LED	Yes; green/red DIAG LED
Potential separation				
Potential separation channels				
• between the channels and backplane bus	Yes	Yes	Yes	Yes
Ambient conditions				
Ambient temperature during operation				
• horizontal installation, min.	-30 °C; < 0 °C as of FS02	-30 °C	-30 °C; < 0 °C as of FS06	-30 °C
• horizontal installation, max.	60 °C	60 °C	60 °C	60 °C
• vertical installation, min.	-30 °C; < 0 °C as of FS02	-30 °C	-30 °C; < 0 °C as of FS06	-30 °C
• vertical installation, max.	50 °C	50 °C	50 °C	50 °C
Altitude during operation relating to sea level				
• Installation altitude above sea level, max.	5 000 m; Restrictions for installation altitudes > 2 000 m, see manual	5 000 m; restrictions for installation altitudes > 2 000 m, see ET 200SP system manual	5 000 m; Restrictions for installation altitudes > 2 000 m, see manual	5 000 m; Restrictions for installation altitudes > 2 000 m, see manual
Dimensions				
Width	15 mm	15 mm	15 mm	15 mm
Height	73 mm	73 mm	73 mm	73 mm
Depth	58 mm	58 mm	58 mm	58 mm
Weights				
Weight, approx.	31 g	31 g	32 g	32 g
Article number	6ES7134-6JF00-0CA1 ET 200SP, AI 8xRTD/TC 2-Wire HF	6ES7134-6JD00-0CA1 ET 200SP, AI 4xRTD/TC 2-/3-/4-Wire HF	6ES7134-6JD00-0DA1 ET 200SP, AI 4x TC HS	
General information				
Product type designation	AI 8xRTD/TC 2-wire HF	AI 4xRTD/TC 2-/3-/4-wire HF	AI 4xTC HS	
Product function				
• Isochronous mode	No	No	No	
• Measuring range scalable	Yes		Yes	
• Adjustment of measuring range		Yes		
Engineering with				
• STEP 7 TIA Portal configurable/ integrated from version	V16, V17 / V18	V12 SP1 / V13	V15 with HSP 265/integrated as of V15.1	
• STEP 7 configurable/ integrated from version	V5.5 SP3 / V5.5 SP4	V5.5 SP3 / V5.5 SP4	V5.5 SP3 or higher	
• PCS 7 configurable/ integrated from version	V8.1 SP1	V8.1 SP1		
• PROFIBUS from GSD version/ GSD revision	One GSD file each, Revision 3 and 5 and higher	GSD Revision 5	One GSD file each, Revision 3 and 5 and higher	
• PROFINET from GSD version/ GSD revision	GSDML V2.35	GSDML V2.3	GSDML V2.3	

Technical specifications

Article number	6ES7134-6JF00-0CA1 ET 200SP, AI 8xRTD/TC 2-Wire HF	6ES7134-6JD00-0CA1 ET 200SP, AI 4xRTD/TC 2-/3-/4-Wire HF	6ES7134-6JD00-0DA1 ET 200SP, AI 4x TC HS
Operating mode			
• Oversampling	No		No
• MSI	No		Yes
Supply voltage			
Rated value (DC)	24 V	24 V	24 V
Reverse polarity protection	Yes	Yes	Yes
Analog inputs			
Number of analog inputs	8	4	4
permissible input voltage for voltage input (destruction limit), max.	30 V	30 V	30 V
Constant measurement current for resistance-type transmitter, typ.	2 mA	2 mA	
Cycle time (all channels), min.	Sum of the basic conversion times and additional processing times (depending on the parameterization of the active channels)	Sum of the basic conversion times and additional processing times (depending on the parameterization of the active channels); for line compensation in case of a three-wire connection, an additional cycle is necessary	5 ms; Sum of the basic conversion times and additional processing times (depending on the parameterization of the active channels)
Technical unit for temperature measurement adjustable	Yes; °C/°F/K	Yes; °C/°F/K	Yes; °C/°F/K
Input ranges (rated values), voltages			
• -1 V to +1 V	Yes; 16 bit incl. sign	Yes; 16 bit incl. sign	Yes; 16 bit incl. sign
• -250 mV to +250 mV	Yes; 16 bit incl. sign	Yes; 16 bit incl. sign	Yes; 16 bit incl. sign
• -50 mV to +50 mV	Yes; 16 bit incl. sign	Yes; 16 bit incl. sign	Yes; 16 bit incl. sign
• -80 mV to +80 mV	Yes; 16 bit incl. sign	Yes; 16 bit incl. sign	Yes; 16 bit incl. sign
Input ranges (rated values), thermocouples			
• Type B	Yes; 16 bit incl. sign	Yes; 16 bit incl. sign	Yes; 16 bit incl. sign
• Type C	Yes; 16 bit incl. sign	Yes; 16 bit incl. sign	Yes; 16 bit incl. sign
• Type E	Yes; 16 bit incl. sign	Yes; 16 bit incl. sign	Yes; 16 bit incl. sign
• Type J	Yes; 16 bit incl. sign	Yes; 16 bit incl. sign	Yes; 16 bit incl. sign
• Type K	Yes; 16 bit incl. sign	Yes; 16 bit incl. sign	Yes; 16 bit incl. sign
• Type L	Yes; 16 bit incl. sign	Yes; 16 bit incl. sign	Yes; 16 bit incl. sign
• Type N	Yes; 16 bit incl. sign	Yes; 16 bit incl. sign	Yes; 16 bit incl. sign
• Type R	Yes; 16 bit incl. sign	Yes; 16 bit incl. sign	Yes; 16 bit incl. sign
• Type S	Yes; 16 bit incl. sign	Yes; 16 bit incl. sign	Yes; 16 bit incl. sign
• Type T	Yes; 16 bit incl. sign	Yes; 16 bit incl. sign	Yes; 16 bit incl. sign
• Type U	Yes; 16 bit incl. sign	Yes; 16 bit incl. sign	Yes; 16 bit incl. sign
• Type TXK/TXK(L) to GOST	Yes; 16 bit incl. sign	Yes; 16 bit incl. sign	Yes; 16 bit incl. sign
Input ranges (rated values), resistance thermometer			
• Cu 10		Yes; 16 bit incl. sign	
• Ni 100	Yes; 16 bit incl. sign	Yes; 16 bit incl. sign	
• Ni 1000	Yes; 16 bit incl. sign	Yes; 16 bit incl. sign	
• LG-Ni 1000	Yes; 16 bit incl. sign	Yes; 16 bit incl. sign	
• Ni 120	Yes; 16 bit incl. sign	Yes; 16 bit incl. sign	
• Ni 200	Yes; 16 bit incl. sign	Yes; 16 bit incl. sign	
• Ni 500	Yes; 16 bit incl. sign	Yes; 16 bit incl. sign	
• Pt 100	Yes; 16 bit incl. sign	Yes; 16 bit incl. sign	
• Pt 1000	Yes; 16 bit incl. sign	Yes; 16 bit incl. sign	
• Pt 200	Yes; 16 bit incl. sign	Yes; 16 bit incl. sign	
• Pt 500	Yes; 16 bit incl. sign	Yes; 16 bit incl. sign	

I/O systems

SIMATIC ET 200 systems for the control cabinet

SIMATIC ET 200SP

I/O modules > Analog input modules**Technical specifications**

Article number	6ES7134-6JF00-0CA1 ET 200SP, AI 8xRTD/TC 2-Wire HF	6ES7134-6JD00-0CA1 ET 200SP, AI 4xRTD/TC 2-/3-/4-Wire HF	6ES7134-6JD00-0DA1 ET 200SP, AI 4x TC HS
Input ranges (rated values), resistors			
• 0 to 150 ohms	Yes; 15 bit	Yes; 15 bit	
• 0 to 300 ohms	Yes; 15 bit	Yes; 15 bit	
• 0 to 600 ohms	Yes; 15 bit	Yes; 15 bit	
• 0 to 3000 ohms	Yes; 15 bit	Yes; 15 bit	
• 0 to 6000 ohms	Yes; 15 bit	Yes; 15 bit	
• PTC	Yes; 15 bit	Yes; 15 bit	
Thermocouple (TC)			
Temperature compensation			
- parameterizable	Yes	Yes	Yes
Cable length			
• shielded, max.	200 m; 50 m with thermocouples	200 m; 50 m with thermocouples	200 m; 100 m for thermocouples
Analog value generation for the inputs			
Integration and conversion time/resolution per channel			
• Resolution with overrange (bit including sign), max.	16 bit	16 bit	16 bit
• Integration time, parameterizable	Yes	Yes	Yes
• Interference voltage suppression for interference frequency f1 in Hz	16.6 / 50 / 60 Hz	16.6 / 50 / 60 Hz	16.6 / 50 / 60 Hz / off
• Conversion time (per channel)	180 / 60 / 50 / (67.5 / 22.5 / 18.75) ms	180 / 60 / 50 / (67.5 / 22.5 / 18.75) ms	180/60/50/1.25 ms
Smoothing of measured values			
• Number of smoothing levels	4; None; 4/8/16 times	4; None; 4/8/16 times	4; None; 4/8/16 times
• parameterizable	Yes	Yes	Yes
Encoder			
Connection of signal encoders			
• for voltage measurement	Yes	Yes	Yes
• for resistance measurement with two-wire connection	Yes	Yes	
• for resistance measurement with three-wire connection	No	Yes	
• for resistance measurement with four-wire connection	No	Yes	
Errors/accuracies			
Basic error limit (operational limit at 25 °C)			
• Voltage, relative to input range, (+/-)	0.05 %	0.05 %	0.05 %; 0.2 % when SFU OFF
• Resistance, relative to input range, (+/-)	0.05 %	0.05 %	
Interference voltage suppression for $f = n \times (f1 \pm 1 \%)$, $f1 =$ interference frequency			
• Series mode interference (peak value of interference < rated value of input range), min.	70 dB; With conversion time 67.5 / 22.5 / 18.75 ms: 40 dB	70 dB; With conversion time 67.5 / 22.5 / 18.75 ms: 40 dB	70 dB
• Common mode voltage, max.	10 V	10 V	60 V; DC
• Common mode interference, min.	90 dB	90 dB	90 dB
Interrupts/diagnostics/status information			
Diagnostics function			Yes
Alarms			
• Diagnostic alarm	Yes		Yes
• Limit value alarm	Yes; two upper and two lower limit values in each case	Yes; two upper and two lower limit values in each case	Yes; two upper and two lower limit values in each case

Technical specifications

Article number	6ES7134-6JF00-0CA1 ET 200SP, AI 8xRTD/TC 2-Wire HF	6ES7134-6JD00-0CA1 ET 200SP, AI 4xRTD/TC 2-/3-/4-Wire HF	6ES7134-6JD00-0DA1 ET 200SP, AI 4x TC HS
Diagnoses			
• Monitoring the supply voltage	Yes	Yes	Yes
• Wire-break	Yes; channel by channel	Yes; channel by channel	Yes; channel by channel
• Group error	Yes	Yes	Yes
• Overflow/underflow	Yes; channel by channel	Yes; channel by channel	Yes; channel by channel
Diagnostics indication LED			
• Monitoring of the supply voltage (PWR-LED)	Yes; green PWR LED	Yes; green PWR LED	Yes; green PWR LED
• Channel status display	Yes; green LED	Yes; green LED	Yes; green LED
• for channel diagnostics	Yes; red LED	Yes; red LED	Yes; red LED
• for module diagnostics	Yes; green/red DIAG LED	Yes; green/red DIAG LED	Yes; green/red LED
Potential separation			
Potential separation channels			
• between the channels and backplane bus	Yes		Yes
Standards, approvals, certificates			
Suitable for applications according to AMS 2750			Yes; Declaration of Conformity, see online support entry 109757262
Suitable for applications according to CQI-9			Yes; Based on AMS 2750 E
Ambient conditions			
Ambient temperature during operation			
• horizontal installation, min.	-30 °C	-30 °C; < 0 °C as of FS08	-30 °C; < 0 °C as of FS02
• horizontal installation, max.	60 °C	60 °C	60 °C
• vertical installation, min.	-30 °C	-30 °C; < 0 °C as of FS08	-30 °C; < 0 °C as of FS02
• vertical installation, max.	50 °C	50 °C	50 °C
Altitude during operation relating to sea level			
• Installation altitude above sea level, max.	2 000 m; On request: Installation altitudes greater than 2 000 m		5 000 m; Restrictions for installation altitudes > 2 000 m, see manual
Dimensions			
Width	15 mm	15 mm	15 mm
Height	73 mm	73 mm	73 mm
Depth	58 mm	58 mm	58 mm
Weights			
Weight, approx.			33 g

I/O systems

SIMATIC ET 200 systems for the control cabinet
SIMATIC ET 200SP

I/O modules > Analog input modules

Technical specifications

Article number	7MH4134-6LB00-0DA0 ET 200SP AI 2 X SG 4-/6-WIRE HS
General information	
Product type designation	AI 2xSG 4-/6-wire HS
Product function	
• Isochronous mode	Yes
• Measuring range scalable	Yes
• Scalable measured values	No
• Adjustment of measuring range	Yes; $\pm 0.5 \dots 320$ mV/V
Engineering with	
• STEP 7 TIA Portal configurable/ integrated from version	V14 SP1
• STEP 7 configurable/ integrated from version	V5.6
• PROFIBUS from GSD version/ GSD revision	V03.01.105
• PROFINET from GSD version/ GSD revision	GSDML V2.33
Operating mode	
• Oversampling	Yes; 2 channels per module
• MSI	No
Supply voltage	
Rated value (DC)	24 V
Reverse polarity protection	Yes
Analog inputs	
Number of analog inputs	2; Differential inputs
Cycle time (all channels), min.	100 μ s
Analog input with oversampling	Yes
• Values per cycle, max.	14
• Resolution, min.	100 μ s
Input ranges	
• Strain gauges (full bridges)	Yes
Cable length	
• shielded, max.	500 m
Analog value generation for the inputs	
Integration and conversion time/ resolution per channel	
• Resolution with overrange (bit including sign), max.	28 bit; 16 bits with oversampling
• Integration time, parameterizable	Yes
• Interference voltage suppression for interference frequency f_1 in Hz	60 / 50 Hz / no
• Conversion time (per channel)	100 μ s
Smoothing of measured values	
• IIR low-pass filter frequency	0.01 ... 600 Hz
• IIR low-pass filter ordinal number	1 ... 4
• Notch filter frequency	0.1 ... 1 000 Hz
• Notch filter quality	5.00 ... 250.00
• Average value filter	0.1 ... 655.3 ms
Encoder	
Connection of signal encoders	
• For strain gauges (full bridges) with 4-conductor connection	Yes
• For strain gauges (full bridges) with 6-conductor connection	Yes
• Resistance of full bridge, min.	80 Ω
• Resistance of full bridge, max.	5 000 Ω

Article number	7MH4134-6LB00-0DA0 ET 200SP AI 2 X SG 4-/6-WIRE HS
Errors/accuracies	
Temperature coefficient, zero point	$\leq \pm 0.25$ μ V/K
Temperature coefficient, span, 4-wire connection (in relation to end value)	$\leq \pm 5$ ppm/K
Temperature coefficient, span, 6-wire connection (in relation to end value)	$\leq \pm 10$ ppm/K
Basic error limit (operational limit at 25 °C)	
• Voltage, relative to input range, (+/-)	0.05 %; See manual for details
Isochronous mode	
Filtering and processing time (TCI), min.	87 μ s
Bus cycle time (TDP), min.	125 μ s
Interrupts/diagnostics/ status information	
Diagnostics function	Yes
Alarms	
• Diagnostic alarm	Yes
• Limit value alarm	Yes; two upper and two lower limit values in each case
Diagnoses	
• Monitoring the supply voltage	Yes
• Wire-break	Yes
• Short-circuit	Yes
• Group error	Yes
• Overflow/underflow	Yes
Diagnostics indication LED	
• Monitoring of the supply voltage (PWR-LED)	Yes; green PWR LED
• Channel status display	Yes; green LED
• for channel diagnostics	Yes; red LED
• for module diagnostics	Yes; green/red DIAG LED
Potential separation	
Potential separation channels	
• between the channels and backplane bus	Yes
Ambient conditions	
Ambient temperature during operation	
• horizontal installation, min.	-25 °C
• horizontal installation, max.	60 °C
• vertical installation, min.	-25 °C
• vertical installation, max.	50 °C
Altitude during operation relating to sea level	
• Ambient air temperature-barometric pressure-altitude	Tmin ... Tmax at 1 140 hPa ... 795 hPa (-1 000 m ... +2 000 m) // Tmin ... (Tmax - 1 K/100 m) at 795 hPa ... 701 hPa (+2 000 m ... +3 000 m)
Dimensions	
Width	15 mm
Height	73 mm
Depth	58 mm
Weights	
Weight, approx.	45 g

Technical specifications

Article number	6ES7134-6PA01-0BU0 ET 200SP AI Energy Meter CT ST	6ES7134-6PA21-0BU0 ET 200SP AI Energy Meter RC ST	6ES7134-6PA01-0CU0 ET 200SP AI Energy Meter CT HF	6ES7134-6PA21-0CU0 ET 200SP AI Energy Meter RC HF
General information				
Product type designation	AI Energy Meter CT ST	AI Energy Meter RC ST	AI Energy Meter CT HF	AI Energy Meter RC HF
Product function				
• Voltage measurement	Yes	Yes	Yes	Yes
- without voltage transformer	Yes	Yes	Yes	Yes
- with voltage transformer	Yes	Yes	Yes	Yes
• Current measurement	Yes; max. 3 + neutral conductor	Yes; max. 3 + neutral conductor	Yes; Max. 4	Yes; Max. 4
- without current transformer	No	No	No	No
- with current transformer	Yes; 1 A or 5 A current transformer	No	Yes; 1 A or 5 A current transformer	No
- With Rogowski coil	No	Yes	No	Yes
- With current-voltage-converter	No	Yes; 333 mV interface	No	Yes; 333 mV interface
• Energy measurement	Yes	Yes	Yes	Yes
• Frequency measurement	Yes	Yes	Yes	Yes
• Power measurement	Yes	Yes	Yes	Yes
• Active power measurement	Yes	Yes	Yes	Yes
• Reactive power measurement	Yes	Yes	Yes	Yes
• Power factor measurement	Yes	Yes	Yes	Yes
• Active factor measurement	Yes	Yes	Yes	Yes
• Reactive power compensation	Yes	Yes	Yes	Yes
• Line analysis	No	No	Yes	Yes
- Monitoring of instantaneous and half-wave values			Yes	Yes
- THD measurement for current and voltage			Yes	Yes
- Harmonics for current and voltage			Yes	Yes
- Voltage dip (DIP)			Yes	Yes
- Voltage swell			Yes	Yes
• I&M data	Yes; I&M0 to I&M3	Yes; I&M0 to I&M3	Yes; I&M0 to I&M3	Yes; I&M0 to I&M3
• Isochronous mode	No	No	No	No
Engineering with				
• STEP 7 TIA Portal configurable/integrated from version	STEP 7 V16 or higher with HSP	STEP 7 V16 or higher with HSP	STEP 7 V16 or higher with HSP	STEP 7 V16 or higher with HSP
• STEP 7 configurable/integrated from version	Configurable via GSD file	Configurable via GSD file	V5.5 SP3 or higher	V5.5 SP3 or higher
• PROFIBUS from GSD version/GSD revision	One GSD file each, Revision 3 and 5 and higher	One GSD file each, Revision 3 and 5 and higher	One GSD file each, Revision 3 and 5 and higher	One GSD file each, Revision 3 and 5 and higher
• PROFINET from GSD version/GSD revision	V2.3	V2.3	V2.3	V2.3
Operating mode				
• Switching between operating modes in RUN	Yes; For module version 32 I/20 Q, it is possible to dynamically switch between 25 user data variants, 23 of which are pre-defined and 2 of which can be defined by the specific user	Yes; For module version 32 I/20 Q, it is possible to dynamically switch between 25 user data variants, 23 of which are pre-defined and 2 of which can be defined by the specific user	Yes; For module version 32 I/20 Q, it is possible to dynamically switch between 25 user data variants, 23 of which are pre-defined and 2 of which can be defined by the specific user	Yes; For module version 32 I/20 Q, it is possible to dynamically switch between 25 user data variants, 23 of which are pre-defined and 2 of which can be defined by the specific user
• Cyclic measured value access	Yes	Yes	Yes	Yes
• Acyclic measured value access	Yes	Yes	Yes	Yes
• Fixed measured value sets	Yes	Yes	Yes	Yes
• Freely definable measured value sets	Yes; For cyclic and acyclic measured value access	Yes; For cyclic and acyclic measured value access	Yes; For cyclic and acyclic measured value access	Yes; For cyclic and acyclic measured value access
Installation type/mounting				
Mounting position	any	any	any	any
Supply voltage				
Rated value (DC)	24 V	24 V	24 V	24 V

I/O systemsSIMATIC ET 200 systems for the control cabinet
SIMATIC ET 200SP**I/O modules > Analog input modules****Technical specifications**

Article number	6ES7134-6PA01-0BU0 ET 200SP AI Energy Meter CT ST	6ES7134-6PA21-0BU0 ET 200SP AI Energy Meter RC ST	6ES7134-6PA01-0CU0 ET 200SP AI Energy Meter CT HF	6ES7134-6PA21-0CU0 ET 200SP AI Energy Meter RC HF
Analog inputs				
Cycle time (all channels), typ.	50 ms; Time for consistent update of all measured and calculated values (cyclic and acyclic data)	50 ms; Time for consistent update of all measured and calculated values (cyclic and acyclic data)	50 ms; Time for consistent update of all measured and calculated values (cyclic and acyclic data)	50 ms; Time for consistent update of all measured and calculated values (cyclic and acyclic data)
Cable length				
• shielded, max.	200 m	200 m	200 m	200 m
Interrupts/diagnostics/ status information				
Alarms				
• Diagnostic alarm	Yes	Yes	Yes	Yes
• Limit value alarm	Yes	Yes	Yes	Yes
• Hardware interrupt	Yes; Monitoring of up to 16 freely selectable process values (exceeding or undershooting of value)	Yes; Monitoring of up to 16 freely selectable process values (exceeding or undershooting of value)	Yes; Monitoring of up to 16 freely selectable process values (exceeding or undershooting of value)	Yes; Monitoring of up to 16 freely selectable process values (exceeding or undershooting of value)
Diagnoses				
• Line quality			Yes	Yes
• Supply voltage	Yes	Yes	Yes	Yes
• Hardware interrupt lost	Yes	Yes	Yes	Yes
• Parameter assignment error	Yes	Yes	Yes	Yes
• Module fault	Yes	Yes	Yes	Yes
• Channel not available	Yes	Yes	Yes	Yes
• Overflow/underflow	Yes	Yes	Yes	Yes
• Overload current	Yes	Yes	Yes	Yes
Diagnostics indication LED				
• Monitoring of the supply voltage (PWR-LED)	Yes	Yes	Yes	Yes
• Channel status display	Yes; green LED	Yes; green LED	Yes; green LED	Yes; green LED
• for channel diagnostics	Yes; red Fn LED	Yes; red Fn LED	Yes; red Fn LED	Yes; red Fn LED
• for module diagnostics	Yes; green/red DIAG LED	Yes; green/red DIAG LED	Yes; green/red DIAG LED	Yes; green/red DIAG LED
Integrated Functions				
Measuring functions				
• Measuring procedure for voltage measurement	TRMS	TRMS	TRMS	TRMS
• Measuring procedure for current measurement	TRMS	TRMS	TRMS	TRMS
• Type of measured value acquisition	seamless	seamless	seamless	seamless
• Curve shape of voltage	Sinusoidal or distorted	Sinusoidal or distorted	Sinusoidal or distorted	Sinusoidal or distorted
• Buffering of measured variables	Yes	Yes	Yes	Yes
• Parameter length	128 byte	128 byte	128 byte	128 byte
• Bandwidth of measured value acquisition	3.2 kHz; Harmonics: 63 / 50 Hz, 52 / 60 Hz	3.2 kHz; Harmonics: 63 / 50 Hz, 52 / 60 Hz	3.2 kHz; Harmonics: 63 / 50 Hz, 52 / 60 Hz	3.2 kHz; Harmonics: 63 / 50 Hz, 52 / 60 Hz
Measuring range				
- Frequency measurement, min.	40 Hz	40 Hz	40 Hz	40 Hz
- Frequency measurement, max.	70 Hz	70 Hz	70 Hz	70 Hz
Measuring inputs for voltage				
- Measurable line voltage between phase and neutral conductor	277 V	277 V	277 V	277 V
- Measurable line voltage between the line conductors	480 V	480 V	480 V	480 V
- Measurable line voltage between phase and neutral conductor, min.	3 V	3 V	3 V	3 V
- Measurable line voltage between phase and neutral conductor, max.	300 V	300 V	300 V	300 V
- Measurable line voltage between the line conductors, min.	6 V	6 V	6 V	6 V
- Measurable line voltage between the line conductors, max.	519 V	519 V	519 V	519 V

Technical specifications

Article number	6ES7134-6PA01-0BU0 ET 200SP AI Energy Meter CT ST	6ES7134-6PA21-0BU0 ET 200SP AI Energy Meter RC ST	6ES7134-6PA01-0CU0 ET 200SP AI Energy Meter CT HF	6ES7134-6PA21-0CU0 ET 200SP AI Energy Meter RC HF
Measuring inputs for voltage (continued)				
- Internal resistance line conductor and neutral conductor	1.5 MΩ	1.5 MΩ	1.5 MΩ	1.5 MΩ
- Power consumption per phase	60 mW; 300 V AC	60 mW; 300 V AC	60 mW; 300 V AC	60 mW; 300 V AC
- Impulse voltage resistance 1,2/50μs	2.5 kV	2.5 kV	2.5 kV	2.5 kV
- Measurement category for voltage measurement in accordance with IEC 61010-2-030	CAT II		CAT II	
- Overvoltage category		CAT II according to IEC 61010 Part 1		CAT II according to IEC 61010 Part 1
Measuring inputs for current				
- measurable relative current (AC), min.	1 %; Relative to measuring range; 1 A, 5 A		1 %; Relative to measuring range; 1 A, 5 A	
- measurable relative current (AC), max.	100 %; Relative to the secondary rated current 5 A		120 %; Relative to the secondary rated current 5 A	
- Continuous current with AC, maximum permissible	5 A		5 A; 6 A permanent thermal overload	
- Apparent power consumption per phase for measuring range 5 A	0.6 VA		0.6 VA	
- Rated value short-time withstand current restricted to 1 s	100 A		100 A	
- Input resistance measuring range 0 to 5 A	25 mΩ; At the terminal		25 mΩ; At the terminal	
- Surge strength	10 A; for 1 minute		10 A; for 1 minute	
- Zero point suppression	0 ... 20%, referred to the nominal current		0 ... 20%, referred to the nominal current	
Measuring inputs for current (Rog. or I/U converter)				
- Measurable current at AC, max.		424 mV		424 mV
- Continuous voltage, maximum permissible		2 V		2 V
- Rated value, short-time withstand voltage restricted to 1 s		30 V		30 V
- Input resistance		120 kΩ		120 kΩ
- Zero point suppression		Yes; 0 ... 20%, referred to the nominal current		Yes; 0 ... 20%, referred to the nominal current
Accuracy class according to IEC 61557-12				
- Measured variable voltage	0,2	0,2	0,2	0,2
- Measured variable current	0,2	0,2	0,2	0,2
- Measured variable apparent power	0.5	0.5	0.5	0.5
- Measured variable active power	0.5	0.5	0.5	0.5
- Measured variable reactive power	1	1	1	1
- Measured variable power factor	0.5	0.5	0.5	0.5
- Measured variable active energy	0.5	0.5	0.5	0.5
- Measured variable reactive energy	1	1	1	1
- Measured variable neutral current	0,2	0,2	0,2	0,2
- Measured variable phase angle	±0.5 °; not covered by IEC 61557-12	±0.5 °; not covered by IEC 61557-12	±0.5 °; not covered by IEC 61557-12	±0.5 °; not covered by IEC 61557-12
- Measured variable frequency	0.05; only valid for the permissible voltage measuring range	0.05; only valid for the permissible voltage measuring range	0.05; only valid for the permissible voltage measuring range	0.05; only valid for the permissible voltage measuring range
- Measured variable harmonic			1	1
- Measured variable THDU			1	1
- Measured variable THDI			1	1

I/O systems

SIMATIC ET 200 systems for the control cabinet

SIMATIC ET 200SP

I/O modules > Analog input modules**Technical specifications**

Article number	6ES7134-6PA01-0BU0 ET 200SP AI Energy Meter CT ST	6ES7134-6PA21-0BU0 ET 200SP AI Energy Meter RC ST	6ES7134-6PA01-0CU0 ET 200SP AI Energy Meter CT HF	6ES7134-6PA21-0CU0 ET 200SP AI Energy Meter RC HF
Accuracy class line analysis acc. to IEC 61000-4-30				
- Measured variable voltage			Class S	Class S
- Measured variable current			Class S	Class S
- Measured variable frequency			Class S	Class S
- Measured variable voltage interruption			Class S	Class S
- Measured variable voltage dip and swell			Class S	Class S
- Measured variable harmonic voltage			Class S	Class S
- Measured variable harmonic current			Class S	Class S
Potential separation				
Potential separation channels				
• between the channels and backplane bus	Yes	Yes	Yes	Yes
Ambient conditions				
Ambient temperature during operation				
• horizontal installation, min.	-30 °C	-30 °C	-30 °C	-30 °C
• horizontal installation, max.	60 °C	60 °C	60 °C	60 °C
• vertical installation, min.	-30 °C	-30 °C	-30 °C	-30 °C
• vertical installation, max.	50 °C	50 °C	50 °C	50 °C
Altitude during operation relating to sea level				
• Installation altitude above sea level, max.	3 000 m; Restrictions for installation altitudes > 2 000 m, see manual	3 000 m; Restrictions for installation altitudes > 2 000 m, see manual	3 000 m; Restrictions for installation altitudes > 2 000 m, see manual	3 000 m; Restrictions for installation altitudes > 2 000 m, see manual
Dimensions				
Width	20 mm	20 mm	20 mm	20 mm
Height	73 mm	73 mm	73 mm	73 mm
Depth	58 mm	58 mm	58 mm	58 mm
Weights				
Weight, approx.	45 g	45 g	45 g	45 g
Other				
Data for selecting a voltage transformer				
• Secondary side, max.	300 V	300 V	300 V	300 V
Data for selecting a current transformer				
• Burden power current transformer x/1A, min.	As a function of cable length and cross section, see device manual		As a function of cable length and cross section, see device manual	
• Burden power current transformer x/5A, min.	As a function of cable length and cross section, see device manual		As a function of cable length and cross section, see device manual	

Overview



- 2 and 4-channel analog output (AQ) modules
 - Apart from the standard type of delivery in an individual package, selected I/O modules and BaseUnits are also available in a pack of 10 units. The pack of 10 units enables the amount of waste to be reduced considerably, as well as saving the time and cost of unpacking individual modules.
- For different requirements, the analog output modules offer:
- Function classes Standard, High Feature and High-Speed
 - BaseUnits for single or multiple-conductor connection with automatic slot coding
 - Potential distributor modules for system-integrated expansion with potential terminals
 - Individual system-integrated potential group formation with self-assembling voltage busbars (a separate power module is no longer required for ET 200SP)

- Option for connecting current and voltage actuators
- Clear labeling on front of module
- LEDs for diagnostics, status, supply voltage and faults
- Electronically readable and non-volatile writable rating plate (I&M data 0 to 3)
- Extended functions and additional operating modes in some cases
 - Oversampling operating mode (n-fold equidistant output of an analog value within one PN cycle and thus the precisely timed output of an analog value or a sequence of analog values)
 - Isochronous mode (simultaneous equidistant output of analog values)
 - Output of substitute value in the event of interruptions to communication (shutdown, output adjustable substitute value, or keep last value)
 - Calibration during runtime
 - Re-parameterization during operation
 - Firmware update
 - Diagnostics of wire break, short-circuit, overflow, underflow
 - Value status (optional binary validity information of the analog value status in the process image)
 - Supports the PROFlenergy profile
- Optional accessories
 - Labeling strips (film or card)
 - Equipment labeling plate
 - Color-coded label with module-specific CC code
 - Shielding terminal

A quick and clear comparison of the functions of the AQ modules is offered by the TIA Selection Tool.

Overview of analog output modules

Analog output	PU	Article No.	CC code	BU type
AQ 2 x U ST	1	6ES7135-6FB00-0BA1	CC00	A0, A1
AQ 2 x I ST	1	6ES7135-6GB00-0BA1	CC00	A0, A1
AQ 4 x U/I ST	1	6ES7135-6HD00-0BA1	CC00	A0, A1
AQ 2 x U/I HF	1	6ES7135-6HB00-0CA1	CC00	A0, A1
AQ 2xU/I HS	1	6ES7135-6HB00-0DA1	CC00	A0, A1
With two operating modes: • High-speed isochronous AQ • Oversampling				
AQ 4xI HART HF	1	6ES7135-6TD00-0CA1	CC00	A0, A1

I/O systems

SIMATIC ET 200 systems for the control cabinet

SIMATIC ET 200SP

I/O modules > Analog output modules**Overview**

Overview of BaseUnits

BaseUnit	PU	Article No.	CC codes for push-in terminals	CC codes for AUX terminals
BU type A0 • New potential group (light) • 16 push-in terminals • With 10 AUX terminals	1	6ES7193-6BP20-0DA0	CC01 to CC05	CC71 to CC73
BU type A0 • New potential group (light) • 16 push-in terminals • With 10 AUX terminals	10	6ES7193-6BP20-2DA0	CC01 to CC05	CC71 to CC73
BU type A0 • New potential group (light) • 16 push-in terminals • Without AUX terminals	1	6ES7193-6BP00-0DA0	CC01 to CC05	--
BU type A0 • New potential group (light) • 16 push-in terminals • Without AUX terminals	10	6ES7193-6BP00-2DA0	CC01 to CC05	--
BU type A0 • Forwarding of the potential group (dark) • 16 push-in terminals • With 10 AUX terminals	1	6ES7193-6BP20-0BA0	CC01 to CC05	CC71 to CC73
BU type A0 • Forwarding of the potential group (dark) • 16 push-in terminals • With 10 AUX terminals	10	6ES7193-6BP20-2BA0	CC01 to CC05	CC71 to CC73
BU type A0 • Forwarding of the potential group (dark) • 16 push-in terminals • Without AUX terminals	1	6ES7193-6BP00-0BA0	CC01 to CC05	--
BU type A0 • Forwarding of the potential group (dark) • 16 push-in terminals • Without AUX terminals	10	6ES7193-6BP00-2BA0	CC01 to CC05	--
BU type A1 • New potential group (light) • With temperature sensor • 16 push-in terminals • With 2x5 additional terminals	1	6ES7193-6BP40-0DA1	CC01 to CC05	CC74
BU type A1 • New potential group (light) • With temperature sensor • 16 push-in terminals • Without 2x5 additional terminals	1	6ES7193-6BP00-0DA1	CC01 to CC05	--
BU type A1 • Forwarding of the potential group (dark) • With temperature sensor • 16 push-in terminals • With 2x5 additional terminals	1	6ES7193-6BP40-0BA1	CC01 to CC05	CC74
BU type A1 • Forwarding of the potential group (dark) • With temperature sensor • 16 push-in terminals • Without 2x5 additional terminals	1	6ES7193-6BP00-0BA1	CC01 to CC05	--

OverviewOverview of potential distributor modules

Potential distributor module	PU	Article No.	CC codes for push-in terminals
PotDis BU Type P1 (light), 17x P1 potential, 1x P2 potential, for starting a new potential group (max. 10 A)	1	6ES7193-6UP00-0DP1	CC00, CC62
PotDis BU Type P1 (dark), 17x P1 potential, 1x P2 potential, for continuing the potential group	1	6ES7193-6UP00-0BP1	CC00, CC62
PotDis BU Type P2 (light), 1x P1 potential, 17x P2 potential, for starting a new potential group (max. 10 A)	1	6ES7193-6UP00-0DP2	CC00, CC63
PotDis BU Type P2 (dark), 1x P1 potential, 17x P2 potential, for continuing the potential group	1	6ES7193-6UP00-0BP2	CC00, CC63
PotDis TB Type BR-W, 18x internally jumped terminals, without reference to P1, P2 or AUX, (total current max. 10 A)	1	6ES7193-6TP00-0TP0	CC10 to CC13
PotDis TB Type P1-R, 18x P1 potential, (total current max. 10 A)	1	6ES7193-6TP00-0TP1	CC10, CC12
PotDis TB Type P2-B, 18x P2 potential, (total current max. 10 A)	1	6ES7193-6TP00-0TP2	CC10, CC13
PotDis TB Type n.c.-G, 18x n.c. (not connected) terminals, without reference to P1, P2 or AUX	1	6ES7193-6TP00-0TN0	CC10

I/O systemsSIMATIC ET 200 systems for the control cabinet
SIMATIC ET 200SP**I/O modules > Analog output modules****Ordering data****Article No.****Article No.****Analog output modules**

Analog output module
AQ 2xU Standard, BU type A0 or
A1, color code CC00, 16-bit

6ES7135-6FB00-0BA1

Analog output module
AQ 2xI Standard, BU type A0 or A1,
color code CC00, 16-bit

6ES7135-6GB00-0BA1

Analog output module
AQ 4xU/I Standard, BU type A0 or
A1, color code CC00, 16-bit, ± 0.3%

6ES7135-6HD00-0BA1

Analog output module
AQ 2xU/I High Feature,
BU type A0 or A1,
color code CC00, 16-bit, ±0.1%

6ES7135-6HB00-0CA1

Analog output module
AQ 2xU/I High Speed,
BU type A0 or A1,
color code CC00, 16-bit, ± 0.3%

6ES7135-6HB00-0DA1

Analog output module
AQ 4xI HART High Feature,
BU type A0 or A1,
color code CC00, 16-bit, ±0.3%

6ES7135-6TD00-0CA1**Usable type A0 BaseUnits**

Types of delivery:
Apart from the standard type of
delivery in a single-unit package,
selected BaseUnits are also
available in a pack of 10 units.
The pack of 10 units enables the
amount of waste to be reduced
considerably, as well as saving the
time and cost of unpacking
individual modules.

The number of modules required is
the number of modules ordered.
The pack type is selected by
selecting the article number.
Packs of 10 can therefore only be
ordered in integer multiples of 10.

BU15-P16+A10+2D

BU type A0; BaseUnit (light)
with 16 push-in terminals (1 ... 16)
to the module and an additional
10 internally jumpered
AUX terminals (1 A to 10 A);
for starting a new potential group
(max. 10 A)

- Pack of 1 unit
- Pack of 10 units;
to order a pack, please order this
article number with an order
quantity of 10.

6ES7193-6BP20-0DA0
6ES7193-6BP20-2DA0**BU15-P16+A0+2D**

BU type A0; BaseUnit (light)
with 16 push-in terminals to the
module; for starting a new
potential group (max. 10 A)

- Pack of 1 unit
- Pack of 10 units;
to order a pack, please order this
article number with an order
quantity of 10.

6ES7193-6BP00-0DA0
6ES7193-6BP00-2DA0**BU15-P16+A10+2B**

BU type A0; BaseUnit (dark)
with 16 push-in terminals (1 ... 16)
to the module and an additional
10 internally jumpered
AUX terminals (1 A to 10 A);
for continuing the potential group

- Pack of 1 unit
- Pack of 10 units;
to order a pack, please order this
article number with an order
quantity of 10.

6ES7193-6BP20-0BA0
6ES7193-6BP20-2BA0**BU15-P16+A0+2B**

BU type A0; BaseUnit (dark)
with 16 push-in terminals to the
module; for continuing the
potential group

- Pack of 1 unit
- Pack of 10 units;
to order a pack, please order this
article number with an order
quantity of 10.

6ES7193-6BP00-0BA0
6ES7193-6BP00-2BA0**Usable type A1 BaseUnits
(temperature detection)****BU15-P16+A0+12D/T**

BU type A1; BaseUnit (light)
with 16 push-in terminals (1 ... 16)
to the module and 2x5 internally
jumpered additional terminals
(1 B to 5 B and 1 C to 5 C);
for starting a new potential group
(max. 10 A)

6ES7193-6BP40-0DA1**BU15-P16+A0+2D/T**

BU type A1; BaseUnit (light) with
16 push-in terminals to the module;
for starting a new
potential group (max. 10 A)

6ES7193-6BP00-0DA1**BU15-P16+A0+12B/T**

BU type A1; BaseUnit (dark)
with 16 push-in terminals (1 ... 16)
to the module and 2x5 internally
jumpered additional terminals
(1 B to 5 B and 1 C to 5 C);
for continuing the potential group

6ES7193-6BP40-0BA1**BU15-P16+A0+2B/T**

BU type A1; BaseUnit (dark)
with 16 push-in terminals to the
module; for continuing the
potential group

6ES7193-6BP00-0BA1

10

Ordering data	Article No.	Article No.
Potential distributor modules		
PotDis BU		
PotDis BU, Type P1 (light), 17x P1 potential, 1x P2 potential, for starting a new potential group (max. 10 A)	6ES7193-6UP00-ODP1	
PotDis BU, Type P1 (dark), 17x P1 potential, 1x P2 potential, for continuing the potential group	6ES7193-6UP00-OBP1	
PotDis BU, Type P2 (light), 1x P1 potential, 17x P2 potential, for starting a new potential group (max. 10 A)	6ES7193-6UP00-ODP2	
PotDis BU, Type P2 (dark), 1x P1 potential, 17x P2 potential, for continuing the potential group	6ES7193-6UP00-OBP2	
PotDis TB		
PotDis TB, type BR-W, 18x internally jumpered terminals, without reference to P1, P2 or AUX, (total current max. 10 A)	6ES7193-6TP00-0TP0	
PotDis TB, type P1-R, 18x P1 potential, (total current max. 10 A)	6ES7193-6TP00-0TP1	
PotDis TB, type P2-B, 18x P2 potential, (total current max. 10 A)	6ES7193-6TP00-0TP2	
PotDis TB, type n.c.-G, 18x n.c. (not connected) terminals, without reference to P1, P2 or AUX	6ES7193-6TP00-0TN0	
Accessories		
Equipment labeling plate	6ES7193-6LF30-0AW0	
10 sheets of 16 labels, for printing with thermal transfer card printer or plotter		
Labeling strips		
500 labeling strips on roll, light gray, for inscription with thermal transfer roll printer	6ES7193-6LR10-0AA0	
500 labeling strips on roll, yellow, for inscription with thermal transfer roll printer	6ES7193-6LR10-0AG0	
1 000 labeling strips DIN A4, light gray, card, perforated, for inscription with laser printer	6ES7193-6LA10-0AA0	
1 000 labeling strips DIN A4, yellow, card, perforated, for inscription with laser printer	6ES7193-6LA10-0AG0	
BU cover		
For covering empty slots (gaps); 5 units	6ES7133-6CV15-1AM0	
• 15 mm	6ES7133-6CV20-1AM0	
• 20 mm		
		Shield connection
		5 shield supports and 5 shield terminals
		Color-coded labels
		Color code CC00, for 16 push-in terminals, BU type A0, A1, gray (terminals 1 to 8), red (terminals 9 to 16); 10 units
		Color code CC71, for 10 AUX terminals, BU type A0, yellow/green (terminals 1 A to 10 A); 10 units
		Color code CC72, for 10 AUX terminals, BU type A0, red (terminals 1 A to 10 A); 10 units
		Color code CC73, for 10 AUX terminals, BU type A0, blue (terminals 1 A to 10 A); 10 units
		Color code CC74, for 2x5 additional terminals, BU type A1, red (terminals 1B to 5B), blue (terminals 1C to 5C); 10 units
		Color-coded labels for PotDis BU
		Color code CC62, for 16 push-in terminals, PotDis BU type P1, red (terminals 1 to 16); 10 units
		Color code CC63, for 16 push-in terminals, PotDis BU type P2, blue (terminals 1 to 16); 10 units
		Color-coded labels for PotDis TB
		Color code CC10, for 18 push-in terminals, PotDis TB, gray (terminals 1 to 18); 10 units
		Color code CC11, for 18 push-in terminals, PotDis TB, yellow-green (terminals 1 to 18); 10 units
		Color code CC12, for 18 push-in terminals, PotDis TB, type P1 and BR, red (terminals 1 to 18); 10 units
		Color code CC13, for 18 push-in terminals, PotDis TB, type P2 and BR, blue (terminals 1 to 18); 10 units
		Mechanical coding elements
		For automatic coding of I/O modules; spare part. 20 units
		Type A
		Type B
		Type C
		Type D
		6ES7193-6SC00-1AM0
		6ES7193-6CP00-2MA0
		6ES7193-6CP71-2AA0
		6ES7193-6CP72-2AA0
		6ES7193-6CP73-2AA0
		6ES7193-6CP74-2AA0
		6ES7193-6CP62-2MA0
		6ES7193-6CP63-2MA0
		6ES7193-6CP10-2MT0
		6ES7193-6CP11-2MT0
		6ES7193-6CP12-2MT0
		6ES7193-6CP13-2MT0
		6ES7193-6KA00-3AA0
		6ES7193-6KB00-3AA0
		6ES7193-6KC00-3AA0
		6ES7193-6KD00-3AA0

I/O systems

SIMATIC ET 200 systems for the control cabinet
SIMATIC ET 200SP

I/O modules > Analog output modules

Technical specifications

Article number	6ES7135-6FB00-0BA1	6ES7135-6GB00-0BA1	6ES7135-6HD00-0BA1	6ES7135-6HB00-0DA1	6ES7135-6HB00-0CA1
	ET 200SP, AQ 2xU Standard, PU 1	ET 200SP, AQ 2xI Standard, PU 1	ET 200SP, AQ 4xU/I ST	ET 200SP, AQ 2 X U/I High Speed	ET 200SP, AQ 2 X U/I High Feature
General information					
Product type designation	AQ 2xU ST	AQ 2xI ST	AQ 4xU/I ST	AQ 2xU/I HS	AQ 2xU/I HF
Product function					
• Isochronous mode	No	No	No	Yes	Yes
• Output range scalable	No	No	No		
Engineering with					
• STEP 7 TIA Portal configurable/ integrated from version	V13 SP1 / -	V13 SP1 / -	V11 SP2 / V13	V13 SP1	V13 / V13
• STEP 7 configurable/ integrated from version	V5.5 SP3 / -	V5.5 SP3 / -	V5.5 SP3 / -	V5.5 SP3 / -	V5.5 SP3 / -
• PCS 7 configurable/ integrated from version			V8.1 SP1		V8.1 SP1
• PROFIBUS from GSD version/ GSD revision	GSD Revision 5	GSD Revision 5	One GSD file each, Revision 3 and 5 and higher	GSD Revision 5	GSD Revision 5
• PROFINET from GSD version/ GSD revision	GSDML V2.3	GSDML V2.3	GSDML V2.3	GSDML V2.3	GSDML V2.3
Operating mode					
• Oversampling	No	No	No	Yes; 2 channels per module	No
• MSO	No	No	No	No	No
Supply voltage					
Rated value (DC)	24 V	24 V	24 V	24 V	24 V
Reverse polarity protection	Yes	Yes	Yes	Yes	Yes
Analog outputs					
Number of analog outputs	2	2	4	2	2
Cycle time (all channels), min.	1 ms	1 ms	5 ms	125 µs	750 µs
Analog output with oversampling	No	No	No	Yes	
• Values per cycle, max.				16	
• Resolution, min.				45 µs; (2 channels), 35 µs (1 channel)	
Output ranges, voltage					
• 0 to 10 V	Yes; 15 bit		Yes; 15 bit	Yes; 15 bit	Yes; 15 bit
• 1 V to 5 V	Yes; 13 bit		Yes; 13 bit	Yes; 13 bit	Yes; 13 bit
• -5 V to +5 V	Yes; 15 bit incl. sign		Yes; 15 bit incl. sign	Yes; 15 bit incl. sign	Yes; 15 bit incl. sign
• -10 V to +10 V	Yes; 16 bit incl. sign		Yes; 16 bit incl. sign	Yes; 16 bit incl. sign	Yes; 16 bit incl. sign
Output ranges, current					
• 0 to 20 mA		Yes; 15 bit	Yes; 15 bit	Yes; 15 bit	Yes; 15 bit
• -20 mA to +20 mA		Yes; 16 bit incl. sign	Yes; 16 bit incl. sign	Yes; 16 bit incl. sign	Yes; 16 bit incl. sign
• 4 mA to 20 mA		Yes; 14 bit	Yes; 14 bit	Yes; 14 bit	Yes; 14 bit
Connection of actuators					
• for voltage output two-wire connection	Yes		Yes	Yes	Yes
• for voltage output four-wire connection	No		Yes	Yes	Yes
• for current output two-wire connection		Yes	Yes	Yes	Yes
Load impedance (in rated range of output)					
• with voltage outputs, min.	2 kΩ		2 kΩ	2 kΩ	2 kΩ
• with voltage outputs, capacitive load, max.	1 µF		1 µF	1 µF	1 µF
• with current outputs, max.		500 Ω	500 Ω	500 Ω	500 Ω
• with current outputs, inductive load, max.		1 mH	1 mH	1 mH	1 mH
Cable length					
• shielded, max.	200 m	1 000 m	1 000 m; 200 m for voltage output	1 000 m; 200 m for voltage output	1 000 m; 200 m for voltage output

Technical specifications

Article number	6ES7135-6FB00-0BA1	6ES7135-6GB00-0BA1	6ES7135-6HD00-0BA1	6ES7135-6HB00-0DA1	6ES7135-6HB00-0CA1
	ET 200SP, AQ 2xU Standard, PU 1	ET 200SP, AQ 2xI Standard, PU 1	ET 200SP, AQ 4xU/I ST	ET 200SP, AQ 2 X U/I High Speed	ET 200SP, AQ 2 X U/I High Feature
Analog value generation for the outputs					
Integration and conversion time/resolution per channel					
<ul style="list-style-type: none"> Resolution with overrange (bit including sign), max. 	16 bit	16 bit	16 bit	16 bit	16 bit
Settling time					
<ul style="list-style-type: none"> for resistive load for capacitive load 	0.1 ms 1 ms	0.1 ms; Typical value	0.1 ms 1 ms	0.05 ms 0.05 ms; Max. 47 nF and 20 m cable length	0.05 ms 0.05 ms; Max. 47 nF and 20 m cable length
<ul style="list-style-type: none"> for inductive load 		0.5 ms	0.5 ms	0.05 ms	0.05 ms
Errors/accuracies					
Basic error limit (operational limit at 25 °C)					
<ul style="list-style-type: none"> Voltage, relative to output range, (+/-) Current, relative to output range, (+/-) 	0.3 % 0.3 %	0.3 % 0.3 %	0.3 % 0.3 %	0.1 % 0.1 %	0.1 % 0.1 %
Isochronous mode					
Execution and activation time (TCO), min.				70 µs	500 µs
Bus cycle time (TDP), min.				125 µs	750 µs
Interrupts/diagnostics/status information					
Diagnostics function	Yes	Yes	Yes	Yes	Yes
Substitute values connectable	Yes	Yes	Yes	Yes	Yes
Alarms					
<ul style="list-style-type: none"> Diagnostic alarm 	Yes	Yes	Yes	Yes	Yes
Diagnoses					
<ul style="list-style-type: none"> Monitoring the supply voltage Wire-break 	Yes	Yes Yes	Yes Yes	Yes Yes; channel-by-channel, only for output type "current"	Yes Yes; channel-by-channel, only for output type "current"
<ul style="list-style-type: none"> Short-circuit 	Yes		Yes	Yes; channel-by-channel, only for output type "voltage"	Yes; channel-by-channel, only for output type "voltage"
<ul style="list-style-type: none"> Group error Overflow/underflow 	Yes Yes	Yes Yes	Yes Yes	Yes Yes	Yes Yes
Diagnostics indication LED					
<ul style="list-style-type: none"> Monitoring of the supply voltage (PWR-LED) Channel status display for channel diagnostics for module diagnostics 	Yes; green PWR LED Yes; green LED No Yes; green/red DIAG LED	Yes; green PWR LED Yes; green LED No Yes; green/red DIAG LED	Yes; green PWR LED Yes; green LED No Yes; green/red DIAG LED	Yes; green PWR LED Yes; green LED Yes; red LED Yes; green/red DIAG LED	Yes; green PWR LED Yes; green LED Yes; red LED Yes; green/red DIAG LED
Potential separation					
Potential separation channels					
<ul style="list-style-type: none"> between the channels and backplane bus 	Yes	Yes	Yes	Yes	Yes
Ambient conditions					
Ambient temperature during operation					
<ul style="list-style-type: none"> horizontal installation, min. horizontal installation, max. vertical installation, min. vertical installation, max. 	-30 °C; < 0 °C as of FS03 60 °C -30 °C; < 0 °C as of FS03 50 °C	-30 °C; < 0 °C as of FS03 60 °C -30 °C; < 0 °C as of FS03 50 °C	-30 °C; < 0 °C as of FS07 60 °C; Observe derating -30 °C; < 0 °C as of FS07 50 °C; Observe derating	-30 °C; < 0 °C as of FS06 60 °C -30 °C; < 0 °C as of FS06 50 °C	-30 °C; < 0 °C as of FS04 60 °C -30 °C; < 0 °C as of FS04 50 °C

I/O systems

SIMATIC ET 200 systems for the control cabinet
SIMATIC ET 200SP

I/O modules > Analog output modules

Technical specifications

Article number	6ES7135-6FB00-0BA1	6ES7135-6GB00-0BA1	6ES7135-6HD00-0BA1	6ES7135-6HB00-0DA1	6ES7135-6HB00-0CA1
	ET 200SP, AQ 2xU Standard, PU 1	ET 200SP, AQ 2xI Standard, PU 1	ET 200SP, AQ 4xU/I ST	ET 200SP, AQ 2 X U/I High Speed	ET 200SP, AQ 2 X U/I High Feature
Altitude during operation relating to sea level					
• Installation altitude above sea level, max.	5 000 m; Restrictions for installation altitudes > 2 000 m, see manual	5 000 m; Restrictions for installation altitudes > 2 000 m, see manual	5 000 m; Restrictions for installation altitudes > 2 000 m, see manual	5 000 m; Restrictions for installation altitudes > 2 000 m, see manual	5 000 m; Restrictions for installation altitudes > 2 000 m, see manual
Dimensions					
Width	15 mm	15 mm	15 mm	15 mm	15 mm
Height	73 mm	73 mm	73 mm	73 mm	73 mm
Depth	58 mm	58 mm	58 mm	58 mm	58 mm
Weights					
Weight, approx.	31 g	31 g	31 g	31 g	31 g

Article number	6ES7135-6TD00-0CA1
	ET 200SP, AQ 4xI HART HF
General information	
Product type designation	AQ 4xI HART HF
Engineering with	
• STEP 7 TIA Portal configurable/integrated from version	V15 SP1
• STEP 7 configurable/integrated from version	V5.6 and higher
• PCS 7 configurable/integrated from version	V9.0 SP1
• PROFIBUS from GSD version/GSD revision	V04.02.14
• PROFINET from GSD version/GSD revision	GSDML V2.34
Supply voltage	
Rated value (DC)	24 V
Reverse polarity protection	Yes
Analog outputs	
Number of analog outputs	4
Cycle time (all channels), min.	3 ms
Output ranges, current	
• 0 to 20 mA	Yes; 16 bit incl. sign
• -20 mA to +20 mA	No
• 4 mA to 20 mA	Yes; 16 bit incl. sign
Connection of actuators	
• for current output two-wire connection	Yes
Load impedance (in rated range of output)	
• with current outputs, max.	750 Ω
• with current outputs, inductive load, max.	10 mH
Cable length	
• shielded, max.	800 m
Analog value generation for the outputs	
Settling time	
• for resistive load	2 ms; 750 ohm
• for capacitive load	2 ms
• for inductive load	2 ms
Errors/accuracies	
Basic error limit (operational limit at 25 °C)	
• Current, relative to output range, (+/-)	0.1 %

Article number	6ES7135-6TD00-0CA1
	ET 200SP, AQ 4xI HART HF
Protocols	
HART protocol	Yes
Interrupts/diagnostics/status information	
Diagnostics function	Yes
Substitute values connectable	Yes
Alarms	
• Diagnostic alarm	Yes
Diagnoses	
• Monitoring the supply voltage	Yes; Module-wise
• Wire-break	Yes; channel by channel
• Short-circuit	Yes
• Overflow/underflow	Yes; channel by channel
Diagnostics indication LED	
• Monitoring of the supply voltage (PWR-LED)	Yes; green PWR LED
• Channel status display	Yes; green LED
• for channel diagnostics	Yes; red LED
• for module diagnostics	Yes; green/red DIAG LED
Potential separation	
Potential separation channels	
• between the channels and backplane bus	Yes
Ambient conditions	
Ambient temperature during operation	
• horizontal installation, min.	-30 °C
• horizontal installation, max.	60 °C
• vertical installation, min.	-30 °C
• vertical installation, max.	50 °C
Altitude during operation relating to sea level	
• Installation altitude above sea level, max.	5 000 m; restrictions for installation altitudes > 2 000 m, see ET 200SP system manual
Dimensions	
Width	15 mm
Height	73 mm
Depth	58 mm
Weights	
Weight, approx.	31 g

Overview



- 4, 8 and 16-channel digital input (DI) modules

For different requirements, the digital input modules offer:

- Function classes Basic, Standard, High Feature and High Speed as well as fail-safe DI (see "Fail-safe I/O modules")
- BaseUnits for single or multiple-conductor connection with automatic slot coding
- Potential distribution modules for system-integrated expansion with additional potential terminals
- Individual system-integrated load group formation with self-assembling voltage distribution bars (a separate power module is no longer required for ET 200SP)
- Option of connecting sensors compliant with IEC 61131 type 1, 2 or 3 (module-dependent) for rated voltages of up to 24 V DC or 230 V AC
- PNP (sink input) and NPN (sourcing input) versions
- Clear labeling on front of module

- LEDs for diagnostics, status, supply voltage and faults (e.g. wire break/short-circuit)
- Electronically readable and non-volatile writable rating plate (I&M data 0 to 3)
- Extended functions and additional operating modes in some cases
 - MSI operating mode (simultaneous reading of input data from as many as three other controllers)
 - Counting operating mode (multi-channel counter for pulse generators with 32-bits counting width and up to 10 kHz counting frequency)
 - Oversampling operating mode (n-fold equidistant acquisition of digital values within one PN cycle for increasing the time resolution for slow CPU cycles)
 - Parameterizable input delay time
 - Isochronous mode (simultaneous equidistant reading of all input channels)
 - Hardware interrupt pulse stretching
 - Re-parameterization during operation
 - Firmware update
 - Diagnosis of wire break and short-circuit (on channel or module basis)
 - Value status (optional binary validity information of the input signal in the process image)
 - Supports the PROFlenergy profile
- Optional accessories
 - Labeling strips (film or card)
 - Equipment labeling plate
 - Color-coded label with module-specific CC code
 - Shielding terminal

A quick and clear comparison of the functions of the different DI modules is offered by the TIA Selection Tool.

Note:

SIPLUS extreme products are based on SIMATIC standard products. The contents listed here were taken from the respective standard products. SIPLUS extreme-specific information was added.

Ordering data

SIPLUS digital input modules

(Extended temperature range and exposure to environmental substances)

DI 8x24VDC Standard, BU type A0, color code CC01

6AG1131-6BF01-7BA0

DI 8x24VDC Source Input, Basic, BU type A0, color code CC02

6AG1131-6BF61-7AA0

DI 16x24VDC Standard, BU type A0, color code CC00

6AG1131-6BH01-7BA0

DI 8x24VDC High Feature, BU type A0, color code CC01, channel-specific diagnostics, isochronous mode, shared input (MSI)

6AG1131-6BF00-7CA0

DI 4x120VAC-230VAC Standard, BU type B1, color code CC41

6AG1131-6FD01-7BB1

DI 8xNAMUR High Feature, BU type A0, color code CC01

6AG1131-6TF00-7CA0

DI 8x24VAC-48VUC Basic, BU type U0, color code CC20, module diagnostics

6AG1131-6CF00-7AU0

Article No.

Usable SIPLUS BaseUnits

BU15-P16+A0+2D

(Extended temperature range and exposure to environmental substances)

BU type A0; BaseUnit (light) with 16 process terminals to the module; for starting a new load group (max. 10 A)

6AG1193-6BP00-7DA0

BU15-P16+A0+2B

(Extended temperature range and exposure to environmental substances)

BU type A0; BaseUnit (dark) with 16 process terminals to the module; for continuing the load group

6AG1193-6BP00-7BA0

BU15-P16+A10+2D

(Extended temperature range and exposure to environmental substances)

BU type A0; BaseUnit (light) with 16 process terminals (1...16) to the module and an additional 10 internally jumpered AUX terminals (1 A to 10 A); for starting a new load group (max. 10 A)

6AG1193-6BP20-7DA0

I/O systemsSIMATIC ET 200 systems for the control cabinet
SIMATIC ET 200SP**I/O modules > SIPLUS digital inputs**

Ordering data	Article No.	Article No.
BU15-P16+A10+2B (Extended temperature range and exposure to environmental substances) BU type A0; BaseUnit (dark) with 16 process terminals (1...16) to the module and an additional 10 internally jumpered AUX terminals (1 A to 10 A); for continuing the load group	6AG1193-6BP20-7BA0	BU20-P16+A0+2B (Extended temperature range and exposure to environmental substances) BU type U0; BaseUnit (dark) with 16 process terminals to the module; for continuing the load group
BU20-P12+A0+4B (Extended temperature range and exposure to environmental substances) BU type B1; BaseUnit (dark) with 12 push-in terminals to the module; for continuing the load group	6AG1193-6BP20-7BB1	Accessories SIPLUS Mounting Kit ET 200SP Mounting accessories for use with increased mechanical vibration and shock loads.
BU20-P16+A0+2D (Extended temperature range and exposure to environmental substances) BU type U0; BaseUnit (light) with 16 process terminals to the module; for starting a new load group (max. 10 A)	6AG1193-6BP00-7DU0	Other accessories See SIMATIC ET 200SP, digital input modules, page 10/26

Technical specifications

Article number	6AG1131-6BF61-7AA0	6AG1131-6BF01-7BA0	6AG1131-6BH01-7BA0
Based on	6ES7131-6BF61-0AA0 SIPLUS ET 200SP DI 8x24VDC SOURCE BA	6ES7131-6BF01-0BA0 SIPLUS ET 200SP DI 8x24VDC ST	6ES7131-6BH01-0BA0 SIPLUS ET 200SP DI 16x24VDC ST
Ambient conditions			
Ambient temperature during operation			
• horizontal installation, min.	-40 °C; = Tmin (incl. condensation/frost)	-40 °C; = Tmin (incl. condensation/frost)	-40 °C; = Tmin (incl. condensation/frost)
• horizontal installation, max.	70 °C; = Tmax	70 °C; = Tmax	70 °C; = Tmax
Altitude during operation relating to sea level			
• Installation altitude above sea level, max.	5 000 m	5 000 m	5 000 m
• Ambient air temperature-barometric pressure-altitude	Tmin ... Tmax at 1 140 hPa ... 795 hPa (-1 000 m ... +2 000 m) // Tmin ... (Tmax - 10 K) at 795 hPa ... 658 hPa (+2 000 m ... +3 500 m) // Tmin ... (Tmax -20 K) at 658 hPa ... 540 hPa (+3 500 m ... +5 000 m)	Tmin ... Tmax at 1 140 hPa ... 795 hPa (-1 000 m ... +2 000 m) // Tmin ... (Tmax - 10 K) at 795 hPa ... 658 hPa (+2 000 m ... +3 500 m) // Tmin ... (Tmax -20 K) at 658 hPa ... 540 hPa (+3 500 m ... +5 000 m)	Tmin ... Tmax at 1 140 hPa ... 795 hPa (-1 000 m ... +2 000 m) // Tmin ... (Tmax - 10 K) at 795 hPa ... 658 hPa (+2 000 m ... +3 500 m) // Tmin ... (Tmax -20 K) at 658 hPa ... 540 hPa (+3 500 m ... +5 000 m)
Relative humidity			
• With condensation, tested in accordance with IEC 60068-2-38, max.	100 %; incl. condensation / frost permitted (no commissioning under condensation conditions)	100 %; incl. condensation / frost permitted (no commissioning under condensation conditions)	100 %; incl. condensation / frost permitted (no commissioning under condensation conditions)
Resistance			
Coolants and lubricants			
- Resistant to commercially available coolants and lubricants	Yes; Incl. diesel and oil droplets in the air	Yes; Incl. diesel and oil droplets in the air	Yes; Incl. diesel and oil droplets in the air
Use in stationary industrial systems			
- to biologically active substances according to EN 60721-3-3	Yes; Class 3B2 mold, fungus and dry rot spores (with the exception of fauna); Class 3B3 on request	Yes; Class 3B2 mold, fungus and dry rot spores (with the exception of fauna); Class 3B3 on request	Yes; Class 3B2 mold, fungus and dry rot spores (with the exception of fauna); Class 3B3 on request
- to chemically active substances according to EN 60721-3-3	Yes; Class 3C4 (RH < 75 %) incl. salt spray acc. to EN 60068-2-52 (severity degree 3); *	Yes; Class 3C4 (RH < 75 %) incl. salt spray acc. to EN 60068-2-52 (severity degree 3); *	Yes; Class 3C4 (RH < 75 %) incl. salt spray acc. to EN 60068-2-52 (severity degree 3); *
- to mechanically active substances according to EN 60721-3-3	Yes; Class 3S4 incl. sand, dust, *	Yes; Class 3S4 incl. sand, dust, *	Yes; Class 3S4 incl. sand, dust, *
- Against mechanical environmental conditions acc. to EN 60721-3-3	Yes; Class 3M8 using the SIPLUS Mounting Kit ET 200SP (6AG1193-6AA00-0AA0)	Yes; Class 3M8 using the SIPLUS Mounting Kit ET 200SP (6AG1193-6AA00-0AA0)	Yes; Class 3M8 using the SIPLUS Mounting Kit ET 200SP (6AG1193-6AA00-0AA0)

Technical specifications

Article number	6AG1131-6BF61-7AA0	6AG1131-6BF01-7BA0	6AG1131-6BH01-7BA0	
Based on	6ES7131-6BF61-0AA0 SIPLUS ET 200SP DI 8x24VDC SOURCE BA	6ES7131-6BF01-0BA0 SIPLUS ET 200SP DI 8x24VDC ST	6ES7131-6BH01-0BA0 SIPLUS ET 200SP DI 16x24VDC ST	
Use on ships/at sea				
- to biologically active substances according to EN 60721-3-6	Yes; Class 6B2 mold and fungal spores (excluding fauna); Class 6B3 on request	Yes; Class 6B2 mold and fungal spores (excluding fauna); Class 6B3 on request	Yes; Class 6B2 mold and fungal spores (excluding fauna); Class 6B3 on request	
- to chemically active substances according to EN 60721-3-6	Yes; Class 6C3 (RH < 75 %) incl. salt spray acc. to EN 60068-2-52 (severity degree 3); *	Yes; Class 6C3 (RH < 75 %) incl. salt spray acc. to EN 60068-2-52 (severity degree 3); *	Yes; Class 6C3 (RH < 75 %) incl. salt spray acc. to EN 60068-2-52 (severity degree 3); *	
- to mechanically active substances according to EN 60721-3-6	Yes; Class 6S3 incl. sand, dust; *	Yes; Class 6S3 incl. sand, dust; *	Yes; Class 6S3 incl. sand, dust; *	
- Against mechanical environmental conditions acc. to EN 60721-3-6	Yes; Class 6M4 using the SIPLUS Mounting Kit ET 200SP (6AG1193-6AA00-0AA0)	Yes; Class 6M4 using the SIPLUS Mounting Kit ET 200SP (6AG1193-6AA00-0AA0)	Yes; Class 6M4 using the SIPLUS Mounting Kit ET 200SP (6AG1193-6AA00-0AA0)	
Usage in industrial process technology				
- Against chemically active substances acc. to EN 60654-4	Yes; Class 3 (excluding trichlorethylene)	Yes; Class 3 (excluding trichlorethylene)	Yes; Class 3 (excluding trichlorethylene)	
- Environmental conditions for process, measuring and control systems acc. to ANSI/ISA-71.04	Yes; Level GX group A/B (excluding trichlorethylene; harmful gas concentrations up to the limits of EN 60721-3-3 class 3C4 permissible); level LC3 (salt spray) and level LB3 (oil)	Yes; Level GX group A/B (excluding trichlorethylene; harmful gas concentrations up to the limits of EN 60721-3-3 class 3C4 permissible); level LC3 (salt spray) and level LB3 (oil)	Yes; Level GX group A/B (excluding trichlorethylene; harmful gas concentrations up to the limits of EN 60721-3-3 class 3C4 permissible); level LC3 (salt spray) and level LB3 (oil)	
Remark				
- Note regarding classification of environmental conditions acc. to EN 60721, EN 60654-4 and ANSI/ISA-71.04	* The supplied plug covers must remain in place over the unused interfaces during operation!	* The supplied plug covers must remain in place over the unused interfaces during operation!	* The supplied plug covers must remain in place over the unused interfaces during operation!	
Conformal coating				
• Coatings for printed circuit board assemblies acc. to EN 61086	Yes; Class 2 for high reliability	Yes; Class 2 for high reliability	Yes; Class 2 for high reliability	
• Protection against fouling acc. to EN 60664-3	Yes; Type 1 protection	Yes; Type 1 protection	Yes; Type 1 protection	
• Military testing according to MIL-I-46058C, Amendment 7	Yes; Discoloration of coating possible during service life	Yes; Discoloration of coating possible during service life	Yes; Discoloration of coating possible during service life	
• Qualification and Performance of Electrical Insulating Compound for Printed Board Assemblies according to IPC-CC-830A	Yes; Conformal coating, Class A	Yes; Conformal coating, Class A	Yes; Conformal coating, Class A	
Article number	6AG1131-6BF00-7CA0	6AG1131-6FD01-7BB1	6AG1131-6TF00-7CA0	6AG1131-6CF00-7AU0
Based on	6ES7131-6BF00-0CA0 SIPLUS ET 200SP DI 8x24VDC HF	6ES7131-6FD01-0BB1 SIPLUS ET 200SP DI 4X120...230VAC ST	6ES7131-6TF00-0CA0 SIPLUS ET 200SP DI 8XNAMUR HF	6ES7131-6CF00-0AU0 SIPLUS ET 200SP DI 8x48VUC BA
Ambient conditions				
Ambient temperature during operation				
• horizontal installation, min.	-40 °C; = Tmin (incl. condensation/frost)	-40 °C; = Tmin (incl. condensation/frost)	-40 °C; = Tmin (incl. condensation/frost); start-up @ -25 °C	-40 °C; = Tmin (incl. condensation/frost)
• horizontal installation, max.	70 °C; = Tmax; > +60 °C encoder supply output current max. 350 mA per channel	70 °C; = Tmax	70 °C; = Tmax; > +60 °C number of simultaneously controllable inputs max. 4 (no adjacent points)	70 °C; = Tmax
Altitude during operation relating to sea level				
• Installation altitude above sea level, max.	5 000 m	2 000 m	5 000 m	2 000 m
• Ambient air temperature-barometric pressure-altitude	Tmin ... Tmax at 1 140 hPa ... 795 hPa (-1 000 m ... +2 000 m) // Tmin ... (Tmax - 10 K) at 795 hPa ... 658 hPa (+2 000 m ... +3 500 m) // Tmin ... (Tmax -20 K) at 658 hPa ... 540 hPa (+3 500 m ... +5 000 m)	Tmin ... Tmax at 1 140 hPa ... 795 hPa (-1 000 m ... +2 000 m)	Tmin ... Tmax at 1 140 hPa ... 795 hPa (-1 000 m ... +2 000 m) // Tmin ... (Tmax - 10 K) at 795 hPa ... 658 hPa (+2 000 m ... +3 500 m) // Tmin ... (Tmax -20 K) at 658 hPa ... 540 hPa (+3 500 m ... +5 000 m)	Tmin ... Tmax at 1 140 hPa ... 795 hPa (-1 000 m ... +2 000 m)
Relative humidity				
• With condensation, tested in accordance with IEC 60068-2-38, max.	100 %; RH incl. condensation / frost (no commissioning in bedewed state), horizontal installation	100 %; incl. condensation / frost permitted (no commissioning under condensation conditions)	100 %; RH incl. condensation / frost (no commissioning in bedewed state), horizontal installation	100 %; RH incl. condensation / frost (no commissioning in bedewed state), horizontal installation

I/O systemsSIMATIC ET 200 systems for the control cabinet
SIMATIC ET 200SP**I/O modules > SIPLUS digital inputs****Technical specifications**

Article number	6AG1131-6BF00-7CA0	6AG1131-6FD01-7BB1	6AG1131-6TF00-7CA0	6AG1131-6CF00-7AU0
Based on	6ES7131-6BF00-0CA0 SIPLUS ET 200SP DI 8x24VDC HF	6ES7131-6FD01-0BB1 SIPLUS ET 200SP DI 4X120...230VAC ST	6ES7131-6TF00-0CA0 SIPLUS ET 200SP DI 8XNAMUR HF	6ES7131-6CF00-0AU0 SIPLUS ET 200SP DI 8x48VUC BA
Resistance				
Coolants and lubricants				
- Resistant to commercially available coolants and lubricants	Yes; Incl. diesel and oil droplets in the air	Yes; Incl. diesel and oil droplets in the air	Yes; Incl. diesel and oil droplets in the air	Yes; Incl. diesel and oil droplets in the air
Use in stationary industrial systems				
- to biologically active substances according to EN 60721-3-3	Yes; Class 3B2 mold, fungus and dry rot spores (with the exception of fauna); Class 3B3 on request	Yes; Class 3B2 mold, fungus and dry rot spores (with the exception of fauna); Class 3B3 on request	Yes; Class 3B2 mold, fungus and dry rot spores (with the exception of fauna); Class 3B3 on request	Yes; Class 3B2 mold, fungus and dry rot spores (with the exception of fauna); Class 3B3 on request
- to chemically active substances according to EN 60721-3-3	Yes; Class 3C4 (RH < 75 %) incl. salt spray acc. to EN 60068-2-52 (severity degree 3); *	Yes; Class 3C4 (RH < 75 %) incl. salt spray acc. to EN 60068-2-52 (severity degree 3); *	Yes; Class 3C4 (RH < 75 %) incl. salt spray acc. to EN 60068-2-52 (severity degree 3); *	Yes; Class 3C4 (RH < 75 %) incl. salt spray acc. to EN 60068-2-52 (severity degree 3); *
- to mechanically active substances according to EN 60721-3-3	Yes; Class 3S4 incl. sand, dust; *	Yes; Class 3S4 incl. sand, dust; *	Yes; Class 3S4 incl. sand, dust; *	Yes; Class 3S4 incl. sand, dust; *
- Against mechanical environmental conditions acc. to EN 60721-3-3	Yes; Class 3M8 using the SIPLUS Mounting Kit ET 200SP (6AG1193-6AA00-0AA0)	Yes; Class 3M8 using the SIPLUS Mounting Kit ET 200SP (6AG1193-6AA00-0AA0)	Yes; Class 3M8 using the SIPLUS Mounting Kit ET 200SP (6AG1193-6AA00-0AA0)	Yes; Class 3M8 using the SIPLUS Mounting Kit ET 200SP (6AG1193-6AA00-0AA0)
Use on ships/at sea				
- to biologically active substances according to EN 60721-3-6	Yes; Class 6B2 mold and fungal spores (excluding fauna); Class 6B3 on request	Yes; Class 6B2 mold and fungal spores (excluding fauna); Class 6B3 on request	Yes; Class 6B2 mold and fungal spores (excluding fauna); Class 6B3 on request	Yes; Class 6B2 mold, fungal and dry rot spores (excluding fauna)
- to chemically active substances according to EN 60721-3-6	Yes; Class 6C3 (RH < 75 %) incl. salt spray acc. to EN 60068-2-52 (severity degree 3); *	Yes; Class 6C3 (RH < 75 %) incl. salt spray acc. to EN 60068-2-52 (severity degree 3); *	Yes; Class 6C3 (RH < 75 %) incl. salt spray acc. to EN 60068-2-52 (severity degree 3); *	Yes; Class 6C3 (RH < 75 %) incl. salt spray acc. to EN 60068-2-52 (severity degree 3); *
- to mechanically active substances according to EN 60721-3-6	Yes; Class 6S3 incl. sand, dust; *	Yes; Class 6S3 incl. sand, dust; *	Yes; Class 6S3 incl. sand, dust; *	Yes; Class 6S3 incl. sand, dust; *
- Against mechanical environmental conditions acc. to EN 60721-3-6	Yes; Class 6M4 using the SIPLUS Mounting Kit ET 200SP (6AG1193-6AA00-0AA0)	Yes; Class 6M4 using the SIPLUS Mounting Kit ET 200SP (6AG1193-6AA00-0AA0)	Yes; Class 6M4 using the SIPLUS Mounting Kit ET 200SP (6AG1193-6AA00-0AA0)	Yes; Class 6M4 using the SIPLUS Mounting Kit ET 200SP (6AG1193-6AA00-0AA0)
Usage in industrial process technology				
- Against chemically active substances acc. to EN 60654-4	Yes; Class 3 (excluding trichlorethylene)	Yes; Class 3 (excluding trichlorethylene)	Yes; Class 3 (excluding trichlorethylene)	Yes; Class 3 (excluding trichlorethylene)
- Environmental conditions for process, measuring and control systems acc. to ANSI/ISA-71.04	Yes; Level GX group A/B (excluding trichlorethylene; harmful gas concentrations up to the limits of EN 60721-3-3 class 3C4 permissible); level LC3 (salt spray) and level LB3 (oil)	Yes; Level GX group A/B (excluding trichlorethylene; harmful gas concentrations up to the limits of EN 60721-3-3 class 3C4 permissible); level LC3 (salt spray) and level LB3 (oil)	Yes; Level GX group A/B (excluding trichlorethylene; harmful gas concentrations up to the limits of EN 60721-3-3 class 3C4 permissible); level LC3 (salt spray) and level LB3 (oil)	Yes; Level GX group A/B (excluding trichlorethylene; harmful gas concentrations up to the limits of EN 60721-3-3 class 3C4 permissible); level LC3 (salt spray) and level LB3 (oil)
Remark				
- Note regarding classification of environmental conditions acc. to EN 60721, EN 60654-4 and ANSI/ISA-71.04	* The supplied plug covers must remain in place over the unused interfaces during operation!	* The supplied plug covers must remain in place over the unused interfaces during operation!	* The supplied plug covers must remain in place over the unused interfaces during operation!	* The supplied plug covers must remain in place over the unused interfaces during operation!
Conformal coating				
• Coatings for printed circuit board assemblies acc. to EN 61086	Yes; Class 2 for high reliability	Yes; Class 2 for high reliability	Yes; Class 2 for high reliability	Yes; Class 2 for high reliability
• Protection against fouling acc. to EN 60664-3	Yes; Type 1 protection	Yes; Type 1 protection	Yes; Type 1 protection	Yes; Type 1 protection
• Military testing according to MIL-I-46058C, Amendment 7	Yes; Discoloration of coating possible during service life	Yes; Discoloration of coating possible during service life	Yes; Discoloration of coating possible during service life	Yes; Discoloration of coating possible during service life
• Qualification and Performance of Electrical Insulating Compound for Printed Board Assemblies according to IPC-CC-830A	Yes; Conformal coating, Class A	Yes; Conformal coating, Class A	Yes; Conformal coating, Class A	Yes; Conformal coating, Class A

Overview



- 4, 8 and 16-channel DQ modules
- 4-channel RQ modules
- BaseUnits for single conductor or multiple-conductor connection
- Function classes Basic, Standard, High Feature and High-Speed as well as fail-safe DQ and RQ
- Clear labeling on front of module
- LEDs for diagnostics, status and errors
- Individual system-integrated load group formation with self-assembling potential multi-terminal busbars (power module not required for ET 200SP)
- Electronically readable rating plate (I&M data)
- Additional operating modes in some cases
- Optional accessories:
 - Labeling strips
 - Equipment marking label
 - Color-coded label with module-specific CC code
 - Shielding terminal

Overview of digital output modules

Digital output	PU	Article No.	CC code	BU type
DQ 16 x 24 V DC/0.5 A ST	1	6AG1132-6BH01-7BA0	CC00	A0
DQ 8 x 24 V DC/0.5 A SNK BA	1	6AG1132-6BF61-7AA0	CC01	A0
DQ 8 x 24 V DC/0.5 A ST	1	6AG1132-6BF01-7BA0	CC02	A0
DQ 8 x 24 V DC/0.5 A HF	1	6AG1132-6BF00-7CA0	CC02	A0
DQ 4 x 24 V DC/2 A ST	1	6AG1132-6BD20-7BA0	CC02	A0
DQ 4 x 24 V DC/2 A HF	1	6AG1132-6BD20-7CA0	CC02	A0
DQ 4 x 24 ... 230 V AC/2 A HF	1	6AG1132-6FD00-7CU0	CC20	U0
With two operating modes: • DQ • PC: Power control via phase angle, half-wave or full-wave control				
RQ 4 x 24 V UC/2 A CO ST	1	6AG1132-6GD51-7BA0	--	A0
RQ 4 x 120 V DC-230 V AC/5 A NO ST	1	6AG1132-6HD01-7BB1	--	B0, B1

Note:

SIPLUS extreme products are based on SIMATIC standard products. The contents listed here were taken from the corresponding standard products. SIPLUS extreme-specific information was added.

I/O systemsSIMATIC ET 200 systems for the control cabinet
SIMATIC ET 200SP**I/O modules > SIPLUS digital outputs**

Ordering data	Article No.	Article No.	
SIPLUS digital output modules (Extended temperature range and exposure to environmental substances) Digital output module DQ 8x24VDC/0.5A Sink output, Basic, BU type A0, color code CC01 Digital output module DQ 4x24VDC/2A Standard, BU type A0, color code CC02 Digital output module DQ 8x24VDC/0.5A Standard, BU type A0, color code CC02 Digital output module DQ 8x24VDC/0.5A High Feature, BU type A0, color code CC02 Digital output module DQ 16x24VDC/0.5A Standard, BU type A0, color code CC00 Digital output module DQ 4x24VDC/2A High Feature, BU type A0, color code CC02, channel-precise diagnostics, isochronous mode, shared output (MSO); PU: 1 unit Signal relay module RQ CO 4x24VUC/2A Standard, changeover contact, BU type A0, color code CC00 Relay module RQ NO 4x120VDC-230VAC/5A Standard, NO contact, BU type B0, B1 Digital output module DQ 4x24VAC...230VAC/2A High Feature for BU type U0, color code CC20, 2 operating modes: DQ and PC (power control via phase angle, half-wave and full-wave control)	6AG1132-6BF61-7AA0 6AG1132-6BD20-7BA0 6AG1132-6BF01-7BA0 6AG1132-6BF00-7CA0 6AG1132-6BH01-7BA0 6AG1132-6BD20-7CA0 6AG1132-6GD51-7BA0 6AG1132-6HD01-7BB1 6AG1132-6FD00-7CU0	BU15-P16+A10+2B (Extended temperature range and exposure to environmental substances) BU type A0; BaseUnit (dark) with 16 process terminals (1...16) to the module and an additional 10 internally jumpered AUX terminals (1 A to 10 A); for continuing the load group BU15-P16+A0+2B (Extended temperature range and exposure to environmental substances) BU type A0; BaseUnit (dark) with 16 process terminals to the module; for continuing the load group BU20-P12+A4+0B (Extended temperature range and exposure to environmental substances) BU type B0; BaseUnit (dark) with 12 process terminals (1...12) to the module and an additional 4 internally jumpered AUX terminals (1 A to 4 A); for continuing the load group; 1 unit BU20-P12+A0+4B (Extended temperature range and exposure to environmental substances) BU type B1; BaseUnit (dark) with 12 process terminals to the module; for continuing the load group; 1 unit BU20-P16+A0+2D (Extended temperature range and exposure to environmental substances) BU type U0; BaseUnit (light) with 16 process terminals to the module; for starting a new load group (max. 10 A) BU20-P16+A0+2B (Extended temperature range and exposure to environmental substances) BU type U0; BaseUnit (dark) with 16 process terminals to the module; for continuing the load group	6AG1193-6BP20-7BA0 6AG1193-6BP00-7BA0 6AG1193-6BP20-7BB0 6AG1193-6BP20-7BB1 6AG1193-6BP00-7DU0 6AG1193-6BP20-7DA0 6AG1193-6BP00-7BU0 6AG1193-6AA00-0AA0
Usable SIPLUS BaseUnits			
BU15-P16+A10+2D (Extended temperature range and exposure to environmental substances) BU type A0; BaseUnit (light) with 16 process terminals (1...16) to the module and an additional 10 internally jumpered AUX terminals (1 A to 10 A); for starting a new load group (max. 10 A)	6AG1193-6BP20-7DA0		
BU15-P16+A0+2D (Extended temperature range and exposure to environmental substances) BU type A0; BaseUnit (light) with 16 process terminals to the module; for starting a new load group (max. 10 A)	6AG1193-6BP00-7DA0	SIPLUS Mounting Kit ET 200SP Mounting accessories for use with increased mechanical vibration and shock loads. Other accessories See SIMATIC ET 200SP, digital output modules, page 10/37	

Technical specifications

Article number	6AG1132-6BF61-7AA0	6AG1132-6BD20-7BA0	6AG1132-6BF01-7BA0
Based on	6ES7132-6BF61-0AA0 SIPLUS ET 200SP DQ 8x24VDC/0,5A SNK BA	6ES7132-6BD20-0BA0 SIPLUS ET200SP DQ 4x24VDC/2A ST	6ES7132-6BF01-0BA0 SIPLUS ET 200SP DQ 8x24VDC/0,5A ST
Ambient conditions			
Ambient temperature during operation			
<ul style="list-style-type: none"> horizontal installation, min. horizontal installation, max. vertical installation, min. vertical installation, max. 	-40 °C; = Tmin (incl. condensation/frost) 70 °C; = Tmax	-40 °C; = Tmin (incl. condensation/frost) 70 °C; = Tmax; > +60 °C number of simultaneously controllable outputs max. 2x 0.25 A or max. 4x 0.125 A, max. total current 0.5 A -40 °C; = Tmin 50 °C; = Tmax	-40 °C; = Tmin (incl. condensation/frost) 70 °C; = Tmax; > +60 °C max. total current 1.0 A
Altitude during operation relating to sea level			
<ul style="list-style-type: none"> Installation altitude above sea level, max. Ambient air temperature-barometric pressure-altitude 	5 000 m Tmin ... Tmax at 1 140 hPa ... 795 hPa (-1 000 m ... +2 000 m) // Tmin ... (Tmax - 10 K) at 795 hPa ... 658 hPa (+2 000 m ... +3 500 m) // Tmin ... (Tmax -20 K) at 658 hPa ... 540 hPa (+3 500 m ... +5 000 m)	5 000 m Tmin ... Tmax at 1 140 hPa ... 795 hPa (-1 000 m ... +2 000 m) // Tmin ... (Tmax - 10 K) at 795 hPa ... 658 hPa (+2 000 m ... +3 500 m) // Tmin ... (Tmax -20 K) at 658 hPa ... 540 hPa (+3 500 m ... +5 000 m)	5 000 m Tmin ... Tmax at 1 140 hPa ... 795 hPa (-1 000 m ... +2 000 m) // Tmin ... (Tmax - 10 K) at 795 hPa ... 658 hPa (+2 000 m ... +3 500 m) // Tmin ... (Tmax -20 K) at 658 hPa ... 540 hPa (+3 500 m ... +5 000 m)
Relative humidity			
<ul style="list-style-type: none"> With condensation, tested in accordance with IEC 60068-2-38, max. 	100 %; incl. condensation / frost permitted (no commissioning under condensation conditions)	100 %; RH incl. condensation / frost (no commissioning in bedewed state), horizontal installation	100 %; incl. condensation / frost permitted (no commissioning under condensation conditions)
Resistance			
Coolants and lubricants			
<ul style="list-style-type: none"> Resistant to commercially available coolants and lubricants 	Yes; Incl. diesel and oil droplets in the air	Yes; Incl. diesel and oil droplets in the air	Yes; Incl. diesel and oil droplets in the air
Use in stationary industrial systems			
<ul style="list-style-type: none"> to biologically active substances according to EN 60721-3-3 to chemically active substances according to EN 60721-3-3 to mechanically active substances according to EN 60721-3-3 Against mechanical environmental conditions acc. to EN 60721-3-3 	Yes; Class 3B2 mold, fungus and dry rot spores (with the exception of fauna); Class 3B3 on request Yes; Class 3C4 (RH < 75 %) incl. salt spray acc. to EN 60068-2-52 (severity degree 3); * Yes; Class 3S4 incl. sand, dust, * Yes; Class 3M8 using the SIPLUS Mounting Kit ET 200SP (6AG1193-6AA00-0AA0)	Yes; Class 3B2 mold, fungus and dry rot spores (with the exception of fauna); Class 3B3 on request Yes; Class 3C4 (RH < 75 %) incl. salt spray acc. to EN 60068-2-52 (severity degree 3); * Yes; Class 3S4 incl. sand, dust, * Yes; Class 3M8 using the SIPLUS Mounting Kit ET 200SP (6AG1193-6AA00-0AA0)	Yes; Class 3B2 mold, fungus and dry rot spores (with the exception of fauna); Class 3B3 on request Yes; Class 3C4 (RH < 75 %) incl. salt spray acc. to EN 60068-2-52 (severity degree 3); * Yes; Class 3S4 incl. sand, dust, * Yes; Class 3M8 using the SIPLUS Mounting Kit ET 200SP (6AG1193-6AA00-0AA0)
Use on ships/at sea			
<ul style="list-style-type: none"> to biologically active substances according to EN 60721-3-6 to chemically active substances according to EN 60721-3-6 to mechanically active substances according to EN 60721-3-6 Against mechanical environmental conditions acc. to EN 60721-3-6 	Yes; Class 6B2 mold and fungal spores (excluding fauna); Class 6B3 on request Yes; Class 6C3 (RH < 75 %) incl. salt spray acc. to EN 60068-2-52 (severity degree 3); * Yes; Class 6S3 incl. sand, dust, * Yes; Class 6M4 using the SIPLUS Mounting Kit ET 200SP (6AG1193-6AA00-0AA0)	Yes; Class 6B2 mold and fungal spores (excluding fauna); Class 6B3 on request Yes; Class 6C3 (RH < 75 %) incl. salt spray acc. to EN 60068-2-52 (severity degree 3); * Yes; Class 6S3 incl. sand, dust, * Yes; Class 6M4 using the SIPLUS Mounting Kit ET 200SP (6AG1193-6AA00-0AA0)	Yes; Class 6B2 mold and fungal spores (excluding fauna); Class 6B3 on request Yes; Class 6C3 (RH < 75 %) incl. salt spray acc. to EN 60068-2-52 (severity degree 3); * Yes; Class 6S3 incl. sand, dust, * Yes; Class 6M4 using the SIPLUS Mounting Kit ET 200SP (6AG1193-6AA00-0AA0)
Usage in industrial process technology			
<ul style="list-style-type: none"> Against chemically active substances acc. to EN 60654-4 Environmental conditions for process, measuring and control systems acc. to ANSI/ISA-71.04 	Yes; Class 3 (excluding trichlorethylene) Yes; Level GX group A/B (excluding trichlorethylene; harmful gas concentrations up to the limits of EN 60721-3-3 class 3C4 permissible); level LC3 (salt spray) and level LB3 (oil)	Yes; Class 3 (excluding trichlorethylene) Yes; Level GX group A/B (excluding trichlorethylene; harmful gas concentrations up to the limits of EN 60721-3-3 class 3C4 permissible); level LC3 (salt spray) and level LB3 (oil)	Yes; Class 3 (excluding trichlorethylene) Yes; Level GX group A/B (excluding trichlorethylene; harmful gas concentrations up to the limits of EN 60721-3-3 class 3C4 permissible); level LC3 (salt spray) and level LB3 (oil)
Remark			
<ul style="list-style-type: none"> Note regarding classification of environmental conditions acc. to EN 60721, EN 60654-4 and ANSI/ISA-71.04 	* The supplied plug covers must remain in place over the unused interfaces during operation!	* The supplied plug covers must remain in place over the unused interfaces during operation!	* The supplied plug covers must remain in place over the unused interfaces during operation!

I/O systemsSIMATIC ET 200 systems for the control cabinet
SIMATIC ET 200SP**I/O modules > SIPLUS digital outputs****Technical specifications**

Article number	6AG1132-6BF61-7AA0	6AG1132-6BD20-7BA0	6AG1132-6BF01-7BA0
Based on	6ES7132-6BF61-0AA0 SIPLUS ET 200SP DQ 8x24VDC/0,5A SNK BA	6ES7132-6BD20-0BA0 SIPLUS ET200SP DQ 4x24VDC/2A ST	6ES7132-6BF01-0BA0 SIPLUS ET 200SP DQ 8x24VDC/0,5A ST
Conformal coating			
<ul style="list-style-type: none"> Coatings for printed circuit board assemblies acc. to EN 61086 Protection against fouling acc. to EN 60664-3 Military testing according to MIL-I-46058C, Amendment 7 Qualification and Performance of Electrical Insulating Compound for Printed Board Assemblies according to IPC-CC-830A 	<ul style="list-style-type: none"> Yes; Class 2 for high reliability Yes; Type 1 protection Yes; Discoloration of coating possible during service life Yes; Conformal coating, Class A 	<ul style="list-style-type: none"> Yes; Class 2 for high reliability Yes; Type 1 protection Yes; Discoloration of coating possible during service life Yes; Conformal coating, Class A 	<ul style="list-style-type: none"> Yes; Class 2 for high reliability Yes; Type 1 protection Yes; Discoloration of coating possible during service life Yes; Conformal coating, Class A
Article number	6AG1132-6BH01-7BA0	6AG1132-6BF00-7CA0	6AG1132-6GD51-7BA0
Based on	6ES7132-6BH01-0BA0 SIPLUS ET 200SP DQ 16x24VDC/0,5A ST	6ES7132-6BF00-0CA0 SIPLUS ET 200SP DQ 8X24VDC/0,5A HF	6ES7132-6GD51-0BA0 SIPLUS ET 200SP RQ 4x24VDC/2A CO ST
Ambient conditions			
Ambient temperature during operation			
<ul style="list-style-type: none"> horizontal installation, min. horizontal installation, max. vertical installation, min. vertical installation, max. 	<ul style="list-style-type: none"> -40 °C; = Tmin (incl. condensation/frost) 70 °C; = Tmax; see Derating BasedOn (e.g. manual), additionally Tmax > 60 °C max. total current 1 A 	<ul style="list-style-type: none"> -40 °C; = Tmin (incl. condensation/frost) 70 °C; = Tmax; > +60 °C max. total current 1.0 A -40 °C; = Tmin 50 °C; = Tmax 	<ul style="list-style-type: none"> -40 °C; = Tmin (incl. condensation/frost) 70 °C; = Tmax; see Derating BasedOn (e.g. manual), additionally Tmax > 60 °C max. aggregate current 2 A per group
Altitude during operation relating to sea level			
<ul style="list-style-type: none"> Installation altitude above sea level, max. Ambient air temperature-barometric pressure-altitude 	<ul style="list-style-type: none"> 5 000 m Tmin ... Tmax at 1 140 hPa ... 795 hPa (-1 000 m ... +2 000 m) // Tmin ... (Tmax - 10 K) at 795 hPa ... 658 hPa (+2 000 m ... +3 500 m) // Tmin ... (Tmax -20 K) at 658 hPa ... 540 hPa (+3 500 m ... +5 000 m) 	<ul style="list-style-type: none"> 5 000 m Tmin ... Tmax at 1 140 hPa ... 795 hPa (-1 000 m ... +2 000 m) // Tmin ... (Tmax - 10 K) at 795 hPa ... 658 hPa (+2 000 m ... +3 500 m) // Tmin ... (Tmax -20 K) at 658 hPa ... 540 hPa (+3 500 m ... +5 000 m) 	<ul style="list-style-type: none"> 5 000 m Tmin ... Tmax at 1 140 hPa ... 795 hPa (-1 000 m ... +2 000 m) // Tmin ... (Tmax - 10 K) at 795 hPa ... 658 hPa (+2 000 m ... +3 500 m) // Tmin ... (Tmax -20 K) at 658 hPa ... 540 hPa (+3 500 m ... +5 000 m)
Relative humidity			
<ul style="list-style-type: none"> With condensation, tested in accordance with IEC 60068-2-38, max. 	100 %; incl. condensation / frost permitted (no commissioning under condensation conditions)	100 %; RH incl. condensation / frost (no commissioning in bedewed state), horizontal installation	100 %; incl. condensation / frost permitted (no commissioning under condensation conditions)
Resistance			
Coolants and lubricants			
<ul style="list-style-type: none"> Resistant to commercially available coolants and lubricants 	Yes; Incl. diesel and oil droplets in the air	Yes; Incl. diesel and oil droplets in the air	Yes; Incl. diesel and oil droplets in the air
Use in stationary industrial systems			
<ul style="list-style-type: none"> to biologically active substances according to EN 60721-3-3 to chemically active substances according to EN 60721-3-3 to mechanically active substances according to EN 60721-3-3 Against mechanical environmental conditions acc. to EN 60721-3-3 	<ul style="list-style-type: none"> Yes; Class 3B2 mold, fungus and dry rot spores (with the exception of fauna); Class 3B3 on request Yes; Class 3C4 (RH < 75 %) incl. salt spray acc. to EN 60068-2-52 (severity degree 3); * Yes; Class 3S4 incl. sand, dust, * Yes; Class 3M8 using the SIPLUS Mounting Kit ET 200SP (6AG1193-6AA00-0AA0) 	<ul style="list-style-type: none"> Yes; Class 3B2 mold, fungus and dry rot spores (with the exception of fauna); Class 3B3 on request Yes; Class 3C4 (RH < 75 %) incl. salt spray acc. to EN 60068-2-52 (severity degree 3); * Yes; Class 3S4 incl. sand, dust, * Yes; Class 3M8 using the SIPLUS Mounting Kit ET 200SP (6AG1193-6AA00-0AA0) 	<ul style="list-style-type: none"> Yes; Class 3B2 mold, fungus and dry rot spores (with the exception of fauna) Yes; Class 3C4 (RH < 75 %) incl. salt spray acc. to EN 60068-2-52 (severity degree 3); * Yes; Class 3S4 incl. sand, dust, * Yes; Class 3M8 using the SIPLUS Mounting Kit ET 200SP (6AG1193-6AA00-0AA0)
Use on ships/at sea			
<ul style="list-style-type: none"> to biologically active substances according to EN 60721-3-6 to chemically active substances according to EN 60721-3-6 to mechanically active substances according to EN 60721-3-6 Against mechanical environmental conditions acc. to EN 60721-3-6 	<ul style="list-style-type: none"> Yes; Class 6B2 mold and fungal spores (excluding fauna); Class 6B3 on request Yes; Class 6C3 (RH < 75 %) incl. salt spray acc. to EN 60068-2-52 (severity degree 3); * Yes; Class 6S3 incl. sand, dust; * Yes; Class 6M4 using the SIPLUS Mounting Kit ET 200SP (6AG1193-6AA00-0AA0) 	<ul style="list-style-type: none"> Yes; Class 6B2 mold and fungal spores (excluding fauna); Class 6B3 on request Yes; Class 6C3 (RH < 75 %) incl. salt spray acc. to EN 60068-2-52 (severity degree 3); * Yes; Class 6S3 incl. sand, dust; * Yes; Class 6M4 using the SIPLUS Mounting Kit ET 200SP (6AG1193-6AA00-0AA0) 	<ul style="list-style-type: none"> Yes; Class 6B2 mold and fungal spores (excluding fauna); Class 6B3 on request Yes; Class 6C3 (RH < 75 %) incl. salt spray acc. to EN 60068-2-52 (severity degree 3); * Yes; Class 6S3 incl. sand, dust; * Yes; Class 6M4 using the SIPLUS Mounting Kit ET 200SP (6AG1193-6AA00-0AA0)

Technical specifications

Article number	6AG1132-6BH01-7BA0	6AG1132-6BF00-7CA0	6AG1132-6GD51-7BA0
Based on	6ES7132-6BH01-0BA0 SIPLUS ET 200SP DQ 16x24VDC/0,5A ST	6ES7132-6BF00-0CA0 SIPLUS ET 200SP DQ 8x24VDC/0,5A HF	6ES7132-6GD51-0BA0 SIPLUS ET 200SP RQ 4x24VDC/2A CO ST
Usage in industrial process technology			
<ul style="list-style-type: none"> - Against chemically active substances acc. to EN 60654-4 - Environmental conditions for process, measuring and control systems acc. to ANSI/ISA-71.04 	Yes; Class 3 (excluding trichlorethylene) Yes; Level GX group A/B (excluding trichlorethylene; harmful gas concentrations up to the limits of EN 60721-3-3 class 3C4 permissible); level LC3 (salt spray) and level LB3 (oil)	Yes; Class 3 (excluding trichlorethylene) Yes; Level GX group A/B (excluding trichlorethylene; harmful gas concentrations up to the limits of EN 60721-3-3 class 3C4 permissible); level LC3 (salt spray) and level LB3 (oil)	Yes; Class 3 (excluding trichlorethylene) Yes; Level GX group A/B (excluding trichlorethylene; harmful gas concentrations up to the limits of EN 60721-3-3 class 3C4 permissible); level LC3 (salt spray) and level LB3 (oil)
Remark			
<ul style="list-style-type: none"> - Note regarding classification of environmental conditions acc. to EN 60721, EN 60654-4 and ANSI/ISA-71.04 	* The supplied plug covers must remain in place over the unused interfaces during operation!	* The supplied plug covers must remain in place over the unused interfaces during operation!	* The supplied plug covers must remain in place over the unused interfaces during operation!
Conformal coating			
<ul style="list-style-type: none"> • Coatings for printed circuit board assemblies acc. to EN 61086 • Protection against fouling acc. to EN 60664-3 • Military testing according to MIL-I-46058C, Amendment 7 • Qualification and Performance of Electrical Insulating Compound for Printed Board Assemblies according to IPC-CC-830A 	Yes; Class 2 for high reliability Yes; Type 1 protection Yes; Discoloration of coating possible during service life Yes; Conformal coating, Class A	Yes; Class 2 for high reliability Yes; Type 1 protection Yes; Discoloration of coating possible during service life Yes; Conformal coating, Class A	Yes; Class 2 for high reliability Yes; Type 1 protection Yes; Discoloration of coating possible during service life Yes; Conformal coating, Class A
Article number	6AG1132-6HD01-7BB1	6AG1132-6BD20-7CA0	6AG1132-6FD00-7CU0
Based on	6ES7132-6HD01-0BB1 SIPLUS ET 200SP RQ 4x120VDC/230VAC/5A	6ES7132-6BD20-0CA0 SIPLUS ET 200SP DQ 4X24VDC/2A HF	6ES7132-6FD00-0CU0 SIPLUS ET 200SP DQ 4X24VDC/2A HF
Ambient conditions			
Ambient temperature during operation			
<ul style="list-style-type: none"> • horizontal installation, min. • horizontal installation, max. • vertical installation, min. • vertical installation, max. 	-40 °C; = Tmin (incl. condensation/frost) 70 °C; = Tmax; see Derating BasedOn (e.g. manual), additionally Tmax > 60 °C max. continuous current of 3 A per relay -40 °C; in all other mounting positions 50 °C; in all other mounting positions	-40 °C; = Tmin (incl. condensation/frost) 70 °C; = Tmax; see Derating BasedOn (e.g. manual), additionally Tmax > 60 °C max. total current 1 A	-40 °C; = Tmin (incl. condensation/frost) 70 °C; = Tmax
Altitude during operation relating to sea level			
<ul style="list-style-type: none"> • Installation altitude above sea level, max. • Ambient air temperature-barometric pressure-altitude 	3 000 m Tmin ... Tmax at 1 140 hPa ... 795 hPa (-1 000 m ... +2 000 m) // Tmin ... (Tmax - 1 K/100 m) at 795 hPa ... 701 hPa (+2 000 m ... +3 000 m)	5 000 m Tmin ... Tmax at 1 140 hPa ... 795 hPa (-1 000 m ... +2 000 m) // Tmin ... (Tmax - 10 K) at 795 hPa ... 658 hPa (+2 000 m ... +3 500 m) // Tmin ... (Tmax -20 K) at 658 hPa ... 540 hPa (+3 500 m ... +5 000 m)	2 000 m Tmin ... Tmax at 1 140 hPa ... 795 hPa (-1 000 m ... +2 000 m)
Relative humidity			
<ul style="list-style-type: none"> • With condensation, tested in accordance with IEC 60068-2-38, max. 	100 %; incl. condensation / frost permitted (no commissioning under condensation conditions)	100 %; RH incl. condensation / frost (no commissioning in bedewed state), horizontal installation	100 %; RH incl. condensation / frost (no commissioning in bedewed state), horizontal installation
Resistance			
Coolants and lubricants			
<ul style="list-style-type: none"> - Resistant to commercially available coolants and lubricants 	Yes; Incl. diesel and oil droplets in the air	Yes; Incl. diesel and oil droplets in the air	Yes; Incl. diesel and oil droplets in the air

I/O systemsSIMATIC ET 200 systems for the control cabinet
SIMATIC ET 200SP**I/O modules > SIPLUS digital outputs****Technical specifications**

Article number	6AG1132-6HD01-7BB1	6AG1132-6BD20-7CA0	6AG1132-6FD00-7CU0
Based on	6ES7132-6HD01-0BB1 SIPLUS ET 200SP RQ 4x120VDC/230VAC/5A	6ES7132-6BD20-0CA0 SIPLUS ET 200SP DQ 4X24VDC/2A HF	6ES7132-6FD00-0CU0 SIPLUS ET 200SP DQ 4X24..230VAC/2A HF
Use in stationary industrial systems			
- to biologically active substances according to EN 60721-3-3	Yes; Class 3B2 mold, fungus and dry rot spores (with the exception of fauna); Class 3B3 on request	Yes; Class 3B2 mold, fungus and dry rot spores (with the exception of fauna); Class 3B3 on request	Yes; Class 3B2 mold, fungus and dry rot spores (with the exception of fauna); Class 3B3 on request
- to chemically active substances according to EN 60721-3-3	Yes; Class 3C4 (RH < 75 %) incl. salt spray acc. to EN 60068-2-52 (severity degree 3); *	Yes; Class 3C4 (RH < 75 %) incl. salt spray acc. to EN 60068-2-52 (severity degree 3); *	Yes; Class 3C4 (RH < 75 %) incl. salt spray acc. to EN 60068-2-52 (severity degree 3); *
- to mechanically active substances according to EN 60721-3-3	Yes; Class 3S4 incl. sand, dust, *	Yes; Class 3S4 incl. sand, dust, *	Yes; Class 3S4 incl. sand, dust, *
- Against mechanical environmental conditions acc. to EN 60721-3-3	Yes; Class 3M8 using the SIPLUS Mounting Kit ET 200SP (6AG1193-6AA00-0AA0)	Yes; Class 3M8 using the SIPLUS Mounting Kit ET 200SP (6AG1193-6AA00-0AA0)	Yes; Class 3M8 using the SIPLUS Mounting Kit ET 200SP (6AG1193-6AA00-0AA0)
Use on ships/at sea			
- to biologically active substances according to EN 60721-3-6	Yes; Class 6B2 mold and fungal spores (excluding fauna); Class 6B3 on request	Yes; Class 6B2 mold and fungal spores (excluding fauna); Class 6B3 on request	Yes; Class 6B2 mold, fungal and dry rot spores (excluding fauna)
- to chemically active substances according to EN 60721-3-6	Yes; Class 6C3 (RH < 75 %) incl. salt spray acc. to EN 60068-2-52 (severity degree 3); *	Yes; Class 6C3 (RH < 75 %) incl. salt spray acc. to EN 60068-2-52 (severity degree 3); *	Yes; Class 6C3 (RH < 75 %) incl. salt spray acc. to EN 60068-2-52 (severity degree 3); *
- to mechanically active substances according to EN 60721-3-6	Yes; Class 6S3 incl. sand, dust; *	Yes; Class 6S3 incl. sand, dust; *	Yes; Class 6S3 incl. sand, dust; *
- Against mechanical environmental conditions acc. to EN 60721-3-6	Yes; Class 6M4 using the SIPLUS Mounting Kit ET 200SP (6AG1193-6AA00-0AA0)	Yes; Class 6M4 using the SIPLUS Mounting Kit ET 200SP (6AG1193-6AA00-0AA0)	Yes; Class 6M4 using the SIPLUS Mounting Kit ET 200SP (6AG1193-6AA00-0AA0)
Usage in industrial process technology			
- Against chemically active substances acc. to EN 60654-4	Yes; Class 3 (excluding trichlorethylene)	Yes; Class 3 (excluding trichlorethylene)	Yes; Class 3 (excluding trichlorethylene)
- Environmental conditions for process, measuring and control systems acc. to ANSI/ISA-71.04	Yes; Level GX group A/B (excluding trichlorethylene; harmful gas concentrations up to the limits of EN 60721-3-3 class 3C4 permissible); level LC3 (salt spray) and level LB3 (oil)	Yes; Level GX group A/B (excluding trichlorethylene; harmful gas concentrations up to the limits of EN 60721-3-3 class 3C4 permissible); level LC3 (salt spray) and level LB3 (oil)	Yes; Level GX group A/B (excluding trichlorethylene; harmful gas concentrations up to the limits of EN 60721-3-3 class 3C4 permissible); level LC3 (salt spray) and level LB3 (oil)
Remark			
- Note regarding classification of environmental conditions acc. to EN 60721, EN 60654-4 and ANSI/ISA-71.04	* The supplied plug covers must remain in place over the unused interfaces during operation!	* The supplied plug covers must remain in place over the unused interfaces during operation!	* The supplied plug covers must remain in place over the unused interfaces during operation!
Conformal coating			
• Coatings for printed circuit board assemblies acc. to EN 61086	Yes; Class 2 for high reliability	Yes; Class 2 for high reliability	Yes; Class 2 for high reliability
• Protection against fouling acc. to EN 60664-3	Yes; Type 1 protection	Yes; Type 1 protection	Yes; Type 1 protection
• Military testing according to MIL-I-46058C, Amendment 7	Yes; Discoloration of coating possible during service life	Yes; Discoloration of coating possible during service life	Yes; Discoloration of coating possible during service life
• Qualification and Performance of Electrical Insulating Compound for Printed Board Assemblies according to IPC-CC-830A	Yes; Conformal coating, Class A	Yes; Conformal coating, Class A	Yes; Conformal coating, Class A

Overview



- 2, 4 and 8-channel AI modules
- Measuring ranges for current, voltage, thermocouples, resistance thermometer, resistor and PTC
- BaseUnits for 2, 3 and 4-conductor connection
- Function classes Basic, Standard, High Feature and High Speed
- Clear labeling on front of module
- LEDs for diagnostics, status and errors
- Individual system-integrated load group formation with self-assembling potential multi-terminal busbars (power module not required for ET 200SP)
- Electronically readable rating plate (I&M data)
- Additional operating modes in some cases
- Optional accessories:
 - Labeling strips
 - Equipment marking label
 - Color-coded label with module-specific CC code
 - Shielding terminal

Overview of SIPLUS analog input modules

Analog input	PU	Article No.	CC code	BU type
AI 8 x I 2/4-wire BA	1	6AG1134-6GF00-7AA1	CC01	A0, A1
AI 8 x U BA	1	6AG1134-6FF00-2AA1	CC02	A0, A1
AI 4 x U/I 2-wire ST	1	6AG1134-6HD01-7BA1	CC03	A0, A1
AI 4 x I 2/4-wire ST	1	6AG1134-6GD01-7BA1	CC03	A0, A1
AI 4 x I 2-wire 4 ... 20 mA HART	1	6AG1134-6TD00-2CA1	CC03	A0, A1
AI 2 x U/I 2/4-wire HF	1	6AG1134-6HB00-2CA1	CC05	A0, A1
AI 2xU/I 2/4-wire HS	1	6AG1134-6HB00-2DA1	CC00	A0, A1
With two operating modes: • High-speed isochronous AI • Oversampling				
AI 8 x RTD/TC 2-wire HF	1	6AG1134-6JF00-2CA1	CC00	A0, A1
AI 4 x RTD/TC 2/3/4-wire HF	1	6AG1134-6JD00-2CA1	CC00	A0, A1
AI 4 x TC High Speed	1	6AG1134-6JD00-2DA1	CC00	A0, A1
AI Energy Meter 480 V AC ST	1	6AG1134-6PA20-7BD0	--	D0

Note:

SIPLUS extreme products are based on SIMATIC standard products. The contents listed here were adopted from the respective standard products. SIPLUS extreme-specific information was added.

I/O systemsSIMATIC ET 200 systems for the control cabinet
SIMATIC ET 200SP**I/O modules > SIPLUS analog inputs****Ordering data****Article No.****Article No.****SIPLUS analog input modules**

(Extended temperature range and exposure to environmental substances)

Analog input module
AI 8xI 2/4-wire BA, BU type A0 or A1, color code CC01**6AG1134-6GF00-7AA1**Analog input module
AI 8xU BA, BU type A0 or A1, color code CC02**6AG1134-6FF00-2AA1**Analog input module
AI 4xU/I 2-wire Standard, BU type A0 or A1, color code CC03, 16-bit, ±0.3%**6AG1134-6HD01-7BA1**Analog input module
AI 4xI 2/4-wire Standard, BU type A0 or A1, color code CC03, 16-bit, ±0.3%**6AG1134-6GD01-7BA1**Analog input module
AI 4xRTD/TC 2-, 3-, 4-wire High Feature, BU type A0 or A1, color code CC00, 16-bit, ±0.1%, scalable measuring range**6AG1134-6JD00-2CA1**Analog input module
AI 4xTC High Speed, BU type A0 or A1, color code CC00, channel diagnostics, 16-bit, +/-0.1%,**6AG1134-6JD00-2DA1**Analog input module
AI 4xI 2-wire 4 ... 20 mA HART, BU type A0 or A1, color code CC03**6AG1134-6TD00-2CA1**Analog input module
AI 2xU/I 2/4-wire High Feature, BU type A0 or A1, color code CC05, 16-bit, ±0.1%, independent channel isolation, isochronous mode above 1 ms**6AG1134-6HB00-2CA1**Analog input module
AI 2xU/I 2/4-wire High Speed, BU type A0 or A1, color code CC00, 16-bit, ±0.3%, isochronous mode above 250 µs, oversampling above 50 µs**6AG1134-6HB00-2DA1**Analog input module
AI 8xRTD/TC 2-wire High Feature, BU type A0 or A1, color code CC00, 16-bit, ±0.1%, scalable measuring range**6AG1134-6JF00-2CA1**Analog input module
AI Energy Meter Standard, 480 V AC, BU type D0**6AG1134-6PA20-7BD0****Usable SIPLUS BaseUnits type A0****BU15-P16+A0+2D**

(Extended temperature range and exposure to environmental substances)

BU type A0; BaseUnit (light) with 16 process terminals to the module; for starting a new load group (max. 10 A)

6AG1193-6BP00-7DA0**BU15-P16+A0+2B**

(Extended temperature range and exposure to environmental substances)

BU type A0; BaseUnit (dark) with 16 process terminals to the module; for continuing the load group

6AG1193-6BP00-7BA0**BU15-P16+A10+2D**

(Extended temperature range and exposure to environmental substances)

BU type A0; BaseUnit (light) with 16 process terminals (1...16) to the module and an additional 10 internally jumpered AUX terminals (1 A to 10 A); for starting a new load group (max. 10 A)

6AG1193-6BP20-7DA0**BU15-P16+A10+2B**

(Extended temperature range and exposure to environmental substances)

BU type A0; BaseUnit (dark) with 16 process terminals (1...16) to the module and an additional 10 internally jumpered AUX terminals (1 A to 10 A); for continuing the load group

6AG1193-6BP20-7BA0**Usable SIPLUS BaseUnits type A1 (temperature detection)****BU15-P16+A0+2D/T**

(Extended temperature range and exposure to environmental substances)

BU type A1; BaseUnit (light) with 16 process terminals to the module; for starting a new load group (max. 10 A)

6AG1193-6BP00-7DA1**BU15-P16+A0+2B/T**

(Extended temperature range and exposure to environmental substances)

BU type A1; BaseUnit (dark) with 16 process terminals to the module; for continuing the load group

6AG1193-6BP00-7BA1**BU15-P16+A0+12D/T**

(Extended temperature range and exposure to environmental substances)

BU type A1; BaseUnit (light) with 16 process terminals (1...16) to the module and also 2x5 internally jumpered additional terminals (1 B to 5 B and 1 C to 5 C); for starting a new load group (max. 10 A)

6AG1193-6BP40-7DA1**BU15-P16+A0+12B/T**

(Extended temperature range and exposure to environmental substances)

BU type A1; BaseUnit (dark) with 16 process terminals (1...16) to the module and also 2x5 internally jumpered additional terminals (1 B to 5 B and 1 C to 5 C); for continuing the load group

6AG1193-6BP40-7BA1**Usable SIPLUS BaseUnits type D0****BU20-P12+A0+0B**

(Extended temperature range and exposure to environmental substances)

BU type D0; BaseUnit with 12 push-in terminals, without AUX terminals, bridged to the left

6AG1193-6BP00-7BD0**Accessories****SIPLUS Mounting Kit ET 200SP**

Mounting accessories for use with increased mechanical vibration and shock loads.

6AG1193-6AA00-0AA0**Other accessories**

See SIMATIC ET 200SP, analog input modules, page 10/54

Technical specifications

Article number	6AG1134-6GF00-7AA1	6AG1134-6FF00-2AA1	6AG1134-6HD01-7BA1	6AG1134-6GD01-7BA1	6AG1134-6TD00-2CA1
Based on	6ES7134-6GF00-0AA1 SIPLUS ET 200SP AI 8xI 2-/4-WIRE BA	6ES7134-6FF00-0AA1 SIPLUS ET 200SP AI 8xU BASIC	6ES7134-6HD01-0BA1 SIPLUS ET 200SP AI 4xU/I 2-w ST	6ES7134-6GD01-0BA1 SIPLUS ET 200SP AI 4xI 2-/4-w ST	6ES7134-6TD00-0CA1 SIPLUS ET 200SP AI 4xI 2-WIRE 4...20MA H
Ambient conditions					
Ambient temperature during operation					
• horizontal installation, min.	-40 °C; = Tmin (incl. condensation/frost)	-40 °C; = Tmin (incl. condensation/frost)	-40 °C; = Tmin (incl. condensation/frost)	-40 °C; = Tmin (incl. condensation/frost)	-40 °C; = Tmin (incl. condensation/frost); start-up @ -30 °C
• horizontal installation, max.	70 °C; = Tmax	60 °C; = Tmax; +70 °C with configured empty slots to the left and right of the module	70 °C; = Tmax; > 60 °C max. 1x ±20 mA or 4x ±10 V permissible	70 °C; = Tmax; > 60 °C max. 1x ±20 mA permissible	60 °C; = Tmax; +70 °C with configured empty slots to the left and right of the module
• vertical installation, min.			-40 °C; = Tmin	-40 °C; = Tmin	-40 °C; = Tmin (incl. condensation/frost); start-up @ -30 °C
• vertical installation, max.			50 °C; = Tmax	50 °C; = Tmax	50 °C; = Tmax
Altitude during operation relating to sea level					
• Installation altitude above sea level, max.	5 000 m	5 000 m	5 000 m	5 000 m	5 000 m
• Ambient air temperature-barometric pressure-altitude	Tmin ... Tmax at 1 140 hPa ... 795 hPa (-1 000 m ... +2 000 m) // Tmin ... (Tmax - 10 K) at 795 hPa ... 658 hPa (+2 000 m ... +3 500 m) // Tmin ... (Tmax -20 K) at 658 hPa ... 540 hPa (+3 500 m ... +5 000 m)	Tmin ... Tmax at 1 140 hPa ... 795 hPa (-1 000 m ... +2 000 m) // Tmin ... (Tmax - 10 K) at 795 hPa ... 658 hPa (+2 000 m ... +3 500 m) // Tmin ... (Tmax -20 K) at 658 hPa ... 540 hPa (+3 500 m ... +5 000 m)	Tmin ... Tmax at 1 140 hPa ... 795 hPa (-1 000 m ... +2 000 m) // Tmin ... (Tmax - 10 K) at 795 hPa ... 658 hPa (+2 000 m ... +3 500 m) // Tmin ... (Tmax -20 K) at 658 hPa ... 540 hPa (+3 500 m ... +5 000 m)	Tmin ... Tmax at 1 140 hPa ... 795 hPa (-1 000 m ... +2 000 m) // Tmin ... (Tmax - 10 K) at 795 hPa ... 658 hPa (+2 000 m ... +3 500 m) // Tmin ... (Tmax -20 K) at 658 hPa ... 540 hPa (+3 500 m ... +5 000 m)	Tmin ... Tmax at 1 140 hPa ... 795 hPa (-1 000 m ... +2 000 m) // Tmin ... (Tmax - 10 K) at 795 hPa ... 658 hPa (+2 000 m ... +3 500 m) // Tmin ... (Tmax -20 K) at 658 hPa ... 540 hPa (+3 500 m ... +5 000 m)
Relative humidity					
• With condensation, tested in accordance with IEC 60068-2-38, max.	100 %; RH incl. condensation / frost (no commissioning in bedewed state), horizontal installation	100 %; RH incl. condensation / frost (no commissioning in bedewed state), horizontal installation	100 %; RH incl. condensation / frost (no commissioning in bedewed state), horizontal installation	100 %; RH incl. condensation / frost (no commissioning in bedewed state), horizontal installation	100 %; RH incl. condensation/frost (no commissioning under condensation conditions)
Resistance					
Coolants and lubricants					
- Resistant to commercially available coolants and lubricants	Yes; Incl. diesel and oil droplets in the air	Yes; Incl. diesel and oil droplets in the air	Yes; Incl. diesel and oil droplets in the air	Yes; Incl. diesel and oil droplets in the air	Yes; Incl. diesel and oil droplets in the air
Use in stationary industrial systems					
- to biologically active substances according to EN 60721-3-3	Yes; Class 3B2 mold, fungus and dry rot spores (with the exception of fauna); Class 3B3 on request	Yes; Class 3B2 mold, fungus and dry rot spores (with the exception of fauna); Class 3B3 on request	Yes; Class 3B2 mold, fungus and dry rot spores (with the exception of fauna); Class 3B3 on request	Yes; Class 3B2 mold, fungus and dry rot spores (with the exception of fauna); Class 3B3 on request	Yes; Class 3B2 mold, fungus and dry rot spores (with the exception of fauna); Class 3B3 on request
- to chemically active substances according to EN 60721-3-3	Yes; Class 3C4 (RH < 75 %) incl. salt spray acc. to EN 60068-2-52 (severity degree 3); *	Yes; Class 3C4 (RH < 75 %) incl. salt spray acc. to EN 60068-2-52 (severity degree 3); *	Yes; Class 3C4 (RH < 75 %) incl. salt spray acc. to EN 60068-2-52 (severity degree 3); *	Yes; Class 3C4 (RH < 75 %) incl. salt spray acc. to EN 60068-2-52 (severity degree 3); *	Yes; Class 3C4 (RH < 75 %) incl. salt spray acc. to EN 60068-2-52 (severity degree 3); *
- to mechanically active substances according to EN 60721-3-3	Yes; Class 3S4 incl. sand, dust, *	Yes; Class 3S4 incl. sand, dust, *	Yes; Class 3S4 incl. sand, dust, *	Yes; Class 3S4 incl. sand, dust, *	Yes; Class 3S4 incl. sand, dust, *
- Against mechanical environmental conditions acc. to EN 60721-3-3	Yes; Class 3M8 using the SIPLUS Mounting Kit ET 200SP (6AG1193-6AA00-0AA0)	Yes; Class 3M8 using the SIPLUS Mounting Kit ET 200SP (6AG1193-6AA00-0AA0)	Yes; Class 3M8 using the SIPLUS Mounting Kit ET 200SP (6AG1193-6AA00-0AA0)	Yes; Class 3M8 using the SIPLUS Mounting Kit ET 200SP (6AG1193-6AA00-0AA0)	Yes; Class 3M8 using the SIPLUS Mounting Kit ET 200SP (6AG1193-6AA00-0AA0)

I/O systems

SIMATIC ET 200 systems for the control cabinet
SIMATIC ET 200SP

I/O modules > SIPLUS analog inputs

Technical specifications

Article number	6AG1134-6GF00-7AA1	6AG1134-6FF00-2AA1	6AG1134-6HD01-7BA1	6AG1134-6GD01-7BA1	6AG1134-6TD00-2CA1
Based on	6ES7134-6GF00-0AA1 SIPLUS ET 200SP AI 8X I 2-/4-WIRE BA	6ES7134-6FF00-0AA1 SIPLUS ET 200SP AI 8xU BASIC	6ES7134-6HD01-0BA1 SIPLUS ET 200SP AI 4xU/I 2-w ST	6ES7134-6GD01-0BA1 SIPLUS ET 200SP AI 4x I 2-/4-w ST	6ES7134-6TD00-0CA1 SIPLUS ET 200SP AI 4X I 2-WIRE 4...20MA H
Use on ships/at sea					
- to biologically active substances according to EN 60721-3-6	Yes; Class 6B2 mold, fungal and dry rot spores (excluding fauna)	Yes; Class 6B2 mold and fungal spores (excluding fauna); Class 6B3 on request	Yes; Class 6B2 mold and fungal spores (excluding fauna); Class 6B3 on request	Yes; Class 6B2 mold and fungal spores (excluding fauna); Class 6B3 on request	Yes; Class 6B2 mold and fungal spores (excluding fauna); Class 6B3 on request
- to chemically active substances according to EN 60721-3-6	Yes; Class 6C3 (RH < 75 %) incl. salt spray acc. to EN 60068-2-52 (severity degree 3); *	Yes; Class 6C3 (RH < 75 %) incl. salt spray acc. to EN 60068-2-52 (severity degree 3); *	Yes; Class 6C3 (RH < 75 %) incl. salt spray acc. to EN 60068-2-52 (severity degree 3); *	Yes; Class 6C3 (RH < 75 %) incl. salt spray acc. to EN 60068-2-52 (severity degree 3); *	Yes; Class 6C3 (RH < 75 %) incl. salt spray acc. to EN 60068-2-52 (severity degree 3); *
- to mechanically active substances according to EN 60721-3-6	Yes; Class 6S3 incl. sand, dust; *	Yes; Class 6S3 incl. sand, dust; *	Yes; Class 6S3 incl. sand, dust; *	Yes; Class 6S3 incl. sand, dust; *	Yes; Class 6S3 incl. sand, dust; *
- Against mechanical environmental conditions acc. to EN 60721-3-6	Yes; Class 6M4 using the SIPLUS Mounting Kit ET 200SP (6AG1193-6AA00-0AA0)	Yes; Class 6M4 using the SIPLUS Mounting Kit ET 200SP (6AG1193-6AA00-0AA0)	Yes; Class 6M4 using the SIPLUS Mounting Kit ET 200SP (6AG1193-6AA00-0AA0)	Yes; Class 6M4 using the SIPLUS Mounting Kit ET 200SP (6AG1193-6AA00-0AA0)	Yes; Class 6M4 using the SIPLUS Mounting Kit ET 200SP (6AG1193-6AA00-0AA0)
Usage in industrial process technology					
- Against chemically active substances acc. to EN 60654-4	Yes; Class 3 (excluding trichlorethylene)	Yes; Class 3 (excluding trichlorethylene)	Yes; Class 3 (excluding trichlorethylene)	Yes; Class 3 (excluding trichlorethylene)	Yes; Class 3 (excluding trichlorethylene)
- Environmental conditions for process, measuring and control systems acc. to ANSI/ISA-71.04	Yes; Level GX group A/B (excluding trichlorethylene; harmful gas concentrations up to the limits of EN 60721-3-3 class 3C4 permissible); level LC3 (salt spray) and level LB3 (oil)	Yes; Level GX group A/B (excluding trichlorethylene; harmful gas concentrations up to the limits of EN 60721-3-3 class 3C4 permissible); level LC3 (salt spray) and level LB3 (oil)	Yes; Level GX group A/B (excluding trichlorethylene; harmful gas concentrations up to the limits of EN 60721-3-3 class 3C4 permissible); level LC3 (salt spray) and level LB3 (oil)	Yes; Level GX group A/B (excluding trichlorethylene; harmful gas concentrations up to the limits of EN 60721-3-3 class 3C4 permissible); level LC3 (salt spray) and level LB3 (oil)	Yes; Level GX group A/B (excluding trichlorethylene; harmful gas concentrations up to the limits of EN 60721-3-3 class 3C4 permissible); level LC3 (salt spray) and level LB3 (oil)
Remark					
- Note regarding classification of environmental conditions acc. to EN 60721, EN 60654-4 and ANSI/ISA-71.04	* The supplied plug covers must remain in place over the unused interfaces during operation!	* The supplied plug covers must remain in place over the unused interfaces during operation!	* The supplied plug covers must remain in place over the unused interfaces during operation!	* The supplied plug covers must remain in place over the unused interfaces during operation!	* The supplied plug covers must remain in place over the unused interfaces during operation!
Conformal coating					
• Coatings for printed circuit board assemblies acc. to EN 61086	Yes; Class 2 for high reliability	Yes; Class 2 for high reliability	Yes; Class 2 for high reliability	Yes; Class 2 for high reliability	Yes; Class 2 for high reliability
• Protection against fouling acc. to EN 60664-3	Yes; Type 1 protection	Yes; Type 1 protection	Yes; Type 1 protection	Yes; Type 1 protection	Yes; Type 1 protection
• Military testing according to MIL-I-46058C, Amendment 7	Yes; Discoloration of coating possible during service life	Yes; Discoloration of coating possible during service life	Yes; Discoloration of coating possible during service life	Yes; Discoloration of coating possible during service life	Yes; Discoloration of coating possible during service life
• Qualification and Performance of Electrical Insulating Compound for Printed Board Assemblies according to IPC-CC-830A	Yes; Conformal coating, Class A	Yes; Conformal coating, Class A	Yes; Conformal coating, Class A	Yes; Conformal coating, Class A	Yes; Conformal coating, Class A
Article number	6AG1134-6HB00-2CA1	6AG1134-6HB00-2DA1	6AG1134-6JF00-2CA1	6AG1134-6JD00-2CA1	6AG1134-6JD00-2DA1
Based on	6ES7134-6HB00-0CA1 SIPLUS ET 200SP AI 2 X U/I 2-, 4-WIRE HF	6ES7134-6HB00-0DA1 SIPLUS ET 200SP AI 2 X U/I 2-, 4-WIRE HS	6ES7134-6JF00-0CA1 SIPLUS ET 200SP AI 8XRTD/TC 2-WIRE HF	6ES7134-6JD00-0CA1 SIPLUS ET 200SP AI 4xRTD/TC HF	6ES7134-6JD00-0DA1 SIPLUS ET 200SP AI 4xTC HS
Ambient conditions					
Ambient temperature during operation					
• horizontal installation, min.	-40 °C; = Tmin (incl. condensation/frost)	-40 °C; = Tmin (incl. condensation/frost)	-40 °C; = Tmin (incl. condensation/frost)	-40 °C; = Tmin (incl. condensation/frost)	-40 °C; = Tmin (incl. condensation/frost)
• horizontal installation, max.	60 °C; = Tmax	60 °C; = Tmax; +70 °C with configured empty slots to the left and right of the module	60 °C; = Tmax; +70 °C with configured empty slots to the left and right of the module	60 °C; = Tmax; +70 °C with configured empty slots to the left and right of the module	60 °C; = Tmax; +70 °C with configured empty slots to the left and right of the module
• vertical installation, min.			-40 °C; = Tmin (incl. condensation/frost)	-40 °C; = Tmin (incl. condensation/frost)	-40 °C; = Tmin (incl. condensation/frost)
• vertical installation, max.			50 °C; = Tmax	50 °C; = Tmax	50 °C; = Tmax

Technical specifications

Article number	6AG1134-6HB00-2CA1	6AG1134-6HB00-2DA1	6AG1134-6JF00-2CA1	6AG1134-6JD00-2CA1	6AG1134-6JD00-2DA1
Based on	6ES7134-6HB00-0CA1	6ES7134-6HB00-0DA1	6ES7134-6JF00-0CA1	6ES7134-6JD00-0CA1	6ES7134-6JD00-0DA1
	SIPLUS ET 200SP AI 2 X U/I 2-, 4-WIRE HF	SIPLUS ET 200SP AI 2 X U/I 2-, 4-WIRE HS	SIPLUS ET 200SP AI 8XRTD/TC 2-WIRE HF	SIPLUS ET 200SP AI 4xRTD/TC HF	SIPLUS ET 200SP AI 4xTC HS
Altitude during operation relating to sea level					
• Installation altitude above sea level, max.	5 000 m	5 000 m	5 000 m	5 000 m	5 000 m
• Ambient air temperature-barometric pressure-altitude	Tmin ... Tmax at 1 140 hPa ... 795 hPa (-1 000 m ... +2 000 m) // Tmin ... (Tmax - 10 K) at 795 hPa ... 658 hPa (+2 000 m ... +3 500 m) // Tmin ... (Tmax -20 K) at 658 hPa ... 540 hPa (+3 500 m ... +5 000 m)	Tmin ... Tmax at 1 140 hPa ... 795 hPa (-1 000 m ... +2 000 m) // Tmin ... (Tmax - 10 K) at 795 hPa ... 658 hPa (+2 000 m ... +3 500 m) // Tmin ... (Tmax -20 K) at 658 hPa ... 540 hPa (+3 500 m ... +5 000 m)	Tmin ... Tmax at 1 140 hPa ... 795 hPa (-1 000 m ... +2 000 m) // Tmin ... (Tmax - 10 K) at 795 hPa ... 658 hPa (+2 000 m ... +3 500 m) // Tmin ... (Tmax -20 K) at 658 hPa ... 540 hPa (+3 500 m ... +5 000 m)	Tmin ... Tmax at 1 080 hPa ... 795 hPa (-1 000 m ... +2 000 m) // Tmin ... (Tmax - 10 K) at 795 hPa ... 658 hPa (+2 000 m ... +3 500 m) // Tmin ... (Tmax -20 K) at 658 hPa ... 540 hPa (+3 500 m ... +5 000 m)	Tmin ... Tmax at 1 140 hPa ... 795 hPa (-1 000 m ... +2 000 m) // Tmin ... (Tmax - 10 K) at 795 hPa ... 658 hPa (+2 000 m ... +3 500 m) // Tmin ... (Tmax -20 K) at 658 hPa ... 540 hPa (+3 500 m ... +5 000 m)
Relative humidity					
• With condensation, tested in accordance with IEC 60068-2-38, max.	100 %; RH incl. condensation / frost (no commissioning in bedewed state), horizontal installation	100 %; RH incl. condensation / frost (no commissioning in bedewed state), horizontal installation	100 %; RH incl. condensation/frost (no commissioning under condensation conditions)	100 %; RH incl. condensation/frost (no commissioning under condensation conditions)	100 %; RH incl. condensation/frost (no commissioning under condensation conditions)
Resistance					
Coolants and lubricants					
- Resistant to commercially available coolants and lubricants	Yes; Incl. diesel and oil droplets in the air	Yes; Incl. diesel and oil droplets in the air	Yes; Incl. diesel and oil droplets in the air	Yes; Incl. diesel and oil droplets in the air	Yes; Incl. diesel and oil droplets in the air
Use in stationary industrial systems					
- to biologically active substances according to EN 60721-3-3	Yes; Class 3B2 mold, fungus and dry rot spores (with the exception of fauna); Class 3B3 on request	Yes; Class 3B2 mold, fungus and dry rot spores (with the exception of fauna); Class 3B3 on request	Yes; Class 3B2 mold, fungus and dry rot spores (with the exception of fauna); Class 3B3 on request	Yes; Class 3B2 mold, fungus and dry rot spores (with the exception of fauna); Class 3B3 on request	Yes; Class 3B2 mold, fungus and dry rot spores (with the exception of fauna); Class 3B3 on request
- to chemically active substances according to EN 60721-3-3	Yes; Class 3C4 (RH < 75 %) incl. salt spray acc. to EN 60068-2-52 (severity degree 3); *	Yes; Class 3C4 (RH < 75 %) incl. salt spray acc. to EN 60068-2-52 (severity degree 3); *	Yes; Class 3C4 (RH < 75 %) incl. salt spray acc. to EN 60068-2-52 (severity degree 3); *	Yes; Class 3C4 (RH < 75 %) incl. salt spray acc. to EN 60068-2-52 (severity degree 3); *	Yes; Class 3C4 (RH < 75 %) incl. salt spray acc. to EN 60068-2-52 (severity degree 3); *
- to mechanically active substances according to EN 60721-3-3	Yes; Class 3S4 incl. sand, dust, *	Yes; Class 3S4 incl. sand, dust, *	Yes; Class 3S4 incl. sand, dust, *	Yes; Class 3S4 incl. sand, dust, *	Yes; Class 3S4 incl. sand, dust, *
- Against mechanical environmental conditions acc. to EN 60721-3-3	Yes; Class 3M8 using the SIPLUS Mounting Kit ET 200SP (6AG1193-6AA00-0AA0)	Yes; Class 3M8 using the SIPLUS Mounting Kit ET 200SP (6AG1193-6AA00-0AA0)	Yes; Class 3M8 using the SIPLUS Mounting Kit ET 200SP (6AG1193-6AA00-0AA0)	Yes; Class 3M8 using the SIPLUS Mounting Kit ET 200SP (6AG1193-6AA00-0AA0)	Yes; Class 3M8 using the SIPLUS Mounting Kit ET 200SP (6AG1193-6AA00-0AA0)
Use on ships/at sea					
- to biologically active substances according to EN 60721-3-6	Yes; Class 6B2 mold and fungal spores (excluding fauna); Class 6B3 on request	Yes; Class 6B2 mold and fungal spores (excluding fauna); Class 6B3 on request	Yes; Class 6B2 mold and fungal spores (excluding fauna); Class 6B3 on request	Yes; Class 6B2 mold and fungal spores (excluding fauna); Class 6B3 on request	Yes; Class 6B2 mold and fungal spores (excluding fauna); Class 6B3 on request
- to chemically active substances according to EN 60721-3-6	Yes; Class 6C3 (RH < 75 %) incl. salt spray acc. to EN 60068-2-52 (severity degree 3); *	Yes; Class 6C3 (RH < 75 %) incl. salt spray acc. to EN 60068-2-52 (severity degree 3); *	Yes; Class 6C3 (RH < 75 %) incl. salt spray acc. to EN 60068-2-52 (severity degree 3); *	Yes; Class 6C3 (RH < 75 %) incl. salt spray acc. to EN 60068-2-52 (severity degree 3); *	Yes; Class 6C3 (RH < 75 %) incl. salt spray acc. to EN 60068-2-52 (severity degree 3); *
- to mechanically active substances according to EN 60721-3-6	Yes; Class 6S3 incl. sand, dust; *	Yes; Class 6S3 incl. sand, dust; *	Yes; Class 6S3 incl. sand, dust; *	Yes; Class 6S3 incl. sand, dust; *	Yes; Class 6S3 incl. sand, dust; *
- Against mechanical environmental conditions acc. to EN 60721-3-6	Yes; Class 6M4 using the SIPLUS Mounting Kit ET 200SP (6AG1193-6AA00-0AA0)	Yes; Class 6M4 using the SIPLUS Mounting Kit ET 200SP (6AG1193-6AA00-0AA0)	Yes; Class 6M4 using the SIPLUS Mounting Kit ET 200SP (6AG1193-6AA00-0AA0)	Yes; Class 6M4 using the SIPLUS Mounting Kit ET 200SP (6AG1193-6AA00-0AA0)	Yes; Class 6M4 using the SIPLUS Mounting Kit ET 200SP (6AG1193-6AA00-0AA0)
Usage in industrial process technology					
- Against chemically active substances acc. to EN 60654-4	Yes; Class 3 (excluding trichlorethylene)	Yes; Class 3 (excluding trichlorethylene)	Yes; Class 3 (excluding trichlorethylene)	Yes; Class 3 (excluding trichlorethylene)	Yes; Class 3 (excluding trichlorethylene)

I/O systemsSIMATIC ET 200 systems for the control cabinet
SIMATIC ET 200SP**I/O modules > SIPLUS analog inputs****Technical specifications**

Article number	6AG1134-6HB00-2CA1	6AG1134-6HB00-2DA1	6AG1134-6JF00-2CA1	6AG1134-6JD00-2CA1	6AG1134-6JD00-2DA1
Based on	6ES7134-6HB00-0CA1	6ES7134-6HB00-0DA1	6ES7134-6JF00-0CA1	6ES7134-6JD00-0CA1	6ES7134-6JD00-0DA1
	SIPLUS ET 200SP AI 2 X U/I 2-, 4-WIRE HF	SIPLUS ET 200SP AI 2 X U/I 2-, 4-WIRE HS	SIPLUS ET 200SP AI 8XRTD/TC 2-WIRE HF	SIPLUS ET 200SP AI 4xRTD/TC HF	SIPLUS ET 200SP AI 4xTC HS
- Environmental conditions for process, measuring and control systems acc. to ANSI/ISA-71.04	Yes; Level GX group A/B (excluding trichlorethylene; harmful gas concentrations up to the limits of EN 60721-3-3 class 3C4 permissible); level LC3 (salt spray) and level LB3 (oil)	Yes; Level GX group A/B (excluding trichlorethylene; harmful gas concentrations up to the limits of EN 60721-3-3 class 3C4 permissible); level LC3 (salt spray) and level LB3 (oil)	Yes; Level GX group A/B (excluding trichlorethylene; harmful gas concentrations up to the limits of EN 60721-3-3 class 3C4 permissible); level LC3 (salt spray) and level LB3 (oil)	Yes; Level GX group A/B (excluding trichlorethylene; harmful gas concentrations up to the limits of EN 60721-3-3 class 3C4 permissible); level LC3 (salt spray) and level LB3 (oil)	Yes; Level GX group A/B (excluding trichlorethylene; harmful gas concentrations up to the limits of EN 60721-3-3 class 3C4 permissible); level LC3 (salt spray) and level LB3 (oil)
Remark					
- Note regarding classification of environmental conditions acc. to EN 60721, EN 60654-4 and ANSI/ISA-71.04	* The supplied plug covers must remain in place over the unused interfaces during operation!	* The supplied plug covers must remain in place over the unused interfaces during operation!	* The supplied plug covers must remain in place over the unused interfaces during operation!	* The supplied plug covers must remain in place over the unused interfaces during operation!	* The supplied plug covers must remain in place over the unused interfaces during operation!
Conformal coating					
• Coatings for printed circuit board assemblies acc. to EN 61086	Yes; Class 2 for high reliability	Yes; Class 2 for high reliability	Yes; Class 2 for high reliability	Yes; Class 2 for high reliability	Yes; Class 2 for high reliability
• Protection against fouling acc. to EN 60664-3	Yes; Type 1 protection	Yes; Type 1 protection	Yes; Type 1 protection	Yes; Type 1 protection	Yes; Type 1 protection
• Military testing according to MIL-I-46058C, Amendment 7	Yes; Discoloration of coating possible during service life	Yes; Discoloration of coating possible during service life	Yes; Discoloration of coating possible during service life	Yes; Discoloration of coating possible during service life	Yes; Discoloration of coating possible during service life
• Qualification and Performance of Electrical Insulating Compound for Printed Board Assemblies according to IPC-CC-830A	Yes; Conformal coating, Class A	Yes; Conformal coating, Class A	Yes; Conformal coating, Class A	Yes; Conformal coating, Class A	Yes; Conformal coating, Class A

Technical specifications

Article number	6AG1134-6PA20-7BD0
Based on	6ES7134-6PA20-0BD0 SIPLUS ET 200SP AI EMETER 480VAC ST
Ambient conditions	
Ambient temperature during operation	
• horizontal installation, min.	-40 °C; = Tmin; < -25 °C min. permissible supply voltage 110 V AC
• horizontal installation, max.	70 °C; = Tmax; > +60 °C max. permissible current 1 A per phase
• vertical installation, min.	-40 °C; = Tmin
• vertical installation, max.	50 °C; = Tmax
Altitude during operation relating to sea level	
• Installation altitude above sea level, max.	2 000 m
• Ambient air temperature-barometric pressure-altitude	Tmin ... Tmax at 1 140 hPa ... 795 hPa (-1 000 m ... +2 000 m)
Relative humidity	
• With condensation, tested in accordance with IEC 60068-2-38, max.	100 %; RH incl. condensation/frost (no commissioning under condensation conditions)
Resistance	
Coolants and lubricants	
- Resistant to commercially available coolants and lubricants	Yes; Incl. diesel and oil droplets in the air
Use in stationary industrial systems	
- to biologically active substances according to EN 60721-3-3	Yes; Class 3B2 mold, fungus and dry rot spores (with the exception of fauna); Class 3B3 on request
- to chemically active substances according to EN 60721-3-3	Yes; Class 3C4 (RH < 75 %) incl. salt spray acc. to EN 60068-2-52 (severity degree 3); *
- to mechanically active substances according to EN 60721-3-3	Yes; Class 3S4 incl. sand, dust, *
- Against mechanical environmental conditions acc. to EN 60721-3-3	Yes; Class 3M8 using the SIPLUS Mounting Kit ET 200SP (6AG1193-6AA00-0AA0)

Article number	6AG1134-6PA20-7BD0
Based on	6ES7134-6PA20-0BD0 SIPLUS ET 200SP AI EMETER 480VAC ST
Use on ships/at sea	
- to biologically active substances according to EN 60721-3-6	Yes; Class 6B2 mold and fungal spores (excluding fauna); Class 6B3 on request
- to chemically active substances according to EN 60721-3-6	Yes; Class 6C3 (RH < 75 %) incl. salt spray acc. to EN 60068-2-52 (severity degree 3); *
- to mechanically active substances according to EN 60721-3-6	Yes; Class 6S3 incl. sand, dust; *
- Against mechanical environmental conditions acc. to EN 60721-3-6	Yes; Class 6M4 using the SIPLUS Mounting Kit ET 200SP (6AG1193-6AA00-0AA0)
Usage in industrial process technology	
- Against chemically active substances acc. to EN 60654-4	Yes; Class 3 (excluding trichlorethylene)
- Environmental conditions for process, measuring and control systems acc. to ANSI/ISA-71.04	Yes; Level GX group A/B (excluding trichlorethylene; harmful gas concentrations up to the limits of EN 60721-3-3 class 3C4 permissible); level LC3 (salt spray) and level LB3 (oil)
Remark	
- Note regarding classification of environmental conditions acc. to EN 60721, EN 60654-4 and ANSI/ISA-71.04	* The supplied plug covers must remain in place over the unused interfaces during operation!
Conformal coating	
• Coatings for printed circuit board assemblies acc. to EN 61086	Yes; Class 2 for high reliability
• Protection against fouling acc. to EN 60664-3	Yes; Type 1 protection
• Military testing according to MIL-I-46058C, Amendment 7	Yes; Discoloration of coating possible during service life
• Qualification and Performance of Electrical Insulating Compound for Printed Board Assemblies according to IPC-CC-830A	Yes; Conformal coating, Class A

I/O systems

SIMATIC ET 200 systems for the control cabinet
SIMATIC ET 200SP

I/O modules > SIPLUS analog outputs

Overview



- 2 and 4-channel analog output (AQ) modules

For different requirements, the digital output modules offer:

- Function classes Standard, High Feature and High-Speed
- BaseUnits for single or multiple-conductor connection with automatic slot coding
- Potential distribution modules for system-integrated expansion with potential terminals
- Individual system-integrated load group formation with self-assembling voltage distribution bars (a separate power module is no longer required for ET 200SP)

- Option for connecting current and voltage actuators
- Clear labeling on front of module
- LEDs for diagnostics, status, supply voltage and faults
- Electronically readable and non-volatile writable rating plate (I&M data 0 to 3)
- Extended functions and additional operating modes in some cases
 - Oversampling operating mode (n-fold equidistant output of an analog value within one PN cycle and thus the precisely timed output of an analog value or a sequence of analog values)
 - Isochronous mode (simultaneous equidistant output of analog values)
 - Output of substitute value in the event of interruptions to communication (shutdown, output adjustable substitute value, or keep last value)
 - Calibration during runtime
 - Re-parameterization during operation
 - Firmware update
 - Diagnosis of wire break, short circuit, overflow, underflow
 - Value status (optional binary validity information of the analog signal in the process image)
 - Supports the PROFlenergy profile
- Optional accessories
 - Labeling strips (film or card)
 - Equipment labeling plate
 - Color-coded label with module-specific CC code
 - Shielding terminal

A quick and clear comparison of the functions of the AQ modules is offered by the TIA Selection Tool.

Overview of analog output modules

Analog output	PU	Article No.	CC code	BU type
AQ 2 x I ST	1	6AG1135-6GB00-7BA1	CC00	A0, A1
AQ 4 x U/I ST	1	6AG1135-6HD00-7BA1	CC00	A0, A1
AQ 2 x U/I HF	1	6AG1135-6HB00-7CA1	CC00	A0, A1
AQ 2 x U/I HS	1	6AG1135-6HB00-2DA1	CC00	A0, A1
With two operating modes: • High-speed isochronous AQ • Oversampling				
AQ 4xI HART HF	1	6AG1135-6TD00-2CA1	CC00	A0, A1

Note:

SIPLUS extreme products are based on SIMATIC standard products. The contents listed here were taken from the respective standard products. SIPLUS extreme-specific information was added.

Ordering data	Article No.	Article No.
<p>SIPLUS analog output modules (Extended temperature range and exposure to environmental substances)</p> <p>Analog output module AQ 2xI Standard, BU type A0 or A1, color code CC00, 16-bit</p> <p>Analog output module AQ 4xU/I Standard, BU type A0 or A1, color code CC03</p> <p>Analog output module AQ 2xU/I High Feature, BU type A0 or A1, color code CC00, 16-bit, ±0.1%</p> <p>Analog output module AQ 2xU/I High Speed, BU type A0 or A1, color code CC00, 16-bit, ± 0.3%</p> <p>Analog output module AQ 4xI HART High Feature, BU type A0 or A1, color code CC00, 16-bit, ± 0.3%</p>	<p>6AG1135-6GB00-7BA1</p> <p>6AG1135-6HD00-7BA1</p> <p>6AG1135-6HB00-7CA1</p> <p>6AG1135-6HB00-2DA1</p> <p>6AG1135-6TD00-2CA1</p>	<p>Usable SIPLUS BaseUnits type A1 (temperature detection)</p> <p>BU15-P16+A0+2D/T (Extended temperature range and exposure to environmental substances) BU type A1; BaseUnit (light) with 16 process terminals to the module; for starting a new load group (max. 10 A)</p> <p>BU15-P16+A0+2B/T (Extended temperature range and exposure to environmental substances) BU type A1; BaseUnit (dark) with 16 process terminals to the module; for continuing the load group</p> <p>BU15-P16+A0+12D/T (Extended temperature range and exposure to environmental substances) BU type A1; BaseUnit (light) with 16 process terminals (1...16) to the module and also 2x5 internally jumpered additional terminals (1 B to 5 B and 1 C to 5 C); for starting a new load group (max. 10 A)</p> <p>BU15-P16+A0+12B/T (Extended temperature range and exposure to environmental substances) BU type A1; BaseUnit (dark) with 16 process terminals (1...16) to the module and also 2x5 internally jumpered additional terminals (1 B to 5 B and 1 C to 5 C); for continuing the load group</p> <p>Accessories</p> <p>SIPLUS Mounting Kit ET 200SP Mounting accessories for use with increased mechanical vibration and shock loads.</p> <p>Other accessories See SIMATIC ET 200SP, analog output modules, page 10/73</p>
<p>Usable SIPLUS BaseUnits type A0</p> <p>BU15-P16+A0+2D (Extended temperature range and exposure to environmental substances) BU type A0; BaseUnit (light) with 16 process terminals to the module; for starting a new load group (max. 10 A)</p> <p>BU15-P16+A0+2B (Extended temperature range and exposure to environmental substances) BU type A0; BaseUnit (dark) with 16 process terminals to the module; for continuing the load group</p> <p>BU15-P16+A10+2D (Extended temperature range and exposure to environmental substances) BU type A0; BaseUnit (light) with 16 process terminals (1...16) to the module and an additional 10 internally jumpered AUX terminals (1 A to 10 A); for starting a new load group (max. 10 A)</p> <p>BU15-P16+A10+2B (Extended temperature range and exposure to environmental substances) BU type A0; BaseUnit (dark) with 16 process terminals (1...16) to the module and an additional 10 internally jumpered AUX terminals (1 A to 10 A); for continuing the load group</p>	<p>6AG1193-6BP00-7DA0</p> <p>6AG1193-6BP00-7BA0</p> <p>6AG1193-6BP20-7DA0</p> <p>6AG1193-6BP20-7BA0</p>	<p>6AG1193-6BP00-7DA1</p> <p>6AG1193-6BP00-7BA1</p> <p>6AG1193-6BP40-7DA1</p> <p>6AG1193-6BP40-7BA1</p> <p>6AG1193-6AA00-0AA0</p>

I/O systems

SIMATIC ET 200 systems for the control cabinet
SIMATIC ET 200SP

I/O modules > SIPLUS analog outputs

Technical specifications

Article number	6AG1135-6HD00-7BA1	6AG1135-6GB00-7BA1	6AG1135-6HB00-2DA1	6AG1135-6HB00-7CA1	6AG1135-6TD00-2CA1
Based on	6ES7135-6HD000-0BA1 SIPLUS ET 200SP AQ 4xU/I ST	6ES7135-6GB00-0BA1 SIPLUS ET 200SP AQ 2xI STANDARD	6ES7135-6HB00-0DA1 SIPLUS ET 200SP AQ 2 X U/I HIGH SPEED	6ES7135-6HB00-0CA1 SIPLUS ET 200SP AQ 2xU/I HF	6ES7135-6TD00-0CA1 SIPLUS ET 200SP AQ 4xI HART High Feature
Ambient conditions					
Ambient temperature during operation					
• horizontal installation, min.	-40 °C; = Tmin (incl. condensation/frost)	-40 °C; = Tmin (incl. condensation/frost)	-40 °C; = Tmin (incl. condensation/frost)	-40 °C; = Tmin (incl. condensation/frost)	-40 °C; = Tmin (incl. condensation/frost)
• horizontal installation, max.	70 °C; = Tmax; > +60 °C max. 2x ±10 V permissible	70 °C; = Tmax	60 °C; = Tmax; +70 °C with configured empty slots to the left and right of the module	70 °C; = Tmax	60 °C; = Tmax; +70 °C with configured empty slots to the left and right of the module
• vertical installation, min.	-40 °C; = Tmin			-40 °C; = Tmin	-40 °C; = Tmin (incl. condensation/frost)
• vertical installation, max.	50 °C; = Tmax			60 °C; = Tmax	50 °C; = Tmax
Altitude during operation relating to sea level					
• Installation altitude above sea level, max.	5 000 m	5 000 m	5 000 m	5 000 m	5 000 m;
• Ambient air temperature-barometric pressure-altitude	Tmin ... Tmax at 1 140 hPa ... 795 hPa (-1 000 m ... +2 000 m) // Tmin ... (Tmax - 10 K) at 795 hPa ... 658 hPa (+2 000 m ... +3 500 m) // Tmin ... (Tmax -20 K) at 658 hPa ... 540 hPa (+3 500 m ... +5 000 m)	Tmin ... Tmax at 1 140 hPa ... 795 hPa (-1 000 m ... +2 000 m) // Tmin ... (Tmax - 10 K) at 795 hPa ... 658 hPa (+2 000 m ... +3 500 m) // Tmin ... (Tmax -20 K) at 658 hPa ... 540 hPa (+3 500 m ... +5 000 m)	Tmin ... Tmax at 1 140 hPa ... 795 hPa (-1 000 m ... +2 000 m) // Tmin ... (Tmax - 10 K) at 795 hPa ... 658 hPa (+2 000 m ... +3 500 m) // Tmin ... (Tmax -20 K) at 658 hPa ... 540 hPa (+3 500 m ... +5 000 m)	Tmin ... Tmax at 1 140 hPa ... 795 hPa (-1 000 m ... +2 000 m) // Tmin ... (Tmax - 10 K) at 795 hPa ... 658 hPa (+2 000 m ... +3 500 m) // Tmin ... (Tmax -20 K) at 658 hPa ... 540 hPa (+3 500 m ... +5 000 m)	Tmin ... Tmax at 1 140 hPa ... 795 hPa (-1 000 m ... +2 000 m) // Tmin ... (Tmax - 10 K) at 795 hPa ... 658 hPa (+2 000 m ... +3 500 m) // Tmin ... (Tmax -20 K) at 658 hPa ... 540 hPa (+3 500 m ... +5 000 m)
Relative humidity					
• With condensation, tested in accordance with IEC 60068-2-38, max.	100 %; RH incl. condensation / frost (no commissioning in bedewed state), horizontal installation	100 %; RH incl. condensation / frost (no commissioning in bedewed state), horizontal installation	100 %; RH incl. condensation / frost (no commissioning in bedewed state), horizontal installation	100 %; RH incl. condensation / frost (no commissioning in bedewed state), horizontal installation	100 %; RH incl. condensation / frost (no commissioning in bedewed state), horizontal installation
Resistance					
Coolants and lubricants					
- Resistant to commercially available coolants and lubricants	Yes; Incl. diesel and oil droplets in the air	Yes; Incl. diesel and oil droplets in the air	Yes; Incl. diesel and oil droplets in the air	Yes; Incl. diesel and oil droplets in the air	Yes; Incl. diesel and oil droplets in the air
Use in stationary industrial systems					
- to biologically active substances according to EN 60721-3-3	Yes; Class 3B2 mold, fungus and dry rot spores (with the exception of fauna); Class 3B3 on request	Yes; Class 3B2 mold, fungus and dry rot spores (with the exception of fauna); Class 3B3 on request	Yes; Class 3B2 mold, fungus and dry rot spores (with the exception of fauna); Class 3B3 on request	Yes; Class 3B2 mold, fungus and dry rot spores (with the exception of fauna); Class 3B3 on request	Yes; Class 3B2 mold, fungus and dry rot spores (with the exception of fauna); Class 3B3 on request
- to chemically active substances according to EN 60721-3-3	Yes; Class 3C4 (RH < 75 %) incl. salt spray acc. to EN 60068-2-52 (severity degree 3); *	Yes; Class 3C4 (RH < 75 %) incl. salt spray acc. to EN 60068-2-52 (severity degree 3); *	Yes; Class 3C4 (RH < 75 %) incl. salt spray acc. to EN 60068-2-52 (severity degree 3); *	Yes; Class 3C4 (RH < 75 %) incl. salt spray acc. to EN 60068-2-52 (severity degree 3); *	Yes; Class 3C4 (RH < 75 %) incl. salt spray acc. to EN 60068-2-52 (severity degree 3); *
- to mechanically active substances according to EN 60721-3-3	Yes; Class 3S4 incl. sand, dust, *	Yes; Class 3S4 incl. sand, dust, *	Yes; Class 3S4 incl. sand, dust, *	Yes; Class 3S4 incl. sand, dust, *	Yes; Class 3S4 incl. sand, dust, *
- Against mechanical environmental conditions acc. to EN 60721-3-3	Yes; Class 3M8 using the SIPLUS Mounting Kit ET 200SP (6AG1193-6AA00-0AA0)	Yes; Class 3M8 using the SIPLUS Mounting Kit ET 200SP (6AG1193-6AA00-0AA0)	Yes; Class 3M8 using the SIPLUS Mounting Kit ET 200SP (6AG1193-6AA00-0AA0)	Yes; Class 3M8 using the SIPLUS Mounting Kit ET 200SP (6AG1193-6AA00-0AA0)	Yes; Class 3M8 using the SIPLUS Mounting Kit ET 200SP (6AG1193-6AA00-0AA0)

Technical specifications

Article number	6AG1135-6HD00-7BA1	6AG1135-6GB00-7BA1	6AG1135-6HB00-2DA1	6AG1135-6HB00-7CA1	6AG1135-6TD00-2CA1
Based on	6ES7135-6HD000-0BA1 SIPLUS ET 200SP AQ 4xU/I ST	6ES7135-6GB00-0BA1 SIPLUS ET 200SP AQ 2xI STANDARD	6ES7135-6HB00-0DA1 SIPLUS ET 200SP AQ 2 X U/I HIGH SPEED	6ES7135-6HB00-0CA1 SIPLUS ET 200SP AQ 2xU/I HF	6ES7135-6TD00-0CA1 SIPLUS ET 200SP AQ 4xI HART High Feature
Use on ships/at sea					
- to biologically active substances according to EN 60721-3-6	Yes; Class 6B2 mold and fungal spores (excluding fauna); Class 6B3 on request	Yes; Class 6B2 mold and fungal spores (excluding fauna); Class 6B3 on request	Yes; Class 6B2 mold and fungal spores (excluding fauna); Class 6B3 on request	Yes; Class 6B2 mold and fungal spores (excluding fauna); Class 6B3 on request	Yes; Class 6B2 mold and fungal spores (excluding fauna); Class 6B3 on request
- to chemically active substances according to EN 60721-3-6	Yes; Class 6C3 (RH < 75 %) incl. salt spray acc. to EN 60068-2-52 (severity degree 3); *	Yes; Class 6C3 (RH < 75 %) incl. salt spray acc. to EN 60068-2-52 (severity degree 3); *	Yes; Class 6C3 (RH < 75 %) incl. salt spray acc. to EN 60068-2-52 (severity degree 3); *	Yes; Class 6C3 (RH < 75 %) incl. salt spray acc. to EN 60068-2-52 (severity degree 3); *	Yes; Class 6C3 (RH < 75 %) incl. salt spray acc. to EN 60068-2-52 (severity degree 3); *
- to mechanically active substances according to EN 60721-3-6	Yes; Class 6S3 incl. sand, dust; *	Yes; Class 6S3 incl. sand, dust; *	Yes; Class 6S3 incl. sand, dust; *	Yes; Class 6S3 incl. sand, dust; *	Yes; Class 6S3 incl. sand, dust; *
- Against mechanical environmental conditions acc. to EN 60721-3-6	Yes; Class 6M4 using the SIPLUS Mounting Kit ET 200SP (6AG1193-6AA00-0AA0)	Yes; Class 6M4 using the SIPLUS Mounting Kit ET 200SP (6AG1193-6AA00-0AA0)	Yes; Class 6M4 using the SIPLUS Mounting Kit ET 200SP (6AG1193-6AA00-0AA0)	Yes; Class 6M4 using the SIPLUS Mounting Kit ET 200SP (6AG1193-6AA00-0AA0)	Yes; Class 6M4 using the SIPLUS Mounting Kit ET 200SP (6AG1193-6AA00-0AA0)
Usage in industrial process technology					
- Against chemically active substances acc. to EN 60654-4	Yes; Class 3 (excluding trichlorethylene)	Yes; Class 3 (excluding trichlorethylene)	Yes; Class 3 (excluding trichlorethylene)	Yes; Class 3 (excluding trichlorethylene)	Yes; Class 3 (excluding trichlorethylene)
- Environmental conditions for process, measuring and control systems acc. to ANSI/ISA-71.04	Yes; Level GX group A/B (excluding trichlorethylene; harmful gas concentrations up to the limits of EN 60721-3-3 class 3C4 permissible); level LC3 (salt spray) and level LB3 (oil)	Yes; Level GX group A/B (excluding trichlorethylene; harmful gas concentrations up to the limits of EN 60721-3-3 class 3C4 permissible); level LC3 (salt spray) and level LB3 (oil)	Yes; Level GX group A/B (excluding trichlorethylene; harmful gas concentrations up to the limits of EN 60721-3-3 class 3C4 permissible); level LC3 (salt spray) and level LB3 (oil)	Yes; Level GX group A/B (excluding trichlorethylene; harmful gas concentrations up to the limits of EN 60721-3-3 class 3C4 permissible); level LC3 (salt spray) and level LB3 (oil)	Yes; Level GX group A/B (excluding trichlorethylene; harmful gas concentrations up to the limits of EN 60721-3-3 class 3C4 permissible); level LC3 (salt spray) and level LB3 (oil)
Remark					
- Note regarding classification of environmental conditions acc. to EN 60721, EN 60654-4 and ANSI/ISA-71.04	* The supplied plug covers must remain in place over the unused interfaces during operation!	* The supplied plug covers must remain in place over the unused interfaces during operation!	* The supplied plug covers must remain in place over the unused interfaces during operation!	* The supplied plug covers must remain in place over the unused interfaces during operation!	* The supplied plug covers must remain in place over the unused interfaces during operation!
Conformal coating					
• Coatings for printed circuit board assemblies acc. to EN 61086	Yes; Class 2 for high reliability	Yes; Class 2 for high reliability	Yes; Class 2 for high reliability	Yes; Class 2 for high reliability	Yes; Class 2 for high reliability
• Protection against fouling acc. to EN 60664-3	Yes; Type 1 protection	Yes; Type 1 protection	Yes; Type 1 protection	Yes; Type 1 protection	Yes; Type 1 protection
• Military testing according to MIL-I-46058C, Amendment 7	Yes; Discoloration of coating possible during service life	Yes; Discoloration of coating possible during service life	Yes; Discoloration of coating possible during service life	Yes; Discoloration of coating possible during service life	Yes; Discoloration of coating possible during service life
• Qualification and Performance of Electrical Insulating Compound for Printed Board Assemblies according to IPC-CC-830A	Yes; Conformal coating, Class A	Yes; Conformal coating, Class A	Yes; Conformal coating, Class A	Yes; Conformal coating, Class A	Yes; Conformal coating, Class A

I/O systems

SIMATIC ET 200 systems for the control cabinet
SIMATIC ET 200SP

I/O modules > Technology modules > TM Count 1x24V counter module

Overview**Technical properties**

- Counter module for ET 200SP
- Interfaces:
 - 24 V encoder signals A, B and N from P, M or push-pull-switching encoders and sensors
 - 24 V encoder supply output, short-circuit proof
 - 3 digital inputs for controlling the count operation, for saving or for setting the count value
 - 2 digital outputs for fast reactions regardless of the counter status or measured value

- Counting frequency 200 kHz (800 kHz with quadruple evaluation)
- Counting range: +/- 31-bit
- Measurement function
- Parameterizable hardware interrupts
- Parameterizable input filters for suppressing interferences at sensor and digital inputs

Supported types of encoders/signals

- 24 V incremental encoder with and without N signal
- 24 V pulse encoder with direction signal
- 24 V pulse encoder without direction signal
- 24 V pulse encoder for pulse up and down respectively

Supported system functions

- Isochronous mode
- Firmware update
- Identification data I&M

Ordering data**Article No.****TM Count 1x24V counter module**

With one channel, max. 200 kHz;
for 24 V encoder

- Pack of 1 unit
- Pack of 10 units;
to order a pack, please order this article number with an order quantity of 10.

6ES7138-6AA01-0BA0
6ES7138-6AA01-2BA0

Suitable BaseUnits**BU15-P16+A10+2D**

BU type A0; BaseUnit (light) with
16 push-in terminals (1 ... 16)
to the module and an additional
10 internally jumpered
AUX terminals (1 A to 10 A);
for starting a new load group
(max. 10 A)

- Pack of 1 unit
- Pack of 10 units;
to order a pack, please order this article number with an order quantity of 10.

6ES7193-6BP20-0DA0
6ES7193-6BP20-2DA0

BU15-P16+A0+2D

BU type A0; BaseUnit (light) with
16 push-in terminals to the module;
for starting a new load group
(max. 10 A)

- Pack of 1 unit
- Pack of 10 units;
to order a pack, please order this article number with an order quantity of 10.

6ES7193-6BP00-0DA0
6ES7193-6BP00-2DA0

Article No.**BU15-P16+A10+2B**

BU type A0; BaseUnit (dark) with
16 push-in terminals (1 ... 16)
to the module and an additional
10 internally jumpered
AUX terminals (1 A to 10 A);
for continuing the load group

- Pack of 1 unit
- Pack of 10 units;
to order a pack, please order this article number with an order quantity of 10.

6ES7193-6BP20-0BA0
6ES7193-6BP20-2BA0

BU15-P16+A0+2B

BU type A0; BaseUnit (dark) with
16 push-in terminals to the module;
for continuing the load group

- Pack of 1 unit
- Pack of 10 units;
to order a pack, please order this article number with an order quantity of 10.

6ES7193-6BP00-0BA0
6ES7193-6BP00-2BA0

Ordering data	Article No.	Article No.
Accessories		
Equipment labeling plate 10 sheets of 16 labels	6ES7193-6LF30-0AW0	6ES7193-6CP71-2AA0
Labeling strips 500 labeling strips on roll, light gray, for inscription with thermal transfer roll printer	6ES7193-6LR10-0AA0	6ES7193-6CP72-2AA0
500 labeling strips on roll, yellow, for inscription with thermal transfer roll printer	6ES7193-6LR10-0AG0	6ES7193-6CP73-2AA0
1 000 labeling strips DIN A4, light gray, card, for inscription with laser printer	6ES7193-6LA10-0AA0	
1 000 labeling strips DIN A4, yellow, card, for inscription with laser printer	6ES7193-6LA10-0AG0	
BU cover For covering empty slots (gaps); 5 units		
• 15 mm wide	6ES7133-6CV15-1AM0	
• 20 mm wide	6ES7133-6CV20-1AM0	
Shield connection 5 shield supports and 5 shield terminals	6ES7193-6SC00-1AM0	
		Color-coded labels
		• Color code CC71, for 10 AUX terminals 1 A to 10 A, for BU type A0, yellow/green, with push-in terminals; 10 units
		• Color code CC72, for 10 AUX terminals 1 A to 10 A, for BU type A0, red, with push-in terminals; 10 units
		• Color code CC73, for 10 AUX terminals 1 A to 10 A, for BU type A0, blue, with push-in terminals; 10 units
		Mechanical coding elements
		For automatic coding of I/O modules; spare part. 20 units
		Type A
		6ES7193-6KA00-3AA0
		Type B
		6ES7193-6KB00-3AA0
		Type C
		6ES7193-6KC00-3AA0
		Type D
		6ES7193-6KD00-3AA0

Technical specifications

Article number	6ES7138-6AA01-0BA0 ET 200SP, TM Count 1x24V
General information	
Product type designation	TM Count 1x24V
Product function	
• I&M data	Yes; I&M0 to I&M3
• Isochronous mode	Yes
Engineering with	
• STEP 7 TIA Portal configurable/integrated from version	STEP 7 V15 SP1 or higher
• STEP 7 configurable/integrated from version	V5.6 and higher
• PROFIBUS from GSD version/GSD revision	One GSD file each, Revision 3 and 5 and higher
• PROFINET from GSD version/GSD revision	GSDML V2.34
Supply voltage	
Load voltage L+	
• Rated value (DC)	24 V
• Reverse polarity protection	Yes
Encoder supply	
Number of outputs	1
24 V encoder supply	
• 24 V	Yes; L+ (-0.8 V)
• Short-circuit protection	Yes; electronic/thermal
• Output current, max.	300 mA
Digital inputs	
Number of digital inputs	3
Digital inputs, parameterizable	Yes
Input characteristic curve in accordance with IEC 61131, type 3	Yes

Article number	6ES7138-6AA01-0BA0 ET 200SP, TM Count 1x24V
Digital input functions, parameterizable	
• Gate start/stop	Yes
• Capture	Yes
• Synchronization	Yes
• Freely usable digital input	Yes
Input voltage	
• Rated value (DC)	24 V
• for signal "0"	-5 ... +5 V
• for signal "1"	+11 to +30V
• permissible voltage at input, min.	-30 V; -5 V continuous, -30 V brief reverse polarity protection
• permissible voltage at input, max.	30 V
Input current	
• for signal "1", typ.	2.5 mA
Input delay (for rated value of input voltage) for standard inputs	
- parameterizable	Yes; none / 0.05 / 0.1 / 0.4 / 0.8 / 1.6 / 3.2 / 12.8 / 20 ms
- at "0" to "1", min.	6 µs; for parameterization "none"
- at "1" to "0", min.	6 µs; for parameterization "none"
for technological functions	
- parameterizable	Yes
Digital outputs	
Type of digital output	Transistor
Number of digital outputs	2
Digital outputs, parameterizable	Yes
Short-circuit protection	Yes; electronic/thermal
Limitation of inductive shutdown voltage to	L+ (-53 V)
Controlling a digital input	Yes

I/O systems

SIMATIC ET 200 systems for the control cabinet
SIMATIC ET 200SP

I/O modules > Technology modules > TM Count 1x24V counter module

Technical specifications

Article number	6ES7138-6AA01-0BA0 ET 200SP, TM Count 1x24V
Digital output functions, parameterizable	
• Switching tripped by comparison values	Yes
• Freely usable digital output	Yes
Switching capacity of the outputs	
• with resistive load, max.	0.5 A; Per digital output
• on lamp load, max.	5 W
Load resistance range	
• lower limit	48 Ω
• upper limit	12 kΩ
Output voltage	
• for signal "1", min.	23.2 V; L+ (-0.8 V)
Output current	
• for signal "1" rated value	0.5 A; Per digital output
• for signal "0" residual current, max.	0.5 mA
Output delay with resistive load	
• "0" to "1", max.	50 μs
• "1" to "0", max.	50 μs
Switching frequency	
• with resistive load, max.	10 kHz
• with inductive load, max.	0.5 Hz; Acc. to IEC 60947-5-1, DC-13; observe derating curve
• on lamp load, max.	10 Hz
Total current of the outputs	
• Current per module, max.	1 A
Encoder	
Connectable encoders	
• 2-wire sensor	Yes
- permissible quiescent current (2-wire sensor), max.	1.5 mA
Encoder signals, incremental encoder (asymmetrical)	
• Input voltage	24 V
• Input frequency, max.	200 kHz
• Counting frequency, max.	800 kHz; with quadruple evaluation
• Cable length, shielded, max.	600 m; depending on input frequency, encoder and cable quality; max. 50 m at 200 kHz
• Signal filter, parameterizable	Yes
• Incremental encoder with A/B tracks, 90° phase offset	Yes
• Incremental encoder with A/B tracks, 90° phase offset and zero track	Yes
• pulse encoder	Yes
• pulse encoder with direction	Yes
• pulse encoder with one impulse signal per count direction	Yes
Encoder signal 24 V	
- permissible voltage at input, min.	-30 V; -5 V continuous, -30 V brief reverse polarity protection
- permissible voltage at input, max.	30 V

Article number	6ES7138-6AA01-0BA0 ET 200SP, TM Count 1x24V
Interface types	
• Source/sink input	Yes
• Input characteristic curve in accordance with IEC 61131, type 3	Yes
Interrupts/diagnostics/status information	
Substitute values connectable	Yes; Parameterizable
Alarms	
• Diagnostic alarm	Yes
• Hardware interrupt	Yes
Diagnoses	
• Monitoring the supply voltage	Yes
• Wire-break	Yes
• Short-circuit	Yes
• A/B transition error at incremental encoder	Yes
• Group error	Yes
Diagnostics indication LED	
• Monitoring of the supply voltage (PWR-LED)	Yes; green PWR LED
• Channel status display	Yes; green LED
• for module diagnostics	Yes; green/red DIAG LED
• Status indicator forward counting (green)	Yes
• Status indicator backward counting (green)	Yes
Integrated Functions	
Counter	Yes
• Number of counters	1
• Counting frequency, max.	800 kHz; with quadruple evaluation
Fast mode	Yes
Counting functions	
• Can be used with TO High_Speed_Counter	Yes
• Continuous counting	Yes
• Counter response parameterizable	Yes
• Hardware gate via digital input	Yes
• Software gate	Yes
• Event-controlled stop	Yes
• Synchronization via digital input	Yes
• Counting range, parameterizable	Yes
Comparator	
- Number of comparators	2
- Direction dependency	Yes
- Can be changed from user program	Yes
Position detection	
• Incremental acquisition	Yes
• Suitable for S7-1500 Motion Control	Yes

Technical specifications

Article number	6ES7138-6AA01-0BA0 ET 200SP, TM Count 1x24V
Measuring functions	
• Measuring time, parameterizable	Yes
• Dynamic measurement period adjustment	Yes
• Number of thresholds, parameterizable	2
Measuring range	
- Frequency measurement, min.	0.04 Hz
- Frequency measurement, max.	800 kHz
- Cycle duration measurement, min.	1.25 µs
- Cycle duration measurement, max.	25 s
Accuracy	
- Frequency measurement	100 ppm; depending on measuring interval and signal evaluation
- Cycle duration measurement	100 ppm; depending on measuring interval and signal evaluation
- Velocity measurement	100 ppm; depending on measuring interval and signal evaluation
Potential separation	
Potential separation channels	
• between the channels and backplane bus	Yes
Standards, approvals, certificates	
Suitable for safety functions	No

Article number	6ES7138-6AA01-0BA0 ET 200SP, TM Count 1x24V
Ambient conditions	
Ambient temperature during operation	
• horizontal installation, min.	-30 °C
• horizontal installation, max.	60 °C
• vertical installation, min.	-30 °C
• vertical installation, max.	50 °C
Altitude during operation relating to sea level	
• Installation altitude above sea level, max.	5 000 m; Restrictions for installation altitudes > 2 000 m, see manual
Decentralized operation	
to SIMATIC S7-300	Yes
to SIMATIC S7-400	Yes
to SIMATIC S7-1200	Yes
to SIMATIC S7-1500	Yes
to standard PROFIBUS master	Yes
to standard PROFINET controller	Yes
Dimensions	
Width	15 mm
Height	73 mm
Depth	58 mm
Weights	
Weight, approx.	45 g

I/O systems

SIMATIC ET 200 systems for the control cabinet
SIMATIC ET 200SP

I/O modules > Technology modules > TM PosInput 1 counter and position detection module

Overview



- Counter frequency 1 MHz (4 MHz with quadruple evaluation)
- Counting range: +/- 31 bits
- Measurement function
- Parameterizable hardware interrupts
- Parameterizable input filters for suppressing interferences at sensor and digital inputs

Supported types of encoders/signals

- Incremental encoders with or without N signal
- Pulse encoders with directional signal
- Pulse encoders without directional signal
- Pulse encoders for forward or reverse pulses
- SSI encoders with a frame length of 10 to 40 bits, of which up to 31 bits position value

Supported system functions

- Isochronous mode
- Firmware update
- Identification data I&M

Technical properties

- Counter and position detection module for ET 200SP
- Interfaces:
 - Encoder signals A, B and N for 5 V TTL or RS422 differential signals
 - SSI interface with clock and data for RS422 differential signals
 - 24 V encoder supply, short-circuit proof
 - 5 V encoder supply, short-circuit proof
 - 2 digital inputs for controlling the counting process, for saving or setting the counter or position value
 - 2 digital outputs for fast reactions depending on the counter reading, position value or measured value

Ordering data

TM PosInput 1 counter and position detection module

With one channel, max. 1 MHz for 5 V TTL or RS422 differential signals or SSI absolute encoder

- Pack of 1 unit
- Pack of 10 units; to order a pack, please order this article number with an order quantity of 10.

6ES7138-6BA01-0BA0
6ES7138-6BA01-2BA0

Suitable BaseUnits

BU15-P16+A10+2D

BU type A0; BaseUnit (light) with 16 push-in terminals (1 ... 16) to the module and an additional 10 internally jumpered AUX terminals (1 A to 10 A); for starting a new load group (max. 10 A)

- Pack of 1 unit
- Pack of 10 units; to order a pack, please order this article number with an order quantity of 10.

6ES7193-6BP20-0DA0
6ES7193-6BP20-2DA0

BU15-P16+A0+2D

BU type A0; BaseUnit (light) with 16 push-in terminals to the module; for starting a new load group (max. 10 A)

- Pack of 1 unit
- Pack of 10 units; to order a pack, please order this article number with an order quantity of 10.

6ES7193-6BP00-0DA0
6ES7193-6BP00-2DA0

BU15-P16+A10+2B

BU type A0; BaseUnit (dark) with 16 push-in terminals (1 ... 16) to the module and an additional 10 internally jumpered AUX terminals (1 A to 10 A); for continuing the load group

- Pack of 1 unit
- Pack of 10 units; to order a pack, please order this article number with an order quantity of 10.

6ES7193-6BP20-0BA0
6ES7193-6BP20-2BA0

BU15-P16+A0+2B

BU type A0; BaseUnit (dark) with 16 push-in terminals to the module; for continuing the load group

- Pack of 1 unit
- Pack of 10 units; to order a pack, please order this article number with an order quantity of 10.

6ES7193-6BP00-0BA0
6ES7193-6BP00-2BA0

Ordering data	Article No.	Article No.
Accessories		
Equipment labeling plate 10 sheets of 16 labels	6ES7193-6LF30-0AW0	6ES7193-6CP71-2AA0
Labeling strips 500 labeling strips on roll, light gray, for inscription with thermal transfer roll printer	6ES7193-6LR10-0AA0	6ES7193-6CP72-2AA0
500 labeling strips on roll, yellow, for inscription with thermal transfer roll printer	6ES7193-6LR10-0AG0	6ES7193-6CP73-2AA0
1 000 labeling strips DIN A4, light gray, card, for inscription with laser printer	6ES7193-6LA10-0AA0	
1 000 labeling strips DIN A4, yellow, card, for inscription with laser printer	6ES7193-6LA10-0AG0	
BU cover For covering empty slots (gaps); 5 units		
• 15 mm wide	6ES7133-6CV15-1AM0	
• 20 mm wide	6ES7133-6CV20-1AM0	
Shield connection 5 shield supports and 5 shield terminals	6ES7193-6SC00-1AM0	
		Color-coded labels
		• Color code CC71, for 10 AUX terminals 1 A to 10 A, for BU type A0, yellow/green, with push-in terminals; 10 units
		• Color code CC72, for 10 AUX terminals 1 A to 10 A, for BU type A0, red, with push-in terminals; 10 units
		• Color code CC73, for 10 AUX terminals 1 A to 10 A, for BU type A0, blue, with push-in terminals; 10 units
		Mechanical coding elements For automatic coding of I/O modules; spare part. 20 units
		Type A
		6ES7193-6KA00-3AA0
		Type B
		6ES7193-6KB00-3AA0
		Type C
		6ES7193-6KC00-3AA0
		Type D
		6ES7193-6KD00-3AA0

Technical specifications

Article number	6ES7138-6BA01-0BA0 ET 200SP, TM Posinput 1
General information	
Product type designation	TM PosInput 1
Product function	
• I&M data	Yes; I&M0 to I&M3
• Isochronous mode	Yes
Engineering with	
• STEP 7 TIA Portal configurable/ integrated from version	STEP 7 V16 or higher
• STEP 7 configurable/ integrated from version	V5.6 (use previous version *6BA00*)
• PROFIBUS from GSD version/ GSD revision	GSD Revision 5
• PROFINET from GSD version/ GSD revision	GSDML V2.34
Supply voltage	
Load voltage L+	
• Rated value (DC)	24 V
• Reverse polarity protection	Yes
Encoder supply	
Number of outputs	2
5 V encoder supply	
• 5 V	Yes
• Short-circuit protection	Yes; electronic/thermal
• Output current, max.	300 mA; Total current of all encoders
24 V encoder supply	
• 24 V	Yes; L+ (-0.8 V)
• Short-circuit protection	Yes; electronic/thermal
• Output current, max.	300 mA; Total current of all encoders
Digital inputs	
Number of digital inputs	2
Digital inputs, parameterizable	Yes
Input characteristic curve in accordance with IEC 61131, type 3	Yes

Article number	6ES7138-6BA01-0BA0 ET 200SP, TM Posinput 1
Digital input functions, parameterizable	
• Gate start/stop	Yes; only for pulse and incremental encoders
• Capture	Yes
• Synchronization	Yes; only for pulse and incremental encoders
• Freely usable digital input	Yes
Input voltage	
• Rated value (DC)	24 V
• for signal "0"	-5 ... +5 V
• for signal "1"	+11 to +30V
• permissible voltage at input, min.	-30 V; -5 V continuous, -30 V brief reverse polarity protection
• permissible voltage at input, max.	30 V
Input current	
• for signal "1", typ.	2.5 mA
Input delay (for rated value of input voltage) for standard inputs	
- parameterizable	Yes; none / 0.05 / 0.1 / 0.4 / 0.8 / 1.6 / 3.2 / 12.8 / 20 ms
- at "0" to "1", min.	6 µs; for parameterization "none"
- at "1" to "0", min.	6 µs; for parameterization "none"
for technological functions	
- parameterizable	Yes

I/O systems

SIMATIC ET 200 systems for the control cabinet
SIMATIC ET 200SP

I/O modules > Technology modules > TM PosInput 1 counter and position detection module

Technical specifications

Article number	6ES7138-6BA01-0BA0 ET 200SP, TM Posinput 1
Digital outputs	
Type of digital output	Transistor
Number of digital outputs	2
Digital outputs, parameterizable	Yes
Short-circuit protection	Yes; electronic/thermal
Limitation of inductive shutdown voltage to	L+ (-53 V)
Controlling a digital input	Yes
Digital output functions, parameterizable	
• Switching tripped by comparison values	Yes
• Freely usable digital output	Yes
Switching capacity of the outputs	
• with resistive load, max.	0.5 A; Per digital output
• on lamp load, max.	5 W
Load resistance range	
• lower limit	48 Ω
• upper limit	12 kΩ
Output voltage	
• for signal "1", min.	23.2 V; L+ (-0.8 V)
Output current	
• for signal "1" rated value	0.5 A; Per digital output
• for signal "0" residual current, max.	0.5 mA
Output delay with resistive load	
• "0" to "1", max.	50 μs
• "1" to "0", max.	50 μs
Switching frequency	
• with resistive load, max.	10 kHz
• with inductive load, max.	0.5 Hz; Acc. to IEC 60947-5-1, DC-13; observe derating curve
• on lamp load, max.	10 Hz
Total current of the outputs	
• Current per module, max.	1 A
Encoder	
Encoder signals, incremental encoder (symmetrical)	
• Input voltage	RS 422
• Input frequency, max.	1 MHz
• Counting frequency, max.	4 MHz; with quadruple evaluation
• Cable length, shielded, max.	32 m; at 1 MHz
• Signal filter, parameterizable	Yes
• Incremental encoder with A/B tracks, 90° phase offset	Yes
• Incremental encoder with A/B tracks, 90° phase offset and zero track	Yes
• pulse encoder	Yes
• Pulse encoder with direction	Yes
• pulse encoder with one impulse signal per count direction	Yes

Article number	6ES7138-6BA01-0BA0 ET 200SP, TM Posinput 1
Encoder signals, incremental encoder (asymmetrical)	
• Input voltage	5 V TTL (push-pull encoders only)
• Input frequency, max.	1 MHz
• Counting frequency, max.	4 MHz; with quadruple evaluation
• Signal filter, parameterizable	Yes
• Incremental encoder with A/B tracks, 90° phase offset	Yes
• Incremental encoder with A/B tracks, 90° phase offset and zero track	Yes
• pulse encoder	Yes
• pulse encoder with direction	Yes
• pulse encoder with one impulse signal per count direction	Yes
Encoder signals, absolute encoder (SSI)	
• Input signal	to RS-422
• Telegram length, parameterizable	10 ... 40 bit
• Clock frequency, max.	2 MHz; 125 kHz, 250 kHz, 500 kHz, 1 MHz, 1.5 MHz or 2 MHz
• Binary code	Yes
• Gray code	Yes
• Cable length, shielded, max.	320 m; Cable length, RS-422 SSI absolute encoders, Siemens type 6FX2001-5, 24 V supply: 125 kHz, 320 meters shielded, max.; 250 kHz, 160 meters shielded, max.; 500 kHz, 60 meters shielded, max.; 1 MHz, 20 meters shielded, max.; 1.5 MHz, 10 meters shielded, max.; 2 MHz, 8 meters shielded, max.
• Parity bit, parameterizable	Yes
• Monoflop time	16, 32, 48, 64 μs & automatic
• Multiturn	Yes
• Singleturn	Yes
Interface types	
• TTL 5 V	Yes; push-pull encoders only
• RS 422	Yes
Interrupts/diagnostics/status information	
Substitute values connectable	Yes; Parameterizable
Alarms	
• Diagnostic alarm	Yes
• Hardware interrupt	Yes
Diagnoses	
• Monitoring the supply voltage	Yes
• Wire-break	Yes
• Short-circuit	Yes
• A/B transition error at incremental encoder	Yes
• Telegram error at SSI encoder	Yes
• Group error	Yes

Technical specifications

Article number	6ES7138-6BA01-0BA0 ET 200SP, TM Posinput 1
Diagnostics indication LED	
• Monitoring of the supply voltage (PWR-LED)	Yes; green PWR LED
• Channel status display	Yes; green LED
• for module diagnostics	Yes; green/red DIAG LED
• Status indicator forward counting (green)	Yes
• Status indicator backward counting (green)	Yes
Integrated Functions	
Counter	Yes
• Number of counters	1
• Counting frequency, max.	4 MHz; with quadruple evaluation
Fast mode	Yes
Counting functions	
• Can be used with TO High_Speed_Counter	Yes; only for pulse and incremental encoders
• Continuous counting	Yes
• Counter response parameterizable	Yes
• Hardware gate via digital input	Yes
• Software gate	Yes
• Event-controlled stop	Yes
• Synchronization via digital input	Yes
• Counting range, parameterizable	Yes
Comparator	
- Number of comparators	2
- Direction dependency	Yes
- Can be changed from user program	Yes
Position detection	
• Incremental acquisition	Yes
• Absolute acquisition	Yes
• Suitable for S7-1500 Motion Control	Yes
Measuring functions	
• Measuring time, parameterizable	Yes
• Dynamic measurement period adjustment	Yes
• Number of thresholds, parameterizable	2
Measuring range	
- Frequency measurement, min.	0.04 Hz
- Frequency measurement, max.	4 MHz
- Cycle duration measurement, min.	0.25 µs
- Cycle duration measurement, max.	25 s
Accuracy	
- Frequency measurement	100 ppm; depending on measuring interval and signal evaluation
- Cycle duration measurement	100 ppm; depending on measuring interval and signal evaluation
- Velocity measurement	100 ppm; depending on measuring interval and signal evaluation

Article number	6ES7138-6BA01-0BA0 ET 200SP, TM Posinput 1
Potential separation	
Potential separation channels	
• between the channels and backplane bus	Yes
Standards, approvals, certificates	
Suitable for safety functions	No
Ambient conditions	
Ambient temperature during operation	
• horizontal installation, min.	-30 °C
• horizontal installation, max.	60 °C; Observe derating
• vertical installation, min.	-30 °C
• vertical installation, max.	50 °C; Observe derating
Altitude during operation relating to sea level	
• Installation altitude above sea level, max.	5 000 m; Restrictions for installation altitudes > 2 000 m, see manual
Decentralized operation	
to SIMATIC S7-300	Yes
to SIMATIC S7-400	Yes
to SIMATIC S7-1200	Yes
to SIMATIC S7-1500	Yes
to standard PROFIBUS master	Yes
to standard PROFINET controller	Yes
Dimensions	
Width	15 mm
Height	73 mm
Depth	58 mm
Weights	
Weight, approx.	45 g

I/O systems

SIMATIC ET 200 systems for the control cabinet
SIMATIC ET 200SP

I/O modules > Technology modules > TM Timer DIDQ 10x24V time-based IO module

Overview



- 4 digital inputs, 6 digital outputs
- Inputs for detecting the input edges with μs accuracy
- Outputs for outputting the switching signals with μs accuracy
- 32x oversampling
- PWM output
- Counter function
- Outputs can be switched between 0.5 A standard and especially fast 0.1 A high-speed mode

Ordering data

TM Timer DIDQ 10x24V time-based IO module

4 time-controlled inputs,
6 time-controlled outputs

Article No.

6ES7138-6CG00-0BA0

Suitable BaseUnits

BU15-P16+A10+2D

BU type A0; BaseUnit (light) with 16 push-in terminals (1 ... 16) to the module and an additional 10 internally jumpered AUX terminals (1 A to 10 A); for starting a new load group (max. 10 A)

- Pack of 1 unit
- Pack of 10 units; to order a pack, please order this article number with an order quantity of 10.

6ES7193-6BP20-0DA0
6ES7193-6BP20-2DA0

BU15-P16+A0+2D

BU type A0; BaseUnit (light) with 16 push-in terminals to the module; for starting a new load group (max. 10 A)

- Pack of 1 unit
- Pack of 10 units; to order a pack, please order this article number with an order quantity of 10.

6ES7193-6BP00-0DA0
6ES7193-6BP00-2DA0

BU15-P16+A10+2B

BU type A0; BaseUnit (dark) with 16 push-in terminals (1 ... 16) to the module and an additional 10 internally jumpered AUX terminals (1 A to 10 A); for continuing the load group

- Pack of 1 unit
- Pack of 10 units; to order a pack, please order this article number with an order quantity of 10.

6ES7193-6BP20-0BA0
6ES7193-6BP20-2BA0

Article No.

BU15-P16+A0+2B

BU type A0; BaseUnit (dark) with 16 push-in terminals to the module; for continuing the load group

- Pack of 1 unit
- Pack of 10 units; to order a pack, please order this article number with an order quantity of 10.

6ES7193-6BP00-0BA0
6ES7193-6BP00-2BA0

Accessories

Equipment labeling plate

10 sheets of 16 labels

6ES7193-6LF30-0AW0

Labeling strips

500 labeling strips on roll, light gray, for inscription with thermal transfer roll printer

6ES7193-6LR10-0AA0

500 labeling strips on roll, yellow, for inscription with thermal transfer roll printer

6ES7193-6LR10-0AG0

1 000 labeling strips DIN A4, light gray, card, for inscription with laser printer

6ES7193-6LA10-0AA0

1 000 labeling strips DIN A4, yellow, card, for inscription with laser printer

6ES7193-6LA10-0AG0

BU cover

For covering empty slots (gaps); 5 units

- 15 mm wide
- 20 mm wide

6ES7133-6CV15-1AM0
6ES7133-6CV20-1AM0

Shield connection

5 shield supports and 5 shield terminals

6ES7193-6SC00-1AM0

10

Ordering data	Article No.	Mechanical coding elements	Article No.
Color-coded labels <ul style="list-style-type: none"> Color code CC71, for 10 AUX terminals 1 A to 10 A, for BU type A0, yellow/green, with push-in terminals; 10 units Color code CC72, for 10 AUX terminals 1 A to 10 A, for BU type A0, red, with push-in terminals; 10 units Color code CC73, for 10 AUX terminals 1 A to 10 A, for BU type A0, blue, with push-in terminals; 10 units 	6ES7193-6CP71-2AA0 6ES7193-6CP72-2AA0 6ES7193-6CP73-2AA0	For automatic coding of I/O modules; spare part. 20 units Type A Type B Type C Type D	6ES7193-6KA00-3AA0 6ES7193-6KB00-3AA0 6ES7193-6KC00-3AA0 6ES7193-6KD00-3AA0

Technical specifications

Article number	Article number
6ES7138-6CG00-0BA0 ET 200SP, TM Timer DIDQ 10x24V	6ES7138-6CG00-0BA0 ET 200SP, TM Timer DIDQ 10x24V
General information Product type designation: TM Timer DIDQ 10x24V	Input voltage <ul style="list-style-type: none"> Type of input voltage: DC Rated value (DC): 24 V for signal "0": -5 ... +5 V for signal "1": +11 to +30V permissible voltage at input, min.: -30 V; -5 V continuous, -30 V brief reverse polarity protection permissible voltage at input, max.: 30 V
Product function <ul style="list-style-type: none"> I&M data: Yes; I&M 0 Isochronous mode: Yes 	Input current <ul style="list-style-type: none"> for signal "1", typ.: 2.5 mA
Engineering with <ul style="list-style-type: none"> STEP 7 TIA Portal configurable/integrated from version: V13 Update 3 STEP 7 configurable/integrated from version: V5.5 SP3 / - 	Input delay (for rated value of input voltage) <ul style="list-style-type: none"> Minimum pulse width for program reactions: 3 µs for parameterization "none"
Supply voltage Load voltage L+ <ul style="list-style-type: none"> Rated value (DC): 24 V Reverse polarity protection: Yes; against destruction 	for standard inputs <ul style="list-style-type: none"> parameterizable: Yes; none / 0.05 / 0.1 / 0.4 / 0.8 ms at "0" to "1", min.: 4 µs at "1" to "0", min.: 4 µs
Encoder supply Number of outputs: 1	Digital outputs <ul style="list-style-type: none"> Type of digital output: Transistor Number of digital outputs: 6 Digital outputs, parameterizable: Yes Short-circuit protection: Yes; electronic/thermal Limitation of inductive shutdown voltage to: -0.8 V
24 V encoder supply <ul style="list-style-type: none"> 24 V: Yes; L+ (-0.8 V) Short-circuit protection: Yes Output current, max.: 500 mA; Observe derating 	Digital output functions, parameterizable <ul style="list-style-type: none"> Digital output with time stamp: Yes - Number, max.: 4 PWM output: Yes - Number, max.: 6 Digital output with oversampling: Yes - Number, max.: 6
Digital inputs <ul style="list-style-type: none"> Number of digital inputs: 4 Digital inputs, parameterizable: Yes Input characteristic curve in accordance with IEC 61131, type 3: Yes 	Switching capacity of the outputs <ul style="list-style-type: none"> with resistive load, max.: 0.5 A; 0.1 A with High Speed output on lamp load, max.: 5 W; 1 W with High Speed output
Digital input functions, parameterizable <ul style="list-style-type: none"> Digital input with time stamp: Yes - Number, max.: 4 Counter: Yes - Number, max.: 3 Counter for incremental encoder: Yes - Number, max.: 1 Digital input with oversampling: Yes - Number, max.: 4 HW enable for digital input: Yes - Number, max.: 1 HW enable for digital output: Yes - Number, max.: 3 	Load resistance range <ul style="list-style-type: none"> lower limit: 48 Ω; 240 ohm with High Speed output upper limit: 12 kΩ

I/O systems

SIMATIC ET 200 systems for the control cabinet
SIMATIC ET 200SP

I/O modules > Technology modules > TM Timer DIDQ 10x24V time-based IO module

Technical specifications

Article number	6ES7138-6CG00-0BA0 ET 200SP, TM Timer DIDQ 10x24V
Output voltage	
• Type of output voltage	DC
• for signal "0", max.	1 V; With High Speed output
• for signal "1", min.	23.2 V; L+ (-0.8 V)
Output current	
• for signal "1" rated value	0.5 A; 0.1 A with High Speed output, observe derating
• for signal "0" residual current, max.	0.5 mA
Output delay with resistive load	
• "0" to "1", max.	1 µs; With High Speed output, 5 µs with Standard output
• "1" to "0", max.	1 µs; With High Speed output, 6 µs with Standard output
Switching frequency	
• with resistive load, max.	10 kHz
• on lamp load, max.	10 Hz
Total current of the outputs	
• Current per module, max.	3.5 A; Observe derating
Encoder	
Connectable encoders	
• Incremental encoder (asymmetrical)	Yes
• 24 V initiator	Yes
• 2-wire sensor	Yes
- permissible quiescent current (2-wire sensor), max.	1.5 mA
Encoder signals, incremental encoder (asymmetrical)	
• Input voltage	24 V
• Input frequency, max.	50 kHz
• Counting frequency, max.	200 kHz; with quadruple evaluation
• Cable length, shielded, max.	600 m; Depending on input frequency, encoder and cable quality; max. 200 m at 50 kHz
• Incremental encoder with A/B tracks, 90° phase offset	Yes
• pulse encoder	Yes
Encoder signal 24 V	
- permissible voltage at input, min.	-30 V
- permissible voltage at input, max.	30 V
Interface types	
• Input characteristic curve in accordance with IEC 61131, type 3	Yes
Isochronous mode	
Bus cycle time (TDP), min.	375 µs

Article number	6ES7138-6CG00-0BA0 ET 200SP, TM Timer DIDQ 10x24V
Interrupts/diagnostics/ status information	
Diagnostics function	Yes
Substitute values connectable	Yes
Alarms	
• Diagnostic alarm	Yes
Diagnoses	
• Monitoring the supply voltage	Yes
• Short-circuit	Yes
Diagnostics indication LED	
• Monitoring of the supply voltage (PWR-LED)	Yes; green PWR LED
• Channel status display	Yes
• for module diagnostics	Yes; green/red DIAG LED
Integrated Functions	
Counter	Yes
• Number of counters	3
• Counting frequency, max.	200 kHz; with quadruple evaluation
Counting functions	
• Continuous counting	Yes
Potential separation	
Potential separation channels	
• between the channels and backplane bus	Yes
Standards, approvals, certificates	
Suitable for safety functions	No
Ambient conditions	
Ambient temperature during operation	
• horizontal installation, min.	-30 °C
• horizontal installation, max.	60 °C; Observe derating
• vertical installation, min.	-30 °C
• vertical installation, max.	50 °C; Observe derating
Altitude during operation relating to sea level	
• Installation altitude above sea level, max.	5 000 m; restrictions for installation altitudes > 2 000 m, see ET 200SP system manual
Decentralized operation	
to SIMATIC S7-1500	Yes
Dimensions	
Width	15 mm
Height	73 mm
Depth	58 mm
Weights	
Weight, approx.	45 g

Overview



2-channel pulse output module for ET 200SP

- Operating modes:
 - Single pulse with defined length
 - Pulse chain with defined number of pulses
 - Pulse width modulation (with flexible ON period, optional current control and dither function)
 - PWM signal for controlling a DC motor
 - ON and OFF delay; rising and falling edge can be delayed separately to the microsecond
 - Frequency output with defined output frequency
- Hardware:
 - 2 channels 24 V, 2 A output current
 - Parallel switching for enhanced performance on 4 A output current
 - Switching frequencies to 10 kHz; at reduced output current to 0.1 A up to 100 kHz
 - Push-pull output driver for especially steep edges at the outputs
 - Polarity change in DC motor operation for direction reversal
 - 1 high-speed 24 V digital input per channel with parameterizable input delay from 4 μ s
- Channel functions:
 - HW enable; start of signal output with the onboard digital input
 - Parameterizable ON delay; for precise deceleration between the HW enable and the start of output
 - Current measurement in the operating modes pulse-width modulation and pulse chain; enables control of the output current mean value over a period. This allows you to compensate for the effect of temperature on the actuator resistance.
 - Cyclic control of the respective main setpoint from the PLC in every operating mode; other values can be modified flexibly from the user program.
- Supported system functions:
 - Isochronous mode; enables precision-timed connection of the setpoint output to a higher-level controller
 - Firmware update
 - Identification data I&M

Ordering data

Article No.

TM Pulse 2x24V pulse output module PWM and pulse output, 2 channels of 2 A for proportional valves and DC motors	6ES7138-6DB00-0BB1
Suitable BaseUnits	
BU20-P12+A0+4B BU type B1; BaseUnit (dark); without AUX terminals; for continuing the load group	6ES7193-6BP20-0BB1
Accessories	
Equipment labeling plate 10 sheets of 16 labels	6ES7193-6LF30-0AW0
Labeling strips 500 labeling strips on roll, light gray, for inscription with thermal transfer roll printer	6ES7193-6LR10-0AA0
500 labeling strips on roll, yellow, for inscription with thermal transfer roll printer	6ES7193-6LR10-0AG0
1 000 labeling strips DIN A4, light gray, card, for inscription with laser printer	6ES7193-6LA10-0AA0
1 000 labeling strips DIN A4, yellow, card, for inscription with laser printer	6ES7193-6LA10-0AG0
BU cover For covering empty slots (gaps); 5 units	
• 15 mm wide	6ES7133-6CV15-1AM0
• 20 mm wide	6ES7133-6CV20-1AM0
Mechanical coding elements For automatic coding of I/O modules; spare part. 20 units	
Type A	6ES7193-6KA00-3AA0
Type B	6ES7193-6KB00-3AA0
Type C	6ES7193-6KC00-3AA0
Type D	6ES7193-6KD00-3AA0

I/O systemsSIMATIC ET 200 systems for the control cabinet
SIMATIC ET 200SP**I/O modules > Technology modules > TM Pulse 2x24V pulse output module****Technical specifications**

Article number	6ES7138-6DB00-0BB1 ET 200SP, TM Pulse 2x24V
General information	
Product type designation	TM Pulse 2x24 V
Product function	
• I&M data	Yes; I&M 0
• Isochronous mode	Yes
Engineering with	
• STEP 7 TIA Portal configurable/ integrated from version	V13 SP1 + HSP
• STEP 7 configurable/ integrated from version	V5.5 SP4 and higher
• PROFIBUS from GSD version/ GSD revision	GSD Revision 5
• PROFINET from GSD version/ GSD revision	GSDML V2.31
Supply voltage	
Load voltage L+	
• Rated value (DC)	24 V
• Short-circuit protection	Yes
• Reverse polarity protection	Yes; against destruction
Encoder supply	
Number of outputs	2; A common 24V encoder supply for both channels
24 V encoder supply	
• 24 V	Yes; L+ (-0.8 V)
• Short-circuit protection	Yes; per module, electronic
• Output current, max.	300 mA
Digital inputs	
Number of digital inputs	2; 1 per channel
Digital inputs, parameterizable	Yes
Input characteristic curve in accordance with IEC 61131, type 3	Yes
Digital input functions, parameterizable	
• Freely usable digital input	Yes
• HW enable for digital output	Yes
Input voltage	
• Type of input voltage	DC
• Rated value (DC)	24 V
• for signal "0"	-5 ... +5 V
• for signal "1"	+11 to +30V
• permissible voltage at input, min.	-30 V; -5 V continuous, -30 V brief reverse polarity protection
• permissible voltage at input, max.	30 V
Input current	
• for signal "1", typ.	2.5 mA
Input delay (for rated value of input voltage) for standard inputs	
- parameterizable	Yes; none / 0.05 / 0.1 / 0.4 / 0.8 / 1.6 / 3.2 / 12.8 / 20 ms
- at "0" to "1", min.	4 µs; for parameterization "none"
- at "1" to "0", min.	4 µs; for parameterization "none"

Article number	6ES7138-6DB00-0BB1 ET 200SP, TM Pulse 2x24V
Digital outputs	
Type of digital output	P- and M-switching
Number of digital outputs	2; 1 per channel
Digital outputs, parameterizable	Yes
Short-circuit protection	Yes; electronic/thermal
Limitation of inductive shutdown voltage to	-0.8 V
Controlling a digital input	Yes
Digital output functions, parameterizable	
• Freely usable digital output	Yes
• PWM output	Yes
- Number, max.	2; 1 per channel
- Cycle duration, parameterizable	Yes; Max. 85 s
• Connection of a proportional valve	Yes
• Dithering	Yes
• Current measurement	Yes
• Current control	Yes
• Connection of a DC motor	Yes
• ON-delay	Yes
• OFF-delay	Yes
• Frequency output	Yes
• Pulse train	Yes
• Pulse output	Yes
Switching capacity of the outputs	
• with resistive load, max.	2 A
• on lamp load, max.	10 W; 1 W with High Speed output
Load resistance range	
• lower limit	12 Ω; 240 ohm with High Speed output
• upper limit	12 kΩ
Output voltage	
• Type of output voltage	DC
• for signal "0", max.	1 V
• for signal "1", min.	23.2 V; L+ (-0.8 V)
Output current	
• for signal "1" rated value	2 A; 0.1 A with High Speed output, observe derating
Output delay with resistive load	
• "0" to "1", typ.	0 µs; With High Speed output, 4.5 µs with Standard output
• "0" to "1", max.	0.8 µs; With High Speed output, 9 µs with Standard output
• "1" to "0", typ.	0 µs; With High Speed output, 4.5 µs with Standard output
• "1" to "0", max.	0.8 µs; With High Speed output, 9 µs with Standard output
Parallel switching of two outputs	
• for uprating	Yes

Technical specifications

Article number	6ES7138-6DB00-0BB1 ET 200SP, TM Pulse 2x24V
Switching frequency	
• with resistive load, max.	100 kHz; With High Speed output, 10 kHz with standard output
• with inductive load, max.	100 kHz; With High Speed output, 10 kHz with standard output
• on lamp load, max.	10 Hz
Total current of the outputs	
• Current per channel, max.	2 A
• Current per group, max.	4 A
• Current per module, max.	4 A
Isochronous mode	
Bus cycle time (TDP), min.	250 µs; with 1 channel configuration, 375 µs with 2 channel configuration
Interrupts/diagnostics/status information	
Diagnostics function	Yes
Substitute values connectable	Yes; Parameterizable
Alarms	
• Diagnostic alarm	Yes
Diagnoses	
• Monitoring the supply voltage	Yes
• Short-circuit	Yes
Diagnostics indication LED	
• Monitoring of the supply voltage (PWR-LED)	Yes; green PWR LED
• Channel status display	Yes
• for module diagnostics	Yes; green/red DIAG LED
Integrated Functions	
Counter	No
Potential separation	
Potential separation channels	
• between the channels and backplane bus	Yes
Standards, approvals, certificates	
Suitable for safety functions	No

Article number	6ES7138-6DB00-0BB1 ET 200SP, TM Pulse 2x24V
Ambient conditions	
Ambient temperature during operation	
• horizontal installation, min.	-30 °C
• horizontal installation, max.	60 °C; Observe derating
• vertical installation, min.	-30 °C
• vertical installation, max.	50 °C; Observe derating
Altitude during operation relating to sea level	
• Installation altitude above sea level, max.	5 000 m; restrictions for installation altitudes > 2 000 m, see ET 200SP system manual
Decentralized operation	
to SIMATIC S7-300	Yes
to SIMATIC S7-400	Yes
to SIMATIC S7-1200	Yes
to SIMATIC S7-1500	Yes
to standard PROFIBUS master	Yes
to standard PROFINET controller	Yes
Dimensions	
Width	20 mm
Height	73 mm
Depth	58 mm
Weights	
Weight, approx.	50 g

I/O systems

SIMATIC ET 200 systems for the control cabinet
SIMATIC ET 200SP

I/O modules > Technology modules > TM StepDrive 24...48V/5A stepper motor control (Phytron Co.)

Overview



The TM StepDrive module from Phytron is a high-precision stepper motor control with integrated power output stage for use in the SIMATIC ET 200SP distributed I/O system. It is the 1-step-drive successor model for SIMATIC ET 200S.

The module can be used together with system and I/O components of the ET 200SP distributed I/O system. Operation is possible with the following head modules:

- IM PROFIBUS
- IM PROFINET
- ET 200SP CPU

Corresponding GSD files and an HSP are available.

The ET 200SP TM StepDrive 24...48V/5A is a product of our Phytron GmbH product partner and is only available from the Phytron GmbH company.

Note

Product partners are external companies outside Siemens AG and its associated companies. Information about and descriptions of products made by product partners are non-binding, and are the responsibility of the product partners. These products are manufactured independently and under the responsibility of the respective product partner, and are sold and supplied by it under its terms of business and delivery.

Unless compulsory by law, Siemens assumes no liability or warranty for these products or for connection with these products of the product partners.

Ordering data

Article No.

TM StepDrive stepper motor control

More information and ordering options via Phytron (company):
<http://www.phytron.com/tm-stepdrive>

High-precision stepper motor control for ET 200SP

Suitable BaseUnits

BU20-P12+A0+4B

6ES7193-6BP20-0BB1

BU type B1; BaseUnit (dark); without AUX terminals; for continuing the load group

Accessories

Mechanical coding elements

For automatic coding of I/O modules; spare part. 20 units

Type A

6ES7193-6KA00-3AA0

Type B

6ES7193-6KB00-3AA0

Type C

6ES7193-6KC00-3AA0

Type D

6ES7193-6KD00-3AA0

Technical specifications

- Suitable for bipolar control of 2-phase stepper motors of 4-, (6-) or 8-wire design (in 4-wire system)
- 5 A peak phase current with adjustable current steps
- Supply voltage from 24 to 48 V DC
- Up to 1/256 microstep (physical resolution: approx. 51 200 positions per revolution (0.007°/step)).
- Maximum stepping rate: 250 000 steps/s
- 2 digital inputs for limit and reference switches
- Diagnostics LEDs (overcurrent, overtemperature, traversing task or motor running ...)
- Short-circuit-proof, overload-proof
- Data record transfer for power output stage parameter assignment and diagnostics during runtime
- Overdrive: Current adaptation for higher clock frequencies
- Booster: Enhanced torque during acceleration or braking
- Adjustable response to CPU stop

More information

You can find more information about the module as well as contact information at:

<http://www.phytron.com/tm-stepdrive>

Here you will also find the manual, the data sheet, the HSP, a link to the GSD files as well as sample function blocks for SIMATIC.

Service and support:

<http://www.phytron.com/support>

Overview



SIMATIC MICRO-DRIVE F-TM ServoDrive HF with Base Unit

In combination with EC Motors and stepper motors up to 280 W the new ET 200SP technology module F-TM ServoDrive HF allows positioning and speed control in very confined spaces. The triple overload capability and the support of BiSS-C multi-turn encoders extend the scope of applications of the TM Drive family.

Engineering in the TIA Portal stands for consistency in a single tool. This facilitates drive dimensioning, commissioning and servicing.

The new drive system consists of:

- The F-TM ServoDrive HF as a new member of the SIMATIC MICRO-DRIVE family,
- The BaseUnit (U0),
- Motors with gearbox for flexible use and
- Connecting cables.

Further information on the distributed I/O system SIMATIC ET 200SP is available in the ST 70 Catalog and on the internet at <https://www.siemens.com/et200sp>

Characteristics

- PROFIdrive profile via PROFINET
- Hardware-STO (SIL3)
- Triple overload
- Digital input
- Integrated braking chopper
- Encoder connection for
 - IQ encoders
 - Incremental encoders
 - BiSS-C encoders

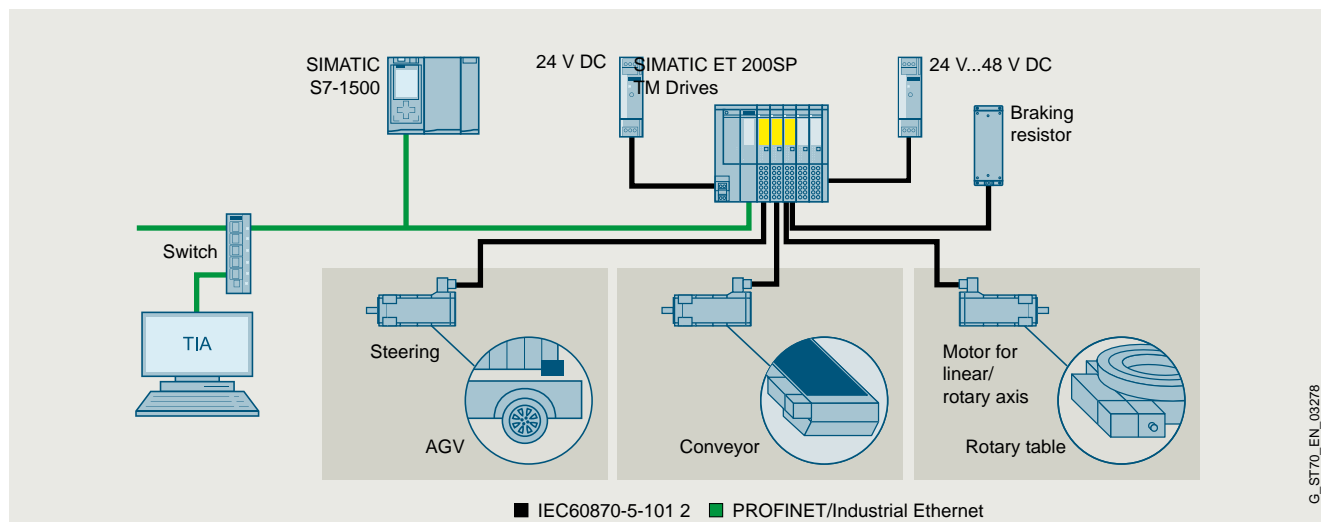

Application example TM Drives

Variant	Power	Peak power	Device width
High Feature	280 W	840 W	20 mm

More information:

<https://www.siemens.com/micro-drive>

Ordering data

Article No.

F-TM ServoDrive HF
for SIMATIC MICRO-DRIVE

- High Feature V1;
24 ... 48 V, 5 A
with hardware STO and
integrated braking chopper

6BK1136-6AB00-0CU0

I/O systemsSIMATIC ET 200 systems for the control cabinet
SIMATIC ET 200SP**I/O modules > Technology modules > F-TM ServoDrive HF****Technical specifications**

Article number	6BK1136-6AB00-0CU0 F-TM ServoDrive HF
General information	
Product type designation	F-TM ServoDrive HF
Product description	control of EC and stepper motors
Product function	
• I&M data	Yes
• Isochronous mode	No
• Four-quadrant operation	Yes
• Speed control with encoder	Yes
• Speed control without encoder	Yes; for stepper motors
• Safety Functions	Yes; Drive controller with hardwired STO
Protection function	
• Undervoltage protection	Yes
• Overvoltage protection	Yes
• Overload protection	Yes
• Ground-fault protection	No
• Short-circuit protection	Yes
Installation type/mounting	
Type of ventilation	Convection cooling
Supply voltage	
Design of the power supply	24 ... 48 V DC, SELV / PELV
Output voltage	
Rated value, min.	24 V
Rated value, max.	48 V
Output current	
Current output (rated value)	5 A
Output current, max.	15 A
Output frequency	599 Hz
Encoder supply	
Number of outputs	1
Digital inputs	
Number of digital inputs	1; input for message signal
Number of safety inputs	1; For STO, antivalent (2-pin) - 24 V DC
Encoder	
Connectable encoders	
• Incremental encoder (symmetrical)	Yes; up to 500 Hz per channel
• Absolute encoder (SSI)	Yes; BiSS-C
• BiSS-C encoder	Yes
Interrupts/diagnostics/status information	
Alarms	
• Diagnostic alarm	Yes
• Hardware interrupt	No
Diagnoses	
• Monitoring the supply voltage	Yes
• Wire-break	Yes
• Short-circuit	Yes
• Telegram error at SSI encoder	Yes; BiSS-C
• Group error	Yes
Diagnostics indication LED	
• RUN LED	Yes
• ERROR LED	Yes
Integrated Functions	
Position detection	
• Incremental acquisition	Yes
• Absolute acquisition	Yes

Article number	6BK1136-6AB00-0CU0 F-TM ServoDrive HF
Potential separation	
Potential separation channels	
• between the channels and backplane bus	Yes
Degree and class of protection	
IP degree of protection	IP20
Standards, approvals, certificates	
CE mark	Yes
cULus	Yes
RCM (formerly C-TICK)	Yes
KC approval	Yes
EAC (formerly Gost-R)	Yes
China RoHS compliance	Yes
Standard for EMC according to EN 61800-3	Yes
Standard for drive acc. to EN 61800-5-1	Yes
Standard for drive acc. to EN 61800-5-2	Yes
Highest safety class achievable in safety mode	
• Performance level according to ISO 13849-1	Category 3, performance level d, according to EN ISO 13849-1:2015
• SIL acc. to IEC 61508	3
Ambient conditions	
Ambient temperature during operation	
• horizontal installation, min.	-30 °C; No condensation, splash water, icing, salt spray or oil mist permitted.
• horizontal installation, max.	60 °C; No condensation, splash water, icing, salt spray or oil mist permitted. Note the derating data!
• vertical installation, min.	-30 °C; No condensation, splash water, icing, salt spray or oil mist permitted.
• vertical installation, max.	50 °C; No condensation, splash water, icing, salt spray or oil mist permitted. Note the derating data!
Ambient temperature during storage/transportation	
• Storage, min.	-30 °C
• Storage, max.	70 °C
Altitude during operation relating to sea level	
• Installation altitude above sea level, max.	3 000 m
Cables	
Cable length for motor, shielded, max.	10 m
Dimensions	
Width	20 mm
Height	73 mm
Depth	58 mm
Weights	
Weight, approx.	55 g
Other	
Brake design	holding brake control via the process image
Braking chopper	Yes

Overview



SIMATIC MICRO-DRIVE F-TM ServoDrive ST Video
https://players.brightcove.net/1813624294001/70fecf0f-fbad-4fad-a077-d0e26af4d84c_default/index.html?videoId=6136813197001

In combination with EC motors, the new ET 200SP technology module F-TM ServoDrive ST allows positioning and speed control of EC motors up to 280 W in very confined spaces.

Engineering in the TIA Portal stands for consistency in a single tool. This facilitates drive dimensioning, commissioning and servicing.

The new drive system consists of

- The F-TM ServoDrive ST as a new member of the SIMATIC MICRO-DRIVE family
- The BaseUnit (U0)
- Motors with gearbox for flexible use and
- Connecting cables.

Further information on the distributed I/O system SIMATIC ET 200SP is available in the ST 70 Catalog and on the internet at <http://www.siemens.com/et200sp>

Characteristics

- PROFIdrive profile via PROFINET
- Hardware STO
- Digital input
- Integrated braking chopper
- Encoder connection for
 - IQ encoders
 - Incremental encoders

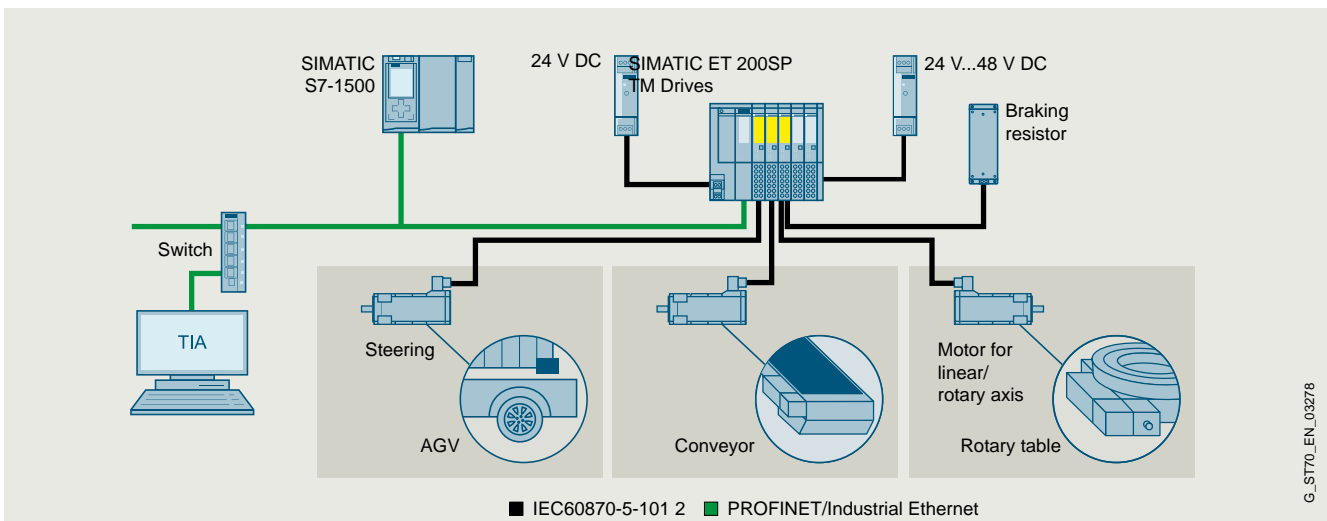

G_ST70_EN_03278

Application example TM Drives

Variant	Power	Device width
Standard	280 W	20 mm

More information:

<https://www.siemens.com/micro-drive>

Ordering data

Article No.

F-TM ServoDrive ST for SIMATIC MICRO-DRIVE
 • Standard V1;
 • 24 ... 48 V, 5 A
 with hardware STO and integrated braking chopper

6BK1136-6AB00-0BU0

I/O systemsSIMATIC ET 200 systems for the control cabinet
SIMATIC ET 200SP**I/O modules > Technology modules > F-TM ServoDrive ST****Technical specifications**

Article number	6BK1136-6AB00-0BU0 F-TM ServoDrive ST
General information	
Product type designation	F-TM ServoDrive ST
Product description	Control of EC motors
Product function	
• I&M data	Yes
• Isochronous mode	No
• Four-quadrant operation	Yes
• Speed control with encoder	Yes
• Speed control without encoder	No
• Safety Functions	Yes; Drive controller with hardwired STO
Protection function	
• Undervoltage protection	Yes
• Overvoltage protection	Yes
• Overload protection	Yes
• Ground-fault protection	No
• Short-circuit protection	Yes
Installation type/mounting	
Type of ventilation	Convection cooling
Supply voltage	
Design of the power supply	24 ... 48 V DC, SELV / PELV
Output voltage	
Rated value, min.	24 V
Rated value, max.	48 V
Output current	
Current output (rated value)	5 A
Output current, max.	10 A
Output frequency	599 Hz
Encoder supply	
Number of outputs	1
Digital inputs	
Number of digital inputs	1; input for message signal
Number of safety inputs	1; For STO, antivalent (2-pin) - 24 V DC
Encoder	
Connectable encoders	
• Incremental encoder (symmetrical)	Yes; up to 500 Hz per channel
Interrupts/diagnostics/ status information	
Alarms	
• Diagnostic alarm	Yes
• Hardware interrupt	No
Diagnoses	
• Monitoring the supply voltage	Yes
• Wire-break	Yes
• Short-circuit	Yes
• Group error	Yes
Diagnostics indication LED	
• RUN LED	Yes
• ERROR LED	Yes
Integrated Functions	
Position detection	
• Incremental acquisition	Yes
Potential separation	
Potential separation channels	
• between the channels and backplane bus	Yes

Article number	6BK1136-6AB00-0BU0 F-TM ServoDrive ST
Degree and class of protection	
IP degree of protection	IP20
Standards, approvals, certificates	
CE mark	Yes
cULus	Yes
RCM (formerly C-TICK)	Yes
KC approval	Yes
EAC (formerly Gost-R)	Yes
China RoHS compliance	Yes
Standard for EMC according to EN 61800-3	Yes, according to second environment Category C2 acc. EN 61800-3
Standard for drive acc. to EN 61800-5-1	Yes
Standard for drive acc. to EN 61800-5-2	Yes
Highest safety class achievable in safety mode	
• Performance level according to ISO 13849-1	Category 3, performance level d, according to EN ISO 13849-1:2015
• SIL acc. to IEC 61508	2
Ambient conditions	
Ambient temperature during operation	
• horizontal installation, min.	-30 °C; No condensation, splash water, icing, salt spray or oil mist permitted.
• horizontal installation, max.	60 °C; No condensation, splash water, icing, salt spray or oil mist permitted. Note the derating data!
• vertical installation, min.	-30 °C; No condensation, splash water, icing, salt spray or oil mist permitted.
• vertical installation, max.	50 °C; No condensation, splash water, icing, salt spray or oil mist permitted. Note the derating data!
Ambient temperature during storage/transportation	
• Storage, min.	-30 °C
• Storage, max.	70 °C
Altitude during operation relating to sea level	
• Installation altitude above sea level, max.	3 000 m
Cables	
Cable length for motor, shielded, max.	10 m
Dimensions	
Width	20 mm
Height	73 mm
Depth	58 mm
Weights	
Weight, approx.	55 g
Other	
Brake design	holding brake control via the process image
Braking chopper	Yes

Overview



Engineering in the TIA Portal stands for consistency in a single tool. This facilitates drive dimensioning, commissioning and servicing.

The new drive system consists of

- The F-TM StepDrive ST as a new member of the SIMATIC MICRO-DRIVE family
- The BaseUnit (U0)

Further information on the distributed I/O system SIMATIC ET 200SP is available in the ST 70 Catalog and on the internet at <http://www.siemens.com/et200sp>

Characteristics

- Bipolar stepper motors
- PROFIdrive profile via PROFINET
- Hardware STO (SIL3)
- Digital input
- Encoderless operation
- Encoder connection for - Incremental encoders

The new ET 200SP technology module F-TM StepDrive ST allows positioning and speed control of stepper motors up to 10 A peak current in very confined spaces.

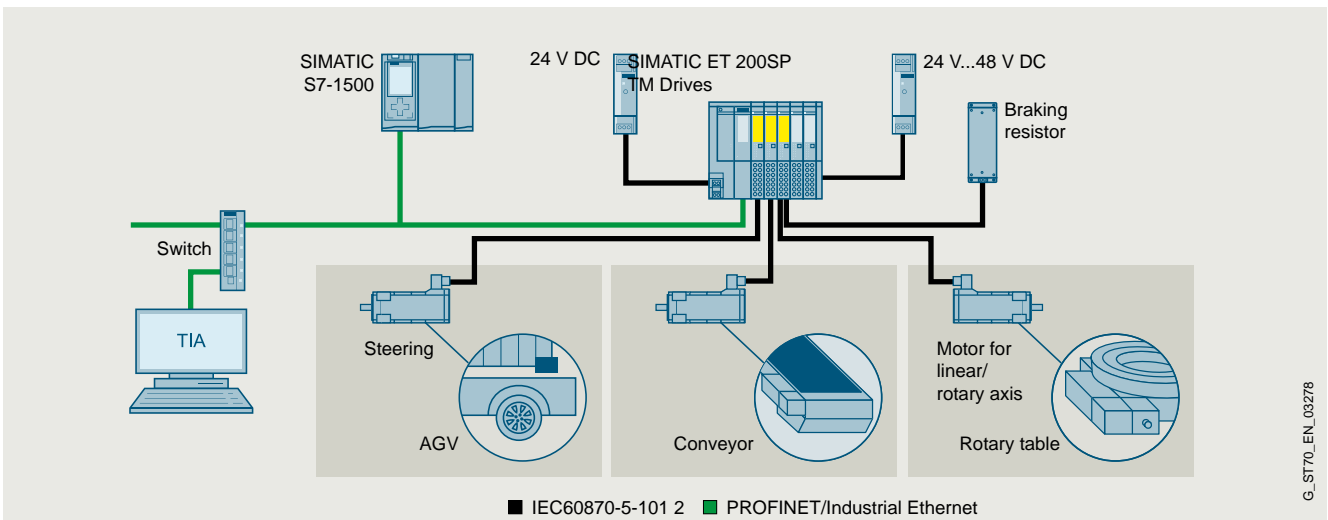

10

G_ST70_EN_03278

Application example TM Drives

Variant	Power	Device width
Standard	280 W	20 mm

More information:

<https://www.siemens.com/micro-drive>

Ordering data

Article No.

F-TM StepDrive ST for SIMATIC MICRO-DRIVE

- Standard V1; 24 ... 48 V, 5 A with hardware STO

6BK1136-6SB00-0BU0

I/O systemsSIMATIC ET 200 systems for the control cabinet
SIMATIC ET 200SP**I/O modules > Technology modules > F-TM StepDrive ST****Technical specifications**

Article number	6BK1136-6SB00-0BU0 F-TM StepDrive ST
General information	
Product type designation	F-TM StepDrive ST
Product description	control of stepper motors
Product function	
• I&M data	Yes
• Isochronous mode	No
• Four-quadrant operation	Yes
• Speed control with encoder	No
• Speed control without encoder	No
• Safety Functions	Yes; Drive controller with hardwired STO
Protection function	
• Undervoltage protection	Yes
• Overvoltage protection	Yes
• Overload protection	Yes
• Ground-fault protection	No
• Short-circuit protection	Yes
Installation type/mounting	
Type of ventilation	Convection cooling
Supply voltage	
Design of the power supply	24 ... 48 V DC, SELV / PELV
Output voltage	
Rated value, min.	24 V
Rated value, max.	48 V
Output current	
Current output (rated value)	5 A
Output current, max.	10 A
Output frequency	1 000 Hz
Encoder supply	
Number of outputs	1
5 V encoder supply	
• 5 V	Yes
• Short-circuit protection	Yes
• Output current, max.	150 mA
Digital inputs	
Number of digital inputs	1; input for message signal
Number of safety inputs	1; For STO, antivalent (2-pin) - 24 V DC
Encoder	
Connectable encoders	
• Incremental encoder (symmetrical)	Yes; up to 500 Hz per channel
Interrupts/diagnostics/ status information	
Alarms	
• Diagnostic alarm	Yes
• Hardware interrupt	No
Diagnoses	
• Monitoring the supply voltage	Yes
• Wire-break	Yes
• Short-circuit	Yes
• Group error	Yes
Diagnostics indication LED	
• RUN LED	Yes
• ERROR LED	Yes
Integrated Functions	
Position detection	
• Incremental acquisition	Yes
• Absolute acquisition	No

Article number	6BK1136-6SB00-0BU0 F-TM StepDrive ST
Potential separation	
Potential separation channels	
• between the channels and backplane bus	Yes
Degree and class of protection	
IP degree of protection	IP20
Standards, approvals, certificates	
CE mark	Yes
cULus	Yes
RCM (formerly C-TICK)	Yes
KC approval	Yes
EAC (formerly Gost-R)	Yes
China RoHS compliance	Yes
Standard for EMC according to EN 61800-3	Yes, according to second environment Category C2 acc. EN 61800-3
Standard for drive acc. to EN 61800-5-1	Yes
Standard for drive acc. to EN 61800-5-2	Yes
Highest safety class achievable in safety mode	
• Performance level according to ISO 13849-1	Category 3, performance level d, according to EN ISO 13849-1:2015
• SIL acc. to IEC 61508	SIL 3 according to DIN EN 61800-5-2:2017
Ambient conditions	
Pollution degree during storage and transport	2
Ambient temperature during operation	
• horizontal installation, min.	-30 °C; No condensation, splash water, icing, salt spray or oil mist permitted.
• horizontal installation, max.	60 °C; No condensation, splash water, icing, salt spray or oil mist permitted. Note the derating data!
• vertical installation, min.	-30 °C; No condensation, splash water, icing, salt spray or oil mist permitted.
• vertical installation, max.	50 °C; No condensation, splash water, icing, salt spray or oil mist permitted. Note the derating data!
Ambient temperature during storage/transportation	
• Storage, min.	-40 °C
• Storage, max.	70 °C
Altitude during operation relating to sea level	
• Installation altitude above sea level, max.	3 000 m
Cables	
Cable length for motor, shielded, max.	10 m
Dimensions	
Width	20 mm
Height	73 mm
Depth	58 mm
Weights	
Weight, approx.	55 g
Other	
Brake design	holding brake control via the process image
Braking chopper	No

Overview

SIPLUS and SIMATIC Electrical Charge Controller (SECC) are the key components in infrastructure solutions for the conductive charging of electric vehicles.

They perform the following functions:

- Detection of the charging cable and its permissible current carrying capacity
- Transfer of the maximum charging current from the charging station to the electric vehicle
- Evaluation of the status signals from the electric vehicle:
 - Ready for charging
 - Charging
 - Charging with ventilation
- Cost-optimized, space-saving charging infrastructure solutions due to compact design based on SIMATIC ET 200SP.

ET 200SP TM ECC 2xPWM ST AC module

- Control of charging outputs according to IEC 61851 by parameterizable SIMATIC ET 200SP TM ECC 2xPWM ST charging controller
- Control of load tap-off
- Control of connector lock
- Evaluation of connector lock or load contactor status

ET 200SP TM ECC PL ST DC module

- The SIMATIC ET 200SP TM ECC PL ST charging controller fully controls a DC charging process according to DIN SPEC 70121.
- The following sequences are performed:
 - Session Setup
 - Service Discovery
 - Service and Payment Selection
 - Contract Authentication
 - Charge Parameter Discovery
 - Power Delivery
 - Charging Status
 - Cable Check
 - Pre Charging
 - Current Demand
 - Welding Detection
 - Session Stop

Accessories: Calibration Kit TM ECC CCS2

Expansion kit for calibration of the power line signal strength of an EVSE.

- According to DIN SPEC 70121 / ISO15118 or design guidelines for CCS charging stations Type 2
- Suitable for the SIMATIC ET 200SP TM ECC PL ST technology module

I/O systems

SIMATIC ET 200 systems for the control cabinet
SIMATIC ET 200SP

I/O modules > Technology modules > SIMATIC ET 200SP ECC charging controllers

Ordering data	Article No.	Article No.
Charging controller SIMATIC ET 200SP TM ECC 2xPWM ST Designed for controlling charging outputs according to IEC 61851 and parameterizable, with 2 charging outputs, ambient temperature -30 °C ... 60 °C 2x control pilot, 2x plug present, 2x DQ switching contact for load contactor as open collector, 2x DI for load contactor feedback or connector lock; 2x ACT for connector lock suitable for BU type BU20-P12+A0+4B and BU20-P12+A4+0B With conformal coating, based on 6FE1242-6TM10-0BB1.	6FE1242-6TM10-0BB1	Technology module SIMATIC ET 200SP TM ECC PL ST Charging controller for the conductive charging of electric vehicles according to DIN SPEC 70121, charging mode 4, ambient temperature -30 °C ... 60 °C 1x control pilot including Powerline Green Phy, 1x plug present/proximity pilot, 1x digital out TRIP function as open collector, 1x digital out (DQ P) as open collector, suitable for BU type BU20-P12+A0+4B or BU type BU20-P12+A4+0B
	6FE1242-6TM10-2BB1	Expansion kit SIMATIC Calibration Kit TM ECC CCS2 Expansion kit for calibration of the power line signal strength of an EVSE according to DIN SPEC 70121 / ISO15118 or design guidelines for CCS charging stations. Suitable for 6FE1242-6TM20-0BB1 SIMATIC ET 200SP TM ECC PL ST
		6FE1242-6TM20-0BB1
		6FE1244-0AD10-0AA0

Technical specifications

Article number	6FE1242-6TM10-0BB1	6AG1242-6TM10-2BB1	6FE1242-6TM20-0BB1
	SIMATIC ET 200SP TM ECC 2xPWM ST	SIPLUS ET 200SP TM ECC 2xPWM ST	SIMATIC ET 200SP TM ECC PL ST
General information			
Product type designation	ECC 2x PWM ST		ECC PL ST
Product description	Technology modules for the conductive AC charging of electric vehicles according to IEC 61851	Communication controller for controlling conductive AC charging according to IEC 61851	Technology module for the conductive charging of electric vehicles according to DIN 70121
usable BaseUnits	BU type B0, B1		
Color code for module-specific color identification plate		CC40	
Number of channels	2; Acc. to IEC 61851-1 Mode 3 and/or SAE J1772	2; According to IEC 61851/SAE J1772	1; Acc. to IEC 61851-1 Mode 4 and DIN SPEC 70121
Product function			
• I&M data	Yes; I&M0 to I&M3		
• Isochronous mode	No		
Engineering with			
• STEP 7 TIA Portal configurable/integrated from version	V14 SP1		STEP 7 V16 or higher
Installation type/mounting			
Mounting type	standard rail		
Mounting position	Horizontal		Horizontal, vertical
Supply voltage			
Type of supply voltage	DC		
Rated value (DC)	24 V		
Reverse polarity protection	Yes; against destruction		
Load voltage L+			
• Rated value (DC)	24 V		24 V
• Reverse polarity protection			Yes
Input current			
Current consumption, typ.	40 mA		
Current consumption, max.	90 mA		100 mA

Technical specifications

Article number	6FE1242-6TM10-0BB1	6AG1242-6TM10-2BB1	6FE1242-6TM20-0BB1
	SIMATIC ET 200SP TM ECC 2xPWM ST SIPLUS ET 200SP TM ECC 2xPWM ST		SIMATIC ET 200SP TM ECC PL ST
Digital inputs			
Number of digital inputs	2; 1 per channel		0
Digital inputs, parameterizable	Yes; 12 V / 24 V		No
Digital input functions, parameterizable			
• Freely usable digital input	No; Readback contact contactor / connector lock		
Input voltage			
• Type of input voltage	DC		
• for signal "0"	<0.2 V (nom)		
• for signal "1"	>0.6 V (nom)		
• permissible voltage at input, min.	0 V		
• permissible voltage at input, max.	30 V		
Cable length			
• shielded, max.			10 m
• unshielded, max.	30 m		
Digital outputs			
Type of digital output	Transistor		
Number of digital outputs	2; 1 per channel		2; 1x digital out TRIP function as open collector, 1x digital out (DQ P) as open collector
Current-sinking			Yes
short-circuit proof	Yes		
Short-circuit protection	Yes; electronic/thermal		
Digital output functions, parameterizable			
• PWM output	Yes; According to IEC 61851		Yes; Acc. to DIN SPEC 70121
- Number, max.	2; 1 per channel		1; 1 per channel
• Connection of a DC motor	Yes; ACT p/n connector locking		No; Only fixed charging cables are permitted for DC charging systems
Switching capacity of the outputs			
• with resistive load, max.	1.3 A		0.6 A; Per digital output
Output voltage			
• Type of output voltage	DC		
• Rated value (DC)	24 V		
Cable length			
• unshielded, max.	30 m; when using a PROFIBUS line	30 m	10 m
Analog outputs			
Number of analog outputs	2; Control pilot acc. to IEC 61851-1 and/or SAE J1772		1
Type of analog output			Control pilot including Powerline Green Phy, acc. to DIN SPEC 70121
Connection of a DC motor	Yes; Motor for connector lock		No
Protocols			
Bus communication	Yes		Yes; Backplane bus
Vehicle communication according to IEC 61851	Yes; MODE 3		Yes; Mode 4
Interrupts/diagnostics/status information			
Alarms			
• Diagnostic alarm	Yes		
Diagnoses			
• Monitoring the supply voltage	No		No; Supply voltage diagnostics
• Wire-break			No
• Short-circuit	Yes		No

I/O systemsSIMATIC ET 200 systems for the control cabinet
SIMATIC ET 200SP**I/O modules > Technology modules > SIMATIC ET 200SP ECC charging controllers****Technical specifications**

Article number	6FE1242-6TM10-0BB1 SIMATIC ET 200SP TM ECC 2xPWM ST	6AG1242-6TM10-2BB1 SIPLUS ET 200SP TM ECC 2xPWM ST	6FE1242-6TM20-0BB1 SIMATIC ET 200SP TM ECC PL ST
Diagnostics indication LED			
• ERROR LED	Yes; red LED		No
• Monitoring of the supply voltage (PWR-LED)	Yes; green PWR LED		
• Channel status display	Yes; green LED		
• for module diagnostics	Yes; green/red DIAG LED		
Potential separation			
Potential separation channels			
• between the channels	No		No; Only one channel is available
• between the channels and backplane bus	Yes		
EMC			
Electrostatic discharge acc. to IEC 61000-4-2	4 kV contact discharge / 8 kV air discharge		
Field-related interference acc. to IEC 61000-4-3	10 V/m (80 ... 1 000 MHz), 3 V/m (1.4 ... 2.0 GHz), 1 V/m (2.0 ... 2.7 GHz)		
Conducted interference due to burst acc. to IEC 61000-4-4	2 kV signal lines		
Conducted interference due to surge acc. to IEC 61000-4-5	On DC supply lines: 0.5 kV symmetrical and asymmetrical		
Conducted interference due to high-frequency radiation acc. to IEC 61000-4-6	10 V (0.15 ... 80 MHz)		
Degree and class of protection			
IP degree of protection	IP20		
Standards, approvals, certificates			
Certificate of suitability	CE / RCM / EAC / UL / KC	CE	CE / RCM / EAC / UL / KC
Ambient conditions			
Ambient temperature during operation			
• min.	-30 °C		-30 °C
• max.	60 °C		60 °C
• horizontal installation, min.	-30 °C	-30 °C; = Tmin	-30 °C
• horizontal installation, max.	60 °C	60 °C; = Tmax	60 °C
• vertical installation, min.	-30 °C	-30 °C; = Tmin	-30 °C
• vertical installation, max.	50 °C	50 °C; = Tmax	50 °C
Ambient temperature during storage/transportation			
• Storage, min.	-40 °C		
• Storage, max.	70 °C		
• Transportation, min.	-40 °C		
• Transportation, max.	70 °C		
Altitude during operation relating to sea level			
• Installation altitude above sea level, max.	2 000 m	5 000 m	2 000 m
• Ambient air temperature-barometric pressure-altitude	Tmin ... Tmax at 1 080 hPa ... 795 hPa (-1 000 m ... +2 000 m)	Tmin ... Tmax at 1 140 hPa ... 795 hPa (-1 000 m ... +2 000 m) // Tmin ... (Tmax - 10 K) at 795 hPa ... 658 hPa (+2 000 m ... +3 500 m) // Tmin ... (Tmax -20 K) at 658 hPa ... 540 hPa (+3 500 m ... +5 000 m)	Tmin ... Tmax at 1 080 hPa ... 795 hPa (-1 000 m ... +2 000 m)
Relative humidity			
• Operation, min.	5 %		5 %
• Operation, max.	95 %; no condensation		95 %; no condensation
• With condensation, tested in accordance with IEC 60068-2-38, max.		100 %; RH incl. condensation / frost (no commissioning in bedewed state), horizontal installation	
Vibrations			
• Vibration resistance during operation acc. to IEC 60068-2-6	10 ... 58 Hz / 0.075 mm, 58 ... 150 Hz / 1 g		
Shock testing			
• Shock resistance acc. to IEC 60068-2-27	15 g / 11 ms		

Technical specifications

Article number	6FE1242-6TM10-0BB1	6AG1242-6TM10-2BB1	6FE1242-6TM20-0BB1
	SIMATIC ET 200SP TM ECC 2xPWM ST	SIPLUS ET 200SP TM ECC 2xPWM ST	SIMATIC ET 200SP TM ECC PL ST
Resistance			
Coolants and lubricants		Yes; Incl. diesel and oil droplets in the air	
Use in stationary industrial systems		Yes; Class 3B2 mold, fungus and dry rot spores (with the exception of fauna); Class 3B3 on request	
- to biologically active substances according to EN 60721-3-3		Yes; Class 3C4 (RH < 75 %) incl. salt spray acc. to EN 60068-2-52 (severity degree 3); *	
- to chemically active substances according to EN 60721-3-3		Yes; Class 3S4 incl. sand, dust, *	
- to mechanically active substances according to EN 60721-3-3		Yes; Class 3M8 using the SIPLUS Mounting Kit ET 200SP (6AG1193-6AA00-0AA0)	
- Against mechanical environmental conditions acc. to EN 60721-3-3			
Usage in industrial process technology		Yes; Class 3 (excluding trichlorethylene)	
- Against chemically active substances acc. to EN 60654-4		Yes; Level GX group A/B (excluding trichlorethylene; harmful gas concentrations up to the limits of EN 60721-3-3 class 3C4 permissible); level LC3 (salt spray) and level LB3 (oil)	
- Environmental conditions for process, measuring and control systems acc. to ANSI/ISA-71.04			
Remark		* The supplied plug covers must remain in place over the unused interfaces during operation!	
- Note regarding classification of environmental conditions acc. to EN 60721, EN 60654-4 and ANSI/ISA-71.04			
Conformal coating		Yes; Class 2 for high reliability	
• Coatings for printed circuit board assemblies acc. to EN 61086		Yes; Type 1 protection	
• Protection against fouling acc. to EN 60664-3		Yes; Discoloration of coating possible during service life	
• Military testing according to MIL-I-46058C, Amendment 7		Yes; Conformal coating, Class A	
• Qualification and Performance of Electrical Insulating Compound for Printed Board Assemblies according to IPC-CC-830A			
Decentralized operation			
to SIMATIC S7-1500	Yes		
Dimensions			
Width	20 mm		
Height	73 mm		
Depth	58 mm		
Weights			
Weight, approx.	32 g		51 g
Other			
Note:			The Tone Mask of the Green Phy defined in DIN 70121 for North America applies

I/O systems

SIMATIC ET 200 systems for the control cabinet
SIMATIC ET 200SP

I/O modules > Technology modules > SIMATIC ET 200SP ECC charging controllers

Technical specifications

Article number	6FE1244-0AD10-0AA0 SIMATIC Calibration Kit TM ECC CCS2
General information	
Product type designation	Calibration kit TM ECC CCS2
Product description	Expansion kit for adjusting the powerline signal strength of an EVSE in accordance with DIN SPEC 70121/ISO 15118 or design guidelines for CCS charging stations
Installation type/mounting	
Mounting type	standard rail
Supply voltage	
Type of supply voltage	DC
Rated value (DC)	24 V; Optional: external infeed
Reverse polarity protection	Yes
Load voltage L+	
• Short-circuit protection	Yes
• Reverse polarity protection	Yes
Input current	
Current consumption, max.	0.5 A
Interfaces	
Number of other interfaces	2; 1x CCS (Combined Charging System) acc. to IEC 62196 1x power supply DC adapter (5.50 mm x 2.10 mm x 9.5 mm) 24 V
Protocols	
Vehicle communication according to IEC 61851	Yes; Mode 4
EMC	
Electrostatic discharge acc. to IEC 61000-4-2	4 kV contact discharge / 8 kV air discharge
Field-related interference acc. to IEC 61000-4-3	10 V/m (80 ... 1 000 MHz), 3 V/m (1.4 ... 2.0 GHz), 1 V/m (2.0 ... 2.7 GHz)
Degree and class of protection	
IP degree of protection	IP30
Standards, approvals, certificates	
Certificate of suitability	CE

Article number	6FE1244-0AD10-0AA0 SIMATIC Calibration Kit TM ECC CCS2
Ambient conditions	
Ambient temperature during operation	
• min.	0 °C
• max.	40 °C
Ambient temperature during storage/transportation	
• Storage, min.	-30 °C
• Storage, max.	85 °C
Altitude during operation relating to sea level	
• Installation altitude above sea level, max.	2 000 m
• Ambient air temperature-barometric pressure-altitude	Up to max. 2 000 m
Relative humidity	
• Operation, min.	5 %
• Operation, max.	95 %
Mechanics/material	
Material of housing	Plastic: polycarbonate, abbreviation: PC- GF 10 FR
Dimensions	
Width	250 mm
Height	122 mm
Depth	160 mm
Weights	
Weight, approx.	1.5 kg

Overview



SIWAREX WP321 is a versatile and flexible weigh beam for the seamless integration of a static scale into the SIMATIC automation environment.

The weighing electronics are integrated within the SIMATIC ET 200SP system series and use all the features of a modern automation system, such as integrated communication, operator control and monitoring, diagnostics units and the project planning tools in the TIA portal, SIMATIC Step 7, WinCC flexible and PCS7.

In conjunction with the digital SIWAREX DB junction box, up to four connected load cells can be diagnosed separately. This enables the weigh beam module to detect the failure of individual load cells and, in the event of an error, to provide relevant load cell data such as order number and location designation directly in the CPU or at the HMI. This increases the operational reliability of the scale, reduces downtimes, makes commissioning easier and simplifies servicing.

All messages and process values of the individual load cell channels are of course available in the SIMATIC controller.

Ordering data

Article No.

TM SIWAREX WP321 weighing module Single-channel, for platform scales or hopper scales with analog load cells (1 - 4 mV/V), 1 x LC, 1 x RS 485.	7MH4138-6AA00-0BA0
SIWAREX WP321 Equipment Manual Available in a range of languages Free download on the Internet at: http://www.siemens.com/weighing	
SIWAREX WP321 "Ready-for-use" TIA Portal and SIMATIC Manager sample configuration Free download on the Internet at: http://www.siemens.com/weighing	
SIWATOOL V4 & V7 Service and commissioning software for SIWAREX weighing modules	7MH4900-1AK01
SIWAREX PCS 7 AddOn Library for PCS7 V8.x and V9.0 <ul style="list-style-type: none"> • Supports PROFINET APL faceplates and function blocks for: <ul style="list-style-type: none"> • SIWAREX U • SIWAREX FTA • SIWAREX FTC_B (belt scale) • SIWAREX WP321 Classic faceplate and function block for: <ul style="list-style-type: none"> • SIWAREX FTC_L (Loss-in-weight) 	7MH4900-1AK61
Accessories (mandatory requirement)	
BaseUnit (Type A0 – one BaseUnit required for each WP321) <ul style="list-style-type: none"> • For opening a new potential group <ul style="list-style-type: none"> - BU15P-16+A0+2D - BU15P-16+A10+2D • For continuing the potential group <ul style="list-style-type: none"> - BU15P-16+A0+2B - BU15P-16+A10+2B 	6ES7193-6BP00-0DA0 6ES7193-6BP20-0DA0 6ES7193-6BP00-0BA0 6ES7193-6BP20-0BA0
Shielded connection for BaseUnit (5 units / for 5 scales) For laying the load cell cable	6ES7193-6SC00-1AM0

I/O systems

SIMATIC ET 200 systems for the control cabinet
SIMATIC ET 200SP

I/O modules > Technology modules > TM SIWAREX WP321 ST weighing module**Ordering data****Article No.****Article No.****Accessories (optional)****SIWAREX JB junction box, aluminum enclosure****7MH5001-0AA20**

For connecting up to 4 load cells in parallel, and for connecting multiple junction boxes.

SIWAREX JB junction box, stainless steel enclosure**7MH5001-0AA00**

For connecting up to 4 load cells in parallel.

SIWAREX JB junction box, stainless steel enclosure (ATEX)**7MH5001-0AA01**

For parallel connection of up to 4 load cells (for zone allocation, see manual or type-examination certificate).

Digital SIWAREX DB junction box

For enhanced diagnostic and monitoring options in conjunction with SIWAREX WP electronics

Enclosure made of:

- Aluminum
- Stainless steel

7MH5001-0AD20
7MH5001-0AD01**SIWAREX IS Ex interface**

For intrinsically-safe connection of load cells. With ATEX approval (not UL/FM). Suitable for SIWAREX electronic weighing systems. Compatibility of load cells must be checked separately.

Approved for use in the EU

- Short-circuit current < 199 mA DC
- Short-circuit current < 137 mA DC

7MH4710-5BA
7MH4710-5CA**Cable (optional)****Cable Li2Y 1 × 2 × 0.75 ST + 2 × (2 × 0.34 ST) – CY**

For connecting SIWAREX electronic weighing systems to junction box (JB), extension box (EB) and Ex interface or between two EBs. For permanent installation. Occasional bending is possible.

External diameter: approx. 10.8 mm (0.43 inch)

Permissible ambient temperature -40 ... +80 °C (-40 ... +176 °F)

Sold by the meter.

- Sheath color: orange
- For hazardous atmospheres. Sheath color: blue.

7MH4702-8AG
7MH4702-8AF**RS485/USB****interface converter**

Commercially available interface converter with FTDI chip, e.g. USB-Nano from CTI

<http://www.cti-shop.com/RS485-Konverter/USB-Nano-485>

Remote display

The Siebert S102 and S302 remote digital displays can be directly connected to the SIWAREX FTA via an RS485 interface.

Siebert Industrieelektronik GmbH
PO Box 1180D-65565 Eppelborn, Germany
Tel: +49 6806/980-9
Fax: +49 6806/980-999

Internet: <https://www.siebert-group.com/en/>

Detailed information is available from the manufacturer.

Technical specifications

SIWAREX WP321	
Integration in automation systems	
SIMATIC S7-300, S7-400, S7-1200 and S7-1500	Via SIMATIC ET 200SP interface module (PROFIBUS or PROFINET)
Other manufacturers (with restrictions)	Via SIMATIC ET 200SP interface module (PROFIBUS or PROFINET)
Communication interfaces	<ul style="list-style-type: none"> • SIMATIC ET 200SP backplane bus • RS 485 (SIWATOOL, Siebert remote display)
Commissioning options	<ul style="list-style-type: none"> • Using SIWATOOL V7 • Using function block in SIMATIC CPU / Touch Panel
Measuring accuracy	
According to DIN 1319-1 of full-scale value at 20 °C ± 10 K (68 °F ± 10 K)	0.05%
Internal resolution	± 2 million parts
Measuring frequency	100 / 120 / 600 Hz
Digital filter	Variable adjustable low-pass and average filter
Typical applications	<ul style="list-style-type: none"> • Non-automatic weighing instruments • Force measurements • Fill-level monitoring • Belt tension monitors
Weighing functions	
Weight values	<ul style="list-style-type: none"> • Gross • Net • Tare
Limit values	<ul style="list-style-type: none"> • 2 × min/max • Empty
Zeroing	Via command by controller or HMI
Tare	Via command by controller or HMI
External tare specification	Via command by controller or HMI
Calibration commands	Via command by controller or HMI

SIWAREX WP321	
Load cells	Full-bridge strain gauges in 4-wire or 6-wire system
Load cell powering	
Supply voltage (value applies at sensor, cable-related voltage drops of up to 5 V are controlled)	4.85 V DC ±2%
Permissible load resistance	
<ul style="list-style-type: none"> • R_{Lmin} • R_{Lmax} 	> 40 Ω < 4 100 Ω
With SIWAREX IS Ex interface	
<ul style="list-style-type: none"> • R_{Lmin} • R_{Lmax} 	> 50 Ω < 4 100 Ω
Load cell characteristic	1 ... 4 mV/V
Permissible range of measuring signal (at greatest set characteristic value)	-21.3 ... +21.3 mV
Max. distance of load cells	1000 m (459.32 ft)
Connection to load cells in Ex zone 1	Optionally via SIWAREX IS Ex interface (compatibility of the load cells must be checked)
Approvals/certificates	<ul style="list-style-type: none"> • ATEX Zone 2 • UL • FM • EAC • KCC • IECEx • RCM
Auxiliary power supply	
Rated voltage	24 V DC
Max. power consumption	Typ. 0.1 A @ 24 V DC (0.2 A max.)
Max. power consumption SIMATIC Bus	30 mA
IP degree of protection to EN 60529; IEC 60529	IP20
Climatic requirements	
$T_{min(IND)} \dots T_{max(IND)}$ (operating temperature)	
<ul style="list-style-type: none"> • Vertical installation in SIMATIC S7 ¹⁾ • Horizontal installation in SIMATIC S7 ¹⁾ 	-25 ... +50 °C (-13 ... 122 °F) -25 ... +60 °C (-13 ... 140 °F)
EMC requirements	According to IEC 61000-6-2, IEC 61000-6-4, OIML R76-1
Dimensions (width)	15 mm (0.6 inch)

¹⁾ The S7 standard modules may not be operated at temperatures below 0 °C (32 °F). For operating conditions below 0 °C (32 °F), SIMATIC modules from the SIPLUS series must be used.

I/O systems

SIMATIC ET 200 systems for the control cabinet
SIMATIC ET 200SP

I/O modules > Technology modules > TM SIWAREX WP351 HF weighing module

Overview



The SIWAREX WP351 is a compact, precise weighing module in the SIMATIC ET 200SP format.

With a width of just 20 mm it is one of the slimmest weighing modules on the market, yet its firmware includes the functionalities of an automatic totalizing weighing instrument and checking, bagging and filling scale.

All operation modes are part of the firmware and certified according to OIML R-51, R-61, R-76 and R-107. This means the WP351 can be used in both scales requiring official calibration and those that do not, where demands are high regarding speed and accuracy.

Ordering data

Article No.

Shield connection for ET 200SP Includes 5 shield connections	6ES7193-6SC00-1AM0
SIWAREX JB junction box, aluminum enclosure For connecting up to 4 load cells in parallel, and for connecting multiple terminal boxes.	7MH5001-0AA20
SIWAREX JB junction box, stainless steel enclosure For connecting up to 4 load cells in parallel.	7MH5001-0AA00
SIWAREX JB junction box, stainless steel enclosure (ATEX) For parallel connection of up to 4 load cells (for zone allocation, see manual or prototype test certificate).	7MH5001-0AA01
SIWAREX IS Ex interface For intrinsically safe connection of load cells. With ATEX approval (not UL/FM). Suitable for SIWAREX electronic weighing systems. Compatibility of load cells must be checked separately. • With short-circuit current < 199 mA DC • With short-circuit current < 137 mA DC	7MH4710-5BA 7MH4710-5CA

Cable (optional)

Cable Li2Y 1 x 2 x 0.75 ST + 2 x (2 x 0.34 ST) – CY

For connecting SIWAREX electronic weighing systems to junction box (JB), extension box (EB) and Ex interface or between two EBs. For permanent installation. Occasional bending is possible.

External diameter:
approx. 10.8 mm (0.43 inch)
Permissible ambient temperature
-40 ... +80 °C (-40 ... +176 °F)

Sold by the meter.

- Sheath color: orange
- For hazardous atmospheres. Sheath color: blue.

7MH4702-8AG
7MH4702-8AF

Commissioning

Commissioning charge for one static scale with SIWAREX module

(Flat charge for travel and setup must be ordered separately)

Scope:

- Recording of data
- Checking of mechanical design of the scale
- Checking of electrical wiring and function
- Static adjustment of the scale

Requirements:

- Mechanical design ready for operation
- Modules electrically wired and tested
- Calibration weights available
- Free access to scale

Flat charge for travel and setup in Germany

9LA1110-8RA10-0AA0

Ordering data

Article No.

TM SIWAREX WP351 HF weighing module SIMATIC ET 200SP, TM SIWAREX WP351 HF, legal-for-trade weighing module for automatic dosing, filling and checking scales and totalizing weighing instruments	7MH4138-6BA00-0CU0
SIWAREX WP351 Equipment Manual Available in a range of languages Free download on the Internet at: http://www.siemens.com/weighing/documentation	
SIWAREX WP351 "Getting Started" sample project Sample software shows beginners how to program the scales in TIA Portal V15.1 Free download on the Internet at: http://www.siemens.com/weighing/documentation	
Calibration set SIWAREX WP351 For verification of up to 3 scales, comprising: 3 × inscription foil for ID label, 1 × protective film, 3 × unlocking protection, 6 × screw. For applications requiring official calibration, follow the calibration regulations of the country of destination.	7MH4138-6BA00-0AY0
ET 200SP BaseUnit type U0 • For constructing a new potential group (white) • For continuing an existing potential group (gray)	6ES7193-6BP00-0DU0 6ES7193-6BP00-0BU0

10

Technical specifications

SIWAREX WP351	
Firmware version	V1.0
• FW update possible	Yes
Usable BaseUnits	BU type U0
Reliability	
Mean time between failures (MTBF)	62 years @ TA = 40 °C
Product function	
I&M data	Yes, I&M0 to I&M3
Engineering with	
• STEP 7 TIA Portal can be configured/ integrated	Configurable as of V15 using HSP0281
• PROFIBUS as of GSD version/ GSD revision	GSD V04.02.41
• PROFINET as of GSD version/ GSD revision	GSDML V2.34
Supply voltage	
Load voltage L+	
• Rated value (DC)	24 V
• Permissible range, low limit, static (DC)	19.2 V
• Permissible range, high limit, static (DC)	28.8 V
• Permissible range, low limit, dynamic (DC)	18.5 V
• Permissible range, high limit, dynamic (DC)	30.2 V
• Reverse polarity protection	Yes
• Non-periodic overvoltages	35 V DC for 500 ms with a recovery time of 50 s
Input current	
Current consumption, max.	Max. 140 mA @ 24 V DC + [DQ 3 × 0.5 A]
Power loss	
Typical power loss	1.7 W
Address range	
Assigned address range	
• Inputs	32 bytes
• Outputs	32 bytes
Power supply from SIMATIC S7 backplane bus	
Current consumption from ET 200SP backplane bus	Max. 27 mA @ 3.5 V (SBK4)
Analog load cell interface connection	
Error limit according to DIN 1319-1 at 20 °C (-4 °F) +/-10 K	≤ 0.002% of end value
Relative accuracy (absolute accuracy can only be achieved with local calibration using calibration standards)	
Measuring accuracy in accordance with OIML R76-1:2006/EN 45501:2015	
• Class	III
• Resolution (d=e)	3 × 6000 d
• Error percentage pi	0.4
• Step voltage	0.4 μV/e

SIWAREX WP351	
Accuracy delivery state	Typ. 0.1% of end value
The accuracy is relevant for module exchange or theoretical adjustment	
Sampling rate	1.024 ms
Input signal resolution	± 20 000 000
Measuring ranges	0 ... ±1 mV/V 0 ... ±2 mV/V 0 ... ±4 mV/V
Common mode voltage range	+2.8 ... 7.7 V
Strain gauge supply (constant voltage)	10 V DC (+1 % / -3 %) at the EXC terminals
Short-circuit and overload protection	Yes
Connection	6-wire or 4-wire (parameterizable)
Sensor voltage monitoring	Typ. ≤ 5.0 V
Min. strain gauge input resistance per channel	
• Without SIWAREX IS Ex-i interface	56 Ω
• With SIWAREX IS Ex-i interface	Lower impedance by means of external supply possible 87 Ω @ type 7MH4710-5BA 180 Ω @ type 7MH4710-5CA
Max. strain gauge resistance	4 100 Ω
Temperature coefficient range	≤ ±5 ppm/K
Temperature coefficient zero point	≤ ±0.015 μV/K
Linearity error	≤ 0.001%
Measured value filtering	Low-pass and average value filter configurable (DR3)
Galvanic isolation	500 V AC
50 Hz / 60 Hz noise suppression CMRR	> 80 dB
Input resistance	
• Signal line	Typ. 8*10 ⁶ Ω
• Sense line	Typ. 300*10 ⁶ Ω
Cable length	
• When using SIWAREX cable 7MH4702-8AG	Max. 500 m
Ambient conditions	
Ambient temperature in operation	
• Horizontal mounting position *	Min. -30 °C Max. +60 °C
• Vertical mounting position *	Min. -30 °C Max. +50 °C
Storage and transport temperature	-40 ... +70 °C (-40 ... +158 °F)

* At a height of more than 2 000 meters above sea level, a derating of the ambient temperature of -1°C / 100 m has to be adhered to. The maximum permissible height is 5 000 meters above sea level. At over 0.6 A total current of the digital outputs DQ, a derating of the ambient temperature of -1°C per 100 mA has to be adhered to. The max. permissible total current is 1.5 A.

I/O systems

SIMATIC ET 200 systems for the control cabinet
SIMATIC ET 200SP

I/O modules > Technology modules > SIPLUS TM Count 1x24V counter module

Overview



Technical properties

- Counter module for ET 200SP
- Interfaces:
 - 24 V encoder signals A, B and N from P, M or push-pull-switching encoders and sensors
 - 24 V encoder supply output, short-circuit proof
 - 3 digital inputs for controlling the count operation, for saving or for setting the count value
 - 2 digital outputs for fast reactions regardless of the counter status or measured value

- Counting frequency 200 kHz (800 kHz with quadruple evaluation)
- Counting range: +/- 31 bits
- Measurement function
- Parameterizable hardware interrupts
- Parameterizable input filters for suppressing interferences at sensor and digital inputs

Supported types of encoders/signals

- 24 V incremental encoder with and without signal N
- 24 V pulse encoder with direction signal
- 24 V pulse encoder without direction signal
- 24 V pulse encoder for pulse up and down respectively

Supported system functions

- Isochronous mode
- Firmware update
- Identification data I&M

Note

SIPLUS extreme products are based on SIMATIC standard products. The contents listed here were taken from the respective standard products. SIPLUS extreme specific information was added.

Ordering data

SIPLUS TM Count 1x24V counter module

(extended temperature range and exposure to environmental substances)

With one channel, max. 200 kHz; for 24 V encoder

Article No.

6AG1138-6AA01-2BA0

Suitable BaseUnits

(extended temperature range and exposure to environmental substances)

BU15-P16+A0+2D

BU type A0; BaseUnit (light) with 16 push-in terminals to the module; for starting a new load group (max. 10 A)

6AG1193-6BP00-7DA0

BU15-P16+A0+2B

BU type A0; BaseUnit (dark) with 16 push-in terminals to the module; for continuing the load group

6AG1193-6BP00-7BA0

Article No.

BU15-P16+A10+2D

BU type A0; BaseUnit (light) with 16 push-in terminals (1...16) to the module and an additional 10 internally jumpered AUX terminals (1 A to 10 A); for starting a new load group (max. 10 A)

6AG1193-6BP20-7DA0

BU15-P16+A10+2B

BU type A0; BaseUnit (dark) with 16 push-in terminals (1...16) to the module and an additional 10 internally jumpered AUX terminals (1 A to 10 A); for continuing the load group

6AG1193-6BP20-7BA0

SIPLUS Mounting Kit ET 200SP

Mounting accessories for use with increased mechanical vibration and shock loads.

6AG1193-6AA00-0AA0

Other accessories

See SIMATIC TM Count 1x24V counter module, page 10/99

Technical specifications

Article number	6AG1138-6AA01-2BA0	Article number	6AG1138-6AA01-2BA0
Based on	6ES7138-6AA01-0BA0 SIPLUS ET 200SP TM COUNT 1X24V	Based on	6ES7138-6AA01-0BA0 SIPLUS ET 200SP TM COUNT 1X24V
Ambient conditions		Usage in industrial process technology	
Ambient temperature during operation		<ul style="list-style-type: none"> - Against chemically active substances acc. to EN 60654-4 - Environmental conditions for process, measuring and control systems acc. to ANSI/ISA-71.04 	
• horizontal installation, min.	-40 °C; = Tmin (incl. condensation/frost)	Yes; Class 3 (excluding trichlorethylene)	
• horizontal installation, max.	60 °C; = Tmax; +70 °C with configured empty slots to the left and right of the module	Yes; Level GX group A/B (excluding trichlorethylene; harmful gas concentrations up to the limits of EN 60721-3-3 class 3C4 permissible); level LC3 (salt spray) and level LB3 (oil)	
• vertical installation, min.	-40 °C; = Tmin (incl. condensation/frost)	Remark	
• vertical installation, max.	50 °C; = Tmax	<ul style="list-style-type: none"> - Note regarding classification of environmental conditions acc. to EN 60721, EN 60654-4 and ANSI/ISA-71.04 	
Altitude during operation relating to sea level		Conformal coating	
• Installation altitude above sea level, max.	5 000 m; Restrictions for installation altitudes > 2 000 m, see manual	<ul style="list-style-type: none"> • Coatings for printed circuit board assemblies acc. to EN 61086 • Protection against fouling acc. to EN 60664-3 • Military testing according to MIL-I-46058C, Amendment 7 • Qualification and Performance of Electrical Insulating Compound for Printed Board Assemblies according to IPC-CC-830A 	
• Ambient air temperature-barometric pressure-altitude	Tmin ... Tmax at 1 140 hPa ... 795 hPa (-1 000 m ... +2 000 m) // Tmin ... (Tmax - 10 K) at 795 hPa ... 658 hPa (+2 000 m ... +3 500 m) // Tmin ... (Tmax -20 K) at 658 hPa ... 540 hPa (+3 500 m ... +5 000 m)	Yes; Class 2 for high reliability	
Relative humidity		Yes; Type 1 protection	
• With condensation, tested in accordance with IEC 60068-2-38, max.	100 %; RH incl. condensation / frost (no commissioning in bedewed state), horizontal installation	Yes; Discoloration of coating possible during service life	
Resistance		Yes; Conformal coating, Class A	
Coolants and lubricants			
- Resistant to commercially available coolants and lubricants	Yes; Incl. diesel and oil droplets in the air		
Use in stationary industrial systems			
- to biologically active substances according to EN 60721-3-3	Yes; Class 3B2 mold, fungus and dry rot spores (with the exception of fauna); Class 3B3 on request		
- to chemically active substances according to EN 60721-3-3	Yes; Class 3C4 (RH < 75 %) incl. salt spray acc. to EN 60068-2-52 (severity degree 3); *		
- to mechanically active substances according to EN 60721-3-3	Yes; Class 3S4 incl. sand, dust, *		
- Against mechanical environmental conditions acc. to EN 60721-3-3	Yes; Class 3M8 using the SIPLUS Mounting Kit ET 200SP (6AG1193-6AA00-0AA0)		
Use on ships/at sea			
- to biologically active substances according to EN 60721-3-6	Yes; Class 6B2 mold, fungal and dry rot spores (excluding fauna)		
- to chemically active substances according to EN 60721-3-6	Yes; Class 6C3 (RH < 75 %) incl. salt spray acc. to EN 60068-2-52 (severity degree 3); *		
- to mechanically active substances according to EN 60721-3-6	Yes; Class 6S3 incl. sand, dust; *		
- Against mechanical environmental conditions acc. to EN 60721-3-6	Yes; Class 6M4 using the SIPLUS Mounting Kit ET 200SP (6AG1193-6AA00-0AA0)		

I/O systems

SIMATIC ET 200 systems for the control cabinet
SIMATIC ET 200SP

I/O modules > Technology modules > SIPLUS TM PosInput 1 counting and position detection module**Overview****Technical properties**

- Counting and position detection module for ET 200SP
- Interfaces:
 - Encoder signals A, B and N for 5 V TTL or RS 422 differential signals
 - SSI interface with clock and data for RS 422 differential signals
 - 24 V encoder supply output, short-circuit proof
 - 2 digital inputs for controlling the counting process, for saving or setting the counter or position value
 - 2 digital outputs for fast reactions depending on the counter reading, position value or measured value
- Counter frequency 1 MHz (4 MHz with four-fold evaluation)
- Counting range: +/- 31 bits
- Measurement function
- Parameterizable hardware interrupts
- Parameterizable input filters for suppressing interferences at sensor and digital inputs

Supported types of encoders/signals

- Incremental encoders with or without N signal
- Pulse encoders with directional signal
- Pulse encoders without directional signal
- Pulse encoders for forward or reverse pulses
- SSI encoders with a frame length of 10 to 40 bits, of which up to 31 bits position value

Supported system functions

- Isochronous mode
- Firmware update
- Identification data I&M

Note

SIPLUS extreme products are based on SIMATIC standard products. The contents listed here were taken from the respective standard products. SIPLUS extreme-specific information was added.

Ordering data**Article No.****SIPLUS TM PosInput 1 counting and position detection module**

(extended temperature range and exposure to environmental substances)

For RS-422 incremental encoders or SSI absolute encoders, 2DI, 2DQ suitable for BU type A0, ambient temperature -40 °C...60 °C;

6AG1138-6BA01-2BA0**Suitable BaseUnits**

(extended temperature range and exposure to environmental substances)

BU15-P16+A0+2D

BU type A0; BaseUnit (light) with 16 push-in terminals to the module; for starting a new load group (max. 10 A)

6AG1193-6BP00-7DA0**BU15-P16+A0+2B**

BU type A0; BaseUnit (dark) with 16 push-in terminals to the module; for continuing the load group

6AG1193-6BP00-7BA0**BU15-P16+A10+2D**

BU type A0; BaseUnit (light) with 16 push-in terminals (1...16) to the module and an additional 10 internally jumpered AUX terminals (1 A to 10 A); for starting a new load group (max. 10 A)

6AG1193-6BP20-7DA0**BU15-P16+A10+2B**

BU type A0; BaseUnit (dark) with 16 push-in terminals (1...16) to the module and an additional 10 internally jumpered AUX terminals (1 A to 10 A); for continuing the load group

6AG1193-6BP20-7BA0**Accessories****SIPLUS Mounting Kit ET 200SP**

Mounting accessories for use with increased mechanical vibration and shock loads.

6AG1193-6AA00-0AA0**Other accessories**

See TM PosInput 1 counter and position detection module, page 10/103

Technical specifications

Article number	6AG1138-6BA01-2BA0
Based on	6ES7138-6BA01-0BA0 SIPLUS ET 200SP TM POSINPUT 1
Ambient conditions	
Ambient temperature during operation	
• horizontal installation, min.	-40 °C; = Tmin (incl. condensation/frost)
• horizontal installation, max.	60 °C; = Tmax; +70 °C with configured empty slots to the left and right of the module
• vertical installation, min.	-40 °C; = Tmin
• vertical installation, max.	50 °C; = Tmax; see Derating BasedOn (e.g. manual)
Altitude during operation relating to sea level	
• Installation altitude above sea level, max.	5 000 m
• Ambient air temperature-barometric pressure-altitude	Tmin ... Tmax at 1 140 hPa ... 795 hPa (-1 000 m ... +2 000 m) // Tmin ... (Tmax - 10 K) at 795 hPa ... 658 hPa (+2 000 m ... +3 500 m) // Tmin ... (Tmax -20 K) at 658 hPa ... 540 hPa (+3 500 m ... +5 000 m)
Relative humidity	
• With condensation, tested in accordance with IEC 60068-2-38, max.	100 %; RH incl. condensation / frost (no commissioning in bedewed state), horizontal installation
Resistance	
Coolants and lubricants	
- Resistant to commercially available coolants and lubricants	Yes; Incl. diesel and oil droplets in the air
Use in stationary industrial systems	
- to biologically active substances according to EN 60721-3-3	Yes; Class 3B2 mold, fungus and dry rot spores (with the exception of fauna); Class 3B3 on request
- to chemically active substances according to EN 60721-3-3	Yes; Class 3C4 (RH < 75 %) incl. salt spray acc. to EN 60068-2-52 (severity degree 3); *
- to mechanically active substances according to EN 60721-3-3	Yes; Class 3S4 incl. sand, dust, *
- Against mechanical environmental conditions acc. to EN 60721-3-3	Yes; Class 3M8 using the SIPLUS Mounting Kit ET 200SP (6AG1193-6AA00-0AA0)

Article number	6AG1138-6BA01-2BA0
Based on	6ES7138-6BA01-0BA0 SIPLUS ET 200SP TM POSINPUT 1
Use on ships/at sea	
- to biologically active substances according to EN 60721-3-6	Yes; Class 6B2 mold and fungal spores (excluding fauna); Class 6B3 on request
- to chemically active substances according to EN 60721-3-6	Yes; Class 6C3 (RH < 75 %) incl. salt spray acc. to EN 60068-2-52 (severity degree 3); *
- to mechanically active substances according to EN 60721-3-6	Yes; Class 6S3 incl. sand, dust; *
- Against mechanical environmental conditions acc. to EN 60721-3-6	Yes; Class 6M4 using the SIPLUS Mounting Kit ET 200SP (6AG1193-6AA00-0AA0)
Usage in industrial process technology	
- Against chemically active substances acc. to EN 60654-4	Yes; Class 3 (excluding trichlorethylene)
- Environmental conditions for process, measuring and control systems acc. to ANSI/ISA-71.04	Yes; Level GX group A/B (excluding trichlorethylene; harmful gas concentrations up to the limits of EN 60721-3-3 class 3C4 permissible); level LC3 (salt spray) and level LB3 (oil)
Remark	
- Note regarding classification of environmental conditions acc. to EN 60721, EN 60654-4 and ANSI/ISA-71.04	* The supplied plug covers must remain in place over the unused interfaces during operation!
Conformal coating	
• Coatings for printed circuit board assemblies acc. to EN 61086	Yes; Class 2 for high reliability
• Protection against fouling acc. to EN 60664-3	Yes; Type 1 protection
• Military testing according to MIL-I-46058C, Amendment 7	Yes; Discoloration of coating possible during service life
• Qualification and Performance of Electrical Insulating Compound for Printed Board Assemblies according to IPC-CC-830A	Yes; Conformal coating, Class A

I/O systems

SIMATIC ET 200 systems for the control cabinet
SIMATIC ET 200SP

I/O modules > Technology modules > SIPLUS TM timer DIDQ 10x24 V time-based IO module

Overview

- 4 digital inputs, 6 digital outputs
- Inputs for detecting the input edges with μs accuracy
- Outputs for outputting the switching signals with μs accuracy
- 32x oversampling
- PWM output
- Counter function
- Outputs can be switched between 0.5 A standard and especially fast 0.1 A high-speed mode

Note

SIPLUS extreme products are based on SIMATIC standard products. The contents listed here were taken from the respective standard products. SIPLUS extreme specific information was added.

Ordering data**Article No.****SIPLUS TM timer DIDQ 10x24 V time-based IO module**

(extended temperature range and exposure to environmental substances)

4 time-controlled inputs,
6 time-controlled outputs

6AG1138-6CG00-2BA0**Suitable BaseUnits**

(extended temperature range and exposure to environmental substances)

BU15-P16+A0+2D**6AG1193-6BP00-7DA0**

BU type A0; BaseUnit (light) with 16 push-in terminals to the module; for starting a new load group (max. 10 A)

BU15-P16+A0+2B**6AG1193-6BP00-7BA0**

BU type A0; BaseUnit (dark) with 16 push-in terminals to the module; for continuing the load group

BU15-P16+A10+2D**6AG1193-6BP20-7DA0**

BU type A0; BaseUnit (light) with 16 push-in terminals (1...16) to the module and an additional 10 internally jumpered AUX terminals (1 A to 10 A); for starting a new load group (max. 10 A)

BU15-P16+A10+2B**6AG1193-6BP20-7BA0**

BU type A0; BaseUnit (dark) with 16 push-in terminals (1...16) to the module and an additional 10 internally jumpered AUX terminals (1 A to 10 A); for continuing the load group

Accessories**SIPLUS Mounting Kit ET 200SP****6AG1193-6AA00-0AA0**

Mounting accessories for use with increased mechanical vibration and shock loads.

Other accessories

See SIMATIC TM timer DIDQ 10x24V time-based IO module, page 10/106

Technical specifications

Article number	6AG1138-6CG00-2BA0
Based on	6ES7138-6CG00-0BA0 SIPLUS ET 200SP TM TIMER DIDQ 10x24V
Ambient conditions	
Ambient temperature during operation	
• horizontal installation, min.	-40 °C; = Tmin (incl. condensation/frost)
• horizontal installation, max.	60 °C; = Tmax; +70 °C with configured empty slots to the left and right of the module
• vertical installation, min.	-40 °C; = Tmin (incl. condensation/frost)
• vertical installation, max.	50 °C; = Tmax; see Derating BasedOn (e.g. manual)
Altitude during operation relating to sea level	
• Installation altitude above sea level, max.	5 000 m
• Ambient air temperature-barometric pressure-altitude	Tmin ... Tmax at 1 140 hPa ... 795 hPa (-1 000 m ... +2 000 m) // Tmin ... (Tmax - 10 K) at 795 hPa ... 658 hPa (+2 000 m ... +3 500 m) // Tmin ... (Tmax -20 K) at 658 hPa ... 540 hPa (+3 500 m ... +5 000 m)
Relative humidity	
• With condensation, tested in accordance with IEC 60068-2-38, max.	100 %; RH incl. condensation / frost (no commissioning in bedewed state), horizontal installation
Resistance	
Coolants and lubricants	
- Resistant to commercially available coolants and lubricants	Yes; Incl. diesel and oil droplets in the air
Use in stationary industrial systems	
- to biologically active substances according to EN 60721-3-3	Yes; Class 3B2 mold, fungus and dry rot spores (with the exception of fauna); Class 3B3 on request
- to chemically active substances according to EN 60721-3-3	Yes; Class 3C4 (RH < 75 %) incl. salt spray acc. to EN 60068-2-52 (severity degree 3); *
- to mechanically active substances according to EN 60721-3-3	Yes; Class 3S4 incl. sand, dust, *
- Against mechanical environmental conditions acc. to EN 60721-3-3	Yes; Class 3M8 using the SIPLUS Mounting Kit ET 200SP (6AG1193-6AA00-0AA0)

Article number	6AG1138-6CG00-2BA0
Based on	6ES7138-6CG00-0BA0 SIPLUS ET 200SP TM TIMER DIDQ 10x24V
Use on ships/at sea	
- to biologically active substances according to EN 60721-3-6	Yes; Class 6B2 mold and fungal spores (excluding fauna); Class 6B3 on request
- to chemically active substances according to EN 60721-3-6	Yes; Class 6C3 (RH < 75 %) incl. salt spray acc. to EN 60068-2-52 (severity degree 3); *
- to mechanically active substances according to EN 60721-3-6	Yes; Class 6S3 incl. sand, dust; *
- Against mechanical environmental conditions acc. to EN 60721-3-6	Yes; Class 6M4 using the SIPLUS Mounting Kit ET 200SP (6AG1193-6AA00-0AA0)
Usage in industrial process technology	
- Against chemically active substances acc. to EN 60654-4	Yes; Class 3 (excluding trichlorethylene)
- Environmental conditions for process, measuring and control systems acc. to ANSI/ISA-71.04	Yes; Level GX group A/B (excluding trichlorethylene; harmful gas concentrations up to the limits of EN 60721-3-3 class 3C4 permissible); level LC3 (salt spray) and level LB3 (oil)
Remark	
- Note regarding classification of environmental conditions acc. to EN 60721, EN 60654-4 and ANSI/ISA-71.04	* The supplied plug covers must remain in place over the unused interfaces during operation!
Conformal coating	
• Coatings for printed circuit board assemblies acc. to EN 61086	Yes; Class 2 for high reliability
• Protection against fouling acc. to EN 60664-3	Yes; Type 1 protection
• Military testing according to MIL-I-46058C, Amendment 7	Yes; Discoloration of coating possible during service life
• Qualification and Performance of Electrical Insulating Compound for Printed Board Assemblies according to IPC-CC-830A	Yes; Conformal coating, Class A

I/O systems

SIMATIC ET 200 systems for the control cabinet
SIMATIC ET 200SP

I/O modules > Technology modules > SIPLUS TM Pulse 2x24V pulse output module

Overview



2-channel pulse output module for SIPLUS ET 200SP

- Operating modes:
 - Single pulse with defined length
 - Pulse chain with defined number of pulses
 - Pulse width modulation (with flexible ON period, optional current control and dither function)
 - PWM signal for controlling a DC motor
 - ON and OFF delay; rising and falling edge can be delayed separately to the microsecond
 - Frequency output with defined output frequency
- Hardware:
 - 2 channels 24 V, 2 A output current output current can be switched in parallel to boost performance to 4 A of output current
 - Switching frequencies to 10 kHz; at reduced output current to 0.1 A up to 100 kHz
 - Push/pull output driver for especially steep edges at the outputs
 - Polarity change in DC motor operation for direction reversal
 - 1 high-speed 24 V digital input per channel with parameterizable input delay from 4 μ s
- Channel functions:
 - HW enable; Start of signal output with the onboard digital input
 - Parameterizable ON delay; for precise deceleration between the HW enable and the start of output
 - Current measurement in the operating modes pulse-width modulation and pulse chain; enables control of the output current mean value over a period. Temperature influences can thus be balanced to the resistance of the actuator.
 - Cyclic control of the respective main setpoint from the PLC in every operating mode; other values can be modified flexibly from the user program.
- Supported system functions:
 - Isochronous mode; enables precision-timed connection of the setpoint output to a higher-level controller
 - Firmware update
 - Identification data I&M

Note

SIPLUS extreme products are based on SIMATIC standard products. The contents listed here were taken from the respective standard products. SIPLUS extreme-specific information was added.

Ordering data

Article No.

SIPLUS TM Pulse 2x24V pulse output module

6AG1138-6DB00-2BB1

(extended temperature range and exposure to environmental substances)

PWM and pulse output, 2 channels of 2 A for proportional valves and DC motors

Suitable BaseUnits

(extended temperature range and exposure to environmental substances)

BU20-P12+A0+4B

6AG1193-6BP20-7BB1

BU type B1; BaseUnit (dark); without AUX terminals; for continuing the load group

Accessories

SIPLUS Mounting Kit ET 200SP

6AG1193-6AA00-0AA0

Mounting accessories for use with increased mechanical vibration and shock loads.

Other accessories

See SIMATIC TM Pulse 2x24V pulse output module, page 10/109

Technical specifications

Article number	6AG1138-6DB00-2BB1	Article number	6AG1138-6DB00-2BB1
Based on	6ES7138-6DB00-0BB1 SIPLUS ET 200SP TM PULSE 2x24V	Based on	6ES7138-6DB00-0BB1 SIPLUS ET 200SP TM PULSE 2x24V
Ambient conditions		Use on ships/at sea	
Ambient temperature during operation		- to biologically active substances according to EN 60721-3-6	
• horizontal installation, min.	-40 °C; = Tmin (incl. condensation/frost)	Yes; Class 6B2 mold and fungal spores (excluding fauna); Class 6B3 on request	
• horizontal installation, max.	60 °C; = Tmax; +70 °C with configured empty slots to the left and right of the module	Yes; Class 6C3 (RH < 75 %) incl. salt spray acc. to EN 60068-2-52 (severity degree 3); *	
• vertical installation, min.	-40 °C; = Tmin (incl. condensation/frost)	Yes; Class 6S3 incl. sand, dust; *	
• vertical installation, max.	50 °C; Observe derating	Yes; Class 6M4 using the SIPLUS Mounting Kit ET 200SP (6AG1193-6AA00-0AA0)	
Altitude during operation relating to sea level		Usage in industrial process technology	
• Installation altitude above sea level, max.	5 000 m	- Against chemically active substances acc. to EN 60654-4	
• Ambient air temperature-barometric pressure-altitude	Tmin ... Tmax at 1 140 hPa ... 795 hPa (-1 000 m ... +2 000 m) // Tmin ... (Tmax - 10 K) at 795 hPa ... 658 hPa (+2 000 m ... +3 500 m) // Tmin ... (Tmax -20 K) at 658 hPa ... 540 hPa (+3 500 m ... +5 000 m)	- Environmental conditions for process, measuring and control systems acc. to ANSI/ISA-71.04	
Relative humidity		Remark	
• With condensation, tested in accordance with IEC 60068-2-38, max.	100 %; RH incl. condensation / frost (no commissioning in bedewed state), horizontal installation	- Note regarding classification of environmental conditions acc. to EN 60721, EN 60654-4 and ANSI/ISA-71.04	
Resistance		Conformal coating	
Coolants and lubricants		• Coatings for printed circuit board assemblies acc. to EN 61086	
- Resistant to commercially available coolants and lubricants	Yes; Incl. diesel and oil droplets in the air	Yes; Class 2 for high reliability	
Use in stationary industrial systems		• Protection against fouling acc. to EN 60664-3	
- to biologically active substances according to EN 60721-3-3	Yes; Class 3B2 mold, fungus and dry rot spores (with the exception of fauna); Class 3B3 on request	• Military testing according to MIL-I-46058C, Amendment 7	
- to chemically active substances according to EN 60721-3-3	Yes; Class 3C4 (RH < 75 %) incl. salt spray acc. to EN 60068-2-52 (severity degree 3); *	• Qualification and Performance of Electrical Insulating Compound for Printed Board Assemblies according to IPC-CC-830A	
- to mechanically active substances according to EN 60721-3-3	Yes; Class 3S4 incl. sand, dust, *	Yes; Type 1 protection	
- Against mechanical environmental conditions acc. to EN 60721-3-3	Yes; Class 3M8 using the SIPLUS Mounting Kit ET 200SP (6AG1193-6AA00-0AA0)	Yes; Discoloration of coating possible during service life	
		Yes; Conformal coating, Class A	

I/O systems

SIMATIC ET 200 systems for the control cabinet
SIMATIC ET 200SP

I/O modules > Technology modules > SIPLUS ET 200SP ECC charging controller

Overview

SIPLUS Electrical Charging Controllers are the key components in infrastructure solutions for the conductive charging of electric vehicles.

They perform the following functions:

- Detection of the charging cable and its permissible current carrying capacity
- Transfer of the maximum charging current from the charging station to the electric vehicle
- Evaluation of the status signals from the electric vehicle:
 - Ready for charging
 - Charging
 - Charging with ventilation
- Cost-optimized, space-saving charging infrastructure solutions due to compact design based on SIMATIC ET 200SP

SIPLUS ET 200SP TM ECC 2xPWM ST AC module

- Control of charging outputs according to IEC 61851 by parameterizable SIPLUS ET 200SP TM ECC 2xPWM ST charging controller
- Control of load tap-off
- Control of connector lock
- Evaluation of connector lock or load contactor status

Note

SIPLUS extreme products are based on SIMATIC standard products. The contents listed here were taken from the respective standard products. SIPLUS extreme-specific information was added.

Ordering data**SIPLUS ET 200SP TM ECC 2xPWM ST charging controller**

(Exposure to environmental substances)

Designed for controlling charging outputs according to IEC 61851 and parameterizable, with 2 charging outputs, ambient temperature -30 °C ... 60 °C;

2x control pilot, 2x plug present, 2x DQ switching contact for load contactor as open collector, 2x DI for load contactor feedback or connector lock;

Accessories**SIPLUS Mounting Kit ET 200SP**

Mounting accessories for use with increased mechanical vibration and shock loads.

Article No.

6AG1242-6TM10-2BB1

6AG1193-6AA00-0AA0

Technical specifications

Article number	6AG1242-6TM10-2BB1
Based on	6ES7242-6TM10-0BB1 SIPLUS ET 200SP TM ECC 2xPWM ST
Ambient conditions	
Ambient temperature during operation	
• horizontal installation, min.	-30 °C; = Tmin
• horizontal installation, max.	60 °C; = Tmax
• vertical installation, min.	-30 °C; = Tmin
• vertical installation, max.	50 °C; = Tmax
Ambient temperature during storage/transportation	
• Storage, min.	-40 °C
• Storage, max.	70 °C
• Transportation, min.	-40 °C
• Transportation, max.	70 °C
Altitude during operation relating to sea level	
• Installation altitude above sea level, max.	5 000 m
• Ambient air temperature-barometric pressure-altitude	Tmin ... Tmax at 1 140 hPa ... 795 hPa (-1 000 m ... +2 000 m) // Tmin ... (Tmax - 10 K) at 795 hPa ... 658 hPa (+2 000 m ... +3 500 m) // Tmin ... (Tmax -20 K) at 658 hPa ... 540 hPa (+3 500 m ... +5 000 m)
Relative humidity	
• With condensation, tested in accordance with IEC 60068-2-38, max.	100 %; RH incl. condensation / frost (no commissioning in bedewed state), horizontal installation
Vibrations	
• Vibration resistance during operation acc. to IEC 60068-2-6	10 ... 58 Hz / 0.075 mm, 58 ... 150 Hz / 1 g
Shock testing	
• Shock resistance acc. to IEC 60068-2-27	15 g / 11 ms
Resistance	
Coolants and lubricants	
- Resistant to commercially available coolants and lubricants	Yes; Incl. diesel and oil droplets in the air

Article number	6AG1242-6TM10-2BB1
Based on	6ES7242-6TM10-0BB1 SIPLUS ET 200SP TM ECC 2xPWM ST
Use in stationary industrial systems	
- to biologically active substances according to EN 60721-3-3	Yes; Class 3B2 mold, fungus and dry rot spores (with the exception of fauna); Class 3B3 on request
- to chemically active substances according to EN 60721-3-3	Yes; Class 3C4 (RH < 75 %) incl. salt spray acc. to EN 60068-2-52 (severity degree 3); *
- to mechanically active substances according to EN 60721-3-3	Yes; Class 3S4 incl. sand, dust, *
- Against mechanical environmental conditions acc. to EN 60721-3-3	Yes; Class 3M8 using the SIPLUS Mounting Kit ET 200SP (6AG1193-6AA00-0AA0)
Usage in industrial process technology	
- Against chemically active substances acc. to EN 60654-4	Yes; Class 3 (excluding trichlorethylene)
- Environmental conditions for process, measuring and control systems acc. to ANSI/ISA-71.04	Yes; Level GX group A/B (excluding trichlorethylene; harmful gas concentrations up to the limits of EN 60721-3-3 class 3C4 permissible); level LC3 (salt spray) and level LB3 (oil)
Remark	
- Note regarding classification of environmental conditions acc. to EN 60721, EN 60654-4 and ANSI/ISA-71.04	* The supplied plug covers must remain in place over the unused interfaces during operation!
Conformal coating	
• Coatings for printed circuit board assemblies acc. to EN 61086	Yes; Class 2 for high reliability
• Protection against fouling acc. to EN 60664-3	Yes; Type 1 protection
• Military testing according to MIL-I-46058C, Amendment 7	Yes; Discoloration of coating possible during service life
• Qualification and Performance of Electrical Insulating Compound for Printed Board Assemblies according to IPC-CC-830A	Yes; Conformal coating, Class A

I/O systems

SIMATIC ET 200 systems for the control cabinet
SIMATIC ET 200SP

I/O modules > Technology modules > SIPLUS SIWAREX WP321

Overview



SIPLUS WP321 is a versatile and flexible weighing module for the seamless integration of a static scale into the SIMATIC automation environment.

The electronic weighing system is integrated in the SIPLUS ET 200SP series and uses all the features of a modern automation system, such as integrated communication, operator control and monitoring, diagnostic system and configuration tools in the TIA Portal, SIMATIC STEP 7, WinCC flexible and PCS 7.

Note

SIPLUS extreme products are based on SIMATIC standard products. The contents listed here were taken from the respective standard products. SIPLUS extreme-specific information has been added.

SIPLUS WP321	
Article No.	6AG1138-6AA00-2BA8
Article No. based on	7MH4138-6AA00-0BA0
Ambient temperature range	-40 ... +60 °C
Conformal coating	Coating of the printed circuit boards and the electronic components
Technical specifications	The technical specifications of the standard product apply, except for the ambient conditions.

Ordering data

Ordering data	Article No.
SIPLUS WP321 weighing module Single-channel, for platform or hopper scales with analog load cells (1–4 mV/V), 1 x LC, 1 x RS 485. Extended temperature range and exposure to environmental substances	6AG1138-6AA00-2BA8
Accessories	
Mandatory	
BaseUnit Type A0 – one BaseUnit required for each WP321 <ul style="list-style-type: none"> For opening a new potential group <ul style="list-style-type: none"> BU15P-16+A0+2D or BU15P-16+A10+2D For continuing the potential group <ul style="list-style-type: none"> BU15P-16+A0+2B BU15P-16+A10+2B 	6ES7193-6BP00-0DA0 6ES7193-6BP20-0DA0 6ES7193-6BP00-0BA0 6ES7193-6BP20-0BA0
Consumables	
Shield connection for BaseUnit For laying the load cell cable (5 units / for 5 weighing instruments)	6ES7193-6SC00-1AM0
Shield connection element Sufficient for one SIWAREX FTA module	6ES7390-5AA00-0AA0
SIWAREX JB junction box, aluminum housing For connecting up to 4 load cells in parallel, and for connecting multiple junction boxes	7MH5001-0AA20
SIWAREX JB junction box, stainless steel housing For connecting up to 4 load cells in parallel.	7MH5001-0AA00

Article No.

SIWAREX JB junction box, stainless steel housing (ATEX) For parallel connection of up to 4 load cells (for zone allocation, see manual or type-examination certificate).	7MH5001-0AA01
Ex interface, type SIWAREX IS For intrinsically safe connection of load cells. With ATEX approval (not UL/FM). Suitable for SIWAREX electronic weighing systems. Compatibility of the load cells must be checked separately. <ul style="list-style-type: none"> With short-circuit current < 199 mA DC With short-circuit current < 137 mA DC 	7MH4710-5BA 7MH4710-5CA
Cables (optional) Cable Li2Y 1 x 2 x 0.75 ST + 2 x (2 x 0.34 ST) – CY, orange sheath For connecting SIWAREX electronic weighing systems to junction boxes (JB), extension boxes (EB) and Ex interface or between two EBs. For permanent installation. Occasional bending is permitted. Outer diameter: approx. 10.8 mm (0.43 inch) Permissible ambient temperature -40 ... +80 °C (-40 ... +176 °F) Sold by the meter Sheath color: orange For hazardous areas. Sheath color: blue	7MH4702-8AG 7MH4702-8AF

Ordering data	Article No.	Article No.
Configuration software		
SIWATOOL V4 & V7 Service and commissioning software for SIWAREX weighing modules	7MH4900-1AK01	
SIWAREX PCS 7 AddOn Library for PCS 7 V8.x and V9.0 • Supports PROFINET APL faceplates and function blocks for: • SIWAREX U • SIWAREX FTA • SIWAREX FTC_B (belt scales) • SIWAREX WP321 Classic faceplate and function block for: • SIWAREX FTC_L (loss in weight)	7MH4900-1AK61	
Documentation		
SIWAREX WP321 Equipment Manual Available in a range of languages Free download from the Internet at: http://www.siemens.com/weighing/documentation		
		SIWAREX WP321 "Ready for use" TIA Portal and SIMATIC Manager sample configuration Free download on the Internet at: http://www.siemens.com/weighing/documentation
		SIMATIC Manual Collection Electronic manuals on DVD, multi-language: LOGO!, SIMADYN, SIMATIC bus components, SIMATIC C7, SIMATIC distributed I/O, SIMATIC HMI, SIMATIC Sensors, SIMATIC NET, SIMATIC PC-based Automation, SIMATIC PCS 7, SIMATIC PG/PC, SIMATIC S7, SIMATIC Software, SIMATIC TDC
		SIMATIC Manual Collection update service for 1 year Current Manual Collection DVD and the three subsequent updates

Technical specifications

SIPLUS WP321	6AG1138-6AA00-2BA8	SIPLUS WP321	6AG1138-6AA00-2BA8
Based on	7MH4138-6AA00-0BA8	Based on	7MH4138-6AA00-0BA8
Environmental conditions		Resistance	
Climatic requirements $T_{min(IND)} \dots T_{max(IND)}$ (operating temperature) • Vertical installation • Horizontal installation	-40 ... +50 °C -40 ... +60 °C	• Coolants and lubricants - Resistant to commercially available coolants and lubricants • For use in stationary industrial equipment - Resistant to biologically active substances, acc. to EN 60721-3-3 - Resistant to chemically active substances acc. to EN 60721-3-3 - Resistant to mechanically active substances acc. to EN 60721-3-3 • For use on ships/at sea - Resistant to biologically active substances acc. to EN 60721-3-6 - Resistant to chemically active substances acc. to EN 60721-3-6 - Resistant to mechanically active substances acc. to EN 60721-3-6 • Note - Note on classification of environmental conditions acc. to EN 60721	Yes; incl. airborne diesel and oil droplets Yes; Class 3B2 mold and fungal spores (excluding fauna); Class 3B3 on request Yes; Class 3C4 (RH < 75 %) incl. salt spray acc. to EN 60068-2-52 (severity 3)* Yes; Class 3S4 incl. sand, dust* Yes; Class 6B2 mold and fungal spores (excluding fauna); Class 6B3 on request Yes; Class 6C3 (RH < 75 %) incl. salt spray acc. to EN 60068-2-52 (severity 3)* Yes; Class 6S3 incl. sand, dust* *. The supplied plug covers must remain in place on the unused interfaces during operation.
Operating height in relation to sea level • Installation altitude above sea level, max. • Ambient temperature, air pressure and altitude	5 000 m Tmin ... Tmax at 1 140 hPa ... 795 hPa (-1 000 m ... +2 000 m) // Tmin ... (Tmax - 10 K) at 795 hPa ... 658 hPa (+2 000 m ... +3 500 m) // Tmin ... (Tmax - 20 K) at 658 hPa ... 540 hPa (+3 500 m ... +5 000 m)	Conformal coating • Coating for PCBs acc. to EN 61086 • Military testing acc. to MIL-I-46058C, Amendment 7 • Qualification and Performance of Electrical Insulating Compound for Printed Wiring Assemblies acc. to IPC-CC-830A	Yes; Class 2 for high availability Yes; coating discoloration possible Yes; conformal coating, class A
Relative humidity • With condensation, tested according to IEC 60068-2-38, max.	100%; RH including condensation/frost (no commissioning when condensation is present), horizontal installation		

I/O systems

SIMATIC ET 200 systems for the control cabinet
SIMATIC ET 200SP

I/O modules > Communication > CM PtP serial interface

Overview



SIMATIC ET 200SP CM PtP video

https://players.brightcove.net/1813624294001/70fecf0f-fbad-4fad-a077-d0e26af4d84c_default/index.html?videoid=6136809673001



- CM PtP communications module; module for serial communication connections with RS232 and RS422 interfaces. RS485 for the Freepoint, 3964(R), Modbus RTU, USS and DMX512 protocols, max. 115.2250 kbps, 2 KB frame length, 4 KB receive buffer.
- Protocols supported
 - Freepoint: User-parameterizable frame format for universal communication, also known as ASCII frame
 - 3964(R) for improved transmission reliability
 - Modbus RTU master (requires instructions in SIMATIC S7)
 - Modbus RTU slave (requires instructions in SIMATIC S7)
 - USS, implemented through instructions
 - DMX512, can be implemented through instructions
- Interface properties
 - RS232 with auxiliary signals
 - RS422 for full-duplex connections
 - RS485 for half-duplex and multi-point connections
 - Transmission rates from 300 to 115200 bps for RS232 and RS422
 - Transmission rates from 300 to 25000 bps for RS485
- Frame lengths
 - In universal operation: 2 KB each in send and receive direction
 - In performance-optimized operation: 30 bytes in send direction, 24 bytes in receive direction
- Can be plugged into type A0 BaseUnits (BU) with automatic coding
- LED display for errors, operation and supply voltage
- Communication display for sending and receiving
- Clear labeling on front of module
 - Plain text identification of the module type and function class
 - 2D matrix code (article and serial number)
 - Connection diagram
 - Color coding of the module type
 - Hardware and firmware version
 - Complete Article No.
- Optional labeling accessories
 - Labeling strips
 - Equipment labeling plate
- Optional system-integrated shield connection

Ordering data	Article No.	Article No.
<p>CM PtP communications module</p> <p>For serial communication connections with RS232, RS422, RS485 interfaces, BU type A0, color code CC00</p> <ul style="list-style-type: none"> • Pack of 1 unit • Pack of 10 units; to order a pack, please order this article number with an order quantity of 10 	<p>6ES7137-6AA01-0BA0 6ES7137-6AA01-2BA0</p>	<p>BU15-P16+A0+2B</p> <p>BU type A0; BaseUnit (dark) with 16 push-in terminals to the module; for continuing the load group</p> <ul style="list-style-type: none"> • Pack of 1 unit • Pack of 10 units; to order a pack, please order this article number with an order quantity of 10.
<p>Accessories</p>		<p>Equipment labeling plate</p> <p>10 sheets of 16 labels</p>
<p>BU15-P16+A10+2D</p> <p>BU type A0; BaseUnit (light) with 16 push-in terminals (1 ... 16) to the module and an additional 10 internally jumpered AUX terminals (1 A to 10 A); for starting a new load group (max. 10 A)</p> <ul style="list-style-type: none"> • Pack of 1 unit • Pack of 10 units; to order a pack, please order this article number with an order quantity of 10. 	<p>6ES7193-6BP20-0DA0 6ES7193-6BP20-2DA0</p>	<p>Labeling strips</p> <p>500 labeling strips on roll, light gray, for inscription with thermal transfer roll printer</p>
<p>BU15-P16+A0+2D</p> <p>BU type A0; BaseUnit (light) with 16 push-in terminals to the module; for starting a new load group (max. 10 A)</p> <ul style="list-style-type: none"> • Pack of 1 unit • Pack of 10 units; to order a pack, please order this article number with an order quantity of 10. 	<p>6ES7193-6BP00-0DA0 6ES7193-6BP00-2DA0</p>	<p>Shield connection</p> <p>5 shield supports and 5 shield terminals, for direct connection</p>
<p>BU15-P16+A10+2B</p> <p>BU type A0; BaseUnit (dark) with 16 push-in terminals (1 ... 16) to the module and an additional 10 internally jumpered AUX terminals (1 A to 10 A); for continuing the load group</p> <ul style="list-style-type: none"> • Pack of 1 unit • Pack of 10 units; to order a pack, please order this article number with an order quantity of 10. 	<p>6ES7193-6BP20-0BA0 6ES7193-6BP20-2BA0</p>	<p>Mechanical coding elements</p> <p>For automatic coding of I/O modules; spare part. 20 units</p> <p>Type A 6ES7193-6KA00-3AA0</p> <p>Type B 6ES7193-6KB00-3AA0</p> <p>Type C 6ES7193-6KC00-3AA0</p> <p>Type D 6ES7193-6KD00-3AA0</p>

I/O systems

SIMATIC ET 200 systems for the control cabinet
SIMATIC ET 200SP

I/O modules > Communication > CM PtP serial interface

Technical specifications

Article number	6ES7137-6AA01-0BA0 ET 200SP, CM PTP, PU 1
General information	
Product type designation	CM PtP
Product function	
• I&M data	Yes; I&M0 to I&M3
Engineering with	
• STEP 7 TIA Portal configurable/ integrated from version	STEP 7 V17 or higher
• STEP 7 configurable/ integrated from version	via GSD as of V5.6 HF4
• PROFIBUS from GSD version/ GSD revision	GSD as of Revision 5
• PROFINET from GSD version/ GSD revision	GSDML V2.34
Supply voltage	
Rated value (DC)	24 V
Reverse polarity protection	Yes
1. Interface	
Interface types	
• RS 485	Yes
• RS 422	Yes
• RS 232	Yes
• Design of the connection	Push-in terminal
Interface types	
RS 232	
• Transmission rate, max.	115.2 kbit/s
• Cable length, max.	15 m
• RS 232 auxiliary signals	RTS, CTS, DTR, DSR, RI, DCD
RS 485	
• Transmission rate, max.	250 kbit/s
• Cable length, max.	1 200 m; 100 to 1200 m, depending on transmission speed
RS 422	
• Transmission rate, max.	115.2 kbit/s
• Cable length, max.	1 200 m
• 4-wire full duplex connection	Yes
• 4-wire multipoint connection	Yes
Protocols	
Integrated protocols	
Freeport	
- Telegram length, max.	2 kbyte; performance mode: receive data max. 24 byte and send data max. 30 byte
- Bits per character	7 or 8
- Number of stop bits	1 or 2 bit
- Parity	None, even, odd, always 1, always 0, any
3964 (R)	
- Telegram length, max.	2 kbyte; performance mode: receive data max. 24 byte and send data max. 30 byte
- Bits per character	7 or 8
- Number of stop bits	1 or 2 bit
- Parity	None, even, odd, always 1, always 0, any

Article number	6ES7137-6AA01-0BA0 ET 200SP, CM PTP, PU 1
Modbus RTU master	
- Address area	1 to 247, extended 1 to 65535
- Number of slaves, max.	32
MODBUS RTU slave	
- Address area	1 to 247, extended 1 to 65535
Telegram buffer	
• Buffer memory for telegrams	4 kbyte
• Number of telegrams which can be buffered	255
Interrupts/diagnostics/ status information	
Diagnostics function	Yes
Alarms	
• Diagnostic alarm	Yes
• Hardware interrupt	No
Diagnoses	
• Wire-break	Yes
Diagnostics indication LED	
• Monitoring of the supply voltage (PWR-LED)	Yes; green PWR LED
• for module diagnostics	Yes; green/red DIAG LED
• Receive RxD	Yes; green LED
• Transmit TxD	Yes; green LED
Potential separation	
between backplane bus and interface	Yes
Ambient conditions	
Ambient temperature during operation	
• horizontal installation, min.	-30 °C
• horizontal installation, max.	60 °C
• vertical installation, min.	-30 °C
• vertical installation, max.	50 °C
Altitude during operation relating to sea level	
• Installation altitude above sea level, max.	5 000 m
Decentralized operation	
to SIMATIC S7-300	Yes
to SIMATIC S7-400	Yes
to SIMATIC S7-1200	Yes
to SIMATIC S7-1500	Yes
to standard PROFINET controller	Yes
Dimensions	
Width	15 mm
Height	73 mm
Depth	58 mm
Weights	
Weight, approx.	30 g

Overview



- CM 4x IO-Link communications module
Serial communication module for connecting up to 4 IO-Link devices in accordance with IO-Link specification V1.0 and V1.1. The IO-Link parameters are configured using the Port Configuration Tool (PCT), version V3.0 and higher
- Time-based IO
Time-based IO ensures that signals are output with a precisely defined response time. By combining inputs and outputs, for example, passing products can be accurately measured or fluids dosed in precise quantities
- Supported data transfer rates
 - COM1 (4.8 kbps)
 - COM2 (38.4 kbps)
 - COM3 (230.4 kbps)

- Expansion limits
 - Length of cable: Max. 20 m
 - Max. 32 bytes of input and output data per port
 - Max. 144 bytes of input data and 128 bytes of output data per module
- Supported ET 200SP system functions
 - Replacement without PG with automatic backup without the engineering tool of the IO-Link device parameters (V1.1 devices only) and the IO-Link master parameters by means of redundant saving of parameters on the e-coding element
 - Re-parameterization during operation
 - Identification data I&M
 - Firmware update
 - PROFlenergy
- Can be plugged into Type A0 BaseUnits (BU) with automatic e-coding
- LEDs
 - DIAG: Operating state indicator (green/red) of the module
 - C1..C4: Port status indicator (green) for Port 1, 2, 3 and 4
 - Q1..Q4: Channel status indicator (green) for Port 1, 2, 3 and 4
 - F1..F4: Port fault indicator (red) for Port 1, 2, 3 and 4
 - PWR: Supply voltage indicator (green)
- Clear labeling on front of module
 - Plain text identification of the module type and function class
 - 2D matrix code (order and serial number)
 - Connection diagram
 - Color-coding of the CM module class: silver
 - Hardware and firmware version
 - Complete Article No.
- Optional accessories
 - Labeling strips
 - Equipment labeling plates
 - Color-coding plate with color code CC04
- Optional system-integrated shield connection

Overview of CM 4 x IO-Link

Communications module	Article No.	CC code	BU type	PU
CM 4 x IO-Link	6ES7137-6BD00-0BA0	CC04	A0	1

I/O systems

SIMATIC ET 200 systems for the control cabinet

SIMATIC ET 200SP

I/O modules > Communication > CM 4x IO-Link**Overview**

Overview of BaseUnits

BaseUnit	Article No.	CC codes for push-in terminals	CC codes for AUX terminals	PU
BU type A0 • New load group (light) • 16 push-in terminals • With 10 AUX terminals	6ES7193-6BP20-0DA0	CC01 to CC05	CC71 to CC73	1
BU type A0 • New load group (light) • 16 push-in terminals • With 10 AUX terminals	6ES7193-6BP20-2DA0	CC01 to CC05	CC71 to CC73	10
BU type A0 • New load group (light) • 16 push-in terminals • Without AUX terminals	6ES7193-6BP00-0DA0	CC01 to CC05	--	1
BU type A0 • New load group (light) • 16 push-in terminals • Without AUX terminals	6ES7193-6BP00-2DA0	CC01 to CC05	--	10
BU type A0 • Forwarding of load group (dark) • 16 push-in terminals • With 10 AUX terminals	6ES7193-6BP20-0BA0	CC01 to CC05	CC71 to CC73	1
BU type A0 • Forwarding of load group (dark) • 16 push-in terminals • With 10 AUX terminals	6ES7193-6BP20-2BA0	CC01 to CC05	CC71 to CC73	10
BU type A0 • Forwarding of load group (dark) • 16 push-in terminals • Without AUX terminals	6ES7193-6BP00-0BA0	CC01 to CC05	--	1
BU type A0 • Forwarding of load group (dark) • 16 push-in terminals • Without AUX terminals	6ES7193-6BP00-2BA0	CC01 to CC05	--	10

Ordering data	Article No.	Ordering data	Article No.
CM 4x IO-Link master V1.1 Standard communications module Serial communications module for connecting up to 4 IO-Link devices, time-based IO, BU type A0, color code CC04	6ES7137-6BD00-0BA0	Labeling strips 500 labeling strips on roll, light gray, for inscription with thermal transfer roll printer	6ES7193-6LR10-0AA0
Accessories Suitable type A0 BaseUnits BU15-P16+A10+2D BU type A0; BaseUnit (light) with 16 push-in terminals (1 ... 16) to the module and an additional 10 internally jumpered AUX terminals (1 A to 10 A); for starting a new load group (max. 10 A) <ul style="list-style-type: none"> • Pack of 1 unit • Pack of 10 units; to order a pack, please order this article number with an order quantity of 10. 	6ES7193-6BP20-0DA0 6ES7193-6BP20-2DA0	500 labeling strips on roll, yellow, for inscription with thermal transfer roll printer 1 000 labeling strips DIN A4, light gray, card, perforated, for inscription with laser printer 1 000 labeling strips DIN A4, light gray, card, perforated, for inscription with laser printer	6ES7193-6LR10-0AG0 6ES7193-6LA10-0AA0 6ES7193-6LA10-0AG0
BU15-P16+A0+2D BU type A0; BaseUnit (light) with 16 push-in terminals to the module; for starting a new load group (max. 10 A) <ul style="list-style-type: none"> • Pack of 1 unit • Pack of 10 units; to order a pack, please order this article number with an order quantity of 10. 	6ES7193-6BP00-0DA0 6ES7193-6BP00-2DA0	Color-coded labels Color code CC04, for 16 push-in terminals, BU type A0, A1, gray (terminals 1 to 8), red (terminals 9 to 12), blue (terminals 13 to 16); 10 units Color code CC71, for 10 AUX terminals, BU type A0, yellow/green (terminals 1 A to 10 A); 10 units Color code CC72, for 10 AUX terminals, BU type A0, red (terminals 1 A to 10 A); 10 units Color code CC73, for 10 AUX terminals, BU type A0, blue (terminals 1 A to 10 A); 10 units	6ES7193-6CP04-2MA0 6ES7193-6CP71-2AA0 6ES7193-6CP72-2AA0 6ES7193-6CP73-2AA0
BU15-P16+A10+2B BU type A0; BaseUnit (dark) with 16 push-in terminals (1 ... 16) to the module and an additional 10 internally jumpered AUX terminals (1 A to 10 A); for continuing the load group <ul style="list-style-type: none"> • Pack of 1 unit • Pack of 10 units; to order a pack, please order this article number with an order quantity of 10. 	6ES7193-6BP20-0BA0 6ES7193-6BP20-2BA0	Spare parts Electronic coding element type H Pack of 5 units; included in scope of supply of CM 4x IO-Link module	6ES7193-6EH00-1AA0
BU15-P16+A0+2B BU type A0; BaseUnit (dark) with 16 push-in terminals to the module; for continuing the load group <ul style="list-style-type: none"> • Pack of 1 unit • Pack of 10 units; to order a pack, please order this article number with an order quantity of 10. 	6ES7193-6BP00-0BA0 6ES7193-6BP00-2BA0	Mechanical coding elements For automatic coding of I/O modules; spare part. 20 units Type A Type B Type C Type D	6ES7193-6KA00-3AA0 6ES7193-6KB00-3AA0 6ES7193-6KC00-3AA0 6ES7193-6KD00-3AA0
Equipment labeling plate 10 sheets of 16 labels, for printing with thermal transfer card printer or plotter	6ES7193-6LF30-0AW0		

I/O systemsSIMATIC ET 200 systems for the control cabinet
SIMATIC ET 200SP**I/O modules > Communication > CM 4x IO-Link****Technical specifications**

Article number	6ES7137-6BD00-0BA0 ET 200SP, cm 4 X IO-Link ST
General information	
Product type designation	CM 4 x IO-Link ST
Product function	
• I&M data	Yes; I&M0 to I&M3
• Isochronous mode	No; Only for PROFINET and configuration as version with FW V2.0 or V2.1
Engineering with	
• STEP 7 TIA Portal configurable/ integrated from version	STEP 7 V15 or higher
• STEP 7 configurable/ integrated from version	STEP 7 V5.5 or higher
• PROFIBUS from GSD version/ GSD revision	One GSD file each, Revision 3 and 5 and higher
• PROFINET from GSD version/ GSD revision	GSDML V2.3
Supply voltage	
Rated value (DC)	24 V
Encoder supply	
Number of outputs	4
Output current	
• Rated value	200 mA; Per channel
24 V encoder supply	
• Short-circuit protection	Yes
IO-Link	
Number of ports	4
• of which simultaneously controllable	4
IO-Link protocol 1.0	Yes
IO-Link protocol 1.1	Yes
Transmission rate	4.8 kBaud (COM1); 38.4 kBaud (COM2), 230.4 kBaud (COM3)
Cycle time, min.	2 ms; dynamic, depending on user data length
Size of process data, input per port	32 byte; max.
Size of process data, input per module	144 byte; max.
Size of process data, output per port	32 byte; max.
Size of process data, output per module	128 byte; max.
Memory size for device parameter	2 kbyte; for each port
Master backup	Yes
Configuration without S7-PCT	Yes
Cable length unshielded, max.	20 m
Operating modes	
• IO-Link	Yes
• DI	Yes
• DQ	Yes; max. 100 mA per channel

Article number	6ES7137-6BD00-0BA0 ET 200SP, cm 4 X IO-Link ST
Time Based IO	
- TIO IO-Link IN	No; Only for PROFINET and configuration as version with FW V2.0 or V2.1
- TIO IO-Link OUT	No; Only for PROFINET and configuration as version with FW V2.0 or V2.1
- TIO IO-Link IN/OUT	No; Only for PROFINET and configuration as version with FW V2.0 or V2.1
Connection of IO-Link devices	
• Port type A	Yes
• Port type B	Yes; 24 V DC via external terminal
• via three-wire connection	Yes
Interrupts/diagnostics/ status information	
Alarms	
• Diagnostic alarm	Yes; The port diagnosis is available in the IO-Link mode only.
Diagnoses	
• Monitoring the supply voltage	Yes
• Wire-break	Yes
• Short-circuit	Yes
• Group error	Yes
Diagnostics indication LED	
• Monitoring of the supply voltage (PWR-LED)	Yes; green PWR LED
• Channel status display	Yes; one green LED for channel status Qn (SIO mode) and port status Cn (IO-Link mode) per channel
• for channel diagnostics	Yes; red Fn LED
• for module diagnostics	Yes; green/red DIAG LED
Potential separation	
Potential separation channels	
• between the channels and backplane bus	Yes
Ambient conditions	
Ambient temperature during operation	
• horizontal installation, min.	-30 °C
• horizontal installation, max.	60 °C
• vertical installation, min.	-30 °C
• vertical installation, max.	50 °C
Altitude during operation relating to sea level	
• Installation altitude above sea level, max.	2 000 m; On request: Installation altitudes greater than 2 000 m
Dimensions	
Width	13 mm
Height	73 mm
Depth	58 mm
Weights	
Weight, approx.	30 g

Overview



SIMATIC ET 200SP DALI video
https://players.brightcove.net/1813624294001/70fecf0f-fbad-4fad-a077-d0e26af4d84c_default/index.html?videoId=6153144008001



- DALI 2 multimaster module for 1 bus strand
- Allows the control, diagnostics and parameter assignment of up to 64 luminaires and 63 sensors via a 2-wire bus line
- Typical areas of application: Lighting in tunnels, (factory) halls or ships
- Realization of the control via prefabricated blocks of a function block library in TIA Portal
- DALI (Digital Addressable Lighting Interface) certification according to DALI V2 for IEC 62386-101/-103 parts
- Different DALI device types, such as LED modules, fluorescent lamps, discharge lamps, low-voltage halogen lamps and others, can be used

Ordering data

Article No.

**DALI V2 multimaster module
CM 1xDALI****6ES7137-6CA00-0BU0**

For control of lighting solutions with DALI V2, BU type U0, color code CC20

Accessories**Suitable type U0 BaseUnits****BU20-P16+A0+2D**

BU type U0; BaseUnit (light) with 16 push-in terminals to the module; for starting a new load group (max. 10 A)

- Pack of 1 unit
- Pack of 10 units; to order a pack, please order this article number with an order quantity of 10.

**6ES7193-6BP00-0DU0
6ES7193-6BP00-2DU0****BU20-P16+A0+2B**

BU type U0; BaseUnit (dark) with 16 push-in terminals to the module; for continuing the load group

- Pack of 1 unit
- Pack of 10 units; to order a pack, please order this article number with an order quantity of 10.

**6ES7193-6BP00-0BU0
6ES7193-6BP00-2BU0****Equipment labeling plate****6ES7193-6LF30-0AW0**

10 sheets of 16 labels

Labeling strips**6ES7193-6LR10-0AA0**

500 labeling strips on roll, light gray, for inscription with thermal transfer roll printer

Mechanical coding elements

For automatic coding of I/O modules; spare part.
20 units

Type A

6ES7193-6KA00-3AA0

Type B

6ES7193-6KB00-3AA0

Type C

6ES7193-6KC00-3AA0

Type D

6ES7193-6KD00-3AA0

I/O systemsSIMATIC ET 200 systems for the control cabinet
SIMATIC ET 200SP**I/O modules > Communication > CM 1xDALI****Technical specifications**

Article number	6ES7137-6CA00-0BU0 ET 200SP, CM 1x DALI
General information	
Product type designation	CM 1xDALI
Product function	
• I&M data	Yes; I&M0 to I&M3
Engineering with	
• STEP 7 TIA Portal configurable/ integrated from version	STEP 7 V15.1 or higher
• PROFIBUS from GSD version/ GSD revision	GSD Revision 5
• PROFINET from GSD version/ GSD revision	GSDML V2.34
Supply voltage	
Rated value (DC)	24 V
Reverse polarity protection	Yes
Interface types	
DALI	
• Integrated power supply	Yes
- Supply current, min.	160 mA
- Supply current, max.	250 mA
- Can be switched off	Yes
• Cable length, max.	300 m
Protocols	
DALI	
• Standard according to DALI	DALI V2 Multi-Master
Supported operating devices	
- Fluorescent lamps (device type 0)	Yes
- Emergency lighting with single battery (device type 1)	Yes
- Discharge lamps (device type 2)	Yes
- Low-voltage halogen lamps (device type 3)	Yes
- Incandescent lamps (device type 4)	Yes
- Direct voltage (device type 5)	Yes
- LED modules (device type 6)	Yes
- Switching function (device type 7)	Yes
- Color control (device type 8)	Yes
- Further operating devices	Yes; general device type
Supported input devices	
- Pushbuttons	Yes
- Absolute input devices	Yes
- Presence detector	Yes
- Light sensor	Yes
- Further input devices	Yes; general device type

Article number	6ES7137-6CA00-0BU0 ET 200SP, CM 1x DALI
Interrupts/diagnostics/ status information	
Alarms	
• Diagnostic alarm	Yes
Diagnoses	
• Short-circuit	Yes; On DALI bus
Diagnostics indication LED	
• ERROR LED	Yes
• Monitoring of the supply voltage (PWR-LED)	Yes; green PWR LED
• Receive RxD	Yes; green LED
• Transmit TxD	Yes; green LED
Potential separation	
between backplane bus and interface	Yes
Standards, approvals, certificates	
CE mark	Yes
RoHS conformity	Yes
Ambient conditions	
Ambient temperature during operation	
• horizontal installation, min.	-30 °C
• horizontal installation, max.	60 °C
• vertical installation, min.	-30 °C
• vertical installation, max.	50 °C
Altitude during operation relating to sea level	
• Installation altitude above sea level, max.	3 000 m; Restrictions for installation altitudes > 2 000 m, see manual
Decentralized operation	
to SIMATIC S7-1200	Yes; FW V4.0 or higher
to SIMATIC S7-1500	Yes
Dimensions	
Width	20 mm
Height	73 mm
Depth	58 mm
Weights	
Weight, approx.	50 g

Overview

- For data exchange between an ET 200SP system and CAN Bus 2.0A/B or CANopen Manager or Slave (according to CiA 301 & 302)
- CANopen features:
 - Node / lifeguarding
 - Heartbeat
 - SYNC (producer / consumer)
- Integrated in TIA via HSP, TIA Portal V15.1 or higher
- CAN connection with push-in terminals
- Integrated CAN bus terminating resistor
- Up to 60 CAN nodes
- 128 receiver and 128 transmitter PDOs
- Galvanic isolation between the two networks
- Diagnostic interrupts
- Optionally with function block SIMATIC ECC CHAdeMO: Realization of digital communication as basis for conductible DC charging of electric vehicles in line with the CHAdeMO standard

Ordering data**Article No.****ET 200SP CM CAN communications modules****6ES7137-6EA00-0BA0**

To connect ET 200SP with CAN bus or CANopen networks CAN bus 2.0A/B, CANopen Manager according to CiA301/302, CANopen Slave according to CiA301/302

Accessories**Function block SIMATIC ECC CHAdeMO****6FE1263-8FB10-0AA0**

For realization of digital communication between a DC charging station and an electric vehicle according to CHAdeMO 1.x-2.0 specification; can be used with TIA Portal as of V15.1; Single license

Usable type A0 BaseUnits**BU15-P16+A0+2D**

BU type A0; BaseUnit (light) with 16 push-in terminals to the module; for starting a new load group (max. 10 A)

- Pack of 1 unit
- Pack of 10 units; to order a pack, please order this article number with an order quantity of 10.

6ES7193-6BP00-0DA0
6ES7193-6BP00-2DA0**BU15-P16+A0+2B**

BU type A0; BaseUnit (dark) with 16 push-in terminals to the module; for continuing the load group

- Pack of 1 unit
- Pack of 10 units; to order a pack, please order this article number with an order quantity of 10.

6ES7193-6BP00-0BA0
6ES7193-6BP00-2BA0**Mechanical coding elements**

For automatic coding of I/O modules; spare part. 20 units

Type A

6ES7193-6KA00-3AA0

Type B

6ES7193-6KB00-3AA0

Type C

6ES7193-6KC00-3AA0

Type D

6ES7193-6KD00-3AA0

I/O systemsSIMATIC ET 200 systems for the control cabinet
SIMATIC ET 200SP**I/O modules > Communication > CM CAN****Technical specifications**

Article number	6ES7137-6EA00-0BA0 ET 200SP CM CAN
General information	
Product type designation	CM 1x CAN ST
Product function	
• I&M data	Yes; I&M0 to I&M3
• Module swapping during operation (hot swapping)	Yes
• Isochronous mode	No
Engineering with	
• STEP 7 TIA Portal configurable/integrated from version	STEP 7 V15.1 or higher
Supply voltage	
Rated value (DC)	24 V
Reverse polarity protection	Yes
1. Interface	
Interface type	CAN according to CiA 303-1
Isolated	Yes; 500 V AC or 707 V DC
Interface types	
• Number of ports	1
• Design of the connection	Push-in terminal
CAN	
• CAN operating modes	CAN Standard CAN 2.0A/B; CANopen Manager / Slave acc. to CiA
• Specification acc. to CiA	CiA 301 & CiA 302
• Transmission rate, min.	10 kbit/s
• Transmission rate, max.	1 000 kbit/s
• Number of slaves, max.	60
• Number of SDOs in parallel	16; Parallel
• Number of PDOs	128; Send / receive
Services	
- Node/life-guarding	Yes
- Heartbeat	Yes
- SYNC	Yes
Interrupts/diagnostics/ status information	
Alarms	Yes
Diagnostics function	Yes
Diagnostics indication LED	
• RUN LED	Yes
• ERROR LED	Yes
• MAINT LED	No
• Monitoring of the supply voltage (PWR-LED)	Yes; green PWR LED

Article number	6ES7137-6EA00-0BA0 ET 200SP CM CAN
Potential separation	
between backplane bus and interface	Yes
Standards, approvals, certificates	
CE mark	Yes
UL approval	Yes
RCM (formerly C-TICK)	Yes
KC approval	Yes; Reg. No.: R-R-S49-ET200SPCMCAN
EAC (formerly Gost-R)	Yes
RoHS conformity	Yes
Ambient conditions	
Ambient temperature during operation	
• horizontal installation, min.	-30 °C
• horizontal installation, max.	60 °C
• vertical installation, min.	-30 °C
• vertical installation, max.	50 °C
Altitude during operation relating to sea level	
• Installation altitude above sea level, max.	5 000 m
Decentralized operation	
to SIMATIC S7-300	No
to SIMATIC S7-400	No
to SIMATIC S7-1200	Yes
to SIMATIC S7-1500	Yes
Dimensions	
Width	15 mm
Height	73 mm
Depth	58 mm
Weights	
Weight, approx.	32 g

Overview



CM AS-i Master ST for SIMATIC ET 200SP



Video: AS-Interface – Powerful integration in SIMATIC ET 200SP
https://players.brightcove.net/1813624294001/70fec0f-fbad-4fad-a077-d0e26af4d84c_default/index.html?videoId=6136807004001

More information

SIMATIC ET 200SP Manual Collection, see
<https://support.industry.siemens.com/cs/ww/en/view/84133942>

Diagnostics blocks with visualization, see
<https://support.industry.siemens.com/cs/ww/en/view/109479103>

AS-Interface block library for SIMATIC PCS 7
 for easy connection of AS-Interface to PCS 7, see
<https://mall.industry.siemens.com/mall/en/ww/Catalog/Products/10046725?tree=CatalogTree>

Released combinations of the AS-i modules for ET 200SP, see
<https://support.industry.siemens.com/cs/ww/en/view/103624653>

AS-Interface I/O modules and other AS-Interface system components
 see Catalog IC 10, www.siemens.com/ic10

More information see www.siemens.com/as-interface

The CM AS-i Master ST communications module is designed for use in the SIMATIC ET 200SP distributed I/O system and has the following features:

- Connection of up to 62 AS-Interface slaves
- Supports all AS-Interface master functions according to the AS-Interface specification V3.0
- User-friendly configuration with graphic or tabular display of the AS-i line in TIA Portal or STEP 7 (Classic) or via GSD in other systems
- Supply via AS-Interface cable

- Suitable for AS-i Power24V and for AS-Interface with 30 V voltage
- Integrated ground-fault monitoring for the AS-Interface cable
- Through connection to AS-Interface, the number of digital inputs and outputs available for the control system is greatly increased (max. 496 DI/496 DQ on the AS-Interface per CM AS-i Master ST)
- Integrated analog value processing

AS-i gateways with ET 200SP

An AS-i gateway or AS-i link enables access to the AS-Interface data via PROFINET or PROFIBUS.

With the CM AS-i Master ST module, flexible and powerful PROFINET/AS-i links or PROFIBUS/AS-i link solutions are set up. Depending on the requirements, even several AS-i masters can be plugged into one ET 200SP station, so that the setup can easily be extended from a single master to double masters or multiple masters.

The maximum number of modules is determined by the ET 200SP interface module (IM): up to 8 AS-i masters with PROFINET IM 155-6PN Standard, up to 43 AS-i masters with IM 155-6PN High Feature, or a single AS-i master with IM 155-6PN Basic. For the connection to PROFIBUS, the IM 155-6DP HF interface module with up to 7 AS-i master modules is used.

Since in many plants an ET 200SP station is provided with I/O, motor starter or other peripheral modules, the AS-i master modules are simply plugged in without any additional effort. There are countless possible combinations.

An AS-i Safety gateway can also be implemented without any problems by adding the safety-related module F-CM AS-i Safety ST in the ET 200SP station. This greatly simplifies the cabling and connection of distributed EMERGENCY STOP pushbuttons and protective door monitoring systems to a fail-safe CPU. The AS-i Safety application is completely configured in TIA Portal/STEP 7.

The ET 200SP modules CM AS-i Master ST and F-CM AS-i Safety ST (see from page 10/218) can of course also be used directly on an ET 200SP CPU or F-CPU, so that an extremely compact SIMATIC control system with AS-i bus connection can be set up.

For further application possibilities, see the brochure "The modular AS-i Master" at www.siemens.com/as-interface.

More information, see
 SIMATIC ET 200SP Manual Collection,
<https://support.industry.siemens.com/cs/ww/en/view/84133942>

Design

The CM AS-i Master ST module has an ET 200SP module enclosure with a width of 20 mm. A C0 type BaseUnit (BU) is required for use in the ET 200SP.

The communications module has LED displays for diagnostics, operation, AS-i voltage and AS-i slave status and offers informative front-side module inscription for

- Plain-text marking of the module type and function class
- 2D matrix code (Article No. and serial number)
- Circuit diagram
- Color coding module type communications module, light gray
- Hardware and firmware version
- Supported BaseUnit type BU: C0

I/O systems

SIMATIC ET 200 systems for the control cabinet
SIMATIC ET 200SP

I/O modules > Communication > CM AS-i Master ST for SIMATIC ET 200SP

Overview

Function

The CM AS-i Master ST communications module supports all specified functions of the AS-Interface specification V3.0.

The input/output values of the digital AS-i slaves can be activated via the cyclic process image. The values of the analog AS-i slaves are accessible via the cyclic process image or via data record transfer.

If required, master calls can be performed with the command interface, e.g. read/write parameters, read/write configuration.

Changeover of the operating mode, automatic application of the slave configuration and the re-addressing of a connected AS-i slave can be implemented via the control panel of the CM AS-i Master ST in STEP 7.

For the implementation of modular machine concepts, the AS-i slaves can be activated or deactivated via the PLC program (option handling). The configuration of AS-i slaves can be modified while being executed, thus enabling variable machine setups and tool changing with integrated input/output modules during ongoing operation. AS-i input/output modules can be added to the system without deactivating the controller.

An existing AS-i installation can be read into the STEP 7 hardware configuration and adapted and documented in the project. Analog values are transmitted via the cyclic process image, the length of which is adjustable and extendable up to 288 bytes (depending on the interface module (IM) used).

Diagnostic information is accessed via automatic alarm indications, via the status information in the process image or via the graphical status display in the online diagnostics of the TIA Portal. The transmission quality of the AS-i network can also be read out. To avoid configuration errors, duplicate addresses can be detected on the AS-i network.

Configuration is possible with SIMATIC CPUs S7-300 up to S7-1500 and with a SINUMERIK 840D sl or other controller.

The online diagnostic status of the AS-i slaves can be displayed directly on the slaves in the network view in TIA Portal (for S7-1500 CPUs with firmware version V 2.0 or higher).

Notes on security

In order to protect plants, systems, machines and networks against cyber threats, it is necessary to implement – and continuously maintain – a holistic, state-of-the-art industrial security concept. Siemens products and solutions represent only one component of such a concept.

For more information about the subject of Industrial Security, see www.siemens.com/industrialsecurity.

Configuration

The following software is required for configuration of the CM AS-i Master ST module:

- STEP 7 (TIA Portal) or
- STEP 7 (Classic) or
- the GSD file of the ET 200SP with STEP 7 or another engineering tool

STEP 7 enables user-friendly configuration and diagnostics of the AS-i master and any connected slaves.

Alternatively, you can also apply the AS-Interface ACTUAL configuration as the TARGET configuration at the "touch of a button" via the control panel integrated in the TIA Portal or an optional expansion button. Configuration with the GSD file is possible only with the button.

The CM AS-i Master ST module occupies up to 288 input bytes and up to 288 output bytes in the I/O data of the ET 200SP station. The I/O assignment depends on the configuration in STEP 7.

Together with an ET 200SP CPU 1510SP, 1512SP or 1515SP PC, preprocessing of AS-i signals directly in the ET 200SP station and setting up of an independent AS-i station without a higher-level CPU are possible.

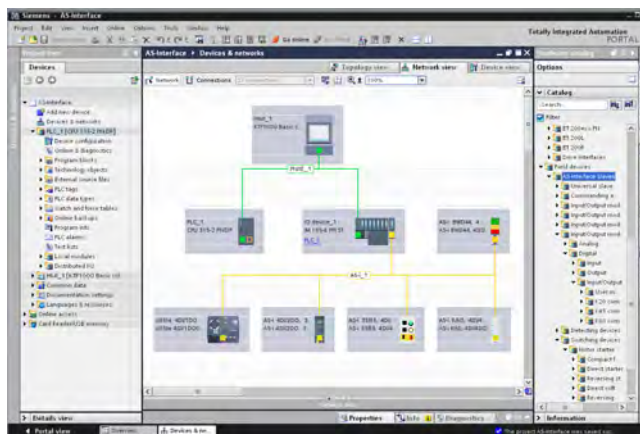

Configuration of an AS-Interface network with CM AS-i Master ST via the TIA Portal

Benefits

The CM AS-i Master ST communications module for ET 200SP enables modular, simple and high-performance expansion of AS-interface networks via engineering in the TIA Portal.

Up to eight CM AS-i Master ST units can be plugged into one ET 200SP station with IM 155-6PN Standard. When using the IM 155-6PN High Feature, the number of CM AS-i Master ST in the ET 200SP station can be further increased. The maximum configuration depends on the interface module used. Multiple masters as well as single masters can thus be implemented in the ET 200SP depending on the number of modules.

Together with the interface module, a scalable PROFINET/AS-i Link or PROFIBUS/AS-i Link can be assembled.

Using STEP 7, the AS-i network is consistently configured and programmed with only one configuration tool.

The PRONETA PC program (for ET 200SP with PROFINET interface module) is available for convenient input/output testing during the commissioning of an AS-i network without a CPU, see www.siemens.com/proneta.

For the connection of an AS-i network to systems with Ethernet/IP and Modbus TCP, the ET 200SP MultiFieldbus interface module IM155-6MF in combination with the CM AS-i Master ST module is available.

For diagnostics during ongoing operation, diagnostics blocks with clearly arranged visualization on the SIMATIC HMI panel are available or can be downloaded free of charge via a web browser, see <https://support.industry.siemens.com/cs/ww/en/view/109479103>.



Diagnostic block for CM AS-i Master ST

10

Application

Configuration examples of AS-Interface networks with CM AS-i Master ST for SIMATIC ET 200SP

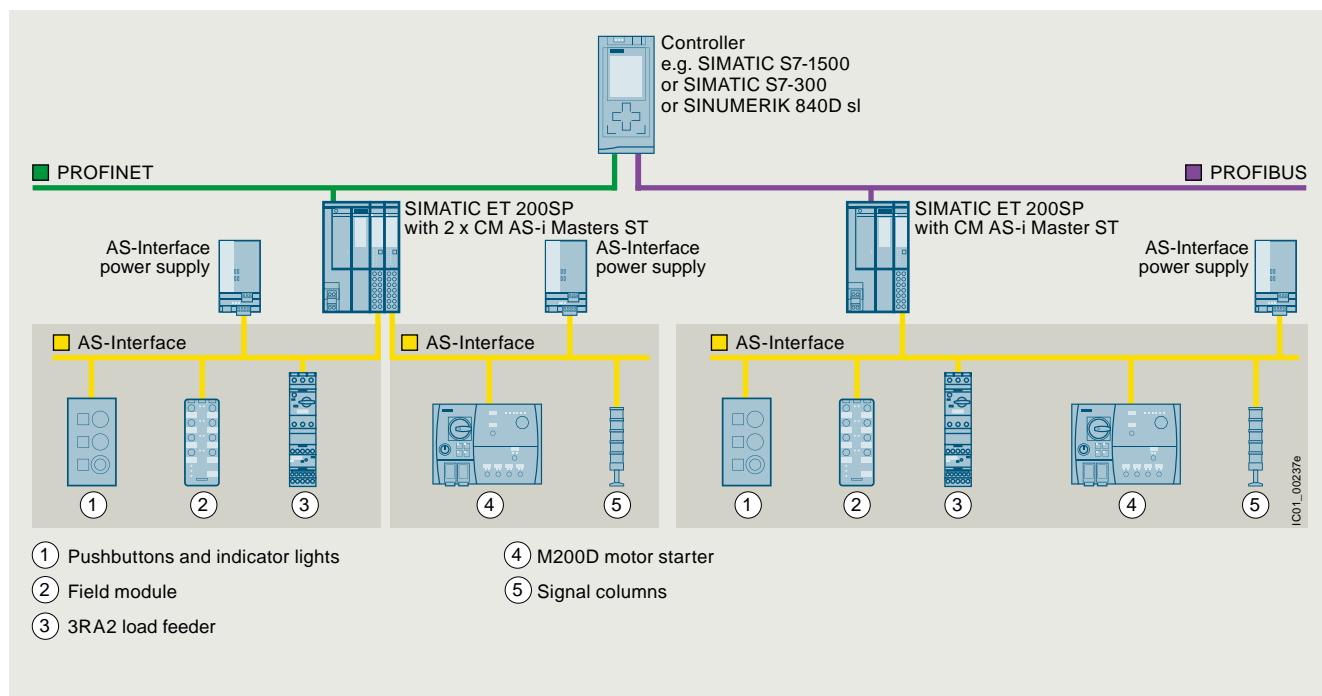

Configuration of AS-Interface networks under a SIMATIC ET 200SP

I/O systems

SIMATIC ET 200 systems for the control cabinet
SIMATIC ET 200SP

I/O modules > Communication > CM AS-i Master ST for SIMATIC ET 200SP

Ordering data

Ordering data	Article No.	Ordering data	Article No.
CM AS-i Master ST communications module <ul style="list-style-type: none"> AS-Interface master for SIMATIC ET 200SP, can be plugged onto BaseUnit type C0 Corresponds to AS-Interface specification V3.0 Dimensions (W x H x D) mm: 20 x 73 x 58 	3RK7137-6SA00-0BC1	PROFIBUS IM 155-6DP High Feature interface modules <p>Max. 32 I/O modules, max. 244 bytes I/O data per station</p> <ul style="list-style-type: none"> Including server module and PROFIBUS plug 	6ES7155-6BA01-0CN0
Accessories		MultiFieldbus IM 155-6MF High Feature interface modules <p>For operation on PROFINET, EtherNet/IP or Modbus TCP controllers, 1 slot for bus adapter, max. 64 I/O modules</p> <ul style="list-style-type: none"> Including server module and optional strain relief (bus adapter must be ordered separately, see below) <p>For more information, see https://support.industry.siemens.com/cs/ww/en/view/109779189.</p>	6ES7155-6MU00-0CN0
BaseUnit BU20-P6+A2+4D <ul style="list-style-type: none"> BaseUnit (light), BU type C0 Suitable for the CM AS-i Master ST module For connection of the AS-Interface cable to the CM AS-i Master ST Start of an AS-i network, isolation of the AS-i voltage from the left-hand module With spring-loaded terminals 	6ES7193-6BP20-0DC0	Bus adapters for PROFINET/Ethernet <p>For connection of the Ethernet cable to the PROFINET IM 155-6PN interface module and the MultiFieldbus IM 155-6MF interface module</p> <ul style="list-style-type: none"> Connection 2 x RJ45 (supplied without RJ45 plug) Connection 2 x FC (FastConnect) <p>For more bus adapters with fiber optic cable connection, see http://www.siemens.com/industrymall</p>	6ES7193-6AR00-0AA0 6ES7193-6AF00-0AA0
PROFINET IM 155-6PN Basic interface modules <p>Max. 12 I/O modules, max. 32 bytes of I/O data per station</p> <ul style="list-style-type: none"> Including server module and 2 x RJ45 ports (supplied without RJ45 plug) 	6ES7155-6AR00-0AN0	AS-Interface addressing unit V3.0 <ul style="list-style-type: none"> For AS-Interface modules and sensors and actuators with integrated AS-Interface according to AS-i specification V3.0 For setting the AS-i address of standard slaves, and slaves with extended addressing mode (A/B slaves) With input/output test function and many other commissioning functions Battery operation with four batteries type AA (IEC LR6, NEDA 15) Degree of protection IP40 Dimensions (W x H x D) mm: 84 x 195 x 35 Scope of supply: <ul style="list-style-type: none"> - Addressing unit with four batteries - Addressing cable, with M12 plug to addressing plug (hollow plug), length 1.5 m 	3RK1904-2AB02
PROFINET IM 155-6PN Standard interface modules <p>Max. 32 I/O modules, max. 256 bytes I/O data per station</p> <ul style="list-style-type: none"> Including server module and bus adapter 2 x RJ45 (supplied without RJ45 plug) Including server module (bus adapter must be ordered separately, see right) 	6ES7155-6AA01-0BN0 6ES7155-6AU01-0BN0		
PROFINET IM 155-6PN High Feature interface modules <p>Max. 64 I/O modules, max. 1 440 bytes I/O data per station</p> <ul style="list-style-type: none"> IM 155-6PN/2 High Feature 2-port IM with a bus adapter slot, including server module and optional strain relief (bus adapter must be ordered separately, see right) IM 155-6PN/3 High Feature 3-port IM with two bus adapter slots, including server module and optional strain relief (bus adapter must be ordered separately, see right) 	6ES7155-6AU01-0CN0 6ES7155-6AU30-0CN0		
PROFINET IM 155-6PN High Speed interface modules <p>Max. 30 I/O modules, max. 1 440 bytes I/O data per station</p> <ul style="list-style-type: none"> Including server module (bus adapter must be ordered separately, see right) 	6ES7155-6AU00-0DN0		

Overview



- PROFIBUS DP master/slave with electrical interface for connecting the ET 200SP CPUs to PROFIBUS at up to 12 Mbps
- Expands the ET 200SP CPUs 1510SP-1 PN / 1512SP-1 PN by one PROFIBUS connection
- For communication with lower-level PROFIBUS devices at bandwidths of 9.6 Kbps to 12 Mbps
- Communication services:
 - PROFIBUS DP
 - PG/OP communication
 - S7 communication:
 - This makes it possible to establish communication between the ET 200SP CPU and other devices, for example those from the SIMATIC S7-300/400/1500 range.
- Time synchronization
- Simple programming and configuration over PROFIBUS
- Cross-network PG communication using S7 routing
- Data set routing

Ordering data

Article No.

CM DP for ET 200SP CPU **6ES7545-5DA00-0AB0**

PROFIBUS DP master/slave with electrical interface for connecting the ET 200SP CPUs to PROFIBUS at up to 12 Mbps

Accessories**Equipment labeling plate** **6ES7193-6LF30-0AW0**

10 sheets of 16 labels

Labeling strips

500 labeling strips on roll, light gray, for inscription with thermal transfer roll printer

6ES7193-6LR10-0AA0

500 labeling strips on roll, yellow, for inscription with thermal transfer roll printer

6ES7193-6LR10-0AG0

1 000 labeling strips DIN A4, light gray, card, for inscription with laser printer

6ES7193-6LA10-0AA0

1 000 labeling strips DIN A4, yellow, card, for inscription with laser printer

6ES7193-6LA10-0AG0**PROFIBUS DP RS 485 bus connector**

With 90° cable outlet, max. transfer rate 12 Mbps

- without PG interface
- with PG interface

6ES7972-0BA12-0XA0
6ES7972-0BB12-0XA0

With 90° cable outlet for FastConnect connection system, max. transfer rate 12 Mbps

- without PG interface, 1 unit
- without PG interface, 100 units
- with PG interface, 1 unit
- with PG interface, 100 units

6ES7972-0BA52-0XA0
6ES7972-0BA52-0XB0
6ES7972-0BB52-0XA0
6ES7972-0BB52-0XB0**FastConnect bus cable****6XV1830-0EH10**

Standard type with special design for quick mounting, 2-wire, shielded, sold by the meter; max. delivery unit 1000 m, minimum order quantity 20 m

Mechanical coding elements

For automatic coding of I/O modules; spare part. 20 units

Type A

6ES7193-6KA00-3AA0

Type B

6ES7193-6KB00-3AA0

Type C

6ES7193-6KC00-3AA0

Type D

6ES7193-6KD00-3AA0

I/O systems

SIMATIC ET 200 systems for the control cabinet
SIMATIC ET 200SP

I/O modules > Communication > CM DP for ET 200SP CPU**Technical specifications**

Article number	6ES7545-5DA00-0AB0 ET 200SP, cm DP for ET 200SP CPU
General information	
Product type designation	CM PROFIBUS DP
Engineering with	
• STEP 7 TIA Portal configurable/ integrated from version	V13 Update 3
Supply voltage	
Rated value (DC)	24 V
Reverse polarity protection	Yes
1. Interface	
Interface types	
• RS 485	Yes
Protocols	
• PROFIBUS DP master	Yes
• PROFIBUS DP slave	Yes
• SIMATIC communication	Yes
PROFIBUS DP master	
• Number of DP slaves, max.	125
Services	
- PG/OP communication	Yes
- Equidistance	No
- Isochronous mode	No
- Activation/deactivation of DP slaves	Yes
PROFIBUS DP slave	
• Transmission rate, max.	12 Mbit/s
• automatic baud rate search	Yes
• Address area, max.	120
• User data per address area, max.	128 byte
Services	
- PG/OP communication	Yes; Only with active interface
- Routing	Yes; Only with active interface
- S7 communication	Yes; Only with active interface
- Direct data exchange (slave-to-slave communication)	Yes; No subscriber possible - only passive publisher
- DPV1	Yes
Transfer memory	
- Inputs	244 byte
- Outputs	244 byte
Interface types	
RS 485	
• Transmission rate, max.	12 Mbit/s
• Cable length, max.	100 m
Protocols	
SIMATIC communication	
• S7 routing	Yes
• Data record routing	Yes

Article number	6ES7545-5DA00-0AB0 ET 200SP, cm DP for ET 200SP CPU
Interrupts/diagnostics/ status information	
Diagnostics function	Yes
Diagnostics indication LED	
• for module diagnostics	Yes; green/red DIAG LED
Potential separation	
between backplane bus and interface	Yes
Ambient conditions	
Ambient temperature during operation	
• horizontal installation, min.	-25 °C; No condensation
• horizontal installation, max.	60 °C
• vertical installation, min.	-25 °C; No condensation
• vertical installation, max.	50 °C
Altitude during operation relating to sea level	
• Installation altitude above sea level, max.	5 000 m; Restrictions for installation altitudes > 2 000 m, see manual
Dimensions	
Width	35 mm
Height	117 mm
Depth	75 mm
Weights	
Weight, approx.	80 g

Overview



ISO	TCP/UDP	PN	MRP	IT	IP-R	PG/OP	S7
	●			●		●	●

G...JK10...XX...50730

The CP 1542SP-1 communications processor connects the ET 200SP Distributed Controller with Industrial Ethernet networks.

The module can also be used for integrating the ET 200SP Distributed Controller into an IPv6-based network. All functions are configured using STEP 7 Professional V14 (TIA Portal) or higher.

The CP 1542SP-1 supports the following communication services:

- PG/OP communication
- S7 communication
- Open communication (Open User Communication)
- IT communication
 - Sending emails via SMTP for authentication on an email server (also with IPv6)
 - SNMPv1 for transfer of network analysis information
- Integration of the ET 200SP Distributed Controller into IPv6-based networks

Ordering data

Article No.

CP 1542SP-1 communications processor For connection of SIMATIC S7 ET 200SP to Industrial Ethernet, open IE communication (TCP/IP, ISO-ON-TCP, UDP), PG/OP, S7 routing, IP broadcast/multicast, SNMPv1, DHCP, email, IPv4/IPv6, time synchronization via NTP, access to web server of CPU, bus adapter required	6GK7542-6UX00-0XE0
Accessories SIMATIC BusAdapter BA 2xRJ45 For PROFINET interface modules, standard function class or above; max. cable length 50 m	6ES7193-6AR00-0AA0
SIMATIC BusAdapter BA 2xFC For PROFINET interface modules, standard function class or above; for increased vibration and EMC loads; max. cable length 50 m	6ES7193-6AF00-0AA0
SIMATIC BusAdapter BA 2xSCRJ For PROFINET interface modules, High Feature function class or above; fiber-optic cable connection for POF or PCF; for increased vibration and EMC load capacity; max. cable length 50 m (POF) or 100 m (PCF)	6ES7193-6AP00-0AA0
SIMATIC BusAdapter BA SCRJ/RJ45 For PROFINET interface modules, High Feature function class or above; fiber-optic cable connection for POF or PCF; for increased vibration and EMC load capacity; max. cable length 50 m (POF) or 100 m (PCF)	6ES7193-6AP20-0AA0
SIMATIC BusAdapter BA SCRJ/FC For PROFINET interface modules, High Feature function class or above; with media converter FOC-cu; for increased vibration and EMC loads; max. cable length 50 m (POF, copper) or 100 m (PCF)	6ES7193-6AP40-0AA0

I/O systemsSIMATIC ET 200 systems for the control cabinet
SIMATIC ET 200SP

I/O modules > Communication > CP 1542SP-1

Ordering data**Article No.****IE FC RJ45 plug 180 2 x 2**

RJ45 plug-in connector for Industrial Ethernet with a rugged metal enclosure and integrated insulation displacement contacts for connecting Industrial Ethernet FC installation cables; with 180° cable outlet; for network components and CPs/CPUs with Industrial Ethernet interface

- 1 pack = 1 unit
- 1 pack = 10 units
- 1 pack = 50 units

6GK1901-1BB10-2AA0
6GK1901-1BB10-2AB0
6GK1901-1BB10-2AE0

IE FC RJ45 plug 4 x 2

RJ45 plug connector for Industrial Ethernet (10/100/1 000 Mbps) with a sturdy metal enclosure and integrated insulation displacement contacts for connecting Industrial Ethernet FC installation cables; 180° cable outlet; for network components and CPs/CPUs with Industrial Ethernet interface

- 1 pack = 1 unit
- 1 pack = 10 units
- 1 pack = 50 units

6GK1901-1BB11-2AA0
6GK1901-1BB11-2AB0
6GK1901-1BB11-2AE0

IE FC TP Standard Cable GP 2 x 2 (Type A)**6XV1840-2AH10**

4-wire, shielded TP installation cable for connection to IE FC RJ45 outlet/ IE FC RJ45 plug; PROFINET-compatible; with UL approval; sold by the meter; max. delivery unit 1 000 m, minimum order quantity 20 m

IE FC TP Standard Cable GP 4 x 2

8-core, shielded TP installation cable for connection to IE FC RJ45 Modular Outlet for universal applications; with UL approval; sold by the meter; max. delivery unit 1 000 m, minimum order quantity 20 m

- AWG22, for connection to IE FC RJ45 Modular Outlet
- AWG24, for connection to IE FC RJ45 plug 4 x 2

6XV1870-2E
6XV1878-2A

IE FC stripping tool**6GK1901-1GA00**

Pre-adjusted stripping tool for fast stripping of Industrial Ethernet FC cables

Article No.**Labeling strips**

500 labeling strips on roll, light gray, for labeling with thermal transfer roll printer

6ES7193-6LR10-0AA0

500 labeling strips on roll, yellow, for labeling with thermal transfer roll printer

6ES7193-6LR10-0AG0

1000 labeling strips DIN A4, light gray, card, perforated, for labeling with laser printer

6ES7193-6LA10-0AA0

1000 labeling strips DIN A4, yellow, card, perforated, for labeling with laser printer

6ES7193-6LA10-0AG0**Equipment labeling plate**

10 sheets of 16 labels, for printing with thermal transfer card printer or plotter

6ES7193-6LF30-0AW0**Spare parts****Server module**

Terminates an ET 200SP station; included in the scope of delivery of the interface modules

6ES7193-6PA00-0AA0**PE connection element for DIN rail 2000 mm**

20 units

6ES7590-5AA00-0AA0**Power supply connector**

Spare part; for connecting the 24 V DC supply voltage; with push-in terminals

6ES7193-4JB00-0AA0Note:

You can find order information for software for communication with PC systems in the Industry Mall under System connections – software overview

Technical specifications

Article number	6GK7542-6UX00-0XE0
product type designation	CP 1542SP-1
transfer rate	
transfer rate	
• at the 1st interface	10 ... 100 Mbit/s
interfaces	
number of interfaces acc. to Industrial Ethernet	1
number of electrical connections	
• at the 1st interface acc. to Industrial Ethernet	2
type of electrical connection	
• at the 1st interface acc. to Industrial Ethernet	via ET 200SP bus adapter (RJ45, FC, SCRJ), integrated switch
supply voltage, current consumption, power loss	
type of voltage of the supply voltage	DC
supply voltage	24 V
supply voltage	19.2 ... 28.8 V
power loss [W]	6 W
ambient conditions	
ambient temperature	
• for vertical installation during operation	-30 ... +50 °C
• for horizontally arranged busbars during operation	-30 ... +60 °C
• during storage	-40 ... +70 °C
• during transport	-40 ... +70 °C
relative humidity	
• at 25 °C without condensation during operation maximum	95 %
protection class IP	IP20
design, dimensions and weights	
width	60 mm
height	117 mm
depth	74 mm
net weight	0.18 kg
fastening method	
• 35 mm top hat DIN rail mounting	Yes
product features, product functions, product components general	
number of units	
• per CPU maximum	2
• note	2 CPUs can be plugged in per CPU, simultaneous operation with BA Send and CM DP is possible

Article number	6GK7542-6UX00-0XE0
product type designation	CP 1542SP-1
performance data open communication	
number of possible connections for open communication	
• by means of T blocks maximum data volume	32
• as user data per ISO on TCP connection for open communication by means of T blocks maximum	65 536 byte
performance data S7 communication	
number of possible connections for S7 communication	
• maximum	16
• with OP connections maximum	16
performance data multi-protocol mode	
number of active connections with multi-protocol mode	32
product functions management, configuration, engineering	
product function MIB support	Yes
protocol is supported	
• SNMP v1	Yes
• SNMP v3	No
• DCP	Yes
• LLDP	Yes
configuration software	
• required	STEP 7 Professional V14 (TIA Portal) or higher
identification & maintenance function	
• I&M0 - device-specific information	Yes
• I&M1 - higher level designation/ location designation	Yes
product functions diagnostics	
product function web-based diagnostics	Yes; via ET 200SP CPU
product functions security	
product function	
• blocking of communication via physical ports	Yes
product functions time	
product function SICLOCK support	Yes
product function pass on time synchronization	No
protocol is supported	
• NTP	Yes
• NTP (secure)	No
time synchronization	
• from NTP-server	Yes
standards, specifications, approvals hazardous environments	
certificate of suitability CCC for hazardous zone according to GB standard	Yes

I/O systems

SIMATIC ET 200 systems for the control cabinet
SIMATIC ET 200SP

I/O modules > Communication > CP 1543SP-1

Overview



ISO	TCP/UDP	PN	MRP	IT	IP-R	PG/OP	S7
	●			●		●	●

G...JK10...XX...50730

The CP 1543SP-1 communications processor connects the ET 200SP Distributed Controller with Industrial Ethernet networks. By combining a variety of security features such as an SPI (Stateful Packet Inspection) firewall, VPN and data encryption protocols (e.g. SNMPv3), the communications processor protects individual ET 200SP distributed controllers or even entire automation cells against unauthorized access.

The module can also be used for integrating the ET 200SP Distributed Controller into an IPv6-based network. All functions can be configured with STEP 7 Professional, V14 (TIA Portal) and higher.

The CP 1543SP-1 supports the following communication services:

- PG/OP communication
- S7 communication
- Open communication (Open User Communication)
- IT communication
 - Sending emails via SMTP or ESMTP with "SMTP-Auth" for authentication on an email server (also with IPv6)
- Support of SINEMA Remote Connect with autoconfiguration
- Security Integrated
 - Stateful Packet Inspection Firewall
 - Secure communication via VPN (IPsec)
- Protocols for secure communication
 - Secure access to the web server of the CPU via the HTTPS protocol
 - Secure transfer of the time of day (NTP)
 - SNMPv3 for tap-proof transfer of network analysis information
- Integration of the ET 200SP Distributed Controller into IPv6-based networks

Ordering data

Article No.

CP 1543SP-1 communications processor

CP 1543SP-1 communications processor for connecting SIMATIC S7 ET 200SP to Industrial Ethernet, Security (firewall and VPN), open IE communication (TCP/IP, ISO-on-TCP, UDP) PG/OP, S7 routing, IP broadcast/multicast, SNMPv1/V3, DHCP, secure email, IPV4/IPV6, time synchronization via NTP, access to web server of CPU, bus adapter required

6GK7543-6WX00-0XE0

Accessories

SIMATIC BusAdapter BA 2xRJ45
For PROFINET interface modules, standard function class or above; max. cable length 50 m

6ES7193-6AR00-0AA0

SIMATIC BusAdapter BA 2xFC
For PROFINET interface modules, standard function class or above; for increased vibration and EMC loads; max. cable length 50 m

6ES7193-6AF00-0AA0

SIMATIC BusAdapter BA 2xSCRJ
For PROFINET interface modules, High Feature function class or above; fiber-optic cable connection for POF or PCF; for increased vibration and EMC load capacity; max. cable length 50 m (POF) or 100 m (PCF)

6ES7193-6AP00-0AA0

SIMATIC BusAdapter BA SCRJ/RJ45
For PROFINET interface modules, High Feature function class or above; fiber-optic cable connection for POF or PCF; for increased vibration and EMC load capacity; max. cable length 50 m (POF) or 100 m (PCF)

6ES7193-6AP20-0AA0

SIMATIC BusAdapter BA SCRJ/FC
For PROFINET interface modules, High Feature function class or above; with media converter FOC-cu; for increased vibration and EMC loads; max. cable length 50 m (POF, copper) or 100 m (PCF)

6ES7193-6AP40-0AA0

IE FC RJ45 plug 180 2 x 2

RJ45 plug-in connector for Industrial Ethernet with a rugged metal enclosure and integrated insulation displacement contacts for connecting Industrial Ethernet FC installation cables; with 180° cable outlet; for network components and CPs/CPU with Industrial Ethernet interface

- 1 pack = 1 unit
- 1 pack = 10 units
- 1 pack = 50 units

6GK1901-1BB10-2AA0
6GK1901-1BB10-2AB0
6GK1901-1BB10-2AE0

Ordering data	Article No.	Ordering data	Article No.
IE FC RJ45 plug 4 x 2 RJ45 plug connector for Industrial Ethernet (10/100/1 000 Mbps) with a rugged metal enclosure and integrated insulation displacement contacts for connecting Industrial Ethernet FC installation cables; 180° cable outlet; for network components and CPs/CPU's with Industrial Ethernet interface <ul style="list-style-type: none"> • 1 pack = 1 unit • 1 pack = 10 units • 1 pack = 50 units 	6GK1901-1BB11-2AA0 6GK1901-1BB11-2AB0 6GK1901-1BB11-2AE0	IE FC stripping tool Pre-adjusted stripping tool for fast stripping of Industrial Ethernet FC cables	6GK1901-1GA00
IE FC TP Standard Cable GP 2 x 2 (Type A) 4-wire, shielded TP installation cable for connection to IE FC RJ45 outlet/IE FC RJ45 plug; PROFINET-compatible; with UL approval; sold by the meter; max. delivery unit 1 000 m, minimum order quantity 20 m	6XV1840-2AH10	Labeling strips 500 labeling strips on roll, light gray, for labeling with thermal transfer roll printer 500 labeling strips on roll, yellow, for labeling with thermal transfer roll printer 1000 labeling strips DIN A4, light gray, card, perforated, for labeling with laser printer 1000 labeling strips DIN A4, yellow, card, perforated, for labeling with laser printer	6ES7193-6LR10-0AA0 6ES7193-6LR10-0AG0 6ES7193-6LA10-0AA0 6ES7193-6LA10-0AG0
IE FC TP Standard Cable GP 4 x 2 8-wire, shielded TP installation cable for connection to IE FC RJ45 modular outlet for universal applications; with UL approval; sold by the meter; max. delivery unit 1 000 m, minimum order quantity 20 m <ul style="list-style-type: none"> • AWG22, for connection to IE FC RJ45 modular outlet • AWG24, for connection to IE FC RJ45 plug 4 x 2 	6XV1870-2E 6XV1878-2A	Equipment labeling plate 10 sheets of 16 labels, for printing with thermal transfer card printer or plotter	6ES7193-6LF30-0AW0
		Spare parts	
		Server module Terminates an ET 200SP station; included in the scope of delivery of the interface modules	6ES7193-6PA00-0AA0
		PE connection element for DIN rail 2000 mm 20 units	6ES7590-5AA00-0AA0
		Power supply connector Spare part; for connecting the 24 V DC supply voltage; with push-in terminals	6ES7193-4JB00-0AA0

Note:

You can find order information for software for communication with PC systems in the Industry Mall under System connections – software overview

I/O systemsSIMATIC ET 200 systems for the control cabinet
SIMATIC ET 200SP**I/O modules > Communication > CP 1543SP-1****Technical specifications**

Article number	6GK7543-6WX00-0XE0
product type designation	CP 1543SP-1
transfer rate	
transfer rate	
• at the 1st interface	10 ... 100 Mbit/s
interfaces	
number of interfaces acc. to Industrial Ethernet	1
number of electrical connections	
• at the 1st interface acc. to Industrial Ethernet	2
type of electrical connection	
• at the 1st interface acc. to Industrial Ethernet	via ET 200SP bus adapter (RJ45, FC, SCRJ), integrated switch
supply voltage, current consumption, power loss	
type of voltage of the supply voltage	DC
supply voltage	24 V
supply voltage	19.2 ... 28.8 V
power loss [W]	6 W
ambient conditions	
ambient temperature	
• for vertical installation during operation	-30 ... +50 °C
• for horizontally arranged busbars during operation	-30 ... +60 °C
• during storage	-40 ... +70 °C
• during transport	-40 ... +70 °C
relative humidity	
• at 25 °C without condensation during operation maximum	95 %
protection class IP	IP20
design, dimensions and weights	
width	60 mm
height	117 mm
depth	74 mm
net weight	0.18 kg
fastening method	
• 35 mm top hat DIN rail mounting	Yes
product features, product functions, product components general	
number of units	
• per CPU maximum	2
• note	2 CPUs can be plugged in per CPU, simultaneous operation with BA Send and CM DP is possible
performance data open communication	
number of possible connections for open communication	
• by means of T blocks maximum	32
data volume	
• as user data per ISO on TCP connection for open communication by means of T blocks maximum	65 536 byte
performance data S7 communication	
number of possible connections for S7 communication	
• maximum	16
• with OP connections maximum	16

Article number	6GK7543-6WX00-0XE0
product type designation	CP 1543SP-1
performance data multi-protocol mode	
number of active connections with multi-protocol mode	32
performance data IT functions	
number of possible connections	
• as email client maximum	1
product functions management, configuration, engineering	
product function MIB support	Yes
protocol is supported	
• SNMP v1	Yes
• SNMP v3	Yes
• DCP	Yes
• LLDP	Yes
configuration software	
• required	STEP 7 Professional V14 (TIA Portal) or higher
identification & maintenance function	
• I&M0 - device-specific information	Yes
• I&M1 - higher level designation/ location designation	Yes
product functions diagnostics	
product function web-based diagnostics	Yes; via ET 200SP CPU
product functions security	
firewall version	stateful inspection
product function with VPN connection	IPsec, SINEMA RC
type of encryption algorithms with VPN connection	AES-256, AES-192, AES-128, 3DES-168, DES-56
type of authentication procedure with VPN connection	Preshared key (PSK), X.509v3 certificates
type of hashing algorithms with VPN connection	MD5, SHA-1
number of possible connections with VPN connection	4
product function	
• switch-off of non-required services	Yes
• blocking of communication via physical ports	Yes
• log file for unauthorized access	Yes
product functions time	
product function SICLOCK support	Yes
product function pass on time synchronization	No
protocol is supported	
• NTP	Yes
• NTP (secure)	Yes
time synchronization	
• from NTP-server	Yes
standards, specifications, approvals hazardous environments	
certificate of suitability CCC for hazardous zone according to GB standard	Yes

Overview



ISO	TCP/UDP	PN	MRP	IT	IP-R	PG/OP	S7
	●			●		●	●

G...IK10...X...50730

The CP 1542SP-1 IRC communications processor connects the ET 200SP Distributed Controller with Industrial Ethernet networks. In addition, control centers can be connected using various telecontrol protocols.

The CP is characterized by the following:

- Ethernet-based connection to TeleControl Server Basic, e.g. via Internet
- Ethernet-based connection to the control center via SINAUT ST7, IEC 60870-5-104 or DNP3 protocol
- Data transfer of measured values, control variable values or alarms optimized for telecontrol systems
- Automatic sending of alert emails
- Data buffering of up to 100,000 values ensures a secure database, even with temporary connection failures
- Clearly laid out LED signaling for fast and easy diagnostics
- Fast commissioning thanks to easy configuration using STEP 7

The module can also be used for integrating the ET 200SP Distributed Controller into an IPv6-based network. All functions are configured using STEP 7 Professional V14 (TIA Portal) or higher.

The CP 1542SP-1 IRC supports the following communication services:

- Support of multiple telecontrol protocols such as SINAUT ST7, DNP3, IEC 60870-5-104 and TeleControl Basic
- PG/OP communication
- S7 communication
- Open communication (Open User Communication)
- IT communication
 - Sending emails via SMTP or SMTPS with "SMTP-Auth" for authentication on an email server (also with IPv6)
 - Email transfer with addressing by program block
 - Email transfer via "Notifications" (alerts)
- Support of SINEMA Remote Connect with autoconfiguration

Ordering data

Article No.

CP 1542SP-1 IRC communications processor

6GK7542-6VX00-0XE0

CP 1542SP-1 IRC communications processor for connection of SIMATIC S7 ET 200SP to Industrial Ethernet, TeleControl Server Basic, IEC 60870-5-104 or DNP3 protocol to a control center; open IE communication (TCP/IP, ISO-on-TCP, UDP), IP broadcast/multicast, SNMPV1, DHCP, secure email, IPV4/IPV6, time synchronization via NTP, access to web server of CPU, bus adapter required

Accessories

SIMATIC BusAdapter BA 2xRJ45
For PROFINET interface modules, standard function class or above; max. cable length 50 m

6ES7193-6AR00-0AA0

SIMATIC BusAdapter BA 2xFC
For PROFINET interface modules, standard function class or above; for increased vibration and EMC loads; max. cable length 50 m

6ES7193-6AF00-0AA0

SIMATIC BusAdapter BA 2xSCRJ
For PROFINET interface modules, High Feature function class or above; fiber-optic cable connection for POF or PCF; for increased vibration and EMC load capacity; max. cable length 50 m (POF) or 100 m (PCF)

6ES7193-6AP00-0AA0

SIMATIC BusAdapter BA SCRJ/RJ45
For PROFINET interface modules, High Feature function class or above; fiber-optic cable connection for POF or PCF; for increased vibration and EMC load capacity; max. cable length 50 m (POF) or 100 m (PCF)

6ES7193-6AP20-0AA0

SIMATIC BusAdapter BA SCRJ/FC
For PROFINET interface modules, High Feature function class or above; with media converter FOC-cu; for increased vibration and EMC loads; max. cable length 50 m (POF, copper) or 100 m (PCF)

6ES7193-6AP40-0AA0

IE FC RJ45 plug 180 2 x 2

RJ45 plug-in connector for Industrial Ethernet with a rugged metal enclosure and integrated insulation displacement contacts for connecting Industrial Ethernet FC installation cables; with 180° cable outlet; for network components and CPs/CPUs with Industrial Ethernet interface

- 1 pack = 1 unit
- 1 pack = 10 units
- 1 pack = 50 units

6GK1901-1BB10-2AA0
6GK1901-1BB10-2AB0
6GK1901-1BB10-2AE0

I/O systemsSIMATIC ET 200 systems for the control cabinet
SIMATIC ET 200SP**I/O modules > Communication > CP 1542SP-1 IRC****Ordering data****IE FC RJ45 plug 4 x 2**

RJ45 plug connector for Industrial Ethernet (10/100/1 000 Mbps) with a sturdy metal enclosure and integrated insulation displacement contacts for connecting Industrial Ethernet FC installation cables; 180° cable outlet; for network components and CPs/CPUs with Industrial Ethernet interface

- 1 pack = 1 unit
- 1 pack = 10 units
- 1 pack = 50 units

6GK1901-1BB11-2AA0
6GK1901-1BB11-2AB0
6GK1901-1BB11-2AE0

IE FC TP standard cable GP 2 x 2 (Type A)

4-wire, shielded TP installation cable for connection to IE FC RJ45 outlet/IE FC RJ45 plug; PROFINET-compatible; with UL approval; **sold by the meter**; max. length per delivery unit 1 000 m, minimum order quantity 20 m

6XV1840-2AH10**IE FC TP standard cable GP 4 x 2**

8-core, shielded TP installation cable for connection to IE FC RJ45 Modular Outlet for universal applications; with UL approval; **sold by the meter**; max. length per delivery unit 1 000 m, minimum order quantity 20 m

- AWG22, for connection to IE FC RJ45 Modular Outlet
- AWG24, for connection to IE FC RJ45 plug 4 x 2

6XV1870-2E
6XV1878-2A

IE FC stripping tool

Pre-adjusted stripping tool for fast stripping of Industrial Ethernet FC cables

6GK1901-1GA00**Labeling strips**

500 labeling strips on roll, light gray, for labeling with thermal transfer roll printer

6ES7193-6LR10-0AA0

500 labeling strips on roll, yellow, for labeling with thermal transfer roll printer

6ES7193-6LR10-0AG0

1000 labeling strips DIN A4, light gray, card, perforated, for labeling with laser printer

6ES7193-6LA10-0AA0

1000 labeling strips DIN A4, yellow, card, perforated, for labeling with laser printer

6ES7193-6LA10-0AG0**Equipment labeling plate**

10 sheets of 16 labels, for printing with thermal transfer card printer or plotter

6ES7193-6LF30-0AW0**Spare parts****Server module**

Terminates an ET 200SP station; included in the scope of delivery of the interface modules

6ES7193-6PA00-0AA0**PE connection element for DIN rail 2000 mm**

20 units

6ES7590-5AA00-0AA0**Power supply connector**

Spare part; for connecting the 24 V DC supply voltage; with push-in terminals

6ES7193-4JB00-0AA0**Note:**

You can find order information for software for communication with PC systems in the Industry Mall under System connections – software overview

Technical specifications

Article number	6GK7542-6VX00-0XE0
product type designation	CP 1542SP-1 IRC
transfer rate	
transfer rate	
• at the 1st interface	10 ... 100 Mbit/s
interfaces	
number of interfaces acc. to Industrial Ethernet	1
number of electrical connections	
• at the 1st interface acc. to Industrial Ethernet	2
type of electrical connection	
• at the 1st interface acc. to Industrial Ethernet	via ET 200SP bus adapter (RJ45, FC, SCRJ), integrated switch
supply voltage, current consumption, power loss	
type of voltage of the supply voltage	DC
supply voltage	24 V
supply voltage	19.2 ... 28.8 V
power loss [W]	6 W

Article number	6GK7542-6VX00-0XE0
product type designation	CP 1542SP-1 IRC
ambient conditions	
ambient temperature	
• for vertical installation during operation	-30 ... +50 °C
• for horizontally arranged busbars during operation	-30 ... +60 °C
• during storage	-40 ... +70 °C
• during transport	-40 ... +70 °C
relative humidity	
• at 25 °C without condensation during operation maximum	95 %
protection class IP	IP20
design, dimensions and weights	
width	60 mm
height	117 mm
depth	74 mm
net weight	0.18 kg
fastening method	
• 35 mm top hat DIN rail mounting	Yes

Technical specifications

Article number	6GK7542-6VX00-0XE0
product type designation	CP 1542SP-1 IRC
product features, product functions, product components general	
number of units	2
<ul style="list-style-type: none"> per CPU maximum note 	2 CPs can be plugged in per CPU, simultaneous operation with BA Send and CM DP is possible
performance data open communication	
number of possible connections for open communication	32
<ul style="list-style-type: none"> by means of T blocks maximum data volume as user data per ISO on TCP connection for open communication by means of T blocks maximum 	65 536 byte
performance data S7 communication	
number of possible connections for S7 communication	16
<ul style="list-style-type: none"> maximum with OP connections maximum 	16
performance data multi-protocol mode	
number of active connections with multi-protocol mode	32
performance data IT functions	
number of possible connections	1
<ul style="list-style-type: none"> as email client maximum 	1
performance data telecontrol	
suitability for use	No
<ul style="list-style-type: none"> node station substation TIM control center 	Yes No
control center connection	IEC 60870-5, DNP3, (Modbus TCP by block solutions of the CPU) capable control stations, connection to Telecontrol Server Basic and ST7 capable control station supported
<ul style="list-style-type: none"> by means of a permanent connection by means of demand-oriented connection note 	supported supported Connection to SCADA system by IEC 60870-5 104, DNP3, Telecontrol Server Basic and ST7 capable control center
protocol is supported	Yes
<ul style="list-style-type: none"> DNP3 IEC 60870-5 SINAUT ST7 protocol 	Yes Yes Yes

Article number	6GK7542-6VX00-0XE0
product type designation	CP 1542SP-1 IRC
product function data buffering if connection is aborted	Yes; TCSB 64000 events, SINAUT ST7 32000 telegrams, DNP3 100000 events, IEC 60870-5 100000 events
number of data points per station maximum	1 500
number of stations for direct communication with Telecontrol Server Basic	3
<ul style="list-style-type: none"> in send direction maximum in receive direction maximum 	15
product functions management, configuration, engineering	
product function MIB support protocol is supported	Yes
<ul style="list-style-type: none"> SNMP v1 SNMP v3 DCP LLDP 	Yes Yes Yes Yes
configuration software	STEP 7 Professional V14 (TIA Portal) or higher
<ul style="list-style-type: none"> required 	STEP 7 Professional V14 (TIA Portal) or higher
identification & maintenance function	Yes
<ul style="list-style-type: none"> I&M0 - device-specific information I&M1 - higher level designation/ location designation 	Yes Yes
product functions diagnostics	
product function web-based diagnostics	Yes; via ET 200SP CPU
product functions security	
product function with VPN connection	SINEMA RC
<ul style="list-style-type: none"> blocking of communication via physical ports 	Yes
product functions time	
product function SICLOCK support	Yes
product function pass on time synchronization	Yes
protocol is supported	Yes
<ul style="list-style-type: none"> NTP NTP (secure) 	Yes No
time synchronization	Yes
<ul style="list-style-type: none"> from NTP-server from control center 	Yes Yes
standards, specifications, approvals hazardous environments	
certificate of suitability CCC for hazardous zone according to GB standard	Yes

I/O systems

SIMATIC ET 200 systems for the control cabinet
SIMATIC ET 200SP

I/O modules > Communication > SCALANCE W761 RJ45 for the control cabinet

Overview



- Space-saving access point, suitable for applications where the device is to be mounted in the control cabinet

Ordering data

Article No.

Access Points SCALANCE W761

IWLAN Access Point with built-in wireless interface; wireless networks IEEE 802.11a/b/g/n at 2.4/5 GHz up to 150 Mbps; WPA2/AES; IP20 degree of protection (0 °C to +55 °C); scope of delivery: Mounting hardware, 3-pin screw terminal for 24 V DC; manual on CD-ROM; German/English

SCALANCE W761-1 RJ45

IWLAN Access Point with one built-in wireless interface

- National approvals for operation outside the USA
- National approvals for operation within the USA¹⁾

6GK5761-1FC00-0AA0

6GK5761-1FC00-0AB0

Accessories

IE FC RJ45 plug 180 2 x 2

RJ45 plug connector for Industrial Ethernet with a rugged metal enclosure and integrated insulation displacement contacts for connecting Industrial Ethernet FC installation cables; with a 180° cable outlet; for network components and CPs/CPU's with Industrial Ethernet interface

- 1 pack = 1 unit
- 1 pack = 10 units
- 1 pack = 50 units

6GK1901-1BB10-2AA0

6GK1901-1BB10-2AB0

6GK1901-1BB10-2AE0

IE FC standard cable GP 2 x 2

4-wire, shielded TP installation cable for connection to IE FC RJ45 outlet plug / IE FC RJ45 plug; PROFINET-compliant; with UL approval; sold by the meter; max. delivery unit 1 000 m, minimum order quantity 20 m

6XV1840-2AH10

IE FC stripping tool

Pre-adjusted stripping tool for fast stripping of Industrial Ethernet FC cables

6GK1901-1GA00

Antennas and miscellaneous WLAN accessories

See Industry Mall, Industrial Wireless LAN/Accessories

¹⁾ Please note national approvals under <http://www.siemens.com/wireless-approvals>

Technical specifications

Article number	6GK5761-1FC00-0AA0 6GK5761-1FC00-0AB0 ¹⁾
product type designation	W761-1 RJ45
transfer rate	
transfer rate	
• with WLAN maximum	150 Mbit/s
• for Industrial Ethernet	10 Mbit/s, 100 Mbit/s
transfer rate for Industrial Ethernet	
• minimum	10 Mbit/s
• maximum	100 Mbit/s
interfaces	
number of electrical connections	
• for network components or terminal equipment	1
• for power supply	1
• for redundant voltage supply	0
type of electrical connection	
• for network components or terminal equipment	RJ45 socket
• for power supply	3-pole screw terminal
design of the removable storage	
• C-PLUG	No
• KEY-PLUG	No
memory	
design of the removable storage	
• C-PLUG	No
• KEY-PLUG	No
interfaces wireless	
number of radio cards permanently installed	1
number of electrical connections for external antenna(s)	1
type of electrical connection for external antenna(s)	R-SMA (socket)
product feature external antenna can be mounted directly on device	Yes
supply voltage, current consumption, power loss	
type of voltage of the supply voltage	DC
consumed current	
• at DC at 24 V typical	0.15 A
power loss [W]	
• at DC at 24 V typical	3.6 W
supply voltage 1	
• from terminal block	19.2 V
supply voltage 2	
• from terminal block	28.8 V
ambient conditions	
ambient temperature	
• during operation	0 ... 55 °C
• during storage	-40 ... +85 °C
• during transport	-40 ... +85 °C
relative humidity at 25 °C without condensation during operation maximum	95 %

¹⁾ Wireless approval in the USA

Technical specifications

Article number	6GK5761-1FC00-0AA0 6GK5761-1FC00-0AB0 ¹⁾
product type designation	W761-1 RJ45
ambient condition for operation	When used under hazardous conditions (Zone 2), the SCALANCE W761-1 RJ45 or W72x-1 RJ45 product must be installed in an enclosure. To comply with EN 50021, this enclosure must meet the requirements of at least IP 54 in compliance with EN 60529.
protection class IP	IP20
design, dimensions and weights	
width	50 mm
height	114 mm
depth	74 mm
width of the enclosure without antenna	50 mm
height of the enclosure without antenna	114 mm
depth of the enclosure without antenna	74 mm
net weight	0.13 kg
fastening method	
• S7-300 rail mounting	No
• S7-1500 rail mounting	No
• 35 mm top hat DIN rail mounting	Yes
• wall mounting	No
radio frequencies	
operating frequency	
• for WLAN in 2.4 GHz frequency band	2.41 ... 2.48 GHz; depending on the country approvals
• for WLAN in 5 GHz frequency band	4.9 ... 5.8 GHz; depending on the country approvals
product features, product functions, product components general	
product function Access Point Mode	Yes
product function client Mode	Yes
number of SSIDs	1
product function	
• iPCF Access Point	No
• iPCF client	No
• iPCF-MC Access Point	No
• iPCF-MC client	No
product function iREF	No
product function iPRP	No
product functions management, configuration, engineering	
number of manageable IP addresses in client	4
product function	
• CLI	Yes
• web-based management	Yes
• MIB support	Yes
• TRAPs via email	Yes
• configuration with STEP 7	Yes
• configuration with STEP 7 in the TIA Portal	Yes
• operation with IWLAN controller	No
• operation with Enterasys WLAN controller	No
• forced roaming on IP down with IWLAN	Yes
• forced roaming on link down with IWLAN	Yes
• WDS	Yes

Article number	6GK5761-1FC00-0AA0 6GK5761-1FC00-0AB0 ¹⁾
product type designation	W761-1 RJ45
protocol is supported	
• Address Resolution Protocol (ARP)	Yes
• ICMP	Yes
• Telnet	Yes
• HTTP	Yes
• HTTPS	Yes
• TFTP	Yes
• DCP	Yes
• LLDP	Yes
identification & maintenance function	
• I&M0 - device-specific information	Yes
• I&M1 – higher level designation/ location designation	Yes
product functions diagnostics	
product function	
• PROFINET IO diagnosis	No
• link check	No
• connection monitoring IP-Alive	No
• localization via Aeroscout	No
• SysLog	Yes
protocol is supported	
• SNMP v1	Yes
• SNMP v2	Yes
• SNMP v3	Yes
product functions VLAN	
product function	
• function VLAN with IWLAN	Yes
product functions DHCP	
product function	
• DHCP client	Yes
• DHCP server	Yes
• DHCP Option 82	Yes
product functions redundancy	
protocol is supported	
• STP/RSTP	Yes
• MSTP	Yes
• RSTP	Yes
product functions security	
product function	
• ACL - MAC-based	Yes
• management security, ACL-IP based	Yes
• IEEE 802.1x (radius)	Yes
• NAT/NAPT	No
• access protection according to IEEE802.11i	Yes
• WPA/WPA2	Yes
• TKIP/AES	Yes
protocol is supported	
• SSH	Yes
• RADIUS	Yes

¹⁾ Wireless approval in the USA

I/O systemsSIMATIC ET 200 systems for the control cabinet
SIMATIC ET 200SP**I/O modules > Communication > SCALANCE W761 RJ45 for the control cabinet****Technical specifications**

Article number	6GK5761-1FC00-0AA0 6GK5761-1FC00-0AB0 ¹⁾
product type designation	W761-1 RJ45
product functions time	
protocol is supported	
• NTP	Yes
• SNTP	Yes
• SIMATIC time synchronization (SIMATIC Time)	Yes
standards, specifications, approvals	
standard	
• for FM	FM 3611: Class I, Division 2, Groups A,B,C,D, T4 / Class 1, Zone 2, Group IIC, T4
• for safety from CSA and UL certificate of suitability	UL 60950-1, CSA C22.2 No. 60950-1
• EC Declaration of Conformity	Yes
• CE marking	Yes
• C-Tick	Yes
• E1 approval	No
• railway application in accordance with EN 50155	No
• railway application in accordance with EN 50121-4	No
• NEMA TS2	No
• IEC 61375	No
• IEC 61850-3	No
• NEMA4X	No
• Power-over-Ethernet according IEEE802.3at for type 1 and IEEE802.3af	No
• Power-over-Ethernet according to IEEE802.3at for type 2	No

Article number	6GK5761-1FC00-0AA0 6GK5761-1FC00-0AB0 ¹⁾
product type designation	W761-1 RJ45
standard for wireless communication	
• IEEE 802.11a	Yes
• IEEE 802.11b	Yes
• IEEE 802.11e	Yes
• IEEE 802.11g	Yes
• IEEE 802.11h	Yes
• IEEE 802.11i	Yes
• IEEE 802.11n	Yes
wireless approval	You will find the current list of countries at: http://www.siemens.com/wireless-approvals
standards, specifications, approvals marine classification	
Marine classification association	
• American Bureau of Shipping Europe Ltd. (ABS)	No
• French marine classification society (BV)	No
• DNV GL	No
• Korean Register of Shipping (KRS)	No
• Lloyds Register of Shipping (LRS)	No
• Nippon Kaiji Kyokai (NK)	No
• Polski Rejestr Statkow (PRS)	No
• Royal Institution of Naval Architects (RINA)	No
standards, specifications, approvals hazardous environments	
standard for hazardous zone	EN 60079-15:2005, EN 60079-0:2006, II 3 G Ex nA II T4 KEMA 07 ATEX 0145X
certificate of suitability CCC for hazardous zone according to GB standard	Yes
accessories	
accessories	24 V DC screw terminal included in scope of delivery

¹⁾ Wireless approval in the USA

Overview



- Space-saving client module, suitable for applications where the device is to be mounted in the control cabinet
- Equipped with iFeatures



ET 200SP station with SCALANCE W722 RJ45

Ordering data

Article No.

SCALANCE W722 client modules

IWLAN Ethernet client modules with iFeatures support and built-in wireless interface; wireless networks IEEE 802.11a/b/g/h/n at 2.4/5 GHz up to 150 Mbps; WPA2/AES; IP20 degree of protection (0 °C to +55 °C); scope of supply: Mounting hardware, 3-pin screw terminal for 24 V DC; manual on CD-ROM; German/English

SCALANCE W722-1 RJ45

For administration of a radio link with iFeatures from a connected device with Industrial Ethernet connection

- Country approvals for operation outside the USA
- Country approvals for operation within the USA¹⁾
- National approvals for operation in Israel²⁾

6GK5722-1FC00-0AA0

6GK5722-1FC00-0AB0

6GK5722-1FC00-0AC0

Accessories**IE FC RJ45 plug 180 2 x 2**

RJ45 connector for Industrial Ethernet with a rugged metal enclosure and integrated insulation-displacement contacts for connecting Industrial Ethernet FC installation cables; with a 180° cable outlet; for network components and CPs/CPU's with Industrial Ethernet interface

- 1 pack = 1 unit
- 1 pack = 10 units
- 1 pack = 50 units

6GK1901-1BB10-2AA0

6GK1901-1BB10-2AB0

6GK1901-1BB10-2AE0

IE FC standard cable GP 2 x 2

4-wire, shielded TP installation cable for connection to IE FC RJ45 outlet plug/IE FC RJ45 plug; PROFINET-compliant; with UL approval; sold by the meter; max. delivery unit 1 000 m, minimum order quantity 20 m

6XV1840-2AH10

IE FC stripping tool

Pre-adjusted stripping tool for fast stripping of Industrial Ethernet FC cables

6GK1901-1GA00

Antennas and miscellaneous IWLAN accessories

See Industry Mall, Industrial Wireless LAN/Accessories

¹⁾ Please note country approvals under: <http://www.siemens.com/wireless-approvals>

I/O systemsSIMATIC ET 200 systems for the control cabinet
SIMATIC ET 200SP**I/O modules > Communication > SCALANCE W722 RJ45 for the control cabinet****Technical specifications**

Article number	6GK5722-1FC00-0AA0 6GK5722-1FC00-0AB0 ¹⁾ 6GK5722-1FC00-0AC0 ²⁾
product type designation	W722-1 RJ45
transfer rate	
transfer rate	
• with WLAN maximum	150 Mbit/s
• for Industrial Ethernet	10 Mbit/s, 100 Mbit/s
transfer rate for Industrial Ethernet	
• minimum	10 Mbit/s
• maximum	100 Mbit/s
interfaces	
number of electrical connections	
• for network components or terminal equipment	1
• for power supply	1
• for redundant voltage supply	0
type of electrical connection	
• for network components or terminal equipment	RJ45 socket
• for power supply	3-pole screw terminal
design of the removable storage	
• C-PLUG	No
• KEY-PLUG	No
memory	
design of the removable storage	
• C-PLUG	No
• KEY-PLUG	No
interfaces wireless	
number of radio cards permanently installed	1
number of electrical connections for external antenna(s)	1
type of electrical connection for external antenna(s)	R-SMA (socket)
product feature external antenna can be mounted directly on device	Yes
supply voltage, current consumption, power loss	
type of voltage of the supply voltage	DC
consumed current	
• at DC at 24 V typical	0.15 A
power loss [W]	
• at DC at 24 V typical	3.6 W
supply voltage 1	
• from terminal block	19.2 V
supply voltage 2	
• from terminal block	28.8 V
ambient conditions	
ambient temperature	
• during operation	0 ... 55 °C
• during storage	-40 ... +85 °C
• during transport	-40 ... +85 °C
relative humidity at 25 °C without condensation during operation maximum	95 %
ambient condition for operation	When used under hazardous conditions (Zone 2), the SCALANCE W761-1 RJ45 or W72x-1 RJ45 product must be installed in an enclosure. To comply with EN 50021, this enclosure must meet the requirements of at least IP 54 in compliance with EN 60529.

Article number	6GK5722-1FC00-0AA0 6GK5722-1FC00-0AB0 ¹⁾ 6GK5722-1FC00-0AC0 ²⁾
product type designation	W722-1 RJ45
protection class IP	IP20
design, dimensions and weights	
width	50 mm
height	114 mm
depth	74 mm
width of the enclosure without antenna	50 mm
height of the enclosure without antenna	114 mm
depth of the enclosure without antenna	74 mm
net weight	0.13 kg
fastening method	
• S7-300 rail mounting	No
• S7-1500 rail mounting	No
• 35 mm top hat DIN rail mounting	Yes
• wall mounting	No
radio frequencies	
operating frequency	
• for WLAN in 2.4 GHz frequency band	2.41 ... 2.48 GHz; depending on the country approvals
• for WLAN in 5 GHz frequency band	4.9 ... 5.8 GHz; depending on the country approvals
product features, product functions, product components general	
product function Access Point Mode	No
product function client Mode	Yes
product function	
• iPCF client	Yes
• iPCF-MC client	Yes
number of iPCF-capable radio modules	1
product function iPRP	Yes
product functions management, configuration, engineering	
number of manageable IP addresses in client	4
product function	
• CLI	Yes
• web-based management	Yes
• MIB support	Yes
• TRAPs via email	Yes
• configuration with STEP 7	Yes
• configuration with STEP 7 in the TIA Portal	Yes
• WDS	No
protocol is supported	
• Address Resolution Protocol (ARP)	Yes
• ICMP	Yes
• Telnet	Yes
• HTTP	Yes
• HTTPS	Yes
• TFTP	Yes
• DCP	Yes
• LLDP	No
identification & maintenance function	
• I&M0 - device-specific information	Yes
• I&M1 - higher level designation/ location designation	Yes

1) Wireless approval in the USA

2) Wireless approval in the Israel

Technical specifications

Article number	6GK5722-1FC00-0AA0 6GK5722-1FC00-0AB0 ¹⁾ 6GK5722-1FC00-0AC0 ²⁾
product type designation	W722-1 RJ45
product functions diagnostics	
product function	
• PROFINET IO diagnosis	Yes
• link check	No
• connection monitoring IP-Alive	No
• SysLog	Yes
protocol is supported	
• SNMP v1	Yes
• SNMP v2	Yes
• SNMP v3	Yes
product functions VLAN	
product function	
• function VLAN with IWLAN	No
product functions DHCP	
product function	
• DHCP client	Yes
• DHCP server	Yes
• DHCP Option 82	Yes
product functions redundancy	
protocol is supported	
• STP/RSTP	Yes
• MSTP	Yes
• RSTP	Yes
product functions security	
product function	
• ACL - MAC-based	Yes
• management security, ACL-IP based	Yes
• IEEE 802.1x (radius)	Yes
• NAT/NAPT	Yes
• access protection according to IEEE802.11i	Yes
• WPA/WPA2	Yes
• TKIP/AES	Yes
protocol is supported	
• SSH	Yes
• RADIUS	Yes
product functions time	
protocol is supported	
• NTP	Yes
• SNTP	Yes
• SIMATIC time synchronization (SIMATIC Time)	Yes

Article number	6GK5722-1FC00-0AA0 6GK5722-1FC00-0AB0 ¹⁾ 6GK5722-1FC00-0AC0 ²⁾
product type designation	W722-1 RJ45
standards, specifications, approvals	
standard	
• for FM	FM 3611: Class I, Division 2, Groups A,B,C,D, T4 / Class 1, Zone 2, Group IIC, T4
• for safety from CSA and UL certificate of suitability	UL 60950-1, CSA C22.2 No. 60950-1
• EC Declaration of Conformity	Yes
• CE marking	Yes
• C-Tick	Yes
• E1 approval	No
• railway application in accordance with EN 50155	No
• NEMA TS2	No
• IEC 61375	No
• IEC 61850-3	No
• NEMA4X	No
• Power-over-Ethernet according IEEE802.3at for type 1 and IEEE802.3af	No
• Power-over-Ethernet according to IEEE802.3at for type 2	No
standard for wireless communication	
• IEEE 802.11a	Yes
• IEEE 802.11b	Yes
• IEEE 802.11e	Yes
• IEEE 802.11g	Yes
• IEEE 802.11h	Yes
• IEEE 802.11i	Yes
• IEEE 802.11n	Yes
wireless approval	You will find the current list of countries at: http://www.siemens.com/wireless-approvals
standards, specifications, approvals marine classification	
Marine classification association	
• American Bureau of Shipping Europe Ltd. (ABS)	No
• French marine classification society (BV)	No
• DNV GL	No
• Korean Register of Shipping (KRS)	No
• Lloyds Register of Shipping (LRS)	No
• Nippon Kaiji Kyokai (NK)	No
• Polski Rejestr Statkow (PRS)	No
• Royal Institution of Naval Architects (RINA)	No
standards, specifications, approvals hazardous environments	
standard for hazardous zone	EN 60079-15:2005, EN 60079-0:2006, II 3 G Ex nA II T4 KEMA 07 ATEX 0145X
certificate of suitability CCC for hazardous zone according to GB standard	Yes
accessories	
accessories	24 V DC screw terminal included in scope of delivery

¹⁾ Wireless approval in the USA

²⁾ Wireless approval in the Israel

I/O systems

SIMATIC ET 200 systems for the control cabinet
SIMATIC ET 200SP

I/O modules > Communication > SCALANCE W721 RJ45 for the control cabinet**Overview**

- Space-saving client module, suitable for applications where the device is to be mounted in the control cabinet

Ordering data**Article No.****Article No.****SCALANCE W721 client modules**

IWLAN Ethernet client modules with built-in wireless interface; wireless networks IEEE 802.11a/b/g/h/n at 2.4/5 GHz up to 150 Mbps; WPA2/AES; IP20 degree of protection (0 °C to +55 °C).
Scope of supply: Mounting hardware, 3-pin screw terminal for 24 V DC; manual on CD-ROM; German/English

SCALANCE W721-1 RJ45

For administration of a radio link from a connected device with Industrial Ethernet connection

- Country approvals for operation outside the USA
- Country approvals for operation within the USA¹⁾

6GK5721-1FC00-0AA0**6GK5721-1FC00-0AB0****Accessories****IE FC RJ45 plug 180 2 x 2**

RJ45 connector for Industrial Ethernet with a rugged metal enclosure and integrated insulation-displacement contacts for connecting Industrial Ethernet FC installation cables; with a 180° cable outlet; for network components and CPs/CPUs with Industrial Ethernet interface

- 1 pack = 1 unit
- 1 pack = 10 units
- 1 pack = 50 units

6GK1901-1BB10-2AA0**6GK1901-1BB10-2AB0****6GK1901-1BB10-2AE0****IE FC standard cable GP 2 x 2**

4-wire, shielded TP installation cable for connection to IE FC RJ45 outlet plug/IE FC RJ45 plug; PROFINET-compliant; with UL approval; sold by the meter; max. delivery unit 1 000 m, minimum order quantity 20 m

6XV1840-2AH10**IE FC stripping tool**

Pre-adjusted stripping tool for fast stripping of Industrial Ethernet FC cables

6GK1901-1GA00**Antennas and miscellaneous IWLAN accessories**

See Industry Mall, Industrial Wireless LAN/Accessories

¹⁾ Please note country approvals under:
<http://www.siemens.com/wireless-approvals>

Technical specifications

Article number	6GK5721-1FC00-0AA0 6GK5721-1FC00-0AB0 ¹⁾
product type designation	W721-1 RJ45
transfer rate	
transfer rate	
• with WLAN maximum	150 Mbit/s
• for Industrial Ethernet	10 Mbit/s, 100 Mbit/s
transfer rate for Industrial Ethernet	
• minimum	10 Mbit/s
• maximum	100 Mbit/s
interfaces	
number of electrical connections	
• for network components or terminal equipment	1
• for power supply	1
• for redundant voltage supply	0
type of electrical connection	
• for network components or terminal equipment	RJ45 socket
• for power supply	3-pole screw terminal
design of the removable storage	
• C-PLUG	No
• KEY-PLUG	No
memory	
design of the removable storage	
• C-PLUG	No
• KEY-PLUG	No
interfaces wireless	
number of radio cards permanently installed	1
number of electrical connections for external antenna(s)	1
type of electrical connection for external antenna(s)	R-SMA (socket)
product feature external antenna can be mounted directly on device	Yes
supply voltage, current consumption, power loss	
type of voltage of the supply voltage	DC
consumed current	
• at DC at 24 V typical	0.15 A
power loss [W]	
• at DC at 24 V typical	3.6 W
supply voltage 1	
• from terminal block	19.2 V
supply voltage 2	
• from terminal block	28.8 V
ambient conditions	
ambient temperature	
• during operation	0 ... 55 °C
• during storage	-40 ... +85 °C
• during transport	-40 ... +85 °C
relative humidity at 25 °C without condensation during operation maximum	95 %
ambient condition for operation	When used under hazardous conditions (Zone 2), the SCALANCE W761-1 RJ45 or W72x-1 RJ45 product must be installed in an enclosure. To comply with EN 50021, this enclosure must meet the requirements of at least IP 54 in compliance with EN 60529.
protection class IP	IP20

Article number	6GK5721-1FC00-0AA0 6GK5721-1FC00-0AB0 ¹⁾
product type designation	W721-1 RJ45
design, dimensions and weights	
width	50 mm
height	114 mm
depth	74 mm
width of the enclosure without antenna	50 mm
height of the enclosure without antenna	114 mm
depth of the enclosure without antenna	74 mm
net weight	0.13 kg
fastening method	
• S7-300 rail mounting	No
• S7-1500 rail mounting	No
• 35 mm top hat DIN rail mounting	Yes
• wall mounting	No
radio frequencies	
operating frequency	
• for WLAN in 2.4 GHz frequency band	2.41 ... 2.48 GHz; depending on the country approvals
• for WLAN in 5 GHz frequency band	4.9 ... 5.8 GHz; depending on the country approvals
product features, product functions, product components general	
product function Access Point Mode	No
product function client Mode	Yes
product function	
• iPCF client	No
• iPCF-MC client	No
product function iREF	No
product function iPRP	No
product functions management, configuration, engineering	
number of manageable IP addresses in client	4
product function	
• CLI	Yes
• web-based management	Yes
• MIB support	Yes
• TRAPs via email	Yes
• configuration with STEP 7	Yes
• configuration with STEP 7 in the TIA Portal	Yes
• WDS	No
protocol is supported	
• Address Resolution Protocol (ARP)	Yes
• ICMP	Yes
• Telnet	Yes
• HTTP	Yes
• HTTPS	Yes
• TFTP	Yes
• DCP	Yes
• LLDP	No
identification & maintenance function	
• I&M0 - device-specific information	Yes
• I&M1 – higher level designation/ location designation	Yes

¹⁾ Wireless approval in the USA

I/O systemsSIMATIC ET 200 systems for the control cabinet
SIMATIC ET 200SP**I/O modules > Communication > SCALANCE W721 RJ45 for the control cabinet****Technical specifications**

Article number	6GK5721-1FC00-0AA0 6GK5721-1FC00-0AB0 ¹⁾
product type designation	W721-1 RJ45
product functions diagnostics	
product function	
• PROFINET IO diagnosis	No
• link check	No
• connection monitoring IP-Alive	No
• SysLog	Yes
protocol is supported	
• SNMP v1	Yes
• SNMP v2	Yes
• SNMP v3	Yes
product functions VLAN	
product function	
• function VLAN with IWLAN	No
product functions DHCP	
product function	
• DHCP client	Yes
• DHCP server	Yes
• DHCP Option 82	Yes
product functions redundancy	
protocol is supported	
• STP/RSTP	Yes
• MSTP	Yes
• RSTP	Yes
product functions security	
product function	
• ACL - MAC-based	Yes
• management security, ACL-IP based	Yes
• IEEE 802.1x (radius)	Yes
• NAT/NAPT	Yes
• access protection according to IEEE802.11i	Yes
• WPA/WPA2	Yes
• TKIP/AES	Yes
protocol is supported	
• SSH	Yes
• RADIUS	Yes
product functions time	
protocol is supported	
• NTP	Yes
• SNTP	Yes
• SIMATIC time synchronization (SIMATIC Time)	Yes

Article number	6GK5721-1FC00-0AA0 6GK5721-1FC00-0AB0 ¹⁾
product type designation	W721-1 RJ45
standards, specifications, approvals	
standard	
• for FM	FM 3611: Class I, Division 2, Groups A,B,C,D, T4 / Class 1, Zone 2, Group IIC, T4
• for safety from CSA and UL certificate of suitability	UL 60950-1, CSA C22.2 No. 60950-1
• EC Declaration of Conformity	Yes
• CE marking	Yes
• C-Tick	Yes
• E1 approval	No
• railway application in accordance with EN 50155	No
• NEMA TS2	No
• IEC 61375	No
• IEC 61850-3	No
• NEMA4X	No
• Power-over-Ethernet according to IEEE802.3at for type 1 and IEEE802.3af	No
• Power-over-Ethernet according to IEEE802.3at for type 2	No
standard for wireless communication	
• IEEE 802.11a	Yes
• IEEE 802.11b	Yes
• IEEE 802.11e	Yes
• IEEE 802.11g	Yes
• IEEE 802.11h	Yes
• IEEE 802.11i	Yes
• IEEE 802.11n	Yes
wireless approval	You will find the current list of countries at: http://www.siemens.com/wireless-approvals
standards, specifications, approvals marine classification	
Marine classification association	
• American Bureau of Shipping Europe Ltd. (ABS)	No
• French marine classification society (BV)	No
• DNV GL	No
• Korean Register of Shipping (KRS)	No
• Lloyds Register of Shipping (LRS)	No
• Nippon Kaiji Kyokai (NK)	No
• Polski Rejestr Statkow (PRS)	No
• Royal Institution of Naval Architects (RINA)	No
standards, specifications, approvals hazardous environments	
standard for hazardous zone	EN 60079-15:2005, EN 60079-0:2006, II 3 G Ex nA II T4 KEMA 07 ATEX 0145X
certificate of suitability CCC for hazardous zone according to GB standard	Yes
accessories	
accessories	24 V DC screw terminal included in scope of delivery

¹⁾ Wireless approval in the USA

Overview



- Communications module CM PtP; Module for serial communication connections with RS232, RS422, RS485 interfaces for the Freeport, 3964(R), Modbus RTU and USS protocols, max. 115.2 kbps, 2 KB frame length, 4 KB receive buffer.
- Protocols supported
 - Freeport: User-parameterizable frame format for universal communication
 - 3964(R) for improved transmission reliability
 - Modbus RTU master (requires instructions in SIMATIC S7)
 - Modbus RTU slave (requires instructions in SIMATIC S7)
 - USS, implemented through instructions
 - DMX512, can be implemented through instructions
- Interface properties
 - RS232 with auxiliary signals
 - RS422 for full-duplex connections
 - RS485 for half-duplex and multi-point connections
 - Transfer rates from 300 to 115 200 bps for RS232 and RS422
 - Transfer rates from 300 to 25 000 bps for RS485
- Frame lengths
 - In universal operation: 2 KB each in send and receive direction
 - In performance-optimized operation: 30 bytes in send direction, 24 bytes in receive direction
- Can be plugged into type A0 BaseUnits (BU) with automatic coding
- LED display for errors, operation, and supply voltage
- Communication display for sending and receiving
- Clear labeling on front of module
 - Plain text identification of the module type and function class
 - 2D matrix code (order and serial number)
 - Connection diagram
 - Color coding of the CM module type: silver
 - Hardware and firmware version
 - Complete Article No.
- Optional labeling accessories
 - Labeling strips
 - Equipment labeling plate
- Optional system-integrated shield connection

Note

SIPLUS extreme products are based on SIMATIC standard products. The contents listed here were taken from the respective standard products. SIPLUS extreme-specific information was added.

Ordering data

Article No.

SIPLUS ET 200SP CM PtP communications module

With conformal coating (-40 ... +70 °C)
For serial connection with RS-422, RS-485 and RS-232, Freeport, 3964 (R), USS, MODBUS RTU master, slave, max. 250 Kbps, suitable for BU type A0, pack quantity: 1 unit

6AG1137-6AA01-7BA0**Accessories****SIPLUS BaseUnits type A0**

(Extended temperature range and exposure to environmental substances)

BU15-P16+A0+2D**6AG1193-6BP00-7DA0**

BU type A0; BaseUnit (light) with 16 push-in terminals to the module; for starting a new load group (max. 10 A)

BU15-P16+A0+2B**6AG1193-6BP00-7BA0**

BU type A0; BaseUnit (dark) with 16 push-in terminals to the module; for continuing the load group

BU15-P16+A10+2D**6AG1193-6BP20-7DA0**

BU type A0; BaseUnit (light) with 16 push-in terminals (1 ... 16) to the module and an additional 10 internally jumpered AUX terminals (1 A to 10 A); for starting a new load group (max. 10 A)

BU15-P16+A10+2B**6AG1193-6BP20-7BA0**

BU type A0; BaseUnit (dark) with 16 push-in terminals (1...16) to the module and an additional 10 internally jumpered AUX terminals (1 A to 10 A); for continuing the load group

Accessories**SIPLUS Mounting Kit ET 200SP****6AG1193-6AA00-0AA0**

Mounting accessories for use with increased mechanical vibration and shock loads.

Other accessories

See SIMATIC CM PtP, page 10/143

I/O systems

SIMATIC ET 200 systems for the control cabinet
SIMATIC ET 200SP

I/O modules > Communication > SIPLUS CM PtP serial interface

Technical specifications

Article number	6AG1137-6AA01-7BA0
Based on	6ES7137-6AA01-0BA0 SIPLUS ET 200SP CM PTP
Ambient conditions	
Ambient temperature during operation	
• horizontal installation, min.	-40 °C; = Tmin (incl. condensation/frost)
• horizontal installation, max.	70 °C; = Tmax
• vertical installation, min.	-40 °C; = Tmin
• vertical installation, max.	50 °C; = Tmax
Altitude during operation relating to sea level	
• Installation altitude above sea level, max.	5 000 m
• Ambient air temperature-barometric pressure-altitude	Tmin ... Tmax at 1 140 hPa ... 795 hPa (-1 000 m ... +2 000 m) // Tmin ... (Tmax - 10 K) at 795 hPa ... 658 hPa (+2 000 m ... +3 500 m) // Tmin ... (Tmax -20 K) at 658 hPa ... 540 hPa (+3 500 m ... +5 000 m)
Relative humidity	
• With condensation, tested in accordance with IEC 60068-2-38, max.	100 %; RH incl. condensation / frost (no commissioning in bedewed state), horizontal installation
Resistance	
Coolants and lubricants	
- Resistant to commercially available coolants and lubricants	Yes; Incl. diesel and oil droplets in the air
Use in stationary industrial systems	
- to biologically active substances according to EN 60721-3-3	Yes; Class 3B2 mold, fungus and dry rot spores (with the exception of fauna); Class 3B3 on request
- to chemically active substances according to EN 60721-3-3	Yes; Class 3C4 (RH < 75 %) incl. salt spray acc. to EN 60068-2-52 (severity degree 3); *
- to mechanically active substances according to EN 60721-3-3	Yes; Class 3S4 incl. sand, dust, *
- Against mechanical environmental conditions acc. to EN 60721-3-3	Yes; Class 3M8 using the SIPLUS Mounting Kit ET 200SP (6AG1193-6AA00-0AA0)
Use on land craft, rail vehicles and special-purpose vehicles	
- Against mechanical environmental conditions acc. to EN 60721-3-5	Yes; Class 5M2 using the SIPLUS Mounting Kit ET 200SP (6AG1193-6AA00-0AA0)
- against mechanical environmental conditions in agriculture acc. to ISO 15003	Yes; level 1 (Location LE) using the SIPLUS Mounting Kit ET 200SP (6AG1193-6AA00-0AA0)
Use on ships/at sea	
- to biologically active substances according to EN 60721-3-6	Yes; Class 6B2 mold, fungal and dry rot spores (excluding fauna)
- to chemically active substances according to EN 60721-3-6	Yes; Class 6C3 (RH < 75 %) incl. salt spray acc. to EN 60068-2-52 (severity degree 3); *
- to mechanically active substances according to EN 60721-3-6	Yes; Class 6S3 incl. sand, dust; *
- Against mechanical environmental conditions acc. to EN 60721-3-6	Yes; Class 6M4 using the SIPLUS Mounting Kit ET 200SP (6AG1193-6AA00-0AA0)

Article number	6AG1137-6AA01-7BA0
Based on	6ES7137-6AA01-0BA0 SIPLUS ET 200SP CM PTP
Usage in industrial process technology	
- Against chemically active substances acc. to EN 60654-4	Yes; Class 3 (excluding trichlorethylene)
- Environmental conditions for process, measuring and control systems acc. to ANSI/ISA-71.04	Yes; Level GX group A/B (excluding trichlorethylene; harmful gas concentrations up to the limits of EN 60721-3-3 class 3C4 permissible); level LC3 (salt spray) and level LB3 (oil)
Remark	
- Note regarding classification of environmental conditions acc. to EN 60721, EN 60654-4 and ANSI/ISA-71.04	* The supplied plug covers must remain in place over the unused interfaces during operation!
Conformal coating	
• Coatings for printed circuit board assemblies acc. to EN 61086	Yes; Class 2 for high reliability
• Protection against fouling acc. to EN 60664-3	Yes; Type 1 protection
• Military testing according to MIL-I-46058C, Amendment 7	Yes; Discoloration of coating possible during service life
• Qualification and Performance of Electrical Insulating Compound for Printed Board Assemblies according to IPC-CC-830A	Yes; Conformal coating, Class A

Overview



- SIPLUS CM 4x IO-Link communication module
 - Serial communication module for connecting up to 4 IO-Link devices in accordance with IO-Link specification V1.0 and V1.1. The IO-Link parameters are configured using the Port Configuration Tool (PCT), version V3.0 and higher.
- Time-based IO
 - Time-based IO ensures that signals are output with a precisely defined response time. By combining inputs and outputs, for example, passing products can be accurately measured or fluids dosed in precise quantities.
- Supported data transfer rates
 - COM1 (4.8 kBd)
 - COM2 (38.4 kBd)
 - COM3 (230.4 kBd)
- Expansion limits
 - Length of cable: Max. 20 m
 - Max. 32 bytes of input and output data per port
 - Max. 144 bytes of input data and 128 bytes of output data per module
- Supported ET 200SP system functions
 - Replacement without PG with automatic backup without the engineering tool of the IO-Link Device Parameter (V1.1 devices only) and the IO-Link master parameters by means of redundant saving of parameters on the e-coding element
 - Re-parameterization during operation
 - Identification data I&M
 - Firmware update
 - PROFlenergy
- Can be plugged into Type A0 BaseUnits (BU) with automatic e-coding
- LED indicators
 - DIAG: Operating state indicator (green/red) of the module
 - C1..C4: Port status indicator (green) for Port 1, 2, 3 and 4
 - Q1..Q4: Channel status indicator (green) for Port 1, 2, 3 and 4
 - F1..F4: Port fault indicator (red) for Port 1, 2, 3 and 4
 - PWR: Supply voltage indicator (green)
- Clear labeling on front of module
 - Plain text identification of the module type and function class
 - 2D matrix code (order and serial number)
 - Connection diagram
 - Color-coding of the module class CM: silver
 - Hardware and firmware version
 - Complete Article No.
- Optional accessories
 - Labeling strips
 - Equipment labeling plate
 - Color-coded label with color code CC04
- Optional system-integrated shield connection

Note

SIPLUS extreme products are based on SIMATIC standard products. The contents listed here were taken from the respective standard products. SIPLUS extreme-specific information was added.

10

Ordering data

Ordering data	Article No.	Ordering data	Article No.
SIPLUS CM 4x IO-Link master V1.1 Standard communications module (Extended temperature range and exposure to environmental substances) Serial communications module for connecting up to 4 IO-Link devices, time-based IO, BU type A0, color code CC04	6AG1137-6BD00-2BA0	BU15-P16+A10+2B (Extended temperature range and exposure to environmental substances) BU type A0; BaseUnit (dark) with 16 process terminals (1...16) to the module and an additional 10 internally jumpered AUX terminals (1 A to 10 A); for continuing the load group	6AG1193-6BP20-7BA0
Usable type A0 BaseUnits BU15-P16+A10+2D (Extended temperature range and exposure to environmental substances) BU type A0; BaseUnit (light) with 16 process terminals (1...16) to the module and an additional 10 internally jumpered AUX terminals (1 A to 10 A); for starting a new load group (max. 10 A)	6AG1193-6BP20-7DA0	BU15-P16+A0+2B (Extended temperature range and exposure to environmental substances) BU type A0; BaseUnit (dark) with 16 push-in terminals to the module; for continuing the load group	6AG1193-6BP00-7BA0
BU15-P16+A0+2D (Extended temperature range and exposure to environmental substances) BU type A0; BaseUnit (light) with 16 push-in terminals to the module; for starting a new load group (max. 10 A)	6AG1193-6BP00-7DA0	Accessories SIPLUS Mounting Kit ET 200SP Mounting accessories for use with increased mechanical vibration and shock loads.	6AG1193-6AA00-0AA0
		Other accessories See SIMATIC CM 4x IO-Link, page 10/147	

I/O systems

SIMATIC ET 200 systems for the control cabinet
SIMATIC ET 200SP

I/O modules > Communication > SIPLUS CM 4x IO-Link

Technical specifications

Article number	6AG1137-6BD00-2BA0
Based on	6ES7137-6BD00-0BA0 SIPLUS ET 200SP CM 4XIO-LINK
Ambient conditions	
Ambient temperature during operation	
• horizontal installation, min.	-40 °C; = Tmin (incl. condensation/frost)
• horizontal installation, max.	60 °C; = Tmax; +70 °C with configured empty slots to the left and right of the module
Altitude during operation relating to sea level	
• Installation altitude above sea level, max.	5 000 m
• Ambient air temperature-barometric pressure-altitude	Tmin ... Tmax at 1 140 hPa ... 795 hPa (-1 000 m ... +2 000 m) // Tmin ... (Tmax - 10 K) at 795 hPa ... 658 hPa (+2 000 m ... +3 500 m) // Tmin ... (Tmax -20 K) at 658 hPa ... 540 hPa (+3 500 m ... +5 000 m)
Relative humidity	
• With condensation, tested in accordance with IEC 60068-2-38, max.	100 %; RH incl. condensation / frost (no commissioning in bedewed state), horizontal installation
Resistance	
Coolants and lubricants	
- Resistant to commercially available coolants and lubricants	Yes; Incl. diesel and oil droplets in the air
Use in stationary industrial systems	
- to biologically active substances according to EN 60721-3-3	Yes; Class 3B2 mold, fungus and dry rot spores (with the exception of fauna); Class 3B3 on request
- to chemically active substances according to EN 60721-3-3	Yes; Class 3C4 (RH < 75 %) incl. salt spray acc. to EN 60068-2-52 (severity degree 3); *
- to mechanically active substances according to EN 60721-3-3	Yes; Class 3S4 incl. sand, dust, *
- Against mechanical environmental conditions acc. to EN 60721-3-3	Yes; Class 3M8 using the SIPLUS Mounting Kit ET 200SP (6AG1193-6AA00-0AA0)
Use on ships/at sea	
- to biologically active substances according to EN 60721-3-6	Yes; Class 6B2 mold and fungal spores (excluding fauna); Class 6B3 on request
- to chemically active substances according to EN 60721-3-6	Yes; Class 6C3 (RH < 75 %) incl. salt spray acc. to EN 60068-2-52 (severity degree 3); *
- to mechanically active substances according to EN 60721-3-6	Yes; Class 6S3 incl. sand, dust; *
- Against mechanical environmental conditions acc. to EN 60721-3-6	Yes; Class 6M4 using the SIPLUS Mounting Kit ET 200SP (6AG1193-6AA00-0AA0)

Article number	6AG1137-6BD00-2BA0
Based on	6ES7137-6BD00-0BA0 SIPLUS ET 200SP CM 4XIO-LINK
Usage in industrial process technology	
- Against chemically active substances acc. to EN 60654-4	Yes; Class 3 (excluding trichlorethylene)
- Environmental conditions for process, measuring and control systems acc. to ANSI/ISA-71.04	Yes; Level GX group A/B (excluding trichlorethylene; harmful gas concentrations up to the limits of EN 60721-3-3 class 3C4 permissible); level LC3 (salt spray) and level LB3 (oil)
Remark	
- Note regarding classification of environmental conditions acc. to EN 60721, EN 60654-4 and ANSI/ISA-71.04	* The supplied plug covers must remain in place over the unused interfaces during operation!
Conformal coating	
• Coatings for printed circuit board assemblies acc. to EN 61086	Yes; Class 2 for high reliability
• Protection against fouling acc. to EN 60664-3	Yes; Type 1 protection
• Military testing according to MIL-I-46058C, Amendment 7	Yes; Discoloration of coating possible during service life
• Qualification and Performance of Electrical Insulating Compound for Printed Board Assemblies according to IPC-CC-830A	Yes; Conformal coating, Class A

Overview



- For data exchange between an ET 200SP system and CAN Bus 2.0A/B or CANopen Manager or Slave (according to CiA 301 & 302)
- CANopen features:
 - Node / lifeguarding
 - Heartbeat
 - SYNC (producer / consumer)
- Integrated in TIA via HSP, TIA Portal V15.1 or higher
- CAN connection with push-in terminals
- Integrated CAN bus terminating resistor
- Up to 60 CAN nodes
- 128 receiver and 128 transmitter PDOs
- Galvanic isolation between the two networks
- Diagnostic interrupts
- Optionally with function block SIMATIC ECC CHAdEMO: Realization of digital communication as basis for conductible DC charging of electric vehicles in line with the CHAdEMO standard

Note

SIPLUS extreme products are based on SIMATIC standard products. The contents listed here were taken from the respective standard products. SIPLUS extreme-specific information was added.

Ordering data

Article No.

SIPLUS ET 200SP CM CAN communications module With conformal coating, -40...+60 °C To connect ET 200SP with CAN or CANopen networks CAN 2.0A/B, CANopen Manager according to CiA 301/302, CANopen Slave according to CiA 301/302	6AG1137-6EA00-2BA0
Accessories Suitable SIPLUS extreme BaseUnits, type A0	
BU15-P16+A10+2D (Extended temperature range and exposure to environmental substances) BU type A0; BaseUnit (light) with 16 push-in terminals (1...16) to the module and an additional 10 internally jumpered AUX terminals (1 A to 10 A); for starting a new load group (max. 10 A)	6AG1193-6BP20-7DA0
BU15-P16+A0+2D (Extended temperature range and exposure to environmental substances) BU type A0; BaseUnit (light) with 16 push-in terminals to the module; for starting a new load group (max. 10 A)	6AG1193-6BP00-7DA0
BU15-P16+A10+2B (Extended temperature range and exposure to environmental substances) BU type A0; BaseUnit (dark) with 16 push-in terminals (1...16) to the module and an additional 10 internally jumpered AUX terminals (1 A to 10 A); for continuing the load group	6AG1193-6BP20-7BA0
BU15-P16+A0+2B (Extended temperature range and exposure to environmental substances) BU type A0; BaseUnit (dark) with 16 push-in terminals to the module; for continuing the load group	6AG1193-6BP00-7BA0
Accessories SIPLUS Mounting Kit ET 200SP Mounting accessories for use with increased mechanical vibration and shock loads.	6AG1193-6AA00-0AA0
Other accessories	See SIMATIC ET 200SP CM CAN, page 10/151

I/O systems

SIMATIC ET 200 systems for the control cabinet
SIMATIC ET 200SP

I/O modules > Communication > SIPLUS ET 200SP CM CAN

Technical specifications

Article number	6AG1137-6EA00-2BA0
Based on	6ES7137-6EA00-0BA0 SIPLUS ET 200SP CM CAN
Ambient conditions	
Ambient temperature during operation	
• horizontal installation, min.	-40 °C; = Tmin (incl. condensation/frost)
• horizontal installation, max.	60 °C; = Tmax; +70 °C with configured empty slots to the left and right of the module
• vertical installation, min.	-40 °C; = Tmin
• vertical installation, max.	50 °C; = Tmax
Altitude during operation relating to sea level	
• Installation altitude above sea level, max.	5 000 m
• Ambient air temperature-barometric pressure-altitude	Tmin ... Tmax at 1 140 hPa ... 795 hPa (-1 000 m ... +2 000 m) // Tmin ... (Tmax - 10 K) at 795 hPa ... 658 hPa (+2 000 m ... +3 500 m) // Tmin ... (Tmax -20 K) at 658 hPa ... 540 hPa (+3 500 m ... +5 000 m)
Relative humidity	
• With condensation, tested in accordance with IEC 60068-2-38, max.	100 %; RH incl. condensation / frost (no commissioning in bedewed state), horizontal installation
Resistance	
Coolants and lubricants	
- Resistant to commercially available coolants and lubricants	Yes; Incl. diesel and oil droplets in the air
Use in stationary industrial systems	
- to biologically active substances according to EN 60721-3-3	Yes; Class 3B2 mold, fungus and dry rot spores (with the exception of fauna); Class 3B3 on request
- to chemically active substances according to EN 60721-3-3	Yes; Class 3C4 (RH < 75 %) incl. salt spray acc. to EN 60068-2-52 (severity degree 3); *
- to mechanically active substances according to EN 60721-3-3	Yes; Class 3S4 incl. sand, dust, *
- Against mechanical environmental conditions acc. to EN 60721-3-3	Yes; Class 3M8 using the SIPLUS Mounting Kit ET 200SP (6AG1193-6AA00-0AA0)

Article number	6AG1137-6EA00-2BA0
Based on	6ES7137-6EA00-0BA0 SIPLUS ET 200SP CM CAN
Use on ships/at sea	
- to biologically active substances according to EN 60721-3-6	Yes; Class 6B2 mold, fungal and dry rot spores (excluding fauna)
- to chemically active substances according to EN 60721-3-6	Yes; Class 6C3 (RH < 75 %) incl. salt spray acc. to EN 60068-2-52 (severity degree 3); *
- to mechanically active substances according to EN 60721-3-6	Yes; Class 6S3 incl. sand, dust; *
- Against mechanical environmental conditions acc. to EN 60721-3-6	Yes; Class 6M4 using the SIPLUS Mounting Kit ET 200SP (6AG1193-6AA00-0AA0)
Usage in industrial process technology	
- Against chemically active substances acc. to EN 60654-4	Yes; Class 3 (excluding trichlorethylene)
- Environmental conditions for process, measuring and control systems acc. to ANSI/ISA-71.04	Yes; Level GX group A/B (excluding trichlorethylene; harmful gas concentrations up to the limits of EN 60721-3-3 class 3C4 permissible); level LC3 (salt spray) and level LB3 (oil)
Remark	
- Note regarding classification of environmental conditions acc. to EN 60721, EN 60654-4 and ANSI/ISA-71.04	* The supplied plug covers must remain in place over the unused interfaces during operation!
Conformal coating	
• Coatings for printed circuit board assemblies acc. to EN 61086	Yes; Class 2 for high reliability
• Protection against fouling acc. to EN 60664-3	Yes; Type 1 protection
• Military testing according to MIL-I-46058C, Amendment 7	Yes; Discoloration of coating possible during service life
• Qualification and Performance of Electrical Insulating Compound for Printed Board Assemblies according to IPC-CC-830A	Yes; Conformal coating, Class A

Overview



- PROFIBUS DP master/slave with electrical interface for connecting the ET 200SP CPUs to PROFIBUS at up to 12 Mbps
- Expands the ET 200SP CPUs 1510SP-1 PN / 1512SP-1 PN by one PROFIBUS connection
- For communication with lower-level PROFIBUS devices at bandwidths of 9.6 kbps to 12 Mbps
- Communication services:
 - PROFIBUS DP
 - PG/OP communication
 - S7 communication:
 - This makes it possible to establish communication between the ET 200SP CPU and other devices, for example those from the SIMATIC S7-300/400/1500 range.
- Time synchronization
- Simple programming and configuration over PROFIBUS
- Cross-network PG communication using S7 routing
- Data set routing

Note

SIPLUS extreme products are based on SIMATIC standard products. The contents listed here were taken from the respective standard products. SIPLUS extreme-specific information was added.

Ordering data

Article No.

SIPLUS CM DP for ET 200SP CPU (Extended temperature range and exposure to environmental substances) PROFIBUS DP master/slave with electrical interface for connecting the ET 200SP CPUs to PROFIBUS at up to 12 Mbps	6AG1545-5DA00-2AB0
Accessories	
SIPLUS Mounting Kit ET 200SP Mounting accessories for use with increased mechanical vibration and shock loads.	6AG1193-6AA00-0AA0
Other accessories	see SIMATIC CM DP, page 10/157

I/O systems

SIMATIC ET 200 systems for the control cabinet
SIMATIC ET 200SP

I/O modules > Communication > SIPLUS CM DP for ET 200SP CPU

Technical specifications

Article number	6AG1545-5DA00-2AB0
Based on	6ES7545-5DA00-0AB0 SIPLUS ET 200SP CM DP
Ambient conditions	
Ambient temperature during operation	
• horizontal installation, min.	-40 °C; = Tmin (incl. condensation/frost)
• horizontal installation, max.	70 °C; = Tmax
• vertical installation, min.	-40 °C; = Tmin (incl. condensation/frost)
• vertical installation, max.	50 °C; = Tmax
Altitude during operation relating to sea level	
• Installation altitude above sea level, max.	5 000 m
• Ambient air temperature-barometric pressure-altitude	Tmin ... Tmax at 1 140 hPa ... 795 hPa (-1 000 m ... +2 000 m) // Tmin ... (Tmax - 10 K) at 795 hPa ... 658 hPa (+2 000 m ... +3 500 m) // Tmin ... (Tmax -20 K) at 658 hPa ... 540 hPa (+3 500 m ... +5 000 m)
Relative humidity	
• With condensation, tested in accordance with IEC 60068-2-38, max.	100 %; RH incl. condensation/frost (no commissioning under condensation conditions)
Resistance	
Coolants and lubricants	
- Resistant to commercially available coolants and lubricants	Yes; Incl. diesel and oil droplets in the air
Use in stationary industrial systems	
- to biologically active substances according to EN 60721-3-3	Yes; Class 3B2 mold, fungus and dry rot spores (with the exception of fauna); Class 3B3 on request
- to chemically active substances according to EN 60721-3-3	Yes; Class 3C4 (RH < 75 %) incl. salt spray acc. to EN 60068-2-52 (severity degree 3); *
- to mechanically active substances according to EN 60721-3-3	Yes; Class 3S4 incl. sand, dust, *
- Against mechanical environmental conditions acc. to EN 60721-3-3	Yes; Class 3M8 using the SIPLUS Mounting Kit ET 200SP (6AG1193-6AA00-0AA0)
Use on ships/at sea	
- to biologically active substances according to EN 60721-3-6	Yes; Class 6B2 mold and fungal spores (excluding fauna); Class 6B3 on request
- to chemically active substances according to EN 60721-3-6	Yes; Class 6C3 (RH < 75 %) incl. salt spray acc. to EN 60068-2-52 (severity degree 3); *
- to mechanically active substances according to EN 60721-3-6	Yes; Class 6S3 incl. sand, dust; *
- Against mechanical environmental conditions acc. to EN 60721-3-6	Yes; Class 6M4 using the SIPLUS Mounting Kit ET 200SP (6AG1193-6AA00-0AA0)

Article number	6AG1545-5DA00-2AB0
Based on	6ES7545-5DA00-0AB0 SIPLUS ET 200SP CM DP
Usage in industrial process technology	
- Against chemically active substances acc. to EN 60654-4	Yes; Class 3 (excluding trichlorethylene)
- Environmental conditions for process, measuring and control systems acc. to ANSI/ISA-71.04	Yes; Level GX group A/B (excluding trichlorethylene; harmful gas concentrations up to the limits of EN 60721-3-3 class 3C4 permissible); level LC3 (salt spray) and level LB3 (oil)
Remark	
- Note regarding classification of environmental conditions acc. to EN 60721, EN 60654-4 and ANSI/ISA-71.04	* The supplied plug covers must remain in place over the unused interfaces during operation!
Conformal coating	
• Coatings for printed circuit board assemblies acc. to EN 61086	Yes; Class 2 for high reliability
• Protection against fouling acc. to EN 60664-3	Yes; Type 1 protection
• Military testing according to MIL-I-46058C, Amendment 7	Yes; Discoloration of coating possible during service life
• Qualification and Performance of Electrical Insulating Compound for Printed Board Assemblies according to IPC-CC-830A	Yes; Conformal coating, Class A

Overview



SIMATIC ET 200SP Safety F-DI video
https://players.brightcove.net/1813624294001/70fecf0f-fbad-4fad-a077-d0e26af4d84c_default/index.html?videoId=6151017420001



Digital fail-safe input module:
F-DI 8x24VDC High Feature for BU type A0, color code CC01

Important features:

- 8-channel digital fail-safe input module for ET 200SP
- For fail-safe reading of sensor information (1 or 2 channels)
- Provides integrated discrepancy evaluation for 2-out-of-2 signals
- 8 internal sensor supplies (incl. test function) onboard
- Certified up to SIL 3 (IEC 61508), PL e (ISO 13849)
- Can be plugged into Type A0 BaseUnits (BU) with automatic coding
- LED display for error, operation, supply voltage and status
- Clear labeling on front of module
 - Plain text identification of the module type and function class
 - 2D matrix code (order and serial number)
 - Connection diagram
 - Color coding of the module type DI: white
 - Hardware and firmware version
 - Color code CC for module-specific color coding of the potentials at the terminals of the BU
 - Complete Article No.
- Optional labeling accessories
 - Labeling strips
 - Equipment labeling plate
- Optional module-specific color identification of the terminals according to the color code CC
- Optional system-integrated shield connection
- The modules support PROFIsafe in both PROFIBUS and PROFINET configurations. Can be used with all fail-safe SIMATIC S7 CPUs.

10

Ordering data

Article No.

Article No.

Digital F-input modules

F-DI 8x24VDC High Feature,
BU type A0, color code CC01

6ES7136-6BA01-0CA0

Spare parts

E-coding element type F

5 units, for ET 200SP F-DI, F-DQ,
F-PM E, F-AI 4xI

6ES7193-6EF00-1AA0

Suitable BaseUnits

BU15-P16+A10+2D

BU type A0; BaseUnit (light) with
16 push-in terminals (1 ... 16)
to the module and an additional
10 internally jumpered
AUX terminals (1 A to 10 A);
for starting a new load group
(max. 10 A)

- Pack of 1 unit
- Pack of 10 units;
to order a pack, please order this
article number with an order
quantity of 10.

6ES7193-6BP20-0DA0
6ES7193-6BP20-2DA0

BU15-P16+A0+2D

BU type A0; BaseUnit (light) with
16 push-in terminals to the module;
for starting a new load group
(max. 10 A)

- Pack of 1 unit
- Pack of 10 units;
to order a pack, please order this
article number with an order
quantity of 10.

6ES7193-6BP00-0DA0
6ES7193-6BP00-2DA0

BU15-P16+A10+2B

BU type A0; BaseUnit (dark) with
16 push-in terminals (1 ... 16)
to the module and an additional
10 internally jumpered
AUX terminals (1 A to 10 A);
for continuing the load group

- Pack of 1 unit
- Pack of 10 units;
to order a pack, please order this
article number with an order
quantity of 10.

6ES7193-6BP20-0BA0
6ES7193-6BP20-2BA0

I/O systems

SIMATIC ET 200 systems for the control cabinet
SIMATIC ET 200SP

Fail-safe I/O modules > Digital F-input modules

Ordering data	Article No.	Ordering data	Article No.
BU15-P16+A0+2B BU type A0; BaseUnit (dark) with 16 push-in terminals to the module; for continuing the load group <ul style="list-style-type: none"> • Pack of 1 unit • Pack of 10 units; to order a pack, please order this article number with an order quantity of 10. 	6ES7193-6BP00-0BA0 6ES7193-6BP00-2BA0	Equipment labeling plate 10 sheets of 16 labels	6ES7193-6LF30-0AW0
Accessories S7 Distributed Safety V5.4 SP5 Update 2 programming tool Task: Configuration software for configuring fail-safe user programs for SIMATIC S7-300F, S7-400F, WinAC RTX F, ET 200S, ET 200M, ET 200iSP, ET 200pro, ET 200eco, ET 200SP Requirement: Windows 7 SP1 (64-bit), Windows 10 Professional/Enterprise (64-bit), Windows Server 2008 R2 SP1 (64-bit), Windows Server 2012 R2 (64-bit), Windows Server 2016 (64-bit); STEP 7 as of V5.5 SP1; Please also consider the operating systems that have been released for the used STEP 7 version Floating license for 1 user; software and documentation on DVD; license key on USB flash drive Floating license for 1 user; software, documentation and license key for download ¹⁾ ; Email address required for delivery	6ES7833-1FC02-0YA5 6ES7833-1FC02-0YH5	Labeling strips 500 labeling strips on roll, light gray, for inscription with thermal transfer roll printer 500 labeling strips on roll, yellow, for inscription with thermal transfer roll printer 1 000 labeling strips DIN A4, light gray, card, for inscription with laser printer 1 000 labeling strips DIN A4, yellow, card, for inscription with laser printer	6ES7193-6LR10-0AA0 6ES7193-6LR10-0AG0 6ES7193-6LA10-0AA0 6ES7193-6LA10-0AG0
S7 Distributed Safety upgrade From V5.x to V5.4; floating license for 1 user; software and documentation on DVD; license key on USB flash drive	6ES7833-1FC02-0YE5	BU cover For covering empty slots (gaps); 5 units <ul style="list-style-type: none"> • 15 mm wide • 20 mm wide 	6ES7133-6CV15-1AM0 6ES7133-6CV20-1AM0
STEP 7 Safety Advanced V17 Task: Engineering tool for configuring and programming fail-safe user programs for SIMATIC S7-1200 FC, S7-1500F, S7-1500F Software Controller, S7-300F, S7-400F, WinAC RTX F, ET 200SP F Controller and the fail-safe I/O ET 200SP, ET 200MP, ET 200S, ET 200M, ET 200iSP, ET 200pro and ET 200eco Requirement: STEP 7 Professional V17 <u>Note:</u> As of TIA Portal V16, the SIMATIC STEP 7 Safety software is an integral component of the SIMATIC STEP 7 product setup. The functionality of SIMATIC STEP 7 Safety is activated by means of the license key supplied in each case. Floating license for 1 user; license key on USB flash drive Floating license for 1 user; license key for download ¹⁾ ; Email address required for delivery	6ES7833-1FA17-0YA5 6ES7833-1FA17-0YH5	Shield connection 5 shield supports and 5 shield terminals	6ES7193-6SC00-1AM0
		Color-coded labels <ul style="list-style-type: none"> • Color code CC01, module-specific, for 16 push-in terminals; for BaseUnit type A0, A1; 10 units • Color code CC01, module-specific, for 16 push-in terminals; for BaseUnit type A0, A1; 50 units • Color code CC71, for 10 AUX terminals 1 A to 10 A, for BU type A0, yellow/green, with push-in terminals; 10 units • Color code CC72, for 10 AUX terminals 1 A to 10 A, for BU type A0, red, with push-in terminals; 10 units • Color code CC73, for 10 AUX terminals 1 A to 10 A, for BU type A0, blue, with push-in terminals; 10 units 	6ES7193-6CP01-2MA0 6ES7193-6CP01-4MA0 6ES7193-6CP71-2AA0 6ES7193-6CP72-2AA0 6ES7193-6CP73-2AA0

¹⁾ For up-to-date information and download availability, see: <http://www.siemens.com/tia-online-software-delivery>

Technical specifications

Article number	6ES7136-6BA01-0CA0 ET 200SP, EI-Mod., F-DI 8x24VDC HF
General information	
Product type designation	F-DI 8x24VDC HF
Engineering with	
<ul style="list-style-type: none"> STEP 7 TIA Portal configurable/ integrated from version STEP 7 configurable/ integrated from version PROFINET from GSD version/ GSD revision 	GSDML V2.35
Supply voltage	
Rated value (DC)	24 V
Reverse polarity protection	Yes
Encoder supply	
Number of outputs	8
Short-circuit protection	
Output current	
<ul style="list-style-type: none"> up to 60 °C, max. 	
24 V encoder supply	
<ul style="list-style-type: none"> 24 V Short-circuit protection 	Yes; min. L+ (-1.5 V) Yes; Electronic (response threshold 0.7 A to 1.8 A)
<ul style="list-style-type: none"> Output current, max. Output current per channel, max. Output current per module, max. 	300 mA 800 mA; Total current of all encoders
Digital inputs	
Number of digital inputs	8
Source/sink input	Yes; P-reading
Input characteristic curve in accordance with IEC 61131, type 1	Yes
Input voltage	
<ul style="list-style-type: none"> Rated value (DC) for signal *0* for signal *1* 	24 V -30 to +5 V +15 to +30 V
Input current	
<ul style="list-style-type: none"> for signal *1*, typ. 	3.7 mA
Input delay (for rated value of input voltage)	
for standard inputs	
- parameterizable	Yes
for technological functions	
- parameterizable	No

Article number	6ES7136-6BA01-0CA0 ET 200SP, EI-Mod., F-DI 8x24VDC HF
Interrupts/diagnostics/ status information	
Diagnostics function	Yes
Alarms	
<ul style="list-style-type: none"> Diagnostic alarm Hardware interrupt 	Yes No
Diagnostics indication LED	
<ul style="list-style-type: none"> RUN LED ERROR LED Monitoring of the supply voltage (PWR-LED) Channel status display for channel diagnostics for module diagnostics 	Yes; green LED Yes; red LED Yes; green PWR LED Yes; green LED Yes; red LED Yes; green/red DIAG LED
Potential separation	
Potential separation channels	
<ul style="list-style-type: none"> between the channels and backplane bus 	Yes
Standards, approvals, certificates	
Suitable for safety functions	Yes
Highest safety class achievable in safety mode	
<ul style="list-style-type: none"> Performance level according to ISO 13849-1 SIL acc. to IEC 61508 	PLe SIL 3
Ambient conditions	
Ambient temperature during operation	
<ul style="list-style-type: none"> horizontal installation, min. horizontal installation, max. vertical installation, min. vertical installation, max. 	0 °C 60 °C 0 °C 50 °C
Altitude during operation relating to sea level	
<ul style="list-style-type: none"> Installation altitude above sea level, max. 	4 000 m; restrictions for installation altitudes > 2 000 m, see ET 200SP system manual
Dimensions	
Width	15 mm
Height	73 mm
Depth	58 mm
Weights	
Weight, approx.	29 g

I/O systems

SIMATIC ET 200 systems for the control cabinet
SIMATIC ET 200SP

Fail-safe I/O modules > Digital F-output modules

Overview



SIMATIC ET 200SP F-DQ 4
Compact fail safe digital output module

SIMATIC ET 200SP Safety F-DQ 4 video
https://players.brightcove.net/1813624294001/70fecf0f-fbad-4fad-a077-d0e26af4d84c_default/index.html?videoid=6154332510001

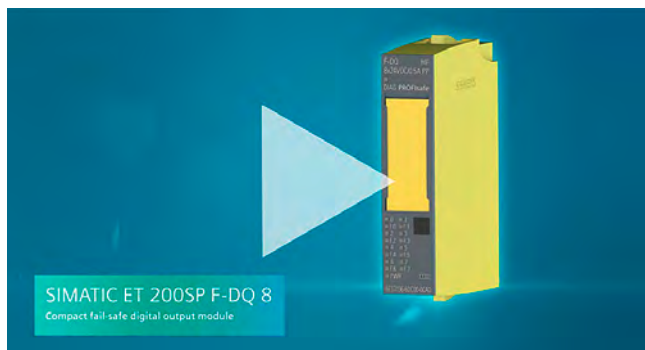

SIMATIC ET 200SP F-DQ 8
Compact fail safe digital output module

SIMATIC ET 200SP Safety F-DQ 8 video
https://players.brightcove.net/1813624294001/70fecf0f-fbad-4fad-a077-d0e26af4d84c_default/index.html?videoid=6154329323001



Digital fail-safe output modules:

- F-DQ 4x24VDC/2A PM High Feature
- F-DQ 8x24VDC/0.5A PP High Feature

Important properties:

- 4 and 8-channel digital fail-safe output modules for the ET 200SP
- Fail-safe 2-channel activation (switching to P/M potential or switching to P/P potential) of actuators
- Actuators can be controlled up to 2 A or 0.5 A
- Certified up to SIL 3 (IEC 61508), PL e (ISO 13849)
- Can be plugged into type A0 BaseUnits (BU) with automatic coding
- LED display for error, operation, supply voltage and status
- Clear labeling on front of module
 - Plain text identification of the module type and function class
 - 2D matrix code (order and serial number)
 - Connection diagram
 - Color coding of the DQ module type: black
 - Hardware and firmware version
 - Color code CC for module-specific color coding of the potentials at the terminals of the BU
 - Complete Article No.
- Optional labeling accessories
 - Labeling strips
 - Equipment labeling plate
- Optional system-integrated shield connection
- The modules support PROFIsafe in both PROFIBUS and PROFINET configurations
- They can be used with all fail-safe SIMATIC S7 CPUs

Ordering data	Article No.	Article No.
Digital F-output modules		Accessories
F-DQ 4x24VDC High Feature, BU type A0, color code CC01	6ES7136-6DB00-0CA0	S7 Distributed Safety V5.4 SP5 Update 2 programming tool
F-DQ 8x24VDC High Feature, switching to PP potential, BU type A0, color code CC01	6ES7136-6DC00-0CA0	
Spare parts		Task: Configuration software for configuring fail-safe user programs for SIMATIC S7-300F, S7-400F, WinAC RTX F, ET 200S, ET 200M, ET 200iSP, ET 200pro, ET 200eco, ET 200SP Requirement: Windows 7 SP1 (64-bit), Windows 10 Professional/Enterprise (64-bit), Windows Server 2008 R2 SP1 (64-bit), Windows Server 2012 R2 (64-bit), Windows Server 2016 (64-bit); STEP 7 as of V5.5 SP1; Please also consider the operating systems that have been released for the used STEP 7 version
E-coding element type F		Floating license for 1 user; software and documentation on DVD; license key on USB flash drive
5 units, for ET 200SP F-DI, F-DQ, F-PM E, F-AI 4x1	6ES7193-6EF00-1AA0	Floating license for 1 user; software, documentation and license key for download ¹⁾ ; Email address required for delivery
Suitable BaseUnits		S7 Distributed Safety upgrade
BU15-P16+A10+2D		From V5.x to V5.4; floating license for 1 user; software and documentation on DVD; license key on USB flash drive
BU type A0; BaseUnit (light) with 16 push-in terminals (1 ... 16) to the module and an additional 10 internally jumpered AUX terminals (1 A to 10 A); for starting a new load group (max. 10 A)	6ES7193-6BP20-0DA0 6ES7193-6BP20-2DA0	STEP 7 Safety Advanced V17
<ul style="list-style-type: none"> • Pack of 1 unit • Pack of 10 units; to order a pack, please order this article number with an order quantity of 10. 		
BU15-P16+A0+2D		Task: Engineering tool for configuring and programming fail-safe user programs for SIMATIC S7-1200 FC, S7-1500F, S7-1500F Software Controller, S7-300F, S7-400F, WinAC RTX F, ET 200SP F Controller and the fail-safe ET 200SP, ET 200MP, ET 200S, ET 200M, ET 200iSP, ET 200pro and ET 200eco I/O Requirement: STEP 7 Professional V17 Note: As of TIA Portal V16, the SIMATIC STEP 7 Safety software is an integral component of the SIMATIC STEP 7 product setup. The functionality of SIMATIC STEP 7 Safety is activated by means of the license key supplied in each case.
BU type A0; BaseUnit (light) with 16 push-in terminals to the module; for starting a new load group (max. 10 A)	6ES7193-6BP00-0DA0 6ES7193-6BP00-2DA0	Floating license for 1 user; license key on USB flash drive
<ul style="list-style-type: none"> • Pack of 1 unit • Pack of 10 units; to order a pack, please order this article number with an order quantity of 10. 		Floating license for 1 user; license key for download ¹⁾ ; Email address required for delivery
BU15-P16+A10+2B		6ES7833-1FA17-0YA5
BU type A0; BaseUnit (dark) with 16 push-in terminals (1 ... 16) to the module and an additional 10 internally jumpered AUX terminals (1 A to 10 A); for continuing the load group	6ES7193-6BP20-0BA0 6ES7193-6BP20-2BA0	6ES7833-1FA17-0YH5
<ul style="list-style-type: none"> • Pack of 1 unit • Pack of 10 units; to order a pack, please order this article number with an order quantity of 10. 		
BU15-P16+A0+2B		
BU type A0; BaseUnit (dark) with 16 push-in terminals to the module; for continuing the load group	6ES7193-6BP00-0BA0 6ES7193-6BP00-2BA0	
<ul style="list-style-type: none"> • Pack of 1 unit • Pack of 10 units; to order a pack, please order this article number with an order quantity of 10. 		
BU20-P12+A4+0B		
BU type B0; BaseUnit (dark) with 12 push-in terminals (1 ... 12) to the module and an additional 4 internally jumpered AUX terminals (1 A to 4 A); for continuing the load group	6ES7193-6BP20-0BB0	

¹⁾ For up-to-date information and download availability, see: <http://www.siemens.com/tia-online-software-delivery>

I/O systemsSIMATIC ET 200 systems for the control cabinet
SIMATIC ET 200SP**Fail-safe I/O modules > Digital F-output modules**

Ordering data	Article No.	Article No.
Equipment labeling plate 10 sheets of 16 labels	6ES7193-6LF30-0AW0	Color-coded labels <ul style="list-style-type: none"> Color code CC02, module-specific, for 16 push-in terminals; for BaseUnit type A0, A1; 10 units Color code CC02, module-specific, for 16 push-in terminals; for BaseUnit type A0, A1; 50 units Color code CC71, for 10 AUX terminals 1 A to 10 A, for BU type A0, yellow/green, with push-in terminals; 10 units Color code CC72, for 10 AUX terminals 1 A to 10 A, for BU type A0, red, with push-in terminals; 10 units Color code CC73, for 10 AUX terminals 1 A to 10 A, for BU type A0, blue, with push-in terminals; 10 units
Labeling strips 500 labeling strips on roll, light gray, for inscription with thermal transfer roll printer	6ES7193-6LR10-0AA0	
500 labeling strips on roll, yellow, for inscription with thermal transfer roll printer	6ES7193-6LR10-0AG0	
1 000 labeling strips DIN A4, light gray, card, for inscription with laser printer	6ES7193-6LA10-0AA0	
1 000 labeling strips DIN A4, yellow, card, for inscription with laser printer	6ES7193-6LA10-0AG0	
BU cover For covering empty slots (gaps); 5 units		
• 15 mm wide	6ES7133-6CV15-1AM0	
• 20 mm wide	6ES7133-6CV20-1AM0	
Shield connection 5 shield supports and 5 shield terminals	6ES7193-6SC00-1AM0	

Technical specifications

Article number	6ES7136-6DB00-0CA0 ET 200SP, EI-Mod., F-DQ 4xDC 24V/2A	6ES7136-6DC00-0CA0 ET 200SP, F-DQ 8x 24VDC/0.5A PP
General information		
Product type designation	F-DQ 4x24 V DC/2A HF	F-DQ 8x24 V DC/0.5 A PP HF
Engineering with		
• STEP 7 TIA Portal configurable/ integrated from version	V12	V14 SP1 with HSP 202
• STEP 7 configurable/ integrated from version	V5.5 SP3 / -	V5.5 SP4 HF5
• PROFINET from GSD version/ GSD revision	V2.31	V2.31
Supply voltage		
Rated value (DC)	24 V	24 V
Reverse polarity protection	Yes	Yes
Digital outputs		
Type of digital output	Transistor	Transistor
Number of digital outputs	4	8
Digital outputs, parameterizable	Yes	Yes
Short-circuit protection	Yes	Yes
Open-circuit detection	Yes	No
Overload protection	Yes	
Limitation of inductive shutdown voltage to	Typ. -2x 47 V	Typ. -39 V
Controlling a digital input		Yes
Switching capacity of the outputs		
• with resistive load, max.	2 A	0.5 A
• on lamp load, max.	10 W	2 W
Load resistance range		
• lower limit	12 Ω	48 Ω
• upper limit	2 000 Ω	12 000 Ω
Output voltage		
• for signal "1", min.	24 V; L+ (-0.5 V)	24 V; L+ (-0.5 V)
Output current		
• for signal "1" rated value	2 A	0.5 A
• for signal "0" residual current, max.	0.5 mA	0.5 mA

Technical specifications

Article number	6ES7136-6DB00-0CA0 ET 200SP, EI-Mod., F-DQ 4xDC 24V/2A	6ES7136-6DC00-0CA0 ET 200SP, F-DQ 8x 24VDC/0.5A PP
Switching frequency		
<ul style="list-style-type: none"> • with resistive load, max. • with inductive load, max. • with capacitive load, max. • on lamp load, max. 	30 Hz; Symmetrical 0.1 Hz; according to IEC 60947-5-1, DC-13, symmetrical 10 Hz; Symmetrical	30 Hz; Symmetrical 0.1 Hz; according to IEC 60947-5-1, DC-13, symmetrical 2 Hz; Symmetrical 10 Hz; Symmetrical
Total current of the outputs		
<ul style="list-style-type: none"> • Current per channel, max. • Current per module, max. 	2 A; note derating data in the manual 6 A; note derating data in the manual	0.5 A; note derating data in the manual 3 A; note derating data in the manual
Total current of the outputs (per module)		
horizontal installation		
<ul style="list-style-type: none"> - up to 40 °C, max. - up to 50 °C, max. - up to 60 °C, max. 		3 A 2.5 A 2 A
vertical installation		
<ul style="list-style-type: none"> - up to 50 °C, max. 		2 A
Interrupts/diagnostics/ status information		
Diagnostics function	Yes	Yes
Substitute values connectable	No	No
Alarms		
<ul style="list-style-type: none"> • Diagnostic alarm 	Yes	Yes
Diagnostics indication LED		
<ul style="list-style-type: none"> • RUN LED • ERROR LED • Monitoring of the supply voltage (PWR-LED) • Channel status display • for channel diagnostics • for module diagnostics 	Yes; green LED Yes; red LED Yes; green PWR LED Yes; green LED Yes; red LED Yes; green/red DIAG LED	Yes; green LED Yes; red LED Yes; green PWR LED Yes; green LED Yes; red LED Yes; green/red DIAG LED
Potential separation		
Potential separation channels		
<ul style="list-style-type: none"> • between the channels and backplane bus 	Yes	Yes
Standards, approvals, certificates		
Suitable for safety functions	Yes	Yes
Highest safety class achievable in safety mode		
<ul style="list-style-type: none"> • Performance level according to ISO 13849-1 • SIL acc. to IEC 61508 	PLe SIL 3	PLe SIL 3
Ambient conditions		
Ambient temperature during operation		
<ul style="list-style-type: none"> • horizontal installation, min. • horizontal installation, max. • vertical installation, min. • vertical installation, max. 	0 °C 60 °C 0 °C 50 °C	0 °C 60 °C 0 °C 50 °C
Altitude during operation relating to sea level		
<ul style="list-style-type: none"> • Installation altitude above sea level, max. 	4 000 m; Restrictions for installation altitudes > 2 000 m, see manual	4 000 m; with derating
Dimensions		
Width	15 mm	15 mm
Height	73 mm	73 mm
Depth	58 mm	58 mm
Weights		
Weight, approx.	57 g	48 g

I/O systems

SIMATIC ET 200 systems for the control cabinet
SIMATIC ET 200SP

Fail-safe I/O modules > Digital F-output module relay

Overview



The digital F electronic module relay 1 F-RQ DC 24VDC/2A.230VAC/5 A has the following characteristics:

- 1 relay output (2 NO contacts)
- Total output current 5 A
- Rated load voltage 24 V DC and 24 ... 230 V AC
- The control circuit of the two safety relays must be routed from the outside to the respective terminals

The attainable safety integrity level is SIL 3 (IEC 61508) when the control of the F-RQ module is implemented via a fail-safe output (e.g. ET 200SP 4F-DQ 24 V DC/2 A PROFIsafe).

Ordering data

Article No.

Digital F output module relay 1 F-RQ

BU type F0, relay output (2 NO contacts), total output current 5 A, load voltages 24 V DC and 24 ... 230 V AC; can be used up to SIL 3/Cat. 4/PLe if controlled via F-DQ

6ES7136-6RA00-0BF0

Suitable BaseUnits

BU20-P8+A4+0B

BU type F0; BaseUnit (dark) with 8 process terminals to the module and 4 internally jumpered AUX terminals (1 A to 4 A); for continuing the load group

6ES7193-6BP20-0BF0

Accessories

S7 Distributed Safety V5.4 SP5 Update 2 programming tool

Task:

Configuration software for configuring fail-safe user programs for SIMATIC S7-300F, S7-400F, WinAC RTX F, ET 200S, ET 200M, ET 200iSP, ET 200pro, ET 200eco, ET 200SP

Requirement:

Windows 7 SP1 (64-bit), Windows 10 Professional/Enterprise (64-bit), Windows Server 2008 R2 SP1 (64-bit), Windows Server 2012 R2 (64-bit), Windows Server 2016 (64-bit); STEP 7 as of V5.5 SP1; Please also consider the operating systems that have been released for the used STEP 7 version

Floating license for 1 user; software and documentation on DVD; license key on USB flash drive

6ES7833-1FC02-0YA5

Floating license for 1 user; software, documentation and license key for download¹⁾; Email address required for delivery

6ES7833-1FC02-0YH5

Article No.

S7 Distributed Safety upgrade

From V5.x to V5.4; floating license for 1 user; software and documentation on DVD; license key on USB flash drive

6ES7833-1FC02-0YE5

STEP 7 Safety Advanced V17

Task:

Engineering tool for configuring and programming fail-safe user programs for SIMATIC S7-1200 FC, S7-1500F, S7-1500F Software Controller, S7-300F, S7-400F, WinAC RTX F, ET 200SP F Controller and the fail-safe I/O ET 200SP, ET 200MP, ET 200S, ET 200M, ET 200iSP, ET 200pro and ET 200eco

Requirement:

STEP 7 Professional V17

Note:

As of TIA Portal V16, the SIMATIC STEP 7 Safety software is an integral component of the SIMATIC STEP 7 product setup. The functionality of SIMATIC STEP 7 Safety is activated by means of the license key supplied in each case.

Floating license for 1 user; license key on USB flash drive

6ES7833-1FA17-0YA5

Floating license for 1 user; license key for download¹⁾; Email address required for delivery

6ES7833-1FA17-0YH5

Equipment labeling plate

6ES7193-6LF30-0AW0

10 sheets of 16 labels

Labeling strips

500 labeling strips on roll, light gray

6ES7193-6LR10-0AA0

500 labeling strips on roll, yellow

6ES7193-6LR10-0AG0

1 000 labeling strips DIN A4, light gray

6ES7193-6LA10-0AA0

1 000 labeling strips DIN A4, yellow

6ES7193-6LA10-0AG0

¹⁾ For up-to-date information and download availability, see: <http://www.siemens.com/tia-online-software-delivery>

Ordering data	Article No.	Mechanical coding elements	Article No.
BU cover For covering empty slots (gaps); 5 units • 20 mm wide	6ES7133-6CV15-1AM0	Mechanical coding elements For automatic coding of I/O modules; spare part. 20 units Type A Type B Type C Type D	6ES7193-6KA00-3AA0 6ES7193-6KB00-3AA0 6ES7193-6KC00-3AA0 6ES7193-6KD00-3AA0
Shield connection 5 shield supports and 5 shield terminals	6ES7193-6SC00-1AM0		
Color-coded labels • Color code CC42, module-specific; for BaseUnit type F0; 10 units	6ES7193-6CP42-2MB0		

Technical specifications

Article number	6ES7136-6RA00-0BF0 ET 200SP, F-RQ 1x24VDC/24...230VAC/5A ST
General information	
Product type designation	F-RQ 24 ... 48VDC/24 ... 230VAC/5A ST
Engineering with	
• STEP 7 TIA Portal configurable/ integrated from version	V13
• STEP 7 configurable/ integrated from version	V5.5 SP4 and higher
• PROFINET from GSD version/ GSD revision	V2.31
Supply voltage	
Rated value (DC)	24 V; Coil voltage
Digital outputs	
Type of digital output	Relays
Number of digital outputs	1
Limitation of inductive shutdown voltage to	No
Controlling a digital input	Yes
Switching capacity of the outputs	
• with resistive load, max.	5 A
• on lamp load, max.	25 W
Switching frequency	
• with resistive load, max.	2 Hz
• with inductive load, max.	0.1 Hz; See data in manual
• with inductive load (acc. to IEC 60947-5-1, DC13), max.	0.1 Hz
• with inductive load (acc. to IEC 60947-5-1, AC15), max.	2 Hz
Total current of the outputs (per module)	
horizontal installation	
- up to 40 °C, max.	5 A; note derating data in the manual
- up to 50 °C, max.	4 A; note derating data in the manual
- up to 60 °C, max.	3 A; note derating data in the manual
vertical installation	
- up to 50 °C, max.	3 A; note derating data in the manual
Relay outputs	
• Number of relay outputs	1; 2 NO contacts
• Rated supply voltage of relay coil L+ (DC)	24 V
• Current consumption of relays (coil current of all relays), max.	70 mA
• external protection for relay outputs	yes; 6 A, see data in manual
• Relay approved acc. to UL 508	Yes; Pilot Duty B300, R300

Article number	6ES7136-6RA00-0BF0 ET 200SP, F-RQ 1x24VDC/24...230VAC/5A ST
Switching capacity of contacts	
- with inductive load, max.	see additional description in the manual
- with resistive load, max.	see additional description in the manual
- Thermal continuous current, max.	5 A
- Switching current, min.	1 mA
- Switching current after exceeding 300 mA, min.	10 mA
- Switching current after exceeding 300 mA, max.	5 A
- Rated switching voltage (DC)	24 V
- Rated switching voltage (AC)	230 V
Interrupts/diagnostics/ status information	
Diagnostics function	Yes
Diagnostics indication LED	
• RUN LED	Yes; green/red DIAG LED
• Channel status display	Yes; green LED
Potential separation	
Potential separation channels	
• between the channels and backplane bus	Yes
Standards, approvals, certificates	
Suitable for safety functions	Yes
Highest safety class achievable in safety mode	
• Performance level according to ISO 13849-1	PLe
• SIL acc. to IEC 61508	SIL 3
Ambient conditions	
Ambient temperature during operation	
• horizontal installation, min.	0 °C
• horizontal installation, max.	60 °C
• vertical installation, min.	0 °C
• vertical installation, max.	50 °C
Dimensions	
Width	20 mm
Height	73 mm
Depth	58 mm
Weights	
Weight, approx.	56 g

I/O systems

SIMATIC ET 200 systems for the control cabinet
SIMATIC ET 200SP

Fail-safe I/O modules > Analog F-input modules

Overview



SIMATIC ET 200SP Safety F-AI-4xU video
https://players.brightcove.net/1813624294001/70fecf0f-fbad-4fad-a077-d0e26af4d84c_default/index.html?videoid=6204918698001



SIMATIC ET 200SP Safety F-AI-4xI video
https://players.brightcove.net/1813624294001/70fecf0f-fbad-4fad-a077-d0e26af4d84c_default/index.html?videoid=6204919583001



Analog fail-safe input modules:

- F-AI 4xI 0(4)..20 mA 2/4-wire High Feature for BU types A0 and A1, color code CC00
- F-AI 4xU 0..10 V HF, BU type A0, A1, color code CC00

Important features:

- 4-channel analog fail-safe digital inputs for ET 200SP
- 4 analog inputs with galvanic isolation between channels and backplane bus
- Measuring ranges: (0)4...20 mA and 0..10 V
- Possibility of connecting current and voltage sensors for measuring temperature, pressure, flow, level, distance measurement, etc.
- Short-circuit-proof power supply for analog sensors
- Resolution: 16 bits including sign
- Certified up to SIL 3 (IEC 61508), PL e (ISO 13849)
- Can be plugged onto type A0 and A1 BaseUnits (BU)
- LED display for error, operation, supply voltage and status
- Interference frequency suppression, smoothing
- Diagnostics: wire break, short-circuit, high/low limit violation
- Firmware update
- Identification data I&M
- Value status
- Clear labeling on front of module
 - Plain text identification of the module type and function class
 - 2D matrix code (order and serial number)
 - Connection diagram
 - Color coding of the module type DI: white
 - Hardware and firmware version
 - Color code CC for module-specific color coding of the potentials at the terminals of the BU
 - Complete Article No.
- Optional labeling accessories
 - Labeling strips
 - Equipment labeling plate
- Optional module-specific color identification of the terminals according to the color code CC
- Optional system-integrated shield connection
- The modules support PROFIsafe in both PROFIBUS and PROFINET configurations. Can be used with all fail-safe SIMATIC S7 CPUs.

Ordering data	Article No.	Ordering data	Article No.
Analog F-input module		BU15-P16+A0+12B/T	6ES7193-6BP40-0BA1
F-AI 4xI 0(4) ... 20 mA 2/4-wire High Feature, BU type A0, A1, color code CC00	6ES7136-6AA00-0CA1	BU type A1; BaseUnit (dark) with 16 push-in terminals (1 ... 16) to the module and 2x5 internally jumpered additional terminals (1 B to 5 B and 1 C to 5 C); for continuing the load group	
F-AI 4xU 0..10 V High Feature, BU type A0, A1, color code CC00	6ES7136-6AB00-0CA1		
Spare parts		BU15-P16+A0+2B/T	6ES7193-6BP00-0BA1
E-coding element type F	6ES7193-6EF00-1AA0	BU type A1; BaseUnit (dark) with 16 push-in terminals to the module; for continuing the load group	
5 units, for ET 200SP F-DI, F-DQ, F-PM E, F-AI 4xI		Accessories	
5x E-coding element type H	6ES7193-6EH00-1AA0	STEP 7 Safety Advanced V17	
5 units, for ET 200SP F-AI 4xU, F-TM Count, F-CM AS-i		Task: Engineering tool for configuring and programming fail-safe user programs for SIMATIC S7-1200 FC, S7-1500F, S7-1500F Software Controller, S7-300F, S7-400F, WinAC RTX F, ET 200SP F Controller and the fail-safe ET 200SP, ET 200MP, ET 200S, ET 200M, ET 200iSP, ET 200pro and ET 200eco I/O Requirement: STEP 7 Professional V17	
Suitable BaseUnits		Note: As of TIA Portal V16, the SIMATIC STEP 7 Safety software is an integral component of the SIMATIC STEP 7 product setup. The functionality of SIMATIC STEP 7 Safety is activated by means of the license key supplied in each case.	
BU15-P16+A10+2D		Floating license for 1 user; license key on USB flash drive	6ES7833-1FA17-0YA5
BU type A0; BaseUnit (light) with 16 push-in terminals (1 ... 16) to the module and an additional 10 internally jumpered AUX terminals (1 A to 10 A); for starting a new load group (max. 10 A)	6ES7193-6BP20-0DA0 6ES7193-6BP20-2DA0	Floating license for 1 user; license key for download ¹⁾ ; Email address required for delivery	6ES7833-1FA17-0YH5
<ul style="list-style-type: none"> • Pack of 1 unit • Pack of 10 units; to order a pack, please order this article number with an order quantity of 10. 		Equipment labeling plate	6ES7193-6LF30-0AW0
BU15-P16+A0+2D		10 sheets of 16 labels	
BU type A0; BaseUnit (light) with 16 push-in terminals to the module; for starting a new load group (max. 10 A)	6ES7193-6BP00-0DA0 6ES7193-6BP00-2DA0	Labeling strips	
<ul style="list-style-type: none"> • Pack of 1 unit • Pack of 10 units; to order a pack, please order this article number with an order quantity of 10. 		500 labeling strips on roll, light gray, for inscription with thermal transfer roll printer	6ES7193-6LR10-0AA0
BU15-P16+A10+2B		500 labeling strips on roll, yellow, for inscription with thermal transfer roll printer	6ES7193-6LR10-0AG0
BU type A0; BaseUnit (dark) with 16 push-in terminals (1 ... 16) to the module and an additional 10 internally jumpered AUX terminals (1 A to 10 A); for continuing the load group	6ES7193-6BP20-0BA0 6ES7193-6BP20-2BA0	1 000 labeling strips DIN A4, light gray, card, for inscription with laser printer	6ES7193-6LA10-0AA0
<ul style="list-style-type: none"> • Pack of 1 unit • Pack of 10 units; to order a pack, please order this article number with an order quantity of 10. 		1 000 labeling strips DIN A4, yellow, card, for inscription with laser printer	6ES7193-6LA10-0AG0
BU15-P16+A0+2B		BU cover	
BU type A0; BaseUnit (dark) with 16 push-in terminals to the module; for continuing the load group	6ES7193-6BP00-0BA0 6ES7193-6BP00-2BA0	For covering empty slots (gaps); 5 units	
<ul style="list-style-type: none"> • Pack of 1 unit • Pack of 10 units; to order a pack, please order this article number with an order quantity of 10. 		• 15 mm wide	6ES7133-6CV15-1AM0
BU15-P16+A0+12D/T	6ES7193-6BP40-0DA1	Shield connection	6ES7193-6SC00-1AM0
BU type A1; BaseUnit (light) with 16 push-in terminals (1 ... 16) to the module and 2x5 internally jumpered additional terminals (1 B to 5 B and 1 C to 5 C); for starting a new load group (max. 10 A)		5 shield supports and 5 shield terminals	
BU15-P16+A0+2D/T	6ES7193-6BP00-0DA1	Color-coded labels	
BU type A1; BaseUnit (light) with 16 push-in terminals to the module; for starting a new load group (max. 10 A)		• Color code CC00, for 16 push-in terminals, BU type A0, A1, gray (terminals 1 to 8), red (terminals 9 to 16); A1; 10 units	6ES7193-6CP00-2MA0

¹⁾ For up-to-date information and download availability, see: <http://www.siemens.com/tia-online-software-delivery>

I/O systemsSIMATIC ET 200 systems for the control cabinet
SIMATIC ET 200SP**Fail-safe I/O modules > Analog F-input modules****Technical specifications**

Article number	6ES7136-6AA00-0CA1	6ES7136-6AB00-0CA1
	ET 200SP, F-AI 4XI (0)4..20mA HF	ET 200SP, F-AI 4xU 0..10V HF
General information		
Product type designation	F-AI 4xI 0(4)..20mA 2-/4-wire HF	F-AI 4XU 0..10V HF
Engineering with		
• STEP 7 TIA Portal configurable/ integrated from version	V15 with HSP 203	V16 with HSP 308
Operating mode		
• cyclic measurement		Yes
• Oversampling		No
• MSI		No
Supply voltage		
Rated value (DC)	24 V	24 V
Reverse polarity protection	Yes	Yes
Analog inputs		
Number of analog inputs	4	4
• For current measurement	4	
• For voltage measurement		4
permissible input voltage for voltage input (destruction limit), max.		36 V
permissible input current for current input (destruction limit), max.	35 mA	
Input ranges (rated values), voltages		
• 0 to +10 V		Yes
Input ranges (rated values), currents		
• 0 to 20 mA	Yes	
• 4 mA to 20 mA	Yes	
Cable length		
• shielded, max.	1 000 m	200 m
Analog value generation for the inputs		
Integration and conversion time/resolution per channel		
• Resolution with overrange (bit including sign), max.	16 bit	16 bit
• Integration time, parameterizable	Yes	Yes
• Integration time (ms)	20 / 16,667	20 / 16,667
• Interference voltage suppression for interference frequency f1 in Hz	50 / 60 Hz	50 / 60 Hz
Smoothing of measured values		
• Number of smoothing levels	7	7
• parameterizable	Yes	Yes
• Average value filter		Yes
Encoder		
Connection of signal encoders		
• for voltage measurement		Yes
• for current measurement as 2-wire transducer	Yes	
- Burden of 2-wire transmitter, max.	650 Ω	
• for current measurement as 4-wire transducer	Yes	
Errors/accuracies		
Basic error limit (operational limit at 25 °C)		
• Voltage, relative to input range, (+/-)		0.1 %
• Current, relative to input range, (+/-)	0.1 %	

Technical specifications

Article number	6ES7136-6AA00-0CA1 ET 200SP, F-AI 4XI (0)4..20mA HF	6ES7136-6AB00-0CA1 ET 200SP, F-AI 4xU 0..10V HF
Interference voltage suppression for $f = n \times (f1 \pm 1 \%)$, f1 = interference frequency		
• Series mode interference (peak value of interference < rated value of input range), min.	40 dB	40 dB
• Common mode voltage, max.		10 V
• Common mode interference, min.	70 dB	70 dB
Interrupts/diagnostics/ status information		
Diagnostics function	Yes	Yes
Alarms		
• Diagnostic alarm	Yes	Yes
• Limit value alarm	No	No
Diagnoses		
• Monitoring the supply voltage	Yes	Yes
• Wire-break	Yes	Yes
• Short-circuit	Yes	
Diagnostics indication LED		
• RUN LED	Yes; green LED	Yes; green LED
• ERROR LED	Yes; red LED	Yes; red LED
• Monitoring of the supply voltage (PWR-LED)	Yes; green PWR LED	Yes; green PWR LED
• Channel status display	Yes; green LED	Yes; green LED
• for channel diagnostics	Yes; red LED	Yes; red LED
• for module diagnostics	Yes; green/red DIAG LED	Yes; green/red DIAG LED
Potential separation		
Potential separation channels		
• between the channels and backplane bus	Yes	Yes
Standards, approvals, certificates		
Highest safety class achievable in safety mode		
• Performance level according to ISO 13849-1	PLe	PLe
• SIL acc. to IEC 61508	SIL 3	SIL 3
Probability of failure (for service life of 20 years and repair time of 100 hours)		
- Low demand mode: PFDavg in accordance with SIL3	< 5.00E-05	< 5.00E-05
- High demand/continuous mode: PFH in accordance with SIL3	< 1.00E-09 1/h	< 1.00E-09 1/h
Ambient conditions		
Ambient temperature during operation		
• horizontal installation, min.	0 °C	0 °C
• horizontal installation, max.	60 °C	60 °C
• vertical installation, min.	0 °C	0 °C
• vertical installation, max.	50 °C	50 °C
Dimensions		
Width	15 mm	15 mm
Height	73 mm	73 mm
Depth	58 mm	58 mm
Weights		
Weight, approx.	48 g	48 g

I/O systems

SIMATIC ET 200 systems for the control cabinet
SIMATIC ET 200SP

Fail-safe I/O modules > Special fail-safe modules

Overview

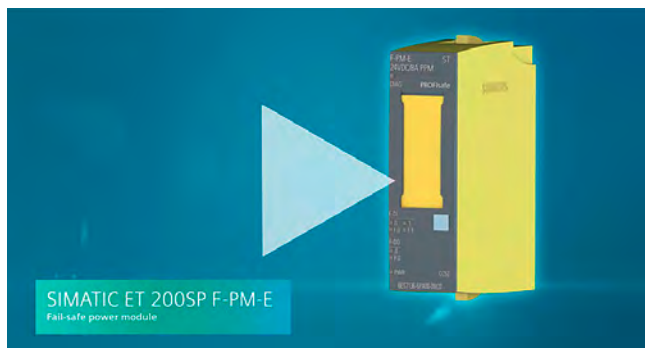

SIMATIC ET 200SP Safety F-PM-E video
https://players.brightcove.net/1813624294001/70fecf0f-fbad-4fad-a077-d0e26af4d84c_default/index.html?videoid=6154262749001



Digital fail-safe power module:
F-PM-E PPM 24 V DC/8 A for BU type C0,
color code CC52

Important properties:

- Certified up to SIL 3 (IEC 61508), PL e (ISO 13849)
- Safety-related shutdown of output modules within the potential group of the F-PM-E
- Two fail-safe digital inputs, for reading of sensor information (1 or 2 channels)
- One fail-safe digital output onboard (switching to PPM potential, up to 2 A, up to SIL 3/PL e)
- Fail-safe digital output and potential supply switching to PP or PM potential can be parameterized
- Parameterizable onboard evaluation of the fail-safe inputs for control of the fail-safe digital outputs and of the potential group
- Digital standard output modules can be shut down up to PL d (ISO 13849) and SIL 2 (IEC61508) (up to 8 A).
- Can be plugged into type C0 BaseUnits (BU) with automatic coding
- LED display for error, operation, supply voltage and status
- Clear labeling on front of module
 - Plain text identification of the module type and function class
 - 2D matrix code (order and serial number)
 - Connection diagram
 - Color coding of the module type DI: white
 - Hardware and firmware version
 - Color code CC for module-specific color coding of the potentials at the terminals of the BU
 - Complete Article No.
- Optional labeling accessories
 - Labeling strips
 - Equipment labeling plate
- Optional module-specific color identification of the terminals according to the color code CC
- Optional system-integrated shield connection
- The modules support PROFIsafe in both PROFIBUS and PROFINET configurations. Can be used with all fail-safe SIMATIC S7 CPUs.

Ordering data	Article No.	Article No.	Article No.
Digital F power module F-PM-E 24 V DC/8 A PPM Standard BU type C0, color code CC52. 2 inputs, 1 output, SIL 3/Cat. 4/PL e	6ES7136-6PA00-0BC0	BU cover For covering empty slots (gaps); 5 units • 20 mm wide	6ES7133-6CV20-1AM0
Spare parts		Shield connection 5 shield supports and 5 shield terminals	6ES7193-6SC00-1AM0
E-coding element type F 5 units, for ET 200SP F-DI, F-DQ, F-PM E, F-AI 4xI	6ES7193-6EF00-1AA0	Color-coded labels • Color code CC52, module-specific, for 8 push-in terminals; 10 units	6ES7193-6CP52-2MC0
Suitable BaseUnits		Mechanical coding elements For automatic coding of I/O modules; spare part. 20 units	
Type C0 BaseUnits		Type A	6ES7193-6KA00-3AA0
BU20-P6+A2+4D BU type C0; BaseUnit (light) with 6 push-in terminals (1 ... 6) to the module and 2 AUX terminals; new load group	6ES7193-6BP20-0DC0	Type B	6ES7193-6KB00-3AA0
Accessories		Type C	6ES7193-6KC00-3AA0
Equipment labeling plate 10 sheets of 16 labels	6ES7193-6LF30-0AW0	Type D	6ES7193-6KD00-3AA0
Labeling strips 1 000 labeling strips DIN A4, yellow, card, for inscription with laser printer	6ES7193-6LA10-0AG0		

Technical specifications

Article number	6ES7136-6PA00-0BC0 ET 200SP, Powermod. F-PM-E PPM, 24V DC
General information	
Product type designation	F-PM-E 24 V DC/8 A PPM ST
Product function	
• I&M data	Yes; I&M0 to I&M3
Engineering with	
• STEP 7 TIA Portal configurable/ integrated from version	V12
• STEP 7 configurable/ integrated from version	V5.5 SP3 / -
• PROFINET from GSD version/ GSD revision	V2.31
Supply voltage	
Rated value (DC)	24 V
Reverse polarity protection	Yes
Encoder supply	
Number of outputs	2
Short-circuit protection	Yes; Electronic (response threshold 0.7 A to 2.1 A)
Output current	
• up to 60 °C, max.	0.3 A
24 V encoder supply	
• 24 V	Yes; min. L+ (-1.5 V)
• Short-circuit protection	Yes
• Output current, max.	600 mA; Total current of all encoders
Digital inputs	
Number of digital inputs	2
Source/sink input	Yes; P-reading
Input characteristic curve in accordance with IEC 61131, type 1	Yes

Article number	6ES7136-6PA00-0BC0 ET 200SP, Powermod. F-PM-E PPM, 24V DC
Input voltage	
• Type of input voltage	DC
• Rated value (DC)	24 V
• for signal "0"	-30 to +5 V
• for signal "1"	+15 to +30 V
Input current	
• for signal "1", typ.	3.7 mA
Input delay (for rated value of input voltage)	
for standard inputs	
- parameterizable	Yes
for technological functions	
- parameterizable	No
Digital outputs	
Number of digital outputs	1
Digital outputs, parameterizable	Yes
Short-circuit protection	Yes
Open-circuit detection	Yes
Overload protection	Yes
Limitation of inductive shutdown voltage to	Max. -1.5 V
Switching capacity of the outputs	
• with resistive load, max.	8 A
• on lamp load, max.	100 W
Load resistance range	
• lower limit	3 Ω
• upper limit	2 000 Ω

I/O systems

SIMATIC ET 200 systems for the control cabinet
SIMATIC ET 200SP

Fail-safe I/O modules > Special fail-safe modules

Technical specifications

Article number	6ES7136-6PA00-0BC0 ET 200SP, Powermod. F-PM-E PPM, 24V DC
Output voltage • for signal "1", min.	24 V; L+ (-0.5 V)
Output current • for signal "1" rated value • for signal "0" residual current, max.	8 A 1.5 mA; PP-switching: max. 1.5 mA; PM-switching: max. 1 mA
Switching frequency • with resistive load, max. • with inductive load, max. • on lamp load, max.	10 Hz; Symmetrical 0.1 Hz; according to IEC 60947-5-1, DC-13, symmetrical 4 Hz; Symmetrical
Total current of the outputs • Current per channel, max. • Current per module, max.	8 A; note derating data in the manual 8 A; note derating data in the manual
Cable length • shielded, max. • unshielded, max.	1 000 m 500 m
Interrupts/diagnostics/ status information	
Diagnostics function	Yes; See Chapter "Alarms/diagnostic messages" in the manual
Substitute values connectable	No
Alarms • Diagnostic alarm • Hardware interrupt	Yes No
Diagnostics indication LED • RUN LED • ERROR LED • Monitoring of the supply voltage (PWR-LED) • Channel status display • for channel diagnostics • for module diagnostics	Yes; green LED Yes; red LED Yes; green PWR LED Yes; green LED Yes; red LED Yes; green/red DIAG LED

Article number	6ES7136-6PA00-0BC0 ET 200SP, Powermod. F-PM-E PPM, 24V DC
Potential separation Potential separation channels • between the channels and backplane bus	Yes
Standards, approvals, certificates Suitable for safety functions	Yes
Highest safety class achievable in safety mode • Performance level according to ISO 13849-1 • SIL acc. to IEC 61508	PLe SIL 3
Probability of failure (for service life of 20 years and repair time of 100 hours) - Low demand mode: PFDavg in accordance with SIL2 - Low demand mode: PFDavg in accordance with SIL3 - High demand/continuous mode: PFH in accordance with SIL2 - High demand/continuous mode: PFH in accordance with SIL3	< 2.00E-04 < 2.00E-05 < 1.00E-08 1/h < 1.00E-09 1/h
Ambient conditions Ambient temperature during operation • horizontal installation, min. • horizontal installation, max. • vertical installation, min. • vertical installation, max.	0 °C 60 °C 0 °C 50 °C
Dimensions Width Height Depth	20 mm 73 mm 55 mm
Weights Weight, approx.	70 g

Overview



Fail-safe technology module:
F-TM Count, 1x1Vpp sin/cos High Feature for BU type A0,
color code CC00

Important properties:

- Technological, fail-safe counter module for ET 200SP
 - Certified up to SIL 3 (IEC 61508), PL e (ISO 13849)
 - 1x sin/cos interface for recording sin/cos differential encoder signals A, A', B, B', N and N'
 - Option to connect sin/cos differential encoders
 - Short-circuit-proof 5 V DC encoder supply
 - High-speed count input up to 200 kHz
 - Counting range: 32-bit (-2.147.483.648 to +2.147.483.647)
 - SW gate for counter control
- Measured values:
 - Speed
 - Frequency
 - Period duration
 - Integrated safety functions:
 - SOS (Safe Operation Stop)
 - SLS (Safely Limited Speed)
 - SDI (Safe Direction)
 - Can be plugged onto type A0 BaseUnits (BU)
 - LED display for error, operation, supply voltage and status
 - Monitoring of encoder signals for wire break, short-circuit and signal strength
 - Firmware update
 - Identification data I&M
 - Value status
 - Clear labeling on front of module
 - Plain text identification of the module type and function class
 - 2D matrix code (order and serial number)
 - Connection diagram
 - Hardware and firmware version
 - Color code CC for module-specific color coding of the potentials at the terminals of the BU
 - Complete Article No.
 - Optional labeling accessories:
 - Labeling strips
 - Equipment labeling plate
 - Optional module-specific color identification of the terminals according to the color code CC
 - Optional system-integrated shield connection
 - The modules support PROFIsafe in both PROFIBUS and PROFINET configurations. Can be used with all fail-safe SIMATIC S7 CPUs.

Ordering data

Fail-safe technology module
F-TM Count

1 x 1Vpp sin/cos High Feature,
BU type A0, color code CC00

Article No.

6ES7136-6CB00-0CA0

Spare parts

E-coding element type H
5 units, for ET 200SP F-AI 4xU,
F-TM Count, F-CM AS-i

6ES7193-6EH00-1AA0

Suitable BaseUnits

BU15-P16+A10+2D

BU type A0; BaseUnit (light) with
16 push-in terminals (1 ... 16)
to the module and an additional
10 internally jumpered
AUX terminals (1 A to 10 A);
for starting a new load group
(max. 10 A)

- Pack of 1 unit
- Pack of 10 units;
to order a pack, please order this
article number with an order
quantity of 10.

6ES7193-6BP20-0DA0
6ES7193-6BP20-2DA0

Article No.

BU15-P16+A0+2D

BU type A0; BaseUnit (light) with
16 push-in terminals to the module;
for starting a new load group
(max. 10 A)

- Pack of 1 unit
- Pack of 10 units;
to order a pack, please order this
article number with an order
quantity of 10.

6ES7193-6BP00-0DA0
6ES7193-6BP00-2DA0

BU15-P16+A10+2B

BU type A0; BaseUnit (dark) with
16 push-in terminals (1 ... 16)
to the module and an additional
10 internally jumpered
AUX terminals (1 A to 10 A);
for continuing the load group

- Pack of 1 unit
- Pack of 10 units;
to order a pack, please order this
article number with an order
quantity of 10.

6ES7193-6BP20-0BA0
6ES7193-6BP20-2BA0

BU15-P16+A0+2B

BU type A0; BaseUnit (dark) with
16 push-in terminals to the module;
for continuing the load group

- Pack of 1 unit
- Pack of 10 units;
to order a pack, please order this
article number with an order
quantity of 10.

6ES7193-6BP00-0BA0
6ES7193-6BP00-2BA0

I/O systemsSIMATIC ET 200 systems for the control cabinet
SIMATIC ET 200SP**Fail-safe I/O modules > Fail-safe technology modules**

Ordering data	Article No.	Ordering data	Article No.
Accessories		Equipment labeling plate	6ES7193-6LF30-0AW0
S7 Distributed Safety V5.4 SP5 Update 2 programming tool		10 sheets of 16 labels	
Task: Configuration software for configuring fail-safe user programs for SIMATIC S7-300F, S7-400F, WinAC RTX F, ET 200S, ET 200M, ET 200iSP, ET 200pro, ET 200eco, ET 200SP Requirement: Windows 7 SP1 (64-bit), Windows 10 Professional/Enterprise (64-bit), Windows Server 2008 R2 SP1 (64-bit), Windows Server 2012 R2 (64-bit), Windows Server 2016 (64-bit); STEP 7 as of V5.5 SP1; Please also consider the operating systems that have been released for the used STEP 7 version		Labeling strips	
Floating license for 1 user; software and documentation on DVD; license key on USB flash drive	6ES7833-1FC02-0YA5	500 labeling strips on roll, light gray, for inscription with thermal transfer roll printer	6ES7193-6LR10-0AA0
Floating license for 1 user; software, documentation and license key for download ¹⁾ ; Email address required for delivery	6ES7833-1FC02-0YH5	500 labeling strips on roll, yellow, for inscription with thermal transfer roll printer	6ES7193-6LR10-0AG0
S7 Distributed Safety upgrade		1 000 labeling strips DIN A4, light gray, card, for inscription with laser printer	6ES7193-6LA10-0AA0
From V5.x to V5.4; floating license for 1 user; software and documentation on DVD; license key on USB flash drive	6ES7833-1FC02-0YE5	1 000 labeling strips DIN A4, yellow, card, for inscription with laser printer	6ES7193-6LA10-0AG0
STEP 7 Safety Advanced V17		BU cover	
Task: Engineering tool for configuring and programming fail-safe user programs for SIMATIC S7-1200 FC, S7-1500F, S7-1500F Software Controller, S7-300F, S7-400F, WinAC RTX F, ET 200SP F Controller and the fail-safe I/O ET 200SP, ET 200MP, ET 200S, ET 200M, ET 200iSP, ET 200pro and ET 200eco Requirement: STEP 7 Professional V17 Note: As of TIA Portal V16, the SIMATIC STEP 7 Safety software is an integral component of the SIMATIC STEP 7 product setup. The functionality of SIMATIC STEP 7 Safety is activated by means of the license key supplied in each case.		For covering empty slots (gaps); 5 units	
Floating license for 1 user; license key on USB flash drive	6ES7833-1FA17-0YA5	• 15 mm wide	6ES7133-6CV15-1AM0
Floating license for 1 user; license key for download ¹⁾ ; Email address required for delivery	6ES7833-1FA17-0YH5	• 20 mm wide	6ES7133-6CV20-1AM0
		Shield connection	6ES7193-6SC00-1AM0
		5 shield supports and 5 shield terminals	
		Color-coded labels	
		• Color code CC01, module-specific, for 16 push-in terminals; for BaseUnit type A0, A1; 10 units	6ES7193-6CP01-2MA0
		• Color code CC01, module-specific, for 16 push-in terminals; for BaseUnit type A0, A1; 50 units	6ES7193-6CP01-4MA0
		• Color code CC71, for 10 AUX terminals 1 A to 10 A, for BU type A0, yellow/green, with push-in terminals; 10 units	6ES7193-6CP71-2AA0
		• Color code CC72, for 10 AUX terminals 1 A to 10 A, for BU type A0, red, with push-in terminals; 10 units	6ES7193-6CP72-2AA0
		• Color code CC73, for 10 AUX terminals 1 A to 10 A, for BU type A0, blue, with push-in terminals; 10 units	6ES7193-6CP73-2AA0

¹⁾ For up-to-date information and download availability, see:
<http://www.siemens.com/tia-online-software-delivery>

Technical specifications

Article number	6ES7136-6CB00-0CA0 F-TM Count 1x1Vpp sin/cos HF
General information	
Product type designation	F-TM Count 1x1Vpp sin/cos HF
Product function	
• I&M data	Yes; I&M0 to I&M3
Engineering with	
• STEP 7 TIA Portal configurable/ integrated from version	Step 7 V17 or higher: use GSDML for prior versions
Supply voltage	
Load voltage L+	
• Rated value (DC)	24 V
• Reverse polarity protection	Yes
Encoder supply	
5 V encoder supply	
• 5 V	Yes; 5.1 V ±3.5 %
• Short-circuit protection	Yes; Electronic overload protection; no protection on applying a normal or counter voltage.
• Output current, max.	300 mA
Digital inputs	
Number of digital inputs	1; (counter input)
Digital inputs, parameterizable	Yes
Digital input functions, parameterizable	
• Gate start/stop	Yes
• Counter for incremental encoder - Number, max.	Yes 1
Input voltage	
• Type of input voltage	sin/cos 1 Vpp
Input delay (for rated value of input voltage)	
• Minimum pulse width for program reactions	2.5 µs for parameterization "none"
for technological functions	
- parameterizable	Yes
Encoder	
Connectable encoders	
• Incremental encoder (symmetrical)	Yes; up to 200 kHz depending on cable type and length
Encoder signals, incremental encoder (symmetrical)	
• Input voltage	1 Vpp, centered at 2.5 V offset
• Input frequency, max.	200 kHz
• Counting frequency, max.	800 kHz; with quadruple evaluation
• Cable length, shielded, max.	150 m
• Incremental encoder with A/B tracks, 90° phase offset	Yes; sin/cos
• Incremental encoder with A/B tracks, 90° phase offset and zero track	Yes; sin/cos/zero

Article number	6ES7136-6CB00-0CA0 F-TM Count 1x1Vpp sin/cos HF
Interrupts/diagnostics/ status information	
Diagnostics function	Yes; see chapter "Diagnostic Messages" in the manual
Alarms	
• Diagnostic alarm	Yes
• Hardware interrupt	No
Diagnoses	
• Monitoring the supply voltage	Yes
• Wire-break	Yes
• Short-circuit	Yes
• A/B transition error at incremental encoder	Yes
Diagnostics indication LED	
• RUN LED	Yes; green LED
• ERROR LED	Yes; red LED
• Monitoring of the supply voltage (PWR-LED)	Yes; green LED
• Channel status display	Yes; green LED
• for channel diagnostics	Yes; red LED
• for module diagnostics	Yes; green/red DIAG LED
Integrated Functions	
Counter	Yes
• Number of counters	1
• Counting frequency, max.	800 kHz; with quadruple evaluation
Safety monitoring functions	
• Safe Operating Stop (SOS)	Yes
• Safely-Limited Speed (SLS)	Yes
• Safe Direction (SDI)	Yes
• Safe Speed Monitor (SSM)	Yes
Counting functions	
• Continuous counting	Yes
• Counter response parameterizable	Yes
• Software gate	Yes
• Counting range, parameterizable	Yes
Measuring functions	
Measuring range	
- Frequency measurement, min.	0.04 Hz
- Frequency measurement, max.	800 kHz; with quadruple evaluation
- Cycle duration measurement, min.	1 µs
- Cycle duration measurement, max.	25 s
- Velocity measurement, min.	0 (speed in configured units per selected time basis - speed*1 000)
- Velocity measurement, max.	2 147 483 (speed in configured units per selected time basis - speed*1 000)

I/O systemsSIMATIC ET 200 systems for the control cabinet
SIMATIC ET 200SP**Fail-safe I/O modules > Fail-safe technology modules****Technical specifications**

Article number	6ES7136-6CB00-0CA0 F-TM Count 1x1Vpp sin/cos HF
Accuracy	
- Frequency measurement	up to 100 ppm; depending on measuring interval and signal evaluation; at low frequency external noise may have an effect on accuracy (reference the graph in 2.2.3)
- Cycle duration measurement	up to 100 ppm; depending on measuring interval and signal evaluation; at low frequency external noise may have an effect on accuracy (reference the graph in 2.2.3)
- Velocity measurement	up to 100 ppm; depending on measuring interval and signal evaluation; at low frequency external noise may have an effect on accuracy (reference the graph in 2.2.3)
Potential separation	
Potential separation channels	
• between the channels and backplane bus	Yes
Standards, approvals, certificates	
Suitable for safety functions	Yes
Highest safety class achievable in safety mode	
• Performance level according to ISO 13849-1	Cat. 4, PLe
• SIL acc. to IEC 61508	SIL 3

Article number	6ES7136-6CB00-0CA0 F-TM Count 1x1Vpp sin/cos HF
Ambient conditions	
Ambient temperature during operation	
• horizontal installation, min.	0 °C
• horizontal installation, max.	60 °C
• vertical installation, min.	0 °C
• vertical installation, max.	55 °C
Altitude during operation relating to sea level	
• Ambient air temperature-barometric pressure-altitude	On request: Installation altitudes greater than 2 000 m
Dimensions	
Width	15 mm
Height	73 mm
Depth	58 mm
Weights	
Weight, approx.	42 g

Overview



Digital fail-safe input module:
F-DI 8x24 V DC High Feature for BU type A0, color code CC01

Important properties:

- 8-channel digital fail-safe input module for the ET 200SP
- For fail-safe reading of sensor information (1 or 2 channels)
- Provides integral discrepancy evaluation for 2-out-of-2 signals
- 8 internal sensor supplies (incl. test function) onboard
- Certified up to SIL 3 (IEC 61508), PL e (ISO 13849)
- Can be plugged into type A0 BaseUnits (BU) with automatic coding
- LED display for error, operation, supply voltage and status
- Clear labeling on front of module
 - Plain text identification of the module type and function class
 - 2D matrix code (order and serial number)
 - Connection diagram
 - Color coding of the module type DI: white
 - Hardware and firmware version
 - Color code CC for module-specific color coding of the potentials at the terminals of the BU
 - Complete Article No.
- Optional labeling accessories
 - Labeling strips
 - Equipment labeling plate
- Optional module-specific color identification of the terminals according to the color code CC
- Optional system-integrated shield connection
- The modules support PROFIsafe in both PROFIBUS and PROFINET configurations. Can be used with all fail-safe SIMATIC S7 CPUs.

Note:

SIPLUS extreme products are based on SIMATIC standard products. The contents listed here were taken from the corresponding standard products. SIPLUS extreme-specific information was added.

Ordering data

Article No.

SIPLUS digital F-input modules

(Extended temperature range and exposure to environmental substances)

F-DI 8x24VDC High Feature,
BU type A0, color code CC01

-30...+60 °C

6AG1136-6BA00-2CA0

-40...+60 °C

6AG1136-6BA01-2CA0

Usable BaseUnits**BU15-P16+A0+2D**

6AG1193-6BP00-7DA0

(Extended temperature range and exposure to environmental substances)

BU type A0; BaseUnit (light) with 16 process terminals to the module; for starting a new load group (max. 10 A)

BU15-P16+A0+2B

6AG1193-6BP00-7BA0

(Extended temperature range and exposure to environmental substances)

BU type A0; BaseUnit (dark) with 16 process terminals to the module; for continuing the load group

BU15-P16+A10+2D

6AG1193-6BP20-7DA0

(Extended temperature range and exposure to environmental substances)

BU type A0; BaseUnit (light) with 16 process terminals (1...16) to the module and an additional 10 internally jumpered AUX terminals (1 A to 10 A); for starting a new load group (max. 10 A)

BU15-P16+A10+2B

6AG1193-6BP20-7BA0

(Extended temperature range and exposure to environmental substances)

BU type A0; BaseUnit (dark) with 16 process terminals (1...16) to the module and an additional 10 internally jumpered AUX terminals (1 A to 10 A); for continuing the load group

Accessories**SIPLUS Mounting Kit ET 200SP**

6AG1193-6AA00-0AA0

Mounting accessories for use with increased mechanical vibration and shock loads.

Other accessories

See SIMATIC ET 200SP, digital F-input modules, page 10/186

I/O systemsSIMATIC ET 200 systems for the control cabinet
SIMATIC ET 200SP**Fail-safe I/O modules > SIPLUS digital F-input modules****Technical specifications**

Article number	6AG1136-6BA00-2CA0	6AG1136-6BA01-2CA0
Based on	6ES7136-6BA00-0CA0 SIPLUS ET 200SP F-DI 4/8x24VDC HF	6ES7136-6BA01-0CA0 SIPLUS ET 200SP F-DI 4/8x24VDC HF
Ambient conditions		
Ambient temperature during operation		
<ul style="list-style-type: none"> horizontal installation, min. horizontal installation, max. vertical installation, min. vertical installation, max. 	-30 °C; = Tmin (incl. condensation/frost) 60 °C; = Tmax; +70 °C with configured empty slots to the left and right of the module -30 °C; = Tmin 50 °C; = Tmax	-40 °C; = Tmin (incl. condensation/frost) 60 °C; = Tmax; +70 °C with configured empty slots to the left and right of the module -40 °C; = Tmin 50 °C; = Tmax
Altitude during operation relating to sea level		
<ul style="list-style-type: none"> Installation altitude above sea level, max. Ambient air temperature-barometric pressure-altitude 	4 000 m Restrictions for installation altitudes > 2 000 m, see entry ID: 109771992	4 000 m Restrictions for installation altitudes > 2 000 m, see entry ID: 109771992
Relative humidity		
<ul style="list-style-type: none"> With condensation, tested in accordance with IEC 60068-2-38, max. 	100 %; RH incl. condensation / frost (no commissioning in bedewed state), horizontal installation	100 %; RH incl. condensation / frost (no commissioning in bedewed state), horizontal installation
Resistance		
Coolants and lubricants		
<ul style="list-style-type: none"> Resistant to commercially available coolants and lubricants 	Yes; Incl. diesel and oil droplets in the air	Yes; Incl. diesel and oil droplets in the air
Use in stationary industrial systems		
<ul style="list-style-type: none"> to biologically active substances according to EN 60721-3-3 to chemically active substances according to EN 60721-3-3 to mechanically active substances according to EN 60721-3-3 Against mechanical environmental conditions acc. to EN 60721-3-3 	Yes; Class 3B2 mold, fungus and dry rot spores (with the exception of fauna); Class 3B3 on request Yes; Class 3C4 (RH < 75 %) incl. salt spray acc. to EN 60068-2-52 (severity degree 3); * Yes; Class 3S4 incl. sand, dust, * Yes; Class 3M8 using the SIPLUS Mounting Kit ET 200SP (6AG1193-6AA00-0AA0)	Yes; Class 3B2 mold, fungus and dry rot spores (with the exception of fauna); Class 3B3 on request Yes; Class 3C4 (RH < 75 %) incl. salt spray acc. to EN 60068-2-52 (severity degree 3); * Yes; Class 3S4 incl. sand, dust, * Yes; Class 3M8 using the SIPLUS Mounting Kit ET 200SP (6AG1193-6AA00-0AA0)
Use on land craft, rail vehicles and special-purpose vehicles		
<ul style="list-style-type: none"> Against mechanical environmental conditions acc. to EN 60721-3-5 against mechanical environmental conditions in agriculture acc. to ISO 15003 	Yes; Class 5M2 using the SIPLUS Mounting Kit ET 200SP (6AG1193-6AA00-0AA0) Yes; level 1 (Location LE) using the SIPLUS Mounting Kit ET 200SP (6AG1193-6AA00-0AA0)	Yes; Class 5M2 using the SIPLUS Mounting Kit ET 200SP (6AG1193-6AA00-0AA0) Yes; level 1 (Location LE) using the SIPLUS Mounting Kit ET 200SP (6AG1193-6AA00-0AA0)
Use on ships/at sea		
<ul style="list-style-type: none"> to biologically active substances according to EN 60721-3-6 to chemically active substances according to EN 60721-3-6 to mechanically active substances according to EN 60721-3-6 Against mechanical environmental conditions acc. to EN 60721-3-6 	Yes; Class 6B2 mold, fungal and dry rot spores (excluding fauna) Yes; Class 6C3 (RH < 75 %) incl. salt spray acc. to EN 60068-2-52 (severity degree 3); * Yes; Class 6S3 incl. sand, dust; * Yes; Class 6M4 using the SIPLUS Mounting Kit ET 200SP (6AG1193-6AA00-0AA0)	Yes; Class 6B2 mold, fungal and dry rot spores (excluding fauna) Yes; Class 6C3 (RH < 75 %) incl. salt spray acc. to EN 60068-2-52 (severity degree 3); * Yes; Class 6S3 incl. sand, dust; * Yes; Class 6M4 using the SIPLUS Mounting Kit ET 200SP (6AG1193-6AA00-0AA0)
Usage in industrial process technology		
<ul style="list-style-type: none"> Against chemically active substances acc. to EN 60654-4 Environmental conditions for process, measuring and control systems acc. to ANSI/ISA-71.04 	Yes; Class 3 (excluding trichlorethylene) Yes; Level GX group A/B (excluding trichlorethylene; harmful gas concentrations up to the limits of EN 60721-3-3 class 3C4 permissible); level LC3 (salt spray) and level LB3 (oil)	Yes; Class 3 (excluding trichlorethylene) Yes; Level GX group A/B (excluding trichlorethylene; harmful gas concentrations up to the limits of EN 60721-3-3 class 3C4 permissible); level LC3 (salt spray) and level LB3 (oil)
Remark		
<ul style="list-style-type: none"> Note regarding classification of environmental conditions acc. to EN 60721, EN 60654-4 and ANSI/ISA-71.04 	* The supplied plug covers must remain in place over the unused interfaces during operation!	* The supplied plug covers must remain in place over the unused interfaces during operation!

Technical specifications

Article number	6AG1136-6BA00-2CA0	6AG1136-6BA01-2CA0
Based on	6ES7136-6BA00-0CA0	6ES7136-6BA01-0CA0
Based on	SIPLUS ET 200SP F-DI 4/8x24VDC HF	SIPLUS ET 200SP F-DI 4/8x24VDC HF
Conformal coating		
• Coatings for printed circuit board assemblies acc. to EN 61086	Yes; Class 2 for high reliability	Yes; Class 2 for high reliability
• Protection against fouling acc. to EN 60664-3	Yes; Type 1 protection	Yes; Type 1 protection
• Military testing according to MIL-I-46058C, Amendment 7	Yes; Discoloration of coating possible during service life	Yes; Discoloration of coating possible during service life
• Qualification and Performance of Electrical Insulating Compound for Printed Board Assemblies according to IPC-CC-830A	Yes; Conformal coating, Class A	Yes; Conformal coating, Class A

I/O systems

SIMATIC ET 200 systems for the control cabinet
SIMATIC ET 200SP

Fail-safe I/O modules > SIPLUS digital F-output modules

Overview



Digital fail-safe output module:
F-DQ 4x24VDC High Feature, BU type A0, color code CC01

Important properties:

- 4-channel digital fail-safe output module for the ET 200SP
- Fail-safe 2-channel activation (switching to P/M potential) of actuators
- Actuators can be controlled up to 2 A
- Certified up to SIL 3 (IEC 61508), PL e (ISO 13849)
- Can be plugged into type A0 BaseUnits (BU) with automatic coding
- LED display for error, operation, supply voltage and status
- Clear labeling on front of module
 - Plain text identification of the module type and function class
 - 2D matrix code (order and serial number)
 - Connection diagram
 - Color coding of the module type DI: white
 - Hardware and firmware version
 - Color code CC for module-specific color coding of the potentials at the terminals of the BU
 - Complete Article No.
- Optional labeling accessories
 - Labeling strips
 - Equipment labeling plate
- Optional module-specific color identification of the terminals according to the color code CC
- Optional system-integrated shield connection
- The modules support PROFI-safe in both PROFIBUS and PROFINET configurations
- They can be used with all fail-safe SIMATIC S7 CPUs

Note:

SIPLUS extreme products are based on SIMATIC standard products. The contents listed here were taken from the corresponding standard products. SIPLUS extreme-specific information was added.

Ordering data

Article No.

SIPLUS digital F-output modules

(Extended temperature range and exposure to environmental substances)

F-DQ 4x24VDC High Feature, BU type A0, color code CC01

6AG1136-6DB00-2CA0

F-DQ 8x24VDC High Feature, switching to PP potential, BU type A0, color code CC01

6AG1136-6DC00-2CA0

Suitable BaseUnits

BU15-P16+A0+2D

(Extended temperature range and exposure to environmental substances)

BU type A0; BaseUnit (light) with 16 push-in terminals to the module; for starting a new load group (max. 10 A)

6AG1193-6BP00-7DA0

BU15-P16+A0+2B

(Extended temperature range and exposure to environmental substances)

BU type A0; BaseUnit (dark) with 16 push-in terminals to the module; for continuing the load group

6AG1193-6BP00-7BA0

BU15-P16+A10+2D

(Extended temperature range and exposure to environmental substances)

BU type A0; BaseUnit (light) with 16 push-in terminals (1 ... 16) to the module and an additional 10 internally jumpered AUX terminals (1 A to 10 A); for starting a new load group (max. 10 A)

6AG1193-6BP20-7DA0

BU15-P16+A10+2B

(Extended temperature range and exposure to environmental substances)

BU type A0; BaseUnit (dark) with 16 push-in terminals (1 ... 16) to the module and an additional 10 internally jumpered AUX terminals (1 A to 10 A); for continuing the load group

6AG1193-6BP20-7BA0

BU20-P12+A4+0B

(Extended temperature range and exposure to environmental substances)

BU type B0; BaseUnit (dark) with 12 process terminals (1...12) to the module and an additional 4 internally jumpered AUX terminals (1 A to 4 A); for continuing the load group; 1 unit

6AG1193-6BP20-7BB0

Accessories

SIPLUS Mounting Kit ET 200SP

Mounting accessories for use with increased mechanical vibration and shock loads.

6AG1193-6AA00-0AA0

Other accessories

See SIMATIC ET 200SP, digital F-output modules, page 10/189

Technical specifications

Article number	6AG1136-6DB00-2CA0	6AG1136-6DC00-2CA0
Based on	6ES7136-6DB00-0CA0	6ES7136-6DC00-0CA0
	SIPLUS ET 200SP F-DQ 4x24VDC/2A PM HF	SIPLUS ET 200SP F-DQ 8x24VDC/0.5A PP HF
Ambient conditions		
Ambient temperature during operation		
<ul style="list-style-type: none"> horizontal installation, min. horizontal installation, max. vertical installation, min. vertical installation, max. 	-30 °C; = Tmin (incl. condensation/frost) 60 °C; = Tmax; +70 °C with configured empty slots to the left and right of the module -30 °C; = Tmin 50 °C; = Tmax	-30 °C; = Tmin (incl. condensation/frost) 60 °C; = Tmax; +70 °C with configured empty slots to the left and right of the module -30 °C; = Tmin 50 °C; = Tmax
Altitude during operation relating to sea level		
<ul style="list-style-type: none"> Installation altitude above sea level, max. Ambient air temperature-barometric pressure-altitude 	4 000 m Restrictions for installation altitudes > 2 000 m, see entry ID: 109771992	4 000 m Restrictions for installation altitudes > 2 000 m, see entry ID: 109771992
Relative humidity		
<ul style="list-style-type: none"> With condensation, tested in accordance with IEC 60068-2-38, max. 	100 %; RH incl. condensation / frost (no commissioning in bedewed state), horizontal installation	100 %; RH incl. condensation / frost (no commissioning in bedewed state), horizontal installation
Resistance		
Coolants and lubricants		
<ul style="list-style-type: none"> Resistant to commercially available coolants and lubricants 	Yes; Incl. diesel and oil droplets in the air	Yes; Incl. diesel and oil droplets in the air
Use in stationary industrial systems		
<ul style="list-style-type: none"> to biologically active substances according to EN 60721-3-3 to chemically active substances according to EN 60721-3-3 to mechanically active substances according to EN 60721-3-3 Against mechanical environmental conditions acc. to EN 60721-3-3 	Yes; Class 3B2 mold, fungus and dry rot spores (with the exception of fauna); Class 3B3 on request Yes; Class 3C4 (RH < 75 %) incl. salt spray acc. to EN 60068-2-52 (severity degree 3); * Yes; Class 3S4 incl. sand, dust, * Yes; Class 3M8 using the SIPLUS Mounting Kit ET 200SP (6AG1193-6AA00-0AA0)	Yes; Class 3B2 mold, fungus and dry rot spores (with the exception of fauna); Class 3B3 on request Yes; Class 3C4 (RH < 75 %) incl. salt spray acc. to EN 60068-2-52 (severity degree 3); * Yes; Class 3S4 incl. sand, dust, * Yes; Class 3M8 using the SIPLUS Mounting Kit ET 200SP (6AG1193-6AA00-0AA0)
Use on land craft, rail vehicles and special-purpose vehicles		
<ul style="list-style-type: none"> Against mechanical environmental conditions acc. to EN 60721-3-5 against mechanical environmental conditions in agriculture acc. to ISO 15003 	Yes; Class 5M2 using the SIPLUS Mounting Kit ET 200SP (6AG1193-6AA00-0AA0) Yes; level 1 (Location LE) using the SIPLUS Mounting Kit ET 200SP (6AG1193-6AA00-0AA0)	Yes; Class 5M2 using the SIPLUS Mounting Kit ET 200SP (6AG1193-6AA00-0AA0) Yes; level 1 (Location LE) using the SIPLUS Mounting Kit ET 200SP (6AG1193-6AA00-0AA0)
Use on ships/at sea		
<ul style="list-style-type: none"> to biologically active substances according to EN 60721-3-6 to chemically active substances according to EN 60721-3-6 to mechanically active substances according to EN 60721-3-6 Against mechanical environmental conditions acc. to EN 60721-3-6 	Yes; Class 6B2 mold, fungal and dry rot spores (excluding fauna) Yes; Class 6C3 (RH < 75 %) incl. salt spray acc. to EN 60068-2-52 (severity degree 3); * Yes; Class 6S3 incl. sand, dust; * Yes; Class 6M4 using the SIPLUS Mounting Kit ET 200SP (6AG1193-6AA00-0AA0)	Yes; Class 6B2 mold, fungal and dry rot spores (excluding fauna) Yes; Class 6C3 (RH < 75 %) incl. salt spray acc. to EN 60068-2-52 (severity degree 3); * Yes; Class 6S3 incl. sand, dust; * Yes; Class 6M4 using the SIPLUS Mounting Kit ET 200SP (6AG1193-6AA00-0AA0)

I/O systems

SIMATIC ET 200 systems for the control cabinet

SIMATIC ET 200SP

Fail-safe I/O modules > SIPLUS digital F-output modules**Technical specifications**

Article number	6AG1136-6DB00-2CA0	6AG1136-6DC00-2CA0
Based on	6ES7136-6DB00-0CA0 SIPLUS ET 200SP F-DQ 4x24VDC/2A PM HF	6ES7136-6DC00-0CA0 SIPLUS ET 200SP F-DQ 8x24VDC/0.5A PP HF
Usage in industrial process technology		
- Against chemically active substances acc. to EN 60654-4	Yes; Class 3 (excluding trichlorethylene)	Yes; Class 3 (excluding trichlorethylene)
- Environmental conditions for process, measuring and control systems acc. to ANSI/ISA-71.04	Yes; Level GX group A/B (excluding trichlorethylene; harmful gas concentrations up to the limits of EN 60721-3-3 class 3C4 permissible); level LC3 (salt spray) and level LB3 (oil)	Yes; Level GX group A/B (excluding trichlorethylene; harmful gas concentrations up to the limits of EN 60721-3-3 class 3C4 permissible); level LC3 (salt spray) and level LB3 (oil)
Remark		
- Note regarding classification of environmental conditions acc. to EN 60721, EN 60654-4 and ANSI/ISA-71.04	* The supplied plug covers must remain in place over the unused interfaces during operation!	* The supplied plug covers must remain in place over the unused interfaces during operation!
Conformal coating		
• Coatings for printed circuit board assemblies acc. to EN 61086	Yes; Class 2 for high reliability	Yes; Class 2 for high reliability
• Protection against fouling acc. to EN 60664-3	Yes; Type 1 protection	Yes; Type 1 protection
• Military testing according to MIL-I-46058C, Amendment 7	Yes; Discoloration of coating possible during service life	Yes; Discoloration of coating possible during service life
• Qualification and Performance of Electrical Insulating Compound for Printed Board Assemblies according to IPC-CC-830A	Yes; Conformal coating, Class A	Yes; Conformal coating, Class A

Overview



The digital F-electronic module relay 1 F-RQ DC 24VDC/24.230VAC/5 A has the following characteristics:

- 1 relay output (2 NO contacts)
- Total output current 5 A
- Rated load voltage 24 V DC and 24 ... 230 V AC
- The control circuit of the two safety relays must be routed from the outside to the respective terminals.

The attainable safety integrity level is SIL 3 (IEC 61508) when the control of the F-RQ module is implemented via a fail-safe output (e.g. ET 200SP 4F-DQ 24 V DC/2 A PROFIsafe).

Note:

SIPLUS extreme products are based on SIMATIC standard products. The contents listed here were taken from the respective standard products. SIPLUS extreme-specific information was added.

Ordering data

Article No.

SIPLUS Digital F-output module relay 1 F-RQ

(Extended temperature range and exposure to environmental substances)

BU type F0, relay output (2 NO contacts), total output current 5 A, load voltages 24 V DC and 24 ... 230 V AC; can be used up to SIL3/Category 4/PL e if controlled via F-DQ

6AG1136-6RA00-2BF0**Suitable BaseUnits****BU20-P8+A4+0B**

(Extended temperature range and exposure to environmental substances)

BU type F0; BaseUnit (dark) with 8 process terminals to the module and an additional 4 internally jumpered AUX terminals (1 A to 4 A); for continuing the load group

6AG1193-6BP20-2BF0**Accessories**

See SIMATIC ET 200SP, digital F-output module relay, page 10/192

I/O systems

SIMATIC ET 200 systems for the control cabinet
SIMATIC ET 200SP

Fail-safe I/O modules > SIPLUS digital F-output module relay

Technical specifications

Article number	6AG1136-6RA00-2BF0
Based on	6ES7136-6RA00-0BF0 SIPLUS ET 200SP F-RQ 24VDC/24-230VAC/5A
Ambient conditions	
Ambient temperature during operation	
• horizontal installation, min.	-30 °C; = Tmin (incl. condensation/frost)
• horizontal installation, max.	60 °C; = Tmax; +70 °C with configured empty slots to the left and right of the module
• vertical installation, min.	-30 °C; = Tmin
• vertical installation, max.	50 °C; = Tmax
Altitude during operation relating to sea level	
• Installation altitude above sea level, max.	2 000 m
• Ambient air temperature-barometric pressure-altitude	Tmin ... Tmax at 1 140 hPa ... 795 hPa (-1 000 m ... +2 000 m)
Relative humidity	
• With condensation, tested in accordance with IEC 60068-2-38, max.	100 %; RH incl. condensation / frost (no commissioning in bedewed state), horizontal installation
Resistance	
Coolants and lubricants	
- Resistant to commercially available coolants and lubricants	Yes; Incl. diesel and oil droplets in the air
Use in stationary industrial systems	
- to biologically active substances according to EN 60721-3-3	Yes; Class 3B2 mold, fungus and dry rot spores (with the exception of fauna); Class 3B3 on request
- to chemically active substances according to EN 60721-3-3	Yes; Class 3C4 (RH < 75 %) incl. salt spray acc. to EN 60068-2-52 (severity degree 3); *
- to mechanically active substances according to EN 60721-3-3	Yes; Class 3S4 incl. sand, dust, *
Use on ships/at sea	
- to biologically active substances according to EN 60721-3-6	Yes; Class 6B2 mold, fungal and dry rot spores (excluding fauna)
- to chemically active substances according to EN 60721-3-6	Yes; Class 6C3 (RH < 75 %) incl. salt spray acc. to EN 60068-2-52 (severity degree 3); *
- to mechanically active substances according to EN 60721-3-6	Yes; Class 6S3 incl. sand, dust; *

Article number	6AG1136-6RA00-2BF0
Based on	6ES7136-6RA00-0BF0 SIPLUS ET 200SP F-RQ 24VDC/24-230VAC/5A
Usage in industrial process technology	
- Against chemically active substances acc. to EN 60654-4	Yes; Class 3 (excluding trichlorethylene)
- Environmental conditions for process, measuring and control systems acc. to ANSI/ISA-71.04	Yes; Level GX group A/B (excluding trichlorethylene; harmful gas concentrations up to the limits of EN 60721-3-3 class 3C4 permissible); level LC3 (salt spray) and level LB3 (oil)
Remark	
- Note regarding classification of environmental conditions acc. to EN 60721, EN 60654-4 and ANSI/ISA-71.04	* The supplied plug covers must remain in place over the unused interfaces during operation!
Conformal coating	
• Coatings for printed circuit board assemblies acc. to EN 61086	Yes; Class 2 for high reliability
• Protection against fouling acc. to EN 60664-3	Yes; Type 1 protection
• Military testing according to MIL-I-46058C, Amendment 7	Yes; Discoloration of coating possible during service life
• Qualification and Performance of Electrical Insulating Compound for Printed Board Assemblies according to IPC-CC-830A	Yes; Conformal coating, Class A

Overview



Analog fail-safe input modules:
SIPLUS F-AI 4xI 0(4) ... 20 mA 2/4-wire High Feature for
BU type A0 and A1, color code CC00

SIPLUS F-AI 4xU 0..10V High Feature
for BU type A0 and A1, color code CC00

Important properties:

- 4 analog inputs with galvanic isolation between channels and backplane bus (up to SIL 3/Cat. 4/PL d)
- Short-circuit-proof power supply of 2 or 4-wire transducers
- Measuring ranges: 0 ... 20 mA and 4 ... 20 mA
- Resolution: 16 bits including sign
- Certified up to SIL 3 (IEC 61508), PL e (ISO 13849)
- Can be plugged onto type A0 and A1 BaseUnits (BU)

- LED display for error, operation, supply voltage and status
- Interference frequency suppression, smoothing
- Diagnostics: wire break, short-circuit, high/low limit violation
- Firmware update
- Identification data I&M
- Value status
- Clear labeling on front of module
 - Plain text identification of the module type and function class
 - 2D matrix code (order and serial number)
 - Connection diagram
 - Color coding of the module type DI: white
 - Hardware and firmware version
 - Color code CC for module-specific color coding of the potentials at the terminals of the BU
 - Complete Article No.
- Optional labeling accessories
 - Labeling strips
 - Equipment labeling plate
- Optional module-specific color identification of the terminals according to the color code CC
- Optional system-integrated shield connection
- The modules support PROFIsafe in both PROFIBUS and PROFINET configurations. Can be used with all fail-safe SIMATIC S7 CPUs.

Note:

SIPLUS extreme products are based on SIMATIC standard products. The contents listed here were taken from the corresponding standard products. SIPLUS extreme-specific information was added.

Ordering data

SIPLUS analog F-input module

(Extended temperature range and exposure to environmental substances)

F-AI 4xI 0(4) ... 20 mA 2/4-wire High Feature, BU type A0, A1, color code CC00

6AG1136-6AA00-2CA1

F-AI 4xU 0..10V High Feature, BU-type A0, A1, color code CC00

6AG1136-6AB00-2CA1

Usable BaseUnits**BU15-P16+A10+2D**

(Extended temperature range and exposure to environmental substances)

BU type A0; BaseUnit (light) with 16 process terminals (1...16) to the module and an additional 10 internally jumpered AUX terminals (1 A to 10 A); for starting a new load group (max. 10 A)

6AG1193-6BP20-7DA0

BU15-P16+A0+2D

(Extended temperature range and exposure to environmental substances)

BU type A0; BaseUnit (light) with 16 process terminals to the module; for starting a new load group (max. 10 A)

6AG1193-6BP00-7DA0

BU15-P16+A10+2B

(Extended temperature range and exposure to environmental substances)

BU type A0; BaseUnit (dark) with 16 process terminals (1...16) to the module and an additional 10 internally jumpered AUX terminals (1 A to 10 A); for continuing the load group

6AG1193-6BP20-7BA0

BU15-P16+A0+2B

(Extended temperature range and exposure to environmental substances)

BU type A0; BaseUnit (dark) with 16 process terminals to the module; for continuing the load group

6AG1193-6BP00-7BA0

BU15-P16+A0+12D/T

(Extended temperature range and exposure to environmental substances)

BU type A1; BaseUnit (light) with 16 process terminals (1...16) to the module and also 2x5 internally jumpered additional terminals (1 B to 5 B and 1 C to 5 C); for starting a new load group (max. 10 A)

6AG1193-6BP40-7DA1

I/O systemsSIMATIC ET 200 systems for the control cabinet
SIMATIC ET 200SP**Fail-safe I/O modules > SIPLUS analog F-input modules**

Ordering data	Article No.	Ordering data	Article No.
BU15-P16+A0+2D/T (Extended temperature range and exposure to environmental substances) BU type A1; BaseUnit (light) with 16 process terminals to the module; for starting a new load group (max. 10 A)	6AG1193-6BP00-7DA1	BU15-P16+A0+2B/T (Extended temperature range and exposure to environmental substances) BU type A1; BaseUnit (dark) with 16 process terminals to the module; for continuing the load group	6AG1193-6BP00-7BA1
BU15-P16+A0+12B/T (Extended temperature range and exposure to environmental substances) BU type A1; BaseUnit (dark) with 16 process terminals (1...16) to the module and also 2x5 internally jumpered additional terminals (1 B to 5 B and 1 C to 5 C); for continuing the load group	6AG1193-6BP40-7BA1	Accessories SIPLUS Mounting Kit ET 200SP Mounting accessories for use with increased mechanical vibration and shock loads.	6AG1193-6AA00-0AA0
		Other accessories	See SIMATIC ET 200SP, analog F-input modules, page 10/195

Technical specifications

Article number	6AG1136-6AA00-2CA1	6AG1136-6AB00-2CA1
Based on	6ES7136-6AA00-0CA1 SIPLUS ET 200SP F-AI 4x1 2-/4-wire HF	6ES7136-6AB00-0CA1 SIPLUS ET 200SP F-AI 4xU 0..10V HF
Ambient conditions		
Ambient temperature during operation		
• horizontal installation, min.	-30 °C; = Tmin (incl. condensation/frost)	-30 °C; = Tmin (incl. condensation/frost)
• horizontal installation, max.	60 °C; = Tmax; +70 °C with configured empty slots to the left and right of the module	60 °C; = Tmax; +70 °C with configured empty slots to the left and right of the module
• vertical installation, min.	-30 °C; = Tmin	-30 °C; = Tmin
• vertical installation, max.	50 °C; = Tmax	50 °C; = Tmax
Altitude during operation relating to sea level		
• Installation altitude above sea level, max.	4 000 m	4 000 m
• Ambient air temperature-barometric pressure-altitude	Restrictions for installation altitudes > 2 000 m, see entry ID: 109771992	Restrictions for installation altitudes > 2 000 m, see entry ID: 109771992
Relative humidity		
• With condensation, tested in accordance with IEC 60068-2-38, max.	100 %; RH incl. condensation / frost (no commissioning in bedewed state), horizontal installation	100 %; RH incl. condensation / frost (no commissioning in bedewed state), horizontal installation
Resistance		
Coolants and lubricants		
- Resistant to commercially available coolants and lubricants	Yes; Incl. diesel and oil droplets in the air	Yes; Incl. diesel and oil droplets in the air
Use in stationary industrial systems		
- to biologically active substances according to EN 60721-3-3	Yes; Class 3B2 mold, fungus and dry rot spores (with the exception of fauna); Class 3B3 on request	Yes; Class 3B2 mold, fungus and dry rot spores (with the exception of fauna); Class 3B3 on request
- to chemically active substances according to EN 60721-3-3	Yes; Class 3C4 (RH < 75 %) incl. salt spray acc. to EN 60068-2-52 (severity degree 3); *	Yes; Class 3C4 (RH < 75 %) incl. salt spray acc. to EN 60068-2-52 (severity degree 3); *
- to mechanically active substances according to EN 60721-3-3	Yes; Class 3S4 incl. sand, dust, *	Yes; Class 3S4 incl. sand, dust, *
- Against mechanical environmental conditions acc. to EN 60721-3-3	Yes; Class 3M8 using the SIPLUS Mounting Kit ET 200SP (6AG1193-6AA00-0AA0)	Yes; Class 3M8 using the SIPLUS Mounting Kit ET 200SP (6AG1193-6AA00-0AA0)
Use on land craft, rail vehicles and special-purpose vehicles		
- Against mechanical environmental conditions acc. to EN 60721-3-5	Yes; Class 5M2 using the SIPLUS Mounting Kit ET 200SP (6AG1193-6AA00-0AA0)	Yes; Class 5M2 using the SIPLUS Mounting Kit ET 200SP (6AG1193-6AA00-0AA0)
- against mechanical environmental conditions in agriculture acc. to ISO 15003	Yes; level 1 (Location LE) using the SIPLUS Mounting Kit ET 200SP (6AG1193-6AA00-0AA0)	Yes; level 1 (Location LE) using the SIPLUS Mounting Kit ET 200SP (6AG1193-6AA00-0AA0)

Technical specifications

Article number	6AG1136-6AA00-2CA1	6AG1136-6AB00-2CA1
Based on	6ES7136-6AA00-0CA1 SIPLUS ET 200SP F-AI 4xI 2-/4-wire HF	6ES7136-6AB00-0CA1 SIPLUS ET 200SP F-AI 4xU 0..10V HF
Use on ships/at sea		
- to biologically active substances according to EN 60721-3-6	Yes; Class 6B2 mold, fungal and dry rot spores (excluding fauna)	Yes; Class 6B2 mold, fungal and dry rot spores (excluding fauna)
- to chemically active substances according to EN 60721-3-6	Yes; Class 6C3 (RH < 75 %) incl. salt spray acc. to EN 60068-2-52 (severity degree 3); *	Yes; Class 6C3 (RH < 75 %) incl. salt spray acc. to EN 60068-2-52 (severity degree 3); *
- to mechanically active substances according to EN 60721-3-6	Yes; Class 6S3 incl. sand, dust; *	Yes; Class 6S3 incl. sand, dust; *
- Against mechanical environmental conditions acc. to EN 60721-3-6	Yes; Class 6M4 using the SIPLUS Mounting Kit ET 200SP (6AG1193-6AA00-0AA0)	Yes; Class 6M4 using the SIPLUS Mounting Kit ET 200SP (6AG1193-6AA00-0AA0)
Usage in industrial process technology		
- Against chemically active substances acc. to EN 60654-4	Yes; Class 3 (excluding trichlorethylene)	Yes; Class 3 (excluding trichlorethylene)
- Environmental conditions for process, measuring and control systems acc. to ANSI/ISA-71.04	Yes; Level GX group A/B (excluding trichlorethylene; harmful gas concentrations up to the limits of EN 60721-3-3 class 3C4 permissible); level LC3 (salt spray) and level LB3 (oil)	Yes; Level GX group A/B (excluding trichlorethylene; harmful gas concentrations up to the limits of EN 60721-3-3 class 3C4 permissible); level LC3 (salt spray) and level LB3 (oil)
Remark		
- Note regarding classification of environmental conditions acc. to EN 60721, EN 60654-4 and ANSI/ISA-71.04	* The supplied plug covers must remain in place over the unused interfaces during operation!	* The supplied plug covers must remain in place over the unused interfaces during operation!
Conformal coating		
• Coatings for printed circuit board assemblies acc. to EN 61086	Yes; Class 2 for high reliability	Yes; Class 2 for high reliability
• Protection against fouling acc. to EN 60664-3	Yes; Type 1 protection	Yes; Type 1 protection
• Military testing according to MIL-I-46058C, Amendment 7	Yes; Discoloration of coating possible during service life	Yes; Discoloration of coating possible during service life
• Qualification and Performance of Electrical Insulating Compound for Printed Board Assemblies according to IPC-CC-830A	Yes; Conformal coating, Class A	Yes; Conformal coating, Class A

I/O systems

SIMATIC ET 200 systems for the control cabinet
SIMATIC ET 200SP

Fail-safe I/O modules > SIPLUS special fail-safe modules

Overview



Digital fail-safe power module:
F-PM-E PPM 24 V DC/8 A for BU type C0,
color code CC52

Important properties:

- Certified up to SIL 3 (IEC 61508), PL e (ISO 13849)
- Safety-related shutdown of output modules within the potential group of the F-PM-E
- Two fail-safe digital inputs, for reading of sensor information (1 or 2 channels)
- One fail-safe digital output onboard (switching to PPM potential, up to 2 A, up to SIL 3/PL e)
- Fail-safe digital output and potential supply switching to PP or PM potential can be parameterized

- Parameterizable onboard evaluation of the fail-safe inputs for control of the fail-safe digital outputs and of the potential group
- Digital standard output modules can be shut down up to PL d (ISO 13849) and SIL 2 (IEC61508) (up to 8 A).
- Can be plugged into type C0 BaseUnits (BU) with automatic coding
- LED display for error, operation, supply voltage and status
- Clear labeling on front of module
 - Plain text identification of the module type and function class
 - 2D matrix code (order and serial number)
 - Connection diagram
 - Color coding of the module type DI: white
 - Hardware and firmware version
 - Color code CC for module-specific color coding of the potentials at the terminals of the BU
 - Complete Article No.
- Optional labeling accessories
 - Labeling strips
 - Equipment labeling plate
- Optional module-specific color identification of the terminals according to the color code CC
- Optional system-integrated shield connection
- The modules support PROFIsafe in both PROFIBUS and PROFINET configurations.
- Can be used with all fail-safe SIMATIC S7 CPUs.

Note:

SIPLUS extreme products are based on SIMATIC standard products. The contents listed here were taken from the corresponding standard products. SIPLUS extreme-specific information was added.

Ordering data

Article No.

SIPLUS digital F-power module F-PM-E 24VDC/8A PPM Standard

6AG1136-6PA00-2BC0

(Extended temperature range and exposure to environmental substances)

BU type C0, color code CC52.
2 inputs, 1 output,
SIL3/Cat.4/PL e

Type C0 BaseUnits

BU20-P6+A2+4D

6AG1193-6BP20-7DC0

(Extended temperature range and exposure to environmental substances)

BU type C0; BaseUnit (light) with
6 push-in terminals (1...6)
to the module and 2 AUX terminals;
new load group

Article No.

Accessories

SIPLUS Mounting Kit ET 200SP

6AG1193-6AA00-0AA0

Mounting accessories for use with increased mechanical vibration and shock loads.

Other accessories

See SIMATIC ET 200SP,
special fail-safe modules,
page 10/199

Technical specifications

Article number	6AG1136-6PA00-2BC0	Article number	6AG1136-6PA00-2BC0
Based on	6ES7136-6PA00-0BC0 SIPLUS ET 200SP F-PM-E 24VDC/8A PPM	Based on	6ES7136-6PA00-0BC0 SIPLUS ET 200SP F-PM-E 24VDC/8A PPM
Ambient conditions		Use on ships/at sea	
Ambient temperature during operation		- to biologically active substances according to EN 60721-3-6 Yes; Class 6B2 mold, fungal and dry rot spores (excluding fauna)	
• horizontal installation, min.	-30 °C; = Tmin (incl. condensation/frost)	- to chemically active substances according to EN 60721-3-6 Yes; Class 6C3 (RH < 75 %) incl. salt spray acc. to EN 60068-2-52 (severity degree 3); *	
• horizontal installation, max.	60 °C; = Tmax; +70 °C with configured empty slots to the left and right of the module	- to mechanically active substances according to EN 60721-3-6 Yes; Class 6S3 incl. sand, dust; *	
• vertical installation, min.	-30 °C; = Tmin	- Against mechanical environmental conditions acc. to EN 60721-3-6 Yes; Class 6M4 using the SIPLUS Mounting Kit ET 200SP (6AG1193-6AA00-0AA0)	
• vertical installation, max.	50 °C; = Tmax	Usage in industrial process technology	
Altitude during operation relating to sea level		- Against chemically active substances acc. to EN 60654-4 Yes; Class 3 (excluding trichlorethylene)	
• Installation altitude above sea level, max.	4 000 m	- Environmental conditions for process, measuring and control systems acc. to ANSI/ISA-71.04 Yes; Level GX group A/B (excluding trichlorethylene; harmful gas concentrations up to the limits of EN 60721-3-3 class 3C4 permissible); level LC3 (salt spray) and level LB3 (oil)	
• Ambient air temperature-barometric pressure-altitude	Restrictions for installation altitudes > 2 000 m, see entry ID: 109771992	Remark	
Relative humidity		- Note regarding classification of environmental conditions acc. to EN 60721, EN 60654-4 and ANSI/ISA-71.04 * The supplied plug covers must remain in place over the unused interfaces during operation!	
• With condensation, tested in accordance with IEC 60068-2-38, max.	100 %; RH incl. condensation / frost (no commissioning in bedewed state), horizontal installation	Conformal coating	
Resistance		• Coatings for printed circuit board assemblies acc. to EN 61086 Yes; Class 2 for high reliability	
Coolants and lubricants		• Protection against fouling acc. to EN 60664-3 Yes; Type 1 protection	
- Resistant to commercially available coolants and lubricants	Yes; Incl. diesel and oil droplets in the air	• Military testing according to MIL-I-46058C, Amendment 7 Yes; Discoloration of coating possible during service life	
Use in stationary industrial systems		• Qualification and Performance of Electrical Insulating Compound for Printed Board Assemblies according to IPC-CC-830A Yes; Conformal coating, Class A	
- to biologically active substances according to EN 60721-3-3	Yes; Class 3B2 mold, fungus and dry rot spores (with the exception of fauna); Class 3B3 on request		
- to chemically active substances according to EN 60721-3-3	Yes; Class 3C4 (RH < 75 %) incl. salt spray acc. to EN 60068-2-52 (severity degree 3); *		
- to mechanically active substances according to EN 60721-3-3	Yes; Class 3S4 incl. sand, dust, *		
- Against mechanical environmental conditions acc. to EN 60721-3-3	Yes; Class 3M8 using the SIPLUS Mounting Kit ET 200SP (6AG1193-6AA00-0AA0)		
Use on land craft, rail vehicles and special-purpose vehicles			
- Against mechanical environmental conditions acc. to EN 60721-3-5	Yes; Class 5M2 using the SIPLUS Mounting Kit ET 200SP (6AG1193-6AA00-0AA0)		
- against mechanical environmental conditions in agriculture acc. to ISO 15003	Yes; level 1 (Location LE) using the SIPLUS Mounting Kit ET 200SP (6AG1193-6AA00-0AA0)		

I/O systems

SIMATIC ET 200 systems for the control cabinet
SIMATIC ET 200SP

Fail-safe modules > Fail-safe communication > F-CM AS-i Safety ST for SIMATIC ET 200SP

Overview



F-CM AS-i Safety ST for SIMATIC ET 200SP

More information

SIMATIC ET200SP Manual Collection, see
<https://support.industry.siemens.com/cs/ww/en/view/84133942>

Diagnostics blocks with visualization, see
<https://support.industry.siemens.com/cs/ww/en/view/109479103>

Released combinations of the AS-i modules for ET 200SP, see
<https://support.industry.siemens.com/cs/ww/en/view/103624653>

AS-Interface I/O modules and other AS-Interface system components
see Catalog IC 10, www.siemens.com/ic10

More information see www.siemens.com/as-interface

The F-CM AS-i Safety ST fail-safe communications module supplements an AS-Interface network without additional wiring to produce a safety-related AS-i network.

Important features:

- Fail-safe communications module for the ET 200SP
 - 31 fail-safe input channels in the process image
 - 16 fail-safe output channels in the process image
 - Certified up to SIL 3 (IEC 62061)/PL e (ISO 13849-1)
 - Parameterization conforms with other fail-safe I/O modules of the ET 200SP
- The communications module supports PROFINET and PROFIBUS configurations. Can be used with fail-safe SIMATIC S7-300F, S7-400F CPUs and S7-1500F CPUs and also the fail-safe versions of the ET 200SP station with ET 200SP F-CPU 1510SP F / 1512SP F or 1515SP PC F.
- For reading up to 31 fail-safe AS-i input slaves
 - Two sensor inputs/signals for each fail-safe AS-i input slave
 - Adjustable evaluation of sensor signals: 2-channel or 2 x 1-channel
 - Integrated discrepancy evaluation in the case of 2-channel signals
 - Integrated AND operation in the case of 2 x 1-channel signals
 - Input delay can be parameterized
 - Start-up test can be set
 - Sequence monitoring can be activated

- For control of up to 16 fail-safe AS-i output circuit groups
 - The output circuit groups are controlled independently of one another.
 - One output circuit group can act on one or more actuators (e.g. to switch drives simultaneously).
 - The F-CM AS-i Safety ST module sends the switching command of the output circuit group to the AS-i cable. A fail-safe AS-i output module installed anywhere on the AS-i cable receives the switching command and switches the actuator (e.g. contactor) connected to it.
 - Simple fault acknowledgment via the process image
- Simple module replacement thanks to automatic importing of the safety parameters from the coding element
- Comprehensive diagnostic options
- Can be plugged onto type C1 or type C0 BaseUnits (BU)
- Informative automatic alarm indications
- Supply via AS-Interface voltage
- Eight LED displays for diagnostics, operating state, fault indication and supply voltage
- Informative front-side module inscription
 - Plain-text marking of the module type and function class
 - 2D matrix code (Article No. and serial number)
 - Circuit diagram
 - Color coding module type communications module: light gray
 - Hardware and firmware version
 - Supported BaseUnit type BU: C1, C0

Design

The fail-safe F-CM AS-i Safety ST module has an ET 200SP module enclosure with a width of 20 mm.

One AS-i master according to the AS-i specification V3.0 and safe AS-i input slaves and/or safe AS-i output modules are needed for operation. The CM AS-i Master ST communications module (Article No. 3RK7137-6SA00-0BC1) is recommended as the AS-i master for the ET 200SP, see from page 10/153.

Simple combination of the CM AS-i Master ST and F-CM AS-i Safety ST modules in one ET 200SP station results in a powerful, safety-related router between PROFINET (or PROFIBUS) and AS-Interface, which can be expanded further in a modular fashion.

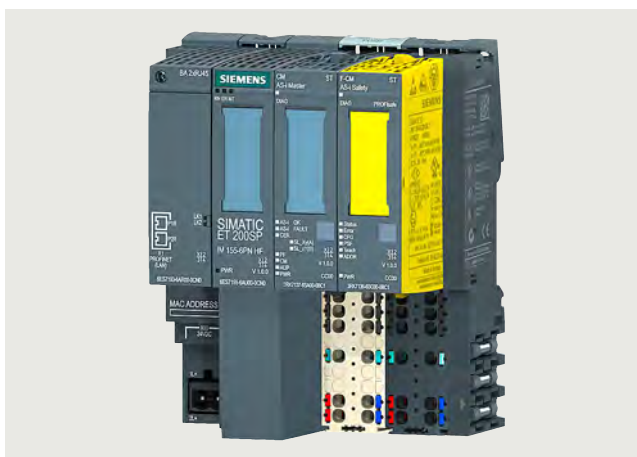

Combination of an ET 200SP interface module, CM AS-i Master ST and F-CM AS-i Safety ST

Overview

With the digital and analog I/O modules of the ET 200SP, additional local inputs and outputs can be realized so as to ensure that the modular AS-i gateway complies precisely with customer requirements. Expansion variants for almost every application are possible thanks to the selection of standard and fail-safe I/O modules.

Besides the single AS-i master, double, triple or generally multiple masters can be realized with or without fail-safe functionality.

Supported BaseUnits

With the combination of the CM AS-i Master ST and F-CM AS-i Safety ST modules, the CM module is plugged onto a light type C0 BaseUnit and, immediately to the right of it, the F-CM module is plugged onto a dark type C1 BaseUnit. The AS-i cable is connected only on the light BaseUnit of the CM module.

Notes on security

In order to protect plants, systems, machines and networks against cyber threats, it is necessary to implement – and continuously maintain – a holistic, state-of-the-art industrial security concept. Siemens products and solutions represent only one component of such a concept.

For more information about the subject of Industrial Security, see www.siemens.com/industrialsecurity.

Configuration

The following software is required for configuration of the F-CM AS-i Safety ST module:

- STEP 7 (TIA Portal) and Safety Advanced or
- STEP 7 (Classic) and Distributed Safety or F-Configuration Pack SP11 or SIMATIC S7 F/FH systems

Configuration and programming are done entirely in the STEP 7 user interface. No additional configuration software is needed for commissioning.

Data management – together with all other configuration data of the SIMATIC – is realized completely in the S7 project.

The input and output channels are assigned to the process image automatically and manual linking via configuration blocks is not necessary.

If the F-CM AS-i Safety ST module is replaced, all necessary settings are automatically imported into the new module.

The F-CM AS-i Safety ST module occupies 16 input bytes and 8 output bytes in the I/O data of the ET 200SP station.

For diagnostics during ongoing operation, diagnostics blocks with clearly arranged visualization on the SIMATIC HMI panel are available or can be downloaded free of charge via a web browser, see <https://support.industry.siemens.com/cs/ww/en/view/109479103>.



Diagnostics block for F-CM AS-i Safety ST

I/O systems

SIMATIC ET 200 systems for the control cabinet
SIMATIC ET 200SP

Fail-safe modules > Fail-safe communication > F-CM AS-i Safety ST for SIMATIC ET 200SP

Application

Thanks to use of the fail-safe module in the ET 200SP, it is possible to fulfill the safety-related application requirements in a manner that is integrated in the overall automation solution.

The safety functions required for fail-safe operation are integrated in the modules. Communication with the fail-safe SIMATIC S7 CPUs is realized via PROFIsafe.

The safety application is programmed in the SIMATIC S7 F-CPU with Distributed Safety, S7 F/FH Systems or Safety Advanced. The fail-safe input signals of the ASIsafe slave modules are read via the AS-i bus line and are combined with any chosen further signals in the fail-safe program.

The fail-safe output signals can be output via safe SIMATIC output modules or also directly via safe AS-i output modules. No special functions are required for this in the program.

Operation with SINUMERIK 840D sl is possible with SINUMERIK software version V4.7 SP2 HF1 or higher.

Together with an ET 200SP station with ET 200SP F-CPU 1510SP F, 1512SP F or 1515SP PC F, pre-processing of safe AS-i signals directly in the ET 200SP station is possible, as well as the configuration of an autonomous AS-i Safety station without a higher-level CPU.

Configuration examples of AS-Interface networks with CM AS-i Master ST and F-CM AS-i Safety ST for SIMATIC ET 200SP

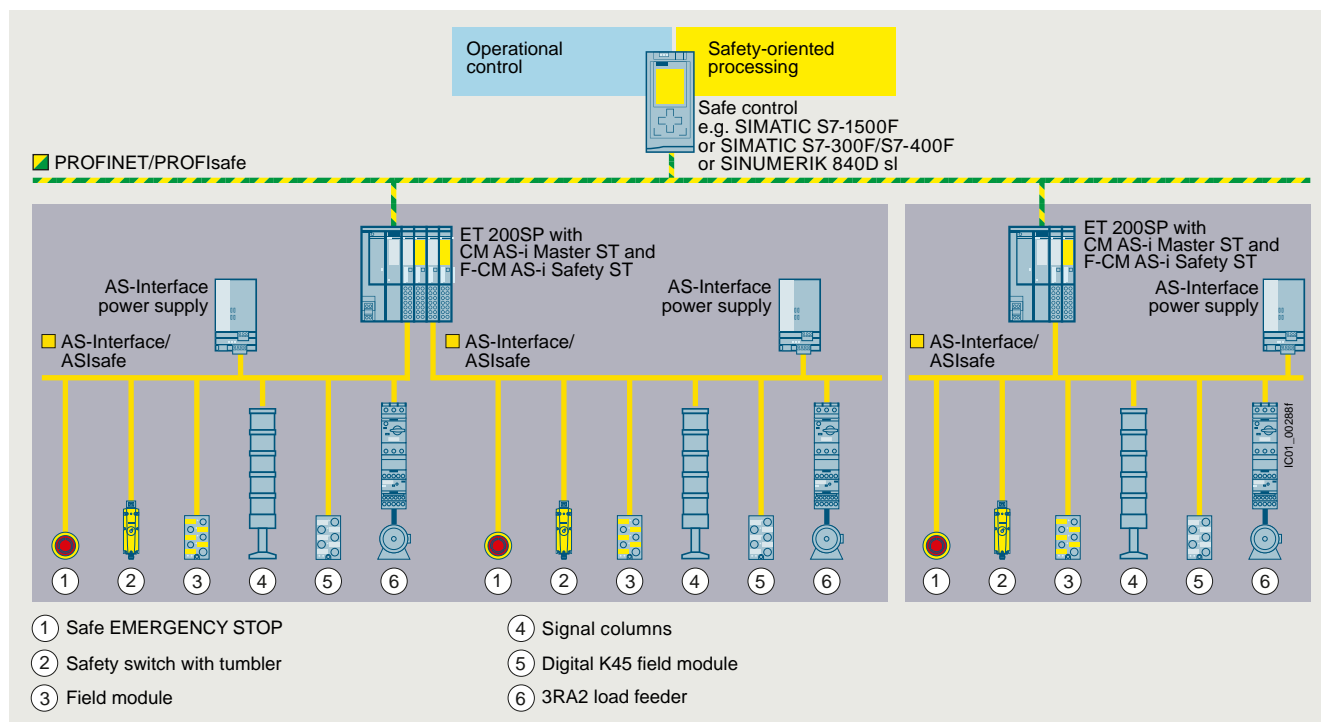

AS-Interface configuration comprising an ET 200SP station with CM AS-i Master ST and F-CM AS-i Safety ST modules

Ordering data

Article No.

Article No.

F-CM AS-i Safety ST communications module

3RK7136-6SC00-0BC1

- Fail-safe module for SIMATIC ET 200SP, can be plugged onto BaseUnit type C1 (alternatively type C0)
- Operation requires an AS-i master, e.g. CM AS-i Master ST, see from page 10/153
- Can be used up to SIL 3 (IEC 62061)/PL e (ISO 13849-1)
- Coding element type H (included in scope of supply)
- Dimensions (W x H x D) mm: 20 x 73 x 58

Accessories

BaseUnit BU20-P6+A2+4B

- BaseUnit (dark), BU type C1
- Suitable for the F-CM AS-i Safety ST failsafe module
- Continuation of an AS-i network, connection with the AS-i voltage of the left-hand module
- With spring-loaded terminals

6ES7193-6BP20-0BC1

Coding element type H (spare part)

- For the ET 200SP modules F-CM AS-i Safety ST and CM 4xIO-Link
- With spring-loaded terminals
- Packing unit 5 items

6ES7193-6EH00-1AA0

More accessories

see CM AS-i Master ST communications module, page 10/156

Overview



ET200SP_Ex_IO_mitPM

The intrinsically safe ET 200SP HA Ex I/O modules extend the SIMATIC ET 200SP HA and SIMATIC ET 200SP distributed I/O systems with the option of integrating devices located in hazardous areas (intrinsically safe sensors, actuators and HART field devices) into the system.

The ET 200SP HA Ex I/O modules with device protection according to intrinsic safety "i" offer channel outputs in Zone 0 or 1. 2-channel HART analog input and output modules and 2/4-channel digital input and output modules with different characteristic curves as well as a power module for intrinsically safe power supply of the modules.

Separate Ex isolators with correspondingly complex wiring and high space requirements are no longer required. The I/O modules can be installed up to ATEX Zone 2 and offer intrinsically safe circuits in Ex ia design for field devices up to Zone 0.

The Ex modules offer channel diagnostics and Configuration in Run and are approved for ambient temperatures from -40 to +70 °C.

Ordering data

Article No.

Ex digital modules SIMATIC ET 200SP HA	
Digital Ex-i input module, Ex-DI 4xNAMUR	6DL1131-6TD00-0HX1
Suitable for BaseUnit Type X1, channel diagnostics	
Digital Ex-i output module Ex-DQ 2x23,1VDC/20 mA	6DL1132-6EB00-0HX1
Suitable for BaseUnit Type X1, channel diagnostics	
Digital Ex-i output module Ex-DQ 2x17,4VDC/27 mA	6DL1132-6CB00-0HX1
Suitable for BaseUnit Type X1, channel diagnostics	
Ex analog modules SIMATIC ET 200SP HA	
Analog Ex-i HART input module, Ex-AI 2xI 2-wire HART	6DL1134-6TB00-0HX1
Suitable for BaseUnit Type X1, channel diagnostics, 16 bits, +/-0.3%	
Analog Ex-i input module, Ex-AI 4xTC/2xRTD 2-/3-/4-wire	6DL1134-6JD00-0HX1
Suitable for BaseUnit Type X1, channel diagnostics, 16 bits, +/-0.05%	
Analog Ex-i HART output module, Ex-AQ 2xI HART HF	6DL1135-6TB00-0HX1
Suitable for BaseUnit Type X1, channel diagnostics, 16 bits, +/-0.3%	
Power module and BaseUnits	
Power module Ex-PM E	6DL1133-6PX00-0HW0
24 V 0.8 A, W x H: 50 mm x 117 mm, suitable for BaseUnit Type W0	
BU Type X1 for I/O modules	6DL1193-6BP00-0BX1
Push-in terminals, W x H: 20 mm x 117 m	
BU Type W0 for Ex power module PM-E	6DL1193-6BP00-0DW0
W x H: 50 mm x 117 mm	

10

Technical specifications

Technical specifications see ET 200SP HA, Ex I/O modules, page 10/280

I/O systems

SIMATIC ET 200 systems for the control cabinet
SIMATIC ET 200SP

ET 200SP motor starters

Overview

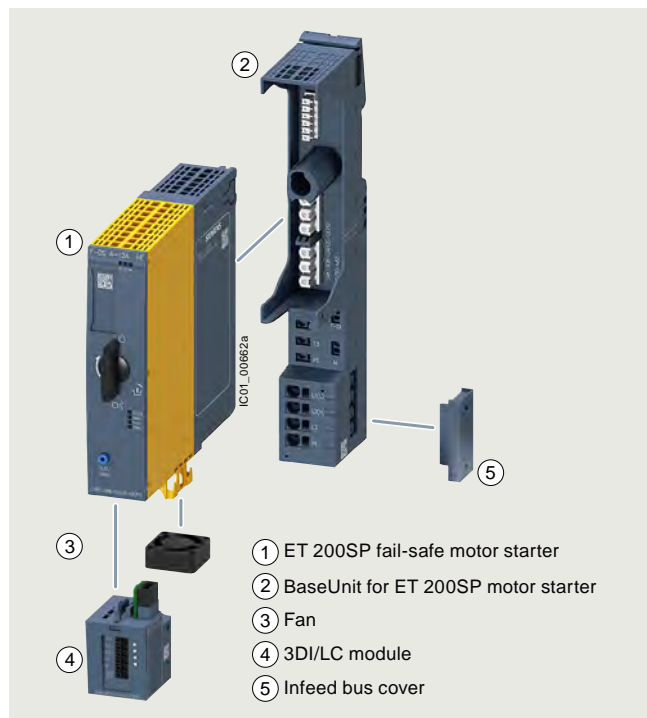

Motor starter, BaseUnit, fan and 3DI/LC control module

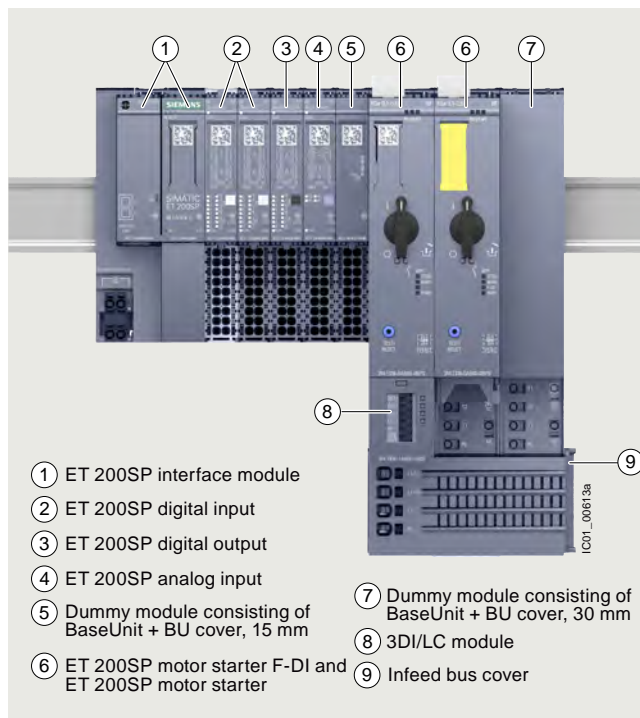

3RK1308 motor starter in the ET 200SP I/O system

More information

Homepage see www.siemens.com/sirius-motorstarter-et200sp

Industry Mall see www.siemens.com/product?3RK1308

TIA Selection Tool see www.siemens.com/TST

Further components in the ET 200SP I/O system see page 10/5

or www.siemens.com/et200sp

Catalog IC 10 see www.siemens.com/ic10

ET 200SP motor starters

ET 200SP is a scalable and extremely flexible modular I/O system with IP20 degree of protection.

As I/O modules, the ET 200SP motor starters are an integral part of this I/O system. They are switching and protection devices for single- and three-phase loads and are available as direct-on-line or reversing starters.



Video: SIMATIC ET 200SP motor starter - Flexible, powerful, compact

Basic functionality

All versions of the ET 200SP motor starter feature the following functionality:

- Fully pre-wired motor starters for switching and protecting any AC loads up to 5.5 kW from 48 V AC to 500 V AC
- Disconnection possible via fail-safe motor starters up to SIL 3 and PL e Cat. 4
- With self-assembling 32 A power bus, i.e. the load voltage is only fed in once for a group of motor starters
- All control supply voltages connected only once, i.e. when modules are added they are automatically connected to the next module
- Hot swapping is permissible

- Digital inputs can optionally be used via a 3DI/LC module
- Control of the motor starter from the control system and diagnostics status via the cyclic process image
- Diagnostics capability for active monitoring of the switching and protection functions
- The signal states in the process image of the motor starter provide information about protective devices (short circuit or overload), the switching states of the motor starter, and system faults.

Starter Kit

The 3RK1908-1SK00 Starter Kit is a favorably priced complete package for switching and monitoring motors in the ET 200SP system, see page 10/230.

It contains:

- a 3RK1308-0BC00-0CP0 reversing starter (0.9 to 3 A)
- a 3RK1908-0AP00-0AP0 BaseUnit with 500 V and 24 V AC/DC infeed
- an EMC distance module (consisting of 6ES7193-6BP00-0BA0 BaseUnit plus 6ES7133-6CV15-1AM0 BU cover 15 mm)

Use of fan

For motor starters with a 12 A rated current, the 3RW4928-8VB00 fan is included in the scope of supply.

This fan can also be ordered as an option for motor starters with lower rated currents, if the boundary conditions demand this. For information on the ambient conditions for the use of motor starters, see chapter "Product overview" in the Equipment Manual.

Designing interference-free motor starters

For interference-free operation of the ET 200SP station in accordance with IEC 60947-4-2 standard, use a dummy module before the first motor starter. The dummy module consists of the 6ES7193-6BP00-0BA0 or 6ES7193-6BP00-0DA0 BaseUnit and the 6ES7133-6CV15-1AM0 BU cover 15 mm.

The 15 mm BU cover protects the plug contacts of the BaseUnit against dirt.

Electromechanical switching devices in series with hybrid motor starters

Switching an inductive load - in particular of motors <1 kW with high inductance - with an electromechanical switching device (e.g. contactor) can cause high and steep voltage edges.

The resulting faults/damage can be prevented by first disconnecting with the hybrid motor starter or by using EMC suppression modules:

- For 3RT2916-1P.. EMC suppression modules for direct mounting on the contactor, see <https://mall.industry.siemens.com/mall/en/WWW/Catalog/Products/10047575>
- For motor suppression modules that are fitted in the main circuit, see page 10/230

Note:

For more information, see <https://support.industry.siemens.com/cs/ww/en/view/109758696>.

3DI/LC control module



3DI/LC control module

This is a digital input module with three inputs for local motor starter functions such as "manual local control", "implementation of fast inputs" or "end position disconnection". For a list of all the functions permitted by the 3DI/LC module, see chapter "Overview of functions" in the Equipment Manual.

The module is plugged into the front of the motor starter from which it is supplied with a 24 V DC operating voltage.

BaseUnits for motor starters

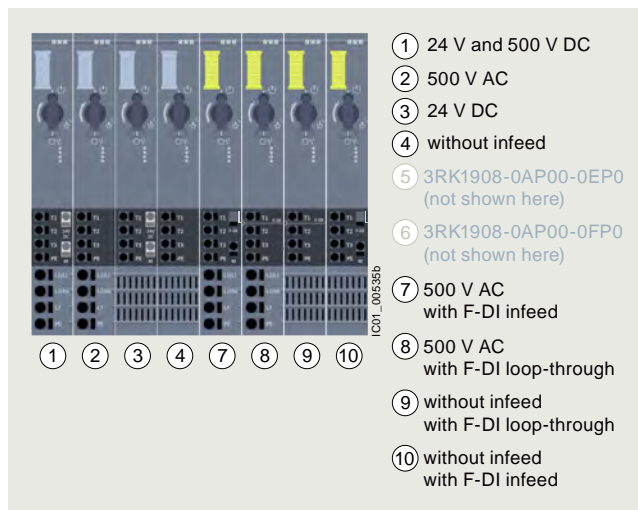

View of the BaseUnit infeeds for the motor starters

BaseUnits are components for accommodating the ET 200SP I/O modules.

The self-assembling voltage buses integrated into the BaseUnits reduce wiring outlay to the single infeed (both of auxiliary and load voltage).

All modules following on the right are automatically supplied upon plugging the BaseUnits together, if BaseUnits are inserted with routing.

The rugged design and keyed connection technology enables use in harsh industrial conditions.

The BaseUnits are available with various infeeds for the motor starters.

I/O systems

SIMATIC ET 200 systems for the control cabinet
SIMATIC ET 200SP

ET 200SP motor starters

Article No. scheme

Product versions		Article number	
Motor starters		3RK1308 - 0 □ □ 0 0 - 0 C P 0	
Product function	Direct-on-line starters	A	For motor standard output 0.09 ... 5.5 kW ¹⁾
	Reversing starters	B	For motor standard output 0.09 ... 5.5 kW ¹⁾
	Fail-safe direct-on-line starters	C	For motor standard output 0.09 ... 5.5 kW ¹⁾
	Fail-safe reversing starters	D	For motor standard output 0.09 ... 5.5 kW ¹⁾
Current range	0.1 ... 0.4 A	A	Maximum current-carrying capacity when starting 4 A
	0.3 ... 1 A	B	Maximum current-carrying capacity when starting 10 A
	0.9 ... 3 A	C	Maximum current-carrying capacity when starting 30 A
	2.8 ... 9 A	D	Maximum current-carrying capacity when starting 90 A
	4 ... 12 A	E	Including fan (3RW4928-8VB00), maximum current-carrying capacity when starting 100 A

Example **3RK1308 - 0 A D 0 0 - 0 C P 0**

¹⁾ For standard motors: Single- or three-phase asynchronous motors, single-phase asynchronous motors, single-phase asynchronous motors, at 400 V AC and 500 V AC; the actual startup characteristics of the motor as well as its rated data are important factors here.

Product versions		Article number	
BaseUnit		3RK1908 - 0 A P 0 0 - 0 □ P 0	
BU infeed	24 V and 500 V AC	A	
	24 V DC	B	
	500 V AC	C	
	without infeed	D	with F-DI infeed
	500 V AC	G	with F-DI loop-through
	500 V AC	H	with F-DI loop-through
	without infeed	J	with F-DI infeed
	without infeed	K	with F-DI infeed

Example **3RK1908 - 0 A P 0 0 - 0 A P 0**

Note:

The Article No. schemes show an overview of product versions for better understanding of the logic behind the article numbers.

For your orders, please use the article numbers quoted in the selection and ordering data.

Benefits

The ET 200SP motor starters offer a number of advantages:

- Fully integrated into the ET 200SP I/O system (including TIA Selection Tool and TIA Portal)
- High degree of flexibility when it comes to safety applications via SIMATIC F-CPU or 3SK safety relays up to SIL 3 and PL e Cat.4
- Simple, integrated current value transmission
- Extensive parameterization by means of TIA Portal
- Increase of plant availability through fast replacement of units (easy mounting and plug-in technology)
- Greater endurance and reduced heat losses thanks to hybrid technology
- Less space required in the control cabinet (20 to 80%) as a result of greater functional density (direct-on-line and reversing starters in same width)
- Extensive diagnostics and information for preventive maintenance
- Parameterizable inputs via 3DI/LC control module
- Less wiring and testing required as a result of integrating several functions into a single device
- Lower overheads for stock keeping and configuration as a result of the wide setting range of the electronic overload release (up to 1:3)
- Technology has lower inherent power losses than speed-controlled drive systems, so that less cooling (and smaller footprint) are possible

- The ET 200SP motor starters can be used with highly energy-efficient IE3/IE4 motors, [see Application manual](#). Take the current characteristics of the connected motor and motor starter into account when dimensioning. In addition to the rated current, the maximum permissible current range of the motor starter and the ratio of the rated current to the starting current of the motor are relevant. For more information on IE3/IE4, [see Catalog IC 10](#).

Standards and approvals

- IEC/EN 60947-4-2
- UL 60947-4-2
- CSA
- ATEX
- IEC62061: SIL 3
- ISO 13849-1: PL e
- CCC approval for China

Application

The ET 200SP motor starters are suitable for the following applications:

- Switching and monitoring of
 - 3-phase motors with overload and short-circuit protection (e.g. 400 V asynchronous motors for secondary drives in conveyor systems)
 - 1-phase motors with overload and short-circuit protection (e.g. 230 V motors for pump applications)
 - Resistive loads by means of current value and diagnostics via the maintenance function (e.g. for heaters)
- Plant monitoring and energy management in conveyor systems:
By means of phase asymmetry and zero current detection, for example, it is possible to monitor drive belts and blocking.

- Track switching and lifting table control in conveyor systems: Track switches can be implemented by means of the quick stop function and lifting table controls by means of the "immediate end position disconnection" function without any laborious programming.
- Safe isolation of drive from main power supply:
- The isolating functions in accordance with IEC 60947-1 offer protection against inadvertent activation during plant maintenance.

Motor starters in the process industry

For the ET 200SP motor starters, special 3RK1908-0AP00-0.H0 BaseUnits are available that enable the device to be used in the ET 200SP HA I/O system, too. This is typically used in process engineering applications.

For more information, see <https://mall.industry.siemens.com/mall/ww/en/Catalog/Products/10398144?tree=CatalogTree>.

Technical specifications

More information	
Industry Mall see www.siemens.com/product?3RK1308	FAQs see https://support.industry.siemens.com/cs/ww/en/ps/21800/faq
Equipment manual see https://support.industry.siemens.com/cs/ww/en/view/109479973	

Motor starter ET 200SP

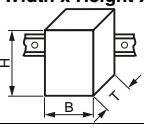
Article number	3RK1308-0.A00-0CP0	3RK1308-0.B00-0CP0	3RK1308-0.C00-0CP0	3RK1308-0.D00-0CP0	3RK1308-0.E00-0CP0	
product category	Motorstarter					
General technical data						
Width x Height x Depth	mm	30 × 142 × 150				
						
design of the switching contact		Hybrid				
type of the motor protection		solid-state				
installation altitude at height above sea level	m	4 000, For derating see manual				
mounting position		Vertical, horizontal (observe derating)				
fastening method		pluggable in BaseUnit				
ambient temperature						
• during operation	°C	-25 ... +60				
• during transport	°C	-40 ... +70				
• during storage	°C	-40 ... +70				
relative humidity during operation	%	10 ... 95				
vibration resistance		15 mm to 6 Hz; 2g to 500 Hz				
shock resistance		6 g / 11 ms				
protection class IP on the front acc. to IEC 60529		IP20				
touch protection on the front acc. to IEC 60529		finger-safe				
type of assignment		1				
Electrical data						
supply voltage at DC rated value	V	24				
operating power at AC-53a at 400 V rated value	kW	0.12	0.25	1.1	4	5.5
operating frequency rated value	Hz	50 ... 60				
breaking capacity maximum short-circuit current (I_{cu})						
• at 400 V rated value	kA	55				
• at 500 V rated value	kA	55				
adjustable current response value current of the current-dependent overload release	A	0.1 ... 0.4	0.3 ... 1	0.9 ... 3	2.8 ... 9	4 ... 12
ampacity when starting maximum	A	4	10	30	90	100
maximum permissible voltage for safe isolation between main and auxiliary circuit	V	500				
insulation voltage rated value	V	500				
trip class		CLASS OFF / 5 / 10 adjustable				

I/O systems

SIMATIC ET 200 systems for the control cabinet
SIMATIC ET 200SP

ET 200SP motor starters

BaseUnits for motor starter

Article number	3RK1908-0AP00-0AP0	3RK1908-0AP00-0BP0	3RK1908-0AP00-0CP0 3RK1908-0AP00-0GP0 3RK1908-0AP00-0HP0	3RK1908-0AP00-0DP0 3RK1908-0AP00-0JP0 3RK1908-0AP00-0KP0
product category	BaseUnit			
General technical data				
Width x Height x Depth mm	30 × 215 × 75			
ambient temperature				
• during operation	°C	-25 ... +60		
• during transport	°C	-40 ... +70		
• during storage	°C	-40 ... +70		
protection class IP on the front acc. to IEC 60529	IP20			
touch protection on the front acc. to IEC 60529	finger-safe			
Connections/ Terminals				
type of connectable conductor cross-sections				
• at the inputs for supply voltage				
- solid	1 x 0.5 ... 2.5 mm ²			--
- finely stranded with core end processing	1 x 0.5 ... 2.5 mm ²			--
- finely stranded without core end processing	1 x 0.5 ... 2.5 mm ²			--
- at AWG cables solid	1 x 20 ... 12			--
• for supply				
- solid	1 x 1 ... 6 mm ²	--	1 x 1 ... 6 mm ²	--
- finely stranded with core end processing	1 x 1 ... 6 mm ²	--	1 x 1 ... 6 mm ²	--
- finely stranded without core end processing	1 x 1 ... 6 mm ²	--	1 x 1 ... 6 mm ²	--
- at AWG cables solid	1 x 18 ... 10	--	1 x 18 ... 10	--
• for load-side outgoing feeder				
- solid	1 x 0.5 ... 2.5 mm ²			
- finely stranded with core end processing	1 x 0.5 ... 2.5 mm ²			
- finely stranded without core end processing	1 x 0.5 ... 2.5 mm ²			
- at AWG cables solid	1 x 20 ... 12			
type of electrical connection for auxiliary and control circuit	spring-loaded terminals (push-in)			
Miscellaneous				
shape of the screwdriver tip	Slot			
size of the screwdriver tip	Standard screwdriver 0.6 mm x 3.5 mm			

3DI/LC control module

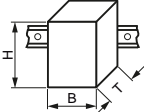
Article number	3RK1908-1AA00-0BP0	
product designation	3DI/LC control module	
General technical data		
Width x Height x Depth	mm	30 × 54.5 × 42.3
		
design of the product	Accessories	
number of digital inputs	4	
installation altitude at height above sea level maximum	m	2 000
mounting position	vertical, horizontal, flat	
fastening method	Can be plugged onto motor starters	
ambient temperature		
• during operation	°C	-25 ... +60
• during transport	°C	-40 ... +70
• during storage	°C	-40 ... +70
Connections/ Terminals		
connectable conductor cross-section for auxiliary contacts		
• solid or stranded	mm ²	0.2 ... 1.5
• finely stranded with core end processing	mm ²	0.25 ... 1.5
• finely stranded without core end processing	mm ²	0.2 ... 1,5
AWG number as coded connectable conductor cross section for auxiliary contacts	24 ... 16	
type of electrical connection for auxiliary and control circuit	spring-loaded terminals (push-in)	
Electrical data		
type of voltage of the control supply voltage	DC	
control supply voltage at DC rated value	V	20.4 ... 28.8
Sonstiges		
shape of the screwdriver tip	Slot	
size of the screwdriver tip	Standard screwdriver 0.6 mm x 3.5 mm	

I/O systems

SIMATIC ET 200 systems for the control cabinet

SIMATIC ET 200SP

ET 200SP motor starters **IE3/IE4 ready****Selection and ordering data**adjustable current response
value current of the current-
dependent overload releaseampacity when
starting maximum

Article number

A

A

Motor starter**Direct-on-line starter**

3RK1308-0AB00-0CP0

0.1 ... 0.4	4
0.3 ... 1	10
0.9 ... 3	30
2.8 ... 9	90
4 ... 12	100

3RK1308-0AA00-0CP0
3RK1308-0AB00-0CP0
3RK1308-0AC00-0CP0
3RK1308-0AD00-0CP0
3RK1308-0AE00-0CP0

Reversing starter

3RK1308-0BB00-0CP0

0.1 ... 0.4	4
0.3 ... 1	10
0.9 ... 3	30
2.8 ... 9	90
4 ... 12	100

3RK1308-0BA00-0CP0
3RK1308-0BB00-0CP0
3RK1308-0BC00-0CP0
3RK1308-0BD00-0CP0
3RK1308-0BE00-0CP0

Fail-safe direct-on-line starter

3RK1308-0CE00-0CP0

0.1 ... 0.4	4
0.3 ... 1	10
0.9 ... 3	30
2.8 ... 9	90
4 ... 12	100

3RK1308-0CA00-0CP0
3RK1308-0CB00-0CP0
3RK1308-0CC00-0CP0
3RK1308-0CD00-0CP0
3RK1308-0CE00-0CP0

Fail-safe reversing starter

3RK1308-0DE00-0CP0

0.1 ... 0.4	4
0.3 ... 1	10
0.9 ... 3	30
2.8 ... 9	90
4 ... 12	100

3RK1308-0DA00-0CP0
3RK1308-0DB00-0CP0
3RK1308-0DC00-0CP0
3RK1308-0DD00-0CP0
3RK1308-0DE00-0CP0

10

design of the product	operating voltage of AC supply	supply voltage of DC supply	Article number
	V	V	

BaseUnits with Push-In terminal¹⁾

3RK1908-0AP00-0AP0

for motor starter

• For AC/DC feed in	500	24	3RK1908-0AP00-0AP0
• For DC feed in	--	24	3RK1908-0AP00-0BP0
• For AC feed in	500	--	3RK1908-0AP00-0CP0
• Without feed in	--	--	3RK1908-0AP00-0DP0

for failsafe motor starters

• with AC infeed, with F-DI infeed	500	--	3RK1908-0AP00-0GP0
• with AC infeed, with F-DI loop-through	500	--	3RK1908-0AP00-0HP0
• without AC/DC infeed, with F-DI loop-through	--	--	3RK1908-0AP00-0JP0
• without AC/DC infeed, with F-DI infeed	--	--	3RK1908-0AP00-0KP0

¹⁾ The voltage is looped-through from BaseUnits with infeed to subsequent BaseUnits without infeed.

Type of product	Supply voltage at DC rated value	Loop through the potential group from the left	Article number
	V		

BaseUnits with Push-In terminal

6ES7193-6BP00-0BA0

For dummy modules

• dark, looping through the potential group	24	Yes	6ES7193-6BP00-0BA0
• light, opening a new potential group	24	No	6ES7193-6BP00-0DA0

10

Control supply voltage at DC rated value	Product function	Article number
	Local contro Digital inputs parameterizable	
V		

3DI/LC control module with Push-In terminal

3RK1908-1AA00-0BP0

20.4 ... 28.8	Yes	Yes	3RK1908-1AA00-0BP0
---------------	-----	-----	---------------------------

I/O systems**SIMATIC ET 200 systems for the control cabinet****SIMATIC ET 200SP****ET 200SP motor starters**

	Product designation	Type of product	Article number
Accessories			
	BU cover 15 mm	for BaseUnits Type A0 or A1	6ES7133-6CV15-1AM0
6ES7133-6CV15-1AM0			
	BU cover 30 mm	For protection of empty slots, 30 mm	3RK1908-1CA00-0BP0
3RK1908-1CA00-0BP0			
	Infeed bus cover (1 bag containing 10 covers)	for ET 200SP	3RK1908-1DA00-2BP0
3RK1908-1DA00-2BP0			
	Mechanical bracket (1 bag containing 5 mechanical brackets)	Mechanical, for ET 200SP	3RK1908-1EA00-1BP0
3RK1908-1EA00-1BP0			
	Fan	Can be used for 3RK1308	3RW4928-8VB00
3RW4928-8VB00			
	Motor suppression module		
3RK1911-6EA00	• Square		3RK1911-6EA00
	• Round		3RK1911-6EB00
			
3RK1911-6EB00			
	Starter Kit	consists of 3RK1308-0BC00-0CP0 reversing starterq (0.9 ... 3 A), 3RK1908-0AP00-0AP0 BaseUnit with 500 V and 24 V AC/DC infeed, and EMC distance module (consisting of 6ES7193-6BP00-0BA0 BaseUnit plus 6ES7133-6CV15-1AM0 BU cover 15 mm)	3RK1908-1SK00
3RK1908-1SK00			

10

Overview

- For pneumatic control of actuators with ET 200SP
- Can be used together with system and IO components of the ET 200SP distributed I/O system.
- Product of the product partners Bürkert Fluid Control Systems, and can only be obtained from Bürkert Fluid Control Systems.

Note

Product partners are external companies outside Siemens AG and its associated companies. Information and descriptions of products made by product partners are non-binding, and are the responsibility of the product partners. These products are manufactured independently and under the responsibility of the particular product partner, and are sold and supplied by it under its terms of business and delivery.

Unless compulsory by law, Siemens assumes no liability and makes no guarantee for for these products or for the connection with these products of the product partners. Please refer also to the note on exemption from liability/use of hyperlinks.

Benefits

- High process safety by using non-return valves and pneumatic infeed modules with pressure monitoring.
- System-wide detailed diagnostics in plain text, and also locally on an LC display
- Quick and easy valve change during operation (hot swapping)
- Reduced number of components in the control cabinet (compact control cabinet is possible)
- Quick installation & configuration of the pneumatic connections

Application

Valve terminals are widely used in industrial automation, and serve as pilot valves for controlling actuators in the food, pharmaceutical and water treatment industries. In combination with the AirLINE SP, type 8647 from the Bürkert Co., the ET 200SP forms a universal interface between process and plant control, and enables the flexible, modular structure of pilot valves and I/O modules. The valve terminal can also be attached to a control cabinet floor with an AirLINE Quick Adapter, which further reduces the space required in the control cabinet, and significantly simplifies the pneumatic installation.

More information

For more detailed information about the AirLINE SP, type 8647 (e.g. data sheet, operating manual) please contact Bürkert directly:

<http://www.burkert.com/en/type/8647>

Disclaimer of liability

This information and the descriptions have been compiled with great care. However, it is not possible for Siemens to verify that the data supplied by product partners is complete, correct and up-to-date. The possibility that individual items of information might be incorrect, incomplete, or not up-to-date cannot therefore be ruled out. Unless compulsory by law, Siemens accepts no liability for the usability of the data or of the products for the user per se.

I/O systems

SIMATIC ET 200 systems for the control cabinet
SIMATIC ET 200SP

Power supplies > 1-phase, 24 V DC (for SIMATIC ET 200SP)

Overview



In terms of design and functionality, the SIMATIC ET 200SP PS single-phase load power supply with automatic range switching of the input voltage is perfectly matched to the SIMATIC ET 200SP. The SIMATIC component and the power supply are wired by means of uniform push-in terminal technology. The 24 V supply provides power to the ET 200SP system components such as the interface module, technology module and communication module, as well as the digital or analog inputs/outputs. Comprehensive certifications, such as UL or GL, facilitate universal use. Its extremely flat design also makes this power supply ideally suited for installation in compact on-site control boxes.

Ordering data

Article No.

SIMATIC ET 200SP PS

Stabilized power supply for SIMATIC ET 200SP
Input: 120/230 V AC
Output: 24 V DC/5 A

6EP7133-6AB00-0BNO

SIMATIC ET 200SP PS

Stabilized power supply for SIMATIC ET 200SP
Input: 120/230 V AC
Output: 24 V DC/10 A

6EP7133-6AE00-0BNO

10

Technical specifications

Article number	6EP7133-6AB00-0BNO	6EP7133-6AE00-0BNO
Product	SIMATIC ET 200SP PS	SIMATIC ET 200SP PS
Power supply, type	24 V/5 A	24 V/10 A
Input		
type of the power supply network	1-phase AC	1-phase AC
supply voltage at AC		
• initial value	Automatic range selection	Automatic range selection
supply voltage		
• 1 at AC rated value	120 V	120 V
• 2 at AC rated value	230 V	230 V
input voltage		
• 1 at AC	85 ... 132 V	85 ... 132 V
• 2 at AC	170 ... 264 V	170 ... 264 V
design of input wide range input	No	No
overvoltage overload capability	$2.3 \times V_{in \text{ rated}}, 1.3 \text{ ms}$	$2.3 \times V_{in \text{ rated}}, 1.3 \text{ ms}$
operating condition of the mains buffering	at $V_{in} = 93/187 \text{ V}$	at $V_{in} = 93/187 \text{ V}$
buffering time for rated value of the output current in the event of power failure minimum	20 ms	20 ms
operating condition of the mains buffering	at $V_{in} = 93/187 \text{ V}$	at $V_{in} = 93/187 \text{ V}$
line frequency		
• 1 rated value	50 Hz	50 Hz
• 2 rated value	60 Hz	60 Hz
line frequency	47 ... 63 Hz	47 ... 63 Hz
input current		
• at rated input voltage 120 V	2.16 A	4.34 A
• at rated input voltage 230 V	1.22 A	1.92 A
current limitation of inrush current at 25 °C maximum	45 A	60 A
I ² t value maximum	3.15 A ² ·s	6.3 A ² ·s
fuse protection type	T 3,15 A/250 V (not accessible)	T 6.3 A/250 V (not accessible)
• in the feeder	recommended LS switch: B/C 6 A/3 A	recommended LS switch: B/C 10 A/6 A

Technical specifications

Article number	6EP7133-6AB00-0BN0	6EP7133-6AE00-0BN0
Product	SIMATIC ET 200SP PS	SIMATIC ET 200SP PS
Power supply, type	24 V/5 A	24 V/10 A
Output		
voltage curve at output	Controlled, isolated DC voltage	Controlled, isolated DC voltage
output voltage at DC rated value	24 V	24 V
output voltage		
• at output 1 at DC rated value	24 V	24 V
relative overall tolerance of the voltage	3 %	3 %
relative control precision of the output voltage		
• on slow fluctuation of input voltage	0.1 %	0.1 %
• on slow fluctuation of ohm loading	1 %	1 %
residual ripple		
• maximum	150 mV	150 mV
• typical	50 mV	50 mV
voltage peak		
• maximum	240 mV	240 mV
• typical	150 mV	150 mV
adjustable output voltage	22.8 ... 28 V	22.8 ... 28 V
product function output voltage adjustable	Yes	Yes
type of output voltage setting	via potentiometer	via potentiometer
display version for normal operation	Green LED for 24 V OK	Green LED for 24 V OK
type of signal at output	Relay contact (NO contact, rating 60 V DC/ 0.3 A) for "24 V OK"	Relay contact (NO contact, rating 60 V DC/ 0.3 A) for "24 V OK"
behavior of the output voltage when switching on	Overshoot of $V_{out} < 3 \%$	Overshoot of $V_{out} < 3 \%$
response delay maximum	0.3 s	0.3 s
voltage increase time of the output voltage		
• typical	30 ms	30 ms
output current		
• rated value	5 A	10 A
• rated range	0 ... 6 A; 5 A up to +60°C; +60 ... +70 °C: Derating 3%/K	0 ... 12 A; 10 A up to +60°C; +60 ... +70 °C: Derating 3%/K
supplied active power typical	120 W	240 W
short-term overload current		
• on short-circuiting during the start-up typical	15 A	30 A
• at short-circuit during operation typical	15 A	30 A
duration of overloading capability for excess current		
• on short-circuiting during the start-up	800 ms	750 ms
• at short-circuit during operation	800 ms	800 ms
product feature		
• bridging of equipment	Yes	Yes
number of parallel-switched equipment resources for increasing the power	2	2
Efficiency		
efficiency in percent	88 %	90 %
power loss [W]		
• at rated output voltage for rated value of the output current typical	17 W	26 W
• during no-load operation maximum	2.7 W	2.8 W
Closed-loop control		
relative control precision of the output voltage with rapid fluctuation of the input voltage by +/- 15% typical	0.3 %	0.3 %
relative control precision of the output voltage at load step of resistive load 10/90/10 % typical	3 %	3 %
setting time		
• load step 10 to 90% typical	1 ms	1 ms
• load step 90 to 10% typical	1 ms	1 ms

I/O systemsSIMATIC ET 200 systems for the control cabinet
SIMATIC ET 200SP**Power supplies > 1-phase, 24 V DC (for SIMATIC ET 200SP)****Technical specifications**

Article number	6EP7133-6AB00-0BN0	6EP7133-6AE00-0BN0
Product	SIMATIC ET 200SP PS	SIMATIC ET 200SP PS
Power supply, type	24 V/5 A	24 V/10 A
Protection and monitoring		
design of the overvoltage protection	protection against overvoltage in case of internal fault $V_{out} < 31.8$ V	protection against overvoltage in case of internal fault $V_{out} < 31.8$ V
response value current limitation	7 ... 7.5 A	14 ... 15 A
property of the output short-circuit proof	Yes	Yes
design of short-circuit protection	Constant current characteristic	Constant current characteristic
enduring short circuit current RMS value		
• typical	7 A	14.1 A
overcurrent overload capability in normal operation	overload capability 150 % I _{out} rated up to 5 s/min	overload capability 150 % I _{out} rated up to 5 s/min
display version for overload and short circuit	-	-
Safety		
galvanic isolation between input and output	Yes	Yes
galvanic isolation	Safety extra-low output voltage U _{out} acc. to EN 60950-1 and EN 50178	Safety extra-low output voltage U _{out} acc. to EN 60950-1 and EN 50178
operating resource protection class	Class I	Class I
leakage current		
• maximum	3.5 mA	3.5 mA
• typical	1 mA	1 mA
protection class IP	IP20	IP20
Approvals		
certificate of suitability		
• CE marking	Yes	Yes
• UL approval	Yes; cULus-Listed (UL61010-2-201, CSA C22.2 No.142); cCSAus (CSA C22.2 No. 60950-1, UL 60950-1)	Yes; cULus-Listed (UL61010-2-201, CSA C22.2 No.142); cCSAus (CSA C22.2 No. 60950-1, UL 60950-1)
• CSA approval	Yes; cULus-Listed (UL61010-2-201, CSA C22.2 No.142), cCSAus (CSA C22.2 No. 60950-1, UL 60950-1)	Yes; cULus-Listed (UL61010-2-201, CSA C22.2 No.142), cCSAus (CSA C22.2 No. 60950-1, UL 60950-1)
• cCSAus, Class 1, Division 2	No	No
• ATEX	Yes; ATEX (EX) II 3G Ex ec nC IIC T3 Gc	Yes; ATEX (EX) II 3G Ex ec nC IIC T3 Gc
certificate of suitability		
• relating to ATEX	IECEX Ex ec nC IIC T3 Gc; ATEX (EX) II 3G Ex ec nC IIC T3 Gc	IECEX Ex ec nC IIC T3 Gc; ATEX (EX) II 3G Ex ec nC IIC T3 Gc
• IECEX	Yes; IECEX Ex ec nC IIC T3 Gc	Yes; IECEX Ex ec nC IIC T3 Gc
• NEC Class 2	No	No
• ULhazloc approval	No	No
type of certification CB-certificate	Yes	Yes
certificate of suitability		
• EAC approval	Yes	Yes
• C-Tick	Yes	Yes
certificate of suitability shipbuilding approval	Yes	Yes
shipbuilding approval	BV, DNV GL	BV, DNV GL
Marine classification association		
• American Bureau of Shipping Europe Ltd. (ABS)	No	No
• French marine classification society (BV)	Yes	Yes
• DNV GL	Yes	Yes
• Lloyds Register of Shipping (LRS)	No	No
• Nippon Kaiji Kyokai (NK)	No	No
EMC		
standard		
• for emitted interference	EN 61000-6-3 Class B	EN 61000-6-3 Class B
• for mains harmonics limitation	EN 61000-3-2	EN 61000-3-2
• for interference immunity	EN 61000-6-2	EN 61000-6-2

Technical specifications

Article number	6EP7133-6AB00-0BN0	6EP7133-6AE00-0BN0
Product	SIMATIC ET 200SP PS	SIMATIC ET 200SP PS
Power supply, type	24 V/5 A	24 V/10 A
environmental conditions		
ambient temperature		
• during operation	-30 ... +70 °C; with natural convection	-30 ... +70 °C; with natural convection
• during transport	-40 ... +85 °C	-40 ... +85 °C
• during storage	-40 ... +85 °C	-40 ... +85 °C
environmental category acc. to IEC 60721	Climate class 3K3, 5 ... 95% no condensation	Climate class 3K3, 5 ... 95% no condensation
Mechanics		
type of electrical connection	Push-in terminals	Push-in terminals
• at input	L, N, PE: 1 push-in terminal each for 0.2 ... 2.5 mm ² single-core/finely stranded	L, N, PE: 1 push-in terminal each for 0.2 ... 2.5 mm ² single-core/finely stranded
• at output	+, -: 2 push-in terminals each for 0.2 ... 2.5 mm ²	+, -: 2 push-in terminals each for 0.2 ... 2.5 mm ²
• for auxiliary contacts	Signaling contact: 2 push-in terminals for 0.2 ... 2.5 mm ²	Signaling contact: 2 push-in terminals for 0.2 ... 2.5 mm ²
• for signaling contact	2 push-in terminals for 0.2 ... 2.5 mm ²	2 push-in terminals for 0.2 ... 2.5 mm ²
product function		
• removable terminal at input	Yes	Yes
• removable terminal at output	Yes	Yes
width of the enclosure	160 mm	160 mm
height of the enclosure	117 mm	117 mm
depth of the enclosure	74 mm	74 mm
required spacing		
• top	50 mm	50 mm
• bottom	50 mm	50 mm
• left	0 mm	0 mm
• right	0 mm	0 mm
net weight	0.5 kg	0.7 kg
product feature of the enclosure housing can be lined up	Yes	Yes
fastening method	Snaps onto DIN rail EN 60715 35x7.5/15	Snaps onto DIN rail EN 60715 35x7.5/15
electrical accessories	Redundancy module, buffer module, selectivity module, DC UPS	Redundancy module, buffer module, selectivity module, DC UPS
MTBF at 40 °C	1 598 441 h	1 114 510 h
other information	Specifications at rated input voltage and ambient temperature +25 °C (unless otherwise specified)	Specifications at rated input voltage and ambient temperature +25 °C (unless otherwise specified)

I/O systems

SIMATIC ET 200 systems for the control cabinet
SIMATIC ET 200SP

BaseUnits

Overview



With the BaseUnits (BUs), the ET 200SP offers a rugged and service-friendly design with permanent wiring:

- No tools needed for one-handed wiring using push-in terminals
- Actuation of the spring NC contacts with a standard screwdriver, with a blade width up to 3.5 mm
- Outstanding access due to arrangement of measuring tap, spring NC contacts and cable entry in columns, while at the same time reducing the space required by 64%
- Fault-proof color coding of the spring NC contacts for better orientation in the terminal panel

- Replacement of I/O modules during operation without affecting the wiring
- Operation with module gaps (gaps without I/O module)
- Automatic coding of the I/O modules prevents destruction of the electronics if a module is accidentally inserted in the wrong slot during replacement
- High EMC interference immunity:
 - self-assembling shielded backplane bus
 - multi-layer conductor plate with shield levels for interference-free signal transmission from the terminal to the I/O module
 - system-integrated, space-saving shield connection for quick installation
- Self-assembling potential groups without external wiring or jumpers
- Replaceable terminal box
- Side-by-side latching of the BUs for high mechanical and EMC loads
- Optional module-specific color identification of the terminals according to the color code CC
- Optional equipment marking using slide-in equipment labeling plates

An ET 200SP station can be expanded via one 'BU-Send' BaseUnit with a "BA-Send" BusAdapter plugged onto it with up to 16 modules from the ET 200AL series of I/O devices with IP67 protection.

Ordering data

Article No.

Article No.

Type A0 BaseUnits

BU15-P16+A10+2D

BU type A0; BaseUnit (light) with 16 push-in terminals (1 ... 16) to the module and an additional 10 internally jumpered AUX terminals (1 A to 10 A); for starting a new potential group (max. 10 A)

- Pack of 1 unit
- Pack of 10 units; to order a pack, please order this article number with an order quantity of 10.

6ES7193-6BP20-0DA0
6ES7193-6BP20-2DA0

BU15-P16+A0+2D

BU type A0; BaseUnit (light) with 16 push-in terminals to the module; for starting a new potential group (max. 10 A)

- Pack of 1 unit
- Pack of 10 units; to order a pack, please order this article number with an order quantity of 10.

6ES7193-6BP00-0DA0
6ES7193-6BP00-2DA0

BU15-P16+A10+2B

BU type A0; BaseUnit (dark) with 16 push-in terminals (1 ... 16) to the module and an additional 10 internally jumpered AUX terminals (1 A to 10 A); for continuing the potential group

- Pack of 1 unit
- Pack of 10 units; to order a pack, please order this article number with an order quantity of 10.

6ES7193-6BP20-0BA0
6ES7193-6BP20-2BA0

BU15-P16+A0+2B

BU type A0; BaseUnit (dark) with 16 push-in terminals to the module; for continuing the potential group

- Pack of 1 unit
- Pack of 10 units; to order a pack, please order this article number with an order quantity of 10.

6ES7193-6BP00-0BA0
6ES7193-6BP00-2BA0

Type B0 BaseUnits

BU20-P12+A4+0B

BU type B0; BaseUnit (dark) with 12 push-in terminals (1 ... 12) to the module and an additional 4 internally jumpered AUX terminals (1 A to 4 A); for continuing the potential group; 1 unit

- Pack of 1 unit
- Pack of 10 units; to order a pack, please order this article number with an order quantity of 10.

6ES7193-6BP20-0BB0
6ES7193-6BP20-2BB0

Type B1 BaseUnits

BU20-P12+A0+4B

BU type B1; BaseUnit (dark) with 12 push-in terminals to the module; for continuing the potential group; 1 unit

- Pack of 1 unit
- Pack of 10 units; to order a pack, please order this article number with an order quantity of 10.

6ES7193-6BP20-0BB1
6ES7193-6BP20-2BB1

Ordering data	Article No.	Ordering data	Article No.
Type C0 BaseUnits		BaseUnits type U0	
BU20-P6+A2+4D	6ES7193-6BP20-0DC0	BU20-P16+A0+2D	
BU type C0; BaseUnit (light) with 6 push-in terminals (1...6) to the module and an additional 2 AUX terminals; new potential group		BU type U0; BaseUnit (light) with 16 push-in terminals to the module; for starting a new potential group (max. 10 A)	
Type C1 BaseUnits		<ul style="list-style-type: none"> • Pack of 1 unit • Pack of 10 units; to order a pack, please order this article number with an order quantity of 10. 	6ES7193-6BP00-0DU0 6ES7193-6BP00-2DU0
BU20-P6+A2+4B	6ES7193-6BP20-0BC1	BU20-P16+A0+2B	
BU type C1; BaseUnit (dark) with 6 push-in terminals (1 ... 6) to the module and 2 AUX terminals; bridged to the left		BU type U0; BaseUnit (dark) with 16 push-in terminals to the module; for continuing the potential group	
Type D0 BaseUnits		<ul style="list-style-type: none"> • Pack of 1 unit • Pack of 10 units; to order a pack, please order this article number with an order quantity of 10. 	6ES7193-6BP00-0BU0 6ES7193-6BP00-2BU0
BU20-P12+A0+0B	6ES7193-6BP00-0BD0	Station expansion with IP67 I/O system ET 200AL	
BU type D0; BaseUnit (dark) with 12 push-in terminals, without AUX terminals, bridged to the left		BaseUnit BU-Send	6ES7193-6BN00-0NE0
Type A1 BaseUnits (with temperature detection)		ET 200SP BusAdapter BA-Send 1 x FC	6ES7193-6AS00-0AA0
BU15-P16+A0+12D/T	6ES7193-6BP40-0DA1	Accessories	
BU type A1; BaseUnit (light) with 16 push-in terminals (1 ... 16) to the module and 2x5 internally jumpered additional terminals (1 B to 5 B and 1 C to 5 C); for starting a new potential group (max. 10 A)		Equipment labeling plate	6ES7193-6LF30-0AW0
BU15-P16+A0+2D/T	6ES7193-6BP00-0DA1	10 sheets of 16 labels	
BU type A1; BaseUnit (light) with 16 push-in terminals to the module; for starting a new potential group (max. 10 A)		BU cover	
BU15-P16+A0+12B/T	6ES7193-6BP40-0BA1	For covering empty slots (gaps); 5 units	
BU type A1; BaseUnit (dark) with 16 push-in terminals (1 ... 16) to the module and 2x5 internally jumpered additional terminals (1 B to 5 B and 1 C to 5 C); for continuing the potential group		<ul style="list-style-type: none"> • 15 mm wide • 20 mm wide 	6ES7133-6CV15-1AM0 6ES7133-6CV20-1AM0
BU15-P16+A0+2B/T	6ES7193-6BP00-0BA1	Shield connection	6ES7193-6SC00-1AM0
BU type A1; BaseUnit (dark) with 16 push-in terminals to the module; for continuing the potential group		5 shield supports and 5 shield terminals	
Type F0 BaseUnits			
BU20-P8+A4+0B	6ES7193-6BP20-0BF0		
BU type F0; BaseUnit (dark) with 8 push-in terminals to the module and an additional 4 internally jumpered AUX terminals (1 A to 4 A); for continuing the potential group			

I/O systems

SIMATIC ET 200 systems for the control cabinet
SIMATIC ET 200SP

BaseUnits

Ordering data

Color-coded labels

- Color code CC01, module-specific, for 16 push-in terminals; for BaseUnit type A0, A1; 10 units
- Color code CC01, module-specific, for 16 push-in terminals; for BaseUnit type A0, A1; 50 units
- Color code CC02, module-specific, for 16 push-in terminals; for BaseUnit type A0, A1; 10 units
- Color code CC02, module-specific, for 16 push-in terminals; for BaseUnit type A0, A1; 50 units
- Color code CC03, module-specific, for 16 push-in terminals; for BaseUnit type A0, A1; 10 units
- Color code CC04, module-specific, for 16 push-in terminals; for BaseUnit type A0, A1; 10 units
- Color code CC71, for 10 AUX terminals 1 A to 10 A, for BU type A0, yellow/green, with push-in terminals; 10 units
- Color code CC72, for 10 AUX terminals 1 A to 10 A, for BU type A0, red, with push-in terminals; 10 units
- Color code CC73, for 10 AUX terminals 1 A to 10 A, for BU type A0, blue, with push-in terminals; 10 units

Article No.

6ES7193-6CP01-2MA0
6ES7193-6CP01-4MA0
6ES7193-6CP02-2MA0
6ES7193-6CP02-4MA0
6ES7193-6CP03-2MA0
6ES7193-6CP04-2MA0
6ES7193-6CP71-2AA0
6ES7193-6CP72-2AA0
6ES7193-6CP73-2AA0

Color-coded labels (Forts.)

- Color code CC74, for 2x5 additional terminals, 5 x red, 5 x blue, BU type A1 with push-in terminals; 10 units
- Color code CC81, for 4 AUX terminals 1 A to 4 A, yellow/green, for BaseUnit type B0; 10 units
- Color code CC82, for 4 AUX terminals 1 A to 4 A, red, for BaseUnit type B0; 10 units
- Color code CC83, for 4 AUX terminals 1 A to 4 A, blue, for BaseUnit type B0; 10 units
- Color code CC41, module-specific, for 12 push-in terminals; for BaseUnit type B1; 10 units
- Color code CC84, for 2 AUX terminals 1 A to 2 A, yellow/green, for BaseUnit type C0; 10 units
- Color code CC85, for 2 AUX terminals 1 A to 2 A, red, for BaseUnit type C0; 10 units
- Color code CC86, for 2 AUX terminals 1 A to 2 A, blue, for BaseUnit type C0; 10 units

Article No.

6ES7193-6CP74-2AA0
6ES7193-6CP81-2AB0
6ES7193-6CP82-2AB0
6ES7193-6CP83-2AB0
6ES7193-6CP41-2MB0
6ES7193-6CP84-2AC0
6ES7193-6CP85-2AC0
6ES7193-6CP86-2AC0

Technical specifications

Article number	6ES7193-6BP20-0DA0	6ES7193-6BP00-0DA0	6ES7193-6BP20-0BA0	6ES7193-6BP00-0BA0
	BaseUnit Type A0, BU15-P16+A10+2D	BaseUnit Type A0, BU15-P16+A0+2D	BaseUnit Type A0, BU15-P16+A10+2B	BaseUnit Type A0, BU15-P16+A0+2B
General information				
Product type designation	BU type A0	BU type A0	BU type A0	BU type A0
Hardware configuration				
Slots				
• Number of slots	1; Type A0	1; Type A0	1; Type A0	1; Type A0
Ambient conditions				
Ambient temperature during operation				
• horizontal installation, min.	-30 °C	-30 °C	-30 °C	-30 °C
• horizontal installation, max.	60 °C	60 °C	60 °C	60 °C
• vertical installation, min.	-30 °C	-30 °C	-30 °C	-30 °C
• vertical installation, max.	50 °C	50 °C	50 °C	50 °C
Altitude during operation relating to sea level				
• Installation altitude above sea level, max.	5 000 m; Restrictions for installation altitudes > 2 000 m, see manual	5 000 m; Restrictions for installation altitudes > 2 000 m, see manual	5 000 m; Restrictions for installation altitudes > 2 000 m, see manual	5 000 m; Restrictions for installation altitudes > 2 000 m, see manual
Connection method				
Terminals				
• Terminal type	Push-in terminal	Push-in terminal	Push-in terminal	Push-in terminal
• Conductor cross-section, min.	0.14 mm ² ; AWG 26	0.14 mm ² ; AWG 26	0.14 mm ² ; AWG 26	0.14 mm ² ; AWG 26
• Conductor cross-section, max.	2.5 mm ² ; AWG 14	2.5 mm ² ; AWG 14	2.5 mm ² ; AWG 14	2.5 mm ² ; AWG 14

Technical specifications

Article number	6ES7193-6BP20-0DA0 BaseUnit Type A0, BU15-P16+A10+2D	6ES7193-6BP00-0DA0 BaseUnit Type A0, BU15-P16+A0+2D	6ES7193-6BP20-0BA0 BaseUnit Type A0, BU15-P16+A10+2B	6ES7193-6BP00-0BA0 BaseUnit Type A0, BU15-P16+A0+2B		
• Number of process terminals to I/O module	16	16	16	16; Pro slot		
• Number of terminals to AUX bus	10	0	10	0		
• Number of add-on terminals	0	0	0	0		
• Number of terminals with connection to P1 and P2 bus	2	2	2	2; Pro slot		
Dimensions						
Width	15 mm	15 mm	15 mm	15 mm		
Height	141 mm	117 mm	141 mm	117 mm		
Depth	35 mm	35 mm	35 mm	35 mm		
Weights						
Weight, approx.	50 g	40 g	50 g	40 g		
Article number	6ES7193-6BP20-0BB0 BaseUnit Type B0, BU20-P12+A4+0B	6ES7193-6BP20-0BB1 BaseUnit Type B1, BU20-P12+A0+4B, PU 1	6ES7193-6BP20-0DC0 BaseUnit Type C0, BU20-P6+A2+4D	6ES7193-6BP20-0BC1 BaseUnit Type C1, BU20-P6+A2+4B	6ES7193-6BP00-0BD0 BaseUnit Type D0, BU20-P12+A0+0B	6ES7193-6BP20-0BF0 BaseUnit Type F0, BU20-P8+A4+0B
General information						
Product type designation	BU type B0	BU type B1	BU type C0	BU type C1	BU type D0	BU type F0
Hardware configuration						
Slots						
• Number of slots	1	1	1	1; Type C1	1; Type D0	1; Type F0
Ambient conditions						
Ambient temperature during operation						
• horizontal installation, min.	-30 °C	-30 °C	-30 °C	-30 °C	-30 °C	-30 °C
• horizontal installation, max.	60 °C	60 °C	60 °C	60 °C	60 °C	60 °C
• vertical installation, min.	-30 °C	-30 °C	-30 °C	-30 °C	-30 °C	-30 °C
• vertical installation, max.	50 °C	50 °C	50 °C	50 °C	50 °C	50 °C
Altitude during operation relating to sea level						
• Installation altitude above sea level, max.	2 000 m; On request: Installation altitudes greater than 2 000 m	2 000 m; On request: Installation altitudes greater than 2 000 m	2 000 m; On request: Installation altitudes greater than 2 000 m	2 000 m; On request: Installation altitudes greater than 2 000 m	2 000 m; On request: Installation altitudes greater than 2 000 m	2 000 m; On request: Installation altitudes greater than 2 000 m
Connection method						
Terminals						
• Terminal type	Push-in terminal	Push-in terminal	Push-in terminal	Push-in terminal	Push-in terminal	
• Conductor cross-section, min.	0.14 mm ² ; AWG 26	0.14 mm ² ; AWG 26	0.14 mm ² ; AWG 26	0.14 mm ² ; AWG 26	0.14 mm ² ; AWG 26	
• Conductor cross-section, max.	2.5 mm ² ; AWG 14	2.5 mm ² ; AWG 14	2.5 mm ² ; AWG 14	2.5 mm ² ; AWG 14	2.5 mm ² ; AWG 14	
• Number of process terminals to I/O module	12; Pro slot	12; Pro slot	12; Pro slot	16; Pro slot	12; Pro slot	
• Number of terminals to AUX bus	0	0	0	0	0	
• Number of add-on terminals	0	0	0	0	0	
• Number of terminals with connection to P1 and P2 bus	0; Pro slot	0; Pro slot	0; Pro slot	2; Pro slot	0; Pro slot	
Dimensions						
Width	20 mm	20 mm	20 mm	20 mm	20 mm	20 mm
Height	117 mm	117 mm	117 mm	117 mm	117 mm	117 mm
Depth	35 mm	35 mm	35 mm	35 mm	35 mm	35 mm
Weights						
Weight, approx.	48 g	48 g	47 g	47 g	47 g	48 g

I/O systems

SIMATIC ET 200 systems for the control cabinet

SIMATIC ET 200SP

BaseUnits**Technical specifications**

Article number	6ES7193-6BP40-0DA1 BaseUnit Type A1, BU15-P16+A0+12D/T	6ES7193-6BP00-0DA1 BaseUnit Type A1, BU15-P16+A0+2D/T	6ES7193-6BP40-0BA1 BaseUnit Type A1, BU15-P16+A0+12B/T	6ES7193-6BP00-0BA1 BaseUnit Type A1, BU15-P16+A0+2B/T
General information				
Product type designation	BU type A1	BU type A1	BU type A1	BU type A1
Hardware configuration				
Slots				
• Number of slots	1; Type A1	1; Type A1	1; Type A1	1; Type A1
Ambient conditions				
Ambient temperature during operation				
• horizontal installation, min.	-30 °C	-30 °C	-30 °C	-30 °C
• horizontal installation, max.	60 °C	60 °C	60 °C	60 °C
• vertical installation, min.	-30 °C	-30 °C	-30 °C	-30 °C
• vertical installation, max.	50 °C	50 °C	50 °C	50 °C
Altitude during operation relating to sea level				
• Installation altitude above sea level, max.	5 000 m; Restrictions for installation altitudes > 2 000 m, see manual	5 000 m; Restrictions for installation altitudes > 2 000 m, see manual	5 000 m; Restrictions for installation altitudes > 2 000 m, see manual	5 000 m; Restrictions for installation altitudes > 2 000 m, see manual
Connection method				
Terminals				
• Terminal type	Push-in terminal	Push-in terminal	Push-in terminal	Push-in terminal
• Conductor cross-section, min.	0.14 mm ² ; AWG 26	0.14 mm ² ; AWG 26	0.14 mm ² ; AWG 26	0.14 mm ² ; AWG 26
• Conductor cross-section, max.	2.5 mm ² ; AWG 14	2.5 mm ² ; AWG 14	2.5 mm ² ; AWG 14	2.5 mm ² ; AWG 14
• Number of process terminals to I/O module	16	16	16	16
• Number of terminals to AUX bus	0	0	0	0
• Number of add-on terminals	2x5	0	2x5	0
• Number of terminals with connection to P1 and P2 bus	2	2	2	2
Dimensions				
Width	15 mm	15 mm	15 mm	15 mm
Height	141 mm	117 mm	141 mm	117 mm
Depth	35 mm	35 mm	35 mm	35 mm
Weights				
Weight, approx.	50 g	40 g	50 g	40 g
Article number	6ES7193-6BP00-0DU0 BaseUnit Type U0, BU20-P16+A0+2D, PU 1		6ES7193-6BP00-0BU0 BaseUnit Type U0, BU20-P16+A0+2B, PU 1	
General information				
Product type designation	BU type U0		BU type U0	
Hardware configuration				
Slots				
• Number of slots	1		1	
Ambient conditions				
Ambient temperature during operation				
• horizontal installation, min.	-30 °C		-30 °C	
• horizontal installation, max.	60 °C		60 °C	
• vertical installation, min.	-30 °C		-30 °C	
• vertical installation, max.	50 °C		50 °C	
Altitude during operation relating to sea level				
• Installation altitude above sea level, max.	3 000 m		3 000 m	

Technical specifications

Article number	6ES7193-6BP00-0DU0 BaseUnit Type U0, BU20-P16+A0+2D, PU 1	6ES7193-6BP00-0BU0 BaseUnit Type U0, BU20-P16+A0+2B, PU 1
Connection method		
Terminals		
• Terminal type	Push-in terminal	Push-in terminal
• Conductor cross-section, min.	0.14 mm ² ; 0.2 mm ² without wire end ferrule	0.14 mm ² ; 0.2 mm ² without wire end ferrule
• Conductor cross-section, max.	2.5 mm ² ; 1.5 mm ² with wire end ferrule	2.5 mm ² ; 1.5 mm ² with wire end ferrule
• Number of process terminals to I/O module	16	16
• Number of terminals to AUX bus	0	0
• Number of add-on terminals	0	0
• Number of terminals with connection to P1 and P2 bus	2	2
Dimensions		
Width	20 mm	20 mm
Height	117 mm	117 mm
Depth	35 mm	35 mm
Weights		
Weight, approx.	50 g	50 g

Article number	6ES7193-6BN00-0NE0 ET 200SP, BaseUnit BU-Send
Hardware configuration	
Slots	
• Number of slots	1
Ambient conditions	
Ambient temperature during operation	
• horizontal installation, min.	-30 °C
• horizontal installation, max.	60 °C
• vertical installation, min.	-30 °C
• vertical installation, max.	50 °C
Altitude during operation relating to sea level	
• Installation altitude above sea level, max.	2 000 m; On request: Installation altitudes greater than 2 000 m
Dimensions	
Width	20 mm
Height	117 mm
Depth	35 mm
Weights	
Weight, approx.	30 g

I/O systems

SIMATIC ET 200 systems for the control cabinet
SIMATIC ET 200SP

SIPLUS BaseUnits

Overview



With the BaseUnits, the ET 200SP offers a rugged and service-friendly design with permanent wiring:

- No tools needed for one-handed wiring using push-in terminals
- Outstanding access due to arrangement of measuring tap, spring NC contacts and cable entry in columns, while at the same time reducing the space required by 64%
- Fault-proof color coding of the spring NC contacts for better orientation in the terminal panel
- Replacement of I/O modules during operation without affecting the wiring
- Operation with module gaps (missing I/O module)
- Automatic coding of the I/O modules prevents destruction of the electronics if a module is accidentally inserted in the wrong slot during replacement
- High immunity to electromagnetic interference due to
 - self-assembling shielded backplane bus
 - multi-layer conductor plate with shield levels for interference-free signal transmission from the terminal to the I/O module
 - system-integrated, space-saving shield connection for quick installation
- Self-assembling potential groups without external wiring or jumpers
- Replaceable terminal box
- Side-by-side latching of the BUs for high mechanical load capacity
- Optional module-specific color identification of the terminals according to the color code CC
- Actuation of the spring NC contacts with a standard screwdriver, with a blade width up to 3.5 mm

Note:

SIPLUS extreme products are based on SIMATIC standard products. The contents listed here were taken from the respective standard products. SIPLUS extreme-specific information was added.

Ordering data

Article No.

Article No.

SIPLUS BaseUnits type A0

BU15-P16+A10+2D

(Extended temperature range and exposure to environmental substances)

BU type A0; BaseUnit (light) with 16 process terminals (1...16) to the module and an additional 10 internally jumpered AUX terminals (1 A to 10 A); for starting a new load group (max. 10 A)

6AG1193-6BP20-7DA0

BU15-P16+A0+2D

(Extended temperature range and exposure to environmental substances)

BU type A0; BaseUnit (light) with 16 process terminals to the module; for starting a new load group (max. 10 A)

6AG1193-6BP00-7DA0

BU15-P16+A10+2B

(Extended temperature range and exposure to environmental substances)

BU type A0; BaseUnit (dark) with 16 process terminals (1...16) to the module and an additional 10 internally jumpered AUX terminals (1 A to 10 A); for continuing the load group

6AG1193-6BP20-7BA0

BU15-P16+A0+2B

(Extended temperature range and exposure to environmental substances)

BU type A0; BaseUnit (dark) with 16 process terminals to the module; for continuing the load group

6AG1193-6BP00-7BA0

SIPLUS BaseUnits type A1 (with temperature detection)

BU15-P16+A0+12D/T

(Extended temperature range and exposure to environmental substances)

BU type A1; BaseUnit (light) with 16 process terminals (1...16) to the module and also 2x5 internally jumpered additional terminals (1 B to 5 B and 1 C to 5 C); for starting a new load group (max. 10 A)

6AG1193-6BP40-7DA1

BU15-P16+A0+2D/T

(Extended temperature range and exposure to environmental substances)

BU type A1; BaseUnit (light) with 16 process terminals to the module; for starting a new load group (max. 10 A)

6AG1193-6BP00-7DA1

BU15-P16+A0+12B/T

(Extended temperature range and exposure to environmental substances)

BU type A1; BaseUnit (dark) with 16 process terminals (1...16) to the module and also 2x5 internally jumpered additional terminals (1 B to 5 B and 1 C to 5 C); for continuing the load group

6AG1193-6BP40-7BA1

BU15-P16+A0+2B/T

(Extended temperature range and exposure to environmental substances)

BU type A1; BaseUnit (dark) with 16 process terminals to the module; for continuing the load group

6AG1193-6BP00-7BA1

Ordering data	Article No.	Ordering data	Article No.
SIPLUS BaseUnits type B0		SIPLUS BaseUnits type F0	
BU20-P12+A4+0B (Extended temperature range and exposure to environmental substances) BU type B0; BaseUnit (dark) with 12 process terminals (1...12) to the module and an additional 4 internally jumpered AUX terminals (1 A to 4 A); for continuing the load group; 1 unit	6AG1193-6BP20-7BB0	BU20-P8+A4+0B (Extended temperature range and exposure to environmental substances) BU type F0; BaseUnit (dark) with 8 process terminals to the module and an additional 4 internally jumpered AUX terminals (1 A to 4 A); for continuing the load group	6AG1193-6BP20-2BF0
SIPLUS BaseUnits type B1		SIPLUS BaseUnits type U0	
BU20-P12+A0+4B (Extended temperature range and exposure to environmental substances) BU type B1; BaseUnit (dark) with 12 process terminals to the module; for continuing the load group; 1 unit	6AG1193-6BP20-7BB1	BU20-P16+A0+2D (Extended temperature range and exposure to environmental substances) BU type U0; BaseUnit (light) with 16 process terminals to the module; for starting a new load group (max. 10 A)	6AG1193-6BP00-7DU0
SIPLUS BaseUnits type C0		BU20-P16+A0+2B (Extended temperature range and exposure to environmental substances) BU type U0; BaseUnit (dark) with 16 process terminals to the module; for continuing the load group	6AG1193-6BP00-7BU0
BU20-P6+A2+4D (Extended temperature range and exposure to environmental substances) BU type C0; BaseUnit (light) with 6 push-in terminals (1...6) to the module and 2 AUX terminals; new load group	6AG1193-6BP20-7DC0	Accessories	
SIPLUS BaseUnits type D0		SIPLUS Mounting Kit ET 200SP	6AG1193-6AA00-0AA0
BU20-P12+A0+0B (Extended temperature range and exposure to environmental substances) BU type D0; BaseUnit (dark) with 12 push-in terminals, without AUX terminals, bridged to the left	6AG1193-6BP00-7BD0	Mounting accessories for use with increased mechanical vibration and shock loads. Can be used with SIPLUS BaseUnits with heights up to 117 mm, types A0/A1 without AUX or add-on terminals as well as types B0, B1, C0, C1, D0, U0	
		Other accessories	See SIMATIC ET 200SP BaseUnits, page 10/237

10

Technical specifications

Article number	6AG1193-6BP00-7BA0	6AG1193-6BP00-7DA0	6AG1193-6BP20-7BA0	6AG1193-6BP20-7DA0
Based on	6ES7193-6BP00-0BA0 SIPLUS ET 200SP BU15-P16+A0+2B	6ES7193-6BP00-0DA0 SIPLUS ET 200SP BU15-P16+A0+2D	6ES7193-6BP20-0BA0 SIPLUS ET 200SP BU15-P16+A10+2B	6ES7193-6BP20-0DA0 SIPLUS ET 200SP BU15-P16+A10+2D
Ambient conditions				
Ambient temperature during operation				
• horizontal installation, min.	-40 °C; = Tmin (incl. condensation/frost)	-40 °C; = Tmin (incl. condensation/frost)	-40 °C; = Tmin (incl. condensation/frost)	-40 °C; = Tmin (incl. condensation/frost)
• horizontal installation, max.	70 °C; = Tmax	70 °C; = Tmax	70 °C; = Tmax	70 °C; = Tmax
Altitude during operation relating to sea level				
• Installation altitude above sea level, max.	5 000 m	5 000 m	5 000 m	5 000 m
• Ambient air temperature-barometric pressure-altitude	Tmin ... Tmax at 1 140 hPa ... 795 hPa (-1 000 m ... +2 000 m) // Tmin ... (Tmax - 10 K) at 795 hPa ... 658 hPa (+2 000 m ... +3 500 m) // Tmin ... (Tmax -20 K) at 658 hPa ... 540 hPa (+3 500 m ... +5 000 m)	Tmin ... Tmax at 1 140 hPa ... 795 hPa (-1 000 m ... +2 000 m) // Tmin ... (Tmax - 10 K) at 795 hPa ... 658 hPa (+2 000 m ... +3 500 m) // Tmin ... (Tmax -20 K) at 658 hPa ... 540 hPa (+3 500 m ... +5 000 m)	Tmin ... Tmax at 1 140 hPa ... 795 hPa (-1 000 m ... +2 000 m) // Tmin ... (Tmax - 10 K) at 795 hPa ... 658 hPa (+2 000 m ... +3 500 m) // Tmin ... (Tmax -20 K) at 658 hPa ... 540 hPa (+3 500 m ... +5 000 m)	Tmin ... Tmax at 1 140 hPa ... 795 hPa (-1 000 m ... +2 000 m) // Tmin ... (Tmax - 10 K) at 795 hPa ... 658 hPa (+2 000 m ... +3 500 m) // Tmin ... (Tmax -20 K) at 658 hPa ... 540 hPa (+3 500 m ... +5 000 m)
Relative humidity				
• With condensation, tested in accordance with IEC 60068-2-38, max.	100 %; RH incl. condensation/frost (no commissioning under condensation conditions)	100 %; RH incl. condensation / frost (no commissioning in bedewed state), horizontal installation	100 %; RH incl. condensation / frost (no commissioning in bedewed state), horizontal installation	100 %; RH incl. condensation / frost (no commissioning in bedewed state), horizontal installation

I/O systems

SIMATIC ET 200 systems for the control cabinet SIMATIC ET 200SP

SIPLUS BaseUnits

Technical specifications

Article number	6AG1193-6BP00-7BA0	6AG1193-6BP00-7DA0	6AG1193-6BP20-7BA0	6AG1193-6BP20-7DA0
Based on	6ES7193-6BP00-0BA0	6ES7193-6BP00-0DA0	6ES7193-6BP20-0BA0	6ES7193-6BP20-0DA0
	SIPLUS ET 200SP BU15-P16+A0+2B	SIPLUS ET 200SP BU15-P16+A0+2D	SIPLUS ET 200SP BU15-P16+A10+2B	SIPLUS ET 200SP BU15-P16+A10+2D
Resistance				
Coolants and lubricants				
- Resistant to commercially available coolants and lubricants	Yes; Incl. diesel and oil droplets in the air	Yes; Incl. diesel and oil droplets in the air	Yes; Incl. diesel and oil droplets in the air	Yes; Incl. diesel and oil droplets in the air
Use in stationary industrial systems				
- to biologically active substances according to EN 60721-3-3	Yes; Class 3B2 mold, fungus and dry rot spores (with the exception of fauna); Class 3B3 on request	Yes; Class 3B2 mold, fungus and dry rot spores (with the exception of fauna); Class 3B3 on request	Yes; Class 3B2 mold, fungus and dry rot spores (with the exception of fauna); Class 3B3 on request	Yes; Class 3B2 mold, fungus and dry rot spores (with the exception of fauna); Class 3B3 on request
- to chemically active substances according to EN 60721-3-3	Yes; Class 3C4 (RH < 75 %) incl. salt spray acc. to EN 60068-2-52 (severity degree 3); *	Yes; Class 3C4 (RH < 75 %) incl. salt spray acc. to EN 60068-2-52 (severity degree 3); *	Yes; Class 3C4 (RH < 75 %) incl. salt spray acc. to EN 60068-2-52 (severity degree 3); *	Yes; Class 3C4 (RH < 75 %) incl. salt spray acc. to EN 60068-2-52 (severity degree 3); *
- to mechanically active substances according to EN 60721-3-3	Yes; Class 3S4 incl. sand, dust; *	Yes; Class 3S4 incl. sand, dust; *	Yes; Class 3S4 incl. sand, dust; *	Yes; Class 3S4 incl. sand, dust; *
- Against mechanical environmental conditions acc. to EN 60721-3-3	Yes; Class 3M8 using the SIPLUS Mounting Kit ET 200SP (6AG1193-6AA00-0AA0)	Yes; Class 3M8 using the SIPLUS Mounting Kit ET 200SP (6AG1193-6AA00-0AA0)		
Use on ships/at sea				
- to biologically active substances according to EN 60721-3-6	Yes; Class 6B2 mold and fungal spores (excluding fauna); Class 6B3 on request	Yes; Class 6B2 mold and fungal spores (excluding fauna); Class 6B3 on request	Yes; Class 6B2 mold and fungal spores (excluding fauna); Class 6B3 on request	Yes; Class 6B2 mold and fungal spores (excluding fauna); Class 6B3 on request
- to chemically active substances according to EN 60721-3-6	Yes; Class 6C3 (RH < 75 %) incl. salt spray acc. to EN 60068-2-52 (severity degree 3); *	Yes; Class 6C3 (RH < 75 %) incl. salt spray acc. to EN 60068-2-52 (severity degree 3); *	Yes; Class 6C3 (RH < 75 %) incl. salt spray acc. to EN 60068-2-52 (severity degree 3); *	Yes; Class 6C3 (RH < 75 %) incl. salt spray acc. to EN 60068-2-52 (severity degree 3); *
- to mechanically active substances according to EN 60721-3-6	Yes; Class 6S3 incl. sand, dust; *	Yes; Class 6S3 incl. sand, dust; *	Yes; Class 6S3 incl. sand, dust; *	Yes; Class 6S3 incl. sand, dust; *
- Against mechanical environmental conditions acc. to EN 60721-3-6	Yes; Class 6M4 using the SIPLUS Mounting Kit ET 200SP (6AG1193-6AA00-0AA0)	Yes; Class 6M4 using the SIPLUS Mounting Kit ET 200SP (6AG1193-6AA00-0AA0)		
Usage in industrial process technology				
- Against chemically active substances acc. to EN 60654-4	Yes; Class 3 (excluding trichlorethylene)	Yes; Class 3 (excluding trichlorethylene)	Yes; Class 3 (excluding trichlorethylene)	Yes; Class 3 (excluding trichlorethylene)
- Environmental conditions for process, measuring and control systems acc. to ANSI/ISA-71.04	Yes; Level GX group A/B (excluding trichlorethylene; harmful gas concentrations up to the limits of EN 60721-3-3 class 3C4 permissible); level LC3 (salt spray) and level LB3 (oil)	Yes; Level GX group A/B (excluding trichlorethylene; harmful gas concentrations up to the limits of EN 60721-3-3 class 3C4 permissible); level LC3 (salt spray) and level LB3 (oil)	Yes; Level GX group A/B (excluding trichlorethylene; harmful gas concentrations up to the limits of EN 60721-3-3 class 3C4 permissible); level LC3 (salt spray) and level LB3 (oil)	Yes; Level GX group A/B (excluding trichlorethylene; harmful gas concentrations up to the limits of EN 60721-3-3 class 3C4 permissible); level LC3 (salt spray) and level LB3 (oil)
Remark				
- Note regarding classification of environmental conditions acc. to EN 60721, EN 60654-4 and ANSI/ISA-71.04	* The supplied plug covers must remain in place over the unused interfaces during operation!	* The supplied plug covers must remain in place over the unused interfaces during operation!	* The supplied plug covers must remain in place over the unused interfaces during operation!	* The supplied plug covers must remain in place over the unused interfaces during operation!
Conformal coating				
• Coatings for printed circuit board assemblies acc. to EN 61086	Yes; Class 2 for high reliability	Yes; Class 2 for high reliability	Yes; Class 2 for high reliability	Yes; Class 2 for high reliability
• Protection against fouling acc. to EN 60664-3	Yes; Type 1 protection	Yes; Type 1 protection	Yes; Type 1 protection	Yes; Type 1 protection
• Military testing according to MIL-I-46058C, Amendment 7	Yes; Discoloration of coating possible during service life	Yes; Discoloration of coating possible during service life	Yes; Discoloration of coating possible during service life	Yes; Discoloration of coating possible during service life
• Qualification and Performance of Electrical Insulating Compound for Printed Board Assemblies according to IPC-CC-830A	Yes; Conformal coating, Class A	Yes; Conformal coating, Class A	Yes; Conformal coating, Class A	Yes; Conformal coating, Class A

Technical specifications

Article number	6AG1193-6BP00-7BA1	6AG1193-6BP00-7DA1	6AG1193-6BP40-7BA1	6AG1193-6BP40-7DA1
Based on	6ES7193-6BP00-0BA1 SIPLUS ET 200SP BU15-P16+A0+2B/T	6ES7193-6BP00-0DA1 SIPLUS ET 200SP BU15-P16+A0+2D/T	6ES7193-6BP40-0BA1 SIPLUS ET 200SP BU15-P16+A0+12B/T	6ES7193-6BP40-0DA1 SIPLUS ET 200SP BU15-P16+A0+12D/T
Ambient conditions				
Ambient temperature during operation				
• horizontal installation, min.	-40 °C; = Tmin (incl. condensation/frost)	-40 °C; = Tmin (incl. condensation/frost)	-40 °C; = Tmin (incl. condensation/frost)	-40 °C; = Tmin (incl. condensation/frost)
• horizontal installation, max.	70 °C; = Tmax	70 °C; = Tmax	70 °C; = Tmax	70 °C; = Tmax
Altitude during operation relating to sea level				
• Installation altitude above sea level, max.	5 000 m	5 000 m	5 000 m	5 000 m
• Ambient air temperature-barometric pressure-altitude	Tmin ... Tmax at 1 140 hPa ... 795 hPa (-1 000 m ... +2 000 m) // Tmin ... (Tmax - 10 K) at 795 hPa ... 658 hPa (+2 000 m ... +3 500 m) // Tmin ... (Tmax -20 K) at 658 hPa ... 540 hPa (+3 500 m ... +5 000 m)	Tmin ... Tmax at 1 140 hPa ... 795 hPa (-1 000 m ... +2 000 m) // Tmin ... (Tmax - 10 K) at 795 hPa ... 658 hPa (+2 000 m ... +3 500 m) // Tmin ... (Tmax -20 K) at 658 hPa ... 540 hPa (+3 500 m ... +5 000 m)	Tmin ... Tmax at 1 140 hPa ... 795 hPa (-1 000 m ... +2 000 m) // Tmin ... (Tmax - 10 K) at 795 hPa ... 658 hPa (+2 000 m ... +3 500 m) // Tmin ... (Tmax -20 K) at 658 hPa ... 540 hPa (+3 500 m ... +5 000 m)	Tmin ... Tmax at 1 140 hPa ... 795 hPa (-1 000 m ... +2 000 m) // Tmin ... (Tmax - 10 K) at 795 hPa ... 658 hPa (+2 000 m ... +3 500 m) // Tmin ... (Tmax -20 K) at 658 hPa ... 540 hPa (+3 500 m ... +5 000 m)
Relative humidity				
• With condensation, tested in accordance with IEC 60068-2-38, max.	100 %; RH incl. condensation/frost (no commissioning under condensation conditions)	100 %; RH incl. condensation / frost (no commissioning in bedewed state), horizontal installation	100 %; RH incl. condensation/frost (no commissioning under condensation conditions)	100 %; RH incl. condensation/frost (no commissioning under condensation conditions)
Resistance				
Coolants and lubricants				
- Resistant to commercially available coolants and lubricants	Yes; Incl. diesel and oil droplets in the air	Yes; Incl. diesel and oil droplets in the air	Yes; Incl. diesel and oil droplets in the air	Yes; Incl. diesel and oil droplets in the air
Use in stationary industrial systems				
- to biologically active substances according to EN 60721-3-3	Yes; Class 3B2 mold, fungus and dry rot spores (with the exception of fauna); Class 3B3 on request	Yes; Class 3B2 mold, fungus and dry rot spores (with the exception of fauna); Class 3B3 on request	Yes; Class 3B2 mold, fungus and dry rot spores (with the exception of fauna); Class 3B3 on request	Yes; Class 3B2 mold, fungus and dry rot spores (with the exception of fauna); Class 3B3 on request
- to chemically active substances according to EN 60721-3-3	Yes; Class 3C4 (RH < 75 %) incl. salt spray acc. to EN 60068-2-52 (severity degree 3); *	Yes; Class 3C4 (RH < 75 %) incl. salt spray acc. to EN 60068-2-52 (severity degree 3); *	Yes; Class 3C4 (RH < 75 %) incl. salt spray acc. to EN 60068-2-52 (severity degree 3); *	Yes; Class 3C4 (RH < 75 %) incl. salt spray acc. to EN 60068-2-52 (severity degree 3); *
- to mechanically active substances according to EN 60721-3-3	Yes; Class 3S4 incl. sand, dust; *	Yes; Class 3S4 incl. sand, dust; *	Yes; Class 3S4 incl. sand, dust; *	Yes; Class 3S4 incl. sand, dust; *
- Against mechanical environmental conditions acc. to EN 60721-3-3	Yes; Class 3M8 using the SIPLUS Mounting Kit ET 200SP (6AG1193-6AA00-0AA0)	Yes; Class 3M8 using the SIPLUS Mounting Kit ET 200SP (6AG1193-6AA00-0AA0)		
Use on ships/at sea				
- to biologically active substances according to EN 60721-3-6	Yes; Class 6B2 mold and fungal spores (excluding fauna); Class 6B3 on request	Yes; Class 6B2 mold and fungal spores (excluding fauna); Class 6B3 on request	Yes; Class 6B2 mold and fungal spores (excluding fauna); Class 6B3 on request	Yes; Class 6B2 mold and fungal spores (excluding fauna); Class 6B3 on request
- to chemically active substances according to EN 60721-3-6	Yes; Class 6C3 (RH < 75 %) incl. salt spray acc. to EN 60068-2-52 (severity degree 3); *	Yes; Class 6C3 (RH < 75 %) incl. salt spray acc. to EN 60068-2-52 (severity degree 3); *	Yes; Class 6C3 (RH < 75 %) incl. salt spray acc. to EN 60068-2-52 (severity degree 3); *	Yes; Class 6C3 (RH < 75 %) incl. salt spray acc. to EN 60068-2-52 (severity degree 3); *
- to mechanically active substances according to EN 60721-3-6	Yes; Class 6S3 incl. sand, dust; *	Yes; Class 6S3 incl. sand, dust; *	Yes; Class 6S3 incl. sand, dust; *	Yes; Class 6S3 incl. sand, dust; *
- Against mechanical environmental conditions acc. to EN 60721-3-6	Yes; Class 6M4 using the SIPLUS Mounting Kit ET 200SP (6AG1193-6AA00-0AA0)	Yes; Class 6M4 using the SIPLUS Mounting Kit ET 200SP (6AG1193-6AA00-0AA0)		

I/O systems

SIMATIC ET 200 systems for the control cabinet
SIMATIC ET 200SP

SIPLUS BaseUnits

Technical specifications

Article number	6AG1193-6BP00-7BA1	6AG1193-6BP00-7DA1	6AG1193-6BP40-7BA1	6AG1193-6BP40-7DA1
Based on	6ES7193-6BP00-0BA1 SIPLUS ET 200SP BU15-P16+A0+2B/T	6ES7193-6BP00-0DA1 SIPLUS ET 200SP BU15-P16+A0+2D/T	6ES7193-6BP40-0BA1 SIPLUS ET 200SP BU15-P16+A0+12B/T	6ES7193-6BP40-0DA1 SIPLUS ET 200SP BU15-P16+A0+12D/T
Usage in industrial process technology				
- Against chemically active substances acc. to EN 60654-4	Yes; Class 3 (excluding trichlorethylene)	Yes; Class 3 (excluding trichlorethylene)	Yes; Class 3 (excluding trichlorethylene)	Yes; Class 3 (excluding trichlorethylene)
- Environmental conditions for process, measuring and control systems acc. to ANSI/ISA-71.04	Yes; Level GX group A/B (excluding trichlorethylene; harmful gas concentrations up to the limits of EN 60721-3-3 class 3C4 permissible); level LC3 (salt spray) and level LB3 (oil)	Yes; Level GX group A/B (excluding trichlorethylene; harmful gas concentrations up to the limits of EN 60721-3-3 class 3C4 permissible); level LC3 (salt spray) and level LB3 (oil)	Yes; Level GX group A/B (excluding trichlorethylene; harmful gas concentrations up to the limits of EN 60721-3-3 class 3C4 permissible); level LC3 (salt spray) and level LB3 (oil)	Yes; Level GX group A/B (excluding trichlorethylene; harmful gas concentrations up to the limits of EN 60721-3-3 class 3C4 permissible); level LC3 (salt spray) and level LB3 (oil)
Remark				
- Note regarding classification of environmental conditions acc. to EN 60721, EN 60654-4 and ANSI/ISA-71.04	* The supplied plug covers must remain in place over the unused interfaces during operation!	* The supplied plug covers must remain in place over the unused interfaces during operation!	* The supplied plug covers must remain in place over the unused interfaces during operation!	* The supplied plug covers must remain in place over the unused interfaces during operation!
Conformal coating				
• Coatings for printed circuit board assemblies acc. to EN 61086	Yes; Class 2 for high reliability	Yes; Class 2 for high reliability	Yes; Class 2 for high reliability	Yes; Class 2 for high reliability
• Protection against fouling acc. to EN 60664-3	Yes; Type 1 protection	Yes; Type 1 protection	Yes; Type 1 protection	Yes; Type 1 protection
• Military testing according to MIL-I-46058C, Amendment 7	Yes; Discoloration of coating possible during service life	Yes; Discoloration of coating possible during service life	Yes; Discoloration of coating possible during service life	Yes; Discoloration of coating possible during service life
• Qualification and Performance of Electrical Insulating Compound for Printed Board Assemblies according to IPC-CC-830A	Yes; Conformal coating, Class A	Yes; Conformal coating, Class A	Yes; Conformal coating, Class A	Yes; Conformal coating, Class A
Article number	6AG1193-6BP20-7BB0	6AG1193-6BP20-7BB1	6AG1193-6BP20-7DC0	6AG1193-6BP00-7BD0
Based on	6ES7193-6BP20-0BB0 SIPLUS ET 200SP BU20-P12+A4+0B	6ES7193-6BP20-0BB1 SIPLUS ET 200SP BU20-P12+A0+4B TYP B1	6ES7193-6BP20-0DC0 SIPLUS ET 200SP BU20-P6+A2+4D	6ES7193-6BP00-0BD0 SIPLUS ET 200SP BU20-P12+A0+0B
Ambient conditions				
Ambient temperature during operation				
• horizontal installation, min.	-40 °C; = Tmin (incl. condensation/frost)	-40 °C; = Tmin (incl. condensation/frost); start-up @ -25 °C	-40 °C; = Tmin (incl. condensation/frost)	-40 °C; = Tmin (incl. condensation/frost)
• horizontal installation, max.	70 °C; = Tmax	70 °C; = Tmax	60 °C; = Tmax	70 °C; = Tmax
• vertical installation, min.	-40 °C	-40 °C	-40 °C; = Tmin	-40 °C
• vertical installation, max.	50 °C	50 °C	50 °C; = Tmax	50 °C
Altitude during operation relating to sea level				
• Installation altitude above sea level, max.	3 000 m	3 000 m	3 000 m	3 000 m
• Ambient air temperature-barometric pressure-altitude	Tmin ... Tmax at 1 140 hPa ... 795 hPa (-1 000 m ... +2 000 m) // Tmin ... Tmax -5K) at 795 hPa ... 701 hPa (+2 000 m ... +3 000 m)	Tmin ... Tmax at 1 140 hPa ... 795 hPa (-1 000 m ... +2 000 m) // Tmin ... Tmax -5K) at 795 hPa ... 701 hPa (+2 000 m ... +3 000 m)	Tmin ... Tmax at 1 140 hPa ... 795 hPa (-1 000 m ... +2 000 m) // Tmin ... Tmax -5K) at 795 hPa ... 701 hPa (+2 000 m ... +3 000 m)	Tmin ... Tmax at 1 140 hPa ... 795 hPa (-1 000 m ... +2 000 m) // Tmin ... Tmax -5K) at 795 hPa ... 701 hPa (+2 000 m ... +3 000 m)
Relative humidity				
• With condensation, tested in accordance with IEC 60068-2-38, max.	100 %; RH incl. condensation/frost (no commissioning under condensation conditions)	100 %; RH incl. condensation / frost (no commissioning in bedewed state), horizontal installation	100 %; RH incl. condensation / frost (no commissioning in bedewed state), horizontal installation	100 %; RH incl. condensation/frost (no commissioning under condensation conditions)
Resistance				
Coolants and lubricants				
- Resistant to commercially available coolants and lubricants	Yes; Incl. diesel and oil droplets in the air	Yes; Incl. diesel and oil droplets in the air	Yes; Incl. diesel and oil droplets in the air	Yes; Incl. diesel and oil droplets in the air

Technical specifications

Article number	6AG1193-6BP20-7BB0	6AG1193-6BP20-7BB1	6AG1193-6BP20-7DC0	6AG1193-6BP00-7BD0
Based on	6ES7193-6BP20-0BB0 SIPLUS ET 200SP BU20-P12+A4+0B	6ES7193-6BP20-0BB1 SIPLUS ET 200SP BU20-P12+A0+4B TYP B1	6ES7193-6BP20-0DC0 SIPLUS ET 200SP BU20-P6+A2+4D	6ES7193-6BP00-0BD0 SIPLUS ET 200SP BU20-P12+A0+0B
Use in stationary industrial systems				
- to biologically active substances according to EN 60721-3-3	Yes; Class 3B2 mold, fungus and dry rot spores (with the exception of fauna); Class 3B3 on request	Yes; Class 3B2 mold, fungus and dry rot spores (with the exception of fauna); Class 3B3 on request	Yes; Class 3B2 mold, fungus and dry rot spores (with the exception of fauna); Class 3B3 on request	Yes; Class 3B2 mold, fungus and dry rot spores (with the exception of fauna); Class 3B3 on request
- to chemically active substances according to EN 60721-3-3	Yes; Class 3C4 (RH < 75 %) incl. salt spray acc. to EN 60068-2-52 (severity degree 3); *	Yes; Class 3C4 (RH < 75 %) incl. salt spray acc. to EN 60068-2-52 (severity degree 3); *	Yes; Class 3C4 (RH < 75 %) incl. salt spray acc. to EN 60068-2-52 (severity degree 3); *	Yes; Class 3C4 (RH < 75 %) incl. salt spray acc. to EN 60068-2-52 (severity degree 3); *
- to mechanically active substances according to EN 60721-3-3	Yes; Class 3S4 incl. sand, dust; *	Yes; Class 3S4 incl. sand, dust; *	Yes; Class 3S4 incl. sand, dust; *	Yes; Class 3S4 incl. sand, dust; *
- Against mechanical environmental conditions acc. to EN 60721-3-3	Yes; Class 3M8 using the SIPLUS Mounting Kit ET 200SP (6AG1193-6AA00-0AA0)	Yes; Class 3M8 using the SIPLUS Mounting Kit ET 200SP (6AG1193-6AA00-0AA0)	Yes; Class 3M8 using the SIPLUS Mounting Kit ET 200SP (6AG1193-6AA00-0AA0)	Yes; Class 3M8 using the SIPLUS Mounting Kit ET 200SP (6AG1193-6AA00-0AA0)
Use on ships/at sea				
- to biologically active substances according to EN 60721-3-6	Yes; Class 6B2 mold and fungal spores (excluding fauna); Class 6B3 on request	Yes; Class 6B2 mold and fungal spores (excluding fauna); Class 6B3 on request	Yes; Class 6B2 mold and fungal spores (excluding fauna); Class 6B3 on request	Yes; Class 6B2 mold and fungal spores (excluding fauna); Class 6B3 on request
- to chemically active substances according to EN 60721-3-6	Yes; Class 6C3 (RH < 75 %) incl. salt spray acc. to EN 60068-2-52 (severity degree 3); *	Yes; Class 6C3 (RH < 75 %) incl. salt spray acc. to EN 60068-2-52 (severity degree 3); *	Yes; Class 6C3 (RH < 75 %) incl. salt spray acc. to EN 60068-2-52 (severity degree 3); *	Yes; Class 6C3 (RH < 75 %) incl. salt spray acc. to EN 60068-2-52 (severity degree 3); *
- to mechanically active substances according to EN 60721-3-6	Yes; Class 6S3 incl. sand, dust; *	Yes; Class 6S3 incl. sand, dust; *	Yes; Class 6S3 incl. sand, dust; *	Yes; Class 6S3 incl. sand, dust; *
- Against mechanical environmental conditions acc. to EN 60721-3-6	Yes; Class 6M4 using the SIPLUS Mounting Kit ET 200SP (6AG1193-6AA00-0AA0)	Yes; Class 6M4 using the SIPLUS Mounting Kit ET 200SP (6AG1193-6AA00-0AA0)	Yes; Class 6M4 using the SIPLUS Mounting Kit ET 200SP (6AG1193-6AA00-0AA0)	Yes; Class 6M4 using the SIPLUS Mounting Kit ET 200SP (6AG1193-6AA00-0AA0)
Usage in industrial process technology				
- Against chemically active substances acc. to EN 60654-4	Yes; Class 3 (excluding trichlorethylene)	Yes; Class 3 (excluding trichlorethylene)	Yes; Class 3 (excluding trichlorethylene)	Yes; Class 3 (excluding trichlorethylene)
- Environmental conditions for process, measuring and control systems acc. to ANSI/ISA-71.04	Yes; Level GX group A/B (excluding trichlorethylene; harmful gas concentrations up to the limits of EN 60721-3-3 class 3C4 permissible); level LC3 (salt spray) and level LB3 (oil)	Yes; Level GX group A/B (excluding trichlorethylene; harmful gas concentrations up to the limits of EN 60721-3-3 class 3C4 permissible); level LC3 (salt spray) and level LB3 (oil)	Yes; Level GX group A/B (excluding trichlorethylene; harmful gas concentrations up to the limits of EN 60721-3-3 class 3C4 permissible); level LC3 (salt spray) and level LB3 (oil)	Yes; Level GX group A/B (excluding trichlorethylene; harmful gas concentrations up to the limits of EN 60721-3-3 class 3C4 permissible); level LC3 (salt spray) and level LB3 (oil)
Remark				
- Note regarding classification of environmental conditions acc. to EN 60721, EN 60654-4 and ANSI/ISA-71.04	* The supplied plug covers must remain in place over the unused interfaces during operation!	* The supplied plug covers must remain in place over the unused interfaces during operation!	* The supplied plug covers must remain in place over the unused interfaces during operation!	* The supplied plug covers must remain in place over the unused interfaces during operation!
Conformal coating				
• Coatings for printed circuit board assemblies acc. to EN 61086	Yes; Class 2 for high reliability	Yes; Class 2 for high reliability	Yes; Class 2 for high reliability	Yes; Class 2 for high reliability
• Protection against fouling acc. to EN 60664-3	Yes; Type 1 protection	Yes; Type 1 protection	Yes; Type 1 protection	Yes; Type 1 protection
• Military testing according to MIL-I-46058C, Amendment 7	Yes; Discoloration of coating possible during service life	Yes; Discoloration of coating possible during service life	Yes; Discoloration of coating possible during service life	Yes; Discoloration of coating possible during service life
• Qualification and Performance of Electrical Insulating Compound for Printed Board Assemblies according to IPC-CC-830A	Yes; Conformal coating, Class A	Yes; Conformal coating, Class A	Yes; Conformal coating, Class A	Yes; Conformal coating, Class A

I/O systemsSIMATIC ET 200 systems for the control cabinet
SIMATIC ET 200SP**SIPLUS BaseUnits****Technical specifications**

Article number	6AG1193-6BP20-2BF0	6AG1193-6BP00-7BU0	6AG1193-6BP00-7DU0
Based on	6ES7193-6BP20-0BF0 SIPLUS ET 200SP BU20-P8+A4+0B	6ES7193-6BP00-0BU0 SIPLUS ET 200SP BU20-P16+A0+2B	6ES7193-6BP00-0DU0 SIPLUS ET 200SP BU20-P16+A0+2D
Ambient conditions			
Ambient temperature during operation			
• horizontal installation, min.	-40 °C; = Tmin (incl. condensation/frost)	-40 °C; = Tmin (incl. condensation/frost)	-40 °C; = Tmin (incl. condensation/frost)
• horizontal installation, max.	70 °C; = Tmax	70 °C; = Tmax	70 °C; = Tmax
• vertical installation, min.	-40 °C; = Tmin		
• vertical installation, max.	50 °C; = Tmax		
Altitude during operation relating to sea level			
• Installation altitude above sea level, max.	5 000 m	2 000 m	2 000 m
• Ambient air temperature-barometric pressure-altitude	Tmin ... Tmax at 1 140 hPa ... 795 hPa (-1 000 m ... +2 000 m) // Tmin ... (Tmax - 10 K) at 795 hPa ... 658 hPa (+2 000 m ... +3 500 m) // Tmin ... (Tmax -20 K) at 658 hPa ... 540 hPa (+3 500 m ... +5 000 m)	Tmin ... Tmax at 1 140 hPa ... 795 hPa (-1 000 m ... +2 000 m)	Tmin ... Tmax at 1 140 hPa ... 795 hPa (-1 000 m ... +2 000 m)
Relative humidity			
• With condensation, tested in accordance with IEC 60068-2-38, max.	100 %; RH incl. condensation / frost (no commissioning in bedewed state), horizontal installation	100 %; RH incl. condensation/frost (no commissioning under condensation conditions)	100 %; RH incl. condensation/frost (no commissioning under condensation conditions)
Resistance			
Coolants and lubricants			
- Resistant to commercially available coolants and lubricants	Yes; Incl. diesel and oil droplets in the air	Yes; Incl. diesel and oil droplets in the air	Yes; Incl. diesel and oil droplets in the air
Use in stationary industrial systems			
- to biologically active substances according to EN 60721-3-3	Yes; Class 3B2 mold, fungus and dry rot spores (with the exception of fauna); Class 3B3 on request	Yes; Class 3B2 mold, fungus and dry rot spores (with the exception of fauna); Class 3B3 on request	Yes; Class 3B2 mold, fungus and dry rot spores (with the exception of fauna); Class 3B3 on request
- to chemically active substances according to EN 60721-3-3	Yes; Class 3C4 (RH < 75 %) incl. salt spray acc. to EN 60068-2-52 (severity degree 3); *	Yes; Class 3C4 (RH < 75 %) incl. salt spray acc. to EN 60068-2-52 (severity degree 3); *	Yes; Class 3C4 (RH < 75 %) incl. salt spray acc. to EN 60068-2-52 (severity degree 3); *
- to mechanically active substances according to EN 60721-3-3	Yes; Class 3S4 incl. sand, dust, *	Yes; Class 3S4 incl. sand, dust, *	Yes; Class 3S4 incl. sand, dust, *
- Against mechanical environmental conditions acc. to EN 60721-3-3	Yes; Class 3M8 using the SIPLUS Mounting Kit ET 200SP (6AG1193-6AA00-0AA0)	Yes; Class 3M8 using the SIPLUS Mounting Kit ET 200SP (6AG1193-6AA00-0AA0)	Yes; Class 3M8 using the SIPLUS Mounting Kit ET 200SP (6AG1193-6AA00-0AA0)
Use on ships/at sea			
- to biologically active substances according to EN 60721-3-6	Yes; Class 6B2 mold and fungal spores (excluding fauna); Class 6B3 on request	Yes; Class 6B2 mold, fungal and dry rot spores (excluding fauna)	Yes; Class 6B2 mold, fungal and dry rot spores (excluding fauna)
- to chemically active substances according to EN 60721-3-6	Yes; Class 6C3 (RH < 75 %) incl. salt spray acc. to EN 60068-2-52 (severity degree 3); *	Yes; Class 6C3 (RH < 75 %) incl. salt spray acc. to EN 60068-2-52 (severity degree 3); *	Yes; Class 6C3 (RH < 75 %) incl. salt spray acc. to EN 60068-2-52 (severity degree 3); *
- to mechanically active substances according to EN 60721-3-6	Yes; Class 6S3 incl. sand, dust; *	Yes; Class 6S3 incl. sand, dust; *	Yes; Class 6S3 incl. sand, dust; *
- Against mechanical environmental conditions acc. to EN 60721-3-6	Yes; Class 6M4 using the SIPLUS Mounting Kit ET 200SP (6AG1193-6AA00-0AA0)	Yes; Class 6M4 using the SIPLUS Mounting Kit ET 200SP (6AG1193-6AA00-0AA0)	Yes; Class 6M4 using the SIPLUS Mounting Kit ET 200SP (6AG1193-6AA00-0AA0)

Technical specifications

Article number	6AG1193-6BP20-2BF0	6AG1193-6BP00-7BU0	6AG1193-6BP00-7DU0
Based on	6ES7193-6BP20-0BF0 SIPLUS ET 200SP BU20-P8+A4+0B	6ES7193-6BP00-0BU0 SIPLUS ET 200SP BU20-P16+A0+2B	6ES7193-6BP00-0DU0 SIPLUS ET 200SP BU20-P16+A0+2D
Usage in industrial process technology			
- Against chemically active substances acc. to EN 60654-4	Yes; Class 3 (excluding trichlorethylene)	Yes; Class 3 (excluding trichlorethylene)	Yes; Class 3 (excluding trichlorethylene)
- Environmental conditions for process, measuring and control systems acc. to ANSI/ISA-71.04	Yes; Level GX group A/B (excluding trichlorethylene; harmful gas concentrations up to the limits of EN 60721-3-3 class 3C4 permissible); level LC3 (salt spray) and level LB3 (oil)	Yes; Level GX group A/B (excluding trichlorethylene; harmful gas concentrations up to the limits of EN 60721-3-3 class 3C4 permissible); level LC3 (salt spray) and level LB3 (oil)	Yes; Level GX group A/B (excluding trichlorethylene; harmful gas concentrations up to the limits of EN 60721-3-3 class 3C4 permissible); level LC3 (salt spray) and level LB3 (oil)
Remark			
- Note regarding classification of environmental conditions acc. to EN 60721, EN 60654-4 and ANSI/ISA-71.04	* The supplied plug covers must remain in place over the unused interfaces during operation!	* The supplied plug covers must remain in place over the unused interfaces during operation!	* The supplied plug covers must remain in place over the unused interfaces during operation!
Conformal coating			
• Coatings for printed circuit board assemblies acc. to EN 61086	Yes; Class 2 for high reliability	Yes; Class 2 for high reliability	Yes; Class 2 for high reliability
• Protection against fouling acc. to EN 60664-3	Yes; Type 1 protection	Yes; Type 1 protection	Yes; Type 1 protection
• Military testing according to MIL-I-46058C, Amendment 7	Yes; Discoloration of coating possible during service life	Yes; Discoloration of coating possible during service life	Yes; Discoloration of coating possible during service life
• Qualification and Performance of Electrical Insulating Compound for Printed Board Assemblies according to IPC-CC-830A	Yes; Conformal coating, Class A	Yes; Conformal coating, Class A	Yes; Conformal coating, Class A

I/O systems

SIMATIC ET 200 systems for the control cabinet
SIMATIC ET 200SP

BusAdapters**Overview**

SIMATIC BusAdapter BA 2xFC for direct laying of the PROFINET cable via FastConnect connection



ET 200SP BusAdapter BA-Send for expansion of an ET 200SP station with ET 200AL modules



SIMATIC BusAdapter BA LC/RJ45 for use as a system-integrated media converter from copper (RJ45) to glass fiber (LC)

For SIMATIC ET 200SP, two types of BusAdapter (BA) are available for selection:

- ET 200SP BusAdapter "BA-Send"
for expansion of an ET 200SP station with up to 16 modules from the ET 200AL I/O series with IP67 protection via an ET connection
- SIMATIC BusAdapter
for the free selection of the connection system (pluggable or direct connection) and physical PROFINET connection (copper, POF, HCS or glass fiber) to devices with a SIMATIC BusAdapter interface.
One further advantage of the SIMATIC BusAdapter: only the adapter needs to be replaced for subsequent conversion to the rugged FastConnect technology or a fiber-optic connection, or to repair defective RJ45 sockets.

Ordering data	Article No.	Ordering data	Article No.
BA 2xRJ45 BusAdapter For IM 155-6PN ST, HF	6ES7193-6AR00-0AA0	BA 2XLC BusAdapter For IM 155-6PN HF; 2 glass FO connections	6ES7193-6AG00-0AA0
BA 2xFC BusAdapter For IM 155-6PN ST, HF; for increased resistance to vibration and EMC loads	6ES7193-6AF00-0AA0	BA LC/RJ45 BusAdapter For IM 155-6PN HF; with media converter glass FO - copper; 1 x LC connection, 1 x RJ45 connection	6ES7193-6AG20-0AA0
BusAdapter BA 2xM12 For IM 155-6PN ST, HF; 2 x M12 push-pull sockets, D-coding, also suitable for standard M12. For PROFINET	6ES7193-6AM00-0AA0	BA LC/FC BusAdapter For IM 155-6PN HF; with media converter glass FO - copper; 1 x LC connection, 1 x FastConnect connection	6ES7193-6AG40-0AA0
BA 2xSCRJ BusAdapter For IM 155-6PN HF; fiber-optic connection for POF or PCF cables up to 250 m, with monitoring of damping	6ES7193-6AP00-0AA0	Station expansion with IP67 I/O system ET 200AL	
BA SCRJ/RJ45 BusAdapter For IM 155-6PN HF; with media converter FOC-Cu; 1 x SCRJ FO connection, 1 x RJ45 connection	6ES7193-6AP20-0AA0	ET 200SP BA-Send 1 x FC BusAdapter	6ES7193-6AS00-0AA0
BA SCRJ/FC BusAdapter For IM 155-6PN HF; with media converter FOC-Cu; 1 x SCRJ FO connection, 1 x FastConnect connection	6ES7193-6AP40-0AA0	BaseUnit BU-Send	6ES7193-6BN00-0NE0
		Accessories	
		Equipment labeling plate 10 sheets of 16 labels, for printing with thermal transfer card printer or plotter	6ES7193-6LF30-0AW0

Technical specifications

Article number	6ES7193-6AR00-0AA0	6ES7193-6AF00-0AA0	6ES7193-6AM00-0AA0	6ES7193-6AP00-0AA0	6ES7193-6AP20-0AA0
	ET 200SP, Busadapter BA 2xRJ45	ET 200SP, Busadapter BA 2XFC	SIMATIC Busadapter BA 2xM12	ET 200SP, Busadapter BA 2xSCRJ	ET 200SP, Busadapter BA SCRJ/RJ45
General information					
Product type designation	BA 2x RJ45	BA 2xFC	BA 2x M12 BusAdapter	BA 2xSCRJ	BA SCRJ/RJ45
Interfaces					
Number of PROFINET interfaces	1	1	1	1; 2 ports (switch) SCRJ FO	1; 2 ports (SCRJ + RJ45)
Supports protocol for PROFINET IO					
• Number of RJ45 ports	2				1
• Number of FC (FastConnect) connections		2			
• Number of SCRJ ports	0			2	1
• Number of LC ports	0			0	0
• Number of M12 ports			2		
Cable length					
- PCF				100 m	100 m
- Plastic FOC (POF)				50 m	50 m
- PCF-GI				250 m	250 m
- Cu conductors	100 m	100 m	100 m		100 m
Ambient conditions					
Altitude during operation relating to sea level					
• Installation altitude above sea level, max.	2 000 m; On request: Installation altitudes greater than 2 000 m	2 000 m; On request: Installation altitudes greater than 2 000 m	5 000 m; Restrictions for installation altitudes > 2 000 m, see manual	2 000 m; On request: Installation altitudes greater than 2 000 m	2 000 m; On request: Installation altitudes greater than 2 000 m
Dimensions					
Width	20 mm	20 mm	20 mm	20 mm	20 mm
Height	69.5 mm	69.5 mm	73.5 mm	69.5 mm	
Depth	59 mm	59 mm	59 mm	59 mm	
Weights					
Weight, approx.	46 g	53 g	59 g	50 g	50 g

I/O systemsSIMATIC ET 200 systems for the control cabinet
SIMATIC ET 200SP**BusAdapters****Technical specifications**

Article number	6ES7193-6AP40-0AA0 ET 200SP, Bus adapter BA SCRJ/FC	6ES7193-6AG00-0AA0 SIMATIC Busadapter BA 2XLC	6ES7193-6AG20-0AA0 SIMATIC Busadapter BA LC/RJ45	6ES7193-6AG40-0AA0 SIMATIC Bus adapter BA LC/FC
General information				
Product type designation	BA SCRJ/FC	BA 2xLC	BA LC/RJ45	BA LC/FC
Interfaces				
Number of PROFINET interfaces	1; 2 ports (SCRJ + FC)	1; 2 ports (switch) LC Multimode Glass Fibre	1; 2 ports (switch) LC / RJ45	1
Supports protocol for PROFINET IO				
• Number of RJ45 ports			1	
• Number of FC (FastConnect) connections	1			1
• Number of SCRJ ports	1	0	0	0
• Number of LC ports	0	2; Wavelength of 1 270 ... 1 380 nm, corresponds to 100BASE-FX	1; Wavelength of 1 270 ... 1 380 nm, corresponds to 100BASE-FX	1; Wavelength of 1 270 ... 1 380 nm, corresponds to 100BASE-FX
Cable length				
- PCF	100 m			
- Plastic FOC (POF)	50 m			
- PCF-GI	250 m			
- Cu conductors	100 m		100 m	100 m
- Multimode graded-index fiber 50/125 µm		3 km	3 km	3 km
- Multimode graded-index fiber 62.5/125 µm		3 km	3 km	3 km
Ambient conditions				
Altitude during operation relating to sea level				
• Installation altitude above sea level, max.	2 000 m; On request: Installation altitudes greater than 2 000 m	2 000 m; On request: Installation altitudes greater than 2 000 m	2 000 m; On request: Installation altitudes greater than 2 000 m	2 000 m; On request: Installation altitudes greater than 2 000 m
Dimensions				
Width	20 mm	20 mm	20 mm	20 mm
Height	69.5 mm	69.5 mm	69.5 mm	69.5 mm
Depth	59 mm	59 mm	59 mm	59 mm
Weights				
Weight, approx.	50 g	40 g	32 g	50 g
Article number	6ES7193-6AS00-0AA0 ET 200SP, Busadapter BA-Send BA1XFC			
General information				
Product type designation	BA-Send 1xFC			
Interfaces				
Supports protocol for PROFINET IO				
Cable length				
- Cu conductors	15 m; from IM firmware V3.3: between BA-send and the first ET-CONNECTION bus node and between all other bus nodes			
ET-Connection				
• Number of interfaces ET connection	1			
• FC (FastConnect)	Yes			
Ambient conditions				
Altitude during operation relating to sea level				
• Installation altitude above sea level, max.	2 000 m; On request: Installation altitudes greater than 2 000 m			
Dimensions				
Width	20 mm			
Weights				
Weight, approx.	44 g			

Overview



SIMATIC BusAdapter BA 2xFC for direct laying of the PROFINET cable via FastConnect connection.



ET 200SP BusAdapter BA-Send for expansion of an ET 200SP station with ET 200AL modules.



SIMATIC BusAdapter BA LC/RJ45 for use as a system-integrated media converter from copper (RJ45) to glass fiber (LC).

- ET 200SP BusAdapter "BA-Send"
for expansion of an ET 200SP station with up to 16 modules from the ET 200AL I/O series with IP67 protection via an ET connection
- SIMATIC BusAdapter
for the free selection of the connection system (pluggable or direct connection) and physical PROFINET connection (copper, POF, HCS or glass fiber) to devices with a SIMATIC BusAdapter interface.
Another advantage of the SIMATIC BusAdapters: only the adapter needs to be replaced for subsequent conversion to the rugged FastConnect technology or a fiber-optic connection, or to repair defective RJ45 sockets.

Note

SIPLUS extreme products are based on SIMATIC standard products. The contents listed here were taken from the respective standard products. SIPLUS extreme-specific information was added.

10

Ordering data**Article No.****SIPLUS BA 2xRJ45 BusAdapter****6AG1193-6AR00-7AA0**

(extended temperature range and exposure to environmental substances)

for IM 155-6PN ST, HF

SIPLUS BA 2xFC BusAdapter**6AG1193-6AF00-7AA0**

(extended temperature range and exposure to environmental substances)

for IM 155-6PN ST, HF;
for increased resistance to vibration and EMC loads

**SIPLUS ET 200SP
BA 2xM12 BusAdapter****6AG1193-6AM00-7AA0**

-40 ... +70 °C,
with conformal coating,
2 x M12 push-pull sockets,
D-coding, also suitable for
standard M12,
suitable for PROFINET

Article No.**SIPLUS BA 2xSCRJ BusAdapter****6AG1193-6AP00-2AA0**

(extended temperature range and exposure to environmental substances)

for IM 155-6PN HF;
fiber-optic cable connection for
POF or PCF cables up to 250 m,
with monitoring of damping

SIPLUS BA 2xLC BusAdapter**6AG1193-6AG00-2AA0**

(extended temperature range and exposure to environmental substances)

for IM 155-6PN HF;
2 glass FO connections

I/O systems

SIMATIC ET 200 systems for the control cabinet
SIMATIC ET 200SP

SIPLUS BusAdapters

Ordering data

Equipment labeling plate

10 sheets of 16 labels,
for printing with thermal transfer
card printer or plotter

Article No.

6ES7193-6LF30-0AW0

Article No.

Accessories

SIPLUS Mounting Kit ET 200SP

Mounting accessories for use
with increased mechanical vibration
and shock loads. Not approved
for SIPLUS BusAdapter BA 2xRJ45

6AG1193-6AA00-0AA0

Technical specifications

Article number	6AG1193-6AR00-7AA0	6AG1193-6AF00-7AA0	6AG1193-6AM00-7AA0	6AG1193-6AP00-2AA0	6AG1193-6AG00-2AA0
Based on	6ES7193-6AR00-0AA0 SIPLUS ET 200SP BA 2xRJ45	6ES7193-6AF00-0AA0 SIPLUS ET 200SP BA 2XFC PN	6ES7193-6AM00-0AA0 SIPLUS ET 200SP BA 2xM12	6ES7193-6AP00-0AA0 SIPLUS ET 200SP BA 2XSCRJ PN	6ES7193-6AG00-0AA0 SIPLUS ET 200SP BA 2XLC
Ambient conditions					
Ambient temperature during operation					
• min.	-40 °C; = Tmin (incl. condensation/ frost)	-40 °C; = Tmin (incl. condensation/ frost)		-40 °C; = Tmin (incl. condensation/ frost); start-up @ -25 °C	-40 °C; = Tmin (incl. condensation/ frost)
• max.	70 °C; = Tmax	70 °C; = Tmax		60 °C; = Tmax	60 °C; = Tmax
Altitude during operation relating to sea level					
• Installation altitude above sea level, max.	5 000 m	5 000 m	5 000 m	5 000 m	5 000 m
• Ambient air temperature-barometric pressure-altitude	Tmin ... Tmax at 1 140 hPa ... 795 hPa (-1 000 m ... +2 000 m) // Tmin ... (Tmax - 10 K) at 795 hPa ... 658 hPa (+2 000 m ... +3 500 m) // Tmin ... (Tmax -20 K) at 658 hPa ... 540 hPa (+3 500 m ... +5 000 m)	Tmin ... Tmax at 1 140 hPa ... 795 hPa (-1 000 m ... +2 000 m) // Tmin ... (Tmax - 10 K) at 795 hPa ... 658 hPa (+2 000 m ... +3 500 m) // Tmin ... (Tmax -20 K) at 658 hPa ... 540 hPa (+3 500 m ... +5 000 m)	Tmin ... Tmax at 1 140 hPa ... 795 hPa (-1 000 m ... +2 000 m) // Tmin ... (Tmax - 10 K) at 795 hPa ... 658 hPa (+2 000 m ... +3 500 m) // Tmin ... (Tmax -20 K) at 658 hPa ... 540 hPa (+3 500 m ... +5 000 m)	Tmin ... Tmax at 1 140 hPa ... 795 hPa (-1 000 m ... +2 000 m) // Tmin ... (Tmax - 10 K) at 795 hPa ... 658 hPa (+2 000 m ... +3 500 m) // Tmin ... (Tmax -20 K) at 658 hPa ... 540 hPa (+3 500 m ... +5 000 m)	Tmin ... Tmax at 1 140 hPa ... 795 hPa (-1 000 m ... +2 000 m) // Tmin ... (Tmax - 10 K) at 795 hPa ... 658 hPa (+2 000 m ... +3 500 m) // Tmin ... (Tmax -20 K) at 658 hPa ... 540 hPa (+3 500 m ... +5 000 m)
Relative humidity					
• With condensation, tested in accordance with IEC 60068-2-38, max.	100 %; RH incl. condensation / frost (no commissioning in bedewed state), horizontal installation	100 %; RH incl. condensation / frost (no commissioning in bedewed state), horizontal installation	100 %; RH incl. condensation / frost (no commissioning in bedewed state), horizontal installation	100 %; RH incl. condensation/frost (no commissioning under condensation conditions)	100 %; RH incl. condensation / frost (no commissioning in bedewed state), horizontal installation
Resistance					
Coolants and lubricants					
- Resistant to commercially available coolants and lubricants	Yes; Incl. diesel and oil droplets in the air	Yes; Incl. diesel and oil droplets in the air	Yes; Incl. diesel and oil droplets in the air	Yes; Incl. diesel and oil droplets in the air	Yes; Incl. diesel and oil droplets in the air
Use in stationary industrial systems					
- to biologically active substances according to EN 60721-3-3	Yes; Class 3B2 mold, fungus and dry rot spores (with the exception of fauna); Class 3B3 on request	Yes; Class 3B2 mold, fungus and dry rot spores (with the exception of fauna); Class 3B3 on request	Yes; Class 3B2 mold, fungus and dry rot spores (with the exception of fauna); Class 3B3 on request	Yes; Class 3B2 mold, fungus and dry rot spores (with the exception of fauna); Class 3B3 on request	Yes; Class 3B2 mold, fungus and dry rot spores (with the exception of fauna); Class 3B3 on request
- to chemically active substances according to EN 60721-3-3	Yes; Class 3C4 (RH < 75 %) incl. salt spray acc. to EN 60068-2-52 (severity degree 3); *	Yes; Class 3C4 (RH < 75 %) incl. salt spray acc. to EN 60068-2-52 (severity degree 3); *	Yes; Class 3C4 (RH < 75 %) incl. salt spray acc. to EN 60068-2-52 (severity degree 3); *	Yes; Class 3C4 (RH < 75 %) incl. salt spray acc. to EN 60068-2-52 (severity degree 3); *	Yes; Class 3C4 (RH < 75 %) incl. salt spray acc. to EN 60068-2-52 (severity degree 3); *
- to mechanically active substances according to EN 60721-3-3	Yes; Class 3S4 incl. sand, dust, *	Yes; Class 3S4 incl. sand, dust, *	Yes; Class 3S4 incl. sand, dust, *	Yes; Class 3S4 incl. sand, dust, *	Yes; Class 3S4 incl. sand, dust, *
- Against mechanical environmental conditions acc. to EN 60721-3-3		Yes; Class 3M8 using the SIPLUS Mounting Kit ET 200SP (6AG1193-6AA00-0AA0)	Yes; Class 3M8 using the SIPLUS Mounting Kit ET 200SP (6AG1193-6AA00-0AA0)	Yes; Class 3M8 using the SIPLUS Mounting Kit ET 200SP (6AG1193-6AA00-0AA0)	Yes; Class 3M8 using the SIPLUS Mounting Kit ET 200SP (6AG1193-6AA00-0AA0)
Use on ships/at sea					
- to biologically active substances according to EN 60721-3-6	Yes; Class 6B2 mold and fungal spores (excluding fauna); Class 6B3 on request	Yes; Class 6B2 mold and fungal spores (excluding fauna); Class 6B3 on request	Yes; Class 6B2 mold, fungal and dry rot spores (excluding fauna)	Yes; Class 6B2 mold and fungal spores (excluding fauna); Class 6B3 on request	Yes; Class 6B2 mold and fungal spores (excluding fauna); Class 6B3 on request

Technical specifications

Article number	6AG1193-6AR00-7AA0	6AG1193-6AF00-7AA0	6AG1193-6AM00-7AA0	6AG1193-6AP00-2AA0	6AG1193-6AG00-2AA0
Based on	6ES7193-6AR00-0AA0 SIPLUS ET 200SP BA 2xRJ45	6ES7193-6AF00-0AA0 SIPLUS ET 200SP BA 2XFC PN	6ES7193-6AM00-0AA0 SIPLUS ET 200SP BA 2xM12	6ES7193-6AP00-0AA0 SIPLUS ET 200SP BA 2XSCRJ PN	6ES7193-6AG00-0AA0 SIPLUS ET 200SP BA 2XLC
- to chemically active substances according to EN 60721-3-6	Yes; Class 6C3 (RH < 75 %) incl. salt spray acc. to EN 60068-2-52 (severity degree 3); *	Yes; Class 6C3 (RH < 75 %) incl. salt spray acc. to EN 60068-2-52 (severity degree 3); *	Yes; Class 6C3 (RH < 75 %) incl. salt spray acc. to EN 60068-2-52 (severity degree 3); *	Yes; Class 6C3 (RH < 75 %) incl. salt spray acc. to EN 60068-2-52 (severity degree 3); *	Yes; Class 6C3 (RH < 75 %) incl. salt spray acc. to EN 60068-2-52 (severity degree 3); *
- to mechanically active substances according to EN 60721-3-6	Yes; Class 6S3 incl. sand, dust; *	Yes; Class 6S3 incl. sand, dust; *	Yes; Class 6S3 incl. sand, dust; *	Yes; Class 6S3 incl. sand, dust; *	Yes; Class 6S3 incl. sand, dust; *
- Against mechanical environmental conditions acc. to EN 60721-3-6		Yes; Class 6M4 using the SIPLUS Mounting Kit ET 200SP (6AG1193-6AA00-0AA0)	Yes; Class 6M4 using the SIPLUS Mounting Kit ET 200SP (6AG1193-6AA00-0AA0)	Yes; Class 6M4 using the SIPLUS Mounting Kit ET 200SP (6AG1193-6AA00-0AA0)	Yes; Class 6M4 using the SIPLUS Mounting Kit ET 200SP (6AG1193-6AA00-0AA0)
Usage in industrial process technology					
- Against chemically active substances acc. to EN 60654-4	Yes; Class 3 (excluding trichlorethylene)	Yes; Class 3 (excluding trichlorethylene)	Yes; Class 3 (excluding trichlorethylene)	Yes; Class 3 (excluding trichlorethylene)	Yes; Class 3 (excluding trichlorethylene)
- Environmental conditions for process, measuring and control systems acc. to ANSI/ISA-71.04	Yes; Level GX group A/B (excluding trichlorethylene; harmful gas concentrations up to the limits of EN 60721-3-3 class 3C4 permissible); level LC3 (salt spray) and level LB3 (oil)	Yes; Level GX group A/B (excluding trichlorethylene; harmful gas concentrations up to the limits of EN 60721-3-3 class 3C4 permissible); level LC3 (salt spray) and level LB3 (oil)	Yes; Level GX group A/B (excluding trichlorethylene; harmful gas concentrations up to the limits of EN 60721-3-3 class 3C4 permissible); level LC3 (salt spray) and level LB3 (oil)	Yes; Level GX group A/B (excluding trichlorethylene; harmful gas concentrations up to the limits of EN 60721-3-3 class 3C4 permissible); level LC3 (salt spray) and level LB3 (oil)	Yes; Level GX group A/B (excluding trichlorethylene; harmful gas concentrations up to the limits of EN 60721-3-3 class 3C4 permissible); level LC3 (salt spray) and level LB3 (oil)
Remark					
- Note regarding classification of environmental conditions acc. to EN 60721, EN 60654-4 and ANSI/ISA-71.04	* The supplied plug covers must remain in place over the unused interfaces during operation!	* The supplied plug covers must remain in place over the unused interfaces during operation!	* The supplied plug covers must remain in place over the unused interfaces during operation!	* The supplied plug covers must remain in place over the unused interfaces during operation!	* The supplied plug covers must remain in place over the unused interfaces during operation!
Conformal coating					
• Coatings for printed circuit board assemblies acc. to EN 61086	Yes; Class 2 for high reliability	Yes; Class 2 for high reliability	Yes; Class 2 for high reliability	Yes; Class 2 for high reliability	Yes; Class 2 for high reliability
• Protection against fouling acc. to EN 60664-3	Yes; Type 1 protection	Yes; Type 1 protection	Yes; Type 1 protection	Yes; Type 1 protection	Yes; Type 1 protection
• Military testing according to MIL-I-46058C, Amendment 7	Yes; Discoloration of coating possible during service life	Yes; Discoloration of coating possible during service life	Yes; Discoloration of coating possible during service life	Yes; Discoloration of coating possible during service life	Yes; Discoloration of coating possible during service life
• Qualification and Performance of Electrical Insulating Compound for Printed Board Assemblies according to IPC-CC-830A	Yes; Conformal coating, Class A	Yes; Conformal coating, Class A	Yes; Conformal coating, Class A	Yes; Conformal coating, Class A	Yes; Conformal coating, Class A

I/O systems

SIMATIC ET 200 systems for the control cabinet
SIMATIC ET 200SP

Accessories

Overview Labeling strips

The head-end stations and I/O modules can optionally be equipped with labeling strips (13 x 31 mm) for system-specific marking. The labeling strips can be inscribed mechanically. Labeling strips are available in two versions in the colors light gray and yellow:

- 500 strips on the roll, for printing on thermal transfer printers. Core diameter 40 mm, external diameter 70 mm, width 62 mm
- 10 DIN A4 sheets with 100 strips each, 180 g/sm card, perforated, for printing using a laser printer direct from TIA Portal or via print templates

Overview Equipment labeling plate



Optionally, one equipment labeling plate each can be plugged onto head-end stations, BusAdapters, BaseUnits, and I/O modules. Equipment labeling plates are supplied in packs of 10 sheets with 16 labels each. The labels can be printed with thermal-transfer card printers or plotters, or stickers can be attached to them. Advantages compared to labels that are attached directly:

- The inscription on the front is not covered
- Simple label replacement when replacing a module
- No parallax errors when marking the BaseUnits on the mounting plate

The size of the labels is 14.8 x 10.5 mm (W x H)

Overview BU cover

The ET 200SP system can be operated with any number of slot gaps (BU slot without inserted I/O module). Applications for this include:

- Partial commissioning
- Prewired but unequipped options

To protect against damage, such slot gaps must be covered by a BU cover.

Within the BU cover, an equipment labeling plate for identification of the I/O module planned for this slot can be stored.

Versions:

- For BaseUnits with a width of 15 mm (pack containing 5 BU covers)
- For BaseUnits with a width of 20 mm (pack containing 5 BU covers)

Overview Shield connection

The shield connection permits the low-cost connection of cable shields. Compared to external shield supports, the system offers the following advantages:

- Quick installation without tools by plugging the shield connection element onto the BaseUnit
- Automatic low-impedance connection to the functional ground (DIN rail)
- Optimized EMC properties by separating the signal lines from the voltage supply lines
- Short unshielded cable lengths
- Requires little space

Overview Color-coded labels

The I/O modules that are plugged onto the BaseUnits determine the potentials connected at the process terminals. The +/- potentials can optionally be identified using module-specific color-coded labels. The potentials of the AUX and add-on terminals can also be marked using color-coded labels. Advantages of the color-coded labels:

- Quick installation (one label for marking 16 terminals)
- Printed terminal numbers
- Avoidance of wiring errors
- Simple detection of potentials during servicing

Overview Server module

The server module is included in the scope of delivery of all head-end stations (interface module, CPU, Open Controller). It concludes the setup of an ET 200SP station.

Overview SIPLUS server module

The SIPLUS server module is included in the scope of supply of all head-end stations (interface module, CPU, Open Controller). It concludes the setup of a SIPLUS ET 200SP station.

Overview e-coding elements

The operation of selected modules requires an electronic coding element that is always included in the scope of delivery of the I/O module. Apart from the mechanical coding function, this contains a re-writable memory for the redundant storage of module-specific configuration data (e.g. F target address for fail-safe modules or parameter data in the case of the IO-Link master). In this way, this data is automatically backed up during a module replacement. This saves the user from having to set addresses manually or back up data when replacing modules.

At present, there are two types of electronic coding element:

- e-coding element (Type H), which can be used in the I/O modules:
 - CM IO-Link master
 - F-CM AS-i Safety
- e-coding element (Type F), which can be used in the I/O modules:
 - F-DI 8x24VDC HF
 - F-DQ 4x24VDC/2A PM HF
 - F-PM-E 24VDC/8A PPM ST

Ordering data	Article No.	Article No.
Labeling strips		
500 labeling strips on roll, light gray, for inscription with thermal transfer roll printer	6ES7193-6LR10-0AA0	
500 labeling strips on roll, yellow, for inscription with thermal transfer roll printer	6ES7193-6LR10-0AG0	
1000 labeling strips DIN A4, light gray, card, for inscription with laser printer	6ES7193-6LA10-0AA0	
1000 labeling strips DIN A4, yellow, card, for inscription with laser printer	6ES7193-6LA10-0AG0	
Equipment labeling plates	6ES7193-6LF30-0AW0	
10 sheets of 16 plates		
BU cover		
For covering empty slots (gaps); 5 units		
<ul style="list-style-type: none"> • 15 mm wide • 20 mm wide 	6ES7133-6CV15-1AM0 6ES7133-6CV20-1AM0	
Shield connection	6ES7193-6SC00-1AM0	
5 shield supports and 5 shield terminals each for plugging onto BaseUnits with automatic low-impedance connection to functional ground		
Module-specific color-coded labels		
(pack containing 10 labels)		
Color code CC00, for 16 push-in terminals, for BU type A0, A1, gray (terminals 1 to 8), red (terminals 9 to 16)	6ES7193-6CP00-2MA0	
Color code CC01, for 16 push-in terminals, for BU type A0, A1, gray (terminals 1 to 8), red (terminals 9 to 16)	6ES7193-6CP01-2MA0	
Color code CC02, for 16 push-in terminals, for BU type A0, A1, gray (terminals 1 to 8), blue (terminals 9 to 16)	6ES7193-6CP02-2MA0	
Color code CC03, for 16 push-in terminals, for BU type A0, A1, gray (terminals 1 to 8), red (terminals 9 to 12), gray (terminals 13 to 16)	6ES7193-6CP03-2MA0	
Color code CC04, for 16 push-in terminals, BU type A0, A1, gray (terminals 1 to 8), red (terminals 9 to 12), blue (terminals 13 to 16)	6ES7193-6CP04-2MA0	
Color code CC05, for 16 push-in terminals, for BU type A0, A1, gray (terminals 1 to 12), red (terminals 13 to 14), blue (terminals 15 to 16)	6ES7193-6CP05-2MA0	
Color code CC41, for 16 push-in terminals; for BU type B1, gray (terminals 1 to 4), red (terminals 5 to 8), blue (terminals 9 to 12)	6ES7193-6CP41-2MB0	
Color code CC42, for 12 push-in terminals, BU type F0, gray (terminals 1 to 8), red (terminals 9 to 10), blue (terminals 11 to 12)	6ES7193-6CP42-2MB0	
Module-specific color-coded labels (continued)		
Color code CC51, for 6 push-in terminals, for BU type C0, C1, gray (terminals 1 to 4), red (terminal 5), blue (terminal 6)	6ES7193-6CP51-2MC0	
Color code CC51, for 6 push-in terminals, for BU type C0, gray (terminals 1, 2 and 5), red (terminals 3 and 4), blue (terminal 6)	6ES7193-6CP52-2MC0	
(pack containing 50 labels)		
Color code CC01, for 16 push-in terminals, for BU type A0, A1, gray (terminals 1 to 8), red (terminals 9 to 16)	6ES7193-6CP01-4MA0	
Color code CC02, for 16 push-in terminals, for BU type A0, A1, gray (terminals 1 to 8), blue (terminals 9 to 16)	6ES7193-6CP02-4MA0	
Color-coded labels for additional terminals		
(pack containing 10 labels)		
Color code CC71, for 10 AUX terminals, BU type A0, yellow/green (terminals 1 A to 10 A)	6ES7193-6CP71-2AA0	
Color code CC72, for 10 AUX terminals, BU type A0, red (terminals 1 A to 10 A)	6ES7193-6CP72-2AA0	
Color code CC73, for 10 AUX terminals, BU type A0, blue (terminals 1 A to 10 A)	6ES7193-6CP73-2AA0	
Color code CC74, for 2x5 additional terminals, BU type A1, red (terminals 1B to 5B), blue (terminals 1C to 5C)	6ES7193-6CP74-2AA0	
Color code CC81, for 4 AUX terminals, BU type B0, yellow/green (terminals 1 A to 4 A)	6ES7193-6CP81-2AB0	
Color code CC82, for 4 AUX terminals, BU type B0, red (terminals 1 A to 4 A)	6ES7193-6CP82-2AB0	
Color code CC83, for 4 AUX terminals, BU type B0, blue (terminals 1 A to 4 A)	6ES7193-6CP83-2AB0	
Color code CC84, for 2 AUX terminals, BU type C0, C1, yellow/green (terminals 1 A to 2 A)	6ES7193-6CP84-2AC0	
Color code CC85, for 2 AUX terminals, for BU type C0, C1, red (terminals 1 A to 2 A)	6ES7193-6CP85-2AC0	
Color code CC86, for 2 AUX terminals, for BU type C0, C1, blue (terminals 1 A to 2 A)	6ES7193-6CP86-2AC0	
Server module	6ES7193-6PA00-0AA0	
Spare part		
SIPLUS server module	6AG1193-6PA00-7AA0	
(Extended temperature range and exposure to media)		
Spare part		
e-coding element		
Type H; pack containing 5 e-coding elements	6ES7193-6EH00-1AA0	
Type F; pack containing 5 e-coding elements	6ES7193-6EF00-1AA0	

I/O systems

SIMATIC ET 200 systems for the control cabinet

SIMATIC ET 200SP HA

Overview

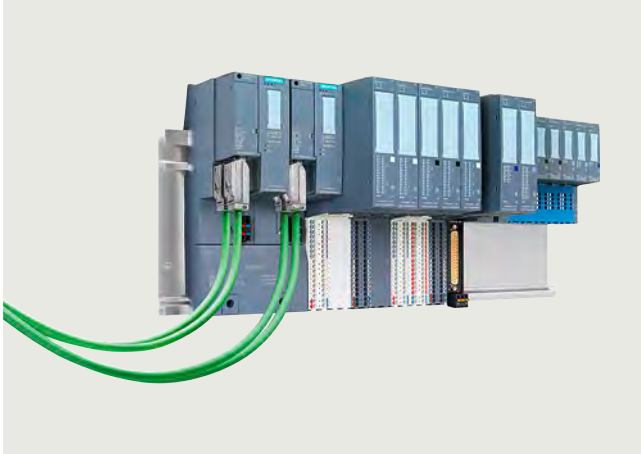

ET 200SP HA with redundant interface module, standard modules, Ex modules and D-SUB terminal block.

Compact design, flexible connection possibilities and high system availability with redundant PROFINET connections: the SIMATIC ET 200SP HA distributed I/O system is perfectly suited to the requirements of the process industry. The new design allows up to 56 I/O modules per station. An impressively high concentration of up to 32 channels on a module that is only 22.5 mm wide allows for maximum economy in the control cabinet.

Redundant PROFINET connections allow the connection of high-availability controllers via two independent networks, with a choice of copper or fiber-optic cables. The system can be scaled and extended in small steps using a variety of available modules, for example with digital and analog I/Os as well as NAMUR, HART, and other protocols. All 24 V standard signals are connected via an identical terminal block type, which allows a high degree of standardization for the control cabinets.

SIMATIC ET 200SP HA is designed for use in the control cabinet as well as for hazardous areas up to hazardous zone 2. The extended temperature range from -40 to +70 °C and the conformal coating of all components allow direct installation in the field.

Overview

IM 155-6 PN HA

IM 155-6 PN HA interface module

The IM 155-6 PN HA together with the IM carrier module and the BusAdapter forms the interface of the ET 200SP HA. The interface is used for communication between the CPU and the connected ET 200SP HA I/O modules over PROFINET.

Ordering data**Article No.****Interface module****PROFINET IM 155-6 PN interface module**

Max. 56 I/O modules,
multi hot swap, no server module

6DL1155-6AU00-0PM0**Accessories****IM cover**

Slot cover for interface module
slots, to protect vacant slots
Width 50 mm, 5 units

6DL1133-6CV50-0AM0

I/O systems

SIMATIC ET 200 systems for the control cabinet
SIMATIC ET 200SP HA

Interface module

Technical specifications

Article number	6DL1155-6AU00-0PM0 ET 200SP HA, IM155-6 PN
General information	
Product type designation	IM 155-6 PN
Product function	
• I&M data	Yes; I&M0 to I&M3
Engineering with	
• STEP 7 TIA Portal configurable/ integrated from version	V16
• STEP 7 configurable/ integrated from version	V5.6
• PCS 7 configurable/ integrated from version	V9.0
• PCS neo can be configured/ integrated from version	V3.0
Supply voltage	
Rated value (DC)	24 V
Reverse polarity protection	Yes
Short-circuit protection	Yes
Address area	
Address space per station	
• Address space per station, max.	1 440 byte; 1 440 bytes R1 and S1 without CiR, otherwise 1 000 bytes
Hardware configuration	
Integrated power supply	Yes; 24 V DC
Rack	
• Modules per rack, max.	56; 56 slots for I/O modules + server module (width without IM ≤ 1.3 m)
Time stamping	
Accuracy	1 ms; In compliance with the supplementary conditions described in the Equipment Manual
Interfaces	
Number of PROFINET interfaces	1; 2 ports (switch)
1. Interface	
Interface types	
• Number of ports	2; via BusAdapter
• integrated switch	Yes
• BusAdapter (PROFINET)	Yes; Compatible BusAdapters: BA 2x RJ45, BA 2x FC, BA 2x LC, BA LC/RJ45, BA LC/FC, BA VD
Protocols	
• PROFINET IO Device	Yes
• Open IE communication	Yes
• Media redundancy	Yes; as MRP client

Article number	6DL1155-6AU00-0PM0 ET 200SP HA, IM155-6 PN
Interface types	
RJ 45 (Ethernet)	
• Transmission procedure	PROFINET with 100 Mbit/s full duplex (100BASE-TX)
• 100 Mbps	Yes; PROFINET with 100 Mbit/s full duplex (100BASE-TX)
• Autonegotiation	Yes
• Autocrossing	Yes
Protocols	
Redundancy mode	
• PROFINET system redundancy (S2)	Yes; S2, R1
Media redundancy	
- MRP	Yes
Open IE communication	
• TCP/IP	Yes
• SNMP	Yes
• LLDP	Yes
Interrupts/diagnostics/ status information	
Status indicator	Yes
Alarms	Yes
Diagnostics function	Yes
Diagnostics indication LED	
• RUN LED	Yes; green LED
• ERROR LED	Yes; red LED
• MAINT LED	Yes; Yellow LED
• ACT LED	Yes; green LED
• Monitoring of the supply voltage (PWR-LED)	Yes; green PWR LED
• Connection display LINK TX/RX	Yes; 2x green link LEDs on BusAdapter
Ambient conditions	
Ambient temperature during operation	
• horizontal installation, min.	-40 °C
• horizontal installation, max.	70 °C
• vertical installation, min.	-40 °C
• vertical installation, max.	60 °C
Dimensions	
Width	50 mm
Height	138 mm
Depth	89 mm
Weights	
Weight, approx.	192 g; without BusAdapter

Overview



- DI 16×24VDC HA digital input module
16 24 V DC digital inputs
- DI 32×24VDC HA digital input module
32 24 V DC digital inputs
- DI 16×NAMUR HA digital input module
16 NAMUR digital inputs
- DI 8×24...125VDC HA digital input module
8 24 ... 125 V DC digital inputs
- DI 8×230VAC HA digital input module
8 230 V AC digital inputs
- DQ 16×24VDC/0.5A HA digital output module
16 24 V DC digital outputs, 0.5 A
- DQ 32×24VDC/0.5A HA digital output module
32 24 V DC digital outputs, 0.5 A
- RQ 4×120VDC-230VAC/5A CO HA digital output module
4 24 ... 120 V DC, 24 ... 230 V AC relay outputs, 5 A

Ordering data

Ordering data	Article No.
DI 16×24VDC HA digital input module 16 24 V DC digital inputs, color code CC01, for terminal block type H1 and M1, channel diagnostics	6DL1131-6BH00-0PH1
DI 32×24VDC HA digital input module 32 24 V DC digital inputs, color code CC00, for terminal block type P0 and H1, channel diagnostics	6DL1131-6BL00-0PH1
DI 16×NAMUR HA digital input module 16 NAMUR digital inputs, color code CC01, for terminal block type H1 and M1, channel diagnostics	6DL1131-6TH00-0PH1
DI 8×24...125VDC HA digital input module 8 24 ... 125 V DC digital inputs, color code CC42, for terminal block type K0, channel diagnostics	6DL1131-6DF00-0PK0
DI 8×230VAC HA digital input module 8 230 V AC digital inputs, color code CC42, for terminal block type K0, module diagnostics	6DL1131-6GF00-0PK0
DQ 16×24VDC/0.5A HA digital output module 16 24 V DC digital outputs, 0.5 A, color code CC02, for terminal block type H1 and M1, channel diagnostics	6DL1132-6BH00-0PH1
DQ 32×24VDC/0.5A HA digital output module 32 24 V DC digital outputs, 0.5 A, color code CC00, for terminal block type NO and H1, channel diagnostics	6DL1132-6BL00-0PH1
RQ 4×120VDC-230VAC/5A CO HA digital output module 4 24 ... 120 V DC, 24 ... 230 V AC relay outputs, 5 A, color code CC40, for terminal block type K0, module diagnostics	6DL1132-6HD50-0PK0

Article No.

Accessories	Article No.
Labeling strips For labeling the I/O modules	
• Roll, light gray (with a total of 500 labeling strips), 1 unit	6DL1193-6LR00-0AA0
• DIN A4 sheet, light gray, 10 items per packing unit, 45 labeling strips per sheet (450)	6DL1193-6LA00-0AA0
• DIN A4 sheet, yellow, 10 items per packing unit, 45 labeling strips per sheet (450)	6DL1193-6LA00-0AG0
Color-coded labels For push-in terminals	
• Color code CC01, 10 units gray (terminals 1 to 16), red (terminals 17 to 32)	6DL1193-6CP01-2HH1
• Color code CC02, 10 units gray (terminals 1 to 16), blue (terminals 17 to 32)	6DL1193-6CP02-2HH1
• Color code CC40, 10 units gray (terminals 1 to 16)	6DL1193-6CP40-2HK0
• Color code CC42, 10 units gray (terminals 1 to 8), blue (terminals 9 to 16)	6DL1193-6CP42-2HK0
Equipment labeling plates 10 sheets with 16 labels each	6ES7193-6LF30-0AW0
TM cover Slot cover for I/O modules, to protect vacant I/O slots Width 22.5 mm, 5 units	6DL1133-6CV22-0AM0

I/O systems

SIMATIC ET 200 systems for the control cabinet

SIMATIC ET 200SP HA

Digital I/O modules**Technical specifications**

Article number	6DL1131-6GF00-0PK0 ET 200SP HA, DI 8x230VAC	6DL1131-6BH00-0PH1 ET 200SP HA, DI 16x24VDC	6DL1131-6BL00-0PH1 ET 200SP HA, DI 32x24VDC	6DL1131-6DF00-0PK0 ET 200SP HA, DI 8x24 ... 125VDC	6DL1131-6TH00-0PH1 ET 200SP HA, DI 16xNAMUR
General information					
Product type designation	DI 8x230VAC HA	DI 16x24VDC HA	DI 32x24VDC HA	DI 8x24 ... 125 V DC HA	DI 16xNAMUR HA
Engineering with					
• STEP 7 TIA Portal configurable/ integrated from version	V16	V16	V16	V16	V16
• STEP 7 configurable/ integrated from version	V5.6	V5.6	V5.6	V5.6	V5.6
• PCS 7 configurable/ integrated from version	V9.0	V9.0	V9.0	V9.0	V9.0
• PCS neo can be configured/ integrated from version	V3.0	V3.0	V3.0	V3.0	V3.0
• PROFINET from GSD version/ GSD revision	GSDML V2.3	GSDML V2.3	GSDML V2.3	GSDML V2.3	GSDML V2.3
Operating mode					
• DI	Yes	Yes	Yes	Yes	Yes
• Counter		No	No	No	No
• Oversampling		No	No	No	No
• MSI		No	No	No	No
Supply voltage					
Rated value (DC)		24 V	24 V	24 V	24 V
Rated value (AC)	230 V				
Reverse polarity protection		Yes	Yes	Yes	Yes
Encoder supply					
Number of outputs		16	32; When terminal block with encoder supply is used (type P0)		16
Short-circuit protection		Yes; electronic (response threshold 0.7 A to 1.3 A; for IO redundancy up to 2.6 A) Ensure sufficient low-resistance cable routing to the sensor/actuator in order to attain the response threshold. Depending on the cable cross-section used, there may be constraints regarding the usable length of cable	Yes; When using TB type P0		Yes
Output current					
• up to 60 °C, max.		2 A; 1 A when mounted vertically; see derating information in Equipment Manual			
• up to 70 °C, max.		1 A; See derating information in Equipment Manual			

Technical specifications

Article number	6DL1131-6GF00-0PK0	6DL1131-6BH00-0PH1	6DL1131-6BL00-0PH1	6DL1131-6DF00-0PK0	6DL1131-6TH00-0PH1
	ET 200SP HA, DI 8X230VAC	ET 200SP HA, DI 16X24VDC	ET 200SP HA, DI 32X24VDC	ET 200SP HA, DI 8X24 ... 125VDC	ET 200SP HA, DI 16XNAMUR
24 V encoder supply					
<ul style="list-style-type: none"> • 24 V • Short-circuit protection 		Yes Yes; electronic (response threshold 0.7 A to 1.3 A; for IO redundancy up to 2.6 A) Ensure sufficient low-resistance cable routing to the sensor/actuator in order to attain the response threshold. Depending on the cable cross-section used, there may be constraints regarding the usable length of cable			
<ul style="list-style-type: none"> • Output current per channel, max. • Output current per module, max. 		0.5 A 2 A			
Digital inputs					
Number of digital inputs	8; Isolated	16	32	8	16; NAMUR
Digital inputs, parameterizable		Yes	Yes		Yes
Source/sink input		Yes; P-reading	Yes; P-reading	Yes; P-reading	
Input characteristic curve in accordance with IEC 61131, type 1		Yes	Yes	Yes	
Input characteristic curve in accordance with IEC 61131, type 2		No	No		
Input characteristic curve in accordance with IEC 61131, type 3	Yes	Yes	Yes	Yes	
Pulse extension		Yes	No		Yes; 0.5 s, 1 s, 2 s
<ul style="list-style-type: none"> • Length 		off, 50 ms, 100 ms, 200 ms, 500 ms, 1 s, 2 s			
Time stamping		Yes; Resolution 10 ms		Yes; Resolution 10 ms	Yes
Time stamp (with precision of 1 ms)		Yes; Resolution 1ms		Yes; Resolution 1ms	No
Edge evaluation		Yes; rising edge, falling edge, edge change	Yes; rising edge, falling edge, edge change		Yes; rising edge, falling edge, edge change
Signal change flutter					Yes; 2 to 32 signal changes
Flutter observation window					Yes; 0.5 s, 1 s to 100 s in 1-s steps
Input voltage					
<ul style="list-style-type: none"> • Rated value (DC) • Rated value (AC) • for signal *0* • for signal *1* 	230 V 0V AC to 40V AC 74 V AC to 264 V AC	24 V -30 to +5 V +11 to +30V	24 V -30 to +5 V +11 to +30V	-125 ... +5 V +11 ... +125 V	8.2 V
Input current					
<ul style="list-style-type: none"> • for signal *1*, typ. 	10.8 mA	2.5 mA	2.5 mA	3.1 mA	
for 10 k switched contact					
- for signal *0*					0.35 to 1.2 mA
- for signal *1*					2.1 ... 6.4 mA
for unswitched contact					
- for signal *0*, max. (permissible quiescent current)					0.5 mA
- for signal *1*					typ. 8 mA
for NAMUR encoders					
- for signal *0*, min.					0.35 mA
- for signal *0*, max.					1.2 mA
- for signal *1*, min.					2.1 mA
- for signal *1*, max.					6.4 mA

I/O systems

SIMATIC ET 200 systems for the control cabinet
SIMATIC ET 200SP HA

Digital I/O modules

Technical specifications

Article number	6DL1131-6GF00-0PK0	6DL1131-6BH00-0PH1	6DL1131-6BL00-0PH1	6DL1131-6DF00-0PK0	6DL1131-6TH00-0PH1
	ET 200SP HA, DI 8X230VAC	ET 200SP HA, DI 16X24VDC	ET 200SP HA, DI 32X24VDC	ET 200SP HA, DI 8X24 ... 125VDC	ET 200SP HA, DI 16XNAMUR
Input delay (for rated value of input voltage)					
<ul style="list-style-type: none"> tolerated changeover time for changeover contacts 					300 ms
for standard inputs					
- parameterizable		Yes; none / 0.05 / 0.1 / 0.4 / 0.8 / 1.6 / 3.2 / 12.8 / 20 ms	No	Yes; 0.05 / 0.1 / 0.4 / 0.8 / 1.6 / 3.2 / 12.8 / 20 ms (in each case + delay of 30 to 500 µs, depending on line length)	
for NAMUR inputs					
- at "0" to "1", max.					17 ms
- at "1" to "0", max.					25 ms
Encoder					
Connectable encoders					
<ul style="list-style-type: none"> NAMUR encoder/changeover contact according to EN 60947 Single contact / changeover contact unconnected Single contact / changeover contact connected with 10 kΩ 2-wire sensor - permissible quiescent current (2-wire sensor), max. 	Yes	Yes 1.5 mA	Yes 1.5 mA	Yes 1.5 mA	Yes Yes Yes Yes; Acc. to NAMUR 1.2 mA
Interrupts/diagnostics/ status information					
Diagnostics function		Yes	Yes		
Alarms					
<ul style="list-style-type: none"> Diagnostic alarm Hardware interrupt 	Yes	Yes; channel by channel Yes; channel by channel	Yes; channel by channel Yes; channel by channel	Yes Yes; Parameterizable, channels 0 to 7, rising/falling edge	Yes; channel by channel Yes; Parameterizable, channels 0 to 15, rising/falling edge
Diagnostics					
<ul style="list-style-type: none"> Diagnostic information readable Monitoring the supply voltage - parameterizable Monitoring of encoder power supply Wire-break Short-circuit Short-circuit to M Group error Changeover contact error 	Yes	Yes Yes; Module-wise Yes Yes Yes; Channel-by-channel, optional protective circuit for preventing wire-break diagnostics in the case of simple encoder contacts: 15 kOhm to 18 kOhm Yes; Encoder supply to M, channel by channel	Yes Yes; Module-wise Yes Yes; Channel-by-channel, optional protective circuit for preventing wire-break diagnostics in the case of simple encoder contacts: 15 kOhm to 18 kOhm No	Yes Yes Yes Yes; channel by channel Yes	Yes Yes Yes Yes Yes
Diagnostics indication LED					
<ul style="list-style-type: none"> MAINT LED Monitoring of the supply voltage (PWR-LED) Channel status display for channel diagnostics for module diagnostics 	Yes; Yellow LED Yes; green LED Yes; green/red DIAG LED	Yes; Yellow LED Yes; green PWR LED Yes; green LED Yes; red LED Yes; green/red LED	Yes; Yellow LED Yes; green PWR LED Yes; green LED No Yes; green/red DIAG LED	Yes; Yellow LED Yes; green PWR LED Yes; green LED Yes; red LED Yes; green/red DIAG LED	Yes; Yellow LED Yes; green PWR LED Yes; green LED Yes; red LED Yes; green/red DIAG LED

Technical specifications

Article number	6DL1131-6GF00-0PK0 ET 200SP HA, DI 8X230VAC	6DL1131-6BH00-0PH1 ET 200SP HA, DI 16X24VDC	6DL1131-6BL00-0PH1 ET 200SP HA, DI 32X24VDC	6DL1131-6DF00-0PK0 ET 200SP HA, DI 8X24 ... 125VDC	6DL1131-6TH00-0PH1 ET 200SP HA, DI 16XNAMUR
Potential separation					
Potential separation channels					
• between the channels and backplane bus	Yes	Yes	Yes	Yes	Yes
Ambient conditions					
Ambient temperature during operation					
• horizontal installation, min.	-40 °C	-40 °C	-40 °C	-40 °C	-40 °C
• horizontal installation, max.	70 °C	70 °C	70 °C	70 °C	70 °C
• vertical installation, min.	-40 °C	-40 °C	-40 °C	-40 °C	-40 °C
• vertical installation, max.	60 °C	60 °C	60 °C	60 °C	60 °C
Dimensions					
Width	22.5 mm	22.5 mm	22.5 mm	22.5 mm	22.5 mm
Height	115 mm	115 mm	115 mm	115 mm	115 mm
Depth	138 mm	138 mm	138 mm	138 mm	138 mm
Weights					
Weight, approx.	148 g	135 g	150 g	165 g	153 g
Article number	6DL1132-6BH00-0PH1 ET 200SP HA, DQ 16X24VDC/0,5A		6DL1132-6BL00-0PH1 ET 200SP HA, DQ 32X24VDC/0,5A	6DL1132-6HD50-0PK0 ET 200SP HA, RQ 4X120VDC-230VAC/5A CO	
General information					
Product type designation	DQ 16x24VDC/0.5A HA		DQ 32x24VDC/0.5A HA	RQ 4x120 V UC ... 230 V AC/5 A CO HA	
Engineering with					
• STEP 7 TIA Portal configurable/ integrated from version	V16		V16	V16	
• STEP 7 configurable/ integrated from version	V5.6		V5.6	V5.6	
• PCS 7 configurable/ integrated from version	V9.0		V9.0	V9.0	
• PCS neo can be configured/ integrated from version	V3.0		V3.0	V3.0	
• PROFINET from GSD version/ GSD revision	GSDML V2.3		GSDML V2.3	GSDML V2.3	
Operating mode					
• DQ	Yes		Yes		
• DQ with energy-saving function	No		No		
• PWM	No		No		
• Oversampling	No		No		
• MSO	No				
Supply voltage					
Rated value (DC)	24 V		24 V	24 V	
Reverse polarity protection	Yes		Yes	Yes	
Digital outputs					
Number of digital outputs	16		32	4	
Current-sinking	No		No		
Current-sourcing	Yes		Yes		
Digital outputs, parameterizable	Yes		Yes		
Short-circuit protection	Yes; Ensure sufficient low-resistance cable routing to the sensor/actuator in order to attain the response threshold. Depending on the cable cross-section used, there may be constraints regarding the usable length of cable.		Yes; Clocked electronically		
Open-circuit detection	Yes; 0.7 mA test current for wire-break diagnostics; this value is doubled in the case of IO redundancy		No		
Overload protection	Yes		Yes		
Limitation of inductive shutdown voltage to	L+ (-37 to 41V)		Typ. L+ (-53 V)		
Controlling a digital input	Yes		Yes		

I/O systemsSIMATIC ET 200 systems for the control cabinet
SIMATIC ET 200SP HA**Digital I/O modules****Technical specifications**

Article number	6DL1132-6BH00-0PH1 ET 200SP HA, DQ 16X24VDC/0,5A	6DL1132-6BL00-0PH1 ET 200SP HA, DQ 32X24VDC/0,5A	6DL1132-6HD50-0PK0 ET 200SP HA, RQ 4X120VDC- 230VAC/5A CO
Switching capacity of the outputs			
• with resistive load, max.	0.5 A	0.5 A	
• on lamp load, max.	5 W	5 W	
Load resistance range			
• lower limit	48 Ω	48 Ω	
• upper limit	12 kΩ	4 kΩ	
Output current			
• for signal "1" rated value	0.5 A	0.5 A	
• for signal "0" residual current, max.	0.7 mA; Test current for wire-break diagnostics; this value is doubled in the case of IO redundancy	0.1 mA	
Output delay with resistive load			
• "0" to "1", typ.	50 μs	54 μs	
• "1" to "0", typ.	100 μs	48 μs	
Parallel switching of two outputs			
• for uprating	No	No	
• for redundant control of a load	Yes	Yes; only outputs of the same group	
Switching frequency			
• with resistive load, max.	100 Hz	100 Hz	2 Hz
• with inductive load, max.	2 Hz	2 Hz	0.5 Hz
• on lamp load, max.	10 Hz	10 Hz	2 Hz
Total current of the outputs			
• Current per channel, max.	0.5 A	0.5 A	
• Current per module, max.	8 A	10 A	
Total current of the outputs (per module)			
horizontal installation			
- up to 30 °C, max.	8 A		
- up to 40 °C, max.	8 A		
- up to 50 °C, max.	8 A		
- up to 60 °C, max.	5.5 A		
- up to 70 °C, max.	3 A	10 A	
vertical installation			
- up to 30 °C, max.	8 A		
- up to 40 °C, max.	6.33 A		
- up to 50 °C, max.	4.67 A		
- up to 60 °C, max.	3 A	10 A	
Relay outputs			
• Number of relay outputs			4
• external protection for relay outputs			yes; 6 A, see data in manual
Switching capacity of contacts			
- with inductive load, max.			2 A; 2 A (24 V DC), 0.5 A (60 V DC), 0.1 A (120 V DC)
- with resistive load, max.			5 A; 5 A (30 V DC), 5 A (230 V AC)
- Switching current, min.			8 mA
- Rated switching voltage (DC)			24 V; 24 V DC to 120 V DC
- Rated switching voltage (AC)			230 V; 24V AC to 230V AC

Technical specifications

Article number	6DL1132-6BH00-0PH1 ET 200SP HA, DQ 16X24VDC/0,5A	6DL1132-6BL00-0PH1 ET 200SP HA, DQ 32X24VDC/0,5A	6DL1132-6HD50-0PK0 ET 200SP HA, RQ 4X120VDC-230VAC/5A CO
Interrupts/diagnostics/ status information			
Diagnostics function	Yes	Yes	Yes
Substitute values connectable	Yes	Yes	Yes
Alarms			
• Diagnostic alarm	Yes	Yes	Yes
Diagnoses			
• Monitoring the supply voltage - parameterizable	Yes	Yes	Yes
• Wire-break	Yes; channel by channel	No	
• Short-circuit		Yes	
• Short-circuit to M	Yes; channel by channel	Yes; channel by channel	
• Short-circuit to L+	Yes; channel by channel	No	
• Group error	Yes	Yes	
Diagnostics indication LED			
• MAINT LED	Yes; Yellow LED	Yes; Yellow LED	Yes; Yellow LED
• Monitoring of the supply voltage (PWR-LED)	Yes; green PWR LED	Yes; green PWR LED	Yes; green PWR LED
• Channel status display	Yes; green LED	Yes; green LED	Yes; green LED
• for channel diagnostics	Yes; red LED	No	
• for module diagnostics	Yes; green/red DIAG LED	Yes; green/red DIAG LED	Yes; green/red DIAG LED
Potential separation			
Potential separation channels			
• between the channels and backplane bus	Yes	Yes	Yes
Ambient conditions			
Ambient temperature during operation			
• horizontal installation, min.	-40 °C	-40 °C	-40 °C; No icing
• horizontal installation, max.	70 °C	70 °C	70 °C
• vertical installation, min.	-40 °C	-40 °C	-40 °C; No icing
• vertical installation, max.	60 °C	60 °C	60 °C
Altitude during operation relating to sea level			
• Ambient air temperature-barometric pressure-altitude			3 000 m due to converter type used
Dimensions			
Width	22.5 mm	22.5 mm	22.5 mm
Height	115 mm	115 mm	115 mm
Depth	138 mm	138 mm	138 mm
Weights			
Weight, approx.	137 g	150 g	162 g

I/O systems

SIMATIC ET 200 systems for the control cabinet
SIMATIC ET 200SP HA

Analog I/O modules**Overview**

- Analog input module AI 16xI 2-wire HART HA
16 analog inputs
Measuring range 0 to 20 mA, 0 to 10 mA, 4 to 20 mA, 4 to 20 mA with HART
- Analog input module AI 16xTC/8xRTD 2-/3-/4-wire HA
16 analog inputs for thermocouples; alternatively 8 analog inputs for thermistors
- AQ 8xI HART HA analog output module
8 analog outputs
Power output in the output ranges 0 to 10 mA, 0 to 20 mA, 4 to 20 mA and 4 to 20 mA HART
- Analog input module AI 4XI 2-/4-wire HART ISOL
4 galvanically isolated analog inputs (2-/4-wire)
- Analog output module AQ 4XI HART ISOL
4 galvanically isolated analog outputs (2-wire)

Ordering data**Article No.**

**Analog input module
AI 16xI 2-wire HART HA**
16 analog inputs

Measuring range 0 to 20 mA,
0 to 10 mA, 4 to 20 mA,
4 to 20 mA with HART

Color code CC01,
for terminal block type H1 and M1,
channel diagnostics, 16-bit

6DL1134-6TH00-0PH1

**Analog input module
AI 16xTC/8xRTD 2-/3-/4-wire HA**
16 analog inputs for
thermocouples, alternatively
8 analog inputs for thermistors

Color code CC00,
for terminal block type H1 and M1,
channel diagnostics, 16-bit

6DL1134-6JH00-0PH1

**AQ 8xI HART HA
analog output module**
8 analog outputs

Power output in the output ranges
0 to 10 mA, 0 to 20 mA,
4 to 20 mA and
4 to 20 mA HART

Color code CC00,
for terminal block type H1 and M1,
channel diagnostics, 16-bit

6DL1135-6TF00-0PH1

**Analog input module
AI 4XI 2-/4-wire HART ISOL**

14 analog inputs

Color code CC01,
for terminal block type K0, L0,
channel diagnostics,
16-bit, +/-0.1%

6DL1134-6UD00-0PK0

**Analog output module
AQ 4XI HART ISOL**

4 analog outputs

Color code CC00,
for terminal block type K0, L0,
channel diagnostics,
16-bit, +/-0.1%

6DL1135-6UD00-0PK0

Article No.**Accessories****Labeling strips**

For labeling the I/O modules

- Roll, light gray
(with a total of 500 labeling strips),
1 unit
- DIN A4 sheet, light gray,
10 items per packing unit,
45 labeling strips per sheet (450)
- DIN A4 sheet, yellow,
10 items per packing unit,
45 labeling strips per sheet (450)

6DL1193-6LR00-0AA0

6DL1193-6LA00-0AA0

6DL1193-6LA00-0AG0

Color-coded labels

For push-in terminals

- Color code CC00, 10 units
gray (terminals 1 to 32)
- Color code CC01, 10 units
gray (terminals 1 to 16),
red (terminals 17 to 32)

6DL1193-6CP00-2HH1

6DL1193-6CP01-2HH1

Equipment labeling plates

10 sheets with 16 labels each

6ES7193-6LF30-0AW0

TM cover

Slot cover for I/O modules,
to protect vacant I/O slots

Width 22.5 mm,
5 units

6DL1133-6CV22-0AM0

Technical specifications

Article number	6DL1134-6JH00-0PH1 ET 200SP HA, AI 16XTC/8XRTD 2-/3-/4-WIRE	6DL1134-6TH00-0PH1 ET 200SP HA, AI 16XI 2-WIRE HART
General information		
Product type designation	AI 16 x TC/8 x RTD 2/3/4-wire HA	AI 16 x I 2-wire mA HART
Engineering with		
• STEP 7 TIA Portal configurable/ integrated from version	V16	
• STEP 7 configurable/ integrated from version	V5.6	
• PCS 7 configurable/ integrated from version	V9.0	V9.0
• PCS neo can be configured/ integrated from version	V3.0	
• PROFINET from GSD version/ GSD revision	GSDML V2.3	
Supply voltage		
Rated value (DC)	24 V	24 V
Reverse polarity protection	Yes	Yes
Analog inputs		
Number of analog inputs		16
• For voltage measurement	16	
• For resistance/resistance thermometer measurement	8	
• For thermocouple measurement	16	
permissible input voltage for voltage input (destruction limit), max.	5 V	
permissible input current for current input (destruction limit), max.		30 mA
Constant measurement current for resistance-type transmitter, typ.	2 mA	
Technical unit for temperature measurement adjustable	Yes; °C/°F/K	
Input ranges (rated values), voltages		
• -1 V to +1 V	Yes; 16 bit incl. sign	
• -250 mV to +250 mV	Yes; 16 bit incl. sign	
• -50 mV to +50 mV	Yes; 16 bit incl. sign	
• -80 mV to +80 mV	Yes; 16 bit incl. sign	
Input ranges (rated values), currents		
• 0 to 20 mA		Yes; 16 bit incl. sign
• 4 mA to 20 mA		Yes; 16 bit incl. sign
Input ranges (rated values), thermocouples		
• Type B	Yes; 16 bit incl. sign	
• Type C	Yes; 16 bit incl. sign	
• Type E	Yes; 16 bit incl. sign	
• Type J	Yes; 16 bit incl. sign	
• Type K	Yes; 16 bit incl. sign	
• Type L	Yes; 16 bit incl. sign	
• Type N	Yes; 16 bit incl. sign	
• Type R	Yes; 16 bit incl. sign	
• Type S	Yes; 16 bit incl. sign	
• Type T	Yes; 16 bit incl. sign	
• Type U	Yes; 16 bit incl. sign	
• Type TXK/TXK(L) to GOST	Yes; 16 bit incl. sign	

I/O systems

SIMATIC ET 200 systems for the control cabinet
SIMATIC ET 200SP HA

Analog I/O modules

Technical specifications

Article number	6DL1134-6JH00-0PH1 ET 200SP HA, AI 16XTC/8XRTD 2-/3-/4-WIRE	6DL1134-6TH00-0PH1 ET 200SP HA, AI 16XI 2-WIRE HART
Input ranges (rated values), resistance thermometer		
• Cu 10	Yes; 16 bit incl. sign	
• Ni 100	Yes; 16 bit incl. sign	
• Ni 1000	Yes; 16 bit incl. sign	
• LG-Ni 1000	Yes; 16 bit incl. sign	
• Ni 120	Yes; 16 bit incl. sign	
• Ni 200	Yes; 16 bit incl. sign	
• Ni 500	Yes; 16 bit incl. sign	
• Pt 100	Yes; 16 bit incl. sign	
• Pt 1000	Yes; 16 bit incl. sign	
• Pt 200	Yes; 16 bit incl. sign	
• Pt 500	Yes; 16 bit incl. sign	
Input ranges (rated values), resistors		
• 0 to 150 ohms	Yes; 15 bit	
• 0 to 300 ohms	Yes; 15 bit	
• 0 to 600 ohms	Yes; 15 bit	
• 0 to 3000 ohms	Yes; 15 bit	
• 0 to 6000 ohms	Yes; 15 bit	
• PTC	Yes; 15 bit	
Thermocouple (TC)		
Temperature compensation		
- parameterizable	Yes	
Cable length		
• shielded, max.	200 m; Measurement ranges for thermocouples / voltages: shielded cable length max. 600 m, loop resistance max 8 kOhm; measuring ranges RTD: shielded cable length max. 600 m, cable resistance (single) max. 75 ohms	800 m; with unshielded cables up to 800 m, remember that (external) EMC loads can cause incorrect measured values
Analog value generation for the inputs		
Integration and conversion time/resolution per channel		
• Resolution with overrange (bit including sign), max.	16 bit	16 bit; 15 bit at 0 ... 10 mA and 60 Hz interference suppression
• Integration time, parameterizable	Yes; Channel-by-channel, results from the selected interference frequency suppression	Yes; channel by channel
• Interference voltage suppression for interference frequency f1 in Hz	16.6 / 50 / 60 Hz, channel-by-channel	
• Conversion time (per channel)	60 ms; 180 / 50 ms, results from the selected interference frequency suppression	
Smoothing of measured values		
• parameterizable	Yes; none, weak, medium, strong, channel-by-channel	Yes; none, weak, medium, strong, channel-by-channel
Encoder		
Connection of signal encoders		
• for current measurement as 2-wire transducer		Yes
Errors/accuracies		
Basic error limit (operational limit at 25 °C)		
• Voltage, relative to input range, (+/-)	0.05 %	
• Current, relative to input range, (+/-)		0.1 %
• Resistance, relative to input range, (+/-)	0.05 %	
Interference voltage suppression for $f = n \times (f1 \pm 1 \%)$, $f1 =$ interference frequency		
• Series mode interference (peak value of interference < rated value of input range), min.	70 dB	
• Common mode voltage, max.	60 V	
• Common mode interference, min.	90 dB	

Technical specifications

Article number	6DL1134-6JH00-0PH1 ET 200SP HA, AI 16XTC/8XRTD 2-/3-/4-WIRE	6DL1134-6TH00-0PH1 ET 200SP HA, AI 16XI 2-WIRE HART
Interrupts/diagnostics/status information		
Diagnostics function	Yes	Yes
Alarms		
• Diagnostic alarm	Yes	Yes
• Limit value alarm	Yes; two upper and two lower limit values in each case	Yes; two upper and two lower limit values in each case
Diagnoses		
• Monitoring the supply voltage	Yes	Yes
• Wire-break	Yes; channel by channel	Yes; channel by channel
• Short-circuit		Yes; Channel-by-channel, short-circuit of the encoder supply to ground or of an input to the encoder supply
• Overflow/underflow	Yes; channel by channel	Yes; channel by channel
Diagnostics indication LED		
• MAINT LED	Yes; Yellow LED	Yes; Yellow LED
• Monitoring of the supply voltage (PWR-LED)	Yes; green PWR LED	Yes; green PWR LED
• Channel status display	Yes; green LED	Yes; green LED
• for channel diagnostics	Yes; red LED	Yes; red LED
• for module diagnostics	Yes; green/red DIAG LED	Yes; green/red DIAG LED
Potential separation		
Potential separation channels		
• between the channels and backplane bus	Yes	Yes
Ambient conditions		
Ambient temperature during operation		
• horizontal installation, min.	-40 °C	-40 °C
• horizontal installation, max.	70 °C	70 °C; Observe derating
• vertical installation, min.	-40 °C	-40 °C
• vertical installation, max.	60 °C	60 °C; Observe derating
Dimensions		
Width	22.5 mm	22.5 mm
Height	115 mm	115 mm
Depth	138 mm	138 mm
Weights		
Weight, approx.	150 g	148 g

I/O systemsSIMATIC ET 200 systems for the control cabinet
SIMATIC ET 200SP HA**Analog I/O modules****Technical specifications**

Article number	6DL1135-6TF00-0PH1 ET 200SP HA, AQ 8XI HART
General information	
Product type designation	AQ 8 x I HART HA
Engineering with	
• STEP 7 TIA Portal configurable/ integrated from version	V16
• STEP 7 configurable/ integrated from version	V5.6
• PCS 7 configurable/ integrated from version	V9.0
• PCS neo can be configured/ integrated from version	V3.0
• PROFINET from GSD version/ GSD revision	GSDML V2.3
Supply voltage	
Rated value (DC)	24 V
Reverse polarity protection	Yes
Analog outputs	
Number of analog outputs	8; short-circuit proof with respect to ground
Output ranges, current	
• 0 to 10 mA	Yes; 14 bit
• 0 to 20 mA	Yes; 15 bit
• -20 mA to +20 mA	No
• 4 mA to 20 mA	Yes; 16 bit incl. sign
Connection of actuators	
• for current output two-wire connection	Yes
Load impedance (in rated range of output)	
• with current outputs, max.	750 Ω
• with current outputs, inductive load, max.	10 mH
Cable length	
• shielded, max.	1 000 m; with unshielded cables up to 800 m, remember that (external) EMC loads can cause incorrect measured values
Analog value generation for the outputs	
Settling time	
• for resistive load	1.2 ms; 750 ohm
• for inductive load	1.2 ms

Article number	6DL1135-6TF00-0PH1 ET 200SP HA, AQ 8XI HART
Errors/accuracies	
Basic error limit (operational limit at 25 °C)	
• Current, relative to output range, (+/-)	0.1 %
Interrupts/diagnostics/ status information	
Diagnostics function	Yes
Substitute values connectable	Yes
Alarms	
• Diagnostic alarm	Yes
Diagnoses	
• Monitoring the supply voltage	Yes
• Wire-break	Yes; channel by channel
• Short-circuit	Yes; channel by channel
• Overflow/underflow	Yes; channel by channel
Diagnostics indication LED	
• MAINT LED	Yes; Yellow LED
• Monitoring of the supply voltage (PWR-LED)	Yes; green PWR LED
• Channel status display	Yes; green LED
• for channel diagnostics	Yes; red LED
• for module diagnostics	Yes; green/red DIAG LED
Potential separation	
Potential separation channels	
• between the channels and backplane bus	Yes
Ambient conditions	
Ambient temperature during operation	
• horizontal installation, min.	-40 °C
• horizontal installation, max.	70 °C
• vertical installation, min.	-40 °C
• vertical installation, max.	60 °C
Dimensions	
Width	22.5 mm
Height	115 mm
Depth	138 mm
Weights	
Weight, approx.	160 g

Technical specifications

Article number	6DL1134-6UD00-0PK0 ET 200SP HA, AI 4xI 2-/4-Wire HART ISOL
General information	
Product type designation	AI 4xI 2-/4-wire HART ISOL HA
Engineering with	
• PROFIBUS from GSD version/ GSD revision	Yes / Yes
• PROFINET from GSD version/ GSD revision	Yes / Yes
Supply voltage	
Rated value (DC)	24 V
Reverse polarity protection	Yes
Encoder supply	
Number of outputs	4
Analog inputs	
Number of analog inputs	4
• For current measurement	4
permissible input current for current input (destruction limit), max.	24 mA
Input ranges (rated values), currents	
• 0 to 20 mA	Yes; 16 bit incl. sign
• 4 mA to 20 mA	Yes; 16 bit incl. sign
Cable length	
• shielded, max.	800 m; with unshielded cables up to 800 m, remember that (external) EMC loads can cause incorrect measured values
Analog value generation for the inputs	
Integration and conversion time/resolution per channel	
• Resolution with overrange (bit including sign), max.	16 bit; 14 bit at 60 Hz (0 ... 10 mA), 16 bit at 10 Hz, 15 bit at 50 Hz and 15 bit at 60 Hz interference suppression
Smoothing of measured values	
• parameterizable	Yes; none, weak, medium, strong, channel-by-channel
Encoder	
Connection of signal encoders	
• for current measurement as 2-wire transducer	Yes
Errors/accuracies	
Basic error limit (operational limit at 25 °C)	
• Current, relative to input range, (+/-)	0.1 %

Article number	6DL1134-6UD00-0PK0 ET 200SP HA, AI 4xI 2-/4-Wire HART ISOL
Interrupts/diagnostics/ status information	
Diagnostics function	Yes
Alarms	
• Diagnostic alarm	Yes
• Limit value alarm	Yes; two upper and two lower limit values in each case
Diagnoses	
• Monitoring the supply voltage	Yes
• Wire-break	Yes; channel by channel
• Short-circuit	Yes; Channel-by-channel, short-circuit of the encoder supply to ground or of an input to the encoder supply
• Overflow/underflow	Yes; channel by channel
Diagnostics indication LED	
• MAINT LED	Yes; Yellow LED
• Monitoring of the supply voltage (PWR-LED)	Yes; green PWR LED
• Channel status display	Yes; green LED
• for channel diagnostics	Yes; red LED
• for module diagnostics	Yes; green/red DIAG LED
Potential separation	
Potential separation channels	
• between the channels and backplane bus	Yes; 125 V AC / 150 V DC
Ambient conditions	
Ambient temperature during operation	
• horizontal installation, min.	-40 °C
• horizontal installation, max.	70 °C; Observe derating
• vertical installation, min.	-40 °C
• vertical installation, max.	70 °C; Observe derating
Dimensions	
Width	22.5 mm
Height	115 mm
Depth	138 mm
Weights	
Weight, approx.	163 g

I/O systemsSIMATIC ET 200 systems for the control cabinet
SIMATIC ET 200SP HA**Analog I/O modules****Technical specifications**

Article number	6DL1135-6UD00-0PK0 ET 200SP HA, AQ 4XI HART ISOL
General information	
Product type designation	AQ 4XI HART ISOL HA
Engineering with	
• PROFIBUS from GSD version/ GSD revision	Yes / Yes
• PROFINET from GSD version/ GSD revision	Yes / Yes
Supply voltage	
Rated value (DC)	24 V
Reverse polarity protection	Yes
Analog outputs	
Number of analog outputs	4
Output ranges, current	
• 0 to 20 mA	Yes; 15 bit
• 4 mA to 20 mA	Yes; 15 bit
Connection of actuators	
• for current output two-wire connection	Yes
Load impedance (in rated range of output)	
• with current outputs, max.	750 Ω
• with current outputs, inductive load, max.	10 mH
Cable length	
• shielded, max.	1 000 m; with unshielded cables up to 800 m, remember that (external) EMC loads can cause incorrect measured values
Analog value generation for the outputs	
Settling time	
• for resistive load	1.2 ms; 750 ohm
• for inductive load	1.2 ms
Errors/accuracies	
Basic error limit (operational limit at 25 °C)	
• Current, relative to output range, (+/-)	0.1 %

Article number	6DL1135-6UD00-0PK0 ET 200SP HA, AQ 4XI HART ISOL
Interrupts/diagnostics/ status information	
Diagnostics function	Yes
Alarms	
• Diagnostic alarm	Yes
Diagnoses	
• Monitoring the supply voltage	Yes
• Wire-break	Yes; channel by channel
• Short-circuit	Yes
• Overflow/underflow	Yes; channel by channel
Diagnostics indication LED	
• MAINT LED	Yes; Yellow LED
• Monitoring of the supply voltage (PWR-LED)	Yes; green PWR LED
• Channel status display	Yes; green LED
• for channel diagnostics	Yes; red LED
• for module diagnostics	Yes; green/red DIAG LED
Potential separation	
Potential separation channels	
• between the channels and backplane bus	Yes; 125 V AC / 150 V DC
Ambient conditions	
Ambient temperature during operation	
• horizontal installation, min.	-40 °C
• horizontal installation, max.	70 °C; Observe derating
• vertical installation, min.	-40 °C
• vertical installation, max.	60 °C; Observe derating
Dimensions	
Width	22.5 mm
Height	115 mm
Depth	138 mm
Weights	
Weight, approx.	165 g

Overview



The I/O module AI-DI 16/DQ 16x24VDC HART HA is available in the following versions:

- DI 16/DQ 16x24VDC HA in digital-only mode
- AI-DI 16/DQ 16x24VDC HART HA as digital/analog module in mixed mode

Time stamping is available with configuration in mixed mode. High-precision time stamping (SoE: Sequence of Events) with a precision of 1 ms is available with configuration in digital-only mode.

In mixed mode, the 16 inputs can also be set channel by channel as either digital inputs or analog inputs with or without HART. HART is only available in mixed mode and with configuration in a measuring range of 4 to 20 mA.

Ordering data

Article No.

AI-DI 16/DQ 16x24VDC HART HA input/output module

16 channels, each with digital output and digital/analog input
Color code CC01,
for terminal block type H1 and M1

6DL1133-6EW00-0PH1

Accessories

Labeling strips

For labeling the I/O modules

- Roll, light gray (with a total of 500 labeling strips), 1 unit
- DIN A4 sheet, light gray, 10 items per packing unit, 45 labeling strips per sheet (450)
- DIN A4 sheet, yellow, 10 items per packing unit, 45 labeling strips per sheet (450)

6DL1193-6LR00-0AA0

6DL1193-6LA00-0AA0

6DL1193-6LA00-0AG0

Color-coded labels

For push-in terminals

- Color code CC01, 10 units gray (terminals 1 to 16), red (terminals 17 to 32)

6DL1193-6CP01-2HH1

Equipment labeling plates

10 sheets with 16 labels each

6ES7193-6LF30-0AW0

Slot cover for I/O modules

22.5 mm wide

6DL1133-6CV22-0AM0

I/O systemsSIMATIC ET 200 systems for the control cabinet
SIMATIC ET 200SP HA**Analog/digital module****Technical specifications**

Article number	6DL1133-6EW00-0PH1 ET 200SP HA, AI-DI16/DQ16X24VDC HART
General information	
Product type designation	AI-DI 16/DQ 16x24VDC HART HA
Engineering with	
• STEP 7 TIA Portal configurable/ integrated from version	V16
• STEP 7 configurable/ integrated from version	V5.6
• PCS 7 configurable/ integrated from version	V9.0
• PCS neo can be configured/integrated from version	V3.0
• PROFINET from GSD version/ GSD revision	GSDML V2.3
Operating mode	
• DI	Yes
• Counter	Yes
• DQ	Yes
• DQ with energy-saving function	No
• PWM	No
• Oversampling	No
• MSI	No
• MSO	No
Supply voltage	
Rated value (DC)	24 V
Reverse polarity protection	Yes
Encoder supply	
Number of outputs	16
Short-circuit protection	Yes; per channel, electronic
Digital inputs	
Number of digital inputs	16
Digital inputs, parameterizable	Yes
Source/sink input	Yes; P-reading
Input characteristic curve in accordance with IEC 61131, type 1	Yes
Input characteristic curve in accordance with IEC 61131, type 2	No
Input characteristic curve in accordance with IEC 61131, type 3	Yes
Pulse extension	Yes; off, 50 ms, 100 ms, 200 ms, 500 ms, 1 s, 2 s
Time stamping	Yes; Resolution 10 ms
Time stamp (with precision of 1 ms)	Yes; Resolution 1ms
Digital input functions, parameterizable	
• Gate start/stop	Yes; Partner channel of n+8 counter
• Freely usable digital input	Yes; Parameterizable input filter
• Counter	Yes; Incl. frequency measurement
Input voltage	
• Rated value (DC)	24 V
• for signal "0"	-30 to +5 V
• for signal "1"	+11 to +30V
Input current	
• for signal "1", typ.	2.5 mA
Input delay (for rated value of input voltage) for standard inputs	
- parameterizable	Yes; 0.05 / 0.1 / 0.4 / 0.8 / 1.6 / 3.2 / 12.8 / 20 ms (in each case + delay of 30 to 500 µs, depending on line length)

Article number	6DL1133-6EW00-0PH1 ET 200SP HA, AI-DI16/DQ16X24VDC HART
Digital outputs	
Number of digital outputs	16
Current-sinking	No
Current-sourcing	Yes
Digital outputs, parameterizable	Yes
Short-circuit protection	Yes; Response threshold 0.7 A to 1.3 A
Open-circuit detection	Yes
Overload protection	Yes
Limitation of inductive shutdown voltage to	L+ (-37 to 41V)
Controlling a digital input	Yes
Switching capacity of the outputs	
• with resistive load, max.	0.5 A
• on lamp load, max.	5 W
Load resistance range	
• lower limit	48 Ω
• upper limit	12 kΩ
Output current	
• for signal "1" rated value	0.5 A
• for signal "0" residual current, max.	0.7 mA
Output delay with resistive load	
• "0" to "1", typ.	50 µs
• "1" to "0", typ.	100 µs
Parallel switching of two outputs	
• for uprating	No
• for redundant control of a load	Yes
Switching frequency	
• with resistive load, max.	100 Hz
• on lamp load, max.	10 Hz
Total current of the outputs	
• Current per channel, max.	0.5 A
• Current per module, max.	2 A
Analog inputs	
Number of analog inputs	16
permissible input current for current input (destruction limit), max.	30 mA
Input ranges	
• Current	Yes; 0 ... 10 mA, 0 ... 20 mA, 4 ... 20 mA, 4 ... 20 mA HART
Input ranges (rated values), currents	
• 0 to 10 mA	Yes
• 0 to 20 mA	Yes; 16 bit incl. sign
• 4 mA to 20 mA	Yes; 16 bit incl. sign
Analog value generation for the inputs	
Integration and conversion time/resolution per channel	
• Resolution with overrange (bit including sign), max.	16 bit; Resolution with overrange (bit including sign), max. 16 bits, exception: 15 bits at 60 Hz interference suppression and 0 to 10 mA
• Integration time, parameterizable	Yes; channel by channel

Technical specifications

Article number	6DL1133-6EW00-0PH1 ET 200SP HA, AI-DI16/DQ16X24VDC HART
Smoothing of measured values	
• parameterizable	Yes; none, weak, medium, strong, channel-by-channel
Encoder	
Connection of signal encoders	
• for current measurement as 2-wire transducer	Yes
Connectable encoders	
• 2-wire sensor	Yes
- permissible quiescent current (2-wire sensor), max.	1.5 mA
Errors/accuracies	
Basic error limit (operational limit at 25 °C)	
• Current, relative to input range, (+/-)	0.1 %
Interrupts/diagnostics/ status information	
Diagnostics function	Yes
Substitute values connectable	Yes
Alarms	
• Diagnostic alarm	Yes
• Maintenance interrupt	Yes
• Limit value alarm	Yes; two upper and two lower limit values in each case
• Hardware interrupt	Yes; Parameterizable, channels 0 to 15, rising/falling edge
Diagnoses	
• Monitoring the supply voltage	Yes
• Wire-break	Yes; channel by channel
• Short-circuit to M	Yes; Encoder supply to M, channel by channel
• Group error	Yes
• Overflow/underflow	Yes; channel by channel
Diagnostics indication LED	
• MAINT LED	Yes; Yellow LED
• Monitoring of the supply voltage (PWR-LED)	Yes; green PWR LED
• Channel status display	No
• for channel diagnostics	No
• for module diagnostics	Yes; green/red DIAG LED

Article number	6DL1133-6EW00-0PH1 ET 200SP HA, AI-DI16/DQ16X24VDC HART
Integrated Functions	
Frequency measurement	Yes
• Number of frequency meters	8
Counting functions	
• Continuous counting	Yes
• Counter response parameterizable	Yes
• Hardware gate via digital input	Yes; Via partner channel (digital input n+8)
• Software gate	Yes
Measuring functions	
• Dynamic measurement period adjustment	Yes
Measuring range	
- Frequency measurement, min.	0.1 Hz
- Frequency measurement, max.	5 kHz
Accuracy	
- Frequency measurement	100 ppm; depending on measuring interval and signal evaluation
Potential separation	
Potential separation channels	
• between the channels and backplane bus	Yes
Ambient conditions	
Ambient temperature during operation	
• horizontal installation, min.	-40 °C
• horizontal installation, max.	70 °C; Observe derating
• vertical installation, min.	-40 °C
• vertical installation, max.	60 °C; Observe derating
Dimensions	
Width	22.5 mm
Height	115 mm
Depth	138 mm
Weights	
Weight, approx.	150 g

I/O systems

SIMATIC ET 200 systems for the control cabinet
SIMATIC ET 200SP HA

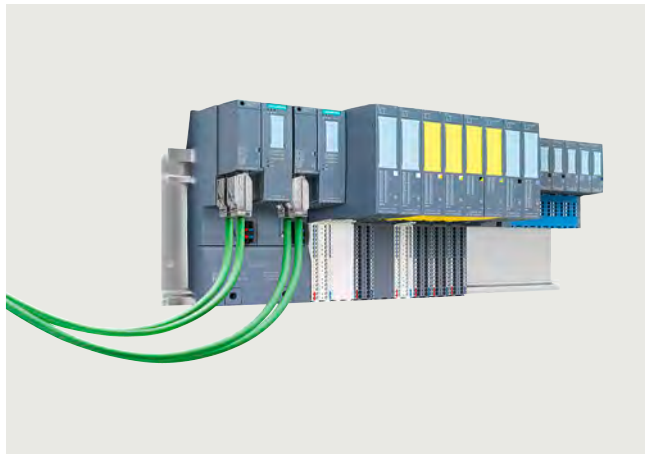
Fail-safe I/O-modules**Overview**

Fail-safe I/O modules permit safety-oriented monitoring and thus, when required, bringing the plant to the defined safe state. The communication and integration into the process control system is enabled with the proven technology SIMATIC Safety Integrated. The fail-safe I/O modules for DI, DQ and AI correspond to the size of the standard modules and are certified by the German Technical Inspectorate up to SIL 3 per channel. All fail-safe I/O modules can be set up in redundant configuration guaranteeing not only fail-safe operation but also highest availability.

SIMATIC ET 200SP HA is perfectly adapted for demanding fail-safe and standard applications in the manufacturing and process industries when high availability and PROFINET R1 redundancy are imperative.

- <https://www.siemens.com/process-safety>

Ordering data**Article No.****F-DI 16x24VDC HA digital input module**

16 digital inputs 24 V DC, color code CC01, for terminal block type H1 and M1, channel diagnostics

6DL1136-6BA00-0PH1**F-DQ 10x24VDC/2A HA digital output module**

10 digital outputs 24 V DC, 2 A, color code CC01, for terminal block type H1 and M1, channel diagnostics

6DL1136-6DA00-0PH1**F-AI 8x1 2-/4-wire HART HA analog input module**

8 digital inputs, color code CC00, for terminal block type H1 and F1, channel diagnostics

6DL1136-6AA00-0PH1Note

The use of fail-safe modules requires SIMATIC S7 F systems.

Overview



ET200SP_Ex_IO_mitPM

The intrinsically safe ET 200SP HA Ex I/O modules extend the SIMATIC ET 200SP HA and SIMATIC ET 200SP distributed I/O systems with the option of integrating devices located in hazardous areas (intrinsically safe sensors, actuators and HART field devices) into the system.

The ET 200SP HA Ex I/O modules with device protection according to intrinsic safety "i" offer channel outputs in Zone 0 or 1. 2-channel HART analog input and output modules and 2/4-channel digital input and output modules with different characteristic curves as well as a power module for intrinsically safe power supply of the modules.

Separate Ex isolators with correspondingly complex wiring and high space requirements are no longer required. The I/O modules can be installed up to ATEX Zone 2 and offer intrinsically safe circuits in Ex ia design for field devices up to Zone 0.

The Ex modules offer channel diagnostics and Configuration in Run and are approved for ambient temperatures from -40 to +70 °C.

Ordering data

Article No.

Ex digital modules SIMATIC ET 200SP HA	
Digital Ex-i input module, Ex-DI 4xNAMUR	6DL1131-6TD00-0HX1
Suitable for BaseUnit Type X1, channel diagnostics	
Digital Ex-i output module Ex-DQ 2x23,1VDC/20 mA	6DL1132-6EB00-0HX1
Suitable for BaseUnit Type X1, channel diagnostics	
Digital Ex-i output module Ex-DQ 2x17,4VDC/27 mA	6DL1132-6CB00-0HX1
Suitable for BaseUnit Type X1, channel diagnostics	
Ex analog modules SIMATIC ET 200SP HA	
Analog Ex-i HART input module, Ex-AI 2xI 2-wire HART	6DL1134-6TB00-0HX1
Suitable for BaseUnit Type X1, channel diagnostics, 16 bits, +/-0.3%	
Analog Ex-i input module, Ex-AI 4xTC/2xRTD 2-/3-/4-wire	6DL1134-6JD00-0HX1
Suitable for BaseUnit Type X1, channel diagnostics, 16 bits, +/-0.05%	
Analog Ex-i HART output module, Ex-AQ 2xI HART HF	6DL1135-6TB00-0HX1
Suitable for BaseUnit Type X1, channel diagnostics, 16 bits, +/-0.3%	
Power module and BaseUnits	
Power module Ex-PM E	6DL1133-6PX00-0HW0
24 V 0.8 A, W x H: 50 mm x 117 mm, suitable for BaseUnit Type W0	
BU Type X1 for I/O modules	6DL1193-6BP00-0BX1
Push-in terminals, W x H: 20 mm x 117 mm	
BU Type W0 for Ex power module PM-E	6DL1193-6BP00-0DW0
W x H: 50 mm x 117 mm	

I/O systemsSIMATIC ET 200 systems for the control cabinet
SIMATIC ET 200SP HA**Ex I/O modules****Technical specifications**

Article number	6DL1131-6TD00-0HX1 ET 200SP HA, EX-DI 4xNAMUR
General information	
Product type designation	Ex-DI 4xNAMUR
Product function	
• Isochronous mode	No
Engineering with	
• STEP 7 TIA Portal configurable/ integrated from version	STEP 7 V16 or higher with HSP
• STEP 7 configurable/ integrated from version	STEP 7 V5.6 SP2 or higher
• PCS 7 configurable/ integrated from version	V9.1
Operating mode	
• DI	Yes
• Counter	Yes
• MSI	Yes
Encoder supply	
Number of outputs	4
Short-circuit protection	Yes
Digital inputs	
Number of digital inputs	4; NAMUR
Digital inputs, parameterizable	Yes
Pulse extension	Yes; 0.5 s, 1 s, 2 s
Time stamping	No
Edge evaluation	Yes; Positive edge, negative edge
Signal change flutter	Yes; 2 to 32 signal changes
Flutter observation window	Yes; 0.5 s, 1 s to 100 s in 1-s steps
Input voltage	
• Rated value (DC)	8.2 V
Input current	
for 10 k switched contact	
- for signal "0"	Max. 1.2 mA
- for signal "1"	Min. 2.1 mA
for unswitched contact	
- for signal "0", max. (permissible quiescent current)	0.5 mA
- for signal "1"	typ. 8 mA
Input delay (for rated value of input voltage) for NAMUR inputs	
- at "0" to "1", max.	12 ms
- at "1" to "0", max.	12 ms
Encoder	
Connectable encoders	
• NAMUR encoder/changeover contact according to EN 60947	Yes
• Single contact / changeover contact unconnected	Yes
• Single contact / changeover contact connected with 10 kΩ	Yes
Interrupts/diagnostics/ status information	
Diagnostics function	Yes
Alarms	
• Diagnostic alarm	Yes
• Maintenance interrupt	Yes
• Hardware interrupt	Yes; channel by channel

Article number	6DL1131-6TD00-0HX1 ET 200SP HA, EX-DI 4xNAMUR
Diagnoses	
• Diagnostic information readable	Yes
• Monitoring the supply voltage	Yes
- parameterizable	Yes
• Monitoring of encoder power supply	Yes
• Wire-break	Yes; channel by channel
• Short-circuit	Yes; channel by channel
• Group error	Yes
Diagnostics indication LED	
• MAINT LED	Yes; Yellow LED
• Monitoring of the supply voltage (PWR-LED)	Yes; green PWR LED
• Channel status display	Yes; green LED
• for channel diagnostics	Yes; red LED
• for module diagnostics	Yes; green/red DIAG LED
Integrated Functions	
Measuring functions	
Accuracy	
- Frequency measurement	1 %
Ex(i) characteristics	
maximum values for connecting terminals for gas group IIC	
• U _o (no-load voltage), max.	9.6 V
• I _o (short-circuit current), max.	61 mA; applies for up to four circuits connected in parallel
• P _o (power output), max.	145 mW; applies for up to four circuits connected in parallel
• C _o (permissible external capacity), max.	3.6 μF; applies for up to four circuits connected in parallel
• L _o (permissible external inductivity), max.	13 mH; applies for up to four circuits connected in parallel
• U _m (voltage at non-intrinsically safe connecting terminals), max.	60 V
Potential separation	
Potential separation channels	
• between the channels and backplane bus	Yes
Ambient conditions	
Ambient temperature during operation	
• horizontal installation, min.	-40 °C
• horizontal installation, max.	70 °C
• vertical installation, min.	-40 °C
• vertical installation, max.	60 °C
Altitude during operation relating to sea level	
• Installation altitude above sea level, max.	2 000 m
Dimensions	
Width	20 mm
Height	73 mm
Depth	58 mm
Weights	
Weight, approx.	55 g

Technical specifications

Article number	6DL1132-6EB00-0HX1 ET 200SP HA, EX-DQ 2x23, 1VDC/20MA	6DL1132-6CB00-0HX1 ET 200SP HA, EX-DQ 2x17, 4VDC/27MA
General information		
Product type designation	Ex-DQ 2x23.1VDC/20mA	Ex-DQ 2x17.4VDC/27mA
Product function		
• Isochronous mode	No	No
Engineering with		
• STEP 7 TIA Portal configurable/ integrated from version	STEP 7 V16 or higher with HSP	STEP 7 V16 or higher with HSP
• STEP 7 configurable/ integrated from version	STEP 7 V5.6 SP2 or higher	STEP 7 V5.6 SP2 or higher
• PCS 7 configurable/ integrated from version	V9.1	V9.1
Operating mode		
• DQ	Yes	Yes
• MSO	Yes	Yes
Digital outputs		
Number of digital outputs	2	2
Current-sinking	No	No
Current-sourcing	Yes	Yes
Digital outputs, parameterizable	Yes	Yes
Short-circuit protection	Yes	Yes
Open-circuit detection	Yes; capacitive loads can cause wire-break diagnostics when the channel is switched off	Yes; capacitive loads can cause wire-break diagnostics when the channel is switched off
Overload protection	Yes	Yes
Limitation of inductive shutdown voltage to	DQ.n- (-1 V)	DQ.n- (-1 V)
Switching capacity of the outputs		
• with resistive load, max.	20 mA; See output characteristic in manual	27 mA; See output characteristic in manual
• with inductive load, max.	20 mA; See output characteristic in manual	27 mA; See output characteristic in manual
Load resistance range		
• lower limit	872 Ω; See output characteristic in manual	480 Ω; parallel operation 240 ohm, see output characteristic in manual
• upper limit	10 kΩ; See output characteristic in manual	10 kΩ; parallel operation 5 kOhm, see output characteristic in manual
Output current		
• for signal "1" rated value	20 mA	27 mA
• for signal "0" residual current, max.	100 µA; 250 µA test current for wire break diagnostics	100 µA; 250 µA test current for wire break diagnostics, parallel operation 500 µA
Output delay with resistive load		
• "0" to "1", typ.	50 µs	50 µs
• "1" to "0", typ.	100 µs	100 µs
Parallel switching of two outputs		
• for uprating	No	Yes
Switching frequency		
• with resistive load, max.	500 Hz	500 Hz
• with inductive load, max.	500 Hz	500 Hz
Total current of the outputs		
• Current per channel, max.	20 mA	27 mA
• Current per module, max.	40 mA	54 mA
Total current of the outputs (per module)		
horizontal installation		
- up to 70 °C, max.	40 mA	54 mA
vertical installation		
- up to 60 °C, max.	40 mA	54 mA

I/O systemsSIMATIC ET 200 systems for the control cabinet
SIMATIC ET 200SP HA**Ex I/O modules****Technical specifications**

Article number	6DL1132-6EB00-0HX1 ET 200SP HA, EX-DQ 2x23, 1VDC/20MA	6DL1132-6CB00-0HX1 ET 200SP HA, EX-DQ 2x17, 4VDC/27MA
Interrupts/diagnostics/status information		
Diagnostics function	Yes	Yes
Substitute values connectable	Yes	Yes
Alarms		
• Diagnostic alarm	Yes	Yes
• Maintenance interrupt	Yes	Yes
Diagnoses		
• Diagnostic information readable	Yes	Yes
• Monitoring the supply voltage	Yes	Yes
- parameterizable	Yes	Yes
• Wire-break	Yes; channel by channel	Yes; channel by channel
• Short-circuit	Yes; channel by channel	Yes; channel by channel
• Group error	Yes	Yes
Diagnostics indication LED		
• MAINT LED	Yes; Yellow LED	Yes; Yellow LED
• Monitoring of the supply voltage (PWR-LED)	Yes; green PWR LED	Yes; green PWR LED
• Channel status display	Yes; green LED	Yes; green LED
• for channel diagnostics	Yes; red LED	Yes; red LED
• for module diagnostics	Yes; green/red DIAG LED	Yes; green/red DIAG LED
Ex(i) characteristics		
maximum values for connecting terminals for gas group IIC		
• U _o (no-load voltage), max.	24.8 V	19.4 V
• I _o (short-circuit current), max.	99 mA	133 mA; parallel operation 266 mA
• P _o (power output), max.	614 mW	645 mW; parallel operation 1 290 mW
• C _o (permissible external capacity), max.	100 nF	232 nF; parallel operation 220 nF
• L _o (permissible external inductivity), max.	3.5 mH	1.9 mH; parallel operation 328 uH
• U _m (voltage at non-intrinsically safe connecting terminals), max.	60 V	60 V
Potential separation		
Potential separation channels		
• between the channels and backplane bus	Yes	Yes
Ambient conditions		
Ambient temperature during operation		
• horizontal installation, min.	-40 °C	-40 °C
• horizontal installation, max.	70 °C	70 °C
• vertical installation, min.	-40 °C	-40 °C
• vertical installation, max.	60 °C	60 °C
Altitude during operation relating to sea level		
• Installation altitude above sea level, max.	2 000 m	2 000 m
Dimensions		
Width	20 mm	20 mm
Height	73 mm	73 mm
Depth	58 mm	58 mm
Weights		
Weight, approx.	55 g	55 g

Technical specifications

Article number	6DL1134-6TB00-0HX1 ET 200SP HA, EX-AI 2xI 2-WIRE HART	6DL1134-6JD00-0HX1 ET 200SP HA, EX-AI 4xTC/2xRTD 2-/3-/4-W
General information		
Product type designation	Ex-AI 2xI 2-wire HART	Ex-AI 4xTC/2xRTD 2-/3-/4-wire
Product function		
• Isochronous mode	No	No
Engineering with		
• STEP 7 TIA Portal configurable/ integrated from version	STEP 7 V16 or higher with HSP	STEP 7 V16 or higher with HSP
• STEP 7 configurable/ integrated from version	STEP 7 V5.6 SP2 or higher	STEP 7 V5.6 SP2 or higher
• PCS 7 configurable/ integrated from version	V9.1	V9.1
Operating mode		
• MSI	Yes	Yes
Analog inputs		
Number of analog inputs	2; Differential inputs	
• For current measurement	2	
• For voltage measurement		4
• For resistance/resistance thermometer measurement		2
• For thermocouple measurement		4
Constant measurement current for resistance-type transmitter, typ.		0.5 mA
Cycle time (all channels), min.	3 ms	
Technical unit for temperature measurement adjustable		Yes; °C/°F/K
Input ranges (rated values), voltages		
• -1 V to +1 V		Yes; 16 bit incl. sign
• -250 mV to +250 mV		Yes; 16 bit incl. sign
• -50 mV to +50 mV		Yes; 16 bit incl. sign
• -80 mV to +80 mV		Yes; 16 bit incl. sign
Input ranges (rated values), currents		
• 0 to 20 mA	Yes	
• 4 mA to 20 mA	Yes; 15 bit + sign	
Input ranges (rated values), thermocouples		
• Type B		Yes; 16 bit incl. sign
• Type C		Yes; 16 bit incl. sign
• Type E		Yes; 16 bit incl. sign
• Type J		Yes; 16 bit incl. sign
• Type K		Yes; 16 bit incl. sign
• Type L		Yes; 16 bit incl. sign
• Type N		Yes; 16 bit incl. sign
• Type R		Yes; 16 bit incl. sign
• Type S		Yes; 16 bit incl. sign
• Type T		Yes; 16 bit incl. sign
• Type U		Yes; 16 bit incl. sign
• Type TXK/TXK(L) to GOST		Yes; 16 bit incl. sign
Input ranges (rated values), resistance thermometer		
• Cu 10		Yes; 16 bit incl. sign
• Ni 100		Yes; 16 bit incl. sign
• LG-Ni 1000		Yes; 16 bit incl. sign
• Ni 120		Yes; 16 bit incl. sign
• Ni 200		Yes; 16 bit incl. sign
• Ni 500		Yes; 16 bit incl. sign
• Pt 100		Yes; 16 bit incl. sign
• Pt 1000		Yes; 16 bit incl. sign
• Pt 200		Yes; 16 bit incl. sign
• Pt 500		Yes; 16 bit incl. sign

I/O systems

SIMATIC ET 200 systems for the control cabinet
SIMATIC ET 200SP HA

Ex I/O modules**Technical specifications**

Article number	6DL1134-6TB00-0HX1 ET 200SP HA, EX-AI 2xI 2-WIRE HART	6DL1134-6JD00-0HX1 ET 200SP HA, EX-AI 4xTC/2xRTD 2-/3-/4-W
Input ranges (rated values), resistors		
<ul style="list-style-type: none"> • 0 to 150 ohms • 0 to 300 ohms • 0 to 600 ohms • 0 to 3000 ohms • 0 to 6000 ohms • PTC 		Yes; 15 bit Yes; 15 bit Yes; 15 bit Yes; 15 bit Yes; 15 bit Yes; 15 bit
Thermocouple (TC)		
Temperature compensation - parameterizable		Yes
Cable length		
<ul style="list-style-type: none"> • shielded, max. 	500 m; Ex characteristic values must be observed	200 m; Ex characteristic values must be observed; line resistance at RTD (simple) max. 25 ohm; loop resistance at TC max. 8 kOhm
<ul style="list-style-type: none"> • unshielded, max. 	300 m; Ex characteristic values must be observed	
Analog value generation for the inputs		
Integration and conversion time/resolution per channel		
<ul style="list-style-type: none"> • Resolution with overrange (bit including sign), max. • Integration time, parameterizable 	16 bit Yes; channel by channel	16 bit Yes; Channel-by-channel, results from the selected interference frequency suppression
<ul style="list-style-type: none"> • Interference voltage suppression for interference frequency f1 in Hz • Conversion time (per channel) 	10 / 50 / 60 Hz	16.6 / 50 / 60 Hz, channel-by-channel 180 / 60 / 50 ms, results from the selected interference frequency suppression
Smoothing of measured values		
<ul style="list-style-type: none"> • Number of smoothing levels • parameterizable 	4; None; 4/8/16 times Yes	Yes; none, weak, medium, strong, channel-by-channel
Encoder		
Connection of signal encoders		
<ul style="list-style-type: none"> • for current measurement as 2-wire transducer - Burden of 2-wire transmitter, max. 	Yes 750 Ω; At 20 mA input current	
Errors/accuracies		
Basic error limit (operational limit at 25 °C)		
<ul style="list-style-type: none"> • Voltage, relative to input range, (+/-) • Current, relative to input range, (+/-) • Resistance, relative to input range, (+/-) 	0.2 %	0.05 % 0.05 %
Interference voltage suppression for $f = n \times (f1 \pm 1\%)$, $f1 =$ interference frequency		
<ul style="list-style-type: none"> • Series mode interference (peak value of interference < rated value of input range), min. • Common mode voltage, max. • Common mode interference, min. 	60 dB	70 dB 60 V; Applicable for use in non-hazardous areas; no common mode voltage permissible in hazardous areas 90 dB
Protocols		
HART protocol	Yes	

Technical specifications

Article number	6DL1134-6TB00-0HX1 ET 200SP HA, EX-AI 2xI 2-WIRE HART	6DL1134-6JD00-0HX1 ET 200SP HA, EX-AI 4xTC/2xRTD 2-/3-/4-W
Interrupts/diagnostics/ status information		
Diagnostics function	Yes	Yes
Alarms		
• Diagnostic alarm	Yes	Yes
• Limit value alarm	Yes	Yes; two upper and two lower limit values in each case
Diagnoses		
• Monitoring the supply voltage	Yes	Yes
• Wire-break	Yes; channel by channel	Yes; channel by channel
• Short-circuit	Yes; channel by channel	
• Group error	Yes	
• Overflow/underflow	Yes; channel by channel	Yes; channel by channel
Diagnostics indication LED		
• MAINT LED	Yes; Yellow LED	Yes; Yellow LED
• Monitoring of the supply voltage (PWR-LED)	Yes; green PWR LED	Yes; green PWR LED
• Channel status display	Yes; green LED	Yes; green LED
• for channel diagnostics	Yes; red LED	Yes; red LED
• for module diagnostics	Yes; green/red DIAG LED	Yes; green/red DIAG LED
Ex(i) characteristics		
maximum values for connecting terminals for gas group IIC		
• U _o (no-load voltage), max.	26 V	5.9 V
• I _o (short-circuit current), max.	93 mA	18 mA
• P _o (power output), max.	605 mW	27 mW
• C _o (permissible external capacity), max.	99 nF	43 µF
• L _o (permissible external inductivity), max.	4 mH	110 mH
• U _i (intrinsically safe input voltage), max.	10 V	
Potential separation		
Potential separation channels		
• between the channels and backplane bus	Yes	Yes
Ambient conditions		
Ambient temperature during operation		
• horizontal installation, min.	-40 °C	-40 °C
• horizontal installation, max.	70 °C	70 °C
• vertical installation, min.	-40 °C	-40 °C
• vertical installation, max.	60 °C	60 °C
Altitude during operation relating to sea level		
• Installation altitude above sea level, max.	2 000 m	2 000 m
Dimensions		
Width	20 mm	20 mm
Height	73 mm	73 mm
Depth	58 mm	58 mm
Weights		
Weight, approx.	55 g	55 g

I/O systemsSIMATIC ET 200 systems for the control cabinet
SIMATIC ET 200SP HA**Ex I/O modules****Technical specifications**

Article number	6DL1135-6TB00-0HX1 ET 200SP HA, EX-AQ 2xI HART
General information	
Product type designation	Ex-AQ 2xI HART
Product function	
• Isochronous mode	No
Engineering with	
• STEP 7 TIA Portal configurable/ integrated from version	STEP 7 V16 or higher with HSP
• STEP 7 configurable/ integrated from version	STEP 7 V5.6 SP2 or higher
• PCS 7 configurable/ integrated from version	V9.1
Operating mode	
• MSO	Yes
Analog outputs	
Number of analog outputs	2
Cycle time (all channels), min.	3 ms
Output ranges, current	
• 0 to 20 mA	Yes; 15 bit
• 4 mA to 20 mA	Yes; 16 bit incl. sign
Connection of actuators	
• for current output two-wire connection	Yes
Load impedance (in rated range of output)	
• with current outputs, max.	500 Ω
• with current outputs, inductive load, max.	Ex characteristic values must be observed
Cable length	
• shielded, max.	500 m; Ex characteristic values must be observed
• unshielded, max.	300 m; Ex characteristic values must be observed
Analog value generation for the outputs	
Settling time	
• for resistive load	1 ms; 500 ohms
Errors/accuracies	
Basic error limit (operational limit at 25 °C)	
• Current, relative to output range, (+/-)	0.2 %
Protocols	
HART protocol	Yes
Interrupts/diagnostics/ status information	
Diagnostics function	Yes
Substitute values connectable	Yes
Alarms	
• Diagnostic alarm	Yes

Article number	6DL1135-6TB00-0HX1 ET 200SP HA, EX-AQ 2xI HART
Diagnoses	
• Monitoring the supply voltage	Yes; Module-wise
• Wire-break	Yes; From output value > 240 μA
• Short-circuit	Yes; < 20 ohms as of 1 mA output value
• Group error	Yes
• Overflow/underflow	Yes; channel by channel
Diagnostics indication LED	
• MAINT LED	Yes; Yellow LED
• Monitoring of the supply voltage (PWR-LED)	Yes; green PWR LED
• Channel status display	Yes; green LED
• for channel diagnostics	Yes; red LED
• for module diagnostics	Yes; green/red DIAG LED
Ex(i) characteristics	
maximum values for connecting terminals for gas group IIC	
• U _o (no-load voltage), max.	22 V
• I _o (short-circuit current), max.	91 mA
• P _o (power output), max.	501 mW
• C _o (permissible external capacity), max.	151 nF
• L _o (permissible external inductivity), max.	4.1 mH
• U _i (intrinsically safe input voltage), max.	10 V
• U _m (voltage at non-intrinsically safe connecting terminals), max.	60 V
Potential separation	
Potential separation channels	
• between the channels and backplane bus	Yes
Ambient conditions	
Ambient temperature during operation	
• horizontal installation, min.	-40 °C
• horizontal installation, max.	70 °C
• vertical installation, min.	-40 °C
• vertical installation, max.	60 °C
Altitude during operation relating to sea level	
• Installation altitude above sea level, max.	2 000 m
Dimensions	
Width	20 mm
Height	73 mm
Depth	58 mm
Weights	
Weight, approx.	55 g

Technical specifications

Article number	6DL1133-6PX00-0HW0 ET 200SP HA, Ex-PM E POWER MODULE
General information	
Product type designation	Ex-PM-E
Product function	
• I&M data	Yes; Asset data
Supply voltage	
Rated value (DC)	24 V
Reverse polarity protection	Yes
Output current	
horizontal installation	
• up to 60 °C, max.	0.8 A
• up to 70 °C, max.	0.6 A
vertical installation	
• up to 50 °C, max.	0.8 A
• up to 60 °C, max.	0.6 A
Interrupts/diagnostics/ status information	
Diagnostics function	Yes
Diagnoses	
• Diagnostic information readable	Yes
• missing load voltage	Yes

Article number	6DL1133-6PX00-0HW0 ET 200SP HA, Ex-PM E POWER MODULE
Diagnostics indication LED	
• MAINT LED	Yes; Yellow LED
• Monitoring of the supply voltage (PWR-LED)	Yes; green PWR LED
• for module diagnostics	Yes; green/red DIAG LED
Ex(i) characteristics	
Module for Ex(i) protection	Yes
maximum values for connecting terminals for gas group IIC	
• Um (voltage at non-intrinsically safe connecting terminals), max.	60 V; power supply and backplane bus
Potential separation	
primary/secondary	Yes
Ambient conditions	
Ambient temperature during operation	
• min.	-40 °C
• max.	70 °C; with derating
Altitude during operation relating to sea level	
• Installation altitude above sea level, max.	2 000 m
Dimensions	
Width	50 mm
Height	114 mm
Depth	67.5 mm
Weights	
Weight, approx.	182 g

Article number	6DL1193-6BP00-0DW0 ET 200SP HA, Ex-BU TYPE W0	6DL1193-6BP00-0BX1 ET 200SP HA, Ex-BU TYPE X1
General information		
Product type designation	BU type W0	BU type X1
Product function		
• I&M data	Yes; Asset data	Yes; Asset data
Hardware configuration		
Slots		
• Number of slots	1	1
Ambient conditions		
Ambient temperature during operation		
• horizontal installation, min.	-40 °C	-40 °C
• horizontal installation, max.	70 °C	70 °C
• vertical installation, min.	-40 °C	-40 °C
• vertical installation, max.	60 °C	60 °C
Altitude during operation relating to sea level		
• Installation altitude above sea level, max.	2 000 m	2 000 m
Connection method		
Terminals		
• Terminal type		Push-in terminal
• Conductor cross-section, min.		0.14 mm ² ; AWG 26
• Conductor cross-section, max.		2.5 mm ² ; AWG 14
• Number of process terminals to I/O module		8
Dimensions		
Width	50 mm	20 mm
Height	117 mm	117 mm
Depth	19 mm	35 mm
Weights		
Weight, approx.	38 g	42 g

I/O systems

SIMATIC ET 200 systems for the control cabinet
SIMATIC ET 200SP HA

Carrier modules

Overview

DIN rails

The DIN rail is required for fitting an ET 200SP HA station in the control cabinet. The IM carrier modules for interface modules, the carrier modules for the I/O modules and the server module are attached to the DIN rail.

The DIN rails are available in lengths of 482 mm (for installation in a 19-inch rack) and 1 500 mm (for maximum configuration and vertical installation in a cabinet).



IM single carrier module



IM redundant carrier module

IM carrier modules for interface modules

Two versions of the IM carrier modules for interface modules are available:

- IM single carrier module for 1 interface module, for single connection to PROFINET
- IM redundant carrier module for 2 interface modules, for redundant connection to PROFINET

The IM carrier modules connect the interface module to the backplane bus. They enable data exchange with the I/O modules.



Carrier module for I/O modules, 8-slot



Carrier module for I/O modules, 2-slot

Carrier modules for I/O modules

The slots for the I/O modules are created by the connection of these carrier modules to the terminal blocks.

Carrier modules for I/O modules are available in the following versions:

- Carrier module, 2-slot, with 2 slots for I/O modules
- Carrier module, 8-slot, with 8 slots for I/O modules
- Carrier module, 8-slot, with 8 slots for I/O modules, without Power Bus function

Overview



ET 200SP HA, server module

Server module

Server module and power bus cover complete the design of the ET 200SP HA. A server module and a power bus cover are supplied with each IM carrier module for the interface module.

Ordering data

Article No.

Ordering data	Article No.
DIN rails for ET 200SP HA	
482 mm (approx. 19 inch) DIN rail Including grounding screw and integrated top hat DIN rail for fitting small components such as clamps, miniature circuit-breakers and relays	6DL1193-6MC00-0AA0
1 500 mm (approx. 59 inch) DIN rail Including grounding screw and integrated top hat DIN rail for fitting small components such as clamps, miniature circuit-breakers and relays	6DL1193-6MD00-0AA0
Grounding screw For connecting PE to the DIN rail; essential for 1 500 mm DIN rail 20 units per packing unit	6ES7590-5AA00-0AA0
IM carrier modules for interface modules Note: A server module and a power bus cover are supplied with each IM carrier module for the interface module.	
IM single carrier module Rack for 1 SIMATIC ET 200SP HA interface module for single connection to PROFINET	6DL1193-6BH00-0SM0
IM redundant carrier module Rack for 2 SIMATIC ET 200SP HA interface modules for redundant connection to PROFINET	6DL1193-6BH00-0RM0
Carrier modules for I/O modules	
Carrier module, 2-slot Rack for 2 SIMATIC ET 200SP HA I/O modules	6DL1193-6GA00-0NN0
Carrier module 8-slot Rack for 8 SIMATIC ET 200SP HA I/O modules	6DL1193-6GC00-0NN0
Carrier module 8-slot Carrier without Power Bus, can only be operated with light-gray or black terminal blocks, for holding 8 I/O modules of the SIMATIC ET 200SP HA	6DL1193-6GC00-8NN0
Spare parts	
Server module (spare part) for ET 200SP HA	6DL1193-6PA00-0AA0

I/O systemsSIMATIC ET 200 systems for the control cabinet
SIMATIC ET 200SP HA**Carrier modules****Technical specifications**

Article number	6DL1193-6BH00-0SM0 CARRIER MODULE IM SINGLE	6DL1193-6BH00-0RM0 CARRIER MODULE IM REDUNDANT	
General information			
Product type designation	IM carrier module, single	Carrier module IM redundant	
Product function			
• I&M data	Yes; Asset data	Yes; Asset data	
Hardware configuration			
Slots			
• Number of slots	1	2	
Ambient conditions			
Ambient temperature during operation			
• horizontal installation, min.	-40 °C	-40 °C	
• horizontal installation, max.	70 °C	70 °C	
• vertical installation, min.	-40 °C	-40 °C	
• vertical installation, max.	60 °C	60 °C	
Dimensions			
Width	100 mm	100 mm	
Height	204 mm	204 mm	
Depth	52 mm	52 mm	
Weights			
Weight, approx.	250 g	224 g	
Article number	6DL1193-6GA00-0NN0 CARRIER MODULE TWOFOLD	6DL1193-6GC00-0NN0 CARRIER MODULE EIGHTFOLD	6DL1193-6GC00-8NN0 CARRIER MODULE EIGHTFOLD w/o PB
General information			
Product type designation	Carrier module 2 times	Carrier module 8 times	carrier module 8x without power bus
Product function			
• I&M data	Yes; Asset data	Yes; Asset data	Yes; Asset data
Hardware configuration			
Slots			
• Number of slots	2	8	8; for light gray and black terminal blocks
Ambient conditions			
Ambient temperature during operation			
• horizontal installation, min.	-40 °C	-40 °C	-40 °C
• horizontal installation, max.	70 °C	70 °C	70 °C
• vertical installation, min.	-40 °C	-40 °C	-40 °C
• vertical installation, max.	60 °C	60 °C	60 °C
Dimensions			
Width	52.5 mm; 45 mm when installed	187.5 mm; 180 mm when installed	187.5 mm; 180 mm when installed
Height	203 mm	203 mm	203 mm
Depth	79 mm	79 mm	79 mm
Weights			
Weight, approx.	111 g	450 g	270 g

Overview

The slots for the I/O modules are created by connecting carrier modules and terminal blocks. The terminal blocks contain the process terminals for connecting sensors, actuators and other devices.

Select the terminal block for the slot of an I/O module based on the following dependencies:

The following table illustrates the terminal block / I/O module assignment (x = standard):

I/O modules in 24 V range

I/O module	TB type H1	TB type H0 (D-SUB)	TB type M1 (IO-RED)	TB type F1 (F-AI IO-RED)	TB type P0 (32x L+)	TB type N0 (32x M)
DI 16x24V	x	x	x			x ^{c)}
DI 32x24V	x ^{a)}	x ^{a)}			x	
DI 16xNAMUR	x	x	x			x ^{c)}
DQ 16x24V / 0.5A	x	x	x			x ^{c)}
DQ 32x24V / 0.5A	x ^{b)}	x ^{b)}				x
DI-AI 16x / DQ 16x HART	x	x	x			x ^{c)}
AI 16xI HART	x	x	x			x ^{c)}
AI 16xTC 8xRTD	x	x ^{d)}	x			
AQ 8xI HART	x	x	x			x ^{c)}
F-DI 16x24V	x		x		x	x
F-DQ 10x24V / 2A	x		x		x	x
F-AI 8xI HART	x			x	x	x
						
Powerbus infeed	Light gray		Light gray		Light gray	Light gray
Powerbus continuer	Dark gray		Dark gray		Dark gray	Dark gray
No powerbus		Black		Black		

a) Encoder supply must be realized separately

b) Ground points must be realized separately

c) Offers 32 additional ground points for field connection

d) No temperature compensation for TC

I/O systems

SIMATIC ET 200 systems for the control cabinet
SIMATIC ET 200SP HA

Terminal blocks

Overview

I/O modules with voltages >24V

I/O modules with channel-selective isolation

I/O module	TB type K0 (ISOL)	TB type L0 (ISOL IO-RED)
DI 8x24 ... 125V DC	x	
DI 8x230VAC	x	
RQ 4x120-230V / 5A CO	x	
AI 4xI HART ISOL	x	x
AQ 4xI HART ISOL	x	x
		
Powerbus infeed	Light gray	Light gray
Powerbus continuer	Dark gray	

Potential groups/color type of the terminal blocks

To help you distinguish between potential groups on an ET 200SP HA station, the terminal blocks come in both a light and a dark version:

- Each light-colored terminal block that is mounted in the station starts a new potential group. The first terminal block mounted (on the first carrier module immediately to the right of the interface module) is therefore light-colored.
- Each dark terminal block forms a contact with the supply voltage of the terminal block to its left, thus extending the potential group.

Note the maximum permissible load current depending on the number of I/O modules:

Number of terminal blocks	Permissible load current in amperes
4	10 A
5	8 A
6	7 A
7	6 A
8	5 A
10	4 A
15	3 A
20	2 A

Ordering data	Article No.	Article No.
Terminal blocks 24 V DC		Terminal blocks insulated (24 V DC / 125 V DC / 230 V AC)
Terminal block type H1 light For starting a new potential group, with 32 push-in terminals, width 22.5 mm, with temperature compensation	6DL1193-6TP00-0DH1	Terminal block type K0 light For starting a new potential group, with 16 push-in terminals, width 22.5 mm
Terminal block type M1 light For starting a new potential group, with 32 push-in terminals, width 45 mm, for redundant configurations, with temperature compensation	6DL1193-6TP00-0DM1	Terminal block type K0 dark For forwarding a potential group, with 16 push-in terminals, width 22.5 mm
Terminal block type P0 light For starting a new potential group, with 32 push-in terminals, additional 32 push-in terminals with encoder supply, width 45 mm, specifically for use with DI 32x24 V DC (6DL1131-6BL00-0PH1)	6DL1193-6TP00-0DP0	Terminal block type L0 light gray For starting a new potential group, with 16 push-in terminals, width 45 mm
Terminal block type N0 light For starting a new potential group, with 32 push-in terminals, additional 32 push-in terminals for ground connection, width 45 mm, for use with DQ 32x 24 V DC (6DL1132-6BL00-0PH1) and other modules	6DL1193-6TP00-0DN0	Accessories
Terminal block type H1 dark For forwarding a potential group, with 32 push-in terminals, width 22.5 mm, with temperature compensation	6DL1193-6TP00-0BH1	Shield connection for terminal block 5 shield supports and 5 shield terminals, for direct connection
Terminal block type M1 dark For forwarding a potential group, with 32 push-in terminals, width 45 mm, for redundant configurations, with temperature compensation	6DL1193-6TP00-0BM1	6ES7193-6SC00-1AM0
Terminal block type P0 dark For forwarding a potential group, with 32 push-in terminals, additional 32 push-in terminals with encoder supply, width 45 mm, specifically for use with DI 32x24 V DC (6DL1131-6BL00-0PH1)	6DL1193-6TP00-0BP0	
Terminal block type N0 dark For starting a new potential group, with 32 push-in terminals, additional 32 push-in terminals for ground connection, width 45 mm, for use with DQ 32x 24 V DC (6DL1132-6BL00-0PH1) and other modules	6DL1193-6TP00-0BN0	
Terminal block type F1 black 32 push-in terminals, width 45 mm, for redundant configuration with fail-safe analog module F-AI, no power bus	6DL1193-6TP00-0DF1	
Terminal block type H0, D-sub, black D-Sub plug 37-pin, 24 V infeed per TB, width 22.5 mm, no power bus	6DL1193-6TC00-0DH0	

I/O systems

SIMATIC ET 200 systems for the control cabinet
SIMATIC ET 200SP HA

Terminal blocks

Technical specifications

Article number	6DL1193-6TP00-0DH1	6DL1193-6TP00-0BH1	6DL1193-6TP00-0DM1	6DL1193-6TP00-0BM1	6DL1193-6TP00-0DP0	6DL1193-6TP00-0BP0
	TERMINAL BLOCK, TYPE H1, LIGHT-GREY	TERMINAL BLOCK, TYPE H1, DARK-GREY	TERMINAL BLOCK, TYPE M1, LIGHT-GREY	TERMINAL BLOCK, TYPE M1, DARK-GREY	TERMINAL BLOCK, TYPE P0, LIGHT-GREY	TERMINAL BLOCK, TYPE P0, DARK-GREY
General information						
Product type designation	Type H1	Type H1	Type M1	Type M1	Type P0	Type P0
Product function						
• I&M data	Yes; Asset data	Yes; Asset data	Yes; Asset data	Yes; Asset data	Yes	Yes
Input current						
Current consumption, max.					640 mA; With one 20 mA encoder supply per channel	640 mA; With one 20 mA encoder supply per channel
Hardware configuration						
Slots						
• Number of slots	1	1	2; For IO redundancy	2; For IO redundancy	1	1
Ambient conditions						
Ambient temperature during operation						
• horizontal installation, min.	-40 °C	-40 °C	-40 °C	-40 °C	-40 °C	-40 °C
• horizontal installation, max.	70 °C	70 °C	70 °C	70 °C	70 °C	70 °C
• vertical installation, min.	-40 °C	-40 °C	-40 °C	-40 °C	-40 °C	-40 °C
• vertical installation, max.	60 °C	60 °C	60 °C	60 °C	60 °C	60 °C
Dimensions						
Width	22.5 mm	22.5 mm	45 mm	45 mm	45 mm	45 mm
Height	175 mm	175 mm	175 mm	175 mm	175 mm	175 mm
Depth	77 mm	77 mm	77 mm	77 mm	77 mm	77 mm
Weights						
Weight, approx.	80 g	80 g	155 g	155 g	155 g	155 g
Article number	6DL1193-6TP00-0DN0	6DL1193-6TP00-0BN0	6DL1193-6TP00-0DK0	6DL1193-6TP00-0BK0		
	TERMINAL BLOCK, TYPE N0, LIGHT-GREY	TERMINAL BLOCK, TYPE N0, DARK-GREY	TERMINAL BLOCK, TYPE K0, LIGHT-GREY	TERMINAL BLOCK, TYPE K0, DARK-GREY		
General information						
Product type designation	Type N0	Type N0	Type K0	Type K0		
Product function						
• I&M data	Yes	Yes	Yes; Asset data	Yes; Asset data		
Hardware configuration						
Slots						
• Number of slots	1	1	1	1		
Ambient conditions						
Ambient temperature during operation						
• horizontal installation, min.	-40 °C	-40 °C	-40 °C	-40 °C		
• horizontal installation, max.	70 °C	70 °C	70 °C	70 °C		
• vertical installation, min.	-40 °C	-40 °C	-40 °C	-40 °C		
• vertical installation, max.	60 °C	60 °C	60 °C	60 °C		
Dimensions						
Width	45 mm	45 mm	22.5 mm	22.5 mm		
Height	175 mm	175 mm	175 mm	175 mm		
Depth	77 mm	77 mm	77 mm	77 mm		
Weights						
Weight, approx.	155 g	155 g	78 g	78 g		

Technical specifications

Article number	6DL1193-6TP00-0DF1	6DL1193-6TC00-0DH0
	TERMINAL BLOCK, TYP F1, F-AI, IO-RED	TERMINAL BLOCK, TYPE H0, D-SUB
General information		
Product type designation	Type F1	type H0, SUB-D
Product function		
• I&M data	Yes; Asset data	Yes; Asset data
Hardware configuration		
Slots		
• Number of slots	2; For IO redundancy	1
Ambient conditions		
Ambient temperature during operation		
• horizontal installation, min.	-40 °C	-40 °C
• horizontal installation, max.	70 °C	70 °C
• vertical installation, min.	-40 °C	-40 °C
• vertical installation, max.	60 °C	60 °C
Dimensions		
Width	45 mm	22.5 mm
Height	175 mm	175 mm
Depth	77 mm	77 mm
Weights		
Weight, approx.	160 g	80 g
Article number		
	6DL1193-6TP00-0DL0	
	TERMINAL BLOCK, TYP L0, LIGHT-GREY	
General information		
Product type designation	Type L0	
Product function		
• I&M data	Yes; Asset data	
Hardware configuration		
Slots		
• Number of slots	2; For IO redundancy	
Ambient conditions		
Ambient temperature during operation		
• horizontal installation, min.	-40 °C	
• horizontal installation, max.	70 °C	
• vertical installation, min.	-40 °C	
• vertical installation, max.	60 °C	
Dimensions		
Width	45 mm	
Height	175 mm	
Depth	77 mm	
Weights		
Weight, approx.	148 g	

I/O systems

SIMATIC ET 200 systems for the control cabinet
SIMATIC ET 200SP HA

BusAdapter

Overview

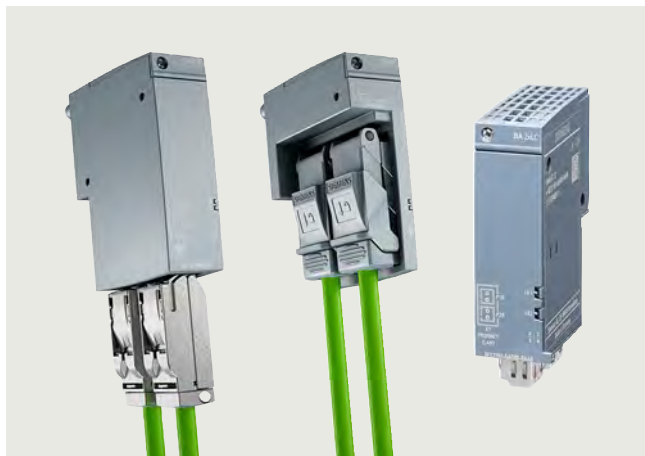

BusAdapter BA 2xRJ45, 2xFC and 2xLC

BusAdapter

A BusAdapter as a separate component allows a free choice of connection technology:

- BA 2xRJ45: 2 electrical connections for bus cable with standard RJ45 connector
- BA 2xFC: 2 electrical connections for direct connection of FastConnect bus cable
- BA 2xLC: 2 optical ports for fiber-optic cables

Ordering data

Article No.

BusAdapter	Article No.
BusAdapter 2xRJ45 2 × RJ45 sockets for PROFINET (standard Ethernet socket)	6DL1193-6AR00-0AA0
BusAdapter 2xFC 2 × FastConnect (FC) connections for PROFINET	6DL1193-6AF00-0AA0
BusAdapter 2xLC 2 × glass fiber-optic connections for PROFINET	6DL1193-6AG00-0AA0
BusAdapter BA LC/RJ45 2 × glass fiber-optic connections	6DL1193-6AG20-0AA0
BusAdapter BA LC/FC 2 × glass fiber-optic connections	6DL1193-6AG40-0AA0
BusAdapter BA 2xRJ45 (VD) 2 × electrical connections for Ethernet communication via 2-, 4- or 8-wire copper cables and distances up to 500 m	6GK5991-2VA00-8AA2

10

Technical specifications

Article number	6DL1193-6AR00-0AA0 ET 200SP HA, BUSADAPTER BA 2XRJ45	6DL1193-6AF00-0AA0 ET 200SP HA, BUSADAPTER BA 2XFC	6DL1193-6AG00-0AA0 ET 200SP HA, BUSADAPTER BA 2XLC
General information			
Product type designation	BA 2x RJ45	BA 2xFC	BA 2xLC
Interfaces			
Number of PROFINET interfaces	1; 2 ports (switch) RJ45	1; 2 ports (switch) FC	1; 2 ports (switch) LC Multimode Glass Fibre
Supports protocol for PROFINET IO			
• Number of RJ45 ports	2		
• Number of FC (FastConnect) connections		2	
• Number of LC ports			2
Cable length			
- Cu conductors	100 m	100 m	
- Multimode graded-index fiber 50/125 µm			3 km
- Multimode graded-index fiber 62.5/125 µm			3 km
Ambient conditions			
Ambient temperature during operation			
• min.	-40 °C	-40 °C	-40 °C
• max.	70 °C	70 °C	65 °C; redundant design (2x 6DL1155-6AU00-0PM0): max. 60 °C horizontal, max. 50 °C vertical. When using different I/O devices, the derating specified there must be observed
Dimensions			
Width	20 mm	20 mm	20 mm
Height	69.5 mm	69.5 mm	75 mm; Without protective caps (approx. 8 mm)
Depth	59 mm	59 mm	59 mm
Weights			
Weight, approx.	46 g	53 g	60 g

Technical specifications

Article number	6DL1193-6AG20-0AA0 ET 200SP HA, BUSADAPTER BA LC/RJ45	6DL1193-6AG40-0AA0 ET 200SP HA, BUSADAPTER BA LC/FC
General information		
Product type designation	BA LC/RJ45	BA LC/FC
Interfaces		
Number of PROFINET interfaces	1; 2 ports (switch) LC / RJ45	1; 2 ports (switch) LC / FC
Supports protocol for PROFINET IO		
• Number of RJ45 ports	1	1
• Number of FC (FastConnect) connections		
• Number of LC ports	1; Wavelength of 1 270 ... 1 380 nm, corresponds to 100BASE-FX	1; Wavelength of 1 270 ... 1 380 nm, corresponds to 100BASE-FX
Cable length		
- Cu conductors	100 m	100 m
- Multimode graded-index fiber 50/125 µm	3 km	3 km
- Multimode graded-index fiber 62.5/125 µm	3 km	3 km
Standards, approvals, certificates		
RoHS conformity	Yes	Yes
China RoHS compliance	Yes	Yes
Ambient conditions		
Ambient temperature during operation		
• min.	-40 °C	-40 °C
• max.	70 °C; = Tmax for horizontal installation; for vertical installation Tmax = 60 °C; redundant setup (2x 6DL1155-6AU00-0PM0): max. 65 °C horizontally, max. 60 °C vertically. When using different IO Devices, the derating specified there must be observed.	65 °C; = Tmax for horizontal installation; for vertical installation Tmax = 60 °C; redundant setup (2x 6DL1155-6AU00-0PM0): max. 60 °C horizontally, max. 55 °C vertically. When using different IO Devices, the derating specified there must be observed.
Dimensions		
Width	20 mm	20 mm
Height	75 mm; Without protective caps (approx. 8 mm)	75 mm; Without protective caps (approx. 8 mm)
Depth	59 mm	59 mm
Weights		
Weight, approx.	32 g	50 g
Article number	6GK5991-2VA00-8AA2	
product type designation	BA 2xRJ45VD HA	
suitability for use	Ethernet transmission via 2, 4 and 8-wire line	
suitability for operation	Products with BusAdapter interface (requirement: the BusAdapter is approved in the firmware of the basic unit)	
interfaces		
number of electrical connections		
• for network components or terminal equipment maximum	2	
number of 10/100 Mbit/s RJ45 ports	2	
type of electrical connection		
• for network components or terminal equipment	RJ45	
operating mode		
• standard Ethernet	Yes	
• VD	Yes; Depending on number of wires (2, 4 or 8-wire)	
standards, specifications, approvals		
certificate of suitability		
• CCC for hazardous zone according to GB standard	Yes	

I/O systems

SIMATIC ET 200 systems for the control cabinet
SIMATIC ET 200SP HA

Additional I/O modules

Overview

Extending the SIMATIC ET 200SP HA system with specific additional I/O modules from the SIMATIC ET 200SP system gives you more options and flexibility.

When these I/O modules are used, the following aspects need to be considered:

- Special slot rules apply. The additional I/O modules from the SIMATIC ET 200SP system can only be operated at the end, after the Standard SIMATIC ET 200SP HA I/O modules. Mixed configuration is not permissible.
- Module redundancy is not supported for the additional I/O modules.
- Attention must be paid to the specific properties of the additional I/O modules, such as ambient temperature, painting, insulation protection. These are usually limited compared to the ET 200SP HA I/O modules.

Analog input module AI Energy Meter Standard, 480 V AC, BU type D0

- Can be plugged into type D0 BaseUnits (BU) with automatic coding
- LED display for error, operation, power, and status
- Clear labeling on front of module
- Optional labeling accessories
- Optional module-specific color coding of the terminals according to the CC color code

SIWAREX WP321 weighing controller

A versatile and flexible weighing module for the seamless integration of a static scale into the SIMATIC automation environment.

The electronic weighing system is integrated in the SIMATIC ET 200SP series and uses all the features of a modern automation system, such as integrated communication, operator control and monitoring, diagnostic systems and configuration tools in the TIA Portal, SIMATIC STEP 7, WinCC flexible and PCS 7.

Valve terminal AirLINE SP type 8647 for integration in ET 200SP HA

- For pneumatic control of actuators with ET 200SP HA
- Can be used together with system and IO components of the ET 200SP HA distributed I/O system
- Bürkert Fluid Control Systems product, can only be obtained from Bürkert Fluid Control Systems product partner

Note:

Product partners are external companies outside Siemens AG and its associated companies. Information and descriptions of products made by product partners are non-binding, and are the responsibility of the product partners. These products are manufactured independently and under the responsibility of the respective product partner, and are sold and supplied by it under its terms of business and delivery.

Unless compulsory by law, Siemens assumes no liability or warranty for these products or for connection with these products of the product partners.

Ordering data

Article No.

Analog input module

AI Energy Meter Standard
480 V AC, BU type D0

6ES7134-6PA20-0BD0

SIWAREX WP321 weighing controller

Single-channel, for platform scales or hopper scales with analog load cells (1 - 4 mV/V), 1 × LC, 1 × RS 485.

7MH4138-6AA00-0BA0

Valve terminal AirLINE SP type 8647 for integration in ET 200SP HA

For more detailed information about the AirLINE SP, type 8647 (e.g. data sheet, operating manual) please contact Bürkert directly:
<https://www.burkert-usa.com/en/type/8647>

* Disclaimer of liability

This information and the descriptions have been compiled with great care. However, it is not possible for Siemens to verify that the data supplied by product partners is complete, correct and up-to-date. The possibility that individual items of information might be incorrect, incomplete, or not up-to-date cannot therefore be ruled out. Unless compulsory by law, Siemens accepts no liability for the usability of the data or of the products for the user per se.

Overview



SIMATIC ET 200MP Video
https://players.brightcove.net/1813624294001/70fecf0f-fbad-4fad-a077-d0e26af4d84c_default/index.html?videoId=6147385583001

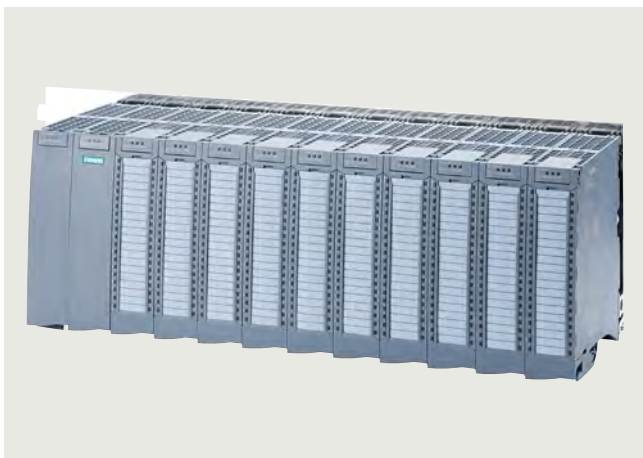

SIMATIC ET 200MP is a modular and scalable I/O system with IP20 degree of protection for universal use, and offers the same system advantages as SIMATIC S7-1500. SIMATIC ET 200MP permits extremely short bus cycle times and very fast response times, even with large quantity structures.

SIMATIC ET 200MP consists of the following components:

- Interface modules for connecting S7-1500 I/O modules to PROFINET; up to 30 modules can be connected to one interface module
- Interface module for connecting S7-1500 I/O modules to PROFIBUS; up to 12 modules can be connected to one interface module

The SIMATIC ET 200MP distributed I/O system is particularly easy to install, wire, and commission.

With its extended ambient conditions, SIMATIC ET 200MP can be used almost anywhere. Many modules can be operated in a temperature range from -30°C to +60°C and at altitudes up to 5,000 m as standard. A wide range of SIPLUS modules is available for requirements beyond this.

Highlights:

- Modular I/O system with IP20 degree of protection for PROFINET or alternatively for PROFIBUS
- Compact dimensions and high channel density
- High degree of user-friendliness due to the following design features:
 - High channel density through 35 mm wide modules with up to 64 digital channels
 - Standardized 40-pin front connector simplifies ordering, logistics, and warehousing
 - Standardized pin assignment per module type simplifies wiring and helps avoid errors
 - Integrated potential bridges simplify wiring and allow flexible subsequent modification of potential groups
 - The cable storage space grows along with the requirements and allows a uniform appearance even with insulated conductors with a large core cross-section and/or thick insulation
 - The prewiring position for the front connector allows convenient wiring during both initial commissioning and when making changes during operation
 - The mounting rail integrated in the S7-1500 DIN rail allows snapping-on of many standard components such as additional terminals, miniature circuit breakers or small relays
 - The 1:1 assignment of channel status and diagnostics LED, terminal and inscription allows fast location and elimination of errors. Assistance is provided by the wiring diagram printed on the inside of the front panels
 - The integrated shielding concept for analog and technology modules allows reliable and rugged operation, in particular with High Speed applications. Installation does not require any tools
 - Particularly space-saving and simple design with slim 25 mm modules and high-density modules; the maximum possible station configuration with power supply (PS), interface module (IM) and 30 I/O modules can be accommodated on a 830 mm-wide S7-1500 mounting rail
- Comprehensive product portfolio comprising digital and analog input or output modules, technology modules, communication modules for IO-Link and point-to-point communication, and F-modules up to SIL3.
 - Integrated technological functions in selected modules, such as counting, pulse width modulation (PWM) or integrated switching cycle counters, make cost-effective and convenient solutions possible.
 - Selected digital output modules enable safety-related load group shutdown in accordance with SILCL 2 via an external safety relay.

I/O systems

SIMATIC ET 200 systems for the control cabinet

SIMATIC ET 200MP

Overview

- Extensive system functions
 - Integrated system diagnostics when operated with S7-1500 and TIA Portal
 - Integrated switching cycle counter for relay modules enables preventive maintenance
 - Consistent use of identification and maintenance data IM0 to IM3 for fast electronic and unambiguous identification of individual modules (Article No., serial number, etc.)
 - Uniform firmware update for the interface module and all I/O modules for subsequent expansion of functions (investment security)
 - Bus cycle time $\geq 250 \mu\text{s}$ and coupling to the isochronous task permit implementation of applications with high performance requirements with PROFINET
 - Up to 30 I/O modules (PROFINET) or 12 I/O modules (PROFIBUS) within a station save on interface modules and installation time
 - MMC not required with PROFINET; automatic address assignment via LLDP or manually via TIA Portal or PST tool
 - Shared device on up to two (IM 155-5 PN BA and IM 155-5 PN ST) or four (IM 155-5 PN HF) IO Controllers
 - Module shared input/module shared output as system function for all S7-1500 I/O modules
- High plant availability:
 - Increased communication availability by means of Media Redundancy Protocol (MRP, MRPD) on PROFINET as well as operation of the IM 155-5 PN HF on an S7-1500 R/H using S2 redundancy; in addition, the IM 155-5 PN HF High Feature interface module can be operated on an S7-400H. Configuration is carried out with STEP 7 V5.5 SP3 and a GSDML file. The IM 155-5 PN HF also supports operation on an S7-400H CPU (system redundancy).
 - Increased plant availability due to the active backplane bus for up to 12 I/O modules per station; allows reaction-free pulling and plugging of I/O modules in operation without a CPU STOP; allows holding of reserves (empty slots) for plant expansion at a later time.

Overview

- Interface modules for connecting ET 200MP to PROFINET
- These handle data exchange with the PROFINET IO Controller in the PLC
- Integrated 2-port switch for line topology

IM 155-5 PN BA

- Max. 12 I/O modules
- Operation of F-modules and PROFIsafe
- Shortest bus cycle time 1 ms
- Media redundancy (MRP)
- Shared device on up to 2 IO controllers
- Omission of SIMATIC Memory Card (SMC); IM replacement without PG using LLDP

IM 155-5 PN ST, IM 155-5 PN HF

- Max. 30 I/O modules
- Shortest bus cycle 250 μ s
- Connecting to the isochronous task of the CPU
- Prioritized fast startup (FSU) with max. 12 I/O modules
- Media Redundancy Protocol (MRP)
- Shared device on up to two IO controllers (when configuring using GSD file; depends on the respective configuration tool)
- Omission of SIMATIC Memory Card (SMC); IM replacement without PG using LLDP
- Operation of F-modules and PROFIsafe
- Submodule-granular shared device with up to two IO controllers
- Configuration control (option handling)
- Module shared input and module shared output (MSI/MSO), i.e. the inputs or outputs of a module can be made available simultaneously to up to two IO controllers

The IM155-5 PN HF interface module has the following additional functions:

- Shared device on up to 4 IO controllers
- Module shared input and module shared output (MSI/MSO) on up to four IO controllers
- Operation on a highly available SIMATIC S7-400H
- Support for the MRPD function (media redundancy with planned duplication)
- S2 redundancy for operation with an S7-1500 R/H
- Operation on the active backplane bus (as of FW V 4.4.1)

I/O systems

SIMATIC ET 200 systems for the control cabinet

SIMATIC ET 200MP

Interface modules > IM 155-5 PN**Overview**

	IM 155-5 PN BA	IM 155-5 PN ST	IM 155-5 PN HF
Article No.	6ES7155-5AA00-0AA0	6ES7155-5AA01-0AB0	6ES7155-5AA00-0AC0
Quantity structures			
IO modules	All except PROFIsafe	All	All
Max. number IO modules / IM	12	30	30
Max. number of bytes / slot	64 inputs 64 outputs	256 inputs 256 outputs	256 inputs 256 outputs
Max. number bytes / station	64 inputs 64 outputs	512 inputs 512 outputs	512 inputs 512 outputs
Update time	1 ms	250 µs	250 µs
Configuration			
GSDML	Yes	Yes	Yes
STEP 7	GSDML	GSDML	GSDML
TIA Portal	Yes	Yes	Yes
PCS 7	No	No	No
General functions			
Reset to factory settings	TIA Portal	TIA Portal	TIA Portal
Device replacement: without PG	LLDP	LLDP	LLDP
Configuration management (option handling)	No	Yes	Yes
I&M data	IM 0 ... 3	IM 0 ... 3	IM 0 ... 3
Isochronous mode	No	Yes	Yes
PROFIsafe	No	Yes	Yes
PROFINET functions			
RT	Yes	Yes	Yes
IRT	No	Yes	Yes
MRP	Yes	Yes	Yes
MRPD	No	No	Yes
S2 redundancy	No	No	Yes
Fast startup	No	Yes	Yes
Shared device	Yes; up to 2 ctrl.	Yes; up to 2 ctrl.	Yes; up to 4 ctrl.
MSI / MSO	Yes	Yes	Yes
Submodules	Yes	Yes	Yes

Ordering data	Article No.	Article No.
IM 155-5 PN interface module IP20 degree of protection, module width 35 mm, installation on S7-1500 DIN rail IM 155-5 PN BA, Basic version IM 155-5 PN ST, Standard version IM 155-5 PN HF, High Feature version with additional functions	6ES7155-5AA00-0AA0 6ES7155-5AA01-0AB0 6ES7155-5AA00-0AC0	Slot cover for active backplane bus To protect against electrostatic discharge as well as provide mechanical stability on the S7-1500 DIN rail; 5 units per packing unit 6ES7590-0CA00-0AA0
Accessories Front flap for IM 155-5 PN (spare part), 5 units SIMATIC S7-1500 DIN rail Fixed lengths, with grounding elements <ul style="list-style-type: none"> 160 mm 245 mm 482 mm 530 mm 830 mm For cutting to length by customer, without drill holes; grounding elements must be ordered separately <ul style="list-style-type: none"> 2 000 mm 	6ES7528-0AA70-7AA0 6ES7590-1AB60-0AA0 6ES7590-1AC40-0AA0 6ES7590-1AE80-0AA0 6ES7590-1AF30-0AA0 6ES7590-1AJ30-0AA0 6ES7590-1BC00-0AA0	IE FC RJ45 plugs RJ45 plug connector for Industrial Ethernet with a rugged metal enclosure and integrated insulation displacement contacts for connecting Industrial Ethernet FC installation cables IE FC RJ45 plug 180 180° cable outlet 1 unit 10 units 50 units IE FC TP standard cable GP 2x2 4-wire, shielded TP installation cable for connection to IE FC RJ45 outlet/IE FC RJ45 plug; PROFINET-compatible; with UL approval; Sold by the meter; max. delivery unit 1 000 m; minimum order quantity 20 m IE FC TP trailing cable 2 x 2 (Type C) 4-wire, shielded TP installation cable for connection to IE FC RJ45 outlet/IE FC RJ45 plug 180/90 for use in cable carrier; PROFINET-compatible; with UL approval; Sold by the meter; max. delivery unit 1 000 m; minimum order quantity 20 m IE FC TP marine cable 2 x 2 (Type B) 4-wire, shielded TP installation cable for connection to IE FC RJ45 outlet/IE FC RJ45 plug 180/90 marine certified; Sold by the meter; max. delivery unit 1 000 m; minimum order quantity 20 m IE FC stripping tool Pre-adjusted stripping tool for fast stripping of Industrial Ethernet FC cables
PE connection element for DIN rail 2 000 mm 20 units System power supply For supplying the S7-1500 backplane bus 24 V DC input voltage, power 25 W 24/48/60 V DC input voltage, power 60 W 24/48/60 V DC input voltage, power 60 W, buffering functionality 120/230 V AC input voltage, power 60 W Power plug With coding element for power supply module; spare part, 10 units Load power supply 24 V DC/3 A 24 V DC/8 A Power supply connector Spare part; for connecting the 24 V DC supply voltage <ul style="list-style-type: none"> with push-in terminals Active backplane bus With 12 slots for ET 200MP I/O modules for hot swapping; for insertion in the S7-1500 DIN rail. Please order S7-1500 DIN rail and slot covers separately	6ES7590-5AA00-0AA0 6ES7505-0KA00-0AB0 6ES7505-0RA00-0AB0 6ES7505-0RB00-0AB0 6ES7507-0RA00-0AB0 6ES7590-8AA00-0AA0 6EP1332-4BA00 6EP1333-4BA00 6ES7193-4JB00-0AA0 6ES7590-0BL00-0AA0	6GK1901-1BB10-2AA0 6GK1901-1BB10-2AB0 6GK1901-1BB10-2AE0 6XV1840-2AH10 6XV1840-3AH10 6XV1840-4AH10 6GK1901-1GA00

I/O systemsSIMATIC ET 200 systems for the control cabinet
SIMATIC ET 200MP**Interface modules > IM 155-5 PN****Technical specifications**

Article number	6ES7155-5AA00-0AA0 ET 200MP, IM 155-5 PN BA	6ES7155-5AA00-0AC0 ET 200MP, IM 155-5 PN HF	6ES7155-5AA01-0AB0 ET 200MP, IM 155-5 PN ST
General information			
Product type designation	IM 155-5 PN BA	IM 155-5 PN HF	IM 155-5 PN ST
Product function			
• I&M data	Yes; I&M0 to I&M3	Yes; I&M0 to I&M3	Yes; I&M0 to I&M3
• Module swapping during operation (hot swapping)	No	Yes; In combination with active backplane bus	No
• Isochronous mode	No	Yes	Yes
Engineering with			
• STEP 7 TIA Portal configurable/integrated from version	V15.1 with HSP 187	V16 with HSP 308	V14 or higher with HSP 0223 / integrated with V15 or higher
• STEP 7 configurable/integrated from version	V5.5 SP3 / -	V5.5 SP3 / -	GSDML V2.32
• PROFINET from GSD version/GSD revision	V2.3 / -	V2.3 / -	V2.3 / -
Supply voltage			
Rated value (DC)	24 V	24 V	24 V
Reverse polarity protection	Yes	Yes	Yes
Short-circuit protection	Yes	Yes	Yes
Input current			
Current consumption (rated value)	1 A	0.2 A	0.2 A
Address area			
Address space per station			
• Address space per station, max.	64 byte; per input / output	512 byte; per input / output	512 byte; per input / output
Hardware configuration			
Integrated power supply	Yes	Yes	Yes
Rack			
• Modules per rack, max.	12; I/O modules	30; I/O modules	30; I/O modules
Submodules			
• Number of submodules per station, max.	108; 9 submodules / I/O modules	256	
Interfaces			
Number of PROFINET interfaces	1; 2 ports (switch) RJ45	1	1
1. Interface			
Interface types			
• RJ 45 (Ethernet)	Yes	Yes	Yes
• Number of ports	2	2	2
• integrated switch	Yes	Yes	Yes
• BusAdapter (PROFINET)	No		
Protocols			
• PROFINET IO Device	Yes	Yes	Yes
• Open IE communication	Yes	Yes	Yes
• Media redundancy	Yes	Yes	Yes; PROFINET MRP
Interface types			
RJ 45 (Ethernet)			
• Transmission procedure	PROFINET with 100 Mbit/s full duplex (100BASE-TX)	PROFINET with 100 Mbit/s full duplex (100BASE-TX)	PROFINET with 100 Mbit/s full duplex (100BASE-TX)
• 100 Mbps	Yes	Yes	Yes
• Autonegotiation	Yes	Yes	Yes
• Autocrossing	Yes	Yes	Yes
Protocols			
PROFINET IO Device			
Services			
- IRT	No	Yes	Yes
- PROFinergy	No	No	No
- Prioritized startup	No	Yes	Yes
- Shared device	Yes	Yes	Yes
- Number of IO Controllers with shared device, max.	2	4	2

Technical specifications

Article number	6ES7155-5AA00-0AA0 ET 200MP, IM 155-5 PN BA	6ES7155-5AA00-0AC0 ET 200MP, IM 155-5 PN HF	6ES7155-5AA01-0AB0 ET 200MP, IM 155-5 PN ST
Redundancy mode			
• PROFINET system redundancy (S2) - on S7-1500R/H - on S7-400H	No	Yes Yes Yes; With GSDML file as of STEP 7 V5.5 SP3	No
• Redundant PROFINET configuration (R1)		No	No
• H-Sync forwarding		Yes	
Media redundancy			
- MRP	Yes	Yes	Yes
- MRPD	No	Yes	No
Open IE communication			
• TCP/IP	Yes	Yes	Yes
• SNMP	Yes	Yes	Yes
• LLDP	Yes	Yes	Yes
Isochronous mode			
Equidistance	No	Yes	Yes
shortest clock pulse		250 µs	250 µs
max. cycle		4 ms	4 ms
Interrupts/diagnostics/status information			
Status indicator	Yes	Yes	Yes
Alarms	Yes	Yes	Yes
Diagnostics function	Yes	Yes	Yes
Diagnostics indication LED			
• RUN LED	Yes; green LED	Yes; green LED	Yes; green LED
• ERROR LED	Yes; red LED	Yes; red LED	Yes; red LED
• MAINT LED	Yes; Yellow LED	Yes; Yellow LED	Yes; Yellow LED
• Connection display LINK TX/RX	Yes; 2x green-yellow LEDs	Yes; 2x green-yellow LEDs	Yes; 2x green-yellow LEDs
Standards, approvals, certificates			
Network loading class	2		
Ambient conditions			
Ambient temperature during operation			
• horizontal installation, min.	-30 °C; From FS03	-25 °C; from FS04	-25 °C; From FS03
• horizontal installation, max.	60 °C	60 °C	60 °C
• vertical installation, min.	-30 °C; From FS03	-25 °C; from FS04	-25 °C; From FS03
• vertical installation, max.	40 °C	40 °C	40 °C
Altitude during operation relating to sea level			
• Installation altitude above sea level, max.	5 000 m; Restrictions for installation altitudes > 2 000 m, see manual	5 000 m; Restrictions for installation altitudes > 2 000 m, see manual	5 000 m; Restrictions for installation altitudes > 2 000 m, see manual
Connection method			
ET-Connection			
• via BU/BA Send		No	No
Dimensions			
Width	35 mm	35 mm	35 mm
Height	147 mm	147 mm	147 mm
Depth	129 mm	129 mm	129 mm
Weights			
Weight, approx.	236 g	350 g	

I/O systemsSIMATIC ET 200 systems for the control cabinet
SIMATIC ET 200MP**Interface modules > IM 155-5 DP****Overview**

- Interface module for connecting ET 200MP to PROFIBUS
- Handles data exchange with the PROFIBUS master in the PLC
- Max. 12 I/O modules
- Automatic detection of baud rate 9.6 kBd ... 12 MBd
- PROFIBUS addresses 1 ... 125; adjustable using DIP switches
- Identification and maintenance data IMO ... IM3

Ordering data**Article No.**

IM 155-5 DP ST interface module IP20 degree of protection, module width 35 mm, installation on S7-1500 DIN rail	6ES7155-5BA00-0AB0
Accessories	
Front flap for IM 155-5 PN (spare part), 5 units	6ES7528-0AA70-7AA0
SIMATIC S7-1500 DIN rail Fixed lengths, with grounding elements	
<ul style="list-style-type: none"> • 160 mm • 245 mm • 482 mm • 530 mm • 830 mm 	6ES7590-1AB60-0AA0 6ES7590-1AC40-0AA0 6ES7590-1AE80-0AA0 6ES7590-1AF30-0AA0 6ES7590-1AJ30-0AA0
For cutting to length by customer, without drill holes; grounding elements must be ordered separately	
<ul style="list-style-type: none"> • 2 000 mm 	6ES7590-1BC00-0AA0
PE connection element for DIN rail 2 000 mm 20 units	6ES7590-5AA00-0AA0
Load power supply 24 V DC/3 A	6EP1332-4BA00
24 V DC/8 A	6EP1333-4BA00
Power supply connector Spare part; for connecting the 24 V DC supply voltage	
<ul style="list-style-type: none"> • With push-in terminals 	6ES7193-4JB00-0AA0
PROFIBUS connector	
<ul style="list-style-type: none"> • Connection plug for PROFIBUS, up to 12 Mbps, 90° cable outlet, insulation displacement method, without PG socket • Connection plug for PROFIBUS, up to 12 Mbps, 90° cable outlet, insulation displacement method, with PG socket 	6ES7972-0BA70-0XA0 6ES7972-0BB70-0XA0
PROFIBUS stripping tool Stripping tool for fast stripping of the PROFIBUS	6GK1905-6AA00

Article No.

PROFIBUS FastConnect bus cable <ul style="list-style-type: none"> • Standard type with special design for quick mounting, 2-wire, shielded, sold by the meter, max. delivery unit 1 000 m, minimum order quantity 20 m • 20 m • 50 m • 100 m • 200 m • 500 m • 1000 m 	6XV1830-0EH10 6XV1830-0EN20 6XV1830-0EN50 6XV1830-0ET10 6XV1830-0ET20 6XV1830-0ET50 6XV1830-0EU10
FC robust cable Bus cable with PUR sheath for use under conditions of extreme mechanical stress or aggressive chemicals, 2-wire, shielded, sold by the meter, max. delivery unit 1 000 m, minimum order quantity 20 m	6XV1830-0JH10
FC flexible cable PROFIBUS bus cable, flexible, with special design for quick mounting, 2-wire, shielded, sold by the meter, max. delivery unit 1 000 m, minimum order quantity 20 m	6XV1831-2K
FC trailing cable PROFIBUS trailing cable, at least 3 million bending cycles, min. bending radius approx. 120 mm, 2-wire, shielded, sold by the meter, max. delivery unit 1 000 m, minimum order quantity 20 m	6XV1830-3EH10
FC bus cable PROFIBUS Food bus cable with PE sheath for use in the food and beverages industry, 2-wire, shielded, sold by the meter, max. delivery unit 1 000 m, minimum order quantity 20 m	6XV1830-0GH10
FC underground cable PROFIBUS underground cable, 2-wire, shielded, sold by the meter, max. delivery unit 1 000 m, minimum order quantity 20 m	6XV1830-3FH10

Ordering data	Article No.	Ordering data	Article No.
FC FRNC cable PROFIBUS bus cable, flame-retardant and halogen-free, with copolymer sheath FRNC, sold by the meter, max. delivery unit 1000 m, minimum order quantity 20 m	6XV1830-0LH10	IE FC stripping tool Preadjusted stripping tool for fast stripping of Industrial Ethernet FC cables	6GK1901-1GA00
FC trailing cable PROFIBUS trailing cable, at least 3 million bending cycles, min. bending radius approx. 120 mm, 2-wire, shielded, sold by the meter, max. delivery unit 1 000 m, minimum order quantity 20 m	6XV1831-2L		

Technical specifications

Article number	6ES7155-5BA00-0AB0 ET 200MP, IM155-5 DP ST
General information	
Product type designation	IM 155-5 DP ST
Product function	
• I&M data	Yes; I&M0 to I&M3
• Module swapping during operation (hot swapping)	No
• Isochronous mode	No
Engineering with	
• STEP 7 TIA Portal configurable/integrated from version	V13 / V13
• STEP 7 configurable/integrated from version	V5.5 SP3 / -
• PROFIBUS from GSD version/GSD revision	V1.0 / V5.1
Supply voltage	
Rated value (DC)	24 V
Reverse polarity protection	Yes
Short-circuit protection	Yes
Input current	
Current consumption (rated value)	0.2 A; at 24 V DC and without load
Address area	
Address space per station	
• Address space per station, max.	244 byte; per input / output
Hardware configuration	
Integrated power supply	Yes
Rack	
• Modules per rack, max.	12; I/O modules
Interfaces	
Number of PROFIBUS interfaces	1
1. Interface	
Interface types	
• RS 485	Yes
Protocols	
• PROFIBUS DP slave	Yes
Interface types	
RS 485	
• Transmission rate, max.	12 Mbit/s

Article number	6ES7155-5BA00-0AB0 ET 200MP, IM155-5 DP ST
Protocols	
Open IE communication	
• TCP/IP	No
PROFIBUS DP	
Services	
- SYNC capability	Yes
- FREEZE capability	Yes
- DPV1	Yes
Interrupts/diagnostics/status information	
Status indicator	Yes
Alarms	Yes
Diagnostics function	Yes
Diagnostics indication LED	
• RUN LED	Yes; green LED
• ERROR LED	Yes; red LED
• MAINT LED	Yes; Yellow LED
• Connection display DP	Yes; green LED
Ambient conditions	
Ambient temperature during operation	
• horizontal installation, min.	-25 °C; from FS04
• horizontal installation, max.	60 °C
• vertical installation, min.	-25 °C; from FS04
• vertical installation, max.	40 °C
Altitude during operation relating to sea level	
• Installation altitude above sea level, max.	5 000 m; Restrictions for installation altitudes > 2 000 m, see manual
Connection method	
ET-Connection	
• via BU/BA Send	No
Dimensions	
Width	35 mm
Height	147 mm
Depth	129 mm
Weights	
Weight, approx.	360 g

I/O systems

SIMATIC ET 200 systems for the control cabinet
SIMATIC ET 200MP

Interface modules > SIPLUS IM 155-5 PN

Overview



- Interface module for linking the ET 200MP to PROFINET
- Handles data exchange with the PROFINET I/O controller in the PLC
- Integrated 2-port switch for line topology
- Max. 30 I/O modules
- Shortest bus cycle 250 µs
- Linking to the isochronous task of the CPU
- Prioritized fast startup (FSU) with 500 ms (max. 12 I/O modules)
- Media Redundancy Protocol (MRP)
- Shared device on up to 2 I/O controllers (when configuring using GSD file; depends on the respective configuration tool)
- Omission of SIMATIC Memory Card (SMC); IM replacement without PG using LLDP

Note:

SIPLUS extreme products are based on SIMATIC standard products. The contents listed here were taken from the corresponding standard products. SIPLUS extreme-specific information was added.

Ordering data

SIPLUS IM 155-5 PN interface module

(Extended temperature range and exposure to environmental substances)

IP 20 degree of protection, module width 35 mm, installation on S7-1500 DIN rail

IM 155-5 PN ST, standard version

IM 155-5 PN HF, High Feature version with additional functions

Accessories

Article No.

6AG1155-5AA01-7AB0

6AG1155-5AA00-2AC0

See SIMATIC ET 200MP, IM 155-5 PN interface module, page 10/303

Technical specifications

Article number	6AG1155-5AA01-7AB0	6AG1155-5AA00-2AC0
Based on	6ES7155-5AA01-0AB0	6ES7155-5AA00-0AC0
	SIPLUS ET 200MP IM 155-5 PN ST	SIPLUS ET 200MP IM155-5 PN HF
Ambient conditions		
Ambient temperature during operation		
<ul style="list-style-type: none"> horizontal installation, min. horizontal installation, max. vertical installation, min. vertical installation, max. 	-40 °C; = Tmin (incl. condensation/frost) 70 °C; = Tmax; from > +60 °C no module permissible left of the IM -40 °C; = Tmin 40 °C	-40 °C; = Tmin (incl. condensation/frost); start-up @ -25 °C 60 °C; = Tmax
Altitude during operation relating to sea level		
<ul style="list-style-type: none"> Installation altitude above sea level, max. Ambient air temperature-barometric pressure-altitude 	5 000 m Tmin ... Tmax at 1 080 hPa ... 795 hPa (-1 000 m ... +2 000 m) // Tmin ... (Tmax - 10 K) at 795 hPa ... 658 hPa (+2 000 m ... +3 500 m) // Tmin ... (Tmax - 20 K) at 658 hPa ... 540 hPa (+3 500 m ... +5 000 m); from 2 000 m max. 132 V AC	5 000 m Tmin ... Tmax at 1 140 hPa ... 795 hPa (-1 000 m ... +2 000 m) // Tmin ... (Tmax - 10 K) at 795 hPa ... 658 hPa (+2 000 m ... +3 500 m) // Tmin ... (Tmax - 20 K) at 658 hPa ... 540 hPa (+3 500 m ... +5 000 m)
Relative humidity		
<ul style="list-style-type: none"> With condensation, tested in accordance with IEC 60068-2-38, max. 	100 %; RH incl. condensation / frost (no commissioning in bedewed state), horizontal installation	100 %; RH incl. condensation/frost (no commissioning under condensation conditions)
Resistance		
Coolants and lubricants		
<ul style="list-style-type: none"> Resistant to commercially available coolants and lubricants 	Yes; Incl. diesel and oil droplets in the air	Yes; Incl. diesel and oil droplets in the air
Use in stationary industrial systems		
<ul style="list-style-type: none"> to biologically active substances according to EN 60721-3-3 to chemically active substances according to EN 60721-3-3 to mechanically active substances according to EN 60721-3-3 	Yes; Class 3B2 mold, fungus and dry rot spores (with the exception of fauna); Class 3B3 on request Yes; Class 3C4 (RH < 75 %) incl. salt spray acc. to EN 60068-2-52 (severity degree 3); * Yes; Class 3S4 incl. sand, dust, *	Yes; Class 3B2 mold, fungus and dry rot spores (with the exception of fauna); Class 3B3 on request Yes; Class 3C4 (RH < 75 %) incl. salt spray acc. to EN 60068-2-52 (severity degree 3); * Yes; Class 3S4 incl. sand, dust, *
Use on ships/at sea		
<ul style="list-style-type: none"> to biologically active substances according to EN 60721-3-6 to chemically active substances according to EN 60721-3-6 to mechanically active substances according to EN 60721-3-6 	Yes; Class 6B2 mold and fungal spores (excluding fauna); Class 6B3 on request Yes; Class 6C3 (RH < 75 %) incl. salt spray acc. to EN 60068-2-52 (severity degree 3); * Yes; Class 6S3 incl. sand, dust; *	Yes; Class 6B2 mold and fungal spores (excluding fauna); Class 6B3 on request Yes; Class 6C3 (RH < 75 %) incl. salt spray acc. to EN 60068-2-52 (severity degree 3); * Yes; Class 6S3 incl. sand, dust; *
Usage in industrial process technology		
<ul style="list-style-type: none"> Against chemically active substances acc. to EN 60654-4 Environmental conditions for process, measuring and control systems acc. to ANSI/ISA-71.04 	Yes; Class 3 (excluding trichlorethylene) Yes; Level GX group A/B (excluding trichlorethylene; harmful gas concentrations up to the limits of EN 60721-3-3 class 3C4 permissible); level LC3 (salt spray) and level LB3 (oil)	Yes; Class 3 (excluding trichlorethylene) Yes; Level GX group A/B (excluding trichlorethylene; harmful gas concentrations up to the limits of EN 60721-3-3 class 3C4 permissible); level LC3 (salt spray) and level LB3 (oil)
Remark		
<ul style="list-style-type: none"> Note regarding classification of environmental conditions acc. to EN 60721, EN 60654-4 and ANSI/ISA-71.04 	* The supplied plug covers must remain in place over the unused interfaces during operation!	* The supplied plug covers must remain in place over the unused interfaces during operation!
Conformal coating		
<ul style="list-style-type: none"> Coatings for printed circuit board assemblies acc. to EN 61086 Protection against fouling acc. to EN 60664-3 Military testing according to MIL-I-46058C, Amendment 7 Qualification and Performance of Electrical Insulating Compound for Printed Board Assemblies according to IPC-CC-830A 	Yes; Class 2 for high reliability Yes; Type 1 protection Yes; Discoloration of coating possible during service life Yes; Conformal coating, Class A	Yes; Class 2 for high reliability Yes; Type 1 protection Yes; Discoloration of coating possible during service life Yes; Conformal coating, Class A

I/O systems

SIMATIC ET 200 systems for the control cabinet
SIMATIC ET 200MP

Interface modules > SIPLUS IM 155-5 DP**Overview**

- Interface module for linking the ET 200MP to PROFIBUS
- Handles data exchange with the PROFIBUS master in the PLC
- Max. 12 I/O modules
- Automatic detection of baud rate 9.6 kBd ... 12 MBd
- PROFIBUS addresses 1 ... 125; adjustable using DIP switches
- Identification and maintenance data IM0 ... IM3

Note:

SIPLUS extreme products are based on SIMATIC standard products. The contents listed here were taken from the respective standard products. SIPLUS extreme-specific information was added.

Ordering data

Ordering data	Article No.
SIPLUS IM 155-5 DP ST interface module (Extended temperature range and exposure to environmental substances) IP 20 degree of protection, module width 35 mm, installation on S7-1500 DIN rail	6AG1155-5BA00-2AB0
Accessories	See SIMATIC ET 200MP, IM 155-5 DP interface module, page 10/306

Technical specifications

Article number	6AG1155-5BA00-2AB0
Based on	6ES7155-5BA00-0AB0 SIPLUS ET 200MP IM155-5 DP ST
Ambient conditions	
Ambient temperature during operation	
• horizontal installation, min.	-40 °C; = Tmin (incl. condensation/frost); start-up @ -25 °C
• horizontal installation, max.	60 °C; = Tmax
Altitude during operation relating to sea level	
• Ambient air temperature-barometric pressure-altitude	Tmin ... Tmax at 1 080 hPa ... 795 hPa (-1 000 m ... +2 000 m) // Tmin ... (Tmax - 10 K) at 795 hPa ... 658 hPa (+2 000 m ... +3 500 m) // Tmin ... (Tmax - 20 K) at 658 hPa ... 540 hPa (+3 500 m ... +5 000 m)

Article number	6AG1155-5BA00-2AB0
Based on	6ES7155-5BA00-0AB0 SIPLUS ET 200MP IM155-5 DP ST
Relative humidity	<ul style="list-style-type: none"> • With condensation, tested in accordance with IEC 60068-2-38, max. 100 %; RH incl. condensation / frost (no commissioning in bedewed state), horizontal installation
Resistance	
Coolants and lubricants	<ul style="list-style-type: none"> - Resistant to commercially available coolants and lubricants Yes; Incl. diesel and oil droplets in the air
Use in stationary industrial systems	<ul style="list-style-type: none"> - to biologically active substances according to EN 60721-3-3 - to chemically active substances according to EN 60721-3-3 - to mechanically active substances according to EN 60721-3-3 Yes; Class 3B2 mold, fungus and dry rot spores (with the exception of fauna); Class 3B3 on request Yes; Class 3C4 (RH < 75%) incl. salt spray according to EN 60068-2-52 (degree of severity 3). The supplied connector covers must remain on the unused interfaces during operation! Yes; Class 3S4 incl. sand, dust. The supplied connector covers must remain on the unused interfaces during operation!
Use on ships/at sea	<ul style="list-style-type: none"> - to biologically active substances according to EN 60721-3-6 - to chemically active substances according to EN 60721-3-6 - to mechanically active substances according to EN 60721-3-6 Yes; Class 6B2 mold and fungal spores (excluding fauna); Class 6B3 on request Yes; Class 6C3 (RH < 75 %) incl. salt spray acc. to EN 60068-2-52 (severity degree 3); * Yes; Class 6S3 incl. sand, dust; *
Usage in industrial process technology	<ul style="list-style-type: none"> - Against chemically active substances acc. to EN 60654-4 - Environmental conditions for process, measuring and control systems acc. to ANSI/ISA-71.04 Yes; Class 3 (excluding trichlorethylene) Yes; Level GX group A/B (excluding trichlorethylene; harmful gas concentrations up to the limits of EN 60721-3-3 class 3C4 permissible); level LC3 (salt spray) and level LB3 (oil)
Remark	<ul style="list-style-type: none"> - Note regarding classification of environmental conditions acc. to EN 60721, EN 60654-4 and ANSI/ISA-71.04 * The supplied plug covers must remain in place over the unused interfaces during operation!
Conformal coating	<ul style="list-style-type: none"> • Coatings for printed circuit board assemblies acc. to EN 61086 • Protection against fouling acc. to EN 60664-3 • Military testing according to MIL-I-46058C, Amendment 7 • Qualification and Performance of Electrical Insulating Compound for Printed Board Assemblies according to IPC-CC-830A Yes; Class 2 for high reliability Yes; Type 1 protection Yes; Discoloration of coating possible during service life Yes; Conformal coating, Class A
Dimensions	
Width	35 mm
Height	147 mm
Depth	129 mm
Weights	
Weight, approx.	360 g

Overview

I/O modules constitute the interface of SIMATIC ET 200MP to the process:

- Digital and analog modules provide exactly the inputs/outputs required for each task
- Technology modules for SIMATIC S7-1500 and ET 200MP
 - With integrated functions for high-speed counting and position detection
 - With integrated inputs and outputs for tasks at the process level and short response times
- Communications modules for SIMATIC S7-1500 and ET 200MP
 - For data exchange using point-to-point coupling
 - For connecting to PROFIBUS
 - For connecting to Industrial Ethernet
- Connection system for user-friendly, low-overhead wiring of the S7-1500 and ET 200MP modules

You can find additional information under [SIMATIC S7-1500, catalog section 4](#).

I/O systems

SIMATIC ET 200 systems for the control cabinet
SIMATIC ET 200MP

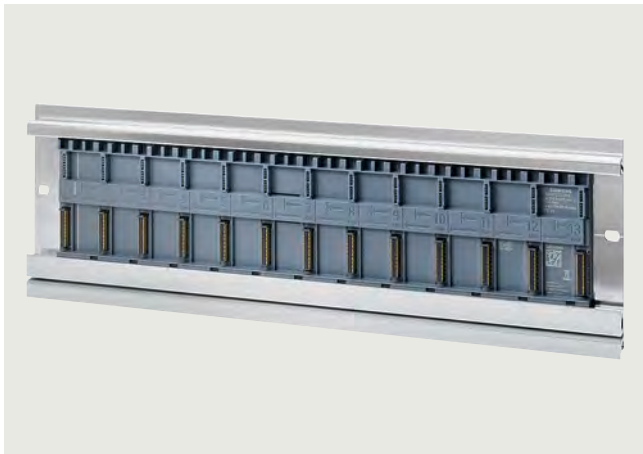
Active backplane bus**Overview**

Active backplane bus in S7-1500 DIN rail

- Considerably enhances system availability:
 - Reaction-free hot swapping of I/O modules during operation; system remains in RUN mode when replacing one or more I/O modules
 - Reserve capacity (= gaps in system configuration) for later use
- Can also be used exclusively with ET 200MP and PROFINET
- Can be inserted in the ET 200MP standard mounting rail, replaces the U connectors
- The comprehensive system functions of ET 200 MP can still all be used
- Can be used with all PROFINET IO controllers by configuring via GSD file and PROFINET

Ordering data**Article No.****Active backplane bus**

With 12 slots for ET 200MP I/O modules for hot swapping; for insertion in the S7-1500 DIN rail.

Please order the S7-1500 DIN rail and slot covers separately.

- 4 slots
- 8 slots:
- 12 slots

6ES7590-0BD00-0AA0
6ES7590-0BH00-0AA0
6ES7590-0BL00-0AA0

Accessories**Slot cover for active backplane bus**

To protect against electrostatic discharge as well as provide mechanical stability on the S7-1500 DIN rail; 5 units per packing unit

6ES7590-0CA00-0AA0

Technical specifications

Article number	6ES7590-0BD00-0AA0 SIMATIC S7-1500 active backplane/4 slot	6ES7590-0BH00-0AA0 SIMATIC S7-1500 act. backplane / 8 slot	6ES7590-0BL00-0AA0 SIMATIC S7-1500 act. backplane/ 12 slot
General information			
Product type designation	Active Backplane ST 1+4 Slot	Active Backplane ST 1+8 Slot	Active backplane ST 1+12 slot
Product function			
• I&M data	Yes; I&M0 to I&M3	Yes; I&M0 to I&M3	Yes; I&M0 to I&M3
• Isochronous mode	Yes	Yes	Yes
• Prioritized startup	Yes	Yes	Yes
Engineering with			
• STEP 7 TIA Portal configurable/integrated from version	V16	V16	V16
• STEP 7 configurable/integrated from version	V5.6 and higher	V5.6 and higher	V5.6 and higher
• PROFINET from GSD version/GSD revision	V2.35 / -	V2.35 / -	V2.34 / -
Hardware configuration			
Slots			
• Grid size	35 mm; Utilization of 25 mm-wide modules possible	35 mm; Utilization of 25 mm-wide modules possible	35 mm; Utilization of 25 mm-wide modules possible
• Number of slots	5	9	13
- of which for CPU, max.	0	0	0
- of which for IM, max.	1	1	1
- of which for PS, max.	2; Max. 2 PS per station	2; Max. 2 PS per station	12; Max. 2 PS per station
- of which for IO/CM/CP/TM, max.	4	8	12
- of which for F-IO, max.	4	8	12
• Number of single-width slots, max.	4	8	12
Ambient conditions			
Ambient temperature during operation			
• horizontal installation, min.	-30 °C	-30 °C	-30 °C
• horizontal installation, max.	60 °C	60 °C	60 °C
• vertical installation, min.	-30 °C	-30 °C	-30 °C
• vertical installation, max.	40 °C	40 °C	40 °C
Altitude during operation relating to sea level			
• Installation altitude above sea level, max.	5 000 m; Restrictions for installation altitudes > 2 000 m, see manual	5 000 m; Restrictions for installation altitudes > 2 000 m, see manual	5 000 m; Restrictions for installation altitudes > 2 000 m, see manual
Dimensions			
Width	154 mm	294 mm	434 mm
Height	99 mm	99 mm	99 mm
Depth	14 mm	14 mm	14 mm
Weights			
Weight, approx.	127 g	245 g	352 g

I/O systems

SIMATIC ET 200 systems for the control cabinet

SIMATIC ET 200M

Overview

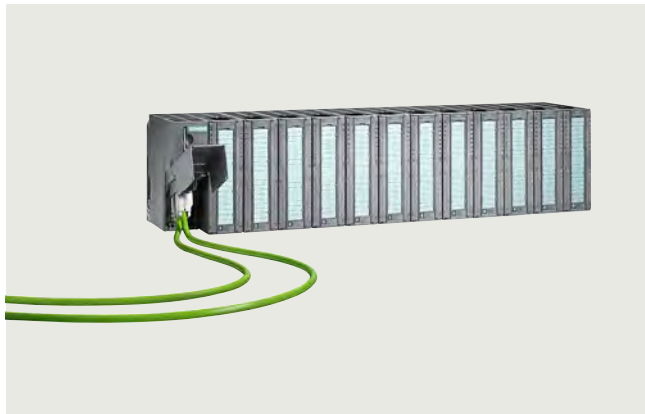

- Modular I/O system with IP20 degree of protection, particularly suitable for user-specific and complex automation tasks
- Consists of a PROFIBUS DP or PROFINET interface module IM 153, up to 8 or 12 I/O modules of the S7-300 automation system (structure with bus connection or with active bus modules), and a power supply if applicable
- Can be expanded with S7-300 automation system signal, communication and function modules
- Applicable Ex analog input or output modules with HART optimize the ET 200M for use in process engineering
- Can be used in redundant systems (S7-400H, S7-400F/FH)
- Modules can be replaced during operation (hot swapping) with the bus modules active
- Transmission rates up to 12 Mbps
- Ex approval to Cat. 3 for Zone 2 acc. to ATEX 100 a
- Fail-safe digital in/outputs as well as analog inputs for safety-oriented signal processing in accordance with PROFIsafe
- Supports modules with expanded user data, e.g. HART modules with HART minor variables

Availability

As part of our established product portfolio, the SIMATIC S7-300/ET 200M system families will generally be available until 2023. Following the product phase-out declaration, products will be available as spare parts for another ten years.

Technical specifications

General technical specifications ET 200M

Cables and connections	Screw and spring-loaded connections in permanent wiring
Degree of protection	IP20
Ambient temperature on vertical wall (preferred mounting position)	<ul style="list-style-type: none"> • with horizontal assembly 0 to +60 °C • with other assembly 0 to +40 °C
Relative humidity	5 to 95% (RH stress level 2 according to IEC 1131-2)
Atmospheric pressure	795 to 1080 hPa
Mechanical stress	
• Vibrations	IEC 68, parts 2 – 6: 10 - 57 Hz (const. amplitude 0.075 mm) 57 - 150 Hz (constant acceleration 1 g)
• Shock	IEC 68, parts 2 – 27 half-sine, 15 g, 11 ms

Overview



The ET 200M system with various interface modules is available for the distributed use of S7-300 I/O modules. Depending on the application purpose, the best suited IM in terms of costs and functions can be selected:

IM153-1 Standard

The IM153-1 is one reasonably priced variant that is excellently suited for most applications in the manufacturing environment. It permits the use of up to 8 S7-300 I/O modules.

IM153-2 High Feature

For higher requirements in manufacturing technology, such as the use of F technology or the highest performance in conjunction with clock synchronization, the IM153-2 High Feature is available. This IM is also designed for use with the PCS7 in the field of process-oriented applications. This IM can be redundantly used and supports typical functions as they are required in the control field. These include, for example, clock synchronization or time stamping with an accuracy of up to 1 ms.

Ordering data

Article No.

Article No.

IM 153-1 interface module

Slave interface for connecting an ET 200M to PROFIBUS DP

- Standard temperature range

6ES7153-1AA03-0XB0

IM 153-2 interface module

Slave interface for connecting an ET 200M to PROFIBUS DP; also for use in redundant systems

- High Feature
- High Feature with extended temperature range

6ES7153-2BA10-0XB0
6ES7153-2BA70-0XB0**Active IM 153/IM 153 bus module**

6ES7195-7HD10-0XA0

For two IM 153-2 High Feature modules for designing redundant systems

Bus module for ET 200M

- For accommodating a power supply and an IM 153 module for the hot-swapping function during RUN, incl. bus module cover

6ES7195-7HA00-0XA0

- For accommodating two 40 mm-wide I/O modules for the hot-swapping function

6ES7195-7HB00-0XA0

- For accommodating one 80 mm-wide I/O module for the hot-swapping function

6ES7195-7HC00-0XA0

ET 200M redundancy bundle

6ES7153-2AR04-0XA0

Comprising two IM 153-2 High Feature modules and one IM 153/IM 153 bus module

Accessories**PROFIBUS bus connector**

90° outgoing cable, terminating resistor with disconnecting function, up to 12 Mbps, FastConnect

Without PG interface

- 1 unit
- 100 units

6ES7972-0BA52-0XA0
6ES7972-0BA52-0XB0

With PG interface

- 1 unit
- 100 units

6ES7972-0BB52-0XA0
6ES7972-0BB52-0XB0**SIMATIC DP DIN rail for ET 200M**

Accommodates up to 5 bus modules; for hot-swapping function

- Length: 483 mm (19")
- Length: 530 mm
- Length: 620 mm
- Length: 2000 mm

6ES7195-1GA00-0XA0
6ES7195-1GF30-0XA0
6ES7195-1GG30-0XA0
6ES7195-1GC00-0XA0**SIMATIC S7-300 DIN rail**

- Length: 160 mm
- Length: 480 mm (19")
- Length: 530 mm
- Length: 830 mm
- Length: 2000 mm

6ES7390-1AB60-0AA0
6ES7390-1AE80-0AA0
6ES7390-1AF30-0AA0
6ES7390-1AJ30-0AA0
6ES7390-1BC00-0AA0**S7 Manual Collection**

6ES7998-8XC01-8YE0

Electronic manuals on DVD, multi-language: S7-200, TD 200, S7-300, M7-300, C7, S7-400, M7-400, STEP 7, Engineering Tools, Runtime Software, SIMATIC DP (Distributed I/O), SIMATIC HMI (Human Machine Interface), SIMATIC NET (Industrial Communication)

S7 Manual Collection update service for 1 year

6ES7998-8XC01-8YE2

Scope of delivery: Current DVD "S7 Manual Collection" and the three subsequent updates

I/O systemsSIMATIC ET 200 systems for the control cabinet
SIMATIC ET 200M**Interface modules > IM 153-1/153-2****Technical specifications**

Article number	6ES7153-1AA03-0XB0 ET200M, Interface Module IM153-1	6ES7153-2BA10-0XB0 ET200M, Interface IM153-2 HF	6ES7153-2BA70-0XB0 ET200M, INTERFACE IM153-2 HF OUTDOOR
General information			
Product type designation	IM 153-1 DP ST	IM 153-2 DP HF	IM 153-2 OD
Supply voltage			
Rated value (DC)	24 V	24 V	24 V
external protection for power supply lines (recommendation)	not necessary	2,5 A	2,5 A
Input current			
Current consumption, max.	350 mA; At 24 V DC	650 mA; with 24 V DC supply	650 mA
Output voltage			
Rated value (DC)	5 V		
Output current			
for backplane bus (5 V DC), max.	1 A	1.5 A	1.5 A
Power loss			
Power loss, typ.	3 W	5.5 W	5.5 W
Address area			
Addressing volume			
• Inputs	128 byte	244 byte	244 byte
• Outputs	128 byte	244 byte	244 byte
Hardware configuration			
Number of modules per DP slave interface, max.	8	12	12
Time stamping			
Accuracy		1 ms; 1 ms at up to 8 modules; 10 ms at up to 12 modules	1 ms; 1 ms at up to 8 modules; 10 ms at up to 12 modules
Number of message buffers		15	15
Messages per message buffer		20	20
Number of stampable digital inputs, max.		128; Max. 128 signals/station; max. 32 signals/slot	128; Max. 128 signals/station; max. 32 signals/slot
Time format		RFC 1119	RFC 1119
Time resolution		0.466 ns	0.466 ns
Time interval for transmitting the message buffer if a message is present		1 000 ms	1 000 ms
Time stamp on signal change		rising / falling edge as signal entering or exiting	rising / falling edge as signal entering or exiting
Interfaces			
Transmission procedure	RS 485	RS 485	RS 485
Transmission rate, max.	12 Mbit/s	12 Mbit/s	12 Mbit/s
1. Interface			
automatic detection of transmission rate	Yes	Yes	Yes
Interface types			
• Output current of the interface, max.	90 mA	70 mA	70 mA
• Design of the connection	9-pin sub D socket	9-pin sub D socket	9-pin sub D socket
PROFIBUS DP slave			
• GSD file	(for DPV1) SIEM801D.GSD; SI01801D.GSG	SI05801E.GSG	SI05801E.GSG
• automatic baud rate search	Yes	Yes	Yes
Protocols			
Bus protocol/transmission protocol	PROFIBUS DP to EN 50170	PROFIBUS DP to EN 50170	PROFIBUS DP to EN 50170
Protocols (Ethernet)			
• TCP/IP	No	No	
PROFIBUS DP			
• Number of node addresses, max.	1 to 125 permitted	1 to 125 permitted	1 to 125 permitted
Services			
- SYNC capability	Yes	Yes	Yes
- FREEZE capability	Yes	Yes	Yes
- Direct data exchange (slave-to-slave communication)	Yes; Sender	Yes; as publisher with all IO, as subscriber with F-IO only	Yes; as publisher with all IO, as subscriber with F-IO only

Technical specifications

Article number	6ES7153-1AA03-0XB0 ET200M, Interface Module IM153-1	6ES7153-2BA10-0XB0 ET200M, Interface IM153-2 HF	6ES7153-2BA70-0XB0 ET200M, INTERFACE IM153-2 HF OUTDOOR
Potential separation			
Potential separation exists	Yes	Yes	Yes
Degree and class of protection			
IP degree of protection	IP20	IP20	IP20
Ambient conditions			
Ambient temperature during operation			
• min.	0 °C	0 °C	
• max.	60 °C	60 °C	
Altitude during operation relating to sea level			
• Installation altitude above sea level, max.	3 000 m	3 000 m	3 000 m
Configuration			
Configuration software			
• STEP 7	STEP 7 / COM PROFIBUS / non-Siemens tools via GSD file	Yes; STEP 7 / COM PROFIBUS / non-Siemens tools via GSD file	Yes; STEP 7 / COM PROFIBUS / non-Siemens tools via GSD file
Dimensions			
Width	40 mm	40 mm	40 mm
Height	125 mm	125 mm	125 mm
Depth	117 mm	117 mm	117 mm
Weights			
Weight, approx.	360 g	360 g	360 g
Article number	6ES7195-7HD10-0XA0 ET200M, Bus Unit f. 2 IM 153-2 red.		
Dimensions			
Width	97 mm		
Height	92 mm		
Depth	30 mm		
Weights			
Weight, approx.	133 g		
Article number	6ES7195-7HA00-0XA0 ET200M, Bus Unit f. PS and IM 153	6ES7195-7HB00-0XA0 ET200M, Bus Unit f. 2 40mm I/O Modules	6ES7195-7HC00-0XA0 ET200M, Bus Unit f. 1 80mm I/O Module
Dimensions			
Width	97 mm	97 mm; 80 mm when installed	97 mm; 80 mm when installed
Height	92 mm	92 mm	92 mm
Depth	30 mm	30 mm	30 mm
Weights			
Weight, approx.	111 g	140 g	127 g

I/O systems

SIMATIC ET 200 systems for the control cabinet
SIMATIC ET 200M

Interface modules > IM 153-4 PN**Overview**

- For connecting ET 200M to PROFINET IO (via copper line, RJ45) as an IO device
- 2 versions:
 - IM 153-4 PN STANDARD
 - IM 153-4 PN HIGH FEATURE: supports, in contrast to the STANDARD version, the operation of PROFI-safe F and HART modules. The operation of an S7-400H high availability PLC (system redundancy) is also possible.
- Integrated 2-port switch
- 12 modules per station
- Usable I/O capacity: 192 bytes each
- Active bus backplane to hot-swap modules available as an option
- Baud rate 10 Mbps / 100 Mbps (autonegotiation / full duplex)
- I&M functions according to PNO Guideline Order No. 3.502, Version V1.1

Note:

Micro Memory Card with at least 64 KB required if not all the stations in the network support LLDP (Link Layer Discovery Protocol; proximity detection).

Ordering data**Article No.****Article No.****IM 153-4 PN interface module**

I/O device to connect an ET 200M to PROFINET

Standard

6ES7153-4AA01-0XB0

High Feature

6ES7153-4BA00-0XB0

Accessories**Bus modules for ET 200M**

- For accommodating a power supply and an IM 153 module for the hot-swapping function during RUN, incl. bus module cover

6ES7195-7HA00-0XA0

- For accommodating two 40 mm-wide I/O modules for the hot-swapping function

6ES7195-7HB00-0XA0

- For accommodating one 80 mm-wide I/O module for the hot-swapping function

6ES7195-7HC00-0XA0

SIMATIC Micro Memory Card

64 KB¹⁾

6ES7953-8LF31-0AA0

SIMATIC DP DIN rail for ET 200M

Accommodates bus modules; for hot-swapping function

- Length: 483 mm (19")

6ES7195-1GA00-0XA0

- Length: 530 mm

6ES7195-1GF30-0XA0

- Length: 620 mm

6ES7195-1GG30-0XA0

- Length: 2 000 mm

6ES7195-1GC00-0XA0

SIMATIC S7-300 DIN rail

Length: 160 mm

6ES7390-1AB60-0AA0

Length: 480 mm (19")

6ES7390-1AE80-0AA0

Length: 530 mm

6ES7390-1AF30-0AA0

Length: 830 mm

6ES7390-1AJ30-0AA0

Length: 2 000 mm

6ES7390-1BC00-0AA0

Power supply connector

For connection of the 24 V DC supply voltage; spare part, 1 pack containing 10 units

Spring-loaded connections

6ES7193-4JB00-0AA0

S7 Manual Collection

6ES7998-8XC01-8YE0

Electronic manuals on DVD, multilingual:
S7-200, TD 200, S7-300, M7-300, C7, S7-400, M7-400, STEP 7, Engineering Tools, Runtime Software, SIMATIC DP (Distributed I/O), SIMATIC HMI (Human Machine Interface), SIMATIC NET (Industrial Communication)

S7 Manual Collection update service for 1 year

6ES7998-8XC01-8YE2

Scope of delivery:
Current DVD "S7 Manual Collection" and the three subsequent updates

Industrial Ethernet FC RJ45 Plug 180

RJ45 plug connector for Industrial Ethernet with a rugged metal housing and integrated insulation displacement contacts for connecting Industrial Ethernet FC installation cables; with 180° cable outlet

1 unit

6GK1901-1BB10-2AA0

10 units

6GK1901-1BB10-2AB0

50 units

6GK1901-1BB10-2AE0

Industrial Ethernet FastConnect installation cables

- FastConnect standard cable
- FastConnect trailing cable
- FastConnect marine cable

6XV1840-2AH10

6XV1840-3AH10

6XV1840-4AH10

Industrial Ethernet FastConnect

Stripping tool

6GK1901-1GA00

¹⁾ To operate the IM153-4, an MMC is required with at least 64 KB memory. Cards with higher memory capacity may also be used.

Technical specifications

Article number	6ES7153-4AA01-0XB0 IM153-4 PN IO for 12 Modules S7-300	6ES7153-4BA00-0XB0 IM153-4 PN IO HF for 12 Modules S7-300
General information		
Product type designation	IM 153-4 PN ST	IM 153-4 PN HF
Supply voltage		
Rated value (DC)	24 V	24 V
external protection for power supply lines (recommendation)	In a construction with grounded reference potential, a fuse is necessary for redundant interface modules (Recommendation: 2.5 A)	In a construction with grounded reference potential, a fuse is necessary for redundant interface modules (Recommendation: 2.5 A)
Input current		
Current consumption, max.	600 mA; with 24 V DC supply	600 mA; with 24 V DC supply
Output voltage		
Rated value (DC)	5 V	5 V
Output current		
for backplane bus (5 V DC), max.	1.5 A	1.5 A
Power loss		
Power loss, typ.	6 W	6 W
Address area		
Addressing volume		
• Inputs	192 byte	672 byte; Extended HART user data
• Outputs	192 byte	192 byte
Hardware configuration		
Number of modules per DP slave interface, max.	12	12
Protocols		
Bus protocol/transmission protocol	PROFINET IO	PROFINET IO
Protocols (Ethernet)		
• TCP/IP	No	Yes
• SNMP		Yes
• LLDP		Yes
• ping		Yes
• ARP		Yes
PROFINET IO Device Services		
- IRT		Yes
- PROFINET energy		No
- Prioritized startup		Yes
- Shared device		Yes
- Number of IO Controllers with shared device, max.		2
Redundancy mode		
• PROFINET system redundancy (S2)	No	Yes
Media redundancy		
- MRP	Yes	Yes
Interrupts/diagnostics/status information		
Diagnostics indication LED		
• LINK LED	Yes; green LED	Yes; green LED
• RX/TX LED	Yes; Yellow LED	Yes; Yellow LED
• for module diagnostics	Yes	Yes
Potential separation		
Potential separation exists	Yes	Yes; Only direction PROFINET, RWB is not separated
Degree and class of protection		
IP degree of protection	IP20	IP20

I/O systems

SIMATIC ET 200 systems for the control cabinet

SIMATIC ET 200M

Interface modules > IM 153-4 PN**Technical specifications**

Article number	6ES7153-4AA01-0XB0 IM153-4 PN IO for 12 Modules S7-300	6ES7153-4BA00-0XB0 IM153-4 PN IO HF for 12 Modules S7-300
Ambient conditions		
Ambient temperature during operation		
• min.	0 °C	0 °C
• max.	60 °C	60 °C
Altitude during operation relating to sea level		
• Installation altitude above sea level, max.	2 000 m	2 000 m
Dimensions		
Width	40 mm	40 mm
Height	125 mm	125 mm
Depth	118 mm	118 mm
Weights		
Weight, approx.	215 g	215 g

Overview

**Note:**

SIPLUS extreme products are based on SIMATIC standard products. The contents listed here were taken from the respective standard products. SIPLUS extreme-specific information was added.

For technical documentation on SIPLUS, see:

<http://www.siemens.com/siplus-extreme>

Ordering data

SIPLUS ET 200M IM 153-1

Slave interface module for connecting an ET 200M to PROFIBUS DP for a maximum of 8 S7-300 modules

- Extended temperature range and exposure to environmental substances

6AG1153-1AA03-2XB0

SIPLUS ET 200M IM 153-2 High Feature

Slave interface module for connecting an ET 200M to PROFIBUS DP for a maximum of 12 S7-300 modules; also for use in redundant systems

- Extended temperature range and exposure to environmental substances

6AG1153-2BA10-7XB0

Bus module for SIPLUS ET 200M

Bus module for accommodating a power supply and an IM 153 module for the hot-swapping function during RUN, incl. bus module cover

- Extended temperature range and exposure to environmental substances

6AG1195-7HA00-2XA0

Bus module for accommodating two 40 mm-wide I/O modules for the hot-swapping function

- Extended temperature range and exposure to environmental substances

6AG1195-7HB00-7XA0

Bus module for accommodating one 80 mm-wide I/O module for the hot-swapping function

- Extended temperature range and exposure to environmental substances

6AG1195-7HC00-2XA0

Bus module for accommodating two IM 153 modules for the hot-swapping function; for setting up redundant systems

- Extended temperature range and exposure to environmental substances

6AG1195-7HD10-2XA0

RS 485 bus connector with 90° cable outlet

Max. transfer rate 12 Mbps

Extended temperature range and exposure to environmental substances

- Without PG interface
- With PG interface

6AG1972-0BA12-2XA0
6AG1972-0BB12-2XA0**Other accessories**

see SIMATIC ET 200M IM 153-1/153-2, page 10/315

10

Technical specifications

	6AG1153-1AA03-2XB0	6AG1153-2BA10-7XB0
Article number	6AG1153-1AA03-2XB0	6AG1153-2BA10-7XB0
Based on	6ES7153-1AA03-0XB0 SIPLUS ET200M IM153-1	6ES7153-2BA10-0XB0 SIPLUS ET200M IM153-2 HF
Ambient conditions		
Ambient temperature during operation		
• min.	-40 °C; = Tmin	-40 °C; = Tmin; Startup @ -25 °C
• max.	70 °C; = Tmax; 60 °C @ UL/cUL, ATEX and FM use	70 °C; = Tmax
• At cold restart, min.	-25 °C	-25 °C
Ambient temperature during storage/transportation		
• min.	-40 °C	-40 °C
• max.	70 °C	70 °C

I/O systems

SIMATIC ET 200 systems for the control cabinet
SIMATIC ET 200M

Interface modules > SIPLUS ET 200M IM 153-1/153-2

Technical specifications

Article number	6AG1153-1AA03-2XB0	6AG1153-2BA10-7XB0
Based on	6ES7153-1AA03-0XB0 SIPLUS ET200M IM153-1	6ES7153-2BA10-0XB0 SIPLUS ET200M IM153-2 HF
Altitude during operation relating to sea level		
<ul style="list-style-type: none"> Installation altitude above sea level, max. Ambient air temperature-barometric pressure-altitude 	5 000 m Tmin ... Tmax at 1 140 hPa ... 795 hPa (-1 000 m ... +2 000 m) // Tmin ... (Tmax - 10 K) at 795 hPa ... 658 hPa (+2 000 m ... +3 500 m) // Tmin ... (Tmax -20 K) at 658 hPa ... 540 hPa (+3 500 m ... +5 000 m)	5 000 m Tmin ... Tmax at 1 140 hPa ... 795 hPa (-1 000 m ... +2 000 m) // Tmin ... (Tmax - 10 K) at 795 hPa ... 658 hPa (+2 000 m ... +3 500 m) // Tmin ... (Tmax -20 K) at 658 hPa ... 540 hPa (+3 500 m ... +5 000 m)
Relative humidity		
<ul style="list-style-type: none"> With condensation, tested in accordance with IEC 60068-2-38, max. 	100 %; RH incl. condensation/frost (no commissioning under condensation conditions)	100 %; RH incl. condensation/frost (no commissioning under condensation conditions)
Resistance		
Use in stationary industrial systems		
<ul style="list-style-type: none"> to biologically active substances according to EN 60721-3-3 to chemically active substances according to EN 60721-3-3 to mechanically active substances according to EN 60721-3-3 	Yes; Class 3B2 mold, fungus and dry rot spores (with the exception of fauna); Class 3B3 on request Yes; Class 3C4 (RH < 75 %) incl. salt spray acc. to EN 60068-2-52 (severity degree 3); * Yes; Class 3S4 incl. sand, dust, *	Yes; Class 3B2 mold, fungus and dry rot spores (with the exception of fauna); Class 3B3 on request Yes; Class 3C4 (RH < 75 %) incl. salt spray acc. to EN 60068-2-52 (severity degree 3); * Yes; Class 3S4 incl. sand, dust, *
Use on ships/at sea		
<ul style="list-style-type: none"> to biologically active substances according to EN 60721-3-6 to chemically active substances according to EN 60721-3-6 to mechanically active substances according to EN 60721-3-6 	Yes; Class 6B2 mold and fungal spores (excluding fauna); Class 6B3 on request Yes; Class 6C3 (RH < 75 %) incl. salt spray acc. to EN 60068-2-52 (severity degree 3); * Yes; Class 6S3 incl. sand, dust; *	Yes; Class 6B2 mold and fungal spores (excluding fauna); Class 6B3 on request Yes; Class 6C3 (RH < 75 %) incl. salt spray acc. to EN 60068-2-52 (severity degree 3); * Yes; Class 6S3 incl. sand, dust; *
Usage in industrial process technology		
<ul style="list-style-type: none"> Against chemically active substances acc. to EN 60654-4 Environmental conditions for process, measuring and control systems acc. to ANSI/ISA-71.04 	Yes; Class 3 (excluding trichlorethylene) Yes; Level GX group A/B (excluding trichlorethylene; harmful gas concentrations up to the limits of EN 60721-3-3 class 3C4 permissible); level LC3 (salt spray) and level LB3 (oil)	Yes; Class 3 (excluding trichlorethylene) Yes; Level GX group A/B (excluding trichlorethylene; harmful gas concentrations up to the limits of EN 60721-3-3 class 3C4 permissible); level LC3 (salt spray) and level LB3 (oil)
Remark		
<ul style="list-style-type: none"> Note regarding classification of environmental conditions acc. to EN 60721, EN 60654-4 and ANSI/ISA-71.04 	* The supplied plug covers must remain in place over the unused interfaces during operation!	* The supplied plug covers must remain in place over the unused interfaces during operation!

Article number	6AG1195-7HA00-2XA0	6AG1195-7HB00-7XA0	6AG1195-7HC00-2XA0	6AG1195-7HD10-2XA0
Based on	6ES7195-7HA00-0XA0 SIPLUS ET200M Bus module	6ES7195-7HB00-0XA0 SIPLUS ET200M Bus module 2X40	6ES7195-7HC00-0XA0 SIPLUS ET200M Bus module	6ES7195-7HD10-0XA0 SIPLUS ET200M Bus module
Ambient conditions				
Ambient temperature during operation				
<ul style="list-style-type: none"> min. max. 	-40 °C; = Tmin 70 °C; = Tmax; 60 °C @ UL/cUL, ATEX and FM use	-40 °C; = Tmin 70 °C; = Tmax; 60 °C @ UL/cUL, ATEX and FM use	-40 °C; = Tmin 70 °C; = Tmax; 60 °C @ UL/cUL, ATEX and FM use	-40 °C; = Tmin 70 °C; = Tmax; 60 °C @ UL/cUL, ATEX and FM use
Ambient temperature during storage/transportation				
<ul style="list-style-type: none"> min. max. 	-40 °C 70 °C	-40 °C 70 °C	-40 °C 70 °C	-40 °C 70 °C
Altitude during operation relating to sea level				
<ul style="list-style-type: none"> Installation altitude above sea level, max. Ambient air temperature-barometric pressure-altitude 	5 000 m Tmin ... Tmax at 1 140 hPa ... 795 hPa (-1 000 m ... +2 000 m) // Tmin ... (Tmax - 10 K) at 795 hPa ... 658 hPa (+2 000 m ... +3 500 m) // Tmin ... (Tmax -20 K) at 658 hPa ... 540 hPa (+3 500 m ... +5 000 m)	5 000 m Tmin ... Tmax at 1 140 hPa ... 795 hPa (-1 000 m ... +2 000 m) // Tmin ... (Tmax - 10 K) at 795 hPa ... 658 hPa (+2 000 m ... +3 500 m) // Tmin ... (Tmax -20 K) at 658 hPa ... 540 hPa (+3 500 m ... +5 000 m)	5 000 m Tmin ... Tmax at 1 140 hPa ... 795 hPa (-1 000 m ... +2 000 m) // Tmin ... (Tmax - 10 K) at 795 hPa ... 658 hPa (+2 000 m ... +3 500 m) // Tmin ... (Tmax -20 K) at 658 hPa ... 540 hPa (+3 500 m ... +5 000 m)	5 000 m Tmin ... Tmax at 1 140 hPa ... 795 hPa (-1 000 m ... +2 000 m) // Tmin ... (Tmax - 10 K) at 795 hPa ... 658 hPa (+2 000 m ... +3 500 m) // Tmin ... (Tmax -20 K) at 658 hPa ... 540 hPa (+3 500 m ... +5 000 m)

Technical specifications

Article number	6AG1195-7HA00-2XA0	6AG1195-7HB00-7XA0	6AG1195-7HC00-2XA0	6AG1195-7HD10-2XA0
Based on	6ES7195-7HA00-0XA0 SIPLUS ET200M Bus module	6ES7195-7HB00-0XA0 SIPLUS ET200M Bus module	6ES7195-7HC00-0XA0 SIPLUS ET200M Bus module	6ES7195-7HD10-0XA0 SIPLUS ET200M Bus module
Relative humidity				
• With condensation, tested in accordance with IEC 60068-2-38, max.	100 %; RH incl. condensation/frost (no commissioning under condensation conditions)	100 %; RH incl. condensation/frost (no commissioning under condensation conditions)	100 %; RH incl. condensation/frost (no commissioning under condensation conditions)	100 %; RH incl. condensation/frost (no commissioning under condensation conditions)
Resistance				
Use in stationary industrial systems				
- to biologically active substances according to EN 60721-3-3	Yes; Class 3B2 mold, fungus and dry rot spores (with the exception of fauna); Class 3B3 on request	Yes; Class 3B2 mold, fungus and dry rot spores (with the exception of fauna); Class 3B3 on request	Yes; Class 3B2 mold, fungus and dry rot spores (with the exception of fauna); Class 3B3 on request	Yes; Class 3B2 mold, fungus and dry rot spores (with the exception of fauna); Class 3B3 on request
- to chemically active substances according to EN 60721-3-3	Yes; Class 3C4 (RH < 75 %) incl. salt spray acc. to EN 60068-2-52 (severity degree 3); *	Yes; Class 3C4 (RH < 75 %) incl. salt spray acc. to EN 60068-2-52 (severity degree 3); *	Yes; Class 3C4 (RH < 75 %) incl. salt spray acc. to EN 60068-2-52 (severity degree 3); *	Yes; Class 3C4 (RH < 75 %) incl. salt spray acc. to EN 60068-2-52 (severity degree 3); *
- to mechanically active substances according to EN 60721-3-3	Yes; Class 3S4 incl. sand, dust; *	Yes; Class 3S4 incl. sand, dust; *	Yes; Class 3S4 incl. sand, dust; *	Yes; Class 3S4 incl. sand, dust; *
Use on ships/at sea				
- to biologically active substances according to EN 60721-3-6	Yes; Class 6B2 mold and fungal spores (excluding fauna); Class 6B3 on request	Yes; Class 6B2 mold and fungal spores (excluding fauna); Class 6B3 on request	Yes; Class 6B2 mold and fungal spores (excluding fauna); Class 6B3 on request	Yes; Class 6B2 mold and fungal spores (excluding fauna); Class 6B3 on request
- to chemically active substances according to EN 60721-3-6	Yes; Class 6C3 (RH < 75 %) incl. salt spray acc. to EN 60068-2-52 (severity degree 3); *	Yes; Class 6C3 (RH < 75 %) incl. salt spray acc. to EN 60068-2-52 (severity degree 3); *	Yes; Class 6C3 (RH < 75 %) incl. salt spray acc. to EN 60068-2-52 (severity degree 3); *	Yes; Class 6C3 (RH < 75 %) incl. salt spray acc. to EN 60068-2-52 (severity degree 3); *
- to mechanically active substances according to EN 60721-3-6	Yes; Class 6S3 incl. sand, dust; *	Yes; Class 6S3 incl. sand, dust; *	Yes; Class 6S3 incl. sand, dust; *	Yes; Class 6S3 incl. sand, dust; *
Usage in industrial process technology				
- Against chemically active substances acc. to EN 60654-4	Yes; Class 3 (excluding trichlorethylene)	Yes; Class 3 (excluding trichlorethylene)	Yes; Class 3 (excluding trichlorethylene)	Yes; Class 3 (excluding trichlorethylene)
- Environmental conditions for process, measuring and control systems acc. to ANSI/ISA-71.04	Yes; Level GX group A/B (excluding trichlorethylene; harmful gas concentrations up to the limits of EN 60721-3-3 class 3C4 permissible); level LC3 (salt spray) and level LB3 (oil)	Yes; Level GX group A/B (excluding trichlorethylene; harmful gas concentrations up to the limits of EN 60721-3-3 class 3C4 permissible); level LC3 (salt spray) and level LB3 (oil)	Yes; Level GX group A/B (excluding trichlorethylene; harmful gas concentrations up to the limits of EN 60721-3-3 class 3C4 permissible); level LC3 (salt spray) and level LB3 (oil)	Yes; Level GX group A/B (excluding trichlorethylene; harmful gas concentrations up to the limits of EN 60721-3-3 class 3C4 permissible); level LC3 (salt spray) and level LB3 (oil)
Remark				
- Note regarding classification of environmental conditions acc. to EN 60721, EN 60654-4 and ANSI/ISA-71.04	* The supplied plug covers must remain in place over the unused interfaces during operation!	* The supplied plug covers must remain in place over the unused interfaces during operation!	* The supplied plug covers must remain in place over the unused interfaces during operation!	* The supplied plug covers must remain in place over the unused interfaces during operation!

I/O systems

SIMATIC ET 200 systems for the control cabinet
SIMATIC ET 200M

Interface modules > SIPLUS ET 200M IM 153-4 PN IO**Overview**

- Integrated 2-port switch
- 12 modules per station
- Usable I/O quantity structure: 192 bytes each
- Active backplane bus for hot swapping of modules optionally available
- Baud rate 10 Mbps / 100 Mbps (Autonegotiation/Full Duplex)
- I&M functions according to PNO Guideline Order-No. 3.502, Version V1.1

Notes:

Micro Memory Card with min. 64 KB required if not all participants in the network support LLDP (Link Layer Discovery Protocol; neighbor detection).

SIPLUS extreme products are based on SIMATIC standard products. The contents listed here were taken from the respective standard products. SIPLUS extreme-specific information was added.

For technical documentation on SIPLUS, see:
<http://www.siemens.com/siplus-extreme>

- For connection of ET 200M as IO device to PROFINET IO (via copper, RJ45)
- 2 versions:
 - IM 153-4 PN STANDARD
 - IM 153-4 PN HIGH FEATURE: additionally to the STANDARD version, operation of PROFI-safe F and HART modules

Ordering data**Article No.****Article No.****SIPLUS ET 200M IM 153-4 PN**

(Extended temperature range and exposure to environmental substances)

Slave interface module for connecting an ET 200M to PROFINET for a maximum of 12 S7-300 modules

- Standard
- High Feature

6AG1153-4AA01-7XB0
6AG1153-4BA00-7XB0

Accessories**IE FC RJ45 plug 180**

180° cable outlet; 1 unit

6AG1901-1BB10-7AA0**Other accessories**

See SIMATIC ET 200M IM 153-4 PN interface module, page 10/318

Technical specifications

Article number	6AG1153-4AA01-7XB0	6AG1153-4BA00-7XB0
Based on	6ES7153-4AA01-0XB0 SIPLUS ET200M IM 153-4 PN IO	6ES7153-4BA00-0XB0 SIPLUS ET200M IM153-4 PN IO HF
General information		
Ambient conditions		
Ambient temperature during operation		
• min.	-25 °C; = Tmin	-40 °C; = Tmin; Startup @ -25 °C
• max.	70 °C; = Tmax; 60 °C @ UL/cUL, ATEX and FM use	70 °C; = Tmax; Tmax > 60 °C output current for backplane bus (5 V DC) max. 0.9 A
• At cold restart, min.		-25 °C
Ambient temperature during storage/transportation		
• min.	-40 °C	-40 °C
• max.	70 °C	70 °C
Altitude during operation relating to sea level		
• Installation altitude above sea level, max.	5 000 m	5 000 m
• Ambient air temperature-barometric pressure-altitude	Tmin ... Tmax at 1 140 hPa ... 795 hPa (-1 000 m ... +2 000 m) // Tmin ... (Tmax - 10 K) at 795 hPa ... 658 hPa (+2 000 m ... +3 500 m) // Tmin ... (Tmax -20 K) at 658 hPa ... 540 hPa (+3 500 m ... +5 000 m)	Tmin ... Tmax at 1 140 hPa ... 795 hPa (-1 000 m ... +2 000 m) // Tmin ... (Tmax - 10 K) at 795 hPa ... 658 hPa (+2 000 m ... +3 500 m) // Tmin ... (Tmax -20 K) at 658 hPa ... 540 hPa (+3 500 m ... +5 000 m)

Technical specifications

Article number	6AG1153-4AA01-7XB0	6AG1153-4BA00-7XB0
Based on	6ES7153-4AA01-0XB0 SIPLUS ET200M IM 153-4 PN IO	6ES7153-4BA00-0XB0 SIPLUS ET200M IM153-4 PN IO HF
Relative humidity		
<ul style="list-style-type: none"> With condensation, tested in accordance with IEC 60068-2-38, max. 	100 %; RH incl. condensation/frost (no commissioning under condensation conditions)	100 %; RH incl. condensation/frost (no commissioning under condensation conditions)
Resistance		
Use in stationary industrial systems		
<ul style="list-style-type: none"> to biologically active substances according to EN 60721-3-3 to chemically active substances according to EN 60721-3-3 to mechanically active substances according to EN 60721-3-3 	Yes; Class 3B2 mold, fungus and dry rot spores (with the exception of fauna); Class 3B3 on request Yes; Class 3C4 (RH < 75 %) incl. salt spray acc. to EN 60068-2-52 (severity degree 3); * Yes; Class 3S4 incl. sand, dust, *	Yes; Class 3B2 mold, fungus and dry rot spores (with the exception of fauna); Class 3B3 on request Yes; Class 3C4 (RH < 75 %) incl. salt spray acc. to EN 60068-2-52 (severity degree 3); * Yes; Class 3S4 incl. sand, dust, *
Use on ships/at sea		
<ul style="list-style-type: none"> to biologically active substances according to EN 60721-3-6 to chemically active substances according to EN 60721-3-6 to mechanically active substances according to EN 60721-3-6 	Yes; Class 6B2 mold and fungal spores (excluding fauna); Class 6B3 on request Yes; Class 6C3 (RH < 75 %) incl. salt spray acc. to EN 60068-2-52 (severity degree 3); * Yes; Class 6S3 incl. sand, dust; *	Yes; Class 6B2 mold and fungal spores (excluding fauna); Class 6B3 on request Yes; Class 6C3 (RH < 75 %) incl. salt spray acc. to EN 60068-2-52 (severity degree 3); * Yes; Class 6S3 incl. sand, dust; *
Usage in industrial process technology		
<ul style="list-style-type: none"> Against chemically active substances acc. to EN 60654-4 Environmental conditions for process, measuring and control systems acc. to ANSI/ISA-71.04 	Yes; Class 3 (excluding trichlorethylene) Yes; Level GX group A/B (excluding trichlorethylene; harmful gas concentrations up to the limits of EN 60721-3-3 class 3C4 permissible); level LC3 (salt spray) and level LB3 (oil)	Yes; Class 3 (excluding trichlorethylene) Yes; Level GX group A/B (excluding trichlorethylene; harmful gas concentrations up to the limits of EN 60721-3-3 class 3C4 permissible); level LC3 (salt spray) and level LB3 (oil)
Remark		
<ul style="list-style-type: none"> Note regarding classification of environmental conditions acc. to EN 60721, EN 60654-4 and ANSI/ISA-71.04 	* The supplied plug covers must remain in place over the unused interfaces during operation!	* The supplied plug covers must remain in place over the unused interfaces during operation!

I/O systems

SIMATIC ET 200 systems for the control cabinet
SIMATIC ET 200M

I/O modules > Digital modules, analog modules

Overview digital modules



- Digital inputs and outputs
- For flexible adaptation of the controller to the respective task
- For connecting digital sensors and actuators

For further information, see SIMATIC S7-300, chapter 5.

Overview analog modules



- Analog inputs and outputs
- For solving even complex tasks with analog process signals
- For connecting analog actuators and sensors without additional measuring amplifiers

For further information, see SIMATIC S7-300, chapter 5.

Overview



- Can only be plugged into ET 200M with IM 153-2 and IM 153-2 FO
- 8 AI HART
- Redundancy switching
- Firmware update
- HART minor variables

Ordering data

SM 331 HART analog input module

8 inputs, 0/4 – 20 mA, HART for ET 200M with IM 153-2 interface module

Accessories**Front connectors**

- 20-pin, with screw contacts
 - 1 unit
 - 100 units
- 20-pin, with spring-loaded contacts
 - 1 unit
 - 100 units

LK 393 cable guide

Mandatory for operation in hazardous areas

SIMATIC DP DIN rail for ET 200M

For mounting of up to 5 bus modules for

- Length: 483 mm (19")
- Length: 530 mm

Article No.

6ES7331-7TF01-0AB0

6ES7392-1AJ00-0AA0
6ES7392-1AJ00-1AB06ES7392-1BJ00-0AA0
6ES7392-1BJ00-1AB0

6ES7393-4AA00-0AA0

6ES7195-1GA00-0XA0
6ES7195-1GF30-0XA0

Article No.

SIMATIC S7-300 DIN rail

- Length: 160 mm
- Length: 480 mm (19")
- Length: 530 mm
- Length: 830 mm
- Length: 2000 mm

Label cover

(10 units, spare part) for signal modules (not 32-channel modules), function modules and CPU 312 IFM

Labeling strips

(10 units, spare part) for signal modules (not 32-channel modules), function modules and CPU 312 IFM

Labeling sheets for machine printing

For modules with 20-pin front connector, DIN A4, for printing with laser printer; 10 units

- Petrol
- Light beige
- Yellow
- Red

6ES7390-1AB60-0AA0
6ES7390-1AE80-0AA0
6ES7390-1AF30-0AA0
6ES7390-1AJ30-0AA0
6ES7390-1BC00-0AA0

6ES7392-2XY00-0AA0

6ES7392-2XX00-0AA0

6ES7392-2AX00-0AA0
6ES7392-2BX00-0AA0
6ES7392-2CX00-0AA0
6ES7392-2DX00-0AA0

I/O systemsSIMATIC ET 200 systems for the control cabinet
SIMATIC ET 200M**I/O modules > Analog modules with HART > Analog input module with HART****Technical specifications**

Article number	6ES7331-7TF01-0AB0 SM331, 8AI, 0/4-20MA HART
Supply voltage	
Load voltage L+	
• Rated value (DC)	24 V
Input current	
from load voltage L+ (without load), max.	20 mA
from backplane bus 5 V DC, max.	120 mA
Output voltage	
Supply voltage of the transmitters	
• present	Yes
• Rated value (DC)	24 V
• short-circuit proof	Yes
• Supply current, max.	60 mA
Power loss	
Power loss, typ.	1.5 W
Analog inputs	
Number of analog inputs	8
permissible input current for current input (destruction limit), max.	40 mA
Input ranges (rated values), currents	
• 0 to 20 mA	Yes
Cable length	
• shielded, max.	800 m
Analog value generation for the inputs	
Measurement principle	Sigma Delta
Integration and conversion time/resolution per channel	
• Resolution with overrange (bit including sign), max.	16 bit
• Integration time, parameterizable	Yes
• Integration time (ms)	20 ms at 50 Hz; 16.6 ms at 60 Hz; 100 ms at 100 Hz
• Basic conversion time, including integration time (ms)	55 ms @ 60 Hz, 65 ms @ 50 Hz, 305 ms @ 100 Hz
• Interference voltage suppression for interference frequency f1 in Hz	10 / 50 / 60 Hz
Smoothing of measured values	
• parameterizable	Yes

Article number	6ES7331-7TF01-0AB0 SM331, 8AI, 0/4-20MA HART
Encoder	
Connection of signal encoders	
• for current measurement as 2-wire transducer	Yes
• for current measurement as 4-wire transducer	Yes
Errors/accuracies	
Operational error limit in overall temperature range	
• Current, relative to input range, (+/-)	0.15 %
Basic error limit (operational limit at 25 °C)	
• Current, relative to input range, (+/-)	0.1 %
Interrupts/diagnostics/status information	
Diagnostics function	Yes
Alarms	
• Diagnostic alarm	Yes
• Limit value alarm	Yes
Degree and class of protection	
IP degree of protection	IP20
Connection method	
required front connector	20-pin
Dimensions	
Width	40 mm
Height	125 mm
Depth	117 mm
Weights	
Weight, approx.	205 g

Overview



- For plugging into ET 200M exclusively with IM 153-2 and IM 153-2 FO
- 8 AO HART
- Redundancy switching
- Firmware update
- HART minor variables

Ordering data

SM 332 HART analog output module

HART analog output,
8 outputs, 0/4 – 20 mA,
HART for ET 200M with IM 153-2

Accessories

Front connector (1 unit)

20-pin, with screw contacts

LK 393 cable guide

Mandatory for operation in hazardous areas

SIMATIC DP DIN rail for ET 200M

For mounting of up to 5 bus modules for

- Length: 483 mm (19")
- Length: 530 mm

SIMATIC S7-300 DIN rail

- Length: 160 mm
- Length: 480 mm
- Length: 530 mm
- Length: 830 mm
- Length: 2000 mm

Label cover

(10 units, spare part) for signal modules (not 32-channel modules), function modules and CPU 312 IFM

Labeling strips

(10 units, spare part) for signal modules (not 32-channel modules), function modules and CPU 312 IFM

Article No.

6ES7332-8TF01-0AB0

6ES7392-1AJ00-0AA0

6ES7393-4AA00-0AA0

6ES7195-1GA00-0XA0

6ES7195-1GF30-0XA0

6ES7390-1AB60-0AA0

6ES7390-1AE80-0AA0

6ES7390-1AF30-0AA0

6ES7390-1AJ30-0AA0

6ES7390-1BC00-0AA0

6ES7392-2XY00-0AA0

6ES7392-2XX00-0AA0

Article No.

S7 Manual Collection

Electronic manuals on DVD, multi-language: S7-200, TD 200, S7-300, M7-300, C7, S7-400, M7-400, STEP 7, Engineering Tools, Runtime Software, SIMATIC DP (Distributed I/O), SIMATIC HMI (Human Machine Interface), SIMATIC NET (Industrial Communication)

S7 Manual Collection update service for 1 year

Scope of delivery:
Current DVD "S7 Manual Collection" and the three subsequent updates

Labeling sheets for machine printing

For modules with 20-pin front connector, DIN A4, for printing with laser printer; 10 units

Petrol

Light beige

Yellow

Red

6ES7998-8XC01-8YE0

6ES7998-8XC01-8YE2

6ES7392-2AX00-0AA0

6ES7392-2BX00-0AA0

6ES7392-2CX00-0AA0

6ES7392-2DX00-0AA0

I/O systems

SIMATIC ET 200 systems for the control cabinet
SIMATIC ET 200M

I/O modules > Analog modules with HART > Analog output module with HART**Technical specifications**

Article number	6ES7332-8TF01-0AB0 SM332, 8AO, 0/4 - 20MA HART	
Supply voltage		
Load voltage L+		
• Rated value (DC)	24 V	
Input current		
from load voltage L+ (without load), max.	350 mA	
from backplane bus 5 V DC, max.	110 mA	
Power loss		
Power loss, typ.	6 W	
Analog outputs		
Number of analog outputs	8	
Current output, no-load voltage, max.	24 V	
Output ranges, current		
• 0 to 20 mA	Yes	
• -20 mA to +20 mA	No	
• 4 mA to 20 mA	Yes	
Connection of actuators		
• for current output two-wire connection	Yes	
Load impedance (in rated range of output)		
• with current outputs, max.	750 Ω	
• with current outputs, inductive load, max.	10 mH	
Cable length		
• shielded, max.	800 m	
Analog value generation for the outputs		
Integration and conversion time/resolution per channel		
• Resolution with overrange (bit including sign), max.	16 bit	
• Basic execution time of the module (all channels released)	10 ms; 10 ms in AO mode 50 ms in HART-AO mode	
Settling time		
• for resistive load	0.1 ms	
• for inductive load	0.5 ms	

Article number	6ES7332-8TF01-0AB0 SM332, 8AO, 0/4 - 20MA HART	
Errors/accuracies		
Operational error limit in overall temperature range		
• Current, relative to output range, (+/-)	0.2 %	
Basic error limit (operational limit at 25 °C)		
• Current, relative to output range, (+/-)	0.1 %	
Interrupts/diagnostics/status information		
Diagnostics function	Yes	
Alarms		
• Diagnostic alarm	Yes	
Degree and class of protection		
IP degree of protection	IP20	
Connection method		
required front connector	20-pin	
Dimensions		
Width	40 mm	
Height	125 mm	
Depth	117 mm	
Weights		
Weight, approx.	220 g	

Overview



- For connecting HART devices in hazardous areas.
- Can only be plugged into ET 200M
- 2 AI HART, Ex
- 2 inputs in 2 channel groups (single-channel isolation)
- Measurement type and range can be selected for each channel
- Diagnostics and diagnostic alarm parameterizable

Ordering data

SM 331 HART analog input module

2 inputs, 0/4 – 20 mA, HART for ET 200M with IM 153-2 interface module
For HART protocol V5.0 and higher

6ES7331-7TB10-0AB0**Accessories****Front connector¹⁾**

20-pin, with screw contacts

- 1 unit
- 100 units

6ES7392-1AJ00-0AA0
6ES7392-1AJ00-1AB0**LK 393 cable guide**

Mandatory for operation in hazardous areas

6ES7393-4AA00-0AA0**SIMATIC DP DIN rail for ET 200M**

For mounting of up to 5 bus modules for

- Length: 483 mm
- Length: 530 mm

6ES7195-1GA00-0XA0
6ES7195-1GF30-0XA0

Article No.

SIMATIC S7-300 DIN rail

- Length: 160 mm
- Length: 480 mm (19")
- Length: 530 mm
- Length: 830 mm
- Length: 2 000 mm

6ES7390-1AB60-0AA0
6ES7390-1AE80-0AA0
6ES7390-1AF30-0AA0
6ES7390-1AJ30-0AA0
6ES7390-1BC00-0AA0**Label cover**

(10 units, spare part) for signal modules (not 32-channel modules), function modules and CPU 312 IFM

6ES7392-2XY00-0AA0**Labeling strips**

(10 units, spare part) for signal modules (not 32-channel modules), function modules and CPU 312 IFM

6ES7392-2XX00-0AA0**Labeling sheets for machine printing**

For modules with 20-pin front connector, DIN A4, for printing with laser printer; 10 units

Petrol

6ES7392-2AX00-0AA0

Light beige

6ES7392-2BX00-0AA0

Yellow

6ES7392-2CX00-0AA0

Red

6ES7392-2DX00-0AA0

¹⁾ A connector with spring-loaded terminals cannot be used if the cable guide is used.

I/O systemsSIMATIC ET 200 systems for the control cabinet
SIMATIC ET 200M**I/O modules > Analog modules with HART > Ex-analog input module with HART****Technical specifications**

Article number	6ES7331-7TB10-0AB0 SM331, 2AE, 0/4-20mA HART
Supply voltage	
Load voltage L+	
• Rated value (DC)	24 V
Input current	
from load voltage L+ (without load), max.	180 mA
from backplane bus 5 V DC, max.	100 mA
Output voltage	
Supply voltage of the transmitters	
• present	Yes
• Rated value (DC)	15 V; at 22 mA
• short-circuit proof	Yes; approx. 30 mA
• No-load voltage (DC)	29.6 V
Power loss	
Power loss, typ.	4.5 W
Analog inputs	
Number of analog inputs	2
permissible input current for current input (destruction limit), max.	40 mA
Input ranges (rated values), currents	
• 0 to 20 mA	Yes
• 4 mA to 20 mA	Yes
Cable length	
• shielded, max.	400 m
Analog value generation for the inputs	
Measurement principle	Sigma Delta
Integration and conversion time/resolution per channel	
• Resolution with overrange (bit including sign), max.	16 bit; 10 bit to 15 bit + sign
• Integration time, parameterizable	Yes
• Integration time (ms)	2.5 / 16.67 / 20 / 100 ms
• Basic conversion time, including integration time (ms)	2.5 / 16.67 / 20 / 100 (1 channel enabled); 7.5 / 50 / 60 / 300 (2 channels enabled)
• Interference voltage suppression for interference frequency f1 in Hz	10 / 50 / 60 / 400 Hz
Encoder	
Connection of signal encoders	
• for current measurement as 2-wire transducer	Yes
• for current measurement as 4-wire transducer	Yes

Article number	6ES7331-7TB10-0AB0 SM331, 2AE, 0/4-20mA HART
Errors/accuracies	
Operational error limit in overall temperature range	
• Current, relative to input range, (+/-)	0.45 %; From 0/4 to 20 mA
Basic error limit (operational limit at 25 °C)	
• Current, relative to input range, (+/-)	0.1 %; From 0/4 to 20 mA
Interrupts/diagnostics/status information	
Diagnostics function	Yes; Parameterizable
Alarms	
• Diagnostic alarm	Yes; Parameterizable
• Limit value alarm	Yes; Parameterizable, channels 0 and 1
Ex(i) characteristics	
Module for Ex(i) protection	Yes
maximum values for connecting terminals for gas group IIC	
• Uo (no-load voltage), max.	26 V
• Io (short-circuit current), max.	96.1 mA
• Po (power output), max.	511 mW
• Co (permissible external capacity), max.	62 nF
• Lo (permissible external inductivity), max.	3 mH
• Um (voltage at non-intrinsically safe connecting terminals), max.	250 V; DC
Standards, approvals, certificates	
CE mark	Yes
UL approval	Yes
FM approval	Yes
RCM (formerly C-TICK)	Yes
KC approval	Yes
EAC (formerly Gost-R)	Yes
Use in hazardous areas	
• ATEX marking	ATEX II 3 G (2) GD Ex nA [ib Gb] [ib IIIC Db] IIC T4 Gc
• FM marking	Class I, Division 2, Group A, B, C, D T4; Class I, Zone 2, Group IIC T4
Ambient conditions	
Ambient temperature during operation	
• min.	0 °C
• max.	60 °C
Connection method	
required front connector	1x 20-pin
Dimensions	
Width	40 mm
Height	125 mm
Depth	120 mm
Weights	
Weight, approx.	260 g

Overview



- For using HART devices in hazardous areas
- Can only be plugged into ET 200M
- 2 AO HART, Ex
- 2 current outputs in 2 channel groups (single-channel isolation)
- Output type and range can be selected for each channel
- Diagnostics and diagnostic alarm parameterizable
- Read-back capability of the analog outputs

Ordering data

SM 332 HART analog output module

HART analog output,
8 outputs, 0/4 – 20 mA,
HART for ET 200M with IM 153-2

For HART protocol V5.0 and higher

Article No.

6ES7332-5TB10-0AB0

Accessories**Front connector**

20-pin, with screw contacts

- 1 unit
- 100 units

6ES7392-1AJ00-0AA0

6ES7392-1AJ00-1AB0

LK 393 cable guide

Mandatory for operation in
hazardous areas

6ES7393-4AA00-0AA0

SIMATIC DP DIN rail for ET 200M

For mounting of up to 5 bus
modules for

- Length: 483 mm (19")
- Length: 530 mm

6ES7195-1GA00-0XA0

6ES7195-1GF30-0XA0

SIMATIC S7-300 DIN rail

- Length: 160 mm
- Length: 480 mm (19")
- Length: 530 mm
- Length: 830 mm
- Length: 2 000 mm

6ES7390-1AB60-0AA0

6ES7390-1AE80-0AA0

6ES7390-1AF30-0AA0

6ES7390-1AJ30-0AA0

6ES7390-1BC00-0AA0

Label cover

(10 units, spare part)
for signal modules
(not 32-channel modules),
function modules
and CPU 312 IFM

6ES7392-2XY00-0AA0

Article No.

Labeling strips

(10 units, spare part)
for signal modules
(not 32-channel modules),
function modules
and CPU 312 IFM

6ES7392-2XX00-0AA0

Software for machine
labeling of modules
directly from the STEP 7 project

Labeling sheets for machine printing

For modules with 20-pin
front connector, DIN A4, for
printing with laser printer;
10 units

Petrol

6ES7392-2AX00-0AA0

Light beige

6ES7392-2BX00-0AA0

Yellow

6ES7392-2CX00-0AA0

Red

6ES7392-2DX00-0AA0

S7 Manual Collection

6ES7998-8XC01-8YE0

Electronic manuals on
DVD, multi-language:
S7-200, TD 200, S7-300, M7-300,
C7, S7-400, M7-400, STEP 7,
Engineering tools,
Runtime Software,
SIMATIC DP (Distributed I/O),
SIMATIC HMI (Human Machine
Interface), SIMATIC NET
(Industrial Communication)

S7 Manual Collection update service for 1 year

6ES7998-8XC01-8YE2

Scope of delivery: Current DVD
"S7 Manual Collection" and the
three subsequent updates

I/O systemsSIMATIC ET 200 systems for the control cabinet
SIMATIC ET 200M**I/O modules > Analog modules with HART > Ex-analog output module with HART****Technical specifications**

Article number	6ES7332-5TB10-0AB0 SIMATIC DP, HART ANALOG OUTPUT
Supply voltage	
Load voltage L+	
• Rated value (DC)	24 V
Input current	
from load voltage L+ (without load), max.	150 mA
from backplane bus 5 V DC, max.	100 mA
Power loss	
Power loss, typ.	3.5 W
Analog outputs	
Number of analog outputs	2
Current output, no-load voltage, max.	19 V
Cycle time (all channels) max.	5 ms
Output ranges, current	
• 0 to 20 mA	Yes
• -20 mA to +20 mA	No
• 4 mA to 20 mA	Yes
Connection of actuators	
• for current output two-wire connection	Yes
Load impedance (in rated range of output)	
• with current outputs, max.	650 Ω
• with current outputs, inductive load, max.	7.5 mH
Cable length	
• shielded, max.	400 m
Analog value generation for the outputs	
Integration and conversion time/resolution per channel	
• Resolution with overrange (bit including sign), max.	12 bit; + sign
• Conversion time (per channel)	40 ms
Settling time	
• for resistive load	2.5 ms
• for capacitive load	4 ms
• for inductive load	2.5 ms

Article number	6ES7332-5TB10-0AB0 SIMATIC DP, HART ANALOG OUTPUT
Errors/accuracies	
Operational error limit in overall temperature range	
• Current, relative to output range, (+/-)	0.55 %
Basic error limit (operational limit at 25 °C)	
• Current, relative to output range, (+/-)	0.15 %
Interrupts/diagnostics/status information	
Diagnostics function	Yes; Parameterizable
Alarms	
• Diagnostic alarm	Yes; Parameterizable
Ex(i) characteristics	
Module for Ex(i) protection	Yes
maximum values for connecting terminals for gas group IIC	
• U _o (no-load voltage), max.	19 V
• I _o (short-circuit current), max.	66 mA
• P _o (power output), max.	506 mW
• C _o (permissible external capacity), max.	230 nF
• L _o (permissible external inductivity), max.	7.5 mH
• U _m (voltage at non-intrinsically safe connecting terminals), max.	60 V; DC
Degree and class of protection	
IP degree of protection	IP20
Standards, approvals, certificates	
FM approval	Yes
Use in hazardous areas	
• ATEX marking	ATEX II 3 G (2) GD Ex nA [ib Gb] [ib IIIC Db] IIC T4 Gc
• FM marking	Class I, Division 2, Group A, B, C, D T4; Class I, Zone 2, Group IIC T4
Ambient conditions	
Ambient temperature during operation	
• max.	60 °C
Connection method	
required front connector	20-pin
Dimensions	
Width	40 mm
Height	125 mm
Depth	120 mm
Weights	
Weight, approx.	290 g

Overview



- Can only be plugged into ET 200M with IM 153-2 and IM 153-2 FO
- 8 AI HART
- Redundant connection
- Firmware update
- HART secondary variables

Note:

SIPLUS extreme products are based on SIMATIC standard products. The contents listed here were taken from the respective standard products. SIPLUS extreme-specific information was added.

For technical documentation on SIPLUS, see:

<http://www.siemens.com/siplus-extreme>

Ordering data

Article No.

SIPLUS SM 331 analog input module with HART

8 inputs, 0/4 – 20 mA, HART for ET 200M with IM 153-2 interface module

Extended temperature range and exposure to environmental substances

6AG1331-7TF01-7AB0

Accessories

See SIMATIC ET 200M analog input module with HART, page 10/327

Technical specifications

Article number	6AG1331-7TF01-7AB0
Based on	6ES7331-7TF01-0AB0 SIPLUS S7-300 SM 331 8AI HART
Ambient conditions	
Ambient temperature during operation	
• min.	-25 °C; = Tmin
• max.	70 °C; = Tmax; 60 °C @ UL/cUL use
Altitude during operation relating to sea level	
• Installation altitude above sea level, max.	5 000 m
• Ambient air temperature-barometric pressure-altitude	Tmin ... Tmax at 1 140 hPa ... 795 hPa (-1 000 m ... +2 000 m) // Tmin ... (Tmax - 10 K) at 795 hPa ... 658 hPa (+2 000 m ... +3 500 m) // Tmin ... (Tmax -20 K) at 658 hPa ... 540 hPa (+3 500 m ... +5 000 m)
Resistance	
Use in stationary industrial systems	
- to biologically active substances according to EN 60721-3-3	Yes; Class 3B2 mold, fungus and dry rot spores (with the exception of fauna); Class 3B3 on request
- to chemically active substances according to EN 60721-3-3	Yes; Class 3C4 (RH < 75 %) incl. salt spray acc. to EN 60068-2-52 (severity degree 3); *
- to mechanically active substances according to EN 60721-3-3	Yes; Class 3S4 incl. sand, dust, *
Use on ships/at sea	
- to biologically active substances according to EN 60721-3-6	Yes; Class 6B2 mold and fungal spores (excluding fauna); Class 6B3 on request
- to chemically active substances according to EN 60721-3-6	Yes; Class 6C3 (RH < 75 %) incl. salt spray acc. to EN 60068-2-52 (severity degree 3); *
- to mechanically active substances according to EN 60721-3-6	Yes; Class 6S3 incl. sand, dust; *
Usage in industrial process technology	
- Against chemically active substances acc. to EN 60654-4	Yes; Class 3 (excluding trichlorethylene)
- Environmental conditions for process, measuring and control systems acc. to ANSI/ISA-71.04	Yes; Level GX group A/B (excluding trichlorethylene; harmful gas concentrations up to the limits of EN 60721-3-3 class 3C4 permissible); level LC3 (salt spray) and level LB3 (oil)
Remark	
- Note regarding classification of environmental conditions acc. to EN 60721, EN 60654-4 and ANSI/ISA-71.04	* The supplied plug covers must remain in place over the unused interfaces during operation!

I/O systems

SIMATIC ET 200 systems for the control cabinet
SIMATIC ET 200M

I/O modules > Analog modules with HART > SIPLUS S7-300 analog output module with HART

Overview



- Can only be plugged onto ET 200M with IM 153-2 and IM 153-2 FO
- 8 AO HART
- Redundant connection
- Firmware update
- HART secondary variables

Note:

SIPLUS extreme products are based on SIMATIC standard products. The contents listed here were taken from the respective standard products. SIPLUS extreme-specific information was added.

For technical documentation on SIPLUS, see:

<http://www.siemens.com/siplus-extreme>

Ordering data

Article No.

SIPLUS SM 332 analog output module with HART

8 outputs, 0/4 ... 20 mA HART, for ET 200M with IM 153-2 interface module

Extended temperature range and exposure to environmental substances

6AG1332-8TF01-2AB0

Accessories

See SIMATIC SM 332 analog output module with HART, page 10/329

Technical specifications

Article number	6AG1332-8TF01-2AB0
Based on	6ES7332-8TF01-0AB0 SIPLUS S7-300 SM 332 HART
Ambient conditions	
Ambient temperature during operation	
• min.	-25 °C; = Tmin
• max.	60 °C; = Tmax
Altitude during operation relating to sea level	
• Installation altitude above sea level, max.	5 000 m
• Ambient air temperature-barometric pressure-altitude	Tmin ... Tmax at 1 140 hPa ... 795 hPa (-1 000 m ... +2 000 m) // Tmin ... (Tmax - 10 K) at 795 hPa ... 658 hPa (+2 000 m ... +3 500 m) // Tmin ... (Tmax -20 K) at 658 hPa ... 540 hPa (+3 500 m ... +5 000 m)
Resistance	
Use in stationary industrial systems	
- to biologically active substances according to EN 60721-3-3	Yes; Class 3B2 mold, fungus and dry rot spores (with the exception of fauna); Class 3B3 on request
- to chemically active substances according to EN 60721-3-3	Yes; Class 3C4 (RH < 75 %) incl. salt spray acc. to EN 60068-2-52 (severity degree 3); *
- to mechanically active substances according to EN 60721-3-3	Yes; Class 3S4 incl. sand, dust, *
Use on ships/at sea	
- to biologically active substances according to EN 60721-3-6	Yes; Class 6B2 mold and fungal spores (excluding fauna); Class 6B3 on request
- to chemically active substances according to EN 60721-3-6	Yes; Class 6C3 (RH < 75 %) incl. salt spray acc. to EN 60068-2-52 (severity degree 3); *
- to mechanically active substances according to EN 60721-3-6	Yes; Class 6S3 incl. sand, dust; *
Usage in industrial process technology	
- Against chemically active substances acc. to EN 60654-4	Yes; Class 3 (excluding trichlorethylene)
- Environmental conditions for process, measuring and control systems acc. to ANSI/ISA-71.04	Yes; Level GX group A/B (excluding trichlorethylene; harmful gas concentrations up to the limits of EN 60721-3-3 class 3C4 permissible); level LC3 (salt spray) and level LB3 (oil)
Remark	
- Note regarding classification of environmental conditions acc. to EN 60721, EN 60654-4 and ANSI/ISA-71.04	* The supplied plug covers must remain in place over the unused interfaces during operation!

Overview F-digital/analog modules

The fail-safe SIMATIC S7 CPUs and the fail-safe signal modules of SIMATIC ET 200S, ET 200pro, ET 200eco and ET 200M have been specially developed for distributed, safety-related applications in production engineering. Thanks to the discreetly modular structure of the fail-safe I/Os, safety technology only has to be applied where actually required. The new system replaces conventional electromechanical components, such as:

- Freely programmable, safe linking of sensors to actuators
- Selective safe shutdown of actuators
- Mixed configuration of F-modules and standard modules in a station
- Single-bus concept; fail-safe signals and standard signals are transferred over a single bus medium (PROFIBUS DP, PROFINET)

Totally Integrated Automation (TIA)

Safety technology (Safety Integrated) is a component of Totally Integrated Automation which provides total integration of safety automation and standard automation (SIMATIC S7).

Whereas standard automation (classical PLCs) and safety automation (electromechanics) are still separate today, these two worlds are growing together into a uniform, integrated overall system.

Siemens can therefore present itself as a complete supplier for automation technology in which safety engineering is part of standard automation and system-wide integration exists.

For further information, see SIMATIC S7-300, chapter 5.

Overview Ex modules

- Input/output modules for applications in chemical plants with explosion hazards
- For connecting sensors and actuators from zones 1 and 2 of plants with explosion hazards
- Associated electrical equipment Ex [ib] [ibD] IIC
- For separating the non-intrinsically-safe electrical circuits of the automation system and the intrinsically-safe electrical circuits of the process

For further information, see SIMATIC S7-300, chapter 5.

I/O systems

SIMATIC ET 200 systems for the control cabinet
SIMATIC ET 200M

I/O modules > Function modules**Overview**

Function modules unburden the CPU of work-intensive tasks such as counting, positioning and controlling

Module spectrum

- Counter modules
- Positioning modules for rapid traverse and creep speed drives
- Positioning modules for stepper motors
- Positioning modules for servo motors
- Positioning and continuous path modules
- SSI position detection modules
- Electronic cam controllers
- High-speed Boolean processor
- Controller modules

Function modules	
Counting	FM 350-1 counter module
	FM 350-2 counter module
Positioning	• of rapid traverse and creep speed drives
	FM 351 positioning module
Position and path control	FM 357-2 path and position control module ¹⁾
SSI position detection	SM 338 POS input modules
Electronic cam control	FM 352 electronic cam controller
High speed logic operation	FM 352-5 high-speed Boolean processor
Controlling	FM 355 controller module
	FM 355-2 temperature controller module
Weighing and proportioning electronics	SIWAREX

¹⁾ Not for ET 200M

Overview**Applicability with ET 200M distributed I/O device**

Almost all function modules can be used in the ET 200M distributed I/O device. In doing so, the following details must be observed:

Module	Article No.	For plugging in behind IM 153-1 (6ES7 153-1AA03-0XB0)		For plugging in behind IM 153-2 (6ES7 153-2BA02-0XB0)		For plugging in behind IM 153-2 FO (6ES7 153-2BB00-0XB0)		For plugging in behind IM 153-4 PN (6ES7 153- 4AA00-0XB0)
		STEP 7 ¹⁾	GSD ²⁾	STEP 7 ¹⁾	GSD ²⁾	STEP 7 ¹⁾	GSD ²⁾	STEP 7 ¹⁾
configurable with								
FM 350-1 counter module	6ES7 350-1AH03-0AEO	<input type="checkbox"/>	--	<input type="checkbox"/>	--	<input type="checkbox"/>	--	<input type="checkbox"/>
FM 350-2 counter module	6ES7 350-2AH01-0AEO	<input type="checkbox"/>	--	<input type="checkbox"/>	--	<input type="checkbox"/>	--	<input type="checkbox"/>
FM 351 positioning module	6ES7 351-1AH01-0AEO	<input type="checkbox"/>	--	<input type="checkbox"/>	--	<input type="checkbox"/>	--	<input type="checkbox"/>
FM 352 cam controller	6ES7 352-1AH02-0AEO	<input type="checkbox"/>	--	<input type="checkbox"/>	--	<input type="checkbox"/>	--	<input type="checkbox"/>
FM 352-5 high-speed Boolean processor	6ES7 352-5AH00-0AEO	<input style="border: 1px solid black; border-radius: 50%; padding: 2px; font-size: 8px; text-align: center;" type="checkbox"/> 3)	<input type="checkbox"/>	<input style="border: 1px solid black; border-radius: 50%; padding: 2px; font-size: 8px; text-align: center;" type="checkbox"/> 3)	<input type="checkbox"/>	<input style="border: 1px solid black; border-radius: 50%; padding: 2px; font-size: 8px; text-align: center;" type="checkbox"/> 3)	<input type="checkbox"/>	<input type="checkbox"/>
FM 352-5 high-speed Boolean processor	6ES7 352-5AH10-0AEO	<input style="border: 1px solid black; border-radius: 50%; padding: 2px; font-size: 8px; text-align: center;" type="checkbox"/> 3)	<input type="checkbox"/>	<input style="border: 1px solid black; border-radius: 50%; padding: 2px; font-size: 8px; text-align: center;" type="checkbox"/> 3)	<input type="checkbox"/>	<input style="border: 1px solid black; border-radius: 50%; padding: 2px; font-size: 8px; text-align: center;" type="checkbox"/> 3)	<input type="checkbox"/>	<input type="checkbox"/>
FM 355 C controller module	6ES7 355-0VH10-0AEO	--	--	<input type="checkbox"/>	--	<input type="checkbox"/>	--	<input type="checkbox"/>
FM 355 S controller module	6ES7 355-1VH10-0AEO	--	--	<input type="checkbox"/>	--	<input type="checkbox"/>	--	<input type="checkbox"/>
FM 355-2 C temperature controller module	6ES7 355-2CH00-0AEO	<input type="checkbox"/>	--	<input type="checkbox"/>	--	<input type="checkbox"/>	--	<input type="checkbox"/>
FM 355-2 S temperature controller module	6ES7 355-2SH00-0AEO	<input type="checkbox"/>	--	<input type="checkbox"/>	--	<input type="checkbox"/>	--	<input type="checkbox"/>
SM 338 POS input module	6ES7 338-4BC01-0AB0	<input type="checkbox"/>	<input type="checkbox"/>	<input type="checkbox"/>	<input type="checkbox"/>	<input type="checkbox"/>	<input type="checkbox"/>	<input type="checkbox"/>

configurable
--: not configurable

- 1) Configuration using the meta-knowledge integrated into STEP 7 (in Hardware Catalog under PROFIBUS DP > ET 200M > IM 153-1 / IM 153-2 or PROFINET IO > I/O > ET 200M > IM153-4 PN).
- 2) Configuration using GSD file (after installation of the GSD file configurable from the Hardware Catalog under PROFIBUS DP > Additional field devices > I/O > ET200M). During configuration on the CP 342-5 as DP master, S5 (IM 308C) as DP master or external masters, the GSD file must be configured.
- 3) Visible and configurable only with the corresponding configuration package in STEP 7.

Note:

Position measurement systems and pre-assembled connecting cables for counter and positioning function are offered under SIMODRIVE Sensor and Motion Connect 500.

<http://www.siemens.com/simatic-technology>

For further information, see SIMATIC S7-300, chapter 5.

I/O systems

SIMATIC ET 200 systems for the control cabinet
SIMATIC ET 200M

I/O modules > Special modules, Communication, Power supplies**Overview special modules**

The special modules provide the user with functions for diagnostics, as well as commissioning.

For further information, see SIMATIC S7-300, chapter 5.

Overview power supplies

- Load current supplies for S7-300/ET 200M
- For converting the line voltage to the required operating voltage (24 V DC)
- Output current 2 A, 5 A or 10 A

For further information, see SIMATIC S7-300, chapter 5.

Overview communication

- Communication boards for data exchange using point-to-point coupling
- Communication board for the connection of identification systems

For further information, see SIMATIC S7-300, chapter 5.

Overview



The ET 200iSP is a modular, intrinsically-safe I/O system with IP30 degree of protection which can be operated in gas and dust atmospheres at ambient temperatures from -20 to +70 °C. It is optimized for use with SIMATIC PCS 7 and SIMATIC S7, but can also be integrated in other systems such as SIMATIC S5 per GSD file.

In accordance with ATEX directive 2014/34/EU, the ET 200iSP remote I/O stations can be installed directly in Ex Zones 1, 2, 21 or 22 as well as in non-hazardous areas. The intrinsically-safe sensors, actuators and HART field devices can also be located in zone 0 or 20 if necessary.

The modular design of the ET 200iSP makes it possible to optimally adapt the remote I/O stations to the respective automation task through individual configuration and flexible expansion. To increase plant availability, the pressure-encapsulated power supply and the intrinsically-safe PROFIBUS DP connection (RS 485-iS) of the stations can also be of redundant design.

The modern architecture with hardwiring and automatic slot coding supports pre-wiring without the electronic modules, simple and reliable hot swapping of individual modules without a fire certificate as well as configuration in run (CiR).

In addition to analog and digital I/O modules for the automation of technological functions of the process (Basic Process Control), the range of electronic modules also includes fail-safe I/O modules for implementing safety applications. The various types of electronic module can be arranged mixed within a station. Comprehensive diagnostic options facilitate commissioning and troubleshooting.

Technical specifications

ET 200iSP – general

Degree of protection	IP30	
Ambient temperature	-20 ... +70 °C	
• Horizontal mounting position	-20 ... +70 °C	
• Other mounting positions	-20 ... +50 °C	
Loading of media	According to ISA-S71.04 severity level G1; G2; G3 (except for NH3, only level G2 in this case)	
EMC	Electromagnetic compatibility according to NE21	
Vibration resistance	0.5 g continuously, 1 g periodically	
Approvals, standards		
• ATEX	II 2 G (1) GD I M2	Ex de [ia/ib] IIC T4 Ex de [ia/ib] I
• IECEX	Zone 1	Ex de [ia/ib] IIC T4
• INMETRO	Zone 1	BR-Ex de [ia/ib] IIC T4
• cFMus	Class I, II, III	NI Division 2, Groups A, B, C, D, E, F, G T4 AIS Division 1, Groups A, B, C, D, E, F, G
• cULus	Class I Class I, II, III	Zone 1, AEx de [ia/ib] IIC T4 Division 2, Groups A, B, C, D, E, F, G T4 providing int. safe circuits for Division 1, Groups A, B, C, D, E, F, G
• NEPSI	Class I Ex de ib[ia] IIC T4 Ex de [ia/ib] IIC T4	Zone 1, AEx de [ia/ib] IIC T4
• PROFIBUS	EN 50170, Volume 2	
• IEC	IEC 61131, Part 2	
• CE	In accordance with ATEX directive 2014/34/EU, EMC Directive 2014/30/EU and LVD-guideline 2014/35/EU	
• KCC	Korea Certification	
• Marine approval	Classification companies	
	• ABS (American Bureau of Shipping)	
	• BV (Bureau Veritas)	
	• DNV (Det Norske Veritas)	
	• GL (Germanischer Lloyd)	
	• LRS (Lloyds Register of Shipping)	
	• Class NK (Nippon Kaiji Kyokai)	

I/O systems

SIMATIC ET 200 systems for the control cabinet
SIMATIC ET 200iSP

Power supply unit

Overview



An ET 200iSP power supply unit consists of a TM-PS terminal module (A or B) and a PS power supply module which is plugged onto this. Terminal modules and power supply modules can be ordered separately.

The power supply modules are suitable for both individual operation (standard) and redundant operation. Depending on the operating mode, they must be combined with the terminal modules as follows:

- Standard: 1 × PS on TM-PS-A UC
- Redundancy: 1 × PS on TM-PS-A UC (left) plus 1 × PS on TM-PS-B UC (right)

Power supply modules are available for supplies of 24 V DC and 120/230 V AC.

The operating state of the power supply modules is indicated by two LEDs on the IM 152 interface module (one for each module).

Ordering data

PS 24 V DC power supply module for ET 200iSP

Article No.

6ES7138-7EA01-0AA0

PS 120/230 V AC power supply module for ET 200iSP

6ES7138-7EC00-0AA0

Article No.

TM-PS-A UC terminal module

For standard operation

6ES7193-7DA20-0AA0

TM-PS-B UC terminal module

Additional terminal module for redundant operation

6ES7193-7DB20-0AA0

Technical specifications

Article number	6ES7138-7EA01-0AA0	6ES7138-7EC00-0AA0
	ET200iSP, POWER SUPPLY MODULE	ET200iSP, POWER SUPPLY MOD. AC120/230V
Supply voltage		
Rated value (DC)	24 V	
Rated value (AC)		230 V; 120/230 V AC
Reverse polarity protection	Yes	
Line frequency		
• permissible range, lower limit		47 Hz
• permissible range, upper limit		63 Hz
Input current		
from supply voltage L+, max.	4 A	
from supply voltage L1, max.		1.04 A; at rated voltage 230 VAC:0.45A at rated voltage 120 VAC:0.75A
Interrupts/diagnostics/status information		
Status indicator	Yes	Yes
Alarms	No	No
Diagnoses		
• Diagnostic information readable	Yes; via IM 152	Yes; via IM 152
Diagnostics indication LED		
• Group error SF (red)	No	No
Potential separation		
primary/secondary	Yes	Yes
between supply voltage and electronics	Yes	No

Technical specifications

Article number	6ES7138-7EA01-0AA0 ET200iSP, POWER SUPPLY MODULE	6ES7138-7EC00-0AA0 ET200iSP, POWER SUPPLY MOD. AC120/230V
Standards, approvals, certificates		
CE mark	Yes	Yes
Use in hazardous areas		
• ATEX marking	Ex de [ib]IIC T4	Ex de [ib]IIC T4
Dimensions		
Width	60 mm	60 mm
Height	190 mm	190 mm
Depth	136.5 mm	136.5 mm
Weights		
Weight, approx.	2 700 g	2 700 g
Article number	6ES7193-7DA20-0AA0 ET200iSP, TERM.-MOD. TM-PS-A UC	6ES7193-7DB20-0AA0 ET200iSP, TERM.-MOD. TM-PS-B UC
Standards, approvals, certificates		
CE mark	Yes	Yes
Use in hazardous areas		
• ATEX marking	see ET 200iSP system	see ET 200iSP system
Dimensions		
Width	60 mm	60 mm
Height	190 mm	190 mm
Depth	52 mm	52 mm
Weights		
Weight, approx.	230 g	230 g

I/O systems

SIMATIC ET 200 systems for the control cabinet
SIMATIC ET 200iSP

Interface module

Overview



The IM 152 interface module connects the ET 200iSP to the PROFIBUS DP with intrinsically-safe RS 485-iS transmission technology with transmission rates of up to 1.5 Mbps. A redundant connection is also possible. In this case the ET 200iSP is connected via two interface modules to two redundant PROFIBUS DP segments of a fault-tolerant automation system.

The IM 152 is plugged onto a special terminal module (to be ordered separately). The following terminal modules are available:

- TM-IM/IM terminal module for two interface modules (for redundant PROFIBUS DP connection)
- TM-IM/EM60 terminal module for one interface module and one watchdog, reserve or electronic module (except 2 DQ relay)
 - with blue screw-type or spring-loaded terminals for hazardous environments
 - with black screw-type terminals for non-hazardous environments

Tasks of the IM 152 interface module

- Connection of ET 200iSP to the intrinsically-safe PROFIBUS DP
- Autonomous communication with the host automation system
- Preparation of data for the fitted electronic modules
- Saving of parameters of the electronic modules
- Time stamping of digital process signals with an accuracy of 20 ms

The maximum address space of the interface module is 244 bytes for inputs, and 244 bytes for outputs.

Ordering data

Article No.

Article No.

ET 200iSP interface module IM 152-1

6ES7152-1AA00-0AB0

ET 200iSP terminal module TM-IM/EM60

For an IM 152 and a watchdog, reserve or electronic module (except 2 DQ relay), including termination module

- For hazardous environments
 - TM-IM/EM60S (blue screw-type terminals)
 - TM-IM/EM60C (blue spring-loaded terminals)
- For non-hazardous environments
 - TM-IM/EM60S (black screw-type terminals)

6ES7193-7AA00-0AA0

6ES7193-7AA10-0AA0

6ES7193-7AA20-0AA0

ET 200iSP terminal module TM-IM/IM

For two IM 152 modules (redundant operation), including termination module

6ES7193-7AB00-0AA0

Accessories

PROFIBUS connection plug with selectable terminating resistor

For connection of IM 152 to PROFIBUS DP with RS 485-iS transmission technology

6ES7972-0DA60-0XA0

RS 485-iS coupler

Isolating transformer for connection of PROFIBUS DP segments with RS 485 and RS 485-iS transmission systems

6ES7972-0AC80-0XA0

Labeling sheet

DIN A4, perforated, each consisting of 10 sheets of 30 strips each for electronic modules and 20 strips each for IM 152

- Petrol
- Yellow

6ES7193-7BH00-0AA0

6ES7193-7BB00-0AA0

Labels, inscribed

For slot numbering, label size H × W (in mm): 5 × 7

- 204 labels, for slots 1 to 20
- 204 labels, for slots 1 to 40
- 136 labels, inscription in plain text

8WA8361-0AB

8WA8361-0AC

8WA8348-0XA

Labels, blank

136 labels for slot numbering, label size H × W (in mm): 5 × 7

8WA8348-2AY

S7-300 DIN rails

- 585 mm long, suitable for assembly of ET 200iSP in a 650 mm wide wall box
- 885 mm long, suitable for assembly of ET 200iSP in a 950 mm wide wall box

6ES7390-1AF85-0AA0

6ES7390-1AJ85-0AA0

Technical specifications

Article number	6ES7152-1AA00-0AB0 ET200iSP, IM152-1 INTERFACE MODULE
General information	
Product function	
• Isochronous mode	No
Input current	
from supply voltage L+, max.	30 mA
Time stamping	
Description	for each digital input, digital input module, total ET 200iS
Accuracy	20 ms
Number of stampable digital inputs, max.	64; for accuracy class 20 ms
Time format	RFC 1119 Internet (ISP)
Time resolution	1 ms
Time interval for transmitting the message buffer if a message is present	1 000 ms
Time stamp on signal change	rising / falling edge as signal entering or exiting
Interfaces	
Interfaces/bus type	RS 485
Transmission rate, max.	1.5 Mbit/s; 9,6 / 19,2 / 45,45 / 93,75 / 187,5 / 500 kbit/s; 1,5 Mbit/s
Protocols	
PROFIBUS DP	Yes
PROFIBUS DP	
Services	
- SYNC capability	Yes
- FREEZE capability	Yes
- Direct data exchange (slave-to-slave communication)	Yes; Slave to slave as publisher

Article number	6ES7152-1AA00-0AB0 ET200iSP, IM152-1 INTERFACE MODULE
Interrupts/diagnostics/status information	
Alarms	Yes
Diagnostics function	Yes
Alarms	
• acyclic function, interrupts	Yes
• acyclic function, parameters	Yes
Diagnostics indication LED	
• Bus fault BF (red)	Yes
• Group error SF (red)	Yes
• Monitoring 24 V voltage supply ON (green)	Yes
Potential separation	
between supply voltage and electronics	Yes
Standards, approvals, certificates	
CE mark	Yes
Dimensions	
Width	30 mm
Height	129 mm
Depth	136.5 mm
Weights	
Weight, approx.	245 g

Article number	6ES7193-7AA00-0AA0 ET200iSP, TERM.-MOD. TM-IM/EM60S, SCREW	6ES7193-7AA10-0AA0 ET200iSP, TERM.-MOD. TM-IM/EM60C ,SPRING	6ES7193-7AB00-0AA0 ET200iSP, TERM.-MOD. TM-IM/IM F. TWO IM
Standards, approvals, certificates			
CE mark	Yes	Yes	Yes
Use in hazardous areas			
• ATEX marking	see ET 200iSP system	see ET 200iSP system	see ET 200iSP system
Dimensions			
Width	60 mm	60 mm	60 mm
Height	190 mm	190 mm	190 mm
Depth	52 mm	52 mm	52 mm
Weights			
Weight, approx.	235 g	235 g	195 g

I/O systems

SIMATIC ET 200 systems for the control cabinet
SIMATIC ET 200iSP

Digital electronic modules

Overview



Digital input modules

- 8-channel digital input module DI NAMUR EEx i, for evaluation of NAMUR sensors, connected and non-connected contacts, as well as for use as counter or frequency meter
Parameterizable connections:
 - NAMUR sensor on/off
 - NAMUR changeover contact
 - Single contact connected (mechanical NO contact)
 - Changeover contact connected (mechanical changeover contact)
 - Single contact non-connected (mechanical NO contact with single contact)
 - Changeover contact non-connected (mechanical changeover contact)
 - Counting function: optional use of 2 channels for recording counter pulses or for frequency measurement
 - Short-circuit and wire-break monitoring

Digital output modules

- 4-channel digital output modules DQ EEx i, 23.1 V DC/20 mA, 17.4 V DC/27 mA, 17.4 V DC/40 mA or 25.5 V DC/22 mA, with external actuator switch-off via High or Low signal (H/L switch-off)
 - Load-free switching of outputs via external intrinsically safe signal
 - Power boosting through parallel connection of two outputs for one actuator with 4 DQ 17.4 V DC/27 mA or 4 DQ 17.4 V DC/40 mA
 - Short-circuit and wire-break monitoring
- 2-channel digital output module DQ Relay EEx e, e.g. for switching solenoid valves, DC contactors or signaling lamps
 - Can be plugged onto TM-RM/RM terminal module
 - Output current up to 2 A with 60 V UC for each of the two relay outputs
 - Installation up to Ex zone 1
 - Intrinsically safe and non-intrinsically safe signals can be mixed in a station

Extra functions

Actuator shutdown function of the 4 DQ EEx i modules

The 4 DQ EEx i modules are equipped with a shutdown function. This permits implementation of an external actuator switch-off independent of the automation system (controller).

As soon as the intrinsically safe switch-off signal (High or Low) is present at the actuator switch-off input of the electronic module, its outputs are deactivated.

You can also combine several DQ modules into a switch-off group. The intrinsically safe power supply for the switch-off device is either via the watchdog module or a separate intrinsically safe source.

Ordering data

Digital input modules

Digital input modules EEx i

8 DI NAMUR

For evaluation of NAMUR sensors, connected/non-connected contacts, as well as for recording counter pulses or measuring frequencies

- 8 × NAMUR (NAMUR sensor on/off, NAMUR changeover contact) or connected/non-connected inputs (single/changeover contact)
- 2 channels optionally usable as counters (max. 5 kHz) or frequency meters (1 Hz ... 5 kHz)
- Time tagging 20 ms, rising or falling edge
- Wire-break monitoring
- Short-circuit monitoring
- Sensor power supply monitoring
- Flutter monitoring

Article No.

6ES7131-7RF00-0AB0

Article No.

Digital output modules

Digital output modules EEx i with H-switch-off (external actuator switch-off via H-signal); for switching of solenoid valves, DC relays, signal lamps, actuators

4 DQ DC 23.1 V/20 mA

- 4 channels with 20 mA each
- Short-circuit monitoring
- Wire-break monitoring
- Configurable connection of substitute value in the event of CPU failure
- Load-free switching of outputs via external intrinsically safe signal

6ES7132-7RD01-0AB0

4 DQ DC 17.4 V/27 mA

- 4 channels with 27 mA each or 2 outputs connected in parallel with 54 mA each
- Short-circuit monitoring
- Wire-break monitoring
- Configurable connection of substitute value in the event of CPU failure
- Load-free switching of outputs via external intrinsically safe signal

6ES7132-7RD11-0AB0

Ordering data	Article No.	Terminal modules	Article No.
4 DQ DC 17.4 V/40 mA <ul style="list-style-type: none"> 4 channels with 40 mA each or 2 outputs connected in parallel with 80 mA each Short-circuit monitoring Wire-break monitoring Configurable connection of substitute value in the event of CPU failure Load-free switching of outputs via external intrinsically safe signal 	6ES7132-7RD22-0AB0	ET 200iSP terminal module TM-EM/EM60 For two modules (reserve module, watchdog module and all electronic modules except 2 DQ relays can be plugged in) <ul style="list-style-type: none"> For hazardous environments <ul style="list-style-type: none"> TM-EM/EM60S (blue screw-type terminals) For non-hazardous environments <ul style="list-style-type: none"> TM-EM/EM60C (blue spring-loaded terminals) TM-EM/EM60S (black screw-type terminals) 	6ES7193-7CA00-0AA0 6ES7193-7CA10-0AA0 6ES7193-7CA20-0AA0
Digital output modules EEx i with L-switch-off (external actuator switch-off via L-signal); for switching of solenoid valves, DC relays, signal lamps, actuators		ET 200iSP terminal module TM-RM/RM 60 For two modules (electronic module 2 DQ Relay and reserve module can be plugged in) <ul style="list-style-type: none"> TM-RM/RM60S (screw-type terminals) 	6ES7193-7CB00-0AA0
4 DQ DC 23.1 V/20 mA <ul style="list-style-type: none"> 4 channels with 20 mA each Short-circuit monitoring Wire-break monitoring Configurable connection of substitute value in the event of CPU failure Load-free switching of outputs via external intrinsically safe signal 	6ES7132-7GD00-0AB0	Accessories Reserve module For any electronic module	6ES7138-7AA00-0AA0
4 DQ DC 17.4 V/27 mA <ul style="list-style-type: none"> 4 channels with 27 mA each or 2 outputs connected in parallel with 54 mA each Short-circuit monitoring Wire-break monitoring Configurable connection of substitute value in the event of CPU failure Load-free switching of outputs via external intrinsically safe signal 	6ES7132-7GD10-0AB0	Labeling sheet DIN A4, perforated, each consisting of 10 sheets of 30 strips each for electronic modules and 20 strips each for IM 151 <ul style="list-style-type: none"> Petrol Yellow 	6ES7193-7BH00-0AA0 6ES7193-7BB00-0AA0
4 DQ DC 17.4 V/40 mA <ul style="list-style-type: none"> 4 channels with 40 mA each or 2 outputs connected in parallel with 80 mA each Short-circuit monitoring Wire-break monitoring Configurable connection of substitute value in the event of CPU failure Load-free switching of outputs via external intrinsically safe signal 	6ES7132-7GD21-0AB0	Labels, inscribed For slot numbering, label size H x W (in mm): 5 x 7 <ul style="list-style-type: none"> 204 labels, for slots 1 to 20 204 labels, for slots 1 to 40 	8WA8361-0AB 8WA8361-0AC
4 DQ DC 25.5 V/22 mA¹⁾ <ul style="list-style-type: none"> 4 channels with 22 mA each Short-circuit monitoring Wire-break monitoring Configurable connection of substitute value in the event of CPU failure Load-free switching of outputs via external intrinsically safe signal 	6ES7132-7GD30-0AB0	Labels, blank 136 labels for slot numbering, label size H x W (in mm): 5 x 7	8WA8348-2AY
Digital output modules EEx e For switching of solenoid valves, DC contactors or indicator lights		S7-300 DIN rails <ul style="list-style-type: none"> 585 mm long, suitable for assembly of ET 200iSP in a 650 mm wide wall box 885 mm long, suitable for assembly of ET 200iSP in a 950 mm wide wall box 	6ES7390-1AF85-0AA0 6ES7390-1AJ85-0AA0
2 DQ Relay, 60 V UC, 2 A <ul style="list-style-type: none"> Can be plugged onto TM-RM/RM terminal module Output current up to 2 A with 60 V UC for each of the two relay outputs Installation up to Ex zone 1 Configurable connection of substitute value in the event of CPU failure 	6ES7132-7HB00-0AB0		

¹⁾ Can be used with SIMATIC PCS 7 V7.1+SP2 or higher

I/O systemsSIMATIC ET 200 systems for the control cabinet
SIMATIC ET 200iSP**Digital electronic modules****Technical specifications**

Article number	6ES7131-7RF00-0AB0 ET200iSP, EL-MOD., 8DI, NAMUR
Input current	
Current consumption, typ.	80 mA
from supply voltage L+, max.	90 mA
Digital inputs	
Number of digital inputs	8
Number of NAMUR inputs	8
Input current	
• for signal "0", max. (permissible quiescent current)	1.2 mA
• for signal "1", min.	2.1 mA
Encoder	
Number of connectable encoders, max.	8
Connectable encoders	
• NAMUR encoder	Yes
Interrupts/diagnostics/ status information	
Diagnostics function	Yes
Alarms	
• Diagnostic alarm	Yes; Parameterizable
• Hardware interrupt	No
Diagnoses	
• Diagnostic information readable	Yes
• Short-circuit	Yes; R load < 150 ohms with NAMUR sensor/sensor and NAMUR changeover contact/sensor to DIN 19234
Diagnostics indication LED	
• Group error SF (red)	Yes
• Status indicator digital input (green)	Yes

Article number	6ES7131-7RF00-0AB0 ET200iSP, EL-MOD., 8DI, NAMUR
Integrated Functions	
Frequency measurement	Yes; (Gate time) 50 ms; 200 ms; 1 s
• Number of frequency meters	2
Potential separation	
Potential separation digital inputs	
• between the channels	No
• between the channels and backplane bus	Yes
Standards, approvals, certificates	
CE mark	Yes
Dimensions	
Width	30 mm
Height	129 mm
Depth	136.5 mm
Weights	
Weight, approx.	255 g

Article number	6ES7132-7RD01-0AB0 ET200iSP, EL-MOD., 4DO, DC 23, 1V, 20MA	6ES7132-7RD11-0AB0 ET200iSP, EL-MOD., 4DO, DC 17,4V, 27MA	6ES7132-7RD22-0AB0 ET200iSP, EL-MOD., 4DO, DC 17.4V, 40MA
Input current			
Current consumption, typ.	290 mA	260 mA	380 mA
from load voltage L+ (without load), max.	340 mA; with actuator supply	300 mA	400 mA
from backplane bus 3.3 V DC, max.	10 mA	10 mA	
Digital outputs			
Number of digital outputs	4; additionally 1 intrinsically-safe input for H shutdown	4; additionally 1 intrinsically-safe input for H shutdown	4; additionally 1 intrinsically-safe input for H shutdown
Short-circuit protection	Yes	Yes	Yes
No-load voltage U _{ao} (DC)	23.1 V	17.4 V	17.4 V
Internal resistor R _i	275 Ω	150 Ω	167 Ω
Trend key points E			
• Voltage U _e (DC)	17.6 V	13.3 V	10.7 V
• Current I _e	20 mA	27 mA	40 mA; 80 mA when outputs connected in parallel
Output current			
• for signal "1" rated value	0.02 A	0.027 A	0.04 A
Output delay with resistive load			
• "0" to "1", max.	2 ms	2 ms	2 ms
• "1" to "0", max.	1.5 ms	1.5 ms	1.5 ms
Parallel switching of two outputs			
• for uprating	No; for Ex reasons not possible; nor for predecessor	Yes	Yes
Switching frequency			
• with resistive load, max.	100 Hz	100 Hz	100 Hz
• with inductive load, max.	2 Hz	2 Hz	2 Hz

Technical specifications

Article number	6ES7132-7RD01-0AB0 ET200iSP, EL-MOD., 4DO, DC 23,1V, 20MA	6ES7132-7RD11-0AB0 ET200iSP, EL-MOD., 4DO, DC 17,4V, 27MA	6ES7132-7RD22-0AB0 ET200iSP, EL-MOD., 4DO, DC 17.4V, 40MA
Cable length			
• shielded, max.	500 m	500 m	500 m
• unshielded, max.	500 m	500 m	500 m
Interrupts/diagnostics/ status information			
Status indicator	Yes	Yes	Yes
Alarms		No	
Diagnostics function	Yes	Yes	
Alarms			
• Diagnostic alarm	Yes; Parameterizable	Yes; Parameterizable	Yes; Parameterizable
Diagnoses			
• Diagnostic information readable	Yes	Yes	Yes
• Wire-break	Yes; R > 10 kohms, I < 100 µA	Yes	Yes; R > 10 kohms, I < 100 µA
• Short-circuit	Yes; R < 800 ohms (one output), R < 40 ohms (outputs connected in parallel)	Yes	Yes; R < 80 Ohm (one output), R < 40 Ohm (outputs connected in parallel)
Diagnostics indication LED			
• Group error SF (red)	Yes	Yes	Yes
• Status indicator digital output (green)	Yes	Yes	Yes; Per channel
Ex(i) characteristics			
maximum values for connecting terminals for gas group IIC			
• U _o (no-load voltage), max.			19.4 V
• I _o (short-circuit current), max.			118 mA
• P _o (power output), max.			572 mW
• C _o (permissible external capacity), max.			241 nF; For IIC, 1507 nF for IIB
• L _o (permissible external inductivity), max.			1.7 mH; For IIC, 10.4 mH for IIB
Potential separation			
Potential separation digital outputs			
• between the channels	No	No	No
• between the channels and backplane bus	Yes	Yes	Yes
• Between the channels and load voltage L+	Yes	Yes	Yes
Standards, approvals, certificates			
CE mark			Yes
Highest safety class achievable in safety mode			
• SIL acc. to IEC 61508	No		No
Dimensions			
Width	30 mm	30 mm	30 mm
Height	129 mm	129 mm	129 mm
Depth	136.5 mm	136.5 mm	136.5 mm
Weights			
Weight, approx.	255 g	255 g	255 g

I/O systemsSIMATIC ET 200 systems for the control cabinet
SIMATIC ET 200iSP**Digital electronic modules****Technical specifications**

Article number	6ES7132-7GD00-0AB0 ET200iSP, EL-MOD., 4DO, DC 23,1V, 20MA	6ES7132-7GD10-0AB0 ET200iSP, EL-MOD., 4DO, DC 17,4V, 27MA	6ES7132-7GD21-0AB0 ET200iSP, EL-MOD., 4DO, DC 17,4V, 40MA	6ES7132-7GD30-0AB0 ET200iSP, EL-MOD., 4DO, DC 25.5V, 22MA
Input current				
Current consumption, typ.	290 mA	260 mA	380 mA	380 mA
from load voltage L+ (without load), max.	340 mA; with actuator supply	300 mA; with actuator supply	400 mA	400 mA
from backplane bus 3.3 V DC, max.	10 mA	10 mA		
Digital outputs				
Number of digital outputs	4; additionally 1 intrinsically-safe input for L shutdown	4; additionally 1 intrinsically-safe input for L shutdown	4; additionally 1 intrinsically-safe input for L shutdown	4; additionally 1 intrinsically-safe input for L shutdown
Short-circuit protection	Yes	Yes	Yes	Yes
No-load voltage U _{ao} (DC)	23.1 V	17.4 V	17.4 V	25.5 V
Internal resistor R _i	275 Ω	150 Ω	167 Ω	260 Ω
Trend key points E				
• Voltage U _e (DC)	17.6 V	13.3 V	10.7 V	19.8 V
• Current I _e	20 mA	27 mA; 54 mA when outputs connected in parallel	40 mA	22 mA
Output current				
• for signal "1" rated value	0.02 A	0.027 A	0.04 A	0.022 A
Output delay with resistive load				
• "0" to "1", max.	2 ms	2 ms	2 ms	2 ms
• "1" to "0", max.	1.5 ms	1.5 ms	1.5 ms	1.5 ms
Parallel switching of two outputs				
• for uprating	No; for Ex reasons not possible; nor for predecessor	Yes	Yes	No
Switching frequency				
• with resistive load, max.	100 Hz	100 Hz	100 Hz	100 Hz
• with inductive load, max.	2 Hz	2 Hz	2 Hz	2 Hz
Cable length				
• shielded, max.	500 m	500 m	500 m	500 m
• unshielded, max.	500 m	500 m	500 m	500 m
Interrupts/diagnostics/status information				
Status indicator	Yes	Yes	Yes	Yes
Diagnostics function	Yes	Yes	Yes	Yes
Alarms				
• Diagnostic alarm	Yes; Parameterizable	Yes; Parameterizable	Yes; Parameterizable	Yes; Parameterizable
Diagnoses				
• Diagnostic information readable	Yes	Yes	Yes	Yes
• Wire-break	Yes; R > 10 kohms, I < 100 μA	Yes; R > 10 kohms, I < 100 μA	Yes; R > 10 kohms, I < 100 μA	Yes; R > 10 kohms, I < 100 μA
• Short-circuit	Yes; R < 80 Ohm (one output), R < 40 Ohm (outputs connected in parallel)	Yes; R < 800 ohms (one output), R < 40 ohms (outputs connected in parallel)	Yes; R < 80 Ohm (one output), R < 40 Ohm (outputs connected in parallel)	Yes; R < 80 ohms
Diagnostics indication LED				
• Group error SF (red)	Yes	Yes	Yes	Yes
• Status indicator digital output (green)	Yes	Yes	Yes; Per channel	Yes; Per channel
Ex(i) characteristics				
maximum values for connecting terminals for gas group IIC				
• U _o (no-load voltage), max.			19.4 V	27.9 V
• I _o (short-circuit current), max.			118 mA	110 mA
• P _o (power output), max.			572 mW	764 mW
• C _o (permissible external capacity), max.			241 nF; For IIC, 1507 nF for IIB	81 nF; For IIC, 651 nF for IIB
• L _o (permissible external inductivity), max.			1.7 mH; For IIC, 10.4 mH for IIB	1.7 mH; For IIC, 11.5 mH for IIB

Technical specifications

Article number	6ES7132-7GD00-0AB0 ET200iSP, EL-MOD., 4DO, DC 23,1V, 20MA	6ES7132-7GD10-0AB0 ET200iSP, EL-MOD., 4DO, DC 17,4V, 27MA	6ES7132-7GD21-0AB0 ET200iSP, EL-MOD., 4DO, DC 17,4V, 40MA	6ES7132-7GD30-0AB0 ET200iSP, EL-MOD., 4DO, DC 25.5V, 22MA
Potential separation				
Potential separation digital outputs				
• between the channels	No	No	No	No
• between the channels and backplane bus	Yes	Yes	Yes	Yes
• between the channels and load voltage L+	Yes	Yes	Yes	Yes
Standards, approvals, certificates				
CE mark	Yes	Yes	Yes	Yes
Highest safety class achievable in safety mode				
• SIL acc. to IEC 61508	No	No	No	No
Dimensions				
Width	30 mm	30 mm	30 mm	30 mm
Height	129 mm	129 mm	129 mm	129 mm
Depth	136.5 mm	136.5 mm	136.5 mm	136.5 mm
Weights				
Weight, approx.	255 g	255 g	255 g	255 g
Article number	6ES7193-7CA00-0AA0 ET200iSP, TERM.-MOD. TM-EM/EM60S F. EM	6ES7193-7CA10-0AA0 ET200iSP, TERM.-MOD. TM-EM/EM60C F. EM	6ES7193-7CA20-0AA0 ET200iSP, TERM.-MOD. TM-EM/EM60S F. EM	
Standards, approvals, certificates				
CE mark	Yes	Yes	Yes	
Use in hazardous areas				
• ATEX marking	see ET 200iSP system	see ET 200iSP system		
Dimensions				
Width	60 mm	60 mm	60 mm	
Height	190 mm	190 mm	190 mm	
Depth	52 mm	52 mm	52 mm	
Weights				
Weight, approx.	275 g	275 g	235 g	
Article number	6ES7132-7HB00-0AB0 ET200iSP, RELAY-MOD., 2DO, UC60V, 2A	Article number		6ES7132-7HB00-0AB0 ET200iSP, RELAY-MOD., 2DO, UC60V, 2A
Input current				
Current consumption, typ.	100 mA			
from load voltage L+ (without load), max.	120 mA			
Digital outputs				
Number of digital outputs	2			
Short-circuit protection	No			
Output current				
• for signal "1" rated value	2 A			
Output delay with resistive load				
• "0" to "1", max.	8 ms			
• "1" to "0", max.	3 ms			
Parallel switching of two outputs				
• for uprating	No			
• for redundant control of a load	No			
Switching frequency				
• with resistive load, max.			0.5 Hz; See data in manual	
• with inductive load, max.			0.2 Hz; See data in manual	
Relay outputs				
Switching capacity of contacts				
		- with resistive load, up to 60 °C, max. 2 A; See data in manual		
		- Thermal continuous current, max. 2 A; See data in manual		
Cable length				
		• shielded, max. 500 m		
		• unshielded, max. 500 m		
Interrupts/diagnostics/status information				
		Status indicator Yes		
		Alarms No		
		Substitute values connectable Yes		
Alarms				
		• Diagnostic alarm Yes		
		• Hardware interrupt No		

I/O systems

SIMATIC ET 200 systems for the control cabinet

SIMATIC ET 200iSP

Digital electronic modules**Technical specifications**

Article number	6ES7132-7HB00-0AB0 ET200iSP, RELAY-MOD., 2DO, UC60V, 2A
Diagnoses	
• Diagnostic information readable	Yes
• Wire-break	No; Cannot be determined in contact power circuit
• Short-circuit	No; Cannot be determined in contact power circuit
Diagnostics indication LED	
• Group error SF (red)	Yes
• Status indicator digital output (green)	Yes; Per channel
Ex(i) characteristics	
maximum values for connecting terminals for gas group IIC	
• U _o (no-load voltage), max.	60 V
• U _m (voltage at non-intrinsically safe connecting terminals), max.	250 V
Potential separation	
Potential separation digital outputs	
• between the channels	Yes
• between the channels and backplane bus	Yes
• Between the channels and load voltage L+	Yes; Channels and power bus

Article number	6ES7132-7HB00-0AB0 ET200iSP, RELAY-MOD., 2DO, UC60V, 2A
Standards, approvals, certificates	
CE mark	Yes
Highest safety class achievable in safety mode	
• SIL acc. to IEC 61508	No
Dimensions	
Width	30 mm
Height	129 mm
Depth	136.5 mm
Weights	
Weight, approx.	255 g

Overview



Analog input modules

- 4-channel analog input module AI 2 WIRE HART EEx i for current measurement in the range 4 to 20 mA, suitable for connection of 2-wire transmitters (with/without HART functionality)
 - Resolution 12 bit + sign
 - Max. load of transmitter 750 Ω
 - Short-circuit and wire break monitoring
- 4-channel analog input module AI 4 WIRE HART EEx i for current measurement in the range 0/4 to 20 mA, suitable for connection of 4-wire transmitters (with/without HART functionality)
 - Resolution 12 bit + sign
 - Max. load of transmitter 750 Ω
 - Wire break monitoring

- 4-channel analog input module AI RTD EEx i for resistance measurement and for temperature measurement by Pt100/Ni100 resistance thermometer
 - Resolution 15 bit + sign
 - 2, 3, or 4-wire connection possible
 - Resistance measurements 600 Ω absolute and 1 000 Ω absolute
 - Wire break monitoring
- 4-channel analog input module AI TC EEx i for thermoelectric EMF measurements and for temperature measurement by thermocouple, type B, E, N, J, K, L, S, R, T, U
 - Resolution 15 bit + sign
 - Internal temperature compensation possible using TC sensor module (included in scope of delivery of module)
 - External temperature compensation by means of a temperature value acquired at an analog module of the same ET 200iSP station
 - Wire break monitoring

Analog output modules

- 4-channel analog output module AO I HART EEx i for output of current signals in the range 0/4 to 20 mA to field devices (with/without HART functionality)
 - Resolution 14 bit
 - Parameterizable substitute value in case of CPU failure
 - Short-circuit and wire break monitoring

Extra functions

Temperature compensation

A TC sensor module for internal temperature compensation is provided with the 4 AI TC module, and is fitted on the corresponding terminals of the associated terminal module.

External temperature compensation is possible via a Pt100 on a 4 AI RTD module.

Ordering data

Article No.

Article No.

Analog input modules

Analog input modules EEx i

4 AI I 2 WIRE HART

For measuring currents with 2-wire transmitters with/without HART functionality

- 4 × 4 ... 20 mA, HART, 2-wire transmitter
- Transmitter load: max. 750 Ω
- Resolution 12 bit + sign
- Short-circuit monitoring
- Wire-break monitoring

6ES7134-7TD00-0AB0

4 AI I 4 WIRE HART

For measuring currents with 4-wire transmitters with/without HART functionality

- 4 × 0/4 ... 20 mA, HART, 4-wire transmitter
- Transmitter load: max. 750 Ω
- Resolution 12 bit + sign
- Wire-break monitoring

6ES7134-7TD50-0AB0

4 AI RTD

For measuring resistances as well as for temperature measurements with resistance thermometers

- 4 × RTD, resistance thermometer Pt100/Ni100
- 2, 3, 4-wire
- Resolution 15 bit + sign
- Short-circuit monitoring
- Wire-break monitoring

6ES7134-7SD51-0AB0

4 AI TC

For thermoelectric EMF measurements as well as for temperature measurements with thermocouples

- 4 × TC (thermocouples)
- Type B [PtRh-PtRh]
- Type N [NiCrSi-NiSi]
- Type E [NiCr-CuNi]
- Type R [PtRh-Pt]
- Type S [PtPh-Pt]
- Type J [Fe-CuNi]
- Type L [Fe-CuNi]
- Type T [Cu-CuNi]
- Type K [NiCr-Ni]
- Type U [Cu-CuNi]
- Resolution 15 bit + sign
- Internal compensation of reference junction temperature possible using TC sensor module (included in scope of supply of module)
- External temperature compensation via Pt100, connected to RTD module of same ET 200iSP station
- Wire-break monitoring

6ES7134-7SD00-0AB0

I/O systems

SIMATIC ET 200 systems for the control cabinet
SIMATIC ET 200iSP

Analog electronic modules

Ordering data	Article No.	Article No.
Analog output modules		
Analog output modules EEx i		
4 AO I HART For output of currents to field devices with/without HART functionality <ul style="list-style-type: none"> 4 × 0/4 ... 20 mA, HART (max. load 750 Ω) Resolution 14-bit Short-circuit monitoring Wire-break monitoring Parameterizable substitute value in case of CPU failure 	6ES7135-7TD00-0AB0	
Terminal modules		
ET 200iSP terminal module TM-EM/EM60 For two modules (reserve module, watchdog module and all electronic modules except 2 DQ relays can be plugged in) <ul style="list-style-type: none"> For hazardous environments <ul style="list-style-type: none"> TM-EM/EM60S (blue screw-type terminals) TM-EM/EM60C (blue spring-loaded terminals) For non-hazardous environments <ul style="list-style-type: none"> TM-EM/EM60S (black screw-type terminals) 	6ES7193-7CA00-0AA0 6ES7193-7CA10-0AA0 6ES7193-7CA20-0AA0	
Accessories		
Reserve module For any electronic module		6ES7138-7AA00-0AA0
Labeling sheet DIN A4, perforated, each consisting of 10 sheets of 30 strips each for electronic modules and 20 strips each for IM 151 <ul style="list-style-type: none"> Petrol Yellow 		6ES7193-7BH00-0AA0 6ES7193-7BB00-0AA0
Labels, inscribed For slot numbering, label size H × W (in mm): 5 × 7 <ul style="list-style-type: none"> 204 labels, for slots 1 to 20 204 labels, for slots 1 to 40 		8WA8361-0AB 8WA8361-0AC
Labels, blank 136 labels for slot numbering, label size H × W (in mm): 5 × 7		8WA8348-2AY
S7-300 DIN rails <ul style="list-style-type: none"> 585 mm long, suitable for assembly of ET 200iSP in a 650 mm wide wall box 885 mm long, suitable for assembly of ET 200iSP in a 950 mm wide wall box 		6ES7390-1AF85-0AA0 6ES7390-1AJ85-0AA0

Technical specifications

Article number	6ES7134-7SD00-0AB0	6ES7134-7SD51-0AB0	6ES7134-7TD00-0AB0	6ES7134-7TD50-0AB0
	ET200iSP, EL-MOD., 4 AI TC	ET200iSP, EL-MOD., 4 AI RTD, PT100/NI100	ET200iSP, EL-MOD., 4 AI, HART, 2-WIRE	ET200iSP, EL-MOD., 4 AI, HART, 4-WIRE
Input current				
Current consumption, typ.	17 mA	19 mA	280 mA	27 mA
from supply voltage L+, max.	30 mA	22 mA	320 mA	30 mA
Output voltage				
Supply voltage of the transmitters <ul style="list-style-type: none"> short-circuit proof Supply current, max. 			Yes 23 mA; per channel	
Analog inputs				
Number of analog inputs	4	4	4	4
permissible input current for current input (destruction limit), max.			90 mA	50 mA
Cycle time (all channels) max.	320 ms; 66 ms basic conversion time x 4 channels with interference frequency suppression 60 Hz, 80 ms basic conversion time x 4 channels with interference frequency suppression 50 Hz	320 ms; 66 ms basic conversion time x 4 channels with interference frequency suppression 60 Hz, 80 ms basic conversion time x 4 channels with interference frequency suppression 50 Hz	120 ms; 30 ms basic conversion time x4 channels with 60 Hz, 50 Hz interference frequency suppression	120 ms; 30 ms basic conversion time x4 channels with 60 Hz, 50 Hz interference frequency suppression
Technical unit for temperature measurement adjustable	Yes	Yes	Yes	Yes
Input ranges (rated values), voltages <ul style="list-style-type: none"> -80 mV to +80 mV 	Yes			
Input ranges (rated values), currents <ul style="list-style-type: none"> 4 mA to 20 mA 			Yes	Yes

Technical specifications

Article number	6ES7134-7SD00-0AB0 ET200iSP, EL-MOD., 4 AI TC	6ES7134-7SD51-0AB0 ET200iSP, EL-MOD., 4 AI RTD, PT100/Ni100	6ES7134-7TD00-0AB0 ET200iSP, EL-MOD., 4 AI, HART, 2-WIRE	6ES7134-7TD50-0AB0 ET200iSP, EL-MOD., 4 AI, HART, 4-WIRE
Input ranges (rated values), thermocouples				
• Type B	Yes			
• Type C	Yes			
• Type E	Yes			
• Type J	Yes			
• Type K	Yes			
• Type L	Yes			
• Type N	Yes			
• Type R	Yes			
• Type S	Yes			
• Type T	Yes			
• Type U	Yes			
Input ranges (rated values), resistance thermometer				
• Ni 100		Yes		
• Pt 100		Yes		
Input ranges (rated values), resistors				
• 0 to 600 ohms		Yes; also 1 000 ohms		
Thermocouple (TC)				
Temperature compensation				
- internal temperature compensation	Yes; via supplied TC sensor module			
- external temperature compensation with compensations socket	Yes; via temperature value, acquired by an analog module of the same ET 200iSP station			
Characteristic linearization				
• parameterizable	Yes	Yes		
- for thermocouples	Yes			
- for resistance thermometer		Yes		
Cable length				
• shielded, max.	50 m	500 m	500 m	500 m
Analog value generation for the inputs				
Measurement principle	integrating (Sigma-Delta)	integrating (Sigma-Delta)	integrating (Sigma-Delta)	integrating (Sigma-Delta)
Integration and conversion time/resolution per channel				
• Resolution with overrange (bit including sign), max.	16 bit	16 bit	13 bit	12 bit; + sign
• Integration time, parameterizable	Yes	Yes	No	Yes
• Basic conversion time, including integration time (ms)	80 ms at 50 Hz; 66 ms at 60 Hz	80 ms at 50 Hz; 66 ms at 60 Hz		30 ms
• Interference voltage suppression for interference frequency f1 in Hz	50 / 60 Hz	50 / 60 Hz	50 / 60 Hz	50 / 60 Hz
Smoothing of measured values				
• parameterizable	Yes; in 4 stages	Yes; in 4 stages	Yes; in 4 stages	Yes; in 4 stages
Encoder				
Connection of signal encoders				
• for current measurement as 2-wire transducer			Yes	
- Burden of 2-wire transmitter, max.			750 Ω	
• for current measurement as 4-wire transducer				Yes
• for resistance measurement with two-wire connection		Yes		
• for resistance measurement with three-wire connection		Yes		
• for resistance measurement with four-wire connection		Yes		

I/O systems

SIMATIC ET 200 systems for the control cabinet

SIMATIC ET 200iSP

Analog electronic modules**Technical specifications**

Article number	6ES7134-7SD00-0AB0 ET200iSP, EL-MOD., 4 AI TC	6ES7134-7SD51-0AB0 ET200iSP, EL-MOD., 4 AI RTD, PT100/NI100	6ES7134-7TD00-0AB0 ET200iSP, EL-MOD., 4 AI, HART, 2-WIRE	6ES7134-7TD50-0AB0 ET200iSP, EL-MOD., 4 AI, HART, 4-WIRE
Errors/accuracies				
Linearity error (relative to input range), (+/-)	0.015 %	0.015 %	0.015 %	0.015 %
Temperature error (relative to input range), (+/-)	0.02 %/K	0.02 %/K	0.005 %/K	0.005 %/K
Crosstalk between the inputs, min.	-50 dB	-50 dB	-50 dB	-50 dB
Repeat accuracy in steady state at 25 °C (relative to input range), (+/-)	0.01 %	0.01 %	0.01 %	0.01 %
Operational error limit in overall temperature range				
<ul style="list-style-type: none"> Voltage, relative to input range, (+/-) Current, relative to input range, (+/-) Resistance thermometer, relative to input range, (+/-) 	0.15 %	0.15 %; Applies to resistances standard ± 0.8 K, climatic ± 0.3 K	0.15 %	0.15 %
Basic error limit (operational limit at 25 °C)				
<ul style="list-style-type: none"> Voltage, relative to input range, (+/-) Current, relative to input range, (+/-) Resistance thermometer, relative to input range, (+/-) 	0.1 %	0.1 %; Applies to resistances standard ± 0.5 K, climatic ± 0.2 K	0.1 %	0.1 %
Interference voltage suppression for $f = n \times (f1 \pm 1 \%)$, $f1 =$ interference frequency				
<ul style="list-style-type: none"> Series mode interference (peak value of interference < rated value of input range), min. Common mode interference, min. 	70 dB 90 dB	70 dB 90 dB	70 dB	70 dB
Interrupts/diagnostics/status information				
Alarms				
<ul style="list-style-type: none"> Diagnostic alarm Limit value alarm 	Yes; Parameterizable Yes; Parameterizable	Yes Yes	Yes; Parameterizable Yes; Parameterizable	Yes; Parameterizable Yes; Parameterizable
Diagnoses				
<ul style="list-style-type: none"> Diagnostic information readable Wire-break Short-circuit Group error 	Yes	Yes Yes Yes Yes	Yes Yes Yes	Yes Yes
Diagnostics indication LED				
<ul style="list-style-type: none"> Group error SF (red) 	Yes	Yes	Yes	Yes
Potential separation				
Potential separation analog inputs				
<ul style="list-style-type: none"> between the channels between the channels and backplane bus Between the channels and load voltage L+ 	Yes; Functional Yes	No Yes Yes; Channels and power bus	No Yes	No Yes
Standards, approvals, certificates				
CE mark	Yes	Yes	Yes	Yes
Highest safety class achievable in safety mode				
<ul style="list-style-type: none"> Performance level according to ISO 13849-1 SIL acc. to IEC 61508 	none No	none No	none No	none No

Technical specifications

Article number	6ES7134-7SD00-0AB0	6ES7134-7SD51-0AB0	6ES7134-7TD00-0AB0	6ES7134-7TD50-0AB0
	ET200iSP, EL-MOD., 4 AI TC	ET200iSP, EL-MOD., 4 AI RTD, PT100/Ni100	ET200iSP, EL-MOD., 4 AI, HART, 2-WIRE	ET200iSP, EL-MOD., 4 AI, HART, 4-WIRE
Dimensions				
Width	30 mm	30 mm	30 mm	30 mm
Height	129 mm	129 mm	129 mm	129 mm
Depth	136.5 mm	136.5 mm	136.5 mm	136.5 mm
Weights				
Weight, approx.	230 g	230 g	230 g	230 g
Technical specifications for 6ES7135-7TD00-0AB0				
Article number	6ES7135-7TD00-0AB0	Article number		6ES7135-7TD00-0AB0
	ET200iSP, EL-MOD., 4 AO, 4-20MA, HART			ET200iSP, EL-MOD., 4 AO, 4-20MA, HART
Input current				
Current consumption, typ.	295 mA	Operational error limit in overall temperature range		0.15 %
from load voltage L+ (without load), max.	330 mA	• Current, relative to output range, (+/-)		
Analog outputs				
Number of analog outputs	4	Basic error limit (operational limit at 25 °C)		0.1 %
Cycle time (all channels) max.	3.6 ms	• Current, relative to output range, (+/-)		
Output ranges, current				
• 0 to 20 mA	Yes	Interrupts/diagnostics/status information		
• 4 mA to 20 mA	Yes	Substitute values connectable		Yes
Connection of actuators				
• for current output two-wire connection	Yes	Alarms		
Load impedance (in rated range of output)				
• with current outputs, max.	750 Ω	• Diagnostic alarm		Yes
Cable length				
• shielded, max.	500 m	Diagnoses		
Analog value generation for the outputs				
• Diagnostic information readable				
Integration and conversion time/resolution per channel				
• Resolution with overrange (bit including sign), max.	14 bit	• Wire-break		Yes
Settling time				
• for resistive load	4 ms	• Short-circuit		Yes
• for capacitive load	40 ms	Diagnostics indication LED		
• for inductive load	40 ms	• Group error SF (red)		Yes
Errors/accuracies				
Linearity error (relative to output range), (+/-)	0.015 %	Potential separation		
Temperature error (relative to output range), (+/-)	0.005 %/K	Potential separation analog outputs		
Crosstalk between the outputs, min.	-50 dB	• between the channels		No
Repeat accuracy in steady state at 25 °C (relative to output range), (+/-)	0.01 %	• between the channels and backplane bus		Yes
Standards, approvals, certificates				
CE mark				
Yes				
Dimensions				
Width				
30 mm				
Height				
129 mm				
Depth				
136.5 mm				
Weights				
Weight, approx.				
265 g				

I/O systems

SIMATIC ET 200 systems for the control cabinet
SIMATIC ET 200iSP

Safety-related electronic modules

Overview



The electronic modules of the SIMATIC ET 200iSP distributed I/O system equipped with safety functions can be used together with the safety-related automation systems (controllers) for the implementation of safety applications. The input modules record the process signals, evaluate them, and prepare them for additional processing by the automation system. The output modules convert the safety-related signals output by the automation systems so that they are suitable for controlling the connected actuators.

F digital input modules

- 8 F-DI Ex NAMUR
 - Safety-related digital input module for evaluating the signals from IEC 60947-5-6/NAMUR sensors and connected/non-connected mechanical contacts in hazardous and non-hazardous areas
 - SIL3/Cat.3/PLe with 8 inputs (1-channel/1oo1 evaluation) or 4 inputs (2-channel/1oo2 evaluation)
 - 8 short-circuit-proof sensor supplies (8 V DC) for 1-channel each
 - Inputs and sensor supplies electrically isolated from power bus and backplane bus
 - Diagnostics evaluation (deactivated for non-connected mechanical contacts)
 - Internal diagnostics buffer
 - Programmable diagnostics interrupt
 - Supports time stamping
 - Channel-selective passivation
 - Firmware update using HW Config possible
 - Exclusively for safety mode
 - LED displays for safety mode, group errors and channel status/fault

F digital output modules

- 4 F-DO Ex DC 17.4 V/40 mA
 - Safety-related digital output module for controlling actuators in hazardous and non-hazardous areas, e.g. solenoid valves, DC current relays or indicator lamps
 - SIL3/Cat.3/PLe with 4 outputs, switching to P/P potential
 - Electrical isolation from power bus and backplane bus
 - Rated load voltage 17.4 V DC
 - Max. output current 40 mA
 - Performance enhancement through parallel connection of two digital outputs for one actuator
 - Short-circuit, overload and wire-break monitoring
 - Configurable diagnostics
 - Internal diagnostics buffer
 - Programmable diagnostics interrupt
 - Channel-selective passivation
 - Firmware update using HW Config possible
 - Exclusively for safety mode
 - LED displays for safety mode, group errors and channel status/fault

F analog input modules

- 4 F-AI Ex HART (0 ... 20 mA or 4 ... 20 mA)
 - Safety-related digital input module for evaluating the signals from current sensors in hazardous and non-hazardous areas, e.g. 2-wire transmitters and HART field devices
 - SIL3/Cat.3/PLe with 4 inputs of one module (1-channel/1oo1 evaluation) or 4 inputs of two modules (2-channel/1oo2 evaluation)
 - Measuring ranges: 0 ... 20 mA or 4 ... 20 mA
 - Resolution 15 bit + sign
 - HART communication in measuring range 4 ... 20 mA
 - 4 short-circuit-proof sensor supplies (min. 12 V DC; max. 26 V DC) for 1-channel each
 - Inputs and sensor supplies electrically isolated from backplane bus
 - Configurable diagnostics
 - Programmable diagnostics interrupt
 - Internal diagnostics buffer
 - Firmware update using HW Config possible
 - Exclusively for safety mode
 - LED displays for safety mode, group errors, channel faults and HART status per channel

Ordering data	Article No.	Article No.
Safety-oriented electronic modules		
<u>F-digital input modules</u>		
8 F-DI Ex NAMUR For evaluating the signals from IEC 60947-5-6/NAMUR sensors and connected/non-connected mechanical contacts in hazardous and non-hazardous areas <ul style="list-style-type: none"> • SIL3/Cat.3/PLe with 8 inputs (1-channel/1oo1 evaluation) or 4 inputs (2-channel/1oo2 evaluation) 	6ES7138-7FN00-0AB0	
<u>F-digital output modules</u>		
4 F-DO Ex 17.4 V DC/40 mA For controlling actuators in hazardous and non-hazardous areas, e.g. solenoid valves, DC current relays or indicator lamps <ul style="list-style-type: none"> • SIL3/Cat.3/PLe with 4 outputs, switching to P/P potential 	6ES7138-7FD00-0AB0	
<u>F-analog input modules</u>		
4 F-AI Ex HART (0 ... 20 mA or 4 ... 20 mA) For evaluating the signals from current sensors in hazardous and non-hazardous areas, e.g. 2-wire transmitters and HART field devices <ul style="list-style-type: none"> • SIL3/Cat.3/PLe with 4 inputs of one module (1-channel/1oo1 evaluation) or 4 inputs of two modules (2-channel/1oo2 evaluation) • Resolution 15 bit + sign • HART communication in measuring range 4 ... 20 mA 	6ES7138-7FA00-0AB0	
		Terminal modules
		ET 200iSP terminal module TM-EM/EM60 For two modules (reserve module, watchdog module and all electronic modules except 2 DQ relays can be plugged in) <ul style="list-style-type: none"> • For hazardous environments <ul style="list-style-type: none"> - TM-EM/EM60S (blue screw-type terminals) - TM-EM/EM60C (blue spring-loaded terminals) • For non-hazardous environments <ul style="list-style-type: none"> - TM-EM/EM60S (black screw-type terminals)
		Accessories
		Reserve module For any electronic module
		Labeling sheet DIN A4, perforated, each consisting of 10 sheets of 30 strips each for electronic modules and 20 strips each for IM 151 <ul style="list-style-type: none"> • Petrol • Yellow
		Labels, inscribed For slot numbering, label size H x W (in mm): 5 x 7 <ul style="list-style-type: none"> • 204 labels, for slots 1 to 20 • 204 labels, for slots 1 to 40
		Labels, blank 136 labels for slot numbering, label size H x W (in mm): 5 x 7
		S7-300 DIN rails <ul style="list-style-type: none"> • 585 mm long, suitable for assembly of ET 200iSP in a 650 mm wide wall box • 885 mm long, suitable for assembly of ET 200iSP in a 950 mm wide wall box

I/O systemsSIMATIC ET 200 systems for the control cabinet
SIMATIC ET 200iSP**Safety-related electronic modules****Technical specifications**

Article number	6ES7138-7FN00-0AB0 ET200iSP, 8F-DI NAMUR EX, FAILSAFE
Input current	
Current consumption, typ. from supply voltage L+, max.	145 mA 150 mA; int. Powerbus
Encoder supply	
Number of outputs	8
Type of output voltage	8 V DC
Digital inputs	
Number of digital inputs	8
Number of NAMUR inputs	8
Input current	
• for signal "0", max. (permissible quiescent current)	1.2 mA
• for signal "1", min.	2.1 mA
• for signal "1", typ.	9.5 mA
Encoder	
Number of connectable encoders, max.	8
Connectable encoders	
• NAMUR encoder	Yes
Interrupts/diagnostics/ status information	
Status indicator	Yes
Diagnostics function	Yes
Alarms	
• Diagnostic alarm	Yes; Parameterizable
• Hardware interrupt	No
Diagnoses	
• Diagnostic information readable	Yes
• Wire-break	Yes; NAMUR encoders or single contact with 10 kOhm parallel resistor
• Short-circuit	Yes; R load < 150 ohms with NAMUR sensor/sensor and NAMUR changeover contact/sensor to DIN 19234
Diagnostics indication LED	
• Group error SF (red)	Yes
Potential separation	
Potential separation digital inputs	
• between the channels	No
• between the channels and backplane bus	Yes
Standards, approvals, certificates	
CE mark	Yes
Highest safety class achievable in safety mode	
• Performance level according to ISO 13849-1	PLe
• SIL acc. to IEC 61508	SIL 3
Dimensions	
Width	30 mm
Height	129 mm
Depth	136.5 mm
Weights	
Weight, approx.	288 g

Article number	6ES7138-7FD00-0AB0 ET200iSP, 4F-DO 40MA EX, FAILSAFE
Input current	
Current consumption, typ. from load voltage L+ (without load), max.	340 mA 510 mA; int. Powerbus
Digital outputs	
Number of digital outputs	4
Short-circuit protection	Yes
Controlling a digital input	No
No-load voltage U _{ao} (DC)	17.4 V
Internal resistor R _i	167 Ω
Load resistance range	
• lower limit	270 Ω
• upper limit	18 kΩ
Trend key points E	
• Voltage U _e (DC)	10.7 V
• Current I _e	40 mA
Output voltage	
• for signal "1", max.	17.4 V
Output current	
• for signal "0" residual current, max.	10 μA
Parallel switching of two outputs	
• for uprating	Yes
• for redundant control of a load	No
Switching frequency	
• with resistive load, max.	30 Hz
• with inductive load, max.	2 Hz
Cable length	
• shielded, max.	500 m
• unshielded, max.	500 m
Interrupts/diagnostics/ status information	
Status indicator	Yes
Substitute values connectable	Yes
Alarms	
• Diagnostic alarm	Yes; Parameterizable
Diagnoses	
• Diagnostic information readable	Yes
• Wire-break	Yes
• Short-circuit	Yes
Diagnostics indication LED	
• Group error SF (red)	Yes
• Status indicator digital output (green)	Yes
Potential separation	
Potential separation digital outputs	
• between the channels	No
• between the channels and backplane bus	Yes
• Between the channels and load voltage L+	Yes

Technical specifications

Article number	6ES7138-7FD00-0AB0 ET200iSP, 4F-DO 40MA EX, FAILSAFE
Standards, approvals, certificates	
CE mark	Yes
Highest safety class achievable in safety mode	
• Performance level according to ISO 13849-1	PLe
• SIL acc. to IEC 61508	SIL 3
Dimensions	
Width	30 mm
Height	129 mm
Depth	136.5 mm
Weights	
Weight, approx.	285 g
Article number	6ES7138-7FA00-0AB0 ET200iSP, 4F-AI HART EX, FAILSAFE
Input current	
Current consumption, typ. from supply voltage L+, max.	315 mA 490 mA; int. Powerbus
Output voltage	
Supply voltage of the transmitters	
• short-circuit proof	Yes
• Supply current, max.	25 mA; Plus 4 mA per channel
Analog inputs	
Number of analog inputs	4
Cycle time (all channels) max.	See data in manual
Input ranges (rated values), currents	
• 0 to 20 mA	Yes
• 4 mA to 20 mA	Yes
Cable length	
• shielded, max.	500 m
Analog value generation for the inputs	
Measurement principle	integrating (Sigma-Delta)
Integration and conversion time/resolution per channel	
• Resolution with overrange (bit including sign), max.	16 bit
• Integration time, parameterizable	Yes
• Interference voltage suppression for interference frequency f1 in Hz	50 / 60 Hz
Smoothing of measured values	
• parameterizable	Yes; in 4 stages
Encoder	
Connection of signal encoders	
• for current measurement as 2-wire transducer	Yes
- Burden of 2-wire transmitter, max.	750 Ω

Article number	6ES7138-7FA00-0AB0 ET200iSP, 4F-AI HART EX, FAILSAFE
Errors/accuracies	
Linearity error (relative to input range), (+/-)	0.015 %
Temperature error (relative to input range), (+/-)	0.005 %/K
Crosstalk between the inputs, min.	-50 dB
Repeat accuracy in steady state at 25 °C (relative to input range), (+/-)	0.015 %
Operational error limit in overall temperature range	
• Current, relative to input range, (+/-)	0.35 %
Basic error limit (operational limit at 25 °C)	
• Current, relative to input range, (+/-)	0.1 %
Interference voltage suppression for $f = n \times (f1 \pm 1 \%)$, f1 = interference frequency	
• Series mode interference (peak value of interference < rated value of input range), min.	40 dB
• Common mode interference, min.	50 dB
Interrupts/diagnostics/status information	
Alarms	
• Diagnostic alarm	Yes; Parameterizable
Diagnoses	
• Diagnostic information readable	Yes
• Wire-break	Yes
• Short-circuit	Yes
Diagnostics indication LED	
• Group error SF (red)	Yes
Potential separation	
Potential separation analog inputs	
• between the channels	No
• between the channels and backplane bus	Yes
• Between the channels and load voltage L+	Yes; Power bus
Standards, approvals, certificates	
CE mark	Yes
Highest safety class achievable in safety mode	
• Performance level according to ISO 13849-1	PLe
• SIL acc. to IEC 61508	SIL 3
Dimensions	
Width	30 mm
Height	129 mm
Depth	136.5 mm
Weights	
Weight, approx.	299 g

I/O systems

SIMATIC ET 200 systems for the control cabinet
SIMATIC ET 200iSP

Watchdog module

Overview



The watchdog module has two fundamental functions:

- Monitoring of the ET 200iSP remote I/O station for hardware failures (hardware lifebeat); external, applicative failure monitoring is also possible via an I/O address area of the module
- Intrinsically-safe power supply for external actuator switch-off

The watchdog module must be plugged onto a terminal module (order separately). The following terminal modules are suitable for this:

- TM-IM/EM60 terminal modules for one interface module and one watchdog, reserve or electronics module (for versions, see Interface module section)
- TM-EM/EM60 terminal modules with two slots for watchdog module, reserve module or electronics modules (except 2 DO relay):
 - with blue screw-type or spring-loaded terminals for hazardous environments
 - with black screw-type terminals for non-hazardous environments

The first slot directly next to the interface module is provided for the watchdog module.

Ordering data

Article No.

Watchdog module

Watchdog module

For failure monitoring and for the intrinsically safe power supply of an external actuator switch-off

6ES7138-7BB00-0AB0

Terminal modules

ET 200iSP terminal module

TM-EM/EM60

For two modules (reserve module, watchdog module and all electronic modules except 2 DQ relays can be plugged in)

- For hazardous environments
 - TM-EM/EM60S (blue screw-type terminals)
 - TM-EM/EM60C (blue spring-loaded terminals)
- For non-hazardous environments
 - TM-EM/EM60S (black screw-type terminals)

6ES7193-7CA00-0AA0

6ES7193-7CA10-0AA0

6ES7193-7CA20-0AA0

Accessories

Labeling sheet

DIN A4, perforated, each consisting of 10 sheets of 30 strips each for electronic modules and 20 strips each for IM 151

- Petrol
- Yellow

6ES7193-7BH00-0AA0

6ES7193-7BB00-0AA0

Labels, inscribed

For slot numbering, label size H x W (in mm): 5 x 7

- 204 labels, for slots 1 to 20
- 204 labels, for slots 1 to 40

8WA8361-0AB

8WA8361-0AC

Labels, blank

136 labels for slot numbering, label size H x W (in mm): 5 x 7

8WA8348-2AY

Technical specifications

Article number	6ES7138-7BB00-0AB0
	ET 200iSP, WATCHDOG MOD.
Digital inputs	
Number of digital inputs	0
Dimensions	
Width	30 mm
Height	129 mm
Depth	136.5 mm

Overview



Tasks of the RS 485-iS coupler

- Conversion of the electrical PROFIBUS DP RS 485 transmission technology into the intrinsically-safe RS 485-iS transmission technology with a transmission rate of 1.5 Mbps
- Required to connect intrinsically-safe PROFIBUS DP stations, e.g. ET 200iSP or devices from other vendors with Ex i DP connection
- Acts as a safety barrier
- Additional use as a repeater in the hazardous area
- Passive bus station (no configuration necessary)
- Certified according to ATEX 100a

Ordering data

Ordering data	Article No.
RS 485-iS coupler Isolating transformer for connection of PROFIBUS DP segments with RS 485 and RS 485-iS transmission systems	6ES7972-0AC80-0XA0
Accessories	
PROFIBUS connection plug with selectable terminating resistor For connection of IM 152 to PROFIBUS DP with RS 485-iS transmission technology	6ES7972-0DA60-0XA0
S7-300 DIN rails Lengths: • 160 mm • 482 mm • 530 mm • 830 mm • 2 000 mm	6ES7390-1AB60-0AA0 6ES7390-1AE80-0AA0 6ES7390-1AF30-0AA0 6ES7390-1AJ30-0AA0 6ES7390-1BC00-0AA0

Ordering data	Article No.
PROFIBUS FastConnect Standard Cable, violet Standard type with special design for fast mounting, 2-wire, shielded, cut-to-length Specify length in m Max. delivery unit 1 000 m, minimum order quantity 20 m Preferred lengths - 20 m - 50 m - 100 m - 200 m - 500 m - 1 000 m	6XV1830-0EH10 6XV1830-0EN20 6XV1830-0EN50 6XV1830-0ET10 6XV1830-0ET20 6XV1830-0ET50 6XV1830-0EU10
PROFIBUS FastConnect Standard Cable IS GP, blue Cable type for use in potentially explosive atmospheres, with special design for fast mounting, 2-wire, shielded, cut-to-length Specify length in m Max. delivery unit 1 000 m, minimum order quantity 20 m	6XV1831-2A

Technical specifications

Technical specifications - RS 485-iS coupler

Dimensions and weight

Dimensions W x H x D (mm)	80 x 125 x 130
Weight	Approx. 500 g

Technical data - General

Degree of protection	IP20
Ambient temperature	- 20 ... + 60 °C

I/O systemsSIMATIC ET 200 systems for the control cabinet
SIMATIC ET 200iSP**RS 485-iS coupler****Technical specifications****Technical specifications - RS 485-iS coupler****Standards and approvals**

• PROFIBUS	IEC 61784-1:2002 Ed1 CP 3/1
• EU directive	94/9/EG (ATEX 100a)
• CENELEC	II 3 (2) G EEx nA[ib] IIC T4
• UL and CSA	Class I, Division2, Group A, B, C, D T4 Class I Zone 2, Group IIC T4 AIS Class I, Division 1, Group A, B, C, D [Aexib] IIC, Class I, Zone1, 2, Group IIC
• FM	Class I, Division2, Group A, B, C, D T4 Class I Zone 2, Group IIC T4 AIS Class I, Division 1, Group A, B, C, D [Aexib] IIC, Class I, Zone1, 2, Group IIC
• IEC	IEC61131-2, Part 2
• CE	Conforming with 89/336/EWG Conforming with 73/23/EWG
• Ship-building certification	Classification companies <ul style="list-style-type: none"> • ABS (American Bureau of Shipping) • BV (Bureau Veritas) • DNV (Det Norske Veritas) • GL (Germanischer Lloyd) • LRD (Lloyds Register of Shipping) • Class NK (Nippon Kaiji Kyokai)

Module-Specific Specifications

Transmission rate on PROFIBUS DP, PROFIBUS RS 485-iS	9.6; 19.2; 45.45; 93.75; 187.5; 500 kbps 1.5 Mbps
Bus-Protocol	PROFIBUS DP

Voltages, Currents, Potentials

Rated supply voltage of RS 485-iS coupler	24 V DC (20.4 ... 28.8 V)
• Polarity reversal protection	Yes
• Voltage drop bypass	Min. 5 ms

Electrical isolation of 24 V power supply

• to PROFIBUS DP	Yes
- tested with	500 V DC
• to PROFIBUS RS 485-iS	Yes
- tested with	AC 500 V

Current consumption RS 485-iS coupler (24 V DC), max. 150 mA

Power loss of the module, typically 3 Watts

Status, alarms, diagnostics

Status display	no
Alarms	None
Diagnostic functions	Yes
• Bus monitoring PROFIBUS DP (primary)	Yellow LED "DP1"
• Bus monitoring PROFIBUS RS 485-iS (secondary)	Yellow LED "DP2"
• Monitoring 24 V power supply	Green LED "ON"

Technical safety notice

V_{DC}	± 4.2 V
I_{SC}	± 93 mA
P_0	0.1 Watts
V_{max}	± 4.2 V
L_l	0
C_i	0
U_m	AC 250 V
T_a	-25 ... +60 °C

RS 485-iS segment

permitted cable length on a single line	RS 485-iS	DP Ex i
• 9.6 to 187.5 Kbps	1 000 m	200 m
• 500 kbit/s	400 m	200 m
• 1.5 Mbps	200 m	200 m
Number of PROFIBUS DP nodes that can be connected, max.	31	16
PROFIBUS RS 485-iS bus terminator switch	integrated, can be added	

Design



ET 200iSP modules can also be installed in stainless steel wall enclosures designed to meet more exacting degree of protection requirements. The enclosures are available in various sizes. They comply with degree of protection IP65 and can be used in Ex zones 1 and 21.

Delivery can be an empty enclosure or include components, depending on the order.

Send your request to:
cabinets.industry@siemens.com

Ordering data

Stainless steel enclosure IP65 for SIMATIC ET 200iSP	6DL2804-	■	■	■	■	■
I/O enclosure						
Surface casing in stainless steel, max. IP66, with mounting plate and equipotential bonding rail, empty enclosure for installation of ET 200iSP components ¹⁾	0					
I/O device consisting of surface casing with installed ET 200iSP components ²⁾	1					
I/O device consisting of surface casing with installed ET 200iSP and pneumatic components ²⁾	2					
Device group						
Device group II, up to zone 1 (including zone 2)	A					
Device group II, up to zone 21 (including zone 22)	D					
Enclosure dimensions W x H x D (in mm)						
650 x 450 x 230, for 15 ET 200iSP modules in non-redundant configuration	D					
950 x 450 x 230, for 25 ET 200iSP modules in non-redundant configuration	E					
800 x 800 x 300, for 2 rows with max. 30 ET 200iSP modules	K					
1000 x 1000 x 300, for 2 rows with max. 42 ET 200iSP modules	T					
1 000 x 1 200 x 300, for 2 rows with max. 42 ET 200iSP modules	U					
Cable entries/number						
M16 cable entries for signals, 3 rows, 39 or 66 units ³⁾ , 2 x M32 for supply voltage, 4 x M20 for bus cables	3					
M20 cable entries for signals, 3 rows, 36 or 57 units ³⁾ , 2 x M32 for supply voltage, 4 x M20 for bus cables	4					
M16 cable entries for signals, 5 rows, 65 or 110 units ³⁾ , 2 x M32 for supply voltage, 4 x M20 for bus cables	5					
M20 cable entries for signals, 5 rows, 60 or 95 units ³⁾ , 2 x M32 for supply voltage, 4 x M20 for bus cables	6					
IcoTek cable entry strip IP65, for up to 45 or 90 signals ³⁾ , 2 x M32 for supply voltage, 4 x M20 for bus cables	7					
Cable entries/material						
Cable entry in plastic, black Ambient operating temperatures: • Surface casing -40...+70 °C • I/O device -40 ... +xx °C ⁴⁾⁵⁾	0					
Cable entry in metal (nickel-plated brass) Ambient operating temperatures: • Surface casing -40...+70 °C • I/O device -40 ... +xx °C ⁴⁾⁵⁾	1					
Cable entry in plastic, blue Ambient operating temperatures: • Surface casing -40...+70 °C • I/O device -40 ... +xx °C ⁴⁾⁵⁾	2					
IcoTek cable entry in plastic, gray HN-24 frame Ambient operating temperatures: • Surface casing -40...+70 °C • I/O device -40 ... +xx °C ⁴⁾⁵⁾	3					

- 1) The supplied certificate is only valid for the empty enclosure.
- 2) The supplied certificate is valid for the supplied enclosure, including the installed components.
- 3) Number of cable entries/signals depends on enclosure dimensions
- 4) Maximum temperature depends on installed components.
- 5) Minus temperatures down to -40 °C when heater installed. This takes up 2 slots for ET 200iSP modules. The heating (6DL9910-8AA) must be ordered separately.

Note:

Depending on the cables used, other types and sizes of cable entries can be fitted (on request).

I/O systems

SIMATIC ET 200 systems without control cabinet

SIMATIC ET 200pro

Overview



SIMATIC ET 200pro video
https://players.brightcove.net/1813624294001/70fecf0f-fbad-4fad-a077-d0e26af4d84c_default/index.html?videoId=6187716010001

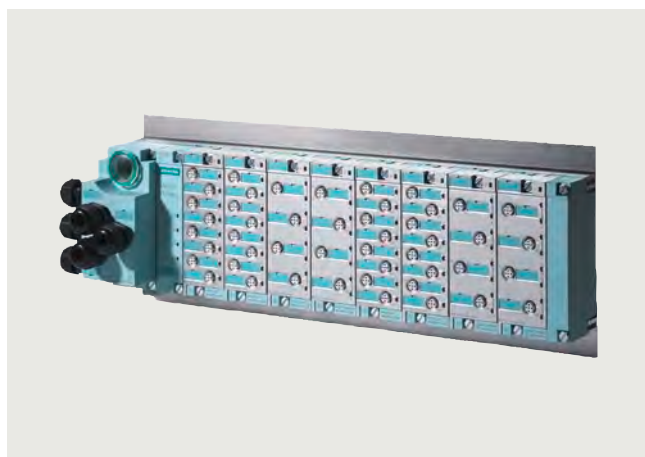

- SIMATIC ET 200pro distributed I/O system with IP65/67 degree of protection for cabinet-free use at the machine
- Small, multifunctional complete solution: Digital inputs/outputs, fail-safe modules, motor starters up to 5.5 kW, etc.
- Communication over PROFIBUS or PROFINET
- Mixed arrangement of fail-safe and standard modules in the same station
- Freely selectable connection technique: direct, ECOFAST or M12 7/8"
- Power module for easy implementation of load groups
- Module replacement during operation (hot swapping)
- Easy installation as well as permanent wiring
- Transmission rate for PROFIBUS DP up to 12 Mbps
- Extensive diagnostics: module-specific or channel-specific
- Intelligent motor starters for starting and protection of motors and loads up to 5.5 kW
 - Versions: direct and reversing starters - Standard and High Feature
- Safety motor starters
- Fail-safe modules with safety-related signal processing according to PROFIsafe
- Frequency converters
- RFID communications modules
- Pneumatic interface modules
- IO-Link master

Technical specifications

General technical specifications	
Electronic modules	<ul style="list-style-type: none"> • Digital inputs/outputs • Analog inputs • Analog outputs
Connections	M12 and M8 round connector with standard assignment for actuator/sensor
Transmission rate, max.	12 Mbps (PROFIBUS DP), 100 Mbps (PROFINET IO)
Supply voltage	24 V DC
Current consumption of ET 200pro (internal and sensor supply, non-switched voltage), up to 55 °C, max.	≤ 5 A
Load current for ET 200pro per incoming supply (IM, PM, switched voltage), up to 55 °C, max.	10 A
For overall configuration with looping through (multiple ET 200pros), up to 55 °C, max.	16 A (with terminal module, directly)
Degree of protection	IP65/66/IP67 for interface, digital and analog modules
Material	Thermoplastic (reinforced with glass fiber)
Ambient conditions	
Temperature	From -25 °C/0 °C to +55 °C
Relative humidity	From 5 to 100%
Air pressure	From 795 to 1080 hPa
Mechanical stress	
<ul style="list-style-type: none"> • Vibration 	Vibration test according to IEC 60068, Part 2-6 (sinusoidal) <ul style="list-style-type: none"> • Constant acceleration 5 g, occasionally 10 g for interface, digital and analog modules • 2 g motor starters
<ul style="list-style-type: none"> • Shock 	Shock test according to IEC 680068 Part 2-27, half-sine, 30 g, 18 ms duration for interface, digital and analog modules <ul style="list-style-type: none"> • 15 g, 11 ms duration for motor starters
Approvals	UL, CSA or cULus

Overview



Interface modules for handling communication between the ET 200pro and the higher-level master over PROFIBUS DP.

Ordering data

Ordering data	Article No.	Ordering data	Article No.
IM154-1 interface module For ET 200pro; for communication between ET 200pro and higher-level masters over PROFIBUS DP.	6ES7154-1AA01-0AB0	PROFIBUS ECOFAST hybrid cable GP, pre-assembled With 2 ECOFAST connectors, trailing-type cable with 2 x Cu 0.64 mm ² and 4 x Cu 1.5 mm ² , in various lengths:	
IM154-2 DP High Feature interface module For ET 200pro; for communication between ET 200pro and higher-level masters over PROFIBUS DP; supports PROFI-safe.	6ES7154-2AA01-0AB0	1.5 m	6XV1860-3PH15
Accessories		3.0 m	6XV1860-3PH30
CM IM DP ECOFAST connection module For connecting PROFIBUS DP and the 24 V power supply to PROFIBUS interface modules, 2 ECOFAST Cu connections.	6ES7194-4AA00-0AA0	5.0 m	6XV1860-3PH50
CM IM DP direct connection module For connecting PROFIBUS DP and the 24 V power supply directly to PROFIBUS interface modules, up to six M20 cable glands.	6ES7194-4AC00-0AA0	10 m	6XV1860-3PN10
CM IM DP M12, 7/8" connection module For connecting PROFIBUS DP and the 24 V power supply to PROFIBUS interface modules, 2 x M12 and 2 x 7/8".	6ES7194-4AD00-0AA0	15 m	6XV1860-3PN15
Accessories for CM IM DP ECOFAST		20 m	6XV1860-3PN20
PROFIBUS ECOFAST hybrid cable, pre-assembled With 2 ECOFAST connectors, trailing-type cable with 2 x Cu 0.64 mm ² and 4 x Cu 1.5 mm ² , in various lengths:		PROFIBUS ECOFAST hybrid cable, non-assembled Trailing-type cable with 2 x Cu 0.64 mm ² and 4 x Cu 1.5 mm ² , sold by the meter, minimum order quantity 20 m, maximum order quantity 1 000 m.	6XV1830-7AH10
1.5 m	6XV1830-7BH15	PROFIBUS ECOFAST hybrid connector 180 ECOFAST Cu, 2 x Cu, 4 x 1.5 mm ² , HANBRID connector	6GK1905-0CA00 6GK1905-0CB00
3.0 m	6XV1830-7BH30	• With male insert, 5-pack	
5.0 m	6XV1830-7BH50	• With female insert, 5-pack	
10 m	6XV1830-7BN10	PROFIBUS ECOFAST hybrid connector angular ECOFAST Cu, 2 x Cu, 4 x 1.5 mm ² , HANBRID connector	6GK1905-0CC00 6GK1905-0CD00
15 m	6XV1830-7BN15	• With male insert, 5-pack	
20 m	6XV1830-7BN20	• With female insert, 5-pack	
		Accessories for CM IM DP direct	
		PROFIBUS trailing cable Max. acceleration 4 m/s ² , at least 3 million bending cycles, bending radius at least 60 mm, 2-wire shielded, sold by the meter, minimum order quantity 20 m, maximum order quantity 1 000 m.	6XV1830-3EH10

I/O systemsSIMATIC ET 200 systems without control cabinet
SIMATIC ET 200pro**Interface modules > IM 154-1 and IM 154-2**

Ordering data	Article No.	Article No.
PROFIBUS FC Food bus cable With PE sheath for use in the food and beverages industry, 2-wire, shielded, sold by the meter, minimum order quantity 20 m, maximum order quantity 1 000 m.	6XV1830-0GH10	M12 sealing cap For protection of unused M12 connections with ET 200pro.
PROFIBUS FC Robust bus cable With PUR sheath for use in environments subject to harsh chemicals and extreme mechanical stress, 2-wire, shielded, sold by the meter, minimum order quantity 20 m, maximum order quantity 1 000 m.	6XV1830-0JH10	Sealing cap 7/8" For protection of unused 7/8" connections with ET 200pro; 10 units per pack.
Power line 5-wire, 5 x 1.5 mm ² , trailing type, sold by the meter, minimum order quantity 20 m, maximum order quantity 1 000 m.	6XV1830-8AH10	General accessories
Accessories for CM IM DP M12, 7/8"		ET 200pro rack
PROFIBUS M12 connecting cable Pre-assembled with two M12 connectors, 5-pin, in various lengths:		<ul style="list-style-type: none"> Narrow, for interface, electronics and power modules <ul style="list-style-type: none"> - 500 mm - 1 000 mm - 2 000 mm, can be cut to length Compact, for interface, electronics and power modules <ul style="list-style-type: none"> - 500 mm - 1 000 mm - 2 000 mm, can be cut to length Wide, for interface, electronics, power modules and motor starters <ul style="list-style-type: none"> - 500 mm - 1 000 mm - 2 000 mm, can be cut to length Wide, for I/O modules and motor starters <ul style="list-style-type: none"> - 500 mm - 1 000 mm - 2 000 mm
1.5 m	6XV1830-3DH15	6ES7194-4GA00-0AA0
2.0 m	6XV1830-3DH20	6ES7194-4GA60-0AA0
3.0 m	6XV1830-3DH30	6ES7194-4GA20-0AA0
5.0 m	6XV1830-3DH50	
10 m	6XV1830-3DN10	6ES7194-4GC70-0AA0
15 m	6XV1830-3DN15	6ES7194-4GC60-0AA0
		6ES7194-4GC20-0AA0
7/8" connecting cable to power supply 5-wire, 5 x 1.5 mm ² , trailing type, pre-assembled with two 7/8" connectors, 5-pin, in various lengths:		Spare fuse 12.5 A fast-blow, for interface and power modules, 10 units per pack.
1.5 m	6XV1822-5BH15	6ES7194-4HB00-0AA0
2.0 m	6XV1822-5BH20	
3.0 m	6XV1822-5BH30	PROFIBUS FastConnect bus cable Standard type with special design for quick mounting, 2-wire, shielded, sold by the meter, max. delivery unit 1 000 m, minimum order quantity 20 m.
5.0 m	6XV1822-5BH50	6XV1830-0EH10
10 m	6XV1822-5BN10	
15 m	6XV1822-5BN15	PROFIBUS hybrid standard cable GP Standard PROFIBUS hybrid cable with 2 energy cables (1.5 mm ²) for supplying data and energy for ET 200pro.
M12 connection plug For ET 200eco, with axial cable outlet.		6XV1860-2R
<ul style="list-style-type: none"> With male insert, 5-pack With female insert, 5-pack 	6GK1905-0EA00 6GK1905-0EB00	SIMATIC Manual Collection Electronic manuals on DVD, multi-language: S7-200, TD 200, S7-300, M7-300, C7, S7-400, M7-400, STEP 7, Engineering Tools, Runtime Software, SIMATIC DP (Distributed I/O), SIMATIC HMI (Human Machine Interface), SIMATIC NET (Industrial Communication).
PROFIBUS M12 bus termination connector With male insert.	6GK1905-0EC00	6ES7998-8XC01-8YE0
7/8" connection plug For ET 200eco, with axial cable outlet.		SIMATIC Manual Collection update service for 1 year Scope of delivery: Current DVD "S7 Manual Collection" and the three subsequent updates.
<ul style="list-style-type: none"> With male insert, 5-pack With female insert, 5-pack 	6GK1905-0FA00 6GK1905-0FB00	6ES7998-8XC01-8YE2

Technical specifications

Article number	6ES7154-1AA01-0AB0 ET 200pro, IM 154-1 DP	6ES7154-2AA01-0AB0 ET 200pro, IM154-2 DP HF
General information		
Product type designation	IM 154-1 DP	IM 154-2 DP HF
Supply voltage		
Rated value (DC)	24 V	24 V
Reverse polarity protection	Yes; against destruction	Yes; against destruction
Short-circuit protection	Yes; over exchangeable fuses	Yes; over exchangeable fuses
Load voltage 2L+		
• Rated value (DC)	24 V	24 V
• Reverse polarity protection	Yes; against destruction	Yes; against destruction
Input current		
from supply voltage 1L+, max.	200 mA	200 mA
Address area		
Addressing volume		
• Inputs	244 byte	244 byte
• Outputs	244 byte	244 byte
Interfaces		
Interfaces/bus type	PROFIBUS DP	PROFIBUS DP
Interface types		
RS 485		
• Transmission rate, max.	12 Mbit/s	12 Mbit/s
• automatic detection of transmission rate	Yes	Yes
Protocols		
PROFIBUS DP		
Services		
- SYNC capability	Yes	Yes
- FREEZE capability	Yes	Yes
- Direct data exchange (slave-to-slave communication)	Yes	Yes
Interrupts/diagnostics/status information		
Alarms		
• Diagnostic alarm	Yes; Parameterizable	Yes; Parameterizable
• Hardware interrupt	Yes; Parameterizable	Yes; Parameterizable
Diagnostics indication LED		
• For load voltage monitoring	Yes	Yes
• Bus fault BF (red)	Yes	Yes
• Group error SF (red)	Yes	Yes
• Monitoring 24 V voltage supply ON (green)	Yes	Yes
Potential separation		
between supply voltage and electronics	Yes	Yes
Degree and class of protection		
IP degree of protection	IP65/67	IP65/67
Ambient conditions		
Ambient temperature during operation		
• min.	-25 °C	-25 °C
• max.	55 °C	55 °C
Ambient temperature during storage/transportation		
• min.	-40 °C	-40 °C
• max.	70 °C	70 °C
Dimensions		
Width	90 mm	90 mm
Height	130 mm	130 mm
Depth	60 mm	60 mm
Weights		
Weight, approx.	375 g	375 g

I/O systems

SIMATIC ET 200 systems without control cabinet
SIMATIC ET 200pro

Interface modules > IM 154-3 PN and IM 154-4 PN

Overview



Interface module for processing the communication between ET 200pro and a higher-level controller over PROFINET IO.

Ordering data

IM 154-3 PN High Feature interface module

For communication between ET 200pro and higher-level controllers via PROFINET IO; supports PROFI-safe.

Connection module 6ES7194-4AK00-0AA0 must be ordered separately.

IM 154-4 PN High Feature interface module

For communication between ET 200pro and higher-level controllers via PROFINET IO; supports PROFI-safe.

Order terminal module 6ES7194-4A...00-0AA0 separately.

Accessories

Connection modules for IM 154-3 PN High Feature

- **Connection module CM IM PN M12, 7/8" S** for connecting PROFINET PN and 24 V power supply to PROFINET interface modules, 2 x M12 and 2 x 7/8"

Connection modules for IM 154-4 PN High Feature

- **Connection module CM IM PN M12, 7/8"** for connecting PROFINET PN and 24 V power supply to PROFINET interface modules, 2 x M12 and 2 x 7/8"
- **Connection module CM IM PN 2xRJ45** for connecting PROFINET PN and 24 V power supply to PROFINET interface modules, 2 x RJ45 and 2 x push-pull power connector
- **Connection module CM IM PN 2xSCRJ FO** for connecting PROFINET PN and 24 V power supply to PROFINET interface modules, 2 x SCRJ FO and 2 x push-pull power connector

Article No.

6ES7154-3AB00-0AB0

6ES7154-4AB10-0AB0

6ES7194-4AK00-0AA0

6ES7194-4AJ00-0AA0

6ES7194-4AF00-0AA0

6ES7194-4AG00-0AA0

Article No.

M12 sealing cap

For protection of unused M12 connections with ET 200pro.

IE M12 connecting cables
Pre-assembled with two M12 connectors, up to 85 m, in various lengths:

0.3 m	6XV1870-8AE30
0.5 m	6XV1870-8AE50
1.0 m	6XV1870-8AH10
1.5 m	6XV1870-8AH15
2.0 m	6XV1870-8AH20
3.0 m	6XV1870-8AH30
5.0 m	6XV1870-8AH50
10 m	6XV1870-8AN10
15 m	6XV1870-8AN15

7/8" sealing caps

1 pack = 10 units

7/8" connecting cable to power supply

5-wire, 5 x 1.5 mm², trailing type, pre-assembled with two 7/8" connectors, 5-pin, up to 50 m, in various lengths:

1.5 m	6XV1822-5BH15
2.0 m	6XV1822-5BH20
3.0 m	6XV1822-5BH30
5.0 m	6XV1822-5BH50
10 m	6XV1822-5BN10
15 m	6XV1822-5BN15

Ordering data	Article No.	Article No.
Power line 5-wire, 5 x 1.5 mm ² , trailing type, sold by the meter, minimum order quantity 20 m, maximum order quantity 1 000 m.	6XV1830-8AH10	
7/8" connection plug For ET 200eco, with axial cable outlet. <ul style="list-style-type: none"> • With male insert, 5-pack • With female insert, 5-pack 	6GK1905-0FA00 6GK1905-0FB00	
Industrial Ethernet FastConnect installation cables <ul style="list-style-type: none"> • IE FC TP standard cable GP 2 x 2: Sold by the meter, max. delivery unit 1 000 m; minimum order quantity 20 m. • IE FC TP trailing cable 2 x 2: sold by the meter, max. delivery unit 1 000 m; minimum order quantity 20 m. • IE FC TP trailing cable GP 2 x 2: sold by the meter, max. delivery unit 1 000 m; minimum order quantity 20 m. • IE TP torsion cable GP 2 x 2: sold by the meter, max. delivery unit 1 000 m; minimum order quantity 20 m. • IE FC TP marine cable 2 x 2: sold by the meter, max. delivery unit 1 000 m; minimum order quantity 20 m. 	6XV1840-2AH10 6XV1840-3AH10 6XV1870-2D 6XV1870-2F 6XV1840-4AH10	
IE RJ45 Plug PRO RJ45 plug connector in IP65/67 degree of protection for on-site assembly, plastic housing, insulation displacement connection system, for SCALANCE X-200 IRT PRO and ET 200pro: 1 pack = 1 unit.	6GK1901-1BB10-6AA0	
IE SC RJ POF Plug PRO SC RJ plug for POF fibers in IP65/67 degree of protection, for on-site assembly, plastic housing, for SCALANCE X-200 IRT PRO and ET 200pro 1 pack = 1 unit	6GK1900-0MB00-6AA0	
IE SC RJ PCF Plug PRO SC RJ plug for PCF fibers in IP65/67 degree of protection, for on-site assembly, plastic housing, for SCALANCE X-200 IRT PRO 1 pack = 1 unit.	6GK1900-0NB00-6AA0	
Power Plug PRO 5-pin power plug for 2 x 24 V power supply in IP65/67 degree of protection, for on-site assembly, plastic housing, for SCALANCE X-200 IRT and ET 200 pro 1 pack = 1 unit.	6GK1907-0AB11-6AA0	
IE panel feed-through Control cabinet feed-through for converting M12 D-coded connection system (IP65) to RJ45 connection system (IP20) <ul style="list-style-type: none"> • 1 pack = 5 units 	6GK1901-0DM20-2AA5	
Push-pull connection plug For 1L+/ 2L+, unassembled	6GK1907-0AB11-6AA0	
Cover caps for push-pull RJ45 female connectors 5 items per pack	6ES7194-4JD50-0AA0	
Cover caps for push-pull female connectors power (1L+, 2L+) 5 units	6ES7194-4JA50-0AA0	
General accessories		
ET 200pro rack <ul style="list-style-type: none"> • Narrow, for interface, electronics and power modules <ul style="list-style-type: none"> - 500 mm - 1 000 mm - 2 000 mm, can be cut to length • Compact, for interface, electronics and power modules <ul style="list-style-type: none"> - 500 mm - 1 000 mm - 2 000 mm, can be cut to length • Wide, for interface, electronics, power modules and motor starters <ul style="list-style-type: none"> - 500 mm - 1 000 mm - 2 000 mm, can be cut to length • Wide, for I/O modules and motor starters <ul style="list-style-type: none"> - 500 mm - 1 000 mm - 2 000 mm 	6ES7194-4GA00-0AA0 6ES7194-4GA60-0AA0 6ES7194-4GA20-0AA0 6ES7194-4GC70-0AA0 6ES7194-4GC60-0AA0 6ES7194-4GC20-0AA0 6ES7194-4GB00-0AA0 6ES7194-4GB60-0AA0 6ES7194-4GB20-0AA0 6ES7194-4GD00-0AA0 6ES7194-4GD10-0AA0 6ES7194-4GD20-0AA0	
Spare fuse 12.5 A fast-blow, for interface and power modules, 10 units per pack.	6ES7194-4HB00-0AA0	
SIMATIC Manual Collection Electronic manuals on DVD, multi-language: LOGO!, SIMADYN, SIMATIC bus components, SIMATIC C7, SIMATIC distributed I/O, SIMATIC HMI, SIMATIC sensors, SIMATIC NET, SIMATIC PC-based Automation, SIMATIC PCS 7, SIMATIC PG/PC, SIMATIC S7, SIMATIC software, SIMATIC TDC	6ES7998-8XC01-8YE0	
SIMATIC Manual Collection update service for 1 year Current "Manual Collection" DVD and the three subsequent updates	6ES7998-8XC01-8YE2	

I/O systems

SIMATIC ET 200 systems without control cabinet
SIMATIC ET 200pro

Interface modules > IM 154-3 PN and IM 154-4 PN**Technical specifications**

Article number	6ES7154-3AB00-0AB0 ET 200pro, IM 154-3 PN HF	6ES7154-4AB10-0AB0 ET 200pro, IM 154-4 PN HF
General information		
Product type designation	IM 154-3 PN HF	IM 154-4 PN HF
Supply voltage		
Rated value (DC)	24 V	24 V
Reverse polarity protection	Yes; against destruction	Yes; against destruction
Short-circuit protection	Yes; Fuse in lower part is exchangeable, the fuse on the IM-LP is not	Yes; Fuse in lower part is exchangeable, the fuse on the IM-LP is not
Load voltage 2L+		
• Rated value (DC)	24 V	24 V
• Reverse polarity protection	Yes; against destruction	Yes; against destruction
Input current		
from supply voltage 1L+, max.	300 mA	400 mA; Dependent on terminal module, typ. maximum value for FO connection method, full load on RWB and 20.4 V input voltage
Address area		
Addressing volume		
• Inputs	256 byte	256 byte
• Outputs	256 byte	256 byte
Interfaces		
Interfaces/bus type	PROFINET IO	PROFINET IO
Interface types		
M12 port		
• Autonegotiation	Yes	Yes
• Transmission rate, max.	100 Mbit/s	100 Mbit/s
Protocols		
Protocols (Ethernet)		
• SNMP	Yes	Yes
• LLDP	Yes	
• ping	Yes	Yes
• ARP	Yes	Yes
Redundancy mode		
Media redundancy		
- MRP	Yes	Yes
Interrupts/diagnostics/ status information		
Alarms		
• Diagnostic alarm	Yes; Parameterizable	Yes; Parameterizable
• Hardware interrupt	Yes; Parameterizable	Yes; Parameterizable
Diagnostics indication LED		
• MAINT LED	Yes	Yes
• LINK LED	Yes	Yes
• RX/TX LED	Yes	Yes
• For load voltage monitoring	Yes	Yes
• Bus fault BF (red)	Yes	Yes
• Group error SF (red)	Yes	Yes
• Monitoring 24 V voltage supply ON (green)	Yes	Yes

Technical specifications

Article number	6ES7154-3AB00-0AB0 ET 200pro, IM 154-3 PN HF	6ES7154-4AB10-0AB0 ET 200pro, IM 154-4 PN HF
Potential separation		
between backplane bus and electronics	No	No
between supply voltage and electronics	Yes	Yes
Degree and class of protection		
IP degree of protection	IP65/67	IP65/67
Ambient conditions		
Ambient temperature during operation		
• min.	-25 °C	-25 °C
• max.	55 °C	55 °C
Ambient temperature during storage/transportation		
• min.	-40 °C	-40 °C
• max.	70 °C	70 °C
Dimensions		
Width	90 mm	135 mm
Height	130 mm	130 mm
Depth	60 mm	60 mm
Weights		
Weight, approx.	375 g	490 g

I/O systemsSIMATIC ET 200 systems without control cabinet
SIMATIC ET 200pro**I/O modules > Digital expansion modules****Overview**

- Expansion modules with digital inputs/outputs for connection of actuators/sensors
- With scalable diagnostics
 - Standard modules with module-specific diagnostics
 - High Feature module with channel-specific diagnostics and parameterizable input delay or hardware interrupts
- Double or single assignment can be implemented for each M12 in the case of the 8 DI and 8 DO module by selecting CM IO 4 x M12 or CM IO 8 x M12
- IO connection modules are available in metal and plastic versions

Ordering data**Article No.****Article No.****8 DI digital input module**

6ES7141-4BF00-0AA0

24 V DC, with module-specific diagnostics, including bus module. Connection module must be ordered separately

8 DI High Feature digital input module

6ES7141-4BF00-0AB0

24 V DC, with channel-specific diagnostics, including bus module. Connection module must be ordered separately

16 DI digital input module

6ES7141-4BH00-0AA0

24 V DC, with module-specific diagnostics, including bus module. Connection module 6ES7194-4CB50-0AA0 must be ordered separately

4 DQ digital output module

6ES7142-4BD00-0AA0

24 V DC, 2 A, with module-specific diagnostics, including bus module. Connection module must be ordered separately

4 DQ High Feature digital output module

6ES7142-4BD00-0AB0

24 V DC, 2 A, with channel-specific diagnostics, including bus module. Connection module must be ordered separately

8 DQ digital output module

6ES7142-4BF00-0AA0

24 V DC, 0.5 A, with module-specific diagnostics, including bus module. Connection module must be ordered separately

4 DI/4 DQ digital input and output module

6ES7143-4BF50-0AA0

24 V DC, 0.5 A, with module-specific diagnostics, including bus module. Connection module must be ordered separately

Digital input and output module 4 DIQ / 4 DQ

6ES7143-4BF00-0AA0

24 V DC, 0.5 A, with module-specific diagnostics, including bus module. Connection module must be ordered separately

Accessories**CM IO 4 x M12 connection module**

6ES7194-4CA00-0AA0

4 M12 sockets for connecting digital or analog sensors or actuators to ET 200pro

CM IO 4 x M12 inverse connection module

6ES7194-4CA50-0AA0

4 M12 sockets for connection of digital actuators to ET 200pro (4 DQ and 4 DQ HF); 2 x M12 single assignment, 2 x M12 double assignment

CM IO 4 x M12 P connection module

6ES7194-4CA10-0AA0

4 M12 sockets for connecting digital sensors/actuators to ET 200pro; plastic version

CM IO 8 x M12 connection module

6ES7194-4CB00-0AA0

8 M12 sockets for connecting digital sensors or actuators to ET 200pro

CM IO 8 x M12 P connection module

6ES7194-4CB10-0AA0

8 M12 sockets for connecting digital sensors or actuators to ET 200pro; plastic version

CM IO 8 x M12D connection module

6ES7194-4CB50-0AA0

8 M12 sockets for connecting digital sensors or actuators to ET 200pro

CM IO 8 x M8 connection module

6ES7194-4EB00-0AA0

8 sockets M8 for connection of digital sensors or actuators to ET 200pro

CM IO 2 x M12 connection module

6ES7194-4FB00-0AA0

2 M12 8-pin sockets; for use with: EM 8 DI, 24 V DC and 8 DQ, 24 V DC/0.5 A

CM IO 1 x M23 connection module

6ES7194-4FA00-0AA0

1 M23 socket; for use with: EM 8 DI, 24 V DC and 8 DQ, 24 V DC/0.5 A

Module identification labels

6ES7194-4HA00-0AA0

For color coding of the CM IOs in the colors of white, red, blue and green; pack with 100 units each

M12 sealing cap

3RX9802-0AA00

For protection of unused M12 connections with ET 200pro

M12 Y circular connector

6ES7194-1KA01-0XA0

For double connection of sensors via a single cable, 5-pin; cannot be used for F-DI 4/8

M12 Y cable

6ES7194-6KA00-0XA0

For double connection of I/O by means of a single cable on ET 200, 5-pin

M8 sealing cap

3RK1901-1PN00

For IP67 modules

Technical specifications

Article number	6ES7141-4BF00-0AA0 ET 200pro, EM 8DI 24V DC	6ES7141-4BF00-0AB0 ET 200pro, EM 8DI 24V DC HF	6ES7141-4BH00-0AA0 ET 200pro, EM 16DI DC 24V
General information			
Product function			
• Isochronous mode	No	No	No
Supply voltage			
Rated value (DC)	24 V	24 V	24 V
Reverse polarity protection	Yes; Against destruction; encoder power supply outputs applied with reversed polarity	Yes; against destruction; load increasing	Yes; Against destruction; encoder power supply outputs applied with reversed polarity
Input current			
from supply voltage 1L+, max.	20 mA	40 mA	30 mA
from backplane bus 3.3 V DC, max.	20 mA	20 mA	20 mA
Encoder supply			
Number of outputs	8	8	8
Short-circuit protection	Yes; per module, electronic	Yes; per channel, electronic	Yes; per module, electronic
Output current			
• up to 55 °C, max.	1 A	1 A	1 A
Digital inputs			
Number of digital inputs	8	8	16
Input characteristic curve in accordance with IEC 61131, type 1	Yes	No	Yes
Input characteristic curve in accordance with IEC 61131, type 2	No	Yes	
Number of simultaneously controllable inputs			
all mounting positions			
- up to 55 °C, max.	8	8	16
Input voltage			
• Rated value (DC)	24 V	24 V	24 V
• for signal "0"	-3 to +5V	-3 to +5V	-3 to +5V
• for signal "1"	13 to 30V	+11 to +30V	+11 to +30V
Input current			
• for signal "1", typ.	7 mA	7 mA	4 mA
Input delay (for rated value of input voltage)			
for standard inputs			
- parameterizable	No	Yes	No
Cable length			
• unshielded, max.	30 m	30 m	30 m
Encoder			
Connectable encoders			
• 2-wire sensor	Yes	Yes	Yes
- permissible quiescent current (2-wire sensor), max.	1.5 mA	1.5 mA	1.5 mA
Interrupts/diagnostics/status information			
Diagnostics function	Yes	Yes; channel by channel, parameterizable	Yes
Alarms			
• Diagnostic alarm	Yes	Yes	Yes
• Hardware interrupt		Yes	
Diagnoses			
• Diagnostic information readable	Yes	Yes	Yes
• Wire-break		Yes; Monitoring, I < 0.3 mA; per channel	
• Short-circuit	Yes; Sensor supply to M; module by module	Yes; channel by channel	Yes; Sensor supply to M; module by module
Diagnostics indication LED			
• Group error SF (red)	Yes	Yes	Yes
• Status indicator digital input (green)	Yes; Per channel	Yes; Per channel	Yes; Per channel

I/O systemsSIMATIC ET 200 systems without control cabinet
SIMATIC ET 200pro**I/O modules > Digital expansion modules****Technical specifications**

Article number	6ES7141-4BF00-0AA0 ET 200pro, EM 8DI 24V DC	6ES7141-4BF00-0AB0 ET 200pro, EM 8DI 24V DC HF	6ES7141-4BH00-0AA0 ET 200pro, EM 16DI DC 24V
Potential separation			
between backplane bus and all other circuit components	Yes	Yes	Yes
Potential separation digital inputs			
• between the channels	No	No	No
• between the channels and backplane bus	Yes	Yes	Yes
Dimensions			
Width	45 mm	45 mm	45 mm
Height	130 mm	130 mm	130 mm
Depth	35 mm	35 mm; without terminal module	35 mm
Weights			
Weight, approx.	140 g	140 g	140 g
Article number	6ES7142-4BD00-0AA0 ET 200pro, EM 4DO 24V DC/2.0A	6ES7142-4BD00-0AB0 ET 200pro, EM 4DO 24VDC/2.0A HF	6ES7142-4BF00-0AA0 ET 200pro, EM 8DO DC24V/0.5A
Supply voltage			
Load voltage 2L+			
• Rated value (DC)	24 V	24 V	24 V
• Short-circuit protection	Yes; per channel, electronic	Yes; per channel, electronic	Yes; per channel, electronic
• Reverse polarity protection	Yes; against destruction; load increasing	Yes; against destruction; load increasing	Yes; against destruction; load increasing
Input current			
from load voltage 2L+ (without load), max.	20 mA	40 mA	30 mA
from backplane bus 3.3 V DC, max.	20 mA	30 mA	30 mA
Digital outputs			
Number of digital outputs	4	4	8
Short-circuit protection	Yes	Yes	Yes
Limitation of inductive shutdown voltage to	2L+ (-47 V)	2L+ (-47 V)	2L+ (-47 V)
Controlling a digital input	Yes	Yes	Yes; Isolation between 1L+ and 2L+ is no longer provided, as 1M and 2M are jumpered
Switching capacity of the outputs			
• on lamp load, max.	10 W	10 W	5 W
Load resistance range			
• lower limit	12 Ω	12 Ω	48 Ω
• upper limit	4 kΩ	4 kΩ	4 kΩ
Output voltage			
• for signal *1*, min.	2L+ (-0,8 V)	2L+ (-0,8 V)	2L+ (-0,8 V)
Output current			
• for signal *1* rated value	2 A	2 A	0.5 A
• for signal *0* residual current, max.	0.5 mA	0.5 mA	0.5 mA
Parallel switching of two outputs			
• for uprating	No	No	No
• for redundant control of a load	Yes	Yes	Yes
Switching frequency			
• with resistive load, max.	100 Hz	100 Hz	100 Hz
• with inductive load, max.	0.5 Hz	0.5 Hz	0.5 Hz
• on lamp load, max.	1 Hz	1 Hz	1 Hz
Total current of the outputs (per group)			
all mounting positions			
- up to 55 °C, max.	4 A	4 A	4 A
Cable length			
• shielded, max.	30 m	30 m	30 m
• unshielded, max.	30 m	30 m	30 m

Technical specifications

Article number	6ES7142-4BD00-0AA0 ET 200pro, EM 4DO 24V DC/2.0A	6ES7142-4BD00-0AB0 ET 200pro, EM 4DO 24VDC/2.0A HF	6ES7142-4BF00-0AA0 ET 200pro, EM 8DO DC24V/0.5A
Interrupts/diagnostics/ status information			
Diagnostics function	Yes	Yes	Yes
Substitute values connectable		Yes	
Alarms			
• Diagnostic alarm	Yes	Yes	Yes
Diagnoses			
• Diagnostic information readable	Yes	Yes	Yes
• Wire-break		Yes; channel by channel	
• Short-circuit	Yes; Short-circuit of outputs to ground; module by module	Yes; channel by channel	Yes; Short-circuit of outputs to ground; module by module
Diagnostics indication LED			
• Group error SF (red)	Yes	Yes	Yes
• Status indicator digital output (green)	Yes	Yes	Yes
• Channel fault indicator F (red)		Yes	
Potential separation			
between backplane bus and all other circuit components	Yes	Yes	Yes
Potential separation digital outputs			
• between the channels	No	No	No
• between the channels and backplane bus	Yes	Yes	Yes
Standards, approvals, certificates			
Suitable for safety-related tripping of standard modules	Yes	Yes	Yes
Highest safety class achievable for safety-related tripping of standard modules			
• Performance level according to ISO 13849-1	PL d	PL d	PL d
• Category according to ISO 13849-1	Cat. 3	Cat. 3	Cat. 3
• SILCL according to IEC 62061	SILCL 2	SILCL 2	SILCL 2
Dimensions			
Width	45 mm	45 mm	45 mm
Height	130 mm	130 mm	130 mm
Depth	35 mm	35 mm; without terminal module	35 mm
Weights			
Weight, approx.	140 g	140 g	140 g

Article number	6ES7143-4BF50-0AA0 ET 200pro, EM 4DI / 4DO DC 24V, 0.5A	6ES7143-4BF00-0AA0 ET 200pro, EM 4 DIO / 4 DO DC 24V, 0.5A
Supply voltage		
Rated value (DC)		24 V
Reverse polarity protection		Yes; Against destruction; encoder power supply outputs applied with reversed polarity
Load voltage 2L+		
• Rated value (DC)	24 V	24 V
• Short-circuit protection	Yes	Yes
• Reverse polarity protection	Yes	Yes; against destruction; load increasing
Input current		
from supply voltage 1L+, max.		20 mA
from load voltage 2L+ (without load), max.	20 mA	20 mA
from backplane bus 3.3 V DC, max.	20 mA	30 mA
Encoder supply		
Short-circuit protection	Yes; per module, electronic	Yes; per module, electronic
Output current		
• up to 55 °C, max.	1 A	1 A

I/O systems

SIMATIC ET 200 systems without control cabinet

SIMATIC ET 200pro

I/O modules > Digital expansion modules**Technical specifications**

Article number	6ES7143-4BF50-0AA0 ET 200pro, EM 4DI / 4DO DC 24V, 0.5A	6ES7143-4BF00-0AA0 ET 200pro, EM 4 DIO / 4 DO DC 24V, 0.5A
Digital inputs		
Number of digital inputs	4	4; 4 DIOs can be parameterized
Input characteristic curve in accordance with IEC 61131, type 3	Yes	Yes
Number of simultaneously controllable inputs all mounting positions		
- up to 55 °C, max.		4
Input voltage		
• Rated value (DC)	24 V	24 V
• for signal "0"	-3 to +5V	-3 to +5V
• for signal "1"	+11 to +30V	+11 to +30V
Input current		
• for signal "1", typ.	7 mA	7 mA
Cable length		
• unshielded, max.	30 m	30 m
Digital outputs		
Number of digital outputs	4	8; 4 DO fixed, 4 DIO parameterizable
• in groups of		4; 2 load groups for 4 outputs each
Short-circuit protection	Yes; per channel, electronic	Yes; per channel, electronic
Limitation of inductive shutdown voltage to	Typ. (2L+) -47 V	Typ. (L1+, L2+) -47 V
Controlling a digital input	Yes	Yes
Switching capacity of the outputs		
• on lamp load, max.	5 W	5 W
Load resistance range		
• lower limit	48 Ω	48 Ω
• upper limit	4 kΩ	4 kΩ
Output voltage		
• for signal "1", min.		2L+ (-0,8 V)
Output current		
• for signal "1" rated value	0.5 A	0.5 A
• for signal "0" residual current, max.	0.5 mA	0.5 mA
Parallel switching of two outputs		
• for uprating	No	No
• for redundant control of a load	Yes	Yes
Switching frequency		
• with resistive load, max.	100 Hz	100 Hz
• with inductive load, max.	0.5 Hz	0.5 Hz
• on lamp load, max.	1 Hz	1 Hz
Total current of the outputs (per group)		
all mounting positions		
- up to 55 °C, max.	2 A	2 A
Cable length		
• unshielded, max.	30 m	30 m
Encoder		
Connectable encoders		
• 2-wire sensor	Yes	Yes
- permissible quiescent current (2-wire sensor), max.	1.5 mA	1.5 mA

Technical specifications

Article number	6ES7143-4BF50-0AA0 ET 200pro, EM 4DI / 4DO DC 24V, 0.5A	6ES7143-4BF00-0AA0 ET 200pro, EM 4 DIO / 4 DO DC 24V, 0.5A
Interrupts/diagnostics/ status information		
Diagnostics function	Yes	Yes
Alarms		
• Diagnostic alarm	Yes	Yes
Diagnoses		
• Diagnostic information readable	Yes	Yes
• Short-circuit	Yes; Short-circuit of outputs to ground; module by module	Yes; Short-circuit of outputs to ground; module by module
Diagnostics indication LED		
• Group error SF (red)		Yes
• Status indicator digital input (green)	Yes	Yes
• Status indicator digital output (green)	Yes	Yes
Potential separation		
between backplane bus and all other circuit components	Yes	Yes
Potential separation digital inputs		
• between the channels	No	No
• between the channels and backplane bus	Yes	Yes
Potential separation digital outputs		
• between the channels	No	
• between the channels and backplane bus	Yes	Yes
Standards, approvals, certificates		
Suitable for safety-related tripping of standard modules		Yes
Highest safety class achievable for safety-related tripping of standard modules		
• Performance level according to ISO 13849-1		PL d
• Category according to ISO 13849-1		Cat. 3
• SILCL according to IEC 62061		SILCL 2
Dimensions		
Width	45 mm	45 mm
Height	130 mm	130 mm
Depth	35 mm	35 mm
Weights		
Weight, approx.	140 g	140 g

I/O systems

SIMATIC ET 200 systems without control cabinet
SIMATIC ET 200pro

I/O modules > Analog expansion modules**Overview**

- Expansion modules with analog inputs and outputs for connecting sensors/actuators
- With diagnostics functionality, limit values and substitute values

Ordering data**Article No.****Article No.****4AI U analog input module****6ES7144-4FF01-0AB0**

High Feature, ± 10 V; ± 5 V;
0 to 10 V; 1 to 5 V,
channel-specific diagnostics,
including bus module. Connection
module must be ordered separately

4AO U analog output module**6ES7145-4FF00-0AB0**

High Feature, ± 10 V; 0 to 10 V;
1 to 5 V, channel-specific
diagnostics, including
bus module. Connection module
must be ordered separately

4AI I analog input module**6ES7144-4GF01-0AB0**

High Feature, ± 20 mA; 0 to 20 mA;
4 to 20 mA, channel-specific
diagnostics, including bus module.
Connection module must be
ordered separately

4AO I analog output module**6ES7145-4GF00-0AB0**

High Feature, ± 20 mA; 0 to 20 mA;
4 to 20 mA, channel-specific
diagnostics, including bus module.
Connection module must be
ordered separately

4AI RTD analog input module**6ES7144-4JF00-0AB0**

High Feature; resistances:
150, 300, 600 and 3000 Ohm;
resistance thermometer: Pt100,
200, 500, 1000, Ni100, 120, 200,
500 and 1000; channel-specific
diagnostics, incl. bus module.
Connection module must be
ordered separately

Accessories**CM IO 4 x M12 connection module****6ES7194-4CA00-0AA0**

4 M12 sockets for connecting
digital or analog sensors or
actuators to ET 200pro

M12 compensation connectors**6ES7194-4AB00-0AA0**

With integral Pt100 for reference
point compensation when
connecting thermocouples

Analog input module 4AI TC**6ES7144-4PF00-0AB0**

High Feature; thermocouples:
Type B, E, J, K, L, N, R, S, T;
voltage measurement ± 80 mV;
channel diagnostics, including
bus module. Connection module
must be ordered separately

Module identification labels**6ES7194-4HA00-0AA0**

For color coding of the CM IOs in
the colors of white, red, blue and
green; pack with 100 units each

M12 sealing cap**3RX9802-0AA00**

For protection of unused M12
connections with ET 200pro

Technical specifications

Article number	6ES7144-4FF01-0AB0 ET 200pro, EM 4AI-U HF	6ES7144-4GF01-0AB0 ET 200pro, EM 4AI-I HF	6ES7144-4JF00-0AB0 ET 200pro, EM 4 AI-RTD HF	6ES7144-4PF00-0AB0 ET 200pro, EM 4 AI-TC HF
Supply voltage				
Rated value (DC)	24 V	24 V	24 V	24 V
Reverse polarity protection	Yes; against destruction	Yes; against destruction	Yes; against destruction	Yes; against destruction
Input current				
from supply voltage 1L+, max.	40 mA; Typical	40 mA; Typical	27 mA; Typical	34 mA; Typical
from backplane bus 3.3 V DC, max.	12 mA; Typical	12 mA; Typical	10 mA; Typical	20 mA; Typical
Encoder supply				
Number of outputs	4	4		
Short-circuit protection	Yes; per module, electronic to frame	Yes; per module, electronic to frame		
Output current				
• up to 55 °C, max.	1 A	1 A		
Analog inputs				
Number of analog inputs	4	4	4	4
permissible input voltage for voltage input (destruction limit), max.	35 V			20 V
permissible input current for current input (destruction limit), max.		40 mA		
Constant measurement current for resistance-type transmitter, typ.			1.25 mA; 1.25 / 0.5 mA depending on measuring range	
Cycle time (all channels) max.	5 ms	10 ms	83 ms; 83 ms at 50 Hz; 69 ms at 60 Hz	Number of active channels per module x basic conversion time
Technical unit for temperature measurement adjustable			Yes; Degrees Celsius/degrees Fahrenheit	Yes; °C/°F/K
Input ranges (rated values), voltages				
• 0 to +10 V	Yes			
• 1 V to 5 V	Yes			
• -10 V to +10 V	Yes			
• -5 V to +5 V	Yes			
• -80 mV to +80 mV				Yes
Input ranges (rated values), currents				
• 0 to 20 mA		Yes		
• -20 mA to +20 mA		Yes		
• 4 mA to 20 mA		Yes		
Input ranges (rated values), thermocouples				
• Type B				Yes
• Type E				Yes
• Type J				Yes
• Type K				Yes
• Type L				Yes
• Type N				Yes
• Type R				Yes
• Type S				Yes
• Type T				Yes
Input ranges (rated values), resistance thermometer				
• Cu 10			No	
• Ni 100			Yes	
• Ni 1000			Yes	
• Ni 120			Yes	
• Ni 200			Yes	
• Ni 500			Yes	
• Pt 100			Yes	
• Pt 1000			Yes	
• Pt 200			Yes	
• Pt 500			Yes	

I/O systems

SIMATIC ET 200 systems without control cabinet

SIMATIC ET 200pro

I/O modules > Analog expansion modules**Technical specifications**

Article number	6ES7144-4FF01-0AB0 ET 200pro, EM 4AI-U HF	6ES7144-4GF01-0AB0 ET 200pro, EM 4AI-I HF	6ES7144-4JF00-0AB0 ET 200pro, EM 4 AI-RTD HF	6ES7144-4PF00-0AB0 ET 200pro, EM 4 AI-TC HF
Input ranges (rated values), resistors				
• 0 to 150 ohms			Yes	
• 0 to 300 ohms			Yes	
• 0 to 600 ohms			Yes	
• 0 to 3000 ohms			Yes	
Thermocouple (TC)				
Temperature compensation				
- internal temperature compensation				Yes
- external temperature compensation with compensations socket				Yes
Characteristic linearization				
• parameterizable			Yes	
- for resistance thermometer			Ptxxx, Nixxx	
Cable length				
• shielded, max.	30 m	30 m	30 m	30 m
Analog value generation for the inputs				
Measurement principle	integrating	integrating	integrating	integrating
Integration and conversion time/resolution per channel				
• Resolution with overrange (bit including sign), max.	15 bit; 15 bit + sign at ±10 V, at ±5 V; 15 bit at 0 V to 10 V, at 1 V to 5 V	15 bit; 15 bit + sign at ±10 V, at ±5 V; 15 bit at 0 V to 10 V, at 1 V to 5 V	15 bit; at 150, 300, 600 and 3 000 ohms; otherwise 15 bits + sign	15 bit; + sign
• Integration time (ms)	0,3 / 16,7 / 20 / 60	0,3 / 16,7 / 20 / 60	20 / 16,667	2,5 / 16,67 / 20 / 100 ms
• Interference voltage suppression for interference frequency f1 in Hz	16,67 / 50 / 60 / 3 600	16,67 / 50 / 60 / 3 600	50 / 60 Hz	10 / 50 / 60 / 400 Hz
• Conversion time (per channel)	1.1 ms	1.1 ms	20.625 ms; 20.625 ms at 50 Hz; 17.25 ms at 60 Hz	4.7/19/22/102 ms
Smoothing of measured values				
• parameterizable	Yes	Yes	Yes	Yes
Encoder				
Connection of signal encoders				
• for voltage measurement	Yes			Yes
• for current measurement as 2-wire transducer		Yes		
• for current measurement as 4-wire transducer		Yes		
• for resistance measurement with two-wire connection			Yes; Line resistances are also measured	
• for resistance measurement with three-wire connection			Yes	
• for resistance measurement with four-wire connection			Yes	
Errors/accuracies				
Linearity error (relative to input range), (+/-)	0.0075 %	0.0075 %	0.05 %	0.01 %
Temperature error (relative to input range), (+/-)	0.00075 %/K	0.00075 %/K	0.002 %/K	0.0004 %/K; Positive temperature
Crosstalk between the inputs, min.	-70 dB	-70 dB	-50 dB	-90 dB; max.
Repeat accuracy in steady state at 25 °C (relative to input range), (+/-)	0.004 %	0.004 %	0.015 %	0.01 %
Operational error limit in overall temperature range				
• Voltage, relative to input range, (+/-)	0.1 %			0.12 %; Positive temperature
• Current, relative to input range, (+/-)		0.1 %		
• Resistance thermometer, relative to input range, (+/-)			0.175 %	

Technical specifications

Article number	6ES7144-4FF01-0AB0 ET 200pro, EM 4AI-U HF	6ES7144-4GF01-0AB0 ET 200pro, EM 4AI-I HF	6ES7144-4JF00-0AB0 ET 200pro, EM 4 AI-RTD HF	6ES7144-4PF00-0AB0 ET 200pro, EM 4 AI-TC HF
Basic error limit (operational limit at 25 °C)				
• Voltage, relative to input range, (+/-)	0.075 %			0.1 %
• Current, relative to input range, (+/-)		0.075 %		
• Resistance thermometer, relative to input range, (+/-)			0.125 %	
Interference voltage suppression for $f = n \times (f1 \pm 1 \%)$, $f1 =$ interference frequency				
• Series mode interference (peak value of interference < rated value of input range), min.			50 dB	42 dB
• Common mode interference (USS < 2.5 V), min.			70 dB; Interference voltage < 5 V	85 dB; Interference voltage < 10 V
Interference voltage suppression for $f = n \times (f1 \pm 0.5 \%)$, $f1 =$ interference frequency				
• Series mode interference (peak value of interference < rated value of input range), min.	60 dB	60 dB		
• Common mode interference (USS < 2.5 V), min.	80 dB; Interference voltage < 10 V	80 dB; Interference voltage < 5 V		
Interrupts/diagnostics/status information				
Diagnostics function	Yes	Yes	Yes	Yes
Alarms				
• Diagnostic alarm	Yes; Parameterizable	Yes; Parameterizable	Yes; Parameterizable	Yes; Parameterizable
• Hardware interrupt	Yes; (limit value alarm), can be parameterized for channel 0	Yes; (limit value alarm), can be parameterized for channel 0	No	No
Diagnoses				
• Diagnostic information readable	Yes	Yes	Yes	Yes
• Wire-break	Yes; at 1 to 5 V	Yes; at 4 to 20 mA	Yes	Yes
• Short-circuit	Yes; at 1 to 5 V	Yes; at 4 to 20 mA		
• Overflow/underflow			Yes	Yes
Diagnostics indication LED				
• Group error SF (red)	Yes	Yes	Yes	Yes
Potential separation				
Potential separation analog inputs				
• between the channels	No	No	No	No
• between the channels and backplane bus	Yes	Yes	Yes	Yes
Standards, approvals, certificates				
Suitable for applications according to AMS 2750				Yes; Declaration of Conformity, see online support entry 109757262
Suitable for applications according to CQI-9				Yes; Based on AMS 2750 E
Dimensions				
Width	45 mm	45 mm	45 mm	45 mm
Height	130 mm	130 mm	130 mm	130 mm
Depth	35 mm	35 mm	35 mm	35 mm
Weights				
Weight, approx.	150 g	150 g	150 g	150 g

I/O systems

SIMATIC ET 200 systems without control cabinet

SIMATIC ET 200pro

I/O modules > Analog expansion modules**Technical specifications**

Article number	6ES7145-4FF00-0AB0 ET 200pro, EM 4AO-U HF	6ES7145-4GF00-0AB0 ET 200pro, EM 4 AO-I HF
Supply voltage		
Rated value (DC)	24 V	24 V
Reverse polarity protection	Yes; against destruction	Yes; against destruction
Input current		
from supply voltage 1L+, max.	65 mA	110 mA
from backplane bus 3.3 V DC, max.	10 mA	10 mA
Actuator supply		
Number of outputs	4	4
Short-circuit protection	Yes; per module	Yes; per module
Output current		
• up to 55 °C, max.	1 A	1 A
Analog outputs		
Number of analog outputs	4	4
Voltage output, short-circuit protection	Yes; per channel, electronic to chassis	Yes; per module, electronic to frame
Voltage output, short-circuit current, max.	50 mA	
Current output, no-load voltage, max.		16 V
Cycle time (all channels) max.	3 ms	3 ms
Output ranges, voltage		
• 0 to 10 V	Yes	
• 1 V to 5 V	Yes	
• -10 V to +10 V	Yes	
Output ranges, current		
• 0 to 20 mA		Yes
• -20 mA to +20 mA		Yes
• 4 mA to 20 mA		Yes
Connection of actuators		
• for voltage output two-wire connection	Yes	
• for voltage output four-wire connection	Yes	
• for current output two-wire connection		Yes
• for current output four-wire connection		Yes
Load impedance (in rated range of output)		
• with voltage outputs, min.	1 000 Ω	
• with voltage outputs, capacitive load, max.	1 μF	
• with current outputs, max.		600 Ω
• with current outputs, inductive load, max.		1 mH
Cable length		
• shielded, max.	30 m	30 m
Analog value generation for the outputs		
Integration and conversion time/resolution per channel		
• Resolution with overrange (bit including sign), max.	15 bit; at -10 to +10 V; 14 bit at 1 to 5 V; 15 bit at 0 to 10 V	15 bit; at ±20 mA; 14 bit at 0 to 20 mA; 15 bit at 4 to 20 mA
• Conversion time (per channel)	0.7 ms	0.7 ms
Settling time		
• for resistive load	0.1 ms	0.1 ms
• for capacitive load	6 ms	
• for inductive load		1 ms

Technical specifications

Article number	6ES7145-4FF00-0AB0 ET 200pro, EM 4AO-U HF	6ES7145-4GF00-0AB0 ET 200pro, EM 4 AO-I HF
Errors/accuracies		
Output ripple (relative to output range, bandwidth 0 to 50 kHz), (+/-)	0.02 %	0.02 %
Linearity error (relative to output range), (+/-)	0.1 %	0.1 %
Temperature error (relative to output range), (+/-)	0.01 %/K	0.01 %/K
Repeat accuracy in steady state at 25 °C (relative to output range), (+/-)	0.05 %	0.05 %
Operational error limit in overall temperature range		
• Voltage, relative to output range, (+/-)	0.2 %	
• Current, relative to output range, (+/-)		0.2 %
Basic error limit (operational limit at 25 °C)		
• Voltage, relative to output range, (+/-)	0.15 %	
• Current, relative to output range, (+/-)		0.15 %
Interrupts/diagnostics/status information		
Diagnostics function		Yes
Substitute values connectable	Yes	Yes
Alarms		
• Diagnostic alarm	Yes; Parameterizable	Yes; Parameterizable
• Hardware interrupt	No	No
Diagnoses		
• Diagnostic information readable	Yes	Yes
• Wire-break	No	Yes; per channel, not in zero range
• Short-circuit	Yes; per channel, not in zero range	No
Diagnostics indication LED		
• Group error SF (red)	Yes	Yes
Potential separation		
Potential separation analog outputs		
• between the channels	No	No
• between the channels and backplane bus	Yes	Yes
Dimensions		
Width	45 mm	45 mm
Height	130 mm	130 mm
Depth	35 mm	35 mm
Weights		
Weight, approx.	150 g	150 g

I/O systems

SIMATIC ET 200 systems without control cabinet
SIMATIC ET 200pro

Communication > IO-Link master modules

Overview

- 45 mm wide 4 IO-LINK HF electronic module
- 4 IO-Link ports according to IO-Link specification V1.1
- Port Class B
- The IO-Link parameters are configured using the Port Configuration Tool (S7-PCT), version V3.4 and higher

Ordering data

Article No.

4 IO-Link HF electronic module	6ES7147-4JD00-0AB0
4 IO-Link ports according to IO-Link specification V1.1, port Class B; High Feature, channel-specific diagnostics, including bus module. Connection module must be ordered separately	
Accessories	
CM IO-Link 4 x M12 P connection module	6ES7194-4CA20-0AA0
4 M12 sockets for connecting IO-Link devices to ET 200pro electronic module 4 IO-Link HF	
Module identification labels	6ES7194-4HA00-0AA0
For color coding of the CM IOs in the colors of white, red, blue and green; pack with 100 units each	
M12 sealing cap	3RX9802-0AA00
For protection of unused M12 connections with ET 200pro	

Technical specifications

Article number	6ES7147-4JD00-0AB0 ET200pro, EM 4 IO-Link HF
Supply voltage	
Rated value (DC)	24 V
Reverse polarity protection	Yes
Load voltage 2L+	
• Rated value (DC)	24 V
• Short-circuit protection	Yes
• Reverse polarity protection	Yes; against destruction; load increasing
Input current	
from supply voltage 1L+, max.	40 mA
from load voltage 2L+ (without load), max.	20 mA
from backplane bus 3.3 V DC, max.	20 mA
Encoder supply	
Number of outputs	4
Short-circuit protection	Yes; per module, electronic
Output current	
• up to 55 °C, max.	2 A

Article number	6ES7147-4JD00-0AB0 ET200pro, EM 4 IO-Link HF
IO-Link	
Number of ports	4
• of which simultaneously controllable	4
IO-Link protocol 1.0	Yes
IO-Link protocol 1.1	Yes
Transmission rate	4.8 kBaud (COM1); 38.4 kBaud (COM2), 230.4 kBaud (COM3)
Size of process data, input per port	32 byte
Size of process data, input per module	32 byte
Size of process data, output per port	32 byte
Size of process data, output per module	32 byte
Memory size for device parameter	2 kbyte; for each port
Master backup	Possible with function block IO_LINK_MASTER
Configuration without S7-PCT	Possible; autostart/manual function
Cable length unshielded, max.	20 m
Operating modes	
• IO-Link	Yes
• DI	Yes
• DQ	Yes; max. 100 mA
Connection of IO-Link devices	
• Port type A	Yes; via 3-core cable
• Port type B	Yes; Additional device supply: for X1 and X2 max. 2 A in total, for X3 and X4 max. 2 A in total
Interrupts/diagnostics/status information	
Diagnostics function	Yes
Alarms	
• Diagnostic alarm	Yes
Diagnoses	
• Diagnostic information readable	Yes
• Wire-break	Yes; channel by channel
• Short-circuit	Yes; channel by channel
Diagnostics indication LED	
• Channel status display	Yes; One green LED for channel status Qn (SIO mode) and port status IO-Ln (IO-Link mode)
• Group error SF (red)	Yes
• Channel fault indicator F (red)	Yes; combined with the IO-Link port status
Potential separation	
between the load voltages	Yes
between backplane bus and all other circuit components	Yes
Potential separation channels	
• between the channels	No
Degree and class of protection	
IP degree of protection	IP65/67
Standards, approvals, certificates	
Suitable for safety-related tripping of standard modules	No
Dimensions	
Width	45 mm
Height	130 mm
Depth	35 mm
Weights	
Weight, approx.	150 g

Overview



Fail-safe digital inputs/outputs with IP65/66/67 degree of protection for cabinet-free application on the machine level.

Fail-safe digital inputs

- For fail-safe reading of sensor information (1 or 2 channels)
- Provide integral discrepancy evaluation for 2-out-of-2 signals
- Internal sensor supplies (incl. test function) available

Fail-safe digital outputs

- Fail-safe 2-channel activation (switching to P/M potential) of actuators
- Actuators can be controlled up to 2 A

All modules are certified up to SIL 3 (IEC 61508) and feature detailed diagnostics.

The modules support PROFIsafe in both PROFIBUS and PROFINET configurations. They can be used with IM151-7 F-CPU, CPU31xF-2 DP, CPU31xF-2 PN/DP and CPU416F-2.

Ordering data

Article No.

**Fail-safe digital input module
8/16 F-DI PROFIsafe**
6ES7148-4FA00-0AB0

24 V DC, including bus module.
Terminal module must be ordered separately

**Fail-safe digital input/output
module 4/8 F-DI, 4 F-DO 2 A**
6ES7148-4FC00-0AB0

24 V DC, including bus module.
Terminal module must be ordered separately

**Fail-safe electronic module
F-Switch PROFIsafe**
6ES7148-4FS00-0AB0

Three fail-safe outputs switching to PP potential for safe switching of the rear panel busbar (2L+, F0, F1); two fail-safe digital inputs, 45 mm; usable up to SIL3 (IEC 61508)

Accessories
Terminal module
6ES7194-4DA00-0AA0

For the fail-safe electronic module F-Switch PROFIsafe

Terminal module
6ES7194-4DC00-0AA0

For the fail-safe electronic module 4/8 F-DI/4 F-DO, 24 V DC/2 A

Terminal module
6ES7194-4DD00-0AA0

For the fail-safe electronic module 8/16 F-DI, 24 V DC

**PROFIBUS DP interface module
IM154-2**
6ES7154-2AA01-0AB0

Including termination module

**PROFINET interface module
IM154-4 PN**
6ES7154-4AB10-0AB0

Including termination module

M12 sealing cap
3RX9802-0AA00

For protection of unused M12 connections with ET 200pro

I/O systems

SIMATIC ET 200 systems without control cabinet

SIMATIC ET 200pro

I/O modules > Fail-safe expansion modules > Fail-safe digital expansion modules**Technical specifications**

Article number	6ES7148-4FA00-0AB0 ET200PRO, EI-Mod., 8/16 F-DI 24V DC
Supply voltage	
Rated value (DC)	24 V
Reverse polarity protection	Yes
Digital inputs	
Number of digital inputs	16
Input current	
• for signal *1*, typ.	3.7 mA

Article number	6ES7148-4FA00-0AB0 ET200PRO, EI-Mod., 8/16 F-DI 24V DC
Standards, approvals, certificates	
Highest safety class achievable in safety mode	
• Performance level according to ISO 13849-1	e
• SIL acc. to IEC 61508	3
Dimensions	
Width	90 mm
Height	130 mm
Depth	65 mm

Article number	6ES7148-4FC00-0AB0 ET200PRO, EI-Mod, 4/8 F-DI/4 F-DO 24VDC/2A	6ES7148-4FS00-0AB0 ET200PRO, EI-Mod, F-Switch PROFIsafe
Supply voltage		
Rated value (DC)	24 V	24 V
Digital inputs		
Number of digital inputs	8	2
Input current		
• for signal *1*, typ.	3.7 mA	3.5 mA
Digital outputs		
Number of digital outputs	4	3
Short-circuit protection	Yes	Yes
Output current		
• for signal *1* rated value	2 A	
Dimensions		
Width	90 mm	45 mm
Height	130 mm	130 mm
Depth	65 mm	65 mm

10

Overview

- PM-E 24 V DC power module

Ordering data**PM-E 24 V DC power module**

For backfeed and group formation of the 24 V DC load voltage for electronic modules within an ET 200pro station.

Accessories**CM PM-E ECOFAST connection module**

For backfeed of 24 V load voltage, 1 ECOFAST Cu connection

CM PM-E direct connection module

For backfeed of 24 V load voltage, up to 2 M20 screwed cable glands

CM PM-E 7/8" connection module

For backfeed of 24 V load voltage, 1 x 7/8"

CM PM-E PP connection module

For supplying 24 V load voltage, 2 x push-pull, with spare fuse

Spare fuse

12.5 A quick-response, for interface and power modules, 10 items per package unit

Article No.**6ES7148-4CA00-0AA0****6ES7194-4BA00-0AA0****6ES7194-4BC00-0AA0****6ES7194-4BD00-0AA0****6ES7194-4BE00-0AA0****6ES7194-4HB00-0AA0****Article No.****PROFIBUS ECOFAST hybrid cable, copper**

Trailing-type cable (PUR sheath), with two shielded Cu wires for PROFIBUS DP plus four Cu wires of 1.5 mm², sold by the meter, minimum order quantity 20 m, maximum order quantity 1 000 m

Preassembled with ECOFAST male and female connector, fixed length

- 1.5 m
- 3 m
- 5 m
- 10 m
- 15 m
- 20 m

6XV1830-7AH10

6XV1830-7BH15
6XV1830-7BH30
6XV1830-7BH50
6XV1830-7BN10
6XV1830-7BN15
6XV1830-7BN20

PROFIBUS ECOFAST hybrid cable, GP

Trailing-type cable with 4 x copper cores and 2 x copper cores, shielded, with UL approval

Preassembled with ECOFAST male and female connector

- 1.5 m
- 3 m
- 5 m
- 10 m
- 15 m
- 20 m

6XV1860-3PH15
6XV1860-3PH30
6XV1860-3PH50
6XV1860-3PN10
6XV1860-3PN15
6XV1860-3PN20

I/O systems

SIMATIC ET 200 systems without control cabinet
SIMATIC ET 200pro

I/O modules > PM-E power module

Ordering data	Article No.	Accessories for CM PM-E 7/8"	Article No.
ECOFAST connection plug, for user assembly Female connector; ordering unit 5 items	6GK1905-0CB00	7/8" connecting cable to power supply 5-wire, 5 x 1.5 mm ² , trailing type, preassembled with two 7/8" connectors, 5-pin <ul style="list-style-type: none"> • 1.5 m long • 2.0 m long • 3.0 m long • 5.0 m long • 10 m long • 15 m long 	6XV1822-5BH15 6XV1822-5BH20 6XV1822-5BH30 6XV1822-5BH50 6XV1822-5BN10 6XV1822-5BN15
PROFIBUS ECOFAST hybrid plug, angled With 2 x shielded copper cores and 4 x 1.5 mm ² copper cores; 5 items; with assembly instructions; female insert	6GK1905-0CD00		
Push-pull connection plug For 1L+/ 2L+, unassembled	6GK1907-0AB11-6AA0		
Cover caps for push-pull female connectors 5 units	6ES7194-4JA50-0AA0	7/8" connection plug With axial cable outlet <ul style="list-style-type: none"> • with female insert, 5 per pack 	6GK1905-0FB00
Accessories for CM PM-E direct			
Power line 5-wire, 5 x 1.5 mm ² , trailing type, sold by the meter, minimum order quantity 20 m, maximum order quantity 1 000 m	6XV1830-8AH10		

Technical specifications

Article number	6ES7148-4CA00-0AA0 ET 200pro, PM-E 24V DC
Supply voltage	
Load voltage 2L+	
<ul style="list-style-type: none"> • Rated value (DC) 	24 V
<ul style="list-style-type: none"> • Short-circuit protection 	Yes; via an exchangeable fuse in the power module
<ul style="list-style-type: none"> • Reverse polarity protection 	Yes; against destruction
Input current	
from load voltage 2L+, max.	3 mA
Current carrying capacity	
max.	10 A; up to 55 °C (on the internal busbars of the ET 200pro)
Power loss	
Power loss, typ.	0.1 W
Interrupts/diagnostics/status information	
Diagnostics function	Yes
Diagnoses	
<ul style="list-style-type: none"> • Diagnostic information readable 	Yes
<ul style="list-style-type: none"> • missing load voltage 	Yes
Diagnostics indication LED	
<ul style="list-style-type: none"> • For load voltage monitoring 	Yes
<ul style="list-style-type: none"> • Group error SF (red) 	Yes

Article number	6ES7148-4CA00-0AA0 ET 200pro, PM-E 24V DC
Potential separation	
between load voltage and backplane bus	Yes
Degree and class of protection	
IP degree of protection	IP65/67
Dimensions	
Width	45 mm
Height	130 mm
Depth	35 mm
Weights	
Weight, approx.	140 g

10

Overview



PM-O 2 x 24 V DC power module with CM PM-O PP

- PM-O 2x 24 V DC power module

Ordering data

PM-O 2 x 24 V DC power module

For drawing the 24 V load voltage 2L+ and electronic/encoder supply voltage 1L+ within an ET 200pro station.

Accessories

CM PM-O PP connection module

For drawing the 24 V load voltage and electronic/encoder supply voltage, 2 x push-pull connector

Article No.

6ES7148-4CA60-0AA0

6ES7194-4BH00-0AA0

Article No.

Push-pull cable connector

For 1L+/ 2L+, unassembled

Cover caps for push-pull female connectors

5 units

6GK1907-0AB11-6AA0

6ES7194-4JA50-0AA0

Technical specifications

Article number	6ES7148-4CA60-0AA0 ET200PRO, PM-O DC 2x24V
Supply voltage	
Load voltage 2L+	
• Rated value (DC)	24 V
• Short-circuit protection	Yes
• Reverse polarity protection	Yes; against destruction
Input current	
from load voltage 2L+, max.	3 mA
Current carrying capacity	
max.	10 A; up to 55 °C (on the internal busbars of the ET 200pro)
Power loss	
Power loss, typ.	1.1 W
Interrupts/diagnostics/status information	
Diagnostics function	Yes
Diagnoses	
• Diagnostic information readable	Yes
• missing load voltage	No
Diagnostics indication LED	
• For load voltage monitoring	No; Signalled in IM or in PM
• Group error SF (red)	Yes

Article number	6ES7148-4CA60-0AA0 ET200PRO, PM-O DC 2x24V
Potential separation	
between load voltage and backplane bus	Yes
Degree and class of protection	
IP degree of protection	IP65/67
Dimensions	
Width	45 mm
Height	130 mm
Depth	35 mm
Weights	
Weight, approx.	150 g

I/O systems

SIMATIC ET 200 systems without control cabinet
SIMATIC ET 200pro

I/O modules > ET 200pro pneumatic interface**Overview**

- Interface for holding an original FESTO CPV 10 or CPV 14 compact performance valve terminal
- For using ET 200pro in applications with flexible pneumatics
- Highly flexible pneumatics due to a variety of valve functions and choice of flow rates

Ordering data**Article No.****Article No.****EM 148-P pneumatic interface**

DO 16 x P/CPV 10 for direct accommodation of FESTO valve terminal CPV 10 16 DO x P

6ES7148-4EA00-0AA0

FESTO CPV 10 valve terminal

available from FESTO

DO 16 x P/CPV 14 for direct accommodation of FESTO valve terminal CPV 14 16 DO x P

6ES7148-4EB00-0AA0

FESTO CPV 14 valve terminal

available from FESTO

FESTO AG & Co
Ruitterstr. 82
D-73732 Esslingen

More addresses
on the Internet at:
<http://www.festo.com>

Technical specifications

Article number	6ES7148-4EA00-0AA0	6ES7148-4EB00-0AA0
	ET200PRO, 16DO,Pneumatic Interface CPV10	ET200PRO, 16DO,Pneumatic Interface CPV14
Supply voltage		
Load voltage 2L+		
• Rated value (DC)	24 V	24 V
• Short-circuit protection	Yes	Yes
• Reverse polarity protection	Yes	Yes
Input current		
from load voltage 2L+, max.	300 mA; Including valves	370 mA; Including valves
from backplane bus 3.3 V DC, max.	25 mA	25 mA
Power loss		
Power loss, typ.	2.6 W	3.7 W
Address area		
Address space per module		
• Address space per module, max.	2 byte	2 byte
Digital outputs		
Number of digital outputs	16	16
Load resistance range		
• lower limit	500 Ω	500 Ω
• upper limit	2 500 Ω	2 500 Ω
Output current		
• for signal "1" rated value	12 mA	16 mA
Switching frequency		
• with inductive load, max.	25 Hz	20 Hz
Total current of the outputs (per group)		
all mounting positions		
- up to 55 °C, max.	250 mA; only up to 50 °C, limited by valves	330 mA; only up to 50 °C, limited by valves

Technical specifications

Article number	6ES7148-4EA00-0AA0	6ES7148-4EB00-0AA0
	ET200PRO, 16DO,Pneumatic Interface CPV10	ET200PRO, 16DO,Pneumatic Interface CPV14
Interrupts/diagnostics/ status information		
Diagnostics function	Yes	Yes
Alarms		
• Diagnostic alarm	Yes	Yes
Diagnoses		
• Diagnostic information readable	Yes	Yes
Diagnostics indication LED		
• Group error SF (red)	Yes	Yes
• Status indicator digital output (green)	Yes	Yes
Pneumatics		
Number of connectable valves, max.	16	16
permissible working pressure, min.	3 bar	3 bar
permissible working pressure, max.	8 bar	8 bar
Rated flow rate	400 l/min	800 l/min
Standards, approvals, certificates		
Suitable for safety-related tripping of standard modules	Yes	Yes
Highest safety class achievable for safety-related tripping of standard modules		
• Performance level according to ISO 13849-1	PL d	PL d
• Category according to ISO 13849-1	Cat. 3	Cat. 3
• SILCL according to IEC 62061	SILCL 2	SILCL 2
Dimensions		
Width	90 mm	120 mm
Height	130 mm	152 mm
Depth	47 mm	47 mm

I/O systems

SIMATIC ET 200 systems without control cabinet
SIMATIC ET 200pro

I/O modules > RF170C

Overview



The SIMATIC RF170C is a communications module for connecting the SIMATIC identification systems to the ET 200pro distributed I/O system. The readers of all RFID systems as well as the MV400 optical readers and MV300 optical handheld readers can be operated on the RF170C. In addition, the RF170C provides a universal RS232/RS422 interface for connecting devices using the Freepoint protocol.

Thanks to the high degree of protection and ruggedness, ET 200pro is particularly suitable for machine-level use. The modular structure with PROFIBUS and PROFINET connection systems allows it to be used in all applications. The uniform plug-in connection system ensures rapid commissioning.

Ordering data

SIMATIC RF170C communications module

For connecting to the ET 200pro distributed I/O system

Article No.

6GT2002-0HD01

Accessories

Connection block for SIMATIC RF170C

For connecting 2 readers or other RS422/RS232 devices via an M12 connector

6GT2002-1HD01

Reader cable for SIMATIC RF200 / RF300 / RF600 / MV440

Or MOBY D extension cable and SIMATIC RF200 / RF300 / RF600 / MV400, PUR material, trailable

2 m, straight plug

6GT2891-4FH20

5 m, straight plug

6GT2891-4FH50

10 m, straight plug

6GT2891-4FN10

20 m, straight plug

6GT2891-4FN20

50 m, straight plug

6GT2891-4FN50

2 m, plug angled at reader

6GT2891-4JH20

5 m, plug angled at reader

6GT2891-4JH50

10 m, plug angled at reader

6GT2891-4JN10

Article No.

Connecting cable for SIMATIC RF1000

Prefabricated RS232, between RF1040R or RF1070R and a communications module; black, length 2 m

6GT2891-4UH20

Reader cable for MV300 handheld readers

Coiled cable with usable length of 1.6 m to 4 m for MV320, PUR material

6GT2191-0BH50

Plug for connection of other RS422/RS232 devices

8-pole M12 plug, male, screw connections for wires up to 0.5 mm².
Order quantity 1 pack with 5 units

6GT2090-0BE00

M12 sealing caps for unused reader connections

Minimum order quantity 10 units, price per 100 units

3RX9802-0AA00

Technical specifications

Article number	6GT2002-0HD01
product type designation	RF170C communication module
suitability for operation	ET 200pro distributed I/O together with RF200/300/1000, MV300/400/500, MOBY D/E/I/U and RS-232 devices
transfer rate	
transfer rate at the point-to-point connection serial maximum	115.2 kbit/s
interfaces	
design of the interface for point-to-point connection	RS422/RS232 via connection block
number of readers connectable	2
type of electrical connection	
• of the backplane bus	ET 200pro backplane bus
• of the PROFIBUS interface	(according to the head module)
• of Industrial Ethernet interface	(according to the head module)
• for supply voltage	ET 200pro backplane bus
design of the interface to the reader for communication	Internal plug to the connection block
mechanical data	
material	Thermoplastic (Valox 467, fiberglass reinforced)
color	IP Basic 714
tightening torque of the screw for securing the equipment maximum	1.5 N·m
supply voltage, current consumption, power loss	
supply voltage	
• at DC rated value	24 V
• at DC	20 ... 30 V
consumed current at DC at 24 V	
• without connected devices typical	0.13 A
• with connected devices maximum	1 A
ambient conditions	
ambient temperature	
• during operation	-25 ... +55 °C
• during storage	-40 ... +70 °C
• during transport	-40 ... +70 °C
protection class IP	IP67
shock resistance	According to IEC 61131-2
shock acceleration	300 m/s ²
vibrational acceleration	100 m/s ²

Article number	6GT2002-0HD01
product type designation	RF170C communication module
design, dimensions and weights	
width	90 mm
height	130 mm
depth	35 mm
net weight	0.27 kg
fastening method	ET 200pro rack
wire length for RS 422 interface maximum	1 000 m
product features, product functions, product components general	
display version	(see connection block)
product function addressable	No
transponder file handler	
protocol is supported	
• S7 communication	Yes
product functions management, configuration, engineering	
type of parameterization	HSP
type of programming	FB 45, FB 55, ID profile, library with functions, (FC 45/55 with restricted functionality)
type of computer-switched communication	acyclic communication
standards, specifications, approvals	
certificate of suitability	CE, FCC, cULus
MTBF	77 y
accessories	
accessories	Connection block for RF170C

I/O systems

SIMATIC ET 200 systems without control cabinet
SIMATIC ET 200pro

Power supplies > 3-phase, 24 V DC (ET200pro PS, IP67)

Overview**Power supply for ET200pro:**

- 3-phase, 24 V DC/8 A

The SIMATIC ET200pro PS power supply unit with IP67 degree of protection is used as the electronics/encoder supply and load voltage supply of the new SIMATIC ET 200pro distributed I/O system for use close to the machine without a cabinet. With a second connector for looping the input voltage.

Product highlights

- 3-phase, 24 V DC/8 A
- Wide-range input, input voltage 340 ... 550 V
- Up to 88% efficiency
- With signaling contact for "24 V OK" and "Overtemperature"
- Status indicator on the device by means of LED (green = "24 V OK")
- Temperature range from -25 °C to +55 °C

Ordering data**SIMATIC ET 200pro PS**

Stabilized power supply in distributed I/O system design, permitting the loop-through of energy to further modules; with degree of protection IP67; Input: 400–480 V 3 AC Output: 24 V DC/8 A

Accessories**Power connector**

For connecting to the distributed I/O system

- For X1 (6 mm²)
- For X2 (4 mm²)

Article No.

6ES7148-4PC00-0HA0

3RK1911-2BE30
3RK1911-2BF10

Article No.**National Fire Protection Association compatible**

These devices are only approved for installation in industrial machinery according to the NFPA79 Electrical Standard for Industrial Machinery.

- for X1 SIMATIC ET200pro PS 61 88 201 1003.xx (AWG10)*
- for X1 SITOP PSU300P 61 88 201 1000.xx / 61 88 201 1002.xx (AWG14)*
- for X2 SIMATIC ET200pro PS 61 88 202 1010.xx (AWG10)*

supplied blanking cap for X2

• for X3
Phoenix-Contact
SAC-5P-M12-M12FS

supplied blanking cap for X3

Sealing cap

For 9-pole power sockets

- X2 (1 unit)
- X2 (10 units)

* <http://www.harting.com/startseite>

3RK1902-0CK00

3RK1902-0CK00
3RK1902-0CJ00

Technical specifications

Article number	6ES7148-4PC00-0HA0
Product	SIMATIC ET200pro PS
Power supply, type	24 V/8 A
Input	
Input	3-phase AC
Rated voltage value $V_{in \text{ rated}}$	400 ... 480 V
Voltage range AC	340 ... 550 V
• Note	320 ... 340 V for max. 1 min
Wide-range input	Yes
Overvoltage resistance	Implemented internally with varistors
Mains buffering	at $V_{in} = 400 \text{ V}$
Mains buffering at $I_{out \text{ rated}}$, min.	15 ms; at $V_{in} = 400 \text{ V}$
Rated line frequency 1	50 Hz
Rated line frequency 2	60 Hz
Rated line range	45 ... 66 Hz

Article number	6ES7148-4PC00-0HA0
Product	SIMATIC ET200pro PS
Power supply, type	24 V/8 A
input current	
• at rated input voltage 400 V	0.5 A
Switch-on current limiting (+25 °C), max.	40 A
I^2t , max.	3.5 A ² ·s
Built-in incoming fuse	T 4 A
Protection in the mains power input (IEC 898)	Required: Circuit breaker 3RV2011-1DA10 or 3RV2711-1DD10 (UL 489)
Output	
Output	Controlled, isolated DC voltage
Rated voltage $V_{out \text{ DC}}$	24 V
• output voltage at output 1 at DC rated value	24 V

Technical specifications

Article number	6ES7148-4PC00-0HA0
Product	SIMATIC ET200pro PS
Power supply, type	24 V/8 A
Total tolerance, static ±	3 %
Static mains compensation, approx.	0.5 %
Static load balancing, approx.	0.5 %
Residual ripple peak-peak, max.	200 mV
Spikes peak-peak, max. (bandwidth: 20 MHz)	250 mV
product function output voltage adjustable	No
Output voltage setting	-
Status display	Green LED for 24 V OK
Signaling	max. 30 V, 10 mA; Power-Good (High-Pegel 1L+ for V _{out} in range 21.3 ... 29 V); Overtemperature warning at least 30 s before switch-off (high level 1L+ when the max. internal temperature is exceeded)
On/off behavior	Overshoot of V _{out} < 2 %
Startup delay, max.	1.5 s
Voltage rise, typ.	40 ms
Rated current value I _{out rated}	8 A
Current range	0 ... 8 A
supplied active power typical	192 W
short-term overload current	
• on short-circuiting during the start-up typical	50 A
• at short-circuit during operation typical	50 A
duration of overloading capability for excess current	
• on short-circuiting during the start-up	100 ms
• at short-circuit during operation	100 ms
Parallel switching for enhanced performance	No
Efficiency	
Efficiency at V _{out rated} , I _{out rated} , approx.	88 %
Power loss at V _{out rated} , I _{out rated} , approx.	25 W
Closed-loop control	
Dynamic mains compensation (V _{in rated} ± 15 %), max.	0.5 %
Dynamic load smoothing (I _{out} : 50/100/50 %), U _{out} ± typ. setting time maximum	1 % 2 ms
Protection and monitoring	
Output overvoltage protection	< 33 V
Current limitation, typ.	9.4 A
property of the output short-circuit proof	Yes
Short-circuit protection	Electronic shutdown, automatic restart
enduring short circuit current RMS value	
• maximum	10 A
Overload/short-circuit indicator	-
Safety	
Primary/secondary isolation	Yes
galvanic isolation	Protective extra low output voltage V _{out} according to EN 60950-1 and EN 50178
Protection class	Class I
leakage current	
• maximum	3.5 mA
• typical	0.4 mA
Degree of protection (EN 60529)	IP67, enclosure type 5 indoor

Article number	6ES7148-4PC00-0HA0
Product	SIMATIC ET200pro PS
Power supply, type	24 V/8 A
Approvals	
certificate of suitability	
• CE marking	Yes
• UL/cUL (CSA) approval	UL-Listed (UL 508) according to NFPA compatibility (National Fire Protection Association), see operating instructions
certificate of suitability	
IECEX	No
NEC Class 2	No
CB-certificate	Yes
EAC approval	Yes
certificate of suitability	No
shipbuilding approval	-
EMC	
Emitted interference	EN 55022 Class A
Supply harmonics limitation	-
Noise immunity	EN 61000-6-2
environmental conditions	
ambient temperature	
• during operation	-25 ... +55 °C
- Note	with natural convection
• during transport	-40 ... +70 °C
• during storage	-40 ... +70 °C
Humidity class according to EN 60721	Climate class 3K3, 5 ... 95% no condensation
Mechanics	
Connection technology	screw-type terminals
Connections	
• Supply input	L1, L2, L3, PE: Plug connector HAN Q4/2 (counterpart see "Electrical accessories")
• Output	L+, M: 2 x 1.5 mm ² each (4-pole cable for +/- with open, labeled ends, 4 x 1.5 mm ²)
• Auxiliary	Alarm signals: M12 plug-in connector 5-pin
width of the enclosure	310 mm
height of the enclosure	135 mm
depth of the enclosure	90 mm
Weight, approx.	2.8 kg
product feature of the enclosure housing can be lined up	No
Installation	Can be mounted onto ET200pro mounting rail
electrical accessories	Power connector (Input: 3RK1911-2BE30 (6 mm ²)) (Output: 3RK1911-2BF10 (4 mm ²))
MTBF at 40 °C	196 354 h
other information	Specifications at rated input voltage and ambient temperature +25 °C (unless otherwise specified)

I/O systems

SIMATIC ET 200 systems without control cabinet
SIMATIC ET 200pro

ET 200pro motor starters > General data

Overview

ET 200pro motor starters in I/O system ET 200pro

SIMATIC ET 200pro is the modular I/O system with high degree of protection IP65/66/67 for local, cabinet-free use. The ET 200pro motor starters with the high degree of protection IP65 are an integral part of ET 200pro.



ET 200pro motor starter: Isolator module, Standard starter and High Feature starter mounted on a wide module rack

ET 200pro motor starters (see pages 10/403 and 10/404)

- Only two variants up to 5.5 kW
- All settings can be parameterized by bus
- Comprehensive diagnostic signals
- Support for PROFlenergy
- Overload can be acknowledged by remote reset
- Current unbalance monitoring
- Stall protection
- EMERGENCY START function on overload
- Current value transmission by bus
- Current limit monitoring
- Full support of acyclic services
- Direct-on-line or reversing starters
- Power bus connection can be plugged in using Han Q4/2 plug-in connectors
- Motor feeder with Han Q8/0 connector
- Conductor cross-section up to 6 x 4 mm²
- 25 A per segment (power looped through using jumper plug)
- In the Standard and High Feature versions (with 4 DI on-board)
- Electromechanical switching and electronic switching
- Electronic starter for direct activation or with integrated soft starter function
- Supplied with 400 V AC brake contact as an option
- Temperature sensor can be connected (Thermoclick or PTC type A)
- Provision of the motor current in PROFlenergy format to higher-level systems, motor current shutdown in dead times using PROFlenergy

More information

Homepage see www.siemens.com/sirius-motor-starter-et200sp

Industry Mall see www.siemens.com/product?ET200pro

Further components in the ET 200pro distributed I/O system:

- Interface modules, CPUs, I/O modules, ET 200pro PS see from page 10/366
- Frequenzumrichter ET 200pro FC-2 see page 10/413

Katalog IC 10 see www.siemens.com/ic10

ET 200pro isolator modules (see page 10/405)

The isolator module with switch disconnecter function is used for safe disconnection of the 400 V operational voltage during repair work in the plant and provides an integrated group fusing function (i.e. additional group short-circuit protection for all subsequently supplied motor starters).

Depending on the power distribution concept, all stations can be equipped with an isolator module as an option.

Safety applications

Safety Solution PROFIsafe (see page 10/406)

With the Safety PROFIsafe modules

- F-Switch and
 - 400 V disconnecting module
- with an appropriate connection, safety levels SIL 3 (according to IEC 62061) and PL e (according to ISO 13849-1) can also be reached.

Functionality

With the ET 200pro motor starters, any three-phase loads can be protected and switched.

The ET 200pro motor starters are available with mechanical and also electronic contacts.

The ET 200pro electromechanical starters are offered as direct-on-line starters (DSe) and reversing starters (RSe) as **Standard** and **High Feature** versions. There are device versions with or without control for externally fed brakes with 400 V AC.

Compared with the Standard motor starters, the **High Feature, mechanical** motor starter also has:

- Four digital inputs
- Advanced parameterization options

The ET 200pro electronic starters are offered as direct-on-line starters (sDSSt/sDSt) and reversing starters (sRSSt/sRSt) in the High Feature version.

Compared with the High Feature mechanical motor starters, the **High Feature, electronic** motor starter also has:

- Soft starting and smooth ramp-down function
- Deactivated soft start function as an electronic starter for applications with a high switching frequency
- Advanced parameterization options

ET 200pro motor starters > General data

As a result of the protection concept with solid-state overload evaluation and the use of SIRIUS switching devices, size S00, additional advantages are realized on the Standard and High Feature motor starters – advantages that soon make themselves positively felt particularly in manufacturing processes with high plant stoppage costs:

- Configuration is made easier by the fine modular structure with ET 200pro. When using ET 200pro motor starters, the parts list per load feeder is reduced to two main items: the bus module and the motor starter. This makes the ET 200pro ideal for modular machine concepts or solutions for conveying systems and in machine-tool building.
- Expansions are easily possible through the subsequent adding of modules. The innovative plug-in technology also does away with the wiring needed up to now. Through the hot swapping function (disconnection and connection during operation) a motor starter can be replaced within seconds if necessary, without having to shut down the ET 200pro station and with it the process in the plant. The motor starters are therefore recommendable in particular for applications with special demands on availability. Storage costs are also optimized by the low level of variance (two units up to 5.5 kW).
- With four locally acting inputs available on the High Feature motor starter it is possible to realize autonomous special functions that work independently of the bus and the higher level control system, e.g. as a quick stop on gate valve controls or limit position disconnectors. In parallel with this, the states of these inputs are signaled to the control system.

Article No. scheme

Product versions		Article number			
Motor starters		3RK1304 – 5 <input type="checkbox"/> S <input type="checkbox"/> 0 <input type="checkbox"/> A A <input type="checkbox"/>			
Setting range	0.15 ... 2.0 A 1.5 ... 12 A	K L			
Product function	Direct-on-line starters DSe		4	4	Standard
	Reversing starters RSe		4	5	Standard
	Direct-on-line starters DSe		4	2	High Feature
	Reversing starters RSe		4	3	High Feature
	Direct-on-line starters sDSSt/sDSt		7	2	High Feature
	Reversing starters sDSSt/sDSt		7	3	High Feature
Inputs/outputs	Without brake output				0
	With brake output				3 400 V AC, with High Feature + 4 inputs
Example		3RK1304 – 5 K S 4 0 – 4 A A 0			

Product versions		Article number			
Modules		3RK1304 – 0 H S 0 0 – <input type="checkbox"/> A A 0			
Product function	Isolator modules				6
	400 V disconnecting module				8 Safety modules PROFIsafe
Example		3RK1304 – 0 H S 0 0 – 6 A A 0			

Note:

The article number schemes show an overview of product versions for better understanding of the logic behind the article numbers.

For your orders, please use the article numbers quoted in the selection and ordering data.

I/O systems

SIMATIC ET 200 systems without control cabinet
SIMATIC ET 200pro

ET 200pro motor starters > General data

Type	Standard motor starters		High Feature motor starters	
	DSe, RSe		DSe, RSe	sDSSSte, sDSte, sRSSSte, sRSte
Technology designation ¹⁾				
Device functions (firmware features)				
Parameterizable rated operational current	✓			
Integrated short-circuit protection	✓			
Parameterizable current limit values	--		✓ 2 limit values	
Parameterizable response in case of current limit violation	--		✓	
Zero current monitoring	✓			
Parameterizable response in case of zero current violation	✓			
Parameterizable current unbalance limit	%	-- Fixed limit value	✓ 30 ... 60 x I _e	
Parameterizable response in case of unbalance limit violation	✓			
Motor blocking monitoring	--		✓	
Parameterizable blocking current limit	%	--	✓ 150 ... 1 000 x I _e	
Parameterizable blocking time limit	s	--	✓ 1 ... 5	
Current value transmission	✓			
Group warning diagnostics	--		✓ Parameterizable	
Group diagnostics	✓ Parameterizable			
EMERGENCY START	✓			
Digital inputs	--		✓ 4 inputs	
• Parameterizable input signal	--		✓ Latching/non-latching	
• Parameterizable input level	--		✓ NC/NO contacts	
• Parameterizable input signal delay	ms	--	✓ 10 ... 80	
• Parameterizable input signal extension	ms	--	✓ 0 ... 200	
• Parameterizable input control actions	--		✓ 12 different actions	
Brake output (400 V AC)	✓ Order option			
Parameterizable brake enabling delay	s	✓ -2.5 ... +2.5		
Parameterizable holding time of the brake during stopping	s	✓ 0 ... 25		
Parameterizable start up type	--		✓	
Parameterizable ramp-down time	--		✓	
Parameterizable starting voltage	--		✓	
Parameterizable stopping voltage	--		✓	
Local device interface	✓			
Firmware update	✓ By specialists			
Thermal motor model	✓			
Parameterizable trip class	-- CLASS 10 fixed		✓ CLASS 5, 10, 15, 20	
Parameterizable response in case of overload of thermal motor model	--		✓ 3 possible states	
Advance warning limit for motor heating	%	--	✓ Parameterizable 0 ... 95	
Advance warning limit time-related trip reserve	s	--	✓ Parameterizable 0 ... 500	
Parameterizable recovery time	min	--	✓ 1 ... 30	
Parameterizable protection against voltage failure	-- Permanently		✓	
Reversing start function	✓ Order option			
Parameterizable interlock time for reversing starters	-- 150 ms fixed		✓ 0 ... 60 s	
Integrated logbook functions	✓ 3 device logbooks			
Integrated statistics data memory	✓			
Parameterizable response in case of CPU/master stop	✓			
PROFenergy profile support	✓			
• Disconnection of the motor current during idle times	✓			
• Measured motor current values	✓			
Device indications				
• Group fault	SF LED (red)			
• Switching state	STATE LED (red, yellow, green)			
• Device status	DEVICE LED (red, yellow, green)			
• Digital inputs	--		IN 1 ... IN 4, LED	

✓ Function available

-- Function not available

¹⁾ DS Direct-on-line starters

RS Reversing starters

DSS .. Direct-on-line soft starters

RSS .. Reversing soft starters

e Electronic motor protection

te Full motor protection (thermal + electronic)

s Electronic switching with semiconductor.

Benefits

ET 200pro motor starters provide the following advantages:

- High flexibility thanks to a modular and compact design
- Little variance among all motor starter versions (two units up to 5.5 kW)
- Extensive parameterization using STEP 7 HW Config
- Increase of plant availability through fast replacement of units (easy mounting and plug-in technology)
- Extensive diagnostics and information for preventive maintenance
- Parameterizable inputs for on-site control functions (High Feature)
- Cabinet-free design thanks to high degree of protection IP65

Application

The SIMATIC ET 200pro motor starters are ideal for the use of several spatially concentrated distributed drive solutions in which several motors, or digital or analog sensors and actuators are addressed from a distributed station. They are perfectly suited for protecting and switching any AC loads.

Application areas

The SIMATIC ET 200pro motor starters are suitable for numerous sectors of industry, e.g. machinery and plant engineering or conveying applications.

Use of ET 200pro motor starters in conjunction with IE3/IE4 motors

Note:

For the use of ET 200pro motor starters in conjunction with highly energy-efficient IE3/IE4 motors, please observe the information on dimensioning and configuring [see Application manual](#).

More Information [see Catalog IC 10](#).

I/O systems

SIMATIC ET 200 systems without control cabinet
SIMATIC ET 200pro

ET 200pro motor starters > General data

Technical specifications

More information			
Manual, see https://support.industry.siemens.com/cs/ww/en/view/22332388		Notes on security: System networking requires suitable protective measures (including network segmentation for IT security) in order to ensure safe plant operation. For more information on the subject of Industrial Security, see www.siemens.com/industrialsecurity .	
Type		Standard motor starters Mechanically switching without inputs	High Feature motor starters Mechanically switching with inputs Mechanically switching with inputs and soft starter function
Technology designation ¹⁾		DSe, RSe	DSe, RSe sDSSSte, sDSte, sRSSSte, sRSte
Mechanics and environment			
Motor starters or modules that can be connected to ET 200pro With width of 110 mm		max. 8	
Mounting dimensions (W x H x D) • Direct-on-line starters and reversing starters	mm	110 x 230 x 150	110 x 230 x 160
Permissible ambient temperature • During operation • During storage	°C	-25 ... +55, from +40 with derating -40 ... +70	
Permissible mounting position		Vertical, horizontal	
Vibration resistance acc. to IEC 60068, Part 2-6	g	2	
Shock resistance acc. to IEC 60068, Part 2-27	g/ms	Half-sine 15/11	
Degree of protection		IP65	
Pollution degree		3, IEC 60664 (IEC 61131)	
Electrical specifications			
Power consumption at 24 V DC • From auxiliary circuit L+/M (U1) • From auxiliary circuit A1/A2 (U2)	mA	Approx. 40 Approx. 200	
Rated operational current I_g for power bus	A	25	
Rated operational voltage U_g • Approval according to EN 60947-1, Appendix N • Approval according to CSA and UL	AC V AC V AC V	400 (50/60 Hz) Up to 400 (50/60 Hz) Up to 600 (50/60 Hz)	Up to 400 (50/60 Hz) Up to 480 (50/60 Hz)
Approval • DIN VDE 0106, Part 101 • CSA and UL approval	V V	Up to 400 Up to 600	Up to 480 Up to 480
Conductor cross-sections • Incoming power supply	mm ²	Max. 6 x 4	
Touch protection		Finger-safe	
Rated impulse withstand voltage U_{imp}	kV	6	
Rated insulation voltage U_i	V	400	
Rated operational current I_g for starters • AC-1 / 2 / 3 at 40 °C - At 400 V - At 500 V • AC-4 at 40 °C - At 400 V	A A A	0.15 ... 2.0/1.5 ... 12.0 0.15 ... 2.0/1.5 ... 9.0 0.15 ... 2.0/1.5 ... 4.0	0.15 ... 2.0/1.5 ... 12.0 ²⁾
Rated short-circuit breaking capacity	kA	100 at 400 V	
Type of coordination acc. to IEC 60947-4-1		1	
Power of three-phase motors at 400 V	kW	Max. 5.5	
Utilization categories		AC-1, AC-2, AC-3, AC-4	AC-53a ⁴⁾ (max. 9 A with deactivated soft start function up to CLASS 10)
Protective separation between main and auxiliary circuits	V	400, acc. to EN 60947-1, Appendix N	
Endurance of contactor • Mechanical • Electrical	Oper. cycles Oper. cycles	30 million Up to 10 million; depending on the current loading	-- --
Permissible switching frequency		Depending on the current loading, motor starting time, and relative ON period (see manual)	
Operating times at 0.85 ... 1.1 x U_g • Closing delay • Opening delay	ms ms	11 ... 50 5 ... 45	-- --

¹⁾ DS Direct-on-line starters
RS Reversing starters
DSS .. Direct-on-line soft starters
RSS .. Reversing soft starters
e Electronic motor protection
te Full motor protection (thermal + electronic)
s Electronic switching with semiconductor.

²⁾ If the soft starter control function is deactivated, the permissible rated operational current is reduced to 9 A to CLASS 10.

³⁾ With parameterization as electronic starter max. 4 kW.

⁴⁾ 8-hour operation.

Overview

The functionality, device functions, and technical specifications of the Standard motor starter are described in

"ET 200pro motor starters, General data", (see page 10/398 onwards).

Selection and ordering data

Version

Article No.

**Standard motor starters, mechanical
Motor protection: thermal model**

DSe Standard

DSe direct-on-line starters¹⁾

- Without brake output
- With brake output 400 V AC

3RK1304-5□S40-4AA0
3RK1304-5□S40-4AA3

RSe reversing starters¹⁾

- Without brake output
- With brake output 400 V AC

3RK1304-5□S40-5AA0
3RK1304-5□S40-5AA3

Setting range
Rated operational current

- 0.15 ... 2.0 A
- 1.5 ... 12.0 A

↑
K
L

¹⁾ Only functions when used together with the backplane bus module and the wide module rack. The backplane bus module and the wide module rack must be ordered separately (see "Accessories for ET 200pro motor starters", page 10/412).

I/O systems

SIMATIC ET 200 systems without control cabinet
SIMATIC ET 200pro

ET 200pro motor starters > High Feature motor starters **IE3/IE4 ready**

Overview

The functionality, device functions, and technical specifications of the High Feature motor starter are described in "ET 200pro motor starters, General data" (see page 10/398 onwards).

The High Feature motor starter differs from the Standard motor starter in having more parameters and four integrated, freely-parameterizable digital inputs.

Selection and ordering data

Version	Article No.
---------	-------------

High Feature motor starters, mechanical Motor protection: thermal model



RSe High Feature

DSe direct-on-line starters¹⁾

- Without brake output and with 4 inputs
- With brake output 400 V AC and 4 inputs

3RK1304-5□S40-2AA0
3RK1304-5□S40-2AA3

RSe reversing starters¹⁾

- Without brake output and with 4 inputs
- With brake output 400 V AC and 4 inputs

3RK1304-5□S40-3AA0
3RK1304-5□S40-3AA3

Setting range
Rated operational current

- 0.15 ... 2.0 A
- 1.5 ... 12.0 A

↑
K
L

High Feature motor starters²⁾, electronic Full motor protection, comprising thermal motor protection and thermistor motor protection



sRSSSte High Feature

Direct-on-line starters sDSSSte/sDSte¹⁾²⁾

- Without brake output and with 4 inputs
- With brake output 400 V AC and 4 inputs

3RK1304-5□S70-2AA0
3RK1304-5□S70-2AA3

Reversing starters sRSSSte/sRSte¹⁾²⁾

- Without brake output and with 4 inputs
- With brake output 400 V AC and 4 inputs

3RK1304-5□S70-3AA0
3RK1304-5□S70-3AA3

Setting range
Rated operational current

- 0.15 ... 2.0 A
- 1.5 ... 12.0 A

↑
K
L

¹⁾ Only functions when used together with the backplane bus module and the wide module rack. The backplane bus module and the wide module rack must be ordered separately (see "Accessories for ET 200pro motor starters", page 10/412).

²⁾ The solid-state motor starters can be used not only as solid-state motor starters with a high level of switching frequency but also as fully fledged soft starters for soft starting and stopping. The changeover from motor starter to soft starter takes place through reparameterization in HW Config. Depending on the setting, this results in the following current ranges:

- Parameterization as solid-state motor starter: 0.15 to 2 A and 1.5 to 9 A (4 kW)
- Parameterization as soft starter: 0.15 to 2 A and 1.5 to 12 A (5.5 kW).

Overview

The isolator module with integrated group fusing function (i.e. additional group short-circuit protection for all subsequently supplied motor starters) and switch disconnecter function is used to safely disconnect the 400 V operating voltage during repair work in the plant.

Depending on the power distribution concept, all stations can be equipped with an isolator module as an option.

The following properties apply to the isolator module:

- Increase of plant availability through fast replacement of units (easy mounting and plug-in technology)
- Cabinet-free design thanks to high degree of protection IP65

Technical specifications

Type	Isolator modules	
General data		
Mounting dimensions (W x H x D)		
• Direct-on-line starters and reversing starters	mm	110 x 230 x 170
Permissible ambient temperature		
• During operation	°C	-25 ... +55
• During storage	°C	-40 ... +70
Permissible mounting position		Any
Vibration resistance acc. to IEC 60068 Part 2-6	g	2
Shock resistance acc. to IEC 60068 Part 2-27	g/ms	Half-sine 15/11
Power consumption		
• From auxiliary circuit L+/M (U1)	mA	Approx. 20
• From auxiliary circuit A1/A2 (U2)		--
Rated operational current I_e for power bus	A	25
Rated operational voltage U_e	V	400
Approvals according to		
• DIN VDE 0106, Part 101	V	Up to 500
• CSA and UL	V	Up to 600
Conductor cross-sections		
• Incoming power supply	mm ²	Max. 6 x 4

Type	Isolator modules	
Degree of protection		IP65
Touch protection		Finger-safe
Pollution degree		3, IEC 60664 (IEC 61131)
Rated impulse withstand voltage U_{imp}	kV	6
Rated insulation voltage U_i	V	400
Rated operational current I_e for starters		
• AC-1 / 2 / 3 at 40 °C		
- At 400 V	A	25
- At 500 V	A	25
Rated short-circuit breaking capacity	kA	50 at 400 V
Type of coordination acc. to IEC 60947-4-1		2
Protective separation between main and auxiliary circuits	V	400, according to DIN VDE 0106, Part 101
Device functions		
• Group diagnostics		Yes, parameterizable
Device indications		
• Group fault		SF LED (red)

Selection and ordering data

Version	Article No.

ET 200pro isolator modules, mechanical

3RK1304-0HS00-6AA0

Isolator modules¹⁾
Rated operational current 25 A

3RK1304-0HS00-6AA0

¹⁾ Only functions when used together with the backplane bus module and the wide module rack. The backplane bus module and the wide module rack must be ordered separately (see "Accessories for ET 200pro motor starters", page 10/412).

I/O systems

SIMATIC ET 200 systems without control cabinet
SIMATIC ET 200pro

ET 200pro Safety motor starters Solutions local/PROFIsafe > Safety modules PROFIsafe

Overview

Safety Solution PROFIsafe

With the Safety PROFIsafe modules

- F-Switch and
- 400 V disconnecting module

With an appropriate connection, safety levels SIL 3 (according to IEC 62061) and PL e (according to ISO 13849-1) can be reached.

F-Switch PROFIsafe

Fail-safe digital inputs/outputs in degrees of protection IP65 to IP67 for near-machine, cabinet-free use.

Fail-safe digital inputs

- For the fail-safe reading in of sensor information (1-/2-channel)
- Including integrated discrepancy evaluation for 2V2 signals
- Internal sensor supplies (incl. testing) available

Fail-safe digital outputs

- Three fail-safe switching to PP potential outputs for safe switching of the backplane busbars

The F-Switch is certified up to SIL 3/PL e and has detailed diagnostics. It supports PROFIsafe in PROFIBUS configurations as well as in PROFINET configurations.

Note:

Safety characteristics, [see](#)

<https://support.industry.siemens.com/cs/ww/en/view/109739348>

Functionality

The PROFIsafe F-Switch is a fail-safe solid-state module for PROFIsafe safety applications. It has two fail-safe inputs and outputs for safe switching of the 24 V supply over backplane busbars. In combination with the 400 V disconnecting module, fail-safe disconnection of ET 200pro motor starters is possible in PROFIsafe applications up to SIL 3/PL e.

400 V disconnecting module

The 400 V disconnecting module enables the safe disconnection of an operational voltage of 400 V up to PL e. For operation in a Safety PROFIsafe application it functions only in combination with the F-Switch.

Funktionalität

The 400 V disconnecting module can be used together with the F-Switch for PROFIsafe safety applications. It contains two contactors connected in series for safety-related disconnection of the main circuit. The auxiliary circuit supply of the device is over a safety power rail in the backplane bus module. The 400 V disconnecting module can be used in conjunction with the F-Switch for safety applications up to PL e.



10

Technical specifications

Type	400 V disconnecting module	
General data		
Mounting dimensions (W x H x D)		
• Direct-on-line starters and reversing starters	mm	110 x 230 x 150
Permissible ambient temperature		
• During operation	°C	-25 ... +55
• During storage	°C	-40 ... +70
Permissible mounting position		Any
Vibration resistance acc. to IEC 60068, Part 2-6		2 g
Shock resistance acc. to IEC 60068, Part 2-27		Half-sine 15 g/11 ms
Power consumption		
• From auxiliary circuit L+/M (U1)	mA	Approx. 20
• From auxiliary circuit A1/A2 (U2)		--
Rated operational current I_e for power bus	A	25
Rated operational voltage U_e	V	400 (50/60 Hz)
Approval DIN VDE 0106, Part 101	V	Up to 500
CSA and UL approval	V	Up to 600
Conductor cross-sections		
Incoming power supply	mm ²	Max. 6 x 4
Degree of protection		IP65
Touch protection		Finger-safe
Pollution degree		3, IEC 60664 (IEC 61131)

Type	400 V disconnecting module	
Rated impulse withstand voltage U_{imp}	kV	6
Rated insulation voltage U_i	V	400
Rated operational current I_e for starters		
• AC-1 / 2 / 3 at 40 °C		
- At 400 V	A	25
- At 500 V	A	25
Rated short-circuit breaking capacity	kA	50 at 400 V
Type of coordination acc. to IEC 60947-4-1		2
Protective separation between main and auxiliary circuits	V	400, according to DIN VDE 0106, Part 101
Operating times at 0.85 ... 1.1 x U_s		
• Closing delay	ms	25 ... 100
• Opening delay	ms	7 ... 10
Device functions		
• Group diagnostics		Yes, parameterizable
Device indications		
• Group fault		SF LED (red)

Selection and ordering data

Version	Article No.
Safety modules PROFIsafe	
 <p>400 V disconnecting modules¹⁾²⁾ Rated operational current 25 A</p> <p>3RK1304-0HS00-8AA0</p>	3RK1304-0HS00-8AA0
 <p>F-Switch PROFIsafe 24 V DC, including bus module <u>Note:</u> Connection module must be ordered separately</p> <p>6ES7148-1FS00-0AB0</p>	6ES7148-4FS00-0AB0
<p>Connection modules for F-Switch 24 V DC</p>	6ES7194-4DA00-0AA0

- ¹⁾ The 400 V disconnecting module functions only when used together with the Safety local isolator module or with the F-Switch.
- ²⁾ The 400 V disconnecting module functions only when used together with the backplane bus module and the wide module rack. The backplane bus module and the wide module rack must be ordered separately (see "Accessories for ET 200pro motor starters", page 10/412).

I/O systems

SIMATIC ET 200 systems without control cabinet
SIMATIC ET 200pro

Accessories for ET 200pro motor starters

Overview

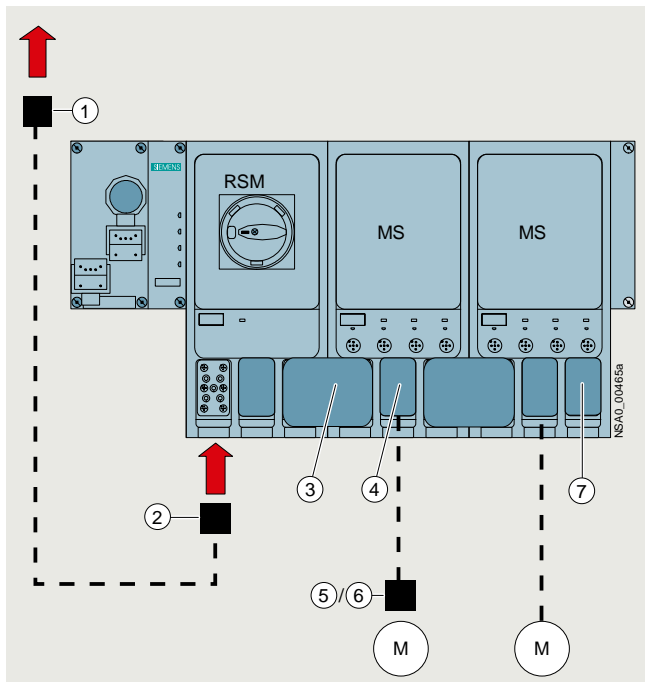

Basic design of an ET 200pro version with (from the left) connection module for IM, interface module for communication (IM), RSM isolator module, two ET 200pro motor starters (MS), and connections for energy and

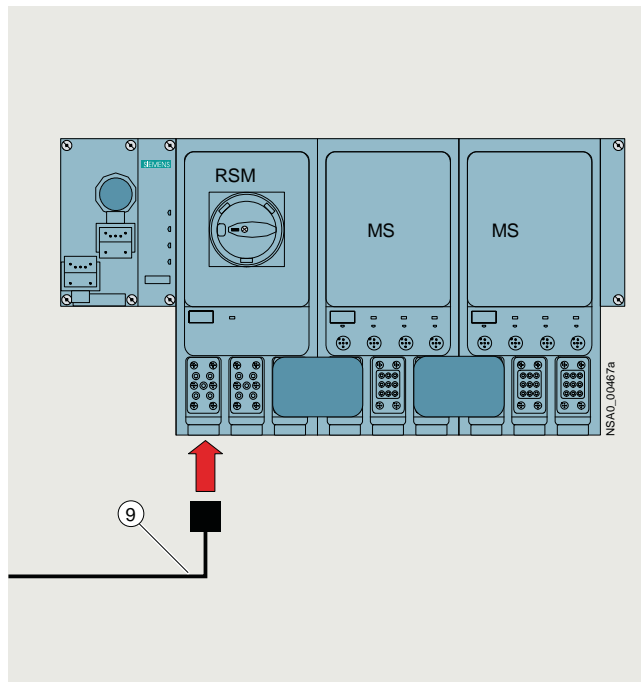

Infeed on the RSM isolator module

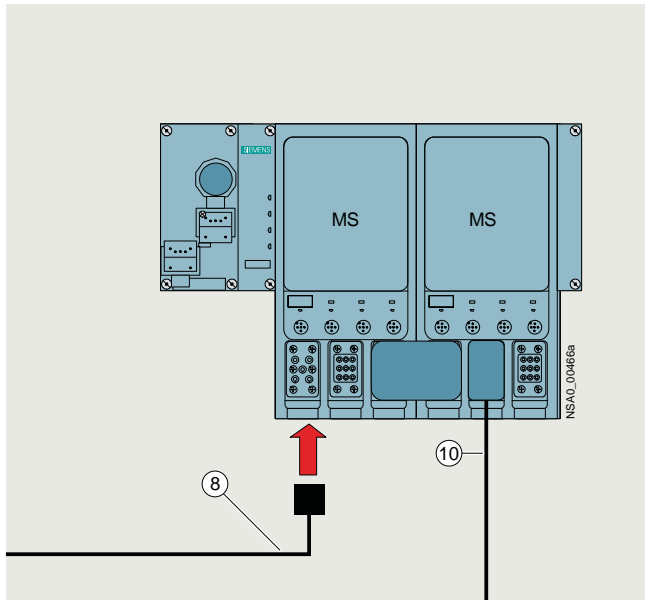

Infeed on the ET 200pro motor starter

Legend:

- ① Power feeder plug (see page 10/410)
- ② Power connection plug (see page 10/410)
- ③ Power jumper plug (see page 10/410)
- ④ Motor connection plug (see page 10/410)
- ⑤ Motor plug (see page 10/410)
- ⑥ Motor plug with EMC suppressor circuit (see page 10/410)
- ⑦ Power loop-through plug (see page 10/410)
- ⑧ Power connection cable (see page 10/410)
- ⑨ Power connection cable for isolator module (see page 10/410)
- ⑩ Motor cable (see page 10/411)

10

Power bus

The power supply to the field devices (ET 200pro motor starters, M200D motor starters) is provided via the power bus, in which the power T terminal connectors or power double-T terminal connectors are connected by power bus cables.

Feeders

From the terminal connectors, spur lines with Han Q4/2 plugs lead to the field devices, from which the motors are supplied with power via motor connection cables.

Interruption-free thanks to power terminal connectors

In finger-safe connection technology the power T terminal connectors and power double-T terminal connectors connect the components of a feeder to the power bus. They ensure interruption-free operation, i.e. the power bus is not interrupted when the components are plugged in.

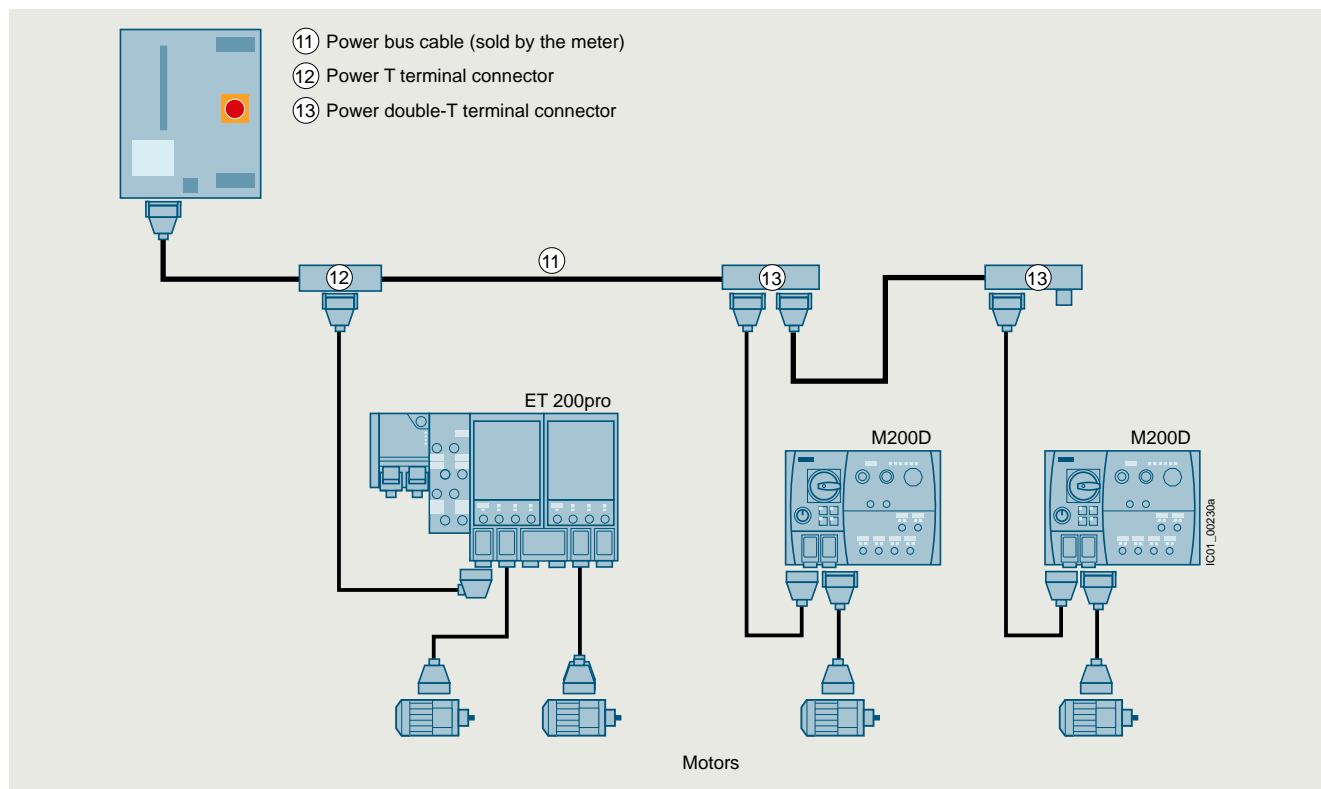

Power supply to the motors via the power bus with power T and double-T terminal connectors linked by power bus cables, spur lines to the field devices (motor starters), and power loop-through connections to the motors via motor connection cables

Motor control via PROFIBUS

The interface modules (IM) for PROFIBUS can be combined with two different connection modules for connecting PROFIBUS DP and the power supply:

- Direct connection with cable bushings
- M12, 7/8" connection
 - with M12 connecting cable and M12 plugs for data transmission with PROFIBUS DP
 - with 7/8" connecting cable and 7/8" plugs for the power supply

For the connection modules with the associated accessories, see "Accessories ET 200pro interface modules", page 10/370.

Motor control via PROFINET

For the connection modules with the associated accessories, see "Accessories ET 200pro interface modules", page 10/370

I/O systems



SIMATIC ET 200 systems without control cabinet

SIMATIC ET 200pro

Accessories for ET 200pro motor starters**Selection and ordering data**

Version	Article No.
Incoming power supply	
① Power feeder plugs Connector set for incoming power supply, e.g. for connecting to T terminal connectors, comprising a coupling enclosure, straight outgoing feeder (with bracket), pin insert for HAN Q4/2, incl. bushing <ul style="list-style-type: none"> • 5 male contacts, 2.5 mm² • 5 male contacts, 4 mm² • 5 male contacts, 6 mm² 	3RK1911-2BS60 3RK1911-2BS20 3RK1911-2BS40
② Power connection plugs Connector set for incoming power supply for connection to ET 200pro motor starters/ET 200pro isolator modules, comprising a cable-end connector hood, angular outgoing feeder, female insert for HAN Q4/2, including bushing <ul style="list-style-type: none"> • 5 female contacts, 2.5 mm² • 5 female contacts, 4 mm² • 5 female contacts, 6 mm² 	3RK1911-2BE50 3RK1911-2BE10 3RK1911-2BE30
⑧ Power connection cables, assembled at one end Power connection cable for ET 200pro motor starters, open at one end, for HAN Q4/2, angular, 4 x 4 mm ² <ul style="list-style-type: none"> • Length 1.5 m • Length 5.0 m 	3RK1911-0DB13 3RK1911-0DB33
⑨ Power connection cables for isolator module, assembled at one end Power connection cable for ET 200pro isolator modules, open at one end, for HAN Q4/2, angular, insert turned at isolator module end, 4 x 4 mm ² <ul style="list-style-type: none"> • Length 1.5 m • Length 5.0 m 	3RK1911-0DF13 3RK1911-0DF33
Power loop-through on the field device	
③ Power jumper plugs	3RK1922-2BQ00
⑦ Power loop-through plugs Connector set for power loop-through for connection to ET 200pro motor starters/ET 200pro isolator modules, comprising a cable-end connector hood, angular outgoing feeder, pin insert for HAN Q4/2, including bushing <ul style="list-style-type: none"> • 4 male contacts, 2.5 mm² • 4 male contacts, 4 mm² 	3RK1911-2BF50 3RK1911-2BF10
Motor cables	
④ Motor connection plugs Connector set for motor cable for connection to ET 200pro motor starters, comprising a cable-end connector hood, angular outgoing feeder, pin insert for HAN Q8/0, incl. bushing <ul style="list-style-type: none"> • 8 male contacts, 1.5 mm² • 6 male contacts, 2.5 mm² 	3RK1902-OCE00 3RK1902-OCC00
⑤ Motor plugs Connector set for motor cable for connection to motors, comprising a cable-end connector hood, straight outgoing feeder, female insert for HAN 10e, incl. star jumper, including bushing <ul style="list-style-type: none"> • 7 female contacts, 1.5 mm² • 7 female contacts, 2.5 mm² 	3RK1911-2BM21 3RK1911-2BM22
⑥ Motor plugs with EMC suppressor circuit Connector set for motor cable for connection to motors, comprising a cable-end connector hood, straight outgoing feeder, female insert for HAN 10e with EMC suppressor circuit, including star jumper, including bushing <ul style="list-style-type: none"> • 7 female contacts, 1.5 mm² • 7 female contacts, 2.5 mm² 	3RK1911-2BL21 3RK1911-2BL22





Accessories for ET 200pro motor starters

Version	Article No.
Motor cables (continued)	
<p>⑩ Motor cables, assembled at one end Open at one end, HAN Q8, angular, length 5 m</p> <ul style="list-style-type: none"> • For motor without brake, for ET 200pro, 4 x 1.5 mm² • For motor with brake for ET 200pro, 6 x 1.5 mm² • For motor without brake, with thermistor, for ET 200pro, 6 x 1.5 mm² • For motor with brake and thermistor for ET 200pro, 8 x 1.5 mm² 	<p>3RK1911-0EB31</p> <p>3RK1911-0ED31</p> <p>3RK1911-0EF31</p> <p>3RK1911-0EG31</p>
Power bus	
<p>⑫ Power T terminal connectors For 400 V AC, for connection of feeders (e.g. motor starters) by means of standard round cable at any point of the power bus, by insulation displacement connection, used with preassembled bus segments</p> <ul style="list-style-type: none"> • 2.5 mm² / 4 mm² • 4 mm² / 6 mm² 	<p>3RK1911-2BF01</p> <p>3RK1911-2BF02</p>
<p>⑬ Power double-T terminal connectors For 400 V AC, for connection of feeders (e.g. motor starters) by means of standard round cable at any point of the power bus, by insulation displacement connection, used with preassembled bus segments, connection of two motor starters possible</p> <ul style="list-style-type: none"> • 4 mm² / 6 mm² 	<p>3RK1911-2BG02</p>
<p>Sealing set (comprising 2 seals) For power T/power double-T terminal connectors</p> <ul style="list-style-type: none"> • For power cables with Ø 10 ... 13 mm • For power cables with Ø 13 ... 16 mm • For power cables with Ø 16 ... 19 mm • For power cables with Ø 19 ... 22 mm • Blanking plugs 	<p>3RK1911-5BA00</p> <p>3RK1911-5BA10</p> <p>3RK1911-5BA20</p> <p>3RK1911-5BA30</p> <p>3RK1911-5BA50</p>
Further accessories for power connections	
 <p>Crimping tool for pins/sockets, 4 mm² and 6 mm²</p> <p>3RK1902-0CW00</p>	<p>3RK1902-0CW00</p>
<p>Dismantling tools</p> <ul style="list-style-type: none"> • For male and female contacts for 9-pole HAN Q4/2 inserts • For male and female contacts for 9-pole HAN Q8 inserts 	<p>3RK1902-0AB00</p> <p>3RK1902-0AJ00</p>
 <p>Sealing caps For 9-pole power socket connectors</p> <ul style="list-style-type: none"> • 1 unit per pack • 10 units per pack <p>3RK1902-0CK00</p>	<p>3RK1902-0CK00</p> <p>3RK1902-0CJ00</p>

I/O systems

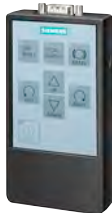
SIMATIC ET 200 systems without control cabinet
SIMATIC ET 200pro

Accessories for ET 200pro motor starters

Version	Article No.
Further accessories	
Module racks, wide¹⁾ <ul style="list-style-type: none"> Length 500 mm Length 1 000 mm Length 2 000 mm 	6ES7194-4GB00-0AA0 6ES7194-4GB60-0AA0 6ES7194-4GB20-0AA0
Module racks, wide, compact¹⁾ <ul style="list-style-type: none"> Length 500 mm Length 1 000 mm Length 2 000 mm 	6ES7194-4GD00-0AA0 6ES7194-4GD10-0AA0 6ES7194-4GD20-0AA0
Backplane bus modules 110 mm²⁾	3RK1922-2BA00
Handheld devices For ET 200pro motor starters (or for ET 200S High Feature and M200D motor starters) for local operation <u>Notes:</u> <ul style="list-style-type: none"> The motor-starter-specific serial interface cables must be ordered separately. The RS 232 interface cable 3RK1922-2BP00 is used for the MS ET 200pro. 	3RK1922-3BA00
 3RK1922-3BA00	
RS 232 interface cable Serial data connection between ET 200pro (or M200D) motor starters and the RS 232 interface of a PC/PG/laptop (with the Motor Starter ES software) or the handheld device 3RK1922-3BA00	3RK1922-2BP00
USB interface cable, 2.5 m Serial data connection between ET 200pro (or M200D) motor starters and the USB interface of a PC/PG/laptop (with the Motor Starter ES software)	6SL3555-0PA00-2AA0
M12 sealing caps For sealing unused M12 input or output sockets (one set contains ten sealing caps)	3RK1901-1KA00
 3RK1901-1KA00	
Motor suppression module RC element for installation in motor terminal box <ul style="list-style-type: none"> Type of construction square 	3RK1911-6EA00
 3RK1911-6EA00	
<ul style="list-style-type: none"> Type of construction round 	3RK1911-6EB00
 3RK1911-6EB00	

¹⁾ The wide module rack can accommodate all ET 200pro motor starters and any optional modules (isolator module, Safety local isolator module and 400 V disconnecting module).

²⁾ The backplane bus module is a prerequisite for operation of the ET 200pro motor starter and the optional module.

- For more connection technology products, see <https://support.industry.siemens.com/cs/ww/en/view/65355810>.

Overview



SIMATIC ET 200pro FC-2 frequency converter

The SIMATIC ET 200pro FC-2 frequency converter has the design of a SIMATIC ET 200pro module. It supplements the SIMATIC ET 200pro system range with distributed, speed-controlled drives. It is suitable for the open-loop and closed-loop control of asynchronous (induction) motors in a wide range of industrial applications. It is predestined for conveyor technology applications using drives networked via PROFIBUS and PROFINET, in particular in distributed designs without control cabinet with high degree of protection (IP65), when combining several drives. The modular, service-friendly concept is ideally suited to manufacturing processes with high plant standstill costs.

Reasons for using distributed drive systems

- Modular drive solutions – therefore standardized mechatronic elements that can be individually tested
- A control cabinet is not required, resulting in a smaller space requirement and lower cooling requirements
- Long motor cables between converter and motor are not required
 - Less power losses
 - Reduced noise radiation
 - Reduced costs for shielded cables
 - No additional filters
- Distributed configurations offer considerable benefits for conveyor systems with their extensive coverage (e.g. in the automotive and logistics sectors)

Siemens family of distributed drives

Siemens offers an innovative portfolio of frequency converters to optimally implement distributed drive solutions. The strengths of the individual members of the drive family permit simple adaptation to the widest range of application demands:

- Identical connection systems
- User-friendly commissioning and configuration tools

Products from the family of distributed drives:

- SINAMICS G115D distributed drive system (wall and motor-mounted)
- SINAMICS G120D frequency converters
- SIMATIC ET 200pro FC-2 frequency converters
- SIRIUS M200D motor starters

Safety Integrated

The distributed SIMATIC ET 200pro FC-2 frequency converters are already equipped with the integrated STO (Safe Torque Off) safety function, certified in accordance with IEC 61508 SIL 2 as well as EN ISO 13849-1 PL d and Category 3. It can be activated locally via the F-RSM or by means of PROFIsafe.

STARTER commissioning tool

The STARTER commissioning tool (V4.4 and higher) plus the corresponding SINAMICS Support Package (SSP) supports the commissioning and maintenance of SIMATIC ET 200pro FC-2 frequency converters.

The operator guidance combined with comprehensive, user-friendly functions for the relevant drive solution allow you to commission the device quickly and easily.

Engineering Framework STEP7 classic (V5.5 and higher)

Hardware Support Packages (HSP) are available to integrate SIMATIC ET 200pro FC-2 in STEP7 classic.

Engineering Framework TIA Portal (as from V13 SP1)

TIA Portal is a powerful engineering framework providing full access to the whole digitized automation.

Hardware Support Packages (HSP) are available to integrate SIMATIC ET 200pro FC-2 in TIA Portal.

I/O systems

SIMATIC ET 200 systems without control cabinet
SIMATIC ET 200pro

SIMATIC ET 200pro FC-2 frequency converter

Ordering data	Article No.	Ordering data	Article No.
SIMATIC ET 200pro FC-2 frequency converter with integrated safety function STO (Safe Torque Off)	6SL3514-1KE13-5AE0	STARTER commissioning tool on DVD-ROM	6SL3072-0AA00-0AG0
Backplane bus module for mounting the frequency converter (absolutely essential for operation of the converter)	6SL3260-2TA00-0AA0	PC converter connection kit 2 Mini USB interface cable for communication with a PC, 3 m (9.84 ft) long	6SL3255-0AA00-2CA0
Accessories		Connecting cable pre-assembled at one end Power supply cable, open at one end, for Q4/2, angled, 4 × 4 mm ²	
IOP-2 Handheld For use with SINAMICS G120 SINAMICS G120C SINAMICS G120P SINAMICS G120D SIMATIC ET 200pro FC-2 Included in the scope of delivery:	6SL3255-0AA00-4HA1	<ul style="list-style-type: none"> • 1.5 m (4.92 ft) long • 5 m (16.4 ft) long 	3RK1911-0DB13 3RK1911-0DB33
<ul style="list-style-type: none"> • IOP-2 • Handheld housing • Rechargeable batteries (4 × AA) • Charging unit (international) • RS232 connecting cable 3 m (9.84 ft) long, can be used in combination with SINAMICS G120 SINAMICS G120C SINAMICS G120P • USB cable 1 m (3.28 ft) long 		Connector set for the power supply Q4/2	
RS232 connecting cable 2.5 m (8.20 ft) long, with optical interface for connecting the IOP-2 Handheld to SINAMICS G120D SIMATIC ET 200pro FC-2	3RK1922-2BP00	<ul style="list-style-type: none"> • 2,5 mm² • 4 mm² • 6 mm² 	3RK1911-2BE50 3RK1911-2BE10 3RK1911-2BE30
<u>Memory cards</u>		Motor cables pre-assembled at one end for motors with brake and temperature sensor with Q8 plug, shielded	(HTG: supplied by Harting) (ZKT: supplied by KnorrTec)
SINAMICS SD card 512 MB	6SL3054-4AG00-2AA0	Cross section	4 × 1,5 mm ² 2 × (2 × 0,75 mm ²)
<u>Optional firmware memory cards</u>		<ul style="list-style-type: none"> • 1.5 m (4.92 ft) long • 3 m (9.84 ft) long • 5 m (16.4 ft) long • 10 m (32.8 ft) long 	HTG: 61 88 201 0288 ZKT: 70020501000150 HTG: 61 88 201 0289 ZKT: 70020501000300 HTG: 61 88 201 0290 ZKT: 70020501000500 HTG: 61 88 201 0299 ZKT: 70020501001000
SINAMICS SD card 512 MB + firmware V4.7 SP13 (Multicard V4.7 SP13)	6SL3054-7TG00-2BA0	Connector set for motor cable Q8, shielded	HTG: 61 83 401 0131 ZKT: 10032001

Technical specifications

Distributed frequency converter	SIMATIC ET 200pro FC-2
Selection features	
Integrated safety functions acc. to IEC 61508 SIL 2 and EN ISO 13849-1 PL d and Category 3	<ul style="list-style-type: none"> • Safe Torque Off (STO) • Control of the integrated safety function via the Safety Local isolator module F-RSM or via F-Switch PROFIsafe
Electrical specifications	
Line voltage	380 ... 480 V 3 AC ±10 %
Power	
<ul style="list-style-type: none"> • With an ambient temperature of 0 ... 55 °C (32 °F... 131 °F) • With an ambient temperature of 0 ... 45 °C (32 °F... 113 °F) 	1.1 kW 1.5 kW
Rated input current/output current	
<ul style="list-style-type: none"> • With an ambient temperature of 0 ... 55 °C (32 °F... 131 °F) • With an ambient temperature of 0 ... 45 °C (32 °F... 113 °F) 	2 A/3.5 A 2.5 A/3.9 A
Line frequency	47 ... 63 Hz
Overload capability	<ul style="list-style-type: none"> • Overload current 1.5 x rated output current (i.e. 150 % overload) for 60 s, cycle time 300 s • Overload current 2 x rated output current (i.e. 200 % overload) for 3 s, cycle time 300 s

Technical specifications

Distributed frequency converter	SIMATIC ET 200pro FC-2				
Output frequency	0 ... 550 Hz				
Pulse frequency	4 kHz (standard), 4 ... 16 kHz (in 2-kHz increments)				
Standard SCCR (Short Circuit Current Rating)	10 kA				
Skipped frequency range	1, parameterizable				
Converter efficiency	95 ... 97 %				
Interfaces	<ul style="list-style-type: none"> • Connection to PROFIBUS and PROFINET over the SIMATIC ET 200pro backplane bus • Mini USB interface for commissioning via PC (as from STARTER V4.4 plus SSP) • Optical interface for commissioning via the IOP-2 Handheld • Slot for an optional memory card (SD) for uploading or downloading parameter settings. Facilitates easy device replacement. • PTC, bimetal, KTY84, Pt1000 interface for motor temperature monitoring 				
Functions					
Open-loop/closed-loop control methods	<ul style="list-style-type: none"> • V/f control – linear ($M \sim n$) with/without flux current control (FCC), quadratic ($M \sim n^2$) or parameterizable • Vector control – sensorless • Closed-loop torque control 				
Operating functions	<ul style="list-style-type: none"> • Jogging • BICO technology • Automatic restart following interruptions in operation due to a power failure • Smooth connection of converter to rotating motor 				
Braking functions	<ul style="list-style-type: none"> • Integrated regenerative feedback functionality • Control of an electromagnetic holding brake 				
	Integrated brake control supplies DC power supply to the brake				
	Line voltage	380 V AC	400 V AC	440 V AC	480 V AC
	Rectified brake voltage	171 V DC	180 V DC	198 V DC	216 V DC
	Recommended brake coil voltage for Siemens motors	170 ... 200 V DC	170 ... 200 V DC 184 ... 218 V DC	184 ... 218 V DC	184 ... 218 V DC
	Disconnection on the DC side permits "fast" braking.				
Protection functions	<ul style="list-style-type: none"> • Undervoltage • Overvoltage • Ground fault • Short-circuit • Stall protection • Thermal motor protection (I^2t or sensor) • Converter overtemperature • Motor blocking protection • Phase failure detection 				
Connectable motors	<ul style="list-style-type: none"> • Low-voltage asynchronous (induction) motors • Motor cable lengths: max. 15 m (49 ft) (shielded) 				
Mechanical specifications					
Degree of protection	IP65				
Operating temperature	0 ... 55 °C (32 ... 131 °F)				
Mounting position	Vertical wall mounting (vertical alignment of the cooling fins)				
Dimensions (W x H x D)	155 mm x 246 mm x 248 mm (6.10 in x 9.69 in x 9.76 in)				
Weight, approx.	4 kg (8.8 lb)				
Standards					
Certificates of suitability	UL508C, cUL, CE, UKCA, Low Voltage Directive 2014/35/EU, EMC Directive 2014/30/EU				

IO Systeme

SIMATIC ET 200 systems without control cabinet
SIMATIC ET 200pro

ET 200pro software > Motor Starter ES

Overview

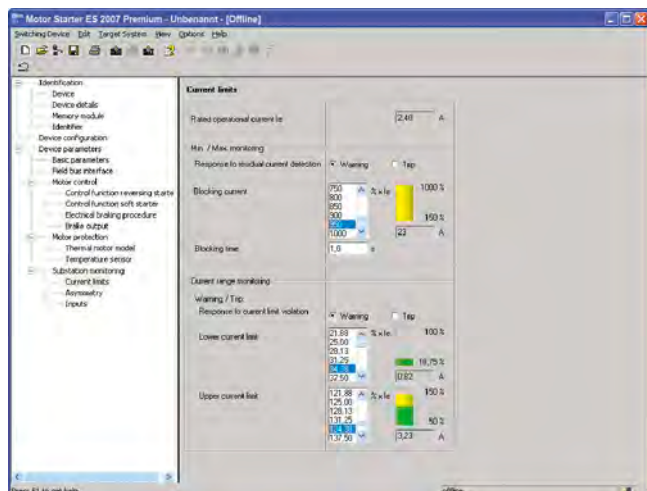

Motor Starter ES for parameterization, monitoring, diagnostics and testing of motor starters

More information

Industry Mall see www.siemens.com/product?3ZS1

Technical specifications and system requirements, see <https://support.industry.siemens.com/cs/ww/en/ps/16713/td>

Catalog IC 10 see www.siemens.com/ic10

Motor Starter ES is used for the startup, parameterization, diagnostics, documentation and preventive maintenance of SIMATIC ET 200S, ET 200pro, ECOFAST and M200D motor starters.

Interfacing is performed

- Via the local interface on the device
- With PROFIBUS DP-V1-capable motor starters from any point in PROFIBUS (applies to ET 200S DP V1/ET 200pro/ECOFAST/M200D)
- With PROFINET-capable motor starters from any point in PROFINET (applies to ET 200S DP V1/ET 200pro/M200D).

Using Motor Starter ES, the communication-capable motor starters are easily parameterized during startup, monitored during normal operation and successfully diagnosed for service purposes. Preventative maintenance is supported by a function for reading out diverse statistical data (e.g. operating hours, operating cycles, cut-off currents, etc.). The user is supported during these procedures with comprehensive Help functions and plain text displays.

Motor Starter ES can either be used as a stand-alone program or it can be integrated into STEP 7 via an Object Manager.

Note:

The Motor Starter ES functionalities in relation to startup, parameterization and diagnostics are integrated directly in the TIA Portal from V17 and are accessible online for the SIMATIC ET 200pro, ET 200SP and M200D motor starters.

Efficient engineering with three program versions

The Motor Starter ES software program is available in three versions which differ in their user-friendliness, scope of functions and price.

Motor Starter ES	Basic	Standard	Premium
ET 200S High Feature PROFIBUS IM	✓	✓	✓
ET 200S High Feature PROFINET IM	✓	✓	✓
ECOFAST AS-Interface High Feature	✓	✓	--
ECOFAST PROFIBUS	✓	✓	✓
ET 200pro PROFIBUS IM	✓	✓	✓
ET 200pro PROFINET IM	✓	✓	✓
M200D AS-Interface Standard	✓	✓	(✓)
M200D PROFIBUS	✓	✓	✓
M200D PROFINET	✓	✓	✓

✓ Function available,

(✓) Available with restricted functionality

-- Function not available

Motor Starter ES	Basic	Standard	Premium
Access via the local interface on the device	✓	✓	✓
Parameter assignment	✓	✓	✓
Operating	✓	✓	✓
Diagnostics	--	✓	✓
Creation of typicals	--	✓	✓
Comparison functions	--	✓	✓
Standard-compliant printout according to EN ISO 7200	--	✓	✓
Service data (slave pointer, statistics data)	--	✓	✓
Access via PROFIBUS	--	--	✓
Access via PROFINET	--	--	✓
S7 routing	--	--	✓
Teleservice via MPI	--	--	✓
STEP 7 object manager ¹⁾	--	--	✓
Trace function	--	✓	✓

✓ Function available

-- Function not available

¹⁾ Only for STEP 7 V5.x

Additional functions

Standard-compliant printouts

The software tool greatly simplifies machine documentation. It enables parameterization printouts according to EN ISO 7200. The elements to be printed are easy to select and group as required.

Easy creation of typicals

Typicals can be created for devices and applications with only minimum differences in their parameters. These typicals contain all the parameters which are needed for the parameterization. In addition it is possible to specify which of these parameters are fixed and which can be adapted, e.g. by the startup engineer.

Teleservice via MPI

The Motor Starter ES Premium version supports the use of MPI Teleservice (comprising the Teleservice software and various Teleservice adapters) for remote diagnostics of the devices. This facilitates diagnostics and maintenance, and it shortens response times for service purposes.

Benefits



- Fast, error-free configuration and startup of motor starters even without extensive previous knowledge
- Transparent setting of the device functions and their parameters – online and offline
- Effective diagnostics functions on the soft starter and display of the most important measured values
- Trace function (oscilloscope function) for recording measured values and events (included in the Motor Starter ES Standard and Premium software version for M200D PROFIBUS and PROFINET).

Selection and ordering data

Parameterization, startup and diagnostics software Motor Starter ES 2007

For ECOFAST Motor Starter, SIMATIC ET 200S High-Feature Starter, SIMATIC ET 200pro Starter and M200D (AS-I Standard, PROFIBUS, PROFINET)

- Delivered without PC cable

	Version	Article No.
Motor Starter ES 2007 Basic		
 <p>3ZS1310-4CC10-0YA5</p>	<p>Floating license for one user Engineering software in limited-function version for diagnostics purposes, Class A, 3 languages (German/English/French), communication via system interface <u>Type of delivery:</u></p> <ul style="list-style-type: none"> • Software and dokumentation on CD and floating license on USB flash drive • Floating license as download 	<p>3ZS1310-4CC10-0YA5</p>
		<p>3ZS1310-4CE10-0YB5</p>
Motor Starter ES 2007 Standard		
 <p>3ZS1310-5CC10-0YA5</p>	<p>Floating license for one user Engineering software, Class A, 3 languages (German/English/French), communication via system interface <u>Type of delivery:</u></p> <ul style="list-style-type: none"> • Software and dokumentation on CD and floating license on USB flash drive • Floating license as download 	<p>3ZS1310-5CC10-0YA5</p>
		<p>3ZS1310-5CE10-0YB5</p>
Motor Starter ES 2007 Premium		
 <p>3ZS1310-6CC10-0YA5</p>	<p>Floating license for one user Engineering-Software, Klasse A, 3 languages (German/English/French), communication via system interface or PROFIBUS/PROFINET, STEP 7 Object Manager <u>Type of delivery:</u></p> <ul style="list-style-type: none"> • Software and dokumentation on CD and floating license on USB flash drive • Floating license as download 	<p>3ZS1310-6CC10-0YA5</p>
		<p>3ZS1310-6CE10-0YB5</p>

For a description of the software versions, [see page 10/416](#).

Accessories

	Version	Article No.
Optional accessories		
	<p>RS 232 interface cable Serial data connection between ET 200pro MS/FC, M200D and laptop/PC/PG or MS</p>	<p>3RK1922-2BP00</p>
	<p>USB interface cable Serial data connection between ET 200pro MS/FC, M200D and laptop/PC/PG or MS</p>	<p>6SL3555-0PA00-2AA0</p>
	<p>USB/serial adapters For connecting an RS 232 PC cable to the USB interface of a PC, recommended for use in conjunction with ET 200S/ECOFAST/ET 200pro motor starters</p>	<p>3UF7946-0AA00-0</p>

I/O systems

SIMATIC ET 200 systems without control cabinet
SIMATIC ET 200pro

Add-on products for ET 200pro > EtherNet/IP interface module

Overview

An interface module (EtherNet/IP adapter) is available for operating ET 200pro on EtherNet/IP. It can be used together

with system and IO components of the ET 200pro distributed I/O system.

Ordering data

SIMATIC ET 200pro interface module for EtherNet/IP

Including:

- Bus terminating module for ET 200pro
- Companion disk with the manuals and the Configuration Tool

Article No.

ZNX:EIP200PRO

Article No.

Terminal module for EtherNet/IP

For connecting the interface module to EtherNet/IP

ZNX:EIP200PROC1

Technical specifications

Article number	ZNX:EIP200PRO Ethernet/IP Head Assembly for ET 200PRO
General information	
Product type designation	Ethernet/IP
Supply voltage	
Rated value (DC)	24 V
Input current	
from supply voltage 1L+, max.	400 mA
Address area	
Addressing volume	
• Inputs	255 byte
• Outputs	255 byte
Interface types	
M12 port	
• Autonegotiation	Yes
• Transmission rate, max.	100 Mbit/s
Interrupts/diagnostics/status information	
Diagnostics indication LED	
• For load voltage monitoring	Yes
• Bus fault BF (red)	Yes
• Group error SF (red)	Yes
• Monitoring 24 V voltage supply ON (green)	Yes
Potential separation	
between backplane bus and electronics	Yes
between supply voltage and electronics	Yes
Degree and class of protection	
IP degree of protection	IP65/67
Ambient conditions	
Ambient temperature during operation	
• min.	-25 °C
• max.	55 °C
Ambient temperature during storage/transportation	
• min.	-40 °C
• max.	70 °C
Dimensions	
Width	135 mm
Height	130 mm
Depth	59.3 mm
Weights	
Weight, approx.	490 g

Article number	ZNX:EIP200PROC1 ET 200pro, CM IM DP M12 / 7/8"
Input current	
from supply voltage 1L+, max.	No current input, only infeed current, max. 8 A
from load voltage 2L+ (without load), max.	No current input, only infeed current, max. 8 A
Dimensions	
Width	90 mm
Height	130 mm
Depth	51 mm
Weights	
Weight, approx.	540 g

Overview



SIMATIC ET 200AL video
https://players.brightcove.net/1813624294001/70fecf0f-fbad-4fad-a077-d0e26af4d84c_default/index.html?videoId=6141316253001



- Modular, distributed I/O system with compact I/O modules in IP65/67.
- Especially easy and flexible installation, even in extremely confined spaces.
- Easy wiring
- Easy commissioning
- SIMATIC ET 200AL consists of the following components:
 - Interface module for communication with IO Controllers on PROFINET.
 - Interface module for communication with all masters on the PROFIBUS.
 - BusAdapter for connection to the ET 200SP I/O system.
 - Various I/O modules, 30 mm and 45 mm wide.
 - IO-Link I/O modules for connection to IO-Link master
- Maximum configuration of an ET 200AL station:
 - Up to 32 I/O modules with PROFINET or PROFIBUS in any combination
 - Up to 16 I/O modules at the ET 200SP in any combination
- Connection of the modules via an internal backplane bus established using bus cables (ET connection).

Highlights

- Compact dimensions
- Low weight
- Safety-oriented collective shutdown of the outputs
- High degree of user-friendliness due to the following design features:
 - Flexible mounting in all positions possible due to screw fastening through the front or side
 - Direct installation on even surfaces or aluminum mounting rails
 - Labels for the identification of channels, modules and slots
 - Integrated cable tie opening
 - Clear and CAx-compliant interface designations
 - Uniform coloring of the system interfaces and system cables
 - 1:1 assignment of channel status LED, I/O socket and label
 - Pin assignment on the side
- I/O module portfolio comprising digital and analog modules, digital fail-safe module, IO-Link communications module and IO-Link I/O modules
- Ambient temperature range from -30 °C/-25 °C to +55 °C
- Extensive system functions
 - All interface and I/O modules support firmware update
 - Configuration control (option handling) via user software
 - System support of PROFlenergy for power saving purposes
 - Consistent use of identification and maintenance data IM0 to IM3/4 (electronic rating plate) for fast electronic and unambiguous identification of individual modules (Article No., serial number, etc.).

I/O systems

SIMATIC ET 200 systems without control cabinet
SIMATIC ET 200AL

Interface modules > IM 157-1 DP**Overview**

- Interface module for connecting ET 200AL to PROFIBUS
- As DPV1 slave it handles the data exchange with the PROFIBUS master in the PLC
- Max. 32 I/O modules can be connected
- Max. data volume of 244 bytes, for input and output data respectively
- Automatic detection of baud rate 9.6 kBd ... 12 MBd
- PROFIBUS addresses 1 ... 99; can be set by means of rotary switch
- Identification and maintenance data IM0 ... IM3
- Firmware update
- Configuration management (option handling)

Ordering data**IM 157-1 DP interface module**

For connecting ET 200AL
to PROFIBUS

Accessories**Bus cable for backplane bus
(ET connection)**

4-pin, shielded

Pre-assembled at both ends,
2 M8 connectors

0.19 m

0.3 m

1 m

2 m

5 m

10 m

15 m

Pre-assembled at both ends,
2 M8 connectors, angled

0.3 m

1 m

2 m

5 m

10 m

15 m

Pre-assembled at one end,
1 M8 connector

2 m

5 m

10 m

15 m

Article No.

6ES7157-1AA00-0AB0

6ES7194-2LH02-0AA0

6ES7194-2LH03-0AA0

6ES7194-2LH10-0AA0

6ES7194-2LH20-0AA0

6ES7194-2LH50-0AA0

6ES7194-2LN10-0AA0

6ES7194-2LN15-0AA0

6ES7194-2LH03-0AB0

6ES7194-2LH10-0AB0

6ES7194-2LH20-0AB0

6ES7194-2LH50-0AB0

6ES7194-2LN10-0AB0

6ES7194-2LN15-0AB0

6ES7194-2LH20-0AC0

6ES7194-2LH50-0AC0

6ES7194-2LN10-0AC0

6ES7194-2LN15-0AC0

Article No.**M8 power cable**

4-pin

Pre-assembled at both ends,
M8 connector and M8 socket

0.19 m

0.3 m

1 m

2 m

5 m

10 m

15 m

Pre-assembled at both ends, angled
M8 connector and angled
M8 socket

0.3 m

1 m

2 m

5 m

10 m

15 m

Pre-assembled at one end,
M8 socket

2 m

5 m

10 m

15 m

M8 connector for ET connection

4-pin, shielded

M8 power connector

Male contact insert, 4-pin

Female contact insert, 4-pin

**ET connection FastConnect
Stripping Tool**

Stripping tool for stripping the
ET connection bus cable

Labels

10 x 5 mm, RAL 9016;
5 frames with 40 labels each

6ES7194-2LH02-1AA0

6ES7194-2LH03-1AA0

6ES7194-2LH10-1AA0

6ES7194-2LH20-1AA0

6ES7194-2LH50-1AA0

6ES7194-2LN10-1AA0

6ES7194-2LN15-1AA0

6ES7194-2LH03-1AB0

6ES7194-2LH10-1AB0

6ES7194-2LH20-1AB0

6ES7194-2LH50-1AB0

6ES7194-2LN10-1AB0

6ES7194-2LN15-1AB0

6ES7194-2LH20-1AC0

6ES7194-2LH50-1AC0

6ES7194-2LN10-1AC0

6ES7194-2LN15-1AC0

6ES7194-2AB00-0AA0

6ES7194-2AA00-0AA0

6ES7194-2AC00-0AA0

6ES7194-2KA00-0AA0

6ES7194-2BA00-0AA0

Technical specifications

Article number	6ES7157-1AA00-0AB0 ET 200AL, IM 157-1 DP
General information	
Product type designation	IM 157-1 DP
Product function	
• I&M data	Yes; I&M0 to I&M3
Engineering with	
• STEP 7 TIA Portal configurable/integrated from version	STEP 7 V13 SP1 or higher
• STEP 7 configurable/integrated from version	From V5.5 SP4 Hotfix 3
• PROFIBUS from GSD version/GSD revision	GSD as of Revision 5
Supply voltage	
Load voltage 1L+	
• Rated value (DC)	24 V
• Reverse polarity protection	Yes; against destruction
Input current	
Current consumption (rated value)	50 mA
from load voltage 1L+ (unswitched voltage)	4 A; Maximum value
from load voltage 2L+, max.	4 A; Maximum value
Address area	
Address space per station	
• Address space per station, max.	244 byte
Interfaces	
Number of PROFIBUS interfaces	1
1. Interface	
Interface type	PROFIBUS DP
Interface types	
• RS 485	Yes
• M12 port	Yes; 2x M12 B-coded
Protocols	
• PROFIBUS DP slave	Yes
Interface types	
RS 485	
• Transmission rate, max.	12 Mbit/s
Protocols	
PROFIBUS DP	
Services	
- SYNC capability	Yes
- FREEZE capability	Yes
- Direct data exchange (slave-to-slave communication)	Yes
- DPV0	Yes
- DPV1	Yes

Article number	6ES7157-1AA00-0AB0 ET 200AL, IM 157-1 DP
Interrupts/diagnostics/status information	
Diagnostics function	Yes
Alarms	
• Diagnostic alarm	Yes
Diagnostics indication LED	
• RUN LED	Yes; green LED
• ERROR LED	Yes; red LED
• MAINT LED	Yes; Yellow LED
• Connection display DP	Yes; green LED
Potential separation	
between the load voltages	Yes
between PROFIBUS DP and all other circuit components	Yes
Degree and class of protection	
IP degree of protection	IP65/67
Standards, approvals, certificates	
Suitable for safety-related tripping of standard modules	Yes; From FS01
Highest safety class achievable for safety-related tripping of standard modules	
• Performance level according to ISO 13849-1	PL d
• Category according to ISO 13849-1	Cat. 3
• SILCL according to IEC 62061	SILCL 2
Ambient conditions	
Ambient temperature during operation	
• min.	-30 °C
• max.	55 °C
Connection method	
Design of electrical connection for supply voltage	M8, 4-pole
ET-Connection	
• ET-Connection	M8, 4-pin, shielded
Dimensions	
Width	45 mm
Height	159 mm
Depth	46 mm
Weights	
Weight, approx.	211 g

I/O systems

SIMATIC ET 200 systems without control cabinet
SIMATIC ET 200AL

Interface modules > IM 157-1 PN**Overview**

- Interface module for connecting ET 200AL to PROFINET
- Handles data exchange with the PROFINET I/O controller in the PLC
- Max. 32 I/O modules can be connected
- Max. data volume of 1430 bytes, for input and output data respectively
- Shortest bus cycle 250 µs
- Automatic power-up by means of topology recognition
- Autocrossover
- Shared device on up to 4 IO controllers
- Support for the MRP (media redundancy protocol) and MRPD (media redundancy with planned duplication) functions
- Identification and maintenance data IM0 ... IM4
- Firmware update
- Configuration management (option handling)
- PROFlenergy

Ordering data**IM 157-1 PN interface module**

For connecting ET 200AL
to PROFINET

Article No.**6ES7157-1AB00-0AB0****Accessories****Bus cable for backplane bus (ET connection)**

4-pin, shielded

Pre-assembled at both ends,
2 M8 connectors

0.19 m

6ES7194-2LH02-0AA0

0.3 m

6ES7194-2LH03-0AA0

1 m

6ES7194-2LH10-0AA0

2 m

6ES7194-2LH20-0AA0

5 m

6ES7194-2LH50-0AA0

10 m

6ES7194-2LN10-0AA0

15 m

6ES7194-2LN15-0AA0

Pre-assembled at both ends,
2 M8 connectors, angled

0.3 m

6ES7194-2LH03-0AB0

1 m

6ES7194-2LH10-0AB0

2 m

6ES7194-2LH20-0AB0

5 m

6ES7194-2LH50-0AB0

10 m

6ES7194-2LN10-0AB0

15 m

6ES7194-2LN15-0AB0

Pre-assembled at one end,
1 M8 connector

2 m

6ES7194-2LH20-0AC0

5 m

6ES7194-2LH50-0AC0

10 m

6ES7194-2LN10-0AC0

15 m

6ES7194-2LN15-0AC0**Article No.****Power cable M8**

4-pin

Pre-assembled at both ends,
M8 connector and M8 socket

0.19 m

6ES7194-2LH02-1AA0

0.3 m

6ES7194-2LH03-1AA0

1 m

6ES7194-2LH10-1AA0

2 m

6ES7194-2LH20-1AA0

5 m

6ES7194-2LH50-1AA0

10 m

6ES7194-2LN10-1AA0

15 m

6ES7194-2LN15-1AA0

Pre-assembled at both ends, angled
M8 connector and angled
M8 socket

0.3 m

6ES7194-2LH03-1AB0

1 m

6ES7194-2LH10-1AB0

2 m

6ES7194-2LH20-1AB0

5 m

6ES7194-2LH50-1AB0

10 m

6ES7194-2LN10-1AB0

15 m

6ES7194-2LN15-1AB0

Pre-assembled at one end,
M8 socket

2 m

6ES7194-2LH20-1AC0

5 m

6ES7194-2LH50-1AC0

10 m

6ES7194-2LN10-1AC0

15 m

6ES7194-2LN15-1AC0**M8 connector for ET connection****6ES7194-2AB00-0AA0**

4-pin, shielded

M8 power connector

Male contact insert, 4-pin

6ES7194-2AA00-0AA0

Female contact insert, 4-pin

6ES7194-2AC00-0AA0**ET connection FastConnect stripping tool****6ES7194-2KA00-0AA0**

Stripping tool for stripping the
ET connection bus cable

Labels**6ES7194-2BA00-0AA0**

10 x 5 mm, RAL 9016;
5 frames with 40 labels each

Technical specifications

Article number	6ES7157-1AB00-0AB0 ET 200AL, IM 157-1 PN
General information	
Product type designation	IM 157-1 PN
Product function	
• I&M data	Yes; I&M0 to I&M4
Engineering with	
• STEP 7 TIA Portal configurable/integrated from version	STEP 7 V13 SP1 or higher
• STEP 7 configurable/integrated from version	From V5.5 SP4 Hotfix 3
• PROFINET from GSD version/GSD revision	GSDML V2.3.1
Supply voltage	
Load voltage 1L+	
• Rated value (DC)	24 V
• Reverse polarity protection	Yes; against destruction
Input current	
Current consumption (rated value)	100 mA
from load voltage 1L+ (unswitched voltage)	4 A; Maximum value
from load voltage 2L+, max.	4 A; Maximum value
Address area	
Address space per station	
• Address space per station, max.	1 430 byte
Interfaces	
Number of PROFINET interfaces	1
1. Interface	
Interface type	PROFINET
Interface types	
• M12 port	Yes; 2x M12 D-coded
• integrated switch	Yes
Protocols	
• PROFINET IO Device	Yes
• Open IE communication	Yes
Interface types	
M12 port	
• Transmission procedure	PROFINET with 100 Mbit/s full duplex (100BASE-TX)
• 10 Mbps	Yes; for Ethernet services
• 100 Mbps	Yes; PROFINET with 100 Mbit/s full duplex (100BASE-TX)
• Autonegotiation	Yes
• Autocrossing	Yes
Protocols	
PROFINET IO Device Services	
- IRT	Yes; 250 µs, 500 µs, 1 ms, 2 ms, 4 ms, 8 ms, 16 ms, 32 ms, 64 ms, 128 ms
- PROFInergy	Yes
- Shared device	Yes
- Number of IO Controllers with shared device, max.	4
Redundancy mode	
Media redundancy	
- MRP	Yes
- MRPD	Yes
Open IE communication	
• TCP/IP	Yes
• SNMP	Yes
• LLDP	Yes

Article number	6ES7157-1AB00-0AB0 ET 200AL, IM 157-1 PN
Interrupts/diagnostics/status information	
Diagnostics function	Yes
Alarms	
• Diagnostic alarm	Yes
Diagnostics indication LED	
• RUN LED	Yes; green LED
• ERROR LED	Yes; red LED
• MAINT LED	Yes; Yellow LED
• Connection display LINK TX/RX	Yes; 2x green LED
Potential separation	
between the load voltages	Yes
between PROFINET and all other circuits	Yes
Degree and class of protection	
IP degree of protection	IP65/67
Standards, approvals, certificates	
Suitable for safety-related tripping of standard modules	Yes; From FS01
Highest safety class achievable for safety-related tripping of standard modules	
• Performance level according to ISO 13849-1	PL d
• Category according to ISO 13849-1	Cat. 3
• SILCL according to IEC 62061	SILCL 2
Ambient conditions	
Ambient temperature during operation	
• min.	-25 °C
• max.	55 °C
Connection method	
Design of electrical connection for supply voltage	M8, 4-pole
ET-Connection	
• ET-Connection	M8, 4-pin, shielded
Dimensions	
Width	45 mm
Height	159 mm
Depth	40 mm
Weights	
Weight, approx.	263 g

I/O systemsSIMATIC ET 200 systems without control cabinet
SIMATIC ET 200AL**I/O modules > Digital I/O modules****Overview**

- 30 and 45 mm wide modules with parameters and diagnostic functions
- 8-channel digital input module with M8 or M12 connection
- 16-channel digital input module with M12 connection
- 8-channel digital input/output module with M8 or M12 connection
- 16-channel digital input / output module with M12 connection
- 8-channel digital output module 2A with M12 connection

Ordering data**Article No.****Digital input modules**

DI 8X24VDC, 8XM8

6ES7141-5BF00-0BA0

DI 8X24VDC, 4XM12

6ES7141-5AF00-0BA0

DI 16X24VDC, 8XM12

6ES7141-5AH00-0BA0**Digital output modules**

DQ 8X24VDC/2A, 8XM12

6ES7142-5AF00-0BA0**Digital input/output modules**

4 DIQ / 4 DQ, 24 V DC, 0.5 A

6ES7143-5BF00-0BA0

DIQ 4+DQ 4X24VDC/0.5A, 4XM12

6ES7143-5AF00-0BA0

DIQ 16X24VDC/0.5A, 8XM12

6ES7143-5AH00-0BA0**Accessories****Bus cable for backplane bus (ET connection)**

4-pin, shielded

Pre-assembled at both ends,
2 M8 connectors

0.19 m

6ES7194-2LH02-0AA0

0.3 m

6ES7194-2LH03-0AA0

1 m

6ES7194-2LH10-0AA0

2 m

6ES7194-2LH20-0AA0

5 m

6ES7194-2LH50-0AA0

10 m

6ES7194-2LN10-0AA0

15 m

6ES7194-2LN15-0AA0Pre-assembled at both ends,
2 M8 connectors, angled

0.3 m

6ES7194-2LH03-0AB0

1 m

6ES7194-2LH10-0AB0

2 m

6ES7194-2LH20-0AB0

5 m

6ES7194-2LH50-0AB0

10 m

6ES7194-2LN10-0AB0

15 m

6ES7194-2LN15-0AB0Pre-assembled at one end,
1 M8 connector

2 m

6ES7194-2LH20-0AC0

5 m

6ES7194-2LH50-0AC0

10 m

6ES7194-2LN10-0AC0

15 m

6ES7194-2LN15-0AC0**Article No.****Power cable M8**

4-pin

Pre-assembled at both ends,
M8 connector and M8 socket

0.19 m

6ES7194-2LH02-1AA0

0.3 m

6ES7194-2LH03-1AA0

1 m

6ES7194-2LH10-1AA0

2 m

6ES7194-2LH20-1AA0

5 m

6ES7194-2LH50-1AA0

10 m

6ES7194-2LN10-1AA0

15 m

6ES7194-2LN15-1AA0Pre-assembled at both ends, angled
M8 connector and angled
M8 socket

0.3 m

6ES7194-2LH03-1AB0

1 m

6ES7194-2LH10-1AB0

2 m

6ES7194-2LH20-1AB0

5 m

6ES7194-2LH50-1AB0

10 m

6ES7194-2LN10-1AB0

15 m

6ES7194-2LN15-1AB0Pre-assembled at one end,
M8 socket

2 m

6ES7194-2LH20-1AC0

5 m

6ES7194-2LH50-1AC0

10 m

6ES7194-2LN10-1AC0

15 m

6ES7194-2LN15-1AC0**M8 connector for ET connection****6ES7194-2AB00-0AA0**

4-pin, shielded

M8 power connector

Male contact insert, 4-pin

6ES7194-2AA00-0AA0

Female contact insert, 4-pin

6ES7194-2AC00-0AA0**ET connection FastConnect stripping tool****6ES7194-2KA00-0AA0**Stripping tool for stripping the
ET connection bus cable**Labels****6ES7194-2BA00-0AA0**10 x 5 mm, RAL 9016;
5 frames with 40 plates each

Technical specifications

Article number	6ES7141-5BF00-0BA0 ET 200AL, DI 8x24VDC, 8xM8	6ES7141-5AF00-0BA0 ET 200AL, DI 8x24VDC, 4xM12	6ES7141-5AH00-0BA0 ET 200AL, DI 16x24VDC, 8xM12
General information			
Product type designation	DI 8x24VDC	DI 8x24VDC	DI 16x24VDC
Product function			
• I&M data	Yes; I&M0 to I&M3	Yes; I&M0 to I&M3	Yes; I&M0 to I&M3
Engineering with			
• STEP 7 TIA Portal configurable/ integrated from version	STEP 7 V13 SP1 or higher	STEP 7 V13 SP1 or higher	STEP 7 V13 SP1 or higher
• STEP 7 configurable/integrated from version	From V5.5 SP4 Hotfix 3	V5.5 SP4 Hotfix 7 or higher	V5.5 SP4 Hotfix 7 or higher
• PROFIBUS from GSD version/ GSD revision	GSD as of Revision 5	GSD as of Revision 5	GSD as of Revision 5
• PROFINET from GSD version/ GSD revision	GSDML V2.3.1	GSDML V2.3.1	GSDML V2.3.1
Supply voltage			
Load voltage 1L+			
• Rated value (DC)	24 V	24 V	24 V
• Reverse polarity protection	Yes; Against destruction; encoder power supply outputs applied with reversed polarity	Yes; Against destruction; encoder power supply outputs applied with reversed polarity	Yes; Against destruction; encoder power supply outputs applied with reversed polarity
Input current			
Current consumption (rated value) from load voltage 1L+ (unswitched voltage)	25 mA; without load 4 A; Maximum value	25 mA; without load 4 A; Maximum value	30 mA; without load 4 A; Maximum value
from load voltage 2L+, max.	4 A; Maximum value	4 A; Maximum value	4 A; Maximum value
Encoder supply			
Number of outputs	8	4	8
Digital inputs			
Number of digital inputs	8	8	16
Input characteristic curve in accordance with IEC 61131, type 3	Yes	Yes	Yes
Number of simultaneously controllable inputs			
all mounting positions			
- up to 55 °C, max.	8	8	16
Input voltage			
• Rated value (DC)	24 V	24 V	24 V
• for signal "0"	-30 to +5 V	-30 to +5 V	-30 to +5 V
• for signal "1"	+11 to +30V	+11 to +30V	+11 to +30V
Input current			
• for signal "1", typ.	3.2 mA	3.2 mA	3.2 mA
Encoder			
Connectable encoders			
• 2-wire sensor	Yes	Yes	Yes
- permissible quiescent current (2-wire sensor), max.	1.5 mA	1.5 mA	1.5 mA
Interrupts/diagnostics/ status information			
Alarms			
• Diagnostic alarm	Yes; Parameterizable	Yes; Parameterizable	Yes; Parameterizable
Diagnoses			
• Short-circuit	Yes; Sensor supply to M; module by module	Yes; Sensor supply to M; module by module	Yes; Sensor supply to M; module by module
Diagnostics indication LED			
• Channel status display	Yes; green LED	Yes; green LED	Yes; green LED
• for module diagnostics	Yes; green/red LED	Yes; green/red LED	Yes; green/red LED

I/O systemsSIMATIC ET 200 systems without control cabinet
SIMATIC ET 200AL**I/O modules > Digital I/O modules****Technical specifications**

Article number	6ES7141-5BF00-0BA0 ET 200AL, DI 8x24VDC, 8xM8	6ES7141-5AF00-0BA0 ET 200AL, DI 8x24VDC, 4xM12	6ES7141-5AH00-0BA0 ET 200AL, DI 16x24VDC, 8xM12
Potential separation			
between the load voltages	Yes	Yes	Yes
Potential separation channels			
• between the channels	No	No	No
• between the channels and backplane bus	Yes	Yes	Yes
• between the channels and the power supply of the electronics	No	No	No
Degree and class of protection			
IP degree of protection	IP65/67	IP65/67	IP65/67
Standards, approvals, certificates			
Suitable for safety-related tripping of standard modules	Yes; From FS01	Yes; From FS01	Yes; From FS01
Highest safety class achievable for safety-related tripping of standard modules			
• Performance level according to ISO 13849-1	PL d	PL d	PL d
• Category according to ISO 13849-1	Cat. 3	Cat. 3	Cat. 3
• SILCL according to IEC 62061	SILCL 2	SILCL 2	SILCL 2
Ambient conditions			
Ambient temperature during operation			
• min.	-30 °C	-30 °C	-30 °C
• max.	55 °C	55 °C	55 °C
Connection method			
Design of electrical connection for the inputs and outputs	M8, 3-pole	M12, 5-pole	M12, 5-pole
Design of electrical connection for supply voltage	M8, 4-pole	M8, 4-pole	M8, 4-pole
ET-Connection			
• ET-Connection	M8, 4-pin, shielded	M8, 4-pin, shielded	M8, 4-pin, shielded
Dimensions			
Width	30 mm	30 mm	45 mm
Height	159 mm	159 mm	159 mm
Depth	40 mm	40 mm	40 mm
Weights			
Weight, approx.	145 g	145 g	184 g
Article number	6ES7142-5AF00-0BA0 ET 200AL, DQ 8x24VDC/2A, 8xM12	Article number	6ES7142-5AF00-0BA0 ET 200AL, DQ 8x24VDC/2A, 8xM12
General information		Input current	
Product type designation	DQ 8x24VDC/2A	Current consumption (rated value)	40 mA; without load
Product function		from load voltage 1L+ (unswitched voltage)	4 A; Maximum value
• I&M data	Yes; I&M0 to I&M3	from load voltage 2L+, max.	4 A; Maximum value
Engineering with		Digital outputs	
• STEP 7 TIA Portal configurable/integrated from version	STEP 7 V13 SP1 or higher	Number of digital outputs	8
• STEP 7 configurable/integrated from version	V5.5 SP4 Hotfix 7 or higher	• in groups of	4; 2 load groups for 4 outputs each
• PROFIBUS from GSD version/GSD revision	GSD as of Revision 5	Short-circuit protection	Yes; per channel, electronic
• PROFINET from GSD version/GSD revision	GSDML V2.3.1	Limitation of inductive shutdown voltage to	2L+ (-47 V)
Supply voltage		Switching capacity of the outputs	
Load voltage 1L+		• on lamp load, max.	10 W
• Rated value (DC)	24 V	Load resistance range	
• Reverse polarity protection	Yes; against destruction; load increasing	• lower limit	12 Ω
Load voltage 2L+		• upper limit	4 kΩ
• Rated value (DC)	24 V	Output voltage	
• Reverse polarity protection	Yes; against destruction; load increasing	• for signal "1", min.	L+ (-0.8 V)

Technical specifications

Article number	6ES7142-5AF00-0BA0 ET 200AL, DQ 8x24VDC/2A, 8xM12
Output current	
• for signal "1" rated value	2 A
• for signal "0" residual current, max.	0.5 mA
Switching frequency	
• with resistive load, max.	100 Hz
• with inductive load, max.	0.1 Hz; 0.25 Hz at 25 °C
• on lamp load, max.	1 Hz
Total current of the outputs	
• Current per group, max.	4 A; For inductive load max. 2 channels per group
Interrupts/diagnostics/status information	
Substitute values connectable	Yes; channel by channel, parameterizable
Alarms	
• Diagnostic alarm	Yes; Parameterizable
Diagnoses	
• Short-circuit	Yes; Outputs to ground; module by module
Diagnostics indication LED	
• Channel status display	Yes; green LED
• for module diagnostics	Yes; green/red LED
• For load voltage monitoring	Yes; green LED
Potential separation	
between the load voltages	Yes
Potential separation channels	
• between the channels, in groups of	4
• between the channels and backplane bus	Yes
• between the channels and the power supply of the electronics	No; 4 channels are non-isolated and 4 channels are isolated from supply voltage 1L+

Article number	6ES7142-5AF00-0BA0 ET 200AL, DQ 8x24VDC/2A, 8xM12
Degree and class of protection	
IP degree of protection	IP65/67
Standards, approvals, certificates	
Suitable for safety-related tripping of standard modules	Yes; From FS01
Highest safety class achievable for safety-related tripping of standard modules	
• Performance level according to ISO 13849-1	PL d
• Category according to ISO 13849-1	Cat. 3
• SILCL according to IEC 62061	SILCL 2
Ambient conditions	
Ambient temperature during operation	
• min.	-30 °C
• max.	55 °C
Connection method	
Design of electrical connection for the inputs and outputs	M12, 5-pole
Design of electrical connection for supply voltage	M8, 4-pole
ET-Connection	
• ET-Connection	M8, 4-pin, shielded
Dimensions	
Width	45 mm
Height	159 mm
Depth	40 mm
Weights	
Weight, approx.	192 g

Article number	6ES7143-5BF00-0BA0 ET 200AL, DIQ 4+DQ 4x24VDC/0,5A, 8xM8	6ES7143-5AF00-0BA0 ET 200AL, DIQ 4+DQ 4x24VDC/0,5A, 4xM12	6ES7143-5AH00-0BA0 ET 200AL, DIQ 16x24VDC/0,5A, 8xM12
General information			
Product type designation	DIQ 4+DQ 4x24VDC/0.5A	DIQ 4+DQ 4x24VDC/0.5A	DIQ 16x24VDC/0.5A
Product function			
• I&M data	Yes; I&M0 to I&M3	Yes; I&M0 to I&M3	Yes; I&M0 to I&M3
Engineering with			
• STEP 7 TIA Portal configurable/integrated from version	STEP 7 V13 SP1 or higher	STEP 7 V13 SP1 or higher	STEP 7 V14 or higher
• STEP 7 configurable/integrated from version	From V5.5 SP4 Hotfix 3	V5.5 SP4 Hotfix 7 or higher	V5.5 SP4 Hotfix 7 or higher
• PROFIBUS from GSD version/GSD revision	GSD as of Revision 5	GSD as of Revision 5	GSD as of Revision 5
• PROFINET from GSD version/GSD revision	GSDML V2.3.1	GSDML V2.3.1	GSDML V2.3.1
Operating mode			
• DI			Yes
• Counter			Yes
• DQ			Yes
Supply voltage			
Load voltage 1L+			
• Rated value (DC)	24 V	24 V	24 V
• Reverse polarity protection	Yes; Against destruction; encoder power supply outputs applied with reversed polarity, loads pick up	Yes; Against destruction; encoder power supply outputs applied with reversed polarity, loads pick up	Yes; Against destruction; encoder power supply outputs applied with reversed polarity, loads pick up

I/O systemsSIMATIC ET 200 systems without control cabinet
SIMATIC ET 200AL**I/O modules > Digital I/O modules****Technical specifications**

Article number	6ES7143-5BF00-0BA0 ET 200AL, DIQ 4+DQ 4x24VDC/0,5A, 8xM8	6ES7143-5AF00-0BA0 ET 200AL, DIQ 4+DQ 4x24VDC/0,5A, 4xM12	6ES7143-5AH00-0BA0 ET 200AL, DIQ 16x24VDC/0,5A, 8xM12
Load voltage 2L+			
• Rated value (DC)	24 V	24 V	24 V
• Reverse polarity protection	Yes; against destruction; load increasing	Yes; against destruction; load increasing	Yes; Against destruction; encoder power supply outputs applied with reversed polarity, loads pick up
Input current			
Current consumption (rated value)	40 mA; without load	40 mA; without load	75 mA; without load
from load voltage 1L+ (unswitched voltage)	4 A; Maximum value	4 A; Maximum value	4 A; Maximum value
from load voltage 2L+, max.	4 A; Maximum value	4 A; Maximum value	4 A; Maximum value
Encoder supply			
Number of outputs	4	4	8
Digital inputs			
Number of digital inputs	4; Parameterizable as DIQ	4; Parameterizable as DIQ	16; Parameterizable as DIQ
Input characteristic curve in accordance with IEC 61131, type 3	Yes	Yes	Yes
Number of simultaneously controllable inputs			
all mounting positions			
- up to 55 °C, max.	4	4	16
Digital input functions, parameterizable			
• Freely usable digital input			Yes
• Counter			Yes
Input voltage			
• Rated value (DC)	24 V	24 V	24 V
• for signal "0"	-3 to +5V	-3 to +5V	-3 to +5V
• for signal "1"	+11 to +30V	+11 to +30V	+11 to +30V
Input current			
• for signal "1", typ.	3.2 mA	3.2 mA	3 mA
Input delay (for rated value of input voltage)			
for standard inputs			
- parameterizable			Yes
for technological functions			
- parameterizable			Yes
Digital outputs			
Number of digital outputs	8; 4 DQ fixed, 4 DIQ parameterizable	8; 4 DQ fixed, 4 DIQ parameterizable	16; Parameterizable as DIQ
• in groups of	4; 2 load groups for 4 outputs each	4; 2 load groups for 4 outputs each	8; 2 load groups for 8 outputs each
Short-circuit protection	Yes; per channel, electronic	Yes; per channel, electronic	Yes; per channel, electronic
Limitation of inductive shutdown voltage to	2L+ (-47 V)	2L+ (-47 V)	L+ (-53 V)
Digital output functions, parameterizable			
• Switching tripped by comparison values			Yes
• Freely usable digital output			Yes
Switching capacity of the outputs			
• on lamp load, max.	5 W	5 W	5 W
Load resistance range			
• lower limit	48 Ω	48 Ω	48 Ω
• upper limit	4 kΩ	4 kΩ	4 kΩ
Output voltage			
• for signal "1", min.	L+ (-0.8 V)	L+ (-0.8 V)	L+ (-0.8 V)
Output current			
• for signal "1" rated value	0.5 A	0.5 A	0.5 A
• for signal "0" residual current, max.	0.5 mA	0.5 mA	0.5 mA

Technical specifications

Article number	6ES7143-5BF00-0BA0 ET 200AL, DIQ 4+DQ 4x24VDC/0,5A, 8xM8	6ES7143-5AF00-0BA0 ET 200AL, DIQ 4+DQ 4x24VDC/0,5A, 4xM12	6ES7143-5AH00-0BA0 ET 200AL, DIQ 16x24VDC/0,5A, 8xM12
Switching frequency			
• with resistive load, max.	100 Hz	100 Hz	100 Hz
• with inductive load, max.	0.5 Hz	0.5 Hz	0.5 Hz
• on lamp load, max.	1 Hz	1 Hz	1 Hz
Total current of the outputs			
• Current per group, max.	2 A	2 A	4 A
Encoder			
Connectable encoders			
• 2-wire sensor	Yes	Yes	Yes
- permissible quiescent current (2-wire sensor), max.	1.5 mA	1.5 mA	1.5 mA
Interrupts/diagnostics/ status information			
Substitute values connectable	Yes; channel by channel, parameterizable	Yes; channel by channel, parameterizable	Yes; channel by channel, parameterizable
Alarms			
• Diagnostic alarm	Yes; Parameterizable	Yes; Parameterizable	Yes; Parameterizable
Diagnoses			
• Short-circuit	Yes; Outputs to M; encoder supply to M; module by module	Yes; Outputs to M; encoder supply to M; module by module	Yes; Outputs to M; encoder supply to M; module by module
Diagnostics indication LED			
• Channel status display	Yes; green LED	Yes; green LED	Yes; green LED
• for module diagnostics	Yes; green/red LED	Yes; green/red LED	Yes; green/red LED
• For load voltage monitoring	Yes; green LED	Yes; green LED	Yes; green LED
Potential separation			
between the load voltages	Yes	Yes	Yes
Potential separation channels			
• between the channels, in groups of	4; DIQ channels are isolated from DQ channels	4; DIQ channels are isolated from DQ channels	8
• between the channels and backplane bus	Yes	Yes	Yes
• between the channels and the power supply of the electronics	No; DIQ channels are non-isolated and DQ channels are isolated from supply voltage 1L+	No; DIQ channels are non-isolated and DQ channels are isolated from supply voltage 1L+	No; 8 channels are non-isolated and 8 channels are isolated from supply voltage 1L+
Degree and class of protection			
IP degree of protection	IP65/67	IP65/67	IP65/67
Standards, approvals, certificates			
Suitable for safety-related tripping of standard modules	Yes; From FS01	Yes; From FS01	
Highest safety class achievable for safety-related tripping of standard modules			
• Performance level according to ISO 13849-1	PL d	PL d	
• Category according to ISO 13849-1	Cat. 3	Cat. 3	
• SILCL according to IEC 62061	SILCL 2	SILCL 2	
Ambient conditions			
Ambient temperature during operation			
• min.	-30 °C	-30 °C	-30 °C
• max.	55 °C	55 °C	55 °C

I/O systems

SIMATIC ET 200 systems without control cabinet

SIMATIC ET 200AL

I/O modules > Digital I/O modules**Technical specifications**

Article number	6ES7143-5BF00-0BA0 ET 200AL, DIQ 4+DQ 4x24VDC/0,5A, 8xM8	6ES7143-5AF00-0BA0 ET 200AL, DIQ 4+DQ 4x24VDC/0,5A, 4xM12	6ES7143-5AH00-0BA0 ET 200AL, DIQ 16x24VDC/0,5A, 8xM12
Connection method			
Design of electrical connection for the inputs and outputs	M8, 3-pole	M12, 5-pole	M12, 5-pole
Design of electrical connection for supply voltage	M8, 4-pole	M8, 4-pole	M8, 4-pole
ET-Connection			
• ET-Connection	M8, 4-pin, shielded	M8, 4-pin, shielded	M8, 4-pin, shielded
Dimensions			
Width	30 mm	30 mm	45 mm
Height	159 mm	159 mm	159 mm
Depth	40 mm	40 mm	40 mm
Weights			
Weight, approx.	145 g	145 g	195 g

Overview



- 30 mm wide module with parameters and diagnostic functions
- For connecting analog actuators and sensors without additional amplifiers
- 4-channel analog input modules with M12 connection
- 4-channel analog output module with M12 connection

Ordering data

Analog input modules

Article No.	Article No.
AI 4xU/I/RTD, 4xM12	6ES7144-5KD00-0BA0
AI 4xRTD/TC, 4xM12	6ES7144-5KD50-0BA0
AQ 4xU/I, 4xM12	6ES7145-5ND00-0BA0

Accessories

Bus cable for backplane bus (ET connection)

Article No.	Article No.
4-pin, shielded	
Pre-assembled at both ends, 2 M8 connectors	
0.19 m	6ES7194-2LH02-0AA0
0.3 m	6ES7194-2LH03-0AA0
1 m	6ES7194-2LH10-0AA0
2 m	6ES7194-2LH20-0AA0
5 m	6ES7194-2LH50-0AA0
10 m	6ES7194-2LN10-0AA0
15 m	6ES7194-2LN15-0AA0
Pre-assembled at both ends, 2 M8 connectors, angled	
0.3 m	6ES7194-2LH03-0AB0
1 m	6ES7194-2LH10-0AB0
2 m	6ES7194-2LH20-0AB0
5 m	6ES7194-2LH50-0AB0
10 m	6ES7194-2LN10-0AB0
15 m	6ES7194-2LN15-0AB0
Pre-assembled at one end, 1 M8 connector	
2 m	6ES7194-2LH20-0AC0
5 m	6ES7194-2LH50-0AC0
10 m	6ES7194-2LN10-0AC0
15 m	6ES7194-2LN15-0AC0

Power cable M8

Article No.	Article No.
4-pin	
Pre-assembled at both ends, M8 connector and M8 socket	
0.19 m	6ES7194-2LH02-1AA0
0.3 m	6ES7194-2LH03-1AA0
1 m	6ES7194-2LH10-1AA0
2 m	6ES7194-2LH20-1AA0
5 m	6ES7194-2LH50-1AA0
10 m	6ES7194-2LN10-1AA0
15 m	6ES7194-2LN15-1AA0
Pre-assembled at both ends, angled M8 connector and angled M8 socket	
0.3 m	6ES7194-2LH03-1AB0
1 m	6ES7194-2LH10-1AB0
2 m	6ES7194-2LH20-1AB0
5 m	6ES7194-2LH50-1AB0
10 m	6ES7194-2LN10-1AB0
15 m	6ES7194-2LN15-1AB0
Pre-assembled at one end, M8 socket	
2 m	6ES7194-2LH20-1AC0
5 m	6ES7194-2LH50-1AC0
10 m	6ES7194-2LN10-1AC0
15 m	6ES7194-2LN15-1AC0

M8 connector for ET connection

4-pin, shielded

M8 power connector

Male contact insert, 4-pin

Female contact insert, 4-pin

ET connection FastConnect stripping tool

Stripping tool for stripping the ET connection bus cable

Labels

10 x 5 mm, RAL 9016;
5 frames with 40 labels each

I/O systemsSIMATIC ET 200 systems without control cabinet
SIMATIC ET 200AL**I/O modules > Analog I/O modules****Technical specifications**

Article number	6ES7144-5KD00-0BA0 ET 200AL, AI 4xU/I/RTD, 4xM12	6ES7144-5KD50-0BA0 ET 200AL, AI 4xRTD/TC, 4xM12
General information		
Product type designation	AI 4xU/I/RTD	AI 4xRTD/TC
Product function		
• I&M data	Yes; I&M0 to I&M3	Yes; I&M0 to I&M3
Engineering with		
• STEP 7 TIA Portal configurable/ integrated from version	STEP 7 V13 SP1 or higher	STEP 7 V16 or higher
• STEP 7 configurable/integrated from version	From V5.5 SP4 Hotfix 3	V5.5 SP4 and higher
• PROFIBUS from GSD version/ GSD revision	GSD as of Revision 5	GSD as of Revision 5
• PROFINET from GSD version/ GSD revision	GSDML V2.3.1	GSDML V2.34
Supply voltage		
Load voltage 1L+		
• Rated value (DC)	24 V	24 V
• Reverse polarity protection	Yes; against destruction	Yes; against destruction
Input current		
Current consumption (rated value) from load voltage 1L+ (unswitched voltage)	35 mA; without load 4 A; Maximum value	25 mA; without load 4 A; Maximum value
from load voltage 2L+, max.	4 A; Maximum value	4 A; Maximum value
Encoder supply		
Number of outputs	4	
Analog inputs		
Number of analog inputs	4	4
• For current measurement	4	
• For voltage measurement	4	4
• For resistance/resistance thermometer measurement	4	4
• For thermocouple measurement		4
permissible input voltage for voltage input (destruction limit), max.	30 V	15 V
permissible input current for current input (destruction limit), max.	50 mA	
Constant measurement current for resistance-type transmitter, typ.		230 ... 300 µA
Cycle time (all channels), min.	8 ms	90 ms
Technical unit for temperature measurement adjustable	Yes; Degrees Celsius / degrees Fahrenheit / Kelvin	Yes; Degrees Celsius / degrees Fahrenheit / Kelvin
Input ranges (rated values), voltages		
• 0 to +10 V	Yes	
• 1 V to 5 V	Yes	
• -80 mV to +80 mV		Yes; 16 bit incl. sign
Input ranges (rated values), currents		
• 0 to 20 mA	Yes	
• 4 mA to 20 mA	Yes	

Technical specifications

Article number	6ES7144-5KD00-0BA0 ET 200AL, AI 4xU/I/RTD, 4xM12	6ES7144-5KD50-0BA0 ET 200AL, AI 4xRTD/TC, 4xM12
Input ranges (rated values), thermocouples		
<ul style="list-style-type: none"> • Type B • Type C • Type E • Type J • Type K • Type L • Type N • Type R • Type S • Type T • Type U 		Yes; 16 bit incl. sign Yes; 16 bit incl. sign Yes; 16 bit incl. sign Yes; 16 bit incl. sign Yes; 16 bit incl. sign Yes; 16 bit incl. sign Yes; 16 bit incl. sign Yes; 16 bit incl. sign Yes; 16 bit incl. sign Yes; 16 bit incl. sign Yes; 16 bit incl. sign
Input ranges (rated values), resistance thermometer		
<ul style="list-style-type: none"> • Ni 100 • Ni 1000 • Pt 100 • Pt 1000 	Yes; Standard/climate Yes; Standard/climate	Yes; Standard/climate Yes; Standard/climate Yes; Standard/climate Yes; Standard/climate
Input ranges (rated values), resistors		
<ul style="list-style-type: none"> • 0 to 150 ohms • 0 to 300 ohms 	Yes Yes	Yes Yes
Thermocouple (TC)		
Temperature compensation - parameterizable		Yes
Cable length		
<ul style="list-style-type: none"> • shielded, max. 	30 m	30 m
Analog value generation for the inputs		
Integration and conversion time/resolution per channel		
<ul style="list-style-type: none"> • Resolution with overrange (bit including sign), max. • Integration time, parameterizable • Integration time (ms) • Basic conversion time, including integration time (ms) • Interference voltage suppression for interference frequency f1 in Hz • Conversion time (per channel) 	16 bit Yes; channel by channel 0,3 / 16,7 / 20 / 60 3 600 / 60 / 50 / 16.7 2 / 18 / 21 / 61 ms	16 bit Yes; channel by channel 16.7 / 20 / 60 18 / 21 / 61 ms 60 / 50 / 16.7
Smoothing of measured values		
<ul style="list-style-type: none"> • parameterizable 	Yes	Yes
Encoder		
Connection of signal encoders		
<ul style="list-style-type: none"> • for voltage measurement • for current measurement as 2-wire transducer • for current measurement as 4-wire transducer • for resistance measurement with two-wire connection • for resistance measurement with three-wire connection • for resistance measurement with four-wire connection 	Yes Yes Yes Yes Yes Yes	Yes Yes Yes Yes

I/O systemsSIMATIC ET 200 systems without control cabinet
SIMATIC ET 200AL**I/O modules > Analog I/O modules****Technical specifications**

Article number	6ES7144-5KD00-0BA0 ET 200AL, AI 4xU/I/RTD, 4xM12	6ES7144-5KD50-0BA0 ET 200AL, AI 4xRTD/TC, 4xM12
Errors/accuracies		
Temperature error of internal compensation		±4 °C
Basic error limit (operational limit at 25 °C)		
• Voltage, relative to input range, (+/-)	0.25 %	0.25 %
• Current, relative to input range, (+/-)	0.25 %	
• Resistance, relative to input range, (+/-)	0.15 %	0.15 %
• Resistance thermometer, relative to input range, (+/-)	0.15 %	0.15 %
• Thermocouple, relative to input range, (+/-)		0.25 %
Interference voltage suppression for $f = n \times (f_1 \pm 0.5 \%)$, $f_1 =$ interference frequency		
• Series mode interference (peak value of interference < rated value of input range), min.	40 dB	40 dB
Interrupts/diagnostics/status information		
Alarms		
• Diagnostic alarm	Yes; Parameterizable	Yes; Parameterizable
• Limit value alarm	Yes; Parameterizable	Yes; Parameterizable
Diagnostics		
• Wire-break	Yes; at 4 mA to 20 mA and 1 V to 5 V	Yes; Not for ±80 mV
• Short-circuit	Yes; Encoder supply to M, channel by channel	
• Overflow/underflow	Yes	Yes
Diagnostics indication LED		
• Channel status display	Yes; green LED	Yes; green LED
• for module diagnostics	Yes; green/red LED	Yes; green/red LED
Potential separation		
between the load voltages	Yes	Yes
Potential separation channels		
• between the channels	No	No
• between the channels and backplane bus	Yes	Yes
• between the channels and the power supply of the electronics	No	No
Degree and class of protection		
IP degree of protection	IP65/67	IP65/67
Standards, approvals, certificates		
Suitable for safety-related tripping of standard modules	Yes; From FS02	Yes; From FS01
Suitable for applications according to AMS 2750		Yes; Declaration of Conformity, see online support entry 109757262
Suitable for applications according to CQI-9		Yes; Based on AMS 2750 E

Technical specifications

Article number	6ES7144-5KD00-0BA0 ET 200AL, AI 4xU/I/RTD, 4xM12	6ES7144-5KD50-0BA0 ET 200AL, AI 4xRTD/TC, 4xM12
Highest safety class achievable for safety-related tripping of standard modules		
<ul style="list-style-type: none"> Performance level according to ISO 13849-1 Category according to ISO 13849-1 SILCL according to IEC 62061 	PL d Cat. 3 SILCL 2	PL d Cat. 3 SILCL 2
Ambient conditions		
Ambient temperature during operation		
<ul style="list-style-type: none"> min. max. 	-30 °C 55 °C	-30 °C 55 °C
Connection method		
Design of electrical connection for the inputs and outputs	M12, 5-pole	M12, 5-pole
Design of electrical connection for supply voltage	M8, 4-pole	M8, 4-pole
ET-Connection		
<ul style="list-style-type: none"> ET-Connection 	M8, 4-pin, shielded	M8, 4-pin, shielded
Dimensions		
Width	30 mm	30 mm
Height	159 mm	159 mm
Depth	40 mm	40 mm
Weights		
Weight, approx.	168 g	168 g

Article number	6ES7145-5ND00-0BA0 ET 200AL, AQ 4xU/I, 4xM12
General information	
Product type designation	AQ 4xU/I
Product function	
<ul style="list-style-type: none"> I&M data 	Yes; I&M0 to I&M3
Engineering with	
<ul style="list-style-type: none"> STEP 7 TIA Portal configurable/integrated from version STEP 7 configurable/integrated from version PROFIBUS from GSD version/GSD revision PROFINET from GSD version/GSD revision 	STEP 7 V14 or higher V5.5 SP4 Hotfix 7 or higher GSD as of Revision 5 GSDML V2.3.1
Supply voltage	
Load voltage 1L+	
<ul style="list-style-type: none"> Rated value (DC) Reverse polarity protection 	24 V Yes; Against destruction; actuator power supply outputs applied with reversed polarity
Input current	
Current consumption (rated value)	110 mA; without load
from load voltage 1L+ (unswitched voltage)	4 A; Maximum value
from load voltage 2L+, max.	4 A; Maximum value
Actuator supply	
Number of outputs	4

Article number	6ES7145-5ND00-0BA0 ET 200AL, AQ 4xU/I, 4xM12
Analog outputs	
Number of analog outputs	4
Voltage output, short-circuit protection	Yes
Voltage output, short-circuit current, max.	24 mA
Current output, no-load voltage, max.	15 V
Cycle time (all channels) max.	1 ms
Output ranges, voltage	
<ul style="list-style-type: none"> 0 to 10 V 1 V to 5 V -10 V to +10 V 	Yes; 15 bit Yes; 14 bit Yes; 16 bit incl. sign
Output ranges, current	
<ul style="list-style-type: none"> 0 to 20 mA -20 mA to +20 mA 4 mA to 20 mA 	Yes; 15 bit Yes; 16 bit incl. sign Yes; 14 bit
Connection of actuators	
<ul style="list-style-type: none"> for voltage output two-wire connection for voltage output four-wire connection for current output two-wire connection for current output four-wire connection 	Yes Yes Yes Yes

I/O systemsSIMATIC ET 200 systems without control cabinet
SIMATIC ET 200AL**I/O modules > Analog I/O modules****Technical specifications**

Article number	6ES7145-5ND00-0BA0 ET 200AL, AQ 4xU/I, 4xM12
Load impedance (in rated range of output)	
• with voltage outputs, min.	1 kΩ
• with voltage outputs, capacitive load, max.	1 μF
• with current outputs, max.	500 Ω
• with current outputs, inductive load, max.	1 mH
Cable length	
• shielded, max.	30 m
Analog value generation for the outputs	
Integration and conversion time/resolution per channel	
• Resolution with overrange (bit including sign), max.	16 bit
Settling time	
• for resistive load	1 ms
• for capacitive load	1 ms
• for inductive load	1 ms
Errors/accuracies	
Basic error limit (operational limit at 25 °C)	
• Voltage, relative to output range, (+/-)	0.15 %
• Current, relative to output range, (+/-)	0.15 %
Interrupts/diagnostics/status information	
Substitute values connectable	Yes; channel by channel, parameterizable
Alarms	
• Diagnostic alarm	Yes; Parameterizable
Diagnostics	
• Wire-break	Yes; channel-by-channel, only for output type "current"
• Short-circuit	Yes; Actuator supply module by module; channel by channel for output type "voltage"
Diagnostics indication LED	
• Channel status display	Yes; green LED
• for module diagnostics	Yes; green/red LED

Article number	6ES7145-5ND00-0BA0 ET 200AL, AQ 4xU/I, 4xM12
Potential separation	
between the load voltages	Yes
Potential separation channels	
• between the channels	No
• between the channels and backplane bus	Yes
• between the channels and the power supply of the electronics	No
Degree and class of protection	
IP degree of protection	IP65/67
Standards, approvals, certificates	
Suitable for safety-related tripping of standard modules	Yes; from FS04
Highest safety class achievable for safety-related tripping of standard modules	
• Performance level according to ISO 13849-1	PL d
• Category according to ISO 13849-1	Cat. 3
• SILCL according to IEC 62061	SILCL 2
Ambient conditions	
Ambient temperature during operation	
• min.	-30 °C
• max.	55 °C
Connection method	
Design of electrical connection for the inputs and outputs	M12, 5-pole
Design of electrical connection for supply voltage	M8, 4-pole
ET-Connection	
• ET-Connection	M8, 4-pin, shielded
Dimensions	
Width	30 mm
Height	159 mm
Depth	40 mm
Weights	
Weight, approx.	175 g

Overview



The ET 200AL fail-safe I/O module expands the ET 200AL PN system family. It is incorporated seamlessly into the Safety Integrated concept of SIMATIC. It also supports safety-related communication via PROFIsafe. The functional safety is certified in accordance with IEC 61508. It is designed for safety-related use up to SIL 3 according to IEC 62061 and PL e according to ISO 13849. The following fail-safe I/O module with 4x digital inputs and 2x digital outputs with 45 mm width is available:

- F-DI 4+F-DQ 2x24VDC/2A, 4xM12 PROFIsafe

Ordering data

Fail-safe digital input/output modules

F-DI 4+F-DQ 2x24VDC/2A, 4xM12

Article No.

6ES7146-5FF00-0BA0

Accessories

M12 Y cable

For connection of single-channel sensors (1oo1 evaluation), 5-pin

6ES7194-6KB00-0XA0

For joint connection of an F-DQ and an F-DI channel by means of an 8-pin M12 socket

6ES7194-6KC00-0XA0

E-coding plug (metal) for fail-safe ET 200 distributed I/O, IP65/67

6ES7194-6KB01-0AA0

Bus cable for backplane bus (ET connection)

4-pin, shielded

Pre-assembled at both ends, 2 M8 plugs

0.19 m

6ES7194-2LH02-0AA0

0.3 m

6ES7194-2LH03-0AA0

1 m

6ES7194-2LH10-0AA0

2 m

6ES7194-2LH20-0AA0

5 m

6ES7194-2LH50-0AA0

10 m

6ES7194-2LN10-0AA0

15 m

6ES7194-2LN15-0AA0

Pre-assembled at both ends, 2 M8 plugs, angled

0.3 m

6ES7194-2LH03-0AB0

1 m

6ES7194-2LH10-0AB0

2 m

6ES7194-2LH20-0AB0

5 m

6ES7194-2LH50-0AB0

10 m

6ES7194-2LN10-0AB0

15 m

6ES7194-2LN15-0AB0

Pre-assembled at one end, 1 M8 plug

2 m

6ES7194-2LH20-0AC0

5 m

6ES7194-2LH50-0AC0

10 m

6ES7194-2LN10-0AC0

15 m

6ES7194-2LN15-0AC0

M8 power cable

4-pin

Pre-assembled at both ends, M8 plug and M8 socket

0.19 m

6ES7194-2LH02-1AA0

0.3 m

6ES7194-2LH03-1AA0

1 m

6ES7194-2LH10-1AA0

2 m

6ES7194-2LH20-1AA0

5 m

6ES7194-2LH50-1AA0

10 m

6ES7194-2LN10-1AA0

15 m

6ES7194-2LN15-1AA0

Pre-assembled at both ends, angled M8 plug and angled M8 socket

0.3 m

6ES7194-2LH03-1AB0

1 m

6ES7194-2LH10-1AB0

2 m

6ES7194-2LH20-1AB0

5 m

6ES7194-2LH50-1AB0

10 m

6ES7194-2LN10-1AB0

15 m

6ES7194-2LN15-1AB0

Pre-assembled at one end, M8 socket

2 m

6ES7194-2LH20-1AC0

5 m

6ES7194-2LH50-1AC0

10 m

6ES7194-2LN10-1AC0

15 m

6ES7194-2LN15-1AC0

M8 plug for ET connection

6ES7194-2AB00-0AA0

4-pin, shielded

M8 power connector

Male contact insert, 4-pin

6ES7194-2AA00-0AA0

Female contact insert, 4-pin

6ES7194-2AC00-0AA0

ET connection FastConnect stripping tool

6ES7194-2KA00-0AA0

Stripping tool for stripping the ET connection bus cable

Labels, yellow

6ES7194-2BB00-0AA0

10 x 5 mm; 5 frames with 40 labels each

I/O systemsSIMATIC ET 200 systems without control cabinet
SIMATIC ET 200AL**I/O modules > Fail-safe I/O modules****Technical specifications**

Article number	6ES7146-5FF00-0BA0 ET 200AL, F-DI 4+F-DQ 2x24VDC/2A, 4xM12
General information	
Product type designation	F-DI 4+F-DQ 2x24VDC/2A, 4xM12
Product function	
• I&M data	Yes; I&M0 to I&M3
Engineering with	
• STEP 7 TIA Portal configurable/ integrated from version	STEP 7 V17 or higher
Operating mode	
• DI	Yes
• DQ	Yes
Supply voltage	
Rated value (DC)	24 V
Load voltage 1L+	
• Rated value (DC)	24 V
• Reverse polarity protection	Yes; against destruction
Load voltage 2L+	
• Rated value (DC)	24 V
• Reverse polarity protection	Yes; against destruction; outputs applied with reversed polarity for loads connected between M-switch and 2L+ will conduct
Input current	
Current consumption (rated value)	55 mA (1L+) / 40 mA (2L+); without load
from load voltage 1L+ (unswitched voltage)	4 A; Maximum value
from load voltage 2L+, max.	4 A; Maximum value
Encoder supply	
Number of outputs	2
Digital inputs	
Number of digital inputs	4
Input characteristic according to IEC 61131	Type 1
Number of simultaneously controllable inputs	
all mounting positions - up to 55 °C, max.	4
Input voltage	
• Rated value (DC)	24 V
• for signal "0"	-30 to +5 V
• for signal "1"	+15 to +30 V
Input current	
• for signal "1", typ.	4.85 mA
Input delay (for rated value of input voltage) for standard inputs	
- parameterizable	Yes
Digital outputs	
Number of digital outputs	2
• in groups of	2
Short-circuit protection	Yes; per channel, electronic
Open-circuit detection	Yes; per channel, only detects when output is off
Overload protection	Yes
Limitation of inductive shutdown voltage to	P-switch: -26 V DC referenced to 2M, M-switch: +48 V DC referenced to 2M

Article number	6ES7146-5FF00-0BA0 ET 200AL, F-DI 4+F-DQ 2x24VDC/2A, 4xM12
Switching capacity of the outputs	
• on lamp load, max.	10 W
Load resistance range	
• lower limit	12 Ω
• upper limit	2 kΩ
Output voltage	
• for signal "1", min.	L+ (-2.0 V), P-switch is L+ (-1.5 V), M-switch is 0.5 V
Output current	
• for signal "1" rated value	2 A
• for signal "0" residual current, max.	0.5 mA
Switching frequency	
• with resistive load, max.	30 Hz
• with inductive load, max.	0.1 Hz
• on lamp load, max.	10 Hz
Total current of the outputs	
• Current per group, max.	4 A
Encoder	
Connectable encoders	
• 2-wire sensor	No
- permissible quiescent current (2-wire sensor), max.	0.5 mA
Interrupts/diagnostics/ status information	
Substitute values connectable	No
Alarms	
• Diagnostic alarm	Yes; Parameterizable
Diagnoses	
• Monitoring the supply voltage	Yes
• Wire-break	Yes; outputs when off
• Short-circuit	Yes; inputs, outputs, encoder supply
Diagnostics indication LED	
• Channel status display	Yes; green LED
• for channel diagnostics	Yes; red LED
• for module diagnostics	Yes; green/red LED
• For load voltage monitoring	Yes; green LED
Potential separation	
between the load voltages	Yes
Potential separation channels	
• between the channels, in groups of	4 DI channels are isolated from 2 DQ channels
• between the channels and backplane bus	Yes
• between the channels and the power supply of the electronics	DI channels are non-isolated from supply voltage 1L+ and DQ channels are isolated from the supply voltage 1L+
Degree and class of protection	
IP degree of protection	IP65/67

Technical specifications

Article number	6ES7146-5FF00-0BA0 ET 200AL, F-DI 4+F-DQ 2x24VDC/2A, 4xM12
Standards, approvals, certificates	
Highest safety class achievable in safety mode	
<ul style="list-style-type: none"> Performance level according to ISO 13849-1 SIL acc. to IEC 61508 	PLd (DI single-channel), PLe (DI two-channel, DQ) SIL 2 (DI single-channel), SIL 3 (DI two-channel, DQ)
Ambient conditions	
Ambient temperature during operation	
<ul style="list-style-type: none"> min. max. 	-30 °C 55 °C

Article number	6ES7146-5FF00-0BA0 ET 200AL, F-DI 4+F-DQ 2x24VDC/2A, 4xM12
Connection method	
Design of electrical connection for the inputs and outputs	M12, 5-pole
Design of electrical connection for supply voltage	M8, 4-pin
ET-Connection	
<ul style="list-style-type: none"> ET-Connection 	M8, 4-pin, shielded
Dimensions	
Width	45 mm
Height	159 mm
Depth	40 mm
Weights	
Weight, approx.	220 g

I/O systemsSIMATIC ET 200 systems without control cabinet
SIMATIC ET 200AL

I/O modules > Communication > CM IO-Link

Overview

- 30 mm wide CM IO-Link communication module
- For the connection of up to 4 IO-Link devices according to IO-Link Specification V1.0 and V1.1 and port Class B
- The IO-Link parameters are configured using the S7-PCT Port Configuration Tool, V3.2 and higher.

Ordering data**Article No.****Article No.****CM IO-Link**

CM 4X IO-Link, 4XM12;
for the connection of up to
4 IO-Link devices according to
IO-Link Specification V1.0
and V1.1 and port Class B

6ES7147-5JD00-0BA0**Accessories****Bus cable for backplane bus
(ET connection)**

4-pin, shielded

Pre-assembled at both ends,
2 M8 connectors

0.19 m

6ES7194-2LH02-0AA0

0.3 m

6ES7194-2LH03-0AA0

1 m

6ES7194-2LH10-0AA0

2 m

6ES7194-2LH20-0AA0

5 m

6ES7194-2LH50-0AA0

10 m

6ES7194-2LN10-0AA0

15 m

6ES7194-2LN15-0AA0Pre-assembled at both ends,
2 M8 connectors, angled

0.3 m

6ES7194-2LH03-0AB0

1 m

6ES7194-2LH10-0AB0

2 m

6ES7194-2LH20-0AB0

5 m

6ES7194-2LH50-0AB0

10 m

6ES7194-2LN10-0AB0

15 m

6ES7194-2LN15-0AB0Pre-assembled at one end,
1 M8 connector

2 m

6ES7194-2LH20-0AC0

5 m

6ES7194-2LH50-0AC0

10 m

6ES7194-2LN10-0AC0

15 m

6ES7194-2LN15-0AC0**Power cable M8**

4-pin

Pre-assembled at both ends,
M8 connector and M8 socket

0.19 m

6ES7194-2LH02-1AA0

0.3 m

6ES7194-2LH03-1AA0

1 m

6ES7194-2LH10-1AA0

2 m

6ES7194-2LH20-1AA0

5 m

6ES7194-2LH50-1AA0

10 m

6ES7194-2LN10-1AA0

15 m

6ES7194-2LN15-1AA0Pre-assembled at both ends, angled
M8 connector and angled
M8 socket

0.3 m

6ES7194-2LH03-1AB0

1 m

6ES7194-2LH10-1AB0

2 m

6ES7194-2LH20-1AB0

5 m

6ES7194-2LH50-1AB0

10 m

6ES7194-2LN10-1AB0

15 m

6ES7194-2LN15-1AB0Pre-assembled at one end,
M8 socket

2 m

6ES7194-2LH20-1AC0

5 m

6ES7194-2LH50-1AC0

10 m

6ES7194-2LN10-1AC0

15 m

6ES7194-2LN15-1AC0**M8 connector for ET connection****6ES7194-2AB00-0AA0**

4-pin, shielded

M8 power connector

Male contact insert, 4-pin

6ES7194-2AA00-0AA0

Female contact insert, 4-pin

6ES7194-2AC00-0AA0**ET connection FastConnect
stripping tool****6ES7194-2KA00-0AA0**Stripping tool for stripping
the ET connection bus cable**Labels****6ES7194-2BA00-0AA0**10 x 5 mm, RAL 9016;
5 frames with 40 labels each

Technical specifications

Article number	6ES7147-5JD00-0BA0 ET 200AL, cm 4x IO-Link, 4xM12
General information	
Product type designation	CM 4x IO-Link
Product function	
• I&M data	Yes; I&M0 to I&M3
Engineering with	
• STEP 7 TIA Portal configurable/integrated from version	STEP 7 V13 SP1 or higher
• STEP 7 configurable/integrated from version	From V5.5 SP4 Hotfix 3
• PROFIBUS from GSD version/GSD revision	GSD as of Revision 5
• PROFINET from GSD version/GSD revision	GSDML V2.3.1
Supply voltage	
Load voltage 1L+	
• Rated value (DC)	24 V
• Reverse polarity protection	Yes
Load voltage 2L+	
• Rated value (DC)	24 V
• Reverse polarity protection	Yes; against destruction; load increasing
Input current	
Current consumption (rated value) from load voltage 1L+ (unswitched voltage)	40 mA; without load 4 A; Maximum value
from load voltage 2L+, max.	4 A; Maximum value
Encoder supply	
Number of outputs	4
IO-Link	
Number of ports	4
• of which simultaneously controllable	4
IO-Link protocol 1.0	Yes
IO-Link protocol 1.1	Yes
Transmission rate	4.8 kBaud (COM1); 38.4 kBaud (COM2), 230 kBaud (COM3)
Size of process data, input per port	32 byte
Size of process data, input per module	132 byte
Size of process data, output per port	32 byte
Size of process data, output per module	128 byte
Memory size for device parameter	2 kbyte; for each port
Master backup	Possible with function block IO_LINK_MASTER
Configuration without S7-PCT	Possible; autostart/manual function
Cable length unshielded, max.	20 m
Operating modes	
• IO-Link	Yes
• DI	Yes
• DQ	Yes; max. 100 mA
Connection of IO-Link devices	
• Port type A	Yes; via 3-core cable
• Port type B	Yes; Additional device supply: 1.6 A total current of all ports

Article number	6ES7147-5JD00-0BA0 ET 200AL, cm 4x IO-Link, 4xM12
Interrupts/diagnostics/status information	
Alarms	
• Diagnostic alarm	Yes; Parameterizable
Diagnoses	
• Monitoring the supply voltage	Yes
• Wire-break	Yes
• Short-circuit	Yes
Diagnostics indication LED	
• Channel status display	Yes; green LED
• for module diagnostics	Yes; green/red LED
• For load voltage monitoring	Yes; green LED
Potential separation	
between the load voltages	Yes
Potential separation channels	
• between the channels	No
• between the channels and backplane bus	Yes
• between the channels and the power supply of the electronics	No
Degree and class of protection	
IP degree of protection	IP65/67
Standards, approvals, certificates	
Suitable for safety-related tripping of standard modules	Yes; From FS01
Highest safety class achievable for safety-related tripping of standard modules	
• Performance level according to ISO 13849-1	PL d
• Category according to ISO 13849-1	Cat. 3
• SILCL according to IEC 62061	SILCL 2
Ambient conditions	
Ambient temperature during operation	
• min.	-30 °C
• max.	55 °C
Connection method	
Design of electrical connection for the inputs and outputs	M12, 5-pole
Design of electrical connection for supply voltage	M8, 4-pole
ET-Connection	
• ET-Connection	M8, 4-pin, shielded
Dimensions	
Width	30 mm
Height	159 mm
Depth	40 mm
Weights	
Weight, approx.	145 g

I/O systems

SIMATIC ET 200 systems without control cabinet
SIMATIC ET 200AL

IO-Link I/O modules

Overview



The IO-Link communication standard enables and standardizes communication between machine and plant PLCs, on the one hand, and sensors, actuators and other field devices, on the other hand.

The IO-Link I/O modules enable the simple connection of binary standard sensors and actuators, whereby the signals and energy supply are transferred via IO-Link (IO-Link master).

The IO-Link I/O modules can be connected to any IO-Link masters and, in this way, fieldbus-independent and distributed I/O units can be formed. The universal usage of the IO-Link DIQ I/O modules enables additional flexibility here.

With the ET 200AL IO-Link I/O modules, a comprehensive portfolio of digital input, output and input/output modules with the design and system features of the ET 200AL is available.

Ordering data

Article No.

IO-Link digital input modules

Degree of protection IP67

- DI 8x 24VDC, 8x M8
- DI 16x 24VDC, 8x M12

6ES7141-5BF00-0BL0
6ES7141-5AH00-0BL0

IO-Link digital output modules

Degree of protection IP67

- DQ 8x 24VDC/2A, 8x M12

6ES7142-5AF00-0BL0

IO-Link digital input/ output modules

Degree of protection IP67

- DIQ 4+DQ 4x 24VDC/0.5A, 8x M8
- DIQ 16x24VDC/0.5A, 8x M12

6ES7143-5BF00-0BL0
6ES7143-5AH00-0BL0

Accessories

Control connecting cable 5 x 0.25

Flexible IO-Link cable with 5 copper cores (0.25 mm²) for connecting IO-Link sensors/actuators (IO-Link port class B); sold by the meter; max. delivery unit 1 000 m minimum order quantity 20 m

6XV1801-2C

M12 coupler plug

Can be assembled, for connecting actuators or sensors, 5-pin, screw connection, max. 0.75 mm², A-coded, max. 4 A

- Straight
- Angled

3RK1902-4BA00-5AA0
3RK1902-4DA00-5AA0

Control line

Pre-assembled on one side with 1 x M12 plug angled, 5-pin, 5 x 0.34 mm², A-coded, max. 4 A, PUR casing, black

- 1.5 m
- 5 m
- 10 m

3RK1902-4HB15-5AA0
3RK1902-4HB50-5AA0
3RK1902-4HC01-5AA0

Article No.

Control connecting cable M12-180/M12-180

Flexible 5-core cable, pre-assembled with A-coded, 5-pin M12 plug and A-coded, 5-pin M12 socket, both ends with a straight cable outlet, for connection of IO-Link sensors/actuators

- 0.5 m
- 1.0 m
- 1.5 m
- 2.0 m
- 3.0 m
- 5.0 m
- 10 m
- 15 m

6XV1801-2CE50
6XV1801-2CH10
6XV1801-2CH15
6XV1801-2CH20
6XV1801-2CH30
6XV1801-2CH50
6XV1801-2CN10
6XV1801-2CN15

Power M12 cable connector PRO

Connection socket for 24 V DC supply voltage, 4-pin, L-coded, with installation instructions, 1 unit

6GK1906-0EB00

M12 sealing cap

For protection of unused M12 connections with ET 200pro

3RX9802-0AA00

M12 sealing cap for IP67 modules

15 mm external diameter, with O-ring, 10 units

3RK1901-1KA00

M8 sealing cap

For IP67 modules

3RK1901-1PN00

M12 Y cable

For double connection of I/O by means of a single cable on ET 200, 5-pin

6ES7194-6KA00-0XA0

Energy Cable 4 x 1.5

Energy cable, suitable for cable carriers, with 4 copper cores (1.5 mm²) for connecting to M12 plug-in connector; sold by the meter; max. delivery unit 1 000 m, minimum order quantity 20 m

6XV1801-2B

Ordering data	Article No.	Article No.	
M12 Power connecting cable M12-180/M12-180 Flexible 4-core power connecting cable, pre-assembled with L-coded, 4-pin M12 plug and L-coded, 4-pin M12 socket to supply terminal devices with 24 V DC Length: <ul style="list-style-type: none"> • 0.5 m • 1.0 m • 1.5 m • 2.0 m • 3.0 m • 5.0 m • 10 m • 15 m 	6XV1801-6DE50 6XV1801-6DH10 6XV1801-6DH15 6XV1801-6DH20 6XV1801-6DH30 6XV1801-6DH50 6XV1801-6DN10 6XV1801-6DN15	M12 Power connecting cable M12-90/M12-90 Flexible 4-core power connecting cable, pre-assembled with L-coded, 4-pin M12 plug and L-coded, 4-pin M12 socket, both sides angled 90°, to supply terminal devices with 24 V DC Length: <ul style="list-style-type: none"> • 0.5 m • 1.0 m • 1.5 m • 2.0 m • 3.0 m • 5.0 m • 10 m • 15 m Labels 10 x 5 mm, RAL 9016; 5 frames with 40 labels each	6XV1801-6GE50 6XV1801-6GH10 6XV1801-6GH15 6XV1801-6GH20 6XV1801-6GH30 6XV1801-6GH50 6XV1801-6GN10 6XV1801-6GN15 6ES7194-2BA00-0AA0

Technical specifications

Article number	6ES7141-5BF00-0BL0	6ES7141-5AH00-0BL0
	ET 200AL, IO-Link, DI 8x24VDC, 8xM8	ET 200AL, IO-Link, DI 16x24VDC, 8xM12
General information		
Product type designation	IO-Link DI 8x24VDC	IO-Link DI 16x24VDC
Engineering with		
• IODD file	Yes	Yes
Supply voltage		
Load voltage 1L+		
• Rated value (DC)	24 V; Supply from 1Us+ of the IO-Link master	24 V; Supply from 1Us+ of the IO-Link master
• Reverse polarity protection	Yes; Against destruction; encoder power supply outputs applied with reversed polarity	Yes; Against destruction; encoder power supply outputs applied with reversed polarity
Input current		
Current consumption (rated value)	15 mA; without load	20 mA; without load
Encoder supply		
Number of outputs	8; Supply from 1Us+ of the IO-Link master	8; Supply from 1Us+ of the IO-Link master
Digital inputs		
Number of digital inputs	8	16
Input characteristic curve in accordance with IEC 61131, type 3	Yes	Yes
Number of simultaneously controllable inputs all mounting positions		
- up to 55 °C, max.	8	16
Input voltage		
• Rated value (DC)	24 V	24 V
• for signal "0"	-30 to +5 V	-30 to +5 V
• for signal "1"	+11 to +30V	+11 to +30V
Input current		
• for signal "1", typ.	3 mA	3 mA
Encoder		
Connectable encoders		
• 2-wire sensor	Yes	Yes
- permissible quiescent current (2-wire sensor), max.	1.5 mA	1.5 mA

I/O systemsSIMATIC ET 200 systems without control cabinet
SIMATIC ET 200AL**IO-Link I/O modules****Technical specifications**

Article number	6ES7141-5BF00-0BL0	6ES7141-5AH00-0BL0
	ET 200AL, IO-Link, DI 8x24VDC, 8xM8	ET 200AL, IO-Link, DI 16x24VDC, 8xM12
IO-Link		
IO-Link protocol 1.1	Yes	Yes
Transmission rate	38.4 kBd (COM2)	38.4 kBd (COM2)
Cycle time, min.	2.1 ms	2.5 ms
Size of process data, input per module	1 byte	2 byte
Size of process data, output per module	0 byte	0 byte
Supported IO-Link profiles	common profile	common profile
Cable length unshielded, max.	20 m	20 m
Connection of IO-Link devices		
• Port type A	Yes	Yes
Interrupts/diagnostics/status information		
Alarms		
• Diagnostic alarm	Yes; Parameterizable	Yes; Parameterizable
Diagnoses		
• Short-circuit	Yes; Sensor supply to M; module by module	Yes; Sensor supply to M; module by module
Diagnostics indication LED		
• Channel status display	Yes; green LED	Yes; green LED
• for module diagnostics	Yes; green/red LED	Yes; green/red LED
Potential separation		
Potential separation channels		
• between the channels	No	No
• between the channels and the power supply of the electronics	No	No
Degree and class of protection		
IP degree of protection	IP65/67	IP65/67
Ambient conditions		
Ambient temperature during operation		
• min.	-30 °C	-30 °C
• max.	55 °C	55 °C
Connection method		
Design of electrical connection for the inputs and outputs	M8, 3-pole	M12, 5-pin, A-coded
Type of electrical connection for IO-Link	M12, 5-pin, A-coded	M12, 5-pin, A-coded
Dimensions		
Width	30 mm	45 mm
Height	159 mm	159 mm
Depth	40 mm	40 mm
Weights		
Weight, approx.	124 g	155 g

Technical specifications

Article number	6ES7142-5AF00-0BL0 ET 200AL, IO-Link, DQ 8x24VDC/2A, 8xM12
General information	
Product type designation	IO-Link DQ 8x24VDC/2A
Engineering with	
• IODD file	Yes
Supply voltage	
Load voltage 1L+	
• Rated value (DC)	24 V; Supply from 1Us+ of the IO-Link master
• Reverse polarity protection	Yes; against destruction
Load voltage 2L+	
• Rated value (DC)	24 V; Supply via M12 connector L-coded
• Reverse polarity protection	Yes; against destruction; load increasing
Input current	
Current consumption (rated value) from load voltage 2L+, max.	12 mA; without load 8 A; Maximum value
Digital outputs	
Number of digital outputs	8
Short-circuit protection	Yes; per channel, electronic
Limitation of inductive shutdown voltage to	2L+ (-47 V)
Switching capacity of the outputs	
• on lamp load, max.	10 W
Load resistance range	
• lower limit	12 Ω
• upper limit	4 kΩ
Output voltage	
• for signal *1*, min.	L+ (-0.8 V)
Output current	
• for signal *1* rated value	2 A (45 °C); 1 A (55 °C)
• for signal *0* residual current, max.	0.5 mA
Switching frequency	
• with resistive load, max.	100 Hz
• with inductive load, max.	0.1 Hz; 0.25 Hz at 25 °C
• on lamp load, max.	1 Hz
Total current of the outputs	
• Current per module, max.	8 A
IO-Link	
IO-Link protocol 1.1	Yes
Transmission rate	38.4 kBd (COM2)
Cycle time, min.	2.1 ms
Size of process data, input per module	0 byte
Size of process data, output per module	1 byte
Supported IO-Link profiles	common profile
Cable length unshielded, max.	20 m
Connection of IO-Link devices	
• Port type A	Yes

Article number	6ES7142-5AF00-0BL0 ET 200AL, IO-Link, DQ 8x24VDC/2A, 8xM12
Interrupts/diagnostics/status information	
Substitute values connectable	Yes; channel by channel, parameterizable
Alarms	
• Diagnostic alarm	Yes; Parameterizable
Diagnoses	
• Short-circuit	Yes; Outputs to ground; module by module
Diagnostics indication LED	
• Channel status display	Yes; green LED
• for module diagnostics	Yes; green/red LED
• For load voltage monitoring	Yes; green LED
Potential separation	
between the load voltages	Yes
Potential separation channels	
• between the channels	No
• between the channels and the power supply of the electronics	Yes
Degree and class of protection	
IP degree of protection	IP65/67
Standards, approvals, certificates	
Suitable for safety-related tripping of standard modules	Yes; From FS01
Highest safety class achievable for safety-related tripping of standard modules	
• Performance level according to ISO 13849-1	PL d
• Category according to ISO 13849-1	Cat. 3
• SILCL according to IEC 62061	SILCL 2
Ambient conditions	
Ambient temperature during operation	
• min.	-30 °C
• max.	55 °C
Connection method	
Design of electrical connection for the inputs and outputs	M12, 5-pin, A-coded
Type of electrical connection for IO-Link	M12, 5-pin, A-coded
Design of electrical connection for supply voltage	M12, 4-pin, L-coded
Dimensions	
Width	45 mm
Height	159 mm
Depth	45 mm
Weights	
Weight, approx.	168 g

I/O systemsSIMATIC ET 200 systems without control cabinet
SIMATIC ET 200AL**IO-Link I/O modules****Technical specifications**

Article number	6ES7143-5BF00-0BL0 ET 200AL, IO-Link, DIQ 4+DQ 4x24VDC/0,5A	6ES7143-5AH00-0BL0 ET 200AL, IO-Link, DIQ 16x24VDC/0,5A
General information		
Product type designation	IO-Link DIQ 4+DQ 4x24VDC/0,5A	DIQ 16x24VDC/0,5A, 8XM12
Engineering with		
• IODD file	Yes	Yes
Supply voltage		
Load voltage 1L+		
• Rated value (DC)	24 V; Supply from 1Us+ of the IO-Link master	24 V; Supply from 1Us+ of the IO-Link master
• Reverse polarity protection	Yes; against destruction	Yes; against destruction
Load voltage 2L+		
• Rated value (DC)	24 V; Supply from 2UA+ of the IO-Link master	24 V; Supply from 2UA+ of the IO-Link master
• Reverse polarity protection	Yes; Against destruction; encoder power supply outputs applied with reversed polarity, loads pick up	Yes; Against destruction; encoder power supply outputs applied with reversed polarity, loads pick up
Input current		
Current consumption (rated value)	15 mA; without load	20 mA; without load
from load voltage 2L+, max.	4 A; Maximum value	4 A; Maximum value
Encoder supply		
Number of outputs	8; Supply from 2UA+ of the IO-Link master	8; Supply from 2UA+ of the IO-Link master
Digital inputs		
Number of digital inputs	4; Parameterizable as DIQ	16; Parameterizable as DIQ
Input characteristic curve in accordance with IEC 61131, type 3	Yes	Yes
Number of simultaneously controllable inputs all mounting positions		
- up to 55 °C, max.	4	16
Input voltage		
• Rated value (DC)	24 V	24 V
• for signal "0"	-3 to +5V	-3 to +5V
• for signal "1"	+11 to +30V	+11 to +30V
Input current		
• for signal "1", typ.	3 mA	3 mA
Digital outputs		
Number of digital outputs	8; 4 DQ fixed, 4 DIQ parameterizable	16; Parameterizable as DIQ
Short-circuit protection	Yes; per channel, electronic	Yes; per channel, electronic
Limitation of inductive shutdown voltage to	2L+ (-50 V)	2L+ (-50 V)
Switching capacity of the outputs		
• on lamp load, max.	5 W	5 W
Load resistance range		
• lower limit	48 Ω	48 Ω
• upper limit	4 kΩ	4 kΩ
Output voltage		
• for signal "1", min.	L+ (-0.8 V)	L+ (-0.8 V)
Output current		
• for signal "1" rated value	0.5 A	0.5 A
• for signal "0" residual current, max.	0.5 mA	0.5 mA
Switching frequency		
• with resistive load, max.	100 Hz	100 Hz
• with inductive load, max.	0.5 Hz	0.5 Hz
• on lamp load, max.	1 Hz	1 Hz
Total current of the outputs		
• Current per module, max.	4 A	4 A
Encoder		
Connectable encoders		
• 2-wire sensor	Yes	Yes
- permissible quiescent current (2-wire sensor), max.	1.5 mA	1.5 mA

Technical specifications

Article number	6ES7143-5BF00-0BL0	6ES7143-5AH00-0BL0
	ET 200AL, IO-Link, DIQ 4+DQ 4x24VDC/0,5A	ET 200AL, IO-Link, DIQ 16x24VDC/0,5A
IO-Link		
IO-Link protocol 1.1	Yes	Yes
Transmission rate	38.4 kBd (COM2)	38.4 kBd (COM2)
Cycle time, min.	2.4 ms	3 ms
Size of process data, input per module	1 byte	2 byte
Size of process data, output per module	1 byte	2 byte
Supported IO-Link profiles	common profile	common profile
Cable length unshielded, max.	20 m	20 m
Connection of IO-Link devices		
• Port type B	Yes	Yes
Interrupts/diagnostics/status information		
Substitute values connectable	Yes; channel by channel, parameterizable	Yes; channel by channel, parameterizable
Alarms		
• Diagnostic alarm	Yes; Parameterizable	Yes; Parameterizable
Diagnoses		
• Short-circuit	Yes; outputs to ground; encoder supply to ground; module by module	Yes; outputs to ground; encoder supply to ground; module by module
Diagnostics indication LED		
• Channel status display	Yes; green LED	Yes; green LED
• for module diagnostics	Yes; green/red LED	Yes; green/red LED
• For load voltage monitoring	Yes; green LED	Yes; green LED
Potential separation		
between the load voltages	Yes	Yes
Potential separation channels		
• between the channels	No	No
• between the channels and the power supply of the electronics	Yes	Yes
Degree and class of protection		
IP degree of protection	IP65/67	IP65/67
Standards, approvals, certificates		
Suitable for safety-related tripping of standard modules	Yes; From FS01	
Highest safety class achievable for safety-related tripping of standard modules		
• Performance level according to ISO 13849-1	PL d	
• Category according to ISO 13849-1	Cat. 3	
• SILCL according to IEC 62061	SILCL 2	
Ambient conditions		
Ambient temperature during operation		
• min.	-30 °C	-30 °C
• max.	55 °C	55 °C
Connection method		
Design of electrical connection for the inputs and outputs	M8, 3-pole	M12, 5-pin, A-coded
Type of electrical connection for IO-Link	M12, 5-pin, A-coded	M12, 5-pin, A-coded
Dimensions		
Width	30 mm	45 mm
Height	159 mm	159 mm
Depth	40 mm	40 mm
Weights		
Weight, approx.	125 g	157 g

I/O systemsSIMATIC ET 200 systems without control cabinet
SIMATIC ET 200AL**Accessories > Cables and connectors****Overview**

- Pre-assembled cables in various designs and lengths:
 - For connecting the interface modules and I/O modules via the internal backplane bus (ET connection).
 - For power supply.

Ordering data**Bus cable for backplane bus (ET connection)**

4-pin, shielded

Pre-assembled at both ends,
2 M8 connectors

0.19 m

0.3 m

1 m

2 m

5 m

10 m

15 m

PUR line, pre-assembled at both
ends, 2 M8 connectors

0.19 m

0.3 m

1 m

2 m

5 m

10 m

15 m

PUR line, pre-assembled at both
ends, 2 M8 connectors, angled

0.3 m

1 m

2 m

5 m

10 m

15 m

Pre-assembled at both ends,
2 M8 connectors, angled

0.3 m

1 m

2 m

5 m

10 m

15 m

Pre-assembled at one end,
1 M8 connector

2 m

5 m

10 m

15 m

PUR line, pre-assembled at one
end, 1 M8 connector

2 m

5 m

10 m

15 m

Article No.**6ES7194-2LH02-0AA0****6ES7194-2LH03-0AA0****6ES7194-2LH10-0AA0****6ES7194-2LH20-0AA0****6ES7194-2LH50-0AA0****6ES7194-2LN10-0AA0****6ES7194-2LN15-0AA0****6ES7194-2MH02-0AA0****6ES7194-2MH03-0AA0****6ES7194-2MH10-0AA0****6ES7194-2MH20-0AA0****6ES7194-2MH50-0AA0****6ES7194-2MN10-0AA0****6ES7194-2MN15-0AA0****6ES7194-2MH03-0AB0****6ES7194-2MH10-0AB0****6ES7194-2MH20-0AB0****6ES7194-2MH50-0AB0****6ES7194-2MN10-0AB0****6ES7194-2MN15-0AB0****6ES7194-2LH03-0AB0****6ES7194-2LH10-0AB0****6ES7194-2LH20-0AB0****6ES7194-2LH50-0AB0****6ES7194-2LN10-0AB0****6ES7194-2LN15-0AB0****6ES7194-2LH20-0AC0****6ES7194-2LH50-0AC0****6ES7194-2LN10-0AC0****6ES7194-2LN15-0AC0****6ES7194-2MH20-0AC0****6ES7194-2MH50-0AC0****6ES7194-2MN10-0AC0****6ES7194-2MN15-0AC0****Article No.****Connecting cable for bus cable for backplane bus (ET connection)**

4-pin, shielded

Pre-assembled at both ends,
2 M8 connectors. 0.2 mPUR line, pre-assembled at both
ends, 2 M8 connectors. 0.2 m**Power cable M8**

4-pin

Pre-assembled at both ends,
M8 connector and M8 socket

0.19 m

0.3 m

1 m

2 m

5 m

10 m

15 m

PUR line, pre-assembled at both
ends, M8 connector and M8 socket

0.19 m

0.3 m

1 m

2 m

5 m

10 m

15 m

Pre-assembled at both ends, angled
M8 connector and angled
M8 socket

0.3 m

1 m

2 m

5 m

10 m

15 m

PUR line, pre-assembled at both
ends, angled M8 connector and
angled M8 socket

0.3 m

1 m

2 m

5 m

10 m

15 m

6ES7194-2LH02-0AD0**6ES7194-2MH02-0AD0****6ES7194-2LH02-1AA0****6ES7194-2LH03-1AA0****6ES7194-2LH10-1AA0****6ES7194-2LH20-1AA0****6ES7194-2LH50-1AA0****6ES7194-2LN10-1AA0****6ES7194-2LN15-1AA0****6ES7194-2MH02-1AA0****6ES7194-2MH03-1AA0****6ES7194-2MH10-1AA0****6ES7194-2MH20-1AA0****6ES7194-2MH50-1AA0****6ES7194-2MN10-1AA0****6ES7194-2MN15-1AA0****6ES7194-2LH03-1AB0****6ES7194-2LH10-1AB0****6ES7194-2LH20-1AB0****6ES7194-2LH50-1AB0****6ES7194-2LN10-1AB0****6ES7194-2LN15-1AB0****6ES7194-2MH03-1AB0****6ES7194-2MH10-1AB0****6ES7194-2MH20-1AB0****6ES7194-2MH50-1AB0****6ES7194-2MN10-1AB0****6ES7194-2MN15-1AB0**

Ordering data	Article No.	Article No.
Power cable M8 (continued)		M8 connector for ET connection
Pre-assembled at one end, M8 socket		4-pin, shielded
2 m	6ES7194-2LH20-1AC0	M8 power connector
5 m	6ES7194-2LH50-1AC0	Male contact insert, 4-pin
10 m	6ES7194-2LN10-1AC0	Female contact insert, 4-pin
15 m	6ES7194-2LN15-1AC0	ET connection FastConnect stripping tool
PUR line, pre-assembled at one end, M8 socket		Stripping tool for stripping the ET connection bus cable
2 m	6ES7194-2MH20-1AC0	
5 m	6ES7194-2MH50-1AC0	
10 m	6ES7194-2MN10-1AC0	
15 m	6ES7194-2MN15-1AC0	

Technical specifications

Article number	6ES7194-2LH02-0AA0	6ES7194-2LH03-0AA0	6ES7194-2LH10-0AA0	6ES7194-2LH20-0AA0	6ES7194-2LH50-0AC0	6ES7194-2LN10-0AA0	6ES7194-2LN15-0AA0
	Bus Cable ET-Connection, 0,19m	Bus Cable ET-Connection, 0,3m	Bus Cable ET-Connection, 1,0M	Bus Cable ET-Connection, 2,0M	Bus Cable ET-Connection, 5,0M	Bus Cable ET-Connection, 10m	Bus Cable ET-Connection, 15m
General information							
Product type designation	Bus cable	Bus cable	Bus cable	Bus cable	Bus cable	Bus cable	Bus cable
Product description	Flexible cable (4-core), preassembled at both ends with 2x M8 plugs, 4-pin, shielded	Flexible cable (4-core), preassembled at both ends with 2x M8 plugs, 4-pin, shielded	Flexible cable (4-core), preassembled at both ends with 2x M8 plugs, 4-pin, shielded	Flexible cable (4-core), preassembled at both ends with 2x M8 plugs, 4-pin, shielded	Flexible cable (4-core), preassembled at one end with 1x M8 plug, 4-pin, shielded	Flexible cable (4-core), preassembled at both ends with 2x M8 plugs, 4-pin, shielded	Flexible cable (4-core), preassembled at both ends with 2x M8 plugs, 4-pin, shielded
Suitability for use	for connecting ET-CONNECTION nodes (e.g. SIMATIC ET 200AL) in degree of protection IP65 / 67	for connecting ET-CONNECTION nodes (e.g. SIMATIC ET 200AL) in degree of protection IP65 / 67	for connecting ET-CONNECTION nodes (e.g. SIMATIC ET 200AL) in degree of protection IP65 / 67	for connecting ET-CONNECTION nodes (e.g. SIMATIC ET 200AL) in degree of protection IP65 / 67	for connecting ET-CONNECTION nodes (e.g. SIMATIC ET 200AL) in degree of protection IP65 / 67	for connecting ET-CONNECTION nodes (e.g. SIMATIC ET 200AL) in degree of protection IP65 / 67	for connecting ET-CONNECTION nodes (e.g. SIMATIC ET 200AL) in degree of protection IP65 / 67
Degree and class of protection							
IP degree of protection	IP65/67	IP65/67	IP65/67	IP65/67	IP65/67	IP65/67	IP65/67
Ambient conditions							
Ambient temperature during assembly, min.	-30 °C	-30 °C	-30 °C	-30 °C	-30 °C	-30 °C	-30 °C
Ambient temperature during assembly, max.	80 °C	80 °C	80 °C	80 °C	80 °C	80 °C	80 °C
Ambient temperature during storage/transportation							
• min.	-40 °C	-40 °C	-40 °C	-40 °C	-40 °C	-40 °C	-40 °C
• max.	80 °C	80 °C	80 °C	80 °C	80 °C	80 °C	80 °C
Cables							
Cable designation	2Y(ST)CY 1x4x0.5/1.0-100-GN	2Y(ST)CY 1x4x0.5/1.0-100-GN	2Y(ST)CY 1x4x0.5/1.0-100-GN	2Y(ST)CY 1x4x0.5/1.0-100-GN	2Y(ST)CY 1x4x0.5/1.0-100-GN	2Y(ST)CY 1x4x0.5/1.0-100-GN	2Y(ST)CY 1x4x0.5/1.0-100-GN
Design of shield	Overlapped aluminum-clad foil, sheathed in a braid of tin-plated copper wires	Overlapped aluminum-clad foil, sheathed in a braid of tin-plated copper wires	Overlapped aluminum-clad foil, sheathed in a braid of tin-plated copper wires	Overlapped aluminum-clad foil, sheathed in a braid of tin-plated copper wires	Overlapped aluminum-clad foil, sheathed in a braid of tin-plated copper wires	Overlapped aluminum-clad foil, sheathed in a braid of tin-plated copper wires	Overlapped aluminum-clad foil, sheathed in a braid of tin-plated copper wires
Cable length	0.19 m	0.3 m	1 m	2 m	5 m	10 m	15 m
Number of electrical cores	4	4	4	4	4	4	4
Outer diameter of inner conductor	0.5 mm	0.5 mm	0.5 mm	0.5 mm	0.5 mm	0.5 mm	0.5 mm
Outer diameter of core insulation	1 mm	1 mm	1 mm	1 mm	1 mm	1 mm	1 mm
Outer diameter of cable sheath	5 mm	5 mm	5 mm	5 mm	5 mm	5 mm	5 mm

I/O systemsSIMATIC ET 200 systems without control cabinet
SIMATIC ET 200AL**Accessories > Cables and connectors****Technical specifications**

Article number	6ES7194-2LH02-0AA0	6ES7194-2LH03-0AA0	6ES7194-2LH10-0AA0	6ES7194-2LH20-0AA0	6ES7194-2LH50-0ACO	6ES7194-2LN10-0AA0	6ES7194-2LN15-0AA0
Bus Cable ET-Connection, 0,19m	Bus Cable ET-Connection, 0,3m	Bus Cable ET-Connection, 1,0M	Bus Cable ET-Connection, 2,0M	Bus Cable ET-Connection, 5,0M	Bus Cable ET-Connection, 10m	Bus Cable ET-Connection, 15m	Bus Cable ET-Connection, 15m
Number of bending cycles	1 000 000; cable carrier compliant for 1 million bending cycles with a bending radius of 100 mm, a speed of 4 m/s and an acceleration of 4 m/s ²	1 000 000; cable carrier compliant for 1 million bending cycles with a bending radius of 100 mm, a speed of 4 m/s and an acceleration of 4 m/s ²	1 000 000; cable carrier compliant for 1 million bending cycles with a bending radius of 100 mm, a speed of 4 m/s and an acceleration of 4 m/s ²	1 000 000; cable carrier compliant for 1 million bending cycles with a bending radius of 100 mm, a speed of 4 m/s and an acceleration of 4 m/s ²	1 000 000; cable carrier compliant for 1 million bending cycles with a bending radius of 100 mm, a speed of 4 m/s and an acceleration of 4 m/s ²	1 000 000; cable carrier compliant for 1 million bending cycles with a bending radius of 100 mm, a speed of 4 m/s and an acceleration of 4 m/s ²	1 000 000; cable carrier compliant for 1 million bending cycles with a bending radius of 100 mm, a speed of 4 m/s and an acceleration of 4 m/s ²
Permissible bending radius, single bend, min.	20 mm	20 mm	20 mm	20 mm	20 mm	20 mm	20 mm
Permissible bending radius, multiple bends, min.	40 mm	40 mm	40 mm	40 mm	40 mm	40 mm	40 mm
Bending radius for continuous bending	100 mm	100 mm	100 mm	100 mm	100 mm	100 mm	100 mm
Color of cable sheath	green	green	green	green	green	green	green
Color of core insulation of data cores	white / yellow / blue / orange	white / yellow / blue / orange	white / yellow / blue / orange	white / yellow / blue / orange	white / yellow / blue / orange	white / yellow / blue / orange	white / yellow / blue / orange
Weight per length	34 kg/km	34 kg/km	34 kg/km	34 kg/km	34 kg/km	34 kg/km	34 kg/km
Mechanics/material							
Outgoing feeder type	180° cable outlet	180° cable outlet	180° cable outlet	180° cable outlet	180° cable outlet	180° cable outlet	180° cable outlet
Material of cable sheath	PVC	PVC	PVC	PVC	PVC	PVC	PVC
Material of core insulation	PE	PE	PE	PE	PE	PE	PE
Material property							
• Halogen-free	No	No	No	No	No	No	No
• Silicone-free	Yes	Yes	Yes	Yes	Yes	Yes	Yes
Article number	6ES7194-2MH02-0AA0	6ES7194-2MH03-0AA0	6ES7194-2MH10-0AA0	6ES7194-2MH20-0AA0	6ES7194-2MH50-0AA0	6ES7194-2MN10-0AA0	6ES7194-2MN15-0AA0
Bus Cable ET-Connection, 0,19m	Bus Cable ET-Connection, 0,3m	Bus Cable ET-Connection, 1,0M	Bus Cable ET-Connection, 2,0M	Bus Cable ET-Connection, 5,0M	Bus Cable ET-Connection, 10m	Bus Cable ET-Connection, 15m	Bus Cable ET-Connection, 15m
General information							
Product type designation	Bus cable	Bus cable	Bus cable	Bus cable	Bus cable	Bus cable	Bus cable
Product description	Flexible cable (4-core), preassembled at both ends with 2x M8 plugs, 4-pin, shielded	Flexible cable (4-core), preassembled at both ends with 2x M8 plugs, 4-pin, shielded	Flexible cable (4-core), preassembled at both ends with 2x M8 plugs, 4-pin, shielded	Flexible cable (4-core), preassembled at both ends with 2x M8 plugs, 4-pin, shielded	Flexible cable (4-core), preassembled at both ends with 2x M8 plugs, 4-pin, shielded	Flexible cable (4-core), preassembled at both ends with 2x M8 plugs, 4-pin, shielded	Flexible cable (4-core), preassembled at both ends with 2x M8 plugs, 4-pin, shielded
Suitability for use	for connecting ET-CONNECTION nodes (e.g. SIMATIC ET 200AL) in degree of protection IP65 / 67	for connecting ET-CONNECTION nodes (e.g. SIMATIC ET 200AL) in degree of protection IP65 / 67	for connecting ET-CONNECTION nodes (e.g. SIMATIC ET 200AL) in degree of protection IP65 / 67	for connecting ET-CONNECTION nodes (e.g. SIMATIC ET 200AL) in degree of protection IP65 / 67	for connecting ET-CONNECTION nodes (e.g. SIMATIC ET 200AL) in degree of protection IP65 / 67	for connecting ET-CONNECTION nodes (e.g. SIMATIC ET 200AL) in degree of protection IP65 / 67	for connecting ET-CONNECTION nodes (e.g. SIMATIC ET 200AL) in degree of protection IP65 / 67
Degree and class of protection							
IP degree of protection	IP65/67	IP65/67	IP65/67	IP65/67	IP65/67	IP65/67	IP65/67
Ambient conditions							
Ambient temperature during assembly, min.	-30 °C	-30 °C	-30 °C	-30 °C	-30 °C	-30 °C	-30 °C
Ambient temperature during assembly, max.	80 °C	80 °C	80 °C	80 °C	80 °C	80 °C	80 °C
Ambient temperature during storage/transportation							
• min.	-40 °C	-40 °C	-40 °C	-40 °C	-40 °C	-40 °C	-40 °C
• max.	80 °C	80 °C	80 °C	80 °C	80 °C	80 °C	80 °C

10

Technical specifications

Article number	6ES7194-2MH02-0AA0	6ES7194-2MH03-0AA0	6ES7194-2MH10-0AA0	6ES7194-2MH20-0AA0	6ES7194-2MH50-0AA0	6ES7194-2MN10-0AA0	6ES7194-2MN15-0AA0
	Bus Cable ET-Connection, 0,19m	Bus Cable ET-Connection, 0,3m	Bus Cable ET-Connection, 1,0M	Bus Cable ET-Connection, 2,0M	Bus Cable ET-Connection, 5,0M	Bus Cable ET-Connection, 10m	Bus Cable ET-Connection, 15m
Cables							
Cable designation	2Y(ST)C11Y 2x2x0.5/1.0- 100-GN	2Y(ST)C11Y 2x2x0.5/1.0- 100-GN	2Y(ST)C11Y 2x2x0.5/1.0- 100-GN	2Y(ST)C11Y 2x2x0.5/1.0- 100-GN	2Y(ST)C11Y 2x2x0.5/1.0- 100-GN	2Y(ST)C11Y 2x2x0.5/1.0- 100-GN	2Y(ST)C11Y 2x2x0.5/1.0- 100-GN
Design of shield	Overlapped aluminum-clad foil, sheathed in a braid of tin-plated copper wires	Overlapped aluminum-clad foil, sheathed in a braid of tin-plated copper wires	Overlapped aluminum-clad foil, sheathed in a braid of tin-plated copper wires	Overlapped aluminum-clad foil, sheathed in a braid of tin-plated copper wires	Overlapped aluminum-clad foil, sheathed in a braid of tin-plated copper wires	Overlapped aluminum-clad foil, sheathed in a braid of tin-plated copper wires	Overlapped aluminum-clad foil, sheathed in a braid of tin-plated copper wires
Cable length	0.19 m	0.3 m	1 m	2 m	5 m	10 m	15 m
Number of electrical cores	4	4	4	4	4	4	4
Outer diameter of inner conductor	0.5 mm	0.5 mm	0.5 mm	0.5 mm	0.5 mm	0.5 mm	0.5 mm
Outer diameter of core insulation	1 mm	1 mm	1 mm	1 mm	1 mm	1 mm	1 mm
Outer diameter of cable sheath	5 mm	5 mm	5 mm	5 mm	5 mm	5 mm	5 mm
Number of bending cycles	1 000 000; cable carrier compliant for 1 million bending cycles with a bending radius of 100 mm, a speed of 4 m/s and an acceleration of 4 m/s ²	1 000 000; cable carrier compliant for 1 million bending cycles with a bending radius of 100 mm, a speed of 4 m/s and an acceleration of 4 m/s ²	1 000 000; cable carrier compliant for 1 million bending cycles with a bending radius of 100 mm, a speed of 4 m/s and an acceleration of 4 m/s ²	1 000 000; cable carrier compliant for 1 million bending cycles with a bending radius of 100 mm, a speed of 4 m/s and an acceleration of 4 m/s ²	1 000 000; cable carrier compliant for 1 million bending cycles with a bending radius of 100 mm, a speed of 4 m/s and an acceleration of 4 m/s ²	1 000 000; cable carrier compliant for 1 million bending cycles with a bending radius of 100 mm, a speed of 4 m/s and an acceleration of 4 m/s ²	
Permissible bending radius, single bend, min.	20 mm	20 mm	20 mm	20 mm	20 mm	20 mm	20 mm
Permissible bending radius, multiple bends, min.	40 mm	40 mm	40 mm	40 mm	40 mm	40 mm	40 mm
Bending radius for continuous bending	100 mm	100 mm	100 mm	100 mm	100 mm	100 mm	100 mm
Color of cable sheath	green	green	green	green	green	green	green
Color of core insulation of data cores	white / yellow / blue / orange	white / yellow / blue / orange	white / yellow / blue / orange	white / yellow / blue / orange	white / yellow / blue / orange	white / yellow / blue / orange	white / yellow / blue / orange
Weight per length	34 kg/km	34 kg/km	34 kg/km	34 kg/km	34 kg/km	34 kg/km	34 kg/km
Mechanics/material							
Outgoing feeder type	180° cable outlet	180° cable outlet	180° cable outlet	180° cable outlet	180° cable outlet	180° cable outlet	180° cable outlet
Material of cable sheath	PUR	PUR	PUR	PUR	PUR	PUR	PUR
Material of core insulation	PE	PE	PE	PE	PE	PE	PE
Material property							
• Halogen-free	Yes	Yes	Yes	Yes	Yes	Yes	Yes
• Silicone-free	Yes	Yes	Yes	Yes	Yes	Yes	Yes

I/O systemsSIMATIC ET 200 systems without control cabinet
SIMATIC ET 200AL**Accessories > Cables and connectors****Technical specifications**

Article number	6ES7194-2LH03-0AB0	6ES7194-2LH10-0AB0	6ES7194-2LH20-0AB0	6ES7194-2LH50-0AB0	6ES7194-2LN10-0AB0	6ES7194-2LN15-0AB0
	Bus Cable ET-Connection, angled, 0,3m	Bus Cable ET-Connection, angled, 1,0M	Bus Cable ET-Connection, angled, 2,0M	Bus Cable ET-Connection, angled, 5,0M	Bus Cable ET-Connection, angled, 10m	Bus Cable ET-Connection, angled, 15m
General information						
Product type designation	Bus cable	Bus cable	Bus cable	Bus cable	Bus cable	Bus cable
Product description	Flexible cable (4-core), preassembled at both ends with 2x M8 plugs, angled, 4-pin, shielded	Flexible cable (4-core), preassembled at both ends with 2x M8 plugs, angled, 4-pin, shielded	Flexible cable (4-core), preassembled at both ends with 2x M8 plugs, angled, 4-pin, shielded	Flexible cable (4-core), preassembled at both ends with 2x M8 plugs, angled, 4-pin, shielded	Flexible cable (4-core), preassembled at both ends with 2x M8 plugs, angled, 4-pin, shielded	Flexible cable (4-core), preassembled at both ends with 2x M8 plugs, angled, 4-pin, shielded
Suitability for use	for connecting ET-CONNECTION nodes (e.g. SIMATIC ET 200AL) in degree of protection IP65 / 67	for connecting ET-CONNECTION nodes (e.g. SIMATIC ET 200AL) in degree of protection IP65 / 67	for connecting ET-CONNECTION nodes (e.g. SIMATIC ET 200AL) in degree of protection IP65 / 67	for connecting ET-CONNECTION nodes (e.g. SIMATIC ET 200AL) in degree of protection IP65 / 67	for connecting ET-CONNECTION nodes (e.g. SIMATIC ET 200AL) in degree of protection IP65 / 67	for connecting ET-CONNECTION nodes (e.g. SIMATIC ET 200AL) in degree of protection IP65 / 67
Degree and class of protection						
IP degree of protection	IP65/67	IP65/67	IP65/67	IP65/67	IP65/67	IP65/67
Ambient conditions						
Ambient temperature during assembly, min.	-30 °C	-30 °C	-30 °C	-30 °C	-30 °C	-30 °C
Ambient temperature during assembly, max.	80 °C	80 °C	80 °C	80 °C	80 °C	80 °C
Ambient temperature during storage/transportation						
• min.	-40 °C	-40 °C	-40 °C	-40 °C	-40 °C	-40 °C
• max.	80 °C	80 °C	80 °C	80 °C	80 °C	80 °C
Cables						
Cable designation	2Y(ST)CY 1x4x0.5/1.0-100-GN	2Y(ST)CY 1x4x0.5/1.0-100-GN	2Y(ST)CY 1x4x0.5/1.0-100-GN	2Y(ST)CY 1x4x0.5/1.0-100-GN	2Y(ST)CY 1x4x0.5/1.0-100-GN	2Y(ST)CY 1x4x0.5/1.0-100-GN
Design of shield	Overlapped aluminum-clad foil, sheathed in a braid of tin-plated copper wires	Overlapped aluminum-clad foil, sheathed in a braid of tin-plated copper wires	Overlapped aluminum-clad foil, sheathed in a braid of tin-plated copper wires	Overlapped aluminum-clad foil, sheathed in a braid of tin-plated copper wires	Overlapped aluminum-clad foil, sheathed in a braid of tin-plated copper wires	Overlapped aluminum-clad foil, sheathed in a braid of tin-plated copper wires
Cable length	0.3 m	1 m	2 m	5 m	10 m	15 m
Number of electrical cores	4	4	4	4	4	4
Outer diameter of inner conductor	0.5 mm	0.5 mm	0.5 mm	0.5 mm	0.5 mm	0.5 mm
Outer diameter of core insulation	1 mm	1 mm	1 mm	1 mm	1 mm	1 mm
Outer diameter of cable sheath	5 mm	5 mm	5 mm	5 mm	5 mm	5 mm
Number of bending cycles	1 000 000; cable carrier compliant for 1 million bending cycles with a bending radius of 100 mm, a speed of 4 m/s and an acceleration of 4 m/s ²	1 000 000; cable carrier compliant for 1 million bending cycles with a bending radius of 100 mm, a speed of 4 m/s and an acceleration of 4 m/s ²	1 000 000; cable carrier compliant for 1 million bending cycles with a bending radius of 100 mm, a speed of 4 m/s and an acceleration of 4 m/s ²	1 000 000; cable carrier compliant for 1 million bending cycles with a bending radius of 100 mm, a speed of 4 m/s and an acceleration of 4 m/s ²	1 000 000; cable carrier compliant for 1 million bending cycles with a bending radius of 100 mm, a speed of 4 m/s and an acceleration of 4 m/s ²	1 000 000; cable carrier compliant for 1 million bending cycles with a bending radius of 100 mm, a speed of 4 m/s and an acceleration of 4 m/s ²
Permissible bending radius, single bend, min.	20 mm	20 mm	20 mm	20 mm	20 mm	20 mm
Permissible bending radius, multiple bends, min.	40 mm	40 mm	40 mm	40 mm	40 mm	40 mm
Bending radius for continuous bending	100 mm	100 mm	100 mm	100 mm	100 mm	100 mm

Technical specifications

Article number	6ES7194-2LH03-0AB0	6ES7194-2LH10-0AB0	6ES7194-2LH20-0AB0	6ES7194-2LH50-0AB0	6ES7194-2LN10-0AB0	6ES7194-2LN15-0AB0
Bus Cable ET-Connection, angled, 0,3m	Bus Cable ET-Connection, angled, 1,0M	Bus Cable ET-Connection, angled, 2,0M	Bus Cable ET-Connection, angled, 5,0M	Bus Cable ET-Connection, angled, 10m	Bus Cable ET-Connection, angled, 15m	
Color of cable sheath	green	green	green	green	green	green
Color of core insulation of data cores	white / yellow / blue / orange	white / yellow / blue / orange	white / yellow / blue / orange	white / yellow / blue / orange	white / yellow / blue / orange	white / yellow / blue / orange
Weight per length	34 kg/km	34 kg/km	34 kg/km	34 kg/km	34 kg/km	34 kg/km
Mechanics/material						
Outgoing feeder type	90 degree cable outlet	90 degree cable outlet	90 degree cable outlet	90 degree cable outlet	90 degree cable outlet	90 degree cable outlet
Material of cable sheath	PVC	PVC	PVC	PVC	PVC	PVC
Material of core insulation	PE	PE	PE	PE	PE	PE
Material property						
• Halogen-free	No	No	No	No	No	No
• Silicone-free	Yes	Yes	Yes	Yes	Yes	Yes
Article number	6ES7194-2MH03-0AB0	6ES7194-2MH10-0AB0	6ES7194-2MH20-0AB0	6ES7194-2MH50-0AB0	6ES7194-2MN10-0AB0	6ES7194-2MN15-0AB0
Bus Cable ET-Connection, angled, 0,3m	Bus Cable ET-Connection, angled, 1,0M	Bus Cable ET-Connection, angled, 2,0M	Bus Cable ET-Connection, angled, 5,0M	Bus Cable ET-Connection, angled, 10m	Bus Cable ET-Connection, angled, 15m	
General information						
Product type designation	Bus cable	Bus cable	Bus cable	Bus cable	Bus cable	Bus cable
Product description	Flexible cable (4-core), preassembled at both ends with 2x M8 plugs, angled, 4-pin, shielded	Flexible cable (4-core), preassembled at both ends with 2x M8 plugs, angled, 4-pin, shielded	Flexible cable (4-core), preassembled at both ends with 2x M8 plugs, angled, 4-pin, shielded	Flexible cable (4-core), preassembled at both ends with 2x M8 plugs, angled, 4-pin, shielded	Flexible cable (4-core), preassembled at both ends with 2x M8 plugs, angled, 4-pin, shielded	Flexible cable (4-core), preassembled at both ends with 2x M8 plugs, angled, 4-pin, shielded
Suitability for use	for connecting ET-CONNECTION nodes (e.g. SIMATIC ET 200AL) in degree of protection IP65 / 67	for connecting ET-CONNECTION nodes (e.g. SIMATIC ET 200AL) in degree of protection IP65 / 67	for connecting ET-CONNECTION nodes (e.g. SIMATIC ET 200AL) in degree of protection IP65 / 67	for connecting ET-CONNECTION nodes (e.g. SIMATIC ET 200AL) in degree of protection IP65 / 67	for connecting ET-CONNECTION nodes (e.g. SIMATIC ET 200AL) in degree of protection IP65 / 67	for connecting ET-CONNECTION nodes (e.g. SIMATIC ET 200AL) in degree of protection IP65 / 67
Degree and class of protection						
IP degree of protection	IP65/67	IP65/67	IP65/67	IP65/67	IP65/67	IP65/67
Ambient conditions						
Ambient temperature during assembly, min.	-30 °C	-30 °C	-30 °C	-30 °C	-30 °C	-30 °C
Ambient temperature during assembly, max.	80 °C	80 °C	80 °C	80 °C	80 °C	80 °C
Ambient temperature during storage/transportation						
• min.	-40 °C	-40 °C	-40 °C	-40 °C	-40 °C	-40 °C
• max.	80 °C	80 °C	80 °C	80 °C	80 °C	80 °C
Cables						
Cable designation	2Y(ST)C11Y 2x2x0.5/1.0-100-GN	2Y(ST)C11Y 2x2x0.5/1.0-100-GN	2Y(ST)C11Y 2x2x0.5/1.0-100-GN	2Y(ST)C11Y 2x2x0.5/1.0-100-GN	2Y(ST)C11Y 2x2x0.5/1.0-100-GN	2Y(ST)C11Y 2x2x0.5/1.0-100-GN
Design of shield	Overlapped aluminum-clad foil, sheathed in a braid of tin-plated copper wires	Overlapped aluminum-clad foil, sheathed in a braid of tin-plated copper wires	Overlapped aluminum-clad foil, sheathed in a braid of tin-plated copper wires	Overlapped aluminum-clad foil, sheathed in a braid of tin-plated copper wires	Overlapped aluminum-clad foil, sheathed in a braid of tin-plated copper wires	Overlapped aluminum-clad foil, sheathed in a braid of tin-plated copper wires
Cable length	0.3 m	1 m	2 m	5 m	10 m	15 m
Number of electrical cores	4	4	4	4	4	4
Outer diameter of inner conductor	0.5 mm	0.5 mm	0.5 mm	0.5 mm	0.5 mm	0.5 mm
Outer diameter of core insulation	1 mm	1 mm	1 mm	1 mm	1 mm	1 mm
Outer diameter of cable sheath	5 mm	5 mm	5 mm	5 mm	5 mm	5 mm

I/O systems

SIMATIC ET 200 systems without control cabinet
SIMATIC ET 200AL

Accessories > Cables and connectors

Technical specifications

Article number	6ES7194-2MH03-0AB0	6ES7194-2MH10-0AB0	6ES7194-2MH20-0AB0	6ES7194-2MH50-0AB0	6ES7194-2MN10-0AB0	6ES7194-2MN15-0AB0
	Bus Cable ET-Connection, angled, 0,3m	Bus Cable ET-Connection, angled, 1,0M	Bus Cable ET-Connection, angled, 2,0M	Bus Cable ET-Connection, angled, 5,0M	Bus Cable ET-Connection, angled, 10m	Bus Cable ET-Connection, angled, 15m
Number of bending cycles	1 000 000; cable carrier compliant for 1 million bending cycles with a bending radius of 100 mm, a speed of 4 m/s and an acceleration of 4 m/s ²	1 000 000; cable carrier compliant for 1 million bending cycles with a bending radius of 100 mm, a speed of 4 m/s and an acceleration of 4 m/s ²	1 000 000; cable carrier compliant for 1 million bending cycles with a bending radius of 100 mm, a speed of 4 m/s and an acceleration of 4 m/s ²	1 000 000; cable carrier compliant for 1 million bending cycles with a bending radius of 100 mm, a speed of 4 m/s and an acceleration of 4 m/s ²	1 000 000; cable carrier compliant for 1 million bending cycles with a bending radius of 100 mm, a speed of 4 m/s and an acceleration of 4 m/s ²	1 000 000; cable carrier compliant for 1 million bending cycles with a bending radius of 100 mm, a speed of 4 m/s and an acceleration of 4 m/s ²
Permissible bending radius, single bend, min.	20 mm	20 mm	20 mm	20 mm	20 mm	20 mm
Permissible bending radius, multiple bends, min.	40 mm	40 mm	40 mm	40 mm	40 mm	40 mm
Bending radius for continuous bending	100 mm	100 mm	100 mm	100 mm	100 mm	100 mm
Color of cable sheath	green	green	green	green	green	green
Color of core insulation of data cores	white / yellow / blue / orange	white / yellow / blue / orange	white / yellow / blue / orange	white / yellow / blue / orange	white / yellow / blue / orange	white / yellow / blue / orange
Weight per length	34 kg/km	34 kg/km	34 kg/km	34 kg/km	34 kg/km	34 kg/km
Mechanics/material						
Outgoing feeder type	90 degree cable outlet	90 degree cable outlet	90 degree cable outlet	90 degree cable outlet	90 degree cable outlet	90 degree cable outlet
Material of cable sheath	PUR	PUR	PUR	PUR	PUR	PUR
Material of core insulation	PE	PE	PE	PE	PE	PE
Material property						
• Halogen-free	Yes	Yes	Yes	Yes	Yes	Yes
• Silicone-free	Yes	Yes	Yes	Yes	Yes	Yes
Article number	6ES7194-2LH20-0AC0	6ES7194-2LH50-0AC0	6ES7194-2LN10-0AC0	6ES7194-2LN15-0AC0		
	Bus Cable ET-Connection, 2,0M	Bus Cable ET-Connection, 5,0M	Bus Cable ET-Connection, 10m	Bus Cable ET-Connection, 15m		
General information						
Product type designation	Bus cable	Bus cable	Bus cable	Bus cable		
Product description	Flexible cable (4-core), preassembled at one end with 1x M8 plug, 4-pin, shielded	Flexible cable (4-core), preassembled at one end with 1x M8 plug, 4-pin, shielded	Flexible cable (4-core), preassembled at one end with 1x M8 plug, 4-pin, shielded	Flexible cable (4-core), preassembled at one end with 1x M8 plug, 4-pin, shielded		
Suitability for use	for connecting ET-CONNECTION nodes (e.g. SIMATIC ET 200AL) in degree of protection IP65 / 67	for connecting ET-CONNECTION nodes (e.g. SIMATIC ET 200AL) in degree of protection IP65 / 67	for connecting ET-CONNECTION nodes (e.g. SIMATIC ET 200AL) in degree of protection IP65 / 67	for connecting ET-CONNECTION nodes (e.g. SIMATIC ET 200AL) in degree of protection IP65 / 67		
Degree and class of protection						
IP degree of protection	IP65/67	IP65/67	IP65/67	IP65/67		
Ambient conditions						
Ambient temperature during assembly, min.	-30 °C	-30 °C	-30 °C	-30 °C		
Ambient temperature during assembly, max.	80 °C	80 °C	80 °C	80 °C		
Ambient temperature during storage/transportation						
• min.	-40 °C	-40 °C	-40 °C	-40 °C		
• max.	80 °C	80 °C	80 °C	80 °C		
Cables						
Cable designation	2Y(ST)CY 1x4x0.5/1.0-100-GN	2Y(ST)CY 1x4x0.5/1.0-100-GN	2Y(ST)CY 1x4x0.5/1.0-100-GN	2Y(ST)CY 1x4x0.5/1.0-100-GN		
Design of shield	Overlapped aluminum-clad foil, sheathed in a braid of tin-plated copper wires	Overlapped aluminum-clad foil, sheathed in a braid of tin-plated copper wires	Overlapped aluminum-clad foil, sheathed in a braid of tin-plated copper wires	Overlapped aluminum-clad foil, sheathed in a braid of tin-plated copper wires		
Cable length	2 m	5 m	10 m	15 m		
Number of electrical cores	4	4	4	4		
Outer diameter of inner conductor	0.5 mm	0.5 mm	0.5 mm	0.5 mm		
Outer diameter of core insulation	1 mm	1 mm	1 mm	1 mm		

Technical specifications

Article number	6ES7194-2LH20-0AC0 Bus Cable ET-Connection, 2,0M	6ES7194-2LH50-0AC0 Bus Cable ET-Connection, 5,0M	6ES7194-2LN10-0AC0 Bus Cable ET-Connection, 10m	6ES7194-2LN15-0AC0 Bus Cable ET-Connection, 15m
Outer diameter of cable sheath	5 mm	5 mm	5 mm	5 mm
Number of bending cycles	1 000 000; cable carrier compliant for 1 million bending cycles with a bending radius of 100 mm, a speed of 4 m/s and an acceleration of 4 m/s ²	1 000 000; cable carrier compliant for 1 million bending cycles with a bending radius of 100 mm, a speed of 4 m/s and an acceleration of 4 m/s ²	1 000 000; cable carrier compliant for 1 million bending cycles with a bending radius of 100 mm, a speed of 4 m/s and an acceleration of 4 m/s ²	
Permissible bending radius, single bend, min.	20 mm	20 mm	20 mm	20 mm
Permissible bending radius, multiple bends, min.	40 mm	40 mm	40 mm	40 mm
Bending radius for continuous bending	100 mm	100 mm	100 mm	100 mm
Color of cable sheath	green	green	green	green
Color of core insulation of data cores	white / yellow / blue / orange	white / yellow / blue / orange	white / yellow / blue / orange	white / yellow / blue / orange
Weight per length	34 kg/km	34 kg/km	34 kg/km	34 kg/km
Mechanics/material				
Outgoing feeder type	180° cable outlet	180° cable outlet	180° cable outlet	180° cable outlet
Material of cable sheath	PVC	PVC	PVC	PVC
Material of core insulation	PE	PE	PE	PE
Material property				
• Halogen-free	No	No	No	No
• Silicone-free	Yes	Yes	Yes	Yes
General information				
Article number	6ES7194-2MH20-0AC0 Bus Cable ET-Connection, 2,0M	6ES7194-2MH50-0AC0 Bus Cable ET-Connection, 5,0M	6ES7194-2MN10-0AC0 Bus Cable ET-Connection, 10m	6ES7194-2MN15-0AC0 Bus Cable ET-Connection, 15m
Product type designation	Bus cable	Bus cable	Bus cable	Bus cable
Product description	Flexible cable (4-core), preassembled at one end with 1x M8 plug, 4-pin, shielded	Flexible cable (4-core), preassembled at one end with 1x M8 plug, 4-pin, shielded	Flexible cable (4-core), preassembled at one end with 1x M8 plug, 4-pin, shielded	Flexible cable (4-core), preassembled at one end with 1x M8 plug, 4-pin, shielded
Suitability for use	for connecting ET-CONNECTION nodes (e.g. SIMATIC ET 200AL) in degree of protection IP65 / 67	for connecting ET-CONNECTION nodes (e.g. SIMATIC ET 200AL) in degree of protection IP65 / 67	for connecting ET-CONNECTION nodes (e.g. SIMATIC ET 200AL) in degree of protection IP65 / 67	for connecting ET-CONNECTION nodes (e.g. SIMATIC ET 200AL) in degree of protection IP65 / 67
Degree and class of protection				
IP degree of protection	IP65/67	IP65/67	IP65/67	IP65/67
Ambient conditions				
Ambient temperature during assembly, min.	-30 °C	-30 °C	-30 °C	-30 °C
Ambient temperature during assembly, max.	80 °C	80 °C	80 °C	80 °C
Ambient temperature during storage/transportation				
• min.	-40 °C	-40 °C	-40 °C	-40 °C
• max.	80 °C	80 °C	80 °C	80 °C
Cables				
Cable designation	2Y(ST)C11Y 2x2x0.5/1.0- 100-GN	2Y(ST)C11Y 2x2x0.5/1.0- 100-GN	2Y(ST)C11Y 2x2x0.5/1.0- 100-GN	2Y(ST)C11Y 2x2x0.5/1.0- 100-GN
Design of shield	Overlapped aluminum-clad foil, sheathed in a braid of tin-plated copper wires	Overlapped aluminum-clad foil, sheathed in a braid of tin-plated copper wires	Overlapped aluminum-clad foil, sheathed in a braid of tin-plated copper wires	Overlapped aluminum-clad foil, sheathed in a braid of tin-plated copper wires
Cable length	2 m	5 m	10 m	15 m
Number of electrical cores	4	4	4	4
Outer diameter of inner conductor	0.5 mm	0.5 mm	0.5 mm	0.5 mm
Outer diameter of core insulation	1 mm	1 mm	1 mm	1 mm
Outer diameter of cable sheath	5 mm	5 mm	5 mm	5 mm

I/O systemsSIMATIC ET 200 systems without control cabinet
SIMATIC ET 200AL**Accessories > Cables and connectors****Technical specifications**

Article number	6ES7194-2MH20-0AC0 Bus Cable ET-Connection, 2,0M	6ES7194-2MH50-0AC0 Bus Cable ET-Connection, 5,0M	6ES7194-2MN10-0AC0 Bus Cable ET-Connection, 10m	6ES7194-2MN15-0AC0 Bus Cable ET-Connection, 15m
Number of bending cycles	1 000 000; cable carrier compliant for 1 million bending cycles with a bending radius of 100 mm, a speed of 4 m/s and an acceleration of 4 m/s ²	1 000 000; cable carrier compliant for 1 million bending cycles with a bending radius of 100 mm, a speed of 4 m/s and an acceleration of 4 m/s ²	1 000 000; cable carrier compliant for 1 million bending cycles with a bending radius of 100 mm, a speed of 4 m/s and an acceleration of 4 m/s ²	1 000 000; cable carrier compliant for 1 million bending cycles with a bending radius of 100 mm, a speed of 4 m/s and an acceleration of 4 m/s ²
Permissible bending radius, single bend, min.	20 mm	20 mm	20 mm	20 mm
Permissible bending radius, multiple bends, min.	40 mm	40 mm	40 mm	40 mm
Bending radius for continuous bending	100 mm	100 mm	100 mm	100 mm
Color of cable sheath	green	green	green	green
Color of core insulation of data cores	white / yellow / blue / orange	white / yellow / blue / orange	white / yellow / blue / orange	white / yellow / blue / orange
Weight per length	34 kg/km	34 kg/km	34 kg/km	34 kg/km
Mechanics/material				
Outgoing feeder type	180° cable outlet	180° cable outlet	180° cable outlet	180° cable outlet
Material of cable sheath	PUR	PUR	PUR	PUR
Material of core insulation	PE	PE	PE	PE
Material property				
• Halogen-free	Yes	Yes	Yes	Yes
• Silicone-free	Yes	Yes	Yes	Yes

Article number	6ES7194-2LH02-1AA0 Power Cable M8, 0,19m	6ES7194-2LH03-1AA0 Power Cable M8, 0,3m	6ES7194-2LH10-1AA0 Power Cable M8, 1,0M	6ES7194-2LH20-1AA0 Power Cable M8, 2,0M	6ES7194-2LH50-1AA0 Power Cable M8, 5,0M	6ES7194-2LN10-1AA0 Power Cable M8, 10m	6ES7194-2LN15-1AA0 Power Cable M8, 15m
General information							
Product type designation	Power cable	Power cable	Power cable	Power cable	Power cable	Power cable	Power cable
Product description	Flexible cable (4-core), preassembled at each end with a 4-pin M8 male / female connector	Flexible cable (4-core), preassembled at each end with a 4-pin M8 male / female connector	Flexible cable (4-core), preassembled at each end with a 4-pin M8 male / female connector	Flexible cable (4-core), preassembled at each end with a 4-pin M8 male / female connector	Flexible cable (4-core), preassembled at each end with a 4-pin M8 male / female connector	Flexible cable (4-core), preassembled at each end with a 4-pin M8 male / female connector	Flexible cable (4-core), preassembled at each end with a 4-pin M8 male / female connector
Suitability for use	For connection to ET 200AL for 24 V DC power supply	For connection to ET 200AL for 24 V DC power supply	For connection to ET 200AL for 24 V DC power supply	For connection to ET 200AL for 24 V DC power supply	For connection to ET 200AL for 24 V DC power supply	For connection to ET 200AL for 24 V DC power supply	For connection to ET 200AL for 24 V DC power supply
Degree and class of protection							
IP degree of protection	IP65/67	IP65/67	IP65/67	IP65/67	IP65/67	IP65/67	IP65/67
Ambient conditions							
Ambient temperature during assembly, min.	-30 °C	-30 °C	-30 °C	-30 °C	-30 °C	-30 °C	-30 °C
Ambient temperature during assembly, max.	80 °C	80 °C	80 °C	80 °C	80 °C	80 °C	80 °C
Ambient temperature during storage/transportation							
• min.	-40 °C	-40 °C	-40 °C	-40 °C	-40 °C	-40 °C	-40 °C
• max.	80 °C	80 °C	80 °C	80 °C	80 °C	80 °C	80 °C
Cables							
Cable designation	4 Li9Y 0.50 mm ² Y	4 Li9Y 0.50 mm ² Y	4 Li9Y 0.50 mm ² Y	4 Li9Y 0.50 mm ² Y	4 Li9Y 0.50 mm ² Y	4 Li9Y 0.50 mm ² Y	4 Li9Y 0.50 mm ² Y
Cable length	0.19 m	0.3 m	1 m	2 m	5 m	10 m	15 m
Number of electrical cores	4	4	4	4	4	4	4
Outer diameter of inner conductor	0.8 mm	0.8 mm	0.8 mm	0.8 mm	0.8 mm	0.8 mm	0.8 mm
Outer diameter of core insulation	1.46 mm	1.46 mm	1.46 mm	1.46 mm	1.46 mm	1.46 mm	1.46 mm
Outer diameter of cable sheath	5.2 mm	5.2 mm	5.2 mm	5.2 mm	5.2 mm	5.2 mm	5.2 mm

Technical specifications

Article number	6ES7194-2LH02-1AA0 Power Cable M8, 0,19m	6ES7194-2LH03-1AA0 Power Cable M8, 0,3m	6ES7194-2LH10-1AA0 Power Cable M8, 1,0M	6ES7194-2LH20-1AA0 Power Cable M8, 2,0M	6ES7194-2LH50-1AA0 Power Cable M8, 5,0M	6ES7194-2LN10-1AA0 Power Cable M8, 10m	6ES7194-2LN15-1AA0 Power Cable M8, 15m
Number of bending cycles	2 500 000; cable carrier compliant for 2.5 million bending cycles with a bending radius of 52 mm, a speed of 3 m/s and an acceleration of 10 m/s ²	2 500 000; cable carrier compliant for 2.5 million bending cycles with a bending radius of 52 mm, a speed of 3 m/s and an acceleration of 10 m/s ²	2 500 000; cable carrier compliant for 2.5 million bending cycles with a bending radius of 52 mm, a speed of 3 m/s and an acceleration of 10 m/s ²	2 500 000; cable carrier compliant for 2.5 million bending cycles with a bending radius of 52 mm, a speed of 3 m/s and an acceleration of 10 m/s ²	2 500 000; cable carrier compliant for 2.5 million bending cycles with a bending radius of 52 mm, a speed of 3 m/s and an acceleration of 10 m/s ²	2 500 000; cable carrier compliant for 2.5 million bending cycles with a bending radius of 52 mm, a speed of 3 m/s and an acceleration of 10 m/s ²	2 500 000; cable carrier compliant for 2.5 million bending cycles with a bending radius of 52 mm, a speed of 3 m/s and an acceleration of 10 m/s ²
Permissible bending radius, single bend, min.	26 mm	26 mm	26 mm	26 mm	26 mm	26 mm	26 mm
Permissible bending radius, multiple bends, min.	52 mm	52 mm	52 mm	52 mm	52 mm	52 mm	52 mm
Bending radius for continuous bending	52 mm	52 mm	52 mm	52 mm	52 mm	52 mm	52 mm
Color of cable sheath	gray	gray	gray	gray	gray	gray	gray
Color of core insulation of energy core	white / brown / blue / black	white / brown / blue / black	white / brown / blue / black	white / brown / blue / black	white / brown / blue / black	white / brown / blue / black	white / brown / blue / black
Weight per length	44 kg/km	44 kg/km	44 kg/km	44 kg/km	44 kg/km	44 kg/km	44 kg/km
Mechanics/material							
Outgoing feeder type	180° cable outlet	180° cable outlet	180° cable outlet	180° cable outlet	180° cable outlet	180° cable outlet	180° cable outlet
Material of cable sheath	PVC	PVC	PVC	PVC	PVC	PVC	PVC
Material of core insulation	PP	PP	PP	PP	PP	PP	PP
Material property							
• Silicone-free	Yes	Yes	Yes	Yes	Yes	Yes	Yes
Article number	6ES7194-2MH02-1AA0 Power Cable M8 0,19m	6ES7194-2MH03-1AA0 Power Cable M8, 0,3m	6ES7194-2MH10-1AA0 Power Cable M8, 1,0M	6ES7194-2MH20-1AA0 Power Cable M8, 2,0M	6ES7194-2MH50-1AA0 Power Cable M8, 5,0M	6ES7194-2MN10-1AA0 Power Cable M8, 10m	6ES7194-2MN15-1AA0 Power Cable M8, 15m
General information							
Product type designation	Power cable	Power cable	Power cable	Power cable	Power cable	Power cable	Power cable
Product description	Flexible cable (4-core), preassembled at each end with a 4-pin M8 male / female connector	Flexible cable (4-core), preassembled at each end with a 4-pin M8 male / female connector	Flexible cable (4-core), preassembled at each end with a 4-pin M8 male / female connector	Flexible cable (4-core), preassembled at each end with a 4-pin M8 male / female connector	Flexible cable (4-core), preassembled at each end with a 4-pin M8 male / female connector	Flexible cable (4-core), preassembled at each end with a 4-pin M8 male / female connector	Flexible cable (4-core), preassembled at each end with a 4-pin M8 male / female connector
Suitability for use	For connection to ET 200AL for 24 V DC power supply	For connection to ET 200AL for 24 V DC power supply	For connection to ET 200AL for 24 V DC power supply	For connection to ET 200AL for 24 V DC power supply	For connection to ET 200AL for 24 V DC power supply	For connection to ET 200AL for 24 V DC power supply	For connection to ET 200AL for 24 V DC power supply
Degree and class of protection							
IP degree of protection	IP65/67	IP65/67	IP65/67	IP65/67	IP65/67	IP65/67	IP65/67
Ambient conditions							
Ambient temperature during assembly, min.	-25 °C	-25 °C	-25 °C	-25 °C	-25 °C	-25 °C	-25 °C
Ambient temperature during assembly, max.	80 °C	80 °C	80 °C	80 °C	80 °C	80 °C	80 °C
Ambient temperature during storage/transportation							
• min.	-25 °C	-25 °C	-25 °C	-25 °C	-25 °C	-25 °C	-25 °C
• max.	80 °C	80 °C	80 °C	80 °C	80 °C	80 °C	80 °C
Cables							
Cable designation	LIF9Y11YFHF 4x 0.50 mm ²	LIF9Y11YFHF 4x 0.50 mm ²	LIF9Y11YFHF 4x 0.50 mm ²	LIF9Y11YFHF 4x 0.50 mm ²	LIF9Y11YFHF 4x 0.50 mm ²	LIF9Y11YFHF 4x 0.50 mm ²	LIF9Y11YFHF 4x 0.50 mm ²
Cable length	0.19 m	0.3 m	1 m	2 m	5 m	10 m	15 m
Number of electrical cores	4	4	4	4	4	4	4
Outer diameter of inner conductor	1 mm	1 mm	1 mm	1 mm	1 mm	1 mm	1 mm
Outer diameter of core insulation	1.46 mm	1.46 mm	1.46 mm	1.46 mm	1.46 mm	1.46 mm	1.46 mm

I/O systemsSIMATIC ET 200 systems without control cabinet
SIMATIC ET 200AL**Accessories > Cables and connectors****Technical specifications**

Article number	6ES7194-2MH02-1AA0 Power Cable M8 0,19m	6ES7194-2MH03-1AA0 Power Cable M8, 0,3m	6ES7194-2MH10-1AA0 Power Cable M8, 1,0M	6ES7194-2MH20-1AA0 Power Cable M8, 2,0M	6ES7194-2MH50-1AA0 Power Cable M8, 5,0M	6ES7194-2MN10-1AA0 Power Cable M8, 10m	6ES7194-2MN15-1AA0 Power Cable M8, 15m
Outer diameter of cable sheath	5.1 mm	5.1 mm	5.1 mm	5.1 mm	5.1 mm	5.1 mm	5.1 mm
Number of bending cycles	2 000 000; cable carrier compliant for 2 million bending cycles with a bending radius of 51 mm, a speed of 5 m/s and an acceleration of 5 m/s ²	2 000 000; cable carrier compliant for 2 million bending cycles with a bending radius of 51 mm, a speed of 5 m/s and an acceleration of 5 m/s ²	2 000 000; cable carrier compliant for 2 million bending cycles with a bending radius of 51 mm, a speed of 5 m/s and an acceleration of 5 m/s ²	2 000 000; cable carrier compliant for 2 million bending cycles with a bending radius of 51 mm, a speed of 5 m/s and an acceleration of 5 m/s ²	2 000 000; cable carrier compliant for 2 million bending cycles with a bending radius of 51 mm, a speed of 5 m/s and an acceleration of 5 m/s ²	2 000 000; cable carrier compliant for 2 million bending cycles with a bending radius of 51 mm, a speed of 5 m/s and an acceleration of 5 m/s ²	2 000 000; cable carrier compliant for 2 million bending cycles with a bending radius of 51 mm, a speed of 5 m/s and an acceleration of 5 m/s ²
Permissible bending radius, single bend, min.	26 mm	26 mm	26 mm	26 mm	26 mm	26 mm	26 mm
Permissible bending radius, multiple bends, min.	51 mm	51 mm	51 mm	51 mm	51 mm	51 mm	51 mm
Bending radius for continuous bending	51 mm	51 mm	51 mm	51 mm	51 mm	51 mm	51 mm
Color of cable sheath	gray	gray	gray	gray	gray	gray	gray
Color of core insulation of energy core	white / brown / blue / black	white / brown / blue / black	white / brown / blue / black	white / brown / blue / black	white / brown / blue / black	white / brown / blue / black	white / brown / blue / black
Weight per length	44 kg/km	44 kg/km	44 kg/km	44 kg/km	44 kg/km	44 kg/km	44 kg/km
Mechanics/material							
Outgoing feeder type	180° cable outlet	180° cable outlet	180° cable outlet	180° cable outlet	180° cable outlet	180° cable outlet	180° cable outlet
Material of cable sheath	PE-PUR	PE-PUR	PE-PUR	PE-PUR	PE-PUR	PE-PUR	PE-PUR
Material of core insulation	PP	PP	PP	PP	PP	PP	PP
Material property							
• Halogen-free	Yes	Yes	Yes	Yes	Yes	Yes	Yes
• Silicone-free	Yes	Yes	Yes	Yes	Yes	Yes	Yes
Article number	6ES7194-2LH03-1AB0 Power Cable M8, angled, 0,3m	6ES7194-2LH10-1AB0 Power Cable M8, angled, 1,0M	6ES7194-2LH20-1AB0 Power Cable M8, angled, 2,0M	6ES7194-2LH50-1AB0 Power Cable M8, angled, 5,0M	6ES7194-2LN10-1AB0 Power Cable M8, angled, 10m	6ES7194-2LN15-1AB0 Power Cable M8, angled, 15m	
General information							
Product type designation	Power cable	Power cable	Power cable	Power cable	Power cable	Power cable	
Product description	Flexible cable (4-core), preassembled at each end with a 4-pin M8 male / female connector, angled	Flexible cable (4-core), preassembled at each end with a 4-pin M8 male / female connector, angled	Flexible cable (4-core), preassembled at each end with a 4-pin M8 male / female connector, angled	Flexible cable (4-core), preassembled at each end with a 4-pin M8 male / female connector, angled	Flexible cable (4-core), preassembled at each end with a 4-pin M8 male / female connector, angled	Flexible cable (4-core), preassembled at each end with a 4-pin M8 male / female connector, angled	
Suitability for use	For connection to ET 200AL for 24 V DC power supply	For connection to ET 200AL for 24 V DC power supply	For connection to ET 200AL for 24 V DC power supply	For connection to ET 200AL for 24 V DC power supply	For connection to ET 200AL for 24 V DC power supply	For connection to ET 200AL for 24 V DC power supply	
Degree and class of protection							
IP degree of protection	IP65/67	IP65/67	IP65/67	IP65/67	IP65/67	IP65/67	
Ambient conditions							
Ambient temperature during assembly, min.	-30 °C	-30 °C	-30 °C	-30 °C	-30 °C	-30 °C	
Ambient temperature during assembly, max.	80 °C	80 °C	80 °C	80 °C	80 °C	80 °C	
Ambient temperature during storage/transportation							
• min.	-40 °C	-40 °C	-40 °C	-40 °C	-40 °C	-40 °C	
• max.	80 °C	80 °C	80 °C	80 °C	80 °C	80 °C	
Cables							
Cable designation	4 Li9Y 0.50 mm ² Y	4 Li9Y 0.50 mm ² Y	4 Li9Y 0.50 mm ² Y	4 Li9Y 0.50 mm ² Y	4 Li9Y 0.50 mm ² Y	4 Li9Y 0.50 mm ² Y	
Cable length	0.3 m	1 m	2 m	5 m	10 m	15 m	
Number of electrical cores	4	4	4	4	4	4	
Outer diameter of inner conductor	0.8 mm	0.8 mm	0.8 mm	0.8 mm	0.8 mm	0.8 mm	

Technical specifications

Article number	6ES7194-2LH03-1AB0	6ES7194-2LH10-1AB0	6ES7194-2LH20-1AB0	6ES7194-2LH50-1AB0	6ES7194-2LN10-1AB0	6ES7194-2LN15-1AB0
	Power Cable M8, angled, 0,3m	Power Cable M8, angled, 1,0M	Power Cable M8, angled, 2,0M	Power Cable M8, angled, 5,0M	Power Cable M8, angled, 10m	Power Cable M8, angled, 15m
Outer diameter of core insulation	1.46 mm	1.46 mm	1.46 mm	1.46 mm	1.46 mm	1.46 mm
Outer diameter of cable sheath	5.2 mm	5.2 mm	5.2 mm	5.2 mm	5.2 mm	5.2 mm
Number of bending cycles	2 500 000; cable carrier compliant for 2.5 million bending cycles with a bending radius of 52 mm, a speed of 3 m/s and an acceleration of 10 m/s ²	2 500 000; cable carrier compliant for 2.5 million bending cycles with a bending radius of 52 mm, a speed of 3 m/s and an acceleration of 10 m/s ²	2 500 000; cable carrier compliant for 2.5 million bending cycles with a bending radius of 52 mm, a speed of 3 m/s and an acceleration of 10 m/s ²	2 500 000; cable carrier compliant for 2.5 million bending cycles with a bending radius of 52 mm, a speed of 3 m/s and an acceleration of 10 m/s ²	2 500 000; cable carrier compliant for 2.5 million bending cycles with a bending radius of 52 mm, a speed of 3 m/s and an acceleration of 10 m/s ²	2 500 000; cable carrier compliant for 2.5 million bending cycles with a bending radius of 52 mm, a speed of 3 m/s and an acceleration of 10 m/s ²
Permissible bending radius, single bend, min.	26 mm	26 mm	26 mm	26 mm	26 mm	26 mm
Permissible bending radius, multiple bends, min.	52 mm	52 mm	52 mm	52 mm	52 mm	52 mm
Bending radius for continuous bending	52 mm	52 mm	52 mm	52 mm	52 mm	52 mm
Color of cable sheath	gray	gray	gray	gray	gray	gray
Color of core insulation of energy core	white / brown / blue / black	white / brown / blue / black	white / brown / blue / black	white / brown / blue / black	white / brown / blue / black	white / brown / blue / black
Weight per length	44 kg/km	44 kg/km	44 kg/km	44 kg/km	44 kg/km	44 kg/km
Mechanics/material						
Outgoing feeder type	90 degree cable outlet	90 degree cable outlet	90 degree cable outlet	90 degree cable outlet	90 degree cable outlet	90 degree cable outlet
Material of cable sheath	PVC	PVC	PVC	PVC	PVC	PVC
Material of core insulation	PP	PP	PP	PP	PP	PP
Material property						
• Silicone-free	Yes	Yes	Yes	Yes	Yes	Yes
Article number	6ES7194-2MH03-1AB0	6ES7194-2MH10-1AB0	6ES7194-2MH20-1AB0	6ES7194-2MH50-1AB0	6ES7194-2MN10-1AB0	6ES7194-2MN15-1AB0
	Power Cable M8, angled, 0,3m	Power Cable M8, angled, 1,0M	Power Cable M8, angled, 2,0M	Power Cable M8, angled, 5,0M	Power Cable M8, angled, 10m	Power Cable M8, angled, 15m
General information						
Product type designation	Power cable	Power cable	Power cable	Power cable	Power cable	Power cable
Product description	Flexible cable (4-core), preassembled at each end with a 4-pin M8 male / female connector, angled	Flexible cable (4-core), preassembled at each end with a 4-pin M8 male / female connector, angled	Flexible cable (4-core), preassembled at each end with a 4-pin M8 male / female connector, angled	Flexible cable (4-core), preassembled at each end with a 4-pin M8 male / female connector, angled	Flexible cable (4-core), preassembled at each end with a 4-pin M8 male / female connector, angled	Flexible cable (4-core), preassembled at each end with a 4-pin M8 male / female connector, angled
Suitability for use	For connection to ET 200AL for 24 V DC power supply	For connection to ET 200AL for 24 V DC power supply	For connection to ET 200AL for 24 V DC power supply	For connection to ET 200AL for 24 V DC power supply	For connection to ET 200AL for 24 V DC power supply	For connection to ET 200AL for 24 V DC power supply
Degree and class of protection						
IP degree of protection	IP65/67	IP65/67	IP65/67	IP65/67	IP65/67	IP65/67
Ambient conditions						
Ambient temperature during assembly, min.	-25 °C	-25 °C	-25 °C	-25 °C	-25 °C	-25 °C
Ambient temperature during assembly, max.	80 °C	80 °C	80 °C	80 °C	80 °C	80 °C
Ambient temperature during storage/transportation						
• min.	-25 °C	-25 °C	-25 °C	-25 °C	-25 °C	-25 °C
• max.	80 °C	80 °C	80 °C	80 °C	80 °C	80 °C
Cables						
Cable designation	LIF9Y11YFHF 4x 0.50 mm ²	LIF9Y11YFHF 4x 0.50 mm ²	LIF9Y11YFHF 4x 0.50 mm ²	LIF9Y11YFHF 4x 0.50 mm ²	LIF9Y11YFHF 4x 0.50 mm ²	LIF9Y11YFHF 4x 0.50 mm ²
Cable length	0.3 m	1 m	2 m	5 m	10 m	15 m
Number of electrical cores	4	4	4	4	4	4
Outer diameter of inner conductor	1 mm	1 mm	1 mm	1 mm	1 mm	1 mm

I/O systemsSIMATIC ET 200 systems without control cabinet
SIMATIC ET 200AL**Accessories > Cables and connectors****Technical specifications**

Article number	6ES7194-2MH03-1AB0 Power Cable M8, angled, 0,3m	6ES7194-2MH10-1AB0 Power Cable M8, angled, 1,0M	6ES7194-2MH20-1AB0 Power Cable M8, angled, 2,0M	6ES7194-2MH50-1AB0 Power Cable M8, angled, 5,0M	6ES7194-2MN10-1AB0 Power Cable M8, angled, 10m	6ES7194-2MN15-1AB0 Power Cable M8, angled, 15m
Outer diameter of core insulation	1.46 mm	1.46 mm	1.46 mm	1.46 mm	1.46 mm	1.46 mm
Outer diameter of cable sheath	5.1 mm	5.1 mm	5.1 mm	5.1 mm	5.1 mm	5.1 mm
Number of bending cycles	2 000 000; cable carrier compliant for 2 million bending cycles with a bending radius of 51 mm, a speed of 5 m/s and an acceleration of 5 m/s ²	2 000 000; cable carrier compliant for 2 million bending cycles with a bending radius of 51 mm, a speed of 5 m/s and an acceleration of 5 m/s ²	2 000 000; cable carrier compliant for 2 million bending cycles with a bending radius of 51 mm, a speed of 5 m/s and an acceleration of 5 m/s ²	2 000 000; cable carrier compliant for 2 million bending cycles with a bending radius of 51 mm, a speed of 5 m/s and an acceleration of 5 m/s ²	2 000 000; cable carrier compliant for 2 million bending cycles with a bending radius of 51 mm, a speed of 5 m/s and an acceleration of 5 m/s ²	2 000 000; cable carrier compliant for 2 million bending cycles with a bending radius of 51 mm, a speed of 5 m/s and an acceleration of 5 m/s ²
Permissible bending radius, single bend, min.	26 mm	26 mm	26 mm	26 mm	26 mm	26 mm
Permissible bending radius, multiple bends, min.	51 mm	51 mm	51 mm	51 mm	51 mm	51 mm
Bending radius for continuous bending	51 mm	51 mm	51 mm	51 mm	51 mm	51 mm
Color of cable sheath	gray	gray	gray	gray	gray	gray
Color of core insulation of energy core	white / brown / blue / black	white / brown / blue / black	white / brown / blue / black	white / brown / blue / black	white / brown / blue / black	white / brown / blue / black
Weight per length	44 kg/km	44 kg/km	44 kg/km	44 kg/km	44 kg/km	44 kg/km
Mechanics/material						
Outgoing feeder type	90 degree cable outlet	90 degree cable outlet	90 degree cable outlet	90 degree cable outlet	90 degree cable outlet	90 degree cable outlet
Material of cable sheath	PE-PUR	PE-PUR	PE-PUR	PE-PUR	PE-PUR	PE-PUR
Material of core insulation	PP	PP	PP	PP	PP	PP
Material property						
• Halogen-free	Yes	Yes	Yes	Yes	Yes	Yes
• Silicone-free	Yes	Yes	Yes	Yes	Yes	Yes
Article number	6ES7194-2LH20-1AC0 Power Cable M8, 2,0M	6ES7194-2LH50-1AC0 Power Cable M8, 5,0M	6ES7194-2LN10-1AC0 Power Cable M8, 10m	6ES7194-2LN15-1AC0 Power Cable M8, 15m		
General information						
Product type designation	Power cable	Power cable	Power cable	Power cable		
Product description	Flexible cable (4-core), preassembled at one end with 1x M8 female connector	Flexible cable (4-core), preassembled at one end with 1x M8 female connector	Flexible cable (4-core), preassembled at one end with 1x M8 female connector	Flexible cable (4-core), preassembled at one end with 1x M8 female connector		
Suitability for use	For connection to ET 200AL for 24 V DC power supply	For connection to ET 200AL for 24 V DC power supply	For connection to ET 200AL for 24 V DC power supply	For connection to ET 200AL for 24 V DC power supply		
Degree and class of protection						
IP degree of protection	IP65/67	IP65/67	IP65/67	IP65/67		
Ambient conditions						
Ambient temperature during assembly, min.	-30 °C	-30 °C	-30 °C	-30 °C		
Ambient temperature during assembly, max.	80 °C	80 °C	80 °C	80 °C		
Ambient temperature during storage/transportation						
• min.	-40 °C	-40 °C	-40 °C	-40 °C		
• max.	80 °C	80 °C	80 °C	80 °C		
Cables						
Cable designation	4 Li9Y 0.50 mm ² Y	4 Li9Y 0.50 mm ² Y	4 Li9Y 0.50 mm ² Y	4 Li9Y 0.50 mm ² Y		
Cable length	2 m	5 m	10 m	15 m		
Number of electrical cores	4	4	4	4		
Outer diameter of inner conductor	0.8 mm	0.8 mm	0.8 mm	0.8 mm		
Outer diameter of core insulation	1.46 mm	1.46 mm	1.46 mm	1.46 mm		
Outer diameter of cable sheath	5.2 mm	5.2 mm	5.2 mm	5.2 mm		

Technical specifications

Article number	6ES7194-2LH20-1AC0 Power Cable M8, 2,0M	6ES7194-2LH50-1AC0 Power Cable M8, 5,0M	6ES7194-2LN10-1AC0 Power Cable M8, 10m	6ES7194-2LN15-1AC0 Power Cable M8, 15m
Number of bending cycles	2 500 000; cable carrier compliant for 2.5 million bending cycles with a bending radius of 52 mm, a speed of 3 m/s and an acceleration of 10 m/s ²	2 500 000; cable carrier compliant for 2.5 million bending cycles with a bending radius of 52 mm, a speed of 3 m/s and an acceleration of 10 m/s ²	2 500 000; cable carrier compliant for 2.5 million bending cycles with a bending radius of 52 mm, a speed of 3 m/s and an acceleration of 10 m/s ²	2 500 000; cable carrier compliant for 2.5 million bending cycles with a bending radius of 52 mm, a speed of 3 m/s and an acceleration of 10 m/s ²
Permissible bending radius, single bend, min.	26 mm	26 mm	26 mm	26 mm
Permissible bending radius, multiple bends, min.	52 mm	52 mm	52 mm	52 mm
Bending radius for continuous bending	52 mm	52 mm	52 mm	52 mm
Color of cable sheath	gray	gray	gray	gray
Color of core insulation of energy core	white / brown / blue / black	white / brown / blue / black	white / brown / blue / black	white / brown / blue / black
Weight per length	44 kg/km	44 kg/km	44 kg/km	44 kg/km
Mechanics/material				
Outgoing feeder type	180° cable outlet	180° cable outlet	180° cable outlet	180° cable outlet
Material of cable sheath	PVC	PVC	PVC	PVC
Material of core insulation	PP	PP	PP	PP
Material property				
• Silicone-free	Yes	Yes	Yes	Yes
Article number	6ES7194-2MH20-1AC0 Power Cable M8, 2,0M	6ES7194-2MH50-1AC0 Power Cable M8, 5,0M	6ES7194-2MN10-1AC0 Power Cable M8, 10m	6ES7194-2MN15-1AC0 Power Cable M8, 15m
General information				
Product type designation	Power cable	Power cable	Power cable	Power cable
Product description	Flexible cable (4-core), preassembled at one end with 1x M8 female connector	Flexible cable (4-core), preassembled at one end with 1x M8 female connector	Flexible cable (4-core), preassembled at one end with 1x M8 female connector	Flexible cable (4-core), preassembled at one end with 1x M8 female connector
Suitability for use	For connection to ET 200AL for 24 V DC power supply	For connection to ET 200AL for 24 V DC power supply	For connection to ET 200AL for 24 V DC power supply	For connection to ET 200AL for 24 V DC power supply
Degree and class of protection				
IP degree of protection	IP65/67	IP65/67	IP65/67	IP65/67
Ambient conditions				
Ambient temperature during assembly, min.	-25 °C	-25 °C	-25 °C	-25 °C
Ambient temperature during assembly, max.	80 °C	80 °C	80 °C	80 °C
Ambient temperature during storage/transportation				
• min.	-25 °C	-25 °C	-25 °C	-25 °C
• max.	80 °C	80 °C	80 °C	80 °C
Cables				
Cable designation	LIF9Y11YFHF 4x 0.50 mm ²	LIF9Y11YFHF 4x 0.50 mm ²	LIF9Y11YFHF 4x 0.50 mm ²	LIF9Y11YFHF 4x 0.50 mm ²
Cable length	2 m	5 m	10 m	15 m
Number of electrical cores	4	4	4	4
Outer diameter of inner conductor	1 mm	1 mm	1 mm	1 mm
Outer diameter of core insulation	1.46 mm	1.46 mm	1.46 mm	1.46 mm
Outer diameter of cable sheath	5.1 mm	5.1 mm	5.1 mm	5.1 mm
Number of bending cycles	2 000 000; cable carrier compliant for 2 million bending cycles with a bending radius of 51 mm, a speed of 5 m/s and an acceleration of 5 m/s ²	2 000 000; cable carrier compliant for 2 million bending cycles with a bending radius of 51 mm, a speed of 5 m/s and an acceleration of 5 m/s ²	2 000 000; cable carrier compliant for 2 million bending cycles with a bending radius of 51 mm, a speed of 5 m/s and an acceleration of 5 m/s ²	2 000 000; cable carrier compliant for 2 million bending cycles with a bending radius of 51 mm, a speed of 5 m/s and an acceleration of 5 m/s ²
Permissible bending radius, single bend, min.	26 mm	26 mm	26 mm	26 mm
Permissible bending radius, multiple bends, min.	51 mm	51 mm	51 mm	51 mm
Bending radius for continuous bending	51 mm	51 mm	51 mm	51 mm

I/O systemsSIMATIC ET 200 systems without control cabinet
SIMATIC ET 200AL**Accessories > Cables and connectors****Technical specifications**

Article number	6ES7194-2MH20-1AC0	6ES7194-2MH50-1AC0	6ES7194-2MN10-1AC0	6ES7194-2MN15-1AC0
	Power Cable M8, 2,0M	Power Cable M8, 5,0M	Power Cable M8, 10m	Power Cable M8, 15m
Color of cable sheath	gray	gray	gray	gray
Color of core insulation of energy core	white / brown / blue / black	white / brown / blue / black	white / brown / blue / black	white / brown / blue / black
Weight per length	44 kg/km	44 kg/km	44 kg/km	44 kg/km
Mechanics/material				
Outgoing feeder type	180° cable outlet	180° cable outlet	180° cable outlet	180° cable outlet
Material of cable sheath	PE-PUR	PE-PUR	PE-PUR	PE-PUR
Material of core insulation	PP	PP	PP	PP
Material property				
• Halogen-free	Yes	Yes	Yes	Yes
• Silicone-free	Yes	Yes	Yes	Yes
Article number	6ES7194-2LH02-0AD0		6ES7194-2MH02-0AD0	
	Connecting Cable ET-Connection, 0,2m		Connecting cable ET-Connection 0,2m	
General information				
Product type designation	Connecting cable for bus cable		Connecting cable for bus cable	
Product description	Flexible cable (4-core), preassembled at both ends with 2x M8 sockets, 4-pin, shielded		Flexible cable (4-core), preassembled at both ends with 2x M8 sockets, 4-pin, shielded	
Suitability for use	For connecting two ET CONNECTION bus cables		For connecting two ET CONNECTION bus cables	
Degree and class of protection				
IP degree of protection	IP65/67		IP65/67	
Ambient conditions				
Ambient temperature during assembly, min.	-30 °C		-30 °C	
Ambient temperature during assembly, max.	80 °C		80 °C	
Ambient temperature during storage/transportation				
• min.	-40 °C		-40 °C	
• max.	80 °C		80 °C	
Cables				
Cable designation	2Y(ST)CY 1x4x0.5/1.0-100-GN		2Y(ST)C11Y 2x2x0.5/1.0-100-GN	
Design of shield	Overlapped aluminum-clad foil, sheathed in a braid of tin-plated copper wires		Overlapped aluminum-clad foil, sheathed in a braid of tin-plated copper wires	
Cable length	0.2 m		0.2 m	
Number of electrical cores	4		4	
Outer diameter of inner conductor	0.5 mm		0.5 mm	
Outer diameter of core insulation	1 mm		1 mm	
Outer diameter of cable sheath	5 mm		5 mm	
Permissible bending radius, single bend, min.	20 mm		20 mm	
Permissible bending radius, multiple bends, min.	40 mm		40 mm	
Bending radius for continuous bending	100 mm		100 mm	
Color of cable sheath	green		green	
Color of core insulation of data cores	white / yellow / blue / orange		white / yellow / blue / orange	
Weight per length	34 kg/km		34 kg/km	
Mechanics/material				
Outgoing feeder type	180° cable outlet		180° cable outlet	
Material of cable sheath	PVC		PUR	
Material of core insulation	PE		PE	
Material property				
• Halogen-free	No		Yes	
• Silicone-free	Yes		Yes	

Technical specifications

Article number	6ES7194-2AA00-0AA0 M8 Power Connector	6ES7194-2AC00-0AA0 M8 Power Connector, Socket
General information		
Product type designation	Power connector	Power connector
Product description	M8 plug connector with high degree of protection, 4-pin, plastic version	M8 plug connector with high degree of protection, socket insert, 4-pin, plastic version
Suitability for use	For connection to ET 200AL for 24 V DC power supply	For connection to ET 200AL for 24 V DC power supply
Degree and class of protection		
IP degree of protection	IP65/67	IP65/67
Ambient conditions		
Ambient temperature during assembly, min.	-30 °C	-30 °C
Ambient temperature during assembly, max.	85 °C	85 °C
Ambient temperature during storage/transportation		
• min.	-40 °C	-40 °C
• max.	85 °C	85 °C
Connection method		
Connector type	M8, 4-pole	M8, 4-pole
Type of electrical connection for mains supply line	Screw terminals	Screw terminals
• connectable cable cross-section for mains supply line, min.	0.14 mm ²	0.14 mm ²
• connectable cable cross-section for mains supply line, max.	0.5 mm ²	0.5 mm ²
• Connectable conductor cross-section for AWG cables, min.	26	26
• Connectable conductor cross-section for AWG cables, max.	20	20
Suitable for cable diameter, min.	4 mm	4 mm
usable for cable diameter, max.	5.5 mm	5.5 mm
Mechanics/material		
Outgoing feeder type	180° cable outlet	180° cable outlet
Material of housing	plastic	plastic
Dimensions		
Width	14 mm	14 mm
Depth	47 mm	47 mm

Article number	6ES7194-2AB00-0AA0 M8 Connector ET-Connection
General information	
Product type designation	Connection plug
Product description	M8 plug connector with high degree of protection, 4-pin, metal version
Suitability for use	for connecting ET-CONNECTION nodes (e.g. SIMATIC ET 200AL) in degree of protection IP65 / 67
Degree and class of protection	
IP degree of protection	IP65/67
Ambient conditions	
Ambient temperature during assembly, min.	-30 °C
Ambient temperature during assembly, max.	80 °C
Ambient temperature during storage/transportation	
• min.	-40 °C
• max.	80 °C
Mechanics/material	
Outgoing feeder type	180° cable outlet
Material of housing	metal
Dimensions	
Width	14 mm
Depth	47 mm

I/O systems

SIMATIC ET 200 systems without control cabinet

SIMATIC ET 200AL

Accessories > Labels

Overview

- Labels for the identification of channels, modules and slots of ET 200AL components
- Can be used for interface modules and I/O modules

Ordering data

Labels

10 x 5 mm, RAL 9016;
5 frames with 40 labels each

Article No.

6ES7194-2BA00-0AA0

Overview



SIMATIC ET 200eco PN video
https://players.brightcove.net/1813624294001/70fecf0f-fbad-4fad-a077-d0e26af4d84c_default/index.html?videoId=6187715895001

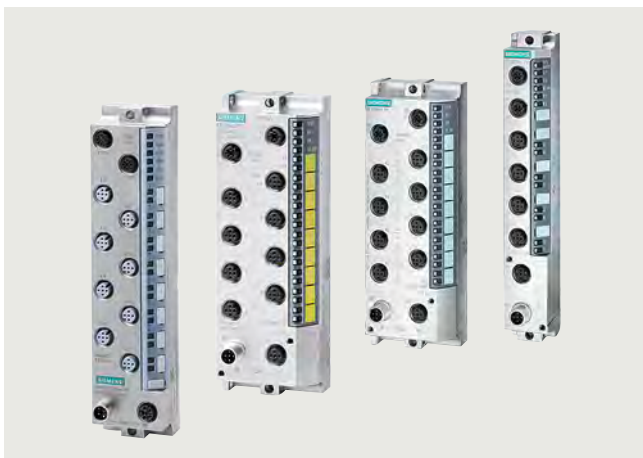

- Fieldbus connection: 2 x M12 D-coded and automatic PROFINET addressing
 - Data transfer rate 100 Mbps
 - LLDP neighborhood discovery for topological configuration
 - Fast startup (run-up within approx. 0.5 seconds)
 - Channel-specific diagnostics, identification and maintenance data IMO ... IM3
 - Firmware update
 - Ambient temperature range -40 °C to 60 °C
 - Increase in communication availability due to Media Redundancy Protocol (MRP) on PROFINET as well as operation on S7-1500 R/H or S7-400H by means of S2 redundancy
 - Variants of the I/O devices with M12 L-coded power connectors:
 - DI 8
 - DI 16
 - DQ 8 (0.5 A)
 - DQ 8 (2 A)
 - DIQ 16 (0.5A/2A)
 - 8 IO-Link + DI 4
 - Variants of the I/O devices with M12 A-coded power connectors:
 - 8 DI
 - 16 DI
 - 8 DQ (2 A)
 - 8 DQ (1.3 A)
 - 8 DQ (0.5 A)
 - 16 DQ (1.3 A)
 - 8 DI/DQ (1.3 A)
 - 8 F-DI/3 F-DO (2 A)
 - 8 AI (U, I, TC, RTD)
 - 8 AI (TC, RTD)
 - 4 AO (U, I)
 - 4 IO-Link
 - 4 IO-Link + 8 DI + 4 DQ (1.3 A)
- Compact block I/O for processing digital, fail-safe digital, analog and IO-Link signals for connecting to bus systems with Ethernet-based protocols PROFINET, EtherNet/IP and Modbus TCP
 - Cabinet-free installation in degree of protection IP65/67 with M12 connection system
 - Extremely rugged and resistant metal enclosure
 - Housing type of the I/O devices with 2x M12 L-coded power connectors
 - 45 mm x 200 mm x 48 mm (W x H x D) with 8 x M12 for digital signals and IO-Link
 - Housing type of the I/O devices with 2x M12 A-coded power connectors
 - 30 mm x 200 mm x 37 mm (W x H x D) with 4 x M12 for digital signals and IO-Link
 - 60 mm x 175 mm x 37 mm (W x H x D) with 8 x M12 for digital and fail-safe digital signals as well as IO-Link
 - 60 mm x 175 mm x 37 mm (W x H x D) with 4 x M12 or 8 x M12 for analog signals

I/O systems

SIMATIC ET 200 systems without control cabinet
SIMATIC ET 200eco PN

I/O devices > Digital I/O devices

Overview

- Digital I/O devices with 2x M12 L-coded power connectors and 45 mm width
 - 8 digital input signals with 8xM12 connection
 - 16 digital input signals with 8xM12 connection
 - 8 digital output signals 8-channel digital output module 0.5A with 8xM12 connection
 - 8 digital output signals 2A with 8xM12 connection
 - 16 digital input/output signals 0.5A/2A with 8xM12 connection



- Digital I/O devices with 2x M12 A-coded power connectors and 60 mm width
 - 8 digital input signals with 8xM12 connection
 - 16 digital input signals with 8xM12 connection
 - 8 digital output signals 1.3 A with 8xM12 connection
 - 8 digital output signals 2 A with 8xM12 connection
 - 16 digital output signals 1.3 A with 8xM12 connection
 - 8 digital input/output signals 1.3 A with 8xM12 connection

10



- Digital I/O devices with 2x M12 A-coded power connectors and 30 mm width
 - 8 digital input signals with 4xM12 connection
 - 8 digital output signals 0.5 A with 4xM12 connection
 - 8 digital output signals 1.3 A with 4xM12 connection

Ordering data	Article No.	Article No.
ET 200eco PN digital input modules		PROFINET M12 connection plug, for user assembly
with M12 L-coded power connector	6ES7141-6BG00-0BB0	Connector for PROFINET, 4-core, shielded
• DI 8 x 24 V DC; 8 x M12, single and dual assignment, degree of protection IP67	6ES7141-6BH00-0BB0	IE M12 Plug PRO connector
• DI 16 x 24 V DC, 8 x M12, dual assignment, degree of protection IP67	6ES7141-6BF00-0AB0	• 1 unit
with M12 A-coded power connector	6ES7141-6BG00-0AB0	• 8 units
• 8 DI 24 V DC; 4 x M12, dual assignment, degree of protection IP67	6ES7141-6BH00-0AB0	IE FC M12 plug PRO connector, for user assembly
• 8 DI 24 V DC; 8 x M12, degree of protection IP67		• 1 unit
• 16 DI 24 V DC; 8 x M12, dual assignment, degree of protection IP67		• 8 units
		M12 connection plug for 24 V DC load power supply
		Connection socket for 24 V DC incoming supply; 4-pin, A-coded, 3 units
		6GK1907-0DC10-6AA3
		Connector for loop-through of 24 V DC; 4-pin, A-coded, 3 units
		6GK1907-0DB10-6AA3
ET 200eco PN digital output modules		Power M12 Plug PRO
with M12 L-coded power connector	6ES7142-6BG00-0BB0	Connector for 24 V DC supply voltage, with installation instructions, 4-pin, L-coded, 1 unit
• DQ 8 x 24 V DC/0.5 A; 8 x M12, single and dual assignment, degree of protection IP67	6ES7142-6BR00-0BB0	
• DQ 8 x 24 V DC/2 A; 8 x M12, single and dual assignment, degree of protection IP67	6ES7142-6BF50-0AB0	Power M12 Cable Connector PRO
with M12 A-coded power connector	6ES7142-6BF00-0AB0	Connection socket for 24 V DC supply voltage, 4-pin, L-coded, with installation instructions, 1 unit
• 8 DQ 24 V DC/0.5 A; 4 x M12, dual assignment, 1 load voltage supply DQ; degree of protection IP67	6ES7142-6BG00-0AB0	
• 8 DQ 24 V DC/1.3 A; 4 x M12, dual assignment, degree of protection IP67	6ES7142-6BR00-0AB0	M12 coupler plug
• 8 DQ 24 V DC/1.3 A; 8 x M12, degree of protection IP67	6ES7142-6BH00-0AB0	Can be assembled, for connecting actuators or sensors, 5-pin, screw connection, max. 0.75 mm ² , A-coded, max. 4 A
• 8 DQ 24 V DC/2 A; 8 x M12, degree of protection IP67		• Straight
• 16 DQ 24 V DC/1.3 A; 8 x M12, dual assignment, degree of protection IP67		• Angled
		M12 coupler socket
		4-pin, screw connection, max. 0.75 mm ² , A-coded, max. 4 A, angled
		3RK1902-4BA00-5AA0
		3RK1902-4DA00-5AA0
		3RK1902-4CA00-4AA0
ET 200eco PN digital input/output modules		PROFINET bus cable
with M12 L-coded power connector	6ES7143-6BH00-0BB0	Assembled on one side with 1 x M12, D-coded, 4-wire, shielded
• DIQ 16 x 24 V DC/0.5 A/2 A; dual assignment, degree of protection IP67	6ES7147-6BG00-0AB0	• 3 m
with M12 A-coded power connector		• 5 m
• 8 DI/DQ 24 V DC/1.3 A; 8 x M12, degree of protection IP67		• 10 m
		IE connecting cable M12-90/M12-90
Accessories	6ES7148-6CB00-0AA0	Pre-assembled
• PD voltage distributor, 24 V DC; 1 X 7/8", 4 X M12	6ES7194-6CA00-0AA0	IE FC TP trailing cable GP 2 x 2 (PROFINET type C)
• Terminal block for ET 200eco PN, 10 A insulation displacement terminals	6ES7194-6HB00-0AA0	with two 4-pin M12 plugs (D-coded) up to 85 m, IP65/IP67 degree of protection, 90° cable outlet
• Spare fuses for terminal block, 10 units	6ES7194-6GA00-0AA0	Length:
• Mounting rail 0.5 m	6ES7194-6MA00-0AA0	• 0.3 m
• Profile screw for mounting rail, 50 units	3RX9802-0AA00	• 0.5 m
• Sealing cap M12 for IP67 modules, 12 mm external diameter, without O-ring, 10 units	3RK1901-1KA00	• 1.0 m
• Sealing cap M12 for IP67 modules, 15 mm external diameter, with O-ring, 10 units	6ES7194-2BA00-0AA0	• 1, 5 m
• Labels 10 mm x 5 mm RAL9016, for I/O devices with 2x M12 L-coded power connectors; 5 frames with 40 labels each	3RT2900-1SB10	• 2.0 m
• Labels 10 mm x 7 mm Ti-grey, for I/O devices with 2x M12 A-coded power connectors; 5 frames with 40 labels each		• 3.0 m
		• 5.0 m
		• 10 m
		• 15 m

I/O systemsSIMATIC ET 200 systems without control cabinet
SIMATIC ET 200eco PN**I/O devices > Digital I/O devices****Ordering data****Article No.****Article No.****IE connecting cable
M12-180/IE FC RJ45 plug-145**

Pre-assembled
IE FC TP trailing cable GP 2 x 2
(PROFINET type C)
with M12 plug (D-coded)
and IE FC RJ45 Plug,
IP65/IP67 degree of protection
Length:
• 2.0 m
• 3.0 m
• 5.0 m
• 10 m
• 15 m

6XV1871-5TH20
6XV1871-5TH30
6XV1871-5TH50
6XV1871-5TN10
6XV1871-5TN15

**IE robust connecting cable
M12-180/M12-180**

Pre-assembled
IE FC TP robust food cable 2 x 2
(PROFINET type C)
with two 4-pin M12 plugs
(D-coded), IP69 degree of protection
Length:
• 1.0 m
• 2.0 m
• 3.0 m
• 5.0 m

6XV1881-5AH10
6XV1881-5AH20
6XV1881-5AH30
6XV1881-5AH50

M12 Y cable

For double connection of I/O
by means of single cable to ET 200,
5-pin

6ES7194-6KA00-0XA0

Control line

Assembled on one side with
1 x M12 plug angled, 5-pin,
5 x 0.34 mm², A-coded, max. 4 A,
PUR casing, black
• 1.5 m
• 5 m
• 10 m

3RK1902-4HB15-5AA0
3RK1902-4HB50-5AA0
3RK1902-4HC01-5AA0
3RK1902-4PB15-3AA0

Assembled, 1 x M12 cable box
straight, 1 x M12 plug,
3 x 0.34 mm², A-coded, max. 4 A,
PUR casing, black

IO-Link connecting cables

Between IO-Link master and reader,
on both sides with M12 plug,
4-pin
• 5 m
• 10 m

6GT2891-4MH50
6GT2891-4MN10

Energy Cable 4 x 1.5

Power line, suitable for cable
carriers, with 4 copper cores
(1.5 mm²) for connecting to
M12 plug-in connectors;
sold by the meter;
max. delivery unit 1000 m;
minimum order quantity 20 m

6XV1801-2B

**M12 power connecting cable
M12-90/M12-90**

Flexible 4-core
power connecting cable,
assembled with A-coded,
5-pin M12 plug and A-coded,
5-pin M12 socket to
supply the ET 200 with 24 V DC;
90° cable outlet
Length:
• 0.3 m
• 0.5 m
• 1.0 m
• 1.5 m
• 2.0 m
• 3.0 m
• 5.0 m
• 10 m
• 15 m

6XV1801-5GE30
6XV1801-5GE50
6XV1801-5GH10
6XV1801-5GH15
6XV1801-5GH20
6XV1801-5GH30
6XV1801-5GH50
6XV1801-5GN10
6XV1801-5GN15

**M12 power connecting cable
M12-90/M12-90**

Flexible 4-wire
power connecting cable,
pre-assembled with L-coded,
4-pin M12 plug and L-coded,
4-pin M12 socket,
both sides angled 90°, to supply
terminal devices with 24 V DC
Length:
• 0.5 m
• 1.0 m
• 1.5 m
• 2.0 m
• 3.0 m
• 5.0 m
• 10 m
• 15 m

6XV1801-6GE50
6XV1801-6GH10
6XV1801-6GH15
6XV1801-6GH20
6XV1801-6GH30
6XV1801-6GH50
6XV1801-6GN10
6XV1801-6GN15

**M12 power connecting cable
M12-180/M12-180**

Flexible 4-core
power connecting cable,
assembled with L-coded,
4-pin M12 plug and L-coded,
4-pin M12 socket to supply
terminal devices with 24 V DC
Length:
• 0.5 m
• 1.0 m
• 1.5 m
• 2.0 m
• 3.0 m
• 5.0 m
• 10 m
• 15 m

6XV1801-6DE50
6XV1801-6DH10
6XV1801-6DH15
6XV1801-6DH20
6XV1801-6DH30
6XV1801-6DH50
6XV1801-6DN10
6XV1801-6DN15

**M12 robust power
connecting cable
M12-180/M12-180**

Flexible 4-wire
power connecting cable,
assembled with A-coded,
5-pin M12 plug and A-coded,
5-pin M12 socket
to supply IP69 components
with 24 V DC;
Length:
• 1.0 m
• 2.0 m
• 3.0 m
• 5.0 m

6XV1801-5AH10
6XV1801-5AH20
6XV1801-5AH30
6XV1801-5AH50

Technical specifications

Article number	6ES7141-6BG00-0BB0 ET 200eco PN, DI 8x24VDC, M12-L	6ES7141-6BH00-0BB0 ET 200eco PN, DI 16x24VDC, M12-L
General information		
Product function		
• Isochronous mode	Yes	Yes
• Prioritized startup	Yes	Yes
Engineering with		
• STEP 7 TIA Portal configurable/ integrated from version	STEP 7 V17 or higher with HSP 0363	STEP 7 V17 or higher with HSP 0363
• PROFINET from GSD version/ GSD revision	GSDML V2.3.x	GSDML V2.3.x
• Multi Fieldbus Configuration Tool (MFCT)	from V1.3 SP1	from V1.3 SP1
Operating mode		
• DI	Yes	Yes
• Counter	No	No
• MSI	Yes	Yes
Supply voltage		
Load voltage 1L+		
• Rated value (DC)	24 V	24 V
• Reverse polarity protection	Yes; Against destruction; encoder power supply outputs applied with reversed polarity	Yes; Against destruction; encoder power supply outputs applied with reversed polarity
Input current		
Current consumption (rated value) from load voltage 1L+ (unswitched voltage)	85 mA; without load 12 A; Maximum value	90 mA; without load 12 A; Maximum value
from load voltage 2L+, max.	12 A; Maximum value	12 A; Maximum value
Encoder supply		
Number of outputs	8	8
Hardware configuration		
Submodules		
• Number of configurable submodules, max.	2	2
Digital inputs		
Number of digital inputs	8	16
Digital inputs, parameterizable	Yes	Yes
Source/sink input	P-reading	P-reading
Input characteristic curve in accordance with IEC 61131, type 3	Yes	Yes
Number of simultaneously controllable inputs		
all mounting positions		
- up to 60 °C, max.	8	16
Input voltage		
• Rated value (DC)	24 V	24 V
• for signal "0"	-30 to +5 V	-30 to +5 V
• for signal "1"	+11 to +30V	+11 to +30V
Input current		
• for signal "1", typ.	2.4 mA	2.4 mA
Input delay (for rated value of input voltage) for standard inputs		
- parameterizable	Yes; 0.05 / 0.1 / 0.4 / 0.8 / 1.6 / 3.2 / 12.8 / 20 ms	Yes; 0.05 / 0.1 / 0.4 / 0.8 / 1.6 / 3.2 / 12.8 / 20 ms
Cable length		
• unshielded, max.	30 m	30 m
Encoder		
Connectable encoders		
• 2-wire sensor	Yes	Yes
- permissible quiescent current (2-wire sensor), max.	1.5 mA	1.5 mA
Interfaces		
Number of PROFINET interfaces	1	1

I/O systemsSIMATIC ET 200 systems without control cabinet
SIMATIC ET 200eco PN**I/O devices > Digital I/O devices****Technical specifications**

Article number	6ES7141-6BG00-0BB0 ET 200eco PN, DI 8x24VDC, M12-L	6ES7141-6BH00-0BB0 ET 200eco PN, DI 16x24VDC, M12-L
1. Interface		
Interface type	PROFINET with 100 Mbit/s full duplex (100BASE-TX)	PROFINET with 100 Mbit/s full duplex (100BASE-TX)
Interface types		
• M12 port	Yes; 2x M12, 4-pin, D-coded	Yes; 2x M12, 4-pin, D-coded
• Number of ports	2	2
• integrated switch	Yes	Yes
Protocols		
• PROFINET IO Device	Yes	Yes
• Open IE communication	Yes	Yes
Interface types		
M12 port		
• Autonegotiation	Yes	Yes
• Autocrossing	Yes	Yes
• Transmission rate, max.	100 Mbit/s	100 Mbit/s
Protocols		
Supports protocol for PROFINET IO	Yes	Yes
PROFIsafe	No	No
EtherNet/IP	Yes	Yes
Modbus TCP	Yes	Yes
PROFINET IO Device		
Services		
- IRT	Yes; 250 µs to 4 ms in 125 µs frame	Yes; 250 µs to 4 ms in 125 µs frame
- Prioritized startup	Yes	Yes
Redundancy mode		
• PROFINET system redundancy (S2)	Yes	Yes
• Redundant PROFINET configuration (R1)	No	No
• H-Sync forwarding	Yes	Yes
Media redundancy		
- MRP	Yes	Yes
EtherNet/IP		
Services		
- CIP Implicit Messaging	Yes	Yes
- CIP Explicit Messaging	Yes	Yes
- CIP Safety	No	No
- Shared device	Yes; 2x EtherNet/IP Scanner	Yes; 2x EtherNet/IP Scanner
- Number of scanners with shared device, max.	2	2
Updating times		
- Requested Packet Interval (RPI)	2 ms	2 ms
Redundancy mode		
- DLR (Device Level Ring)	No	No
Address area		
- Address space per module, max.	20 byte	20 byte
- LargeForwardOpen (Class3)	No	No
Modbus TCP		
Services		
- read coils (code=1)	Yes	Yes
- read discrete inputs (code=2)	Yes	Yes
- Read Holding Registers (Code=3)	Yes	Yes
- write single coil (code=5)	Yes	Yes
- write multiple coils (code=15)	Yes	Yes
- Write Multiple Registers (Code=16)	Yes	Yes
- Parameter change by master	No	No
- Modbus TCP Security Protocol	No	No
Address space per station		
- Address space per station, max.	20 byte	20 byte
- Access-consistent address space	2 byte	2 byte

Technical specifications

Article number	6ES7141-6BG00-0BB0 ET 200eco PN, DI 8x24VDC, M12-L	6ES7141-6BH00-0BB0 ET 200eco PN, DI 16x24VDC, M12-L
Updating time		
- I/O request interval	2 ms	2 ms
Connections		
- Number of connections per slave	12	12
Open IE communication		
• TCP/IP	Yes; (only EtherNet/IP or Modbus TCP)	Yes; (only EtherNet/IP or Modbus TCP)
• SNMP	Yes	Yes
• LLDP	Yes	Yes
• ARP	Yes	Yes
Isochronous mode		
Equidistance	Yes	Yes
shortest clock pulse	250 µs	250 µs
max. cycle	4 ms	4 ms
Interrupts/diagnostics/ status information		
Alarms		
• Diagnostic alarm	Yes; Parameterizable	Yes; Parameterizable
• Maintenance interrupt	Yes; Parameterizable	Yes; Parameterizable
• Hardware interrupt	Yes; Parameterizable	Yes; Parameterizable
Diagnoses		
• Diagnostic information readable	Yes	Yes
• Monitoring the supply voltage	Yes	Yes
- parameterizable	Yes	Yes
• Wire-break	Yes; DI, input current < 0.3 mA, per channel	Yes; DI, input current < 0.3 mA, per channel
• Short-circuit encoder supply	Yes; Per channel group	Yes; Per channel group
Diagnostics indication LED		
• RUN LED	Yes; green LED	Yes; green LED
• ERROR LED	Yes; red LED	Yes; red LED
• MAINT LED	Yes; Yellow LED	Yes; Yellow LED
• NS LED	Yes; green/red LED	Yes; green/red LED
• MS LED	Yes; green/red LED	Yes; green/red LED
• IO LED	Yes; red-green-yellow LED	Yes; red-green-yellow LED
• Channel status display	Yes; green LED	Yes; green LED
• for channel diagnostics	Yes; red LED	Yes; red LED
• Connection display LINK TX/RX	Yes; green LED, only link	Yes; green LED, only link
Potential separation		
between the load voltages	Yes	Yes
between Ethernet and electronics	Yes	Yes
Potential separation channels		
• between the channels	No	No
• between the channels and the power supply of the electronics	No	No
Degree and class of protection		
IP degree of protection	IP65/67	IP65/67
Standards, approvals, certificates		
Suitable for safety-related tripping of standard modules	Yes; From FS01	Yes; From FS01
Highest safety class achievable for safety-related tripping of standard modules		
• Performance level according to ISO 13849-1	PL d	PL d
• Category according to ISO 13849-1	Cat. 3	Cat. 3
• SILCL according to IEC 62061	SILCL 2	SILCL 2

I/O systemsSIMATIC ET 200 systems without control cabinet
SIMATIC ET 200eco PN**I/O devices > Digital I/O devices****Technical specifications**

Article number	6ES7141-6BG00-0BB0 ET 200eco PN, DI 8x24VDC, M12-L	6ES7141-6BH00-0BB0 ET 200eco PN, DI 16x24VDC, M12-L	
Ambient conditions			
Ambient temperature during operation			
• min.	-40 °C	-40 °C	
• max.	60 °C	60 °C	
Altitude during operation relating to sea level			
• Ambient air temperature-barometric pressure-altitude	Up to max. 5 000 m, at installation height > 2 000 m additional restrictions	Up to max. 5 000 m, at installation height > 2 000 m additional restrictions	
Connection method			
Design of electrical connection	4/5-pin M12 circular connectors	4/5-pin M12 circular connectors	
Design of electrical connection for the inputs and outputs	M12, 5-pin, A-coded	M12, 5-pin, A-coded	
Design of electrical connection for supply voltage	M12, 4-pin, L-coded	M12, 4-pin, L-coded	
Dimensions			
Width	45 mm	45 mm	
Height	200 mm	200 mm	
Depth	48 mm	48 mm	
Weights			
Weight, approx.	780 g	780 g	
Article number	6ES7141-6BF00-0A00 ET 200eco, 8DI, DC24V, 4xM12	6ES7141-6BG00-0A00 ET 200eco PN, 8DI, DC24V, 8xM12	6ES7141-6BH00-0A00 ET 200eco PN, 16DI, DC24V, 8xM12
Supply voltage			
Rated value (DC)	24 V	24 V	24 V
Reverse polarity protection	Yes	Yes	Yes
Input current			
Current consumption, typ.	100 mA	100 mA	100 mA
from supply voltage 1L+, max.	4 A	4 A	4 A
Encoder supply			
Number of outputs	4	8	8
Digital inputs			
Number of digital inputs	8	8	16
• in groups of	2	1	2
Input characteristic curve in accordance with IEC 61131, type 3	Yes	Yes	Yes
Number of simultaneously controllable inputs			
all mounting positions			
- up to 60 °C, max.	8	8	16
Input voltage			
• Rated value (DC)	24 V	24 V	24 V
• for signal *0*	-3 to +5V	-3 to +5V	-3 to +5V
• for signal *1*	+11 to +30V	+11 to +30V	+11 to +30V
Input current			
• for signal *1*, typ.	7 mA	7 mA	7 mA
Cable length			
• unshielded, max.	30 m	30 m	30 m
Encoder			
Connectable encoders			
• 2-wire sensor	Yes	Yes	Yes
- permissible quiescent current (2-wire sensor), max.	1.5 mA	1.5 mA	1.5 mA
Interfaces			
Transmission procedure	100BASE-TX	100BASE-TX	100BASE-TX
Number of PROFINET interfaces	1	1	1

Technical specifications

Article number	6ES7141-6BF00-0AB0	6ES7141-6BG00-0AB0	6ES7141-6BH00-0AB0
	ET 200eco, 8DI, DC24V, 4xM12	ET 200eco PN, 8DI, DC24V, 8xM12	ET 200eco PN, 16DI, DC24V, 8xM12
1. Interface			
Interface types			
• M12 port	Yes	Yes	Yes
• integrated switch	Yes	Yes	Yes
Interface types			
M12 port			
• Autonegotiation	Yes	Yes	Yes
• Autocrossing	Yes	Yes	Yes
• Transmission rate, max.	100 Mbit/s	100 Mbit/s	100 Mbit/s
Protocols			
Supports protocol for PROFINET IO	Yes	Yes	Yes
PROFINET CBA	No	No	No
PROFIsafe	No	No	No
PROFINET IO Device			
Services			
- IRT with the option "high flexibility"	Yes	Yes	Yes
- Prioritized startup	Yes	Yes	Yes
Redundancy mode			
Media redundancy			
- MRP	Yes	Yes	Yes
Open IE communication			
• TCP/IP	No	No	No
• SNMP	Yes	Yes	Yes
• DCP	Yes	Yes	Yes
• LLDP	Yes	Yes	Yes
• ping	Yes	Yes	Yes
• ARP	Yes	Yes	Yes
Interrupts/diagnostics/ status information			
Diagnostics function	Yes	Yes	Yes
Alarms			
• Diagnostic alarm	Yes	Yes	Yes
Diagnoses			
• Diagnostic information readable	Yes	Yes	Yes
• Monitoring the supply voltage	Yes; green "ON" LED	Yes; green "ON" LED	Yes; green "ON" LED
• Wire-break in signal transmitter cable	Yes	Yes	Yes
• Short-circuit encoder supply	Yes; Per channel group	Yes; Per channel group	Yes; Per channel group
• Group error	Yes; Red/yellow "SF/MT" LED	Yes; Red/yellow "SF/MT" LED	Yes; Red/yellow "SF/MT" LED
Potential separation			
between the load voltages	Yes	Yes	Yes
between load voltage and all other switching components	No	No	No
between Ethernet and electronics	Yes	Yes	Yes
Potential separation channels			
• between the channels	No	No	No
Degree and class of protection			
IP degree of protection	IP65/67	IP65/67	IP65/67
Connection method			
Design of electrical connection	4/5-pin M12 circular connectors	4/5-pin M12 circular connectors	4/5-pin M12 circular connectors
Dimensions			
Width	30 mm	60 mm	60 mm
Height	200 mm	175 mm	175 mm
Depth	49 mm	49 mm	49 mm
Weights			
Weight, approx.	550 g	910 g	910 g

I/O systems

SIMATIC ET 200 systems without control cabinet
SIMATIC ET 200eco PN

I/O devices > Digital I/O devices**Technical specifications**

Article number	6ES7142-6BG00-0BB0 ET 200eco PN, DQ 8x24VDC/0,5A, M12-L	6ES7142-6BR00-0BB0 ET 200eco PN, DQ 8x24VDC/2A, M12-L
General information		
Product function		
• Isochronous mode	Yes	Yes
• Prioritized startup	Yes	Yes
Engineering with		
• STEP 7 TIA Portal configurable/ integrated from version	STEP 7 V17 or higher with HSP 0363	STEP 7 V17 or higher with HSP 0363
• PROFINET from GSD version/ GSD revision	GSDML V2.3.x	GSDML V2.3.x
• Multi Fieldbus Configuration Tool (MFCT)	from V1.3 SP1	from V1.3 SP1
Operating mode		
• DQ	Yes	Yes
• MSO	Yes	Yes
Supply voltage		
Load voltage 1L+		
• Rated value (DC)	24 V	24 V
• Reverse polarity protection	Yes	Yes
Load voltage 2L+		
• Rated value (DC)	24 V	24 V
• Reverse polarity protection	Yes; against destruction; load increasing	Yes; against destruction
Input current		
Current consumption (rated value)	65 mA; without load	65 mA; without load
from load voltage 1L+ (unswitched voltage)	12 A; Maximum value	12 A; Maximum value
from load voltage 2L+, max.	12 A; Maximum value	12 A; Maximum value
Hardware configuration		
Submodules		
• Number of configurable submodules, max.	2	2
Digital outputs		
Number of digital outputs	8	8
Current-sourcing	Yes	Yes
Short-circuit protection	Yes; per channel, electronic	Yes; per channel, electronic
Limitation of inductive shutdown voltage to	Typ. 2L+ (-52 V)	Type -14 V
Controlling a digital input	Yes	Yes
Switching capacity of the outputs		
• with resistive load, max.	0.5 A	2 A
• with inductive load, max.	0.5 A	2 A
• on lamp load, max.	5 W	10 W
Load resistance range		
• lower limit	48 Ω	12 Ω
• upper limit	4 kΩ	4 kΩ
Output voltage		
• for signal "1", min.	2L+ (-0,8 V)	2L+ (-0,8 V)
Output current		
• for signal "1" rated value	0.5 A	2 A
• for signal "0" residual current, max.	0.1 mA	0.2 mA
Parallel switching of two outputs		
• for uprating	No	No
• for redundant control of a load	Yes	Yes
Switching frequency		
• with resistive load, max.	100 Hz	100 Hz
• with inductive load, max.	0.5 Hz	0.5 Hz
• on lamp load, max.	1 Hz	1 Hz
Total current of the outputs		
• Current per module, max.	4 A	8 A
Cable length		
• unshielded, max.	30 m	30 m

Technical specifications

Article number	6ES7142-6BG00-0BB0 ET 200eco PN, DQ 8x24VDC/0,5A, M12-L	6ES7142-6BR00-0BB0 ET 200eco PN, DQ 8x24VDC/2A, M12-L
Interfaces		
Number of PROFINET interfaces	1	1
1. Interface		
Interface type	PROFINET with 100 Mbit/s full duplex (100BASE-TX)	PROFINET with 100 Mbit/s full duplex (100BASE-TX)
Interface types		
• M12 port	Yes; 2x M12, 4-pin, D-coded	Yes; 2x M12, 4-pin, D-coded
• Number of ports	2	2
• integrated switch	Yes	Yes
Protocols		
• PROFINET IO Device	Yes	Yes
• Open IE communication	Yes	Yes
Interface types		
M12 port		
• Autonegotiation	Yes	Yes
• Autocrossing	Yes	Yes
• Transmission rate, max.	100 Mbit/s	100 Mbit/s
Protocols		
Supports protocol for PROFINET IO	Yes	Yes
PROFIsafe	No	No
EtherNet/IP	Yes	Yes
Modbus TCP	Yes	Yes
PROFINET IO Device		
Services		
- IRT	Yes; 250 µs to 4 ms in 125 µs frame	Yes; 250 µs to 4 ms in 125 µs frame
- Prioritized startup	Yes	Yes
- Shared device	Yes	Yes
- Number of IO Controllers with shared device, max.	2	2
Redundancy mode		
• PROFINET system redundancy (S2)	Yes	Yes
• Redundant PROFINET configuration (R1)	No	No
• H-Sync forwarding	Yes	Yes
Media redundancy		
- MRP	Yes	Yes
EtherNet/IP		
Services		
- CIP Implicit Messaging	Yes	Yes
- CIP Explicit Messaging	Yes	Yes
- CIP Safety	No	No
- Shared device	Yes; 2x EtherNet/IP Scanner	Yes; 2x EtherNet/IP Scanner
- Number of scanners with shared device, max.	2	2
Updating times		
- Requested Packet Interval (RPI)	2 ms	2 ms
Redundancy mode		
- DLR (Device Level Ring)	No	No
Address area		
- Address space per module, max.	20 byte	20 byte
- LargeForwardOpen (Class3)	No	No
Modbus TCP		
Services		
- read coils (code=1)	Yes	Yes
- read discrete inputs (code=2)	Yes	Yes
- Read Holding Registers (Code=3)	Yes	Yes
- write single coil (code=5)	Yes	Yes
- write multiple coils (code=15)	Yes	Yes
- Write Multiple Registers (Code=16)	Yes	Yes
- Parameter change by master	No	No
- Modbus TCP Security Protocol	No	No

I/O systems

SIMATIC ET 200 systems without control cabinet

SIMATIC ET 200eco PN

I/O devices > Digital I/O devices**Technical specifications**

Article number	6ES7142-6BG00-0BB0 ET 200eco PN, DQ 8x24VDC/0,5A, M12-L	6ES7142-6BR00-0BB0 ET 200eco PN, DQ 8x24VDC/2A, M12-L
Address space per station		
- Address space per station, max.	20 byte	20 byte
- Access-consistent address space	2 byte	2 byte
Updating time		
- I/O request interval	2 ms	2 ms
Connections		
- Number of connections per slave	12	12
Open IE communication		
• TCP/IP	Yes; (only EtherNet/IP or Modbus TCP)	Yes; (only EtherNet/IP or Modbus TCP)
• SNMP	Yes	Yes
• LLDP	Yes	Yes
• ARP	Yes	Yes
Isochronous mode		
Equidistance	Yes	Yes
shortest clock pulse	250 µs	250 µs
max. cycle	4 ms	4 ms
Interrupts/diagnostics/ status information		
Substitute values connectable	Yes	Yes
Alarms		
• Diagnostic alarm	Yes; Parameterizable	Yes; Parameterizable
• Maintenance interrupt	Yes; Parameterizable	Yes; Parameterizable
Diagnoses		
• Diagnostic information readable	Yes	Yes
• Monitoring the supply voltage	Yes	Yes
- parameterizable	Yes	Yes
• Wire-break	Yes	Yes
• Short-circuit	Yes; Outputs to M; channel by channel	Yes; Outputs to M; channel by channel
Diagnostics indication LED		
• RUN LED	Yes; green LED	Yes; green LED
• ERROR LED	Yes; red LED	Yes; red LED
• MAINT LED	Yes; Yellow LED	Yes; Yellow LED
• NS LED	Yes; green/red LED	Yes; green/red LED
• MS LED	Yes; green/red LED	Yes; green/red LED
• IO LED	Yes; red-green-yellow LED	Yes; red-green-yellow LED
• Channel status display	Yes; green LED	Yes; green LED
• for channel diagnostics	Yes; red LED	Yes; red LED
• For load voltage monitoring	Yes; green LED	Yes; green LED
• Connection display LINK TX/RX	Yes; green LED, only link	Yes; green LED, only link
Potential separation		
between the load voltages	Yes	Yes
between Ethernet and electronics	Yes	Yes
Potential separation channels		
• between the channels	No	No
• between the channels and the power supply of the electronics	Yes	Yes
Degree and class of protection		
IP degree of protection	IP65/67	IP65/67
Standards, approvals, certificates		
Suitable for safety-related tripping of standard modules	Yes; From FS02	Yes; From FS02

Technical specifications

Article number	6ES7142-6BG00-0BB0 ET 200eco PN, DQ 8x24VDC/0,5A, M12-L	6ES7142-6BR00-0BB0 ET 200eco PN, DQ 8x24VDC/2A, M12-L
Highest safety class achievable for safety-related tripping of standard modules		
<ul style="list-style-type: none"> Performance level according to ISO 13849-1 Category according to ISO 13849-1 SILCL according to IEC 62061 	PL d Cat. 3 SILCL 2	PL d Cat. 3 SILCL 2
Ambient conditions		
Ambient temperature during operation		
<ul style="list-style-type: none"> min. max. 	-40 °C 60 °C	-40 °C 60 °C
Altitude during operation relating to sea level		
<ul style="list-style-type: none"> Ambient air temperature-barometric pressure-altitude 	Up to max. 5 000 m, at installation height > 2 000 m additional restrictions	Up to max. 5 000 m, at installation height > 2 000 m additional restrictions
Connection method		
Design of electrical connection	4/5-pin M12 circular connectors	4/5-pin M12 circular connectors
Design of electrical connection for the inputs and outputs	M12, 5-pin, A-coded	M12, 5-pin, A-coded
Design of electrical connection for supply voltage	M12, 4-pin, L-coded	M12, 4-pin, L-coded
Dimensions		
Width	45 mm	45 mm
Height	200 mm	200 mm
Depth	48 mm	48 mm
Weights		
Weight, approx.	780 g	780 g

Article number	6ES7142-6BF50-0AB0 ET 200eco PN, 8DO, DC24V/0,5A, 4xM12	6ES7142-6BF00-0AB0 ET 200eco PN, 8DO, DC24V/1,3A, 4xM12	6ES7142-6BG00-0AB0 ET 200eco PN, 8DO, DC24V/1,3A, 8xM12	6ES7142-6BR00-0AB0 ET 200eco PN, 8 DO, DC24V/2A, 8xM12	6ES7142-6BH00-0AB0 ET 200eco PN, 16DO DC24V/1,3A, 8xM12
Supply voltage					
Rated value (DC)	24 V	24 V	24 V	24 V	24 V
Reverse polarity protection	Yes	Yes	Yes	Yes	Yes
Load voltage 1L+					
<ul style="list-style-type: none"> Rated value (DC) Reverse polarity protection 	24 V Yes	24 V Yes	24 V Yes	24 V Yes	24 V Yes
Load voltage 2L+					
<ul style="list-style-type: none"> Rated value (DC) Reverse polarity protection 	24 V Yes	24 V Yes	24 V Yes	24 V Yes	24 V Yes
Input current					
Current consumption, typ.	100 mA	100 mA	100 mA	100 mA	100 mA
from supply voltage 1L+, max.	4 A	4 A	4 A	4 A	4 A
from load voltage 1L+ (unswitched voltage)	100 mA	4 A	4 A	4 A	4 A
from load voltage 2L+, max.	4 A	4 A	4 A	4 A	4 A
Digital outputs					
Number of digital outputs	8	8	8	8	16
<ul style="list-style-type: none"> in groups of 	8	4	4	4	8
Short-circuit protection	Yes	Yes	Yes	Yes	Yes
Limitation of inductive shutdown voltage to	Typ. (L1+, L2+) -47 V	Typ. (L1+, L2+) -47 V	Typ. (L1+, L2+) -47 V	Typ. (L1+, L2+) -47 V	Typ. (L1+, L2+) -47 V
Controlling a digital input	Yes	Yes	Yes	Yes	Yes
Switching capacity of the outputs					
<ul style="list-style-type: none"> on lamp load, max. 	5 W	5 W	5 W	10 W	5 W

I/O systems

SIMATIC ET 200 systems without control cabinet

SIMATIC ET 200eco PN

I/O devices > Digital I/O devices**Technical specifications**

Article number	6ES7142-6BF50-0AB0	6ES7142-6BF00-0AB0	6ES7142-6BG00-0AB0	6ES7142-6BR00-0AB0	6ES7142-6BH00-0AB0
	ET 200eco PN, 8DO, DC24V/0,5A, 4xM12	ET 200eco PN, 8DO, DC24V/1,3A, 4xM12	ET 200eco PN, 8DO, DC24V/1,3A, 8xM12	ET 200eco PN, 8 DO, DC24V/2A, 8xM12	ET 200eco PN, 16DO DC24V/1,3A, 8xM12
Output current					
• for signal "1" rated value	0.5 A	1.3 A; Maximum	1.3 A; Maximum	2 A	1.3 A; Maximum
• for signal "0" residual current, max.	1.5 mA	1.5 mA	1.5 mA	1.5 mA	1.5 mA
Parallel switching of two outputs					
• for uprating	No	No	No	No	No
• for redundant control of a load	Yes	Yes	Yes	Yes	Yes
Switching frequency					
• with resistive load, max.	100 Hz	100 Hz	100 Hz	100 Hz	100 Hz
• with inductive load, max.	0.5 Hz	0.5 Hz	0.5 Hz	0.5 Hz	0.5 Hz
• on lamp load, max.	1 Hz	1 Hz	1 Hz	1 Hz	1 Hz
Total current of the outputs (per group)					
all mounting positions					
- up to 55 °C, max.		3.9 A			
- up to 60 °C, max.	4 A	2.6 A	3.9 A	3.9 A	3.9 A
Cable length					
• unshielded, max.	30 m	30 m	30 m	30 m	30 m
Interfaces					
Transmission procedure	100BASE-TX	100BASE-TX	100BASE-TX	100BASE-TX	100BASE-TX
Number of PROFINET interfaces	1	1	1	1	1
1. Interface					
Interface types					
• M12 port		Yes			
• integrated switch	Yes	Yes	Yes	Yes	Yes
Interface types					
M12 port					
• Autonegotiation	Yes	Yes	Yes	Yes	Yes
• Autocrossing	Yes	Yes	Yes	Yes	Yes
• Transmission rate, max.	100 Mbit/s	100 Mbit/s	100 Mbit/s	100 Mbit/s	100 Mbit/s
Protocols					
Supports protocol for PROFINET IO	Yes	Yes	Yes	Yes	Yes
PROFINET CBA	No	No	No	No	No
PROFIsafe	No	No	No	No	No
PROFINET IO Device					
Services					
- IRT with the option "high flexibility"	Yes	Yes	Yes	Yes	Yes
- Prioritized startup	Yes	Yes	Yes	Yes	Yes
Redundancy mode					
Media redundancy					
- MRP	Yes	Yes	Yes	Yes	Yes
Open IE communication					
• TCP/IP	No	No	No	No	No
• SNMP	Yes	Yes	Yes	Yes	Yes
• DCP	Yes	Yes	Yes	Yes	Yes
• LLDP	Yes	Yes	Yes	Yes	Yes
• ping	Yes	Yes	Yes	Yes	Yes
• ARP	Yes	Yes	Yes	Yes	Yes
Interrupts/diagnostics/status information					
Diagnostics function	Yes	Yes	Yes	Yes	Yes
Alarms					
• Diagnostic alarm	Yes	Yes	Yes	Yes	Yes

Technical specifications

Article number	6ES7142-6BF50-0AB0	6ES7142-6BF00-0AB0	6ES7142-6BG00-0AB0	6ES7142-6BR00-0AB0	6ES7142-6BH00-0AB0
	ET 200eco PN, 8DO, DC24V/0,5A, 4xM12	ET 200eco PN, 8DO, DC24V/1,3A, 4xM12	ET 200eco PN, 8DO, DC24V/1,3A, 8xM12	ET 200eco PN, 8 DO, DC24V/2A, 8xM12	ET 200eco PN, 16DO DC24V/1,3A, 8xM12
Diagnoses					
• Diagnostic information readable	Yes	Yes	Yes	Yes	Yes
• Monitoring the supply voltage	Yes; green "ON" LED	Yes; green "ON" LED	Yes; green "ON" LED	Yes; green "ON" LED	Yes; green "ON" LED
• Wire-break in actuator cable	Yes	Yes	Yes	Yes	Yes
• Short-circuit	Yes	Yes	Yes	Yes	Yes
• Group error	Yes; Red/yellow "SF/MT" LED	Yes; Red/yellow "SF/MT" LED	Yes; Red/yellow "SF/MT" LED	Yes; Red/yellow "SF/MT" LED	Yes; Red/yellow "SF/MT" LED
Potential separation					
between the load voltages	Yes	Yes	Yes	Yes	Yes
between load voltage and all other switching components	No	No	No	No	No
between Ethernet and electronics	Yes	Yes	Yes	Yes	Yes
Potential separation channels					
• between the channels	No	No	No	No	No
Degree and class of protection					
IP degree of protection	IP65/67	IP65/67	IP65/67	IP65/67	IP65/67
Standards, approvals, certificates					
Suitable for safety-related tripping of standard modules	Yes	Yes	Yes	Yes	Yes
Highest safety class achievable for safety-related tripping of standard modules					
• Performance level according to ISO 13849-1	PL d	PL d	PL d	PL d	PL d
• Category according to ISO 13849-1	Cat. 3	Cat. 3	Cat. 3	Cat. 3	Cat. 3
• SILCL according to IEC 62061	SILCL 2	SILCL 2	SILCL 2	SILCL 2	SILCL 2
Connection method					
Design of electrical connection	4/5-pin M12 circular connectors	4/5-pin M12 circular connectors	4/5-pin M12 circular connectors	4/5-pin M12 circular connectors	4/5-pin M12 circular connectors
Dimensions					
Width	30 mm	30 mm	60 mm	60 mm	60 mm
Height	200 mm	200 mm	175 mm	175 mm	175 mm
Depth	49 mm	49 mm	49 mm	49 mm	49 mm
Weights					
Weight, approx.	550 g	550 g	910 g	910 g	910 g
Article number	6ES7143-6BH00-0BB0			Article number	
	ET 200eco PN, DIQ 16x24VDC/2A, M12-L			6ES7143-6BH00-0BB0	
				ET 200eco PN, DIQ 16x24VDC/2A, M12-L	
General information				Supply voltage	
Product function				Load voltage 1L+	
• Isochronous mode	No			• Rated value (DC)	
• Prioritized startup	Yes			• Reverse polarity protection	
Engineering with				24 V	
• STEP 7 TIA Portal configurable/ integrated from version	STEP 7 V17 or higher with HSP 0363			Yes; Against destruction; encoder power supply outputs applied with reversed polarity, loads pick up	
• PROFINET from GSD version/ GSD revision	GSDML V2.3.x			Load voltage 2L+	
• Multi Fieldbus Configuration Tool (MFCT)	from V1.3 SP1			• Rated value (DC)	
Operating mode				• Reverse polarity protection	
• DI	Yes			24 V	
• Counter	No			Yes; against destruction	
• DQ	Yes			Input current	
• MSI	Yes			Current consumption (rated value)	
• MSO	Yes			from load voltage 1L+ (unswitched voltage)	
				from load voltage 2L+, max.	
				90 mA; without load	
				12 A; Maximum value	
				12 A; Maximum value	

I/O systemsSIMATIC ET 200 systems without control cabinet
SIMATIC ET 200eco PN**I/O devices > Digital I/O devices****Technical specifications**

Article number	6ES7143-6BH00-0BB0 ET 200eco PN, DIQ 16x24VDC/2A, M12-L
Hardware configuration	
Submodules	
• Number of configurable submodules, max.	2
Digital inputs	
Number of digital inputs	16; Parameterizable as DIQ
• in groups of	8
Digital inputs, parameterizable	Yes
Source/sink input	P-reading
Input characteristic curve in accordance with IEC 61131, type 3	Yes
Number of simultaneously controllable inputs	
all mounting positions	
- up to 60 °C, max.	16
Input voltage	
• Rated value (DC)	24 V
• for signal "0"	-3 to +5V
• for signal "1"	+11 to +30V
Input current	
• for signal "1", typ.	2.4 mA
Input delay (for rated value of input voltage) for standard inputs	
- parameterizable	Yes; 0.05 / 0.1 / 0.4 / 0.8 / 1.6 / 3.2 / 12.8 / 20 ms
Cable length	
• unshielded, max.	30 m
Digital outputs	
Number of digital outputs	16; Parameterizable as DIQ
• in groups of	8; 2 load groups for 8 outputs each
Current-sourcing	Yes
Short-circuit protection	Yes; per channel, electronic
Limitation of inductive shutdown voltage to	0.5 A: Type 1L+ (-70 V) / 2 A: Type (-18 V)
Controlling a digital input	Yes
Switching capacity of the outputs	
• with resistive load, max.	0.5 A / 2 A
• with inductive load, max.	0.5 A / 2 A
• on lamp load, max.	0.5 A: 5 W / 2 A 10 W
Load resistance range	
• lower limit	0.5 A: 48 ohms / 2 A: 12 ohms
• upper limit	4 kΩ
Output voltage	
• for signal "1", min.	1L+ (-0.8 V) / 2L+ (-0.8 V)
Output current	
• for signal "1" rated value	0.5 A / 2 A
• for signal "0" residual current, max.	0.1 mA
Parallel switching of two outputs	
• for uprating	No
• for redundant control of a load	Yes

Article number	6ES7143-6BH00-0BB0 ET 200eco PN, DIQ 16x24VDC/2A, M12-L
Switching frequency	
• with resistive load, max.	0.5 A: 100 Hz / 2 A: 40 Hz
• with inductive load, max.	0.5 Hz
• on lamp load, max.	1 Hz
Total current of the outputs	
• Current per group, max.	1L+: 2 A / 2L+: 6 A
• Current per module, max.	8 A
Cable length	
• unshielded, max.	30 m
Encoder	
Connectable encoders	
• 2-wire sensor	Yes
- permissible quiescent current (2-wire sensor), max.	1.5 mA
Interfaces	
Number of PROFINET interfaces	1
1. Interface	
Interface type	PROFINET with 100 Mbit/s full duplex (100BASE-TX)
Interface types	
• M12 port	Yes; 2x M12, 4-pin, D-coded
• Number of ports	2
• integrated switch	Yes
Protocols	
• PROFINET IO Device	Yes
• Open IE communication	Yes
Interface types	
M12 port	
• Autonegotiation	Yes
• Autocrossing	Yes
• Transmission rate, max.	100 Mbit/s
Protocols	
Supports protocol for PROFINET IO	Yes
PROFIsafe	No
EtherNet/IP	Yes
Modbus TCP	Yes
PROFINET IO Device	
Services	
- IRT	Yes; 250 μs to 4 ms in 125 μs frame
- Prioritized startup	Yes
- Shared device	Yes
- Number of IO Controllers with shared device, max.	2
Redundancy mode	
• PROFINET system redundancy (S2)	Yes
• Redundant PROFINET configuration (R1)	No
• H-Sync forwarding	Yes
Media redundancy	
- MRP	Yes

Technical specifications

Article number	6ES7143-6BH00-0BB0 ET 200eco PN, DIQ 16x24VDC/2A, M12-L
EtherNet/IP	
Services	
- CIP Implicit Messaging	Yes
- CIP Explicit Messaging	Yes
- CIP Safety	No
- Shared device	Yes; 2x EtherNet/IP Scanner
- Number of scanners with shared device, max.	2
Updating times	
- Requested Packet Interval (RPI)	2 ms
Redundancy mode	
- DLR (Device Level Ring)	No
Address area	
- Address space per module, max.	20 byte
- LargeForwardOpen (Class3)	No
Modbus TCP	
Services	
- read coils (code=1)	Yes
- read discrete inputs (code=2)	Yes
- Read Holding Registers (Code=3)	Yes
- write single coil (code=5)	Yes
- write multiple coils (code=15)	Yes
- Write Multiple Registers (Code=16)	Yes
- Parameter change by master	No
- Modbus TCP Security Protocol	No
Address space per station	
- Address space per station, max.	20 byte
- Access-consistent address space	2 byte
Updating time	
- I/O request interval	2 ms
Connections	
- Number of connections per slave	12
Open IE communication	
• TCP/IP	Yes; (only EtherNet/IP or Modbus TCP)
• SNMP	Yes
• LLDP	Yes
• ARP	Yes
Interrupts/diagnostics/status information	
Substitute values connectable	Yes
Alarms	
• Diagnostic alarm	Yes; Parameterizable
• Maintenance interrupt	Yes; Parameterizable
• Hardware interrupt	Yes; Parameterizable
Diagnoses	
• Diagnostic information readable	Yes
• Monitoring the supply voltage	Yes
- parameterizable	Yes
• Wire-break	Yes; DI, input current < 0.3 mA, per channel
• Short-circuit	Yes; Outputs to M and P; channel by channel
• Short-circuit encoder supply	Yes; Per channel group

Article number	6ES7143-6BH00-0BB0 ET 200eco PN, DIQ 16x24VDC/2A, M12-L
Diagnostics indication LED	
• RUN LED	Yes; green LED
• ERROR LED	Yes; red LED
• MAINT LED	Yes; Yellow LED
• NS LED	Yes; green/red LED
• MS LED	Yes; green/red LED
• IO LED	Yes; red-green-yellow LED
• Channel status display	Yes; green LED
• for channel diagnostics	Yes; red LED
• For load voltage monitoring	Yes; green LED
• Connection display LINK TX/RX	Yes; green LED, only link
Potential separation	
between the load voltages	Yes
between Ethernet and electronics	Yes
Potential separation channels	
• between the channels	Yes
• between the channels, in groups of 8	8
• between the channels and the power supply of the electronics	8 channels are non-isolated and 8 channels are isolated from supply voltage 1L+
Degree and class of protection	
IP degree of protection	IP65/67
Standards, approvals, certificates	
Suitable for safety-related tripping of standard modules	Yes; From FS01
Highest safety class achievable for safety-related tripping of standard modules	
• Performance level according to ISO 13849-1	PL d
• Category according to ISO 13849-1	Cat. 3
• SILCL according to IEC 62061	SILCL 2
Ambient conditions	
Ambient temperature during operation	
• min.	-40 °C
• max.	60 °C
Altitude during operation relating to sea level	
• Ambient air temperature-barometric pressure-altitude	Up to max. 5 000 m, at installation height > 2 000 m additional restrictions
Connection method	
Design of electrical connection	4/5-pin M12 circular connectors
Design of electrical connection for the inputs and outputs	M12, 5-pin, A-coded
Design of electrical connection for supply voltage	M12, 4-pin, L-coded
Dimensions	
Width	45 mm
Height	200 mm
Depth	48 mm
Weights	
Weight, approx.	780 g

I/O systemsSIMATIC ET 200 systems without control cabinet
SIMATIC ET 200eco PN**I/O devices > Digital I/O devices****Technical specifications**

Article number	6ES7147-6BG00-0AB0 ET200eco PN, 8 DIO, DC24V/1,3A, 8xM12
Supply voltage	
Rated value (DC)	24 V
Reverse polarity protection	Yes
Load voltage 2L+	
• Rated value (DC)	24 V
• Reverse polarity protection	Yes
Input current	
Current consumption, typ.	100 mA
from supply voltage 1L+, max.	4 A
from load voltage 1L+ (unswitched voltage)	4 A
from load voltage 2L+, max.	4 A
Digital inputs	
Number of digital inputs	8
• in groups of	4
Input characteristic curve in accordance with IEC 61131, type 3	Yes
Number of simultaneously controllable inputs all mounting positions	
- up to 60 °C, max.	8
Input voltage	
• Rated value (DC)	24 V
• for signal "0"	-3 to +5V
• for signal "1"	+11 to +30V
Input current	
• for signal "1", typ.	7 mA
Cable length	
• unshielded, max.	30 m
Digital outputs	
Number of digital outputs	8
• in groups of	4
Short-circuit protection	Yes; Electronic
Limitation of inductive shutdown voltage to	Typ. (L1+, L2+) -47 V
Controlling a digital input	Yes
Switching capacity of the outputs	
• on lamp load, max.	5 W
Output current	
• for signal "1" rated value	1.3 A; Maximum
• for signal "0" residual current, max.	1.5 mA
Parallel switching of two outputs	
• for uprating	No
• for redundant control of a load	Yes
Switching frequency	
• with resistive load, max.	100 Hz
• with inductive load, max.	0.5 Hz
• on lamp load, max.	1 Hz

Article number	6ES7147-6BG00-0AB0 ET200eco PN, 8 DIO, DC24V/1,3A, 8xM12
Total current of the outputs (per group) all mounting positions	
- up to 60 °C, max.	3.9 A
Cable length	
• unshielded, max.	30 m
Encoder	
Connectable encoders	
• 2-wire sensor	Yes
- permissible quiescent current (2-wire sensor), max.	1.5 mA
Interfaces	
Transmission procedure	100BASE-TX
Number of PROFINET interfaces	1
1. Interface	
Interface types	
• M12 port	Yes
• integrated switch	Yes
Interface types	
M12 port	
• Autonegotiation	Yes
• Autocrossing	Yes
• Transmission rate, max.	100 Mbit/s
Protocols	
Supports protocol for PROFINET IO	Yes
PROFINET CBA	No
PROFIsafe	No
PROFINET IO Device	
Services	
- IRT with the option "high flexibility"	Yes
- Prioritized startup	Yes
Redundancy mode	
Media redundancy	
- MRP	Yes
Open IE communication	
• TCP/IP	No
• SNMP	Yes
• DCP	Yes
• LLDP	Yes
• ping	Yes
• ARP	Yes
Interrupts/diagnostics/ status information	
Diagnostics function	Yes
Alarms	
• Diagnostic alarm	Yes

Technical specifications

Article number	6ES7147-6BG00-0AB0 ET200eco PN, 8 DIO, DC24V/1,3A, 8xM12
Diagnoses	
• Diagnostic information readable	Yes
• Monitoring the supply voltage	Yes; green "ON" LED
• Wire-break in actuator cable	Yes
• Wire-break in signal transmitter cable	Yes
• Short-circuit	Yes
• Short-circuit encoder supply	Yes
• Group error	Yes; Red/yellow "SF/MT" LED
Potential separation	
between the load voltages	Yes
between load voltage and all other switching components	No
between Ethernet and electronics	Yes
Potential separation channels	
• between the channels	No

Article number	6ES7147-6BG00-0AB0 ET200eco PN, 8 DIO, DC24V/1,3A, 8xM12
Degree and class of protection	
IP degree of protection	IP65/67
Standards, approvals, certificates	
Suitable for safety-related tripping of standard modules	No
Connection method	
Design of electrical connection	4/5-pin M12 circular connectors
Dimensions	
Width	60 mm
Height	175 mm
Depth	49 mm
Weights	
Weight, approx.	910 g

I/O systems

SIMATIC ET 200 systems without control cabinet
SIMATIC ET 200eco PN

I/O devices > Analog I/O devices**Overview**

Analog I/O devices with 2x M12 A-coded power connectors and 60 mm width

- 8 analog input signals U/I/RTD/TC with 8xM12 connection
- 8 analog input signals RTD/TC with 8xM12 connection
- 4 analog output signals U/I with 4xM12 connection

Ordering data**Article No.****Article No.****ET 200eco PN analog input modules**

- 8 AI 4 U/I + 4 RTD/TC; 8 x M12, degree of protection IP67
- 8 AI RTD/TC; 8 x M12, degree of protection IP67

6ES7144-6KD00-0AB0

6ES7144-6KD50-0AB0

ET 200eco PN analog output modules

- 4 AQ U/I; 4 x M12, degree of protection IP67

6ES7145-6HD00-0AB0

Accessories

- PD voltage distributor, 24 V DC; 1 X 7/8", 4 X M12
- Terminal block for ET 200eco PN, 10 A insulation displacement terminals
- Spare fuses for terminal block, 10 units
- Mounting rail 0.5 m
- Profile screw for mounting rail, 50 units
- Sealing cap M12 for IP67 modules, 12 mm external diameter, without O-ring, 10 units
- Sealing cap M12 for IP67 modules, 15 mm external diameter, with O-ring, 10 units
- Labels 10 mm x 7 mm Ti-grey, for I/O devices with 2x M12 A-coded power connectors; 5 frames with 40 labels each

6ES7148-6CB00-0AA0

6ES7194-6CA00-0AA0

6ES7194-6HB00-0AA0

6ES7194-6GA00-0AA0

6ES7194-6MA00-0AA0

3RX9802-0AA00

3RK1901-1KA00

3RT2900-1SB10

PROFINET M12 connection plug, for user assembly

Connector for PROFINET, 4-core, shielded

IE M12 Plug PRO connector

- 1 unit
- 8 units

IE FC M12 plug PRO connector, for user assembly

- 1 unit
- 8 units

3RK1902-2DA00

6GK1901-0DB10-6AA0

6GK1901-0DB10-6AA8

6GK1901-0DB20-6AA0

6GK1901-0DB20-6AA8

M12 connection plug for 24 V DC load power supply

Connection socket for 24 V DC incoming supply; 4-pin, A-coded, 3 units

6GK1907-0DC10-6AA3

Connector for loop-through of 24 V DC; 4-pin, A-coded, 3 units

6GK1907-0DB10-6AA3

M12 coupler plug

Can be assembled, for connecting actuators or sensors, 5-pin, screw connection, max. 0.75 mm², A-coded, max. 4 A

- Straight
- Angled

3RK1902-4BA00-5AA0

3RK1902-4DA00-5AA0

M12 coupler socket

4-pin, screw connection, max. 0.75 mm², A-coded, max. 4 A, angled

3RK1902-4CA00-4AA0

PROFINET bus cable

Assembled on one side with 1 x M12, D-coded, 4-wire, shielded

- 3 m
- 5 m
- 10 m

3RK1902-2HB30

3RK1902-2HB50

3RK1902-2HC10

IE connecting cable M12-90/M12-90

Pre-assembled IE FC TP trailing cable GP 2 x 2 (PROFINET type C) with two 4-pin M12 plugs (D-coded) up to 85 m, IP65/IP67 degree of protection, 90° cable outlet
Length:

- 0.3 m
- 0.5 m
- 1.0 m
- 1, 5 m
- 2.0 m
- 3.0 m
- 5.0 m
- 10 m
- 15 m

6XV1870-8GE30

6XV1870-8GE50

6XV1870-8GH10

6XV1870-8GH15

6XV1870-8GH20

6XV1870-8GH30

6XV1870-8GH50

6XV1870-8GN10

6XV1870-8GN15

Ordering data	Article No.	Article No.
IE connecting cable M12-180/IE FC RJ45 plug-145 Pre-assembled IE FC TP trailing cable GP 2 x 2 (PROFINET type C) with M12 plug (D-coded) and IE FC RJ45 Plug, IP65/IP67 degree of protection Length: <ul style="list-style-type: none"> • 2.0 m • 3.0 m • 5.0 m • 10 m • 15 m 	6XV1871-5TH20 6XV1871-5TH30 6XV1871-5TH50 6XV1871-5TN10 6XV1871-5TN15	M12 power connecting cable M12-90/M12-90 Flexible 4-core power connecting cable, assembled with A-coded, 5-pin M12 plug and A-coded, 5-pin M12 socket to supply the ET 200 with 24 V DC; 90° cable outlet Length: <ul style="list-style-type: none"> • 0.3 m • 0.5 m • 1.0 m • 1.5 m • 2.0 m • 3.0 m • 5.0 m • 10 m • 15 m
IE robust connecting cable M12-180/M12-180 Pre-assembled IE FC TP robust food cable 2 x 2 (PROFINET type C) with two 4-pin M12 plugs (D-coded), IP69 degree of protection Length: <ul style="list-style-type: none"> • 1.0 m • 2.0 m • 3.0 m • 5.0 m 	6XV1881-5AH10 6XV1881-5AH20 6XV1881-5AH30 6XV1881-5AH50	M12 robust power connecting cable M12-180/M12-180 Flexible 4-wire power connecting cable, assembled with A-coded, 5-pin M12 plug and A-coded, 5-pin M12 socket to supply IP69 components with 24 V DC; Length: <ul style="list-style-type: none"> • 1.0 m • 2.0 m • 3.0 m • 5.0 m
		6XV1801-5GE30 6XV1801-5GE50 6XV1801-5GH10 6XV1801-5GH15 6XV1801-5GH20 6XV1801-5GH30 6XV1801-5GH50 6XV1801-5GN10 6XV1801-5GN15
		6XV1801-5AH10 6XV1801-5AH20 6XV1801-5AH30 6XV1801-5AH50

Technical specifications

Article number	6ES7144-6KD00-0AB0	6ES7144-6KD50-0AB0
	ET200eco PN, 8AI; 4 U/I; 4 RTD/TC 8xM12	ET200eco PN, 8AI RTD/TC 8xM12
Supply voltage		
Rated value (DC)	24 V	24 V
Reverse polarity protection	Yes	Yes; against destruction
Input current		
Current consumption, typ.	110 mA	110 mA
Encoder supply		
Number of outputs	4	
Analog inputs		
Number of analog inputs	8	8
Input ranges (rated values), voltages		
• 0 to +10 V	Yes	
• 1 V to 5 V	Yes	
• -10 V to +10 V	Yes	
• -80 mV to +80 mV	Yes	Yes
Input ranges (rated values), currents		
• 0 to 20 mA	Yes	
• -20 mA to +20 mA	Yes	
• 4 mA to 20 mA	Yes	

I/O systems

SIMATIC ET 200 systems without control cabinet

SIMATIC ET 200eco PN

I/O devices > Analog I/O devices

Technical specifications

Article number	6ES7144-6KD00-0AB0 ET200eco PN, 8AI; 4 U/I; 4 RTD/TC 8xM12	6ES7144-6KD50-0AB0 ET200eco PN, 8AI RTD/TC 8xM12
Input ranges (rated values), thermocouples		
• Type E	Yes	Yes
• Type J	Yes	Yes
• Type K	Yes	Yes
• Type N	Yes	Yes
Input ranges (rated values), resistance thermometer		
• Ni 100	Yes	Yes
• Ni 1000	Yes	Yes
• Ni 120	Yes	Yes
• Ni 200	Yes	Yes
• Ni 500	Yes	Yes
• Pt 100	Yes	Yes
• Pt 1000	Yes	Yes
• Pt 200	Yes	Yes
• Pt 500	Yes	Yes
Input ranges (rated values), resistors		
• 0 to 150 ohms	Yes	Yes
• 0 to 300 ohms	Yes	Yes
• 0 to 600 ohms	Yes	Yes
• 0 to 3000 ohms	Yes	Yes
Thermocouple (TC)		
Temperature compensation		
- parameterizable	Yes	Yes
- internal temperature compensation	Yes	Yes
- external temperature compensation with Pt100		Yes
- external temperature compensation with compensations socket	Yes	Yes
- dynamic reference temperature value		Yes
- for definable comparison point temperature		Yes
Cable length		
• shielded, max.	30 m	30 m
Analog value generation for the inputs		
Analog value display	SIMATIC S7 format	SIMATIC S7 format
Measurement principle	integrating	integrating
Integration and conversion time/resolution per channel		
• Resolution with overrange (bit including sign), max.	16 bit	16 bit
• Integration time, parameterizable	Yes	Yes
• Integration time (ms)	2/16.67/20/100 ms	2/16.67/20/100 ms
• Interference voltage suppression for interference frequency f1 in Hz	500 / 60 / 50 / 10 Hz	500 / 60 / 50 / 10 Hz
• Conversion time (per channel)	4 / 19 / 22 / 102 ms	4 / 19 / 22 / 102 ms
Smoothing of measured values		
• parameterizable	Yes	Yes
Encoder		
Number of connectable encoders, max.	8	8

10

Technical specifications

Article number	6ES7144-6KD00-0AB0 ET200eco PN, 8AI; 4 U/I; 4 RTD/TC 8xM12	6ES7144-6KD50-0AB0 ET200eco PN, 8AI RTD/TC 8xM12
Connection of signal encoders		
• for voltage measurement	Yes	
• for current measurement as 2-wire transducer	Yes	
• for current measurement as 4-wire transducer	Yes	
• for resistance measurement with two-wire connection	Yes	Yes
• for resistance measurement with three-wire connection	Yes	Yes
• for resistance measurement with four-wire connection	Yes	Yes
Errors/accuracies		
Linearity error (relative to input range), (+/-)	0.01 %	0.01 %
Temperature error (relative to input range), (+/-)	U: 0.0035%/°C; I:0.006%/°C; RTD: 0.0005%/°C; TC: 0.0035%/°C	RTD: 0.0005%/°C; TC: 0.0035%/°C
Crosstalk between the inputs, min.	85 dB	-85 dB
Repeat accuracy in steady state at 25 °C (relative to input range), (+/-)	0.008 %	0.008 %
Interference voltage suppression for $f = n \times (f1 \pm 1 \%)$, $f1 =$ interference frequency		
• Series mode interference (peak value of interference < rated value of input range), min.	46 dB	46 dB
• Common mode interference, min.	70 dB	70 dB
Interfaces		
Transmission procedure	100BASE-TX	100BASE-TX
Number of PROFINET interfaces	1	1
1. Interface		
Interface types		
• M12 port	Yes	
• integrated switch	Yes	Yes
Interface types		
M12 port		
• Autonegotiation	Yes	Yes
• Autocrossing	Yes	Yes
• Transmission rate, max.	100 Mbit/s	100 Mbit/s
Protocols		
Supports protocol for PROFINET IO	Yes	Yes
PROFINET CBA	No	No
PROFIsafe	No	No
PROFINET IO Device		
Services		
- IRT with the option "high flexibility"	Yes	
- Prioritized startup	Yes	Yes
Redundancy mode		
Media redundancy		
- MRP	Yes	Yes
Open IE communication		
• TCP/IP	No	No
• SNMP	Yes	Yes
• DCP	Yes	Yes
• LLDP	Yes	Yes
• ping	Yes	Yes
• ARP	Yes	Yes

I/O systems

SIMATIC ET 200 systems without control cabinet
SIMATIC ET 200eco PN

I/O devices > Analog I/O devices

Technical specifications

Article number	6ES7144-6KD00-0AB0 ET200eco PN, 8AI; 4 U/I; 4 RTD/TC 8xM12	6ES7144-6KD50-0AB0 ET200eco PN, 8AI RTD/TC 8xM12
Interrupts/diagnostics/ status information		
Diagnostics function	Yes	Yes
Alarms		
• Diagnostic alarm	Yes	Yes
Diagnoses		
• Diagnostic information readable	Yes	Yes
• Monitoring the supply voltage	Yes; green "ON" LED	Yes; green "ON" LED
• Short-circuit encoder supply	Yes; per module	
• Group error	Yes; Red/yellow "SF/MT" LED	Yes; Red/yellow "SF/MT" LED
• Overflow/underflow	Yes	Yes
Potential separation		
between the load voltages	Yes	Yes
between load voltage and all other switching components	No	No
between Ethernet and electronics	Yes	Yes
Potential separation channels		
• between the channels	No	No
Degree and class of protection		
IP degree of protection	IP65/67	IP65/67
Standards, approvals, certificates		
Suitable for applications according to AMS 2750	Yes; Declaration of Conformity, see online support entry 109757262	Yes; Declaration of Conformity, see online support entry 109757262
Suitable for applications according to CQI-9	Yes; Based on AMS 2750 E	Yes; Based on AMS 2750 E
Connection method		
Design of electrical connection	4/5-pin M12 circular connectors	4/5-pin M12 circular connectors
Dimensions		
Width	60 mm	60 mm
Height	175 mm	175 mm
Depth	49 mm	49 mm
Weights		
Weight, approx.	930 g	930 g

Article number	6ES7145-6HD00-0AB0 ET200eco PN, 4AO U/I 4xM12
Supply voltage	
Rated value (DC)	24 V
Reverse polarity protection	Yes
Input current	
Current consumption, typ.	280 mA
Actuator supply	
Number of outputs	4
Analog outputs	
Number of analog outputs	4
Voltage output, short-circuit protection	Yes
Voltage output, short-circuit current, max.	30 mA
Current output, no-load voltage, max.	20 V
Output ranges, voltage	
• 0 to 10 V	Yes
• 1 V to 5 V	Yes
• -10 V to +10 V	Yes

Article number	6ES7145-6HD00-0AB0 ET200eco PN, 4AO U/I 4xM12
Output ranges, current	
• 0 to 20 mA	Yes
• -20 mA to +20 mA	Yes
• 4 mA to 20 mA	Yes
Connection of actuators	
• for voltage output two-wire connection	Yes
• for current output two-wire connection	Yes
Load impedance (in rated range of output)	
• with voltage outputs, min.	1 kΩ
• with voltage outputs, capacitive load, max.	1 μF
• with current outputs, max.	600 Ω
• with current outputs, inductive load, max.	1 mH
Cable length	
• shielded, max.	30 m
Analog value generation for the outputs	
Analog value display	SIMATIC S7 format
Conversion principle	Resistor network

Technical specifications

Article number	6ES7145-6HD00-0AB0 ET200eco PN, 4AO U/I 4xM12
Integration and conversion time/resolution per channel	
• Resolution with overrange (bit including sign), max.	16 bit
• Conversion time (per channel)	1 ms
Settling time	
• for resistive load	2 ms
• for capacitive load	1.8 ms
• for inductive load	2 ms
Errors/accuracies	
Output ripple (relative to output range, bandwidth 0 to 50 kHz), (+/-)	U: ±0.6 mVrms; I: ±0.4 nArms
Linearity error (relative to output range), (+/-)	0.02 %
Temperature error (relative to output range), (+/-)	U: 0.001%/°C; I: 0.0025%/°C
Crosstalk between the outputs, min.	70 dB
Repeat accuracy in steady state at 25 °C (relative to output range), (+/-)	0.008 %
Interfaces	
Transmission procedure	100BASE-TX
Number of PROFINET interfaces	1
1. Interface	
Interface types	
• M12 port	Yes
• integrated switch	Yes
Interface types	
M12 port	
• Autonegotiation	Yes
• Autocrossing	Yes
• Transmission rate, max.	100 Mbit/s
Protocols	
Supports protocol for PROFINET IO	Yes
PROFINET CBA	No
PROFIsafe	No
PROFINET IO Device	
Services	
- IRT with the option "high flexibility"	Yes
- Prioritized startup	Yes

Article number	6ES7145-6HD00-0AB0 ET200eco PN, 4AO U/I 4xM12
Redundancy mode	
Media redundancy	
- MRP	Yes
Open IE communication	
• TCP/IP	No
• SNMP	Yes
• DCP	Yes
• LLDP	Yes
• ping	Yes
• ARP	Yes
Interrupts/diagnostics/status information	
Diagnostics function	Yes
Substitute values connectable	Yes
Alarms	
• Diagnostic alarm	Yes
Diagnoses	
• Diagnostic information readable	Yes
• Monitoring the supply voltage	Yes; green "ON" LED
• Wire-break	Yes; Channel-by-channel with current output
• Short-circuit	Yes; Channel-by-channel with voltage output
• Group error	Yes; Red/yellow "SF/MT" LED
Potential separation	
between the load voltages	Yes
between load voltage and all other switching components	No
between Ethernet and electronics	Yes
Potential separation channels	
• between the channels	No
Degree and class of protection	
IP degree of protection	IP65/67
Connection method	
Design of electrical connection	4/5-pin M12 circular connectors
Dimensions	
Width	60 mm
Height	175 mm
Depth	49 mm
Weights	
Weight, approx.	930 g

I/O systems

SIMATIC ET 200 systems without control cabinet
SIMATIC ET 200eco PN

I/O devices > Fail-safe I/O device

Overview



The ET 200eco PN fail-safe I/O device expands the ET 200eco PN system family. It is incorporated seamlessly into the Safety Integrated concept like with ET 200MP / ET 200SP and ET200pro. It also supports safety-related communication via PROFINET. The functional safety is certified in accordance with IEC 61508. It is designed for safety-related use up to SIL 3 according to IEC 62061 and PL e according to ISO 13849.

The following fail-safe I/O device with 2x M12 A-coded power connectors and 60 mm width is available:

- F-DI 8x24V /F-DQ 3x24V 2A with 8xM12 connection

Ordering data

Article No.

Article No.

ET 200eco PN fail-safe digital input/output modules

- 8 F-DI 24 V DC/
3 F-DQ 24 V DC/2 A;
PROFINET, certified up to SIL 3 (IEC 61508), PL e (ISO 13849);
4 x M12/3 x M12, degree of protection IP65/67

6ES7146-6FF00-0AB0

Accessories

- PD voltage distributor, 24 V DC; 1 X 7/8", 4 X M12
- Terminal block for ET 200eco PN, 10 A insulation displacement terminals
- Spare fuses for terminal block, 10 units
- Mounting rail 0.5 m
- Profile screw for mounting rail, 50 units
- Sealing cap M12 for IP67 modules, 12 mm external diameter, without O-ring, 10 units
- Sealing cap M12 for IP67 modules, 15 mm external diameter, with O-ring, 10 units
- Labels 10 mm x 7 mm yellow, for I/O devices with 2x M12 A-coded power connectors; 17 frames with 48 labels each

6ES7148-6CB00-0AA0

6ES7194-6CA00-0AA0

6ES7194-6HB00-0AA0

6ES7194-6GA00-0AA0

6ES7194-6MA00-0AA0

3RX9802-0AA00

3RK1901-1KA00

6ES7194-6HA00-0AA0

PROFINET M12 connection plug, for user assembly

Connector for PROFINET, 4-core, shielded

IE M12 Plug PRO connector

- 1 unit
- 8 units

IE FC M12 plug PRO connector, for user assembly

- 1 unit
- 8 units

3RK1902-2DA00

6GK1901-0DB10-6AA0

6GK1901-0DB10-6AA8

6GK1901-0DB20-6AA0

6GK1901-0DB20-6AA8

M12 connection plug for 24 V DC load power supply

Connection socket for 24 V DC incoming supply; 4-pin, A-coded, 3 units

Connector for loop-through of 24 V DC; 4-pin, A-coded, 3 units

6GK1907-0DC10-6AA3

6GK1907-0DB10-6AA3

M12 coupler plug

Can be assembled, for connecting actuators or sensors, 5-pin, screw connection, max. 0.75 mm², A-coded, max. 4 A

- Straight
- Angled

3RK1902-4BA00-5AA0
3RK1902-4DA00-5AA0

M12 coupler socket

4-pin, screw connection, max. 0.75 mm², A-coded, max. 4 A, angled

3RK1902-4CA00-4AA0

PROFINET bus cable

Assembled on one side with 1 x M12, D-coded, 4-wire, shielded

- 3 m
- 5 m
- 10 m

3RK1902-2HB30
3RK1902-2HB50
3RK1902-2HC10

IE connecting cable M12-90/M12-90

Pre-assembled IE FC TP trailing cable GP 2 x 2 (PROFINET type C) with two 4-pin M12 plugs (D-coded) up to 85 m, IP65/IP67 degree of protection, 90° cable outlet

Length:

- 0.3 m
- 0.5 m
- 1.0 m
- 1, 5 m
- 2.0 m
- 3.0 m
- 5.0 m
- 10 m
- 15 m

6XV1870-8GE30
6XV1870-8GE50
6XV1870-8GH10
6XV1870-8GH15
6XV1870-8GH20
6XV1870-8GH30
6XV1870-8GH50
6XV1870-8GN10
6XV1870-8GN15

IE connecting cable M12-180/IE FC RJ45 plug-145

Pre-assembled IE FC TP trailing cable GP 2 x 2 (PROFINET type C) with M12 plug (D-coded) and IE FC RJ45 Plug, IP65/IP67 degree of protection

Length:

- 2.0 m
- 3.0 m
- 5.0 m
- 10 m
- 15 m

6XV1871-5TH20
6XV1871-5TH30
6XV1871-5TH50
6XV1871-5TN10
6XV1871-5TN15

Ordering data	Article No.	Article No.
IE robust connecting cable M12-180/M12-180 Pre-assembled IE FC TP robust food cable 2 x 2 (PROFINET type C) with two 4-pin M12 plugs (D-coded), IP69 degree of protection Length: <ul style="list-style-type: none"> • 1.0 m • 2.0 m • 3.0 m • 5.0 m 	6XV1881-5AH10 6XV1881-5AH20 6XV1881-5AH30 6XV1881-5AH50	IO-Link connecting cables Between IO-Link master and reader, on both sides with M12 plug, 4-pin <ul style="list-style-type: none"> • 5 m • 10 m
M12 Y cable For connection of single-channel sensors (1001 evaluation), 5-pin For joint connection of an F-DQ and an F-DI channel by means of an 8-pin M12 socket	6ES7194-6KB00-0XA0 6ES7194-6KC00-0XA0	M12 power connecting cable M12-90/M12-90 Flexible 4-core power connecting cable, assembled with A-coded, 5-pin M12 plug and A-coded, 5-pin M12 socket to supply the ET 200 with 24 V DC; 90° cable outlet Length: <ul style="list-style-type: none"> • 0.3 m • 0.5 m • 1.0 m • 1.5 m • 2.0 m • 3.0 m • 5.0 m • 10 m • 15 m
E-coding plug for fail-safe ET 200 distributed I/O, IP65/67	6ES7194-6KB00-0AA0	6GT2891-4MH50 6GT2891-4MN10
E-coding plug (metal) for fail-safe ET 200 distributed I/O, IP65/67	6ES7194-6KB01-0AA0	
Control line Assembled on one side with 1 x M12 plug angled, 5-pin, 5 x 0.34 mm ² , A-coded, max. 4 A, PUR casing, black <ul style="list-style-type: none"> • 1.5 m • 5 m • 10 m Assembled, 1 x M12 cable box straight, 1 x M12 plug, 3 x 0.34 mm ² , A-coded, max. 4 A, PUR casing, black	3RK1902-4HB15-5AA0 3RK1902-4HB50-5AA0 3RK1902-4HC01-5AA0 3RK1902-4PB15-3AA0	M12 robust power connecting cable M12-180/M12-180 Flexible 4-wire power connecting cable, assembled with A-coded, 5-pin M12 plug and A-coded, 5-pin M12 socket to supply IP69 components with 24 V DC; Length: <ul style="list-style-type: none"> • 1.0 m • 2.0 m • 3.0 m • 5.0 m
		6XV1801-5GE30 6XV1801-5GE50 6XV1801-5GH10 6XV1801-5GH15 6XV1801-5GH20 6XV1801-5GH30 6XV1801-5GH50 6XV1801-5GN10 6XV1801-5GN15
		6XV1801-5AH10 6XV1801-5AH20 6XV1801-5AH30 6XV1801-5AH50

10

Technical specifications

Article number	6ES7146-6FF00-0AB0 ET 200eco PN, F-DI 8x24V /F-DQ 3x24V 2A	Article number	6ES7146-6FF00-0AB0 ET 200eco PN, F-DI 8x24V /F-DQ 3x24V 2A
General information		Digital inputs	
Engineering with		Number of digital inputs	8; 8 (one-channel); 4 (two-channel)
• STEP 7 TIA Portal configurable/integrated from version	V15 with HSP 204	Digital inputs, parameterizable	Yes
Operating mode		Input characteristic curve in accordance with IEC 61131, type 1	Yes
• DI	Yes	Number of simultaneously controllable inputs	
• DQ	Yes	all mounting positions	
Supply voltage		- up to 60 °C, max.	8
Rated value (DC)	24 V	Input voltage	
Reverse polarity protection	Yes	• Rated value (DC)	24 V
Load voltage 1L+		• for signal "0"	-30 V DC to +5 V DC
• Rated value (DC)	24 V	• for signal "1"	15 V DC to 30 V DC
• Reverse polarity protection	Yes	Input delay (for rated value of input voltage) for standard inputs	
Load voltage 2L+		- parameterizable	Yes; 0.8 / 1.6 / 3.2 / 6.4 / 12.8 ms
• Rated value (DC)	24 V		
• Reverse polarity protection	Yes		
Input current			
Current consumption, typ.	200 mA		
from supply voltage 1L+, max.	4 A		
from load voltage 2L+, max.	4 A		

I/O systems

SIMATIC ET 200 systems without control cabinet
SIMATIC ET 200eco PN

I/O devices > Fail-safe I/O device**Technical specifications**

Article number	6ES7146-6FF00-0AB0 ET 200eco PN, F-DI 8x24V /F-DQ 3x24V 2A
Cable length • unshielded, max.	30 m
Digital outputs	
Number of digital outputs	3
• in groups of	3
Short-circuit protection	Yes; Electronic
Limitation of inductive shutdown voltage to	PM-switching: Typ. -26 V to (-48 V)
Controlling a digital input	No
Switching capacity of the outputs • on lamp load, max.	10 W
Output current • for signal "1" rated value • for signal "0" residual current, max.	2 A 0.5 mA
Parallel switching of two outputs • for uprating • for redundant control of a load	No No
Switching frequency • with resistive load, max. • with inductive load, max. • on lamp load, max.	30 Hz 0.1 Hz 10 Hz
Total current of the outputs (per group) all mounting positions - up to 60 °C, max.	3.9 A
Cable length • unshielded, max.	30 m
Encoder	
Connectable encoders • 2-wire sensor - permissible quiescent current (2-wire sensor), max.	No 0.5 mA
Interfaces	
Transmission procedure	100BASE-TX
Number of PROFINET interfaces	1
1. Interface	
Interface types • M12 port • integrated switch	Yes Yes
Interface types	
M12 port • Autonegotiation • Autocrossing • Transmission rate, max.	Yes Yes 100 Mbit/s
Protocols	
Supports protocol for PROFINET IO	Yes
PROFINET CBA	No
PROFIsafe	Yes
PROFINET IO Device	
Services - IRT with the option "high flexibility" - Prioritized startup	No; module will participate within an IRT topology No

Article number	6ES7146-6FF00-0AB0 ET 200eco PN, F-DI 8x24V /F-DQ 3x24V 2A
Open IE communication • TCP/IP • SNMP • DCP • LLDP • ping • ARP	No Yes Yes Yes Yes Yes
Interrupts/diagnostics/status information	
Diagnostics function	Yes
Alarms • Diagnostic alarm	Yes
Diagnoses • Diagnostic information readable • Monitoring the supply voltage • Wire-break in actuator cable • Wire-break in signal transmitter cable • Short-circuit • Short-circuit encoder supply • Group error	Yes Yes; green "ON" LED Yes Yes Yes Yes Yes; Red/yellow "SF/MT" LED
Potential separation between the load voltages between load voltage and all other switching components between Ethernet and electronics	Yes No Yes
Potential separation channels • between the channels	No
Degree and class of protection IP degree of protection	IP65/67
Standards, approvals, certificates Suitable for safety-related tripping of standard modules	No
Highest safety class achievable in safety mode • Performance level according to ISO 13849-1 • SIL acc. to IEC 61508 • SILCL according to IEC 62061	PLe SIL 2 (single-channel), SIL 3 (two-channel) SIL 3
Ambient conditions	
Ambient temperature during operation • min. • max.	-25 °C 60 °C
Connection method Design of electrical connection	4/5-pin M12 circular connectors
Dimensions Width Height Depth	60 mm 175 mm 49 mm
Weights Weight, approx.	940 g

Overview

IO-Link master with 2x M12 L-coded power connectors and 45 mm width

- IO-Link communication modules for connecting up to 8 IO-Link devices
- IO-Link master with 4x Class A port and 4x Class B port as well as additional 4 digital inputs
- The IO-Link specifications V1.0 and V1.1 are supported



IO-Link master with 2x M12 A-coded power connectors and 60 mm width

- IO-Link communication modules for connecting up to 4 IO-Link devices
- IO-Link master with 4x Class A port and additional 8 digital inputs and 4 digital outputs
- The IO-Link specification V1.0 is supported



IO-Link master with 2x M12 A-coded power connectors and 30 mm width

- IO-Link communication modules for connecting up to 4 IO-Link devices
- IO-Link master with 4x Class B port
- The IO-Link specifications V1.0 and V1.1 are supported

I/O systemsSIMATIC ET 200 systems without control cabinet
SIMATIC ET 200eco PN**I/O devices > IO-Link master****Ordering data****Article No.****Article No.****ET 200eco PN IO-Link master**

- 4 IO-L + 8 DI + 4 DO, 24 V DC/1.3 A;
8 x M12, degree of protection IP67, enclosure width 60 mm;
for connecting up to 4 IO-Link devices according to IO-Link specification V1.0 and Class A port as well as 8 digital inputs and 4 digital outputs
- 4 IO-L;
4 x M12, degree of protection IP67, enclosure width 30 mm;
for connecting up to 4 IO-Link devices according to IO-Link specification V1.0 and V1.1 and Class B port
- 8 IO-L + 4 DI 24 V DC;
8 x M12, degree of protection IP67, enclosure width 45 mm;
for connecting up to 8 IO-Link devices according to IO-Link specification V1.0 and V1.1, 4x Class A port and 4 x Class B port, as well as 4 additional digital inputs

6ES7148-6JA00-0AB0**6ES7148-6JD00-0AB0****6ES7148-6JG00-0BB0****Accessories**

- PD voltage distributor, 24 V DC; 1 X 7/8", 4 X M12
- Terminal block for ET 200eco PN, 10 A insulation displacement terminals
- Spare fuses for terminal block, 10 units
- Mounting rail 0.5 m
- Profile screw for mounting rail, 50 units
- Sealing cap M12 for IP67 modules, 12 mm external diameter, without O-ring, 10 units
- Sealing cap M12 for IP67 modules, 15 mm external diameter, with O-ring, 10 units
- Labels 10 mm x 5 mm RAL9016, for I/O devices with 2x M12 L-coded power connectors; 5 frames with 40 labels each
- Labels 10 mm x 7 mm Ti-grey, for I/O devices with 2x M12 A-coded power connectors; 5 frames with 40 labels each

6ES7148-6CB00-0AA0**6ES7194-6CA00-0AA0****6ES7194-6HB00-0AA0****6ES7194-6GA00-0AA0****6ES7194-6MA00-0AA0****3RX9802-0AA00****3RK1901-1KA00****6ES7194-2BA00-0AA0****3RT2900-1SB10****PROFINET M12 connection plug, for user assembly**

Connector for PROFINET, 4-core, shielded

IE M12 plug PRO connector

- 1 unit
- 8 units

IE FC M12 plug PRO connector, for user assembly

- 1 unit
- 8 units

3RK1902-2DA00**6GK1901-0DB10-6AA0****6GK1901-0DB10-6AA8****6GK1901-0DB20-6AA0****6GK1901-0DB20-6AA8****M12 connection plug for 24 V DC load current supply**

Connection socket for 24 V DC incoming supply; 4-pin, A-coded, 3 units

Connector for loop-through of 24 V DC; 4-pole, A-coded, 3 units

6GK1907-0DC10-6AA3**6GK1907-0DB10-6AA3****M12 circular connector**Can be assembled, for connecting actuators or sensors, 5-pin, screw connection, max. 0.75 mm², A-coded, max. 4 A

- Straight
- Angled

3RK1902-4BA00-5AA0**3RK1902-4DA00-5AA0****M12 coupling socket**4-pole, screw connection, max. 0.75 mm², A-coded, max. 4 A, angled**3RK1902-4CA00-4AA0****PROFINET bus cable**

Pre-assembled on one side with 1 x M12, D-coded, 4-wire, shielded

- 3 m
- 5 m
- 10 m

3RK1902-2HB30**3RK1902-2HB50****3RK1902-2HC10****IE connecting cable M12-90/M12-90**Pre-assembled IE FC TP trailing cable GP 2 x 2 (PROFINET type C) with two 4-pole M12 plugs (D-coded) up to 85 m, IP65/IP67 degree of protection, 90° cable outlet
Length:

- 0.3 m
- 0.5 m
- 1.0 m
- 1.5 m
- 2.0 m
- 3.0 m
- 5.0 m
- 10 m
- 15 m

6XV1870-8GE30**6XV1870-8GE50****6XV1870-8GH10****6XV1870-8GH15****6XV1870-8GH20****6XV1870-8GH30****6XV1870-8GH50****6XV1870-8GN10****6XV1870-8GN15****IE connecting cable M12-180/IE FC RJ45 plug-145**Pre-assembled IE FC TP trailing cable GP 2 x 2 (PROFINET type C) with M12 plug (D-coded) and IE FC RJ45 plug, IP65/IP67 degree of protection
Length:

- 2.0 m
- 3.0 m
- 5.0 m
- 10 m
- 15 m

6XV1871-5TH20**6XV1871-5TH30****6XV1871-5TH50****6XV1871-5TN10****6XV1871-5TN15****IE Robust connecting cable M12-180/M12-180**Pre-assembled IE FC TP Robust Food Cable 2 x 2 (PROFINET type C) with two 4-pole M12 connectors (D-coded), IP69 degree of protection
Length:

- 1.0 m
- 2.0 m
- 3.0 m
- 5.0 m

6XV1881-5AH10**6XV1881-5AH20****6XV1881-5AH30****6XV1881-5AH50****M12 Y cable**

for double connection of I/O by means of single cable to ET 200, 5-pin

6ES7194-6KA00-0XA0

Ordering data	Article No.	Article No.
<p>Control line</p> <p>Pre-assembled on one side with 1 x M12 plug angled, 5-pin, 5 x 0.34 mm², A-coded, max. 4 A, PUR casing, black</p> <ul style="list-style-type: none"> • 1.5 m • 5 m • 10 m <p>Pre-assembled, 1 x M12 cable box straight, 1 x M12 plug, 3 x 0.34 mm², A-coded, max. 4 A, PUR casing, black</p>	<p>3RK1902-4HB15-5AA0</p> <p>3RK1902-4HB50-5AA0</p> <p>3RK1902-4HC01-5AA0</p> <p>3RK1902-4PB15-3AA0</p>	<p>M12 Power connecting cable M12-180/M12-180</p> <p>Flexible 4-core power connecting cable, pre-assembled with L-coded, 4-pole M12 plug and L-coded, 4-pole M12 socket to supply terminal devices with 24 V DC</p> <p>Length:</p> <ul style="list-style-type: none"> • 0.5 m • 1.0 m • 1.5 m • 2.0 m • 3.0 m • 5.0 m • 10 m • 15 m
<p>IO-Link connecting cables</p> <p>between IO-Link master and reader, on both sides with M12 plug, 4-pole</p> <ul style="list-style-type: none"> • 5 m • 10 m 	<p>6GT2891-4MH50</p> <p>6GT2891-4MN10</p>	<p>M12 Power connecting cable M12-90/M12-90</p> <p>Flexible 4-core power connecting cable, pre-assembled with L-coded, 4-pole M12 plug and L-coded, 4-pole M12 socket, both sides angled 90°, to supply terminal devices with 24 V DC</p> <p>Length:</p> <ul style="list-style-type: none"> • 0.5 m • 1.0 m • 1.5 m • 2.0 m • 3.0 m • 5.0 m • 10 m • 15 m
<p>Energy Cable 4 x 1.5</p> <p>Energy cable, suitable for cable carriers, with 4 copper cores (1.5 mm²) for connecting to M12 plug-in connector; sold by the meter; max. delivery unit 1 000 m, minimum order quantity 20 m</p>	<p>6XV1801-2B</p>	<p>M12 Robust Power connecting cable M12-180/M12-180</p> <p>Flexible 4-core power connecting cable, pre-assembled with A-coded, 5-pin M12 connector and A-coded, 5-pin M12 socket to supply IP69 components with 24 V DC;</p> <p>Length:</p> <ul style="list-style-type: none"> • 1.0 m • 2.0 m • 3.0 m • 5.0 m
<p>M12 Power connecting cable M12-90/M12-90</p> <p>Flexible 4-core power connecting cable, pre-assembled with A-coded, 5-pin M12 plug and A-coded, 5-pin M12 socket to supply the ET 200 with 24 V DC; 90° cable outlet</p> <p>Length:</p> <ul style="list-style-type: none"> • 0.3 m • 0.5 m • 1.0 m • 1.5 m • 2.0 m • 3.0 m • 5.0 m • 10 m • 15 m 	<p>6XV1801-5GE30</p> <p>6XV1801-5GE50</p> <p>6XV1801-5GH10</p> <p>6XV1801-5GH15</p> <p>6XV1801-5GH20</p> <p>6XV1801-5GH30</p> <p>6XV1801-5GH50</p> <p>6XV1801-5GN10</p> <p>6XV1801-5GN15</p>	<p>Power M12 plug PRO</p> <p>Connector for 24 V DC supply voltage, with installation instructions, 4-pole, L-coded, 1 unit</p> <p>Power M12 cable connector PRO</p> <p>Connection socket for 24 V DC supply voltage, 4-pole, L-coded, with installation instructions, 1 unit</p>
		<p>6XV1801-6DE50</p> <p>6XV1801-6DH10</p> <p>6XV1801-6DH15</p> <p>6XV1801-6DH20</p> <p>6XV1801-6DH30</p> <p>6XV1801-6DH50</p> <p>6XV1801-6DN10</p> <p>6XV1801-6DN15</p>
		<p>6XV1801-6GE50</p> <p>6XV1801-6GH10</p> <p>6XV1801-6GH15</p> <p>6XV1801-6GH20</p> <p>6XV1801-6GH30</p> <p>6XV1801-6GH50</p> <p>6XV1801-6GN10</p> <p>6XV1801-6GN10</p>
		<p>6XV1801-5AH10</p> <p>6XV1801-5AH20</p> <p>6XV1801-5AH30</p> <p>6XV1801-5AH50</p>
		<p>6GK1906-0EA00</p>
		<p>6GK1906-0EB00</p>

I/O systems

SIMATIC ET 200 systems without control cabinet

SIMATIC ET 200eco PN

I/O devices > IO-Link master**Technical specifications**

Article number	6ES7148-6JA00-0AB0 ET 200eco PN, 4xIO-Link + 8DI/4DO, 8xM12	6ES7148-6JD00-0AB0 ET 200eco PN, 4xIO-Link 4xM12	6ES7148-6JG00-0BB0 ET 200eco PN, CM 8x IO-Link, M12-L
General information			
Product function			
• Isochronous mode			No
• Prioritized startup			Yes
Engineering with			
• STEP 7 TIA Portal configurable/ integrated from version			STEP 7 V17 or higher with HSP 0378
• PROFINET from GSD version/ GSD revision			GSDML V2.3.x
• Multi Fieldbus Configuration Tool (MFCT)			from V1.3 SP1
Supply voltage			
Rated value (DC)	24 V	24 V	
Reverse polarity protection	Yes	Yes	
Load voltage 1L+			
• Rated value (DC)			24 V
• Reverse polarity protection			Yes; Against destruction; encoder power supply outputs applied with reversed polarity
Load voltage 2L+			
• Rated value (DC)	24 V	24 V	24 V
• Reverse polarity protection	Yes	Yes; against destruction; load increasing	Yes; against destruction
Input current			
Current consumption (rated value)			70 mA; without load
Current consumption, typ. from supply voltage 1L+, max.	200 mA 4 A	100 mA 4 A	
from load voltage 1L+ (unswitched voltage)			12 A; Maximum value
from load voltage 2L+, max.	4 A	4 A	12 A; Maximum value
Encoder supply			
Number of outputs	6	4	8
Hardware configuration			
Submodules			
• Number of configurable submodules, max.			9
Digital inputs			
Number of digital inputs	8		4
Source/sink input			P-reading
Input characteristic curve in accordance with IEC 61131, type 3	Yes		Yes
Number of simultaneously controllable inputs			
all mounting positions			
- up to 60 °C, max.	8		4
Input voltage			
• Rated value (DC)	24 V		24 V
• for signal "0"	-3 to +5V		-3 to +5V
• for signal "1"	+11 to +30V		+11 to +30V
Input current			
• for signal "0", max. (permissible quiescent current)	1.5 mA		
• for signal "1", typ.	7 mA		2.5 mA
Cable length			
• unshielded, max.	30 m		30 m
Digital outputs			
Number of digital outputs	4		
Short-circuit protection	Yes; Electronic		
Limitation of inductive shutdown voltage to	Typ. (L1+, L2+) -47 V		
Controlling a digital input	Yes		

Technical specifications

Article number	6ES7148-6JA00-0AB0	6ES7148-6JD00-0AB0	6ES7148-6JG00-0BB0
	ET 200eco PN, 4xIO-Link + 8DI/4DO, 8xM12	ET 200eco PN, 4xIO-Link 4xM12	ET 200eco PN, CM 8x IO-Link, M12-L
Switching capacity of the outputs			
• on lamp load, max.	5 W		
Output current			
• for signal "1" rated value	1.3 A; Maximum		
• for signal "0" residual current, max.	1.5 mA		
Parallel switching of two outputs			
• for uprating	No		
• for redundant control of a load	Yes		
Switching frequency			
• with resistive load, max.	100 Hz		
• with inductive load, max.	0.5 Hz		
• on lamp load, max.	1 Hz		
Total current of the outputs (per group)			
all mounting positions			
- up to 60 °C, max.	3.9 A		
Cable length			
• unshielded, max.	30 m		
IO-Link			
Number of ports	4	4	8
• of which simultaneously controllable	4	4	8
IO-Link protocol 1.0	Yes	Yes	Yes
IO-Link protocol 1.1	No	Yes	Yes
Transmission rate	4.8 kBd (COM1); 38.4 kBd (COM2)	4.8 kBaud (COM1); 38.4 kBaud (COM2), 230 kBaud (COM3)	4.8 kBaud (COM1); 38.4 kBaud (COM2), 230 kBaud (COM3)
Cycle time, min.			2 ms
Size of process data, input per port	32 byte	32 byte	33 byte
Size of process data, input per module	32 byte	128 bytes + 4 bytes PQI	264 byte
Size of process data, output per port	32 byte	32 byte	32 byte
Size of process data, output per module	32 byte	128 byte	256 byte
Memory size for device parameter		2 kbyte; for each port	2 kbyte; for each port
Master backup		Possible with function block IO_LINK_MASTER	Possible with function block IO_LINK_MASTER
Configuration without S7-PCT		Possible; autostart/manual function	Possible; autostart/manual function
Cable length unshielded, max.	20 m	20 m	20 m
Operating modes			
• IO-Link	Yes	Yes	Yes
• DI	Yes	Yes	Yes
• DQ	Yes	Yes; max. 100 mA	Yes; max. 100 mA
Connection of IO-Link devices			
• Port type A	Yes	Yes; via 3-core cable	Yes; via 3-core cable
• Port type B		Yes; Additional device supply: max. 2 A per port, max. 4 A per module	Yes; additional device supply: max. 2 A per port, max. 6 A per module
• via three-wire connection	Yes		
Interfaces			
Transmission procedure	100BASE-TX	100BASE-TX	
Number of PROFINET interfaces	1	1	1
1. Interface			
Interface type			PROFINET with 100 Mbit/s full duplex (100BASE-TX)
Interface types			
• M12 port	Yes	Yes	Yes; 2x M12, 4-pin, D-coded
• Number of ports			2
• integrated switch	Yes	Yes	Yes
Protocols			
• PROFINET IO Device			Yes
• Open IE communication			Yes

I/O systemsSIMATIC ET 200 systems without control cabinet
SIMATIC ET 200eco PN**I/O devices > IO-Link master****Technical specifications**

Article number	6ES7148-6JA00-0AB0 ET 200eco PN, 4xIO-Link + 8DI/4DO, 8xM12	6ES7148-6JD00-0AB0 ET 200eco PN, 4xIO-Link 4xM12	6ES7148-6JG00-0BB0 ET 200eco PN, CM 8x IO-Link, M12-L
Interface types			
M12 port			
• Autonegotiation	Yes	Yes	Yes
• Autocrossing	Yes	Yes	Yes
• Transmission rate, max.	100 Mbit/s	100 Mbit/s	100 Mbit/s
Protocols			
Supports protocol for PROFINET IO	Yes	Yes	Yes
PROFINET CBA	No	No	No
PROFIsafe	No	No	No
EtherNet/IP	No	No	Yes
Modbus TCP			Yes
PROFINET IO Device			
Services			
- IRT			Yes; 250 µs to 4 ms in 125 µs frame
- IRT with the option "high flexibility"	Yes	Yes	
- Prioritized startup			Yes
- Shared device			Yes
- Number of IO Controllers with shared device, max.			2
Redundancy mode			
• PROFINET system redundancy (S2)			Yes
• Redundant PROFINET configuration (R1)			No
• H-Sync forwarding			Yes
Media redundancy			
- MRP	Yes	Yes	Yes
EtherNet/IP			
Services			
- CIP Implicit Messaging			Yes
- CIP Explicit Messaging			Yes
- CIP Safety			No
- Shared device			Yes; 2x EtherNet/IP Scanner
- Number of scanners with shared device, max.			2
Updating times			
- Requested Packet Interval (RPI)			2 ms
Redundancy mode			
- DLR (Device Level Ring)			No
Address area			
- Address space per module, max.			300 byte
- LargeForwardOpen (Class3)			No
Modbus TCP			
Services			
- read coils (code=1)			Yes
- read discrete inputs (code=2)			Yes
- Read Holding Registers (Code=3)			Yes
- write single coil (code=5)			Yes
- write multiple coils (code=15)			Yes
- Write Multiple Registers (Code=16)			Yes
- Parameter change by master			No
- Modbus TCP Security Protocol			No
Address space per station			
- Address space per station, max.			300 byte
- Access-consistent address space			2 byte
Updating time			
- I/O request interval			2 ms
Connections			
- Number of connections per slave			12

Technical specifications

Article number	6ES7148-6JA00-0AB0 ET 200eco PN, 4xIO-Link + 8DI/4DO, 8xM12	6ES7148-6JD00-0AB0 ET 200eco PN, 4xIO-Link 4xM12	6ES7148-6JG00-0BB0 ET 200eco PN, CM 8x IO-Link, M12-L
Open IE communication			
• TCP/IP	No	No	Yes; (only EtherNet/IP or Modbus TCP)
• SNMP	Yes	Yes	Yes
• DCP	Yes	Yes	
• LLDP	Yes	Yes	Yes
• ping	Yes	Yes	
• ARP	Yes	Yes	Yes
Interrupts/diagnostics/ status information			
Diagnostics function	Yes	Yes	
Alarms			
• Diagnostic alarm	Yes	Yes	Yes; Parameterizable
• Maintenance interrupt			Yes; Parameterizable
Diagnoses			
• Diagnostic information readable	Yes	Yes	Yes
• Monitoring the supply voltage - parameterizable	Yes; green "ON" LED	Yes; green "ON" LED	Yes Yes
• Wire-break			Yes
• Wire-break in actuator cable	Yes		
• Wire-break in signal transmitter cable	Yes		
• Short-circuit	Yes	Yes; Device supply to M	
• Short-circuit encoder supply	Yes		Yes; Per channel
• Group error	Yes; Red/yellow "SF/MT" LED	Yes; Red/yellow "SF/MT" LED	
Diagnostics indication LED			
• RUN LED			Yes; green LED
• ERROR LED			Yes; red LED
• MAINT LED			Yes; Yellow LED
• NS LED			Yes; green/red LED
• MS LED			Yes; green/red LED
• IO LED			Yes; red-green-yellow LED
• Channel status display			Yes; green LED
• for channel diagnostics			Yes; red LED
• For load voltage monitoring			Yes; green LED
• Connection display LINK TX/RX			Yes; green LED, only link
Potential separation			
between the load voltages	Yes	Yes	Yes
between load voltage and all other switching components	No	No	
between Ethernet and electronics	Yes	Yes	Yes
Potential separation channels			
• between the channels	No		No
• between the channels and the power supply of the electronics			No
Degree and class of protection			
IP degree of protection	IP65/67	IP65/67	IP65/67
Standards, approvals, certificates			
Suitable for safety-related tripping of standard modules		No	Yes; From FS01
Highest safety class achievable for safety-related tripping of standard modules			
• Performance level according to ISO 13849-1			PL d
• Category according to ISO 13849-1			Cat. 3
• SILCL according to IEC 62061			SILCL 2

I/O systems

SIMATIC ET 200 systems without control cabinet

SIMATIC ET 200eco PN

I/O devices > IO-Link master**Technical specifications**

Article number	6ES7148-6JA00-0AB0	6ES7148-6JD00-0AB0	6ES7148-6JG00-0BB0
	ET 200eco PN, 4xIO-Link + 8DI/4DO, 8xM12	ET 200eco PN, 4xIO-Link 4xM12	ET 200eco PN, CM 8x IO-Link, M12-L
Ambient conditions			
Ambient temperature during operation			
• min.			-40 °C
• max.			60 °C
Altitude during operation relating to sea level			
• Ambient air temperature-barometric pressure-altitude			Up to max. 5 000 m, at installation height > 2 000 m additional restrictions, see manual for details
Connection method			
Design of electrical connection		3/5-pin M12 round connectors	4/5-pin M12 circular connectors
Design of electrical connection for the inputs and outputs			M12, 5-pin, A-coded
Design of electrical connection for supply voltage			M12, 4-pin, L-coded
Dimensions			
Width	60 mm	30 mm	45 mm
Height	175 mm	200 mm	200 mm
Depth	49 mm	49 mm	48 mm
Weights			
Weight, approx.	910 g	550 g	780 g

Overview Mounting rail

- Aluminum mounting rail for installation of SIMATIC ET 200eco PN
- Securing the I/O devices via two profile screws
- Length of mounting rail 0.5 m

Ordering data**Article No.****Mounting rail for ET 200eco PN****6ES7194-6GA00-0AA0**

Length 0.5 m

Profile screw for mounting rail**6ES7194-6MA00-0AA0**

For fixing the I/O devices on the mounting rail; 50 units

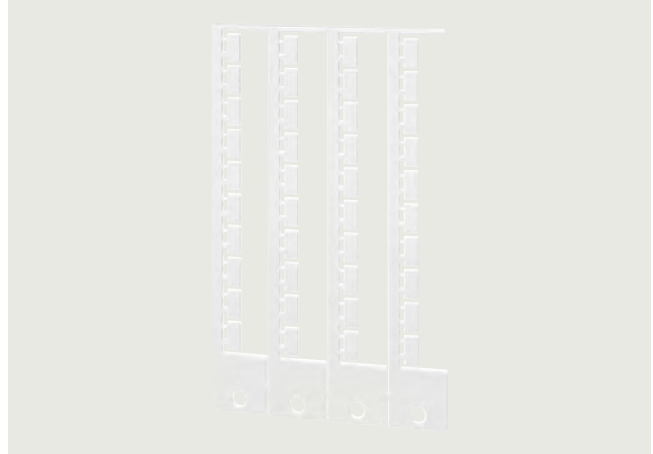
Overview Labels

- Labels for channel and device labeling of the ET 200eco PN components

Ordering data**Article No.****Labels 10 mm x 5 mm RAL9016****6ES7194-2BA00-0AA0**

For I/O devices with 2x M12 L-coded power connectors; 5 frames with 40 labels each

Labels 10 x 7 mm Ti-grey**3RT2900-1SB10**

For I/O devices with 2x M12 A-coded power connectors; 5 frames with 40 labels each

Labels 10 mm x 7 mm yellow**6ES7194-6HA00-0AA0**

For I/O devices with 2x M12 A-coded power connectors; 17 frames with 48 labels each

I/O systems

IO systems for heating elements

IO systems for heating elements

Overview

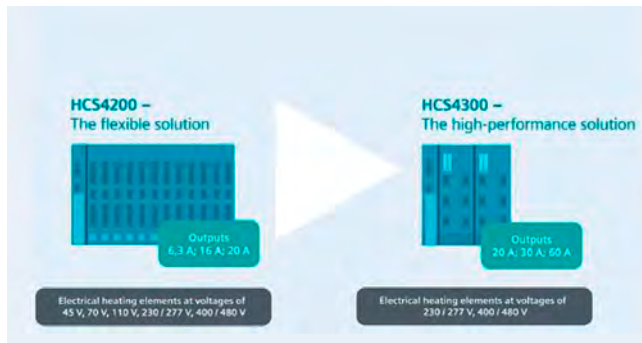

SIMATIC ET 200SP HCS video

https://players.brightcove.net/1813624294001/70fecf0f-fbad-4fad-a077-d0e26af4d84c_default/index.html?videoId=6149950597001



SIPLUS HCS family

SIPLUS HCS heating control systems: Industrial heating processes – maximum precision and efficiency

In manufacturing processes where temperature plays a crucial role, deviations of just a few degrees can cause enormous quality problems. To avoid this and to minimize rejection rates, high-precision and reliable, individual control of the electrical heating elements is essential.

Nearly all industrially manufactured products undergo heat treatment. Even small deviations in the heating process can result in enormous negative effects on product quality.

To increase the quality and quantity of a heat-treated product, it is important to be able to focus the energy required with the highest level of spatial and temporal precision. The SIPLUS HCS ensures utmost precision in the control of electric heating elements such as infrared heaters.

Two heating control systems are available:

- HCS4200 – The flexible choice
- HCS4300 – The powerful solution

The SIPLUS HCS family of heating control systems saves time, costs and resources when it comes to configuring, commissioning, operation and maintenance.

This is achieved by:

- Simple integration into existing automation systems such as SIMATIC and SIMOTION
- Lower wiring costs and user-friendly engineering
- Intelligent diagnostics options for swift fault detection
- Service-friendly design thanks to ready-to-use function and data blocks
- Reduced volume in the control cabinet with space savings of up to 50%

For more information, see <http://www.siemens.com/hcs>

Overview

HCS4200 family

The SIPLUS HCS4200 heating control system controls and switches heat emitters and other resistive loads in industrial environments in a range of voltages: 45 V AC, 70 V AC, 110 V AC, 230 V AC, 277 V AC, 400 V AC, and 480 V AC.

Communication takes place over PROFINET or PROFIBUS and, in combination with SIMATIC S7, SIMOTION or an industrial PC, forms a high-performance, state-of-the-art automation system. The modular, compact and space-saving distributed I/O system can be individually adapted to suit the application.

I/O systems

IO systems for heating elements

SIPLUS HCS4200 heating control system

Rack

Overview



SIPLUS HCS4200 heating control system

The rack constitutes the basic mechanical structure of the SIPLUS HCS4200.

Ordering data

Article No.

Article No.

SIPLUS HCS Rack 4200 for 12 POMs

Rack for accommodating up to 12 POM4320 Power Output Modules

6BK1942-0AA00-0AA0

SIPLUS HCS Rack 4200 for 4 POMs

Rack for accommodating up to 4 POM4320 Power Output Modules

6BK1942-0BA00-0AA0

Accessories

SIPLUS HCS4200 Fan Module

6BK1942-4AA00-0AA0

SIPLUS HCS FM4240 Fan Module High Performance

6BK1942-4BA00-0AA0

Is attached to the top of the rack for accommodating up to 4 Power Output Modules

Blanking cover (10 items)

6BK1942-6DA00-0AA0

For covering unoccupied slots in the rack

Technical specifications

Article number	6BK1942-0AA00-0AA0 HCS Rack4200 for 12 POM	6BK1942-0BA00-0AA0 HCS Rack4200 for 4 POM
General information		
Product type designation	Rack4200 for 12 POMs	RACK4200 for 4 POMs
Installation type/mounting		
Mounting type	Control cabinet backplane	
Mounting position	Horizontal	
Type of ventilation	Self ventilation or forced ventilation	
Hardware configuration		
Type of power output connectable	POM4220	
Slots		
• Number of slots	12	4
Interfaces		
Interfaces/bus type	system interface	
Isolation		
Degree of pollution	2	
EMC		
EMC interference emission	Limit value in accordance with IEC 61000-6-4:2007 + A1:2011	
Electrostatic discharge acc. to IEC 61000-4-2	4 kV contact discharge / 8 kV air discharge	
Field-related interference acc. to IEC 61000-4-3	10 V/m (80 ... 1 000 MHz), 3 V/m (1.4 ... 2.0 GHz), 1 V/m (2.0 ... 2.7 GHz)	
Degree and class of protection		
IP degree of protection	IP20	
Standards, approvals, certificates		
reference designation according to IEC 81346-2 (2009)	K	

Technical specifications

Article number	6BK1942-0AA00-0AA0 HCS Rack4200 for 12 POM	6BK1942-0BA00-0AA0 HCS Rack4200 for 4 POM
Ambient conditions		
Ambient temperature during operation		
• min.	0 °C	
• max.	55 °C	
Ambient temperature during storage/transportation		
• Storage, min.	-25 °C	
• Storage, max.	70 °C	
• Transportation, min.	-25 °C	
• Transportation, max.	70 °C	
Air pressure acc. to IEC 60068-2-13		
• Operation, min.	860 Pa	
• Operation, max.	1 080 Pa	
• Storage, min.	660 Pa	
• Storage, max.	1 080 Pa	
Altitude during operation relating to sea level		
• Installation altitude above sea level, max.	2 000 m	
Relative humidity		
• Operation at 25 °C, max.	95 %	
• Operation at 50 °C, max.	50 %; 95 % at 25 °C, decreasing linearly to 50 % at 50 °C	
Vibrations		
• Vibration resistance during operation acc. to IEC 60068-2-6	10 ... 58 Hz / 0.075 mm, 58 ... 150 Hz / 1 g	
• Vibration resistance during storage acc. to IEC 60068-2-6	5 ... 8.5 Hz / 3.5 mm, 8.5 ... 500 Hz / 1 g	
Shock testing		
• Shock resistance during operation acc. to IEC 60068-2-27	15 g / 11 ms / 3 shocks/axis	
• Shock resistance during storage acc. to IEC 60068-2-29	25 g / 6 ms / 1 000 shocks/axis	
Dimensions		
Width	488 mm	204 mm
Height	285 mm	
Depth	293 mm	

I/O systems

IO systems for heating elements

SIPLUS HCS4200 heating control system

Central Interface Module (CIM)

Overview



The Central Interface Module (CIM) is the intelligent processor module of the SIPLUS HCS4200 heating control system.

Ordering data

SIPLUS HCS4200 CIM4210 PROFINET

Central Interface Module with PROFINET communication

Article No.

6BK1942-1AA00-0AA0

SIPLUS HCS4200 CIM4210 compact version PROFINET

Central Interface Module with PROFINET communication

6BK1942-1AA00-0AA1

SIPLUS HCS4200 CIM4210 PROFIBUS

Central Interface Module with PROFIBUS communication

6BK1942-1BA00-0AA0

Accessories

SIPLUS HCS4200 connector set

As spare part, consisting of 20 x 2-pin connectors (24 V DC power supply)

6BK1942-6FA00-0AA0

Article No.

SIPLUS HCS4000 temperature I/O module

For recording temperatures using temperature sensors, thermocouples and pyrometers

6BK1900-0AA00-0AA0

SIPLUS HCS4000 DI/DQ I/O module

With 8 digital outputs and 8 configurable inputs/outputs

6BK1900-0BA00-0AA0

SIPLUS HCS4000 U/I I/O module

For current and voltage measurement (line voltage compensation)

6BK1900-0CA00-0AA0

Technical specifications

Article number	6BK1942-1AA00-0AA0	6BK1942-1AA00-0AA1	6BK1942-1BA00-0AA0
	HCS CIM4210 PROFINET	HCS CIM4210C PROFINET	HCS CIM4210 PROFIBUS
General information			
Product type designation	CIM4210 PROFINET	CIM4210C PROFINET	CIM4210 PROFIBUS
Installation type/mounting			
Mounting type	Screw mounting to rack	Backplane mounting	Screw mounting to rack
Mounting position	vertical		
Type of ventilation	Forced ventilation	Self-ventilation	Forced ventilation
Supply voltage			
Type of supply voltage	DC		
Rated value (DC)	24 V		
relative symmetrical tolerance of the supply voltage	20 %		
Connection method			
• Design of electrical connection for supply voltage	plug, 2x 2-pole with spring-type terminal, push-in		
- Connectable conductor cross-sections, solid	1x (0.2 ... 2.5 mm ²)		
- Connectable conductor cross-sections, finely stranded with wire end processing	1x (0.2 ... 2.5 mm ²)		
- Connectable conductor cross-sections for AWG cables	1x (26 ... 12)		

Technical specifications

Article number	6BK1942-1AA00-0AA0	6BK1942-1AA00-0AA1	6BK1942-1BA00-0AA0
	HCS CIM4210 PROFINET	HCS CIM4210C PROFINET	HCS CIM4210 PROFIBUS
Power			
Active power input	3 W	8 W	3 W
Hardware configuration			
Type of power output connectable	POM4220		
Slots			
• Number of slots	1	2; POM4220	1
Interfaces			
Interfaces/bus type	PROFINET IO		PROFIBUS DP
Transmission rate, max.	100 Mbit/s		12 Mbit/s
PROFIBUS DP			
• Design of electrical connection			9-pin sub D socket
Supports protocol for PROFINET IO			
• Design of electrical connection of PROFINET interface	2x RJ45		
Protocols			
Supports protocol for PROFINET IO	Yes		No
PROFIBUS DP	No		Yes
EtherNet/IP	No		
Interrupts/diagnostics/status information			
Number of status displays	3		
LED status display	LED green = ready, LED yellow = heating on/off, LED red = error display		
Isolation			
Overvoltage category	III		
Degree of pollution	2		
EMC			
EMC interference emission	Limit value in accordance with IEC 61000-6-4:2007 + A1:2011		
Electrostatic discharge acc. to IEC 61000-4-2	4 kV contact discharging, 8 kV air discharging		
Field-related interference acc. to IEC 61000-4-3	10 V/m (80 ... 1 000 MHz), 3 V/m (1.4 ... 2.0 GHz), 1 V/m (2.0 ... 2.7 GHz)		
Conducted interference due to burst acc. to IEC 61000-4-4	2 kV power supply lines, 2 kV PROFINET cables		2 kV power supply lines / 2 kV PROFIBUS cables
Conducted interference due to surge acc. to IEC 61000-4-5	DC supply lines: 0.5 kV symmetric and unsymmetric PROFINET cables: 1 kV unsymmetric		DC supply lines: 0.5 kV symmetrical and asymmetrical, PROFIBUS lines: 1 kV asymmetrical
Conducted interference due to high-frequency radiation acc. to IEC 61000-4-6	10 V (0.15 ... 80 MHz)		
Degree and class of protection			
IP degree of protection	IP20		
Standards, approvals, certificates			
reference designation according to IEC 81346-2 (2009)	K		
Ambient conditions			
Ambient temperature during operation			
• min.	0 °C		
• max.	55 °C		
Ambient temperature during storage/transportation			
• Storage, min.	-25 °C		
• Storage, max.	70 °C		
• Transportation, min.	-25 °C		
• Transportation, max.	70 °C		

I/O systems

IO systems for heating elements

SIPLUS HCS4200 heating control system

Central Interface Module (CIM)**Technical specifications**

Article number	6BK1942-1AA00-0AA0 HCS CIM4210 PROFINET	6BK1942-1AA00-0AA1 HCS CIM4210C PROFINET	6BK1942-1BA00-0AA0 HCS CIM4210 PROFIBUS
Air pressure acc. to IEC 60068-2-13			
• Operation, min.	860 hPa		
• Operation, max.	1 080 hPa		
• Storage, min.	660 hPa		
• Storage, max.	1 080 hPa		
Altitude during operation relating to sea level			
• Installation altitude above sea level, max.	2 000 m		
Relative humidity			
• Operation at 25 °C, max.	95 %		
• Operation at 50 °C, max.	50 %; 95 % at 25 °C, decreasing linearly to 50 % at 50 °C		
Vibrations			
• Vibration resistance during operation acc. to IEC 60068-2-6	10 ... 58 Hz / 0.075 mm, 58 ... 150 Hz / 1 g		
• Vibration resistance during storage acc. to IEC 60068-2-6	5 ... 8.5 Hz / 3.5 mm, 8.5 ... 500 Hz / 1 g		
Shock testing			
• Shock resistance during operation acc. to IEC 60068-2-27	15 g / 11 ms / 3 shocks/axis		
• Shock resistance during storage acc. to IEC 60068-2-29	25 g / 6 ms / 1 000 shocks/axis		
Dimensions			
Width	43 mm	104 mm	43 mm
Height	285 mm	339 mm	285 mm
Depth	136 mm	296 mm	136 mm

Overview



The Power Output Modules (POMs) are an essential component of the SIPLUS HCS4200 heating control system. Up to 24 Power Output Modules can be operated on one Central Interface Module (CIM), split over 2 racks.

There are 4 Power Output Module versions:

- POM4220 Lowend
- POM4220 Midrange phase control
- POM4220 Highend
- POM4220 Flexible

Ordering data

Ordering data	Article No.	Ordering data	Article No.
SIPLUS HCS4200 POM4220 Lowend Power Output Module with 16 outputs for connecting resistive loads	6BK1942-2AA00-0AA0	Spare fuse, 25 A/600 V, for the POM4220 Highend	6BK1942-6KA00-0AA0
SIPLUS HCS4200 POM4220 Midrange phase control Power Output Module with 12 outputs for connecting resistive loads	6BK1942-2CA00-0AA1	SIPLUS HCS4200 connector set as accessory, comprising 10 connectors, 3-pin, for incoming supply, POM4220 Lowend	6BK1943-6AA00-0AA0
SIPLUS HCS4200 POM4220 Highend Power Output Module with 8 outputs for connecting resistive loads	6BK1942-2DA00-0AA0	SIPLUS HCS4200 connector set as accessory, comprising 5 connectors, 8-pin, for power outputs, POM4220 Lowend	6BK1942-6CA00-0AA0
SIPLUS HCS4200 POM4220 Flexible Power Output Module with 12 outputs for connecting resistive loads	6BK1942-2FA00-0AA0	SIPLUS HCS4200 connector set as accessory, comprising 6 connectors, 3-pin, for incoming supply, POM4220 Midrange phase control	6BK1942-6GA00-0AA0
Accessories		SIPLUS HCS4200 connector set as accessory, comprising 5 connectors, 6-pin, for power outputs, POM4220 Midrange phase control/Flexible	6BK1942-6EA00-0AA0
Spare fuse, 6.3 A/250 V, for the POM4220 Lowend	6BK1942-6AA00-0AA0	SIPLUS HCS4200 connector set as accessory, comprising 5 connectors, 4-pin, for power outputs, POM4220 Highend	6BK1942-6LA00-0AA0
Spare fuse, 16 A/500 V, for the POM4220 Midrange phase control	6BK1942-6HA00-0AA0		

Technical specifications

Article number	6BK1942-2AA00-0AA0 HCS POM4220 Lowend	6BK1942-2CA00-0AA1 HCS POM4220 Midrange phase angle control	6BK1942-2DA00-0AA0 HCS POM4220 Highend	6BK1942-2FA00-0AA0 HCS POM4220 Flexible
General information				
Product type designation	POM4220 Lowend	POM4220 mid-range phase control	POM4220 High-end	POM4220 Flexible
Installation type/mounting				
Mounting type	Screw mounting to rack			
Mounting position	vertical			
Type of ventilation	Self ventilation or forced ventilation			
Supply voltage				
Type of supply voltage	AC			
Rated value (AC)	230 V; phase - neutral conductor			
• Relative negative tolerance	10 %			
• Relative positive tolerance	10 %		30 %	

I/O systems

IO systems for heating elements

SIPLUS HCS4200 heating control system

Power Output Module (POM)**Technical specifications**

Article number	6BK1942-2AA00-0AA0 HCS POM4220 Lowend	6BK1942-2CA00-0AA1 HCS POM4220 Midrange phase angle control	6BK1942-2DA00-0AA0 HCS POM4220 Highend	6BK1942-2FA00-0AA0 HCS POM4220 Flexible
2nd rated value (AC)		277 V; phase - neutral conductor 25 %		
• Relative negative tolerance		8 %		
• Relative positive tolerance			400 V; Phase - phase	110 V; phase - neutral conductor
3rd rated value (AC)			10 %	
• Relative negative tolerance			30 %	50 %
• Relative positive tolerance			480 V; Phase - phase	70 V; phase - neutral conductor
4th rated value (AC)			25 %	10 %
• Relative negative tolerance			8 %	15 %
• Relative positive tolerance				45 V; phase - neutral conductor
5th rated value (AC)				10 %
• Relative negative tolerance				15 %
• Relative positive tolerance				
Line frequency				
• Rated value 50 Hz	Yes			
• Rated value 60 Hz	Yes			
• Relative symmetrical tolerance	5 %			
Mains buffering				
• Recovery time after power failure, typ.	1 s			
Connection method				
• Design of electrical connection for supply voltage	plug, 3-pole with spring-type terminal, push-in			
- Connectable conductor cross-sections, solid	1x (0.2 ... 10 mm ²)	1x (0.75 ... 16 mm ²)		
- Connectable conductor cross-sections, finely stranded with wire end processing	1x (0.25 ... 6 mm ²)	1x (0.75 ... 16 mm ²)		
- Connectable conductor cross-sections for AWG cables	1x (24 ... 8)	1x (18 ... 4)		
Input voltage				
device version of the power supply for electronics	Power supply via rack			
Power				
Active power input, max.	1 W		1.5 W	1 W
Power electronics				
Type of load	Ohmic load			
Power capacity, max.	16.1 kW; at 230 V AC	29.4 kW; at 230 V AC	51.2 kW; At 400 V AC 51.2 kW; At 400 V AC	29.4 kW; at 230 V AC
• For phase against phase with fan at 40 °C, max.			12.5 kW; At 400 V AC	
• For phase against phase without fan at 40 °C, max.				
• For phase against neutral with fan at 40 °C, max.	16.1 kW; at 230 V AC	29.4 kW; at 230 V AC		
• For phase against neutral without fan at 40 °C, max.	7.3 kW; at 230 V AC			
Switching capacity current per phase, max.	35 A	64 A		
Short-time withstand current (SCCR) acc. to UL 508A	50 kA	100 kA		
Control of heating elements				
• Half-wave control	Yes			
• Soft start	No	Yes		No
• Phase control	No	Yes		No
Load connection type				
• Star connection with neutral conductor (single-phase)	Yes			
• Open delta connection (single-phase)	No		Yes	No
• closed delta connection (2-phase)	No			
• Closed delta connection (3-phase)	No			
• Star connection with neutral conductor (2-phase)	No		Yes; Economy circuit	No

Technical specifications

Article number	6BK1942-2AA00-0AA0 HCS POM4220 Lowend	6BK1942-2CA00-0AA1 HCS POM4220 Midrange phase angle control	6BK1942-2DA00-0AA0 HCS POM4220 Highend	6BK1942-2FA00-0AA0 HCS POM4220 Flexible
<ul style="list-style-type: none"> star connection without neutral conductor (3-phase) 2-pole switching 	No		Yes; Phase - neutral conductor, phase - phase	No
Setpoint input				
<ul style="list-style-type: none"> Percent Watts 	Yes No		Yes	No
Heating power				
<ul style="list-style-type: none"> Number of digital outputs Number of heating elements per output, max. Output voltage for heating power 2nd output voltage for heating power 3rd output voltage for heating power 4th output voltage for heating power 5th output voltage for heating power Power carrying capacity per output, min. Power carrying capacity per output, max. - for heating elements with high inrush current, max. Output current for heating power Melting I²t value Design of short-circuit protection per output Design of overvoltage protection 	16 1 230 V 230 V 277 V 400 V 480 V 40 W; at 230 V AC 1 449 W; at 230 V AC 750 W; at 230 V AC 6.3 A; max. 57 A ² ·s Safety fuse 6.3 A Transil Diode	12 277 V 60 W; at 230 V AC 3 680 W; at 230 V AC 1 600 W; at 230 V AC 16 A; max. 20 A ² ·s Fuse 16 A	8 5; Recommended, depends on tolerance of heating elements 400 V 480 V 400 W; at 230 V AC 4 600 W; at 230 V AC 2 700 W; at 230 V AC 20 A; max. 120 A ² ·s Melting fuse 25 A	12 1 110 V 70 V 45 V 100 W; at 230 V AC 3 680 W; at 230 V AC 1 600 W; at 230 V AC 16 A; max. 20 A ² ·s Fuse 16 A
Connection method				
<ul style="list-style-type: none"> Design of electrical connection at output for heating and fan - Connectable conductor cross-sections, solid - Connectable conductor cross-sections, finely stranded with wire end processing - Connectable conductor cross-sections for AWG cables, stranded 	plug, 8-pole with spring-type terminal, push-in 1x (0.2 ... 10 mm ²) 1x (0.25 ... 6 mm ²) 1x (24 ... 8)	plug, 6-pole with spring-type terminal, push-in	plug, 4-pole with spring-type terminal, push-in	plug, 6-pole with spring-type terminal, push-in
Interfaces				
Interfaces/bus type	system interface			
Interrupts/diagnostics/status information				
Number of status displays	19	15	11	15
LED status display	LED green = ready, LED yellow = heating on/off, LED red = error display, LED red = error for each channel			
Diagnostics function	Voltage diagnostics		Voltage and current diagnosis	Voltage diagnostics
Diagnoses				
<ul style="list-style-type: none"> Fuse blown Load failure Triac error Switch-off threshold for internal device temperature Parallel-connected heating elements Rotating field fault Communication error Supply voltage not connected Line voltage outside the permissible range Frequency outside the permissible range Fault current too high 	Yes Yes Yes Yes No Yes Yes Yes Yes Yes No	No No	Yes Yes Yes	No No No

I/O systems

IO systems for heating elements

SIPLUS HCS4200 heating control system

Power Output Module (POM)

Technical specifications

Article number	6BK1942-2AA00-0AA0	6BK1942-2CA00-0AA1	6BK1942-2DA00-0AA0	6BK1942-2FA00-0AA0
	HCS POM4220 Lowend	HCS POM4220 Midrange phase angle control	HCS POM4220 Highend	HCS POM4220 Flexible
Integrated Functions				
Monitoring functions				
• Temperature monitoring	Yes			
• Type of temperature monitoring	NTC thermistor			
Measuring functions				
• Voltage measurement	No		Yes	No
• Current measurement	No		Yes	No
• Fault current detection	No		Yes; For 2-pole switching	No
Potential separation				
Design of electrical isolation between the outputs	Optocoupler and/or protective impedance between main circuit and PELV No			
Isolation				
Overvoltage category	III			
Degree of pollution	2			
EMC				
EMC interference emission	Limit value in accordance with IEC 61000-6-4:2007 + A1:2011			
Electrostatic discharge acc. to IEC 61000-4-2	4 kV contact discharge / 8 kV air discharge			
Field-related interference acc. to IEC 61000-4-3	10 V/m (80 ... 1 000 MHz), 3 V/m (1.4 ... 2.0 GHz), 1 V/m (2.0 ... 2.7 GHz)			
Conducted interference due to burst acc. to IEC 61000-4-4	2 kV power supply lines, 2 kV load lines			
Conducted interference due to surge acc. to IEC 61000-4-5	Supply and load lines: 1 kV symmetrical, 2 kV asymmetrical			
Conducted interference due to high-frequency radiation acc. to IEC 61000-4-6	10 V (0.15 ... 80 MHz)			
Degree and class of protection				
IP degree of protection	IP20			
Standards, approvals, certificates				
reference designation according to IEC 81346-2 (2009)	Q			
Ambient conditions				
Ambient temperature during operation				
• min.	0 °C			
• max.	55 °C			
Ambient temperature during storage/transportation				
• Storage, min.	-25 °C			
• Storage, max.	70 °C			
• Transportation, min.	-25 °C			
• Transportation, max.	70 °C			
Air pressure acc. to IEC 60068-2-13				
• Operation, min.	860 hPa			
• Operation, max.	1 080 hPa			
• Storage, min.	660 hPa			
• Storage, max.	1 080 hPa			
Altitude during operation relating to sea level				
• Installation altitude above sea level, max.	2 000 m			
Relative humidity				
• Operation at 25 °C, max.	95 %			
• Operation at 50 °C, max.	50 %; 95 % at 25 °C, decreasing linearly to 50 % at 50 °C			

Technical specifications

Article number	6BK1942-2AA00-0AA0 HCS POM4220 Lowend	6BK1942-2CA00-0AA1 HCS POM4220 Midrange phase angle control	6BK1942-2DA00-0AA0 HCS POM4220 Highend	6BK1942-2FA00-0AA0 HCS POM4220 Flexible
Vibrations				
• Vibration resistance during operation acc. to IEC 60068-2-6	10 ... 58 Hz / 0.075 mm, 58 ... 150 Hz / 1 g			
• Vibration resistance during storage acc. to IEC 60068-2-6	5 ... 8.5 Hz / 3.5 mm, 8.5 ... 500 Hz / 1 g			
Shock testing				
• Shock resistance during operation acc. to IEC 60068-2-27	15 g / 11 ms / 3 shocks/axis			
• Shock resistance during storage acc. to IEC 60068-2-29	25 g / 6 ms / 1 000 shocks/axis			
Dimensions				
Width	36 mm			
Height	285 mm			
Depth	281 mm			

I/O systems

IO systems for heating elements

SIPLUS HCS4300 heating control system

Overview



HCS4300 2POM

The SIPLUS HCS4300 heating control system controls heating elements and other resistive loads in 230 V/277 V and 400 V/480 V voltage supply systems in industrial environments.

Communication takes place via PROFINET or PROFIBUS and can be used together with SIMATIC S7, for example, to form a highly modern and powerful automation system.

Overview



The Central Interface Module (CIM) is the intelligent processor module of the SIPLUS HCS4300 heating control system.

Ordering data

SIPLUS HCS4300 CIM4310

Central Interface Module with PROFINET communication

Article No.

6BK1943-1AA00-0AA0

Central Interface Module with PROFIBUS communication

6BK1943-1BA00-0AA0

Accessories

SIPLUS HCS4300 EM4315

Expansion module for SIPLUS HCS4300, extends the configuration with 8 Power Output Modules

6BK1943-1AA50-0AA0

Article No.

SIPLUS HCS4000 I/O module temperature

For recording temperatures using temperature sensors, thermocouples and pyrometers

6BK1900-0AA00-0AA0

SIPLUS HCS4000 I/O module DI/DO

With 8 digital outputs and 8 configurable inputs/outputs

6BK1900-0BA00-0AA0

SIPLUS HCS4000 I/O module U/I

For current and voltage measurement (line voltage compensation)

6BK1900-0CA00-0AA0

Technical specifications

Article number	6BK1943-1AA00-0AA0 HCS CIM4310 PROFINET	6BK1943-1BA00-0AA0 HCS CIM4310 PROFIBUS	6BK1943-1AA50-0AA0 HCS EM4315 Extension Module
General information			
Product type designation	CIM4310 PROFINET	CIM4310 PROFIBUS	EM4315
Installation type/mounting			
Mounting type	Screw mounting to POM		
Mounting position	vertical		
Type of ventilation	Forced ventilation		
Supply voltage			
Type of supply voltage	DC		
Rated value (DC)	24 V		
relative symmetrical tolerance of the supply voltage	20 %		
Connection method			
• Design of electrical connection for supply voltage	plug, 2x 2-pole with spring-type terminal, push-in		
- Connectable conductor cross-sections, solid	1x (0.2 ... 2.5 mm ²)		
- Connectable conductor cross-sections, finely stranded with wire end processing	1x (0.2 ... 2.5 mm ²)		
- Connectable conductor cross-sections for AWG cables	1x (26 ... 12)		
Power			
Active power input	3 W		1 W

I/O systems

IO systems for heating elements

SIPLUS HCS4300 heating control system

Central Interface Module (CIM)

Technical specifications

Article number	6BK1943-1AA00-0AA0	6BK1943-1BA00-0AA0	6BK1943-1AA50-0AA0
	HCS CIM4310 PROFINET	HCS CIM4310 PROFIBUS	HCS EM4315 Extension Module
Hardware configuration			
Type of power output connectable	POM4320		
Slots			
• Number of slots	1		0
Interfaces			
Interfaces/bus type	PROFINET IO	PROFIBUS DP	system interface
Transmission rate, max.	100 Mbit/s	12 Mbit/s	
PROFIBUS DP			
• Design of electrical connection		9-pin sub D socket	
Supports protocol for PROFINET IO			
• Design of electrical connection of PROFINET interface	2x RJ45		
Protocols			
Supports protocol for PROFINET IO	Yes	No	
PROFIBUS DP	No	Yes	No
EtherNet/IP	No		
Interrupts/diagnostics/status information			
Number of status displays	3		1
LED status display	LED green = ready, LED yellow = heating on/off, LED red = error display		LED green = ready
Isolation			
Overvoltage category	III		
Degree of pollution	2		
EMC			
EMC interference emission	Limit value in accordance with IEC 61000-6-4:2007 + A1:2011		
Electrostatic discharge acc. to IEC 61000-4-2	4 kV contact discharge / 8 kV air discharge		
Field-related interference acc. to IEC 61000-4-3	10 V/m (80 ... 1 000 MHz), 3 V/m (1.4 ... 2.0 GHz), 1 V/m (2.0 ... 2.7 GHz)		
Conducted interference due to burst acc. to IEC 61000-4-4	2 kV power supply lines, 2 kV PROFINET cables	2 kV power supply lines / 2 kV PROFIBUS cables	2 kV power supply lines
Conducted interference due to surge acc. to IEC 61000-4-5	DC supply lines: 0.5 kV symmetrical and unsymmetrical PROFINET cables: 1 kV unsymmetrical	DC supply lines: 0.5 kV symmetrical and asymmetrical, PROFIBUS lines: 1 kV asymmetrical	On DC supply lines: 0.5 kV symmetrical and asymmetrical
Conducted interference due to high-frequency radiation acc. to IEC 61000-4-6	10 V (0.15 ... 80 MHz)		
Degree and class of protection			
IP degree of protection	IP20		
Standards, approvals, certificates			
reference designation according to IEC 81346-2 (2009)	K		
Ambient conditions			
Ambient temperature during operation			
• min.	0 °C		
• max.	55 °C		
Ambient temperature during storage/transportation			
• Storage, min.	-25 °C		
• Storage, max.	70 °C		
• Transportation, min.	-25 °C		
• Transportation, max.	70 °C		
Air pressure acc. to IEC 60068-2-13			
• Operation, min.	860 hPa		
• Operation, max.	1 080 hPa		
• Storage, min.	660 hPa		
• Storage, max.	1 080 hPa		
Altitude during operation relating to sea level			
• Installation altitude above sea level, max.	2 000 m		

Technical specifications

Article number	6BK1943-1AA00-0AA0	6BK1943-1BA00-0AA0	6BK1943-1AA50-0AA0
	HCS CIM4310 PROFINET	HCS CIM4310 PROFIBUS	HCS EM4315 Extension Module
Relative humidity	<ul style="list-style-type: none"> • Operation at 25 °C, max. 95 % • Operation at 50 °C, max. 50 %; 95 % at 25 °C, decreasing linearly to 50 % at 50 °C 		
Vibrations	<ul style="list-style-type: none"> • Vibration resistance during operation acc. to IEC 60068-2-6 10 ... 58 Hz / 0.075 mm, 58 ... 150 Hz / 1 g • Vibration resistance during storage acc. to IEC 60068-2-6 5 ... 8.5 Hz / 3.5 mm, 8.5 ... 500 Hz / 1 g 		
Shock testing	<ul style="list-style-type: none"> • Shock resistance during operation acc. to IEC 60068-2-27 15 g / 11 ms / 3 shocks/axis • Shock resistance during storage acc. to IEC 60068-2-29 25 g / 6 ms / 1 000 shocks/axis 		
Dimensions			
Width	56 mm		
Height	285 mm		
Depth	136 mm		122 mm

Article number	6BK1900-0BA00-0AA0
	HCS I/O4000 DI/DO
General information	
Product type designation	PM4000 DI/DO
Installation type/mounting	
Mounting type	Screw mounting to CIM
Mounting position	vertical
Type of ventilation	Forced ventilation
Supply voltage	
Design of the power supply	Power supply via CIM
Power	
Active power input, max.	1 W
Digital inputs	
Number of digital inputs	8
Connection method	
<ul style="list-style-type: none"> • Design of electrical connection at the digital inputs - Connectable conductor cross-sections, solid - Connectable conductor cross-sections, finely stranded with wire end processing - Connectable conductor cross-sections for AWG cables 	plug, 18-pin with spring-type terminal, push-in 1x (0.2 ... 1.5 mm ²) 1x (0.25 ... 1.5 mm ²) 1x (24 ... 16)
Digital outputs	
Type of digital output	semiconductor output (high side switch)
Number of digital outputs	16
Switching performance	monostable
short-circuit proof	Yes
Output voltage	
<ul style="list-style-type: none"> • Type of output voltage • Rated value (DC) • permissible voltage at output, min. • permissible voltage at output, max. 	DC 24 V 19.2 V 28.8 V
Output current	
<ul style="list-style-type: none"> • for signal "1" permissible range, max. 	500 mA

Article number	6BK1900-0BA00-0AA0
	HCS I/O4000 DI/DO
Connection method	
<ul style="list-style-type: none"> • Design of electrical connection at the digital outputs - Connectable conductor cross-sections, solid - Connectable conductor cross-sections, finely stranded with wire end processing - Connectable conductor cross-sections for AWG cables • Design of electrical connection for control supply voltage - Connectable conductor cross-sections with wire end processing - Connectable conductor cross-sections for AWG cables 	plug, 18-pin with spring-type terminal, push-in 1x (0.2 ... 1.5 mm ²) 1x (0.25 ... 1.5 mm ²) 1x (24 ... 16) plug, 18-pin with spring-type terminal, push-in 1x (0.25 ... 1.5 mm ²) 1x (24 ... 16)
Interfaces	
Interfaces/bus type	system interface
Interrupts/diagnostics/status information	
Number of status displays	18
LED status display	LED green = Ready, LED red = Error display, 1 LED yellow per output: LED on - H status; LED off -L status
Potential separation	
between outputs and system interface	Yes
Isolation	
Overvoltage category	III
Degree of pollution	2
EMC	
EMC interference emission	Limit value in accordance with IEC 61000-6-4:2007 + A1:2011
Electrostatic discharge acc. to IEC 61000-4-2	4 kV contact discharge / 8 kV air discharge
Field-related interference acc. to IEC 61000-4-3	10 V/m (80 ... 1 000 MHz), 3 V/m (1.4 ... 2.0 GHz), 1 V/m (2.0 ... 2.7 GHz)
Conducted interference due to burst acc. to IEC 61000-4-4	2 kV signal lines
Conducted interference due to surge acc. to IEC 61000-4-5	DC supply cables: 0.5 kV balanced and unbalanced
Conducted interference due to high-frequency radiation acc. to IEC 61000-4-6	10 V (0.15 ... 80 MHz)

I/O systems

IO systems for heating elements

SIPLUS HCS4300 heating control system

Central Interface Module (CIM)

Technical specifications

Article number	6BK1900-0BA00-0AA0 HCS I/O4000 DI/DO
Degree and class of protection	
IP degree of protection	IP20
Standards, approvals, certificates	
reference designation according to IEC 81346-2 (2009)	K
Ambient conditions	
Ambient temperature during operation	
• min.	0 °C
• max.	55 °C
Ambient temperature during storage/transportation	
• Storage, min.	-25 °C
• Storage, max.	70 °C
• Transportation, min.	-25 °C
• Transportation, max.	70 °C
Air pressure acc. to IEC 60068-2-13	
• Operation, min.	860 hPa
• Operation, max.	1 080 hPa
• Storage, min.	660 hPa
• Storage, max.	1 080 hPa
Altitude during operation relating to sea level	
• Installation altitude above sea level, max.	2 000 m
Relative humidity	
• Operation at 25 °C, max.	95 %
• Operation at 50 °C, max.	50 %; 95 % at 25 °C, decreasing linearly to 50 % at 50 °C
Vibrations	
• Vibration resistance during operation acc. to IEC 60068-2-6	10 ... 58 Hz / 0.075 mm, 58 ... 150 Hz / 1 g
• Vibration resistance during storage acc. to IEC 60068-2-6	5 ... 8.5 Hz / 3.5 mm, 8.5 ... 500 Hz / 1 g
Shock testing	
• Shock resistance during operation acc. to IEC 60068-2-27	15 g / 11 ms / 3 shocks/axis
• Shock resistance during storage acc. to IEC 60068-2-29	25 g / 6 ms / 1 000 shocks/axis
Dimensions	
Width	27 mm
Height	141 mm
Depth	110 mm
Article number	6BK1900-0CA00-0AA0 HCS I/O4000 U/I
General information	
Product type designation	For PM4000 U/I
Installation type/mounting	
Mounting type	Screw mounting to CIM
Mounting position	vertical
Type of ventilation	Forced ventilation
Supply voltage	
Design of the power supply	Power supply via CIM
Power	
Active power input, max.	1 W
Interfaces	
Interfaces/bus type	system interface
Interrupts/diagnostics/status information	
Number of status displays	2
LED status display	LED green = Ready, LED red = Error display

Article number	6BK1900-0CA00-0AA0 HCS I/O4000 U/I
Integrated Functions	
Measuring functions	
• Voltage measurement	Yes
• Current measurement	Yes
Operating mode for measured value acquisition	
- Operating frequency, min.	50 Hz
- Operating frequency, max.	60 Hz
Measuring inputs for voltage	
- Voltage measurement range, min.	230 V
- Voltage measuring range, max.	480 V
- Relative measuring accuracy voltage	0.5 %
- Design of electrical connection at the measuring inputs for voltage	plug, 6-pole with spring-type terminal, push-in
- Connectable conductor cross-sections, solid	1x (0.2 ... 10 mm ²)
- Connectable conductor cross-sections, finely stranded with wire end processing	1x (0.25 ... 6 mm ²)
- Connectable conductor cross-sections for AWG cables	1x (24 ... 8)
Measuring inputs for current	
- Current measurement range, min.	0 A
- Current measurement range, max.	5 A
- Relative measuring accuracy current	0.5 %
- Design of electrical connection at the measuring inputs for current	plug, 8-pole with spring-type terminal, push-in
- Connectable conductor cross-sections, solid	1x (0.2 ... 1.5 mm ²)
- Connectable conductor cross-sections, finely stranded with wire end processing	1x (0.2 ... 1.5 mm ²)
- Connectable conductor cross-sections for AWG cables	1x (24 ... 16)
Isolation	
Overvoltage category	III
Degree of pollution	2
EMC	
EMC interference emission	Limit value in accordance with IEC 61000-6-4:2007 + A1:2011
Electrostatic discharge acc. to IEC 61000-4-2	4 kV contact discharge / 8 kV air discharge
Field-related interference acc. to IEC 61000-4-3	10 V/m (80 ... 1 000 MHz), 3 V/m (1.4 ... 2.0 GHz), 1 V/m (2.0 ... 2.7 GHz)
Conducted interference due to burst acc. to IEC 61000-4-4	2 kV signal lines
Conducted interference due to surge acc. to IEC 61000-4-5	Voltage measurement inputs: 1 kV balanced, 2 kV unbalanced
Conducted interference due to high-frequency radiation acc. to IEC 61000-4-6	10 V (0.15 ... 80 MHz)
Degree and class of protection	
IP degree of protection	IP20
Standards, approvals, certificates	
reference designation according to IEC 81346-2 (2009)	K
Ambient conditions	
Ambient temperature during operation	
• min.	0 °C
• max.	55 °C

Technical specifications

Article number	6BK1900-0CA00-0AA0 HCS I/O4000 U/I
Ambient temperature during storage/transportation	
• Storage, min.	-25 °C
• Storage, max.	70 °C
• Transportation, min.	-25 °C
• Transportation, max.	70 °C
Air pressure acc. to IEC 60068-2-13	
• Operation, min.	860 hPa
• Operation, max.	1 080 hPa
• Storage, min.	660 hPa
• Storage, max.	1 080 hPa
Altitude during operation relating to sea level	
• Installation altitude above sea level, max.	2 000 m
Relative humidity	
• Operation at 25 %, max.	95 %
• Operation at 50 %, max.	50 %; 95 % at 25 °C, decreasing linearly to 50 % at 50 °C
Vibrations	
• Vibration resistance during operation acc. to IEC 60068-2-6	10 ... 58 Hz / 0.075 mm, 58 ... 150 Hz / 1 g
• Vibration resistance during storage acc. to IEC 60068-2-6	5 ... 8.5 Hz / 3.5 mm, 8.5 ... 500 Hz / 1 g
Shock testing	
• Shock resistance during operation acc. to IEC 60068-2-27	15 g / 11 ms / 3 shocks/axis
• Shock resistance during storage acc. to IEC 60068-2-29	25 g / 6 ms / 1 000 shocks/axis
Dimensions	
Width	27 mm
Height	141 mm
Depth	110 mm
Article number	6BK1900-0AA00-0AA0 HCS I/O4000 Temperature
General information	
Product type designation	PM4000 temperature
Installation type/mounting	
Mounting type	Screw mounting to CIM
Mounting position	vertical
Type of ventilation	Forced ventilation
Supply voltage	
Design of the power supply	Power supply via CIM
Power	
Active power input, max.	1 W
Analog inputs	
Number of analog inputs	4
• for 2-wire system	4
• for 4-wire system	2
Sensor current, typ.	210 µA
Impulse voltage resistance, max.	15 V
Input ranges	
• Thermocouple	Yes
• Resistance thermometer	Yes

Article number	6BK1900-0AA00-0AA0 HCS I/O4000 Temperature
Measuring range	
• Temperature for type J thermocouple, min.	0 °C
• Temperature for type J thermocouple, max.	650 °C
• Temperature for type K thermocouple, min.	0 °C
• Temperature for type K thermocouple, max.	440 °C
• Temperature for type L thermocouple, min.	0 °C
• Temperature for type L thermocouple, max.	640 °C
• Temperature for Pt 100 according to IEC 60751, min.	0 °C
• Temperature for Pt 100 according to IEC 60751, max.	410 °C
• Temperature for Pt 1000 according to IEC 60751, min.	0 °C
• Temperature for Pt 1000 according to IEC 60751, max.	850 °C
Connection method	
• Design of electrical connection for temperature sensors	plug, 8-pole with spring-type terminal, push-in
- Connectable conductor cross-sections for AWG cables	1x (24 ... 16)
- Connectable conductor cross-sections, solid	1x (0.2 ... 1.5 mm ²)
- Connectable conductor cross-sections with wire end processing	1x (0.25 ... 1.5 mm ²)
Analog value generation for the inputs	
Type of A/D conversion	Sigma Delta
Conversion time	150 ms
Errors/accuracies	
Measuring accuracy	±1 K
Temperature drift per °C, typ.	0.05 %/°C
Temperature offset per K, max.	0.1 K/K
Interfaces	
Interfaces/bus type	system interface
Interrupts/diagnostics/status information	
Number of status displays	2
LED status display	LED green = Ready, LED red = Error display
Integrated Functions	
Measuring functions	
• Current measurement	Yes
Measuring inputs for current	
- Current measurement range, min.	0 mA
- Current measurement range, max.	20 mA
- Relative measuring accuracy current	0.5 %
- Design of electrical connection at the measuring inputs for current	plug, 8-pole with spring-type terminal, push-in
- Connectable conductor cross-sections, solid	1x (0.2 ... 1.5 mm ²)
- Connectable conductor cross-sections, finely stranded with wire end processing	1x (0.25 ... 1.5 mm ²)
- Connectable conductor cross-sections for AWG cables	1x (24 ... 16)

I/O systems

IO systems for heating elements

SIPLUS HCS4300 heating control system

Central Interface Module (CIM)

Technical specifications

Article number	6BK1900-0AA00-0AA0 HCS I/O4000 Temperature
Potential separation between the channels	No
Isolation Overvoltage category Degree of pollution	III 2
EMC EMC interference emission	Limit value in accordance with IEC 61000-6-4:2007 + A1:2011
Electrostatic discharge acc. to IEC 61000-4-2	4 kV contact discharge / 8 kV air discharge
Field-related interference acc. to IEC 61000-4-3	10 V/m (80 ... 1 000 MHz), 3 V/m (1.4 ... 2.0 GHz), 1 V/m (2.0 ... 2.7 GHz)
Conducted interference due to burst acc. to IEC 61000-4-4	2 kV signal lines
Conducted interference due to surge acc. to IEC 61000-4-5	Not applicable
Conducted interference due to high-frequency radiation acc. to IEC 61000-4-6	10 V (0.15 ... 80 MHz)
Degree and class of protection IP degree of protection	IP20
Standards, approvals, certificates reference designation according to IEC 81346-2 (2009)	K
Ambient conditions Ambient temperature during operation • min. • max.	0 °C 55 °C

Article number	6BK1900-0AA00-0AA0 HCS I/O4000 Temperature
Ambient temperature during storage/transportation • Storage, min. • Storage, max. • Transportation, min. • Transportation, max.	-25 °C 70 °C -25 °C 70 °C
Air pressure acc. to IEC 60068-2-13 • Operation, min. • Operation, max. • Storage, min. • Storage, max.	860 hPa 1 080 hPa 660 hPa 1 080 hPa
Altitude during operation relating to sea level • Installation altitude above sea level, max.	2 000 m
Relative humidity • Operation at 25 °C, max. • Operation at 50 °C, max.	95 % 50 %; 95 % at 25 °C, decreasing linearly to 50 % at 50 °C
Vibrations • Vibration resistance during operation acc. to IEC 60068-2-6 • Vibration resistance during storage acc. to IEC 60068-2-6	10 ... 58 Hz / 0.075 mm, 58 ... 150 Hz / 1 g 5 ... 8.5 Hz / 3.5 mm, 8.5 ... 500 Hz / 1 g
Shock testing • Shock resistance during operation acc. to IEC 60068-2-27 • Shock resistance during storage acc. to IEC 60068-2-29	15 g / 11 ms / 3 shocks/axis 25 g / 6 ms / 1 000 shocks/axis
Dimensions Width Height Depth	27 mm 141 mm 110 mm

Design



- Module (encapsulated) in a metal enclosure.
- There are 6 versions:
 - POM4320 busbar mounting (IEC): a current of up to 16 A can be used per output
 - POM4320 busbar mounting (UL): a current of up to 15 A can be used per output
 - POM4320 rear panel mounting (IEC): a current of up to 16 A can be used per output
 - POM4320 rear panel mounting (UL): a current of up to 15 A can be used per output
 - POM4320 Highend busbar mounting: a current of up to 60 A can be used per output
 - POM4320 Highend rear panel mounting: a current of up to 60 A can be used per output
- Heat dissipation by fan fitted to top of module.
- Internal serial interface.
- Three diagnostics LEDs for displaying module faults.
- POM4320: 9 diagnostics LEDs for displaying output errors.
- POM4320 Highend: 6 diagnostics LEDs for displaying output errors.

Ordering data

SIPLUS HCS4300 POM4320

Power output module with 9 outputs for connecting resistive loads

IEC, busbar mounting, redesign version with enhanced interference immunity

UL, busbar mounting, redesign version with enhanced interference immunity and 100 kA SCCR

IEC, rear panel mounting, redesign version with enhanced interference immunity

UL, rear panel mounting, redesign version with enhanced interference immunity and 100 kA SCCR

POM4320 Highend, busbar mounting

POM4320 Highend, panel mounting

Article No.

6BK1943-2AA00-0AA2

6BK1943-2BA00-0AA2

6BK1943-2CA00-0AA2

6BK1943-2DA00-0AA2

6BK1943-2AH00-0AA0

6BK1943-2CH00-0AA0

Article No.

Accessories

SIPLUS HCS4300 connecting cable from POM to POM

- Consisting of 10 units, 100 mm long
- Consisting of 10 units, 250 mm long
- Consisting of 10 units, 1000 mm long
- Consisting of 10 units, 1500 mm long

6BK1943-5AA00-0AA0

6BK1943-5BA00-0AA0

6BK1943-5CA00-0AA0

6BK1943-5DA00-0AA0

HCS4300 connector set for POM4320

- Consisting of 10 x 3-pin connectors

6BK1943-6AA00-0AA0

Spare fuse, 16 A/500 V, for POM4320

6BK1943-6BA00-0AA0

Fan as spare part POM4320

6BK1700-2GA00-0AA0

Spare fuse, 32 A/690 V, for POM4320 Highend

6BK1943-6EA00-0AA0

HCS4300 connector set for POM4320 Highend

6BK1943-6FA00-0AA0

Fan as spare part POM4320 Highend

6BK1943-6GA00-0AA0

HCS Jumper POM4320 Highend

6BK1943-6HA00-0AA0

I/O systems

IO systems for heating elements

SIPLUS HCS4300 heating control system

Power Output Module (POM)

Technical specifications

Article number	6BK1943-2AA00-0AA2	6BK1943-2AH00-0AA0	6BK1943-2BA00-0AA2	6BK1943-2CA00-0AA2	6BK1943-2CH00-0AA0	6BK1943-2DA00-0AA2
	HCS POM4320 busbar mounting (IEC)	HCS POM4320 Highend busbar mounting	HCS POM4320 busbar mounting (UL)	HCS POM4320 panel mounting (IEC)	HCS POM4320 Highend panel mounting	HCS POM4320 panel mounting (UL)
General information						
Product type designation	POM4320 busbar mounting (IEC)	POM4320 Highend	POM4320 busbar mounting (UL)	POM4320 rear panel mounting (IEC)	POM4320 Highend	POM4320 rear panel mounting (UL)
Installation type/mounting						
Mounting type	Busbar mounting			Backplane mounting		
Mounting position	vertical					
Type of ventilation	Self-ventilation					
Supply voltage						
Type of supply voltage	AC					
Rated value (AC)	400 V; Phase - phase	230 V; phase - neutral conductor	400 V; Phase - phase		230 V; phase - neutral conductor	400 V; Phase - phase
• Relative negative tolerance	10 %					
• Relative positive tolerance	30 %					
2nd rated value (AC)	480 V; Phase - phase	277 V; phase - neutral conductor	480 V; Phase - phase		277 V; phase - neutral conductor	480 V; Phase - phase
• Relative negative tolerance	25 %					
• Relative positive tolerance	8 %					
3rd rated value (AC)		400 V; Phase - phase			400 V; Phase - phase	
• Relative negative tolerance	10 %					
• Relative positive tolerance	30 %					
4th rated value (AC)		480 V; Phase - phase			480 V; Phase - phase	
• Relative negative tolerance	25 %					
• Relative positive tolerance	8 %					
Line frequency						
• Rated value 50 Hz	Yes					
• Rated value 60 Hz	Yes					
• Relative symmetrical tolerance	5 %					
Mains buffering						
• Recovery time after power failure, typ.	1 s					
Connection method						
• Design of electrical connection for supply voltage	Busbar mounting, 3-pole + PE	Busbar adapter, 3-pole + N + PE	Busbar mounting, 3-pole + PE		Terminal, 3-pole + N + PE 1x (1.5 ... 50 mm ²)	Busbar mounting, 3-pole + PE
- Connectable conductor cross-sections, solid						1x (1.5 ... 35 mm ²)
- Connectable conductor cross-sections, finely stranded with wire end processing						1x (16 ... 1)
- Connectable conductor cross-sections for AWG cables						
- Cable cross-sections for N						1x (0.2 ... 2.5 mm ²)
Input voltage						
device version of the power supply for electronics	Power supply via CIM					
Power						
Active power input, max.	8 W	10 W	8 W		10 W	8 W
Power electronics						
Type of load	Ohmic load					
Power capacity, max.	57.6 kW; At 400 V AC	76.8 kW; At 400 V AC	64.8 kW; At 480 V AC	57.6 kW; At 400 V AC	76.8 kW; At 400 V AC	64.8 kW; At 480 V AC
• For phase against phase with fan at 40 °C, max.	57.6 kW; At 400 V AC	76.8 kW; At 400 V AC	64.8 kW; At 480 V AC	57.6 kW; At 400 V AC	76.8 kW; At 400 V AC	64.8 kW; At 480 V AC
• For phase against neutral with fan at 40 °C, max.	44.16 kW; at 230 V AC					
Switching capacity current per phase, max.	83 A		80 A	83 A	105 A; 90 A (UL)	
Short-time withstand current (SCCR) acc. to UL 508A				100 kA	100 kA	

Technical specifications

Article number	6BK1943-2AA00-0AA2	6BK1943-2AH00-0AA0	6BK1943-2BA00-0AA2	6BK1943-2CA00-0AA2	6BK1943-2CH00-0AA0	6BK1943-2DA00-0AA2
	HCS POM4320 busbar mounting (IEC)	HCS POM4320 Highend busbar mounting	HCS POM4320 busbar mounting (UL)	HCS POM4320 panel mounting (IEC)	HCS POM4320 Highend panel mounting	HCS POM4320 panel mounting (UL)
Control of heating elements						
• Half-wave control	Yes					
• Soft start	Yes					
• Phase control	Yes					
Load connection type						
• Star connection with neutral conductor (single-phase)	No	Yes	No		Yes	No
• Open delta connection (single-phase)	Yes; Incoming fuse contained in the device	Yes; Incoming fuse in the device optionally possible	Yes; Incoming fuse contained in the device		Yes; Incoming fuse in the device optionally possible	Yes; Incoming fuse contained in the device
• closed delta connection (2-phase)	No	Yes; Economy circuit	No		Yes; Economy circuit	No
• Closed delta connection (3-phase)	No	Yes	No		Yes	No
• Star connection with neutral conductor (2-phase)	No	Yes; Economy circuit	No		Yes; Economy circuit	No
• star connection without neutral conductor (3-phase)	No	Yes	No		Yes	No
• 2-pole switching	No	Yes; Phase - phase	No		Yes; Phase - phase	No
Setpoint input						
• Percent	Yes					
• Watts	No	Yes	No		Yes	No
Heating power						
• Number of digital outputs	9	6; Possible parallel switching of 2 outputs	9		6; Possible parallel switching of 2 outputs	9
• Number of heating elements per output, max.	1	5	1		5	1
• Output voltage for heating power	400 V	230 V	400 V		230 V	400 V
• 2nd output voltage for heating power	480 V	277 V	480 V		277 V	480 V
• 3rd output voltage for heating power		400 V			400 V	
• 4th output voltage for heating power		480 V			480 V	
• Power carrying capacity per output, min.	200 W; At 400 V AC	1 200 W; At 400 V AC	240 W; At 480 V AC	200 W; At 400 V AC	1 200 W; At 400 V AC	240 W; At 480 V AC
• Power carrying capacity per output, max.	6 400 W; At 400 V AC	12 800 W; At 400 V AC	7 200 W; At 480 V AC	6 400 W; At 400 V AC	12 800 W; At 400 V AC	7 200 W; At 480 V AC
- for heating elements with high inrush current, max.	4 000 W; At 400 V AC	6 000 W; At 400 V AC	4 000 W; At 480 V AC	4 000 W; At 400 V AC	6 000 W; At 400 V AC	4 000 W; At 480 V AC
• Output current for heating power	16 A; max.	32 A; max.	15 A; max.	16 A; max.	32 A; max.	15 A; max.
• Melting I2t value	250 A ² ·s		400 A ² ·s	250 A ² ·s		400 A ² ·s
• Design of short-circuit protection per output	Fuse 16 A	Melting fuse 32 A	Melting fuse 20 A	Fuse 16 A	Melting fuse 32 A	Melting fuse 20 A
• Design of overvoltage protection	Transil Diode					
Connection method						
• Design of electrical connection at output for heating and fan	plug, 3-pole with spring-type terminal, push-in	plug, 3-pole, with operating lever, push-in	plug, 3-pole with spring-type terminal, push-in	plug, 3-pole, with operating lever, push-in	plug, 3-pole, with operating lever, push-in	plug, 3-pole with spring-type terminal, push-in
- Connectable conductor cross-sections, solid	1x (0.2 ... 10 mm ²)	1x (0.75 ... 16 mm ²)	1x (0.2 ... 10 mm ²)	1x (0.75 ... 16 mm ²)	1x (0.75 ... 16 mm ²)	1x (0.2 ... 10 mm ²)
- Connectable conductor cross-sections, finely stranded with wire end processing	1x (0.25 ... 6 mm ²)	1x (0.75 ... 16 mm ²)	1x (0.25 ... 6 mm ²)	1x (0.75 ... 16 mm ²)	1x (0.75 ... 16 mm ²)	1x (0.25 ... 6 mm ²)
- Connectable conductor cross-sections for AWG cables, stranded	1x (24 ... 8)	1x (18 ... 4)	1x (24 ... 8)	1x (18 ... 4)	1x (18 ... 4)	1x (24 ... 8)

I/O systems

IO systems for heating elements

SIPLUS HCS4300 heating control system

Power Output Module (POM)

Technical specifications

Article number	6BK1943-2AA00-0AA2	6BK1943-2AH00-0AA0	6BK1943-2BA00-0AA2	6BK1943-2CA00-0AA2	6BK1943-2CH00-0AA0	6BK1943-2DA00-0AA2
	HCS POM4320 busbar mounting (IEC)	HCS POM4320 Highend busbar mounting	HCS POM4320 busbar mounting (UL)	HCS POM4320 panel mounting (IEC)	HCS POM4320 Highend panel mounting	HCS POM4320 panel mounting (UL)
Interfaces						
Interfaces/bus type	system interface					
Interrupts/diagnostics/status information						
Number of status displays	12	9	12		9	12
LED status display	LED green = ready, LED yellow = heating on/off, LED red = error display, LED red = error for each channel					
Diagnostics function	Voltage diagnostics	Voltage and current diagnosis	Voltage diagnostics		Voltage and current diagnosis	Voltage diagnostics
Diagnoses						
• Fuse blown	Yes					
• Load failure	Yes					
• Triac error	Yes					
• Switch-off threshold for internal device temperature	Yes					
• Parallel-connected heating elements	No	Yes	No		Yes	No
• Rotating field fault	Yes					
• Communication error	Yes					
• Supply voltage not connected	Yes					
• Line voltage outside the permissible range	Yes					
• Frequency outside the permissible range	Yes					
• Fault current too high	No	Yes	No		Yes	No
Integrated Functions						
Monitoring functions						
• Temperature monitoring	Yes					
• Type of temperature monitoring	NTC thermistor					
Measuring functions						
• Voltage measurement	Yes					
• Current measurement	No	Yes	No		Yes	No
• Fault current detection	No	Yes; For 2-pole switching	No		Yes; For 2-pole switching	No
Potential separation						
Design of electrical isolation between the outputs	Optocoupler and/or protective impedance between main circuit and PELV					
	No					
Isolation						
Overtoltage category	III					
Degree of pollution	2					
EMC						
EMC interference emission	Limit value in accordance with IEC 61000-6-4:2007 + A1:2011					
Electrostatic discharge acc. to IEC 61000-4-2	4 kV contact discharge / 8 kV air discharge					
Field-related interference acc. to IEC 61000-4-3	10 V/m (80 ... 1 000 MHz), 3 V/m (1.4 ... 2.0 GHz), 1 V/m (2.0 ... 2.7 GHz)					
Conducted interference due to burst acc. to IEC 61000-4-4	2 kV power supply lines, 2 kV load lines					
Conducted interference due to surge acc. to IEC 61000-4-5	on supply and load lines: 1 kV symmetric, 2 kV unsymmetric					
Conducted interference due to high-frequency radiation acc. to IEC 61000-4-6	10 V (0.15 ... 80 MHz)					
Degree and class of protection						
IP degree of protection	IP20					
Standards, approvals, certificates						
reference designation according to IEC 81346-2 (2009)	Q					

Technical specifications

Article number	6BK1943-2AA00-0AA2	6BK1943-2AH00-0AA0	6BK1943-2BA00-0AA2	6BK1943-2CA00-0AA2	6BK1943-2CH00-0AA0	6BK1943-2DA00-0AA2
	HCS POM4320 busbar mounting (IEC)	HCS POM4320 Highend busbar mounting	HCS POM4320 busbar mounting (UL)	HCS POM4320 panel mounting (IEC)	HCS POM4320 Highend panel mounting	HCS POM4320 panel mounting (UL)
Ambient conditions						
Ambient temperature during operation						
• min.	0 °C					
• max.	55 °C					
Ambient temperature during storage/transportation						
• Storage, min.	-25 °C					
• Storage, max.	70 °C					
• Transportation, min.	-25 °C					
• Transportation, max.	70 °C					
Air pressure acc. to IEC 60068-2-13						
• Operation, min.	860 hPa					
• Operation, max.	1 080 hPa					
• Storage, min.	660 hPa					
• Storage, max.	1 080 hPa					
Altitude during operation relating to sea level						
• Installation altitude above sea level, max.	2 000 m					
Relative humidity						
• Operation at 25 °C, max.	95 %					
• Operation at 50 °C, max.	50 %; 95 % at 25 °C, decreasing linearly to 50 % at 50 °C					
Vibrations						
• Vibration resistance during operation acc. to IEC 60068-2-6	10 ... 58 Hz / 0.075 mm, 58 ... 150 Hz / 1 g					
• Vibration resistance during storage acc. to IEC 60068-2-6	5 ... 8.5 Hz / 3.5 mm, 8.5 ... 500 Hz / 1 g					
Shock testing						
• Shock resistance during operation acc. to IEC 60068-2-27	15 g / 11 ms / 3 shocks/axis					
• Shock resistance during storage acc. to IEC 60068-2-29	25 g / 6 ms / 1 000 shocks/axis					
Dimensions						
Width	104 mm					
Height	340 mm			344 mm		
Depth	250 mm			217 mm		

I/O systems

PROFIBUS components

Diagnostics

PROFIBUS DP diagnostic repeater**Overview**

- RS 485 repeater with online line diagnostics for PROFIBUS DP
- PROFIBUS DP standard slaves (DP-V1)
- Automatic determination of fault types and locations
- Data transmission rate 9.6 kbps to 12 Mbps
- Connection via FastConnect using IDC

Ordering data**Article No.****Article No.****RS 485 diagnostics repeater****6ES7972-0AB01-0XA0**

For connection of 1 or 2 segments to PROFIBUS DP; with online diagnostics functions for monitoring the bus lines

Accessories**RS 485 bus connector with 90° cable outlet**

With screw terminals, max. transfer rate 12 Mbps

- Without PG interface
- With PG interface

6ES7972-0BA12-0XA0
6ES7972-0BB12-0XA0

PROFIBUS FastConnect bus connector RS 485 with 90° cable outlet

With insulation displacement terminals, max. transfer rate 12 Mbps

Without PG interface

- 1 unit
- 100 units

6ES7972-0BA52-0XA0
6ES7972-0BA52-0XB0

With PG interface

- 1 unit
- 100 units

6ES7972-0BB52-0XA0
6ES7972-0BB52-0XB0

Without PG interface, grounding via control cabinet cover

- 1 unit

6ES7972-0BA70-0XA0

With PG interface, grounding via control cabinet cover

- 1 unit

6ES7972-0BB70-0XA0**RS 485 bus connector with angled cable outlet (35°)**

With screw terminals, max. transfer rate 12 Mbps

- Without PG interface
- With PG interface

6ES7972-0BA42-0XA0
6ES7972-0BB42-0XA0

PROFIBUS FastConnect RS 485 bus connector with angular cable outlet (35°)

With insulation displacement terminals, max. transfer rate 12 Mbps

- Without PG interface
- With PG interface

6ES7972-0BA61-0XA0
6ES7972-0BB61-0XA0

PROFIBUS FastConnect Stripping Tool**6GK1905-6AA00**

Preadjusted stripping tool for fast stripping of PROFIBUS FastConnect bus cables

PROFIBUS FC Standard Cable**6XV1830-0EH10**

Standard type with special design for quick mounting, 2-wire, shielded, sold by the meter, max. delivery unit 1000 m, minimum ordering quantity 20 m

S7 Manual Collection**6ES7998-8XC01-8YE0**

Electronic manuals on DVD, multilingual: S7-200, TD 200, S7-300, M7-300, C7, S7-400, M7-400, STEP 7, Engineering Tools, Runtime Software, SIMATIC DP (distributed I/O), SIMATIC HMI (Human Machine Interface), SIMATIC NET (Industrial Communication)

S7 Manual Collection update service for 1 year**6ES7998-8XC01-8YE2**

Scope of delivery: Current DVD "S7 Manual Collection" and the three subsequent updates

Connecting cable for PROFIBUS**6ES7901-4BD00-0XA0**

12 Mbps, for PG connection to PROFIBUS DP, pre-assembled with 2 x 9-pin sub D plug, 3.0 m

Technical specifications

Article number	6ES7972-0AB01-0XA0 Diagnostic repeater f. PROFIBUS-DP,
Supply voltage	
Rated value (DC)	24 V
Interfaces	
PROFIBUS DP	
• Transmission rate, max.	12 Mbit/s; 9.6 kbit/s to 12 Mbit/s
Degree and class of protection	
IP degree of protection	IP20
Ambient conditions	
Ambient temperature during operation	
• min.	0 °C
• max.	60 °C
Ambient temperature during storage/transportation	
• min.	-40 °C
• max.	70 °C
Relative humidity	
• Operation, max.	95 %; at 25 °C

Article number	6ES7972-0AB01-0XA0 Diagnostic repeater f. PROFIBUS-DP,
Connection method	
Design of electrical connection for supply voltage	Terminal module
Design of electrical connection for PROFIBUS cables	FastConnect insulation displacement, 10 clamping cycles possible
Dimensions	
Width	80 mm
Height	125 mm
Depth	67.5 mm
Weights	
Weight, approx.	300 g

I/O systems

PROFIBUS components

Diagnostics

SIPLUS diagnostic repeater for PROFIBUS

Overview



- RS 485 repeater with online line diagnostics for PROFIBUS DP
- PROFIBUS DP standard slave (DP-V1)
- Automatic determination of fault type and location
- Transmission rate from 9.6 kbps to 12 Mbps
- Connection via FastConnect IDC

Note:

SIPLUS extreme products are based on SIMATIC standard products. The contents listed here were taken from the respective standard products. SIPLUS extreme-specific information was added.

For technical documentation on SIPLUS, see:

<http://www.siemens.com/siplus-extreme>

Ordering data

Article No.

Article No.

SIPLUS RS 485 diagnostics repeater

To connect up to 2 segments to PROFIBUS DP, with online diagnostics functions for monitoring the bus lines

Exposure to environmental substances

6AG1972-0AB01-4XA0

Accessories

RS 485 bus connector with 90° cable outlet

Max. transfer rate 12 Mbps

Extended temperature range and exposure to environmental substances

- Without PG interface
- With PG interface

6AG1972-0BA12-2XA0
6AG1972-0BB12-2XA0

RS 485 bus connector with angled cable outlet

(Extended temperature range -40 °C ... +70 °C and exposure to environmental substances)

Max. transfer rate 12 Mbps

- Without PG interface
- With PG interface

6AG1972-0BA42-7XA0
6AG1972-0BB42-7XA0

Other accessories

See SIMATIC RS 485 diagnostics repeater, page 10/526

10

Technical specifications

Article number	6AG1972-0AB01-4XA0
Based on	6ES7972-0AB01-0XA0 SIPLUS DP diagnostic repeater
Ambient conditions	
Ambient temperature during operation	
• min.	0 °C; = Tmin (incl. condensation/frost)
• max.	60 °C; = Tmax
Ambient temperature during storage/transportation	
• min.	-40 °C
• max.	70 °C
Altitude during operation relating to sea level	
• Installation altitude above sea level, max.	5 000 m
• Ambient air temperature-barometric pressure-altitude	Tmin ... Tmax at 1 140 hPa ... 795 hPa (-1 000 m ... +2 000 m) // Tmin ... (Tmax - 10 K) at 795 hPa ... 658 hPa (+2 000 m ... +3 500 m) // Tmin ... (Tmax -20 K) at 658 hPa ... 540 hPa (+3 500 m ... +5 000 m)
Relative humidity	
• With condensation, tested in accordance with IEC 60068-2-38, max.	100 %; RH incl. condensation/frost (no commissioning under condensation conditions)
Resistance	
Use in stationary industrial systems	
- to biologically active substances according to EN 60721-3-3	Yes; Class 3B2 mold, fungus and dry rot spores (with the exception of fauna); Class 3B3 on request
- to chemically active substances according to EN 60721-3-3	Yes; Class 3C4 (RH < 75 %) incl. salt spray acc. to EN 60068-2-52 (severity degree 3); *
- to mechanically active substances according to EN 60721-3-3	Yes; Class 3S4 incl. sand, dust, *
Use on ships/at sea	
- to biologically active substances according to EN 60721-3-6	Yes; Class 6B2 mold and fungal spores (excluding fauna); Class 6B3 on request
- to chemically active substances according to EN 60721-3-6	Yes; Class 6C3 (RH < 75 %) incl. salt spray acc. to EN 60068-2-52 (severity degree 3); *
- to mechanically active substances according to EN 60721-3-6	Yes; Class 6S3 incl. sand, dust; *

Article number	6AG1972-0AB01-4XA0
Based on	6ES7972-0AB01-0XA0 SIPLUS DP diagnostic repeater
Usage in industrial process technology	
- Against chemically active substances acc. to EN 60654-4	Yes; Class 3 (excluding trichlorethylene)
- Environmental conditions for process, measuring and control systems acc. to ANSI/ISA-71.04	Yes; Level GX group A/B (excluding trichlorethylene; harmful gas concentrations up to the limits of EN 60721-3-3 class 3C4 permissible); level LC3 (salt spray) and level LB3 (oil)
Remark	
- Note regarding classification of environmental conditions acc. to EN 60721, EN 60654-4 and ANSI/ISA-71.04	* The supplied plug covers must remain in place over the unused interfaces during operation!
Conformal coating	
• Coatings for printed circuit board assemblies acc. to EN 61086	Yes; Class 2 for high reliability
• Protection against fouling acc. to EN 60664-3	Yes; Type 1 protection
• Military testing according to MIL-I-46058C, Amendment 7	Yes; Discoloration of coating possible during service life
• Qualification and Performance of Electrical Insulating Compound for Printed Board Assemblies according to IPC-CC-830A	Yes; Conformal coating, Class A

I/O systems

PROFIBUS components

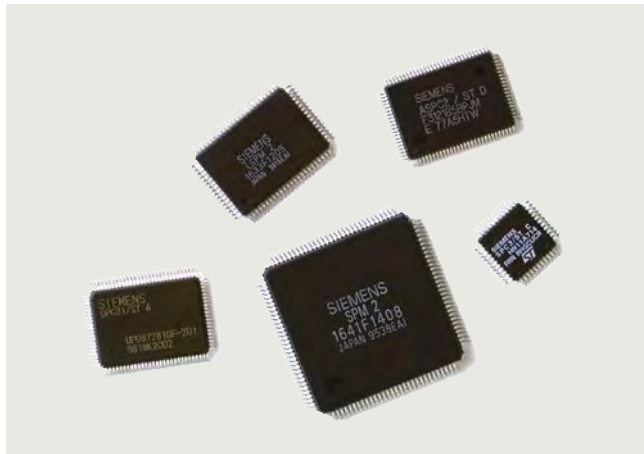
PROFIBUS DP ASICs**Overview**

- Easy connection of field devices to PROFIBUS
- Integrated low-power management
- Different ASICs for the different functional requirements and application areas

Ordering data**Article No.****Article No.****ASIC ASPC2**

For constructing master interface modules (quantity discount)

- 6 units (lead-free)
- 66 units (lead-free)
- 660 units (lead-free)
- 4620 units (lead-free)

6ES7195-0AA05-0XA0
6ES7195-0AA15-0XA0
6ES7195-0AA25-0XA0
6ES7195-0AA35-0XA0

ASIC LSPM2

For constructing simple slave interface modules (quantity discount)

- 330 units (lead-free)

6ES7195-0BA22-0XA0

ASIC SPC3

For constructing intelligent DP slave interface modules (quantity discount)

- 6 units (lead-free)
- 96 units (lead-free)
- 960 units (lead-free)
- 4800 units (lead-free)
- 750 units (lead-free) (tape & reel)

6ES7195-0BD04-0XA0
6ES7195-0BD14-0XA0
6ES7195-0BD24-0XA0
6ES7195-0BD34-0XA0
6ES7195-0BD44-0XA0

ASIC SPC3LV

For constructing intelligent DP slave interface modules (quantity discount)

- 160 units (lead-free)
- 800 units (lead-free)
- 4800 units (lead-free)
- 1000 units (lead-free) (tape & reel)

6ES7195-0BG10-0XA0
6ES7195-0BG20-0XA0
6ES7195-0BG30-0XA0
6ES7195-0BG40-0XA0

DPC31 ASIC STEP C1

For constructing intelligent DP slave interface modules (quantity discount)

- 6 units (lead-free)
- 66 units (lead-free)
- 660 units (lead-free)
- 4620 units (lead-free)

6ES7195-0BF02-0XA0
6ES7195-0BF12-0XA0
6ES7195-0BF22-0XA0
6ES7195-0BF32-0XA0

ASIC SPC 4-2

For constructing intelligent DP slave interface modules (quantity discount)

- 5 units for laboratory development (lead-free)
- 160 units (lead-free, 1 tray)

6GK1588-3AA00
6GK1588-3AA15

ASIC SIM 1-2

For connection according to IEC H1 for PROFIBUS PA with a transmission rate of 31.25 kbps

- 60 units (in tube)
- 1 000 units (tape & reel)

6GK1588-3BB02
6GK1588-3BB21

Technical specifications

	LSPM2	SPC3	SPC3LV	DPC31
Protocol	PROFIBUS DP	PROFIBUS DP	PROFIBUS DP	PROFIBUS DP, PROFIBUS PA
Application range	Simple slave application	Intelligent slave application	Intelligent slave application	Intelligent slave application
Transmission rate, max.	12 Mbps	12 Mbps	12 Mbps	12 Mbps
Bus access	in ASIC	in ASIC	in ASIC	in ASIC
Automatic determination of transmission rate	Yes	Yes	Yes	Yes
Microprocessor required	No	Yes	Yes	integrated
Scope of firmware	not required	6 to 24 KB	6 to 24 KB	Approx. 38 KB
Message buffer	-	1.5 KB	1.5 KB	6 KB
Power supply	5 V DC	5 V DC	3.3 V DC	3.3 V DC
Power loss, max.	0.35 W	0.5 W	<0.5 W	0.2 W
Permissible ambient temperature	-40 °C to +75 °C	-40 °C to +85 °C	-40 °C to +85 °C	-40 °C to +85 °C
Enclosure	MQFP, 80-pin	PQFP, 44-pin	PQFP, 44-pin	PQFP, 100-pin
Frame size	4 cm ²	2 cm ²	2 cm ²	4 cm ²
Delivery quantities (pcs.)	6/66/330/4950	6/96/750/960/4800	5/160/800/1000/4800	STEP B: 6/60/300/5100 STEP C1: 6/66/660/4620

	SPC 4-2	ASPC2	SIM 1-2
Protocol	PROFIBUS DP PROFIBUS FMS PROFIBUS PA	PROFIBUS DP PROFIBUS FMS PROFIBUS PA	PROFIBUS PA
Application range	Intelligent slave application	Master application	Medium Attachment
Transfer rate, max.	12 Mbps	12 Mbps	31.25 Kbps
Bus access	in ASIC	in ASIC	-
Automatic determination of transfer rate	Yes	Yes	-
Microprocessor required	Yes	Yes	-
Scope of firmware	3 to 30 KB	80 KB	not required
Message buffer	3 KB	1 MB (external)	-
Power supply	5 V DC, 3.3 V	5 V DC	via bus
Power loss, max.	0.6 W at 5V 0.01 W at 3.3 V	0.9 W	0.05 W
Permissible ambient temperature	-40 °C to +85 °C	-40 °C to +85 °C	-40 °C to +85 °C
Enclosure	TQFP, 44-pin	P-MQFP, 100-pin	MLPQ, 40-pin
Frame size	2 cm ²	4 cm ²	36 mm ²
Delivery quantities (pcs.)	5/160	6/66/660/4620	30/60/1000

I/O systems

PROFINET components

ERTEC Enhanced Real-Time Ethernet Controller

Overview

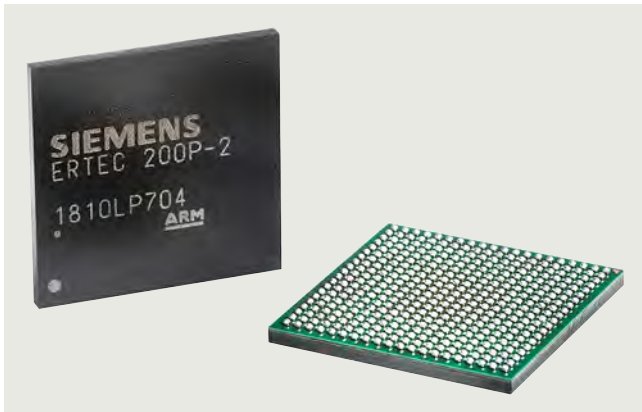

Innovative and well-proven

As a dedicated PI member, Siemens has been actively advancing the development of PROFINET from the beginning. Siemens technology components benefit from the accumulated know-how. They have been field-proven in countless products, provide maximum performance capability and can be scaled to exact requirements.

And that is not all. Siemens Competence Centers offer advice for choosing the right technology component for the device, training opportunities and support throughout the development process, up to and including successful certification.

ERTEC 200P-2 – Your path to the fastest PROFINET

The ERTEC 200P-2 (Enhanced Real-Time Controller) sets new standards for communication. Designed for cycle times as low as 125 μ s, the performance upgrade for PROFINET has been integrated in the ERTEC 200P-2. With its 250 MHz ARM9 CPU and integrated IRT (isochronous real-time) switch, field devices with demanding performance requirements can be implemented. The reduced chip size simplifies integration into compact field devices. The CPU also allows integration of a user's own applications, which makes an external host CPU unnecessary depending on the application.

Development kit for ERTEC 200P-2

The development kit includes an evaluation board with sample applications so that commissioning can be completed in minimum time. The PROFINET stack is delivered as source code and includes the eCos open source real-time operating system and all development tools, analysis programs and documentation. Field devices with RT (real-time) and IRT (isochronous real-time) can be implemented with the ERTEC ASICs. The integrated switch allows the construction of field devices with two ports.

Functions:

- Isochronous mode
- Shared device for 4 controllers
- S2 system redundancy
- PROFINET performance upgrade with a minimum cycle time of 125 μ s.
- MRP/MRPD
- Regular, no-cost updates
- Current technology certificate

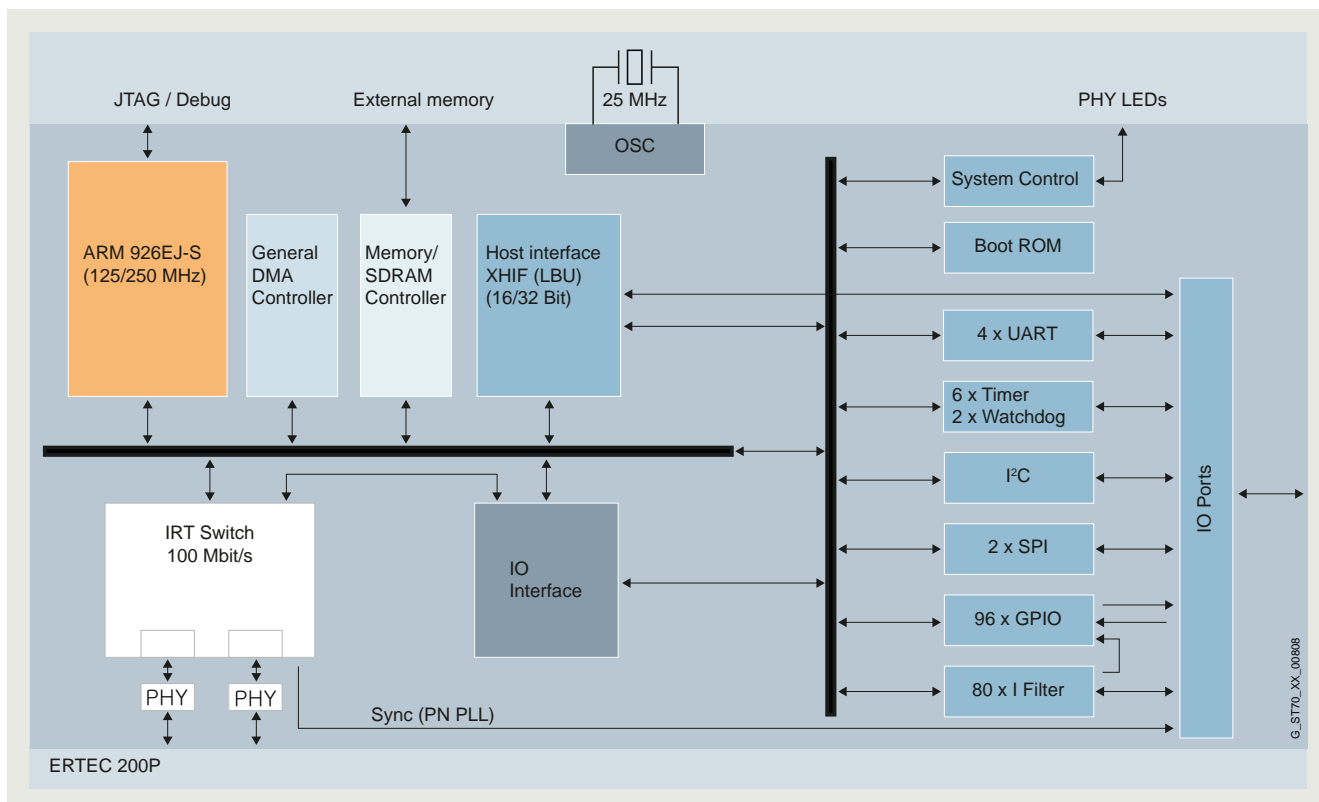

Internal structure of ERTEC 200P-2

ERTEC Enhanced Real-Time Ethernet Controller

Ordering data	Article No.	Technical specifications																					
ERTEC 200P-2 ASIC for connection to switched Ethernet 100 Mbps, Ethernet controller with integrated 2-port switch, ARM 926 processor and integrated PHYs; recommended for new developments <ul style="list-style-type: none"> • 10 units (evaluation pack) • 90 units (single tray) • 450 units (drypack, 5 trays) • 1 000 units (tape & reel) 	6ES7195-0BH02-0XA0 6ES7195-0BH12-0XA0 6ES7195-0BH22-0XA0 6ES7195-0BH32-0XA0	<table border="1"> <thead> <tr> <th colspan="2" data-bbox="1136 287 1461 319">ERTEC 200P-2</th> </tr> </thead> <tbody> <tr> <td data-bbox="813 319 1136 351">Integrated IRT switch</td> <td data-bbox="1136 319 1461 351">2-port</td> </tr> <tr> <td data-bbox="813 351 1136 383">Integrated PHYs</td> <td data-bbox="1136 351 1461 383">Yes</td> </tr> <tr> <td data-bbox="813 383 1136 436">Copper and fiber-optic cable supported</td> <td data-bbox="1136 383 1461 436">Yes</td> </tr> <tr> <td data-bbox="813 436 1136 468">Minimum cycle time</td> <td data-bbox="1136 436 1461 468">125 µs</td> </tr> <tr> <td data-bbox="813 468 1136 500">ARM CPU</td> <td data-bbox="1136 468 1461 500">ARM 926</td> </tr> <tr> <td data-bbox="813 500 1136 532">Clock frequency</td> <td data-bbox="1136 500 1461 532">250 MHz</td> </tr> <tr> <td data-bbox="813 532 1136 585">Configurable IOs, general purpose IOs</td> <td data-bbox="1136 532 1461 585">96</td> </tr> <tr> <td data-bbox="813 585 1136 617">Enclosure size</td> <td data-bbox="1136 585 1461 617">17x17 mm</td> </tr> <tr> <td data-bbox="813 617 1136 649">Ball pitch</td> <td data-bbox="1136 617 1461 649">0.8 mm</td> </tr> </tbody> </table>		ERTEC 200P-2		Integrated IRT switch	2-port	Integrated PHYs	Yes	Copper and fiber-optic cable supported	Yes	Minimum cycle time	125 µs	ARM CPU	ARM 926	Clock frequency	250 MHz	Configurable IOs, general purpose IOs	96	Enclosure size	17x17 mm	Ball pitch	0.8 mm
ERTEC 200P-2																							
Integrated IRT switch	2-port																						
Integrated PHYs	Yes																						
Copper and fiber-optic cable supported	Yes																						
Minimum cycle time	125 µs																						
ARM CPU	ARM 926																						
Clock frequency	250 MHz																						
Configurable IOs, general purpose IOs	96																						
Enclosure size	17x17 mm																						
Ball pitch	0.8 mm																						
EK-ERTEC 200P PN IO evaluation kit with ERTEC 200P-2	6ES7195-3BE00-0YA0																						
ERTEC 200 ASIC ERTEC 200 for connection to Switched Ethernet 10/100 Mbps, Ethernet controller with integral 2-port switch, ARM 946 processor and integral PHYs <ul style="list-style-type: none"> • 70 units (single tray) • 350 units (drypack, 5 trays) • 3500 units (package, 10 drypacks) • 1050 units (tape & reel) 	6GK1182-0BB01-0AA1 6GK1182-0BB01-0AA2 6GK1182-0BB01-0AA3 6GK1182-0BB01-0AA4																						
ERTEC 400 ASIC ERTEC 400 for connection to Switched Ethernet 10/100 Mbps, Ethernet controller with integrated 4-port switch, ARM 946 processor and PCI interface (V2.2), data preparation for real-time and isochronous real-time for PROFINET IO <ul style="list-style-type: none"> • 70 units (single tray) • 350 units (drypack, 5 trays) 	6GK1184-0BB01-0AA1 6GK1184-0BB01-0AA2																						

I/O systems

PROFINET components

Development kits

Overview



With the development packages for PROFINET, compact or modular PROFINET field devices can be developed quickly and with little effort. Depending on the application, different development packages are available.

The development packages for the ASICs of the ERTEC family (Enhanced Real-Time Ethernet Controller) are suitable for the development of field devices with an integrated IRT switch (Isochronous Real-Time). The demand for real-time capability, linear topology capability, and for IT integration is therefore met perfectly.

With the help of the development package for standard Ethernet controllers, PROFINET devices can be developed on the basis of a standard Ethernet controller. Devices with RT (Real-Time) can be implemented in the field device without special hardware.

The PROFIsafe starter kit permits the implementation of fail-safe devices. In so doing, the PROFIsafe stack applicatively builds on the PROFINET stack.

Ordering data

Article No.

ERTEC development kits / evaluation kits

EK-ERTEC 200P PN IO evaluation kit for ERTEC 200P-2

6ES7195-3BE00-0YA0

PROFIsafe starter kit V3.5 according to the PROFIsafe V2.6.1 profile

6ES7195-3BF03-0YA0

ERTEC ASICs

ERTEC 200P-2

ASIC for connection to Switched Ethernet 100 Mbps, Ethernet controller with integral 2-port switch, ARM 926 processor and integral PHYs

- 10 units (evaluation pack)
- 90 units (single tray)
- 450 units (drypack, 5 trays)
- 1 000 units (tape & reel)

6ES7195-0BH02-0XA0
6ES7195-0BH12-0XA0
6ES7195-0BH22-0XA0
6ES7195-0BH32-0XA0

Accessories

PROFINET IO product line license for one product line

6ES7195-3BC10-0YA0

OverviewPROFINET driver for controllers

Reasonably priced components are a major competitive advantage, especially in series machine building. Here, users often develop in-house control software. For reasons of performance, flexibility and cost, the individual application is then implemented on standard PCs. The PROFINET driver supports this in-house development and requires no special hardware thanks to its conventional Ethernet interface.

Because the PROFINET driver is delivered as source code, proprietary solutions can be ported into various operating systems and hardware platforms. As a result, the PROFINET driver can also be optimally used in embedded systems for in-house controller solutions. Design and configuration is easy and takes place via an open XML interface without the need for engineering tools. The well-proven PROFINET stack from SIMATIC forms the centerpiece.

The PROFINET driver is suitable for both simple applications, such as individual PROFINET lines, as well as for complex machines. It supports PROFINET RT for cycle times starting from 1 ms via a standard Ethernet interface. Alternatively, PROFINET IRT can also be used for cycle times starting from 500 μ s, in connection with the CP1625 controller development kit.

PROFINET ConfigLib

PROFINET networks must be planned. This can be carried out for the PROFINET driver using the TIA Portal. A license is not required. ConfigLib is a standalone API for generating PROFINET hardware configurations. It can be used to create RT and IRT projects, whereby ConfigLib takes over the planning algorithm.

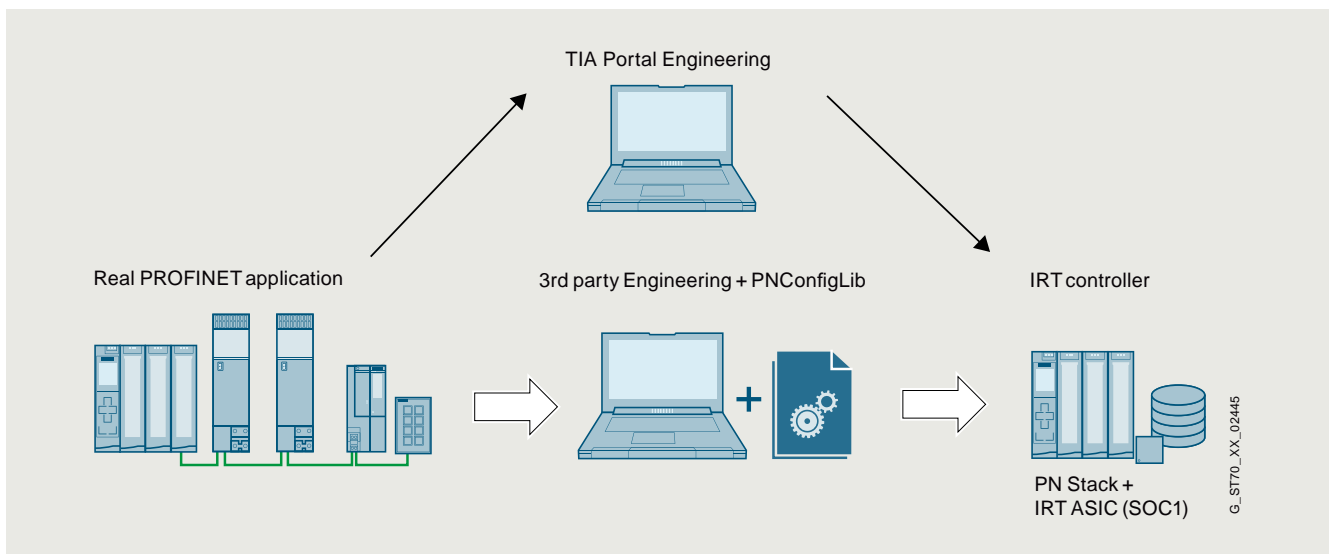

PNConfigLib – Efficient creation of hardware configurations without the TIA Portal

CP1625 Controller Development Kit

Siemens SOC1 gives you the hardware support required to build an IRT controller. The CP1625 Controller Development Kit is suitable for both standalone and host modes.

- Stand-alone mode: PN stack and application run on the CP1625
- Host mode: Application runs on the PC or, for example, ARM. The stack runs on the CP1625



SIMATIC CP1625

I/O systems

PROFINET components

PROFINET drivers

Ordering data**Article No.****PROFINET Driver V2.1**

For connecting distributed I/O and drives to user-specific control applications via PROFINET

PN Driver V2.1 development license and PN ConfigLib

6ES7195-3AA00-0YA0

SIMATIC CP1625 Development Board; PCIe card for PROFINET IRT

6ES7648-2CF10-1BA0

Runtime licenses

- 1 unit
- 10 units
- 50 units
- 200 units
- 500 units

6ES7195-3AA05-0XA0**6ES7195-3AA10-0XA0****6ES7195-3AA20-0XA0****6ES7195-3AA30-0XA0****6ES7195-3AA40-0XA0**

Overview



- Terminates bus segments at data transmission rates of 9.6 Kbps to 12 Mbps
- Power supply independent of bus stations.

Designed for Industry

- Terminal-independent bus termination through onboard power supply

Ordering data

Article No.

Active RS 485 terminating element for PROFIBUS

For terminating bus segments at transmission rates of 9.6 kbps to 12 Mbps

6ES7972-0DA00-0AA0

Technical specifications

Article number	6ES7972-0DA00-0AA0 RS485 Termin. resistor f. PROFIBUS/MPI,
Supply voltage	
Rated value (DC)	24 V
Input current	
Current consumption, typ.	30 mA
Power loss	
Power loss, max.	0.72 W
Interfaces	
PROFIBUS DP	
• Transmission rate, max.	12 Mbit/s; 9.6 kbit/s to 12 Mbit/s
Degree and class of protection	
IP degree of protection	IP20
Ambient conditions	
Ambient temperature during operation	
• min.	0 °C
• max.	60 °C
Ambient temperature during storage/transportation	
• min.	-40 °C
• max.	70 °C
Relative humidity	
• Operation, max.	95 %; at +25 °C
Connection method	
Design of electrical connection for supply voltage	Screw terminal block
Design of electrical connection for PROFIBUS cables	Screw terminal block
Dimensions	
Width	60 mm
Height	70 mm
Depth	43 mm
Weights	
Weight, approx.	95 g

I/O systems

Network components for PROFIBUS
Electrical networks (RS 485)

RS 485 repeater for PROFIBUS

Overview



- Automatic detection of transmission rates
- Transmission rates from 9.6 kbps to 12 Mbps are possible, incl. 45.45 kbps
- 24 V DC voltage display
- Indication of segment 1 and 2 bus activity
- The separation of segment 1 and segment 2 by means of switches is possible
- Separation of the right segment with an inserted terminating resistor
- Decoupling of segment 1 and segment 2 in the case of static interference

Designed for Industry

- For increasing the expansion
- Galvanic isolation of segments
- Commissioning support
 - Switches for separation of segments
 - Bus activity display
 - Segment separation in the case of an incorrectly inserted terminating resistor

In this context, please also note the diagnostics repeater that provides extensive diagnostics functions for physical line diagnostics in addition to the normal repeater functionality. This is described in "Distributed I/O / diagnostics / diagnostics repeater for PROFIBUS DP".

Technical specifications

Article number	6ES7972-0AA02-0XA0 Repeater RS485 f. PROFIBUS/MPI
Supply voltage	
Rated value (DC)	24 V
Input current	
Current consumption, max.	100 mA; 100 mA without loads at PG/OP socket; 130 mA load at PG/OP socket (5 V/90 mA); 200 mA load at PG/OP socket (24 V/100 mA)
Power loss	
Power loss, typ.	0.7 W
Interfaces	
PROFIBUS DP	
• Transmission rate, max.	12 Mbit/s; 9.6 kbit/s to 12 Mbit/s
Degree and class of protection	
IP degree of protection	IP20
Ambient conditions	
Ambient temperature during operation	
• min.	0 °C
• max.	60 °C
Ambient temperature during storage/transportation	
• min.	-40 °C
• max.	70 °C
Relative humidity	
• Operation, max.	95 %; at 25 °C
Connection method	
Design of electrical connection for supply voltage	Terminal module
Design of electrical connection for PROFIBUS cables	2 terminal blocks
Dimensions	
Width	45 mm
Height	128 mm
Depth	67 mm
Weights	
Weight, approx.	350 g

Ordering data

Article No.

RS 485 repeater for PROFIBUS

6ES7972-0AA02-0XA0

Transfer rate up to
max. 12 Mbps, 24 V DC,
IP20 enclosure

SIPLUS DP active RS 485 terminating element

Overview



- Used to terminate bus segments at rates of 9.6 kbps to 12 Mbps
- Power supply independent of the bus participants

Designed for Industry

- End-device independent bus termination thanks to own power supply

Note:

SIPLUS extreme products are based on SIMATIC standard products. The contents listed here were taken from the respective standard products. SIPLUS extreme-specific information was added.

For technical documentation on SIPLUS, see:

<http://www.siemens.com/siplus-extreme>

Ordering data

SIPLUS active RS 485 terminating element for PROFIBUS

To terminate bus segments at transfer rates of 9.6 kbps to 12 Mbps

Extended temperature range and exposure to environmental substances

Article No.

6AG1972-0DA00-2AA0

I/O systems

Network components for PROFIBUS
Electrical networks (RS 485)

SIPLUS DP active RS 485 terminating element

Technical specifications

Article number	6AG1972-0DA00-2AA0
Based on	6ES7972-0DA00-0AA0 SIPLUS DP Terminator RS485
Ambient conditions	
Ambient temperature during operation	
• min.	-25 °C; = Tmin (incl. condensation/frost)
• max.	60 °C; = Tmax
Ambient temperature during storage/transportation	
• min.	-40 °C
• max.	70 °C
Altitude during operation relating to sea level	
• Installation altitude above sea level, max.	5 000 m
• Ambient air temperature-barometric pressure-altitude	Tmin ... Tmax at 1 140 hPa ... 795 hPa (-1 000 m ... +2 000 m) // Tmin ... (Tmax - 10 K) at 795 hPa ... 658 hPa (+2 000 m ... +3 500 m) // Tmin ... (Tmax -20 K) at 658 hPa ... 540 hPa (+3 500 m ... +5 000 m)
Relative humidity	
• With condensation, tested in accordance with IEC 60068-2-38, max.	100 %; RH incl. condensation/frost (no commissioning under condensation conditions)
Resistance	
Use in stationary industrial systems	
- to biologically active substances according to EN 60721-3-3	Yes; Class 3B2 mold, fungus and dry rot spores (with the exception of fauna); Class 3B3 on request
- to chemically active substances according to EN 60721-3-3	Yes; Class 3C4 (RH < 75 %) incl. salt spray acc. to EN 60068-2-52 (severity degree 3); *
- to mechanically active substances according to EN 60721-3-3	Yes; Class 3S4 incl. sand, dust, *

Article number	6AG1972-0DA00-2AA0
Based on	6ES7972-0DA00-0AA0 SIPLUS DP Terminator RS485
Use on ships/at sea	
- to biologically active substances according to EN 60721-3-6	Yes; Class 6B2 mold and fungal spores (excluding fauna); Class 6B3 on request
- to chemically active substances according to EN 60721-3-6	Yes; Class 6C3 (RH < 75 %) incl. salt spray acc. to EN 60068-2-52 (severity degree 3); *
- to mechanically active substances according to EN 60721-3-6	Yes; Class 6S3 incl. sand, dust; *
Usage in industrial process technology	
- Against chemically active substances acc. to EN 60654-4	Yes; Class 3 (excluding trichlorethylene)
- Environmental conditions for process, measuring and control systems acc. to ANSI/ISA-71.04	Yes; Level GX group A/B (excluding trichlorethylene; harmful gas concentrations up to the limits of EN 60721-3-3 class 3C4 permissible); level LC3 (salt spray) and level LB3 (oil)
Remark	
- Note regarding classification of environmental conditions acc. to EN 60721, EN 60654-4 and ANSI/ISA-71.04	* The supplied plug covers must remain in place over the unused interfaces during operation!
Conformal coating	
• Coatings for printed circuit board assemblies acc. to EN 61086	Yes; Class 2 for high reliability
• Protection against fouling acc. to EN 60664-3	Yes; Type 1 protection
• Military testing according to MIL-I-46058C, Amendment 7	Yes; Discoloration of coating possible during service life
• Qualification and Performance of Electrical Insulating Compound for Printed Board Assemblies according to IPC-CC-830A	Yes; Conformal coating, Class A

Overview

- Automatically detects transmission rate
- 45.45 kbps transmission rate is possible
- 24 V DC voltage display
- Indication of segment 1 and 2 bus activity
- The separation of segment 1 and segment 2 by means of switches is possible
- Separation of the right segment with an inserted terminating resistor
- Decoupling of segment 1 and segment 2 in the case of static interference

Designed for Industry

- For increasing the number of participants and the expansion
- Electric isolation of segments
- Commissioning support
 - Segment separation switch
 - Bus activity display
 - Segment separation in the case of an incorrectly inserted terminating resistor

In this context, please also note the diagnostics repeater that provides extensive diagnostics functions for physical line diagnostics in addition to the normal repeater functionality. This is described in "Distributed I/O / diagnostics / diagnostics repeater for PROFIBUS DP".

Note:

SIPLUS extreme products are based on SIMATIC standard products. The contents listed here were taken from the respective standard products. SIPLUS extreme-specific information was added.

For technical documentation on SIPLUS, see:

<http://www.siemens.com/siplus-extreme>

Ordering data**SIPLUS RS 485 repeater for PROFIBUS**

Transfer rate up to max. 12 Mbps, 24 V DC, enclosure IP20

Extended temperature range and exposure to environmental substances

Article No.

6AG1972-0AA02-7XA0

I/O systems

Network components for PROFIBUS
Electrical networks (RS 485)

SIPLUS RS 485 repeater

Technical specifications

Article number	6AG1972-0AA02-7XA0
Based on	6ES7972-0AA02-0XA0 SIPLUS DP RS485-Repeater
Ambient conditions	
Ambient temperature during operation	
• min.	-25 °C; = Tmin (incl. condensation/frost)
• max.	70 °C; = Tmax
Ambient temperature during storage/transportation	
• min.	-40 °C
• max.	70 °C
Altitude during operation relating to sea level	
• Installation altitude above sea level, max.	5 000 m
• Ambient air temperature-barometric pressure-altitude	Tmin ... Tmax at 1 140 hPa ... 795 hPa (-1 000 m ... +2 000 m) // Tmin ... (Tmax - 10 K) at 795 hPa ... 658 hPa (+2 000 m ... +3 500 m) // Tmin ... (Tmax -20 K) at 658 hPa ... 540 hPa (+3 500 m ... +5 000 m)
Relative humidity	
• With condensation, tested in accordance with IEC 60068-2-38, max.	100 %; RH incl. condensation/frost (no commissioning under condensation conditions)
Resistance	
Use in stationary industrial systems	
- to biologically active substances according to EN 60721-3-3	Yes; Class 3B2 mold, fungus and dry rot spores (with the exception of fauna); Class 3B3 on request
- to chemically active substances according to EN 60721-3-3	Yes; Class 3C4 (RH < 75 %) incl. salt spray acc. to EN 60068-2-52 (severity degree 3); *
- to mechanically active substances according to EN 60721-3-3	Yes; Class 3S4 incl. sand, dust, *

Article number	6AG1972-0AA02-7XA0
Based on	6ES7972-0AA02-0XA0 SIPLUS DP RS485-Repeater
Use on ships/at sea	
- to biologically active substances according to EN 60721-3-6	Yes; Class 6B2 mold and fungal spores (excluding fauna); Class 6B3 on request
- to chemically active substances according to EN 60721-3-6	Yes; Class 6C3 (RH < 75 %) incl. salt spray acc. to EN 60068-2-52 (severity degree 3); *
- to mechanically active substances according to EN 60721-3-6	Yes; Class 6S3 incl. sand, dust; *
Usage in industrial process technology	
- Against chemically active substances acc. to EN 60654-4	Yes; Class 3 (excluding trichlorethylene)
- Environmental conditions for process, measuring and control systems acc. to ANSI/ISA-71.04	Yes; Level GX group A/B (excluding trichlorethylene; harmful gas concentrations up to the limits of EN 60721-3-3 class 3C4 permissible); level LC3 (salt spray) and level LB3 (oil)
Remark	
- Note regarding classification of environmental conditions acc. to EN 60721, EN 60654-4 and ANSI/ISA-71.04	* The supplied plug covers must remain in place over the unused interfaces during operation!
Conformal coating	
• Coatings for printed circuit board assemblies acc. to EN 61086	Yes; Class 2 for high reliability
• Protection against fouling acc. to EN 60664-3	Yes; Type 1 protection
• Military testing according to MIL-I-46058C, Amendment 7	Yes; Discoloration of coating possible during service life
• Qualification and Performance of Electrical Insulating Compound for Printed Board Assemblies according to IPC-CC-830A	Yes; Conformal coating, Class A

Overview

- Fast deterministic data exchange between CPUs with PROFINET controller, even beyond network boundaries
- Configuration with two PROFINET devices completely independent of the communication technology

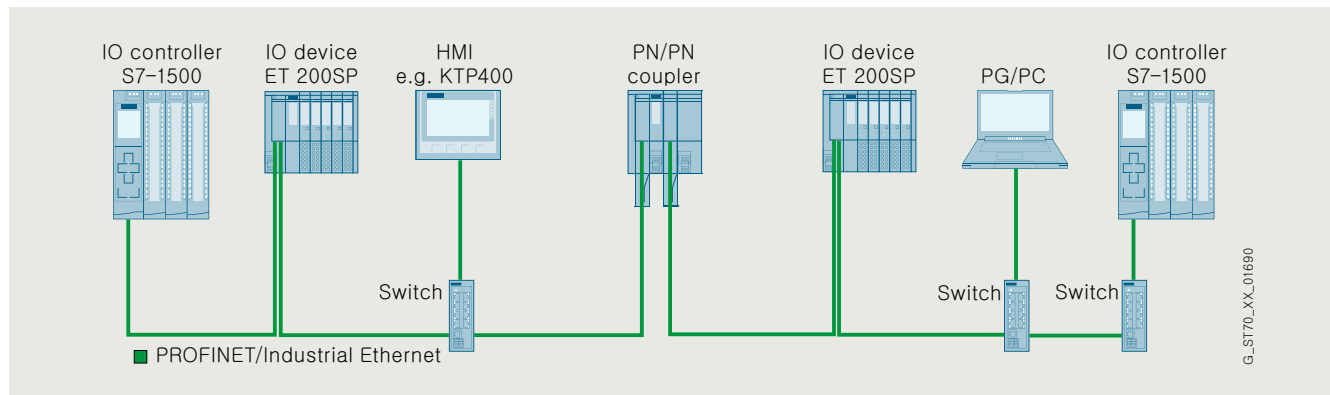

Data transmission between two S7-1500 IO controllers beyond a PROFINET limit

- Very simple configuration of the data exchange via virtual IO modules or alternatively via data records for larger amounts of data
- Simultaneous data transfer to up to 3 CPUs on own network side and/or up to 4 CPUs on opposite network side
- Easy to integrate into any PROFINET network with 2 ports per network side
- Fieldbus connection via a SIMATIC BusAdapter; this allows free selection of the connection system (RJ45, FC cable direct connection) and connection hardware (copper, POF, PCF, glass fiber). FO-to-copper media conversion can also be realized economically and without external converters.
- Firmware update
- Support for Ethernet services (ping, arp, SNMP, MIP-2, LLDP)
- Comprehensive diagnostics via LED displays and interrupts
- Extensive compatibility with the PN/PN coupler up to firmware version V3.0

Additional functions

- Quantity structures
 - Cyclic transmission: Up to 1 440 bytes each for input and output data
 - Data record transfer: Up to 4 096 bytes per slot. Buffering of up to eight data records per slot
 - Maximum 16 input/output areas for data exchange
 - Max. 254 bytes of input and 253 bytes of output data per module
- Exchange of fail-safe data between two F-CPU's via F-SendDP and F_ReceiveDP
- Shared device with up to four IO controllers per network side
- Module-internal shared input / shared output (MSI/MSO)
- Device replacement without programming device
 - With topological configuration via proximity detection (LLDP)
 - Without topological configuration via redundant storage of the station name in the BusAdapter. A separate removable memory card is not required.
- Reset button for restoring the factory settings
- Redundant power supply
- Galvanic isolation between the two PROFINET IO subnets
- Media redundancy (MRP and MRPD)
- I&M data

I/O systems

Network transitions

PN/PN couplers

Ordering data

Ordering data	Article No.	Ordering data	Article No.
PN/PN coupler For deterministic data exchange between max. 4 PN controllers per side, also beyond network boundaries Transfer of PROFI-safe, I/O, MSI, MSO and data record communication, redundant power supply PN connection via SIMATIC BusAdapter (BA) Delivery without BusAdapter	6ES7158-3AD10-0XA0	BusAdapter BA 2XLC PROFINET BusAdapter; 2 glass fiber-optic connections	6ES7193-6AG00-0AA0
Accessories		BusAdapter BA LC/RJ45 PROFINET BusAdapter; with media converter glass FO-Cu; 1 x LC connection, 1 x RJ45 connection	6ES7193-6AG20-0AA0
DIN rail 35 mm • Length: 483 mm for 19" cabinets • Length: 530 mm for 600 mm cabinets • Length: 830 mm for 900 mm cabinets • Length: 2 m	6ES5710-8MA11 6ES5710-8MA21 6ES5710-8MA31 6ES5710-8MA41	BusAdapter BA LC/FC PROFINET BusAdapter; with media converter glass FO-Cu; 1 x LC connection, 1 x FastConnect connection for direct connection of the bus cable	6ES7193-6AG40-0AA0
BusAdapter BA 2xRJ45 PROFINET BusAdapter with standard Ethernet socket	6ES7193-6AR00-0AA0	Equipment labeling plate 10 sheets of 16 labels	6ES7193-6LF30-0AW0
BusAdapter BA 2xFC PROFINET BusAdapter with FastConnect Ethernet connection; for increased vibration and EMC load capacity	6ES7193-6AF00-0AA0	Labeling strips 500 labeling strips on roll, light gray, for inscription with thermal transfer roll printer 500 labeling strips on roll, yellow, for inscription with thermal transfer roll printer	6ES7193-6LR10-0AA0 6ES7193-6LR10-0AG0
BusAdapter BA 2xSCRJ PROFINET BusAdapter with fiber-optic connection for POF or PCF cables up to 250 m, with monitoring of damping	6ES7193-6AP00-0AA0	1 000 labeling strips DIN A4, light gray, card, for inscription with laser printer 1 000 labeling strips DIN A4, yellow, card, for inscription with laser printer	6ES7193-6LA10-0AA0 6ES7193-6LA10-0AG0
BusAdapter BA SCRJ/RJ45 PROFINET BusAdapter; with media converter FO-Cu; 1 x SCRJ FO connection, 1 x RJ45 connection	6ES7193-6AP20-0AA0	Spare parts	
BusAdapter BA SCRJ/FC PROFINET BusAdapter; with media converter FO-Cu; 1 x SCRJ FO connection, 1 x FastConnect connection for direct connection of the bus cable	6ES7193-6AP40-0AA0	Cover for bus adapter interface 5 units	6ES7591-3AA00-0AA0
		Power supply connector For connecting the 24 V DC supply voltage • With push-in terminals	6ES7193-4JB00-0AA0

Technical specifications

Article number	6ES7158-3AD10-0XA0	Article number	6ES7158-3AD10-0XA0
	SIMATIC PN/PN Coupler		SIMATIC PN/PN Coupler
General information		Engineering with	
Product type designation	PN/PN coupler	• STEP 7 TIA Portal configurable/ integrated from version	STEP 7 V15.1 or higher
Product function		• PROFINET from GSD version/ GSD revision	V2.3
• I&M data	Yes; I&M0 to I&M3	Installation type/mounting	
• Isochronous mode	No; For operation on isochronous bus	Mounting	Mounting rail 7.5 mm and 15 mm
• Tool changer	Yes; Docking station and docking unit	Supply voltage	
• Local coupling, IO data	Yes	Rated value (DC)	24 V
- Number of coupling modules	16	Reverse polarity protection	Yes
- Number of coupling submodules per module	4; 1x write, 3x read	Mains buffering	
• Local coupling, data records	Yes	• Mains/voltage failure stored energy time	10 ms
- Number of coupling modules	16	Input current	
- Number of coupling submodules per module	4; 1x write, 3x read	Current consumption, max.	360 mA; For 19.2 V input voltage at the right-hand supply terminal, including 2 plugged BA 2x LC
- Record length, max.	4 096 byte		
- FIFO depth in storage mode	8		

Technical specifications

Article number	6ES7158-3AD10-0XA0 SIMATIC PN/PN Coupler
from supply voltage 1L+, max.	320 mA; For 19.2 V input voltage at the left-hand supply terminal, including 2 plugged BA 2x LC
Power loss	
Power loss, typ.	4 W; For 24 V input voltage and 2 plugged BA 2x RJ45 If BusAdapters with an optical interface are plugged, there is an additional 750 mW per optical interface (3 W with 2 plugged BA 2x LC)
Address area	
Address space per module	
• Address space per module, max.	254 byte; max. 254 bytes of input data and 253 bytes of output data
Address space per station	
• Address space per station, max.	1 440 byte; per input / output
Hardware configuration	
Submodules	
• Number of submodules per station, max.	116
Interfaces	
Number of PROFINET interfaces	2; One PROFINET interface per line side
Optical interface	Yes; Via SIMATIC BusAdapter
Transmission rate, max.	100 Mbit/s
1. Interface	
Interface types	
• Number of ports	2; via BusAdapter
• integrated switch	Yes
• BusAdapter (PROFINET)	Yes; Compatible BusAdapter: BA 2x RJ45, BA 2x FC, BA 2x SCRJ, BA SCRJ / RJ45, BA SCRJ / FC, BA 2x LC, BA LC / RJ45, BA LC / FC
Protocols	
• PROFINET IO Device	Yes
• Open IE communication	Yes
• Media redundancy	Yes; As MRP or MRPD client; max. 50 or 30 devices in the ring
2. Interface	
Interface types	
• Number of ports	2; via BusAdapter
• integrated switch	Yes
Protocols	
• PROFINET IO Device	Yes
• Open IE communication	Yes
• Media redundancy	Yes; As MRP or MRPD client; max. 50 or 30 devices in the ring
Interface types	
RJ 45 (Ethernet)	
• Transmission procedure	PROFINET with 100 Mbit/s full duplex (100BASE-TX)
• 10 Mbps	No
• 100 Mbps	Yes; PROFINET with 100 Mbit/s full duplex (100BASE-TX)
• Autonegotiation	Yes
• Autocrossing	Yes
Protocols	
Supports protocol for PROFINET IO	Yes
Protocols (Ethernet)	
• TCP/IP	Yes
• SNMP	Yes
• LLDP	Yes
• ping	Yes
• ARP	Yes

Article number	6ES7158-3AD10-0XA0 SIMATIC PN/PN Coupler
PROFINET IO Device Services	
- IRT	Yes
- PROFIenergy	No
- Prioritized startup	Yes
- Shared device	Yes
- Number of IO Controllers with shared device, max.	4; per line side
Redundancy mode	
• PROFINET system redundancy (S2)	Yes; NAP S2 acc. to IEC
• H-Sync forwarding	Yes
Media redundancy	
- MRP	Yes
- MRPD	Yes
Open IE communication	
• TCP/IP	Yes
• SNMP	Yes
• LLDP	Yes
Interrupts/diagnostics/status information	
Status indicator	Yes
Alarms	Yes
Diagnostics function	Yes; Parameterizable
Diagnostics indication LED	
• RUN LED	Yes; green LED
• ERROR LED	Yes; red LED
• MAINT LED	Yes; Yellow LED
• LINK LED	Yes; 2x green link LEDs on BusAdapter
• Monitoring of the supply voltage (PWR-LED)	Yes; green PWR LED
Potential separation	
between supply voltage and electronics	Yes; to power input 2
between Ethernet and electronics	Yes
Standards, approvals, certificates	
Network loading class	3
Security level	According to Security Level 1 Test Cases V1.1.4
Ambient conditions	
Ambient temperature during operation	
• min.	-30 °C; From FS05
• max.	60 °C; = Tmax for horizontal installation; for vertical installation Tmax = 50 °C
Altitude during operation relating to sea level	
• Installation altitude above sea level, max.	5 000 m; restrictions for installation altitudes > 2 000 m, see section "Climatic and mechanical environmental conditions"
Mechanics/material	
Strain relief	Yes; Optional, for RJ45 and FC BusAdapter only
Dimensions	
Width	100 mm; Minimized with good handling
Height	117 mm
Depth	74 mm; with mounting rail
Weights	
Weight, approx.	200 g; without BusAdapter

I/O systems

Network transitions

PN/CAN LINK

Overview



- For data exchange between PROFINET and CAN Bus 2.0A/B or CANopen Manager or Slave (according to CiA 301 & 302)
- CANopen features:
 - Node / lifeguarding
 - Heartbeat
 - SYNC (producer / consumer)
- Integrated in TIA via HSP, TIA Portal V14 or higher
- PROFINET switch and 9-pin D-sub plug integrated for CAN
- Up to 126 CAN nodes
- 512 receiver/transmitter PDOs
- Electrical isolation between the two networks
- Diagnostic interrupts
- Supported controllers: S7-1200, S7-1500, ET 200SP, Open Controller
- Optionally with function block SIMATIC ECC CHAdeMO: Realization of digital communication as basis for conductive DC charging of electric vehicles in line with the CHAdeMO standard

Ordering data

SIMATIC PN/CAN LINK

PROFINET network transition according to CAN Bus 2.0A/B, CANopen Manager according to CiA301/302, CANopen Slave according to CiA301/302; IP20

Article No.

6BK1620-0AA00-0AA0

Article No.

Accessories

Function block SIMATIC ECC CHAdeMO

For realization of digital communication between a DC charging station and an electric vehicle according to CHAdeMO 1.x-2.0 specification; can be used with TIA Portal as of V15.1; Single license

6FE1263-8FB10-0AA0

Technical specifications

Article number	6BK1620-0AA00-0AA0 SIMATIC PN/CAN LINK
General information	
Product type designation	PN/CAN Link
Product function	
• I&M data	Yes; I&M0 to I&M3
Engineering with	
• STEP 7 TIA Portal configurable/ integrated from version	STEP 7 V14 or higher
Installation type/mounting	
Mounting	DIN rail, wall mounting, portrait mounting
Mounting position	any
Recommended mounting position	Horizontal
Rail mounting	Yes
Control cabinet installation	Yes
Supply voltage	
Type of supply voltage	DC
Rated value (DC)	24 V
Reverse polarity protection	Yes
Overvoltage protection	Yes
Short-circuit protection	Yes
Mains buffering	
• Mains/voltage failure stored energy time	10 ms

Article number	6BK1620-0AA00-0AA0 SIMATIC PN/CAN LINK
Input current	
Current consumption (rated value)	0.09 A
Current consumption, max.	0.11 A
Power loss	
Power loss, typ.	2.2 W
Interfaces	
Interfaces/bus type	2x Ethernet (RJ45), 1x Sub-D (9-pin)
Supports protocol for PROFINET IO	
• automatic detection of transmission rate	No
• Transmission rate, max.	100 Mbit/s
• Number of RJ45 ports	2
• Number of FC (FastConnect) connections	2
PROFINET functions	
• Assignment of the IP address, supported	Yes
• Assignment of the device name, supported	Yes

Technical specifications

Article number	6BK1620-0AA00-0AA0 SIMATIC PN/CAN LINK
1. Interface	
Interface type	CAN according to CiA 303-1
Isolated	Yes; 500 V AC or 707 V DC
Interface types	
• Number of ports	1
• Design of the connection	9-pin sub D socket
CAN	
• CAN operating modes	CAN Standard CAN 2.0A/B; CANopen Manager / Slave acc. to CiA
• Specification acc. to CiA	CiA 301 & CiA 302
• Transmission rate, min.	50 kbit/s
• Transmission rate, max.	1 000 kbit/s
• Number of slaves, max.	126
• Number of SDOs in parallel	16; Parallel
• Number of PDOs	512; Send / receive
Services	
- Node/life-guarding	Yes
- Heartbeat	Yes
- SYNC	Yes
2. Interface	
Interface type	PROFINET
Isolated	Yes; 1 500 V AC or 2 250 V DC
Interface types	
• RJ 45 (Ethernet)	Yes
• Number of ports	2
• integrated switch	Yes
Protocols	
• PROFINET IO Device	Yes
Interrupts/diagnostics/status information	
Status indicator	Yes
Alarms	Yes
Diagnostics function	Yes
Diagnostics indication LED	
• RUN LED	Yes
• ERROR LED	Yes
• MAINT LED	Yes
• LINK LED	Yes
• RX/TX LED	Yes

Article number	6BK1620-0AA00-0AA0 SIMATIC PN/CAN LINK
Potential separation	
Potential separation exists	Yes
Degree and class of protection	
IP degree of protection	IP20
Standards, approvals, certificates	
CE mark	Yes
UL approval	Yes
cULus	Yes
RCM (formerly C-TICK)	Yes
KC approval	Yes
EAC (formerly Gost-R)	Yes
PNO certificate	Yes
RoHS conformity	Yes
Marine approval	
• Germanischer Lloyd (GL)	Yes
• American Bureau of Shipping (ABS)	Yes
• Bureau Veritas (BV)	Yes
• Nippon Kaiji Kyokai (Class NK)	Yes
Ambient conditions	
Ambient temperature during operation	
• horizontal installation, min.	-25 °C
• horizontal installation, max.	60 °C
• vertical installation, min.	-25 °C
• vertical installation, max.	55 °C
• ceiling installation, min.	-25 °C
• ceiling installation, max.	45 °C
• floor installation, min.	-25 °C
• floor installation, max.	45 °C
Ambient temperature during storage/transportation	
• min.	-40 °C
• max.	85 °C
Relative humidity	
• Operation, max.	95 %
Software	
Runtime software	
Target system	
- ET 200SP	Yes
- Open Controller	Yes
- S7-1200	Yes
- S7-1500	Yes
Dimensions	
Width	70 mm
Height	112 mm
Depth	75 mm
Weights	
Weight, approx.	212 g

I/O systems

Network transitions

SIPLUS PN/CAN LINK**Overview**

- For data exchange between PROFINET and CAN Bus 2.0A/B or CANopen Manager or Slave (according to CiA 301 & 302)
- CANopen features:
 - Node / lifeguarding
 - Heartbeat
 - SYNC (producer / consumer)
- Integrated in TIA via HSP, TIA Portal V14 or higher
- PROFINET switch and 9-pin D-sub plug integrated for CAN
- Up to 126 CAN nodes
- 512 receiver/transmitter PDOs
- Galvanic isolation between the two networks
- Diagnostic interrupts
- PLCs supported: S7-1200, S7-1500, ET 200SP, Open Controller

Note:

SIPLUS extreme products are based on SIMATIC standard products. The contents listed here were taken from the corresponding standard products. SIPLUS extreme-specific information was added.

For technical documentation on SIPLUS, see:

<http://www.siemens.com/siplus-extreme>

Ordering data**SIPLUS PN/CAN Link**

PROFINET network transition according to CAN Bus 2.0A/B, CANopen Manager according to CiA301/302, CANopen Slave according to CiA301/302; IP20

Ambient temperature
-40 ... +70 °C (+85 °C for 10 min.)

Article No.

6AG1620-0AA00-7AA0

Technical specifications

Article number	6AG1620-0AA00-7AA0
Based on	6BK7620-0AA00-0AA0 SIPLUS PN/CAN LINK
Ambient conditions	
Ambient temperature during operation	
• horizontal installation, min.	-40 °C; = Tmin (incl. condensation/frost)
• horizontal installation, max.	70 °C; = Tmax
Ambient temperature during storage/transportation	
• min.	-40 °C
• max.	85 °C
Altitude during operation relating to sea level	
• Installation altitude above sea level, max.	5 000 m
• Ambient air temperature-barometric pressure-altitude	Tmin ... Tmax at 1 140 hPa ... 795 hPa (-1 000 m ... +2 000 m) // Tmin ... (Tmax - 10 K) at 795 hPa ... 658 hPa (+2 000 m ... +3 500 m) // Tmin ... (Tmax -20 K) at 658 hPa ... 540 hPa (+3 500 m ... +5 000 m)
Relative humidity	
• With condensation, tested in accordance with IEC 60068-2-38, max.	100 %; incl. condensation / frost permitted (no commissioning under condensation conditions)
Resistance	
Coolants and lubricants	
- Resistant to commercially available coolants and lubricants	Yes; Incl. diesel and oil droplets in the air
Use in stationary industrial systems	
- to biologically active substances according to EN 60721-3-3	Yes; Class 3B2 mold, fungus and dry rot spores (with the exception of fauna); Class 3B3 on request
- to chemically active substances according to EN 60721-3-3	Yes; Available soon
- to mechanically active substances according to EN 60721-3-3	Yes; Class 3S4 incl. sand, dust, *

Article number	6AG1620-0AA00-7AA0
Based on	6BK7620-0AA00-0AA0 SIPLUS PN/CAN LINK
Use on ships/at sea	
- to biologically active substances according to EN 60721-3-6	Yes; Class 6B2 mold and fungal spores (excluding fauna); Class 6B3 on request
- to chemically active substances according to EN 60721-3-6	Yes; Class 6C3 (RH < 75 %) incl. salt spray acc. to EN 60068-2-52 (severity degree 3); *
- to mechanically active substances according to EN 60721-3-6	Yes; Class 6S3 incl. sand, dust; *
Usage in industrial process technology	
- Against chemically active substances acc. to EN 60654-4	Yes; Class 3 (excluding trichlorethylene)
- Environmental conditions for process, measuring and control systems acc. to ANSI/ISA-71.04	Yes; Level GX group A/B (excluding trichlorethylene; harmful gas concentrations up to the limits of EN 60721-3-3 class 3C4 permissible); level LC3 (salt spray) and level LB3 (oil)
Remark	
- Note regarding classification of environmental conditions acc. to EN 60721, EN 60654-4 and ANSI/ISA-71.04	* The supplied plug covers must remain in place over the unused interfaces during operation!
Conformal coating	
• Coatings for printed circuit board assemblies acc. to EN 61086	Yes; Class 2 for high reliability
• Protection against fouling acc. to EN 60664-3	Yes; Type 1 protection
• Military testing according to MIL-I-46058C, Amendment 7	Yes; Discoloration of coating possible during service life
• Qualification and Performance of Electrical Insulating Compound for Printed Board Assemblies according to IPC-CC-830A	Yes; Conformal coating, Class A
Dimensions	
Width	70 mm
Height	112 mm
Depth	75 mm
Weights	
Weight, approx.	212 g

I/O systems

Network transitions

PN/J1939 LINK**Overview**

- For data exchange between PROFINET and SAE J1939 networks
- J1939 functions:
 - Broadcast Announce Message (BAM)
 - Connection Mode Data Transfer (CMDT)
 - PDU 1 & 2
- Integrated into Totally Integrated Automation via gsdml file in TIA Portal. No separate software required
- Integrated PROFINET switch with 9-pin Sub-D socket for J1939
- Up to 253 logical nodes
- Up to 30 addressable ECUs
- Galvanic isolation between the two networks
- Diagnostic interrupts
- Controllers supported: S7-1200, S7-1500, ET 200SP, Open Controller

Ordering data**Article No.**

SIMATIC PN/J1939 LINK
Network transition from PROFINET to J1939 networks; IP20

6BK1623-0AA00-0AA0

Technical specifications

Article number	6BK1623-0AA00-0AA0 SIMATIC PN/J1939 LINK
General information	
Product type designation	PN/J1939 LINK
Product function	
• I&M data	Yes
• Isochronous mode	No
Engineering with	
• STEP 7 TIA Portal configurable/ integrated from version	STEP 7 V14 SP1 or higher
Installation type/mounting	
Mounting	DIN rail, wall mounting, portrait mounting
Mounting position	any
Recommended mounting position	Horizontal
Rail mounting	Yes
Control cabinet installation	Yes
Supply voltage	
Type of supply voltage	DC
Rated value (DC)	24 V
Reverse polarity protection	Yes
Overvoltage protection	Yes
Short-circuit protection	Yes
Mains buffering	
• Mains/voltage failure stored energy time	10 ms; PN side
Input current	
Current consumption (rated value)	0.09 A
Current consumption, max.	0.11 A
Power loss	
Power loss, typ.	2.2 W
Interfaces	
Interfaces/bus type	2x Ethernet (RJ45), 1x Sub-D (9-pin)
Supports protocol for PROFINET IO	
• automatic detection of transmission rate	No
• Transmission rate, max.	100 Mbit/s
• Number of RJ45 ports	2
• Number of FC (FastConnect) connections	2
PROFINET functions	
• Assignment of the IP address, supported	Yes
• Assignment of the device name, supported	Yes

Technical specifications

Article number	6BK1623-0AA00-0AA0 SIMATIC PN/J1939 LINK
1. Interface	
Interface type	J1939 according to the standard "SAE J1939"
Isolated	Yes; 500 V AC or 707 V DC
Interface types	
• Number of ports	1
• Design of the connection	9-pin sub D socket
CAN	
• CAN operating modes	J1939 according to the standard "SAE J1939"
• Transmission rate, min.	100 kbit/s
• Transmission rate, max.	500 kbit/s
• Number of slaves, max.	30
J1939	
• Addressable ECUs, max.	30
• Logical nodes, max.	253
• PDU 1	Yes
• PDU 2	Yes
• DM data	Yes
• BAM	Yes
• CMDT	Yes
2. Interface	
Interface type	PROFINET
Isolated	Yes; 1 500 V AC or 2 250 V DC
Interface types	
• RJ 45 (Ethernet)	Yes
• Number of ports	2
• integrated switch	Yes
Protocols	
• PROFINET IO Device	Yes
Interrupts/diagnostics/status information	
Status indicator	Yes
Alarms	Yes
Diagnostics function	Yes
Diagnostics indication LED	
• RUN LED	Yes
• ERROR LED	Yes
• MAINT LED	Yes
• LINK LED	Yes
• RX/TX LED	Yes
Potential separation	
Potential separation exists	Yes
Degree and class of protection	
IP degree of protection	IP20

Article number	6BK1623-0AA00-0AA0 SIMATIC PN/J1939 LINK
Standards, approvals, certificates	
CE mark	Yes
UL approval	Yes
cULus	Yes
RCM (formerly C-TICK)	Yes
KC approval	Yes
EAC (formerly Gost-R)	Yes
PNO certificate	Yes
RoHS conformity	Yes
Marine approval	
• Germanischer Lloyd (GL)	Yes
• Det Norske Veritas (DNV)	Yes
• Nippon Kaiji Kyokai (Class NK)	Yes
Ambient conditions	
Ambient temperature during operation	
• horizontal installation, min.	-25 °C
• horizontal installation, max.	60 °C
• vertical installation, min.	-25 °C
• vertical installation, max.	55 °C
• ceiling installation, min.	-25 °C
• ceiling installation, max.	45 °C
• floor installation, min.	-25 °C
• floor installation, max.	45 °C
Ambient temperature during storage/transportation	
• min.	-40 °C
• max.	85 °C
Relative humidity	
• Operation, max.	95 %
Software	
Runtime software	
Target system	
- ET 200SP	Yes
- Open Controller	Yes
- S7-1200	Yes
- S7-1500	Yes
Dimensions	
Width	70 mm
Height	112 mm
Depth	75 mm
Weights	
Weight, approx.	212 g

I/O systems

Network transitions

PN/BACnet LINK**Overview**

- Gateway between PROFINET and BACnet/IP networks according to EN ISO16484-5 and Addendum ANSI/ASHRAE Standard 135-2012.
- Integrated in Totally Integrated Automation via HSP, TIA Portal V14 or higher
- Integrated PROFINET switch and RJ45 socket for BACnet
- 1 000 BACnet objects/object references
- 1 000 subscribe services
- BACnet features:
 - Client & Server
 - Device profile: B-GW
 - Change of value / cyclic and acyclic data exchange
 - Scan of BACnet/IP network
- Supported BACnet object types:
 - Device
 - Binary input
 - Binary output
 - Analog input
 - Analog output
- Supported BACnet services:
 - DS-COV-A/B
 - DM-DDB-A/B
 - DM-DOB-B
 - DS-RP-A/B
 - DS-WP-A/P
 - GW-EO-B
- Galvanic isolation between the two networks
- Diagnostic interrupts
- Controllers supported: S7-1200, S7-1500, ET 200SP, Open Controller

Ordering data**Article No.****SIMATIC PN/BACnet LINK****6BK1621-0AA00-0AA0**

Network transition of PROFINET to BACnet/IP networks, device profile B-GW, IP20

Technical specifications

Article number	6BK1621-0AA00-0AA0 SIMATIC PN/BACnet LINK
General information	
Product type designation	PN/BACnet Link
Product function	
• I&M data	Yes
• Isochronous mode	No
Engineering with	
• STEP 7 TIA Portal configurable/ integrated from version	V14 SP1
Installation type/mounting	
Mounting	DIN rail, wall mounting, portrait mounting
Mounting position	any
Recommended mounting position	Horizontal
Rail mounting	Yes
Control cabinet installation	Yes
Supply voltage	
Type of supply voltage	DC
Rated value (DC)	24 V
Reverse polarity protection	Yes
Overvoltage protection	Yes
Short-circuit protection	Yes
Mains buffering	
• Mains/voltage failure stored energy time	10 ms
Input current	
Current consumption (rated value)	0.11 A
Current consumption, max.	0.13 A
Power loss	
Power loss, typ.	2.7 W
Interfaces	
Supports protocol for PROFINET IO	
• automatic detection of transmission rate	No
• Transmission rate, max.	100 Mbit/s
• Number of RJ45 ports	2
• Number of FC (FastConnect) connections	2
PROFINET functions	
• Assignment of the IP address, supported	Yes
• Assignment of the device name, supported	Yes
1. Interface	
Interface type	BACnet/IP
Isolated	Yes; 1 500 V AC or 2 250 V DC
Interface types	
• RJ 45 (Ethernet)	Yes
• Number of ports	1
• Design of the connection	RJ45
BACnet	
• BACnet device profile	B-GW
• Supported character sets	ISO 10646 (UTF-8)
• Network Security	No
• Number if BACnet objects/object references	1 000
• Number of subscription services	1 000

Technical specifications

Article number	6BK1621-0AA00-0AA0 SIMATIC PN/BACnet LINK
2. Interface	
Interface type	PROFINET
Isolated	Yes; 1 500 V AC or 2 250 V DC
Interface types	
• RJ 45 (Ethernet)	Yes
• Number of ports	2
• integrated switch	Yes
Protocols	
• PROFINET IO Device	Yes
Interrupts/diagnostics/ status information	
Status indicator	Yes
Alarms	Yes
Diagnostics function	Yes
Diagnostics indication LED	
• RUN LED	Yes
• ERROR LED	Yes
• MAINT LED	Yes
• LINK LED	Yes
• RX/TX LED	Yes
Potential separation	
Potential separation exists	Yes
Degree and class of protection	
IP degree of protection	IP20
Standards, approvals, certificates	
CE mark	Yes
UL approval	Yes
cULus	Yes
RCM (formerly C-TICK)	Yes
KC approval	Yes
PNO certificate	Yes
BTL certificate	Yes
RoHS conformity	Yes

Article number	6BK1621-0AA00-0AA0 SIMATIC PN/BACnet LINK
Ambient conditions	
Ambient temperature during operation	
• horizontal installation, min.	-25 °C
• horizontal installation, max.	60 °C
• vertical installation, min.	-25 °C
• vertical installation, max.	55 °C
• ceiling installation, min.	-25 °C
• ceiling installation, max.	45 °C
• floor installation, min.	-25 °C
• floor installation, max.	45 °C
Ambient temperature during storage/transportation	
• min.	-40 °C
• max.	85 °C
Relative humidity	
• Operation, max.	95 %
Software	
Runtime software	
Target system	
- ET 200SP	Yes
- Open Controller	Yes
- S7-1200	Yes
- S7-1500	Yes
Connection method	
Design of electrical connection	Screw connection
Dimensions	
Width	70 mm
Height	112 mm
Depth	75 mm
Weights	
Weight, approx.	210 g

I/O systems

Network transitions

PN/M-Bus LINK**Overview**

- For data exchange between PROFINET and M-Bus networks
- M-Bus functions:
 - M-Bus master
 - Primary address
 - Secondary address
 - Read-only access to M-Bus slaves
 - Short-circuit detection
- Integrated into Totally Integrated Automation via gsdml file in TIA Portal. No separate software required
- Integrated PROFINET switch with 3-pin screw terminal for M-Bus
- Up to 40 slaves (loads/units)
- Diagnostic interrupts
- Controllers supported: S7-1200, S7-1500, ET 200SP, Open Controller

Ordering data**Article No.****SIMATIC PN/M-Bus LINK****6BK1622-0AA00-0AA0**

PROFINET gateway to M-Bus networks; M-Bus master, IP20

Technical specifications

Article number	6BK1622-0AA00-0AA0 SIMATIC PN/M-Bus LINK
General information	
Product type designation	PN/M-Bus LINK
Product function	
• I&M data	Yes
• Isochronous mode	No
Engineering with	
• STEP 7 TIA Portal configurable/ integrated from version	STEP 7 V15 or higher
Installation type/mounting	
Mounting	DIN rail, wall mounting, portrait mounting
Mounting position	any
Recommended mounting position	Horizontal
Rail mounting	Yes
Control cabinet installation	Yes
Supply voltage	
Type of supply voltage	DC
Rated value (DC)	24 V
Reverse polarity protection	Yes
Overvoltage protection	Yes
Short-circuit protection	Yes
Mains buffering	
• Mains/voltage failure stored energy time	10 ms; PN side
Input current	
Current consumption (rated value)	0.11 A; At 24 V and 5 loads
Current consumption, max.	0.4 A; At 20.4 V, 40 loads + 100 mA short-circuit current
Power loss	
Power loss, typ.	2.4 W
Interfaces	
Supports protocol for PROFINET IO	
• automatic detection of transmission rate	No
• Transmission rate, max.	100 Mbit/s
• Number of RJ45 ports	2
• Number of FC (FastConnect) connections	2

Technical specifications

Article number	6BK1622-0AA00-0AA0 SIMATIC PN/M-Bus LINK
PROFINET functions	
• Assignment of the IP address, supported	Yes
• Assignment of the device name, supported	Yes
1. Interface	
Interface type	M-Bus master
Isolated	No
Interface types	
• Number of ports	1
• Design of the connection	3-wire screw-type terminal
M-Bus	
• Bus voltage, typ.	36 V
• Transmission rate, min.	300 bit/s
• Transmission rate, max.	9 600 bit/s
• Number of slaves, max.	40
• Short-circuit detection	Yes
• short-circuit proof	Yes
• Connectable conductor cross-section	1.5 mm ²
• Cable length, max.	300 m
2. Interface	
Interface type	PROFINET
Isolated	Yes; 1 500 V AC or 2 250 V DC
Interface types	
• RJ 45 (Ethernet)	Yes
• Number of ports	2
• integrated switch	Yes
Protocols	
• PROFINET IO Device	Yes
Interrupts/diagnostics/status information	
Status indicator	Yes
Alarms	Yes
Diagnostics function	Yes
Diagnostics indication LED	
• RUN LED	Yes
• ERROR LED	Yes
• MAINT LED	Yes
• LINK LED	Yes
• RX/TX LED	Yes

Article number	6BK1622-0AA00-0AA0 SIMATIC PN/M-Bus LINK
Potential separation	
Potential separation exists	Yes
Degree and class of protection	
IP degree of protection	IP20
Standards, approvals, certificates	
CE mark	Yes
RoHS conformity	Yes
Ambient conditions	
Ambient temperature during operation	
• horizontal installation, min.	-25 °C
• horizontal installation, max.	60 °C
• vertical installation, min.	-25 °C
• vertical installation, max.	55 °C
• ceiling installation, min.	-25 °C
• ceiling installation, max.	45 °C
• floor installation, min.	-25 °C
• floor installation, max.	45 °C
Ambient temperature during storage/transportation	
• min.	-40 °C
• max.	70 °C
Relative humidity	
• Operation, max.	95 %
Software	
Runtime software	
Target system	
- ET 200SP	Yes
- Open Controller	Yes
- S7-1200	Yes
- S7-1500	Yes
Dimensions	
Width	70 mm
Height	112 mm
Depth	75 mm
Weights	
Weight, approx.	215 g

I/O systems

Network transitions

DP/DP couplers**Overview**

- For interconnecting two PROFIBUS DP networks
- The interchange of data between both DP networks takes place by internal copying in the coupler

Ordering data**Article No.****DP/DP coupler****6ES7158-0AD01-0XA0**

Note:

The manual is available free on the Internet.

Technical specifications**DP/DP transceiver**

PROFIBUS transmission rate	max. 12 Mbit/s
Interfaces	<ul style="list-style-type: none"> • PROFIBUS DP
Supply voltage	24 V DC
Current consumption typ.	150 mA
Mounting	Upright (DIP switches above)
Perm. environmental conditions	
• Operating temperature	
- horizontal mounting	0°C ... +60°C
- all other mounting positions	0°C ... +40°C
• Transport/storage temperature	-40 °C ... +70 °C
• Relative humidity	10-95 % at +25 °C
Design	
• Dimensions (W x H x D) in mm	40 x 127 x 117
• Weight	approx. 250 g
Degree of protection	IP20

Overview

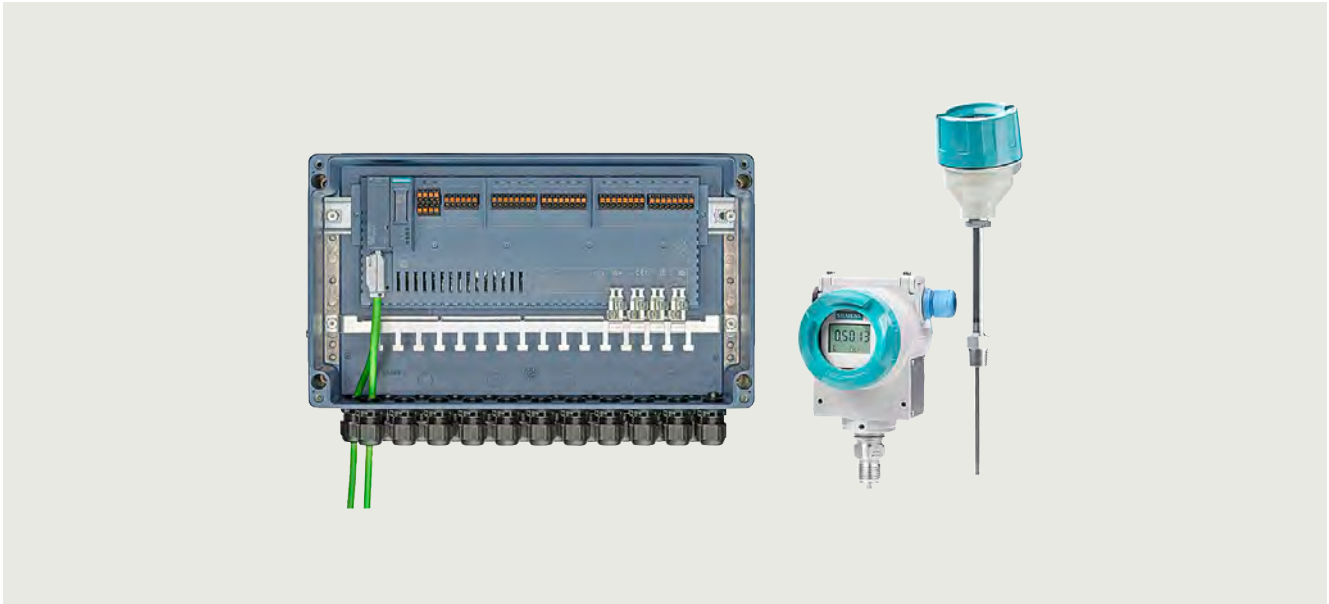
**Smart Field Distributor – SIMATIC Compact Field Unit**

With the new SIMATIC Compact Field Unit (CFU), we are re-interpreting the conventional approach to field device connection. The smart field distributor is installed at the process level and is connected via PROFINET, the world's leading Industrial Ethernet standard, directly to the automation system to form the foundation for digitalization in the field.

You benefit from greater flexibility and very simple handling coupled with maximum availability. This allows you to efficiently transfer your familiar system concept to the digital world.

Today's challenges for field device connection:

- High overhead for device integration and replacement
- Complicated, error-prone wiring and routing over multiple levels, making the hardware FAT very complex
- Extremely long copper cables and numerous terminal points in the field
- Multiple individual control cabinets
- Large numbers of different components and protocols necessitate costly spare parts inventories and training sessions
- High planning and documentation costs

I/O systems

Network transitions

SIMATIC CFU

Overview

SIMATIC CFU – The answer to these challenges

Mode of operation

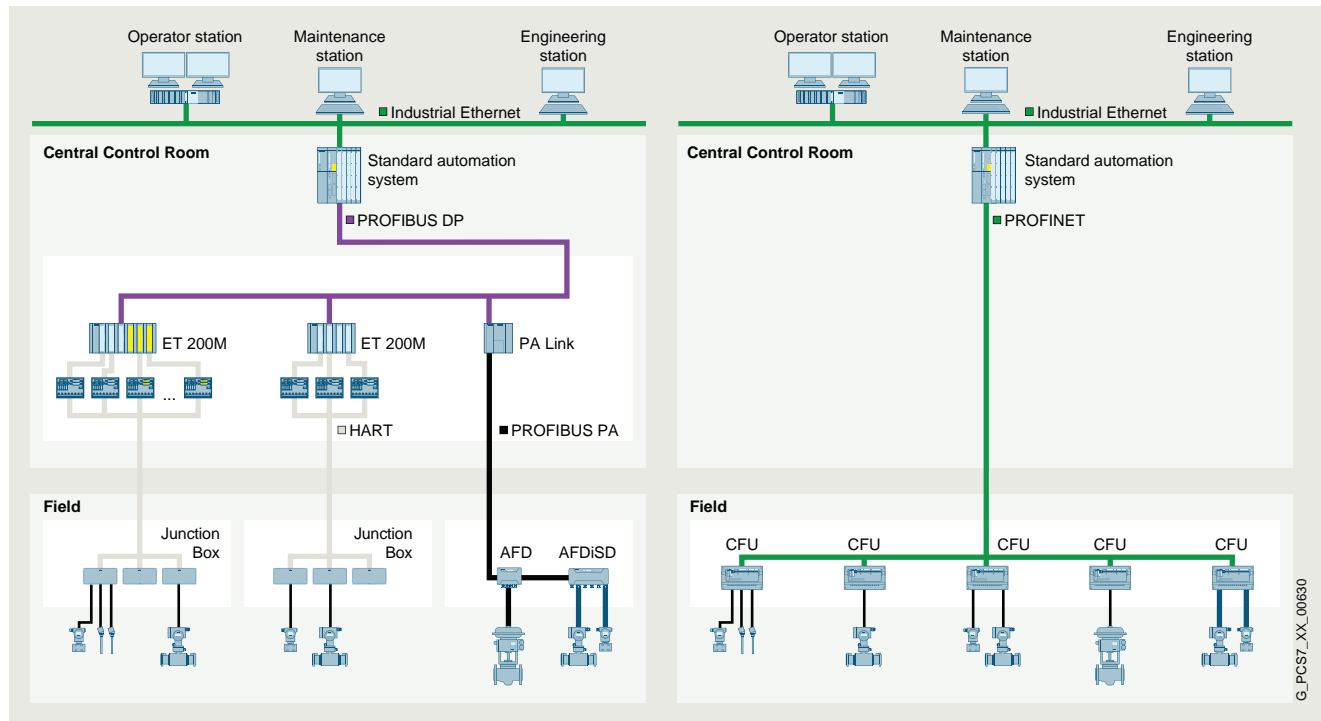

Field device connection with previous technology (left) and with SIMATIC CFU (right)

The SIMATIC Compact Field Unit (CFU) is a real game-changer in field device connection and offers you entirely new prospects regarding simplicity, flexibility and standardization. The smart field distributor is installed at the process level and is connected via PROFINET directly to the automation system to form the foundation for digitalization in the field. Utilization of digital fieldbus communication considerably simplifies device interfacing compared to conventional 4 ... 20 mA engineering.

Greater flexibility thanks to consistent decentralization

Distributed installation of the SIMATIC CFU means that classic control cabinets are no longer required and you can make considerable savings in cabling and the number of terminal points, as well as reducing planning and documentation overheads. The high granularity (16 I/O per SIMATIC CFU) enables flexible assignment to the higher-level controllers.

Overview



SIMATIC CFU here with BusAdapter, PROFINET bus cable and push-in terminals

SIMATIC CFU PA Edition

Plug-and-produce simplicity

Digitalization requires a digital infrastructure facilitating integrated digital communication right down to the sensors and actuators. You can use the established and proven PROFIBUS PA standard to achieve this. It is integrated into the PA Edition of the SIMATIC CFU, thus combining ruggedness and easy handling with all the advantages of the PROFINET standard based on Industrial Ethernet. Connected devices are automatically addressed. The device is integrated via standardized communication profiles.

This innovative new implementation of the PROFIBUS PA concept makes it possible to combine the simplicity of a point-to-point wiring system with the scalability of digital PROFIBUS PA fieldbus communication. As with digital field devices, it is not necessary to know prior to connection whether the discrete field device is a sensor or actuator – This can be easily configured afterwards via software.

Combination of digital fieldbus and discrete I/Os

- 8 × digital fieldbus (PROFIBUS PA)
- 8 × digital inputs/outputs, freely configurable (1 × counter functionality / frequency measurement)

Easy to use

- Automatic addressing of PROFIBUS PA field devices
- System-supported detection and integration of PROFIBUS PA field devices into the process control system
 - Utilization of standardized PA profiles
 - Commissioning, device replacement and maintenance wizards
- Implementation of diagnostic messages according to NAMUR NE 107
- Installation on a 35 mm DIN rail

Aluminum field housing



SIMATIC CFU aluminum field housing, open



SIMATIC CFU aluminum field housing, closed

The die-cast aluminum housing is suitable for use in zone 2/22 hazardous areas. The following are included in the housing scope of delivery:

- 22 × M20 plastic cable glands (incl. blanking plugs)
- 35 mm DIN rail
- Rail for strain relief and shield support

The enclosure has a display window for LED diagnostics.

10

Ordering data

SIMATIC CFU PA bundle with push-in terminals

Comprising:

- SIMATIC CFU PA, Article No. 6ES7655-5PX11-0XX0
- SIMATIC CFU push-in terminals, Article No. 6ES7655-5PX00-1XX0

pre-assembled and tested

Article No.

6ES7655-5PX11-1XX0

Article No.

SIMATIC CFU PA bundle with aluminum enclosure

Comprising:

- SIMATIC CFU PA, Article No. 6ES7655-5PX11-0XX0
- SIMATIC CFU push-in terminals, Article No. 6ES7655-5PX00-1XX0
- Aluminum enclosure with cable glands, shield busbar, shield connection clamps

pre-assembled and tested

6ES7655-5PX11-1AX0

I/O systemsNetwork transitions
SIMATIC CFU**SIMATIC CFU PA Edition****Technical specifications**

Article number	6ES7655-5PX11-1XX0 SIMATIC CFU PA BUNDLE	6ES7655-5PX11-1AX0 SIMATIC CFU PA Bundle with Alu housing
General information		
Product type designation	PA Bundle	
Number of channels	16	
Product function		
• I&M data	Yes; I&M0 to I&M4	
• Isochronous mode	No	
• The user can configure digital channels as input/output as required	Yes	
• Digital channels can be parameterized	Yes	
Engineering with		
• STEP 7 TIA Portal configurable/integrated from version	V17	
• STEP 7 configurable/integrated from version	V5.6 HF2 and higher	
• PCS 7 configurable/integrated from version	V9.0 SP2 and higher	
• PCS neo can be configured/integrated from version	V3.0	
• PROFIBUS from GSD version/GSD revision	- / -	
• PROFINET from GSD version/GSD revision	GSDML V2.3	
Operating mode		
• Counter	Yes	
Installation type/mounting		
Mounting	on 35 mm DIN rail, 2 spacing units wide	
Mounting position	Horizontal, vertical	Horizontal, vertical
Recommended mounting position		horizontal set up
Supply voltage		
Type of supply voltage	24 V DC	
Rated value (DC)	24 V	
Reverse polarity protection	Yes	
Short-circuit protection	Yes	
Redundant power supply	Yes	
Mains buffering		
• Mains/voltage failure stored energy time	5 ms; Bridging for field devices and communication	
Input current		
Current consumption (rated value)	2.5 A	
Current consumption, max.	2.55 A	
Inrush current, max.	8 A	
I^2t	0.3 A ² ·s	
Encoder supply		
Number of outputs	8	
Output voltage, min.	18.2 V	
Short-circuit protection	Yes; Electronic	
Output current		
• up to 60 °C, max.	2 A	
• up to 70 °C, max.	1 A	
Power loss		
Power loss, typ.	8.2 W; Depending on the type of BusAdapter used (typ. RJ45)	
Address area		
Address space per station		
• Address space per station, max.	1 440 byte; Dependent on configuration	

Technical specifications

Article number	6ES7655-5PX11-1XX0 SIMATIC CFU PA BUNDLE	6ES7655-5PX11-1AX0 SIMATIC CFU PA Bundle with Alu housing
Digital inputs		
Number of digital inputs	8	
Source/sink input	Yes; P-reading	
Input characteristic curve in accordance with IEC 61131, type 1	Yes	
Input characteristic curve in accordance with IEC 61131, type 2	No	
Input characteristic curve in accordance with IEC 61131, type 3	Yes	
Pulse extension	No	
Number of simultaneously controllable inputs		
horizontal installation		
- up to 60 °C, max.	8; Total current must be observed, see DQ	
- up to 70 °C, max.	8; Total current must be observed, see DQ	
vertical installation		
- up to 60 °C, max.	8; Total current must be observed, see DQ	
Digital input functions, parameterizable		
• Counter	Yes	
- Number, max.	1	
- Counting frequency, max.	1 kHz	
- Counting width	32 bit	
- Counting direction up/down	Yes; Up	
Input voltage		
• Rated value (DC)	24 V	
• for signal *0*	-30 to +5 V	
• for signal *1*	+11 to +30V	
Input current		
• for signal *1*, typ.	2.5 mA; Typical	
Input delay (for rated value of input voltage) for standard inputs		
- parameterizable	No	
- at *0* to *1*, max.	3.2 ms; for counter function 0,1 ms	
- at *1* to *0*, max.	3.2 ms; for counter function 0,1 ms	
Cable length		
• shielded, max.	1 000 m	
• unshielded, max.	600 m	
Digital outputs		
Type of digital output	Transistor	
Number of digital outputs	8	
Current-sinking	No	
Current-sourcing	Yes	
Short-circuit protection	Yes	
• Response threshold, typ.	0.7 to 1.3 A	
Limitation of inductive shutdown voltage to	Typ. L+ (-50 V)	
Controlling a digital input	Yes	
Switching capacity of the outputs		
• on lamp load, max.	5 W	
Load resistance range		
• lower limit	48 Ω	
• upper limit	12 kΩ	
Output voltage		
• Type of output voltage	DC	
• for signal *1*, min.	Ue minus 1 V	
Output current		
• for signal *1* rated value	0.5 A	
• for signal *0* residual current, max.	0.1 mA	

I/O systemsNetwork transitions
SIMATIC CFU**SIMATIC CFU PA Edition****Technical specifications**

Article number	6ES7655-5PX11-1XX0 SIMATIC CFU PA BUNDLE	6ES7655-5PX11-1AX0 SIMATIC CFU PA Bundle with Alu housing
Output delay with resistive load		
• "0" to "1", max.	50 µs	
• "1" to "0", max.	100 µs	
Parallel switching of two outputs		
• for uprating	No	
• for redundant control of a load	No	
Switching frequency		
• with resistive load, max.	100 Hz	
• with inductive load, max.	2 Hz	
• on lamp load, max.	10 Hz	
Total current of the outputs		
• Current per channel, max.	0.5 A	
horizontal installation		
- up to 60 °C, max.	2 A	
- up to 70 °C, max.	1 A	
vertical installation		
- up to 60 °C, max.	2 A	
Cable length		
• shielded, max.	1 000 m	
• unshielded, max.	600 m	
Encoder		
Connectable encoders		
• 2-wire sensor	Yes	
- permissible quiescent current (2-wire sensor), max.	1.5 mA	
Interfaces		
Number of PROFINET interfaces	1	
Number of PROFIBUS interfaces	0	
PROFIBUS PA		
• Transmission rate, max.	31.25 kbit/s	
• Number of connectable PA field devices	8; electrically isolated from other interfaces, isolation tested at 2 500 V DC	
• Current output to PA field devices, max.	320 mA	
• permissible current per spur line	40 mA	
• Automatic addressing	Yes	
• System-supported integration of field devices via PA profiles	Yes	
• Extended fieldbus diagnostics	Yes	
1. Interface		
Interface type	PROFINET	
Isolated	Yes	
Interface types		
• Number of ports	2	
• integrated switch	Yes	
• BusAdapter (PROFINET)	Yes	
Protocols		
• PROFINET IO Device	Yes	
• PROFIBUS DP slave	No	
Interface types		
RJ 45 (Ethernet)		
• 100 Mbps	Yes	
• Autonegotiation	Yes	
• Autocrossing	Yes	

Technical specifications

Article number	6ES7655-5PX11-1XX0	6ES7655-5PX11-1AX0
	SIMATIC CFU PA BUNDLE	SIMATIC CFU PA Bundle with Alu housing
Protocols		
Supports protocol for PROFINET IO	Yes	
Redundancy mode		
• PROFINET system redundancy (S2)	Yes; Type S2	
Media redundancy		
- MRP	Yes	
Open IE communication		
• LLDP	Yes	
Interrupts/diagnostics /status information		
Status indicator	Yes	
Alarms	Yes	
Diagnostics function	Yes	
Diagnoses		
• Monitoring of encoder power supply	Yes	
• Wire-break	Yes	
• Short-circuit	Yes	
Diagnostics indication LED		
• RUN LED	Yes; green LED	
• ERROR LED	Yes; red LED	
• MAINT LED	Yes; Yellow LED	
• Monitoring of the supply voltage (PWR-LED)	Yes	
• Status indicator digital input (green)	Yes	
• Status indicator digital output (green)	Yes	
• Spur line status/fault	Yes	
Potential separation		
between the channels and PROFINET	Yes	
Potential separation digital inputs		
• between the channels	No	
• between the channels and the power supply of the electronics	No	
Potential separation digital outputs		
• between the channels	No	
• between the channels and the power supply of the electronics	No	
Degree and class of protection		
IP degree of protection	IP20	IP66
Ambient conditions		
Ambient temperature during operation		
• min.	-40 °C	
• max.	70 °C	
Connection method		
Design of electrical connection	Connection plug	

I/O systemsNetwork transitions
SIMATIC CFU**SIMATIC CFU PA Edition****Technical specifications**

Article number	6ES7655-5PX11-1XX0 SIMATIC CFU PA BUNDLE	6ES7655-5PX11-1AX0 SIMATIC CFU PA Bundle with Alu housing
Spur line		
• Number of spur lines	8	
• Type of cable	Type A	
• Cable diameter, min.	6 mm	
• Cable diameter, max.	12 mm	
• Conductor cross-section, min.	0.2 mm ²	
• Conductor cross-section, max.	2.5 mm ²	
• Cable length, max.	120 m	
• total current output to field devices, max.	320 mA	
• Number of connectable field devices	8	
• Current limitation per field device, max.	40 mA	
• No-load voltage, max.	15.3 V	
• short-circuit proof	Yes	
• Short-circuit current (test current); max.	8 mA	
• intrinsically safe according to FISCO model	Yes	
• Debounce logic	Yes	
Dimensions		
Width	329 mm	414 mm
Height	123 mm	266 mm
Depth	74 mm	111 mm
Weights		
Weight, approx.	650 g	5.5 kg

Overview

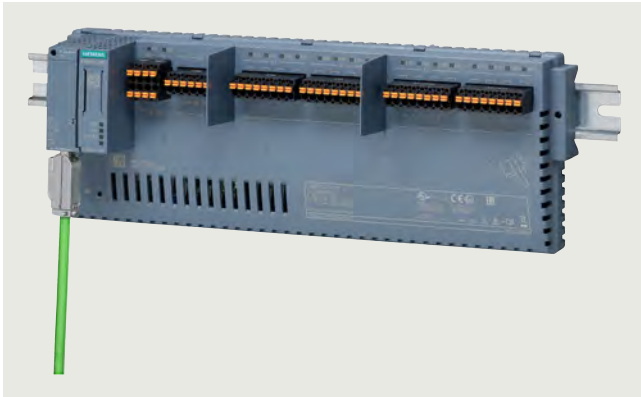

SIMATIC CFU DIQ Edition

Individual, customer-specific solutions and flexible system/plant extensions are requirements that are becoming increasingly important in the process industry due to digitalization. SIMATIC CFU DIQ Edition with 16 freely configurable digital IO channels offers a solution for the growing demands of distributed I/O.

SIMATIC CFU also has expansion functions for optional configuration. Two additional operating modes can be activated for selected digital inputs. "Counter" operating mode and "Frequency measurement" operating mode with a cut-off frequency of 1 kHz.

Actuator shutdown can be set for the digital outputs. The actuator shutdown of the SIMATIC CFU uses a monitoring channel (DI channel) to quickly set all digital outputs to a low digital level.

- 16 × digital inputs/outputs, freely configurable (2 × counter functionality / frequency measurement)

Aluminum field housing



SIMATIC CFU aluminum field housing, open



SIMATIC CFU aluminum field housing, closed

The die-cast aluminum housing is suitable for use in zone 2/22 hazardous areas. The following are included in the housing scope of delivery:

- 22 × M20 plastic cable glands (incl. blanking plugs)
- 35 mm DIN rail
- Rail for strain relief and shield support

The enclosure has a display window for LED diagnostics.

Ordering data

SIMATIC CFU DIQ with aluminum housing

Comprising:

- SIMATIC CFU DIQ, Article No. 6ES7655-5PX31-0XX0
- SIMATIC CFU push-in terminals, Article No. 6ES7655-5PX00-1XX0
- Aluminum housing with cable glands, shield busbar, shield connection clamp

pre-assembled and tested

Article No.

6ES7655-5PX31-1AX0

Article No.

6ES7655-5PX31-1XX0

SIMATIC CFU DIQ

Comprising:

- SIMATIC CFU DIQ, Article No. 6ES7655-5PX31-0XX0
- SIMATIC CFU push-in terminals, Article No. 6ES7655-5PX31-1XX0

pre-assembled and tested

I/O systemsNetwork transitions
SIMATIC CFU**SIMATIC CFU DIQ Edition****Technical specifications**

Article number	6ES7655-5PX31-1AX0 SIMATIC CFU DIQ with Alu housing	6ES7655-5PX31-1XX0 SIMATIC CFU DIQ
General information		
Product type designation	DIQ Bundle	DIQ Bundle
Number of channels		16
Product function		
<ul style="list-style-type: none"> I&M data Isochronous mode The user can configure digital channels as input/output as required Digital channels can be parameterized 		Yes; I&M0 to I&M4 No Yes Yes
Engineering with		
<ul style="list-style-type: none"> STEP 7 TIA Portal configurable/integrated from version STEP 7 configurable/integrated from version PCS 7 configurable/integrated from version PCS neo can be configured/integrated from version PROFIBUS from GSD version/GSD revision PROFINET from GSD version/GSD revision 	V17 V5.6 HF2 and higher V9.0 SP2 and higher V3.1 - / - GSDML V2.3	V17 V5.6 HF2 and higher V9.0 SP2 and higher V3.1 - / - GSDML V2.3
Operating mode		
<ul style="list-style-type: none"> Counter 		Yes
Installation type/mounting		
Mounting		on 35 mm DIN rail, 2 spacing units wide
Mounting position	Horizontal, vertical	Horizontal, vertical
Recommended mounting position	horizontal set up	
Supply voltage		
Type of supply voltage		24 V DC
Rated value (DC)		24 V
Reverse polarity protection		Yes
Short-circuit protection		Yes
Redundant power supply		Yes
Mains buffering		
<ul style="list-style-type: none"> Mains/voltage failure stored energy time 		5 ms; For communication
Input current		
Current consumption (rated value)		5.12 A
Current consumption, max.		5.13 A
Inrush current, max.		4.8 A
I_t		0.073 A ² ·s
Encoder supply		
Number of outputs		16
Output voltage, min.		18.2 V
Short-circuit protection		Yes; Electronic
Output current		
<ul style="list-style-type: none"> up to 60 °C, max. up to 70 °C, max. 		5 A 4 A
Power loss		
Power loss, typ.		2.88 W; Depending on the type of BusAdapter used (typ. RJ45)
Address area		
Address space per station		
<ul style="list-style-type: none"> Address space per station, max. 		1 440 byte; Dependent on configuration

Technical specifications

Article number	6ES7655-5PX31-1AX0 SIMATIC CFU DIQ with Alu housing	6ES7655-5PX31-1XX0 SIMATIC CFU DIQ
Digital inputs		
Number of digital inputs		16
Source/sink input		Yes; P-reading
Input characteristic curve in accordance with IEC 61131, type 1		Yes
Input characteristic curve in accordance with IEC 61131, type 2		No
Input characteristic curve in accordance with IEC 61131, type 3		Yes
Pulse extension		No
Number of simultaneously controllable inputs		
horizontal installation		
- up to 60 °C, max.		16; Total current must be observed, see DQ
- up to 70 °C, max.		16; Total current must be observed, see DQ
vertical installation		
- up to 60 °C, max.		16; Total current must be observed, see DQ
Digital input functions, parameterizable		
• Counter		Yes
- Number, max.		2
- Counting frequency, max.		1 kHz
- Counting width		32 bit
- Counting direction up/down		Yes; Up
Input voltage		
• Rated value (DC)		24 V
• for signal *0*		-30 to +5 V
• for signal *1*		+11 to +30V
Input current		
• for signal *1*, typ.		2.5 mA; Typical
Input delay (for rated value of input voltage) for standard inputs		
- parameterizable		No
- at *0* to *1*, max.		3.2 ms; for counter function 0,1 ms
- at *1* to *0*, max.		3.2 ms; for counter function 0,1 ms
Cable length		
• shielded, max.		1 000 m
• unshielded, max.		600 m
Digital outputs		
Type of digital output		Transistor
Number of digital outputs		16
Current-sinking		No
Current-sourcing		Yes
Short-circuit protection		Yes
• Response threshold, typ.		0.7 to 1.3 A
Limitation of inductive shutdown voltage to		Typ. L+ (-50 V)
Controlling a digital input		Yes
Switching capacity of the outputs		
• on lamp load, max.		5 W
Load resistance range		
• lower limit		48 Ω
• upper limit		12 kΩ
Output voltage		
• Type of output voltage		DC
• for signal *1*, min.		Ue minus 1 V
Output current		
• for signal *1* rated value		0.5 A
• for signal *0* residual current, max.		0.1 mA

I/O systemsNetwork transitions
SIMATIC CFU**SIMATIC CFU DIQ Edition****Technical specifications**

Article number	6ES7655-5PX31-1AX0 SIMATIC CFU DIQ with Alu housing	6ES7655-5PX31-1XX0 SIMATIC CFU DIQ
Output delay with resistive load		
<ul style="list-style-type: none"> • "0" to "1", max. • "1" to "0", max. 		50 µs 100 µs
Parallel switching of two outputs		
<ul style="list-style-type: none"> • for uprating • for redundant control of a load 		No No
Switching frequency		
<ul style="list-style-type: none"> • with resistive load, max. • with inductive load, max. • on lamp load, max. 		100 Hz 2 Hz 10 Hz
Total current of the outputs		
<ul style="list-style-type: none"> • Current per channel, max. 		0.5 A
horizontal installation		
<ul style="list-style-type: none"> - up to 60 °C, max. - up to 70 °C, max. 		5 A 4 A
vertical installation		
<ul style="list-style-type: none"> - up to 60 °C, max. 		5 A
Cable length		
<ul style="list-style-type: none"> • shielded, max. • unshielded, max. 		1 000 m 600 m
Encoder		
Connectable encoders		
<ul style="list-style-type: none"> • 2-wire sensor - permissible quiescent current (2-wire sensor), max. 		Yes 1.5 mA
Interfaces		
Number of PROFINET interfaces		1
Number of PROFIBUS interfaces		0
1. Interface		
Interface type		PROFINET
Isolated		Yes
Interface types		
<ul style="list-style-type: none"> • Number of ports • integrated switch • BusAdapter (PROFINET) 		2 Yes Yes
Protocols		
<ul style="list-style-type: none"> • PROFINET IO Device • PROFIBUS DP slave 		Yes No
Interface types		
RJ 45 (Ethernet)		
<ul style="list-style-type: none"> • 100 Mbps • Autonegotiation • Autocrossing 		Yes Yes Yes
Protocols		
Supports protocol for PROFINET IO		Yes
Redundancy mode		
<ul style="list-style-type: none"> • PROFINET system redundancy (S2) 		Yes; Type S2
Media redundancy		
<ul style="list-style-type: none"> - MRP 		Yes
Open IE communication		
<ul style="list-style-type: none"> • LLDP 		Yes

Technical specifications

Article number	6ES7655-5PX31-1AX0 SIMATIC CFU DIQ with Alu housing	6ES7655-5PX31-1XX0 SIMATIC CFU DIQ
Interrupts/diagnostics/ status information		
Status indicator		Yes
Alarms		Yes
Diagnostics function		Yes
Diagnoses		
• Monitoring of encoder power supply		Yes
• Wire-break		Yes
• Short-circuit		Yes
Diagnostics indication LED		
• RUN LED		Yes; green LED
• ERROR LED		Yes; red LED
• MAINT LED		Yes; Yellow LED
• Monitoring of the supply voltage (PWR-LED)		Yes
• Status indicator digital input (green)		Yes
• Status indicator digital output (green)		Yes
Potential separation		
between the channels and PROFINET		Yes
Potential separation digital inputs		
• between the channels		No
• between the channels and the power supply of the electronics		No
Potential separation digital outputs		
• between the channels		No
• between the channels and the power supply of the electronics		No
Degree and class of protection		
IP degree of protection	IP66	IP20
Ambient conditions		
Ambient temperature during operation		
• min.		-40 °C
• max.		70 °C
Connection method		
Design of electrical connection		Connection plug
Dimensions		
Width	414 mm	329 mm
Height	266 mm	123 mm
Depth	111 mm	74 mm
Weights		
Weight, approx.	5.5 kg	610 g

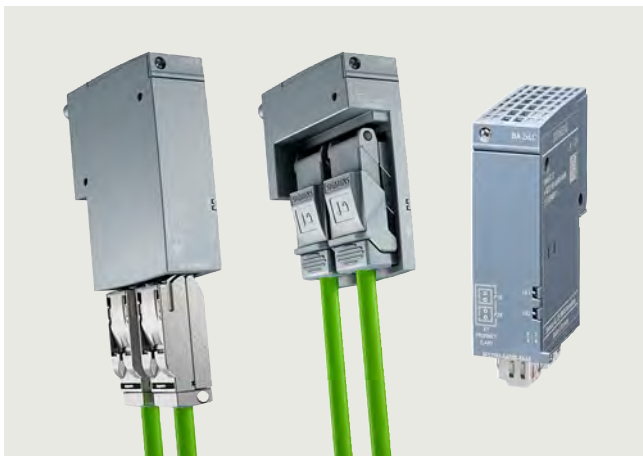
I/O systemsNetwork transitions
SIMATIC CFU**BusAdapter****Overview**

BusAdapter BA 2xRJ45, 2xFC and 2xLC

BusAdapter

A BusAdapter as a separate component allows a free choice of SIMATIC CFU connection to PROFINET:

- BA 2xRJ45:
2 electrical connections for bus cables with standard RJ45 connectors
- BA 2xFC:
2 electrical connections for direct connection of FastConnect bus cable
- BA 2xLC:
2 optical ports for fiber-optic cables
- BA 1xLC, 1xRJ45:
Combination bus adapter comprising 1 optical connection and one electrical connection standard RJ45
- BA 1xLC, 1xFC:
Combination bus adapter 1 optical connection and 1 electrical connection for direct connection of FastConnect bus cable
- BA 2xRJ45 VD:
2 electrical connections for Ethernet communication via 2, 4 or 8-wire copper cables and distances up to 500 m

Ordering data**Article No.**

BusAdapter	Article No.
BusAdapter BA 2xRJ45 2 × RJ45 connections for PROFINET (standard Ethernet socket)	6DL1193-6AR00-0AA0
BusAdapter BA 2xFC 2 × FastConnect (FC) connections for PROFINET	6DL1193-6AF00-0AA0
BusAdapter BA 2xLC 2 × glass fiber-optic connections	6DL1193-6AG00-0AA0
BusAdapter BA LC/RJ45 2 × glass fiber-optic connections	6DL1193-6AG20-0AA0
BusAdapter BA LC/FC 2 × glass fiber-optic connections	6DL1193-6AG40-0AA0
BusAdapter BA 2xRJ45 (VD) 2 × electrical connections for Ethernet communication via 2, 4 or 8-wire copper cables and distances up to 500 m	6GK5991-2VA00-8AA2

Technical specifications

Article number	6DL1193-6AR00-0AA0 ET 200SP HA, BUSADAPTER BA 2XRJ45	6DL1193-6AF00-0AA0 ET 200SP HA, BUSADAPTER BA 2XFC	6DL1193-6AG00-0AA0 ET 200SP HA, BUSADAPTER BA 2XLC
General information			
Product type designation	BA 2x RJ45	BA 2xFC	BA 2XLC
Interfaces			
Number of PROFINET interfaces	1; 2 ports (switch) RJ45	1; 2 ports (switch) FC	1; 2 ports (switch) LC Multimode Glass Fibre
Supports protocol for PROFINET IO			
<ul style="list-style-type: none"> Number of RJ45 ports Number of FC (FastConnect) connections Number of LC ports 	2	2	2
Cable length			
- Cu conductors	100 m	100 m	
- Multimode graded-index fiber 50/125 µm			3 km
- Multimode graded-index fiber 62.5/125 µm			3 km
Ambient conditions			
Ambient temperature during operation			
• min.	-40 °C	-40 °C	-40 °C
• max.	70 °C	70 °C	65 °C; redundant design (2x 6DL1155-6AU00-0PM0): max. 60 °C horizontal, max. 50 °C vertical. When using different I/O devices, the derating specified there must be observed
Dimensions			
Width	20 mm	20 mm	20 mm
Height	69.5 mm	69.5 mm	75 mm; Without protective caps (approx. 8 mm)
Depth	59 mm	59 mm	59 mm
Weights			
Weight, approx.	46 g	53 g	60 g
Article number	6DL1193-6AG20-0AA0 ET 200SP HA, BUSADAPTER BA LC/RJ45	6DL1193-6AG40-0AA0 ET 200SP HA, BUSADAPTER BA LC/FC	
General information			
Product type designation	BA LC/RJ45	BA LC/FC	
Interfaces			
Number of PROFINET interfaces	1; 2 ports (switch) LC / RJ45	1; 2 ports (switch) LC / FC	
Supports protocol for PROFINET IO			
<ul style="list-style-type: none"> Number of RJ45 ports Number of FC (FastConnect) connections Number of LC ports 	1	1	
	1; Wavelength of 1 270 ... 1 380 nm, corresponds to 100BASE-FX	1; Wavelength of 1 270 ... 1 380 nm, corresponds to 100BASE-FX	
Cable length			
- Cu conductors	100 m	100 m	
- Multimode graded-index fiber 50/125 µm	3 km	3 km	
- Multimode graded-index fiber 62.5/125 µm	3 km	3 km	
Standards, approvals, certificates			
RoHS conformity	Yes	Yes	
China RoHS compliance	Yes	Yes	

I/O systemsNetwork transitions
SIMATIC CFU**BusAdapter****Technical specifications**

Article number	6DL1193-6AG20-0AA0 ET 200SP HA, BUSADAPTER BA LC/RJ45	6DL1193-6AG40-0AA0 ET 200SP HA, BUSADAPTER BA LC/FC
Ambient conditions		
Ambient temperature during operation		
• min.	-40 °C	-40 °C
• max.	70 °C; = Tmax for horizontal installation; for vertical installation Tmax = 60 °C; redundant setup (2x 6DL1155-6AU00-0PM0): max. 65 °C horizontally, max. 60 °C vertically. When using different IO Devices, the derating specified there must be observed.	65 °C; = Tmax for horizontal installation; for vertical installation Tmax = 60 °C; redundant setup (2x 6DL1155-6AU00-0PM0): max. 60 °C horizontally, max. 55 °C vertically. When using different IO Devices, the derating specified there must be observed.
Dimensions		
Width	20 mm	20 mm
Height	75 mm; Without protective caps (approx. 8 mm)	75 mm; Without protective caps (approx. 8 mm)
Depth	59 mm	59 mm
Weights		
Weight, approx.	32 g	50 g

Article number	6GK5991-2VA00-8AA2
product type designation	BA 2xRJ45VD HA
suitability for use	Ethernet transmission via 2, 4 and 8-wire line
suitability for operation	Products with BusAdapter interface (requirement: the BusAdapter is approved in the firmware of the basic unit)

interfaces	
number of electrical connections	
• for network components or terminal equipment maximum	2
number of 10/100 Mbit/s RJ45 ports	2
type of electrical connection	
• for network components or terminal equipment	RJ45
operating mode	
• standard Ethernet	Yes
• VD	Yes; Depending on number of wires (2, 4 or 8-wire)

standards, specifications, approvals	
certificate of suitability	
• CCC for hazardous zone according to GB standard	Yes

Ordering data	Article No.
Connection system	
SIMATIC CFU screw-type terminals Complete set of screw-type terminals for SIMATIC CFU: two-tier 2x2 (24 V), single-tier 1x6 (GND) and single-tier 4x8 (IO)	6ES7655-5PX00-2XX0
SIMATIC CFU push-in terminals Complete set of push-in terminals for SIMATIC CFU: two-tier 2x2 (24 V), single-tier 1x6 (GND) and single-tier 4x8 (IO)	6ES7655-5PX00-1XX0

I/O systems

Notes

10

SIMATIC control systems



11/2	FM 458-1 DP application module
11/2	Introduction
11/3	FM 458-1 DP basic module
11/5	EXM 438-1 input/output expansion
11/7	EXM 448-2 universal communication expansion module
11/8	D7-SYS

11/9	SIMATIC TDC multiprocessor control system
11/9	Introduction, UR6021 rack
11/10	CPU555, CPU 551 processor modules
11/11	MC5xx program memory module, CP50M1 communications module
11/12	CP51M1 communications module, CP53M0 coupling module
11/13	SM500 I/O module
11/15	SM500 DI/DQ I/O module
11/16	GlobalDataMemory
11/17	Accessories

SIMATIC control systems

FM 458-1 DP application module

Introduction

Overview



SIMATIC FM 458-1 DP integrated in SIMATIC S7-400

- Designed for high-performance and user-configurable closed-loop control tasks in the SIMATIC S7-400.
- Can be adapted to individual requirements as required, such as:
Controlling, computing, closed-loop control as well as motion control. Can therefore be used flexibly for a wide variety of applications.
- Extensive library with approx. 300 function blocks:
E.g. simple functions such as AND, ADD and OR through to complex GMC (general motion control) blocks as virtual master or gear functions.
- User-friendly graphical configuration with the SIMATIC engineering tool CFC (Continuous Function Chart) and the D7-SYS add-on software package:
Optimum code generation by the compiler, therefore SCL is not required.
- PROFIBUS DP interface onboard.

SIMATIC FM 458-1 DP is based on more than 15 years experience with high-performance control systems and combines this know-how with the advantages of SIMATIC – the leading automation system for decades. In contrast to other function modules with static structures/functions, the FM 458-1 DP application module can be configured flexibly and adapted to individual requirements.

Overview



- Basic module for computing, closed-loop control and open-loop control tasks
- PROFIBUS DP interface for connection of distributed I/O and drives
- Modular design with expansion modules for I/O and communication

Ordering data

Ordering data	Article No.	Ordering data	Article No.
FM 458-1 DP application module Basic module for computing, closed-loop control and open-loop control tasks; with PROFIBUS DP interface	6DD1607-0AA2	RS 485 bus connector with 90° cable outlet Max. transfer rate 12 Mbps Without PG interface With PG interface	6ES7972-0BA12-0XA0 6ES7972-0BB12-0XA0
Micro Memory Card For FM 458-1 DP basic module 2 MB 4 MB 8 MB	6ES7953-8LL31-0AA0 6ES7953-8LM32-0AA0 6ES7953-8LP31-0AA0	RS 485 bus connector with angled cable outlet Max. transfer rate 12 Mbps Without PG interface With PG interface	6ES7972-0BA42-0XA0 6ES7972-0BB42-0XA0
FM 458-1 DP Know-How-Protect For protection of technological application modules against unauthorized copying	6DD1607-0GA0	RS 485 bus connector with 90° cable outlet for FastConnect connection system Max. transfer rate 12 Mbps Without PG interface • 1 unit • 100 units With PG interface • 1 unit • 100 units	6ES7972-0BA52-0XA0 6ES7972-0BA52-0XB0 6ES7972-0BB52-0XA0 6ES7972-0BB52-0XB0
SC 64 interface cable To connect FM 458-1 to the serial port of a programming device/ PC	6DD1684-0GE0	PROFIBUS FastConnect bus cable Standard type with special design for quick mounting, 2-wire, shielded, sold by the meter; max. delivery unit 1000 m, minimum ordering quantity 20 m Preferred lengths:	6XV1830-0EH10 6XV1830-0EN20 6XV1830-0EN50 6XV1830-0ET10
SB10 interface module To connect 8 binary I/Os to FM 458-1 DP	6DD1681-0AE2		
SB61 interface module To connect 8 binary I/Os to FM 458-1 DP, input voltage: 24/48 V DC	6DD1681-0EB3		
SU12 interface module To connect 10 signals to FM 458-1 DP	6DD1681-0AJ1		

SIMATIC control systems

FM 458-1 DP application module

FM 458-1 DP basic module**Technical specifications**

Article number	6DD1607-0AA2 FM458-1 DP Application Module
Supply voltage	
Rated value (DC)	
• 5 V DC	Yes
• 24 V DC	Yes
Input current	
Current consumption, typ.	1.5 A
Current consumption, max.	3 A
Memory	
Backup	
• present	Yes; SRAM
Battery	
Backup battery	
• Backup current, max.	15 µA
Time of day	
Clock	
• Hardware clock (real-time)	Yes

Article number	6DD1607-0AA2 FM458-1 DP Application Module
Digital inputs	
Number of digital inputs	8; Connector X2
Input voltage	
• Rated value (DC)	24 V
• for signal "0"	-1 to +6V
• for signal "1"	13.5 to 33V
Input current	
• for signal "0", max. (permissible quiescent current)	0 mA
• for signal "1", typ.	3 mA; at 24 V
Input delay (for rated value of input voltage) for standard inputs	
- at "0" to "1", max.	5 µs
Protocols	
PROFIBUS DP	
Services	
- Equidistance	Yes; With connection to interrupt tasks
- Direct data exchange (slave-to-slave communication)	Yes
Interrupts/diagnostics/status information	
Alarms	Yes
Potential separation	
Potential separation digital inputs	
• Potential separation digital inputs	No; only via optional interface modules
Weights	
Weight, approx.	1 000 g

Overview



- Optional plug-in expansion module for the FM 458-1 DP basic module
- Used to read in and output time-critical signals
- With digital and analog inputs/outputs
- Incremental and absolute encoders can be connected
- 4 high-resolution analog outputs
- Fan-free operation up to 40 °C

Ordering data

Article No.

EXM 438-1 input/output expansion For direct exchange of digital and analog signals between FM 458-1 DP and the plant	6DD1607-0CA1
SB10 interface module To connect 8 binary inputs or outputs to FM 458-1 DP	6DD1681-0AE2
SB61 interface module To connect 8 binary inputs to FM 458-1 DP, input voltage: 24/48 V DC	6DD1681-0EB3
SB71 interface module To connect 8 binary outputs to FM 458-1 DP, output voltage: 24/48 V DC	6DD1681-0DH1
SU12 interface module To connect 10 signals to FM 458-1 DP	6DD1681-0AJ1
SU13 interface module To connect 50 signals to FM 458-1 DP	6DD1681-0GK0
SC 62 interface cable To connect EXM 438-1 with up to 5 SBxx or SU12	6DD1684-0GC0
SC 63 interface cable To connect EXM 438-1 with an SU13	6DD1684-0GD0

Technical specifications

Article number	6DD1607-0CA1 EXM 438-1 I/O Expansion
Supply voltage	
Rated value (DC)	
• 5 V DC	Yes
• 24 V DC	Yes; to be set up externally
Input current	
Current consumption, typ.	1.5 A
Encoder supply	
Type of output voltage	about 14 V (non-isolated)
Short-circuit protection	Yes; Electronic
Output current	
• Rated value	100 mA
Power loss	
Power loss, typ.	7.5 W
Digital inputs	
Number of digital inputs	16
Input voltage	
• Rated value (DC)	24 V
• for signal "0"	-1 to +6 V or input open
• for signal "1"	+13 to +33V
Input current	
• for signal "0", max. (permissible quiescent current)	0 mA
• for signal "1", typ.	3 mA

Article number	6DD1607-0CA1 EXM 438-1 I/O Expansion
Input delay (for rated value of input voltage) for standard inputs	
- at "0" to "1", max.	200 µs
Digital outputs	
Number of digital outputs	8
Short-circuit protection	Yes; electronic/thermal
• Response threshold, typ.	250 mA
Limitation of inductive shutdown voltage to	Supply voltage +1 V
Output voltage	
• for signal "0", max.	3 V
• for signal "1", max.	Supply voltage -2.5 V
Output current	
• for signal "1" rated value	50 mA
• for signal "1" permissible range for 0 to 40 °C, min.	100 mA
• for signal "0" residual current, max.	20 µA
• Total switching current	80% at 50 °C all outputs 50 mA
Output delay with resistive load	
• "0" to "1", max.	15 µs

SIMATIC control systems

FM 458-1 DP application module

EXM 438-1 input/output expansion

Technical specifications

Article number	6DD1607-0CA1 EXM 438-1 I/O Expansion
Analog inputs	
Number of analog inputs	5; Differential inputs
Input ranges (rated values), voltages	
• -10 V to +10 V	Yes; -10 V: ± 4 LSB; to +10 V: ± 4 LSB (1 LSB = 4.88 mV)
- Input resistance (-10 V to +10 V)	470 k Ω
Analog outputs	
Number of analog outputs	8; 4 outputs 16 bit; 4 outputs 12 bit
Voltage output, short-circuit protection	Yes; relative to frame
Voltage output, short-circuit current, max.	16 bit: 27 mA; 12 bit: 100 mA
Output ranges, voltage	
• -10 V to +10 V	Yes
Analog value generation for the inputs	
Integration and conversion time/resolution per channel	
• Resolution with overrange (bit including sign), max.	12 bit
• Conversion time (per channel)	45 μ s
Analog value generation for the outputs	
Integration and conversion time/resolution per channel	
• Resolution with overrange (bit including sign), max.	4 AO: 16 bit, 4 AO: 12 bit
• Conversion time (per channel)	4 AO (16 bit): 2 μ s; 4 AO (12 bit): 4 μ s
Encoder	
Number of connectable encoders, max.	12; 8 incremental encoders (synchronizable), 4 absolute encoders
Connectable encoders	
• Incremental encoder (symmetrical)	Yes
• Incremental encoder (asymmetrical)	Yes
• Absolute encoder (SSI)	Yes; Single or multturn encoder with SSI (synchronous serial) or EnDat interface

Article number	6DD1607-0CA1 EXM 438-1 I/O Expansion
Encoder signals, incremental encoder (symmetrical)	
• Trace mark signals	1) for tracks A and B (90° out of phase), poss. with zero pulse N; 2) for separate forward and backward track
• Input voltage	With 0 signal: -5 to 0 V; with 1 signal: +3 to +5 V; permissible input voltage range: differential voltage -5 to +5 V; max. input current: 15 mA (important: not limited on module side!)
Encoder signals, incremental encoder (asymmetrical)	
• Trace mark signals	Track A and B (phase-shifted by 90 degrees), possibly with zero pulse N
• Input voltage	with 0 signal: -30 to +4 V (at 15 mA load); with 1 signal: +8 to 30 V (at 15 mA load); permissible input voltage range: differential voltage -30 to +30 V
Encoder signals, absolute encoder (SSI)	
• Input signal	5 V acc. to RS 422
• Data signal	Dual-, Gray-, Gray-Excess-Code
• Clock frequency, max.	2 MHz; 100 kHz to 2 MHz (depending on cable length)
Errors/accuracies	
Linearity error (relative to output range), (+/-)	(± 1 LSB)
Potential separation	
Potential separation digital inputs	
• Potential separation digital inputs	No
Potential separation digital outputs	
• Potential separation digital outputs	No
Potential separation analog inputs	
• Potential separation analog inputs	No
Potential separation analog outputs	
• Potential separation analog outputs	No
Dimensions	
Width	24 mm
Height	290 mm
Depth	210 mm
Weights	
Weight, approx.	1 kg

EXM 448-2 universal communication expansion module

Overview



- Optional plug-in expansion module for the FM 458-1 DP basic module
- For high-speed communication over up to 2 SIMOLINK interfaces
- For coupling several FM 458-1 DP application modules in synchronism with the sampling time

Ordering data

Article No.

EXM 448-2 universal communication expansion

For high-speed communication with drives; for establishing two SIMOLINK fiber optic connections

6DD1607-0EA2

Technical specifications

Article number	6DD1607-0EA2 SIMATIC S7-400 EXM 448-2 Comm.-Expans.
Supply voltage	
Rated value (DC)	
• 5 V DC	Yes
Input current	
Current consumption, typ.	0.6 A
Dimensions	
Width	25 mm
Height	290 mm
Depth	210 mm
Weights	
Weight, approx.	0.9 kg

SIMATIC control systems

FM 458-1 DP application module

D7-SYS

Overview

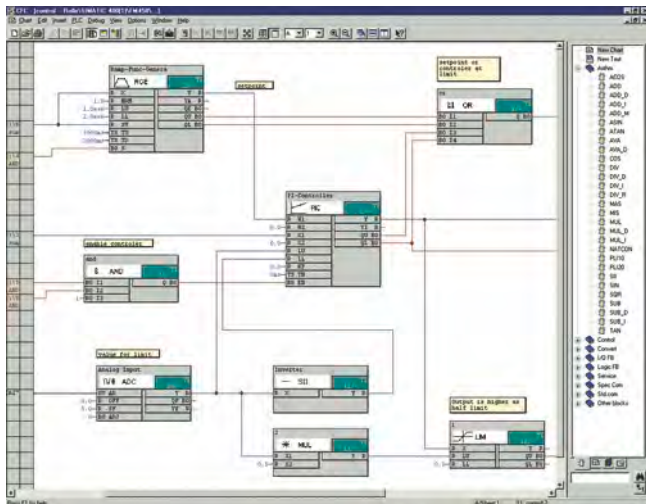

- Optional package for STEP 7 V5.6 SP2 or STEP 7 V5.7 for configuring closed-loop control and automation tasks with SIMATIC TDC and FM 458-1 DP
- Extensive block library
- Generation of user libraries in ANSI C with D7-FB-GEN function block generator

Licensing

- D7-SYS is delivered with a floating license. The floating license allows installation of the software on any number of computers. This means one user per license can use the software independently of the computer used and without being tied to a certain workplace. The number of existing licenses determines the number of computers on which the software can be used simultaneously.
- An upgrade to version 9.1 is available for users of previous versions from V8.1.
- A separate Software Update Service can be purchased for D7-SYS.
- As of version 8.1, the D7-FB-GEN block generator that was previously sold separately is included in the D7-SYS scope of delivery.

You can find more information on the Software Update Service, license types, Online Software Delivery and handling your software licenses with the Automation License Manager here:

<http://www.siemens.com/simatic-licenses>

Ordering data

Article No.

SIMATIC D7-SYS V9.1

Reference hardware:
SIMATIC TDC, FM 458-1 DP
Requirement:
MS Windows 10 Pro and Enterprise (64 bit);
MS Windows Server 2016 Standard Edition (64 bit);
MS Windows Server 2019 Standard Edition (64 bit);
STEP 7 V5.6 SP2 or STEP 7 V5.7
Type of delivery:
On DVD, en, de, with electronic documentation

Floating license

Upgrade license from V8.1 to V9.1

Software Update Service¹⁾

6ES7852-0CC07-0YA5

6ES7852-0CC07-0YE5

6ES7852-0CC01-0YL5

¹⁾ For more information on the Software Update Service, see, page 12/2.

Accessories

Overview

- Interface modules and interface cables for the FM 458-1 DP application modules

Note:

For information on interface cables SC 62, SC 63, SC 64 and interface modules SB10, SB61, SB71, SU12 and SU13, see SIMATIC TDC multiprocessor control system, accessories, page 11/17.

Introduction



SIMATIC TDC (Technology and Drives Control) is a digital automation system featuring very high computing power and the ability to process very large programs. An extensive library with approx. 300 ready-made function blocks is available for fast engineering.

Overview UR6021 racks



- UR6021 rack as the base component for SIMATIC TDC
- Integrated system power supply and system fan
- With high-performance 64-bit backplane bus for high-speed data exchange between the inserted modules
- Requirement for operating the CPU555

Ordering data

Article No.

UR6021 racks	6DD1682-0CH3
Spare-part compatible successor of 6DD1682-0CH2	
Accessories	
SR51 slot cover	6DD1682-0DA1
Spare parts	
Backup battery	6ES7971-0BA00
Fan insert for UR6021	6DD1683-0CH3

SIMATIC control systems

SIMATIC TDC multiprocessor control system

CPU555, CPU 551 processor modules

Overview CPU555 processor module



- Graphic freely configurable processor module
- For implementing highly dynamic open and closed-loop control functions

Overview CPU551 processor module



High-performance CPU module for open and closed-loop control and arithmetic tasks.

Ordering data

Article No.

CPU555 processor module	6DD1600-0BB0
Accessories	
SIMATIC Micro Memory Card	
2 MB	6ES7953-8LL31-0AA0
4 MB	6ES7953-8LM32-0AA0
8 MB	6ES7953-8LP31-0AA0
Crossed twisted pair cables 4x2 with RJ45 connectors	
0.5 m	6XV1870-3RE50
1 m	6XV1870-3RH10
2 m	6XV1870-3RH20
6 m	6XV1870-3RH60
10 m	6XV1870-3RN10

Ordering data

Article No.

CPU551 processor module	6DD1600-0BA3
Accessories	
MC500 memory module (4 MB)	6DD1610-0AH4
MC510 memory module (8 MB)	6DD1610-0AH6
MC521 memory module (2 MB)	6DD1610-0AH3

Technical specifications

CPU551	
Required space / width	1 slot
Weight	0.6 kg
Display	5x7 LED
Local service interface	Serial RS232 interface
Sampling intervals	from 100 µs
SDRAM	128 MB
Synchronous cache	8 MB
Clock frequency	500 MHz
CPU	64 bit RISC CPU with floating point unit
SRAM	512 KB, battery buffered
Power supply	
Voltage / Power supply (at 25°C)	+3.3 V, 2.0 A typically +5 V, 1.5 A typically +12 V, 0.04 A typically -12 V, 0.04 A typically
Buffer battery	3.0 V, 3 µA typically
Power loss, typical	15 W
Digital inputs	
Number	8 inputs, 4 with alarm capability
Galvanic isolation	Only through optional interface modules
Input voltage	
• Rated voltage	24 V
• For 0 signal	-1 V ... +6 V
• For 1 signal	+13.5 V ... +33 V
Input power	
• At 0 signal	0 mA
• At 1 signal	3 mA
Delay time	100 µs
Real-time clock, resolution	0.1 ms

SIMATIC control systems

SIMATIC TDC multiprocessor control system

MC5xx program memory module, CP50M1 communications module

Overview MC5xx program memory module

Program memory module for the program designed with CFC.

Ordering data

Article No.

MC500 memory module (4 MB)	6DD1610-0AH4
MC510 memory module (8 MB)	6DD1610-0AH6
MC521 memory module (2 MB)	6DD1610-0AH3

Overview CP50M1 communications module



The CP50M1 communications module provides two PROFIBUS DP/MPI interfaces and an 8 MB interprocessor memory for inter-CPU communication. The interfaces can be used as PROFIBUS DP master, slave, as master and slave simultaneously or as MPI node.

Ordering data

Article No.

CP50M1 communications module	6DD1661-0AD1
------------------------------	--------------

Technical specifications

Power supply	
Voltage / Power supply	+5 V, 1.0 A typical
Power loss, typical	5 W
Required space / width	1 slot
Weight	0.34 kg

SIMATIC control systems

SIMATIC TDC multiprocessor control system

CP51M1 communications module, CP53M0 coupling module

Overview CP51M1 communications module

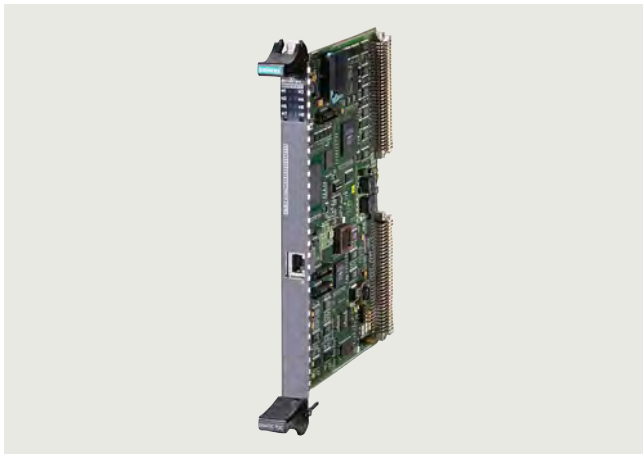

The CP51M1 communications module is an Industrial Ethernet interface module for the SIMATIC TDC automation system.

Overview CP53M0 coupling module



The CP53M0 coupling module allows coupling of a SIMATIC TDC system to a SIMADYN D system for fast data exchange, e.g. when expanding existing SIMADYN D systems.

Ordering data

Article No.

CP51M1 communications module 6DD1661-0AE1

Technical specifications

Up-to-date technical specifications can be taken from the user documentation provided at the start of delivery

Required space / width	1 slot
Weight	
Connection for Industrial Ethernet	RJ45
Protocols	TCP/IP and/or UDP
Message frame lengths	also larger than 2 KB
Modes of transfer	Refresh, Handshake, Multiple and Select
Autosensing	for 10 Mbit or 100 Mbit network
Default router	adjustable

Ordering data

Article No.

CP53M0 coupling module 6DD1660-0BJ0

For connection of a SIMATIC TDC system to a SIMADYN D system or to two further SIMATIC TDC racks

Technical specifications

CP53M0 coupling module	
Memory	
Communication memory	SRAM, 128 KB
Communications buffer	SDRAM, 8 MB
FOC interface	
Number	2 (master mode) 1 (slave mode)
Data transfer rate	96 Mbit/s
Coding	5B/6B
Voltage, currents	
Voltages / currents	+5 V / 0.3 A 3.3 V / 0.5 A
Power loss	
Power loss, typical	3.1 W
Dimensions	
Number of slots required in rack	1
Dimensions W x H x D (in mm)	20 x 233 x 160
Weight	0.6 kg

Overview

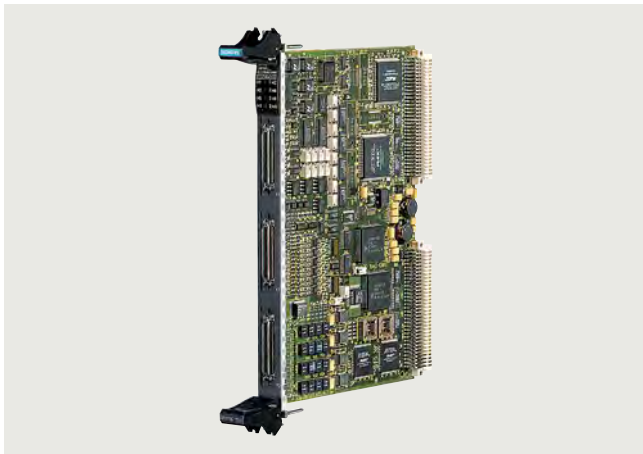

The SM500 I/O module provides analog and digital inputs/outputs as well as incremental and absolute value encoder connections.

Ordering data

Article No.

SM500 I/O module

6DD1640-0AH0

Technical specifications

Power supply	
Voltage / Power supply (at 25°C)	+5 V typically 1.0 A +3.3 V typically 0.05 A +12 V typically 0.3 A -12 V typically 0.3 A
Typical power loss	12.5 W
Required space / width	1 slot
Weight	0.7 kg
Analog outputs	
Number	8
Version	Output with associated ground
Galvanic isolation	No
Output voltage range	-10 V to +10 V
Output current	±10 mA
Resolution	12 bit
Typical conversion time per channel	4 µs
Accuracy:	
• Max. differential linearity error	± 1 LSB (monotony guaranteed)
• Max. amplification error	± 0.3 %
• Max. offset error	± 24 LSB
Slew rate	Approx. 3.5 V/µs
Voltage output:	
• Short-circuit protection to ground	yes
• Short-circuit current	Approximately 100 mA
Analog inputs	
Number	8
Version	Differential inputs
Galvanic isolation	No
Input voltage range	-10 V to +10V
Resolution	12 bit
Max. conversion time per channel	Approx. 20 µs
Accuracy:	
• Max. differential linearity error	± 1 LSB (no missing code)
• Max. amplification error	± 0.3 %
• Max. offset error	± 5 LSB
Input resistance	20 kΩ
Input filter	34 kHz
Reverse polarity protection	Yes, as differential inputs are used
Integrating analog inputs (V/f)	
Number	4
Version	Differential inputs
Galvanic isolation	No
Input voltage range	-10 V to +10 V
Resolution	Depending on the integration time, e.g. 15 bits for a 4 ms integration time.
Max. integration time per channel	Configurable
Accuracy:	
• Max. amplification error	0.05 %
• Max. integral linearity error	1 %
• Max. offset error	± 2 LSB (software adjustment)
Input resistance	470 kΩ
Input filter	2 kHz
Reverse polarity protection	Yes, as differential inputs are used

SIMATIC control systems

SIMATIC TDC multiprocessor control system

SM500 I/O module**Technical specifications****Digital outputs**

Number	16
Galvanic isolation	Only through optional interface modules
External power supply:	
• Rated voltage	24 V
• Permissible range	20 to 30
• Short-term	35 V for max. 0.5 s
• Max. current consumption, without load	40mA
Output voltage range:	
• With 0 signal, max.	3 V
• With 1 signal, min.	ext. supply voltage -2.5 V
Output current:	
• With 0 signal, min.	- 20 µA
• With 1 signal	
- Rated value	50 mA
- Permissible range, max.	100 mA
Delay time	100µs
Max. switching frequency of the outputs under resistive load	6 kHz
Short-circuit protection to	
• Mass	yes
• Ext. power supply	No
Max. short-circuit current	250 mA
Total current of outputs (up to 60°C)	16 x 50mA
Limiting of inductive cut-off voltage.	External power supply +1 V

Digital inputs

Number	16
Electrical isolation	Only through optional interface modules
Input voltage:	
• Rated voltage	24 V
• For 0 signal	-1 V to +6 V
• For 1 signal	+13.5 V to +33 V
Input current:	
• With 0 signal	0 mA
• With 1 signal	3 mA
Delay time	100 µs

Incremental encoder

Number	4
Connectable types	Incremental encoders with 90 degree track phase offset
Version	Differential inputs, switchable between 15 V (HTL) and 5 V (TTL) encoder signals
Track signals	Tracks A, B with or without zero pulse
Min. phase difference of the track signals	200 ns
Max. pulse frequency (track frequency)	1 MHz

Input voltage:	
• 15 V encoder	
- Permissible range	- 30 V to + 30 V
- With 0 signal	- 30 V to + 4 V
- With 1 signal	+ 8 V to +30 V
• 5 V encoder	
- Permissible range	- 7 V to + 7 V
- With 0 signal	- 7 V to - 0.7 V
- With 1 signal	+1.5 V to + 7 V
Input current	
• With 15 V encoder (typical, absolute)	5.0 mA
• With 5 V encoder (typical, absolute)	1.5 mA
Monitoring output	Not available
Monitoring input	Specification as for digital input
Interrupt reset output	
• Short-circuit protection against ground	yes
- Ext. power supply	No
- Max. short-circuit current	20 mA
Alarm input:	
• Input voltage (permissible range)	0 V to 5 V
- 0 signal, max.	< 0.5 V
- 1 signal, min.	> 2.0 V
• Input current	
- 0 signal	- 2.8 mA
- 1 signal	1.6 mA

Sensor supply voltage

Number	1
Electrical isolation	No
Typical output voltage	13.5 V
Max. output current	150 mA, short-circuit-proof against ground, short-circuit current approx. 250 mA

Absolute encoder inputs

Number	4
Version	Differential inputs, RS485 signal level
Connectable types	Single or multturn encoder
Protocols	SSI, EnDat
Data formats	Gray code, binary
Data direction	
• Unidirectional	SSI
• Bi-directional	EnDat
Data bits	SSI: 13+Parity, 25+Parity EnDat: variable
Max. pulse frequency	2 MHz, depending on cable length
Input voltage	
• Permissible range	RS485 signal level

Overview

The SM500 DI/DQ I/O module provides digital inputs and outputs.

Ordering data

SM500 DI/DQ I/O module

16 DI/16 DQ; 6 LEDs

Article No.

6DD1640-0AH1

Technical specifications

Power supply

Voltage / Power supply (at 25°C)	+5 V typically 0.4 A +3.3 V typically 0.05 A
----------------------------------	---

Typical power loss	3 W
--------------------	-----

Required space / width	1 slot
------------------------	--------

Weight	0.6 kg
--------	--------

Digital outputs

Number	16
--------	----

Galvanic isolation	Only through optional interface modules
--------------------	---

External power supply:	
• Rated voltage	24 V
• Permissible range	20.4 V to 28.8 V
• Short-term	35 V for max. 0.5 s
• Max. current consumption, without load	40mA

Output voltage range:	
• At 0 signal, max.	3 V
• At 1 signal, min.	ext. supply voltage -2.5 V

Output current:	
• At 0 signal, min.	- 20 µA
• At 1 signal	
- Rated value	50 mA
- Permissible range, max.	100 mA

Delay time	100 µs
------------	--------

Max. switching frequency of the outputs under resistive load	6 kHz
--	-------

Short-circuit protection to	
• Mass	Yes
• Ext. power supply	No

Max. short-circuit current	250 mA
----------------------------	--------

Total current of outputs (up to 60°C)	16 x 50mA
---------------------------------------	-----------

Limiting of inductive cut-off voltage.	External supply voltage +1 V
--	------------------------------

Digital inputs

Number	16
--------	----

Galvanic isolation	Only through optional interface modules
--------------------	---

Input voltage:	
• Rated voltage	24 V
• For 0 signal	-1 V to +6 V
• For 1 signal	+13.5 V to +33 V

Input current:	
• At 0 signal	0 mA
• At 1 signal	3 mA

Delay time	100 µs
------------	--------

SIMATIC control systems

SIMATIC TDC multiprocessor control system

GlobalDataMemory

Overview

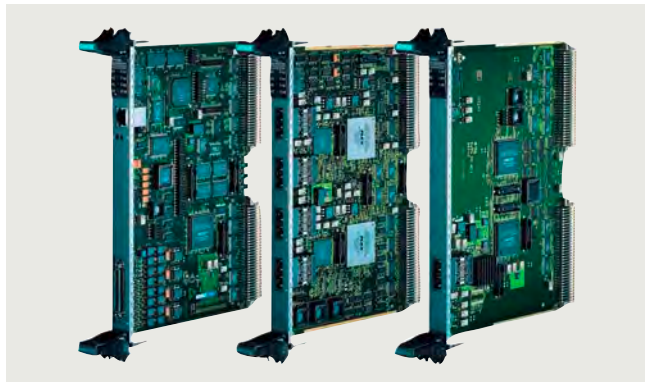

GlobalDataMemory

Data can be exchanged between all of the CPU modules in the system, over all of the networked subracks, using the memory in the GlobalDataMemory (GDM). Up to 44 subracks can be coupled in synchronism through the central memory. This means that a maximum of 836 CPU modules can be used.

Ordering data

Article No.

CP52M0 memory module	6DD1660-0BF0
CP52IO interface module	6DD1660-0BG0
CP52A0 access module	6DD1660-0BH1

Technical specifications

CP52M0

Power supply

Voltage / Power supply (at 25°C)	+5 V typically 0.4 A +3.3 V typically 0.7 A +12 V typically 0.01 A -12 V typically 0.01 A
----------------------------------	--

Power loss, typical	4.5 W
---------------------	-------

Required space / width	1 slot
------------------------	--------

Weight	0.6 kg
--------	--------

Digital outputs

Number	16
--------	----

Galvanic isolation	No
--------------------	----

External power supply:

• Rated voltage	24 V
• Permissible range	20 to 30
• Short-term	35 V for max. 0.5 s
• Max. current consumption, without load	40 mA

Output voltage range:

• For 0 signal, max.	3 V
• For 1 signal, min.	External supply voltage -2.5 V

Output current:

• For 0 signal, min.	-20 µA
• For 1 signal	
- Rated value	50 mA
- Permissible range, max.	100 mA

Delay time	100 µs
------------	--------

Max. switching frequency of the outputs under resistive load	6 kHz
--	-------

Short-circuit protection to

• Ground	Yes
• External power supply	No

Max. short-circuit current	250 mA
----------------------------	--------

Total current of outputs (up to 60°C)	16 x 50mA
---------------------------------------	-----------

Limiting of inductive cut-off voltage.	External supply voltage +1 V
--	------------------------------

CP52IO

Power supply

Voltage / Power supply (at 25°C)	+5 V typically 3 A +3.3 V typically 0.8 A
----------------------------------	--

Power loss, typical	18 W
---------------------	------

Required space / width	1 slot
------------------------	--------

Weight	0.6 kg
--------	--------

CP52A0

Power supply

Voltage / Power supply (at 25°C)	+5 V typ. 1.5 A +3.3 V typ. 0.4 A
----------------------------------	--------------------------------------

Power loss, typical	9 W
---------------------	-----

Required space / width	1 slot
------------------------	--------

Weight	0.6 kg
--------	--------

Overview SB10 interface module



May deviate from figure.

The interface module is used to connect 8 digital inputs or outputs.

Overview SB71 interface module



The interface module is used to connect 8 digital outputs with conversion of the module-side 24 V DC to system-side max. 24/48 V DC by means of transistors.

Overview SB60 interface module



Interface module for connecting 8 digital inputs with 120 V DC/AC to 24 V DC conversion.

Overview SB70 interface module



The interface module is used to connect 8 digital outputs with conversion of the 24 V DC voltage on the module side to a max. of 120 V DC/AC on the plant side using relays.

Overview SB61 interface module



It is used to connect 8 digital inputs with conversion from 24/48 V DC to 24 V DC.

Overview SC62 interface cable



Cable for connecting the SIMATIC TDC SM500 I/O module or SIMATIC S7-400 EXM 438-1 expansion module with up to five SB10, SB60, SB70, SB61 SB71 and/or SU12 interface modules.

SIMATIC control systems

SIMATIC TDC multiprocessor control system

Accessories

Overview SC63 interface cable



Cable for connecting the SIMATIC TDC SM500 I/O module or SIMATIC S7-400 EXM 438-1 expansion module with an SU13 interface module.

Overview SC67 service cable



Service cable for the SIMATIC TDC CPU551 processor module and a local configuration / service PC.

Overview SC64 interface cable



(Similar to figure)

Interface cable for FM 458-1 DP basic module and SB10, SB60, SB61 and SU12 interface modules.

Overview SU12 interface module



The interface module is used to connect 10 signals; there is no electronic conversion.

Overview SC66 interface cable



Interface cable for the SIMATIC TDC CPU551 processor module and the SB10, SB60, SB61 and SU12 interface modules

Overview SU13 interface module



This interface module can be used to connect 50 signals; there is no electronic conversion.

Ordering data	Article No.		Article No.
SB10 interface module 8 digital inputs/outputs, 24 V DC	6DD1681-0AE2	SC63 interface cable between SM500 or EXM 438-1 module and SU13 interface module, 2 m long	6DD1684-0GD0
SB60 interface module 8 digital inputs, 120 V AC	6DD1681-0AF4	SC64 interface cable between FM 458-1 DP (X2) module with SBxx or SU12 interface module, 2 m long	6DD1684-0GE0
SB61 interface module 8 digital inputs, 24/48 V DC	6DD1681-0EB3	SC66 interface cable between CPU551 and interface module SB10, SB60, SB61 or SU12, 2 m long	6DD1684-0GG0
SB70 interface module 8 digital outputs with relays	6DD1681-0AG2	SC67 service cable between CPU551 and PG/PC, 7 m long	6DD1684-0GH0
SB71 interface module 8 digital outputs with transistors, 24/48 V DC	6DD1681-0DH1	SU12 interface module with plug-in connector, 10-pole	6DD1681-0AJ1
SC62 interface cable between SM500 or EXM 438-1 module and max. 5 SB10, SB60, SB70, SB61, SB71 and/or SU12 interface modules, 2 m long	6DD1684-0GC0	SU13 interface module with screw-type plug-in connector	6DD1681-0GK0

SIMATIC control systems

SIMATIC TDC multiprocessor control system

Accessories**Technical specifications****Technical data for interface module SB 10**

Number of digital inputs/outputs	8
Galvanic isolation	No
Connectable conductor cross-section	1.5 mm ²
Dimensions (W x H x D) in mm	45 x 130 x 156
Weight	0.3 kg

Technical data for interface module SB 60

Number of digital inputs	8
• Input voltage	120 V DC/AC
Insulation voltage	<ul style="list-style-type: none"> • Safe isolation assured between inputs and outputs • Galvanic isolation assured between input circuits • 1125 V AC test voltage
Connectable conductor cross-section	1.5 mm ²
Dimensions (W x H x D) in mm	45 x 130 x 156
Weight	0.31 kg

Technical data for interface module SB 61

Number of digital inputs	8
• Input voltage	24/48 V DC
Galvanic isolation	Yes, via optocoupler
Connectable conductor cross-section	1.5 mm ²
Dimensions (W x H x D) in mm	45 x 130 x 156
Weight	0.32 kg

Technical data for interface module SB 70

Number of digital outputs	8
• Output voltage, max.	120 V DC/AC
Relay switching current	
• At 120 V AC	2 A
• At 120 V DC	0.2 A
Galvanic isolation	via relay
Insulation voltage	<ul style="list-style-type: none"> • Safe isolation assured between inputs and outputs • Galvanic isolation assured between input circuits • 1125 V AC test voltage
Connectable conductor cross-section	1.5 mm ²
Dimensions (W x H x D) in mm	45 x 130 x 156
Weight	0.32 kg

Technical data for interface module SB 71

Number of digital outputs	8
• Output voltage, max.	24/48 V DC
Output current, max.	40 mA, short-circuit proof
Galvanic isolation	Yes, via optocoupler
Connectable conductor cross-section	1.5 mm ²
Dimensions (W x H x D) in mm	45 x 130 x 156
Weight	0.32 kg

Technical data for interface module SU 12

Number of connectable signal lines	10
Signal strength per signal, max.	60 V, 0.5 A
Galvanic isolation	No
Connectable conductor cross-section	1.5 mm ²
Dimensions (W x H x D) in mm	45 x 130 x 156
Weight	0.28 kg

Technical data for interface module SU 13

Number of connectable signal lines	50
Signal strength per signal, max.	60 V, 0.5 A
Galvanic isolation	No
Connectable conductor cross-section	1.5 mm ²
Dimensions (W x H x D) in mm	45 x 130 x 156
Weight	0.3 kg

Software for SIMATIC Controllers

**12/2 Introduction**

- 12/2 Information on software licensing
- 12/2 Software Update Service

12/3 TIA Portal

- 12/3 TIA Portal Cloud
- 12/4 PLC programming
- 12/4 STEP 7 Basic (TIA Portal)
- 12/6 STEP 7 Professional (TIA Portal)
- 12/9 STEP 7 (TIA Portal) options
 - 12/9 - STEP 7 CFC (TIA Portal)
 - 12/10 - STEP 7 Safety (TIA Portal)
 - 12/12 - S7-PLCSIM Advanced
 - 12/14 - ODK 1500S
 - 12/15 - SIMATIC Target for Simulink
 - 12/16 - SIMATIC Safe Kinematics
 - 12/17 - SIMATIC Kinematics Operate
 - 12/18 - PID Professional (TIA Portal)
 - 12/19 - Easy Motion Control (TIA Portal)
 - 12/20 - SIMATIC TPCamGen technology package
 - 12/21 - OPC UA S7-1200/S7-1500
 - 12/22 - SIMATIC Robot Library
- 12/23 TIA Portal options
- 12/23 TIA Portal Multiuser Engineering
- 12/24 TIA Portal Test Suite
- 12/25 TIA Portal Cloud Connector
- 12/26 TIA Portal Teamcenter Gateway
- 12/27 SIMATIC Visualization Architect
- 12/28 SIMATIC ProDiag
- 12/29 SIMATIC Modular Application Creator
- 12/30 Central user management (UMC)

12/31 STEP 7 V5.x

- 12/31 Basic software and editors
- 12/31 STEP 7
- 12/33 STEP 7 Professional
- 12/36 S7-SCL
- 12/38 S7-GRAPH
- 12/40 S7-PLCSIM
- 12/41 Options for programming and design
- 12/41 CFC
- 12/43 S7 Distributed Safety
- 12/44 Safety Integrated for Process Automation
 - 12/46 - SIMATIC S7 F Systems
 - 12/47 - SIMATIC S7 Safety Matrix
- 12/49 Software redundancy
- 12/50 DOCPRO
- 12/51 Options for diagnostics and service
- 12/51 S7-PDIAG
- 12/52 PRODAVE
- 12/53 Options for technology and drive systems
- 12/53 - Standard PID Control
- 12/55 - Modular PID Control
- 12/58 - PID Self-Tuner
- 12/59 S7-Technology
- 12/60 Easy Motion Control
- 12/61 D7-SYS
- 12/62 Drive ES engineering software

12/64 Software for common tasks

- 12/64 For network planning/commissioning
- 12/64 SINETPLAN 2.0 network planning
- 12/65 PROFINET Asset Management
- 12/65 PRONETA Professional
- 12/66 For maintenance
- 12/66 SIMATIC Automation Tool
- 12/68 SIMATIC PDM
- 12/74 For administration
- 12/74 Central user management (UMC)
- 12/75 SIMATIC Version Cross Manager
- 12/76 Version Trail

Software for SIMATIC Controllers

Introduction

Information on software licensing, Software Update Service

Overview Licensing

Siemens Digital Industry offers various types of software license. For more information, see page 17/15.

Overview Software Update Service

- Service for automatic dispatch of all new software versions during contract lifetime
- Reduced logistics effort thanks to automatic contract extension
- Reduced costs as updates are provided free of charge

Ordering

- The Software Update Service is ordered in the same way as any other product. The corresponding order number is given in the ordering information of the software product in question.
- You must own the current version of the software.
- One Software Update Service is ordered for each software license installed.
- The Software Update Service runs for 1 year from date of order.
- It is extended automatically by a further year in each case, as long as it is not canceled 3 months before it expires.
- An annual lump sum is invoiced per license.

Application

SIMATIC Software is continuously enhanced and improved. The **Software Update Service** (previously: software maintenance service) is the easiest way to regularly take advantage of these improvements. It ensures automatic delivery of all new software versions that are released after ordering the Software Update Service so that your software is always up to date.

The Software Update Service

- Saves time and effort:
Once it is ordered, the Software Update Service is automatically renewed every year.
- Lowers costs:
The service pays for itself after the first update as it costs less than an individually ordered update.
- Makes budgeting easier:
Software expenditures can be accounted for early in the budgeting process and they are easier to write off.

Design

Scope of supply

- All new software versions that are released after ordering the Software Update Service (usually several deliveries per year)
- CD-ROM SIMATIC Customer Support Knowledge Base with FAQs, tips & tricks and downloads (several times per year).

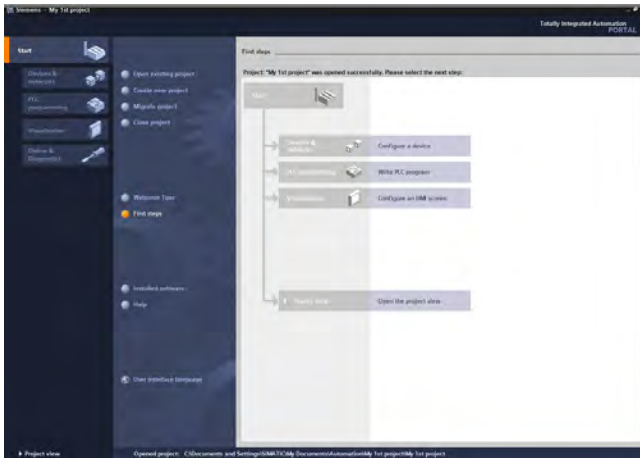
Overview

TIA Portal Cloud enables the use of the TIA Portal software in a virtualized cloud environment. No local installation of the software is required. Local projects can be transferred to the cloud via a file share service and also loaded back.

TIA Portal Cloud includes the main packages of the TIA Portal versions V15.1, V16 and V17 as well as the most important option packages of these versions.

Licensing

TIA Portal Cloud is offered under the new subscription licensing model. This model increases flexibility and enables a quick start.

- The monthly subscription offers unlimited usage within one month. The subscription is automatically renewed for a further month unless it is canceled before the end of the contract period.
- The pay-per-use option provides hourly billing for actual usage time.

More information

More information is available on this at:
<https://support.industry.siemens.com/cs/ww/en/view/109794456>

Ordering data**TIA Portal Cloud**

TIA Portal software packages for use in a virtual cloud environment without local installation. Can only be ordered via Industry Mall.

Consignee email address required for delivery

- Monthly subscription; unlimited use within one month, with automatic monthly renewal if not canceled.
- Pay-per-use with hourly billing

Article No.**6ES7804-0CP41-2YA0****6ES7804-0CP41-3YA0**

Software for SIMATIC Controllers

TIA Portal

PLC programming

STEP 7 Basic (TIA Portal)

Overview

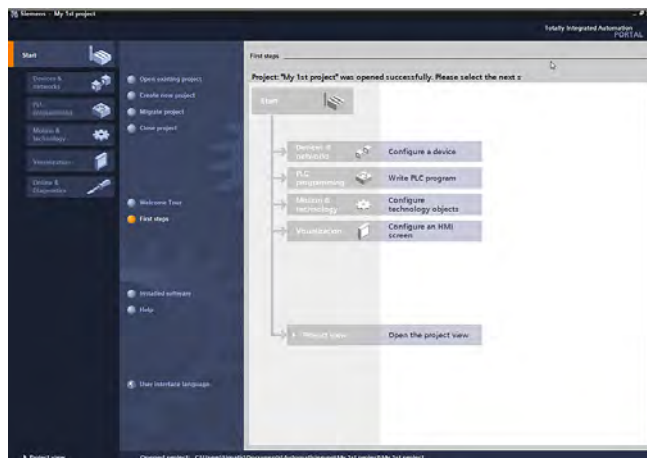

STEP 7 Basic V17 (TIA Portal), portal view

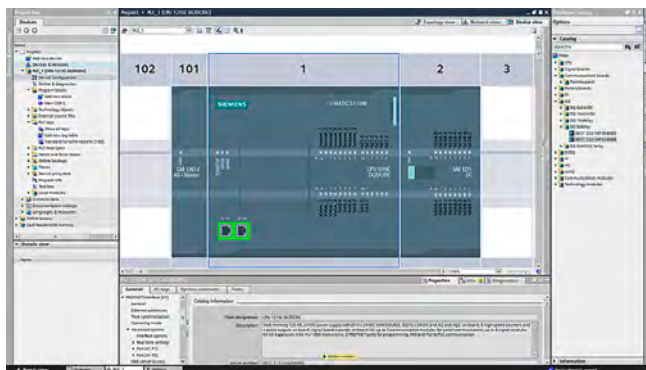

STEP 7 Basic V17 (TIA Portal), device view: Configuring and parameterizing in realistic photo-quality representation

Intuitive, efficient and future-oriented - the engineering software for programming SIMATIC Controllers

SIMATIC STEP 7 Basic V17 is the engineering system for the SIMATIC S7-1200.

STEP 7 Basic V17 is based on the Totally Integrated Automation Portal (TIA Portal) central engineering framework which offers users a uniform, efficient and intuitive solution to all automation tasks.

New with V17

- New programming language Cause Effect Matrix (CEM) for efficient and fast programming in a connection matrix
- Download and upload of the folder structure for program blocks, PLC data types and PLC tags to the PLC
- Extended functions for the cross-references (freeze the display, show access to higher-level structures, improved display of PLC tags with overlapping input or output addresses)
- Extended functions for TIA Portal Openness
- Improved performance and support of new CPUs in PLCSIM
- Offline/offline comparison of the hardware configuration up to the parameter level
- Innovated type instance and versioning concept for blocks in TIA Portal libraries
- Extended functions of TIA Portal user management: Introduction of engineering function rights, anonymous users without password, locking of open projects, ...

Licensing

- STEP 7 Basic V17 is supplied with a floating license. The floating license allows the software to be used on any number of computers. This means one user per license can use the software independently of the computer used and without being tied to a specific workstation. The number of licenses acquired determines the number of computers on which the software can be used simultaneously.
- Existing STEP 7 Basic licenses of versions V11-V16 can be upgraded to V17. This requires an upgrade license.
- A STEP 7 Basic V17 license can be upgraded to a STEP 7 Professional V17 license with a PowerPack.

You can find more information on the Software Update Service, license types, Online Software Delivery and handling your SW licenses with the Automation License Manager here:

<http://www.siemens.com/simatic-licenses>

Ordering data

Article No.

STEP 7 Basic V17

Target system:
SIMATIC S7-1200, S7-1500,
S7-300, S7-400, WinAC

Requirement:

- Windows 10 (64-bit)
- Windows 10 Home Version 1909, 2004, 20H2
 - Windows 10 Professional Version 1909, 2004, 20H2
 - Windows 10 Enterprise Version 1909, 2004, 20H2
 - Windows 10 IoT Enterprise 2016 LTSC
 - Windows 10 IoT Enterprise 2019 LTSC
- Windows Server (64-bit)
- Windows Server 2016 Standard (full installation)
 - Windows Server 2019 Standard (full installation)

Type of delivery:

9 languages: de, en, zh included,
fr, sp, it, ru, jp, kr as download

STEP 7 Basic V17, floating license **6ES7822-0AA07-0YA5**

STEP 7 Basic V17, floating license, software download including license key¹⁾ **6ES7822-0AE07-0YA5**

Consignee email address required for delivery

STEP 7 Basic/Professional V17, trial license **6ES7822-1AA07-0YA7**

Upgrade from STEP 7 Basic V11...V16 to STEP 7 Basic V17, floating license **6ES7822-0AA07-0YE5**

Upgrade from STEP 7 Basic V11...V16 to STEP 7 Basic V17, floating license, software download incl. license key¹⁾ **6ES7822-0AE07-0YE5**

Consignee email address required for delivery

PowerPack STEP 7 Basic V17 to STEP 7 Professional V17, floating license **6ES7822-1AA07-0YC5**

¹⁾ For up-to-date information and download availability, see: <http://www.siemens.com/tia-online-software-delivery>

PowerPack STEP 7 Basic V17 to STEP 7 Professional V17, floating license, software download including license key ¹⁾ Consignee email address required for delivery	6ES7822-1AE07-0YC5
Software Update Service For a period of 12 months and for a fixed price, the customer is automatically provided with all upgrades and Service Packs for each installed software package. The contract is automatically extended by a further year unless canceled at least 12 weeks prior to expiration. Requires the current software version	
Software Update Service (Standard Edition) ²⁾ The delivery is implemented according to the number of ordered SUS products (e.g. 10 upgrade packages with 10 DVDs, 10 USB flash drives, etc.) <ul style="list-style-type: none"> • STEP 7 Basic 	6ES7822-0AA00-0YLO
Software Update Service (Compact Edition) ²⁾ The delivery items are combined. For several contracts, only 1 package with 1 data storage medium set, 1 USB flash drive with the corresponding number of licenses and the corresponding number of CoLs will be supplied. Delivery items to be combined must be ordered as one item. <ul style="list-style-type: none"> • STEP 7 Basic 	6ES7822-0AA00-0YM0
Software Update Service (Download) ²⁾ Upgrades and Service Packs are available for downloading. Consignee email address required for delivery <ul style="list-style-type: none"> • STEP 7 Basic 	6ES7822-0AE00-0YY0

¹⁾ For up-to-date information and download availability, see: <http://www.siemens.com/tia-online-software-delivery>

²⁾ For more information on the Software Update Service, see page 12/2.

Technical specifications

STEP 7 Basic V17 (TIA Portal)	
Type of license	Floating license
Software class	A
Current version	V17
Target system	SIMATIC S7-1200
Operating systems	Windows 10 (64-bit) <ul style="list-style-type: none"> • Windows 10 Home Version 1909, 2004, 20H2 • Windows 10 Professional Version 1909, 2004, 20H2 • Windows 10 Enterprise Version 1909, 2004, 20H2 • Windows 10 IoT Enterprise 2016 LTSB • Windows 10 IoT Enterprise 2019 LTSC Windows Server (64-bit) <ul style="list-style-type: none"> • Windows Server 2016 Standard (full installation) • Windows Server 2019 Standard (full installation)
Recommended PC hardware	
Computer	SIMATIC Field PG M6 Advanced or higher (or comparable PC)
Processor	Intel Core i5-8400H (up to 4.2 GHz)
RAM	16 GB or more (min. 8 GB, 32 GB for large projects)
Hard disk	SSD with at least 50 GB storage space available
Network	1 Gbit (for multi-user)
Screen	15.6" full HD display (1920 x 1080 or higher)

Compatibility with other SIMATIC products

STEP 7 V17 can be installed on a PC in parallel with other versions of STEP 7 V13 SSP2 to V16 and STEP 7 V5.6.

As of TIA Portal project version V13 SP1, projects can be directly upgraded to V17. Upgrading of projects from previous project versions (V11 ... V13) is carried out on the basis of the TIA Portal products (e.g. STEP 7) used in the project in version V13 SP1 or V13 SP2 (latest update recommended).

Important note

TIA Portal project versions V13 SP1.. V16 are upgraded with TIA Portal V17 to the project version V17. If you need to edit a TIA Portal project version V13 SP1.. V16, we recommend an additional installation of the corresponding software to TIA Portal V17. The license purchased for V17 is also valid for all older TIA Portal versions.

Program code and hardware configuration from STEP 7 V5.4 SP5 can be migrated directly to a TIA Portal V17 project with STEP 7 V17.

Software for SIMATIC Controllers

TIA Portal
PLC programming

STEP 7 Professional (TIA Portal)

Overview

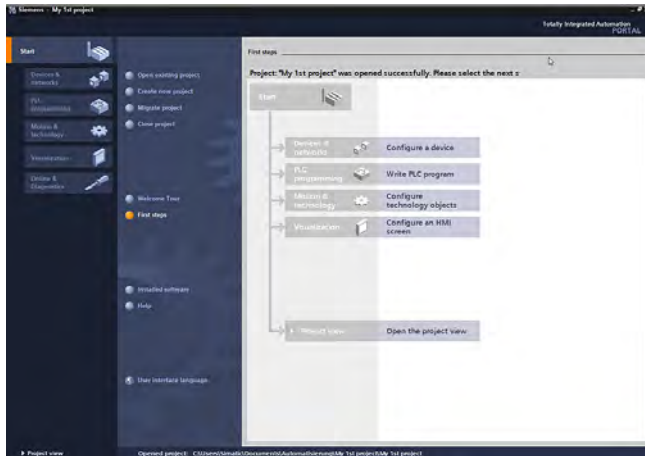

STEP 7 Professional V17 (TIA Portal), portal view

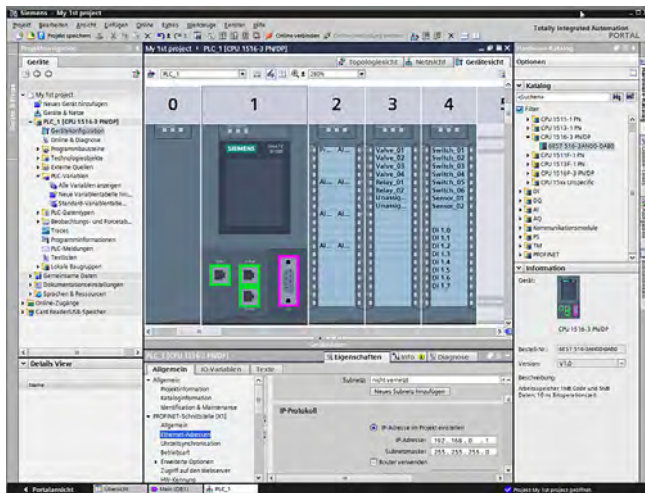

STEP 7 Professional V17 (TIA Portal), device view: Configuring and parameterizing in realistic photo-quality representation

Intuitive, efficient and future-oriented - the engineering software for programming the SIMATIC Controllers

SIMATIC STEP 7 Professional V17 is the engineering system for the SIMATIC S7-1200, S7-1500, S7-300, S7-400 Controllers, WinAC and Software Controllers.

STEP 7 V17 is based on the Totally Integrated Automation Portal (TIA Portal) central engineering framework which offers users a uniform, efficient and intuitive solution to all automation tasks.

New with V17

- New programming language Cause Effect Matrix (CEM) for efficient and fast programming in a connection matrix
- Download and upload of the folder structure for program blocks, PLC data types and PLC tags to the PLC
- Extended functions for the cross-references (freeze the display, show access to higher-level structures, improved display of PLC tags with overlapping input or output addresses)
- Extended functions for TIA Portal Openness
- Improved performance and support of new CPUs in PLCSIM
- Offline/offline comparison of the hardware configuration up to the parameter level
- Innovated type instance and versioning concept for blocks in TIA Portal libraries
- Extended functions of TIA Portal user management: Introduction of engineering function rights, anonymous users without password, locking of open projects, ...

Licenses

- STEP 7 Professional V17 is supplied with a STEP 7 Professional V17 floating license. The floating license allows the software to be used on any number of computers. This means one user per license can use the software independently of the computer used and without being tied to a specific workstation. The number of licenses acquired determines the number of computers on which the software can be used simultaneously.
- Existing STEP 7 Professional licenses on versions V11-V16 can be upgraded to V17. This requires an upgrade license.
- The user receives a combo license when upgrading from STEP 7 V5.x. The combo license enables engineering to be performed both on the STEP 7 V 5.x and the STEP 7 V17 platform.
- The STEP 7 Basic V17 license can be upgraded to a STEP 7 Professional V17 license with a PowerPack.

You can find more information on the Software Update Service, license types, Online Software Delivery and handling your SW licenses with the Automation License Manager here:

<http://www.siemens.com/simatic-licenses>

Ordering data	Article No.	Article No.	
STEP 7 Professional V17 Target system: SIMATIC S7-1200, S7-1500, S7-300, S7-400, WinAC Requirement: Windows 10 (64-bit) <ul style="list-style-type: none"> Windows 10 Professional Version 1909, 2004, 20H2 Windows 10 Enterprise Version 1909, 2004, 20H2 Windows 10 IoT Enterprise 2016 LTSC Windows 10 IoT Enterprise 2019 LTSC Windows Server (64-bit) <ul style="list-style-type: none"> Windows Server 2016 Standard (full installation) Windows Server 2019 Standard (full installation) Type of delivery: 9 languages: de, en, zh included, fr, sp, it, ru, jp, kr as download		Upgrade from STEP 7 Professional V11...16 to STEP 7 Professional V17 or STEP 7 Professional V11...V16/201x Combo to V17/2021 Combo or STEP 7 Professional 2006...2010 to V17/2021 Combo, floating license Upgrade from STEP 7 Professional V11...16 to STEP 7 Professional V17 or STEP 7 Professional V11...V16/201x Combo to V17/2021 Combo or STEP 7 Professional 2006...2010 to V17/2021 Combo, floating license Software download including license key¹⁾ Consignee email address required for delivery	6ES7822-1AA07-0YE5 6ES7822-1AE07-0YE5
STEP 7 Professional V17, floating license	6ES7822-1AA07-0YA5	PowerPack STEP 7 Professional V17 Trial 365 to STEP 7 Prof. V17, floating license. Only valid if ordered together with Software Update Service 6ES7 822-1AE00-0YY0 (STEP 7 Professional V1x) Prerequisite is a STEP 7 V17 Trial 365 license. License key download ¹⁾ Consignee email address required for delivery	6ES7822-1BE07-0YC5
STEP 7 Professional V17, floating license, software download including license key¹⁾ Consignee email address required for delivery	6ES7822-1AE07-0YA5		
STEP 7 Professional V17/2021 Combo, floating license	6ES7810-5CC14-0YA5		
STEP 7 Professional V17/2021 Combo, floating license, software download incl. license key¹⁾ Consignee email address required for delivery	6ES7810-5CE14-0YB5		
STEP 7 Professional V17, trial license	6ES7822-1AA07-0YA7	50 hours of engineering with STEP 7 Professional Combo, WinCC Professional (incl. WinCC flexible 2008) and STEP 7 Safety Advanced (incl. Distributed Safety), floating license Software download incl. license key¹⁾ Consignee email address required for delivery	6ES7823-1GE07-0YA5
Conversion package STEP 7 Professional V17 Only valid if ordered together with Software Update Service 6ES7 810-5CC04-0YE2 (STEP 7 Professional and STEP 7 Professional in TIA Portal). <ul style="list-style-type: none"> PowerPack & upgrade from STEP 7 V5.7 to STEP 7 Professional V17/2021 Combo, floating license. STEP 7 Software Update Service is a prerequisite. PowerPack & upgrade from STEP 7 V5.7 to STEP 7 Professional V17/2021 Combo, floating license. STEP 7 Software Update Service is a prerequisite. Software download including license key ¹⁾ Consignee email address required for delivery 	6ES7822-1AA07-0XC2 6ES7822-1AE07-0XC2	PowerPack & upgrade from STEP 7 V5.3...V5.7 to STEP 7 Professional V17/2021 Combo, floating license PowerPack & upgrade from STEP 7 V5.43...V5.7 to STEP 7 Professional V17/2021 Combo, floating license Software download including license key¹⁾ Consignee email address required for delivery	6ES7822-1AA07-0XC5 6ES7822-1AE07-0XC5

¹⁾ For up-to-date information and download availability, see:
<http://www.siemens.com/tia-online-software-delivery>

Software for SIMATIC Controllers

TIA Portal

PLC programming

STEP 7 Professional (TIA Portal)

Software Update Service

For a period of 12 months and for a fixed price, the customer is automatically provided with all upgrades and Service Packs for each installed software package. The contract is automatically extended by a further year unless canceled at least 12 weeks prior to expiration. Requires the current software version

Software Update Service (Standard Edition)²⁾

The delivery is implemented according to the number of ordered SUS products (e.g. 10 upgrade packages with 10 DVDs, 10 USB flash drives, etc.)

- STEP 7 Professional in the TIA Portal
- STEP 7 Professional and STEP 7 Professional in the TIA Portal

6ES7822-1AA00-0YL5
6ES7810-5CC04-0YE2

Software Update Service (Compact Edition)²⁾

The delivery items are combined. For several contracts, only 1 package with 1 data storage medium set, 1 USB flash drive with the corresponding number of licenses and the corresponding number of CoLs will be supplied.

Delivery items to be combined must be ordered as one item.

- STEP 7 Professional in the TIA Portal
- STEP 7 Professional and STEP 7 Professional in the TIA Portal

6ES7822-1AA00-0YM5
6ES7810-5CC00-0YM2

Software Update Service (Download)²⁾

Upgrades and Service Packs are available for downloading.

Consignee email address required for delivery

- STEP 7 Professional V1x
- STEP 7 Professional and STEP 7 Professional in the TIA Portal

6ES7822-1AE00-0YY0
6ES7810-5CC04-0YY2

¹⁾ For up-to-date information and download availability, see: <http://www.siemens.com/tia-online-software-delivery>

²⁾ For more information on the Software Update Service, see page 12/2

Technical specifications

	STEP 7 Professional V17 (TIA Portal)
Type of license	Floating license
Software class	A
Current version	V17
Target system	SIMATIC S7-1200, S7-1500, S7-300, S7-400, WinAC, Software Controllers
Operating systems	Windows 10 (64-bit) <ul style="list-style-type: none"> • Windows 10 Professional Version 1909, 2004, 20H2 • Windows 10 Enterprise Version 1909, 2004, 20H2 • Windows 10 IoT Enterprise 2016 LTSC • Windows 10 IoT Enterprise 2019 LTSC Windows Server (64-bit) <ul style="list-style-type: none"> • Windows Server 2016 Standard (full installation) • Windows Server 2019 Standard (full installation)
Recommended PC hardware	
Computer	SIMATIC Field PG M6 Advanced or higher (or comparable PC)
Processor	Intel Core i5-8400H (up to 4.2 GHz)
RAM	16 GB or more (min. 8 GB, 32 GB for large projects)
Hard disk	SSD with at least 50 GB storage space available
Network	1 Gbit (for multi-user)
Screen	15.6" Full HD display (1 920 x 1 080 or higher)

Compatibility with other SIMATIC products

STEP 7 V17 can be installed on a PC in parallel with other versions of STEP 7 V13 SP2 to V16 and STEP 7 V5.6.

As of TIA Portal project version V13 SP1, projects can be directly upgraded to V17. Upgrading of projects from previous project versions (V11 ... V13) is carried out on the basis of the TIA Portal products (e.g. STEP 7) used in the project in version V13 SP1 or V13 SP2 (latest update recommended).

Important note

TIA Portal project versions V13 SP1.. V16 are upgraded with TIA Portal V17 to the project version V17. If you need to edit a TIA Portal project version V13 SP1.. V16, we recommend an additional installation of the corresponding software to TIA Portal V17. The license purchased for V17 is also valid for all older TIA Portal versions.

Program code and hardware configuration from STEP 7 V5.4 SP5 can be migrated directly to a TIA Portal V17 project with STEP 7 V17.

Overview

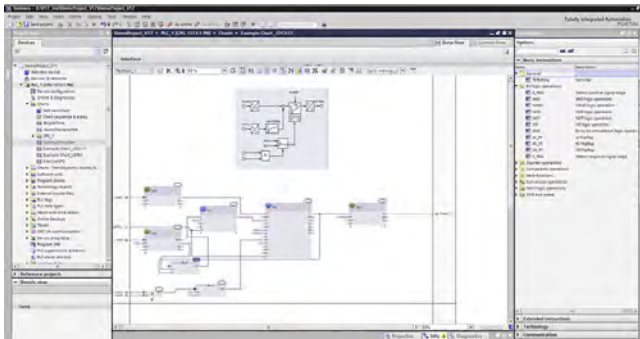

- Creation of automation programs by drawing a technology chart
- Minimized outlay and reduced error susceptibility due to the interconnection of ready-made blocks
- Optimal integration in the TIA Portal automation world
- Can be used for SIMATIC S7-1500 (recommended: CPU 1513-1 to CPU 1518-4, 1507S and 1508S).

Licensing

- SIMATIC STEP 7 CFC requires an engineering license and a runtime license per CPU
- Engineering license: For configuration of CFC charts, a license key needs to be installed on the PC.
- Runtime licenses: A license key is required for each PLC. Depending on the number of instance data blocks created during configuration with CFC, a limited or unlimited license is required:
 - A limited license allows a limited number of instance DBs to be created and loaded into the PLC.
 - With an unlimited license, any number of instance DBs can be created and loaded.

Ordering data

Article No.

SIMATIC STEP 7 CFC V17

Task:
Graphic configuring and programming of automation applications in the form of technology charts
Target system:
SIMATIC S7-1500
Requirement:
STEP 7 V17 or higher
Type of delivery:
Engineering software and electronic documentation on CD-ROM, license key on USB flash drive

Floating license

6ES7658-1ET17-0YA5

Floating license for download.

6ES7658-1ET17-0YH5

Email address required for delivery²⁾

Runtime license for 100 objects; one runtime license is required per PLC

6ES7658-1ET00-3YH5

Runtime license for an unlimited number of objects; one runtime license is required per PLC

6ES7658-1ET00-4YH5

Software Update Service (requires current software version)¹⁾

6ES7658-1ET00-0YV8

¹⁾ For more information on the Software Update Service, see page 12/2.

²⁾ For up-to-date information and download availability, see: <http://www.siemens.com/tia-online-software-delivery>

Technical specifications

Engineering tool	SIMATIC STEP 7 CFC
Current version	V17.0
Software class	A
Application areas	
Can be used for	Graphical creation, interconnection and parameterization of (preconfigured) blocks and functions
Marketing message	Simply interconnect and configure instead of programming!
Advantages	<ul style="list-style-type: none"> • Can be used to optimum effect even during the design phase • Reduced configuration effort thanks to graphical interconnection • High degree of reusability of charts that have already been created • Quick and easy familiarization • Quick and transparent interconnection of preconfigured functions • Technological creation of the program as a whole • Clear representation of control loop structures • Comment fields with texts and images • Short commissioning time
Sectors	<ul style="list-style-type: none"> • Automobile engineering • Chemicals industry • Power engineering and supply • Rubber and plastics machines • Metalworking machines • Food and beverage machines • Petrochemicals • Rolling mills • Water industry • Coilers
Target systems	
Can be used in	S7-1500
System prerequisites	
Operating system	Windows 10 (64-bit) <ul style="list-style-type: none"> • Windows 10 IoT Enterprise 2016 LTSC • Windows 10 IoT Enterprise 2019 LTSC Windows Server (64-bit) <ul style="list-style-type: none"> • Windows Server 2016 Standard (full installation) • Windows Server 2019 Standard (full installation)
Required software	SIMATIC STEP 7 V17 or higher
Properties	
Monitoring tags	Yes
Controlling tags	Yes
Single-step processing	-
Integration in CFC	Yes
Program runtimes	
With S7-1500 (typical)	Depending on the interconnected blocks
Supported standards	
IEC 61131-3	Based on the IEC standard
Status of PLCopen activities	-
Available versions/licenses	
Floating license	<ul style="list-style-type: none"> • 1 CD • 1 license key memory stick

Software for SIMATIC Controllers

TIA Portal

PLC programming

STEP 7 (TIA Portal) options > STEP 7 Safety (TIA Portal)

Overview

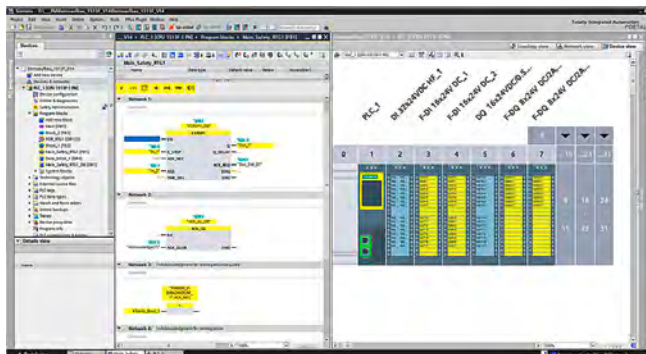

STEP 7 Safety Advanced, configuration and programming

- For creating safety-related programs on the STEP 7 user interface
- For seamless and easy to use integration of safety-related functions into the standard automation
- All the required configuration and programming tools are integrated into the STEP 7 user interface and utilize a common project structure
- STEP 7 Safety Basic option package for parameter assignment and programming of the fail-safe S7-1200 Basic Controller
- STEP 7 Safety Advanced option package for all fail-safe TIA SIMATIC controller classes (S7-1200, S7-1500, S7-1500 Software Controller, S7-300, S7-400, WinAC)

Licensing

- The engineering software can be installed on multiple computers. The number of existing licenses determines the number of computers on which the software can be used simultaneously (floating license).
- STEP 7 Safety Basic is a subset of STEP 7 Safety Advanced for programming the fail-safe S7-1200 F Basic Controller.
- PowerPacks can be used to upgrade an existing STEP 7 Safety Basic license.
- Combo licenses allow you to choose between programming with the predecessor product S7 Distributed Safety and STEP 7 Safety Advanced.
- An upgrade to a combo license is offered for the latest version of S7 Distributed Safety.
- Software Update Service (SUS) contracts can be concluded for both STEP 7 Safety Basic and STEP 7 Safety Advanced.

You can find more information on the Software Update Service, license types, Online Software Delivery and handling your software licenses with the Automation License Manager here:

<http://www.siemens.com/simatic-licenses>

Ordering data

Article No.

STEP 7 Safety Advanced V17

Task:

Engineering tool for configuring and programming fail-safe user programs for SIMATIC S7-1200 FC, S7-1500F, S7-1500F Software Controller, S7-300F, S7-400F, WinAC RTX F, ET 200SP F Controller and the fail-safe ET 200SP, ET 200MP, ET 200S, ET 200M, ET 200iSP, ET 200pro and ET 200eco I/O

Requirement:

STEP 7 Professional V17

Note:

As of TIA Portal V16, the SIMATIC STEP 7 Safety software is an integral component of the SIMATIC STEP 7 product setup. The functionality of SIMATIC STEP 7 Safety is activated by means of the license key supplied in each case.

Floating license for 1 user;
license key on USB flash drive

6ES7833-1FA17-0YA5

Floating license for 1 user,
license key for download²⁾;
Email address required for delivery

6ES7833-1FA17-0YH5

Software Update Service
(Standard Edition)¹⁾

6ES7833-1FC00-0YX2

The delivery is implemented according to the number of ordered SUS products (e.g. 10 upgrade packages with 10 DVDs, 10 USB flash drives, etc.). Requires the current software version.

STEP 7 Safety Advanced V17 Combo

Delivery includes STEP 7 Safety Advanced V17 and S7 Distributed Safety V5.4 SP5 Update 2

Floating combo license for 1 user;
software and documentation on DVD;
license key on USB flash drive

6ES7833-1FC17-0YA5

Floating combo license for 1 user;
software, documentation and license key for download²⁾;
Email address required for delivery

6ES7833-1FC17-0YH5

Software Update Service

Software Update Service
(Compact Edition)¹⁾

6ES7833-1FC00-0YM2

The delivery items are combined. For several contracts, only 1 package with 1 data storage medium set, 1 USB flash drive with the corresponding number of licenses and the corresponding number of CoLs will be supplied. The deliveries that are to be grouped together must be ordered as a single item. Requires the current software version.

Minimum order quantity: 3 units

Software Update Service
(Download)¹⁾

6ES7833-1FC00-0YY0

Requires the current software version.

Email address required for delivery

¹⁾ For more information on the Software Update Service, see page 12/2.

²⁾ For up-to-date information and download availability, see: <http://www.siemens.com/tia-online-software-delivery>

Ordering data	Article No.	Article No.	
<p>STEP 7 Safety Advanced Upgrade</p> <p><u>Note:</u> As of TIA Portal V16, the SIMATIC STEP 7 Safety software is an integral component of the SIMATIC STEP 7 product setup. The functionality of SIMATIC STEP 7 Safety is activated by means of the license key supplied in each case.</p> <p>Upgrade from Distributed Safety V5.4 SP5 or STEP 7 Safety Advanced V11..V16 (Combo) to STEP 7 Safety Advanced V17 (Combo) for parallel use of the versions; upgrade of combo license for 1 user; license key on USB flash drive</p> <p>Upgrade from Distributed Safety V5.4 SP5 or STEP 7 Safety Advanced V11..V16 (Combo) to STEP 7 Safety Advanced V17 (Combo) for parallel use of the versions; upgrade of combo license for 1 user; license key for download²⁾; Email address required for delivery</p>	<p>6ES7833-1FA17-0YF5</p> <p>6ES7833-1FA17-0YY5</p>	<p>STEP 7 Safety Basic Upgrade</p> <p><u>Note:</u> As of TIA Portal V16, the SIMATIC STEP 7 Safety software is an integral component of the SIMATIC STEP 7 product setup. The functionality of SIMATIC STEP 7 Safety is activated by means of the license key supplied in each case.</p> <p>Upgrade from STEP 7 Safety Basic V13 SP1...V16 to STEP 7 Safety Basic V17 for parallel use of the versions; upgrade license for 1 user; license key on USB flash drive;</p> <p>Upgrade from STEP 7 Safety Basic V13 SP1...V16 to STEP 7 Safety Basic V17 for parallel use of the versions; upgrade license for 1 user; license key for download²⁾; Email address required for delivery</p> <p><u>Software Update Service (Standard Edition)</u>¹⁾</p> <p>The delivery is implemented according to the number of ordered SUS products (e.g. 10 upgrade packages with 10 DVDs, 10 USB flash drives, etc.). Requires the current software version.</p> <p><u>Software Update Service (Compact Edition)</u>¹⁾</p> <p>The delivery items are combined. For several contracts, only 1 package with 1 data storage medium set, 1 USB flash drive with the corresponding number of licenses and the corresponding number of CoLs will be supplied. The deliveries that are to be grouped together must be ordered as a single item. Requires the current software version.</p> <p>Minimum order quantity: 3 units</p> <p><u>Software Update Service (Download)</u>¹⁾</p> <p>Requires the current software version. Email address required for delivery</p>	<p>6ES7833-1FB17-0YE5</p> <p>6ES7833-1FB17-0YK5</p> <p>6ES7833-1FD00-0YX2</p> <p>6ES7833-1FD00-0YM2</p> <p>6ES7833-1FD00-0YN2</p>
<p>STEP 7 Safety Advanced PowerPack</p> <p>PowerPack STEP 7 Safety Basic V17 to STEP 7 Safety Advanced V17; floating license for 1 user; license key on USB flash drive</p> <p>PowerPack STEP 7 Safety Basic V17 to STEP 7 Safety Advanced V17; floating license for 1 user; license key for download²⁾; Email address required for delivery</p>	<p>6ES7833-1FA17-0YC5</p> <p>6ES7833-1FA17-0YJ5</p>		
<p>STEP 7 Safety Basic V17</p> <p><u>Task:</u> Engineering tool for configuring fail-safe user programs for SIMATIC S7-1200 FC</p> <p><u>Requirement:</u> STEP 7 Basic V17 or higher</p> <p><u>Note:</u> As of TIA Portal V16, the SIMATIC STEP 7 Safety software is an integral component of the SIMATIC STEP 7 product setup. The functionality of SIMATIC STEP 7 Safety is activated by means of the license key supplied in each case.</p> <p>Floating license for 1 user; license key on USB flash drive</p> <p>Floating license for 1 user; license key for download²⁾; Email address required for delivery</p>	<p>6ES7833-1FB17-0YA5</p> <p>6ES7833-1FB17-0YH5</p>		

¹⁾ For more information on the Software Update Service, see page 12/2.

²⁾ For up-to-date information and download availability, see: <http://www.siemens.com/tia-online-software-delivery>

Software for SIMATIC Controllers

TIA Portal

PLC programming

STEP 7 (TIA Portal) options > S7-PLCSIM Advanced

Overview

With SIMATIC S7-PLCSIM Advanced, virtual controllers can be used for simulation of S7-1500 and ET 200SP controllers and for extensive function simulation.

The virtual controllers can also be tested and validated in conjunction with a plant/machine. An extensive API is available for interfacing plant/machine simulations.

New with V4.0

- The control code for the following SIMATIC PLCs can now be loaded directly and simulated with S7-PLCSIM Advanced:
 - SIMATIC S7-1500 H/R CPUs
 - SIMATIC ET 200pro CPUs
 - SIMATIC Drive Controller S7-1504 D TF and S7-1507 D TF
 - SIMATIC S7-1518 T/TF
 - SIMATIC S7-SIPLUS CPUs (equivalents of the supported standard CPU types)
- Expansion of communication capabilities similar to hardware CPU S7-1500 with firmware version V2.9:
 - Support of up to 128 UDP multicast connections
 - DHCP and DNS support
- Secure communication...
 - Via Secure Open User Communication (secure TCP communication) as of STEP 7 V17
 - Via OPC UA Server as of STEP 7 V17
 - Via HTTPS connections to the web server as of STEP 7 V17
- TCP/IP communication with NpCap:
 - The WinPcab TCP/IP driver has been replaced by the current NpCap version, which is now automatically included in installation via the setup.

Licensing

- The engineering software can be installed on multiple computers. The number of existing licenses determines the number of computers on which the software can be used simultaneously (floating license). For each license, the use of two simultaneously started S7-PLCSIM Advanced instances is permitted.
- An upgrade to version 4.0 is available for users of the previous 1.0/2.x/3.0 versions.
- It is also possible to procure the software as an annual subscription.
- It is possible to conclude Software Update Service (SUS) contracts.

You can find more information on the Software Update Service, license types, Online Software Delivery and handling your software licenses with the Automation License Manager here:

<http://www.siemens.com/simatic-licenses>

Ordering data

Article No.

SIMATIC S7-PLCSIM Advanced V4.0

Option for simulation of S7-1500 and ET 200SP

Floating license, software and documentation on DVD; license key on USB flash drive

6ES7823-1FA03-0YA5

Floating license, software, documentation and license key for download ¹⁾

6ES7823-1FE03-0YA5

Email address required for delivery

Upgrade

Upgrade from SIMATIC S7-PLCSIM Advanced V1.0/V2.x/V3.0 to V4.0, floating license

6ES7823-1FA03-0YE5

Upgrade from SIMATIC S7-PLCSIM Advanced V1.0/V2.x/V3.0 to V4.0, floating license for download ¹⁾;

6ES7823-1FE03-0YE5

Email address required for delivery

Software Subscription Service

SIMATIC S7-PLCSIM Advanced Subscription Download, Single License, software, documentation and license key for download ¹⁾

6ES7823-1FE00-0YN5

Email address required for delivery

Software Update Service²⁾

For a period of 12 months and for a fixed price, the customer is automatically provided with all upgrades and Service Packs for each installed software package. The contract is automatically extended by a further year unless canceled at least 12 weeks prior to expiration. Requires the current software version.

Software Update Service: Upgrades and Service Packs are provided in the form of DVDs, USB flash drives etc.

6ES7823-1FA00-0YL5

Software Update Service (Download)¹⁾

Upgrades and Service Packs are available for downloading.

6ES7823-1FE00-0YL5

Email address required for delivery

¹⁾ For up-to-date information and download availability, see: <http://www.siemens.com/tia-online-software-delivery>

²⁾ For more information on the Software Update Service, see page 12/2.

Technical specifications**Minimum requirements for use**

Hardware / software	Requirements
Processor	<ul style="list-style-type: none"> • One logical Intel Core™ i7 6th generation core for each started instance • At least one additional core for the operating system • At least one additional core for additional active applications
RAM	<ul style="list-style-type: none"> • 1 GB for each started instance • At least 4 GB for the Windows operating system • Additional RAM work memory according to the requirements of the remaining active applications
Free hard disk space	5 GB
Operating systems (64-bit version)	<ul style="list-style-type: none"> • Windows 10 Home Version 1909 • Windows 10 Home Version 2004 • Windows 10 Home Version 2009/20H2 • Windows 10 Professional Version 1909 • Windows 10 Professional Version 2004 • Windows 10 Professional Version 2009/20H2 • Windows 10 Enterprise Version 1909 • Windows 10 Enterprise Version 2004 • Windows 10 Enterprise Version 2009/20H2 • Windows 10 Enterprise 2016 LTSC • Windows 10 Enterprise 2019 LTSC • Windows Server 2016 Standard (full installation) • Windows Server 2019 Standard (full installation)
Screen resolution	min. 1024 x 768

Compatibility with other products

- S7-PLCSIM Advanced V4.0 and S7-PLCSIM V17 can be installed and operated on the same PC or the same virtual machine. Communication between the two applications cannot be simulated.
- Compatible with TIA Portal projects from versions V14 to V17
- Support of the CPU firmware versions V1.8 to V2.9

Software for SIMATIC Controllers

TIA Portal

PLC programming

STEP 7 (TIA Portal) options > ODK 1500S

Overview

- For developing dynamically loadable function libraries for the S7-1500 Software Controllers and S7-1500 Advanced Controllers CPU 1518 MFP and PLCSIM Advanced:
 - Implementation of function libraries for the SIMATIC S7-1500 Software Controller that are executed under Windows with the high-level languages C/C++, C# and VB
 - Implementation of function libraries for the PLCSIM Advanced that are executed under Windows with the high-level languages C/C++
 - Implementation of function libraries that are executed in real-time in the context of the user program of the CPU with the high-level language C++
 - Implementation of applications for the C++ runtime of the CPU 1518 MFP
- "Eclipse" development environment for real-time function libraries in the CPU user program and applications for the C++ runtime in the scope of delivery.
- Development of library functions under Windows with MS Visual Studio (optional)
- Easy introduction to development by using basic projects via templates
- Automatic creation of function blocks for calling the library functions
- Simple integration of the function blocks into STEP 7 by importing.
- Simple use of the library functions in the PLC without specific high-level language know-how.

Licensing

- ODK 1500S is supplied with a floating license. The floating license allows installation of the software on any number of computers. The number of existing licenses determines the number of computers on which the software can be used simultaneously.
- The integrated development environment Eclipse, required for developing real-time libraries, is included in the scope of supply of ODK 1500S as well as templates for Visual Studio.
- SIMATIC ODK 1500S is available as a standalone product or in a bundle with SIMATIC Target 1500S™ for Simulink®.

You can find more information on the Software Update Service, license types, Online Software Delivery and handling your software licenses with the Automation License Manager here:

<http://www.siemens.com/simatic-licenses>

Ordering data

SIMATIC ODK 1500S

Open Development Kit V2.5 for support in developing high-level language applications for SIMATIC S7-1500 Advanced Controllers; supplied on DVD, license key (floating license) on USB flash drive

Open Development Kit V2.5 for support in developing high-level language applications for SIMATIC S7-1500 Advanced Controllers; software download including license key (floating license) ¹⁾ Email address required for delivery

¹⁾ For up-to-date information and download availability, see: <http://www.siemens.com/tia-online-software-delivery>

Article No.

6ES7806-2CD03-0YA0

6ES7806-2CD03-0YG0

Technical specifications

System requirements

The SIMATIC ODK 1500S can be used on PC platforms with the following requirements:

- Operating systems Windows 7/8.1/10
- Min. 3 GB hard disk memory
- Min. 4 GB work memory
- Mouse, keyboard, monitor

Overview

SIMATIC Target™ is an add-on for the Simulink® software from The MathWorks. This makes it possible to also use model-based design with MATLAB® and Simulink for SIMATIC S7-1500 Controllers and SIMATIC Industrial Edge. For this purpose, executable code for all ODK-compatible S7-1500 Controllers (S7-1500 Software Controllers, ET 200SP Open Controllers, CPU 1518 ODK/MFP and PLCSIM Advanced as of V3.0) or the LiveTwin Edge app is generated directly from Simulink via SIMATIC Target.

New with V5.0

- Code generation also for the LiveTwin Edge app. This means there is free choice as to whether the Simulink model should run in real time on an S7-1500 Controller or via LiveTwin on any SIMATIC Edge device. This is also why SIMATIC Target 1500S has been renamed SIMATIC Target.
- Support of the Embedded Coder® for code generation. The generated code can be optimized further with this.
- Support of Custom Storage Class for code generation.
- Simplified integration of the generated code in the S7-1500 user program.
- The S functions for the link between Simulink and PLCSIM Advanced are now supplied directly as Simulink library with SIMATIC Target.

Licensing

- The engineering software can be installed on multiple computers. The number of licenses acquired determines the number of computers on which the software can be used simultaneously (floating license).
- SIMATIC Target™ for Simulink® V5.0 is available as a standalone product or in a bundle with the SIMATIC S7-1500 Software Controller Open Development Kit.
- An upgrade to latest versions is available for previous versions

You can find more information on the Software Update Service, license types, Online Software Delivery and handling your SW licenses with the Automation License Manager here:

<http://www.siemens.com/simatic-licenses>

Ordering data**Article No.****SIMATIC Target for Simulink V5.0****6ES7823-1BE04-0YA5**Download incl. license key ¹⁾

Email address required for delivery

Upgrade**6ES7823-1BE04-0YE5**Upgrade of SIMATIC Target 1500S for Simulink V2.0...V4.0 to V5.0, download incl. license key ¹⁾

Email address required for delivery

SIMATIC Target + ODK 1500S bundle**6ES7823-1BE14-0YA0**Download incl. license key ¹⁾

Email address required for delivery

¹⁾ For up-to-date information and download availability, see: <http://www.siemens.com/tia-online-software-delivery>

Technical specifications**Requirements at the MATLAB end**

MATLAB 2019b (64-bit) or more recent version

- MATLAB 9.7
- MATLAB Coder 4.3
- Simulink 10.0
- Simulink Coder 9.2

Requirements at the SIMATIC end

SIMATIC ODK 1500S V2.0/V2.5

Must be installed together with target 1500S, MATLAB and Simulink on the same PC

STEP 7 Professional as of V15.1

For configuration of the S7-1500 CPUs, not essentially on the same PC as the target 1500S

Supported CPUs

- CPU 1507S(F) with firmware V2.0 or higher
- CPU 1515SP PC (F) with firmware V2.0 or higher
- CPU 1518 (F) ODK/MFP
- S7-PLCSIM Advanced as of V3.0

Software for SIMATIC Controllers

TIA Portal

PLC programming

STEP 7 (TIA Portal) options > SIMATIC Safe Kinematics

Overview

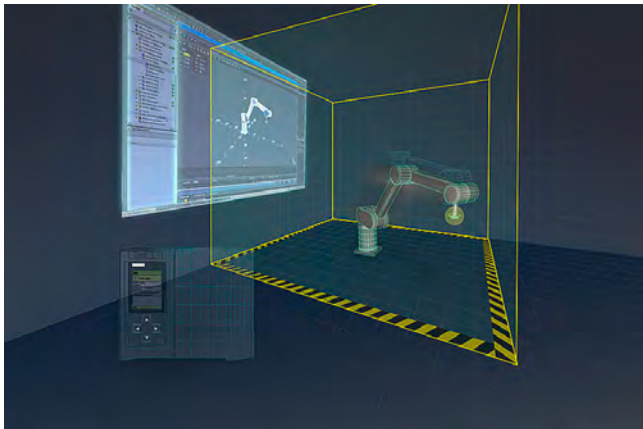

SIMATIC Safe Kinematics V17 enables safe monitoring of the movement of predefined kinematics with up to 12 interpolating axes in multidimensional space. The following monitoring functions are available:

- **Safe Speed Monitor:**
Safe speed monitoring can be used to monitor the Cartesian speed of individual points in the kinematics, e.g. at the tool center point or at joints.
- **Safe Zone Monitor:**
Safe zone monitoring is used to monitor the position of the kinematics in the Cartesian space, e.g. to limit the traversing range of the kinematics or to monitor areas that can be entered by operating personnel.
- **Safe Orientation Monitor:**
Safe orientation monitoring enables monitoring of the orientation of the flange on user-defined serial kinematics, e.g. a workpiece may only be machined if the tool is perpendicular to the floor.

The following kinematics are supported:

- Cartesian portal
- Roller picker (vertical and horizontal)
- Delta pickers
- SCARA
- Articulated arm
- User-defined serial kinematics

SIMATIC Safe Kinematics V17 is an option package of the TIA Portal and is subsequently installed as setup in TIA Portal V17. The product contains a fail-safe block library that can be integrated in the STEP 7 Safety Advanced programming environment and can be connected on the input and output side.

SIMATIC Safe Kinematics V17 supports the following control platforms:

- S7-1500 F-CPU (CPU 1517(T)F, CPU 1518(T)F)
- Open Controller
- SIMATIC Drive Controller (CPU 1507D TF)
- Software Controller
- SINUMERIK ONE

System requirements

- SIMATIC STEP 7 Professional (TIA Portal) V17
- STEP 7 Safety Advanced V17

SIMATIC Safe Kinematics requires as a subordinate drive system SINAMICS S120 with CU320-2 as of firmware V5.1 with Safety Integrated Advanced Functions.

Licensing

- The software is supplied with a Single Runtime License. A license is required for each F-CPU on which SIMATIC Safe Kinematics runs.
- The software can only be ordered via Online Software Delivery (OSD). The download contains one license certificate and the TIA Portal installation setup for SIMATIC Safe Kinematics.
- The following additional licenses are required to use SIMATIC Safe Kinematics:
 - SIMATIC STEP 7 Professional (TIA Portal) V17
 - STEP 7 Safety Advanced V17
 - SINAMICS Safety Integrated Advanced Functions (for each monitored axis of the kinematics)

Ordering data

Article No.

SIMATIC Safe Kinematics V17

TIA Portal option package for safe monitoring of the movement of pre-defined kinematics with up to 12 interpolating axes in multidimensional space.

Requirement:
SIMATIC STEP 7 Professional (TIA Portal) V17
STEP 7 Safety Advanced V17
Executable on:
S7-1500 F-CPU (CPU 1517(T)F, CPU 1518(T)F)
Open Controller
SIMATIC Drive Controller (CPU 1507D TF)
Software Controller
SINUMERIK ONE

Single Runtime License Download¹⁾; contains license certificate and installation setup for SIMATIC Safe Kinematics block library; Email address required for delivery

6ES7823-0FE02-1AA0

¹⁾ For up-to-date information and download availability, see: <http://www.siemens.com/tia-online-software-delivery>

Overview

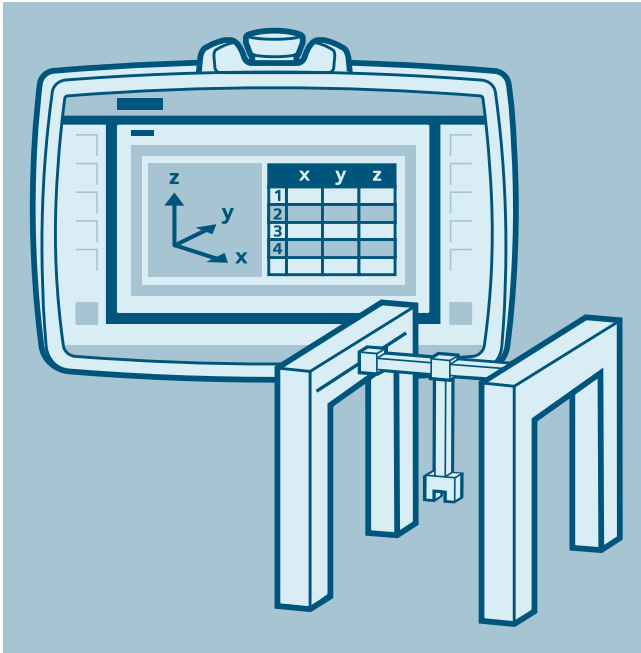

With SIMATIC Kinematics Operate, kinematics can be configured, programmed and operated with up to 6 positioning axes with synchronous point-to-point control (sPTP). The Plug & Play solution comprises a convenient user interface for programming, diagnostics and operation of the kinematics via HMI.

The SIMATIC Kinematics Operate V1.0 software solution consists of a TIA Portal project and an HMI project for TIA Portal as of V15.0.

SIMATIC Kinematics Operate V1.0 contains the following HMI configuration functions:

- Configuration of kinematics and additional axes; 6 axes are available in total for multi-axis positioning with sPTP. The axes not used in the multi-axis group can be created as independent single axes.
- Axis configuration; the dynamic parameters, the axis limits and the homing of the different axes can be configured.
- Tag and I/O configuration; Bool and Real tags can be created. Logical step enabling conditions consisting of multiple inputs and tags can be combined into one Boolean tag. Digital inputs and outputs can be configured via the I/O address.
- Points table; By means of input or teaching of axis positions, path points can be defined that can be used for programming the kinematics.
- Zone configuration; multiple restricted zones can be created in the workspace as protection zones. These are checked cyclically against both the target coordinates and the current axis values. A violation leads to a stop response of the axes

The program editor offers the following functions:

- Synchronous point-to-point commands; all axes are traversed synchronously with multi-axis positioning. The destination is specified either using the points table or by direct input with optional blending.
- Single axis commands; the additional axes can be homed, positioned, torque-limited or speed-controlled.
- Wait functions; Step enabling conditions, based on a digital input, a Bool tag or a wait time, can be programmed.
- Calculate tags and assign values; digital outputs can be set via an input mask. In addition, floating point tags can be calculated, incremented or assigned absolute values.
- Program control structures; labels, branches, loops and parallel sequences allow flexible program design.

SIMATIC Kinematics Operate can be run on SIMATIC S7-1500 CPU S7-1511T-1 PN. Alternatively, SIMATIC S7-1500 CPU S7-1512C-1 PN or a faster CPU can be used. Please refer to the operating instructions for details on scalability and the configuration limits.

System requirements

- SIMATIC STEP 7 Professional (TIA Portal) as of V15
- SIMATIC WinCC Advanced ES as of V15

Licensing

- SIMATIC Kinematics Operate is available as Runtime option for TIA Portal. A license is required for each CPU on which SIMATIC Kinematics Operate runs.
- The product can only be ordered via Online Software Delivery (OSD). The download contains the license certificate. The software is downloaded via the Siemens Industry Online Support Portal.
- The following additional licenses are required to use SIMATIC Safe Kinematics:
 - SIMATIC STEP 7 Professional (TIA Portal) as of V15
 - SIMATIC WinCC Advanced ES as of V15

Ordering data

Article No.

SIMATIC Kinematics Operate V1.0

TIA Portal Runtime option for configuring, programming and operation of kinematics with up to 6 positioning axes with synchronous point-to-point control (sPTP). Comprises a convenient user interface for programming, diagnostics and operation of the kinematics via HMI

Requirement:

SIMATIC STEP 7 Professional (TIA Portal) as of V15
SIMATIC WinCC Advanced ES as of V15

Runs on:

SIMATIC S7-1500 CPU 1511T-1 PN
SIMATIC S7-1500 CPU 1512C-1 PN
or faster

Single Runtime License
Download¹⁾;
contains license certificate;
Email address required for delivery

6ES7823-0GE00-1AA0

¹⁾ For up-to-date information and download availability, see: <http://www.siemens.com/tia-online-software-delivery>

Software for SIMATIC Controllers

TIA Portal

PLC programming

STEP 7 (TIA Portal) options > PID Professional (TIA Portal)

Overview

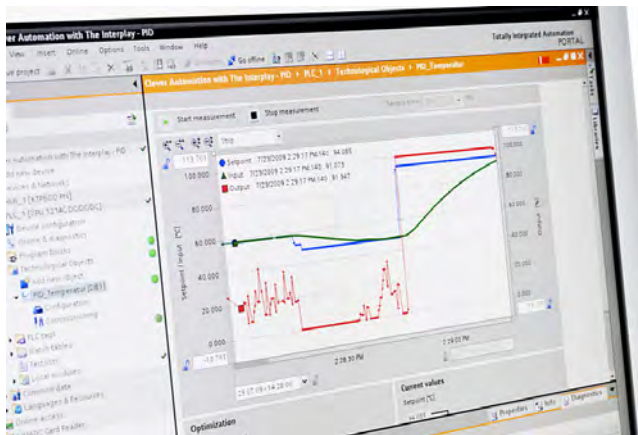

- PID Professional combines the two option packages Modular PID Control and Standard PID Control in TIA Portal.
- Permits the simple integration of continuous PID Controllers, pulse controllers and step controllers in the application program
- Can be used for simple to complex closed-loop control tasks in SIMATIC S7-300 (CPU 313 or higher), S7-400, and WinAC.
- The engineering software for PID Professional is already included in the STEP 7 package in STEP 7 V13 or higher.
- Tuning functionality by means of PID Self-Tuner (part of STEP 7 as of V11 SP1).
- Reduces engineering costs thanks to time-saving parameterization and optimization of the controller

Licensing

- The engineering software can be installed on multiple computers. The number of existing licenses determines the number of computers on which the software can be used simultaneously (floating license).
- The engineering software requires STEP 7 Professional. The software is part of the STEP 7 Professional DVD and/or the program download. A license key is required for activation.
- During runtime, each CPU requires its own runtime license.
- Upgrades to PID Professional (engineering license or single runtime license) are offered for Standard PID Control/Modular PID Control from V11 onwards.

You can find more information on the Software Update Service, license types, Online Software Delivery and handling your software licenses with the Automation License Manager here:

<http://www.siemens.com/simatic-licenses>

Ordering data

Article No.

PID Professional for TIA Portal

Task:
Function blocks and editors for PID controllers
Requirement:
STEP 7 V13 or higher
Delivery package:
Licenses on USB flash drive/
downloadable

Floating license for the engineering and single license for runtime

6ES7860-1XA02-0XA5

Single license (Certificate of License) for runtime;
per CPU (all versions)

6ES7860-1XA01-0XB0

Floating license for the engineering; download (email address required for delivery)¹⁾

6ES7860-1XA01-0XH5

Upgrade from Standard PID Control or Modular PID Control V5.1 to PID Professional for TIA Portal; floating license for the engineering; download (email address required for delivery)¹⁾

6ES7860-1XA01-0XK5

Upgrade from Standard PID Control or Modular PID Control V5.1 to PID Professional for TIA Portal; single license for runtime

6ES7860-1XA02-0XE5

¹⁾ For up-to-date information and download availability, see: <http://www.siemens.com/tia-online-software-delivery>

Overview



- Low-priced package for simple, controlled positioning and simple geared synchronous motion
- For use with any standard variable-speed drive, such as frequency converter or servo drive
- For incremental and absolute encoders

Licensing

- The engineering software can be installed on multiple computers. The number of existing licenses determines the number of computers on which the software can be used simultaneously (floating license).
- The engineering software requires STEP 7 Professional. The software is part of the STEP 7 Professional DVD and/or the program download. A license key is required for activation.
- During runtime, each CPU requires its own runtime license.

You can find more information on the Software Update Service, license types, Online Software Delivery and handling your software licenses with the Automation License Manager here:

<http://www.siemens.com/simatic-licenses>

Ordering data

Article No.

Easy Motion Control for TIA Portal

Requirement:
STEP 7 from V12 SP1;
software included in STEP 7 V13

Floating license and single license (Runtime)

6ES7864-2XA02-0XA5

Type of delivery:
CoL for the configuration software,
USB flash drive with a license key
for the configuration software,
CoL for a runtime license;
without software or documentation

Floating license download by email,
valid for V11 or higher (email
address required for delivery¹⁾);
without software or documentation

6ES7864-2XA01-0XH5

Easy Motion Control Runtime License

Type of delivery:
CoL for one runtime single
license (valid for Easy Motion
Control V2.x and V11 or higher),
without software or documentation

6ES7864-0AF01-0YX0

¹⁾ For up-to-date information and download availability, see:
<http://www.siemens.com/tia-online-software-delivery>

Technical specifications

Supported hardware:

Easy Motion Control is runnable on the following CPUs:

- S7-300.
- S7-400.
- WinAC.
- ET 200S.
- ET 200pro.

Supported modules for the measuring of actual values:

- CPU 314C (FW version 2.0 of the CPU or higher).
- ET 200S 1 Count 5V/500 kHz.
- ET 200S 1 Count 24V/100kHz.
- ET 200S 1SSI.
- SM 338.
- FM 350-1, FM 450-1.
- SIMODRIVE Sensor with PROFIBUS DP.
- IM 174.
- Other modules for measuring actual values (using free driver).

Supported modules for setpoint output:

- ET 200S 2AO U.
- SM 332.
- SM 432.
- IM 174.
- Other modules for setpoint output (using free driver).

Supported drives using PROFIBUS DP:

- Micromaster 4.
- SINAMICS G120.
- SINAMICS S120.

Storage space requirements

Required work memory in bytes		
Block	Required work memory per block	Additional work memory required per instance
MC_Init	1086	-
MC_MoveAbsolute	3924	112
MC_MoveRelative	2982	110
MC_MoveJog	3110	110
MC_Home	2886	104
MC_StopMotion	1114	70
MC_Control	1756	58
MC_Simulation	410	64
MC_GearIn	3476	128
Input driver	1416 ... 2654	76 ... 128
Output driver	384 ... 1242	52 ... 68
Axis data block	-	294

Software for SIMATIC Controllers

TIA Portal

PLC programming

STEP 7 (TIA Portal) options > SIMATIC TPCamGen technology package

Overview

The SIMATIC Software option package, TPCamGen, is used to calculate optimized motion profiles for servo presses where the tool is connected to the drive axle via a connecting rod.

When calculating the profiles, TPCamGen takes into account various constraints, e.g.:

- Maximum eccentric speed
- Maximum ram speed
- Maximum acceleration
- etc.

It minimizes the drive load at the same time.

TPCamGen is the core of the SIMATIC SimaPressServo software package and can only be used suitably in conjunction with this application software.

The runtime environment is currently based on the SIMATIC Open Controller platform.

System requirements:

- SIMATIC STEP 7 (TIA Portal) as of V17.
- ET 200 SP Open Controller: Technology CPU 1515SP PC2 T or 1515SP PC2 TF.

Licensing

- The software can only be obtained as download via Online Software Delivery (OSD). The download includes a license certificate and a ZIP file containing the Windows Installation Setup, TPCamGen function blocks for TIA Portal and the Function Manual (DE/EN).
- The software purchase includes the license for a specific servo press configuration.
- The software is additionally delivered with a Floating Runtime License. It allows the installation of the software on any number of Open Controller CPUs.
- To use the TPCamGen, a signature is additionally required, which is provided in coordination with Siemens. This signature corresponds to a technical license key and is queried each time the software package is generated in the context of the specific press solution. The signature must be stored once in the implemented solution.
More information is available on this at Siemens Industry Online Support:
<https://support.industry.siemens.com/cs/ww/en/view/109804905>
- Note:
You may use one software license and the associated signature for any number of presses with identical design. For a press with changed design data you need a new license, which has to be ordered separately.

Ordering data

TPCamGen technology package

Trend tool for servo presses, single license for one press configuration

Requirement:
SIMATIC STEP 7 (TIA Portal) as of V17

Runs on:
ET 200 SP Open Controller
CPU 1515SP PC2 T or
TF as of firmware V21.9

Floating License Download¹⁾; contains license certificate, Windows Installation Setup, TPCamGen function blocks for TIA Portal and Function Manual (de/en); consignee email address required for delivery

Article No.

6ES7823-0FE30-1AA0

¹⁾ For up-to-date information and download availability, see: <http://www.siemens.com/tia-online-software-delivery>

Overview

The vendor- and platform-independent OPC Unified Architecture (UA) is the communication standard for Industry 4.0 and is the standard mechanism for accessing SIMATIC S7-1500 and S7-1200 data from non-Siemens devices.

New with V17 and S7-1200 (firmware V4.5)

- OPC UA Server on S7-1200 CPUs with following functionality:
 - Methods for consistent data transfer
 - Structured data types and arrays
 - Additional diagnostic buffer entries for OPC UA Server and OPC UA diagnostics in the TIA Portal

New with V17 and S7-1500 (firmware V2.9)

- PC UA Server:
 - Alarms & Conditions on Standard SIMATIC Interface
- Global Discovery Service (GDS) support for certificate management
- Supports further PLC data types for mapping to OPC UA:
 - Localized Text and Byte strings
- Automatic creation of OPC UA instances in the server interface for data types of an OPC UA reference namespace to an FB or UDT
- Improvement of modeling for server interface or companion specifications
- OPC UA Client:
 - New blocks for easy handling

Licensing

An OPC UA Server or OPC UA Client is available on the target systems (CPUs) and is activated using runtime licenses. Runtime licenses are offered in three levels for different target systems:

Target system	OPC UA S7-1200 Basic	OPC UA S7-1500 Small	OPC UA S7-1500 Medium	OPC UA S7-1500 Large
S7-1200 CPUs	Yes	No	No	No
ET 200SP CPU 1510SP/1512SP/1515SP (Open Controller)	No	Yes	Yes	Yes
S7-1500 CPU 1511/1513 CPU 1504D Drive Controller				
ET 200pro CPU 1516pro S7-1500 CPU 1515/1516 PLC 1507S software	No	No	Yes	Yes
S7-1500 CPU 1517/1518/1508S CPU 1507D Drive Controller	No	No	No	Yes

The runtime license includes the certificate for OPC UA (Server and Client) and can be run on the respective target systems including F, C and T/TF as from firmware V2.0 (Client V2.6).

You can find more information on the Software Update Service, license types, Online Software Delivery and handling your software licenses with the Automation License Manager here:

<http://www.siemens.com/simatic-licenses>

Ordering data**Article No.****SIMATIC OPC UA S7-1200 Basic**

Single runtime license; can run on all S7-1200 CPUs (incl. F) from firmware V4.4

License certificate for OPC UA server (data access)

6ES7823-0BA00-2BA0

Download incl. license certificate for OPC UA server (data access) ¹⁾

6ES7823-0BE00-2BA0

Email address required for delivery

SIMATIC OPC UA S7-1500 Small

Single runtime license; can run on ET 200SP CPU 1510SP/1512SP/1515SP (Open Controller), S7-1500 CPU 1511/1513, CPU 1504D Drive Controller

License certificate for OPC UA server (data access and OPC UA client)

6ES7823-0BA00-1BA0

Download incl. license certificate for OPC UA server (data access and OPC UA client) ¹⁾

6ES7823-0BE00-1BA0

Email address required for delivery

SIMATIC OPC UA S7-1500 Medium

Single runtime license; can run on ET 200pro CPU 1516pro, ET 200SP CPU 1510SP/1512SP/1515SP (Open Controller), S7-1500 CPU 1511/1513/1515/1516, PLC 1507S software, CPU 1504D Drive Controller

License certificate for OPC UA server (data access and OPC UA client)

6ES7823-0BA00-1CA0

Download incl. license certificate for OPC UA server (data access and OPC UA client) ¹⁾

6ES7823-0BE00-1CA0

Email address required for delivery

SIMATIC OPC UA S7-1500 Large

Single runtime license; can run on ET 200pro CPU 1516pro, ET 200SP CPU 1510SP/1512SP/1515SP (Open Controller), S7-1500 CPU 1511/1513/1515/1516/1517/1518, PLC 1507S software, 1508S, CPU 1504D, CPU 1507D Drive Controller

License certificate for OPC UA server (data access and OPC UA client)

6ES7823-0BA00-1DA0

Download incl. license certificate for OPC UA server (data access and OPC UA client) ¹⁾

6ES7823-0BE00-1DA0

Email address required for delivery

¹⁾ For up-to-date information and download availability, see: <http://www.siemens.com/tia-online-software-delivery>

Technical specifications**Can be used for**

SIMATIC OPC UA S7-1200	For all S7-1200 CPUs from firmware V4.4
SIMATIC OPC UA S7-1500	For all S7-1500 CPUs and ET 200SP CPUs with firmware V2.0 or higher (incl. S/F/T versions) and PLCSIM Advanced

Software for SIMATIC Controllers

TIA Portal

PLC programming

STEP 7 (TIA Portal) options > SIMATIC Robot Library

Overview



With the SIMATIC Robot Library, robot arms of different robot manufacturers can be programmed consistently in the Totally Integrated Automation Portal (TIA Portal).

The SIMATIC Robot Library concept moves the command sets of a robot control to the Totally Integrated Automation Portal (TIA Portal), thus enabling manufacturer-independent and consistent programming of industry robots (incl. cobots) in the TIA Portal for the first time. The programs can be run on a SIMATIC S7-1500 Controllers. Additional programming on the robot control is not necessary.

Note:

The SIMATIC Robot Library can be supplemented by the free application example SIMATIC Robot Integrator. This offers a comprehensive user interface for industry robots incl. configuration, teaching, jog mode and diagnostics for SIMATIC HMI.

System requirements

- SIMATIC STEP 7 (TIA Portal) as of V16.
- Interpreter software from the respective robot manufacturer on the robot control required.
- Executable on SIMATIC S7-1500 as of firmware V2.8.

Licensing

- A Single Runtime License is required for each controlled robot arm.
- The licenses can only be obtained via Online Software Delivery (OSD). The download contains the software and a license certificate for a robot arm. For information on activating the license, please read the Readme file included in the download.
- The SIMATIC Robot Library V1.0 can also be requested as trial version via the Siemens Industry Online Support or Technical Support and can then be used free of charge for eight hours.
- The Interpreter software for the respective robot control is made available by the respective robot manufacturer. Siemens has no influence on the Interpreter license model of the robot manufacturer. Therefore, please contact the relevant robot manufacturer directly (if you wish, Siemens can assist you with finding a contact partner).

Ordering data

SIMATIC Robot Library V1.0

STEP 7 (TIA Portal) runtime option for consistent programming of robot arms of various robot manufacturers in the Totally Integrated Automation Portal (TIA Portal).

Requirement:
SIMATIC STEP 7 (TIA Portal) as of V16;
Interpreter software from the respective robot manufacturer on the robot control required.

Executable on:
SIMATIC S7-1500
Controller family as of firmware V2.8

Single Runtime License Download¹⁾ contains license certificate for 1 robot alarm

Consignee email address required for delivery

Article No.

6ES7823-0RE00-3AA0

¹⁾ For up-to-date information and download availability, see: <http://www.siemens.com/tia-online-software-delivery>

Overview

TIA Portal Multiuser Engineering allows several users to work on the same project simultaneously. This results in a significant reduction in configuration times, and projects can be commissioned faster.

The basic principle:

The project administration is handled by an autonomous server application. This can be installed independent of a TIA Portal.

New with V17

- Multiuser sessions can be stored on network drives and local sessions can also be saved as TIA Portal archive (single project).
- All user IDs are now saved during check-in.
- Export/import of projects is possible directly from the administration tool.
- Openness functions can be used in a Multiuser session. This allows the use of existing Openness applications within Multiuser Engineering.
- TIA Portal V17 provides new Multiuser Openness APIs for integrating Multiuser workflows into dedicated automation workflows.
- Combining Openness functions and the new Multiuser Openness APIs enables efficient, automated Multiuser operations via own applications or in TIA Portal add-ins.
- With V17, the asynchronous commissioning mode supports the loading of PLCs with activated access protection and of program changes to the F program component.

Licensing

- The software can be installed on multiple computers. The number of licenses acquired determines the number of computers on which the software can be used simultaneously (floating license).
- The software is part of the STEP 7/WinCC (TIA Portal) DVD and/or of the program download; a license key is required for activation.
- An upgrade to version V17 is available for users of the previous V14...V16 versions.
- It is possible to conclude Software Update Service (SUS) contracts.

You can find more information on the Software Update Service, license types, Online Software Delivery and handling your SW licenses with the Automation License Manager here:

<http://www.siemens.com/simatic-licenses>

Ordering data**Article No.****TIA Portal Multiuser Engineering V17**

Software is a component of STEP 7 / WinCC as of V17. Only the Certificates of License (CoL) are delivered with the license.

Data storage medium package, floating license, license key on USB flash drive

6ES7823-1AA07-0YA5

Download incl. license key, floating license; license key for download ¹⁾

6ES7823-1AE07-0YA5

Email address required for delivery

Upgrade

Software is a component of STEP 7 / WinCC as of V17. Only the Certificates of License (CoL) are delivered with the license.

Upgrade TIA Portal Multiuser Engineering V14...V16 to V17, floating license; license key on USB flash drive

6ES7823-1AA07-0YE5

Upgrade TIA Portal Multiuser Engineering V14...V16 to V17, floating license; license key for download ¹⁾

6ES7823-1AE07-0YE5

Email address required for delivery

Software Update Service ²⁾

Data storage medium package

6ES7823-1AA00-0YL5

Download ¹⁾

6ES7823-1AE00-0YL5

Email address required for delivery

¹⁾ For up-to-date information and download availability, see: <http://www.siemens.com/tia-online-software-delivery>

²⁾ For more information on the Software Update Service, see page 12/2.

Software for SIMATIC Controllers

TIA Portal

TIA Portal options

TIA Portal Test Suite

Overview

- Software to support quality assurance of automation programs in the TIA Portal
- Contains tools for checking the programming style and for creating test routines for software modules:
 - Styleguide Checker:
 - to ensure a unified programming style, rule sets with programming guidelines in the TIA Portal project can be defined as well as their compliance regularly checked.
 - Application test:
 - to check the correct processing of individual logic blocks or entire S7-1500 applications, test routines with function tests can be created in a TIA Portal project and subsequently executed and validated with help of SIMATIC S7-PLCSIM Advanced V3.0.

New with V17

- For inclusion in continuous integration workflows, the following functions can be run via an Openness API:
 - XML/ASCII file export and import for rule sets and test cases
 - Export and import from libraries (copy templates)
 - Running of styleguide checker and application test
 - Test results are provided as .NET objects in the Openness application and can thus be exported with a user-defined export format.
- Application test now also supports ET 200pro, S7-1500 R/H and SIMATIC Drive Controller (requires SIMATIC S7-PLCSIM Advanced V4.0 installation)
- New instruction "Assert.InRange (variable, lowerBound, upperBound)" for integer and real tags

Licensing

- The software can be installed on multiple computers. The number of licenses acquired determines the number of computers on which the software can be used simultaneously (floating license).
- The application tests created with the Test Suite can only be executed in conjunction with SIMATIC S7-PLCSIM Advanced V3.0 including Update 1 or higher. An additional SIMATIC S7-PLCSIM Advanced V3.0 license is, however, not necessary for this.
- There is also the option of completing a Software Update Service.

You can find more information on the Software Update Service, license types, Online Software Delivery and handling your SW licenses with the Automation License Manager here:

<http://www.siemens.com/simatic-licenses>

Ordering data

Article No.

TIA Portal Test Suite Advanced V17

Software to support quality assurance of automation programs in the TIA Portal; Software can exclusively be used together with STEP 7 Prof. / WinCC as of V17. To execute application tests, the SIMATIC S7-PLCSIM Advanced V3.0 software including Update 1 must also be installed.

Floating license, software, documentation and license key for download ¹⁾

Email address required for delivery

6ES7823-1TE07-0AA5

Upgrade

Upgrade TIA Portal Test Suite Advanced V16 to V17, floating license, software, documentation and license key for download ¹⁾

Email address required for delivery

6ES7823-1TE07-0AE5

Software Update Service ²⁾

Download incl. license key ¹⁾

Email address required for delivery

6ES7823-1TE00-0AL5

¹⁾ For up-to-date information and download availability, see: <http://www.siemens.com/tia-online-software-delivery>

²⁾ For more information on the Software Update Service, see page 12/2.

Overview

The TIA Portal Cloud Connector enables access to local PG/PC interfaces and connected SIMATIC hardware from the TIA Portal Engineering while the engineering is taking place via a remote desktop on a server of a private cloud.

Licensing

- Software for use with separately licensed TIA Portal products that have been released for use with the Cloud Connector. The "Special Terms for the Use of Software with the TIA Portal Cloud Connector" apply:
<https://support.industry.siemens.com/cs/ww/en/view/109739390>
- The software is part of the STEP 7/WinCC (TIA Portal) DVD and/or the program download.

Ordering data**TIA Portal Cloud Connector**

Single license;
software is component of
STEP 7 / WinCC V14 and higher.
Only the Certificates of License
(CoL) are delivered with the license.

- Data storage medium package
- Download including license key ¹⁾
Email address required for
delivery

¹⁾ For up-to-date information and download availability, see:
<http://www.siemens.com/tia-online-software-delivery>

Article No.

6ES7823-1CA00-0YA0
6ES7823-1CE00-0YA0

Software for SIMATIC Controllers

TIA Portal

TIA Portal options

TIA Portal Teamcenter Gateway

Overview

The Teamcenter Gateway permits storage and management of TIA Portal projects and global libraries in Teamcenter. Program handling is integrated into the TIA Portal.

Licensing

- Please note the compatibility of the installed program versions for the operation of the Teamcenter Gateway.
- The software can be installed on multiple computers. The number of licenses acquired determines the number of computers on which the software can be used simultaneously (floating license).
- An upgrade to version V17 is available for users of the previous V14...V16 versions.
- It is possible to conclude Software Update Service (SUS) contracts.

You can find more information on the Software Update Service, license types, Online Software Delivery and handling your SW licenses with the Automation License Manager here:

<http://www.siemens.com/simatic-licenses>

Ordering data

Article No.

TIA Portal Teamcenter Gateway

Data storage medium package, floating license, license key on USB flash drive

6ES7823-1EA07-0YA5

Download incl. license certificate and license key for TIA Portal Teamcenter Gateway V17, floating license¹⁾

6ES7823-1EE07-0YA5

Email address required for delivery

Upgrade

Upgrade TIA Portal Teamcenter Gateway V14...V16 to V17, floating license

6ES7823-1EA07-0YE5

Upgrade TIA Portal Teamcenter Gateway V14...V16 to V17, floating license; license key for download¹⁾;

6ES7823-1EE07-0YE5

Email address required for delivery

Software Update Service²⁾

For a period of 12 months and for a fixed price, the customer is automatically provided with all upgrades and Service Packs for each installed software package. The contract is automatically extended by a further year unless canceled at least 12 weeks prior to expiration. Requires the current software version

Data storage medium package

6ES7823-1EA00-0YL5

Download¹⁾

6ES7823-1EE00-0YL5

Email address required for delivery

¹⁾ For up-to-date information and download availability, see: <http://www.siemens.com/tia-online-software-delivery>

²⁾ For more information on the Software Update Service, see page 12/2.

Technical specifications

Can be used with:

- TIA Portal V17 with V14 or higher
- Teamcenter V11, V12 and V13

Overview**SIMATIC Visualization Architect**Challenge:

- To standardize the user interfaces of the visualizations throughout the plant
- Significant reduction of the engineering costs for generating the visualizations
- To make the in-house work standard usable

Solution:

- Automatic generation and creation of the visualizations, based on the program code of the PLC and corresponding visualization objects within the framework of system-wide library concepts.

Licensing

- The software can be installed on multiple computers. The number of existing licenses determines the number of computers on which the software can be used simultaneously (floating license).
- An upgrade to the subsequent version is offered for users of previous versions.
- A rental license is available for temporary use
- A trial license is available for testing purposes.
- It is possible to conclude Software Update Service (SUS) contracts

You can find more information on the Software Update Service, license types, Online Software Delivery and handling your software licenses with the Automation License Manager here:

<http://www.siemens.com/simatic-licenses>

Ordering data**Article No.****SIMATIC Visualization Architect V17**As package

- SIMATIC Visualization Architect V17
- SIMATIC Visualization Architect V17 Rental
- SIMATIC Visualization Architect V17 Trial
Download in Customer Support Portal

6AV2107-0PX07-0AA5**6AV2107-0PX07-0AA6****6AV2107-0PX07-0AA7**As download ¹⁾

- SIMATIC Visualization Architect V17
- SIMATIC Visualization Architect V17 Rental

6AV2107-0PX07-0AH5**6AV2107-0PX07-0AH6****Upgrade****SIMATIC Visualization Architect**

Engineering software in the TIA Portal; software and documentation on CD, License key on USB flash drive Class A; 6 languages: en, de, fr, es, it, zh

V16 -> V17

- As package
- As download ¹⁾
Email address required for delivery

6AV2107-3PX07-0AA5**6AV2107-3PX07-0AH5****V15/V15.1 -> V16**

- As package
- As download ¹⁾
Email address required for delivery

6AV2107-3PX06-0AA5**6AV2107-3PX06-0AH5**

¹⁾ For up-to-date information and download availability, see: <http://www.siemens.com/tia-online-software-delivery>

Technical specifications**SIMATIC Visualization Architect**

Operating system requirements	In accordance with the requirements of the TIA Portal components: <ul style="list-style-type: none"> • SIMATIC STEP 7 (TIA Portal) • SIMATIC WinCC Unified, Professional, Advanced, Comfort, Basic
Supported STEP 7 version	SIMATIC STEP 7 V17
Supported WinCC versions	SIMATIC WinCC V17 Unified, Professional, Advanced, Comfort, Basic

Software for SIMATIC Controllers

TIA Portal

TIA Portal options

SIMATIC ProDiag

Overview

The TIA Portal option ProDiag makes it possible to monitor a machine or plant and to intervene in the event of a fault. The monitoring messages which can be generated for the various faults provide specific information on the monitoring mode, location and cause of the fault. Information on troubleshooting can be provided in addition. Plant operators can then not only recognize faults, they can also identify any potential danger in advance and take appropriate countermeasures.

Licensing

- The runtime license for controllers includes 250 supervisions or an unlimited number of supervisions per CPU. From FW 2.0 onwards, the software can run on S7-1500/ET 200SP CPUs regardless of the TIA Portal version.
- For the visualization of the messages, the controls are licensed according to the HMI runtime platforms.

You can find more information on the Software Update Service, license types, Online Software Delivery and handling your software licenses with the Automation License Manager here:

<http://www.siemens.com/simatic-licenses>

Ordering data

Article No.

SIMATIC ProDiag S7-1500 for 250 monitoring functions

For SIMATIC S7-1500 CPUs and ET 200SP CPUs with FW 2.0 and higher. Independent of the TIA Portal version.

Package with data storage medium

6ES7823-0AA00-1AA0

Download incl. license key ¹⁾

6ES7823-0AE00-1AA0

Email address required for delivery

SIMATIC ProDiag S7-1500 for all configured monitoring functions on a CPU

For SIMATIC S7-1500 CPUs and ET 200SP CPUs with FW 2.0 and higher. Independent of the TIA Portal version.

Package with data storage medium

6ES7823-0AA00-1DA0

Download incl. license key ¹⁾

6ES7823-0AE00-1DA0

Email address required for delivery

SIMATIC ProDiag for SIMATIC Comfort / Mobile Panels

Controls for SIMATIC WinCC as of V14.

Package with data storage medium

6AV2107-0UP00-0BB0

Download incl. license key ¹⁾

6AV2107-0UP00-0BH0

Email address required for delivery

SIMATIC ProDiag for WinCC Runtime Advanced

Controls for SIMATIC WinCC as of V14.

Package with data storage medium

6AV2107-0UA00-0BB0

Download incl. license key ¹⁾

6AV2107-0UA00-0BH0

Email address required for delivery

SIMATIC ProDiag for WinCC Runtime Professional

Controls for SIMATIC WinCC as of V14

Package with data storage medium

6AV2107-0UB00-0BB0

Download incl. license key ¹⁾

6AV2107-0UB00-0BH0

Email address required for delivery

¹⁾ For up-to-date information and download availability, see: <http://www.siemens.com/tia-online-software-delivery>

Technical specifications

Can be used for

SIMATIC ProDiag S7-1500

For all S7-1500 CPUs and ET 200SP CPUs with FW V2.0 and higher

Overview

The SIMATIC Modular Application Creator enables the automated generation of TIA Portal projects based on pre-defined software modules. Especially with complex machine configurations, such as a multi-belt control, a printing machine or other applications with many axes, this is very efficient compared to manually creating and parameterizing the associated automation project directly in the TIA Portal.

The software modules provide a technological view of the application and can be used in the TIA Portal without programming knowledge. They are stored in a separate repository, independent of the tool, which needs to be connected to the tool.

Licensing

- The SIMATIC Modular Application Creator and the existing modules are available as a free download via the Siemens Industry Online Support.
- A corresponding license is required for each CPU into which a module is generated.

Ordering data

Article No.

SIMATIC Modular Application Creator

For automated generation of TIA Portal projects with use of pre-configured software modules

For download at <https://support.industry.siemens.com/cs/ww/en/view/109762852>

SIMATIC Modular Application Creator Equipment Module

Pre-configured software modules for use with the SIMATIC Modular Application Creator

For download at <https://support.industry.siemens.com/cs/ww/en/view/109762849>

SIMATIC Modular Application Creator licenses

For the generation of executable TIA Portal projects with integrated Modular Application Creator software modules; a license must be purchased for each CPU on which the project is to run:

For standard modules without use of technological objects (e.g. OMAC or Weihenstephan)

- Single Basic License, Certificate of License
- Single Basic License, Certificate of License for download¹⁾
Email address required for delivery

6ES7823-0MA00-1BA0

6ES7823-0ME00-1BA0

For modules with use of technological objects (e.g. Intelligent Belt)

- Single Advanced License, Certificate of License
- Single Advanced License, Certificate of License for download¹⁾
Email address required for delivery

6ES7823-0MA00-1DA0

6ES7823-0ME00-1DA0

¹⁾ For up-to-date information and download availability, see: <http://www.siemens.com/tia-online-software-delivery>

Technical specifications

The SIMATIC Modular Application Creator can be used for:

- TIA Portal and StartDrive as of V16.0, with activated Openness interface and
- All SIMATIC S7-1500 CPUs as of FW version 4.8.

Software for SIMATIC Controllers

TIA Portal

TIA Portal options

Central user management (UMC)

Overview

The User Management Component (UMC) provides the possibility of central user management. Through the connection to the TIA Portal, users and user groups can be defined and managed across projects. Connection to a Microsoft Active Directory is also possible.

Licensing

- Central user management (UMC) is supplied with the TIA Portal.
- The license model depends on the number of user accounts per UMC domain.
- Up to ten user accounts can be used without a license.
- For additional user accounts, 365-day rental licenses are available to accumulate the required number of centrally managed users.

Ordering data

Central user management (UMC)

Software component to implement central user management, included in the scope of supply of the respective products (e.g. TIA Portal).

The license model depends on the number of user accounts per UMC domain. Use of max. 10 user accounts possible without a license.

6 languages: en, de, fr, es, it, zh; executable under Windows 7 (64-bit), Windows 10 (64-bit), Windows Server 2012R2 (64-bit), Windows Server 2016/2019 (64-bit)

- Rental license 365 days with license certificate for 100 user accounts
- Rental license 365 days with license certificate for 4 000 user accounts

Article No.

6ES7823-1UE30-0YA0

6ES7823-1UE10-0YA0

Overview

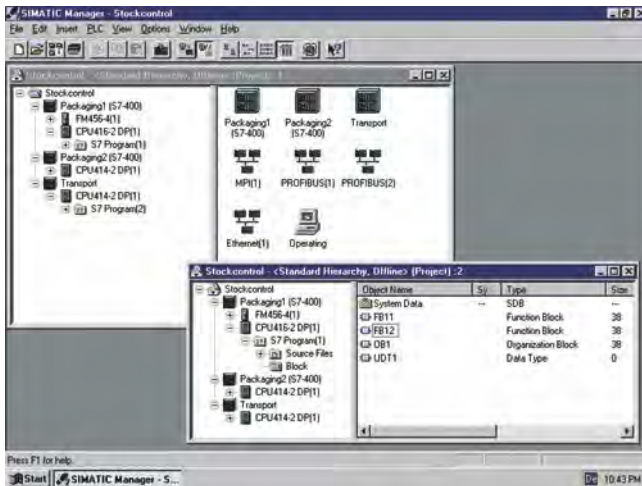

- Basic software STEP 7:
The standard tool for the SIMATIC S7, SIMATIC C7 and SIMATIC WinAC automation systems.
- For fully utilizing the performance capability of the systems.
- With user-friendly functions for all phases of an automation project:
 - Configuration and parameter assignment of the hardware
 - Specifying the communication
 - Programming
 - Testing, commissioning and service
 - Documentation, archiving
 - Operating, diagnostic functions

Note

The STEP 7 (TIA Portal) engineering software is required to program the new generation of S7-1200, S7-1500 and ET 200SP CPU PLCs as well as the S7-1500 Software Controller; it can also be used for programming the S7-300, S7-400 and SIMATIC WinAC.

Siemens offers a combo license for both platforms which enables you to work using both STEP 7 (TIA Portal) as well as traditional engineering software. See "STEP 7 Professional" for more information.

Licensing

- STEP 7 V5.7 can be installed on multiple computers.
The number of licenses acquired determines the number of computers on which the software can be used simultaneously (floating license).
- A 50 h rental license is available for limited use.
- An upgrade to version V5.7 is offered for users of the previous V5.3...5.6 versions.
- A 5.6 license is also valid for the version V5.7.
- A trial license is available for testing purposes.

You can find more information on the Software Update Service, license types, Online Software Delivery and handling your SW licenses with the Automation License Manager here:

<http://www.siemens.com/simatic-licenses>

Ordering data

Article No.

STEP 7 Version 5.7

Target system:
SIMATIC S7-300/400, SIMATIC C7
Requirement:
Windows 10 Professional/
Enterprise, Windows Server 2016,
Windows Server 2019
Type of delivery:
German, English, French,
Spanish, Italian;
incl. license key on USB flash drive,
with electronic documentation

Floating license on DVD

6ES7810-4CC12-0YA5

Floating license, download¹⁾;
Software, license key and
documentation as download;
Consignee email address required
for delivery

6ES7810-4CE12-0YB5

Rental license for 50 hours;

6ES7810-4CC12-0YA6

Software and documentation on
DVD, license key on USB flash drive

6ES7810-4CE12-0YB6

Rental license for 50 hours,
download¹⁾;
Software, license key and
documentation as download;
Consignee email address required
for delivery

6ES7810-4CC12-0YE5

Upgrade floating license
V5.3...5.6 to V5.7; on DVD

6ES7810-4CE12-0YE5

Upgrade floating license
V5.3...V5.6 to V5.7, download¹⁾;
Software, license key and
documentation as download;
Consignee email address required
for delivery

6ES7810-4CC12-0YA7

STEP 7 V5.7 Trial License;
On DVD, operational for 21 days

STEP 7 Version 5.7 Japanese

Target system:
SIMATIC S7-300/400, SIMATIC C7,
SIMATIC WinAC
Requirement:
Windows 10 Professional/
Enterprise, Windows Server 2016,
Windows Server 2019
Type of delivery:
English, Japanese;
incl. license key on USB flash drive,
with electronic documentation

Floating license Japanese on DVD

6ES7810-4CC12-0JA5

Upgrade floating license Japanese
V5.3...V5.6 to V5.7; on DVD

6ES7810-4CC12-0JE5

STEP 7 Version 5.7 Chinese

Target system:
SIMATIC S7-300/400, SIMATIC C7
Requirement:
Windows 10 Professional/
Enterprise, Windows Server 2016,
Windows Server 2019
Type of delivery:
English, Chinese;
incl. license key on USB flash drive,
with electronic documentation

Floating license Chinese on DVD

6ES7810-4CC12-0KA5

Upgrade floating license
Chinese V5.3...V5.6 to V5.7;
on DVD

6ES7810-4CC12-0KE5

¹⁾ For up-to-date information and download availability, see:
<http://www.siemens.com/tia-online-software-delivery>

Software for SIMATIC Controllers

STEP 7 V5.x

Basic software and editors

STEP 7

Ordering data	Article No.	Ordering data	Article No.
SIMATIC Manual Collection Electronic manuals on DVD, multi-language: LOGO!, SIMADYN, SIMATIC bus components, SIMATIC C7, SIMATIC distributed I/O, SIMATIC HMI, SIMATIC Sensors, SIMATIC NET, SIMATIC PC-based Automation, SIMATIC PCS 7, SIMATIC PG/PC, SIMATIC S7, SIMATIC Software, SIMATIC TDC	6ES7998-8XC01-8YE0	Components for connecting a PC to MPI and PROFIBUS For PCs with a free PCI slot: CP 5612	6GK1561-2AA00
SIMATIC Manual Collection update service for 1 year Current Manual Collection DVD and the three subsequent updates	6ES7998-8XC01-8YE2	For PCs without a free PCI slot: USB A2 PC adapter	6GK1571-0BA00-0AA0
EPROM programming device, USB Prommer For programming SIMATIC Memory Cards and EPROM modules	6ES7792-0AA00-0XA0	Components for connecting the PC to Industrial Ethernet For PCs with a free PCI slot: Layer 2 Ethernet cards	
MPI cable For linking SIMATIC S7 and PG through MPI (5 m)	6ES7901-0BF00-0AA0		

Technical specifications

Article number	6GK1571-0BA00-0AA0	Article number	6GK1571-0BA00-0AA0
product type designation	PC adapter USB A2	product type designation	PC adapter USB A2
transfer rate		design, dimensions and weights	
transfer rate		module format	USB V2.0 adapter
<ul style="list-style-type: none"> at the 1st interface acc. to PROFIBUS 	9.6 kbit/s ... 12 Mbit/s	width	58 mm
interfaces		height	26 mm
number of electrical connections		depth	105 mm
<ul style="list-style-type: none"> at the 1st interface acc. to PROFIBUS 	1	net weight	365 g
number of interfaces according to USB	1	fastening method 35 mm top hat DIN rail mounting	No
type of electrical connection		product features, product functions, product components general	
<ul style="list-style-type: none"> at the 1st interface acc. to PROFIBUS 	9-pin Sub-D socket (RS 485)	number of plug-in cards of same design plug-in per PC station	1
<ul style="list-style-type: none"> of the USB interface 	Standard-B socket	number of units note	-
standard for interfaces USB 2.0	Yes	product functions diagnostics	
supply voltage, current consumption, power loss		product function	
type of voltage of the supply voltage	DC	<ul style="list-style-type: none"> port diagnostics 	Yes
type of voltage supply optional external power supply	No	standards, specifications, approvals	
supply voltage		standard	
<ul style="list-style-type: none"> from USB 	5 V	<ul style="list-style-type: none"> for EMC 	2004/108/EC
<ul style="list-style-type: none"> note 	Supply direct from USB	<ul style="list-style-type: none"> for safety from CSA and UL 	cULus, UL 60950-1, CSA22.2
relative symmetrical tolerance at DC		<ul style="list-style-type: none"> for emitted interference 	EN 61000-6-3, EN 61000-6-4
<ul style="list-style-type: none"> at 5 V 	5 %	<ul style="list-style-type: none"> for interference immunity 	EN 61000-6-1, EN 61000-6-2
consumed current		certificate of suitability	
<ul style="list-style-type: none"> from USB 	0.2 A	<ul style="list-style-type: none"> CE marking 	Yes
power loss [W]	1 W	<ul style="list-style-type: none"> C-Tick 	Yes
ambient conditions			
ambient temperature			
<ul style="list-style-type: none"> during operation 	0 ... 60 °C		
<ul style="list-style-type: none"> during storage 	-40 ... +70 °C		
<ul style="list-style-type: none"> during transport 	-40 ... +70 °C		
relative humidity at 30 °C during operation maximum	95 %		
protection class IP	IP20		

Overview



STEP 7 Professional supports all IEC languages.

In addition to the languages familiar from STEP 7:

- LAD
- FBD
- STL

the following are also available:

- "Sequential function chart"
- "Structured text"

An offline simulation of user programs created with these languages is included. STEP 7 Professional thus replaces the combination of the individual packages STEP 7, S7-GRAPH, S7-SCL and S7-PLCSIM.

A PowerPack (conversion package) is available for customers who use STEP 7 already and wish to change. A valid STEP 7 license is required for purchasing the POWERPACK. A separate Software Update Service can be purchased for STEP 7 Professional.

Note

The STEP 7 (TIA Portal) engineering software is required to program the new generation of S7-1200, S7-1500 and ET 200SP CPU PLCs as well as the S7-1500 Software Controller; it can also be used for programming the S7-300, S7-400 and SIMATIC WinAC.

Siemens offers a combo license for both platforms which enables you to work using both STEP 7 (TIA Portal) as well as traditional engineering software. See "Licensing" for more information.

Licensing

- New installations of STEP 7 Professional 2021 are only available as combo licenses together with STEP 7 Professional V17 (TIA Portal). The software can be installed on multiple computers. The number of existing licenses determines the number of computers on which the software can be used simultaneously (floating license). A 50 h rental license is available for limited use.
- An upgrade to V17/2021 Combo is available for users of the previous STEP 7 Professional 2006...2010 versions.
- The license of the version V16/2017 Combo can also be used for STEP 7 V5.7.
- PowerPack and upgrade enable migration from STEP 7 V5.7 to STEP 7 Professional V17/2021 Combo.
- A trial license is available for testing purposes.
- It is possible to conclude Software Update Service (SUS) contracts.

You can find more information on the Software Update Service, license types, Online Software Delivery and handling your software licenses with the Automation License Manager here:

<http://www.siemens.com/simatic-licenses>

Ordering data	Article No.	Article No.
STEP 7 Professional V17/2021 Target system: SIMATIC S7-300/-400, SIMATIC S7-1200/-1500, SIMATIC C7, SIMATIC WinAC Requirement: Windows Server 2016/2019, Windows 10 Professional, Windows 10 Enterprise Type of delivery: English, German, French, Spanish, Italian; license key on USB flash drive, with electronic documentation		
Floating combo license on DVD	6ES7810-5CC14-0YA5	
Floating license, license key download²⁾ Software and documentation as download; Consignee email address required for delivery	6ES7810-5CE14-0YB5	
Rental license for 50 hours, license key download²⁾ Software and documentation as download; Consignee email address required for delivery	6ES7823-1GE07-0YA5	
		Conversion package STEP 7 Professional V17 Only valid if ordered together with a Software Update Service 6ES7810-5CC04-0YE2 (STEP 7 Professional and STEP 7 Professional in the TIA Portal). <ul style="list-style-type: none"> • PowerPack & upgrade from STEP 7 V5.7 to STEP 7 Professional V17/2021 Combo, floating license. STEP 7 Software Update Service is a prerequisite. • PowerPack & upgrade from STEP 7 V5.7 to STEP 7 Professional V17/2021 Combo, floating license. STEP 7 Software Update Service is a prerequisite. Software download including license key²⁾ Consignee email address required for delivery
		6ES7822-1AA07-0XC2 6ES7822-1AE07-0XC2

²⁾ For up-to-date information and download availability, see: <http://www.siemens.com/tia-online-software-delivery>

Software for SIMATIC Controllers

STEP 7 V5.x

Basic software and editors

STEP 7 Professional

Ordering data

Ordering data	Article No.
Upgrade from STEP 7 Professional V11...16 to STEP 7 Professional V17 or STEP 7 Professional V11...V16/2017 Combo to V17/2021 Combo or STEP 7 Professional 2006...2010 to V17/2021 Combo, floating license	6ES7822-1AA07-0YE5
Upgrade from STEP 7 Professional V11...16 to STEP 7 Professional V17 or STEP 7 Professional V11...V16/2017 Combo to V17/2021 Combo or STEP 7 Professional 2006...2010 to V17/2021 Combo, floating license Software download including license key²⁾ Consignee email address required for delivery	6ES7822-1AE07-0YE5
PowerPack & upgrade from STEP 7 V5.3...V5.7 to STEP 7 Professional V17/2021 Combo, floating license	6ES7822-1AA07-0XC5
STEP 7 Professional 2021 Trial License; On DVD, operational for 21 days	6ES7810-5CC13-0YA7
Software Update Service For a period of 12 months and for a fixed price, the customer is automatically provided with all upgrades and Service Packs for each installed software package. The contract is automatically extended by a further year unless canceled at least 12 weeks prior to expiration. Requires the current software version	
Software Update Service (Standard Edition)¹⁾ The delivery is implemented according to the number of ordered SUS products (e.g. 10 upgrade packages with 10 DVDs, 10 USB flash drives, etc.) <ul style="list-style-type: none"> STEP 7 Professional and STEP 7 Professional in the TIA Portal 	6ES7810-5CC04-0YE2

Article No.

Software Update Service (Compact Edition)¹⁾

The delivery items are combined. For several contracts, only 1 package with 1 data storage medium set, 1 USB flash drive with the corresponding number of licenses and the corresponding number of CoLs will be supplied.

Delivery items to be combined must be ordered as one item.

- STEP 7 Professional and STEP 7 Professional in the TIA Portal

6ES7810-5CC00-0YM2

Software Update Service (download)¹⁾²⁾

Upgrades and Service Packs are available for downloading.

Consignee email address required for delivery

- STEP 7 Professional and STEP 7 Professional in the TIA Portal

6ES7810-5CC04-0YY2

EPROM programming device, USB Prommer

6ES7792-0AA00-0XA0

For programming SIMATIC Memory Cards and EPROM modules

MPI cable

6ES7901-0BF00-0AA0

For linking SIMATIC S7 and PG through MPI (5 m)

Components for connecting a PC to MPI and PROFIBUS

For PCs with a free PCI slot:

CP 5612

6GK1561-2AA00

For PCs without a free PCI slot:

USB A2 PC adapter

6GK1571-0BA00-0AA0

For connecting a programming device/PC or notebook to PROFIBUS or MPI; USB cable included in scope of supply

Components for connecting the PC to Industrial Ethernet

For PCs with a free PCI slot:

Layer 2 Ethernet cards

¹⁾ For more information on the Software Update Service, see page 12/2.

²⁾ For up-to-date information and download availability, see: <http://www.siemens.com/tia-online-software-delivery>

Technical specifications

Article number	6GK1571-0BA00-0AA0
product type designation	PC adapter USB A2
transfer rate	
transfer rate	
• at the 1st interface acc. to PROFIBUS	9.6 kbit/s ... 12 Mbit/s
interfaces	
number of electrical connections	
• at the 1st interface acc. to PROFIBUS	1
number of interfaces according to USB	1
type of electrical connection	
• at the 1st interface acc. to PROFIBUS	9-pin Sub-D socket (RS 485)
• of the USB interface	Standard-B socket
standard for interfaces USB 2.0	Yes
supply voltage, current consumption, power loss	
type of voltage of the supply voltage	DC
type of voltage supply optional external power supply	No
supply voltage	
• from USB	5 V
• note	Supply direct from USB
relative symmetrical tolerance at DC	
• at 5 V	5 %
consumed current	
• from USB	0.2 A
power loss [W]	1 W
ambient conditions	
ambient temperature	
• during operation	0 ... 60 °C
• during storage	-40 ... +70 °C
• during transport	-40 ... +70 °C
relative humidity at 30 °C during operation maximum	95 %
protection class IP	IP20

Article number	6GK1571-0BA00-0AA0
product type designation	PC adapter USB A2
design, dimensions and weights	
module format	USB V2.0 adapter
width	58 mm
height	26 mm
depth	105 mm
net weight	365 g
fastening method 35 mm top hat DIN rail mounting	No
product features, product functions, product components general	
number of plug-in cards of same design plug-in per PC station	1
number of units note	-
product functions diagnostics	
product function	
• port diagnostics	Yes
standards, specifications, approvals	
standard	
• for EMC	2004/108/EC
• for safety from CSA and UL	cULus, UL 60950-1, CSA22.2
• for emitted interference	EN 61000-6-3, EN 61000-6-4
• for interference immunity	EN 61000-6-1, EN 61000-6-2
certificate of suitability	
• CE marking	Yes
• C-Tick	Yes

Software for SIMATIC Controllers

STEP 7 V5.x

Basic software and editors

S7-SCL

Overview

- PASCAL-type high-level language
- Optimized for programming PLCs
- With PLCopen Base Level certificate
- For use in SIMATIC S7-300 (recommended for CPU 314 and CPU 312C), S7-400, C7 and WinAC



Licensing

- S7-SCL is an integral part of the STEP 7 Professional software package or is available as a stand-alone software product.
- S7-SCL V5.7 is delivered with a floating license. The floating license allows installation of the software on any number of computers. This means one user per license can use the software independently of the computer used and without being tied to a specific workstation. The number of licenses acquired determines the number of computers on which the software can be used simultaneously.
- An upgrade to version 5.7 is available for users of the previous versions as of V5.3.
- A separate update service can be purchased for S7-SCL.
- A trial license valid for 21 days is available for download from Industry Online Support:
<https://support.industry.siemens.com/cs/ww/en/view/109795037>

You can find more information on the Software Update Service, license types, Online Software Delivery and handling your SW licenses with the Automation License Manager here:

<http://www.siemens.com/simatic-licenses>

Ordering data

Article No.

SIMATIC S7-SCL, Version 5.7

Task:

High-level language programming

Target system:

SIMATIC S7-300 (CPU 314 or higher),
SIMATIC S7-400,
SIMATIC C7

Requirement:

STEP 7 as of V5.7;
Windows 10 Professional/Enterprise,
Windows Server 2016,
Windows Server 2019

Type of delivery:

On CD; English, German,
French, Spanish, Italian;
license key on USB flash drive,
with electronic documentation

Floating license

6ES7811-1CC08-0YA5

Software Update Service (requires
current software version)¹⁾

6ES7811-1CA01-0YX2

Upgrade floating from V5.3 to V5.7

6ES7811-1CC08-0YE5

SIMATIC Manual Collection

6ES7998-8XC01-8YE0

Electronic manuals on

DVD, multi-language:

LOGO!, SIMADYN, SIMATIC
bus components, SIMATIC C7,
SIMATIC Distributed I/O,
SIMATIC HMI, SIMATIC sensors,
SIMATIC NET, SIMATIC PC-based
Automation, SIMATIC PCS 7,
SIMATIC PG/PC, SIMATIC S7,
SIMATIC software, SIMATIC TDC

SIMATIC Manual Collection update service for 1 year

6ES7998-8XC01-8YE2

Current Manual Collection DVD and
the three subsequent updates

¹⁾ For more information on the Software Update Service, see page 12/2.

Technical specifications

Engineering tool	S7-SCL
Current version	V5.3
Software class	7
Application areas	
Can be used for	Text-based high-level language programming of simple and complex calculations, CASE, loop, jump, and comparison functions
Marketing message	Programming of algorithms and calculations made easy!
Advantages	<ul style="list-style-type: none"> • Clear and easy-to-read programs • Functional, module-based programming • CASE instruction replaces a large number of jump and comparison functions • Easily understood by PLC programmers, as the programming philosophy of LAD/FBD/STL is retained • Easy switchover to PLC programming for PC programmers • Exchangeability (porting) of subroutines in accordance with IEC 61131-3 • Less time required for engineering compared to LAD/FBD/STL: Up to 20% for simple programs; at least 50% for demanding program structures
Sectors	<ul style="list-style-type: none"> • Labeling machines • Chemical plants (e.g. oxygen extraction, evaluation of measured values) • Rubber and plastics machines • Woodworking machines • Storage and logistics systems • Paper and printing machinery • Punching and cutting machines • Water industry • Coilers
Target systems	
Can be used in	S7-300 (CPU 313 or higher and CPU 312C or higher recommended) S7-400 C7 (C7-626 or higher recommended) WinAC
System requirements	
Operating system	Windows 10 Windows Server 2016/2019
Required hard drive memory in the programming device/PC approx.	50 MB

Engineering tool	S7-SCL
Properties	
Monitoring tags	Yes
Controlling tags	Yes
Single-step processing	Yes
Integration in CFC	Yes
Program runtimes	
with S7-300 (typical)	Similar to LAD/FBD/STL
with S7-400 (typical)	Similar to LAD/FBD/STL
Diagnostics	
Integration of diagnostic data in ProAgent	-
Integration of diagnostic data in ProTool/Pro	-
Integration of diagnostic data in WinCC	-
Supported standards	
IEC 61131-3	PLCopen certification <ul style="list-style-type: none"> • Base level ST available • Reusability Level ST available
Available versions/licenses	
Floating license	CD-ROM with <ul style="list-style-type: none"> • Tool • Electronic manual • Getting Started guide • Examples License on USB flash drive Certificate of License Product information
Upgrade (floating license)	CD-ROM with <ul style="list-style-type: none"> • Tool • Electronic manual • Getting Started guide • Examples License on USB flash drive Certificate of License Product information
Software Update Service (SUS)	
Also a component part of	
STEP 7 Professional	Yes
S7 Trainer Package	Yes
PCS 7	Yes
D7-SYS	-

Software for SIMATIC Controllers

STEP 7 V5.x

Basic software and editors

S7-GRAPH

Overview

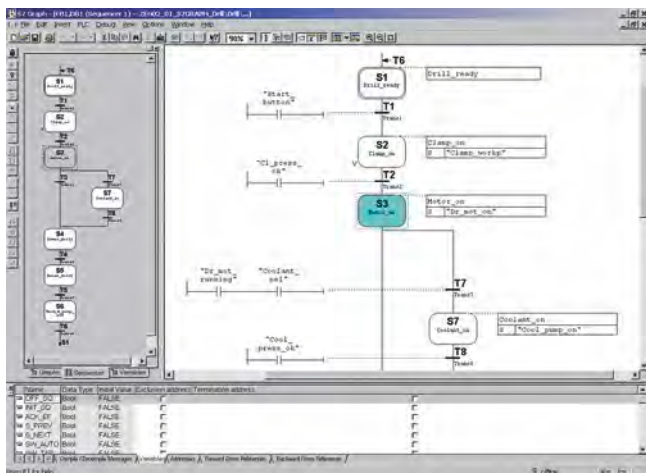

- For configuring and programming sequential processes using sequencers
- Standardized representation to EN 1131-3
- Clearly comprehensible program thanks to structuring of the process into separate steps
- With extensive diagnostic functions, integrated in the SIMATIC diagnostic concept
- With PLCopen Base Level certificate
- For use in SIMATIC S7-300 (recommended for CPU 315 and CPU 312C or higher), S7-400, C7 and WinAC



Licensing

- S7 GRAPH is an integral part of the STEP 7 Professional software package or is available as a stand-alone software product.
- S7-Graph V5.7 is supplied with a floating license. The floating license allows installation of the software on any number of computers. This means one user per license can use the software independently of the computer used and without being tied to a specific workstation. The number of licenses acquired determines the number of computers on which the software can be used simultaneously.
- An upgrade to version 5.7 is available for users of previous versions as of V5.3.
- A separate update service can be purchased for S7-GRAPH.
- A trial license valid for 21 days is available for download from Industry Online Support: <https://support.industry.siemens.com/cs/ww/en/view/109795038>

You can find more information on the Software Update Service, license types, Online Software Delivery and handling your SW licenses with the Automation License Manager here:

<http://www.siemens.com/simatic-licenses>

Ordering data

Article No.

SIMATIC S7-GRAPH, Version 5.7

Task:
Configuring and programming of sequences
Target system:
SIMATIC S7-300, SIMATIC S7-400, SIMATIC C7
Requirement:
STEP 7 V5.7;
Windows 10 Professional/Enterprise, Windows Server 2016, Windows Server 2019
Type of delivery:
on CD; German, English, French, Spanish, Italian; including license key on USB flash drive, with electronic documentation

Floating license

6ES7811-0CC08-0YA5

Software Update Service (requires current software version)¹⁾

6ES7811-0CA01-0YX2

Upgrade floating license from V5.3 to V5.7

6ES7811-0CC08-0YE5

SIMATIC Manual Collection

6ES7998-8XC01-8YE0

Electronic manuals on DVD, multi-language:
LOGO!, SIMADYN, SIMATIC bus components, SIMATIC C7, SIMATIC Distributed I/O, SIMATIC HMI, SIMATIC sensors, SIMATIC NET, SIMATIC PC-based Automation, SIMATIC PCS 7, SIMATIC PG/PC, SIMATIC S7, SIMATIC software, SIMATIC TDC

SIMATIC Manual Collection update service for 1 year

6ES7998-8XC01-8YE2

Current Manual Collection DVD and the three subsequent updates

¹⁾ For more information on the Software Update Service, see page 12/2.

Technical specifications

Engineering tool	S7-GRAPH
Current version	V5.7
Software class	A
Application areas	
Can be used for	Graphical programming of sequential controls and sequencers
Marketing message	Fast, elegant way to program sequential processes easily and transparently!
Advantages	<ul style="list-style-type: none"> • Can be used to optimum effect even during the design phase • Less configuration effort thanks to graphical structuring and programming • Quick and easy familiarization • Precise fault localization thanks to integrated diagnostics in combination with ProAgent for ProTool/Pro and WinCC • Less time required for engineering compared to LAD/FBD/STL: approx. 40 to 70%
Sectors	<ul style="list-style-type: none"> • Automotive industry (e.g. body-in-white, final assembly) • Electrical equipment manufacture • Rubber and plastics machines • Pick-and-place machines • Woodworking machines • Metalworking machines • Paper and printing machinery • Testing machines • Rolling mills • Coilers • Leisure and entertainment facilities
Target systems	
Can be used in	S7-300 (CPU 314 or higher and CPU 312C or higher recommended) S7-400 C7 (C7-626 or higher recommended) WinAC
System requirements	
Operating system	Windows 10 Windows Server 2016/2019
Required hard drive memory in the programming device/PC approx.	50 MB
Required software	STEP 7 V5.7

Engineering tool	S7-GRAPH
Properties	
Monitoring tags	Yes
Controlling tags	Yes
Single-step processing	Yes
Integration in CFC	-
Program runtimes	
with S7-300 (typical)	3 ms per block + 1 ms per active step
with S7-400 (typical)	0.4 ms per block + 0.06 ms per active step
Diagnostics	
Integration of diagnostic data in ProAgent	Yes
Integration of diagnostic data in ProTool/Pro	Via ProAgent
Integration of diagnostic data in WinCC	Via ProAgent
Supported standards	
IEC 61131-3	PLCopen certification • Base Level SFC available
Status of PLCopen activities	-
Available versions/licenses	
Floating license	CD-ROM with <ul style="list-style-type: none"> • Tool • Electronic manual • Getting Started guide • Examples License key on USB flash drive Certificate of License Product information
Upgrade (floating license)	CD-ROM with <ul style="list-style-type: none"> • Tool • Electronic manual • Getting Started guide • Examples License key on USB flash drive Certificate of License Product information
Software Update Service (SUS)	
Also a component part of	
STEP 7 Professional	Yes
S7 Trainer Package	Yes
PCS 7	-
D7-SYS	-

Software for SIMATIC Controllers

STEP 7 V5.x

Basic software and editors

S7-PLCSIM

Overview

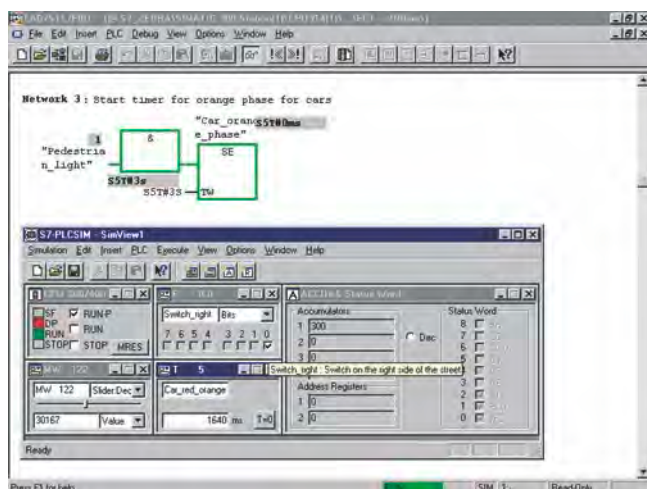

- For functional testing of the generated SIMATIC S7 user blocks on a programming device or PC, independent of the availability of the target hardware
- Shifts the detection and correction of programming errors to an early stage of development
- Enables an accelerated and cost-effective initial commissioning and enhances the program quality
- Can be used for LAD, FBD, STL, S7-GRAPH, S7-HiGraph, S7-SCL, CFC, S7-PDIAG, WinCC (local installation)

Licensing

- S7-PLCSIM is an integral part of the STEP 7 Professional software package or is available as a stand-alone software product
- S7-PLCSIM V5.4 is delivered with a floating license. The floating license allows installation of the software on any number of computers. This means one user per license can use the software independently of the computer used and without being tied to a specific workstation. The number of licenses acquired determines the number of computers on which the software can be used simultaneously.
- An upgrade to version 5.4 is offered for users of the previous versions.
- A separate update service can be purchased for S7-PLCSIM.
- A trial license valid for 14 days is available for download from Industry Online Support:
<https://support.industry.siemens.com/cs/ww/en/view/109750064>

You can find more information on the Software Update Service, license types, Online Software Delivery and handling your SW licenses with the Automation License Manager here:

<http://www.siemens.com/simatic-licenses>

Ordering data

S7-PLCSIM, Version 5.4

Task:
Functional testing of SIMATIC S7 user blocks on programming device/PC
Target system:
SIMATIC S7-300, SIMATIC S7-400, SIMATIC C7
Requirement:
STEP 7 V5.4 or higher incl. SP4/SP5 or STEP 7 > V5.5
Type of delivery:
on CD; English, German, French, Spanish, Italian;
license key on USB flash drive, with electronic documentation

Floating license

Software Update Service (requires current software version)¹⁾

Floating license upgrade to V5.4

SIMATIC Manual Collection

Electronic manuals on DVD, multi-language: LOGO!, SIMADYN, SIMATIC bus components, SIMATIC C7, SIMATIC Distributed I/O, SIMATIC HMI, SIMATIC sensors, SIMATIC NET, SIMATIC PC-based Automation, SIMATIC PCS 7, SIMATIC PG/PC, SIMATIC S7, SIMATIC software, SIMATIC TDC

SIMATIC Manual Collection update service for 1 year

Current Manual Collection DVD and the three subsequent updates

¹⁾ For more information on the Software Update Service, see page 12/2.

Article No.

6ES7841-0CC05-0YA5

6ES7841-0CA01-0YX2

6ES7841-0CC05-0YE5

6ES7998-8XC01-8YE0

6ES7998-8XC01-8YE2

Technical specifications

Engineering tool	S7-PLCSIM
Type of license	Floating license
Software class	A
Current version	V5.4
Target system (recommended)	SIMATIC S7-300 SIMATIC S7-400 SIMATIC C7
Operating system	Windows XP Professional Windows 7 Professional Windows 7 Ultimate
Required software packages	STEP 7 V5.4 with SP4 or SP5 or STEP 7 > V5.5
Disk space required in programming device/PC	5 MB

Overview

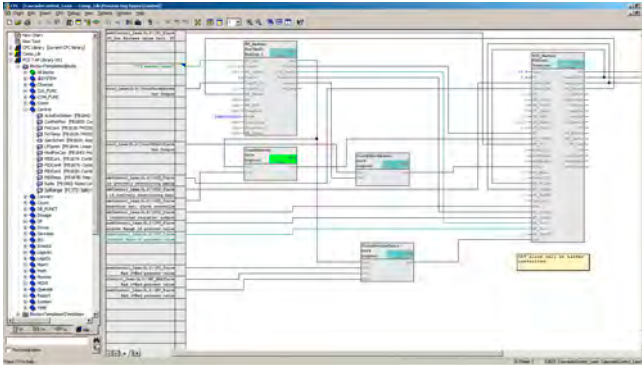

- For the generation of automation programs by drawing a technology chart
- With extensive libraries of ready-made software blocks to which user-created blocks can be added
- Minimized outlay and reduced error susceptibility due to the interconnection of ready-made blocks
- Optimized integration in the world of automation, for example, through guaranteed compatibility with all STEP 7 tools
- Can be used for SIMATIC S7-300 (recommended for CPU 316 or CPU 314C or higher), SIMATIC S7-400, SIMATIC WinAC and D7-SYS

Licensing

- SIMATIC CFC V9.0 is supplied with a floating license. The floating license allows installation of the software on any number of computers. This means one user per license can use the software independently of the computer used and without being tied to a certain workplace. The number of existing licenses determines the number of computers on which the software can be used simultaneously.
- An upgrade to version 9.0 is available for users of the previous 8.x versions.
- For SIMATIC CFC, the Software Update Service is available with the Standard, Compact and Download types of delivery.

You can find more information on the Software Update Service, license types, Online Software Delivery and handling your software licenses with the Automation License Manager here:

<http://www.siemens.com/simatic-licenses>

Ordering data

Article No.

SIMATIC CFC, Version 9.0

Task:
Graphic configuring and programming of automation applications in the form of technology-oriented diagrams
Target system:
SIMATIC S7-300/400,
SIMATIC WinAC, D7-SYS
Requirements:
STEP 7 V5.6 or higher
Type of delivery:
Engineering software and electronic documentation on CD-ROM,
license key on USB flash drive,
Certificate of License

Floating license

6ES7658-1EX58-0YA5

Floating License for download.

6ES7658-1EX58-0YH5

Email address required for delivery²⁾

Floating license upgrade from V8.x to V9.0

6ES7658-1EX58-0YE5

Floating License Upgrade from V8.x to V9.0 for download.

6ES7658-1EX58-0YK5

Email address required for delivery²⁾

Software Update Service (requires current software version)¹⁾

6ES7658-1EX00-2YL8

Software Update Service for multiple orders (requires current software version); the delivery items are combined. For multiple contracts, only 1 package (1 data storage medium set and the corresponding number of licenses) will be supplied. Can be ordered with 5 or more contracts¹⁾

6ES7658-1EX00-2YM8

Delivery items to be combined must be ordered as one item.

Software Update Service (requires current software version)¹⁾

6ES7658-1EX00-2YV8

Email address required for delivery

SIMATIC Manual Collection

6ES7998-8XC01-8YE0

Electronic manuals on DVD, multilingual:
LOGO!, SIMADYN,
SIMATIC bus components,
SIMATIC C7,
SIMATIC distributed I/O,
SIMATIC HMI, SIMATIC sensors,
SIMATIC NET, SIMATIC PC-Based Automation, SIMATIC PCS 7,
SIMATIC PG/PC, SIMATIC S7,
SIMATIC software, SIMATIC TDC

SIMATIC Manual Collection update service for 1 year

6ES7998-8XC01-8YE2

Current Manual Collection DVD and the three subsequent updates

¹⁾ For more information on the Software Update Service, see page 12/2.

²⁾ For up-to-date information and download availability, see: <http://www.siemens.com/tia-online-software-delivery>

Software for SIMATIC Controllers

STEP 7 V5.x

Options for programming and design

CFC

Technical specifications

EngineeringTool	CFC
Current version	V9.0
Software class	A
Application areas	
Can be used for	Graphical creation, interconnection and parameterization of (preconfigured) blocks and functions
Marketing message	Simply interconnect and configure instead of programming!
Advantages	<ul style="list-style-type: none"> • Can be used to optimum effect even during the design phase • Reduced configuration effort thanks to graphical interconnection • High degree of reusability of diagrams that have already been created • Quick and easy familiarization • Quick and transparent interconnection of ready-made functions • Technological creation of the program as a whole • Clear representation of control loop structures • Short commissioning time • High plant availability • Less time required for engineering compared to LAD/FBD/STL: up to 50%
Sectors	<ul style="list-style-type: none"> • Automotive industry (e.g. thermostats, tire production processes) • Chemicals • Power engineering and supply • Rubber and plastics machines • Metalworking machines • Food and beverage machines • Petrochemicals • Rolling mills • Water industry • Coilers
Target systems	
Can be used in	S7-300 S7-400 F/H systems WinAC
System prerequisites	
Operating system	MS Windows 7 Professional with SP1 (64-bit) MS Windows 7 Ultimate with SP1 (64-bit) MS Windows 7 Enterprise with SP1 (64-bit) MS Windows 10 Pro (64-bit) MS Windows 10 Enterprise 2015 LTSB (64-bit) MS Windows Server 2008 R2 Standard Edition with SP1 (64-bit) MS Windows Server 2012 R2 Update Standard Edition (64-bit)
Required hard drive memory in the PG/PC	approx. 80 MB
Required software	STEP 7 V5.6 or higher

EngineeringTool	CFC
Properties	
Monitoring tags	Yes
Controlling tags	Yes
Single-step processing	-
Integration in CFC	Yes
Program runtimes	
with S7-300 (typical)	Depending on the interconnected blocks
with S7-400 (typical)	Depending on the interconnected blocks
Diagnostics	
Integration of diagnostic data in ProAgent	-
Integration of diagnostic data in ProTool/Pro	-
Integration of diagnostic data in WinCC	-
Supported standards	
IEC 61131-3	based on the IEC standard
Status of PLCopen activities	-
Available versions/licenses	
Floating license	<ul style="list-style-type: none"> • 1 CD • 1 license key memory stick • 1 Certificate of License
Upgrade (floating license)	<ul style="list-style-type: none"> • 1 CD • 1 license key memory stick • 1 Certificate of License
Software Update Service (SUS)	
Also a component part of	
STEP 7 Professional	-
S7 Trainer Package	-
PCS 7	Yes
D7-SYS	Yes

Overview

- For creating safety-related automation applications with SIMATIC S7 in LAD or FBD (STEP 7 required)
- Implementation of safety functions by simply connecting function blocks
- With prefabricated block library
- Custom block creation possible
- Optimal embedding in the automation world thanks to total integration in the STEP 7 tools
- Scope of delivery:
 - Distributed Safety Editor
 - Code generator
 - Debugger
 - Standard block libraries

Licensing

- SIMATIC S7 Distributed Safety is delivered with a floating license. The floating license allows installation of the software on any number of computers. This means one user per license can use the software independently of the computer used and without being tied to a certain workplace. The number of existing licenses determines the number of computers on which the software can be used simultaneously.
- An upgrade to version 5.4 is offered for users of the previous versions 5.x.
- A trial license valid for 14 days is available for download from Industry Online Support:
<https://support.industry.siemens.com/cs/document/109749360>

You can find more information on the Software Update Service, license types, Online Software Delivery and handling your software licenses with the Automation License Manager here:

<http://www.siemens.com/simatic-licenses>

Ordering data**Article No.****S7 Distributed Safety V5.4 SP5 update 2 programming tool****Task:**

Configuration software for configuring fail-safe user programs for SIMATIC S7-300F, S7-400F, WinAC RTX F, ET 200S, ET 200M, ET 200iSP, ET 200pro, ET 200eco, ET 200SP

Requirement:

Windows 7 SP1 (64-bit)
Windows 10 Professional/Enterprise (64-bit)
Windows Server 2008 R2 SP1 (64-bit)
Windows Server 2012 R2 (64-bit),
Windows Server 2016 (64-bit)
STEP 7 from V5.5 SP1

Please also consider the operating systems that have been released for the STEP 7 version used

Floating license for 1 user, software and documentation on DVD, license key on USB flash drive

6ES7833-1FC02-0YA5

Floating license for 1 user, software, documentation and license key for download¹⁾
Email address required for delivery

6ES7833-1FC02-0YH5**S7 Distributed Safety upgrade**

From V5.x to V5.4;
floating license for 1 user, software and documentation on DVD; license key on USB flash drive

6ES7833-1FC02-0YE5

¹⁾ For up-to-date information and download availability, see: <http://www.siemens.com/tia-online-software-delivery>

Software for SIMATIC Controllers

STEP 7 V5.x

Options for programming and design

Safety Integrated for Process Automation

Overview



Safety Integrated for Process Automation is the comprehensive range of products and services from Siemens for safe, fault-tolerant applications in the process industry. This is characterized by:

- Safety-related F/FH automation systems of the S7-400 series (see Catalog ST PCS 7, section "Automation Systems")
- Safe communication with the PROFIsafe profile via PROFIBUS (see section "Industrial Communication, PROFIBUS") or PROFINET (see Catalog ST PCS 7, section "Industrial Communication, PROFINET")
- Fail-safe transmitters (SITRANS P DS III) on the PROFIBUS PA with PROFIsafe (see Catalog FI 01, Field devices for process automation)
- ET 200SP HA, ET 200iSP, ET 200M, ET 200S and ET 200pro distributed I/O systems with safety-oriented F-I/O modules/submodules (see Catalog ST PCS 7, section "Process I/O" section)
- Fail-safe process instruments/devices for connection to ET 200 distributed I/O systems (see Catalog FI 01, section Field Instruments for Process Automation)
- SIMATIC Safety Integrated software for implementation and operation of safety applications, with additional components for the Engineering System and the operator stations: SIMATIC S7 F-systems, SIMATIC S7 Safety Matrix
- Special applications, for example, Partial Stroke Test
- Safety lifecycle management with support by highly qualified solution partners: services for all phases in the lifecycle of a safety instrumented system (analysis, implementation, and operation)

Design

Single-channel, non-redundant configuration

Distributed I/O and direct fieldbus interfacing

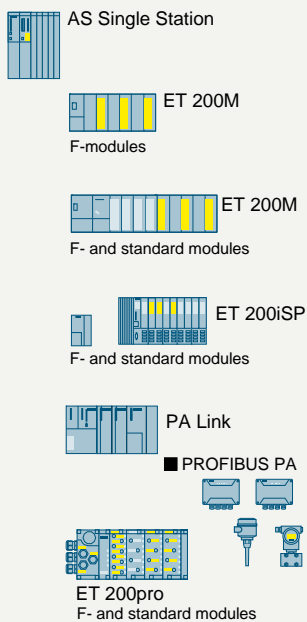

Redundant, high-availability and fault-tolerant configuration

Distributed I/O

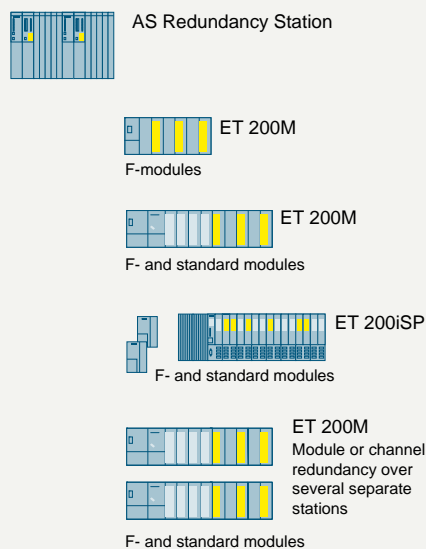

Flexible Modular Redundancy at module or device level

Direct fieldbus interfacing

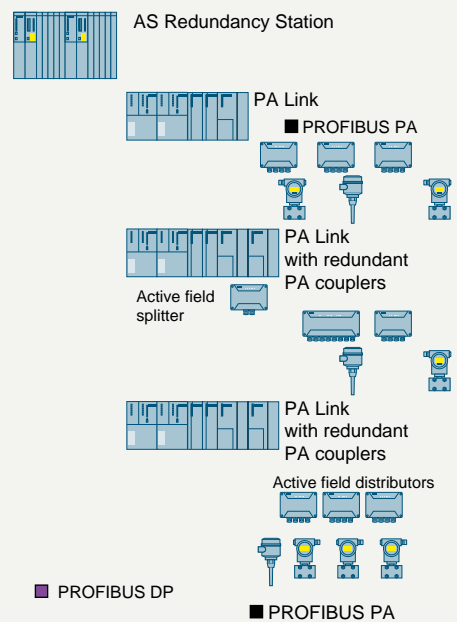

G_PCS7_XX_00130

Safety-related design versions with PROFIBUS

Design

The PROFIsafe profile allows safety-related communication between the automation system (controller) and the process I/O via either PROFIBUS or PROFINET. The decision for choosing either PROFINET IO or the PROFIBUS DP/PA fieldbuses has a significant influence on the architecture of the safety-related system.

Safety-related design versions with PROFIBUS

In the case of a safety-related system with PROFIBUS communication integrated into SIMATIC PCS 7, a distinction is made across all architecture levels between two design versions:

- Single-channel, non-redundant design
- Redundant, fault-tolerant design

Both design versions are extremely variable, and offer a large scope for different customer requirements. Standard automation (basic process control) and safety-related functions can be combined flexibly, not only in the area of distributed I/O. Even at the controller level, they can be combined in one system or separated. In addition, there are numerous possibilities arising from the use of flexible modular redundancy.

At the individual architectural levels (controller, fieldbus, I/O), you have the configuration alternatives shown in the figure in line with the I/O used (ET 200SP HA, ET 200iSP, ET 200M and ET 200pro remote I/O stations or PROFIBUS PA devices with PA profile 3.0 or higher).

Safety-related design versions with PROFINET

Safety-related AS single stations (F systems) and AS redundancy stations (FH systems) from the S7-400 range can be networked simply and effectively with ET 200M remote I/O stations via PROFINET IO. For this purpose, the PN/IE interface integrated in the CPU and the corresponding PROFINET interface module in the remote I/O stations (e.g. IM 155-6 PN HA for ET 200SP HA) are available on the automation system side.

The availability of the I/O devices on an AS Single Station (F-system) can be increased by a ring topology with media redundancy. If the transmission link in the ring is interrupted at one point, for example, due to a break in the ring cable or the failure of a station, the redundancy manager then immediately activates the alternative communication path.

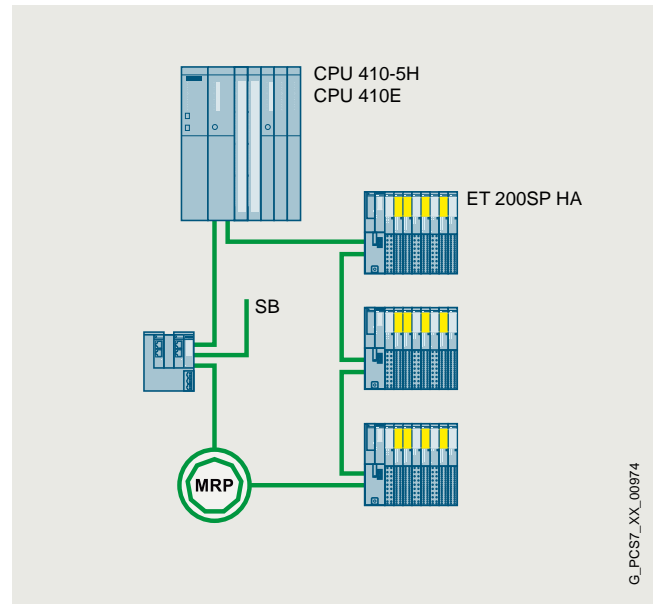

Safety-related PROFINET IO communication with media redundancy

The maximum availability with minimum error handling times is achieved by the AS Redundancy Station (FH system) in conjunction with the redundant PROFINET configuration R1. From the CPUs of the H system onwards, the R1 devices are connected via two separate line structures. In order to increase availability, we recommend reverse cabling (as shown in the blueprint). In contrast to the single-sided I/O device connection to only one CPU, failure of a CPU in this case does not automatically lead to failure of the connected I/O devices.

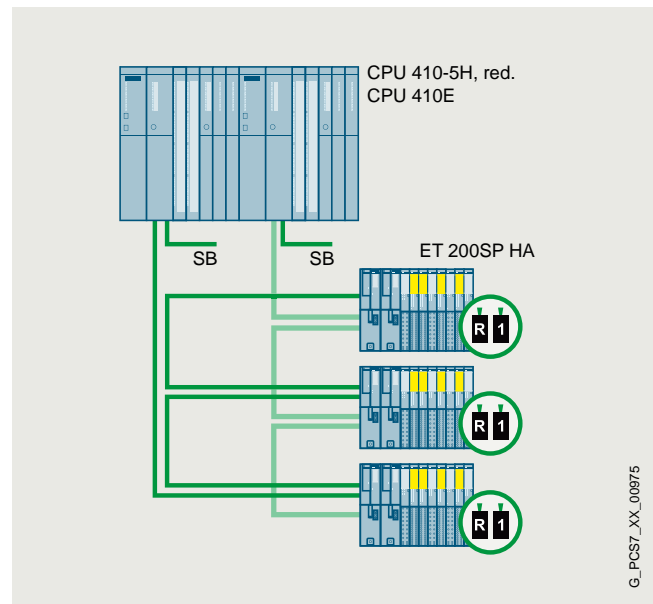

Safety-related PROFINET IO communication with system redundancy

Software for SIMATIC Controllers

STEP 7 V5.x

Options for programming and design

Safety Integrated for Process Automation > SIMATIC S7 F Systems

Overview

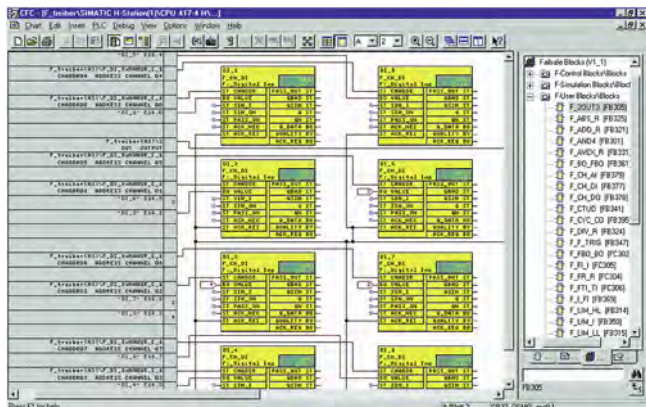

The SIMATIC S7 F Systems engineering tool for configuration of safety-related SIMATIC PCS 7 automation systems and

safety-related F-modules from the ET 200 range is integrated in the SIMATIC Manager. SIMATIC S7 F Systems are based on pre-configured and German Technical Inspectorate certified blocks. The following functions are then available:

- Parameterization of CPU and F signal modules
- Creation of safety-related applications in the CFC

Information on ordering and delivery

Installation software for the SIMATIC S7 F Systems is provided in the form of a software media package. Software media packages and product-specific software licenses are separate packages. They are not merged into a single delivery unit when supplied in package form.

The number of delivered software media packages can be determined by the number of ordered items. You can find more information under "Goods delivery" in the "Software Media and Logistics" section, subsection "PCS 7 software packages" of the ST PCS 7 Catalog.

Ordering data

Article No.

Article No.

SIMATIC S7 F Systems

SIMATIC S7 F Systems V6.4

Programming and configuration environment for creating and using safety-oriented STEP 7 programs

2 languages (English, German), software class A

Runs on the following operating systems

- Windows 10 Enterprise 2015 LTSC (64-bit), Windows 10 Enterprise 2019 LTSC 64-bit, Windows Server 2016 Standard Edition 64-bit, Windows Server 2016 Datacenter Edition 64-bit, Windows Server 2019 Standard Edition 64-bit, Windows Server 2019 Datacenter Edition 64-bit

Floating license for 1 user, without SIMATIC PCS 7 Software Media Package

- Goods delivery License key on USB flash drive and Certificate of License, bundled with 1 x SIMATIC S7 F Systems Software Media Package per order item

- Online delivery License key download and online Certificate of License combined with SIMATIC S7 F Systems Software Media Package (software download and online Certificate of License)

Note: Email address required

6ES7833-1CC46-0YA5

6ES7833-1CC46-0YH5

SIMATIC S7 F Systems Software Media Package

SIMATIC S7 F Systems Software Media Package V6.4

Installation software without license 2 languages (English, German), software class A

Runs on the following operating systems:

- Windows 10 Enterprise 2015 LTSC 64-bit, Windows 10 Enterprise 2019 LTSC 64-bit, Windows Server 2016 Standard Edition 64-bit, Windows Server 2016 Datacenter Edition 64-bit, Windows Server 2019 Standard Edition 64-bit, Windows Server 2019 Datacenter Edition 64-bit

Without SIMATIC PCS 7 Software Media Package

Note:

Can only be used in conjunction with a valid license.

- Goods delivery Software on DVD and Certificate of License

- Online delivery Software download and online Certificate of License

Note: Email address required!

6ES7833-4CC46-0YT8

6ES7833-4CC46-0YG8

Upgrades for SIMATIC S7 F Systems

See "Upgrades for Safety Integrated for Process Automation" in section "Update/upgrade packages", "Updates/upgrades asynchronous to the PCS 7 version".

Note:

With a SIMATIC S7 F Systems Upgrade from V5.x to V6.x, the type of SIMATIC S7 F Systems License changes from single license to floating license.

Overview

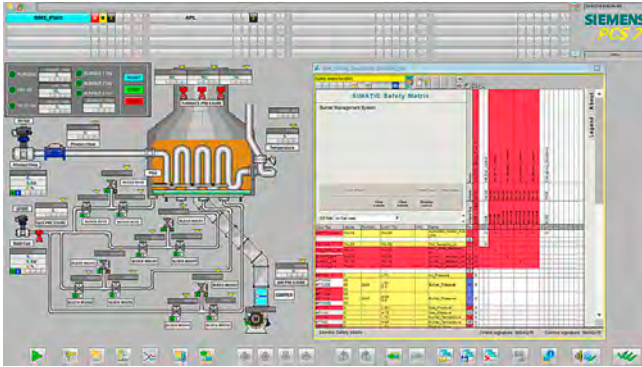

Process image of an operator station with the SIMATIC S7 Safety Matrix Viewer displayed

The SIMATIC S7 Safety Matrix, which can be used in addition to the CFC, is an innovative safety lifecycle tool from Siemens that can be used not only for user-friendly configuration of safety applications, but also for their operation and service. The tool, which is based on the proven principle of a cause & effect matrix, is ideally suited to processes where defined states require specific safety reactions.

The SIMATIC S7 Safety Matrix means that programming of the safety logic is not only significantly simpler and more convenient, but also much faster than conventional processes. During the risk analysis of a plant, the configuration engineer can assign precisely defined reactions (effects) to events (causes) which may occur during a process.

Information on ordering and delivery

Installation software for the SIMATIC S7 Safety Matrix is provided in the form of a software media package. Software media packages and product-specific software licenses are separate packages, which are not merged into a single package item for a goods delivery.

The number of delivered software media packages can be determined by the number of ordered items. You can find more information under "Goods delivery" in the "Software Media and Logistics" section, subsection "PCS 7 software packages" in the ST PCS 7 Catalog.

Ordering data

Article No.

Article No.

SIMATIC S7 Safety Matrix

Runs with the following operating systems (see SIMATIC S7 Safety Matrix V6.3 Readme for the latest information):

- On engineering station under:
 - MS Windows 7 SP1 (64-bit) (Ultimate, Enterprise, Professional)
 - MS Windows 10 Enterprise 2015 LTSC
 - MS Windows 10 Enterprise 2019 LTSC
 - MS Windows Server 2008 R2 SP1
 - MS Windows Server 2012 R2 Standard
 - MS Windows Server 2016 Standard
 - MS Windows Server 2019 Standard
- On operator station (for Safety Matrix Viewer) under:
 - MS Windows 7 Ultimate SP1 (32-bit)
 - MS Windows 7 SP1 (64-bit) (Ultimate, Enterprise, Professional)
 - MS Windows 10 Enterprise 2015 LTSC
 - MS Windows 10 Enterprise 2019 LTSC
 - MS Windows Server 2008 R2 SP1
 - MS Windows Server 2012 R2 Standard
 - MS Windows Server 2016 Standard
 - MS Windows Server 2019 Standard

SIMATIC S7 Safety Matrix Tool V6.3

Creation, configuration, compilation and loading of the SIMATIC S7 Safety Matrix as well as operator control and monitoring in a SIMATIC PCS 7 environment

2 languages (German, English), software class A, floating license for 1 user

Without SIMATIC PCS 7 Software Media Package

- Goods delivery
License key on USB flash drive and Certificate of License, bundled with 1 x SIMATIC S7 Safety Matrix Software Media Package per order item
- Online delivery
License key download and online Certificate of License, combined with SIMATIC S7 Safety Matrix Software Media Package (software download and online Certificate of License)
Note:
Email address required; installation software also available separately as SIMATIC S7 Safety Matrix Software Media Package.

6ES7833-1SM03-0YA5

6ES7833-1SM03-0YH5

Software for SIMATIC Controllers

STEP 7 V5.x

Options for programming and design

Safety Integrated for Process Automation > SIMATIC S7 Safety Matrix

Ordering data	Article No.	Article No.
<p>SIMATIC S7 Safety Matrix Viewer V6.3 For operator control and monitoring of the SIMATIC S7 Safety Matrix via OS Single Station/OS Client</p> <p>Runtime software, 2 languages (German, English), software class A, floating license for 1 user</p> <p>Without SIMATIC PCS 7 Software Media Package</p> <ul style="list-style-type: none"> • Goods delivery License key on USB flash drive and Certificate of License, bundled with 1 x SIMATIC S7 Safety Matrix Software Media Package per order item • Online delivery License key download and online Certificate of License, combined with SIMATIC S7 Safety Matrix Software Media Package (software download and online Certificate of License) Note: Email address required; installation software also available separately as SIMATIC S7 Safety Matrix Software Media Package. 	<p>6ES7833-1SM63-0YA5</p> <p>6ES7833-1SM63-0YH5</p>	<p>SIMATIC S7 Safety Matrix Software Media Package</p> <p>SIMATIC S7 Safety Matrix Software Media Package V6.3 (incl. SP) Installation software without license, 2 languages (German, English), software class A</p> <p>Without SIMATIC PCS 7 Software Media Package</p> <p>Note: Can only be used in conjunction with a valid license.</p> <ul style="list-style-type: none"> • Goods delivery Software on DVD and Certificate of License • Online delivery Software download and online Certificate of License Note: Email address required! <p>Upgrades for SIMATIC S7 Safety Matrix Tool and SIMATIC S7 Safety Matrix Viewer See "Safety Integrated Upgrades for Process Automation", chapter "Update/upgrade packages", section "Updates/upgrades asynchronous to the PCS 7 version"</p>
		<p>6ES7833-4SM36-0YT8</p> <p>6ES7833-4SM36-0YG8</p>

Technical specifications

	Safety lifecycle support	Operating modes	Hardware requirements	Software requirements
SIMATIC S7 Safety Matrix Tool V6.3	Complete lifecycle: <ul style="list-style-type: none"> • Analysis phase • Implementation phase • Operation and maintenance phase 	Offline, online	SIMATIC PCS 7 with safety-related automation systems (SIMATIC S7 F Systems RT license integrated) Installation basis: SIMATIC PCS 7 Engineering Station	<ul style="list-style-type: none"> • Microsoft Windows operating system (in line with the software requirements of the SIMATIC PCS 7 version) • For offline testing: S7-PLCSIM or SIMIT • SIMATIC S7 F Systems V6.1 SP2 and higher
SIMATIC S7 Safety Matrix Viewer V6.3	Operating phase (operator control and monitoring)	Online	SIMATIC PCS 7 with safety-related automation systems (SIMATIC S7 F Systems RT license integrated) Installation basis: SIMATIC PCS 7 Operator Station, single station or client version	Microsoft Windows operating system (in line with the software requirements of the SIMATIC PCS 7 version)

System requirements for SIMATIC S7 Safety Matrix

Overview

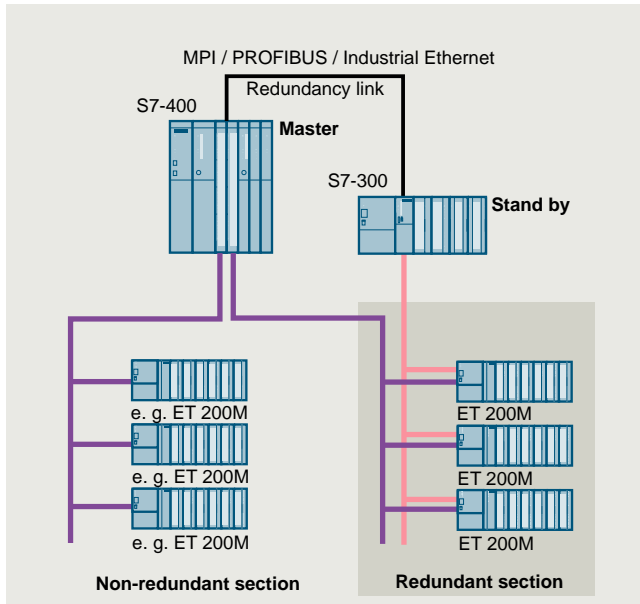

- Software package for assembling fault-tolerant control systems based on software
- Designed for control systems with single-channel distributed I/O
- For use in applications with low demands on changeover speed, such as the control of hydroelectric power plants, cooling circuits, traffic flows, level control, measured data acquisition
- Inexpensive thanks to the use of standard S7-300 and S7-400 components
- I/O linking with PROFIBUS DP in redundant configuration
- Optional control via WinCC operator station

Ordering data

Article No.

Program package software redundancy V1.2

Task:
Configuring a redundant control.
Target system:
SIMATIC S7-300, S7-400
Requirement:
STEP 7 V5.2, NCM S7 for PROFIBUS
Delivery package:
incl. electronic documentation (English, German, French, Spanish, Italian), 4 application examples and faceplate for WinCC on CD-ROM

Single license (for 2 CPUs)

Single license, without software and documentation

6ES7862-0AC01-0YA0

6ES7862-0AC01-0YA1

SIMATIC Manual Collection

Electronic manuals on DVD, multilingual:
LOGO!, SIMADYN, SIMATIC bus components, SIMATIC C7, SIMATIC distributed I/O, SIMATIC HMI, SIMATIC Sensors, SIMATIC NET, SIMATIC PC-based Automation, SIMATIC PCS 7, SIMATIC PG/PC, SIMATIC S7, SIMATIC software, SIMATIC TDC

6ES7998-8XC01-8YE0

SIMATIC Manual Collection update service for 1 year

Current "Manual Collection" DVD and the three subsequent updates

6ES7998-8XC01-8YE2

Technical specifications

Technical specifications

Hardware requirements

CPU	S7-300: CPU 313C-2 DP, 314C-2 DP, 315-2 DP, 316-2 DP, 318-2 DP S7-400: all CPUs
Redundancy link of the CPUs	MPI, PROFIBUS, Industrial Ethernet; existing connections can also be used.
Suitable modules for ET 200M	IM 153-2; all DI/O, AI/O for ET 200M; FM 350-1 counter module CP 341

Software requirements

Configuring/programming	STEP 7 V4.0
Communication configuration for redundant PROFIBUS DP	NCM S7 for PROFIBUS

Software for SIMATIC Controllers

STEP 7 V5.x

Options for programming and design

DOCPRO

Overview

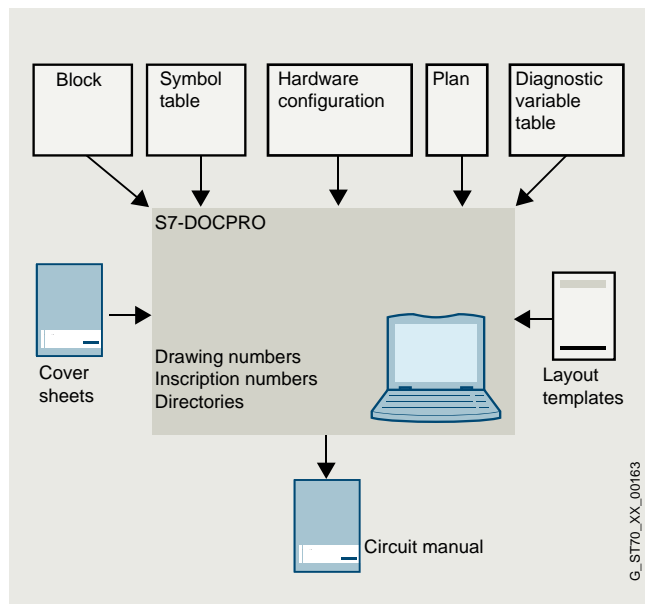

- For creating and managing plant documentation
- Permits structuring of project data, preparation in the form of wiring manuals, and uniform printouts
- For use in SIMATIC S7-300, S7-400 and C7

Licensing

- SIMATIC S7 DOCPRO is supplied with a floating license. The floating license allows installation of the software on any number of computers. This means one user per license can use the software independently of the computer used and without being tied to a certain workplace. The number of existing licenses determines the number of computers on which the software can be used simultaneously.
- A separate S7-DOCPRO update service is available for ordering.
- An upgrade to version 5.4 is available for users of previous versions.

You can find more information on the Software Update Service, license types, Online Software Delivery and handling your software licenses with the Automation License Manager here: <http://www.siemens.com/simatic-licenses>

Ordering data

Article No.

DOCPRO, Version 5.4

Task:
Creation of circuit manuals for plant documentation management

Target system:
SIMATIC S7-300, SIMATIC S7-400, SIMATIC C7

Requirement:
from STEP 7 V5.4

Delivery package:
on CD; German, English, French, Spanish, Italian;
incl. authorization diskette,
with electronic documentation

Floating license

6ES7803-0CC03-0YA5

Software Update Service
(requires current software version)¹⁾

6ES7803-0CA01-0YX2

Floating license upgrade to V5.4

6ES7803-0CC03-0YE5

SIMATIC Manual Collection

6ES7998-8XC01-8YE0

Electronic manuals on DVD, multilingual:
LOGO!, SIMADYN, SIMATIC bus components, SIMATIC C7, SIMATIC distributed I/O, SIMATIC HMI, SIMATIC Sensors, SIMATIC NET, SIMATIC PC-based Automation, SIMATIC PCS 7, SIMATIC PG/PC, SIMATIC S7, SIMATIC software, SIMATIC TDC

SIMATIC Manual Collection update service for 1 year

6ES7998-8XC01-8YE2

Current "Manual Collection" DVD and the three subsequent updates

¹⁾ For more information on the software update service, see page 12/2.

Technical specifications

Engineering tool	DOCPRO
Type of license	Floating license
Software class	A
Current version	V5.4
Target system (recommended)	SIMATIC S7-300/400 SIMATIC C7
Operating system	Windows XP Professional Windows 7 Ultimate/Professional from DOCPRO V5.4 SP1
Required software packages	STEP 7, V5.4 and higher; for operation under Windows 7 STEP 7, V5.5 and higher
Disk space required in programming device/PC	5 MB

Overview

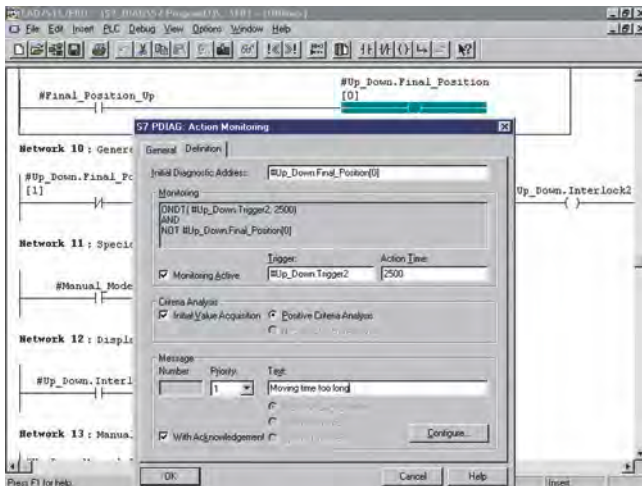

- For configuration of process diagnostics with SIMATIC S7
- Increases the availability of machines and production plants and provides supports with fault analysis and elimination on-site
- For use on the SIMATIC S7-300, S7-400

Licensing

- S7-PDIAG V5.7 is delivered with a floating license. The floating license allows installation of the software on any number of computers. This means one user per license can use the software independently of the computer used and without being tied to a certain workplace. The number of existing licenses determines the number of computers on which the software can be used simultaneously.
- An upgrade to version 5.7 is available for users of previous versions.

You can find more information on the Software Update Service, license types, Online Software Delivery and handling your software licenses with the Automation License Manager here:

<http://www.siemens.com/simatic-licenses>

Ordering data

Article No.

S7-PDIAG, Version 5.7

Task:
Configuring of process diagnostics for LAD/FBD/STL

Target system:
SIMATIC S7-300
(CPU 314 and higher);
SIMATIC S7-400

Requirement:
From STEP 7 V5.7;
under Windows Server 2016,
Windows Server 2019,
Windows 10 Professional,
Windows 10 Enterprise

Type of delivery:
on CD; German, English,
French, Spanish, Italian;
incl. authorization diskette,
with electronic documentation

Floating license

6ES7840-0CC08-0YA5

Software Update Service
(requires current software version)¹⁾

6ES7840-0CA01-0YX2

Upgrade to V5.7

6ES7840-0CC08-0YE5

SIMATIC Manual Collection

6ES7998-8XC01-8YE0

Electronic manuals on
DVD, multi-language:
LOGO!, SIMADYN,
SIMATIC bus components,
SIMATIC C7,
SIMATIC distributed I/O,
SIMATIC HMI, SIMATIC Sensors,
SIMATIC NET, SIMATIC PC-based
Automation, SIMATIC PCS 7,
SIMATIC PG/PC, SIMATIC S7,
SIMATIC Software, SIMATIC TDC

SIMATIC Manual Collection update service for 1 year

6ES7998-8XC01-8YE2

Current Manual Collection DVD and
the three subsequent updates

¹⁾ For more information on the Software Update Service, see page 12/2.

Technical specifications

Engineering tool	S7-PDIAG
Type of license	Floating license
Software class	A
Current version	V5.7
Target system (recommended)	SIMATIC S7-300 (CPU 314 or higher) SIMATIC S7-400
Operating system	Windows Server 2016, Windows Server 2019, Windows 10 Professional, Windows 10 Enterprise
Required software packages	STEP 7 V5.7 or higher
Disk space required in programming device/PC	26 MB

Software for SIMATIC Controllers

STEP 7 V5.x

Options for diagnostics and service

PRODAVE

Overview

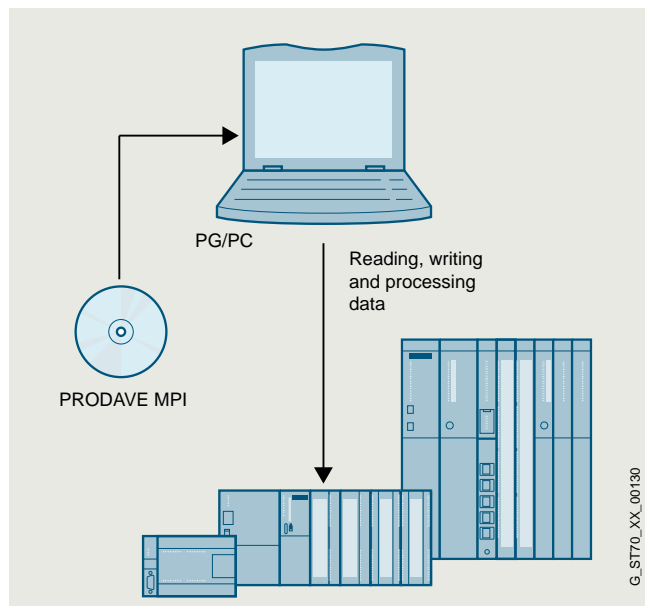

- The toolbox for exchange of process data between SIMATIC S7, SIMATIC C7 and a PG/PC
- For autonomous handling of data traffic over MPI/PPI, PROFIBUS and Industrial Ethernet

Licensing

- PRODAVE is supplied with a single license. The single license permits the software to be installed on just one computer.
- It is possible to acquire a single license without software and documentation for installation on more than one computer.

You can find more information on the Software Update Service, license types, Online Software Delivery and handling your software licenses with the Automation License Manager here:

<http://www.siemens.com/simatic-licenses>

Technical specifications

Runtime software	
Parameterization software	PRODAVE
Type of license	Simple license, copy license
Software class	A
Current version	V6.2
Target system	SIMATIC S7-200 SIMATIC S7-300 SIMATIC S7-400 SIMATIC C7
Operating system	Windows XP Professional, Windows 7 Professional and Ultimate (32 and 64-bit in each case)
Required software packages	-
Main memory configuration in target system	8 MB on PG/PC
Disk space required in PG/PC	2 MB
Standard FBs	
Required libraries	-

Ordering data

Article No.

PRODAVE MPI/IE V6.2 for Windows XP Professional, Windows 7 Professional and Ultimate (32 and 64-bit in each case)

Task:

Data link between PG/PC and SIMATIC S7/C7 via MPI (S7-200 via PPI) or Industrial Ethernet

Requirements:

Windows XP Professional, Windows 7 Professional and Ultimate (32 and 64-bit in each case); CP 5611, integrated MPI or PC adapter

Delivery package: CD incl. electr. documentation (German, English)

Single license

6ES7807-4BA03-0YA0

Copy license, without software and documentation

6ES7807-4BA03-0YA1

PRODAVE MPI Mini V6.0 for Windows 95/98/ME/NT 4.0/2000 Prof./XP Prof.

Task:

Data link between PG/PC and SIMATIC S7/C7 over MPI (S7-200 over PPI); with reduced functional scope

Requirement:

Windows 95/98/ME/NT 4.0/2000 Prof./XP Prof.; CP 5611, integrated MPI or PC adapter

Delivery package: CD incl. electr. documentation (German, English)

Single license

6ES7807-3BA01-0YA0

Copy license, without software and documentation

6ES7807-3BA01-0YA1

SIMATIC Manual Collection

6ES7998-8XC01-8YE0

Electronic manuals on DVD, multilingual: LOGO!, SIMADYN, SIMATIC bus components, SIMATIC C7, SIMATIC distributed I/O, SIMATIC HMI, SIMATIC Sensors, SIMATIC NET, SIMATIC PC Based Automation, SIMATIC PCS 7, SIMATIC PG/PC, SIMATIC S7, SIMATIC Software, SIMATIC TDC

SIMATIC Manual Collection update service for 1 year

6ES7998-8XC01-8YE2

Current "Manual Collection" DVD and the three subsequent updates

Overview

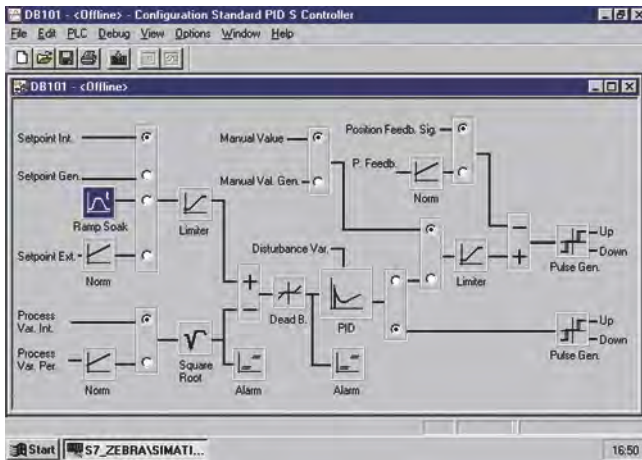

- For integrating continuous PID Controllers, pulse controllers and step controllers in the application program
- Reduces engineering costs thanks to time-saving parameterization and optimization of the controller
- For use in SIMATIC S7-300 (CPU 313 or higher), S7-400 and WinAC

Licensing

- The Standard PID Control consists of a parameterization tool (engineering software) and function blocks (runtime software).
- The engineering software can be installed on multiple computers. The number of existing licenses determines the number of computers on which the software can be used simultaneously (floating license).
- Function blocks may be copied as often as required onto any programming devices/PCs. However, one license is always required for each CPU on which they are used.

You can find more information on the Software Update Service, license types, Online Software Delivery and handling your software licenses with the Automation License Manager here:

<http://www.siemens.com/simatic-licenses>

Ordering data

Article No.

Standard PID Control parameterization tool, V5.2

Task:
Parameter assignment tool for standard controllers
Requirement:
STEP 7 V5.6 or higher
Type of delivery:
With electronic manual/Getting Started English, German; incl. authorization diskette

Floating license

6ES7830-2AA22-0YX0

Standard function blocks for Standard PID Control, V5.2

Task:
Standard FBs for standard controllers
Target system:
SIMATIC S7-300 (CPU 313 or higher), S7-400
Type of delivery:
With electronic manual/Getting Started English, German

Single license

6ES7860-2AA21-0YX0

Single license without software and documentation

6ES7860-2AA21-0YX1

SIMATIC Manual Collection

6ES7998-8XC01-8YE0

Electronic manuals on DVD, multilingual:
LOGO!, SIMADYN, SIMATIC bus components, SIMATIC C7, SIMATIC distributed I/O, SIMATIC HMI, SIMATIC Sensors, SIMATIC NET, SIMATIC PC Based Automation, SIMATIC PCS 7, SIMATIC PG/PC, SIMATIC S7, SIMATIC Software, SIMATIC TDC

SIMATIC Manual Collection update service for 1 year

6ES7998-8XC01-8YE2

Current "Manual Collection" DVD and the three subsequent updates

Software for SIMATIC Controllers

STEP 7 V5.x

Options for technology and drive systems

Loadable function blocks > Standard PID Control

Technical specifications

Parameterization software	Standard PID Control					
Type of license	Single license					
Software class	A					
Current version	V5.2 SP4					
Target system	SIMATIC S7-300 (CPU 313 or higher) SIMATIC S7-400 SIMATIC C7					
Required software packages	STEP 7 V5.6 or higher					
Main memory configuration in PG/PC	16 MB					
Disk space required in PG/PC	1.85 MB					
Standard function blocks	PID_CP (FB 1)		PID_ES (FB 2)		LP_SCHED (FC 1)	
Storage space requirements	Load memory	Work memory	Load memory	Work memory	Load memory	Work memory
• FB length in the memory	8956 bytes	7796 bytes	9104 bytes	7982 bytes	1064 bytes	976 bytes
• DB length in the memory	1168 bytes	510 bytes	1124 bytes	484 bytes	184 bytes ²⁾	100 bytes ²⁾
Runtimes						
• In S7-300 ¹⁾	0.18 - 4.4 ms		0.2 - 5.1 ms		0.03 - 0.3 ms	
• In S7-400 ¹⁾	0.13 - 0.35 ms		0.16 - 0.35 ms		0.03 - 0.08 ms	
Required libraries	Standard PID Control FBs					
Licensing forms	Simple license and 1 runtime license; 1 runtime license					
Software class	A					
Current version	V5.2 SP3					
Target system	SIMATIC S7-300 (CPU 313 or higher) SIMATIC S7-400 SIMATIC C7					
Required software packages	STEP 7 V5.6 or higher					
Main memory configuration in PG/PC	16 MB					
Disk space required in PG/PC	1.85 MB					

1) Depending on the CPU

2) With 5 control loops

Overview

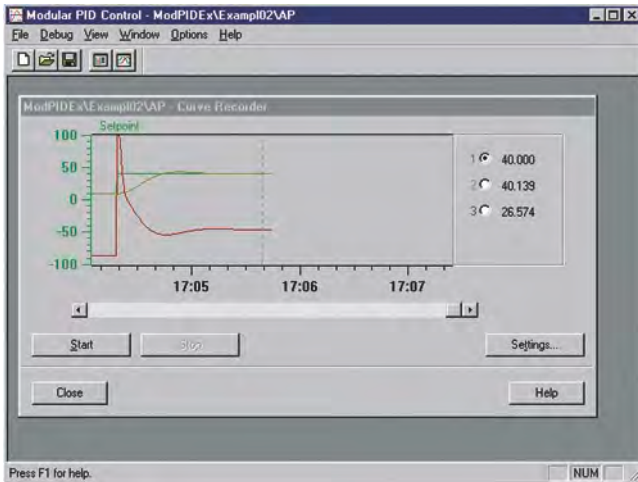

- For creating complex closed-loop control structures
- Preferred for implementation in closed-loop control equipment in mid-range and high-end applications and in process engineering
- For use in SIMATIC S7-300 (CPU 313 or higher), S7-400 and WinAC

Licensing

- The Modular PID Control consists of a parameterization tool (engineering software) and function blocks (runtime software).
- The engineering software can be installed on multiple computers. The number of existing licenses determines the number of computers on which the software can be used simultaneously (floating license).
- Function blocks may be copied as often as required onto any programming devices/PCs. However, one license is always required for each CPU on which they are used.

You can find more information on the Software Update Service, license types, Online Software Delivery and handling your software licenses with the Automation License Manager here:

<http://www.siemens.com/simatic-licenses>

Ordering data

Article No.

Modular PID Control commissioning tool, V5.1 for SIMATIC S7 and WinAC

Task:
Commissioning tool for modular PID controllers
Requirement:
STEP 7 V5.6 or higher
Type of delivery:
With electronic manual, English, German;
incl. authorization diskette

Floating license

6ES7830-1AA11-0YX0

Standard function blocks for Modular PID Control, V5.1

Task:
Standard FBs for modular PID controllers
Target system:
SIMATIC S7-300 (CPU 313 or higher), S7-400, WinAC
Type of delivery:
English, German;
with electronic manual

Single license

6ES7860-1AA10-0YX0

Single license, without software and documentation

6ES7860-1AA10-0YX1

SIMATIC Manual Collection

6ES7998-8XC01-8YE0

Electronic manuals on DVD, multilingual:
LOGO!, SIMADYN, SIMATIC bus components, SIMATIC C7, SIMATIC distributed I/O, SIMATIC HMI, SIMATIC Sensors, SIMATIC NET, SIMATIC PC-based Automation, SIMATIC PCS 7, SIMATIC PG/PC, SIMATIC S7, SIMATIC software, SIMATIC TDC

SIMATIC Manual Collection update service for 1 year

6ES7998-8XC01-8YE2

Current "Manual Collection" DVD and the three subsequent updates

Technical specifications

Parameterization software	Modular PID Control
Type of license	Single license
Software class	A
Current version	V5.1 SP4
Target system	SIMATIC S7-300 (CPU 313 or higher) SIMATIC S7-400 SIMATIC C7
Required software packages	STEP 7 V5.6 or higher
Main memory configuration in PG/PC	16 MB
Disk space required in PG/PC	1.85 MB
Processor, at least	486
Windows swap area, approx.	20 MB (max. possible)

Software for SIMATIC Controllers

STEP 7 V5.x

Options for technology and drive systems

Loadable function blocks > Modular PID Control

Technical specifications

Standard function blocks	A_DEAD_B		CRP_IN		CPR_OUT	
Storage space requirements	Load memory	Work memory	Load memory	Work memory	Load memory	Work memory
• FB length in the memory	898 bytes	692 bytes	182 bytes	70 bytes	206 bytes	96 bytes
• DB length in the memory	186 bytes	44 bytes	122 bytes	20 bytes	114 bytes	14 bytes
Runtimes in S7-300	0.13 to 0.17 ms		0.06 ms		0.18 to 0.22 ms	
Runtimes in S7-400	0.01 to 0.03 ms		0.01 to 0.02 m		0.01 to 0.04 ms	
Target system	SIMATIC S7-300 (CPU 313 and higher), S7-400, WinAC		SIMATIC S7-300 (CPU 313 and higher), S7-400, WinAC		SIMATIC S7-300 (CPU 313 and higher), S7-400, WinAC	

Standard function blocks	DEAD_T		DEAD_BAND		DIF	
Storage space requirements	Load memory	Work memory	Load memory	Work memory	Load memory	Work memory
• FB length in the memory	532 bytes	394 bytes	232 bytes	120 bytes	410 bytes	268 bytes
• DB length in the memory	142 bytes	22 bytes	114 bytes	16 bytes	158 bytes	30 bytes
Runtimes in S7-300	0.26 to 0.33 ms		0.16 to 0.21 ms		0.55 to 0.71 ms	
Runtimes in S7-400	0.02 to 0.06 m		0.01 to 0.03 ms		0.03 to 0.09 ms	
Target system	SIMATIC S7-300 (CPU 313 and higher), S7-400, WinAC		SIMATIC S7-300 (CPU 313 and higher), S7-400, WinAC		SIMATIC S7-300 (CPU 313 and higher), S7-400, WinAC	

Standard function blocks	ERR_MON		INTEG		LAG1ST	
Storage space requirements	Load memory	Work memory	Load memory	Work memory	Load memory	Work memory
• FB length in the memory	558 bytes	360 bytes	488 bytes	314 bytes	534 bytes	368 bytes
• DB length in the memory	206 bytes	52 bytes	168 bytes	36 bytes	156 bytes	30 bytes
Runtimes in S7-300	0.27 to 0.35 ms		0.40 to 0.51 ms		0.52 to 0.67 ms	
Runtimes in S7-400	0.01 to 0.05 ms		0.02 to 0.07 ms		0.03 to 0.09 ms	
Target system	SIMATIC S7-300 (CPU 313 and higher), S7-400, WinAC		SIMATIC S7-300 (CPU 313 and higher), S7-400, WinAC		SIMATIC S7-300 (CPU 313 and higher), S7-400, WinAC	

Standard function blocks	LAG2ND		LIMALARM		LIMITER	
Storage space requirements	Load memory	Work memory	Load memory	Work memory	Load memory	Work memory
• FB length in the memory	690 bytes	516 bytes	390 bytes	240 bytes	262 bytes	140 bytes
• DB length in the memory	190 bytes	46 bytes	152 bytes	28 bytes	124 bytes	20 bytes
Runtimes in S7-300	0.88 to 1.14 ms		0.47 to 0.61 ms		0.14 to 0.17 ms	
Runtimes in S7-400	0.04 to 0.16 ms		0.02 to 0.07 ms		0.03 to 0.01 ms	
Target system	SIMATIC S7-300 (CPU 313 and higher), S7-400, WinAC		SIMATIC S7-300 (CPU 313 and higher), S7-400, WinAC		SIMATIC S7-300 (CPU 313 and higher), S7-400, WinAC	

Standard function blocks	LMNGEN_C		LMNGEN_S		NONLIN	
Storage space requirements	Load memory	Work memory	Load memory	Work memory	Load memory	Work memory
• FB length in the memory	1576 bytes	1280 bytes	2578 bytes	2152 bytes	826 bytes	672 bytes
• DB length in the memory	276 bytes	80 bytes	360 bytes	110 bytes	138 bytes	18 bytes
Runtimes in S7-300	0.32 to 0.41 ms		1.16 to 1.47 ms		0.32 to 0.41 ms	
Runtimes in S7-400	0.02 to 0.06 ms		0.06 to 0.18 ms		0.02 to 0.07 ms	
Target system	SIMATIC S7-300 (CPU 313 and higher), S7-400, WinAC		SIMATIC S7-300 (CPU 313 and higher), S7-400, WinAC		SIMATIC S7-300 (CPU 313 and higher), S7-400, WinAC	

12

Technical specifications

Standard function blocks	NORM		OVERRIDE		PARA_CTL	
Storage space requirements	Load memory	Work memory	Load memory	Work memory	Load memory	Work memory
• FB length in the memory	234 bytes	122 bytes	362 bytes	214 bytes	406 bytes	232 bytes
• DB length in the memory	130 bytes	24 bytes	146 bytes	28 bytes	234 bytes	82 bytes
Runtimes in S7-300	0.33 to 0.43 ms		0.15 to 0.18 ms		0.12 to 0.15 ms	
Runtimes in S7-400	0.02 to 0.07 ms		0.01 to 0.04 ms		0.01 to 0.03 ms	
Target system	SIMATIC S7-300 (CPU 313 and higher), S7-400, WinAC		SIMATIC S7-300 (CPU 313 and higher), S7-400, WinAC		SIMATIC S7-300 (CPU 313 and higher), S7-400, WinAC	

Standard function blocks	PID		PULSEGEN		RMP_SOAK	
Storage space requirements	Load memory	Work memory	Load memory	Work memory	Load memory	Work memory
• FB length in the memory	1560 bytes	1242 bytes	1110 bytes	872 bytes	1706 bytes	1500 bytes
• DB length in the memory	340 bytes	98 bytes	190 bytes	34 bytes	212 bytes	62 bytes
Runtimes in S7-300	1.15 to 1.46 ms		0.17 to 0.20 ms		0.16 to 0.20 ms	
Runtimes in S7-400	0.06 to 0.18 ms		0.01 to 0.05 ms		0.01 to 0.04 ms	
Target system	SIMATIC S7-300 (CPU 313 and higher), S7-400, WinAC		SIMATIC S7-300 (CPU 313 and higher), S7-400, WinAC		SIMATIC S7-300 (CPU 313 and higher), S7-400, WinAC	

Standard function blocks	ROC_LIM		SCALE		SP_GEN	
Storage space requirements	Load memory	Work memory	Load memory	Work memory	Load memory	Work memory
• FB length in the memory	1242 bytes	980 bytes	136 bytes	32 bytes	658 bytes	484 bytes
• DB length in the memory	222 bytes	50 bytes	114 bytes	16 bytes	164 bytes	40 bytes
Runtimes in S7-300	0.53 to 0.68 ms		0.10 to 0.13 ms		0.27 to 0.35 ms	
Runtimes in S7-400	0.02 to 0.09 ms		0.01 to 0.02 ms		0.02 to 0.06 ms	
Target system	SIMATIC S7-300 (CPU 313 and higher), S7-400, WinAC		SIMATIC S7-300 (CPU 313 and higher), S7-400, WinAC		SIMATIC S7-300 (CPU 313 and higher), S7-400, WinAC	

Standard function blocks	SPLT_RAN		SWITCH		LP_SCHED	
Storage space requirements	Load memory	Work memory	Load memory	Work memory	Load memory	Work memory
• FB length in the memory	304 bytes	180 bytes	238 bytes	116 bytes	1104 bytes	972 bytes ¹⁾
• DB length in the memory	138 bytes	28 bytes	118 bytes	18 bytes	234 bytes	64 bytes ¹⁾
Runtimes in S7-300	0.09 to 0.11 ms		0.07 to 0.09 ms		0.28 to 0.34 ms	
Runtimes in S7-400	0.01 to 0.02 ms		0.01 to 0.03 ms		0.03 to 0.08 ms	
Target system	SIMATIC S7-300 (CPU 313 and higher), S7-400, WinAC		SIMATIC S7-300 (CPU 313 and higher), S7-400, WinAC		SIMATIC S7-300 (CPU 313 and higher), S7-400, WinAC	

¹⁾ With 5 control loops

Standard FBs in general	
Required libraries	Modular PID Control FBs
Licensing forms	Simple license and 1 runtime license; 1 runtime license
Software class	A
Current version	V5.1 SP3
Required software packages	STEP 7 V5.6 or higher
Main memory configuration in PG/PC	16 MB
Disk space required in PG/PC	1.85 MB

Software for SIMATIC Controllers

STEP 7 V5.x

Options for technology and drive systems

Loadable function blocks > PID Self-Tuner

Overview

- PID Self-Tuner: For expanding existing PID Controllers to create self-tuning PI or PID Controllers.
- Optimization of PI or PID Controllers with 3-step action (HEATING – OFF – COOLING)
- Convenient online initial setting and online adaptation during operation
- Ideally applicable to temperature controllers, but also suitable for level and flow controllers
- Can be used with SIMATIC S7-300 (CPU 313 or higher), SIMATIC S7-400 and WinAC; in combination with PID Control (integrated in STEP 7), Standard PID Control, Modular PID Control, FM 355, FM 455 as well as with any PID algorithm

Licensing

- The PID Self-Tuner complements the Standard PID Control or Modular PID Control software packages.
- Function blocks may be copied as often as required onto any programming devices/PCs. However, one license is always required for each CPU on which they are used.

You can find more information on the Software Update Service, license types, Online Software Delivery and handling your software licenses with the Automation License Manager here:

<http://www.siemens.com/simatic-licenses>

Ordering data

Article No.

PID Self-Tuner V5.1

Task:
Online tuning for PID controller
Target system:
SIMATIC S7-300
(CPU 313 or higher),
S7-400, WinAC
Type of delivery:
Standard function blocks, electronic
manual and Getting Started
English/German

Single license

6ES7860-4AA01-0YX0

Single license, without software and
documentation

6ES7860-4AA01-0YX1

SIMATIC Manual Collection

6ES7998-8XC01-8YE0

Electronic manuals on
DVD, multilingual:
LOGO!, SIMADYN,
SIMATIC bus components,
SIMATIC C7,
SIMATIC distributed I/O,
SIMATIC HMI, SIMATIC Sensors,
SIMATIC NET, SIMATIC PC-based
Automation, SIMATIC PCS 7,
SIMATIC PG/PC, SIMATIC S7,
SIMATIC software, SIMATIC TDC

SIMATIC Manual Collection update service for 1 year

6ES7998-8XC01-8YE2

Current "Manual Collection" DVD
and the three subsequent updates

Technical specifications

Parameterization software	PID Self-Tuner			
Type of license	-			
Software class	-			
Current version	-			
Target system	-			
Operating system	-			
Required software packages	-			
Main memory configuration in PG/PC	-			
Disk space required in PG/PC	-			
Standard FBs	-			
PID Self-Tuner	TUN_EC	TUN_ES		
Storage space requirements • FB length in the memory • DB length in the memory	Load memory approx. 6542 bytes 644 bytes	Work memory approx. 5956 bytes 294 bytes	Load memory 6332 bytes 638 bytes	Work memory 5714 bytes 288 bytes
Runtimes • In S7-300 • In S7-400	1.0 ms to 1.5 ms ¹⁾ 0.06 ms to 0.19 ms ¹⁾		1.0 ms to 1.5 ms ¹⁾ 0.06 ms to 0.19 ms ¹⁾	
Required libraries	PID Self-Tuner FBs V5.1			
Licensing forms	-			
Software class	A			
Current version	V5.1 SP3			
Target system	SIMATIC S7-300 (CPU 313 or higher) SIMATIC S7-400 SIMATIC C7-620			
Required software packages	STEP 7 V5.6 or higher			
Main memory configuration in PG/PC	-			
Disk space required in PG/PC	-			

¹⁾ Depending on the CPU selected

Overview

- Option package for creating Motion Control applications for CPU 31xT and CPU 317TF
- Optimal embedding in the automation world thanks to total integration in the STEP 7 tools
- Programming in the standard SIMATIC programming languages LAD, FBD and STL
- Additional engineering tools such as S7-SCL or S7-GRAPH can be used

Licensing

- The engineering software can be installed on multiple computers. The number of existing licenses determines the number of computers on which the software can be used simultaneously (floating license).

You can find more information on the Software Update Service, license types, Online Software Delivery and handling your software licenses with the Automation License Manager here:

<http://www.siemens.com/simatic-licenses>

Ordering data**Article No.****S7 Technology V4.2**

Task:

Option package for configuring and programming technology tasks with SIMATIC S7 CPU 31xT and SIMATIC S7 CPU 317TF

Requirement:

STEP 7 V5.6 and higher

Type of delivery:

On DVD

Incl. documentation for CPU 31xT, CPU 317TF (included on DVD)

Floating license

Floating license for 1 user, license key download without software or documentation¹⁾; Email address required for delivery

6ES7864-1CC42-0YA5**6ES7864-1CC42-0XH5**

¹⁾ For up-to-date information and download availability, see: <http://www.siemens.com/tia-online-software-delivery>

Software for SIMATIC Controllers

STEP 7 V5.x

Options for technology and drive systems

Easy Motion Control

Overview



- Low-priced package for simple, controlled positioning and simple geared synchronous motion
- For use with any standard variable-speed drive, such as frequency converter or servo drive
- For incremental and absolute encoders

Licensing

- The engineering interface for STEP 7 up to V5.5 is included in Easy Motion Control V2.1 and can be installed without license.
- The function blocks of Easy Motion Control require one runtime license for each CPU onto which they are loaded. Easy Motion Control V2.1 includes a runtime single license; other licenses can be ordered separately.

You can find more information on the Software Update Service, license types, Online Software Delivery and handling your software licenses with the Automation License Manager here:

<http://www.siemens.com/simatic-licenses>

Note of product versions

Easy Motion Control is an option for STEP 7 V5.x or STEP 7 Professional 2010/17 for controllers of the SIMATIC S7-300/S7-400 series and WinAC. When using STEP 7 (TIA Portal) to program these controllers, you require the optional package Easy Motion Control (TIA Portal)

Ordering data

Article No.

Easy Motion Control V2.1

6ES7864-0AC01-0YX0

Requirement:
STEP 7 V5.3 SP2 up to V5.5
Type of delivery:
Software and documentation in
2 languages (English, German)
on CD and CoL for one runtime
single license

Easy Motion Control Runtime License

6ES7864-0AF01-0YX0

Type of delivery:
CoL for one runtime single
license (valid for Easy Motion
Control V2.x and V11 or higher),
without software or documentation

Technical specifications

Supported hardware:

Easy Motion Control is runnable on the following CPUs:

- S7-300.
- S7-400.
- WinAC.
- ET 200S.
- ET 200pro.

Supported modules for the measuring of actual values:

- CPU 314C (FW version 2.0 of the CPU or higher).
- ET 200S 1 Count 5V/500 kHz.
- ET 200S 1 Count 24V/100kHz.
- ET 200S 1SSI.
- SM 338.
- FM 350-1, FM 450-1.
- SIMODRIVE Sensor with PROFIBUS DP.
- IM 174.
- Other modules for measuring actual values (using free driver).

Supported modules for setpoint output:

- ET 200S 2AO U.
- SM 332.
- SM 432.
- IM 174.
- Other modules for setpoint output (using free driver).

Supported drives using PROFIBUS DP:

- Micromaster 4.
- SINAMICS G120.
- SINAMICS S120.

Storage space requirements

Required work memory in bytes		
Block	Required work memory per block	Additional work memory required per instance
MC_Init	1086	-
MC_MoveAbsolute	3924	112
MC_MoveRelative	2982	110
MC_MoveJog	3110	110
MC_Home	2886	104
MC_StopMotion	1114	70
MC_Control	1756	58
MC_Simulation	410	64
MC_GearIn	3476	128
Input driver	1416 ... 2654	76 ... 128
Output driver	384 ... 1242	52 ... 68
Axis data block	-	294

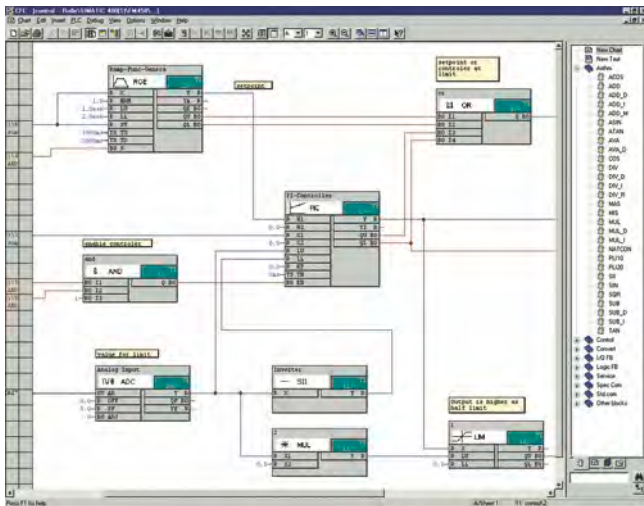
Overview

- Optional package for STEP 7 V5.6 SP2 or STEP 7 V5.7 for configuring closed-loop control and automation tasks with SIMATIC TDC and FM 458-1 DP
- Extensive block library
- Generation of user libraries in ANSI C with D7-FB-GEN function block generator

Licensing

- D7-SYS is delivered with a floating license. The floating license allows installation of the software on any number of computers. This means one user per license can use the software independently of the computer used and without being tied to a certain workplace. The number of existing licenses determines the number of computers on which the software can be used simultaneously.
- An upgrade to version 9.1 is available for users of previous versions from V8.1.
- A separate Software Update Service can be purchased for D7-SYS.
- As of version 8.1, the D7-FB-GEN block generator that was previously sold separately is included in the D7-SYS scope of delivery.

You can find more information on the Software Update Service, license types, Online Software Delivery and handling your software licenses with the Automation License Manager here:

<http://www.siemens.com/simatic-licenses>

Ordering data**Article No.****SIMATIC D7-SYS V9.1**

Reference hardware:

SIMATIC TDC, FM 458-1 DP

Requirement:

MS Windows 10 Pro and Enterprise (64 bit);

MS Windows Server 2016 Standard

Edition (64 bit);

MS Windows Server 2019 Standard

Edition (64 bit);

STEP 7 V5.6 SP2 or STEP 7 V5.7

Type of delivery:

On DVD, en, de, with electronic

documentation

Floating license

Upgrade license from V8.1 to V9.1

Software Update Service¹⁾

6ES7852-0CC07-0YA5

6ES7852-0CC07-0YE5

6ES7852-0CC01-0YL5

¹⁾ For more information on the Software Update Service, see page 12/2.

Software for SIMATIC Controllers

STEP 7 V5.x

Options for technology and drive systems

Drive ES engineering software

Overview

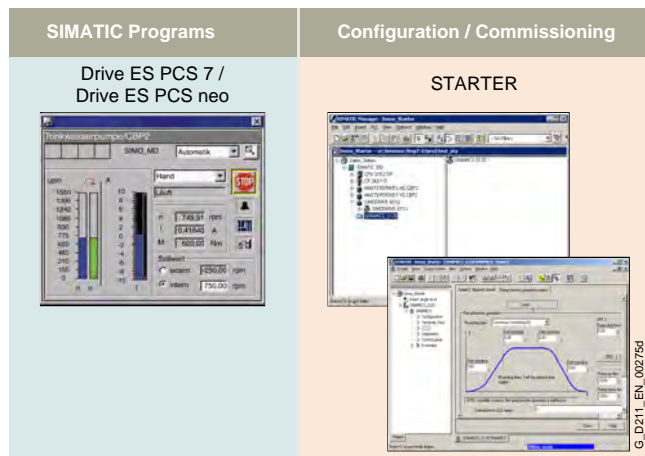

Drive ES/STARTER is the engineering system used to integrate the communication, configuration and data management functions of Siemens drive technology into the SIMATIC automation world easily, efficiently and cost-effectively.

The following software packages are available for selection:

- STARTER
- Drive ES PCS 7 / Drive ES PCS neo

The Drive ES (**Drive Engineering Software**) fully integrates drives from Siemens into the world of Totally Integrated Automation (STEP 7 V5.x).

Ordering data

Article No.

Article No.

Drive ES PCS 7 V8.2 SPx ¹⁾

Block library for PCS 7 for the integration of drives in Classic Style (as predecessor)

Requirement:

PCS 7 V8.2 and higher

Type of delivery:

CD-ROM

Languages:

en, de, fr, it, es

With electronic documentation

- Single-user license incl. 1 runtime license
- Runtime license (without data storage medium)
- Update service for single-user license
- Upgrade from V6.x/V7.x/V8.x to V8.2 SPx ¹⁾

6SW1700-8JD00-2AA0

6SW1700-5JD00-1AC0

6SW1700-0JD00-0AB2

6SW1700-8JD00-2AA4

Drive ES PCS 7 APL V8.2 SPx ¹⁾

Block library for PCS 7 for the integration of drives in APL Style (Advanced Process Library)

Requirement:

PCS 7 V8.2 and higher

Type of delivery: CD-ROM

Languages:

en, de, fr, it, es

With electronic documentation

- Single-user license incl. 1 runtime license
- Runtime license (without data storage medium)
- Update service for single-user license
- Upgrade of APL V8.x to V8.2 SPx ¹⁾ or Drive ES PCS 7 V6.x, V7.x, V8.x classic to Drive ES PCS 7 APL V8.2 SPx ¹⁾

6SW1700-8JD01-2AA0

6SW1700-5JD00-1AC0

6SW1700-0JD01-0AB2

6SW1700-8JD01-2AA4

Drive ES PCS 7 V9.0 SPx ¹⁾

Block library for PCS 7 for the integration of drives in Classic Style (as predecessor)

Requirement:

PCS 7 V9.0 or higher

Type of delivery: CD-ROM

Languages:

en, de, fr, it, es

With electronic documentation

- Single-user license incl. 1 runtime license
- Runtime license (without data storage medium)
- Update service for single-user license
- Upgrade from V6.x/V7.x/V8.x/V9.x to V9.0 SPx ¹⁾

6SW1700-1JD00-0AA0

6SW1700-5JD00-1AC0

6SW1700-0JD00-0AB2

6SW1700-1JD00-0AA4

Drive ES PCS 7 APL V9.0 SPx ¹⁾

Block library for PCS 7 for the integration of drives in APL Style (Advanced Process Library)

Requirement:

PCS 7 V9.0 or higher

Type of delivery:

CD-ROM

Languages:

en, de, fr, it, es

With electronic documentation

- Single-user license incl. 1 runtime license
- Runtime license (without data storage medium)
- Update service for single-user license
- Upgrade of APL V8.x, V9.x to V9.0 SPx ¹⁾ or Drive ES PCS 7 V6.x, V7.x, V8.x, V9.x classic to Drive ES PCS 7 APL V9.0 SPx ¹⁾

6SW1700-1JD01-0AA0

6SW1700-5JD00-1AC0

6SW1700-0JD01-0AB2

6SW1700-1JD01-0AA4

Drive ES PCS 7 V9.1 SPx ¹⁾

Block library for PCS 7 for the integration of drives in Classic Style (as predecessor)

Requirement:

PCS 7 V9.1 or higher

Type of delivery:

CD-ROM

Languages:

en, de, fr, it, es

With electronic documentation

- Single-user license incl. 1 runtime license
- Runtime license (without data storage medium)
- Update service for single-user license
- Upgrade from V6.x/V7.x/V8.x/V9.x to V9.1 SPx ¹⁾

6SW1700-2JD00-0AA0

6SW1700-5JD00-1AC0

6SW1700-0JD00-0AB2

6SW1700-2JD00-0AA4

¹⁾ Orders are automatically supplied with the latest Service Pack (SP).

Ordering data	Article No.	Article No.
<p>Drive ES PCS 7 APL V9.1 SPx ^{*)} Block library for PCS 7 for the integration of drives in APL Style (Advanced Process Library) Requirement: PCS 7 V9.1 or higher Type of delivery: CD-ROM Languages: en, de, fr, it, es With electronic documentation</p> <ul style="list-style-type: none"> • Single-user license incl. 1 runtime license • Runtime license (without data storage medium) • Update service for single-user license • Upgrade of APL V8.x, V9.x to V9.1 SPx ^{*)} or Drive ES PCS 7 V6.x, V7.x, V8.x, V9.x classic to Drive ES PCS 7 APL V9.1 SPx ^{*)} 	<p>6SW1700-2JD01-0AA0</p> <p>6SW1700-5JD00-1AC0</p> <p>6SW1700-0JD01-0AB2</p> <p>6SW1700-2JD01-0AA4</p>	<p>Drive ES PCS neo V3.0 / V3.1 Block library for SIMATIC PCS neo for the integration of SINAMICS drives Requirement: PCS neo V3.0 or higher Type of delivery V3.0: The SINAMICS library is a component of the SIMATIC PCS neo V3.0 product. Type of delivery V3.1: Integration via the import of a SINAMICS device type file (product support). License reference for the license code and the Certificate of License for the Drive ES PCS neo SINAMICS library via OSD Languages: de, en</p> <hr/> <p><u>License for the Drive ES PCS neo SINAMICS library (engineering and runtime software)</u></p> <p>Floating license for 1 engineering user on the engineering server A runtime license for a PCS neo Controller (single license for 1 installation)</p> <hr/> <p><u>Runtime license Drive ES PCS neo SINAMICS library</u></p> <p>To execute the function blocks for a SIMATIC PCS neo Controller Language-neutral, single license for 1 installation Type of delivery: Electronic Certificate of License (OSD)</p>
		<p>6SW1700-1JE01-0AH0</p> <hr/> <p>6SW1700-1JE00-1AH0</p>

^{*)} Orders are automatically supplied with the latest Service Pack (SP).

Software for SIMATIC Controllers

Software for common tasks

For network planning/commissioning

SINETPLAN 2.0 network planning

Overview

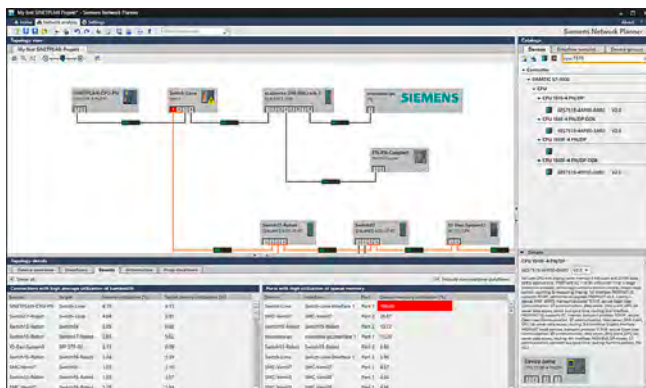

SINETPLAN topology view

The SINETPLAN Siemens Network Planner

- supports planners of automation systems based on PROFINET and
- facilitates the professional and proactive simulation of a plant/system network.

Licenses

- The engineering software can be installed on multiple computers. The number of existing licenses determines the number of computers on which the software can be used simultaneously (floating license).

You can find more information on the Software Update Service, license types, Online Software Delivery and handling your software licenses with the Automation License Manager here:

<http://www.siemens.com/simatic-licenses>

Ordering data

Article No.

Siemens Network Planner SINETPLAN V2.0

Software for simulating PROFINET networks; 3 languages en/de/zh, executable under Windows 7 and Windows 10 (64-bit each)

- Floating license; software and documentation on DVD, license key on USB flash drive
- Floating license; software download incl. license key¹⁾
Email address required for delivery

6ES7853-0AA01-0YA5

6ES7853-0AE01-0YA5

Siemens Network Planner SINETPLAN Upgrade V2.0

Software for simulating PROFINET networks; upgrade from V1.x to V2.0; 3 languages en/de/zh, executable under Windows 7 and Windows 10 (64-bit each)

- Floating license; software and documentation on DVD, license key on USB flash drive
- Floating license; software download incl. license key¹⁾
Email address required for delivery

6ES7853-0AA01-0YE5

6ES7853-0AE01-0YE5

¹⁾ For up-to-date information and download availability, see: <https://support.industry.siemens.com/cs/ww/en/view/109763136>

Technical specifications

SINETPLAN V2.0 can be used on the following operating systems (64-bit each):

- Microsoft Windows 7 Professional SP1
- Microsoft Windows 7 Enterprise SP1
- Microsoft Windows 7 Ultimate SP1
- Microsoft Windows 10 Home Version 1809
- Microsoft Windows 10 Pro Version 1809
- Microsoft Windows 10 Enterprise Version 1809

Overview

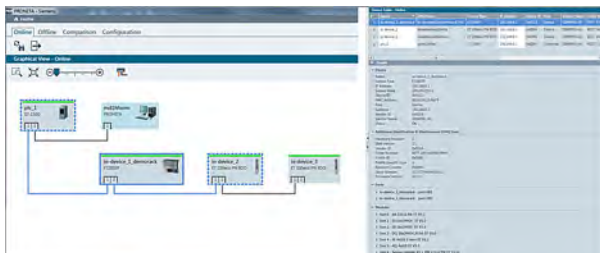

PRONETA Professional

Asset management and diagnostics with PRONETA Professional

With PRONETA Professional, the network can be scanned automatically at regular intervals and the real plant configuration can thereby be documented transparently. This allows for new opportunities and for better planning of maintenance and servicing which, in turn, optimizes plant operation. This prevents undesired situations, such as a missing, compatible spare part, during maintenance and service. This increases production availability.

In addition, with PROFlenergy diagnostics, device statuses can be recognized or the mode can be changed. The measured values can also be displayed for devices with the PROFlenergy metering function. Furthermore, the data record wizard provides the option of sending PROFINET data records to PROFINET devices via acyclic communication.

Licenses

- The software can be installed on one computer (single license).

You can find more information on the Software Update Service, license types, Online Software Delivery and handling your software licenses with the Automation License Manager here:

<https://www.siemens.com/simatic-licenses>

Ordering data

PRONETA Professional V1.1

Software for asset management with API, PROFlenergy diagnostics, data record wizard; 2 languages en/de, can be run under Windows 7 (32-bit and 64-bit) and Windows 10 (64-bit)

Single license; software, documentation and license for download

Single license upgrade from V1.0 to V1.1; software, documentation and license for download

Article No.

6ES7853-2BE01-0YA0

6ES7853-2BE01-0YE0

Technical specifications

PRONETA Professional V1.1 can be used on the following operating systems:

- Microsoft Windows 7 (32-bit and 64-bit)
 - Microsoft Windows 7 Professional SP1
 - Microsoft Windows 7 Enterprise SP1
 - Microsoft Windows 7 Ultimate SP1
- Microsoft Windows 10 (64-bit):
 - Microsoft Windows 10 Home version 1809
 - Microsoft Windows 10 Pro version 1809
 - Microsoft Windows 10 Enterprise version 1809

Software for SIMATIC Controllers

Software for common tasks

For maintenance

SIMATIC Automation Tool

Overview

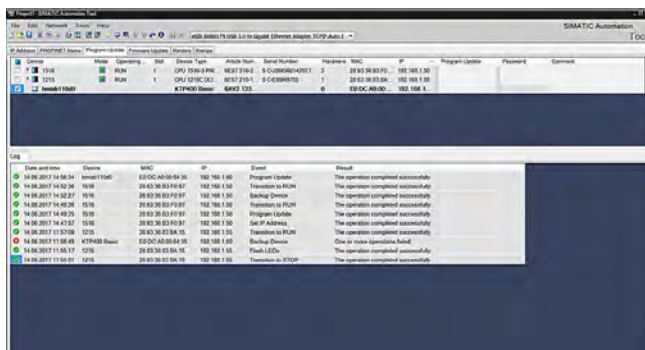

- To support commissioning and service activities independent of the engineering framework
- For configuration, operation, maintenance and documentation of automation networks
- Rapid overview of the status of the SIMATIC automation system
- Time savings thanks to parallel operations (license required)
- Optimum upgrade support for the devices used and their versions through the display of article numbers, firmware versions and HW versions
- Simple traceability of performed operations and resulting changes in the system through the optional, automatic storage of event log entries in a file
- Automated processes for optimum API-based workflows (license required)

Supported products:

- SIMATIC ET 200
 - ET 200AL IM
 - ET 200AL SM and IO-Link
 - ET 200eco
 - ET 200M IM
 - ET 200MP IM
 - ET 200S IM
 - ET 200pro IM
 - ET 200pro IO-Link and RFID
 - ET 200SP CPU
 - ET 200SP IM and server modules
 - ET 200SP SM, AS-i, CM, CP, TM, IO-Link, motor starters
- SIMATIC S7-1200
 - S7-1200 CPU
 - S7-1200 SM and CM
- SIMATIC S7-1500
 - S7-1500 CPU
 - S7-1500 SM and other modules
- SIMATIC HMI
 - HMI Basic 2nd Generation
 - HMI Comfort
 - HMI Mobile
- SITOP power supplies
- RFID and MOBY
- SCALANCE

Licenses

- The software can be installed on multiple computers. The number of existing licenses determines the number of computers on which the software can be used simultaneously (floating license).
- The following license types are provided:
 - 21-day trial license (without license key); download as registered customer from <https://support.industry.siemens.com/cs/ww/en/view/98161300>
 - SIMATIC Automation Tool – Basic scope of functions
 - SIMATIC Automation Tool Advanced – extended scope of functions, including:
 - Scheduler for planning device operations at a specific time and with selectable frequency
 - Card browser for working with files and folders on SIMATIC Memory Cards in CPUs
 - Extended options for handling SIMATIC Automation Tool projects - Archiving of SAT projects and associated file data
 - Support of devices downstream from a NAT router
 - Possibility to insert multiple devices in one operation
 - Support of CPUs connected via a CM (communications module) or CP (communications processor)
 - Firmware installation in 2 sequences - Option to download the firmware update files to devices and activate the new firmware at a later time.
- SIMATIC Automation Tool Advanced PowerPack V3/V4 upgrade to Advanced V4 - License key upgrade for activating the extended V4 functions based on an available V3/V4 license key.

You can find more information on the Software Update Service, license types, Online Software Delivery and handling your software licenses with the Automation License Manager here:

<http://www.siemens.com/simatic-licenses>

Ordering data	Article No.	Article No.
SIMATIC Automation Tool V4.0 Commissioning and service software for machines and plants; 6 languages: en, de, fr, es, it, zh; executable under Windows 10 (64-bit) Floating license; software download incl. license key ¹⁾²⁾ ; Email address required for delivery	6ES7853-1AE04-0YA5	SIMATIC Automation Tool SDK V4.0 API software and documentation for creating customer applications for commissioning and servicing machines and plants; 6 languages: en, de, fr, es, it, zh; executable under Windows 7 and Windows 10 (64-bit) Software download ¹⁾ ; Email address required for delivery SIMATIC LINUX Transfer Tool To perform commissioning and service activities on SIMATIC S7-1200 and S7-1500 independently of TIA Portal under LINUX <u>SIMATIC Transfer Tool LINUX V3</u> Software download incl. license key ¹⁾ ; Consignee email address required for delivery Single license Volume license, unlimited number of servers <u>SIMATIC Transfer Tool LINUX V4</u> Software download incl. license key ¹⁾ ; Consignee email address required for delivery Single license Volume license, unlimited number of servers
SIMATIC Automation Tool V4.0 Advanced Commissioning and service software for machines and plants with extended scope of functions (e.g. scheduler, support for devices downstream from a NAT router, archiving function for SAT projects and associated file data); 6 languages: en, de, fr, es, it, zh; executable under Windows 10 (64-bit) Floating license; software download incl. license key ¹⁾ ; Email address required for delivery	6ES7853-1AE14-0YA5	
PowerPack SIMATIC Automation Tool V3/V4 to SIMATIC Automation Tool Advanced V4 Upgrade for activating the extended V4 functions based on an available V3/V4 license key Floating license; software download incl. license key ¹⁾ ; Email address required for delivery	6ES7853-1KE04-0YA5	

¹⁾ For up-to-date information and download availability, see:
<https://support.industry.siemens.com/cs/ww/en/view/98161300>

²⁾ V3 license keys can also be used for V4, except for the Advanced functions.

Technical specifications

The SIMATIC Automation Tool can be used on the following operating systems (64-bit only):

- Windows 7 Home Premium SP1 (only V3.1)
- Windows 7 Professional SP1 (only V3.1)
- Windows 7 Enterprise SP1 (only V3.1)
- Windows 7 Ultimate SP1 (only V3.1)
- Windows 10 Home
- Windows 10 Pro
- Windows 10 Enterprise
- Windows 10 IoT Enterprise

Software for SIMATIC Controllers

Software for common tasks
For maintenance

SIMATIC PDM

Overview

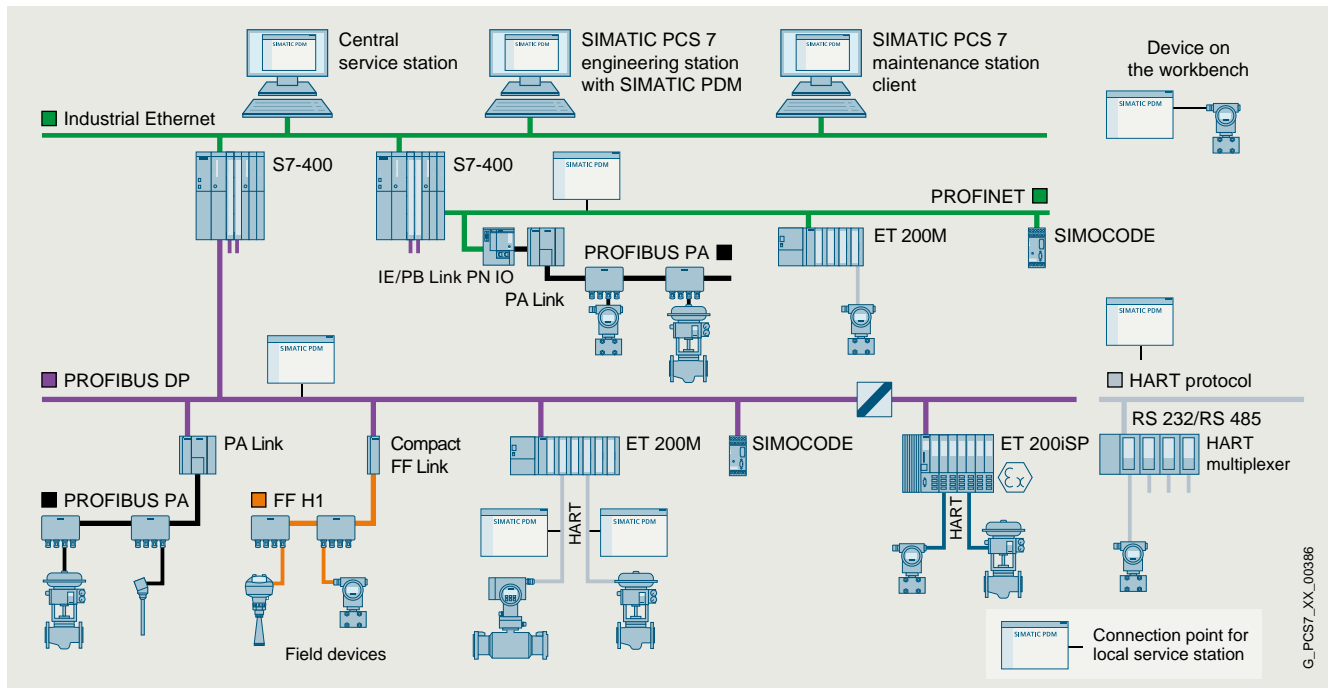

Configuration options with SIMATIC PDM

SIMATIC PDM (Process Device Manager) is a universal, vendor-independent tool for the configuration, parameter assignment, commissioning, diagnostics and servicing of intelligent field devices (sensors and actuators) and field components (remote I/Os, multiplexers, control-room devices, compact controllers), which in the following sections will be referred to simply as devices.

With *one* software product, SIMATIC PDM enables users to work with over 4 000 devices and device variants from Siemens and over 200 other manufacturers worldwide on a *single* homogeneous user interface.

The user interface satisfies the requirements of the VDI/VDE GMA 2187 and IEC 65/349/CD directives. Parameters and functions for all supported devices are displayed in a consistent and uniform fashion independent of their communications interface. Even complex devices with several hundred parameters can be represented clearly and processed quickly. Using SIMATIC PDM it is very easy to navigate in highly complex stations such as remote I/Os and even connected field devices.

From the viewpoint of device integration, SIMATIC PDM is the most powerful open process device manager on the global market. Devices not previously supported can be integrated in SIMATIC PDM by importing their device description packages (either EDD or FDI). This provides security for your investment and saves you investment costs, training expenses and follow-up costs.

SIMATIC PDM supports the operative system management in particular through:

- Uniform representation and operation of devices
- Uniform representation of diagnostics information
- Indicators for preventive maintenance and servicing
- Detection of changes in the project and device
- Increasing the operational reliability
- Reducing the investment, operating and maintenance costs
- Quantity options for
 - Transfer of parameters between devices
 - Transfer of parameter sets to the devices
 - Export and import functions
 - Diagnostics update

SIMATIC PDM can be used extremely flexibly and tailored to a specific task for field device service:

- Single-point station for point-to-point connection to field devices
- Local service and parameter assignment station with connection to fieldbus segments
- Central service and parameter assignment station with connection to plant bus
- Central HART service and parameter assignment station for HART multiplexers and WirelessHART field devices
- Integrated into the stand-alone SIMATIC PDM Maintenance Station
- Integrated into the SIMATIC PCS 7 process control system

Overview

Maintenance personnel can assign field device parameters at mobile and stationary workstations with SIMATIC PDM. Practically every workstation integrated in the production plant can be used for configuration. Service personnel are thus able to work directly at the location of the field device, while data is stored centrally in the engineering station or maintenance station. This leads to a significant shortening of maintenance and travel times. Additional device-independent system functions support higher-level maintenance stations for creating progress lists for work and servicing.

When a maintenance station is configured in the SIMATIC PCS 7 process control system, SIMATIC PDM is integrated into it and transmits parameter data, diagnostic information and processing information. You can switch directly to the SIMATIC PDM views from the diagnostics faceplates in the maintenance station to perform diagnostics and work on the device in more detail.

A SIMATIC PDM user administration system based on SIMATIC Logon is used to assign various roles with defined function privileges to users. These function privileges refer to SIMATIC PDM system functions, e.g. writing to the device.

For all devices integrated with device description packages, SIMATIC PDM provides a range of information for display and further processing on the maintenance station, for example:

- Device type information (electronic rating plate)
- Detailed diagnostics information (manufacturer information, information on error diagnostics and troubleshooting, further documentation)
- Results of internal condition monitoring functions
- Status information (for example local configuration changes), device test completed
- Information on changes (Audit Trail report)
- Parameter information

Ordering data

Article No.

SIMATIC PDM Stand alone product packages

Minimum configuration

SIMATIC PDM Single Point V9.2 including 1 TAG; product package for operation and configuration of one field device; communication via PROFIBUS DP/PA, HART (modem, RS 232, PROFIBUS/PROFINET), Modbus, Ethernet or PROFINET

Additional functions or SIMATIC PDM TAGs are not possible

6 languages (English, German, French, Italian, Spanish, Chinese), software class A, runs with Windows 10 Professional 64-bit, Windows 10 Enterprise 2019 LTSC 64-bit, for operation within the product family SIMATIC PCS 7 the specifications there take precedence, (see SIMATIC PDM V9.2 Readme for the latest information), floating license for 1 user

Without SIMATIC PCS 7 Software Media Package

- Goods delivery
License key on USB flash drive and Certificate of License, bundle with 1 x SIMATIC PDM Software Media Package per order item
- Online delivery
License key download and online Certificate of License combined with SIMATIC PDM Software Media Package (SIMATIC PDM and device library software download)
Note: Email address required!

6ES7658-3HA78-0YA5

6ES7658-3HA78-0YH5

Article No.

Basic configuration for individual product packages

SIMATIC PDM Basic V9.2

including 4 TAGs; product package for operation and configuration of field devices and components; communication via PROFIBUS DP/PA, HART (modem, RS 232, PROFIBUS/PROFINET), Modbus, Ethernet or PROFINET

6 languages (English, German, French, Italian, Spanish, Chinese), software class A, runs with Windows 10 Professional 64-bit, Windows 10 Enterprise 2019 LTSC 64-bit, for operation within the product family SIMATIC PCS 7 the specifications there take precedence, (see SIMATIC PDM V9.2 Readme for the latest information), floating license for 1 user

Without SIMATIC PCS 7 Software Media Package

- Goods delivery
License key on USB flash drive and Certificate of License, bundle with 1 x SIMATIC PDM Software Media Package per order item
- Online delivery
License key download and online Certificate of License combined with SIMATIC PDM Software Media Package (SIMATIC PDM and device library software download)
Note:
Email address required!

6ES7658-3AB78-0YA5

6ES7658-3AB78-0YH5

Software for SIMATIC Controllers

Software for common tasks

For maintenance

SIMATIC PDM

Ordering data

Article No.

Article No.

Configuration for a local service and parameter assignment station

SIMATIC PDM Service V9.2

Product package for service and measuring circuit tests on a local service station, with

- SIMATIC PDM Basic incl. 4 TAGs
- 50 TAGs

6 languages (English, German, French, Italian, Spanish, Chinese), software class A, runs with Windows 10 Professional 64-bit, Windows 10 Enterprise 2019 LTSC 64-bit, for operation within the product family SIMATIC PCS 7 the specifications there take precedence, (see SIMATIC PDM V9.2 Readme for the latest information), floating license for 1 user

Without SIMATIC PCS 7 Software Media Package

- Goods delivery
License key on USB flash drive and Certificate of License, bundle with 1 x SIMATIC PDM Software Media Package per order item
- Online delivery
License key download and online Certificate of License combined with SIMATIC PDM Software Media Package (SIMATIC PDM and device library software download)
Note: Email address required!

6ES7658-3JD78-0YA5

6ES7658-3JD78-0YH5

Configuration for a central service and parameter assignment station

SIMATIC PDM Stand-alone Server V9.2

Product package for service and device management in plant units, with

- SIMATIC PDM Basic incl. 4 TAGs
- SIMATIC PDM Extended
- SIMATIC PDM Server
- 2 x SIMATIC PDM 1 Client
- 100 TAGs

6 languages (English, German, French, Italian, Spanish, Chinese), software class A, runs with Windows 10 Professional 64-bit, Windows 10 Enterprise 2019 LTSC 64-bit, for operation within the product family SIMATIC PCS 7 the specifications there take precedence, (see SIMATIC PDM V9.2 Readme for the latest information), single license for 1 installation

Without SIMATIC PCS 7 Software Media Package

- Goods delivery
License key on USB flash drive and Certificate of License, bundle with 1 x SIMATIC PDM Software Media Package per order item
- Online delivery
License key download and online Certificate of License combined with SIMATIC PDM Software Media Package (SIMATIC PDM and device library software download)
Note: Email address required!

6ES7658-3TX78-0YA5

6ES7658-3TX78-0YH5

SIMATIC PDM system-integrated product packages

Configuration for integration in SIMATIC S7 configuration environment

SIMATIC PDM S7 V9.2

Product package for use in a SIMATIC S7 configuration environment, with

- SIMATIC PDM Basic incl. 4 TAGs
- SIMATIC PDM Extended
- SIMATIC PDM Integration in STEP 7/PCS 7
- 100 TAGs

6 languages (English, German, French, Italian, Spanish, Chinese), software class A, runs with Windows 10 Professional 64-bit, Windows 10 Enterprise 2019 LTSC 64-bit, for operation within the product family SIMATIC PCS 7 the specifications there take precedence, (see SIMATIC PDM V9.2 Readme for the latest information), floating license for 1 user

Without SIMATIC PCS 7 Software Media Package

- Goods delivery
License key on USB flash drive and Certificate of License, bundle with 1 x SIMATIC PDM Software Media Package per order item
- Online delivery
License key download and online Certificate of License combined with SIMATIC PDM Software Media Package (SIMATIC PDM and device library software download)
Note: Email address required!

6ES7658-3KD78-0YA5

6ES7658-3KD78-0YH5

Configuration for integration in SIMATIC PCS 7 configuration environment

SIMATIC PDM PCS 7 V9.2

Product package for use in a SIMATIC PCS 7 configuration environment

6 languages (English, German, French, Italian, Spanish, Chinese), software class A, runs with Windows 10 Professional 64-bit, Windows 10 Enterprise 2019 LTSC 64-bit, for operation within the product family SIMATIC PCS 7 the specifications there take precedence, (see SIMATIC PDM V9.2 Readme for the latest information)

Floating license for 1 user, with

- SIMATIC PDM Basic incl. 4 TAGs
- SIMATIC PDM Extended
- SIMATIC PDM Integration in STEP 7/PCS 7
- SIMATIC PDM Routing
- 100 TAGs

Without SIMATIC PCS 7 Software Media Package

- Goods delivery
License key on USB flash drive and Certificate of License, bundle with 1 x SIMATIC PDM Software Media Package per order item
- Online delivery
License key download and online Certificate of License combined with SIMATIC PDM Software Media Package (SIMATIC PDM and device library software download)
Note: Email address required!

6ES7658-3LD78-0YA5

6ES7658-3LD78-0YH5

Ordering data	Article No.	Article No.
<p>SIMATIC PDM PCS 7-FF V9.2 Product package for use in a SIMATIC PCS 7 configuration environment, including FOUNDATION Fieldbus H1 communication</p> <p>6 languages (English, German, French, Italian, Spanish, Chinese), software class A, runs with Windows 10 Professional 64-bit, Windows 10 Enterprise 2019 LTSC 64-bit, for operation within the product family SIMATIC PCS 7 the specifications there take precedence, (see SIMATIC PDM V9.2 Readme for the latest information)</p> <p>Floating license for 1 user, with</p> <ul style="list-style-type: none"> - SIMATIC PDM Basic incl. 4 TAGs - SIMATIC PDM Extended - SIMATIC PDM Integration in STEP 7/PCS 7 - SIMATIC PDM Routing - SIMATIC PDM Communication FOUNDATION Fieldbus - 100 TAGs <p>Without SIMATIC PCS 7 Software Media Package</p> <ul style="list-style-type: none"> • Goods delivery License key on USB flash drive and Certificate of License, bundle with 1 × SIMATIC PDM Software Media Package per order item • Online delivery License key download and online Certificate of License combined with SIMATIC PDM Software Media Package (SIMATIC PDM and device library software download) <u>Note:</u> Email address required! 	<p>6ES7658-3MD78-0YA5</p> <p>6ES7658-3MD78-0YH5</p>	<p>Optional product components for SIMATIC PDM</p> <p>SIMATIC PDM Extended V9.2 For enabling additional system functions</p> <p>6 languages (English, German, French, Italian, Spanish, Chinese), software class A, runs with Windows 10 Professional 64-bit, Windows 10 Enterprise 2019 LTSC 64-bit, for operation within the product family SIMATIC PCS 7 the specifications there take precedence, (see SIMATIC PDM V9.2 Readme for the latest information), floating license for 1 user</p> <p>Without SIMATIC PCS 7/SIMATIC PDM Software Media Package</p> <ul style="list-style-type: none"> • Goods delivery License key on USB flash drive and Certificate of License • Online delivery (without SIMATIC PCS 7/SIMATIC PDM Software Media Package) License key download and online Certificate of License <u>Note:</u> Email address required! <p>SIMATIC PDM Integration in STEP 7/SIMATIC PCS 7 V9.2 For integration in a SIMATIC S7/SIMATIC PCS 7 configuration environment</p> <p>6 languages (English, German, French, Italian, Spanish, Chinese), software class A, runs with Windows 10 Professional 64-bit, Windows 10 Enterprise 2019 LTSC 64-bit, for operation within the product family SIMATIC PCS 7 the specifications there take precedence, (see SIMATIC PDM V9.2 Readme for the latest information), floating license for 1 user</p> <p>Without SIMATIC PCS 7/SIMATIC PDM Software Media Package</p> <ul style="list-style-type: none"> • Goods delivery License key on USB flash drive and Certificate of License • Online delivery License key download and online Certificate of License <u>Note:</u> Email address required!
<p>SIMATIC PDM PCS 7 Server V9.2 Product package for use in a SIMATIC PCS 7 configuration environment, including server functionality</p> <p>6 languages (English, German, French, Italian, Spanish, Chinese), software class A, runs with Windows 10 Professional 64-bit, Windows 10 Enterprise 2019 LTSC 64-bit, for operation within the product family SIMATIC PCS 7 the specifications there take precedence, (see SIMATIC PDM V9.2 Readme for the latest information)</p> <p>Single license for 1 installation, with</p> <ul style="list-style-type: none"> - SIMATIC PDM Basic incl. 4 TAGs - SIMATIC PDM Extended - SIMATIC PDM Integration in STEP 7/PCS 7 - SIMATIC PDM Routing - SIMATIC PDM Server - 100 TAGs <p>Without SIMATIC PCS 7 Software Media Package</p> <ul style="list-style-type: none"> • Goods delivery License key on USB flash drive and Certificate of License, bundle with 1 × SIMATIC PDM Software Media Package per order item • Online delivery License key download and online Certificate of License combined with SIMATIC PDM Software Media Package (SIMATIC PDM and device library software download) <u>Note:</u> Email address required! 	<p>6ES7658-3TD78-0YA5</p> <p>6ES7658-3TD78-0YH5</p>	<p>Without SIMATIC PCS 7/SIMATIC PDM Software Media Package</p> <ul style="list-style-type: none"> • Goods delivery License key on USB flash drive and Certificate of License • Online delivery License key download and online Certificate of License <u>Note:</u> Email address required! <p>SIMATIC PDM Routing V9.2 For plant-wide navigation to field devices</p> <p>6 languages (English, German, French, Italian, Spanish, Chinese), software class A, runs with Windows 10 Professional 64-bit, Windows 10 Enterprise 2019 LTSC 64-bit, for operation within the product family SIMATIC PCS 7 the specifications there take precedence, (see SIMATIC PDM V9.2 Readme for the latest information), floating license for 1 user</p> <p>Without SIMATIC PCS 7/SIMATIC PDM Software Media Package</p> <ul style="list-style-type: none"> • Goods delivery License key on USB flash drive and Certificate of License • Online delivery License key download, online Certificate of License <u>Note:</u> Email address required!

Software for SIMATIC Controllers

Software for common tasks

For maintenance

SIMATIC PDM

Ordering data

SIMATIC PDM Server V9.2

For activating the server functionality

6 languages (English, German, French, Italian, Spanish, Chinese), software class A, runs with Windows 10 Professional 64-bit, Windows 10 Enterprise 2019 LTSC 64-bit, for operation within the product family SIMATIC PCS 7 the specifications there take precedence, (see SIMATIC PDM V9.2 Readme for the latest information), single license for 1 installation

Without SIMATIC PCS 7/SIMATIC PDM Software Media Package

- Goods delivery
License key on USB flash drive, Certificate of License
- Online delivery
License key download and online Certificate of License
Note:
Email address required!

6ES7658-3TX78-2YB5

6ES7658-3TX78-2YH5

SIMATIC PDM Communication FOUNDATION Fieldbus V9.2

For communication with field devices on FOUNDATION Fieldbus H1

6 languages (English, German, French, Italian, Spanish, Chinese), software class A, runs with Windows 10 Professional 64-bit, Windows 10 Enterprise 2019 LTSC 64-bit, for operation within the product family SIMATIC PCS 7 the specifications there take precedence, (see SIMATIC PDM V9.2 Readme for the latest information), floating license for 1 user

Without SIMATIC PCS 7/SIMATIC PDM Software Media Package

- Goods delivery
License key on USB flash drive and Certificate of License
- Online delivery
License key download and online Certificate of License
Note:
Email address required!

6ES7658-3QX78-2YB5

6ES7658-3QX78-2YH5

SIMATIC PDM HART Server V9.2

For using HART multiplexers as well as for configuration of WirelessHART field devices

6 languages (English, German, French, Italian, Spanish, Chinese), software class A, runs with Windows 10 Professional 64-bit, Windows 10 Enterprise 2019 LTSC 64-bit, for operation within the product family SIMATIC PCS 7 the specifications there take precedence, (see SIMATIC PDM V9.2 Readme for the latest information), floating license for 1 user

Without SIMATIC PCS 7/SIMATIC PDM Software Media Package

- Goods delivery
License key on USB flash drive and Certificate of License
- Online delivery
License key download and online Certificate of License
Note:
Email address required!

6ES7658-3EX78-2YB5

6ES7658-3EX78-2YH5

SIMATIC PDM Command Interface V9.2

Use of remote control of SIMATIC PDM with 1 × SIMATIC PDM 1 Client

Note: Special conditions of purchase and supply

- Goods delivery
(without SIMATIC PCS 7/SIMATIC PDM Software Media Package)
License key on USB flash drive and Certificate of License

6ES7658-3SX78-2YB5

SIMATIC PDM 1 Client

Cumulative client license for SIMATIC PDM configurations with SIMATIC PDM Server, software class A, single license for 1 installation

- Goods delivery
License key on USB flash drive and Certificate of License
- Online delivery
License key download and online Certificate of License
Note:
Email address required!

6ES7658-3UA00-2YB5

6ES7658-3UA00-2YH5

SIMATIC PDM TAGs

TAG licenses for expanding the available TAG volume, cumulative, software class A, floating license for 1 user

- Goods delivery
License key on USB flash drive and Certificate of License
 - 10 TAGs
 - 100 TAGs
 - 1 000 TAGs
- Online delivery
License key download and online Certificate of License
Note:
Email address required!
 - 10 TAGs
 - 100 TAGs
 - 1 000 TAGs

6ES7658-3XC00-2YB5

6ES7658-3XD00-2YB5

6ES7658-3XE00-2YB5

6ES7658-3XC00-2YH5

6ES7658-3XD00-2YH5

6ES7658-3XE00-2YH5

SIMATIC PDM Software Media Package

SIMATIC PDM Software Media Package V9.2

Installation software without license, 6 languages (English, German, French, Italian, Spanish, Chinese), software class A, runs with Windows 10 Professional 64-bit, Windows 10 Enterprise 2019 LTSC 64-bit, for operation within the product family SIMATIC PCS 7 the specifications there take precedence, (see SIMATIC PDM V9.2 Readme for the latest information)

Without SIMATIC PCS 7 Software Media Package

Note:
Can only be used in conjunction with a valid license or in demo mode!

- Goods delivery
SIMATIC PDM and device library software on DVD
- Online delivery
SIMATIC PDM and device library software download
Note:
Email address required!

6ES7658-3GX78-0YT8

6ES7658-3GX78-0YG8

Technical specifications**SIMATIC PDM V9.2**

Hardware	<ul style="list-style-type: none">• PG/PC/notebook with processor corresponding to operating system requirements
Operating system (alternatives)	<ul style="list-style-type: none">• Windows 10 Professional• Windows 10 Enterprise 2019 LTSC• When integrated, specifications for SIMATIC PCS 7 take precedence
Integration in STEP 7/PCS 7	<ul style="list-style-type: none">• SIMATIC PCS 7 V8.1/V8.2 (without Communication FOUNDATION Fieldbus)• SIMATIC PCS 7 V9.x
SIMATIC PDM Client	<ul style="list-style-type: none">• Microsoft Internet Explorer 10 or 11• Google Chrome

Software for SIMATIC Controllers

Software for common tasks

For administration

Central user management (UMC)

Overview

The User Management Component (UMC) provides the possibility of central user management. Through the connection to the TIA Portal, users and user groups can be defined and managed across projects. Connection to a Microsoft Active Directory is also possible.

Licensing

- Central user management (UMC) is supplied with the TIA Portal.
- The license model depends on the number of user accounts per UMC domain.
- Up to ten user accounts can be used without a license.
- For additional user accounts, 365-day rental licenses are available to accumulate the required number of centrally managed users.

Ordering data

Central user management (UMC)

Software component to implement central user management, included in the scope of supply of the respective products (e.g. TIA Portal).

The license model depends on the number of user accounts per UMC domain. Use of max. 10 user accounts possible without a license.

6 languages: en, de, fr, es, it, zh; executable under Windows 7 (64-bit), Windows 10 (64-bit), Windows Server 2012R2 (64-bit), Windows Server 2016/2019 (64-bit)

- Rental license 365 days with license certificate for 100 user accounts
- Rental license 365 days with license certificate for 4 000 user accounts

Article No.

6ES7823-1UE30-0YA0

6ES7823-1UE10-0YA0

Overview

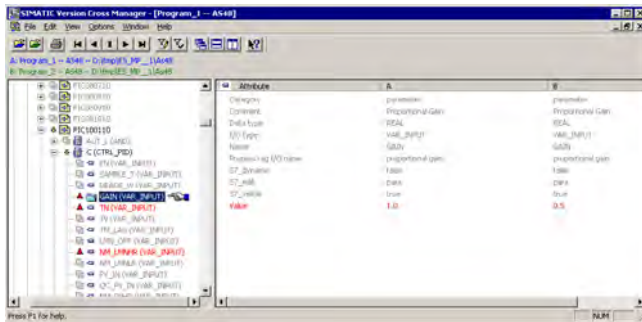

The SIMATIC Version Cross Manager is a user-friendly tool for determining the differences between various versions of individual projects or multiprojects by:

- Tracing missing, additional or differing objects by comparing hardware configuration, communication, plant hierarchy, CFC/SFC charts, SFC details, block types, messages, global tags, signals and run sequences
- Graphic display of comparison results in a combination of tree and tabular formats
- Clear hierarchical structuring according to the technological hierarchy of the plant
- Color-coded identification of the differences

Note:

As the function "Control Module adjustment" is based on a basic functionality of the Version Cross Manager (VXM), you need a VXM license to use this function. In the absence of a license, a message appears telling you to install Version Cross Manager. This is not actually necessary, all you need to install is a valid VXM license that will enable the relevant functionality on the engineering station.

Ordering data

Article No.

SIMATIC Version Cross Manager V9.0

6 languages (English, German, French, Italian, Spanish, Chinese), software class A

Runs with the following operating systems (see VXM Readme in the Siemens Industry Online Support for the latest information)

- Windows 7 Ultimate 64-bit
- Windows 10 Enterprise 2015 LTS 64-bit
- Windows Server 2012 R2 Standard Edition 64-bit
- Windows Server 2016 Standard Edition 64-bit

Floating license for 1 user, without SIMATIC PCS 7 Software Media Package

- Goods delivery
License key on USB flash drive and Certificate of License as well as TIA Engineering Toolset CD
- Online delivery
License key download, online Certificate of License and TIA Engineering Toolset (software download)
Note:
Email address required!

6ES7658-1CX58-2YA5

6ES7658-1CX58-2YH5

Upgrade package (only for TIA applications)**SIMATIC Version Cross Manager upgrade from V7.1/V8.2 to V9.0**

6 languages (English, German, French, Italian, Spanish, Chinese), software class A, for operating systems see above

Floating license for 1 user, without SIMATIC PCS 7 Software Media Package

- Goods delivery
License key on USB flash drive, Certificate of License and TIA Engineering Toolset CD
- Online delivery
License key download, online Certificate of License and TIA Engineering Toolset (software download)
Note:
Email address required!

6ES7658-1CX58-2YE5

6ES7658-1CX58-2YK5

Software for SIMATIC Controllers

Software for common tasks
For administration

Version Trail

Overview

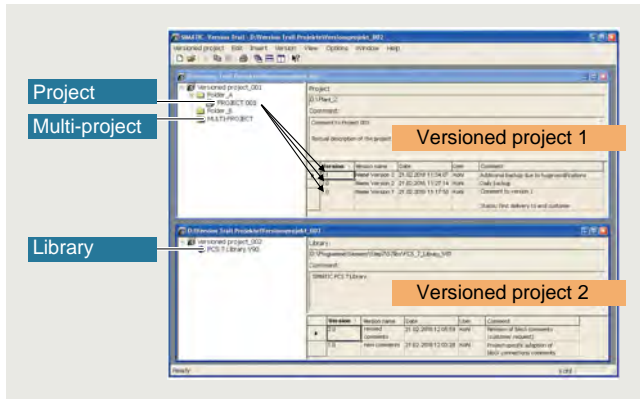

SIMATIC Version Trail is a software option for engineering which, together with the SIMATIC Logon central user administration, can assign a version history to libraries, projects and multiprojects.

Ordering data

Article No.

SIMATIC Version Trail V9.0

6 languages (English, German, French, Italian, Spanish, Chinese), software class A

Runs with the following operating systems (see VT Readme in the Siemens Industry Online Support for the latest information)

- Windows 7 Ultimate 64-bit
- Windows 10 Enterprise 2015 LTS 64-bit
- Windows Server 2012 R2 Standard Edition 64-bit
- Windows Server 2016 Standard Edition 64-bit

Floating license for 1 user, without SIMATIC PCS 7 Software Media Package

- Goods delivery
License key on USB flash drive, Certificate of License and TIA Engineering Toolset CD
- Online delivery
License key download, online Certificate of License and TIA Engineering Toolset (software download)
Note:
Email address required!

6ES7658-1FX58-2YA5

6ES7658-1FX58-2YH5

Upgrade package (only for TIA applications)

SIMATIC Version Trail Upgrade V8.x to V9.0

6 languages (English, German, French, Italian, Spanish, Chinese), software class A, for operating systems see above

Floating license for 1 user, without SIMATIC PCS 7 Software Media Package

- Goods delivery
License key on USB flash drive, Certificate of License
- Online delivery
License key download, online Certificate of License and TIA Engineering Toolset (software download)
Note:
Email address required!

6ES7658-1FX58-2YE5

6ES7658-1FX58-2YK5

SIMATIC programming devices



- 13/2** **Programming devices**
- 13/2 [Field PG M6](#)
- 13/7 [Accessories](#)
- 13/7 [External prommer](#)
- 13/8 [Communications software](#)
- 13/8 [SOFTNET for PROFIBUS](#)
- 13/10 [SOFTNET for Industrial Ethernet](#)

SIMATIC programming devices

Programming devices

Field PG M6

Overview



- The mobile, industry-standard programming device for automation engineers with a powerful, eighth-generation Intel® Core™ i processor (Coffee Lake) and high-speed RAM (DDR4 RAM)
- Elegant, robust enclosure made of light-weight stable injection-molded magnesium with rubber-protected corners and retractable carry-handle
- Can optimally be used both for engineering in the office and for the commissioning, service or maintenance of automation systems
- Industrial notebook with all commonly used interfaces for industrial applications
- Can be used immediately thanks to pre-installed SIMATIC engineering software

Ordering data

Article No.

Article No.

Field PG M6 Comfort programming device

6ES7718- 0 ■ ■ 0 ■ - ■ ■ ■ 2

Intel i5-8400H processor (8 MB Smart Cache, 2.5 to 4.2 GHz, 4 cores + Hyper-Threading), 15.6" display, Full HD (1920x1280), DVD+-RW drive, UHD graphics 630, WLAN 802.11ac, Bluetooth v5.0; without SIMATIC S5 interface, without SIMATIC S5 EPROMMER

RAM

- 1 x 8 GB DDR4 SDRAM SO-DIMM **A**
- 1 x 16 GB DDR4 SDRAM SO-DIMM **B**
- 1 x 32 GB DDR4 SDRAM SO-DIMM **C**
- 2 x 32 GB DDR4 SDRAM SO-DIMM **D**

Hard disk

- 256 GB SSD SATA (2.5") **A**
- 512 GB SSD SATA (2.5") **B**
- 2 TB SSD SATA (2.5") **C**

Keyboard and power cable (essential)

- Keyboard: QWERTY (& German); power supply cable: Germany, France, the Netherlands, Spain, Belgium, Austria, Sweden, Finland **0**
- Keyboard: AZERTY (France); power supply cable: Germany, France, the Netherlands, Spain, Belgium, Austria, Sweden, Finland **1**
- Keyboard: QWERTY (& German); power supply cable: Italy **2**
- Keyboard: QWERTY (& German); power supply cable: Switzerland **3**
- Keyboard: QWERTY (& German); power supply cable: USA **4**
- Keyboard: QWERTY (& German); power supply cable: United Kingdom **5**
- Keyboard: QWERTY (& German); power supply cable: China; approval for China (CCC) **6**
- Keyboard: QWERTY (& German); without power supply cable **7**
- Keyboard: QWERTY (& German); power supply cable: India **8**

M.2 NVME hard drive

- Without M.2 hard drive **0**
- 512 GB SSD NVME (M.2) **1**
- 1 TB SSD NVME M.2 **2**

Operating system

- Windows 10 Enterprise, 64-bit **A**
- Windows 10 Enterprise LTSC 2019, 64-bit **B**
- Without operating system **N**

Field PG M6 Comfort programming device

6ES7718- 0 ■ ■ 0 ■ - ■ ■ ■ 2

SIMATIC Software licenses

- Trial license: STEP 7 Professional Combo (STEP 7 Prof. V17 and STEP 7 Prof. 2017 SR1), WinCC Advanced Combo (WinCC V17 and WinCC flexible 2008 SP5), Safety Advanced Combo (Safety Adv. V17 and Distributed Safety V5.4 SP5) **A**
- License: STEP 7 & WinCC & Safety in the TIA Portal: STEP 7 Prof. V17, WinCC Adv. V17, Safety Advanced V17 **B**
- License: STEP 7 & WinCC & Safety Combo: STEP 7 Professional Combo (STEP 7 Prof. V17 and STEP 7 Prof. 2017 SR1), WinCC Advanced Combo (WinCC V17 and WinCC flexible 2008 SP5), Safety Advanced Combo (Safety Adv. V17 and Distributed Safety V5.4 SP5) **C**

13

Ordering data	Article No.	Article No.	
Field PG M6 Advanced programming device Intel i7-8850H processor (9 MB Smart Cache, 2.6 to 4.3 GHz, 6 cores + Hyper-Threading), 15.6" display, full HD (1920x1280), DVD+-RW drive, UHD graphics 630, WLAN 802.11ac, Bluetooth v5.0 RAM • 1 x 8 GB DDR4 SDRAM SO-DIMM • 1 x 16 GB DDR4 SDRAM SO-DIMM • 1 x 32 GB DDR4 SDRAM SO-DIMM • 2 x 32 GB DDR4 SDRAM SO-DIMM Hard disk • 256 GB HDD SATA • 512 GB SSD SATA • 2 TB SSD SATA SIMATIC S5 interface • Without S5 interface, without S5 EPROMMER • With S5 interface, with S5 EPROMMER; incl. STEP 5 license, S5 PLC cable and EPROM adapter Keyboard and power cable (essential) • Keyboard: QWERTY (& German); power supply cable: Germany, France, the Netherlands, Spain, Belgium, Austria, Sweden, Finland • Keyboard: AZERTY (France); power supply cable: Germany, France, the Netherlands, Spain, Belgium, Austria, Sweden, Finland • Keyboard: QWERTY (& German); power supply cable: Italy • Keyboard: QWERTY (& German); power supply cable: Switzerland • Keyboard: QWERTY (& German); power supply cable: USA • Keyboard: QWERTY (& German); power supply cable: United Kingdom • Keyboard: QWERTY (& German); power supply cable: China; approval for China (CCC) • Keyboard: QWERTY (& German); without power supply cable • Keyboard: QWERTY (& German); power supply cable: India	6ES7718- 1 ■ ■ ■ ■ ■ - ■ ■ ■ ■ ■ 2 A B C D A B C 0 1 0 1 2 3 4 5 6 7 8	Field PG M6 Advanced programming device M.2 NVME hard drive • Without M.2 hard drive • 512 GB SSD NVME (M.2) • 1 TB SSD NVME M.2 Operating system • Windows 10 Enterprise, 64-bit • Windows 10 Enterprise LTSC 2019, 64-bit • Without operating system SIMATIC Software licenses • Trial license: STEP 7 Professional Combo (STEP 7 Prof. V17 and STEP 7 Prof. 2017 SR1), WinCC Advanced Combo (WinCC V17 and WinCC flexible 2008 SP5), Safety Advanced Combo (Safety Adv. V17 and Distributed Safety V5.4 SP5) • License: STEP 7 & WinCC & Safety in the TIA Portal: STEP 7 Prof. V17, WinCC Adv. V17, Safety Advanced V17 • License: STEP 7 & WinCC & Safety Combo: STEP 7 Professional Combo (STEP 7 Prof. V17 and STEP 7 Prof. 2017 SR1), WinCC Advanced Combo (WinCC V17 and WinCC flexible 2008 SP5), Safety Advanced Combo (Safety Adv. V17 and Distributed Safety V5.4 SP5)	6ES7718- 1 ■ ■ ■ ■ ■ - ■ ■ ■ ■ ■ 2 0 1 2 A B N A B C

SIMATIC programming devices

Programming devices

Field PG M6

Ordering data	Article No.	Article No.
Accessories		Rucksack for Field PG M4/M5/M6 6ES7798-0DA02-0XA0
Memory expansion		SIMATIC IPC Image & Partition Creator V3.6 6ES7648-6AA13-6YA0
8 GB RAM	6ES7648-3AK00-0PA0	Software tool for very easy preventive data backup and efficient partition management on SIMATIC IPCs
16 GB RAM	6ES7648-3AK10-0PA0	
32 GB RAM	6ES7648-3AK20-0PA0	
AC/DC external power supply unit	6ES7798-0GA05-0XA0	SIMATIC IPC Remote Manager V1.3 6ES7648-6EA01-3YA0
For Field PG M6 only; spare part, included in the scope of supply of the Field PG M6		Software tool for efficient remote maintenance and management of a SIMATIC IPC
Power cable (length 3 m)		Software Update Service (Standard Edition)²⁾
For Field PG M2/M4/M5/M6 only		The delivery is implemented according to the number of ordered SUS products (e.g. 10 upgrade packages with 10 DVDs, 10 USB flash drives, etc.)
For Germany, France, the Netherlands, Spain, Belgium, Austria, Sweden, Finland	6ES7900-5AA00-0XA0	• STEP 7 Professional V1x 6ES7822-1AA00-0YL5
For Great Britain	6ES7900-5BA00-0XA0	• STEP 7 Professional Combo (STEP 7 Prof. V1x (TIA Portal) and STEP 7 Prof.) 6ES7810-5CC04-0YE2
For Switzerland	6ES7900-5CA00-0XA0	
For USA	6ES7900-5DA00-0XA0	• SIMATIC WinCC Advanced 6AV6613-0AA00-0AL0
For Italy	6ES7900-5EA00-0XA0	• SIMATIC STEP 7 Safety Advanced 6ES7833-1FC00-0YX2
For China	6ES7900-5FA00-0XA0	
For India	6ES7900-5GA00-0XA0	
Spare battery (lithium ion, 8.25 Ah)¹⁾	6ES7798-0AA10-0XA0	Software Update Service (download)²⁾
For Field PG M6 only; spare part, included in the scope of supply of the Field PG M6		Upgrades and Service Packs are available for downloading. Email address required for delivery
MPI cable	6ES7901-0BF00-0AA0	• STEP 7 Professional V1x 6ES7822-1AE00-0YY0
For connecting a PG and SIMATIC S7 via MPI; 5 m		• STEP 7 Professional Combo (STEP 7 Prof. V1x (TIA Portal) and STEP 7 Prof.) 6ES7810-5CC04-0YY2
S5 EPROM programming adapter	6ES7798-0CA00-0XA0	• SIMATIC WinCC Advanced 6AV6613-0AA00-0AY0
For SIMATIC S5 EPROM programming using the Field PG		• SIMATIC STEP 7 Safety Advanced 6ES7833-1FC00-0YY0
Replaceable SSD kit		
Replaceable SSD 512 GB serial ATA; with protective pocket and torx screwdriver; for Field PG M5/M6	6ES7791-2BA22-0AA0	
Replaceable SSD 2 TB serial ATA; with protective pocket and torx screwdriver; for Field PG M6	6ES7791-2BA25-0AA0	
Adapter serial ATA to USB 3.0	6ES7790-1AA01-0AA0	
For using the removable hard disk in the hard disk kit as an external hard disk (only for Field PG M4/M5/M6)		

¹⁾ The capacity of the battery decreases for technological reasons with each charging/discharging cycle and also as a result of being stored at excessively high or low temperatures. The running time per charge decreases therefore over the course of time. With normal use, the battery can be charged and discharged over a period of six months from when the Field PG is purchased. Capacitance loss is not covered by the warranty. For the battery's operation we grant a warranty of six months. We recommend replacing the battery with an original Siemens battery at the end of these six months if there is a significant drop in performance.

²⁾ For more information on the Software Update Service, see Catalog section 12, page 12/2.

Technical specifications

Article number	6ES7718-.....-.... SIMATIC Field PG M6
General information	
Design of the programming device	Notebook
Display	
Design of display	15.6" full HD display in 16:9 format
Resolution (pixels)	
• Horizontal image resolution	1 920 pixel
• Vertical image resolution	1 080 pixel
General features	
• Non-reflecting	Yes
• Luminance	300 cd/m ²
Backlighting	
• Type of backlighting	LED
Control elements	
Keyboard fonts	
• Design	QWERTZ/QWERTY or AZERTY (French); 87 keys
Touch operation	
• Integrated touch pad	Yes; Clickpad
Supply voltage	
Design of the power supply	External wide-range power supply; 3-pole
Line frequency	
• permissible range, lower limit	47 Hz
• permissible range, upper limit	63 Hz
Processor	
Processor type	Intel Core i5-8400H (2.5 to 4.2 GHz, 4 cores and hyper-threading, 8 MB Smart Cache) or i7-8850H (2.6 to 4.3 GHz 6 cores and hyper-threading, 9 MB Smart Cache)
Chipset	Intel CM246
Hyper-threading	Yes
Turbo Boost Technology 2.0	Yes
Graphic	
Graphics controller	Intel® UHD Graphics 630
Drives	
DVD-RW	Yes
SSD	Yes; Easy to replace
• Memory capacity	256 Gbyte; Up to 2 TB SSD
TPM Security Chip	Yes; 2.0 (version for China without TPM)
Memory	
Type of memory	DDR4 SO-DIMM
Work memory	
• Number of slots	2; can be equipped with 1x 8 GB, 1x 16 GB, 1x 32 GB or 2x32 GB
Accumulator	
Replaceable	Yes; Lithium-ion battery
Capacity	8.25 A·h

Article number	6ES7718-.....-.... SIMATIC Field PG M6
Interfaces	
Number of interfaces PROFIBUS DP	1; 1x PROFIBUS DP / MPI; 9-pin Sub-D socket; 9.6 kBAud to 12 Mbaud
Number of RS 232 interfaces	1; 25-pin socket
Number of USB interfaces	4
• Type A	3; 1x USB port incl. integrated charging function for USB devices (e.g. smartphone) - also with device switched off
• Type C	1; USB 3.1 Gen. 2
Number of chip-card readers	1; Smart Card Reader (ISO/IEC 7816)
Bluetooth radio standard	Yes; V5.0
Multimedia card/SD card slot	2 in 1 (SDHC UHS-II, MMC)
Card reader for SIMATIC memory cards	SIMATIC memory cards (for S7-300/400), SMC (for S7-1x00), SIMATIC micro memory card (for S7-300/C7/ET 200) - including programming interfaces
Universal Audio Jack	Yes; Audio socket for 3.5 mm jack
Video interfaces	
• analog video signal (VGA)	Yes; via adapter from DVI to VGA
• DVI-I	Yes; 1x
• DisplayPort	Yes; 1x
Industrial Ethernet	
• Industrial Ethernet interface	2x Ethernet (RJ45)
- 100 Mbps	Yes
- 1000 Mbps	Yes; Gigabit Ethernet; 2x RJ45 with 2 independent MAC/IP addresses
• Wake on LAN	Yes
• IAMT (Intel Active Management Technology)	Yes
WLAN	
• Type	802.11ac
Interrupts/diagnostics/status information	
LED status display	Battery status, device status, access to HDD/DVD, access to SD/MMC, MPI/DP, S5 and S7 modules / Card Reader (except Smart Card Reader), Num Lock, Caps Lock, WLAN active
EMC	
Interference immunity against discharge of static electricity	
• Interference immunity against discharge of static electricity acc. to IEC 61000-4-2	Yes; ±4 kV contact discharge acc. to IEC 61000-4-2, ESD; ±8 kV air discharge acc. to IEC 61000-4-2, ESD
Interference immunity to cable-borne interference	
• Interference immunity on supply cables	±2 kV (according to IEC 61000-4-4, burst); ±1 kV (according to IEC 61000-4-5, surge pulse/line to line); ±2 kV (according to IEC 61000-4-5, surge pulse/line to ground)
• Interference immunity on signal cables	±1 kV (according to IEC 61000-4-4, burst, length < 30 m); ±2 kV (according to IEC 61000-4-4, burst, length > 30 m); ±2 kV (according to IEC 61000-4-5, surge sym./line to ground, length > 30 m)

SIMATIC programming devices

Programming devices

Field PG M6

Technical specifications

Article number	6ES7718-.....-.... SIMATIC Field PG M6
Standards, approvals, certificates	
CE mark	Yes
CSA approval	Yes
UL approval	Yes
DIN/ISO 9001	Yes
Ambient conditions	
Ambient temperature during operation	
• min.	5 °C; Max. 10 °C/h (no condensation)
• max.	40 °C; Max. 10 °C/h (no condensation)
Operating systems	
Local language of operating system	Multi-Language User Interface (MUI): 6 languages (English, German, French, Spanish, Italian, Chinese)
pre-installed operating system	
• Windows 10	Yes; Windows 10 Enterprise 64-bit
Software	
Preinstalled	
• STEP 7 Professional (TIA Portal)	Yes; software version: V17
• STEP 7	Yes; Professional 2017 SR2
• WinCC flexible Advanced 2008	Yes; Software version: SP5
• WinCC Advanced (TIA Portal)	Yes; software version: V17
• STEP 5	Yes; Optional; software version: STEP 5 V7.23 HF2 (incl. GRAPH 5/II V7.15)
Mechanics/material	
Material of housing	metal
Handle	Yes; retractable
Socket for Kensington lock	Yes
rubber corner guards	Yes

Article number	6ES7718-.....-.... SIMATIC Field PG M6
Dimensions	
Width	385 mm
Height	53 mm
Depth	275 mm
Weights	
Weight, approx.	3.4 kg; incl. rechargeable battery
Scope of supply	
Accumulator	Yes
Power supply	Yes
Backpack	Yes
SIMATIC Software	Yes
Recovery media	Yes; Restore & Recovery

Overview

- External EPROM programming device
- For programming SIMATIC Memory Cards, SIMATIC Micro Memory Cards as well as SIMATIC EPROM and EEPROM modules
- For connection to the PC via the USB interface

Technical specifications

Article number	6ES7792-0AA00-0XA0 USB Prommer
General information	
Design of the programming device	Desktop device
Display	
Design of display	without
Supply voltage	
Design of the power supply	12 V DC, 1.25 A (via power supply included 100 - 240 V / 50 - 60 Hz / 400 - 200 mA)
Ambient conditions	
Ambient temperature during operation	
• min.	5 °C
• max.	40 °C
Dimensions	
Width	172 mm
Height	40 mm
Depth	121 mm
Weights	
Weight, approx.	400 g

Ordering data
Article No.
**EPROM programming device,
USB Prommer**
6ES7792-0AA00-0XA0

 For programming SIMATIC Memory
 Cards and EPROM modules

SIMATIC programming devices

Accessories

Communications software

SOFTNET for PROFIBUS

Overview

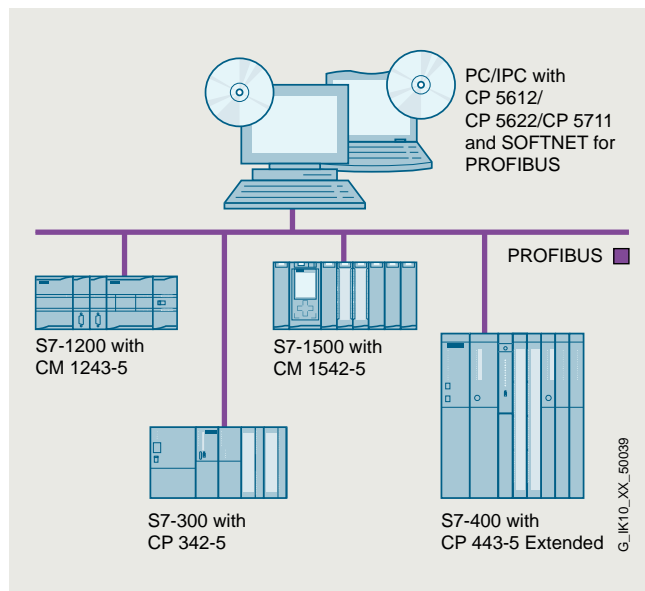

DP-M	DP-S	FMS	OPC	PG/OP	S7/S5
●	●		●	●	●

- Software for connecting PCs/PGs and notebooks to automation systems
- Communications services:
 - PROFIBUS DP master Class 1 and 2 with acyclic expansions
 - PROFIBUS DP slave
 - PG/OP communication
 - S7 communication
 - Open communication (SEND/RECEIVE) based on the FDL interface
- The appropriate OPC servers and configuration tools are included in the scope of supply of the respective communications software

Ordering data

Article No.

SOFTNET-PB S7

Software for S7 communication, including FDL protocol with OPC server and configuration tool, runtime software, software and electronic manual on DVD-ROM, license key on USB flash drive, Class A; for CP 5612, CP 5622, CP 5711

SOFTNET-PB S7 V17 SP1

For 64-bit:

Windows 10 Professional/Enterprise
 Windows 11 Professional/Enterprise
 Windows 10 (IoT) Enterprise 2021 LTSC
 Windows 10 (IoT) Enterprise 2019 LTSC
 Windows 10 (IoT) Enterprise 2016 LTSC
 Windows Server 2016 (Standard, Datacenter)
 Windows Server 2019 (Standard, Datacenter)
 English/German

- Single license for one installation

6GK1704-5CW17-0AA0

Software Update Service

6GK1704-5CW00-3AL0

For one year with automatic extension
 Requirement:
 current software version

Upgrade

- From Edition 2006 to SOFTNET-S7 Edition 2008 or V15

6GK1704-5CW00-3AE0

Article No.

SOFTNET-PB DP

Software for DP protocol (Master Class 1 and 2), including FDL protocol with OPC server and configuration tool; runtime software, software and electronic manual on DVD-ROM, license key on USB flash drive; for CP 5612, CP 5622, CP 5711

SOFTNET-PB DP V17 SP1

For 64-bit:

Windows 10 Professional/Enterprise
 Windows 11 Professional/Enterprise
 Windows 10 (IoT) Enterprise 2021 LTSC
 Windows 10 (IoT) Enterprise 2019 LTSC
 Windows 10 (IoT) Enterprise 2016 LTSC
 Windows Server 2016 (Standard, Datacenter)
 Windows Server 2019 (Standard, Datacenter)
 English/German

- Single license for one installation

6GK1704-5DW17-0AA0

Software Update Service

6GK1704-5DW00-3AL0

For one year with automatic extension
 Requirement:
 current software version

Upgrade

- From Edition 2006 to SOFTNET-DP Edition 2008 or V15

6GK1704-5DW00-3AE0

Ordering data	Article No.	Technical specifications													
<p>SOFTNET-PB DP Slave</p> <p>Software for DP slave, with OPC server and configuration tool, Single License for one installation, runtime software, software and electronic manual on DVD-ROM, license key on USB flash drive, Class A; for CP 5612, CP 5622, CP 5711</p>		<table border="1"> <thead> <tr> <th data-bbox="810 293 1109 319">Performance data</th> <th data-bbox="1109 293 1457 319">CP 5612/CP 5622/CP 5711</th> </tr> </thead> <tbody> <tr> <td colspan="2" data-bbox="810 325 1457 351"><u>Mono protocol mode</u></td> </tr> <tr> <td data-bbox="810 357 1109 383">Number of connectable DP slaves</td> <td data-bbox="1109 357 1457 383">max. 60</td> </tr> <tr> <td data-bbox="810 389 1109 414">Number of FDL tasks waiting</td> <td data-bbox="1109 389 1457 414">max. 50</td> </tr> <tr> <td data-bbox="810 421 1109 446">Number of PG/OP and S7 connections</td> <td data-bbox="1109 421 1457 446">max. 8</td> </tr> <tr> <td data-bbox="810 453 1109 514"> <ul style="list-style-type: none"> • DP master • DP slave </td> <td data-bbox="1109 453 1457 514"> DP-V0, DP-V1 with SOFTNET-PB DP DP-V0, DP-V1 with SOFTNET-PB DP slave </td> </tr> </tbody> </table>		Performance data	CP 5612/CP 5622/CP 5711	<u>Mono protocol mode</u>		Number of connectable DP slaves	max. 60	Number of FDL tasks waiting	max. 50	Number of PG/OP and S7 connections	max. 8	<ul style="list-style-type: none"> • DP master • DP slave 	DP-V0, DP-V1 with SOFTNET-PB DP DP-V0, DP-V1 with SOFTNET-PB DP slave
Performance data	CP 5612/CP 5622/CP 5711														
<u>Mono protocol mode</u>															
Number of connectable DP slaves	max. 60														
Number of FDL tasks waiting	max. 50														
Number of PG/OP and S7 connections	max. 8														
<ul style="list-style-type: none"> • DP master • DP slave 	DP-V0, DP-V1 with SOFTNET-PB DP DP-V0, DP-V1 with SOFTNET-PB DP slave														
<p>SOFTNET-PB DP Slave V17 SP1</p> <p>For 64-bit: Windows 10 Professional/Enterprise Windows 11 Professional/Enterprise Windows 10 (IoT) Enterprise 2021 LTSC Windows 10 (IoT) Enterprise 2019 LTSC Windows 10 (IoT) Enterprise 2016 LTSC Windows Server 2016 (Standard, Datacenter) Windows Server 2019 (Standard, Datacenter) English/German</p> <ul style="list-style-type: none"> • Single license for one installation 	<p>6GK1704-5SW17-0AA0</p>														
<p>Software Update Service</p> <p>For one year with automatic extension Requirement: current software version</p>	<p>6GK1704-5SW00-3AL0</p>														
<p>Upgrade</p> <ul style="list-style-type: none"> • From Edition 2006 to SOFTNET-DP Slave Edition 2008 or V15 	<p>6GK1704-5SW00-3AE0</p>														

SIMATIC programming devices

Accessories

Communications software

SOFTNET for Industrial Ethernet

Overview

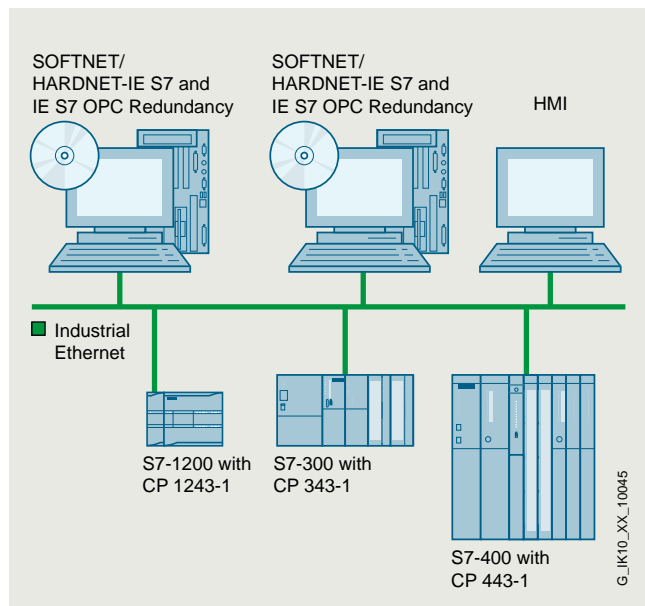

System configuration SOFTNET for Industrial Ethernet

ISO	TCP/UDP	PN	MRP	OPC	PG/OP	S7/S5	IT
●	●			●	●	●	

- Software for coupling PGs/PCs/workstations to automation systems
- Communications services:
 - PG/OP communication
 - S7 communication
 - Open communication (SEND/RECEIVE)
- Can be used with
 - Layer 2 Ethernet card (PCI/PCIe), e.g. CP 1612 A2
 - Integrated Industrial Ethernet interface
 - Modem/ISDN (Remote Access Service RAS)
- Complete protocol stack as a software package
- Increased availability thanks to additional option packages such as OPC server redundancy

Ordering data

Article No.

Article No.

SOFTNET S7 for Industrial Ethernet

Software for S7 and open communication, incl. OPC server, PG/OP communication, and NCM PC/STEP 7 Professional, runtime software, software and electronic manual on DVD, license key on USB flash drive, Class A

SOFTNET-IE S7 V17 SP1

For 64-bit:
 Windows 10 Professional/Enterprise
 Windows 11 Professional/Enterprise
 Windows 10 (IoT) Enterprise 2021 LTSC
 Windows 10 (IoT) Enterprise 2019 LTSC
 Windows 10 (IoT) Enterprise 2016 LTSC
 Windows Server 2016 (Standard, Datacenter)
 Windows Server 2019 (Standard, Datacenter)

English/German;
 up to 64 connections; floating license for one installation

- On DVD
- Download ¹⁾

Software Update Service

For one year with automatic extension
 Requirement:
 current software version

6GK1704-1CW17-0AA0
 6GK1704-1CW17-0AK0

6GK1704-1CW00-3AL0

Upgrade

- As of Edition 2006 to current version
- From V6.0, V6.1, V6.2 or V6.3 to V13

6GK1704-1CW00-3AE0

6GK1704-1CW00-3AE1

SOFTNET-IE S7 REDCONNECT V17 SP1

Software for fail-safe S7 communication via redundant networks, incl. S7 OPC server, runtime software, software and electronic manual on DVD, license key on USB flash drive, Class A

For 64-bit:
 Windows 10 Professional/Enterprise
 Windows 11 Professional/Enterprise
 Windows 10 (IoT) Enterprise 2021 LTSC
 Windows 10 (IoT) Enterprise 2019 LTSC
 Windows 10 (IoT) Enterprise 2016 LTSC
 Windows Server 2016 (Standard, Datacenter)
 Windows Server 2019 (Standard, Datacenter)

English/German;
 floating license for one installation

- On DVD
- Download ¹⁾

6GK1704-0HB17-0AA0
 6GK1704-0HB17-0AK0

¹⁾ You can find more details of online software delivery here:
<http://www.siemens.com/tia-online-software-delivery>
 under Ordering data.

Ordering data	Article No.	Technical specifications	
<p>SOFTNET-IE S7 Lean Edition V17 SP1</p> <p>For 64-bit: Windows 10 Professional/Enterprise Windows 11 Professional/Enterprise Windows 10 (IoT) Enterprise 2021 LTSC Windows 10 (IoT) Enterprise 2019 LTSC Windows 10 (IoT) Enterprise 2016 LTSB Windows Server 2016 (Standard, Datacenter) Windows Server 2019 (Standard, Datacenter)</p> <p>up to eight connections; English/German; floating license for one installation</p> <ul style="list-style-type: none"> • On DVD • Download ¹⁾ <p>Software Update Service</p> <p>For one year with automatic extension Requirement: current software version</p> <p>Upgrade</p> <ul style="list-style-type: none"> • As of Edition 2006 to current version • From V6.0, V6.1, V6.2 or V6.3 to V13 	<p>6GK1704-1LW17-0AA0 6GK1704-1LW17-0AK0</p> <p>6GK1704-1LW00-3AL0</p> <p>6GK1704-1LW00-3AE0 6GK1704-1LW00-3AE1</p>	<p>Performance data</p> <p>S7 and PG/OP communication (number of operable connections)</p> <ul style="list-style-type: none"> • SOFTNET-IE S7 Extended • SOFTNET-IE S7 • SOFTNET-IE S7 Lean 	<p>Max. 255 (S7-300 / S7-400) Max. 512 (S7-1200 / S7-1500)</p> <p>Max. 64</p> <p>Max. 8</p>

¹⁾ You can find more details of online software delivery here:
<http://www.siemens.com/tia-online-software-delivery>
 under Ordering data.

SIMATIC programming devices

Accessories

Communications software

Notes

Products for specific requirements

**14/2 Telecontrol systems for comprehensive applications**

- 14/3 [SIPLUS RIC for IEC protocol](#)
- 14/4 SIPLUS RIC libraries for S7-1500 (R/H), ET 200SP and Software Controller
- 14/5 SIPLUS RIC libraries for ET 200S
- 14/6 SIPLUS RIC libraries for S7-300
- 14/7 SIPLUS RIC libraries for S7-400/S7-400H
- 14/8 SIPLUS RIC libraries for WinAC

14/9 Automatic door controls

- 14/10 [Automatic door controls for elevators](#)
- 14/11 Control devices
 - 14/11 - SIDOOR AT40 elevator door drive
 - 14/14 - SIDOOR ATE500E elevator door drive
- 14/17 Power supplies
 - 14/17 - Power supply unit
 - 14/19 - Switched-mode power supply
- 14/20 Additional units
 - 14/20 - Software kit
 - 14/20 - Service tool
- 14/21 Geared motors
- 14/23 Direct drives
- 14/24 Accessories
- 14/28 [Automatic door controls for industrial applications](#)
- 14/29 Control devices
 - 14/29 - SIDOOR ATD401W
 - 14/31 - SIDOOR ATD420W
 - 14/33 - SIDOOR ATD430W
- 14/35 Power supplies
 - 14/36 - 3-phase, 36 V DC
- 14/38 Additional units
 - 14/38 - Software kit
 - 14/38 - Service tool
- 14/39 Geared motors
- 14/42 Accessories

14/45 [Automatic door controls for railway applications](#)

- 14/46 Control devices
 - 14/46 - Platform screen door drive
 - 14/49 - Control device for gap fillers
 - 14/51 - Interior railway door drives
- 14/53 Additional units
 - 14/53 - Software kit
 - 14/53 - Service tool
- 14/54 Geared motors
- 14/56 Direct drives
- 14/57 Accessories

14/60 Condition monitoring systems

- 14/60 [SIPLUS CMS1200 Condition Monitoring System](#)
- 14/61 SIPLUS CMS1200 SM 1281 Condition Monitoring
- 14/63 Accessories

Products for specific requirements

Telecontrol systems for comprehensive applications

Telecontrol systems for comprehensive applications

Overview

Telecontrol systems for controlling and monitoring widely distributed plants usually consist of a supervisory control system (telecontrol center) and one or more outstations connected over large distances for the automation of distributed plant sections.

It provides secure communication with reduced data volume for reliable operation in the Wide Area Network (WAN) thanks to event-driven, time-stamped transmission and monitored output of commands.

SIPLUS RIC is a versatile telecontrol system that uses the internationally standardized telecontrol protocols:

- Serial transmission IEC 60870-5-101
- Ethernet (TCP/IP) IEC 60870-5-104
- Connection of protection devices IEC 60870-5-103

Application

SIPLUS RIC offers maximum functionality and modularity to meet the requirements made upon the monitoring and control of spatially distributed systems, even under extreme environmental conditions.

It is therefore suitable for sectors such as Oil, Gas, Water, Wastewater, Power Generation/Distribution, and Transportation.

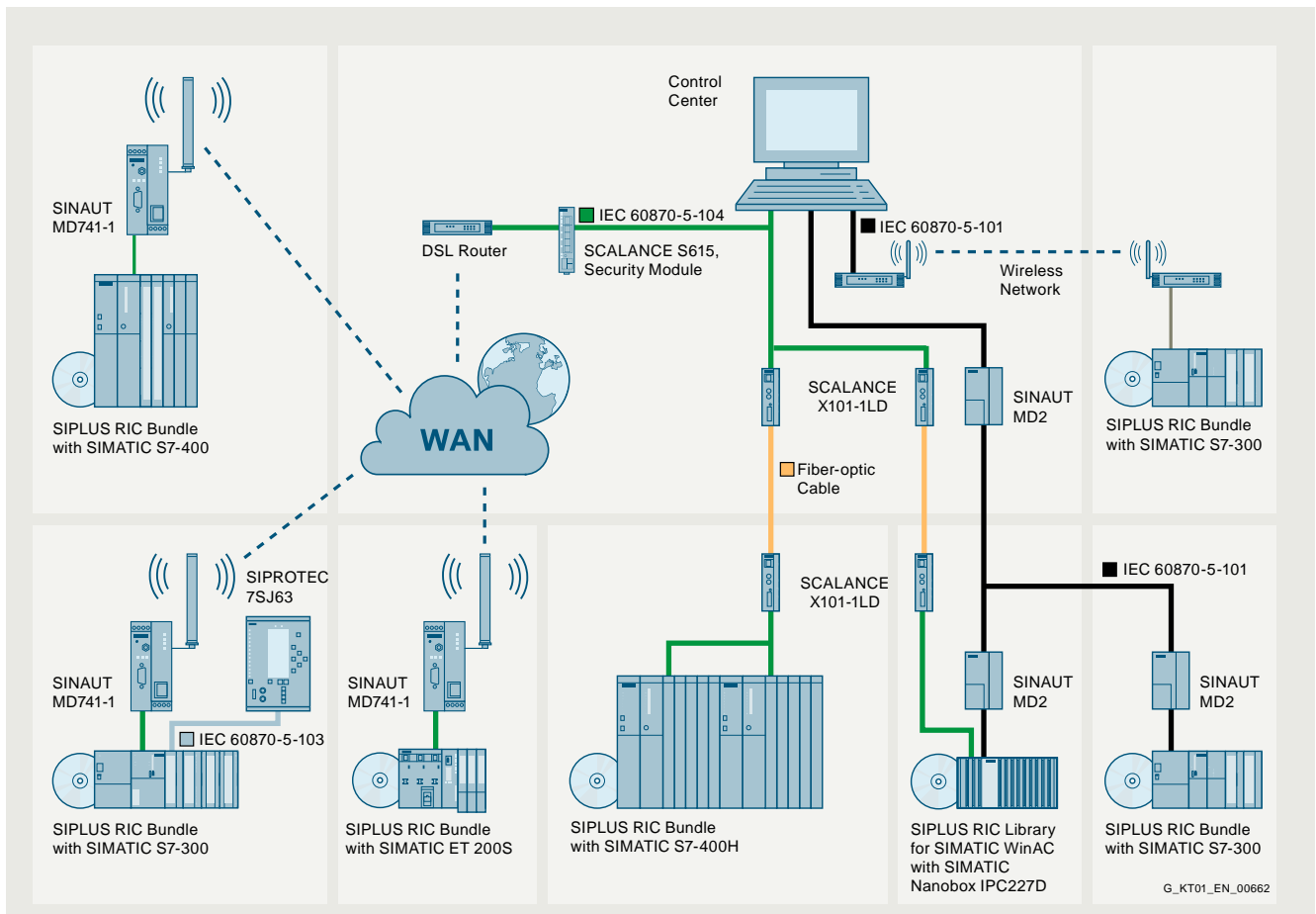

Overview

IEC 60870-5-101, -103, -104 are standardized, vendor-independent protocols. With SIPLUS RIC, they can be parameterized with the SIMATIC Manager or TIA Portal without the need for additional installations.

The IEC 60870-5-101 protocol supports classical WAN connections via dedicated lines,

The coupling is made

- directly
- via media converters (e.g. modems) or
- via the serial interfaces (RS232 or RS485) of the communications modules, e.g. 1SI, CP 341, CP 441 or CM PtP/PTP

The IEC 60870-5-103 protocol permits serial communication with protection devices, e.g. SIPROTEC. The link is made similar to IEC 60870-5-101 via serial communications modules.

The IEC 60870-5-104 protocol supports TCP/IP-based WAN connections such as internet/DSL or GPRS/UMTS/LTE. Either the PN interfaces of the CPUs or the Industrial Ethernet communications modules, e.g. CP 343, CP 443 and CM/CP 154x, are used as interfaces. Redundancy groups and substitute routes (combinations of serial and Ethernet transmission paths) are both possible and enabled via the interfaces.

Security requirements for IEC 104 communication can be achieved with:

- external components (firewall/VPN gateways such as SCALANCE S)
- integrated security features (e.g. firewall/VPN of Advanced CPs)

TLS can be used within the mechanisms (and limitations) provided by SIMATIC for the encryption of IEC 60870-5-104 communication.

The libraries for the IEC 60870-5-101 and -104 protocols are supplied as master (SCADA/Control Center/Controlling Station (control system)) and slave (substation/RTU/Controlled Station) including activation for PN-CPU and CP interface.

The IEC 60870-5-103 library is only available as master.

SIMATIC Controllers can also communicate with third-party products by means of the IEC protocols and exchange data from the SIMATIC Controller.

By combining the different library variants (within a CPU), information from lower-level stations and also protection devices can be forwarded to the control stations (node or gateway functionality). Reversed direction signal paths are also supported.

The modular concept in connection with presets enables a fast configuration of stations with basic functionality. Specific requirements (e.g. individual addresses, transfer of external time stamps) can also be parameterized and programmed individually. Example projects are available to make starting easier. They can be used as a basis for one's own projects or initial tests.

Libraries including the example projects and documentation can be downloaded from Siemens Online Support as trial versions and used without a valid license (activation code) in demo mode (15 minutes of full functionality after each CPU restart).

Products for specific requirements

Telecontrol systems for comprehensive applications
SIPLUS RIC for IEC protocol

SIPLUS RIC libraries for S7-1500 (R/H), ET 200SP and Software Controller

Overview



If a system based on SIMATIC S7-1500, S7-1500R/H, ET 200SP or Software Controller is to communicate with a Siemens control center, e.g. SIMATIC PCS 7 TeleControl, WinCC TeleControl, WinCC OA, or a control center of a third-party supplier using the IEC 60870-5 telecontrol standard, the IEC 60870-5-101 (serial), -103 (protection) or -104 (TCP/IP) telecontrol protocols can be used in the SIMATIC automation systems.

SIPLUS RIC libraries offer an integrated, scalable system based on SIMATIC S7-1500/ET 200SP functionalities for the following data volumes:

- 200 data points, for use with CPU 1510SP-1 PN¹⁾, CPU 1511-1 PN and CPU 1511C-1 PN
- 800 data points, for use with CPU 1512SP-1 PN and CPU 1512C-1 PN
- 1000 data points, for use with CPU 1513-1 PN
- 2000 data points, for use with CPU 1515-2 PN
- 4000 data points, for use with CPU 1516-3 PN/DP
- 5000 data points, for use with CPU 1517-3 PN/DP and with CPU 1518-4 PN/DP

The work memory for data is used for buffering the message frames. Longer communication failure times can thus be bridged. The SIPLUS RIC software libraries are based on the standard TIA Portal and can be used on various, mutually compatible types of SIMATIC S7 devices, thus saving hardware costs and programming overhead.

The libraries and licenses are delivered digitally or as a download (OSD, Online Software Delivery). Three variants are available for selection:

- 50 data points ("Tags")
- 500 data points
- Unlimited number of data points

Only information objects in monitoring direction (e.g. messages, measured values) are counted.

A license certificate is supplied with the order, which can be used to request activation codes for permanent use of the purchased protocols on the employed hardware (linked to serial number). More information is available on this at <https://support.industry.siemens.com/cs/ww/en/view/109803457>.

The license certificate required for the activation of all telecontrol protocols IEC 60870-5-101 (serial), -103 (protection) or -104 (TCP/IP) is available for download in the Siemens Mall after purchase.

¹⁾ CPU 1510SP-1 PN is only suitable for small installations due to the small amount of work memory. If the CPU is used for other tasks besides the IEC protocol, it is absolutely necessary to check the work memory load beforehand.

Ordering data

Article No.

SIPLUS RIC libraries for SIMATIC S7-1500/S7-1500 RH/ ET 200SP/Software Controller

Runtime license, software download, incl. license key¹⁾

Consignee email address required for delivery

Max. 50 tags (information objects in the monitoring direction)

6AG6003-7CF01-0LE0

Max. 500 tags (information objects in the monitoring direction)

6AG6003-7CF01-0LFO

Unlimited number of tags (information objects in the monitoring direction)

6AG6003-7CF01-0LPO

¹⁾ For up-to-date information and download availability, see: <https://www.siemens.com/tia-online-software-delivery>

Products for specific requirements

Telecontrol systems for comprehensive applications

SIPLUS RIC for IEC protocol

SIPLUS RIC libraries for ET 200S

Overview



If a SIMATIC ET 200S-based system is to communicate with a Siemens control center, e.g. SIMATIC PCS 7 TeleControl, WinCC TeleControl, WinCC OA, or a control center of a third-party supplier using the IEC 60870-5 telecontrol standard, the IEC 60870-5-101 (serial), -103 (protection) or -104 (TCP/IP) telecontrol protocols can be used in the SIMATIC automation systems.

SIPLUS RIC libraries offer an integrated, scalable system based on SIMATIC ET 200S functionalities, for data volumes up to 200 information points.

The non-retain memory can also be used for buffering message frames. Longer communication failure times can thus be bridged. The SIPLUS RIC software libraries are based on the standard SIMATIC Manager or TIA Portal and can be used on various, mutually compatible types of SIMATIC S7 devices – this saves hardware costs and programming overhead.

The libraries and licenses are delivered digitally or as a download (OSD, Online Software Delivery).

A license certificate is supplied with the order, which can be used to request activation codes for permanent use of the purchased protocols on the employed hardware (linked to serial number). More information is available on this at <https://support.industry.siemens.com/cs/ww/en/view/109803457>.

The license certificate required for the activation of all telecontrol protocols IEC 60870-5-101 (serial), -103 (protection) or -104 (TCP/IP) is available for download in the Siemens Mall after purchase.

Ordering data

Article No.

SIPLUS RIC libraries for SIMATIC ET 200S

Runtime license, software download, incl. license key¹⁾

Consignee email address required for delivery

6AG6003-5CF01-0DA0

¹⁾ For up-to-date information and download availability, see: <https://www.siemens.com/tia-online-software-delivery>

Products for specific requirements

Telecontrol systems for comprehensive applications
SIPLUS RIC for IEC protocol

SIPLUS RIC libraries for S7-300

Overview



If a SIMATIC S7-300-based system is to communicate with a Siemens control center, e.g. SIMATIC PCS 7 TeleControl, WinCC TeleControl, WinCC OA, or a control center of a third-party supplier using the IEC 60870-5 telecontrol standard, the IEC 60870-5-101 (serial), -103 (protection) or -104 (TCP/IP) telecontrol protocols can be used in the SIMATIC automation systems.

SIPLUS RIC libraries offer an integrated, scalable system based on SIMATIC S7-300 functionalities, for the following data volumes:

- 200 information points, for use with CPU 314
- 1 000 information points, for use with CPU 315
- 2 000 information points, for use with CPU 317
- 5 000 information points, for use with CPU 319

The non-retain memory can also be used for buffering message frames. Longer communication failure times can thus be bridged. The SIPLUS RIC software libraries are based on the standard SIMATIC Manager or TIA Portal and can be used on various, mutually compatible types of SIMATIC S7 devices – this saves hardware costs and programming overhead.

The libraries and licenses are delivered digitally or as a download (OSD, Online Software Delivery).

A license certificate is supplied with the order, which can be used to request activation codes for permanent use of the purchased protocols on the employed hardware (linked to serial number). More information is available on this at <https://support.industry.siemens.com/cs/ww/en/view/109803457>.

The license certificate required for the activation of all telecontrol protocols IEC 60870-5-101 (serial), -103 (protection) or -104 (TCP/IP) is available for download in the Siemens Mall after purchase.

Ordering data

Article No.

SIPLUS RIC libraries for SIMATIC S7-300

Runtime license, software download, incl. license key¹⁾

Consignee email address required for delivery

6AG6003-1CF01-0DA0

¹⁾ For up-to-date information and download availability, see: <https://www.siemens.com/tia-online-software-delivery>

Products for specific requirements

Telecontrol systems for comprehensive applications
SIPLUS RIC for IEC protocol

SIPLUS RIC libraries for S7-400/S7-400H

Overview



If a SIMATIC S7-400/S7-400H-based system is to communicate with a Siemens control center, e.g. SIMATIC PCS 7 TeleControl, WinCC TeleControl, WinCC OA, or a control center of a third-party supplier using the IEC 60870-5 telecontrol standard, the IEC 60870-5-101 (serial), -103 (protection) or -104 (TCP/IP) telecontrol protocols can be used in the SIMATIC automation systems.

SIPLUS RIC libraries offer an integrated, scalable system based on SIMATIC S7-400/S7-400H functionalities for the following data volumes:

- 1 000 information points, for use with CPU 412 or CPU 412H
- 2 000 information points, for use with CPU 414 or CPU 414H
- 5 000 information points, for use with CPU 410H, CPU 416/CPU 416H or CPU 417/CPU 417H

The data memory, which is limited to 256 MB in the CPU 410H for data blocks generated online, is used for buffering the frames. Longer communication failure times can thus be bridged. The SIPLUS RIC software libraries are based on the standard SIMATIC Manager or TIA Portal and can be used on various, mutually compatible types of SIMATIC S7 devices – this saves hardware costs and programming overhead.

The libraries and licenses are delivered digitally or as a download (OSD, Online Software Delivery).

A license certificate is supplied with the order, which can be used to request activation codes for permanent use of the purchased protocols on the employed hardware (linked to serial number).

More information is available on this at <https://support.industry.siemens.com/cs/ww/en/view/109803457>.

The license certificate required for the activation of all telecontrol protocols IEC 60870-5-101 (serial), -103 (protection) or -104 (TCP/IP) is available for download in the Siemens Mall after purchase.

Ordering data

SIPLUS RIC libraries for SIMATIC S7-400

Runtime license for SIMATIC S7-400 from firmware version 4.x; software download, incl. license key¹⁾

Consignee email address required for delivery

Note:
If used in S7-400H systems, a license will be required for both CPUs.

¹⁾ For up-to-date information and download availability, see: <https://www.siemens.com/tia-online-software-delivery>

Article No.

6AG6003-3CF01-0AA0

Products for specific requirements

Telecontrol systems for comprehensive applications
SIPLUS RIC for IEC protocol

SIPLUS RIC libraries for WinAC

Overview



If a system based on SIMATIC WinAC RTX is to communicate with a Siemens control center, e.g. SIMATIC PCS 7 TeleControl, WinCC TeleControl, WinCC OA, or a control center of a third-party supplier, using the IEC 60870-5 telecontrol standard, the IEC 60870-5-101 (serial), -103 (protection) or -104 (TCP/IP) telecontrol protocols can be used in the SIMATIC automation systems.

The SIPLUS RIC software libraries are based on the standard SIMATIC Manager (WinAC) or TIA Portal and can be used on various, mutually compatible types of SIMATIC S7 devices – this saves hardware costs and programming overhead.

The libraries and licenses are delivered digitally or as a download (OSD, Online Software Delivery).

A license certificate is supplied with the order, which can be used to request activation codes for permanent use of the purchased protocols on the employed hardware (linked to serial number). More information is available on this at <https://support.industry.siemens.com/cs/ww/en/view/109803457>.

The license certificate required for the activation of all telecontrol protocols IEC 60870-5-101 (serial), -103 (protection) or -104 (TCP/IP) is available for download in the Siemens Mall after purchase.

Ordering data

SIPLUS RIC libraries for Software Controllers

Runtime license, software download, incl. license key¹⁾

Consignee email address required for delivery

¹⁾ For up-to-date information and download availability, see: <https://www.siemens.com/tia-online-software-delivery>

Article No.

6AG6003-0CF01-0AA0

Overview



SIDOOR automatic door control systems

Door control system is the general term for a controller of an access system.

The SIDOOR product family is primarily intended for the operation of sliding doors, whereby these doors can be operated both horizontally and vertically.

Door control systems are characterized by the fact that there are always two defined states for the open and closed position of the door.

The door is always controlled, regulated and moved between these two positions in accordance with the guidelines of the respective application.

In a defined learn run via "single-button operation", the door system independently determines the values for the door width, the dynamic door weight and the drive direction of the geared motor and stores these data in a non-volatile memory.

The optimum drive characteristics at the door are automatically calculated and are consistently adhered to.

The travel curve transitions are rounded off so that the door movement is smooth and jerk-free.

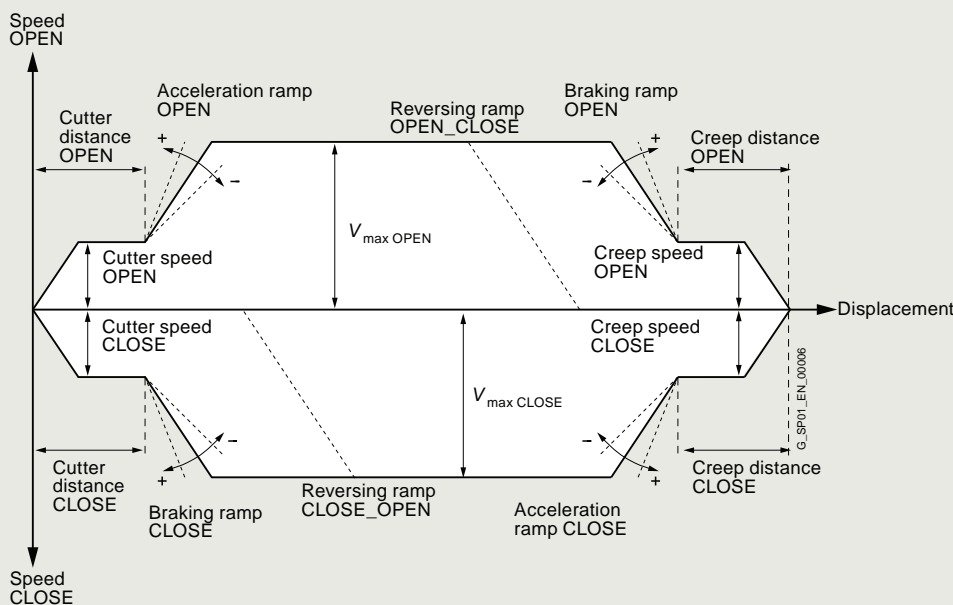

Creep speed	Reduced speed in the vicinity of the OPEN position of the elevator door (creep distance)
Cutter speed	Reduced speed in the vicinity of the CLOSED position of the elevator door (cutter distance)
Creep distance	Range of door travel in the vicinity of the OPEN position
Cutter distance	Range of door travel in the vicinity of the CLOSED position
V_{max}	Maximum permissible door speed

Reversing ramp OPEN_CLOSE Travel reverses from the OPEN to the CLOSE direction
 Reversing ramp CLOSE_OPEN Travel reverses from the CLOSE to the OPEN direction

Note:

When reversing from the open to the close direction, the door is braked with the reversing ramp OPEN_CLOSE, and starts the closing movement with the acceleration ramp CLOSE.

Travel curve

Products for specific requirements

Automatic door controls

for elevators

Overview

The elevator door drive is comprised of a controller and the maintenance-free drive unit, geared motor or gearless EC technology direct drive motor.

Control devices are electronic controllers connected to the power supply via an external power supply unit (SIDOOR NT40 or SIDOOR Transformer). They are generally connected to the higher-level controller via digital or fieldbus interfaces, and can be configured via a user interface.

The SIDOOR AT40 and SIDOOR ATE500E control devices can be used to operate horizontally operated cabin and shaft doors as well as vertical doors for lifting or rolling doors at adjustable speeds and accelerations.

Geared motors form the maintenance-free drive unit in the door drive. The geared motors feature DC motors with non-self-locking gearing, and are speed-controlled. The set force and speed limits are not exceeded. The gearless motor (direct drive) is the maintenance-free drive unit of the door drive.

Operation of the named door drives does not require limit switches. The door width and the "OPEN"/"CLOSE" positions are determined automatically.

The power is transmitted by a toothed belt. The toothed belt passes over a deflector pulley and can be fitted with 2 door clutch holders. This enables it to drive both one-sided and centrally-opening doors. The accessories are not included in the scope of supply, see "Additional units", page 14/24.

Design

The product-specific property of the elevator door controllers is based on the fact that the closing weights/closing springs integrated in the shaft doors are also taken into account.

These weights/springs are integrated in the shaft doors so that open doors close automatically if the cabin is not at the relevant floor.

They must also be moved by the elevator door drive in their opening direction and support it in the closing movement.

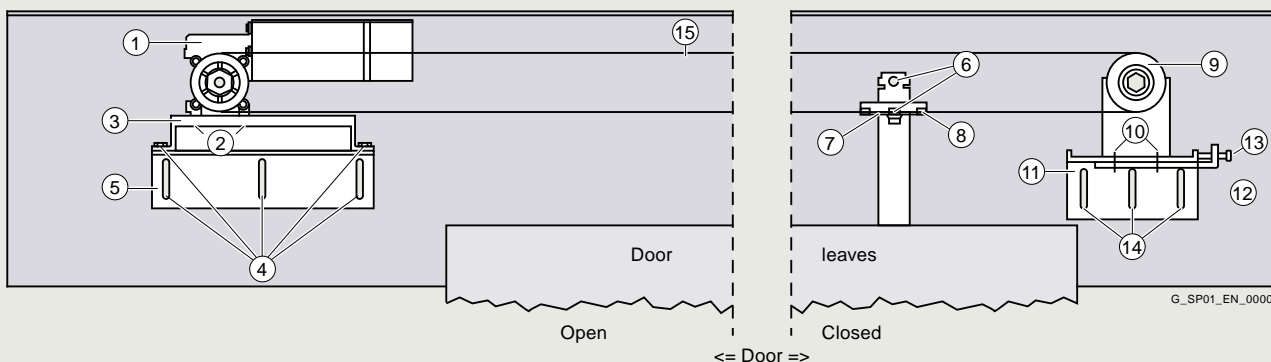

Complete motor mounting

- ① Geared motor
- ② 4 x locking hexagonal safety bolts M5 x 10
- ③ Rubber-metal anti-vibration mount
- ④ 10 x locking hexagonal safety bolts M6 x 16
- ⑤ Mounting bracket for the motor mounting

Mounting material for door clutch holder

- ⑥ 2 x locking hexagonal safety bolts M6 x 12
- ⑦ Door clutch holder
- ⑧ Clamping plate

Deflector unit and clamping device

- ⑨ Deflector unit
- ⑩ 2 x locking hexagonal safety bolts M6 x 12
- ⑪ Mounting bracket for the deflector unit and tensioning device
- ⑫ Tensioning lug for the deflector unit and tensioning device
- ⑬ Tensioning screw M6 x 30
- ⑭ 10 x locking hexagonal safety bolts M6 x 16
- ⑮ Toothed belt (length 4 m)

Mounting suggestion for door control systems

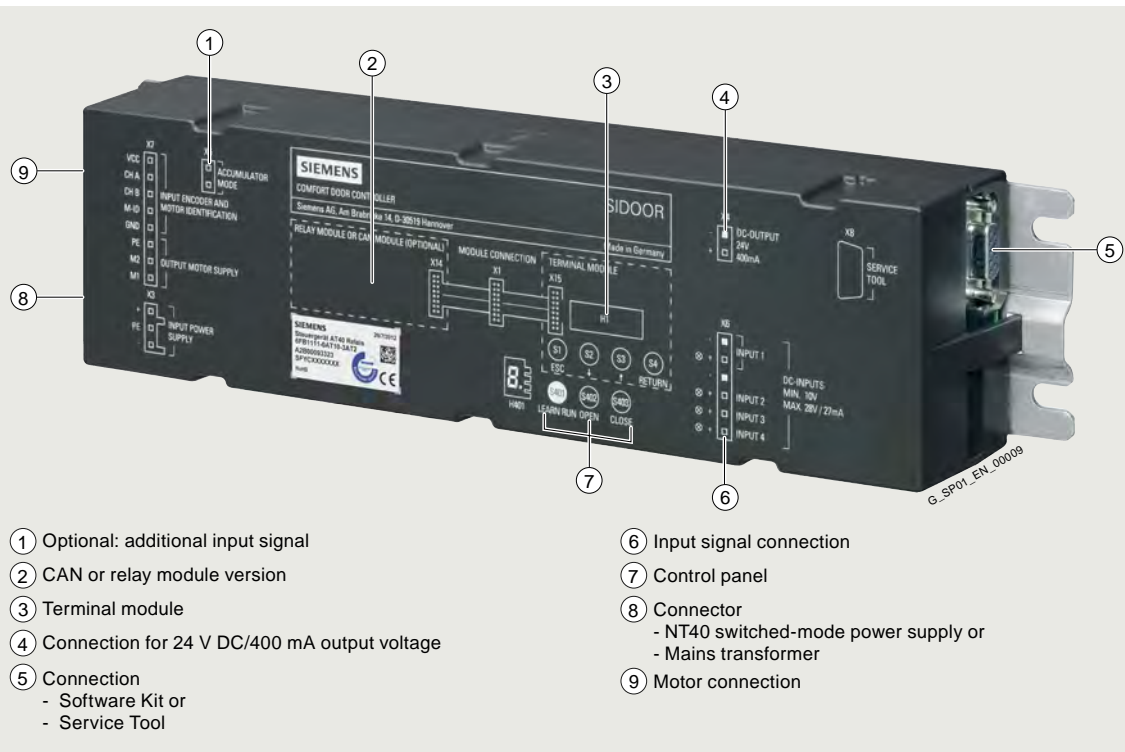
Overview

SIDOOR AT40 elevator door drive (relay module version)

SIDOOR AT40 – SIDOOR enables the quick, easy and versatile installation, configuration and operation of a wide range of elevator door systems.

- Version:
- RELAY (including relay and terminal module)
- CAN (including CAN and terminal module), two controllers are available: SIDOOR AT40 CAN and CAN ADV.
 - Certified by CiA (CiA 301 / CiA 417).
 - The door system can be visualized and parameterized by the elevator controller using the "Virtual Terminal" function.
 - With the SIDOOR AT40 CAN ADV controller, parameters for evaluating mechanical wear can be provided at the door. These parameters can be accessed from the CAN-BUS via the elevator controller or other bus nodes and can be evaluated floor-dependently by an external evaluation logic. It includes, e.g. event counters, maximum current values in the slow end distance of the door, traversing times and energy values of the opening and closing cycles, as well as other performance values.
 - The evaluation can affect the maintenance cycles of the elevator system.

- For dynamic door weights up to 600 kg, depending on motor variant
- Automatic door weight detection
- 4 to 8 kg maximum counterweight (depending on motor version)
- Operating temperature -20 to +50 °C
- Flexible motor management (four different motor types), automatic detection
- Opening width 0.3 to 5 m
- Auxiliary power output 24 V DC \pm 15 %; 0.4 A (short-circuit-proof)
- Output stage short-circuit-proof
- Supports power-optimized operation in the elevator cabin
- Vandal-proof
- IP54 degree of protection for 180 to 600 kg motor versions, gear unit IP40 (SIDOOR M5: entirely IP54)
- The current operating states are indicated via a 7-segment display or a terminal module directly in the elevator door drive or externally. The SIDOOR SOFTWARE KIT or the SIDOOR SERVICE TOOL are used for this, see Additional units, page 14/20.

Ordering data
Article No.

SIDOOR AT40 elevator door drive
horizontal, up to 600 kg door weight

Control device with RELAY
(including relay and terminal module)

6FB1111-0AT10-3AT2

Article No.

Control device with CAN
(including CAN and terminal module)

6FB1111-1AT10-3AT3

Control device with CAN module and maintenance data via CANopen

6FB1111-1AT11-3AT3

Products for specific requirements

Automatic door controls
for elevators

Control devices > SIDOOR AT40 elevator door drive

Technical specifications

Article number	6FB1111-0AT10-3AT2 SIDOOR AT40 RELAY	6FB1111-1AT10-3AT3 SIDOOR AT40 CAN	6FB1111-1AT11-3AT3 SIDOOR AT40 CAN ADV
General information			
Product type designation	AT40 RELAY		AT40 CAN ADV
Supply voltage			
Design of the power supply	via SIDOOR TRANSFORMER / NT40		
Input current			
Current consumption, max.	10 A		
I ² t, min.	30 A ² ·s		
Encoder supply			
Output voltage (DC)	24 V; Ensure correct polarity! CAUTION: Do not supply with external voltage!		
short-circuit proof	Yes		
24 V encoder supply			
• Output current, max.	400 mA		
Power			
Active power input	80 W		
Active power input, max.	540 W		
Active power input (standby mode)	5 W	6 W	
Digital inputs			
Control inputs isolated	Yes		
Control inputs p-switching	Yes		
Input voltage			
• for signal *0*, min.	-3 V		
• for signal *0*, max.	5 V		
• for signal *1*, min.	10 V		
• for signal *1*, max.	28 V		
Input current			
• for signal *0*, max. (permissible quiescent current)	0.5 mA		
• for signal *1*, min.	9 mA		
• for signal *1*, max.	27 mA		
Digital outputs			
Relay outputs			
Switching capacity of contacts			
- at 30 V DC, min.	0.01 A		
- at 30 V DC, max.	1 A		0.5 A
- at 50 V DC, min.	0.01 A; Switching voltage 50 V DC		
- at 50 V DC, max.	1 A; Switching voltage 50 V DC		
- at 230 V AC, min.	0.01 A		
- at 230 V AC, max.	1 A		
Mechanical data			
Opening width of door, min.	0.3 m		
Opening width of door, max.	5 m		
Weight of door, max.	600 kg		
Operating cycle frequency of door, max.	180 1/h		
Counterforce, max.	80 N		
Kinetic energy, max.	100 J		
Counterweight			
• with SIDOOR M2 geared motor, max.	4 kg		
• with SIDOOR M3 geared motor, max.	6 kg		
• with SIDOOR M4 geared motor, max.	8 kg		
• with SIDOOR M5 geared motor, max.	8 kg		

Technical specifications

Article number	6FB1111-0AT10-3AT2	6FB1111-1AT10-3AT3	6FB1111-1AT11-3AT3
	SIDOOR AT40 RELAY	SIDOOR AT40 CAN	SIDOOR AT40 CAN ADV
Interfaces			
Interfaces/bus type	without	CANopen, CiA standard 301, profile 417	
Number of bus nodes		32	
Standards, approvals, certificates			
Certificate of suitability according to EN 81	Yes		
CE mark	Yes		
UL approval	No		
EAC (formerly Gost-R)	Yes		
TÜV Inspectorate approval	Yes		
TÜV prototype tested	Yes		
China RoHS compliance	Yes		
Standard for safety	EN 61010-1 / EN 61010-2-201 / EN 81-20		
Ambient conditions			
Ambient temperature during operation			
• min.	-20 °C		
• max.	50 °C		
Ambient temperature during storage/transportation			
• Storage, min.	-40 °C		
• Storage, max.	50 °C		
Altitude during operation relating to sea level			
• Installation altitude above sea level, max.	2 000 m		
Relative humidity			
• No condensation, min.	10 %		
• No condensation, max.	93 %		
Dimensions			
Width	320 mm		
Height	60 mm		
Depth	80 mm		

Products for specific requirements

Automatic door controls
for elevators

Control devices > SIDOOR ATE500E elevator door drive

Overview

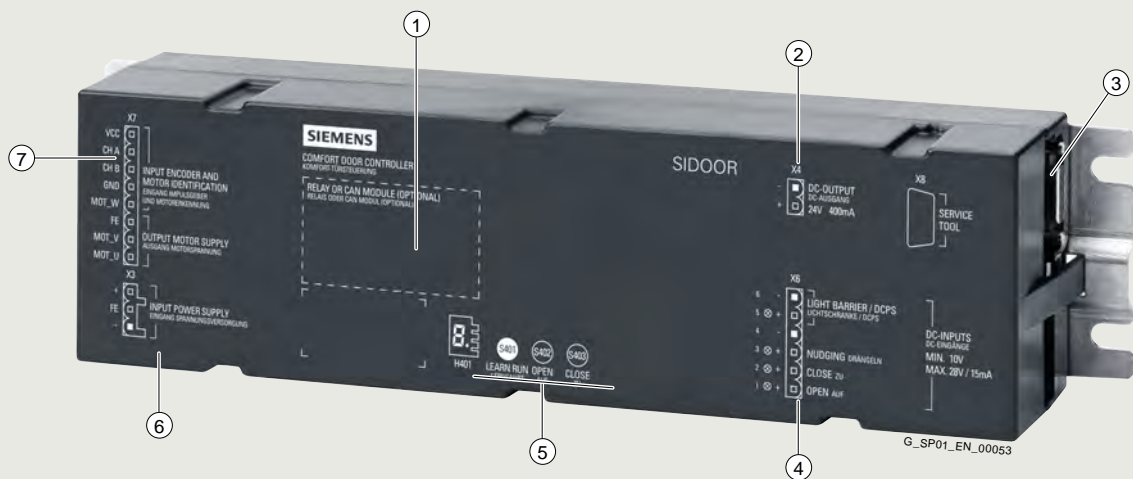

- | | |
|--|--|
| <ul style="list-style-type: none"> ① CAN module or RELAY module ② Connection for 24 V DC/400 mA output voltage ③ Connection <ul style="list-style-type: none"> - Service Tool or - Software Kit ④ Input signal connection | <ul style="list-style-type: none"> ⑤ Control panel ⑥ Connection <ul style="list-style-type: none"> - NT40 switched-mode power supply - Transformer ⑦ Motor connection (direct drive) |
|--|--|

SIDOOR ATE500E elevator door drive

The SIDOOR ATE500E elevator door drive enables the quick, easy and versatile installation, configuration and operation of EC technology gearless elevator door systems.

- Design:
 - Relay module
 - CAN module
- For dynamic door weights up to 280 kg
- High control performance and optimized drive characteristic transitions
- Automatic door weight detection (single-button commissioning)
- 6 kg maximum counterweight of the coupled floor door
- Operating temperature -25 to +50 °C without restrictions

- Automatic identification of the connected motor
- Opening width 0.3 to 5 m
- Auxiliary voltage output 24 V DC \pm 15%; 0.4 A (short-circuit-proof)
- Output stage short-circuit-proof
- Optimized energy consumption during cabin operation (DCPS)
- Vandal-proof
- IP20 degree of protection
- The current operating states are indicated via a 7-segment display directly in the elevator door drive or externally using the Software Kit or Service Tool, see "Additional units", page 14/20.

Ordering data

Article No.

SIDOOR ATE500E elevator door drive

Control device with relay module
Control device with CAN module

6FB1211-5AT10-7AT2
6FB1211-1AT10-7AT3

Technical specifications

Article number	6FB1211-5AT10-7AT2	6FB1211-1AT10-7AT3
	SIDOOR ATE500E RELAY	SIDOOR ATE500E CAN
General information		
Mean time between failures (MTBF)	19 y	
Installation type/mounting		
Installation and mounting instructions	no direct solar radiation, final application-specific requirements must be observed; installation outside a control cabinet only in horizontal mounting position NFPA elevator environment: must be installed in a fire protection enclosure	
Supply voltage		
Design of the power supply	Via SIDOOR TRANSFORMER / NT40 or via DC	
Rated value (DC)	36 V; with MED280: At 24 V DC max. door speed of 500 mm/s; at 28.8 V DC max. door speed of 800 mm/s	
Input current		
I ² t, min.	30 A ² ·s	
Encoder supply		
Output voltage (DC)	24 V; Ensure correct polarity! CAUTION: Do not supply with external voltage!	
short-circuit proof	Yes	
Overload-proof	Yes	
24 V encoder supply		
• Output current, max.	400 mA	
Power		
Active power input	85 W	
Active power input, max.	540 W	
Active power input (standby mode)	5 W	6 W
Digital inputs		
Control inputs isolated	Yes	
Control inputs p-switching	Yes	
Input voltage		
• for signal *0*, min.	-3 V	
• for signal *0*, max.	5 V	
• for signal *1*, min.	10 V	
• for signal *1*, max.	28 V	
Input current		
• for signal *1*, min.	3 mA	
• for signal *1*, max.	15 mA	
Digital outputs		
Relay outputs		
Switching capacity of contacts		
- at 30 V DC, min.	0.01 A	
- at 30 V DC, max.	1 A	0.5 A
- at 50 V DC, min.	0.01 A; 50 V DC switching voltage not released for NFPA-relevant countries	
- at 50 V DC, max.	1 A; 50 V DC switching voltage not released for NFPA-relevant countries	
- at 230 V AC, min.	0.01 A	
- at 230 V AC, max.	1 A	
Mechanical data		
Opening width of door, min.	0.3 m	
Opening width of door, max.	5 m	
Weight of door, max.	280 kg	
Operating cycle frequency of door, max.	180 1/h	
Kinetic energy, max.	75 J	
Counterweight		
• with SIDOOR MED280 direct drive, max.	6 kg	
Interfaces		
Interfaces/bus type	without	CANopen, CiA standard 301, profile 417
Number of bus nodes		32

Products for specific requirements

Automatic door controls
for elevators

Control devices > SIDOOR ATE500E elevator door drive

Technical specifications

Article number	6FB1211-5AT10-7AT2	6FB1211-1AT10-7AT3
	SIDOOR ATE500E RELAY	SIDOOR ATE500E CAN
Standards, approvals, certificates		
Certificate of suitability according to EN 81	Yes	
CE mark	Yes	
UL approval	Yes	
EAC (formerly Gost-R)	Yes	
TÜV Inspectorate approval	Yes	
TÜV prototype tested	Yes	
China RoHS compliance	Yes	
Standard for safety	EN 61010-1 / EN 61010-2-201 / UL 61010-1 / UL 61010-2-201 / EN 81-20 / EN ISO 13849-1 Cat. 2 PL d / IEC 62061: SIL 2	
Ambient conditions		
Ambient temperature during operation		
• min.	-25 °C	
• max.	50 °C	
• Remark	Bolt the controller onto a metal mounting surface so that thermal conductivity is ensured	
Ambient temperature during storage/transportation		
• Storage, min.	-40 °C	
• Storage, max.	85 °C	
Altitude during operation relating to sea level		
• Installation altitude above sea level, max.	2 000 m	
Relative humidity		
• No condensation, min.	10 %	
• No condensation, max.	93 %	
Dimensions		
Width	320 mm	
Height	60 mm	
Depth	80 mm	

Overview



SIDOOR Transformer

The SIDOOR TRANSFORMER and SIDOOR TRANSFORMER UL are standard power supply units operated with 220-240 V AC, 50/60 Hz, from the SIDOOR product range. They can be used for controllers capable of controlling masses of up to 400 kg.

Ordering data

Article No.

SIDOOR Transformer power supply	6FB1112-0AT20-2TR0
SIDOOR Transformer power supply with UL approval	6FB1112-0AT21-2TR0

Technical specifications

Article number	6FB1112-0AT20-2TR0	6FB1112-0AT21-2TR0
	SIDOOR TRANSFORMER	SIDOOR TRANSFORMER UL
Installation type/mounting		
Mounting type	Hexagon head bolt M6, L > 70 mm	
Supply voltage		
relative symmetrical tolerance of the supply voltage	10 %	
Line frequency		
• permissible range, lower limit	50 Hz	
• permissible range, upper limit	60 Hz	
Mains filter		
• integrated	Yes	
Input current		
Current consumption, max.	1.6 A	
Operational current of fuse protection at input, min.	6 A	
Operational current of fuse protection at input, max.	10 A	
Tripping characteristic class of fuse protection at input	D6, C10	
Output voltage		
RMS value (pulsating DC voltage at full load)	17.3 V; at 230 V AC	
RMS value (pulsating DC voltage at full load), min.	16.5 V	
RMS value (pulsating DC voltage at full load), max.	18 V	
RMS value (pulsating DC voltage at 0.7 mA peak current), max.	27 V; At 264 V AC	
Output current		
Current output (rated value)	14.3 A; t on 2 s / t off 8 s	
Power		
Emitted active power, max.	115 W; Average value above 10 s	

Products for specific requirements

Automatic door controls
for elevators

Power supplies > Power supply unit

Technical specifications

Article number	6FB1112-0AT20-2TRO	6FB1112-0AT21-2TRO
	SIDOOR TRANSFORMER	SIDOOR TRANSFORMER UL
Standards, approvals, certificates		
CE mark	Yes	
EAC (formerly Gost-R)	Yes	
RoHS conformity	Yes	
China RoHS compliance	Yes	
Standard for EMC	EN 12015 / EN 12016 / EN 61000-6-2 / EN 61000-6-3 / EN 61000-3-2 / EN 61000-3-3	
Standard for safety	Low Voltage Directive (LVD) 2014/35/EU	UL 61010-1, CSA C22.2 No. 61010-1-12, Low Voltage Directive (LVD) 2014/35/EU
Ambient conditions		
Ambient temperature during operation		
• min.	-20 °C	
• max.	55 °C	
• Remark	No direct exposure to the sun	
Ambient temperature during storage/transportation		
• Storage, min.	-20 °C	
• Storage, max.	70 °C	
• Transportation, min.	-40 °C	
• Transportation, max.	70 °C	
Altitude during operation relating to sea level		
• Installation altitude above sea level, max.	2 000 m	
Relative humidity		
• No condensation, min.	10 %	
• No condensation, max.	93 %	
Cables		
Cable length		
• Input side	2 m	
• Output side	1.5 m	
Connection method		
Design of electrical connection at input	SCHUKO connector DIN 49.441, CEE7/VII	equipped with ferrules
Dimensions		
Width	145 mm	
Height	65 mm	
Depth	126 mm	

Overview

The SIDOOR NT40 switched-mode power supply unit is operated with 230 V AC ($\pm 15\%$), 50/60 Hz, to power the elevator door controllers.

It is especially suitable for door systems with high door weights.

On the output side, the power supply unit delivers a voltage of 36 V DC ($\pm 3\%$) SELV at a rated output power of < 100 W.

In order to enable fast acceleration/deceleration of the doors by the controller, the device can briefly (< 2 s) deliver a current of 15 A (corresponds to a short-time power output of 540 W).

Ordering data
Article No.

SIDOOR NT40 switched-mode power supply

6FB1112-0AT20-3PS0

Technical specifications

Article number	6FB1112-0AT20-3PS0 SIDOOR NT40
Installation type/mounting	
Mounting type	Four 5 mm screws
Supply voltage	
Rated value (AC)	230 V
relative symmetrical tolerance of the supply voltage	15 %
Line frequency	
• permissible range, lower limit	50 Hz
• permissible range, upper limit	60 Hz
Input current	
Current consumption for 2 s, max.	3.5 A
Rated value at 230 V AC	0.7 A
Operational current of fuse protection at input, min.	6 A
Operational current of fuse protection at input, max.	10 A
Tripping characteristic class of fuse protection at input	B
Output voltage	
Rated value (DC)	36 V; SELV
Relative symmetrical tolerance of the output voltage	3 %

Article number	6FB1112-0AT20-3PS0 SIDOOR NT40
Output current	
Current output (rated value)	2.5 A
Temporary overload current (for 2 s maximum)	15 A
Power	
Active power input, max.	100 W
Emitted active power, max.	100 W
Emitted active power (restricted to 2 s)	540 W
Efficiency at 230 V AC (with 100 W emitted active power)	90 %
Active apparent power, max.	650 V·A
Standards, approvals, certificates	
CE mark	Yes
EAC (formerly Gost-R)	Yes
TÜV Inspectorate approval	Yes
China RoHS compliance	Yes
Standard for EMC	EMC Directive 2004/108/EC, EN 12015, EN 12016
Standard for safety	EN 61010-1 / EN 61010-2-201
Ambient conditions	
Ambient temperature during operation	
• min.	-20 °C
• max.	55 °C
• Remark	No direct exposure to the sun
Ambient temperature during storage/transportation	
• Storage, min.	-20 °C
• Storage, max.	70 °C
• Transportation, min.	-40 °C
• Transportation, max.	70 °C
Altitude during operation relating to sea level	
• Installation altitude above sea level, max.	2 000 m
Relative humidity	
• No condensation, min.	10 %
• No condensation, max.	93 %
Cables	
Cable length	
• Input side	2 m
• Output side	1.5 m
Connection method	
Design of electrical connection at input	SCHUKO connector DIN 49.441, CEE7/VII
Dimensions	
Width	270 mm
Height	55 mm
Depth	80 mm

Products for specific requirements

Automatic door controls
for elevators

Additional units > Software kit, Service tool

Overview Software Kit



SIDOOR Software Kit

The scope of delivery of the SIDOOR Software Kit includes an installation CD.

The CD includes the following functionalities:

SIDOOR User Software	The component that enables the door control system to be configured, parameters to be assigned, and analyzed.
Siemens HCS12 Firmware Loader	This component is used to update the operating software of the door controller.
SIDOOR USB to UART Bridge Driver	This driver is essential for operation of the USB adapter.

Note:

Some firmware updates are offered as free downloads in the Siemens Industry Online Support. For information on the availability and acquisition of more firmware, please contact Technical Support.

Ordering data

Article No.

SIDOOR Software Kit	6FB1105-0AT01-6SW0
----------------------------	---------------------------

Overview Service Tool



The Service Tool can be used to input run commands, change run parameters and read out learned parameters, door states, input/output signals and service data.

The Service Tool is connected to the various controllers by the respective cable.

You do not need to open the cover of the controller to do this.

Note:

If the Service Tool is in the "Quick adjustment" or "Total adjustment" menu, the run commands of the controller are blocked via the command inputs.

Ordering data

Article No.

SIDOOR Service Tool, hand-held terminal	6FB1105-0AT01-6ST0
--	---------------------------

for parameter assignment of control devices

Overview

SIDOOR geared motors are a combination of gear unit, motor and sensor. They are easy to connect to the controller via the interface provided and are automatically detected during commissioning.

The maintenance-free, variable speed drive unit comprises a DC motor with non-self-locking gearing.

The geared motors must be selected according to the mass to be moved. Two different versions are available for each of the SIDOOR M2 to SIDOOR M5 geared motors, with gear output on the left or on the right: The gear outlet direction is defined as left or right when viewing the gear unit from the front.

- SIDOOR M2 geared motors (max. door weight 120 kg)
 - SIDOOR M2 L (pinion left) 6FB1103-0AT10-5MA0
 - SIDOOR M2 R (pinion right) 6FB1103-0AT11-5MA0
- SIDOOR M3 geared motors (max. door weight 180 kg)
 - SIDOOR M3 L (pinion left) 6FB1103-0AT10-4MB0
 - SIDOOR M3 R (pinion right) 6FB1103-0AT11-4MB0
- SIDOOR M4 geared motors (max. door weight 400 kg)
 - SIDOOR M4 L (pinion left) 6FB1103-0AT10-3MC0
 - SIDOOR M4 R (pinion right) 6FB1103-0AT11-3MC0
- SIDOOR M5 geared motors (max. door weight 600 kg)
 - SIDOOR M5 L (pinion left) 6FB1103-0AT10-3MD0
 - SIDOOR M5 R (pinion right) 6FB1103-0AT11-3MD0



Geared motors:
SIDOOR M2 L 6FB1103-0AT10-5MA0 (version with pinion left),
SIDOOR M3 L 6FB1103-0AT10-4MB0 (version with pinion left),
SIDOOR M4 L 6FB1103-0AT10-3MC0 (version with pinion left),
SIDOOR M5 L 6FB1103-0AT10-3MD0 (version with pinion left)
(Images are shown in the order from bottom to top)

Ordering data**SIDOOR M2 geared motors**

M2 L	6FB1103-0AT10-5MA0
M2 R	6FB1103-0AT11-5MA0

SIDOOR M3 geared motors

M3 L	6FB1103-0AT10-4MB0
M3 R	6FB1103-0AT11-4MB0

SIDOOR M4 geared motors

M4 L	6FB1103-0AT10-3MC0
M4 R	6FB1103-0AT11-3MC0

SIDOOR M5 geared motors

M5 L	6FB1103-0AT10-3MD0
M5 R	6FB1103-0AT11-3MD0

Technical specifications

Article number	6FB1103-0AT10-5MA0 SIDOOR M2 L	6FB1103-0AT11-5MA0 SIDOOR M2 R	6FB1103-0AT10-4MB0 SIDOOR M3 L	6FB1103-0AT11-4MB0 SIDOOR M3 R	6FB1103-0AT10-3MC0 SIDOOR M4 L	6FB1103-0AT11-3MC0 SIDOOR M4 R	6FB1103-0AT10-3MD0 SIDOOR M5 L	6FB1103-0AT11-3MD0 SIDOOR M5 R
Supply voltage								
Rated value (DC)	24 V		30 V					
Input current								
Operational current (rated value)	1.8 A		4 A				7.5 A	
Power								
Active power input	43 W		120 W				225 W	
Mechanical data								
Torque of the rotary operating mechanism (rated value)	1.05 N·m		3 N·m				6.8 N·m	
Speed, max.	0.5 m/s		0.65 m/s		0.75 m/s		0.5 m/s	
Gear ratio	15							
Number of pulses per revolution, max.	100							
Weight of door, max.	120 kg		180 kg		400 kg		600 kg	

Products for specific requirements

Automatic door controls
for elevators

Geared motors

Technical specifications

Article number	6FB1103-0AT10-5MA0	6FB1103-0AT11-5MA0	6FB1103-0AT10-4MB0	6FB1103-0AT11-4MB0	6FB1103-0AT10-3MC0	6FB1103-0AT11-3MC0	6FB1103-0AT10-3MD0	6FB1103-0AT11-3MD0
	SIDOOR M2 L	SIDOOR M2 R	SIDOOR M3 L	SIDOOR M3 R	SIDOOR M4 L	SIDOOR M4 R	SIDOOR M5 L	SIDOOR M5 R
Standards, approvals, certificates								
CE mark	Yes							
UL approval	No		Yes					
EAC (formerly Gost-R)	Yes							
TÜV Inspectorate approval	Yes							
China RoHS compliance	Yes							
Ambient conditions								
Ambient temperature during operation								
• min.	-20 °C							
• max.	50 °C							
Ambient temperature during storage/transportation								
• Storage, min.	-40 °C							
• Storage, max.	85 °C							
Dimensions								
Height of motor	90 mm		98 mm		115 mm		124 mm	
Length of motor	207 mm		236 mm		275 mm		344 mm	
Diameter of motor	48 mm		63 mm				80 mm	
Width of gear unit, including drive pinion	90 mm		85 mm		105 mm		111 mm	

Overview



SIDOOR MED280 direct drive

SIDOOR direct drives are a combination of motor and sensor. They are easy to connect to the controller via the interface provided and are automatically detected during commissioning.

The maintenance-free drive unit consists of a gearless, speed-controlled, electronically commutated motor with non-self-locking gearing.

Direct drives are designed for certain masses and can control both drive directions.

- SIDOOR MED280 direct drive for max. 280 kg (6FB1203-0AT12-7DA0)

Ordering data

Article No.

SIDOOR MED280 direct drive
 Motor for door control, for max. dynamic door weights of 280 kg

6FB1203-0AT12-7DA0

Technical specifications

Article number	6FB1203-0AT12-7DA0 SIDOOR MED280
Supply voltage	
Rated value (DC)	24 V
Input current	
Operational current (rated value)	9.7 A
Power	
Active power input	233 W
Mechanical data	
Torque of the rotary operating mechanism (rated value)	4.7 N·m
Speed, max.	0.8 m/s
Number of pulses per revolution, max.	1 024
Weight of door, max.	280 kg
Standards, approvals, certificates	
CE mark	Yes
UL approval	Yes
EAC (formerly Gost-R)	Yes
TÜV Inspectorate approval	Yes
China RoHS compliance	Yes
Ambient conditions	
Ambient temperature during operation	
• min.	-25 °C
• max.	70 °C
Ambient temperature during storage/transportation	
• Storage, min.	-40 °C
• Storage, max.	85 °C
Dimensions	
Width of motor	160 mm
Height of motor	140 mm
Length of motor	56 mm
• including drive pinion	91 mm

Products for specific requirements

Automatic door controls
for elevators

Accessories

Overview

A range of accessories is available for SIDOOR elevator door drive systems with geared motors:

This is necessary to ensure low-noise operation of the door leaves by the controller. The geared motors can be optimally integrated into the respective door drive system.

Rubber-metal anti-vibration mounts for geared motors

To ensure low-noise door operation, SIDOOR geared motors are integrated in the door system using rubber-metal anti-vibration mounts.

- Rubber-metal anti-vibration mount 6FB1104-0AT02-0AD0 for SIDOOR M2 and SIDOOR M3 geared motors.
- Rubber-metal anti-vibration mount 6FB1104-0AT01-0AD0 for SIDOOR M4 and SIDOOR M5 geared motors.



Rubber-metal anti-vibration mount 6FB1104-0AT02-0AD0



Rubber-metal anti-vibration mount 6FB1104-0AT01-0AD0

Mounting brackets

Two different mounting brackets are available with elongated holes:

- Mounting bracket 6FB1104-0AT01-0AS0 for the geared motors for flexible accommodation of the rubber-bonded metal
- Mounting bracket 6FB1104-0AT02-0AS0 for the deflector unit. For setting the toothed belt to the required belt tension.



Mounting bracket 6FB1104-0AT01-0AS0 for mounting the geared motor



Mounting bracket 6FB1104-0AT02-0AS0 for the deflector unit

Door clutch holder

The door clutch holder serves to connect the respective door leaf by means of a toothed belt while also functioning as a toothed-belt lock. One door clutch holder per door leaf is required. The toothed-belt lock can accommodate both open ends of the toothed belt.

A door clutch holder is available for each toothed belt width:

- Width 12 mm: 6FB1104-0AT01-0CP0
- Width 14 mm: 6FB1104-0AT02-0CP0



Door clutch holder 6FB1104-0AT01-0CP0 (packaging size = 1 unit)

Deflector unit

The deflector unit 6FB1104-0AT03-0AS0 contains an embedded belt pulley which can be mounted on the door system.

The STS toothed belt is redirected via this deflector unit (toothed belt width 12 mm or 14 mm).



Deflector unit 6FB1104-0AT03-0AS0

OverviewSTS toothed belt

The door system is moved between the end positions of the door using the STS toothed belts. Two different toothed belt lengths can be ordered for each toothed belt width.

Toothed belt width 12 mm:

- Length 4 m: 6FB1104-0AT01-0AB0
- Length 45 m: 6FB1104-0AT02-0AB0

Toothed belt width 14 mm:

- Length 4 m: 6FB1104-0AT03-0AB0
- Length 55 m: 6FB1104-0AT04-0AB0

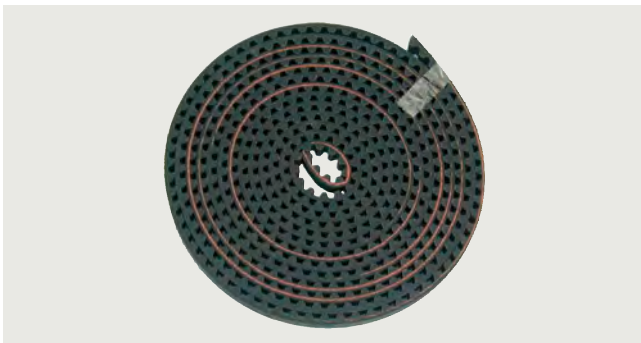

Toothed belt 6FB1104-0AT01-0AB0, length 4 m



Toothed belt 6FB1104-0AT02-0AB0, length 45 m

A range of accessories is available for SIDOOR elevator door systems with EC technology:

Motor holder 6FB1104-0AT03-0AD0 for accommodation of the SIDOOR MED280 direct drive.

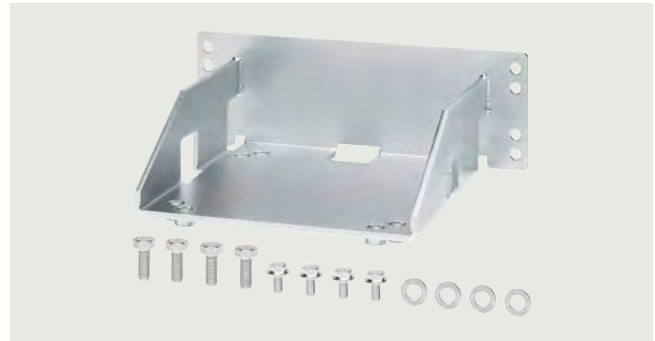
Mounting bracket:

- For mounting the SIDOOR motor holder 6FB1104-0AT01-0AS0



- With tensioning device for mounting the deflector unit and setting the toothed belt to the required tension (large) 6FB1104-0AT05-0AS4



SIDOOR mounting bracket, large

- With tensioning device for mounting the deflector unit and setting the toothed belt to the required tension (small) 6FB1104-0AT05-0AS5



SIDOOR mounting bracket, small

Products for specific requirements

Automatic door controls
for elevators

Accessories

Overview

Door clutch holder

- For attaching both ends of the toothed belt and connecting the respective door leaf to the toothed belt, width 20 mm 6FB1104-0AT05-0AS1



SIDOOR door clutch holder

Deflector unit:

For attaching the SIDOOR toothed belt and fixing to the door 6FB1104-0AT07-0AS0



SIDOOR deflector unit

STD toothed belt

As a connection between the door system and the end positions of the door

Toothed belt width 20 mm. Length 4 m 6FB1104-0AT05-0AB0



SIDOOR toothed belt, small

Toothed belt width 20 mm. Length 45 m 6FB1104-0AT06-0AB1



SIDOOR toothed belt, large

Ordering data	Article No.	Ordering data	Article No.
Elevator door systems with geared motors		Elevator door systems with EC technology	
Rubber-metal anti-vibration mounts for geared motors		Motor holder for SIDOOR MED280 direct drive	6FB1104-0AT03-0AD0
<ul style="list-style-type: none"> SIDOOR rubber-metal anti-vibration mount for SIDOOR M2 and SIDOOR M3 geared motors 	6FB1104-0AT02-0AD0	Mounting bracket for mounting the motor holder	6FB1104-0AT01-0AS0
<ul style="list-style-type: none"> SIDOOR rubber-metal anti-vibration mount for SIDOOR M4 and SIDOOR M5 geared motors 	6FB1104-0AT01-0AD0	Mounting bracket with tensioning device for mounting the deflector unit	
Mounting bracket		<ul style="list-style-type: none"> Large Small 	6FB1104-0AT05-0AS4 6FB1104-0AT05-0AS5
<ul style="list-style-type: none"> SIDOOR mounting bracket for geared motor 	6FB1104-0AT01-0AS0	SIDOOR door clutch holder	6FB1104-0AT05-0AS1
<ul style="list-style-type: none"> SIDOOR mounting bracket with tensioning device for deflector pulley 	6FB1104-0AT02-0AS0	For toothed belt, width 20 mm	
SIDOOR door clutch holder		SIDOOR deflector unit	6FB1104-0AT07-0AS0
<ul style="list-style-type: none"> For toothed belt, width 12 mm For toothed belt, width 14 mm 	6FB1104-0AT01-0CP0 6FB1104-0AT02-0CP0	SIDOOR STD toothed belt	
SIDOOR deflector unit	6FB1104-0AT03-0AS0	Width 20 mm	
SIDOOR deflector roller for the STS toothed belt	6FB1104-0AT04-0AS2	<ul style="list-style-type: none"> 4 m 55 m 	6FB1104-0AT05-0AB0 6FB1104-0AT06-0AB1
SIDOOR STS toothed belt			
Width 12 mm			
<ul style="list-style-type: none"> 4 m 45 m 	6FB1104-0AT01-0AB0 6FB1104-0AT02-0AB0		
SIDOOR STS toothed belt			
Width 14 mm			
<ul style="list-style-type: none"> 4 m 55 m 	6FB1104-0AT03-0AB0 6FB1104-0AT04-0AB0		

Products for specific requirements

Automatic door controls

for industrial applications

Overview

The door drive system consists of a controller and a maintenance-free drive unit, the geared motors.

Controllers are electronic controllers connected to the power supply via an external power supply unit. They are generally connected to the higher-level controller via digital or fieldbus interfaces, and can be configured via a user interface.

These controllers are available for selection for industrial applications:

- SIDOOR ATD401W, digital I/O, masses of up to 700 kg
- SIDOOR ATD420W, connected to the higher-level controller via PROFIBUS interface, masses of up to 700 kg
- SIDOOR ATD430W, connected to the higher-level controller via PROFINET interface, masses of up to 700 kg

The safe functions – force limitation, energy limitation and end position detection – fulfill the requirements according to EN ISO 13849-1 for Category 2 and Performance Level d. The drives are suitable for power-operated guards according to EN ISO 14120

Geared motors form the maintenance-free drive unit in the door drive. The geared motors are DC motors with non-self-locking gearing, and are speed-controlled. The set force and speed limits are not exceeded.

Operation of the named door drives does not require limit switches. The door width and the "OPEN"/"CLOSE" positions are determined automatically.

The power is transmitted by a toothed belt. The toothed belt passes over a deflector pulley and can be fitted with 2 door clutch holders. This enables it to drive both one-sided and centrally-opening doors. The accessories are not included in the scope of supply, see "Additional units", page 14/42.

Overview

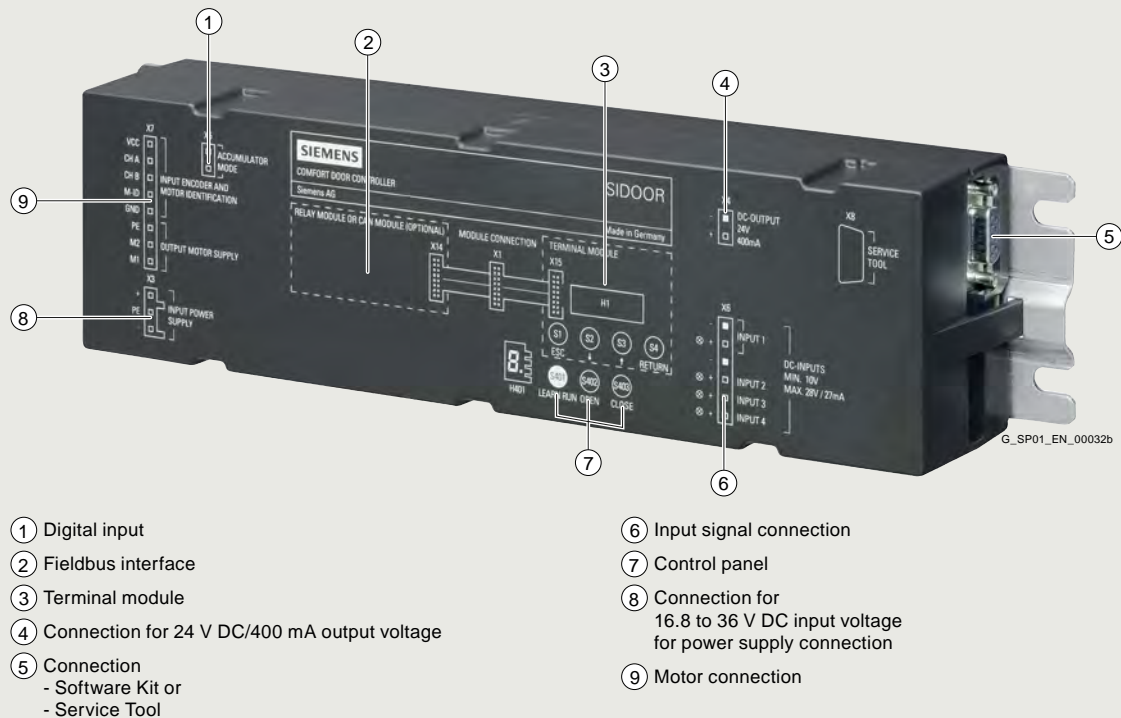

SIDOOR ATD401W

The SIDOOR ATD401W enables the quick, easy and versatile installation, configuration and operation of a wide range of industrial door drive systems.

- Relay module design
- Masses of up to 700 kg
- Automatic determination of the door weight and friction during the learn run
- Digital inputs, for example for direct connection of a light barrier as type 2 ESPE (electro-sensitive protective equipment) according to EN 61496-1
- 3 relay outputs for position feedback and reversing feedback

- Operating temperature -20 to +50 °C
- Flexible motor management, automatic recognition of the geared motor
- Opening width 0.3 to 5 m
- Auxiliary voltage output 24 V DC \pm 15%; 0.4 A (short-circuit-proof)
- Output stage for the motor control is short-circuit-proof
- Indicates the current operating states on a 7-segment display directly on the controller or using the Software Kit or the Service Tool

Ordering data

Article No.

SIDOOR ATD401W

6FB1141-1AT11-3WE2

Control device,
relay module design

Products for specific requirements

Automatic door controls
for industrial applications

Control devices > SIDOOR ATD401W

Technical specifications

Article number	6FB1141-1AT11-3WE2 SIDOOR ATD401W
Installation type/mounting	
Installation and mounting instructions	No direct solar radiation, final application-specific requirements must be observed. Installation outside a control cabinet only in horizontal mounting position
Supply voltage	
Design of the power supply	Via SIDOOR TRANSFORMER / SIDOOR TRANSFORMER UL / NT40 / SITOP PSU8200 13 A, 36 V or via DC
Rated value (DC)	36 V
Input current	
I ² t, min.	30 A ² ·s
Encoder supply	
Output voltage (DC)	24 V; Ensure correct polarity! CAUTION: Do not supply with external voltage!
short-circuit proof	Yes
Overload-proof	Yes
24 V encoder supply	
• Output current, max.	400 mA
Power	
Active power input	145 W
Active power input, max.	540 W
Active power input (standby mode)	5 W
Digital inputs	
Control inputs isolated	Yes
Control inputs p-switching	Yes
Input voltage	
• for signal *0*, min.	-3 V
• for signal *0*, max.	5 V
• for signal *1*, min.	10 V
• for signal *1*, max.	28 V
Input current	
• for signal *1*, min.	9 mA
• for signal *1*, max.	27 mA
Digital outputs	
Relay outputs	
Switching capacity of contacts	
- at 30 V DC, min.	0.01 A
- at 30 V DC, max.	1 A

Article number	6FB1141-1AT11-3WE2 SIDOOR ATD401W
Mechanical data	
Opening width of door, min.	0.3 m
Opening width of door, max.	5 m
Weight of door, max.	600 kg
Operating cycle frequency of door, max.	180 1/h
Counterforce, max.	75 N
Kinetic energy, max.	100 J
Interfaces	
Interfaces/bus type	without
Standards, approvals, certificates	
Certificate of suitability according to EN 81	No
CE mark	Yes
UL approval	Yes
EAC (formerly Gost-R)	Yes
TÜV Inspectorate approval	Yes
China RoHS compliance	Yes
Standard for safety	EN 61010-1 / EN 61010-2-201 / UL 61010-1 / UL 61010-2-201 / EN ISO 13849-1 Cat. 2 PL d
Ambient conditions	
Ambient temperature during operation	
• min.	-20 °C
• max.	50 °C
Ambient temperature during storage/transportation	
• Storage, min.	-40 °C
• Storage, max.	70 °C
Altitude during operation relating to sea level	
• Installation altitude above sea level, max.	2 000 m
Relative humidity	
• No condensation, min.	10 %
• No condensation, max.	93 %
Dimensions	
Width	320 mm
Height	60 mm
Depth	80 mm

Overview

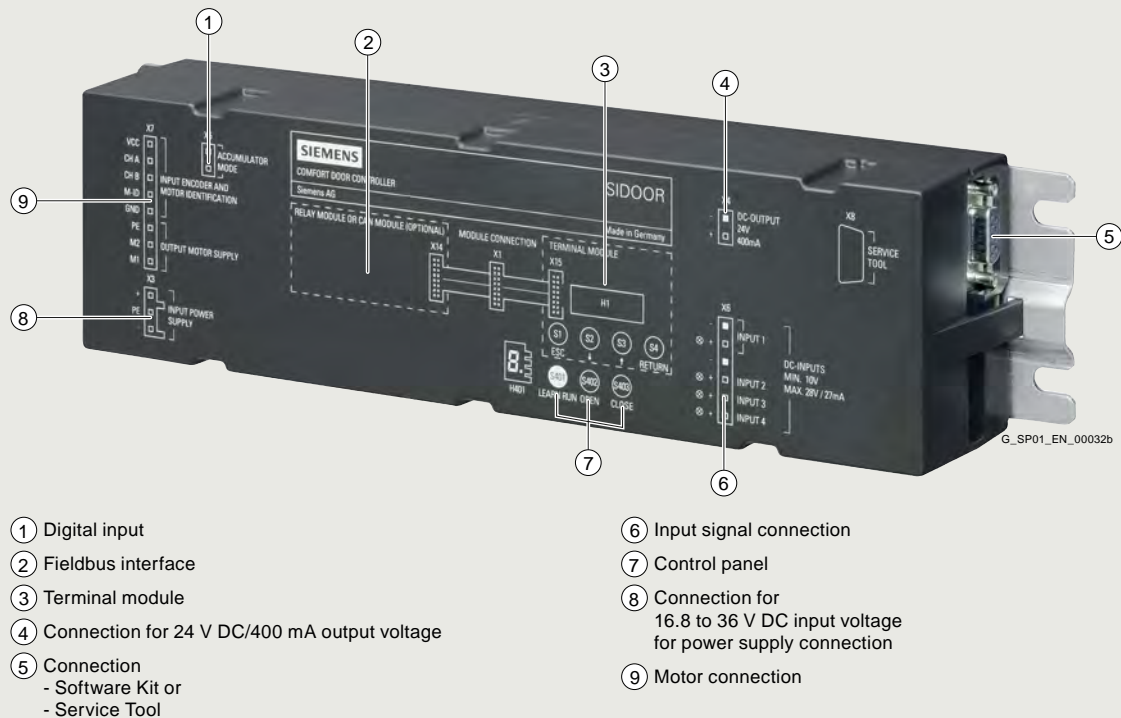

- | | |
|---|--|
| <ul style="list-style-type: none"> ① Digital input ② Fieldbus interface ③ Terminal module ④ Connection for 24 V DC/400 mA output voltage ⑤ Connection
- Software Kit or
- Service Tool | <ul style="list-style-type: none"> ⑥ Input signal connection ⑦ Control panel ⑧ Connection for
16.8 to 36 V DC input voltage
for power supply connection ⑨ Motor connection |
|---|--|

SIDOOR ATD420W

The SIDOOR ATD420W can be used to operate horizontal sliding doors. The drive system has been specially designed for use in a very wide range of machine tools. The communication-capable ATD420W controller offers complete flexibility for integration with a machine tool via PROFIBUS

- Masses of up to 700 kg
- Integrated PROFIBUS interface
- 5 freely parameterizable digital inputs for signal acquisition, of which one input is optionally parameterizable for:
 - Connection of a light barrier as type 2 ESPE (electro-sensitive protective equipment) according to EN 61496-1
 - Connection of a pressure-sensitive edge according to ISO 13856-2
- 2 relay contacts for additional position signals
- Automatic determination of the door weight and friction during the learn run
- Parameter assignment and analysis of the door parameters via PROFIdrive

- Operating temperature -20 to +50 °C
- Flexible motor management, i.e. automatic recognition of the geared motor
- Assisted drive (motor-assisted movement of the door)
- Impulse stop (door stopped automatically by applying light force)
- Impulse drive (automatic door movement after applying light force)
- Opening width 0.3 to 5 m
- Auxiliary power output 24 V DC $\pm 15\%$ and 0.4 A (short-circuit-proof)
- Output stage for the motor control is short-circuit proof
- Indicates the current operating states on a 7-segment display directly on the controller or using the Software Kit or the Service Tool

Ordering data

Article No.

SIDOOR ATD420W

6FB1141-2AT10-3WE2

Control device, integrated
PROFIBUS interface

Products for specific requirements

Automatic door controls
for industrial applications

Control devices > SIDOOR ATD420W

Technical specifications

Article number	6FB1141-2AT10-3WE2 SIDOOR ATD420W
Installation type/mounting	
Installation and mounting instructions	No direct solar radiation, final application-specific requirements must be observed. Installation outside a control cabinet only in horizontal mounting position
Supply voltage	
Design of the power supply	Via SIDOOR TRANSFORMER / SIDOOR TRANSFORMER UL / NT40 / SITOP PSU8200 13 A, 36 V or via DC
Rated value (DC)	36 V
Input current	
I^2t , min.	30 A ² ·s
Encoder supply	
Output voltage (DC)	24 V; Ensure correct polarity! CAUTION: Do not supply with external voltage!
short-circuit proof	Yes
Overload-proof	Yes
24 V encoder supply	
• Output current, max.	400 mA
Power	
Active power input	145 W
Active power input, max.	540 W
Active power input (standby mode)	5 W
Digital inputs	
Control inputs isolated	Yes
Control inputs p-switching	Yes
Input voltage	
• for signal *0*, min.	-3 V
• for signal *0*, max.	5 V
• for signal *1*, min.	10 V
• for signal *1*, max.	28 V
Input current	
• for signal *1*, min.	9 mA
• for signal *1*, max.	27 mA
Digital outputs	
Relay outputs	
Switching capacity of contacts	
- at 30 V DC, min.	0.01 A
- at 30 V DC, max.	0.5 A

Article number	6FB1141-2AT10-3WE2 SIDOOR ATD420W
Mechanical data	
Opening width of door, min.	0.3 m
Opening width of door, max.	5 m
Weight of door, max.	600 kg
Operating cycle frequency of door, max.	180 1/h
Counterforce, max.	75 N
Kinetic energy, max.	100 J
Interfaces	
Interfaces/bus type	PROFIBUS according to IEC 61784-3
Number of bus nodes	32
Standards, approvals, certificates	
Certificate of suitability according to EN 81	No
CE mark	Yes
UL approval	Yes
EAC (formerly Gost-R)	Yes
TÜV Inspectorate approval	Yes
PNO certificate	Yes
China RoHS compliance	Yes
Standard for safety	EN 61010-1 / EN 61010-2-201 / UL 61010-1 / UL 61010-2-201 / EN ISO 13849-1 Cat. 2 PL d
Ambient conditions	
Ambient temperature during operation	
• min.	-20 °C
• max.	50 °C
Ambient temperature during storage/transportation	
• Storage, min.	-40 °C
• Storage, max.	70 °C
Altitude during operation relating to sea level	
• Installation altitude above sea level, max.	2 000 m
Relative humidity	
• No condensation, min.	10 %
• No condensation, max.	93 %
Dimensions	
Width	320 mm
Height	60 mm
Depth	80 mm

Overview

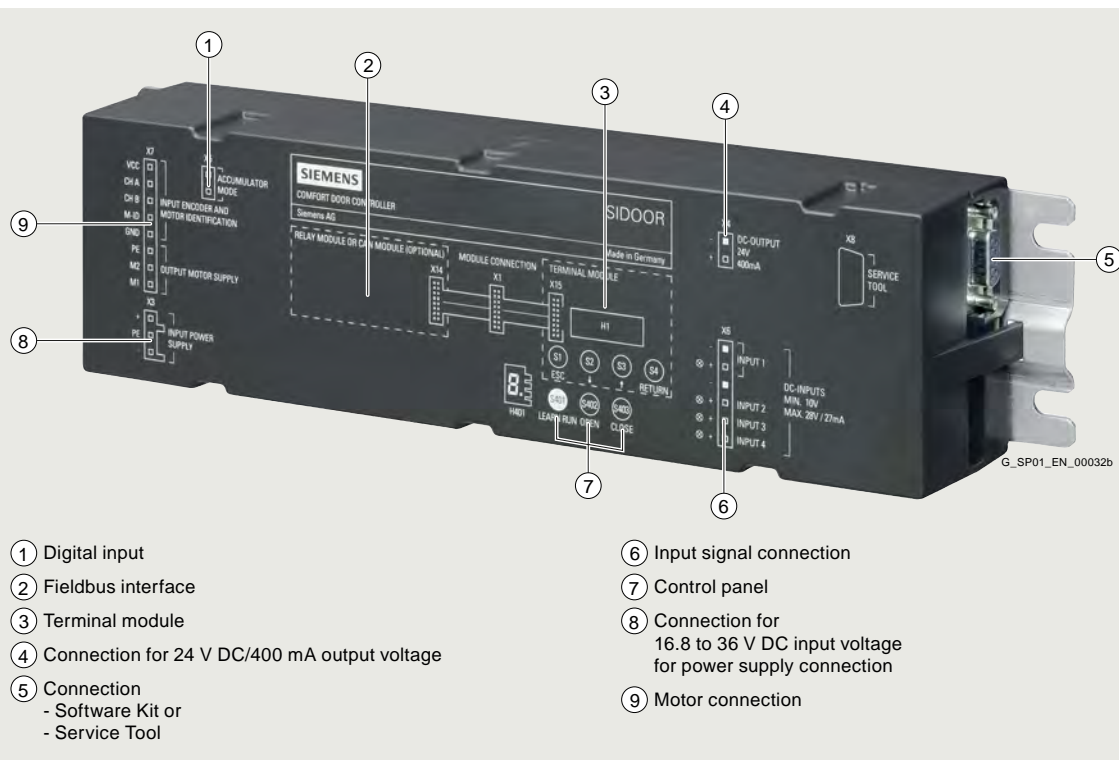

SIDOOR ATD430W

The SIDOOR ATD430W machine tool door drive can be used to operate horizontal sliding doors. The drive system has been specially designed for use in a very wide range of machine tools. The communication-capable ATD430W controller offers complete flexibility for integration into a machine tool via PROFINET.

- Masses of up to 700 kg
- Integrated PROFINET interface (2 RJ45 ports)
- 5 freely parameterizable digital inputs for signal acquisition, of which one input is optionally parameterizable for:
 - Connection of a light barrier as type 2 ESPE (electro-sensitive protective equipment) according to EN 61496-1
 - Connecting a pressure-sensitive edge according to ISO 13856-22, relay contacts for additional position signals
- 2 relay contacts for additional position signals
- Automatic determination of the door weight and friction during the learn run

- Parameter assignment and analysis of the door parameters
- Operating temperature -20 to +50 °C
- Flexible motor management, i.e. automatic recognition of the geared motor
- Assisted drive (motor-assisted movement of the door)
- Impulse stop (door stopped automatically by applying light force)
- Impulse drive (automatic door movement after applying light force)
- Opening width 0.3 to 5 m
- Auxiliary power output 24 V DC $\pm 15\%$ and 0.4 A (short-circuit-proof)
- Output stage for the motor control is short-circuit-proof
- Indicates the current operating states on a 7-segment display directly on the controller or using the Software Kit or the Service Tool

Ordering data

Article No.

SIDOOR ATD430W

6FB1141-3AT10-3WE2

Control device, integrated
PROFINET interface
(2 RJ45 ports)

Products for specific requirements

Automatic door controls
for industrial applications

Control devices > SIDOOR ATD430W

Technical specifications

Article number	6FB1141-3AT10-3WE2 SIDOOR ATD430W
Installation type/mounting	
Installation and mounting instructions	No direct solar radiation, final application-specific requirements must be observed. Installation outside a control cabinet only in horizontal mounting position
Supply voltage	
Design of the power supply	Via SIDOOR TRANSFORMER / SIDOOR TRANSFORMER UL / NT40 / SITOP PSU8200 13 A, 36 V or via DC
Rated value (DC)	36 V
Input current	
I ² t, min.	30 A ² ·s
Encoder supply	
Output voltage (DC)	24 V; Ensure correct polarity! CAUTION: Do not supply with external voltage!
short-circuit proof	Yes
Overload-proof	Yes
24 V encoder supply	
• Output current, max.	400 mA
Power	
Active power input	145 W
Active power input, max.	540 W
Active power input (standby mode)	5 W
Digital inputs	
Control inputs isolated	Yes
Control inputs p-switching	Yes
Input voltage	
• for signal *0*, min.	-3 V
• for signal *0*, max.	5 V
• for signal *1*, min.	10 V
• for signal *1*, max.	28 V
Input current	
• for signal *1*, min.	9 mA
• for signal *1*, max.	27 mA
Digital outputs	
Relay outputs	
Switching capacity of contacts	
- at 30 V DC, min.	0.01 A
- at 30 V DC, max.	0.5 A
Mechanical data	
Opening width of door, min.	0.3 m
Opening width of door, max.	5 m
Weight of door, max.	600 kg
Operating cycle frequency of door, max.	180 1/h
Counterforce, max.	75 N
Kinetic energy, max.	100 J

Article number	6FB1141-3AT10-3WE2 SIDOOR ATD430W
Interfaces	
Interfaces/bus type	PROFINET IO according to Conformance Class C
Standards, approvals, certificates	
Certificate of suitability according to EN 81	No
CE mark	Yes
UL approval	Yes
EAC (formerly Gost-R)	Yes
TÜV Inspectorate approval	Yes
PNO certificate	Yes
China RoHS compliance	Yes
Standard for safety	EN 61010-1 / EN 61010-2-201 / UL 61010-1 / UL 61010-2-201 / EN ISO 13849-1 Cat. 2 PL d
Ambient conditions	
Ambient temperature during operation	
• min.	-20 °C
• max.	50 °C
• Remark	Screw control device thermally conductive onto a metallic mounting surface or standard rail mounting, otherwise the maximum operating temperature is only 40 °C
Ambient temperature during storage/transportation	
• Storage, min.	-40 °C
• Storage, max.	70 °C
Altitude during operation relating to sea level	
• Installation altitude above sea level, max.	2 000 m
Relative humidity	
• No condensation, min.	10 %
• No condensation, max.	93 %
Dimensions	
Width	320 mm
Height	60 mm
Depth	80 mm

Overview

The power supplies can be used for the various SIDOOR controllers:

SIDOOR Transformer and Transformer UL power supply units:
For masses of up to 400 kg and moderate performance.

- SIDOOR AT40 and ATE500E elevator door drives
- SIDOOR ATD4xxW machine tool door drives
- SIDOOR ATE53xS platform screen door drives

SIDOOR NT40 switched mode power supply:

For masses of up to 600 kg and maximum performance.

- SIDOOR AT40 and ATE500E elevator door drives
- SIDOOR ATD4xxW machine tool door drives

SITOP PSU8200 3-phase stabilized power supply, 36 V DC/13 A:
For masses of up to 700 kg and maximum performance.

- SIDOOR ATD4xxW machine tool door drives

Overview Power supply unit

SIDOOR Transformer

The SIDOOR TRANSFORMER and SIDOOR TRANSFORMER UL are standard power supply units operated with 220-240 V AC, 50/60 Hz, from the SIDOOR product range. They can be used for controllers capable of controlling masses of up to 400 kg.

Further information see page 14/17.

Overview Switched-mode power supply

The SIDOOR NT40 switched-mode power supply unit is operated with 230 V AC ($\pm 15\%$), 50/60 Hz, to power the elevator door controllers.

It is especially suitable for door systems with high door weights.

On the output side, the power supply unit delivers a voltage of 36 V DC ($\pm 3\%$) SELV at a rated output power of < 100 W.

In order to enable fast acceleration/deceleration of the doors by the controller, the device can briefly (< 2 s) deliver a current of 15 A (corresponds to a short-time power output of 540 W).

Further information see page 14/19.

Products for specific requirements

Automatic door controls
for industrial applications

Power supplies > 3-phase, 36 V DC

Overview



The 3-phase SITOP PSU8200 are technology power supplies for challenging solutions. The wide-range input allows a connection to almost any electricity supply network worldwide and ensures a high degree of safety even if there are large voltage fluctuations.

To further increase 36 V availability, SITOP power supplies can be combined with redundancy modules.

Product highlights

- 3-phase, 36 V DC / 13 A
- Input voltage 320 ... 575 V AC
- Up to 94% efficiency
- cULus, cCSAus, ABS and DNV GL certifications

Ordering data

Ordering data	Article No.
SITOP PSU8200 3-phase, 36 V DC/13 A	6EP3446-8SB10-0AY0
Stabilized power supply Input: 400 ... 500 V 3 AC Output: 36 V DC/13 A	
Add-on modules	
SITOP redundancy modules RED1200¹⁾	
Accessories	
Device identification label	3RT2900-1SB20

¹⁾ For more information, visit:
<https://www.siemens.com/sitop-redundancy/mall>

Technical specifications

Article number	6EP3446-8SB10-0AY0
Product	SITOP PSU8200
Power supply, type	36 V/13 A
Input	
type of the power supply network	3-phase AC
supply voltage at AC	
• minimum rated value	400 V
• maximum rated value	500 V
• initial value	320 V
• full-scale value	575 V
design of input wide range input	Yes
operating condition of the mains buffering	at Vin = 400 V
buffering time for rated value of the output current in the event of power failure minimum	15 ms
operating condition of the mains buffering	at Vin = 400 V
line frequency	
• 1 rated value	50 Hz
• 2 rated value	60 Hz
line frequency	47 ... 63 Hz
input current	
• at rated input voltage 400 V	1.2 A
• at rated input voltage 500 V	1 A
current limitation of inrush current at 25 °C maximum	16 A
I2t value maximum	0.8 A ² ·s
fuse protection type	none
• in the feeder	Required: 3-pole connected miniature circuit breaker 6 ... 16 A characteristic C or circuit breaker 3RV2011-1DA10 (setting 3 A) or 3RV2711-1DD10 (UL 489)
Output	
voltage curve at output	Controlled, isolated DC voltage
output voltage at DC rated value	36 V
output voltage	
• at output 1 at DC rated value	36 V
relative overall tolerance of the voltage	3 %
relative control precision of the output voltage	
• on slow fluctuation of input voltage	0.1 %
• on slow fluctuation of ohm loading	0.2 %
residual ripple	
• maximum	100 mV
voltage peak	
• maximum	200 mV
adjustable output voltage	36 ... 42 V
product function output voltage adjustable	Yes
type of output voltage setting	via potentiometer; max. 480 W
display version for normal operation	Green LED for 36 V OK
type of signal at output	Relay contact (NO contact, rating 60 V DC/ 0.3 A) for 36 V OK
behavior of the output voltage when switching on	No overshoot of Vout (soft start)
response delay maximum	2.5 s
voltage increase time of the output voltage	
• maximum	500 ms
output current	
• rated value	13 A
• rated range	0 ... 13 A; +60 ... +70 °C: Derating 2%/K
supplied active power typical	468 W
short-term overload current	
• at short-circuit during operation typical	39 A

Technical specifications

Article number	6EP3446-8SB10-0AY0
Product	SITOP PSU8200
Power supply, type	36 V/13 A
duration of overloading capability for excess current	
• at short-circuit during operation	25 ms
constant overload current	
• on short-circuiting during the start-up typical	14 A
product feature	
• bridging of equipment	Yes; switchable characteristic
number of parallel-switched equipment	2
resources for increasing the power	
Efficiency	
efficiency in percent	94 %
power loss [W]	
• at rated output voltage for rated value of the output current typical	30 W
Closed-loop control	
relative control precision of the output voltage with rapid fluctuation of the input voltage by +/- 15% typical	0.1 %
relative control precision of the output voltage load step of resistive load 50/100/50 % typical	1 %
setting time	
• load step 50 to 100% typical	0.2 ms
• load step 100 to 50% typical	0.2 ms
relative control precision of the output voltage at load step of resistive load 10/90/10 % typical	2 %
setting time	
• load step 10 to 90% typical	0.2 ms
• load step 90 to 10% typical	0.2 ms
• maximum	10 ms
Protection and monitoring	
design of the overvoltage protection	< 48 V
response value current limitation typical	14 A
property of the output short-circuit proof	Yes
design of short-circuit protection	Alternatively, constant current characteristic approx. 14 A or latching shutdown
enduring short circuit current RMS value	
• typical	14 A
overcurrent overload capability in normal operation	overload capability 150 % I _{out} rated up to 5 s/min
display version for overload and short circuit	LED yellow for "overload", LED red for "latching shutdown"
Safety	
galvanic isolation between input and output	Yes
galvanic isolation	Safety extra low output voltage V _{out} according to EN 60950-1
operating resource protection class	Class I
leakage current	
• maximum	3.5 mA
• typical	0.9 mA
protection class IP	IP20
Approvals	
certificate of suitability	
• CE marking	Yes
• UL approval	Yes; cULus-Listed (UL 508, CSA C22.2 No. 107.1), File E197259; cCSAus (CSA C22.2 No. 60950-1, UL 60950-1)
• CSA approval	Yes; cULus-Listed (UL 508, CSA C22.2 No. 107.1), File E197259; cCSAus (CSA C22.2 No. 60950-1, UL 60950-1)

Article number	6EP3446-8SB10-0AY0
Product	SITOP PSU8200
Power supply, type	36 V/13 A
• cCSAus, Class 1, Division 2	No
• ATEX	No
certificate of suitability	
• IECEX	No
• NEC Class 2	No
• ULhazloc approval	No
• FM registration	No
type of certification CB-certificate of suitability	Yes
• EAC approval	Yes
certificate of suitability shipbuilding approval	Yes
shipbuilding approval	DNV GL
Marine classification association	
• American Bureau of Shipping Europe Ltd. (ABS)	No
• French marine classification society (BV)	No
• DNV GL	Yes
• Lloyds Register of Shipping (LRS)	No
• Nippon Kaiji Kyokai (NK)	No
EMC	
standard	
• for emitted interference	EN 55022 Class B
• for mains harmonics limitation	EN 61000-3-2
• for interference immunity	EN 61000-6-2
environmental conditions	
ambient temperature	
• during operation	-25 ... +70 °C; with natural convection
• during transport	-40 ... +85 °C
• during storage	-40 ... +85 °C
environmental category acc. to IEC 60721	Climate class 3K3, 5 ... 95% no condensation
Mechanics	
type of electrical connection	screw-type terminals
• at input	L1, L2, L3, PE: 1 screw terminal each for 0.2 ... 4 mm ² single-core/finely stranded
• at output	+, -: 2 screw terminals each for 0.2 ... 4 mm ²
• for auxiliary contacts	13, 14 (alarm signal): 1 screw terminal each for 0.14 ... 1.5 mm ² ; 15, 16 (Remote): 1 screw terminal each for 0.14 ... 1.5 mm ²
width of the enclosure	70 mm
height of the enclosure	125 mm
depth of the enclosure	125 mm
required spacing	
• top	50 mm
• bottom	50 mm
• left	0 mm
• right	0 mm
net weight	1.2 kg
product feature of the enclosure housing can be lined up	Yes
fastening method	Snaps onto DIN rail EN 60715 35x7.5/15
mechanical accessories	Device identification label 20 mm x 7 mm, TI-grey 3RT2900-1SB20
other information	Specifications at rated input voltage and ambient temperature +25 °C (unless otherwise specified)

Products for specific requirements

Automatic door controls
for industrial applications

Additional units > Software kit, Service tool

Overview Software kit



SIDOOR Software Kit

The scope of delivery of the SIDOOR Software Kit includes an installation CD.

The CD includes the following functionalities:

SIDOOR User Software	The component that enables the door control system to be configured, parameters to be assigned, and analyzed.
Siemens HCS12 Firmware Loader	This component is used to update the operating software of the door controller.
SIDOOR USB to UART Bridge Driver	This driver is essential for operation of the USB adapter.

Note:

Some firmware updates are offered as free downloads in the Siemens Industry Online Support. For information on the availability and acquisition of more firmware, please contact Technical Support.

Ordering data

Article No.

SIDOOR Software Kit	6FB1105-0AT01-6SW0
----------------------------	---------------------------

Overview Service tool



The Service Tool can be used to input run commands, change run parameters and read out learned parameters, door states, input/output signals and service data.

The Service Tool is connected to the various controllers by the respective cable.

You do not need to open the cover of the controller to do this.

Note:

If the Service Tool is in the "Quick adjustment" or "Total adjustment" menu, the run commands of the controller are blocked via the command inputs.

Ordering data

Article No.

SIDOOR Service Tool, hand-held terminal

6FB1105-0AT01-6ST0

for parameter assignment of control devices

Overview

The SIDOOR geared motor is a combination of a gear unit, motor and incremental encoder matched to the complete system. It is easy to connect to the controller via the interface provided, and is automatically detected during commissioning.

The maintenance-free, variable speed drive unit comprises a DC motor with non-self-locking gearing. All geared motors are available with the output shaft on the left or right. The view is toward the front of the gear unit.

The "mass to be moved" has to be taken into account when selecting the geared motor:

The weight to be moved is calculated from the sum of the mass equivalent of the moment of inertia of the motor rotor, the moved door weight and the moved door mechanism weight. The weight of the door to be moved and the moved weight of the door mechanism depend on the application. You can find additional information in the system manual.

The **output shaft** is appropriately prepared for the mechanical coupling of the door.

- SIDOOR M3, M4 and M5 Basic motors: Output gear with 56 mm effective diameter for the use of a S8M toothed belt (see Accessories).
- Advanced motors: Gearbox output shaft with groove and feather key A 5x5 according to DIN 6885; the output gear design and effective diameter can be freely configured between 28 mm and 122 mm. Advanced motors are recommended, among other things, for a mechanical coupling to the door via gear rack or chain.

Advanced motors:

SIDOOR MDG3 L	6FB1103-0AT14-4MB1
SIDOOR MDG3 R	6FB1103-0AT13-4MB1
SIDOOR MDG4 L	6FB1103-0AT14-3MG2
SIDOOR MDG4 R	6FB1103-0AT13-3MG2
SIDOOR MDG5 L	6FB1103-0AT14-3MG2
SIDOOR MDG5 R	6FB1103-0AT13-3MG2

Version	Advanced motors			Basic motors		
SIDOOR designation	MDG3	MDG4	MDG5	M3	M4	M5
Maximum mass to be moved	180 kg	400 kg	700 kg	180 kg	400 kg	600 kg
Connection to door controller	via SIDOOR MDG CABLE (see Accessories)			Connecting cable permanently integrated with the geared motor, cable length 1.5 m		
Degree of protection	IP56			IP40		IP54
Design of output shaft	Gearbox output shaft with groove and feather key, optional output gear for S8M toothed belt available (see Accessories)			Fixed, pressed-on output gear for S8M toothed belt (see Accessories)		



SIDOOR M3 L to SIDOOR M5 L geared motors for automatic door control



SIDOOR MDG3 L, MDG4 L and MDG5 L

Products for specific requirements

Automatic door controls
for industrial applications

Geared motors

Ordering data	Article No.	Ordering data	Article No.
SIDOOR M3 geared motors		SIDOOR MDG3 geared motors	
M3 L	6FB1103-0AT10-4MB0	MDG3 L	6FB1103-0AT14-4MB1
M3 R	6FB1103-0AT11-4MB0	MDG3 R	6FB1103-0AT13-4MB1
SIDOOR M4 geared motors		SIDOOR MDG4 geared motor	
M4 L	6FB1103-0AT10-3MC0	MDG4 L	6FB1103-0AT14-3MC2
M4 R	6FB1103-0AT11-3MC0	MDG4 R	6FB1103-0AT13-3MC2
SIDOOR M5 geared motors		SIDOOR MDG5 geared motor	
M5 L	6FB1103-0AT10-3MD0	MDG5 L	6FB1103-0AT14-3MG2
M5 R	6FB1103-0AT11-3MD0	MDG5 R	6FB1103-0AT13-3MG2

Technical specifications

Article number	6FB1103-0AT10-4MB0	6FB1103-0AT11-4MB0	6FB1103-0AT10-3MC0	6FB1103-0AT11-3MC0	6FB1103-0AT10-3MD0	6FB1103-0AT11-3MD0
	SIDOOR M3 L	SIDOOR M3 R	SIDOOR M4 L	SIDOOR M4 R	SIDOOR M5 L	SIDOOR M5 R
Supply voltage						
Rated value (DC)	30 V					
Input current						
Operational current (rated value)	4 A			7.5 A		
Power						
Active power input	120 W			225 W		
Mechanical data						
Torque of the rotary operating mechanism (rated value)	3 N·m			6.8 N·m		
Speed, max.	0.65 m/s		0.75 m/s		0.5 m/s	
Gear ratio	15					
Number of pulses per revolution, max.	100					
Weight of door, max.	180 kg			400 kg		600 kg
Standards, approvals, certificates						
CE mark	Yes					
UL approval	Yes					
EAC (formerly Gost-R)	Yes					
TÜV Inspectorate approval	Yes					
China RoHS compliance	Yes					
Ambient conditions						
Ambient temperature during operation						
• min.	-20 °C					
• max.	50 °C					
Ambient temperature during storage/transportation						
• Storage, min.	-40 °C					
• Storage, max.	85 °C					
Dimensions						
Height of motor	98 mm		115 mm		124 mm	
Length of motor	236 mm		275 mm		344 mm	
Diameter of motor	63 mm					
Width of gear unit, including drive pinion	85 mm			105 mm		111 mm

Technical specifications

Article number	6FB1103-0AT14-4MB1	6FB1103-0AT13-4MB1	6FB1103-0AT14-3MC2	6FB1103-0AT13-3MC2	6FB1103-0AT14-3MG2	6FB1103-0AT13-3MG2
	SIDOOR MDG3 L	SIDOOR MDG3 R	SIDOOR MDG4 L	SIDOOR MDG4 R	SIDOOR MDG5 L	SIDOOR MDG5 R
General information						
Product type designation	MDG3 L	MDG3 R	MDG4 L	MDG4 R	MDG5 L	MDG5 R
Supply voltage						
Rated value (DC)	30 V					
Input current						
Operational current (rated value)	4 A				7.5 A	
Power						
Active power input	120 W				225 W	
Mechanical data						
Torque of the rotary operating mechanism (rated value)	3 N·m				6 N·m	
Speed, max.	0.65 m/s		0.75 m/s		0.5 m/s	
Mass to be moved, max.	180 kg		400 kg		700 kg	
Gear unit	Yes					
Gear ratio	15					
Number of pulses per revolution, max.	100					
Fixed output gear	No					
Standards, approvals, certificates						
CE mark	Yes					
UL approval	Yes					
EAC (formerly Gost-R)	Yes					
China RoHS compliance	Yes					
Ambient conditions						
Ambient temperature during operation						
• min.	-20 °C					
• max.	50 °C					
Ambient temperature during storage/transportation						
• Storage, min.	-40 °C					
• Storage, max.	85 °C					
Cables						
Fixed connecting cable	No					
Dimensions						
Diameter of output gear, min.	28 mm					
Diameter of output gear, max.	122 mm					
Height of motor	98 mm		115 mm		124 mm	
Length of motor	264 mm		303 mm		348 mm	
Diameter of motor	63 mm				80 mm	
Width of gearbox	85 mm		106 mm		109 mm	

Products for specific requirements

Automatic door controls
for industrial applications

Accessories

Overview

An extensive range of accessories is available for the door control drives.

This is necessary to ensure low-noise operation of the door leaves by the motor. The geared motors can be optimally integrated into the respective door drive system.

Accessories for all controllers for industrial applications

Rubber-metal anti-vibration mounts for geared motors

To ensure low-noise door operation, SIDOOR geared motors are integrated in the door system using rubber-metal anti-vibration mounts.

- Rubber-metal anti-vibration mount 6FB1104-0AT02-0AD0 for SIDOOR M3 and SIDOOR MDG3 geared motors
- Rubber-metal anti-vibration mount 6FB1104-0AT01-0AD0 for SIDOOR M4 and MDG4 as well as SIDOOR M5 and MDG5 geared motors



Rubber-metal anti-vibration mount 6FB1104-0AT02-0AD0 for geared motors with masses to be moved of up to 180 kg



Rubber-metal anti-vibration mount 6FB1104-0AT01-0AD0 for geared motors with masses of up to 700 kg

Mounting bracket

Two different mounting brackets are available with elongated holes:

- Mounting bracket 6FB1104-0AT01-0AS0 for mounting SIDOOR geared motors, for flexible accommodation of the rubber-bonded metal
- Mounting bracket 6FB1104-0AT02-0AS0 for the deflector unit. For setting the toothed belt to the required belt tension.



Mounting bracket 6FB1104-0AT01-0AS0 for mounting the geared motor



Mounting bracket 6FB1104-0AT02-0AS0 for the deflector unit

Mounting rail holder

The standard mounting rail holder 6FB1144-0AT00-3SA0 is available for mounting controllers on the TH 35 standard mounting rail according to IEC 60715.

Door clutch holder

The door clutch holder serves to connect the respective door leaf by means of a toothed belt while also functioning as a toothed-belt lock. One door clutch holder per door leaf is required. The toothed-belt lock can accommodate both open ends of the toothed belt.

A door clutch holder is available for each toothed belt width:

- Width 12 mm: 6FB1104-0AT01-0CP0
- Width 14 mm: 6FB1104-0AT02-0CP0



Door clutch holder 6FB1104-0AT01-0CP0 (packaging size = 1 unit)

Deflector unit

The deflector unit 6FB1104-0AT03-0AS0 contains an embedded belt pulley which can be mounted on the door system. The STS toothed belt is redirected via this deflector unit.



Deflector unit 6FB1104-0AT03-0AS0

OverviewSTS toothed belt

The door system is moved between the end positions of the door using the STS toothed belts. Two different toothed belt lengths can be ordered for each toothed belt width.

- Toothed belt width 12 mm:
 - Length 4 m: 6FB1104-0AT01-0AB0
 - Length 45 m: 6FB1104-0AT02-0AB0
- Toothed belt width 14 mm:
 - Length 4 m: 6FB1104-0AT03-0AB0
 - Length 55 m: 6FB1104-0AT04-0AB0

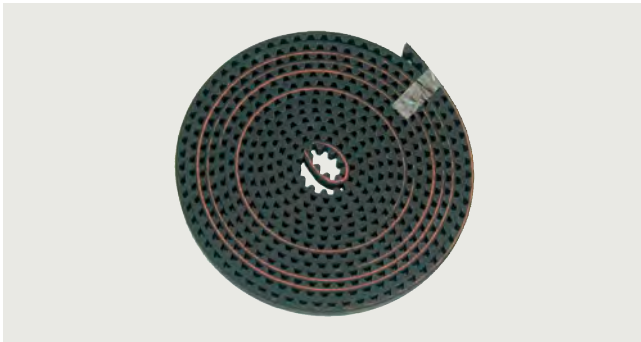

Toothed belt 6FB1104-0AT01-0AB0 (width 12 mm, length 4 m)



Toothed belt 6FB1104-0AT02-0AB0 (width 12 mm, length 45 m)

MDG-PULLEY belt pulley

This belt pulley is used for DC geared motors with the S8M toothed belt with an effective diameter of 56 mm.

- for SIDOOR MDG4, MDG5 DC geared motors: 6FB1104-0AT14-0AS1
- for SIDOOR MDG3 DC geared motors: 6FB1104-0AT10-0AS1

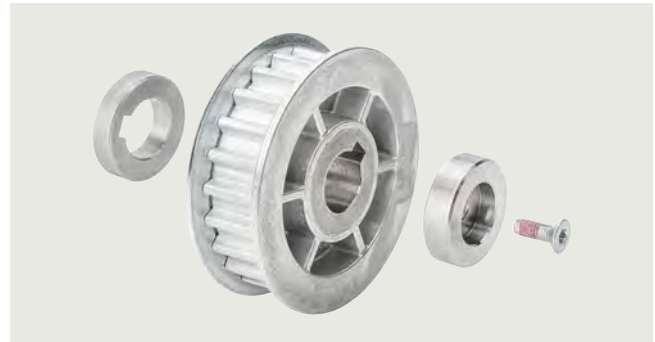

SIDOOR MDG-PULLEY 14-S8M-56, 6FB1104-0AT14-0AS1

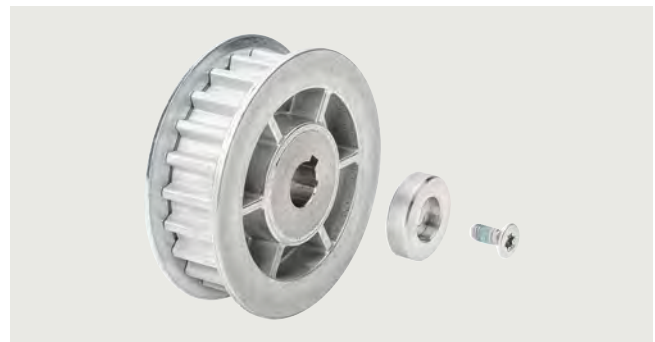

SIDOOR MDG-PULLEY 10-S8M-56, 6FB1104-0AT10-0AS1

Accessories for machine tool door drives onlySIDOOR MDG-CABLE cable set

This cable set connects the ATD4xxW door controller to the SIDOOR MDG3, MDG 4 and MDG 5 geared motors. Various lengths are available.

- Length 5 m: 6FB1104-0AT05-0CB2
- Length 10 m: 6FB1104-0AT10-0CB2
- Length 15 m: 6FB1104-0AT15-0CB2
- Length 20 m: 6FB1104-0AT20-0CB2

Products for specific requirements

Automatic door controls
for industrial applications

Accessories

Ordering data	Article No.		Article No.
Rubber-metal anti-vibration mounts for geared motors <ul style="list-style-type: none"> SIDOOR rubber-metal anti-vibration mount for geared motors with masses of up to 180 kg SIDOOR rubber-metal anti-vibration mount for geared motors with masses of up to 700 kg 	6FB1104-0AT02-0AD0 6FB1104-0AT01-0AD0	SIDOOR STS toothed belt Width 14 mm <ul style="list-style-type: none"> 4 m 55 m 	6FB1104-0AT03-0AB0 6FB1104-0AT04-0AB0
Mounting bracket <ul style="list-style-type: none"> SIDOOR mounting bracket for geared motor SIDOOR mounting bracket with tensioning device for deflector pulley 	6FB1104-0AT01-0AS0 6FB1104-0AT02-0AS0	For industrial applications only SIDOOR MDG-CABLE cable set <ul style="list-style-type: none"> 5 m 10 m 15 m 20 m 	6FB1104-0AT05-0CB2 6FB1104-0AT10-0CB2 6FB1104-0AT15-0CB2 6FB1104-0AT20-0CB2
DIN rail holder For mounting controllers on the standard DIN rail TH 35	6FB1144-0AT00-3AS0	SIDOOR door clutch holder <ul style="list-style-type: none"> For toothed belt, width 14 mm 	6FB1104-0AT02-0CP0
SIDOOR door clutch holder <ul style="list-style-type: none"> For toothed belt width of 12 mm 	6FB1104-0AT01-0CP0	SIDOOR MDG-PULLEY <ul style="list-style-type: none"> SIDOOR MDG-PULLEY 14-S8M-56 belt pulley for MDG4 and MDG5 DC geared motors and S8M toothed belt, effective diameter 56 mm SIDOOR MDG-PULLEY 10-S8M-56, belt pulley for MDG3 DC geared motor and S8M toothed belt, effective diameter 56 mm 	6FB1104-0AT14-0AS1 6FB1104-0AT10-0AS1
SIDOOR deflector unit	6FB1104-0AT03-0AS0		
SIDOOR STS toothed belt Width 12 mm <ul style="list-style-type: none"> 4 m 45 m 	6FB1104-0AT01-0AB0 6FB1104-0AT02-0AB0		

Overview

The product-specific application/requirement lies in complying with the special railway requirements concerning functional safety.

Interior railway doors have a closing spring which must always bring the door into the "CLOSED" position. This applies to either side, even when a train car is inclined at 10°.

These specific operating states are handled by the door controller.

Products for specific requirements

Automatic door controls
for railway applications

Control devices > Platform screen door drive

Overview

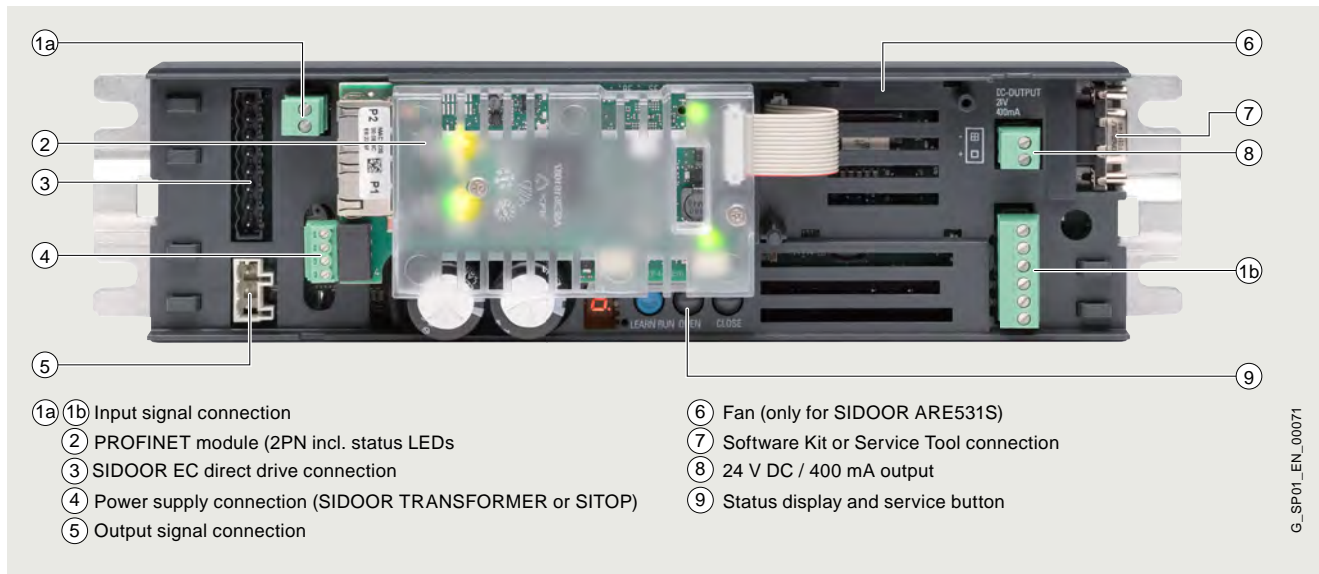

SIDOOR ATE530S/531S wiring diagram

The SIDOOR ATE53xS door controller is an “intelligent” door drive which can be used for safety-oriented operation of platform screen doors (PSD) according to individual requirements. Siemens has once again shown just how easy integration can be with the innovative SIDOOR ATE53xS platform screen door drive in conjunction with SIDOOR MED280 or MEG251 motors. The PROFINET module integrated in the SIDOOR ATE53xS enables standardized, certified connection to PROFINET IO systems.

- Use of standard automation components
- Full integration into TIA Portal and STEP 7 thanks to PROFINET connection
- Parameter assignment and monitoring of door control parameters via the PROFINET interface (function blocks available as example applications in SIOS).

- Application example:
Synchronization of two-panel and independent platform screen doors with SIDOOR ATE530S PROFINET EC door drive and S7-1500 CPU via TIA Portal
<https://support.industry.siemens.com/cs/ww/en/view/109480495>
- Application example:
Safety-oriented automation of platform screen doors with SIDOOR ATE530S PROFINET EC door drive and S7-1500 CPU via TIA Portal
<https://support.industry.siemens.com/cs/ww/en/view/109477186>
- Read-in of two safe signals (two-channel, antivalent)
- High level of system safety thanks to safe torque off (e.g. self-release in the event of a fault)
- Firmware update for all SIDOOR controllers on an entire platform possible centrally via TCP/IP
- SIL 2 according to IEC 62061

14

Ordering data

SIDOOR ATE530S Platform screen door drive

SIDOOR ATE530S coated, version with protective coating

Article No.

6FB1231-3BM12-7AT0

Article No.

SIDOOR ATE531S Platform screen door drive

SIDOOR ATE531S, version with protective coating and extended temperature range

6FB1231-3BM11-7AT0

Technical specifications

Article number	6FB1231-3BM12-7AT0 SIDOOR ATE530S COATED	6FB1231-3BM11-7AT0 SIDOOR ATE531S
General information		
Product type designation		ATE531S
Mean time between failures (MTBF)	13 y	
Installation type/mounting		
Installation and mounting instructions	No direct exposure to the sun	
Supply voltage		
Design of the power supply	Via SIDOOR TRANSFORMER or via DC	
Rated value (DC)	36 V; with MED280: at 24 V DC max. door speed of 500 mm/s, at 28.8 V DC max. door speed of 800 mm/s. With MEG251: at 24 V DC max. door speed of 500 mm/s, at 28.8 V DC max. door speed of 750 mm/s	
Encoder supply		
Output voltage (DC)	24 V; Ensure correct polarity! CAUTION: Do not supply with external voltage!	
short-circuit proof	Yes	
Overload-proof	Yes	
24 V encoder supply		
• Output current, max.	400 mA	
Power		
Active power input	80 W	
Active power input, max.	540 W	
Active power input (standby mode)	7 W	
Digital inputs		
Control inputs isolated	Yes	
Control inputs p-switching	Yes	
Input voltage		
• for signal *0*, min.	-3 V	
• for signal *0*, max.	5 V	
• for signal *1*, min.	10 V	
• for signal *1*, max.	28 V	
Input current		
• for signal *1*, min.	3 mA	
• for signal *1*, max.	15 mA	
Digital outputs		
Relay outputs		
Switching capacity of contacts		
- at 30 V DC, min.	0.01 A	
- at 30 V DC, max.	0.5 A	
Mechanical data		
Opening width of door, min.	0.35 m	
Opening width of door, max.	5 m	
Weight of door, max.	280 kg	
Operating cycle frequency of door, max.	180 1/h	
Kinetic energy, max.	75 J	
Interfaces		
Interfaces/bus type	PROFINET according to Conformance Class A, B, C; integrated switch for linear and ring structure	

Products for specific requirements

Automatic door controls
for railway applications

Control devices > Platform screen door drive

Technical specifications

Article number	6FB1231-3BM12-7AT0	6FB1231-3BM11-7AT0
	SIDOOR ATE530S COATED	SIDOOR ATE531S
Standards, approvals, certificates		
CE mark	Yes	No
UL approval	No	
China RoHS compliance	Yes	
Standard for safety	EN 61010-1 / EN 61010-2-201 / EN 14752 / EN ISO 13849-1 Cat. 2 PL d / IEC 62061: SIL 2	
Ambient conditions		
Ambient temperature during operation		
• min.	-25 °C	70 °C
• max.	50 °C	
• Remark	Screw control device thermally conductive onto a metallic mounting surface or standard rail mounting, otherwise the maximum operating temperature is only 40 °C	to ensure compliance with MTBF value, ensure that the ambient temperature is less than 50 °C for 90 % of operating time and screw the control unit onto a metallic mounting surface in a manner that ensures thermal conductivity or use standard rail mounting. At operating temperatures above 50 °C, the maximum output current of the 24 V DC output is a maximum of 0.1 A and the maximum number of cycles is 60/h
Ambient temperature during storage/transportation		
• Storage, min.	-40 °C	
• Storage, max.	85 °C	
Altitude during operation relating to sea level		
• Installation altitude above sea level, max.	2 000 m	
Relative humidity		
• No condensation, min.	10 %	
• No condensation, max.	93 %	
Dimensions		
Width	320 mm	
Height	60 mm	
Depth	80 mm	

Overview

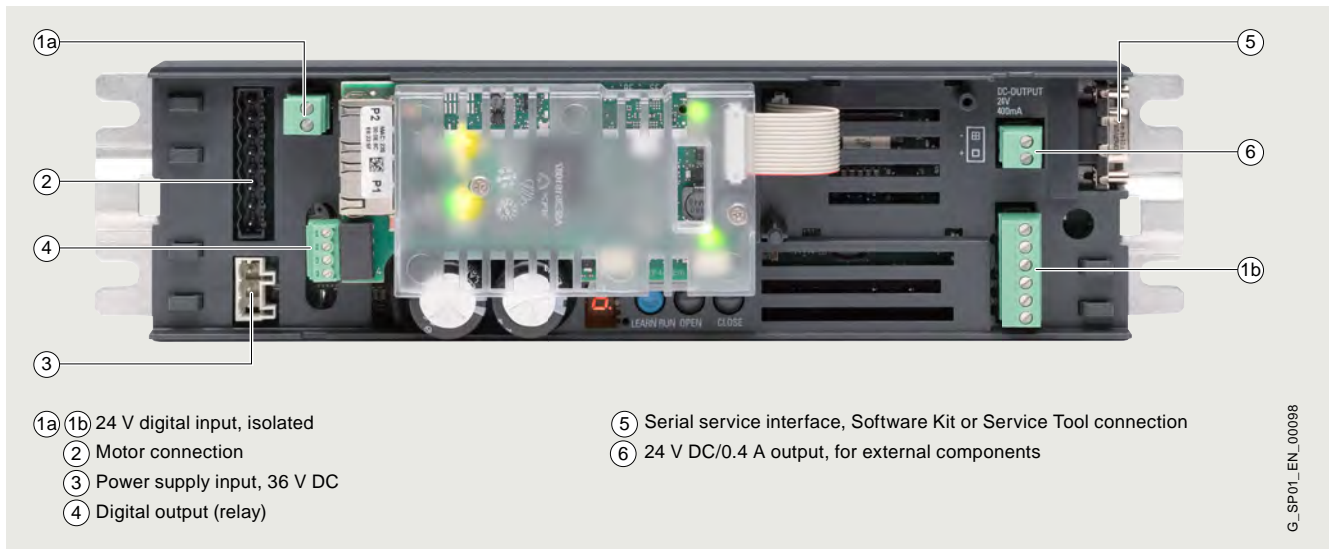

SIDOOR ATE530G

The SIDOOR ATE530G drive control is designed for controlling gap fillers between external train doors and the platform edge. The gap filler facilitates easy access for passengers. The innovative SIDOOR ATE530G drive solution enables operation of a gap filler with adjustable speed, acceleration and motor currents.

A project-specific motor is used depending on the application. The SIDOOR ATE530G controller is activated by digital signals from a higher-level door control, and reports information about its current state via digital signals back to the door control.

The following drive functions are supported:

- System start-up after power failure
- "Extend", "Retract" command
- Gap filler is moved by a travel curve profile
- Obstruction detection
- Ice-breaker function
Icing can be shifted broken by repeated extension and retraction of the gap filler with increased force.
- Reversing at the platform edge

The SIDOOR ATE530G controller fulfills Basic Integrity in accordance with EN 50657:2017

Ordering data

Article No.

**SIDOOR ATE530G
control device for gap fillers**

SIDOOR ATE530G coated,
for controlling gap fillers between
external train doors and the platform
edge.

6FB1221-5SM10-7BP0

Products for specific requirements

Automatic door controls
for railway applications

Control devices > Control device for gap fillers

Technical specifications

Article number	6FB1221-5SM10-7BP0 SIDOOR ATE530G COATED
General information	
Product type designation	ATE530G COATED
Mean time between failures (MTBF)	13 y
Installation type/mounting	
Installation and mounting instructions	No direct exposure to the sun
Supply voltage	
Design of the power supply	Via SIDOOR TRANSFORMER or via DC
Rated value (DC)	36 V
Encoder supply	
Output voltage (DC)	24 V; Ensure correct polarity! CAUTION: Do not supply with external voltage!
short-circuit proof	Yes
Overload-proof	Yes
24 V encoder supply	
• Output current, max.	400 mA
Power	
Active power input	80 W
Active power input, max.	540 W
Active power input (standby mode)	7 W
Digital inputs	
Control inputs isolated	Yes
Control inputs p-switching	Yes
Input voltage	
• for signal *0*, min.	-3 V
• for signal *0*, max.	5 V
• for signal *1*, min.	10 V
• for signal *1*, max.	28 V
Input current	
• for signal *1*, min.	3 mA
• for signal *1*, max.	15 mA
Digital outputs	
Relay outputs	
Switching capacity of contacts	
- at 30 V DC, min.	0.01 A
- at 30 V DC, max.	0.5 A

Article number	6FB1221-5SM10-7BP0 SIDOOR ATE530G COATED
Standards, approvals, certificates	
CE mark	Yes
EAC (formerly Gost-R)	Yes
Ambient conditions	
Ambient temperature during operation	
• min.	-25 °C
• max.	50 °C
• Remark	Screw control device thermally conductive onto a metallic mounting surface or standard rail mounting, otherwise the maximum operating temperature is only 40 °C
Ambient temperature during storage/transportation	
• Storage, min.	-40 °C
• Storage, max.	85 °C
Altitude during operation relating to sea level	
• Installation altitude above sea level, max.	2 000 m
Relative humidity	
• No condensation, min.	10 %
• No condensation, max.	93 %
Dimensions	
Width	320 mm
Height	60 mm
Depth	80 mm

Overview

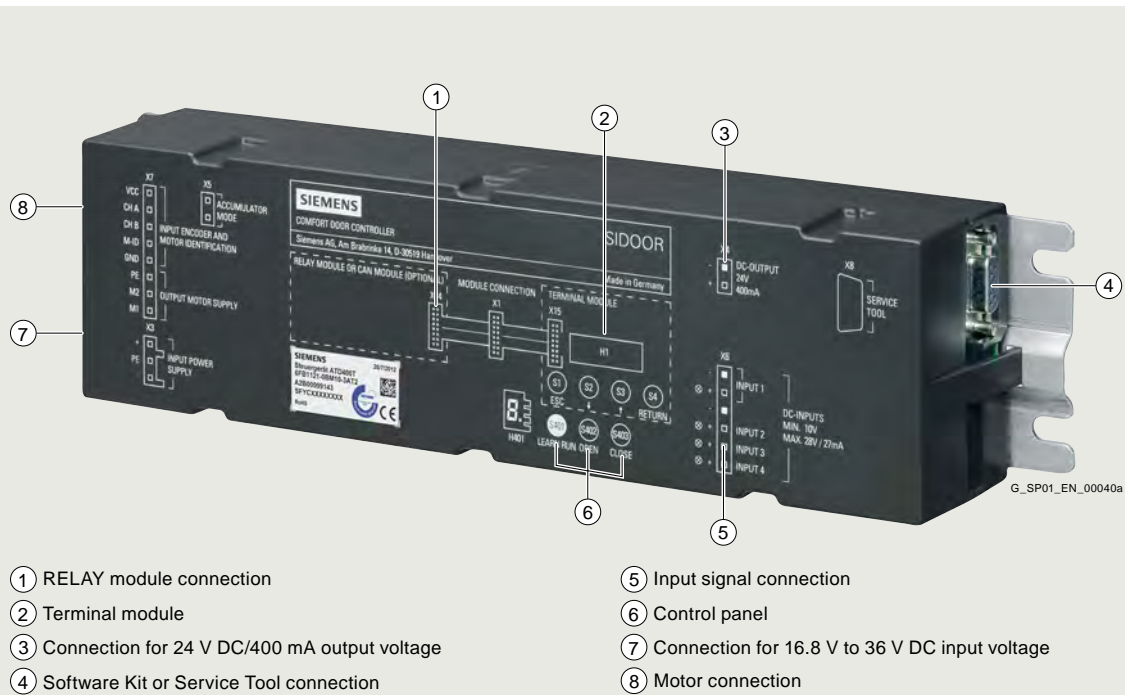

SIDOOR ATD400T interior railway door drive

The SIDOOR ATD400T interior railway door drive is an "intelligent" door drive which enables interior and gangway doors to be opened and closed at adjustable speeds and accelerations.

- Relay module design
- For dynamic door weights up to 180 kg
- Automatic door weight detection
- Operating temperature -20 to +70 °C ¹⁾
- Flexible motor management (two different motor types), automatic detection
- Opening width 0.25 to 4 m
- Door can be operated with and without closing springs (60 to 80 N)
- With two identical door leaves, can be used up to a train inclination of 0 to 10%
- Forces and energies are limited in accordance with EN 14752
- EMC according to EN 50121-3-2
- Fulfills HL3 according to fire protection standard EN 45545-2 (Railway applications – Fire protection on rail vehicles)
- Vandal-proof

1) Note:

- Maximum output current at 24 V DC:
 - 0.4 A at ≤ 55 °C ambient temperature during operation
 - 0.1 A from 55 °C to 70 °C ambient temperature during operation, with restrictions at operating temperatures > 55 °C
- Maximum ambient temperature during operation:
 - 55 °C
 - 70 °C with restrictions at operating temperatures > 55 °C
- Restrictions at operating temperatures > 55 °C:
 - Use the 24 V output voltage only for operating the control inputs (max. 0.1 A)
 - Use a sufficiently large (at least 350 x 350 mm), unpainted metal mounting plate
 - The maximum drive parameters are restricted to the default values
 - If temperature class T3 according to EN 50155 is used, the maximum air temperature of 85 °C must not be exceeded near the printed-circuit board

Ordering data

Article No.

SIDOOR ATD400T

Control device for interior railway doors, relay module design

6FB1121-0BM13-3AT2

Products for specific requirements

Automatic door controls
for railway applications

Control devices > Interior railway door drives

Technical specifications

Article number	6FB1121-OBM13-3AT2 SIDOOR ATD400T RELAY
General information	
Product type designation	ATD400T relay
Installation type/mounting	
Installation and mounting instructions	At operating temperatures > 55 °C a sufficiently large (at least 350 mm x 350 mm), unpainted, metal mounting plate must be used
Supply voltage	
Design of the power supply	DC
Rated value (DC)	24 V
Input current	
Current consumption, max.	15 A
Encoder supply	
Output voltage (DC)	24 V; Ensure correct polarity! CAUTION: Do not supply with external voltage!
short-circuit proof	Yes
Overload-proof	Yes
24 V encoder supply	
• Output current, max.	400 mA
• output current at 55 °C to 70 °C, max.	100 mA
Power	
Active power input	80 W
Active power input, max.	540 W
Digital inputs	
Control inputs isolated	Yes
Control inputs p-switching	Yes
Input voltage	
• for signal *0*, min.	-3 V
• for signal *0*, max.	5 V
• for signal *1*, min.	10 V
• for signal *1*, max.	28 V
Input current	
• for signal *1*, min.	9 mA
• for signal *1*, max.	27 mA
Digital outputs	
Relay outputs	
Switching capacity of contacts	
- at 50 V DC, min.	0.01 A; 50 V DC switching voltage not released for NFPA-relevant countries
- at 50 V DC, max.	1 A; 50 V DC switching voltage not released for NFPA-relevant countries
- at 230 V AC, min.	0.01 A
- at 230 V AC, max.	1 A

Article number	6FB1121-OBM13-3AT2 SIDOOR ATD400T RELAY
Mechanical data	
Opening width of door, min.	0.25 m
Opening width of door, max.	4 m
Weight of door, max.	180 kg
Operating cycle frequency of door, max.	180 1/h
Counterforce, max.	80 N
Counterweight	
• with SIDOOR M3 geared motor, max.	6 kg
Interfaces	
Interfaces/bus type	without
Standards, approvals, certificates	
CE mark	Yes
UL approval	No
China RoHS compliance	Yes
Ambient conditions	
Ambient temperature during operation	
• min.	-25 °C
• max.	70 °C; At operating temperatures > 55 °C the operating parameters are limited to default values
• Remark	At operating temperatures > 55 °C, the maximum air temperature of 85 °C must not be exceeded near the printed-circuit board if temperature class T3 according to EN 50155 is used
Ambient temperature during storage/transportation	
• Storage, min.	-40 °C
• Storage, max.	50 °C
Altitude during operation relating to sea level	
• Installation altitude above sea level, max.	2 000 m
Relative humidity	
• No condensation, min.	10 %
• No condensation, max.	93 %
Fire resistance	
• Behavior in fire	complies with EN 45545-2 Hazard Level HL3
Dimensions	
Width	320 mm
Height	60 mm
Depth	80 mm

Overview Software kit

SIDOOR Software Kit

The scope of delivery of the SIDOOR Software Kit includes an installation CD.

The CD includes the following functionalities:

SIDOOR User Software	The component that enables the door control system to be configured, parameters to be assigned, and analyzed.
Siemens HCS12 Firmware Loader	This component is used to update the operating software of the door controller.
SIDOOR USB to UART Bridge Driver	This driver is essential for operation of the USB adapter.

Note:

Some firmware updates are offered as free downloads in the Siemens Industry Online Support. For information on the availability and acquisition of more firmware, please contact Technical Support.

Ordering data**Article No.****SIDOOR Software Kit****6FB1105-0AT01-6SW0****Overview Service tool**

The Service Tool can be used to input run commands, change run parameters and read out learned parameters, door states, input/output signals and service data.

The Service Tool is connected to the various controllers by the respective cable.

You do not need to open the cover of the controller to do this.

Note:

If the Service Tool is in the "Quick adjustment" or "Total adjustment" menu, the run commands of the controller are blocked via the command inputs.

Ordering data**Article No.****SIDOOR Service Tool,
hand-held terminal****6FB1105-0AT01-6ST0**

for parameter assignment of control devices

Products for specific requirements

Automatic door controls
for railway applications

Geared motors

Overview

SIDOOR motors are speed controlled, taking set force and speed limits into account. The gear outlet direction is defined as left or right when viewing the gear unit from the front. Force transmission is via a toothed belt. The toothed belt passes over a deflector pulley and can be fitted with two door clutch holders. This enables it to drive both single-side and centrally opening doors.

SIDOOR geared motors are available in two technological versions.

- 1. DC technology in version
(area of application: interior railway doors)
 - DC geared motor
SIDOOR geared motors are a combination of gear unit, motor, and encoder. They are easy to connect to the controller via the interface provided and are automatically detected during commissioning. The variable speed drive unit comprises a speed-controlled DC motor with non-self-locking gearing.
- 2. EC technology in version
(area of application: platform screen doors)
 - EC direct drive
SIDOOR direct drives are a combination of motor and sensor. They are easy to connect to the controller via the interface provided and are automatically detected during commissioning. The maintenance-free drive unit consists of a gearless, speed-controlled, electronically commutated motor. The EC direct drive can be fitted in various mounting orientations, facilitating reduced inventory management and minimizing assets.
 - EC geared motors
EC geared motors are electronically commutated DC motors with non-self-locking gearing and are speed-controlled. They are easy to connect to the controller via the interface provided and are automatically detected during commissioning. Due to the brushless drive technology, EC geared motors are subject to less abrasion compared with DC geared motors and thus have a longer service life. On account of the brushless drive technology, no commutation noises come from this motor, so it generates less noise than the DC geared motors.

Motors for interior railway door drives

The following **DC geared motors** are available for interior railway door drives. They should be selected according to the dynamic door weight.

- SIDOOR MDG180 geared motors, compliance with fire protection standard EN 45545-2 (max. door weight 180 kg)
 - SIDOOR MDG180 L EN 45545-2 (pinion left) 6FB1103-0AT16-4MB0
 - SIDOOR MDG180 R EN 45545-2 (pinion right) 6FB1103-0AT15-4MB0
- SIDOOR M3 geared motors (max. door weight 180 kg)
 - SIDOOR M3 L (pinion left) 6FB1103-0AT10-4MB0
 - SIDOOR M3 R (pinion right) 6FB1103-0AT11-4MB0

Motors for platform screen door drives

EC technology:

- SIDOOR MEG251 geared motors (max. door weight 250 kg)
 - SIDOOR MEG251 L (pinion left), 6FB1203-5AT00-7MP0
 - SIDOOR MEG251 R (pinion right), 6FB1203-5AT01-7MP0



Photo: DC geared motor SIDOOR M3 L, 6FB1103-0AT10-4MB0 or SIDOOR MDG180 L, 6FB1103-0AT16-4MB0. (version with pinion left)



Photo: EC geared motor SIDOOR MEG251 L, 6FB1203-5AT00-7MP0. (version with pinion left)

Ordering data	Article No.	Article No.
Motors for interior railway door drives SIDOOR MDG180 geared motors <ul style="list-style-type: none"> • MDG180 L, EN 45545-2 • MDG180 R, EN 45545-2 SIDOOR M3 geared motors <ul style="list-style-type: none"> • M3 L • M3 R 	6FB1103-0AT16-4MB0 6FB1103-0AT15-4MB0 6FB1103-0AT10-4MB0 6FB1103-0AT11-4MB0	Motors for platform screen doors SIDOOR MEG251 EC technology geared motor <ul style="list-style-type: none"> • MEG251 L • MEG251 R

6FB1203-5AT00-7MP0
6FB1203-5AT01-7MP0

Technical specifications

Article number	6FB1103-0AT16-4MB0	6FB1103-0AT15-4MB0	6FB1103-0AT10-4MB0	6FB1103-0AT11-4MB0	6FB1203-5AT00-7MP0	6FB1203-5AT01-7MP0
	SIDOOR MDG180 L EN 45545-2	SIDOOR MDG180 R EN 45545-2	SIDOOR M3 L	SIDOOR M3 R	SIDOOR MEG251 L	SIDOOR MEG251 R
Supply voltage					24 V	
Rated value (DC)	30 V					
Input current					6.8 A	
Operational current (rated value)	4 A					
Power					163 W	
Active power input	120 W					
Mechanical data					4.1 N·m	
Torque of the rotary operating mechanism (rated value)	3 N·m					
Speed, max.	0.65 m/s				0.75 m/s	
Gear ratio	15					
Number of pulses per revolution, max.	100					
Weight of door, max.	180 kg				250 kg	
Breakaway force, max.					50 N	
Standards, approvals, certificates					No	
CE mark	Yes					
UL approval	No				Yes	
EAC (formerly Gost-R)	Yes					
TÜV Inspectorate approval					Yes	
China RoHS compliance	Yes					
Ambient conditions					70 °C	
Ambient temperature during operation						
• min.	-20 °C					
• max.	50 °C					
Ambient temperature during storage/transportation						
• Storage, min.	-40 °C					
• Storage, max.	85 °C					
Fire resistance						
• Behavior in fire	complies with EN 45545-2 Hazard Level HL3					
Dimensions					100 mm	
Height of motor	98 mm					
Length of motor	236 mm				249 mm	
Diameter of motor	63 mm				62 mm	
Width of gear unit, including drive pinion	85 mm				86 mm	

Products for specific requirements

Automatic door controls
for railway applications

Direct drives

Overview



SIDOOR MED280 direct drive

SIDOOR direct drives are a combination of motor and sensor. They are easy to connect to the controller via the interface provided and are automatically detected during commissioning.

The maintenance-free drive unit consists of a gearless, speed-controlled, electronically commutated motor with non-self-locking gearing.

Direct drives are designed for certain masses and can control both drive directions.

- SIDOOR MED280 direct drive for max. 280 kg (6FB1203-0AT12-7DA0)

Ordering data

Article No.

SIDOOR MED280 direct drive

Motor for door control, for max. dynamic door weights of 280 kg

6FB1203-0AT12-7DA0

Technical specifications

Article number	6FB1203-0AT12-7DA0 SIDOOR MED280
Supply voltage	
Rated value (DC)	24 V
Input current	
Operational current (rated value)	9.7 A
Power	
Active power input	233 W
Mechanical data	
Torque of the rotary operating mechanism (rated value)	4.7 N·m
Speed, max.	0.8 m/s
Number of pulses per revolution, max.	1 024
Weight of door, max.	280 kg
Standards, approvals, certificates	
CE mark	Yes
UL approval	Yes
EAC (formerly Gost-R)	Yes
TÜV Inspectorate approval	Yes
China RoHS compliance	Yes
Ambient conditions	
Ambient temperature during operation	
• min.	-25 °C
• max.	70 °C
Ambient temperature during storage/transportation	
• Storage, min.	-40 °C
• Storage, max.	85 °C
Dimensions	
Width of motor	160 mm
Height of motor	140 mm
Length of motor	56 mm
• including drive pinion	91 mm

Overview

A comprehensive range of accessories is available for the SIDOOR systems. This is necessary to ensure low-noise operation of the door leaves by the controller.

Accessories for SIDOOR DC and EC geared motorsRubber-metal anti-vibration mount

To ensure low-noise door operation, the SIDOOR geared motors are integrated in the door system using rubber-metal anti-vibration mounts.

- Rubber-metal anti-vibration mount 6FB1104-0AT02-0AD0 for SIDOOR M3 and SIDOOR MDG180 DC geared motors (also for EN 45545-2) and SIDOOR MEG251 EC geared motors (door weights up to 250 kg)
- Rubber-metal anti-vibration mount 6FB1104-0AT01-0AD0 for SIDOOR M4 DC geared motors (door weights up to 400 kg)



Rubber-metal anti-vibration mount 6FB1104-0AT02-0AD0



Rubber-metal anti-vibration mount 6FB1104-0AT01-0AD0

Mounting bracket

Two different mounting brackets are available with elongated holes:

- Mounting bracket 6FB1104-0AT01-0AS0 for SIDOOR M3 and SIDOOR MDG180 DC geared motors (also for EN 45545-2) and SIDOOR MEG251 EC geared motors for flexible accommodation of the rubber-bonded metal.
- Mounting bracket 6FB1104-0AT02-0AS0 for the deflector unit, this enables the toothed belt to be set to the required belt tension.



Mounting bracket 6FB1104-0AT01-0AS0 for mounting the geared motor



Mounting bracket 6FB1104-0AT02-0AS0 for the deflector unit

Door clutch holder

The door clutch holder 6FB1104-0AT01-0CP0 serves to connect the respective door leaf by means of a toothed belt while also functioning as a toothed-belt lock. One door clutch holder per door leaf is required. The toothed-belt lock can accommodate both open ends of the toothed belt.



Door clutch holder 6FB1104-0AT01-0CP0 (packaging size = 1 unit)

Deflector unit

The deflector unit 6FB1104-0AT03-0AS0 contains an embedded belt pulley which can be mounted on the door system.

The STS toothed belt is redirected via this deflector unit.



Deflector unit 6FB1104-0AT03-0AS0

STS toothed belt

The door system is moved between the end positions of the door using the STS toothed belt 6FB1104-0AT0.-0AB0. Two different toothed belt lengths are available.

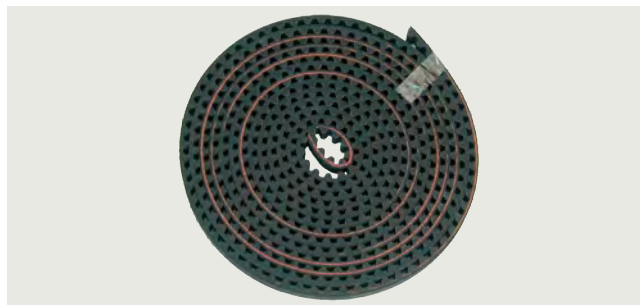

Toothed belt 6FB1104-0AT01-0AB0, length 4 m



Toothed belt 6FB1104-0AT02-0AB0, length 45 m

Products for specific requirements

Automatic door controls
for railway applications

Accessories

Overview

Accessories for the SIDOOR MED280 EC direct drive, for the controller for the SIDOOR ATE530S/ATE531S platform screen door drive

Motor holder

- Motor holder 6FB1104-0AT03-0AD0 for accommodation of the SIDOOR MED280 direct drive.

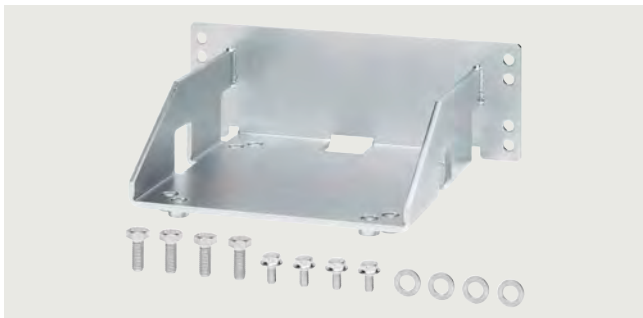

SIDOOR motor holder

Mounting bracket

- For mounting the SIDOOR motor holder 6FB1104-0AT01-0AS0. Identical to the mounting bracket 6FB1104-0AT01-0AS0 for DC geared motors.



Mounting bracket for geared motor

- With tensioning device for mounting the deflector unit and setting the toothed belt to the required tension (large) 6FB1104-0AT05-0AS4



SIDOOR mounting bracket, large

- With tensioning device for mounting the deflector unit and setting the toothed belt to the required tension (small) 6FB1104-0AT05-0AS5



SIDOOR mounting bracket, small

Door clutch holder

- For attaching both ends of the toothed belt and connecting the respective door panel to the toothed belt, width 20 mm, 6FB1104-0AT05-0AS1



SIDOOR door clutch holder

Deflector unit

- For attaching the SIDOOR toothed belt and fixing to the door 6FB1104-0AT07-0AS0



SIDOOR deflector unit

STD toothed belt

- As a connection between the door system and the end positions of the door, toothed belt width 20 mm. Length 4 m, 6FB1104-0AT05-0AB0



SIDOOR toothed belt, small

- Toothed belt width 20 mm. Length 45 m 6FB1104-0AT06-0AB1



SIDOOR toothed belt, large

Ordering data	Article No.	Ordering data	Article No.
Accessories for the SIDOOR MED280 EC direct drive, for the control device for the SIDOOR ATE530S/ATE531S platform screen door drive		Accessories for SIDOOR DC and EC geared motors	
Motor holder for SIDOOR MED280 direct drive	6FB1104-0AT03-0AD0	Rubber-metal anti-vibration mounts for geared motors	
Mounting bracket for mounting the motor holder	6FB1104-0AT01-0AS0	<ul style="list-style-type: none"> SIDOOR rubber-metal anti-vibration mount for geared motors for door weights up to 300 kg 	6FB1104-0AT02-0AD0
Mounting bracket with tensioning device for mounting the deflector unit		<ul style="list-style-type: none"> SIDOOR rubber-metal anti-vibration mount for geared motors for door weights from 300 kg 	6FB1104-0AT01-0AD0
<ul style="list-style-type: none"> Large Small 	6FB1104-0AT05-0AS4 6FB1104-0AT05-0AS5	Mounting bracket	
SIDOOR door clutch holder		<ul style="list-style-type: none"> SIDOOR mounting bracket for geared motor 	6FB1104-0AT01-0AS0
<ul style="list-style-type: none"> For toothed belt, width 20 mm 	6FB1104-0AT05-0AS1	<ul style="list-style-type: none"> SIDOOR mounting bracket with tensioning device for deflector pulley 	6FB1104-0AT02-0AS0
SIDOOR deflector unit	6FB1104-0AT07-0AS0	SIDOOR door clutch holder	
SIDOOR STD toothed belt		<ul style="list-style-type: none"> For toothed belt, width 12 mm 	6FB1104-0AT01-0CP0
Width 20 mm		SIDOOR deflector unit	6FB1104-0AT03-0AS0
<ul style="list-style-type: none"> 4 m 45 m 	6FB1104-0AT05-0AB0 6FB1104-0AT06-0AB1	SIDOOR STS toothed belt	
		Width 12 mm	
		<ul style="list-style-type: none"> 4 m 45 m 	6FB1104-0AT01-0AB0 6FB1104-0AT02-0AB0

Products for specific requirements

Condition monitoring systems

Introduction, SIPLUS CMS1200 condition monitoring system

Overview



SIPLUS CMS family

With the Condition Monitoring System from Siemens you can constantly monitor your machines and plants. Maintenance procedures can be planned better and only performed when they are actually necessary – predictive maintenance.

Overview SIPLUS CMS1200 condition monitoring system



The SIPLUS CMS1200 Condition Monitoring System is part of SIMATIC S7-1200 and is designed for the early detection of mechanical damage.

It provides the following benefits:

- vRMS machine monitoring in acc. with ISO 10816-3
- aRMS machine monitoring
- Detailed identification of damage with frequency-selective diagnostics
- Raw data recording and export for SIPLUS CMS X-Tools
- Trend recording and analysis
- Signaling of limit violations
- Permanent monitoring to protect the machines
- Effective monitoring of important processes and systems
- Early detection of damage
- Scheduled maintenance instead of spontaneous repair
- Reduction in maintenance costs
- Increase in system availability
- Optimum utilization of the service life of the units

Products for specific requirements

Condition monitoring systems

SIPLUS CMS1200 Condition Monitoring System

SIPLUS CMS1200 SM 1281 Condition Monitoring

Overview



SIPLUS CMS1200 SM 1281 Condition Monitoring forms part of SIMATIC S7-1200 and is used for the:

- Monitoring of motors, generators, pumps, fans, or other mechanical components
- Recording and analysis of vibrations
- Expansion capability of up to 7 modules

Ordering data

SIPLUS CMS1200 SM 1281 Condition Monitoring

Module for SIMATIC S7-1200 for monitoring vibrations in mechanical components based on characteristic values and frequency-selective analysis functions.

Article No. **6AT8007-1AA10-0AA0**

SIPLUS CMS1200 Ready to use Bundle

Consisting of:

- SM1281 Condition Monitoring
- SM1281 Shield clamp set
- S7-1214C-CPU
- S7-1200 Battery Board
- Memory card with TIA project

Article No. **6AT8007-1AA30-0AA0**

SIPLUS CMS1200 X-Tools Bundle

Consisting of:

- SM1281 Condition Monitoring
- SM1281 Shield clamp set
- X-Tools Professional V05.00
- X-Tool Analysis library V05.00

Article No. **6AT8007-1AA31-0AA0**

Accessories

SIPLUS CMS1200 SM 1281 Shield clamp set

For EMC-compliant connection of signal and encoder cables to SIPLUS CMS1200 SM 1281 Condition Monitoring.

Article No. **6AT8007-1AA20-0AA0**

Article No.

SIPLUS CMS VIB-SENSOR

Piezoelectric sensor for connection to SIPLUS CMS1200 SM 1281 Condition Monitoring.

- SIPLUS CMS VIB-Sensor S01, frequency range 0,5 Hz to 15 kHz; measuring range 50G; sensitivity 100 mV/G (+/-10 %); MIL connector on top
- SIPLUS CMS VIB-Sensor S02, frequency range 1 Hz to 15 kHz; measuring range 500G; sensitivity 10 mV/G (+/-10 %); MIL connector on top
- SIPLUS CMS VIB-Sensor S03, frequency range 0,2 Hz to 3 kHz; measuring range 10G; sensitivity 500 mV/G (+/-10 %); MIL connector on top

Article No. **6AT8002-4AB00**

Article No. **6AT8008-2AA00-0AA0**

Article No. **6AT8008-2AA02-0AA0**

VIB-SENSOR S01 vibration sensor

SIPLUS CABLE-MIL

For connection of VIB-SENSOR S01, S02 and S03 vibration sensor to SIPLUS CMS1200 SM 1281 Condition Monitoring.

- SIPLUS CABLE-MIL-300; length 3 m
- SIPLUS CABLE-MIL-1000; length 10 m
- SIPLUS CABLE-MIL-3000; length 30 m

Article No. **6AT8002-4AC03**

Article No. **6AT8002-4AC10**

Article No. **6AT8008-2BA12-0AA0**

Products for specific requirements

Condition monitoring systems

SIPLUS CMS1200 Condition Monitoring System

SIPLUS CMS1200 SM 1281 Condition Monitoring

Technical specifications

Article number	6AT8007-1AA10-0AA0 SM1281_Condition_Monitoring
General information	
Product type designation	SM1281
Product description	S7-1200 module for the monitoring of vibrations on mechanical components based on parameters and frequency-selective analysis functions
Installation type/mounting	
Mounting type	Rail or wall mounting
Mounting position	Horizontal, vertical
Recommended mounting position	Horizontal
Supply voltage	
Type of supply voltage	DC
Rated value (DC)	24 V
permissible range, lower limit (DC)	20.4 V
permissible range, upper limit (DC)	28.8 V
Input current	
Current consumption, typ.	200 mA
Current consumption, max.	250 mA
from backplane bus 5 V DC, typ.	80 mA
from backplane bus 5 V DC, max.	85 mA
Power loss	
Power loss, typ.	4.8 W
Memory	
Total memory capacity	1 Gbyte
Hardware configuration	
Design of hardware configuration	Modular, up to 7 modules per CPU
Speed input	
Number of speed inputs	1
Input voltage	
• 24 V DC digital	Yes
Sensor input	
Number of IEPE sensor inputs	4
Sampling frequency, max.	46 875 Hz
Interfaces	
Type of data transmission	Export of raw data as WAV file for further analysis (e.g. using CMS X-Tools) can be downloaded via browser/FTP, online data transfer to CMS X-Tools
Ethernet interface	Yes
Protocols	
Bus communication	Yes
Web server	
• HTTP	Yes

Article number	6AT8007-1AA10-0AA0 SM1281_Condition_Monitoring
Interrupts/diagnostics/status information	
Alarms	
• Diagnostic alarm	Yes
Diagnostics indication LED	
• for status of the inputs	Yes
• for maintenance	Yes
• Status indicator digital input (green)	No
Integrated Functions	
Monitoring functions	
• Monitoring of the sensor inputs	Yes; Cable break and short-circuit
• Vibration characteristic monitoring via RMS value of the vibration speed	Yes
• Vibration characteristic monitoring via RMS value of the vibration acceleration	Yes
• Vibration characteristic monitoring via diagnostic characteristic value	Yes
• Frequency-selective monitoring via vibration speed spectrum	Yes
• Frequency-selective monitoring via vibration acceleration spectrum	Yes
• Frequency-selective monitoring via envelope curve analysis	Yes
Measuring functions	
• Physical measuring principle	Vibration acceleration
Measuring range	
- Measurement range vibration frequency, min.	0.1 Hz
- Measurement range vibration frequency, max.	10 000 Hz
Standards, approvals, certificates	
Certificate of suitability	CE
Ambient conditions	
Free fall	
• Fall height, max.	0.3 m; five times, in product package
Software	
Browser software required	Web browser Mozilla Firefox (ESR31) or Microsoft Internet Explorer (10/11)
Connection method	
required front connector	Yes
Design of electrical connection	Screw connection
Mechanics/material	
Material of housing	Plastic: polycarbonate, abbreviation: PC- GF 10 FR
Dimensions	
Width	70 mm
Height	112 mm
Depth	75 mm
Weights	
Weight, approx.	260 g

Overview

SIPLUS CMS1200 SM 1281 shield clamp set

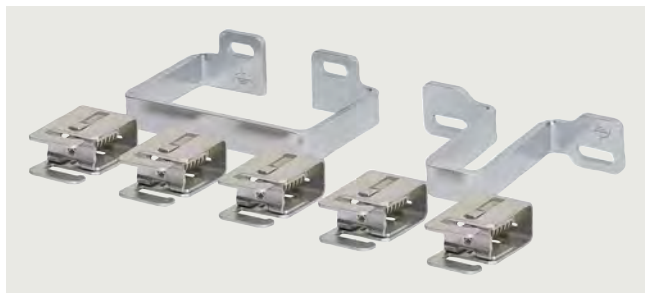

CMS1200 accessories

SIPLUS CMS1200 SM 1281 shield clamp set,
 6AT8007-1AA20-0AA0

An additional shield clamp set must be ordered for the EMC-compliant connection of cables to the SIPLUS CMS1200 SM 1281 Condition Monitoring.

The shield clamp set comprises two shield clamps and five terminal clamps. One shield clamp is screwed on above and one below the module. The sensor cable shields are connected to the shield clamps by means of the terminal clamps.

VIB-SENSOR vibration sensors



VIB-SENSOR S01 vibration sensor

- VIB-SENSOR S01 vibration sensor,
 6AT8002-4AB00
- VIB-SENSOR S02 vibration sensor,
 6AT8008-2AA00-0AA0
- VIB-SENSOR S03 vibration sensor,
 6AT8008-2AA02-0AA0

The VIB-SENSOR vibration sensor with IEPE (integrated electronics piezo-electric) interface can be directly connected to the CMS1200 SM1281 Condition Monitoring module.

The sensor detects vibration accelerations.

A threaded screw with an M8 male thread for mounting to the measuring point is included in the scope of delivery. The connecting cable is connected to the vibration sensor via the MIL connector.

SIPLUS CABLE-MIL connecting cables



SIPLUS CABLE-MIL connecting cables

- SIPLUS CABLE-MIL connecting cables 6AT8002-4AC03,
 6AT8002-4AC10 and 6AT8008-2BA12-0AA0

The VIB-SENSOR vibration sensor is connected to the SIPLUS CMS1200 SM1281 Condition Monitoring module by means of the SIPLUS CMS CABLE-MIL connecting cable.

This high-quality industrial cable is made of black polyurethane and is pre-assembled on one end with a MIL connector (MIL-C5015). The open cable end of the shielded two-wire cable is connected directly to the screw terminals of the basic unit.

The connecting cable is available in lengths of 3 m, 10 m and 30 m.

Products for specific requirements

Condition monitoring systems

SIPLUS CMS1200 Condition Monitoring System

Accessories

Ordering data	Article No.	Article No.
SIPLUS CMS1200 SM 1281 Shield clamp set For EMC-compliant connection of signal and encoder cables to SIPLUS CMS1200 SM 1281 Condition Monitoring.	6AT8007-1AA20-0AA0	
VIB-SENSOR S01, S02 and S03 vibration sensors Piezoelectric sensor for connection to SIPLUS CMS1200 SM 1281 Condition Monitoring.	6AT8002-4AB00 6AT8008-2AA00-0AA0 6AT8008-2AA02-0AA0	SIPLUS CABLE-MIL For connection of VIB-SENSOR S01 vibration sensor to SIPLUS CMS1200 SM 1281 Condition Monitoring.
<ul style="list-style-type: none"> • SIPLUS CMS VIB sensor S01, frequency range 0.5 Hz to 15 kHz; measuring range 50G; sensitivity 100 mV/G (+/-10%); MIL connector on top • SIPLUS CMS VIB sensor S02, frequency range 1 Hz to 15 kHz; measuring range 500G; sensitivity 10 mV/G (+/-10%); MIL connector on top • SIPLUS CMS VIB sensor S03, frequency range 0.2 Hz to 3 kHz; measuring range 10G; sensitivity 500 mV/G (+/-10%); MIL connector on top 		<ul style="list-style-type: none"> • SIPLUS CABLE-MIL-300; length 3 m • SIPLUS CABLE-MIL-1000; length 10 m • SIPLUS CABLE-MIL-3000; length 30 m
		6AT8002-4AC03 6AT8002-4AC10 6AT8008-2BA12-0AA0

Technical specifications

Article number	6AT8007-1AA20-0AA0 SM 1281 shield clamp set	Article number	6AT8007-1AA20-0AA0 SM 1281 shield clamp set
General information		Installation type/mounting	
Product type designation	Shield clamp set for SM1281	Mounting type	Wall mount
Product description	For the EMC-compliant connection of cables to the SIPLUS CMS1200 SM 1281 Condition Monitoring Module	Connection method	
		Number of signal cables connectable to the shield support	5

Article number	6AT8002-4AB00 SIPLUS CMS2000 VIB-SENSOR S01	6AT8008-2AA00-0AA0 SIPLUS CMS VIB-SENSOR S02	6AT8008-2AA02-0AA0 SIPLUS CMS VIB-SENSOR S03
General information			
Product type designation	VIB sensor S01	VIB-Sensor S02	VIB-Sensor S03
Product description	piezoelectric sensor for connection to the SIPLUS CMS2000 Basic Unit VIB or the SIPLUS CMS2000 VIB-MUX expansion module	piezoelectric sensor for connection to SIPLUS CMS1200 or SIPLUS CMS2000	
Installation type/mounting	incl. mounting bolts UNF1/4-28 on M6 and M8		
Input current			
Type of power supply	IEPE 2 to 10 mA		
Encoder			
Encoder signals, IEPE			
• Signal voltage (DC), min.	10 V		
• Signal voltage (DC), max.	14 V		
Integrated Functions			
Measuring functions	Piezo-quartz recorder with integrated evaluation electronics		
• Physical measuring principle	0.5 Hz		
• Operating range of sensor at +/- 3 dB, min.	1 Hz		
• Operating range of sensor at +/- 3 dB, max.	0.2 Hz		
• Resonance frequency	15 000 Hz		
	3 000 Hz		
	23 kHz		
	16 kHz		

Technical specifications

Article number	6AT8002-4AB00 SIPLUS CMS2000 VIB-SENSOR S01	6AT8008-2AA00-0AA0 SIPLUS CMS VIB-SENSOR S02	6AT8008-2AA02-0AA0 SIPLUS CMS VIB-SENSOR S03
Measuring range			
- Measurement range vibration acceleration, max.	50 gn	500 gn	10 gn
- Sensitivity, typ.	100 mV/gn	10 mV/gn	500 mV/gn
Ambient conditions			
Ambient temperature during operation			
• min.	-50 °C		
• max.	120 °C	121 °C	
Cables			
Cable length, max.	30 m		
Mechanics/material			
Material of housing	Stainless steel		
Article number	6AT8002-4AC03 SIPLUS CMS2000 CABLE 3m	6AT8002-4AC10 SIPLUS CMS2000 CABLE 10m	6AT8008-2BA12-0AA0 SIPLUS CMS CABLE 30m
General information			
Product type designation	Cable MIL-300	Cable MIL-1000	Cable-MIL-3000
Product description	For connection of the VIB-SENSOR S01 vibration sensor to the SIPLUS CMS2000 Basic Unit VIB or the SIPLUS CMS2000 VIB-MUX expansion module		for connection of VIB-Sensor vibration sensor to SIPLUS CMS1200 or SIPLUS CMS2000
Ambient conditions			
Ambient temperature during operation			
• min.	-25 °C		
• max.	122 °C		121 °C
Cables			
Type of insulation	black polyurethane		
Design of shield	Braided shielding with stranded drain wire		
Cable length	3 m	10 m	30 m
Connection method			
Type of connection	MIL-C5015 / open cable end		

Products for specific requirements

Notes

Overviews



15/2	SIMATIC HMI
15/4	PC-based Automation
15/5	SIMATIC PCS 7
15/8	Industrial communication (SIMATIC NET)
15/10	Industrial Identification and Locating
15/10	Introduction
15/11	SIMATIC Ident
15/13	SIMATIC RTLS

Overviews

SIMATIC HMI

Introduction

Overview



SIMATIC HMI operator control and monitoring systems – efficient machine-level operator control and monitoring

Equipment for monitoring and operator control is needed wherever people have to work with or on machinery and plants performing diverse tasks from cylinder driers to waste compactors. It is not difficult to find the right device for your specific task. The challenge is to find a solution that is future-proof and flexible, that can be integrated into higher-level networks, and that can also meet the ever-increasing demands for transparency and data provision. SIMATIC HMI Panels have proven their value in a variety of different applications in all industrial sectors over many years. The range of the systems in use is just as wide as that of the applications and technologies in the respective plants.

SIMATIC HMI stands for highly efficient machine-level operator control and monitoring and has some unique advantages:

- Efficient engineering
Visualization can be created more quickly and easily than ever before.
- Innovative design and operation
Visualization becomes the outstanding feature of the machine.
- Brilliant HMI operator panels
The right operator panel for every application.
- Backup – with security
Protection for investments and know-how, secure operation.
- Commissioning in the fast lane
Lose no time with testing and servicing.
- Openness with PC-based
For flexible, independent applications.

<http://www.siemens.com/hmi>

NEW: SIMATIC WinCC Unified system – unlimited visualization for every application

SIMATIC WinCC Unified is a totally new visualization system for meeting the challenges of digitalization in machine and plant construction.

State-of-the-art hardware and software technologies make this possible now and in the future. Tried and tested engineering in the TIA Portal, the latest web technology and great reserves of performance for the coming years combined with the freedom to implement your ideas as you imagine them.

<http://www.siemens.com/wincc-unified>

SIMATIC HMI software – a lot more than just visualization software

With the SIMATIC WinCC (TIA Portal), SIMATIC WinCC and SIMATIC WinCC Open Architecture product families, SIMATIC HMI covers the entire engineering and visualization software spectrum for the human machine interface.

- Almost the entire range of SIMATIC operator panels can be configured with SIMATIC WinCC (TIA Portal), the successor to SIMATIC WinCC flexible. The functionality covers both visualization tasks at machine level and SCADA applications on PC-based multi-user systems.
- The current version 7.5 of SIMATIC WinCC is available for extremely complex process visualization tasks and SCADA applications, e.g. taking account of redundant solutions and vertical integration all the way to plant intelligence solutions.
- Ultimately, SIMATIC WinCC Open Architecture addresses applications that require extensive customer-specific adaptations or manage large and/or complex applications, as well as projects that demand special system requirements and functions.

<http://www.siemens.com/hmi-software>

NEW: SIMATIC WinCC Unified visualization software

SIMATIC WinCC Unified software enables access to open interfaces, modern web technologies and consistent integration in order to implement modern visualization concepts simply and easily in the TIA Portal.

<http://www.siemens.com/wincc-unified-software>

SIMATIC HMI – brilliant and rugged operator panels

Basic HMI – for the entry level

- Key Panels
Pre-assembled and ready for installation, for conventional operator panels. No configuration required with WinCC!
<http://www.siemens.com/key-panels>
- Basic Panels
The entry level series for simple HMI applications.
<http://www.siemens.com/basic-panels>

Advanced HMI Panel-based - for higher requirements

- New: SIMATIC HMI Unified Comfort Panels
High-end performance and state-of-the-art technology for the future of visualization.
<http://www.siemens.com/wincc-unified-hardware>
- Comfort Panels
High-end functionality for demanding indoor and outdoor HMI applications.
<http://www.siemens.com/comfort-panels>
- Mobile Panels
Portable operator panels for mobile deployment on site.
<http://www.siemens.com/mobile-panels>

Individual HMI devices in customized versions

<http://www.siemens.com/customized-automation>

Overview

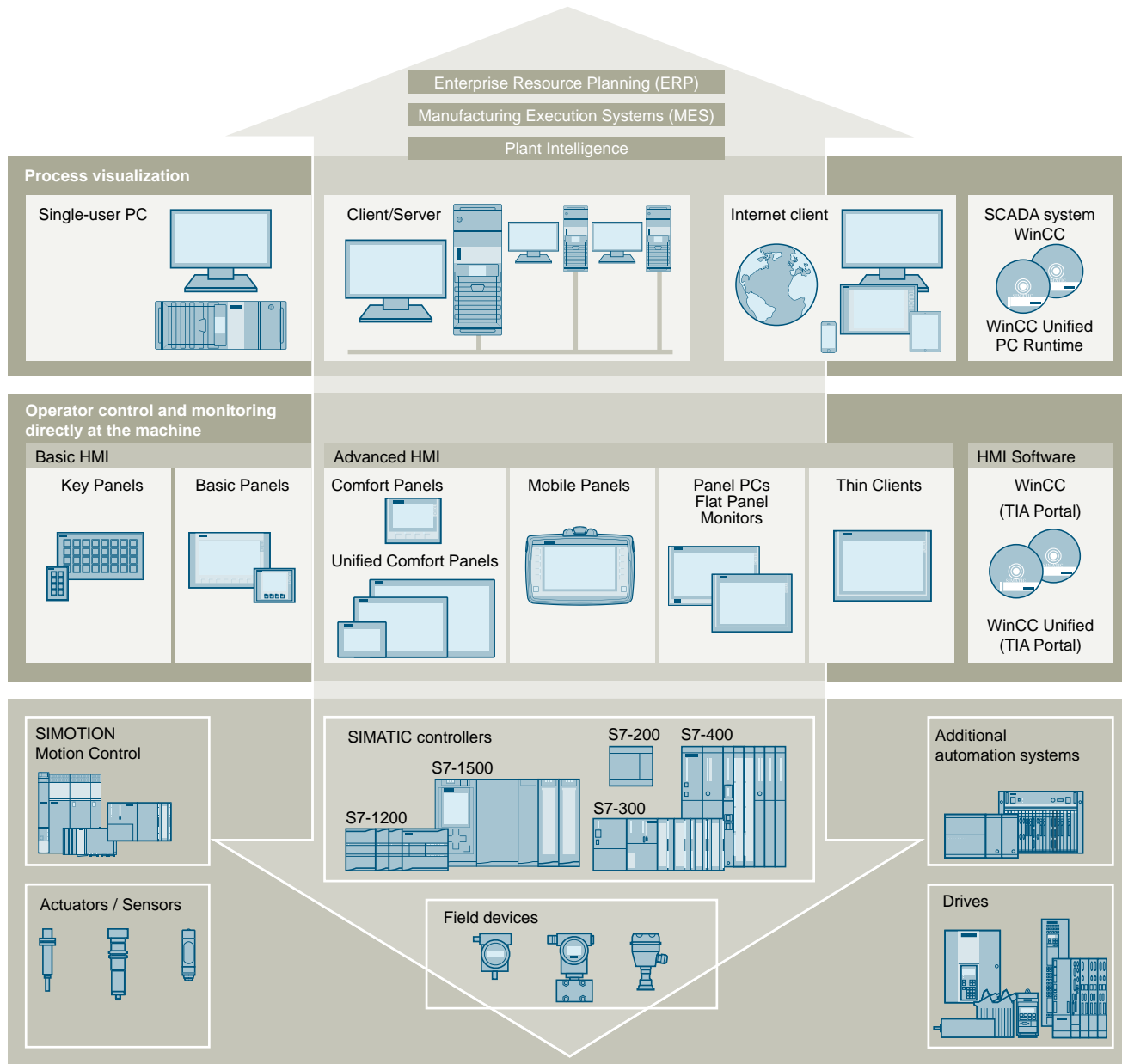

G_ST80_XX_00365

Overviews

PC-based Automation

Introduction

Overview

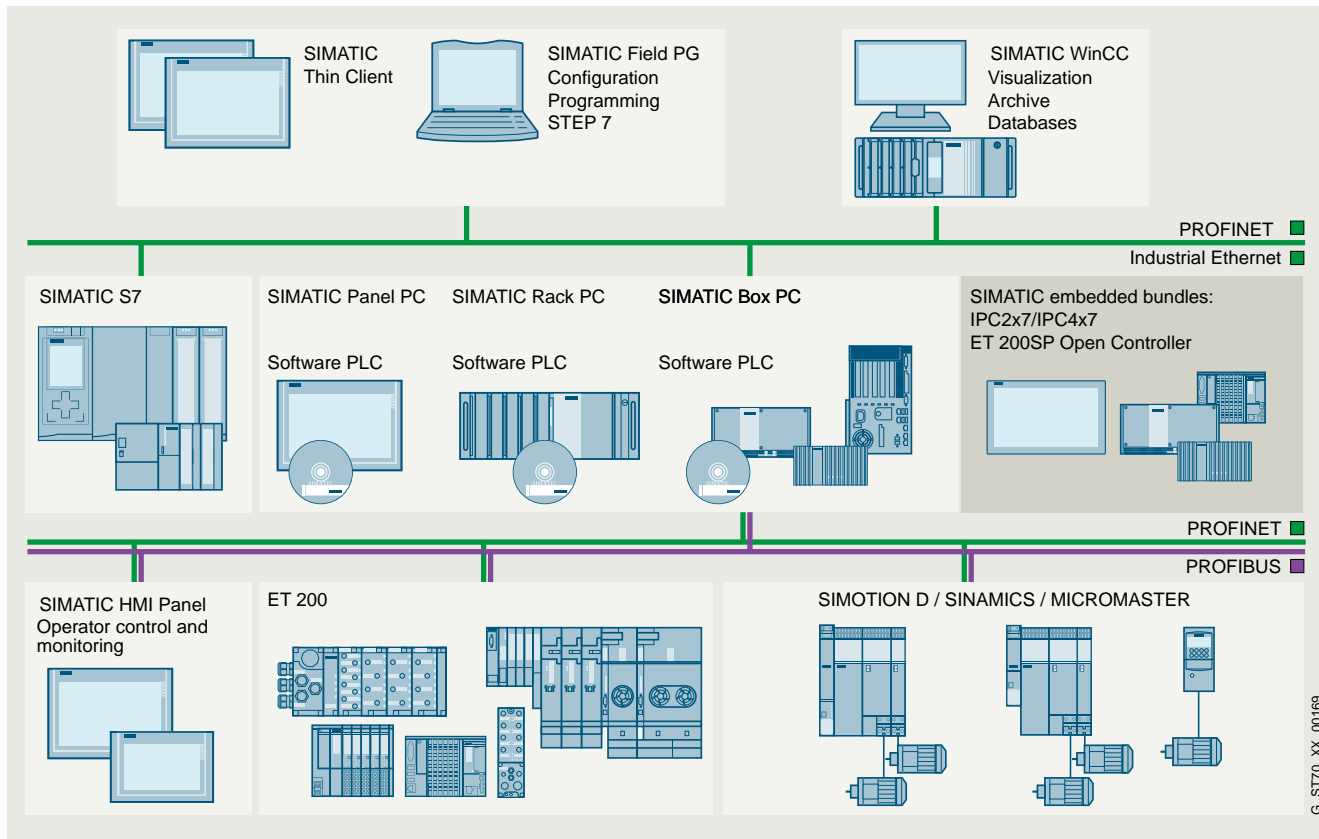

SIMATIC PC-based Automation

<http://www.siemens.com/pc-based>

Industrial IoT Gateway - SIMATIC IOT2000

An intelligent gateway which harmonizes communication between the various sources of data before analyzing it and forwarding it to the corresponding recipients. An easy-to-implement solution.

<http://siemens.com/iot2000>

Industrial PCs

Our reliable and innovative industrial PCs are the optimal PC hardware platform for PC-based Automation from Siemens.

- Rack PC
- Box PC
- Panel PC
- Tablet PC
- Industrial monitors and thin clients
- Devices for special requirements
 - Fully-enclosed IP65 devices
 - Devices with stainless steel fronts
 - Devices for hazardous areas
- IPC software
- Embedded bundles/software packages

<http://www.siemens.com/simatic-ipc>

Software controller

The SIMATIC S7-1500 Software Controller implements a SIMATIC S7-1500 Controller on SIMATIC IPC. It is particularly suitable for control solutions in special-purpose machine manufacturing which involve a high-performance implementation of complex control tasks, the integration of PC applications, or the realization of multiple tasks on a single device.

<http://www.siemens.com/software-controller>

PC-based controllers

PC-based controllers combine the functions of a PC-based software controller with visualization, PC applications and central I/Os (inputs/outputs) in a single, compact device. The SIMATIC ET 200SP Open Controller is an industrial PC with the design of the ET 200SP I/O system and a pre-installed S7-1500 Software Controller.

<http://www.siemens.com/open-controller>

G_ST70_XX_00169

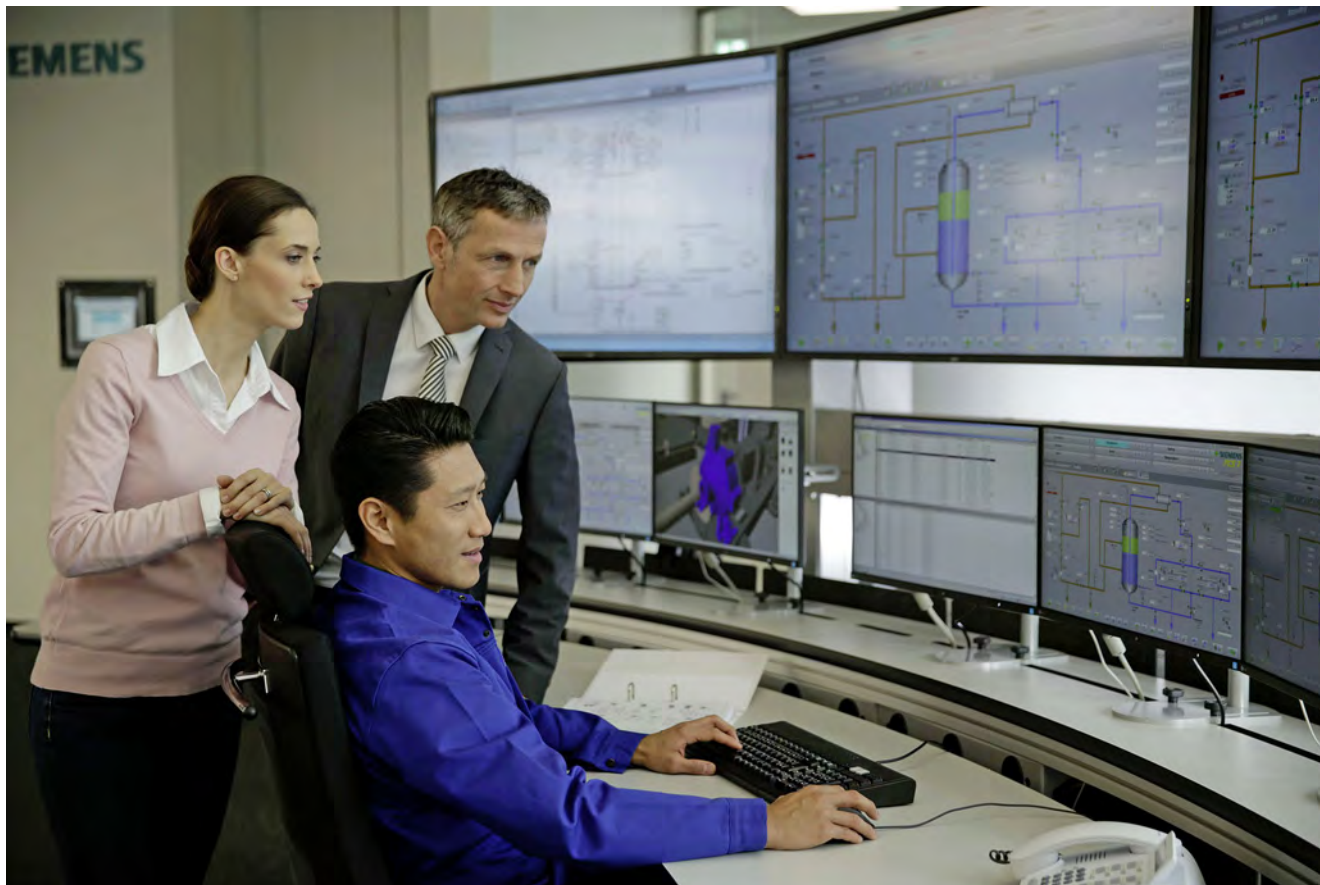
Overview

SIMATIC PCS 7

***Distributed Control System SIMATIC PCS 7:
Room for new perspectives***

In process engineering plants, the process control system is the starting point for optimal value added: All procedures and processes can be operated, monitored and influenced with the process control system.

The more powerful the process control system, the more effectively this potential can be used. For this reason, performance is in the foreground with SIMATIC PCS 7, alongside scalability, flexibility, and integration. Starting with planning and engineering, the process control system offers powerful tools, functions and features for cost-effective and efficient plant operation through all phases of the plant life cycle.

Performance through integration

Integration is one of the special strengths of SIMATIC PCS 7. This has many aspects:

- Horizontal integration into TIA
- Vertical integration into hierarchical communication
- System-integrated tools for engineering tasks
- Integration of the field level, including drives, switchgear, etc.
- Integrated functions, e.g. for batch process automation, route control, process safety, energy management, telecontrol tasks, etc.

Horizontal integration

A system for integrated automation of the entire process chain, from incoming raw materials to outgoing goods – this is one of the decisive advantages resulting from the seamless integration of SIMATIC PCS 7 into Totally Integrated Automation.

The process control system is mainly responsible for automating the primary processes here, but it can do much more: All auxiliary facilities, as well as the electrical infrastructure in the form of low-voltage or medium-voltage switchgear and the building management system, can also be integrated into the system.

Integration of selected SIMATIC standard components – automation systems, industrial PCs, network components, or distributed process I/O – into the process control system guarantees optimum interaction of individual components, and secures economic benefits such as simple selection, reduced stock keeping, and global support.

Vertical integration

The hierarchical communication of a company encompasses the field level, the control level, and the process level, up to management and enterprise resource planning (ERP). Thanks to standardized interfaces – based on international industry standards as well as internal interfaces – SIMATIC PCS 7 is able to provide process data for analysis, planning, coordination, and optimization of plant sequences or production and business processes – in real time, and at any location in the company.

Overviews

SIMATIC PCS 7

Introduction

Overview

Central engineering

SIMATIC PCS 7 convinces with graded functional diversity, consistent operator control philosophy, and uniformly structured engineering and management tools. A central engineering system with a coordinated range of tools for integrated system engineering and configuring of batch automation, safety functions, material transport or telecontrol systems creates value added over the entire life cycle. Reductions in configuring and training costs result in minimization of total cost of ownership (TCO) over the entire plant life cycle.

Functional diversity

Depending on the typical process automation or customer-specific requirements, SIMATIC PCS 7 can be functionally expanded for the following, for example:

- Batch process automation (SIMATIC BATCH)
- Functional safety and protection functions (Safety Integrated for Process Automation)
- Route control for material transport (SIMATIC Route Control)
- Telecontrol of remote units (SIMATIC PCS 7 TeleControl)
- Automation of electrical switchgear (SIMATIC PCS 7 PowerControl)

Custom automation

The unique scalable system architecture makes SIMATIC PCS 7 the ideal basis for cost-effective implementation of individual automation solutions and a cost effective operation of process plants.

SIMATIC PCS 7 users receive sustainable benefits from the modular system platform, based on SIMATIC standard components. Its uniformity enables flexible scaling of hardware and software, as well as perfect interaction, both within the system and beyond system limits. The architecture of the process control system SIMATIC PCS 7 is designed in such a way that the control technology can be used for the project planning according to the customer's requirements, optimally adapted to the dimensions of the plant. The control technology allows retrofit or reconfiguration for capacity expansion or technological changes at any time. If the plant grows, then SIMATIC PCS 7 simply grows along with it – making expensive reserve capacities unnecessary!

Use the opportunities offered by the object-oriented type and instance concept of SIMATIC PCS 7. The technological connections, variant formation and bidirectional comparison of the types with the instances make the control module types (CMT) even more powerful compared to the original function block templates. The technological connections of a Control Module such as parameters, signals or messages can be provided with attributes and used via drag and drop, e.g. on an SFC plan. In turn, options and variants can be used to extend the core function of the CMT with specific modules or functions, which can be activated individually for each instance. This minimizes the number of types required and thus reduces the effort for maintenance and service. For the technological content of the CM types, the future-oriented Advanced Process Library (APL) is included in the standard of SIMATIC PCS 7. Another major advantage resulting from the comprehensive type and instance concept is the seamless integration into other tools like SIMATIC PCS 7 Plant Automation Accelerator or SIMIT.

Flexibility and performance in engineering

The workflow in the engineering of process plants is and remains a challenge: Numerous participants, many different data formats and multiple interfaces frequently result in transmission errors and system discontinuity and thus in greater time input and costs. Information generally gets lost or needs to be corrected manually when data is exchanged between multiple disciplines.

For the first time, a fully integrated solution is now available for planning and documenting plant projects: the SIMATIC PCS 7 Plant Automation Accelerator. Customers benefit in particular from consistent engineering without system discontinuities between automation planning and the control system.

The object-oriented approach of the SIMATIC PCS 7 Plant Automation Accelerator makes it possible to work on a central data platform, thus ensuring completely integrated planning – from plant engineering through to automation – based on an electronic workflow. This workflow ranges from planning, the preparation of bids – including bills of material – and the automatic generation of control data from the electrical plans of the SIMATIC PCS 7 process control system, through to controlled mass data engineering and direct as-is documentation of the plant.

This modular engineering approach enhances overall project efficiency and minimizes risks. A high level of standardization and simple configuration additionally save engineering time and costs during the implementation phase. Simple synchronization between planning and engineering avoids duplicate input and interface losses and reduces project runtimes.

Flexibility in operation

Process control also becomes more complex due to the multi-layer nature of automation engineering and the increased merging with information technology. Intuitive and fault-free operation is therefore more important than ever with regard to efficient working and the minimization of downtimes and servicing requirements. Using effective Advanced Process Control (APC) functions and an excellent operator system, SIMATIC PCS 7 supports optimization as well as user-friendly and safe control of the process. Monitoring of product quality and performance indicators additionally allows the process to be operated more economically. At the same time, SIMATIC PCS 7 convinces with high flexibility, plant availability, and investment security.

Process control and maintenance

SIMATIC PCS 7's operator system is used to monitor process operation using various views, and permits interventions when necessary. Its architecture is flexible and scalable – from single-user systems up to multi-user systems with a redundant client/server architecture. The operator interface takes account of the current specifications of NAMUR (user association of automation technology in the process industries) and PI (Profibus International) and offers a high level of user-friendliness for simple, intuitive interaction with the plant. Ergonomic symbols, task-oriented faceplates, uniform representation of status information, and optimized alarm functions allow safe process control.

Overview

The alarm management function integrated in SIMATIC PCS 7 is able to focus on essential alarms and to specifically guide the operator in exceptional circumstances. In this way, it systematically reduces the workload of operating staff.

Preventive and predictive maintenance strategies reduce total cost of ownership. With the SIMATIC PCS 7 Maintenance Station, maintenance personnel always have a watchful eye on critical production equipment such as pumps, valves, distillation columns or motors, and can carry out the relevant maintenance measures in good time before servicing is required – independent of the maintenance plan and without the risk of an unplanned plant standstill.

Process optimization

SIMATIC PCS 7 supports process optimization in many different manners, including:

- Control Performance Monitoring
- Advanced Process Control
- Process Historian

The Control Performance Monitoring function monitors and signals the control quality of the closed-loop control block. If the performance declines, the controller can be optimized in good time or specific maintenance measures can be initiated.

The integrated I&C libraries of SIMATIC PCS 7 also provide higher quality closed-loop control functions with which cost-effective Advanced Process Control applications can be implemented: multi-variable control, predictive control, or override control. It is thus possible to effectively improve profitability, product quality, safety, and environmental protection in small and medium-sized plants.

Current and historic process data form the basis of all optimization. Secure and user-friendly real-time data storage and analysis is handled using the Process Historian. The process values, messages, and batch data managed in the database of the Process Historian can be called extremely rapidly. User-specific processing and visualization of this historic data are supported by the information server, which is a reporting system based on the Microsoft Reporting Services.

SIMATIC PCS 7 system and technology components

With the rugged, high-performance SIMATIC PCS 7 system components from Catalog ST PCS 7, you already have a versatile platform for cost-effective implementation and economical operation of your process control systems. Perfect interplay of these system components makes it possible for you to sustain high-quality production and to establish new products significantly faster on the market.

With SIMATIC PCS 7 technology components from Catalog ST PCS 7 T that can be seamlessly integrated into the process control system, you can expand the functional scope of the system components in a carefully targeted manner for specific automation tasks.

This covers a wide spectrum, for example:

- Telecontrol for monitoring and controlling remote plant units
- Automation technology for electrical low-voltage or medium-voltage switchgear
- Industry-specific automation systems for the cement and mining industries, as well as for laboratory and training facilities
- Graphical objects for task-oriented optimization of process visualization
- Block libraries for technological functions, package unit and panel integration, monitoring and analyzing mechanical assets, as well as for building automation systems (heating, ventilation, air-conditioning – FMCS/HVAC)
- Editors and function blocks for the efficient configuration of small or medium-sized automation systems with simple parameter control and materials management
- Process analytical technology for quality assurance through optimization of development and production processes based on up-to-date measurements, and critical quality and performance attributes
- Simulation system for testing and commissioning of plant-specific application software
- Flexible, high-performance Manufacturing Execution System (MES)
- System expansion for operator systems for the integration of third-party controllers, programmable logic controllers and package units
- Products for migration of the process control systems TELEPERM M, APACS+/QUADLOG or Bailey INFI 90/NET 90 with SIMATIC PCS 7

Additional functionality can be integrated using add-on products

Modularity, flexibility, scalability, and the openness of SIMATIC PCS 7 offer optimal prerequisites for integrating supplementary components and solutions in the process control system in an applicative manner and thus extend and round off its functionality.

Many supplementary add-on products for SIMATIC PCS 7 have been developed by Siemens as well as by external partners (see Catalog ST PCS 7 AO, Add-ons for the SIMATIC PCS 7 Process Control System). These software packages and hardware components authorized by the system manufacturer enable cost-effective implementation of SIMATIC PCS 7 for special automation tasks.

Overviews

Industrial communication (SIMATIC NET)

Introduction

Overview

Industrial communication – the backbone of automation

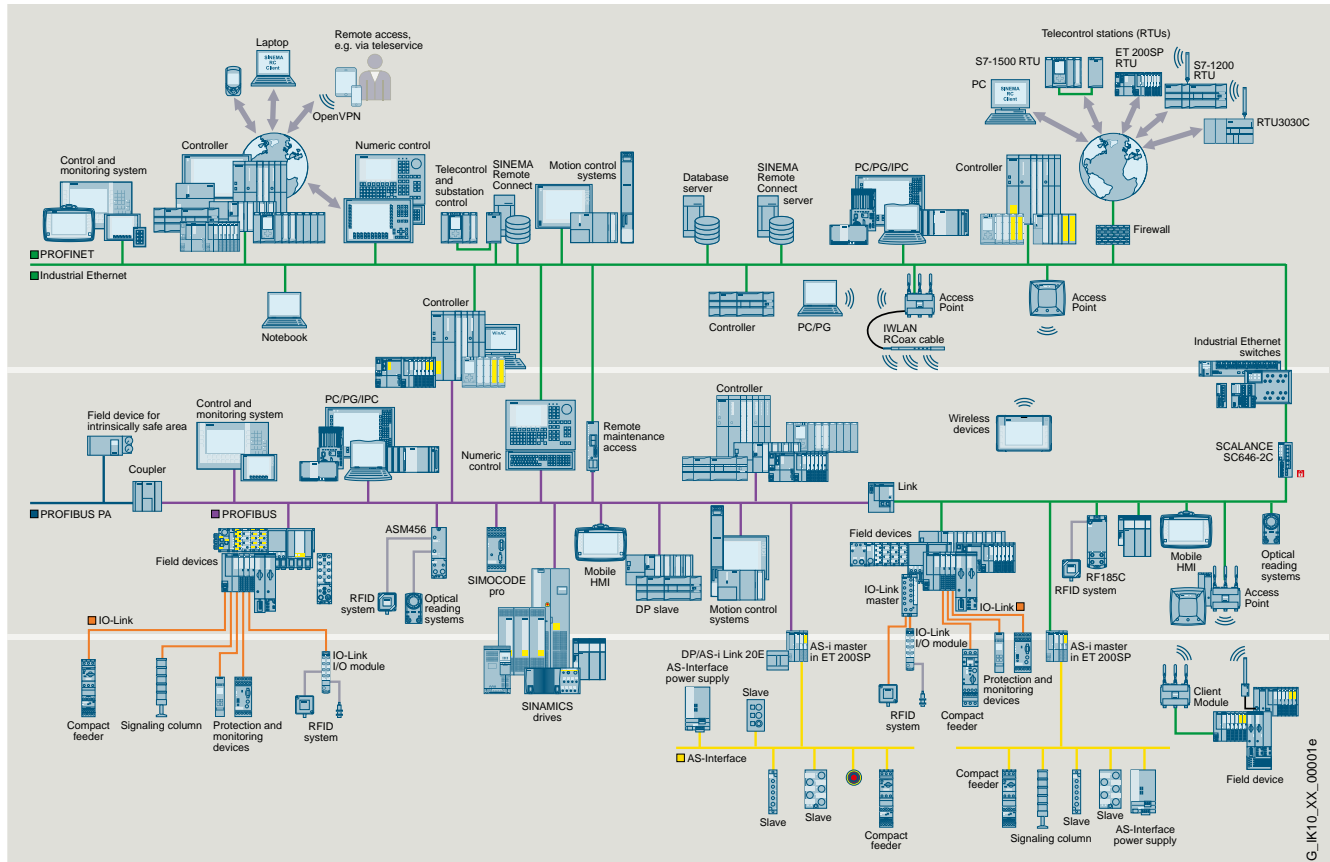

Powerful and open communication systems ensure trouble-free communication for automation systems, covering

- data communication or
- process or field communication.

Openness and flexibility of the individual communication systems in different topologies enable linking of a wide variety of systems and their subsequent expansions. By using standardized communication systems, it is possible to connect standardized components from different suppliers without any problems. This ensures maximum protection of investment, as existing networks can be extended without any adverse effects.

Overview

In the area of industrial communication, Siemens provides components for an integrated overall solution beyond the network's limits.

These include:

- Passive network components, e.g. FastConnect cabling systems
- Active network components, e.g. SCALANCE X Industrial Ethernet switches as well as RUGGEDCOM devices for harsh ambient conditions.
- Interfaces for connecting programmable controllers to the communication systems:
 - Integrated interfaces
 - Communications processors
- Components for wireless networks, e.g. Industrial Wireless LAN, SCALANCE W Access Points, and Client Modules (incl. latest Wi-Fi 6 devices) as well as first 5G components
- Components for industrial security, e.g. network security with Industrial Security Appliances SCALANCE S
- Remote monitoring and control with solutions for both telecontrol systems and units.
- Simple remote access for TeleService and remote maintenance with SCALANCE M and SINEMA Remote Connect
- Network transitions, e.g. IE/PB LINK PN IO
- Components for AS interface
- SINEC software family for efficient network management

More information

- Internet:
www.siemens.com/industrial-communication

Overviews

Industrial Identification and Locating

Introduction

Overview



SIMATIC Ident and SIMATIC RTLS for cross-company data intelligence

Industrial processes in the digital enterprise require full transparency and a high degree of customization. Our solutions close the gap between the real and the digital world – and thus open up new added value potential throughout the production and supply chain. Today, we already offer the industry of tomorrow a unique, comprehensive and integrated range of identification and locating systems for customized applications. The connection to TIA enables products to be seamlessly integrated into automation solutions in the process. The connection to cloud applications ensures maximum flexibility and makes manufacturing future-proof. Plant availability, the degree of utilization and energy saving potential become transparent. For competitiveness and a flexible future.

More information

- Internet:
www.siemens.com/simatic-ident

Overview

Let the data journey begin.
SIMATIC Ident: Industrial Identification for company-wide data intelligence

Small batch sizes, a wide range of increasingly complex products, an extremely high degree of customization and complicated processes present major challenges for industry.

For all these challenges Siemens offers SIMATIC Ident, a unique integrated and scalable range of RFID and optical identification systems. These enable virtual data flows from IT systems to be synchronized with the actual flow of goods – throughout the value chain. This provides the necessary clarity and answers the question: When is which product in which location and what is its status? Because data transparency is becoming an increasingly central factor of success, especially in the industrial environment.

With SIMATIC Ident, quality requirements can be reliably met, production can be more flexibly structured, the number of manual operations reduced, and potential sources of faults identified and removed immediately. This means greater efficiency in logistics, material management, production, and service. For competitiveness and for a flexible future.

In addition, SIMATIC Ident supplies production data to cloud applications, e.g. MindSphere – the cloud-based, open IoT operating system from Siemens..

This makes SIMATIC Ident a key technology for the digital enterprise. Our solutions close the gap between the real and the digital world – and open up new added value potential for our customers.

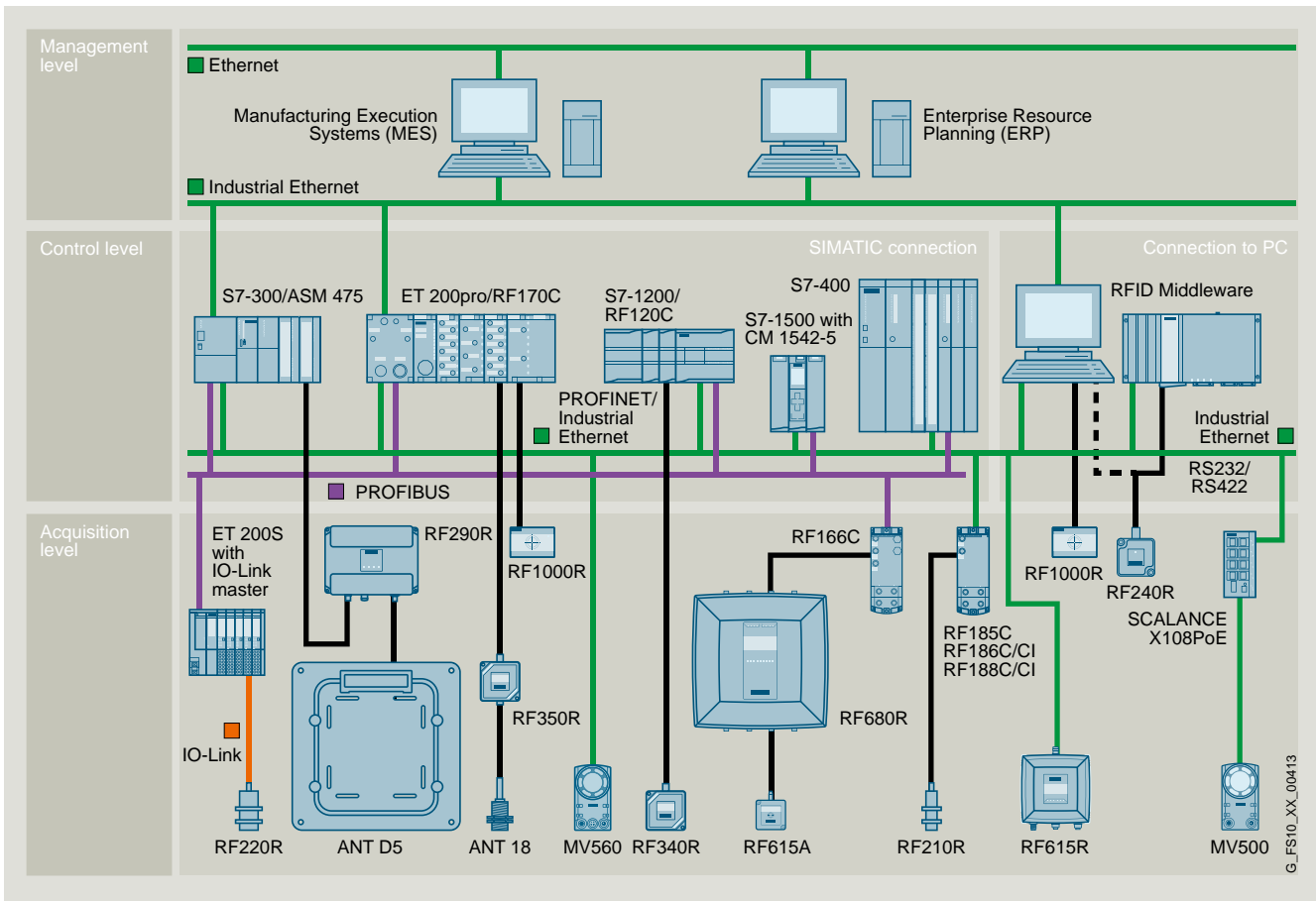

G_FS10_XX_00413

Overviews

Industrial Identification and Locating

SIMATIC Ident

Overview

RFID systems



Openness and flexibility of the individual communication systems in different topologies enable linking of a wide variety of systems and their subsequent expansions. By using standardized communication systems, it is possible to connect standardized components from different suppliers without any problems. This ensures maximum protection of investment, as existing networks can be extended without any adverse effects.

Line of sight between the write/read device and the transponder is not necessary. Rugged, compact readers in a high degree of protection with either integrated or external antennas are available for interference-free data communication. Cost-efficient, maintenance-free, passive labels and passive transponders in various designs and with various memory capacities are likewise available, as are powerful antennas.

Optical identification systems



The SIMATIC MV optical readers are powerful, intelligent reading devices for both standard, high-contrast 1D/2D codes as well as difficult-to-read DPM codes applied straight onto the different product surfaces. The optical readers also permit text recognition, object recognition, and inspection of marking quality. The readers of the SIMATIC MV family boast powerful image acquisition capabilities for different resolutions and integrated lighting, allowing them to be used in a range of applications. device configuration via web-based management and system integration via the TIA Portal ensure easy handling.

More information

- Internet:
www.siemens.com/rfid
www.siemens.com/codereader

Overview



Precision for automation. Driven by data.

Knowing what is located where at all times: SIMATIC RTLS enables optimized and transparent processes for production and logistics thanks to data-based, real-time locating to the nearest centimeter of all relevant objects. Material flows can be navigated, mobile transport systems controlled, the use of components monitored and the assembly of the end product documented in full. This makes SIMATIC RTLS an essential component of the digital infrastructure of the factory of tomorrow.

The scalable RTLS system supplements the digital twin of all production processes – from supply all the way through further processing to the final assembly. To do this, all relevant objects in the factory or warehouse (workpieces, containers, transport units, persons, etc.) are equipped with a transponder. Gateways bundle the transponder signals and make them available to the higher-level System Locating Manager. The positions calculated here are then forwarded to intelligent automation systems and production units.

Ultra-wide band technology (UWB) ensures the utmost accuracy and reliability: A large frequency range (3-7 GHz) with a bandwidth of at least 500 MHz is used for close range radio communication to transmit relatively weak radio signals. This prevents other systems from being disrupted. The result is accurate and safe locating of objects to within a few centimeters. Search times are reduced, material flows optimized, and bottlenecks are detected in time. More transparency, fact-based decision-making and increased quality can be established thanks to digital processes which are optimally matched to each other.

More information

- Internet: www.siemens.com/rtls

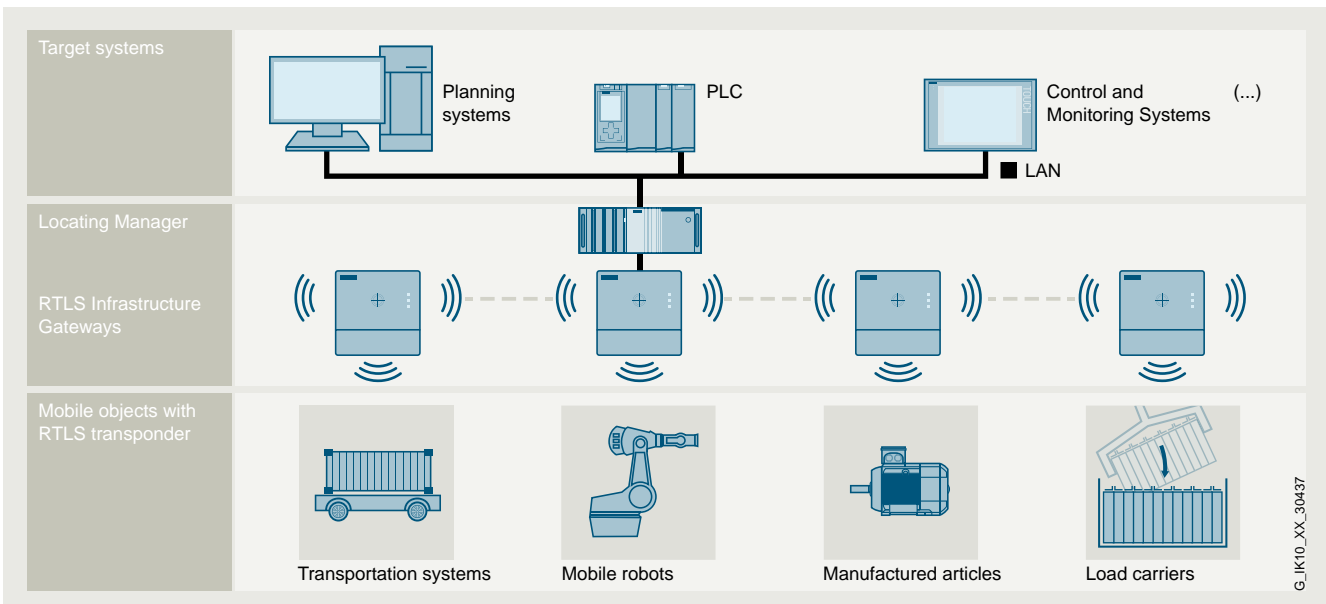

System architecture of RTLS applications

G_IK10_XX_30437

Overviews

Notes

Supplementary Components



16/2	Drive systems
16/2	SINAMICS drive system
16/16	SIMATIC MICRO-DRIVE drive system
16/17	Overvoltage protection
16/17	SICROWBAR overvoltage protection
16/18	Timing, coupling and monitoring relays
16/18	SIRIUS relays
16/20	Measuring systems
16/20	Motion Control Encoder measuring systems
16/21	Automation systems
16/21	SIMOTION Motion Control System
16/22	SINUMERIK CNC automation systems
16/22	- SINUMERIK 828D
16/23	- SINUMERIK 840D sl
16/24	- SINUMERIK ONE
16/25	- SINUMERIK MC
16/26	System cabling
16/26	MOTION-CONNECT connection systems

Supplementary components

Drive systems

SINAMICS drive system

Overview

The SINAMICS range



- Totally integrated range of drives for any application and every industry
- Wide range of power ratings from 0.05 kW to 85 MW
- Broad functional scope, from simple U/f control through to highly dynamic servo control
- Designed for problem-free interaction with other Siemens automation components
- Shared platform concept with uniform functionality, engineering, commissioning, operation as well as a uniform diagnostics concept and communication mechanisms

Low voltage										Direct voltage	Medium voltage
Standard performance frequency converters		Distributed frequency converters	Industry-specific frequency converters		Servo drives			High performance frequency converters		DC converters	Converters for applications with high outputs
SINAMICS V20 G120C G120	SINAMICS G130 G150	SINAMICS G115D G120D SIMATIC ET 200pro FC-2	SINAMICS G120X	SINAMICS G180	SINAMICS V90	SINAMICS S110	SINAMICS S210	SINAMICS S120 S120M	SINAMICS S150	SINAMICS DCM DCP ¹⁾	SINAMICS GH150 GH180 GM150 SM150 GL150 SL150 SH150
0.12 kW to 250 kW	75 kW to 2700 kW	0.37 kW to 7.5 kW	0.75 kW to 630 kW	2.2 kW to 6600 kW	0.05 kW to 7 kW	0.55 kW to 132 kW	0.05 kW to 7 kW	0.55 kW to 5700 kW	75 kW to 1200 kW	6 kW to 30 MW	0.15 MW to 85 MW
Pumps, fans, compressors, conveyor belts, mixers, mills, spinning machines, textile machines, refrigerated display counters, fitness equipment, ventilation systems, single-axis positioning applications in machine and plant engineering	Pumps, fans, compressors, conveyor belts, mixers, mills, extruders	Conveyor technology, single-axis positioning applications (G120D)	Pumps, fans, compressors, building management systems, process industry, HVAC, water/waste water industries	Pumps, fans, compressors, conveyor belts, extruders, mixers, mills, kneaders, centrifuges, separators	Handling machines, packaging machines, automatic assembly machines, metal forming machines, printing machines, winding and unwinding units	Single-axis positioning applications in machine and plant engineering	Packaging machines, handling equipment, feed and withdrawal devices, stacking units, automatic assembly machines, laboratory automation, wood, glass and ceramics industry, digital printing machines	Production machines (packaging, textile and printing machines, paper machines, plastic processing machines), machine tools, plants, process lines and rolling mills, marine drives, test bays	Test bays, cross cutters, centrifuges	Rolling mill drives, wire-drawing machines, extruders and kneaders, cableways and lifts, test bay drives	Pumps, fans, compressors, mixers, extruders, mills, crushers, rolling mills, conveyor technology, excavators, test bays, marine drives, blast furnace fans, retrofit
Catalog D 31.1	Catalog D 11	Catalog D 31.2	Catalog D 31.5	Catalog D 18.1	Catalog D 33	Catalog D 31.1	Catalog D 32	Catalogs D 21.3, D 21.4 NC 62	Catalog D 21.3	Catalog D 23.1, Industry Mall	Internet ²⁾

Engineering tools (e.g. Drive Technology Configurator, SIZER for Siemens Drives, STARTER and SINAMICS Startdrive)

¹⁾ DC/DC controllers, see Industry Mall.

²⁾ www.siemens.com/medium-voltage-converter

Overview
**SINAMICS V20 –
the perfect solution for basic applications**

- Power range from 0.12 kW to 30 kW
- Voltage:
 - 230 V 1 AC: 200 V to 240 V 1 AC (-15 % to +10 %)
 - 400 V 3 AC: 380 V to 480 V 3 AC (-15 % to +10 %)
- Integrated USS and Modbus RTU interfaces
- Integrated braking module for 7.5 kW to 30 kW
- Parameter readout and cloning without power supply
- Integrated connection and application macros
- ECO mode for U/f , U^2/f
- Integrated hibernation mode in idle state
- Wireless commissioning, operation and diagnostics via mobile device or laptop thanks to optional SINAMICS V20 Smart Access web server module
- Expansion of 400 V converters with two digital inputs and two digital outputs (relay outputs) thanks to optional SINAMICS V20 I/O Extension Module
- SINAMICS CONNECT 300 for connecting up to eight converters to the MindSphere cloud

More information

- Catalog D 31.1
- Internet:
 - <http://www.siemens.com/sinamics-v20>
 - <http://www.siemens.com/d31-1>
 - <http://www.siemens.com/industrymall>

**SINAMICS V90 basic servo drive system –
the performance-optimized, easy-to-operate servo drive system**

- SINAMICS V90 and SIMOTICS S-1FL6 form an optimized servo drive system for positioning as well as speed and torque control. Thanks to the optimized design, the system permits enhanced servo performance combined with a high level of ruggedness in a simple, low-cost way.
- SINAMICS V90 is designed for all-purpose servo applications while taking into consideration the challenges for machine builders and system integrators in terms of costs and time-to-market.
- The SINAMICS V90 system can essentially be commissioned effortlessly by means of a simple plug-and-play procedure. The SINAMICS V90 drive offers optimum servo performance, can be integrated quickly into SIMATIC PLCs and provides a high level of reliability. The connection can be made via PROFINET, by means of a pulse-direction interface or via analog inputs/outputs. A seamless drive system can be created by combining the SINAMICS V90 servo drive with our SIMOTICS S-1FL6 servomotor.
- SINAMICS V90 offers internal positioning, positioning with pulse sequence, and speed and torque control.
- With integral auto-tuning in real time and automatic suppression of machine resonances, the system automatically optimizes itself to achieve a highly dynamic performance and smooth operation. In addition, it makes it easier for the pulse sequence input to achieve excellent positioning accuracy on the basis of its high frequency limit of up to 1 MHz.

More information

- Catalog D 33
- Internet:
 - <http://www.siemens.com/sinamics-v90>
 - <http://www.siemens.com/d33>
 - <http://www.siemens.com/industrymall>

Supplementary components

Drive systems

SINAMICS drive system

Overview

**SINAMICS G120P –
the specialist for pumps, fans, and compressors**



- Power range from 0.37 kW to 630 kW
- Automatic switchover to line operation at rated speed
- Variety of functions for pumps, fans and compressors, e. g. energy-saving mode, Pt1000/LG-Ni1000/DIN-Ni1000 temperature sensor interface, cascade connection, programmable time switches, bypass mode, multi-zone control
- Communication: RS485, USS, Modbus RTU, BACnet MS/TP, FLN P1, PROFINET, EtherNet/IP, PROFIBUS DP
- Integrated in the TIA Portal with SINAMICS Startdrive
- Energy efficient through minimal apparent power losses, automatic adaptation of the motor current to the actual load conditions with ECO mode

More information

- Catalog D 35
- Internet:
<http://www.siemens.com/sinamics-g120p>
<http://www.siemens.com/d35>
<http://www.siemens.com/industrymall>

**SINAMICS G120X –
the infrastructure converter for HVAC/water/wastewater**



- Power range from 0.75 kW to 630 kW
- The specialist for pump, fan and compressor applications
- Thanks to the integrated DC link reactor with a maximum output of 250 kW and optional resistance to harmful gases up to environmental class 3C3, the rugged and dependable design ensures reliable, stable and largely robust operation.
- Variety of functions relevant for pumps, fans and compressors, e.g. deragging or pipe fill mode, automatic restart, flying restart, flux reduction, cascade connection, hibernation mode and real-time clock
- Functions especially for building technology as well as heating/air conditioning/ventilation applications, e.g. four integrated PID controllers, essential service mode, bypass mode and programmable time switches
- Communication: PROFINET, EtherNet/IP, PROFIBUS DP, USS, Modbus RTU, BACnet MS/TP
- SINAMICS CONNECT 300 for connecting up to eight converters to the MindSphere cloud
- Innovative hardware and software functions for saving energy, e.g. for controlling synchronous reluctance drive systems with SIMOTICS reluctance motors

More information

- Catalog D 31.5
- Internet:
<http://www.siemens.com/sinamics-g120x>
<http://www.siemens.com/d31-5>
<http://www.siemens.com/industrymall>

Overview

**SINAMICS G120C –
the compact and versatile frequency converter with
optimum functionality**



- Compact unit
- Highest power density in its class
- Power range from 0.55 kW to 132 kW
- Easy commissioning and maintenance
- With BOP-2 or IOP-2 operator panel
- Safety Integrated: STO
- Available communication: PROFIBUS DP, USS, Modbus RTU, PROFINET, EtherNet/IP
- Wireless commissioning, operation and diagnostics via mobile device or laptop thanks to optional SINAMICS G120 Smart Access web server module
- SINAMICS CONNECT 300 for connecting up to eight converters to the MindSphere cloud
- Integrated in the TIA Portal with SINAMICS Startdrive

More information

- Catalog D 31.1
- Internet:
<http://www.siemens.com/sinamics-g120c>
<http://www.siemens.com/d31-1>
<http://www.siemens.com/industrymall>

**SINAMICS G120 –
the modular single-motor drive for low to medium power
ratings**



- Power range from 0.37 kW to 250 kW
- Safety Integrated: STO, SS1, SBC, SLS, SDI and SSM encoderless
- Communication via PROFIBUS, PROFINET, EtherNet/IP, RS485, USS, Modbus RTU, CANopen, BACnet MS/TP
- Energy efficient thanks to regenerative feedback and low line harmonic distortion
- Parameter copy function for standard commissioning
- Wireless commissioning, operation and diagnostics via mobile device or laptop thanks to optional SINAMICS G120 Smart Access web server module
- SINAMICS CONNECT 300 for connecting up to eight converters to the MindSphere cloud
- Integrated in the TIA Portal with SINAMICS Startdrive

More information

- Catalog D 31.1
- Internet:
<http://www.siemens.com/sinamics-g120>
<http://www.siemens.com/d31-1>
<http://www.siemens.com/industrymall>

Supplementary components

Drive systems

SINAMICS drive system

Overview

SINAMICS G115D – the distributed wall-mounted or motor-mounted drive system

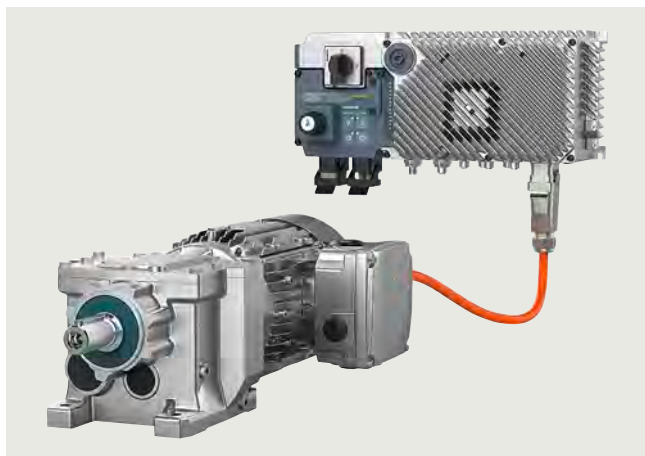

Example: SINAMICS G115D distributed drive system, wall-mounted

The SINAMICS G115D distributed drive system meets all the requirements that system manufacturers place on drives for applications in conveyor technology with a focus on the intralogistics and airport industries as well as for simple, horizontal applications in the automotive and food and beverage industries. The converter is supplied with degree of protection up to IP66 and sets standards in terms of efficiency – from the installation phase to commissioning and all the way to handling. The SINAMICS G115D drive system is the first choice for users who want to move conveyed material quickly and efficiently.

Integration via PROFINET communication with PROFIsafe, AS-Interface, EtherNet/IP into a higher-level control system is very easy thanks to full TIA Portal integration, which provides a tool as well as an operating and data management concept. In addition, an optional web server module is available with the web server module SINAMICS G120 Smart Access (SAM) – a WLAN-based web server solution for simple and fast wireless setup with tablets or smartphones during commissioning and for diagnostics.

More information

- Catalog D 31.2
- Internet:
<http://www.siemens.com/sinamics-g115d>
<http://www.siemens.com/d31-2>
<http://www.siemens.com/industrymall>

SINAMICS G120D – the distributed single drive for high-performance solutions



- Positioning capability
- Power range from 0.75 kW to 7.5 kW
- Energy-efficient due to regenerative feedback and low line harmonic distortion
- Safety Integrated: STO, SS1, SDI, SSM and SLS encoderless
- Thanks to the modular design, electronics stocks are minimal
- Interchangeable memory card
- Communication via PROFIBUS DP, PROFINET, EtherNet/IP
- Integrated in the TIA Portal with SINAMICS Startdrive

More information

- Catalog D 31.2
- Internet:
<http://www.siemens.com/sinamics-g120d>
<http://www.siemens.com/d31-2>
<http://www.siemens.com/industrymall>

Overview

SINAMICS G130/SINAMICS G150 – the universal frequency converters for high-performance single drives



- Available as a standardized control cabinet or built-in units
- Output range from 75 kW to 800 kW or 2700 kW with parallel switching
- Specially for drives with quadratic and constant load characteristics, medium performance requirements, but no regenerative feedback capability
- Service-friendly thanks to easy-to-access device modules
- Communication via PROFIBUS DP, PROFINET, EtherNet/IP, CANopen
- Energy-efficient due to variable-speed operation
- Sensorless vector control
- Safety Integrated: STO, SBC, SS1 with SBR/SAM; SLS, SSM, SDI, SBT
- Simple commissioning and parameterization via the AOP30 Advanced Operator Panel or PC-supported using the STARTER IOP commissioning tool

More information

- Catalog D 11
- Internet:
<http://www.siemens.com/sinamics-g130>
<http://www.siemens.com/sinamics-g150>
<http://www.siemens.com/d11>
<http://www.siemens.com/industrymall>

Supplementary components

Drive systems

SINAMICS drive system

Overview

SINAMICS G180 – the specific converter for the oil & gas, chemical and process industries



The LOHER DYNAVERT T frequency converter integrated as SINAMICS G180 into the SINAMICS range has been deployed for over forty years for applications where maximum reliability and availability of the drive are of paramount importance.

SINAMICS G180 converters can be supplied for standard voltages 400, 500 and 690 V in the power range up to 6.6 MW. They are available as a compact unit, a cabinet system or a cabinet unit, with air or liquid cooling, for operation with synchronous and asynchronous motors.

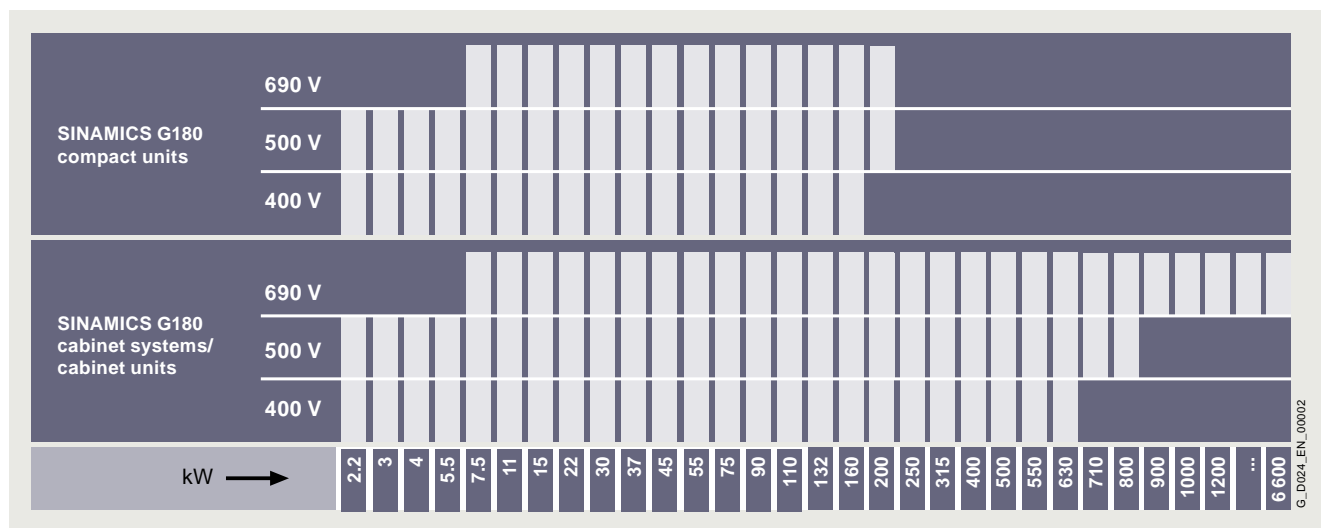

- A wide range of add-on electrical components allow the drive system to be optimized for specific requirements
- Simplified configuring and shortened commissioning due to predefined interfaces and pre-parameterized factory settings
- Sensorless vector control without additional speed actual value encoder (encoder evaluation units are available if required)
- Can be flexibly integrated in all automation concepts
- Communication: Apart from the standard converter interface (compliant with Namur NE37), PROFINET, PROFIBUS DP, Modbus RTU, Modbus TCP, CANopen can also be used optionally

Optionally available peripheral boards can be selected to add the following inputs/outputs to the converter:

- Digital and analog inputs and outputs
- 2 PTC thermistor inputs for ATEX-certified motor temperature monitoring for motors in hazardous zones (prewarning/trip)

More information

- Catalog D 18.1
- Internet:
<http://www.siemens.com/sinamics-g180>
<http://www.siemens.com/sinamics-g150>
<http://www.siemens.com/d18-1>
<http://www.siemens.com/industrymall>

Overview
**SINAMICS S210 –
the single-axis servo drive for highly dynamic applications**

The servo drive system comprises a SINAMICS S210 servo converter, a SIMOTICS S-1FK2, S-1FT2 or S-1FS2 servomotor and a matching One Cable Connection (OCC) for connecting the motor to the converter. SINAMICS S210 is a single-axis AC/AC servo converter system with high performance and dynamic response for mid-range Motion Control applications.

SINAMICS S210 servo converters are available for the following line voltages:

- 200 V to 240 V 1 AC (1 AC series)
- 200 V to 480 V 3 AC (3 AC series)

The high performance of the SINAMICS S210 servo drive system in conjunction with the SIMOTICS S-1FK2, S-1FT2 or S-1FS2 servomotor derives from the following features:

- Low moment of inertia and high overload capability of the motor
- High-resolution encoder with fast scanning
- Current controller clock cycle of 62.5 μ s and a pulse frequency of 8 kHz of the servo converter

This enables short cycle times on the machine even with complex motion control.

More information

- Catalog D 32
- Internet:
<http://www.siemens.com/sinamics-s210>
<http://www.siemens.com/d32>
<http://www.siemens.com/industrymall>

**SINAMICS S110 –
the specialist for simple positioning tasks**

- Servo control
- Power range from 0.55 kW to 132 kW
- Safety Integrated
- Integrated positioning functions
- Straightforward system interface with higher-level controllers (e.g. PLC) with PROFIBUS DP or PROFINET

More information

- Catalog D 31.1
- Internet:
<http://www.siemens.com/sinamics-s110>
<http://www.siemens.com/d31-1>
<http://www.siemens.com/industrymall>

Supplementary components

Drive systems

SINAMICS drive system

Overview

SINAMICS S120 – the flexible, modular drive system for demanding single-axis and multi-axis applications from the low-end to the high-end performance range



- Modular drive system for single-axis and multi-axis applications in all areas of machine and plant manufacturing
- Servo/vector control, U/f control
- Power range from 0.12 kW to 5700 kW
- Various types of construction for different application areas
- Highly flexible due to, for example, modular system architecture, different cooling methods, support for a wide range of motors/encoders, easy expansion
- High degree of scalability with regard to performance, number of axes, functionality
- Integrated safety functions
- Comprehensive motion control functionality
- High availability and efficiency, even in unstable networks
- Automatic parameterization and easy drive commissioning/optimization

More information

- Catalogs D 21.3, D 21.4
- Internet:
 - <http://www.siemens.com/sinamics-s120>
 - <http://www.siemens.com/d21-3>
 - <http://www.siemens.com/d21-4>
 - <http://www.siemens.com/industrymall>



Overview

SINAMICS S150 – the sophisticated drive solution for single drives in the medium to top performance ranges



- Particularly suitable for applications with high requirements regarding precision and dynamic response in the mid to upper performance range, as well as for frequent braking cycles with high braking energies and four-quadrant operation
- Ready-to-operate control cabinet
- Power range from 75 kW to 1200 kW
- Straightforward configuring and commissioning provided by the SIZER for Siemens Drives and STARTER engineering tools
- High availability and efficiency, even in unstable networks
- Efficient operation through standard energy recovery
- Line-friendly operation thanks to Clean Power Filter (line feedback < 1 %)
- Reactive power compensation possible
- Equipped as standard with PROFIBUS DP interface for connection to higher-level controls

More information

- Catalog D 21.3
- Internet:
<http://www.siemens.com/sinamics-s150>
<http://www.siemens.com/d21-3>
<http://www.siemens.com/industrymall>

SINAMICS DCP – the compact DC/DC converter for smart applications



With the SINAMICS DCP, Siemens is offering a new generation of bidirectional DC/DC converters. In these, Siemens is combining its expertise in DC technology with the advantages of the well-proven SINAMICS family. SINAMICS DCP is setting new standards when it comes to quality, reliability and technical functionality.

The SINAMICS DCP is suitable for industrial and multi-generator applications in the renewable energy sector. As a bidirectional boost and buck converter with scalable power rating, it combines multiple functions in one single device. With variable voltage levels, current can flow in both directions. This makes the SINAMICS DCP ideal for charging and discharging batteries and supercapacitors.

Special features

- Bidirectional boost and buck converter in one unit
- High efficiency
- High switching frequency
- Compact: The reactor, power unit and control station form one unit

Software feature

- Voltage and current regulation
- 3 overload profiles
- Stable voltage in the DC link
- Voltage control
- Overload capability
- Temperature-controlled fans (only for DCP 120 kW)
- Incorporated MPPT (Maximum Power Point Tracker)
- No-load voltage limitation of a PV field
- Battery charging characteristic
- Communications interfaces: EtherNet/IP, Modbus TCP, PROFIBUS, PROFINET

The functionality can be expanded with other SINAMICS components such as Active Line Modules.

More information

- Internet:
<http://www.siemens.com/dc-dc-converter>
<http://www.siemens.com/d23-1>
<http://www.siemens.com/industrymall>

Supplementary components

Drive systems

SINAMICS drive system

Overview

SINAMICS DCM –
the scalable drive system for basic and sophisticated DC drive applications



- Power range 6 kW to 30 MW
- For machinery and plants in industry
 - Steel/aluminum
 - Plastic
 - Printing
 - Paper
 - Hoisting gear
 - Mining
 - Oil and gas
 - Static excitation units
 - Heating applications
 - Magnet applications
- New systems and retrofit business
- Communication as standard via PROFIBUS DP, RS485 or USS, and optionally via PROFINET, EtherNet/IP or Modbus RTU
- Safety Integrated: STO, SS1 acc. to IEC 61508 SIL 3 as well as EN ISO 13849-1 PL e
- Control unit variance
- Field power supply in line with requirements
- Electronics power supply for connection to 24 V DC
- Power unit isolated to ground (isolated voltage sensing)
- Free function blocks and Drive Control Chart (DCC)
- Expandable functionality using SINAMICS components
- Single-phase operation possible
- Coated modules and nickel-plated copper busbars
- Wide temperature range
- High overload capability
- Low torque ripple at low speeds
- Very compact design

More information

- Catalog D 23.1
- Internet:
 - <http://www.siemens.com/sinamics-dcm>
 - <http://www.siemens.com/d23-1>
 - <http://www.siemens.com/industrymall>

SINAMICS PERFECT HARMONY GH180



Core Applications

- Single and multi-motor applications (sync transfer) such as pumps, fans, compressors, mills, crushers, conveyor systems, retrofit projects, etc.

Product Highlights

- Integrated and optimized drive and transformer design – Minimized plant footprint, combined cooling system and plug-and-play drive system setup.
- Over 16,000 drives sold worldwide – The most trusted and proven drive on the market today with installations in every major process industry.
- Extremely motor-friendly – Capable of being configured with virtually any motor thanks to an almost sinusoidal output voltage
- Cell bypass, cell redundancy and blower redundancy – Maximize process availability thanks to its Advanced Cell Bypass feature for maintaining a balanced output voltage without torque or speed reductions.

More information

- Internet:
 - <http://www.siemens.com/sinamics-perfect-harmony-gh180>

Overview
SINAMICS PERFECT HARMONY GH150

Core Applications

- Single motor applications such as pumps, fans, compressors, conveyor systems (uphill) and retrofit projects.

Product Highlights

- Transformer flexibility – Able to utilize separate dry type or oil-filled standard converter transformers or high primary voltages or number of pulses
- Flexible cooling arrangement perfect for any installation requirements – Water or air cooled design, duct air outside, use integral or separate air-to-air or integral air-to-water heat exchanger, stand alone control cabinet.
- Extremely motor-friendly – Capable of being configured with virtually any motor thanks to an almost sinusoidal output voltage up to 13.8 kV.
- Cell bypass and cell redundancy – Maximize process availability thanks to a high speed cell bypass feature for maintaining a balanced output voltage without torque or speed reduction.

More information

- Internet: <http://www.siemens.com/sinamics-perfect-harmony-gh150>

SINAMICS GM150

Core Applications

- Single-motor applications such as basic pump, fan and compressors applications, and mine hoists, especially in marine and offshore applications.

Product Highlights

- Easy to maintain and operate safely and reliably – Fuseless, tested arc proof design.
- Optimized footprint and design – Compact, rugged; saves costs and space.
- Common housing / system for IGBT and IGCT cooling principles – Freely selected based on customer needs to meet requirements.
- Transformer flexibility – Able to utilize dry type or oil-filled standard converter transformers or high primary voltages or number of pulses.

More information

- Internet: <http://www.siemens.com/sinamics-gm150>

Supplementary components

Drive systems

SINAMICS drive system

Overview

SINAMICS GL150



Core Applications

- Mainly used in large high-power and high-speed applications such as pumps, fans, compressors, main marine propulsion, extruders and rolling mills, boiler feed pumps, wire rod mills, starting generators, pump storage and starting applications (e.g., blast furnaces).

Product Highlights

- Compared to VSI drives, most cost-competitive solution for large power ratings – Power density per M2.
- Mature and proven LCI topology – With over 40 years of experience and large installed base.
- Rugged and compact design for complex high-power applications – Fault tolerant, high MTBF, utilized in marine, starting and high-power applications, most rugged thyristor technology. Regenerative capability for energy-saving drive system solutions.

More information

- Internet:
<http://www.siemens.com/sinamics-gl150>

SINAMICS SH150



Core Applications

- Special applications such as shaft generators on ships, onshore power supply for ships and offshore platforms, regenerating test stands, 50/60 Hz grid coupling, VAR compensation by AFE-drives.

Product Highlights

- Extremely motor- and line-friendly – Motors of literally any type - old or new - can be operated with standard winding insulation without additional stress. Transformer-less connection to local grids on request.
- Active Front End (AFE) for grid applications – Dedicated U/f droop control to create an island grid or to co-supply together with other generators. Additionally supply dynamic reactive power for voltage stabilization (STATCOM).
- Active Front End (AFE) for regenerating motors – Simultaneous 2Q or 4Q operation and grid VAR compensation with AFE and motor-side inverter. Also for rotating generators.
- Robust & reliable – Cell redundancy with automatic cell bypass for increased availability. Marine classification for ship and offshore applications.

More information

- Internet:
<http://www.siemens.com/sinamics-sh150>

Overview
SINAMICS SM150

Core Applications

- Single- and multi-motor applications such as mills, crushers, conveyor belts, test stands, rolling mills and mine hoists.

Product Highlights

- 4-quadrant operation – Regenerative capability for energy-saving drive system solutions.
- Single- and multi-motor capability – Utilizing a common DC link.
- Optimized footprint and design – Compact, rugged; saves costs and space.
- High dynamic performance

More information

- Internet: <http://www.siemens.com/sinamics-sm150>

SINAMICS SL150

Core Applications

- Perfect for complex high-torque and low-speed applications such as rolling mills, mine hoists, mine winders, ore and cement crushers, excavators and conveyors

Product Highlights

- Fewest drive components for any given power rating - Low component variety to reduce capital investment and associated costs for storage and logistics.
- Compact and rugged design for extreme environments - High altitudes, temperatures and air quality, plus service friendliness for remote areas.
- Optimal configuration and operation – Integrated test routines, feedback and self-diagnostics, including thyristors, improved commissioning and tuning.
- Use of standard HV cable due to the typical low switching speed of thyristors (no screened or armored cables required).

More information

- Internet: <http://www.siemens.com/sinamics-sl150>

Supplementary components

Drive systems

SIMATIC MICRO-DRIVE drive system

Overview



The SIMATIC MICRO-DRIVE servo drive system is comprised of the main components

- PDC Drives
- TM Drives
- Motor or geared motor
- Plug-in cables

In addition, other system components are also available, e.g. a brake control module (available soon) or shielding bracket sets.

Component selection and dimensioning of the right components based on physical key data, travel profiles and/or load profiles can be done directly in the "download" file of the TIA Selection Tool:

<https://www.siemens.com/tst>

Properties

- DC supply voltage for logic (24 V DC) and power (up to 48 V DC)
- Different performance classes from 100 W to 1000 W for servo converters/PDC drive controllers, and 280 W for F-TM ServoDrive
- Communication via PROFINET with PROFIdrive profiles
- Failsafe communication via PROFIsafe for the failsafe variants (e.g. PDC100F)
- Extended Safety drive functions (e.g. SLS or SLT ¹⁾) for the failsafe variants already possible with the encoders integrated in the motors)
- 24/48 V DC EC motors/geared motors (brushless) from multiple Siemens Product Partners, can also be partially ordered directly via Siemens
- 24/48 V DC DC motors (with brushes) can also be operated with PDC100 and PDC100F
- Pre-assembled plug-in cables from multiple Siemens Product Partners, also can be partially ordered directly via Siemens

¹⁾ Only for PDC100F.

More information

- Catalog D 34
- Internet
 - <https://www.siemens.com/micro-drive>
 - <https://www.siemens.com/d34>
 - <https://www.siemens.com/industrymall>

Overview

SICROWBAR AC

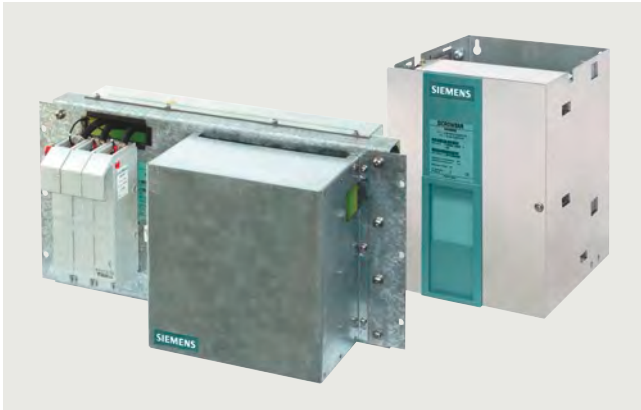

SICROWBAR AC is used to protect power semiconductors in converters (thyristors and diodes) against overvoltage that occurs between the phases of a three-phase network. The range of applications is not restricted to protecting DC drive converters, but also comprises infeed/regenerative feedback units of the AC drive technology that are equipped with thyristors.

Overvoltage that occurs on the AC side of converters is mainly caused by switching operations when disconnecting from the line supply at the transformer's primary side. This applies both to operational switching operations (shutdown at no-load) as well as in the case of a fault (shutdown under load).

The overvoltage protection is mainly used in the following configuration:

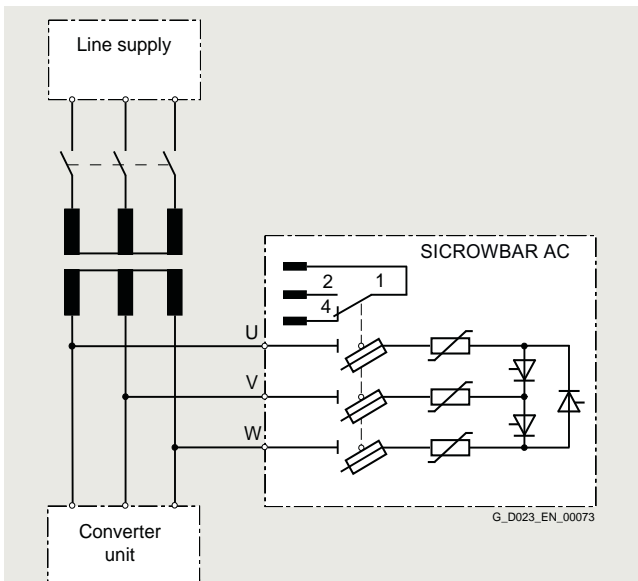

More information

- Catalog D 23.1
- Internet:
<http://www.siemens.com/sinamics-dcm>
<http://www.siemens.com/industrymall>

SICROWBAR DC



SICROWBAR DC protects coils and converters against overvoltage conditions when they are used to supply large inductances, for instance, the excitation coils of synchronous machine motors, DC machine motors or hoisting solenoids. An appropriate de-excitation/discharge resistor must be provided. A thermostatic switch can be ordered as an option for the resistor from the manufacturer.

The fast de-excitation option G11 (module 7VV3003-7FG00) makes it possible to initiate fast de-excitation, triggered by a higher-level signal, for the 7VV3003-5... units.

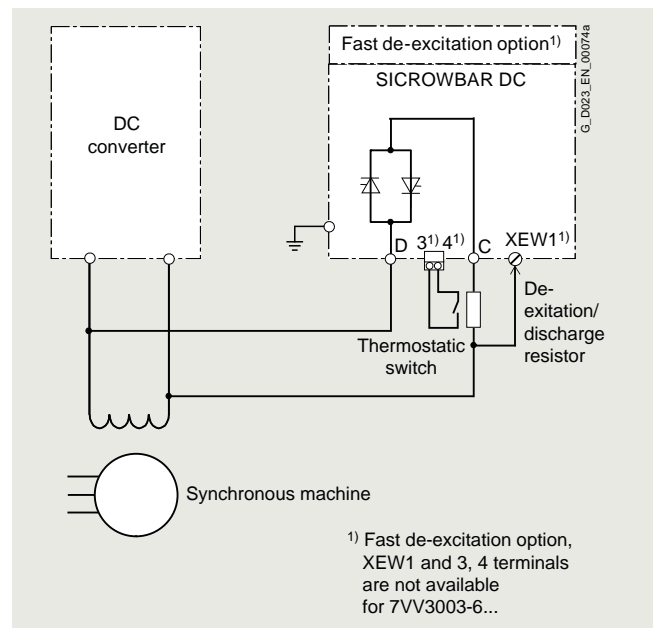

More information

- Catalog D 23.1
- Internet:
<http://www.siemens.com/sinamics-dcm>
<http://www.siemens.com/industrymall>

Supplementary components

Timing, coupling and monitoring relays

SIRIUS relays

Overview



SIRIUS relays – one range for every application

Our range of SIRIUS relays offers you everything you need for a motor feeder application. Easy and convenient – and all from one source. Whether you require compact timing relays or reliable monitoring relays, particularly narrow coupling relays, plug-in relays, low-noise power relays or signal converters – it will not be easy to find a more complete and comprehensive range of relays anywhere. Quite simply, there is one for every possible need. What is more: all SIRIUS relays are particularly easy to use. So take a closer look at our range and convince yourself – you will be surprised.

SIRIUS 3UG, 3RR, 3RN, 3RS monitoring relays – Reliable monitoring and protection

SIRIUS relays from Siemens offer maximum protection for machines and plants, and they communicate with the control level thanks to IO-Link. The SIRIUS relays for IO-Link reliably monitor network quality, power values, voltages, speeds and temperatures and at the same time they open up an even wider field of applications for you.

3UG monitoring relays are used to monitor electric and non-electric variables which cannot (or should not) be directly recorded by an automation system.

- Monitoring of networks for overvoltage or undervoltage, direction of rotation, or asymmetry
- Monitoring of loads using Cos-phi or current measurement
- Monitoring for insulation faults and fault currents
- Monitoring of levels or speeds of rotation

The 3RR current monitoring relays are suitable not only for monitoring motors or other loads, but are also well suited to monitoring multiphase currents of the entire plant or the driven process. In this way, for example, an idling pump or an overload is promptly detected and reported in good time.

The 3RR2 monitoring relays can be set up individually or integrated directly into the load feeder.

3RN thermistor motor protection devices monitor the winding temperature of motors fitted with a PTC sensor.

- Compliance with the ATEX directive 2014/34/EC through conformity with EN 50495 and EN 60947-8 standards.
- Compliance with the safety requirements for PL c according to ISO 13849 or SIL 1 according to IEC 61508
- Fast fault diagnostics through display of open-circuit and short-circuit.
- Solid-state compatible output due to hard gold-plated contacts.

The **3RS2 temperature monitoring relays** can be used to measure temperatures in solid, liquid and gas media. The temperature is acquired by means of sensors in the medium, evaluated by the device and monitored for overshoot, undershoot or location within a specified range (window function).

The family comprises an analog multi-function device which can be set using DIP switches and potentiometers, and digital devices which can be parameterized via an intuitive LCD display. The digital device is also available as a version with IO-Link.

All 3RS26 digital devices, including the 3RS28 versions with IO-Link, have safety certification according to IEC 61508/IEC 62061 or ISO 13849 up to SIL 1/PL c as well as EN 14597 for heat generating systems and EN 50156 for burners.

Furthermore, the functionality of the 3RS26/3RS28 digital devices can be expanded using a 3RS29 sensor expansion module with two additional resistance sensors, e.g. for monitoring three-phase motors or transformers.

The 3RS29 sensor expansion module also features an additional relay for outputting the sensor status, and an additional analog input 4 to 20 mA. This analog input allows ATEX applications to be implemented when using an intrinsically safe temperature sensor or other appropriate type of protection. The 3RS29 is connected wirelessly via a SIL 1-certified infrared communication interface.

Notes:

The SIRIUS 3RS2 temperature monitoring relays fully replace the 3RS1 predecessor.

SIRIUS speaks IO-Link

With the SIRIUS monitoring relay for IO-Link you are opting for maximum flexibility: As well as the autonomous monitoring function that is still available, measured values and data can also be transferred directly to the controller via IO-Link. Parameters can also be assigned locally or via IO-Link. This means that the SIRIUS relays for IO-Link are fully integrated into Totally Integrated Automation, our open system architecture for integrated automation. You also profit from significantly simplified device replacement – thanks to data matching and automatic re-parameterization via a parameter server.

Overview

SIRIUS 3RP, 7PV timing relays

Electronic timing relays are used for all delayed switching operations in open-loop control, starting, protection and closed-loop control circuits.

Thanks to their sophisticated and compact design, the 3RP timing relays are ideal timer modules for control cabinet, switchgear and controller manufacturers from the industry. Due to their narrower design, the 7PV timing relays are particularly suitable for use in heating, ventilation and air-conditioning systems and compressors.

SIRIUS 3RA28 function modules and solid-state time-delayed auxiliary switch blocks

The 3RA281. function modules permit the construction of starters and contactor combinations for direct and star-delta starting. They include the essential control functions that are needed for the respective feeder – for example, timing and electrical interlocking functions. Function modules that function as timing relays can easily and quickly be fitted to SIRIUS contactors – without any significant wiring effort. They permit both ON-delay and OFF-delay switching of contactors.

The 3RA283. solid-state time-delayed auxiliary switch blocks can be connected to contactors and are designed for contactor coil voltages in the 24 to 240 V AC/DC wide voltage range. Auxiliary switches for control and alarm signals are used specially for switching the smallest signals for electronics applications. They are used, for example, for allowing a pump or fan to run on, in a similar way to an OFF-delay time relay or for the delayed activation of a gate drive. Simply by snapping and locking it into place, both the electrical and mechanical connection is made. To attenuate switching overvoltages of the contactor coil, a varistor is integrated in the time-delayed auxiliary switch.

SIRIUS 3RQt to 3RQ3, 3TG10 and LZS coupling relays

The SIRIUS coupling relays are ideally suitable for coupling to and from controllers and are thus the perfect partner for SIMATIC controllers. They can be used for electrical isolation, for voltage conversion, for signal amplification and for overvoltage and EMC protection.

The force-guided **3RQ1 coupling relays** (up to SIL 3/PL e) are available in widths of 17.5 mm and 22.5 mm. Due to the forced guidance according to IEC 60947-5-1 (IEC 61810-3), the contacts of the installed relays are mechanically connected to each other in such a way that NO and NC contacts are never closed simultaneously. As a result, an opening failure can be reliably detected and maximum safety can be ensured. 3RQ1 coupling relays serve to reliably couple safe controllers, also for safety applications up to SIL 3/PL e.

The **3RQ2 coupling relays** for universal use set standards: With a wide voltage range from 24 V to 240 V AC/DC they are the star attraction on the coupler market. The reduced variety of components simplifies product selection and standardization. In this series, we offer you devices in the field-proven 22.5 mm industrial enclosure with one, two or three changeover contacts and with screw-type or spring-loaded connections (push-in technology). The versions with hard gold-plated contacts ensure an especially high contact reliability even at low currents. Thanks to the well-proven industrial enclosure, you can enjoy the benefits of user-friendly connection systems with permanent wiring, just the same as with our timing relays.

The **3RQ3 coupling relays** are now available in a new uniform enclosure design. With their narrow width of 6.2 mm and low installation depth/height, they are ideal for space-optimized use in control cabinets with short gaps between tiers, and in flat control boxes. All versions are available with screw-type or spring-loaded terminals (push-in technology). Wiring time is reduced because conductors are inserted and clamped from the front.

3RQ3 coupling relays are available as:

- Coupling relay with relay output (not plug-in)
- Coupling relay with plug-in relay
- Coupling relay with semiconductor output (not plug-in)

3TG10 power relays/miniature contactors prove their worth wherever small, low-noise relays or contactors are required at a reasonable price. This makes them ideal for simple controllers, especially for use in large-series manufactured devices and controllers. For applications that do not require an overload relay and need only one auxiliary switch – and which therefore need more switching power, higher switching voltage, and a longer service life.

LZS coupling relays with plug-in relays are available as complete devices or as individual modules for self-assembly or spare parts requirements. This series is divided into three designs: RT, PT, and MT.

- Can be used for contact multiplication, adaptation of potential, or for switching small loads.
- Max. 4 changeover contacts in one device:
 - Wide-voltage versions with or without hard gold-plated contacts.
 - With screw-type or push-in spring-loaded terminals.

SIRIUS 3RS70 signal converters

The 3RS70 signal converters share the enclosure concept with the 3RQ3 coupling relays. They are used mainly for the electrical isolation and conversion of analog signals. Sensors/actuators and controllers usually have different potentials and therefore require electrical isolation in the signal circuit. This is done either in the controller or by means of signal converters.

The conversion of one signal into another is required if, for example, a voltage signal has to be converted into a current signal for transmission over a longer distance, or if the output of a sensor and the input of a controller do not match.

The implemented frequency outputs offer another application. The input signal is converted to a proportional frequency here. This means that analog signals can be processed with digital inputs.

This is important if a controller offers no possibility for an analog input, or if all analog inputs are already occupied, for example, in the case of retrofits.

More information

- [Catalog IC 10](#)
- [Brochure "SIRIUS relays"](#)
- Internet: www.siemens.com/sirius-monitor

Supplementary components

Measuring systems

Motion Control Encoder measuring systems

Overview

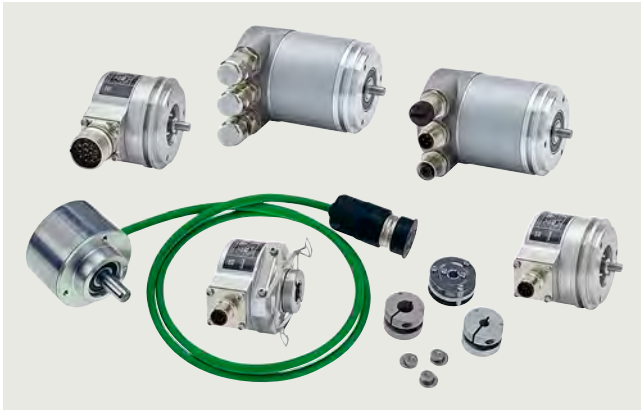

More information

- Internet:
<http://www.siemens.com/sensor-systems>
<https://www.siemens.com/industrymall>

- Measuring systems are encoders for recording distances, angles of rotation, and speeds.
- Can be used on machines in various industries, such as production machines, handling equipment, machine tools, and special-purpose machines.
- Can be connected to SIMATIC, SINAMICS, SINUMERIK and SIMOTION
- Couplings, mounting material, connectors, and completely pre-assembled signal cables are available as accessories.
- Built-on encoders are available as incremental or absolute encoders.
- Incremental encoders:
 - Interfaces RS422 (TTL), 1 V_{pp} and HTL
 - Operating voltage 5 V DC or 10 V to 30 V DC
- Absolute encoders:
 - All absolute encoders are available in single-turn and multi-turn versions.
 - Synchronous serial interface (SSI) or connection for EnDat, PROFIBUS DP, PROFINET IO with RT/IRT and DRIVE-CLiQ.
 - Encoders with PROFIBUS DP support Class 1 ... 3 profiles as well as isochronous mode, slave-to-slave communication, and application-specific supplementary functions. They are parameterizable.
 - Encoders with PROFINET IO support Class 1 ... 4 profiles.

All measuring systems are available in synchro flange or clamp flange versions. The absolute encoders are available in a hollow shaft design.

Overview



SIMOTION system

The well-proven, modular and scalable SIMOTION Motion Control System with high-end functions for motion control is the ideal solution for applications in mechanical engineering, in which modularity, maximum precision and speed are vital.

SIMOTION ensures a high level of flexibility at low engineering outlay with the modular technology object approach. Object-oriented programming and a programming model with units and libraries enable the creation of reusable software modules and the effective implementation of large quantity structures.

SIMOTION simplifies the development and integration of standard modules in an executable project with libraries for industry-specific applications and the SIMOTION easyProject project generator.

The SIMOTION system is made up of three components:

Engineering system

The SCOUT engineering system enables Motion Control, PLC and technology functions to be incorporated in one comprehensive, integrated system and provides all the necessary tools:

From programming and parameterization through testing and commissioning, to diagnostics.

SCOUT can be used in SIMATIC STEP 7, either with standardized data management and configuring procedures, or as a stand-alone engineering tool (SCOUT Stand-Alone). SCOUT TIA (SIMOTION in the TIA Portal) is available as an optional package for TIA Portal V13 and above and is included in the scope of supply of SCOUT.

The following options, for example, are available in the engineering system for programming:

- Graphic programming with Motion Control Chart (MCC)
- Ladder Diagram (LAD)/Function Block Diagram (FBD)
- High-level language Structured Text (ST), including object-oriented programming

Runtime system

The runtime system offers a high-performance execution system for cyclic and sequential tasks. The runtime software modules make the different PLC, Motion Control and technology functions available. By selecting the appropriate modules, the overall functionality of the system can be flexibly adapted to the machine.

Hardware platforms

The hardware platforms are the basis of the SIMOTION Motion Control System. The application created with the engineering system and the associated runtime software modules can be implemented on different hardware platforms. The scalable SIMOTION hardware supports centralized, distributed and mixed topologies for all machine designs with up to 128 axes per controller.

SIMOTION D – Compact and integrated in the drive

- The complete machine automation with drive control, PLC, Motion Control and technology functionality in one compact unit of SINAMICS S120 design.
- Particularly fast response
- Versatile networking options via PROFINET, PROFIBUS or Ethernet
- Scalable since multiple performance versions available
- SIMOTION D is available in two configurations:
 - As a single-axis system SIMOTION D410-2 with multi-axis option (blocksize configuration). The Control Units are available in D410-2 DP and D410-2 DP/PN versions and are snapped onto the SINAMICS S120 PM240-2 Power Modules in blocksize format.
 - As a multi-axis system SIMOTION D4x5-2 in four performance variants for as many as 128 axes (booksize format)
- Ideal for:
 - Compact machines
 - Distributed automation concepts, e.g. on machines with a large number of axes
 - Modular machines
 - Time-critical demands on the axis couplings

SIMOTION C – Modularity and flexibility

- Controllers in SIMATIC S7-300-design
- 2 versions, optionally with PROFINET interface or with integrated drive interfaces for analog and stepper drives
- Onboard inputs/outputs expandable using I/O modules from the SIMATIC S7-300 range of products
- With integrated isochronous PROFIBUS interfaces
- Ideal for:
 - Highest possible level of freedom for drive selection
 - Broad range of process signals
 - Retrofit applications by means of integrated analog interfaces

More information

- Internet:
 - <http://www.siemens.com/simotion>
 - <http://www.siemens.com/industrymall>

Supplementary components

Automation systems

SINUMERIK CNC automation systems

SINUMERIK 828D

Overview



SINUMERIK 828D – the powerhouse among the compact CNCs

With their unique CNC performance, SINUMERIK 828D CNCs set productivity benchmarks when it comes to milling and turning on standard machines as well as functions for easy automation of grinding machines.

Rugged and maintenance-free

Their die-cast magnesium operator panel fronts, the panel-based CNC design with minimal interfaces, as well as a high degree of protection, make SINUMERIK 828D CNCs reliable partners even in harsh environments.

Designed without a fan or hard disk, with NVRAM memory technology and no back-up battery, SINUMERIK 828D CNCs are completely maintenance-free.

User-friendly

The SINUMERIK 828D CNCs are very easy to operate thanks to a full QWERTY CNC keyboard with short-stroke keys and a high-resolution 10.4" TFT color display or 15.6" touch display.

CNC data are quickly and easily transferred via USB, CF card (for 10.4") and RJ45 interfaces on the operator panel front.

Optimum scalability

Based on the three CNC performance versions SW24x, SW26x and SW28x of the SINUMERIK 828D CNCs, favorably-priced compact as well as more complex machines with additional axes/spindles and 2 machining channels and 2 handling channels can be implemented.

Preconfigured technology for use in standard turning and milling machines

SINUMERIK 828D is perfectly adapted for use in standard machines and provides optimum support for turning and milling technologies. With two preconfigured system software variants for machining technology, the SINUMERIK 828D CNC systems are ready for use in turning and milling machines on dispatch from the factory.

The ideal basis for implementing a compact grinding machine

The G-Tech technology variant provides grinding machine manufacturers with a perfect platform for designing grinding machines – both cylindrical and surface grinding machines are supported.

Since grinding machine manufacturers want to fully incorporate their specific process know-how so that it is even reflected in the operating philosophy of the CNC, the G-Tech variant of the SINUMERIK 828D offers a number of sophisticated grinding and dressing cycles. Additionally, SINUMERIK Run MyScreens and Run MyHMI /3GL provide manufacturers with the option of designing their own HMI.

More information

- Internet:
<https://www.siemens.com/industrymall>
<https://www.siemens.com/sinumerik>
<https://www.siemens.com/nc82>
- For full details of SINUMERIK 828, please refer to the market-specific solutions in the Industry Mall:
<https://mall.industry.siemens.com/mall/ww/en/Catalog/Products/10078797>

Overview



SINUMERIK 840D sl – ultimate performance in the premium class

The SINUMERIK 840D sl CNC offers modularity, openness, flexibility and uniform structures for operation, programming, and visualization. It provides a system platform with trend-setting functions for almost all technologies.

Integrated into the SINAMICS S120 drive system and complemented by the SIMATIC S7-300 automation system, the SINUMERIK 840D sl forms a complete digital system that is ideally suited for the mid- to upper-performance range.

The SINUMERIK 840D sl is characterized by:

- A high degree of flexibility
- Excellent dynamic response and precision
- Optimum integration into networks

Benefits

- Outstanding performance and flexibility for multi-axis systems of average to high complexity thanks to scalable hardware and software
- Universal openness of the user interface, the PLC and the NCK area to allow integration of your specialist know-how
- Integrated safety functions for man and machine: SINUMERIK Safety Integrated
- Comprehensive range of products for integrating machine tools into communication, engineering and production processes: SINUMERIK Integrate

Application

The SINUMERIK 840D sl can be deployed around the world for the following technologies:

- Turning
- Drilling
- Milling
- Grinding
- Laser machining
- Nibbling
- Punching
- Tool and mold making
- High-speed cutting applications
- Woodworking and glass processing
- Handling
- Transfer lines
- Rotary indexing machines
- Mass production
- JobShop production

The SINUMERIK 840DE sl is available as an export version for use in countries where approval is required.

More information

- Internet:
 - <https://www.siemens.com/industrymall>
 - <https://www.siemens.com/sinumerik>
 - <https://www.siemens.com/nc62>
- For full details of SINUMERIK 840D sl, please refer to the market-specific solutions in the Industry Mall:
 - <https://mall.industry.siemens.com/mall/ww/en/Catalog/Products/10121243>

Supplementary components

Automation systems

SINUMERIK CNC automation systems

SINUMERIK ONE

Overview



SINUMERIK ONE: the next level CNC in the premium class

SINUMERIK ONE – the digital native CNC with the pioneering CNC system for highly productive machine tools. Thanks to its digital twin, the key element in digital transformation, SINUMERIK ONE helps to simulate and test work processes completely virtually - saving time, resources and costs.

Boosting productivity with SINUMERIK and digitalization solutions

Shorter product introduction times and increasing individualization of products influence production with machine tools. High productivity is more important than ever for machine manufacturers and users. The key factor is optimum interaction of automation and CNC solutions and sophisticated technology – and the effective integration of digital solutions. This applies to all areas: from design and construction of a machine to operation and service. SINUMERIK connects automation, competence in technology, and digitalization to form a single solution offering for more productivity. SINUMERIK CNC systems are the optimum solution for the production of individual parts or series production, for simple or complex workpieces.

Benefits

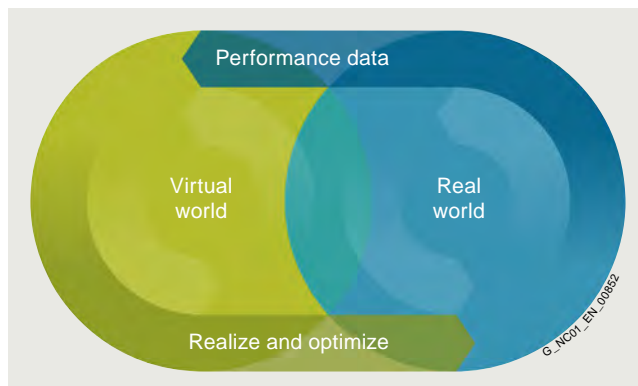

Merging the real world with the virtual world

The new SINUMERIK ONE is specifically designed for smart manufacturing.

- The digital twin is an integral part of the CNC system; virtual and real CNC merge and complement each other
- Significant reduction in product development and market launch times thanks to the **digital first** strategy
- Improved networking and data communication capabilities
- Significant reduction in the duration of real commissioning thanks to virtual commissioning preparation
- Significantly increased CNC performance
- Significantly shorter downtimes and complete integration into the TIA Portal thanks to the integrated SIMATIC S7-1500F PLC

This means that the SINUMERIK ONE can be seamlessly integrated into digital solutions and workflows.

More information

- Internet:
 - <https://www.siemens.com/industrymall>
 - <https://www.siemens.com/sinumerik-one>
 - <https://www.siemens.com/nc63>
- For full details of SINUMERIK ONE, please refer to the market-specific solutions in the Industry Mall:
 - <https://mall.industry.siemens.com/mall/ww/en/Catalog/Products/10028455>

Overview



SINUMERIK MC – the universal and open CNC which can be easily integrated into existing machine solutions

Thanks to its integrated SINUMERIK CNC, SIMATIC controller and Windows 10 operating system, the SINUMERIK MC is the ideal solution for machine tools with customized user interfaces.

The areas of application range from machining wood, stone and glass and adhesive application to simple grinding applications and special machine tool technologies such as sheet metal cutting, laser and water jet cutting, as well as additive manufacturing.

- The integrated Windows operating system allows the user interface to be designed simply and matched to customer requirements. The **open operating concept** and extensive interfaces make the SINUMERIK MC an integrated and open control system.
- The proven SINUMERIK CNC technology enables maximum precision in motion control and – thanks to **G code programming** – freedom and flexibility in machine control.
- Shorter response times of the latest SIMATIC S7-1500F PLC enable **increased processing speed** and significantly boost automation performance.
- Symbolic programming, modern programming languages and extensive toolboxes for implementing standard applications make **engineering in the TIA Portal** simple and efficient.
- SINUMERIK MC offers **Safety Integrated** as a uniform Siemens industry safety standard and implements the multi-level defense-in-depth concept for IT security.
- **Attractive option packages** offer the best possible adaptation to individual machine requirements.

More information

- Internet:
<https://www.siemens.com/industrymall>
<https://www.siemens.com/sinumerik>
<https://www.siemens.com/nc64>
- For full details of SINUMERIK MC, please refer to the market-specific solutions in the Industry Mall:
<https://mall.industry.siemens.com/mall/ww/en/Catalog/Products/10367270>

Supplementary components

System cabling

MOTION-CONNECT connection systems

Overview

MOTION-CONNECT includes connection systems and components which are optimally tailored to individual areas of application. MOTION-CONNECT cables feature state-of-the-art connection systems to ensure fast, reliable connection of different components, and offer maximum quality as well as system-tested reliability.



MOTION-CONNECT power cable and signal cable

MOTION-CONNECT cables are available as fully-assembled power and signal cables or sold by the meter. The pre-assembled cables can be ordered in length units of 10 cm (3.94 in) and can be extended, if necessary.

Whatever your machine requirements, MOTION-CONNECT offers the solution.

- **Robust, high-performance and easy to use** thanks to pre-assembled cables with a rugged metal connector in degree of protection IP67 and reliable SPEED-CONNECT quick-release lock
- **Outstanding and proven quality** achieved by consistent quality management and system-tested cables

Cables are available in two different qualities – MOTION-CONNECT 500 and MOTION-CONNECT 800PLUS.

MOTION-CONNECT 500	MOTION-CONNECT 800PLUS
<ul style="list-style-type: none"> • Cost-effective solution for predominantly fixed installation • Tested for travel distances up to 5 m (16.4 ft) 	<ul style="list-style-type: none"> • Meets requirements for use in cable carriers • Oil-resistant • Tested for travel distances of up to 50 m (164 ft)

More information

- Internet:
 - <http://www.siemens.com/motion-connect>
 - <http://www.siemens.com/industrymall>

Appendix



17/2	SITRAIN – Digital Industry Academy
17/4 17/4	Additional documentation SIMATIC Manual Collection
17/5 17/5 17/6	Standards and approbations CE marking Certificates
17/6	Quality management
17/7 17/7	Siemens Automation Cooperates with Education (SCE) Teaching made easy - Comprehensive support on the way to Industry 4.0
17/10 17/10 17/11	Partners Siemens Partner Program Partners at Siemens
17/12 17/14	Industry Services Online Support
17/15	Software licenses
17/17	Conditions of sale and delivery

Appendix

SITRAIN – Digital Industry Academy

Introduction



SITRAIN – DIGITAL INDUSTRY ACADEMY

The Future of Learning starts now

The Future of Learning starts now

Globalization, digitalization, new work, Internet of Things, new business models – our way of working, living and learning is changing rapidly. With SITRAIN, the future of learning begins today: SITRAIN stands for a modern learning culture that focuses on the needs of learners and the demands of innovative companies.

With SITRAIN – Digital Industry Academy, the future of learning is yours.

Face-to-face training or digital training, location-independent, 24/7, on-demand or learning at fixed dates and course times? With a personal learning consultant, in a team, or on your own responsibility? Everything is possible. SITRAIN offers a wide range of different learning options with the "Learning Journey", "Learning Membership" and "Learning Event".

The three learning formats of SITRAIN – Digital Industry Academy



Learning Journey

The combination for sustainable learning success

- The optimal mix of self-study units and guided live modules
- Includes a Learning Membership to work through the self-study modules and access on-demand content
- The SITRAIN learning consultant is available for questions and one-on-one consultations
- Ideal integration into the daily work routine and adaptation to one's own learning pace.



Learning Membership

Securing knowledge through continuous learning on your own responsibility

- With access to the comprehensive and constantly growing range of self-study units on SITRAIN access, the digital learning platform
- Search and find specific learning content or simply have a look around – anytime and anywhere
- A modern learning culture through continuous learning on your own responsibility and transparency about your learning success in the team or company.



Learning Event

Acquire theoretical and practical knowledge in a compact and guided format

- You achieve a defined learning goal in the shortest possible time
- The learning consultant guides you through the practical exercises and is also exclusively available to you during the theoretical sessions for the entire duration
- Focused learning, outside of the daily work routine, in a protected learning environment – virtually, in the training center, or at your company.

Introduction

Expand your knowledge, apply what you have learned, develop future skills

The SITRAIN Digital Industry Academy combines didactically effective methods and modular options.



Effective



Flexible



Relevant



Continuous

Education and training directly from the manufacturer

For individual knowledge building, the following topics concerning the industrial product and solution portfolio of Siemens are available. Experience the new learning culture with SITRAIN.

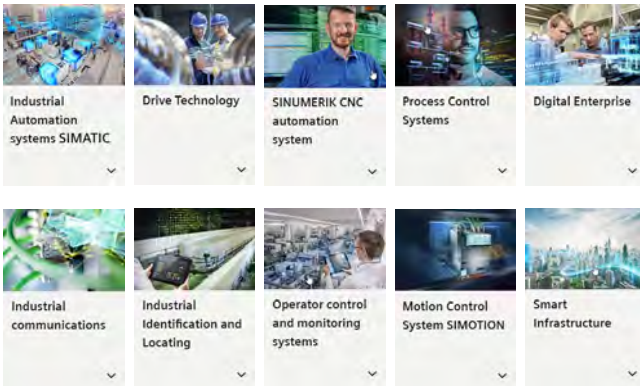

The four building blocks of SITRAIN – Digital Industry Academy

Different methods for maximum learning success:

- Live
- On your own responsibility
- On demand
- Individual

Learn the way you want to learn. For learning success that takes you further.



Training cases catalog

www.siemens.com/sitrain-catalog-training-cases

Find
your local
offer here



SITRAIN – Digital Industry Academy worldwide

You will find the regional knowledge offer in the country selection. One click will take you to the corresponding website.

SITRAIN – Digital Industry Academy

www.siemens.com/sitrain

- SITRAIN Learning Journey:
www.siemens.com/sitrain-learning-journey
- SITRAIN Learning Membership:
www.siemens.com/sitrain-learning-membership
- SITRAIN Learning Event:
www.siemens.com/sitrain-learning-event

Appendix

Additional documentation

SIMATIC Manual Collection

Overview

The SIMATIC manual collection brings together the manuals of Totally Integrated Automation in the smallest possible package. It is eminently suitable for startup and service, replaces the space-consuming paper version in the office and provides fast access to the information.

The manual collection contains manuals in 5 languages for

- LOGO!
- SIMADYN
- SIMATIC bus components
- SIMATIC C7
- SIMATIC Distributed I/O
- SIMATIC HMI
- SIMATIC Sensors
- SIMATIC NET
- SIMATIC PC-based Automation
- SIMATIC PCS 7
- SIMATIC PG/PC
- SIMATIC S7
- SIMATIC Software
- SIMATIC TDC

Manuals that are not yet available in all 5 languages will at least be included in English and German.

There is an update contract for the SIMATIC Manual Collection that encompasses supply of the up-to-date collection and three subsequent updates which is valid for one year. If the update contract is not cancelled, it is automatically extended and the list price will be charged to the customer.

Ordering data

SIMATIC Manual Collection

Electronic manuals on DVD, multilingual:
LOGO!, SIMADYN, SIMATIC bus components, SIMATIC C7, SIMATIC Distributed I/O, SIMATIC HMI, SIMATIC Sensors, SIMATIC NET, SIMATIC PC-based Automation, SIMATIC PCS 7, SIMATIC PG/PC, SIMATIC S7, SIMATIC Software, SIMATIC TDC

SIMATIC Manual Collection update service for 1 year

Current "Manual Collection" DVD and the three subsequent updates

Article No.

6ES7998-8XC01-8YE0

6ES7998-8XC01-8YE2

Overview

The electronic products described in this catalog comply with the requirements and protection objectives of the following EU directives insofar as they relate to the product concerned. They also comply with the corresponding harmonized European standards (EN) published for these products in the Official Journals of the European Community.

- 2014/35/EU "Electrical equipment designed for use within certain voltage limits" (Low Voltage Directive)
- 2014/30/EU "Electromagnetic Compatibility" (EMC Directive)
- 2014/34/EU "Equipment and protective systems intended for use in potentially explosive atmospheres" (Explosion Protection Directive)
- 2011/65/EU "Restriction of the use of certain hazardous substances in electrical and electronic equipment" (RoHS Directive)
- For F-modules, the following also applies: 2006/42/EC "Machinery Directive"

The originals of the declarations of conformity are kept available by us for the responsible supervisory authorities.

They are also available for download on the Siemens Industry Online Support website (<https://support.industry.siemens.com/cs/ww/en/>), keyword "Declaration of Conformity".

Note on the EMC Directive:

In terms of their interference emissions, SIMATIC products are designed for industrial applications.

If individual products deviate from this specification, it is noted in the catalog with the products.

The installation instructions in the manuals must be adhered to when installing and operating the products described in this catalog. These contain, for example, important information on installation in cabinets and on the use of shielded cables.

Notes for machine manufacturers

The SIMATIC automation system is not a machine within the context of the EU machine guidelines. Therefore a declaration of conformity with regard to the EU machine directive 89/392/EEC or 2006/42/EU (new edition, applicable from end of 2009) may not be provided for SIMATIC.

The EU machine directive regulates the requirements placed on a machine or a part thereof. A machine is understood for the purposes of this guideline to be a combination of interconnected parts or mechanisms (see also EN 292-1, Paragraph 3.1).

SIMATIC is part of the electrical equipment of a machine, and must therefore be integrated into the evaluation of the complete machine by the machine manufacturer.

As electrical equipment, SIMATIC is subject to the low-voltage directive which, as a "total safety directive", covers all dangers just like the machine directive.

The EN 60204-1 standard (safety of machines, general requirements for the electrical equipment of machines) is applicable to the electrical equipment of machines.

The following table will help you in the provision of your declaration of conformity, and shows which criteria according to EN 60204-1 (2006-06) apply to SIMATIC. You can obtain further information from the enclosed declaration of conformity according to the low-voltage and EMC directives (with list of included standards).

EN 60204-1	Topic/criterion	Notes
Paragraph 4	General requirements	The requirements are met when the equipment is assembled/ installed in accordance with the installation guidelines. Please note the relevant information in the manuals.
Paragraph 11.2	Digital input/ output interfaces	The requirements are met
Paragraph 12.3	Programmable equipment	The requirements are met when the equipment is installed in lockable cabinets to protect against alteration of the memory contents by unauthorized persons
Paragraph 20.4	Voltage tests	The requirements are met

Appendix

Standards and approbations, quality management

Certificates, authorizations, approbations, declarations of conformity

An overview of the certificates available for SIMATIC products (CE, UL, CSA, FM, shipping authorizations) can be found in the internet at

<http://www.siemens.com/simatic/certificates>

The lists are continuously updated. The data for products which have not yet been included in the overview is continuously collected and prepared for the subsequent edition.

You can also find certificates, approbations, verification certificates or characteristic curves under Product support "Entry list"

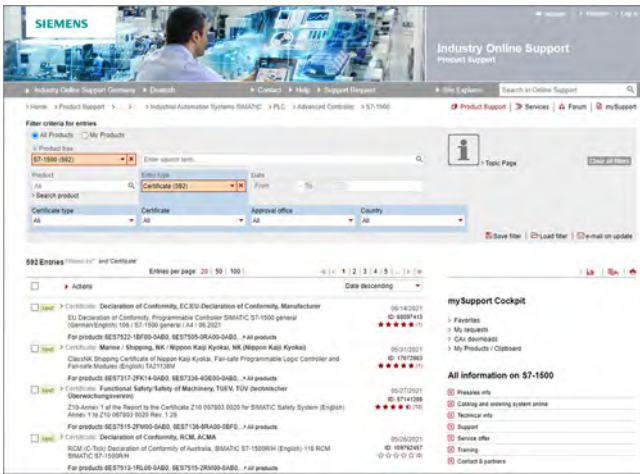

or by going directly to the Link Box:

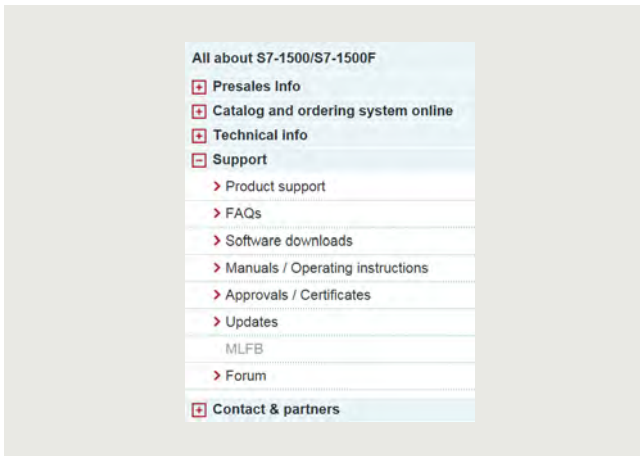

Quality management

The quality management system of the Siemens Operating Company Digital Industries, Business Unit Factory Automation, complies with the international standard ISO 9001.

The products and systems described in this catalog are sold under application of a quality management system certified by DQS in accordance with DIN EN ISO 9001.

The DQS certificate is recognized in all IQ Net countries.

DQS Registered Certificate No.:

Siemens AG

- DI FA
Reg.-Nr.: 001323 QM15

Knowledge & technology – the keystones to success in digitalization



Digitalization is quickly and radically changing our world. What does this mean for education?

In the world of Industry 4.0, companies can expect a host of new opportunities and challenges. New systems are verified on the spot through simulations. Automated mass production processes can make every product on the conveyor belt a unique product.

New products are now market-ready much faster. Siemens is shaping this transformation as a technology leader in the field of automation and process lifecycle management (PLM).

These new digitalization processes are changing the know-how requirements for employees. Many educational institutions are facing the challenge of conveying Industry 4.0 know-how as part of their teaching and training. The Siemens Automation Cooperates with Education (SCE) program is supporting educators on the way to Industry 4.0.

The SCE digitalization concept for educators

The SCE digitalization concept presented here shows how digitalization can be implemented in educational institutions – from vocational schools to universities.

Digitalization (or Industry 4.0) know-how is now introduced through computer aided technology, Industrial Edge and IIoT as well as Cloud technologies. It is founded on the basics of automation, such as digital technologies, PLC and information technologies, and on advanced automation and industrial communication technologies.

The level of digitalization knowledge can be weighted, depending on the vocational field or branch of study – e.g. mechanical engineering, automation engineering or computer science.

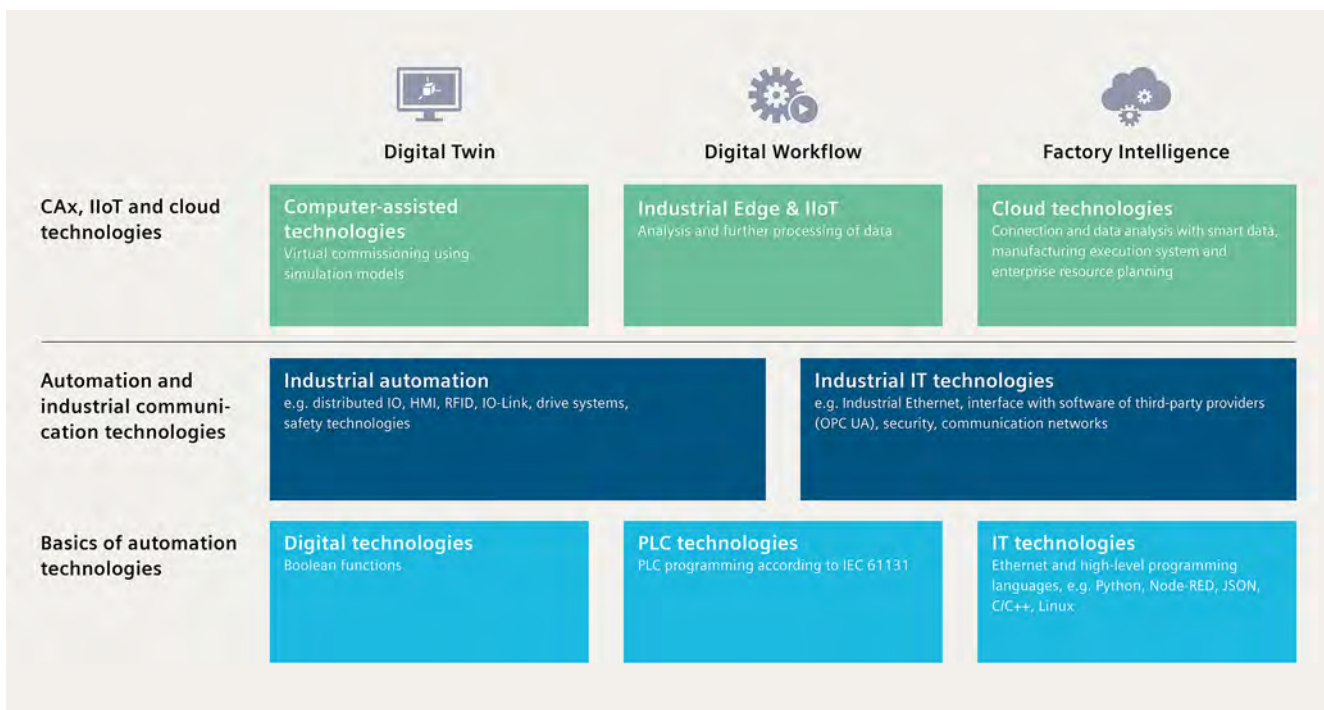

Appendix

Siemens Automation Cooperates with Education (SCE)

Teaching made easy - Comprehensive support on the way to Industry 4.0

The SCE digitalization concept for educators (continued)

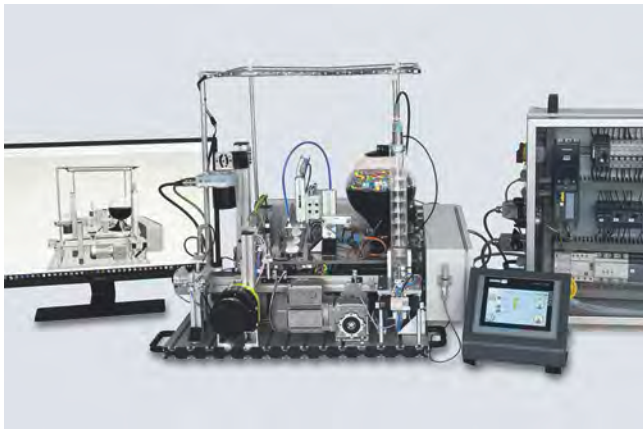

As part of their project work, students at Vocational School 2 in Wolfsburg, Germany, have implemented the three levels of the SCE Industry 4.0 concept. A virtual twin created with the Siemens NX Mechatronics Designer (MCD) CAD software was used for the design and virtual commissioning. This enables fast and efficient assembly of the real automation system, e.g. with SIMATIC S7-1500/ET 200SP/RFID, for use in classes. Production data, such as the number of bottles filled, production date and system parameters, are uploaded to a cloud using SIMATIC IOT2000.

siemens.com/sce/iot2000

siemens.com/nx

The SCE offers



Learning and training documents

More than 100 didactically prepared learning and training documents are available through SCE and incorporate the digitalization concept. They are designed for use in classes, but can also be customized or used for individual study. These documents are available for free download, most of them in 7 languages.

siemens.com/sce/documents

Educator courses

Excellent teaching content is needed to introduce students to digitalization. For this purpose, SCE holds educator courses in certain regions. Based on our learning and training documents and through practical exercises, educators acquire the latest Industry 4.0 know-how.

siemens.com/sce/courses



Trainer packages

The 90 SCE trainer packages help educators teaching and implementing the SCE digitalization concept. Trainer packages comprise specially compiled, genuine Siemens hardware and software products. The trainer packages are based on the learning and training documents and are offered to schools, colleges and universities at special terms.

siemens.com/sce/tp

Support for your projects / textbooks

We support you on selected projects with advice and assistance from SCE contact partners.

As a special service, we support textbook authors. We maintain a list of textbooks on the SCE website.

siemens.com/sce/contact

siemens.com/sce/books

Partnerships for proliferation of Industry 4.0 in education

**Partnership with WorldSkills**

As a technology powerhouse, we support vocational training of students around the world. Since 2010, we have partnered with WorldSkills as a Global Industry Partner in order to amplify this cause.

WorldSkills is an international organization whose mission is to raise the profile and recognition of skilled people, and show how important vocational skills are in achieving economic growth and personal success. Every two years, WorldSkills hosts the world championships of skills.

Siemens provides the competitors with automation products, such as SIMATIC S7-1500 and LOGO!, for the disciplines: industrial control, electrical installations, Polymechanics/Automation and manufacturing technology.

Additionally, we support selected continental and regional competitions.

[siemens.com/worldskills](https://www.siemens.com/worldskills)

Partnerships with educators

We provide support to educators and educational organizations in the form of one-on-one advice through SCE contact partners and Siemens experts as well as long-term cooperation.

[siemens.com/sce/contact](https://www.siemens.com/sce/contact)

Partnerships with producers of learning systems

For practical training in classrooms and labs, numerous producers of learning systems offer a wide range of complete didactic solutions based on SCE trainer packages.

[siemens.com/sce/learningsystems](https://www.siemens.com/sce/learningsystems)

Information portal



To facilitate your teaching assignment and/or for selfstudy, we offer educators and students a comprehensive SCE information portal. At this portal you have quick access to all SCE offers, e.g. learning and training documents including projects, Getting Started information, videos, manuals, trial software and newsletters.

[siemens.com/sce](https://www.siemens.com/sce)



Appendix

Partners

Siemens Partner Program

Overview

Siemens Solution and Approved Partner – Partners for your success



Highest competence in automation and drive technology

Siemens works closely together with selected partner companies around the world in order to ensure that customer requirements for all aspects of automation and drives are fulfilled as best as possible – wherever you are, and whatever the time.

We place great value on our customers acting in accordance with the same ideals which characterize Siemens as a whole: Competence, professionalism and quality. That is why continuous development through qualification and certification measures in line with global standards is a central aspect of our Partner Program. This means that with our partners, you benefit from the same high quality standards all over the world. The partner emblem is the symbol for tried and tested quality.

The partner network for industry

The Siemens Partner Program offers you expertise and experience close at hand.

Within our global network, we distinguish between Solution Partners and Approved Partners. We currently work with more than 1,500 Solution Partners around the world. Our network of over 150 Approved Partners continues to grow. In more than 80 countries worldwide.

Siemens Solution Partner – Automation Drives



At present we are working with more than 1,500 Solution Partners worldwide. They are characterized by extensive application, system and sector knowledge, as well as proven project experience, and are able to implement future-proof tailored solutions of the highest quality, based on our product and system portfolio.

Siemens Approved Partner – Value Added Reseller



With their detailed technical knowledge, Siemens Approved Partners – Value Added Resellers offer a combination of products and services that range from specialist technologies and customized modifications to the provision of high-quality system and product packages. They also provide qualified technical support and assistance.

Siemens Approved Partner – Industry Services



Siemens Approved Partner – Industry Services put their unique expertise entirely at the service of enhancing your productivity and can be instrumental in ensuring the availability of your plants.

Partner Finder

The ideal partner for your task is just a mouse click away!

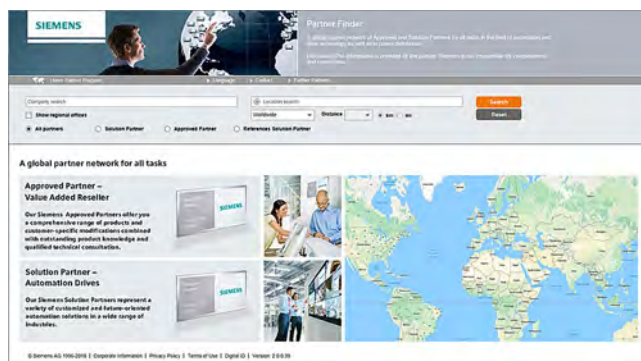

In the Siemens global Solution Partner Program, customers are certain to find the optimum partner for their specific requirements – with no great effort. The Partner Finder is basically a comprehensive database that showcases the profiles of all our partners.

Easy selection:

Set filters in the search screen form according to the criteria that are relevant to you. You can also directly enter the name of an existing partner.

Skills at a glance:

Gain a quick insight into the specific competencies of any particular partner with the reference reports.

Direct contact option:

Use our electronic query form:

www.siemens.com/partnerfinder

Additional information of the Siemens Partners for industry is available online at:

www.siemens.com/partnerprogram

Overview

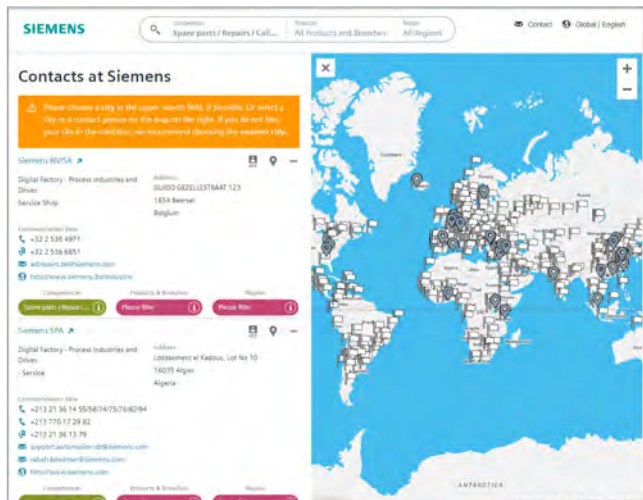

At your service locally, around the globe for consulting, sales, training, service, support, spare parts on the entire portfolio of Siemens.

Your partner can be found in our Personal Contacts Database at: www.siemens.com/automation-contact

You start by selecting

- the required competence,
- products and branches,
- a country and a city

or by a

- location search or free text search.

Appendix

Industry Services

Overview

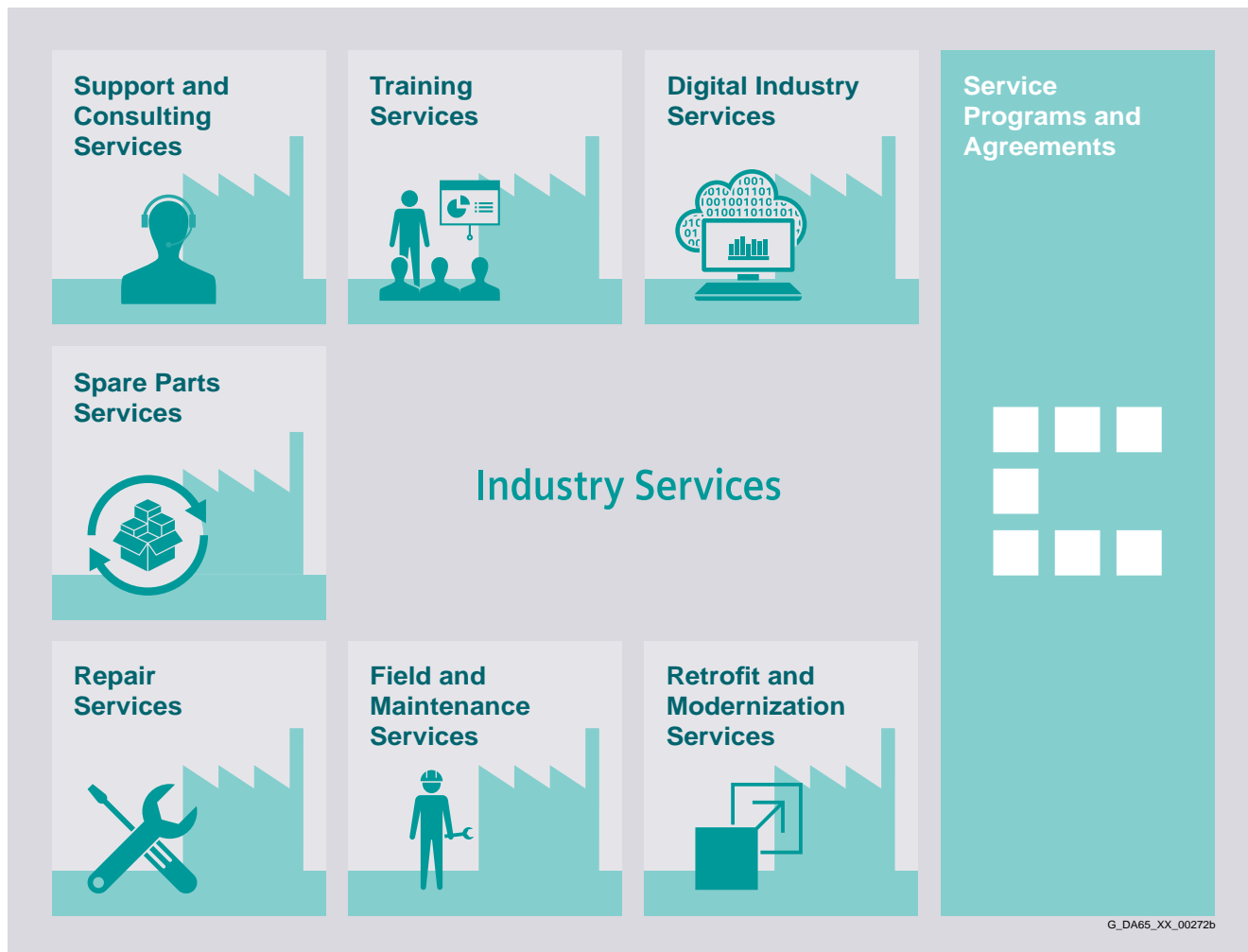

Keep your business running and shaping your digital future – with Industry Services

Optimizing the productivity of your equipment and operations can be a challenge, especially with constantly changing market conditions. Working with our service experts makes it easier. We understand your industry's unique processes and provide the services needed so that you can better achieve your business goals.

You can count on us to maximize your uptime and minimize your downtime, increasing your operations' productivity and reliability. When your operations have to be changed quickly to meet a new demand or business opportunity, our services give you the flexibility to adapt. Of course, we take care that your production is protected against cyber threats. We assist in keeping your operations as energy and resource efficient as possible and reducing your total cost of ownership. As a trendsetter, we ensure that you can capitalize on the opportunities of digitalization and by applying data analytics to enhance decision making: You can be sure that your plant reaches its full potential and retains this over the longer lifespan.

You can rely on our highly dedicated team of engineers, technicians and specialists to deliver the services you need – safely, professionally and in compliance with all regulations. We are there for you, where you need us, when you need us.

www.siemens.com/industryservices

Overview



Digital Industry Services

Digital Industry Services make your industrial processes transparent to gain improvements in productivity, asset availability, and energy efficiency.

Production data is generated, filtered and translated with intelligent analytics to enhance decision-making.

This is done whilst taking data security into consideration and with continuous protection against cyber-attack threats.

www.siemens.com/global/en/products/services/industry/digital-industry-services.html

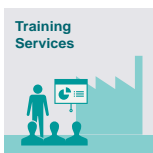

Training Services

From the basics and advanced to specialist skills, SITRAIN courses provide expertise right from the manufacturer – and encompass the entire spectrum of Siemens products and systems for the industry.

Worldwide, SITRAIN courses are available wherever you need a training course in more than 170 locations in over 60 countries. <https://support.industry.siemens.com/cs/ww/en/sc/2226>

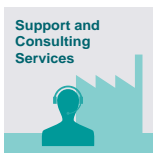

Support and Consulting Services

Industry Online Support site for comprehensive information, application examples, FAQs and support requests.

Technical and Engineering Support for advice and answers for all inquiries about functionality, handling, and fault clearance. The Service Card as prepaid support for value added services such as Priority Call Back or Extended Support offers the clear advantage of quick and easy purchasing.

Information & Consulting Services, e.g. SIMATIC System Audit; clarity about the state and service capability of your automation system or Lifecycle Information Services; transparency on the lifecycle of the products in your plants.

<https://support.industry.siemens.com/cs/ww/en/sc/2235>



Spare Parts

Spare Parts Services are available worldwide for smooth and fast supply of spare parts – and thus optimal plant availability. Genuine spare parts are available for up to ten years. Logistic experts take care of procurement, transport, custom clearance, storage and order management.

Reliable logistics processes ensure that components reach their destination as needed.

Since not all spare parts can be kept in stock at all times, Siemens offers a preventive measure for spare parts provisioning on the customer's premises with optimized **Spare Parts Packages** for individual products, custom-assembled drive components and entire integrated drive trains – including risk consulting.

Asset Optimization Services help you design a strategy for parts supply where your investment and carrying costs are reduced and the risk of obsolescence is avoided.

<https://support.industry.siemens.com/cs/ww/en/sc/2110>



Repair Services

Repair Services are offered on-site and in regional repair centers for fast restoration of faulty devices' functionality.

Also available are extended repair services, which include additional diagnostic and repair measures, as well as emergency services.

<https://support.industry.siemens.com/cs/ww/en/sc/2154>



Field and Maintenance Services

Siemens specialists are available globally to provide expert field and maintenance services, including commissioning, functional testing, preventive maintenance and fault clearance.

All services can be included in customized service agreements with defined reaction times or fixed maintenance intervals.

<https://support.industry.siemens.com/cs/ww/en/sc/2265>



Retrofit and Modernization Services

Provide a cost-effective solution for the expansion of entire plants, optimization of systems or upgrading existing products to the latest technology and software, e.g. migration services for automation systems.

Service experts support projects from planning through commissioning and, if desired over the entire extended lifespan, e.g. Retrofit for Integrated Drive Systems for an extended lifetime of your machines and plants.

<https://support.industry.siemens.com/cs/ww/en/sc/2286>



Service Programs and Agreements

A technical Service Program or Agreement enables you to easily bundle a wide range of services into a single annual or multi-year agreement.

You pick the services you need to match your unique requirements or fill gaps in your organization's maintenance capabilities.

Programs and agreements can be customized as KPI-based and/or performance-based contracts.

<https://support.industry.siemens.com/cs/ww/en/sc/2275>

Appendix
Industry Services

Online Support

Overview

Online Support – fast, intuitive, whenever you want, wherever you need

Web

www.siemens.com/online-support

App

Scan the QR code for information on our Online Support app.

FAQ / Application examples

Information about industrial products, programming and configuration as well as application examples

Technical information

Videos, documentation, manuals, updates, product notes, compatibility tool, certificates, planning data such as dimensional drawings, product data, 3D models

Forum

Exchange information and experience with other users and experts

Online Support for Siemens Industry Products

Siemens Industry and Online Support with some 1.7 million visitors per month is one of the most popular web services provided by Siemens. It is the central access point for comprehensive technical know-how about products, systems and services for automation and drives applications as well as for process industries.

In connection with the challenges and opportunities related to digitalization you can look forward to continued support with innovative offerings.

Overview**Software types**

Software requiring a license is categorized into types. The following software types have been defined:

- Engineering software
- Runtime software

Engineering software

This includes all software products for creating (engineering) user software, e.g. for configuring, programming, parameterizing, testing, commissioning or servicing.

Data generated with engineering software and executable programs can be duplicated for your own use or for use by third-parties free-of-charge.

Runtime software

This includes all software products required for plant/machine operation, e.g. operating system, basic system, system expansions, drivers, etc.

The duplication of the runtime software and executable programs created with the runtime software for your own use or for use by third-parties is subject to a charge.

You can find information about license fees according to use in the ordering data (e.g. in the catalog). Examples of categories of use include per CPU, per installation, per channel, per instance, per axis, per control loop, per variable, etc.

Information about extended rights of use for parameterization/configuration tools supplied as integral components of the scope of supply can be found in the readme file supplied with the relevant product(s).

License types

Siemens Industry Automation & Drive Technologies offers various types of software license:

- Floating license
- Single license
- Rental license
- Rental floating license
- Trial license
- Demo license
- Demo floating license

Floating license

The software may be installed for internal use on any number of devices by the licensee. Only the concurrent user is licensed. The concurrent user is the person using the program. Use begins when the software is started.

A license is required for each concurrent user.

Single license

Unlike the floating license, a single license permits only one installation of the software per license.

The type of use licensed is specified in the ordering data and in the Certificate of License (CoL). Types of use include for example per instance, per axis, per channel, etc.

One single license is required for each type of use defined.

Rental license

A rental license supports the "sporadic use" of engineering software. Once the license key has been installed, the software can be used for a specific period of time (the operating hours do not have to be consecutive).

One license is required for each installation of the software.

Rental floating license

The rental floating license corresponds to the rental license, except that a license is not required for each installation of the software. Rather, one license is required per object (for example, user or device).

Trial license

A trial license supports "short-term use" of the software in a non-productive context, e.g. for testing and evaluation purposes. It can be transferred to another license.

Demo license

The demo license support the "sporadic use" of engineering software in a non-productive context, for example, use for testing and evaluation purposes. It can be transferred to another license. After the installation of the license key, the software can be operated for a specific period of time, whereby usage can be interrupted as often as required.

One license is required per installation of the software.

Demo floating license

The demo floating license corresponds to the demo license, except that a license is not required for each installation of the software. Rather, one license is required per object (for example, user or device).

Certificate of License (CoL)

The CoL is the licensee's proof that the use of the software has been licensed by Siemens. A CoL is required for every type of use and must be kept in a safe place.

Downgrading

The licensee is permitted to use the software or an earlier version/release of the software, provided that the licensee owns such a version/release and its use is technically feasible.

Delivery versions

Software is constantly being updated.

The following delivery versions

- PowerPack
- Upgrade

can be used to access updates.

Existing bug fixes are supplied with the ServicePack version.

PowerPack

PowerPacks can be used to upgrade to more powerful software. The licensee receives a new license agreement and CoL (Certificate of License) with the PowerPack. This CoL, together with the CoL for the original product, proves that the new software is licensed.

A separate PowerPack must be purchased for each original license of the software to be replaced.

Upgrade

An upgrade permits the use of a new version of the software on the condition that a license for a previous version of the product is already held.

The licensee receives a new license agreement and CoL with the upgrade. This CoL, together with the CoL for the previous product, proves that the new version is licensed.

A separate upgrade must be purchased for each original license of the software to be upgraded.

Appendix

Software licenses

Overview

ServicePack

ServicePacks are used to debug existing products. ServicePacks may be duplicated for use as prescribed according to the number of existing original licenses.

License key

Siemens Industry Automation & Drive Technologies supplies software products with and without license keys.

The license key serves as an electronic license stamp and is also the "switch" for activating the software (floating license, rental license, etc.).

The complete installation of software products requiring license keys includes the program to be licensed (the software) and the license key (which represents the license).

Software Update Service (SUS)

As part of the SUS contract, all software updates for the respective product are made available to you free of charge for a period of one year from the invoice date. The contract will automatically be extended for one year if it is not canceled three months before it expires.

The possession of the current version of the respective software is a basic condition for entering into an SUS contract.

You can download explanations concerning license conditions from https://mall.industry.siemens.com/legal/ww/en/terms_of_trade_en.pdf

1. General Provisions

By using this catalog you can purchase products (hardware, software and services) described therein from Siemens Aktiengesellschaft subject to the following Terms and Conditions of Sale and Delivery (hereinafter referred to as "T&C"). Please note that the scope, the quality and the conditions for supplies and services, including software products, by any Siemens entity having a registered office outside Germany, shall be subject exclusively to the General Terms and Conditions of the respective Siemens entity. The following T&C apply exclusively for orders placed with Siemens Aktiengesellschaft, Germany.

1.1 For customers with a seat or registered office in European Union

For customers with a seat or registered office in European Union, the following terms and conditions apply subordinate to T&C:

- for products, which include specific terms and conditions in the description text, these specific terms and conditions shall apply and subordinate thereto,
- for stand-alone software products and software products forming a part of a product or project, the "General License Conditions for Software Products for Automation and Drives for Customers with a Seat or registered Office in Germany"¹⁾ and/or
- for consulting services the "Allgemeine Geschäftsbedingungen für Beratungsleistungen der Division DF – Deutschland" (available only in German) and/or
- for other services, the „Supplementary Terms and Conditions for Services ("BL")"¹⁾ and/or
- for other supplies the "General Conditions for the Supply of Products and Services of the Electrical and Electronics Industry"¹⁾.
In case such supplies should contain Open Source Software, the conditions of which shall prevail over the "General Conditions for the Supply of Products and Services of the Electrical and Electronics Industry"¹⁾, a notice will be contained in the scope of delivery in which the applicable conditions for Open Source Software are specified. This shall apply mutatis mutandis for notices referring to other third party software components.

1.2 For customers with a seat or registered office outside European Union

For customers with a seat or registered office outside European Union, the following terms and conditions apply subordinate to T&C:

- for products, which include specific terms and conditions in the description text, these specific terms and conditions shall apply and subordinate thereto,
- for consulting services the "Standard Terms and Conditions for Consulting Services of the Division DF for Customers with a Seat or Registered Office Outside of Germany"¹⁾ and/or
- for other services the "International Terms & Conditions for Services"¹⁾ supplemented by "Software Licensing Conditions"¹⁾ and/or
- for other supplies of hard- and software the "International Terms & Conditions for Products"¹⁾ supplemented by "Software Licensing Conditions"¹⁾

1.3 For customers with master or framework agreement

To the extent our supplies and/or services offered are covered by an existing master or framework agreement, the terms and conditions of that agreement shall apply instead of T&C.

2. Prices

The prices are in € (Euro) ex point of delivery, exclusive of packaging.

The sales tax (value added tax) is not included in the prices. It shall be charged separately at the respective rate according to the applicable statutory legal regulations.

Prices are subject to change without prior notice. We will charge the prices valid at the time of delivery.

To compensate for variations in the price of raw materials (e.g. silver, copper, aluminum, lead, gold, dysprosium and neodym), surcharges are calculated on a daily basis using the so-called metal factor for products containing these raw materials.

A surcharge for the respective raw material is calculated as a supplement to the price of a product if the basic official price of the raw material in question is exceeded.

The metal factor of a product indicates the basic official price (for those raw materials concerned) as of which the surcharges on the price of the product are applied, and with what method of calculation.

An exact explanation of the metal factor can be downloaded at: https://mall.industry.siemens.com/legal/ww/en/terms_of_trade_en.pdf

To calculate the surcharge (except in the cases of dysprosium and neodym), the official price from the day prior to that on which the order was received or the release order was effected is used.

To calculate the surcharge applicable to dysprosium and neodym ("rare earths"), the corresponding three-month basic average price in the quarter prior to that in which the order was received or the release order was effected is used with a one-month buffer (details on the calculation can be found in the explanation of the metal factor).

3. Additional Terms and Conditions

The dimensions are in mm. In Germany, according to the German law on units in measuring technology, data in inches apply only to devices for export.

Illustrations are not binding.

Insofar as there are no remarks on the individual pages of this catalog – especially with regard to data, dimensions and weights given – these are subject to change without prior notice.

¹⁾ The text of the Terms and Conditions of Siemens AG can be downloaded at https://mall.industry.siemens.com/legal/ww/en/terms_of_trade_en.pdf

Appendix

Conditions of sale and delivery

4. Export Regulations

We shall not be obligated to fulfill any agreement if such fulfillment is prevented by any impediments arising out of national or international foreign trade or customs requirements or any embargoes and/or other sanctions.

Export may be subject to license. We shall indicate in the delivery details whether licenses are required under German, European and US export lists.

Our products are controlled by the U.S. Government (when labeled with "ECCN" unequal "N") and authorized for export only to the country of ultimate destination for use by the ultimate consignee or end-user(s) herein identified. They may not be resold, transferred, or otherwise disposed of, to any other country or to any person other than the authorized ultimate consignee or end-user(s), either in their original form or after being incorporated into other items, without first obtaining approval from the U.S. Government or as otherwise authorized by U.S. law and regulations. Products labeled with "AL" unequal "N" are subject to European / national export authorization.

The export indications can be viewed in advance in the description of the respective goods on the Industry Mall, our online catalog system. Only the export labels "AL" and "ECCN" indicated on order confirmations, delivery notes and invoices are authoritative.

Products without label, with label "AL:N" / "ECCN:N", or label "AL:9X9999" / "ECCN: 9X9999" may require authorization from responsible authorities depending on the final end-use, or the destination.

If you transfer goods (hardware and/or software and/or technology as well as corresponding documentation, regardless of the mode of provision) delivered by us or works and services (including all kinds of technical support) performed by us to a third party worldwide, you shall comply with all applicable national and international (re-)export control regulations. In any event of such transfer of goods, works and services you shall comply with the (re-) export control regulations of the Federal Republic of Germany, of the European Union and of the United States of America.

Prior to any transfer of goods, works and services provided by us to a third party you shall in particular check and guarantee by appropriate measures that

- there will be no infringement of an embargo imposed by the European Union, by the United States of America and/ or by the United Nations by such transfer, by brokering of contracts concerning those goods, works and services or by provision of other economic resources in connection with those goods, works and services, also considering the limitations of domestic business and prohibitions of by-passing those embargoes;
- such goods, works and services are not intended for use in connection with armaments, nuclear technology or weapons, if and to the extent such use is subject to prohibition or authorization, unless required authorization is provided;
- the regulations of all applicable Sanctioned Party Lists of the European Union and the United States of America concerning the trading with entities, persons and organizations listed therein are considered.

If required to enable authorities or us to conduct export control checks, you, upon request by us, shall promptly provide us with all information pertaining to the particular end customer, the particular destination and the particular intended use of goods, works and services provided by us, as well as any export control restrictions existing.

You acknowledge that under the EU embargo regulations against Iran, Syria and Russia respectively the sale of certain listed goods and related services is subject to authorization by the competent export control authorities of the European Union. If (i) the goods or services ordered by you are destined for Iran, Syria or Russia, and (ii) the contract for our supplies and/or services is subject to prior authorization of the competent export control authorities of the European Union, the contract between you and us shall come into force in this respect only upon granting of such authorization.

The products listed in this catalog may be subject to European/German and/or US export regulations. Any export requiring approval is therefore subject to authorization by the relevant authorities.

Errors excepted and subject to change without prior notice.

Selection and ordering at Siemens Industry Mall, downloading and ordering catalogs

Easy product selection and ordering: Industry Mall

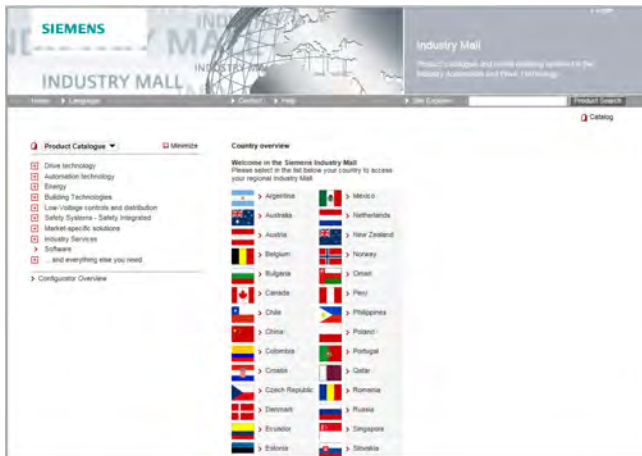

Industry Mall

The Industry Mall is a Siemens AG Internet ordering platform. It provides you with online access to a comprehensive product spectrum that is presented in an informative, well-organized way.

Powerful search functions help you select the required products, while configurators enable you to configure complex product and system components quickly and easily. CAx data are also available for you to use.

Data transfer allows the entire procedure, from selection through ordering to tracking and tracing, to be carried out online. Availability checks, individual customer discounting, and quotation preparation are also possible.

www.siemens.com/industrymall

Downloading catalogs

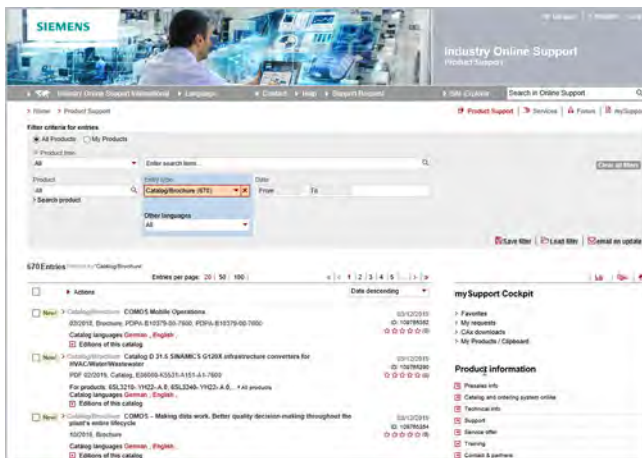

Siemens Industry Online Support

You can download catalogs and brochures in PDF format from Siemens Industry Online Support without having to register.

The filter box makes it possible to perform targeted searches.

www.siemens.com/industry-catalogs

Ordering printed catalogs



Please contact your local Siemens branch if you are interested in ordering printed catalogs.

Addresses can be found at www.siemens.com/automation-contact

Published by
Siemens AG

Digital Industries
Digital Factory
P.O. Box 48 48
90026 Nuremberg
Germany

For the U.S. published by
Siemens Industry Inc.

100 Technology Drive
Alpharetta, GA 30005
United States

PDF (E86060-K4670-A101-B9-7600)
KG 0522 PDF 1660 En
Produced in Germany
© Siemens 2022

Security information

Siemens provides products and solutions with industrial security functions that support the secure operation of plants, systems, machines and networks.

In order to protect plants, systems, machines and networks against cyber threats, it is necessary to implement – and continuously maintain – a holistic, state-of-the-art industrial security concept.

Siemens' products and solutions constitute one element of such a concept.

Customers are responsible for preventing unauthorized access to their plants, systems, machines and networks. Such systems, machines and components should only be connected to an enterprise network or the internet if and to the extent such a connection is necessary and only when appropriate security measures (e.g. firewalls and/or network segmentation) are in place.

For additional information on industrial security measures that may be implemented, please visit <https://www.siemens.com/industrialsecurity>

Siemens' products and solutions undergo continuous development to make them more secure. Siemens strongly recommends that product updates are applied as soon as they are available and that the latest product versions are used. Use of product versions that are no longer supported, and failure to apply the latest updates may increase customer's exposure to cyber threats.

To stay informed about product updates, subscribe to the Siemens Industrial Security RSS Feed under <https://www.siemens.com/industrialsecurity>

Subject to changes and errors. The information given in this document only contains general descriptions and/or performance features which may not always specifically reflect those described, or which may undergo modification in the course of further development of the products.

The requested performance features are binding only when they are expressly agreed upon in the concluded contract.

All product designations may be trademarks or product names of Siemens AG or other companies whose use by third parties for their own purposes could violate the rights of the owners.

