

STANLEY

MASTER CATALOG 2014

# STANLEY®

## MASTER CATALOG 2014

# STANLEY®

All rights reserved. Neither this catalog nor its text, illustrations, drawings or any part thereof, may be reproduced, stored in a retrieval system, photocopied, recorded or transmitted in any form, whether electronic or otherwise, without our consent. To the best of our knowledge, all descriptions and illustrations contained in this catalog are correct at the time of print. We cannot, however, be held liable for any inaccuracies of description or illustration and reserve the right to change specifications without notification.  
© Stanley Works 2014.



001-001-2014



[www.stanleytools.com](http://www.stanleytools.com)

# STANLEY®

## HISTORY TIMELINE



**1843**

Frederick T. Stanley founded The Stanley Works, originally a bolt and door hardware manufacturing company located in New Britain, Connecticut.

**1857**

Frederick's cousin, Henry Stanley, founded The Stanley Rule and Level Company.

**1899**

Stanley Works first patents a ball bearing hinge



**1920**

The Stanley Works Rule and Level Company merged with The Stanley Works and would go on to become its famous Hand Tools Division.

**1930**

STANLEY® Access Technologies introduces the first Automatic Door. The Stanley Magic Door was first installed in Pennsylvania Station in New York City.



**1940s**

STANLEY®'s fleet of Rollorama coaches carried more than 1,300 sample items to retailers.

**1963**

STANLEY® Supply & Services started out as Contact East – a small, independent organization representing various manufacturers of capital equipment and services. As electronic packaging miniaturization accelerated, so did the need for specialized tools, supplies and bench top equipment used in the electronics workplace. Finding all these products from one source, however, was a challenge. Recognizing the need for a distributor of these products, the company launched its first catalogue founding Stanley Assembly Technologies, an operating group of The Stanley Works, in the process.

# STANLEY®

## Hydraulics Tools

**1984**

In 1984, The Stanley Works purchased HED, Inc., the largest U.S. manufacturer of mounted hydraulic breakers and compactors, and integrated HED's product line, design and manufacturing expertise with the Hydraulic Tools Product Group. Today, STANLEY® Hydraulic Tools is the world's largest handheld hydraulic tool manufacturer and world-wide market leader offering over 150 handheld hydraulic tools and over 30 mounted impact tools.

LaBounty

JENSEN®

**1992**

Jensen Tools is integrated into Contact East to add more than 50 years' experience of being the foremost supplier of tools and tool kits for installation, maintenance service and repair professionals. The Stanley Works also purchased LaBounty Manufacturing, Inc., the global market leader for mounted, nonimpact attachments serving general contractors, scrap metal recyclers, demolition experts, and heavy construction.



In the world where dependability is more important than ever, Stanley Black & Decker delivers the tools and solutions that industrial companies, professionals, and consumers count on to be successful when it really matters.

*Our passion for excellence is seen around the world in our disciplined operations, purposeful business growth, and loyal customer relationships.*

## SOUTHEAST ASIA OFFICES

### SINGAPORE

Stanley Works Asia Pacific Pte Ltd / Black & Decker Asia Pacific Pte Ltd  
No.25, Senoko South Road  
Woodlands East Industrial Estate  
Singapore 758081  
Tel: (65) 6752 2001, Fax: (65) 6752 2697  
Email: SG.Sales@sbdinc.com / SG.Service@sbdinc.com

### MALAYSIA

Black & Decker Asia Pacific (M) Sdn Bhd  
No. 15-1 & 15-2, Jalan SS23/15,  
Taman SEA, 47400 Petaling Jaya,  
Selangor Darul Ehsan, Malaysia  
Tel: (603) 7880 1913  
Fax: (603) 7880 5191 / (603) 7880 6191  
Email: MY.Sales@sbdinc.com / MY.Service@sbdinc.com

### INDONESIA

PT. Stanley Black & Decker  
Green Central City  
Unit CB/Lt.1 No. 01-02-09  
Jl. Gajah Mada 188, Jakarta Barat 11120,  
Indonesia  
Tel: (6221) 3616 0092  
Email: ID.Sales@sbdinc.com / ID.Service@sbdinc.com

### THAILAND

Black & Decker (Thailand) Co., Ltd  
11F., Bangkok Business Center  
29 Soi Ekamai, Sukhumvit 63 Road,  
Klongton-Nua, Wattana, Bangkok 10110, Thailand  
Tel: (66) 2714 4482  
Fax: (66) 2714 0538  
Email: TH.Sales@sbdinc.com / TH.Service@sbdinc.com

### PHILIPPINES

Black & Decker Asia Pacific Pte. Ltd. (Philippines)  
G/F VSK Corporate Circle Bldg.  
Shaw Blvd. cor. Acacia Lane  
Mandaluyong City, 1552 Philippines  
Tel: (632) 533-9694/95, Fax: (632) 533-7746  
Email: PH.Sales@sbdinc.com / PH.service@sbdinc.com

### VIETNAM

Stanley Works Asia Pacific Pte Ltd  
3G Office Building  
6th Floor, 374 -374 B Vo Van Tan, Ward 5, District 3,  
Ho Chi Minh City  
Tel: (84) 38329395 / (84) 8 54044159, Fax: (84) 8 54044159  
Email: VN.Sales@sbdinc.com / VN.Service@sbdinc.com

For other enquiries, contact us at enquiries-SEA@sbdinc.com

# STANLEY®

STANLEY®

## FatMax®

1999

The Stanley Works launched the STANLEY® FatMax® Tape Rule. The innovation of STANLEY® FatMax® Tapes revolutionized the measuring market with the worlds' first 1-1/4" wide tape measure delivering 11ft, or 60% longer tape blade standout. The first generation of the STANLEY® FatMax® AntiVibe® hammer is launched, utilizing STANLEY®'s innovative and patented AntiVibe® technology to minimize shock and vibration at impact.

2013

Stanley Black & Decker introduced a new brand identity for its STANLEY® branded products and businesses, modernizing one of the most recognizable brands in the world. The new brand identity exemplifies the STANLEY® 170-year reputation for innovation, quality and performance. The common core of all of our STANLEY® branded products and businesses is excellence in performance.



STANLEY® commemorates its 50 years of innovation with a series of limited edition 50<sup>th</sup> anniversary STANLEY® PowerLock® tape measures. Since it was launched in 1963, it is still one of the most popular tape measures in the US and continues to be manufactured in the original plant in New Britain, Connecticut, USA.

2000

STANLEY® was awarded the Prestigious Golden Hammer Award for New Product Innovation.

2005

STANLEY® launched the STANLEY® FatMax® Xtreme™ product line, spawning new platforms of professional tools and innovation like the FUBAR® Utility Bar.



2011

STANLEY® Power Tools range was launched in S.E.A. to deliver products which are engineered for the trade, offering the ultimate in Power Tools and durability in a range of PowerTools for drilling & grinding on metalworking, woodworking and concrete working applications.

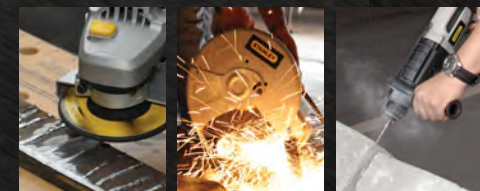

2012

STANLEY® launched its Professional Accessories for Power Tools to offer a complete solution for professionals in metal working and construction markets. Based on extensive end-user research, the accessories range are designed to accomplish the applications users encounter on the toughest job sites or in their homes. STANLEY® designed its tools for longer life, durability and consistent product quality to ensure complete satisfaction.

# STANLEY®

## A NEW STORY BEHIND EVERY TOOL

STANLEY® has been manufacturing high quality tools since 1834, well before Henry Ford's Model T and Orville and Wilbur's fun fly at Kitty Hawk. Ten years later, A. Stanley & Company was founded and began producing folding wooden rules for carpenters and other tradesmen. From those humble beginnings, STANLEY® Tools grew to become today's gold standard by which other hand tools are measured.

In 12 March 2010, STANLEY® completed a merger with the Black & Decker Corporation. Black & Decker is a leading global manufacturer and marketer of power tools and accessories, hardware and home improvement products, and technology-based (engineered) fastening systems. With the merger, Stanley Works changed its name to Stanley Black & Decker, Inc. The combination would bring together two companies whose product lines are complementary. STANLEY®, a diversified industrial company that sells hand tools and construction equipment, while Black & Decker is known for its power tools.

The organization's purpose has then burgeoned, leading to embrace a refined approach in the way the organization handles its everyday operations and interactions. Looking to communicate the breadth of its offering and establish a unified brand, STANLEY® introduced a new logo and identity, modernizing it as one of the most recognizable brands in the world. The new brand identity exemplifies STANLEY®'s 170-year reputation for innovation, quality and performance. This change is the result of a rebranding effort designed to mirror the growth and transformation of the STANLEY® brand throughout the years.

Today, STANLEY® is proud of its reputation for excellence. STANLEY® is dedicated to continually test, design and improve its products to ensure quality and maximum function. The product offerings range from measuring & layout tools, to cutting & fastening tools, and spans across power tools and accessories. So regardless of whether you're a professional contractor, a do-it-yourselfer— you can always trust the quality and accuracy of STANLEY® tools, as people have for nearly 8 generations.



# CONTENTS

Section 1 : Measuring & Layout Tools	02
Section 2 : Laser Measuring System	20
Section 3 : Cutting And Holding Tools	36
Section 4 : Fastening Tools	68
Section 5 : Striking And Stuck Tools	88
Section 6 : Illumination Tools	104
Section 7 : Painting And Finishing Tools	108
Section 8 : Mechanic Tools	126
Section 9 : Tools Storage	174
Section 10 : Power Cleaning Tools	188
Section 11 : Power Tools	196
Section 12 : Power Tool Accessories	212
Product Index	218



# 1 MEASURING AND LAYOUT TOOLS

## ACCURACY, DEPENDABILITY & DURABILITY

STANLEY®'s measuring innovation has established STANLEY® as a leading worldwide Tape Rule manufacturer. Our expanded line builds on this great heritage. For example, our new FatMax® Xtreme™ Tape Rules features 13" of blade standout, the longest in the world. We've also improved on classics by adding BladeArmor™ Coating to FatMax® and FatMax® Xtreme™ Tape Rules to extend the life of the blade. And that's only the beginning. Take a look at our tape line and see why after years of innovation, STANLEY®'s Tape quality and durability are unmatched.

### WHY STANLEY® SHORT TAPES?

- 1 **Blade Stand Out**
    - 1-1/4" Wide Tape Rule Blade - 40% Longer Standout
    - Selective Cross-Curve Blade -10-15% Longer Standout
    - Multi-Catch End-Hook -Top, bottom, side-side catch utility
  - 2 **Product Durability**
    - BladeArmor – 2x Longer Life
    - Multi-Layer Blade Armor – Blade Life
    - Chemically Bonded Tape Case Elastomer grip – Bi-Mat Grips
  - 3 **Compact Case / Longer Blade Length**
    - 1-1/4" Wide Spring & Micro-Hub - 10% Smaller case
- Hi-Vis Mylar – Easy to read in low lighting (patent pending)
  - Bi-Material Wear Plate – 500x Longer Life
  - Hook Bend Protection – Extends End-hook Life
  - Bi-Material Slide Lock – Crush Proof



- 1 **Blade durability: stronger, less/no breakage**
  - New "fiber" co-extrusion process
  - 3/4" Wide Blade
  - 50% more Reinforcing strands (+5x)
  - Low Temp "PVC" (+15 - 10c)
  - BladeArmor End Reinforcement (+2x)
- 2 **Blade Abrasion resistance: print longevity**
  - Extruded over-coat Clear PVC (+500%)
- 3 **Retraction Speed: Fast**
  - Gear Drive 3:1

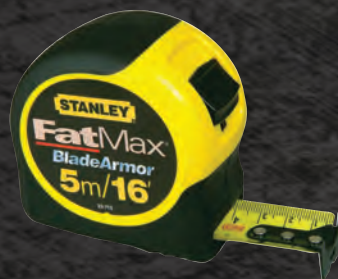



### ACCURACY

- When a level is placed on a perfectly level surface, the bubble within the vial is equivalent between the rings
- The accuracy of a level is the measure of maximum lift, over 1 Meter, to bring the bubble dead centre on a perfectly flat and level surface
- Solid Block vials have an Accuracy of 0.5"/inch
- 360° Vials have Accuracy no better than 1.5"/inch

### BOX

- Magnetic
- Non-Magnetic

### TYPES OF LEVELS

#### I-Beam

- Magnetic
- Non-Magnetic

#### TORPEDO

- Magnetic



For half a decade, STANLEY® has stayed true to the iconic image of the PowerLock® Tape Rule, improving only on its performance and durability. Furthermore, STANLEY® has maintained the heritage of manufacturing tapes in New Britain, CT, USA\*. This tape design is a dedication to the original PowerLock®, brandishing the same design and markings of the first PowerLock® Tapes manufactured in 1963. Since its launch 50 years ago, it remains one of the best selling tapes in the world. Each PowerLock® Tape features a sliding lock, holding the blade in place, a rigid 7 feet standout Mylar® protective blade coating for durability and a Tru-Zero™ end hook for accurate measurements. Get your 50<sup>th</sup> Anniversary PowerLock Tape Limited Edition Today! Whilst stocks lasts.

\*Manufactured with global materials.

# 1 MEASURING & LAYOUT TOOLS

## MEASURING TAPE SELECTION GUIDE

SHORT TAPES	STANDOUT	TAPE WIDTH	CASE MATERIAL	CASE COLOR	LENGTH	
					METRIC	IMPERIAL
RubberGrip Tape Rule		1/2"	ABS/Rubber	Yellow/Black	3m, 3.5m, 5m	-
Global Tape Rule		1/2", 3/4", 1"	ABS	Yellow	3m, 5m, 8m	10', 16', 26'
Tylon Tape Rule		1"	ABS/Rubber	Yellow/Black	5m, 8m	16', 26'
LeverLock Tape Rule		1/2", 3/4", 1"	ABS	Yellow/Black	3m, 5m, 8m	10', 16', 26'
PowerLock Tape Rule	8'	1/2", 3/4", 1"	ABS Chromed	Chrome	3m, 3.5m, 5m, 8m, 10m	10', 12', 16', 26', 33'
FatMax Tape Rule	11'	3/4", 1", 1-1/4"	ABS/Rubber	Yellow/Black	5m, 8m, 10m	16', 26', 33'
FatMax Xtreme Tape Rule	13'	1-1/4"	ABS Chromed	Yellow/Black	5m, 8m, 10m	-

LONG TAPES	TYPE	TAPE WIDTH	CASE MATERIAL	CASE COLOR	LENGTH	
					METRIC	IMPERIAL
Fiberglass Long Tape	Open Reel	1/2"	ABS/Rubber	Yellow/Black	30m, 60m	100', 200'
	Closed Reel	1/2"	ABS	Yellow/Black	10m, 15m, 20m, 30m, 50m	50', 100', 165'
Stainless Steel Long Tape	Closed Case	3/8"	ABS	Yellow/Black	15m, 20m, 30m	50', 100'



# 1 MEASURING & LAYOUT TOOLS

1 MEASURING & LAYOUT TOOLS

2 LASER MEASURING SYSTEM

3 CUTTING & HOLDING TOOLS

4 FASTENING TOOLS

5 STRIKING & STRUCK TOOLS

6 ILLUMINATION TOOLS

7 PAINTING & FINISHING TOOLS

8 MECHANIC TOOLS

9 TOOLS STORAGE

10 POWER CLEANING TOOLS

11 POWER TOOLS

12 POWER TOOL ACCESSORIES

13 PRODUCT INDEX

5

## New STANLEY® Global Tapes

NEW



30-456N

- Tylon-coated blade withstands abrasion
- High-impact ABS case for durability
- 16" and 19.2" stud center markings simplify framing jobs
- Corrosion-resistant Tru-zero end hook for accurate measurements

SKU#	BLADE LENGTH		BLADE WIDTH		BOX/CTN
	feet	meters	inches	mm	
30-486N	10'	3	½"	12.7	6/36
30-496N	16'	5	¾"	19	6/36
30-456N	26'	8	1"	25	6/24

## New STANLEY® Fatmax Tapes

NEW



33-719

- 11' blade standout
- 1-1/4" wide blade for easy readability
- BladeArmor™ coating on the first 4-1/2" maximizes durability of the blade
- Mylar® polyester film extends life of entire blade
- High-impact ABS case with durable rubber-holds up to heavy use
- Top-forward blade lock makes locking and unlocking easy
- 16" and 19.2" stud center markings simplify framing jobs
- Cushion grip provides comfortable, slip-resistant hold
- Specially designed multi-catch hook grabs on top or bottom for versatility
- Three-riquet, corrosion-resistant Tru-zero end hook for accurate measurements

SKU#	BLADE LENGTH		BLADE WIDTH		BOX/CTN
	feet	meters	inches	mm	
33-719	16'	5	¾"	19	6/12
33-726	26'	8	1"	25	4/24
33-805	33'	10	1-¼"	31	1/24

Mylar® is a registered trademark of DuPont Teijin Films for its polyester film. Only Dupont Teijin Films makes Mylar® polyester film.

## New STANLEY® Fatmax XI Tapes

NEW



33-887

- 13' blade standout
- 1-1/4" wide blade for easy readability
- 150% larger hook (compared to STANLEY® 1" tapes) designed to grab on side, top or bottom for versatility
- BladeArmor™ coating on the first 6" maximizes durability of the blade
- High-visibility Mylar® polyester film extends life of entire blade and provides visibility in low lighting
- Chrome case with durable rubber-holds up to heavy use
- AirLock™ rubber slide lock is resistant to impact and makes locking and unlocking easy
- 16" and 19.2" stud center markings simplify framing jobs

SKU#	BLADE LENGTH		BLADE WIDTH		BOX/CTN
	feet	meters	inches	mm	
33-887	-	5	1-¼"	-	4/24
33-892	-	8	1-¼"	-	4/24
33-897	-	10	1-¼"	-	4/24

# 1 MEASURING & LAYOUT TOOLS



## STANLEY® RubberGrip® Tape Rule



30-608L

- Exclusive cushion grip built into case for comfortable non-slip and impact resistance
- Lacquered blade for maximum durability
- Improved blade readability with high contrast colour easy to read in all lighting conditions
- Massive bumper designed for increased hook life

SKU#	BLADE LENGTH		BLADE WIDTH		BOX/CTN
	feet	meters	inches	mm	
30-608L	-	3	½"	12.7	6/36
30-611L	-	3.5	½"	12.7	6/36
30-616	-	5	½"	12.7	6/36

## STANLEY® Tylon Tape



30-696

- Entire Blade coated with Mylar polyester film for added durability
- 16" and 19.2" stud center markings simplify framing jobs
- Compact, ergonomic case is 10% smaller than PowerLock® classic tapes, making it perfect for smaller settings
- ABS, shock-proof, chrome steel case
- 3-rivet, corrosion-resistant hook moves for accurate inside/outside measurements
- Forward blade lock design simplifies locking and unlocking the blade
- Wear plate protects case from cuts and nicks
- Belt clip on back of case

SKU#	BLADE LENGTH		BLADE WIDTH		BOX/CTN
	feet	meters	inches	mm	
30-696	16'	5	1"	25	6/36
30-656	26'	8	1"	25	6/36

## STANLEY® Leverlock® Tape Rule



30-815

- Unique power-return feature, with automatic bottom lock, streamlines tape operation
- High-visibility case makes it easy to find in a tool box or on the job
- Special Tru-Zero hook does double-duty as a pivot for drawing circles and arcs
- Three-rivet, corrosion-resistant hook for durability (1" blades only)
- Polymer coating and heat-treated spring extends life
- Belt clip on back of case assures effortless accessibility

SKU#	BLADE LENGTH		BLADE WIDTH		BOX/CTN
	feet	meters	inches	mm	
30-808	10'	3	1/2"	12.7	6/36
30-815	16'	5	3/4"	19	6/36
30-824	26'	8	1"	25	4/24
30-809	-	3	-	12.7	6/36
30-854T	25'	-	1"	-	12/12

# 1 MEASURING & LAYOUT TOOLS

## STANLEY® Powerlock® Tape Rule

- Highly resistant chrome plated plastic case
- Belt Clip
- Tru-Zero hook
- Class II Accuracy
- Anti abrasion Mylar® polyester film coated blade for long life



33-428-2

SKU#	BLADE LENGTH		BLADE WIDTH		Box/CTN
	feet	meters	inches	mm	
33-231-2	10'	3	1/2"	13	6/36
33-215-2	12'	3.5	1/2"	13	6/36
33-158-2	16'	5	3/4"	19	6/36
33-428-2	26'	8	1"	25	6/24
33-463-2	33'	10	1"	25	6/24
33-218-2	-	3	-	13	6/36
33-194-2	-	5	-	19	6/36

## STANLEY® Contractor Grade™ Open Reel Fiberglass LongTape

- 26 Strand 12mm wide blade
- PVC blades allow wound wet and easily cleaned
- Metric English blade printed both sides
- Bi-material handle and shaped winder for ease of use
- Class III Accuracy
- High-impact ABS case withstands rugged conditions



34-791

SKU#	BLADE LENGTH		BLADE WIDTH		Box/CTN
	feet	meters	inches	mm	
34-791	100'	30	1/2"	13	2/8
34-794	200'	60	1/2"	13	2/8
34-792	-	30	-	13	2/8
34-795	-	60	-	13	2/8
34-777	300'	100	1/2"	13	2/8

1 MEASURING & LAYOUT TOOLS

2 LASER MEASURING SYSTEM

3 CUTTING & HOLDING TOOLS

4 FASTENING TOOLS

5 STRIKING & STRUCK TOOLS

6 ILLUMINATION TOOLS

7 PAINTING & FINISHING TOOLS

8 MECHANIC TOOLS

9 TOOLS STORAGE

10 POWER CLEANING TOOLS

11 POWER TOOLS

12 POWER TOOL ACCESSORIES

13 PRODUCT INDEX

7

# 1 MEASURING & LAYOUT TOOLS

## STANLEY® Fiberglass LongTape

- 26 strands, 12mm wide blade
- 2 colour graduations - easy to read in all conditions
- High impact, high visibility yellow ABS case
- Handle folds for storage
- Class III Accuracy



34-260

SKU#	DESCRIPTION	BLADE LENGTH		BLADE WIDTH		Box/CTN
		feet	meters	inches	mm	
34-260	LONG TAPE CLOSED F/G 15M	50'	15	1/2"	13	6/60
34-262	LONG TAPE CLOSED F/G 30M	100'	30	1/2"	13	6/42
34-263	LONG TAPE CLOSED F/G 50M	165'	50	1/2"	13	6/36
34-295	FIBERGLASS LONG TAPE CASE 10M	-	10	-	13	6/72
34-296	FIBERGLASS LONG TAPE CASE 20M	-	20	-	13	6/60
34-297	FIBERGLASS LONG TAPE CASE 30M	-	30	-	13	6/42
34-298	FIBERGLASS LONG TAPE CASE 50M	-	50	-	13	6/36

## STANLEY® Steel LongTape

- 9.5mm wide yellow blade with abrasion resistant polymer coating for durability
- 2 colour graduations - easy to read in all conditions
- High impact, high visibility yellow ABS case
- Hook with spurs for ease of use
- Class III Accuracy



34-108N

SKU#	DESCRIPTION	BLADE LENGTH		BLADE WIDTH		Box/CTN
		feet	meters	inches	mm	
34-104N	15M/50' STEEL LONG TAPE	50'	15	3/8"	9.5	6/24
34-107N	30M/100' STEEL LONG TAPE	100'	30	3/8"	9.5	6/24
34-105N	STEEL LONG TAPE 20M	-	20	-	9.5	6/24
34-108N	STEEL LONG TAPE 30M	-	30	-	9.5	6/24
34-132N	30M/100' FATMAX ST. LONG TAPE	100'	30	3/8"	9.5	6/24

# 1 MEASURING & LAYOUT TOOLS

1 MEASURING & LAYOUT TOOLS

2 LASER MEASURING SYSTEM

3 CUTTING & HOLDING TOOLS

4 FASTENING TOOLS

5 STRIKING & STRUCK TOOLS

6 ILLUMINATION TOOLS

7 PAINTING & FINISHING TOOLS

8 MECHANIC TOOLS

9 TOOLS STORAGE

10 POWER CLEANING TOOLS

11 POWER TOOLS

12 POWER TOOL ACCESSORIES

13 PRODUCT INDEX

9

## New STANLEY® High Impact ABS Level

NEW

- Durable, shock-resistant ABS construction
- Top-read center vial for improved readability
- Measuring scale adds utility
- Non-marring material helps prevent damage to finished surfaces
- High-visibility yellow is easy to spot on the job site



42-476

SKU#	DESCRIPTION	LENGTH inches	# OF VIALS	BOX/CTN
42-466	Plastic, Non-Magnetic	12"	3	-/10
42-467	Plastic, Non-Magnetic	18"	3	-/6
42-468	Plastic, Non-Magnetic	24"	3	-/6
42-470	Plastic, Non-Magnetic	48"	3	-/6

SKU#	DESCRIPTION	LENGTH cm	# OF VIALS	BOX/CTN
42-474	Plastic, Non-Magnetic	30	3	-/10
42-475	Plastic, Non-Magnetic	45	3	-/6
42-476	Plastic, Non-Magnetic	60	3	-/6
42-471	Plastic, Non-Magnetic	120	3	-/6

## New STANLEY® Classic Box Level

NEW

- Solid block center vial magnified for easier reading and accurate to 0.0005in/in and 0.5mm/m
- Enlarged plumb vials over 25% larger than standard vials for easy reading
- Plumb vials feature clear covers for protection and easy cleaning
- Shock-absorbing end caps protect level
- New concave body design provides durability and comfortable handling



SKU#	DESCRIPTION	LENGTH cm	# OF VIALS	BOX/CTN
43-102	Non-Magnetic	40	2	-/10
43-103	Non-Magnetic	60	2	-/10
43-104	Non-Magnetic	80	2	-/10
43-105	Non-Magnetic	100	3	-/10
43-106	Non-Magnetic	120	3	-/10
43-107	Non-Magnetic	150	3	-/6
43-108	Non-Magnetic	180	3	-/6
43-109	Non-Magnetic	200	3	-/6

# 1 MEASURING & LAYOUT TOOLS



## New STANLEY® Classic Box Level (Magnetic)

**NEW**



- Solid block center vial magnified for easier reading and accurate to 0.0005in/in and 0.5mm/m
- Enlarged plumb vials over 25% larger than standard vials for easy reading
- Plumb vials feature clear covers for protection and easy cleaning
- Shock-absorbing end caps protect level
- New concave body design provides durability and comfortable handling
- Precision milled utility surface for accuracy

SKU#	DESCRIPTION	LENGTH cm	# OF VIALS	BOX/CTN
43-110	Magnetic	40	2	-/10
43-111	Magnetic	60	2	-/10
43-112	Magnetic	80	2	-/10
43-113	Magnetic	100	3	-/10
43-114	Magnetic	120	3	-/10
43-115	Magnetic	150	3	-/6
43-116	Magnetic	180	3	-/6
43-117	Magnetic	200	3	-/6

## STANLEY® Fatmax™ Xtreme Box Beam Level (Non-Magnetic)

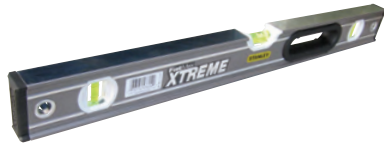

43-648

- Durable box-beam construction is up to 5x stronger than other STANLEY® levels
- Block vials provide accuracy of 0.0005 in/in (0.5mm/m)
- Magnified center vial for improved visibility
- Machined levelling surfaces improves accuracy
- Lifetime Accuracy Warranty

SKU#	DESCRIPTION	LENGTH inches	# OF VIALS	BOX/CTN
43-624	Non-Magnetic	24"	3	3/3
43-648	Non-Magnetic	48"	3	3/3
43-672	Non-Magnetic	72"	3	3/3

## STANLEY® FatMax™ Xtreme Box Beam Level (Magnetic)



43-625

- Same features as non-magnetic Box Beam Levels but with rare earth magnets
- Rare earth magnets are twice as strong as basic strip magnets and are built into the level for stability

SKU#	DESCRIPTION	LENGTH inches	# OF VIALS	BOX/CTN
43-625	Magnetic	24"	3	3/3
43-649	Magnetic	48"	3	3/3

# 1 MEASURING & LAYOUT TOOLS

1 MEASURING & LAYOUT TOOLS

2 LASER MEASURING SYSTEM

3 CUTTING & HOLDING TOOLS

4 FASTENING TOOLS

5 STRIKING & STRUCK TOOLS

6 ILLUMINATION TOOLS

7 PAINTING & FINISHING TOOLS

8 MECHANIC TOOLS

9 TOOLS STORAGE

10 POWER CLEANING TOOLS

11 POWER TOOLS

12 POWER TOOL ACCESSORIES

13 PRODUCT INDEX

11

## STANLEY® Fatmax™ II Level (Non-Magnetic)



43-548

- Built from a single piece of aluminum extrusion for increased durability and rugged use
- Feature 2 block vials on each end to provide maximum accuracy
- A center MaxEdge™ vial enables users to scribe continuous lines with an improved view
- Dual bi-material

SKU#	DESCRIPTION	LENGTH inches	# OF VIALS	BOX/CTN
43-524	Non-Magnetic	24"	3	6/6
43-536	Non-Magnetic	36"	3	6/6
43-548	Non-Magnetic	48"	3	3/3
43-572	Non-Magnetic	72"	3	3/3

## STANLEY® Fatmax™ II Level (Magnetic)



43-525

- Built from a single piece of aluminum extrusion for increased durability and rugged use
- Feature 2 block vials on each end to provide maximum accuracy
- A center MaxEdge™ vial enables users to scribe continuous lines with an improved view
- Dual bi-material

SKU#	DESCRIPTION	LENGTH inches	# OF VIALS	BOX/CTN
43-525	Magnetic	24"	3	3/3
43-537	Magnetic	36"	3	6/6
43-549	Magnetic	48"	3	6/6

## STANLEY® I-Beam Pro180° Level



42-920



42-923



42-919

- Rigid I-Beam cross section features low profile, shock-absorbing end caps for durability
- 180° rotating view for a range of situations
- Durable I-Beam Girder Section Aluminium Body
- Measuring scale printed directly on the level eases layout work
- Powder-coated frame withstands nicks and offers a comfortable hold
- Clear acrylic vial covers for easy readability
- 3 tubular vials: 1 top read level vial, 1 plumb vial and 1 180° rotating angle vial (double graduation for 0° up to 90° and in 10° markings)
- Accuracy +/- 1.5mm/m (0.0015in/in)

SKU#	LENGTH		# OF VIALS	ACCURACY IN		BOX/CTN
	mm	inches		mm/m		
42-919	400	16	2	1.5		6/6
42-920	600	24	3	1.5		6/6
42-921	800	32	3	1.5		6/6
42-922	1000	40	3	1.5		3/6
42-923	1200	48	3	1.5		6/6

# 1 MEASURING & LAYOUT TOOLS



## New STANLEY® Fatmax® I-Beam Level (Non-Magnetic)



43-553

- Aluminum body removes excess dirt and prolongs life
- Solid vials for better control and less slips
- Magnified center vial for more user comfort
- Vials accuracy of 0.5mm/m for improved accuracy
- Top read scale for fast measurements
- MaxEdge center vial : bridged center vial for continuous marking surface
- Shock absorbing end caps makes it long lasting & shock resistant
- Pencil included, quick help for marking
- Accuracy +/- 1.5mm/m (0.0015in/in)

SKU#	DESCRIPTION	LENGTH		BOX/CTN
		inches	# OF VIALS	
43-553	Non-Magnetic	24"	3	2/2
43-555	Non-Magnetic	48"	3	2/2
43-557	Non-Magnetic	72"	3	2/2

## New STANLEY® Fatmax I-Beam Level (Magnetic)



43-554

- Aluminum body removes excess dirt and prolongs life
- Solid vials for better control and less slips
- Magnified center vial for more user comfort
- Vials accuracy of 0.5mm/m for improved accuracy
- Top read scale for fast measurements
- MaxEdge center vial : bridged center vial for continuous marking surface
- Shock absorbing end caps makes it long lasting & choc resistant

SKU#	DESCRIPTION	LENGTH		BOX/CTN
		inches	# OF VIALS	
43-554	Magnetic	24"	3	2/2
43-556	Magnetic	48"	3	2/2
43-558	Magnetic	78"	3	2/2

## I-Beam Level - Top Read

- Durable, lightweight aluminium construction suited to all purpose use
- Pipe groove allows use on round objects
- Top-read center vial designed for easy readability
- Yellow vial covers increase visibility and readability
- Shock-absorbing end caps hold up to heavy use
- Hang hole simplifies storage
- Replaceable 360° vials and cover



42-075

SKU#	LENGTH		# OF VIALS	BOX/CTN
	mm	inches		
42-072	305	12"	2	10/10
42-073	457.5	18"	3	5/5
42-074	610	24"	3	5/5
42-075	915	36"	3	5/5
42-076	1220	48"	3	5/5



# 1 MEASURING & LAYOUT TOOLS

1 MEASURING & LAYOUT TOOLS  
 2 LASER MEASURING SYSTEM  
 3 CUTTING & HOLDING TOOLS  
 4 FASTENING TOOLS  
 5 STRIKING & STRUCK TOOLS  
 6 ILLUMINATION TOOLS  
 7 PAINTING & FINISHING TOOLS  
 8 MECHANICAL TOOLS  
 9 TOOLS STORAGE  
 10 POWER CLEANING TOOLS  
 11 POWER TOOLS  
 12 POWER TOOL ACCESSORIES  
 13 PRODUCT INDEX

## STANLEY® Box Level

- Box Section Level for DIY
- Lightweight aluminium box section body
- 2 plumb, 1 horizontal vial, permanently fixed
- Easy to clean epoxy finish to all surfaces
- Accurate to 1.0mm/m



42-362

SKU#	LENGTH		# OF VIALS	BOX/CTN
	mm	inches		
42-362	300	12"	2-level/plumb	20/20
42-643	457	18"	3-level/plumb	20/20
42-684	600	24"	3-level/plumb	10/10
42-685	915	36"	3-level/plumb	10/10
42-686	1220	48"	3-level/plumb	10/10

## STANLEY® Contractor Grade™ Torpedo Level

- Combines accuracy and lightweight, ideal for all small installations
- 3 vials: horizontal, plumb and 45°



42-465

SKU#	LENGTH		# OF VIALS	BOX/CTN
	mm	inches		
42-465	229	9"	3level/45°/1Plumb with Magnetic Base	6/36

## STANLEY® Torpedo Level

- High-impact ABS plastic for durability
- Handy and economical
- 3 vials: horizontal, plumb and 45°

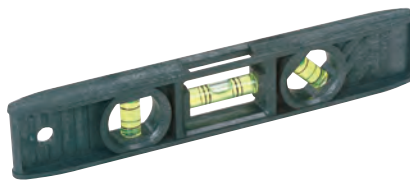

42-294

SKU#	DESCRIPTION	LENGTH		# OF VIALS	BOX/CTN
		mm	inches		
42-264	Magnetic	229	9"	3(level/45°/1Plumb)	6/36
42-291	Magnetic	203	8"	3(level/45°/1Plumb)	4/36
42-294	Standard	203	8"	3(level/45°/1Plumb)	4/24

## STANLEY® Line Level

- Special hooks allow level to slide freely
- Flat bottom for surface leveling
- High visibility tinted liquid provides clear readings



42-287-0

SKU#	DESCRIPTION	LENGTH	# OF VIALS	BOX/CTN
42-287-0	LEVEL LINE 3-1/4"-1 YELLOW	3",76.2mm	1	6/72

# 1 MEASURING & LAYOUT TOOLS



45-530

## STANLEY® Steel Rafter / Roofing Square

- Embossed graduations and figures on work-hardened steel
- Metric roofing table
- Buffed finish with a clear lacquer that resists rust

SKU#	FINISH	LENGTH		GRADUATION		
		BODY	TONGUE	FACE	BACK	BOX/CTN
45-530 (Metric)	Buffed	600 x 500mm	400 x 8mm	2mm	2mm	6/6



45-500

## STANLEY® Steel Carpenter Square

- Tempered steel designed for durability
- Deep graduations for easy reading on face and back
- Surface protected with a clear finish that resists rust
- Reverse reading scale makes measuring more efficient

SKU	FINISH	LENGTH		GRADUATION		
		BODY	TONGUE	FACE	BACK	BOX/CTN
45-500 (Imperial)	Buffed	24" x 12"	16 x 1- 1/2"	1/8"	1/8"	1/4
45-600 (M/E)	Buffed	24" x 16"	16 x 1- 1/2"	1/8"	1/8"	6/6



46-530

## STANLEY® Try Square

- Try square with stamped graduations and figures
- Cast zinc handle
- Metric / Imperial marking on ruler

SKU#	BLADE		HANDLE		BOX/CTN
	mm	inches	mm	inches	
46-530	152	6"	124	4-7/8"	10/10
46-532	203	8"	124	4-7/8"	10/10
46-534	254	10"	184	7-1/4"	10/10
46-536	305	12"	184	7-1/4"	10/10



46-012

## STANLEY® Combination Square

- Try square with stamped graduations and figures
- Cast zinc handle
- Metric / Imperial marking on ruler

SKU#	DESCRIPTION	LENGTH inches	# OF VIALS	BOX/CTN
46-143	Combination, Metric, 11-13/16"	24"	3	10/60
46-012	12"	36"	3	6/6
46-028	Die cast	48"	3	3/3

# 1 MEASURING & LAYOUT TOOLS



46-825-0

## STANLEY® Bevel Edge

- High carbon steel-tempered blade
- Nickel-plated
- Tough plastic handle

SKU#	DESCRIPTION		O/ A LENGTH		BOX/CTN
	mm	inches	mm	inches	
46-825-0	203	8"	140	5-1/2"	6/36



45-103

## STANLEY® Maxstick Rule

- Rigid, yet lightweight aluminum construction
- Ideal for marking edges precisely
- Multi-purpose design provides an accurate measure and can also be used as a saw guide
- Laminated tape-rule guide is permanently adhered for durability
- Center gripping rib protects fingers
- Additional easy-to-read scale on back
- Helpful markings provide standard heights for light switches, dead bolts, door locks and electrical outlets

SKU#	LENGTH		BOX/CTN
	inches	mm	
45-103	48	1219.2	4/4



42-087

## STANLEY® Digital Angle Finder

- Angle measurement 0° up to 180°
- Clear LCD Screen
- Horizontal and vertical vials
- Anodized aluminum profile
- Accuracy ± 0.1°

SKU#	DESCRIPTION	LENGTH	# OF VIALS	BOX/CTN
		cm		
42-087	Digital	40	2	1/4

- 1 MEASURING & LAYOUT TOOLS
- 2 LASER MEASURING SYSTEM
- 3 CUTTING & HOLDING TOOLS
- 4 FASTENING TOOLS
- 5 STRIKING & STRICK TOOLS
- 6 ILLUMINATION TOOLS
- 7 PAINTING & FINISHING TOOLS
- 8 MECHANIC TOOLS
- 9 TOOLS STORAGE
- 10 POWER CLEANING TOOLS
- 11 POWER TOOLS
- 12 POWER TOOL ACCESSORIES
- 13 PRODUCT INDEX

# 1 MEASURING & LAYOUT TOOLS



47-460

## STANLEY® Powerwinder® Chalk Line

- 3 1/2 to 1 gear ratio-rewind 3.5x faster
- Quick gear release-crank will not spin when pulling out line
- Clear view case-see amount of chalk inside case
- Case holds over 1.5 oz. of chalk
- Sliding door for quick and easy refill
- Weight and style combination provides "plumb bob" utility
- High impact ABS case

SKU#	LENGTH		BOX/CTN
	meter	feet	
47-460	30	100	1/6



47-465

## STANLEY® Powerwinder® w/ Red Chalk And Line Level

- Kit contains one 100ft (30m) polypropylene chalk reel and 4oz (113gm)chalk container with blue chalk
- 3 1/2 to 1 gear ratio for 3.5 times faster rewind
- ClearView case to see the amount of chalk left inside
- Case holds 45g chalk
- Weight and style combination provides plumb bob utility
- Stainless steel end hook does not rust
- Sliding door for quick and easy refill

SKU#	LENGTH		BOX/CTN
	meter	feet	
47-465	30	100	5/5



47-440

## STANLEY® Chalk Line

- On-board hook storage
- High impact ABS case for durability
- Sliding door for quick and easy refill
- Stainless steel end hook for added durability and rust prevention
- 1oz. chalk capacity

SKU#	LENGTH		BOX/CTN
	meter	feet	
47-440	30	100	6/24

# 1 MEASURING & LAYOUT TOOLS



47-443

## STANLEY® w/ Blue Chalk And Line Level

- Kit contains 30m chalk line, 113g blue chalk
- High Impact ABS case for durability
- Sliding door for quick and easy refill
- Stainless steel end hook does not rust
- 30g chalk capacity
- Can be used vertically as a plumb bob

SKU#	LENGTH		BOX/CTN
	meter	feet	
47-443	30	100	2/6



47-487L

## Fatmax® Xtreme™ Chalk Reel With Red Fatmax® Xtreme™ Chalk Kit

- Die-cast aluminum housing for durability
- Rewinds 5x faster – has a 5:1 gear ratio
- Quick gear release – crank will not spin when pulling out line
- Stainless steel hook and crank handle
- On-Board Hook Storage
- Patented ChalkView™ case – see amount of chalk inside case
- Premium polymer string resists breakage and fraying
- Includes 4 oz. waterproof red FatMax® Xtreme™ chalk

SKU#	DESCRIPTION	BOX/CTN
47-487L	Fatmax® Xtreme™ Chalkreel w/ Red Fatmax® Xtreme™ Chalk Kit	1/6



47-827

## Fatmax® Xtreme™ 5Lb. Red Chalk

- Waterproof chalk will not fade or bleed in a wet environment
- Eliminates chalk clumping inside the chalk reel
- Square bottle will not roll off of work surfaces

SKU#	DESCRIPTION	BOX/CTN
47-827	Fatmax® Xtreme™ 5lb Red Chalk	4/4

1 MEASURING & LAYOUT TOOLS

2 LASER MEASURING SYSTEM

3 CUTTING & HOLDING TOOLS

4 FASTENING TOOLS

5 STRIKING & STRUCK TOOLS

6 ILLUMINATION TOOLS

7 PAINTING & FINISHING TOOLS

8 MECHANIC TOOLS

9 TOOLS STORAGE

10 POWER CLEANING TOOLS

11 POWER TOOLS

12 POWER TOOL ACCESSORIES

13 PRODUCT INDEX

17

# 1 MEASURING & LAYOUT TOOLS



47-828

## Fatmax® Xtreme™ Chalk 5Lb. – Black

- Waterproof chalk will not fade or bleed in a wet environment
- Eliminates chalk clumping inside the chalk reel
- Square bottle will not roll off of work surfaces

SKU#	DESCRIPTION	BOX/CTN
47-828	Fatmax® Xtreme™ Chalk 5lb Black	4/4

## STANLEY® Chalk Refills

- Powder specially formulated for good adhesion and high visibility
- Water Resistant
- Good resistance to all atmospheric conditions
- Blue: All round colour for interior and exterior use
- Red: Easier to use for external masonry work, inedible, easy to use



47-403

SKU#	WEIGHT		COLOUR	BOX/CTN
	grams	ounce		
47-403-1	113	4	Blue dot	12/12
47-404-1	113	4	Red dot	12/12
47-803-1	226	8	Blue Powder	12/12
47-804-1	226	8	Red Powder	12/12
47-808	226	8	Black Powder	12/12
47-809	226	8	Orange Powder	12/12
47-405-1	113	4	White Powder	12/12

# 1 MEASURING & LAYOUT TOOLS



47-064

## STANLEY® Marking Gauge

- Plastic marking gauge
- Plastic stock with metal insert for abrasion resistance
- Stem calibrated for easy setting
- Graduation at 2mm

SKU#	DESCRIPTION	BOX/CTN
47-064	STANLEY® Marking Gauge	5/30



47-973

## STANLEY® Solid Brass Plumb Bob

- Screw top to easily attach string to center of plumb
- Polished lacquered solid brass construction resists rust
- Thru hole for easy tightening
- Additional tip included on 8 oz size

SKU#	WEIGHT		LENGTH		BOX/CTN
	grams	ounce	mm	inches	
47-973	226	8	133	5 - 1/4"	6/36

1 MEASURING & LAYOUT TOOLS

2 LASER MEASURING SYSTEM

3 CUTTING & HOLDING TOOLS

4 FASTENING TOOLS

5 STRIKING & STRUCK TOOLS

6 ILLUMINATION TOOLS

7 PAINTING & FINISHING TOOLS

8 MECHANICAL TOOLS

9 TOOLS STORAGE

10 POWER CLEANING TOOLS

11 POWER TOOLS

12 POWER TOOL ACCESSORIES

13 PRODUCT INDEX

19

# 2 LASER MEASURING SYSTEM

## ACCURACY, DEPENDABILITY & DURABILITY

STANLEY®'s team of world-class engineers and industrial designers has developed a series of versatile electronic tools that deliver an unprecedented level of accuracy, reliability and long-term performance. The lineup includes three different laser distance measurers. These handheld, battery-powered devices feature state-of-the-art electronics and easy read LCD screens that make the process of taking long measurements or performing complex calculations fast and easy. The range of STANLEY® Laser Distance Measurers is designed to accelerate both the estimating and execution of jobs for a wide range of people, making them more productive.

People like:

- Builders and remodelers
- Tradesmen, like drywallers, painters, flooring installers
- Inspectors, appraisers, realtors, architects
- Homeowners/DIYers

Regardless of the application, STANLEY®'s Laser Measuring Systems are a perfect addition to any tool box.





## THE MAIN TYPES OF STANLEY® LASER TOOLS



**LASER DISTANCE MEASURING TOOLS**



**CROSSLINE LASER TOOLS**



**SPOT LASER TOOLS**



**ROTATING LASER TOOLS**



**SUB-SURFACE DETECTOR TOOLS**



**LASER ACCESSORIES TOOLS**

## THE 4 MAIN FUNCTIONS OF LASER TOOLS



Angles and slopes

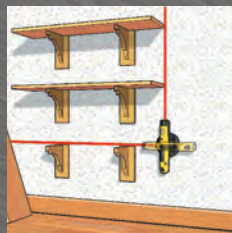

Squaring

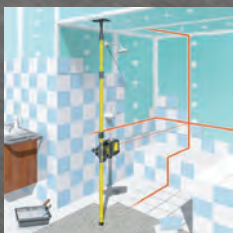

Plumb line - take a point from floor to ceiling

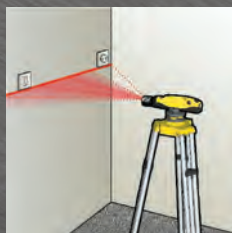

Horizontal & vertical levelling & alignment

## WHAT IS A LASER?

LASER stands for 'Light Amplification by Stimulated Emission of Radiation'. A diode is used to create a concentrated laser beam of light in one wavelength. The shorter the wavelength the brighter and more visible the laser beam. STANLEY® lasers have a standard wavelength of 635 nanometers, which is suitable for use up to 300m.

## IP RATING

When working in dusty and damp conditions, the IP rating of the laser is also important. A selection of STANLEY® lasers are rated IP54 (dust resistant and splash proof) or IP66 (dust resistant and completely waterproof).

## ARE LASERS POTENTIALLY HAZARDOUS?

Lasers are classed from 1 up to 4 in terms of potential hazard. STANLEY® laser classes range from class 1 up to class 2M, which pose little or no hazard.

Class 1 - Poses no threat of biological damage.

Class 2 - The output could harm a person if they were to stare into a beam for a long period of time.

Class 2M - Lasers have a divergent beam and may be hazardous if an optical instrument is placed in front of the eye such as a magnifying glass.

# LASER APPLICATION GUIDE



SITE LAYOUT

● : Functional for ...    ◻ : Ideal use

CATEGORY	PRODUCT DESCRIPTION	Levelling Foundation Form Work	Surface Levelling Drainage Gradings	Levelling Roads/Paths Driveways Landscaping
Optical Level	 AL24 GVP Levelling Set 1-77-160	●	●	●
Rotary Laser	 FatMax Rotary Laser RL HW+ 1-77-429	●	●	●
	 FatMax Rotary Laser RL HGW 1-77-439	●	●	●
	 FatMax Rotary Laser RL HVPW 1-77-427	●	●	●
Crossline Laser	 FatMax Multiline Laser 1-77-122	●	◻	●
	 FatMax SML Multiline Laser 1-77-322	●	◻	●
	 Stanley SLL360 Line Laser 360° with Cross STHT1-77137	●	◻	●
	 FatMax CL2i Crossline Laser 1-77-120	●	◻	●
	 FatMax CL90i Crossline Laser 1-77-021	●	◻	●
Combi Laser	 SLP5 Self-Leveling 5-Point Laser Level 1-77-319	●	◻	●
	 SCL-D Self-Leveling Cross Laser 1-77-321	●	◻	●
Spot Laser	 FatMax PB5 Self-Leveling Multi-cross Dot Laser 1-77-119	●	◻	◻
	 FatMax PB3 Self-Leveling Multi-cross Dot Laser 1-77-118	●	◻	◻
Laser Distance Measurer	 TLM330 Laser Distance Measurer STHT1-77140	◻	◻	◻
	 TLM165 Laser Distance Measurer STHT1-77139	◻	◻	◻
	 TLM99 Laser Distance Measurer STHT1-77138	◻	◻	◻
Distance Measure (Ultrasonic)	 Intellimeasure Ultrasonic Distance Estimator 0-77-018	◻	◻	◻



## 2 LASER MEASURING SYSTEM

### LASER DISTANCE MEASURING TOOLS

#### TLM330 True Laser Distance Measurer



STHT1-77140

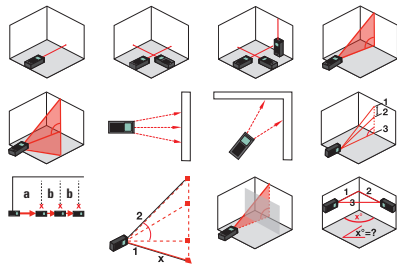

- Range: 330' (100m)
- Accuracy: +/- 1/32" (1mm)
- Distance/area/volume calculation
- Inclination sensor - Integrated digital leveling feature for leveling surfaces and identifying angles and position for accurate measurements
- Continuous measurement - Finds distance from a target quickly and easily
- Indirect measurement using Pythagoras - Measure distances even when point A and/or point B isn't accessible for linear measurement
- Memory - Unit stores last 20 measurements taken for reference
- Backlit, 3 line display - Large LCD provides visibility in all working conditions
- Multi-functional end piece - Folding end piece makes true corner-to-corner measurements easy and accurate
- Overmolded housing and IP 54 water/debris resistance - Durable product with high level of protection from dust/debris/water

SKU#	DESCRIPTION	BOX/CTN
STHT1-77140	TLM330 True Laser Distance Measurer	1/1

#### TLM165 True Laser Distance Measurer



STHT1-77139

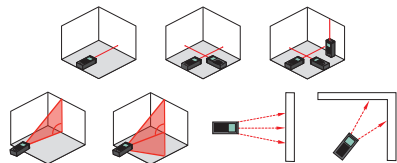

- Range: 165' (50m)
- Accuracy: +/- 1/16" (1.5mm)
- Distance/area/volume calculation
- Continuous measurement - Finds distance from a target quickly and easily
- Addition / subtraction - Convenient way to calculate in the field, using standard measurement units
- Indirect measurement using Pythagoras - Measure distances even when point A and/or point B isn't accessible for linear measurement
- Memory - Unit stores last 5 measurements taken for reference
- Backlit, 2 line display - Provides visibility in all working conditions
- Corner stand-off - End post makes true corner-to-corner measurements easy and accurate
- Overmolded housing and IP 54 water/debris resistance - Durable product with high level of protection from dust/debris/water

SKU#	DESCRIPTION	BOX/CTN
STHT1-77139	TLM165 True Laser Distance Measurer	1/1

## 2 LASER MEASURING SYSTEM



STHT1-77138

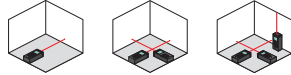

### TLM99 True Laser Distance Measurer

- Range: 100' (30m)
- Accuracy: +/- 3/32" (2mm)
- Distance/area/volume calculation
- Continuous measurement "tracking" function - Finds distance from a target quickly and easily
- Addition / subtraction - Convenient way to calculate in the field, using standard measurement units

SKU#	DESCRIPTION	BOX/CTN
STHT1-77138	TLM99 True Laser Distance Measurer	1/1

## ULTRASONIC DISTANCE MEASURING TOOLS



0-77-018

### Intellimeasure Ultrasonic Distance Estimator

- Calculates volume, distance and volumes
- Ultrasound measurement
- Measures distances up to 12meters / 40" at ± 0.5% accuracy
- Displays last 3 measurements
- Requires a 9V battery (not included)
- Maximum interior measurement 12m

SKU#	DESCRIPTION	BOX/CTN
0-77-018	Intellimeasure Ultrasonic Distance Estimator	1/1

## OPTICAL LEVEL TOOLS

### AL24 GVP Leveling Set

High quality, competitively priced 24X automatic optical level, supplied with Tripod and Rod, with many features normally seen on a high-priced product

- Large easy to use focusing knob
- Right angle prism for easy bubble viewing
- Large effective aperture with 30cm minimum range
- Fits to standard tripod
- Scope has sun-shade for bright light working
- Available in 360 degree or 400gon versions



1-77-160

SKU#	DESCRIPTION	BOX/CTN
1-77-160	AL24 GVP Leveling Set	1/1

## 2 LASER MEASURING SYSTEM

### ROTATING LASER TOOLS



1-77-429

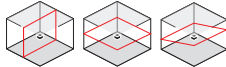

#### FatMax® Rotary Laser RL HW+

- Operates up to 300m range with a detector
- 0.05Mm/m accuracy – 600rpm rotation speed
- Grading function to set slopes up to +/- 6 degrees
- Rated to IP66 for total protection against dust and water
- Self-leveling
- Rechargeable battery lasting up to 24 hours between charges
- Supplied with a detector for external use, grid target, recharging lead and
- 4 x rechargeable batteries

SKU#	DESCRIPTION	BOX/CTN
1-77-429	FatMax® Rotary Laser RL HW+	1/4



1-77-439

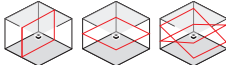

#### FatMax® Rotary Laser RL HGW

- Working range 600m
- The rotating head can be set up for a 15% slope
- Rotation Speed (RPM): 0 - 300 - 600 - 1000 - Automatic Leveling
- Anti-drift system
- Glass enclosed head provides IP rating IP66
- Horizontal and Vertical Use

SKU#	DESCRIPTION	BOX/CTN
1-77-439	FatMax® Rotary Laser RL HGW	1/4



1-77-427

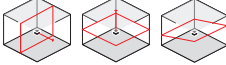

#### FatMax® Rotary Laser RL HVWP

- Operates up to 300m range with a detector / 0.05mm/m accuracy
- 0-300-600 rpm rotation speeds
- Grading function to set slopes up to +/- 6 degrees
- Scanning mode for 10-45-90 degrees / Self-leveling
- Rated to IP66 for total protection against dust and water
- Rechargeable battery lasting up to 24 hours between charges
- Supplied with wall mount, grid target, remote control, recharging lead,
- 4 x rechargeable batteries and laser glasses

SKU#	DESCRIPTION	BOX/CTN
1-77-427	FatMax® Rotary Laser RL HVWP	1/4

## 2 LASER MEASURING SYSTEM

### CROSSLINE LASER TOOLS

#### FatMax® Multiline Laser



1-77-122

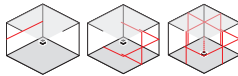

- 25m range in interior and exterior working environment
- Projects 4 vertical laser lines, plus 1 horizontal line
- 3 leg tripod supplied attached to laser with smooth rotation mechanism
- Magnetically dampened pendulum
- 3 pendulum lock for safe transportation
- Delivered with tripod

SKU#	DESCRIPTION	BOX/CTN
1-77-122	FatMax® Multiline Laser	1/4

#### FatMax® SML Multiline Laser



1-77-322

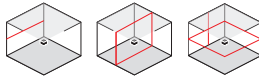

- 50m working range with +/-0.15mm/m accuracy
- 1 horizontal line with 4 x 90° vertical lines, and down plump dot
- Detector delivers additional range and allows use in bright light situations
- Rotating base
- Durable design with IP54 debris and water resistance

SKU#	DESCRIPTION	BOX/CTN
1-77-322	FatMax® SML Multiline Laser	1/4

#### SLL360 Line Laser 360°



STHT1-77137

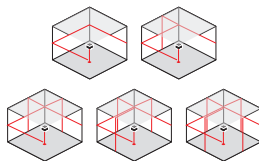

- Self-leveling 360° laser line and 1 vertical line
- 10m range with +/-0.4mm/m
- Fine vertical-adjust base for easy set-up
- Locking Pendulum
- Robust over-molded housing

SKU#	DESCRIPTION	BOX/CTN
STHT1-77137	SLL360 Line Laser 360°	1/4

1 MEASURING & LAYOUT TOOLS

2 LASER MEASURING SYSTEM

3 CUTTING & HOLDING TOOLS

4 FASTENING TOOLS

5 STRIKING & STRUCK TOOLS

6 ILLUMINATION TOOLS

7 PAINTING & FINISHING TOOLS

8 MECHANIC TOOLS

9 TOOLS STORAGE

10 POWER CLEANING TOOLS

11 POWER TOOLS

12 POWER TOOL ACCESSORIES

13 PRODUCT INDEX

27

## 2 LASER MEASURING SYSTEM



1-77-120

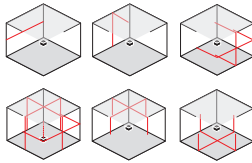

### FatMax® CL2I Crossline Laser

- 25m range
- 0.3mm/m accuracy
- Projects 1 horizontal and 1 vertical line to create a cross line
- Pulsed beam mode allows operation outdoors in combination with the detector (1-77-023)
- Out of True level sensor
- Self-leveling
- Runs on 3 x AA batteries (supplied)
- Pendulum lock for safe transportation
- Rated to IP54 to protect against dust and water splashes

SKU#	DESCRIPTION	BOX/CTN
1-77-120	FatMax® CL2I Crossline Laser	1/1

### FatMax® CL90I Crossline Laser



1-77-021

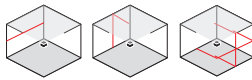

- Projects lines up to 30m using a detector (supplied)
- 0.33mm/m accuracy
- Projects 2 vertical and 1 horizontal line to create a cross line and a vertical line at 90 degrees to the right
- Pulsed beam mode allows operation outdoors in combination with the detector (supplied)
- Rated to IP54 to protect against dust and water splashes
- Self-leveling
- For laying out stud walling, pipe work, shelving, lighting, kitchens, fencing, landscaping & tiling

SKU#	DESCRIPTION	BOX/CTN
1-77-021	FatMax® CL90I Crossline Laser	1/1



## 2 LASER MEASURING SYSTEM

### COMBI LASER TOOLS

#### SLP5 Self-Leveling 5-point Laser Level



1-77-319

- Project 5 spot beams and 1 horizontal line
- 30m (spot) / 10m (line) working range
- Best in class accuracy +/- 0.3mm/m
- Provides dot visibility and clearance / alignment for wall track layout
- Magnetic pivoting base

SKU#	DESCRIPTION	BOX/CTN
1-77-319	SLP5 Self-Leveling 5-point Laser Level	1/4

#### SCL-D Self-Leveling Cross Laser



1-77-321

- Projects cross line and plumb spots
- 30m spot / 50m line working range with detector
- Best in class accuracy +/- 0.3mm/m
- Pulse mode for use with detector
- Locking pendulum
- Robust over-molded housing
- Magnetic pivoting base

SKU#	DESCRIPTION	BOX/CTN
1-77-321	SCL-D Self-Leveling Cross Laser	1/4

1 MEASURING & LAYOUT TOOLS

2 LASER MEASURING SYSTEM

3 CUTTING & HOLDING TOOLS

4 FASTENING TOOLS

5 STRIKING & STRUCK TOOLS

6 ILLUMINATION TOOLS

7 PAINTING & FINISHING TOOLS

8 MECHANIC TOOLS

9 TOOLS STORAGE

10 POWER CLEANING TOOLS

11 POWER TOOLS

12 POWER TOOL ACCESSORIES

13 PRODUCT INDEX

29

## 2 LASER MEASURING SYSTEM

### SPOT LASER TOOLS



1-77-119



#### FatMax® PB5 Self-Leveling Multi-cross Dot Laser

- 30m range, and interior and exterior working environment
- Projects 5 beams at 90 degrees to each other at 3x horizontal, 1x vertical and 1x plumb
- Magnetically dampened pendulum
- Trivet allows magnetization to steel frames, plus a universal thread for attaching to a pole or tripod
- Kit contains; laser grid target, trivet, carry case and 2x AA batteries

SKU#	DESCRIPTION	BOX/CTN
1-77-119	FatMax® PB5 Self-Leveling Multi-cross Dot Laser	1/10



1-77-118





#### FatMax® PB3 Self-Leveling Multi-cross Dot Laser

- Has a 30m range in an interior working environment
- Projects 3 beams at 90 degrees to each other at 1x horizontal, 1x vertical and 1x plumb
- Magnetically dampened pendulum
- Trivet allows magnetization to steel frames, plus a universal thread for attaching to a pole or tripod
- Kit contains; laser grid target, carry case and 2x AA batteries

SKU#	DESCRIPTION	BOX/CTN
1-77-118	FatMax® PB3 Self-Leveling Multi-cross Dot Laser	1/10

# DETECTORS APPLICATION GUIDE

• : Functional for ...

CATEGORY	PRODUCT DESCRIPTION	MATERIALS DETECTED				FEATURES			
		Moisture	Wood	Metal	Electric	Multi Depth	LCD Screen	AC Detection	Audible indicator
Sub-Surface Detectors	 <p>IntelliLaser Pro2 (Fastener length: 12mm, 25mm, 38mm) 0-77-500</p>		•	•	•	•	•	•	•
	 <p>STANLEY Moisture Meter 0-77-030</p>	•							

## SUB-SURFACE DETECTORS TOOLS

### IntelliLaser™ Pro Stud Sensor and Laser Line Level



0-77-500

- Horizontal, vertical and orientable laser line
- Detects wood and metal up to 38mm depth
- Detects electric cables (230v)
- Automatic calibration for fast operation
- Laser : 635nm - Class 2
- Batteries : 1 x 9V 6LR61 and 2 x batteries AAA LR03 (not included)

SKU#	DESCRIPTION	BOX/CTN
0-77-500	IntelliLaser Pro2	1/1

### STANLEY® Moisture Meter



0-77-030



- Dual measurement scale, LCD display with bar graph
- Measures wood moisture from 6% to 44%
- Measures building material moisture from 0.2% to 2.0%
- Self-contained, pocket-sized meter
- Impact-proof housing
- CR-2032 button batteries included

SKU#	DESCRIPTION	BOX/CTN
0-77-030	STANLEY® Moisture Meter	1/1

1 MEASURING & LAYOUT TOOLS

2 LASER MEASURING SYSTEM

3 CUTTING & HOLDING TOOLS

4 FASTENING TOOLS

5 STRIKING & STRUCK TOOLS

6 ILLUMINATION TOOLS

7 PAINTING & FINISHING TOOLS

8 MECHANIC TOOLS

9 TOOLS STORAGE

10 POWER CLEANING TOOLS

11 POWER TOOLS

12 POWER TOOL ACCESSORIES

13 PRODUCT INDEX

# LASER ACCESSORIES

• : Functional for ...

CATEGORY	CODE	ITEM DESCRIPTION				
			Optical Level	Rotary Laser		
			1-77-160	1-77-429	1-77-439	1-77-427
Line Detector	1-77-023	FatMax Line Detector				
Laser Accessories	1-77-221	Professional Pole w/ Magnetic Mount				
	1-77-164	Aluminum Tripod 119cm to 292cm	•	•	•	•
	1-77-163	Aluminum Tripod 97cm to 160cm	•	•	•	•
	1-77-022	Stanley Laser Tripole				
	1-77-161	5 Section 5M Grade Rod Aluminum	•	•	•	•
	1-77-201	Camera Tripod 1/4"				
	1-77-171	Laser Glasses		•	•	•



1-77-023



1-77-221



1-77-164



1-77-163

# ES SELECTION GUIDE

## SUITABLE FOR

Crossline Laser					Combi Laser		Spot Laser		Laser Distance Measurer		
1-77-122	1-77-322	STHT1-77137	1-77-120	1-77-021	1-77-319	1-77-321	1-77-119	1-77-118	STHT1-77140	STHT1-77139	STHT1-77138
•	•	•	•	•	•	•					
•	•	•	•	•	•	•					
•	•										
•	•										
•			•	•			•	•			
•			•	•			•	•			
•	•	•	•	•	•	•	•	•	•	•	•



1-77-022



1-77-161



1-77-201



1-77-171

1 MEASURING & LAYOUT TOOLS

2 LASER MEASURING SYSTEM

3 CUTTING & HOLDING TOOLS

4 FASTENING TOOLS

5 STRIKING & STRUCK TOOLS

6 ILLUMINATION TOOLS

7 PAINTING & FINISHING TOOLS

8 MECHANIC TOOLS

9 TOOLS STORAGE

10 POWER CLEANING TOOLS

11 POWER TOOLS

12 POWER TOOL ACCESSORIES

13 PRODUCT INDEX

## 2 LASER MEASURING SYSTEM

### LINE DETECTOR TOOLS

#### FatMax® Line Detector



1-77-023

- Compatible with all STANLEY / FatMax line lasers with pulse mode
- 100m working range with +/-1mm accuracy
- 20mm window reception width
- 15 hours battery life
- For interior and exterior use

SKU#	DESCRIPTION	BOX/CTN
1-77-023	FatMax® Line Detector	1/1

### LASER ACCESSORIES TOOLS

#### Professional Pole w/ Magnetic Mount



1-77-221

- Can be used with all line laser range
- Telescopic for easy transportation
- Aluminium, both strong and lightweight

SKU#	DESCRIPTION	BOX/CTN
1-77-221	Professional Pole w/ Magnetic Mount	1/1

#### Aluminum Tripod 119cm to 292cm



1-77-164

- Strong, aluminium body with cast flat baseplate
- Working height 1.02m to 2.92m
- Lightweight and durable aluminum hinge, clamp and shoe casting
- 5/8" thread

SKU#	DESCRIPTION	BOX/CTN
1-77-164	Aluminum Tripod 119cm to 292cm	1/1

#### Aluminum Tripod 97cm to 160cm



1-77-163

- Strong, aluminium body with cast flat baseplate
- Working height 1.02m to 2.92m
- Lightweight and durable aluminum hinge, clamp and shoe casting
- 5/8" thread

SKU#	DESCRIPTION	BOX/CTN
1-77-163	Aluminum Tripod 97cm to 160cm	1/1

## 2 LASER MEASURING SYSTEM



1-77-022

### STANLEY® Laser Tripole

- 5 section telescopic pole
- Comes with a tripod base for better stability
- Extends to 3.6 meters
- Can be used with 1-77-119, 1-77-118, 1-77-120, 1-77-121, 1-77-117, 1-77-122 and 1-77-021

SKU#	DESCRIPTION	BOX/CTN
1-77-022	STANLEY® Laser Tripole	1/5



1-77-201

### Camera Tripod

- ¼ thread compatible with all line and spot lasers
- Compatible with LDMs

SKU#	DESCRIPTION	BOX/CTN
1-77-201	Camera Tripod	1/10



1-77-161

### 5 Section 5M Grade Rod Aluminum

- 5m overall with 5 sections graduated in cm & mm
- Strong, lightweight aluminium construction

SKU#	DESCRIPTION	BOX/CTN
1-77-161	5 Section 5M Grade Rod Aluminum	1/1



1-77-171

### Laser Glasses

- Laser Glasses designed to enhance the brightness of the laser line internally and externally
- Suitable for STANLEY® spot & line lasers
- Important - these are not to be confused with laser SAFETY glasses

SKU#	DESCRIPTION	BOX/CTN
1-77-171	Laser Glasses	1/1

1 MEASURING & LAYOUT TOOLS

2 LASER MEASURING SYSTEM

3 CUTTING & HOLDING TOOLS

4 FASTENING TOOLS

5 STRIKING & STRUCK TOOLS

6 ILLUMINATION TOOLS

7 PAINTING & FINISHING TOOLS

8 MECHANIC TOOLS

9 TOOLS STORAGE

10 POWER CLEANING TOOLS

11 POWER TOOLS

12 POWER TOOL ACCESSORIES

13 PRODUCT INDEX

35

# 3 CUTTING AND HOLDING TOOLS

## DURABLE, SHARP AND ERGONOMIC

STANLEY® manufactured its first utility knife back in 1935, and it didn't take long for the world to take notice. Compact, rugged, comfortable to hold and armed with a razor-sharp blade, it quickly became an indispensable tool for a wide variety of tradesmen, fabricators and installers. STANLEY® now makes nearly 60 different sizes and styles of utility knives. Specialty knives and blades manufactured for specific tasks, such as cutting carpeting, roofing materials, acrylic sheets, plastic laminates, linoleum and even sod. Some of the many features STANLEY® developed and first brought to market include its interlocking nose, which securely locks together the two knife halves for precise cutting, and an Instant Change™ design that allows you to quickly change blades without using a screwdriver to open the knife. This ingenious "no tools required" blade changing solution on our utility knives and innovations like SharpTooth™ technology that enable our saws to cut wood 50% faster than conventional saws, sets us apart from our competitors.

### FIXED BLADE KNIVES

These are designed for the heaviest of applications. Although the blade is fixed, the majority of STANLEY® Fixed Blade Knives incorporate a rapid blade changing mechanism.



### RETRACTABLE BLADE KNIVES

These offer similar performance to the fixed blade models and the blade can be retracted safely into the handle when not in use.



### SNAP-OFF BLADE KNIVES

The snap-off blade offers constant sharp edges, but is also strong and thick enough to apply heavy pressure without the blade breaking.



### 9MM SNAP-OFF BLADE KNIVES

The thinner 9mm Snap-off blade is ideal for thinner more delicate sheet materials and general craft work.





## SAW SELECTION CRITERIA

There are three criterion upon which a saw could be judged :

1. The **SHAPE** of the teeth

2. The **SET** of the teeth

3. The **SHARPNESS** of the teeth



### SHAPE & SIZE OF SAW TEETH



UNIVERSAL

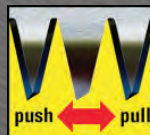

JET CUT

The **SHAPE** and **SIZE** of the teeth determines the Speed of the saw and the Smoothness of the cut.

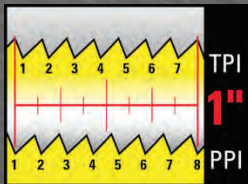

Low No. TPI :



fast cut, coarse finish

High No. TPI :



slower cut, smooth finish

\* This is always denoted as the number of Teeth Per Inch (T.P.I.) and Points Per Inch (P.P.I.)

### SET OF SAW TEETH

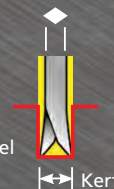

**Teeth SET in Patterns:**

Left, Right, Middle, Middle or Left x3, Middle, Right x3

Middle Teeth have no set and act as Rakers to clear out sawdust

### PERFORMANCE

STANLEY® cutting tools are the best in its class, having features that ensure durability and performance such as:

- Blade Armor
- Tri-Material handle
- Sharpness and cutting life
- Application Specific
- Comfort and Ergonomic Instant-Change Handle

STANLEY® knives and blades are designed to work together to be more efficient, faster, safer and durable. In other words, the only things our tools don't cut are corners.

## 3 CUTTING AND HOLDING TOOLS



10-780N

### FatMax® Fixed Blade Utility Knife

NEW

- Ergonomic design for ease of use
- Soft-touch panels/grips allow control, fewer slips
- Blade clamp eliminates blade wobble, gives control
- Pop-up blade dispenser for easy access and fast changeover
- Cartridge holds up to 5 blades
- Supplied with FatMax® blades
- Dual blade position in nose for versatility

SKU#	LENGTH		BOX /CTN
	mm	inches	
10-780N	160	6-1/4"	6/36



10-789

### FatMax® Xtreme™ Twin Blade Knife

NEW

- 2 knives in 1 - new twin blade design allows the user to alternate between 2 blades without carrying more than 1 knife
- InstantChange™ feature allows the user to replace dull blades in seconds
- Easy access blade storage holds up to 9 blades for fast and easy blade change
- Interlocking blade sliders so that only 1 blade is extended at a time
- Rubber comfort grip minimizes fatigue and reduces slippage
- Knife includes 2 straight and 2 hook blades
- Total blade storage capacity - 11 (9 storage + 2 in use)

SKU#	LENGTH		BOX /CTN
	mm	inches	
10-789	175	6-7/8"	6/24



10-099

### Classic 99 Retractable Utility Knife

- Interlocking nose to hold blade securely
- Three-position retractable blade
- Blade storage in handle
- Three blades included inside

SKU#	LENGTH		BOX /CTN
	mm	inches	
10-099	152	6"	6/36



10-777

**FatMax**

### FatMax® Retractable Utility Knife

- Adjustable thumb-dial locking wheel holds blade in place and prevents shifting
- Swivels open for quick blade change – no tools required
- Rear blade storage for seven blades
- Ergonomically designed rubber grip fits comfortably in hand
- Lightweight, durable body

SKU#	LENGTH		BOX /CTN
	mm	inches	
10-777	165	6.5"	6/36

## 3 CUTTING AND HOLDING TOOLS

### DynaGrip® Retractable Utility Knife



10-779

- Reduced heat/cold transfer
- Patented InterLock® nose secures blade
- Grip is non-slip, even with gloved hands, or on an angled surface
- Additional comfort in extreme temperatures
- 3 pcs blade in handle

SKU#	O / A LENGTH		BOX/CTN
	mm	inches	
10-779	144	5-5/8"	6/36

### Retractable Utility Knife



10-175

- Lightweight, economical utility knife
- Plastic & die cast zinc body shaped for comfort in use
- Multi-position blade slide
- 3 pcs Blade Storage handle

SKU#	O / A LENGTH		BOX/CTN
	mm	inches	
10-175	156	6-1/8"	6/36

### InterLock® Self-Retracting Utility Knife



10-189C

- Spring-loaded blade retracts automatically when pressure on slide button is released
- Patented interlocking nose secures blade safely between knife halves

SKU#	O / A LENGTH		BOX/CTN
	mm	inches	
10-189C	144	5-5/8"	6/36

### Plastic Retractable Knife



10-065

- Versatile plastic body knife
- Great for a variety of light-duty cutting and trimming jobs
- Unique patented snap closure allows quick blade changes
- No need for a screwdriver
- Five position retractable blade
- Stainless steel blade carrier
- Furnished with one 11-921 heavy-duty utility blade
- For light-duty use only

SKU#	COLOR #	HANDLE LENGTH	NUMBER OF BLADES	BOX/CTN
10-065	Yellow	152mm, 6"	1	6/36

1 MEASURING & LAYOUT TOOLS

2 LASER MEASURING SYSTEM

3 CUTTING & HOLDING TOOLS

4 FASTENING TOOLS

5 STRIKING & STRUCK TOOLS

6 ILLUMINATION TOOLS

7 PAINTING & FINISHING TOOLS

8 MECHANIC TOOLS

9 TOOLS STORAGE

10 POWER CLEANING TOOLS

11 POWER TOOLS

12 POWER TOOL ACCESSORIES

13 PRODUCT INDEX

39

### 3 CUTTING AND HOLDING TOOLS



#### Basic Snap-Off Knife

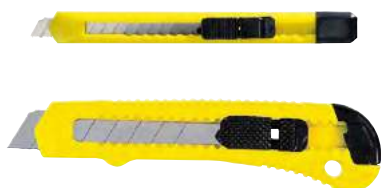

10-131 & 10-143

- Lightweight and economical snap-off blade knife
- Works with most light-weight applications
- Tips in use can be removed with the snapper at the end-cap of the knife
- Pocket clip included on the 9mm (10-131) Snap-Off Knife

SKU#	DESCRIPTION	BLADE WIDTH	O / A LENGTH		BOX/CTN
			mm	inches	
10-131	9mm snap-off knife	9mm	137	5-3/8"	6/864
10-143	18mm snap-off knife	18mm	152	6"	6/432

#### 18mm Standard Snap-Off Knife



10-280-0

- Made with stainless steel and high impact polymer components
- Smooth slider mechanism features an audible "click" and is self-locking for security
- Blade sections snap off to provide fresh, sharp cutting points
- Removable blade snapper included in cap of knife
- Hang hole for storage or lanyard
- High visibility spare blade holder designed for safety

SKU#	BLADE WIDTH		O / A LENGTH		BOX/CTN
	mm	mm	mm	inches	
10-280-0	18	172	172	6-3/4"	12/72

#### 18mm Snap-Off Cartridge Knife



10-380-0

- This 18mm Snap-Off Cartridge Knife has a 6-5/8" handle length
- Features a blade cartridge which rapidly and automatically slides new blade into position after old blade is removed
- Ergonomically designed for comfort and cutting power
- The smooth slider mechanism features an audible click-stop and is self locking for greater blade security
- Hang hole for storage or lanyard
- Blade capacity of six heavy-duty blades or five extra heavy-duty blades
- Supplied with three 11-301 heavy-duty blades (equals 24 points)

SKU#	BLADE WIDTH		O / A LENGTH		BOX/CTN
	mm	mm	mm	inches	
10-380-0	18	172	172	6-3/4" Handle 6-5/8"	6/36

## 3 CUTTING AND HOLDING TOOLS

### 18mm DynaGrip® Snap-Off Cartridge Knife



10-480

- Blade cartridge automatically slides new blade into position after old blade is removed
- Stainless steel blade dispenser cartridge resists rust
- Ergonomically designed for comfort and cutting power
- Smooth, slider mechanism features audible click stop and is self-locking
- Strong, durable tri-material construction with soft-grip panels
- Hang hole for storage or lanyard
- Blade capacity of six heavy-duty or five extra heavy-duty blades
- Comes with six 11-301 heavy-duty blades (equals 32 points)

SKU#	BLADE WIDTH		O / A LENGTH		BOX/CTN
	mm	mm	mm	inches	
10-480	18	Handle 172	6-3/4"		6/36

### Quick Point Knife



10-150-0

- Light-duty, retractable knife with Quick-Point™ snap-off blades
- Blade sections snap off providing fresh, sharp cutting points
- Removable blade snapper included in cap of knife
- Pocket clip included
- Comes with one blade (equals 13 points)

SKU#	BLADE WIDTH		O / A LENGTH		BOX/CTN
	mm	mm	mm	inches	
10-150-0	9	130	5-1/8"		6/72

### Quick Point Knife



10-151-0

- Light-duty, retractable knife with Quick-Point™ snap-off blades
- Blade sections snap off providing fresh, sharp cutting points
- Removable blade snapper included in cap of knife
- Comes with one blade (equals 8 points)

SKU#	BLADE WIDTH		O / A LENGTH		BOX/CTN
	mm	mm	mm	inches	
10-151-0	18	156	6-1/8"		6/72

## 3 CUTTING AND HOLDING TOOLS



10-409



10-418

### 9mm & 18mm Knives with DynaGrip®

- Metal and high impact polymer construction for durability
- Blade sections snap-off providing the user with fresh, sharp cutting points
- Removable blade snapper included in cap of knife
- High impact polymer body contains elastomer for great grip and comfort
- Rigid stainless steel barrel provides smooth action and corrosion resistance
- Metal blade slide for positive blade positioning
- Pocket clip included on 10-409 9mm DynaGrip® Snap Off knife
- Supplied with one Quick-Point™ blade

SKU#	BLADE WIDTH		O / A LENGTH		BOX/CTN
	mm	mm	mm	inches	
10-409	9	130	5-3/8"	12/72	
10-418	18	152	6-1/2"	6/36	

### 25mm Snap-Off-Knife with DynaGrip®



10-425

- Thumb dial blade release for easy blade change
- 25mm/1" snap-off blades to help resist snapping and adds durability
- 8 segments with 8 sharp tips
- Rubber DynaGrip® Panels for secure, comfortable grip
- Yellow ABS plastic body

SKU#	BLADE WIDTH		HANDLE LENGTH		BOX/CTN
	mm	mm	mm	inches	
10-425	25	180	7"	6/72	

### Sport Utility™ Knife



10-804

- Comes with holster, blades dispenser & 10 pcs spare blades "sport" blade
- Retractable utility blade at opposite end allows for convenience when cutting applications change
- Rubber panels provide a comfortable non-slip grip
- Patented interlocking nose prevents knife halves from spreading
- Furnished with one 11-921 heavy-duty utility blade

SKU#	HANDLE LENGTH		BOX/CTN
	mm	inches	
10-804	168	6-5/8"	2/6

## 3 CUTTING AND HOLDING TOOLS

### STANLEY® 12-in-1 Multi-Tool

NEW

- Stainless-steel construction
- High quality nylon holster
- Includes the following tools:

- \* Long nose pliers
- \* Curve jaw pliers
- \* Wire cutter
- \* Saw
- \* Phillips® screwdriver
- \* Standard screwdrivers (1/4", 5/16", 1/8")
- \* Small knife
- \* Large knife
- \* Bottle opener
- \* File



84-519K

SKU#	DESCRIPTION	BOX/CTN
84-519K	STANLEY® 12-in-1 Multi-tool	1/1

### Metal Mitey-Knife® Pocket Knife

- Rugged metal body
- Same silhouette as STANLEY® Interlock® knives
- Retractable blade with two cutting positions
- Two blades and handy keychain included



10-239

SKU#	DESCRIPTION	BOX/CTN
10-239	Metal Mitey-Knife® Pocket Knife	12/144

### Carbide Utility Blade

NEW

- Longest lasting blade on the job site
- Improved durability and wear. Lasts more than 5 times longer than competitive utility blades
- Tungsten Carbide durability and hardness is second only to diamond
- Steel body allows more flexibility to prevent breaking
- Meets contractors' needs and leads to greater productivity on the jobsite



11-800T

SKU#	DESCRIPTION	BLADE PACK	BOX/CTN
11-800T	Carbide Utility Blade	10 Per Card	1/1

### Classic 1992® Heavy-duty Utility Blade

- Heavy-duty blade, ideal for carpet and vinyl
- Replacement blade for 10-099, 10-175, 10-777, 10-779 & 10-804

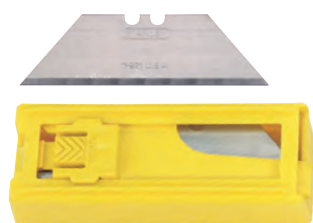

11-921T

SKU#	#OF BLADES	LENGTH mm	BLADE WIDTH mm	BLADE WIDTH inches	BLADE THICKNESS	BLADES PACK DETAILS	BOX/CTN
11-921H	100	62	19	3/4"	0.65mm	10 Dispensers of 10pcs	1/24
11-921T	10	62	19	3/4"	0.65mm	10 per Dispensers	12/72

## 3 CUTTING AND HOLDING TOOLS



11-983

### Large Hook Blade

- Sharpened hook with point for penetrating and cutting sheet material
- Replacement blade for 10-777, 10-779, 10-099, 10-175 & 10-804

SKU#	#OF BLADES	LENGTH mm	BLADE WIDTH		BLADE THICKNESS	BLADES PACK DETAILS	BOX/ CTN
			mm	inches			
11-983-0	5	50	19	3/4"	0.65mm	Card (5)	10/10
11-983-1	100	50	19	3/4"	0.65mm	Box of 100	1/20

BLADE SELECTION GUIDE		BLADE				BOX/ CTN
REPLACEMENT BLADE	SIZE	11-921H	11-921T	11-983-0	11-983-1	
10-099	3/4"	•	•	•	•	6/36
10-175	3/4"	•	•	•	•	6/36
10-777	3/4"	•	•	•	•	6/36
10-779	3/4"	•	•	•	•	6/36
10-804	3/4"	•	•	•	•	2/6



11-325-0

### Quick-Point™ Blade

- Replacement blade for STANLEY 1" or 25mm snap-off knife 11-425

SKU#	#OF BLADES	LENGTH mm	BLADE WIDTH		BLADE THICKNESS	BLADES PACK DETAILS	BOX/ CTN
			mm	inches			
11-325-0	10	110	25	1"	0.9 mm	10 pcs carded dispensers	10/100

### Quick-Point™ Blade

- Replacement blade for 10-380, 10-280, 10-418, 10-151 and other 18mm snap-off knives
- Blade with 8 cutting points



11-301T

SKU#	#OF BLADES	LENGTH mm	BLADE WIDTH		BLADE THICKNESS	BLADES PACK DETAILS	BOX/ CTN
			mm	inches			
11-301T	10	110	18	3/4"	0.55mm	10 pcs dispensers	24/288
11-301H	100	110	18	3/4"	0.55mm	100 blades in dispensers of 10 each	1/27
11-300T	10	110	9	3/8"	0.43mm	10 pcs dispensers	48/576
11-300H	100	110	9	3/8"	0.43mm	100 blades in dispensers of 10 each	48/96



## 3 CUTTING AND HOLDING TOOLS

### Carpet Knife Blade



11-525

- High carbon steel blade with double cutting edge
- Fits STANLEY® and most other carpet knives
- Five blades per card

SKU#	LENGTH #	PACKED	THICKNESS	BOX/CTN
11-525	2-1/4",57.15mm	5/Card	.015"	10/100

BLADE SELECTION GUIDE		BLADE				BOX/CTN
REPLACEMENT BLADE	SIZE	11-301T	11-301H	11-325-0	11-325-1	
10-151-0	3/4"	•	•			6/72
10-280-0	3/4"	•	•			12/72
10-380-0	3/4"	•	•			6/36
10-418	3/4"	•	•			6/36
11-425	3/4"			•	•	6/72

### Wood Handle Saw



20-502

- Machine set and sharpened teeth for accurate cutting
- High carbon steel blade hardened and tempered for sharpness and durability
- Comes with full length sleeve

SKU#	CONTENTS	TOOTH PATTERN	BOX/CTN
20-502	18"	Crosscut / 7TPI	12/24
20-503	20"	Crosscut / 7TPI	12/48
20-504	22"	Crosscut / 7TPI	12/24
20-505	24"	Crosscut / 7TPI	12/24

### Plastic Handle Saw



20-080

- Handle offers a square/mitre feature with 45° and 90° angles
- Contoured sturdy handle designed for comfort and control
- Full length protective sleeve

SKU#	BLADE LENGTH	TOOTH PATTERN	BOX/CTN
20-080	18"	Crosscut / 6TPI	12/48
20-081	20"	Crosscut / 6TPI	12/48
20-082	22"	Crosscut / 6TPI	12/24
20-083	24"	Crosscut / 6TPI	12/24
20-004	18"	Crosscut / 7TPI	12/48
20-005	20"	Crosscut / 7TPI	12/48
20-006	22"	Crosscut / 7TPI	12/24
20-007	24"	Crosscut / 7TPI	12/24
20-026	26"	Crosscut / 7TPI	12/24

## 3 CUTTING AND HOLDING TOOLS



20-600

### Clamping Mitre Box with Saw

- One piece injection moulded mitre box for strength and durability
- Holds material securely for accurate cuts
- Material secures to the base with a twist of the cam pins
- Cuts miters on 45° and 90° angles, face angle 45° and 22-1/2° angles
- Molded-in storage compartments hold cam pins and pencil
- Molded lip on base edge for easy use without mounting
- Complete with fine tooth built-in backsaw to prevent cutting into mitre box
- Holes in base for fastening to workbench with patented cam lock clamping system which holds work piece securely in place.

SKU#	DIMENSIONS IN MM			BOX/CTN
	Length	Max. Height	Max Width	
20-600	300	80	130	6/6



15-509

### Thrifty® Backsaw

- Hardened and tempered steel for durability with contoured, molded handle for comfort

SKU#	BLADE LENGTH		TOOTH PATTERN	BOX/CTN
	mm	inches		
15-509	305	14"	12TPI	6/36



20-073

### Hard Teeth Hand Saw

- Induction hardened teeth stay sharp up to 5 times longer than standard teeth
- Ergonomically designed handle for better grip and improved comfort

SKU#	BLADE LENGTH		TOOTH PATTERN	BOX/CTN
	mm	inches		
20-073	457	18"	Triple Teeth / 7TPI	4/24
20-074	508	20"	Triple Teeth / 7TPI	4/24



20-221

### Mini Utility SharpTooth™ Saw

- 12- point induction hardened teeth stay sharp 3 to 5 times longer than standard teeth
- Aggressive 3-sided tooth design cuts wood 50% faster than conventional handsaws
- 10" blade is ideal for access in tight spaces and cutting a variety of materials such as plastic, particle board and wood
- Hardwood handle is contoured to fit the hand comfortably
- Compact 1 5-1/2" overall length fits conveniently in most toolboxes

SKU#	BLADE LENGTH		TOOTH PATTERN	BOX/CTN
	mm	inches		
20-221	254	10"	11 TPI	6/6

## 3 CUTTING AND HOLDING TOOLS



15-104A

### 4-3/4" Depth FatMax® Coping Saw

- Hardened, tempered blade provides clean, controlled cutting action
- Ergonomically designed cushion grip handle for comfort

SKU#	BLADE LENGTH	FRAME DEPTH	TOOTH PATTERN	BOX/CTN
15-104A	6-3/8"	4-3/4"	15 TPI	6/6



15-106A

### 6-3/4" Depth FatMax® Coping Saw

- Hardened, tempered blade provides clean, controlled cutting action
- Ergonomically designed cushion grip handle for comfort

SKU#	BLADE LENGTH	FRAME DEPTH	TOOTH PATTERN	BOX/CTN
15-106A	6-3/8"	6-3/4"	15 TPI	6/6

### Coping Saw Blade

- State-of-the-art manufacturing processes produce strong, yet flexible blades that simply last longer
- Extra narrow blade for sharp surrounding cuts



15-061

SKU#	SIZE	TOOTH PATTERN	BOX/CTN
15-059	6-1/2"	20 TPI	10/50
15-061	6-1/2"	15 TPI	10/50



20-036

### High-Tension Hacksaw and Metal Mini-Hack™ Utility Saw

NEW

- Pack includes 2 hacksaws – ideal for cutting metal & plastic.
- Rugged Design for heavy-duty use.
- Quick Release blade changing mechanism maintains tension setting.
- Mni-Hack is lightweight, comfortable & durable.
- Mini-Hack's handle covers blade to help cover user's hand.

SKU#	DEPTH OF THROAT	HACKSAW	MINI-HACK	BOX/CTN
20-036	102mm (4")	305mm (12")	254mm (10")	8/8

1 MEASURING & LAYOUT TOOLS

2 LASER MEASURING SYSTEM

3 CUTTING & HOLDING TOOLS

4 FASTENING TOOLS

5 STRIKING & STRUCK TOOLS

6 ILLUMINATION TOOLS

7 PAINTING & FINISHING TOOLS

8 MECHANIC TOOLS

9 TOOLS STORAGE

10 POWER CLEANING TOOLS

11 POWER TOOLS

12 POWER TOOL ACCESSORIES

13 PRODUCT INDEX

## 3 CUTTING AND HOLDING TOOLS



### SharpTooth™ Nest-Of-Saw

- 3 versatile interchangeable blades in a comfortable moulded handle
- Perfect for curves, circles and trim work
- Includes a fast-cutting 12" ShortCut® finishing made suitable for cutting moulding, PVC pipe and wood



15-090

SKU#	DESCRIPTION	BOX/CTN
15-090	3 Blades - consist of:	6/6
15-091	12" ShortCut® wood cutting blade	-
15-092	10" Compass Saw blade	-
15-093	6" Metal cutting blade	-

### Multi-Purpose 3-in-1 Saw

- Ergonomically designed handle made with glass-filled, high strength nylon to support six different blade positions
- Diamond pattern and rubber over moulding on the handle allows end users to use the saw with reduced slip grip
- No tools required for blade change
- Integrated blade storage. The turn knob allows the user to conveniently store all 3 blades on the handle when not in use
- Multiple position handle allows access to tight corners
- 10" Universal blade cuts on the pull stroke and is less likely to jam or bend
- 10" Universal blade cuts through tree limbs, 2x4's and plastic pipes
- 8" Compass saw blade carves patterns and shapes out of wood
- 6" Metal cutting blade cuts through metal pipes and metal rods



20-092

SKU#	BLADE LENGTH	# OF BLADES	BOX/CTN
	inches		
20-092	6", 8" & 10"	3	2/8

### Folding Pocket Saw

- Folds like a jack knife for safe & easy storage
- Versatile for all cutting jobs
- Blade storage in handle



15-333

SKU#	CONTENTS	BLADE LENGTH		TOOTH PATTERN	BOX/CTN
		mm	inches		
15-333	Folding Pocket 8"/203mm	203	8"	11TPI	6/6
15-005	Replacement Blade	203	8"	11TPI	12/120

## 3 CUTTING AND HOLDING TOOLS

### 4-Way™ Keyhole Saw

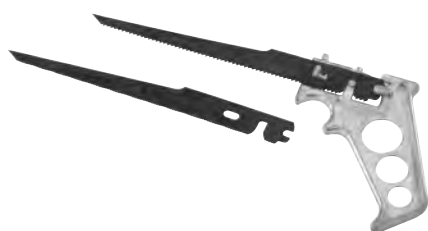

15-275

- 4-Way™ blade positioning cuts curves circles and frets into places where an ordinary hacksaw cannot reach
- Cuts wood, nails, metal latch, composition board, BX cable, conduit, etc
- Lightweight, pistol grip handle fits hand
- Complete with one wood cutting blade and one metal cutting blade

SKU#	BLADE LENGTH inches	# OF BLADES	BOX/CTN
15-275	1 pcs of Wood & 1 pcs of Metal cutting blade	2	6/6

### Junior Hacksaw



15-218-0

- Quick release hacksaw features a lever moulded into grip handle for easy blade change
- Deep throat for good work capacity
- 1 blade free

SKU#	OVERALL LENGTH		BLADE LENGTH		BOX/CTN
	mm	inches	mm	inches	
15-218-0	254	10"	150	6	10/60

### 10" Blade Length x 15 Points Per Inch Dovetail Saw



15-022

- This Dovetail Saw has a hardwood handle
- Cuts a true, smooth and narrow kerf
- Comfortably designed hardwood handle provides positive grip
- Fine cutting
- Comes with plastic blade guard for protection
- Blade Length 10", 254mm
- Points per inch 15

SKU#	LENGTH		BLADE SIZE		BOX/CTN
	mm	inches	mm	inches	
15-022	254	10"	254	10"	2/2

### Steel Frame Hacksaw



15-166

- Positive locking mechanism
- Two blade position 90°/55°
- Aluminium handle - 12" blades

SKU#	LENGTH		BLADE SIZE		BOX/CTN
	mm	inches	mm	inches	
15-166	450	17-3/4"	305	12"	6/36

1 MEASURING & LAYOUT TOOLS

2 LASER MEASURING SYSTEM

3 CUTTING & HOLDING TOOLS

4 FASTENING TOOLS

5 STRIKING & STRUCK TOOLS

6 ILLUMINATION TOOLS

7 PAINTING & FINISHING TOOLS

8 MECHANIC TOOLS

9 TOOLS STORAGE

10 POWER CLEANING TOOLS

11 POWER TOOLS

12 POWER TOOL ACCESSORIES

13 PRODUCT INDEX

49

### 3 CUTTING AND HOLDING TOOLS



#### Tubular Frame Hacksaw



15-408

- Heavy gauge tubular steel frame nickel-plated will not tarnish or rust provides handy holding compartment for extra blades
- Easy adjustment of frame for 10" (255 mm) and 12" (305 mm) blade
- Blade can be faced in four directions
- Rugged cast handle with guard designed to protect knuckles
- Furnished with 10" (255 mm) standard carbon steel blade

SKU#	DEPTH OF THROAT		BLADE LENGTH		BOX/CTN
	mm	inches	mm	inches	
15-408	98	3-7/8"	255 & 305	10" & 12"	2/12

#### 12" High Tension Hacksaw



15-113

- Rugged design for heavy-duty use
- Fully adjustable tension holds blade up to 32,000 psi – delivers fast, accurate cuts and long blade life
- Blade storage is integrated into frame
- Quick-release, blade-changing mechanism in handle maintains tension setting
- Blade can be positioned at 45° or 90° cutting angle
- Blade Length 12" / 305mm
- Throat Depth 3-7/8" / 98mm

NEW

SKU#	LENGTH		BLADE SIZE		BOX/CTN
	mm	inches	mm	inches	
15-113	98	3-7/8"	305	12"	2/12

#### 10" v 12" Adjustable Blade Rubber Grip Hacksaw



15-265

- Easy adjustment of frame for 10" and 12" blades
- Rigid steel frame with molded cushion grip
- D-shape guard helps protect hands and knuckles
- Blade Length 10" / 254mm or 12"/305mm
- Throat Depth 3-7/8" / 98mm

SKU#	LENGTH		BLADE SIZE		BOX/CTN
	mm	inches	mm	inches	
15-265	98	3-7/8"	305	12"	6/6

#### 10" Rod Saw - Carbide Grit Hacksaw Blade



15-410

- Tungsten carbide particles enable blade to cut on both forward and reverse strokes
- Makes thin straight cuts in ceramic, hardened steel, cast iron and masonry
- Fits standard hacksaw frame
- Blade Length 10" / 254mm

SKU#	LENGTH		BLADE SIZE		BOX/CTN
	mm	inches	mm	inches	
15-410	-	-	254	10"	100/100

## 3 CUTTING AND HOLDING TOOLS

### 10" v 12" Adjustable Blade Hacksaw



15-565

- Rugged plated steel frame
- Fits 10" and 12" blades
- Comfort pistol-grip handle
- Blade Length 10"/254mm or 12"/305mm
- Throat Depth 2-3/4" / 70mm

SKU#	LENGTH		BLADE SIZE		BOX/CTN
	mm	inches	mm	inches	
15-565	70	2-3/4"	254/300	10"/12"	6/6

### 12" Composite Hacksaw



15-892-2

- Patented design with I-beam frame construction
- 12" fixed blade frame is made of high-impact polymer with a steel core
- Sloped nose for access into hard-to-reach places
- Easy-open lever for quick blade change
- High-tension blade for straight accurate cuts
- Ergonomically designed, slip-resistant grip
- Blade Length 12"/305mm
- Throat Depth 4"/100mm

SKU#	LENGTH		BLADE SIZE		BOX/CTN
	mm	inches	mm	inches	
15-892-2	100	4"	100	4"	6/6

### Mini-Hack™ Saw



20-807

- Ergonomically designed grip with thumb rest for maximum comfort
- 35mm cutting capacity
- Back blade stop for safe handling and use

SKU#	DEPTH OF THROAT		BLADE LENGTH		BOX/CTN
	mm	inches	mm	inches	
20-807	220	8-3/4"	254	10"	6/36

### High Speed Steel Hacksaw Blade



15-988

- Teeth are precision milled and set
- Entire blade hardened to 65RC
- Cuts mild steel, cast iron, aluminium, copper
- Packed 100 per box

SKU#	O / A LENGTH		WIDTH/TEETH	BOX/CTN
	mm	inches	mm	
15-988	305	12"	1/2" x 0.025", 18T	1/10
15-984	305	12"	1/2" x 0.025", 24T	1/10

1 MEASURING & LAYOUT TOOLS

2 LASER MEASURING SYSTEM

3 CUTTING & HOLDING TOOLS

4 FASTENING TOOLS

5 STRIKING & STRUCK TOOLS

6 ILLUMINATION TOOLS

7 PAINTING & FINISHING TOOLS

8 MECHANIC TOOLS

9 TOOLS STORAGE

10 POWER CLEANING TOOLS

11 POWER TOOLS

12 POWER TOOL ACCESSORIES

13 PRODUCT INDEX

51

### 3 CUTTING AND HOLDING TOOLS

#### Bi-Metal HSS Hacksaw Blade



20-175

- Quality high speed steel bi-metal blades
- Cuts mild steel, cast iron, Aluminum, copper ranging from 1/8" to 1" in thickness
- Packed 100 per box

SKU#	O / A LENGTH		WIDTH/TEETH	BOX/CTN
	mm	inches	mm	
20-175	305	12"	1/2" x 0.025" x 18T	5/10
20-176	305	12"	1/2" x 0.025" x 24T	5/10
20-177	305	12"	1/2" x 0.025" x 32T	5/10

#### Hacksaw Blade



15-928A

- High carbon steel blades cut mild steel, cast-iron, aluminum, copper
- Good value for general use
- Blade Length 12" / 305mm
- Packed 2/Card
- Points per Inch 19
- Teeth per inch 18

SKU#	LENGTH		WIDTH / TEETH	BOX/CTN
	mm	inches	mm	
15-928A	305	12"	1/2" x 0.025" x 18T	10/100

#### Glass Cutter



14-125

- Die cast handle has a wide contoured comfort grip and ball end for tapping
- Steel wheel with general purpose cutting angle delivers precise scoring clean breakout, and smooth edges
- 3 Break-off notches for various depths
- Honed Cutting wheel
- Cuts glass up to 3 ram

SKU#	O / A LENGTH		BOX/CTN
	mm	inches	
14-125	130	5-1/8"	24/288



## 3 CUTTING AND HOLDING TOOLS

### Precision Pliers

- 2 times longer cutting life 25% less cutting effort
- Cutting edge are precision ground & pre-finished before assembly for consistent performance
- Full collar, anti-slip ergonomic handle for comfort & superior gripping
- Machined teeth for maximum gripping in tight spaces
- Made of strong chrome vanadium material for longer lasting cutting
- Maximum anti-rust capability

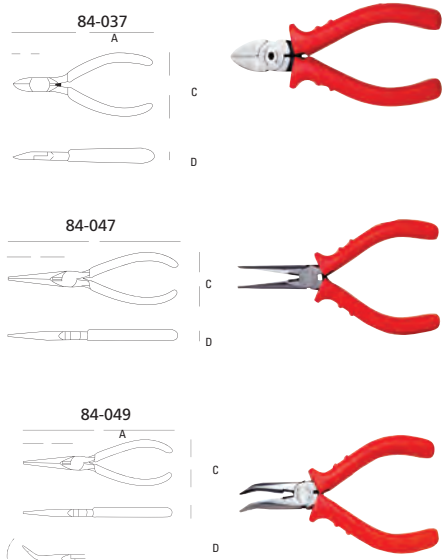

SKU#	DESCRIPTION	A (mm)	B (mm)	C (mm)	D (mm)	BOX/CTN
84-036	100mm/4" Precision Nipper Cutter	115	23.8	48	8	6/36
84-037	125mm/5" Precision Nipper Cutter	125	26.5	48.5	9	6/36
84-038	150mm/6" Precision Nipper Cutter	153	29.5	50	10	6/36

SKU#	DESCRIPTION	A (mm)	B (mm)	C (mm)	D (mm)	BOX/CTN
84-047	125mm/5" Precision Long Cutter	134.5	47	49.6	12	6/36
84-048	150mm/6" Precision Long Cutter	163.6	58	51.6	12	6/36

SKU#	DESCRIPTION	A (mm)	B (mm)	C (mm)	D (mm)	E (°)	BOX/CTN
84-049	125mm/5" Bent Nose	130.8	43.3	49.6	12	45°	6/36
84-054	150mm/6" Bent Nose	158.6	53	51.6	12	45°	6/36

1 MEASURING & LAYOUT TOOLS

2 LASER MEASURING SYSTEM

3 CUTTING & HOLDING TOOLS

4 FASTENING TOOLS

5 STRIKING & STRUCK TOOLS

6 ILLUMINATION TOOLS

7 PAINTING & FINISHING TOOLS

8 MECHANIC TOOLS

9 TOOLS STORAGE

10 POWER CLEANING TOOLS

11 POWER TOOLS

12 POWER TOOL ACCESSORIES

13 PRODUCT INDEX

### 3 CUTTING AND HOLDING TOOLS

#### FatMax® VDE Pliers

- Safe live line working to 1,000v
- Individually tested to 10,000v
- Compliant to EN60900, IEC/CEI900, VDE688
- Bi-material handle with secure grip grooving for comfort
- Heat treated high chrome steel forging for long life and durability
- Hand ground, induction hardened blade for long life and accuracy
- Finger guard for better control & added user safety
- Interlocking joint assembly for smooth cutting
- DIN/ ASO/ ANSI Compliant



84-001



84-004



84-007



84-008

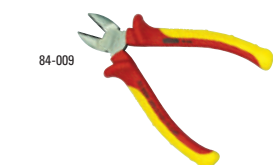

84-009



84-011



84-294

SKU#	LENGTH DESCRIPTION	BOX/CTN
84-000	160mm/6" Combination (2101NV)	4/24
84-001	180mm/7" Combination (2201NV)	4/24
84-002	200mm/8" Combination (2301NV)	4/24

SKU#	LENGTH DESCRIPTION	BOX/CTN
84-003	180mm/7" Diagonal Pliers (2031NV)	4/24
84-004	200mm/8" Diagonal Pliers (2032NV)	4/24
84-005	210mm/9" Diagonal Pliers (2033NV)	4/24

SKU#	LENGTH DESCRIPTION	BOX/CTN
84-006	180mm/7" Long Nose Pliers (2021NV)	4/24
84-007	200mm/8" Long Nose Pliers (2023NV)	4/24

SKU#	LENGTH DESCRIPTION	BOX/CTN
84-008	200mm/8" Bent Nose Pliers (2023NBV)	4/24

SKU#	LENGTH DESCRIPTION	BOX/CTN
84-009	160mm/6-1/4" Narrow Head Diagonal Pliers	4/24

SKU#	LENGTH DESCRIPTION	BOX/CTN
84-011	3pcs Pliers Sets (84-001, 84-003 & 84-007)	4/4

SKU#	LENGTH DESCRIPTION	BOX/CTN
84-294	250mm/10" Water Pump Pliers (AA-01V)	4/24

# 3 CUTTING AND HOLDING TOOLS

## DYNAGRIP PLIERS

### Linesman Pliers



84-029-2

- Gripping combined with cutting, known as side cutting pliers.
- Made popular by electricians
- Used for cutting as well as bending and twisting wire and as fish tape puller

SKU#	DESCRIPTION	LENGTH inches	BOX/CTN
84-623-2	6" HD combination plier - carbon steel, polished	6"	6/36
84-035-2	7" Linesman plier - carbon steel, polished	7"	6/36
84-029-2	8" Linesman plier - carbon steel, polished	8"	6/36
84-609-2	9" Linesman plier - carbon steel, polished	9"	6/36

### Diagonal Pliers



84-027-2



84-028-2

- The cutting jaws are at an angle to the handles, allowing the user to cut close to a surface with the hand clear of obstructions. Also used for wire stripping

SKU#	DESCRIPTION	LENGTH inches	BOX/CTN
84-027-2	6" Diagonal cutting plier - carbon steel, polished	6"	6/36
84-028-2	7.5" HD diagonal plier - carbon steel, polished	7.5"	6/36
84-607-2	8" Diagonal plier - carbon steel, polished	8"	6/36

### Groove Joint Pliers



84-034-2

84-024-2

84-021-2

- Originally designed for work on plumbing fittings, with serrated curved jaws to grip round objects

SKU#	DESCRIPTION	LENGTH inches	BOX/CTN
84-034-2	8" Groove joint plier - carbon steel, polished	8"	6/36
84-024-2	10" Groove joint plier - carbon steel, polished	10"	6/36
84-021-2	12" Groove joint plier - carbon steel, polished	12"	6/36

1 MEASURING & LAYOUT TOOLS

2 LASER MEASURING SYSTEM

3 CUTTING & HOLDING TOOLS

4 FASTENING TOOLS

5 STRIKING & SHOCK TOOLS

6 ILLUMINATION TOOLS

7 PAINTING & FINISHING TOOLS

8 MECHANICAL TOOLS

9 TOOLS STORAGE

10 POWER CLEANING TOOLS

11 POWER TOOLS

12 POWER TOOL ACCESSORIES

13 PRODUCT INDEX

## 3 CUTTING AND HOLDING TOOLS



84-077-2

### End Cutter Plier

- Used for cutting wire, cutting edge is at 90° to the handle, to allow close cropping of wire and is commonly used for tile cutting

SKU#	DESCRIPTION	LENGTH inches	BOX/CTN
84-077-2	6" End nipper plier - carbon steel, polished	6"	6/36
84-167-2	8" End nipper plier - carbon steel, polished	8"	6/36



84-075-2

### Wire Strippers

- Carbon Steel hardened cutting edges and jaws
- Heavy-duty steel riveted joints
- Dyna grip handles for maximum comfort
- Hard chrome finish with anti-corrosion surface

SKU#	DESCRIPTION	LENGTH inches	BOX/CTN
84-075-2	6" Wire stripper - carbon steel, polished	6"	6/36



84-071-2

### Bent Nose Pliers

- The angled nose is capable of gripping and manouvering objects in obstructed situations

SKU#	DESCRIPTION	LENGTH inches	BOX/CTN
84-071-2	6" Bent nose plier - carbon steel, polished	6"	6/36
84-072-2	8" Bent nose plier - carbon steel, polished	8"	6/36



84-031-2

### Long Nose Pliers

- Smooth tapering jaws are capable of gripping and manouvering wire in confined areas. Also used to bend, loop and cut wire

SKU#	DESCRIPTION	LENGTH inches	BOX/CTN
84-031-2	6" Long nose plier - carbon steel, polished	6"	6/36
84-032-2	8" Pliers HD long nose - carbon steel, polished	8"	6/36

## 3 CUTTING AND HOLDING TOOLS

### Slip Joint Pliers



84-055-2

- Provide reliable and sturdy grasping and prying ability
- Forged, chrome carbon steel construction meets or exceeds ANSI standards
- Rust-resistant finish, hardened edges for strength, and machined jaws for slip-resistant grip
- Double-dipped handles provide comfortable use

SKU#	DESCRIPTION	LENGTH inches	BOX/CTN
84-055-2	6" Slip joint plier - carbon steel, chrome plated	6"	6/36
84-026-2	8" Slip joint plier - carbon steel, chrome plated	8"	6/36



84-073 -2

### Flat Nose Pliers

- With serrated, tapering jaws allowing manoeuvrability of small flat objects

SKU#	DESCRIPTION	LENGTH inches	BOX/CTN
84-073 -2	6" Flat nose plier - carbon steel, polished	6"	6/36



84-074-2

### Round Nose Pliers

- Smooth tapering jaws are capable of gripping and manoeuvring wire in confined areas

SKU#	DESCRIPTION	LENGTH inches	BOX/CTN
84-074-2	6" Round nose plier - carbon steel, polished	6"	6/36



84-096



84-125

### Miniature Pliers

- Small sized for precision work
- Chrome nickel for durability
- Double dip handles for comfort

SKU#	DESCRIPTION	LENGTH		BOX/CTN
		mm	inches	
84-119	Long Nose Pliers	127	5"	6/36
84-124	Diagonal Cutting Pliers	102	4"	6/36
84-096	Needle Nose Pliers	127	5"	6/36

SKU#	DESCRIPTION	LENGTH		BOX/CTN
		mm	inches	
84-125	End Nipper Pliers	102	4"	6/36
84-126	Bent Nose Pliers	127	5"	6/36
84-122	Flat Nose Pliers	102	4"	6/36

1 MEASURING & LAYOUT TOOLS

2 LASER MEASURING SYSTEM

3 CUTTING & HOLDING TOOLS

4 FASTENING TOOLS

5 STRIKING & STRUCK TOOLS

6 ILLUMINATION TOOLS

7 PAINTING & FINISHING TOOLS

8 MECHANIC TOOLS

9 TOOLS STORAGE

10 POWER CLEANING TOOLS

11 POWER TOOLS

12 POWER TOOL ACCESSORIES

13 PRODUCT INDEX

### 3 CUTTING AND HOLDING TOOLS

#### MaxSteel™ Aviation Snips



14-562



14-563



14-564

- Excellent for cutting aluminium, vinyl siding, screening, cardboard, leather & copper
- Exceeds ANSI standards for cutting performance and durability
- Double overwind spring for longer life
- High leverage, compound cutting design cuts up to 18-Gauge steel
- Patented hinge plate for easy product function identification

SKU#	LENGTH		CUT TYPE	CUTTING LENGTH	COPPER (SOFT)	CUTTING CAPACITY (mm)				BOX/CTN
	mm	inches				COLD-ROLLED STEEL (MILD)	HARD STEEL HRC30 (HARD)	HARD STEEL HRC40 (HARD)	STAIN-LESS STEEL 304	
14-562	254	10"	Left Curve	35	1.50	1.20	1.00	0.60	0.90	6/24
14-563	254	10"	Straight Cut	35	1.50	1.20	1.00	0.60	0.90	6/24
14-564	254	10"	Right Curve	35	1.50	1.20	1.00	0.60	0.90	6/24

#### MaxSteel™ All Purpose Snips (Straight Pattern)



14-556

- Exceeds ANSI Standards for cutting performance & durability
- Tough alloy steel blade
- Comfortable vinyl grips
- Cuts up to 0.78mm of cold rolled steel and 0.46mm of stainless steel

SKU#	O / A LENGTH		CUTTING CAPACITIES (MM)			BOX/CTN
	mm	inches	COPPER (SOFT)	COLD-ROLLED STEEL (MILD)	HARD STEEL HRC30 (HARD)	
14-569	178	7"	0.94	0.56	0.38	6/24
14-556	254	10"	0.94	0.78	0.6	6/24
14-558	305	12"	1.15	0.91	0.7	6/24

#### Tinsnips



14-164

- Drop-forged carbon steel material, hardened, tempered, grown, glazed & tested to last

SKU#	CUTTING CAPACITY		SIZE	BOX/CTN
	Cold-rolled Steel	Stainless Steel		
14-163	0.61	0.41	8"	6/36
14-164	0.78	0.45	10"	6/36
14-165	0.91	0.63	12"	6/24
14-166	1.20	0.70	14"	6/24

## 3 CUTTING AND HOLDING TOOLS

### Bolt Cutter



14-308



14-312

- A range of bolt cutters in most popular sizes
- Cutter blades are of chrome molybdenum tempered steel with cutting jaws tempered HRC 60° (FBS std)
- Special heat treatment give blades extra hardness and durability

SKU#	LENGTH		MAX CUTTING LOAD (kg)	BOX/CTN
	mm	inches		
14-308	203	8"	36	6/48
14-312	305	12"	46	6/24
14-314	355	14"	54	6/24
14-318	457	18"	65	6/12
14-324	609	24"	61	2/6
14-330	762	30"	84	1/4
14-336	914	36"	104	1/4

### Pruning Shears



14-302

- Blades of precision steel
- Cuts up to 18mm / 3/4" thickness
- Padded handle for comfort and reduced hand fatigue
- Safety lock feature

SKU#	O / A LENGTH		TYPE	BOX/CTN
	mm	inches		
14-302	200	8"	Bypass	10/60
14-303	200	8"	Anvil	10/60

### STANLEY® Hedge Shear



74-390

- Lower blade middle carbon steel
- Aluminium handles with soft grip
- Tension adjustment
- Length 60 cm

SKU#	CONTENTS	BOX/CTN
74-390	Hedge Shear	6/12

### STANLEY® Accuscape 6" Folding Pruner



74-906

- Ideal for cutting sheetrock tree limbs and firewood plumbing pipe and cutting screw heads off.
- Comfort grip. Folding saw.
- Aggressive teeth cut 50% faster.
- Push button positive lock and unlock.
- Easy and accurate cutting.
- Versatile for all cutting jobs.

SKU#	CONTENTS	BOX/CTN
74-906	6" Folding Pruner	6/48

### 3 CUTTING AND HOLDING TOOLS

#### Locking Pliers



- Serrated jaws made of chrome molybdenum material
- Heat-treated adjustable screw
- Long straight nose provides easy access in narrow, hard to reach places
- Ideal for precision work
- Curved jaws puts tremendous pressure on 4 points at any style or bolt head
- Straight jaws provides maximum contact on flat, square & hex work - ideal for welding & other metal work

SKU#	CONTENTS	LENGTH		BOX/CTN
		mm	inches	
84-367-1	Curved Jaw	127	5"	6/48
84-368-1	Curved Jaw	175	7"	6/36
84-370-1	Straight Jaw	175	7"	6/36
84-396	Long Nose	165	6.5"	6/48

#### Combination Snap Ring Pliers



84-168

- Internal- External positioning 45°- 90°-180°
- 10-50mm range

SKU#	LENGTH		BOX/CTN
	mm	inches	
84-168	152	6"	20/60

#### Locking Pliers with Bi-Material Handle



- Bi-material handle for anti-slip & comfort
- Serrated jaws made of chrome molybdenum material
- Heat treated adjustable screw
- Long straight nose provides easy access in narrow, hard to reach places
- Ideal for precision work
- Curved jaws puts tremendous pressure on four points at any style or bolt head
- Straight jaws provides maximum contact on flat, square & hex work - ideal for welding & other metal work

SKU#	CONTENTS	LENGTH		BOX/CTN
		mm	inches	
84-369-1	Curved Jaw	254	10"	6/36
84-371-1	Straight Jaw	254	10"	6/36
84-389	Long Nose	229	9.5"	6/36



## 3 CUTTING AND HOLDING TOOLS

### Circlip Pliers



84-272

- Tempered alloy steel for strength and durability
- Rust resistant protective finish

SKU#	CONTENTS	BLADE LENGTH		BOX/CTN
		mm	inches	
84-271	Straight ext.	175	7"	12/120
84-273	Straight int.	175	7"	12/120
84-272	Bent ext.	175	7"	12/120
84-274	Bent int.	175	7"	12/120

### Crimping Pliers



84-223

- Cuts electrical wires, strips insulation, shears screws and bolts clean (Warning: Grips do not protect against electrical shock.)

SKU#	O / A LENGTH		BOX/CTN
	mm	inches	
84-223 (Plier)	230	9"	10/100
84-253 (Set)	230	9"	6/36

### Wire Stripper/Crimper AWG Standard



84-475

- Cuts electrical wires, strips insulation, shears screws and bolts clean (Warning: Grips do not protect against electrical shock.)
- Professional peeled, cut line ideal tool.
- can be used in the pressure line and a curved line.
- Laser etched scale - easy to see
- AWG (American Wire Gauge) is a distinction between the standard of the diameter of the wire; the larger the value, the smaller the diameter of the wire.

SKU#	Diameter (US Regulations)	O / A LENGTH			BOX/CTN
		Specifications (")	Length (mm)	Diameter (mm)	
84-475	AWG12-22	6	168	2.6 --- 0.6	10/100
84-477	AWG16-26	6	168	1.6 --- 0.5	10/100
84-325	AWG20-30	6	168	0.8 --- 0.25	10/100

### Wire Stripper



84-214

- Convenient hole for looping or bending wire
- Ideal for cutting, stripping speaker wire & appliance cords
- Slide adjust for various gauge wire

SKU#	O / A LENGTH		BOX/CTN
	mm	inches	
84-214	130	5-1/4"	15/150

1 MEASURING & LAYOUT TOOLS

2 LASER MEASURING SYSTEM

3 CUTTING & HOLDING TOOLS

4 FASTENING TOOLS

5 STRIKING & STRUCK TOOLS

6 ILLUMINATION TOOLS

7 PAINTING & FINISHING TOOLS

8 MECHANIC TOOLS

9 TOOLS STORAGE

10 POWER CLEANING TOOLS

11 POWER TOOLS

12 POWER TOOL ACCESSORIES

13 PRODUCT INDEX

## 3 CUTTING AND HOLDING TOOLS



### Water Pump Pliers



84-015

- Slim water pump pliers
- For use on pipes and nuts

SKU#	O / A LENGTH		BOX/CTN
	mm	inches	
84-015	254	10"	12/72

### Tower Pincer



84-288

- Forged from high alloy steel with precision broached jaws & cutting edge

SKU#	DESCRIPTION	BOX/CTN
84-281	200mm Tower Pincer	6/36
84-282	250mm Tower Pincer	6/36
84-288	200mm HD Pincer	6/36

### MaxSteel® Adjustable Wrench



90-948

- Bi-material cushion grip for comfort
- Use for plumbing, automotive or home use
- Precision machined face with etched measurement scale in English and Metric
- Strong chrome vanadium steel exceed ANSI specifications
- Slip-resistant bi-material cushion grip
- Rust-resistant phosphate coating
- Handy hang/storage hole in handle

SKU#	LENGTH		BOX/CTN
	mm	inches	
90-947	153	6"	2/12
90-948	203	8"	2/12
90-949	250	10"	2/12
90-950	305	12"	2/12

### Adjustable Wrench



87-433-1

- Jaws fully hardened and tempered
- 25% more torque
- For holding on fastening nuts and bolts
- Rust resistant finish

SKU#	LENGTH		BOX/CTN
	mm	inches	
87-430-1	100	4"	6/120
87-431-1	150	6"	6/120
87-432-1	200	8"	6/60
87-433-1	250	10"	6/60
87-434-1	300	12"	6/24
87-435-1	375	15"	4/24
87-371-1	457	18"	2/12

## 3 CUTTING AND HOLDING TOOLS

### Adjustable Wrench



87-796

- Comfortable & anti-slip grip
- For holding on fastening nuts and bolts
- Jaws fully hardened and tempered
- 25% more torque
- Rust resistant finish

SKU#	LENGTH		BOX/CTN
	mm	inches	
87-796	460	18"	1/12
87-797	609	24"	1/6

### Pipe Wrench



87-626

- Two-way toothing and spring loaded jaw provide positive grip
- Cast iron handle with drop forged jaw, heat-treated
- Knurled large carbon steel nut

SKU#	LENGTH		MAX JAW OPENING		WEIGHT (kg)	PERFORMANCE UNDER STANDARD TORQUE		BOX/CTN
	mm	inches	mm	inches		STANDARD TORQUE	BOX/CTN	
87-620	140	6"	25	0.98"	0.225	169N.M	6/72	
87-621	186	8"	34	1.33"	0.38	373N.M	6/36	
87-622	248	10"	45	1.77"	0.81	790N.M	6/24	
87-623	297	12"	55	2.16"	1.14	1129N.M	6/12	
87-624	332	14"	65	2.55"	1.4	1468N.M	6/12	
87-625	414	18"	80	3.14"	2.38	2258N.M	2/8	
87-626	553	24"	95	3.74"	3.83	3161N.M	1/4	
87-627	805	36"	140	5.51"	7.88	5137N.M	1/2	

### Aluminum Pipe Wrench



84-451

- Offer same durability and ease-of-use found in all STANLEY heavy-duty wrenches
- Min 40% lighter than heavy-duty wrenches
- Easier to maneuver
- Heat-treated steel jaws to ensure maximum durability

SKU#	DESCRIPTION	LENGTH inches	BOX/CTN
84-451	10" Aluminum Pipe Wrench	10"	6/36
84-463	12" Aluminum Pipe Wrench	12"	6/24
84-465	14" Aluminum Pipe Wrench	14"	6/24
84-466	18" Aluminum Pipe Wrench	18"	2/12
84-467	24" Aluminum Pipe Wrench	24"	2/6

### Basin Wrench



87-448

- Alloy steel, spring loaded head flops over for loosening and tightening at different angles

SKU#	LENGTH		CAPACITY		BOX/CTN
	mm	inches	mm	inches	
87-448	254	10"	22	7/8"	10/40

## 3 CUTTING AND HOLDING TOOLS

### Cable Cutter

- Designed for electric cable, copper, aluminum, etc
- Notched jaw holds & cuts cables in a clean & sharp way



84-258

SKU#	TYPE	LENGTH inches	MAX CUTTING (mm <sup>2</sup> )	BOX/CTN
84-258	10" Cable Cutter	10"	60	6/36
84-629	12" Cable Cutter	12"	125	6/24
84-630	21" Cable Cutter	21"	250	1/10
84-632	32" Cable Cutter	32"	500	1/5

### PVC Pipe Cutter

- Heavy-duty PVC Pipe Cutter
- Stainless steel blades
- Heat-treated for durability



14-442

SKU#	O / A LENGTH		BOX/CTN
	mm	inches	
14-442	42	1-5/8"	10/40

### Tubing Cutter

- Tubing cutters for cutting copper/plastic tubing



93-033

SKU#	O / A LENGTH		BOX/CTN
	mm	inches	
93-033	3 - 16	1/8" - 3/4"	20/200
93-020	3 - 28	1/8" - 1-1/8"	10/60
93-021	3 - 31	1/8" - 1-1/4"	10/60
93-028	6 - 64	1/4" - 2-1/2"	6/36

### Replacement Cutting Wheel

- Hardened alloy steel replacement cutting wheels



93-019-0

SKU#	CONTENTS	COMPATIBLE TO-	BOX/CTN
93-016-1	Carded - 2 pcs for plastic pipe	93-028	25/250
93-017-1	Carded - 2 pcs for copper & metal	93-628	25/250
93-019-0	Carded - 2 pcs/card	93-020/021	25/250
93-019-1	Bulk - 10 pcs/card	93-020/021	25/250
93-018-1	Carded - 2 pcs/card	93-033	25/250

## 3 CUTTING AND HOLDING TOOLS

### Professional Tile Cutter



94-809

- For parallel & angled cuts
- Angled cuts from 0° to 45°
- Cuts up to 14mm thick
- With 30cm length of gauge for accurate cuts
- Die casting cutting assembly with ball bearing for tough cutting action
- High quality titanium-coated cutting blades, size at 22x6x2mm, cuts up to 500mm metres long
- The diameter of solid chromed rod: 16mm.
- The width of base: 165mm, the thickness at 1.8mm
- Reinforced steel sheet on the back of base
- Packaging: blow mould case, with color sleeve sheet

SKU#	DESCRIPTION	SIZE inches	BOX/CTN
94-809	Professional Tile Cutter	16"	1/1
94-811	Professional Tile Cutter	24"	1/1

### Tile Cutter Wheel Set - 7/8"



94-815

- Size is 22 (diameter of outer circle) x 6 (diameter of inner circle) x 2mm (thickness of blade)
- Hardness is HRA 90.5 to 91 degree
- With 'STANLEY' logo engrave on the body
- Three pieces per set

SKU#	DESCRIPTION	CUTTING LENGTH	BOX/CTN
94-815	Tile Cutter Wheel Set - 3pcs	500m	12/120
94-816	Tile Cutter Titanium Wheel Set - 3pcs	600m	12/120

### Cast Steel Bench Vise

- Better Performance
- Better than Iron
- Lightweight compared to Iron



81-602-1

SKU#	DESCRIPTION	JAW WIDTH/ MAX OPENING	THROAT DEPTH	N.W. (Kg)	CLAMP FORCE (Kg)	BOX/CTN	
81-600-1	Bench Vice w/ Base	3"	3"/3"	2"	6kgs	1,500kgs	1/1
81-601-1	Bench Vice w/ Base	4"	4"/4"	2-1/4"	7.5kgs	2,500kgs	1/1
81-602-1	Bench Vice w/ Base	5"	5"/5"	2-5/8"	11kgs	3,000kgs	1/1
81-603-1	Bench Vice w/ Base	6"	6"/6"	3"	14.5kgs	3,500kgs	1/1
81-604-1	Bench Vice w/ Base	8"	8"/8"	3-1/2"	20.5kgs	4,500kgs	1/1
81-605-1	Bench Vice w/ Base	10"	10"/10"	4"	25.6kgs	5,500kgs	1/1

## 3 CUTTING AND HOLDING TOOLS



### Tile Cutting Pincer



94-824

- Cuts up to 10mm thick
- High quality cutting blades, YG6X, size at 13 ( diameter of outer circle) x 6 (diameter of inner circle) x 1mm (thickness of blade)
- Cuts up to 500 metres long
- Hardness is HRA 90.5 to 91 degree

SKU#	DESCRIPTION	CUTTING LENGTH	THICKNESS CUTTING CAPACITY		BOX/CTN
			mm		
94-824	Tile Cutting Pincer	500m	10		6/36

### Bit Braces



02-110

- Holds shank bit from 1/8" to 7/16"
- Steel clad ball bearing head
- Chrome plated finish for rust resistance
- Available in 10" and 12" sweep

SKU#	O / A LENGTH		CHUCK SIZE		BOX/CTN
	mm	inches	mm	inches	
02-110	255	10"	13	1/2"	6/24
02-112	305	12"	13	1/2"	6/24
02-130	255	10"	16	5/8"	6/24

## 3 CUTTING AND HOLDING TOOLS

### Hand Drill



03-011

- Ideal for rapid drilling of small holes in both wood and metal as well as countersinking screw heads
- Self centering 3-jaw steel chuck with 1/4" and 5/16" capacity
- Double pinion gears for smooth operation

SKU#	O / A LENGTH		CHUCK SIZE		BOX/CTN
	mm	inches	mm	inches	
03-011	305	12"	6	1/4"	6/36
03-608	305	12"	8	5/16"	6/36

### Powerbore Bits

- Fully heat-treated carbon steel
- Brad point feeds evenly – will not pull
- Shank has triangular flats for positive grip in 1/4" and large chucks
- For wood and plastics only
- Max. 3000RPM



04-006

SKU#	O / A LENGTH		CHUCK SIZE		BOX/CTN
	mm	inches	mm	inches	
04-006	140	5-1/2"	10	3/8"	6/24
04-008	140	5-1/2"	13	1/2"	12/72
04-010	140	5-1/2"	16	5/8"	12/72
04-012	140	5-1/2"	19	3/4"	12/72
04-014	140	5-1/2"	22	7/8"	12/60
04-016	140	5-1/2"	25	1"	12/60

1 MEASURING & LAYOUT TOOLS

2 LASER MEASURING SYSTEM

3 CUTTING & HOLDING TOOLS

4 FASTENING TOOLS

5 STRIKING & STRUCK TOOLS

6 ILLUMINATION TOOLS

7 PAINTING & FINISHING TOOLS

8 MECHANIC TOOLS

9 TOOLS STORAGE

10 POWER CLEANING TOOLS

11 POWER TOOLS

12 POWER TOOL ACCESSORIES

13 PRODUCT INDEX

67

# 4 FASTENING TOOLS

## LONG REACH, COMFORTABLE AND SECURE

STANLEY® is one of the world's preeminent manufacturers of fastening tools which are indispensable, must-own line of tools in every professional toolbox. This broad category includes four distinct and distinguished tool lines: staplers (manual and electric), hammer tackers, hand "pop" riveters and electric glue guns. There are nearly 2 dozen fastening tools, so if you've got something to fasten down or hold together, STANLEY® has the tool to get the job done right.

Comfort, quality and versatility are the three attributes we engineer into our screwdriver line. STANLEY® screwdriver handles are shaped and sized to provide comfort in the hand and torque at the fastener head. The materials and construction are of the highest quality to resist corrosion, chipping and breaking. And with tips ranging from standard to Phillips® to Torx® to square, STANLEY® screwdrivers cover almost every application.

### FIXED SCREWDRIVER BARS

#### TIP

- Forged
- Shoulder grind
- Face grind
- Can be magnetic, black oxide, or blasted

Fully heat treated bar for toughness & strength

#### BAR

- Coated to prevent rust
  - Lacquer
  - Black oxide
  - Nickel plate
  - Chrome
- Can be mill finished, tumbled, blasted or polished

#### BOLSTER

- Allows extra torque to be applied with a wrench when necessary
- Stops bar push-through when struck

#### WINGS

Two wings are formed in the blade at the handle end: These cut into the hole of the handle when driven in under pressure and prevent the bar turning inside the handle.

Phillips® is a registered trademark of Phillips Screw Company  
Torx® is a registered trademark of Acument Intellectual Properties, LLC





### SCREWDRIVER HANDLES

Handle materials impervious to chemicals

Shape/texturing for grip and mechanical advantage

Tip identification

Small diameter for speed turning

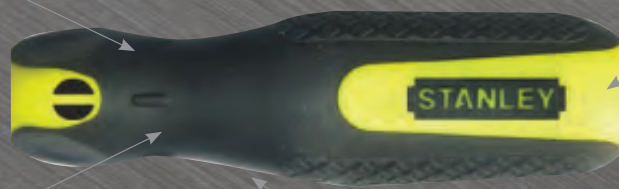

### TIP DIFFERENCES

#### SLOTTED TIP DIFFERENCES



SLOTTED Screwdrivers are referred to by their Blade Length and Tip Configuration



**Flared Tip :**  
The strongest, for heavy-duty

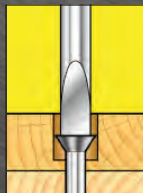

**Cabinet Tip :**  
Used when fitting into counter bore

#### PHILLIPS & POZIDRIV



Referred to by a Number Point  
smallest = 0 point to largest = 4 point

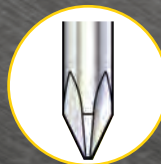

**PHILLIPS**  
Screws have 4 recessed cross 'slots' tapered conically.

Driver Tip has 4 tapered wings separated by 4 hollow flutes.



**POZIDRIV** (common in Europe)

Screws have 4 recessed parallel cross 'slots' and, also, a square recess at the centre.

Driver Tip has 4 straight parallel wings and between each wing is a square-section rib to fit the screw centre.

## 4 FASTENING TOOLS

### VDE Screwdriver

- Insulation directly injection-molded around the blade according to EN60900
- Ergonomic, shock resistant, anti-slip handle and for greater torque to be applied with less effort
- Each screwdriver is individually tested to 10,000V in a water bath for 10 SCEa
- Hardness and torque values exceed ISO/ DIN standards



65-966



65-973

SKU#	TYPE	LENGTH mm	TIP SIZE mm	BOX/CTN
65-966	Std Parallel	3 x 100	0.5 x 3.0	12/240
65-967	Std Parallel	4 x 100	0.8 x 4.0	12/240
65-968	Std Parallel	5.5 x 125	1.0 x 5.5	12/120
65-969	Std Parallel	6.5 x 150	1.2 x 6.5	12/120
65-970	Std Parallel	8 x 175	1.6 x 10.0	12/120
65-971	Std Parallel	10 x 200	-	12/120
65-972	Phillips®	#0 x 60	-	12/240
65-973	Phillips®	#1 x 80	-	12/120
65-974	Phillips®	#2 x 100	-	12/120
65-975	Phillips®	#3 x 150	-	12/120



65-980

### VDE Screwdriver 6pc Set with Bonus

SKU#	CONTENT	BOX/CTN
65-980	6 pc set: VDE Screwdriver Standard Parallel - 3 x 100mm VDE Screwdriver Standard Parallel - 4 x 100mm VDE Screwdriver Standard Parallel - 5.5 x 125mm VDE Screwdriver Standard Parallel - 6.5 x 150mm VDE Screwdriver Phillips® - #1 x 80mm VDE Screwdriver Phillips® - #2 x 100mm	10/10

## Cushion Grip 2 Screwdriver

- Improved ergonomic design for maximum grip and torque
- Ergonomically designed, bi-material handles for maximum comfort and for greater torque to be applied with less effort
- Chrome vanadium blade with tough hardened black oxide tips
- Nickel-plated bar for corrosion resistance
- High quality, heat treated plated bars for lasting "pro" performance and rust resistance



65-157-2

SKU#	TYPE	LENGTH		BOX/CTN
		mm	inches	
65-157-2	Phillips®	#0 x 60	1/8" x 2-3/8" x 0PT	12/72
65-158-2	Phillips®	#0 x 100	1/8" x 4" x 0PT	12/72
65-159-2	Phillips®	#0 x 125	1/8" x 5" x 0PT	12/72
65-160-2	Phillips®	#0 x 150	1/8" x 6" x 0PT	12/72
65-162-2	Phillips®	#1 x 75	3/6" x 3" x 1PT	12/72
65-163-2	Phillips®	#1 x 100	3/6" x 4" x 1PT	12/72
65-164-2	Phillips®	#1 x 150	3/6" x 6" x 1PT	12/72
65-165-2	Phillips®	#1 x 200	3/6" x 8" x 1PT	12/72
65-166-2	Phillips®	#2 x 45	1/4" x 1-1/2" x 2PT	12/72
65-167-2	Phillips®	#2 x 100	1/4" x 4" x 2PT	12/72
65-168-2	Phillips®	#2 x 125	1/4" x 5" x 2PT	12/72
65-169-2	Phillips®	#2 x 150	1/4" x 6" x 2PT	12/72
65-170-2	Phillips®	#2 x 200	1/4" x 8" x 2PT	12/72
65-171-2	Phillips®	#2 x 250	1/4" x 10" x 2PT	12/72
65-172-2	Phillips®	#3 x 150	5/16" x 6" x 3PT	12/72
65-173-2	Phillips®	#3 x 200	5/16" x 8" x 3PT	12/72
65-174-2	Phillips®	#3 x 250	5/16" x 10" x 3PT	12/72



65-180-2

SKU#	TYPE	LENGTH		BOX/CTN
		mm	inches	
65-180-2	Slotted	3 x 75	1/8" x 3"	12/72
65-181-2	Slotted	3 x 100	1/8" x 4"	12/72
65-182-2	Slotted	3 x 125	1/8" x 5"	12/72
65-183-2	Slotted	3 x 150	1/8" x 6"	12/72
65-186-2	Slotted	5 x 75	3/16" x 3"	12/72
65-187-2	Slotted	5 x 100	3/16" x 4"	12/72
65-188-2	Slotted	5 x 150	3/16" x 6"	12/72
65-189-2	Slotted	5 x 200	3/16" x 8"	12/72
65-190-2	Slotted	6.5 x 45	1/4" x 3/4"	12/72
65-191-2	Slotted	6.5 x 100	1/4" x 4"	12/72
65-192-2	Slotted	6.5 x 125	1/4" x 5"	12/72
65-193-2	Slotted	6.5 x 150	1/4" x 6"	12/72
65-194-2	Slotted	6.5 x 200	1/4" x 8"	12/72
65-195-2	Slotted	6.5 x 250	1/4" x 10"	12/72
65-196-2	Slotted	8 x 150	5/16" x 6"	12/72
65-197-2	Slotted	8 x 200	5/16" x 8"	12/72
65-198-2	Slotted	8 x 250	5/16" x 10"	12/72

SKU#	TYPE	LENGTH		BOX/CTN
		mm	inches	
65-227-2	Standard	5 x 100	3/16" x 3"	12/72
65-228-2	Standard	5 x 150	3/16" x 4"	12/72
65-229-2	Standard	5 x 200	3/16" x 6"	12/72

1 MEASURING & LAYOUT TOOLS

2 LASER MEASURING SYSTEM

3 CUTTING & HOLDING TOOLS

4 FASTENING TOOLS

5 STRIKING & STRUCK TOOLS

6 ILLUMINATION TOOLS

7 PAINTING & FINISHING TOOLS

8 MECHANIC TOOLS

9 TOOLS STORAGE

10 POWER CLEANING TOOLS

11 POWER TOOLS

12 POWER TOOL ACCESSORIES

13 PRODUCT INDEX

## 4 FASTENING TOOLS



65-144-2

SKU#	TYPE	SIZE	LENGTH		BOX/CTN
			inches	mm	
65-144-2	Torx®	T5 x 80mm	(1/8" x 3-1/8")	1.37	12/72
65-145-2	Torx®	T6 x 80mm	(1/8" x 3-1/8")	1.65	12/72
65-146-2	Torx®	T7 x 80mm	(1/8" x 3-1/8")	1.97	12/72
65-147-2	Torx®	T8 x 80mm	(1/8" x 3-1/8")	2.30	12/72
65-148-2	Torx®	T10 x 80mm	(1/8" x 3-1/8")	2.72	12/72
65-149-2	Torx®	T15 x 80mm	(3/16" x 3-1/8")	3.26	12/72
65-150-2	Torx®	T20 x 120mm	(3/16" x 4-3/4")	3.26	12/72
65-151-2	Torx®	T25 x 120mm	(1/4" x 4-3/4")	4.40	12/72
65-152-2	Torx®	T27 x 120mm	(1/4" x 4-3/4")	4.96	12/72
65-153-2	Torx®	T30 x 120mm	(1/4" x 4-3/4")	5.49	12/72
65-154-2	Torx®	T40 x 120mm	(5/16" x 4-3/4")	6.60	12/72



65-156-2

SKU#	CONTENTS	SIZE	BOX/CTN
65-155-2	Torx® Set 5 pcs	T5, T6, T8, T10, T15 x 80mm	12/12
65-156-2	Torx® Set 6 pcs	T10, T15, x80mm & T20, T25, T30, T40 x 120mm	12/12

### Cushion Grip 2 Screwdriver Set

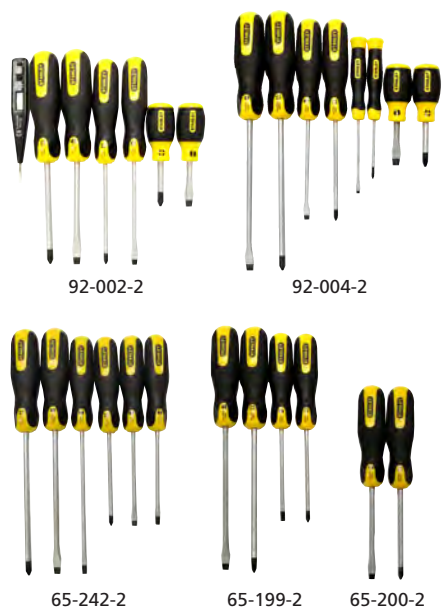

92-002-2

92-004-2

65-242-2

65-199-2

65-200-2

SKU#	CONTENTS	BOX/CTN
92-004-2	8 pc set: Phillips #0 x 60mm Phillips #1 x 100mm Phillips #2 x 45mm Phillips #2 x 150mm Slotted 3mm x 75mm Slotted 5mm x 100mm Slotted 6.5mm x 45mm Slotted 6.5mm x 150mm	12/12
92-002-2	6 pc set with bonus: Phillips #1 x 100mm Phillips #2 x 100mm Phillips #2 x 45mm Slotted 5mm x 100mm Slotted 6.5mm x 100mm Slotted 6.5mm x 45mm <b>Free: Digital Test Pen (AN-100)</b>	12/12
65-242-2	6 pc set: Phillips #1 x 100mm Phillips #2 x 150mm Std Parallel 5mm x 100mm Std Parallel 5mm x 150mm Slotted 6.5mm x 150mm Slotted 5mm x 100mm	12/12
65-199-2	4 pc set: Phillips #1 x 100mm Phillips #2 x 150mm Std Parallel 5mm x 100mm Slotted 6.5mm x 150mm	24/24
65-200-2	2 pc set: Phillips #2 x 100mm Slotted 6.5mm x 100mm	24/24

## 6 Way Screwdriver™



68-012

- All-in-one screwdriver with 6 tips: #1 and #2 Phillips®, 1/4" and 3/16" Slotted, 1/4" and 5/16" Nut Driver
- Convenient and space saving, ideal for kitchen drawer or car – no need for extra screwdrivers
- Ergonomically designed bi-material handle for superb comfort
- Tri-lobe shape fits hand comfortably
- Soft, diamond textured handle provides a firm grip for extra torque without strain
- Bar is chrome-plated for rust resistance.
- Attach wrench to bolster nut for additional leverage and torque
- High quality bits for long life
- Available in an attractive 24 piece merchandiser
- Slip resistant rubber grip provides comfort

SKU#	CONTENTS	O / A LENGTH		BOX/CTN
		mm	inches	
68-012	1/4", 3/9" Slotted 1PT, 2PT, Phillips® 1/4", 5/6" Nut Driver	7.75	196.9"	6/24

## Cushion Grip Multi Bits 2-Way



65-201

- Bi-Material Handle for comfortable grip
- Larger handles for greater torque
- Chrome plated bars for rust resistant
- Magnetized Tips

SKU#	CONTENTS	O / A LENGTH		BOX/CTN
		mm	inches	
65-201	Slotted 6mm x 100mm	6 x 100	1/4" x 4"	12/72
	Phillips #2 x 100mm	#2 x 100	#2 x 4"	

## 10-Piece Multi-Bit Ratcheting Screwdriver



3-WAY AUDIBLE RATCHET

68-010

- Bit storage system for easy visibility, access and security
- Magnetic bit holder for quick, secure change-over of bits
- Top quality, three-position audible ratcheting mechanism; forward, reverse and fixed for lifelong efficiency
- Supplied with 10 bits to suit a wide variety of purposes

SKU#	CONTENTS	O / A LENGTH		BOX/CTN
		mm	inches	
68-010	Ratcheting screwdriver c/w 10 bits 1&2PT – Philip/Pozi/Robertson 5&6.5mm slotted T10 & T15 Torx	254	10"	6/36

## 4 FASTENING TOOLS

### Screwdriver Insert Bit Set

- Made from chrome vanadium steel
- Recommended for manual applications in multi-bit screwdrivers



68-070



68-071



68-072



68-075

SKU#	CONTENTS	INDIVIDUAL PRODUCT			BOX/ CTN
		length	width	height	
68-070	9 pc set: Phillips #1,#2,#3,PZ2,S2 Slotted 3/16", 1/4", 5/16"	21.2"	16.4"	1.5"	6/36
68-071	29 pc set: Phillips #1,#2,#2,#3,PZ1,PZ2,PZ3,S2 Slotted 6/8", 8/10", 10/12" Torx T5,T20,T25, T30 Hex 3/32", 1/8", 5/32", S1, S2, S3 Nutdriver 3/16", 1/4", 5/16", 11/32", 3/8", Bit Hold	21.2"	15"	2"	6/48
68-072	33 pc set: 6.35mm / 1/4" 1pc 2-3/8" bits holder Phillips 2x#0,3x#1,3x#2,1x#3 Slotted 5-6,6-8,8-10,10-12 POZI 0,1,2,3 Star T10-15- 20-25-30-40 Square S1,S2,S3 Hex 1/8", 3/32", 5/32", 3/16", 7/32", 1/4"	21.2"	22.4"	3.4"	6/48
68-075	36 pc set: Phillips #1,#1,#2,#2,#3,PZ0,PZ1,PZ 1,PZ2,P2, PZ3,S0,S1,S1,S2,S2,S3 Slotted 1/8", 3/16", 1/4", 7/32" Torx T10,T15, T20a,T25,T27,T30 Hex 1/16", 1/8", 5/32", 3/16", 7/32", 1/4"	21.2"	15"	3.2"	6/36

### 9 Way Screwdriver™

- 9 tips for all access
- Convenient & space saving
- Ergonomically designed bi-material handle
- Bar is chrome plated for rust resistance
- 10pc Cushion Grip Driver Set :
- 3pc Philip #0, #1, #2, 3 pcs Standard 1/8", 3/16", 1/4", 1 Awl, 1 Tack Puller, 1 Hook Driver
- BOX/CTN: 6/24



62-511



SKU#	CONTENTS	BOX/CTN
62-511	9 Way Interchangeable Screwdriver 10pc Cushion Grip Driver Set: 3pc Phillips® - #0, #1, #2 3pc Standard - 1/8", 3/16", 1/4" 1 Awl - 1 pc 1 Tack Puller - 1pc 1 Hook Driver - 1pc	6/24

## 6-Piece Bi-Material Handle Precision Screwdriver Set



66-052

66-039

- Attractive bi-material handles designed for easy and comfortable grip
- Chrome vanadium steel bars in black oxide finished with hardened tips - HRC 53
- Comes in 6 popular sizes

SKU#	CONTENTS	BOX/CTN
66-052	0 & 1 pt Phil, 1.4, 2, 2.4, 3mm Standard	12/72
66-039	0 & 1 pt Phil, 1.4, 2, 2.4, 3mm Standard	12/72

## Spark Detecting Screwdriver



66-119 & 66-120

- Test range of 100~500V
- Pocket size model c/w clip
- Attractive PP card packaging

SKU#	BLADE LENGTH		O / A LENGTH		TIP WIDTH		BOX/CTN
	mm	inches	mm	inches	mm	inches	
66-119	50	2-3/4"	127	5-1/2"	3	1/8"	20/600
66-120	100	4"	178	7-1/2"	5	3/16"	20/480

## Multifunctional Digital Tester With LCD Display and Neon Lamp Display

NEW



66-133

- Easy single button operation
- Easy to read & practical screen
- Ergonomic design & shape , Bi-Material body combination
- Pocket clip for easy carrying
- Neon lamp for electriciferous test
- International standard, CE certified
- Rubber hands provides comfort & insulation

SKU#	DESCRIPTION	BOX/CTN
66-133	Multifunctional Digital Tester with LCD Display and Neon Lamp Display	12/96

## Multifunctional Digital Tester With LCD Display

NEW



66-137

Induction test, break-point & voltage reading button

- Easy to read & practical screen
- Pocket clip for easy carrying
- International standard, CE certified
- Longer tip for deep insertion

SKU#	DESCRIPTION	BOX/CTN
66-137	Multifunctional Digital Tester with LCD Display	12/240

1 MEASURING & LAYOUT TOOLS

2 LASER MEASURING SYSTEM

3 CUTTING & HOLDING TOOLS

4 FASTENING TOOLS

5 STRIKING & STRUCK TOOLS

6 ILLUMINATION TOOLS

7 PAINTING & FINISHING TOOLS

8 MECHANIC TOOLS

9 TOOLS STORAGE

10 POWER CLEANING TOOLS

11 POWER TOOLS

12 POWER TOOL ACCESSORIES

13 PRODUCT INDEX

## 4 FASTENING TOOLS



### 100 Plus® Cabinet Tip Screwdriver



66-182

- For cabinet building and other precision woodworking

SKU#	BLADE		OVERALL LENGTH	TIP WIDTH	BOX/CTN
	DIAMETER	BLADE LENGTH			
66-182	5mm, 3/16"	305mm, 12"	400mm, 15-3/4"	5mm, 3/16"	6/24

### Hex Key Set



SKU#	DESCRIPTION	CONTENTS	BOX/CTN
69-261	Hex Key Set 7pc Fldg MM	1.5/2/2.5/3/4/5/6 mm	12/72
69-262	Hex Key Set 7pc Fldg MM	2.5/3/4/5/6/8/10 mm	12/48
69-251	Hex Key Set 8pc S/arm MM	1.0/1.5/2/2.5/3/4/5/5.5/6 mm	12/72
69-119	Hex Key Set 9pc Chrome MM	1.5/2/2.5/3/4/5/6/8/10 mm – Ball tips	6/36
69-256	Hex Key Set 9pc L/arm MM	1.5/2/2.5/3/4/5/6/8/10 mm – Ball tips	6/36
69-213	Hex Key Set 10pc Ring MM	1.5/2/2.5/3/4/5/5.5/6/8/10 mm	12/72
69-253	Hex Key Set 10pc S/arm MM	1.5/2/2.5/3/4/5/5.5/6/8/10 mm	12/72
69-260	Hex Key Set 5pc Fldg IMP	3/16, 7/32, 1/4, 5/16, 3/8	12/48
69-252	Hex Key Set 8pc S/arm IMP	1/16, 5/64, 3/32, 1/8, 5/32, 3/16, 7/32, 1/4"	12/72
69-259	Hex Key Set 9pc Fldg IMP	5/64, 3/32, 7/64, 1/8, 9/64, 5/32, 3/16, 7/32, 1/4"	12/72
69-230	Hex Key Set 10pc Ring IMP	1/16, 5/64, 3/32, 1/8, 5/32, 3/16, 7/32, 1/4, 5/16, 3/8"	12/72
69-254	Hex Key Set 10pc S/arm IMP	1/16, 5/64, 3/32, 1/8, 5/32, 3/16, 7/32, 1/4, 5/16, 3/8"	12/72
69-257	Hex Key Set 12pc L/arm IMP	1/16, 5/64, 3/32, 7/64, 1/8, 9/64, 5/32, 3/16, 7/32, 1/4, 5/16, 3/8" – Ball tips	6/36
69-263	Hex Key Set 8pc Fldg Torx®	T9/ T10/ T15 / T20/ T25/ T27 T30/ T40	12/72



## Tank Thru Screwdriver

- 4 different sizes of handles
- Easy color differentiation: yellow for standard screwdriver, black for Phillips®
- Heavy-duty purpose
- Material: Chrome vanadium hardness : 56-62
- Anti-slip design handle
- 18% bigger impact surface



65-243-1



65-245-1

SKU#	DESCRIPTION	SIZE		BOX / CTN
		Blade Tip	Blade Dia. x Length	
65-243-1	Tank Thru Screwdriver	5mm x 4" (100mm)	Std 0.76 x 4.76	12/180
65-244-1	Tank Thru Screwdriver	5mm x 6" (150mm)	Std 0.76 x 4.76	12/180
65-247-1	Tank Thru Screwdriver	6mm x 4" (100mm)	Std 0.94 x 6.35	12/120
65-248-1	Tank Thru Screwdriver	6mm x 5" (125mm)	Std 0.94 x 6.35	12/120
65-249-1	Tank Thru Screwdriver	6mm x 6" (150mm)	Std 0.94 x 6.35	12/120
65-253-1	Tank Thru Screwdriver	8mm x 6" (150mm)	Std 1.07 x 7.94	12/72
65-254-1	Tank Thru Screwdriver	8mm x 8" (200mm)	Std 1.07 x 7.94	12/72
65-255-1	Tank Thru Screwdriver	8mm x 10" (250mm)	Std 1.07 x 7.94	12/72
65-256-1	Tank Thru Screwdriver	8mm x 12" (300mm)	Std 1.07 x 7.94	12/72

SKU#	DESCRIPTION	SIZE		BOX / CTN
		Blade Tip	Blade Dia. x Length	
65-245-1	Tank Thru Screwdriver	5mm x 4" (100mm)	Phil 1PT	12/180
65-246-1	Tank Thru Screwdriver	5mm x 6" (150mm)	Phil 1PT	12/180
65-250-1	Tank Thru Screwdriver	6mm x 4" (100mm)	Phil 2PT	12/120
65-251-1	Tank Thru Screwdriver	6mm x 5" (125mm)	Phil 2PT	12/120
65-252-1	Tank Thru Screwdriver	6mm x 6" (150mm)	Phil 2PT	12/120
65-257-1	Tank Thru Screwdriver	8mm x 6" (150mm)	Phil 3PT	12/72
65-258-1	Tank Thru Screwdriver	8mm x 8" (200mm)	Phil 3PT	12/72
65-259-1	Tank Thru Screwdriver	8mm x 10" (250mm)	Phil 3PT	12/72
65-260-1	Tank Thru Screwdriver	8mm x 12" (300mm)	Phil 3PT	12/72

1 MEASURING & LAYOUT TOOLS

2 LASER MEASURING SYSTEM

3 CUTTING & HOLDING TOOLS

4 FASTENING TOOLS

5 STRIKING & STRUCK TOOLS

6 ILLUMINATION TOOLS

7 PAINTING & FINISHING TOOLS

8 MECHANIC TOOLS

9 TOOLS STORAGE

10 POWER CLEANING TOOLS

11 POWER TOOLS

12 POWER TOOL ACCESSORIES

13 PRODUCT INDEX

## 4 FASTENING TOOLS

### T-Handle Hex Key

- 2 way T-handle features two drive ends: both top & bottom
- Ball point feature provides greater strength & enable all angle operation
- Attractive color for easy recognition



SKU#	DESCRIPTION	SIZE	BOX/CTN
69-277	2-Way T-handle Ball-Point Hex Key - Yellow	2.0mm	12/72
69-278	2-Way T-handle Ball-Point Hex Key - Yellow	2.5mm	12/72
69-279	2-Way T-handle Ball-Point Hex Key - Yellow	3.0mm	12/72
69-280	2-Way T-handle Ball-Point Hex Key - Yellow	4.0mm	12/72
69-281	2-Way T-handle Ball-Point Hex Key - Yellow	5.0mm	12/72
69-282	2-Way T-handle Ball-Point Hex Key - Yellow	6.0mm	12/48
69-283	2-Way T-handle Ball-Point Hex Key - Yellow	7.0mm	12/48
69-284	2-Way T-handle Ball-Point Hex Key - Yellow	8.0mm	12/48
69-285	2-Way T-handle Ball-Point Hex Key - Yellow	10.0mm	12/48



SKU#	DESCRIPTION	SIZE	BOX/CTN
69-298	2-Way T-handle Torx Key - Grey	T7	12/72
69-299	2-Way T-handle Torx Key - Grey	T8	12/72
69-300	2-Way T-handle Torx Key - Grey	T9	12/72
69-301	2-Way T-handle Torx Key - Grey	T10	12/72
69-302	2-Way T-handle Torx Key - Grey	T15	12/72
69-303	2-Way T-handle Torx Key - Grey	T20	12/72
69-304	2-Way T-handle Torx Key - Grey	T25	12/72
69-305	2-Way T-handle Torx Key - Grey	T27	12/72
69-306	2-Way T-handle Torx Key - Grey	T30	12/72
69-307	2-Way T-handle Torx Key - Grey	T40	12/48
69-308	2-Way T-handle Torx Key - Grey	T45	12/48



SKU#	DESCRIPTION	SIZE inches	BOX/CTN
69-286	2-Way T-handle Ball-Point Hex Key - Black	5/64"	12/72
69-287	2-Way T-handle Ball-Point Hex Key - Black	3/32"	12/72
69-288	2-Way T-handle Ball-Point Hex Key - Black	7/64"	12/72
69-289	2-Way T-handle Ball-Point Hex Key - Black	1/8"	12/72
69-290	2-Way T-handle Ball-Point Hex Key - Black	9/64"	12/72
69-291	2-Way T-handle Ball-Point Hex Key - Black	5/32"	12/72
69-292	2-Way T-handle Ball-Point Hex Key - Black	3/16"	12/72
69-293	2-Way T-handle Ball-Point Hex Key - Black	7/32"	12/72
69-294	2-Way T-handle Ball-Point Hex Key - Black	1/4"	12/48
69-295	2-Way T-handle Ball-Point Hex Key - Black	5/16"	12/48
69-296	2-Way T-handle Ball-Point Hex Key - Black	3/8"	12/48

## GluePro™ Mini Hot Melt Glue Gun



69-GR10B

- Small, portable size for quick gluing jobs in tight spaces
- Trigger-feed mechanism controls glue flow
- Uses GS10DT standard mini hot melt sticks
- Fold-out stand for safe, handy storage while in use

SKU#	CONTENTS	GLUE STICK	BOX/CTN
69-GR10B	Mini Hot Melt Glue Gun 100-240V/15W Round Pin	GS10DT	6/36
69-GR10C	Mini Hot Melt Glue Gun 100-240V/15W Flat Pin	GS10DT	6/36

## GluePro™ Mini Dual Temp Melt Glue Gun



69-GR15C

- Ideal for hobbies, crafts and repairs
- Convenient, one-touch high/low selector switch
- Uses mini dual-temperature glue on both settings and mini hot-melt on high settings
- Fold-out stand for safe, handy storage while in use

SKU#	CONTENTS	GLUE STICK	BOX/CTN
69-GR15B	Mini Dual Temp Glue Gun 100-240V/15W Round Pin	GS10DT	6/36
69-GR15C	Mini Dual Temp Glue Gun 100-240V/15W Flat Pin	GS10DT	6/36

## GluePro™ Trigger Feed Hot Melt Glue Gun



69-GR20B

- Quality engineered for reliable performance
- Trigger-feed mechanism controls glue flow
- Heats up quickly and bonds within 60 seconds
- Uses standard GS10DT hot melt glue sticks
- Fold-out stand for safe, handy storage while in use

SKU#	CONTENTS	GLUE STICK	BOX/CTN
69-GR20B	Trigger Feed Hot Melt Glue Gun 100-240V/40W Round Pin	GS20DT/25DT/GS260 &500	6/24
69-GR20C	Trigger Feed Hot Melt Glue Gun 100-240V/40W Flat Pin	GS20DT/25DT/GS260 &500	6/24

1 MEASURING & LAYOUT TOOLS

2 LASER MEASURING SYSTEM

3 CUTTING & HOLDING TOOLS

4 FASTENING TOOLS

5 STRIKING & STRUCK TOOLS

6 ILLUMINATION TOOLS

7 PAINTING & FINISHING TOOLS

8 MECHANIC TOOLS

9 TOOLS STORAGE

10 POWER CLEANING TOOLS

11 POWER TOOLS

12 POWER TOOL ACCESSORIES

13 PRODUCT INDEX

## 4 FASTENING TOOLS



69-GR25B

### GluePro™ Trigger Feed Dual Melt Glue Gun

- Offers the versatility of high and low temperature gluing in one gun
- Convenient, one-touch high/low selector switch
- Uses standard dual-temperature glue on both settings and hot melt formulas on high setting
- Heats up quickly and bonds within 60 seconds
- Fold-out stand for safe, handy storage while in use

SKU#	CONTENTS	GLUE STICK	BOX/CTN
69-GR25B	Trigger Feed Dual Melt Glue Gun 100-240V/80W Round Pin	GS20DT/25DT/GS260 &500	6/24
69-GR25C	Trigger Feed Dual Melt Glue Gun 100-240V/80W Flat Pin	GS20DT/25DT/GS260 &500	6/24



69-GR90B

### GluePro™ Cord Free 2-Way Glue Gun

- Versatile glue gun works with or without cord
- Cordless operation for up to 12 minutes
- Heats up quickly
- Fold-out stand for safe, handy storage while in use

SKU#	CONTENTS	GLUE STICK	BOX/CTN
69-GR90B	Cord Free 2 Way Glue Gun 100-240V/40W Round Pin	GS20DT/25DT/GS260 &500	6/24
69-GR90C	Cord Free 2 Way Glue Gun 100-240V/40W Flat Pin	GS20DT/25DT/GS260 &500	6/24



GS10DT

### Dual Temp 4" Mini Glue Stick

- For use in mini hot melt, low temperature, and dual temperature glue guns
- Excellent for bonding heat sensitive materials, as well as general applications

SKU#	LENGTH		FOR	PACK(BOX)	BOX/CTN
	mm	inches			
GS10DT	100 x 7.1	4" x 0.28"	GR10, GR15 glue guns	24 pcs	5/60



GS25DT

## Dual Temp 4" Glue Stick

- For use in mini hot melt, low temperature, and dual temperature glue guns
- Excellent for bonding heat sensitive materials, as well as general applications
- Standard diameter glue sticks in 4" length

SKU#	LENGTH		FOR	PACK(BOX)	BOX/CTN
	mm	inches			
GS20DT	100 x 11.3	4" x 0.45"	GR20, GR25 & GR90	24 pcs	5/60
GS25DT	254 x 11.3	10" x 0.45"	GR20, GR25 & GR90	12 pcs	5/50



GS260

## Woodworking 4" Glue Stick

- Hot Melt Formula for woodworking jobs
- Standard diameter glue sticks in 4" length

SKU#	LENGTH		FOR	PACK(BOX)	BOX/CTN
	mm	inches			
GS260	100 x 11.3	4" x 0.45"	GR20, GR25 & GR90	6 pcs	5/60



GS500

## Formula II - Super Strength 4" Glue Stick

- Extra strength adhesive
- Standard diameter glue sticks in 4" length

SKU#	LENGTH		FOR	PACK(BOX)	BOX/CTN
	mm	inches			
GS500	100 x 11.3	4" x 0.45"	GR20, GR25 & GR90	6 pcs	5/60



83-122

## Bailey® Heavy-Duty Corner Clamp

- Articulating design allows for work pieces of equal or varying thickness to be joined at right angles
- Patent-pending reversible head design allows for use as a parallel clamp
- Comfort and maximum torque achieved with bi-material, tri-lobular handle
- Mounting holes allow clamp to be securely attached to work surface
- Heavy-duty, cast-zinc construction for durability

SKU#	LENGTH		BOX/CTN
	mm	inches	
83-122	57	2-1/4"	2/12

1 MEASURING & LAYOUT TOOLS

2 LASER MEASURING SYSTEM

3 CUTTING & HOLDING TOOLS

4 FASTENING TOOLS

5 STRIKING & STRUCK TOOLS

6 ILLUMINATION TOOLS

7 PAINTING & FINISHING TOOLS

8 MECHANIC TOOLS

9 TOOLS STORAGE

10 POWER CLEANING TOOLS

11 POWER TOOLS

12 POWER TOOL ACCESSORIES

13 PRODUCT INDEX

## 4 FASTENING TOOLS



83-031K

### MaxSteel™ C-Clamp

- High-visibility, corrosion-resistant finish
- Advanced frame design resists flexing and bending
- Heavy-duty, malleable iron and steel construction
- Roll-formed screw threads ensure smooth operation and durability
- Oversized "T" handle for extra torque

SKU#	LENGTH		BOX/CTN
	mm	inches	
83-031K	30 x 25	1" x 1-3/16"	12/72
83-032K	33 x 50	2" x 1-5/16"	12/72
83-033K	57 x 75	3" x 2-1/4"	6/36
83-034K	75 x 100	4" x 3"	6/24
83-035K	89 x 150	6" x 3-1/2"	6/12
83-036K	100 x 200	8" x 4"	3/6



69-033C

### Soldering Iron

- Suitable for soldering metals like copper, tin, brass and stained glass
- Working temperature reached in 2 minutes
- Slim pencil like handle for easy use and control

SKU#	PIN HEAD	CAPACITY	BOX/CTN
69-031B	Round	30W/220V	20/80
69-031C	Flat	30W/220V	20/80
69-033B	Round	45W/220V	20/80
69-033C	Flat	45W/220V	20/80



69-041B

### Soldering Gun

- Suitable for soldering light gauge wires, thin metals and hobby work
- Reaches working temperature in 12 seconds
- Come with 2 soldering tips

SKU#	CONTENTS	PIN HEAD	BOX/CTN
69-041B	100W/220V Complete kit comprising: Soldering gun. Tip Solder	Round	6/24
69-041C	100W/220V Complete kit comprising: Soldering gun. Tip Solder	Flat	6/24

## 4 FASTENING TOOLS



69-646



69-799

### Riveter

- 69-799 body is nickel-plated
- Versatile tool for joining sheet metal, fabric, leather, plastic parts, etc
- Spring loaded handle ejects rivets stem
- All steel body with non-slip grip and wrench for changing nosepieces

SKU#	CONTENTS	BOX/CTN
69-646	Medium-duty riveter c/w 3 nosepieces for 1/8", 5/32", 3/16" rivets	5/30
69-799	Heavy-duty riveter c/w 4 nosepieces for 3/32", 1/8", 5/32", 3/16" rivets	6/24

### Swivel Head Riveter



MR77C

- 360° rotating head, makes it easy to apply rivets in tight spaces
- Rugged die-cast metal construction for long life
- Extra nose pieces and wrench are conveniently stored in handle
- Long handle makes riveter easy to squeeze

SKU#	DESCRIPTION	BOX/CTN
MR77C	Swivel Header Riveter	6/24

### Light-Duty Staple Gun



TR45



TR110

- Perfect for everyday stapling needs around the home or office
- Lightweight with convenient handle lock for safe storage
- Quick-jam-clear mechanism saves time and hassles
- Chrome-plated steel construction for durability

SKU#	STAPLE USED	BOX/CTN
TR45	TRA200 or Arrow® JT-21® light-duty staples	40/720
TR110	SharpShooter® TRA700 or ArrowT-50® heavy-duty staples	1/3

1 MEASURING & LAYOUT TOOLS

2 LASER MEASURING SYSTEM

3 CUTTING & HOLDING TOOLS

4 FASTENING TOOLS

5 STRIKING & STRUCK TOOLS

6 ILLUMINATION TOOLS

7 PAINTING & FINISHING TOOLS

8 MECHANICAL TOOLS

9 TOOLS STORAGE

10 POWER CLEANING TOOLS

11 POWER TOOLS

12 POWER TOOL ACCESSORIES

13 PRODUCT INDEX

## 4 FASTENING TOOLS



TR150



TR150HL

### Heavy-Duty Staple Gun

- Easy-squeeze handle reduces hand fatigue
- Anti-jam mechanism saves time on the job
- High-visibility yellow color easy to spot in a toolbox or workshop
- Durable aircraft-aluminum housing withstands heavy use
- Delivers high power and deep penetration
- Easy-slide full-stick staple load

SKU#	STAPLE USED	BOX/CTN
TR150	SharpShooter® TRA700 or Arrow® T-50® heavy-duty staples	1/6
TR150HL	SharpShooter® TRA700 series or Arrow® T-50® heavy-duty staples	1/6

### 2-in-1 Staple & Brad Nail Gun



95-063

- Hi-impact plastic housing
- Durable working parts
- Includes working parts
- Bottom loading for easy jam clearing
- Safety handle lock

SKU#	STAPLE USED	BOX/CTN
95-063	6mm - 10mm, 18 Gauge, 10mm, Brad Nail	12/24

### Heavy-Duty Staple Gun / Brad Nailer



TR250

- Easy-squeeze product works overtime as a staple gun, brad-nailer, cable-tacker and wire-tacker
- All-metal drive channel ensures better penetration
- Less force to squeeze and more driving power
- Heavy-duty aircraft-aluminum housing for long-lasting durability
- Hi/Lo power lever for hard and soft materials
- Flush-nose design solves the problem of stapling in tight spots
- Lock-down handle for safe storage
- Quick-view window simplifies staple identification
- Easy-slide full-stick staple load

SKU#	STAPLE USED	BOX/CTN
TR250	SharpShooter® TRA700 series or Arrow® T-50® heavy-duty narrow crown staples and 1/2", 9/16" and 5/8" Brads	1/6



## Cable Tacker 2-in-1 Staple Gun



CT10X

- 30% easier to squeeze than leading competitor
- Patented Anti-jam mechanism
- Hi/Lo power adjustment
- Lightweight Aircraft Aluminum housing
- Built-in wire guide prevents stapling into the wire
- Quick drop-in staple loading
- Narrow front allows stapling in tight spaces
- Comfort soft grip handle with lock

SKU#	STAPLE USED	BOX/CTN
CT10X	CT106 STAPLES 10MM U-TYPE Takes both round crown and flat crown staples	1/6

## Staples For CT10X



CT306

10MM CABLE STAPLES	1000PK
Staple Type:	Cable
Bore Diameter Nom:	10mm
Leg Length:	10mm

- For heavy-duty stapling jobs
- Galvanized to reduce corrosion
- Color-coded packaging makes size and product selection a cinch
- Sturdy plastic packaging reduces staple breakage
- Fits Arrow® T2025

SKU#	DESCRIPTION	BOX/CTN
CT305	STAPLES 5/6" (8MM) FOR CT10X	6/48
CT306	STAPLES 3/8" (10MM) FOR CT10X	5/40
CT106	STAPLES (10MM) FOR CT10X (4 Type)	6/48

## Heavy-Duty Hammer Tacker



PHT150

- Used for fast installation of carpeting, roofing materials or insulation
- Contractor-quality design
- Full-rubber grip absorbs shock and protects hand
- Heavy-duty steel construction for added durability
- Loads two full sticks of STANLEY® SharpShooter® TRA700 or Arrow® T-50® heavy-duty staples (1/4"-3/8")

SKU#	STAPLE USED	BOX/CTN
PHT150	Loads two full sticks of STANLEY® SharpShooter® TRA700 or Arrow® T-50® heavy-duty staples (1/4"-3/8")	1/6

## 4 FASTENING TOOLS



PHT250

### Heavy-Duty Hammer Tacker

- Durable all-steel construction withstands heavy use
- Contractor-quality heavy-duty steel construction
- Safety-grip handle guards against hand fatigue and injury

SKU#	STAPLE USED	BOX/CTN
PHT250	Loads two full sticks of STANLEY® SharpShooter® TRA700 or Arrow® T-50® heavy-duty staples (5/16"-1/2")	8/48

### FatMax™ EXTREME Heavy-Duty Hammer Tacker



PHT350

- Professional grade Heavy-Duty Hammer Tacker with an auto retractable built in blade
- Extendable blade that retracts when not in use – easy and secure
- Blade release allows user to remove blade with the push of a button
- Professionals can staple down roofing paper with the Hammer Tacker and then cut away any excess materials with the blade
- Housing design secures blade, allows for easy removal, and replacement of blade
- Features bottom loading - faster and easier to load staples
- Staple exit with patented anti-jam technology
- The PHT350 Hammer Tacker with blade comes with 3 free blades. Uses STANLEY® 11-921, 11-937 or 11-987 blades

SKU#	STAPLE USED	BOX/CTN
PHT350	Loads two full sticks of STANLEY® SharpShooter® TRA700 or Arrow® T-50® heavy-duty staples (5/16"-1/2")	12/48

### SharpShooter™ Staple



TRA705T

- For light-duty household and crafting stapling jobs
- Colour-coded packaging makes size and product selection a cinch
- Sturdy plastic packaging reduces staple breakage
- Light-Duty - Narrow Crown - fits TR45 and Arrow® JT-21
- Heavy-Duty - Narrow Crown - fits TR110, TR200, TRE500 Series, PHT150, PHT250 and Arrow® T-50

SKU#	DESCRIPTION	HEIGHT		PACK SIZE	BOX/CTN
		mm	inches		
TRA204	1/4" Light-Duty Staples	6	1/4"	1,000 pcs	7/56
TRA205	5/16" Light-Duty Staples	8	5/16"	1,000 pcs	6/48
TRA206	3/8" Light-Duty Staples	10	3/8"	1,000 pcs	5/40

SKU#	DESCRIPTION	HEIGHT		PACK SIZE	BOX/CTN
		mm	inches		
TRA704T	1/4" Heavy-Duty Staples	6	1/4"	1,000 pcs	7/56
TRA705T	5/16" Heavy-Duty Staples	8	5/16"	1,000 pcs	6/48
TRA706T	3/8" Heavy-Duty Staples	10	3/8"	1,000 pcs	5/40
TRA708T	1/2" Heavy-Duty Staples	12	1/2"	1,000 pcs	4/32
TRA709T	9/16" Heavy-Duty Staples	14	9/16"	1,000 pcs	4/32

# 4 FASTENING TOOLS

STAPLE SELECTION GUIDE		SUITABLE FOR STAPLERS				
Staples	Size	TR250	TR150HL	TR150	TR110	TR45
Heavy-Duty Staples						
TRA704T	1/4"	•	•	•	•	
TRA705T	5/16"	•	•	•	•	
TRA706T	3/8"	•	•	•	•	
TRA708T	1/2"	•	•	•	•	
TRA709T	9/16"	•	•	•	•	
Light-Duty Staples						
TRA204	1/4"					•
TRA205	5/16"					•
TRA206	3/8"					•

STAPLE SELECTION GUIDE		SUITABLE FOR HAMMER TACKER		
Staples	Size	PHT350	PHT250C	PHT150C
Heavy-Duty Staples				
TRA705T	5/16"	•	•	•
TRA706T	3/8"	•	•	•
TRA708T	1/2"	•	•	

1 MEASURING & LAYOUT TOOLS

2 LASER MEASURING SYSTEM

3 CUTTING & HOLDING TOOLS

4 FASTENING TOOLS

5 STRIKING & STRUCK TOOLS

6 ILLUMINATION TOOLS

7 PAINTING & FINISHING TOOLS

8 MECHANICAL TOOLS

9 TOOLS STORAGE

10 POWER CLEANING TOOLS

11 POWER TOOLS

12 POWER TOOL ACCESSORIES

13 PRODUCT INDEX

# 5 STRIKING AND STRUCK TOOLS

## POWERFUL, QUALITY AND ADVANCE

STANLEY®'s world-renown and world-class research and development teams design hammers that not only exceed customers' expectations, but also live up to the proud STANLEY® name. And in its state-of-the-art manufacturing facilities, STANLEY® produces hammers made from the finest materials available, including wood, fiberglass, steel and graphite. At STANLEY®, every hammer is engineered with safety in mind. That's why you'll find shock absorption features on many of our striking tools. You'll also find balanced heads, ergonomically-designed grips and handles shaped to prevent slipping. You can be confident that STANLEY® hammers exceed the industry standard for safety and durability.

### WHY STANLEY® HAMMER?

#### 1 Superior quality

10 extensive tests to ensure the best quality on the market

- Pound Test
- Handle Bend Test
- Head Pull Test

#### 2 Technology

- STANLEY® is the only hammer that is rim tempered to reduce spalling
- Patent Pending 70%+ Large strike face for striking accuracy
- Patented AntiVibe® reduces are damaging vibrations
- Patented Stabilizers reduce arm twisting torsion

### HAMMER TERMINOLOGY





### USE THE RIGHT WEIGHT OF HAMMER

Choosing the right weight is important, because there is no benefit in lifting a 22oz hammer to drive nails no longer than 50mm (2"). In the same way a 16oz hammer will make heavy work in driving a 75mm nail. As a reasonable compromise a 20oz claw hammer is a good general-purpose choice.

### HAMMER END USER CUES



- 1 **Head Type**
  - Curve Claw = DIY
  - Ball Pein = Pro
  - 10 Specialty Head Types = Pro, Advanced DIY
- 2 **Handle Length**
  - < 14" = DIY and Pro
  - > 14" = Pro (Framing)
- 3 **Durability**
  - 2pc = Wood, Fiberglass, Graphite, Steel & Titanium
  - 1pc = Steel and Titanium
- 4 **Weight**
  - DIY = 7oz, 13oz, 16oz
  - Pro = 16oz, 20oz, 22oz, 28oz
- 5 **Grip Feel**
- 6 **Balance**
- 7 **Face**
  - Smooth
  - Checked

## 5 STRIKING & STRUCK TOOLS



### FatMax™ Functional Utility Bar



55-119R

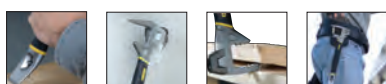

- Multifunction usage
- Tough and versatile tool
- 4-in-1 tool for prying, splitting, board bending and striking jobs
- 2.5 lbs - fits easily in the hammer loop and easy to swing
- One piece forged steel bar for increased durability
- Board grabbing jaw sized for 2x lumber
- Beveled nail slot for pulling & prying nails
- Serrated gripping jaw, textured grip for excellent comfort & control, even when wet
- The short and light weight lends itself to coping with harder to reach corners
- Tempered steel that prevents chipping

SKU#	DESCRIPTION	LENGTH		WEIGHT		BOX/ CTN
		inches	mm	lbs	kg	
55-119R	FatMax™ Functional Utility Bar	15"	381	2.5lbs	1.13	2/20

### FatMax™ Xtreme® FuBar® Utility Bar - 18"



55-099

- Recipient of Popular Science "Best of What's New" Award.
- Utility bar for heavy demolition work
- 4-in-1 tool for prying, splitting, board bending and striking jobs
- One-piece forged steel bar for durability
- Board-grabbing jaw sized for 2X lumber
- Beveled nail slot for pulling and prying nails
- Textured grip for excellent comfort and control
- Heat-treated and tempered striking face helps prevent chipping
- High-visibility powder-coated finish

SKU#	DESCRIPTION	LENGTH		WEIGHT		BOX/ CTN
		inches	mm	lbs	kg	
55-099	FatMax™ Xtreme® FuBar® Utility Bar Blade Width 1-1/2" / 38mm	18"	457	4lbs	1.81	2/2

## 5 STRIKING & STRUCK TOOLS

### FatMax™ Xtreme® Functional Utility Bar III



55-120R

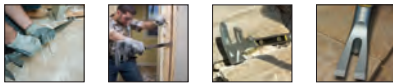

- The ultimate multi-purpose demolition tool
- Excellent for prying, splitting, board bending & heavy striking jobs
- Superior leverage with its 30" length
- 8.5 lb total weight is precision balanced for maximum striking power
- Sledge hammer face
- Ripping hook
- One piece forged steel construction for increased durability
- Textured grip for excellent control and comfort
- Nail puller & pry bar

SKU#	DESCRIPTION	LENGTH		WEIGHT		BOX/CTN
		inches	mm	lbs	kg	
55-120R	FatMax™ Xtreme™ Functional Utility Bar III	30"	762	8.5lbs	3.85	1/6

### STANLEY® Fubar® Forcible Entry Tool

Our premier forcible entry tool designed by responders for vehicle extrication and extreme demolition:

- 8-in-1 tool for prying, splitting, board bending and striking jobs
  - Demolition head
  - Gas shut-off feature
  - Spanner wrench
  - Pry bar for ripping
  - Hydrant wrench
  - 2nd tier board jaw also fits square hydrant nuts
  - Board jaw sized specifically for grabbing common dimensional lumber
  - Beveled nail slot for pulling & prying nails
- One piece forged steel bar for increased durability
- Heat treated and tempered striking face prevents chipping
- Heat-resistant grips are durable and lightweight
- Carabiner holes for easy attachment of shoulder strap
- Hi-visibility 3M™ Scotchlite™ enhances visibility



55-121

SKU#	DESCRIPTION	LENGTH	WEIGHT	BOX/CTN
55-121	FUBAR WITH NYLON GRIP 18"	18",457.2mm	6 lbs, 2.72 kilos	4/4
55-122	FUBAR WITH NYLON GRIP 30"	30",762mm	11 lbs, 4.99 kilos	2/2

1 MEASURING & LAYOUT TOOLS

2 LASER MEASURING SYSTEM

3 CUTTING & HOLDING TOOLS

4 FASTENING TOOLS

5 STRIKING & STRUCK TOOLS

6 ILLUMINATION TOOLS

7 PAINTING & FINISHING TOOLS

8 MECHANIC TOOLS

9 TOOLS STORAGE

10 POWER CLEANING TOOLS

11 POWER TOOLS

12 POWER TOOL ACCESSORIES

13 PRODUCT INDEX

## 5 STRIKING & STRUCK TOOLS

### Mallet Hammer



56-112



TIP



MALLET

- Plastic tips on this hammer are designed to wear away as they protect the surface being struck
- Replacement is as easy as unscrew off the old tip and screw on the new one
- Forged, high carbon, quality steel head

SKU#	MALLET HEAD LENGTH		BOX/CTN
	mm	inches	
56-112	0.8	22"	6/60
56-113	1.1	28"	6/36
56-114	1.3	35"	6/36
56-115	1.7	45"	6/24
56-116	2.3	60"	4/16

### FatMax® Xtreme™ AntiVibe® Curve Claw Nailing Hammer



**FatMax<sup>®</sup>  
XTREME**

51-162

- 75% larger\* strike face for improved striking accuracy
- AntiVibe® technology minimizes vibration and shock at impact
- Torsion control stabilizers reduce arm-twisting fatigue
- Magnetic Nail Start feature for extended reach for one-handed nailing
- Exclusive rim temper reduces incidences of chipping or spalling
- Forged, one-piece steel construction for strength and durability
- Slip-resistant handle for a secure grip and comfort
- Precision balanced, curved claw, smooth face

*\*Than traditional hammers*

Overall Length 13-1/2" / 343mm

SKU#	HEAD LENGTH		WEIGHT		BOX/CTN
	mm	inches	grams	oz	
51-162	343	13-1/2"	454	16	4/4
51-164	343	13-1/2"	567	20	4/4

### Jacketed Steel Handle Hammer



51-081

- Shaft 15% longer for better balance & control in usage
- Grip 15% longer for better performance
- Individually heat-treated for long life
- Hardened and tempered tubular steel shaft for strength
- Flock-filled rubber grip for comfort and durability
- Meets ANSI standards

SKU#	HEAD LENGTH		WEIGHT		BOX/CTN
	mm	inches	grams	oz	
51-081	335	13-1/4"	450	16	6/36
51-082	335	13-1/4"	570	20	6/36



## 5 STRIKING & STRUCK TOOLS

### Fiberglass Nail Hammer



51-072

- Fiberglass shaft with polypropylene outer jacket
- Tape Lock union between head and shaft for safety
- Flock-filled rubber grip impervious to heat
- Meets ANSI standards
- Improved handle design for greater comfort & control

SKU#	HEAD LENGTH		WEIGHT		BOX/CTN
	mm	inches	grams	oz	
51-071	335	13-1/4"	450	16	6/36
51-072	335	13-1/4"	570	20	6/36

### Jacketed Fiberglass Engineering Hammer



56-202

- Heat treated high carbon alloy steel heads for long life and durability
- Machined striking face for accuracy
- Jacketed fiberglass handle for overstrike protection

SKU#	HEAD LENGTH		WEIGHT		BOX/CTN
	mm	inches	grams	oz	
56-202	112	4-3/8"	1100	40	4/4
56-204	135	5-1/4"	1800	64	4/4

### Jacketed Fiberglass Drilling Hammer



56-701

- New England pattern head is forged from high grade, hardened, tempered steel
- Machined striking face for accuracy
- Jacketed fiberglass handle for overstrike protection

SKU#	HEAD LENGTH		WEIGHT		BOX/CTN
	mm	inches	grams	oz	
56-701	106	4-1/4"	930	32	4/4
56-705	116	4-1/2"	1400	50	4/4

### Jacketed Fiberglass Blacksmith Hammer



56-218

- Heat treated high carbon alloy steel heads for long life and durability
- Machined striking face for accuracy
- High visibility yellow handle is made of jacketed fiberglass for strength and durability

SKU#	HEAD LENGTH		WEIGHT		BOX/CTN
	mm	inches	grams	oz	
56-218	125	5"	1100	40	4/4
56-220	135	5-1/8"	1800	64	4/4

1 MEASURING & LAYOUT TOOLS

2 LASER MEASURING SYSTEM

3 CUTTING & HOLDING TOOLS

4 FASTENING TOOLS

5 STRIKING & STRUCK TOOLS

6 ILLUMINATION TOOLS

7 PAINTING & FINISHING TOOLS

8 MECHANIC TOOLS

9 TOOLS STORAGE

10 POWER CLEANING TOOLS

11 POWER TOOLS

12 POWER TOOL ACCESSORIES

13 PRODUCT INDEX

93

## 5 STRIKING & STRUCK TOOLS

### Wood Handle Nail Hammer



51-271

- The hammer head is attached with 2 wedges for better durability
- Natural hardwood handle
- Meets ANSI standards
- Hammer claws 15% longer for greater ease in pulling nails

SKU#	HEAD LENGTH		WEIGHT		BOX/CTN
	mm	inches	grams	oz	
51-269	330	13"	370	13	6/36
51-271	330	13"	450	16	6/36
51-274	335	13-1/4"	570	20	6/36

### Ball Pein Hammer



54-190

- The hammer head is attached with 2 wedges for better durability
- Ball end used for riveting and poll used for normal striking
- Meets ANSI standards
- Handle 25% longer in 16-32oz sizes for better balance and control

SKU#	HEAD LENGTH		WEIGHT		BOX/CTN
	mm	inches	grams	oz	
54-189	311	12-1/4"	230	8	6/48
54-190	345	13"	340	12	6/48
54-191	355	14"	450	16	6/36
54-192	381	15"	680	24	6/24
54-193	405	16"	910	32	6/24

### Contractor Grade™ Hickory Handle Engineering Hammer



56-804

- Forged steel head-hardened and tempered
- Faces machine finished
- Selected clear lacquered hickory handle

SKU#	HEAD LENGTH		WEIGHT		BOX/CTN
	mm	inches	grams	oz	
56-803	130	5-1/8"	1,400	50	4/4
56-804	135	5-1/4"	1,800	64	4/4

## 5 STRIKING & STRUCK TOOLS

### Contractor Grade™ Hickory Handle Sledge Hammer



56-812

- Forged steel head-hardened and tempered
- Faces machine finished
- Selected clear lacquered hickory handle

SKU#	HEAD LENGTH		WEIGHT		BOX/CTN
	mm	inches	grams	oz	
56-808	165	6-1/2"	3,600	127	4/4
56-812	195	7-3/4"	5,400	190	4/4
56-816	215	8-1/2"	7,300	258	2/2

### Compo-Cast® Standard Head Soft Face Hammer



57-532

- Non-Sparking soft face hammers
- No exposed metal
- Soft face doesn't mar surfaces or equipment
- Steel reinforced handles provide added strength and safety, resist breaking on overstrike

SKU#	FACE DIAM.		HEAD LENGTH		O / A LENGTH		WEIGHT		BOX/CTN
	mm	inches	mm	inches	mm	inches	grams	oz.	
57-530	30	1.2"	79	3-1/8"	257	10-1/8"	284	10	1/4
57-531	40	1.6"	95	3-3/4"	286	11-1/4"	510	18	1/4
57-532	45	1.8"	103	4-1/16"	327	12-7/8"	595	21	1/4
57-533	53	2.1"	117	4-5/8"	362	14-1/4"	1,191	42	4/4
57-534	63	2.5"	136	5-3/8"	387	15-1/4"	1,474	52	1/2

### Compo-Cast® Slimline Head Soft Face Hammer



57-543

- Non-Sparking soft slimline hammers
- No exposed metal
- Soft face doesn't mar surfaces
- Ideal for assembly and repair applications in confined areas
- Steel reinforced handles provide added strength and safety, resist breaking on overstrike

SKU#	FACE DIAM.		HEAD LENGTH		O / A LENGTH		WEIGHT		BOX/CTN
	mm	inches	mm	inches	mm	inches	grams	oz.	
57-540	17.5	0.7"	73	2-7/8"	238	9-3/8"	142	5	1/4
57-541	27	1.1"	106	4-3/16"	268	10-9/16"	397	14	1/4
57-542	33	1.3"	108	4-1/4"	308	12-1/8"	510	18	1/2
57-543	35	1.4"	133	5-1/4"	327	12-7/8"	595	21	1/2

1 MEASURING & LAYOUT TOOLS

2 LASER MEASURING SYSTEM

3 CUTTING & HOLDING TOOLS

4 FASTENING TOOLS

5 STRIKING & STRUCK TOOLS

6 ILLUMINATION TOOLS

7 PAINTING & FINISHING TOOLS

8 MECHANICAL TOOLS

9 TOOLS STORAGE

10 POWER CLEANING TOOLS

11 POWER TOOLS

12 POWER TOOL ACCESSORIES

13 PRODUCT INDEX

95

## 5 STRIKING & STRUCK TOOLS



57-527

### Rubber Mallet

- For striking blows where steel hammers would mar or damage surface of the work

SKU#	O / A LENGTH		WEIGHT		BOX/CTN
	mm	inches	grams	oz	
57-527	350	13"	450	16	6/36
57-528	350	13"	680	24	6/24

### Cushion Grip Nail Set

- Grip is slip-resistant in all weather conditions and ribbed to absorb shock, improving precision
- 25% longer length enables user to set nails in hard to reach areas
- Fully hardened, precision-milled steel for long life
- Long, beveled tip for easy nail head alignment
- Colour coded by tip size for quick identification
- Patented design developed for professional use
- 3 pc nail set (SKU# - 58-930) contains 58-911, 58-912 and 58-913



58-930

SKU#	COLOUR	O / A LENGTH		TIP		BOX/CTN
		mm	inches	mm	inches	
58-911	Yellow	127	5"	0.8	1/32"	6/96
58-912	Grey	127	5"	1.6	2/32"	6/96
58-913	Red	127	5"	2.4	3/32"	6/96
58-930	(3 Pc Set)					6/96

### 4/32" Tip Square Head Nail Set

- Ideal for setting nails into materials
- Long length for setting nails in hard-to-reach areas
- Fully hardened, precision-milled steel for long life
- Long, beveled tip for easy nail head alignment
- Square head prevents rolling when set down



58-114

SKU#	COLOUR	O / A LENGTH		TIP		BOX/CTN
		mm	inches	mm	inches	
58-114	Grey	101	4"	3.17	4/32	6/72

## 5 STRIKING & STRUCK TOOLS

### 1/8" (3.2mm) Center Punch



58-120

- This Center Punch has a 1/8" (0.125"/3.2mm) tip
- 4" overall length
- 5/16" stock size
- Square head
- Hardened & tempered alloy steel centre punch
- Tips are cupped & chamfered to locate accurately onto nail head

SKU#	COLOUR	O /A LENGTH		TIP		BOX/CTN
		mm	inches	mm	inches	
58-120	Grey	100	4"	3.2	1/8"	6/72

### 6-Piece Wood Carving Set



16-120

- Handy carving knives in various cut ideal for DIY handicrafts
- 1 ea square chisel
- 1 ea sken chisel
- 1 ea curved gouge
- 1 ea straight gouge
- 1 ea curved flat
- 1 ea curved U tool

SKU#	CONTENTS	BOX/CTN
16-120	Square & Sken Chisel, Curved & Straight Gouge, Curved flat, Curved U tool	12/72

### 150 Series - 3-Piece Wood Chisel Set



16-089

- Durable precision ground cutting edges
- Blades uniformly hardened for full length use
- Blades are also heat tempered and lacquer coated to prevent rust

SKU#	DESCRIPTION	LENGTH	BOX/CTN
		inches	
16-089	3 pcs Wood Chisel Set	1/2" x 7-3/4"	5/30
		3/4" x 7-3/4"	
		1" x 7-3/4"	

1 MEASURING & LAYOUT TOOLS

2 LASER MEASURING SYSTEM

3 CUTTING & HOLDING TOOLS

4 FASTENING TOOLS

5 STRIKING & STRUCK TOOLS

6 ILLUMINATION TOOLS

7 PAINTING & FINISHING TOOLS

8 MECHANIC TOOLS

9 TOOLS STORAGE

10 POWER CLEANING TOOLS

11 POWER TOOLS

12 POWER TOOL ACCESSORIES

13 PRODUCT INDEX

97

## 5 STRIKING & STRUCK TOOLS

### DynaGrip® Chisel

- Blade guard for storage safety
- Fully precision ground blade on all faces
- Ergonomic hi-impact resistant bi-material handle
- Rust-resistant, lacquered coated blade



16-282

SKU#	CONTENTS		BOX/CTN
	mm	inches	
16-273	6	1/4"	6/36
16-274	8	5/16"	6/36
16-275	10	3/8"	6/36
16-276	12	1/2"	6/36
16-277	14	9/16"	6/36
16-278	16	5/8"	6/36
16-279	18	3/4"	6/36
16-280	20	13/16"	6/36
16-281	22	7/8"	6/36
16-282	25	1"	6/36
16-286	30	1"	6/36
16-283	32	1-1/4"	6/36
16-287	36	1-1/2"	6/36
16-284	38	1-1/2"	6/36
16-285	12, 18, 25	1/2", 3/4", 1"	4/24

### FatMax™ Concrete Chisel with Bi-Material Hand Guard

- Durable bull point that cuts fast and lasts long
- Ideal for cutting through and breaking up concrete



16-329

SKU#	CONTENT	LENGTH	BOX/CTN
		inches	
16-329	Concrete Chisel 3/4" x 12" w/Guard	3/4" x 12"	3/18

### FatMax™ Floor Chisel with Bi-Material Hand Guard

- Used for cutting, prying or ripping of hardwood flooring and nails
- Designed with offset blade and shorter bite for increased leverage



16-331

SKU#	CONTENTS	LENGTH	BOX/CTN
		inches	
16-331	FatMax™ Floor Chisel 3" x 11" with guard	3" x 11"	3/18

## 5 STRIKING & STRUCK TOOLS



16-332

### FatMax™ Cold Chisel with Bi-Material Hand Guard

- For cutting/ shaping wrought iron, cast iron, steel, brass, bronze, copper, aluminum, bolts, nuts and rivets

SKU#	CONTENTS	LENGTH inches	BOX/CTN
16-332	FatMax™ Cold Chisel 1" x 12" with guard	1" x 12"	3/18



16-334

### FatMax™ Mason's Chisel with Bi-Material Hand Guard

- Used for cutting and splitting hard stone, brick and concrete

SKU#	CONTENTS	LENGTH inches	BOX/CTN
16-334	FatMax Mason's Chisel 2-3/4" x 8-1/2" with guard	2-3/4" x 8-1/2"	3/18



16-286-2

### STANLEY® Cold Chisel

- One-piece construction forged from chrome vanadium steel for increased strength and durability
- Hardened, quenched and tempered for long life and added safety
- Powder coat finish for increased visibility
- For cutting/ shaping wrought iron, cast iron, steel, brass, bronze, copper, aluminum, bolts, nuts and rivets

SKU#	LENGTH inches	BOX/CTN
16-286-2	3/8" x 5-9/16"	3/24
16-287-2	1/2" x 6"	3/24
16-288	5/8" x 6-3/4"	3/24
16-289	3/4" x 6-7/8"	3/24
16-290	7/8" x 8"	3/24
16-291	1" x 12"	3/24



16-229

### Starter Punch

- Used for starting drill holes
- One-piece construction forged from tempered tool steel for strength
- Hardened and tempered for long life
- Powder coat finish for increased visibility

SKU#	LENGTH inches	BOX/CTN
16-229	3/32" x 5-1/2"	3/24

1 MEASURING & LAYOUT TOOLS

2 LASER MEASURING SYSTEM

3 CUTTING & HOLDING TOOLS

4 FASTENING TOOLS

5 STRIKING & STRUCK TOOLS

6 ILLUMINATION TOOLS

7 PAINTING & FINISHING TOOLS

8 MECHANIC TOOLS

9 TOOLS STORAGE

10 POWER CLEANING TOOLS

11 POWER TOOLS

12 POWER TOOL ACCESSORIES

13 PRODUCT INDEX

## 5 STRIKING & STRUCK TOOLS



### Pin Punch

- One piece construction forged from tempered tool steel for strength
- Hardened and tempered for long life
- Powder coat finish for increased visibility



16-230

SKU#	LENGTH inches	BOX/CTN
16-230	Pin Punch 1/16" x 6"	3/24
16-231	Pin Punch 1/8" x 6"	3/24
16-232	Pin Punch 5/32" x 6"	3/24
16-233	Pin Punch 3/16" x 6"	3/24
16-234	Pin Punch 1/4" x 6"	3/24
16-235	Pin Punch 5/16" x 6"	3/24

### Prick Punch

- Used for marking metal
- One-piece construction forged from tempered tool steel for strength
- Hardened and tempered for long life
- Powder coat finish for increased visibility



16-236

SKU#	LENGTH inches	BOX/CTN
16-236	3/8" x 5-1/2"	3/24

### Center Punch

- Used for marking metal or making indentations for starting drill holes
- One piece construction forged from tempered tool steel for strength
- Hardened and tempered for long life



16-228

SKU#	CENTER PUNCH inches	BOX/CTN
16-227	1/4" x 4"	3/24
16-228	5/16" x 4-1/2"	3/24

### 6-Piece Punch Kit

- Accessible packaging enables customer to easily evaluate products in store



16-226

SKU#	CONTENTS	BOX/CTN
16-226	16-231, 16-233, 16-234, 16-235, 16-232, 16-230	3/24



# 5 STRIKING & STRUCK TOOLS

## Claw Bar

- Flat striking face allows claw to be driven under deeply embedded nails
- Forged, high carbon alloy steel for long life
- Tempered for safety and heat treated for durability
- Polished, beveled claws allow for precision nail pulling and prying



55-113

SKU#	OVERALL LENGTH		BOX/CTN
	mm	inches	
55-113	203	8"	6/6
55-114	254	10"	2/6
55-115	305	12"	2/6

1 MEASURING & LAYOUT TOOLS

2 LASER MEASURING SYSTEM

3 CUTTING & HOLDING TOOLS

4 FASTENING TOOLS

5 STRIKING & STRUCK TOOLS

6 ILLUMINATION TOOLS

7 PAINTING & FINISHING TOOLS

8 MECHANIC TOOLS

9 TOOLS STORAGE

10 POWER CLEANING TOOLS

11 POWER TOOLS

12 POWER TOOL ACCESSORIES

13 PRODUCT INDEX

## 5 STRIKING & STRUCK TOOLS

### Hexagonal Straight Bar



55-150

- A basic tool used in demolition of all type of construction, including concrete

SKU#	OVERALL LENGTH		WEIGHT	BOX/CTN
	m		lbs	
55-150	1.5		15	6/6
55-175	1.8		17	6/6

### Molding Bar



55-116

- Flat surface allows users to cleanly pry molding and trim reducing material damage
- Forged high carbon alloy steel for long life
- Tempered for safety and heat treated for durability
- Polished, beveled claws allow for precision nail pulling and prying

SKU#	OVERALL LENGTH		BLADE WIDTH		BOX/CTN
	mm	inches	mm	inches	
55-116	203	8"	45	1.75"	2/6
55-117	254	10"	45	1.75"	2/6

### FatMax™ Wrecking Bar



55-101

- Forged, high-carbon steel able to withstand 975 ft-lbs, of bending momentum
- Tri-lobe design increases strength, durability and ease of use
- High-visibility, powder-coated finish
- Slotted claw and beveled ends improve functionality and performance

SKU#	OVERALL LENGTH		BLADE WIDTH		BOX/CTN
	mm	inches	mm	inches	
55-101	356	14"	25	1"	4/4
55-102	610	24"	38	1.5"	4/4
55-104	914	36"	38	1.5"	4/4

## 5 STRIKING & STRUCK TOOLS

### Forged Hexagonal Steel Ripping Bar

- High carbon steel adds prying strength
- Chisel end is beveled
- Both slotted claw and chisel ends are polished



55-118

SKU#	LENGTH		BOX/CTN
	mm	inches	
55-118	16 x 455	5/8" x 18"	6/6
55-124	19 x 610	3/4" x 24"	6/6
55-130	19 x 760	3/4" x 30"	6/6

### Wonder Bar X21 Pry Bar

- Forged high carbon steel for increased strength and durability
- 21" long for better reach and greater leverage
- Excellent for pulling nails, lifting or prying
- High-visibility, powder-coated finish



55-526

SKU#	OVERALL LENGTH		BLADE WIDTH		BOX/CTN
	mm	inches	mm	inches	
55-526	533	21"	44	1.75"	4/4

1 MEASURING & LAYOUT TOOLS

2 LASER MEASURING SYSTEM

3 CUTTING & HOLDING TOOLS

4 FASTENING TOOLS

5 STRIKING & STRUCK TOOLS

6 ILLUMINATION TOOLS

7 PAINTING & FINISHING TOOLS

8 MECHANIC TOOLS

9 TOOLS STORAGE

10 POWER CLEANING TOOLS

11 POWER TOOLS

12 POWER TOOL ACCESSORIES

13 PRODUCT INDEX

103

# 6 ILLUMINATION TOOLS

## EFFICIENT, PORTABLE AND LONG LASTING

STANLEY® offers a full range of hands-free work lights and high-performance aluminum flashlights that boast the latest design innovations and LED bright-light technologies. The expanded line of LED flashlights provides convenience in a range of size and styles. The MaxLife™ 369™ Tripod and Mini Tripod models provide hands-free lighting options. Both durable and water-resistant, the flashlights offer such features as patented MaxLife™ 369™ technology, which enables the light to operate on 3, 6, or 9 batteries and to generate more than 200 hours of continuous light. These models also feature a hands-free tripod design and a multi-position head, which allows the user to aim a focused beam of light where needed. Weather-resistant and durable, this flashlight incorporates anodized aluminum space frame construction with a graphite/ABS composite head.



## STANLEY® INNOVATIONS

This category includes the innovative new hands-free STANLEY® Clamp Light, which has a large spring-loaded handle that opens up to 4 inches wide for grabbing onto exposed ceiling joists, wall studs, fence posts, tabletops and/or car hoods. It features an oversized rotating, tilting head; impact-resistant housing; non-slip comfort grip; and super-bright LED bulb with shatterproof lens.

Another innovation pioneered by STANLEY® is its line of LED tripod lights. Each light can be used as a standard flashlight, but at the push of a button, 3 legs pop out, converting the handheld flashlight into a freestanding lantern. There are 4 different sizes of tripod lights, including the 3-in-1 model that can be used as a powerful handheld flashlight, as a freestanding lantern, or disassembled and used as 3 separate smaller flashlights.

## WHY STANLEY® ILLUMINATION TOOLS

### 1 Competitive Advantage

10 extensive tests to ensure the best quality on the market

- Patented hands free tripod design
- Patented 3, 6, 9 technology – ability to use 3, 6, or 9 batteries without sacrificing brightness
- Patented 3 flashlights in 1 technology

### 2 Market Trends

- L.E.D. flashlights = more energy efficient, brighter light, longer life
- Inconsistent lumen claims = ANSI standards



## 6 ILLUMINATION TOOLS



### 3-in-1 Tripod LED Flashlight



95-155



- Patented hands free tripod design
- Separates into 3 independent flashlights
- Combines into one powerful flashlight
- Each independent flashlight generates 20 lumens of light
- Three 120 degree multi-directional rotating heads
- Shatter resistant lens
- ON/OFF switch turns all flashlights on or off when placed inside the tripod base
- One-touch tripod release button
- Uses 6 AA batteries

SKU#	BATTERIES		BRIGHTNESS	BULB TYPE	BEAM DISTANCE		IMPACT RESISTANCE		HEIGHT		BOX/CTN
	(NOT INCLUDED)	RUN TIME			ft	m	ft	m	in	mm	
95-155	6 AA (2 per Flashlight)	5 Hrs	100 Lumens (34 Lumens @)	1/2W LED	375	115	3	0.9	13-3/4"	349	4/4

### MAXLIFE™ 369™ Tripod Flashlight



95-112W

- Tripod design provides capability for hands-free use
- Magnetized and anodized aluminum tripod legs fold together to become a regular hand-held flashlight
- 3-6-9 technology gives user the choice to run the flashlight on 3, 6 or 9 AA batteries
- 100° rotational head with shatter-resistant lens focuses light where it's needed most
- One 1/2-watt bright white, long-lasting LED delivers a strong spot beam
- Slip-resistant rubber grip and feet
- On/Off switch
- Compliant with ANSI, CE and RoHs standards

SKU#	BATTERIES		BRIGHTNESS	BULB TYPE	BEAM DISTANCE		IMPACT RESISTANCE		HEIGHT		BOX/CTN
	(NOT INCLUDED)	RUN TIME			ft	m	ft	m	in	mm	
95-112W	3,6 or 9 AA	90 hrs (using 9 AA)	20 Lumens	1/2 W LED	282	86	3	0.9	11-8/9"	302	6/6

## MAXLIFE™ Mini LED Tripod Flashlight



95-111

- Innovative, compact tripod design offers hands-free convenience
- Weather-resistant anodized aluminum space frame construction tripod legs fold to become a regular hand-held flashlight.
- Perfect for a project or emergency situation
- Multi-position head focuses light precisely where it's needed
- Low-power indicator light flashes so you're never caught in the dark
- Durable, impact-resistant design with a graphite ABS composite head and shatter-resistant polycarbonate lens
- Simple 4-position switch lets you choose Low, Medium, High or Off
- Runs on 3 AAA batteries (not included) - must run on minimum of 3 batteries

SKU#	BATTERIES		BRIGHTNESS	BULB TYPE	IMPACT				BOX/CTN
	(NOT INCLUDED)	RUN TIME			RESISTANCE	HEIGHT	HEIGHT	HEIGHT	
95-111	3AAA	10 hrs	8 Lumen	5mm LED	ft	m	in	mm	4/24

## MAXLIFE™ 369™ Tripod Flashlight - Titanium Finish



95-115

- Bright-white 1.25 Watt LED light
- Spot-to-flood light focusing capability
- Innovative tripod design offers hands-free convenience
- Weather-resistant anodized aluminum space frame construction tripod legs
- Perfect for a project or emergency situation
- Multi-position head focuses light precisely where it's needed
- Low-power indicator light flashes so you're never caught in the dark
- Durable, impact-resistant design with a graphite ABS composite head and shatter-resistant polycarbonate lens
- Simple 3-position switch lets you choose Low, High or Off
- Runs on 3, 6, or 9 AA batteries (not included) depending on usage requirement

SKU#	DESCRIPTION	BOX/CTN
95-115	MaxLife™ 369 Tripod Flashlight - Titanium Finish	1/4

## Mini Tripod LED Flashlight with keychain-Black/Sliver Finish



95-113X

- Patented tripod design offers hands-free convenience
- Multi-position head focuses light precisely where it's needed
- On/Off Switch
- Swivel key ring for convenience
- Bulbs: One 5mm LEDs last 100,000 hrs
- Brightness: 2 Lumens
- Run time: 6 hours
- Includes 3 replaceable lithium button cell batteries (LR41)

SKU#	BATTERIES		BRIGHTNESS	BULB TYPE	IMPACT				BOX/CTN
	INCLUDED	RUN TIME			RESISTANCE	HEIGHT	HEIGHT	HEIGHT	
95-113X	3LR41	6 hrs	2 Lumens	5mm LED	ft	m	in	mm	10/60

# 7 PAINTING AND FINISHING TOOLS

## SMOOTH, FAST AND ACCURATE

STANLEY® is proud of its long-standing commitment to manufacturing some of the world's best finishing tools. Owning quality finishing tools says a lot about how serious a woodworker you are. STANLEY's line of finishing tools is made with quality materials. The parts are precision ground. And they have features that give woodworkers greater control and accuracy. STANLEY's celebrated line of Surform® tools, which comprises five different super-versatile implements designed for quickly smoothing, shaping and contouring a wide variety of materials ranging from wood, drywall and rabbit to copper, aluminum and brass. A wide variety of Surform® replacement blades is available too.

### WHAT IS SURFORM®?

The word SURFORM® is derived from the two words : SURface FORMing

- **ALL-IN-ONE:** Two-handed planes, files, one-handed planes and shaver
- **REPLACEABLE BLADES:** Blade provides the advantages over other tool alternatives, such as files; rasps and planes
  1. Rows of "D" shaped holes are punched through the blade
  2. Producing sharp chisel-like teeth
  3. After hardening, the teeth will cut through materials in the same way that a grater cuts cheese
  4. Shavings pass through the blade and do not clog



### IDEAL FOR ANY SURFACE REMOVAL

- Remove paint
- Drywall edging
- Automotive body filler
- Filing
- Planing
- Shaving

### HOW TO USE SURFORM® TOOLS

For **FAST CUTTING** use the tool at an angle of about 30° to the direction of cut

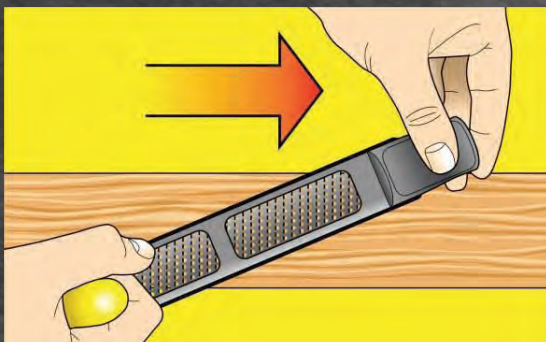

For **SMOOTHING** and **FINISHING**, use the tool parallel to the direction of cut

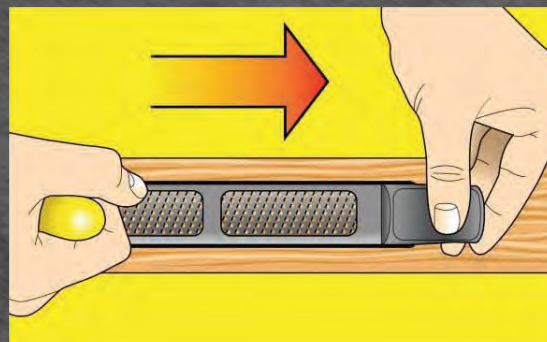





### SURFORM® TOOLS

**SURFORM® Shaver**



- Two handed use
- Light material removal
- Side cut teeth in blade useful for shaving in corners
- Works on the pull stroke

**Pocket Plane**



- One handed use
- Light wood removal
- ideal for end grain work, sheet rocking & smoothing edges of laminates

**SURFORM® Flat File**



- Two handed use
- Moderate to heavy wood removal
- Superb tool for use as a rasp on wood, plastic and soft metals

**SURFORM® Plane**



- Two handed use
- Moderate wood removal
- For materials that would dull a traditional bench plane blades

**Standard Cut**



- Light material removal
- All-Purpose blade
- Serrated edge for edge cutting

**Fine Cut**



- Light wood removal
- Ideal for finishing work, end grain, wallboards and soft metals

**Round File**



- Moderate wood removal
- Used for enlarging or changing the shape of holes or small concave edges

**Shaver**



- Light material removal
- Side cut teeth in blade useful for shaving in corners

**Half Round**



- Moderate wood removal
- Half Round convex blade used for fast stock removal and shaping curved surfaces

## 7 PAINTING & FINISHING TOOLS

### Paint Roller - Complete

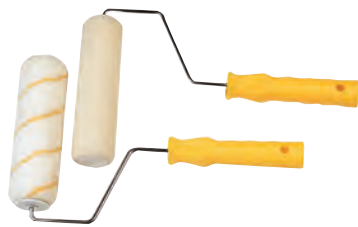

29-493-1

SKU#	CONTENTS	FOR USE ON	LENGTH		DIAMETER		BOX/ CTN
			mm	inches	mm	inches	
29-064-1	7" Cage roller/ mogloss short refill	Gloss and eggshell paints on smooth surfaces	175	7"	37	1-1/2"	24/48
29-494-1	7" Cage roller/ acrylic med refill	Flat of masonry paint on semi smooth/rough surfaces	175	7"	37	1-1/2"	24/48
29-493-1	7" Cage roller/ acrylic long refill	Flat of masonry paint on semi smooth/rough surfaces	175	7"	37	1-1/2"	24/48
29-069-1	9" Cage roller/ mogloss short refill	Gloss and eggshell paints on smooth surfaces	255	9"	37	1-1/2"	24/48
29-401-1	9" Cage roller/ acrylic med refill	Flat/matt paint smooth/ semi smooth surfaces	255	9"	37	1-1/2"	24/48
29-400-1	9" Cage roller/ acrylic long refill	Flat/matt paint smooth/ semi smooth surfaces	255	9"	37	1-1/2"	24/48

### Mini Roller & Refill



29-814-1

SKU#	CONTENTS	FOR USE ON	LENGTH		BOX/ CTN
			mm	inches	
29-814-1	Mini Roller Frame + Refill (29-086-0 + 29-816)	Water based gloss and eggshell	100	4"	24/48
29-078-2	Acrylic Yellow Stripe Refill - 2/pk	Flat/ matt paint on smooth surfaces	100	4"	10/100
29-078-5	Acrylic Yellow Stripe Refill - 10/pk	Flat/ matt paint on smooth surfaces	100	4"	10/20
29-816-2	High Density Foam Refill - 2/pk	Water based gloss and eggshell paints on smooth surfaces	100	4"	20/100
29-816-5	High Density Foam Refill - 10/pk	Water based gloss and eggshell paints on smooth surfaces	100	4"	10/20
29-808-5	Velour Roller Refills	Velour Fabric for gloss paints on smooth surfaces	100	4"	10/20
29-480-1	Mini Roller Kit : 1 roller head for flat/ matt paint and 1 for gloss and varnish	Dual purpose- for emulsion and gloss	100	4"	24/48

# 7 PAINTING & FINISHING TOOLS

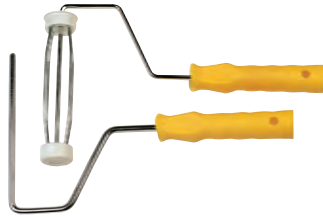

29-076-1

## Stick & Cage Frame Roller

SKU#	CONTENTS	LENGTH		DIAMETER		BOX/CTN
		mm	inches	mm	inches	
29-076-1	7" Stick Roller Frame	-	7"	-	-	24/48
29-772-1	9" Stick Roller Frame	-	9"	-	-	24/48
29-044-1	7" Cage Frame	175	7"	37	1-1/2"	24/48
29-045-1	9" Cage Frame	255	9"	37	1-1/2"	24/48

## Stick Roller Refill



SKU#	CONTENTS	FOR USE ON	LENGTH		BOX/CTN
			mm	inches	
29-278-0	9" Green Acrylic Long Pile	Flat/ matt paint on smooth surfaces	225	9"	24/48
29-277-0	9" Acrylic Yellow Stripe Med Pile	Flat/ matt paint on smooth surfaces	225	9"	24/48
29-256-0	7" Mogloss Short Pile	Gloss and eggshell paints on smooth surfaces	175	7"	24/48
29-276-0	9" Mogloss Short Pile	Gloss and eggshell paints on smooth surfaces	225	9"	24/48
29-082-1	4" Stick Frame and 1 velour refill	-	102	4"	24/48
29-086-0	4" Stick Frame and refill	-	102	4"	25/100

## Cage Frame Roller Refill



SKU#	CONTENTS	FOR USE ON	LENGTH		LENGTH		BOX/CTN
			mm	inches	mm	inches	
29-999-0	9" Green Acrylic Long Pile	Flat/ matt paint on smooth surfaces for 29-045-1 Cage Roller Frame	225	9"	37	1-1/12"	36/144
29-259-0	7" Acrylic Yellow Stripe Med Pile	Flat/ matt paint on smooth surfaces for 29-044-1 Cage Roller Frame	175	7"	37	1-1/12"	36/144
29-279-0	9" Acrylic Yellow Stripe Med Pile	Flat/ matt paint on smooth surfaces for 29-045-1 Cage Roller Frame	225	9"	37	1-1/12"	36/144
29-861-0	7" Mogloss Short Pile	Gloss and eggshell paints on smooth surfaces for 1-29-044 Cage Roller Frame	175	7"	37	1-1/12"	36/144
29-862-0	9" Mogloss Short Pile	Gloss and eggshell paints on smooth surfaces for 29-045-1 Cage Roller Frame	225	9"	37	1-1/12"	36/144

## 7 PAINTING & FINISHING TOOLS



29-821-1

### Cage Frame Roller & Tray Set

SKU#	CONTENTS	FOR USE ON	LENGTH		LENGTH		BOX/CTN
			mm	inches	mm	inches	
29-821-1	7" Rollers & Tray Set (29-044-1 + 29-259-0)	For flat/matt paint on smooth or semi smooth surfaces	175	7"	37	1-1/2"	12/24
29-822-1	9" Rollers & Tray Set (29-045-1 + 29-279-0)	For flat/matt paint on smooth or semi smooth surfaces	225	9"	37	1-1/2"	12/12

### Extension Pole



29-671-1

- 2.3m length, extends over 7ft
- Sturdy metal construction
- Easy twist
- Ideal for use with paint rollers and paint pads

SKU#	OVERALL LENGTH	BOX/CTN (DOZEN)
29-671-1	1.3 - 2.3m	1/24

### AllMaster Paint Brush



29-033-1

29-035-1

- Long bristle for durability and superior finish
- Wooden handle for comfort in use
- Stainless steel ferrules
- Superior finish with all paints

SKU#	SIZE		THICKNESS		LENGTH-OUT		BOX/CTN (DOZEN)
	mm	inches	mm	inches	mm	inches	
29-030-1	19	3/4"	9	11/32"	49	2"	12/288
29-031-1	25	1"	15	13/16"	58	2-1/4"	12/288
29-032-1	38	1-1/2"	18	5/8"	58	2-1/4"	12/288
29-033-1	50	2"	19	2/3"	67	2-5/8"	12/144
29-034-1	63	2-1/2"	20	2/3"	72	2-7/8"	12/144
29-035-1	75	3"	23	3/4"	79	3-1/8"	6/72
29-036-1	100	4"	23	3/4"	83	3-1/4"	6/72

### Planer File



21-122-5

- Can be used as either a plane or a file
- Fitted with replaceable standard cut blade and supplied with one spare blade

SKU#	DESCRIPTION	SIZE		PACKAGING	BOX/CTN
		mm	inches		
21-122-5	10" Surform Planer File	250	10"	Clamshell	2/12

## 7 PAINTING & FINISHING TOOLS



21-115-5

### Shaver Tool

- Lightweight, molded body
- Work on pull stroke
- For universal use

SKU#	DESCRIPTION	SIZE		PACKAGING	BOX/CTN
		mm	inches		
21-115-5	2-1/2" Surform® Shaver Tool	64	2-1/2"	Clamshell	6/6



21-399-5

### Block Plane

- One handed tool specially suited for smoothing edges and small surfaces areas

SKU#	DESCRIPTION	SIZE		PACKAGING	BOX/CTN
		mm	inches		
21-399-5	5-1/2" Surform® Block Plane	140	5-1/2"	Clamshell	2/24



21-103-5

### Plane

- Lightweight, molded body
- General purpose use

SKU#	DESCRIPTION	SIZE		PACKAGING	BOX/CTN
		mm	inches		
21-103-5	10" Surform® Plane	250	10"	Clamshell	6/6



21-104-5

### Block Plane

- Lightweight, moulded body
- For edges and confined spaces

SKU#	DESCRIPTION	SIZE		PACKAGING	BOX/CTN
		mm	inches		
21-104-5	5-1/2" Surform® Block Plane	140	5-1/2"	Clamshell	6/6

1 MEASURING & LAYOUT TOOLS

2 LASER MEASURING SYSTEM

3 CUTTING & HOLDING TOOLS

4 FASTENING TOOLS

5 STRIKING & STRUCK TOOLS

6 ILLUMINATION TOOLS

7 PAINTING & FINISHING TOOLS

8 MECHANIC TOOLS

9 TOOLS STORAGE

10 POWER CLEANING TOOLS

11 POWER TOOLS

12 POWER TOOL ACCESSORIES

13 PRODUCT INDEX

## 7 PAINTING & FINISHING TOOLS



21-102-5

### Flat File

- Lightweight, molded body
- Slight curve on blade for increased stock removal

SKU#	DESCRIPTION	SIZE		PACKAGING	BOX/CTN
		mm	inches		
21-102-5	5-1/2" Surform Flat File	140	5-1/2"	Clamshell	6/6

### Standard Cut Blade



21-293-5

- All purpose blade
- Use on wood, vinyl, plaster thermalite, fiberglass and linoleum
- Standard cut blade features teeth flush to the blade edge for working into edges

SKU#	DESCRIPTION	LENGTH		WIDTH		FOR USE ON	BOX/CTN
		mm	inches	mm	inches		
21-293-5	Surform® Standard Cut Blade	250	10"	42	1-5/8"	21-103, 21-122, 21-195, 21-296	12/12

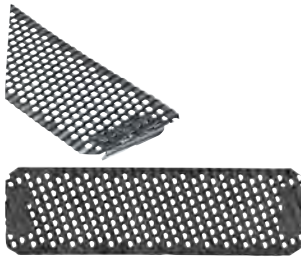

21-398-5

### Fine Cut Blade

SKU#	DESCRIPTION	LENGTH		WIDTH		FOR USE ON	BOX/CTN
		mm	inches	mm	inches		
21-398-5	Surform® Fine Cut Blade	140	5-1/2"	42	1-5/8"	21-102, 21-104, 21-399	12/12

### Metal & Plastic Blade



21-508-5

- Use on soft metals (e.g. brass, lead, aluminum, copper and mild steel), plastic, laminates, plastic fillers and fiberglass

SKU#	DESCRIPTION	LENGTH		WIDTH		FOR USE ON	BOX/CTN
		mm	inches	mm	inches		
21-508-5	Surform® Metal & Plastic	250	10"	42	1-5/8"	21-103, 21-122, 21-295, 21-296	12/12

## 7 PAINTING & FINISHING TOOLS

### 10" Surform® Round Replacement Blade

- Length - 10"/254mm
- Width - 5/8", 15.88mm
- Cut Type - Regular
- Used for enlarging holes and smoothing curved surfaces
- Can be used as a replacement blade on 21-297 Surform® Round File



21-291-5

SKU#	DESCRIPTION	LENGTH		WIDTH		FOR USE ON	BOX/CTN
		mm	inches	mm	inches		
21-291-5	Surform Round Replacement Blade	254	10"	15.8	5/8"	21-297	6/6

### Surform® Flat File – Regular Cut Blade

- Length – 17-3/8", 441.33mm
- Width – 1-5/8", 41.28mm
- Cut Type – Regular
- Superb tool for use as a rasp on wood, plastic, soft metals and many other materials
- Manufactured with a metallic-gray, die-cast alloy body
- High-impact polymer handle holds up to heavy use
- Fitted with a replaceable (10"/250mm) blade
- Use replacement blade 21-293 for standard cut, 21-393 for fine cut and 21-299 for half round



21-295-5

SKU#	DESCRIPTION	LENGTH		WIDTH		FOR USE ON	BOX/CTN
		mm	inches	mm	inches		
21-295-5	Surform Flat File - Regular Cut Blade	441.33	17-3/8"	41.28	1-5/8"	Wood, Plastic, Soft Metals, etc.	2/2

### 10" Surform® Half Round Regular Cut Replacement Blade

- Length – 10", 254mm
- Width – 1-1/2", 38.1mm
- Cut Type - Regular
- Half-round convex blade used for fast stock removal and shaping curved surfaces
- Ideal for work on fiberglass and removing filler (for cars and boats)
- Can be used as a replacement blade on 21-295 Surform® Flat File - Regular Cut Blade and 21-296 Surform® Plane Type - Regular Cut Blade



21-299-5

SKU#	DESCRIPTION	LENGTH		WIDTH		FOR USE ON	BOX/CTN
		mm	inches	mm	inches		
21-299-5	Regular Cut Replacement Blade	254	10"	38.1	1-1/2"	21-295, 21-296	12/12

1 MEASURING & LAYOUT TOOLS

2 LASER MEASURING SYSTEM

3 CUTTING & HOLDING TOOLS

4 FASTENING TOOLS

5 STRIKING & SHOCK TOOLS

6 ILLUMINATION TOOLS

7 PAINTING & FINISHING TOOLS

8 MECHANICAL TOOLS

9 TOOLS STORAGE

10 POWER CLEANING TOOLS

11 POWER TOOLS

12 POWER TOOL ACCESSORIES

13 PRODUCT INDEX

## 7 PAINTING & FINISHING TOOLS



### 10" Surform® Standard Cut Flat Replacement Blade



21-393-5

- Length - 10"/254mm
- Width - 1-5/8", 41.28mm
- Cut Type - Fine
- Produces a fine finish on hardwoods, end grains and soft metals
- Can be used as a replacement blade on 21-295 Surform® Flat File - Regular Cut Blade and 21-296 Surform® Plane Type - Regular Cut Blade

SKU#	DESCRIPTION	LENGTH		WIDTH		FOR USE ON	BOX/CTN
		mm	inches	mm	inches		
21-393-5	Standard Cut Flat Replacement Blade	254	10"	41.28	1-5/8"	21-295, 21-296	12/12

### 2-1/2" Surform® Shaver Replacement Blade



21-515-5

- Length - 2-1/2"/63.5mm
- Width - 1-5/8", 41.28mm
- Cut Type - Regular
- Curved blade speeds up stock removal
- Works on the pull stroke
- Can be used as a replacement blade on 21-115, 7-1/4" Surform® Shaver

SKU#	DESCRIPTION	LENGTH		WIDTH		FOR USE ON	BOX/CTN
		mm	inches	mm	inches		
21-515-5	Surform Shaver Replacement Blade	63.5	2-1/2"	41.28	1-5/8"	21-115	12/12

### Grout Knife



94-826

- TPR handle
- With extra cutting knife
- With STANLEY® logo engraved on the body

SKU#	DESCRIPTION	BOX/CTN
94-826	Carbide Tile Grout/1 pcs extra cutting knife	6/36

### Grout Blade



94-825

- With STANLEY® logo engraved on the body
- Three pieces per set

SKU#	DESCRIPTION	BOX/CTN
94-825	3 pcs/set/ Tile Grout Blades	12/120



## 7 PAINTING & FINISHING TOOLS

### 3" Putty Knife



28-205

- Ergonomic bi-material handle
- Flexible metal tip for even coverage
- Hardened, tempered and polished steel blade
- Permanently fastened full tang blade
- Blade Width 3"

SKU#	DESCRIPTION	BOX/CTN
28-205	Putty knife, flexible tip 3"	6/24
28-208	Putty knife, flexible tip 4"	4/16

### Retractable Razor Blade Scraper



28-500

- Removes paint, glue, putty or adhesive from glass, tile, walls, floors or other smooth surfaces
- Blade retracts for safe storage
- Uses standard single edge razor blades
- Comes with 5 blades

SKU#	DESCRIPTION	OVERALL LENGTH		CHUCK SIZE		BOX/CTN
		mm	inches	mm	inches	
28-500	Retractable Razor Blade Scraper	95	3-3/4"	-	-	10/100

### 10-Pack Single Edge Razor Blades



28-510

- Steel-backed high carbon steel blade fits most standard razor blade tools
- Replacement blades for STANLEY® 28-100 and 28-500 scrapers

SKU#	DESCRIPTION	OVERALL LENGTH			BOX/CTN
		mm	inches	Thickness	
28-510	Scraper-bl'd for 28-500	38	1-1/2"	0.009"	10/100

### Single-Edge Razor Blade



11-515

- Steel backed high carbon steel blade fits all standard razor blade tools
- Replacement blades for 28-100 and 28-500 scrapers

SKU#	DESCRIPTION	OVERALL LENGTH			BOX/CTN
		mm	inches	Thickness	
11-515	Single Edge Razor Blade - 100pcs/Box	38	1-1/2"	0.009"	1/50

1 MEASURING & LAYOUT TOOLS

2 LASER MEASURING SYSTEM

3 CUTTING & HOLDING TOOLS

4 FASTENING TOOLS

5 STRIKING & STRUCK TOOLS

6 ILLUMINATION TOOLS

7 PAINTING & FINISHING TOOLS

8 MECHANICAL TOOLS

9 TOOLS STORAGE

10 POWER CLEANING TOOLS

11 POWER TOOLS

12 POWER TOOL ACCESSORIES

13 PRODUCT INDEX

117

## 7 PAINTING & FINISHING TOOLS



### Bailey® Professional Smoothing Plane



12-004-1

- General purpose planes for workshop, site or fine finishing or high quality work

SKU#	LENGTH		CUTTER		BOX/CTN
	mm	inches	mm	inches	
12-003-1	240	9-1/2"	45	1-3/4"	1/6
12-004-1	245	9-3/4"	50	2"	1/6

### Bailey® Professional Fore Plane



12-006-1

- For stock removal and truing up long edges or leveling wide boards

SKU#	LENGTH		CUTTER		BOX/CTN
	mm	inches	mm	inches	
12-006-1	460	18"	60	2- 3/8"	1/1

### Bailey® Professional Jack Plane



12-005-1

- For rapid stock removal prior to commencing construction work
- A good general purpose plane

SKU#	LENGTH		CUTTER		BOX/CTN
	mm	inches	mm	inches	
12-005-1	355	14"	50	2"	1/6

### Bailey® Professional Jointer Plane



12-007-1

- For accurate truing of long edges

SKU#	LENGTH		CUTTER		BOX/CTN
	mm	inches	mm	inches	
12-007-1	560	22"	60	2-3/8"	1/1

## 7 PAINTING & FINISHING TOOLS



12-220-1

### Professional™ Block Plane

- Adjustable for depth of cut and alignment
- General purpose

SKU#	LENGTH		CUTTER		BOX/CTN
	mm	inches	mm	inches	
12-220-1	180	7"	40	1-5/8"	1/6



12-060-1

### Professional™ Block Plane

- Low angle cutter seats at 13-1/2"
- For end grain and plastic laminates

SKU#	LENGTH		CUTTER		BOX/CTN
	mm	inches	mm	inches	
12-060-1	150	6"	35	1-3/8"	1/6



12-116-1

### Block Plane

- General purpose block plane
- Ideal for model makers

SKU#	LENGTH		CUTTER		BOX/CTN
	mm	inches	mm	inches	
12-116-1	180	7"	40	1-5/8"	1/6



12-102-1

### Block Plane

- Small block plane - ideal for use by model makers

SKU#	LENGTH		CUTTER		BOX/CTN
	mm	inches	mm	inches	
12-102-1	140	5-1/2"	35	1-3/8"	1/6



12-078-1

### Professional Duplex Rabbet Plane

- Two cutter positions for regular and bull nose work
- Cutter adjustable for depth of cut in the rear position
- Supplied with an adjustable fence, depth gauge and cutting spur

SKU#	LENGTH		CUTTER		BOX/CTN
	mm	inches	mm	inches	
12-078-1	254	10"	38	1-1/2"	1/1

1 MEASURING & LAYOUT TOOLS

2 LASER MEASURING SYSTEM

3 CUTTING & HOLDING TOOLS

4 FASTENING TOOLS

5 STRIKING & STRUCK TOOLS

6 ILLUMINATION TOOLS

7 PAINTING & FINISHING TOOLS

8 MECHANIC TOOLS

9 TOOLS STORAGE

10 POWER CLEANING TOOLS

11 POWER TOOLS

12 POWER TOOL ACCESSORIES

13 PRODUCT INDEX

## 7 PAINTING & FINISHING TOOLS



12-020-1

### Professional™ Smoothing Plane

- Fully adjustable for depth of cut, cutter alignment and size of mouth
- Cutter seats at 21°
- For end grain and general purpose fine finishing

SKU#	LENGTH		CUTTER		BOX/CTN
	mm	inches	mm	inches	
12-020-1	160	6-1/4"	40	1-5/8"	1/6



12-203-1

### Smoothing Plane

- Fine grey iron castings machined and ground for precision
- Fully hardened carbon chrome steel cutter is adjustable for depth of cut and alignment

SKU#	LENGTH		CUTTER		BOX/CTN
	mm	inches	mm	inches	
12-203-1	240	9-1/2"	45	1-3/4"	1/6
12-204-1	245	9-3/4"	50	2"	1/6
12-205-1	355	14"	50	2"	1/6



12-034-1

### Bench Plane

- Light-duty, easy and simple to adjust smoothing planes

SKU#	LENGTH		CUTTER		BOX/CTN
	mm	inches	mm	inches	
12-033-1	222	8-3/4"	45	1-3/4"	1/6
12-034-1	247	9-3/4"	50	2"	1/6



12-350-1

### Spokeshaves Blade

- Heat-treated carbon steel

SKU#	COMPATIBLE TO -	WIDTH		BOX/CTN
		mm	inches	
12-350-1	12-151, 12-152	55	2-1/8"	6/6
12-336-1	12-064, 12-062	45	1-3/4"	6/6

## 7 PAINTING & FINISHING TOOLS

### Replacement Plane Iron

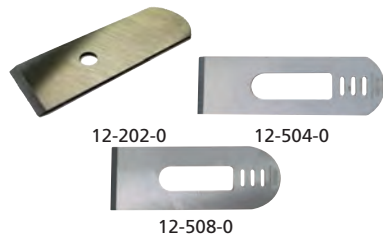

SKU#	COMPATIBLE TO -	WIDTH		BOX/CTN
		mm	inches	
12-202-0	12-102	34	1-5/16"	6/6
12-504-0	12-060	35	1-3/8"	6/6
12-508-0	12-020 & 12-220	40	1-5/8"	6/6
12-330-0	12-116	40	1-5/8"	6/6

### Replacement Plane Iron



12-134-0

- Use suffix '0' for carded product

SKU#	COMPATIBLE TO -	WIDTH		BOX/CTN
		mm	inches	
12-134-0	2" for 12-034-1	50	2"	6/6

### Single Iron



12-312-1

- A flat surface that is easier to sharpen
- An accurately ground edge of 25°
- Use suffix '0' for carded product
- Chrome carbon steel which has excellent edge retention characteristics and allows a razor sharp edge to be honed

SKU#	DESCRIPTION	COMPATIBLE TO -	WIDTH		BOX/CTN
			mm	inches	
12-312-0	Iron-single 25mm 1"	12-003	25	1"	6/6
12-312-1	Iron-single 45mm 1-3/4"	12-003	45	1-3/4"	6/96
12-313-0	Iron-single 50mm 2"(carded)	12-004, 12-005	50	2"	6/6
12-313-1	Iron-single 50mm 2"	12-004, 12-005	50	2"	6/96

1 MEASURING & LAYOUT TOOLS

2 LASER MEASURING SYSTEM

3 CUTTING & HOLDING TOOLS

4 FASTENING TOOLS

5 STRIKING & STRUCK TOOLS

6 ILLUMINATION TOOLS

7 PAINTING & FINISHING TOOLS

8 MECHANIC TOOLS

9 TOOLS STORAGE

10 POWER CLEANING TOOLS

11 POWER TOOLS

12 POWER TOOL ACCESSORIES

13 PRODUCT INDEX

# 7 PAINTING & FINISHING TOOLS

Step #1 - Match file type to material shape



Step #2 – Select File coarseness



Single cut for light removal of material



Double cut for moderate removal of material



Rasp cut for fastest removal of material

Step #3 – Select Spacing of File Teeth

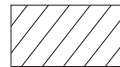

Bastard Cut  
General purpose sharpening and smoothing



Second Cut  
Moderate cut for smoother finish



Smooth Cut  
Fine cut for sharpest edge on cutting tools

## Tapered File

- For sharpening handsaws

INDIVIDUALLY CARDED



22-090

SKU#	DESCRIPTION	LENGTH		BOX/CTN (DOZEN)
		mm	inches	
22-090	Extra Slim Tapered - Second Cut	100	4"	1/12
22-091	Double Extra Slim Tapered - Second Cut	100	4"	1/12
22-092	Slim Tapered - Second Cut	175	7"	1/9
22-093	Slim Tapered - Second Cut	200	8"	1/9
22-094	Slim Tapered - Second Cut	250	10"	1/6
22-214	Three Square Tapered - Bastard Cut	250	10"	1/6
22-222	Three Square Tapered - Bastard Cut	150	6"	1/12
22-223	Three Square Tapered - Bastard Cut	200	8"	1/9
22-224	Three Square Tapered - Bastard Cut	300	12"	1/4
22-225	Three Square Tapered - Second Cut	300	12"	1/4
22-226	Three Square Tapered - Smooth Cut	150	6"	1/12
22-227	Three Square Tapered - Smooth Cut	200	8"	1/9
22-228	Three Square Tapered - Smooth Cut	250	10"	1/6
22-229	Three Square Tapered - Smooth Cut	300	12"	1/4
22-304	Slim Tapered - Second Cut	100	4"	1/12
22-305	Slim Tapered - Second Cut	125	5"	1/12
22-306	Slim Tapered - Second Cut	150	6"	1/12

# 7 PAINTING & FINISHING TOOLS

## Round File

- For circular openings and concave surfaces

### INDIVIDUALLY CARDED

SKU#	DESCRIPTION	LENGTH		BOX/CTN (DOZEN)
		mm	inches	
22-098	Rounded - Bastard Cut	200	8"	1/9
22-178	Rounded - Bastard Cut	250	10"	1/6
22-179	Rounded - Second Cut	300	12"	1/4
22-180	Rounded - Second Cut	150	6"	1/12
22-181	Rounded - Second Cut	200	8"	1/9
22-182	Rounded - Second Cut	250	10"	1/6
22-183	Rounded - Smooth Cut	300	12"	1/4
22-193	Rounded - Smooth Cut	300	12"	1/4
22-235	Rounded - Smooth Cut	150	6"	1/12
22-236	Rounded - Smooth Cut	200	8"	1/9
22-237	Rounded - Smooth Cut	250	10"	1/6
22-238	Rounded - Smooth Cut	100	4"	1/12
22-307	Rounded - Bastard Cut	150	6"	1/12



22-098

## Half Round File

- For flat, concave and convex surfaces

### INDIVIDUALLY CARDED W/HANDLE

SKU#	DESCRIPTION	LENGTH		BOX/CTN (DOZEN)
		mm	inches	
22-099	Half-round Bastard	250	10"	1/6
22-184	Half-round Bastard	150	6"	1/12
22-185	Half-round Bastard	300	12"	1/4
22-186	Half-round 2nd Cut	150	6"	1/12
22-187	Half-round 2nd Cut	200	8"	1/9
22-188	Half-round 2nd Cut	250	10"	1/6
22-189	Half-round 2nd Cut	300	12"	1/4
22-192	Half-round Smooth	300	12"	1/4
22-209	Half-round Smooth	100	4"	1/12
22-210	Half-round Smooth	150	6"	1/12
22-211	Half-round Smooth	200	8"	1/9
22-212	Half-round Smooth	250	10"	1/6
22-308	Half-round Bastard	200	8"	1/9



22-099

- 1 MEASURING & LAYOUT TOOLS
- 2 LASER MEASURING SYSTEM
- 3 CUTTING & HOLDING TOOLS
- 4 FASTENING TOOLS
- 5 STRIKING & STRUCK TOOLS
- 6 ILLUMINATION TOOLS
- 7 PAINTING & FINISHING TOOLS
- 8 MECHANIC TOOLS
- 9 TOOLS STORAGE
- 10 POWER CLEANING TOOLS
- 11 POWER TOOLS
- 12 POWER TOOL ACCESSORIES
- 13 PRODUCT INDEX

## 7 PAINTING & FINISHING TOOLS

### Flat File

- For general work on iron & steel

INDIVIDUALLY CARDED

SKU#	DESCRIPTION	LENGTH		BOX/CTN (DOZEN)
		mm	inches	
22-095	Mill Bastard	150	6"	1/12
22-096	Mill bastard	250	10"	1/8
22-097	Mill bastard	300	12"	1/4
22-169	Flat Bastard	100	4"	1/12
22-170	Flat Bastard	150	6"	1/12
22-171	Flat Bastard	200	8"	1/9
22-172	Flat Bastard	250	10"	1/6
22-173	Flat Bastard	300	12"	1/4
22-174	Flat 2nd Cut	150	6"	1/12
22-175	Flat 2nd Cut	200	8"	1/9
22-176	Flat 2nd Cut	250	10"	1/6
22-177	Flat 2nd Cut	300	12"	1/4
22-190	Flat Smooth	150	6"	1/12
22-191	Flat Smooth	300	12"	1/4
22-198	Flat Smooth	100	4"	1/12
22-233	Flat Smooth	200	8"	1/9
22-234	Flat Smooth	250	10"	1/6
22-309	Mill Bastard	200	8"	1/9



22-172

### Handy File

- For sharpening agricultural tools including blades of reaping and mowing machines

INDIVIDUALLY CARDED

SKU#	DESCRIPTION	LENGTH		BOX/CTN (DOZEN)
		mm	inches	
22-078H	File Handy 8" C/W Handle	200	8"	1/6
22-078HC	Handy File - Bastard Cut	200	8"	1/6
22-080B	File-Handy 10" (12pcs/box)	250	10"	1/6



22-078HC



## 7 PAINTING & FINISHING TOOLS

### Chain Saw File

- For sharpening chain saws

INDIVIDUALLY CARDED

SKU#	DESCRIPTION	LENGTH		BOX/CTN (DOZEN)
		mm	inches	
22-082	Chain Saw File	4 x 200	5/32" x 8"	1/9
22-083	Chain Saw File	5 x 500	3/16" x 8"	1/9
22-087	Chain Saw File	6 x 200	7/32" x 8"	1/9
22-089	Chain Saw File	6.25 x 200	1/4" x 8"	1/9

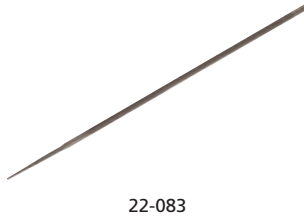

22-083

### Square File

INDIVIDUALLY CARDED

SKU#	DESCRIPTION	LENGTH		BOX/CTN (DOZEN)
		mm	inches	
22-194	Square - Bastard Cut	150	6"	1/12
22-195	Square - Bastard Cut	250	10"	1/6
22-196	Square - Second Cut	250	10"	1/6
22-197	Square - Smooth Cut	250	10"	1/6
22-213	Square - Bastard Cut	200	8"	1/9
22-215	Square - Bastard Cut	300	12"	1/4
22-216	Square - Second Cut	300	12"	1/4
22-217	Square - Smooth Cut	150	6"	1/12
22-218	Square - Smooth Cut	200	8"	1/9
22-219	Square - Smooth Cut	300	12"	1/4



### Knife File

INDIVIDUALLY CARDED

SKU#	DESCRIPTION	LENGTH		BOX/CTN (DOZEN)
		mm	inches	
22-241	Knife - Bastard Cut	150	6"	1/12
22-242	Knife - Bastard Cut	200	8"	1/9
22-243	Knife - Bastard Cut	250	10"	1/6
22-246	Knife - Smooth Cut	150	6"	1/12
22-247	Knife - Smooth Cut	200	8"	1/9
22-248	Knife - Smooth Cut	250	10"	1/6

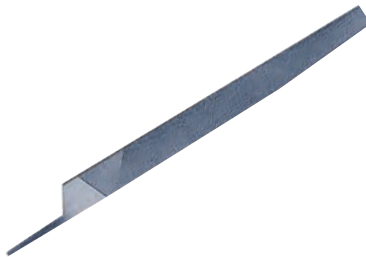

1 MEASURING & LAYOUT TOOLS

2 LASER MEASURING SYSTEM

3 CUTTING & HOLDING TOOLS

4 FASTENING TOOLS

5 STRIKING & STRUCK TOOLS

6 ILLUMINATION TOOLS

7 PAINTING & FINISHING TOOLS

8 MECHANICAL TOOLS

9 TOOLS STORAGE

10 POWER CLEANING TOOLS

11 POWER TOOLS

12 POWER TOOL ACCESSORIES

13 PRODUCT INDEX

125

# 8 MECHANIC TOOLS

## STRONG, ECONOMICAL AND EFFECTIVE

The STANLEY® offering of Mechanic tools supplies professionals with a wide range of product options to successfully accomplish the job at hand.



### MAKE YOUR SOCKET SETS WORK HARDER

#### NUTS SHOULD TURN SMOOTHLY

To effectively use sockets you need to be sensitive to the way in which the nut turns on the bolt or screw stud. If the nut does not rotate smoothly check to see that the thread is not 'crossed' or if the thread size or type differs from the bolt.

#### TAKE CARE NOT TO OVER TIGHTEN

Run the nut up until finger tight and then apply the socket to finally tighten the nut. Under normal conditions do not be tempted to over tighten fastenings.

#### USE A TORQUE WRENCH FOR EXACT SPECIFICATIONS

If the torque required to complete the fastening needs to be specific for functional or safety reasons you should use a torque wrench.

#### USE THE RIGHT SIZE SOCKET

Even though the socket may locate on a nut that is slightly smaller the result may well be that the corners of the fastener will be deformed and make future removal difficult. The size of the ratchet handle is also carefully matched to a given set of socket sizes so that damage to the fastening is minimised. Whenever possible pull the ratchet handle towards you for better control.

#### LOCKING EXTENSION BAR

If you need to work on a fastener beyond your normal reach a locking extension bar will enable you to reach the nut without the risk of leaving the socket embedded in the machinery or engine compartment.

## SOCKETS



Sockets are available in either hex (6 points) or bi-hex (12 points). The bi-hex socket provides greater access when the nut is in a hard to reach position. The hex socket, although with reduced angular accessibility, tends to be able to withstand heavier duty use.

Maxi Drive profile sockets are the most efficient and offer protection to both the fastener and the socket wall by taking the driving force away from the extreme corners of the nut where there is the greatest risk of damage.

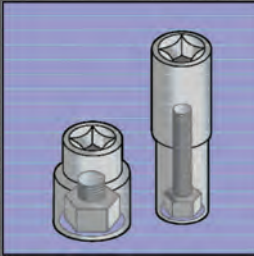

Sockets are available in standard length, for most general-purpose applications and deep drive, which come into their own if you need to tighten a nut on longer screw studs.

## THE RIGHT WRENCH FOR THE JOB

### COMBINATION SPANNERS

These combine in a single tool an open-ended jaw and a ring, both have the same dimension. The open-ended jaw is offset by 15° which enables the operator to turn any nut provided there is even a very small amount of access. The Bi-Hex (12 point) Ring end is also cranked at 15° from the horizontal, which enables you to grip the handle without risking injury to the knuckles.

### OPEN-ENDED SPANNERS

Both ends of these spanners are open with the heads set at 15°. The open-ended format is ideal for working on pipelines where only side access is possible. Select slim open-ended jaws to give greater accessibility within the thickness of the fastener.

### ADJUSTABLE WRENCH

This must be used carefully and sparingly if damage to the fastener is to be avoided, but it is still a very useful item for any toolkit.

### COMBINATION SPANNER WITH RATCHETING RING END

A very useful specialist set of 6 spanners with the benefit of a ring end which ratchets with a 5° angle of engagement so that you can work in very restricted spaces and have the added advantage of an open ended end profile to work on fastenings that do not have 360° access as occurs on pipe work.

### ACCELERATOR COMBINATION SPANNER

The open-end part of the tool incorporates an innovative jaw form which enables the user to engage and disengage without removing the spanner from the nut.

## RATCHETS

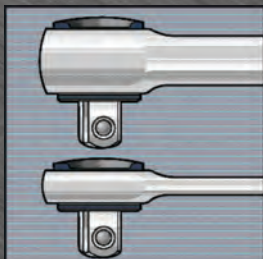

The turning force on the socket is imparted by the drive handle through a square recess forged into the end of the socket. The size of this recess varies depending on the size of the socket - 1/4" 3/8" or 1/2" square drive. Specific sets for each drive size are available, together with sets that combine drive sizes, which enable you to deal with fastenings from 4mm up to 32mm.

FatMax® and MicroTough™ ratchets offer the smoothest operation and allow access to fasteners in restricted areas. The smaller head is 20% - 30% smaller than standard ratchet heads and the fine tooth mechanism offers a 5° angle of engagement.

When working with oily hands it is important that the ratchet handle incorporates a quick socket release facility.

## 8 MECHANIC TOOLS

### "Full Polish" Quick Release Ratchet

ISO 3315 / DIN 3122

- Full polish finish, double-nickel with chrome plating for extra rust resistance and prolonged life
- Fine-tooth pear head ratchet 1/4" dr - 45 tooth gear and 3/8" & 1/2" 54 tooth gear design for small 6.8 degree arc swing
- Thin Head design for accessibility
- Quick release push button provide extra safety and handy operation
- Reversing level designed for quick, one hand operation

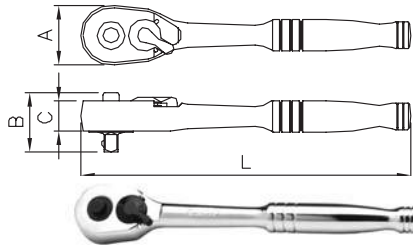

89-817

1/4"	SKU#	L mm	A mm	B mm	C mm	WEIGHT (g)	BOX/CTN
	89-817	143.0	24.5	21.3	11.5	125	4/48

3/8"	SKU#	L mm	A mm	B mm	C mm	WEIGHT (g)	BOX/CTN
	89-818	198.0	32.5	28.0	14.0	320	4/48

1/2"	SKU#	L mm	A mm	B mm	C mm	WEIGHT (g)	BOX/CTN
	89-819	253.0	41.0	35.3	18.0	586	4/24

### Round Head Ratchet

- Full polish finish, double-nickel with chrome plating for extra rust resistance and prolonged life
- Round head ratchet for tight access area
- Anti-slip and durable knurled metal handle design suit most industrial applications
- Flip drive ratchet head for easy directional rotation

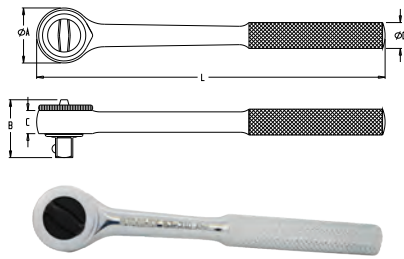

87-710

1/4"	SKU#	L mm	A mm	B mm	C mm	D mm	WEIGHT (g)	BOX/CTN
	87-710	146.0	26.0	28.0	11.8	12.7	150	4/48

3/8"	SKU#	L mm	A mm	B mm	C mm	D mm	WEIGHT (g)	BOX/CTN
	87-715	201.0	36.5	37.4	15.6	15.9	370	4/48

1/2"	SKU#	L mm	A mm	B mm	C mm	D mm	WEIGHT (g)	BOX/CTN
	87-720	256.0	43.5	43.9	17.6	19.0	620	4/48

## Quick Release Ratchet - Round Head

ISO 3315 / DIN 3120

- Three way quick release ratchet head for directional rotation
- Round head ratchet for tight access area
- Comfortable and durable molded plastic handle withstands most industrial solvents
- Quick release push button provide extra safety and handy operation

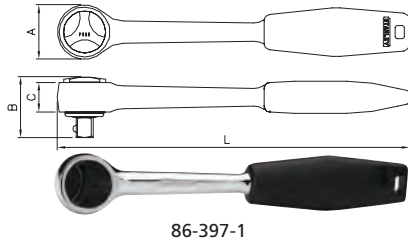

86-397-1

1/4"	SKU#	L mm	A mm	B mm	C mm	WEIGHT (g)	BOX/CTN
	86-395-1	150.0	26.0	29.0	13.5	150	4/48

3/8"	SKU#	L mm	A mm	B mm	C mm	WEIGHT (g)	BOX/CTN
	86-396-1	203.0	36.5	36.4	17.0	370	4/48

1/2"	SKU#	L mm	A mm	B mm	C mm	WEIGHT (g)	BOX/CTN
	86-397-1	265.0	41.0	46.1	21.9	620	4/48

## Quick Release Ratchet - Pear Head

ISO 3315 / DIN 3122

- Chrome vanadium steel (Cr-V) forging, hardness toughness
- High torque output, more than 50% of the ANSI standard, powerful to use, reliable and durable
- 60-tooth ratchet head design, turn 6 ° can drive sleeve, suitable for narrow space
- There are pros and cons of rapid shedding and commutation function, easy operation
- Dual material handle, oil slip, comfortable grip

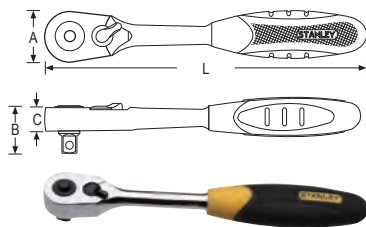

95-895

1/4"	SKU#	L mm	A mm	B mm	C mm	BOX/CTN
	95-895	144	20	22.1	9.9	4/48

3/8"	SKU#	L mm	A mm	B mm	C mm	BOX/CTN
	95-894	195	27	27.4	13.8	4/48

1/2"	SKU#	L mm	A mm	B mm	C mm	BOX/CTN
	95-893	240	32.5	35.7	16.5	4/48

## 8 MECHANIC TOOLS

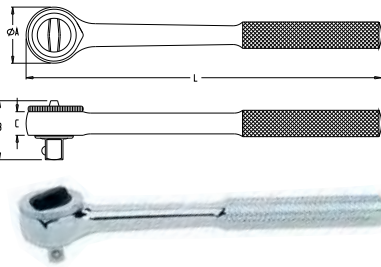

91-316

### Drive Round Head Ratchet Knurled Handle

ISO 3315 / DIN 3122

- Forged from high quality steel and finished in high-polish chrome
- Articulation angle of 8.4°
- Knurled handle for comfort and anti-slip operation
- Sockets and extensions remain locked onto the drive until disengaged with an easy-to-reach low-profile quick-release button

3/4"	SKU#	L mm	A mm	B mm	C mm	BOX/CTN
	91-316	495	65	55	30	2/8

### Offset Handle

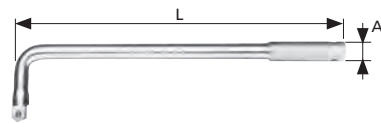

86-375

- Forged from high-quality steel and finished in high-polish chrome

3/4"	SKU#	L mm	A mm	BOX/CTN
	86-375	460.0	23.0	10/20

### L-Handle

DIN 3122 / ISO 3315

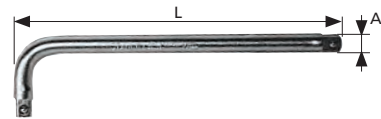

86-493

- Made of Chrome Vanadium Steel
- Sturdy construction to withstand high torque
- "L" shape protects hands during operation
- Allows access to hard-to-reach fasteners

1/2"	SKU#	L mm	A mm	WEIGHT (g)	BOX/CTN
	86-493	250.0	19.0	325	20/40

### Sliding T-Bar

ISO 3315 / DIN 3122

- Made of Chrome Vanadium Steel
- Allows the application of high torque using both hands
- Place the socket adapter at the extremes of the bar for higher leverage

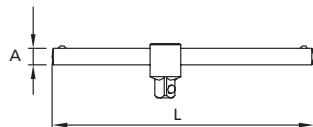

86-010-1

1/4"	SKU#	L mm	A mm	WEIGHT (g)	BOX/CTN
	86-010-1	108.0	6.4	38	6/96

3/8"	SKU#	L mm	A mm	WEIGHT (g)	BOX/CTN
	86-202-1	170.0	9.5	128	6/72

1/2"	SKU#	L mm	A mm	WEIGHT (g)	BOX/CTN
	86-440-1	243.0	12.7	289	4/32

3/4"	SKU#	L mm	A mm	WEIGHT (g)	BOX/CTN
	89-303-1	480.0	20.0	1400	2/18

## Speeder Handle

ISO 3315 / DIN 3122

- Made of Chrome Vanadium Steel
- Facilitates the fast tightening or removal of fasteners, and provides easy access to hard-to-reach places

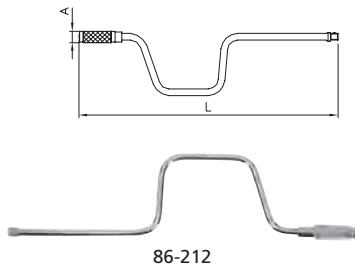

86-212

3/8"	SKU#	L mm	A mm	WEIGHT (g)	BOX/CTN
	86-212-1	380.0	17.0	328	6/18

1/2"	SKU#	L mm	A mm	WEIGHT (g)	BOX/CTN
	86-412-1	420.0	21.0	330	6/96

## Flex Handle Bar

ISO 3315 / DIN 3122 (1/4" - 1/2")

ISO 1174 / DIN 3120 (3/4")

- Made of Chrome Vanadium Steel
- For applications where high leverage is needed to tighten or release a fastener

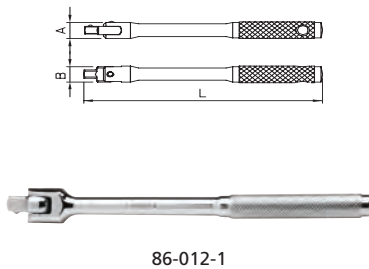

86-012-1

1/4"	SKU#	L mm	A mm	B mm	WEIGHT (g)	BOX/CTN
	86-012-1	147.0	12.7	12.0	92	6/48

3/8"	SKU#	L mm	A mm	B mm	WEIGHT (g)	BOX/CTN
	86-213-1	215.5	21.0	17.0	270	6/96

1/2"	SKU#	L mm	A mm	B mm	WEIGHT (g)	BOX/CTN
	86-413-1	439.0	28.0	20.1	713	6/36
	86-405-1	254.0	28.0	21.0	485	4/32
	86-415-1	381.0	28.0	21.0	646	6/24

3/4"	SKU#	L mm	A mm	B mm	WEIGHT (g)	BOX/CTN
	89-302-1	500.0	41.0	34.0	1850	2/16

## Spinner

ISO 3315 / DIN 3122

- Adapts to socket to work as a nut driver

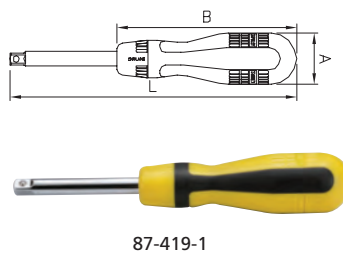

87-419-1

1/4"	SKU#	L mm	A mm	B mm	WEIGHT (g)	BOX/CTN
	87-419-1	146.0	21.0	90.0	60	6/48

1 MEASURING & LAYOUT TOOLS

2 LASER MEASURING SYSTEM

3 CUTTING & HOLDING TOOLS

4 FASTENING TOOLS

5 STRIKING & STRUCK TOOLS

6 ILLUMINATION TOOLS

7 PAINTING & FINISHING TOOLS

8 MECHANIC TOOLS

9 TOOLS STORAGE

10 POWER CLEANING TOOLS

11 POWER TOOLS

12 POWER TOOL ACCESSORIES

13 PRODUCT INDEX

# 8 MECHANIC TOOLS



## Flex Extension

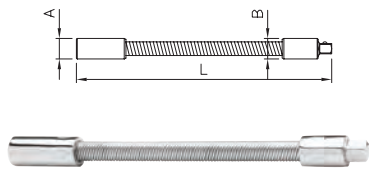

86-001-1

- Made of Chrome Vanadium Steel
- Allows access to hard-to-reach fasteners
- Flexible body allows for adjusting and removal regardless of fastener location

1/4"	SKU#	SIZE	L mm	A mm	B mm	WEIGHT (g)	BOX/CTN
	86-001-1	6"	150.0	12.2	12.2	66	6/144

## 3/8" Drive Locking Extension

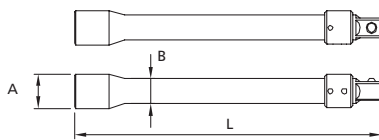

93-498

- Made of Chrome Vanadium Steel
- Locking device holds socket securely till job is done
- Solid 1-piece design
- Patented locking system

3/8"	SKU#	DESCRIPTION	L mm	A mm	B mm	BOX/CTN
	93-498	3" Extension	75	18	12.2	6/120
	93-499	6" Extension	150	18	12.2	6/120
	93-500	10" Extension	250	18	12.2	6/60

## Extension Bar

ISO 3316 / DIN 3123

- Made of Chrome Vanadium Steel

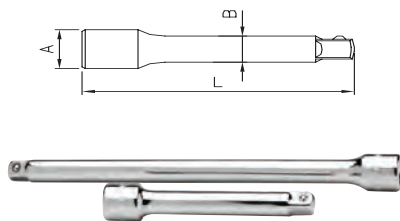

86-006-1

1/4"	SKU#	SIZE	L mm	A mm	B mm	WEIGHT (g)	BOX/CTN
	91-059-1	2"	51.0	12.5	8.2	25	6/48
	86-006-1	3"	76.2	12.5	8.2	35	6/96
	91-339-1	4"	101.6	12.5	8.2	45	6/72
	86-007-1	6"	152.4	12.5	8.2	65	6/96
	86-372-1	10"	254.0	12.5	8.2	110	6/48

3/8"	SKU#	SIZE	L mm	A mm	B mm	WEIGHT (g)	BOX/CTN
	86-206-1	3"	76.2	17.0	12.2	75	6/96
	86-207-1	6"	152.4	17.0	12.2	145	6/96
	86-208-1	10"	245.0	17.0	12.2	235	6/72
	86-258-1	12"	306.0	17.0	12.2	280	6/48
	86-318-1	20"	508.0	17.0	12.2	470	6/48

1/2"	SKU#	SIZE	L mm	A mm	B mm	WEIGHT (g)	BOX/CTN
	86-406-1	2 1/2"	62.0	22.5	16.3	100	4/60
	88-930-1	3"	76.2	22.5	16.3	134	4/96
	86-407-1	5"	125.0	22.5	16.3	204	4/40
	86-408-1	10"	252.0	22.5	16.3	398	4/48
	88-729-1	20"	506.0	22.5	12.7	539	4/48

3/4"	SKU#	SIZE	L mm	A mm	WEIGHT (g)	BOX/CTN
	89-306-1	4"	102.0	35.5	405	4/32
	89-307-1	8"	203.0	35.5	700	4/24
	89-308-1	16"	406.0	35.5	1260	2/16



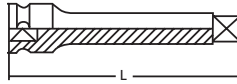

89-462-1

## 1/2" Drive Impact Extension Bar

- Provides strength and durability

1/2"	SKU#	L mm	WEIGHT (g)	BOX/CTN
	89-462-1	5	140	20/80

## Universal Joint

ISO 3316 / IN 3123

- Made of Chrome Vanadium Steel

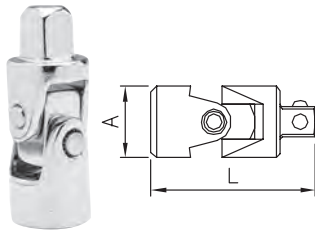

86-011-1

1/4"	SKU#	L mm	A mm	WEIGHT (g)	BOX/CTN
	86-011-1	34.0	14.0	25	12/96

3/8"	SKU#	L mm	A mm	WEIGHT (g)	BOX/CTN
	86-211-1	54.2	19.0	65	8/96

1/2"	SKU#	L mm	A mm	WEIGHT (g)	BOX/CTN
	86-411-1	68.5	24.9	165	4/96

3/4"	SKU#	L mm	A mm	WEIGHT (g)	BOX/CTN
	93-091-1	110.0	40.0	600	4/32

## 1/2" Drive Impact Universal Joint

- CR-Mo Strong Impact Resistance
- Meets ANSI Standards
- Black oxidized coating

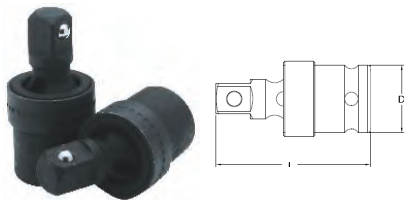

89-463

1/2"	SKU#	DESCRIPTION	D mm	L mm	WEIGHT (g)	BOX/CTN
	89-463	1/2" Universal Joint	28	65	160	20/80

1 MEASURING & LAYOUT TOOLS

2 LASER MEASURING SYSTEM

3 CUTTING & HOLDING TOOLS

4 FASTENING TOOLS

5 STRIKING & STRUCK TOOLS

6 ILLUMINATION TOOLS

7 PAINTING & FINISHING TOOLS

8 MECHANIC TOOLS

9 TOOLS STORAGE

10 POWER CLEANING TOOLS

11 POWER TOOLS

12 POWER TOOL ACCESSORIES

13 PRODUCT INDEX

## 8 MECHANIC TOOLS



### Adapter

ISO 3316 / DIN 3120

- Made of Chrome Vanadium Steel
- Allows the use of a certain size drive ratchet with sockets of a different size

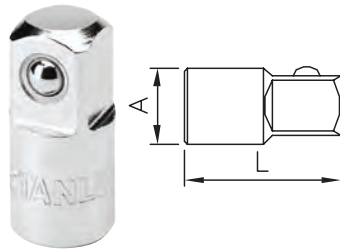

86-002-1

1/4"	SKU#	SIZE	L mm	A mm	WEIGHT (g)	BOX/CTN
	86-002-1	1/4"Fx3/8"M	25.0	12.2	18	12/96

3/8"	SKU#	SIZE	L mm	A mm	WEIGHT (g)	BOX/CTN
	86-214-1	3/8"Fx1/4"M	25.4	17.4	20	6/96
	86-215-1	3/8"Fx1/2"M	36.0	18.0	45	6/96

1/2"	SKU#	SIZE	L mm	A mm	WEIGHT (g)	BOX/CTN
	86-414-1	1/2"Fx3/8"M	34.5	22.0	48	6/96
	88-558-1	1/2"Fx3/4"M	42.0	25.2	113	6/96

3/4"	SKU#	SIZE	L mm	A mm	WEIGHT (g)	BOX/CTN
	88-908-1	3/4"Fx1/2"M	48.0	35.0	120	4/48
	88-909-1	3/4"Fx1"M	62.0	37.3	390	4/32

### Bit Adapter

ISO 1174 / DIN 3120

- Forged from high-quality steel and finished in high-polish chrome
- Allows for the use of insert bits of 1/4" base with a ratchet or flex handle

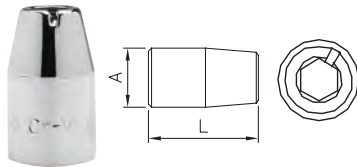

86-124-1

1/4"	SKU#	SIZE	L mm	A mm	WEIGHT (g)	BOX/CTN
	86-124-1	1/4" hex	25.2	24.2	25	12/96

3/8"	SKU#	SIZE	L mm	A mm	WEIGHT (g)	BOX/CTN
	86-250-1	1/4" hex	27	17.3	-	6/96

## 6 Point Standard Socket – Inch

ANSI B107.1

- Made of Chrome Vanadium Steel
- Chromed finish for exceptional resistance to rust.
- MaxiDrive™ gripping system: rounded gripping surface allows for 15% more torque and avoids rounding off fasteners, providing higher tenacity

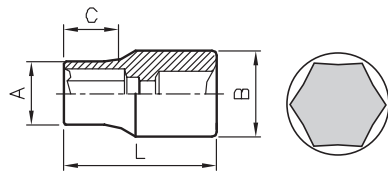

86-021-1

1/4"	SKU#	SIZE	L	A	B	C	WEIGHT	BOX/CTN
			mm	mm	mm	mm	(g)	
	86-021-1	5/32"	25.0	6.9	12.0	3.6	10	12/96
	86-022-1	3/16"	25.0	8.0	12.0	3.6	12	12/96
	86-023-1	7/32"	25.0	8.8	12.0	4.2	12	12/96
	86-024-1	1/4"	25.0	10.0	12.0	4.8	12	12/96
	86-025-1	9/32"	25.0	10.9	12.0	4.0	13	12/96
	86-026-1	5/16"	25.0	12.0	12.0	4.0	13	12/96
	86-027-1	11/32"	25.0	13.2	13.2	4.5	18	12/96
	86-028-1	3/8"	25.0	14.7	14.4	4.5	19	12/96
	86-029-1	7/16"	25.0	16.0	16.0	6.0	22	12/96
	86-030-1	1/2"	25.0	17.7	17.7	7.2	28	12/96

1/2"	SKU#	SIZE	L	A	B	C	WEIGHT	BOX/CTN
			mm	mm	mm	mm	(g)	
	86-384-1	1/4"	38.0	10.2	21.8	6.5	43	6/96
	86-441-1	5/16"	38.0	12.4	21.8	8.0	43	6/96
	86-442-1	3/8"	38.0	14.7	21.8	9.0	46	6/96
	86-443-1	7/16"	38.0	17.0	21.8	9.0	50	6/96
	86-444-1	1/2"	38.0	19.0	21.8	10.0	52	6/96
	86-445-1	9/16"	38.0	20.8	21.8	12.5	55	6/96
	86-446-1	19/32"	38.0	21.8	21.8	14.3	55	6/96
	88-766-1	5/8"	38.0	22.5	23.3	14.3	62	6/96
	88-767-1	11/16"	38.0	24.7	23.0	14.3	72	6/96
	88-768-1	3/4"	38.0	26.3	24.0	20.0	76	6/96
	86-450-1	25/32"	38.0	27.7	25.0	20.0	80	4/96
	88-769-1	13/16"	38.0	28.8	28.8	20.0	80	4/96
	88-770-1	7/8"	40.0	29.8	29.8	21.0	95	4/96
	88-771-1	15/16"	40.0	31.8	27.0	21.0	110	6/96
	88-772-1	31/32"	40.0	33.4	28.0	21.0	115	6/96
	88-773-1	1"	43.0	33.4	28.0	21.0	120	4/96
	88-774-1	1 1/16"	43.0	35.8	30.0	23.0	145	2/96
	88-775-1	1 1/8"	43.0	37.8	31.0	23.0	150	2/96
	86-458-1	1 3/16"	43.0	39.8	33.0	23.0	190	2/96
	88-776-1	1 1/4"	43.0	41.8	35.0	23.0	205	2/96

1 MEASURING & LAYOUT TOOLS

2 LASER MEASURING SYSTEM

3 CUTTING & HOLDING TOOLS

4 FASTENING TOOLS

5 STRIKING & STRUCK TOOLS

6 ILLUMINATION TOOLS

7 PAINTING & FINISHING TOOLS

8 MECHANIC TOOLS

9 TOOLS STORAGE

10 POWER CLEANING TOOLS

11 POWER TOOLS

12 POWER TOOL ACCESSORIES

13 PRODUCT INDEX

# 8 MECHANIC TOOLS

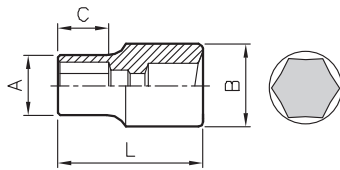

86-101-1

## 6 Point Standard Socket – Metric

ISO 2725 / DIN 3124

- Made of Chrome Vanadium Steel
- Chromed finish for exceptional resistance to rust
- MaxiDrive™ gripping system: rounded gripping surface allows for 15% more torque and avoids rounding off fasteners, providing higher tenacity

SKU#	SIZE	L mm	A mm	B mm	C mm	WEIGHT (g)	BOX/CTN
86-101-1	4	25.0	6.9	12.0	3.6	10	12/96
86-110-1	4.5	25.0	7.5	12.0	3.6	12	12/96
86-102-1	5	25.0	8.1	12.0	4.2	12	12/96
86-111-1	5.5	25.0	8.8	12.0	4.2	12	12/96
86-103-1	6	25.0	9.4	12.0	4.8	12	12/96
86-104-1	7	25.0	10.9	12.0	4.0	13	12/96
86-105-1	8	25.0	12.0	12.0	4.0	13	12/96
86-106-1	9	25.0	13.2	13.2	4.5	18	12/96
86-107-1	10	25.0	14.7	14.7	6.0	19	12/96
86-108-1	11	25.0	16.0	16.0	6.0	22	12/96
86-109-1	12	25.0	16.9	16.9	7.0	25	12/96
86-112-1	13	25.0	17.7	17.7	7.5	28	12/96
86-114-1	14	25.0	19.7	19.7	8.4	38	12/96

SKU#	SIZE	L mm	A mm	B mm	C mm	WEIGHT (g)	BOX/CTN
86-301-1	6	25.7	10.0	17.1	4.0	20	6/96
86-302-1	7	25.7	10.8	17.1	4.0	21	6/96
86-303-1	8	25.7	12.0	17.1	4.5	25	6/96
86-304-1	9	25.7	13.1	17.1	5.0	26	6/96
86-305-1	10	25.7	14.7	17.1	5.0	26	6/96
86-306-1	11	25.7	16.0	17.1	7.0	26	6/96
86-307-1	12	25.7	17.1	17.1	7.0	29	6/96
86-308-1	13	25.7	18.3	18.3	7.0	32	6/96
86-309-1	14	25.7	19.5	19.5	9.0	40	6/96
86-310-1	15	25.7	20.4	20.4	10.0	43	6/96
86-311-1	16	29.0	22.1	22.1	10.0	43	6/96
86-312-1	17	29.0	23.3	23.3	10.0	50	6/96
88-131-1	18	29.0	24.2	20.0	15.5	56	6/144
88-132-1	19	29.0	25.7	21.0	15.5	64	6/96
88-133-1	20	29.0	26.8	22.0	15.5	70	4/96
88-134-1	21	29.0	27.7	23.0	15.5	78	4/96
88-135-1	22	29.0	29.8	24.0	15.5	82	4/96
88-136-1	23	29.0	30.7	25.0	15.5	85	4/96
88-137-1	24	29.0	31.9	26.0	15.5	97	4/96

SKU#	SIZE	L mm	A mm	B mm	C mm	WEIGHT (g)	BOX/CTN
86-508-1	8	38.0	13.0	21.8	9.0	43	6/96
86-509-1	9	38.0	14.5	21.8	10.0	45	6/96
86-510-1	10	38.0	15.5	21.8	10.0	47	6/96
86-511-1	11	38.0	16.7	21.8	10.0	49	6/96
86-512-1	12	38.0	18.0	21.8	10.0	51	6/96
86-513-1	13	38.0	19.2	21.8	10.0	52	6/96
86-514-1	14	38.0	20.5	21.8	10.0	52	6/96
86-515-1	15	38.0	21.7	23.3	14.0	53	6/96
88-738-1	16	38.0	22.5	23.3	14.3	62	6/96
88-739-1	17	38.0	24.2	23.0	14.3	80	6/96
88-740-1	18	38.0	24.7	23.0	15.3	82	6/96
88-741-1	19	38.0	26.3	24.0	16.7	88	6/96
88-742-1	20	38.0	27.7	25.0	17.3	96	6/96
88-743-1	21	38.0	28.8	25.0	18.0	104	4/96
88-744-1	22	40.0	29.8	26.0	18.0	113	4/96
88-745-1	23	40.0	30.8	27.0	18.0	120	4/96
88-746-1	24	40.0	31.8	27.0	18.0	126	4/96
88-747-1	25	40.0	33.4	28.0	20.0	136	4/96
88-748-1	26	43.0	34.8	29.0	20.0	140	4/96
88-749-1	27	43.0	35.8	30.0	20.0	166	4/96
88-750-1	28	43.0	37.8	31.0	20.0	172	4/96
88-751-1	29	43.0	38.8	32.0	20.0	180	4/96
88-752-1	30	43.0	39.8	33.0	20.0	191	2/96
88-753-1	32	43.0	41.8	35.0	22.0	222	2/96
86-196-1	34	45.5	43.8	35.0	25.0	254	2/96
86-536-1	36	57.2	50.0	38.0	23.0	495	2/96

SKU#	SIZE	L mm	A mm	B mm	C mm	WEIGHT (g)	BOX/CTN
89-319-1	19	49.5	30.0	35.0	14.0	210	4/48
89-321-1	21	49.5	31.0	35.0	14.0	210	4/48
89-322-1	22	49.5	32.0	36.0	14.0	210	4/48
89-324-1	24	49.5	34.0	36.0	16.0	210	4/48
89-325-1	25	50.0	37.0	36.0	21.0	210	4/48
89-327-1	27	52.0	38.4	36.0	24.0	210	4/48
89-328-1	28	52.0	39.2	36.0	24.0	230	4/48
89-330-1	30	54.0	42.3	38.0	25.0	260	4/48
89-332-1	32	56.0	44.2	38.0	26.0	280	4/48
89-333-1	33	56.0	46.2	38.0	26.0	310	4/48
89-334-1	34	56.0	47.2	38.0	26.0	340	6/48
89-336-1	36	58.0	50.2	42.0	28.0	400	4/24
89-338-1	38	60.0	52.2	45.0	29.0	450	4/24
89-341-1	41	64.0	56.0	45.0	32.0	540	4/24
89-346-1	46	68.0	62.0	48.0	35.0	650	4/24
89-350-1	50	72.0	68.0	48.0	38.0	780	4/24

## 12 Point Standard Socket – Metric

ISO 2725 / DIN 3124

- Made of Chrome Vanadium Steel
- Chromed finish for exceptional resistance to rust
- MaxiDrive™ gripping system: rounded gripping surface allows for 15% more torque and avoids rounding off fasteners, providing higher tenacity

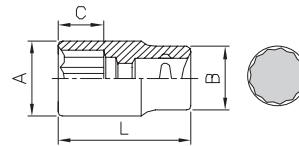

86-342-1

	3/8"							
	SKU#	SIZE	L mm	A mm	B mm	C mm	WEIGHT (g)	BOX/CTN
	86-342-1	7	25.7	10.8	17.1	4.0	21	6/96
	86-343-1	8	25.7	12.0	17.1	4.5	25	6/96
	86-344-1	9	25.7	13.1	17.1	5.0	26	6/96
	86-345-1	10	25.7	14.7	17.1	5.0	26	6/96
	86-346-1	11	25.7	16.0	17.1	7.0	26	6/96
	86-347-1	12	25.7	17.1	17.1	7.0	29	6/96
	86-348-1	13	25.7	18.3	18.3	7.0	32	6/96
	86-349-1	14	25.7	19.5	19.5	9.0	40	6/96
	86-350-1	15	25.7	20.4	20.4	10.0	43	6/96
	86-351-1	16	29.0	22.1	22.1	10.0	43	6/96
	86-352-1	17	29.0	23.3	23.3	10.0	50	6/96
	88-146-1	18	29.0	24.2	20.0	15.5	56	6/96
	88-147-1	19	29.0	25.7	21.0	15.5	64	6/96
	88-148-1	20	29.0	26.8	22.0	15.5	70	4/96
	88-149-1	21	29.0	27.7	23.0	15.5	78	4/96
	88-150-1	22	29.0	29.8	24.0	15.5	82	4/96
	88-151-1	23	29.0	30.7	25.0	15.5	82	4/96

	1/2"							
	SKU#	SIZE	L mm	A mm	B mm	C mm	WEIGHT (g)	BOX/CTN
	86-540-1	8	38.0	13.0	21.8	9.0	43	6/96
	86-541-1	9	38.0	14.5	21.8	10.0	45	6/96
	86-542-1	10	38.0	15.5	21.8	10.0	47	6/96
	86-543-1	11	38.0	16.7	21.8	10.0	49	6/96
	86-544-1	12	38.0	18.0	21.8	10.0	51	6/96
	86-545-1	13	38.0	19.2	21.8	10.0	52	6/96
	86-546-1	14	38.0	20.5	21.8	10.0	52	6/96
	86-547-1	15	38.0	21.7	23.3	14.0	53	6/96
	88-788-1	16	38.0	22.5	23.3	14.3	62	6/96
	88-789-1	17	38.0	24.2	23.3	14.3	80	6/96
	88-790-1	18	38.0	24.7	23.3	15.3	82	6/96
	88-791-1	19	38.0	26.3	24.0	16.7	88	6/96
	88-792-1	20	38.0	27.7	25.0	17.3	96	4/96
	88-793-1	21	38.0	28.8	25.0	18.0	104	4/96
	88-794-1	22	40.0	29.8	26.0	18.0	113	4/96
	88-795-1	23	40.0	30.8	27.0	18.0	120	4/96
	88-796-1	24	40.0	31.8	27.0	18.0	126	4/96
	88-797-1	25	40.0	33.4	28.0	20.0	136	4/96
	88-798-1	26	43.0	34.8	29.0	20.0	140	4/96
	88-799-1	27	43.0	35.8	30.0	20.0	166	4/96
	88-800-1	28	43.0	37.8	31.0	20.0	172	4/96
	88-801-1	29	43.0	38.8	32.0	20.0	180	2/96
	88-802-1	30	43.0	39.8	33.0	20.0	191	2/96
	88-803-1	32	43.0	41.8	35.0	22.0	222	2/96
	86-192-1	34	45.5	43.8	35.0	25.0	254	6/96
	88-187-1	36	57.2	50.0	38.0	23.0	495	2/24

	3/4"							
	SKU#	SIZE	L mm	A mm	B mm	C mm	WEIGHT (g)	BOX/CTN
	89-619-1	19	49.5	30.0	35.0	14.0	210	4/48
	89-621-1	21	49.5	21.0	35.0	14.0	210	4/48
	89-622-1	22	49.5	32.0	36.0	14.0	210	4/48
	89-623-1	23	49.5	33.0	36.0	14.0	210	4/48
	89-624-1	24	49.5	34.0	36.0	16.0	210	4/48
	89-625-1	25	50.0	37.0	36.0	21.0	210	4/48
	89-626-1	26	50.0	37.0	36.0	22.0	210	4/48
	89-627-1	27	52.0	38.4	36.0	24.0	210	4/48
	89-628-1	28	52.0	39.2	36.0	24.0	230	4/48
	89-629-1	29	52.0	40.0	38.0	24.0	240	4/48
	89-630-1	30	54.0	42.3	38.0	25.0	260	4/48
	89-631-1	31	56.0	44.2	38.0	26.0	280	4/48
	89-632-1	32	56.0	44.2	38.0	26.0	280	4/48
	89-633-1	33	56.0	46.2	38.0	26.0	310	4/48
	89-634-1	34	56.0	47.2	38.0	26.0	340	4/48
	89-635-1	35	58.0	48.2	42.0	28.0	370	4/24
	89-636-1	36	58.0	50.2	42.0	28.0	400	4/24
	89-638-1	38	60.0	52.2	45.0	29.0	450	4/24
	89-640-1	40	62.0	54.0	45.0	30.0	540	4/24
	89-641-1	41	64.0	56.0	45.0	32.0	540	4/24
	89-642-1	42	64.0	57.0	45.0	32.0	580	4/24
	89-644-1	44	66.0	60.0	48.0	34.0	600	4/24
	89-646-1	46	68.0	62.0	48.0	35.0	650	4/24
	89-650-1	50	72.0	68.0	48.0	38.0	780	4/24
	89-654-1	54	74.0	71.5	48.0	40.0	950	4/20
	89-655-1	55	76.0	74.5	48.0	42.0	980	4/20
	89-658-1	58	76.0	76.5	48.0	42.0	1000	4/20
	89-660-1	60	78.0	80.5	48.0	43.0	1050	4/20

1 MEASURING & LAYOUT TOOLS

2 LASER MEASURING SYSTEM

3 CUTTING & HOLDING TOOLS

4 FASTENING TOOLS

5 STRIKING & STRUCK TOOLS

6 ILLUMINATION TOOLS

7 PAINTING & FINISHING TOOLS

8 MECHANIC TOOLS

9 TOOLS STORAGE

10 POWER CLEANING TOOLS

11 POWER TOOLS

12 POWER TOOL ACCESSORIES

13 PRODUCT INDEX

# 8 MECHANIC TOOLS

## 12 Point Standard Socket – Inch

ANSI B107.1

- Made of Chrome Vanadium Steel
- Chromed finish for exceptional resistance to rust
- MaxiDrive™ gripping system: rounded gripping surface allows for 15% more torque and avoids rounding off fasteners, providing higher tenacity

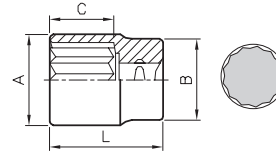

86-260-1

	SKU#	SIZE	L	A	B	C	WEIGHT	BOX/
			mm	mm	mm	mm	(g)	CTN
3/8"	86-260-1	1/4"	25.7	10.0	17.1	3.2	21	6/96
	86-261-1	5/16"	25.7	11.7	17.1	4.5	23	6/96
	91-132-1	3/8"	25.7	14.2	17.1	5.0	24	6/96
	91-138-1	7/16"	25.7	16.3	17.1	7.0	26	6/96
	91-151-1	1/2"	25.7	18.3	18.3	7.0	34	6/96
	91-186-1	9/16"	25.7	19.5	19.5	9.0	38	6/96
	91-283-1	5/8"	29.0	22.1	22.1	10.0	46	6/96
	88-176-1	11/16"	29.0	24.2	20.0	10.0	50	6/96
	88-177-1	3/4"	29.0	25.7	21.0	12.0	60	6/96
	88-179-1	13/16"	29.0	27.7	23.0	13.0	68	6/96
88-180-1	7/8"	29.0	29.5	24.0	13.0	75	6/96	

	SKU#	SIZE	L	A	B	C	WEIGHT	BOX/
			mm	mm	mm	mm	(g)	CTN
1/2"	86-494-1	1/4"	38.0	10.2	21.8	6.5	43	6/96
	86-460-1	5/16"	38.0	12.4	21.8	8.0	43	6/96
	86-461-1	3/8"	38.0	14.7	21.8	9.0	46	6/96
	86-462-1	7/16"	38.0	17.0	21.8	9.0	50	6/96
	86-463-1	1/2"	38.0	19.0	21.8	10.0	52	6/96
	86-464-1	9/16"	38.0	20.8	21.8	12.5	55	6/96
	86-497-1	19/32"	38.0	21.8	21.8	14.3	55	6/96
	88-815-1	5/8"	38.0	22.5	23.3	14.3	62	6/96
	88-816-1	11/16"	38.0	24.7	23.0	14.3	72	6/96
	88-817-1	3/4"	38.0	26.3	24.0	20.0	76	6/96
	86-498-1	25/32"	38.0	27.7	25.0	20.0	80	4/96
	88-818-1	13/16"	38.0	28.8	28.8	20.0	80	4/96
	88-819-1	7/8"	40.0	29.8	29.8	21.0	95	4/96
	88-820-1	15/16"	40.0	31.8	27.0	21.0	110	6/96
	86-499-1	31/32"	40.0	33.4	28.0	21.0	115	4/96
	88-821-1	1"	43.0	33.4	28.0	21.0	120	4/96
	88-822-1	1-1/16"	43.0	35.8	30.0	23.0	145	4/96
	88-823-1	1-1/8"	43.0	37.8	31.0	23.0	150	4/96
	86-496-1	1-3/16"	43.0	39.8	33.0	23.0	190	6/96
	88-824-1	1-1/4"	43.0	41.8	35.0	23.0	205	2/96

	SKU#	SIZE	L	A	B	C	WEIGHT	BOX/
			mm	mm	mm	mm	(g)	CTN
3/4"	89-661-1	3/4"	49.5	30.0	35.0	14.0	200	4/48
	89-662-1	13/16"	49.5	31.0	35.0	14.0	200	4/48
	89-663-1	7/8"	49.5	32.0	36.0	14.0	210	4/48
	89-664-1	15/16"	49.5	34.0	36.0	15.0	220	4/48
	89-665-1	1"	50.0	37.0	36.0	22.0	220	4/48
	89-666-1	1-1/16"	52.0	38.4	36.0	24.0	220	4/48
	89-667-1	1-1/8"	52.0	40.0	38.0	24.0	240	4/48
	89-668-1	1-3/16"	54.0	42.3	38.0	25.0	280	4/48
	89-669-1	1-1/4"	56.0	44.2	38.0	26.0	280	4/48
	89-670-1	1-5/16"	56.0	46.2	38.0	26.0	326	4/48
	89-671-1	1-3/8"	58.0	48.2	42.0	28.0	360	4/24
	89-672-1	1-7/16"	58.0	50.2	42.0	28.0	380	4/24
	89-673-1	1-1/2"	60.0	52.2	45.0	29.0	420	4/24
	89-674-1	1-5/8"	64.0	56.0	45.0	32.0	520	4/24
	89-675-1	1-11/16"	65.0	58.0	46.0	33.0	540	4/24
	89-676-1	1-3/4"	66.0	60.0	48.0	34.0	580	4/24
	89-677-1	1-13/16"	68.0	62.0	48.0	35.0	640	4/24
	89-678-1	1-7/8"	70.0	64.0	48.0	36.0	700	4/24
	89-679-1	2"	72.0	68.0	48.0	38.0	740	4/24
	88-958-1	2-1/8"	74.0	71.5	48.0	40.0	820	4/20
88-959-1	2-3/16"	76.0	74.5	48.0	42.0	930	4/20	
88-960-1	2-1/4"	76.0	76.5	48.0	42.0	930	4/20	
88-997-1	2-5/16"	78.0	78.0	48.0	43.0	1000	4/20	

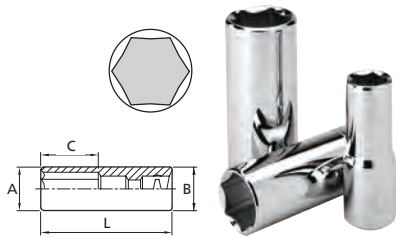

86-322-1

## 6 Point Deep Socket – Metric

ISO 2725 / DIN 3124

- Made of Chrome Vanadium Steel
- Chromed finish for exceptional resistance to rust
- MaxiDrive™ gripping system: rounded gripping surface allows for 15% more torque and avoids rounding off fasteners, providing higher tenacity

	3/8"		L	A	B	C	WEIGHT	BOX/
	SKU#	SIZE	mm	mm	mm	mm	(g)	CTN
	86-322-1	10	45.5	14.7	16.5	15.0	60	6/96
	86-323-1	11	45.5	16.5	16.5	17.0	70	6/96
	86-324-1	12	45.5	17.1	17.1	18.0	75	6/96
	86-325-1	13	35.5	18.5	18.5	18.0	85	6/96
	86-326-1	14	50.0	19.5	19.5	18.0	95	6/96
	86-327-1	15	53.0	20.4	20.4	20.0	100	6/96
	88-825-1	16	53.0	22.0	22.0	20.0	105	6/96
	86-328-1	17	56.0	23.3	23.3	20.0	120	6/96
	88-826-1	18	56.0	24.2	23.0	20.0	125	6/96
	86-329-1	19	56.0	25.7	24.0	20.0	130	6/96
	88-827-1	20	63.5	26.8	25.0	22.0	140	6/96
	88-828-1	21	63.5	27.7	26.0	22.0	165	6/96
	88-829-1	22	63.5	29.5	27.0	22.0	165	6/96
	88-837-1	23	63.5	30.7	28.0	22.0	180	6/96

	1/2"		L	A	B	C	WEIGHT	BOX/
	SKU#	SIZE	mm	mm	mm	mm	(g)	CTN
	93-525-1	10	79.0	15.5	22.0	17.0	124	6/96
	93-526-1	11	79.0	16.7	22.0	18.0	129	6/96
	93-527-1	12	79.0	18.0	22.0	19.0	129	6/96
	93-528-1	13	79.0	19.2	22.0	21.0	134	6/96
	93-529-1	14	79.0	20.5	22.0	25.0	134	6/96
	93-530-1	15	79.0	21.5	22.0	28.0	134	6/96
	93-531-1	16	79.0	22.5	22.5	31.0	149	6/96
	93-532-1	17	79.0	24.2	24.2	34.0	154	6/96
	93-533-1	18	79.0	25.4	25.4	34.0	164	6/96
	93-534-1	19	79.0	26.7	26.7	34.0	189	6/96
	93-535-1	21	79.0	27.8	27.8	34.0	194	4/32
	93-536-1	22	79.0	27.8	27.8	34.0	199	4/32
	93-537-1	23	79.0	29.8	30.0	34.0	229	4/96
	93-538-1	24	79.0	31.8	32.0	34.0	239	4/96
	93-539-1	27	79.0	35.8	33.0	34.0	279	4/48
	93-541-1	30	79.0	39.8	35.0	34.0	359	4/96
	93-542-1	32	79.0	41.3	36.5	34.0	379	4/96

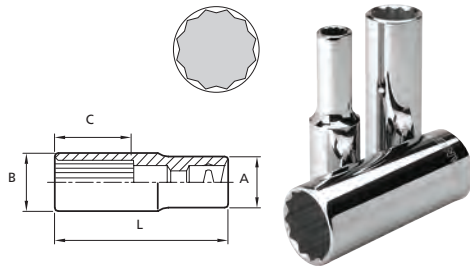

86-418-1

## 12-Point Deep Socket – Metric

DIN 3124

- Made of Chrome Vanadium Steel
- Chromed finish for exceptional resistance to rust
- MaxiDrive™ gripping system: rounded gripping surface allows for 15% more torque and avoids rounding off fasteners, providing higher tenacity

	3/8"		L	A	B	C	WEIGHT	BOX/
	SKU#	SIZE	mm	mm	mm	mm	(g)	CTN
	86-338-1	8	45.5	12.0	16.5	12.0	50	6/96
	86-339-1	9	45.5	13.1	16.5	14.0	55	6/96
	86-362-1	10	45.5	14.7	16.5	15.0	60	6/96
	86-363-1	11	45.5	16.5	16.5	17.0	70	6/96
	86-364-1	12	45.5	17.1	17.1	18.0	75	6/96
	86-365-1	13	45.5	18.5	18.5	18.0	85	6/96
	86-366-1	14	50.0	19.5	19.5	18.0	95	6/96
	86-367-1	15	53.0	20.4	20.4	20.0	100	6/96
	86-369-1	17	56.0	23.3	23.3	20.0	120	6/96
	86-370-1	18	56.0	24.2	23.0	20.0	125	6/96
	86-371-1	19	56.0	25.7	24.0	20.0	130	6/96

	1/2"		L	A	B	C	WEIGHT	BOX/
	SKU#	SIZE	mm	mm	mm	mm	(g)	CTN
	86-418-1	10	79.0	15.5	22.0	17.0	125	6/96
	86-419-1	11	79.0	16.7	22.0	18.0	130	6/96
	86-420-1	12	79.0	18.0	22.0	19.0	130	6/96
	86-421-1	13	79.0	19.2	22.0	21.0	135	6/96
	86-422-1	14	79.0	20.5	22.0	25.0	135	6/96
	86-423-1	15	79.0	21.5	22.0	28.0	135	6/96
	86-424-1	16	79.0	22.5	23.3	31.0	150	6/96
	86-425-1	17	79.0	24.2	24.2	34.0	155	6/96
	86-426-1	18	79.0	25.4	25.4	34.0	165	6/96
	86-427-1	19	79.0	26.7	26.7	34.0	190	6/96
	86-428-1	20	79.0	27.8	27.8	34.0	195	6/96
	86-429-1	21	79.0	27.8	27.8	34.0	200	4/96
	86-430-1	22	79.0	29.8	29.8	34.0	230	4/96
	86-431-1	23	79.0	30.8	28.0	34.0	230	4/96
	86-432-1	24	79.0	31.8	28.5	34.0	240	4/96
	86-433-1	25	79.0	32.8	29.0	34.0	250	4/96
	86-434-1	26	79.0	33.8	30.0	34.0	250	4/96
	86-435-1	27	79.0	35.8	32.0	34.0	280	4/96
	86-436-1	28	79.0	37.8	33.0	34.0	320	4/96
	86-438-1	30	79.0	39.8	35.0	34.0	360	4/96
	86-439-1	32	79.0	41.3	36.5	34.0	380	4/96

- 1 MEASURING & LAYOUT TOOLS
- 2 LASER MEASURING SYSTEM
- 3 CUTTING & HOLDING TOOLS
- 4 FASTENING TOOLS
- 5 STRIKING & STRUCK TOOLS
- 6 ILLUMINATION TOOLS
- 7 PAINTING & FINISHING TOOLS
- 8 MECHANIC TOOLS
- 9 TOOLS STORAGE
- 10 POWER CLEANING TOOLS
- 11 POWER TOOLS
- 12 POWER TOOL ACCESSORIES
- 13 PRODUCT INDEX

## 8 MECHANIC TOOLS

### 12-Point Deep Socket – Inch

ANSI B107.1

- Made of Chrome Vanadium Steel
- Chromed finish for exceptional resistance to rust
- MaxiDrive™ gripping system: rounded gripping surface allows for 15% more torque and avoids rounding off fasteners, providing higher tenacity

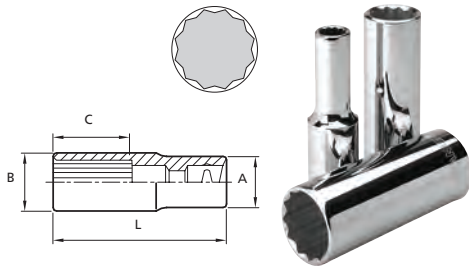

86-279-1

	SKU#	SIZE	L mm	A mm	B mm	C mm	WEIGHT (g)	BOX/CTN
3/8"	86-279-1	1/4"	45.5	9.8	16.5	10.0	38	6/96
	91-284-1	5/16"	45.5	11.7	16.5	12.0	41	6/96
	91-286-1	3/8"	45.5	14.2	16.5	15.0	43	6/96
	91-287-1	7/16"	45.5	16.5	16.5	17.0	50	6/96
	91-288-1	1/2"	45.5	18.5	18.5	18.0	62	6/96
	91-289-1	9/16"	50.0	19.5	19.5	18.0	72	6/96
	91-296-1	5/8"	53.0	22.0	22.0	20.0	97	6/96
	91-297-1	11/16"	56.0	24.2	24.2	20.0	125	6/96
	91-298-1	3/4"	56.0	25.7	25.7	22.0	130	6/96
	91-302-1	13-16"	63.5	27.7	27.7	22.0	140	6/96

	SKU#	SIZE	L mm	A mm	B mm	C mm	WEIGHT (g)	BOX/CTN
1/2"	86-481-1	1/2"	79.0	19.0	22.0	20.0	135	6/96
	86-482-1	9/16"	79.0	20.8	22.0	22.0	135	6/96
	86-483-1	5/8"	79.0	22.5	23.3	24.0	150	6/96
	86-484-1	11/16"	79.0	24.3	24.3	26.0	170	6/96
	86-485-1	3/4"	79.0	26.8	26.8	29.0	185	6/96
	86-486-1	13/16"	79.0	27.8	27.8	31.0	210	4/96
	86-487-1	7/8"	79.0	29.8	29.8	31.0	250	4/96
	86-488-1	15/16"	79.0	31.8	31.8	33.0	265	4/96
	86-489-1	1"	79.0	33.8	33.8	33.0	290	4/96
	86-490-1	1-1/16"	79.0	35.8	35.8	33.0	315	4/96
	86-491-1	1-1/8"	79.0	37.8	37.8	33.0	350	4/96

### 1/2" Drive Torx® Socket

- Made of Chrome Vanadium Steel
- To remove fasteners with Torx® shaped head

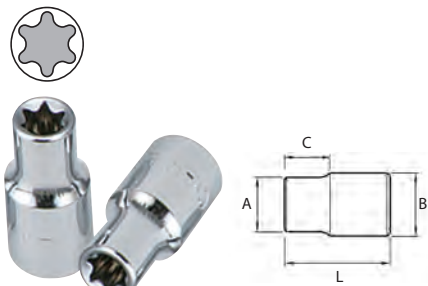

92-545-1

	SKU#	SIZE	L mm	A mm	B mm	C mm	BOX/CTN
1/2"	92-545-1	E10	38.0	13.3	21.8	10.0	6/96
	92-478-1	E12	38.0	15.0	21.8	12.0	6/96
	92-479-1	E14	38.0	17.0	21.8	12.0	6/96
	92-489-1	E16	38.0	18.5	21.8	12.0	6/96
	92-503-1	E18	38.0	20.0	21.8	12.0	6/96
	92-505-1	E20	38.0	23.3	21.8	13.0	6/96



## Hex Bit Socket – Metric

ANSI B107

- Made of Chrome Vanadium Steel
- Chromed finish for exceptional resistance to rust
- MaxiDrive™ gripping system: rounded gripping surface allows for 15% more torque and avoids rounding off fasteners, providing higher tenacity
- Our sockets comply with the most stringent international standards: ANSI, DIN and ISO

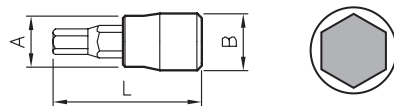

86-373-1

1/4"	SKU#	SIZE	L mm	A mm	B mm	WEIGHT (g)	BOX/CTN
	86-373-1	3	32.0	11.0	12.0	13	12/96
86-721-1	4	32.0	11.0	12.0	13	12/96	
86-723-1	5	32.0	11.0	12.0	14	12/96	
86-725-1	6	32.0	11.0	12.0	15	12/96	
86-726-1	7	32.0	11.0	12.0	16	12/96	
86-727-1	8	32.0	11.0	12.0	16	12/96	
86-729-1	10	32.0	11.0	12.0	19	12/96	

3/8"	SKU#	SIZE	L mm	A mm	B mm	WEIGHT (g)	BOX/CTN
	87-965-1	3	49.5	8.0	17.9	36	6/96
87-971-1	4	49.5	10.0	17.9	37	6/96	
87-972-1	5	49.5	12.0	17.9	38	6/96	
87-973-1	6	49.5	14.0	17.9	38	6/96	
87-974-1	7	49.5	15.0	17.9	38	6/96	
87-975-1	8	49.5	16.0	17.9	40	6/96	
87-976-1	10	49.5	17.0	17.9	42	6/96	

1/2"	SKU#	SIZE	L mm	A mm	B mm	WEIGHT (g)	BOX/CTN
	89-188-1	6	55.0	16.0	22.0	64	6/96
89-189-1	8	55.0	16.0	22.0	74	6/96	
89-190-1	10	55.0	18.0	22.0	83	6/96	
89-191-1	12	55.0	19.0	22.0	94	6/96	
89-192-1	14	55.0	21.0	22.0	105	6/96	
89-193-1	17	55.0	24.4	24.4	143	6/96	
89-194-4	19	60.0	25.9	25.9	182	6/96	

## Torx® Temper-Resistant Bit Socket

- Made of Chrome Vanadium Steel
- Corrosion-Resistant Finish
- Iso Fits Standard Torx® Sizes: T and TS
- Perfect use for temper-proof star fasteners in today's cars, trucks and appliances
- Precision-machined tip for exact fit

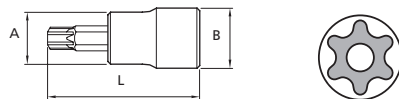

93-360-1

1/4"	SKU#	SIZE	L mm	A mm	B mm	BOX/CTN
	93-360-1	T-10	55.0	14.0	22.0	6/96
93-361-1	T-15	55.0	14.0	22.0	6/96	
93-362-1	T-20	55.0	14.0	22.0	6/96	
93-363-1	T-25	55.0	14.0	22.0	6/96	
93-364-1	T-27	55.0	14.0	22.0	6/96	
93-365-1	T-30	55.0	14.0	22.0	6/96	
93-366-1	T-40	55.0	14.0	22.0	6/96	
93-367-1	T-45	55.0	15.5	22.0	6/96	
93-368-1	T-50	55.0	15.5	22.0	6/96	
93-369-1	T-55	55.0	18.0	22.0	6/96	
93-370-1	T-60	55.0	19.2	22.0	6/96	

## 8 MECHANIC TOOLS

### Hex Bit Socket – Inch

- Made of Chrome Vanadium Steel
- Chromed finish for exceptional resistance to rust
- MaxiDrive™ gripping system: rounded gripping surface allows for 15% more torque and avoids rounding off fasteners, providing higher tenacity

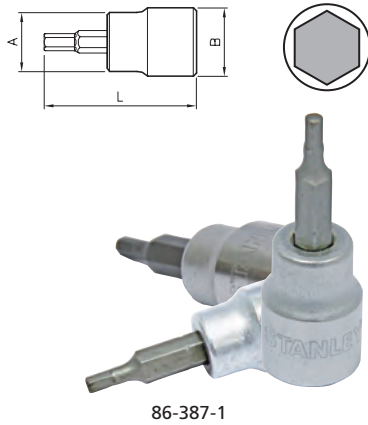

86-387-1

	3/8"						
	SKU#	SIZE	L mm	A mm	B mm	WEIGHT (g)	BOX/CTN
	86-387-1	1/8"	49.5	8.0	17.9	36	6/96
	86-376-1	9/64"	49.5	9.5	17.9	37	6/96
	86-388-1	5/32"	49.5	10.0	17.9	38	6/96
	86-389-1	3/16"	49.5	12.0	17.9	38	6/96
	86-390-1	7/32"	49.5	13.0	17.9	38	6/96
	86-391-1	1/4"	49.5	14.0	17.9	40	6/96
	86-392-1	5/16"	49.5	16.0	17.9	40	6/96
	86-377-1	3/8"	49.5	17.0	17.9	42	6/144

	1/2"						
	SKU#	SIZE	L mm	A mm	B mm	WEIGHT (g)	BOX/CTN
	89-180-1	5/16"	55.0	16.0	22.0	74	6/144
	89-181-1	3/8"	55.0	17.0	22.0	74	6/144
	89-182-1	7/16"	55.0	18.0	22.0	83	6/144
	89-183-1	1/2"	55.0	19.5	22.0	94	6/144
	89-184-1	9/16"	55.0	21.0	22.0	105	6/144
	89-185-1	5/8"	55.0	23.0	24.0	134	6/144

### Long Hex Bit Socket - Metric

DIN 7422

- Made of Chrome Vanadium Steel
- Chromed finish for exceptional resistance to rust
- MaxiDrive™ gripping system: rounded gripping surface allows for 15% more torque and avoids rounding off fasteners, providing higher tenacity
- Our sockets comply with the most stringent international standards: ANSI, DIN and ISO

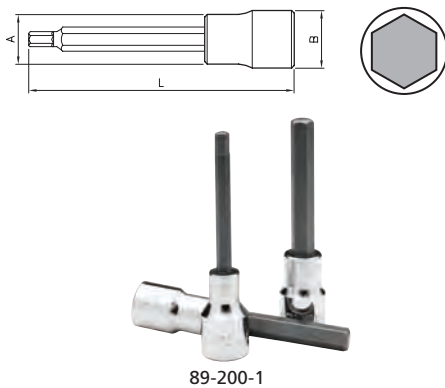

89-200-1

	1/2"						
	SKU#	SIZE	L mm	A mm	B mm	WEIGHT (g)	BOX/CTN
	89-200-1	5	100.0	14.0	22.0	82	6/96
	89-201-1	6	100.0	14.0	22.0	82	6/96
	89-202-1	7	100.0	15.0	22.0	85	6/96
	89-203-1	8	100.0	16.0	22.0	90	6/96
	89-204-1	10	100.0	18.0	22.0	105	6/96
	89-205-1	12	100.0	19.0	22.0	135	6/96

## Torx® Bit Socket

- Made of Chrome Vanadium Steel
- Chromed finish for exceptional resistance to rust
- MaxiDrive™ gripping system: rounded gripping surface allows for 15% more torque and avoids rounding off fasteners, providing higher tenacity

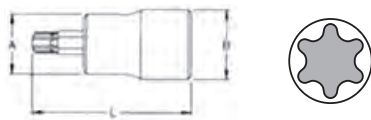

91-576-1

1/4"	SKU#	SIZE	L mm	A mm	B mm	BOX/CTN
	91-576-1	T-08	32.0	11.0	12.0	6/144
91-577-1	T-10	32.0	11.0	12.0	6/144	
91-578-1	T-15	32.0	11.0	12.0	6/144	
91-579-1	T-20	32.0	11.0	12.0	6/144	
91-580-1	T-25	32.0	11.0	12.0	6/144	
91-582-1	T-30	32.0	11.0	12.0	12/144	
91-583-1	T-40	32.0	11.0	12.0	6/144	

3/8"	SKU#	SIZE	L mm	A mm	B mm	BOX/CTN
	87-404-1	T-10	49.5	8.0	17.9	6/96
87-141-1	T-15	49.5	10.0	17.9	6/96	
87-142-1	T-20	49.5	12.0	17.9	6/96	
87-143-1	T-25	49.5	14.0	17.9	6/96	
87-406-1	T-27	49.5	15.0	17.9	6/96	
87-144-1	T-30	49.5	16.0	17.9	6/96	
87-145-1	T-40	49.5	16.0	17.9	6/96	
87-146-1	T-45	49.5	16.0	17.9	6/96	
87-147-1	T-50	49.5	17.0	17.9	6/96	
87-407-1	T-55	49.5	17.0	17.9	6/96	

1/2"	SKU#	SIZE	L mm	A mm	B mm	BOX/CTN
	89-215-1	T-20	55.0	14.0	22.0	6/96
89-216-1	T-25	55.0	14.0	22.0	6/96	
89-217-1	T-27	55.0	14.0	22.0	6/96	
89-218-1	T-30	55.0	14.0	22.0	6/96	
89-219-1	T-40	55.0	14.0	22.0	6/96	
89-230-1	T-45	55.0	16.0	22.0	6/96	
89-231-1	T-50	55.0	16.0	22.0	6/96	
89-232-1	T-55	55.0	18.0	22.0	6/96	
89-233-1	T-60	55.0	19.0	22.0	6/96	

## Phillips® Bit Socket

- Made of Chrome Vanadium Steel
- Chromed finish for exceptional resistance to rust
- MaxiDrive™ gripping system: rounded gripping surface allows for 15% more torque and avoids rounding off fasteners, providing higher tenacity

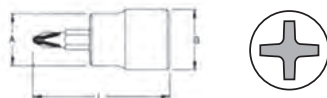

86-176-1

1/4"	SKU#	SIZE	L mm	A mm	B mm	BOX/CTN
	89-063-1	1 PT	32.0	11.0	12.0	6/144
89-064-1	2 PT	32.0	11.0	12.0	6/144	
89-065-1	3 PT	32.0	11.0	12.0	6/144	

3/8"	SKU#	SIZE	L mm	A mm	B mm	BOX/CTN
	86-176-1	0 PT	49.5	14.0	17.9	6/144
86-335-1	1 PT	49.5	14.0	17.9	6/144	
86-177-1	2 PT	49.5	14.0	17.9	6/144	
86-336-1	3 PT	49.5	14.0	17.9	6/96	
86-178-1	4 PT	49.5	14.0	17.9	6/144	

## 8 MECHANIC TOOLS

### Slotted Bit Socket – Metric

ISO 2380 / DIN 5264

- Made of Chrome Vanadium Steel
- Chromed finish for exceptional resistance to rust
- MaxiDrive™ gripping system: rounded gripping surface allows for 15% more torque and avoids rounding off fasteners, providing higher tenacity

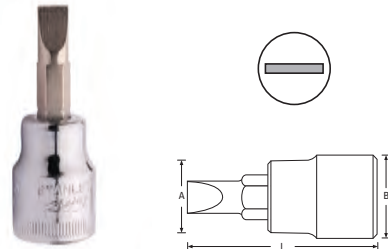

89-154-1

1/4"	SKU#	SIZE	L	A	B	WEIGHT	BOX/CTN
			mm	mm	mm	(g)	
	86-374-1	3.5	32.0	11.0	12.0	12	6/144
	86-745-1	4	32.0	11.0	12.0	13	6/144
	86-743-1	5.5	32.0	11.0	12.0	13	6/144
	86-744-1	6.5	32.0	11.0	12.0	13	6/144
	86-747-1	7	32.0	11.0	12.0	14	6/144
	86-297-1	8	32.0	11.0	12.0	14	6/144

3/8"	SKU#	SIZE	L	A	B	WEIGHT	BOX/CTN
			mm	mm	mm	(g)	
	89-150-1	3.5	49.5	14.0	17.9	33	6/144
	89-151-1	4	49.5	14.0	17.9	36	6/144
	89-152-1	4.5	49.5	14.0	17.9	36	6/144
	89-153-1	5.5	49.5	14.0	17.9	36	6/144
	89-154-1	6.5	49.5	14.0	17.9	37	6/144
	89-155-1	7	49.5	14.0	17.9	37	6/144
	89-156-1	8	49.5	16.0	17.9	42	6/144
	89-157-1	10	49.5	16.0	17.9	45	6/144

1/2"	SKU#	SIZE	L	A	B	WEIGHT	BOX/CTN
			mm	mm	mm	(g)	
	89-208-1	6.5	55.0	16.0	22.0	74	6/144
	89-209-1	8	55.0	16.0	22.0	74	6/144
	89-210-1	10	55.0	18.0	22.0	76	6/144
	89-211-1	12	55.0	19.0	22.0	80	6/144

### Torx® Bit Socket - 100mm

- Made of Chrome Vanadium Steel
- Chromed finish for exceptional resistance to rust
- MaxiDrive™ gripping system: rounded gripping surface allows for 15% more torque and avoids rounding off fasteners, providing higher tenacity

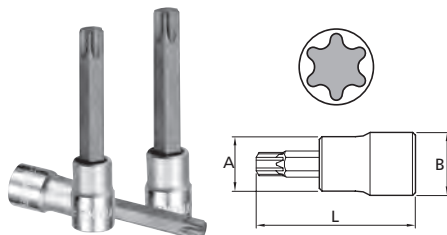

89-991-1

1/2"	SKU#	SIZE	L	A	B	BOX/CTN
			mm	mm	mm	
	89-991-1	T-30	100.0	14.0	22.0	6/48
	89-992-1	T-40	100.0	14.0	22.0	6/48
	89-993-1	T-45	100.0	15.5	22.0	6/48
	89-994-1	T-50	100.0	15.5	22.0	6/48
	89-995-1	T-55	100.0	18.0	22.0	6/48
	89-998-1	T-60	100.0	19.2	22.0	6/48

### Pozidriv® Bit Socket

- Made of Chrome Vanadium Steel
- Chromed finish for exceptional resistance to rust
- MaxiDrive™ gripping system: rounded gripping surface allows for 15% more torque and avoids rounding off fasteners, providing higher tenacity

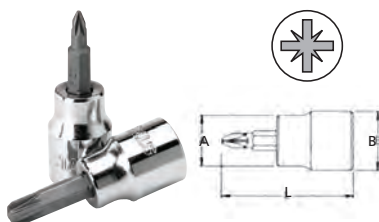

89-170-1

3/8"	SKU#	SIZE	L	A	B	WEIGHT	BOX/CTN
			mm	mm	mm	(g)	
	89-170-1	0 PT	49.5	14.0	17.9	37	6/144
	89-171-1	1 PT	49.5	14.0	17.9	37	6/144
	89-172-1	2 PT	49.5	14.0	17.9	37	6/144
	89-173-1	3 PT	49.5	14.0	17.9	38	6/144
	89-174-1	4 PT	49.5	14.0	17.9	38	6/144

## 6 Point Spark Plug Sockets - Metric / Inch

- Made of Chrome Vanadium Steel
- Chromed finish for exceptional resistance to rust



3/8"	SKU#	SIZE	L mm	A mm	WEIGHT (g)	BOX/CTN
	86-380-1	5/8"	64.0	22.0	100	6/96
86-381-1	13/16"	70.0	28.0	16	4/96	

1/2"	SKU#	SIZE	L mm	A mm	WEIGHT (g)	BOX/CTN
	86-580-1	5/8"	64.0	23.0	130	4/96
	86-581-1	13/16"	70.0	28.0	165	4/48
	86-582-1	14mm	77.0	22.0	141	4/72
	86-583-1	16mm	65.0	65.0	97	4/72
	86-584-1	18mm	77.0	26.0	151	4/72
	86-585-1	21mm	70.0	65.0	146	4/72

## T-handle Fixed Head 6 Point Sockets

- Made of Chrome Vanadium Steel
- Chromed finish for exceptional resistance to rust

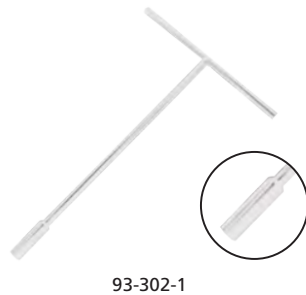

SKU#	DESCRIPTION	BOX/CTN
93-302-1	T-Handle 6pt Socket 08mm x L300mm	50/50
93-303-1	T-Handle 6pt Socket 09mm x L300mm	50/50
93-304-1	T-Handle 6pt Socket 10mm x L300mm	50/50
93-305-1	T-Handle 6pt Socket 11mm x L300mm	50/50
93-306-1	T-Handle 6pt Socket 12mm x L300mm	50/50
93-307-1	T-Handle 6pt Socket 13mm x L300mm	40/40
93-308-1	T-Handle 6pt Socket 14mm x L300mm	40/40
93-309-1	T-Handle 6pt Socket 17mm x L300mm	30/30
93-311-1	T-Handle 6pt Socket 19mm x L300mm	35/35
95-744-1	T-Handle 6pt Socket 16mm x L300mm	35/35
95-745-1	T-Handle 6pt Socket 18mm x L300mm	35/35
95-746-1	T-Handle 6pt Socket 21mm x L300mm	30/30

## T-handle Flex Head 6 Point Sockets

- Made of Chrome Vanadium Steel
- Chromed finish for exceptional resistance to rust



SKU#	DESCRIPTION	BOX/CTN
79-076	T-Handle Flex Head 6pt Socket - 08mm x L500mm	40/40
79-077	T-Handle Flex Head 6pt Socket - 09mm x L500mm	40/40
79-078	T-Handle Flex Head 6pt Socket - 10mm x L500mm	40/40
79-079	T-Handle Flex Head 6pt Socket - 12mm x L500mm	40/40
79-080	T-Handle Flex Head 6pt Socket - 13mm x L500mm	40/40
79-081	T-Handle Flex Head 6pt Socket - 14mm x L500mm	40/40
79-082	T-Handle Flex Head 6pt Socket - 17mm x L500mm	40/40
79-083	T-Handle Flex Head 6pt Socket - 19mm x L500mm	40/40
79-084	T-Handle Flex Head 6pt Socket - 21mm x L500mm	30/30

1 MEASURING & LAYOUT TOOLS

2 LASER MEASURING SYSTEM

3 CUTTING & HOLDING TOOLS

4 FASTENING TOOLS

5 STRIKING & STRUCK TOOLS

6 ILLUMINATION TOOLS

7 PAINTING & FINISHING TOOLS

8 MECHANIC TOOLS

9 TOOLS STORAGE

10 POWER CLEANING TOOLS

11 POWER TOOLS

12 POWER TOOL ACCESSORIES

13 PRODUCT INDEX

# 8 MECHANIC TOOLS



79-085

## T-handle Flex Spark Plug 6 Point Sockets

- Made of Chrome Vanadium Steel
- Chromed finish for exceptional resistance to rust

SKU#	DESCRIPTION	BOX/CTN
79-085	T-Handle Flex Spark Plug 6pt - 14mm x L530mm	40/40
79-086	T-Handle Flex Spark Plug 6pt - 16mm x L530mm	40/40
79-087	T-Handle Flex Spark Plug 6pt - 18mm x L530mm	40/40
79-092	T-Handle Flex Spark Plug 6pt - 21mm x L530mm	30/30

## 6 Point Standard Impact Sockets

- Chrome Molybdenum for stronger torque

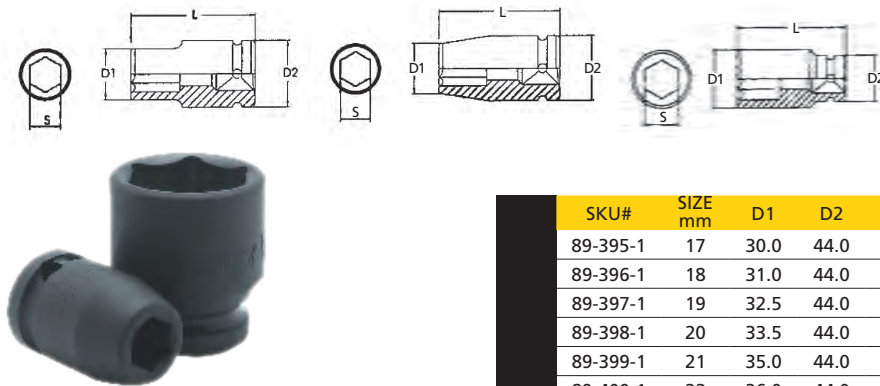

89-395-1

SKU#	SIZE mm	D1	D2	L1	TYPE	BOX/CTN	
89-435-1	8	15.0	25	38	A	10/ 200	
89-436-1	9	16.0	25	38	A	10/ 200	
89-437-1	10	17.0	25	38	A	10/ 200	
89-438-1	11	18.5	25	38	A	10/ 200	
89-439-1	12	20.0	25	38	A	10/ 200	
89-440-1	13	21.0	25	38	A	10/ 200	
89-441-1	14	22.5	25	38	A	10/ 200	
89-442-1	15	23.0	30	38	B	10/180	
89-443-1	16	25.0	30	38	B	10/180	
89-444-1	17	26.0	30	38	B	10/180	
89-445-1	18	27.3	30	38	B	10/180	
89-446-1	19	28.5	30	38	B	10/180	
1/2'	89-447-1	20	30.0	30	38	B	10/180
89-448-1	21	30.0	30	38	B	10/180	
89-449-1	22	32.0	30	38	C	10/150	
89-450-1	23	34.0	30	38	C	10/150	
89-451-1	24	34.0	30	38	C	10/150	
89-452-1	25	36.0	30	38	C	10/150	
89-453-1	26	36/38	30	38	C	10/100	
89-454-1	27	38.0	30	42	C	10/100	
89-455-1	28	40.0	30	42	C	10/100	
89-456-1	30	42.0	30	42	C	10/100	
89-457-1	31	42.0	30	42	C	6/90	
89-458-1	32	44.0	30	44	C	6/90	
89-459-1	33	44.0	30	44	C	6/90	
89-460-1	34	46.0	30	44	C	6/48	
89-461-1	36	46/48	30	48	C	6/48	

SKU#	SIZE mm	D1	D2	L1	Type	BOX/CTN	
89-395-1	17	30.0	44.0	51	A	6/48	
89-396-1	18	31.0	44.0	51	A	6/48	
89-397-1	19	32.5	44.0	51	A	6/48	
89-398-1	20	33.5	44.0	51	A	6/48	
89-399-1	21	35.0	44.0	51	A	6/48	
89-400-1	22	36.0	44.0	51	A	6/48	
89-401-1	23	37.5	44.0	51	A	6/48	
89-402-1	24	38.5	44.0	51	A	6/48	
89-403-1	25	40.0	44.0	51	A	6/48	
89-404-1	26	41.0	44.0	51	A	6/48	
89-405-1	27	42.5	44.0	51	A	6/48	
89-406-1	28	44.0	44.0	51	B	6/48	
89-407-1	29	45.0	44.0	51	C	6/36	
89-408-1	30	46.0	44.0	51	C	6/36	
89-409-1	31	47.5	44.0	57	C	6/36	
89-410-1	32	48.5	44.0	57	C	6/36	
89-411-1	33	50.0	44.0	57	C	6/36	
89-412-1	34	51.0	44.0	57	C	6/36	
89-413-1	35	52.5	44.0	57	C	6/36	
3/4"	89-414-1	36	53.5	44.0	57	C	6/24
89-415-1	37	55.0	44.0	57	C	6/24	
89-416-1	38	56.0	44.0	57	C	6/24	
89-417-1	40	58.5	44.0	58	C	6/24	
89-418-1	41	60.0	44.0	58	C	6/24	
89-419-1	43	62.5	44.0	62	C	6/24	
89-420-1	45	65.0	44.0	62	C	6/24	
89-421-1	46	66.0	44.0	62	C	6/24	
89-422-1	48	68.0	44.0	68	C	6/24	
89-423-1	50	71.0	44.0	68	C	4/12	
89-424-1	52	73.0	54.0	71	C	4/12	
89-425-1	54	75.5	54.0	71	C	4/12	
89-426-1	55	77.5	54.0	71	C	4/12	
89-427-1	57	80.0	54.0	73	C	4/12	
89-428-1	58	81.0	54.0	73	C	4/12	
89-429-1	59	81.0	54.0	73	C	4/12	
89-430-1	60	83.0	54.0	73	C	4/12	
89-431-1	63	86.5	54.0	75	C	4/12	
89-432-1	65	88.0	54.0	78	C	4/12	
89-433-2	70	94.0	54.0	83	C	4/12	

## 1/2" 6 Point Deep Impact Sockets

- Chrome Molybdenum for stronger torque

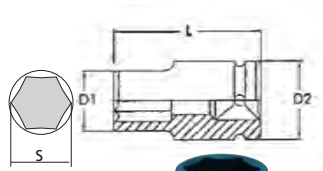

91-377-1

1/2"	SKU#	SIZE	L mm	D1 mm	D2 mm	WEIGHT (g)	BOX/CTN
	91-377-1	10	77	17	24	120	10/120
91-378-1	11	77	18	24	120	10/120	
91-379-1	12	77	19	24	120	10/120	
91-380-1	13	77	20	24	120	10/120	
87-501-1	14	77	21	24	130	10/120	
87-504-1	17	77	26	26	150	10/80	
87-506-1	19	77	28	28	180	10/80	
87-507-1	21	77	30	30	200	10/80	
87-508-1	24	77	34	34	260	10/60	
87-509-1	27	77	38	38	340	10/40	

## Double Open End Wrench Set

- Made of Chrome Vanadium Steel
- Ends are slanted 15° for quick operation
- Two sizes per wrench
- Comprehensive set of open end wrench for the most common sizes
- Anti-slip feature



87-718-1

SKU#	CONTENTS	WEIGHT (g)	BOX/CTN
87-716-1	"Slimline" wrench: (Metric) 6 x7, 8 x9, 10 x11, 12 x13, 14 x15, 16 x17 Heavy-duty nylon pouch	590	1/30
87-718-1	"Slimline" wrench: (Metric) 6 x7, 8 x9, 10 x11, 12 x13, 14 x15, 16 x17, 18 x19, 20 x22mm Heavy-duty nylon pouch Inner box	590	1/12
87-712-1	"Slimline" wrench: (Inch) 1/4" x 5/16", 3/8" x 7/16", 1/2" x 9/16", 9/16" x 5/8", 11/16" x 3/4", 13/16" x 7/8", 15/16" x 1" Heavy-duty nylon pouch, Inner box	590	12/12

## Slimline 8 Piece Combination Wrench Set

- Made of Chrome Vanadium Steel
- Both the open ended head and the ring are angled at 15° for optimum accessibility
- Nickel chrome plating protects against corrosion
- Slim pattern
- MaxiDrive™ and anti-slip open ended jaw shape maintains grip on fastener with only slight rotational pressure
- Anti-slip feature

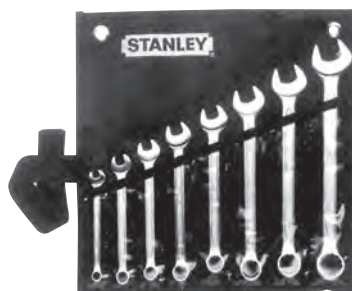

87-011-1

SKU#	CONTENTS	WEIGHT (g)	BOX/CTN
87-011-1	"Slimline" wrench: 8, 10, 11, 13, 14, 17, 19, 22mm Heavy-duty nylon pouch Inner box	920	20/20

## 8 MECHANIC TOOLS



### Slimline 9 Piece Combination Wrench Set

ISO 3318 / DIN 3113

- Made of Chrome Vanadium Steel
- Both the open ended head and the ring are angled at 15° for optimum accessibility
- Nickel chrome plating protects against corrosion
- Slim pattern
- MaxiDrive™ and anti-slip open ended jaw shape maintains grip on fastener with only slight rotational pressure
- Anti-slip feature

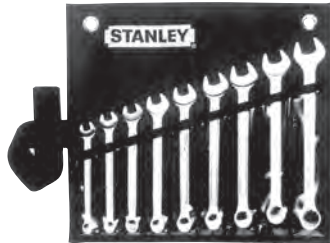

87-033-1

SKU#	CONTENTS	WEIGHT (g)	BOX/CTN
87-034-1	"Slimline" wrench: 8, 9, 10, 11, 12, 13, 14, 15, 17mm Heavy-duty nylon pouch Inner box	910	20/20
87-033-1	"Slimline" wrench: 10, 11, 12, 13, 14, 15, 16, 17, 19mm Heavy-duty nylon pouch Inner box	1490	16/16

### Slimline 14 Piece Combination Wrench Set

ISO 3318 / DIN 3113

- Made of Chrome Vanadium Steel
- Both the open ended head and the ring are angled at 15° for optimum accessibility
- Nickel chrome plating protects against corrosion
- Slim pattern
- MaxiDrive™ and anti-slip open ended jaw shape maintains grip on fastener with only slight rotational pressure
- Anti-slip feature



87-036-1

SKU#	CONTENTS	WEIGHT (g)	BOX/CTN
87-036-1	"Slimline" wrench: 8, 9, 10, 11, 12, 13, 14, 15, 16, 17, 19, 21, 22, 24mm Heavy-duty nylon pouch Inner box	3600	10/10
87-038-1	"Slimline" wrench: 10, 11, 12, 13, 14, 17, 19, 21, 22, 23, 24, 26, 30, 32mm Heavy-duty nylon pouch Inner box	2300	1/6
87-709-1	"Slimline" wrench: 3/8", 7/16", 1/2", 9/16", 5/8", 11/16", 3/4", 13/16", 7/8", 15/16", 1", 1 1/16", 1 1/8", 1 1/4" Heavy-duty nylon pouch Inner box	10400	1/6



## 75° Offset Ring End Wrench Set

ISO 1711 / DIN 838 / 1085

- Double ring wrench chrome vanadium steel
- MaxiDrive™ Plus profile - Attacks on the sides, not the corners of the nut or bolt
- Twelve-edged head for optimal support of hexagonal and square nuts
- Polished and chrome-plated finish for excellent protection
- Heads to 70 ° for greater access in tight spaces
- Powerful and safe working
- Anti-slip feature



87-617-1

SKU#	CONTENTS	WEIGHT (g)	BOX/CTN
87-576-1 8 pc	"Slimline" wrench: (Metric) 6 x 7, 8 x 9, 10 x 11, 12 x 13, 14 x 15, 16 x 17, 18 x 19, 20 x 22mm Inner box	1400	12/12
87-617-1 10 pc	"Slimline" wrench: (Metric) 6 x 7, 8 x 9, 10 x 11, 12 x 13, 14 x 15, 16 x 17, 18 x 19, 20 x 22, 21 x 23, 24 x 27mm Inner box	2200	10/10
87-714 7 pc	"Slimline" wrench: (Inch) 1/4" x 5/16", 3/8" x 7/16", 7/16" x 1/2", 9/16" x 5/8", 11/16" x 3/4", 13/16" x 7/8", 1" x 1-1/8" Heavy-duty nylon pouch, Inner box	1800	1/4

## 12-Piece Slimline Combination Wrench Set - Metric

- Made of Chrome Vanadium Steel
- Both the open ended head and the ring are angled at 15° for optimum accessibility
- Nickel chrome plating protects against corrosion
- Slim pattern
- MaxiDrive™ and anti-slip open ended jaw shape maintains grip on fastener with only slight rotational pressure
- Anti-slip feature



95-094-1

SKU#	SIZE	CONTENTS							WEIGHT (g)	BOX / CTN
		L mm	A mm	B mm	C mm	D mm	H mm	T mm		
95-094-1	6	100.0	4.7	10.1	4.0	15.5	7.1	2.7	15	1/10
	8	120.0	5.5	12.8	4.5	19.2	8.4	3.0	23	1/10
	9	130.0	5.9	14.2	4.5	21.2	9.0	3.3	33	1/10
	10	140.0	6.5	15.6	5.0	23.2	9.6	3.5	38	1/10
	11	150.0	6.9	16.9	5.4	25.3	10.4	3.7	50	1/10
	12	160.0	7.3	18.3	5.5	27.2	11.3	3.9	58	1/10
	13	170.0	7.8	19.7	5.9	29.4	12.1	4.1	66	1/10
	14	180.0	8.3	21.2	6.2	31.5	12.9	4.4	88	1/10
	15	190.0	8.6	22.5	6.4	33.2	13.5	4.6	96	1/10
	17	210.0	9.3	25.3	6.9	36.5	14.6	5.0	124	1/10
	19	230.0	10.5	28.1	7.4	40.7	15.9	5.4	169	1/10
	22	260.0	11.5	32.6	8.2	46.9	18.0	5.8	212	1/10

## 8 MECHANIC TOOLS



89-897A

### 117-Piece Wrench Merchandizer Set - Metric

- 6 sets of "Slimline" combination wrench :  
6, 7, 8, 9, 10, 11, 12, 13, 14, 15, 16, 17, 18, 19mm
- 4 sets of "Slimline" combination wrench :  
21, 22, 24, 27, 25, 26, 30, 32mm
- Merchandizer Board
- Anti-slip feature

SKU#	DESCRIPTION	BOX/CTN
89-897A	117-Piece Wrench Merchandizer Set - Metric	1/1

### 40° Offset Ring Wrenches

ISO 1711 / DIN 838

- Double ring wrench chrome vanadium steel
- Maxi Drive Plus profile - Attacks on the sides, not the corners of the nut or bolt
- Twelve-edged head for optimal support of hexagonal and square nuts
- Polished and chrome-plated finish for excellent protection
- Powerful and safe working

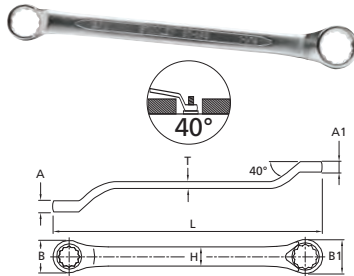

86-127

SKU#	SIZE	L	A	A1	B	B1	H	T	BOX/CTN
86-127	8x9	170	6.0	5.5	16.5	14.5	8.8	4.0	50/250
93-621	8x10	170	6.0	5.5	16.5	14.5	8.8	4.0	50/250
93-622	10x12	195	7.0	6.5	19.2	17.2	9.8	4.3	50/250
93-623	11x13	206	8.0	7.5	22.0	20.0	11.8	5.1	50/250
93-624	12x14	206	8.0	7.5	22.0	20.0	11.8	5.1	50/250
93-625	14x17	237	9.5	9.0	26.0	24.0	13.8	5.6	20/100
93-626	17x19	270	11.0	10.5	29.5	28.0	15.8	7.3	20/100
93-627	19x21	292	11.7	11.2	32.5	29.0	16.6	7.6	20/100
86-896	21x23	346	12.5	12.0	34.8	32.8	18.4	8.0	25/50
93-628	22x24	346	12.5	12.0	34.8	32.8	18.4	8.0	25/50
93-629	23x26	362	13.0	12.5	36.5	34.5	19.8	8.3	25/50
95-880	24x27	410	15.5	15.0	42.7	38.2	21.8	9.3	5/20
95-881	30x32	465	18.0	17.5	47.2	43.5	24.8	10.3	5/20

## 75° Offset Ring End Wrench

ISO 1711 / DIN 838/ 1085

- Double ring wrench chrome vanadium steel
- MaxiDrive™ Plus profile - Attacks on the sides, not the corners of the nut or bolt
- Twelve-edged head for optimal support of hexagonal and square nuts
- Polished and chrome-plated finish for excellent protection
- Heads to 70° for greater access in tight spaces
- Powerful and safe working

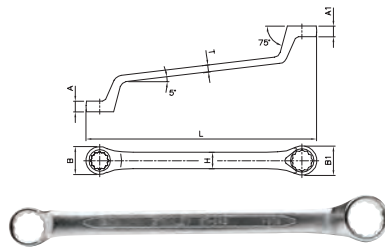

87-801-1

SKU#	SIZE	L mm	A mm	A1 mm	B mm	B1 mm	H mm	T mm	BOX/CTN
87-801-1	6x7	168.0	5.7	6.3	10.7	12.2	8.0	4.1	6/60
87-802-1	8x9	183.0	6.6	7.0	13.6	15.1	9.3	4.5	6/24
87-803-1	10x11	198.0	7.4	7.7	16.6	18.0	11.3	4.9	6/24
87-804-1	12x13	217.0	8.1	8.4	19.5	20.9	13.0	5.4	6/72
87-805-1	14x15	239.0	8.8	9.1	22.4	23.7	13.8	5.7	6/48
87-806-1	16x17	260.0	9.5	9.8	25.3	26.7	15.0	6.2	6/48
87-807-1	18x19	292.0	10.1	10.4	28.2	29.7	16.0	6.6	6/48
87-808-1	20x22	318.0	10.9	11.4	31.1	34.0	17.6	7.1	4/24
87-809-1	21x23	326.5	11.2	11.6	32.6	35.5	18.0	7.6	4/24
87-810-1	24x27	329.0	12.4	13.4	36.9	41.0	20.0	8.1	4/24
87-811-1	25x28	347.0	12.7	13.7	38.4	42.8	20.6	8.5	2/16
87-812-1	30x32	362.0	14.4	15.2	45.5	48.5	21.5	9.0	2/16

SKU#	SIZE	L mm	A mm	A1 mm	B mm	B1 mm	H mm	T mm	BOX/CTN
87-687-1	1/4"x5/16"	168.0	5.6	6.3	10.7	12.2	8.0	4.1	6/24
87-688-1	15/16"x3/8"	183.0	6.6	7.0	13.6	15.1	9.3	4.5	6/24
87-689-1	3/8"x7/16"	198.0	7.4	7.7	16.6	18.0	11.3	4.9	6/24
87-690-1	7/16"x1/2"	217.0	8.1	8.4	19.5	20.9	13.0	5.4	6/24
87-691-1	9/16"x5/8"	239.0	8.8	9.1	22.4	23.7	13.8	5.7	6/24
87-692-1	5/8"x11/16"	260.0	9.5	9.8	25.3	26.7	15.0	6.2	6/24
87-693-1	11/16"x3/4"	292.0	10.1	10.4	28.2	29.7	16.0	6.6	6/24
87-694-1	13/16"x7/8"	318.0	10.9	11.4	31.1	34.0	17.6	7.1	4/24
87-695-1	15/16"x1 1/16"	329.0	12.4	13.4	36.9	41.0	20.0	8.1	4/24
87-696-1	1"x1 1/8"	347.0	12.7	13.7	38.4	42.8	20.6	8.5	2/12
87-697-1	1 1/8"x1 1/4"	362.0	14.4	15.2	45.5	48.5	21.5	9.0	2/12

1 MEASURING & LAYOUT TOOLS

2 LASER MEASURING SYSTEM

3 CUTTING & HOLDING TOOLS

4 FASTENING TOOLS

5 STRIKING & STRUCK TOOLS

6 ILLUMINATION TOOLS

7 PAINTING & FINISHING TOOLS

8 MECHANIC TOOLS

9 TOOLS STORAGE

10 POWER CLEANING TOOLS

11 POWER TOOLS

12 POWER TOOL ACCESSORIES

13 PRODUCT INDEX

# 8 MECHANIC TOOLS

## Slimline Combination Wrench

ISO 3318 / DIN 3113

- Made of Chrome Vanadium Steel
- Both the open ended head and the ring are angled at 15° for optimum accessibility
- Nickel chrome plating protects against corrosion
- Slim pattern
- MaxiDrive™ and anti-slip open ended jaw shape maintains grip on fastener with only slight rotational pressure
- Anti-slip feature

SKU#	SIZE	L mm	A mm	B mm	C mm	D mm	H mm	T mm	BOX/CTN
87-660-1	1/4"	100.0	4.7	10.1	4.0	15.5	7.1	2.7	6/72
87-661-1	5/16"	120.0	5.5	12.8	4.5	19.2	8.4	3.0	6/90
87-662-1	3/8"	140.0	6.5	15.6	5.0	23.2	9.6	3.5	6/72
87-663-1	7/16"	150.0	6.9	16.9	5.4	25.3	10.4	3.7	6/90
87-664-1	1/2"	170.0	7.8	19.7	5.9	29.4	12.1	4.1	6/90
87-665-1	9/16"	180.0	8.3	21.2	6.2	31.5	12.9	4.4	6/54
87-666-1	5/8"	200.0	8.9	24.0	6.7	34.7	13.9	4.8	6/54
87-667-1	11/16"	210.0	9.3	25.3	6.9	36.5	14.6	5.0	6/54
87-668-1	3/4"	230.0	10.5	28.1	7.4	40.7	15.9	5.4	6/60
87-669-1	13/16"	250.0	11.3	31.3	8.0	44.8	17.3	5.7	4/24
87-670-1	7/8"	260.0	11.5	32.6	8.2	46.9	18.0	5.8	4/24
87-671-1	15/16"	280.0	12.1	35.5	8.7	50.4	19.5	6.0	4/24
87-672-1	1"	290.0	12.5	36.9	8.9	52.0	20.1	6.2	4/24
87-673-1	1-1/16"	310.0	13.1	39.6	9.4	55.7	21.8	6.6	4/24
87-674-1	1-1/8"	330.0	13.3	40.9	9.7	57.6	22.5	6.8	2/12
87-675-1	1-1/4"	360.0	14.3	46.4	10.4	65.8	24.8	7.3	2/12

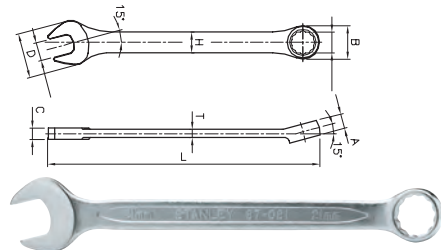

87-424-1

SKU#	SIZE	L mm	A mm	B mm	C mm	D mm	H mm	T mm	BOX /CTN
87-424-1	5	95.0	4.1	8.9	3.5	13.6	6.2	2.4	6/72
87-429-1	5.5	95.0	4.1	8.9	3.5	13.6	6.2	2.4	6/72
87-066-1	6	100.0	4.7	10.1	4.0	15.5	7.1	2.7	6/72
87-057-1	7	110.0	5.0	11.5	4.0	17.0	7.8	2.8	6/90
87-058-1	8	120.0	5.5	12.8	4.5	19.2	8.4	3.0	6/90
87-069-1	9	130.0	5.9	14.2	4.5	21.2	9.0	3.3	6/72
87-070-1	10	140.0	6.5	15.6	5.0	23.2	9.6	3.5	6/72
87-071-1	11	150.0	6.9	16.9	5.4	25.3	10.4	3.7	6/72
87-072-1	12	160.0	7.3	18.3	5.5	27.2	11.3	3.9	6/72
87-073-1	13	170.0	7.8	19.7	5.9	29.4	12.1	4.1	6/54
87-074-1	14	180.0	8.3	21.2	6.2	31.5	12.9	4.4	6/54
87-075-1	15	190.0	8.6	22.5	6.4	33.2	13.5	4.6	6/54
87-076-1	16	200.0	8.9	24.0	6.7	34.7	13.9	4.8	6/54
87-077-1	17	210.0	9.3	25.3	6.9	36.5	14.6	5.0	6/54
87-078-1	18	220.0	9.9	26.8	7.2	38.7	15.3	5.2	6/54
87-079-1	19	230.0	10.5	28.1	7.4	40.7	15.9	5.4	6/60
87-080-1	20	240.0	10.9	29.7	7.7	43.1	16.8	5.6	4/24
87-081-1	21	250.0	11.3	31.3	8.0	44.8	17.3	5.7	4/24
87-082-1	22	260.0	11.5	32.6	8.2	46.9	18.0	5.8	4/24
87-083-1	23	270.0	11.8	34.2	8.4	48.3	18.7	5.9	4/24
87-084-1	24	280.0	12.1	35.5	8.7	50.4	19.5	6.0	4/24
87-085-1	25	290.0	12.5	36.9	8.9	52.0	20.1	6.2	4/24
87-086-1	26	300.0	12.8	38.2	9.2	53.6	21.0	6.4	4/24
87-087-1	27	310.0	13.1	39.6	9.4	55.7	21.8	6.6	4/24
87-088-1	28	320.0	13.3	40.9	9.7	57.6	22.5	6.8	2/12
87-089-1	29	330.0	13.5	42.3	9.9	59.7	23.3	7.0	2/12
87-090-1	30	340.0	13.7	43.7	10.1	61.8	23.9	7.1	2/12
87-092-1	32	360.0	14.3	46.4	10.4	65.8	24.8	7.3	2/12
87-263	33	408.0	14.5	11.0	48.0	62	23.0	11.0	1/30
87-264	34	408.0	14.5	11.0	48.0	62	23.0	11.0	1/25
87-265	35	430.0	17.0	15.0	56.5	70	26.0	12.0	1/25
87-266	36	430.0	17.0	15.0	56.5	70	26.0	12.0	1/25
87-268	38	460.0	17.0	15.0	56.5	70	26.0	12.0	1/20
87-271	41	490.0	19.0	16.5	65.0	83	29.0	14.0	1/15
87-272	42	490.0	19.0	16.5	65.0	83	29.0	14.0	1/15
87-276	46	540.0	19.0	16.5	65.0	83	29.0	14.0	1/15
87-278	48	563.0	24.0	19.0	72.5	94	35.0	15.0	1/10
87-280	50	587.0	24.0	19.0	72.5	94	35.0	15.0	1/10

## Open End Wrench

Metric obtains DIN 3110 / ISO 10102

Inch obtains DIN 1085 / ISO 1711

- Made of Chrome Vanadium Steel
- Ends are slanted 15° for quick operation
- Two sizes per wrench
- Anti-slip feature

SKU#	SIZE	L mm	A mm	B mm	C mm	H mm	T mm	WEIGHT (g)	BOX/CTN
87-096-1	6x7	122.0	16.2	18.1	3.3	8.6	2.2	25	6/90
87-097-1	8x9	140.0	20.2	22.2	3.6	10.7	2.5	35	6/120
84-758	8x10	140.0	20.2	22.2	3.6	10.7	2.5	43	20/500
87-098-1	10x11	156.0	23.6	25.6	4.6	11.7	3.0	50	20/200
84-759	10x12	156.0	23.6	25.6	4.6	11.7	3.0	63	20/200
87-099-1	12x13	172.0	27.4	28.6	5.1	12.7	3.4	75	20/200
84-760	12x14	180.0	28.6	31.6	5.1	13.7	3.8	90	20/200
87-100-1	14x15	188.0	31.5	34.0	5.6	14.2	3.8	105	20/200
84-764	14x17	188.0	31.5	34.0	5.6	14.2	3.8	130	20/200
87-101-1	16x17	204.0	36.1	38.4	6.1	15.8	4.3	155	20/100
84-765	17x19	220.0	38.6	42.1	6.5	16.8	4.7	173	12/120
87-102-1	18x19	220.0	38.6	42.1	6.5	16.8	4.7	190	12/120
84-766	19x21	234.0	42.0	46.1	7.2	18.3	4.8	205	12/60
87-103-1	20x22	234.0	42.0	46.1	7.2	18.3	4.8	220	12/60
87-104-1	21x23	247.0	45.4	48.6	7.5	19.3	4.8	245	12/60
84-767	22x24	247.0	45.4	48.6	7.5	19.3	4.8	275	12/60
87-105-1	24x27	266.0	50.8	56.3	8.2	20.8	5.4	305	4/32
87-106-1	25x28	285.0	53.8	62.3	8.4	22.4	5.6	340	2/36
87-107-1	30x32	302.0	60.3	65.3	9.1	24.4	6.1	465	2/32

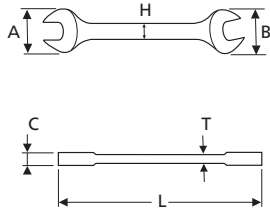

87-676-1

SKU#	SIZE	L mm	A mm	B mm	C mm	H mm	T mm	WEIGHT (g)	BOX/CTN
87-676-1	1/4"x5/16"	123.0	15.5	18.0	3.7	8.0	2.9	25	6/72
87-677-1	5/16"x3/8"	140.0	20.4	22.7	4.0	10.2	3.1	35	6/120
87-678-1	3/8"x7/16"	156.0	24.9	27.1	5.0	11.7	3.4	50	6/72
87-679-1	7/16"x1/2"	172.0	29.2	31.2	5.5	13.1	3.8	75	6/90
87-705-1	1/2"x9/16"	180.0	31.3	33.3	5.5	14.0	4.0	85	6/90
87-680-1	9/16"x5/8"	188.5	33.3	35.3	5.9	14.8	4.1	105	6/48
87-681-1	5/8"x11/16"	204.0	37.1	38.9	6.3	15.6	4.4	155	6/54
87-682-1	11/16"x3/4"	221.0	40.9	42.8	6.7	16.6	4.6	190	6/24
87-683-1	13/16"x7/8"	237.0	44.8	48.8	7.1	18.5	4.9	220	6/48
87-706-1	15/16"x1"	255.0	50.8	56.8	7.9	21.4	5.3	270	4/32
87-684-1	15/16"x1-1/16"	263.0	52.8	59.1	8.1	22.1	5.4	305	4/24
87-685-1	1"x1-1/8"	279.0	54.8	61.3	8.5	23.0	5.7	340	2/12
87-686-1	1-1/8"x1-1/4"	298.0	65.4	69.8	9.0	24.6	6.0	465	2/12

## Double Flex Socket Wrenches - Metric

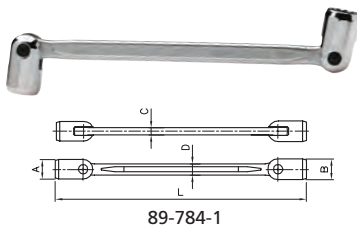

89-784-1

SKU#	SIZE	L mm	A mm	B mm	C mm	D mm	WEIGHT (g)	BOX / CTN
89-780-1	8x9	174.1	12.5	13.8	4.3	7.5	65	6/90
89-781-1	10x11	201.3	14.5	15.6	5.5	8.7	100	6/72
89-782-1	12x13	218.8	17.2	18.2	6.0	9.7	140	6/72
89-783-1	14x15	237.1	20.0	22.0	6.5	10.4	210	6/60
89-784-1	16x17	259.0	23.0	24.2	8.0	12.0	320	6/48
89-785-1	18x19	275.0	25.3	26.2	9.0	14.0	370	6/48

# 8 MECHANIC TOOLS

## Flare Nut Wrenches

ANSI B107.6

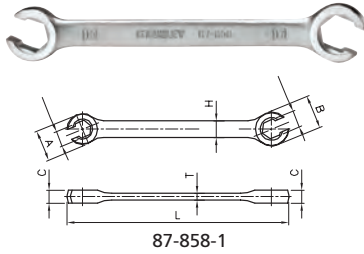

SKU#	SIZE	L mm	A mm	B mm	C mm	H mm	T mm	WEIGHT (g)	BOX/CTN
87-392-1	8x10	146.5	18.4	21.4	7.5	9.8	4.0	60	6/72
87-393-1	12x14	178.6	25.0	27.4	10.0	13.1	5.7	115	6/48
87-858-1	15x17	196.0	29.9	31.9	11.6	15.1	6.4	165	6/48
87-886-1	19x22	207.7	34.2	38.2	13.8	17.0	7.4	215	6/24

SKU#	SIZE	L mm	A mm	B mm	C mm	H mm	T mm	WEIGHT (g)	BOX/CTN
87-850-1	3/8"x7/16"	152.4	21.4	23.0	7.9	10.7	4.3	65	6/72
87-851-1	1/2"x9/16"	178.6	25.0	27.4	10.0	13.1	5.7	115	6/60
87-852-1	5/8"x11/16"	196.0	29.9	31.9	11.6	15.1	6.4	165	6/48
87-853-1	3/4"x7/8"	207.0	34.2	38.2	13.8	17.0	7.4	215	6/24

## Reversible Geared Wrench - Metric

- 13° offset head angle provides finger and obstruction clearance
- Higher efficiency and ergonomic
- Provides ability to work in tight and hard to access areas
- Works with just 5° of sweep to turn a fastener (Traditional wrenches need 30°)
- Easy-access reversing switch
- Best used in automotive garages

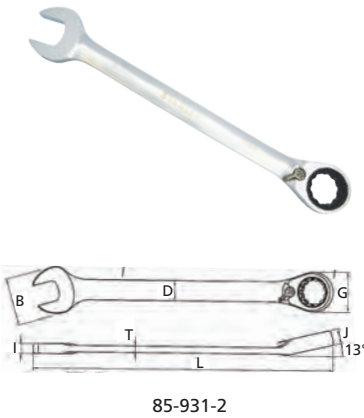

SKU#	SIZE	B mm	D mm	G mm	I mm	T mm	J mm	L mm	WEIGHT (kg)	BOX/CTN
85-931-2	8	16.75	7.6	16.6	4.6	3.0	6.5	140	0.061	10/100
89-519-2	9	18.8	8.3	18.4	4.9	3.1	6.9	150	0.069	10/100
85-933-2	10	20.8	9.1	20.0	5.3	3.4	7.3	159	0.081	10/100
89-558-2	11	23	10.0	21.8	5.6	3.8	7.7	165	0.09	10/100
85-934-2	12	25	10.8	22.7	6.0	4.0	8.2	172	0.106	10/100
85-936-2	13	27.1	11.8	24.7	6.4	4.1	8.6	178	0.123	6/60
85-937-2	14	29.2	12.4	27.0	6.8	4.4	9.0	191	0.142	6/60
85-938-2	15	31.3	13.3	28.3	7.0	4.6	9.4	200	0.16	6/60
89-473-2	16	33.4	14.1	30.0	7.2	4.8	9.9	208	0.183	6/60
89-474-2	17	35.5	15.9	31.8	7.7	5.1	10.3	226	0.173	6/48
85-939-2	18	37.6	15.9	32.6	8.2	5.3	10.7	237	0.197	6/48
89-515-2	19	39.7	16.7	33.8	8.8	5.6	11.2	248	0.22	6/48

## 72 Teeth Reversible Multiple Geared Wrenches - Metric

- Chrome-vanadium special heat-treat provides a strong thin wall
- 72-teeth ratcheting system provides high torque and 5° of operation in tight areas
- An unique 15° offset design enables access to countersink bolts
- Worldwide patent

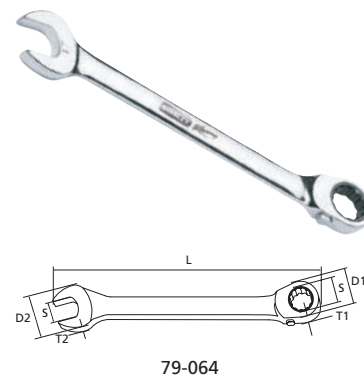

SKU#	SIZE	D1 mm	D2 mm	T1 mm	T2 mm	L mm	BOX/CTN
79-064	8	18.0	17.0	7.4	4.7	144	10/100
79-065	9	19.5	18.8	7.4	5.3	150	10/100
79-066	10	21.0	21.7	8.4	5.7	158	10/100
79-067	11	22.0	23.0	8.4	6.1	165	10/100
79-068	12	23.5	25.2	8.4	6.4	173	10/100
79-069	13	25.0	26.5	8.4	6.6	182	10/100
79-070	14	26.5	29.5	8.4	7.3	190	10/100
79-071	15	28.0	31.3	8.4	7.5	202	10/100
79-072	16	29.0	33.4	10.0	7.7	215	10/100
79-073	17	30.5	36.3	10.0	7.9	229	10/100
79-074	18	32.0	38.0	11.5	8.4	240	10/100
79-075	19	34.0	39.0	11.5	8.7	252	10/100

## Locking Flex-Head Geared Wrench - Metric

- Higher efficiency and ergonomic
- Provides ability to work in tight and hard to access areas
- Work with just 5° swing
- Ratcheting head rotates 180°
- Locks at desired working angle
- Smaller profile than competitor's models for better access to fasteners
- Best use in automotive garages

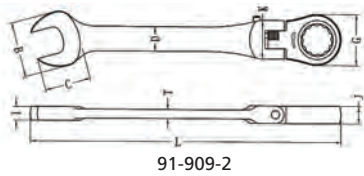

SKU#	SIZE	B mm	C mm	D mm	G mm	I mm	T mm	J mm	L mm	K mm	Weight (kg)	BOX/CTN
91-888-2	8	17	14	8	16.6	4.3	3.0	6.5	127.0	13.2	0.047	10/100
91-889-2	9	19	16	9	18.5	4.6	3.1	6.9	131.5	14.8	0.057	10/100
91-890-2	10	21	18	9.5	20	5.0	3.4	7.3	136.0	16.2	0.077	10/100
91-891-2	11	23	20	10	21.5	5.4	3.8	7.7	141.0	17.2	0.087	10/100
91-892-2	12	25	21	11	22.6	5.8	4.0	8.2	147.5	18.2	0.106	10/100
91-893-2	13	27	23	12	24.6	6.1	4.1	8.6	154.0	19.2	0.127	10/100
91-894-2	14	29	25	13	27	6.4	4.4	9.0	160.0	20.2	0.140	10/100
91-895-2	15	31	27	13.6	28.3	6.9	4.6	9.4	169.0	21.2	0.160	6/60
91-896-2	16	33	28	14.4	30	7.2	4.8	9.9	179.0	22.2	0.285	6/60
91-897-2	17	36	30	15.5	32	7.6	5.1	10.3	190.0	23.2	0.220	6/60
91-898-2	18	38	32	16.2	33	8.0	5.3	10.7	203.0	24.2	0.200	6/48
91-909-2	19	40	34	17	34	8.6	5.6	11.2	215.0	25.2	0.285	6/48

## 3/4" Impact Wrench 1626Nm



- End cap slider-guide trigger - designed for easy operation
- Improved throttle valve seat - allows easier maintenance
- Composite grip - super lightweight, ergonomic design isolating from the coldness
- Improved air inlet - effectively reduces the damage and loss of thread
- Three-speed control for forward and one-speed full output for reverse direction
- Patented three-way air inlet function - increase 10% and more at horsepower delivery than same level tools
- **Service Kit Content :**  
O-ring 8, Spring 2, Steel ball 1, Ball-bearing 2, Rotor blade 6, Gasket 2, Socket retainer 1, Muffler element 1

SKU#	SQUARE DRIVE inch	STANDARD BOLT Size inch	FREE SPEED RPM	MAX. TORQUE Nm	OVERALL LENGTH mm	AIR INLET PT	AIR HOSE I.D	AVG. AIR CONSUMPTION cfm (l/min)	NOISE LEVEL dB	NET WEIGHT (kg)	SERVICE KIT	BOX/CTN
79-088	3/4	1	6,500	1626	225	3/8	1/2	6.7 (190)	95.2	3.89	79-088RK	1/1

1 MEASURING &amp; LAYOUT TOOLS

2 LASER MEASURING SYSTEM

3 CUTTING &amp; HOLDING TOOLS

4 FASTENING TOOLS

5 STRIKING &amp; STRUCK TOOLS

6 ILLUMINATION TOOLS

7 PAINTING &amp; FINISHING TOOLS

8 MECHANIC TOOLS

9 TOOLS STORAGE

10 POWER CLEANING TOOLS

11 POWER TOOLS

12 POWER TOOL ACCESSORIES

13 PRODUCT INDEX

## 8 MECHANIC TOOLS



### 1/2" Impact Wrench 813Nm

- End cap slider-guide trigger - designed for easy operation
- Improved throttle valve seat - allows easier maintenance
- Composite grip - super lightweight, ergonomic design isolating from the coldness
- Improved air inlet - effectively reduces the damage and loss of thread
- Three-speed control for forward and one-speed full output for reverse direction
- Patented three-way air inlet function - increase 10% and more at horsepower delivery than same level tools
- **Service Kit Content :**  
O-ring 9, Spring 2, Steel ball 1, Ball-bearing 2, Rotor blade 6, Gasket 1

SKU#	SQUARE DRIVE inch	STANDARD BOLT Size inch	FREE SPEED RPM	MAX. TORQUE Nm	OVERALL LENGTH mm	AIR INLET PT	AIR HOSE I.D	AVG. AIR CONSUMPTION cfm (l/min)	NOISE LEVEL dB	NET WEIGHT (kg)	SERVICE KIT	BOX/CTN
79-089	1/2	3/4	8,000	813	193	1/4	3/8	4.4 (125)	83.79	2.15	79-089RK	1/8



### 1/2"(542Nm) & 3/4"(813Nm) Impact Wrench

- Built-in regulator
- Twin hammer mechanism for durability
- forward/ reverse directional control and variable speed trigger
- Applicable for automotive service centre
- **89-474 Service Kit Content :**  
O-ring 5, Spring 3, Steel ball 2, Ball-bearing 2, Retainer 1, Rotor blade 6, Gasket 2, Socket retainer 1
- **89-475 Service Kit Content :**  
O-ring 5, Spring 3, Steel ball 2, Ball-bearing 2, Retainer 1, Rotor blade 6, Gasket 2, Socket retainer 1, Muffler element 1

SKU#	SQUARE DRIVE inch	STANDARD BOLT Size inch	FREE SPEED RPM	MAX. TORQUE Nm	OVERALL LENGTH mm	AIR INLET PT	AIR HOSE I.D	AVG. AIR CONSUMPTION cfm (l/min)	NOISE LEVEL dB	NET WEIGHT (kg)	SERVICE KIT	BOX/CTN
89-474	1/2	5/8	8,000	542	186	1/4	3/8	4 (113)	97.93	2.56	89-474RK	1/8
89-475	3/4	53/64	7,500	813	217	1/4	3/8	6.5 (184)	98.11	3	89-475RK	1/4



### 1/4" Angle Grinder

- Suitable for all workshops
- Easy to access into confined areas
- Ideal for grinding, edge-breaking, debarring, porting and polishing
- Swivel exhaust
- Adjustable regulator

SKU#	COLLET DRIVE inch	STANDARD BOLT Size inch	FREE SPEED RPM	MAX. TORQUE Nm	OVERALL LENGTH mm	AIR INLET PT	AIR HOSE I.D	AVG. AIR CONSUMPTION cfm (l/min)	NOISE LEVEL dB	NET WEIGHT (kg)	SERVICE KIT	BOX/CTN
78-413	1/4	-	20,000	-	176	1/4	3/8	2 (57)	96.8	0.57	N.A.	2/4





89-472

## 3/8" Drive Reversible Keyless Air Drill

- Lightweight, balanced 3/8" drill great for most applications
- Reversible
- Variable speed trigger control
- 3/8" Jacobs Keyless Chuck
- Easy access forward/reverse lever
- Textured grip

SKU#	SQUARE DRIVE	STANDARD BOLT Size	FREE SPEED	MAX. TORQUE	OVERALL LENGTH	AIR INLET	AIR HOSE	AVG. AIR CONSUMPTION	NOISE LEVEL	NET WEIGHT	SERVICE KIT	BOX/CTN
	inch	inch	RPM	Nm	mm	PT	I.D	cfm (l/min)	dB	(kg)		
89-472	-	-	1,800	-	193.7	1/4	3/8	5.2 (147)	90	1.7	N.A.	1/10



78-341

## 6" Dual Action Sander, 10k rpm

- Lock off throttle for prevention of accidents
- Comfort insulated grip
- Velcro type design for pad
- Bottom exhaust

SKU#	PAD SIZE	ORBITAL OPTION	FREE SPEED	MAX. TORQUE	OVERALL LENGTH	AIR INLET	AIR HOSE	AVG. AIR CONSUMPTION	NOISE LEVEL	NET WEIGHT	SERVICE KIT	BOX/CTN
	inch	inch	RPM	Nm	mm	PT	I.D	cfm (l/min)	dB	(kg)		
78-341	6	5	10,000	-	220	1/4	3/8	2.6 (74)	88	1.5	N.A.	1/2

## 4" Angle Grinder / Cutter



78-032

- Spindle lock design
- Spindle thread
- Front exhaust
- Safety lever
- Swivel guard adjustable in 9 positions
- ANSI standard
- One-year limited warranty
- **Service Kit Content :**
  - \* Ball Bearing
  - \* Rotor Blade
  - \* Bevel Gear 1
  - \* Bevel Gear 2
  - \* Spring, Safety Lever
  - \* Spring Pin

SKU#	SQUARE DRIVE	HORSE POWER	DISC SIZE	FREE SPEED	SPINDLE SIZE	OVERALL LENGTH	AIR INLET	AIR HOSE	AVG. AIR CONSUMPTION	NOISE LEVEL	NET WEIGHT	SERVICE KIT	BOX/CTN
	inch		inch (mm)	RPM		LENGTH	PT	I.D	cfm (l/min)	dB	(kg)		
78-032	-	0.8	4"(100mm)	12,000	M10x1.5	238	1/4	3/8	3 (85)	87	2.0	78-032RK	10/10

- 1 MEASURING & LAYOUT TOOLS
- 2 LASER MEASURING SYSTEM
- 3 CUTTING & HOLDING TOOLS
- 4 FASTENING TOOLS
- 5 STRIKING & STRUCK TOOLS
- 6 ILLUMINATION TOOLS
- 7 PAINTING & FINISHING TOOLS
- 8 MECHANIC TOOLS
- 9 TOOLS STORAGE
- 10 POWER CLEANING TOOLS
- 11 POWER TOOLS
- 12 POWER TOOL ACCESSORIES
- 13 PRODUCT INDEX

## 8 MECHANIC TOOLS



### 7" Angle Grinder / Cutter



- Spindle lock design
- Spindle thread
- Front exhaust
- Safety lever
- Swivel guard adjustable in 9 positions
- ANSI standard
- One-year limited warranty
- **Service Kit Content :**
  - \* Rotor Blade 4
  - \* Pinion Gear 1
  - \* Bevel Gear 1
  - \* Ball Bearing 2

SKU#	SQUARE DRIVE		DISC SIZE inch (mm)	FREE SPEED RPM	SPINDLE SIZE	OVERALL LENGTH	AIR INLET		AVG. AIR CONSUMPTION cfm (l/min)	NOISE LEVEL dB	NET WEIGHT (kg)	SERVICE KIT	BOX/CTN
	inch	HORSE POWER					PT	AIR HOSE I.D.					
78-033	-	1.3	7"(175mm)	7,500	5/8	350	3/8	3/8	5 (142)	97	3.5	78-033RK	6/24

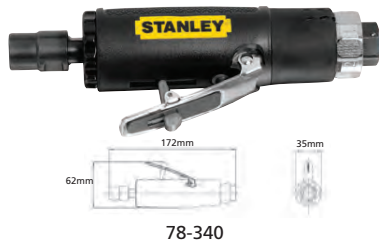

### 1/4" Mini Die Grinder

- Lightweight housing
- Durable bearing and smooth operation
- Safety trigger to prevent accident
- Suitable for professional users
- Adjustable regulator
- 360° Swivel Exhaust

SKU#	COLLET DRIVE inch	STANDARD BOLT Size inch	FREE SPEED RPM	MAX. TORQUE Nm	OVERALL LENGTH mm	AIR INLET		AVG. AIR CONSUMPTION cfm (l/min)	NOISE LEVEL dB	NET WEIGHT (kg)	SERVICE KIT	BOX/CTN
						PT	AIR HOSE I.D.					
78-340	1/4	-	25,000	-	170	1/4	3/8	2.3 (65)	90	0.4	N.A.	2/4



### Power Chisel With Hexagonal Shank, 3.6k rpm

- Ideal for various automotive
- Designed for cutting metals, chipping and scrapping surfaces
- 3 chisels included
- Handle exhaust

SKU#	SHANK OPENING inch	PISTON STROKE inch	FREE SPEED RPM	MAX. TORQUE Nm	OVERALL LENGTH mm	AIR INLET		AVG. AIR CONSUMPTION cfm (l/min)	NOISE LEVEL dB	NET WEIGHT (kg)	SERVICE KIT	BOX/CTN
						PT	AIR HOSE I.D.					
78-339	0.401	2 - 5/8	3,500	-	172	1/4	3/8	2.7 (77)	93	1.4	N.A.	1/2



## Reciprocating Air Saw, 10k rpm

- Ideal for body repair workshop
- Safety trigger function
- Cut tight radius curves on flat
- Suitable for cutting all types of sheet metal, Fibreglass, aluminium and plastic
- Front exhaust

SKU#	CUTTING CAPACITY (mm)		FREE SPEED RPM	MAX. TORQUE Nm	OVERALL LENGTH mm	AIR INLET PT	AIR HOSE I.D.	AVG. AIR CONSUMPTION cfm (l/min)	NOISE LEVEL dB	NET WEIGHT (kg)	SERVICE KIT	BOX/CTN
	Steel	Aluminium										
78-405	1.2	1.6	10,000	-	265	1/4	3/8	2 (57)	88	0.62	N.A.	1/2



## 10-Piece Sanding Disks Kit

- 10 piece 6" Sanding Disks Kit (220, 180, 80 Grits) – DA Sander

SKU#	DESCRIPTION	BOX/CTN
78-309	10-Piece Sanding Disks Kit	3/12



## 5-Piece Saw Blades Set

- 5 pieces of saw blades
- 32 teeth per inch-recip. saw

SKU#	DESCRIPTION	BOX/CTN
78-308	5-Piece Saw Blades Set	3/12



## 5-Piece Grinding Stone Set

- Fits rotary tools with 1/4 in. collets - 22,000 Max. RPM 2.
- Includes 5 of the most frequently used grinding wheels for air powered grinders (4 - 60 Grit, 1 - 45 Grit)

SKU#	DESCRIPTION	WEIGHT (g)	BOX/CTN
97-127	5-Piece Grinding Stone Set	227	3/12

## 8 MECHANIC TOOLS



78-031

### Lever Action Grease Gun

- Precision-fitted and hardened plunger prevents lubricant escape from cartridge
- Extra-long handle for increased leverage and easy operation
- Rugged cast pump head for strength and durability and tough impact resistant construction
- Uses standard grease cartridge or can be used for bulk fill
- Heavy-duty
- Easy to operate
- Non-slip grip handle
- 12000PSI pressure
- High volume operation

SKU#	DESCRIPTION	VOLUME		LENGTH		BOX / CTN
		oz	gr	inch	mm	
78-031	Lever Action Grease Gun	14	400	6	150	6/24



95-710

### Tire Inflator With Hose

- Ideal for garage
- Clip design at the end hands free
- Built-in Relief Valve
- 1/4" NPT inlet
- Comes with 25ft air hose, combined inflation gun, chuck and gauge

SKU#	DESCRIPTION	BOX / CTN
95-710	Tire inflator with hose	5/20



97-124

### 20 Piece Accessory Kit

- For use with air compressors
- 1/4 in. x 25 ft. Coil Air Hose - Max 200 PSI
- Blow Gun
- Dual-Head Tire Chuck
- Tire Gauge
- 1/4 in. Male Connector
- Blow Gun Nozzle 8. Blow Gun Adaptor
- Blow Gun Safety Nozzle 10 2-1/4 in. Female Quick-Connect coupler
- 1/4 in. Female Connector
- 2-1/4 in Female Quick-connect Plug
- 2-1/4 in. Male Quick-connect Plug
- Inflation needles
- Blow Gun Tapered Nozzle 16 Threaded Seal Tape

SKU#	DESCRIPTION	WEIGHT (g)	BOX/CTN
97-124	20 Piece Accessory Kit	907	1/3

## Snap Ring Pliers (Internal And External)



89-479

- Cushion grip handles
- Interchangeable design for either internal or external use

SKU#	DESCRIPTION	OVERALL LENGTH inch	BOX/CTN
89-479	Snap Ring Pliers – 5 1/2" Bent Jaws	5 1/2	12/120
89-480	Snap Ring Pliers – 5 1/2" Bent Jaws	7 1/2	12/120

## Lock-Ring Pliers



89-481

- Spreads piston rings
- Spreads snap-lock rings found on brakes, transmission, pedal shifts, and machine tools
- O / A Length : 9", 229mm

SKU#	DESCRIPTION	WEIGHT (g)	BOX/CTN
89-481	Lock-Ring Pliers	254	12/48

## 1-1/2" Lock-Ring Pliers



89-482

- Straight tip design for spreading snap-lock rings
- Jaw opening : 1 1/2" (38.1mm)
- O / A Length : 9", 229mm

SKU#	DESCRIPTION	WEIGHT (g)	BOX/CTN
89-482	1-1/2" Lock-Ring Pliers	254	12/48

## All-Brass Hammer



89-483

- Brass head
- Handle can be used for light striking applications

SKU#	CONTENTS	BOX QUANTITY
89-483	850g and 198mm(L) All-Brass Hammer	12
89-484	1450g and 222mm(L) All-Brass Hammer	24

## 8 MECHANIC TOOLS



82-100

### Reversible 3-Jaw Puller

- Can be used with two or three jaws
- Ideal for industrial and automotive use
- Length: 4"
- Designed for heavy pulling jobs
- Chrome-vanadium steel
- Heat-treated
- Reversible jaws for external or internal pulling
- Flexible
- Heavy-duty

SKU#	DESCRIPTION	LENGTH		BOX/CTN
		inch	mm	
82-100	4" (100mm) 3-Jaw Puller plus 1 extra yoke	4	100	6/12

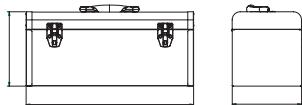

93-544

### General Purpose Tool Box

- Overall dimension 430 x 178 x 191mm (W x D x H)
- ElectroPowder Coating to resist scratch and solvent markings
- Heavy-duty metal for body construction and handle to provide ultimate durability
- Double latch for greater strength
- Removable steel tray

SKU#	DESCRIPTION	BOX/CTN
93-544	General Purpose Tool Box	1/1

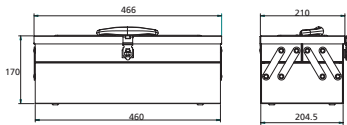

94-192

### 3-Tray Cantilever Box

- Overall dimension 466 x 210 x 170mm (W x D x H)
- Electro-Powder Coating to resist scratch and solvent markings
- Heavy-duty metal for body construction and handle to provide Ultimate durability
- Single latch for greater strength
- Tray swing out for easy tool access

SKU#	DESCRIPTION	BOX/CTN
94-192	3 Tray Cantilever Box	1/1

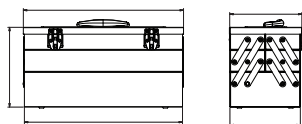

93-545

### 5-Tray Cantilever Box

- Overall dimension 466 X 204.5 X 232mm (W x D x H)
- Electro-Powder coating to resist scratch and solvent markings
- Double latch for greater strength
- Tray swing out for easy tool access

SKU#	DESCRIPTION	BOX/CTN
93-545	5 Tray Cantilever Box	1/1

## 3 Drawers Roller Cabinet



95-890

- 3 Drawers roller cabinet
- Overall dimension 600 x 400 x 900mm (W x D x H)
- Drawer Dimension 490 x 385 x 80mm (W x D x H)
- Comes with left side tray and left holder tray
- Lockable wheel with Rubber Castor
- Exchangeable handle (left or right)
- Bumper rubber on corners to prevent scratching
- Load capacity of top tray is 25kg, every drawer is 12kg, and bottom is 20kg

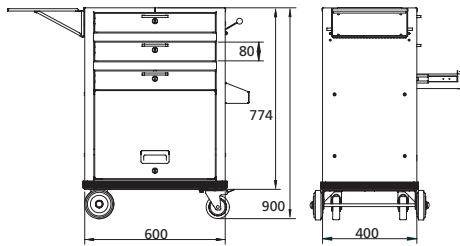

SKU#	DESCRIPTION	BOX/CTN
95-890	3 Drawers Roller Cabinet	1/1

## 4 Drawers Roller Cabinet



99-069

- Overall dimension 698 x 477 x 973mm (W x D x H)
- Drawer dimension 560 x 410 x 75.5mm (W x D x H)
- Load capacity of top tray is 30kg, every drawer is 25kg, and bottom is 35kg
- Plastic top tray to organize tools
- Comes with folding tray
- Lockable wheel with Rubber Castor
- Concave on both sides to hold more tools
- Bumper rubber on corners to prevent scratching

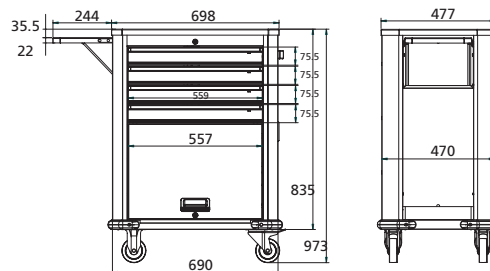

SKU#	DESCRIPTION	BOX/CTN
99-069	4 Drawers Roller Cabinet	1/1

## 8 MECHANIC TOOLS



93-547

\*Notebook as image above is for illustration only

### 7 Drawers Roller Cabinet

- Electro-Powder Coating to resist scratch & solvent markings
- Overall dimension 680 x 458 x 855.5mm (W x D x H)
- Ball bearing slide with quick disconnect
- Double wall construction with heavy-duty metal side handle to provide ultimate durability
- Full-length drawer pulls with liners included
- Heavy-duty 5" x 2" casters and easy grip cabinet side handle for better mobility

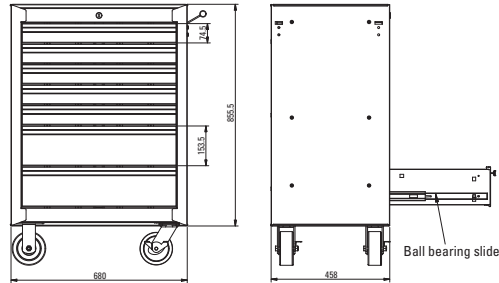

SKU#	DESCRIPTION	BOX/CTN
93-547	7 Drawers Roller Cabinet	1/1

### 6 Drawer Top Chest



93-546

- Overall dimension 660 x 306 x 378mm (W x D x H)
- Electro-Powder Coating to resist scratch and solvent markings
- Ball bearing slide with quick disconnect
- Double wall construction with heavy-duty metal side handle to provide ultimate durability
- Full-length drawer pulls with liners included

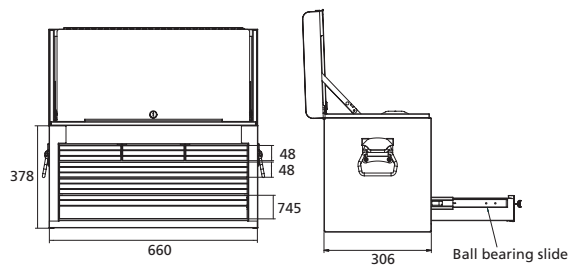

SKU#	DESCRIPTION	BOX/CTN
93-546	6 Drawer Top Chest	1/1



## 11 Piece 3/8" Drive Tune Up Kit Set



95-107

- Made with CR-V material with mirror finish
- Perfect tool for automotive and motorcycle maintenance
- Ideal for motorcycle repair shops and small machine repairs
- Sockets come with a clip rail for easy tool management

### METRIC

- **7 pcs 3/8" dr 6 pt sockets :**  
8, 10, 11, 12, 13, 17, 19mm
- **3 pcs 3/8" dr accessories:**  
1 Spark plug socket: 16mm, 1 Spark plug socket: 14mm,  
1 Extension bar: 3"
- 1 pc 3/8" dr Round head ratchet

SKU#	DESCRIPTION	BOX/CTN
95-107	11 Piece 3/8" Drive Tune Up Kit Set	1/24

## 9 Piece 1/2" Drive Torx® Bit Socket Set



89-098

- Drop-forged, heat-treated chrome vanadium steel
- Corrosion-resistant finish
- Also Fits Standard Torx® Sizes: T and TS
- Perfect use for temper-proof star fasteners in today's cars, trucks and appliances
- Precision-machined tip for exact fit

### METRIC

- **9 pcs 1/2" dr Torx® bit socket set:**  
t20, t25, t27, t30, t40, t45, t50, t55 & t60

SKU#	DESCRIPTION	WEIGHT (kg)	BOX/CTN
89-098	9 Piece 1/2" Drive Torx® Bit Socket Set	0.9	1/12

## 7-Piece 1/2" Drive Hex Bit Socket Set



89-099-1

- Perfect use for temper-proof star fasteners in today's automotive vehicles and appliances
- Drop-forged, heat-treated chrome vanadium steel
- Corrosion-resistant finish
- Perfect use for temper-proof star fasteners in today's cars, trucks and appliances
- Precision-machined tip for exact fit

### METRIC

- **7 pcs 1/2" dr Hex bit socket set :**  
6, 8, 10, 12, 14, 17, 19mm
- 1 Blow-mold case

SKU#	DESCRIPTION	WEIGHT (g)	BOX/CTN
89-099-1	7 Piece 1/2" Drive Hex Bit Socket Set	1200	1/12

## 8 MECHANIC TOOLS



86-117

### 16-Piece 1/4" Drive Socket Set

METRIC

- **11 pcs 1/4" dr 6 pt sockets :**  
4, 5, 5.5, 6, 7, 8, 9, 10, 11, 12, 13mm
- **4 pcs 1/4" dr accessories :**  
3" & 6" Extension bar, 1/4" ratchet, 1 Universal joint, 1 Sliding T-bar
- 1 pc 1/4" Flip drive ratchet

SKU#	DESCRIPTION	WEIGHT (kg)	BOX/CTN
86-117	16-Piece 1/4" Drive Socket Set	0.98	1/12

### 21-Piece 1/4" Drive Socket Set

METRIC

- **8 pcs 1/4" dr 6 pt sockets :**  
5, 6, 7, 8, 10, 11, 12, 13mm

INCH

- **8 pcs 1/4" dr 6 pt sockets :**  
3/16, 7/32, 1/4, 9/32, 5/16, 3/8, 7/16, 1/2"
- **4 pcs 1/4" dr accessories :**  
2 Extension bar: 2" & 6", 1 Universal joint, 1 Spinner handle



89-507

SKU#	DESCRIPTION	WEIGHT (kg)	BOX/CTN
89-507	21-Piece 1/4" Drive Socket Set	4.58	4/4

### 35-Piece 1/4" Drive Socket Set

METRIC

- **13 pcs 1/4" dr 6 pt sockets :**  
4, 4.5, 5, 5.5, 6, 7, 8, 9, 10, 11, 12, 13, 14mm
- **5 pcs 1/4" dr accessories :**  
1 Spinner handle, 2 Extensions: 75, 150mm, 1 Universal joint, 1 Hex bit holder
- **4 Hex bits : 3, 4, 5, 6mm, 6 Torx® bits :**  
T10, 15, 20, 25, 30, 40
- **3 Posidriv bits :** 1, 2, 3, and 3 Slotted bits: 4, 5.5, 6.5mm
- 1 pc Quick release ratchet pear head
- 1 Blow-mould case



89-033-1

SKU#	DESCRIPTION	WEIGHT (kg)	BOX/CTN
89-033	35-Piece 1/4" Drive Socket Set	1.2	1/16

## 37-Piece 1/4" & 3/8" Drive Socket Set

METRIC

- 9 pcs 1/4" dr 6 pt sockets :  
4, 5, 6, 7, 8, 9, 10, 11, 12mm
- 9 pcs 3/8" dr 12 pt sockets :  
8, 10, 11, 12, 13, 14, 16, 17, 19mm

INCH

- 9 pcs 1/4" dr 6 pt sockets :  
3/16, 7/32, 1/4, 9/32, 5/16, 11/32, 3/8, 7/16, 1/2"
- 7 pcs 3/8" dr 12 pt sockets :  
3/8, 7/16, 1/2, 9/16, 5/8, 11/16, 3/4"
- 2 pcs 3/8" dr accessories :  
1 Adapter, 1 1/4" dr spinner handle
- 1 "Full Polish" Quick release ratchet
- 1 Metal box



89-518

SKU#	DESCRIPTION	WEIGHT (kg)	BOX/CTN
89-518	37-Piece 1/4" & 3/8" Drive Socket Set	5.14	2/2

## 10-Piece 3/8" Drive Socket Set

INCH

- 7 pcs 3/8" dr 6 pt sockets :  
3/8, 7/16, 1/2, 9/16, 5/8, 11/16 & 3/4"
- 1 pc 3/8" dr accessories :  
1 Extension bar: 3"
- 1 pc 3/8" dr ratchet



86-219

SKU#	DESCRIPTION	WEIGHT (kg)	BOX/CTN
86-219	10-Piece 3/8" Drive Socket Set	0.85	4/24

## 24-Piece 3/8" Drive Socket Set

METRIC

- 19 pcs 3/8" dr 6 pt sockets :  
6, 7, 8, 9, 10, 11, 12, 13, 14, 15, 16, 17, 18, 19, 20, 21, 22, 23, 24mm
- 4 pcs 3/8" dr accessories :  
2 Extensions: 75, 150mm, 1 Universal joint, 1 Sliding T-bar
- 1 pc 3/8" Quick release ratchet pear head
- 1 Blow-mold case



89-035-1

SKU#	DESCRIPTION	WEIGHT (kg)	BOX/CTN
89-035-1	24-Piece 3/8" Drive Socket Set	3	1/8

1 MEASURING & LAYOUT TOOLS

2 LASER MEASURING SYSTEM

3 CUTTING & HOLDING TOOLS

4 FASTENING TOOLS

5 STRIKING & STRUCK TOOLS

6 ILLUMINATION TOOLS

7 PAINTING & FINISHING TOOLS

8 MECHANIC TOOLS

9 TOOLS STORAGE

10 POWER CLEANING TOOLS

11 POWER TOOLS

12 POWER TOOL ACCESSORIES

13 PRODUCT INDEX

## 8 MECHANIC TOOLS



### 48-Piece 3/8" Drive Socket Set

METRIC

- **12 pcs 3/8" dr 12 pt sockets :**  
8, 9, 10, 11, 12, 13, 14, 15, 16, 17, 18, 19mm

INCH

- **7 pcs 3/8" dr 12 pt sockets :**  
3/8, 7/16, 1/2, 9/16, 5/8, 11/16, 3/4"
- **18 pcs 1/4" dr Bit set :**  
6 Hex bits: 3, 4, 5, 6, 7, 8mm, 6 Torx® bits: T10, 15, 20, 25, 30, 40,  
3 Posidriv bits: 1, 2, 3, and 3 Slotted bits: 4, 5, 6.5mm
- **8 pcs 3/8" dr accessories:**  
2 Spark plug 6pt socket: 5/8" & 13/16", 2 Extension bar: 3" & 6",  
1 Universal joint, 1 Adapter, 1 1/4" dr spinner handle,  
1 1/4" dr bit adapter
- 1 pc "Full Polish" Quick release ratchet
- 1 Metal box



89-516-1

SKU#	DESCRIPTION	WEIGHT (kg)	BOX/CTN
89-516-1	48-Piece 3/8" Drive Socket Set	6.12	2/2

### 11-Piece 1/2" Drive Socket Set

METRIC

- **10 pcs 1/2" dr 12 pt sockets:**  
10, 11, 12, 13, 14, 15, 16, 17, 18 & 19mm
- 1 pc 1/2" dr ratchet



86-734

SKU#	DESCRIPTION	BOX/CTN
86-734	11-Piece 1/2" Drive Socket Set	3/12

### 13-Piece 1/2" Drive Socket Set

METRIC

- **10 pcs 1/2" dr 12 pt sockets:**  
10, 11, 12, 13, 14, 16, 17, 19, 21, 22mm
- **2 pcs 1/2" dr accessories:**  
1 Extension bar: 5", 1 Sliding T bar
- 1 pc 1/2" Flip drive ratchet



86-501

SKU#	DESCRIPTION	BOX/CTN
86-501	13-Piece 1/2" Drive Socket Set	1/6

## 16-Piece 1/2" Drive Socket Set



89-092-1

METRIC

- 13 pcs 1/2" dr 12 pt sockets :  
8, 10, 11, 12, 13, 14, 16, 17, 18, 19, 21, 22, 24mm
- 2 pcs 1/2" dr accessories :  
125mm Extension bar, Universal joint
- 1 pc 1/2" Quick release ratchet pear head
- 1 Blow-mould case

SKU#	DESCRIPTION	WEIGHT (kg)	BOX/CTN
89-092-1	16-Piece 1/2" Drive Socket Set	3	1/6

## 22-Piece 1/2" Drive Socket Set



86-531

METRIC

- 17 pcs 1/2" dr 12 pt sockets :  
12, 13, 14, 15, 16, 17, 18, 19, 20, 21, 22, 23, 24, 26, 27, 28, 30mm
- 4 pcs 1/2" dr accessories :  
5" Extension bar, 10" Extension bar, Sliding T bar, Universal joint
- 1 pc 1/2" dr ratchet

SKU#	DESCRIPTION	BOX/CTN
86-531	22-Piece 1/2" Drive Socket Set	1/4

## 25-Piece 1/2" Drive Socket Set



86-589-1

METRIC

- 17 pcs 1/2" dr 6 pt sockets :  
10, 11, 12, 13, 14, 15, 17, 18, 19, 20, 21, 22, 23, 24, 27, 30, 32mm
- 6 pcs 1/2" dr accessories:  
1 Spark plug socket, 1 Sliding T-Bar: 10",  
1 Universal joint, 1 Flex handle: 17", 2 Extension bar: 5" & 10"
- 1 pc "Fully polished" Quick release ratchet
- 1 Blow-mold case

SKU#	DESCRIPTION	WEIGHT (kg)	BOX/CTN
86-589-1	25-Piece 1/2" Drive Socket Set	5.8	1/4

1 MEASURING & LAYOUT TOOLS

2 LASER MEASURING SYSTEM

3 CUTTING & HOLDING TOOLS

4 FASTENING TOOLS

5 STRIKING & STRUCK TOOLS

6 ILLUMINATION TOOLS

7 PAINTING & FINISHING TOOLS

8 MECHANIC TOOLS

9 TOOLS STORAGE

10 POWER CLEANING TOOLS

11 POWER TOOLS

12 POWER TOOL ACCESSORIES

13 PRODUCT INDEX

## 8 MECHANIC TOOLS



86-478-1

### 27-Piece 1/2" Drive Socket Set

INCH

- **20 pcs 1/2" dr 12 pt sockets :**  
1/4, 5/16, 3/8, 7/16, 1/2, 9/16, 19/32, 5/8, 11/16, 3/4, 25/32, 13/16, 7/8, 15/16, 31/32, 1, 1-1/16, 1-1/8, 1-3/16, 1-1/4"
- **5 pcs 1/2" dr accessories :**  
2 Extension bar: 5" & 10", 1 Universal joint,  
1 Spark plug socket 6 pt 13/16", 1 Sliding T-Bar: 9.5"
- 1 pc Flip-drive ratchet
- 1 Blow-mold case

SKU#	DESCRIPTION	WEIGHT (kg)	BOX/CTN
86-478-1	27-Piece 1/2" Drive Socket Set	4.59	4/4

### 27-Piece 1/2" Drive Socket Set

METRIC



86-477

- **20 pcs 1/2" dr 12 pt sockets :**  
10, 11, 12, 13, 14, 15, 16, 17, 18, 19, 20, 21, 22, 23, 24, 25, 26, 27, 30, 32mm
- **5 pcs 1/2" dr accessories :**  
2 Extension bar: 5" & 10", 1 Universal joint,  
1 Spark plug socket 6pt 13/16", 1 sliding T-Bar: 9.5"
- 1 pc Flip-drive ratchet
- 1 Blow-mold case

SKU#	DESCRIPTION	WEIGHT (kg)	BOX/CTN
86-477	27-Piece 1/2" Drive Socket Set	4.55	1/4

### 29-Piece 1/2" Drive Socket Set

METRIC



86-504

- **21 pcs 1/2" dr 12 pt sockets :**  
10, 11, 12, 13, 14, 15, 16, 17, 18, 19, 20, 21, 22, 23, 24, 25, 26, 27, 28, 30, 32mm
- **4 pcs 1/2" dr accessories :**  
2 Extensions: 5" & 10", 1 adapter, 1 handle
- 1 pc Flip-drive ratchet

SKU#	DESCRIPTION	BOX/CTN
86-504	29-Piece 1/2" Drive Socket Set	1/3

## 43-Piece 1/2" Drive Socket Set

### METRIC

- 20 pcs 1/2" dr 12 pt sockets :  
10, 11, 12, 13, 14, 15, 16, 17, 18, 19, 20, 21, 22, 23, 24, 26, 27, 28, 30, 32mm

### INCH

- 15 pcs 1/2" dr 12 pt sockets :  
3/16, 7/16, 1/2, 9/16, 5/8, 11/16, 3/4, 13/16, 7/8, 15/16, 1, 1-1/16, 1-1/8, 1-3/16, 1 1/4"
- 7 pcs 1/2" dr accessories :  
2 Spark plug 6pt socket: 5/8" & 13/16",  
3 Extension bar: 3", 5" & 10", 1 Universal joint,  
1 Flex handle: 375mm
- 1 pc "Full Polish" Quick release ratchet
- 1 Metal box



89-509

SKU#	DESCRIPTION	WEIGHT (kg)	BOX/CTN
89-509	43-Piece 1/2" Drive Socket Set	7.86	2/2

## 15-Piece 3/4" Drive Socket Set

### METRIC

- 10 pcs 3/4" dr 12 pt sockets :  
30, 32, 34, 36, 38, 41, 46, 50, 55, 60mm
- 4 pcs 3/4" dr accessories :  
2 Extension bar: 4" & 8", 1 Universal joint, 1 Sliding joint
- 1 pc Professional ratchet
- 1 Metal box



91-943-1

SKU#	DESCRIPTION	WEIGHT (kg)	BOX/CTN
91-943-1	15-Piece 3/4" Drive Socket Set	13.7	1/1

## 19-Piece 3/4" Drive Socket Set

### METRIC

- 15 pcs 3/4" dr 12 pt sockets :  
22, 24, 27, 28, 29, 30, 32, 33, 34, 36, 38, 41, 42, 46, 50mm
- 3 pcs 3/4" dr accessories :  
2 Extension 100 & 200mm, 1 Sliding T-bar 250mm
- 1 pc Standard ratchet
- 1 Blow-mold case



89-101-1

SKU#	DESCRIPTION	WEIGHT (kg)	BOX/CTN
89-101-1	19-Piece 3/4" Drive Socket Set	13	1/1

1 MEASURING & LAYOUT TOOLS

2 LASER MEASURING SYSTEM

3 CUTTING & HOLDING TOOLS

4 FASTENING TOOLS

5 STRIKING & STRUCK TOOLS

6 ILLUMINATION TOOLS

7 PAINTING & FINISHING TOOLS

8 MECHANIC TOOLS

9 TOOLS STORAGE

10 POWER CLEANING TOOLS

11 POWER TOOLS

12 POWER TOOL ACCESSORIES

13 PRODUCT INDEX

## 8 MECHANIC TOOLS



89-133-1

### 19-Piece 3/4" Drive Socket Set

INCH

- 15 pcs 3/4" dr 12 pt sockets :  
7/8, 15/16, 1, 1 1/6, 1 1/8, 1 3/16, 1 1/4, 1 5/16, 1 3/8, 1 13/16,  
1 11/16, 1 5/8, 1 1/2, 1 7/8, 2"
- 3 pcs 3/4" dr accessories :  
2 Extensions: 100 & 200mm, 1 Sliding T-Bar: 250mm
- 1 pc standard ratchet
- 1 Blow-mold case

SKU#	DESCRIPTION	WEIGHT (kg)	BOX/CTN
89-133-1	19-Piece 3/4" Drive Socket Set	13.4	1/2

### 5-Piece Screwdriver Bit Socket Clip Rail - 3/8" Drive

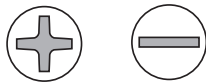

87-344

- A comprehensive set of the most common Standard and Phillips® bit sizes  
Allows for the tightening and removal of standard and Phillips® screws with a 3/8" ratchet

INCH

- 5 pcs 3/8" dr Screwdriver bit socket clip rail:  
⊕ : #1, #2, #3      ⊖ : 1/4 & 9/32

SKU#	DESCRIPTION	BOX/CTN
87-344	5 Piece Screwdriver Bit Socket Clip Rail - 3/8" Drive	3/12

### 5-Piece Hex Bit Socket Clip Rail - 3/8" Drive



87-343

- A comprehensive set of the most common Standard and Phillips® bit sizes  
Allows for the tightening and removal of Hex screws with a 3/8" ratchet

INCH

- 5 pcs 3/8" dr Hex bit socket clip rail :  
3/16, 7/32, 1/4, 5/16 & 3/8

SKU#	DESCRIPTION	BOX/CTN
87-343	5 Piece Hex Bit Socket Clip Rail - 3/8" Drive	3/12



## 7-Piece Torx® Socket Clip Rail - 3/8" Drive



87-342

- A comprehensive set of the most common Torx® bit sizes  
Allows for the tightening and removal of Torx® screws with a 3/8" ratchet

INCH

- 7 pcs 3/8" dr Torx® socket clip rail :  
t15, t20, t25, t30, t40, t45 & t50

SKU#	DESCRIPTION	BOX/CTN
87-342	7 Piece Torx® Socket Clip Rail - 3/8" Drive	6/12

## 161- Piece 1/2" Drive Socket Merchandizer Set



89-001A

METRIC

- 12 pcs 1/2" dr 6pt std sockets :  
8, 10, 11, 12, 13, 14, 15, 17, 18, 19mm
- 8 pcs 1/2" dr 6pt std sockets :  
21, 22, 24, 27mm
- 4 pcs 1/2" dr 6pt std sockets :  
30, 32mm
- 1 pc 1/2" dr Socket Merchandizer

SKU#	DESCRIPTION	BOX/CTN
89-001A	161 Piece 1/2" Drive Socket Merchandizer Set	1/1

## 167- Piece 1/2" Drive Socket Merchandizer Set



89-001

METRIC

- 12 pcs 1/2" dr 6pt std sockets :  
8, 10, 11, 12, 13, 14, 15, 17, 18, 19mm
- 8 pcs 1/2" dr 6pt std sockets :  
21, 22, 24, 27mm
- 4 pcs 1/2" dr 6pt std sockets :  
30, 32mm
- 6pcs 1/2" dr 6pt std socket:  
16mm
- 1 pc 1/2" dr Socket Merchandizer

SKU#	DESCRIPTION	BOX/CTN
89-001	167 Piece 1/2" Drive Socket Merchandizer Set	1/1

## 1/2" Drive Socket Set Merchandizer



89-001MB

- Plastic casing only

SKU#	DESCRIPTION	BOX/CTN
89-001MB	1/2" Drive Socket Set Merchandizer	1/1

1 MEASURING & LAYOUT TOOLS

2 LASER MEASURING SYSTEM

3 CUTTING & HOLDING TOOLS

4 FASTENING TOOLS

5 STRIKING & STRUCK TOOLS

6 ILLUMINATION TOOLS

7 PAINTING & FINISHING TOOLS

8 MECHANIC TOOLS

9 TOOLS STORAGE

10 POWER CLEANING TOOLS

11 POWER TOOLS

12 POWER TOOL ACCESSORIES

13 PRODUCT INDEX

# 9 TOOLS STORAGE

## PROFESSIONAL DESIGN, VERSATILITY & DURABILITY

Quality, innovation and durability – the same principles used to build world-class hand tools is applied to the manufacture of our tools storage products. This comprehensive category is divided into 6 product lines: tool bags, toolboxes, mobile storage devices, organizers and bins, garage workshop cabinets, and collapsible sawhorses. In total, there are more than 80 storage products available, and each one is well-engineered, thoughtfully designed and job-site tough.



### ZAG® MODULAR ROLLING WORKSHOP W/ONE TOUCH LATCH TOOLBOX + DRAWER



- Portable detachable containers with handles on top allows for the customization of storage options and to carry only the options you need.
- Top detachable toolbox with drawer and one hand operation latch, 2 drawer storage unit with shallow & deep drawer and bottom flip bin with back pocket for long tools storage (saw & level) - versatile organization for various sizes of tools and small parts.
- Aluminum telescopic back handle for easy elevation; handle can be lowered for storage.
- Heavy-duty ball bearing slides for the drawers-quality drawer sliding system with better grip and locking mechanism.
- Heavy-duty 7" wheels for easy on-site maneuverability.
- On top 19" toolbox with one hand operation latch allowing to open the box when the other hand is occupied.



“

We understand that transporting the right tools and components quickly and easily to the jobsite is an issue for every pro, so having examined the needs of different trades we've created our Modular Rolling Workshop. The 7" full rubber wheels are designed for tough terrains, it has a large flip bin for power tools, a two drawer organizer unit and a toolbox with a further organizer drawer. Each unit can be easily separated and carried individually, or two can be carried together, connected by the heavy-duty side latches.

”

## 9 TOOLS STORAGE



### MOBILE WORK CENTER™ 2 IN 1 WITH SOFT FRONT POCKET + 12.5" SERIES 2000 WITH 2 BUILT-IN ORGANIZERS WITHOUT TRAY



#### Mobile Work Center (18600) + 13" Tool Box

##### Mobile Work Center 2-in-1 with Soft Front Pocket

- 2-in-1 = separates in seconds into an extra large box and giant bin
- Small parts storage with swivel front drawer (carousel) and front fabric organizer with bungee cord
- Smooth mobility - large "truck" wheels
- Easy to operate with an aluminum telescopic pull handle
- Load capacity 40KG
- Conveniently fits into a car

##### 12.5" Series 2000 with Built-In Organizers w/o tray

- 2 top organizers for small parts storage – accessible without opening the tool box
- Pad lock eye
- Tote tray

SKU#	DESCRIPTION	ITEM SIZE	BOX/CTN
60729	Mobile Work Center (18600) + 13" Tool Box	47 x 29.8 x 61.9 cm 18-1/2" x 11-13/16" x 24-3/8"	1/4

### STANLEY® 2-in-1 Mobile Work Center



18603

- 2 storage solutions in one includes extra large toolbox, storage bin
- Large, heavy-duty nickel-plated metal latches
- Two transparent lid organizers and middle carousel offer extensive small parts storage
- Front pocket for storage of extension cord, other cables
- Large truck wheels enable smooth, easy mobility
- Conveniently fits into car trunk or back seat

SKU#	DESCRIPTION	ITEM SIZE	BOX/CTN
18603	STANLEY® 2-in-1 Mobile Work Center	25" x 19" x 12" (635mm x 482.6mm x 304.8mm)	2/2

### STANLEY® Pro Mobile Tool Chest



97-503

The STANLEY® Pro Mobile Tool Chest with durable plastic outer meets all your storage solutions in a handy portable form. With removable compartments for small parts and soft grip handle for comfort when carrying

SKU#	DESCRIPTION	ITEM SIZE	BOX/CTN
97-503	STANLEY® Pro Mobile Tool Chest	24" x 16.5" x 14" (620mm x 419mm x 375mm)	1/1



92-703

**Mobile Tool Chest with 2 Built-in Organizers, 2 Trays & Pull Handle**

SKU#	DESCRIPTION	ITEM SIZE	CARTON LOADING	CARTON SIZE	CARTON WEIGHT	BOX/CTN
92-703	Mobile Tool Chest w/ 2 Organizers, 2 Trays & Pull Handle	56.2 x 31.4 x 28.3 cm 22-1/8" x 12-3/8" x 11-1/8"	2	62.8 x 38.8 x 85.8 cm 24-11/6" x 15-5/16" x 33-13/16"	7.5 kg 16.5 lbs	2/2



20580

**20" Metal Rolling Workshop**

SKU#	CARTON SIZE	CARTON WEIGHT	40ft HICUBE	40ft CONT.	20ft CONT.	ITEM SIZE	BOX/CTN
20580	22-2/5x 16-1/8x28-7/8 in 57.0x41.0x73.5cm	25.33lb 11.5kg	403	339	159	22-2/5x5-7/8x11-2/5" 56.8x38.9x73 cm	1/1



60929

**Metal Plastic Rolling Tool Chest (Yellow)**

SKU#	CARTON SIZE	CARTON WEIGHT	40ft HICUBE	40ft CONT.	20ft CONT.	ITEM SIZE	BOX/CTN
60929	25-7/8x15-3/4x 25-1/2 in 65.8x39.9x64.8cm	24.22lb 11kg	404	357	169	25-2/3x 15-2/5x25-1/8" 65.0x39.0x64.0 cm	1/1



33280

**Metal Plastic Rolling Tool Chest (Yellow)**

SKU#	CARTON SIZE	CARTON WEIGHT	40ft HICUBE	40ft CONT.	20ft CONT.	ITEM SIZE	BOX/CTN
33280	25-7/8x 15-3/4x17-1/8 in 65.8x39.9x43.5cm	15.92lb 7.23kg	622	505	240	25-2/3x 15-2/5x16-7/8" 65.0x39.0x43.0 cm	1/1



18700

**All Project Vehicle**

- Innovative design - eye catcher
- 2-in-1 = Easily separates into 2 units
- Bottom bin and top part which can be carried like a tool box
- Wide heavy-duty wheels
- Durable pull handle - comfortable grip

SKU#	DESCRIPTION	BOX/CTN
18700	All Project Vehicle	2/2

- 1 MEASURING & LAYOUT TOOLS
- 2 LASER MEASURING SYSTEM
- 3 CUTTING & HOLDING TOOLS
- 4 FASTENING TOOLS
- 5 STRIKING & STRUCK TOOLS
- 6 ILLUMINATION TOOLS
- 7 PAINTING & FINISHING TOOLS
- 8 MECHANIC TOOLS
- 9 TOOLS STORAGE
- 10 POWER CLEANING TOOLS
- 11 POWER TOOLS
- 12 POWER TOOL ACCESSORIES
- 13 PRODUCT INDEX

## 9 TOOLS STORAGE



### Open Mouth Wheeled Tool Bag – 20"



93-328

- Made of durable, tough wear and water-resistant plastic wrapped in and virtually maintenance-free 600 denier polyester fabric
- Integrated foam rubber and plastic structure reinforcements create a non-collapsing design
- Elevated fee
- Open mouth design with zipper allows for easy access/secure transport of bag contents
- Heavy-duty metal framework supports open mouth design
- Large handles for comfort and grip with padded over wrap to fasten both handles together
- Telescoping handle extends to a height of 39" for easy tool transport
- Two (2) 1.5" wide casters bracket mounted with heavy-duty metal rivets

SKU#	DESCRIPTION	ITEM SIZE	MAIN STORAGE	BOX/CTN
93-328	Open Mouth Wheeled Tool Bag – 20"	19" x 9" x 12" 50mm x 23mm x 30mm	2,052 inch <sup>3</sup>	1/2



20080

### 20" Metal Plastic Tool Box (Yellow)

SKU#	CARTON SIZE	CARTON WEIGHT	40ft HICUBE	40ft CONT.	20ft CONT.	ITEM SIZE	BOX/CTN
20080	20x11-4/5x 35-3/5in 50.8x30.3x89.3 cm	23.1 lb 10.5 kg	1,968	1,812	880	19-1/2x 11-1/2x5-5/8" 49.7x29.3x 22.2 cm	1/1



20300

### 20" Professional Tool Box

SKU#	CARTON SIZE	CARTON WEIGHT	40ft HICUBE	40ft CONT.	20ft CONT.	ITEM SIZE	BOX/CTN
20300	22-1/2x21x 31-7/8in 57.2x53.3x 81.1 cm	37.1 lb 17.1 kg	1,584	1,404	702	19-7/8x 10-7/8x10-5/8" 50.5x27.6x 26.9 cm	6/6



26300

### 26" Professional Tool Box

SKU#	CARTON SIZE	CARTON WEIGHT	40ft HICUBE	40ft CONT.	20ft CONT.	ITEM SIZE	BOX/CTN
26300	26-3/4x22-1/2x 31-15/16in 67.9x57.2x 81.1 cm	46.5 lb 21.1 kg	1,224	1,614	551	25-1/2x10-3/4x 10-1/2" 65.1x27.6x 26.9 cm	6/6

## JUMBO TOOL BOX WITH 2 PULL OUT ORGANIZERS, BIT HOLDER AND METAL LATCHES

### Combo 19028 + 13013



60-886

- Organizers, accessible without opening the box
- 2 organizers are removable and can be carried outside the toolbox
- Tote tray
- Padlock eye
- Soft wide rubber coated handle - easy grip
- Nickel-plated latches

12.5" Series 2000 with Built-in Organizers without tray

- With 12.5" tool box inside with top organizers for small parts storage
- Inclusive of tray inside

SKU#	DESCRIPTION	ITEM SIZE	BOX/CTN
60-886	Combo Jumbo Tool Box (19028 & 13013)	48.6 x 27.6 x 23.2 cm 19-1/8" x 10-7/8" x 9-1/8"	1/6



92-116

### Jumbo 16" Tool Box With 2 Pull Out Organizers and Bit Holder

SKU#	DESCRIPTION	ITEM SIZE	CARTON LOADING	CARTON SIZE	CARTON WEIGHT	BOX/CTN
92-116	Jumbo 16" Tool Box w/2 Pull Out Organizers & Bit Holder	39.4 x 25.4 x 17.8 cm 15-1/2" x 10" x 7"	6	48.5 x 40.8 x 55.9 cm 19-1/8" x 16-1/8" x 22"	7.7 kg 17 lbs	6/6



92-120

### Jumbo 19" Tool Box With 2 Pull Out Organizers and Bit Holder

SKU#	DESCRIPTION	ITEM SIZE	CARTON LOADING	CARTON SIZE	CARTON WEIGHT	BOX/CTN
92-120	Jumbo 19" Tool Box w/2 Pull Out Organizers & Bit Holder	48.6 x 27.6 x 23.2 cm 19-1/8" x 10-7/8" x 9-1/8"	6	48.5 x 40.8 x 55.9 cm 19-1/8" x 16-1/8" x 22"	11.7 kg 25.8 lbs	6/6

1 MEASURING & LAYOUT TOOLS

2 LASER MEASURING SYSTEM

3 CUTTING & HOLDING TOOLS

4 FASTENING TOOLS

5 STRIKING & STRUCK TOOLS

6 ILLUMINATION TOOLS

7 PAINTING & FINISHING TOOLS

8 MECHANIC TOOLS

9 TOOLS STORAGE

10 POWER CLEANING TOOLS

11 POWER TOOLS

12 POWER TOOL ACCESSORIES

13 PRODUCT INDEX

## 9 TOOLS STORAGE



92-146

### Jumbo 22" Tool Box With 2 Pull Out Organizers and Bit Holder

SKU#	DESCRIPTION	ITEM SIZE	CARTON LOADING	CARTON SIZE	CARTON WEIGHT	BOX/CTN
92-146	Jumbo 22" Tool Box w/2 Pull Out Organizers & Bit Holder	56.2 x 31.4 x 28.3 cm 22-1/8" x 12-3/8" x 11-1/8"	3	88 x 56.5 x 29.5 cm 34-5/8" x 22-5/16" x 11-5/8"	7.5 kg 16.5 lbs	3/3



92-905

### Jumbo 16" Tool Box With 2 Pull Out Organizers, Bit Holder and Metal Latches

SKU#	DESCRIPTION	ITEM SIZE	CARTON LOADING	CARTON SIZE	CARTON WEIGHT	BOX/CTN
92-905	Jumbo 16" Tool Box with 2 Pull Out Organizers, Bit Holder & Metal Latches	39.4 x 25.4 x 17.8 cm 15-1/2" x 10" x 7"	6	53.5 x 49.5 x 72.5cm 21-1/8" x 19-1/2" x 28-5/8"	7.7 kg 17 lbs	6/6



92-906

### Jumbo 19" Tool Box With 2 Pull Out Organizers, Bit Holder and Metal Latches

SKU#	DESCRIPTION	ITEM SIZE	CARTON LOADING	CARTON SIZE	CARTON WEIGHT	BOX/CTN
92-906	Jumbo 19" Tool Box with 2 Pull Out Organizers, Bit Holder & Metal Latches	48.6 x 27.6 x 23.2 cm 19-1/8" x 10-7/8" x 9-1/18"	6	53.5 x 49.5 x 72.5cm 21-1/8" x 19-1/2" x 28-5/8"	11.7 kg 25.8 lbs	6/6



92-908

### Jumbo 22" Tool Box With 2 Pull Out Organizers, Bit Holder and Metal Latches

SKU#	DESCRIPTION	ITEM SIZE	CARTON LOADING	CARTON SIZE	CARTON WEIGHT	BOX/CTN
92-908	Jumbo 22" Tool Box with 2 Pull Out Organizers, Bit Holder & Metal Latches	56.2 x 31.4 x 28.3 cm 22-1/8" x 12-3/8" x 11-1/8"	3	88 x 56.5 x 29.5cm 34-5/8" x 22-5/16" x 11-5/8"	7.5 kg 16.5 lbs	3/3





92-064

## 12.5" Series 2000 With 2 Built-In Organizers & Tray, Metal Latch

SKU#	CARTON SIZE	CARTON WEIGHT	40ft HICUBE	40ft CONT.	20ft CONT.	ITEM SIZE	BOX/CTN
92-064	19-11/16x 12-7/8x11 in 50x32.7x 28 cm	7.7 lb 3.5 kg	9,624	8,316	4,116	12-1/2x7x 5-1/8" 31.8x17.8x 13 cm	6/6



16011

## 16" Series 2000 With 2 Built-In Organizers & Tray

SKU#	CARTON SIZE	CARTON WEIGHT	40ft HICUBE	40ft CONT.	20ft CONT.	ITEM SIZE	BOX/CTN
16011	22-5/8 x 16- 1/2 x 15 in 57.3 x 41.8 x 38.1 cm	16.5 Lb 7.5 Kg	4,746	4,194	1,950	15-7/8 x 8- 1/8 x 7-1/8" 40.3 x 17.8 x 13 cm	6/6



15101

## 15" Tool Box With Built-In Organizer & Tray

SKU#	CARTON SIZE	CARTON WEIGHT	40ft HICUBE	40ft CONT.	20ft CONT.	ITEM SIZE	BOX/CTN
15101	19-5/8x12-7/8x 11 in 49.9x32.7x 28 cm	7.7 lb 3.5 kg	9,600	8,520	4,152	12-1/4x 7x5" 31.4x17.8x 12.7 cm	6/6



13011

## 12.5" Series 2000 With 2 Built-In Organizers & Tray

SKU#	CARTON SIZE	CARTON WEIGHT	40ft HICUBE	40ft CONT.	20ft CONT.	ITEM SIZE	BOX/CTN
13011	19-11/16x 12-7/8x11 in 50x32.7x 28 cm	7.7 lb 3.5 kg	9,624	8,346	4,116	12-1/2x7x 5-1/8" 31.8x17.8x 13 cm	6/6



19011

## 19" Series 2000 With 2 Built-In Organizers & Tray

SKU#	CARTON SIZE	CARTON WEIGHT	40ft HICUBE	40ft CONT.	20ft CONT.	ITEM SIZE	BOX/CTN
19011	23x14x27 in 72x50x51 cm	24.7 lb 11.7 kg	2,160	1,830	840	19-1/4x10- 1/4x9-3/4" 46.9x26x 24.8 cm	6/6

1 MEASURING & LAYOUT TOOLS

2 LASER MEASURING SYSTEM

3 CUTTING & HOLDING TOOLS

4 FASTENING TOOLS

5 STRIKING & STRUCK TOOLS

6 ILLUMINATION TOOLS

7 PAINTING & FINISHING TOOLS

8 MECHANIC TOOLS

9 TOOLS STORAGE

10 POWER CLEANING TOOLS

11 POWER TOOLS

12 POWER TOOL ACCESSORIES

13 PRODUCT INDEX

## 9 TOOLS STORAGE



92-764

### Power Tool Case with Organizer

SKU#	CARTON SIZE	CARTON WEIGHT	40ft HICUBE	40ft CONT.	20ft CONT.	ITEM SIZE	BOX/CTN
92-764	29-1/8x15-1/2x 22-7/8" 74x39.3x58.2 cm	23.5 lb 10.7 kg	2,412	2,256	1,056	14-7/8x 14-3/8x 7-5/16" 37.8x36.5x 18.4 cm	6/6



518160

### FatMax® 18" Open Tote (Grey / Black)

SKU#	CARTON SIZE	CARTON WEIGHT	40ft HICUBE	40ft CONT.	20ft CONT.	ITEM SIZE	BOX/CTN
518160	20-5/8x 19-7/16x27-3/8" 53x49.5x70.5 cm	22 lb 10 kg	1,300	1,020	485	18-7/8x 9-7/8x13" 48x25x33 cm	4/4



516110

### 16" Multi Purpose Tool Bag (Black / Grey)

SKU#	CARTON SIZE	CARTON WEIGHT	40ft HICUBE	40ft CONT.	20ft CONT.	ITEM SIZE	BOX/CTN
516110	18-3/4x 17-1/8x10-1/2" 47x43.6x26.7 cm	8.3 lb 3.7 kg	2,442	2,212	1,068	16-1/4x 8-5/8x9-7/8" 41x22x25 cm	2/2



512100

### 12" Tool Bag (Grey / Black )

SKU#	CARTON SIZE	CARTON WEIGHT	40ft HICUBE	40ft CONT.	20ft CONT.	ITEM SIZE	BOX/CTN
512100	12-3/4x10-1/4x 9" 32.6x26.1x23 cm	3.4 lb 1.548 kg	6,760	6,126	2,958	11-3/4x5x 9-3/4" 30x13x25 cm	2/2



509100

### 9" Pouch (Black / Grey)

SKU#	CARTON SIZE	CARTON WEIGHT	40ft HICUBE	40ft CONT.	20ft CONT.	ITEM SIZE	BOX/CTN
509100	16-3/4x10-1/4x 12-3/8" 42.5x26x31.3 cm	7.1 lb 3.2 kg	22,068	19,992	9,648	6-1/4x4-1/4x 9-3/8" 16x11x24 cm	12/12



14325

## 25 Compartment Professional Organizer

SKU#	CARTON SIZE	CARTON WEIGHT	40ft HICUBE	40ft CONT.	20ft CONT.	ITEM SIZE	BOX/CTN
14325	26x17-5/16x 13-1/2" 66x44x34.4 cm	35.3 lb 16 kg	2,634	2,350	1,104	16-1/4x17x 4-1/3" 49.2x43.1x11 cm	12/12



14004

## Organizer 160 14 Compartments Organizer

SKU#	CARTON SIZE	CARTON WEIGHT	40ft HICUBE	40ft CONT.	20ft CONT.	ITEM SIZE	BOX/CTN
14004	26-5/8x13-1/2x 10-1/16" 67.5x34.4x 27.1 cm	13.2 lb 6 kg	13,452	12,144	6,072	13-1/8x10x 2-1/8" 33.23x25.4x 5.4 cm	12/12



14209

## 9 Compartment Professional Organizer

SKU#	CARTON SIZE	CARTON WEIGHT	40ft HICUBE	40ft CONT.	20ft CONT.	ITEM SIZE	BOX/CTN
14209	21-3/16x 17-3/16x27" 53.8x43.7x 68.6 cm	55.1 lb 25 kg	17,320	13,800	6,720	8-1/4x13-1/8x 2-1/4" 21.1x33.4x 5.2 cm	40/40



14408 & 14408 New

## 8 Compartment Professional Organizer

SKU#	CARTON SIZE	CARTON WEIGHT	40ft HICUBE	40ft CONT.	20ft CONT.	ITEM SIZE	BOX/CTN
14408	26x17-5/16x 13-1/2" 66x44x34.4 cm	24 lb 10.9 kg	4,482	2,930	1,860	16-9/16x 13-1/8x 4-1/8" 42.3x33.4x10.5 cm	6/6



60565

## Organizer 33 (3 x 14003)

SKU#	CARTON SIZE	CARTON WEIGHT	40ft HICUBE	40ft CONT.	20ft CONT.	ITEM SIZE	BOX/CTN
60565	26-1/4x21x 24-7/8" 41.4x53.5x 63.4 cm	46.2 lb 21 kg	27,840	25,500	12,480	7-7/8x4x 3-7/8" 20.1x10.3x 10.1 cm	60/60

1 MEASURING & LAYOUT TOOLS

2 LASER MEASURING SYSTEM

3 CUTTING & HOLDING TOOLS

4 FASTENING TOOLS

5 STRIKING & STRUCK TOOLS

6 ILLUMINATION TOOLS

7 PAINTING & FINISHING TOOLS

8 MECHANIC TOOLS

9 TOOLS STORAGE

10 POWER CLEANING TOOLS

11 POWER TOOLS

12 POWER TOOL ACCESSORIES

13 PRODUCT INDEX

## 9 TOOLS STORAGE



56208

### Bonus Pack (8 Bin #2 + 3 Bin Hangers)

SKU#	CARTON SIZE	CARTON WEIGHT	40ft HICUBE	40ft CONT.	20ft CONT.	ITEM SIZE	BOX/CTN
56208	29-13/16x 22-3/4x 13-7/8" 75.8x57.8x 35.3 cm	36.7 lb 16.2 kg	9,261	7,938	3,906	4-1/4x7-1/2x 13-3/8" 10.8x19.1x 34 cm	21/21



56304

### Bonus Pack (4 Bin #3 + 2 Bin Hangers)

SKU#	CARTON SIZE	CARTON WEIGHT	40ft HICUBE	40ft CONT.	20ft CONT.	ITEM SIZE	BOX/CTN
56304	30-3/16x 19-11/16x 25-13/16" 76.6x50x 65.5 cm	39.2 lb 17.8kg	5,520	4,200	2,040	5-3/4x9-3/8x 12-5/8" 14.6x23.8x 32.1 cm	20/20

### 25-Piece Do-it-all Tools Set



92-006

- 1 pc Wood Handle Nail Hammers 7oz
- 1 pc STANLEY Tape Rules 3meter 1
- 1 pc Knife
- 1 pc Metric Hex Key Set 10pcs
- 1 pc Linesman Pliers 8"
- 1 pc Long nose Pliers 6"
- 1 pc Adjustable wrench 8"
- 1 pc 6-way screwdriver
- 1 pc Digital Spark Test Pen
- 1 pc Torch Light
- 1 pc Waterproof Tools Bag

SKU#	DESCRIPTION	BOX/CTN
92-006	25 pcs Electrician's Tools Set	1/9



90-596N

## 7-Piece Tools Set

- 1pc Linesman Pliers : 7"
- 1pc Adjustable Wrench : 8"
- 1pc Cushion Grip : 6x100
- 1pc Cushion Grip : M6x100
- 1pc STANLEY Tape Rules : 3m
- 1pc Snap-Off Blade : 18mm
- 1pc Test Pen : 100-500V24

SKU#	DESCRIPTION	BOX/CTN
90-596N	7-pc Tools Set	1/36



92-003-2

## 6-Piece Slim Tools Set

- 1pc Slim Standard Screwdriver : 3 x 125mm
- 1pc Slim Standard Screwdriver : 3 x 150mm
- 1pc Slim Phillips Screwdriver : #0 x 125mm
- 1pc Slim Phillips Screwdriver : #0 x 125mm
- 1pc Slim Diagonal Cutting Pliers : 125mm
- 1pc Slim Long Nose Pliers : 100mm

SKU#	DESCRIPTION	BOX/CTN
92-003-2	6 pcs Slim Tools Set	6/24



90-597

## 18-Piece Tools Set

- 1pc Precision Screwdriver Set
- 1pc Linesman Pliers : 8"
- 1pc Long Nose Pliers : 6"
- 1pc Adjustable Wrench : 8"
- 1pc Test Pen 100-500V AC : 150mm
- 1pc Snap-Off Knife : 9mm
- 1pc Cushion Grip : 3 x 100mm
- 1pc Cushion Grip : #0 x 100mm
- 1pc Cushion Grip : 6.5 x 150mm
- 1pc Cushion Grip : #2 x 150mm
- 1pc Solder Iron : 30W/220W
- 1pc STANLEY Tape Rules : 8m
- 1pc Metric Hex Key Set : 10pcs
- 1pc Wood Handle Nail Hammers : 130Z
- 1pc Mini Hacksaw : 8-3/4"
- 1pc Torch Light
- 1pc Pinch
- 1pc Scissor
- 1pc Nylon Bag

SKU#	DESCRIPTION	BOX/CTN
90-597	18-pc Tools Set	1/5

1 MEASURING & LAYOUT TOOLS

2 LASER MEASURING SYSTEM

3 CUTTING & HOLDING TOOLS

4 FASTENING TOOLS

5 STRIKING & STRUCK TOOLS

6 ILLUMINATION TOOLS

7 PAINTING & FINISHING TOOLS

8 MECHANIC TOOLS

9 TOOLS STORAGE

10 POWER CLEANING TOOLS

11 POWER TOOLS

12 POWER TOOL ACCESSORIES

13 PRODUCT INDEX

## 9 TOOLS STORAGE



92-009

### 19-Piece Home-Use Tools Set

- 1 pc STANLEY Tape Rules : 3m
- 1 pc 6-way Screwdriver
- 1 pc Linesman Pliers : 8"
- 1 pc Snap-Off Knife : 18mm
- 1 pc Adjustable Wrench : 8"
- 1 pc Mini Hacksaw : 8-3/4"
- 1 pc Precision Screwdriver Set
- 1 pc Wood Handle Nail Hammers : 13oz
- 1 pc Digital Spark Test Pen
- 1 pc Water Proof Tool Bag

SKU#	DESCRIPTION	BOX/CTN
92-009	19-pc Home-use Tools Set	1/5



92-010

### 22-Piece Must-Have Tools Set

- 1pc STANLEY Tape Rules : 5m
- 1pc Cushion Grip Screwdriver Phillips® : #1x100mm
- 1pc Cushion Grip Screwdriver Phillips® : #2x150mm
- 1pc Cushion Grip Screwdriver : 5x100mm
- 1pc Cushion Grip Screwdriver : 6.5x100mm
- 1pc Metric Hex Key Set : 10 pcs
- 1pc MaxGrip® Pliers Linesman : 8"
- 1pc MaxGrip® Pliers Long Nose : 6"
- 1pc Knife Snap Off Blade
- 1pc Adjustable Wrench : 8"
- 1pc Mini Hacksaw : 3/4"
- 1pc Hammer 16oz Claw
- 1pc Tool Bag

SKU#	DESCRIPTION	BOX/CTN
92-010	22-pc Must-have Tools Set	1/5



92-005

## 22-Piece Electrician's Tools Set

- 1pc STANLEY Tape Rules : 3m
- 1pc Multimeter
- 1pc Slip Joint Pliers : 8"
- 1pc Long Nose Pliers : 6"
- 1pc Metric Hex Key Set : 10pcs
- 1pc Adjustable Wrench : 6"
- 1pc Cushion Grip : #1 x 100mm
- 1pc Cushion Grip : 5 x 100mm
- 1pc Digital Spark Test Pen
- 1pc Torch Light
- 1pc PVC Adhesive Tape
- 1pc Electrician Knife
- 1pc Waterproof Tool Bag

SKU#	DESCRIPTION	BOX/CTN
92-005	22-pc Electrician's Tools Set	1/6

1 MEASURING & LAYOUT TOOLS

2 LASER MEASURING SYSTEM

3 CUTTING & HOLDING TOOLS

4 FASTENING TOOLS

5 STRIKING & STRUCK TOOLS

6 ILLUMINATION TOOLS

7 PAINTING & FINISHING TOOLS

8 MECHANIC TOOLS

9 TOOLS STORAGE

10 POWER CLEANING TOOLS

11 POWER TOOLS

12 POWER TOOL ACCESSORIES

13 PRODUCT INDEX

# 10 POWER CLEANING TOOLS

## INDUSTRIAL, POWERFUL & PORTABLE

STANLEY® Power Cleaning Tools provide superior performance in any environment. From the portable 1400W Pressure Washer to 16 Gallons Stainless Steel Wet/Dry Vacuum Cleaner for heavy-duty use, STANLEY® cleaning tools makes even the toughest jobs easy, saving you time and effort. With a full line-up of products geared towards a multitude of tasks, no job is too big... or too small. All STANLEY® Power Cleaning Tools are built with practical features and useful accessories, and equipped with easy-to-operate powerful motors and double filtration systems for dry vacuum applications which provides optimum performance and clean exhaust air.

### STANLEY® PRESSURE WASHER



ON-BOARD ACCESSORY STORAGE

Innovative storage for lance, gun, cable and hose

Transparent filter increases pump life whilst easy to clean



SPECIAL WATER INLET FILTER



# STANLEY® VACUUM CLEANER



All latches are upgraded with better holding which is strongly secured to the main body of the vacuum chamber.



Every 8 gallons and above comes with blower port. The powerful blower port instantly converts vacuum to blower power.



All STANLEY® wet / dry vacuums are covered under a 1-year warranty



Top strong handles for easy transport.



Uniquely designed drain outlet promotes easy emptying.

# 10 POWER CLEANING TOOLS

## STANLEY® Vacuum Cleaner Portable Series

All latches UPGRADED for better holding. Strongly secured to the main body of the vacuum chamber.



- High performance motor provides maximum power
- Light weight compact design for easy carrying
- 6 - 10' power cord with cord wrap design for easy organization and storage
- Wall-mounted design for convenient storage

### Accessories for 3 & 5 gallons include:

Flexible hose, three extension wands, crevice nozzle, floor brush, reusable dry filter, disposable filter bag



95-950



SKU#	DESCRIPTION	BOX/CTN
95-950	3 Gallons Portable Wet / Dry Vac	1/1
95-943	5 Gallons Stainless Steel Wet / Dry Vac	1/1

## STANLEY® Vacuum Cleaner Portable Series

- High performance motor provides maximum power
- Lightweight compact design for easy carrying
- Lower power cord with cord wrap design for easy organization and storage
- Wall-mounted design for convenient storage

### Accessories for 1 & 2.5 gallons include:

Flexible hose, crevice nozzle, utility nozzle, reusable dry filter



95-947



95-949



SKU#	DESCRIPTION	BOX/CTN
95-947	Hangup 1 Gallon Plastic Wet / Dry Vac	1/1
95-949	Hangup 2.5 Gallons Plastic Wet / Dry Vac	1/1

## STANLEY® Vacuum Cleaner Professional Series



Every 8 gallons and above comes with blower port. The powerful blower port instantly converts vacuum to blower power.

95-944

- High performance motor provides maximum power
- Light weight compact design for easy carrying
- 6 - 10' power cord with cord wrap design for easy organization and storage
- Wall mounted design for convenient storage

### Accessories for 8 & 10 gallons include:

Flexible hose, three extension wands, crevice nozzle, floor brush, reusable dry filter, disposable filter bag.



SKU#	DESCRIPTION	BOX/CTN
95-944	8 Gallons Stainless Steel Wet / Dry Vac	1/1
95-945	10 Gallons Stainless Steel Wet / Dry Vac	1/1

## STANLEY® Vacuum Cleaner Heavy-Duty Industrial Series



Every 8 gallons and above comes with blower port. The powerful blower port instantly converts vacuum to blower power.

95-946

- Powerful heavy-duty motor for industry leading performance provides maximum power of suction and blowing for heavy-duty pickup
- High efficiency particulate air filter treated with Microbion fights and inhibits the growth of mold, mildew and bacteria.
- Great for drywall dust, fine filtration, washable, reusable, use for both wet and dry pickups
- Strong handle for easy carrying
- Large on/off switch with waterproof design for sale & quick access
- 16' power cord with cord wrap design
- Heavy-duty rear wheels with swivelling front casters provide ease of movement in any direction
- On-board storage box keeps tools in order
- Easy-to-assemble removable steel handle for easy storage

### Accessories for 16 gallons include:

Flexible hose, three extension wands, crevice nozzle, floor brush, reusable dry filter, disposable filter bag.



SKU#	DESCRIPTION	BOX/CTN
95-946	Heavy-duty 16 Gallons Stainless Steel Wet / Dry Vac	1/1

1 MEASURING & LAYOUT TOOLS

2 LASER MEASURING SYSTEM

3 CUTTING & HOLDING TOOLS

4 FASTENING TOOLS

5 STRIKING & STRUCK TOOLS

6 ILLUMINATION TOOLS

7 PAINTING & FINISHING TOOLS

8 MECHANIC TOOLS

9 TOOLS STORAGE

10 POWER CLEANING TOOLS

11 POWER TOOLS

12 POWER TOOL ACCESSORIES

13 PRODUCT INDEX

# ACCESSORIES LIST

NO	SKU#	ITEM DESCRIPTION	95-947-23 1 Gal / 4L
1	97-526	Flexible Hose, 4" (95-947, 95-949)	•
2	97-527	Flexible Hose, 5" (95-950, 95-943)	
3	97-528	Flexible Hose, 6" (95-944, 95-945)	
4	97-529	Flexible Hose, 7" (95-946)	
5	97-530	Extension Wands, 3 pcs (95-947, 95-949, 95-950, 95-943)	•
6	97-531	Extension Wands, 2 pcs (95-944, 95-945)	
7	97-532	Extension Wands, 2 pcs (95-946)	
8	97-533	Crevice Nozzle (95-947, 95-949, 95-950, 95-943, 95-944, 95-945)	•
9	97-534	Crevice Nozzle (95-946)	
10	97-535	Utility Nozzle (95-947, 95-949, 95-950, 95-943, 95-944, 95-945)	•
11	97-536	Suction Latch (95-946)	
12	97-537	Floor Brush (95-947, 95-949, 95-950, 95-943, 95-944, 95-945)	•
13	97-538	Floor Brush (95-946)	
14	97-539	Wall-Mounted Bracket (95-946)	•
15	97-540	Reusable Dry Filter 1pc w/ Mounting Ring (95-947, 95-949, 95-950, 95-943)	•
16	97-541	Reusable Dry Filter, 3pcs w/o Mounting Ring (95-947, 95-949, 95-950, 95-943)	•
17	97-542	Foam Filter (95-947, 95-949, 95-950, 95-943)	•
18	97-543	Disposable Filter Bag (95-950)	
19	97-544	Disposable Filter Bag (95-943)	
20	97-545	Paper Dust Bag (95-944, 95-945)	
21	97-546	Paper Dust Bag (95-946)	
22	97-547	Cartridge/HEPA Filter (95-944, 95-945, 95-946)	

95-949-23 2.5 Gal / 10L	95-950-23 3 Gal / 11L	95-943-23 5 Gal / 19L	95-944-23 8 Gal / 30L	95-945-23 10 Gal / 40L	95-946-23 16 Gal / 60L
•					
	•	•			
			•	•	
					•
•	•	•			
			•	•	
					•
•	•	•	•	•	
					•
•	•	•	•	•	
					•
•					
•	•	•			
•	•	•			
•	•	•			
	•				
		•			
			•	•	
					•
			•	•	•

- 1 MEASURING & LAYOUT TOOLS
- 2 LASER MEASURING SYSTEM
- 3 CUTTING & HOLDING TOOLS
- 4 FASTENING TOOLS
- 5 STRIKING & STRUCK TOOLS
- 6 ILLUMINATION TOOLS
- 7 PAINTING & FINISHING TOOLS
- 8 MECHANIC TOOLS
- 9 TOOLS STORAGE
- 10 POWER CLEANING TOOLS
- 11 POWER TOOLS
- 12 POWER TOOL ACCESSORIES
- 13 PRODUCT INDEX

## 10 POWER CLEANING TOOLS



### STANLEY® Pressure Washer 1400W



STPW1400

- Unique on-board storage design for all accessories
- Powerful 1400W motor
- 100 Bar Max Pressure
- With handle & wheel for easy carrying
- Cast aluminum pump for improved durability
- Auto Stop System

#### Accessories for STPW1400 include:

5m high pressure hose, variable nozzle, rotating nozzle, soap bottle, quick connect adaptors



SKU#	POWER	VOLTAGE	MAX PRESSURE	MAX FLOW	MOTOR	AUTO SHUT OFF	WEIGHT (kg)	CABLE LENGTH m
STPW1400	1400W	220V – 240V 50/60Hz	100 Bar	Max 5.5 L/Min or 330 L/Hr	UNIVERSAL	YES	5.86	5

## STANLEY® Pressure Washer 1800W



STPW1800

- Unique on-board storage design for all accessories
- Powerful 1800W motor
- 140 bar max pressure
- With handle & wheel for easy carrying
- Cast aluminum pump for improved durability Auto Stop System

Accessories for STPW1800 include:  
5m high pressure hose, variable nozzle, rotating nozzle, fixed brush, soap bottle, quick connect adaptors

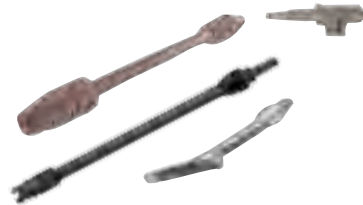

SKU#	POWER	VOLTAGE	MAX PRESSURE	MAX FLOW	MOTOR	AUTO SHUT OFF	WEIGHT (kg)	CABLE LENGTH m
STPW1800	1800W	220V – 240V 50/60Hz	140 Bar	Max 6.7 L/Min, 400 L/Hr	UNIVERSAL	YES	8.4	5

1 MEASURING & LAYOUT TOOLS

2 LASER MEASURING SYSTEM

3 CUTTING & HOLDING TOOLS

4 FASTENING TOOLS

5 STRIKING & STRUCK TOOLS

6 ILLUMINATION TOOLS

7 PAINTING & FINISHING TOOLS

8 MECHANIC TOOLS

9 TOOLS STORAGE

10 POWER CLEANING TOOLS

11 POWER TOOLS

12 POWER TOOL ACCESSORIES

13 PRODUCT INDEX

# 11 POWER TOOLS

## ERGONOMIC DESIGN, EASE OF USE & DURABILITY

With the comprehensive range of STANLEY® Power Tools, you can always find the right tool for the job. STANLEY® Power Tools range includes drills, saws, planer and grinders which are jobsite tested not just to prove they drive results, but also that they can make the job easier. Switches, adjustments, shape, weight, torque and handles are all designed with the professional contractors in mind, which is why so many professional contractors choose STANLEY® Power Tools. We're confident you'll find the right tool with the power you need to do the job better.



**DRILLING**



**METAL WORKING**



**CORDLESS**





### 100MM SLIDE SMALL ANGLE GRINDER

#### DURABILITY

- Heavy-duty Switch
- Ball Bearing Design

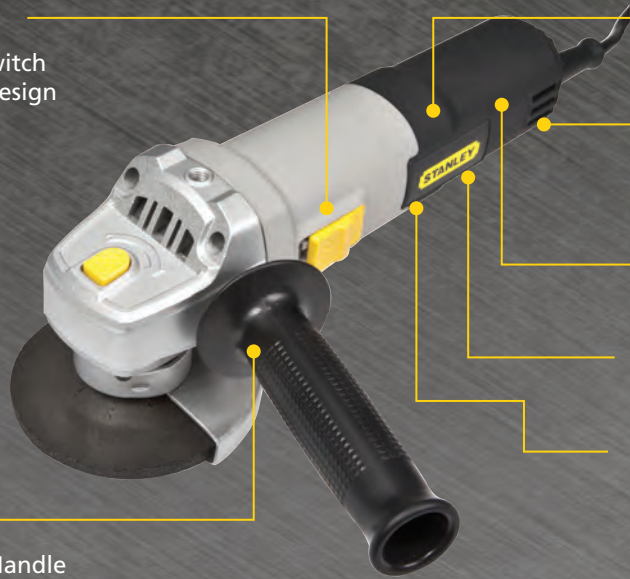

#### ERGONOMIC

Compact design for user comfort & convenience

#### ERGONOMIC

Rubber overmold for better handling

#### DURABILITY

Long-life Brushes

#### USER CONVENIENCE

Easy Access Brushes

#### HIGH PERFORMANCE

750W Powerful Motor

#### CONTROL

3-Position Side-Handle

**STEL815**

### 24MM 2 MODE SDS ROTARY HAMMER/HAMMER DRILL

#### HIGH PERFORMANCE

- 720W Powerful Motor
- Heavy-duty Chuck



#### USER

#### CONVENIENCE

Lock-on

#### VERSATILITY

- 3 Mode Selector
- Rotary Drill
- Hammer Drill
- Chiselling

#### ERGONOMIC

Soft Grip for comfortable handling

**STEL503K**

### 355MM CHOP SAW

#### HIGH PERFORMANCE

High Torque Motor

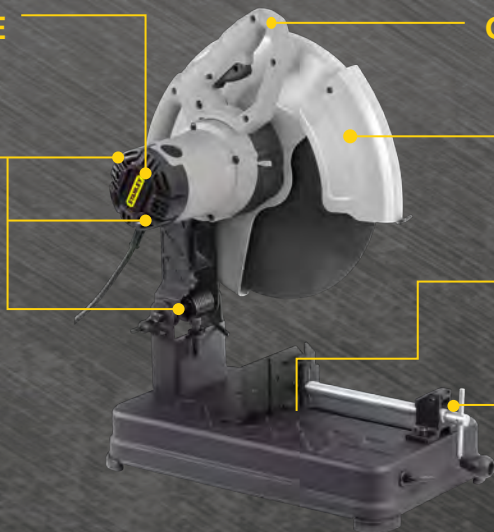

#### COMFORT & CONTROL

Horizontal Handle

#### DURABILITY

- Long-life Brushes
- Ball Bearing Design
- Super Spring

#### DURABILITY

Heavy-duty Guard

#### VERSATILITY

Mitre Adjustment

#### EASE OF USE

Quick Release Clamp

**STEL701**

## METAL WORKING

### 100mm Slim Small Angle Grinder



STEL810

SKU#	POWER	NO LOAD SPEED	SWITCH TYPE	SPINDLE SIZE	CABLE LENGTH	NET WEIGHT	CARBON BRUSH PART NUMBER
STEL810	600W	11,000rpm	Slide	M10	2m	1.52kg	1004438-40

#### FEATURES & BENEFITS

- Slim design and light weight for increased comfort & control
- External brush doors for easy access
- Excellent value for end users

### 100mm Slide Small Angle Grinder



STEL811

SKU#	POWER	NO LOAD SPEED	SWITCH TYPE	SPINDLE SIZE	CABLE LENGTH	NET WEIGHT	CARBON BRUSH PART NUMBER
STEL811	610W	11,500rpm	Slide	M10	2m	1.5kg	1004683-57

#### FEATURES & BENEFITS

- Large diameter steelgears design for longer life
- Simple brush change
- Textured body design / Taper tail design to improve handling
- Spindle lock for easy & quick accessory change

### 100mm Slide Small Angle Grinder



STEL815

SKU#	POWER	NO LOAD SPEED	SWITCH TYPE	SPINDLE SIZE	CABLE LENGTH	NET WEIGHT	CARBON BRUSH PART NUMBER
STEL815	750W	11,000rpm	Slide	M10	2m	1.7kg	1004525-38

#### FEATURES & BENEFITS

- Large diameter steelgears design for longer life
- Textured body design
- Taper tail design to improve handling
- Three-position auxiliary handle for better comfort and handling



STEL805

## 100mm Toggle Small Angle Grinder

SKU#	POWER	NO LOAD SPEED	SWITCH TYPE	SPINDLE SIZE	CABLE LENGTH	NET WEIGHT	CARBON BRUSH PART NUMBER
STEL805	750W	11,000rpm	Toggle	M10	2m	1.7kg	1004525-38

### FEATURES & BENEFITS

- Powerful motor for good performance
- Great durability
- Slim grip with toggle switch for comfortable use
- Excellent value for end users



STEL812

## 100mm Slide Small Angle Grinder

SKU#	POWER	NO LOAD SPEED	SWITCH TYPE	SPINDLE SIZE	CABLE LENGTH	NET WEIGHT	CARBON BRUSH PART NUMBER
STEL812	900W	11,000rpm	Slide	M10	2m	2.1kg	1004557-26

### FEATURES & BENEFITS

- Powerful motor - 900W for heavy-duty applications
- Great durability
- Comfortable with ergonomic design
- Easy to use
- Excellent value for end users



STEL816

## 125mm Slide Small Angle Grinder

SKU#	POWER	NO LOAD SPEED	SWITCH TYPE	SPINDLE SIZE	CABLE LENGTH	NET WEIGHT	CARBON BRUSH PART NUMBER
STEL816	750W	11,000rpm	Slide	M14	2m	1.87kg	1004525-38

### FEATURES & BENEFITS

- Powerful motor for good performance
- Comfortable with ergonomic design
- Easy to use
- Special air channels to optimize motor cooling for tool durability
- Excellent value for end users



STEL844

## 180mm Large Angle Grinder

SKU#	POWER	NO LOAD SPEED	SWITCH TYPE	SPINDLE SIZE	CABLE LENGTH	NET WEIGHT	CARBON BRUSH PART NUMBER
STEL844	2,200W	8,400rpm	Trigger	M14	3m	5.4kg	1004684-37

### FEATURES & BENEFITS

- High Performance Motor - 2200W
- Increased ergonomics
- Tool free safety guard for quick & easy adjustment
- 3 position side handle for easy control and reduce user fatigue

1 MEASURING & LAYOUT TOOLS

2 LASER MEASURING SYSTEM

3 CUTTING & HOLDING TOOLS

4 FASTENING TOOLS

5 STRIKING & STRUCK TOOLS

6 ILLUMINATION TOOLS

7 PAINTING & FINISHING TOOLS

8 MECHANIC TOOLS

9 TOOLS STORAGE

10 POWER CLEANING TOOLS

11 POWER TOOLS

12 POWER TOOL ACCESSORIES

13 PRODUCT INDEX

# 11 POWER TOOLS



## 230mm Large Angle Grinder



STEL845

SKU#	POWER	NO LOAD SPEED	SWITCH TYPE	SPINDLE SIZE	CABLE LENGTH	NET WEIGHT	CARBON BRUSH PART NUMBER
STEL845	2,200W	6,500rpm	Trigger	M14	3m	5.5kg	1004684-37

### FEATURES & BENEFITS

- High performance motor - 2200w
- Increased ergonomics
- Tool free safety guard for quick & easy adjustment
- 3 position side handle for easy control and reduce user fatigue

## Die Grinder



STEL861

SKU#	POWER	NO LOAD SPEED	CABLE LENGTH	CHUCK SIZE	CARBON BRUSH PART NUMBER
STEL861	500W	27,000rpm	Toggle	6mm	90593494

### FEATURES & BENEFITS

- Rubber padded handle for comfortable handling
- Shuttered vents to prevent dust from entering
- Brush holder cap for easy brush change
- Forward air vent to lower temperature

## 355mm Chop Saw



STEL701

SKU#	POWER	NO LOAD SPEED	CARBON BRUSH PART NUMBER
STEL701	2,100W	3,800rpm	5170001-29

### FEATURES & BENEFITS

- High performance with powerful 2,100W motor
- Easy and efficient wheel change with spindle lock
- Fast and secure material clamp with quick release mechanism

## 355mm Chop Saw



STEL705

SKU#	POWER	NO LOAD SPEED	CARBON BRUSH PART NUMBER
STEL705	2,300W	3,800rpm	5140063-05

### FEATURES & BENEFITS

- Increased performance with powerful 2,300W motor
- Easy and efficient wheel change with spindle lock
- Fast and secure material clamp with quick release mechanism

## DRILLING

### 10mm Rotary Drill



STEL101

SKU#	POWER	NO LOAD SPEED	SWITCH TYPE	REVERSE	STEEL	WOOD	CORD LENGTH	CARBON BRUSH PART NUMBER
STEL101	400W	0-2,700rpm	2- finger VSR	Yes	10mm	20mm	2m	90595071

#### FEATURES & BENEFITS

- Compact size enables easy drilling in all areas
- Increased ergonomics reduce the user fatigue
- 680W powerful motor can cover most of the applications
- Speed dial control for easy screw driving



STEL105

### 10mm Rotary Drill

SKU#	POWER	NO LOAD SPEED	SWITCH TYPE	REVERSE	STEEL	WOOD	CORD LENGTH	CARBON BRUSH PART NUMBER
STEL105	420W	0-3,000rpm	2- finger VSR	Yes	10mm	20mm	3m	673916-03

#### FEATURES & BENEFITS

- Cast aluminium and 420W Motor
- Ball bearing construction
- New ergonomic design - balanced for the professional user



STEL145

### 10mm Percussion Drill

SKU#	POWER	NO LOAD SPEED	SWITCH TYPE	REVERSE	STEEL	WOOD	MASONRY	CORD LENGTH	CARBON BRUSH PART NUMBER
STEL145	500W	0-3,000rpm	2- finger VSR	Yes	10mm	20mm	13mm	3m	673916-03

#### FEATURES & BENEFITS

- Cast aluminium and 500W Motor
- Ball bearing construction - smoother operation and longer life
- 2-Tools-in-1: Hammer Mode - for masonry work and drill mode for drilling and driving

- 1 MEASURING & LAYOUT TOOLS
- 2 LASER MEASURING SYSTEM
- 3 CUTTING & HOLDING TOOLS
- 4 FASTENING TOOLS
- 5 STRIKING & STRUCK TOOLS
- 6 ILLUMINATION TOOLS
- 7 PAINTING & FINISHING TOOLS
- 8 MECHANIC TOOLS
- 9 TOOLS STORAGE
- 10 POWER CLEANING TOOLS
- 11 POWER TOOLS
- 12 POWER TOOL ACCESSORIES
- 13 PRODUCT INDEX

# 11 POWER TOOLS

## 10mm Percussion Drill With Kit Box & Acc



STEL141K

SKU#	POWER	NO LOAD SPEED	SWITCH TYPE	REVERSE	STEEL	WOOD	MASONRY	CORD LENGTH	CARBON BRUSH PART NUMBER
STEL141K	550W	0-2,800rpm	2- finger VSR	Yes	10mm	20mm	13mm	2m	90579768

### FEATURES & BENEFITS

- 550W powerful motor for good performance
- Variable speed offers more control and is essential for driving screws
- Soft grip - more comfortable and ease of control
- Secondary handle to provide additional control

## 13mm Percussion Drill



STEL146

SKU#	POWER	NO LOAD SPEED	SWITCH TYPE	REVERSE	STEEL	WOOD	MASONRY	CORD LENGTH	CARBON BRUSH PART NUMBER
STEL146	620W	0-3,000rpm	2- finger VSR	Yes	13mm	25mm	16mm	3m	637916-03

### FEATURES & BENEFITS

- High quality ball bearing and pre-cast aluminium design for longer life
- Both drilling and driving tools in 1
- "2 finger" variable speed control for ease of use

## 13mm Percussion Drill With Kit Box & Acc



STEL142K

SKU#	POWER	NO LOAD SPEED	SWITCH TYPE	REVERSE	STEEL	WOOD	MASONRY	CORD LENGTH	CARBON BRUSH PART NUMBER
STEL142K	650W	0-2,800rpm	2- finger VSR	Yes	13mm	25mm	16mm	2m	90579768

### FEATURES & BENEFITS

- 650W powerful motor for good performance
- Variable speed offers more control and is essential for driving screws
- Soft grip - more comfortable and ease of control
- Secondary handle to provide additional control

## CONCRETE WORKING

### 22mm 3-Mode Rotary Hammer/ Hammer Drill



STEL503K

SKU#	POWER	CHUCK	NO LOAD SPEED	BPM	IMPACT ENERGY	VSR	CABLE LENGTH	CARBON BRUSH PART NUMBER
STEL503	720W	22 mm	0 - 980rpm	0 - 5,200	2J	Yes	2m	90587066

#### FEATURES & BENEFITS

- 51 Chisel positions (3 modes) for maximum convenience
- 2J Impact energy for great power & performance
- Ergonomic design for comfort & control
- 3 Application modes (Rotary Drill/Hammer Drill/Chiselling)
- Variable speed F/R switch max control

### 24mm 2-Mode SDS Rotary Hammer/Hammer Drill



STEL505K

SKU#	POWER	CHUCK	NO LOAD SPEED	BPM	IMPACT ENERGY	VSR	CABLE LENGTH	CARBON BRUSH PART NUMBER
STEL505K	750W	24mm	0 - 1,050rpm	0 - 5,000	2.7J	Yes	2.5m	1004518-50

#### FEATURES & BENEFITS

- 51 Chisel positions (3 modes) for maximum convenience
- 2.7J Impact energy for great power & performance
- Ergonomic design for comfort & control
- 3 Application modes (Rotary Drill/Hammer Drill/Chiselling)
- Variable speed F/R switch max control

### 24mm 3-Mode Rotary Hammer/Hammer Drill



STEL506K

SKU#	POWER	CHUCK	NO LOAD SPEED	BPM	IMPACT ENERGY	VSR	CABLE LENGTH	CARBON BRUSH PART NUMBER
STEL506K	750W	24mm	0 - 1,050rpm	0 - 5,000	2.7J	Yes	2m	1004518-50

#### FEATURES & BENEFITS

- 51 Chisel positions (3 modes) for maximum convenience
- 2.7J Impact energy for great power & performance
- Ergonomic design for comfort & control
- 3 Application modes (Rotary Drill/Hammer Drill/Chiselling)
- Variable speed F/R switch max control

1 MEASURING & LAYOUT TOOLS

2 LASER MEASURING SYSTEM

3 CUTTING & HOLDING TOOLS

4 FASTENING TOOLS

5 STRIKING & STRUCK TOOLS

6 ILLUMINATION TOOLS

7 PAINTING & FINISHING TOOLS

8 MECHANIC TOOLS

9 TOOLS STORAGE

10 POWER CLEANING TOOLS

11 POWER TOOLS

12 POWER TOOL ACCESSORIES

13 PRODUCT INDEX

# 11 POWER TOOLS



STEL785

## 110mm Tile Cutter

SKU#	POWER	WHEEL DIAMETER	NO LOAD SPEED	MAX. CAPACITY	NET. WEIGHT	CABLE LENGTH	CARBON BRUSH PART NUMBER
STEL785	1,200W	110mm	13,000rpm	34mm	2.7kg	2m	90553946

### FEATURES & BENEFITS

- High torque efficient motor increases performance & durability
- Ergonomic compact design for better user handling & ease of use
- Super extended brush life increases productivity



## CORDLESS



STDC801NB

### 9.6V Cordless Drill, 2 Batt, 1.5 Hrs Charger

SKU#	VOLTAGE	CHUCK SIZE	NO LOAD SPEED	MAX TORQUE	CLUTCH SETTING	REVERSE	STEEL	WOOD
STDC801NB	9.6V	10mm	0 - 750rpm	10.4Nm	24	Yes	10mm	25mm

#### FEATURES & BENEFITS

- 24 torque clutch - for perfect screwdriving into a variety of materials with different screw sizes
- Spring loaded slide pack battery system for quick and easy battery change and a more secure fit
- Reverse switch for added versatility



STDC005NB

### 12V Cordless Drill/ Driver

SKU#	VOLTAGE	CHUCK SIZE	NO LOAD SPEED	MAX TORQUE	CLUTCH SETTING	REVERSE	STEEL	WOOD
STDC005NB	12V	10mm	0 - 350/0 - 1,200rpm	21Nm	16	Yes	10mm	25mm

#### FEATURES & BENEFITS

- High performance motor for maximum power & durability
- Super compact & light weight design brings superior comfort & ease of use
- Variable speed & reverse with 2 speed gear-box ensures maximum control & performance



STDC001NB

### 12V Cordless Drill, 2 Batt, 1.5Hrs Charger

SKU#	VOLTAGE	CHUCK SIZE	NO LOAD SPEED	MAX TORQUE	CLUTCH SETTING	REVERSE	STEEL	WOOD
STDC001NB	12V	10mm	0 - 750rpm	11Nm	24	Yes	10mm	25mm

#### FEATURES & BENEFITS

- 24 torque clutch - for perfect screwdriving into a variety of materials with different screw sizes
- Spring loaded slide pack battery system for quick and easy battery change and a more secure fit
- Reverse switch for added versatility

- 1 MEASURING & LAYOUT TOOLS
- 2 LASER MEASURING SYSTEM
- 3 CUTTING & HOLDING TOOLS
- 4 FASTENING TOOLS
- 5 STRIKING & STRUCK TOOLS
- 6 ILLUMINATION TOOLS
- 7 PAINTING & FINISHING TOOLS
- 8 MECHANIC TOOLS
- 9 TOOLS STORAGE
- 10 POWER CLEANING TOOLS
- 11 POWER TOOLS
- 12 POWER TOOL ACCESSORIES
- 13 PRODUCT INDEX

# 11 POWER TOOLS



STDC201NB

## 14.4V Cordless Drill, 2 Batt, 1.5 Hrs Charger

SKU#	VOLTAGE	CHUCK SIZE	NO LOAD SPEED	MAX TORQUE	CLUTCH SETTING	REVERSE	STEEL	WOOD
STDC201NB	14.4V	10mm	0 - 750rpm	12.1Nm	24	Yes	10mm	25mm

### FEATURES & BENEFITS

- 24 torque clutch - for perfect screwdriving into a variety of materials with different screw sizes
- Spring loaded slide pack battery system for quick and easy battery change and a more secure fit
- Reverse switch for added versatility



STDC001LB

## 10.8V Li-ion Drill

SKU#	VOLTAGE	BATTERY AMP/HOUR	BATTERY TYPE	CHUCK SIZE	NO LOAD SPEED	MAX TORQUE	CLUTCH SETTING	RE-VERSE
STDC001LB	10.8V	1.3Ah	Lithium Ion	10mm	0 - 315 / 0 - 1,200rpm	27Nm	20	Yes

### FEATURES & BENEFITS

- Compact size with high power
- Magnetic bit storage & belt clip
- Intelligent energy efficient fast charger
- Comfortable with ergonomic design
- Easy to use



STDC041LB

## 10.8V Li-ion Impact Drill

SKU#	VOLTAGE	BATTERY AMP/HOUR	BATTERY TYPE	CHUCK SIZE	NO LOAD SPEED	MAX TORQUE	REVERSE
STDC041LB	10.8V	1.3Ah	Lithium Ion	6.35mm	0 - 2,400 rpm	107Nm	Yes

### FEATURES & BENEFITS

- Compact size with high power
- Anti-vibration, rubber padded handle improves handling, comfort & safety
- Belt hook for safety and prevents accidental drops
- Energy efficient & fast charging



STDC441LB

## 18V Impact Driver

SKU#	VOLTAGE	BATTERY AMP/HOUR	BATTERY TYPE	CHUCK SIZE	NO LOAD SPEED	MAX TORQUE	REVERSE
STDC441LB	18V	1.5Ah	Li-ion	6.35mm	0 - 2,800rpm	164Nm	Yes

### FEATURES & BENEFITS

- VSR switch and Lock on
- Battery energy indicator
- 18V Lithium Battery
- Two bits holder for user convenience
- Two position belt hook



STDC130LA

## 10.8V Li-ion Recip Saw, 1 Batt, 1 Charger

SKU#	VOLTAGE	STROKES/MIN	STROKE LENGTH	KEYLESS BLADE CLAMP	OBITAL ACTION	ADJUSTABLE SHOE	VARIABLE-SPEED TRIGGER
STDC130LA	10.8V	0-3,000spm	16mm	Yes	No	Yes	Yes

### FEATURES & BENEFITS

- Reduces material vibration and allows for one handed use
- Could use as a traditional Reciprocating Saw or Jigsaw
- Charger will auto cut-off when battery is fully charged
- Delivers fast straight-cutting and controlled detail-cutting



STBT12L

## Cordless 10.8V Battery & Charger

SKU#	DESCRIPTION	Voltage	Battery Type	Battery Capacity	Charging Time	Part Number
STBT12L	Battery	10.8V *Comes with Blister Pack	Lithium-Ion	1.3Ah	-	-
	Charger	10.8V * Available as spare part	Lithium-Ion	-	30 mins	90576992

\* only available for STANLEY® 10.8V Li-Ion Power Tools

1 MEASURING & LAYOUT TOOLS

2 LASER MEASURING SYSTEM

3 CUTTING & HOLDING TOOLS

4 FASTENING TOOLS

5 STRIKING & STRUCK TOOLS

6 ILLUMINATION TOOLS

7 PAINTING & FINISHING TOOLS

8 MECHANIC TOOLS

9 TOOLS STORAGE

10 POWER CLEANING TOOLS

11 POWER TOOLS

12 POWER TOOL ACCESSORIES

13 PRODUCT INDEX

## WOOD WORKING

### Planer



STEL630

SKU#	POWER	VOLTAGE	DEPTH OF CUT (PLANER)	WIDTH OF CUT (PLANER)	SPEED	NO LOAD SPEED	REBATING DEPTH	CARBON BRUSH PART NUMBER
STEL630	750W	230V	0-2.0mm	82mm	Single	16,000rpm	12mm	1004526-16

#### FEATURES & BENEFITS

- Left & right dust extraction which can be used in any direction with effective dust extraction
- 12 Position dial at 0.2mm increments for increased accuracy
- Improved dust bag design for easy-fit and enhanced dust entrapment
- 3 Chamfer grooves to maximize versatility
- Increased rebate cut with 12mm maximum depth of cut

### 1/3 Sheet Sander



STEL421

SKU#	POWER	NO-LOAD OSCILLATIONS	NO LOAD ORBITS	CARBON BRUSH NUMBER
STEL421	210W	14,000 - 30,000/min	7,000 - 15,000/min	90579732

#### FEATURES & BENEFITS

- Compact design gets you closer to the work surface for greater control
- Variable speed for greater control when sanding
- Large orbit size and high sander speed for faster material removal
- Lightweight sander with front and rear handles for maximum comfort and control
- Quick & easy paper change - hook & loop or traditional clip attachment
- Ergonomic front handle allows for comfortable operation of the sander

### 1/4 Sheet Sander



STEL401

SKU#	POWER	NO-LOAD OSCILLATIONS	NO LOAD ORBITS	CARBON BRUSH NUMBER
STEL401	220W	32,000/min	16,000/min	90579705

#### FEATURES & BENEFITS

- Powerful 220W motor gets the job done quicker
- Compact design gets you closer to the work surface for greater control
- Large orbit size and high sander speed for faster material removal
- Palm grip design for single-handed sanding
- Quick & easy paper change - hook & look or traditional clip attachment
- Large quality dust bag ensure less mess when sanding for clearer work area

## Jigsaw



STEL345

SKU#	POWER	NO-LOAD OSCILLATIONS	STROKE LENGTH	WEIGHT	CABLE LENGTH	CARBON BRUSH PART NUMBER
STEL345	650W	3,200/min	20mm	2.7kg	3m	90554571

### FEATURES & BENEFITS

- 650W motor delivers power in demanding applications
- 7 position speed dial (0- 3,200 SPM) provides multiple speed settings for optimal cutting results
- 4 Orbital settings provides best cutting performance in a variety of materials
- Tool free bevel adjustment at 0°, 15°, 30° and 45° makes bevel changes fast and easy
- Keyless blade change makes blade replacements fast and easy
- LED light provides greater visibility on the cutting surface
- Soft grip handle and front grip area provides greater control and comfort during use

1 MEASURING & LAYOUT TOOLS

2 LASER MEASURING SYSTEM

3 CUTTING & HOLDING TOOLS

4 FASTENING TOOLS

5 STRIKING & STRUCK TOOLS

6 ILLUMINATION TOOLS

7 PAINTING & FINISHING TOOLS

8 MECHANIC TOOLS

9 TOOLS STORAGE

10 POWER CLEANING TOOLS

11 POWER TOOLS

12 POWER TOOL ACCESSORIES

13 PRODUCT INDEX

# 11 POWER TOOLS

## SAWS

### Reciprocating Saw



STEL365

SKU#	POWER	STROKES/MIN	STROKE LENGTH	KEYLESS BLADE CLAMP	ADJUSTABLE SPEED TRIGGER
STEL365	850W	0 - 3,200rpm	28.5mm	Yes	Yes

#### FEATURES & BENEFITS

- 850W powerful motor
- High quality switch
- Soft grip to deliver best comfort for end users
- Keyless blade clamp
- Adjustable material fence for various cutting applications

### Circular Saw



STEL311

SKU#	POWER	NO LOAD SPEED	BLADE DIAMETER	DEPTH OF CUT	BEVEL CAPACITY
STEL311	1,510W	5,500rpm	185mm	62mm	45 Degrees

#### FEATURES & BENEFITS

- 1510W powerful motor
- Soft grip for comfortable handling
- Dust extraction lever
- Front of handle
- Retractable lower guard
- Quick release depth adjustment
- Steel-stamped shoe
- 0 - 45 degrees bevel

## GENERAL APPLICATIONS

### Heatgun



STEL670

SKU#	POWER	HEAT SETTING	SWITCH CONTROL	TEMPERATURE	AIR FLOW	CABLE LENGTH
STEL670	2,000W	Variable	2 Stages	50-450°C/ 90-600°C	300 litres per min/ 500 litres per min	3m

#### FEATURES & BENEFITS

- Spherical nozzle avoid accidental blockages during operations
- Versatility of application : Full variable temperature settings and two air flow stages
- Self-standing design for hands-free use

### Blower



STEL680

SKU#	POWER	NO LOAD SPEED	AIR VOLUME	CORD LENGTH	CARBON BRUSH PART NUMBER
STEL680	600W	0 - 11,000rpm	3.5m <sup>3</sup> /min	3m	1004138-00

#### FEATURES & BENEFITS

- 600W powerful motor
- Variable speed control
- 2-tools-in-1: Blower and vacuum cleaner

1 MEASURING & LAYOUT TOOLS

2 LASER MEASURING SYSTEM

3 CUTTING & HOLDING TOOLS

4 FASTENING TOOLS

5 STRIKING & STRUCK TOOLS

6 ILLUMINATION TOOLS

7 PAINTING & FINISHING TOOLS

8 MECHANIC TOOLS

9 TOOLS STORAGE

10 POWER CLEANING TOOLS

11 POWER TOOLS

12 POWER TOOL ACCESSORIES

13 PRODUCT INDEX

# 12 POWER TOOL ACCESSORIES

PROFESSIONAL DESIGN, VERSATILITY & DURABILITY

Selecting the best drill bit, abrasive wheel or other professional power tool accessory to get the job done is as important as choosing the right power tool. STANLEY®'s product and engineering teams spend thousands of hours on jobsites during product design; testing the performance of our accessories. We rigorously test our products under demanding conditions and deliver innovative solutions that matter and measure up – accessories that work for you and your job.

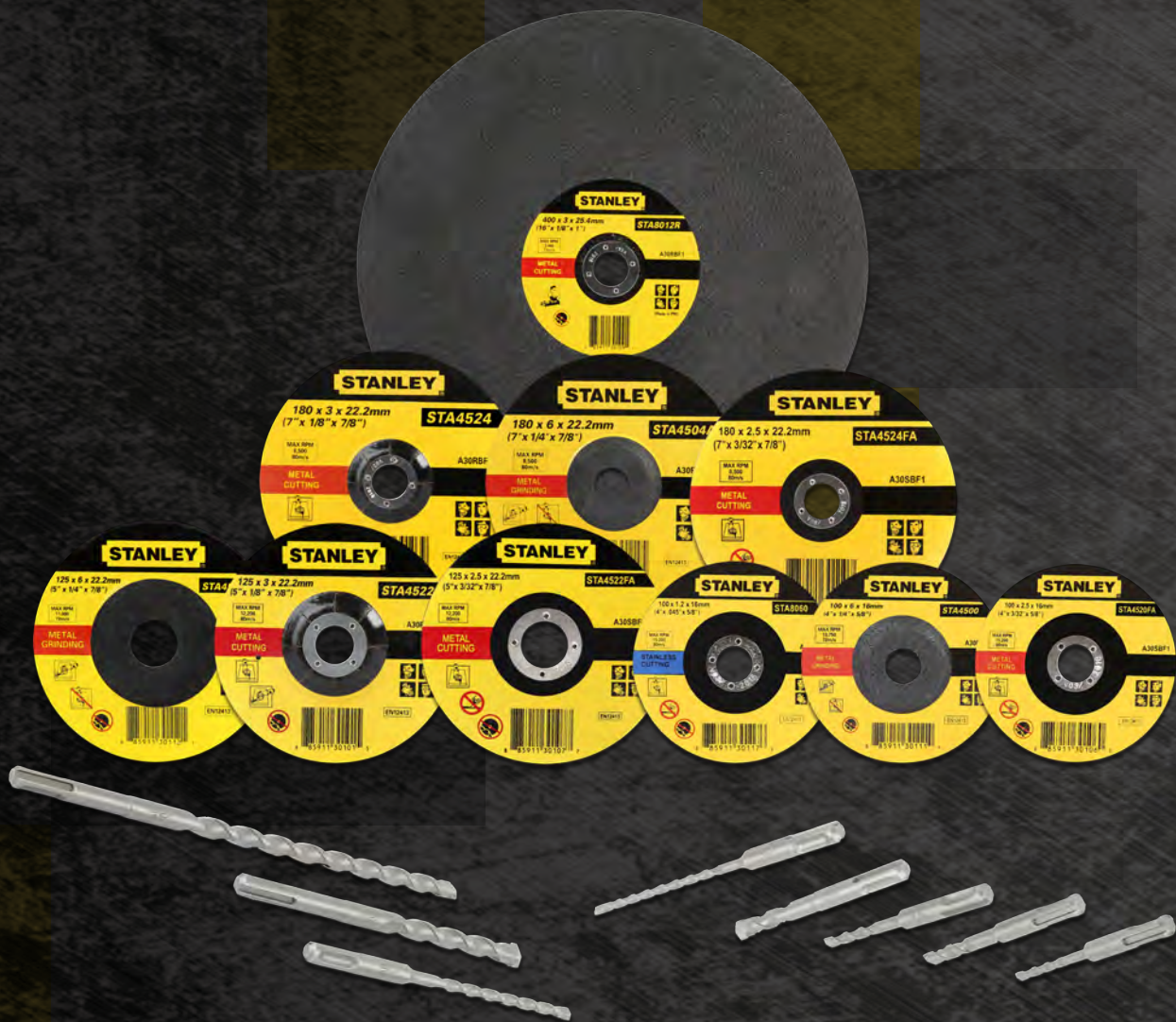



## GRINDING WHEELS

### KEY FEATURES

REINFORCED WITH 2.5 GLASS FIBRES THAT PROVIDE STRENGTH AND SAFETY

ROUGH ON GRINDING FACE WITH SHARP ABRASIVES

WELL BALANCED WHEEL

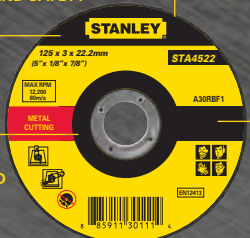

CONTROLLED DIMENSIONAL TOLERANCES

### WIN WITH STANLEY

- Superior performance - 13% to 34% faster than competition
- Good wheel life
- Designed for safety
- Consistent quality
- Best suited for a variety of jobs

### APPLICATIONS

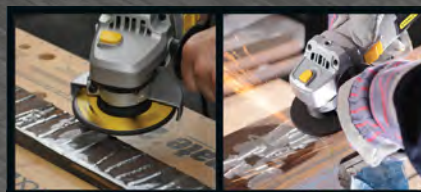

STANLEY ABRASIVES GRIND FASTER BY 13% TO 34% PERFORMANCE CHART\*

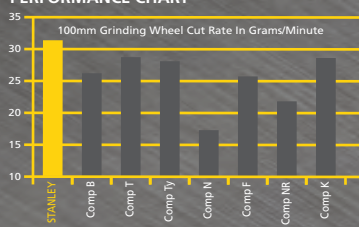

\* Performance of Grinding Wheels was evaluated with an automated test rig on standard steel and grinding conditions.

## CHOP SAW CUTTING WHEELS

### KEY FEATURES

REINFORCEMENT OF GLASS FIBRE INCREASES STRENGTH AND PROVIDES WHEEL SAFETY

ROUGH GRINDING SURFACE WITH SHARP ABRASIVES

WELL BALANCED WHEEL



CONTROLLED DIMENSIONAL TOLERANCES

### WIN WITH STANLEY

- Superior performance
- Longer life: 5% to 86% longer than competition
- Better cutting
- Designed for safety
- Consistent quality
- Best suited for a variety of jobs

### APPLICATIONS



STANLEY CHOP SAW WHEELS LASTS LONGER BY 5% TO 86% PERFORMANCE CHART\*

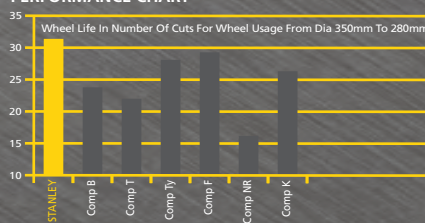

\* Performance of Chop Saw Wheels was evaluated with an automated test rig on standard steel and cutting conditions.

## SDS PLUS CARBIDE DRILL BITS

### KEY FEATURES



SUPERIOR QUALITY OF CARBIDE

FLUTE DESIGNED FOR FASTER DRILLING

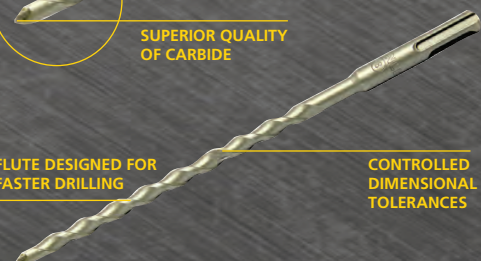

CONTROLLED DIMENSIONAL TOLERANCES

### WIN WITH STANLEY

- Superior performance on hard concrete and bricks
- Longer life: 4.5% to 16% longer than competition
- Consistent quality

### APPLICATIONS



STANLEY SDS PLUS CARBIDE DRILL BITS LASTS LONGER BY 4.5% TO 16% PERFORMANCE CHART\*

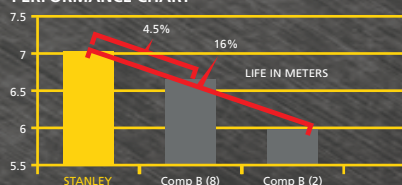

\* Performance of Carbide Drill Bits was evaluated with an automated test rig on hard concrete and standard drilling conditions.

## 12 POWER TOOL ACCESSORIES



### Grinding Wheels



STA4502A

SKU#	TYPE	DIAMETER mm	THICKNESS mm	BORE mm	GRADE	MAX RPM	UNITS PER PACK
STA4510	27	100	4	16	Metal	13,750	25
STA4500	27	100	6	16	Metal	13,750	25
STA4502A	27	125	6	22.2	Metal	11,000	25
STA4503A	27	150	6	22.2	Metal	10,100	10
STA4504A	27	180	6	22.2	Metal	8,500	10
STA4505A	27	230	6	22.2	Metal	6,600	10

#### FEATURES & BENEFITS

- Grinding of steel, iron plates, rebar & weld
- Good grinding efficiency
- High quality aluminum oxide grain
- Reinforced fibreglass for high durability

### Cutting Wheels



STA4524FA

SKU#	TYPE	DIAMETER mm	THICKNESS mm	BORE mm	GRADE	MAX RPM	UNITS PER PACK
STA8060	1	100	1.2	16	Stainless Steel	15,200	25
STA8050	1	100	1.6	16	Stainless Steel	15,200	25
STA4520FA	1	100	2.5	16	Metal	15,200	25
STA4522FA	1	125	2.5	22.2	Metal	12,200	25
STA4523FA	1	150	2.5	22.2	Metal	10,100	10
STA4524FA	1	180	2.5	22.2	Metal	8,500	10

#### FEATURES & BENEFITS

- Cutting of steel, iron plates, rebar & weld
- Good cutting efficiency
- High quality aluminum oxide grain
- Reinforced fibreglass for high durability

## Grinding/ Cutting Wheels



STA4522

SKU#	TYPE	DIAMETER mm	THICKNESS mm	BORE mm	GRADE	MAX RPM	UNITS PER PACK
STA4520	27	100	3	16	Metal	15,200	25
STA4522	27	125	3	22.2	Metal	12,200	25
STA4523	27	150	3	22.2	Metal	10,100	10
STA4524	27	180	3	22.2	Metal	8,500	10

### FEATURES & BENEFITS

- Cutting & grinding of steel, iron plates, rebar & weld
- Good cutting and grinding efficiency
- High quality aluminum oxide grain
- Reinforced fibreglass for high durability

## Chop Saw Wheels



STA8011R

SKU#	TYPE	DIAMETER mm	THICKNESS mm	BORE mm	GRADE	MAX RPM	UNITS PER PACK
STA8011R	1	350	3	25.4	Metal	3875	10
STA8012R	1	400	3	25.4	Metal	3440	10

### FEATURES & BENEFITS

- Cutting of steel, iron plates, rebar & weld
- Good cutting efficiency
- High quality aluminum oxide grain
- Reinforced fibreglass for high durability

1 MEASURING & LAYOUT TOOLS

2 LASER MEASURING SYSTEM

3 CUTTING & HOLDING TOOLS

4 FASTENING TOOLS

5 STRIKING & STRUCK TOOLS

6 ILLUMINATION TOOLS

7 PAINTING & FINISHING TOOLS

8 MECHANIC TOOLS

9 TOOLS STORAGE

10 POWER CLEANING TOOLS

11 POWER TOOLS

12 POWER TOOL ACCESSORIES

13 PRODUCT INDEX

## 12 POWER TOOL ACCESSORIES



### Circular Saw Blades (Wood)

- Tungsten carbide tips for longer life
- Thin kerf design for more efficient cuts
- Expansion slot for longer lasting blade due to cooler cutting
- For ripping and cross cutting of hard/soft wood, plywood
- Manufactured with Auto-grinding and Auto-welding processes



20-521

SKU#	DESCRIPTION	RPM	WEIGHT	BOX/CTN
20-521	Circular Saw Blade For Wood - 7 1/4" x 1" x 24T with 16 & 20mm Adaptor	7500	0.340	25/50
20-522	Circular Saw Blade For Wood - 7 1/4" x 1" x 40T with 16 & 20mm Adaptor	7500	0.340	25/50
20-523	Circular Saw Blade For Wood - 7 1/4" x 1" x 60T with 16 & 20mm Adaptor	7500	0.340	25/50
20-524	Circular Saw Blade For Wood - 8 1/4" x 1" x 40T with 16 & 20mm Adaptor	7000	0.420	25/50
20-525	Circular Saw Blade For Wood - 8 1/4" x 1" x 60T with 16 & 20mm Adaptor	7000	0.420	25/50
20-535	Circular Saw Blade For Wood - 10" x 1" x 40T with 16 & 20mm Adaptor	5500	0.800	25/25
20-536	Circular Saw Blade For Wood - 10" x 1" x 60T with 16 & 20mm Adaptor	5500	0.800	25/25
20-537	Circular Saw Blade For Wood - 12" x 1" x 100T with 16 & 20mm Adaptor	4500	1.250	20/20

### Circular Saw Blades (Non-Ferrous)

- Tungsten carbide tips for longer life
- Thin kerf design for more efficient cuts
- Expansion slot for longer lasting blade due to cooler cutting
- For cutting of Aluminum, Copper, Lead, Zinc, Tin



20-538

SKU#	DESCRIPTION	RPM	WEIGHT	BOX/CTN
20-538	Circular Saw Blade For Aluminum - 10" x 1" x 100T with 16 & 20mm Adaptor	5500	0.800	25/25
20-539	Circular Saw Blade For Aluminum - 10" x 1" x 120T with 16 & 20mm Adaptor	5500	0.800	25/25

## 12 POWER TOOL ACCESSORIES

### SDS Plus Hammer Carbide Drill Bits



SKU#	PRODUCT DESCRIPTION	DIAMETER mm	TOTAL LENGTH mm
STA54237-XJ	SDS Hammer	4	110
STA54002-XJ	SDS Hammer	5	110
STA54282-XJ	SDS Hammer	5	160
STA54007-XJ	SDS Hammer	5.5	110
STA54277-XJ	SDS Hammer	5.5	160
STA54012-XJ	SDS Hammer	6	110
STA54032-XJ	SDS Hammer	6	160
STA54312-XJ	SDS Hammer	6.5	110
STA54147-XJ	SDS Hammer	6.5	160
STA54152-XJ	SDS Hammer	7	160
STA54022-XJ	SDS Hammer	8	110
STA54037-XJ	SDS Hammer	8	160
STA54057-XJ	SDS Hammer	8	210
STA54317-XJ	SDS Hammer	8	260
STA54027-XJ	SDS Hammer	10	110
STA54042-XJ	SDS Hammer	10	160
STA54062-XJ	SDS Hammer	10	210
STA54207-XJ	SDS Hammer	10	260
STA54322-XJ	SDS Hammer	10	310
STA54047-XJ	SDS Hammer	12	160
STA54067-XJ	SDS Hammer	12	210

#### FEATURES & BENEFITS

- Drilling on hard concrete & bricks
- Long life
- Excellent durability

SKU#	PRODUCT DESCRIPTION	DIAMETER mm	TOTAL LENGTH mm
STA54097-XJ	SDS Hammer	12	260
STA54327-XJ	SDS Hammer	12	310
STA54122-XJ	SDS Hammer	12	450
STA54332-XJ	SDS Hammer	13	160
STA54337-XJ	SDS Hammer	13	260
STA54052-XJ	SDS Hammer	14	160
STA54072-XJ	SDS Hammer	14	210
STA54102-XJ	SDS Hammer	14	310
STA54077-XJ	SDS Hammer	16	210
STA54107-XJ	SDS Hammer	16	310
STA54127-XJ	SDS Hammer	16	450
STA54082-XJ	SDS Hammer	18	210
STA54112-XJ	SDS Hammer	18	310
STA54132-XJ	SDS Hammer	18	450
STA54087-XJ	SDS Hammer	20	210
STA54117-XJ	SDS Hammer	20	310
STA54137-XJ	SDS Hammer	20	450
STA54357-XJ	SDS Hammer	22	250
STA54217-XJ	SDS Hammer	22	450
STA54362-XJ	SDS Hammer	24	450
STA54367-XJ	SDS Hammer	25	250
STA54227-XJ	SDS Hammer	25	450

1 MEASURING & LAYOUT TOOLS

2 LASER MEASURING SYSTEM

3 CUTTING & HOLDING TOOLS

4 FASTENING TOOLS

5 STRIKING & STRUCK TOOLS

6 ILLUMINATION TOOLS

7 PAINTING & FINISHING TOOLS

8 MECHANIC TOOLS

9 TOOLS STORAGE

10 POWER CLEANING TOOLS

11 POWER TOOLS

12 POWER TOOL ACCESSORIES

13 PRODUCT INDEX

217

# PRODUCT INDEX

SKU#	Descriptor	Page	SKU#	Descriptor	Page
0-77-018	INTELLIMEASURE ULTRASONIC DISTANCE ESTIMATOR	25	12-312-0	SINGLE IRON - 25mm/ 1"	121
0-77-030	STANLEY® MOISTURE METER	31	12-312-1	SINGLE IRON - 45mm/ 1-3/4"	121
0-77-500	INTELLILASER PRO 2	31	12-313-0	SINGLE IRON - 50mm/2" (CARDED)	121
02-110	BIT BRACE - 255mm/10"	66	12-313-1	SINGLE IRON - 50mm/2"	121
02-112	BIT BRACE - 305mm/12"	66	12-330-0	REPLACEMENT PANE IRON (COMPATIBLE TO 12-116)	121
02-130	BIT BRACE - 255mm/10"	66	12-336-1	SPOKESHAVES BLADE	120
03-011	HAND DRILL - 305mm/12" (1/4" CHUCK)	67	12-350-1	SPOKESHAVES BLADE	120
03-608	HAND DRILL - 305mm/12" (5/16" CHUCK)	67	12-504-0	REPLACEMENT PANE IRON (COMPATIBLE TO 12-060)	121
04-006	POWERBORE BITS - 140mm/5-1/2" (3/8" CHUCK)	67	12-508-0	REPLACEMENT PANE IRON (COMPATIBLE TO 12-020 & 12-220)	121
04-008	POWERBORE BITS - 140mm/5-1/2" (1/2" CHUCK)	67	13011	12.5" SERIES 2000 WITH 2 BUILT-IN ORGANIZERS & TRAY	181
04-010	POWERBORE BITS - 140mm/5-1/2" (5/8" CHUCK)	67	14-125	GLASS CUTTER - 130mm	52
04-012	POWERBORE BITS - 140mm/5-1/2" (3/4" CHUCK)	67	14-163	TINSNIP - 8"	58
04-014	POWERBORE BITS - 140mm/5-1/2" (7/8" CHUCK)	67	14-164	TINSNIP - 10"	58
04-016	POWERBORE BITS - 140mm/5-1/2" (1" CHUCK)	67	14-165	TINSNIP - 12"	58
1-77-021	FATMAX® CL901 CROSSLINE LASER	28	14-166	TINSNIP - 14"	58
1-77-022	STANLEY® LASER TRIPOLE	35	14-302	PRUNING SHEARS - 200mm/8" (BYPASS)	59
1-77-023	FATMAX® LINE DETECTOR	34	14-303	PRUNING SHEARS - 200mm/8" (ANVIL)	59
1-77-118	FATMAX® PB3 SELF-LEVELING MULTI-CROSS DOT LASER	30	14-308	BOLT CUTTER - 203mm/8"	59
1-77-119	FATMAX® PB3 SELF-LEVELING MULTI-CROSS DOT LASER	30	14-312	BOLT CUTTER - 305mm/12"	59
1-77-120	FATMAX® CL21 CROSSLINE LASER	28	14-314	BOLT CUTTER - 355mm/14"	59
1-77-122	FATMAX® MULTILINE LASER	27	14-318	BOLT CUTTER - 457mm/18"	59
1-77-160	AL24 GVP LEVELLING SET	25	14-324	BOLT CUTTER - 609mm/24"	59
1-77-161	5 SECTION 5M GRADE ROD ALUMINIUM	35	14-330	BOLT CUTTER - 762mm/30"	59
1-77-163	ALUMINIUM TRIPOD 97CM TO 160CM	34	14-336	BOLT CUTTER - 914mm/36"	59
1-77-164	ALUMINIUM TRIPOD 119CM TO 292CM	34	14-442	PVC PIPE CUTTER - 42mm	64
1-77-171	LASER GLASSES	35	14-556	MAXSTEEL™ ALL PURPOSE SNIP - 254mm/10"	58
1-77-201	CAMERA TRIPOD	35	14-558	MAXSTEEL™ ALL PURPOSE SNIP - 305mm/12"	58
1-77-221	PROFESSIONAL POLE W/ MAGNETIC MOUNT	34	14-562	MAXSTEEL AVIATION SNIP - 254mm/10", LEFT CURVE	58
1-77-319	SLP5 SELF-LEVELING 5-POINT LASER LEVEL	29	14-563	MAXSTEEL AVIATION SNIP - 254mm/10", STRAIGHT CUT	58
1-77-321	SCL-D SELF-LEVELING CROSS LASER	29	14-564	MAXSTEEL AVIATION SNIP - 254mm/10", RIGHT CURVE	58
1-77-322	FATMAX® SML MULTILINE LASER	27	14-569	MAXSTEEL™ ALL PURPOSE SNIP - 178mm/7"	58
1-77-427	FATMAX® ROTARY LASER RL HVWP	26	14004	ORGANIZER 160 14 COMPARTMENTS ORGANIZER	183
1-77-429	FATMAX® ROTARY LASER RL HW+	26	14209	9 COMPARTMENT PROFESSIONAL ORGANIZER	183
1-77-439	FATMAX® ROTARY LASER RL HGW	26	14325	25 COMPARTMENT PROFESSIONAL ORGANIZER	183
10-065	PLASTIC RETRACTABLE KNIFE	39	14408	8 COMPARTMENT PROFESSIONAL ORGANIZER	183
10-099	CLASSIC 99 RETRACTABLE UTILITY KNIFE	38	15-005	FOLDING POCKET SAW - 8" (15-333) REPLACEMENT BLADE	48
10-131	BASIC SNAP OFF KNIFE - 9mm	40	15-022	10" BLADE LENGTH x 15 POINTS PER INCH DOVETAIL SAW	49
10-143	BASIC SNAP OFF KNIFE - 18mm	40	15-059	CHOPING SAW BLADE - 6-1/2"/20TPI (4/PK)	47
10-150-0	QUICK POINT KNIFE - 9mm	41	15-061	CHOPING SAW BLADE - 6-1/2"/20TPI (4/PK)	47
10-151-0	QUICK POINT KNIFE - 18mm	41	15-090	SHARPTOOTH™ NEST-OF-SAW - 3 BLADES	48
10-175	RETRACTABLE UTILITY KNIFE	39	15-091	12" SHORTCUT® WOOD CUTTING BLADE	48
10-189C	INTERLOCK® SELF-RETRACTING UTILITY KNIFE	39	15-092	10" COMPASS SAW BLADE	48
10-239	METAL MITEY-KNIFE® POCKET KNIFE	43	15-093	6" METAL CUTTING BLADE	48
10-280-0	STANDARD SNAP OFF KNIFE - 18mm	40	15-104A	4-3/4" DEPTH FATMAX® COPING SAW	47
10-380-0	SNAP OFF CARTRIDGE KNIFE - 18mm	40	15-106A	6-3/4" DEPTH FATMAX® COPING SAW	47
10-409	DYNAGRIP® SNAP OFF BLADE KNIFE - 9mm	42	15-113	12" HIGH TENSION HACKSAW	50
10-418	DYNAGRIP® SNAP OFF BLADE KNIFE - 18mm	42	15-166	STEEL FRAME HACKSAW	49
10-425	DYNAGRIP® SNAP OFF BLADE KNIFE - 25mm	42	15-218-0	JUNIOR HACKSAW	49
10-480	DYNAGRIP® SNAP OFF CARTRIDGE KNIFE - 18mm	41	15-265	10" V 12" ADJUSTABLE RUBBER GRIP HACKSAW	50
10-777	FATMAX® RETRACTABLE UTILITY KNIFE	38	15-275	4-WAY™ KEYHOLE SAW	49
10-779	DYNAGRIP® RETRACTABLE UTILITY KNIFE	39	15-333	FOLDING POCKET SAW - 8"	48
10-780N	FATMAX® FIXED BLADE UTILITY KNIFE	38	15-408	TUBULAR FRAME HACKSAW	50
10-789	FATMAX® XTREME TWIN BLADE KNIFE	38	15-410	10" ROD SAW - CARBIDE GRIT HACKSAW BLADE	50
10-804	SPORT UTILITY™ KNIFE	42	15-509	THRIFTY® BACKSAW - 14"	46
11-300H	QUICK-POINT™ BLADES - 9mm (100PCS)	44	15-565	10" V 12" ADJUSTABLE BLADE HACKSAW	51
11-300T	QUICK-POINT™ BLADES - 9mm (10PCS)	44	15-892-2	COMPOSITE HACKSAW - 12"	51
11-301H	QUICK-POINT™ BLADES - 18mm (100PCS)	44	15-928A	HACKSAW BLADE	52
11-301T	QUICK-POINT™ BLADES - 18mm (10PCS)	44	15-984	HIGH SPEED STEEL HACKSAW BLADE - 12" x 24T	51
11-325-0	QUICK-POINT™ BLADE - 25mm (10PCS)	44	15-988	HIGH SPEED STEEL HACKSAW BLADE - 12" x 18T	51
11-515	SINGLE EDGE RAZOR BLADE	117	15101	15" TOOL BOX WITH BUILT-IN ORGANIZER & TRAY	181
11-525	CARPET KNIFE BLADE	45	16-089	150 SERIES - 3-PIECE WOOD CHISEL SET	97
11-800T	CARBIDE UTILITY BLADE	43	16-120	6-PIECE WOOD CARVING SET	97
11-921H	CLASSIC 1992® HEAVY DUTY UTILITY BLADE - 100PCS	43	16-226	6-PIECE PUNCH KIT	100
11-921T	CLASSIC 1992® HEAVY DUTY UTILITY BLADE - 10PCS	43	16-227	CENTER PUNCH - 1/4" x 4"	100
11-983-0	LARGE HOOK BLADE - 5PCS	44	16-228	CENTER PUNCH - 5/16" x 4-1/2"	100
11-983-1	LARGE HOOK BLADE - 100 PCS	44	16-229	STARTER PUNCH - 3/32" x 5-1/2"	99
12-003-1	BAILEY® PROFESSIONAL SMOOTHING PLANE - 240mm/9-1/2"	118	16-230	PIN PUNCH - 1/16" x 6"	100
12-004-1	BAILEY® PROFESSIONAL SMOOTHING PLANE - 245mm/9-3/4"	118	16-231	PIN PUNCH - 1/8" x 6"	100
12-005-1	BAILEY® PROFESSIONAL JACK PLANE - 355mm/14"	118	16-232	PIN PUNCH - 5/32" x 6"	100
12-006-1	BAILEY® PROFESSIONAL FORE PLANE - 460mm/18"	118	16-233	PIN PUNCH - 3/16" x 6"	100
12-007-1	BAILEY® PROFESSIONAL JOINTER PLANE - 560mm/22"	118	16-234	PIN PUNCH - 1/4" x 6"	100
12-020-1	PROFESSIONAL™ SMOOTHING PLANE - 160mm/6-1/4"	120	16-235	PIN PUNCH - 5/16" x 6"	100
12-033-1	BENCH PLANE - 222mm/8-3/4"	120	16-236	PRICK PUNCH - 3/8" x 5-1/2"	100
12-034-1	BENCH PLANE - 247mm/9-3/4"	120	16-273	DYNAGRIP® CHISEL - 6mm/ 1/4"	98
12-060-1	PROFESSIONAL™ BLOCK PLANE - 150mm/6"	119	16-274	DYNAGRIP® CHISEL - 8mm/ 5/16"	98
12-078-1	PROFESSIONAL DUPLÉ x RABBIT PLANE - 254mm/10"	119	16-275	DYNAGRIP® CHISEL - 10mm/ 3/8"	98
12-102-1	BLOCK PLANE - 140mm/5-1/2"	119	16-276	DYNAGRIP® CHISEL - 12mm/ 1/2"	98
12-116-1	BLOCK PLANE - 180mm/7"	119	16-277	DYNAGRIP® CHISEL - 14mm/ 9/16"	98
12-134-0	REPLACEMENT PANE IRON - 2" FOR 12-034-1	121	16-278	DYNAGRIP® CHISEL - 16mm/ 5/8"	98
12-202-0	REPLACEMENT PANE IRON (COMPATIBLE TO 12-102)	121	16-279	DYNAGRIP® CHISEL - 18mm/ 3/4"	98
12-203-1	SMOOTHING PLANE - 240mm/9-1/2"	120	16-280	DYNAGRIP® CHISEL - 20mm/ 13/16"	98
12-204-1	SMOOTHING PLANE - 245mm/9-3/4"	120	16-281	DYNAGRIP® CHISEL - 22mm/ 7/8"	98
12-205-1	SMOOTHING PLANE - 355mm/14"	120	16-282	DYNAGRIP® CHISEL - 25mm/ 1"	98
12-220-1	PROFESSIONAL™ BLOCK PLANE - 180mm/7"	119	16-283	DYNAGRIP® CHISEL - 32mm/ 1-1/4"	98

SKU#	Descriptor	Page	SKU#	Descriptor	Page
16-284	DYNAGRIP® CHISEL - 38mm/ 1-1/2"	98	22-099	HALF ROUND FILE (BASTARD CUT) - 10"	123
16-285	3 PIECE DYNAGRIP® CHISEL - 12", 18", 25"	98	22-169	FLAT FILE (FLAT BASTARD) - 4"	124
16-286	DYNAGRIP® CHISEL - 30mm/ 1"	98	22-170	FLAT FILE (FLAT BASTARD) - 6"	124
16-286-2	STANLEY™ COLD CHISEL - 3/8" x 5-9/16"	99	22-171	FLAT FILE (FLAT BASTARD) - 8"	124
16-287	DYNAGRIP® CHISEL - 36mm/ 1-1/2"	98	22-172	FLAT FILE (FLAT BASTARD) - 10"	124
16-287-2	STANLEY™ COLD CHISEL - 1/2" x 6"	99	22-173	FLAT FILE (FLAT BASTARD) - 12"	124
16-288	STANLEY™ COLD CHISEL - 5/8" x 6-3/4"	99	22-174	FLAT FILE (FLAT SECOND CUT) - 6"	124
16-289	STANLEY™ COLD CHISEL - 3/4" x 6-7/8"	99	22-175	FLAT FILE (FLAT SECOND CUT) - 8"	124
16-290	STANLEY™ COLD CHISEL - 7/8" x 8"	99	22-176	FLAT FILE (FLAT SECOND CUT) - 10"	124
16-291	STANLEY™ COLD CHISEL - 1" x 12"	99	22-177	FLAT FILE (FLAT SECOND CUT) - 12"	124
16-329	FATMAX™ CONCRETE CHISEL WITH BI-MATERIAL HAND GUARD	98	22-178	ROUND FILE (BASTARD CUT) - 10"	123
16-331	FATMAX™ FLOOR CHISEL WITH BI-MATERIAL HAND GUARD	98	22-179	ROUND FILE (SECOND CUT) - 12"	123
16-332	FATMAX™ COLD CHISEL WITH BI-MATERIAL HAND GUARD	99	22-180	ROUND FILE (SECOND CUT) - 6"	123
16-334	FATMAX™ MASON'S CHISEL WITH BI-MATERIAL HAND GUARD	99	22-181	ROUND FILE (SECOND CUT) - 8"	123
16011	16" SERIES 2000 WITH 2 BUILT-IN ORGANIZERS & TRAY	181	22-182	ROUND FILE (SECOND CUT) - 10"	123
18603	STANLEY® 2-IN-1 MOBILE WORK CENTER	176	22-183	ROUND FILE (SMOOTH CUT) - 12"	123
18700	ALL PROJECT VEHICLE	177	22-184	HALF ROUND FILE (BASTARD CUT) - 6"	123
19011	19" SERIES 2000 WITH 2 BUILT-IN ORGANIZERS & TRAY	181	22-185	HALF ROUND FILE (BASTARD CUT) - 12"	123
20-004	PLASTIC HANDLE SAW - 18"/7PT	45	22-186	HALF ROUND FILE (SECOND CUT) - 6"	123
20-005	PLASTIC HANDLE SAW - 20"/7PT	45	22-187	HALF ROUND FILE (SECOND CUT) - 8"	123
20-006	PLASTIC HANDLE SAW - 22"/7PT	45	22-188	HALF ROUND FILE (SECOND CUT) - 10"	123
20-007	PLASTIC HANDLE SAW - 24"/7PT	45	22-189	HALF ROUND FILE (SECOND CUT) - 12"	123
20-026	PLASTIC HANDLE SAW - 26"/7PT	45	22-190	FLAT FILE (FLAT SMOOTH) - 6"	124
20-036	HIGH-TENSION HACKSAW AND METAL MINI-HACK™ UTILITY SAW	47	22-191	FLAT FILE (FLAT SMOOTH) - 12"	124
20-073	HARD TEETH HAND SAW 18"/7TPI	46	22-192	HALF ROUND FILE (SMOOTH CUT) - 12"	123
20-074	HARD TEETH HAND SAW 20"/7TPI	46	22-193	ROUND FILE (SMOOTH CUT) - 12"	123
20-080	PLASTIC HANDLE SAW - 18"/6PT	45	22-194	SQUARE FILE (BASTARD CUT) - 6"	125
20-081	PLASTIC HANDLE SAW - 20"/6PT	45	22-195	SQUARE FILE (BASTARD CUT) - 10"	125
20-082	PLASTIC HANDLE SAW - 22"/6PT	45	22-196	SQUARE FILE (SECOND CUT) - 10"	125
20-083	PLASTIC HANDLE SAW - 24"/6PT	45	22-197	SQUARE FILE (SMOOTH CUT) - 10"	125
20-092	MULTI-PURPOSE 3 IN 1 SAW - 6", 8" & 10"	48	22-198	FLAT FILE (FLAT SMOOTH) - 4"	124
20-175	BI-METAL HSS HACKSAW BLADE - 12" x 18T	52	22-209	HALF ROUND FILE (SMOOTH CUT) - 4"	123
20-176	BI-METAL HSS HACKSAW BLADE - 12" x 24T	52	22-210	HALF ROUND FILE (SMOOTH CUT) - 6"	123
20-177	BI-METAL HSS HACKSAW BLADE - 12" x 32T	52	22-211	HALF ROUND FILE (SMOOTH CUT) - 8"	123
20-221	MINI UTILITY SHARPTOOTH™ SAW	46	22-212	HALF ROUND FILE (SMOOTH CUT) - 10"	123
20-502	WOOD HANDLE SAW - 18" x 7T	45	22-213	SQUARE FILE (BASTARD CUT) - 8"	125
20-503	WOOD HANDLE SAW - 20" x 7T	45	22-214	THREE SQUARE TAPERED FILE (BASTARD CUT) - 10"	122
20-504	WOOD HANDLE SAW - 22" x 7T	45	22-215	SQUARE FILE (BASTARD CUT) - 12"	125
20-505	WOOD HANDLE SAW - 24" x 7T	45	22-216	SQUARE FILE (SECOND CUT) - 12"	125
20-521	CIRCULAR SAW BLADE FOR WOOD - 7-1/4" x 1" x 24T	216	22-217	SQUARE FILE (SMOOTH CUT) - 6"	125
20-522	CIRCULAR SAW BLADE FOR WOOD - 7-1/4" x 1" x 40T	216	22-218	SQUARE FILE (SMOOTH CUT) - 8"	125
20-523	CIRCULAR SAW BLADE FOR WOOD - 7-1/4" x 1" x 60T	216	22-219	SQUARE FILE (SMOOTH CUT) - 12"	125
20-524	CIRCULAR SAW BLADE FOR WOOD - 8-1/4" x 1" x 40T	216	22-222	THREE SQUARE TAPERED FILE (BASTARD CUT) - 6"	122
20-525	CIRCULAR SAW BLADE FOR WOOD - 8-1/4" x 1" x 60T	216	22-223	THREE SQUARE TAPERED FILE (BASTARD CUT) - 8"	122
20-535	CIRCULAR SAW BLADE FOR WOOD - 10" x 1" x 40T	216	22-224	THREE SQUARE TAPERED FILE (BASTARD CUT) - 12"	122
20-536	CIRCULAR SAW BLADE FOR WOOD - 10" x 1" x 60T	216	22-225	THREE SQUARE TAPERED FILE (SECOND CUT) - 12"	122
20-537	CIRCULAR SAW BLADE FOR WOOD - 12" x 1" x 100T	216	22-226	THREE SQUARE TAPERED FILE (SMOOTH CUT) - 6"	122
20-538	CIRCULAR SAW BLADE FOR ALUMINUM - 10" x 1" x 100T	216	22-227	THREE SQUARE TAPERED FILE (SMOOTH CUT) - 8"	122
20-539	CIRCULAR SAW BLADE FOR ALUMINUM - 10" x 1" x 120T	216	22-228	THREE SQUARE TAPERED FILE (SMOOTH CUT) - 10"	122
20-600	CLAMPING MITRE BOX WITH SAW	46	22-229	THREE SQUARE TAPERED FILE (SMOOTH CUT) - 12"	122
20-807	MINI-HACK™ SAW	51	22-233	FLAT FILE (FLAT SMOOTH) - 8"	124
20080	20" METAL PLASTIC TOOL BOX (YELLOW)	178	22-234	FLAT FILE (FLAT SMOOTH) - 10"	124
20300	20" PROFESSIONAL TOOL BOX	178	22-235	ROUND FILE (SMOOTH CUT) - 6"	123
20580	20" METAL ROLLING WORKSHOP	177	22-236	ROUND FILE (SMOOTH CUT) - 8"	123
21-102-5	SURFORM® FLAT FILE - 5-1/2"	114	22-237	ROUND FILE (SMOOTH CUT) - 10"	123
21-103-5	SURFORM® PLANE - 10"	113	22-238	ROUND FILE (SMOOTH CUT) - 4"	123
21-104-5	SURFORM® BLOCK PLANE - 5-1/2"	113	22-241	KNIFE FILE (BASTARD CUT) - 6"	125
21-115-5	SURFORM® SHAVER TOOL - 2-1/2"	113	22-242	KNIFE FILE (BASTARD CUT) - 8"	125
21-122-5	SURFORM® PLANER FILE - 10"	112	22-243	KNIFE FILE (BASTARD CUT) - 10"	125
21-291-5	SURFORM® ROUND REPLACEMENT BLADE - 10"/250mm	115	22-246	KNIFE FILE (SMOOTH CUT) - 6"	125
21-293-5	SURFORM® STANDARD CUT BLADE - 10"	114	22-247	KNIFE FILE (SMOOTH CUT) - 8"	125
21-295-5	SURFORM® FLAT FILE (REGULAR CUT BLADE) - 17-3/8"	115	22-248	KNIFE FILE (SMOOTH CUT) - 10"	125
21-299-5	SURFORM® HALF ROUND REGULAR CUT REPLACEMENT BLADE - 10"	115	22-304	SLIM TAPERED FILE (SECOND CUT) - 4"	122
21-393-5	SURFORM® STANDARD CUT FLAT REPLACEMENT BLADE - 10"	116	22-305	SLIM TAPERED FILE (SECOND CUT) - 5"	122
21-398-5	SURFORM® FINE CUT BLADE - 5-1/2"	114	22-306	SLIM TAPERED FILE (SECOND CUT) - 6"	122
21-399-5	SURFORM® BLOCK PLANE - 5-1/2"	113	22-307	ROUND FILE (SMOOTH CUT) - 6"	123
21-508-5	SURFORM® METAL & PLASTIC BLADE - 10"	114	22-308	HALF ROUND FILE (BASTARD CUT) - 8"	123
21-515-5	SURFORM® SHAVER REPLACEMENT BLADE - 2-1/2"	116	22-309	FLAT FILE (MIL BASTARD) - 8"	124
22-078H	HANDY FILE - 8" W HANDLE	124	26300	26" PROFESSIONAL TOOL BOX	178
22-078HC	HANDY FILE (BASTARD CUT) - 8"	124	28-205	PUTTY KNIFE, FLEXIBLE TIP - 3"	117
22-080B	HANDY FILE (12 PCS/BOX) - 10"	124	28-208	PUTTY KNIFE, FLEXIBLE TIP - 4"	117
22-082	CHAIN SAW FILE - 4mm x 200mm	125	28-500	RETRACTABLE RAZOR BLADE SCRAPER	117
22-083	CHAIN SAW FILE - 5mm x 500mm	125	28-510	10 PACK SINGLE EDGE RAZOR BLADE FOR 28-500	117
22-087	CHAIN SAW FILE - 6mm x 200mm	125	29-030-1	ALLMASTER PAINT BRUSH - 3/4"	112
22-089	CHAIN SAW FILE - 6.25mm x 200mm	125	29-031-1	ALLMASTER PAINT BRUSH - 1"	112
22-090	EXTRA SLIM TAPERED FILE (SECOND CUT) - 4"	122	29-032-1	ALLMASTER PAINT BRUSH - 1-1/2"	112
22-091	DOUBLE EXTRA SLIM TAPERED FILE (SECOND CUT) - 4"	122	29-033-1	ALLMASTER PAINT BRUSH - 2"	112
22-092	SLIM TAPERED FILE (SECOND CUT) - 7"	122	29-034-1	ALLMASTER PAINT BRUSH - 2-1/2"	112
22-093	SLIM TAPERED FILE (SECOND CUT) - 8"	122	29-035-1	ALLMASTER PAINT BRUSH - 3"	112
22-094	SLIM TAPERED FILE (SECOND CUT) - 10"	122	29-036-1	ALLMASTER PAINT BRUSH - 4"	112
22-095	FLAT FILE (MILE BASTARD) - 6"	124	29-044-1	7" CAGE FRAME ROLLER	111
22-096	FLAT FILE (MILE BASTARD) - 10"	124	29-045-1	9" CAGE FRAME ROLLER	111
22-097	FLAT FILE (MILE BASTARD) - 12"	124	29-064-1	7" CAGE ROLLER/ MOGLOSS SHORT REFILL	110
22-098	ROUND FILE (BASTARD CUT) - 8"	123	29-069-1	9" CAGE ROLLER/ MOGLOSS SHORT REFILL	110

# PRODUCT INDEX

SKU#	Descriptor	Page	SKU#	Descriptor	Page
29-076-1	7" STICK ROLLER FRAME	111	42-362	STANLEY® BOX LEVEL - 12"	13
29-078-2	100mm/4" ACRYLIC YELLOW STRIPE REFILL - 2/PK	110	42-465	STANLEY® CONTRACTOR GRADE™ TORPEDO LEVEL - 9", MAGNETIC	13
29-078-5	100mm/4" ACRYLIC YELLOW STRIPE REFILL - 10/PK	110	42-466	NEW STANLEY® HIGH IMPACT ABS LEVEL - 12", 3 VIAL	9
29-082-1	4" STICK FRAME AND 1 VELOUR REFILL	111	42-467	NEW STANLEY® HIGH IMPACT ABS LEVEL - 18", 3 VIAL	9
29-086-0	4" STICK FRAME AND REFILL	111	42-468	NEW STANLEY® HIGH IMPACT ABS LEVEL - 24", 3 VIAL	9
29-256-0	7" STICK ROLLER REFILL - MOGLOSS SHORT PILE	111	42-470	NEW STANLEY® HIGH IMPACT ABS LEVEL - 48", 3 VIAL	9
29-259-0	7" CAGE FRAME ROLLER REFILL - ACRYLIC YELLOW STRIPE MED PILE	111	42-471	NEW STANLEY® HIGH IMPACT ABS LEVEL - 120cm, 3 VIAL	9
29-276-0	9" STICK ROLLER REFILL - MOGLOSS SHORT PILE	111	42-474	NEW STANLEY® HIGH IMPACT ABS LEVEL - 30cm, 3 VIAL	9
29-277-0	9" STICK ROLLER REFILL - ACRYLIC YELLOW STRIPE MED PILE	111	42-475	NEW STANLEY® HIGH IMPACT ABS LEVEL - 45cm, 3 VIAL	9
29-278-0	9" STICK ROLLER REFILL - GREEN ACRYLIC LONG PILE	111	42-476	NEW STANLEY® HIGH IMPACT ABS LEVEL - 60cm, 3 VIAL	9
29-279-0	9" CAGE FRAME ROLLER REFILL - ACRYLIC YELLOW STRIPE MED PILE	111	42-643	STANLEY® BOX LEVEL - 18"	13
29-400-1	9" CAGE ROLLER/ ACRYLIC LONG REFILL	110	42-684	STANLEY® BOX LEVEL - 24"	13
29-401-1	9" CAGE ROLLER/ ACRYLIC MED REFILL	110	42-685	STANLEY® BOX LEVEL - 36"	13
29-480-1	100mm/4" MINI ROLLER KIT: 1 ROLLER HEAD FOR FLAT/MATT PAINT AND 1 FOR GLOSS AND VARNISH	110	42-686	STANLEY® BOX LEVEL - 48"	13
29-493-1	7" CAGE ROLLER/ ACRYLIC LONG REFILL	110	42-919	STANLEY® I-BEAM PRO180 LEVEL - 16", 2 VIALS	11
29-494-1	7" CAGE ROLLER/ ACRYLIC MED REFILL	110	42-920	STANLEY® I-BEAM PRO180 LEVEL - 24", 3 VIALS	11
29-671-1	EXTENSION POLE - 1.3M - 2.3M	112	42-921	STANLEY® I-BEAM PRO180 LEVEL - 32", 3 VIALS	11
29-772-1	9" STICK ROLLER FRAME	111	42-922	STANLEY® I-BEAM PRO180 LEVEL - 40", 3 VIALS	11
29-808-5	100mm/4" VELOUR ROLLER REFILLS	110	42-923	STANLEY® I-BEAM PRO180 LEVEL - 48", 3 VIALS	11
29-814-1	100mm/4" MINI ROLLER FRAME + REFILL (29-086 + 29-816)	110	43-102	NEW STANLEY® LEVEL - 40cm, CLASSIC BOX	9
29-816-2	100mm/4" HIGH DENSITY FOAM REFILL - 2/PK	110	43-103	NEW STANLEY® LEVEL - 60cm, CLASSIC BOX	9
29-816-5	100mm/4" HIGH DENSITY FOAM REFILL - 10/PK	110	43-104	NEW STANLEY® LEVEL - 80cm, CLASSIC BOX	9
29-821-1	7" CAGE FRAME PAINT ROLLER & TRAY SET COMPLETE (29-044-1 + 29-259-1)	112	43-105	NEW STANLEY® LEVEL - 100cm, CLASSIC BOX	9
29-822-1	9" CAGE FRAME PAINT ROLLER & TRAY SET COMPLETE (29-045-1 + 29-279-0)	112	43-106	NEW STANLEY® LEVEL - 120cm, CLASSIC BOX	9
29-861-0	7" CAGE FRAME ROLLER REFILL - MOGLOSS SHORT PILE	111	43-107	NEW STANLEY® LEVEL - 150cm, CLASSIC BOX	9
29-862-0	9" CAGE FRAME ROLLER REFILL - MOGLOSS SHORT PILE	111	43-108	NEW STANLEY® LEVEL - 180cm, CLASSIC BOX	9
29-999-0	9" CAGE FRAME ROLLER REFILL - GREEN ACRYLIC LONG PILE	111	43-109	NEW STANLEY® LEVEL - 200cm, CLASSIC BOX	9
30-456N	NEW STANLEY® GLOBAL TAPE - 8M/26'	5	43-110	NEW STANLEY® LEVEL - 40cm, CLASSIC BOX, MAGNETIC	10
30-486N	NEW STANLEY® GLOBAL TAPE - 3M/10'	5	43-111	NEW STANLEY® LEVEL - 60cm, CLASSIC BOX, MAGNETIC	10
30-496N	NEW STANLEY® GLOBAL TAPE - 5M/16'	5	43-112	NEW STANLEY® LEVEL - 80cm, CLASSIC BOX, MAGNETIC	10
30-608L	STANLEY® RUBBERGRIP TAPE RULE - 3M	6	43-113	NEW STANLEY® LEVEL - 100cm, CLASSIC BOX, MAGNETIC	10
30-611L	STANLEY® RUBBERGRIP TAPE RULE - 3.5M	6	43-114	NEW STANLEY® LEVEL - 120cm, CLASSIC BOX, MAGNETIC	10
30-616	STANLEY® RUBBERGRIP TAPE RULE - 5M	6	43-115	NEW STANLEY® LEVEL - 150cm, CLASSIC BOX, MAGNETIC	10
30-656	STANLEY® TYLON TAPE - 8M/26'	6	43-116	NEW STANLEY® LEVEL - 180cm, CLASSIC BOX, MAGNETIC	10
30-696	STANLEY® TYLON TAPE - 5M/16'	6	43-117	NEW STANLEY® LEVEL - 200cm, CLASSIC BOX, MAGNETIC	10
30-808	STANLEY® LEVERLOCK TAPE RULE - 3M/10'	6	43-524	STANLEY® FATMAX II LEVEL - 24", 3 VIALS	11
30-809	STANLEY® LEVERLOCK TAPE RULE - 3M	6	43-525	STANLEY® FATMAX II LEVEL - 24", 3 VIALS, MAGNETIC	11
30-815	STANLEY® LEVERLOCK TAPE RULE - 5M/16'	6	43-536	STANLEY® FATMAX II LEVEL - 36", 3 VIALS	11
30-824	STANLEY® LEVERLOCK TAPE RULE - 8M/26'	6	43-537	STANLEY® FATMAX II LEVEL - 36", 3 VIALS, MAGNETIC	11
30-854T	STANLEY® LEVERLOCK TAPE RULE - 25'	6	43-548	STANLEY® FATMAX II LEVEL - 48", 3 VIALS	11
33-158-2	STANLEY® POWERLOCK TAPE RULE - 5M/16'	7	43-549	STANLEY® FATMAX II LEVEL - 48", 3 VIALS, MAGNETIC	11
33-194-2	STANLEY® POWERLOCK TAPE RULE - 5M	7	43-553	STANLEY® FATMAX I-BEAM LEVEL - 24", 3 VIALS	12
33-215-2	STANLEY® POWERLOCK TAPE RULE - 3.5M/12'	7	43-554	STANLEY® FATMAX I-BEAM LEVEL MAGNETIC - 24", 3 VIALS	12
33-218-2	STANLEY® POWERLOCK TAPE RULE - 3M	7	43-555	STANLEY® FATMAX I-BEAM LEVEL - 48", 3 VIALS	12
33-231-2	STANLEY® POWERLOCK TAPE RULE - 3M/10'	7	43-556	STANLEY® FATMAX I-BEAM LEVEL MAGNETIC - 36", 3 VIALS	12
33-428-2	STANLEY® POWERLOCK TAPE RULE - 8M/26'	7	43-557	STANLEY® FATMAX I-BEAM LEVEL - 72", 3 VIALS	12
33-463-2	STANLEY® POWERLOCK TAPE RULE - 10M/33'	7	43-558	STANLEY® FATMAX I-BEAM LEVEL MAGNETIC - 48", 3 VIALS	12
33-719	NEW STANLEY® FATMAX TAPES - 5M/16'	5	43-572	STANLEY® FATMAX II LEVEL - 72", 3 VIALS	11
33-726	NEW STANLEY® FATMAX TAPES - 8M/26'	5	43-624	STANLEY® FATMAX EXTREME BOX BEAM LEVEL - 24", NON MAGNETIC	10
33-805	NEW STANLEY® FATMAX TAPES 10M/33'	5	43-625	STANLEY® FATMAX EXTREME BOX BEAM LEVEL - 24", MAGNETIC	10
33-887	NEW STANLEY® FATMAX XL TAPE - 5M	5	43-648	STANLEY® FATMAX EXTREME BOX BEAM LEVEL - 48", NON MAGNETIC	10
33-892	NEW STANLEY® FATMAX XL TAPE - 8M	5	43-649	STANLEY® FATMAX EXTREME BOX BEAM LEVEL - 48", MAGNETIC	10
33-897	NEW STANLEY® FATMAX XL TAPE - 10M	5	43-672	STANLEY® FATMAX EXTREME BOX BEAM LEVEL - 72", NON MAGNETIC	10
33280	METAL PLASTIC ROLLING TOOL CHEST (YELLOW)	177	45-103	STANLEY® MAXSTICK RULE - 1219.2mm/48"	15
34-104N	STANLEY® STEEL LONGTAPE - 15M/50'	8	45-500	STANLEY® STEEL CARPENTER SQUARE - IMPERIAL	14
34-105N	STANLEY® STEEL LONG TAPE - 20M	8	45-530	STANLEY® STEEL RAFTER - METRIC	14
34-107N	STANLEY® STEEL LONGTAPE - 30M/100'	8	45-600	STANLEY® CARPENTER SQUARE - M/E	14
34-108N	STANLEY® STEEL LONG TAPE - 30M	8	46-012	STANLEY® COMBINATION SQUARE - 36"	14
34-132N	STANLEY® FATMAX STEEL LONGTAPE - 30M/100'	8	46-028	STANLEY® COMBINATION SQUARE - 48"	14
34-260	STANLEY® FIBERGLASS LONG TAPE CLOSED - 15M/50'	8	46-143	STANLEY® COMBINATION SQUARE - 24"	14
34-262	STANLEY® FIBERGLASS LONG TAPE CLOSED - 30M/100'	8	46-530	STANLEY® TRY SQUARE - 152mm/6"	14
34-263	STANLEY® FIBERGLASS LONG TAPE CLOSED - 50M/165'	8	46-532	STANLEY® TRY SQUARE - 203mm/8"	14
34-295	STANLEY® FIBERGLASS LONG TAPE CASE - 10M	8	46-534	STANLEY® TRY SQUARE - 254mm/10"	14
34-296	STANLEY® FIBERGLASS LONG TAPE CASE - 20M	8	46-536	STANLEY® TRY SQUARE - 305mm/12"	14
34-297	STANLEY® FIBERGLASS LONG TAPE CASE - 30M	8	46-825-0	STANLEY® BEVEL EDGE - 203mm/8"	15
34-298	STANLEY® FIBERGLASS LONG TAPE CASE - 50M	8	47-064	STANLEY® MARKING GAUGE	19
34-777	STANLEY® OPEN REEL FIBERGLASS LONG TAPE - 100M/300'	7	47-403-1	STANLEY® CHALK BLUE REFILL - 4 OZ	18
34-791	STANLEY® OPEN REEL FIBERGLASS LONG TAPE - 30M/100'	7	47-404-1	STANLEY® CHALK RED REFILL - 4 OZ	18
34-792	STANLEY® OPEN REEL FIBERGLASS LONG TAPE - 30M	7	47-405-1	STANLEY® CHALK WHITE REFILL - 4OZ	18
34-794	STANLEY® OPEN REEL FIBERGLASS LONG TAPE - 60M/200'	7	47-440	STANLEY® CHALK LINE - 30M/100'	16
34-795	STANLEY® OPEN REEL FIBERGLASS LONG TAPE - 60M	7	47-443	STANLEY® W/ BLUE CHALK AND LINE LEVEL	17
42-072	STANLEY® I-BEAM LEVEL TOP READ - 12", 2 VIALS	12	47-460	STANLEY® POWERWINDER® CHALK LINE - 30M/100'	16
42-073	STANLEY® I-BEAM LEVEL TOP READ - 18", 3 VIALS	12	47-465	STANLEY® POWERWINDER® W/ RED CHALK AND LINE LEVEL - 30M/100'	16
42-074	STANLEY® I-BEAM LEVEL TOP READ - 24", 3 VIALS	12	47-487L	FATMAX® XTREME™ CHALK REEL W/ RED FATMAX® XTREME™ CHALK KIT	17
42-075	STANLEY® I-BEAM LEVEL TOP READ - 36", 3 VIALS	12	47-803-1	STANLEY® CHALK BLUE REFILL - 8 OZ	18
42-076	STANLEY® I-BEAM LEVEL TOP READ - 48", 3 VIALS	12	47-804-1	STANLEY® CHALK RED REFILL - 8 OZ	18
42-087	STANLEY® DIGITAL ANGLE FINDER - 40cm	15	47-808	STANLEY® CHALK BLACK REFILL - 8 OZ	18
42-264	STANLEY® TORPEDO LEVEL - 9", MAGNETIC	13	47-809	STANLEY® CHALK FLOURESCENT ORANGE REFILL - 8 OZ	18
42-287-0	STANLEY® LEVEL LINE - 3", 1 VIAL	13	47-827	FATMAX® XTREME™ CHALK 5LB. - RED	17
42-291	STANLEY® TORPEDO LEVEL - 8", MAGNETIC	13			
42-294	STANLEY® TORPEDO LEVEL - 8", STANDARD	13			



# PRODUCT INDEX

SKU#	Descriptor	Page	SKU#	Descriptor	Page
47-828	FATMAX® EXTREME™ CHALK 5LB - BLACK	18	65-144-2	CUSHION GRIP 2 SCREWDRIVER - TORX T5 x 80mm	72
47-973	STANLEY® SOLID BRAS PLUMB BOB - 226G/8 OZ	19	65-145-2	CUSHION GRIP 2 SCREWDRIVER - TORX T6 x 80mm	72
509100	9" POUCH (BLACK / GREY)	182	65-146-2	CUSHION GRIP 2 SCREWDRIVER - TORX T7 x 80mm	72
51-071	FIBERGLASS NAIL HAMMER (450G) - 335mm	93	65-147-2	CUSHION GRIP 2 SCREWDRIVER - TORX T8 x 80mm	72
51-072	FIBERGLASS NAIL HAMMER (570G) - 335mm	93	65-148-2	CUSHION GRIP 2 SCREWDRIVER - TORX T10 x 80mm	72
51-081	JACKETED STEEL HANDLE HAMMER (450G) - 335mm	92	65-149-2	CUSHION GRIP 2 SCREWDRIVER - TORX T15 x 80mm	72
51-082	JACKETED STEEL HANDLE HAMMER (570G) - 335mm	92	65-150-2	CUSHION GRIP 2 SCREWDRIVER - TORX T20 x 120mm	72
51-162	FATMAX® XTREME™ ANTIVIBE® CURVE CLAW NAILING HAMMER (454G) - 343mm	92	65-151-2	CUSHION GRIP 2 SCREWDRIVER - TORX T25 x 120mm	72
51-164	FATMAX® XTREME™ ANTIVIBE® CURVE CLAW NAILING HAMMER (567G) - 343mm	92	65-152-2	CUSHION GRIP 2 SCREWDRIVER - TORX T27 x 120mm	72
51-269	WOODHANDLE NAIL HAMMER (370G) - 13"	94	65-153-2	CUSHION GRIP 2 SCREWDRIVER - TORX T30 x 120mm	72
51-271	WOODHANDLE NAIL HAMMER (450G) - 13"	94	65-154-2	CUSHION GRIP 2 SCREWDRIVER - TORX T40 x 120mm	72
51-274	WOODHANDLE NAIL HAMMER (570G) - 13-1/4"	94	65-155-2	CUSHION GRIP 2 SCREWDRIVER TORX SET - 5PCS T5,T6,T8,T10,T15	72
512100	12" TOOL BAG (GREY / BLACK)	182	65-156-2	CUSHION GRIP 2 SCREWDRIVER TORX SET - 6PCS T10,T15,T20,T25,	72
516110	16" MULTI PURPOSE TOOL BAG (BLACK / GREY)	182	65-157-2	CUSHION GRIP 2 SCREWDRIVER - PHILLIPS #0 x 60mm	71
518160	FATMAX® 18" OPEN TOTE (GREY / BLACK)	182	65-158-2	CUSHION GRIP 2 SCREWDRIVER - PHILLIPS #0 x 100mm	71
54-189	BALL PEIN HAMMER - 12-1/4"	94	65-159-2	CUSHION GRIP 2 SCREWDRIVER - PHILLIPS #0 x 125mm	71
54-190	BALL PEIN HAMMER - 13"	94	65-160-2	CUSHION GRIP 2 SCREWDRIVER - PHILLIPS #0 x 150mm	71
54-191	BALL PEIN HAMMER - 14"	94	65-162-2	CUSHION GRIP 2 SCREWDRIVER - PHILLIPS #1 x 75mm	71
54-192	BALL PEIN HAMMER - 15"	94	65-163-2	CUSHION GRIP 2 SCREWDRIVER - PHILLIPS #1 x 100mm	71
54-193	BALL PEIN HAMMER - 16"	94	65-164-2	CUSHION GRIP 2 SCREWDRIVER - PHILLIPS #1 x 150mm	71
55-099	FATMAX™ XTREME™ FUBAR® UTILITY BAR - 18"	90	65-165-2	CUSHION GRIP 2 SCREWDRIVER - PHILLIPS #1 x 200mm	71
55-101	FATMAX™ WRECKING BAR - 14"	102	65-166-2	CUSHION GRIP 2 SCREWDRIVER - PHILLIPS #2 x 45mm	71
55-102	FATMAX™ WRECKING BAR - 24"	102	65-167-2	CUSHION GRIP 2 SCREWDRIVER - PHILLIPS #2 x 100mm	71
55-104	FATMAX™ WRECKING BAR - 36"	102	65-168-2	CUSHION GRIP 2 SCREWDRIVER - PHILLIPS #2 x 125mm	71
55-113	CLAW BAR - 8"	101	65-169-2	CUSHION GRIP 2 SCREWDRIVER - PHILLIPS #2 x 150mm	71
55-114	CLAW BAR - 10"	101	65-170-2	CUSHION GRIP 2 SCREWDRIVER - PHILLIPS #2 x 200mm	71
55-115	CLAW BAR - 12"	101	65-171-2	CUSHION GRIP 2 SCREWDRIVER - PHILLIPS #2 x 250mm	71
55-116	MOLDING BAR - 8"	102	65-172-2	CUSHION GRIP 2 SCREWDRIVER - PHILLIPS #3 x 150mm	71
55-117	MOLDING BAR - 10"	102	65-173-2	CUSHION GRIP 2 SCREWDRIVER - PHILLIPS #3 x 200mm	71
55-118	FORGED HEXAGONAL STEEL RIPPING BAR - 5/8" x 18"	103	65-174-2	CUSHION GRIP 2 SCREWDRIVER - PHILLIPS #3 x 250mm	71
55-119R	FATMAX™ FUNCTIONAL UTILITY BAR.	90	65-180-2	CUSHION GRIP 2 SCREWDRIVER - SLOTTED 3mm x 75	71
55-120R	FATMAX™ XTREME® FUNCTIONAL UTILITY BAR III	91	65-181-2	CUSHION GRIP 2 SCREWDRIVER - SLOTTED 3mm x 100	71
55-121	STANLEY® FUBAR® FOCIBLE ENTRY TOOL - 18"	91	65-182-2	CUSHION GRIP 2 SCREWDRIVER - PHILLIPS #2 x 125	71
55-122	STANLEY® FUBAR® FOCIBLE ENTRY TOOL - 30"	91	65-183-2	CUSHION GRIP 2 SCREWDRIVER - SLOTTED 3mm x 150	71
55-124	FORGED HEXAGONAL STEEL RIPPING BAR - 3/4 x 24"	103	65-186-2	CUSHION GRIP 2 SCREWDRIVER - SLOTTED 5mm x 75	71
55-130	FORGED HEXAGONAL STEEL RIPPING BAR - 3/4 x 30"	103	65-187-2	CUSHION GRIP 2 SCREWDRIVER - SLOTTED 5mm x 100	71
55-150	HEXAGONAL STRAIGHT BAR - 1.5M	102	65-188-2	CUSHION GRIP 2 SCREWDRIVER - SLOTTED 5mm x 150	71
55-175	HEXAGONAL STRAIGHT BAR - 1.8M	102	65-189-2	CUSHION GRIP 2 SCREWDRIVER - SLOTTED 5mm x 200	71
55-526	WONDER BAR X21 PRY BAR	103	65-190-2	CUSHION GRIP 2 SCREWDRIVER - SLOTTED 6.5mm x 45mm	71
56-112	MALLET HAMMER - 22mm/0.8"	92	65-191-2	CUSHION GRIP 2 SCREWDRIVER - SLOTTED 6.5mm x 100mm	71
56-113	MALLET HAMMER - 28mm/1.1"	92	65-192-2	CUSHION GRIP 2 SCREWDRIVER - SLOTTED 6.5mm x 125mm	71
56-114	MALLET HAMMER - 35mm/1.3"	92	65-193-2	CUSHION GRIP 2 SCREWDRIVER - SLOTTED 6.5mm x 150mm	71
56-115	MALLET HAMMER - 45mm/1.7"	92	65-194-2	CUSHION GRIP 2 SCREWDRIVER - SLOTTED 6.5mm x 200mm	71
56-116	MALLET HAMMER - 60mm/2.3"	92	65-195-2	CUSHION GRIP 2 SCREWDRIVER - SLOTTED 6.5mm x 250mm	71
56-202	JACKETED FIBERGLASS ENGINEERING HAMMER (1100G) - 4-3/8"	93	65-196-2	CUSHION GRIP 2 SCREWDRIVER - SLOTTED 8mm x 150mm	71
56-204	JACKETED FIBERGLASS ENGINEERING HAMMER (1800G) - 5-1/4"	93	65-197-2	CUSHION GRIP 2 SCREWDRIVER - SLOTTED 8mm x 200mm	71
56-218	JACKETED FIBERGLASS BLACKSMITH HAMMER (1100G) - 5"	93	65-198-2	CUSHION GRIP 2 SCREWDRIVER - SLOTTED 8mm x 250mm	71
56-220	JACKETED FIBERGLASS BLACKSMITH HAMMER (1400G) - 5-1/8"	93	65-199-2	CUSHION GRIP 2 SCREWDRIVER SET - 4PCS	72
56-701	JACKETED FIBERGLASS DRILLING HAMMER (930G) - 4-1/4"	93	65-200-2	CUSHION GRIP 2 SCREWDRIVER SET - 2PCS	72
56-705	JACKETED FIBERGLASS DRILLING HAMMER (1400G) - 4-1/2"	93	65-201	CUSHION GRIP MULTI BITS 2-WAY	73
56-803	CONTRACTOR GRADE™ HICKORY HANDLE ENGINEERING HAMMER - 5-1/8"	94	65-227-2	CUSHION GRIP 2 SCREWDRIVER - STANDARD PARALLEL 5 x 100mm	71
56-804	CONTRACTOR GRADE™ HICKORY HANDLE ENGINEERING HAMMER - 5-1/4"	94	65-228-2	CUSHION GRIP 2 SCREWDRIVER STANDARD PARALLEL - 5 x 150mm	71
56-808	CONTRACTOR GRADE™ HICKORY HANDLE SLEDGE HAMMER - 6-1/2"	95	65-229-2	CUSHION GRIP 2 SCREWDRIVER STANDARD PARALLEL - 5 x 200mm	71
56-812	CONTRACTOR GRADE™ HICKORY HANDLE SLEDGE HAMMER - 7-3/4"	95	65-242-2	CUSHION GRIP 2 SCREWDRIVER SET - 6PCS	72
56-816	CONTRACTOR GRADE™ HICKORY HANDLE SLEDGE HAMMER - 8-1/2"	95	65-243-1	TANK THRU SCREWDRIVER - STD0.76 x 4.76 / 5mm x 4"	77
56208	BONUS PACK (8 BIN #2 + 3 BIN HANGERS)	184	65-244-1	TANK THRU SCREWDRIVER - STD0.76 x 4.76 / 5mm x 6"	77
56304	BONUS PACK (4 BIN #3 + 2 BIN HANGERS)	184	65-245-1	TANK THRU SCREWDRIVER - 5mmX4" x #1	77
57-527	RUBBER MALLET (450G) - 350mm/13"	96	65-246-1	TANK THRU SCREWDRIVER - 5mmX6" x #1	77
57-528	RUBBER MALLET (680G) - 350mm/13"	96	65-247-1	TANK THRU SCREWDRIVER - STD0.94 x 6.35 / 6mm x 4"	77
57-530	COMPO-CAST® STANDARD HEAD SOFT FACE HAMMER - 30mm	95	65-248-1	TANK THRU SCREWDRIVER - STD0.94 x 6.35 / 6mm x 5"	77
57-531	COMPO-CAST® STANDARD HEAD SOFT FACE HAMMER - 40mm	95	65-249-1	TANK THRU SCREWDRIVER - STD0.94 x 6.35 / 6mm x 6"	77
57-532	COMPO-CAST® STANDARD HEAD SOFT FACE HAMMER - 45mm	95	65-250-1	TANK THRU SCREWDRIVER - 6mmX4" x #2	77
57-533	COMPO-CAST® STANDARD HEAD SOFT FACE HAMMER - 53mm	95	65-251-1	TANK THRU SCREWDRIVER - 6mmX5" x #2	77
57-534	COMPO-CAST® STANDARD HEAD SOFT FACE HAMMER - 63mm	95	65-252-1	TANK THRU SCREWDRIVER - 6mmX6" x #2	77
57-540	COMPO-CAST® SLIMLINE HEAD SOFT FACE HAMMER - 17.5mm	95	65-253-1	TANK THRU SCREWDRIVER - STD1.07 x 7.94 / 8mm x 6"	77
57-541	COMPO-CAST® SLIMLINE HEAD SOFT FACE HAMMER - 27mm	95	65-254-1	TANK THRU SCREWDRIVER - STD1.07 x 7.94 / 8mm x 8"	77
57-542	COMPO-CAST® SLIMLINE HEAD SOFT FACE HAMMER - 33mm	95	65-255-1	TANK THRU SCREWDRIVER - STD1.07 x 7.94 / 8mm x 10"	77
57-543	COMPO-CAST® SLIMLINE HEAD SOFT FACE HAMMER - 35mm	95	65-256-1	TANK THRU SCREWDRIVER - STD1.07 x 7.94 / 8mm x 12"	77
58-114	TIP SQUARE HEAD NAIL SET - 4/32"	96	65-257-1	TANK THRU SCREWDRIVER - 8mm x 6" x #3	77
58-120	CENTER PUNCH - 1/8"	97	65-258-1	TANK THRU SCREWDRIVER - 8mm x 8" x #3	77
58-911	CUSHION GRIP NAIL SET (YELLOW) - 1/32"	96	65-259-1	TANK THRU SCREWDRIVER - 8mm x 10" x #3	77
58-912	CUSHION GRIP NAIL SET (GREY) - 2/32"	96	65-260-1	TANK THRU SCREWDRIVER - 8mm x 12" x #3	77
58-913	CUSHION GRIP NAIL SET (RED) - 3/32"	96	65-966	VDE SCREWDRIVER STD PARALLEL - 3mm x 100mm	70
58-930	CUSHION GRIP NAIL SET - 3PCS (1/32", 2/32" & 3/32")	96	65-967	VDE SCREWDRIVER STD PARALLEL - 4mm x 100mm	70
60-886	JUMBO TOOL BOX WITH 2 PULL OUT ORGANIZERS, BIT HOLDER AND METAL LATCHES	179	65-968	VDE SCREWDRIVER STD PARALLEL - 5.5mm x 125mm	70
60565	ORGANIZER 33 (3 x 14003)	183	65-969	VDE SCREWDRIVER STD PARALLEL - 6.5mm x 150mm	70
60729	MOBILE WORK CENTER (18600) + 13" TOOL BOX	176	65-970	VDE SCREWDRIVER STD PARALLEL - 8mm x 175mm	70
60929	METAL PLASTIC ROLLING TOOL CHEST (YELLOW)	177	65-971	VDE SCREWDRIVER STD PARALLEL - 10mm x 200mm	70
62-511	9 WAY SCREWDRIVER™	74	65-972	VDE SCREWDRIVER PHILLIPS® #0 x 60mm	70
			65-973	VDE SCREWDRIVER PHILLIPS® #1 x 80mm	70
			65-974	VDE SCREWDRIVER PHILLIPS® #2 x 100mm	70
			65-975	VDE SCREWDRIVER PHILLIPS® #3 x 150mm	70

# PRODUCT INDEX

SKU#	Descriptor	Page	SKU#	Descriptor	Page
65-980	VDE SCREWDRIVER 6 PC SET WITH BONUS	70	74-390	STANLEY® HEDGE SHEARS - 60CM	59
66-039	6-PIECE BI-MATERIAL HANDLE PRECISION SCREWDRIVER SET	75	74-906	STANLEY® ACCUSCAPE 6" FOLDING PRUNER	59
66-052	6-PIECE BI-MATERIAL HANDLE PRECISION SCREWDRIVER SET	75	78-031	LEVER ACTION GREASE GUN	160
66-119	SPARK DETECTING SCREWDRIVER (100-500V) - 50mm	75	78-032	4" ANGLE GRINDER / CUTTER	157
66-120	SPARK DETECTING SCREWDRIVER (100-500V) - 100mm	75	78-308	5 PIECE SAW BLADES SET	159
66-133	MULTIFUNCTIONAL DIGITAL TESTER WITH LCD DISPLAY AND NEON LAMP DISPLAY	75	78-309	10 PIECE SANDING DISKS KIT	159
66-137	MULTIFUNCTIONAL DIGITAL TESTER WITH LCD DISPLAY	75	78-339	POWER CHISEL WITH HEXAGONAL SHANK, 3.6K RPM	158
66-182	100 PLUS® CABINET TIP SCREWDRIVER	76	78-340	1/4" MINI DIE GRINDER	158
68-010	10-PIECE MULTI BIT RATCHETING SCREWDRIVER	73	78-341	6" DUAL ACTION SANDER, 10K RPM	157
68-012	6 WAY SCREWDRIVER™	73	78-405	RECIPROCATING AIR SAW, 10K RPM	159
68-070	SCREWDRIVER INSERT BIT SET - 9PC	74	78-413	1/4" ANGLE GRINDER	156
68-071	SCREWDRIVER INSERT BIT SET - 29PC	74	79-033	7" ANGLE GRINDER / CUTTER	158
68-072	SCREWDRIVER INSERT BIT SET - 33PC	74	79-064	72TH REVERSIBLE MULTIPLE GEARED WRENCH - 8mm	154
68-075	SCREWDRIVER INSERT BIT SET - 36PC	74	79-065	72TH REVERSIBLE MULTIPLE GEARED WRENCH - 9mm	154
69-031B	SOLDERING IRON - 30W/220V (ROUND)	82	79-066	72TH REVERSIBLE MULTIPLE GEARED WRENCH - 10mm	154
69-031C	SOLDERING IRON - 30W/220V (FLAT)	82	79-067	72TH REVERSIBLE MULTIPLE GEARED WRENCH - 11mm	154
69-033B	SOLDERING IRON - 45W/220V (ROUND)	82	79-068	72TH REVERSIBLE MULTIPLE GEARED WRENCH - 12mm	154
69-033C	SOLDERING IRON - 45W/220V (FLAT)	82	79-069	72TH REVERSIBLE MULTIPLE GEARED WRENCH - 13mm	154
69-041B	SOLDERING GUN - 100W/220V (ROUND)	82	79-070	72TH REVERSIBLE MULTIPLE GEARED WRENCH - 14mm	154
69-041C	SOLDERING GUN - 100W/220V (FLAT)	82	79-071	72TH REVERSIBLE MULTIPLE GEARED WRENCH - 15mm	154
69-119	HEX KEY SET - 9PC S/ARM MM	76	79-072	72TH REVERSIBLE MULTIPLE GEARED WRENCH - 16mm	154
69-213	HEX KEY SET - 10PC RING MM	76	79-073	72TH REVERSIBLE MULTIPLE GEARED WRENCH - 17mm	154
69-230	HEX KEY SET - 10PC RING IMP	76	79-074	72TH REVERSIBLE MULTIPLE GEARED WRENCH - 18mm	154
69-251	HEX KEY SET - 8PC S/ARM MM	76	79-075	72TH REVERSIBLE MULTIPLE GEARED WRENCH - 19mm	154
69-252	HEX KEY SET - 8PC S/ARM IMP	76	79-076	T-HANDLE FLEX HEAD 6 PT SOCKET - 08mm x L500mm	145
69-253	HEX KEY SET - 10PC RING S/ARM	76	79-077	T-HANDLE FLEX HEAD 6 PT SOCKET - 09mm x L500mm	145
69-254	HEX KEY SET - 10PC S/ARM IMP	76	79-078	T-HANDLE FLEX HEAD 6 PT SOCKET - 10mm x L500mm	145
69-256	HEX KEY SET - 9PC CHROME MM	76	79-079	T-HANDLE FLEX HEAD 6 PT SOCKET - 12mm x L500mm	145
69-257	HEX KEY SET - 12PC L/ARM IMP	76	79-080	T-HANDLE FLEX HEAD 6 PT SOCKET - 13mm x L500mm	145
69-259	HEX KEY SET - 9PC FLDG IMP	76	79-081	T-HANDLE FLEX HEAD 6 PT SOCKET - 14mm x L500mm	145
69-260	HEX KEY SET - 5PC FLDG IMP	76	79-082	T-HANDLE FLEX HEAD 6 PT SOCKET - 17mm x L500mm	145
69-261	HEX KEY SET - 7PC FLDG MM	76	79-083	T-HANDLE FLEX HEAD 6 PT SOCKET - 19mm x L500mm	145
69-262	HEX KEY SET - 7PC FLDG MM	76	79-084	T-HANDLE FLEX HEAD 6 PT SOCKET - 21mm x L500mm	145
69-263	HEX KEY SET - 8PC FLDG TORX®	76	79-085	T-HANDLE FLEX SPARK PLUG 6 PT - 14mm x L530mm	146
69-277	2-WAY T-HANDLE BALL POINT HEX KEY - 2.0mm	78	79-086	T-HANDLE FLEX SPARK PLUG 6 PT - 16mm x L530mm	146
69-278	2-WAY T-HANDLE BALL POINT HEX KEY - 2.5mm	78	79-087	T-HANDLE FLEX SPARK PLUG 6 PT - 18mm x L530mm	146
69-279	2-WAY T-HANDLE BALL POINT HEX KEY - 3.0mm	78	79-088	3/4" IMPACT WRENCH 1626NM	155
69-280	2-WAY T-HANDLE BALL POINT HEX KEY - 4.0mm	78	79-089	1/2" IMPACT WRENCH 813NM	156
69-281	2-WAY T-HANDLE BALL POINT HEX KEY - 5.0mm	78	79-092	T-HANDLE FLEX SPARK PLUG 6 PT - 21mm x L530mm	146
69-282	2-WAY T-HANDLE BALL POINT HEX KEY - 6.0mm	78	81-600-1	CAST STEEL BENCH VISE W/ BASE - 3"	65
69-283	2-WAY T-HANDLE BALL POINT HEX KEY - 7.0mm	78	81-601-1	CAST STEEL BENCH VISE W/ BASE - 4"	65
69-284	2-WAY T-HANDLE BALL POINT HEX KEY - 8.0mm	78	81-602-1	CAST STEEL BENCH VISE W/ BASE - 5"	65
69-285	2-WAY T-HANDLE BALL POINT HEX KEY - 10.0mm	78	81-603-1	CAST STEEL BENCH VISE W/ BASE - 6"	65
69-286	2-WAY T-HANDLE BALL POINT HEX KEY - 5/64"	78	81-604-1	CAST STEEL BENCH VISE W/ BASE - 8"	65
69-287	2-WAY T-HANDLE BALL POINT HEX KEY - 3/32"	78	81-605-1	CAST STEEL BENCH VISE W/ BASE - 10"	65
69-288	2-WAY T-HANDLE BALL POINT HEX KEY - 7/64"	78	82-100	REVERSIBLE 3-JAW PULLER	162
69-289	2-WAY T-HANDLE BALL POINT HEX KEY - 1/8"	78	83-031K	MAXSTEEL™ C-CLAMP - 30mm x 25mm/ 1" x 1-3/16"	82
69-290	2-WAY T-HANDLE BALL POINT HEX KEY - 9/64"	78	83-032K	MAXSTEEL™ C-CLAMP - 33mm x 50mm/ 2" x 1-5/16"	82
69-291	2-WAY T-HANDLE BALL POINT HEX KEY - 5/32"	78	83-033K	MAXSTEEL™ C-CLAMP - 57mm x 75mm/ 3" x 2-1/4"	82
69-292	2-WAY T-HANDLE BALL POINT HEX KEY - 3/16"	78	83-034K	MAXSTEEL™ C-CLAMP - 75mm x 100mm/ 4" x 3"	82
69-293	2-WAY T-HANDLE BALL POINT HEX KEY - 7/32"	78	83-035K	MAXSTEEL™ C-CLAMP - 89mm x 150mm/ 6" x 3-1/2"	82
69-294	2-WAY T-HANDLE BALL POINT HEX KEY - 1/4"	78	83-036K	MAXSTEEL™ C-CLAMP - 100mm x 200mm/ 8" x 4"	82
69-295	2-WAY T-HANDLE BALL POINT HEX KEY - 5/16"	78	83-122	BAILEY® HEAVY DUTY CORNER CLAMP	81
69-296	2-WAY T-HANDLE BALL POINT HEX KEY - 3/8"	78	84-000	FATMAX® VDE COMBINATION PLIER - 160mm/6"	54
69-298	2-WAY T-HANDLE TORX KEY (GREY) - T7	78	84-001	FATMAX® VDE COMBINATION PLIER - 100mm/7"	54
69-299	2-WAY T-HANDLE TORX KEY (GREY) - T8	78	84-002	FATMAX® VDE COMBINATION PLIER - 200mm/8"	54
69-300	2-WAY T-HANDLE TORX KEY (GREY) - T9	78	84-003	FATMAX® VDE DIAGONAL PLIER - 180mm/7"	54
69-301	2-WAY T-HANDLE TORX KEY (GREY) - T10	78	84-004	FATMAX® VDE DIAGONAL PLIER - 200mm/ 8"	54
69-302	2-WAY T-HANDLE TORX KEY (GREY) - T15	78	84-005	FATMAX® VDE DIAGONAL PLIER - 210mm/9"	54
69-303	2-WAY T-HANDLE TORX KEY (GREY) - T20	78	84-006	FATMAX® VDE LONG NOSE PLIER - 180mm/7"	54
69-304	2-WAY T-HANDLE TORX KEY (GREY) - T25	78	84-007	FATMAX® VDE LONG NOSE PLIER - 200mm/8"	54
69-305	2-WAY T-HANDLE TORX KEY (GREY) - T27	78	84-008	FATMAX® VDE BENT NOSE PLIER - 200mm/8"	54
69-306	2-WAY T-HANDLE TORX KEY (GREY) - T30	78	84-009	FATMAX® VDE NARROW HEAD DIAGONAL PLIER - 160mm/6-1/4"	54
69-307	2-WAY T-HANDLE TORX KEY (GREY) - T40	78	84-011	FATMAX® VDE 3PCS PLIER SET (84-001, 84-003, 84-007)	54
69-308	2-WAY T-HANDLE TORX KEY (GREY) - T45	78	84-015	WATER PUMP PLIER - 254mm/10"	62
69-646	RIVETER - MEDIUM DUTY C/W 3 NOSEPIECES	83	84-021-2	GROOVE JOINT PLIER - 12"	55
69-799	RIVETER - HEAVY DUTY C/W 4 NOSEPIECES	83	84-024-2	GROOVE JOINT PLIER - 10"	55
69-GR10B	GLUEPRO™ MINI HOT MELT GLUE GUN 100-240V/15W - ROUND PIN	79	84-026-2	SLIP JOINT PLIER - 8"	57
69-GR10C	GLUEPRO™ MINI HOT MELT GLUE GUN 100-240V/15W - FLAT PIN	79	84-027-2	DIAGONAL CUTTING PLIER - 6"	55
69-GR15B	GLUEPRO™ MINI DUAL TEMP MELT GLUE GUN 100-240V/15W - ROUND PIN	79	84-028-2	HD DIAGONAL PLIER - 7.5"	55
69-GR15C	GLUEPRO™ MINI DUAL TEMP MELT GLUE GUN 100-240V/15W - FLAT PIN	79	84-029-2	LINESMAN PLIER - 8"	55
69-GR20B	GLUEPRO™ TRIGGER FEED HOT MELT GLUE GUN 100-240V - ROUND PIN	79	84-031-2	LONG NOSE PLIER - 6"	56
69-GR20C	GLUEPRO™ TRIGGER FEED HOT MELT GLUE GUN 100-240V - FLAT PIN	79	84-032-2	LONG NOSE PLIER - 8"	56
69-GR25B	GLUEPRO™ TRIGGER FEED DUAL MELT GLUE GUN 100-240V - ROUND PIN	80	84-034-2	GROOVE JOINT PLIER - 8"	55
69-GR25C	GLUEPRO™ TRIGGER FEED DUAL MELT GLUE GUN 100-240V - FLAT PIN	80	84-035-2	LINESMAN PLIER - 7"	55
69-GR90B	GLUEPRO™ CORD FREE 2-WAY GLUE GUN - ROUND PIN	80	84-036	PRECISION NIPPER PLIER - 100mm/4"	53
69-GR90C	GLUEPRO™ CORD FREE 2-WAY GLUE GUN - FLAT PIN	80	84-037	PRECISION NIPPER PLIER - 125mm/5"	53
			84-038	PRECISION NIPPER PLIER - 150mm/6"	53
			84-047	PRECISION LONG CUTTER - 125mm/5"	53
			84-048	PRECISION LONG CUTTER - 150mm/6"	53
			84-049	PRECISION BENT NOSE - 125mm/5"	53
			84-054	PRECISION BENT NOSE - 150mm/6"	53
			84-055-2	SLIP JOINT PLIER - 6"	57
			84-071-2	BENT NOSE PLIER - 6"	56

# PRODUCT INDEX

SKU#	Descriptor	Page
84-072-2	BENT NOSE PLIER - 8"	56
84-073-2	FLAT NOSE PLIER - 6"	57
84-074-2	ROUND NOSE PLIER - 6"	57
84-075-2	WIRE STRIPPER - 6"	56
84-077-2	END CUTTER PLIER - 6"	56
84-096	MINI NEEDLE NOSE PLIER - 127mm/5"	57
84-119	MINI LONG NOSE PLIER - 127mm/5"	57
84-122	MINI FLAT NOSE PLIER - 102mm/4"	57
84-124	MINI DIAGONAL CUTTING PLIER - 102mm/4"	57
84-125	MINI END NIPER PLIER - 102MM/4"	57
84-126	MINI BENT NOSE PLIERS - 127mm/5"	57
84-167-2	END CUTTER PLIER - 8"	56
84-168	COMBINATION SNAP RING PLIER - 152mm/6"	60
84-214	WIRE STRIPPER - 130mm	61
84-223	CRIMPING PLIER - 230mm/9"	61
84-253	CRIMPING PLIER - 230mm/9" (SET)	61
84-258	CABLE CUTTER - 10"	64
84-271	CIRCLIP PLIER - 175mm/7" (STRAIGHT EXT.)	61
84-272	CIRCLIP PLIER - 175mm/7" (BENT EXT.)	61
84-273	CIRCLIP PLIER - 175mm/7" (STRAIGHT INT.)	61
84-274	CIRCLIP PLIER - 175mm/7" (BENT INT.)	61
84-281	TOWER PINCER - 200mm	62
84-282	TOWER PINCER - 250mm	62
84-288	HD PRINCERS - 200mm	62
84-294	FATMAX® VDE WATER PUMP PLIER (AA-01V)	54
84-325	WIRE STRIPPER/CRIMPER - 6" (AWG20-30)	61
84-367-1	LOCKING PLIER - 127mm/5" (CURVED JAW)	60
84-368-1	LOCKING PLIER - 175mm/7" (CURVED JAW)	60
84-369-1	LOCKING PLIER WITH BI-MATERIAL HANDLE - 254mm/10" (CURVED JAW)	60
84-370-1	LOCKING PLIER - 175mm/7" (STRAIGHT JAW)	60
84-371-1	LOCKING PLIER WITH BI-MATERIAL HANDLE - 254mm/10" (STRAIGHT JAW)	60
84-371-1	ADJUSTABLE WRENCH - 457mm/18"	62
84-389	LOCKING PLIER WITH BI-MATERIAL HANDLE - 229mm/9.5" (LONG NOSE)	60
84-396	LOCKING PLIER - 165mm/6.5" (LONG NOSE)	60
84-430-1	ADJUSTABLE WRENCH - 100mm/4"	62
84-431-1	ADJUSTABLE WRENCH - 150mm/6"	62
84-432-1	ADJUSTABLE WRENCH - 200mm/8"	62
84-433-1	ADJUSTABLE WRENCH - 25mm/10"	62
84-434-1	ADJUSTABLE WRENCH - 300mm/12"	62
84-435-1	ADJUSTABLE WRENCH - 375mm/15"	62
84-451	ALUMINUM PIPE WRENCH - 10"	63
84-463	ALUMINUM PIPE WRENCH - 12"	63
84-465	ALUMINUM PIPE WRENCH - 14"	63
84-466	ALUMINUM PIPE WRENCH - 18"	63
84-467	ALUMINUM PIPE WRENCH - 24"	63
84-475	WIRE STRIPPER/CRIMPER - 6" (AWG12-22)	61
84-477	WIRE STRIPPER/CRIMPER - 6" (AWG16-26)	61
84-519K	STANLEY® 12-IN-1 MULTI-TOOL	43
84-607-2	DIAGONAL PLIER - 8"	55
84-609-2	LINESMAN PLIER - 9"	55
84-623-2	HD COMBINATION PLIER - 6"	55
84-629	CABLE CUTTER - 12"	64
84-630	CABLE CUTTER - 21"	64
84-632	CABLE CUTTER - 32"	64
84-758	OPEN END WRENCHES - 8 x 10mm	153
84-759	OPEN END WRENCHES - 10 x 12mm	153
84-760	OPEN END WRENCHES - 12 x 14mm	153
84-764	OPEN END WRENCHES - 14 x 17mm	153
84-765	OPEN END WRENCHES - 17 x 19mm	153
84-766	OPEN END WRENCHES - 19 x 21mm	153
84-767	OPEN END WRENCHES - 22 x 24mm	153
85-931-2	REVERSIBLE GEARED WRENCH - 8mm	154
85-933-2	REVERSIBLE GEARED WRENCH - 10mm	154
85-934-2	REVERSIBLE GEARED WRENCH - 12mm	154
85-936-2	REVERSIBLE GEARED WRENCH - 13mm	154
85-937-2	REVERSIBLE GEARED WRENCH - 14mm	154
85-938-2	REVERSIBLE GEARED WRENCH - 15mm	154
85-939-2	REVERSIBLE GEARED WRENCH - 18mm	154
86-001-1	FLEX EXTENSION	132
86-002-1	1/4" DRIVE ADAPTER - 1/4"F x 3/8"M	134
86-006-1	1/4" DRIVE EXTENSION BAR - 3"	132
86-007-1	1/4" DRIVE EXTENSION BAR - 6"	132
86-010-1	1/4" DRIVE SLIDING T-BAR	130
86-011-1	1/4" DRIVE UNIVERSAL JOINT	133
86-012-1	1/4" DRIVE FLEX HANDLE - 147mm	131
86-021-1	1/4" DRIVE 6 POINT STANDARD SOCKETS - 5/32"	135
86-022-1	1/4" DRIVE 6 POINT STANDARD SOCKETS - 3/16"	135
86-023-1	1/4" DRIVE 6 POINT STANDARD SOCKETS - 7/32"	135
86-024-1	1/4" DRIVE 6 POINT STANDARD SOCKETS - 1/4"	135
86-025-1	1/4" DRIVE 6 POINT STANDARD SOCKETS - 9/32"	135
86-026-1	1/4" DRIVE 6 POINT STANDARD SOCKETS - 5/16"	135

SKU#	Descriptor	Page
86-027-1	1/4" DRIVE 6 POINT STANDARD SOCKETS - 11/32"	135
86-028-1	1/4" DRIVE 6 POINT STANDARD SOCKETS - 3/8"	135
86-029-1	1/4" DRIVE 6 POINT STANDARD SOCKETS - 7/16"	135
86-030-1	1/4" DRIVE 6 POINT STANDARD SOCKETS - 1/2"	135
86-101-1	1/4" DRIVE 6 POINT STANDARD SOCKETS - 4mm	136
86-102-1	1/4" DRIVE 6 POINT STANDARD SOCKETS - 5mm	136
86-103-1	1/4" DRIVE 6 POINT STANDARD SOCKETS - 6mm	136
86-104-1	1/4" DRIVE 6 POINT STANDARD SOCKETS - 7mm	136
86-105-1	1/4" DRIVE 6 POINT STANDARD SOCKETS - 8mm	136
86-106-1	1/4" DRIVE 6 POINT STANDARD SOCKETS - 9mm	136
86-107-1	1/4" DRIVE 6 POINT STANDARD SOCKETS - 10mm	136
86-108-1	1/4" DRIVE 6 POINT STANDARD SOCKETS - 11mm	136
86-109-1	1/4" DRIVE 6 POINT STANDARD SOCKETS - 12mm	136
86-110-1	1/4" DRIVE 6 POINT STANDARD SOCKETS - 4.5mm	136
86-111-1	1/4" DRIVE 6 POINT STANDARD SOCKETS - 5.5mm	136
86-112-1	1/4" DRIVE 6 POINT STANDARD SOCKETS - 13mm	136
86-114-1	1/4" DRIVE 6 POINT STANDARD SOCKETS - 14mm	136
86-117	16-PIECE 1/4" DRIVE SOCKET SET	166
86-124-1	1/4" DRIVE BIT ADAPTER	134
86-127	40° OFFSET RING WRENCH LONG - 8 x 9	150
86-176-1	3/8" DRIVE PHILLIPS BIT SOCKET - 0PT	143
86-177-1	3/8" DRIVE PHILLIPS BIT SOCKET - 2PT	143
86-178-1	3/8" DRIVE PHILLIPS BIT SOCKET - 4PT	143
86-192-1	1/2" DRIVE 12 POINT STANDARD SOCKETS - 34mm	137
86-196-1	1/2" DRIVE 6 POINT STANDARD SOCKETS - 34mm	136
86-202-1	3/8" DRIVE SLIDING T-BAR	130
86-206-1	3/8" DRIVE EXTENSION BAR - 3"	132
86-207-1	3/8" DRIVE EXTENSION BAR - 6"	132
86-208-1	3/8" DRIVE EXTENSION BAR - 10"	132
86-211-1	3/8" DRIVE UNIVERSAL JOINT	133
86-212-1	3/8" DRIVE SPEEDER HANDLE	131
86-213-1	3/8" DRIVE FLEX HANDLE - 215.5mm	131
86-214-1	3/8" DRIVE ADAPTER - 3/8"FX1/4"M	134
86-215-1	3/8" DRIVE ADAPTER - 3/8"FX1/2"M	134
86-219	10-PIECE 3/8" DRIVE SOCKET SET	167
86-250-1	3/8" DRIVE BIT ADAPTER	134
86-258-1	3/8" DRIVE EXTENSION BAR - 12"	132
86-260-1	3/8" DRIVE 12 POINT STANDARD SOCKETS - 1/4"	138
86-261-1	3/8" DRIVE 12 POINT STANDARD SOCKETS - 5/16"	138
86-279-1	3/8" DRIVE 12 POINT DEEP SOCKETS - 1/4"	140
86-297-1	1/4" DRIVE SLOTTED BIT SOCKETS - 8mm	144
86-301-1	3/8" DRIVE 6 POINT STANDARD SOCKETS - 6mm	136
86-302-1	3/8" DRIVE 6 POINT STANDARD SOCKETS - 7mm	136
86-303-1	3/8" DRIVE 6 POINT STANDARD SOCKETS - 8mm	136
86-304-1	3/8" DRIVE 6 POINT STANDARD SOCKETS - 9mm	136
86-305-1	3/8" DRIVE 6 POINT STANDARD SOCKETS - 10mm	136
86-306-1	3/8" DRIVE 6 POINT STANDARD SOCKETS - 11mm	136
86-307-1	3/8" DRIVE 6 POINT STANDARD SOCKETS - 12mm	136
86-308-1	3/8" DRIVE 6 POINT STANDARD SOCKETS - 13mm	136
86-309-1	3/8" DRIVE 6 POINT STANDARD SOCKETS - 14mm	136
86-310-1	3/8" DRIVE 6 POINT STANDARD SOCKETS - 15mm	136
86-311-1	3/8" DRIVE 6 POINT STANDARD SOCKETS - 16mm	136
86-312-1	3/8" DRIVE 6 POINT STANDARD SOCKETS - 17mm	136
86-318-1	3/8" DRIVE EXTENSION BAR - 20"	132
86-322-1	3/8" DRIVE 6 POINT DEEP SOCKETS - 10mm	139
86-323-1	3/8" DRIVE 6 POINT DEEP SOCKETS - 11mm	139
86-324-1	3/8" DRIVE 6 POINT DEEP SOCKETS - 12mm	139
86-325-1	3/8" DRIVE 6 POINT DEEP SOCKETS - 13mm	139
86-326-1	3/8" DRIVE 6 POINT DEEP SOCKETS - 14mm	139
86-327-1	3/8" DRIVE 6 POINT DEEP SOCKETS - 15mm	139
86-328-1	3/8" DRIVE 6 POINT DEEP SOCKETS - 17mm	139
86-329-1	3/8" DRIVE 6 POINT DEEP SOCKETS - 19mm	139
86-335-1	3/8" DRIVE PHILLIPS BIT SOCKET - 1PT	143
86-336-1	3/8" DRIVE PHILLIPS BIT SOCKET - 3PT	143
86-338-1	3/8" DRIVE 12 POINT DEEP SOCKETS - 8mm	139
86-339-1	3/8" DRIVE 12 POINT DEEP SOCKETS - 9mm	139
86-342-1	3/8" DRIVE 12 POINT STANDARD SOCKETS - 7mm	137
86-343-1	3/8" DRIVE 12 POINT STANDARD SOCKETS - 8mm	137
86-344-1	3/8" DRIVE 12 POINT STANDARD SOCKETS - 9mm	137
86-345-1	3/8" DRIVE 12 POINT STANDARD SOCKETS - 10mm	137
86-346-1	3/8" DRIVE 12 POINT STANDARD SOCKETS - 11mm	137
86-347-1	3/8" DRIVE 12 POINT STANDARD SOCKETS - 12mm	137
86-348-1	3/8" DRIVE 12 POINT STANDARD SOCKETS - 13mm	137
86-349-1	3/8" DRIVE 12 POINT STANDARD SOCKETS - 14mm	137
86-350-1	3/8" DRIVE 12 POINT STANDARD SOCKETS - 15mm	137
86-351-1	3/8" DRIVE 12 POINT STANDARD SOCKETS - 16mm	137
86-352-1	3/8" DRIVE 12 POINT STANDARD SOCKETS - 17mm	137
86-362-1	3/8" DRIVE 12 POINT DEEP SOCKETS - 10mm	139
86-363-1	3/8" DRIVE 12 POINT DEEP SOCKETS - 11mm	139
86-364-1	3/8" DRIVE 12 POINT DEEP SOCKETS - 12mm	139
86-365-1	3/8" DRIVE 12 POINT DEEP SOCKETS - 13mm	139
86-366-1	3/8" DRIVE 12 POINT DEEP SOCKETS - 14mm	139
86-367-1	3/8" DRIVE 12 POINT DEEP SOCKETS - 15mm	139
86-369-1	3/8" DRIVE 12 POINT DEEP SOCKETS - 17mm	139

# PRODUCT INDEX

SKU#	Descriptor	Page
86-370-1	3/8" DRIVE 12 POINT DEEP SOCKETS - 18mm	139
86-371-1	3/8" DRIVE 12 POINT DEEP SOCKETS - 19mm	139
86-372-1	1/4" DRIVE EXTENSION BAR - 10"	132
86-373-1	1/4" DRIVE HEX BIT SOCKETS - 3	141
86-374-1	1/4" DRIVE SLOTTED BIT SOCKETS - 3.5mm	144
86-375	OFFSET HANDLE	130
86-376-1	3/8" DRIVE HEX BIT SOCKETS - 9/64"	142
86-377-1	3/8" DRIVE HEX BIT SOCKETS - 3/8"	142
86-380-1	3/8" DRIVE 6 POINT SPARK PLUG SOCKETS - 5/8"	145
86-381-1	3/8" DRIVE 6 POINT SPARK PLUG SOCKETS - 13/16"	145
86-384-1	1/2" DRIVE 6 POINT STANDARD SOCKETS - 1/4"	135
86-387-1	3/8" DRIVE HEX BIT SOCKETS - 1/8"	142
86-388-1	3/8" DRIVE HEX BIT SOCKETS - 5/32"	142
86-389-1	3/8" DRIVE HEX BIT SOCKETS - 3/16"	142
86-390-1	3/8" DRIVE HEX BIT SOCKETS - 7/32"	142
86-391-1	3/8" DRIVE HEX BIT SOCKETS - 1/4"	142
86-392-1	3/8" DRIVE HEX BIT SOCKETS - 5/16"	142
86-395-1	1/4" DRIVE QUICK RELEASE RATCHET - ROUND HEAD	129
86-396-1	3/8" DRIVE QUICK RELEASE RATCHET - ROUND HEAD	129
86-397-1	1/2" DRIVE QUICK RELEASE RATCHET - ROUND HEAD	129
86-405-1	1/2" DRIVE FLEX HANDLE - 254mm	131
86-406-1	1/2" DRIVE EXTENSION BAR - 2 1/2"	132
86-407-1	1/2" DRIVE EXTENSION BAR - 5"	132
86-408-1	1/2" DRIVE EXTENSION BAR - 10"	132
86-411-1	1/2" DRIVE UNIVERSAL JOINT	133
86-412-1	1/2" DRIVE SPEEDER HANDLE	131
86-413-1	1/2" DRIVE FLEX HANDLE - 439mm	131
86-414-1	1/2" DRIVE ADAPTER - 1/2" FX3/8" M	134
86-415-1	1/2" DRIVE FLEX HANDLE - 381mm	131
86-418-1	1/2" DRIVE 12 POINT DEEP SOCKETS - 10mm	139
86-419-1	1/2" DRIVE 12 POINT DEEP SOCKETS - 11mm	139
86-420-1	1/2" DRIVE 12 POINT DEEP SOCKETS - 12mm	139
86-421-1	1/2" DRIVE 12 POINT DEEP SOCKETS - 13mm	139
86-422-1	1/2" DRIVE 12 POINT DEEP SOCKETS - 14mm	139
86-423-1	1/2" DRIVE 12 POINT DEEP SOCKETS - 15mm	139
86-424-1	1/2" DRIVE 12 POINT DEEP SOCKETS - 16mm	139
86-425-1	1/2" DRIVE 12 POINT DEEP SOCKETS - 17mm	139
86-426-1	1/2" DRIVE 12 POINT DEEP SOCKETS - 18mm	139
86-427-1	1/2" DRIVE 12 POINT DEEP SOCKETS - 19mm	139
86-428-1	1/2" DRIVE 12 POINT DEEP SOCKETS - 20mm	139
86-429-1	1/2" DRIVE 12 POINT DEEP SOCKETS - 21mm	139
86-430-1	1/2" DRIVE 12 POINT DEEP SOCKETS - 22mm	139
86-431-1	1/2" DRIVE 12 POINT DEEP SOCKETS - 23mm	139
86-432-1	1/2" DRIVE 12 POINT DEEP SOCKETS - 24mm	139
86-433-1	1/2" DRIVE 12 POINT DEEP SOCKETS - 25mm	139
86-434-1	1/2" DRIVE 12 POINT DEEP SOCKETS - 26mm	139
86-435-1	1/2" DRIVE 12 POINT DEEP SOCKETS - 27mm	139
86-436-1	1/2" DRIVE 12 POINT DEEP SOCKETS - 28mm	139
86-438-1	1/2" DRIVE 12 POINT DEEP SOCKETS - 30mm	139
86-439-1	1/2" DRIVE 12 POINT DEEP SOCKETS - 32mm	139
86-440-1	1/2" DRIVE SLIDING T-BAR	130
86-441-1	1/2" DRIVE 6 POINT STANDARD SOCKETS - 5/16"	135
86-442-1	1/2" DRIVE 6 POINT STANDARD SOCKETS - 3/8"	135
86-443-1	1/2" DRIVE 6 POINT STANDARD SOCKETS - 7/16"	135
86-444-1	1/2" DRIVE 6 POINT STANDARD SOCKETS - 1/2"	135
86-445-1	1/2" DRIVE 6 POINT STANDARD SOCKETS - 9/16"	135
86-446-1	1/2" DRIVE 6 POINT STANDARD SOCKETS - 19/32"	135
86-450-1	1/2" DRIVE 6 POINT STANDARD SOCKETS - 25/32"	135
86-458-1	1/2" DRIVE 6 POINT STANDARD SOCKETS - 1 3/16"	135
86-460-1	1/2" DRIVE 12 POINT STANDARD SOCKETS - 5/16"	138
86-461-1	1/2" DRIVE 12 POINT STANDARD SOCKETS - 3/8"	138
86-462-1	1/2" DRIVE 12 POINT STANDARD SOCKETS - 7/16"	138
86-463-1	1/2" DRIVE 12 POINT STANDARD SOCKETS - 1/2"	138
86-464-1	1/2" DRIVE 12 POINT STANDARD SOCKETS - 9/16"	138
86-477	27-PIECE 1/2" DRIVE SOCKET SET	170
86-478-1	27-PIECE 1/2" DRIVE SOCKET SET	170
86-481-1	1/2" DRIVE 12 POINT DEEP SOCKETS - 1/2"	140
86-482-1	1/2" DRIVE 12 POINT DEEP SOCKETS - 9/16"	140
86-483-1	1/2" DRIVE 12 POINT DEEP SOCKETS - 5/8"	140
86-484-1	1/2" DRIVE 12 POINT DEEP SOCKETS - 11/16"	140
86-485-1	1/2" DRIVE 12 POINT DEEP SOCKETS - 3/4"	140
86-486-1	1/2" DRIVE 12 POINT DEEP SOCKETS - 13/16"	140
86-487-1	1/2" DRIVE 12 POINT DEEP SOCKETS - 7/8"	140
86-488-1	1/2" DRIVE 12 POINT DEEP SOCKETS - 15/16"	140
86-489-1	1/2" DRIVE 12 POINT DEEP SOCKETS - 1"	140
86-490-1	1/2" DRIVE 12 POINT DEEP SOCKETS - 1 1/16"	140
86-491-1	1/2" DRIVE 12 POINT DEEP SOCKETS - 1 1/8"	140
86-493	L- HANDLE	130
86-494-1	1/2" DRIVE 12 POINT STANDARD SOCKETS - 1/4"	138
86-496-1	1/2" DRIVE 12 POINT STANDARD SOCKETS - 1 3/6"	138
86-497-1	1/2" DRIVE 12 POINT STANDARD SOCKETS - 19/32"	138
86-498-1	1/2" DRIVE 12 POINT STANDARD SOCKETS - 25/32"	138
86-499-1	1/2" DRIVE 12 POINT STANDARD SOCKETS - 31/32"	138
86-501	13-PIECE 1/2" DRIVE SOCKET SET	168

SKU#	Descriptor	Page
86-504	29-PIECE 1/2" DRIVE SOCKET SET	170
86-508-1	1/2" DRIVE 6 POINT STANDARD SOCKETS - 8mm	136
86-509-1	1/2" DRIVE 6 POINT STANDARD SOCKETS - 9mm	136
86-510-1	1/2" DRIVE 6 POINT STANDARD SOCKETS - 10mm	136
86-511-1	1/2" DRIVE 6 POINT STANDARD SOCKETS - 11mm	136
86-512-1	1/2" DRIVE 6 POINT STANDARD SOCKETS - 12mm	136
86-513-1	1/2" DRIVE 6 POINT STANDARD SOCKETS - 13mm	136
86-514-1	1/2" DRIVE 6 POINT STANDARD SOCKETS - 14mm	136
86-515-1	1/2" DRIVE 6 POINT STANDARD SOCKETS - 15mm	136
86-531	22-PIECE 1/2" DRIVE SOCKET SET	169
86-536-1	1/2" DRIVE 6 POINT STANDARD SOCKETS - 36mm	136
86-540-1	1/2" DRIVE 12 POINT STANDARD SOCKETS - 8mm	137
86-541-1	1/2" DRIVE 12 POINT STANDARD SOCKETS - 9mm	137
86-542-1	1/2" DRIVE 12 POINT STANDARD SOCKETS - 10mm	137
86-543-1	1/2" DRIVE 12 POINT STANDARD SOCKETS - 11mm	137
86-544-1	1/2" DRIVE 12 POINT STANDARD SOCKETS - 12mm	137
86-545-1	1/2" DRIVE 12 POINT STANDARD SOCKETS - 13mm	137
86-546-1	1/2" DRIVE 12 POINT STANDARD SOCKETS - 14mm	137
86-547-1	1/2" DRIVE 12 POINT STANDARD SOCKETS - 15mm	137
86-580-1	1/2" DRIVE 6 POINT SPARK PLUG SOCKETS - 5/8"	145
86-581-1	1/2" DRIVE 6 POINT SPARK PLUG SOCKETS - 13/16"	145
86-582-1	1/2" DRIVE 6 POINT SPARK PLUG SOCKETS - 14mm	145
86-583-1	1/2" DRIVE 6 POINT SPARK PLUG SOCKETS - 16mm	145
86-584-1	1/2" DRIVE 6 POINT SPARK PLUG SOCKETS - 18mm	145
86-585-1	1/2" DRIVE 6 POINT SPARK PLUG SOCKETS - 21mm	145
86-721-1	1/4" DRIVE HEX BIT SOCKETS - 4	141
86-723-1	1/4" DRIVE HEX BIT SOCKETS - 5	141
86-725-1	1/4" DRIVE HEX BIT SOCKETS - 6	141
86-726-1	1/4" DRIVE HEX BIT SOCKETS - 7	141
86-727-1	1/4" DRIVE HEX BIT SOCKETS - 8	141
86-729-1	1/4" DRIVE HEX BIT SOCKETS - 10	141
86-734	11-PIECE 3/8" DRIVE SOCKET SET	168
86-743-1	1/4" DRIVE SLOTTED BIT SOCKETS - 5.5mm	144
86-744-1	1/4" DRIVE SLOTTED BIT SOCKETS - 6.5mm	144
86-745-1	1/4" DRIVE SLOTTED BIT SOCKETS - 4mm	144
86-747-1	1/4" DRIVE SLOTTED BIT SOCKETS - 7mm	144
86-766-1	1/2" DRIVE 6 POINT STANDARD SOCKETS - 5/8"	135
86-767-1	1/2" DRIVE 6 POINT STANDARD SOCKETS - 11/16"	135
86-768-1	1/2" DRIVE 6 POINT STANDARD SOCKETS - 3/4"	135
86-769-1	1/2" DRIVE 6 POINT STANDARD SOCKETS - 13/16"	135
86-896	40" OFFSET RING WRENCH LONG - 21X23	150
87-011-1	SLIMLINE 8 PIECE COMBINATION WRENCH SET	147
87-033-1	SLIMLINE 9 PIECE COMBINATION WRENCH SET	148
87-034-1	SLIMLINE 9 PIECE COMBINATION WRENCH SET	148
87-036-1	SLIMLINE 14 PIECE COMBINATION WRENCH SET	148
87-038-1	SLIMLINE 14 PIECE COMBINATION WRENCH SET	148
87-057-1	SLIMLINE COMBINATION WRENCH - 7mm	152
87-058-1	SLIMLINE COMBINATION WRENCH - 8mm	152
87-066-1	SLIMLINE COMBINATION WRENCH - 6mm	152
87-069-1	SLIMLINE COMBINATION WRENCH - 9mm	152
87-070-1	SLIMLINE COMBINATION WRENCH - 10mm	152
87-071-1	SLIMLINE COMBINATION WRENCH - 11mm	152
87-072-1	SLIMLINE COMBINATION WRENCH - 12mm	152
87-073-1	SLIMLINE COMBINATION WRENCH - 13mm	152
87-074-1	SLIMLINE COMBINATION WRENCH - 14mm	152
87-075-1	SLIMLINE COMBINATION WRENCH - 15mm	152
87-076-1	SLIMLINE COMBINATION WRENCH - 16mm	152
87-077-1	SLIMLINE COMBINATION WRENCH - 17mm	152
87-078-1	SLIMLINE COMBINATION WRENCH - 18mm	152
87-079-1	SLIMLINE COMBINATION WRENCH - 19mm	152
87-080-1	SLIMLINE COMBINATION WRENCH - 20mm	152
87-081-1	SLIMLINE COMBINATION WRENCH - 21mm	152
87-082-1	SLIMLINE COMBINATION WRENCH - 22mm	152
87-083-1	SLIMLINE COMBINATION WRENCH - 23mm	152
87-084-1	SLIMLINE COMBINATION WRENCH - 24mm	152
87-085-1	SLIMLINE COMBINATION WRENCH - 25mm	152
87-086-1	SLIMLINE COMBINATION WRENCH - 26mm	152
87-087-1	SLIMLINE COMBINATION WRENCH - 27mm	152
87-088-1	SLIMLINE COMBINATION WRENCH - 28mm	152
87-089-1	SLIMLINE COMBINATION WRENCH - 29mm	152
87-090-1	SLIMLINE COMBINATION WRENCH - 30mm	152
87-092-1	SLIMLINE COMBINATION WRENCH - 32mm	152
87-096-1	OPEN END WRENCH - 6 x 7mm	153
87-097-1	OPEN END WRENCH - 8 x 9mm	153
87-098-1	OPEN END WRENCH - 10 x 11mm	153
87-099-1	OPEN END WRENCH - 12 x 13mm	153
87-100-1	OPEN END WRENCH - 14 x 15mm	153
87-101-1	OPEN END WRENCH - 16 x 17mm	153
87-102-1	OPEN END WRENCH - 18 x 19mm	153
87-103-1	OPEN END WRENCH - 20 x 22mm	153
87-104-1	OPEN END WRENCH - 21 x 23mm	153
87-105-1	OPEN END WRENCH - 24 x 27mm	153
87-106-1	OPEN END WRENCH - 25 x 28mm	153
87-107-1	OPEN END WRENCH - 30 x 32mm	153

# PRODUCT INDEX

SKU#	Descriptor	Page	SKU#	Descriptor	Page
87-141-1	3/8" DRIVE TORX® BIT SOCKETS - T15	143	87-706-1	OPEN END WRENCH - 15/16" x 1"	153
87-142-1	3/8" DRIVE TORX® BIT SOCKETS - T20	143	87-709-1	SLIMLINE 14 PIECE COMBINATION WRENCH SET	148
87-143-1	3/8" DRIVE TORX® BIT SOCKETS - T25	143	87-710	1/4" DRIVE ROUND HEAD RATCHET	128
87-144-1	3/8" DRIVE TORX® BIT SOCKETS - T30	143	87-712-1	7 PIECE DOUBLE OPEN END WRENCH SET - INCH	147
87-145-1	3/8" DRIVE TORX® BIT SOCKETS - T40	143	87-714	7 PIECE 75° OFFSET RING END WRENCH SET - INCH	149
87-146-1	3/8" DRIVE TORX® BIT SOCKETS - T45	143	87-715	3/8" DRIVE ROUND HEAD RATCHET	128
87-147-1	3/8" DRIVE TORX® BIT SOCKETS - T50	143	87-716-1	6 PIECE DOUBLE OPEN END WRENCH SET - METRIC	147
87-263	SLIMLINE COMBINATION WRENCH - 33mm	152	87-718-1	8 PIECE DOUBLE OPEN END WRENCH SET - METRIC	147
87-264	SLIMLINE COMBINATION WRENCH - 34mm	152	87-720	1/2" DRIVE ROUND HEAD RATCHET	128
87-265	SLIMLINE COMBINATION WRENCH - 35mm	152	87-796	ADJUSTABLE WRENCH - 460mm/18"	63
87-266	SLIMLINE COMBINATION WRENCH - 36mm	152	87-797	ADJUSTABLE WRENCH - 609mm/24"	63
87-268	SLIMLINE COMBINATION WRENCH - 38mm	152	87-801-1	75° OFFSET RING WRENCH LONG - 6 x 7	151
87-271	SLIMLINE COMBINATION WRENCH - 41mm	152	87-802-1	75° OFFSET RING WRENCH LONG - 8 x 9	151
87-272	SLIMLINE COMBINATION WRENCH - 42mm	152	87-803-1	75° OFFSET RING WRENCH LONG - 10 x 11	151
87-276	SLIMLINE COMBINATION WRENCH - 46mm	152	87-804-1	75° OFFSET RING WRENCH LONG - 12 x 13	151
87-278	SLIMLINE COMBINATION WRENCH - 48mm	152	87-805-1	75° OFFSET RING WRENCH LONG - 14 x 15	151
87-280	SLIMLINE COMBINATION WRENCH - 50mm	152	87-806-1	75° OFFSET RING WRENCH LONG - 16 x 17	151
87-342	7-PIECE TORX BIT SOCKET CLIP RAIL - 3/8" DRIVE	173	87-807-1	75° OFFSET RING WRENCH LONG - 18 x 19	151
87-343	5-PIECE HEX BIT SOCKET CLIP RAIL - 3/8" DRIVE	172	87-808-1	75° OFFSET RING WRENCH LONG - 20 x 22	151
87-344	5-PIECE SCREWDRIVER BIT SOCKET CLIP RAIL - 3/8" DRIVE	172	87-809-1	75° OFFSET RING WRENCH LONG - 21 x 23	151
87-392-1	FLARE NUT WRENCH - 8 x 10	154	87-810-1	75° OFFSET RING WRENCH LONG - 24 x 27	151
87-393-1	FLARE NUT WRENCH - 12 x 14	154	87-811-1	75° OFFSET RING WRENCH LONG - 25 x 28	151
87-404-1	3/8" DRIVE TORX® BIT SOCKETS - T10	143	87-812-1	75° OFFSET RING WRENCH LONG - 30 x 32	151
87-406-1	3/8" DRIVE TORX® BIT SOCKETS - T27	143	87-850-1	FLARE NUT WRENCH - 3/8" x 7/16"	154
87-407-1	3/8" DRIVE TORX® BIT SOCKETS - T55	143	87-851-1	FLARE NUT WRENCH - 1/2" x 9/16"	154
87-419-1	SPINNER	131	87-852-1	FLARE NUT WRENCH - 5/8" x 11/16"	154
87-424-1	SLIMLINE COMBINATION WRENCH - 5mm	152	87-853-1	FLARE NUT WRENCH - 3/4" x 7/8"	154
87-429-1	SLIMLINE COMBINATION WRENCH - 5.5mm	152	87-858-1	FLARE NUT WRENCH - 15 x 17	154
87-448	BASIN WRENCH - 254mm/10"	63	87-886-1	FLARE NUT WRENCH - 19 x 22	154
87-501-1	1/2" 6 POINT DEEP IMPACT SOCKETS 14mm	147	87-965-1	3/8" DRIVE HEX BIT SOCKETS - 3	141
87-504-1	1/2" 6 POINT DEEP IMPACT SOCKETS 17mm	147	87-971-1	3/8" DRIVE HEX BIT SOCKETS - 4	141
87-506-1	1/2" 6 POINT DEEP IMPACT SOCKETS 19mm	147	87-972-1	3/8" DRIVE HEX BIT SOCKETS - 5	141
87-507-1	1/2" 6 POINT DEEP IMPACT SOCKETS 21mm	147	87-973-1	3/8" DRIVE HEX BIT SOCKETS - 6	141
87-508-1	1/2" 6 POINT DEEP IMPACT SOCKETS 24mm	147	87-974-1	3/8" DRIVE HEX BIT SOCKETS - 7	141
87-509-1	1/2" 6 POINT DEEP IMPACT SOCKETS 27mm	147	87-975-1	3/8" DRIVE HEX BIT SOCKETS - 8	141
87-576-1	8 PIECE 75° OFFSET RING END WRENCH SET - METRIC	149	87-976-1	3/8" DRIVE HEX BIT SOCKETS - 10	141
87-617-1	10 PIECE 75° OFFSET RING END WRENCH SET - METRIC	149	88-131-1	3/8" DRIVE 6 POINT STANDARD SOCKETS - 18mm	136
87-620	PIPE WRENCH - 140mm/6"	63	88-132-1	3/8" DRIVE 6 POINT STANDARD SOCKETS - 19mm	136
87-621	PIPE WRENCH - 186mm/8"	63	88-133-1	3/8" DRIVE 6 POINT STANDARD SOCKETS - 20mm	136
87-622	PIPE WRENCH - 248mm/10"	63	88-134-1	3/8" DRIVE 6 POINT STANDARD SOCKETS - 21mm	136
87-623	PIPE WRENCH - 297mm/12"	63	88-135-1	3/8" DRIVE 6 POINT STANDARD SOCKETS - 22mm	136
87-624	PIPE WRENCH - 332mm/14"	63	88-136-1	3/8" DRIVE 6 POINT STANDARD SOCKETS - 23mm	136
87-625	PIPE WRENCH - 414mm/18"	63	88-137-1	3/8" DRIVE 6 POINT STANDARD SOCKETS - 24mm	136
87-626	PIPE WRENCH - 553mm/24"	63	88-146-1	3/8" DRIVE 12 POINT STANDARD SOCKETS - 18mm	137
87-627	PIPE WRENCH - 805mm/36"	63	88-147-1	3/8" DRIVE 12 POINT STANDARD SOCKETS - 19mm	137
87-660-1	SLIMLINE COMBINATION WRENCH - 1/4"	152	88-148-1	3/8" DRIVE 12 POINT STANDARD SOCKETS - 20mm	137
87-661-1	SLIMLINE COMBINATION WRENCH - 5/16"	152	88-149-1	3/8" DRIVE 12 POINT STANDARD SOCKETS - 21mm	137
87-662-1	SLIMLINE COMBINATION WRENCH - 3/8"	152	88-150-1	3/8" DRIVE 12 POINT STANDARD SOCKETS - 22mm	137
87-663-1	SLIMLINE COMBINATION WRENCH - 7/16"	152	88-151-1	3/8" DRIVE 12 POINT STANDARD SOCKETS - 23mm	137
87-664-1	SLIMLINE COMBINATION WRENCH - 1/2"	152	88-176-1	3/8" DRIVE 12 POINT STANDARD SOCKETS - 11/16"	138
87-665-1	SLIMLINE COMBINATION WRENCH - 9/16"	152	88-177-1	3/8" DRIVE 12 POINT STANDARD SOCKETS - 3/4"	138
87-666-1	SLIMLINE COMBINATION WRENCH - 5/8"	152	88-179-1	3/8" DRIVE 12 POINT STANDARD SOCKETS - 13/16"	138
87-667-1	SLIMLINE COMBINATION WRENCH - 11/16"	152	88-180-1	3/8" DRIVE 12 POINT STANDARD SOCKETS - 7/8"	138
87-668-1	SLIMLINE COMBINATION WRENCH - 3/4"	152	88-187-1	1/2" DRIVE 12 POINT STANDARD SOCKETS - 36mm	137
87-669-1	SLIMLINE COMBINATION WRENCH - 13/16"	152	88-558-1	1/2" DRIVE ADAPTER - 1/2" F x 3/4" M	134
87-670-1	SLIMLINE COMBINATION WRENCH - 7/8"	152	88-729-1	1/2" DRIVE EXTENSION BAR - 20"	132
87-671-1	SLIMLINE COMBINATION WRENCH - 15/16"	152	88-738-1	1/2" DRIVE 6 POINT STANDARD SOCKETS - 16mm	136
87-672-1	SLIMLINE COMBINATION WRENCH - 1"	152	88-739-1	1/2" DRIVE 6 POINT STANDARD SOCKETS - 17mm	136
87-673-1	SLIMLINE COMBINATION WRENCH - 1-1/16"	152	88-740-1	1/2" DRIVE 6 POINT STANDARD SOCKETS - 18mm	136
87-674-1	SLIMLINE COMBINATION WRENCH - 1-1/8"	152	88-741-1	1/2" DRIVE 6 POINT STANDARD SOCKETS - 19mm	136
87-675-1	SLIMLINE COMBINATION WRENCH - 1-1/4"	152	88-742-1	1/2" DRIVE 6 POINT STANDARD SOCKETS - 20mm	136
87-676-1	OPEN END WRENCH - 1/4" x 5/16"	153	88-743-1	1/2" DRIVE 6 POINT STANDARD SOCKETS - 21mm	136
87-677-1	OPEN END WRENCH - 5/16" x 3/8"	153	88-744-1	1/2" DRIVE 6 POINT STANDARD SOCKETS - 22mm	136
87-678-1	OPEN END WRENCH - 3/8" x 7/16"	153	88-745-1	1/2" DRIVE 6 POINT STANDARD SOCKETS - 23mm	136
87-679-1	OPEN END WRENCH - 7/16" x 1/2"	153	88-746-1	1/2" DRIVE 6 POINT STANDARD SOCKETS - 24mm	136
87-680-1	OPEN END WRENCH - 9/16" x 5/8"	153	88-747-1	1/2" DRIVE 6 POINT STANDARD SOCKETS - 25mm	136
87-681-1	OPEN END WRENCH - 5/8" x 11/16"	153	88-748-1	1/2" DRIVE 6 POINT STANDARD SOCKETS - 26mm	136
87-682-1	OPEN END WRENCH - 11/16" x 3/4"	153	88-749-1	1/2" DRIVE 6 POINT STANDARD SOCKETS - 27mm	136
87-683-1	OPEN END WRENCH - 13/16" x 7/8"	153	88-750-1	1/2" DRIVE 6 POINT STANDARD SOCKETS - 28mm	136
87-684-1	OPEN END WRENCH - 15/16" x 1-1/16"	153	88-751-1	1/2" DRIVE 6 POINT STANDARD SOCKETS - 29mm	136
87-685-1	OPEN END WRENCH - 1" x 1-1/8"	153	88-752-1	1/2" DRIVE 6 POINT STANDARD SOCKETS - 30mm	136
87-686-1	OPEN END WRENCH - 1 1/8" x 1-1/4"	153	88-753-1	1/2" DRIVE 6 POINT STANDARD SOCKETS - 32mm	136
87-687-1	75° OFFSET RING WRENCH LONG - 1/4" x 5/16"	151	88-770-1	1/2" DRIVE 6 POINT STANDARD SOCKETS - 7/8"	135
87-688-1	75° OFFSET RING WRENCH LONG - 15/16" x 3/8"	151	88-771-1	1/2" DRIVE 6 POINT STANDARD SOCKETS - 15/16"	135
87-689-1	75° OFFSET RING WRENCH LONG - 3/8" x 7/16"	151	88-772-1	1/2" DRIVE 6 POINT STANDARD SOCKETS - 31/32"	135
87-690-1	75° OFFSET RING WRENCH LONG - 7/16" x 1/2"	151	88-773-1	1/2" DRIVE 6 POINT STANDARD SOCKETS - 1"	135
87-691-1	75° OFFSET RING WRENCH LONG - 9/16" x 5/8"	151	88-774-1	1/2" DRIVE 6 POINT STANDARD SOCKETS - 1-1/16"	135
87-692-1	75° OFFSET RING WRENCH LONG - 5/8" X 11/16"	151	88-775-1	1/2" DRIVE 6 POINT STANDARD SOCKETS - 1-1/8"	135
87-693-1	75° OFFSET RING WRENCH LONG - 11/16" X 3/4"	151	88-776-1	1/2" DRIVE 6 POINT STANDARD SOCKETS - 1-1/4"	135
87-694-1	75° OFFSET RING WRENCH LONG - 13/16" x 7/8"	151	88-788-1	1/2" DRIVE 12 POINT STANDARD SOCKETS - 16mm	137
87-695-1	75° OFFSET RING WRENCH LONG - 15/16" x 1-1/16"	151	88-789-1	1/2" DRIVE 12 POINT STANDARD SOCKETS - 17mm	137
87-696-1	75° OFFSET RING WRENCH LONG - 1" x 1-1/8"	151	88-790-1	1/2" DRIVE 12 POINT STANDARD SOCKETS - 18mm	137
87-697-1	75° OFFSET RING WRENCH LONG - 1-1/8" x 1-1/4"	151	88-791-1	1/2" DRIVE 12 POINT STANDARD SOCKETS - 19mm	137
87-705-1	OPEN END WRENCH - 1/2" x 9/16"	153	88-792-1	1/2" DRIVE 12 POINT STANDARD SOCKETS - 20mm	137

# PRODUCT INDEX

SKU#	Descriptor	Page
88-793-1	1/2" DRIVE 12 POINT STANDARD SOCKETS - 21mm	137
88-794-1	1/2" DRIVE 12 POINT STANDARD SOCKETS - 22mm	137
88-795-1	1/2" DRIVE 12 POINT STANDARD SOCKETS - 23mm	137
88-796-1	1/2" DRIVE 12 POINT STANDARD SOCKETS - 24mm	137
88-797-1	1/2" DRIVE 12 POINT STANDARD SOCKETS - 25mm	137
88-798-1	1/2" DRIVE 12 POINT STANDARD SOCKETS - 26mm	137
88-799-1	1/2" DRIVE 12 POINT STANDARD SOCKETS - 27mm	137
88-800-1	1/2" DRIVE 12 POINT STANDARD SOCKETS - 28mm	137
88-801-1	1/2" DRIVE 12 POINT STANDARD SOCKETS - 29mm	137
88-802-1	1/2" DRIVE 12 POINT STANDARD SOCKETS - 30mm	137
88-803-1	1/2" DRIVE 12 POINT STANDARD SOCKETS - 32mm	137
88-815-1	1/2" DRIVE 12 POINT STANDARD SOCKETS - 5/8"	138
88-816-1	1/2" DRIVE 12 POINT STANDARD SOCKETS - 11/16"	138
88-817-1	1/2" DRIVE 12 POINT STANDARD SOCKETS - 3/4"	138
88-818-1	1/2" DRIVE 12 POINT STANDARD SOCKETS - 13/16"	138
88-819-1	1/2" DRIVE 12 POINT STANDARD SOCKETS - 7/8"	138
88-820-1	1/2" DRIVE 12 POINT STANDARD SOCKETS - 15/16"	138
88-821-1	1/2" DRIVE 12 POINT STANDARD SOCKETS - 1"	138
88-822-1	1/2" DRIVE 12 POINT STANDARD SOCKETS - 1/16"	138
88-823-1	1/2" DRIVE 12 POINT STANDARD SOCKETS - 1-1/8"	138
88-824-1	1/2" DRIVE 12 POINT STANDARD SOCKETS - 1-1/4"	138
88-825-1	3/8" DRIVE 6 POINT DEEP SOCKETS - 16mm	139
88-826-1	3/8" DRIVE 6 POINT DEEP SOCKETS - 18mm	139
88-827-1	3/8" DRIVE 6 POINT DEEP SOCKETS - 20mm	139
88-828-1	3/8" DRIVE 6 POINT DEEP SOCKETS - 21mm	139
88-829-1	3/8" DRIVE 6 POINT DEEP SOCKETS - 22mm	139
88-837-1	3/8" DRIVE 6 POINT DEEP SOCKETS - 23mm	139
88-908-1	3/4" DRIVE ADAPTER - 3/4" F x 1/2" M	134
88-909-1	3/4" DRIVE ADAPTER - 3/4" F x 1" M	134
88-930-1	1/2" DRIVE EXTENSION BAR - 3"	132
88-958-1	3/4" DRIVE 12 POINT STANDARD SOCKETS - 2 1/8"	138
88-959-1	3/4" DRIVE 12 POINT STANDARD SOCKETS - 2 3/16"	138
88-960-1	3/4" DRIVE 12 POINT STANDARD SOCKETS - 2 1/4"	138
88-997-1	3/4" DRIVE 12 POINT STANDARD SOCKETS - 2 5/16"	138
89-001	167-PIECE 1/2" DRIVE SOCKET MECHANDISER SET	173
89-001A	161-PIECE 1/2" DRIVE SOCKET MECHANDISER SET	173
89-001MB	1/2" DRIVE SOCKET MECHANDISER - PLASTIC CASING ONLY	173
89-033-1	35-PIECE 1/4" DRIVE SOCKET SET	166
89-035-1	24-PIECE 3/8" DRIVE SOCKET SET	167
89-063-1	1/4" DRIVE PHILLIPS BIT SOCKET - 1PT	143
89-064-1	1/4" DRIVE PHILLIPS BIT SOCKET - 2PT	143
89-065-1	1/4" DRIVE PHILLIPS BIT SOCKET - 3PT	143
89-092-1	16-PIECE 1/2" DRIVE SOCKET SET	169
89-098	9 PIECE 1/2" DRIVE TORX BIT SOCKET SET	165
89-099-1	7 PIECE 1/2" DRIVE HEX BIT SOCKET SET	165
89-101-1	19-PIECE 3/4" DRIVE SOCKET SET	171
89-133-1	19-PIECE 3/4" DRIVE SOCKET SET	172
89-150-1	3/8" DRIVE SLOTTED BIT SOCKETS - 3.5mm	144
89-151-1	3/8" DRIVE SLOTTED BIT SOCKETS - 4mm	144
89-152-1	3/8" DRIVE SLOTTED BIT SOCKETS - 4.5mm	144
89-153-1	3/8" DRIVE SLOTTED BIT SOCKETS - 5.5mm	144
89-154-1	3/8" DRIVE SLOTTED BIT SOCKETS - 6.5mm	144
89-155-1	3/8" DRIVE SLOTTED BIT SOCKETS - 7mm	144
89-156-1	3/8" DRIVE SLOTTED BIT SOCKETS - 8mm	144
89-157-1	3/8" DRIVE SLOTTED BIT SOCKETS - 10mm	144
89-170-1	3/8" DRIVE POZIDRIV® BIT SOCKETS - OPT	144
89-171-1	3/8" DRIVE POZIDRIV® BIT SOCKETS - 1PT	144
89-172-1	3/8" DRIVE POZIDRIV® BIT SOCKETS - 2PT	144
89-173-1	3/8" DRIVE POZIDRIV® BIT SOCKETS - 3PT	144
89-174-1	3/8" DRIVE POZIDRIV® BIT SOCKETS - 4PT	144
89-180-1	1/2" DRIVE HEX BIT SOCKETS - 5/16"	142
89-181-1	1/2" DRIVE HEX BIT SOCKETS - 3/8"	142
89-182-1	1/2" DRIVE HEX BIT SOCKETS - 7/16"	142
89-183-1	1/2" DRIVE HEX BIT SOCKETS - 1/2"	142
89-184-1	1/2" DRIVE HEX BIT SOCKETS - 9/16"	142
89-185-1	1/2" DRIVE HEX BIT SOCKETS - 5/8"	142
89-188-1	1/2" DRIVE HEX BIT SOCKETS - 6	141
89-189-1	1/2" DRIVE HEX BIT SOCKETS - 8	141
89-190-1	1/2" DRIVE HEX BIT SOCKETS - 10	141
89-191-1	1/2" DRIVE HEX BIT SOCKETS - 12	141
89-192-1	1/2" DRIVE HEX BIT SOCKETS - 14	141
89-193-1	1/2" DRIVE HEX BIT SOCKETS - 17	141
89-194-4	1/2" DRIVE HEX BIT SOCKETS - 19	141
89-200-1	1/2" DRIVE LONG HEX BIT SOCKETS - 5mm	142
89-201-1	1/2" DRIVE LONG HEX BIT SOCKETS - 6mm	142
89-202-1	1/2" DRIVE LONG HEX BIT SOCKETS - 7mm	142
89-203-1	1/2" DRIVE LONG HEX BIT SOCKETS - 8mm	142
89-204-1	1/2" DRIVE LONG HEX BIT SOCKETS - 10mm	142
89-205-1	1/2" DRIVE LONG HEX BIT SOCKETS - 12mm	142
89-208-1	1/2" DRIVE SLOTTED BIT SOCKETS - 6.5mm	144
89-209-1	1/2" DRIVE SLOTTED BIT SOCKETS - 8mm	144
89-210-1	1/2" DRIVE SLOTTED BIT SOCKETS - 10mm	144
89-211-1	1/2" DRIVE SLOTTED BIT SOCKETS - 12mm	144
89-215-1	1/2" DRIVE TORX® BIT SOCKETS - T20	143

SKU#	Descriptor	Page
89-216-1	1/2" DRIVE TORX® BIT SOCKETS - T25	143
89-217-1	1/2" DRIVE TORX® BIT SOCKETS - T27	143
89-218-1	1/2" DRIVE TORX® BIT SOCKETS - T30	143
89-219-1	1/2" DRIVE TORX® BIT SOCKETS - T40	143
89-230-1	1/2" DRIVE TORX® BIT SOCKETS - T45	143
89-231-1	1/2" DRIVE TORX® BIT SOCKETS - T50	143
89-232-1	1/2" DRIVE TORX® BIT SOCKETS - T55	143
89-233-1	1/2" DRIVE TORX® BIT SOCKETS - T60	143
89-302-1	3/4" DRIVE FLEX HANDLE	131
89-303-1	3/4" DRIVE SLIDING T-BAR	130
89-306-1	3/4" DRIVE EXTENSION BAR - 4"	132
89-307-1	3/4" DRIVE EXTENSION BAR - 8"	132
89-308-1	3/4" DRIVE EXTENSION BAR - 16"	132
89-319-1	3/4" DRIVE 6 POINT STANDARD SOCKETS - 19mm	136
89-321-1	3/4" DRIVE 6 POINT STANDARD SOCKETS - 21mm	136
89-322-1	3/4" DRIVE 6 POINT STANDARD SOCKETS - 22mm	136
89-324-1	3/4" DRIVE 6 POINT STANDARD SOCKETS - 24mm	136
89-325-1	3/4" DRIVE 6 POINT STANDARD SOCKETS - 25mm	136
89-327-1	3/4" DRIVE 6 POINT STANDARD SOCKETS - 27mm	136
89-328-1	3/4" DRIVE 6 POINT STANDARD SOCKETS - 28mm	136
89-330-1	3/4" DRIVE 6 POINT STANDARD SOCKETS - 30mm	136
89-332-1	3/4" DRIVE 6 POINT STANDARD SOCKETS - 32mm	136
89-333-1	3/4" DRIVE 6 POINT STANDARD SOCKETS - 33mm	136
89-334-1	3/4" DRIVE 6 POINT STANDARD SOCKETS - 34mm	136
89-336-1	3/4" DRIVE 6 POINT STANDARD SOCKETS - 36mm	136
89-338-1	3/4" DRIVE 6 POINT STANDARD SOCKETS - 38mm	136
89-341-1	3/4" DRIVE 6 POINT STANDARD SOCKETS - 41mm	136
89-346-1	3/4" DRIVE 6 POINT STANDARD SOCKETS - 46mm	136
89-350-1	3/4" DRIVE 6 POINT STANDARD SOCKETS - 50mm	136
89-395-1	3/4" DRIVE 6 POINT STANDARD IMPACT SOCKET - 17mm	146
89-396-1	3/4" DRIVE 6 POINT STANDARD IMPACT SOCKET - 18mm	146
89-397-1	3/4" DRIVE 6 POINT STANDARD IMPACT SOCKET - 19mm	146
89-398-1	3/4" DRIVE 6 POINT STANDARD IMPACT SOCKET - 20mm	146
89-399-1	3/4" DRIVE 6 POINT STANDARD IMPACT SOCKET - 21mm	146
89-400-1	3/4" DRIVE 6 POINT STANDARD IMPACT SOCKET - 22mm	146
89-401-1	3/4" DRIVE 6 POINT STANDARD IMPACT SOCKET - 23mm	146
89-402-1	3/4" DRIVE 6 POINT STANDARD IMPACT SOCKET - 24mm	146
89-403-1	3/4" DRIVE 6 POINT STANDARD IMPACT SOCKET - 25mm	146
89-404-1	3/4" DRIVE 6 POINT STANDARD IMPACT SOCKET - 26mm	146
89-405-1	3/4" DRIVE 6 POINT STANDARD IMPACT SOCKET - 27mm	146
89-406-1	3/4" DRIVE 6 POINT STANDARD IMPACT SOCKET - 28mm	146
89-407-1	3/4" DRIVE 6 POINT STANDARD IMPACT SOCKET - 29mm	146
89-408-1	3/4" DRIVE 6 POINT STANDARD IMPACT SOCKET - 30mm	146
89-409-1	3/4" DRIVE 6 POINT STANDARD IMPACT SOCKET - 31mm	146
89-410-1	3/4" DRIVE 6 POINT STANDARD IMPACT SOCKET - 32mm	146
89-411-1	3/4" DRIVE 6 POINT STANDARD IMPACT SOCKET - 33mm	146
89-412-1	3/4" DRIVE 6 POINT STANDARD IMPACT SOCKET - 34mm	146
89-413-1	3/4" DRIVE 6 POINT STANDARD IMPACT SOCKET - 35mm	146
89-414-1	3/4" DRIVE 6 POINT STANDARD IMPACT SOCKET - 36mm	146
89-415-1	3/4" DRIVE 6 POINT STANDARD IMPACT SOCKET - 37mm	146
89-416-1	3/4" DRIVE 6 POINT STANDARD IMPACT SOCKET - 38mm	146
89-417-1	3/4" DRIVE 6 POINT STANDARD IMPACT SOCKET - 40mm	146
89-418-1	3/4" DRIVE 6 POINT STANDARD IMPACT SOCKET - 41mm	146
89-419-1	3/4" DRIVE 6 POINT STANDARD IMPACT SOCKET - 43mm	146
89-420-1	3/4" DRIVE 6 POINT STANDARD IMPACT SOCKET - 45mm	146
89-421-1	3/4" DRIVE 6 POINT STANDARD IMPACT SOCKET - 46mm	146
89-422-1	3/4" DRIVE 6 POINT STANDARD IMPACT SOCKET - 48mm	146
89-423-1	3/4" DRIVE 6 POINT STANDARD IMPACT SOCKET - 50mm	146
89-424-1	3/4" DRIVE 6 POINT STANDARD IMPACT SOCKET - 52mm	146
89-425-1	3/4" DRIVE 6 POINT STANDARD IMPACT SOCKET - 54mm	146
89-426-1	3/4" DRIVE 6 POINT STANDARD IMPACT SOCKET - 55mm	146
89-427-1	3/4" DRIVE 6 POINT STANDARD IMPACT SOCKET - 57mm	146
89-428-1	3/4" DRIVE 6 POINT STANDARD IMPACT SOCKET - 58mm	146
89-429-1	3/4" DRIVE 6 POINT STANDARD IMPACT SOCKET - 59mm	146
89-430-1	3/4" DRIVE 6 POINT STANDARD IMPACT SOCKET - 60mm	146
89-431-1	3/4" DRIVE 6 POINT STANDARD IMPACT SOCKET - 63mm	146
89-432-1	3/4" DRIVE 6 POINT STANDARD IMPACT SOCKET - 65mm	146
89-433-2	3/4" DRIVE 6 POINT STANDARD IMPACT SOCKET - 70mm	146
89-435-1	1/2" DRIVE 6 POINT STANDARD IMPACT SOCKET - 8mm	146
89-436-1	1/2" DRIVE 6 POINT STANDARD IMPACT SOCKET - 9mm	146
89-437-1	1/2" DRIVE 6 POINT STANDARD IMPACT SOCKET - 10mm	146
89-438-1	1/2" DRIVE 6 POINT STANDARD IMPACT SOCKET - 11mm	146
89-439-1	1/2" DRIVE 6 POINT STANDARD IMPACT SOCKET - 12mm	146
89-440-1	1/2" DRIVE 6 POINT STANDARD IMPACT SOCKET - 13mm	146
89-441-1	1/2" DRIVE 6 POINT STANDARD IMPACT SOCKET - 14mm	146
89-442-1	1/2" DRIVE 6 POINT STANDARD IMPACT SOCKET - 15mm	146
89-443-1	1/2" DRIVE 6 POINT STANDARD IMPACT SOCKET - 16mm	146
89-444-1	1/2" DRIVE 6 POINT STANDARD IMPACT SOCKET - 17mm	146
89-445-1	1/2" DRIVE 6 POINT STANDARD IMPACT SOCKET - 18mm	146
89-446-1	1/2" DRIVE 6 POINT STANDARD IMPACT SOCKET - 19mm	146
89-447-1	1/2" DRIVE 6 POINT STANDARD IMPACT SOCKET - 20mm	146
89-448-1	1/2" DRIVE 6 POINT STANDARD IMPACT SOCKET - 21mm	146
89-449-1	1/2" DRIVE 6 POINT STANDARD IMPACT SOCKET - 22mm	146
89-450-1	1/2" DRIVE 6 POINT STANDARD IMPACT SOCKET - 23mm	146

SKU#	Descriptor	Page	SKU#	Descriptor	Page
89-451-1	1/2" DRIVE 6 POINT STANDARD IMPACT SOCKET - 24mm	146	89-785-1	DOUBLE FLEX SOCKET WRENCH - 18 x 19	153
89-452-1	1/2" DRIVE 6 POINT STANDARD IMPACT SOCKET - 25mm	146	89-817	1/4" DRIVE "FULL POLISH" QUICK RELEASE RATCHET	128
89-453-1	1/2" DRIVE 6 POINT STANDARD IMPACT SOCKET - 26mm	146	89-818	3/8" DRIVE "FULL POLISH" QUICK RELEASE RATCHET	128
89-454-1	1/2" DRIVE 6 POINT STANDARD IMPACT SOCKET - 27mm	146	89-819	1/2" DRIVE "FULL POLISH" QUICK RELEASE RATCHET	128
89-455-1	1/2" DRIVE 6 POINT STANDARD IMPACT SOCKET - 29mm	146	89-897A	117 PIECE WRENCH MERCHANDISER SET - METRIC	150
89-456-1	1/2" DRIVE 6 POINT STANDARD IMPACT SOCKET - 30mm	146	89-991-1	1/2" DRIVE TORX® BIT SOCKET 100mm - T30	144
89-457-1	1/2" DRIVE 6 POINT STANDARD IMPACT SOCKET - 31mm	146	89-992-1	1/2" DRIVE TORX® BIT SOCKET 100mm - T40	144
89-458-1	1/2" DRIVE 6 POINT STANDARD IMPACT SOCKET - 32mm	146	89-993-1	1/2" DRIVE TORX® BIT SOCKET 100mm - T45	144
89-459-1	1/2" DRIVE 6 POINT STANDARD IMPACT SOCKET - 33mm	146	89-994-1	1/2" DRIVE TORX® BIT SOCKET 100mm - T50	144
89-460-1	1/2" DRIVE 6 POINT STANDARD IMPACT SOCKET - 34mm	146	89-995-1	1/2" DRIVE TORX® BIT SOCKET 100mm - T55	144
89-461-1	1/2" DRIVE 6 POINT STANDARD IMPACT SOCKET - 36mm	146	89-998-1	1/2" DRIVE TORX® BIT SOCKET 100mm - T60	144
89-462-1	1/2" DRIVE IMPACT EXTENSION BAR	133	90-596N	7-PIECE TOOLS SET	185
89-463	1/2" DRIVE IMPACT UNIVERSAL JOINT	133	90-597	18-PIECE TOOLS SET	185
89-472	3/8" DRIVE REVERSIBLE KEYLESS AIR DRILL	157	90-947	MAXSTEEL® ADJUSTABLE WRENCH - 153mm/6"	62
89-473-2	REVERSIBLE GEARED WRENCH - 16mm	154	90-948	MAXSTEEL® ADJUSTABLE WRENCH - 203mm/8"	62
89-474	1/2"(542NM) IMPACT WRENCH	156	90-949	MAXSTEEL® ADJUSTABLE WRENCH - 250mm/10"	62
89-474-2	REVERSIBLE GEARED WRENCH - 17mm	154	90-950	MAXSTEEL® ADJUSTABLE WRENCH - 305mm/12"	62
89-475	3/4"(813NM) IMPACT WRENCH	156	91-059-1	1/4" DRIVE EXTENSION BAR - 2"	132
89-479	SNAP RING PLIERS - 5-1/2" BENT JAWS	161	91-132-1	3/8" DRIVE 12 POINT STANDARD SOCKETS - 3/8"	138
89-480	SNAP RING PLIERS - 5-1/2" BENT JAWS	161	91-138-1	3/8" DRIVE 12 POINT STANDARD SOCKETS - 7/16"	138
89-481	LOCK-RING PLIERS	161	91-151-1	3/8" DRIVE 12 POINT STANDARD SOCKETS - 1/2"	138
89-482	1-1/2" LOCK-RING PLIERS	161	91-186-1	3/8" DRIVE 12 POINT STANDARD SOCKETS - 9/16"	138
89-483	ALL BRASS HAMMER - 850G & 198mm (L)	161	91-283-1	3/8" DRIVE 12 POINT STANDARD SOCKETS - 5/8"	138
89-484	ALL BRASS HAMMER - 1450G & 222mm (L)	161	91-284-1	3/8" DRIVE 12 POINT DEEP SOCKETS - 16"	140
89-507	21-PIECE 1/4" DRIVE SOCKET SET	166	91-286-1	3/8" DRIVE 12 POINT DEEP SOCKETS - 3/8"	140
89-509	43-PIECE 1/2" DRIVE SOCKET SET	171	91-287-1	3/8" DRIVE 12 POINT DEEP SOCKETS - 7/16"	140
89-515-2	REVERSIBLE GEARED WRENCH - 19mm	154	91-288-1	3/8" DRIVE 12 POINT DEEP SOCKETS - 1/2"	140
89-516-1	48-PIECE 3/8" DRIVE SOCKET SET	168	91-289-1	3/8" DRIVE 12 POINT DEEP SOCKETS - 9/16"	140
89-518	37-PIECE 1/4" & 3/8" DRIVE SOCKET SET	167	91-296-1	3/8" DRIVE 12 POINT DEEP SOCKETS - 5/8"	140
89-519-2	REVERSIBLE GEARED WRENCH - 9mm	154	91-297-1	3/8" DRIVE 12 POINT DEEP SOCKETS - 11/16"	140
89-558-2	REVERSIBLE GEARED WRENCH - 11mm	154	91-298-1	3/8" DRIVE 12 POINT DEEP SOCKETS - 3/4"	140
89-589-1	25-PIECE 1/2" DRIVE SOCKET SET	169	91-302-1	3/8" DRIVE 12 POINT DEEP SOCKETS - 13-16"	140
89-619-1	3/4" DRIVE 12 POINT STANDARD SOCKETS - 19mm	137	91-316	3/4" DRIVE ROUND HEAD RATCHET KNURLED HANDLE	130
89-621-1	3/4" DRIVE 12 POINT STANDARD SOCKETS - 21mm	137	91-339-1	1/4" DRIVE EXTENSION BAR - 4"	132
89-622-1	3/4" DRIVE 12 POINT STANDARD SOCKETS - 22mm	137	91-377-1	1/2" 6 POINT DEEP IMPACT SOCKETS - 10mm	147
89-623-1	3/4" DRIVE 12 POINT STANDARD SOCKETS - 23mm	137	91-378-1	1/2" 6 POINT DEEP IMPACT SOCKETS - 11mm	147
89-624-1	3/4" DRIVE 12 POINT STANDARD SOCKETS - 24mm	137	91-379-1	1/2" 6 POINT DEEP IMPACT SOCKETS - 12mm	147
89-625-1	3/4" DRIVE 12 POINT STANDARD SOCKETS - 25mm	137	91-380-1	1/2" 6 POINT DEEP IMPACT SOCKETS - 13mm	147
89-626-1	3/4" DRIVE 12 POINT STANDARD SOCKETS - 26mm	137	91-576-1	1/4" DRIVE TORX® BIT SOCKETS - T08	143
89-627-1	3/4" DRIVE 12 POINT STANDARD SOCKETS - 27mm	137	91-577-1	1/4" DRIVE TORX® BIT SOCKETS - T10	143
89-628-1	3/4" DRIVE 12 POINT STANDARD SOCKETS - 28mm	137	91-578-1	1/4" DRIVE TORX® BIT SOCKETS - T15	143
89-629-1	3/4" DRIVE 12 POINT STANDARD SOCKETS - 29mm	137	91-579-1	1/4" DRIVE TORX® BIT SOCKETS - T20	143
89-630-1	3/4" DRIVE 12 POINT STANDARD SOCKETS - 30mm	137	91-580-1	1/4" DRIVE TORX® BIT SOCKETS - T25	143
89-631-1	3/4" DRIVE 12 POINT STANDARD SOCKETS - 31mm	137	91-582-1	1/4" DRIVE TORX® BIT SOCKETS - T30	143
89-632-1	3/4" DRIVE 12 POINT STANDARD SOCKETS - 32mm	137	91-583-1	1/4" DRIVE TORX® BIT SOCKETS - T40	143
89-633-1	3/4" DRIVE 12 POINT STANDARD SOCKETS - 33mm	137	91-888-2	LOCKING FLEX-HEAD GEARED WRENCH - 8mm	155
89-634-1	3/4" DRIVE 12 POINT STANDARD SOCKETS - 34mm	137	91-889-2	LOCKING FLEX-HEAD GEARED WRENCH - 9mm	155
89-635-1	3/4" DRIVE 12 POINT STANDARD SOCKETS - 35mm	137	91-890-2	LOCKING FLEX-HEAD GEARED WRENCH - 10mm	155
89-636-1	3/4" DRIVE 12 POINT STANDARD SOCKETS - 36mm	137	91-891-2	LOCKING FLEX-HEAD GEARED WRENCH - 11mm	155
89-638-1	3/4" DRIVE 12 POINT STANDARD SOCKETS - 38mm	137	91-892-2	LOCKING FLEX-HEAD GEARED WRENCH - 12mm	155
89-640-1	3/4" DRIVE 12 POINT STANDARD SOCKETS - 40mm	137	91-893-2	LOCKING FLEX-HEAD GEARED WRENCH - 13mm	155
89-641-1	3/4" DRIVE 12 POINT STANDARD SOCKETS - 41mm	137	91-894-2	LOCKING FLEX-HEAD GEARED WRENCH - 14mm	155
89-642-1	3/4" DRIVE 12 POINT STANDARD SOCKETS - 42mm	137	91-895-2	LOCKING FLEX-HEAD GEARED WRENCH - 15mm	155
89-644-1	3/4" DRIVE 12 POINT STANDARD SOCKETS - 44mm	137	91-896-2	LOCKING FLEX-HEAD GEARED WRENCH - 16mm	155
89-646-1	3/4" DRIVE 12 POINT STANDARD SOCKETS - 46mm	137	91-897-2	LOCKING FLEX-HEAD GEARED WRENCH - 17mm	155
89-650-1	3/4" DRIVE 12 POINT STANDARD SOCKETS - 50mm	137	91-898-2	LOCKING FLEX-HEAD GEARED WRENCH - 18mm	155
89-654-1	3/4" DRIVE 12 POINT STANDARD SOCKETS - 54mm	137	91-909-2	LOCKING FLEX-HEAD GEARED WRENCH - 19mm	155
89-655-1	3/4" DRIVE 12 POINT STANDARD SOCKETS - 55mm	137	91-943-1	15-PIECE 3/4" DRIVE SOCKET SET	171
89-658-1	3/4" DRIVE 12 POINT STANDARD SOCKETS - 58mm	137	92-002-2	CUSHION GRIP 2 SCREWDRIVER SET - 6PCS W/BONUS	72
89-660-1	3/4" DRIVE 12 POINT STANDARD SOCKETS - 60mm	137	92-003-2	6-PIECE SLIM TOOLS SET	185
89-661-1	3/4" DRIVE 12 POINT STANDARD SOCKETS - 3/4"	138	92-004-2	CUSHION GRIP 2 SCREWDRIVER SET - 8PC	72
89-662-1	3/4" DRIVE 12 POINT STANDARD SOCKETS - 13/16"	138	92-005	22-PIECE ELECTRICIAN'S TOOLS SET	187
89-663-1	3/4" DRIVE 12 POINT STANDARD SOCKETS - 7/8"	138	92-006	25-PIECE DO-IT-ALL TOOLS SET	184
89-664-1	3/4" DRIVE 12 POINT STANDARD SOCKETS - 15/16"	138	92-009	19-PIECE HOME-USE TOOLS SET	186
89-665-1	3/4" DRIVE 12 POINT STANDARD SOCKETS - 1"	138	92-010	22-PIECE MUST-HAVE TOOLS SET	186
89-666-1	3/4" DRIVE 12 POINT STANDARD SOCKETS - 1-1/6"	138	92-064	12.5" SERIES 2000 WITH 2 BUILT-IN ORGANIZERS & TRAY, METAL LATCH	181
89-667-1	3/4" DRIVE 12 POINT STANDARD SOCKETS - 1-1/8"	138	92-116	JUMBO 16" TOOL BOX WITH 2 PULL OUT ORGANIZERS AND BIT HOLDER	179
89-668-1	3/4" DRIVE 12 POINT STANDARD SOCKETS - 1-3/16"	138	92-120	JUMBO 19" TOOL BOX WITH 2 PULL OUT ORGANIZERS AND BIT HOLDER	179
89-669-1	3/4" DRIVE 12 POINT STANDARD SOCKETS - 1-1/4"	138	92-146	JUMBO 22" TOOL BOX WITH 2 PULL OUT ORGANIZERS AND BIT HOLDER	180
89-670-1	3/4" DRIVE 12 POINT STANDARD SOCKETS - 1-5/16"	138	92-478-1	1/2" DRIVE TORX SOCKET - E12	140
89-671-1	3/4" DRIVE 12 POINT STANDARD SOCKETS - 1-3/8"	138	92-479-1	1/2" DRIVE TORX SOCKET - E14	140
89-672-1	3/4" DRIVE 12 POINT STANDARD SOCKETS - 1-7/16"	138	92-489-1	1/2" DRIVE TORX SOCKET - E16	140
89-673-1	3/4" DRIVE 12 POINT STANDARD SOCKETS - 1-1/2"	138	92-503-1	1/2" DRIVE TORX SOCKET - E18	140
89-674-1	3/4" DRIVE 12 POINT STANDARD SOCKETS - 1-5/8"	138	92-505-1	1/2" DRIVE TORX SOCKET - E20	140
89-675-1	3/4" DRIVE 12 POINT STANDARD SOCKETS - 1-11/16"	138	92-545-1	1/2" DRIVE TORX SOCKET - E10	140
89-676-1	3/4" DRIVE 12 POINT STANDARD SOCKETS - 1-3/4"	138	92-703	MOBILE TOOL CHEST WITH 2 BUILT-IN ORGANIZERS, 2 TRAYS & PULL HANDLE	177
89-677-1	3/4" DRIVE 12 POINT STANDARD SOCKETS - 1-13/16"	138	92-764	HEAVY DUTY POWER TOOL CASE WITH ORGANIZER	182
89-678-1	3/4" DRIVE 12 POINT STANDARD SOCKETS - 1-7/8"	138	92-905	JUMBO 16" TOOL BOX WITH 2 PULL OUT ORGANIZERS, BIT HOLDER AND METAL LATCHES	180
89-679-1	3/4" DRIVE 12 POINT STANDARD SOCKETS - 2"	138			
89-780-1	DOUBLE FLEX SOCKET WRENCH - 8 x 9	153			
89-781-1	DOUBLE FLEX SOCKET WRENCH - 10 x 11	153			
89-782-1	DOUBLE FLEX SOCKET WRENCH - 12 x 13	153			
89-783-1	DOUBLE FLEX SOCKET WRENCH - 14 x 15	153			
89-784-1	DOUBLE FLEX SOCKET WRENCH - 16 x 17	153			

# PRODUCT INDEX

SKU#	Descriptor	Page
92-906	JUMBO 19" TOOL BOX WITH 2 PULL OUT ORGANIZERS, BIT HOLDER AND METAL LATCHES	180
92-908	JUMBO 22" TOOL BOX WITH 2 PULL OUT ORGANIZERS, BIT HOLDER AND METAL LATCHES	180
93-016-1	REPLACEMENT CUTTING WHEEL - CARDED 2PCS FOR PLASTIC PIPE	64
93-017-1	REPLACEMENT CUTTING WHEEL - CARDED 2PCS FOR COPPER & METAL	64
93-018-1	REPLACEMENT CUTTING WHEEL - CARDED 2PCS/CARD	64
93-019-0	REPLACEMENT CUTTING WHEEL - CARDED 2PCS/CARD	64
93-019-1	REPLACEMENT CUTTING WHEEL - BULK 10PCS/CARD	64
93-020	TUBING CUTTER - 3 - 28mm	64
93-021	TUBING CUTTER - 3 - 31mm	64
93-028	TUBE CUTTER - 6 - 64mm	64
93-033	TUBING CUTTER - 3 - 6mm	64
93-091-1	3/4" DRIVE UNIVERSAL JOINT	133
93-302-1	T-HANDLE 6 POINT SOCKET 08mm x L300mm	145
93-303-1	T-HANDLE 6 POINT SOCKET 09mm x L300mm	145
93-304-1	T-HANDLE 6 POINT SOCKET 10mm x L300mm	145
93-305-1	T-HANDLE 6 POINT SOCKET 11mm x L300mm	145
93-306-1	T-HANDLE 6 POINT SOCKET 12mm x L300mm	145
93-307-1	T-HANDLE 6 POINT SOCKET 13mm x L300mm	145
93-308-1	T-HANDLE 6 POINT SOCKET 14mm x L300mm	145
93-309-1	T-HANDLE 6 POINT SOCKET 17mm x L300mm	145
93-311-1	T-HANDLE 6 POINT SOCKET 19mm x L300mm	145
93-328	OPEN MOUTH WHEELED TOOL BAG - 20"	178
93-360-1	TORX® TEMPER RESISTANT BIT SOCKETS - T10	141
93-361-1	TORX® TEMPER RESISTANT BIT SOCKETS - T15	141
93-362-1	TORX® TEMPER RESISTANT BIT SOCKETS - T20	141
93-363-1	TORX® TEMPER RESISTANT BIT SOCKETS - T25	141
93-364-1	TORX® TEMPER RESISTANT BIT SOCKETS - T27	141
93-365-1	TORX® TEMPER RESISTANT BIT SOCKETS - T30	141
93-366-1	TORX® TEMPER RESISTANT BIT SOCKETS - T40	141
93-367-1	TORX® TEMPER RESISTANT BIT SOCKETS - T45	141
93-368-1	TORX® TEMPER RESISTANT BIT SOCKETS - T50	141
93-369-1	TORX® TEMPER RESISTANT BIT SOCKETS - T55	141
93-370-1	TORX® TEMPER RESISTANT BIT SOCKETS - T60	141
93-498	3/8" DRIVE LOCKING EXTENSION - 3"	132
93-499	3/8" DRIVE LOCKING EXTENSION - 6"	132
93-500	3/8" DRIVE LOCKING EXTENSION - 10"	132
93-525-1	1/2" DRIVE 6 POINT DEEP SOCKETS - 10mm	139
93-526-1	1/2" DRIVE 6 POINT DEEP SOCKETS - 11mm	139
93-527-1	1/2" DRIVE 6 POINT DEEP SOCKETS - 12mm	139
93-528-1	1/2" DRIVE 6 POINT DEEP SOCKETS - 13mm	139
93-529-1	1/2" DRIVE 6 POINT DEEP SOCKETS - 14mm	139
93-530-1	1/2" DRIVE 6 POINT DEEP SOCKETS - 15mm	139
93-531-1	1/2" DRIVE 6 POINT DEEP SOCKETS - 16mm	139
93-532-1	1/2" DRIVE 6 POINT DEEP SOCKETS - 17mm	139
93-533-1	1/2" DRIVE 6 POINT DEEP SOCKETS - 18mm	139
93-534-1	1/2" DRIVE 6 POINT DEEP SOCKETS - 19mm	139
93-535-1	1/2" DRIVE 6 POINT DEEP SOCKETS - 21mm	139
93-536-1	1/2" DRIVE 6 POINT DEEP SOCKETS - 22mm	139
93-537-1	1/2" DRIVE 6 POINT DEEP SOCKETS - 23mm	139
93-538-1	1/2" DRIVE 6 POINT DEEP SOCKETS - 24mm	139
93-539-1	1/2" DRIVE 6 POINT DEEP SOCKETS - 27mm	139
93-541-1	1/2" DRIVE 6 POINT DEEP SOCKETS - 30mm	139
93-542-1	1/2" DRIVE 6 POINT DEEP SOCKETS - 32mm	139
93-544	GENERAL PURPOSE TOOL BOX	162
93-545	5 TRAY CANTILEVER BOX	162
93-546	6 DRAWER TOP CHEST	164
93-547	7 DRAWERS ROLLER CABINET	164
93-621	40° OFFSET RING WRENCH LONG - 8 x 10	150
93-622	40° OFFSET RING WRENCH LONG - 10 x 12	150
93-623	40° OFFSET RING WRENCH LONG - 11 x 13	150
93-624	40° OFFSET RING WRENCH LONG - 12 x 14	150
93-625	40° OFFSET RING WRENCH LONG - 14 x 17	150
93-626	40° OFFSET RING WRENCH LONG - 17 x 19	150
93-627	40° OFFSET RING WRENCH LONG - 19 x 21	150
93-628	40° OFFSET RING WRENCH LONG - 22 x 24	150
93-629	40° OFFSET RING WRENCH LONG - 23 x 26	150
94-192	3-TRAY CANTILEVER BOX	162
94-809	PROFESSIONAL TILE CUTTER - 16"	65
94-811	PROFESSIONAL TILE CUTTER - 24"	65
94-815	TILE CUTTER WHEEL SET - 7/8" (500M/3PCS)	65
94-816	TILE CUTTER TITANIUM WHEEL SET - 7/8" (600M/3PCS)	65
94-824	TILE CUTTING PINCER	66
94-825	GROUT BLADE	116
94-826	GROUT KNIFE	116
95-063	2-IN1 STAPLE & BRAD NAIL GUN	84
95-094-1	SLIMLINE 12 PIECE COMBINATION WRENCH SET - METRIC	149
95-107	11-PIECE 3/8" DRIVE TUNE UP KIT SET	165
95-111	MAXLIFE MINI LED TRIPOD FLASHLIGHT	107
95-112W	MAXLIFE™ 369™ TRIPOD FLASHLIGHT	106

SKU#	Descriptor	Page
95-113X	MINI TRIPOD LED FLASHLIGHT WITH KEYCHAIN BLACK/SLIVER FINISH	107
95-115	MAXLIFE 369 TRIPOD FLASHLIGHT - TITANIUM FINISH	107
95-155	3-IN-1 TRIPOD LED FLASHLIGHT	106
95-710	TIRE INFLATOR WITH HOSE	160
95-744-1	T-HANDLE 6 POINT SOCKET 16mm x L300mm	145
95-745-1	T-HANDLE 6 POINT SOCKET 18mm x L300mm	145
95-746-1	T-HANDLE 6 POINT SOCKET 21mm x L300mm	145
95-880	40° OFFSET RING WRENCH LONG - 24X27	150
95-881	40° OFFSET RING WRENCH LONG - 30X32	150
95-890	3 DRAWERS ROLLER CABINET	163
95-893	1/2" DRIVE QUICK RELEASE RATCHET - PEAR HEAD	129
95-894	3/8" DRIVE QUICK RELEASE RATCHET - PEAR HEAD	129
95-895	1/4" DRIVE QUICK RELEASE RATCHET - PEAR HEAD	129
95-943	VACUUM CLEANER PORTABLE SERIES (5 GALLONS)	190
95-944	VACUUM CLEANER PROFESSIONAL SERIES (8 GALLONS)	191
95-945	VACUUM CLEANER PROFESSIONAL SERIES (10 GALLONS)	191
95-946	VACUUM CLEANER HEAVY DUTY SERIES (16 GALLONS)	191
95-947	VACUUM CLEANER PORTABLE SERIES (1 GALLON)	190
95-949	VACUUM CLEANER PORTABLE SERIES (2.5 GALLONS)	190
95-950	VACUUM CLEANER PORTABLE SERIES (3 GALLONS)	190
97-124	20 PIECE ACCESSORY KIT	160
97-127	5 PIECE GRINDING STONE SET	159
97-503	STANLEY® PRO MOBILE TOOL CHEST	176
97-526	HOSE, FLEX 4" (95-947/49)	192
97-527	HOSE, FLEX 5" (95-943/50)	192
97-528	HOSE, FLEX 6" (95-944/45)	192
97-529	HOSE, FLEX 7" (95-946)	192
97-530	WAND, EXT 3PC (95-943/47/49/50)	192
97-531	WAND, EXT 2PC (95-944/45)	192
97-532	WAND, EXT 2PC (95-946)	192
97-533	NOZZLE, CREVICE (43-45/47/49/50)	192
97-534	NOZZLE, CREVICE (95-946)	192
97-535	NOZZLE, UTILITY (43-45/47/49/50)	192
97-536	LATCH, SUCT (95-946)	192
97-537	BRUSH, FLR (43-45/47/49/50)	192
97-538	BRUSH, FLR (95-946)	192
97-539	BRACKET, WALL (95-946)	192
97-540	FILTER, DRY1 P-W/RG (43/47/49/50)	192
97-541	FILTER, DRY3P-W/O-RG43/47/49/50	192
97-542	FILTER, FOAM (95-943/47/49/50)	192
97-543	BAG, FILTER (95-950)	192
97-544	BAG, FILTER (95-943)	192
97-545	BAG, DUST (95-944/45)	192
97-546	BAG, DUST (95-946)	192
97-547	FILTER, HEPA (95-944/45/46)	192
99-069	4 DRAWERS ROLLER CABINET	163
CT106	STAPLES 10mm FOR CT10 x (U-TYPE)	85
CT10X	CABLE TACKER 2-IN-1 STAPLE GUN	85
CT305	STAPLES 5/6" (8mm) FOR CT10X	85
CT306	STAPLES 3/8" (10mm) FOR CT10X	85
GS10DT	DUAL TEMP 4" MINI GLUE STICK	80
GS20DT	DUAL TEMP 4" GLUE STICK (24PCS) - 100mm x 11.3mm / 4" x 0.45"	81
GS25DT	DUAL TEMP 4" GLUE STICK (12PCS) - 254mm x 11.3mm / 10" x 0.45"	81
GS260	WOODWORKING 4" GLUE STICK	81
GS500	FORMULA II - SUPER STRENGTH 4" GLUE STICK	81
MR77C	SWIVEL HEAD RIVETER	83
PHT150	HEAVY DUTY HAMMER TACKER (1/4" - 3/8")	85
PHT250	HEAVY DUTY HAMMER TACKER (5/16" - 1/2")	86
PHT350	FATMAX™ EXTREME HEAVY DUTY HAMMER TACKER (5/16" - 1/2") W/3 PCS BLADE	86
STA4500	100 x 6 x 16.0 mm METAL GRINDING WHEEL	214
STA4502A	125 x 6 x 22.2 mm METAL GRINDING WHEEL	214
STA4503A	150 x 6 x 22.2 mm METAL GRINDING WHEEL	214
STA4504A	180 x 6 x 22.2 mm METAL GRINDING WHEEL	214
STA4505A	230 x 6 x 22.2 mm METAL GRINDING WHEEL	214
STA4510	100 x 4 x 16.0 mm METAL GRINDING WHEEL	214
STA4520	100 x 3 x 16 mm METAL CUTTING/GRINDING WHEEL	215
STA4520FA	100 x 2.5 x 16 mm METAL CUTTING WHEEL	214
STA4522	125 x 3 x 22.2 mm METAL CUTTING/GRINDING WHEEL	215
STA4522FA	125 x 2.5 x 22.2 mm METAL CUTTING WHEEL	214
STA4523	150 x 3 x 22.2 mm METAL CUTTING/GRINDING WHEEL	215
STA4523FA	150 x 2.5 x 22.2 mm METAL CUTTING WHEEL	214
STA4524	180 x 3 x 22.2 mm METAL CUTTING/GRINDING WHEEL	215
STA4524FA	180 x 2.5 x 22.2 mm METAL CUTTING WHEEL	214
STA54002-XJ	5 x 110 mm SDS HAMMER CARBIDE DRILL BIT	217
STA54007-XJ	5.5 x 110 mm SDS HAMMER CARBIDE DRILL BIT	217
STA54012-XJ	6 x 110 mm SDS HAMMER CARBIDE DRILL BIT	217
STA54022-XJ	8 x 110 mm SDS HAMMER CARBIDE DRILL BIT	217
STA54027-XJ	10 x 110 mm SDS HAMMER CARBIDE DRILL BIT	217
STA54032-XJ	6 x 160 mm SDS HAMMER CARBIDE DRILL BIT	217
STA54037-XJ	8 x 160 mm SDS HAMMER CARBIDE DRILL BIT	217
STA54042-XJ	10 x 160 mm SDS HAMMER CARBIDE DRILL BIT	217
STA54047-XJ	12 x 160 mm SDS HAMMER CARBIDE DRILL BIT	217



SKU#	Descriptor	Page	SKU#	Descriptor	Page
STA54052-XJ	14 x 160 mm SDS HAMMER CARBIDE DRILL BIT	217	TR150HL	SHARPSHOOTER® TRA700 SERIES OR ARROW T-50® HEAVY DUTY STAPLES	84
STA54057-XJ	8 x 210 mm SDS HAMMER CARBIDE DRILL BIT	217	TR250	HEAVY DUTY STAPLE GUN / BRAD NAILER	84
STA54062-XJ	10 x 210 mm SDS HAMMER CARBIDE DRILL BIT	217	TR45	TRA200 OR ARROW® JT-21® LIGHT DUTY STAPLES	83
STA54067-XJ	12 x 210 mm SDS HAMMER CARBIDE DRILL BIT	217	TRA204	1/4" LIGHT DUTY STAPLES - 6mm	86
STA54072-XJ	14 x 210 mm SDS HAMMER CARBIDE DRILL BIT	217	TRA205	5/16" LIGHT DUTY STAPLES - 8mm	86
STA54077-XJ	16 x 210 mm SDS HAMMER CARBIDE DRILL BIT	217	TRA206	3/8" LIGHT DUTY STAPLES - 10mm	86
STA54082-XJ	18 x 210 mm SDS HAMMER CARBIDE DRILL BIT	217	TRA704T	1/4" HEAVY DUTY STAPLES - 6mm	86
STA54087-XJ	20 x 210 mm SDS HAMMER CARBIDE DRILL BIT	217	TRA705T	5/16" HEAVY DUTY STAPLES - 8mm	86
STA54097-XJ	12 x 260 mm SDS HAMMER CARBIDE DRILL BIT	217	TRA706T	3/8" HEAVY DUTY STAPLES - 10mm	86
STA54102-XJ	14 x 310 mm SDS HAMMER CARBIDE DRILL BIT	217	TRA708T	1/2" HEAVY DUTY STAPLES - 12mm	86
STA54107-XJ	16 x 310 mm SDS HAMMER CARBIDE DRILL BIT	217	TRA709T	9/16" HEAVY DUTY STAPLES - 14mm	86
STA54112-XJ	18 x 310 mm SDS HAMMER CARBIDE DRILL BIT	217			
STA54117-XJ	20 x 310 mm SDS HAMMER CARBIDE DRILL BIT	217			
STA54122-XJ	12 x 450 mm SDS HAMMER CARBIDE DRILL BIT	217			
STA54127-XJ	16 x 450 mm SDS HAMMER CARBIDE DRILL BIT	217			
STA54132-XJ	18 x 450 mm SDS HAMMER CARBIDE DRILL BIT	217			
STA54137-XJ	20 x 450 mm SDS HAMMER CARBIDE DRILL BIT	217			
STA54147-XJ	6.5 x 160 mm SDS HAMMER CARBIDE DRILL BIT	217			
STA54152-XJ	7 x 160 mm SDS HAMMER CARBIDE DRILL BIT	217			
STA54207-XJ	10 x 260 mm SDS HAMMER CARBIDE DRILL BIT	217			
STA54217-XJ	22 x 450 mm SDS HAMMER CARBIDE DRILL BIT	217			
STA54227-XJ	25 x 450 mm SDS HAMMER CARBIDE DRILL BIT	217			
STA54237-XJ	4 x 110 mm SDS HAMMER CARBIDE DRILL BIT	217			
STA54277-XJ	5.5 x 110 mm SDS HAMMER CARBIDE DRILL BIT	217			
STA54282-XJ	5 x 160 mm SDS HAMMER CARBIDE DRILL BIT	217			
STA54312-XJ	6.5 x 110 mm SDS HAMMER CARBIDE DRILL BIT	217			
STA54317-XJ	8 x 260 mm SDS HAMMER CARBIDE DRILL BIT	217			
STA54322-XJ	10 x 310 mm SDS HAMMER CARBIDE DRILL BIT	217			
STA54327-XJ	12 x 310 mm SDS HAMMER CARBIDE DRILL BIT	217			
STA54332-XJ	13 x 160 mm SDS HAMMER CARBIDE DRILL BIT	217			
STA54337-XJ	13 x 260 mm SDS HAMMER CARBIDE DRILL BIT	217			
STA54357-XJ	22 x 250 mm SDS HAMMER CARBIDE DRILL BIT	217			
STA54362-XJ	24 x 450 mm SDS HAMMER CARBIDE DRILL BIT	217			
STA54367-XJ	25 x 250 mm SDS HAMMER CARBIDE DRILL BIT	217			
STA8011R	350 x 3 x 25.4 mm METAL CHOP SAW WHEEL	215			
STA8012R	400 x 3 x 25.4 mm METAL CHOP SAW WHEEL	215			
STA8050	100 x 1.6 x 16 mm STAINLESS STEEL CUTTING WHEEL	214			
STA8060	100 x 1.2 x 16 mm STAINLESS STEEL CUTTING WHEEL	214			
STBT12L	CORDLESS 10.8V BATTERY & CHARGER	207			
STDC001LB	10.8V LI-ION DRILL	206			
STDC001NB	12V CORDLESS DRILL, 2 BATT, 1.5HRS CHARGER	205			
STDC005NB	12V CORDLESS DRILL/ DRIVER	205			
STDC041LB	10.8V LI-ION IMPACT DRILL	206			
STDC130LA	10.8V LI-ION RECIP SAW, 1 BATT, 1 CHARGER	207			
STDC201NB	14.4V CORDLESS DRILL, 2 BATT, 1.5 HRS CHARGER	206			
STDC441LB	18V IMPACT DRIVER	207			
STDC801NB	9.6V CORDLESS DRILL, 2 BATT, 1.5 HRS CHARGER	205			
STEL101	10mm ROTARY DRILL	201			
STEL105	10mm ROTARY DRILL	201			
STEL141K	10mm PERCUSSION DRILL WITH KIT BOX & ACC	202			
STEL142K	13mm PERCUSSION DRILL WITH KIT BOX & ACC	202			
STEL145	10mm PERCUSSION DRILL	201			
STEL146	13mm PERCUSSION DRILL	202			
STEL311	CIRCULAR SAW	210			
STEL345	JIGSAW	209			
STEL365	RECIPROCATING SAW	210			
STEL401	1/4 SHEET SANDER	208			
STEL421	1/3 SHEET SANDER	208			
STEL503K	22mm 3 MODE ROTARY HAMMER/ HAMMER DRILL	203			
STEL505K	24mm 2 MODE SDS HAMMER DRILL/ HAMMER DRILL	203			
STEL506K	24mm 3 MODE ROTARY HAMMER/ HAMMER DRILL	203			
STEL630	PLANER	208			
STEL670	HEATGUN	211			
STEL680	BLOWER	211			
STEL701	355mm CHOP SAW	200			
STEL705	355mm CHOP SAW	200			
STEL785	110mm TILE CUTTER	204			
STEL805	100mm TOGGLE SMALL ANGLE GRINDER	199			
STEL810	100mm SLIM SMALL ANGLE GRINDER	198			
STEL811	100mm SLIDE SMALL ANGLE GRINDER	198			
STEL812	100mm SLIDE SMALL ANGLE GRINDER	199			
STEL815	100mm SLIDE SMALL ANGLE GRINDER	198			
STEL816	125mm SLIDE SMALL ANGLE GRINDER	199			
STEL844	180mm LARGE ANGLE GRINDER	199			
STEL845	230mm LARGE ANGLE GRINDER	200			
STEL861	DIE GRINDER	200			
STHT1-77137	SLL360 LINE LASER 360°	27			
STHT1-77138	TLM99 TRUE LASER DISTANCE MEASURER	25			
STHT1-77139	TLM165 TRUE LASER DISTANCE MEASURER	24			
STHT1-77140	TLM330 TRUE LASER DISTANCE MEASURER	24			
STPW1400	1400W PRESSURE WASHER	194			
STPW1800	1800W PRESSURE WASHER	195			
TR110	SHARPSHOOTER® TRA700 OR ARROW T-50® HEAVY DUTY STAPLES	83			
TR150	SHARPSHOOTER® TRA700 OR ARROW T-50® HEAVY DUTY STAPLES	84			