



Make it warm

www.leipole.com

SHANGHAI LEIPOLD ELECTRIC CO., LTD.



LEIPOLE

Our company, Leipole was established in June 2001 as a manufacturer that producing plastic parts of electrical products for ABB, Siemens, and Schneider. Years later, Leipole was engaged in the design and sale of Terminal blocks, which provide interconnection of electrical systems. In 2004, we registered LEIPOLE brand to distribute terminal blocks, fan filters, transformers and panel accessories all over the world. As reputation grows by high quality and customer service from feedbacks of end users, Leipole become a well-know brand in its industrial field.

Leipole believes QUALITY is critical. We committed ISO9001 from paper to real work in each position in the company. From supplier audits and incoming material inspection to quality control and final packing, we take each step very carefully to assure our product quality.

We have widely located our distribution offices in 34 cities in China and 10 cities or countries worldwide such as Singapore, Ho Chi Minh, Kuala Lumpur, Hong Kong, Johannesburg, Istanbul, Dubai, Ecuador, Sao Paulo, Poland and Denmark. Our talented, committed and globally-connected team of associates collaborate with our clients, and with each other, to understand and respond to our customers' needs. Our warranty policy is the better proof of our commitment to make things every day better.

SHANGHAI LEIPOLD ELECTRIC CO., LTD.

Telephone: +86-21-6915-7636
E-mail to: info@leipole.com
Address: 1569 SIYI ROAD,
SHANGHAI CHINA
Http://www.leipole.net

LEIPOLE SOUTHEAST ASIA PTE. LTD.

Telephone: +65 6265 0208
E-mail to: Calvin@leipole.com
Address: 81 TAGORE LANE, TAG.A #03-12
SINGAPORE 787502

ISO9001-2008



CB

SGS

CE

CQC US



Cabinet Climate Control

LEIPOLE Cooler



96

New Sensor



97

FKL55 series fan and filter



98-106

FK66 series fan and filter



107-113

FKL66 series Fan and Filter



114-121

PAGE

FK7726 Serie Fan and Filter



122

FK89 series fan and filter



123-128

FB98 series fan and filter



129-134

FK99 series fan and filter



135-140

Cabinet Top Ventilator



141

PAGE

Material

Stainless steel



Leipole Cooler™ is a low cost, reliable way to cool and purge electronic control panels. The compact Leipole Cooler can be installed in minutes through a standard electrical knockout. It is designed to cool dust-tight, oil-tight, splash resistant, indoor/outdoor enclosures. It transfers the air from compressor and generates cold air into the cabinet which cool down the temperature inside.

- * Provides clean, cold air to sensitive electronics
- * No moving parts, don't need maintenance
- * Easy to install through a standard electrical knockout
- * Durable aluminum construction with stainless steel vortex tube

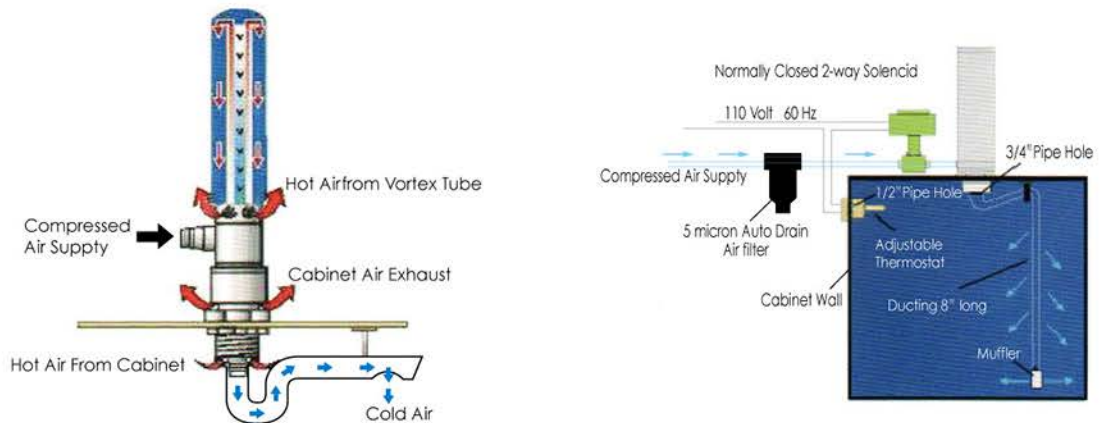

Model		Air inlet	Vortex capacity		Refrigerating capacity	
IP54	IP66	Psi/Bar	scfm	l/min	BTU/Hr	WATTS
LCL106	N/A	100/6.9	6	170	420	123
LCL108	LCL108V	100/6.9	8	230	560	164
LCL111	N/A	100/6.9	11	310	770	225
LCL115	LCL115V	100/6.9	15	450	1100	322
LCL125	LCL125V	100/6.9	25	710	1750	513
LCL130	LCL130V	100/6.9	30	850	2100	615
LCL135	N/A	100/6.9	35	990	2450	718
LCL140	LCL140V	100/6.9	40	1132	2800	820
LCL145	N/A	100/6.9	45	1273	3150	923
LCL150	N/A	100/6.9	50	1415	3500	1026
LCL170	N/A	100/6.9	70	1981	4850	1421

New Sensor

LPFG series New Sensor

Material	Retardent Rating	IP rating
PA66	UL94-V2	IP55

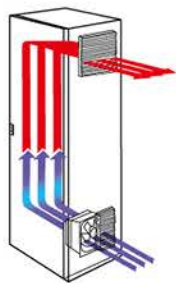

LEIPOLE

Size diagram

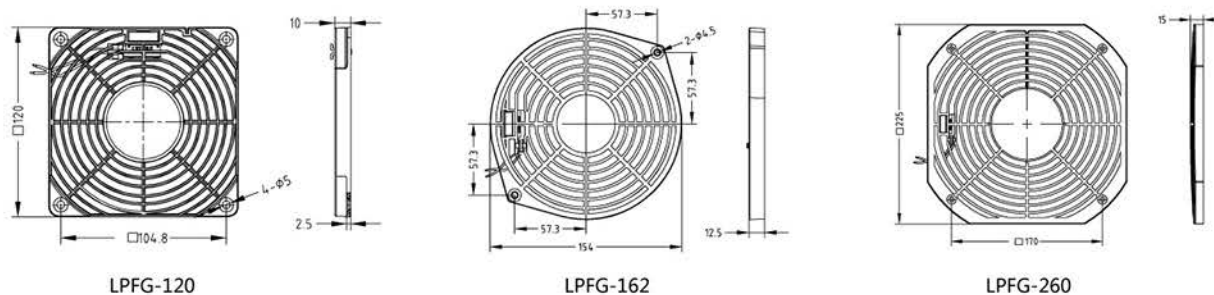

Function

Through the high-power axial fan, we can choose the way of blowing or pumping to install the new type of wind energy micro motion sensor and load, which can directly prompt the operation of the user filter. The perfect combination makes the whole product more intelligent and humanized.

Technical data

Model	LPFG-120/NO	LPFG-162/NO	LPFG-260/NO
Order number	2022.001	2022.003	2022.005
Features	Microactuator assembly (ON)		
working condition	Green light		
Rated working voltage	175V		
Rated working current	0.5A		
Load power	10W		
Breaking ability	100 million times		
Minimum wind speed	4m/s		
Ambient temperature	-30°C to +70°C		
Remarks	Special voltage needs can call the inquiry of the Company		

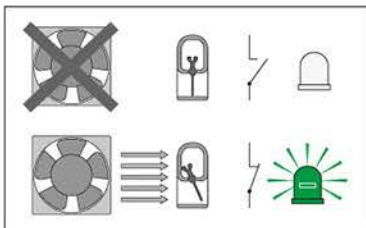

Micromotion sensor (often open) schematic



Features

This is ultr-thin type of fan filter with gasket on the back which can reach up to IP55. It is easily install on the cabinet by snap the whole filter onto the pre-cutted hole. The user can also very change the filter mat when it needed.

Design

FKL55 series comply with the colour RAL7032 and RAL7035. The rang of filters are from 150mm to 325mm. The air flow is bigger than normal which up to 560m³/h.



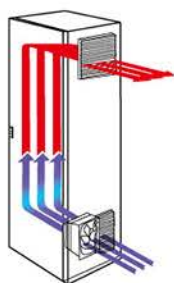

FKL5521

Certification	Material	Retardent Rating	IP rating
CE	ABS	UL94-V2	IP55

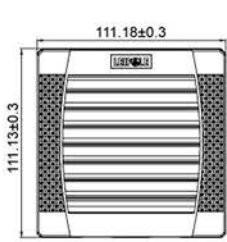

Available colors: RAL7035 ◆
RAL7032 ◆

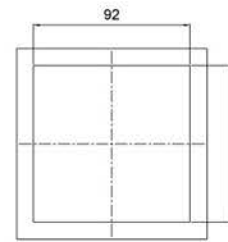
Fans and filters FKL 5521....	Fans and filters FKL 5521.024/230	Exit filter FKL 5521.300	Drawing FKL 5521....
			
	FKL5521.024	FKL5521.230	26.9

Technical data

Model	FKL5521.230	FKL5521.115	FKL5521.024
Available colors	RAL7035/RAL7032	RAL7035/RAL7032	RAL7035/RAL7032
Order number	2025.022/2025.046	2025.023/2025.047	2025.024/2025.048
Standard fan	F2E-80B-230	F2E-80B-115	F2E-80B-24
Rated voltage (V / Hz)	230/50/60	115/50/60	24(DC)
Air flow, free blowing	20/25m³/h		40m³/h
Axial Fan	Automatically shield pole motor		DC Motor
Rated current (A)	0.08/0.07	0.16/0.14	0.15
Power (W)	13/11	13/11	2.16
Noise level (dB)	36/38		34
Operating temperature range	-10°C to +55°C		
Exit filter	FKL5521.300 RAL7035(2025.021)/RAL7032(2025.045)		
Filter mat model	1m×1.8m×20mm thickness 8011.145(IP55)/ 1m×1.8m×12mm thickness 8011.146(IP54)/ 1m×1.8m×6mm thickness 8011.147(IP54)		

Standard material for finger guard is PA66, special requests please contact with your local sales representative.

FKL5522

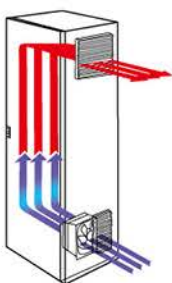

Certification	Material	Retardent Rating	IP rating
CE	ABS	UL94-V2	IP55



Available colors: RAL7035 ◆
RAL7032 ◆

Fans and filters FKL 5522....	Fans and filters FKL 5522.230	Exit filter FKL 5522.300	Drawing FKL 5522....

Technical data

Model	FKL5522.230	FKL5522.115	FKL5522.024
Available colors	RAL7035/RAL7032	RAL7035/RAL7032	RAL7035/RAL7032
Order number	2025.001/2025.025	2025.002/2025.026	2025.003/2025.027
Standard fan	F2E-120S-230	F2E-120S-115	F2E-120S-24
Rated voltage (V / Hz)	230/50/60	115/50/60	24(DC)
Air flow, free blowing	55/66m ³ /h		75m ³ /h
Axial Fan	Automatically shield pole motor		DC Motor
Rated current (A)	0.12/0.10	0.24/0.20	0.24
Power (W)	19/14	18/15	5.7
Noise level (dB)	50/52		
Operating temperature range	-10°C to +55°C		
Exit filter	FKL5522.300 RAL7035(2025.004)/RAL7032(2025.028)		
Filter mat model	1m×1.8m×20mm thickness 8011.145(IP55)/ 1m×1.8m×12mm thickness 8011.146(IP54)/ 1m×1.8m×6mm thickness 8011.147(IP54)		

Standard material for finger guard is PA66, special requests please contact with your local sales representative.

FKL5523

Certification	Material	Retardent Rating	IP rating
CE	ABS	UL94-V2	IP55

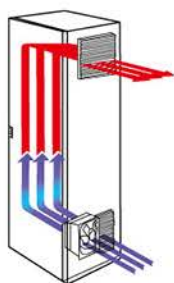

Available colors: RAL7035 ◆
RAL7032 ◆

Fans and filters FKL 5523....	Fans and filters FKL 5523.230	Exit filter FKL 5525.300	Drawing FKL 5523....
----------------------------------	----------------------------------	-----------------------------	-------------------------

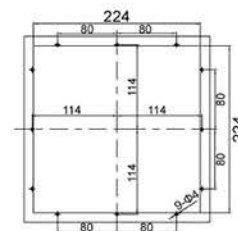
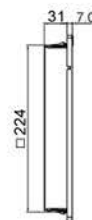
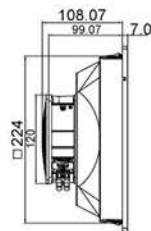
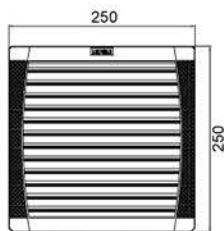

Technical data

Model	FKL5523.230	FKL5523.115	FKL5523.024
Available colors	RAL7035/RAL7032	RAL7035/RAL7032	RAL7035/RAL7032
Order number	2025.005/2025.029	2025.006/2025.030	2025.007/2025.031
Standard fan	F2E-120S-230	F2E-120S-115	F2E-120S-24
Rated voltage (V / Hz)	230/50/60	115/50/60	24(DC)
Air flow, free blowing	105/120m ³ /h		135m ³ /h
Axial Fan	Automatically shield pole motor		DC Motor
Rated current (A)	0.12/0.10	0.24/0.20	0.24
Power (W)	19/14	18/15	5.7
Noise level (dB)	50/52		
Operating temperature range	-10°C to +55°C		
Exit filter	FKL5525.300 RAL7035(2025.008)/RAL7032(2025.032)		
Filter mat model	1m×1.8m×20mm thickness 8011.145(IP55)/ 1m×1.8m×12mm thickness 8011.146(IP54)/ 1m×1.8m×6mm thickness 8011.147(IP54)		

Standard material for finger guard is PA66, special requests please contact with your local sales representative.

FKL5525-150

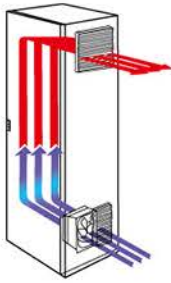

Certification	Material	Retardent Rating	IP rating
CE	ABS	UL94-V2	IP55



Available colors: RAL7035 ◆
RAL7032 ◆

Fans and filters FKL 5525-150....	Fans and filters FKL 5525-150.230	Exit filter FKL 5525.300	Drawing FKL 5525-150....
--------------------------------------	--------------------------------------	-----------------------------	-----------------------------

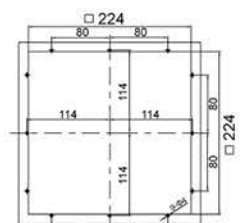
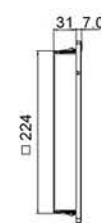
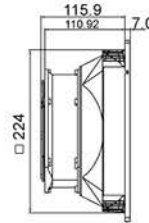

Technical data

Model	FKL5525-150.230	FKL5525-150.115
Available colors	RAL7035/RAL7032	RAL7035/RAL7032
Order number	2025.009/2025.033	2025.010/2025.034
Standard fan	F2E-150S-230	F2E-150S-115
Rated voltage (V / Hz)	230/50/60	115/50/60
Air flow, free blowing	230/265m ³ /h	
Axial Fan	Automatically shield pole motor	
Rated current (A)	0.27/0.24	0.50
Power (W)	36	
Noise level (dB)	58	
Operating temperature range	-10°C to +55°C	
Exit filter	FKL5525.300 RAL7035(2025.008)/RAL7032(2025.032)	
Filter mat model	1m×1.8m×20mm thickness 8011.145(IP55)/ 1m×1.8m×12mm thickness 8011.146(IP54)/ 1m×1.8m×6mm thickness 8011.147(IP54)	

FKL5525-162

Certification	Material	Retardent Rating	IP rating
CE	ABS	UL94-V2	IP55

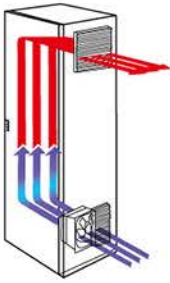

LEIPOLE

Available colors: RAL7035 ◆
RAL7032 ◆

Fans and filters FKL 5525-162....	Fans and filters FKL 5525-162.230	Exit filter FKL 5525.300	Drawing FKL 5525-162....

Technical data

Model	FKL5525-162.230	FKL5525-162.115	FKL5525-162.024
Available colors	RAL7035/RAL7032	RAL7035/RAL7032	RAL7035/RAL7032
Order number	2025.012/2025.036	2025.013/2025.037	2025.011/2025.035
Standard fan	F2E-162B-230	F2E-162B-115	F2E-162B-24-B
Rated voltage (V / Hz)	230/50/60	115/50/60	24(DC)
Air flow, free blowing	200/235m³/h		
Axial Fan	Automatically shield pole motor		DC Motor
Rated current (A)	0.26/0.20	0.51/0.42	0.46
Power (W)	37/33	36/34	11.04
Noise level (dB)	48/53		
Operating temperature range	-10C to +55C		
Exit filter	FKL5525.300 RAL7035(2025.008)/RAL7032(2025.032)		
Filter mat model	1m×1.8m×20mm thickness 8011.145(IP55)/ 1m×1.8m×12mm thickness 8011.146(IP54)/ 1m×1.8m×6mm thickness 8011.147(IP54)		

FKL5525-200

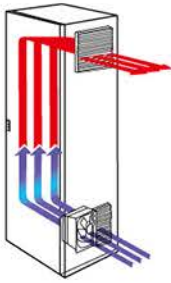

Certification	Material	Retardent Rating	IP rating
CE	ABS	UL94-V2	IP55



Available colors: RAL7035 ◆
RAL7032 ◆

Fans and filters FKL 5525-200....	Fans and filters FKL 5525-200.230	Exit filter FKL 5525.300	Drawing FKL 5525-200....
--------------------------------------	--------------------------------------	-----------------------------	-----------------------------

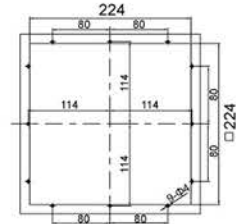
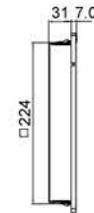

Technical data

Model	FKL5525-200.230	FKL5525-200.115
Available colors	RAL7035/RAL7032	RAL7035/RAL7032
Order number	2025.014/2025.038	2025.015/2025.039
Standard fan	F2E-200B-230	F2E-200B-115
Rated voltage (V / Hz)	230/50/60	115/50/60
Air flow, free blowing	485/500m ³ /h	
Axial Fan	Automatically shield pole motor	
Rated current (A)	0.36/0.40	0.70/0.83
Power (W)	50/48	
Noise level (dB)	63/67	
Operating temperature range	-10°C to +55°C	
Exit filter	FKL5525.300 RAL7035(2025.008)/RAL7032(2025.032)	
Filter mat model	1m×1.8m×20mm thickness 8011.145(IP55)/ 1m×1.8m×12mm thickness 8011.146(IP54)/ 1m×1.8m×6mm thickness 8011.147(IP54)	

FKL5526-D

Certification	Material	Retardent Rating	IP rating
CE	ABS	UL94-V2	IP55



Available colors: RAL7035 ◆
RAL7032 ◆

Fans and filters FKL 5526-D....	Fans and filters FKL 5526-D.230	Exit filter FKL 5526.300	Drawing FKL 5526-D....

Technical data

Model	FKL5526-D.230	FKL5526-D.115
Available colors	RAL7035/RAL7032	RAL7035/RAL7032
Order number	2025.018/2025.042	2025.019/2025.043
Standard fan	F2E-320B-230	F2E-320B-115
Rated voltage (V / Hz)	230/50/60	115/50/60
Air flow, free blowing	1048/1156m ³ /h	1180m ³ /h
Axial Fan	Automatically shield pole motor	
Rated current (A)	0.47/0.59	1.10/1.20
Power (W)	104/135	110/136
Noise level (dB)	68/70	
Operating temperature range	-10°C to +55°C	
Exit filter	FKL5526.300 RAL7035(2025.020)/RAL7032(2025.044)	
Filter mat model	1m×1.8m×20mm thickness 8011.145(IP55)/ 1m×1.8m×12mm thickness 8011.146(IP54)/ 1m×1.8m×6mm thickness 8011.147(IP54)	



Patent: ZL 2013 3 0051068.9

The most simplest way to change the filter mat

When the fan filter install on the cabinet, the traditional way to change the filter mat is very complicated and may take users a few hours. Now the solution is simple, for the LEIPOLE FK99 series, users only need to slide the button to open the cover, change the filter and close it.

The whole process only need to take a few seconds.

Now you can monitor the airflow

The indicator on the filter shows whether the fan is blowing or out of work. It protects electronic components is working under safty climate. Users can choose either normally open or normally close fans under their requirement.

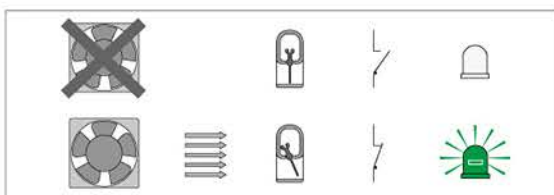

Normally open

Slide to open the cover



FK9922

Material	Retardent Rating	IP rating
ABS	UL94-V2	IP54

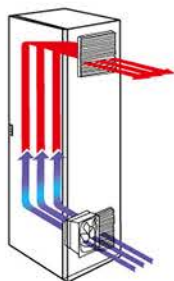

Patent: ZL 2013 3 0051068.9
RAL7035

Fans and filters
FK 9922....

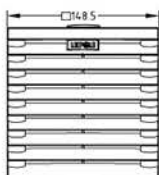

Fans and filters
FK 9922.230....

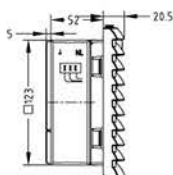

Exit filter
FK 9922.300

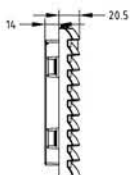

Fans and filters
FK9922.230-120.NO

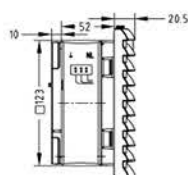

Drawing
FK 9922....

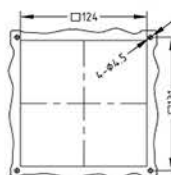

Performance
FK 9922....

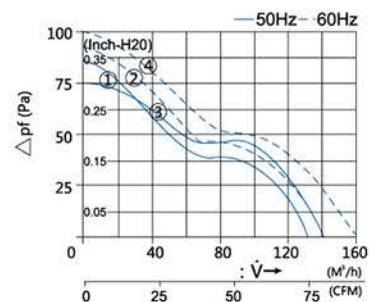

Technical data

Model/Order number	FK9922.230 2023.001	FK9922.115 2023.002	FK9922.024 2023.003
Normally open/close/Order number	FK9922.230-120.NO 2023.004	FK9922.115-120.NO 2023.005	FK9922.024-120.NO 2023.006
Model EMC/Order number	FK9922.230-EMC 2023.052		
Standard fan	F2E-120S-230	F2E-120S-115	F2E-120S-24
Rated voltage (V / Hz)	230/50/60	115/50/60	24 (DC)
Air flow, free blowing	55/66m³/h		
Air flow With export filters	1xFK9922.300:43/50m³/h		
Axial Fan	Automatically shield pole motor		DC Motor
Rated current (A)	0.12/0.10	0.24/0.20	0.3
Power (W)	19/14	18/15	3.5
Noise level (dB)	50/52		
Service life	70,000 hours at 25°C / 52,000 hours at 50°C		
Operating temperature range	-10°C to +55°C		
Exit filter/Order number	FK9922.300/FK9922.300-EMC 2023.010/2023.053		
Remarks	Special voltage needs can call the inquiry of the Company		

FK9923

Material	Retardent Rating	IP rating
ABS	UL94-V2	IP54

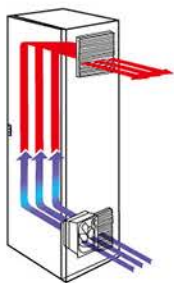

Patent: ZL 2013 3 0051068.9

RAL7035

LEIPOLE

Fans and filters
FK 9923....



Fans and filters
FK 9923.230....

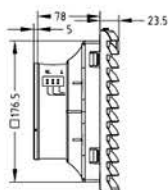

Exit filter
FK 9923.300

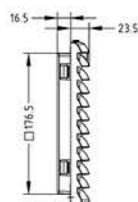

Fans and filters
FK9923.230-120.NO

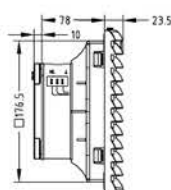

Drawing
FK 9923....

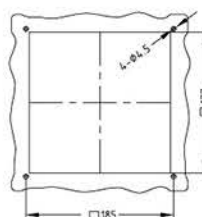

Performance
FK 9923....

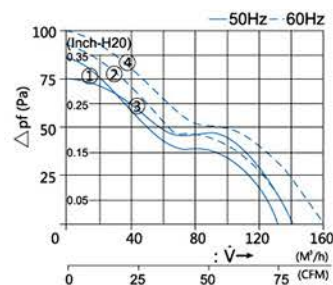

Technical data

Model/Order number	FK9923.230 2023.011	FK9923.115 2023.012	FK9923.024 2023.013
Normally open/close/Order number	FK9923.230-120.NO 2023.014	FK9923.115-120.NO 2023.015	FK9923.024-120.NO 2023.016
Model EMC/Order number	FK9923.230-EMC 2023.054		
Standard fan	F2E-120S-230	F2E-120S-115	F2E-120S-24
Rated voltage (V / Hz)	230/50/60	115/50/60	24 (DC)
Air flow, free blowing	105/120m³/h		
Air flow With export filters	1xFK9923.300:71/82m³/h		
Axial Fan	Automatically shield pole motor		DC Motor
Rated current (A)	0.12/0.10	0.24/0.20	0.3
Power (W)	19/14	18/15	3.5
Noise level (dB)	50/52		
Service life	70,000 hours at 25°C / 49,000 hours at 50°C		
Operating temperature range	-10°C to +55°C		
Exit filter/Order number	FK9923.300/FK9923.300-EMC 2023.020/2023.055		
Remarks	Special voltage needs can call the inquiry of the Company		

FK9925

Material	Retardent Rating	IP rating
ABS	UL94-V2	IP54

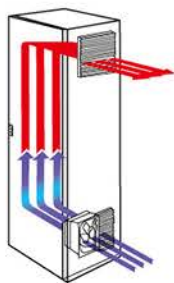

Patent: ZL 2013 3 0051068.9
RAL7035

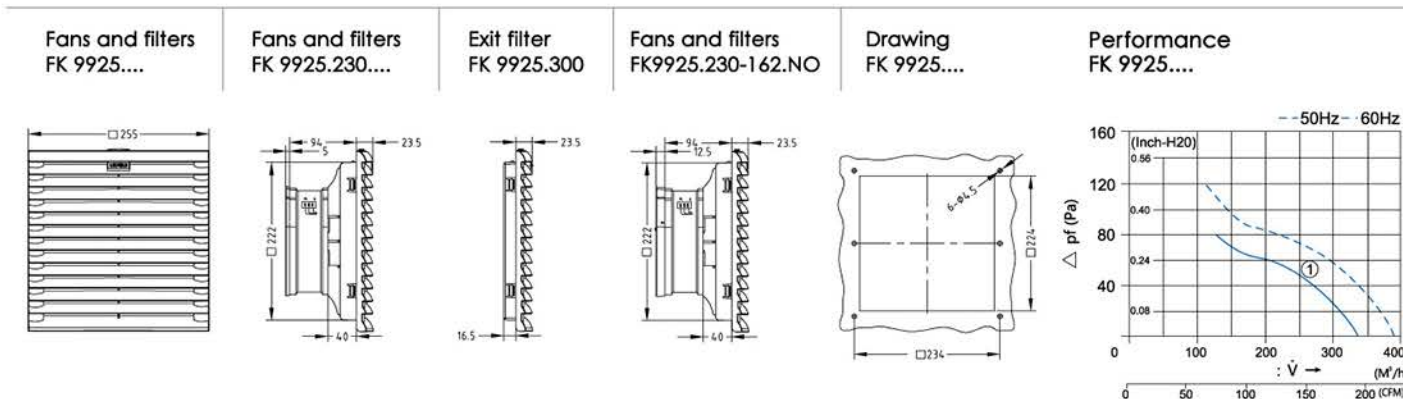

Technical data

Model/Order number	FK9925.230 2023.021	FK9925.115 2023.022	FK9925.024 2023.023
Normally open/close/Order number	FK9925.230-162.NO 2023.024	FK9925.115-162.NO 2023.025	FK9925.024-162.NO 2023.026
Model EMC/Order number	FK9925.230-EMC 2023.056		
Standard fan	F2E-162B-230	F2E-162B-115	F2E-162B-24-B
Rated voltage (V / Hz)	230/50/60	115/50/60	24 (DC)
Air flow, free blowing	230/265m³/h		
Air flow With export filters	1xFK9925.300:170/205m³/h		
Axial Fan	Automatically shield pole motor		DC Motor
Rated current (A)	0.26/0.20	0.51/0.42	0.46
Power (W)	37/33	40/35	14
Noise level (dB)	48/52		
Service life	70,000 hours at 25°C / 47,700 hours at 50°C		
Operating temperature range	-10°C to +55°C		
Exit filter/Order number	FK9925.300/FK9925.300-EMC 2023.030/2023.057		
Remarks	Special voltage needs can call the inquiry of the Company		

FK9926

Material	Retardent Rating	IP rating
ABS	UL94-V2	IP54

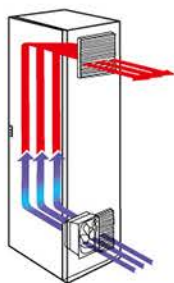

Patent: ZL 2013 3 0051068.9
RAL7035

LEIPOLE

Fans and filters
FK 9926....



Fans and filters
FK 9926.230....

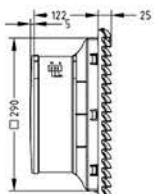

Exit filter
FK 9926.300

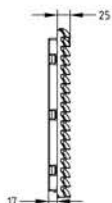

Fans and filters
FK9926.230-260.NO

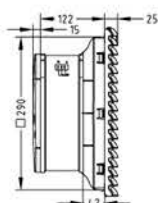

Drawing
FK 9926....

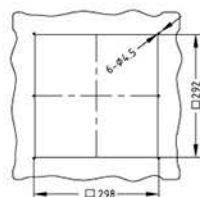

Performance
FK 9926....

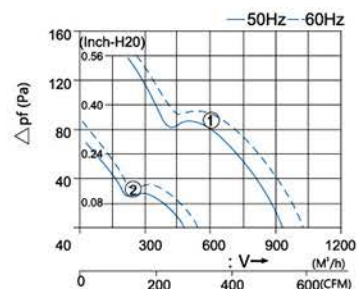

Technical data

Model/Order number	FK9926.230 2023.031	FK9926.115 2023.032
Normally open/close/Order number	FK9926.230-260.NO 2023.034	FK9926.115-260.NO 2023.035
Model EMC/Order number	FK9926.230-EMC 2023.058	
Standard fan	F2E-260B-230	F2E-260B-115
Rated voltage (V / Hz)	230/50/60	115/50/60
Air flow, free blowing	500/560m³/h	
Air flow With export filters	1xFK9926.300:360/390m³/h	
Axial Fan	Electric capacitance	
Rated current (A)	0.29/0.33	0.61/0.63
Power (W)	65/77	61/71
Noise level (dB)	62/64	
Service life	70,000 hours at 25°C / 48,000 hours at 50°C	
Operating temperature range	-10°C to +55°C	
Exit filter/Order number	FK9926.300/FK9926.300-EMC 2023.040/2023.059	
Remarks	Special voltage needs can call the inquiry of the Company	

FK9926-D

Material	Retardent Rating	IP rating
ABS	UL94-V2	IP54

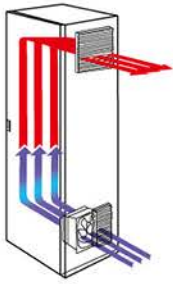

Patent: ZL 2013 3 0051068.9

RAL7035

Fans and filters
FK 9926.230-D....



Fans and filters
FK 9926.230-D....

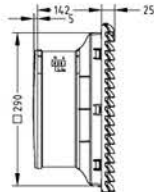

Drawing
FK 9926....

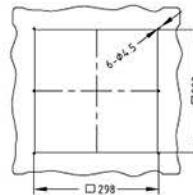

Performance
FK 9926-D....

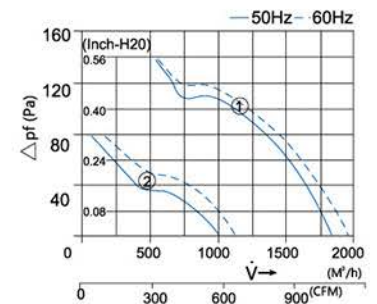

Technical data

Model/Order number	FK9926.230-D 2023.041	FK9926.115-D 2023.042
Model EMC/Order number	FK9926.230D-EMC 2023.060	
Standard fan	F2E-320B-230	F2E-320B-115
Rated voltage (V / Hz)	230/50/60	115/50/60
Air flow, free blowing	1282.44m³/h	
Air flow With export filters	1xFK9926.300:769/890m³/h 2xFK9926.300:910/1000m³/h	
Axial Fan	Electric capacitance	
Rated current (A)	0.26/0.20	0.51/0.42
Power (W)	37/33	40/35
Noise level (dB)	68/70	
Service life	70,000 hours at 25°C / 48,000 hours at 50°C	
Operating temperature range	-10°C to +55°C	
Exit filter/Order number	FK9926.300/FK9926.300-EMC 2023.040/2023.059	
Remarks	Special voltage needs can call the inquiry of the Company	



Features

The biggest advantage of FK66 series is easy to install, economic, and popular shape for customer to use. The filter mats are easily to change only need to snap out the cover.

Design

FK66 series comply with the colour RAL7032 and RAL7035. The range of filters are from 117mm to 323mm. The air flow is up to 560m³/h.



FK6621

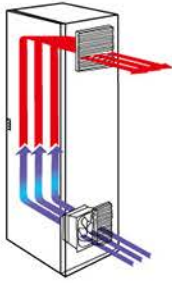

Certification	Material	Retardent Rating	IP rating
CE	ABS	UL94-V2	IP54

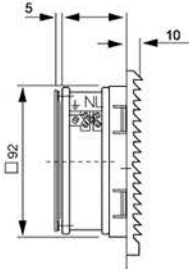
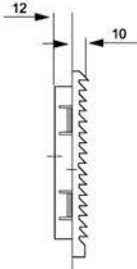
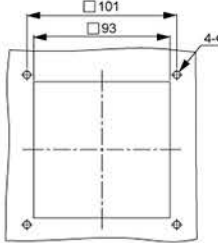

Available colors: RAL7035 ◆
RAL7032 ◆

Fans and filters FK 6621....	Fans and filters FK 6621.230	Exit filter FK 6621.300	Drawing FK 6621....
			

Technical data

Model	FK6621.230	FK6621.115	FK6621.024
Available colors	RAL7032/RAL7035	RAL7032/RAL7035	RAL7032/RAL7035
Order number	2012.005/2012.036	2012.006/2012.037	2012.007/2012.038
Standard fan	F2E-92S-230	F2E-92S-115	F2E-92S-24
Rated voltage (V / Hz)	230/50/60	115/50/60	24(DC)
Air flow, free blowing	20/25m³/h		
Air flow With export filters	1xFK6621.300:15/18m³/h		
Axial Fan	Automatically shield pole motor		DC Motor
Rated current (A)	0.07/0.06	0.12/0.10	0.18
Power (W)	5.5/5.3	11/13	4.3
Noise level (dB)	36/38		
Operating temperature range	-10°C to +55°C		
Exit filter	FK6621.300 RAL7032(2012.008)/RAL7035(2012.039)		
Remarks	Special voltage needs can call the inquiry of the Company		

Performance

FK 6621....

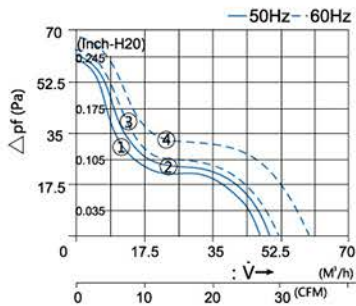

FK6622

Certification	Material	Retardent Rating	IP rating
CE	ABS	UL94-V2	IP54

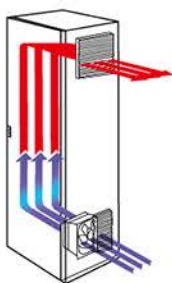

LEIPOLE

Available colors: RAL7035 ◆
RAL7032 ◆

Fans and filters FK 6622....	Fans and filters FK 6622.230	Exit filter FK 6622.300	Drawing FK 6622....

Technical data

Model	FK6622.230	FK6622.115	FK6622.024
Available colors	RAL7032/RAL7035	RAL7032/RAL7035	RAL7032/RAL7035
Order number	2012.009/2012.040	2012.010/2012.041	2012.011/2012.042
Standard fan	F2E-120S-230	F2E-120S-115	F2E-120S-24
Rated voltage (V / Hz)	230/50/60	115/50/60	24(DC)
Air flow, free blowing		55/66m ³ /h	
Air flow With export filters	1xFK6622.300:43/50m ³ /h 2xFK6622.300:48/55m ³ /h		
Axial Fan	Automatically shield pole motor		DC Motor
Rated current (A)	0.12/0.10	0.24/0.20	0.30
Power (W)	19/14	18/15	3.5
Noise level (dB)	50/52		
Operating temperature range	-10°C to +55°C		
Exit filter	FK6622.300 RAL7032(2012.012)/RAL7035(2012.043)		
Remarks	Special voltage needs can call the inquiry of the Company		

Performance FK 6622....

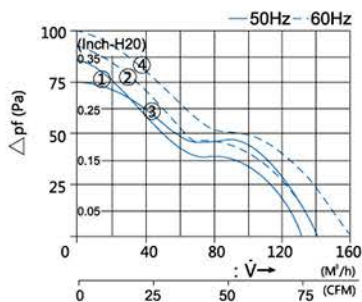

FK6623

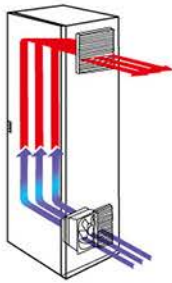

Certification	Material	Retardent Rating	IP rating
CE	ABS	UL94-V2	IP54



Available colors: RAL7035 ◆
RAL7032 ◆

Fans and filters FK 6623....	Fans and filters FK 6623.230	Exit filter FK 6623.300	Drawing FK 6623....
---------------------------------	---------------------------------	----------------------------	------------------------

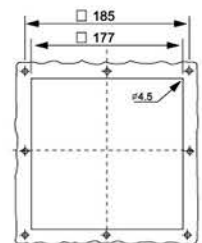
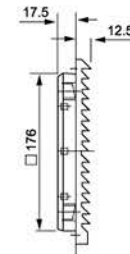
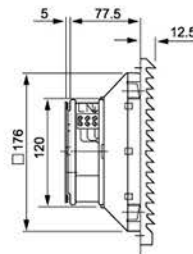
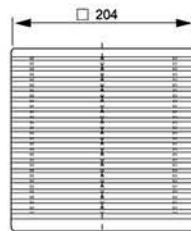

Performance FK 6623....

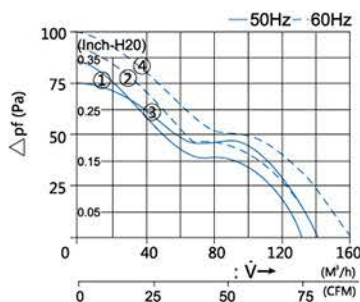

Technical data

Model	FK6623.230	FK6623.115	FK6623.024
Available colors	RAL7032/RAL7035	RAL7032/RAL7035	RAL7032/RAL7035
Order number	2012.013/2012.044	2012.014/2012.045	2012.015/2012.046
Standard fan	F2E-120S-230	F2E-120S-115	F2E-120S-24
Rated voltage (V / Hz)	230/50/60	115/50/60	24(DC)
Air flow, free blowing	105/120m³/h		
Air flow With export filters	1xFK6623.300:71/82m³/h 2xFK6623.300:85/98m³/h		
Axial Fan	Automatically shield pole motor		DC Motor
Rated current (A)	0.12/0.10	0.24/0.20	0.30
Power (W)	19/14	18/15	3.5
Noise level (dB)	50/52		
Operating temperature range	-10°C to +55°C		
Exit filter	FK6623.300 RAL7032(2012.016)/RAL7035(2012.047)		
Remarks	Special voltage needs can call the inquiry of the Company		

FK6625

Certification	Material	Retardent Rating	IP rating
CE	ABS	UL94-V2	IP54

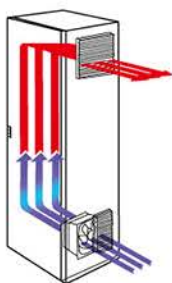

Available colors: RAL7035 ◆
RAL7032 ◆

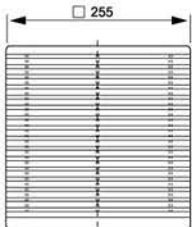
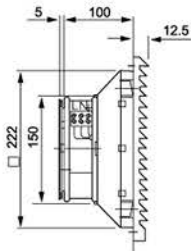
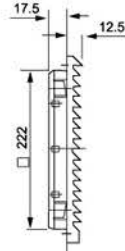
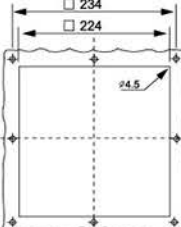
Fans and filters FK 6625....	Fans and filters FK 6625.230	Exit filter FK 6625.300	Drawing FK 6625....
			

Technical data

Model	FK6625.230	FK6625.115	FK6625.024
Available colors	RAL7032/RAL7035	RAL7032/RAL7035	RAL7032/RAL7035
Order number	2012.017/2012.048	2012.018/2012.049	2012.019/2012.050
Standard fan	F2E-162B-230	F2E-162B-115	F2E-162B-24-B
Rated voltage (V / Hz)	230/50/60	115/50/60	24(DC)
Air flow, free blowing	230/265m ³ /h		
Air flow With export filters	1xFK6625.300:170/205m ³ /h 2xFK6625.300:200/230m ³ /h		
Axial Fan	Automatically shield pole motor		DC Motor
Rated current (A)	0.26/0.20	0.51/0.42	0.46
Power (W)	37/33	40/35	14
Noise level (dB)	48/52		
Operating temperature range	-10°C to +55°C		
Exit filter	FK6625.300 RAL7032(2012.020)/RAL7035(2012.051)		
Remarks	Special voltage needs can call the inquiry of the Company		

Performance FK6625....

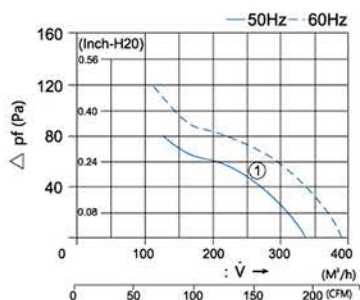

FK6626

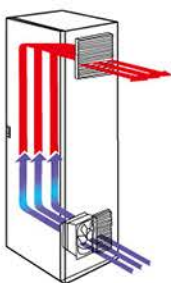

Certification	Material	Retardent Rating	IP rating
CE UL	ABS	UL94-V2	IP54



Available colors: RAL7035 ◆
RAL7032 ◆

Fans and filters FK 6626....	Fans and filters FK 6626.230	Exit filter FK 6626.300	Drawing FK 6626....

Technical data

Model	FK6626.230	FK6626.115
Available colors	RAL7032/RAL7035	RAL7032/RAL7035
Order number	2012.021/2012.052	2012.022/2012.053
Standard fan	F2E-260B-230	F2E-260B-115
Rated voltage (V / Hz)	230/50/60	115/50/60
Air flow, free blowing	500/560m ³ /h	
Air flow With export filters	1xFK6626.230:360/390m ³ /h 2xFK6626.230:440/495m ³ /h	
Axial Fan	Electric capacitance	
Rated current (A)	0.29/0.33	0.61/0.63
Power (W)	65/77	61/71
Noise level (dB)	62/64	
Operating temperature range	-10°C to +55°C	
Exit filter	FK6626.300 RAL7032(2012.023)/RAL7035(2012.054)	
Remarks	Special voltage needs can call the inquiry of the Company	

Performance FK6626

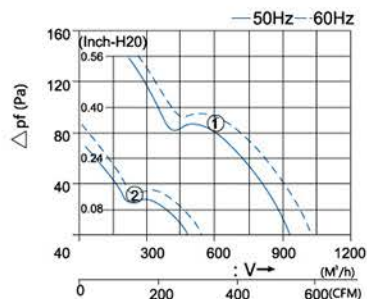

FK6627

Exit Filter

Certification	Material	Retardent Rating	IP rating
CE UL	ABS	UL94-V2	IP54



LEIPOLE

Features

This design can be fitted with three fans with the size of 120mm*120mm which have more power.

Available colors	Order number
RAL7035 ◆	2012.055
RAL7032 ◆	2012.024

Performance FK6627.300

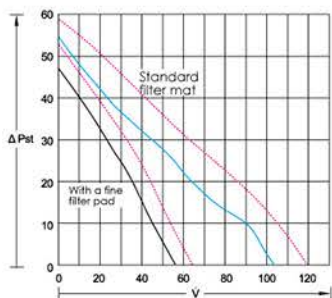

Exit filter only
FK 6627.300

Drawing
FK 6627.300

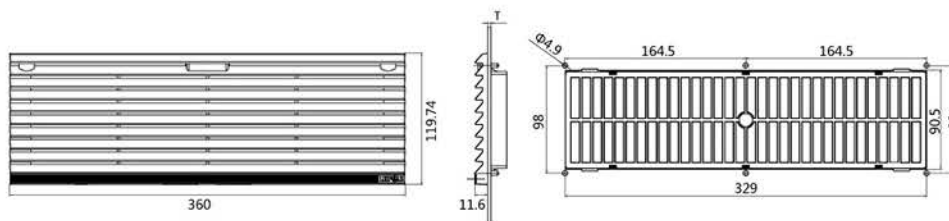

FK 6628 Exit Filter only

Certification	Material	Retardent Rating	IP rating
CE UL	ABS	UL94-V2	IP54

FK6628

Economic type of FK66 series. This filter can be used with the fans below.

The filter mate is used to prevent dust particles 10 microns or more.

Packing: 2 pcs/pack



	Model	Order number	Model	Order number	Model	Order number	Model	Order number
RAL7032	FK6628.230	2012.030	FK6628.115	2012.029	FK6628.024	2012.028	FK6628.300	2012.025
RAL7035		2012.061		2012.060		2012.063		2012.056
Standard fan	F2E-120S-230		F2E-120B-230		F2E-120S-24			
Rated current (A)	0.12/0.10		0.24/0.20		0.3			
Power (W)	19/14		18/15		3.5			

Available colors
RAL7035 ◆
RAL7032 ◆



FK6628.300

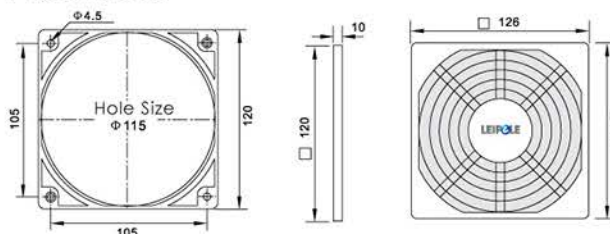



Features

This is the most common type for the users. The shape is the same as FK66 series but with gasket on the back which improve the protection class to IP54 according to the EN60529/10.91.

Design

FKL66 series comply with the colour RAL7032 and RAL7035. The range of filters are from 117mm to 323mm. The air flow is bigger than normal which up to 1350m³/h.

FKL6621

Certification	Material	Retardent Rating	IP rating
CE UL	ABS	UL94-V2	IP54

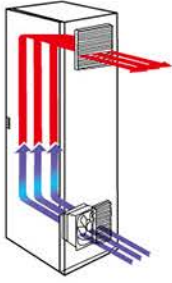

Available colors: RAL7035 ◆
RAL7032 ◆

Fans and filters FKL 6621....	Fans and filters FKL 6621.230	Exit filter FKL 6621.300	Drawing FKL 6621....
----------------------------------	----------------------------------	-----------------------------	-------------------------

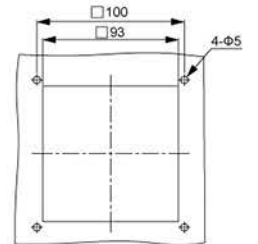
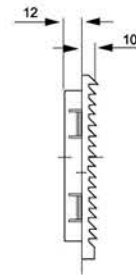
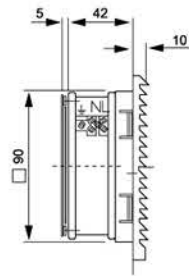

Performance FKL 6621....

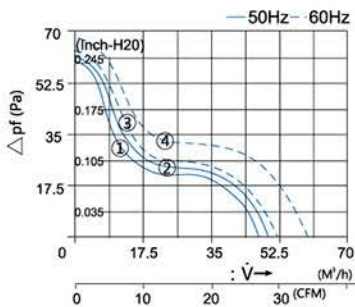

Technical data

Model	FKL6621.230	FKL6621.115	FKL6621.024
Available colors	RAL7035/RAL7032	RAL7035/RAL7032	RAL7035/RAL7032
Order number	2013.001/2013.022	2013.002/2013.023	2013.003/2013.024
Standard fan	F2E-92S-230	F2E-92S-115	F2E-92S-24
Rated voltage (V / Hz)	230/50/60	115/50/60	24(DC)
Air flow, free blowing	20/25m³/h		
Air flow With export filters	1xFKL6621.300:15/18m³/h		
Axial Fan	Automatically shield pole motor		DC Motor
Rated current (A)	0.07/0.06	0.12/0.10	0.18
Power (W)	5.5/5.3	11/13	24
Noise level (dB)	36/38		
Operating temperature range	-10°C to +55°C		
Exit filter	FKL6621.300 RAL7035(2013.004)/RAL7032(2013.025)		
Remarks	Special voltage needs can call the inquiry of the Company		

FKL6622

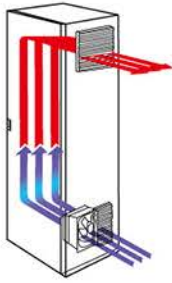

Certification	Material	Retardent Rating	IP rating
CE UL	ABS	UL94-V2	IP54



Available colors: RAL7035 ◆
RAL7032 ◆

Fans and filters FKL 6622....	Fans and filters FKL 6622.230	Exit filter FKL 6622.300	Drawing FKL 6622....

Technical data

Model	FKL6622.230	FKL6622.115	FKL6622.024
Available colors	RAL7035/RAL7032	RAL7035/RAL7032	RAL7035/RAL7032
Order number	2013.005/2013.026	2013.006/2013.027	2013.007/2013.028
Standard fan	F2E-120S-230	F2E-120S-115	F2E-120S-24
Rated voltage (V / Hz)	230/50/60	115/50/60	24(DC)
Air flow, free blowing	55/66m ³ /h		
Air flow With export filters	1xFKL6622.300:43/50m ³ /h 2xFKL6622.300:48/55m ³ /h		
Axial Fan	Automatically shield pole motor		DC Motor
Rated current (A)	0.12/0.10	0.24/0.20	0.30
Power (W)	19/14	18/15	3.5
Noise level (dB)	50/52		
Operating temperature range	-10°C to +55°C		
Exit filter	FKL6622.300 RAL7035(2013.008)/RAL7032(2013.029)		
Remarks	Special voltage needs can call the inquiry of the Company		

Performance FKL 6622....

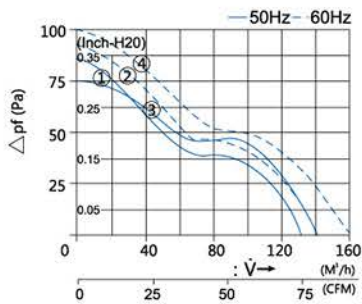

FKL6623

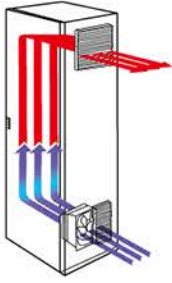

Certification	Material	Retardent Rating	IP rating
CE UL	ABS	UL94-V2	IP54



Available colors: RAL7035 ◆
RAL7032 ◆

Fans and filters
FKL 6623....

Fans and filters
FKL 6623.230

Exit filter
FKL 6623.300

Drawing
FKL 6623....

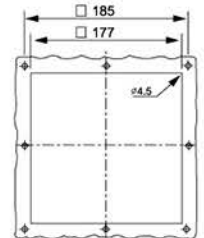
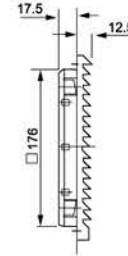
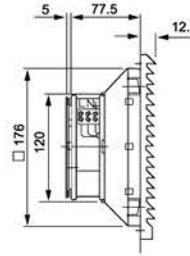
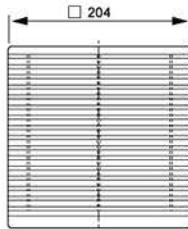

Performance FKL 6623....

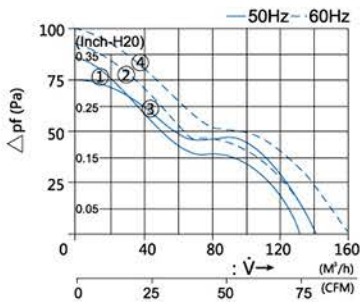

Technical data

Model	FKL6623.230	FKL6623.115	FKL6623.024
Available colors	RAL7035/RAL7032	RAL7035/RAL7032	RAL7035/RAL7032
Order number	2013.009/2013.030	2013.010/2013.031	2013.011/2013.032
Standard fan	F2E-120S-230	F2E-120S-115	F2E-120S-24
Rated voltage (V / Hz)	230/50/60	115/50/60	24(DC)
Air flow, free blowing	105/120m³/h		
Air flow With export filters	1xFKL6623.300:71/82m³/h 2xFKL6623.300:85/98m³/h		
Axial Fan	Automatically shield pole motor		DC Motor
Rated current (A)	0.12/0.10	0.24/0.20	0.30
Power (W)	19/14	18/15	3.5
Noise level (dB)	50/52		
Operating temperature range	-10°C to +55°C		
Exit filter	FKL6623.300 RAL7035(2013.012)/RAL7032(2013.033)		
Remarks	Special voltage needs can call the inquiry of the Company		

FKL6625

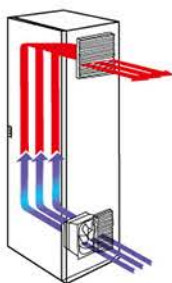

Certification	Material	Retardent Rating	IP rating
CE UL	ABS	UL94-V2	IP54



Available colors: RAL7035 ◆
RAL7032 ◆

Fans and filters FKL 6625....	Fans and filters FKL 6625.230	Exit filter FKL 6625.300	Drawing FKL 6625....
----------------------------------	----------------------------------	-----------------------------	-------------------------

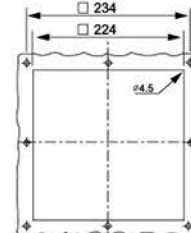
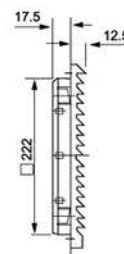
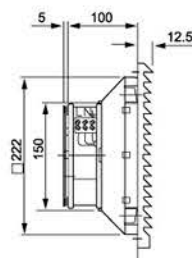
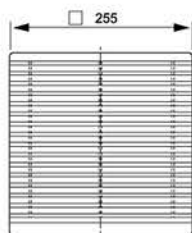

Technical data

	FKL6625.230	FKL6625.115	FKL6625.024
Model	FKL6625.230	FKL6625.115	FKL6625.024
Available colors	RAL7035/RAL7032	RAL7035/RAL7032	RAL7035/RAL7032
Order number	2013.034/2013.013	2013.035/2013.014	2013.036/2013.015
Standard fan	F2E-162B-230	F2E-162B-115	F2E-162B-24-B
Rated voltage (V / Hz)	230/50/60	115/50/60	24(DC)
Air flow, free blowing	230/265m³/h		
Air flow With export filters	1xFKL6625.300:170/205m³/h 2xFKL6625.300:200/230m³/h		
Axial Fan	Automatically shield pole motor		DC Motor
Rated current (A)	0.26/0.20	0.51/0.42	0.46
Power (W)	37/33	40/35	14
Noise level (dB)	48/52		
Operating temperature range	-10°C to +55°C		
Exit filter	FKL6625.300 RAL7035[2013.037]/RAL7032[2013.016]		
Remarks	Special voltage needs can call the inquiry of the Company		

Performance FKL 6625....

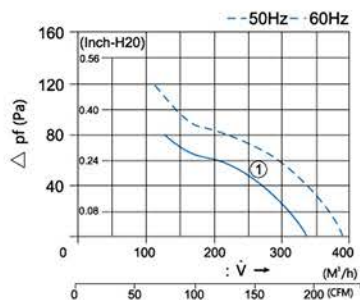

FKL6625-D

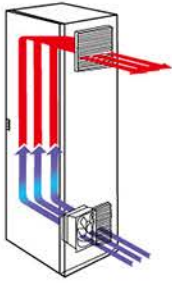

Certification	Material	Retardent Rating	IP rating
CE UL	ABS	UL94-V2	IP54

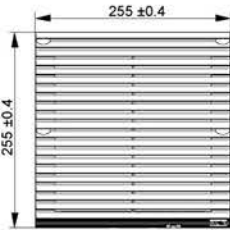
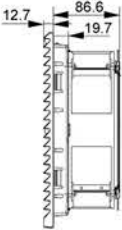
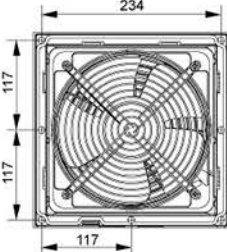
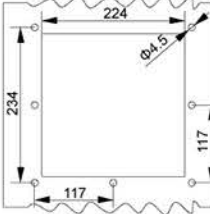

Available colors: RAL7035 ◆
RAL7032 ◆

Fans and filters FKL 6625....	Fans and filters FKL 6625.230-D	Exit filter FKL 6625.300	Drawing FKL 6625....
			

Technical data

Model	FKL6625.230-D
Available colors	RAL7035/RAL7032
Order number	2013.055/2013.056
Standard fan	F2E-200B-230
Rated voltage (V / Hz)	230/50/60
Air flow, free blowing	485/500m ³ /h
Air flow With export filters	1xFKL6625.300:170/205m ³ /h 2xFKL6625.300:200/230m ³ /h
Axial Fan	Electric capacitance
Rated current (A)	0.36/0.40
Power (W)	50/48
Noise level (dB)	63/67
Operating temperature range	-10°C to +55°C
Exit filter	FKL6625.300 RAL7035(2013.016)/RAL7032(2013.017)
Remarks	Special voltage needs can call the inquiry of the Company

FKL6626

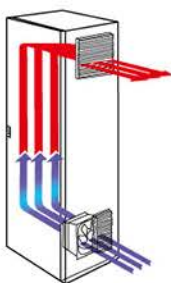

Certification	Material	Retardent Rating	IP rating
CE UL RoHS	ABS	UL94-V2	IP54



Available colors: RAL7035 ◆
RAL7032 ◆

Fans and filters FKL 6626....	Fans and filters FKL 6626.230	Exit filter FKL 6626.300	Drawing FKL 6626....
----------------------------------	----------------------------------	-----------------------------	-------------------------

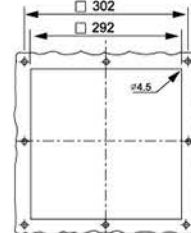
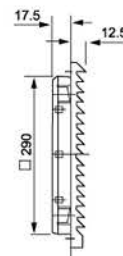
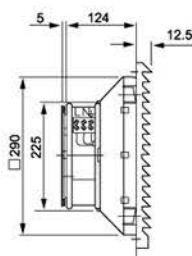
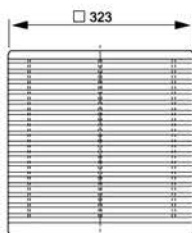

Technical data

Model	FKL6626.230	FKL6626.115
Available colors	RAL7035/RAL7032	RAL7035/RAL7032
Order number	2013.038/2013.017	2013.039/2013.018
Standard fan	F2E-260B-230	F2E-260B-115
Rated voltage (V / Hz)	230/50/60	115/50/60
Air flow, free blowing	500/560m ³ /h	
Air flow With export filters	1xFKL6626.300:360/390m ³ /h 2xFKL6626.300:440/495m ³ /h	
Axial Fan	Electric capacitance	
Rated current (A)	0.29/0.33	0.61/0.63
Power (W)	65/77	61/71
Noise level (dB)	62/64	
Operating temperature range	-10°C to +55°C	
Exit filter	FKL6626.300 RAL7035(2013.040)/RAL7032(2013.019)	
Remarks	Special voltage needs can call the inquiry of the Company	

Performance FKL 6626....

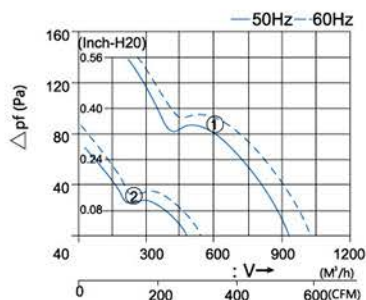

FKL6626-D

Certification	Material	Retardent Rating	IP rating
CE UL RoHS	ABS	UL94-V2	IP54

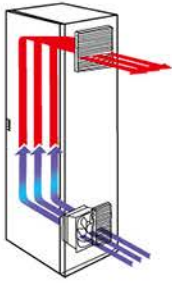

LEIPOLE

Available colors: RAL7035 ◆
RAL7032 ◆

Fans and filters FKL 6626....	Fans and filters FKL 6626.230-D	Exit filter FKL 6626.300	Drawing FKL 6626....
----------------------------------	------------------------------------	-----------------------------	-------------------------

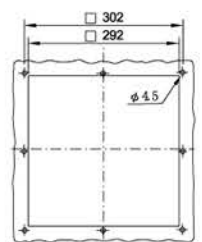
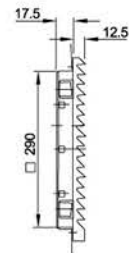
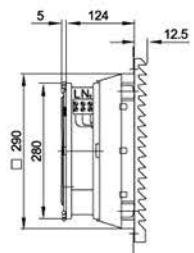
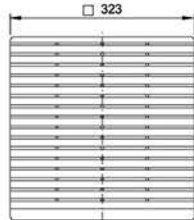

Technical data

Model	FKL6626.230-D	FKL6626.115-D
Available colors	RAL7035/RAL7032	RAL7035/RAL7032
Order number	2013.041/2013.020	2013.042/2013.021
Standard fan	F2E-320B-230	F2E-320B-115
Rated voltage (V / Hz)	230/50/60	115/50/60
Air flow, free blowing	1048/1156m³/h	1180m³/h
Air flow With export filters	1xFKL6626.300:769/890m³/h 2xFKL6626.300:910/1000m³/h	
Axial Fan	beetric capacitance	
Rated current (A)	0.47/0.59	1.10/1.20
Power (W)	104/135	110/136
Noise level (dB)	68/70	
Operating temperature range	-10°C to +55°C	
Exit filter	FKL6626.300 RAL7035(2013.040)/RAL7032(2013.019)	
Remarks	Special voltage needs can call the inquiry of the Company	

Performance FKL 6626....

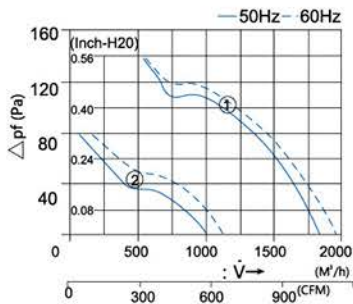

FK7726

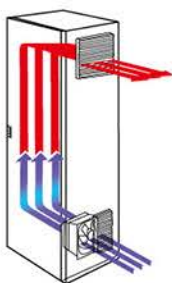

Certification	Material	Retardent Rating	IP rating
CE RoHS	ABS	UL94-V2	IP55



Available colors: RAL7035 ◆
RAL7032 ◆

Fans and filters FK 7726....	Fans and filters FK 7726.230	Exit filter FK 7726.300	Drawing FK 7726....
---------------------------------	---------------------------------	----------------------------	------------------------

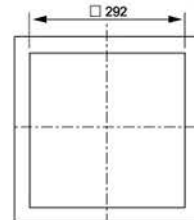
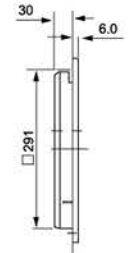
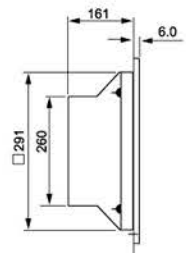
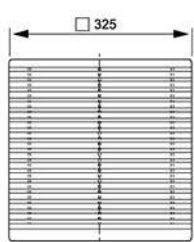

Technical data

Model	FK7726.230	FK7726.115
Available colors	RAL7032/RAL7035	RAL7032/RAL7035
Order number	2014.013/2014.028	2014.014/2014.029
Standard fan	FJ2E-250 A	FJ2E-250 A
Rated voltage (V / Hz)	230/50/60	115/50/60
Air flow, free blowing	1020/1050m ³ /h	
Air flow With export filters	1xFK7726.230:550/580m ³ /h 2xFK7726.230:620/680m ³ /h	
Axial Fan	bectric capacitance	
Rated current (A)	0.55	1.40/1.70
Power (W)	120	135/180
Noise level (dB)	68/71	
Operating temperature range	-10°C to +55°C	
Exit filter	FK7726.300 RAL7032[2014.015]/RAL7035[2014.030]	
Remarks	Special voltage needs can call the inquiry of the Company	

Performance FK 7726....

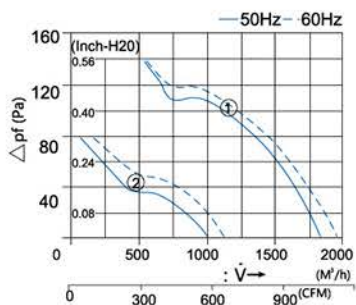



Features

This is ultra-thin type of fan filter with gasket on the back which can reach up to IP55. It is easily install on the cabinet by snap the whole filter onto the pre-cutted hole. The user can also very change the filter mat when it needed.

Design

This curved-shape surface is an unique design which is to meet clients needs. It is important to have this new series to fill up the completed range of fan filter.



Slide to open the cover



FK8921

Material	Retardent Rating	IP rating
ABS	UL94-V2	IP54

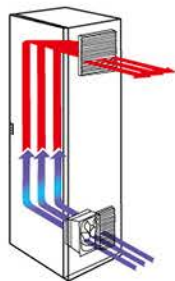

RAL7032 ◆

Fans and filters
FK 8921....

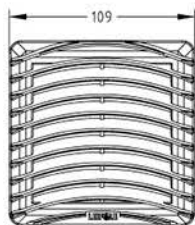

Fans and filters
FK 8921.230

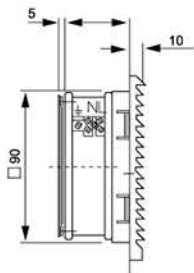

Exit filter
FK 8921.300

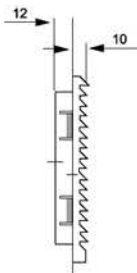

Drawing
FK 8921....

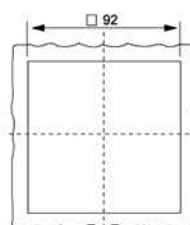

Performance
FK 8921....

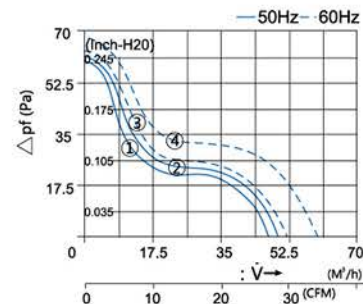

Technical data

Model	FK8921.230	FK8921.115	FK8921.024
Order number	2024.001	2024.002	2024.003
Standard fan	F2E-80B-230	F2E-80B-115	F2E-80B-24
Rated voltage (V / Hz)	230/50/60	115/50/60	24(DC)
Air flow, free blowing		20/25m ³ /h	
Air flow With export filters	1xFK8921.300:15/18m ³ /h		
Axial Fan	Automatically shield pole motor		DC Motor
Rated current (A)	0.07/0.06	0.12/0.10	0.18
Power (W)	11/13	11/13	4.3
Noise level (dB)	36/38		
Operating temperature range	-10°C to +55°C		
Exit filter	FK8921.300	2024.004	
Remarks	Special voltage needs can call the inquiry of the Company		

FK8922

Material	Retardent Rating	IP rating
ABS	UL94-V2	IP54

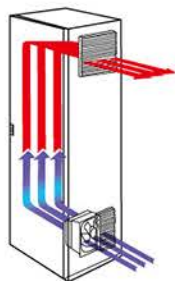

RAL7032

LEIPOLE

Fans and filters
FK 8922....

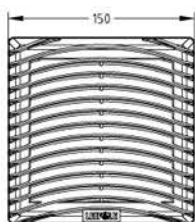

Fans and filters
FK 8922.230

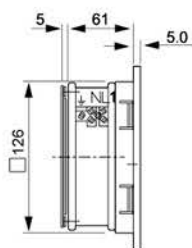

Exit filter
FK 8922.300

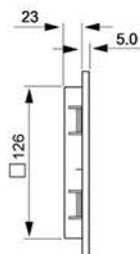

Drawing
FK 8922....

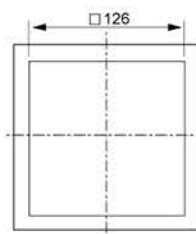

Performance
FK 8922....

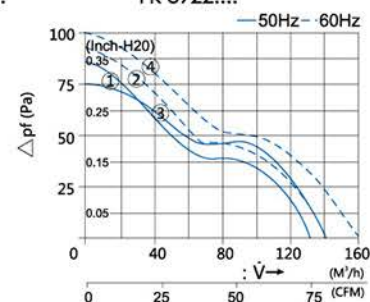

Technical data

Model	FK8922.230	FK8922.115	FK8922.024
Order number	2024.005	2024.006	2024.007
Standard fan	F2E-120S-230	F2E-120S-115	F2E-120S-24
Rated voltage (V / Hz)	230/50/60	115/50/60	24(DC)
Air flow, free blowing		55/66m³/h	
Air flow With export filters	1xFK8922.300:43/50m³/h 2xFK8922.300:48/50m³/h		
Axial Fan	Automatically shield pole motor		DC Motor
Rated current (A)	0.12/0.10	0.24/0.20	0.3
Power (W)	19/14	18/15	3.5
Noise level (dB)	50/52		
Operating temperature range	-10°C to +55°C		
Exit filter	FK8922.300 2024.008		
Remarks	Special voltage needs can call the inquiry of the Company		

FK8923

Material	Retardent Rating	IP rating
ABS	UL94-V2	IP55

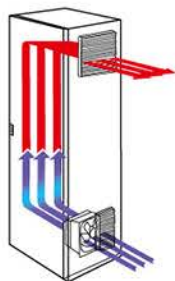

RAL7032

Fans and filters
FK 8923....

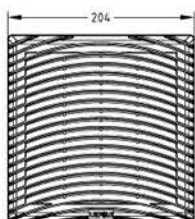

Fans and filters
FK 8923.230

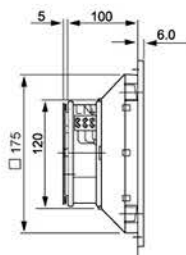

Exit filter
FK 8923.300

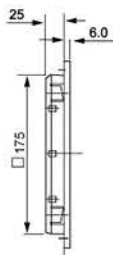

Drawing
FK 8923....

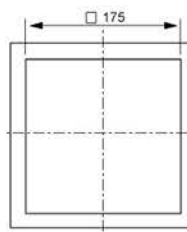

Performance
FK 8923....

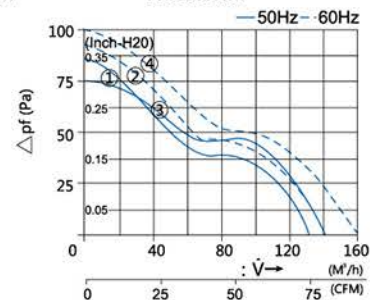

Technical data

Model	FK8923.230	FK8923.115	FK8923.024
Order number	2024.009	2024.010	2024.011
Standard fan	F2E-120S-230	F2E-120S-115	F2E-120S-24
Rated voltage (V / Hz)	230/50/60	115/50/60	24(DC)
Air flow, free blowing		105/120m³/h	
Air flow With export filters		1xFK8923.300:71/82m³/h 2xFK8923.300:85/98m³/h	
Axial Fan	Automatically shield pole motor		DC Motor
Rated current (A)	0.12/0.10	0.24/0.20	0.3
Power (W)	19/14	18/15	3.5
Noise level (dB)	50/52		
Operating temperature range	-10°C to +55°C		
Exit filter	FK8923.300 2024.012		
Remarks	Special voltage needs can call the inquiry of the Company		

FK8925

Material	Retardent Rating	IP rating
ABS	UL94-V2	IP55

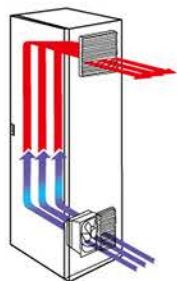

RAL7032

LEIPOLE

Fans and filters
FK 8925....

Fans and filters
FK 8925.230

Exit filter
FK 8925.300

Drawing
FK 8925....

Performance
FK 8925....

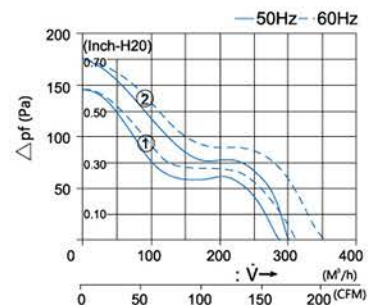
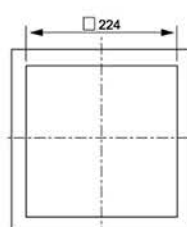
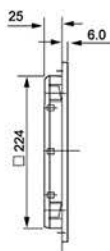
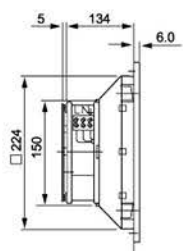
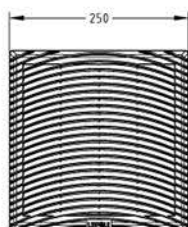

Technical data

Model	FK8925.230	FK8925.115	FK8925.024
Order number	2024.013	2024.014	2024.015
Standard fan	F2E-150S-230	F2E-150S-115	F2E-162B-24-B
Rated voltage (V / Hz)	230/50/60	115/50/60	24(DC)
Air flow, free blowing		230/265m³/h	
Air flow With export filters		1xFK8925.300:170/205m³/h 2xFK8925.300:200/230m³/h	
Axial Fan	Automatically shield pole motor		DC Motor
Rated current (A)	0.27/0.24	0.50	0.46
Power (W)	36	36	1.4
Noise level (dB)	58		
Operating temperature range	-10°C to +55°C		
Exit filter	FK8925.300 2024.016		
Remarks	Special voltage needs can call the inquiry of the Company		

FK8926

Material	Retardent Rating	IP rating
ABS	UL94-V2	IP55

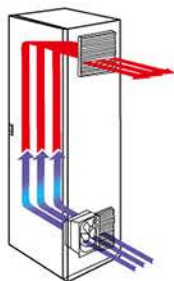

RAL7032

Fans and filters
FK 8926....



Fans and filters
FK 8926.230

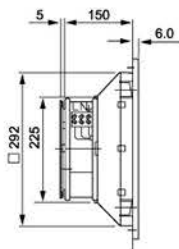

Exit filter
FK 8926.300

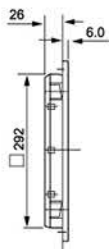

Drawing
FK 8926....

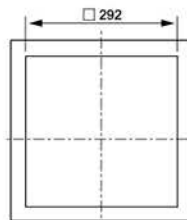

Performance
FK 8926....

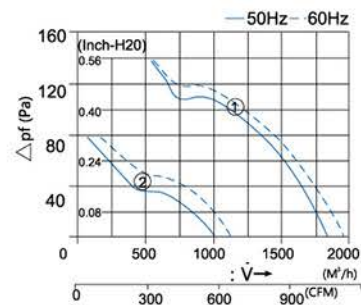

Technical data

Model	FK8926.230	FK8926.115
Order number	2024.017	2024.018
Standard fan	F2E-260B-230	F2E-260B-115
Rated voltage (V / Hz)	230/50/60	115/50/60
Air flow, free blowing	500/560m³/h	
Air flow With export filters	1xFK8926.300:360/390m³/h 2xFK8926.300:440/495m³/h	
Axial Fan	Electric capacitance	
Rated current (A)	0.29/0.33	0.61/0.63
Power (W)	65/77	61/71
Noise level (dB)	62/64	
Operating temperature range	-10°C to +55°C	
Exit filter	FK8926.300 2024.019	
Remarks	Special voltage needs can call the inquiry of the Company	



Features

This is a new generation of ultra-thin filter ventilator. Users can only purchase exit filters to match with different size of fans which give them more variety of options to choose.

Design

FB98 series comply with the colour RAL7032 and RAL7035. The rang of filters are from 148mm to 320mm. The air flow is up to 1020m³/h.



FB9803

Certification	Material	Retardent Rating	IP rating
CE RoHS	ABS	UL94-V2	IP54

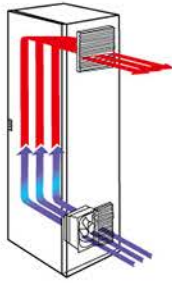

Available colors: RAL7035 ◆
RAL7032 ◆

Dimensions

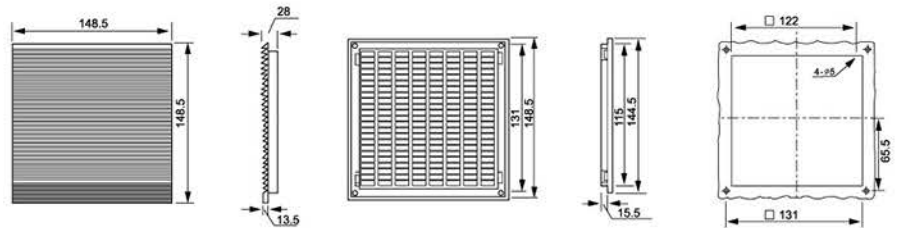

Performance FB 9803....

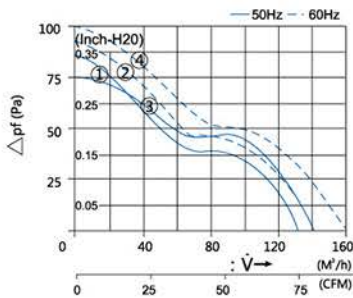

Technical data

Model/Standard fan	FB9803/120S-230	FB9803/120B-230	FB9803/120S-115	FB9803/120B-115
Available colors	RAL7032/RAL7035	RAL7032/RAL7035	RAL7032/RAL7035	RAL7032/RAL7035
Order number	2016.006/2016.037	2016.007/2016.038	2016.008/2016.039	2016.009/2016.040
Rated voltage (V / Hz)	230/50/60		115/50/60	
Air flow, free blowing	105/120m³/h			
Air flow With export filters	1x FB9803:71/82m³/h 2x FB9803:85/98m³/h			
Axial Fan	Automatically shield pole motor			
Rated current (A)	0.12/0.10		0.25/0.23	
Power (W)	19/14		18/15	
Noise level (dB)	43/50			
Operating temperature range	-10°C to +55°C			
Exit filter	FK9803 RAL7032(2016.001)/RAL7035(2016.032)			
Remarks	Special voltage needs can call the inquiry of the Company			

FB9804

Certification	Material	Retardent Rating	IP rating
CE RoHS	ABS	UL94-V2	IP54

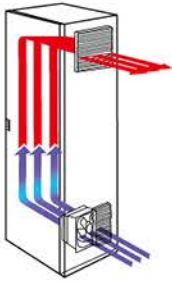

Available colors: RAL7035 ◆
RAL7032 ◆

Dimensions

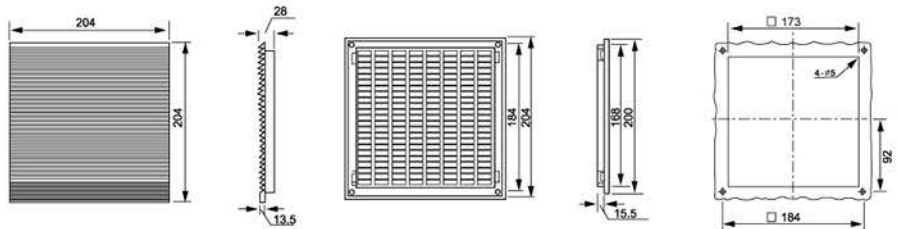

Technical data

Model/Standard fan	FB9804/120S-230 FB9804/120B-230	FB9804/150S-230 FB9804/150B-230	FB9804/120S-115 FB9804/120B-115	FB9804/150S-115 FB9804/150B-115
Available colors	RAL7032/RAL7035	RAL7032/RAL7035	RAL7032/RAL7035	RAL7032/RAL7035
Order number	2016.010/2016.041 2016.011/2016.042	2016.012/2016.043 2016.013/2016.044	2016.014/2016.045 2016.015/2016.046	2016.016/2016.047 2016.017/2016.048
Rated voltage (V / Hz)	230/50/60		115/50/60	
Air flow, free blowing	120/128m ³ /h			
Air flow With export filters	1xFB9804:71/82m ³ /h 2xFB9804:85/98m ³ /h			
Axial Fan	Automatically shield pole motor			
Rated current (A)	0.12/0.10	0.25	0.24/0.23	0.50
Power (W)	10/14	36	19/15	36
Noise level (dB)	43/50	58	43/50	58
Operating temperature range	-10°C to +55°C			
Exit filter	FK9804 RAL7032(2016.002)/RAL7035(2016.033)			
Remarks	Special voltage needs can call the inquiry of the Company			

Performance FB 9804....

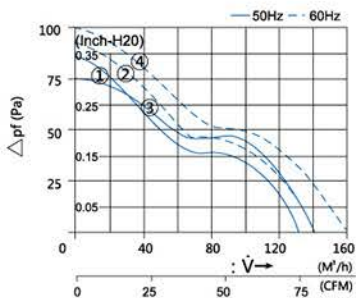

FB9805

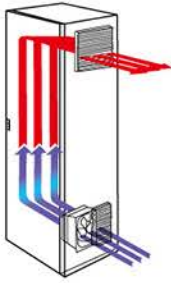

Certification	Material	Retardent Rating	IP rating
CE RoHS	ABS	UL94-V2	IP54



Available colors: RAL7035 ◆
RAL7032 ◆

Dimensions

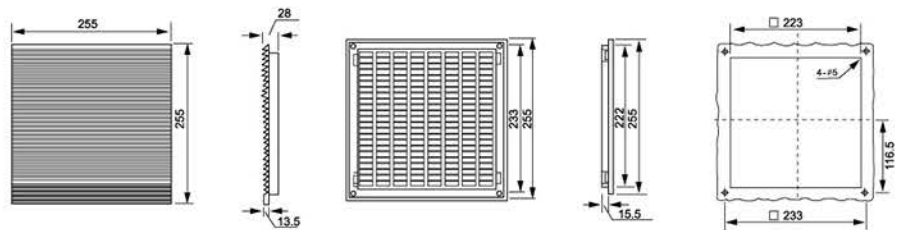

Technical data

Model/Standard fan	FB9805/150S-230 FB9805/150B-230	FB9805/220B-230	FB9805/150S-115 FB9805/150B-115	FB9805/220B-115		
Available colors	RAL7032/RAL7035	RAL7032/RAL7035	RAL7032/RAL7035	RAL7032/RAL7035		
Order number	2016.018/2016.049 2016.019/2016.050	2016.020/2016.051	2016.021/2016.052 2016.022/2016.053	2016.023/2016.054		
Rated voltage (V / Hz)	230/50/60		115/50/60			
Air flow, free blowing	190/220m³/h					
Air flow With export filters	1xFB9805:170/205m³/h 2xFB9805:210/235m³/h					
Axial Fan	Automatically shield pole motor					
Rated current (A)	0.25	0.25	0.45	0.50	0.50	0.90
Power (W)	36	36	65	36	36	65
Noise level (dB)	58/65					
Operating temperature range	-10 C to +55 C					
Exit filter	FK9805 RAL7032(2016.003)/RAL7035(2016.034)					
Remarks	Special voltage needs can call the inquiry of the Company					

Performance FB 9805....

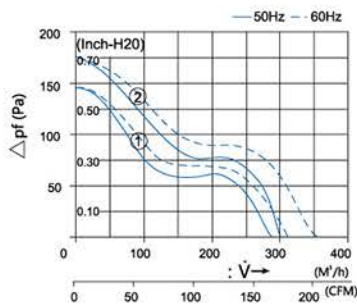

FB9806

Certification	Material	Retardent Rating	IP rating
CE RoHS	ABS	UL94-V2	IP54

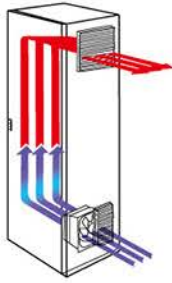

Available colors: RAL7035 ◆
RAL7032 ◆

Dimensions

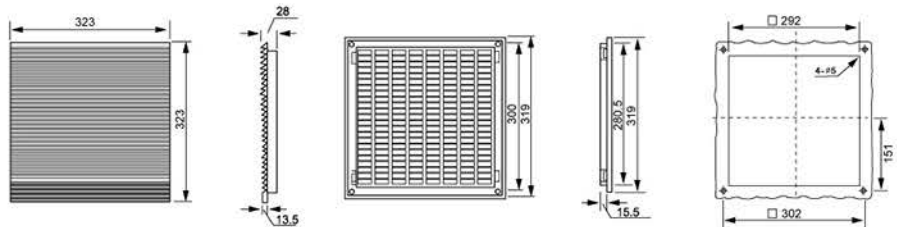

Performance

FB 9806....

Fan Air flow - Pressure Curve
GAMCA) 210-74 GB/T2059-1995
Install filters

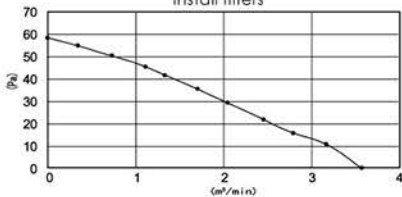

Fan Air flow - Pressure Curve
GAMCA) 210-74 GB/T2059-1995
Install filters

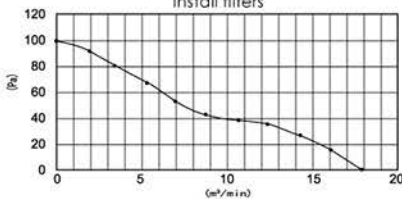

Technical data

Model/Standard fan	FB9806/150S-230 FB9806/150B-230	FB9806/250B-230	FB9806/150S-115 FB9806/150B-115	FB9806/250B-115
Available colors	RAL7032/RAL7035	RAL7032/RAL7035	RAL7032/RAL7035	RAL7032/RAL7035
Order number	2016.024/2016.055 2016.025/2016.056	2016.026/2016.057	2016.027/2016.058 2016.028/2016.059	2016.029/2016.060
Rated voltage (V / Hz)	230/50/60		115/50/60	
Air flow, free blowing	960/1020m³/h			
Air flow With export filters	1xFB9806:185/205m³/h 2xFB9806:215/230m³/h			
Axial Fan	Automatically shield pole motor			
Rated current (A)	0.25/0.23	0.25/0.23	0.25	0.48/0.55 0.48/0.55 0.50
Power (W)	35/38	35/38	60	41/38 41/38 60
Noise level (dB)	59/68			
Operating temperature range	-10°C to +55°C			
Exit filter	FK9806 RAL7032(2016.004)/RAL7035(2016.035)			
Remarks	Special voltage needs can call the inquiry of the Company			

FB9807

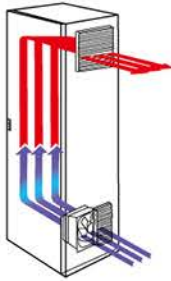

Certification	Material	Retardent Rating	IP rating
CE RoHS	ABS	UL94-V2	IP54



Available colors: RAL7035 ◆
RAL7032 ◆

Dimensions

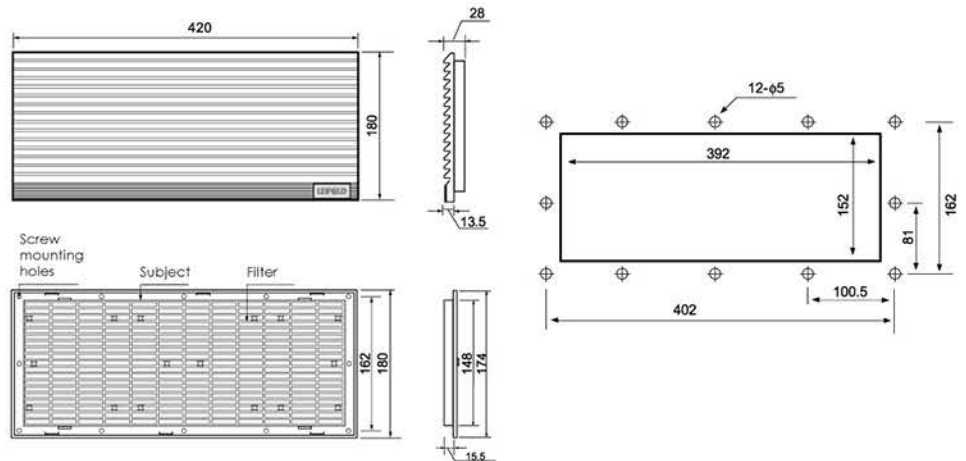

Technical data

Model	FB9807
Order number	RAL7032(2016.005)/RAL7035(2016.036)
Effective wind	100m ³ /MIN
Maximum wind speed	2.0M/SEC
Dust removal rate	80%
Pressure Loss Range	6.7~20 INCH-H ₂ O
Use of	Indoor-10°C+85°C

The fan can be installed F2E-120B-230 three fans, F2E-120S-230 three sets of fans, which is characterized by the installation of assembly, good flexibility, widely applicable. Do not use pneumatic tools to install and other high-torque apparatus.

Cabinet Exhaust Fan

F2E new generation of Cabinet top ventilator

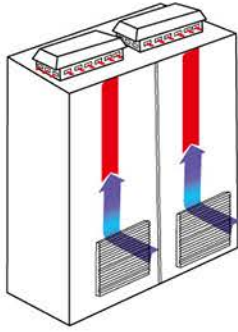

Certification	Material	Retardent Rating
CE	ABS	UL94-V2



LEIPOLE

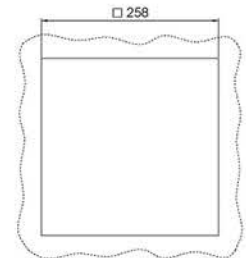
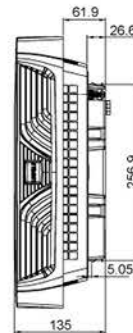

DVP hole size

- The upgraded locking system which allows it to be locked from inside of enclosure
- Easy plug connector LP769V-5.0
- Easy to change filter mat
- IP rate comply to IEC60529
 - IP22 without filter mat
 - IP55, with filter mat
- Color
 - RAL7035
 - RAL7032

Technical data

Model	F2E190-230-DVP	F2E220-230-DVP	F2E225-115-DVP	F2E225-230-DVP	F2E225-380-DVP
Order number	RAL7035 2017.018 RAL7032 2017.023	2017.019 2017.024	2017.020 2017.025	2017.021 2017.026	2017.022 2017.027
Rated voltage (V / Hz)	230AC-50/60	230AC-50/60	115AC-50/60	230AC-50/60	380AC,1,-50/60
Voltage range (V)	200~240AC	200~240AC	100~120AC	200~240AC	350~400AC
Air flow, free blowing No filter mat IP22 (m ³ /h)	570/620	860/900		1200/1340	
Air flow, free blowing filter mat IP55 (m ³ /h)	430/465	675/702		870/960	
Rated current (A)	0.28/0.31	0.46/0.51	1.30/1.45	0.60/0.74	0.34/0.45
Power (W)	60/71	98/118	130/171	131/170	130/171
Size (WxHxL mm)	400x135x400				
Hole size (mm)	258x258				
Centrifugal fan	Capacitive motor				
Operating temperature	-20°C to +55°C				
Storage temperature	-25°C to +70°C				
Noise level (dB)	71	74		71	
With exit filters	FKL6626.300				

IP RATING CHART

Protection of persons and protection of equipment indicated by the IP code.

Protection provided by enclosures for electrical equipment is indicated by the IP codes two:

CHARACTERISTIC NUMERALS

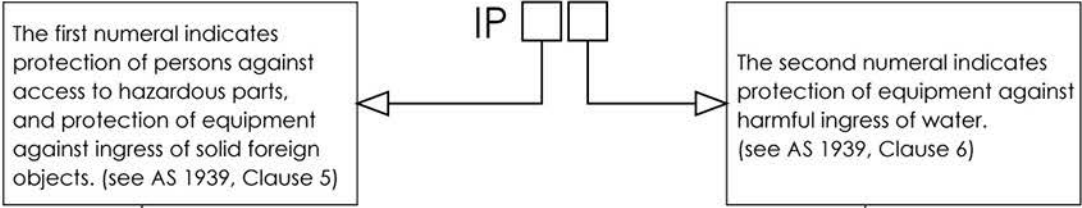

The "flash" symbol indicates hazardous parts (live or moving)

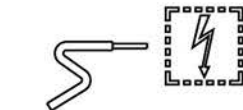
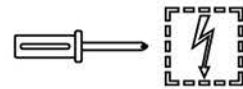
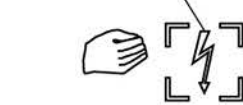

First Numeral	Description	Second Numeral	Description
X	Protection unspecified (untested)	X	Protection unspecified (untested)
0	Non-protected	0	Non-protected
1	Protection of the back of the hand against accidental access to hazardous parts, and protection of equipment against objects larger than 50mm.	1	Protection against drops of water falling vertically.
2	Protection of fingers against access to hazardous parts, and protection of equipment against objects larger than 12.5mm.	2	Protection against drops of water falling vertically when the object is tilted up to 15° from its normal position (in any direction)
3	Protection of persons holding tools or wires (larger than 2.5mm diameter), and protection of equipment against objects larger than 2.5mm (e.g. ball bearings)	3	Protection against spraying water at up to 60° from the vertical.
4	Protection of persons holding small tools or wires (larger than 1mm diameter), and protection of equipment against objects larger than 1mm. (e.g. ball bearings)	4	Protection against splashing and spraying water from all practicable directions.
5	Protection against entry of dust in sufficient quantity to interfere with satisfactory operation of equipment.	5	Protection against low pressure jets of water from all practicable directions.
6	Complete protection against entry of dust.	6	Protection against heavy seas or a strong jet of water from all practicable directions.
		7	Protection against temporary immersion.
		8	Protection against continuous submersion (tests subject to agreement, but no less severe than second numeral 7)

Equipments



Show room



Processing workshop



Assembly lines



Walking Sija



Plastic injection



Electrical pulse



High-speed precision press



Projector



Laboratory



Die assembly

V20.11

