

YW Series



Innovative Design, Space-Saving, Safety, and Self-Cleaning Contacts



• See website for details on approvals and standards.

Emergency Stop Switches

Satisfy International Standards

- Safety Lock Mechanism
- Direct Opening Action →
- Safe Pushbutton Design

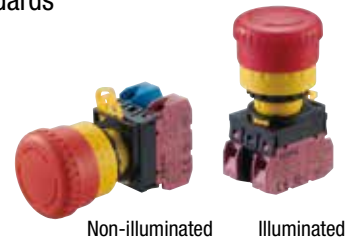

Non-illuminated

Illuminated

Easy Operation

- Push-to-lock, Pull/Turn-to-release

YW emergency stop switches can be unlatched by either pulling or turning the operator.



Unlatching by pulling



Unlatching by turning

Unibody Pilot Lights

- Higher Brightness
- Measures only 42mm depth behind the panel
- Four Lens Shapes
- Panel Mounting



Flush

Flush w/marking

Extended

Dome

Key Selector Switches

A variety of operations, key removal positions, and circuits.



Plastic Bezel



Metal Bezel

Save

New Contact Block Design

YW series

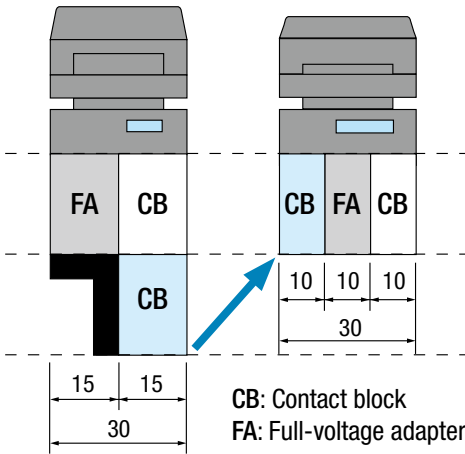

The contact block design reduces the depth behind the panel.



Reliable

Retained Locking Lever

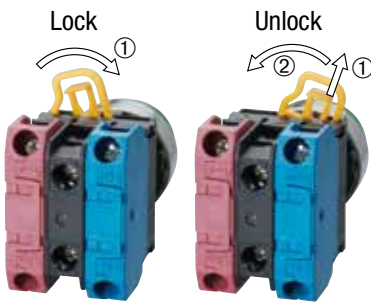

- Heavy-Duty Rugged Construction
- Self-Cleaning Wiping-Action Contacts with Scored Contact Surfaces

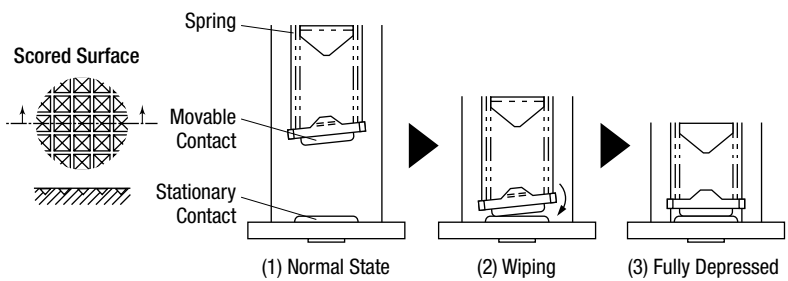

Safety



Integrated Finger-safe Terminal Cover
Degree of Protection: IP20 (From panel front: IP65)

APEM

Switches & Pilot Lights

Control Boxes

Emergency Stop Switches

Enabling Switches

Safety Products

Explosion Proof

Terminal Blocks

Relays & Sockets

Circuit Protectors

Power Supplies

LED Illumination

Controllers

Operator Interfaces

Sensors

AUTO-ID

Flush Silhouette

ø16

ø22

ø30

Miniature

Pilot Lights

HW

TW

YW

YW Series Switches & Pilot Lights

Space-saving, 10-mm-thick contact blocks. Removable operator.



Contact Ratings (Contact Block)

Rated Insulation Voltage		600V			
Rated Thermal Current		10A			
Operating Voltage		24V	120V	240V	380V
AC 50/60 Hz	Resistive Load (AC-12)	10A	10A	6A	2A
	Inductive Load (AC-15)	10A	6A	3A	1.9A
DC	Resistive Load (DC-12)	8A	2.2A	1.1A	—
	Inductive Load (DC-13)	4A	1.1A	0.55A	—

LED Illuminated Unit Specifications

Pilot Light (removable lamp terminal type)
Illuminated Pushbutton

Unit					LED Lamp					
Unit Type	Input Type	Rated Voltage	Operating Voltage	Color Code	Lamp Base	Part No.	Rated Voltage	Current Draw	Color Code	
Pilot Light (removable lamp terminal type)	Full Voltage	6V AC/DC	6V AC/DC	±10%	A: amber G: green PW: pure white R: red S: blue W: white Y: yellow	BA9S/13	LSED-6□□	6V AC/DC	8mA (A, R, Y) 6mA (G, PW, S)	A: amber G: green PW: pure white R: red S: blue Y: yellow
		12V AC/DC	12V AC/DC				LSED-1□□	12V AC/DC	7mA (A, R, Y) 6mA (G, PW, S)	
		24V AC/DC	24V AC/DC				LSED-2□□	24V AC/DC	4mA (A, R, Y) 4mA (G, PW, S)	
		110V AC/DC	110V AC/DC				LSED-H□□	110V AC/DC	3mA	
		230/240V AC/DC	207 to 250V AC/DC				LSED-M3□□	230/240V AC/DC	3mA	
Illuminated Pushbutton	Transformer (pilot light only) 50/60 Hz	100/110V AC	100/110V AC	±10%			LSED-6□□	6V AC/DC	8mA (A, R, Y) 6mA (G, PW, S)	Specify a color code in place of □ in the Part No.
		200/220V AC	200/220V AC							
		115/120V AC	115/120V AC							
		230/240V AC	207 to 250V AC							

Pilot Light (unibody type)

Unit Type	Rated Voltage	Operating Voltage	Current Draw	Color Code	
Pilot Light (unibody type)	6V AC/DC	6V AC/DC	±10%	A: amber G: green PW: pure white R: red S: blue W: white Y: yellow	
	12V AC/DC	12V AC/DC			16mA (A, R, W, Y) 13mA (G, PW, S)
	24V AC/DC	24V AC/DC			20mA
	100/110V AC (50/60 Hz sine wave)	100/110V AC			20mA
	230/240V AC (50/60 Hz sine wave)	230/240V AC			207 to 250V AC

Incandescent Illuminated Unit Specifications

Pilot Light (removable lamp terminal type) Illuminated Pushbutton

Unit					Incandescent Lamp			
Unit Type	Input Type	Rated Voltage	Operating Voltage	Color Code	Lamp Base	Part No.	Rating	
Pilot Light (removable lamp terminal type)	Full Voltage	6V AC/DC	6V AC/DC	±10%	A: amber G: green R: red S: blue W: white Y: yellow	BA9S/13	LS-T6	1W (6.3V)
		12V AC/DC	12V AC/DC				LS-T8	1W (18V)
		24V AC/DC	24V AC/DC				LS-T3	1W (30V)
Illuminated Pushbutton	Transformer (pilot light only) 50/60 Hz	100/110V AC	100/110V AC				LS-T6	1W (6.3V)
		200/220V AC	200/220V AC					
		115/120V AC	115/120V AC					
		230/240V AC	207 to 250V AC					

Specifications

Operating Conditions	Operating temperature: -20 to +55°C (no freezing) Operating humidity: 45 to 85% RH (no condensation) Storage temperature: -45 to +80°C Storage humidity: 95% RH maximum
Degree of Protection	From panel front: IP65 (IEC 60529) Terminal: IP20 (IEC 60529)
Insulation Resistance	100 MΩ
Dielectric Strength	Contact block: 2,500V, 1 minute Pilot light: 2,000V, 1 minute
Vibration Resistance	<Emergency stop switch> Operating extremes / Damage limits: 10 to 500 Hz, amplitude 0.35 mm, acceleration 50 m/s ² (5G) <Pushbutton, pilot light, illuminated pushbutton, selector switch, and key selector switch> Operating extremes: 5 to 55 Hz, amplitude 0.5 mm Damage limits: 30 Hz, amplitude 1.5 mm
Shock Resistance	<Emergency stop switch> Operating extremes: 150 m/s ² (10G) Damage limits: 1,000 m/s ² (100G) <Pushbutton, pilot light, illuminated pushbutton, selector switch, and key selector switch> Operating extremes: 100 m/s ² (10G) Damage limits: 1,000 m/s ² (100G)
Mechanical Life (minimum operations)	<Emergency stop switch> 250,000 (single contact block) <Pushbutton and illuminated pushbutton> Momentary: 5,000,000 (single contact block) 1,000,000 (double contact block) Maintained: 250,000 (single contact block) 100,000 (double contact block) <Selector switch and key selector switch> 250,000 (single contact block) 100,000 (double contact block)
Electrical Life (minimum operations)	<Emergency stop switch> 100,000 (single contact block) <Pushbutton, selector switch, and key selector switch> 100,000 (single contact block) 50,000 (double contact block)

Mounting Hole Layout

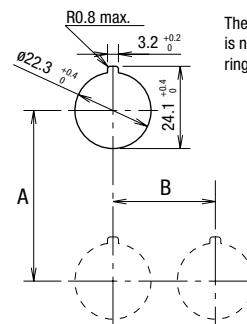

Unit	A (mm)	B (mm)
Emergency stop switch	50 min.	50 min.
Pushbutton	50 min.	30 min.
Selector switch		
Key selector switch		
Mushroom pushbutton	50 min.	40 min.
Pilot light (with removable lamp terminal)	30 min.*	30 min.
Pilot light (unibody)	50 min.	30 min.

* Keep a minimum spacing of 50 mm when using a lamp of over 1W.

APEM

Switches & Pilot Lights

Control Boxes

Emergency Stop Switches

Enabling Switches

Safety Products

Explosion Proof

Terminal Blocks

Relays & Sockets

Circuit Protectors

Power Supplies

LED Illumination

Controllers

Operator Interfaces

Sensors

AUTO-ID

Flush Silhouette

ø16

ø22

ø30

Miniature

Pilot Lights

HW

TW

YW

ø22 YW Series Emergency Stop Switches

Non-illuminated Emergency Stop Switches (Pushlock Pull/Turn Reset)

Package Quantity: 1

Style	Contact	Contact Block Mounting Position			Part No.	Button Color Code
		1	2	3		
 ø40mm Mushroom	1NC	—	—	NC	YW1B-V4E01R	Red only
	2NC	NC	—	NC	YW1B-V4E02R	
	3NC	NC	NC	NC	YW1B-V4E03R	
	1NO-1NC	NO	—	NC	YW1B-V4E11R	
	1NO-2NC	NO	NC	NC	YW1B-V4E12R	
	2NO-1NC	NO	NC	NO	YW1B-V4E21R	

- When pressed, the button is locked in the depressed position, and is reset when either pulled or turned clockwise.

Dimensions

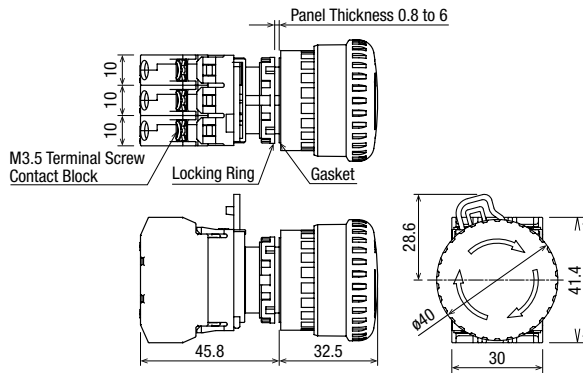

Contact Block Mounting Position



Illuminated Emergency Stop Switches (Pushlock Pull/Turn Reset)

Package Quantity: 1

Style	Lamp	Contacts	Contact Block Mounting Position			Part No.	③ Operating Voltage Code	Lens Color Code
			1	2	3			
 ø40mm Mushroom	Without Lamp	1NC	—	FA	NC	YW1L-V4E01Q0R	0: without lamp 250V AC/DC max.	Red only
		2NC	NC	FA	NC	YW1L-V4E02Q0R		
		1NO-1NC	NO	FA	NC	YW1L-V4E11Q0R		
	LED	1NC	—	FA	NC	YW1L-V4E01Q③R	2: 6V AC/DC 3: 12V AC/DC 4: 24V AC/DC H: 110V AC/DC M3: 230/240V AC/DC	
		2NC	NC	FA	NC	YW1L-V4E02Q③R		
		1NO-1NC	NO	FA	NC	YW1L-V4E11Q③R		
	Incandescent	1NC	—	FA	NC	YW1L-V4E01Q③R	5: 6V AC/DC 6: 12V AC/DC 7: 24V AC/DC	
		2NC	NC	FA	NC	YW1L-V4E02Q③R		
		1NO-1NC	NO	FA	NC	YW1L-V4E11Q③R		

- Specify an operating voltage code in place of ③ in the Part No.
- When pressed, the button is locked in the depressed position, and is reset when either pulled or turned clockwise.

FA: Full voltage adapter

Dimensions

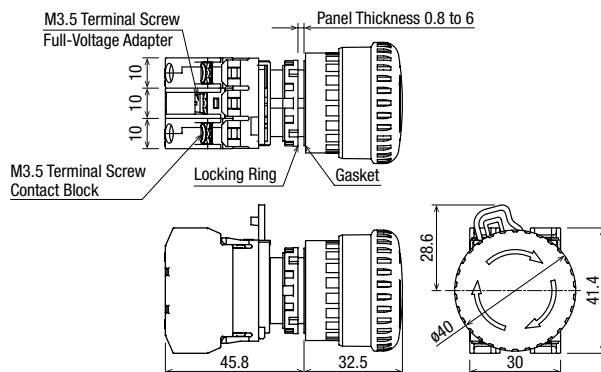



Contact Block Mounting Position



Pushbuttons with Plastic Bezel (Pushlock Pull/Turn Reset)

Package Quantity: 1

Shape	Operation	Contact	Contact Block Mounting Position			Part No.	① Button Color Code			
			1	2	3					
	Momentary	1NO	NO	—	—	YW1B-M1E10①	B: black G: green R: red S: blue W: white Y: yellow			
		1NC	—	—	NC	YW1B-M1E01①				
		2NO	NO	—	NO	YW1B-M1E20①				
		2NC	NC	—	NC	YW1B-M1E02①				
		1NO-1NC	NO	—	NC	YW1B-M1E11①				
		3NO	NO	NO	NO	YW1B-M1E30①				
		3NC	NC	NC	NC	YW1B-M1E03①				
	Maintained	2NO-1NC	NO	NC	NO	YW1B-M1E21①				
		1NO-2NC	NO	NC	NC	YW1B-M1E12①				
		1NO	NO	—	—	YW1B-A1E10①				
		1NC	—	—	NC	YW1B-A1E01①				
		2NO	NO	—	NO	YW1B-A1E20①				
		2NC	NC	—	NC	YW1B-A1E02①				
		1NO-1NC	NO	—	NC	YW1B-A1E11①				
	Momentary	1NO	NO	—	—	YW1B-M2E10①	B: black G: green R: red S: blue W: white Y: yellow			
		1NC	—	—	NC	YW1B-M2E01①				
		2NO	NO	—	NO	YW1B-M2E20①				
		2NC	NC	—	NC	YW1B-M2E02①				
	Maintained	1NO-1NC	NO	—	NC	YW1B-M2E11①				
		1NO	NO	—	—	YW1B-A2E10①				
		1NC	—	—	NC	YW1B-A2E01①				
		2NO	NO	—	NO	YW1B-A2E20①				
		2NC	NC	—	NC	YW1B-A2E02①				
		1NO-1NC	NO	—	NC	YW1B-A2E11①				
			Momentary	1NO	NO	—		—	YW1B-M4E10①	B: black G: green R: red S: blue W: white Y: yellow
				1NC	—	—		NC	YW1B-M4E01①	
				2NO	NO	—		NO	YW1B-M4E20①	
				2NC	NC	—		NC	YW1B-M4E02①	
Maintained	1NO-1NC		NO	—	NC	YW1B-M4E11①				
	1NO		NO	—	—	YW1B-A4E10①				
	1NC		—	—	NC	YW1B-A4E01①				
	2NO		NO	—	NO	YW1B-A4E20①				
	2NC		NC	—	NC	YW1B-A4E02①				
	1NO-1NC		NO	—	NC	YW1B-A4E11①				

Note: Specify a button color code in place of ① in the Part No.

Dimensions

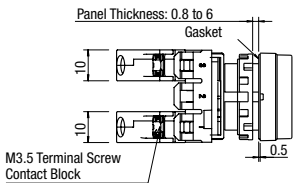

Contact Block Mounting Position



Flush

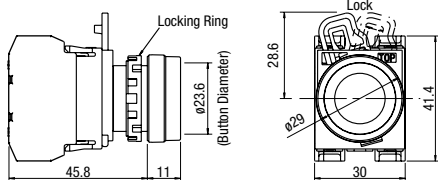

Extended

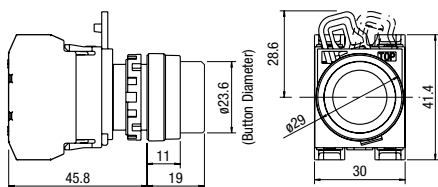

Mushroom

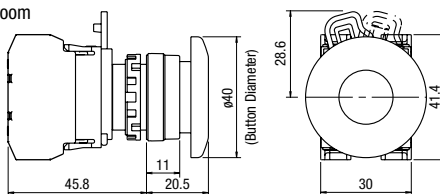



All dimensions in mm.

- APEM
- Switches & Pilot Lights
- Control Boxes
- Emergency Stop Switches
- Enabling Switches
- Safety Products
- Explosion Proof
- Terminal Blocks
- Relays & Sockets
- Circuit Protectors
- Power Supplies
- LED Illumination
- Controllers
- Operator Interfaces
- Sensors
- AUTO-ID
- Flush Silhouette
- ø16
- ø22
- ø30
- Miniature
- Pilot Lights

HW
TW
YW

Pushbuttons with Metal Bezel

Package Quantity: 1

Shape	Operation	Contact	Contact Block Mounting Position			Part No.	① Button Color Code			
			1	2	3					
	Momentary	1NO	NO	—	—	YW4B-M1E10①	B: black G: green R: red S: blue W: white Y: yellow			
		1NC	—	—	NC	YW4B-M1E01①				
		2NO	NO	—	NO	YW4B-M1E20①				
		2NC	NC	—	NC	YW4B-M1E02①				
		1NO-1NC	NO	—	NC	YW4B-M1E11①				
		3NO	NO	NO	NO	YW4B-M1E30①				
		3NC	NC	NC	NC	YW4B-M1E03①				
	Maintained	2NO-1NC	NO	NC	NO	YW4B-M1E21①				
		1NO-2NC	NO	NC	NC	YW4B-M1E12①				
		1NO	NO	—	—	YW4B-A1E10①				
		1NC	—	—	NC	YW4B-A1E01①				
		2NO	NO	—	NO	YW4B-A1E20①				
		2NC	NC	—	NC	YW4B-A1E02①				
		1NO-1NC	NO	—	NC	YW4B-A1E11①				
	Momentary	1NO	NO	—	—	YW4B-M2E10①	B: black G: green R: red S: blue W: white Y: yellow			
		1NC	—	—	NC	YW4B-M2E01①				
		2NO	NO	—	NO	YW4B-M2E20①				
		2NC	NC	—	NC	YW4B-M2E02①				
	Maintained	1NO-1NC	NO	—	NC	YW4B-M2E11①				
		1NO	NO	—	—	YW4B-A2E10①				
		1NC	—	—	NC	YW4B-A2E01①				
		2NO	NO	—	NO	YW4B-A2E20①				
		2NC	NC	—	NC	YW4B-A2E02①				
		1NO-1NC	NO	—	NC	YW4B-A2E11①				
			Momentary	1NO	NO	—		—	YW4B-M4E10①	B: black G: green R: red S: blue W: white Y: yellow
				1NC	—	—		NC	YW4B-M4E01①	
				2NO	NO	—		NO	YW4B-M4E20①	
				2NC	NC	—		NC	YW4B-M4E02①	
Maintained	1NO-1NC		NO	—	NC	YW4B-M4E11①				
	1NO		NO	—	—	YW4B-A4E10①				
	1NC		—	—	NC	YW4B-A4E01①				
	2NO		NO	—	NO	YW4B-A4E20①				
	2NC		NC	—	NC	YW4B-A4E02①				
	1NO-1NC		NO	—	NC	YW4B-A4E11①				

Note: Specify a button color code in place of ① in the Part No.

Dimensions

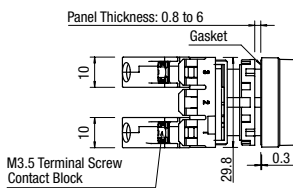

Contact Block Mounting Position



Flush

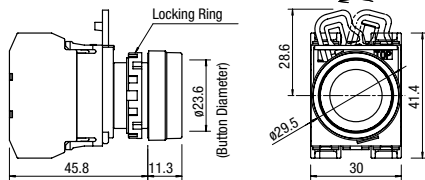

Extended

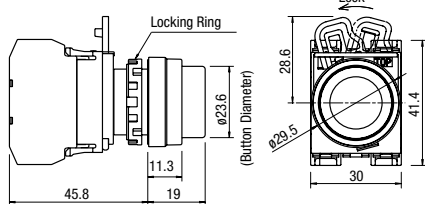

Mushroom

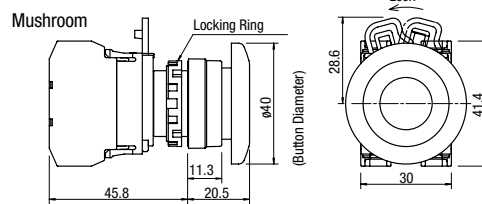

All dimensions in mm.

Pilot Lights (Unibody)

Package Quantity: 1

Shape	Lamp	Operating Voltage	Part No.	② Lens Color Code
Flush Full Voltage 	LED	6V AC/DC	YW1P-1UQ2②	A: amber G: green PW: pure white R: red S: blue W: white Y: yellow
		12V AC/DC	YW1P-1UQ3②	
		24V AC/DC	YW1P-1UQ4②	
		100/110V AC	YW1P-1UQH②	
		230/240V AC	YW1P-1UQM3②	
Flush Marking Full Voltage 	LED	6V AC/DC	YW1P-1BUQ2②	
		12V AC/DC	YW1P-1BUQ3②	
		24V AC/DC	YW1P-1BUQ4②	
		100/110V AC	YW1P-1BUQH②	
		230/240V AC	YW1P-1BUQM3②	
Extended Full Voltage 	LED	6V AC/DC	YW1P-2TUQ2②	
		12V AC/DC	YW1P-2TUQ3②	
		24V AC/DC	YW1P-2TUQ4②	
		100/110V AC	YW1P-2TUQH②	
		230/240V AC	YW1P-2TUQM3②	
Dome Full Voltage 	LED	6V AC/DC	YW1P-2UQ2②	
		12V AC/DC	YW1P-2UQ3②	
		24V AC/DC	YW1P-2UQ4②	
		100/110V AC	YW1P-2UQH②	
		230/240V AC	YW1P-2UQM3②	

- APEM
- Switches & Pilot Lights
- Control Boxes
- Emergency Stop Switches
- Enabling Switches
- Safety Products
- Explosion Proof
- Terminal Blocks
- Relays & Sockets
- Circuit Protectors
- Power Supplies
- LED Illumination
- Controllers
- Operator Interfaces
- Sensors
- AUTO-ID



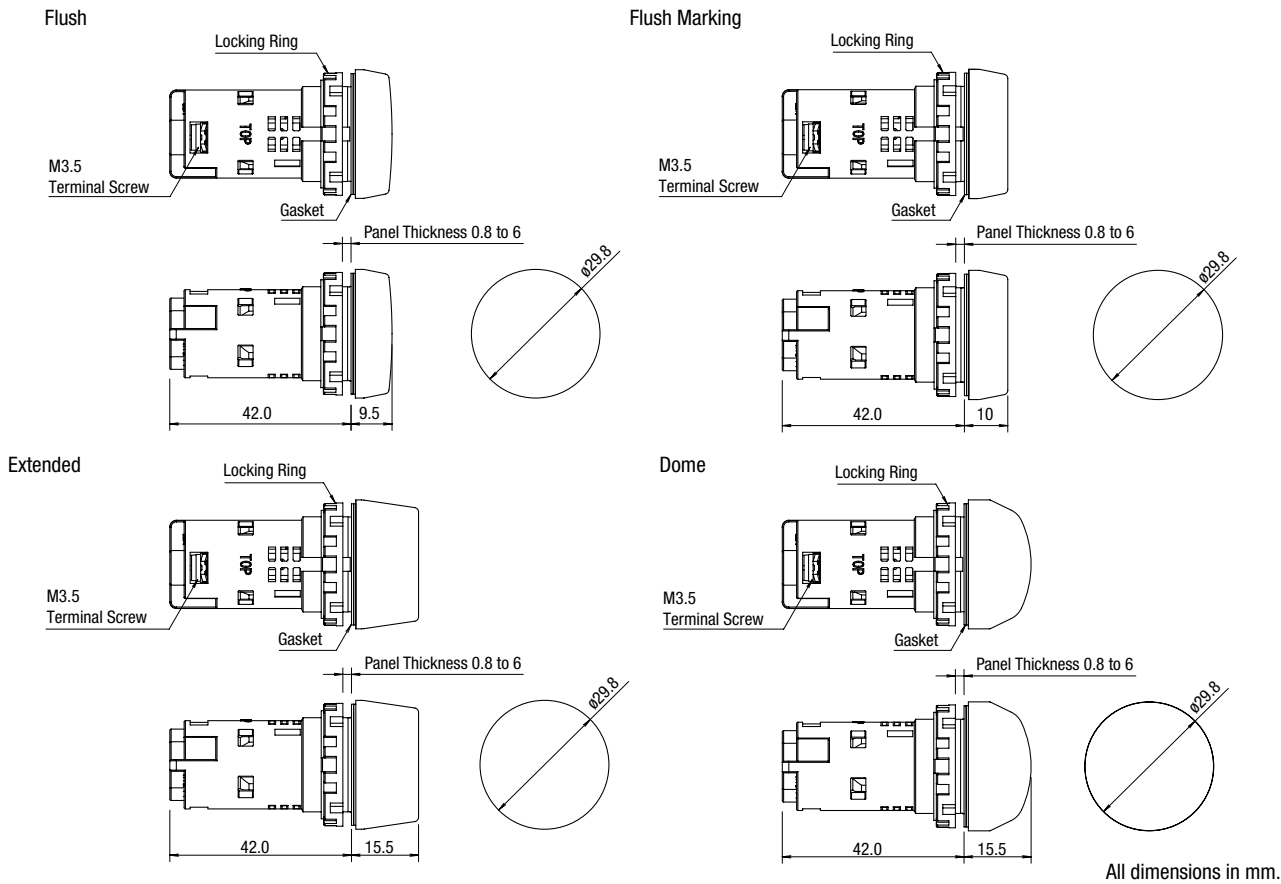

Dimensions



- Flush Silhouette
- ø16
- ø22
- ø30
- Miniature
- Pilot Lights
- HW
- TW
- YW

Pilot Lights (with Removable Lamp Terminal)

Package Quantity: 1

Shape	Lamp	Operating Voltage	Part No.	② Lens Color Code
Flush Full Voltage 	Without Lamp	250V AC/DC max.	YW1P-1EQ0②	A (amber), C (clear), G (green), R (red), S (blue), W (white), Y (yellow)
	LED	6V AC/DC	YW1P-1EQ2②	A (amber), G (green), PW (pure white), R (red), S (blue), W (white), Y (yellow) Built-in LED lamp: LSED-③②N
		12V AC/DC	YW1P-1EQ3②	
		24V AC/DC	YW1P-1EQ4②	
		110V AC/DC	YW1P-1EQH②	
		230/240V AC/DC	YW1P-1EQM3②	
	Incandescent	6V AC/DC	YW1P-1EQ5②	A (amber), C (clear), G (green), R (red), S (blue), W (white), Y (yellow) Built-in incandescent lamp: LS-T③
		12V AC/DC	YW1P-1EQ6②	
		24V AC/DC	YW1P-1EQ7②	
	Flush Transformer 	LED	100/110V AC	YW1P-1EH2②
200/220V AC			YW1P-1EM2②	
115/120V AC			YW1P-1EH22②	
230/240V AC			YW1P-1EM42②	
Incandescent		100/110V AC	YW1P-1EH5②	A (amber), C (clear), G (green), R (red), S (blue), W (white), Y (yellow) Built-in incandescent lamp: LS-T6
		200/220V AC	YW1P-1EM5②	
		115/120V AC	YW1P-1EH25②	
		230/240V AC	YW1P-1EM45②	
Flush Marking Full Voltage 	Without Lamp	250V AC/DC max.	YW1P-1BEQ0②	A (amber), G (green), R (red), S (blue), W (white), Y (yellow)
	LED	6V AC/DC	YW1P-1BEQ2②	A (amber), G (green), PW (pure white), R (red), S (blue), W (white), Y (yellow) Built-in LED lamp: LSED-③②N
		12V AC/DC	YW1P-1BEQ3②	
		24V AC/DC	YW1P-1BEQ4②	
		110V AC/DC	YW1P-1BEQH②	
		230/240V AC/DC	YW1P-1BEQM3②	
	Incandescent	6V AC/DC	YW1P-1BEQ5②	A (amber), G (green), R (red), S (blue), W (white), Y (yellow) Built-in incandescent lamp: LS-T③
		12V AC/DC	YW1P-1BEQ6②	
		24V AC/DC	YW1P-1BEQ7②	
	Flush Marking Transformer 	LED	100/110V AC	YW1P-1BEH2②
200/220V AC			YW1P-1BEM2②	
115/120V AC			YW1P-1BEH22②	
230/240V AC			YW1P-1BEM42②	
Incandescent		100/110V AC	YW1P-1BEH5②	A (amber), G (green), R (red), S (blue), W (white), Y (yellow) Built-in incandescent lamp: LS-T6
		200/220V AC	YW1P-1BEM5②	
		115/120V AC	YW1P-1BEH25②	
		230/240V AC	YW1P-1BEM45②	

Note: Specify a lens color code in place of ② in the Part No.
Clear lenses are used for PW (pure white) illumination of pilot lights.

Pilot Lights (with Removable Lamp Terminal)

Package Quantity: 1

Shape	Lamp	Operating Voltage	Part No.	② Lens Color Code
Extended Full Voltage 	Without Lamp	250V AC/DC max.	YW1P-2TEQ0②	A (amber), C (clear), G (green), R (red), S (blue), W (white), Y (yellow)
	LED	6V AC/DC	YW1P-2TEQ2②	A (amber), G (green), PW (pure white), R (red), S (blue), W (white), Y (yellow) Built-in LED lamp: LSED-③②N
		12V AC/DC	YW1P-2TEQ3②	
		24V AC/DC	YW1P-2TEQ4②	
		110V AC/DC	YW1P-2TEQH②	
		230/240V AC/DC	YW1P-2TEQM3②	
	Incandescent	6V AC/DC	YW1P-2TEQ5②	A (amber), C (clear), G (green), R (red), S (blue), W (white), Y (yellow) Built-in incandescent lamp: LS-T③
		12V AC/DC	YW1P-2TEQ6②	
		24V AC/DC	YW1P-2TEQ7②	
	Extended Transformer 	LED	100/110V AC	YW1P-2TEH2②
200/220V AC			YW1P-2TEM2②	
115/120V AC			YW1P-2TEH22②	
230/240V AC			YW1P-2TEM42②	
Incandescent		100/110V AC	YW1P-2TEH5②	A (amber), C (clear), G (green), R (red), S (blue), W (white), Y (yellow) Built-in incandescent lamp: LS-T6
		200/220V AC	YW1P-2TEM5②	
		115/120V AC	YW1P-2TEH25②	
		230/240V AC	YW1P-2TEM45②	
Dome Full Voltage 	Without Lamp	250V AC/DC max.	YW1P-2EQ0②	A (amber), C (clear), G (green), R (red), S (blue), W (white), Y (yellow)
	LED	6V AC/DC	YW1P-2EQ2②	A (amber), G (green), PW (pure white), R (red), S (blue), W (white), Y (yellow) Built-in LED lamp: LSED-③②N
		12V AC/DC	YW1P-2EQ3②	
		24V AC/DC	YW1P-2EQ4②	
		110V AC/DC	YW1P-2EQH②	
		230/240V AC/DC	YW1P-2EQM3②	
	Incandescent	6V AC/DC	YW1P-2EQ5②	A (amber), C (clear), G (green), R (red), S (blue), W (white), Y (yellow) Built-in incandescent lamp: LS-T③
		12V AC/DC	YW1P-2EQ6②	
		24V AC/DC	YW1P-2EQ7②	
	Dome Transformer 	LED	100/110V AC	YW1P-2EH2②
200/220V AC			YW1P-2EM2②	
115/120V AC			YW1P-2EH22②	
230/240V AC			YW1P-2EM42②	
Incandescent		100/110V AC	YW1P-2EH5②	A (amber), C (clear), G (green), R (red), S (blue), W (white), Y (yellow) Built-in incandescent lamp: LS-T6
		200/220V AC	YW1P-2EM5②	
		115/120V AC	YW1P-2EH25②	
		230/240V AC	YW1P-2EM45②	

Note: Specify a lens color code in place of ② in the Part No.
Clear lenses are used for PW (pure white) illumination of pilot lights.

APEM

Switches & Pilot Lights

Control Boxes

Emergency Stop Switches

Enabling Switches

Safety Products

Explosion Proof

Terminal Blocks

Relays & Sockets

Circuit Protectors

Power Supplies

LED Illumination

Controllers

Operator Interfaces

Sensors

AUTO-ID

Flush Silhouette

ø16

ø22

ø30

Miniature

Pilot Lights

HW

TW

YW

Dimensions

All dimensions in mm

Pilot Lights (with Removable Lamp Terminal)

Flush Full Voltage

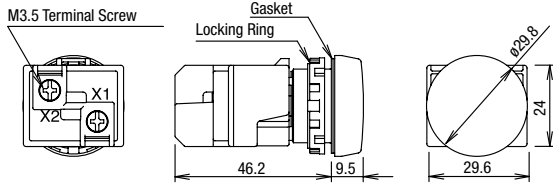
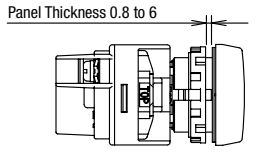

Flush Marking Full Voltage

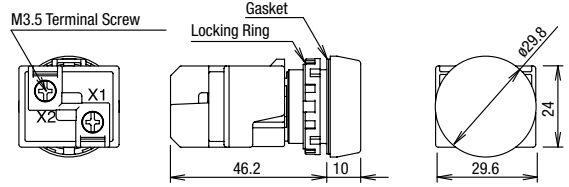
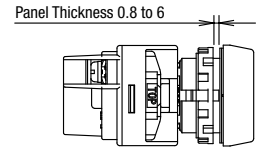

Transformer

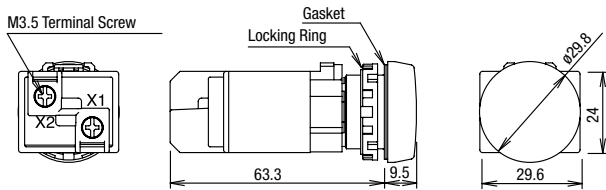
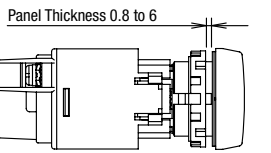

Transformer

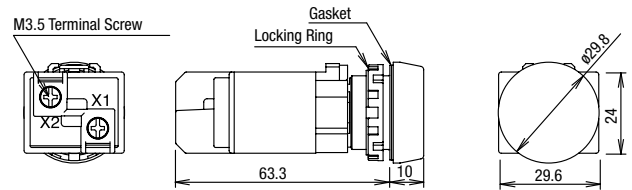
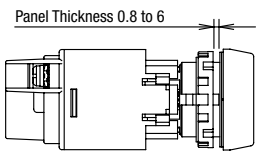

Extended Full Voltage

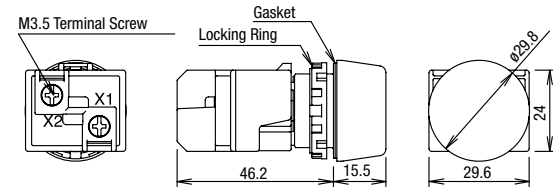
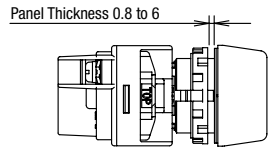

Dome Full Voltage

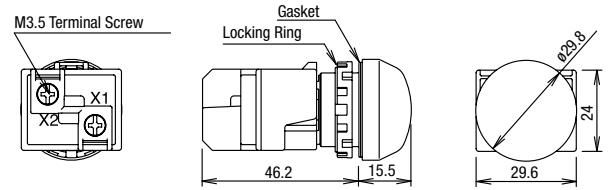
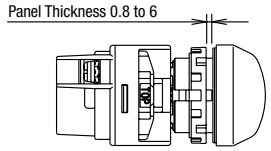

Transformer

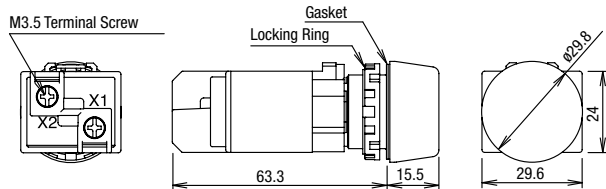
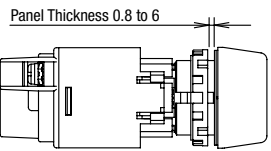

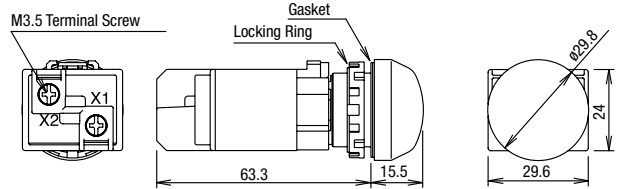
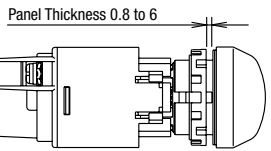

Transformer



- APEM
- Switches & Pilot Lights
- Control Boxes
- Emergency Stop Switches
- Enabling Switches
- Safety Products
- Explosion Proof
- Terminal Blocks
- Relays & Sockets
- Circuit Protectors
- Power Supplies
- LED Illumination
- Controllers
- Operator Interfaces
- Sensors
- AUTO-ID
- Flush Silhouette
- ø16
- ø22
- ø30
- Miniature
- Pilot Lights
- HW
- TW
- YW

Illuminated Pushbuttons with Plastic Bezel

Package Quantity: 1

Shape	Lamp	Operation	Contact	Contact Block Mounting Position			Part No.	③ Operating Voltage Code	② Lens Color Code			
				1	2	3						
	Without Lamp	Momentary	1NO	NO	FA	—	YW1L-M2E10Q0②	0: without lamp 250V AC/DC max.	A: amber G: green R: red S: blue W: white Y: yellow			
			1NC	—	FA	NC	YW1L-M2E01Q0②					
			2NO	NO	FA	NO	YW1L-M2E20Q0②					
			2NC	NC	FA	NC	YW1L-M2E02Q0②					
		1NO-1NC	NO	FA	NC	YW1L-M2E11Q0②						
		Maintained	1NO	NO	FA	—	YW1L-A2E10Q0②					
			1NC	—	FA	NC	YW1L-A2E01Q0②					
			2NO	NO	FA	NO	YW1L-A2E20Q0②					
			2NC	NC	FA	NC	YW1L-A2E02Q0②					
		1NO-1NC	NO	FA	NC	YW1L-A2E11Q0②						
		LED	Momentary	1NO	NO	FA	—			YW1L-M2E10Q③②	2: 6V AC/DC 3: 12V AC/DC 4: 24V AC/DC H: 110V AC/DC M3: 230/240V AC/DC	A: amber G: green PW: pure white R: red S: blue W: white Y: yellow Built-in LED lamp: LSED-③②N
				1NC	—	FA	NC			YW1L-M2E01Q③②		
	2NO			NO	FA	NO	YW1L-M2E20Q③②					
	2NC			NC	FA	NC	YW1L-M2E02Q③②					
	1NO-1NC		NO	FA	NC	YW1L-M2E11Q③②						
	Maintained		1NO	NO	FA	—	YW1L-A2E10Q③②					
			1NC	—	FA	NC	YW1L-A2E01Q③②					
			2NO	NO	FA	NO	YW1L-A2E20Q③②					
			2NC	NC	FA	NC	YW1L-A2E02Q③②					
	1NO-1NC		NO	FA	NC	YW1L-A2E11Q③②						
	Incandescent		Momentary	1NO	NO	FA	—	YW1L-M2E10Q③②	5: 6V AC/DC 6: 12V AC/DC 7: 24V AC/DC	A: amber G: green R: red S: blue W: white Y: yellow Built-in incandescent lamp: LS-T③		
				1NC	—	FA	NC	YW1L-M2E01Q③②				
		2NO		NO	FA	NO	YW1L-M2E20Q③②					
		2NC		NC	FA	NC	YW1L-M2E02Q③②					
1NO-1NC		NO	FA	NC	YW1L-M2E11Q③②							
Maintained		1NO	NO	FA	—	YW1L-A2E10Q③②						
		1NC	—	FA	NC	YW1L-A2E01Q③②						
		2NO	NO	FA	NO	YW1L-A2E20Q③②						
		2NC	NC	FA	NC	YW1L-A2E02Q③②						
1NO-1NC		NO	FA	NC	YW1L-A2E11Q③②							
		Without Lamp	Momentary	1NO	NO	FA	—	YW1L-MF2E10Q0②			0: without lamp 250V AC/DC max.	A: amber G: green R: red S: blue W: white Y: yellow
				1NC	—	FA	NC	YW1L-MF2E01Q0②				
	2NO			NO	FA	NO	YW1L-MF2E20Q0②					
	2NC			NC	FA	NC	YW1L-MF2E02Q0②					
	1NO-1NC		NO	FA	NC	YW1L-MF2E11Q0②						
	Maintained		1NO	NO	FA	—	YW1L-AF2E10Q0②					
			1NC	—	FA	NC	YW1L-AF2E01Q0②					
			2NO	NO	FA	NO	YW1L-AF2E20Q0②					
			2NC	NC	FA	NC	YW1L-AF2E02Q0②					
	1NO-1NC		NO	FA	NC	YW1L-AF2E11Q0②						
	LED		Momentary	1NO	NO	FA	—	YW1L-MF2E10Q③②	2: 6V AC/DC 3: 12V AC/DC 4: 24V AC/DC H: 110V AC/DC M3: 230/240V AC/DC	A: amber G: green PW: pure white R: red S: blue W: white Y: yellow Built-in LED lamp: LSED-③②N		
				1NC	—	FA	NC	YW1L-MF2E01Q③②				
		2NO		NO	FA	NO	YW1L-MF2E20Q③②					
		2NC		NC	FA	NC	YW1L-MF2E02Q③②					
		1NO-1NC	NO	FA	NC	YW1L-MF2E11Q③②						
		Maintained	1NO	NO	FA	—	YW1L-AF2E10Q③②					
			1NC	—	FA	NC	YW1L-AF2E01Q③②					
			2NO	NO	FA	NO	YW1L-AF2E20Q③②					
			2NC	NC	FA	NC	YW1L-AF2E02Q③②					
		1NO-1NC	NO	FA	NC	YW1L-AF2E11Q③②						
		Incandescent	Momentary	1NO	NO	FA	—	YW1L-MF2E10Q③②			5: 6V AC/DC 6: 12V AC/DC 7: 24V AC/DC	A: amber G: green R: red S: blue W: white Y: yellow Built-in incandescent lamp: LS-T③
				1NC	—	FA	NC	YW1L-MF2E01Q③②				
	2NO			NO	FA	NO	YW1L-MF2E20Q③②					
	2NC			NC	FA	NC	YW1L-MF2E02Q③②					
1NO-1NC	NO		FA	NC	YW1L-MF2E11Q③②							
Maintained	1NO		NO	FA	—	YW1L-AF2E10Q③②						
	1NC		—	FA	NC	YW1L-AF2E01Q③②						
	2NO		NO	FA	NO	YW1L-AF2E20Q③②						
	2NC		NC	FA	NC	YW1L-AF2E02Q③②						
1NO-1NC	NO		FA	NC	YW1L-AF2E11Q③②							

Note: Specify a lens color code in place of ② in the Part No.
Specify an operating voltage code in place of ③ in the Part No.

FA: Full voltage adapter

- APEM
- Switches & Pilot Lights
- Control Boxes
- Emergency Stop Switches
- Enabling Switches
- Safety Products
- Explosion Proof
- Terminal Blocks
- Relays & Sockets
- Circuit Protectors
- Power Supplies
- LED Illumination
- Controllers
- Operator Interfaces
- Sensors
- AUTO-ID
- Flush Silhouette
- ø16
- ø22
- ø30
- Miniature
- Pilot Lights
- HW
- TW
- YW

Illuminated Pushbuttons with Plastic Bezel

Package Quantity: 1

Shape	Lamp	Operation	Contact	Contact Block Mounting Position			Part No.	③ Operating Voltage Code	② Lens Color Code			
				1	2	3						
	Without Lamp	Momentary	1NO	NO	FA	—	YW1L-M4E10Q0②	0: without lamp 250V AC/DC max.	A: amber G: green R: red S: blue W: white Y: yellow			
			1NC	—	FA	NC	YW1L-M4E01Q0②					
			2NO	NO	FA	NO	YW1L-M4E20Q0②					
			2NC	NC	FA	NC	YW1L-M4E02Q0②					
		Maintained	1NO-1NC	NO	FA	NC	YW1L-M4E11Q0②					
			1NO	NO	FA	—	YW1L-A4E10Q0②					
			1NC	—	FA	NC	YW1L-A4E01Q0②					
			2NO	NO	FA	NO	YW1L-A4E20Q0②					
		LED	Momentary	2NC	NC	FA	NC			YW1L-A4E02Q0②	2: 6V AC/DC 3: 12V AC/DC 4: 24V AC/DC H: 110V AC/DC M3: 230/240V AC/DC	A: amber G: green PW: pure white R: red S: blue W: white Y: yellow Built-in LED lamp: LSED-③②N
				1NO-1NC	NO	FA	NC			YW1L-M4E11Q③②		
				1NO	NO	FA	—			YW1L-A4E10Q③②		
				1NC	—	FA	NC			YW1L-A4E01Q③②		
	Maintained		2NO	NO	FA	NO	YW1L-A4E20Q③②					
			2NC	NC	FA	NC	YW1L-A4E02Q③②					
			1NO-1NC	NO	FA	NC	YW1L-A4E11Q③②					
			1NO	NO	FA	—	YW1L-M4E10Q③②					
	Incandescent		Momentary	1NC	—	FA	NC	YW1L-M4E01Q③②	5: 6V AC/DC 6: 12V AC/DC 7: 24V AC/DC	A: amber G: green R: red S: blue W: white Y: yellow Built-in incandescent lamp: LS-T③		
				2NO	NO	FA	NO	YW1L-M4E20Q③②				
				2NC	NC	FA	NC	YW1L-M4E02Q③②				
				1NO-1NC	NO	FA	NC	YW1L-M4E11Q③②				
		Maintained	1NO	NO	FA	—	YW1L-A4E10Q③②					
			1NC	—	FA	NC	YW1L-A4E01Q③②					
			2NO	NO	FA	NO	YW1L-A4E20Q③②					
			2NC	NC	FA	NC	YW1L-A4E02Q③②					
1NO-1NC		NO	FA	NC	YW1L-A4E11Q③②							

Note: Specify a lens color code in place of ② in the Part No.
Specify an operating voltage code in place of ③ in the Part No.

FA: Full voltage adapter

Dimensions
(Illuminated Pushbuttons with Plastic Bezel)

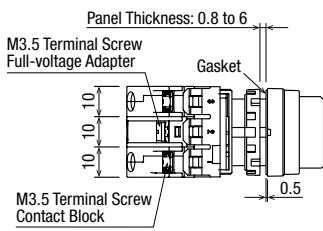

Contact Block Mounting Position



Extended

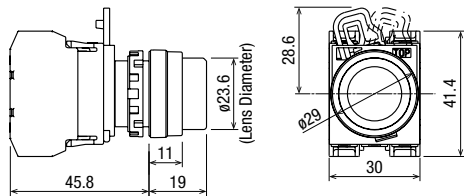

Mushroom

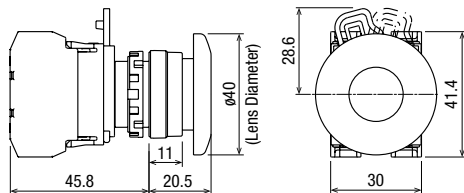

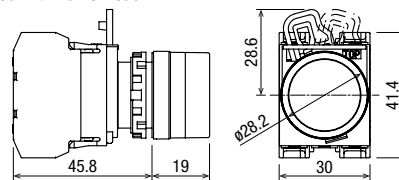

Extended with Full Shroud



All dimensions in mm.

Illuminated Pushbuttons with Metal Bezel

Package Quantity: 1

Shape	Lamp	Operation	Contact	Contact Block Mounting Position			Part No.	③ Operating Voltage Code	② Lens Color Code			
				1	2	3						
	Without Lamp	Momentary	1NO	NO	FA	—	YW4L-M2E10Q0②	0: without lamp 250V AC/DC max.	A: amber G: green R: red S: blue W: white Y: yellow			
			1NC	—	FA	NC	YW4L-M2E01Q0②					
			2NO	NO	FA	NO	YW4L-M2E20Q0②					
			2NC	NC	FA	NC	YW4L-M2E02Q0②					
		1NO-1NC	NO	FA	NC	YW4L-M2E11Q0②						
		Maintained	1NO	NO	FA	—	YW4L-A2E10Q0②					
			1NC	—	FA	NC	YW4L-A2E01Q0②					
			2NO	NO	FA	NO	YW4L-A2E20Q0②					
			2NC	NC	FA	NC	YW4L-A2E02Q0②					
		1NO-1NC	NO	FA	NC	YW4L-A2E11Q0②						
		LED	Momentary	1NO	NO	FA	—			YW4L-M2E10Q③②	2: 6V AC/DC 3: 12V AC/DC 4: 24V AC/DC H: 110V AC/DC M3: 230/240V AC/DC	A: amber G: green PW: pure white R: red S: blue W: white Y: yellow Built-in LED lamp: LSED-③②N
				1NC	—	FA	NC			YW4L-M2E01Q③②		
	2NO			NO	FA	NO	YW4L-M2E20Q③②					
	2NC			NC	FA	NC	YW4L-M2E02Q③②					
	1NO-1NC		NO	FA	NC	YW4L-M2E11Q③②						
	Maintained		1NO	NO	FA	—	YW4L-A2E10Q③②					
			1NC	—	FA	NC	YW4L-A2E01Q③②					
			2NO	NO	FA	NO	YW4L-A2E20Q③②					
			2NC	NC	FA	NC	YW4L-A2E02Q③②					
	1NO-1NC		NO	FA	NC	YW4L-A2E11Q③②						
	Incandescent		Momentary	1NO	NO	FA	—	YW4L-M2E10Q③②	5: 6V AC/DC 6: 12V AC/DC 7: 24V AC/DC	A: amber G: green R: red S: blue W: white Y: yellow Built-in incandescent lamp: LS-T③		
				1NC	—	FA	NC	YW4L-M2E01Q③②				
		2NO		NO	FA	NO	YW4L-M2E20Q③②					
		2NC		NC	FA	NC	YW4L-M2E02Q③②					
1NO-1NC		NO	FA	NC	YW4L-M2E11Q③②							
Maintained		1NO	NO	FA	—	YW4L-A2E10Q③②						
		1NC	—	FA	NC	YW4L-A2E01Q③②						
		2NO	NO	FA	NO	YW4L-A2E20Q③②						
		2NC	NC	FA	NC	YW4L-A2E02Q③②						
1NO-1NC		NO	FA	NC	YW4L-A2E11Q③②							
		Without Lamp	Momentary	1NO	NO	FA	—	YW4L-MF2E10Q0②			0: without lamp 250V AC/DC max.	A: amber G: green R: red S: blue W: white Y: yellow
				1NC	—	FA	NC	YW4L-MF2E01Q0②				
	2NO			NO	FA	NO	YW4L-MF2E20Q0②					
	2NC			NC	FA	NC	YW4L-MF2E02Q0②					
	1NO-1NC		NO	FA	NC	YW4L-MF2E11Q0②						
	Maintained		1NO	NO	FA	—	YW4L-AF2E10Q0②					
			1NC	—	FA	NC	YW4L-AF2E01Q0②					
			2NO	NO	FA	NO	YW4L-AF2E20Q0②					
			2NC	NC	FA	NC	YW4L-AF2E02Q0②					
	1NO-1NC		NO	FA	NC	YW4L-AF2E11Q0②						
	LED		Momentary	1NO	NO	FA	—	YW4L-MF2E10Q③②	2: 6V AC/DC 3: 12V AC/DC 4: 24V AC/DC H: 110V AC/DC M3: 230/240V AC/DC	A: amber G: green PW: pure white R: red S: blue W: white Y: yellow Built-in LED lamp: LSED-③②N		
				1NC	—	FA	NC	YW4L-MF2E01Q③②				
		2NO		NO	FA	NO	YW4L-MF2E20Q③②					
		2NC		NC	FA	NC	YW4L-MF2E02Q③②					
		1NO-1NC	NO	FA	NC	YW4L-MF2E11Q③②						
		Maintained	1NO	NO	FA	—	YW4L-AF2E10Q③②					
			1NC	—	FA	NC	YW4L-AF2E01Q③②					
			2NO	NO	FA	NO	YW4L-AF2E20Q③②					
			2NC	NC	FA	NC	YW4L-AF2E02Q③②					
		1NO-1NC	NO	FA	NC	YW4L-AF2E11Q③②						
		Incandescent	Momentary	1NO	NO	FA	—	YW4L-MF2E10Q③②			5: 6V AC/DC 6: 12V AC/DC 7: 24V AC/DC	A: amber G: green R: red S: blue W: white Y: yellow Built-in incandescent lamp: LS-T③
				1NC	—	FA	NC	YW4L-MF2E01Q③②				
	2NO			NO	FA	NO	YW4L-MF2E20Q③②					
	2NC			NC	FA	NC	YW4L-MF2E02Q③②					
1NO-1NC	NO		FA	NC	YW4L-MF2E11Q③②							
Maintained	1NO		NO	FA	—	YW4L-AF2E10Q③②						
	1NC		—	FA	NC	YW4L-AF2E01Q③②						
	2NO		NO	FA	NO	YW4L-AF2E20Q③②						
	2NC		NC	FA	NC	YW4L-AF2E02Q③②						
1NO-1NC	NO		FA	NC	YW4L-AF2E11Q③②							

Note: Specify a lens color code in place of ② in the Part No.
Specify an operating voltage code in place of ③ in the Part No.

FA: Full voltage adapter

- APEM
- Switches & Pilot Lights
- Control Boxes
- Emergency Stop Switches
- Enabling Switches
- Safety Products
- Explosion Proof
- Terminal Blocks
- Relays & Sockets
- Circuit Protectors
- Power Supplies
- LED Illumination
- Controllers
- Operator Interfaces
- Sensors
- AUTO-ID
- Flush Silhouette
- ø16
- ø22
- ø30
- Miniature
- Pilot Lights
- HW
- TW
- YW

Illuminated Pushbuttons with Metal Bezel

Package Quantity: 1

Style	Lamp	Operation	Contact	Contact Block Mounting Position			Part No.	③ Operating Voltage Code	② Lens Color Code			
				1	2	3						
	Without Lamp	Momentary	1NO	NO	FA	—	YW4L-M4E10Q0②	0: without lamp 250V AC/DC max.	A: amber G: green R: red S: blue W: white Y: yellow			
			1NC	—	FA	NC	YW4L-M4E01Q0②					
			2NO	NO	FA	NO	YW4L-M4E20Q0②					
			2NC	NC	FA	NC	YW4L-M4E02Q0②					
		Maintained	1NO-1NC	NO	FA	NC	YW4L-M4E11Q0②					
			1NO	NO	FA	—	YW4L-A4E10Q0②					
			1NC	—	FA	NC	YW4L-A4E01Q0②					
			2NO	NO	FA	NO	YW4L-A4E20Q0②					
		LED	Momentary	2NC	NC	FA	NC			YW4L-A4E02Q0②	2: 6V AC/DC 3: 12V AC/DC 4: 24V AC/DC H: 110V AC/DC M3: 230/240V AC/DC	A: amber G: green PW: pure white R: red S: blue W: white Y: yellow Built-in LED lamp: LSED-③②N
				1NO-1NC	NO	FA	NC			YW4L-M4E11Q③②		
				1NO	NO	FA	—			YW4L-M4E10Q③②		
				1NC	—	FA	NC			YW4L-M4E01Q③②		
	Maintained		2NO	NO	FA	NO	YW4L-M4E20Q③②					
			2NC	NC	FA	NC	YW4L-M4E02Q③②					
			1NO-1NC	NO	FA	NC	YW4L-A4E11Q③②					
			1NO	NO	FA	—	YW4L-A4E10Q③②					
	Incandescent		Momentary	1NC	—	FA	NC	YW4L-A4E01Q③②	5: 6V AC/DC 6: 12V AC/DC 7: 24V AC/DC	A: amber G: green R: red S: blue W: white Y: yellow Built-in incandescent lamp: LS-T③		
				2NO	NO	FA	NO	YW4L-M4E20Q③②				
				2NC	NC	FA	NC	YW4L-M4E02Q③②				
				1NO-1NC	NO	FA	NC	YW4L-M4E11Q③②				
		Maintained	1NO	NO	FA	—	YW4L-A4E10Q③②					
			1NC	—	FA	NC	YW4L-A4E01Q③②					
			2NO	NO	FA	NO	YW4L-A4E20Q③②					
			2NC	NC	FA	NC	YW4L-A4E02Q③②					
Incandescent		1NO-1NC	NO	FA	NC	YW4L-A4E11Q③②						

Note: Specify a lens color code in place of ② in the Part No.
Specify an operating voltage code in place of ③ in the Part No.
FA: Full voltage adapter

Dimensions (Illuminated Pushbutton with Metal Bezel)

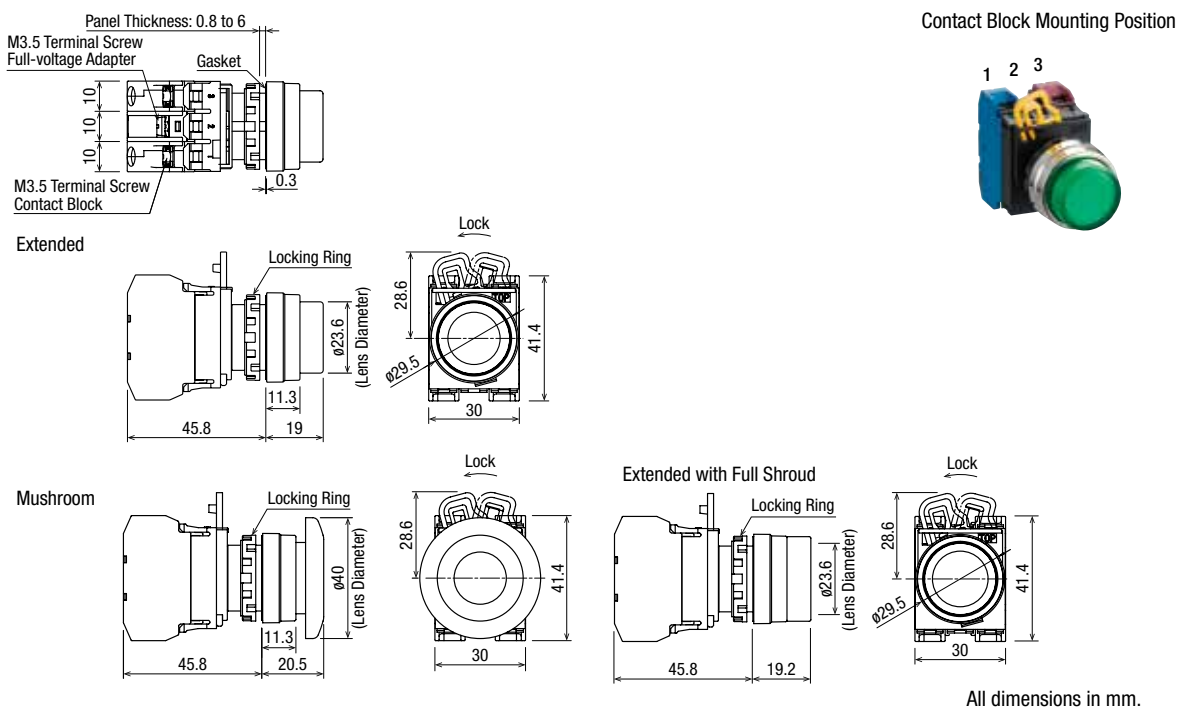

Selector Switches with Plastic Bezel

Package Quantity: 1

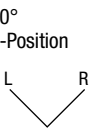
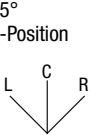
Shape				Knob							
No. of Positions	Contact Configuration	Contact Block Mounting Position	Operator Position			Maintained	Spring Return from Right	—	—		
			L	R	—						
90° 2-Position 	1NO (10)	1	NO		●		YW1S-2E10	YW1S-21E10	—	—	
		2									
		3									
	1NC (01)	1			●		YW1S-2E01	YW1S-21E01	—	—	
		2									
		3	NC	●							
	2NO (20)	1	NO			●	YW1S-2E20	YW1S-21E20	—	—	
		2									
		3	NO			●					
	2NC (02)	1	NC	●			YW1S-2E02	YW1S-21E02	—	—	
		2									
		3	NC	●							
	1NO-1NC (11)	1	NO			●	YW1S-2E11	YW1S-21E11	—	—	
		2									
		3	NC	●							
	3NO (30)	1	NO			●	YW1S-2E30	YW1S-21E30	—	—	
		2	NO			●					
		3	NO			●					
3NC (03)	1	NC	●			YW1S-2E03	YW1S-21E03	—	—		
	2	NC	●								
	3	NC	●								
2NO-1NC (21)	1	NO			●	YW1S-2E21	YW1S-21E21	—	—		
	2	NC	●								
	3	NO			●						
1NO-2NC (12)	1	NO			●	YW1S-2E12	YW1S-21E12	—	—		
	2	NC	●								
	3	NC	●								
No. of Positions	Contact Configuration	Contact Block Mounting Position	Operator Position			Maintained	Spring Return from Right	Spring Return from Left	Spring Return Two-Way		
			L	C	R						
45° 3-Position 	2NO (20)	1	NO	●			YW1S-3E20	YW1S-31E20	YW1S-32E20	YW1S-33E20	
		2									
		3	NO								●
	2NO (20N1)	1						YW1S-3E20N1	YW1S-31E20N1	YW1S-32E20N1	YW1S-33E20N1
		2	NO	●			●				
		3	NO				●				
	2NC (02)	1	NC				■	YW1S-3E02	YW1S-31E02	YW1S-32E02	YW1S-33E02
		2									
		3	NC	■							
	2NC (02N1)	1						YW1S-3E02N1	YW1S-31E02N1	YW1S-32E02N1	YW1S-33E02N1
		2	NC			●					
		3	NC	■							
	1NO-1NC (11)	1	NO	●				YW1S-3E11	YW1S-31E11	YW1S-32E11	YW1S-33E11
		2									
		3	NC	■							
	1NO-1NC (11N1)	1	NC				■	YW1S-3E11N1	YW1S-31E11N1	YW1S-32E11N1	YW1S-33E11N1
		2									
		3	NO				●				
	1NO-1NC (11N2)	1	NO	●				YW1S-3E11N2	YW1S-31E11N2	YW1S-32E11N2	YW1S-33E11N2
		2	NC			●					
		3									
	1NO-1NC (11N3)	1						YW1S-3E11N3	YW1S-31E11N3	YW1S-32E11N3	YW1S-33E11N3
		2	NC			●					
		3	NO				●				
1NO-1NC (11N4)	1						YW1S-3E11N4	YW1S-31E11N4	YW1S-32E11N4	YW1S-33E11N4	
	2	NO	●			●					
	3	NC	■								
3NO (30)	1	NO	●				YW1S-3E30	YW1S-31E30	YW1S-32E30	YW1S-33E30	
	2	NO	●								
	3	NO				●					
3NC (03)	1	NC				■	YW1S-3E03	YW1S-31E03	YW1S-32E03	YW1S-33E03	
	2	NC			●						
	3	NC	■								
2NO-1NC (21)	1	NO			●		YW1S-3E21	YW1S-31E21	YW1S-32E21	YW1S-33E21	
	2	NC	●								
	3	NO				●					
1NO-2NC (12)	1	NC				■	YW1S-3E12	YW1S-31E12	YW1S-32E12	YW1S-33E12	
	2	NO	●			●					
	3	NC	■								

- APEM
- Switches & Pilot Lights
- Control Boxes
- Emergency Stop Switches
- Enabling Switches
- Safety Products
- Explosion Proof
- Terminal Blocks
- Relays & Sockets
- Circuit Protectors
- Power Supplies
- LED Illumination
- Controllers
- Operator Interfaces
- Sensors
- AUTO-ID

- Flush Silhouette
- ø16
- ø22
- ø30
- Miniature
- Pilot Lights
- HW
- TW
- YW

Selector Switches with Metal Bezel

Package Quantity: 1

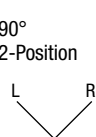
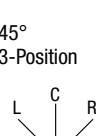
Shape				Knob							
No. of Positions	Contact Configuration	Contact Block Mounting Position	Operator Position			Maintained	Spring Return from Right	—	—		
			L	R	—						
90° 2-Position 	1NO (10)	1	NO		●		YW4S-2E10	YW4S-21E10	—	—	
		2									
		3									
	1NC (01)	1						YW4S-2E01	YW4S-21E01	—	—
		2									
		3	NC	●							
	2NO (20)	1	NO		●		YW4S-2E20	YW4S-21E20	—	—	
		2									
		3	NO		●						
	2NC (02)	1	NC	●			YW4S-2E02	YW4S-21E02	—	—	
		2									
		3	NC	●							
	1NO-1NC (11)	1	NO		●		YW4S-2E11	YW4S-21E11	—	—	
		2									
		3	NC	●							
	3NO (30)	1	NO		●		YW4S-2E30	YW4S-21E30	—	—	
		2	NO		●						
		3	NO		●						
3NC (03)	1	NC	●			YW4S-2E03	YW4S-21E03	—	—		
	2	NC	●								
	3	NC	●								
2NO-1NC (21)	1	NO		●		YW4S-2E21	YW4S-21E21	—	—		
	2	NC	●								
	3	NO		●							
1NO-2NC (12)	1	NO		●		YW4S-2E12	YW4S-21E12	—	—		
	2	NC	●								
	3	NC	●								
No. of Positions	Contact Configuration	Contact Block Mounting Position	Operator Position			Maintained	Spring Return from Right	Spring Return from Left	Spring Return Two-Way		
L	C	R									
45° 3-Position 	2NO (20)	1	NO	●			YW4S-3E20	YW4S-31E20	YW4S-32E20	YW4S-33E20	
		2									
		3	NO			●					
	2NO (20N1)	1	NO	●		●	YW4S-3E20N1	YW4S-31E20N1	YW4S-32E20N1	YW4S-33E20N1	
		2									
		3	NO			●					
	2NC (02)	1	NC			■	YW4S-3E02	YW4S-31E02	YW4S-32E02	YW4S-33E02	
		2									
		3	NC	■							
	2NC (02N1)	1	NC			■	YW4S-3E02N1	YW4S-31E02N1	YW4S-32E02N1	YW4S-33E02N1	
		2	NC		●						
		3	NC	■							
1NO-1NC (11)	1	NO	●			YW4S-3E11	YW4S-31E11	YW4S-32E11	YW4S-33E11		
	2										
	3	NC	■								
1NO-1NC (11N1)	1	NC			■	YW4S-3E11N1	YW4S-31E11N1	YW4S-32E11N1	YW4S-33E11N1		
	2										
	3	NO			●						
1NO-1NC (11N2)	1	NO	●			YW4S-3E11N2	YW4S-31E11N2	YW4S-32E11N2	YW4S-33E11N2		
	2	NC		●							
	3										
1NO-1NC (11N3)	1					YW4S-3E11N3	YW4S-31E11N3	YW4S-32E11N3	YW4S-33E11N3		
	2	NC		●							
	3	NO			●						
1NO-1NC (11N4)	1					YW4S-3E11N4	YW4S-31E11N4	YW4S-32E11N4	YW4S-33E11N4		
	2	NO	●		●						
	3	NC	■								
3NO (30)	1	NO	●			YW4S-3E30	YW4S-31E30	YW4S-32E30	YW4S-33E30		
	2	NO	●								
	3	NO			●						
3NC (03)	1	NC			■	YW4S-3E03	YW4S-31E03	YW4S-32E03	YW4S-33E03		
	2	NC		●							
	3	NC	■								
2NO-1NC (21)	1	NO	●			YW4S-3E21	YW4S-31E21	YW4S-32E21	YW4S-33E21		
	2	NC		●							
	3	NO			●						
1NO-2NC (12)	1	NC			■	YW4S-3E12	YW4S-31E12	YW4S-32E12	YW4S-33E12		
	2	NO	●		●						
	3	NC	■								

- APEM
- Switches & Pilot Lights
- Control Boxes
- Emergency Stop Switches
- Enabling Switches
- Safety Products
- Explosion Proof
- Terminal Blocks
- Relays & Sockets
- Circuit Protectors
- Power Supplies
- LED Illumination
- Controllers
- Operator Interfaces
- Sensors
- AUTO-ID

- Flush Silhouette
- ø16
- ø22
- ø30
- Miniature
- Pilot Lights
- HW
- TW
- YW

Dimensions

All dimensions in mm

Selector Switch with Plastic Bezel

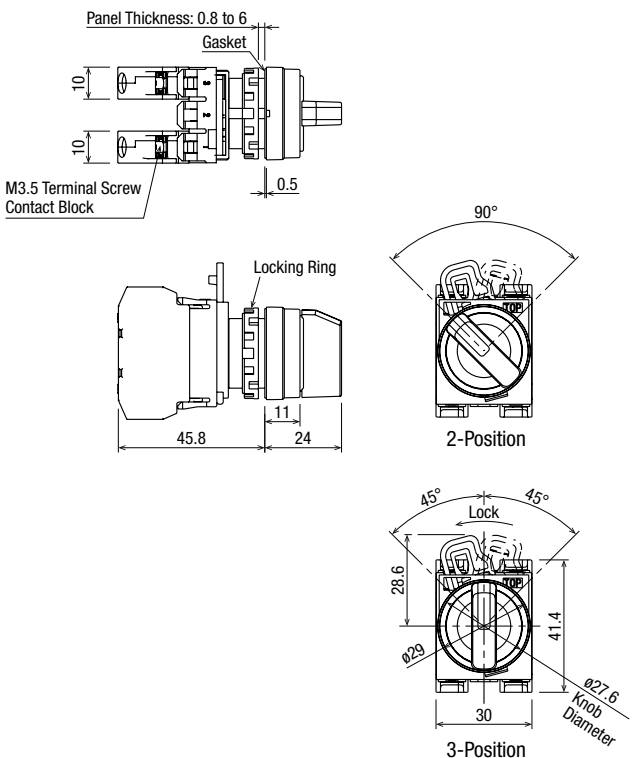

Selector Switch with Metal Bezel

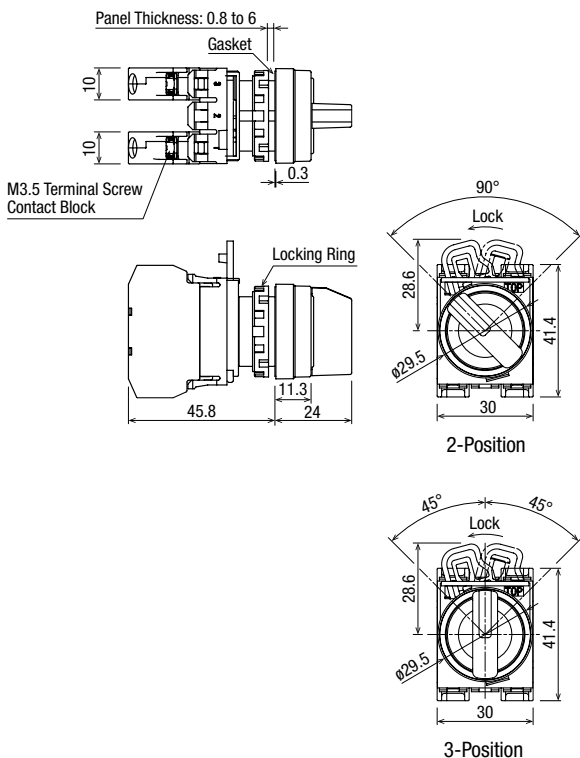

Contact Block Mounting Position

Selector Switch with Plastic Bezel

Contact Block Mounting Position







Selector Switch with Metal Bezel

Contact Block Mounting Position



Key Selector Switches (90° 2-Position)



Package Quantity: 1

No. of Positions	Contact Configuration	Contact Block Mounting Position		Operator Position		Part No.		
				L	R	Plastic Bezel	Metal Bezel	
								
90° 2-position Maintained 	1NO (10)	1	NO		●	YW1K-2AE10	YW4K-2AE10	
		2						
		3						
	1NC (01)	1					YW1K-2AE01	YW4K-2AE01
		2						
		3	NC	●				
	2NO (20)	1	NO			●	YW1K-2AE20	YW4K-2AE20
		2						
		3	NO		●			
	2NC (02)	1	NC	●			YW1K-2AE02	YW4K-2AE02
		2						
		3	NC	●				
	1NO-1NC (11)	1	NO			●	YW1K-2AE11	YW4K-2AE11
		2						
		3	NC	●				
	3NO (30)	1	NO			●	YW1K-2AE30	YW4K-2AE30
		2	NO			●		
		3	NO			●		
	3NC (03)	1	NC	●			YW1K-2AE03	YW4K-2AE03
		2	NC	●				
		3	NC	●				
	2NO-1NC (21)	1	NO			●	YW1K-2AE21	YW4K-2AE21
		2	NC	●				
		3	NO		●			
1NO-2NC (12)	1	NO			●	YW1K-2AE12	YW4K-2AE12	
	2	NC	●					
	3	NC	●					
90° 2-position Spring Return from Right 	1NO (10)	1	NO		●	YW1K-21BE10	YW4K-21BE10	
		2						
		3						
	1NC (01)	1					YW1K-21BE01	YW4K-21BE01
		2						
		3	NC	●				
	2NO (20)	1	NO			●	YW1K-21BE20	YW4K-21BE20
		2						
		3	NO		●			
	2NC (02)	1	NC	●			YW1K-21BE02	YW4K-21BE02
		2						
		3	NC	●				
	1NO-1NC (11)	1	NO			●	YW1K-21BE11	YW4K-21BE11
		2						
		3	NC	●				
	3NO (30)	1	NO			●	YW1K-21BE30	YW4K-21BE30
		2	NO			●		
		3	NO			●		
	3NC (03)	1	NC	●			YW1K-21BE03	YW4K-21BE03
		2	NC	●				
		3	NC	●				
	2NO-1NC (21)	1	NO			●	YW1K-21BE21	YW4K-21BE21
		2	NC	●				
		3	NO		●			
1NO-2NC (12)	1	NO			●	YW1K-21BE12	YW4K-21BE12	
	2	NC	●					
	3	NC	●					

- On the spring-returned types, the key can be removed only from the maintained position. On the maintained types, the key can be removed from every position. Key retained positions are also available. See Part No. Development shown on B-288.
- Each key selector switch is supplied with two identical keys.

Key Selector Switches (45° 3-Position)

Package Quantity: 1

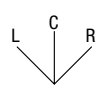
No. of Positions	Contact Configuration	Contact Block Mounting Position		Operator Position			Part No.		
				L	C	R	Plastic Bezel	Metal Bezel	
									
45° 3-position Maintained 	2NO (20)	1	NO	●			YW1K-3AE20	YW4K-3AE20	
		2							
		3	NO			●			
	2NO (20N1)	1						YW1K-3AE20N1	YW4K-3AE20N1
		2	NO	●		●			
		3	NO			●			
	2NC (02)	1	NC		■			YW1K-3AE02	YW4K-3AE02
		2							
		3	NC	■					
	2NC (02N1)	1						YW1K-3AE02N1	YW4K-3AE02N1
		2	NC		●				
		3	NC	■					
	1NO-1NC (11)	1	NO	●				YW1K-3AE11	YW4K-3AE11
		2							
		3	NC	■					
	1NO-1NC (11N1)	1	NC		■			YW1K-3AE11N1	YW4K-3AE11N1
		2							
		3	NO			●			
	1NO-1NC (11N2)	1	NO	●				YW1K-3AE11N2	YW4K-3AE11N2
		2	NC		●				
		3							
	1NO-1NC (11N3)	1						YW1K-3AE11N3	YW4K-3AE11N3
		2	NC		●				
		3	NO			●			
1NO-1NC (11N4)	1						YW1K-3AE11N4	YW4K-3AE11N4	
	2	NO	●		●				
	3	NC	■						
3NO (30)	1	NO	●				YW1K-3AE30	YW4K-3AE30	
	2	NO	●		●				
	3	NO			●				
3NC (03)	1	NC		■			YW1K-3AE03	YW4K-3AE03	
	2	NC		●					
	3	NC	■						
2NO-1NC (21)	1	NO	●				YW1K-3AE21	YW4K-3AE21	
	2	NC		●					
	3	NO			●				
1NO-2NC (12)	1	NC		■			YW1K-3AE12	YW4K-3AE12	
	2	NO	●		●				
	3	NC	■						

- APEM
- Switches & Pilot Lights
- Control Boxes
- Emergency Stop Switches
- Enabling Switches
- Safety Products
- Explosion Proof
- Terminal Blocks
- Relays & Sockets
- Circuit Protectors
- Power Supplies
- LED Illumination
- Controllers
- Operator Interfaces
- Sensors
- AUTO-ID

- Flush Silhouette
- ø16
- ø22
- ø30
- Miniature
- Pilot Lights

- HW
- TW
- YW

- On the maintained types, the key can be removed from every position. Key retained positions are also available. See Part No. Development below.
- Each key selector switch is supplied with two identical keys.

Part No. Development

YW1K-2 A E21

- Key removal position code
- 2-position
- A: Removable in all positions
- B: Removable in left only
- C: Removable in right only
- 3-position
- A: Removable in all positions
- B: Removable in left and center
- C: Removable in right and center
- D: Removable in center only
- E: Removable in right and left
- G: Removable in left only
- H: Removable in right only

Contact Block Mounting Position

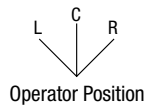

Contact Block Mounting Position

1 2 3



Key Selector Switches (45° 3-Position)



Package Quantity: 1

No. of Positions	Contact Configuration	Contact Block Mounting Position		Operator Position			Part No.		
				L	C	R	Plastic Bezel	Metal Bezel	
									
45° 3-position Spring Return from Right 	2NO (20)	1	NO	●			YW1K-31BE20	YW4K-31BE20	
		2							
		3	NO			●			
	2NO (20N1)	1						YW1K-31BE20N1	YW4K-31BE20N1
		2	NO	●		●			
		3	NO			●			
	2NC (02)	1	NC		■			YW1K-31BE02	YW4K-31BE02
		2							
		3	NC	■					
	2NC (02N1)	1						YW1K-31BE02N1	YW4K-31BE02N1
		2	NC		●				
		3	NC	■					
	1NO-1NC (11)	1	NO	●				YW1K-31BE11	YW4K-31BE11
		2							
		3	NC	■					
	1NO-1NC (11N1)	1	NC		■			YW1K-31BE11N1	YW4K-31BE11N1
		2							
		3	NO			●			
	1NO-1NC (11N2)	1	NO	●				YW1K-31BE11N2	YW4K-31BE11N2
		2	NC		●				
		3							
	1NO-1NC (11N3)	1						YW1K-31BE11N3	YW4K-31BE11N3
		2	NC		●				
		3	NO			●			
1NO-1NC (11N4)	1			●			YW1K-31BE11N4	YW4K-31BE11N4	
	2	NO	●		●				
	3	NC	■						
3NO (30)	1	NO	●				YW1K-31BE30	YW4K-31BE30	
	2	NO	●		●				
	3	NO			●				
3NC (03)	1	NC		■			YW1K-31BE03	YW4K-31BE03	
	2	NC		●					
	3	NC	■						
2NO-1NC (21)	1	NO	●				YW1K-31BE21	YW4K-31BE21	
	2	NC		●					
	3	NO			●				
1NO-2NC (12)	1	NC		■			YW1K-31BE12	YW4K-31BE12	
	2	NO	●		●				
	3	NC	■						

- On the spring-returned types, the key can be removed only from the maintained position. Key retained positions are also available. See Part No. Development shown on **B-288**.
- Each key selector switch is supplied with two identical keys.

Key Selector Switches (45° 3-Position)

Package Quantity: 1

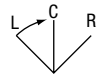

No. of Positions	Contact Configuration	Contact Block Mounting Position		Operator Position			Part No.		
				L	C	R	Plastic Bezel	Metal Bezel	
									
45° 3-position Spring Return from Left 	2NO (20)	1	NO	●			YW1K-32CE20	YW4K-32CE20	
		2							
		3	NO			●			
	2NO (20N1)	1						YW1K-32CE20N1	YW4K-32CE20N1
		2	NO	●		●			
		3	NO			●			
	2NC (02)	1	NC		■			YW1K-32CE02	YW4K-32CE02
		2							
		3	NC	■					
	2NC (02N1)	1						YW1K-32CE02N1	YW4K-32CE02N1
		2	NC		●				
		3	NC	■					
	1NO-1NC (11)	1	NO	●				YW1K-32CE11	YW4K-32CE11
		2							
		3	NC	■					
	1NO-1NC (11N1)	1	NC		■			YW1K-32CE11N1	YW4K-32CE11N1
		2							
		3	NO			●			
	1NO-1NC (11N2)	1	NO	●				YW1K-32CE11N2	YW4K-32CE11N2
		2	NC		●				
		3							
	1NO-1NC (11N3)	1						YW1K-32CE11N3	YW4K-32CE11N3
		2	NC		●				
		3	NO			●			
1NO-1NC (11N4)	1						YW1K-32CE11N4	YW4K-32CE11N4	
	2	NO	●		●				
	3	NC	■						
3NO (30)	1	NO	●				YW1K-32CE30	YW4K-32CE30	
	2	NO	●		●				
	3	NO			●				
3NC (03)	1	NC		■			YW1K-32CE03	YW4K-32CE03	
	2	NC		●					
	3	NC	■						
2NO-1NC (21)	1	NO	●				YW1K-32CE21	YW4K-32CE21	
	2	NC		●					
	3	NO			●				
1NO-2NC (12)	1	NC		■			YW1K-32CE12	YW4K-32CE12	
	2	NO	●		●				
	3	NC	■						

- On the spring-returned types, the key can be removed only from the maintained position. Key retained positions are also available. See Part No. Development shown on B-288.
- Each key selector switch is supplied with two identical keys.

- APEM
- Switches & Pilot Lights
- Control Boxes
- Emergency Stop Switches
- Enabling Switches
- Safety Products
- Explosion Proof
- Terminal Blocks
- Relays & Sockets
- Circuit Protectors
- Power Supplies
- LED Illumination
- Controllers
- Operator Interfaces
- Sensors
- AUTO-ID
- Flush Silhouette
- ø16
- ø22
- ø30
- Miniature
- Pilot Lights
- HW
- TW
- YW

Key Selector Switches (45° 3-Position)

Package Quantity: 1

No. of Positions	Contact Configuration	Contact Block Mounting Position		Operator Position			Part No.		
				L	C	R	Plastic Bezel	Metal Bezel	
									
45° 3-position Spring Return Two-way 	2NO (20)	1	NO	●			YW1K-33DE20	YW4K-33DE20	
		2							
		3	NO			●			
	2NO (20N1)	1						YW1K-33DE20N1	YW4K-33DE20N1
		2	NO	●		●			
		3	NO			●			
	2NC (02)	1	NC		■			YW1K-33DE02	YW4K-33DE02
		2							
		3	NC	■					
	2NC (02N1)	1						YW1K-33DE02N1	YW4K-33DE02N1
		2	NC		●				
		3	NC	■					
	1NO-1NC (11)	1	NO	●				YW1K-33DE11	YW4K-33DE11
		2							
		3	NC	■					
	1NO-1NC (11N1)	1	NC		■			YW1K-33DE11N1	YW4K-33DE11N1
		2							
		3	NO			●			
	1NO-1NC (11N2)	1	NO	●				YW1K-33DE11N2	YW4K-33DE11N2
		2	NC			●			
		3							
	1NO-1NC (11N3)	1						YW1K-33DE11N3	YW4K-33DE11N3
		2	NC		●				
		3	NO			●			
1NO-1NC (11N4)	1			●			YW1K-33DE11N4	YW4K-33DE11N4	
	2	NO	●		●				
	3	NC	■						
3NO (30)	1	NO	●				YW1K-33DE30	YW4K-33DE30	
	2	NO	●		●				
	3	NO			●				
3NC (03)	1	NC		■			YW1K-33DE03	YW4K-33DE03	
	2	NC		●					
	3	NC	■						
2NO-1NC (21)	1	NO	●				YW1K-33DE21	YW4K-33DE21	
	2	NC		●					
	3	NO			●				
1NO-2NC (12)	1	NC		■			YW1K-33DE12	YW4K-33DE12	
	2	NO	●		●				
	3	NC	■						

- On the spring-returned types, the key can be removed only from the maintained position. Key retained positions are also available. See Part No. Development shown on **B-288**.
- Each key selector switch is supplied with two identical keys.

Dimensions All dimensions in mm

Plastic Bezel

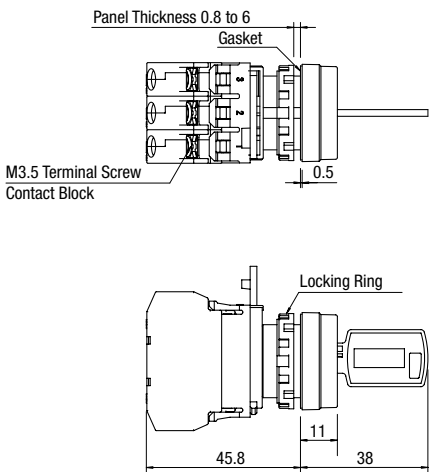

Metal Bezel

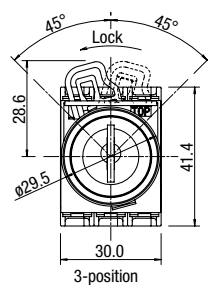
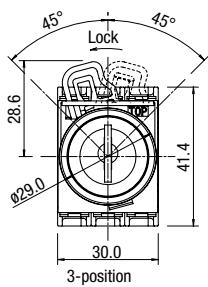
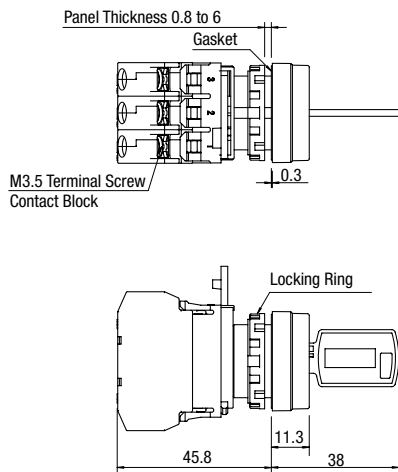

Contact Block Mounting Position

Plastic Bezel

Contact Block Mounting Position

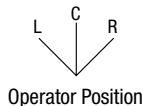

Metal Bezel



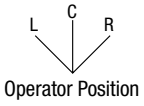





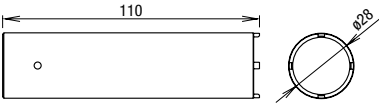

Contact Block Mounting Position

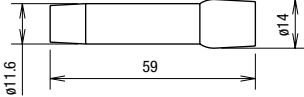

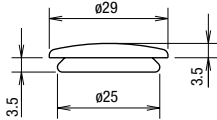
- APEM
- Switches & Pilot Lights
- Control Boxes
- Emergency Stop Switches
- Enabling Switches
- Safety Products
- Explosion Proof
- Terminal Blocks
- Relays & Sockets
- Circuit Protectors
- Power Supplies
- LED Illumination
- Controllers
- Operator Interfaces
- Sensors
- AUTO-ID

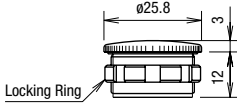
- Flush Silhouette
- ø16
- ø22
- ø30
- Miniature
- Pilot Lights
- HW
- TW
- YW

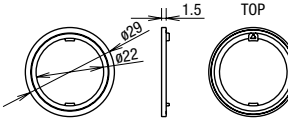
Accessories

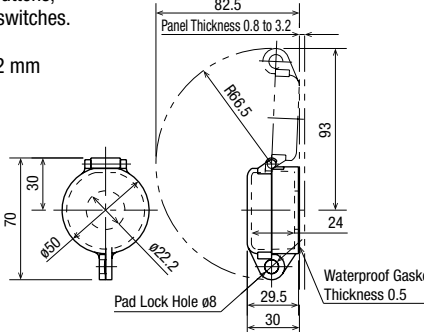
Name & Shape	Part No.	Description & Dimensions (mm)	Package Quantity
	MW9Z-T1	<p>Metallic tool used to tighten the plastic locking ring when installing the YW series in a panel.</p> 	1
	OR-55	<p>Made of rubber. Used for replacing lamps.</p> 	1
	OB-31PN05	<p>Used for plugging unused mounting holes in the panel. Color: Black</p> 	5
	LW9Z-BM	<p>Used for plugging unused mounting holes in the panel. Weight: Approx. 18g</p> 	1
	HW9Z-RLPN10	<p>Prevents rotation of switches in panel. Mainly used with selector switches when no nameplate is used. With waterproof gasket (IP65). Made of plastic (black). Applicable panel thickness: 1.2 to 4.5 mm</p> 	10
	HW9Z-KL1	<p>Plastic hinged cover to protect pushbuttons, illuminated pushbuttons, or selector switches. Degree of protection: IP65. Applicable panel thickness: 0.8 to 3.2 mm</p> 	1

HW

TW

YW

Maintenance Parts					
Name & Shape	Part No.	Description & Dimensions (mm)			Package Quantity
	YW-E10	Contact: 1NO	Color: blue		10
	YW-E01	Contact: 1NC	Color: reddish purple		
	YW-EW20	Contact: 2NO	Color: blue	 <p>Note: Double contact blocks cannot be used on emergency stop switches.</p>	10
	YW-EW02	Contact: 2NC	Color: reddish purple		
	YW-EW11	Contact: 1NO-1NC	Color: blue and reddish purple		
	LSED-6⊙N	6V AC/DC	Specify a color code in place of ⊙ in the Part No.: A (amber), G (green), PW (pure white), R (red), S (blue), Y (yellow) See B-271 for applicable units and rated current. Note: Yellow LED lamps are used for white illumination of pilot lights and illuminated pushbuttons.		1
	LSED-1⊙N	12V AC/DC			
	LSED-2⊙N	24V AC/DC			
	LSED-H⊙N	110V AC/DC			
	LSED-M3⊙N	230/240V AC/DC			
	LS-T6P	6.3V, 1W	One pack contains 100 incandescent lamps.		100
	LS-T8P	18V, 1W			
	LS-T3P	30V, 1W			
	YW9Z-SK00PN02				2

Maintenance Parts

Buttons, Lenses, and Marking Plates

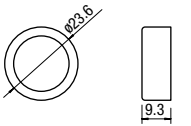
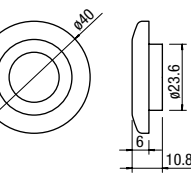
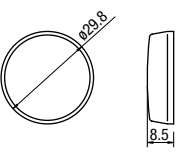
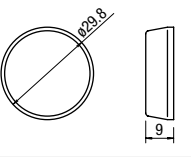
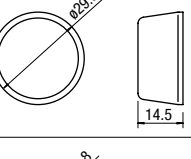
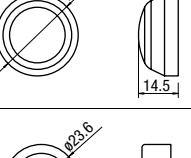
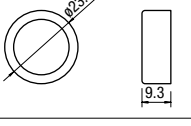
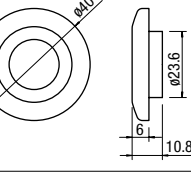
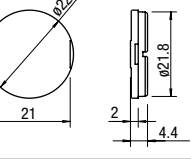
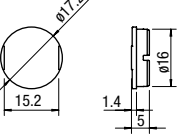
Name	Style	Part No.	① ② Color Code	Dimensions (mm)	Package Quantity
Button (for pushbuttons)	Extended	YW9Z-B12①PN10	B: black G: green R: red S: blue W: white Y: yellow		10
	Mushroom ø40mm	YW9Z-B14①PN10			
Lens (for pilot lights)	Flush	YW9Z-PL11②PN10	A: amber C: clear G: green R: red S: blue W: white Y: yellow		10
	Flush Marking	YW9Z-PL11B②PN10	A: amber C: clear G: green R: red S: blue Y: yellow		10
	Extended	YW9Z-PL12T②PN10	A: amber C: clear G: green R: red S: blue W: white Y: yellow		10
	Dome	YW9Z-PL12②PN10	A: amber C: clear G: green R: red S: blue W: white Y: yellow		10
	Lens (for illuminated pushbuttons)	Extended	YW9Z-L12②PN10	A: amber C: clear G: green R: red S: blue Y: yellow	
Mushroom ø40mm		YW9Z-L14②PN10			
Marking Plate (for pilot lights)	—	YW9Z-PP12PN10	—		10
Marking Plate (for illuminated pushbuttons)	—	YW9Z-P12PN10	—		10

- APEM
- Switches & Pilot Lights
- Control Boxes
- Emergency Stop Switches
- Enabling Switches
- Safety Products
- Explosion Proof
- Terminal Blocks
- Relays & Sockets
- Circuit Protectors
- Power Supplies
- LED Illumination
- Controllers
- Operator Interfaces
- Sensors
- AUTO-ID

- Flush Silhouette
- ø16
- ø22

- ø30
- Miniature
- Pilot Lights

- HW
- TW
- YW

Nameplates

HWAM, HWAQ, HWAS, and HWAV

Name	Legend	Material	Part No.	Ordering No.	Package Quantity	Dimensions (mm)
HWAM	Order marking plate separately.	Plastic (black) 1.5 mm thick	HWAM	HWAM	1	
				HWAMPN10	10	
HWAQ	Order marking plate separately.	Plastic (black) 1.5 mm thick	HWAQ	HWAQ	1	
				HWAQPN10	10	
HWAQ	Blank	Plastic (black) 1.5 mm thick	HWAS-0	HWAS-0	1	
				HWAS-OPN10	10	
HWAV	Blank	Plastic (yellow) 1.5 mm thick	HWAV-0	HWAV-0	1	
	EMERGENCY STOP			HWAV-27	HWAV-27	

Making Plate

Description	Material	Part No.	Ordering No.	Package Quantity	Dimensions (mm)
HWNP	Aluminum (black) 1.0 mm thick	HWNP-*	HWNP-*	1	White legend on black background.
			HWNP-*PN10	10	

• Specify a legend code in place of * in the Ordering No.

Legends

Code	Legend
0	(blank)
1	ON
2	OFF
3	START
4	STOP
31	OFF-ON
35	HAND-AUTO
53	HAND-OFF-AUTO

• Installing the marking plate on a nameplate

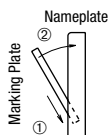



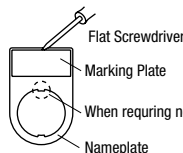





• To remove the marking plate, insert the flat screwdriver between the marking plate and nameplate.

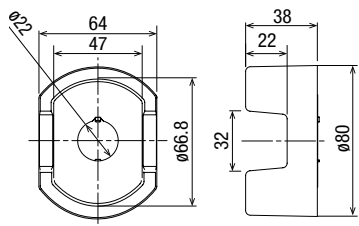

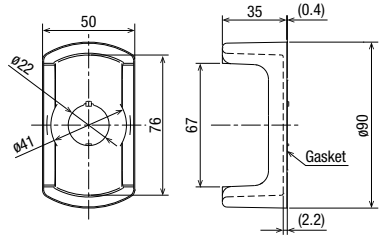
Note: When using an nameplate, the mounting panel thickness is decreased by 1.5 mm.

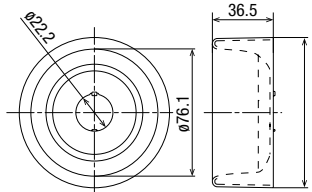
Switch Guards

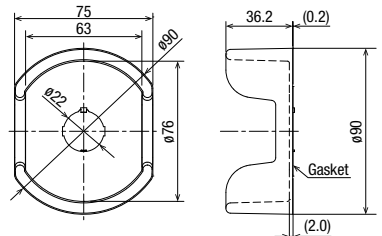
Package Quantity: 1

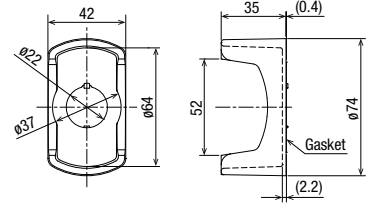
Part No. & Shape (mm)	Dimensions	Part No. & Shape	Dimensions (mm)
HW9Z-KG1  EMO Switch Guard SEMI S2 compliant (Note 1)	 Dimensions: 64, 47, 38, 22, 22, 32, 66.8, 80	HW9Z-KG4  EMO Switch Guard SEMI S2 compliant (Note 1) SEMATECH compliant (Note 3) ISO 13850 compliant	 Dimensions: 50, 35 (0.4), 67, 76, 61, 90, 2.2
HW9Z-KG2  EMO Switch Guard SEMI S2 compliant (Note 1) SEMATECH compliant (Note 3)	 Dimensions: 22.2, 36.5, 76.1, 90	HW9Z-KG5  EMO Switch Guard SEMI S2 compliant (Note 2) SEMATECH compliant (Note 3) ISO 13850 compliant	 Dimensions: 75, 63, 60, 36.2 (0.2), 76, 90, 2.0
HW9Z-KG3  EMO Switch Guard SEMI S2 compliant (Note 1) ISO 13850 compliant	 Dimensions: 42, 35 (0.4), 52, 64, 67.4, 37, 2.2	Material: Polyamide (PA6) Color: Yellow, Munsell 2.5Y 8/10 equivalent Degree of protection: IP65 • Degree of protection IP65 applies to the combination of an emergency stop switch and an EMO switch guard. Note 1: SEMI S2-0703 12.5.1 compliant. Note 2: The combination of IDEC's emergency stop switches and EMO switch guards are approved by TÜV Rheinland for compliance with SEMI S2 standard. Note 3: SEMATECH Application Guide for SEMI S2-93, 12.4.c. compliant.	

Transformer

Din Rail Mount Transformer For 6V

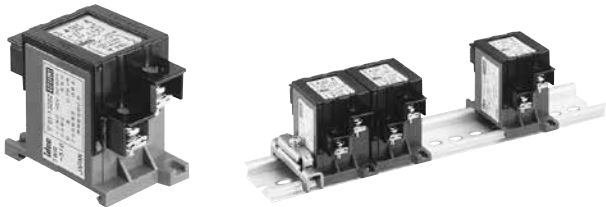

Dimensions (mm)

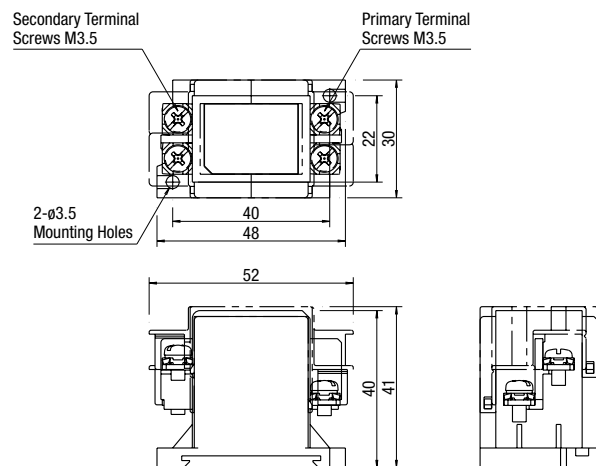

Note: Finger-safe terminal cover is supplied with the transformer.

Primary Voltage (50/60 Hz)	Part No.	Applicable Lamp Rating
110V AC	TWR516	One full voltage type illuminated unit containing LED lamp LSED-6N (6V AC/DC) or incandescent lamp LS-T6 (6.3V)
115V AC	TWR5116	
120V AC	TWR5126	
220V AC	TWR526	
230V AC	TWR5236	
240V AC	TWR5246	
380V AC	TWR5386	
440V AC	TWR546	
480V AC	TWR5486	

Accessories

When ordering, specify the Ordering No.

Shape	Material	Part No.	Ordering No.	Package Quantity	Dimensions (mm)
DIN 35 mm Rail	Aluminum	BAA1000	BAA1000PN10	10	Length: 1000 mm Weight: 200g approx.
End Clip	Metal (zinc-plated steel)	BNL6	BNL6PN10	10	Applicable rail: AA1000, BAP1000 Weight: 15g approx.

• See **H-071** for DIN rail products.

⚠ Safety Precautions

- Turn off the power to the YW series before starting installation, removal, wiring, maintenance, and inspection of the products. Failure to turn power off may cause electrical shocks or fire hazard.
- To avoid burning your hand, use the lamp holder tool when replacing lamps.

Instructions

Panel Mounting

- Remove the contact block from the operator (for pilot lights, remove the transformer or full voltage unit from the pilot light). Remove the locking ring from the operator. Insert the operator into the panel cut-out from the front, tighten the locking ring from the back, then install the contact block to the operator.

Removing and Installing the Contact Block

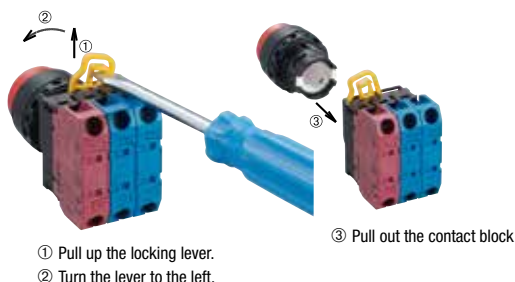

1. To remove the operator from the contact block, pull up the locking lever and turn it to the left. Then the operator can be pulled out.
2. To reinstall, place the TOP marking on the operator and the TOP marking on the contact block mounting adapter in the same direction, and insert the operator into the contact block mounting adapter. Then turn the locking lever to the right.



Removing and Installing the Transformer

1. Insert a flat screwdriver (5 mm wide at maximum) into the latch hole on the transformer unit as shown in the photo below, and disengage the latch. Then pull out the operator.
2. To reinstall, place the TOP marking on the operator and the latch in the same direction, and push the operator into the transformer.

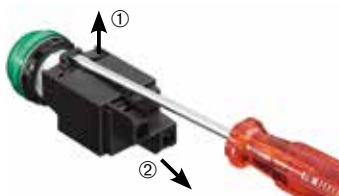

Removing the Full Voltage Unit

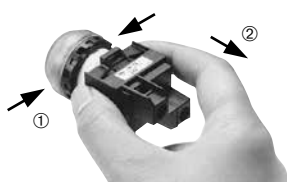

1. To remove the full voltage unit, squeeze the full voltage unit from both sides to disengage the latch as shown, and pull it out. Like the transformer unit, the full voltage unit can also be pulled out by inserting a flat screwdriver into the latch hole as shown.

- For wiring, use wires of a proper size to meet the voltage and current requirements. Tighten the M3.5 terminal screws to a tightening torque of 1.0 N·m. Failure to tighten the terminal screws may cause overheating and fire.

2. To reinstall, place the TOP markings on the operator and the latch on the full voltage unit in the same direction, and insert the operator into the full voltage unit.

Notes for Panel Mounting

1. Use the optional locking ring wrench (MW9Z-T1) to mount the operator onto a panel. Tightening torque must not exceed 2.0 N·m. Do not use pliers. Excessive tightening will damage the locking ring.
2. For contact blocks and transformers housing LED and incandescent lamps, make sure not to press the lamps too hard, otherwise the lamp socket may be damaged.

Insertion Order of Lens and Marking Plate

Illuminated Pushbutton

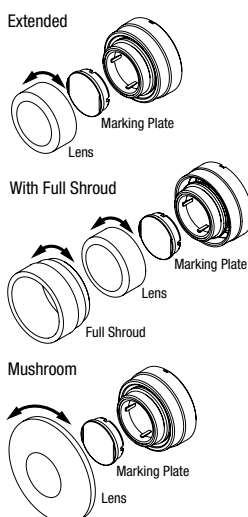

Pilot Light

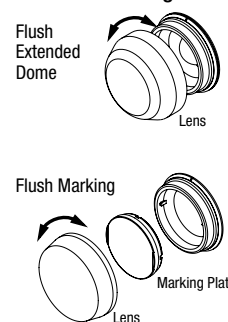

Marking

For YW series pilot lights and illuminated pushbuttons, legends and symbols can be engraved on built-in marking plates, or printed mylar film can be inserted under the lens for labeling purposes. Mylar film is not supplied with the YW series and must be supplied by the end user.

Built-in Marking Plate and Marking Film Size

Unit	Pilot Light	Illuminated Pushbutton
Built-in Marking Plate		
	Engraving depth: 0.5 mm maximum Marking plate material: White acrylic	
Applicable Marking Film		
	0.1-mm-thick × 2 sheets or 0.2-mm-thick × 1 sheet Film material: Mylar (recommended) Note: Marking film is not supplied with the pilot light or illuminated pushbutton.	

APEM

Switches & Pilot Lights

Control Boxes

Emergency Stop Switches

Enabling Switches

Safety Products

Explosion Proof

Terminal Blocks

Relays & Sockets

Circuit Protectors

Power Supplies

LED Illumination

Controllers

Operator Interfaces

Sensors

AUTO-ID

Flush Silhouette

ø16

ø22

ø30

Miniature

Pilot Lights

HW

TW

YW

Instructions

Replacement (LED and incandescent lamps)

Lamps can be replaced using the lamp holder tool (OR-55) from the front of the panel, or by removing the contact block from the operator unit.

Removing the Lamp from the Front of the Panel



To remove, gently insert the lamp holder tool onto the lamp head. Then push slightly, and turn the lamp holder tool to the left.

Installing the Lamp from the Front of the Panel

1. To install, insert the lamp head into the lamp holder tool, and hold the lamp as shown in the figure below.

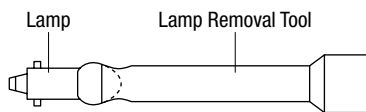

2. Place the pins on the lamp base to the grooves in the lamp socket. Insert the lamp and turn it to the right.

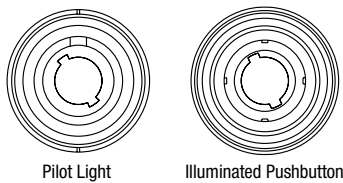

Note: LED lamps in unibody pilot lights cannot be replaced.

Removing Contact Blocks and Full Voltage Adapters

Insert a flat screwdriver between the latch and contact block mounting adapter, and disengage the latch.

Make sure to remove the lamp and contact blocks before removing the full voltage adapter.

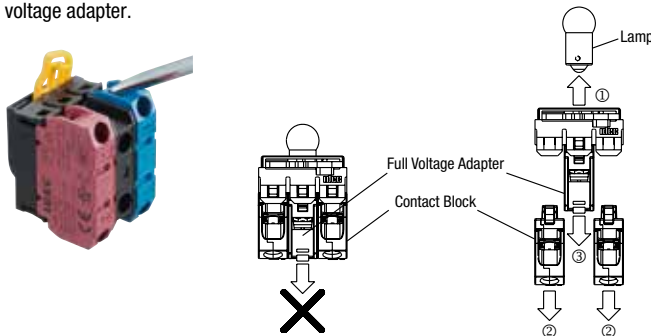

Tightening Torque for Terminal Screws

Tighten terminal screws to a torque of 1.0 N·m.

Anti-rotation Ring and Mounting Panel

Turn the TOP marking on the operator and the ▲ mark on the anti-rotation ring to the recess on the mounting panel.

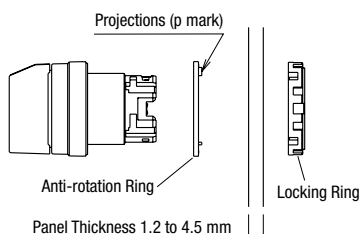

Mounting Panel Thickness

The mounting panel must be 0.8 to 6.0 mm in thickness. When optional accessories are added, the applicable panel thickness changes as shown below.

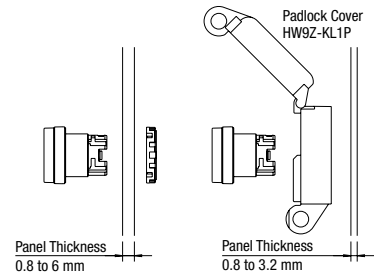

Wiring

Applicable Wires

Stranded wire: 2.0 mm² maximum (14AWG)
Solid wire: ø1.6 mm maximum (16AWG)

One or two wires can be connected to the terminal.

Applicable Crimping Terminals

[Spade terminal]

When using crimping terminals, be sure to use insulating tubes or use insulated crimping terminals.

Note: Ring terminals cannot be used.

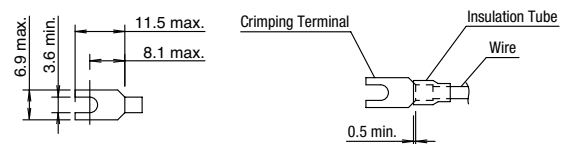

[Ferrule]

When connecting two ferrules to one terminal, use ferrules without insulation.

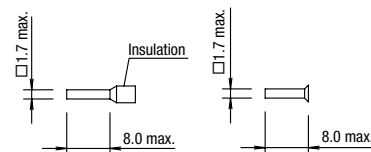

When using spade terminals or ferrules, insert them to the bottom.

[Solid Wire]

When connecting two wires directly, use wires of the same size.

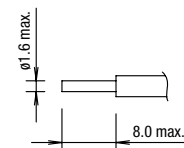

Contact Bounce

When pressing or turning the operator, the NC and NO contacts will bounce. When designing a control circuit, take the contact bounce time into consideration (reference value: 20 ms).

APEM

Switches & Pilot Lights

Control Boxes

Emergency Stop Switches

Enabling Switches

Safety Products

Explosion Proof

Terminal Blocks

Relays & Sockets

Circuit Protectors

Power Supplies

LED Illumination

Controllers

Operator Interfaces

Sensors

AUTO-ID

Flush Silhouette

ø16

ø22

ø30

Miniature

Pilot Lights

HW

TW

YW

Instructions

Precautions for Noise

When using the unibody pilot light in an environment where it is subjected to noise, connect a noise suppressor across terminals X1 and X2 as shown below.

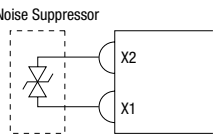

Key Selector Switch

Before operation, ensure that the key is inserted into the key hole completely. Operating the key selector switch with a loose key will cause damage to the key selector switch.

LED Illumination

LED lamps consist of semiconductors. If the applied voltage exceeds the rated voltage, LED elements deteriorate due to overheat, resulting in significant decrease in brightness, hue change, or failure of lighting. Also, if extraneous noise, transient voltage, or transient current is applied to the circuit, similar effects will be caused. When using LED lamps, observe the following instructions.

Rated Voltage

The LED illuminated units are rated at 6V, 12V, 24V, 110V, or 230/240V AC/DC, and can be used within ±10% the rated voltage of either AC or DC, except the 230/240V AC/DC types can be used on 250V AC/DC maximum.

DC Power

1. Switching power supply
Regulated voltage from a switching power supply is best suited. Make sure to use within the rated voltage of the LED lamp.
2. Rechargeable battery
Note that the battery voltage may exceed the rated voltage of the LED lamp while the battery is being charged and immediately after the charging is complete. Be sure to use the LED lamp on a voltage of ±10% the rated voltage, except the 230/240V AC/DC types on 250V AC/DC maximum.
3. Full-wave rectification
Since the LED lamp is AC/DC compatible, a diode bridge for rectification is not necessary. If the LED lamp is used on a full-wave rectification current through a diode bridge, the rectifier diodes will reduce the voltage, resulting in lower brightness.
4. Single-phase half-wave rectification
This is not suitable for the power source of LED lamps. Use constant-voltage DC power.

Noise

LED elements deteriorate due to extraneous noise, resulting in significant decrease in brightness, hue change, or failure of lighting. When such effects are anticipated, take a protection measure shown below, such as RC elements or a surge absorber.

Nameplate

When anti-rotation is not required, remove the projection from the nameplate using pliers.

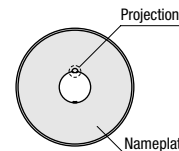

Handling

Do not expose the switch to excessive shock and vibration, otherwise the switch may be deformed or damaged, causing malfunction or operation failure.



[Protection Example 1] For AC circuit

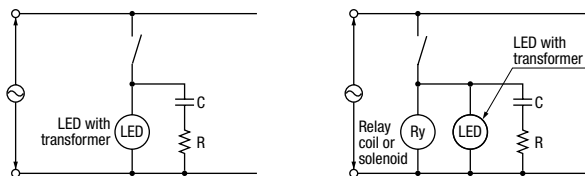

[Protection Example 2] For DC circuit

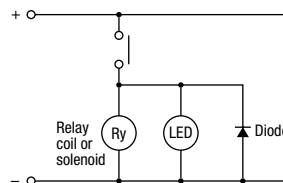

Countermeasures against Dim Lighting

1. Leakage current through transistors or a contact protection circuit may cause the LED lamp to illuminate dimly even when the output is off.
2. When the LED lamp is illuminated by a transistor output, take the following measure.

[Circuit Example]

Connect shunt resistor R in parallel with the LED lamp.

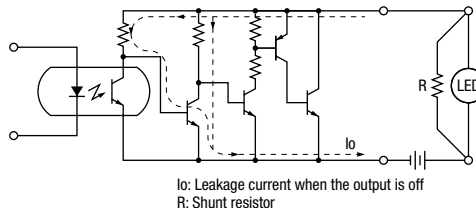

Ordering Information

- When ordering, specify the Part No. and quantity.
- Replacement contact blocks are supplied in a package containing 10 pieces.

Ordering Terms and Conditions

Thank you for using IDEC Products.

By purchasing products listed in our catalogs, datasheets, and the like (hereinafter referred to as "Catalogs") you agree to be bound by these terms and conditions. Please read and agree to the terms and conditions before placing your order.

1. Notes on contents of Catalogs

- (1) Rated values, performance values, and specification values of IDEC products listed in this Catalog are values acquired under respective conditions in independent testing, and do not guarantee values gained in combined conditions.
Also, durability varies depending on the usage environment and usage conditions.
- (2) Reference data and reference values listed in Catalogs are for reference purposes only, and do not guarantee that the product will always operate appropriately in that range.
- (3) The specifications / appearance and accessories of IDEC products listed in Catalogs are subject to change or termination of sales without notice, for improvement or other reasons.
- (4) The content of Catalogs is subject to change without notice.

2. Note on applications

- (1) If using IDEC products in combination with other products, confirm the applicable laws / regulations and standards.
Also, confirm that IDEC products are compatible with your systems, machines, devices, and the like by using under the actual conditions. IDEC shall bear no liability whatsoever regarding the compatibility with IDEC products.
- (2) The usage examples and application examples listed in Catalogs are for reference purposes only. Therefore, when introducing a product, confirm the performance and safety of the instruments, devices, and the like before use. Furthermore, regarding these examples, IDEC does not grant license to use IDEC products to you, and IDEC offers no warranties regarding the ownership of intellectual property rights or non-infringement upon the intellectual property rights of third parties.
- (3) When using IDEC products, be cautious when implementing the following.
 - i. Use of IDEC products with sufficient allowance for rating and performance
 - ii. Safety design, including redundant design and malfunction prevention design that prevents other danger and damage even in the event that an IDEC product fails
 - iii. Wiring and installation that ensures the IDEC product used in your system, machine, device, or the like can perform and function according to its specifications
- (4) Continuing to use an IDEC product even after the performance has deteriorated can result in abnormal heat, smoke, fires, and the like due to insulation deterioration or the like. Perform periodic maintenance for IDEC products and the systems, machines, devices, and the like in which they are used.
- (5) IDEC products are developed and manufactured as general-purpose products for general industrial products. They are not intended for use in the following applications, and in the event that you use an IDEC product for these applications, unless otherwise agreed upon between you and IDEC, IDEC shall provide no guarantees whatsoever regarding IDEC products.
 - i. Use in applications that require a high degree of safety, including nuclear power control equipment, transportation equipment (railroads / airplanes / ships / vehicles / vehicle instruments, etc.), equipment for use in outer space, elevating equipment, medical instruments, safety devices, or any other equipment, instruments, or the like that could endanger life or human health
 - ii. Use in applications that require a high degree of reliability, such as provision systems for gas / waterworks / electricity, etc., systems that operate continuously for 24 hours, and settlement systems
 - iii. Use in applications where the product may be handled or used deviating from the specifications or conditions / environment listed in the Catalogs, such as equipment used outdoors or applications in environments subject to chemical pollution or electromagnetic interference
If you would like to use IDEC products in the above applications, be sure to consult with an IDEC sales representative.

3. Inspections

We ask that you implement inspections for IDEC products you purchase without delay, as well as thoroughly keep in mind management/maintenance regarding handling of the product before and during the inspection.

4. Warranty

- (1) Warranty period
The warranty period for IDEC products shall be one (1) year after purchase or delivery to the specified location. However, this shall not apply in cases where there is a different specification in the Catalogs or there is another agreement in place between you and IDEC.
- (2) Warranty scope
Should a failure occur in an IDEC product during the above warranty period for reasons attributable to IDEC, then IDEC shall replace or repair that product, free of charge, at the purchase location / delivery location of the product, or an IDEC service base. However, failures caused by the following reasons shall be deemed outside the scope of this warranty.
 - i. The product was handled or used deviating from the conditions / environment listed in the Catalogs
 - ii. The failure was caused by reasons other than an IDEC product
 - iii. Modification or repair was performed by a party other than IDEC
 - iv. The failure was caused by a software program of a party other than IDEC
 - v. The product was used outside of its original purpose
 - vi. Replacement of maintenance parts, installation of accessories, or the like was not performed properly in accordance with the user's manual and Catalogs
 - vii. The failure could not have been predicted with the scientific and technical standards at the time when the product was shipped from IDEC
 - viii. The failure was due to other causes not attributable to IDEC (including cases of force majeure such as natural disasters and other disasters)Furthermore, the warranty described here refers to a warranty on the IDEC product as a unit, and damages induced by the failure of an IDEC product are excluded from this warranty.

5. Limitation of liability

The warranty listed in this Agreement is the full and complete warranty for IDEC products, and IDEC shall bear no liability whatsoever regarding special damages, indirect damages, incidental damages, or passive damages that occurred due to an IDEC product.

6. Service scope

The prices of IDEC products do not include the cost of services, such as dispatching technicians. Therefore, separate fees are required in the following cases.

- (1) Instructions for installation / adjustment and accompaniment at test operation (including creating application software and testing operation, etc.)
- (2) Maintenance inspections, adjustments, and repairs
- (3) Technical instructions and technical training
- (4) Product tests or inspections specified by you

The above content assumes transactions and usage within your region. Please consult with an IDEC sales representative regarding transactions and usage outside of your region. Also, IDEC provides no guarantees whatsoever regarding IDEC products sold outside your region.

IDEC CORPORATION

Head Office 6-64, Nishi-Miyahara-2-Chome, Yodogawa-ku, Osaka 532-0004, Japan

USA IDEC Corporation
EMEA APEM SAS

Singapore IDEC Izumi Asia Pte. Ltd.
Thailand IDEC Asia (Thailand) Co., Ltd.
India IDEC Controls India Private Ltd.

China IDEC (Shanghai) Corporation
IDEC Izumi (H.K.) Co., Ltd.
Taiwan IDEC Taiwan Corporation

 www.idec.com

Japan IDEC Corporation

Specifications and other descriptions in this brochure are subject to change without notice.

2021 IDEC Corporation, All Rights Reserved.

