



DIN 17.5mm

Features :

- 13 Functions
- 10 Time Ranges
- LED Indications : Relay ON, Power ON
- Front knobs for Time Range, Time Scale & Mode Setting
- Slim, Space Saving Design

Certifications :  

Display Specifications

LED Indications	Relay ON, Power ON
-----------------	--------------------

Input Specifications

Accuracy	Setting : $\pm 5\%$ of F.S. Repeat : $\pm 0.5\%$ (F.S. = Full Scale)
----------	---

Output Specifications

Relay Contact	1 C/O SPDT
Contact Rating	5A @ 250V AC

Functional Specifications

Modes	On delay (A) Interval (B) Cyclic equal OFF first (C) Cyclic equal ON first (Ci) Pulse output, 500ms fixed (D) Delay on break (E) Delay on make / Delay on break (F) Interval after break (H) Single shot (I) Retriggerable single shot (J) Latching relay (K) Delay on make with totalise (Ai) Interval with totalise (Bi)
Time Ranges	0.1 - 1sec, 0.3 - 3sec, 1 - 10sec, 3 - 30sec 0.1 - 1min, 0.3 - 3min, 1 - 10min, 3 - 30min 0.1 - 1hr, 0.3 - 3hr
Resolution	0.1sec
Reset	On power interruption Reset time < 100msec

Auxiliary Supply Specifications

Supply Voltage	20 to 240V AC (50 / 60Hz), 12 to 240V DC
Power Consumption	3.2 VA max

Environmental Specifications

Temperature	Operating : 0 to 50°C (32 to 122°F) Storage : -20 to 75°C (-4 to 167°F)
Humidity (non - condensing)	95% RH

Mechanical Specifications

Mounting	DIN Rail Mount
Weight	64gms

Dimensions

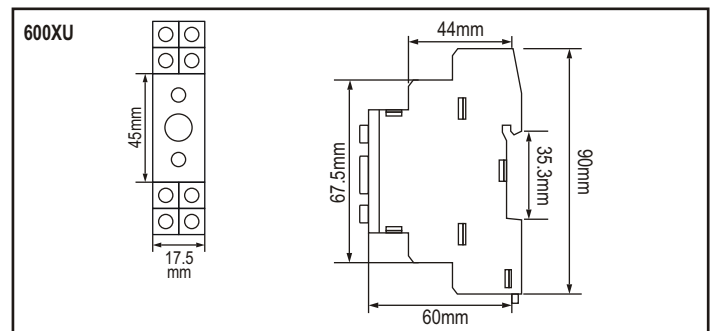

Terminal Connections

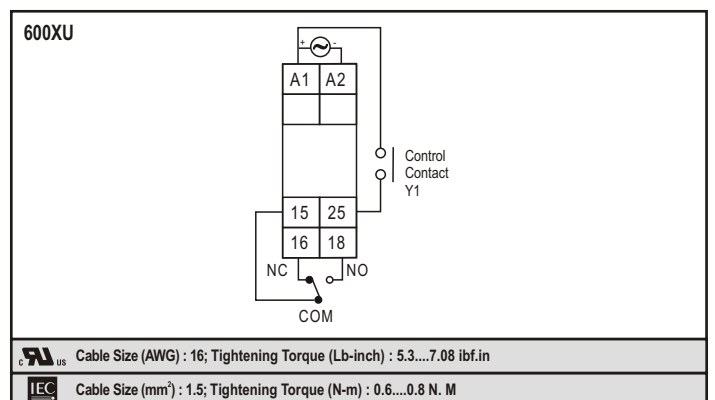

Timing Diagram

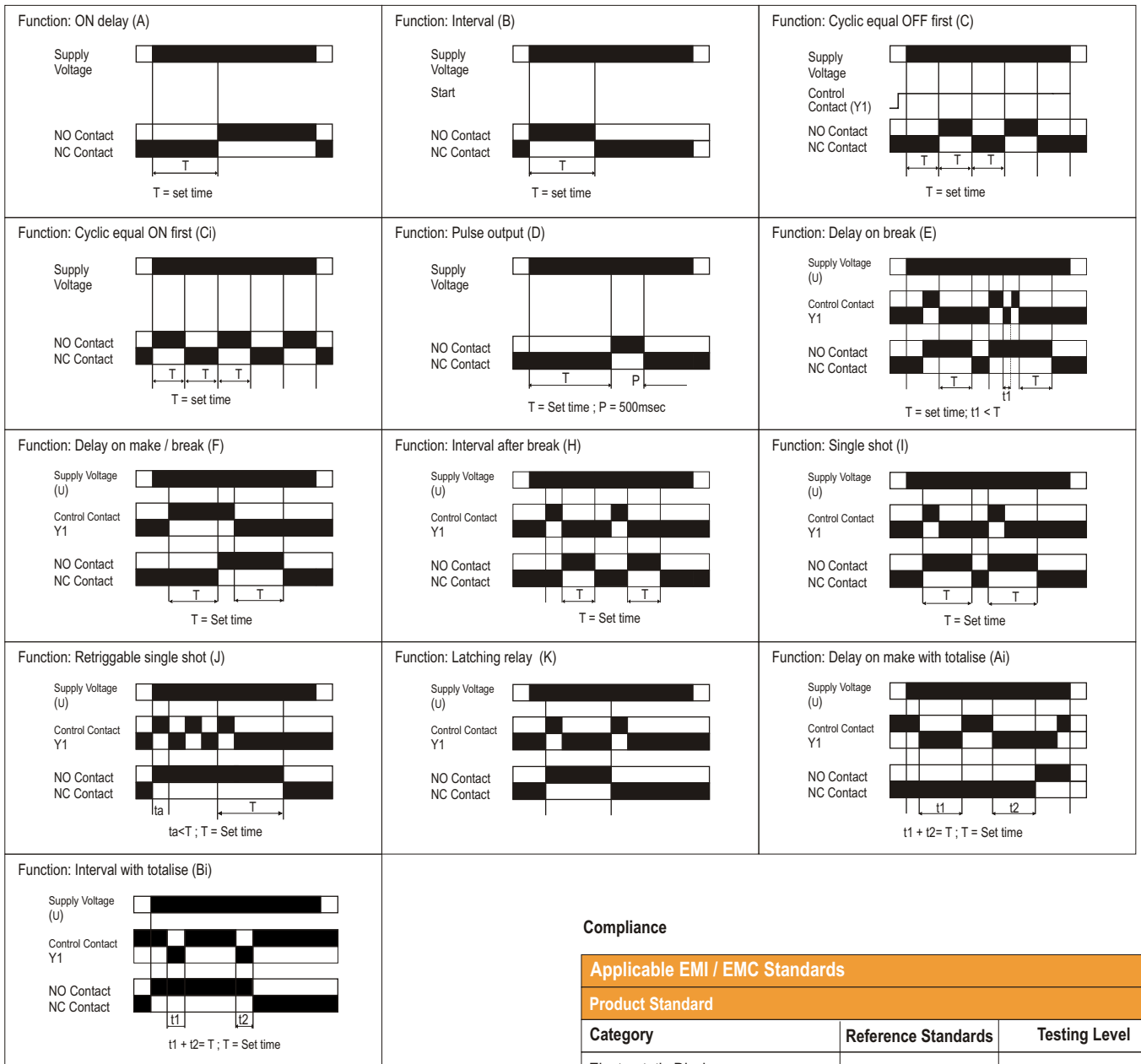

Ordering Information

Product Code	Supply Voltage	Certification
600XU-A-1-CU	20 to 240V AC, 12 to 240V DC	CE LISTED 4576 100-20001-00

Compliance

Applicable EMI / EMC Standards		
Product Standard		
Category	Reference Standards	Testing Level
Electrostatic Discharge	IEC 61000-4-2	Level-3
Electrical Fast Transient / Burst	IEC 61000-4-4	Level-3
Electromagnetic Field	IEC 61000-4-3	Level-3
Surge	IEC 61000-4-5	Level-3
Conducted RF	IEC 61000-4-6	Level-2
Rated Power Frequency	IEC 61000-4-8	Level-4
Voltage Dip / Short Interruptions	IEC 61000-4-11	Level-3
Conducted Emissions	CISPR-11	Class-B
Rated Emissions	CISPR-22	Class-A
Emission & Immunity	IEC 61326-1	
Safety	IEC 61010-1	
PFMF (Passing criteria)	IEC 61000-4-8	Class A