



**MITSUBISHI
ELECTRIC**

Changes for the Better

for a greener tomorrow



Molded Case Circuit Breakers
Earth Leakage Circuit Breakers

World Super **WS-V** Series

Mitsubishi Molded Case Circuit Breakers and Earth Leakage Circuit Breakers



**Empowering
Industries**

INDEX

1	Introduction and Features of WS-V Series	2
	1. Outline of Mitsubishi Circuit Breakers.....	10
	1) Product Line-up	10
	2) Instructions for Application	12
	2. Detailed Specifications	13
2	1 Molded Case Circuit Breakers.....	14
	1) NF-C (Economy class)	14
	2) NF-S (Standard class).....	16
	3) NF-L/NF-H/NF-R (High-performance class).....	20
	4) NF-U (Ultra current-limiting class)	23
3	2 Earth Leakage Circuit Breakers	24
	1) NV-C (Economy class).....	24
	2) NV-S (Standard class).....	26
	3) NV-H/NV-R (High-performance class)	28
	3 Motor Protection Breakers.....	30
	1) NF-MB.....	30
	4 UL 489 Listed Circuit Breakers.....	31
	1) UL 489 Listed Molded Case Circuit Breakers	31
	2) UL 489 Listed Earth Leakage Circuit Breakers	34
	5 Measuring Display Unit Breakers.....	35
	1) MDU Breakers.....	35
	6 Miniature Circuit Breakers	44
	1) BH	44
	2) BV.....	48
	7 Circuit Protectors	51
	1) CP	51
	8 Low Voltage Air Circuit Breakers	54
	1) Low Voltage Air Circuit Breakers (AE-SW Series)	54
	9 Earth Leakage Relays.....	56
	1) Earth Leakage Relays	56
4	3. Special-purpose Breakers	59
	1) Mag Only (Instantaneous Tripping Circuit Breakers).....	60
	2) DC MCCBs and DSN Switches.....	60
	3) 400Hz MCCBs.....	60
5	4. Selection	61
	1 Construction and Operation.....	62
	1) Construction of MCCB.....	62
	2) Construction of ELCB.....	64
	2 Selection of MCCB and ELCB	65
	1) Selecting Procedure	65
	2) Features and Performance.....	66
	3) Current-carrying Capacity and Operating Temperature	68
	4) Application of Circuit Breaker According to Breaking Capacity.....	70
	5) Selection of Circuit Breaker for Electric Lamp or Heater Circuit	71
	6) Selection of Circuit Breaker for Motor Branch Circuit.....	73
	7) Selection of Motor Protection Breaker.....	75
	8) Selection of Circuit Breaker for Inverter Circuit	76
	9) Selection of Circuit Breaker for Transformer Primary Side	77
	10) Combination for Selective Breaking	81
	11) Combinations for Cascade Breaking.....	83
	12) International Standard Conformance List.....	85
	3 Selection of ELCB.....	88
	1) Electric Shock Protection	88
	2) ELCB Grounding Method	89
	3) Rated Voltage and Number of Poles.....	90
	4) Earth Fault Protection Coordination and Combination of Devices.....	91
6	5. Installation and Connection	93
	1) Connection Types.....	94
	2) Connecting Parts.....	96
	3) Standard Tightening Torque	97
	4) Crimp Terminal Type	98
	5) Busbar	100
	6) Insulation Distance on Power Source Side	101
	7) Effect of Installation Orientation	102
	8) Connection of Line and Load	102
8	6. Accessories.....	103
	1 Internal Accessories.....	104
	1) Internal Accessories	104
	2) Kinds of Internal Accessories	105
	3) Operations and Ratings of Switches	105
	4) Maximum Number of Internal Accessories	106
	5) Cassette Type Accessories	111
	6) Shunt Trip (SHT)	113
	7) Undervoltage Trip (UVT)	114
	8) Lead Wire Drawing	116
	9) Lead Wire Terminal Block	116
	10) Test Button Module (TBM)	117
	11) Pre-Alarm Module (PAL)	118
	2 External Accessories	119
	1) F-type Operating Handle (Breaker Mount Type).....	119
	2) V-type Operating Handle (Door Mount Type).....	121
	3) Terminal Covers	123
	4) Insulating Barriers	126
	5) Handle Lock Devices, Lock Covers, Auxiliary Handles, Card Holders	129
	6) Mechanical Interlocks (MI)	131
	7) Boxes for Circuit Breakers and Boxed Circuit Breakers.....	132
	8) Electrical Operated Circuit Breakers and Electrical Operation Device.....	135
	9) Distribution Board Mounting Parts, Lock Covers and Handle Caps.....	138
	10) IEC 35-mm Rail Mounting Adapters.....	139

7. Characteristics and Dimensions 141

1 Molded Case Circuit Breakers 142

- NF30-CS 142
- NF32-SV, NF63-CV/SV/HV 144
- NF125-CV/SV/HV 146
- NF125-UV 148
- NF250-CV/SV/HV 150
- NF250-UV 152
- NF125-SGV/LGV/HGV/RGV, NF160-SGV/LGV/HGV,
NF250-SGV/LGV/HGV/RGV 154
- NF125-SEV/HEV, NF250-SEV/HEV 156
- NF400-CW/SW 158
- NF400-SEW/HEW/REW 160
- NF400-UEW 162
- NF630-CW/SW 164
- NF630-SEW/HEW/REW 166
- NF800-CEW/SEW/HEW/REW 168
- NF800-SDW 170
- NF800-UEW 172
- NF1000-SEW, NF1250-SEW 174
- NF1250-SDW 176
- NF1600-SEW 178
- NF1600-SDW 180

2 Earth Leakage Circuit Breakers 182

- NV32-SV, NV-63CV/SV/HV 182
- NV125-CV/SV/HV 184
- NV250-CV/SV/HV 186
- NV125-SEV/HEV, NV250-SEV/HEV 188
- NV400-CW/SW 190
- NV400-SEW/HEW/REW 192
- NV630-CW/SW 194
- NV630-SEW/HEW 196
- NV800-SEW/HEW 198

3 UL 489 Listed Circuit Breakers 200

- NF50-SVFU, NV50-SVFU 200
- NF100-CVFU, NV100-CVFU 202
- NF125-SVU/HVU, NV125-SVU/HVU 204
- NF225-CWU 206
- NF250-SVU/HVU, NV250-SVU/HVU 208
- NF-SKW 210
- NF-SLW 212

4 Measuring Display Unit Breakers 214

- NF250-SEV/HEV with MDU 214
- NF400-SEP/HEP with MDU 216
- NF630-SEP/HEP with MDU, NF800-SEP/HEP with MDU 218

**5 Miniature Circuit Breakers,
Residual Current Circuit Breakers,
Residual Current Circuit Breakers
with Overcurrent Protection and
Isolating Switch 220**

- BH, BH-P 220
- BH-S 221
- BH-PS 222
- BH-D6, BH-D10 223
- BH-DN 224
- BV-D 225
- BV-DN 226
- KB-D 227

6 Circuit Protectors 228

- CP30-BA 228

7 Electrical Operated Circuit Breakers 229

8. Handling and Maintenance 235

- 1) Storage and Transportation 236
- 2) Standard Working Conditions 236
- 3) Mounting and Connections 236
- 4) Maintenance and Inspections 238
- 5) Troubleshooting 240

9. Appendix 243

- 1) Handle Operation Angle Dimensions 244
- 2) MCCB Trip Button, Instantaneous Adjustment Dial Drilling and Terminal Cover Mounting Hole Dimensions 245
- 3) ELCB Button and Switch Dimensions 246
- 4) List of Product Weights 247
- 5) Switching the Adjustable Items 248
- 6) Breaker Mounting Screw Dimensions 251
- 7) List of Mold Surface Temperature-rise Values 252
- 8) Ordering Information 253
- 9) Melshort 2 255
- 10) Low Voltage Products Website 256

1

2

3

4

5

6

7

8

9

Breaking Through

Since we, Mitsubishi Electric, launched the first low-voltage circuit breakers in Japan in 1933, Mitsubishi low-voltage circuit breakers has satisfied the needs of the age and led the industry market for more than half a century all over the world.

By bringing together our years of experience and technologies, we would like to introduce “WS-V Series” circuit breakers with superior aspects such as the higher breaking capacity, design for easy use, standardization of accessory parts, compliance to the up to date international standards and so on.

We believe “WS-V Series” circuit breakers will fulfill every customer’s needs with its high performance and we will continue to develop and manufacture superior products that contribute to a better life for all people.



The Industry



World Super

WS-V Series

High-Performance

Technologies based on long year experience are brought together to realize more improved performance

- The new circuit breaking technology “Expanded ISTAC” has improved the current-limiting performance and upgraded the overall breaking capacity. Expansion of the conductor under the stator shortens the contact parting time of the mover as compared to the conventional ISTAC structure. The current-limiting performance has been improved remarkably. (The maximum peak current value has been reduced by approx. 10%.)

Example of breaking capacity improvement

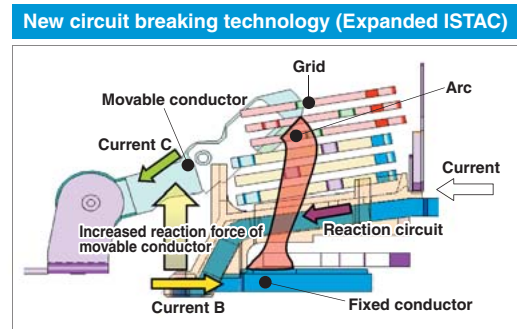

Breaking capacity of 5 models is 20% to 50% higher than the W & WS Series

- Improvement of breaking capacity on 250AF-C/S/H models (Fixed) & 125.250AF-R models (Thermal/Adjustable).

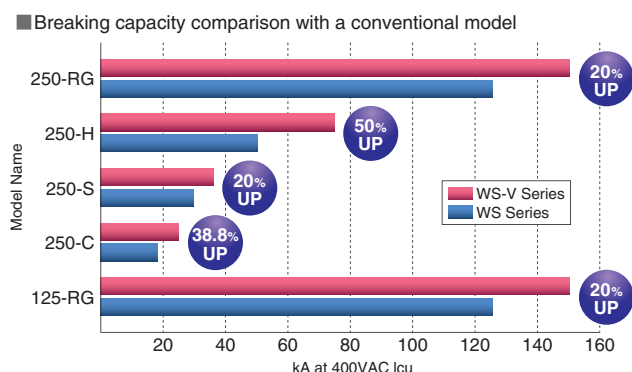



The new electronic circuit breakers (with display) and MDU breakers can display various measurement items

■ This will enable energy management through “visualization”, which leads to energy saving.



Electronic Circuit Breaker (with display)



Measuring Display Unit Breaker

- The display is on the circuit breaker body and shows circuit information.
- Detailed setting can be done on the display.
- The display turns red during alarms.

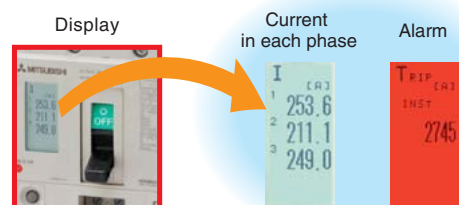

Intelligent Communications through CC-Link

■ Measuring data can be transmitted to Personal Computer through CC-Link.

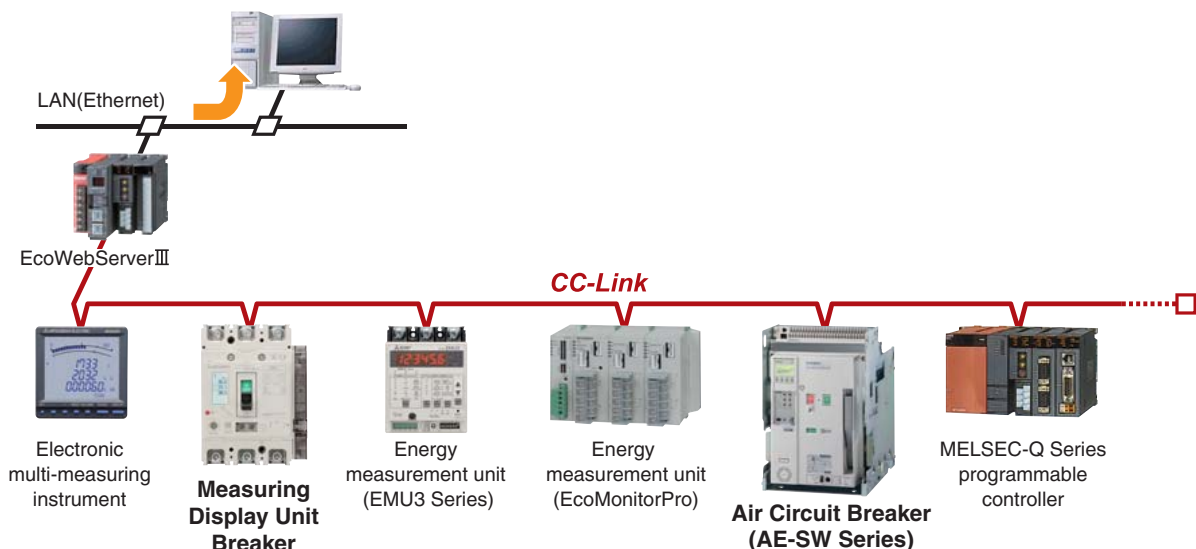



Compact design for easy to use

- The thermal adjustable circuit breakers and electronic circuit breakers are smaller.

NF250-SGW



(Conventional model : 105 × 165 × **86mm**)



NF250-SGV



(New model : 105 × 165 × **68mm**)

Volume ratio 79%

(Compared with our conventional models)

- 250AF circuit breakers' fixed types (NF250-CV, NF250-SV, NF250-HV, NV250-CV, NV250-SV, NV250-HV), thermal adjustable types (NF250-SGV, NF250-HGV, NF250-RGV), and electronic types (NF250-SEV, NF250-HEV, NV250-SEV, NV250-HEV) are the same size, leading to the reduction and standardization of panel design.

Types of internal accessories are reduced from 3 types to 1 type

- Standardization of internal accessories contributes to the reduction of stock and delivery time.

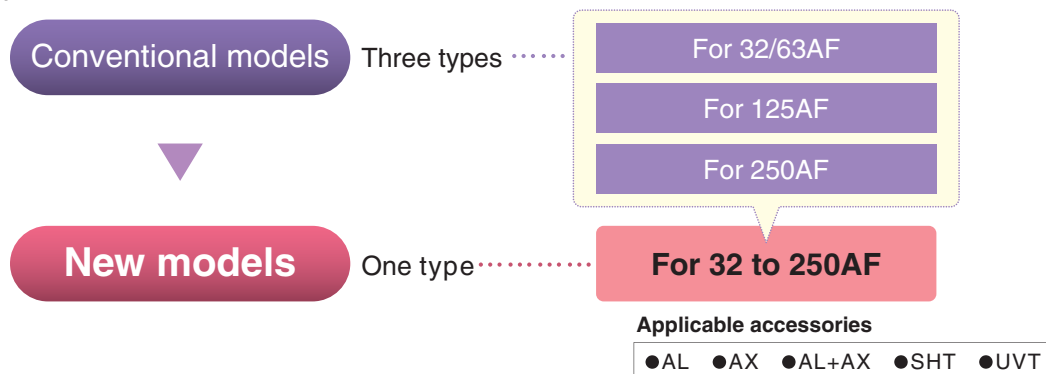

- 32AF and 63AF circuit breakers can now be used in both AC and DC circuits without specifying when ordering. This will lead to prevention of ordering mistakes.

- The earth leakage circuit breakers can now be equipped with a voltage shunt trip device (SHT).

High Quality

Innovative manufacturing using a robot-cell production line

- This manufacturing innovation takes the pursuit of increased productivity, shortened manufacturing lead-time and improved quality to the upper limits.



Robot-cell Production Line

Individual unit production management system

- A multi-model, single-unit flow production system is utilized the ultimate multi-cycle production method. The production line is controlled using barcodes to manage the model information for each unit. Small-lot, flexible production that's one step ahead!

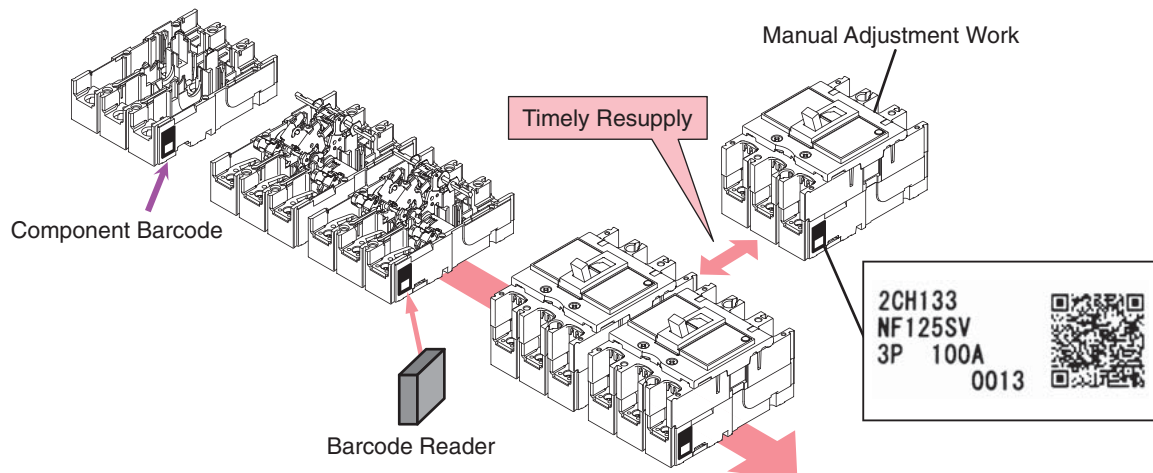

Use of Various Recyclable Materials

- The circuit breakers are made of thermo-plastic materials that are easy to recycle. (Some models are partially made of thermoset materials.)
The major plastic parts bear material identifications so that they can be recycled.

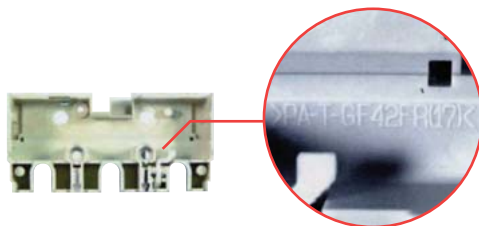

Nonuse of Hazardous Substances

- Eco-friendly design is used for all circuit breakers, and they do not use hazardous substances. The circuit breakers comply with RoHS regulation.

Energy Saving at Mitsubishi Electric Corporation Fukuyama Works

- Mitsubishi Electric Corporation Fukuyama Works uses energy saving support devices such as MDU breakers and EcoServer to save energy through “visualization” of energy. Along with “visualization”, Fukuyama Works also installed high-efficiency equipments to further promote energy saving.
Through energy saving activity, Fukuyama Works has successfully reduced its electrical power consumption rate by 27% in 2007 (compared with 1990).



Global Networks of Sales Offices and Production Bases

■ Our sales networks are designed to comfort customers internationally through the worldwide distributors. Constantly contactable distributors enable us to accommodate customer's needs for smooth supply.

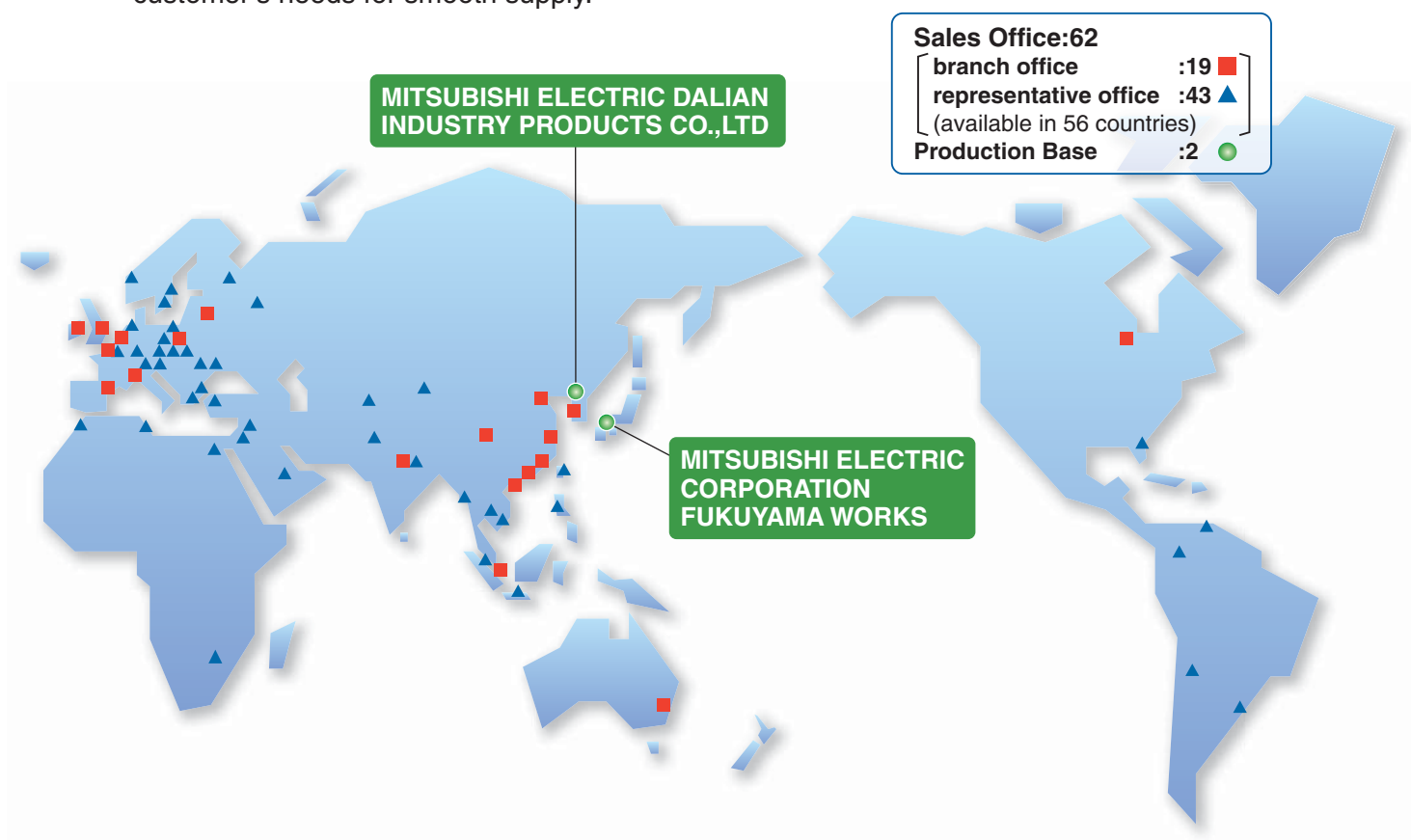

1 Outline of Mitsubishi Circuit Breakers

Product Line-up

Outline of Mitsubishi Circuit Breakers







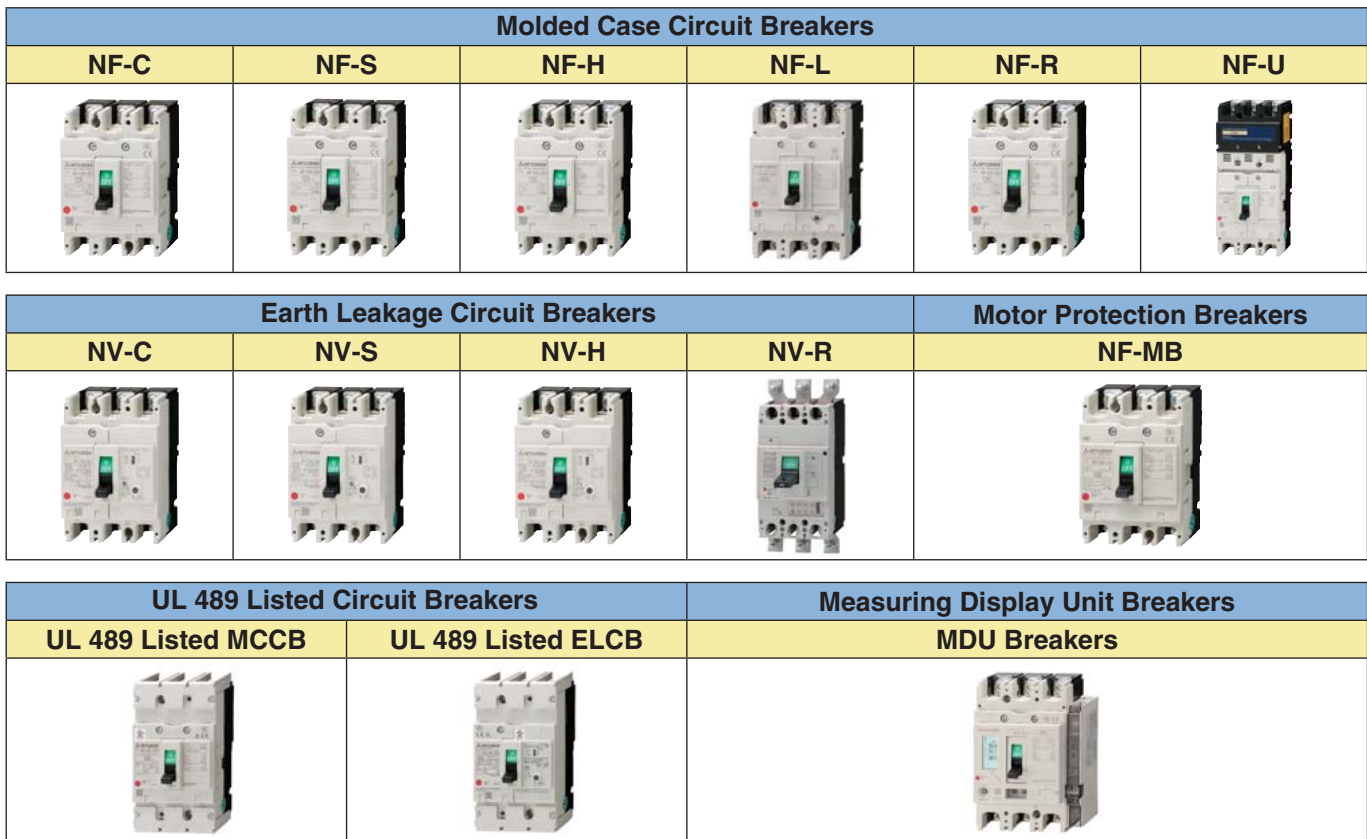







Classification		Frame (A)	20 30 32	40 50 60 63	70 100 125	160
Molded Case Circuit Breakers	NF-C Economy class	NF30-CS		NF63-CV	NF125-CV	
	NF-S Standard class	NF32-SV		NF63-SV	NF125-SV NF125-SGV	NF160-SGV
	NF-H/L High-performance class			NF63-HV	NF125-HV NF125-LGV	NF160-LGV
	NF-R/U Ultra current-limiting class				NF125-HEV NF125-HGV	NF160-HGV
Earth Leakage Circuit Breakers	NV-C Economy class			NV63-CV	NV125-CV	
	NV-S Standard class	NV32-SV		NV63-SV	NV125-SV NV125-SEV	
	NV-H/R High-performance class			NV63-HV	NV125-HV NV125-HEV	
Motor Protection Breakers	NF-MB	MB30-CS		NF63-CV (*1) NF63-SV (*1)	NF125-SV (*1)	
		NF32-SV (*1)				
UL 489 Listed Circuit Breakers	UL 489 Listed MCCB			NF50-SVFU	NF100-CVFU NF125-SVU NF125-HVU	
	UL 489 Listed ELCB			NV50-SVFU	NV100-CVFU NV125-SVU NV125-HVU	
Measuring Display Unit Breakers	MDU Breakers					
Miniature Circuit Breakers		BH-DN		BH-S BH-D6 BH-PS BH-D10	BH BH-P	
Residual Current Circuit Breaker				BV-D		
Residual Current Circuit Breaker with Overload Protection				BV-DN		
Isolating Switch				KB-D		
Circuit Protectors		CP30-BA CP-S				
Air Circuit Breakers	AE-SW					
Related Components	Earth Leakage Relays	NV-ZBA, NV-ZSA, NV-ZHA, NV-ZLA				

Note *1 When placing an order, specify "MB."

■ WS-V Series (New models)



	225 250	400	600 630	800	1000	1250	1600	2000	2500	3200	4000	5000	6300
	NF250-CV	NF400-CW	NF630-CW	NF800-CEW									
	NF250-SV NF250-SGV NF250-SEV	NF400-SW NF400-SEW	NF630-SW NF630-SEW	NF800-SDW NF800-SEW	NF1000-SEW	NF1250-SDW NF1250-SEW	NF1600-SDW NF1600-SEW						
	NF250-HV NF250-LGV NF250-HEV NF250-HGV NF250-RGV NF250-UV	NF400-HEW NF400-REW NF400-UEW	NF630-HEW NF630-REW	NF800-HEW NF800-REW NF800-UEW									
	NV250-CV	NV400-CW	NV630-CW										
	NV250-SV NV250-SEV NV250-HV NV250-HEV	NV400-SW NV400-SEW NV400-HEW NV400-REW	NV630-SW NV630-SEW NV630-HEW	NV800-SEW NV800-HEW									
	NF250-SV (*1)												
	NF225-CWU NF250-SVU NF250-HVU	NF-SKW	NF-SLW										
	NV250-SVU NV250-HVU												
	NF250-SEV with MDU NF250-HEV with MDU	NF400-SEP with MDU NF400-HEP with MDU	NF630-SEP with MDU NF630-HEP with MDU	NF800-SEP with MDU NF800-HEP with MDU									
			AE630-SW		AE1000-SW	AE1250-SW	AE1600-SW	AE2000-SW AE2000-SWA	AE2500-SW	AE3200-SW	AE4000-SWA AE4000-SW	AE5000-SW	AE6300-SW

Miniature Circuit Breakers						
BH-DN	BH-S	BH-D6	BH-PS	BH-D10	BH	BH-P
						
Residual Current Circuit Breaker			Residual Current Circuit Breaker with Overload Protection		Isolating Switch	
BV-D			BV-DN		KB-D	
						
Circuit Protectors		Air Circuit Breakers			Related Components	
CP30-BA	CP-S	AE-SW			Earth Leakage Relays	
						

Instructions for Application

1. Safety Precautions

- Carefully read the safety precautions prior to use the circuit breaker correctly.
- Important safety instructions are given below. Strictly observe the instructions.
- Be sure to communicate these safety precautions to the end user.

⚠ DANGER

- Do not touch the terminal area. Doing so can cause an electric shock.
- The earth leakage circuit breakers are designed to operate when the difference between leaving current and returning current exceeds the specified value. In the case shown in this figure, earth leakage is not detected. Therefore, never touch the two bare live parts. The circuit breaker will not operate upon occurrence of an electric shock.

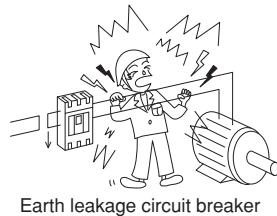

[Explanation of warning symbols]

⚠ DANGER	Incorrect handling of the product will result in a hazardous situation, such as death or serious injury.
⚠ CAUTION	Incorrect handling of the product may result in a hazardous situation according to circumstances.

Instructions for use

⚠ CAUTION

- When the circuit breaker automatically breaks a circuit, turn on the handle after removing the cause. Failure to do so may cause an electric shock or a fire.
- [Earth leakage circuit breaker]
- Ground the earth terminal of electrical equipment. Failure to do so may cause an electric shock or a fire.
 - Press the test button to check the operation once a month or so. If the earth leakage circuit breaker is not turned off, it is out of order. Consult an electrician.

Instructions for installation

⚠ CAUTION

- The electrical work shall be performed by qualified personnel (electrical workers).
 - Before performing wiring work, turn off the upstream circuit breaker, and ensure that no current is flowing through the circuit breaker to be wired. Failure to do so may expose you to shock hazard.
 - When connecting any wire, tighten the terminal screw to the torque specified in the instruction manual. Failure to do so may cause a fire.
 - When the model comes with insulating barriers as standard accessories, install the insulating barriers without fail.
 - Do not install the circuit breaker in an abnormal environment with high temperature, high moisture, dust, corrosive gas, vibration or shock. Doing so may cause a fire or make the circuit breaker inoperative.
 - Protect the circuit breaker so that foreign particles, such as dust, concrete powder and iron powder, and rain water will not enter the circuit breaker. Failure to do so may make the circuit breaker inoperative.
- [Earth leakage circuit breaker]
- When using an earth leakage circuit breaker for use only in single-phase 3-wire or 3-phase 4-wire systems, connect the neutral wire to the neutral phase without fail. If they are not connected, the circuit breaker may not operate in the case of open phase or overcurrent, thereby resulting in a fire.
 - Connect the circuit breaker to a power supply appropriate to the rating of its body. Failure to do so may make the circuit breaker inoperative or damage it.
 - Tighten securely the lead wire in the open phase to the neutral wire on the load side. If the wires are not connected, the open phase of the neutral wire cannot be detected.
 - When there are two terminal screws for the neutral pole, tighten the screws alternately. Failure to do so may loosen the screws, thereby causing a fire.

Instructions for maintenance

⚠ CAUTION

- The circuit breakers shall be maintained by persons with specialized knowledge.
- Before maintaining, turn off the upstream circuit breaker, and ensure that no current is flowing through the circuit breaker to be maintained. Failure to do so may expose you to shock hazard.
- Retighten the terminals periodically. Failure to do so may cause a fire.

Instructions for disposal

⚠ CAUTION

- When disposing of the product, treat it as industrial waste.

2. Instructions for Application

- (1) Please note that the specifications for the products in this catalog are subject to change without prior notice.
- (2) The products in this catalog are designed and manufactured as general-purpose products for general industrial uses. If you intend to use them for a special purpose, such as nuclear power, electric power, aerospace, medical or passenger vehicle equipment or systems, please contact our sales representative.
- (3) We are not responsible for compensation for damage caused by any reason not attributable to us, opportunity loss or lost earnings of customer caused by trouble of our product, damage, secondary damage, accidents or damage to any product other than our product caused by special circumstances or any other operation.

2

Detailed Specifications

1	Molded Case Circuit Breakers	14
1)	NF-C (Economy class).....	14
2)	NF-S (Standard class).....	16
3)	NF-L/NF-H/NF-R (High-performance class)	20
4)	NF-U (Ultra current-limiting class).....	23
2	Earth Leakage Circuit Breakers	24
1)	NV-C (Economy class)	24
2)	NV-S (Standard class).....	26
3)	NV-H/NV-R (High-performance class)	28
3	Motor Protection Breakers	30
1)	NF-MB	30
4	UL 489 Listed Circuit Breakers	31
1)	UL 489 Listed Molded Case Circuit Breakers	31
2)	UL 489 Listed Earth Leakage Circuit Breakers	34
5	Measuring Display Unit Breakers	35
1)	MDU Breakers	35
6	Miniature Circuit Breakers	44
1)	BH	44
2)	BV	48
7	Circuit Protectors	51
1)	CP	51
8	Low Voltage Air Circuit Breakers	54
1)	Low Voltage Air Circuit Breakers (AE-SW Series)	54
9	Earth Leakage Relays	56
1)	Earth Leakage Relays.....	56

NF-C (Economy class)

Frame (A)	30	50	60	63	100	125			
Model	NF30-CS		NF63-CV			NF125-CV			
Image									
Rated current In (A)	3 5 10 15 20 30	3 4 (5) 6 10 (15) 16	(60)	63	50 (60) 63 (75) 80 100	125			
Rated ambient temperature 40°C (45°C for marine use)		20 25 (30) 32 40 50							
Number of poles	2 3	2 3	2 3	2 3	2 3	2 3			
Rated insulation voltage Ui (V)	500	600	600	600	600	600			
Rated short-circuit breaking capacities (kA)	IEC 60947-2 EN 60947-2 (Icu/Ics)	AC	690V	-	-	-	-	-	
			500V	-	2.5/2.5	2.5/2.5	2.5/2.5	7.5/4	7.5/4
			440V	-	2.5/2.5	2.5/2.5	2.5/2.5	10/5	10/5
			415V	1.5/1.5	2.5/2.5	2.5/2.5	2.5/2.5	10/5	10/5
			400V	1.5/1.5	5/5	5/5	5/5	10/5	10/5
			380V	1.5/1.5	5/5	5/5	5/5	10/5	10/5
			230V	2.5/2 (240V)	7.5/7.5	7.5/7.5	7.5/7.5	30/15	30/15
			200V	2.5/2 (240V)	7.5/7.5	7.5/7.5	7.5/7.5	30/15	30/15
DC	250V	-	2.5/2.5 (*7)	2.5/2.5 (*7)	2.5/2.5 (*7)	7.5/4 (*4)	7.5/4 (*4)		
Rated impulse withstand voltage Uimp (kV)	4	8	8	8	8	8			
Current (*1)	AC	AC/DC compatible	AC/DC compatible	AC/DC compatible	AC/DC compatible	AC/DC compatible			
Suitability for isolation	-	Compatible	Compatible	Compatible	Compatible	Compatible			
Reverse connection	-	Possible	Possible	Possible	Possible	Possible			
Number of operating cycles	Without current	10,000	10,000	10,000	10,000	10,000			
	With current (440VAC)	6,000 (AC415V)	6,000	6,000	6,000	6,000			
Utilization category	A	A	A	A	A	A			
Pollution degree	2	3	3	3	3	3			
EMC environment condition (environment A or B)	N/A	N/A	N/A	N/A	N/A	N/A			
Overall dimensions (mm)		a	45 67.5	50 75	50 75	50 75	60 90		
		b	96	130	130	130	130		
		c	52	68	68	68	68		
		ca	67	90	90	90	90		
Mass of front-face type (kg)	0.25 0.35	0.45 0.65	0.5 0.7	0.5 0.7	0.6 0.9	0.6 0.9			
Installation and connections	Front connection (F)	Page	●Screw terminal	●Screw terminal	●Screw terminal	●Screw terminal	●Screw terminal		
	Solderless (BOX) terminal (SL)		-	-	-	-	-		
	Rear (B)	94	●Round stud (assembled in)	●Round stud	●Round stud	●Round stud	●Bar stud		
Cassette-type accessories	Plug-in (PM)		●	●	●	●	●		
	Alarm switch (AL)		● (*5)	● (*6)	● (*6)	● (*6)	● (*6)		
	Auxiliary switch (AX)	104	● (*5)	● (*6)	● (*6)	● (*6)	● (*6)		
	Shunt trip (SHT)		-	● (*6)	● (*6)	● (*6)	● (*6)		
	Undervoltage trip (UVT)		-	● (*6)	● (*6)	● (*6)	● (*6)		
	With lead-wire terminal block (SLT)	116	●	●	●	●	●		
	Pre-alarm (PAL)	118	-	-	-	-	-		
External accessories	Enclosure	Closed (S)	●	●	●	●	●		
		Dustproof (I)	-	●	●	●	●		
		Waterproof (W)	-	-	●	●	●		
	Electrical operation device (NFM)		135	-	-	-	●	●	
		Mechanical interlock (M) (*10)	131	-	●	●	●	●	
	Handle lock device	Panel mounting		●	●	●	●		
		LC		●	●	●	●		
		HL	129	●	●	●	●		
	External operating handle	HL-S		-	●	●	●		
		(F)	119	-	●	●	●		
Terminal cover (TC-L, TC-S, TTC, BTC, PTC)	(V)	123	●	●	●	●			
Rear stud (B-ST)		96	-	●	●	●			
Plug-in (PM)			●	●	●	●			
IEC 35mm rail mounting adapters		139	●	●	●	●			
CE marking	TÜV approval	Self-declaration	Self-declaration	Self-declaration	Self-declaration	Self-declaration			
CCC recognition	Recognition in process	Recognition in process	Recognition in process	Recognition in process	Recognition in process	Recognition in process			
Marine use approval (NK, LR, ABS, GL)	☆ (NK, LR, ABS)	☆	☆	☆	☆	☆			
Automatic tripping device	Hydraulic magnetic	Thermal-magnetic	Thermal-magnetic	Thermal-magnetic	Thermal-magnetic	Thermal-magnetic			
Trip button	- (*2)	Equipped	Equipped	Equipped	Equipped	Equipped			
Page of Characteristics and dimensions	142		144		146				

- Notes: *1 The trip action characteristics differ between AC and DC for products that are compatible with both AC and DC.
 *2 It is attached with the alarm switch.
 *3 In case of a current rating of 100A, it does not specify NK rating.
 *4 Use two poles for three- and four-pole products. In this case, do not use the neutral pole of the four-pole products. If wired as shown on the right, three and four poles can be used for up to 400 and 500VDC, respectively.
 *5 The standard lead drawing is performed laterally. Load drawing is also available.
 *6 The cassette type design makes it easy for customer to install. Available for installation on side below 250A frame (excluding UVT).
 *7 Use two poles for three- and four-pole products. In this case, do not use the neutral pole of the four-pole products. Not available for use with connection as shown on the right.
 *8 Place an order of other models in conjunction with the circuit breaker.
 *9 Solid state relay output is option. Please specify if other output is necessary. (Standard type is thus SLT equipped).
 *10 Not isolation compatible, excluding 400 to 800A frame.

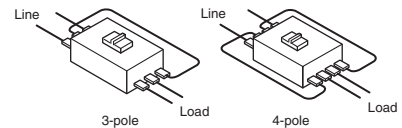

NF-S (Standard class)

Frame (A)		30			32			50			60			63					
Model		NF32-SV												NF63-SV					
Image																			
Rated current In (A)		3 4 (5) 6 10			32			3 4 (5) 6 10 (15) 16			(60)			63					
Rated ambient temperature 40°C (45°C for marine use)		15 16 20 25 (30)						20 25 (30) 32 40 50											
Number of poles		2			2			2			2			2					
Rated insulation voltage Ui (V)		600			600			600			600			600					
Relative short-circuit capacities (kA)	IEC 60947-2 EN 60947-2 (Icu/Ics)	AC	690V	-			-			-			-						
			500V	2.5/2.5			2.5/2.5			7.5/7.5			7.5/7.5						
			440V	2.5/2.5			2.5/2.5			7.5/7.5			7.5/7.5						
			415V	2.5/2.5			2.5/2.5			7.5/7.5			7.5/7.5						
			400V	5/5			5/5			7.5/7.5			7.5/7.5						
			380V	5/5			5/5			7.5/7.5			7.5/7.5						
			230V	7.5/7.5			7.5/7.5			15/15			15/15						
			200V	7.5/7.5			7.5/7.5			15/15			15/15						
			DC 250V	2.5/2.5 (*5)			2.5/2.5 (*5)			7.5/7.5 (*5)			7.5/7.5 (*5)						
Rated impulse withstand voltage Uimp (kV)		8			8			8			8			8					
Current (*1)		AC/DC compatible			AC/DC compatible			AC/DC compatible			AC/DC compatible			AC/DC compatible					
Suitability for isolation		Compatible			Compatible			Compatible			Compatible			Compatible					
Reverse connection		Possible			Possible			Possible			Possible			Possible					
Number of operating cycles	Without current	10,000			10,000			10,000			15,000			15,000					
	With current (440VAC)	6,000			6,000			6,000			8,000			8,000					
Utilization category		A			A			A			A			A					
Pollution degree		3			3			3			3			3					
EMC environment condition (environment A or B)		N/A			N/A			N/A			N/A			N/A					
Overall dimensions (mm)		a	50			50			50			50			50				
		b	130			130			130			130			130				
		c	68			68			68			68			68				
		ca	90			90			90			90			90				
Mass of front-face type (kg)		0.45 0.65			0.45 0.65			0.5 0.7 0.9			0.55 0.75 1.0			0.55 0.75 1.0					
Installation and connections	Front connection (F)	●Screw terminal			●Screw terminal			●Screw terminal			●Screw terminal			●Screw terminal					
	Solderless (BOX) terminal (SL)	-			-			-			-			-					
	Rear (B)	●Bar stud			●Round stud			●Round stud			●Round stud			●Round stud					
Cassette-type accessories	Plug-in (PM)	-			-			-			-			-					
	Alarm switch (AL)	●(*4)			●(*4)			●(*4)			●(*4)			●(*4)					
Auxiliary switch (AX)	●(*4)			●(*4)			●(*4)			●(*4)			●(*4)						
Shunt trip (SHT)	●(*4)			●(*4)			●(*4)			●(*4)			●(*4)						
Undervoltage trip (UVT)	●(*4)			●(*4)			●(*4)			●(*4)			●(*4)						
With lead-wire terminal block (SLT)	-			-			-			-			-						
Pre-alarm (PAL)	-			-			-			-			-						
External accessories	Enclosure	Closed (S)	●			●			●			●			●				
		Dustproof (I)	-			-			-			-			-				
		Waterproof (W)	-			-			-			-			-				
	Electrical operation device (NFM)	Panel mounting	-			-			-			-			-				
		Breaker mounting	●			●			●			●			●				
	Handle lock device	LC	●			●			●			●			●				
		HL	●			●			●			●			●				
		HL-S	●			●			●			●			●				
	External operating handle	(F)	●			●			●			●			●				
		(V)	●			●			●			●			●				
Terminal cover (TC-L, TC-S, TTC, BTC, PTC)	-			-			-			-			-						
Rear stud (B-ST)	●			●			●			●			●						
Plug-in (PM)	-			-			-			-			-						
IEC 35mm rail mounting adapters	-			-			-			-			-						
CE marking		Self-declaration			Self-declaration			Self-declaration			Self-declaration			Self-declaration					
CCC recognition		Recognition in process			Recognition in process			Recognition in process			Recognition in process			Recognition in process					
Marine use approval (NK, LR, ABS, GL)		☆			☆			☆			☆			☆					
Automatic tripping device		Thermal-magnetic			Thermal-magnetic			Thermal-magnetic			Thermal-magnetic			Thermal-magnetic					
Trip button		Equipped			Equipped			Equipped			Equipped			Equipped					
Page of Characteristics and dimensions		144			144			144			144			144					

- Notes:
- *1 The trip action characteristics differ between AC and DC for products that are compatible with both AC and DC.
 - *2 In case of a current rating of 100A, it does not specify NK rating.
 - *3 Use two poles for three- and four-pole products. In this case, do not use the neutral pole of the four-pole products. If wired as shown on the right, three and four poles can be used for up to 400 and 500VDC, respectively. (In case of NF250-SV, three and four poles can be used for up to 500 and 600VDC)
 - *4 The cassette type design makes it easy for customer to install. Available for installation on side below 250A frame (excluding UVT).
 - *5 Use two poles for three- and four-pole products. In this case, do not use the neutral pole of the four-pole products. Not available for use with connection as shown on the right.
 - *6 Place an order of other models in conjunction with the circuit breaker.
 - *7 Not isolation compatible. excluding 400 to 800A frame.

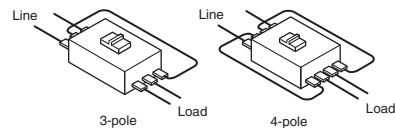

NF-S (Standard class)

Frame (A)		250			250			400			400			600			630				
Model		NF250-SGV			NF250-SEV			NF400-SW			NF400-SEW			NF630-SW							
Image																					
Rated current In (A)		125-160 140-200			80-160 125-250			250 300 350 400			Adjustable 200 225 250 300 350 400			500 600			630				
Rated ambient temperature 40°C (45°C for marine use)		175-250																			
Number of poles		2 3 4			3 4			2 3 4			3 4			2 3 4			2 3 4				
Rated insulation voltage Ui (V)		690			690			690			690			690			690				
Relative short-circuit breaking capacities (kA)	IEC 60947-2 EN 60947-2 (Icu/Ics)	AC	690V	8/8			8/8			10/10			10/10			10/10					
			500V	30/30			30/30			30/30			30/30			30/30					
			440V	36/36			36/36			42/42			42/42			42/42					
			415V	36/36			36/36			45/45			50/50			50/50					
			400V	36/36			36/36			45/45			50/50			50/50					
			380V	36/36			36/36			50/50			50/50			50/50					
			230V	85/85			85/85			85/85			85/85			85/85					
			200V	85/85			85/85			85/85			85/85			85/85					
			DC 250V	20/20 (300V) (*2)			-			40/40 (*2)			-			40/40 (*2)			40/40 (*2)		
			Rated impulse withstand voltage Uimp (kV)		8			8			8			8			8			8	
Current		AC/DC compatible			AC			AC/DC compatible			AC			AC/DC compatible			AC/DC compatible				
Suitability for isolation		Compatible			Compatible			Compatible			Compatible			Compatible			Compatible				
Reverse connection		Possible			Possible			Possible			Possible			Possible			Possible				
Number of operating cycles	Without current	25,000			25,000			6,000			6,000			6,000			6,000				
	With current (440VAC)	10,000			10,000			1,000			1,000			1,000			1,000				
Utilization category		A			A			A			B			A			A				
Rated short time with stand current Icw (kA) at 0.25s		-			-			-			5			-			-				
Pollution degree		3			3			3			3			3			3				
EMC environment condition (environment A or B)		N/A			A			N/A			A			N/A			N/A				
Overall dimensions (mm)		a	105 140		105 140		140 185		140 185		140 185		140 185		140 185		140 185				
		b	165		165		257		257		257		257		257		257				
		c	68		68		103		103		103		103		103		103				
		ca	92		92		155		155		155		155		155		155				
Mass of front-face type (kg)		1.4 1.6 2.0		1.7 2.2		4.6 5.2 6.8		6.0 7.6		5.4 6.2 8.0		5.4 6.2 8.0		5.4 6.2 8.0		5.4 6.2 8.0					
Installation and connections	Front connection (F)	Page		●Screw terminal		●Screw terminal		●Busbar terminal		●Busbar terminal		●Busbar terminal		●Busbar terminal		●Busbar terminal					
	Solderless (BOX) terminal (SL)	94		●Bar stud		●Bar stud		●Bar stud		●Bar stud		●Bar stud		●Bar stud		●Bar stud					
	Rear (B)	94		●Bar stud		●Bar stud		●Bar stud		●Bar stud		●Bar stud		●Bar stud		●Bar stud					
	Plug-in (PM)	94		●Bar stud		●Bar stud		●Bar stud		●Bar stud		●Bar stud		●Bar stud		●Bar stud					
Cassette-type accessories	Alarm switch (AL)	●(*3)		●(*3)		●(*3)		●(*3)		●(*3)		●(*3)		●(*3)		●(*3)					
	Auxiliary switch (AX)	●(*3)		●(*3)		●(*3)		●(*3)		●(*3)		●(*3)		●(*3)		●(*3)					
	Shunt trip (SHT)	●(*3)		●(*3)		●(*3)		●(*3)		●(*3)		●(*3)		●(*3)		●(*3)					
	Undervoltage trip (UVT)	●(*3)		●(*3)		●(*3)		●(*3)		●(*3)		●(*3)		●(*3)		●(*3)					
	With lead-wire terminal block (SLT)	116		●		●		●		●		●		●		●					
	Pre-alarm (PAL)	118		-		●		-		●(*5)		-		-		-					
External accessories	Enclosure	Closed (S)	●		●		●		●		●		●		●		●				
		Dustproof (I)	●		●		●		●		●		●		●		●				
		Waterproof (W)	●		●		●		●		●		●		●		●				
	Electrical operation device (NFM)	Panel mounting	●		●		●(*6)		●(*6)		●(*6)		●(*6)		●(*6)		●(*6)				
		Mechanical interlock (MI) (*7)	●		●		●		●		●		●		●		●				
	Handle lock device	LC	●		●		-		-		-		-		-		-				
		HL	●		●		●		●		●		●		●		●				
		HL-S	●		●		●		●		●		●		●		●				
	External operating handle	(F)	●		●		●		●		●		●		●		●				
		(V)	●		●		●		●		●		●		●		●				
Terminal cover (TC-L, TC-S, TTC, BTC, PTC)	123		●		●		●		●		●		●		●		●				
Rear stud (B-ST)	96		●		●		●		●		●		●		●		●				
Plug-in (PM)	96		●		●		●		●		●		●		●		●				
IEC 35mm rail mounting adapters	139		-		-		-		-		-		-		-		-				
CE marking		Self-declaration			Self-declaration			Self-declaration			Self-declaration			Self-declaration			Self-declaration				
CCC recognition		Recognition in process			Recognition in process			Recognition in process			Recognition in process			Recognition in process			Recognition in process				
Marine use approval (NK, LR, ABS, GL)		☆(LR, ABS, GL) -			☆(LR, ABS, GL) -			☆ -			☆ -			☆ -			☆ -				
Automatic tripping device		Thermal-magnetic			Electronic (effective value detection)			Thermal-magnetic			Electronic (effective value detection)			Thermal-magnetic			Thermal-magnetic				
Trip button		Equipped			Equipped			Equipped			Equipped			Equipped			Equipped				
Page of Characteristics and dimensions		154			156			158			160			164							

- Notes:
- *1 The trip action characteristics differ between AC and DC for products that are compatible with both AC and DC.
 - *2 Use two poles for three- and four-pole products. In this case, do not use the neutral pole of the four-pole products. If wired as shown on the right, three and four poles can be used for up to 400 and 500VDC, respectively.
 - *3 The cassette type design makes it easy for customer to install. Available for installation on side below 250A frame (excluding UVT).
 - *4 Use two poles for three- and four-pole products. In this case, do not use the neutral pole of the four-pole products. Not available for use with connection as shown on the right.
 - *5 Solid state relay output is option. Please specify if other output is necessary. (Standard type is thus SLT equipped) AS for flush plate type, an outline differs from a standard.
 - *6 Place an order of other models in conjunction with the circuit breaker.
 - *7 Not isolation compatible. excluding 400 to 800A frame.

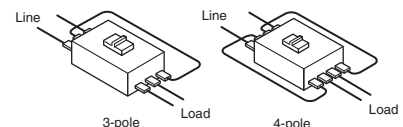

NF-H / NF-R (High-performance class)

Frame (A)		250		400				630				800				
Model		NF250-HEV		NF400-HEV		NF400-REW		NF630-HEV		NF630-REW		NF800-HEV		NF800-REW		
Image																
Rated current In (A)		80-160 125-250		Adjustable 200 225 250 300 350 400		Adjustable 200 225 250 300 350 400		Adjustable 200 350 400 500 600 630		Adjustable 300 350 400 500 600 630		Adjustable 400 450 500 600 700 800		Adjustable 400 450 500 600 700 800		
Rated ambient temperature 40°C (45°C for marine use)																
Number of poles		3 4		3 4		3		3 4		3		3 4		3		
Rated insulation voltage Ui (V)		690		690		690		690		690		690		690		
Rated short-circuit breaking capacities (kA)	IEC 60947-2 EN 60947-2 (Icu/Ics)	AC	690V	10/8	35/18	-	35/18	-	15/15	-						
			500V	50/38	50/50	70/35	50/50	70/35	50/50	70/35						
			440V	65/65	65/65	125/63	65/65	125/63	65/65	125/63						
			415V	70/70	70/70	125/63	70/70	125/63	70/70	125/63						
			400V	75/75	70/70	125/63	70/70	125/63	70/70	125/63						
			380V	75/75	70/70	125/63	70/70	125/63	70/70	125/63						
			230V	100/100	100/100	150/75	100/100	150/75	100/100	150/75						
			200V	100/100	100/100	150/75	100/100	150/75	100/100	150/75						
			DC	250V	-	-	-	-	-	-						
			Rated impulse withstand voltage Uimp (kV)		8		8		8		8		8		8	
Current		AC		AC		AC		AC		AC		AC		AC		
Suitability for isolation		Compatible		Compatible		Compatible		Compatible		Compatible		Compatible		Compatible		
Reverse connection		Possible		Possible		Possible		Possible		Possible		Possible		Possible		
Number of operating cycles	Without current	25,000		6,000		6,000		6,000		6,000		4,000		4,000		
	With current (440VAC)	10,000		1,000		1,000		1,000		1,000		500		500		
Utilization category		A		B		B		B		B		B		B		
Rated short time with stand current Icu (kA) at 0.25s		-		5		5		7.6		7.6		9.6		9.6		
Pollution degree		3		3		3		3		3		3		3		
EMC environment condition (environment A or B)		A		A		A		A		A		A		A		
Overall dimensions (mm)	a	105	140	140	185	140	185	140	185	140	280	210	280	210		
	b	165		257		257		257		257		275		275		
	c	68		103		103		103		103		103		103		
	ca	92		155		155		155		155		155		155		
Mass of front-face type (kg)		1.7 2.2		6.0 7.6		6.0		6.5 8.3		6.0		10.9 14.2		10.9		
Installation and connections	Front connection (F)	Screw terminal		Busbar terminal		Busbar terminal		Busbar terminal		Busbar terminal		Busbar terminal		Busbar terminal		
	Solderless (BOX) terminal (SL)	●		●		●		●		●		●		●		
	Rear (B)	●		●		●		●		●		●		●		
Cassette-type accessories	Alarm switch (AL)	● (*1)		● (*1)		● (*1)		● (*1)		● (*1)		● (*1)		● (*1)		
	Auxiliary switch (AX)	● (*1)		● (*1)		● (*1)		● (*1)		● (*1)		● (*1)		● (*1)		
	Shunt trip (SHT)	● (*1)		● (*1)		● (*1)		● (*1)		● (*1)		● (*1)		● (*1)		
	Undervoltage trip (UVT)	● (*1)		●		●		●		●		●		●		
	With lead-wire terminal block (SLT)	●		●		●		●		●		●		●		
	Pre-alarm (PAL)	●		● (*2)		● (*2)		● (*2)		● (*2)		● (*2)		● (*2)		
	External accessories	Enclosure Closed (S)	-		-		-		-		-		-		-	
		Dustproof (I)	●		-		-		-		-		-		-	
		Waterproof (W)	●		-		-		-		-		-		-	
		Electrical operation device (NFM)	●		● (*3)		● (*3)		● (*3)		● (*3)		● (*3)		● (*3)	
Mechanical interlock (MI) (*4)		●		●		●		●		●		●		●		
Handle lock device LC		●		-		-		-		-		-		-		
HL		●		●		●		●		●		●		●		
HL-S		●		●		●		●		●		●		●		
External operating handle (F)		●		●		●		●		●		●		●		
(V)		●		●		●		●		●		●		●		
Terminal cover (TC-L, TC-S, TTC, BTC, PTC)	●		●		●		●		●		●		●			
Rear stud (B-ST)	●		●		●		●		●		●		●			
Plug-in (PM)	●		●		●		●		●		●		●			
IEC 35mm rail mounting adapters	-		-		-		-		-		-		-			
CE marking	Self-declaration		Self-declaration		Self-declaration		Self-declaration		Self-declaration		Self-declaration		Self-declaration			
CCC recognition	Recognition in process		Recognition in process		Recognition in process		Recognition in process		Recognition in process		Recognition in process		Recognition in process			
Marine use approval (NK, LR, ABS, GL)	☆ (LR, ABS, GL)		-		☆		-		☆		-		☆			
Automatic tripping device	Electronic (effective value detection)		Electronic (effective value detection)		Electronic (effective value detection)		Electronic (effective value detection)		Electronic (effective value detection)		Electronic (effective value detection)		Electronic (effective value detection)			
Trip button	Equipped		Equipped		Equipped		Equipped		Equipped		Equipped		Equipped			
Page of Characteristics and dimensions	156		160		160		166		166		168		168			

Notes: *1 The cassette type design makes it easy for customer to install. Available for installation on side below 250A frame (excluding UVT).



*2 Solid state relay output is option. Please specify if other output is necessary. (Standard type is thus SLT equipped).

*3 Place an order of other models in conjunction with the circuit breaker.

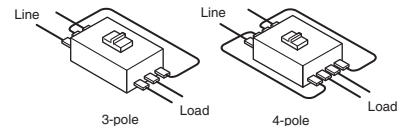
*4 Not isolation compatible, excluding 400 to 800A frame.

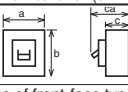

NV-C (Economy class) Harmonic Surge Ready

Frame (A)		50		60		63		100			125		
Model		NV63-CV						NV125-CV					
Image													
Rated current In (A)		(5) (10) (15) 16 20 25		(60)		63		(60) 63 (75) 80 100			125		
Rated ambient temperature 40°C		(30) 32 40 50											
Number of poles		2 3		2 3		2 3		3			3		
Phase line (*1)		1φ2W 3φ3W, 1φ3W, 1φ2W		1φ2W 3φ3W, 1φ3W, 1φ2W		1φ2W 3φ3W, 1φ3W, 1φ2W		3φ3W, 1φ3W, 1φ2W			3φ3W, 1φ3W, 1φ2W		
Rated operational voltage Ue (V) (*2) AC		100-240 100-440		100-240 100-440		100-240 100-440		100-440			100-440		
High-speed type	Rated current sensitivity (mA)	30		30		30		30			30		
	Max. operating time (s)	at IΔn at 5IΔn		0.1 0.04		0.1 0.04		0.1 0.04			0.1 0.04		
Time-delay type	Rated current sensitivity (mA)	-		-		-		(100/200/500 selectable)			(100/200/500 selectable)		
	Max. operating time (s) (*3)	-		-		-		(0.45/1.0/2.0 selectable)			(0.45/1.0/2.0 selectable)		
	Internal non-operating (s) (or more)	-		-		-		(0.1/0.5/1.0)			(0.1/0.5/1.0)		
Earth leakage indication system		Mechanical type (button)		Mechanical type (button)		Mechanical type (button)		Mechanical type (button)			Mechanical type (button)		
Rated short-circuit breaking capacities (kA)	AC	440V	-		2.5/2.5		-		2.5/2.5			10/5	
		415V	-		2.5/2.5		-		2.5/2.5			10/5	
		400V	-		5/5		-		5/5			10/5	
		230V	7.5/7.5		7.5/7.5		7.5/7.5		30/15			30/15	
		200V	7.5/7.5		7.5/7.5		7.5/7.5		30/15			30/15	
		100V	7.5/7.5		7.5/7.5		7.5/7.5		30/15			30/15	
Rated impulse withstand voltage Uimp (kV)		6		6		6		6			6		
Current		AC		AC		AC		AC			AC		
Suitability for isolation		Compatible		Compatible		Compatible		Compatible			Compatible		
Reverse connection (below 230VAC)		Possible		Possible		Possible		Possible			Possible		
Number of operating cycles	Without current	10,000		10,000		10,000		10,000			10,000		
	With current	6,000		6,000		6,000		6,000			6,000		
Utilization category		A		A		A		A			A		
Pollution degree		2		2		2		2			2		
EMC environment condition (environment A or B)		A		A		A		A			A		
Overall dimensions (mm)		a	75		75		75		90			90	
		b	130		130		130		130			130	
		c	68		68		68		68			68	
		ca	90		90		90		90			90	
Mass of front-face type (kg)		0.7 0.75		0.7 0.75		0.7 0.75		1.0			1.0		
Installation and connections	Front connection (F) Page	●Screw terminal		●Screw terminal		●Screw terminal		●Screw terminal			●Screw terminal		
	Solderless (BOX) terminal (SL)	-		-		-		-			-		
	Rear (B) 94	●Round stud		●Round stud		●Round stud		●Bar stud			●Bar stud		
	Plug-in (PM)	-		-		-		-			-		
Cassette-type accessories	Alarm switch (AL)	●(*4)		●(*4)		●(*4)		●(*4)			●(*4)		
	Auxiliary switch (AX)	●(*4)		●(*4)		●(*4)		●(*4)			●(*4)		
	Shunt trip (SHT)	●(*4)		●(*4)		●(*4)		●(*4)			●(*4)		
	Undervoltage trip (UVT)	●(*4)		●(*4)		●(*4)		●(*4)			●(*4)		
	Earth leakage alarm switch (EAL)	-		-		-		-			-		
	With lead-wire terminal block (SLT) 116	●		●		●		●			●		
Test button module (TBM) 117	●(*5)		●(*5)		●(*5)		●(*5)			●(*5)			
External accessories	Enclosure	Closed (S)	-		-		-		-			-	
		Dustproof (I)	-		-		-		-			-	
		Waterproof (W)	-		-		-		-			-	
	Electrical operation device (NFM)	Mechanical interlock (MI) (*7) 131	●		●		●		●			●	
		Panel mounting Breaker mounting	●		●		●		●			●	
	Handle lock device	LC 129	●		●		●		●			●	
		HL HL-S	●		●		●		●			●	
	External operating handle	(F) 119	●		●		●		●			●	
		(V)	●		●		●		●			●	
	Terminal cover (TC-L, TC-S, TTC, BTC, PTC) 123	●		●		●		●			●		
Rear stud (B-ST) 96	●		●		●		●			●			
Plug-in (PM)	-		-		-		-			-			
IEC 35mm rail mounting adapters 139	●		●		●		●			●			
CE marking		Self-declaration		Self-declaration		Self-declaration		Self-declaration			Self-declaration		
CCC recognition		- Recognition in process		- Recognition in process		- Recognition in process		Recognition in process			Recognition in process		
Marine use approval (NK, LR, ABS, GL)		-		-		-		-			-		
Automatic tripping device		Thermal-magnetic		Thermal-magnetic		Thermal-magnetic		Thermal-magnetic			Thermal-magnetic		
Trip button		Equipped		Equipped		Equipped		Equipped			Equipped		
Page of Characteristics and dimensions		182						184					

Notes: *1 If using a 3-pole earth leakage circuit breaker as a 1-pole 2-phase device, connect the left and right poles and not the central pole. When wiring to single-phase 3-wire, connect the neutral line to the central pole.
 *2 In case of time delay type, rated voltage is 200-440VAC.
 *3 When the operating time are 0.45, 1.0 and 2.0 seconds, the Earth Leakage circuit breaker operates between 0.15 and 0.45 seconds, between 0.6 and 1.0 seconds and between 1.2 and 2.0 seconds respectively.
 *4 The cassette type design makes it easy for customer to install. Available for installation on side below 250A frame (excluding UVT).
 *5 Standard type is SLT equipped.

*6 Place an order of other models in conjunction with the circuit breaker.
 *7 Not isolation compatible, excluding 400 to 630A frame.
 *8 AC100V does not acquire the CCC certification.

NV-S (Standard class) Harmonic Surge Ready

Frame (A)		30	32	50	60	63	100	125	125	
Model		NV32-SV			NV63-SV		NV125-SV		NV125-SEV	
Image										
Rated current In (A)		(5) 6 10 (15)	(32)	(5) (10) (15) 16 20	(60)	63	(15) 16 20 (30) 32 40 50	125	63-125	
Rated ambient temperature 40°C		16 20 25 (30)		(25) (30) 32 40 50			(60) 63 (75) 80 100 (*3)			
Number of poles		3	3	3	3	3	3 4	3 4	3 4	
Phase line (*1)		3φ3W, 1φ3W, 1φ2W	3φ3W, 1φ3W, 1φ2W	3φ3W, 1φ3W, 1φ2W	3φ3W, 1φ3W, 1φ2W	3φ3W, 1φ3W, 1φ2W	3φ3W, 1φ3W, 1φ2W 3φ4W	3φ3W, 1φ3W, 1φ2W 3φ4W	3φ3W, 1φ3W, 1φ2W 3φ4W	
Rated operational voltage Ue (V) (*2) AC		100-440								
High-speed type	Rated current sensitivity (mA)	30,100/200/500 selectable								
	Max. operating time (s)	at IΔn 0.1 at 5IΔn 0.04								
Time-delay type	Rated current sensitivity (mA)	-								
	Max. operating time (s) (*4)	-								
Internal non-operating (s) (or more)		-								
Earth leakage indication system		Mechanical type (button)								
Rated short-circuit breaking capacities (kA)	AC	440V 5/5	5/5	7.5/7.5	7.5/7.5	7.5/7.5	25/25	25/25	36/36	
	IEC 60947-2	415V 5/5	5/5	7.5/7.5	7.5/7.5	7.5/7.5	30/30	30/30	36/36	
	EN 60947-2	400V 5/5	5/5	7.5/7.5	7.5/7.5	7.5/7.5	30/30	30/30	36/36	
	(Icu/Ics)	230V 10/10	10/10	15/15	15/15	15/15	50/50	50/50	85/85	
		200V 10/10	10/10	15/15	15/15	15/15	50/50	50/50	85/85	
		100V 10/10	10/10	15/15	15/15	15/15	50/50	50/50	85/85	
Rated impulse withstand voltage Uimp (kV)		6								
Current		AC								
Suitability for isolation		Compatible								
Reverse connection (below 230VAC)		Possible								
Number of operating cycles	Without current	10,000								
	With current	6,000								
Utilization category		A								
Rated short time withstand current Icu (kA) at 0.25s		-								
Pollution degree		2								
EMC environment condition (environment A or B)		A								
Overall dimensions (mm)	a	75	75	75	75	75	90 120	90 120	105 140	
	b	130	130	130	130	130	130	130	165	
	c	68	68	68	68	68	68	68	68	
	ca	90	90	90	90	90	90	90	92	
Mass of front-face type (kg)		0.75	0.75	0.75	0.8	0.8	1.1 1.4	1.1 1.4	1.9 2.5	
Installation and connections	Front connection (F)	●Screw terminal								
	Solderless (BOX) terminal (SL)	-								
	Rear (B)	●Round stud								
	Plug-in (PM)	-								
Cassette-type accessories	Alarm switch (AL)	●(*5)								
	Auxiliary switch (AX)	●(*5)								
	Shunt trip (SHT)	●(*5)								
	Undervoltage trip (UVT)	●(*5)								
	Earth leakage alarm switch (EAL)	-								
	With lead-wire terminal block (SLT)	-								
Test button module (TBM)	●(*6)									
External accessories	Enclosure	Closed (S)	-							
		Dustproof (I)	-							
		Waterproof (W)	-							
	Electrical operation device (NFM)	Panel mounting	●							
		Breaker mounting	●							
	Handle lock device	LC	●							
		HL	●							
		HL-S	●							
	External operating handle	(F)	●							
		(V)	●							
Terminal cover (TC-L, TC-S, TTC, BTC, PTC)	●									
Rear stud (B-ST)	●									
Plug-in (PM)	-									
IEC 35mm rail mounting adapters	●									
CE marking		Self-declaration								
CCC recognition		Recognition in process								
Marine use approval (NK, LR, ABS, GL)		-								
Automatic tripping device		Thermal-magnetic								
Trip button		Equipped								
Page of Characteristics and dimensions		182			182		184		188	

Notes: *1 If using a 3-pole earth leakage circuit breaker as a 1-pole 2-phase device, connect the left and right poles and not the central pole. When wiring to single-phase 3-wire, connect the neutral line to the central pole.
 *2 In case of time delay type, rated voltage is 200-440VAC.
 *3 In case of time delay type, rated current is produced with 20 amp. or less.
 *4 When the operating time are 0.45, 1.0 and 2.0 seconds, the Earth Leakage circuit breaker operates between 0.15 and 0.45 seconds, between 0.6 and 1.0 seconds and between 1.2 and 2.0 seconds respectively.

*5 Cassette type accessories are field mountable type. It can respond to adhesion attachment of a breaker as standard below 250A frame. (excluding UVT.)
 *6 Standard type is SLT equipped.
 *7 Place an order of other models in conjunction with the circuit breaker.
 *8 Not isolation compatible, excluding 400 to 800A frame.
 *9 AC100V does not acquire the CCC certification.





NV-H / NV-R (High-performance class) Harmonic Surge Ready

Frame (A)		50	60	63	100	125	125	225	250	250	
Model		NV63-HV			NV125-HV		NV125-HEV	NV250-HV		NV250-HEV	
Image											
Rated current In (A)		(15) 16 20	(60)	63	(15) 16 20 (30) 32 40 50	125	63-125	125 150 175	250	125-250	
Rated ambient temperature 40°C		(30) 32 40 50			(60) 63 (75) 80 100 (*3)			200 225			
Number of poles		3	3	3	3	4	3	4	3	3	
Phase line (*1)		3φ3W, 1φ3W, 1φ2W	3φ3W, 1φ3W, 1φ2W	3φ3W, 1φ3W, 1φ2W	3φ3W, 1φ3W, 1φ2W	3φ4W	3φ3W, 1φ3W, 1φ2W	3φ4W	3φ3W, 1φ3W, 1φ2W	3φ3W, 1φ2W	
Rated operational voltage Ue (V) (*2) AC		100-440									
High-speed type	Rated current sensitivity (mA)	30, 100/200/500 selectable									
	Max. operating time (s)	0.1									
	at IΔn	0.04									
	at 5IΔn	0.04									
Time-delay type	Rated current sensitivity (mA)	-									
	Max. operating time (s) (*4)	-									
	Internal non-operating (s) (or more)	-									
Earth leakage indication system		Mechanical type (button)									
Rated short-circuit breaking capacities (kA)	AC	440V	10/8	10/8	10/8	50/38	50/38	65/65	65/65	65/65	65/65
	IEC 60947-2	415V	10/8	10/8	10/8	50/38	50/38	70/70	70/70	70/70	70/70
	EN 60947-2	400V	10/8	10/8	10/8	50/38	50/38	75/75	75/75	75/75	75/75
	(Icu/Ics)	230V	25/19	25/19	25/19	100/75	100/75	100/100	100/100	100/100	100/100
		200V	25/19	25/19	25/19	100/75	100/75	100/100	100/100	100/100	100/100
		100V	25/19	25/19	25/19	100/75	100/75	100/100	100/100	100/100	100/100
Rated impulse withstand voltage Uimp (kV)		6	6	6	6	6	6	6	6	6	
Current		AC	AC	AC	AC	AC	AC	AC	AC	AC	
Suitability for isolation		Compatible	Compatible	Compatible	Compatible	Compatible	Compatible	Compatible	Compatible	Compatible	
Reverse connection (below 230VAC)		-	-	-	-	-	-	-	-	-	
Number of operating cycles	Without current	15,000	15,000	15,000	25,000	25,000	25,000	25,000	25,000	25,000	
	With current	8,000	8,000	8,000	10,000	10,000	10,000	10,000	10,000	10,000	
Utilization category		A	A	A	A	A	A	A	A	A	
Rated short time withstand current Icu (kA) at 0.25s		-	-	-	-	-	-	-	-	-	
Pollution degree		2	2	2	2	2	2	2	2	2	
EMC environment condition (environment A or B)		A	A	A	A	A	A	A	A	A	
Overall dimensions (mm)	a	75	75	75	90	120	90	120	105	140	
	b	130	130	130	130	130	130	165	165	165	
	c	68	68	68	68	68	68	68	68	68	
	ca	90	90	90	90	90	90	92	92	92	
Mass of front-face type (kg)		0.75	0.8	0.8	1.1	1.4	1.1	1.4	1.8	1.8	
Installation and connections	Front connection (F)	Page	●Screw terminal	●Screw terminal	●Screw terminal	●Screw terminal	●Screw terminal	●Screw terminal	●Screw terminal	●Screw terminal	
	Solderless (BOX) terminal (SL)	94	●Round stud	●Round stud	●Round stud	●Bar stud	●Bar stud	●Bar stud	●Bar stud	●Bar stud	
	Rear (B)		-	-	-	-	-	-	-	-	
Cassette-type accessories	Plug-in (PM)		-	-	-	-	-	-	-	-	
	Alarm switch (AL)	104	●(*5)	●(*5)	●(*5)	●(*5)	●(*5)	●(*5)	●(*5)	●(*5)	
	Auxiliary switch (AX)		●(*5)	●(*5)	●(*5)	●(*5)	●(*5)	●(*5)	●(*5)	●(*5)	
	Shunt trip (SHT)		●(*5)	●(*5)	●(*5)	●(*5)	●(*5)	●(*5)	●(*5)	●(*5)	
	Undervoltage trip (UVT)		●(*5)	●(*5)	●(*5)	●(*5)	●(*5)	●(*5)	●(*5)	●(*5)	
	Earth leakage alarm switch (EAL)		-	-	-	-	-	-	-	-	
	With lead-wire terminal block (SLT)	116	●	●	●	●	●	●	●	●	
Test button module (TBM)	117	●(*6)	●(*6)	●(*6)	●(*6)	●(*6)	●(*6)	●(*6)	●(*6)		
External accessories	Enclosure	Closed (S)	-	-	-	-	-	-	-	-	
		Dustproof (I)	-	-	-	-	-	-	-	-	
		Waterproof (W)	-	-	-	-	-	●	-	-	
	Electrical operation device (NFM)	135	-	-	-	●	●	●	●	●	
		Mechanical interlock (MI) (*7)	131	●	●	●	●	●	●	●	
	Handle lock device	LC	●	●	●	●	●	●	●	●	
		HL	●	●	●	●	●	●	●	●	
		HL-S	●	●	●	●	●	●	●	●	
	External operating handle	(F)	119	●	●	●	●	●	●	●	
		(V)		●	●	●	●	●	●	●	
Terminal cover (TC-L, TC-S, TTC, BTC, PTC)	123	●	●	●	●	●	●	●	●		
Rear stud (B-ST)	96	●	●	●	●	●	●	●	●		
Plug-in (PM)	96	-	-	-	-	-	-	-	-		
IEC 35mm rail mounting adapters	139	●	●	●	●	●	●	●	●		
CE marking		Self-declaration	Self-declaration	Self-declaration	Self-declaration	Self-declaration	Self-declaration	Self-declaration	Self-declaration	Self-declaration	
CCC recognition		Recognition in process	Recognition in process	Recognition in process	Recognition in process	Recognition in process	Recognized	Recognition in process	Recognition in process	Recognized	
Marine use approval (NK, LR, ABS, GL)		-	-	-	-	-	-	-	-	-	
Automatic tripping device		Thermal-magnetic	Thermal-magnetic	Thermal-magnetic	Thermal-magnetic	Thermal-magnetic	Electronic (effective value detector)	Thermal-magnetic	Thermal-magnetic	Electronic (effective value detector)	
Trip button		Equipped	Equipped	Equipped	Equipped	Equipped	Equipped	Equipped	Equipped	Equipped	
Page of Characteristics and dimensions		182			184		188	186		188	

Notes: *1 If using a 3-pole earth leakage circuit breaker as a 1-pole 2-phase device, connect the left and right poles and not the central pole. When wiring to single-phase 3-wire, connect the neutral line to the central pole.
 *2 In case of time delay type, rated voltage is 200-440VAC.
 *3 In case of time delay type, rated current is produced with 20 amp. or less.
 *4 When the operating time are 0.45, 1.0 and 2.0 seconds, the Earth Leakage circuit breaker operates between 0.15 and 0.45 seconds, between 0.6 and 1.0 seconds and between 1.2 and 2.0 seconds respectively.

*5 Cassette type accessories are field mountable type. It can respond to adhesion attachment of a breaker as standard. (excluding UVT.)
 *6 Standard type is SLT equipped.
 *7 Not isolation compatible.
 *8 AC100V does not acquire the CCC certification.

NV-H / NV-R (High-performance class) Harmonic Surge Ready

400 NV400-HEW		400 NV400-REW		630 NV630-HEW		800 NV800-HEW	
							
Adjustable 200 225 250 300 350 400		Adjustable 200 225 250 300 350 400		Adjustable 300 350 400 500 600 630		Adjustable 400 450 500 600 700 800	
3		3		3		3	
3φ3W, 1φ3W, 1φ2W		3φ3W, 1φ3W, 1φ2W		3φ3W, 1φ3W, 1φ2W		3φ3W, 1φ3W, 1φ2W	
100-440		100-440		100-440		100-440	
(30), 100/200/500 selectable		(30), 100/200/500 selectable		-		-	
0.1		0.1		-		-	
0.04		0.04		-		-	
(100/200/500 selectable)		(100/200/500 selectable)		(100/200/500 selectable)		(100/200/500 selectable)	
(0.45/1.0/2.0)		(0.45/1.0/2.0)		(0.45/1.0/2.0)		(0.45/1.0/2.0 selectable)	
(0.1/0.5/1.0)		(0.1/0.5/1.0)		(0.1/0.5/1.0)		(0.1/0.5/1.0)	
Mechanical type (button)		Mechanical type (button)		Mechanical type (button)		Mechanical type (button)	
65/65		125/63		65/65		65/65	
70/70		125/63		70/70		70/70	
70/70		125/63		70/70		70/70	
100/100		150/75		100/100		100/100	
100/100		150/75		100/100		100/100	
100/100		150/75		100/100		100/100	
8		8		8		8	
AC		AC		AC		AC	
Compatible		Compatible		Compatible		Compatible	
-		-		-		-	
6,000		6,000		6,000		4,000	
1,000		1,000		1,000		500	
B		B		B		B	
5		5		7.6		9.6	
3		3		3		3	
A		A		A		A	
140		140		140		210	
257		257		257		275	
103		103		103		103	
155		155		155		155	
6.6		6.6		7.1		15.3	
●Busbar terminal		●Busbar terminal		●Busbar terminal		●Busbar terminal	
-		-		-		-	
●Bar stud		●Bar stud		●Bar stud		●Bar stud	
-		-		-		-	
●(*5)		●(*5)		●(*5)		●(*5)	
●(*5)		●(*5)		●(*5)		●(*5)	
●(*5)		●(*5)		●(*5)		●(*5)	
●		●		●		●	
●		●		●		●	
●(*6)		●(*6)		●(*6)		●(*6)	
-		-		-		-	
●		●		●		●	
●		●		●		●	
●(*7)		●(*7)		●(*7)		●(*7)	
●		●		●		●	
●		●		●		●	
●		●		●		●	
●		●		●		●	
●		●		●		●	
●		●		●		●	
-		-		-		-	
-		-		-		-	
Self-declaration		Self-declaration		Self-declaration		Self-declaration	
Recognition in process		Recognition in process		Recognition in process		Recognition in process	
-		-		-		-	
Electronic (effective value detection)		Electronic (effective value detection)		Electronic (effective value detection)		Electronic (effective value detection)	
Equipped		Equipped		Equipped		Equipped	
192		192		196		198	

- Remarks: 1. Products with rated current parenthesized are produced when an order is placed.
 2. The setting is set to 500mA and delivered when not specifying the rated current sensitivity and the time of time-delay type of operation to 2.0 seconds.
 3. Specify "FP-LT" when using a flush plate product with a lead-wire terminal block.
 4. Specify "P-LT" when using a plug-in product with a lead-wire terminal block.
 5. The circuit breaker has the rated short-circuit breaking capacity specified in the shaded cells.

Rated operational voltage	Applicable circuit voltage	Available voltage range
100-440V	100/110/200/220/240/254/265/380/400/415/440V	80-484V
200-440V	200/220/240/254/265/380/400/415/440V	160-484V

NF-MB

Please specify MB

Frame (A)		30			32			50			100			225					
Model		NF32-SV						NF63-CV			NF63-SV			NF125-SV			NF250-SV		
Rated current In (A)		A	200/220V kW	400/440V kW	A	200/220V kW	400/440V kW	A	200/220V kW	400/440V kW	A	200/220V kW	400/440V kW	A	200/220V kW	400/440V kW	A	200/220V kW	400/440V kW
Rated motor capacity (kW)		25	5.5	11	32	7.5	15	45	11	22	7.1	1.5	-	100	-	55	225	55	110
Rated ambient temperature 40°C (45°C for marine use)		16	3.7	7.5				40	-	18.5	5	-	2.2	90	22	45	200	-	-
		12	-	5.5				32	7.5	15	4	0.75	1.5	71	18.5	37	175	45	90
		10	2.2	-				25	5.5	11				63	15	30	150	37	75
		8	-	3.7				16	3.7	7.5				45	11	22	125	30	-
		7.1	1.5	-				12	-	5.5				(40)	-	19			
		5	-	-				10	2.2	-				32	7.5	15			
		4	0.75	1.5				8	-	3.7				(25)	5.5	11			
														(16)	3.7	7.5			
														(12.5)	-	5.5			
Number of poles		3						3			3			3			3		
Rated insulation voltage Ui (V)		500						500			500			500			500		
Rated short-circuit breaking capacities (kA)	440V	2.5/2.5			2.5/2.5			2.5/2.5			7.5/7.5			25/25			36/36		
	415V	2.5/2.5			2.5/2.5			2.5/2.5			7.5/7.5			30/30			36/36		
	400V	5/5			5/5			5/5			7.5/7.5			30/30			36/36		
	380V	5/5			5/5			5/5			7.5/7.5			30/30			36/36		
	230V	7.5/7.5			7.5/7.5			7.5/7.5			15/15			50/50			85/85		
Rated impulse withstand voltage Uimp (kV)	8						8			8			8			8			
Current	AC						AC			AC			AC			AC			
Suitability for isolation	Compatible						Compatible			Compatible			Compatible			Compatible			
Reverse connection	Possible						Possible			Possible			Possible			Possible			
Number of operating cycles	Without current	10,000			10,000			10,000			15,000			25,000			25,000		
	With current (440VAC)	6,000			6,000			6,000			8,000			10,000			10,000		
Utilization category	A						A			A			A			A			
Pollution degree	3						3			3			3			3			
EMC environment condition (environment A or B)	N/A						N/A			N/A			N/A			N/A			
Overall dimensions (mm)	a	75			75			75			75			90			105		
	b	130			130			130			130			130			165		
	c	68			68			68			68			68			68		
	ca	90			90			90			90			90			92		
	Mass of front-face type (kg)	0.65			0.65			0.65			0.7			1.0			1.6		
Installation and connections	Front connection (F)	●Screw terminal						●Screw terminal			●Screw terminal			●Screw terminal			●Screw terminal		
	Solderless (BOX) terminal (SL)	-						-			-			-			-		
	Rear (B)	●Round stud						●Round stud			●Round stud			●Bar stud			●Bar stud		
Cassette-type accessories	Plug-in (PM)	●						●			●			●			●		
	Alarm switch (AL)	●(*1)						●(*1)			●(*1)			●(*1)			●(*1)		
	Auxiliary switch (AX)	●(*1)						●(*1)			●(*1)			●(*1)			●(*1)		
	Shunt trip (SHT)	●(*1)						●(*1)			●(*1)			●(*1)			●(*1)		
	Undervoltage trip (UVT)	●(*1)						●(*1)			●(*1)			●(*1)			●(*1)		
	With lead-wire terminal block (SLT)	●						●			●			●			●		
External accessories	Enclosure	Closed (S)	●			●			●			●			●				
		Dustproof (I)	●			●			●			●			●				
		Waterproof (W)	●			●			●			●			●				
	Electrical operation device (NFM)	-						-			-			●(*3)			●(*3)		
	Mechanical interlock (MI) (*2)	Panel mounting	●			●			●			●			●				
		Breaker mounting	●			●			●			●			●				
	Handle lock device	LC	●			●			●			●			●				
		HL	●			●			●			●			●				
		HL-S	●			●			●			●			●				
	External operating handle	(F)	●			●			●			●			●				
		(V)	●			●			●			●			●				
	Terminal cover (TC-L, TC-S, TTC, BTC, PTC)	●						●			●			●			●		
	Rear stud (B-ST)	●						●			●			●			●		
Plug-in (PM)	●						●			●			●			●			
IEC 35mm rail mounting adapters	●						●			●			-			-			
CE marking	Self-declaration						Self-declaration			Self-declaration			Self-declaration			TUV approval			
CCC recognition	Recognition in process						Recognition in process			Recognition in process			Recognition in process			Recognition in process			
Marine use approval (NK, LR, ABS, GL)	☆						☆			☆			☆			☆			
Automatic tripping device	Thermal-magnetic						Thermal-magnetic			Thermal-magnetic			Thermal-magnetic			Thermal-magnetic			
Trip button	Equipped						Equipped			Equipped			Equipped			Equipped			
Page of Characteristics and dimensions	144						144			144			146			150			

Notes: *1 The cassette type design makes it easy for customer to install. Available for installation on side (excluding UVT).
 *2 Not isolation compatible.
 *3 Place an order of other models in conjunction with the circuit breaker.

Remarks: 1. The motor circuit breakers do not have an applicable rated motor capacity. Select a motor circuit breaker based on the total load current of the motor.
 2. Products with rating parenthesized are produced when an order is placed.
 3. Specify "P-LT" when using a plug-in product with a lead wire terminal block.
 4. The circuit breaker has the rated short circuit breaking capacity specified in the shaded cells.
 5. Please refer to "Table 4-17", of Page 75 for details.

UL 489 Listed Molded Case Circuit Breakers

Frame (A)		50		100		125		125					
Model		NF50-SVFU		NF100-CVFU		NF125-SVU		NF125-HVU					
Image													
Rated current In (A) (*4) Rated ambient temperature 40°C (IEC 30°C)		(3) 5 10 15 20 30 40 50		60 (70) 75 (80) (90) 100		15 20 30 40 50 60 (70) 75 (80) (90) 100		125 15 20 30 40 50 60 (70) 75 (80) (90) 100					
Number of poles		2 3		2 3		2 3		2 3					
Rated short-circuit breaking capacities (kA)	UL 489 CSA C22.2 No.5-02	Rated voltage	AC (V)	240		240		480		480			
			DC (V)	-		-		-		-			
		AC	600Y/347V	-		-		-		-		600Y/347	
			480V	-		-		30		30		18	
			480Y/277V	-		-		-		-		50	
			240V	14		14		50		50		100	
	DC	120V	-		-		-		-		-		
		60V	-		-		-		-		-		
	IEC 60947-2 EN 60947-2 (Icu/Ics)	Rated insulation voltage Ui (V)	AC (V)	440		600		690		690		690	
			DC (V)	-		-		-		-		-	
		AC	690V	-		-		8/4		8/4		10/5	
			500V	-		7.5/4		18/9		18/9		25/13	
			440V	7.5/4		10/5		30/15		30/15		50/25	
			415V	10/5		10/5		30/15		30/15		50/25	
400V			10/5		10/5		30/15		30/15		50/25		
380V			10/5		10/5		30/15		30/15		50/25		
230V			15/8		15/8		50/25		50/25		100/50		
250V			-		-		-		-		-		
DC	60V	-		-		-		-		-			
	60V	-		-		-		-		-			
Rated impulse withstand voltage Uimp (kV)		6		8		8		8		8			
Current (*1)		AC		AC		AC		AC		AC			
Suitability for isolation		Compatible		Compatible		Compatible		Compatible		Compatible			
Reverse connection		-		Possible		Possible		Possible		Possible			
Utilization category		A		A		A		A		A			
Pollution degree		3		3		3		3		3			
EMC environment condition (environment A or B)		N/A		N/A		N/A		N/A		N/A			
Overall dimensions (mm)		a	36	54	50	75	90	90	90	90	90		
		b	120		150		160		160		160		
		c	68		68		68		68		68		
		ca	90		90		90		90		90		
Mass of front-face type (kg)		0.3 0.45		0.55 0.8		1.0 1.1		1.0 1.1		1.1 1.1			
Installation and connections	Front (F)	Screw terminal (AMP-N)	●		●		●		●		●		
		Solderless terminal (SL)	-		-		-		-		-		
		Bar (BAR)	-		● (*5)		-		-		-		
		Power supply solderless load bar (SLBAR)	-		● (*5, 6)		● (*6)		● (*6)		● (*6)		
Cassette-type accessories (*2)	Alarm switch (AL)	Auxiliary switch (AX)	● (*7)		● (*7)		● (*7)		● (*7)		● (*7)		
		Shunt trip (SHT)	● (*7)		● (*7)		● (*7)		● (*7)		● (*7)		
		Undervoltage trip (UVT)	● (*7)		● (*7)		● (*7)		● (*7)		● (*7)		
		With lead-wire terminal block (SLT)	●		●		●		●		●		
External accessories (*2)	Mechanical interlock (MI)	Handle lock device (HL)	-		-		-		-		-		
		Handle lock device (HL-S)	-		-		-		-		-		
		External operating handle (F)	●		●		●		●		●		
		External operating handle (V)	●		●		●		●		●		
Terminal cover	Large terminal cover (TC-L)	123		123		123		123		123			
	Small terminal cover (TC-S)	124		124		124		124		124			
IEC 35mm rail mounting adapters		139		139		139		139		139			
CE marking		TUV approval		TUV approval		TUV approval		TUV approval		TUV approval			
CCC recognition		Recognition in process		Recognition in process		Recognition in process		Recognition in process		Recognition in process			
Automatic tripping device		Thermal-magnetic		Thermal-magnetic		Thermal-magnetic		Thermal-magnetic		Thermal-magnetic			
Trip button		Equipped		Equipped		Equipped		Equipped		Equipped			
Page of Characteristics and dimensions		200		202		204		204		204			

Notes: *1 The trip action characteristics differ between AC and DC for products that are compatible with both AC and DC.
 *2 These accessories differ from the general and CE/CCC products in specifications. Please consult us for details.
 *3 The standard structure conforms to IP20 (finger protection).
 *4 The rated ambient temperature for NF50-SVFU, NF100-CVFU, NF125-SVU and NF125-HVU is specified at 40°C also by IEC.
 *5 The circuit breakers with busbar terminals have insulation barriers.
 *6 Circuit breakers for power supply solderless load screw terminal (SL/AMP-N) are available. In this case, a busbar terminal is not provided on the load side.
 *7 These cassette type circuit breakers can be installed by the customer. They can be installed with their side faces in close contact (except NF50-SVFU and UVT).

Remarks: 1. Products with rated current parenthesized are produced when an order is placed.
 2. The circuit breaker has the rated short-circuit breaking capacity specified in the shaded cells.
 3. The 3-pole circuit breakers can be used on single-phase circuits.

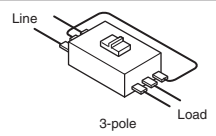

US UL Standard 489
 UL File No.E167691 Body
 UL File No.E108284 Accessories

Canada CSA Standard
 C22.2 No.5

UL 489 Listed Molded Case Circuit Breakers

Frame (A)		225		250					
Model		NF225-CWU		NF250-SVU		NF250-HVU			
Image									
Rated current In (A) (*5)		125 150 175	(250)	125 150 175	250	125 150 175	250		
Rated ambient temperature 40°C (IEC 30°C)		200 225		200 225		200 225			
Number of poles		3	3	3	3	3	3		
Rated short-circuit breaking capacities (kA)	UL 489 CSA C22.2 No.5-02	Rated voltage	AC (V)	240	240	480	480	600Y/347	600Y/347
			DC (V)	-	-	-	-	-	-
		AC	600Y/347V	-	-	-	-	18	18
			480V	-	-	35	35	50	50
			480Y/277V	-	-	-	-	-	-
	DC	240V	35	35	65	65	100	100	
		120V	-	-	-	-	-	-	
		60V	-	-	-	-	-	-	
	IEC 60947-2 EN 60947-2 (Icu/Ics)	Rated insulation voltage Ui (V)	AC (V)	600	600	690	690	690	690
			DC (V)	-	-	-	-	-	-
AC		690V	-	-	8/4	8/4	10/5	10/5	
		500V	10/5	-	25/13	25/13	36/18	36/18	
		440V	15/8	15/8	36/18	36/18	50/25	50/25	
		415V	18/9	18/9	36/18	36/18	50/25	50/25	
		400V	18/9	18/9	36/18	36/18	50/25	50/25	
		380V	18/9	18/9	36/18	36/18	50/25	50/25	
		230V	35/18	35/18	65/33	65/33	100/50	100/50	
		250V (*3)	10/5	10/5	-	-	-	-	
DC	60V	-	-	-	-	-	-		
Rated impulse withstand voltage Uimp (kV)		6	6	8	8	8	8		
Current (*1)		AC/DC compatible	AC/DC compatible	AC	AC	AC	AC		
Suitability for isolation		Compatible	Compatible	Compatible	Compatible	Compatible	Compatible		
Reverse connection		Possible	Possible	Possible	Possible	Possible	Possible		
Utilization category		A	A	A	A	A	A		
Pollution degree		3	3	3	3	3	3		
EMC environment condition (environment A or B)		N/A	N/A	N/A	N/A	N/A	N/A		
Overall dimensions (mm)		a	105	105	105	105	105		
		b	165	165	185	185	185		
		c	68	68	68	68	68		
		ca	92	92	92	92	92		
		Mass of front-face type (kg)	1.5	1.5	1.6	1.6	1.6	1.6	
Installation and connections	Front (F)	Screw terminal (AMP-N)	●	●	●	●	●		
		Solderless terminal (SL)	-	-	●	●	●		
		Bar (BAR)	●	●	●	●	●		
		Power supply solderless load bar (SUBAR)	-	-	●(*8)	●(*8)	●(*8)	●(*8)	
Cassette-type accessories (*2)	104	Alarm switch (AL)	●	●	●(*7)	●(*7)	●(*7)		
		Auxiliary switch (AX)	●	●	●(*7)	●(*7)	●(*7)		
		Shunt trip (SHT)	●	●	●(*7)	●(*7)	●(*7)		
		Undervoltage trip (UVT)	●	●	●(*7)	●(*7)	●(*7)		
		With lead-wire terminal block (SLT)	●	●	●	●	●		
External accessories (*2)	131	Mechanical interlock (MI)	●(*6)	●(*6)	-	-	-		
		Handle lock device	(HL)	●	●	●	●	●	
			(HL-S)	●	●	●	●	●	
		External operating handle	(F)	●	●	●	●	●	
			(V)	●	●	●	●	●	
Terminal cover	Large terminal cover (TC-L)	123	123	123	123	123			
Small terminal cover (TC-S)	124	124	124	124	124				
IEC 35mm rail mounting adapters	139	139	139	139	139				
CE marking		TÜV approval	Self-declaration	TÜV approval	TÜV approval	TÜV approval	TÜV approval		
CCC recognition		Recognition in process	-	Recognition in process	Recognition in process	Recognition in process	Recognition in process		
Automatic tripping device		Thermal-magnetic	Thermal-magnetic	Thermal-magnetic	Thermal-magnetic	Thermal-magnetic	Thermal-magnetic		
Trip button		Equipped	Equipped	Equipped	Equipped	Equipped	Equipped		
Page of Characteristics and dimensions		206		208		208			

- Notes:
- *1 The trip action characteristics differ between AC and DC for products that are compatible with both AC and DC.
 - *2 These accessories differ from the general products in specifications. Please consult us for details.
 - *3 When using a 3-pole circuit breaker, use two poles. When wired as shown right, NF225-CWU can be used at up to 400 V DC.
 - *4 Since NF225-CWU comes with a protective cover, it has an IP20 (finger protection) structure as standard. Other models have IP20 (finger protection) structures as standard.
 - *5 The rated ambient temperature for NF250-SVU and NF250-HVU is specified at 40°C also by IEC.
 - *6 Not isolation compatible.
 - *7 These cassette type circuit breakers can be installed by the customer. They can be installed with their side faces in close contact (except UVT).
 - *8 Circuit breakers for power supply solderless load screw terminal (SL/AMP-N) are available. In this case, a busbar terminal is not provided on the load side.

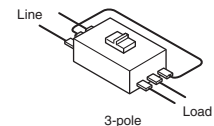

- Remarks:
1. Products with rated current parenthesized are produced when an order is placed.
 2. The circuit breaker has the rated short-circuit breaking capacity specified in the shaded cells.
 3. The 3-pole circuit breakers can be used on single-phase circuits.



US UL Standard 489
 UL File No.E167691 Body
 UL File No.E108284 Accessories

Canada CSA Standard
 C22.2 No.5

UL 489 Listed Molded Case Circuit Breakers

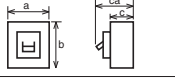
Frame (A)		400		600		
Model		NF-SKW		NF-SLW		
Image						
Rated current In (A) Rated ambient temperature 40°C		250 300 350 400		500 600		
Number of poles		3		3		
Rated short-circuit breaking capacities (kA)	UL 489 CSA C22.2 No.5-02	Rated voltage	AC (V)	600Y/347		
			DC (V)	-		
		AC	600Y/347V	20		
			480V	35		
			480Y/277V	-		
	DC	240V	65			
		120V	-			
		60V	-			
	IEC 60947-2 EN 60947-2 (Icu/Ics)	Rated insulation voltage Ui (V)	AC	690		
			DC	-		
AC		690V	10/10 (5/5) (*5)			
		500V	30/30 (25/25) (*5)			
		440V	42/42 (36/36) (*5)			
		415V	45/45 (36/36) (*5)			
		400V	45/45 (36/36) (*5)			
		380V	50/50 (42/42) (*5)			
		230V	85/85 (65/65) (*5)			
		250V	-			
DC	60V	-				
Rated impulse withstand voltage Uimp (kV)		8		8		
Current (*1)		AC		AC		
Suitability for isolation		Compatible		Compatible		
Reverse connection		Possible		Possible		
Utilization category		A		A		
Pollution degree		3		3		
EMC environment condition (environment A or B)		N/A		N/A		
Overall dimensions (mm)		a	140			
		b	257			
		c	103			
		ca	155			
		cb	155			
Mass of front-face type (kg)		5.7		9.6		
Installation and connections	Front (F)	Screw terminal (AMP-N)	Page			
		Solderless terminal (SL)	-			
		Bar (BAR)	94			
		Power supply solderless load bar (SLBAR)	-			
			●(*3)			
Cassette-type accessories (*2)	Alarm switch (AL)	-		●		
	Auxiliary switch (AX)	-		●		
	Shunt trip (SHT)	104		●		
	Undervoltage trip (UVT)	-		●		
	With lead-wire terminal block (SLT)	116		●		
External accessories (*2)	Mechanical interlock (MI)	131		●(*6)		
	Handle lock device	(HL)	129		●(*4)	
		(HL-S)	-		-	
	External operating handle	(F)	119		●	
		(V)	-		●	
Terminal cover	Large terminal cover (TC-L)	123		●		
	Small terminal cover (TC-S)	124		●		
	IEC 35mm rail mounting adapters	139		-		
CE marking		TUV approval		TUV approval		
CCC recognition		-		-		
Automatic tripping device		Thermal-magnetic		Thermal-adjustable magnetic		
Trip button		Equipped		Equipped		
Page of Characteristics and dimensions		210		212		

Notes: *1 The trip action characteristics differ between AC and DC for products that are compatible with both AC and DC.
 *2 These accessories differ from the general products in specifications. Please consult us for details.
 *3 The circuit breakers with busbar terminals have insulation barriers.
 *4 Please consult us. (Models which are not UL or TUV certified but can be locked in the ON and OFF positions are available.)
 *5 The values in parentheses apply to the circuit breakers with solderless terminals.
 *6 Not isolation compatible.

Remarks: 1. Products with rated current parenthesized are produced when an order is placed.
 2. The circuit breaker has the rated short-circuit breaking capacity specified in the shaded cells.
 3. The 3-pole circuit breakers can be used on single-phase circuits.

US UL Standard 489
UL File No.E167691 Body
UL File No.E108284 Accessories

Canada CSA Standard
C22.2 No.5

UL 489 Listed Earth Leakage Circuit Breakers (Harmonic Surge Ready)

Frame (A)		50		100		125		250					
Model		NV50-SVFU		NV100-CVFU		NV125-SVU		NV125-HVU		NV250-SVU		NV250-HVU	
Image													
Rated current I _n (A)		(5) (10) 15 20		60 (70) 75		15 20 30 (40)		15 20 30 (40)		125 150 175		125 150 175	
Rated ambient temperature 40°C		30 40 50		(80) (90) 100		50 60 75 100		125		200 225		250	
Number of poles		2 3		3		3		3		3		3	
Phase line (*1)		1φ2W 3φ3W, 1φ2W		3φ3W, 1φ2W		3φ3W, 1φ2W		3φ3W, 1φ2W		3φ3W, 1φ2W		3φ3W, 1φ2W	
Rated operational voltage AC V		UL 489 IEC 60947-2 EN 60947-2		120-240		120-240		120-480		120-480		120-480	
High-speed type		100-240		100-440		100-440		100-440		100-440		100-440	
Rated current sensitivity I _{Δn} mA		30 50		30 50 100		30, 50, 100/200/500 selectable		30, 50, 100/200/500 selectable		30, 50, 100/200/500 selectable		30, 50, 100/200/500 selectable	
Pickup current, UL 1053		75% of I _{Δn}		75% of I _{Δn}		75% of I _{Δn}		75% of I _{Δn}		75% of I _{Δn}		75% of I _{Δn}	
Max. operating time (s) at 5I _{Δn} (*4)		0.04		0.04		0.04		0.04		0.04		0.04	
Earth leakage indication system		Display window		Mechanical type (button)		Mechanical type (button)		Mechanical type (button)		Mechanical type (button)		Mechanical type (button)	
Rated short-circuit breaking capacities (kA)		UL 489 CSA C22.2 No.5-02		AC		480V		-		-		-	
		240V		-		14		14		14		14	
		120V		14		14		14		14		14	
		440V		7.5/4		10/5		30/15		30/15		50/25	
		400V		10/5		10/5		30/15		30/15		50/25	
		230V		15/8		15/8		50/25		50/25		100/50	
		100V		15/8		15/8		50/25		50/25		100/50	
Rated impulse withstand voltage U _{imp} (kV)		4		6		6		6		6		6	
Suitability for isolation		Compatible		Compatible		Compatible		Compatible		Compatible		Compatible	
Reverse connection (below 240VAC)		-		Possible		Possible		Possible		Possible		Possible	
Utilization category		A		A		A		A		A		A	
Pollution degree		2		2		2		2		2		2	
EMC environment condition (environment A or B)		A		A		A		A		A		A	
Overall dimensions (mm)				a 36 54		75		90		90		105	
		b 120		150		160		160		160		185	
		c 68		68		68		68		68		68	
		ca 90		90		90		90		90		92	
Mass of front-face type (kg)		0.4 0.5		0.9		1.2		1.2		1.2		1.8	
Installation and connections		Screw terminal (AMP/N)		Page		●		●		●		●	
		Solderless terminal (SL)		94		●		●		●		●	
		Bar (BAR)		-		●(*5)		●		●		●	
		Power supply solderless load bar (SLBAR)		-		-		●		●		●	
Cassette-type accessories (*2)		Alarm switch (AL)		-		●(*8)		●(*8)		●(*8)		●(*8)	
		Auxiliary switch (AX)		-		●(*8)		●(*8)		●(*8)		●(*8)	
		Shunt trip (SHT)		-		●(*8)		●(*8)		●(*8)		●(*8)	
		Undervoltage trip (UVT)		-		●(*8)		●(*8)		●(*8)		●(*8)	
		With lead-wire terminal block (SLT)		116		-		●		●		●	
		Test button module (TBM)		116		●(*9)		-		-		-	
External accessories (*2)		Mechanical interlock (MI)		131		-		-		-		-	
		Handle lock device (HL)		129		●		●		●		●	
		External operating handle (F)		119		●		●		●		●	
		Terminal Large terminal cover (TC-L)		123		●		●		●		●	
		Small terminal cover (TC-S)		124		●(*3)		-(*3)		-(*3)		-(*3)	
		IEC 35mm rail mounting adapters		139		Standard accessory		Standard accessory		-		-	
CE marking		TUV approval		TUV approval		TUV approval		TUV approval		TUV approval		TUV approval	
CCC recognition		Recognition in process		Recognition in process		Recognition in process		Recognition in process		Recognition in process		Recognition in process	
Automatic tripping device		Thermal-magnetic		Thermal-magnetic		Thermal-magnetic		Thermal-magnetic		Thermal-magnetic		Thermal-magnetic	
Trip button		Equipped		Equipped		Equipped		Equipped		Equipped		Equipped	
Page of Characteristics and dimensions		200		202		204		204		208		208	

- Notes: *1 If using a 3-pole earth leakage circuit breaker as a 1-pole 2-phase device, connect the left and right poles and not the central pole.
 *2 These are different from general models in specifications. Consult us for the details.
 *3 The standard structure conforms to IP20 (finger protection).
 *4 The maximum operating time is 0.1 according to UL 1053.
 *5 The circuit breakers with busbar terminals have insulation barriers.
 *6 Circuit breakers for power supply solderless load screw terminal (SL/AMP-N) are available. In this case, a bar terminal is not provided on the load side.
 *7 Circuit breakers for 100 V AC do not have obtained CCC certificate.
 *8 These cassette type accessories can be installed by the customer. They can be installed with their side faces in close contact with circuit breakers (except NV50-SVFU and UVT).
 *9 Standard type is SLT equipped.





Remarks: 1. Products with rated current parenthesized are produced when an order is placed.

Rated operational voltage	Applicable circuit voltage	Available voltage range
120-240V (UL)	120/240V	66-264V
120-240-480V (UL)	120/240/480V	66-528V
240V (UL)	240V	132-264V
100-230V (IEC)	100/110/200/220/230V	85-253V
100-240V (IEC)	100/110/200/220/230/240V	85-264V
100-230-400-440V (IEC)	100/110/200/220/230/240/254/265/380/400/415/440V	85-484V
230-400-440V (IEC)	230/240/254/265/380/400/415/440V	195-484V

US UL Standard 489
 UL File No.E167691 Body
 UL File No.E108284 Accessories

Canada CSA Standard
 C22.2 No.144
 C22.2 No.5

MDU Breakers

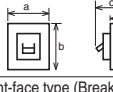
Frame (A)		250				400				630				800					
Model		NF250-SEV with MDU NF250-HEV with MDU				NF400-SEP with MDU NF400-HEP with MDU				NF630-SEP with MDU NF630-HEP with MDU				NF800-SEP with MDU NF800-HEP with MDU					
Image																			
Rated current In (A) Rated ambient temperature 40°C		Adjustable 125-250A (12.5A Step)				Adjustable 200 225 250 300 350 400				Adjustable 300 350 400 500 600 630				Adjustable 400 450 500 600 700 800					
Number of poles		3		4		3		4		3		4		3		4			
Phase line		3φ3W, 1φ3W, 1φ2W		3φ4W		3φ3W, 1φ3W, 1φ2W		3φ4W		3φ3W, 1φ3W, 1φ2W		3φ4W		3φ3W, 1φ3W, 1φ2W		3φ4W			
Rated insulation voltage Ui (V)		690				690				690				690					
Rated short-circuit breaking capacities (kA)	IEC 60947-2 (Icu/Ics)	AC	690V	8/8		10/8		10/10		10/10		10/10		15/15		10/10		15/15	
			500V	18/18		30/23		30/30		50/50		30/30		50/50		30/30		50/50	
			440V	36/36		50/50		42/42		65/65		42/42		65/65		42/42		65/65	
			415V	36/36		70/70		45/45		70/70		45/45		70/70		45/45		70/70	
			400V	36/36		75/75		45/45		70/70		45/45		70/70		45/45		70/70	
			380V	36/36		75/75		45/45		70/70		45/45		70/70		45/45		70/70	
			230V	85/85		100/100		85/85		100/100		85/85		100/100		85/85		100/100	
			200V	85/85		100/100		85/85		100/100		85/85		100/100		85/85		100/100	
			100V	-		-		-		-		-		-		-		-	
			Rated impulse withstand voltage Uimp (kV)		8				8				8				8		
Current		AC				AC				AC				AC					
Suitability for isolation		Compatible				Compatible				Compatible				Compatible					
Reverse connection (below 240VAC)		-				-				-				-					
Number of operating cycles		Without current		25,000				6,000				6,000				4,000			
		With current		10,000				1,000				1,000				500			
Utilization category		A				B				B				B					
Pollution degree		3				3				3				3					
EMC environment condition (environment A or B)		A				A				A				A					
Overall dimensions (mm)			a	105	140	105	140	140	185	140	185	210	280	210	280	210	280	210	280
			b	165				257				275				275			
			c	68				103				103				103			
			ca	92				155				155				155			
Mass of front-face type (Breaker mounting) (kg)		1.8	2.3	1.8	2.3	6.2	8	6.2	8	10.7	13.8	10.7	13.8	11.1	14.4	11.1	14.4		
MDU installation		Breaker mounting, Panel mounting (*1)								Breaker mounting, Panel mounting (*2)									
Insulation connections	Front (F)		●				●				●				●				
	Rear (*3) (B)		●				●				●				●				
Plug-in (PM)		94				-				-				-					
Cassette-type accessories	Alarm switch (AL)		●(*4)		●(*4)		●(*4)		●(*4)		●(*4)		●(*4)		●(*4)		●(*4)		
	Auxiliary switch (AX)		●(*4)		●(*4)		●(*4)		●(*4)		●(*4)		●(*4)		●(*4)		●(*4)		
	Shunt trip (SHT)		●(*4)		●(*4)		●(*4)		●(*4)		●(*4)		●(*4)		●(*4)		●(*4)		
	Undervoltage trip (UVT)		●(*4)		●(*4)		●(*4)		●(*4)		●(*4)		●(*4)		●(*4)		●(*4)		
	MDU transform AL, AX, AL + AX (MG)		●(*4)		●(*4)		●(*4)		●(*4)		●(*4)		●(*4)		●(*4)		●(*4)		
	With lead-wire terminal block (SLT)		●		●		●		●		●		●		●		●		
	Alarm contact output (*5) (PAL)		●		●		●		●		●		●		●		●		
Trip-indicator (TI)		-		-		● PAL 1a, OAL 1a		● PAL 1a, OAL 1a		● PAL 1a, OAL 1a		● PAL 1a, OAL 1a		● PAL 1a, OAL 1a		● PAL 1a, OAL 1a			
Electrical operation device (*6) (NFM)		135				Available only for the MDU panel mounting type				Available only for the MDU panel mounting type. Disavailable alarm contact output.				-					
Mechanical interlock (MI) (*7)		Panel mounting		●		Panel mounting		●		Panel mounting		●		Panel mounting		●			
Handle lock device		LC		●		LC		●		LC		●		LC		●			
External operating handle		HL		●		HL		●		HL		●		HL		●			
Terminal cover		HL-S		-		HL-S		-		HL-S		-		HL-S		-			
Rear stud (B-ST)		96		●(*8)		●(*8)		●(*8)		●(*8)		●(*8)		●(*8)		●(*8)			
Automatic tripping device		Electronic (effective value detection)				Electronic (effective value detection)				Electronic (effective value detection)				Electronic (effective value detection)					
MDU measurement specifications		-				-				-				-					
Trip button		Equipped				Equipped				Equipped				Equipped					
Page of Characteristics and dimensions		214				216				218				218					

- Notes: *1 In the case of panel mounting, the panel holder plate, the screws and the MDU connection cable (2m) are packed as standard. The MDU connection cable of 0.5m, 3m, 5m and 10m can be specified when ordering. And dimension of the front panel drilling of the breaker is different between breaker mounting and panel mounting.
- *2 In the case of panel mounting, the panel holder plate, the nuts and the MDU connection cable (2m) are packed as standard. The MDU connection cable of 0.5m, 3m, 5m and 10m can be specified when ordering.
- *3 For 250AF breakers, the studs are packed as standard. For 400/630/800AF breakers, please specify the installation angle of the studs because it is installed to the breaker before shipping.
- *4 It can be installed to the breaker by each customer.
- *5 In the case of the breaker with alarm contact output, the module (terminal) is attached to the right side of the breaker and the control power (AC/DC 100-240V 50-60Hz 5VA) is needed. The Output function for alarm output of PAL/EAL can set "Self-holding" or "Auto-reset". Default setup is "Auto-reset".
- *6 For 250AF of electrical operation device, AL is used for the trip indication as standard. The breaker with alarm output contact is not available.
- *7 Not isolation compatible.
- *8 In the case of breaker mounting, the terminal cover is special type for MDU breaker.

Remarks: 1.

Rated operational voltage	Applicable circuit voltage	Available voltage range
100-440V	100/110/200/220/240/254/265/380/400/415/440V	80-484V
200-440V	200/220/240/254/265/380/400/415/440V	160-484V

Measuring Display Unit Breakers (Circuit Breakers with Measuring Display Unit)

● Three major features of Mitsubishi Measuring Display Unit Breakers

1. Saving of space and labor for installation
2. Improved and diversified functions
3. Provision of total cost advantages

Mitsubishi Measuring Display Unit Breakers with built-in VT and CT and Measuring Display Unit realize measurement, display and transmission of electric circuit information in small space with less installation and wiring work and provide total cost advantages.

The Measuring Display Unit Breakers full of functions in small bodies are suitable for monitoring and protection of electric circuits and maintenance of equipment. A wide variety of models applicable to various networks supports the customers' energy saving activities through detailed energy control as energy saving supporting devices.

● Simply realizing measurement and monitoring of electric circuits for supporting various types of energy saving control

The circuit breakers measure and display the load current, line voltage, electric power, electric energy, harmonic current, leak current and power factor to realize detailed energy control. They support customers' energy saving control.

WS-V Series Measuring Display Unit Breakers

Applicable models
NF250-SEV with MDU, NF250-HEV with MDU

- The measuring display unit can be installed on the body or panel.

【Examples of installation of measuring display unit】

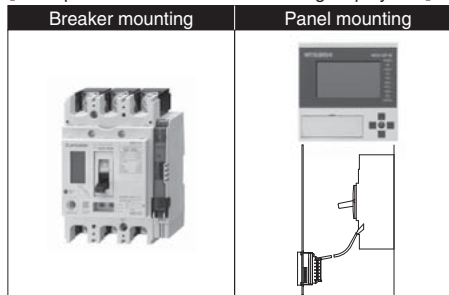

Note: The size of holes in the face board of the circuit breaker body varies depending on whether the measuring display unit is installed on the body or the panel.

◆ Model list

Model type	Type name
CC-Link communication	MDU-DP-C
Electric energy pulse output	MDU-DP-P
No transmission	MDU-DP-N

◆ Measuring Display Unit cable list

Type name	Cable length
MDU-DP-CB-2M	2m
MDU-DP-CB-3M	3m
MDU-DP-CB-5M	5m
MDU-DP-CB-10M	10m

W & WS Series Measuring Display Unit Breakers

Applicable models
NF400-SEP with MDU, NF400-HEP with MDU, NF630-SEP with MDU, NF630-HEP with MDU, NF800-SEP with MDU, NF800-HEP with MDU

- The measuring display unit can be installed on the body or panel.

【Examples of installation of measuring display unit】

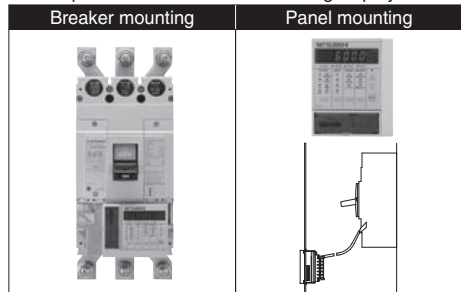

◆ Model list

Model type	Type name	Remarks
CC-Link communication	MDU-AC ○○○	• The model names do not include ○○○.
Electric energy pulse output	MDU-AP ○○○	• When installing the Measuring Display Unit on the body, specify the A frame type in ○○○.
No transmission	MDU-AN ○○○	For example, when the circuit breaker NF400-SEP with MDU and the Measuring Display Unit with CC-Link communication are combined, the model name is MDU-AC400. If 630A frame or 800A frame is used, specify 630 or 800 in ○○○. • When installing the Measuring Display Unit on the panel, specify the cable length (0.5 m, 2 m, 3 m, 5 m or 10 m) in ○○○. For example, when the Measuring Display Unit with CC-Link communication is installed on the panel with a 3-m cable, the model name is MDU-AC-PANEL 3M.

● Specifications for Measuring Display Unit (1)

The measurement and display items vary depending on the model or frame A.
(For the measurement accuracy, please refer to page 39.)

Applicable models
NF250-SEV with MDU, NF250-HEV with MDU

Table 2-1

Measurement and memory items (accuracy) (*1) (*2)		Model	Display	Storage (*3)	With CC-Link communication	Remarks
Load current (±1.0%)	Present value	Each phase	●	—	●	
		General (average value) (*5)	●	—	●	
		Phase with max. value	—	—	●	
	Present value of demand (*4)	Each phase	●	—	●	
		Phase with max. value	●	—	●	
Max. demand value among all phases		●	●	●		
Line voltage (±1.0%)	Present value	Between each lines	●	—	●	
		General (average value) (*5)	●	—	●	
		Max. value among all lines	●	●	●	
	Time of occurrence of max. value among all lines	●	●	●		
	Harmonic current (±2.5%)	Present value	Fundamental wave of each phase	●	—	●
Each order of each phase			●	—	●	
General of each phase (*6)			●	—	●	
Max. value of fundamental wave among all phases		●	●	●		
Time of occurrence of max. value of fundamental wave among all phases		●	●	—		
Max. value in each order of each phase		●	●	●		
Time of occurrence of max. value in each order of each phase		●	●	●		
Demand value (*4)		General of each phase (*6)	●	—	●	
		General max. value among all phases	●	●	●	
		Time of occurrence of general max. value among all phases	●	●	—	
General distortion factor of each phase	●	—	—			
Content in each order of each phase	●	—	—			
Electric power (±1.5%)	Present value	Present value	●	—	●	
		Max. value	●	●	●	
		Time of occurrence of max. value	●	●	—	
Reactive power (±2.5%)	Present value	Present value	●	—	●	
		Max. value	●	●	●	
		Time of occurrence of max. value	●	●	—	
Electric energy (±2.0%) (*7)	Integrated value	Amount for last 1 hour	●	—	●	Value accumulated from previous reset to present
		Max. value of amount for 1 hour	●	●	●	
		Time of occurrence of max. value of amount for 1 hour	●	●	—	
		Time of occurrence of max. value of amount for 1 hour	●	●	—	
Reactive energy (±3.0%) (*7)	Integrated value	Amount for last 1 hour	●	—	●	Value accumulated from previous reset to present
		Max. value of amount for 1 hour	●	●	●	
		Time of occurrence of max. value of amount for 1 hour	●	●	—	
		Time of occurrence of max. value of amount for 1 hour	●	●	—	
Leakage current (±2.5%) (*8) (*9)	Present value	Present value	●	—	●	
		Max. value	●	●	●	
		Time of occurrence of max. value	●	●	—	
		Time of occurrence of max. value	●	●	—	
Leakage current containing harmonics (±2.5%) (*9)	Present value	Present value	●	—	●	
		Max. value	●	●	●	
		Time of occurrence of max. value	●	●	—	
		Time of occurrence of max. value	●	●	—	
Cause of fault (*10)	Fault current (accuracy: ±15%) (*11)	Cause of fault	●	—	●	Information on fault after previous reset or last fault, and cause of fault (continuously monitored)
		Cause of fault	●	—	●	
Power factor (±5.0%)	Present value	Present value	●	—	●	
		Max. value	●	●	●	
		Time of occurrence of max. value	●	●	—	
Frequency (±2.5%)	Present value	●	—	●		
Alarm of circuit breaker (*12)	PAL, OVER, EPAL, ECA, IDM_AL, ILA_AL, IUB_AL, Neutral line open phase alarm	●	—	●	The neutral line open phase alarm is given only on the display.	
State of circuit breaker	Tripping state of circuit breaker (AL)	—	—	●	On installation of alarm switch for transmission with Measuring Display Unit (option)	
	ON/OFF state of circuit breaker (AX)	—	—	●	On installation of auxiliary switch for transmission with Measuring Display Unit (option)	
	Number of times of tripping of circuit breaker	—	●	●	On installation of alarm switch for transmission with Measuring Display Unit (option)	
	Number of times of opening and closing of circuit breaker	—	●	●	On installation of auxiliary switch for transmission with Measuring Display Unit (option)	
Default settings	Time setting	●	●	●	Initial setting and resetting after power failure are necessary (no power failure compensation)	
	Demand time limit setting (*4)	●	●	●	By default, the demand time limit is 2 min. It can be set in the range from 0 to 15 min in 1-min steps.	
	EPAL sensitivity current setting	●	●	●	By default, the function is off. The parameters can be set in the following ranges. Function: ON/OFF Sensitivity current: 5, 10, 15, 20 to 100 mA (10-mA step), 100 to 1000 mA (100-mA step) Operating time: 0.1 to 1.0 (0.1-sec step), 1.0 to 10.0 (1-sec step)	
	IDM_AL (current demand alarm)	●	●	●	By default, the function is off. The parameters can be set in the following ranges. Function: ON/OFF Pickup current: 50 to 100% (1% step) Demand time limit: 1 to 10 min (1-min step), 15, 20, 25 and 30 min	
	ILA_AL (current open phase alarm)	●	●	●	By default, the function is off. The parameters can be set in the following ranges. Function: ON/OFF Pickup current: 10%, fixed (no setting) Operating time: 30 sec (no setting)	
	IUB_AL (unbalanced current alarm)	●	●	●	By default, the function is off. The parameters can be set in the following ranges. Function: ON/OFF Pickup current: 30%, fixed (no setting) Operating time: 30 sec (no setting)	
	Neutral line open phase alarm	●	●	●	30 When the single-phase 3-wire type is set, the function is turned on. Rated operating overvoltage: 135 V AC (no setting) Operating time: 1 sec (no setting)	
	Phase switching setting	●	●	●	Default: No phase switching	
	Alarm retention (self-retention or automatic reset) setting	●	●	●	Default: Automatic reset	
	Phase and wire type	●	●	●	Default: 3-phase 3-wire	
Electric energy arbitrary setting	●	●	●			
Reactive energy arbitrary setting	●	●	●			
Display direction	●	●	●	Default: Vertical One of vertical, horizontal 1 and horizontal 2 can be selected.		

Notes: *1 The term "each phase" used for load current and harmonic current refers to phase 1, 2, 3 or N. However, the phase N is provided only on 4-pole circuit breakers. The term "between each phase" used for line voltage refers to between phases 1 and 2, 2 and 3, 3 and 1, 1 and N, 2 and N or 3 and N. However, voltage between phases 1 and N, 2 and N and 3 and N is applicable only on 4-pole circuit breakers. These circuit breakers measure the values every 0.25 sec. Therefore, even when a low order circuit breaker operates, operating current may not be measured. *2 Each maximum value is the largest value among values obtained from the start of operation (after the previous reset) to the present. *3 The integrated value of electric energy and the integrated value of reactive energy are stored upon occurrence of power failure and every 30 minutes, the fault current and the cause are stored upon occurrence of fault, the set values are stored when they are set, and other values are stored every 30 minutes in the nonvolatile E²PROM. *4 The demand time limit cannot be set individually. It is common to the items. *5 The average values of load current and line voltage are calculated as shown below when the phase and wire type is specified.

Phase and wire type	Average present value of current	Average present value of voltage
Single-phase 2-wire	Average present value of current = phase 3 current	Average present value of voltage = voltage between phases 2 and 3
Single-phase 3-wire	Average present value of current = (phase 1 current + phase 3 current)/2	Average present value of voltage = (voltage between phases 1 and 2 + voltage between phases 2 and 3)/2
3-phase 3-wire	Average present value of current = (phase 1 current + phase 2 current + phase 3 current)/3	Average present value of voltage = (voltage between phases 1 and 2 + voltage between phases 2 and 3 + voltage between phases 3 and 1 phases)/3

*6 Sum of values of harmonic components in third to 19th orders except fundamental wave component
*7 The reverse power is not measured.
*8 When leakage current does not contain harmonics, the leakage current value is measured after removing the harmonic components with a digital filter having the same cutoff frequency as the earth leakage circuit breaker applicable to harmonics and surge.
*9 When a motor is used as a load, the maximum demand value of leakage current may be affected by the motor starting current.
*10 If the upper limit of the fault current measurement range (rated current 125 to 250 A (adjustable); 4000 A, rated current 50, 60, 75, 100, 125 A (fixed); 2000 A) is exceeded when overload or short circuit fault occurs, the cause of the fault may not be displayed, and the fault current may not be measured. For fault current, display of cause of fault and measurement of fault current are enabled when the AL for transmission with the Measuring Display Unit (option) is installed.
*11 The leakage fault current value is the value calculated without harmonics.
*12 When the alarm retention mode has been set to Automatic reset, the alarm display on the Measuring Display Unit will be reset automatically. When the alarm retention mode is Self-retention, the alarm display will be self-retained. In the self-retention mode, the display can be reset through the alarm reset operation (collective reset). OVER will be automatically reset regardless of the mode setting.

● Specifications for Measuring Display Unit (1)

The measurement and display items vary depending on the model or frame A.
(For the measurement accuracy, please refer to page 40.)

Applicable models
NF400-SEP with MDU, NF400-HEP with MDU, NF630-SEP with MDU, NF630-HEP with MDU, NF800-SEP with MDU, NF800-HEP with MDU

Table 2-2

Measurement and memory items (accuracy) (*3)		Model	MDU Display	Storage (*1)	Electric energy with pulse output Pulse output (*1)	With CC-Link communication Communication	Remarks	
Load current (±2.5%)	Present value of each phase	●	●	—	—	●	Time limit: 0 to 15 min, changeable (Same as the present value when 0 min is specified) } Max. demand value after previous reset	
	Demand value of each phase	●	●	—	—	●		
	Average present value (*11)	●	●	—	—	●		
	Max. demand value (general value) (*4)	●	●	—	—	●		
	Time of occurrence of max. value (year, month, day, hour, minute)	—	●	●	—	—		●
Line voltage (±2.5%)	Present value between each phases	●	●	—	—	●	} Max. value after previous reset (not demand value)	
	Average present value (*11)	●	●	—	—	●		
	Max. value (general value) (*4)	●	●	—	—	●		
	Time of occurrence of max. value (year, month, day, hour, minute)	—	●	●	—	—		●
Harmonic current (±2.5%)	Current value in 3rd, 5th, 7th ... 19th orders of each phase	●	●	—	—	●	} Max. value after previous reset (not demand value)	
	Max. value in 3rd, 5th, 7th ... 19th orders (general value) (*4)	●	●	—	—	●		
	Time of occurrence of max. value (year, month, day, hour, minute)	—	●	●	—	—		●
	Current value of general harmonics of each phase (*10)	●	●	—	—	●		Time limit: 0 to 15 min, changeable (Same as the present value when 0 min is specified) } Max. demand value after previous reset
Demand value of general harmonics of each phase (*10)	●	●	—	—	●			
Electric power (±2.5%)	Current value (also reverse power is measured)	●	●	—	—	●	Time limit: 0 to 15 min, changeable (Same as the present value when 0 min is specified) } Max. demand value after previous reset	
	Demand value (also reverse power is measured)	●	●	—	—	●		
	Max. demand value	●	●	—	—	●		
	Time of occurrence of max. value (year, month, day, hour, minute)	—	●	●	—	—		●
Electric energy (±2.5%)	Electric energy (integrated value) (*5)	●	●	●	●	●	Value accumulated from previous reset to present Amount for 1 hour from hour to hour on built-in clock } Max. demand value after previous reset	
	Electric energy per time (*5)	●	●	—	—	●		
	Max. value of electric energy per time (*5)	●	●	—	—	●		
	Time of occurrence of max. value (year, month, day, hour, minute)	—	●	●	—	—		●
Cause of fault	Fault current (accuracy: ±15%) (*11)	●	●	—	—	●	Information on fault after previous reset or last fault, and cause of fault (continuously monitored)	
Power factor (±5%)	Present value	●	—	—	—	●		
Alarm of circuit breaker	PAL, OVER, EPAL, ECA (*6) (*11)	● LED on	—	—	—	●		
State of circuit breaker	Tripping state of circuit breaker (AL) ON/OFF state of circuit breaker (AX)	— —	— —	— —	— —	● ●	When alarm switch for transmission with Measuring Display Unit (option) is installed When auxiliary switch for transmission with Measuring Display Unit (option) is installed	
Default settings	Time setting	—	—	—	—	●	Initial setting and resetting after power failure are necessary (no power failure compensation).	
	Demand time limit setting (*7)	●	●	—	—	●	Default: 2 min Setting in 1-min steps in range from 0 to 15 min	
	EPAL sensitivity current setting	●	●	—	—	●	Default: 0 mA Setting in 10-mA steps in range from 0 to 250 mA At 0 mA, EPAL is ineffective.	
	PAL pickup current setting * Setting on circuit breaker body The Measuring Display Unit does not have the setting function.	●	●	—	—	●	Default: 100% Setting in 5% steps in range from 70 to 100% Default setting on breaker body is 70% unless otherwise specified.	
	Pulse unit setting	●	●	—	—	—	Default: 1 kWh/pulse Setting to 1 kWh, 10 kWh, 100 kWh, 1000 kWh or 10000 kWh	
	Phase switching setting	●	●	—	—	●	Default: No phase switching	
	Alarm retention (self-retention or automatic reset) setting	●	●	—	—	●	Default: Automatic reset	

Notes: *1 The electric energy (integrated value) is stored upon occurrence of power failure and every 2 hours, the fault current and the cause are stored upon occurrence of fault, the demand time limit, EPAL sensitivity current, PAL pickup current, pulse unit, alarm retention and phase switching settings are stored when they are set, and other values are stored every 2 hours in the nonvolatile E²PROM.
Each maximum value is the largest value among values obtained from the start of operation (after the previous reset) to the present.
*2 Every time the electric energy is integrated in the pulse unit (the unit can be set to 1 kWh, 10 kWh, 100 kWh, 1000 kWh or 10000 kWh), a pulse is output. Counting can be performed with a PLC.
*3 The term "each phase" used for load current and harmonic current refers to phase 1, 2, 3 or N. However, the phase N is provided only on 4-pole circuit breakers.
The term "between each phase" used for line voltage refers to between phases 1 and 2, 2 and 3, 3 and 1, 1 and N, 2 and N or 3 and N. However, voltage between phases 1 and N, 2 and N and 3 and N is applicable only on 4-pole circuit breakers.
The electric energy data is 6-digit data of up to 999999 kWh. The voltage and harmonic current are 3-digit data, and others are 4-digit.
These circuit breakers measure the values every 0.25 sec. Therefore, even when a low order circuit breaker operates, operating current may not be measured.
*4 Each general value indicates the value only of the phase with the maximum value.
*5 The electric energy is not measured in the case of reverse power flow.
*6 When the alarm retention mode has been set to Automatic reset, the PAL, EPAL, ECA alarm LED display on the Measuring Display Unit front panel will be reset automatically.
When the alarm retention mode is Self-retention, the alarm display will be self-retained. In the self-retention mode, the display can be reset through alarm reset operation (collective reset). OVER will be automatically reset regardless of the mode setting.
*7 The demand time limit cannot be set individually. It is common to the items.
*8 Sum of values of harmonic components in third to 19th orders except fundamental wave component.
*9 The average present value of load current is the average value of current among phases 1, 2 and 3 (the current of the phase N is not included even in the case of a 4-pole circuit breaker). When the circuit breaker is used on a single-phase 3-wire circuit, the calculated value is displayed. However, ignore it. The average present value of line voltage is the average value of voltages between phases 1 and 2, 2 and 3 and 3 and 1 (the voltages between phases 1 and N, 2 and N and 3 and N are not included in the case of a 4-pole circuit breaker).
*10 Setting at the pre-alarm current I_p (which can be set in the range from 70 to 100% of the rated current I_n in 5% steps) on the circuit breaker body. The Measuring Display Unit does not have the setting function.
*11 The operating time of PAL and EPAL is shown below.

PAL	Same as pre-alarm operating time T _p on circuit breaker body
EPAL	3s (fixed)

● Specifications for Measuring Display Unit (2)

Applicable models
NF250-SEV with MDU, NF250-HEV with MDU

Table 2-3

Item	Specification	
Data updating cycle	250 ms (harmonic current: 2 s)	
Tolerances	Current and voltage: ±1.0% (to rating input) Electric power: ±1.5% (to rating input) Reactive power: ±2.5% (to rating input) Harmonic current: ±2.5% (to rating input) Power factor: ±5% Frequency: ±2.5% Electric energy: ±2.0% (voltage 100 V to 440 V, range from 5 to 100% of current rating, power factor 1) Reactive energy: ±3.0% (voltage 100 V to 440 V, range from 10 to 100% of current rating, power factor 0) Leakage current: ±2.5% (to rating input) (*1) Fault current: ±15% (*2)	
Demand time limit setting range	0 to 15 min (1-min steps)	
Rated input	Voltage circuit (1φ2W, 3φ3W)	
	Voltage circuit (1φ3W)	440 V (only 4-pole breakers applicable to 3φ4W)
	Voltage circuit (3φ4W)	
	Current circuit	Load current/harmonic current: 125 A/250 A (Automatic discrimination. Determined based on A frame of circuit breaker. 125 A when rated current of 250 A frame is 125 A or less) Leakage current: 500 mA
Power failure compensation	Frequency	50 Hz/60 Hz (automatic discrimination of frequency)
	(1) Wh (integrated value)	Stored in EEPROM (nonvolatile memory)
	(2) Max. value	* Wh and varh are stored upon occurrence of power failure and every 30 min.
Clock	(3) Setting data	Max. value is stored every 30 min. Setting data are stored when they are set.
	Clock	No power failure compensation
Clock accuracy	Approx. 1 min/month	
External dimensions (unit: mm)	See Characteristics and Dimensions.	
Control power supply	Compatible with 100 to 240 V AC/DC, 50/60 Hz (allowable voltage range: 85% to 110%), 12 VA	
Other functions	Function for switching phases to be measured to 1-3 and 3-1 ECA/PAL alarm, self-retention/automatic reset setting function Function for counting number of times of opening and closing of circuit breaker body (*3)	

Notes: *1 It is measured on earth leakage circuit breakers.

*2 The measurement of fault current of load is enabled when the AL switch for transmission with Measuring Display Unit (option) is installed in the Measuring Display Unit Breaker body.

*3 The function is enabled when the AX switch for transmission with Measuring Display Unit (option) is installed in the Measuring Display Unit Breaker body.

● Network Specifications for Measuring Display Unit

[Electric energy pulse output]

[CC-Link communication]

Table 2-4

Item	Specification
Output elements	Solid state relay (SSR), no voltage a contact (Ca and Cb terminals: no polarity)
Contact capacity	Compatible with 24V DC and 100 to 200 V AC, 20 mA
Output pulse unit	1, 10, 100, 1000 and 10000 kWh/pulse (settable)
Output pulse width	0.35 to 0.45 s
Max. wiring length	100m

Table 2-5

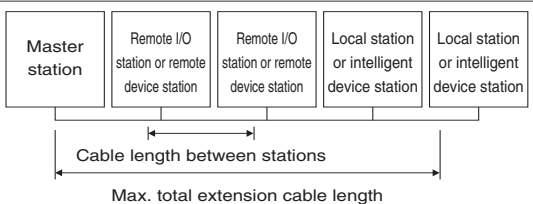
Item	Specification																		
Communication speed	10M/5M/2.5M/625k/156kbps																		
Communication method	Broadcast polling method																		
Synchronization method	Frame synchronization method																		
Encoding method	NRZI																		
Transmission format	Conforming to HDLC																		
Number of occupied stations	Remote device occupying 1 station																		
Number of connected units	Meet the following conditions. When a system consists only of Measuring Display Units, up to 42 units can be connected. Condition 1 for number of connected units $\{(1 \times a) + (2 \times b) + (3 \times c) + (4 \times d)\} \leq 64$ a: Number of units occupying 1 station b: Number of units occupying 2 stations c: Number of units occupying 3 stations d: Number of units occupying 4 stations Condition 2 for number of connected units $\{(16 \times A) + (54 \times B) + (88 \times C)\} \leq 2304$ A: Number of units at 1 remote I/O station ≤ 64 B: Number of units at remote device station ≤ 42 C: Number of units at local station ≤ 26																		
	Station number	Setting in range from 1 to 64 (Set the station number without fail.)																	
	CC-Link version	CC-Link Ver. 1.10																	
	Max. total extension cable length and cable length between stations	 <p>Cables applicable to CC-Link Ver. 1.10 (with use of 110-ohm terminal resistance)</p> <table border="1"> <tr> <td>Communication speed</td> <td>156kbps</td> <td>625kbps</td> <td>2.5Mbps</td> <td>5Mbps</td> <td>10Mbps</td> </tr> <tr> <td>Cable length between stations</td> <td colspan="5">0.2 m or more</td> </tr> <tr> <td>Max. total extension cable length</td> <td>1200m</td> <td>900m</td> <td>400m</td> <td>160m</td> <td>100m</td> </tr> </table>	Communication speed	156kbps	625kbps	2.5Mbps	5Mbps	10Mbps	Cable length between stations	0.2 m or more					Max. total extension cable length	1200m	900m	400m	160m
Communication speed	156kbps	625kbps	2.5Mbps	5Mbps	10Mbps														
Cable length between stations	0.2 m or more																		
Max. total extension cable length	1200m	900m	400m	160m	100m														
Connecting cable	Cables applicable to CC-Link Ver. 1.10 (shielded 3-core twisted pair cables) * Cables applicable to Ver. 1.10 supplied by different manufacturers can be used simultaneously.																		

Note: For more information, visit the website of CC-Link Partner Association (HYPERLINK "<http://www.cc-link.org/>").

Specifications for Measuring Display Unit (2)

Applicable models
NF400-SEP with MDU, NF400-HEP with MDU, NF630-SEP with MDU, NF630-HEP with MDU, NF800-SEP with MDU, NF800-HEP with MDU

Table 2-6

Item	Specification
Data updating cycle	250 ms (harmonic current: 2 s)
Tolerances	Current, voltage and Electric power: $\pm 2.5\%$ (to rating input) Power factor: $\pm 5\%$ Electric energy: $\pm 2.5\%$ (voltage 100 V to 440 V, range from 5 to 100% of current rating, power factor 1) Fault current: $\pm 15\%$
Demand time limit setting range	0 to 15 min (1-min steps)
Rated input	Voltage circuit (1 ϕ 2W, 3 ϕ 3W)
	Voltage circuit (1 ϕ 3W)
	Voltage circuit (3 ϕ 4W)
Current circuit	440 V (only 4-pole breakers applicable to 3 ϕ 4W)
Frequency	Load current/harmonic current: 100 A/225 A/400 A/600 A/800 A (Automatic discrimination. Determined based on A frame of circuit breaker. 100 A when rated current of 225 A frame is 100 A or less) Leakage current: 500 mA
Power failure compensation	(1) Wh (integrated value) (2) Max. value (3) Setting data Stored in EEPROM (nonvolatile memory) * Wh is stored upon occurrence of power failure and every 2 hours The max. value is stored every 2 hours. The setting data is stored when it is set.
Clock	No power failure compensation
Clock accuracy	Approx. 1 min/month
External dimensions (unit: mm)	WxDxH: 90x75x30
Control power supply	Compatible with 100 to 240 V AC/DC, 50/60 Hz (allowable voltage range: 85% to 110%), 12 VA
Other functions	Function for switching phases to be measured to 1-3 and 3-1 ECA/PAL alarm, self-retention/automatic reset setting function

Network Specifications for Measuring Display Unit

[Electric energy pulse output]

[CC-Link communication]

Table 2-7

Item	Specification
Output elements	Solid state relay (SSR), no voltage a contact (Ca and Cb terminals: no polarity)
Contact capacity	Compatible with 24V DC and 100 to 200 V AC, 20 mA
Output pulse unit	1, 10, 100, 1000 and 10000 kWh/pulse (settable)
Output pulse width	0.35 to 0.45 s
Max. wiring length	100m

Table 2-8

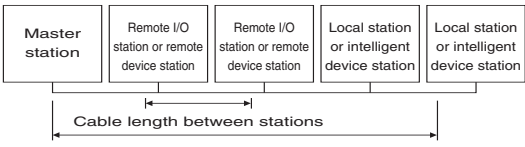
Item	Specification																																				
Communication speed	10M/5M/2.5M/625k/156kbps																																				
Communication method	Broadcast polling method																																				
Synchronization method	Frame synchronization method																																				
Encoding method	NRZI																																				
Transmission format	Conforming to HDLC																																				
Number of occupied stations	Remote device occupying 1 station																																				
Number of connected units	Meet the following conditions. When a system consists only of Measuring Display Units, up to 42 units can be connected. Condition 1 for number of connected units $\{(1 \times a) + (2 \times b) + (3 \times c) + (4 \times d)\} \leq 64$ a: Number of units occupying 1 station b: Number of units occupying 2 stations c: Number of units occupying 3 stations d: Number of units occupying 4 stations Condition 2 for number of connected units $\{(16 \times A) + (54 \times B) + (88 \times C)\} \leq 2304$ A: Number of units at 1 remote I/O station ≤ 64 B: Number of units at remote device station ≤ 42 C: Number of units at local station ≤ 26																																				
Station number	Setting in range from 1 to 64 (Set the station number without fail.)																																				
CC-Link version	Installation of Measuring Display Unit on body: CC-Link Ver. 1.10 Installation of Measuring Display Unit on panel: CC-Link Ver. 1.00																																				
Max. total extension cable length and cable length between stations	 <p>Cables applicable to CC-Link Ver. 1.10 (with use of 110-ohm terminal resistance)</p> <table border="1"> <thead> <tr> <th>Communication speed</th> <th>156kbps</th> <th>625kbps</th> <th>2.5Mbps</th> <th>5Mbps</th> <th>10Mbps</th> </tr> </thead> <tbody> <tr> <td>Cable length between stations</td> <td colspan="5">0.2 m or more</td> </tr> <tr> <td>Max. total extension cable length</td> <td>1200m</td> <td>900m</td> <td>400m</td> <td>160m</td> <td>100m</td> </tr> </tbody> </table> <p>Cables applicable to CC-Link Ver. 1.00</p> <table border="1"> <thead> <tr> <th>Communication speed</th> <th>156kbps</th> <th>625kbps</th> <th>2.5Mbps</th> <th>5Mbps</th> <th>10Mbps</th> </tr> </thead> <tbody> <tr> <td>Cable length between stations</td> <td colspan="5">Between master or local station or intelligent device station and station on downstream or upstream side: 1 m or more Between remote I/O stations and remote device stations: 0.3 m or more</td> </tr> <tr> <td>Max. total extension cable length</td> <td>1200m</td> <td>600m</td> <td>200m</td> <td>150m</td> <td>100m</td> </tr> </tbody> </table> <p>When the Measuring Display Unit is installed on the panel, the terminal block on the panel mounting plate and the terminal block on the Measuring Display Unit are connected with a CC-Link cable having a one-way length of 15 cm and an entire length of 30 cm. When connecting the unit in consideration of the following three points. (1) The one-way length of the CC-Link cable, 15 cm, is included in the distance between stations. (2) The entire length of the CC-Link cable, 30 cm, is included in the maximum transmission distance (total extension distance). (3) Use CC-Link cables of the same type as the connecting cable (cable FANC-SB made by Kuramo Electric Co., Ltd.). When using CC-Link cables other than FANC-SB, replace the cable between the front panel of the Measuring Display Unit and the terminal block at the rear with the same cable. When the Measuring Display Unit is installed on the panel, CC-Link cable of CC-Link Ver.1.00 (FANC-SB made by Kuramo Electric Co., Ltd.) is used between the Measuring Display Unit front panel and the terminal block at the rear. Replace this CC-Link cable with a cable applicable to CC-Link Ver. 1.10 to configure the entire system with cables applicable to CC-Link Ver. 1.10, and the conditions for the cable length between stations can be simplified.</p>	Communication speed	156kbps	625kbps	2.5Mbps	5Mbps	10Mbps	Cable length between stations	0.2 m or more					Max. total extension cable length	1200m	900m	400m	160m	100m	Communication speed	156kbps	625kbps	2.5Mbps	5Mbps	10Mbps	Cable length between stations	Between master or local station or intelligent device station and station on downstream or upstream side: 1 m or more Between remote I/O stations and remote device stations: 0.3 m or more					Max. total extension cable length	1200m	600m	200m	150m	100m
Communication speed	156kbps	625kbps	2.5Mbps	5Mbps	10Mbps																																
Cable length between stations	0.2 m or more																																				
Max. total extension cable length	1200m	900m	400m	160m	100m																																
Communication speed	156kbps	625kbps	2.5Mbps	5Mbps	10Mbps																																
Cable length between stations	Between master or local station or intelligent device station and station on downstream or upstream side: 1 m or more Between remote I/O stations and remote device stations: 0.3 m or more																																				
Max. total extension cable length	1200m	600m	200m	150m	100m																																
Connecting cable	Cables applicable to CC-Link Ver. 1.10 (shielded 3-core twisted pair cables) * Cables applicable to Ver. 1.10 supplied by different manufacturers can be used simultaneously. * When the Measuring Display Unit is installed on the panel, use FANC-SB (CC-Link Ver. 1.00) made by Kuramo Electric Co., Ltd.																																				

Note: For more information, visit the website of CC-Link Partner Association (HYPERLINK "<http://www.cc-link.org/>").

● Cautions when Using Measuring Display Unit Breakers (common instructions)

Measuring accuracy

- (1) The accuracy of measurement of current or voltage is indicated as the percentage of error to the rated current or voltage for measurement by the Measuring Display Unit.
 The measurement rated current is the maximum rated current of each ampere frame. For W & WS Series Measuring Display Unit Breakers, the accuracy is the max. rated current $\times \pm 2.5\%$. For WS-V Series Measuring Display Unit Breakers, the accuracy is the max. rated current $\times \pm 1\%$.
 (For example, when the rated current of NF630-SEP with Measuring Display Unit is 350 A, the measurement rated current is 630 A, and the current accuracy is $630 \text{ A} \times \pm 2.5\% = \pm 15 \text{ A}$.)
 However, the measurement rated current of the following breakers is determined as follows.
 <WS-V Measuring Display Unit Breakers>
 ◆ Rated current 50 A, 60 A, 75 A, 100 A, 125 A: Measurement rated current 125 A
 ◆ Rated current 125 to 250 A: Measurement rated current 250 A
 * The measurement rated voltage is 440 V. (Common to all A frames)
 When the current is less than 1.0% of the measurement rated current in the case of WS-V Series Measuring Display Unit Breakers or less than 2.0% of the measurement rated current in the case of W & WS Series Measuring Display Unit Breakers or when the voltage is less than 5.0% of the measurement rated voltage in the case of WS-V Series Measuring Display Unit Breakers or less than 2.0% of the measurement rated current in the case of W & WS Series Measuring Display Unit Breakers, the current or voltage is cut off, and zero is displayed.
- (2) When the current is cut off, the current is displayed as 0 A. However, if the current is 0.4% or more of the measurement rated current, the electric energy is measured.
- (3) The accuracy of power factor is the percentage to electrical angle of 90°. A power factor of 50% or less is displayed as a reference value.
- (4) The accuracy of electric energy is $\pm 2.0\%$ of the true value in the case of WS-V Series Measuring Display Unit Breakers and $\pm 2.5\%$ of the true value in the case of W & WS Series Measuring Display Unit Breakers in the range of measurement rated voltage (100 V to 440 V) \times current (measurement rated current of 5 to 100%).
- (5) The accuracy of leakage current is $\pm 2.5\%$ of the measurement rated current of 500 mA.

How to use Measuring Display Unit Breaker on single-phase 2-wire circuitry

- (1) Connect the breaker as shown in the right figure.
 The phase 1 on the load side is charged. Insulate it.
 As measurement data, use the current of the phases 2 and 3 and the voltage between the phases 2 and 3.
 Although the current of the phase 1 and the voltage between the phases 1 and 2 and the phases 3 and 1 are measured, ignore the measurements. The Measuring Display Unit is designed for 3-phase 3-wire and single-phase and 3-wire circuits.
 On W & WS Series Measuring Display Unit Breakers, the average values of load current and line voltage are calculated from the values of the phases 1, 2 and 3 (between the phases). Ignore these measurement values.
 Also when the breaker is used on a single-phase 3-wire circuit, ignore these values.
 When using any WS-V Series Measuring Display Unit Breaker, set the phase and wire type.

Connection on single-phase 2-wire circuit

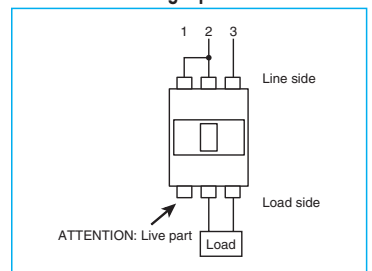

Phase sequence of Measuring Display Unit Breaker

The phase sequence of Measuring Display Unit Breaker can be set by using the phase switching function as shown below.
 When the breaker is installed vertically with the power supply side upward (see the right figure), the phase sequence is set as stated below.
 No phase switching: 1, 2, 3 and N from the left (default)
 With phase switching: 3, 2, 1, and N from the left
 Set the phase sequence in accordance with the installation and wiring methods.
 Notes (1) The phase N is provided only on 4-pole circuit breakers.
 (2) Note that the position of the phase N is unchanged regardless of the phase switching setting.

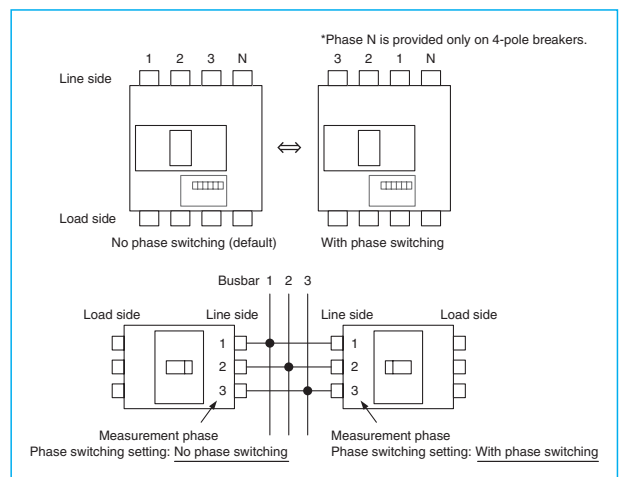

Reverse connection of Measuring Display Unit Breaker

The Measuring Display Unit Breakers cannot be connected with the power supply and load sides set reversely.

Installation of Measuring Display Unit Breaker in close contact

- The Measuring Display Unit Breakers must not be installed in close contact.
- (1) In the case of 400, 630 or 800A frame, install the breaker body securing a wiring space of 30 mm or more on the right side of the breaker to connect the connecting cables and fitting the connecting cable connectors.
 - (2) In the case of WS-V Series Measuring display Unit Breaker, install the breaker body securing a wiring space of 30 mm or more on the right side of the breaker to connect the connecting cables.

● Cautions when using Measuring Display Unit Breaker (For Measuring Display Unit)

Transmission method

- (1) One of No transmission, With pulse output and With CC-Link communication should be specified.
- (2) W & WS Series Measuring Display Unit Breaker with CC-Link communication cannot be manufactured for installing the Measuring Display Unit on the breaker body.
- (3) When With transmission is selected, data which can be transmitted depends on the function of the Measuring Display Unit Breaker body. The transmission options cannot be installed or changed later. Specify the options when issuing the initial order.
- (4) For the maximum number of connected units and transmission distance for each transmission type, see the following tables.
 <WS-V Measuring Display Unit Breakers>
 Tables 2-4 and 2-5
 <W & WS Measuring Display Unit Breakers>
 Tables 2-7 and 2-8

Installation of Measuring Display Unit

- (1) When the installation of Measuring Display Unit on panel has been specified, the breaker will come with the panel mounting parts, mounting screws and 2-m connecting cable (standard).
 (The 0.5-, 3-, 5- or 10-m connecting cable can be specified.)
- (2) If the installation position of the Measuring Display Unit of a 4P breaker is changed from the panel to the body or vice versa, the Measuring Display Unit and the breaker body must be returned to the manufacturer for modification.

Measuring Display Unit Breaker with CC-Link communication (W & WS Series Measuring Display Unit Breakers)

- (1) If you intend to use the circuit breaker with its pane out on the face board, specify the installation on panel.

● Change of display direction for breaker mounting

<WS-V Series Measuring Display Unit Breaker>



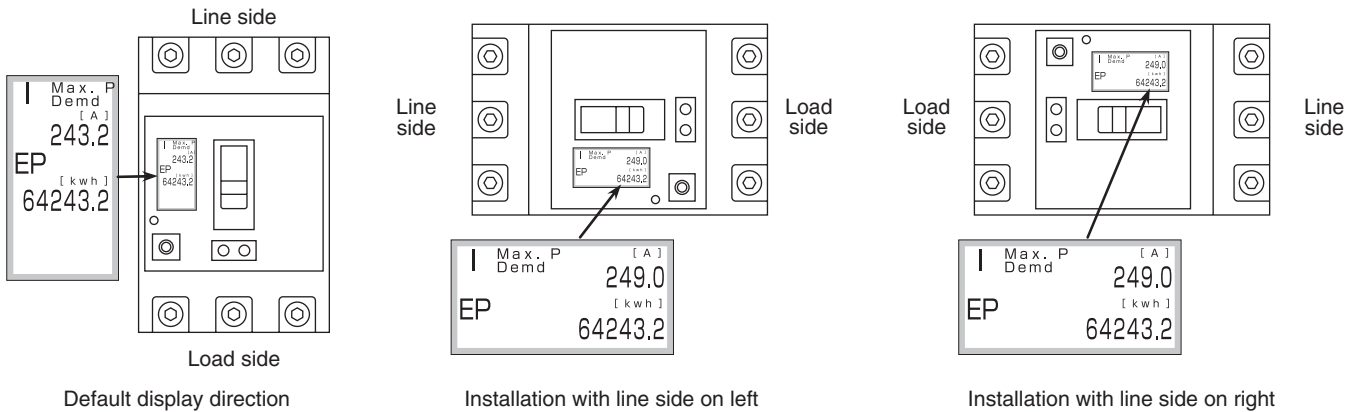



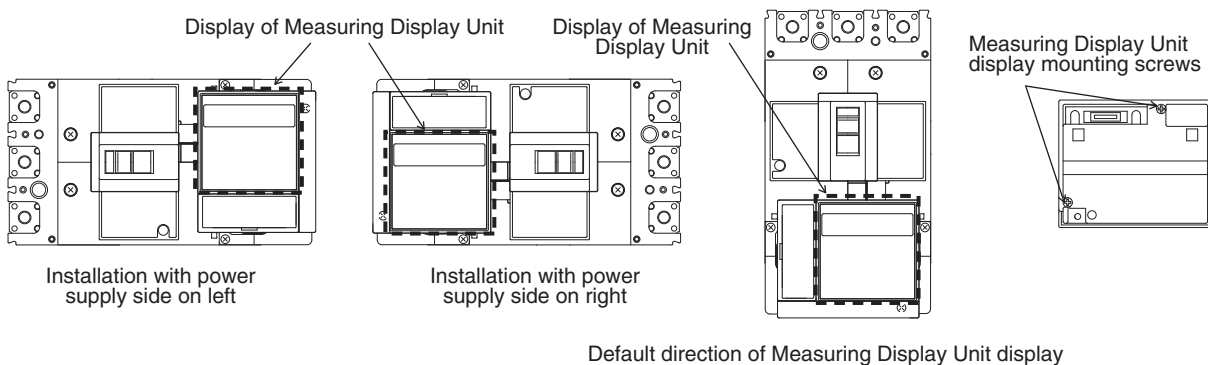

- (1) When installing the Measuring Display Unit on the breaker body installed in the horizontal direction, the direction of the display can be changed according to the installation direction.
- (2) The display direction is set on the display unit.







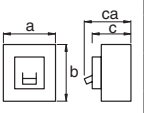



<W & WS Series Measuring Display Unit Breaker>

- (1) When installing the Measuring Display Unit on the breaker body installed in the horizontal direction, the direction of the display of Measuring Display Unit can be changed for ease in reading according to the installation direction.
- (2) Remove the screws on the rear panel of the Measuring Display Unit, and change the direction according to the installation direction.





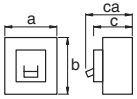





Model		BH			BH-P			
Frame (A)		70	100	100	70	100	100	
Image								
Number of poles		1	2	3	1	2	3	
Rated current (A) at ambient temperature 40°C		70	70, 100	70, 100	70	70, 100	70, 100	
Rated voltage (V)		AC	230/400			230/400		
		DC	125			125		
Rated short circuit capacity (kA)	IEC 60898	AC230/400V	3	-		3	-	
		AC400V	-	3		-	3	
	-	DC125V	1			1		
Instantaneous tripping		Type C (5 I _n <, ≤10 I _n)						
Dimensions (mm)		a	25	50	75	25	50	75
	b	95			74			
	c	57.5			60.5			
	ca	77.5			79			
Mass (kg)		0.16	0.32	0.48	0.13	0.26	0.38	
Connection (*1)		Clamp terminal			Plug-in (line) Clamp (load)			
								
Automatic tripping device		Thermal, magnetic						
Optional accessories	Terminal cover	●			-			
	Mounting plate	●			-			
	Terminal base	-			●			
	Lock cover	●			●			
Approved by		-	LR, GL, NK	-	-	LR, BV, AB, GL, NK	-	

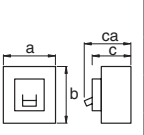

Notes: *1 If required solderless terminal can be supplied.
(BH : Line and Load side, BH-P : Load side only)

Model		BH-S M3			BH-S M6			
Image								
Number of poles		1	2	3	1	2	3	
Rated current (A) at ambient temperature 40°C		5, 10, 15, 20, (25), 30, 40, 50, 60	10, 15, 20, (25), 30, 40, 50, 60	15, 20, (25), 30, 40, 50, 60	5, 10, 15, 20, (25), 30, 40, 50, 60	10, 15, 20, (25), 30, 40, 50, 60	15, 20, (25), 30, 40, 50, 60	
Rated voltage (V)	AC	230/400	400	400	230/400	400	400	
	DC	–	125	–	–	125	–	
Rated short circuit capacity (kA)	IEC 60898	AC230/400V	3	–	6	–	–	
		AC400V	–	3	–	6	–	
	–	DC125V	–	1	–	–	1	–
Instantaneous tripping		Types B, C, D (*2)						
Dimensions (mm)		a	25	50	75	25	50	75
		b	95			95		
		c	57.5			57.5		
		ca	76			76		
Mass (kg)		0.15	0.32	0.50	0.15	0.32	0.50	
Connection (*1)		Clamp terminal						
								
Automatic tripping device		Thermal, magnetic						
Optional accessories	Terminal cover	●						
	Mounting plate	●						
	Handle lock	●						
	Lock cover	–						
Approved by		–						

Notes: *1 If required solderless terminal can be supplied. (Line and Load side)
*2 Type B (3 In <, ≦ 5 In), Type C (5 In <, ≦ 10 In), Type D (10 In <, ≦ 20 In)

Model		BH-PS M3			BH-PS M9			
Image								
Number of poles		1	2	3	1	2	3	
Rated current (A) at ambient temperature 40°C		10, 15, 20, 30, 40, 50, 60	10, 15, 20, 30, 40, 50, 60	15, 20, 30, 40, 50, 60	6, 10, 16, 20, (25), 32, 40, 50, 60	10, 16, 20, (25), 32, 40, 50, 60	10, 16, 20, (25), 32, 40, 50, 60	
Rated voltage (V)		AC	230/400	400	400	230/400	400	
		DC	-	125	-	-		
Rated short circuit capacity (kA)	IEC 60898	AC230/400V	3	-	9	-		
		AC400V	-	3	-	9		
	-	DC125V	-	1	-	-		
Instantaneous tripping		Types B, C, D (*1)						
Dimensions (mm)		a	25	50	75	25	50	75
		b	81.5			81.5		
		c	60.5			60.5		
		ca	79			79		
Mass (kg)		0.15	0.32	0.50	0.15	0.32	0.50	
Connection		Plug-in (line)			Clamp (load)			
								
Automatic tripping device		Thermal, magnetic						
Optional accessories	Terminal cover	-						
	Terminal base	●						
	Lock cover	-						
	Handle lock	●						
Approved by		-			LR			

Note: *1 Type B (3 In <, ≤ 5 In), Type C (5 In <, ≤ 10 In), Type D (10 In <, ≤ 20 In)

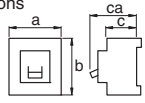
Model		BH-D6					BH-D10				BH-DN			
Image														
Number of poles [P]		1	2	3	4(3+N) ^{*1}	2(1+N) ^{*1}	1	2	3	4(3+N) ^{*1}	2 (1+N) ^{*1}			
Instantaneous tripping		Type B, C, D ^{*2}					Type B, C, D ^{*2}				Type C ^{*2}			
Rated insulation voltage U_i [V]		440					440				230			
Rated current I_n [A] at ambient temperature 30°C		0.5, 1, 1.6, 2, 3, 4, 6, 10, 13, 16, 20, 25, 32, 40, 50, 63					0.5, 1, 1.6, 2, 3, 4, 6, 10, 13, 16, 20, 25, 32, 40				0.5, 1, 1.6, 2, 3, 4, 6, 10, 13, 16, 20, 25, 32, 40, 50, 63		6, 10, 16, 20	
Rated short-circuit capacity [kA] (I _{cn})	IEC60898-1 (I _{cn})	AC	230V	6	-		6	10	-		-		4.5	
			230/400V	6	-		-	10	-		-		-	
			400V	-	6		-	-	10		-		-	
Number of operating cycles	Without current		8,000					10,000				20,000		
	With current		8,000					10,000				20,000		
Dimensions [mm]		a	18	36	54	72	36	18	36	54	72	18		
		b	87					87				88		
		c	44					44				44		
		ca	70					70				70		
Type of overcurrent release		Thermal-magnetic					Thermal-magnetic				Thermal-magnetic			
Mounting		IEC35mm rail					IEC35mm rail				IEC35mm rail			
Applicable wire size		1 to 25mm ²					1 to 25mm ²				1 to 10mm ²			
Weight [kg]		0.15	0.3	0.45	0.55	0.25	0.15	0.3	0.45	0.55	0.12			
Mass optional accessories	Alarm switch (AL)		●					●				-		
	Auxiliary switch (AX)		●					●				-		
	Shunt trip (SHT)		●					●				-		
Terminal connection		Solderless					Solderless				Solderless			
Based on standard		IEC60898-1					IEC60898-1				IEC60898-1			
CE marking		EN60898-1 : Self-declaration					EN60898-1 : Self-declaration				EN60898-1 : Self-declaration			
CCC		GB10963.1					GB10963.1				GB10963.1			

Notes: *1 N pole is a switched neutral pole (without overcurrent release device).
*2 Type B (3 I_n <, ≤ 5 I_n), Type C (5 I_n <, ≤ 10 I_n), Type D (10 I_n <, ≤ 20 I_n)

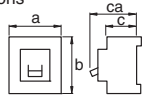
Model		BH-D10 (For DC)			
Image					
Number of poles [P]		1		2	
Instantaneous tripping		Type B, C ^{*3}			
Rated insulation voltage U_i [V]		250			
Rated current I_n [A] at ambient temperature 30°C		0.5, 1, 1.6, 2, 3, 4, 6, 10, 13, 16, 20, 25, 32, 40, 50, 63			
Rated short-circuit capacity [kA] (I _{cn})	IEC60898-2 (I _{cn})	DC	125V	10	-
		250V	-	-	10
Number of operating cycles	Without current		8,000		
	With current		4,000		
Dimensions [mm]		a	18	36	
		b	87		
		c	44		
		ca	70		
Type of overcurrent release		Thermal-magnetic			
Mounting		IEC35mm rail			
Applicable wire size		1 to 25mm ²			
Weight [kg]		0.15	0.3		
Mass optional accessories	Alarm switch (AL)		●		
	Auxiliary switch (AX)		●		
	Shunt trip (SHT)		●		
Terminal connection		Solderless			
Based on standard		IEC60898-2			
CE marking		EN60898-2 : Self-declaration			
CCC		GB10963.2			

Notes: *3 Type B: (5 I_n <, ≤ 7 I_n), Type C: (7 I_n <, ≤ 15 I_n)



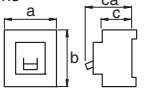

Model		RCCB		
		BV-D		
Image				
Number of poles [P]		$2(1+N)^{*1}$	$4(3+N)^{*1}^{*3}$	
Rated current [A] at ambient temperature 30°C		25, 40, 63		
Rated voltage [VAC]		230	230/400	
Rated current sensitivity $I_{\Delta n}$ [mA]		30, 300		
Max. operating time at $5I_{\Delta n}$ [s]		0.04		
Pulsating current sensitivity		Type AC		
Rated conditional short-circuit current [kA]		6		
Dimensions [mm] 		a	36	72
		b	85	
		c	44	
		ca	70	
Mass [kg]		0.2	0.35	
Rated making and breaking capacity I_m [A]		500(In 25,40A), 630(In63A)		
Rated conditional short-circuit current I_{nc} [kA]		6		
Rated residual making and breaking capacity $I_{\Delta m}$ [A]		500(In 25,40A), 630(In63A)		
Rated conditional residual short-circuit current $I_{\Delta c}$ [kA]		6		
Number of operating cycles	Without current	8,000		
	With current	8,000		
Type of overcurrent release		-		
Mounting		IEC35mm rail		
Applicable wire size		1 to 25mm ²		
Weight [kg]		0.2	0.35	
Terminal connection		Solderless		
Based on standard		IEC61008-1		
CE marking		EN61008-1 : Self-declaration		
CCC		GB16916		

Notes: *1 N pole is a switched neutral pole (without overcurrent release device).

*2 Type C: (5 In <, ≤ 10 In)

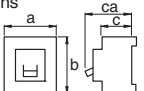
*3 For use to three phase 4-wire type. When using, it be sure to connect the neutral wire to the neutral phase. Not available for use to three phase 3-wire type.

Model		RCBO	
		BV-DN	
Image			
Number of poles [P]		$2(1+N)^{*1}$	
Rated current [A] at ambient temperature 30°C		6, 10, 16, 20, 25, 32, 40	
Rated voltage [VAC]		230	
Rated current sensitivity $I_{\Delta n}$ [mA]		30, 100, 300	
Max. operating time at $5I_{\Delta n}$ [s]		0.04	
Pulsating current sensitivity		Type AC	
Breaking capacity [kA] sym. (IEC 61009)		4.5	
Tripping characteristics		Type C ^{*2}	
Dimensions [mm] 		a	36
		b	88
		c	44
		ca	70
Mass [kg]		0.19	
Automatic tripping device		Thermal, magnetic	
Number of operating cycles	Without current	20,000	
	With current	20,000 (In 6,10,16,20A) 15,000 (In 25A) 10,000 (In 32,40A)	
Type of overcurrent release		Thermal-magnetic	
Mounting		IEC35mm rail	
Applicable wire size		1 to 16mm ²	
Weight [kg]		0.19	
Terminal connection		Solderless	
Based on standard		IEC61009-1	
CE marking		EN61009-1 : Self-declaration	
CCC		GB16917	

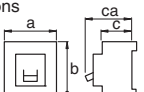
Model		Isolating switch				
		KB-D				
Image						
Number of poles [P]		1	2	3	$4(3+N)$	
Utilization category		AC22A class				
Rated current [A] at ambient temperature 30°C		32, 63, 80				
Rated voltage [VAC]		230	400			
Short time withstand current [A]		$20 \times I_n, 1s$				
Short-circuit making capacity [A]		$20 \times I_n$				
Dimensions [mm] 		a	18	36	54	72
		b	87			
		c	44			
		ca	70			
Mass [kg]		0.09	0.18	0.27	0.36	
Number of operating cycles	Without current	20,000				
	With current	3,000				
Mounting		IEC35mm rail				
Applicable wire size		1 to 25mm ²				
Weight [kg]		0.1	0.2	0.3	0.4	
Terminal connection		Solderless				
Based on standard		IEC60947-3				
CE marking		EN60947-3 : Self-declaration				
CCC		GB14048.3				

Accessories for Miniature Circuit Breakers

Functions of Accessories

Internal accessory	Function
AL Alarm switch	Electrically indicates the trip status of the circuit breaker.
AX Auxiliary switch	Electrically indicates the On/Off status of the circuit breaker.
SHT Shunt trip	Electrically trips the circuit breaker from a remote location. Permissible working voltages are 70 to 110% of the AC rated voltage or 70 to 125% of the DC rated voltage.

Equipping of Accessories

Accessory \ Model	BH-D6	BH-D10	BH, BH-P, BH-S, BH-PS, BH-DN, BV-DN, KB-D, BV-D
AL	○	○	-
AX	○	○	
SHT	○	○	

○: Accessory equipped

–: Accessory not equipped

Specifications

Type		AL	AX	AL+AX	AX+AX
		AL-05DLS	AX-05DLS	ALAX-05DLS	AX2-05DLS
Contact	Configuration	1C	1C	2C	2C
	Contact capacity	400VAC, 2A	230VAC, 5A	130VDC, 0.4A	48VDC, 1.5A
Function	Line	–	–	AX	AX
	Load	AL	AX	AL	AX
Connection		Busbar terminal			
Compliance standard		IEC60947-5-1 GB14048.5			

Type	SHT	
	SHTA400-05DLS	SHTD048-05DLS
Cut-off switch	Equipped	
Voltage	110-400VAC	24-48VDC
Input power requirement	110VAC 60VA 230VAC 250VA 400VAC 750VA	24VDC 75VA 48VDC 300VA
Operating time [ms]	<20	
Connection	Solderless terminal	
Compliance standard	IEC60947-2 GB14048.2	

* Secure a sufficient input power supply so that the voltage will not drop below the permissible lower working voltage (70% of the lowest rated voltage).

* The operating time denotes the time from when the rated voltage is applied to SHT until the time the main contact of the breaker starts to open.

Combinations of Accessories

Accessory connection combinations	AL	
	AX	
	2AX	
	ALAX	
	SHT	
	AX+SHT	
	AL+SHT	
	2AX+SHT	
ALAX+SHT		



Outline Drawing

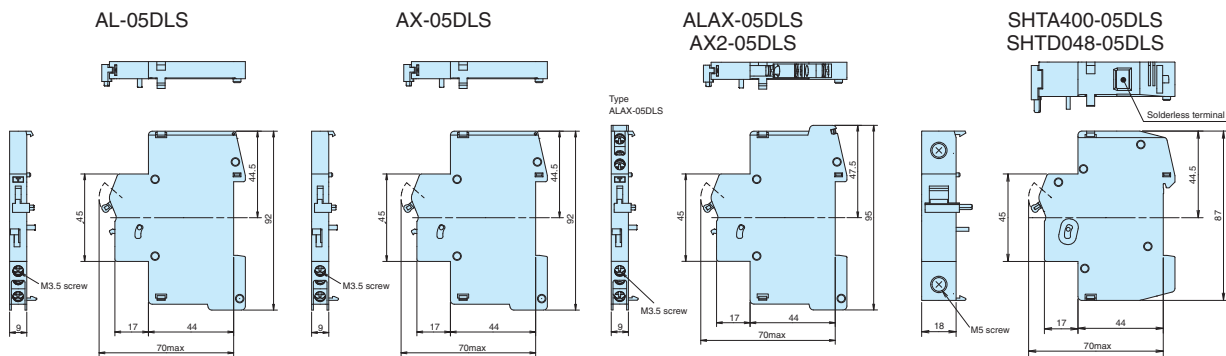

Connection of Line and Load Side

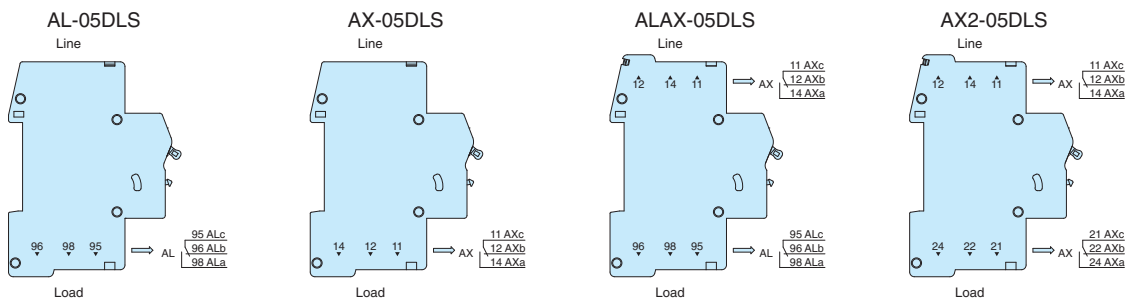

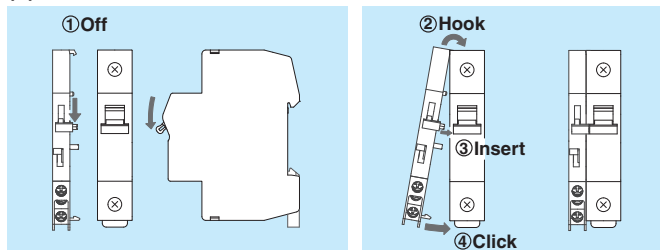

Installation of Accessories (AX, AL, SHT)

(1) Installation

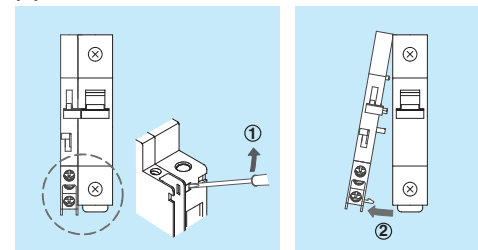

(2) Removal



Frame (A)		30						
Model		CP30-BA			CP-S			
Image								
Number of poles		1	2	3	1	2	3	
Rated insulation voltage Ui (V)		250			250			
Rated impulse withstand voltage Uimp (kV)		2.5			2.5			
Rated current (A)		0.1 0.25 0.3 0.5 1 2 3 5 7 10 15 20 30			0.05 0.1 0.25 0.3 0.5 0.75 1 2 2.5 3 5 7 7.5 10 15 20 25 30			
Rated short-circuit capacity (kA)	UL 1077 CSA C22.2 No.235 (*11)	Rated voltage (V) AC (V) DC (V)	250			250		–
			65	125	–	65	–	–
	IEC 60934 EN 60934 (Icn)	Rated insulation voltage Ui (V) AC DC	2.5kA at 250V			1.5kA at 250V		–
			2.5kA at 65V	2.5kA at 125V	–	1kA at 65V	–	–
	EN 60947-2 IEC 60947-2 (Icu/Ics)	Rated insulation voltage Ui (V) AC DC	250			250		–
			2.5kA at 60V	2.5kA at 120V	–	1kA at 60V	1kA at 120V (1kA at 60V) (*7)	1kA at 60V
	AC-DC common use		●			– (*8)		– (*8)
	Reverse connection		●			–		
Rated short time current (for switch only type)		–			AC250V 50/60Hz 1500A 0.02s AC125V 50/60Hz 2500A 0.02s DC65V 1000A 0.02s DC125V 1000A 0.02s		–	
Rated ambient temperature (°C)		40 (T40)			25 (T25)			
Operating characteristics		Instantaneous type (I); Medium type (M), (MD); Slow type (S), (SD); Fast type (F) (*2)			Instantaneous type (I); Medium type (M), (MD); Slow type (S), (SD); Fast type (F) (FD)			
Mode of tripping		Instantaneous type (I): magnetic only [MO] Medium type (M), (MD) Slow type (S), (SD) : hydraulic-magnetic [HM] Fast type (F)			Instantaneous type (I): magnetic only [MO] Medium type (M), (MD) Slow type (S), (SD) : hydraulic-magnetic [HM] Fast type (F), (FD)			
Method of operation		S-type (IEC 60934)						
Trip-free behaviour		Trip-free (IEC 60934)						
Mass (kg)		0.08	0.16	0.23	0.06	0.12	0.18	
Accessories	Retractable small terminal cover (TC-S)		●Standard IP20 (front, terminal covers closed) [Certified of TUV]			–		
	Inertial delay (ID)		● (Medium, Slow type: AC only)			● (Medium, Slow, Fast type: AC only)		
	Alarm switch (AL)		● (1c)			● (1c) (*7)		
	Auxiliary switch (AX)		● (1c)			● (1c)		
	Shunt trip (SHT)		● (for relay type) (*3)			● (for parallel and relay type: AC only)		
	Large terminal cover (TC-L)		● (*6)			–		
	Flushpanel mounting brackets (FP)		●			–		
	Back facing wiring terminal (BT)		● (*4), (*6)			–		
	Lock cover (LC)		–			●		
Accessory terminal cover (TC)		● (*6)			–			
Connection	Main body		20A or less : Screw terminal M4 30A : Screw terminal M5			Male tub terminal 6.3mm (#250) [Screw terminal M4 (series type only)]		
	Alarm switch / Auxiliary switch		Screw terminal M3.5			Male tub terminal 2.8mm (#110)		
Main body mounting method		Surface, IEC rail mounting Flush panel mounting (option)			Panel mounting			
International standard		UL(cURus), CCC (*5)			UL(UR) (*9), (*10)			
CE Marking		EN 60934 : TUV approval EN 60947-2 : Self-declaration (*5)			EN 60934 : TUV approval (*10)			

- Notes: *1 The 3-pole products are for AC use only.
 *2 Contact us for operating characteristics other than those mentioned above.
 *3 In poles equipped with a shunt tripping mechanism, the overcurrent tripping element is not operative (switched shunt tripping).
 *4 For back-face wiring terminals, specify if it will be used with 30A, or 20A or less.
 *5 UL(cURus), CCC, and CE Marking are displayed on standard products.
 *6 It is recognition of UL(cURus), CCC, and TUV.
 *7 In case of DC use, only DC65V is available.
 *8 Specify if for DC use when ordering.
 *9 Specify when ordering. (In case of CP-S UL, type name is CP-SU.)
 *10 Connection is male tub terminal only.
 *11 CP30-BA only.

- Remarks: 1. Products for non-standard conditions are special order. (Low temperature, 1st and 2nd-degree moisture fungal treatment, corrosion-resistant)
 2. Although a buzzing sound may occur when an instantaneous type becomes 80% or more of the rated current for AC use, performance is not effected. Please take this point into consideration when selecting units for use in quiet environments.
 3. Please use in environments free of high temperatures, humidity, dust, corrosive gas, vibration, and impact.
 Also, do not use it in a circuit with inrush current or harmonics. Problems may result.

Internal circuits and examples of application

Internal circuit	Available model	Operating characteristics								
		Instantaneous type	High speed type			Medium speed type		Low speed type		shunt trip
		I	F	FD	M	MD	S	SD		
Serial type	CP30-BA CP-S	●	●	-	●	●	●	●	-	
Serial type with auxiliary switch	CP30-BA CP-S	●	●	-	●	●	●	●	-	
Serial type with alarm switch	CP30-BA CP-S	●	●	-	●	●	●	●	-	
Relay type shunt trip (with SHT)	CP30-BA CP-S	-	-	-	-	-	-	-	●	
Parallel type shunt trip (with SHT)	CP-S	-	-	-	-	-	-	-	●	
Relay type current trip	CP-S	●	●	●	●	●	●	●	-	
Parallel type current trip	CP-S	●	●	●	●	●	●	●	-	
Switch type	CP-S	-	-	-	-	-	-	-	-	

Internal accessories

Auxiliary switch (AX)

Operates in conjunction with the main circuit operating mechanism to electrically retrieve the ON/OFF status of protector.

Alarm switch (AL)

Operates in conjunction with the main circuit operating mechanism to electrically retrieve the tripping status of protector.

Remarks (1) When the handle of CP30-BA is constrained in the ON status, it does not issue the alarm signal even if it is tripped.
(2) The alarm switch will be reset when the body is reset or turned on.

Shunt trip (SHT)

A parallel relay type protector, which can break the circuit instantaneously when receiving an external signal

Inertial delay device

The inertial delay device is designed to avoid unnecessary operation caused by inrush current of transformer or lamp load. The device can withstand unrepeated one pulse of crest value 20 times higher than the rated current (pulse time = 8 ms). It can be added to circuits having high, medium and low speed operating characteristics. (It cannot be added to instantaneous or DC types.)

Table 1 List of numbers of internal accessories which can be fitted

Type name	AX			AX More than one				AL			AL+AX			SHT			AL+SHT or AX+SHT			AL+AX+SHT	
	1P	2P	3P	1P	2P	3P	3P	1P	2P	3P	1P	2P	3P	1P	2P	3P	1P	2P	3P	3P	
CP30-BA	○	○	○	-	○	○	○	○	○	○	○	○	○	○	○	○	○	○	○	○	○
CP-S	○	○	○	-	○	○	○	○	○	○	○	○	○	○	○	○	○	○	○	○	○

Remark: 1. All accessories should be fitted on the internal accessory terminal block.

Ratings of alarm switches (AL) and auxiliary switches (AX)

(1) For CP30-BA

Ratings of items other than those shaded in Table 1	For general load	Max.	AC			DC		
			Voltage (V)	Current (A)		Voltage (V)	Current (A)	
				Resistive load	Inductive load		Resistive load	Inductive load
			(250)	(1)	(0.5)	50	1	0.5
			125	3	1	30	2	1
			Min. 0.1A/15VAC			Min. 0.1A/15VDC		
			Min. 1mA/24VDC, 2mA/12VDC, 5mA/6VDC					

Remarks: 1. The switches having the ratings in parentheses are manufactured at the customer's request. (Specify the voltage). Such switches do not conform to UL (cURus), CCC or CE Marking requirements.

(2) For CP-S

Voltage (V)	AC Current (A)		Voltage (V)	DC Current (A)	
	Resistive load	Inductive load		Resistive load	Inductive load
250	3	2	250	0.2	0.2
125	5	3	125	0.4	0.4
-	-	-	30	4	3
-	-	-	14	5	4

Remarks: 1. When using these switches to a circuit with a minute load (125 V AC, 0.1 A or 30 V DC, 0.1 A or less), designate the application as minute load.

Ratings of shunt trip (SHT) coils

(1) For CP30-BA

Rated operating voltage (V)		Time rating
100-200	Compatible with 100 to 200 V AC and 100 V DC	10 sec or less
24-48	Compatible with 24 to 48 V DC	

Coil resistance, resistance and impedance (at 25°C)

Voltage (V)	Impedance for AC (Ω)	DC resistance for DC (Ω)
24-48	-	160
100-200	2400	2100

Remarks: 1. The allowable range is 70 to 110% of the rated voltage for AC and 75 to 120% of the rated voltage for DC.

2. The time rating is 10 seconds or less. Configure the circuit on which voltage will not be applied for more than 10 seconds.

(2) For CP-S

Rated operating voltage (V)		Time rating
100	Compatible with 100 to 120 V AC (50/60Hz)	10 sec or less
200	Compatible with 200 to 240 V AC (50/60Hz)	
24, 48, 100	DC24, DC48, DC100	

Coil resistance, resistance and impedance (at 25°C)

Voltage (V)	Impedance for AC (Ω)	DC resistance for DC (Ω)
24	-	110
48	-	110
100	1100	400
200	1100	-



Remarks: 1. The allowable range is 70 to 110% of the rated voltage for AC and 75 to 120% of the rated voltage for DC.

2. The time rating is 10 seconds or less. Configure the circuit on which voltage will not be applied for more than 10 seconds.

Operation of auxiliary switch and alarm switch

Protector status		Switch status CP30-BA, CP-S	
AX	Off or trip		AXa (open) / ALa (closed) AXb (open) / ALb (closed) AXc / ALc
AL	Off or ON		
AX	ON		AXa (closed) / ALa (open) AXb (closed) / ALb (open) AXc / ALc
AL	Trip		

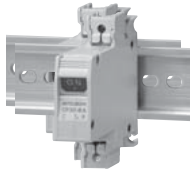
Installation and connection

Installation method	With screws	On IEC rails	With embedded fittings	On panel
Appearance			 Circuit protectors with AL, AX and/or SHT cannot be installed by this method.	
CP30-BA	●	●	●	-
CP-S	-	-	-	●

Installation posture

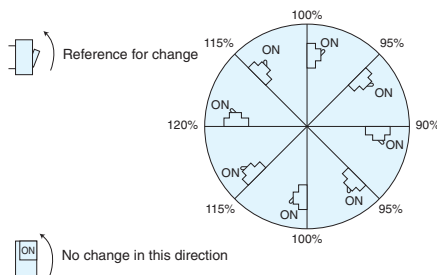

The operating characteristics of electromagnetic (instantaneous) type circuit protectors are not affected by the installation posture. However, when installing a fluid electromagnetic (high, medium or low speed) type circuit protector, pay attention to the installation angle because the operating current value is changed under the influence of the gravity applied to the iron core in the oil dash pot.

Generally, it is recommended to use the circuit protectors in the vertical direction.





Electric wires which can be connected and applicable screw terminals

CP30-BA

Classification	Shape of terminal	Electric wire size used (mm ²)	Applicable screw terminals	Tightening torque (N • m)	
Body	Threaded terminal (standard specification)  Cross recessed or slotted	20 A or less M4	R1.25-4 R1.25-5	M4 1-1.4	
		30A M5	R2-4 R2-5	M5 1.8-2.2	
	Wire retaining screw (square washer)  Cross recessed or slotted	M3.5	0.25-1.65	R1.25-3.5	0.7-0.9
			1.04-2.63	R2-3.5	
		2.63-6.64	R5.5-4 R5.5-5		
		6.64-10.52	*8-5NS (made by JST)		

*Use the screw terminal 8-5NS made by JST.

Low Voltage Air Circuit Breakers (AE-SW Series)

Frame (A)	630	1000	1250	1600	2000	2000	2500	3200	4000		
Model	AE630-SW	AE1000-SW	AE1250-SW	AE1600-SW	AE2000-SWA	AE2000-SW	AE2500-SW	AE3200-SW	AE4000-SWA		
Image											
	AE1600-SW (Drawout type)				● See the catalog of Mitsubishi Low Voltage Air Circuit Breakers, Y-0622, for the details.						
Rated current (CT rating) In (A)	630 (*1)	1000	1250	1600	2000	2000 (*1)	2500	3200	4000		
Rated current setting Ir (A) (adjustable) (Rated ambient temperature 40°C) (For marine use 45°C)	315-346.5-378-409.5-441-472.5-504-535.5-567-598.5-630 (*1)	500-550-600-650-700-750-800-850-900-950-1000	625-687.5-750-812.5-875-937.5-1000-1062.5-1125-1187.5-1250	800-880-960-1040-1120-1200-1280-1360-1440-1520-1600	1000-1100-1200-1300-1400-1500-1600-1700-1800-1900-2000	1000-1100-1200-1300-1400-1500-1600-1700-1800-1900-2000 (*1)	1250-1375-1500-1625-1750-1875-2000-2125-2250-2375-2500	1600-1760-1920-2080-2240-2400-2560-2720-2880-3040-3200	2000-2200-2400-2600-2800-3000-3200-3400-3600-3800-4000		
Number of poles					3, 4 (*2)						
Rated insulation voltage V					1000						
Current carrying capacity of neutral pole A	630	1000	1250	1600	2000	2000	2500	3200	4000		
Rated breaking capacity (kA symmetrical RMS)	IEC 60947-2, EN 60947-2	AC690V		65				75			
	BS	AC600V		65				75			
	JIS C 8201-2-1 Ann.1 Ann.2 NK, LR, GL, BV, ABS, DNV, CCS	AC240-500V		65				85			
Ics = % Icu					100%						
Rated short-time withstand current (kA symmetrical RMS)	1 second		65				75				
Suitability for isolation					Compatible						
Reverse connection					Possible						
Number of operating cycles	Without current		25000				20000				
	With current (690 V AC)		5000		1500		1500		1000	500	
Outline dimension (mm) Height (H) x width (W) x depth (D)	Fixed type	3-pole product	410×340×290				410×475×290				
		4-pole product	410×425×290				410×605×290				
Drawout type	3-pole product	430×300×368				430×435×368		430×439×368			
		4-pole product		430×385×368		430×565×368		430×569×368			
Weight (kg) (Without Accessory)	Fixed type	3-pole product	40	41	42	47	60	61	63	81	
		4-pole product	50	51	52	57	72	73	75	99	
	Drawout type	3-pole product	63	64	65	70	92	93	95	108	
		4-pole product	77	78	79	84	113	114	116	136	
	Cradle only	3-pole product					31		36		49
		4-pole product					35		43		61
CE Marking	Self-declaration										
CCC recognition (☆ Certified)	☆										
Marine approval	☆ Certified (NK, LR, GL, BV, ABS, DNV, CCS)										
Automatic tripping device	Electronic (effective value detection)										

● When the MCR is provided, the breaking capacity may be changed. See the catalog of Mitsubishi Low Voltage Air Circuit Breakers, Y-0622.

● See the catalog of Mitsubishi Low-voltage Air Circuit Breakers, Y-0622, for the details of the accessories.

Notes: *1 AE630-SW and AE2000-SW having low rating types are available. See the catalog of Mitsubishi Low Voltage Air Circuit Breakers, Y-0622, for the details.

*2 The 4-pole products do not have obtained the marine approval.

*3 4 (HN) means the neutral poles current capacity is 50% of the rated current, for 4poles.

*4 (FN) means the neutral poles current capacity is 100% of the rated current, for 4poles.

*4 () shows the value for 4P FN type.

*5 Marine approval value is 138kA.

Features

● Higher reliability by High operating durability (Mechanical)

● Increase of rated short-time withstand current

Combination of the Electronic trip relay (ETR) with MCR (*1) enables increase of the choice coordination range.

● Applicability to increase and decrease of load and improvement of protection coordination

The electronic tripping system enables detailed setting of tripping characteristics. The system uses RMS detection resistant to distorted waves.

● More improved Electronic trip relay (ETR) and transmission functions









To flexibly meet various requirements, functions suitable for purposes can be selected effectively. In addition, improved measuring functions are provided, so that the circuit breakers are applicable to CC-Link, PROFIBUS-DP and MODBUS transmission and helpful in establishing various electrical circuit measurement monitoring systems and energy-saving systems in combination with measuring display unit breakers.

Notes: *1 MCR is an abbreviation for marking current release. It has INST characteristic only when the circuit breaker in the OFF state turns ON (closes). The circuit breaker will lose the INST characteristic after closing, and it will have LTD and STD characteristics.

● Various connections



Various connections for panel structures are available. (See the following figure.)

Connections

Connections Model	Horizontal (standard)	Vertical (*1) (VT)	Front (FT)	Vertical terminal adapter (VTA)	Front terminal adapter (FTA)
Fixed type (FIX)	 (Standard)	 FIX-VT	—	 (FIX-VTA)	 (FIX-FTA)
Drawout type (DR)	 (Standard)	 (DR-VT)	 (DR-FT)	 (DR-VTA)	 (DR-FTA)

Notes: *1 For AE2000-SWA, AE4000-SWA, AE4000-SW, AE5000-SW and AE6300-SW models, vertical terminal only is available.

Low Voltage Air Circuit Breakers (AE-SW Series)

Frame (A)	4000	5000	6300
Model	AE4000-SW	AE5000-SW	AE6300-SW
Image (Reference)	 AE6300-SW (Drawout type)		 ●See the catalog of Mitsubishi Low Voltage Air Circuit Breakers, Y-0622, for the details.
Rated current (CT rating) In (A)	4000	5000	6300
Rated current setting Ir (A) (adjustable) (Rated ambient temperature 40°C) (For marine use 45°C)	2000-2200-2400-2600-2800-3000-3200-3400-3600-3800-4000	2500-2750-3000-3250-3500-3750-4000-4250-4500-4750-5000	3150-3465-3780-4095-4410-4725-5040-5355-5670-5985-6300
Number of poles	3, 4 (HN, FN) (*3)		
Rated insulation voltage V	1000		
Current carrying capacity of neutral pole A	2000 (4000) (*4)		
Rated breaking capacity (asymmetrical RMS) Ics = % Icu	2500 (5000) (*4)		
	3150 (6300) (*4)		
	85		
	130 (*5)		
Rated short-time withstand current (4A symmetrical RMS) 1 second	100%		
Suitability for isolation	Compatible		
Reverse connection	Possible		
Number of operating cycles	10000 (3P) / 5000 (4P)		
	1000		
Outline dimension (mm) Height (H) x width (W) x depth (D)	Fixed type 3-pole product	414x873x290	
	Fixed type 4-pole product	414x1003x290	
Drawout type 3-pole product	480x875x368		
	Drawout type 4-pole product	480x1005x368	
Weight (kg) (without Accessory)	Fixed type 3-pole product	160	160
	Fixed type 4-pole product	180	180
	Drawout type 3-pole product	233	233
	Drawout type 4-pole product	256	263
	Cradle only 3-pole product	118	118
	Cradle only 4-pole product	133	133
CE Marking	Self-declaration		
CCC recognition (☆ Certified)	☆		
Marine approval	☆Certified (NK, LR, GL, BV, ABS)		
Automatic tripping device	Electronic (effective value detection)		

Electronic trip relay (ETR) Type code

Main setting module

WS1, WB1, WM1, WF1	AE630-1600-SW, AE2000-3200-SW, AE4000-SW
WS2, WB2, WM2, WF2	AE2000-SWA, AE4000-SWA, AE5000-SW
WS3, WB3, WM3, WF3	AE6300-SW

WS : General use
WM : Generator protection use
WB : INST/MCR only
WF : Protective coordination use

Optional setting module

G1: Ground fault protection
N5: Neutral pole 50% protection
E1: Earth leakage protection
AP: 2nd Additional Pre-alarm
NA: Without optional setting

ETR Auxiliary Equipment

Temperature alarm(TAL)
 MCR switch(MCR-SW)

For the details of the characteristics, alarm contact output and expanded functions of the ETR, see the catalog of Mitsubishi Low Voltage Air Circuit Breakers, Y-0622.

Power supply

P1: AC-DC100-240V
P2: DC24-60V
P3: AC100-240V / DC100-125V with output contact
P4: DC24-60V with output contact
P5: DC100-240V with output contact (SSR)

Additional function

Extension module(EX1) **Network**

Display(DP1) BIF-CC
 Display onto panel board(DP2) BIF-PR
 VT unit(VT) BIF-MD

Wire system (when EX1 is specified)

EX1 — 3φ3W
 3φ4W
 Normal connection
 Reverse connection

Normal connection: Upper terminal is connected to power supply.
Reverse connection: Lower terminal is connected to power supply.

*The display is optional.



Earth Leakage Relays

Model		Interchangeable leakage relays (*1)												
		Electrical self-hold type				Mechanical self-hold type				Harmonic surge ready		Harmonic surge ready		
		NV-ZBA				NV-ZSA				Electrical self-hold type		Mechanical self-hold type		
Hole diameter mm		15		30		40		60		80		100		
Model name of ZCT combined (*5)		ZT15B		ZT30B		ZT40B		ZT60B		ZT80B		ZT100B		
Image														
Phase line type		3φ4W, 3φ3W, 1φ3W, 1φ2W												
Control voltage AC V		JIS		120 • 240 selectable		120 • 240 selectable 240 • 415 selectable		-		-		-		
		UL/JIS (*2) UL/CE (*3)		-		-		120 • 240 selectable 240 • 440 selectable		120 • 240 selectable 240 • 440 selectable 480		-		
JIS	High speed type	Rated sensitivity current mA		100 • 200 • 500 selectable		100 • 200 • 500 selectable		100 • 200 • 500 selectable		100 • 200 • 500 selectable		-		
		Max. operating time (s)		0.1		0.1		0.1		0.1		-		
JIS	Delay type	Rated sensitivity current mA		100 • 200 • 500 selectable		100 • 200 • 500 selectable (200 • 500 • 1000 selectable)		-		-		-		
		Operating time (s) (*4)		0.3 • 0.8 • 1.6 selectable		0.3 • 0.8 • 1.6 selectable		-		-		-		
		Inertial non-operating time (s) or longer than (s)		0.1 • 0.5 • 1.1		0.1 • 0.5 • 1.1		-		-		-		
UL/JIS	High speed type	Rated sensitivity current mA		-		-		30 50		30 50		-		
		Max. operating time (s)		-		-		0.1		0.1		-		
	High speed type	Rated sensitivity current mA		-		-		100 • 200 • 500 selectable		100 • 200 • 500 selectable		-		
		Max. operating time (s) (*4)		-		-		0.1 • 0.45 • 1.0 selectable		0.1 • 0.45 • 1.0 selectable		-		
UL/CE	Delay type	Rated sensitivity current mA		-		-		30 • 50 • 100 selectable		30 • 50 • 100 selectable		-		
		Max. operating time (s) at 5IΔn		-		-		0.04		0.04		-		
Earth leakage indication		Electric type (LED)		Mechanical type (button)		Electric type (LED)		Mechanical type (button)		Electric type (LED)		Mechanical type (button)		
Resetting method		Push button or control power switch off		Push button (combined with earth leakage indicator)		Push button or control power switch off		Push button (combined with earth leakage indicator)		Push button or control power switch off		Push button (combined with earth leakage indicator)		
Built-in contact	Configuration		1c		1a1c		1a1c		1a1c		1a1c		1a1c	
	Continuous current capacity A		5		5		5		5		5		5	
	Contact capacity A		cosφ=1		cosφ=0.4 L/R=0.007		cosφ=1		cosφ=0.4 L/R=0.007		cosφ=1		cosφ=0.4 L/R=0.007	
			120VAC		5 2		120VAC		5 3		120VAC		5 3	
240VAC			5 2		240VAC		3 2		240VAC		3 2			
24VDC			5 2		415VAC		2 1		24VDC		5 2		480VAC 1 1	
						30VDC		4 3		30VDC		3 3		
						100VDC		0.4 0.4		Use auxiliary relay for AC415V contact.				
						200VDC		0.2 0.2						
Connection		Front		●Clamp terminal		●Clamp terminal		●Clamp terminal		●Clamp terminal		●Clamp terminal		
		Rear		-		●Clamp terminal		●Clamp terminal		●Clamp terminal		●Clamp terminal		
Standard attachment (Front connection)		Mounting screw												
Mass kg		0.3		0.4		0.4		0.4		0.4		0.4		
External accessories		Terminal cover		● (TC-ZBA)		● (TC-ZSA)		● (TC-ZSA) (*6)		● (TC-ZSA) (*6)		● (TC-ZSA) (*6)		
		Mounting hook for IEC 35mm rail (DIN rail) Fixture		● (DIN-ZBA)		-		-		-		-		
Max. consumption VA		3												
Conforming standard	US UL standard (UR certified)		-		-		UL1053 Recognized component (File No.E196562)		UL1053 Recognized component (File No.E196562)		UL1053 Recognized component (File No.E196562)		UL1053 Recognized component (File No.E196562)	
	Canada CSA standard		-		-		LR103083(Certified No.)		LR103083(Certified No.)		LR103083(Certified No.)		LR103083(Certified No.)	
	European CE marking		-		-		Declaration for conformity IEC 60947-2 AnnexB EN 60947-2 AnnexB		Declaration for conformity IEC 60947-2 AnnexB EN 60947-2 AnnexB		Declaration for conformity IEC 60947-2 AnnexB EN 60947-2 AnnexB		Declaration for conformity IEC 60947-2 AnnexB EN 60947-2 AnnexB	

Notes: *1 Interchangeable leakage relays can be easily combined with other relays and our ZCT. However, products with 30mA sensitivity (excluding NV-ZHA/ZLA) can only be used in combination with ZT15B, ZT30B and ZT40B.
 *2 Indicates the UL-standard control voltage. UL, CSA and JIS standards are indicated together. For JIS voltage indications, 100-200V changeover is 120-240V changeover, 200-415V changeover is 240-440V changeover, and 460V and 480V are described together. When ordering, specify "UL/JIS".
 *3 Indicates the UL-standard control voltage. UL, CSA and CE standards are indicated together. For CE voltage indications, 120-230V changeover is 120-240V changeover, 230-440V changeover is 240-440V selectable, which are described together. When ordering, specify "UL/CE".
 *4 When operating times are 0.3 and 0.45sec, 0.8 and 1.0sec and 1.6sec, the relay operates between 0.15 and 0.45sec, 0.6 and 1.0sec and 1.2 and 2.0sec, respectively.
 *5 Can be combined with an interchangeable ZCT equipped with a primary conductor. Refer to the next page for details.
 *6 Not UL-certified.

Remarks: 1. Relays with rates shown in parentheses are special-order.
 2. The relay complies with CE marking conformity declaration only when used with CE marking type MITSUBISHI MCCB with a voltage tripping device to interrupt current during ground fault.
 3. NV-ZBA/ZSA

Control voltage	Available voltage range	Example of applicable circuit voltage
120V	80-126V	100 • 110V • 120V
240V	160-252V	200 • 220 • 240V
415V	320-484V	400 • 415 • 440V

4. NV-ZHA/ZLA

Control voltage	Available voltage range	Example of applicable circuit voltage
120V	80-132V	100 • 110 • 120V
240V	160-264V	200 • 220 • 230 • 240V
440V	304-484V	380 • 400 • 415 • 440V
480V	368-528V	460 • 480V

Interchangeable ZCT

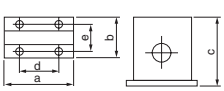
Type		ZT15B	ZT30B	ZT40B	ZT60B	ZT80B	ZT100B
Aperture diameter (mm)		15	30	40	60	80	100
Mass (kg)		0.2	0.4	0.6	2.0	2.6	3.3
Rated short time current		50 (peak value)					
	a	48	68	85	140	160	185
	b	52	52	52	90	90	90
	c	70	90	100	150	169	190
	d	25	50	50	100	100	100
	e	40	40	40	70	70	70

ZCT aperture diameter and wire size

	ZCT aperture diameter (mm)	15	30	40	60	80	100
		Max. 600V rated wire size in mm ² (current in amperes)					
1φ2w	Polyvinyl-chloride insulated wire	14 (88)	60 (217)	150 (395)	325 (650)	600 (992)	800 (1185)
	Cross-linked polyethylene insulated cable	2 (33)	38 (190)	60 (260)	250 (655)	400 (870)	600 (1140)
1φ3w 3φ3w	Polyvinyl-chloride insulated wire	8 (61)	38 (162)	100 (298)	250 (556)	500 (842)	725 (1095)
	Cross-linked polyethylene insulated cable	2 (33)	22 (135)	60 (260)	200 (560)	325 (760)	600 (1140)
3φ4w	Polyvinyl-chloride insulated wire	8 (61)	38 (162)	100 (298)	150 (395)	325 (650)	600 (992)
	Cross-linked polyethylene insulated cable	–	14 (105)	38 (190)	100 (365)	250 (655)	400 (870)

Interchangeable ZCTs with primary conductors

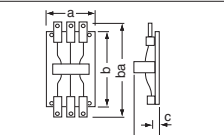
Type	ZTA600A	ZTA1200A	ZTA2000A	
Number of poles	3			
Rated voltage (VAC)	600			
Rated short time current (kA)	100 (peak value)			
	a	227	227	360
	b	256	298	250
	ba	366	444	594
	c	42	78	79
	ca	125	176	214

ELRs with a ZCT with primary conductors

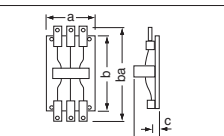
Frame (A)		600	1200	2000	3200
Type	ZBA	Interchangeable ELR and interchangeable ZCTs with primary conductors			NV-ZBA3200
	ZSA				NV-ZSA3200
	ZHA				NV-ZHA3200
	ZLA				NV-ZLA3200
Number of poles		3			
Rated voltage (VAC)		600			
Rated short time current (kA)		100 (peak value)			
	a	227	227	360	490
	b	256	298	250	320
	ba	366	444	594	868
	c	42	78	79	111
	ca	125	176	214	290
Mass (kg)		6.5	11	27	54

Specification of ELRs	Type	Control voltage (VAC)	Rated current sensitivity (mA)	Max. operating time (s)	Inertial non-operating time (s)
		High-speed type		120 • 240 (*1)	100 • 200 • 500 (*1)
Time-delay type		120 • 240 (*1) 240 • 415 (*1)	100 • 200 • 500 (*1)	0.3 • 0.8 • 1.6 (*1)	0.1 • 0.5 • 1.1
High-speed • Time-delay type	ZBA	120 • 240 (*1)	100 • 200 • 500 (*1)	0.3 • 0.8 • 1.6 (*1)	0.1 • 0.5 • 1.1
	ZSA	120 • 240 (*1) 240 • 415 (*1)	100 • 200 • 500 (*1) (200 • 500 • 1000 (*1))	0.3 • 0.8 • 1.6 (*1)	0.1 • 0.5 • 1.1
	ZHA	120 • 240 (*1) 240 • 440 (*1)	100 • 200 • 500 (*1) 100 • 300 • 500 (*1) 300 • 500 • 1000 (*1)	0.1 • 0.45 • 1.0 (*1) 0.45 • 1.0 (*1) (at 2IΔn)	– • 0.1 • 0.5 0.1 • 0.5 (at 2IΔn)
	ZLA	120 • 240 (*1) 240 • 440 (*1) 480	100 • 200 • 500 (*1) 100 • 300 • 500 (*1) 300 • 500 • 1000 (*1)	0.1 • 0.45 • 1.0 (*1) 0.45 • 1.0 (*1) (at 2IΔn)	– • 0.1 • 0.5 0.1 • 0.5 (at 2IΔn)

Note: *1 Selectable.

3

Special-purpose Breakers

1) Mag Only (Instantaneous Tripping Circuit Breakers)	60
2) DC MCCBs and DSN Switches	60
3) 400Hz MCCBs	60

1. Mag Only (Instantaneous Tripping Circuit Breakers)

Fixed	NF63-CV/SV/HV	AC, DC	Rated current x 10 (AC) (DC)
	NF125-CV/SV/HV	AC, DC	
	NF250-CV/SV/HV	AC, DC	
	NF400-CW/SW	AC, DC	
	NF630-CW/SW		
Adjustable	NF800-SEW	AC	High: Rated current x 10 Low: Rated current x 2
	NF800-SDW	DC	High: 8000A Low: 3200A
	NF1000-SEW	AC	High: Rated current x 10 Low: Rated current x 2
	NF1250-SEW		
	NF1600-SEW	AC	High: Rated current x 10 Low: Rated current x 2
	NF1250-SDW	DC	High: 8000A Low: 3200A
NF1600-SDW			

Remarks: 1. The size, weight, accessories, etc., are all identical to the same-designation C, S and H series breakers.
2. For more details, contact your dealer.

2. DC MCCBs and DSN Switches

Breaking is more difficult with direct currents because the current value never reaches zero. While ordinary DC breakers are suitable for low voltages, special-voltage DC breakers are recommended for voltages in excess of 250VDC. Breakers for 550V are all 4-pole models. The size, shape, drilling plan, accessories, etc., are all identical to the S Series breakers with the same designations.

Wiring diagram for DC usage.

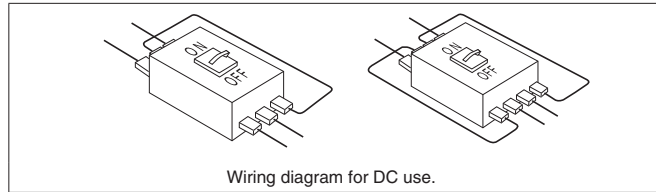

Remark: 1. The tripping characteristics will change if the wiring differs from the one shown here.

Model	NF63-SV		NF125-SV		NF250-SV		NF400-SW		NF630-SW		NF800-SDW		NF1250-SDW		NF1600-SDW	
Number of poles	3	4	3	4	3	4	3	4	3	4	3	4	3	4	3	4
Rated voltage (VDC)	400	550	440	550	500	600	500	600	500	600	500	600	500	600	500	600
Rated breaking capacity (kA) IEC 60947-2 (Icu/Ics)	2/2		10/10		20/20		40/40		40/40		40/40		40/20		40/20	

Remark: 1. Time constant: 10ms or below.

●DC side

These breakers are designed as thyristor-Leonard system DC side breakers. They protect the thyristor from short circuiting when there is a power or

communication failure (Mag Only breakers can also be used for this purpose). Use these breakers in combination with fast fuses for even greater protection.

Model	NF125-SV		NF250-SV		NF400-SW		NF630-SW		NF800-SDW		NF1250-SDW		NF1600-SDW	
Number of poles	2	3	2	3	2	3	2	3	2	3	2	3	2	3
Rated voltage (VDC)	250	440	300	500	250	480	250	480	250	480	250	480	250	480
Rated breaking capacity (kA) IEC 60947-2 (Icu/Ics)	40/40	10/10	20/20		20/20		20/20		20/20		20/20		20/20	
Instantaneous trip current (min.)	3 times rated current		3 times rated current		900A		1000A		1400A		2500A		3200A	

●DSN switches

These are standard MCCBs without the automatic tripping element. The tripping capacity is about six times the rated current.

The appearance, size, drilling plan and available accessories are all identical to similar standard S and C Series MCCBs.

Model	DSN63-CV		DSN125-CV		DSN250-CV		DSN400-CW		DSN630-CW		DSN800-CW	
Rated current (A)	63		125		250		400		630		800	
Number of poles	2	3	2	3	2	3	2	3	2	3	2	3
Rated voltage (AC/DC)	500/250		500/250		500/250		600/250		600/250		600/250	
Max. switching current (AC/DC)	378/155		750/310		1500/625		2400/1000		3780/1575		4800/2000	

Model	DSN32-SV	DSN63-SV	DSN125-SV	DSN125-SGV	DSN160-SGV	DSN250-SV	DSN250-SGV	DSN400-SW	DSN630-SW	DSN800-SW	DSN1000-SW	DSN1250-SW	DSN1600-SW
Rated current (A)	32	63	125	125	160	250	250	400	630	800	1000	1250	1600
Number of poles	2	3	2	3	4	2	3	4	2	3	4	3	4
Rated voltage (AC/DC)	500/250	500/250	690/250	690/300	690/300	690/250	690/300	690/250	690/250	690/250	690/250	690/250	690/250
Max. switching current (AC/DC)	192/80	378/155	750/310	750/315	960/400	1500/625	1500/625	2400/1000	3780/1575	4800/2000	6000/2500	7500/3125	9600/4000

3. 400Hz MCCBs

Standard MCCBs cannot be used in 400Hz circuits. When standard MCCBs are used in high-frequency circuits (eq. 400Hz), the instantaneous characteristics are shifted higher. The 400Hz MCCB is recommended for use in 400Hz circuits.

●Specifications

The appearance, size, rated interrupting capacity, drilling plan, accessories, etc., are all identical to the standard S and H Series breakers of the same designation.

Model	NF125-SV	NF125-HV	NF250-SV	NF250-HV	NF400-SW	NF400-SEW	NF630-SW (*)	NF630-SEW	NF800-SEW	NF1250-SEW	NF1600-SEW	
Rated current (A)	16, 20, 32, 40, 50, 63, 80, 100	16, 20, 32, 40, 50, 63, 80, 100	125, 150, 175, 200	125, 150, 175, 200	225, 250, 300, 350	200-350 adjustable	400, 500	300-500 adjustable	400-600 adjustable	600-800 adjustable	800-1200 adjustable	
Number of poles	2	3	4	2	3	4	2	3	4	3	4	
Rated insulation voltage (V)	690											
Rated breaking capacity (kA) IEC 60947-2 (Icu/Ics)	690V	8/8	10/8	8/8	10/8	10/10	10/10	10/10	10/10	10/10	25/13	25/13
	500V	18/18	30/23	30/30	50/38	30/30	30/30	30/30	30/30	30/30	65/33	65/33
	440V	25/25	50/38	36/36	65/65	42/42	42/42	42/42	42/42	42/42	85/43	85/43
	400V	30/30	50/38	36/36	75/75	45/45	50/50	50/50	50/50	50/50	85/43	85/43
	230V	50/50	100/75	85/85	100/100	85/85	85/85	85/85	85/85	85/85	125/63	125/63

Note: *1 Instantaneous trip current : Rated current x 14 (Fix)

4

Selection

1 Construction and Operation	62
1) Construction of MCCB.....	62
2) Construction of ELCB	64
2 Selection of MCCB and ELCB	65
1) Selecting Procedure	65
2) Features and Performance	66
3) Current-carrying Capacity and Operating Temperature	68
4) Application of Circuit Breaker According to Breaking Capacity	70
5) Selection of Circuit Breaker for Electric Lamp or Heater Circuit	71
6) Selection of Circuit Breaker for Motor Branch Circuit	73
7) Selection of Motor Protection Breaker	75
8) Selection of Circuit Breaker for Inverter Circuit	76
9) Selection of Circuit Breaker for Transformer Primary Side	77
10) Combination for Selective Breaking	81
11) Combination for Cascade Breaking.....	83
12) International Standard Conformance List	85
3 Selection of ELCB	88
1) Electric Shock Protection	88
2) ELCB Grounding Method	89
3) Rated Voltage and Number of Poles.....	90
4) Earth Fault Protection Coordination and Combination of Devices	91

1. Construction of MCCB

Adjustable Instantaneous Tripping Current

On electronic molded case circuit breakers, the instantaneous tripping current can be adjusted only by turning the knob. Therefore, optimum characteristics for load can be obtained.

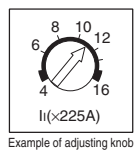

Arc-Extinguishing Device

Mitsubishi MCCBs feature excellent arc-extinguishing performance by virtue of the optimum combination of grid gap, shape, and material.

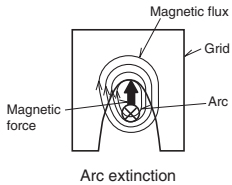

Switching Mechanism

The contacts open and close rapidly, regardless of the moving speed of the handle, minimizing contact wear and ensuring safety.

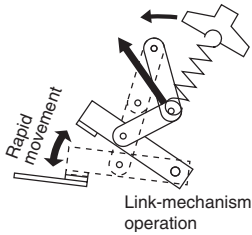

Trip Button (Push to Trip)

Enables tripping mechanically from outside, for confirming the operation of the accessory switches and the manual resetting function.

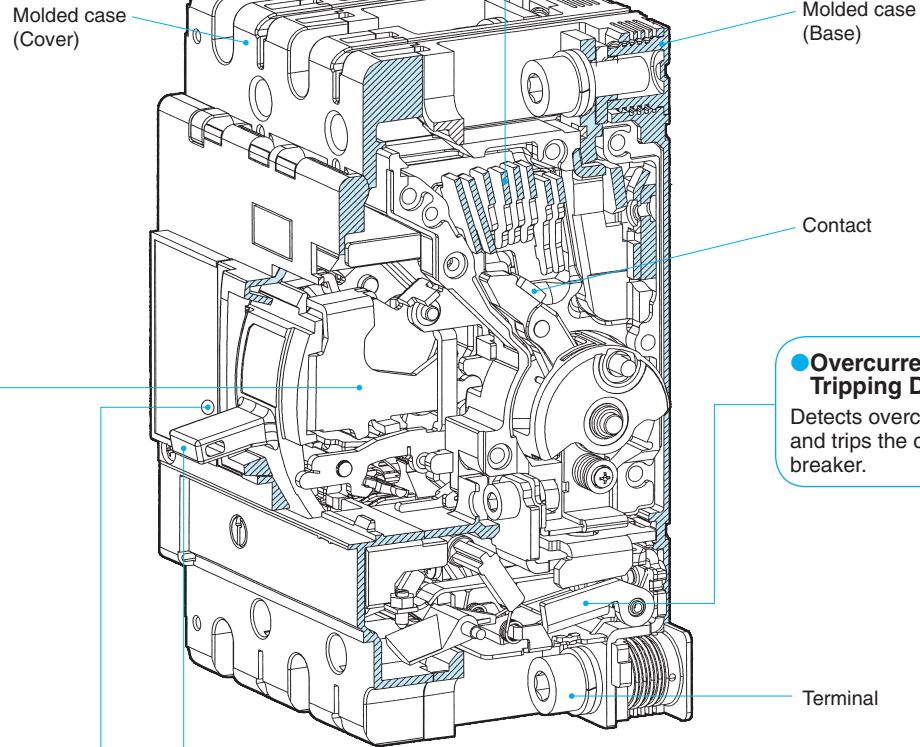

Fig. 4.1 Construction

Overcurrent Tripping Device

Detects overcurrent and trips the circuit breaker.

Handle

1. Trip indication

The automatically tripped condition is indicated by the handle in the center position between ON and OFF, the yellow (or white) line cannot be seen in this position.

2. Resetting

Resetting after tripping is performed by first moving the handle to the OFF position to engage the mechanism, then returning the handle to ON to reclose the circuit.

3. Trip-Free

Even if the handle is held at ON, the breaker will trip if an overcurrent flows.



Handle indication

4. Contact On Mechanism

Even in the worst case in which welding occurs owing to an overcurrent, the breaker will trip and the handle will maintain to ON, indicating the energizing state.

4-pole Breaker

- The 4-pole breaker is designed for 3-phase 4-wire circuits. A neutral pole without an overcurrent tripping element is provided at the right end. The construction and operation are the same as class S, H and U breakers. (Electronic molded case circuit breakers with frame size of 1600A or less have overcurrent tripping elements on the neutral poles.)
- Since the four poles are simultaneously opened and closed, the user will not fail in turning on the neutral pole or carelessly open the pole. (The standard construction is designed to close the neutral pole earlier and open it later than the voltage pole except for the construction with frame size of 2000A.)

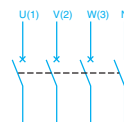

Fig. 4.2 4-pole Breaker (NF250-SV)

● Automatic Tripping Devices

Thermal-Magnetic Type

(NF32-SV, NF63-CV/SV/HV, NF125-CV/SV/HV, NF250-CV/SV/HV)
(NF400-CW/SW, NF630-CW/SW, NF800-SDW, etc.)

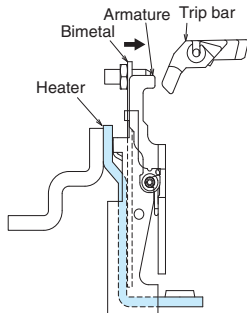

Fig. 4.3

1. Time-Delay Operation
An overcurrent heats and warps the bimetal to actuate the trip bar.
2. Instantaneous Operation
If the overcurrent is excessive, the armature is attracted and the trip bar actuated.

Thermal-Magnetic Type (NF1250-SDW)

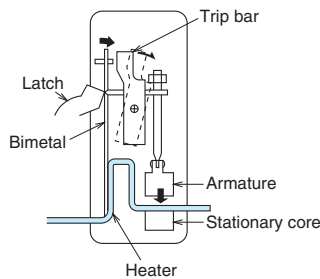

Fig. 4.4

1. Time-Delay Operation
An overcurrent heats and warps the bimetal to actuate the trip bar.
2. Instantaneous Operation
If the overcurrent is excessive, magnetization of the stationary core is strong enough to attract the armature and actuate the trip bar.

Hydraulic-Magnetic Type (NF30-CS etc.)

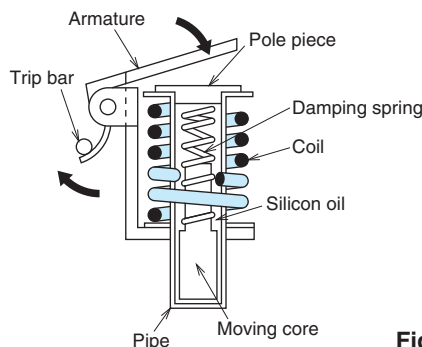

Fig. 4.5

1. Time-Delay Operation
At an overcurrent flow, the magnetic force of the coil overcomes the spring, the core closes to the pole piece, attracts the armature, and actuates the trip bar.
The delay is obtained by the viscosity of silicon oil.
2. Instantaneous Operation
If the overcurrent is excessive, the armature is instantly attracted, without the influence of the moving core.

Principle of Electronic Trip Relay (ETR) Operation

(NF125-SEV/HEV, NF250-SEV/HEV, etc.) (NF400-SEW~NF800-CEW)
(NF1000-SEW~NF1600-SEW, etc.)

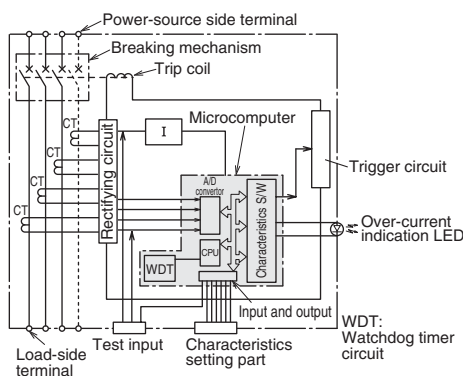

Fig. 4.6.1

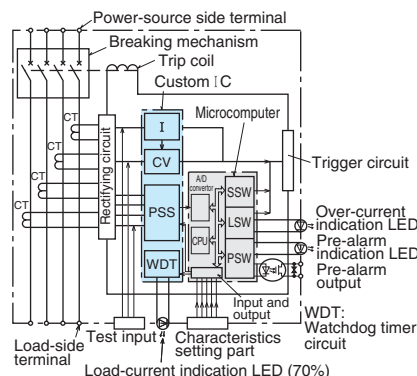

Fig. 4.6.2

1. The current flowing in each phase is monitored by a current transformer (CT).
2. Each phase of the transformed current undergoes full-phase rectification in the rectifier circuit.
3. After rectification, each of the currents are converted by a peak-conversion and an effective-value conversion circuit.
4. The largest phase is selected from the converted currents.
5. Each time-delay circuit generates a time delay corresponding to the largest phase.
6. The trigger circuit outputs a trigger signal.
7. The trip coil is excited, operating the switching mechanism.

Number of tripping devices

Descriptions (e.g. 2P1E and 2P0E) are not given in the number of poles fields of some models. For these models, the same number of overcurrent tripping devices as the number of poles is provided in the circuit breakers.

2 poles: 2P2E, 3 poles: 3P3E, 4 poles: 4P4E or 4P3E

(Some 4-pole models do not have overcurrent tripping devices for the neutral poles.)

2. Construction of ELCB

● Arc-Extinguishing Device

Mitsubishi ELCBs feature excellent arc-extinguishing performance by virtue of the optimum combination of grid gap, shape, and material.

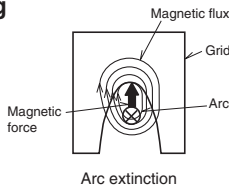

● Trip Button (Push to Trip)

Enables tripping mechanically from outside, for confirming the operation of the accessory switches and the manual resetting function.

● Overcurrent Tripping Device

The use of the proven mechanism of Mitsubishi ELCBs ensures reliable detection of overcurrent.

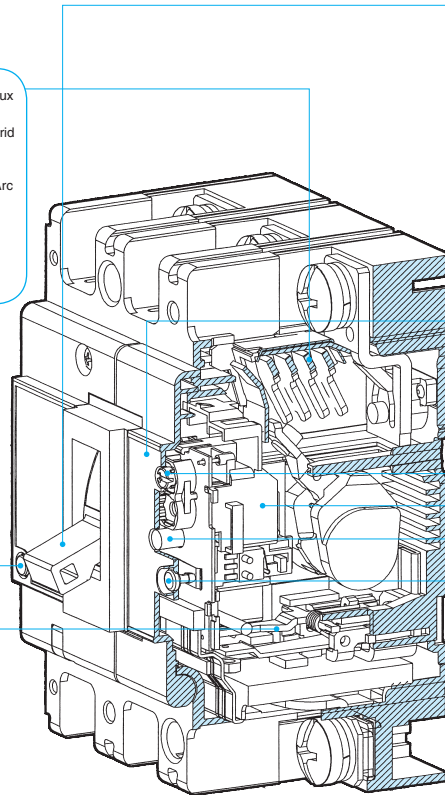

Fig. 4.7 Construction

● Switching Mechanism

The contacts open and close rapidly, regardless of the moving speed of the handle, minimizing contact wear and ensuring safety.

● Window Frame

Since the handle, trip button, test button, leakage display button and nameplate are located in one area, it is easy to cut the panel.

● Sensitivity Switching Device

The rated sensitivity current can be easily changed. A 3-stage switching device for 100, 200 and 500 mA and a 2-stage switching device for 200 and 500 mA are available.

● Leakage Display

Target type with display button. The display is automatically reset by the handle.

● Test Button

The button has excellent durability and performance to withstand inspection at start.

● Leakage Tripping Device

- The semiconductor circuit unit, which is the most important part of the device, is an electronic type using highly reliable ICs.
- For improvement of the function for removing harmonic and surge components, two filters are provided to prevent unnecessary operations.
- The ZCT detects any minute current. It is covered with a magnetic shield and never operates unnecessarily owing to motor starting current.

Rated operational voltage	Applicable circuit voltage	Available voltage range
100-240V	100/110/200/220/230/240V	80 to 264V
100-440V	100/110/200/220/240/254/265/380/400/415/440V	80 to 484V
200-440V	200/220/240/254/265/380/400/415/440V	160 to 484V
100-200-415V	100/110/200/220/240/254/265/380/400/415/440V	80 to 484V
200-415V	200/220/240/254/265/380/400/415/440V	160 to 484V

● Operation

1. When an earth fault occurs, voltage is induced on the secondary side of the ZCT.
2. Factors of unnecessary operations, i.e. surge and noise components, are removed from the induced voltage.
3. The signal level is discriminated, and, when the level exceeds the specified level, the electromagnetic device is excited to trip the circuit breaker body.

Overload and short-circuit

The use of the proven mechanism of Mitsubishi ELCBs ensures reliable detection of overcurrent and earth fault to break the circuit.

Revision to EN and GB Standards

Products for European markets must conform to the CE Marking Directives. To affix the CE mark to a product, it is necessary that the product conforms to European Standard (EN Standard).

Products for China must conform to Chinese GB Standard to affix the CCC mark.

The third edition (2003) of EN Standard for circuit breakers, EN 60947-2, and GB Standard GB 14048.2 (2008) prescribe that the functions of earth leakage circuit breakers should normally work even in open phase condition. Products based on the previous EN Standard (second edition) have not been approved since June, 2006. Products based on the previous GB Standard (2001) have not been approved since January, 2011.

☆WS-V Series Earth Leakage Circuit Breakers (conforming to CE and CCC Standards) and UL 489 Listed Molded Case Circuit Breakers with earth leakage protection conform to the third edition of EN 60947-2 and GB 14048.2 2008 as 3-phase power supply earth leakage circuit breakers.

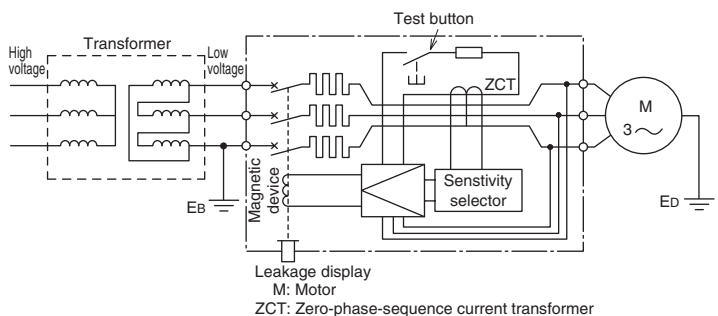

Fig. 4.8 Circuit configuration of ELCB (NV63-SV)

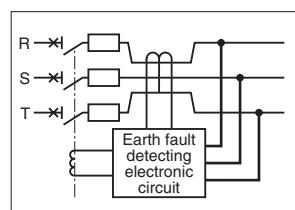

Fig. 4.9 Circuit diagram in 3-phase power supply ELCB

1. Selecting Procedure

■ MCCB (NF)

Circuit used Applicable standard	Phase and wire type, voltage, DC or AC, frequency, standard	<ul style="list-style-type: none"> ●Applicable phase and wire type 2 poles: 1-phase 2-wire 3 poles: 1-phase 2-wire, 1-phase 3-wire, 3-phase 3-wire 4 poles: 3-phase 4-wire ●Specification list (pages 14 to 35) ●List of received certifications (page 86)
Determination of rated current	Kind and size of electric wire Kind and working conditions of load Selection conditions in internal standard and electrical equipment technical standards	<ul style="list-style-type: none"> ●Relationship between temperature and electric wire (page 68) ●Selection of circuit breaker for motor branch circuit (page 73) ●Selection of circuit breaker for electric lamp or electric heater circuit (page 71) ●Selection of motor protection breaker (page 75) ●Selection of circuit breaker for inverter circuit (page 76) ●Selection of circuit breaker on transformer primary side (page 77)
Determination of interrupting capacity	Transformer capacity Electric wire thickness and length	<ul style="list-style-type: none"> ●Application based on breaking capacity (page 70) ●Table of combinations for cascade breaking (page 83)
Examination of coordination	Selective breaking	<ul style="list-style-type: none"> ●Operating characteristic curve (pages 142 to 218) ●Table of combinations for selective breaking (page 81)
Determination of model	Use	●Circuit Breakers for special purpose (pages 60)
Installation method	Connection and molded case circuit breaker	<ul style="list-style-type: none"> ●Installation and connection (pages 94 to 102) ●Boxed Circuit Breakers (page 132)
Accessories	Internal accessories and external accessories Electric operation	<ul style="list-style-type: none"> ●Internal accessories (pages 104 to 118) ●External accessories (pages 119 to 139) ●Electrical Operated Circuit Breakers (pages 135 to 137)

■ ELCB (NV)

Circuit used Applicable standard	Phase and wire type, voltage, DC or AC, frequency, standard	<ul style="list-style-type: none"> ●Specification list (pages 24 to 34) ●List of received certifications (page 86)
Determination of rated current	Kind and size of electric wire Kind and working conditions of load Selection conditions in internal standard and electrical equipment technical standards	<ul style="list-style-type: none"> ●Relationship between temperature and electric wire (page 68) ●Selection of circuit breaker for motor branch circuit (page 73) ●Selection of circuit breaker for electric lamp or electric heater circuit (page 71) ●Selection of circuit breaker for inverter circuit (page 76) ●Selection of circuit breaker on transformer primary side (page 77)
Determination of interrupting capacity	Transformer capacity Electric wire thickness and length	<ul style="list-style-type: none"> ●Application based on breaking capacity (page 70) ●Table of combinations for cascade breaking (page 83)
Determination of rated sensitivity current	Purpose of protection Obligation of installation	<ul style="list-style-type: none"> ●Purpose of protection (page 88) ●Selection of rated sensitivity current of circuit breaker for inverter circuit (page 76) ●Method of switching between rated voltage and rated sensitivity current (page 250)
Examination of coordination	Selective breaking Ground fault protection coordination	<ul style="list-style-type: none"> ●Operating characteristic curve (pages 182 to 205) ●Table of combinations for selective breaking (page 81) ●Combinations of ground fault protection coordination and devices (page 91)
Determination of model	Use	●Circuit Breakers for special purpose (pages 60)
Installation method	Connection and molded case circuit breaker	<ul style="list-style-type: none"> ●Installation and connection (pages 94 to 102) ●Boxed Circuit Breakers (page 132)
Accessories	Internal accessories and external accessories Electric operation	<ul style="list-style-type: none"> ●Internal accessories (pages 104 to 118) ●External accessories (pages 119 to 139) ●Electrical Operated Circuit Breakers (pages 135 to 137)

2. Features and Performance

■ Features of MCCB

● Molded Case Circuit Breakers (NF)

① Time-delay trip function

This function conforms to the allowable current and time characteristics of electric wire and prevents operation caused by the starting current of a load device. When the overcurrent is large, the operating time is short, and when the overcurrent is small, the operating time is long.

● In the case of electronic type

The electronic time-delay trip function includes a long time limit trip function conforming to the allowable current and time characteristics of conductor and a short time limit trip function for selective breaking for branch NFB. The short time limit function operates after a delay of some cycles (0.06 to 0.3 s) at overcurrent exceeding the short time limit tripping current. These functions can be adjusted by the knob.

② Instantaneous trip function

This function breaks the circuit immediately when short-circuit current flows. A circuit breaker on which the instantaneous tripping current is adjustable has the advantage that coordination in operation with other protective devices, such as electromagnetic switches and low-voltage air circuit breakers, can be easily obtained. The instantaneous operating time (total interrupting time) can be divided as shown in Fig. 4-10.

③ Operating characteristic curve

The operating characteristic curve indicates the relationship between magnitude of overcurrent and operating time. The maximum-minimum operating characteristic curve indicates that the operating time is in the range. Figs. 4-11 and 4-12 show examples of operating characteristic curves.

Table 4-1 Overcurrent trip operating time (IEC 60947-2)

Rated current of circuit breaker (A)	Operating time for 130% current
63 or less	Within 1 hr.
Over 63	Within 2 hrs.

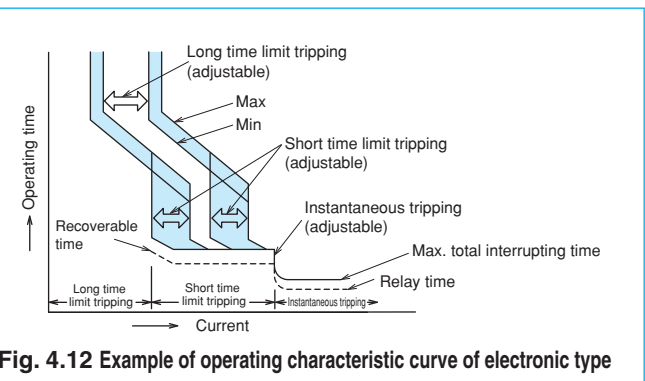
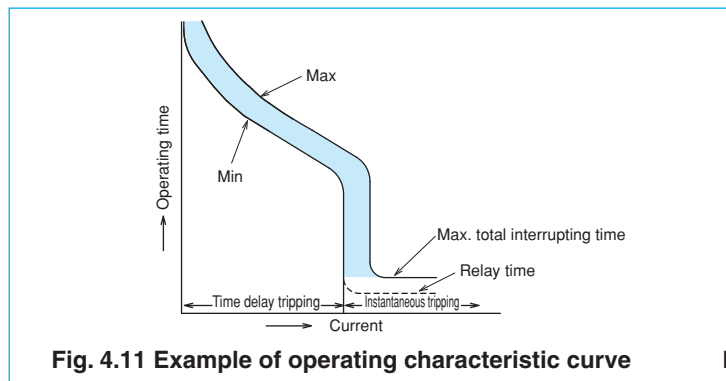
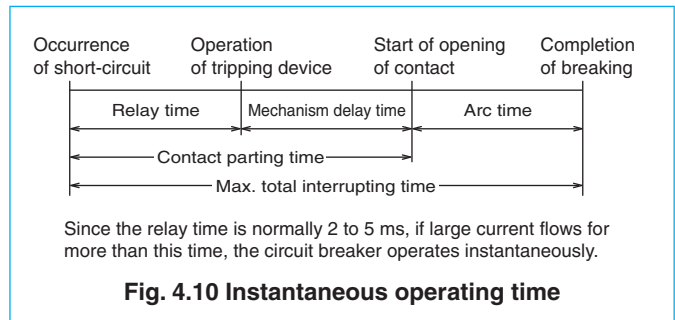

● Motor Protection Breakers

- The motor protection breakers are circuit breakers to be used to protect general induction motors. They prevent motors being burnt not only by short-circuit current of circuits, but also by overcurrent caused by overload operation and locking of motors.
- The Motor Protection Breakers are finely classified according to rated current so that the breakers can be applied to various types of motors.
- Although their time-delay trip and instantaneous trip functions are almost the same as those of MCCB, they are designed to operate within 2 seconds to 30 seconds at 600% of the rated current in consideration of protection from motor starting current and locked current.

- There are many kinds of motors, and the motors have various allowable characteristics for overcurrent. Therefore, when applying a motor breaker, it is necessary to compare the allowable characteristics and the operating characteristics of the motor breaker. Note that, particularly, submersible motors may not be protected by ordinary motor breakers because their allowable locked time is short.
- When the motor starting current is large and the starting time is long and when the frequency of intermittent operation is high, motor breakers are unsuitable. In such a case, the use of a combination of an electromagnetic switch and MCCB (combination starter) is recommended.

● Characteristics of MCCB for DC circuits

When a 2-pole MCCB (250 V DC or less) is used on a DC circuit, connect the poles in series. When a 3- or 4-pole MCCB is used, refer to page 60 (for special DC voltage) or pages 14 to 21 (for DC).
If the breaker is not connected as specified, its tripping characteristics and breaking performance will change, and it cannot be used.

● Current-limiting characteristic

The current limiting refers to reduction of estimated short-circuit current depending on the circuit to prevent flow of the larger short-circuit current. The use of a class S, H or R which has excellent current-limiting characteristic or class U enables to reduce the passing energy at short-circuiting and protect the devices in the electric circuit from electromagnetic force and thermal stress.

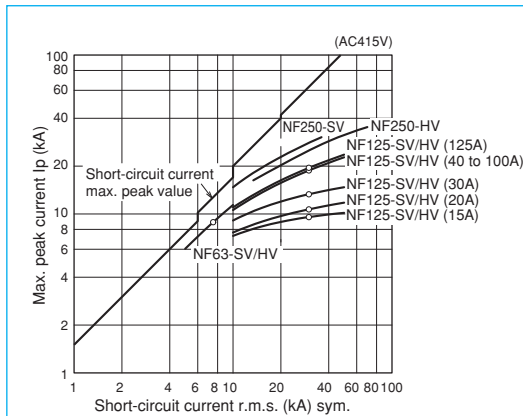
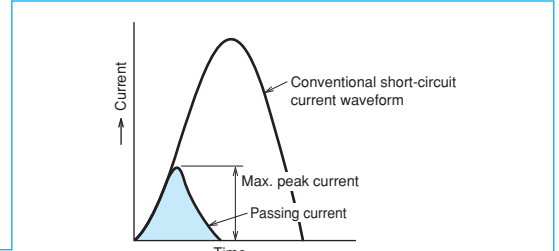

Fig. 4.13
Passing current peak value characteristic of classes S and H (415 VAC)

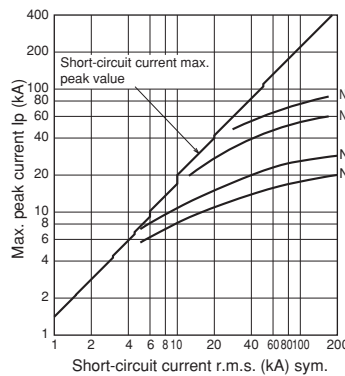

Fig. 4.14
Passing current peak value characteristic of classes U (415 VAC)

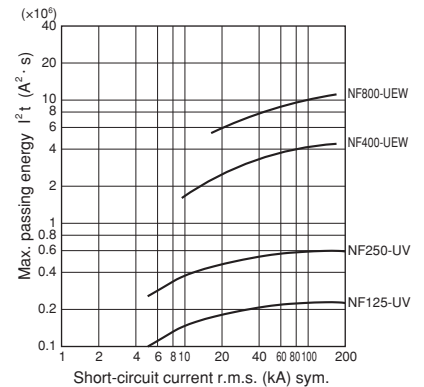

Fig. 4.15
Passing I^2t characteristic of class U (415 VAC)

■ Performance

● Short-circuit breaking performance

Short-circuit current corresponding to the rated interrupting capacity is interrupted.

● Outline of short-circuit test (IEC 60947-2)

- ① Rated limit short-circuit interrupting capacity (I_{cu})
Operating duty: O – 3 min – CO
- ② Rated service short-circuit interrupting capacity (I_{cs})
Operating duty: O – 3 min – CO – 3 min – CO
Upper limit of temperature rise of terminal after breaking: 80K or less
O duty: The circuit breaker in the ON status carries and interrupts short-circuit current.
CO duty: A shorted circuit is formed, and the circuit breaker is turned on to carry and interrupt short-circuit current.

● Opening/closing performance

Table 4-2 shows the durability against opening and closing. See the durability against opening and closing as reference when using a circuit breaker as a switchgear. The durability against tripping by SHT (shunt tripping device), UVT (undervoltage tripping device) and trip button is 10% of the total durability against opening and closing.

Note: Opening and closing operations are regarded as one time.

If a circuit breaker is regularly used to trip, the life of the circuit breaker will be significantly reduced.

Table 4-2 Durability of MCCB against opening and closing (IEC 60947-2)

Rated current (A)	Frequency of opening and closing (times/hour)	Durability against opening and closing (times)		
		With current flow	Without current flow	Total
100 or less	120	1500	8500	10000
101 to 315	120	1000	7000	8000
316 to 630	60	1000	4000	5000
631 to 2500	20	500	2500	3000
2501 or more	10	500	1500	2000

3. Current-carrying Capacity and Operating Temperature

■ Operating current vs. ambient temperature

Rated current of circuit breakers is adjusted for the rated ambient temperature. This is because circuit breakers are often installed in a casing as a switchboard or a control board, and temperature of the installed place of the breaker becomes higher than ambient temperature of the wires. If temperature of the installation site of circuit breakers greatly differ from the rated ambient temperature, it is necessary to correct rated current according to the temperature correction curve (shown in the Paragraph of characteristics and outside shape in the catalog). Load current can be increased up to the rated current corrected according to ambient temperature.

However, set current rating with enough allowance while taking fluctuation of power voltage and load current into consideration so that maximum operating current may not exceed the rated current.

(1) Cautionary instructions for using heat resistive wire

For using insulated wires of higher heat resistance than that of 600 V PVC insulated wire (allowable temperature 60°C), it is necessary to take the following points into consideration.

For circuit breakers, size of test wire is stipulated by each test current in IEC60947-1

If size of connection wire is thinner than the test wire size, temperature of the breaker terminals increases and overcurrent tripping operation characteristic may change in some cases. (Operating time becomes shorter usually.)

At motor load, for example, influence of change in operation characteristic by difference in size of connection wire is insignificant and can be disregarded because the load current is far lower than the rated current of the circuit breaker.

Table 4-3 Size of test wire

Range of test current (A)	Conductor size (mm ²)
0 < ≤ 8	1.0
8	1.5
12	2.5
15	2.5
20	4.0
25	6.0
32	10
50	16
65	25
85	35
100	35
115	50
130	50
150	70
175	95
200	95
225	120
250	150
275	185
300	185
350	240

(2) Connection of aluminum conductors

- When aluminum conductors are connected, be careful to prevent the contact resistance (due to the oxidized film of aluminum) from being increased.
- The surface of the connection point of the aluminum conductors shall be properly treated by plating (zinc displacement-Copper-Silver) or by joint compound. If the treatment is done only by joint compound, reliability is low, this should be limited to when plating is impossible (eg. at site).
- For aluminum cables, use compression terminals that are exclusively for aluminum cables.
- The compression portion of the terminal shall be provided with taping, and the aluminum wire shall not be exposed to the atmosphere.

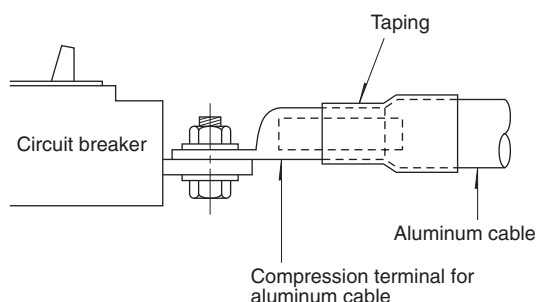

Fig. 4.16 Example of connection of aluminum conductor

(3) Maximum operating current of installation without clearance between breakers

In case of installation without clearance between breakers, because malfunction failures can result by heat of breaker, use the operating current not to exceed the below value.

Table 4-4

Model								Maximum operating current	
BH	BH-P	BH-S	BH-PS					80% of rated current	
CP30-BA	CP-B	CP-S							
NF30-CS									
NF32-SV	NF63-CV			NV32-SV	NV63-CV				
NF63-SV	NF63-HV			NV63-SV	NV63-HV				
NF125-CV	NF125-SGV	NF125-SEV		NV125-CV					
NF125-SV	NF125-LGV	NF125-HEV		NV125-SV					
NF125-HV	NF125-HGV			NV125-HV					
NF125-RGV									
NF160-SGV	NF160-LGV	NF160-HGV							
NF250-CV	NF250-LGV			NV250-CV					
NF250-SV	NF250-SGV			NV250-SV	NV250-SEV				
NF250-HV	NF250-HGV	NF250-RGV		NV250-HV	NV250-HEV				
NF400-CW	NF400-SW	NF400-SEW	NF400-HEW	NV400-CW	NV400-SW	NV400-SEW	NV400-HEW		90% of rated current
NF400-REW	NF400-U EW			NV400-REW					
NF630-CW	NF630-SW	NF630-SEW	NF630-HEW	NV630-CW	NV630-SW	NV630-SEW	NV630-HEW		
NF630-REW									
NF800-CEW	NF800-SDW	NF800-SEW	NF800-HEW	NV800-SEW	NV800-HEW				
NF800-REW	NF800-U EW								

4 Selection 2 Selection of MCCB and ELCB

4. Application of Circuit Breaker According to Breaking Capacity

MCCB (NF)

Class C, FAU Series Classes S, H and R

(The correlation between transformers and interrupting capacities is intended for short-circuiting just under the secondary voltage of 3-phase standard transformer, 210 V or 420 V, or the voltage of single-phase 3-wire transformer, 210 V.)

Table 4-5 230VAC

3ph trans. capacity (kVA)	30 or less	50 to 75	100	150 to 300	500 to 1500	2000 to 3000										
1ph trans. capacity (kVA)	20 or less	30 to 50	75	100 to 150	200 to 300	-										
Breaking capacity (kA) (sym)	2.5	5	7.5	10	15	25	30	35	36	50	85	100	125	150	170	200
Frame (A)	30 • 32	NF30-CS NF30-FAU (*1)	NF32-SV													
	50 • 60 • 63	NF50-FAU (*1)	NF63-CV	NF63-SV	NF63-HV											
	100 • 125	NF125-CV				NF125-SV	NF125-SEV		NF125-HEV	NF125-RGV		NF125-UV				
	225 • 250	NF250-CV				NF250-SV	NF250-SEV		NF250-HV	NF250-RGV		NF250-UV				
	400	NF400-CW				NF400-SW/SEW		NF400-HEW	NF400-REW	NF400-UEW						
	600 • 630	NF630-CW				NF630-SW/SEW		NF630-HEW	NF630-REW	NF630-UEW						
	800	NF800-CEW				NF800-SEW		NF800-HEW	NF800-REW	NF800-UEW						
	1000 to 4000	NF1000-SEW~NF1600-SEW														

*1 The breaking capacity of NF30-FAU and NF50-FAU having a rated current of 5 A is 1.5 kA.

Table 4-6 440VAC

Trans. capacity (kVA)	30 or less	50 to 100	150 to 300	500 to 1000	1500 to 2000	2500 to 5000										
Breaking capacity (kA) (sym)	1.5	2.5	7.5	10	15	20	25	30	35	36	50	65	85	125	200	
Frame (A)	30 • 32	NF30-CS	NF32-SV													
	50 • 60 • 63	NF63-CV	NF63-SV	NF63-HV												
	100 • 125	NF125-CV			NF125-SV	NF125-HV		NF125-SEV		NF125-HEV	NF125-RV		NF125-UV			
	225 • 250	NF250-CV			NF250-SV	NF250-SEV		NF250-HV	NF250-HEV		NF250-RV		NF250-UV			
	400	NF400-CW			NF400-SW/SEW		NF400-HEW	NF400-REW	NF400-UEW							
	600 • 630	NF630-CW			NF630-SW/SEW		NF630-HEW	NF630-REW	NF630-UEW							
	800	NF800-CEW			NF800-SEW		NF800-HEW	NF800-REW	NF800-UEW							
	1000 to 4000	NF1000-SEW~NF1600-SEW														

ELCB (NV)

Class C, FAU Series Classes S, H and R

(The correlation between transformers and interrupting current is intended for short-circuiting just under the secondary voltage of 3-phase standard transformer, 210 V or 420 V, or the voltage of single-phase 3-wire transformer, 210 V.)

Table 4-7 230VAC

3ph trans. capacity (kVA)	30 or less	50 to 75	100	150 to 300	500 to 1500	2000 to 3000								
1ph trans. capacity (kVA)	20 or less	30 to 50	75	100 to 150	200 to 300	-								
Breaking capacity (kA) (sym)	1.5	2.5	5	7.5	10	15	25	30	35	36	50	85	100	125
Frame (A)	30 • 32	NV30-FAU (*1)	NV32-SV											
	50 • 60 • 63	NV50-FAU (*1)	NV63-CV	NV63-SV	NV63-HV									
	100 • 125	NV125-CV				NV125-SV	NV125-HV		NV125-SEV		NV125-HEV			
	225 • 250	NV250-CV				NV250-SV	NV250-SEV		NV250-HV	NV250-HEV				
	400	NV400-CW				NV400-SW/SEW		NV400-HEW	NV400-REW	NV400-UEW				
	600 • 630	NV630-CW				NV630-SW/SEW		NV630-HEW	NV630-REW	NV630-UEW				
	800	NV800-SEW				NV800-SEW		NV800-HEW	NV800-REW	NV800-UEW				

*1 The interrupting current of NF30-FAU and NF50-FAU having a rated current of 5 A is 1.5 kA.

Table 4-8 440VAC

Trans. capacity (kVA)	30 or less	50 to 100	150 to 300	500 to 1000	1500 to 2000	2500 to 5000								
Breaking capacity (kA) (sym)	2.5	5	7.5	10	15	25	30	35	36	50	65	70	85	125
Frame (A)	30 • 32	NV32-SV												
	50 • 60 • 63	NV63-CV	NV63-SV	NV63-HV										
	100 • 125	NV125-CV			NV125-SV	NV125-HV		NV125-SEV		NV125-HEV				
	225 • 250	NV250-CV			NV250-SV	NV250-SEV		NV250-HV	NV250-HEV					
	400	NV400-CW			NV400-SW/SEW		NV400-HEW	NV400-REW	NV400-UEW					
	600 • 630	NV630-CW			NV630-SW/SEW		NV630-HEW	NV630-REW	NV630-UEW					
	800	NV800-SEW			NV800-SEW		NV800-HEW	NV800-REW	NV800-UEW					

In some lighting apparatuses, the service life of circuit breakers may be reduced by the influence of inrush current applied when the lamps are turned on. Periodically check for abnormal temperature rise of the circuit breaker in such an apparatus.

5. Selection of Circuit Breaker for Electric Lamp or Heater Circuit

The maximum working current is 0.8 times the rated current of each circuit breaker.

■ MCCB (NF)

Table 4-9 230VAC

Max. working current (A)	Rated current of circuit breaker (A)	Breaking capacity (kA) 230 V AC (Icu sym)														
		2.5	5	7.5	10	15	25	30	36	50	85	100	125	150	170	200
12	15	NF30-CS BH-P	BH-P (110/220V)	NF32-SV	NF63-SV	NF63-HV	NF125-SV	NF125-HV	NF125-SV	NF125-HV	NF125-HV	NF125-HV	NF125-HV	NF125-HV	NF125-HV	NF125-HV
16	20			NF32-SV												
24	30	BH-P (110/220V)		NF63-CV	NF63-SV	NF63-HV	NF125-SV	NF125-HV	NF125-SV	NF125-HV	NF125-SV	NF125-HV	NF125-SV	NF125-HV	NF125-HV	NF125-HV
32	40	NF63-CV	NF125-SV	NF125-HV												
40	50	NF125-CV														
48	60	NF125-CV														
60	75	NF125-CV														
80	100	NF125-CV														
100	125	NF125-CV														
120	150	NF125-CV														
140	175	NF125-CV														
160	200	NF250-CV														
180	225	NF250-CV														
200	250	NF250-CV														
240	300	NF250-CV														
280	350	NF250-CV														
320	400	NF250-CV														
400	500	NF400-CW														
480	600	NF400-CW														
560	700	NF400-CW														
640	800	NF400-CW														
800	1000	NF630-CW														
960	1200	NF630-CW														
1120	1400	NF800-CEW														
1280	1600	NF800-CEW														
		NF1000-SEW														
		NF1250-SEW														
		NF1600-SEW														

Table 4-10 440VAC

Max. working current (A)	Rated current of circuit breaker (A)	Breaking capacity (kA) 440 V AC (Icu sym)														
		1.5	2.5	5	7.5	10	25	30	36	45	50	70	85	125	150	200
12	15	NF30-CS	NF32-SV	NF32-SV	NF63-SV	NF63-HV	NF125-SV	NF125-SV	NF125-HV	NF125-SV	NF125-HV	NF125-SV	NF125-HV	NF125-SV	NF125-HV	NF125-SV
16	20															
24	30	NF63-CV		NF63-CV	NF63-SV	NF63-HV	NF125-SV	NF125-SV	NF125-HV	NF125-SV	NF125-HV	NF125-SV	NF125-HV	NF125-SV	NF125-HV	NF125-SV
32	40	NF63-CV	NF63-CV	NF125-SV												
40	50	NF125-CV														
48	60	NF125-CV														
60	75	NF125-CV														
80	100	NF125-CV														
100	125	NF125-CV														
120	150	NF125-CV														
140	175	NF250-CV														
160	200	NF250-CV														
180	225	NF250-CV														
200	250	NF250-CV														
240	300	NF250-CV														
280	350	NF400-CW														
320	400	NF400-CW														
400	500	NF630-CW														
480	600	NF630-CW														
560	700	NF800-CEW														
640	800	NF800-CEW														
800	1000	NF1000-SEW														
960	1200	NF1250-SEW														
1120	1400	NF1600-SEW														
1280	1600	NF1600-SEW														

4 Selection 2 Selection of MCCB and ELCB

ELCB (NV)

Table 4-11 230VAC

Max. working current (A)	Rated current (A)	Breaking capacity (kA) 230 V AC (Icu sym)											
		2.5	5	7.5	10	15	25	30	36	50	85	100	125
12	15	NV32-SV		NV32-SV		NV63-HV		NV125-HV					
16	20	NV32-SV		NV32-SV		NV63-HV		NV125-HV					
24	30	NV32-SV		NV32-SV		NV63-HV		NV125-HV					
32	40	NV32-SV		NV32-SV		NV63-HV		NV125-HV					
40	50	NV63-CV		NV63-SV		NV63-HV		NV125-SV		NV125-HV NV125-SEV		NV125-HV NV125-HEV	NV125-HEV
48	60	NV63-CV		NV63-SV		NV63-HV		NV125-SV		NV125-HV NV125-SEV		NV125-HV NV125-HEV	NV125-HEV
60	75	NV63-CV		NV63-SV		NV63-HV		NV125-SV		NV125-HV NV125-SEV		NV125-HV NV125-HEV	NV125-HEV
80	100	NV125-CV		NV125-SV		NV125-HV		NV125-SV		NV125-HV NV125-SEV		NV125-HV NV125-HEV	NV125-HEV
100	125	NV125-CV		NV125-SV		NV125-HV		NV125-SV		NV125-HV NV125-SEV		NV125-HV NV125-HEV	NV125-HEV
120	150	NV250-CV		NV250-SV		NV250-HV		NV250-SV NV250-SEV		NV250-HV NV250-HEV		NV250-HV NV250-HEV	NV250-HEV
140	175	NV250-CV		NV250-SV		NV250-HV		NV250-SV NV250-SEV		NV250-HV NV250-HEV		NV250-HV NV250-HEV	NV250-HEV
160	200	NV250-CV		NV250-SV		NV250-HV		NV250-SV NV250-SEV		NV250-HV NV250-HEV		NV250-HV NV250-HEV	NV250-HEV
180	225	NV250-CV		NV250-SV		NV250-HV		NV250-SV NV250-SEV		NV250-HV NV250-HEV		NV250-HV NV250-HEV	NV250-HEV
200	250	NV250-CV		NV250-SV		NV250-HV		NV250-SV NV250-SEV		NV250-HV NV250-HEV		NV250-HV NV250-HEV	NV250-HEV
240	300	NV400-CW		NV400-SV		NV400-HV		NV400-SV NV400-SEV		NV400-HV NV400-HEV		NV400-HV NV400-HEV	NV400-REW
280	350	NV400-CW		NV400-SV		NV400-HV		NV400-SV NV400-SEV		NV400-HV NV400-HEV		NV400-HV NV400-HEV	NV400-REW
320	400	NV400-CW		NV400-SV		NV400-HV		NV400-SV NV400-SEV		NV400-HV NV400-HEV		NV400-HV NV400-HEV	NV400-REW
400	500	NV630-CW		NV630-SV		NV630-HV		NV630-SV NV630-SEV		NV630-HV NV630-HEV		NV630-HV NV630-HEV	NV630-REW
480	600	NV630-CW		NV630-SV		NV630-HV		NV630-SV NV630-SEV		NV630-HV NV630-HEV		NV630-HV NV630-HEV	NV630-REW
560	700	NV800-SEW		NV800-SV		NV800-HV		NV800-SV NV800-SEV		NV800-HV NV800-HEV		NV800-HV NV800-HEV	NV800-REW
640	800	NV800-SEW		NV800-SV		NV800-HV		NV800-SV NV800-SEV		NV800-HV NV800-HEV		NV800-HV NV800-HEV	NV800-REW

Table 4-12 440VAC

Max. working current (A)	Rated current (A)	Breaking capacity (kA) 440 V AC (Icu sym)													
		2.5	5	7.5	10	25	30	36	45	50	70	85	125		
12	15	NV32-SV		NV63-SV		NV63-HV		NV125-SV		NV125-HV					
16	20	NV32-SV		NV63-SV		NV63-HV		NV125-SV		NV125-HV					
24	30	NV32-SV		NV63-SV		NV63-HV		NV125-SV		NV125-HV					
32	40	NV32-SV		NV63-SV		NV63-HV		NV125-SV		NV125-HV					
40	50	NV63-CV		NV63-SV		NV63-HV		NV125-SV		NV125-HV NV125-SEV		NV125-HV NV125-HEV		NV125-HEV	
48	60	NV63-CV		NV63-SV		NV63-HV		NV125-SV		NV125-HV NV125-SEV		NV125-HV NV125-HEV		NV125-HEV	
60	75	NV125-CV		NV125-SV		NV125-HV		NV125-SV NV125-SEV		NV125-HV NV125-SEV		NV125-HV NV125-HEV		NV125-HEV	
80	100	NV125-CV		NV125-SV		NV125-HV		NV125-SV NV125-SEV		NV125-HV NV125-SEV		NV125-HV NV125-HEV		NV125-HEV	
100	125	NV125-CV		NV125-SV		NV125-HV		NV125-SV NV125-SEV		NV125-HV NV125-SEV		NV125-HV NV125-HEV		NV125-HEV	
120	150	NV250-CV		NV250-SV		NV250-HV		NV250-SV NV250-SEV		NV250-HV NV250-HEV		NV250-HV NV250-HEV	NV250-HEV		
140	175	NV250-CV		NV250-SV		NV250-HV		NV250-SV NV250-SEV		NV250-HV NV250-HEV		NV250-HV NV250-HEV	NV250-HEV		
160	200	NV250-CV		NV250-SV		NV250-HV		NV250-SV NV250-SEV		NV250-HV NV250-HEV		NV250-HV NV250-HEV	NV250-HEV		
180	225	NV250-CV		NV250-SV		NV250-HV		NV250-SV NV250-SEV		NV250-HV NV250-HEV		NV250-HV NV250-HEV	NV250-HEV		
200	250	NV250-CV		NV250-SV		NV250-HV		NV250-SV NV250-SEV		NV250-HV NV250-HEV		NV250-HV NV250-HEV	NV250-HEV		
240	300	NV400-CW		NV400-SV		NV400-HV		NV400-SV NV400-SEV		NV400-HV NV400-HEV		NV400-HV NV400-HEV	NV400-REW		
280	350	NV400-CW		NV400-SV		NV400-HV		NV400-SV NV400-SEV		NV400-HV NV400-HEV		NV400-HV NV400-HEV	NV400-REW		
320	400	NV400-CW		NV400-SV		NV400-HV		NV400-SV NV400-SEV		NV400-HV NV400-HEV		NV400-HV NV400-HEV	NV400-REW		
400	500	NV630-CW		NV630-SV		NV630-HV		NV630-SV NV630-SEV		NV630-HV NV630-HEV		NV630-HV NV630-HEV	NV630-REW		
480	600	NV630-CW		NV630-SV		NV630-HV		NV630-SV NV630-SEV		NV630-HV NV630-HEV		NV630-HV NV630-HEV	NV630-REW		
560	700	NV800-SEW		NV800-SV		NV800-HV		NV800-SV NV800-SEV		NV800-HV NV800-HEV		NV800-HV NV800-HEV	NV800-REW		
640	800	NV800-SEW		NV800-SV		NV800-HV		NV800-SV NV800-SEV		NV800-HV NV800-HEV		NV800-HV NV800-HEV	NV800-REW		

6. Selection of Circuit Breaker for Motor Branch Circuit

(direct-to-line starting or Y-Δ starting)

MCCB (NF)

Table 4-13 200/220VAC for 3-phase induction motor

Motor is protected from overload by electromagnetic switch. Circuit breaker is installed to protect circuit from short-circuit.

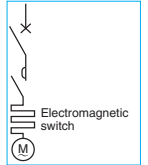

For 4-pole motor	Electromagnetic contactor			Breaking capacity (kA) 230 V AC (Icu sym)																					
				2.5		7.5		15		25		30(*1)		50		85		100		150(*2)		200			
Output (kW)	Full-load current (A)	Model	Heater nominal (A)	Model	Rating	Model	Rating	Model	Rating	Model	Rating	Model	Rating	Model	Rating	Model	Rating	Type name	Rating	Model	Rating	Model	Rating		
0.1	0.7	N10-N21	0.7	NF30-CS	(3)	NF32-SV	(3)	NF63-SV	(3)	NF63-HV	(10)			NF125-SV	(15)			NF125-HV	(15)			NF125-UV	(15)		
0.2	1.2																								
0.4	2.1	N10-N21	2.1	NF30-CS	5	NF32-SV	5	NF63-SV	5	NF63-HV	(10)			NF125-SV	(15)								NF125-UV	(15)	
0.75	3.7	N10-N21	3.6	NF30-CS	10	NF32-SV	10	NF63-SV	10	NF63-HV	10			NF125-SV	(15)									NF125-UV	(15)
1.5	6.4	N10-N25	6.6	NF30-CS	15	NF32-SV	15	NF63-SV	15	NF63-HV	15			NF125-SV	(15)									NF125-UV	(15)
2.2	9.1	N10-N35	9	NF30-CS	20	NF32-SV	20	NF63-SV	20	NF63-HV	20			NF125-SV	20									NF125-UV	20
3.7	15	N18-N35	15	NF30-CS	30	NF32-SV	30	NF63-SV	30	NF63-HV	30			NF125-SV	30									NF125-UV	30
5.5	22	N25-N35-N50-N65	22			NF63-CV	50	NF63-SV	50	NF63-HV	50			NF125-SV	50									NF125-UV	50
7.5	29	N35-N50-N80	29			NF63-CV	60	NF63-SV	60	NF63-HV	60			NF125-SV	60									NF125-UV	60
11	44	N50-N95	42											NF125-CV	75									NF125-UV	75
15	55	N65-N125	54											NF125-CV	100									NF125-UV	100
5.5	22	—	22			NF63-CV	50	NF63-SV	50	NF63-HV	50			NF125-SV	50									NF125-UV	50
7.5	29	—	29			NF63-CV	60	NF63-SV	60	NF63-HV	60			NF125-SV	60									NF125-UV	60
11	44	—	42											NF125-CV	75									NF125-UV	75
15	55	—	54											NF125-CV	100									NF125-UV	100
18.5	67	N80-N125	67											NF125-SV	100									NF125-UV	100
22	85	N95-N150	82											NF250-SV	150			NF250-SV	150					NF250-UV	150
30	110	N125-N220	105											NF250-CV	175			NF250-SV	175	NF250-HV	175			NF250-UV	175
37	130	N150-N220	125											NF250-CV	225			NF250-SV	225	NF250-HV	225			NF250-UV	225
45	164	N180-N400	150																						
55	195	N220-N400	180											NF400-CW	350	NF400-SW	250	NF400-HEW	250	NF400-REW	250	NF400-UEW	250		
75	267	N300-N400 (N600)	250											NF630-CW	500	NF400-SW	300	NF400-HEW	300	NF400-REW	300	NF400-UEW	300		
90	320	N300-N400 (N600-N800)	330											NF630-CW	600	NF630-SW	500	NF400-HEW	400	NF400-REW	400	NF400-UEW	400		
110	385	N300-N400 (N600-N800)	330											NF800-CEW	600	NF630-SW	600	NF630-HEW	500	NF630-REW	500	NF800-UEW	500		
132	470	(N600-N800)	500											NF800-CEW	600	NF630-SEW	600	NF630-HEW	600	NF630-REW	600	NF800-UEW	600		
160	580	(N600-N800)	500																						
200	720	(N800)	600																						

Notes *1 The breaking capacity of NF250-CV is 36kA. *2 The breaking capacity of NF1000- to 1600-SEW is 125kA.

Table 4-14 400/440VAC for 3-phase induction motor

For 4-pole motor	Electromagnetic contactor			Breaking capacity (kA) 415 V AC (Icu sym)																						
				1.5		2.5		7.5		10		25		30(*1)		50(*2)		70		150(*3)		200				
Output (kW)	Full-load current (A)	Model	Heater nominal (A)	Model	Rating	Model	Rating	Model	Rating	Model	Rating	Model	Rating	Model	Rating	Model	Rating	Model	Rating	Model	Rating	Model	Rating			
0.2	0.6	N10-N21	0.7	NF30-CS	(3)	NF32-SV	(3)	NF63-SV	(3)	NF63-HV	10			NF125-SV	(15)	NF125-HV	(15)									
0.4	1.1																									
0.4	1.1	N10-N21	1.3	NF30-CS	(3)	NF32-SV	(3)	NF63-SV	(3)	NF63-HV	10			NF125-SV	(15)	NF125-HV	(15)							NF125-UV	(15)	
0.75	1.9	N10-N21	1.7	NF30-CS	5	NF32-SV	5	NF63-SV	5	NF63-HV	10			NF125-SV	(15)	NF125-HV	(15)								NF125-UV	(15)
1.5	3.2	N10-N21	3.6	NF30-CS	10	NF32-SV	10	NF63-SV	10	NF63-HV	10			NF125-SV	(15)	NF125-HV	(15)								NF125-UV	(15)
2.2	4.6	N10-N21	5	NF30-CS	10	NF32-SV	10	NF63-SV	10	NF63-HV	10			NF125-SV	(15)	NF125-HV	(15)								NF125-UV	(15)
3.7	7.5	N11-N35	6.6	NF30-CS	20	NF32-SV	20	NF63-SV	20	NF63-HV	20			NF125-SV	20	NF125-HV	20								NF125-UV	20
5.5	11	N18-N35	11	NF30-CS	30	NF32-SV	30	NF63-SV	30	NF63-HV	30			NF125-SV	30	NF125-HV	30								NF125-UV	30
7.5	15	N20-N35-N50	15	NF30-CS	30	NF32-SV	30	NF63-SV	30	NF63-HV	30			NF125-SV	30	NF125-HV	30								NF125-UV	30
11	22	N25-N35-N50-N65	22			NF63-CV	50	NF63-SV	50	NF63-HV	50			NF125-SV	50	NF125-HV	50								NF125-UV	50
15	28	N35-N50-N80	28			NF63-CV	60	NF63-SV	60	NF63-HV	60			NF125-SV	60	NF125-HV	60								NF125-UV	60
18.5	34	N50-N95	35			NF63-CV	60	NF63-SV	60	NF125-CV	60			NF125-SV	60	NF125-HV	60								NF125-UV	60
22	42	N50-N95	42											NF125-CV	75	NF125-HV	75								NF125-UV	75
30	55	N65-N125	54											NF125-CV	100	NF125-HV	100								NF125-UV	100
37	65	N80-N150	67											NF125-CV	100	NF125-HV	100								NF125-UV	100
45	82	N95-N150	82											NF250-CV	125	NF250-SV	125			NF250-HV	125				NF250-UV	125
5.5	11	—	11			NF63-CV	30	NF63-SV	30	NF63-HV	30			NF125-SV	30	NF250-HV	30								NF125-UV	30
7.5	15	—	15			NF63-CV	40	NF63-SV	40	NF63-HV	40			NF125-SV	40	NF250-HV	40								NF125-UV	40
11	22	—	22			NF63-CV	50	NF63-SV	50	NF63-HV	50			NF125-SV	50	NF250-HV	50								NF125-UV	50
15	28	—	28			NF63-CV	60	NF63-SV	60	NF125-CV	60			NF125-SV	60	NF250-HV	60								NF125-UV	60
18.5	34	—	35			NF63-CV	60	NF63-SV	60	NF125-CV	60			NF125-SV	60	NF250-HV	60								NF125-UV	60
22	42	—	42											NF125-CV	75	NF250-HV	75								NF125-UV	75
30	55	—	54											NF125-CV	100	NF250-HV	100								NF125-UV	100
37	65	—	67											NF125-CV	100	NF250-HV	100								NF125-UV	100
45	82	—	82											NF125-CV	100	NF250-HV	100								NF125-UV	100
55	96	N125-N220	105											NF250-CV	150	NF250-SV	150			NF250-HV	150				NF250-UV	150
75	134	N150-N220	125											NF250-CV	175	NF250-SV	175			NF250-HV	175				NF250-UV	175
90	160	N180-N400	150											NF250-CV	225	NF250-SV	225			NF250-HV	225				NF250-UV	225
110	192	N180-N400	180											NF250-SEW	225					NF250-HEV	225	NF400-REW	225		NF400-UEW	225

4 Selection 2 Selection of MCCB and ELCB

ELCB (NV)

Table 4-15 200/220VAC for 3-phase induction motor

For 4-pole motor	Electromagnetic contactor			Breaking capacity (kA) 230 V AC (Icu sym)																			
				2.5		7.5		15(*1)		25		30(*2)		50		85		100		150			
Output (kW)	Full-load current (A)	Model	Heater nominal (A)	Model	Rating	Model	Rating	Model	Rating	Model	Rating	Model	Rating	Model	Rating	Model	Rating	Model	Rating	Model	Rating		
0.1 0.7		N10-N21	0.7	NV30-CS	(5)	NV63-CV	(5)	NV32-SV	(15)	NV63-HV	(15)			NV125-SV	(15)			NV125-HV	(15)				
0.2 1.2		N10-N21	1.3	NV30-CS	5	NV63-CV	5	NV32-SV	(15)	NV63-HV	(15)			NV125-SV	(15)			NV125-HV	(15)				
0.4 2.1		N10-N21	2.1	NV30-CS	10	NV63-CV	10	NV32-SV	(15)	NV63-HV	(15)			NV125-SV	(15)			NV125-HV	(15)				
0.75 3.7		N10-N21	3.6	NV30-CS	15	NV63-CV	15	NV32-SV	(15)	NV63-HV	(15)			NV125-SV	15			NV125-HV	(15)				
1.5 6.4		N10-N25	6.6	NV30-CS	20	NV63-CV	20	NV32-SV	20	NV63-HV	20			NV125-SV	20			NV125-HV	20				
2.2 9.1		N10-N35	9	NV30-CS	30	NV63-CV	30	NV32-SV	30	NV63-HV	30			NV125-SV	30			NV125-HV	30				
3.7 15		N18-N35	15	NV30-CS	50	NV63-CV	50	NV32-SV	50	NV63-HV	50			NV125-SV	50			NV125-HV	50				
5.5 22		N25 • N35 • N50 • N65	22			NV63-CV	60	NV63-SV	60	NV63-HV	60			NV125-SV	60			NV125-HV	60				
7.5 29		N35 • N50-N80	29			NV63-CV	60	NV63-SV	60	NV63-HV	60			NV125-SV	60			NV125-HV	60				
11 44		N50-N95	42											NV125-CV	75			NV125-HV	75				
15 55		N65-N125	54											NV125-CV	100			NV125-HV	100				
5.5 22		-	22			NV63-CV	50	NV63-SV	50	NV63-HV	50			NV125-SV	50			NV125-HV	50				
7.5 29		-	29			NV63-CV	60	NV63-SV	60	NV63-HV	60			NV125-SV	60			NV125-HV	60				
11 44		-	42											NV125-CV	75			NV125-HV	75				
15 55		-	54											NV125-CV	100			NV125-HV	100				
18.5 67		N80-N125	67											NV125-CV	100			NV125-HV	100				
22 85		N95-N150	82											NV250-CV	150			NV250-SV	150				
30 110		N125-N220	105											NV250-CV	175			NV250-SV	175				
37 130		N150-N220	125											NV250-CV	225			NV250-SV	225				
45 164		N180-N400	150															NV400-SW	250	NV400-HEW	250	NV400-REW	250
55 195		N220-N400	180															NV400-SW	300	NV400-HEW	300	NV400-REW	300
75 267		N300 • N400 • (N600)	250															NV400-SW	400	NV400-HEW	400	NV400-REW	400
90 320		N300 • N400 • (N600 • N800)	330															NV400-SW	500	NV400-HEW	500	NV400-REW	500
110 385		N300 • N400 • (N600 • N800)	330															NV400-SW	600	NV400-HEW	600	NV400-REW	600

Notes *1 The breaking capacity of NV32-SV is 10kA. *2 The breaking capacity of NV250-CV is 36kA.

Table 4-16 400/440VAC for 3-phase induction motor

For 4-pole motor	Electromagnetic contactor			Breaking capacity (kA) 415 V AC (Icu sym)																		
				2.5		5		7.5		10		25		30(*1)		50(*2)		70		125		
Output (kW)	Full-load current (A)	Model	Heater nominal (A)	Model	Rating	Model	Rating	Model	Rating	Model	Rating	Model	Rating	Model	Rating	Model	Rating	Model	Rating	Model	Rating	
0.2 0.6		N10-N21	0.7	NV63-CV	(5)	NV32-SV	(5)	NV63-SV	(5)	NV63-HV	(15)			NV125-SV	(15)	NV125-HV	(15)					
0.4 1.1		N10-N21	1.3	NV63-CV	(5)	NV32-SV	(5)	NV63-SV	(5)	NV63-HV	(15)			NV125-SV	(15)	NV125-HV	(15)					
0.75 1.9		N10-N21	1.7	NV63-CV	5	NV32-SV	5	NV63-SV	5	NV63-HV	(15)			NV125-SV	(15)	NV125-HV	(15)					
1.5 3.2		N10-N21	3.6	NV63-CV	10	NV32-SV	10	NV63-SV	10	NV63-HV	(15)			NV125-SV	(15)	NV125-HV	(15)					
2.2 4.6		N10-N21	5	NV63-CV	10	NV32-SV	10	NV63-SV	10	NV63-HV	(15)			NV125-SV	(15)	NV125-HV	(15)					
3.7 7.5		N11-N35	6.6	NV63-CV	20	NV32-SV	20	NV63-SV	20	NV63-HV	20			NV125-SV	20	NV125-HV	20					
5.5 11		N18-N35	11	NV63-CV	30	NV32-SV	30	NV63-SV	30	NV63-HV	30			NV125-SV	30	NV125-HV	30					
7.5 15		N20-N35 • N50	15	NV63-CV	30	NV32-SV	30	NV63-SV	30	NV63-HV	30			NV125-SV	30	NV125-HV	30					
11 22		N25 • N35 • N50 • N65	22	NV63-CV	50			NV63-SV	50	NV63-HV	50			NV125-SV	50	NV125-HV	50					
15 28		N35 • N50-N80	28	NV63-CV	60			NV63-SV	60	NV63-HV	60			NV125-SV	60	NV125-HV	60					
18.5 34		N50-N95	35											NV125-CV	60	NV125-HV	60					
22 42		N50-N95	42											NV125-CV	75	NV125-HV	75					
30 55		N65-N125	54											NV125-CV	100	NV125-HV	100					
37 65		N80-N150	67											NV125-CV	100	NV125-HV	100					
45 82		N95-N150	82											NV125-CV	100	NV125-HV	100					
5.5 11		-	11	NV63-CV	30	NV32-SV	30	NV63-SV	30	NV63-HV	30			NV125-SV	30	NV125-HV	30					
7.5 15		-	15	NV63-CV	40			NV63-SV	40	NV63-HV	40			NV125-SV	40	NV125-HV	40					
11 22		-	22	NV63-CV	50			NV63-SV	50	NV63-HV	50			NV125-SV	50	NV125-HV	50					
15 28		-	28	NV63-CV	60			NV63-SV	60	NV63-HV	60			NV125-SV	60	NV125-HV	60					
18.5 34		-	35											NV125-CV	60	NV125-HV	60					
22 42		-	42											NV125-CV	75	NV125-HV	75					
30 55		-	54											NV125-CV	100	NV125-HV	100					
37 65		-	67											NV125-CV	100	NV125-HV	100					
45 82		-	82											NV125-CV	100	NV125-HV	100					
55 96		N125-N220	105											NV250-CV	150	NV250-SV	150			NV250-HV	150	
75 134		N150-N220	125											NV250-CV	175	NV250-SV	175			NV250-HV	175	
90 160		N180-N400	150											NV250-CV	225	NV250-SV	225			NV250-HV	225	
110 192		N180-N400	180																	NV250-SEW	225	
132 233		N220-N400	250																			
160 290		N300 • N400 • (N600)	250																			
200 360		N300 • N400 • (N600 • N800)	330																			

Notes *1 The breaking capacity of NV250-SV and NV250-SEW is 36kA. *2 The breaking capacity of NV400-SW is 45kA.

Remark: 1. For the selecting conditions, please refer to the remarks on page 73.

Example of Y-Δ starting current waveform (crest value envelope)

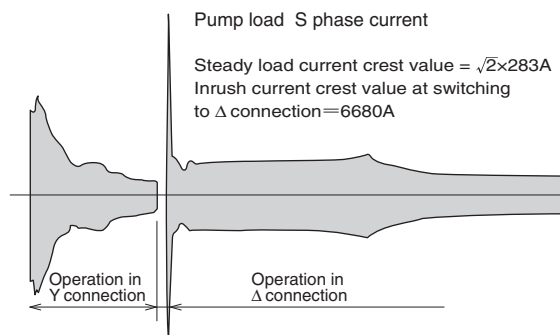

7. Selection of Motor Protection Breaker

Motor Protection Breakers

In principle, the operating characteristic curve of a selected motor breaker must be lower than the heat characteristic of the motor. The following table shows the rated capacities of Mitsubishi's standard squired-cage 3-phase motors (4-pole). The starting conditions are shown in the table.

Table 4-17 for 3-phase induction motor

Model	Motor Protection Breaker	NF32-SV	NF63-CV	NF63-SV	NF125-SV	NF250-SV	
Rated breaking capacity (kA)	230V	7.5	7.5	15	50	85	
	415V	2.5	2.5	7.5	30	36	
600% starting time limit (s)		2	32 A or less: 2 40 A or more: 7	32 A or less: 2 40 A or more: 7	32 A or less: 2 40 A or more: 7	5	
Startup inrush current limit (%)		1200	1200	1200	1200	1100	
Example of rated capacity of motor (kW)		Rated current	Rated current	Rated current	Rated current	Rated current	Model for combination with electromagnetic contactor
200/220V	400/440V						
							N10-N21
	0.4						
0.2							
	0.75						
0.4							
	1.5						
0.75		4	4	4			
	2.2						
1.5		7.1	7.1	7.1			
	3.7						
							N11-N35
2.2		10	10	10			
	5.5				(12.5)		N18-N35 N20-N35 N50
3.7		16	16	16	(16)		
							N25 • N35 N50 • N65
5.5		25	25	25	(25)		
							N35 N50-N80
7.5		32	32	32	32		
			40	40	(40)		N50-N95
11			45	45	45		
							N65-N125
15					63		
	30						N80-N125
18.5					71		
							N90-N125
22					90		
	45						N125-N220
	55				100		
						125	N150-N400
30						150	
	75						N180-N400
37						175	
	90						N220-N400
45						200	
						225	
55							

Remarks: 1. For the rated current in parentheses, breakers will be manufactured to order.
 2. The approximate values of inrush current at direct-to-line starting are shown below. Up to 7.5 kW: 1000% 11 kW or more: 1200% 75 kW or more: 1400%
 When the starting current is large and the starting power factor is low, a combination with an electromagnetic switch selected in accordance with "Table of selection of circuit breaker for motor branch circuit" shown on page 73 is suitable.

Cautions

- Note that any circuit breaker operates when the startup inrush current, starting current and starting time exceed the conditions shown in the above table. Particularly, high-efficiency motors generally have higher starting current and lower starting torque compared to general-purpose motors, and motor breakers cannot be used for such motors.
- Note that a circuit breaker may operate when an electromagnetic contactor is opened or closed while a motor is running.
- Select a motor breaker having rated current approx. 1.0 to 1.1 times higher than the full load current of motor.

8. Selection of Circuit Breaker for Inverter Circuit

■ Selection of Circuit Breaker for Inverter Circuit

Since current containing harmonic components will flow, the rated current of circuit breaker must be approx. 1.4 times the inverter input current.

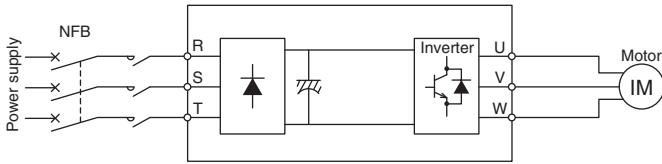

Install MCCB or ELCB on the primary side (power supply side) of the inverter. If it is installed on the secondary side, it may cause electronic circuit trouble or overheating.

Note The life cycle of the circuit breaker for the circuit on the inverter primary side will be reduced under the influence of transient inrush current. Install a switch.

Table 4-18 3-phase 200 V class

Inverter input capacity kVA	Rated current of circuit breaker A	Inverter input capacity kVA	Rated current of circuit breaker A
5.5	30	41	175
9	40	52	225
12	50	66	300
17	75	80	350
20	100	100	500
28	125	110	500
34	150	132	600

■ Selection of rated sensitivity current of Earth Leakage Circuit Breaker for Inverter Circuit

Select the rated sensitivity current as stated below.

Circuit breakers for harmonics and surge: Rated sensitivity current $I_{\Delta n} \geq 10 \times \{I_{g1} + I_{gn} + I_{g2} + I_{gm}\}$

General circuit breakers: Rated sensitivity current $I_{\Delta n} \geq 10 \times \{I_{g1} + I_{gn} + 3 \times (I_{g2} + I_{gm})\}$

Table 4-19-1

Examples of leakage current from line when IV cable is wired in close contact with ground (wiring in metallic conduit) (3-phase 220V 60Hz)

Wire size mm ²	Leakage current/km mA
6	135
10	140
16	169
25	176
35	203
50	205
70	241
95	247

Example 1

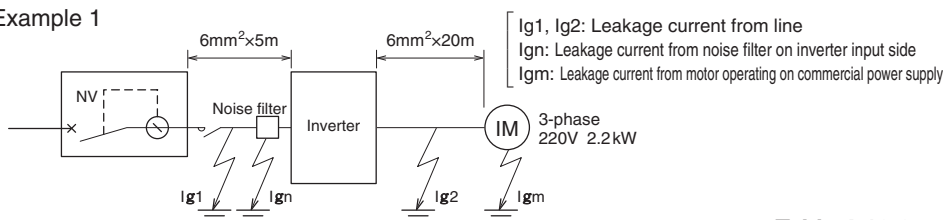

Example 2

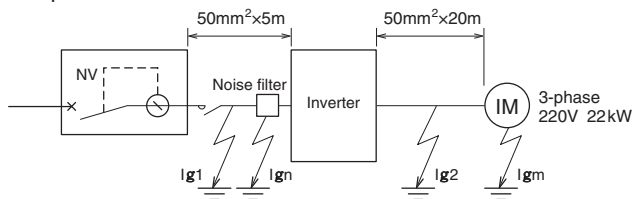

Table 4-19-2

Example of leakage current from 3-phase induction motor (220V 60Hz)

Motor output (kW)	Leakage current (mA)
2.2	0.2
3.7	0.29
5.5	0.32
7.5	0.42
11	0.55
15	0.63
18.5	0.72
22	0.8
30	0.96
37	1.1

Example of selection 1

	Breaker for harmonics and surge	General breaker
Leakage current I_{g1}	$135 \times \frac{5}{1000} = 0.675$	$135 \times \frac{5}{1000} = 0.675$
Leakage current I_{gn}	0 (without noise filter)	
Leakage current I_{g2}	$135 \times \frac{20}{1000} = 2.7$	$135 \times \frac{20}{1000} \times 3 = 8.1$
Leakage current I_{gm}	0.18	$0.18 \times 3 = 0.54$
Total leakage current I_g	3.555	11.465
Rated sensitivity current ($> I_g \times 10$)	100	200

Example of selection 2

	Breaker for harmonics and surge	General breaker
Leakage current I_{g1}	$205 \times \frac{5}{1000} = 1.025$	$205 \times \frac{5}{1000} = 1.025$
Leakage current I_{gn}	0 (without noise filter)	
Leakage current I_{g2}	$205 \times \frac{20}{1000} = 4.1$	$205 \times \frac{20}{1000} = 12.3$
Leakage current I_{gm}	0.72	$0.72 \times 3 = 2.16$
Total leakage current I_g	5.845	15.485
Rated sensitivity current ($> I_g \times 10$)	100	500

Remarks: 1. Circuit breakers for harmonics and surge can detect earth fault on the secondary side of inverter only when the operating frequency is 120 Hz or less. In the case of star connection by neutral point grounding method, the sensitivity current for earth fault on the inverter secondary side is degraded. In this case, for protective ground for load device, apply Class C grounding (10 Ω or less).

2. For general circuit breakers, the leakage current from the line between inverter and motor shall be calculated as three times the leakage current at the commercial frequency in consideration of harmonic content.

3. For the model names of circuit breakers for harmonics and surge, refer to the specification list in Section 2 of this document. Models not for harmonics and surge are general breakers.

9. Selection of Circuit Breaker for Transformer Primary Side

Notes 1. The life cycle of the circuit breaker for the circuit on the transformer primary side will be significantly reduced under the influence of excited inrush current. Install a switch to open and close the circuit.

2. Select a circuit breaker based on the example of excited inrush current of each transformer. When using a circuit breaker for a transformer, check the magnitude of excited inrush current with the transformer manufacturer.

Single-phase 210-V

Table 4-20-1 MCCB

Transformer capacity kVA	Rated primary current A	Example of transformer excited inrush current ①			Example of transformer excited inrush current ②			Example of transformer excited inrush current ③		
		Crest value of first wave (multiple)	Model	Rating A	Crest value of first wave (multiple)	Model	Rating A	Crest value of first wave (multiple)	Model	Rating A
5	23.8	45	NF125-CV(*1)	60	NF63-CV(*1)	50	24	NF63-CV(*1)	30	
			NF125-CV, NF125-SV, NF125-HV		NF125-CV(*1)			NF63-CV, NF63-SV		
			NF125-SEV, NF125-HEV		NF125-CV, NF125-SV			NF125-CV(*2)		
7.5	35.7	45	NF250-CV, NF250-SV, NF250-HV	150	NF125-SEV	50	24	NF63-CV(*1)	50	
			NF250-SEV, NF250-HEV		NF125-CV(*1)			NF125-CV(*1)(*2)		
					NF250-CV, NF250-SV			NF125-CV, NF125-SV		
10	47.6	43	NF250-CV, NF250-SV, NF250-HV	200	NF125-CV(*1)	100	24	NF125-CV(*1)	60	
			NF250-SEV, NF250-HEV		NF250-CV, NF250-SV			NF125-CV, NF125-SV		
					NF250-SEV					
15	71.4	43	NF400-CW	400	NF250-CV, NF250-SV	225	23	NF125-CV(*1)	100	
			NF400-SW		NF250-SEV			NF250-CV, NF250-SV		
			NF400-SEW, NF400-HEW							
20	95.2	43	NF400-SW	400	NF400-SW	350	23	NF250-CV, NF250-SV	200	
			NF400-SEW, NF400-HEW		NF400-SEW			NF250-SEV		
30	143	37	NF400-SW, NF400-HEW	200	NF400-SW	200	23	NF400-SW	300	
			NF630-SW		NF400-SEW			NF400-SEW		
50	238	35	NF630-SEW(*1)	300	NF630-SEW	300	23	NF400-SEW(*1)	300	
			NF1000-SEW					NF630-SEW		
75	357	30	NF800-SEW(*1)	400	NF800-SEW(*1)	400	22	NF630-SEW	400	
			NF1250-SEW							
100	476	27	NF1000-SEW	800	NF1600-SEW	800	20	NF800-SEW(*1)	600	
150	714	24	-	-	-	-	19	NF1600-SEW	800	
200	952	21	-	-	-	-	19	-	-	
300	1429	17	-	-	-	-	16	-	-	
500	2381	-	-	-	-	-	-	-	-	

Table 4-20-2 ELCB

Transformer capacity kVA	Rated primary current A	Example of transformer excited inrush current ①			Example of transformer excited inrush current ②			Example of transformer excited inrush current ③		
		Crest value of first wave (multiple)	Model	Rating A	Crest value of first wave (multiple)	Model	Rating A	Crest value of first wave (multiple)	Model	Rating A
5	23.8	45	NV125-CV, NV125-SV, NV125-HV	100	NV125-CV, NV125-SV	75	24	NV63-CV, NV63-SV	50	
			NV125-SEV, NV125-HEV		NV125-SV			NV125-CV		
					NV125-SEV			NV125-SV		
7.5	35.7	45	NV250-CV, NV250-SV, NV250-HV	150	NV125-SEV	50	24	NV125-CV, NV125-SV	75	
			NV250-SEV, NV250-HEV		NV250-CV, NV250-SV			NV125-SEV		
					NV250-SEV			NV125-SEV		
10	47.6	43	NV250-CV, NV250-SV, NV250-HV	200	NV250-CV, NV250-SV	150	24	NV125-CV, NV125-SV	100	
			NV250-SEV, NV250-HEV		NV250-SEV			NV250-CV, NV250-SV		
15	71.4	43	NV400-CW	400	NV250-CV, NV250-SV	225	23	NV250-CV, NV250-SV	150	
			NV400-SW		NV250-SEV			NV250-SEV		
			NV400-SEW, NV400-HEW							
20	95.2	43	NV400-SW	400	NV400-SW	350	23	NV250-CV, NV250-SV	200	
			NV400-SEW, NV400-HEW		NV400-SEW			NV250-SEV		
30	143	37	NV400-SW, NV400-HEW	200	NV400-SW	200	23	NV400-SW	300	
			NV630-SEW		NV400-SEW			NV400-SEW		
50	238	35	-	-	NV630-SEW	300	23	NV630-SEW	300	
								NV800-SEW		
								NV630-SEW		
75	357	30	-	-	-	-	22	NV630-SEW	400	
100	476	27	-	-	-	-	20	-	-	
150	714	24	-	-	-	-	19	-	-	
200	952	21	-	-	-	-	19	-	-	
300	1429	17	-	-	-	-	16	-	-	
500	2381	-	-	-	-	-	-	-	-	

Notes *1 Examples of selection of high-instantaneous circuit breakers (special models) for primary side of transformer.

*2 The circuit breakers with rating in parentheses are special models.

Remarks: 1. For the circuit breakers whose rated current is adjustable, the rated current values are shown.

2. The crest value of the first wave of excited inrush current shall be calculated based on the multiple for the crest value of the first wave in the table, and the calculated value shall not exceed the lower limit crest value of instantaneous tripping current of circuit breaker. The circuit breakers are selected on condition that the transformer rated current value does not exceed 0.9 times the circuit breaker rated current. If the multiple for the crest value of the first wave is different from that shown in the table, a circuit breaker must be separately selected.

4 Selection 2 Selection of MCCB and ELCB

Single-phase 420-V

Table 4-21-1 MCCB

Transformer capacity kVA	Rated primary current A	Example of transformer excited inrush current ①			Example of transformer excited inrush current ②			Example of transformer excited inrush current ③		
		Peak value of first wave (multiple)	Model	Rating A	Peak value of first wave (multiple)	Model	Rating A	Peak value of first wave (multiple)	Model	Rating A
5	11.9	45	NF63-CV(*1)	30	NF32-SV	15	24	NF32-SV, NF63-CV, NF63-SV	15	
			NF63-CV, NF63-SV, NF63-HV	50	NF63-CV, NF63-SV	15		NF125-SV	15	
			NF125-CV, NF125-SV, NF125-HV	50	NF125-SV	15		NF125-SV	15	
7.5	17.9	45	NF63-CV(*1)	50	NF63-CV(*1)	40	24	NF32-SV, NF63-CV, NF63-SV	30	
			NF125-CV, NF125-SV, NF125-HV	75	NF63-CV, NF63-SV	60		NF125-SV	30	
10	23.8	43	NF125-CV(*1)	60	NF63-CV(*1)	50	24	NF63-CV, NF63-SV	30	
			NF125-CV, NF125-SV, NF125-HV	100	NF125-CV, NF125-SV	75		NF125-CV(*2)	(50)	
15	35.7	43	NF125-CV(*1)	100	NF125-CV(*1)	60	23	NF63-CV(*1)	50	
			NF250-CV, NF250-SV, NF250-HV	150	NF125-CV, NF125-SV	100		NF125-CV(*1)(*2)	60(50)	
			NF250-SEV, NF250-HEV	125	NF125-CV, NF125-SV	75		NF125-CV, NF125-SV	75	
20	47.6	43	NF250-CV, NF250-SV, NF250-HV	200	NF125-CV(*1)	100	23	NF125-CV(*1)	60	
			NF250-SEV, NF250-HEV	125	NF250-CV, NF250-SV	150		NF125-CV, NF125-SV	100	
30	71.4	37	NF250-SEV, NF250-HEV	125	NF250-CV, NF250-SV	225	23	NF125-CV(*1)	100	
			NF400-CW	350	NF250-SEV	125		NF250-CV, NF250-SV	150	
50	119	35	NF400-SW	400	NF400-SW	400	23	NF250-SEV	150	
			NF400-SEW, NF400-HEW	200	NF400-SEW	200				
75	179	30	NF400-SEW, NF400-HEW	200	NF400-SEW	200	22	NF400-SW	400	
			NF630-SW	500				NF400-SEW	200	
100	238	27	NF400-SEW(*1)	300	NF400-SEW(*1)	300	20	NF400-SEW	350	
			NF630-SW	600	NF630-SEW	300				
150	357	24	NF630-SEW(*1)	400	-	-	19	NF400-SEW(*1)	400	
								NF630-SEW	400	
200	476	21	NF800-SEW(*1)	600	NF800-SEW(*1)	600	19	NF800-SEW(*1)	600	
300	714	17	NF1250-SEW	800	NF1600-SEW	800	16	NF1250-SEW	800	
500	1190	-	-	-	-	-	-	-	-	

Table 4-21-2 ELCB

Transformer capacity kVA	Rated primary current A	Example of transformer excited inrush current ①			Example of transformer excited inrush current ②			Example of transformer excited inrush current ③		
		Peak value of first wave (multiple)	Model	Rating A	Peak value of first wave (multiple)	Model	Rating A	Peak value of first wave (multiple)	Model	Rating A
5	11.9	45	NV63-CV, NV63-SV, NV63-HV	50	NV32-SV	15	24	NV32-SV	15	
			NV125-CV	60	NV63-CV, NV63-SV	15		NV63-CV, NV63-SV	15	
			NV125-SV, NV125-HV	50	NV125-SV	15		NV125-SV	15	
7.5	17.9	45	NV125-CV, NV125-SV, NV125-HV	75	NV63-CV, NV63-SV	60	24	NV32-SV	30	
					NV125-CV, NV125-SV	60		NV63-CV, NV63-SV	30	
10	23.8	43	NV125-CV, NV125-SV, NV125-HV	100	NV125-CV, NV125-SV	75	24	NV63-CV, NV63-SV	50	
			NV125-SEV, NV125-HEV	50	NV125-SEV	50		NV125-CV	60	
15	35.7	43	NV250-CV, NV250-SV, NV250-HV	150	NV125-CV, NV125-SV	100	23	NV125-CV, NF125-SV	75	
			NV250-SEV, NV250-HEV	125	NV125-SEV	50		NV125-SEV	50	
20	47.6	43	NV250-CV, NV250-SV, NV250-HV	200	NV250-CV, NV250-SV	150	23	NV125-CV, NF125-SV	100	
			NV250-SEV, NV250-HEV	125	NV250-SEV	125		NV125-SEV	60	
30	71.4	37	NV250-SEV, NV250-HEV	125	NV250-CV, NV250-SV	225	23	NV250-SV, NV250-SV	150	
			NV400-CW	350	NV250-SEV	125		NV250-SEV	125	
50	119	35	NV400-SW	400	NV400-SW	400	23	NV250-SEV	150	
			NV400-SEW, NV400-HEW	200	NV400-SEW	200				
75	179	30	NV400-SEW, NV400-HEW	200	NV400-SEW	200	22	NV400-SW	400	
			NV630-SEW, NV630-HEW	300				NV400-SEW	200	
100	238	27	NV630-SEW, NV630-HEW	300	NV630-SEW	300	20	NV400-SEW	350	
			NV800-SEW, NV800-HEW	400	NV800-SEW	400				
150	357	24	-	-	24	-	19	NV630-SEW	400	
200	476	21	-	-	22	-	19	-	-	
300	714	17	-	-	18	-	16	-	-	
500	1190	-	-	-	-	-	-	-	-	

Notes *1 Examples of selection of high-instantaneous circuit breakers (special models) for primary side of transformer.

*2 The circuit breakers with rating in parentheses are special models.

Remarks: 1. For the circuit breakers whose rated current is adjustable, the rated current values are shown.

2. The peak value of the first wave of excited inrush current shall be calculated based on the multiple for the peak value of the first wave in the table, and the calculated value shall not exceed the lower limit peak value of instantaneous tripping current of circuit breaker. The circuit breakers are selected on condition that the transformer rated current value does not exceed 0.9 times the circuit breaker rated current. If the multiple for the peak value of the first wave is different from that shown in the table, a circuit breaker must be separately selected.

3-phase 210-V

Table 4-21-3 MCCB

Transformer capacity kVA	Rated primary current A	Example of transformer excited inrush current ①			Example of transformer excited inrush current ②			Example of transformer excited inrush current ③		
		Peak value of first wave (multiple)	Model	Rating A	Peak value of first wave (multiple)	Model	Rating A	Peak value of first wave (multiple)	Model	Rating A
5	13.7	25	NF32-SV NF63-CV, NF63-SV, NF63-HV NF125-SV, NF125-HV	20 20 20	26	NF32-SV, NF63-CV, NF63-SV NF125-SV	20 20	18	NF32-SV, NF63-CV, NF63-SV NF125-SV	20 20
7.5	20.6	25	NF63-CV(*1) NF63-CV, NF63-SV, NF63-HV NF125-CV(*2) NF125-SV, NF125-HV	30 50 (50) 50	26	NF63-CV(*1) NF63-CV, NF63-SV NF125-CV, NF125-SV	30 50 50	18	NF32-SV, NF63-CV, NF63-SV NF125-CV(*2) NF125-SV	30 (50) 30
10	27.5	24	NF63-CV(*1) NF63-CV, NF63-SV, NF63-HV NF125-CV(*1) NF125-SV, NF125-HV	40 60 50 60	26	NF63-CV(*1) NF63-CV, NF63-SV NF125-CV, NF125-SV	40 60 60	18	NF63-CV, NF63-SV NF125-CV(*2) NF125-SV	50 (50) 50
15	41.2	24	NF63-CV(*1) NF125-CV, NF125-SV, NF125-HV	50 100	26	NF125-CV(*1) NF125-CV, NF125-SV	60 100	18	NF63-CV(*1) NF63-CV, NF63-SV NF125-CV, NF125-SV	50 60 60
20	55.0	20	NF125-CV(*1) NF125-CV, NF125-SV, NF125-HV	75 100	26	NF125-CV(*1) NF125-SEV NF250-CV, NF250-SV	75 75 125	18	NF125-CV(*1) NF125-CV, NF125-SV	75 100
30	82.5	20	NF125-CV(*1) NF250-CV, NF250-SV, NF250-HV NF250-SEV, NF250-HEV	100 150 125	26	NF250-CV, NF250-SV NF250-SEV	200 125	18	NF125-CV(*1) NF250-CV, NF250-SV	100 150
50	137	20	NF250-SEV, NF250-HEV NF400-CW NF400-SW	175 350 250	23	NF400-CW NF400-SW NF400-SEW	400 300 200	16	NF250-CV, NF250-SV NF250-SEV	200 175
75	206	21	NF400-SW NF400-SEW, NF400-HEW	400 250	18	NF400-SW NF400-SEW	350 250	14	NF400-SW NF400-SEW	300 250
100	275	21	NF400-SEW(*1) NF630-SW NF630-SEW, NF630-HEW	350 600 350	17	NF400-SEW	350	13	NF400-SW NF400-SEW	350 300
150	412	17	NF630-SEW, NF630-HEW	500	14	NF630-SEW	500	13	NF630-SW NF630-SEW	500 500
200	550	16	NF800-SEW(*1)	700	13	NF800-SEW	700	12	NF800-SEW	700
300	825	16	NF1600-SEW	1000	13	NF1250-SEW	1000	12	NF1000-SEW	1000
500	1375	-	-	-	11	NF1600-SEW	1600	11	NF1600-SEW	1600

Table 4-21-4 ELCB

Transformer capacity kVA	Rated primary current A	Example of transformer excited inrush current ①			Example of transformer excited inrush current ②			Example of transformer excited inrush current ③		
		Peak value of first wave (multiple)	Model	Rating A	Peak value of first wave (multiple)	Model	Rating A	Peak value of first wave (multiple)	Model	Rating A
5	13.7	25	NV32-SV NV63-CV, NV63-SV, NV63-HV NV125-SV, NV125-HV	20 20 20	26	NV32-SV NV63-CV, NV63-SV NV125-SV	20 20 20	18	NV32-SV NV63-CV, NV63-SV NV125-SV	20 20 20
7.5	20.6	25	NV63-CV, NV63-SV, NV63-HV NV125-CV NV125-SV, NV125-HV	50 60 50	26	NV63-CV, NV63-SV NV125-CV NV125-SV	50 60 50	18	NV32-SV NV63-CV, NV63-SV NV125-SV	30 30 30
10	27.5	24	NV63-CV, NV63-SV, NV63-HV NV125-CV, NV125-SV, NV125-HV	60 60	26	NV63-CV, NV63-SV NV125-CV, NV125-SV	60 60	18	NV63-CV, NV63-SV NV125-CV NV125-SV	50 60 50
15	41.2	24	NV125-CV, NV125-SV, NV125-HV NV125-SEV, NV125-HEV	100 50	26	NV125-CV, NV125-SV NV125-SEV	100 50	18	NV63-CV, NV63-SV NV125-CV, NV125-SV	60 60
20	55.0	20	NV125-CV, NV125-SV, NV125-HV NV125-SEV, NV125-HEV	100 75	26	NV125-SEV NV250-CV, NV250-SV	75 125	18	NV125-CV, NV125-SV NV125-SEV	100 75
30	82.5	20	NV250-CV, NV250-SV, NV250-HV NV250-SEV, NV250-HEV	150 125	26	NV250-CV, NV250-SV NV250-SEV	200 125	18	NV250-CV, NV250-SV NV125-SEV	150 125
50	137	20	NV250-SEV, NV250-HEV NV400-CW NV400-SW	175 350 250	23	NV400-CW NV400-SW NV400-SEW	400 300 200	16	NV250-CV, NV250-SV NV250-SEV	200 175
75	206	21	NV400-SW NV400-SEW, NV400-HEW	400 250	18	NV400-SW NV400-SEW	250 350	14	NV400-SW NV400-SEW	300 250
100	275	21	NV630-SEW, NV630-HEW NV800-SEW, NV800-HEW	350 400	17	NV400-SEW	350	13	NV400-SW NV400-SEW	350 300
150	412	17	NV630-SEW, NV630-HEW	500	14	NV630-SEW NV800-SEW	500 500	13	NV630-SEW NV800-SEW	500 500
200	550	16	-	-	13	-	-	12	NV800-SEW	700
300	825	16	-	-	13	-	-	12	-	-
500	1375	-	-	-	11	-	-	11	-	-

Notes *1 Examples of selection of high-instantaneous circuit breakers (special models) for primary side of transformer.

*2 The circuit breakers with rating in parentheses are special models.

Remarks: 1. For the circuit breakers whose rated current is adjustable, the rated current values are shown.

2. The peak value of the first wave of excited inrush current shall be calculated based on the multiple for the peak value of the first wave in the table, and the calculated value shall not exceed the lower limit peak value of instantaneous tripping current of circuit breaker. The circuit breakers are selected on condition that the transformer rated current value does not exceed 0.9 times the circuit breaker rated current. If the multiple for the peak value of the first wave is different from that shown in the table, a circuit breaker must be separately selected.

4 Selection 2 Selection of MCCB and ELCB

3-phase 420-V

Table 4-21-5 MCCB

Transformer capacity kVA	Rated primary current A	Example of transformer excited inrush current ①			Example of transformer excited inrush current ②			Example of transformer excited inrush current ③		
		Peak value of first wave (multiple)	Model	Rating A	Peak value of first wave (multiple)	Model	Rating A	Peak value of first wave (multiple)	Model	Rating A
5	6.9	32	NF32-SV	10	26	NF30-CS	30	18	NF32-SV, NF63-CV, NF63-SV	10
			NF63-CV, NF63-SV, NF63-HV	10		NF32-SV, NF63-CV, NF63-SV	10		NF125-SV	15
			NF125-SV, NF125-HV	15						
7.5	10.3	32	NF32-SV	15	26	NF32-SV, NF63-CV, NF63-SV	15	18	NF32-SV, NF63-CV, NF63-SV	15
			NF63-CV, NF63-SV, NF63-HV	15		NF125-SV	15		NF125-SV	15
			NF125-SV, NF125-HV	15						
10	13.7	31	NF32-SV	20	26	NF32-SV	20	18	NF32-SV	20
			NF63-CV, NF63-SV, NF63-HV	20		NF63-CV, NF63-SV	20		NF63-CV, NF63-SV	20
			NF125-CV(*2)	(50)		NF125-SV	20		NF125-SV	20
15	20.6	31	NF63-CV(*1)	40	26	NF63-CV(*1)	30	18	NF32-SV, NF63-CV, NF63-SV	30
			NF63-CV, NF63-SV, NF63-HV	60		NF63-CV, NF63-SV	50		NF125-CV(*2)	(50)
			NF125-CV, NF125-SV, NF125-HV	60		NF125-CV, NF125-SV	50		NF125-SV	30
20	27.5	26	NF63-CV(*1)	40	26	NF63-CV(*1)	40	18	NF63-CV(*1)	40
			NF63-CV, NF63-SV, NF63-HV	60		NF63-CV, NF63-SV	60		NF63-CV, NF63-SV	50
			NF125-CV(*1)	50		NF125-CV, NF125-SV	60		NF125-CV, NF125-SV	50
30	41.2	24	NF63-CV(*1)	50	26	NF125-CV(*1)	60	18	NF63-CV(*1)	50
			NF125-CV(*1)	50		NF125-CV, NF125-SV	100		NF125-CV, NF125-SV	75
			NF125-CV, NF125-SV, NF125-HV	100						
50	68.7	22	NF125-CV(*1)	100	23	NF125-CV(*1)	100	16	NF125-CV, NF125-SV	100
			NF250-CV, NF250-SV, NF250-HV	150		NF250-CV, NF250-SV	150			
			NF250-SEV, NF250-HEV	125						
75	103	15	NF250-CV, NF250-SV, NF250-HV	150	18	NF250-CV, NF250-SV	175	14	NF250-CV, NF250-SV	150
			NF250-SEV, NF250-HEV	125		NF250-SEV	125			
100	137	15	NF250-CV, NF250-SV, NF250-HV	200	17	NF250-CV, NF250-SV	200	13	NF250-CV, NF250-SV	175
			NF250-SEV, NF250-HEV	175		NF250-SEV	175			
150	206	15	NF400-CW	400	14	NF400-SW	300	13	NF400-CW	400
			NF400-SW	300		NF400-SW	250		NF400-SW	250
			NF400-SEW, NF400-HEW	250		NF400-SEW	250		NF400-SEW	250
200	275	14	NF400-SW	350	13	NF400-SW/SEW	350/350	12	NF400-SW	350
			NF400-SEW, NF400-HEW	350					NF400-SEW	350
300	412	10	NF630-CW	600	13	NF630-SEW	500	12	NF630-SW	500
			NF630-SW	500					NF630-SEW	500
			NF630-SEW, NF630-HEW	500						
500	687	15	NF800-SEW(*1)	800	11	NF800-SEW	800	11	NF800-SEW	800
			NF1250-SEW	800						

Table 4-21-6 ELCB

Transformer capacity kVA	Rated primary current A	Example of transformer excited inrush current ①			Example of transformer excited inrush current ②			Example of transformer excited inrush current ③		
		Peak value of first wave (multiple)	Model	Rating A	Peak value of first wave (multiple)	Model	Rating A	Peak value of first wave (multiple)	Model	Rating A
5	6.9	32	NV32-SV(*1)	15(10)	26	NV32-SV(*1)	15(10)	18	NV32-SV(*1)	15(10)
			NV63-CV, NV63-SV(*1)	15(10)		NV63-CV, NV63-SV(*1)	15(10)		NV63-CV, NV63-SV(*1)	15(10)
			NV63-HV	15		NV125-SV	15		NV125-SV	15
7.5	10.3	32	NV32-SV	15	26	NV32-SV	15	18	NV32-SV	15
			NV63-CV, NV63-SV, NV63-HV	15		NV63-CV, NV63-SV	15		NV63-CV, NV63-SV	15
			NV125-SV, NV125-HV	15		NV125-SV	15		NV125-SV	15
10	13.7	31	NV32-SV	20	26	NV32-SV	20	18	NV32-SV	20
			NV63-CV, NV63-SV, NV63-HV	20		NV63-CV, NV63-SV	20		NV63-CV, NV63-SV	20
			NV125-CV	50		NV125-SV	20		NV125-SV	20
15	20.6	31	NV63-CV, NV63-SV, NV63-HV	60	26	NV63-CV, NV63-SV	50	18	NV32-SV	30
			NV125-CV, NV125-SV, NV125-HV	60		NV125-CV	60		NV63-CV, NV63-SV	30
			NV125-SEV, NV125-HEV	50		NV125-SV	50		NV125-SV	30
20	27.5	26	NV63-CV, NV63-SV, NV63-HV	60	26	NV63-CV, NV63-SV	60	18	NV63-CV, NV63-SV	50
			NV125-CV, NV125-SV, NV125-HV	60		NV125-CV, NV125-SV	60		NV125-CV	60
									NV125-SV	50
30	41.2	24	NV125-CV, NV125-SV, NV125-HV	100	26	NV125-CV, NV125-SV	100	18	NV125-CV, NV125-SV	75
			NV125-SEV, NV125-HEV	50		NV125-SEV	50			
50	68.7	22	NV250-CV, NV250-SV, NV250-HV	150	23	NV250-CV, NV250-SV	150	16	NV125-CV, NV125-SV	100
			NV250-SEV, NV250-HEV	125		NV250-SEV	125			
75	103	15	NV250-CV, NV250-SV, NV250-HV	150	18	NV250-CV, NV250-SV	175	14	NV250-CV, NV250-SV	150
			NV250-SEV, NV250-HEV	125		NV250-SEV	125			
100	137	15	NV250-CV, NV250-SV, NV250-HV	200	17	NV250-CV, NV250-SV	200	13	NV250-CV, NV250-SV	175
			NV250-SEV, NV250-HEV	175		NV250-SEV	175			
150	206	15	NV400-CW	400	14	NV400-SW	300	13	NV400-CW	400
			NV400-SW	300		NV400-SW	250		NV400-SW	250
			NV400-SEW, NV400-HEW	250		NV400-SEW	250		NV400-SEW	250
200	275	14	NV400-SW	350	13	NV400-SW	350	12	NV400-SW	350
			NV400-SEW, NV400-HEW	350		NV400-SEW	350		NV400-SEW	350
300	412	10	NV630-CW, NV630-SW	600	13	NV630-SEW	500	12	NV630-SW	500
			NV630-SEW, NV630-HEW	500		NV800-SEW	500		NV630-SEW	500
500	687	15	-	-	11	-	-	11	-	-

Notes *1 Examples of selection of high-instantaneous circuit breakers (special models) for primary side of transformer.

*2 The circuit breakers with rating in parentheses are special models.

Remarks: 1. For the circuit breakers whose rated current is adjustable, the rated current values are shown.

2. The peak value of the first wave of excited inrush current shall be calculated based on the multiple for the peak value of the first wave in the table, and the calculated value shall not exceed the lower limit peak value of instantaneous tripping current of circuit breaker. The circuit breakers are selected on condition that the transformer rated current value does not exceed 0.9 times the circuit breaker rated current. If the multiple for the peak value of the first wave is different from that shown in the table, a circuit breaker must be separately selected.

4 Selection 2 Selection of MCCB and ELCB

Table 4-22-2 Combination for selective breaking with AE-SW Series

440VAC (IEC 60947-2)

sym.kA

Rated ultimate short-circuit breaking capacity of each breaker	Main breaker	Low-voltage air circuit breaker AE-SW									
		AE630-SW		AE1000-SW		AE1250-SW		AE1600-SW		AE2000-SWA	
		65	65	65	65	65	85	85	85	85	
Branch breaker	l _{cu} (kA)	65	65	65	65	65	85	85	85	85	
NF32-SV		2.5	2.5	2.5	2.5	2.5	2.5	2.5	2.5	2.5	
		5	5	5	5	5	5	5	5	5	
NF63-SV		7.5	7.5	7.5	7.5	7.5	7.5	7.5	7.5	7.5	
		10	9(10)	10	10	10	10	10	10	10	
NF125-SV		25	7(25)	20(25)	25	25	25	25	25	25	
		36	7(36)	20(36)	25(36)	30(36)	36	36	36	36	
NF125-SGV		36	9(36)	20(36)	36	36	36	36	36	36	
		50	9(50)	20(50)	36(50)	50	50	50	50	50	
NF125-LGV		50	9(50)	30(50)	50	50	50	50	50	50	
		65	9(65)	20(65)	36(65)	65	65	65	65	65	
NF160-SGV		36	9(36)	15(36)	25(36)	36	36	36	36	36	
		50	9(50)	15(50)	25(50)	42(50)	42(50)	50	50	50	
NF160-LGV		65	9(65)	15(65)	25(65)	42(65)	42(65)	65	65	65	
		36	7(36)	14(36)	19(36)	25(36)	25(36)	36	36	36	
NF250-SV		36	7(36)	15(36)	25(36)	36	36	36	36	36	
		50	7(50)	15(50)	25(50)	42(50)	42(50)	50	50	50	
NF250-SGV		50	7(50)	15(50)	25(50)	42(50)	42(50)	50	50	50	
		65	7(65)	15(65)	25(65)	42(65)	42(65)	65	65	65	
NF250-LGV		65	7(65)	15(65)	25(65)	42(65)	42(65)	65	65	65	
		42	-	-	18(42)	24(42)	24(42)	33(42)	42	42	
NF400-SW		42	-	-	18(42)	24(42)	24(42)	30(42)	39(42)	42	
		65	9(65)	15(65)	18(65)	24(65)	24(65)	30(65)	39(65)	65	
NF400-SEW		125	9(65)	15(65)	18(65)	24(65)	24(65)	30(75)	39(75)	80	
		42	-	-	-	24(42)	24(42)	30(42)	37(42)	42	
NF630-SW		65	-	15(65)	18(65)	24(65)	24(65)	30(65)	37(65)	48(65)	
		65	-	15(65)	18(65)	24(65)	24(65)	30(65)	37(65)	48(65)	
NF630-SEW		100	-	15(65)	18(65)	24(65)	24(65)	30(75)	40(75)	60(75)	
		85	-	-	-	24(42)	24(42)	30(42)	37(42)	42	
NF800-SEW		42	-	-	18(42)	24(42)	24(42)	30(42)	37(42)	42	
		65	-	-	18(65)	24(65)	24(65)	30(65)	37(65)	48(65)	
NF800-HEW		65	-	-	18(65)	24(65)	24(65)	30(65)	37(65)	48(65)	
		2.5	2.5	2.5	2.5	2.5	2.5	2.5	2.5	2.5	
NF63-CV		10	9(10)	10	10	10	10	10	10	10	
		15	9(15)	15	15	15	15	15	15	15	
NF250-CV		25	-	15(25)	18(25)	25	25	25	25	25	
		36	-	-	-	24(36)	24(36)	30(42)	36	36	
NF630-CW		36	-	-	-	24(36)	24(36)	30(42)	36	36	
		36	-	-	18(36)	24(36)	24(36)	30(42)	36	36	
NF800-CEW		125	35(65)	65	65	65	65	85	85	85	
		200	50(65)	65	65	65	65	85	85	85	
NF125-RGV		125	9(65)	50(65)	65	65	65	85	85	85	
		200	9(65)	65	65	65	65	85	85	85	
NF250-RGV		200	9(65)	65	65	65	65	85	85	85	
		200	9(65)	15(65)	18(65)	24(65)	24(65)	30(75)	37(75)	48(75)	
NF400-UEW		200	-	-	18(65)	24(65)	24(65)	30(75)	37(75)	48(75)	
		200	-	-	18(65)	24(65)	24(65)	30(75)	37(75)	48(75)	

230VAC (IEC 60947-2)

sym.kA

Rated ultimate short-circuit breaking capacity of each breaker	Main breaker	Low-voltage air circuit breaker AE-SW									
		AE630-SW		AE1000-SW		AE1250-SW		AE1600-SW		AE2000-SWA	
		65	65	65	65	65	85	85	85	85	
Branch breaker	l _{cu} (kA)	65	65	65	65	65	85	85	85	85	
NF32-SV		7.5	7.5	7.5	7.5	7.5	7.5	7.5	7.5	7.5	
		10	9(10)	10	10	10	10	10	10	10	
NF63-SV		15	9(10)	15	15	15	15	15	15	15	
		25	9(25)	25	25	25	25	25	25	25	
NF125-SV		50	9(50)	45(50)	50	50	50	50	50	50	
		85	9(65)	45(65)	50(65)	50(65)	50(65)	85	85	85	
NF125-SGV		85	16(65)	45(65)	65	65	65	85	85	85	
		90	16(65)	45(65)	65	65	65	85	85	85	
NF125-LGV		100	9(65)	50(65)	65	65	65	85	85	85	
		100	16(65)	45(65)	65	65	65	85	85	85	
NF125-HV		100	9(65)	50(65)	65	65	65	85	85	85	
		100	9.4(65)	25(65)	40(65)	42(65)	42(65)	50(85)	85	85	
NF160-SGV		85	9.4(65)	25(65)	40(65)	42(65)	42(65)	50(85)	85	85	
		90	9.4(65)	25(65)	40(65)	42(65)	42(65)	50(85)	85	85	
NF160-LGV		100	9.4(65)	25(65)	40(65)	42(65)	42(65)	50(85)	85	85	
		100	9.4(65)	25(65)	40(65)	42(65)	42(65)	50(85)	85	85	
NF250-SV		85	9(65)	20(65)	22(65)	22(65)	22(65)	42(65)	50(85)	85	
		85	9.4(65)	25(65)	40(65)	42(65)	42(65)	50(85)	85	85	
NF250-SGV		90	9.4(65)	25(65)	40(65)	42(65)	42(65)	50(85)	85	85	
		90	9.4(65)	25(65)	40(65)	42(65)	42(65)	50(85)	85	85	
NF250-LGV		100	9(65)	25(65)	40(65)	42(65)	42(65)	50(85)	85	85	
		100	9.4(65)	25(65)	40(65)	42(65)	42(65)	50(85)	85	85	
NF250-HV		100	9(65)	25(65)	40(65)	42(65)	42(65)	50(85)	85	85	
		100	9.4(65)	25(65)	40(65)	42(65)	42(65)	50(85)	85	85	
NF250-HEV		100	9(65)	25(65)	40(65)	42(65)	42(65)	50(85)	85	85	
		100	9.4(65)	25(65)	40(65)	42(65)	42(65)	50(85)	85	85	
NF400-SW		85	-	-	20(65)	30(65)	30(65)	48(75)	70(75)	85	
		85	9(65)	15(65)	20(65)	30(65)	30(65)	48(75)	70(75)	85	
NF400-SEW		100	9(65)	15(65)	20(65)	30(65)	30(65)	48(75)	70(75)	85	
		150	9(65)	15(65)	20(65)	30(65)	30(65)	48(75)	70(75)	85	
NF400-REW		85	-	-	-	24(65)	24(65)	30(75)	40(75)	60(75)	
		85	-	-	-	24(65)	24(65)	30(75)	40(75)	60(75)	
NF630-SW		100	-	15(65)	18(65)	24(65)	24(65)	30(75)	40(75)	60(75)	
		100	-	15(65)	18(65)	24(65)	24(65)	30(75)	40(75)	60(75)	
NF630-SEW		85	-	-	-	24(65)	24(65)	30(75)	40(75)	60(75)	
		85	-	-	-	18(65)	24(65)	24(65)	30(75)	40(75)	
NF800-SEW		85	-	-	18(65)	24(65)	24(65)	30(75)	40(75)	60(75)	
		100	-	-	18(65)	24(65)	24(65)	30(75)	40(75)	60(75)	
NF800-HEW		7.5	7.5	7.5	7.5	7.5	7.5	7.5	7.5	7.5	
		30	9(30)	15(30)	18(30)	24(30)	24(30)	30	30	30	
NF125-CV		36	9(36)	15(36)	18(36)	24(36)	24(36)	36	36	36	
		50	-	15(50)	20(50)	27(50)	27(50)	42(50)	50	50	
NF400-CW		50	-	-	-	24(50)	24(50)	30(50)	40(50)	50	
		50	-	-	-	24(50)	24(50)	30(50)	40(50)	50	
NF630-CW		150	65	65	65	65	65	85	85	85	
		200	65	65	65	65	65	85	85	85	
NF125-RGV		150	9(65)	65	65	65	65	85	85	85	
		200	9(65)	65	65	65	65	85	85	85	
NF250-RGV		200	9(65)	65	65	65	65	85	85	85	
		200	9(65)	15(65)	18(65)	24(65)	24(65)	30(75)	37(75)	48(75)	
NF400-UEW		200	-	-	18(65)	24(65)	24(65)	30(75)	37(75)	48(75)	
		200	-	-	18(65)	24(65)	24(65)	30(75)	37(75)	48(75)	

Notes *1 The values in the table represent the max. rated current for both Series AE-SW air circuit breakers and branch breakers, and the selective co-ordination applies when the air circuit breakers instantaneous pick up is set to maximum.
*2 The numerals shown in parentheses are for AE-SW with MCR. (When set MCR.)

12. International Standard Conformance List

12.1 UL and CSA Approval Product

● UL (Underwriter's Laboratories) Standards: UL 489, UL 1077

UL is an organization in the US which establishes safety standards, i.e. UL Standards, conducts safety verification test based on the UL Standards, issues the certificates to approved products and allows the manufacturers to attach the certification mark to the products. The UL certification mark has been spread widely in the US. Some states and cities oblige manufacturers to receive the UL certification. When devices, control panels and machines are exported to the US, these products must be UL certified. UL certified products have received UL Recognition or UL Listing in conformity to UL Standards (UL 489, UL1077) and allowed to be used in control panels and machines to be exported to the US.



UL Recognition

Refers to component certification for products designed to be built in other products and devices. UL recognized products can be used in control panels, machine tools and control units.



UL Listing

Refers to product certification for products which can be sold directly to end-users and used by end-users. These products can be used also as built-in components in control panels, machine tools and control units. Some models vary in external dimensions and terminal structure from standard models. Please refer to the page of UL listed products for details.

● CSA (Canadian Standard Association) Standards: CSA C22.2 No.5-02

The CSA Standards are product safety standards established by CSA. In Canada, the safety of electric products is regulated by the state laws, and some state laws prescribe that circuit breakers shall be certified by the CSA Standards. Therefore, when devices, control panels and machines are exported to Canada, these products must be CSA certified. UL certified products have received CSA certification from the testing body UL and allowed to be used in control panels and machines to be exported to Canada. UL has been authorized as a testing, certification and quality certification body by SCC, and CSA certified products tested by UL have been approved by the safety regulations in all states of Canada. It is allowed to attach the following certification marks to products certified by both UL and CSA. (It is also allowed to attach the separate marks for the US and Canada as before.)



Recognition for US and Canada

UL and CSA recognition of components by testing body UL



Listing for US and Canada

UL and CSA recognition of components by testing body UL

12.2 CCC (China Compulsory Certification) Approval Product

Low-voltage circuit breakers are designated as products to be compulsorily certified in China. To export such products to China and sell them in China, it is necessary to obtain the CCC certification.



12.3 Corresponding to EC (European Community) Directive

● Corresponding to LVD (Low Voltage Directive)

(1) When using a low voltage circuit breaker as a component and indicating conformity with the EC Directives

The CE Marking is required when a low voltage circuit breaker is distributed as a single device in EU. However, when the CE Mark is indicated on a machine tool or a control unit, it is unnecessary to affix the CE Mark to the low-voltage circuit breaker used as a built-in component. When the CE Mark is indicated on a machine tool or a control unit, it is recommended to use a product certified by a third party shown in Item (3) (TÜV certified product) as a low voltage circuit breaker.



(2) Measures for export of low voltage circuit breaker as single unit

When exporting a low-voltage circuit breaker as a single unit in EU, the circuit breaker is covered by the Low Voltage Directive. The certification of conformity with the Low Voltage Directive is self-declared as a rule. The applicable product standards are shown below.

EN 60947-2 Low-voltage switchgear and controlgear-Part 2: Circuit-breakers

EN 60934 Circuit-breakers for equipment (CBE)

(3) Models certified by third party (TÜV certified products)

When the CE Mark is indicated on a machine tool or a control unit, it is recommended to use a low voltage circuit breaker certified by a third party (TÜV certified product) as a built-in component.

● Corresponding to EMC (Electromagnetic Compatibility) Directive

The Directive prescribes that products shall not emit high-intensity radio waves to the outside and shall not be affected by external electromagnetic waves. Molded case circuit breakers (electronic type) and earth leakage circuit breakers are covered by the EMC Directive.

● Corresponding to Machinery Directive

Low voltage circuit breakers are components used in equipment, such as machine tools and control units, and are not covered by any machinery directive. When the CE Mark is indicated on a machine tool or a control unit, it is recommended to use a low voltage circuit breaker certified by a third party (TÜV certified product) as a built-in component.

4 Selection 2 Selection of MCCB and ELCB

●Molded Case Circuit Breakers and Motor Protection Breakers

Specifications	Class	Applicable Models and Assignments	North American Safety Mark					Compulsory Mark		Third Party Mark	Classification Society (*1)
			UL Standards			CSA Standards		CCC	CE	TÜV Rheinland	NK
			USA			Canada		China	Europe	Germany	Japan
General	C	NF30-CS	-	-	-	-	-	●	●	●	●
		NF63-CV, NF125-CV	-	-	-	-	-	●	●(Self Declaration)	-	●
		NF250-CV	-	-	-	-	-	●	●	●	●
		NF400-CW, NF630-CW, NF800-CEW	-	-	-	-	-	●	●(Self Declaration)	-	●
	S	NF32-SV, NF63-SV, NF125-SV	-	-	-	-	-	●	●(Self Declaration)	-	●
		NF125-SEV	-	-	-	-	-	●	●(Self Declaration)	-	-
		NF250-SV	-	-	-	-	-	●	●	●	●
		NF125-SGV, NF160-SGV, NF250-SGV, NF250-SEV	-	-	-	-	-	●	●(Self Declaration)	(Except for 4P)	-
		NF400-SW, NF630-SW	-	-	-	-	-	●	●(Self Declaration)	-	●
		NF400-SEW, NF630-SEW	-	-	-	-	-	●	●(Self Declaration)	-	●
		NF800-SEW, NF800-SDW	-	-	-	-	-	●	●(Self Declaration)	-	-
		NF1000-SEW, NF1250-SEW	-	-	-	-	-	●	●(Self Declaration)	-	●
		NF1600-SEW	-	-	-	-	-	●	●(Self Declaration)	-	-
		NF1250-SDW, NF1600-SDW	-	-	-	-	-	●	●(Self Declaration)	-	-
	L/H/R	NF63-HV	-	-	-	-	-	●	●(Self Declaration)	-	●
		NF125-HV	-	-	-	-	-	●	●(Self Declaration)	-	●
		NF125-HEV	-	-	-	-	-	●	●(Self Declaration)	-	-
		NF250-HV	-	-	-	-	-	●	●(Self Declaration)	-	●
		NF125-LGV, NF125-HGV, NF160-LGV, NF250-LGV, NF250-HGV, NF250-HEV, NF125-RGV, NF250-RGV	-	-	-	-	-	●	●(Self Declaration)	-	-
		NF400-HEW, NF400-REW, NF630-HEW, NF630-REW, NF800-HEW, NF800-REW	-	-	-	-	-	●	●(Self Declaration)	-	●
U	NF125-UV	-	-	-	-	-	-	●(Self Declaration)	-	●	
	NF250-UV, NF400-UEW	-	-	-	-	-	-	●(Self Declaration)	-	●	
	NF800-UEW	-	-	-	-	-	-	●(Self Declaration)	-	-	
Motor Protection	NF32-SV MB, NF63-CV MB, NF63-SV MB, NF125-SV MB	-	-	-	-	-	●	●(Self Declaration)	-	●	
	NF250-SV MB	-	-	-	-	-	●	●	●	●	
UL	UL 489 Listed	NF50-SVFU, NF100-CVFU	-	-	-	●	-	●	●	●	-
		NF125-SVU, NF125-HVU	-	-	-	●	-	●	●	●	-
		NF225-CWU	-	-	-	●	-	●	●	●	-
		NF250-SVU, NF250-HVU	-	-	-	●	-	●	●	●	-
		NF-SKW, NF-SLW	-	-	-	●	-	●	●	●	-

Note *1 Except for 4 poles breaker.

Remark: 1. KC (Korea Certification) Mark and GOST-R (Russian Standards) approval products are prepared. Please inquire details.

●Earth Leakage Circuit Breakers

Specifications	Class	Applicable Models and Assignments	North American Safety Mark					Compulsory Mark		Third Party Mark	Classification Society
			UL Standards			CSA Standards		CCC	CE	TÜV Rheinland	NK
			USA			Canada		China	Europe	Germany	Japan
CE and CCC	C	NV63-CV, NV125-CV	-	-	-	-	-	●	●(Self Declaration)	-	-
		NV250-CV	-	-	-	-	-	●	●	●	-
		NV400-CW, NV630-CW	-	-	-	-	-	●	●(Self Declaration)	-	-
	S	NV32-SV, NV63-SV	-	-	-	-	-	●	●(Self Declaration)	-	-
		NV125-SV	-	-	-	-	-	●	●(Self Declaration)	-	-
		NV250-SV	-	-	-	-	-	●	●	●	-
		NV125-SEV, NV250-SEV, NV400-SW, NV400-SEW, NV630-SW, NV630-SEW, NV800-SEW	-	-	-	-	-	●	●(Self Declaration)	-	-
	H/R	NV63-HV	-	-	-	-	-	●	●(Self Declaration)	-	-
		NV125-HV	-	-	-	-	-	●	●(Self Declaration)	-	-
		NV125-HEV, NV250-HV, NV250-HEV	-	-	-	-	-	●	●(Self Declaration)	-	-
		NV400-HEW, NV400-REW, NV630-HEW, NV800-HEW	-	-	-	-	-	-	-	-	
UL	UL 489 Listed	NV50-SVFU, NV100-CVFU	-	-	-	●	-	●	●	●	-
		NV125-SVU, NV125-HVU	-	-	-	●	-	●	●	●	-
		NV250-SVU, NV250-HVU	-	-	-	●	-	●	●	●	-

Remark: 1. KC (Korea Certification) Mark and GOST-R (Russian Standards) approval products are prepared. Please inquire details.

●Miniature Circuit Breakers

Specifications	Class	Applicable Models	Compulsory Mark	
			CCC	CE
			China	Europe
IEC	BH	BH	-	-
		BH-P	-	-
		BH-S	-	-
		BH-PS	-	-
General	DIN	BH-D6	●	●(Self Declaration)
		BH-D10	●	●(Self Declaration)
		BH-DN	●	●(Self Declaration)
		BV-D	●	●(Self Declaration)
		BV-DN	●	●(Self Declaration)
		KB-D	●	●(Self Declaration)

●Circuit Protectors

Specifications	Class	Applicable Models and Assignments	North American Safety Mark					Compulsory Mark		Third Party Mark	Classification Society
			UL Stgandards			CSA Standards		CCC	CE	TÜV Rheinland Germany	NK
			USA			Canada		China	Europe	Germany	Japan
General	CP	CP30-BA	-	-	●	-	-	●	●(EN 60934) ●(EN 60947-2) (Self-Declaration)	●(EN 60934)	-
		CP-S	-	-	-	-	-	-	-	-	-

Remark: 1. KC (Korea Certification) Mark and GOST-R (Russian Standards) approval products are prepared. Please inquire details.

●Air Circuit Breakers

Specifications	Class	Applicable Models	Assignments	North American Safety Mark					Compulsory Mark		Third Party Mark
				UL Stgandards			CSA Standards		CCC	CE	TÜV Rheinland Germany
				USA			Canada		China	Europe	Germany
IEC	SW	AE630-SW, AE1000-SW AE1250-SW, AE1600-SW AE2000-SWA, AE2000-SW AE2500-SW, AE3200-SW AE4000-SWA, AE4000-SW AE5000-SW, AE6300-SW	IEC 60947-2 or JIS C 8201-2-1	-	-	-	-	-	-	●(Self Declaration)	-
	SH	AE630-SH, AE1000-SH AE1250-SH, AE1600-SH AE2000-SH, AE2500-SH AE3200-SH	IEC 60947-2	-	-	-	-	-	-	●(Self Declaration)	-
JEC	SW	AE630-SW, AE1000-SW AE1250-SW, AE1600-SW AE2000-SWA, AE2000-SW AE2500-SW, AE3200-SW AE4000-SWA, AE4000-SW AE5000-SW, AE6300-SW	JEC 160	-	-	-	-	-	-	-	-
	SH	AE630-SH, AE1000-SH AE1250-SH, AE1600-SH AE2000-SH, AE2500-SH AE3200-SH		-	-	-	-	-	-	-	-
CCC	SW	AE630-SW, AE1000-SW AE1250-SW, AE1600-SW AE2000-SWA, AE2000-SW AE2500-SW, AE3200-SW AE4000-SWA, AE4000-SW AE5000-SW, AE6300-SW	CCC	-	-	-	-	-	●	●(Self Declaration)	-

Note *1 Except for four poles breaker.

Remark: 1. GOST-R (Russian Standards) approval products are prepared. Please inquire details.

●Molded Case Circuit Breakers , Motor Protection Breakers, Air Circuit Breakers, Circuit Protectors and Miniature Circuit Breakers (Classification Society)

Specifications	Class	Applicable Models	Classification societies (Note)							
			NK	LR	ABS	GL	BV	CCS	DNV	
			Japan	United Kingdom	USA	Germany	France	China	Norway	
General	C	NF30-CS	●	●	●	-	-	-	-	
		NF63-CV, NF125-CV	●	●	●	●	●	Scheduled to be certified	●	
		NF250-CV	●	●	●	●	●	Scheduled to be certified	●	
		NF400-CW, NF630-CW	●	●	●	●	●	-	-	
		NF800-CEW	●	●	●	●	●	-	●	
	S	NF32-SV, NF63-SV, NF125-SV	●	●	●	●	●	Scheduled to be certified	●	
		NF250-SV	●	●	●	●	●	Scheduled to be certified	●	
		NF400-SW, NF630-SW	-	-	-	-	-	-	-	
		NF400-SEW, NF630-SEW	●	●	●	●	●	●	●	
		NF800-SEW	-	-	-	-	-	-	●	
	H/R	NF1000-SEW, NF1250-SEW	●	●	●	-	-	-	-	
		NF63-HV, NF125-HV	●	●	●	●	●	Scheduled to be certified	●	
		NF250-HV	●	●	●	●	●	Scheduled to be certified	●	
		NF400-HEW, NF400-REW	●	●	●	●	●	●	-	
		NF630-HEW, NF630-REW NF800-HEW, NF800-REW	●	●	●	●	●	(HEW)	-	
	U	NF125-UV, NF250-UV NF400-UEW, NF800-UEW	●	●	●	●	●	Scheduled to be certified	●	
		NF125-UV, NF250-UV NF400-UEW, NF800-UEW	●	●	●	●	●	-	-	
	Motor Protection	NF32-SV MB, NF63-CV MB NF63-SV MB, NF125-SV MB NF250-SV MB	●	●	●	●	●	Scheduled to be certified	●	
		NF32-SV MB, NF63-CV MB NF63-SV MB, NF125-SV MB NF250-SV MB	●	●	●	●	●	Scheduled to be certified	●	
	AE	AE630-SW, AE1000-SW AE1250-SW, AE1600-SW AE2000-SWA, AE2000-SW AE2500-SW, AE3200-SW AE4000-SWA	●	●	●	●	●	●	●	
AE4000-SW, AE5000-SW, AE6300-SW		●	●	●	●	●	-	-		
CP30-BA		●	-	-	-	-	-	-		
BH-P		●	●	●	●	●	-	-		
BH-P		●	●	●	●	●	-	-		

Remark: 1. Four poles breakers does not acquire Classification Society approval.

1. Electric Shock Protection

The safety standards for current passing through the human body are determined based on physiological phenomena as shown below.

- In places where secondary accidents may be caused by electric shock: Area below the curve b
- In places where secondary accidents will not be caused by electric shock: Area below the curve c1

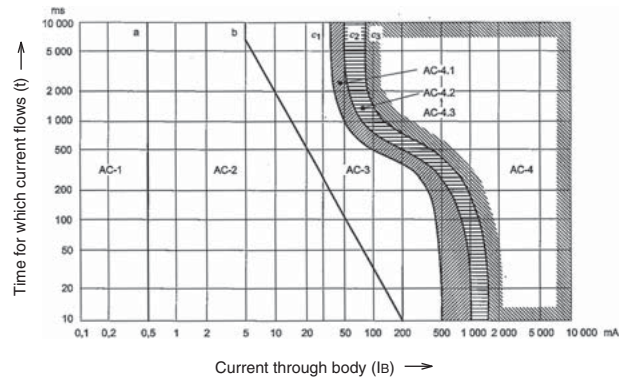

Fig. 4.17 Influence of AC (15 Hz to 100 Hz) on human body (IEC/TS60479-1)

2. ELCB Grounding Method

Select the rated sensitivity current based on the grounding method, purpose of protection and protection ground resistance value of load device. If the line is excessively long, the circuit breaker may operate unnecessarily owing to leakage current. Calculate the leakage current referring to Table 4-25. In this case, it is common to select sensitivity current approx. 10 times as high as the leakage current.

Table 4-24

Type of earthing system	TN system			TT system	IT system	
	TN-C system	TN-S system	TN-C-S system			
Typical arrangement						
Protective condition	The touch voltage is limited to 50V.					
	$Z_s \times I_a \leq 50 \text{ V}$ Z_s : fault loop impedance (Ω) I_a : current causing the automatic operation of the disconnecting device within the time as below (A) U_0 : nominal line to earth voltage (V)			$R_A \times I_{\Delta n} \leq 50 \text{ V}$ R_A : sum of the resistances of the earth electrode and the protective conductor (Ω) $I_{\Delta n}$: rated current sensitivity (A)		$I_d \times R_A \leq 50 \text{ V}$ R_A : sum of the resistances of the earth electrode and the protective conductor (Ω) I_d : first fault current (A)
Earth leakage protective device	Maximum disconnection times (sec)					
	U ₀ AC	Branch circuits rated 32 A and less				Others
		120 V	230 V	400 V	Over 400 V	
TN system	0.8	0.4	0.2	0.1	5	
TT system	0.3	0.2	0.07	0.04	1	
Earth leakage protective device	- MCCBs Not ELCBs	- MCCBs - ELCBs	- MCCBs - ELCBs (except in TN-C zone)		- ELCBs	- Insulation monitoring devices + ELCBs

Table 4-25 Leakage current when 600-V vinyl insulated wire is laid on 1-km Δ -connected 3-phase 3-wire 200-V line

Distance from grounded part	Ⓐ 4 m or more	Ⓑ 10 cm or more	Ⓒ 1.5 mm or more	Ⓓ In close contact
Wiring work	<ul style="list-style-type: none"> Wiring on first floor ceiling of wooden building Wiring on second and higher floors of wooden building Aerial wiring (Except Ⓒ and Ⓓ)	<ul style="list-style-type: none"> Wiring in RC building Wiring with vinyl tube and exposed wiring in steel frames (Except Ⓒ and Ⓓ)	<ul style="list-style-type: none"> Vinyl tube burying Vinyl tube laying in close contact with steel frames in steel building 	<ul style="list-style-type: none"> Wiring in metallic conduit Wiring in metallic duct
Wire size				
8 mm ² or less	0.60 mA/km	1.29 mA/km	19.9 mA/km	100 mA/km
14	0.66	1.44	22.1	110
22	0.72	1.55	23.9	120
38	0.81	1.75	26.9	135
60	0.99	2.14	32.9	165
100	1.14	2.46	37.9	189
150	1.25	2.72	41.8	209
250	1.46	3.16	48.6	243
325	1.52	3.29	50.7	253
500	1.71	3.69	56.8	284

Notes *1 The leakage current on rubber insulated wire (RB) is about 70% of the above values, and that on 3-core 600-V cross-linked polyethylene insulated wire (CV) is about 50%.

*2 At 50 Hz, the values are 84% of the above values.

*3 To obtain the leakage current on another line, multiply the values shown in Table 4-25 by the magnification shown in Table 4-26.

*4 To determine the line length, add the length of all wires after ELCB installation point.

Table 4-26 Leakage current conversion table

Type of line	Magnification
Single-phase 100-V line	0.3
Single-phase 3-wire 200-V line	0.3
3-phase 415-V line (Δ connection)	0.7

3. Rated Voltage and Number of Poles

Select the rated voltage and number of poles according to the circuit voltage and type. The following table shows the standard circuit voltage values. However, even at special voltage, if the voltage including the circuit voltage fluctuation is within the voltage range shown right, the leakage protection device will operate.

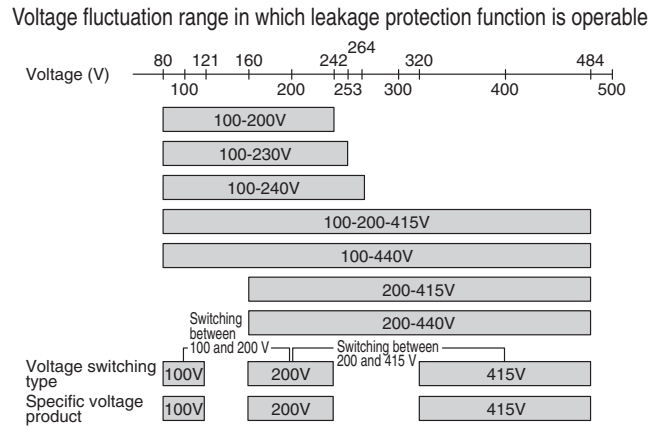

Table 4-27

Circuit type	Single-phase 2-wire 100- or 200-V circuit	Single-phase 3-wire 100- and 200-V circuit
Example of connection	<ul style="list-style-type: none"> • 100-440V • 100-200-415V • 100-200V • 100-240V • 100-440V • 100-200-415V • 100-200V • 100-230V • 100V • 100-440V • 100-200-415V • 100-200V • 100-240V • 100-440V • 100-200-415V • 100-200V • 100-230V • 200-415V • 200-440V 	<ul style="list-style-type: none"> • 100-200-415V • 100-200V • 200-415V • 100-230V • 100-440V • 200-440V • 100-200-415V • 100-200V • 100V • 200-415V • 100-240V • 100-230V • 100-440V • 100-440V • 100-200-415V • 100-200V • 100-415V • 100-240V • 100-230V • 100-440V • 200-440V
Circuit type	3-phase 3-wire 200-V circuit	3-phase 3-wire 415-V circuit
Example of connection	<ul style="list-style-type: none"> • 100-200-415V • 100-200V • 200-415V • 100-440V • 100-230V • 200-440V • 100-200-415V • 100-200V • 200-415V • 100-440V • 200-440V 	<ul style="list-style-type: none"> • 100-200-415V • 200-415V • 415V • 100-440V • 200-440V • 100-200-415V • 200-415V • 415V • 100-440V • 200-440V
Circuit type	3-phase 4-wire 415-V circuit	
Example of connection	<ul style="list-style-type: none"> • 100-200-415V • 200-415V • 100-440V • 200-440V • 100-200-415V • 200-415V • 415V • 100-440V • 200-440V • 100-200-415V • 200-415V • 415V • 100-440V • 200-440V • 100-200-415V • 200-415V • 100-240V • 100-440V • 200-440V 	

<Cautions when selecting and connecting>

(1) When a 3-pole circuit breaker is used as a 2-pole one, use the right and left poles.

(2) For the mains of a 3-phase 4-wire 415-V circuit, use a 4-pole circuit breaker having a rated voltage of 415 V or 440 V, and connect the neutral pole to the N pole on the right side.

4. Earth Fault Protection Coordination and Combination of Devices

Table 4-28

Protection type	Details	Installation point	Combination
With selectivity only for earth fault breaking	● On general lines, the protection grounding resistance is relatively large and the earth fault current is small. In this case, install a time-delay relay on the main circuit and a high-speed relay on a branch circuit.	Main circuit	• Time-delay ELCB • Combination of MCCB and time-delay earth leakage relay
		Branch circuit	High-speed ELCB
With selectivity for earth fault breaking and cascade type of short-circuit breaking	● The selectivity for earth fault breaking is as stated above. ● Significant short-circuit fault very rarely occurs because of its nature (in most cases, circuits are broken at the early stage of earth fault). This protection is applied when the continuity of power supply is expendable. (Refer to the combination for cascade breaking on page 83.)	Main circuit	• Class S time-delay ELCB • Combination of MCCB (class U) and time-delay earth leakage relay
		Branch circuit	• Class C time-delay ELCB • Combination of MCCB (class C) and high-speed earth leakage relay
With selectivity for earth fault breaking and short-circuit breaking	● This protection is applied when selectivity is necessary in the entire area of fault. (Refer to the combination for selective breaking on page 81.)	Main circuit	Combination of electronic MCCB and time-delay earth leakage relay
		Branch circuit	• High-speed ELCB • Combination of MCCB and high-speed earth leakage relay

Remark: 1. "Time-delay or high-speed earth leakage relay" refers to NV-ZBA, NV-ZSA, NV-ZHA or NV-ZLA.

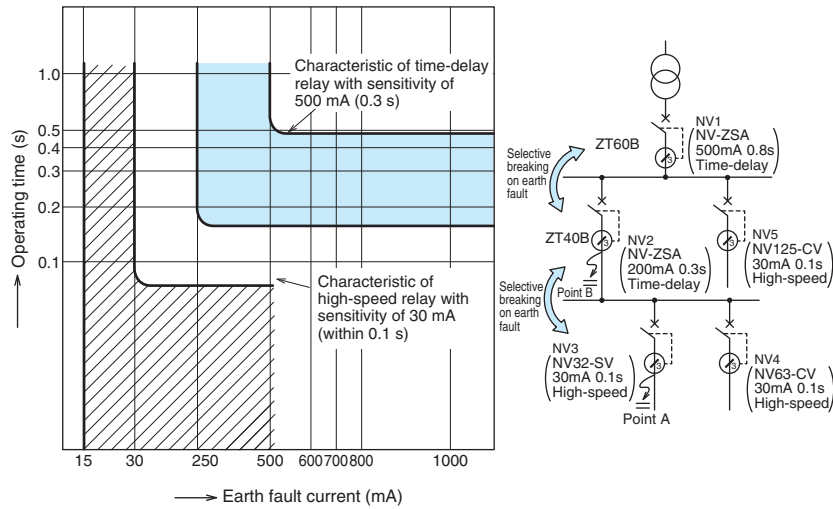

Fig. 4.18 Example of coordination of time-delay and high-speed relays for earth fault breaking

MEMO

4

3 Selection











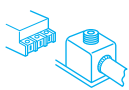

5

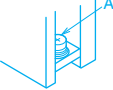
Installation and Connection

1) Connection Types	94
2) Connecting Parts	96
3) Standard Tightening Torque	97
4) Crimp Terminal Type	98
5) Busbar	100
6) Insulation Distance on Power Source Side	101
7) Effect of Installation Orientation	102
8) Connection of Line and Load	102

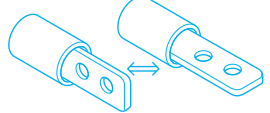
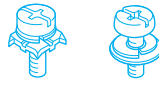
1. Connection Types

Table 5-1 Connection

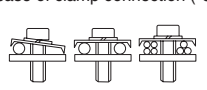
Connection type (Code address)		Front connection (F)			Rear (B)	
		Screw terminal (AMP-N)	Busbar terminal (BAR)	Solderless (BOX) terminal (SL)	Bar stud (B-ST)	Round stud (B-ST)
Image		 Please refer to page 98.				
						
C S H M B MCCB R U UL BH ELCB	NF30-CS	●	-	-	-	●
	NF32-SV • NF63-CV • NF63-SV • NF63-HV	●	●	-	-	●
	NF125-CV • NF125-SEV • NF125-SV • NF125-SGV • NF125-LGV • NF125-HEV • NF125-HV • NF125-HGV	●	●	-	●	-
	NF160-SGV • NF160-LGV • NF160-HGV • NF250-CV • NF250-SV • NF250-HV • NF250-SEV • NF250-HEV • NF250-SGV • NF250-LGV • NF250-HGV	●	●	-	●	-
	NF400-SW • NF400-SEW • NF400-HEW • NF400-REW • NF400-CW	-	●	-	●	-
	NF630-SW • NF630-SEW • NF630-HEW • NF630-REW • NF630-CW	-	●	-	●	-
	NF800-SEW • NF800-HEW • NF800-REW • NF800-SDW • NF800-CEW	-	●	-	●	-
	NF1000-SEW • NF1250-SEW • NF1600-SEW	-	●	-	●	-
	NF125-UV	●	●	-	●	-
	NF125-RGV • NF250-RGV • NF250-UV	●	●	-	●	-
	NF400-UEW	-	●	-	●	-
	NF800-UEW	-	●	-	●	-
	NF50-SVFU	●	●	-	-	-
	NF100-CVFU	●	●	●	-	-
	NF125-SVU	●	●	●	-	-
	NF125-HVU	●	●	●	-	-
	NF250-SVU	●	●	●	-	-
	NF250-HVU	●	●	●	-	-
	NF225-CWU	●	●	-	-	-
	NF-SKW • NF-SLW	-	●	●	-	-
BH-K • BH-C1 • BH-C2 • BV-C1 • BV-C2	●	-	-	-	-	
BH-P	● (Only load side)	-	-	-	-	
NV32-SV • NV63-CV • NV63-SV • NV63-HV	●	●	-	-	●	
NV125-CV • NV125-SV • NV125-HV • NV125-SEV • NV125-HEV	●	●	-	-	●	
NV250-CV/SV/HV • NV250-SEV/HEV	●	●	-	-	●	
NV400-SW • NV400-SEW • NV400-HEW • NV400-REW • NV400-CW	-	●	-	-	●	
NV630-SW • NV630-SEW • NV630-HEW • NV630-CW	-	●	-	-	●	
NV800-SEW • NV800-HEW	-	●	-	-	●	
Shape	Kind of terminal screw (A) (Circuit breakers having frame size of 1000A and more are not provided with terminal screws (A).)					<ul style="list-style-type: none"> ● With insulating base (tube) for installation of metallic board ● The bar stud installation position can be turned 90° on all models (except NF800-UEW, NF1200-UR and breakers having frame size of 2500A and more). The current-carrying capacity of a vertically installed bus bar is larger than that of a horizontally installed bus bar even if the bus bars have the same dimensions. 
	 Pan-head screw with clamp	 Pan-head screw	 Bolt (Hex-socket)	 Bolt		
Screw size	M5	M8	M8	2×M8	M10	
Remarks	NF32-SV 63-CV 63-SV 63-HV 50-SVFU(*3)	NF 63-CV(60, 63A) 63-SV(60, 63A) 63-HV(60, 63A) 125-CV 125-SV 125-HV 125-SEV 125-HEV 100-CVFU 125-SVU 125-HVU 125-UV	NV 63-CV(60, 63A) 63-SV(60, 63A) 63-HV(60, 63A) 125-CV 125-SV 125-HV 125-SEV 125-HEV	NF 125-SEV 125-HEV 125-RGV 125-SGV 125-LGV 125-HGV 160-SGV 160-LGV 160-HGV 250-CV 250-SV 250-HV 250-SEV 250-HEV 250-SGV 250-LGV 250-HGV 250-RGV 250-UV 225-CWU 250-SVU 250-HVU NV 125-SEV 125-HEV 250-CV 250-SV 250-HV 250-SEV 250-HEV	NV 800-SEW 800-HEW NF 400-CW 400-SW 400-SEW 400-HEW 400-REW 400-UEW(3P) 630-CW 630-SW 630-SEW 630-HEW 630-REW NV 400-CW 400-SW 400-SEW 400-HEW 400-REW 630-CW 630-SW 630-SEW 630-HEW	
Type	In case of clamp connection (*3)					
						
	<ol style="list-style-type: none"> ① When the wire size is 5.5 mm² or more, divide the wires, and connect them. ② When connecting wires differing in size, for example, φ1.6 wires and 5.5-mm² wires, connect the two kinds of wires together to a crimp terminal because the thinner wires easily come off. ③ Do not tighten directly solid wires and cords consisting of thin copper wires used as strands, for example φ1.6 and 1.25-mm² wires, together. 					

Notes *1 For 50A or less, a pan-head screw M5 with clamp is provided.
*2 A pan-head screw M5 is provided on the power supply side of BH-C1 and C2 and BV-C1 and C2.
*3 It is impossible to directly connect the wires of 40- and 50-A, NF/NV 50-SVFU.

	Plug-in (PM)		Plug-in type for distribution board For distribution board for electric lamps (BPA)
	Bar stud (PM)	Screw terminal (PM)	
			
	-	-	-
	-	●	-
	-	●	-
	●	-	-
	●	-	-
	●	-	-
	(Except for NF1600-SEW)	-	-
	-	●(Except for 4P)	-
	●(Except for 4P)	-	-
	(Except for NF800-UEW)	-	-
	-	-	-
	-	-	-
	-	-	-
	-	-	-
	-	-	-
	-	-	-
	-	-	-
	-	●	●
	-	●	-
	●	-	-
	●	-	-
The circuit breaker can be connected only by pushing it onto the preliminarily wired terminal block. Install it tightening the supplied screws through the mounting holes.			Mounting base for distribution board for electric lamps. For the external dimensions, refer to page 139.

Table 5-2 List of terminal screws (B)

Model		Connection type	Front	Rear	Plug-in
MCCB	H	NF400-CW • NF400-SW • NF400-SEW • NF400-HEW • NF400-REW • NF630-CW • NF630-SW • NF630-SEW	M12 bolt		
		NF630-HEW • NF630-REW • NF800-CEW • NF800-SEW • NF800-HEW • NF800-REW • NF800-SDW • NF-SKW • NF-SLW	M12 bolt		
		NF1000-SEW • NF1250-SEW	M10 bolt		—
U		NF400-UEW	M12 bolt		
		NF800-UEW	M12 bolt		—
ELCB	I	NV400-SW • NV400-SEW • NV400-HEW • NV400-REW • NV400-CW • NV630-SW • NV630-SEW • NV630-HEW • NV630-CW • NV-SKW	M12 bolt		
		NV800-SEW • NV800-HEW	M12 bolt		

2. Connecting Parts

For the connection shown in the table on the previous page, the following parts are available as connecting parts.

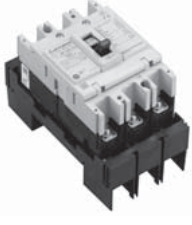
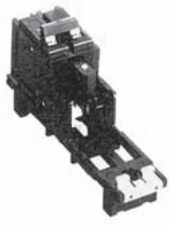
Table 5-3 Studs on rear surface (B-ST)

Type name	Number of poles	Applicable models		Set of order	Stud shape and major included parts	Remarks
		MCCB	ELCB			
ST-05SV2	2	NF32-SV, NF63-CV, NF63-SV NF63-HV	NV32-SV, NV63-CV	sets	★Round studs ●Round studs (with insulating tube) (2-pole: 4 pcs, 3-pole: 6 pcs, 4-pole: 8 pcs) ●Bolts and nuts	One set includes the parts for one unit. Please place an order for the number of circuit breakers.
ST-05SV3	3		NV63-SV, NV63-HV			
ST-05SV4	4	NF63-SV, NF63-HV	—			
ST-1SV2	2	NF125-CV, NF125-SV NF125-HV(3, 4P)	—	sets	★Bar studs ●Bar studs (with insulating tube) (2-pole: 4 pcs, 3-pole: 6 pcs, 4-pole: 8 pcs) ●Bolts and nuts	
ST-1SV3	3		NV125-CV, NV125-SV			
ST-1SV4	4		NV125-HV			
ST-1HV2	2		—			
ST-2SV2	2	NF125-SEV, NF125-HEV, NF125-RGV NF125-SGV, NF125-LGV, NF125-HGV NF160-SGV, NF160-LGV, NF160-HGV NF250-SGV, NF250-LGV, NF250-HGV NF250-CV, NF250-SV NF250-LGV/HGV, NF250-HV NF250-SEV, NF250-RGV NF250-HEV, NF125-SGV/HGV NF125-LGV, NF160-SGV NF160-LGV/HGV	—	sets	★Bar studs ●Bar studs (with insulating tube) (2-pole: 4 pcs, 3-pole: 6 pcs, 4-pole: 8 pcs) ●Bolts and nuts	
ST-2SV3	3		NV125-SEV, NV125HEV NV250-CV, NV250-SV NV250-HV, NV250-SEV NV250-HEV			
ST-2SV4	4		—			
ST-4SW2	2	NF400-CW, NF400-SW NF400-SEW, NF400-HEW NF400-REW	—	sets	★Bar studs ●Insulating bases (2-pole: 4 pcs, 3-pole: 6 pcs, 4-pole: 8 pcs) ●Bar studs (2-pole: 4 pcs, 3-pole: 6 pcs, 4-pole: 8 pcs) ●Mounting screws, bolts and nuts	
ST-4SW3	3		NV400-CW, NV400-SW NV400-SEW			
ST-4SW4	4		NV400-HEW NV400-REW			
ST-6SW2	2	NF630-CW, NF630-SW NF630-SEW, NF630-HEW NF630-REW	—	sets	★Bar studs ●Insulating base (2 pcs) ●Bar studs (2-pole: 4 pcs, 3-pole: 6 pcs, 4-pole: 8 pcs) ●Mounting screws, bolts and nuts	
ST-6SW3	3		NV630-CW, NV630-SW			
ST-6SW4	4		NV630-SEW, NV630-HEW			
ST-8SW2	2	NF800-SDW, NF800-CEW NF800-SEW, NF800-HEW NF800-REW	—	sets	★Bar studs ●Insulating base (2 pcs) ●Bar studs (2-pole: 4 pcs, 3-pole: 6 pcs, 4-pole: 8 pcs) ●Mounting screws, bolts and nuts	
ST-8SW3	3		NV800-SEW, NV800-HEW			
ST-8SW4	4					

Table 5-4 Plug-in type terminal blocks (PM)

Type name	Number of poles	Applicable models	Set of order	Major included parts
PM-05SV2	2	NF32-SV, NF63-CV, NF63-SV, NF63-HV	sets	Plug-in type terminal block (1 pc)
PM-05SV3	3	NV32-SV, NV63-CV (3P) , NV63-SV (3P) , NV63-HV		
PM-05SV4	4	NF63-SV, NF63-HV		
PM-NV05SV2	2	NV63-CV, NV63-SV	sets	Plug-in type terminal block (1 pc) (2-pole: 4 pcs)
PM-1SV2	2	NF125-CV, NF125-SV	sets	Plug-in type terminal block (1 pc) Tulip terminals (2-pole: 4 pcs, 3-pole: 6 pcs, 4-pole: 8 pcs)
PM-1SV3	3	NF125-CV, NF125-SV, NF125-HV, NV125-CV, NV125-SV NV125-HV		
PM-1SV4	4	NF125-SV, NF125-HV, NV125-SV, NV125-HV		
PM-1HV2	2	NF125-HV		
PM-2SV2	2	NF125-SEV, NF125-HEV, NF250-CV, NF250-SV, NF250-HV NF250-SEV, NF250-HEV, NF125-SGV, NF125-LGV NF125-HGV, NF160-SGV, NF160-LGV, NF160-HGV NF250-SGV, NF250-LGV, NF250-HGV, NV125-SEV NV125-HEV, NV250-CV, NV250-SV, NV250-HV, NV250-SEV NV250-HEV, NF250-LGV/HGV, NF250-RGV, NF125-SGV/HGV NF125-LGV, NF160-SGV, NF160-LGV/HGV	sets	Plug-in type terminal block (1 pc) Plug-in type barriers (2-pole: 2 pcs, 3-pole: 4 pcs, 4-pole: 6 pcs) Tulip terminals (2-pole: 4 pcs, 3-pole: 6 pcs, 4-pole: 8 pcs)
PM-2SV3	3			
PM-2SV4	4			
PM-4SW3	3	NF400-CW, NF400-SW, NF400-SEW, NF400-HEW, NF400-REW NV400-CW, NV400-SW, NV400-SEW, NV400-HEW, NV400-REW	sets	Plug-in type terminal block (2 pcs) Plug-in type barriers (4 pcs) Tulip terminals (3-pole: 6 pcs)
PM-6SW3	3	NF630-CW, NF630-SW, NF630-SEW, NF630-HEW, NF630-REW NV630-CW, NV630-SW, NV630-SEW, NV630-HEW	sets	Plug-in type terminal block (2 pcs) Tulip terminals (3-pole: 6 pcs)
PM-8SW3	3	NF800-CEW, NF800-SEW, NF800-HEW, NF800-REW NV800-SEW, NV800-HEW	sets	Plug-in type terminal block (2 pcs) Tulip terminals (3-pole: 6 pcs)
PM-10SW3	3	NF1000-SEW, NF1250-SEW	sets	Plug-in type terminal block (2 pcs) Tulip terminals (3-pole: 6 pcs)

Note *1 In addition to the circuit breakers shown above, 4-pole and 2-pole circuit breakers are available. We are ready to manufacture such circuit breakers to order. Please consult us.

3. Standard Tightening Torque

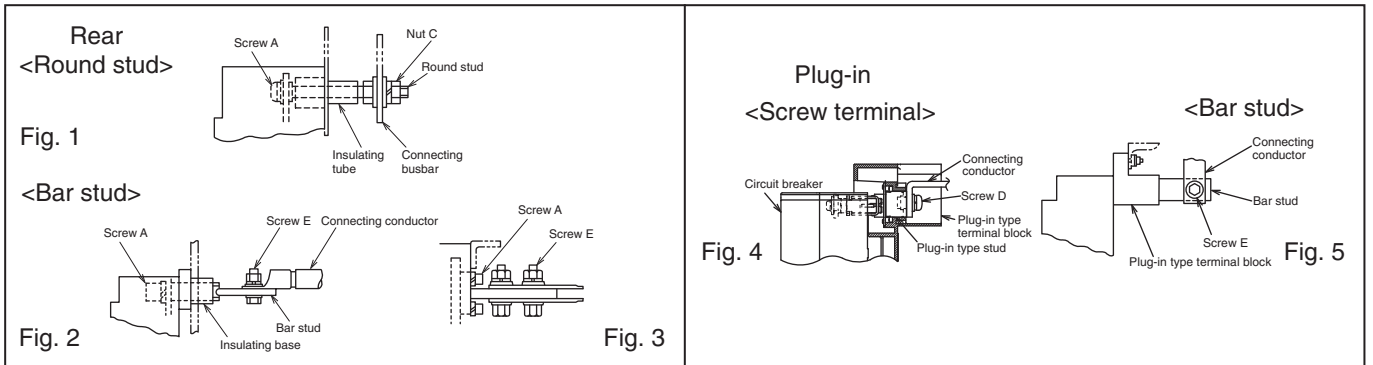

Table 5-5 Standard tightening torque (*1)

Model		Connection type		Tightening torque N·m									
				Rear				Plug-in					
				Round stud		Bar stud		Screw terminal		Bar stud			
				Fig.1		Fig. 2, Fig.3		Fig.4		Fig.5			
MCCB	ELCB	Screw A		Nut C		Screw A		Screw E		Screw D		Screw E	
		Size	Tightening torque	Size	Tightening torque	Size	Tightening torque	Size	Tightening torque	Size	Tightening torque	Size	Tightening torque
NF30-CS	-	M4x0.7	1	M6	2	-	-	-	-	-	-	-	-
NF32-SV, NF63-CV NF63-SV, NF63-HV	NV32-SV, NV63-CV NV63-SV, NV63-HV	M4x0.7	1	M6	2	-	-	-	-	M6	3	-	-
NF125-CV, NF125-SV NF125-HV, NF125-UV	NV125-CV, NV125-SV NV125-HV	-	-	-	-	M6	4	M8	12	M8	6	-	-
NF125-SEV, NF125-HEV, NF125-RGV NF250-CV, NF250-SV, NF250-HV, NF250-SEV NF250-HEV, NF250-RGV, NF250-UV NF250-LGV/HGV, NF250-RGV, NF125-SGV/HGV NF125-LGV, NF160-SGV, NF160-LGV/HGV NF125-SGV, NF125-LGV, NF125-HGV NF160-SGV, NF160-LGV, NF160-HGV NF250-SGV, NF250-LGV, NF250-HGV	NV125-SEV, NV125-HEV NV250-CV, NV250-SV NV250-HV, NV250-SEV NV250-HEV	-	-	-	-	M6	10	M8	12	-	-	M8	12
NF400-CW, NF400-SW, NF400-SEW NF400-HEW, NF400-REW NF400-UEW (3P) NF400-UEW (4P)	NV400-CW, NV400-SW NV400-SEW, NV400-HEW NV400-REW	-	-	-	-	M8	20	M12	45	-	-	M12	45
NF630-CW, NF630-SW, NF630-SEW NF630-HEW, NF630-REW	NV630-CW, NV630-SW NV630-SEW NV630-HEW	-	-	-	-	M8	20	M12	45	-	-	M12	45
NF800-CEW, NF800-SDW NF800-SEW, NF800-HEW, NF800-REW NF800-UEW (*2)	NV800-SEW NV800-HEW	-	-	-	-	M10	30	2-M12	45	-	-	2-M12	45
NF1000-SEW NF1250-SEW	-	-	-	-	-	4-M8	12	2-M12	45	-	-	2-M12	45
NF1600-SEW	-	-	-	-	-	4-M8	12	4-M10	25	-	-	-	-

Notes *1 The appropriate range of tightening torque is ±20% of each value (standard tightening torque) shown in the above table. Please refer to the supplied assembly manual and instruction manual for more information.

*2 The plug-in type is not available.

4. Crimp Terminal Type

As the terminals in , commercially available crimp terminals can be used. Please purchase the terminals at an electric material store.

For others, the crimp terminals for Mitsubishi MCCB must be used. Place an order with us. For the connection types shown in Fig. a and Fig. b, only crimp terminals will be delivered.

Table 5-6 List of applicable crimp terminals

Frame (A)	Nominal sectional area mm ²		2	5.5	8	14	22
	Allowable current (600 V, IV wire at 30°C, not in conduit) (*4)		27A	49A	61A	88A	115A
Model	Size of mm ²		1.04 to 2.63	2.63 to 6.64	6.64 to 10.52	10.52 to 16.78	16.78 to 26.66
	MCCB	ELCB					
30 50 100	BH-K, BH-P	—	R-2-5	R-5.5-5	R-8-5	R-14-5	BH-22 (L330T459-23)
	BH-K100, BH-P100	—			R-8-8	R-14-8	R-22-8
30 32 50 60 63	NF30-CS, NF32-SV, NF63-CV*, NF63-SV* NF63-HV* *50A or below	NV32-SV, NV63-CV*, NV63-SV* NV63-HV* *50A or below	R-2-5 *(R-2-6)	R-5.5-5 *(R-5.5-6)	R-8-5	R-14-5	JST22-S5 BH-22 (L330T459-23)
	NF63-CV, NF63-SV, NF63-HV 60, 63A	NV63-CV, NV63-SV, NV63-HV 60, 63A	R-2-8	R-5.5-8	R-8-8	R-14-8	R-22-8
125	—	—	R-2-5 (R-2-6)	R-5.5-5 (R-5.5-6)	R-8-5	R-14-5	JST22-S5 (L330T459-23)
	NF125-CV, NF125-SV, NF125-HV, NF125-UV 60A or more	NV125-CV, NV125-SV, NV125-HV 60A or more	R-2-8	R-5.5-8	R-8-8	R-14-8	R-22-8
125 225 250	NF125-SEV, NF125-HEV, NF125-RGV NF250-CV, NF250-SV, NF250-HV, NF250-UV NF250-SEV, NF250-HEV, NF250-RGV NF125-SGV, NF160-SGV, NF250-SGV NF125-LGV, NF160-LGV, NF250-LGV NF125-HGV, NF160-HGV, NF250-HGV	NV125-SEV, NV125-HEV NV250-CV, NV250-SV, NV250-HV NV250-SEV, NV250-HEV				R-14-8	R-22-8
400 600 630	NF400-CW, NF400-SW, NF400-SEW NF400-HEW, NF400-REW, NF400-UEW NF630-CW, NF630-SW, NF630-SEW NF630-HEW, NF630-REW	NV400-CW, NV400-SW NV400-SEW, NV400-HEW NV400-REW, NV630-CW NV630-SW, NV630-SEW NV630-HEW					
800 1000 1200 1250	NF800-CEW, NF800-SEW, NF800-HEW NF800-REW, NF800-UEW, NF800-SDW NF1000-SEW, NF1250-SEW	NV800-SEW, NV800-HEW					

Reference drawings of connection types

Method of connecting directly to terminal(s) of body

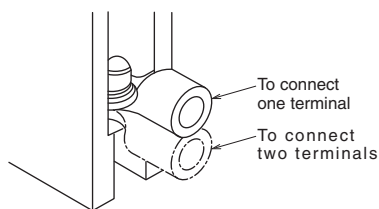

(Fig. a)

Method of connecting to front bar terminal

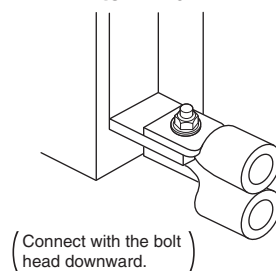

(Fig. b)

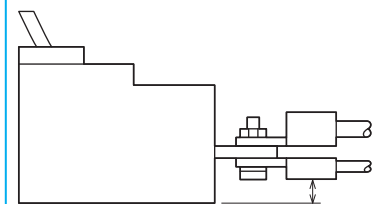

Carefully check the insulating distance between the connecting bus bar, crimp terminal and tightening bolt and the ground and the phase-to-phase insulating distance.

<Explanation of abbreviations> R.....Product specified by JIS
 CB.....Product specified by JEM 1399
 AMP.....Product made by Nippon AMP
 JST.....Product made by J.S.T. Mfg. Co., Ltd.
 NTK.....Product made by Nippon Tanshi Co., Ltd.
 NTM.....Product made by Nichifu Co., Ltd.
 DST.....Product made by Daido Solderless Terminal Mfg. Co., Ltd.

							Crimp terminal tightening screw			Remarks	Reference drawing of connection type
38	60	100	150	200	325	Screw size	Tightening torque N·m	Shape			
162A	217A	298A	395A	469A	650A						
26.66 to 42.42	42.42 to 60.57	96.3 to 117.2	117.2 to 152.05	192.6 to 242.27	242.27 to 325						
AMP #322870 JST 38-S8 NTK R38-8S	1AF-60 (L330T459-12) CB60-S8					M5	2 to 3		When connecting two crimp terminals, set the terminals as shown below if the *-marked terminals are used. (Fig. a)		
					M8	5 to 7					
					M5	2 to 3					
					M8	5 to 7					
AMP #322870 JST 38-S8 NTK R38-8S	1AF-60 (L330T459-12) CB60-S8					M5	2 to 3				
						M8	5 to 7				
R-38-8	R-60-8	2AF (LN300T920-20) CB100-S8	2CR-150(*1) (LN300T920-21) (*1)CB150-S8			M8	8 to 13		When using 2AF, use a crimp tool having a nominal size of 100.		
R-38-12	R-60-12	R-100-12	R-150-12	R-200-12	JST325-12	M12	40 to 50		Fit to a front type bar terminal. Up to two pieces can be fitted to one terminal.	(Fig. b)	
R-38-12	R-60-12	R-100-12	R-150-12 RD150-12 SD150-12	R-200-12 RD200-12 SD200-12	JST325-12 RD325-12 SD325-12						

Notes *1 When using 2CR-150 or CB150-S8, insulate it from TC-S with insulating tube or tape. For a 2- or 3-pole circuit breaker, TCL-2SV3L is applicable.
 *2 On the power supply side, pan-head screws M5 are used.
 *3 When tightening a terminal screw without connecting a wire, crimp terminal or bar, tighten the screw to 20 to 30% of the torque shown in the above table (to prevent damage to the threads).
 *4 The table shows not the allowable current values of circuit breakers, but those of wires applicable to crimp terminals.
 Remark: 1. For the crimp terminals for UL listed circuit breakers, refer to the page of the characteristics and external dimensions of UL 489 Listed Circuit Breakers.

● Dimensions of crimp terminals <extracted from catalog of JST>

Part number	Shape	Applicable screw size	External dimensions						Applicable wire mm ²
			φd2	B	L	F	E	Thickness	
R2-5	A	M5	5.3	9.5	16.8	7.3	4.8	0.8	1.04 to 2.63
R2-6		M6	6.4	12.0	21.8	11.0			1.04 to 2.63
R2-8		M8	8.4	12.0	21.8	11.0			1.04 to 2.63
R5.5-5	A	M5	5.3	9.5	19.8	8.3	6.8	1.0	2.63 to 6.64
R5.5-6		M6	6.4	12.0	25.8	13.0			2.63 to 6.64
R5.5-8		M8	8.4	15.0	28.0	13.7			2.63 to 6.64
R8-5	A	M5	5.3	12.0	23.8	9.3	8.5	1.2	6.64 to 10.52
8-5NS		M5	5.3	9.0	22.3				6.64 to 10.52
R8-6		M6	6.4	12.0	23.8				6.64 to 10.52
R8-8		M8	8.4	15.0	29.8	13.8			10.52 to 16.78
8-5SC-9		M5	5.3	9	23.8	9.3	8.5	1.2	6.64 to 10.52
R14-5	A	M5	5.3	12.0	29.8	13.3	10.5	1.5	10.52 to 16.78
14-5NS		M5	5.3	9.0	28.3				10.52 to 16.78
R14-6		M6	6.4	12.0	29.8				10.52 to 16.78
R14-8		M8	8.4	16.0	32.8	14.5			
L330T459-23		M5	5.3	12.0	30.0	12.0	12.0	1.8	16.78 to 26.66
22-5NS	M5	5.3	9.5	28.7	16.78 to 26.66				
22-S6	M6	6.4	12.0	30.0	16.78 to 26.66				
R22-8	A	M8	8.4	16.5	33.7	13.5	14.0	1.8	26.66 to 42.42
R22-12		M12	13.0	22.0	42.5	19.5			26.66 to 42.42
38-S8		M8	8.4	15.5	38.0	16.0			26.66 to 42.42
R38-8	A	M8	8.4	22.0	42.7	17.7	18.0	2.0	42.42 to 60.57
R38-12		M12	13.0	22.0	49.7	20.7			42.42 to 60.57
L330T459-12		M8	8.4	16.0	46.7	20.7			42.42 to 60.57
R60-8	A	M8	8.4	22.0	49.7	20.7	21.0	2.6	96.3 to 117.2
R60-12		M12	13.0	28.5	55.6	20.4			96.3 to 117.2
LN300T920-20		B	M8	8.4	22.5	51.0			20.0
R100-12	A	M12	13.0	28.5	55.6	20.4	21.0	2.6	96.3 to 117.2

Part number	Shape	Applicable screw size	External dimensions						Applicable wire mm ²
			φd2	B	L	F	E	Thickness	
LN300T920-21	B	M8	8.4	22.5	70.0	33.0	27.0	3.2	117.2 to 152.05
L330T402-8		M8	8.4	25.3	61.5	23.0			117.2 to 152.05
R150-12		A	M12	13.0	36.0	66.0			21.0
R200-12	A	M12	13.0	44.0	78.0	24.5	31.5	4.0	192.6 to 242.27
325-12	A	M12	13.0	50.5	88.0	33.5	35.5	4.5	242.27 to 325
CB60-S8	B	M8	8.4	16.0	46.7	20.7	18.0	2.0	42.42 to 60.57
CB100-S8			8.4	22.0	52.5	20.5	21.0	2.6	96.3 to 117.2
CB150-S8			8.4	22.0	61.0	23.0	27.0	3.2	117.2 to 152.05

Part number	Shape	Applicable screw size	External dimensions							Applicable wire mm ²
			φd2	B	L	F	E	N	Thickness	
RD60-12	C	M12	14.0	22.0	89.0	20.0	18.0		2.0	42.42 to 60.57
RD100-12			14.0	28.5	95.5	20.3	21.0		2.6	96.3 to 117.2
RD150-12			14.0	36.0	106.0	21.0	27.0	40	3.2	117.2 to 152.05
RD200-12			14.0	44.0	116.5	23.0	31.5		4.0	192.6 to 242.27
RD325-12			14.0	50.5	123.8	23.0	35.5		4.5	242.27 to 325
SD150-12	C	M12		36.0	107.0	29.0	28.0		3.2	117.2 to 152
SD200-12			14.0	44.0	108.0	36.0	32.0	32	4.0	192.6 to 242.2
SD325-12					50.5	125.0	38.0	37.0		4.5

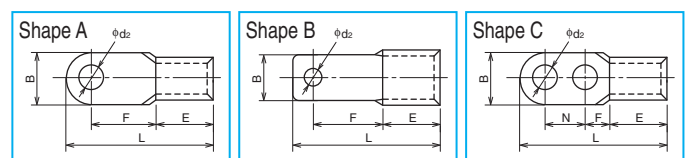

5. Busbar

The size of the conductor that can be connected is shown on the outline drawing of each model. The following special busbars are available. Use them as needed. When using any busbar, isolate it from the bare busbar on the circuit breaker power supply side with an insulating barrier.

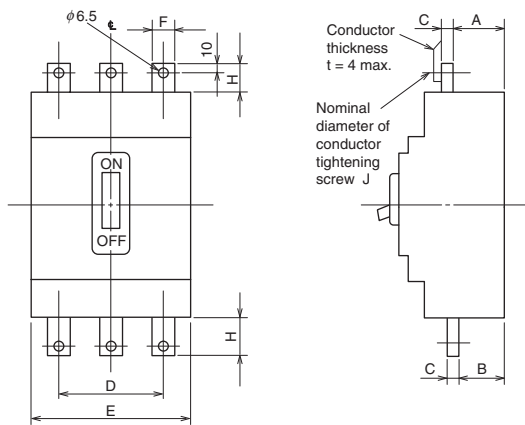

Fig. 1

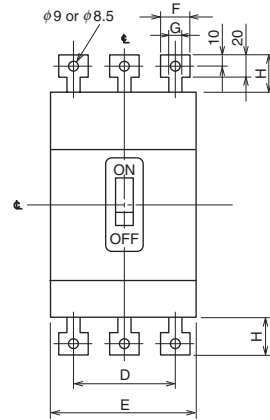

Fig. 2

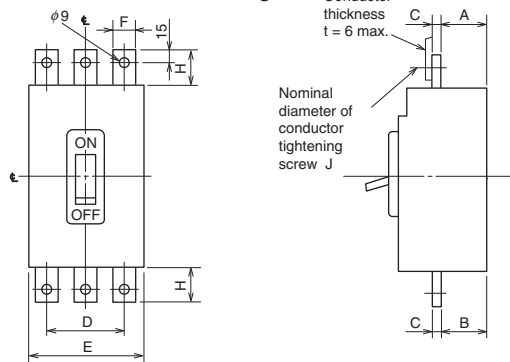

Fig. 3

Table 5-7 Table of variable dimensions

Type name	Applicable models		Outline and dimensions	Busbar									
	MCCB	ELCB		Fig.	A	B	C	D	E	F	G	H	J
FB-05SV	NF32-SV NF63-CV (50A or below) NF63-SV (50A or below) NF63-HV (50A or below)	NV32-SV NV63-CV (50A or below) NV63-SV (50A or below) NV63-HV (50A or below)		1	24	24	2	50	75	11.5	-	25	M5x0.8
FB-1SV	NF125-CV, NF125-SV NF125-HV, NF125-UV	NV125-CV NV125-SV NV125-HV		2	24	24	4	60	90	18	15	29	M8
FB-2SV	NF125-SEV NF125-HEV, NF125-RGV NF250-CV, NF250-SV, NF250-HV NF250-UV, NF250-SEV NF250-HEV, NF250-RGV NF125-SGV/LGV/HGV NF160-SGV/LGV/HGV NF250-SGV/LGV/HGV	NV125-SEV NV125-HEV NV250-CV, NV250-SV NV250-HV, NV250-SEV NV250-HEV		3	24	24	6	70	105	20	-	37	M8

6. Insulation Distance on Power Source Side

●Basic concept

Insulation distance (distance indicated in standards)

Be sure to at least secure the insulation distances (spatial distance and creeping distance) specified by the codes and standards of the relevant equipment and facilities where the circuit breakers are installed.

It is recommended that insulation barriers and insulation tape be used to enhance the electrical insulation between bare-live parts and between bare-live parts and ground to avoid accidents otherwise caused by a loose metal piece, conductive dust, abnormal surge voltage in the circuit or a similar event so as to improve the reliability of panels.

Arc Space (insulation space)

At the exhaust outlet side of breaker, arc space is necessary. When the actual load circuit is opened, especially when a large current such as overload or short-circuit is interrupted, ionized gas is emitted from the exhaust outlet. This gas can cause a short circuit between bare, live parts such as busbars, and also can cause grounding faults between conductive installation metal panels.

Therefore, it is important to secure enough arc space at the exhaust outlet side of the breaker and to strengthen insulation of parts exposed to the gas. In addition, securing enough space at the front of the exhaust outlet is necessary, because when the gas emission is blocked, failures such as deterioration of breaking performance can be caused.

●Insulation required part

With regard to insulation of bare, live parts of the line side of the breaker, please make sure to insulate at least C part C indicated in the diagram above with insulation tape, a tube or a terminal cover.

- ①A : Distance from the circuit breaker to the ceiling plate
- ②B1 : Distance from the circuit breaker to the uncovered conducting part of the upper circuit breaker terminal (front connection)
- ③B2 : Distance from the lower circuit breaker to the end face of the upper circuit breaker (rear connection)
- ④D1 : Distance from the side of the breaker to the side plate
- ⑤C : Insulated length of the power source terminal of the circuit breaker (front connection)

Please secure insulation using insulating tape, insulating tubing, insulation barrier, or a terminal cover, between bare charge parts within this size range. Please refer to a table a necessary size must.

◇When using insulation tape and insulation tubing together with insulation barriers and terminal covers, make them overlap with the other by at least 10 mm.

◇For the models with insulation barriers supplied as standard, please make sure to use the barriers.

a : clearance specified in standard

⑥D2 : Side-to-side spacing of breakers

While the circuit breakers can basically be installed together without a clearance in between, be sure to observe the following instructions.

◇It is desirable to install an insulation barrier between the adjacent circuit breakers or insulate the bare-live parts considering the effect of cutoff gas.

◇Be sure to secure the insulation distance (dimension a) as the minimum, indispensable requirement.

◇With a leakage circuit breaker and a leakage alarm circuit breaker installed in close contact with the other, a current of 2,500A or higher flowing through one of the circuit breakers could cause the other to operate falsely.

Be sure to secure a distance of at least 50 mm in between.

◇A circuit breaker of 400-ampere frame or larger with an SHT or a UVT could operate falsely if a current of 50 kA or higher flows through the adjacent circuit breaker.

Be sure to secure a distance of at least 50 mm in between.

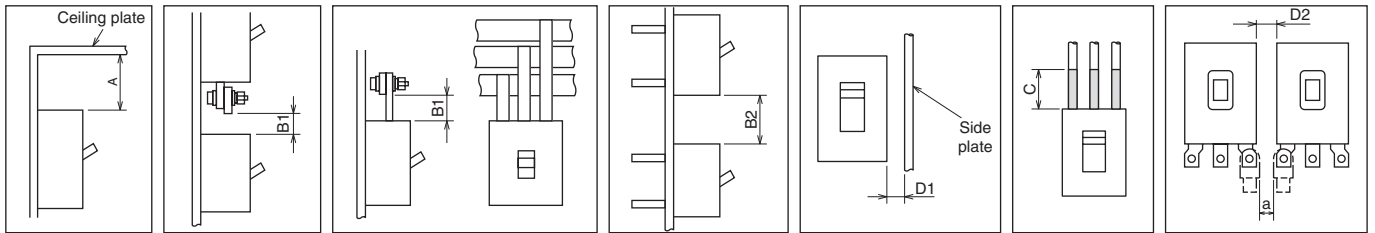

Table 5-8 Insulation distance (mm) (440VAC or below) *Figures in parentheses are for 230VAC or below.

Class • Series	Model		Ceiling plate			Vertical spacing		C	Horizontal spacing D1
	MCCB	ELCB	A		B1, B2				
			Uncovered metal Plate Without terminal cover	Insulated plate, coated plate With terminal cover	Without terminal cover	With terminal cover			
C • S • H • R • MB	NF30-CS	-	10	10	10	20	20	(*1)	20
	NF32-SV, NF63-CV	NV63-CV	5	5	5	20	20	(*1)	20
	NF63-SV, NF63-HV	NV32-SV, NV63-SV, NV63-HV	10	10	10	30	30	30	25
	NF125-CV	NV125-CV	50(30)	40(30)	10	50	50	(*1)	25
	NF125-SV	NV125-SV	50(10)	30(10)	10	50	50	50	25
	NF125-HV	NV125-HV	50	40	40	80	80	80	40
	NF250-CV	NV250-CV	40	40	40	50	50	50	50
	NF125-SEV, NF250-SV, NF250-SEV	NV125-SEV, NV250-SV, NV250-SEV	70(40)	40	40	70(50)	50	70(50)	50
	NF125-SGV, NF160-SGV, NF250-SGV	-	-	-	-	-	-	-	-
	NF125-HEV, NF250-HV, NF250-HEV	-	-	-	-	-	-	-	-
	NF125-LGV, NF160-LGV, NF250-LGV	NV125-HEV, NV250-HV, NV250-HEV	80	60	60	80	80	80	60
	NF125-HGV, NF160-HGV, NF250-HGV	-	-	-	-	-	-	-	-
	NF400-CW	NV400-CW	60	60	60	60	60	60	40
	NF400-SW, NF400-SEW	NV400-SW, NV400-SEW	70	70	70	70	70	70	70
	NF400-HEW, NF400-REW	NV400-HEW, NV400-REW	200	200	200	200	200	200	150
NF630-SW, NF630-SEW, NF630-CW	NV630-CW, NV630-SW, NV630-SEW	70	70	70	70	70	70	70	
NF630-HEW, NF630-REW	NV630-HEW	200	200	200	200	200	200	150	
NF800-SW, NF800-SEW	NV800-SW	80	80	80	80	80	80	80	
NF800-HEW, NF800-REW	NV800-HEW	200	200	200	200	200	200	150	
NF1000-SEW, NF1250-SEW	-	100	100	100	100	100	100	100	
NF1600-SEW	-	-	-	-	-	-	-	-	
R • U	NF125-RGV, NF250-RGV	-	30 (*6)	30 (*6)	30 (*6)	50 (*9)	50 (*9)	50	5
	NF125-UV, NF250-UV	-	(*1)	(*1)	(*1)	(*1)	(*1)	(*1)	25
	NF400-UEW	-	70	70	70	70	70	70	70
	NF800-UEW	-	80	80	80	80	80	80	80
BH	BH-K, BH-K100	-	(*1)	(*1)	(*1)	(*1)	(*1)	(*1)	20
	NF225-CWU	-	(40)	-	(40)	(50)	-	(50)	(50)
UL	NF50-SVFU	-	10 (*6)	10 (*6)	10 (*6)	20 (*7)	20 (*7)	30	10
	NF100-CVFU	-	50(25)	40(25)	10	50	50	50	25(15)
	NF125-SVU(*4)	-	40(10)	30(10)	10	50	50	50	25(20)
	NF125-HVU(*5)	-	40	40	40	80	80	80	25(20)
	NF250-SVU(*4)	-	40	40	40	70(50)	50	70(50)	50(20)
	NF250-HVU(*5)	-	40	40	40	80	80	80	50(20)
	NF-SKW(*5)	-	70	70	70	70	70	70	70
	NF-SLW(*5)	-	70	70	70	70	70	70	70

Remark: 1. The table shows the dimensions in the case of the use of a large terminal cover (TC-L).

Notes *1 It is not necessary to provide an insulation distance (an arc space) on the power supply side. However, if a grounding metal piece or the like comes in close contact with the terminal, be sure to completely insulate the terminals or the bare-live parts of the cable conductors.

*2 At more than 440 V AC, the distance shall be 10 mm.

*3 For 480Y/277V AC.

*4 For 480V AC.

*5 For 600Y/347V AC.

*6 An exhaust port is provided also on the circuit breaker load side. Secure the dimension A both on the power supply side and on the load side.

*7 When any of the circuit breakers NF125-RGB to NF250-RGV is used on the upstream side, an exhaust port is provided also on the circuit breaker load side. Secure the larger distance of the dimension B1 of NF125-RGV, NF250-RGV or NF50-SVFU and the dimension B1 of the downstream circuit breaker.

7. Effect of Installation Orientation

Installation orientation does not affect the operating characteristics of circuit breakers of electronic or thermo-magnetic operation types. However, the installation orientation affects the operating current of fully magnetic type circuit breakers as the iron core in the oil dash pot is under gravitational force. It is generally suggested they be installed vertically.

●Hydraulic-magnetic (The same applies to other models of hydraulic-magnetic type.)

MCCB	
Class	Model
C	NF30-CS

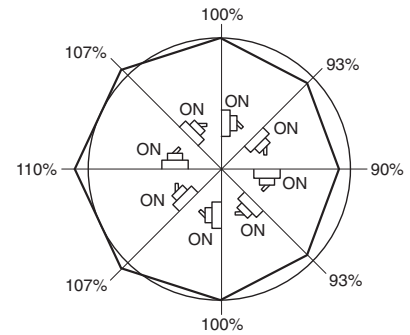

Rate of change of rated current by mounting angle

8. Connection of Line and Load

The standard wiring of line and load on the circuit breaker is as shown in (a) normal connection on the right.

Avoid the wiring shown in (b) reverse connection. This may lead to a decrease in breaking performance.

However, the reverse connection is allowed for the following models (excluding MDU breakers).

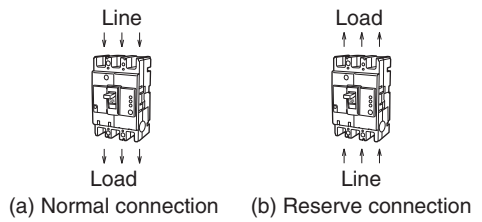

Connection methods

NF-C, NF-S, NF-H, NF-R and NF-U class BH-P, CP30-BA, NV-C, S, H and R class of 400 to 800AF, NF100-CVFU, NF125-SVU, NF125-HVU, NF250-SVU, NF250-HVU	Reverse connection is allowed for the standard models.
--	--

6

Accessories

1 Internal Accessories	104
1) Internal Accessories	104
2) Kinds of Internal Accessories	105
3) Operations and Ratings of Switches	105
4) Maximum Number of Internal Accessories	106
5) Cassette Type Accessories	111
6) Shunt Trip (SHT)	113
7) Undervoltage Trip (UVT)	114
8) Lead Wire Drawing	116
9) Lead Wire Terminal Block	116
10) Test Button Module (TBM)	117
11) Pre-Alarm Module (PAL)	118
2 External Accessories	119
1) F-type Operating Handle (Breaker Mount Type)	119
2) V-type Operating Handle (Door Mount Type)	121
3) Terminal Covers	123
4) Insulating Barriers.....	126
5) Handle Lock Devices, Lock Covers, Auxiliary Handles, Card Holders	129
6) Mechanical Interlocks (MI)	131
7) Boxes for Circuit Breakers and Boxed Circuit Breakers	132
8) Electrical Operated Circuit Breakers and Electrical Operation Devices	135
9) Distribution Board Mounting Parts, Lock Covers and Handle Caps	138
10) IEC 35-mm Rail Mounting Adapters	139

1. Internal Accessories

The accessories to be installed in circuit breakers include the followings. For the numbers of the accessories which can be installed, refer to the tables on pages 106 to 110. The standard internal accessories have lead wires (450 mm long) drawn out. (However, some of Models UVT and TBM have vertical lead wire terminal blocks as standard.)

When circuit breakers are installed side by side, keep a space of 8 mm or more for lead wires between the circuit breakers. (Models with lead wires drawn out toward load and models with lead wire grooves in the side faces can be installed in close contact.)

SHT (Shunt trip)

Device to electrically trip a circuit breaker from a distance. The allowable operating voltage range is 70 to 110% of the rated voltage. (JIS C 8201-2-1 Ann.1, Ann.2)

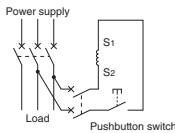

Connection diagram

AL (Alarm switch)

Switch to electrically display the tripping status of circuit breaker

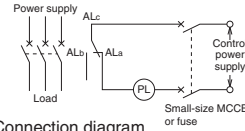

Connection diagram

AX (Auxiliary switch)

Switch to electrically display the ON-OFF status of circuit breaker

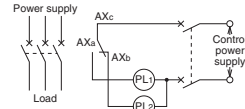

Connection diagram

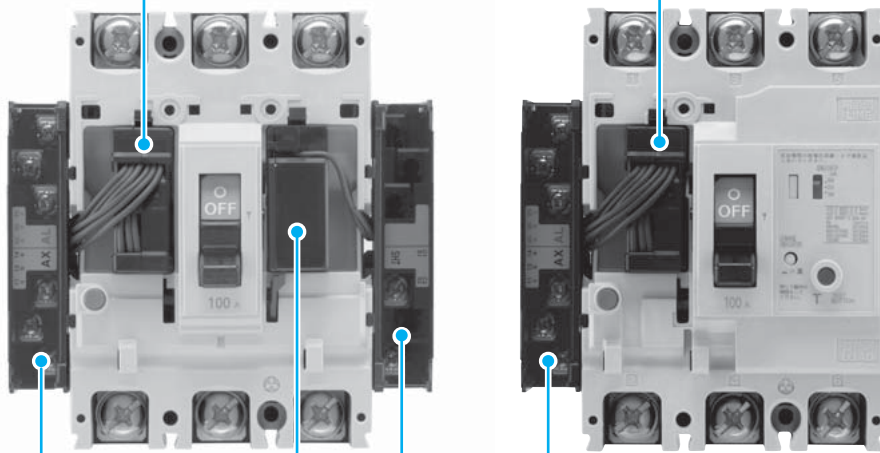

UVT (Undervoltage trip)

Device to automatically trip a circuit breaker when the voltage drops. The operating voltage is 70 to 35% of the UVT rated voltage. (JIS C 8201-2-1 Ann.1)
When the voltage recovers at least to 85% or more, the circuit breaker can be turned on after the device is manually reset.

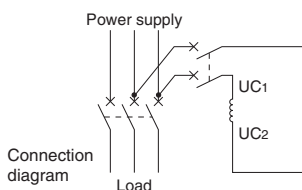

Connection diagram

SLT (Lead wire terminal block)

Terminals for connecting with internal accessories. The terminal block will be manufactured to order. For the detailed dimensions, refer to pages 116 and 117. (The dimensions of SLT slightly vary depending on the number of installed accessories and the model.)
However, circuit breakers with a frame size of 400A and above having an electrical operation device are normally provided with SLT.

TBM (Test button module)



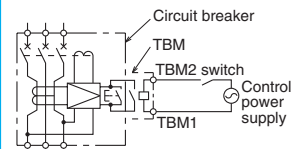



Unit to perform test under voltage from a distance. TBMs can be connected in parallel. (The standard TBMs are provided with SLT. In the case of the flush plate type, the external dimensions are partially different from those of the standard type.)



TBM circuit diagram

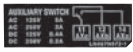

2. Kinds of Internal Accessories

Table 6-1

Accessory name	Nameplate (sample)	Accessory name	Nameplate (sample)
AL Alarm switch		EAL Earth leakage trip alarm switch	
AX Auxiliary switch			
SHT Shunt tripping device			
UVT Undervoltage tripping device		TBM Test button module	

3. Operations and Ratings of Switches

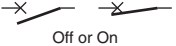
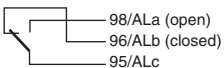
Table 6-2 Operations of AL switch

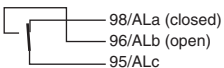
Status of circuit breaker	Contact status of AL switch
 Off or On	
 Trip	

* The terminal numbers 98/ALa, 96/ALb and 95/ALc may vary depending on the number of installed switches and the installation poles.

Table 6-3 Operations of AX switch

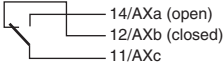
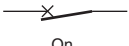
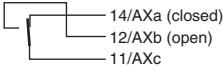
Status of circuit breaker	Contact status of AX switch
 Off or Trip	
 On	

* The terminal numbers 14/AXa, 12/AXb and 11/AXc may vary depending on the number of installed switches and the installation poles.

Table 6-4 Ratings of AL and AX switches

Applied switch	AC		DC			
	Voltage V	Current A		Voltage V	Current A	
		Resistive load	Inductive load		Resistive load	Inductive load
A	(250)	(1)	(0.5)	(50)	(1)	(0.5)
	125	3	(1)	30	(2)	(1)
	460	—	—	250	0.2	0.2
S	250	3	2	125	0.4	0.4
	125	5	3	30	4	3
	460	5	2	250	0.3	0.3
V	250	10	10	125	0.6	0.6
	125	10	10	30	10	6

Remarks: 1. The ratings in parentheses do not conform to UL.
2. For the applied switches, refer to Tables 6-9-1 to 6-14-1.

4. Maximum Number of Internal Accessories

MCCB and Motor Protection Breakers

Table 6-5 Table of maximum number of internal accessories

● AL ○ AX SHT or UVT
 ■ PAL

→ Outgoing direction of lead wires



are cassette type accessories. (Some of UVT are not provided with cassettes. Refer to page XXX for details.)

Model	C	NF30-CS	NF63-CV NF125-CV	NF63-CV NF125-CV NF250-CV		NF400-CW NF630-CW	NF800-CEW	
	S		NF32-SV NF63-SV NF125-SV	NF32-SV NF63-SV NF125-SGV NF160-SGV NF250-SV NF250-SGV	NF125-SEV NF250-SEV	NF400-SW NF400-SEW NF630-SW NF630-SEW	NF800-SEW NF800-SDW	NF1000-SEW NF1250-SEW NF1600-SEW
L • H • R			NF63-HV	NF63-HV NF125-HV NF125-LGV NF125-HGV NF125-RGV NF160-LGV NF160-HGV NF250-HV NF250-LGV NF250-HGV NF250-RGV	NF125-HEV NF250-HEV	NF400-HEW NF400-REW NF630-HEW NF630-REW	NF800-HEW NF800-REW	
	U			NF125-UV NF250-UV		NF400-UEW(3P)	NF400-UEW(4P) NF800-UEW	
Number of poles AL and AX (standard) switches		2 or 3 poles	2 poles	2, 3 or 4 poles	3, 4 poles	2, 3 or 4 poles	2, 3 or 4 poles	2, 3 or 4 poles
Accessory		S						V
AL								
AX								
SHT or UVT								
AL + AX								
SHT or UVT AL +								
SHT or UVT AX +								
SHT or UVT AL + AX +								
PAL (contact output)								

- Notes
- *1 When UVT is provided, the UVT voltage module will come in the vertical lead wire terminal block type. (SHT does not have a voltage module.)
 - *2 The second AX can be installed in place of the AL on the left pole side. When placing an order, specify the incorporation of the switches in the body.
 - *3 Although the lead wires are normally drawn out laterally, those with lead wires drawn out toward load are available. (Only for front connection type)
 - *4 PAL (contact output) can be installed together with AL and AX on the left pole side. (It cannot be installed together with SHT or UVT.)
The standard type is provided with SLT. PAL control voltage (compatible with 100 to 200 V AC) is necessary.
 - *5 SHT and UVT can be installed on the left side.
 - *6 SHT and UVT are normally installed on the right pole side. If you intend to install them on the left pole side, specify so. (The reset preventing UVT must be installed on the left pole side.)
 - *7 In the case where three or more accessories are installed on the left pole side and AL, AX or AL and AX are installed on the pole on which SLT, SHT or UVT is installed, the SLT will be manufactured to order.
 - *8 When AL, AX or AL and AX are installed on the pole on which UVT is installed, the UVT voltage module must be installed separately.
 - *9 SLT is provided as standard. A control power supply (100 to 200 V AC) is required. (In this case, other internal accessories cannot be installed on the right pole side.)
- Remarks:
1. For electrically operated automatic reset type circuit breakers having a frame size of 400A or above, the numbers of AL switches which can be installed are smaller by 1 than the values shown above.
 2. The encircled numbers indicate the order of installation.

ELCB

●AL ○AX  SHT or UVT

Table 6-6 Table of maximum number of internal accessories

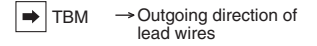
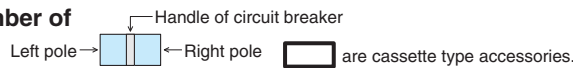

Model	C	NV63-CV NV125-CV NV250-CV	NV400-CW NV630-CW	
	S	NV32-SV NV63-SV NV125-SV NV125-SEV NV250-SV NV250-SEV	NV400-SW NV400-SEW NV630-SW NV630-SEW	NV800-SEW
H • R	NV63-HV NV125-HV NV125-HEV NV250-HV NV250-HEV	NV400-HEW NV400-REW NV630-HEW		NV800-HEW
U				
Number of poles	2, 3, or 4 poles		3 poles	
Switch	S			
Accessory	S			
AL				(*6)
AX				(*6)
AL + AX				(*6)
SHT or UVT				(*5)
SHT or UVT + AL				(*4) (*5) (*6)
SHT or UVT + AX				(*4) (*5) (*6)
SHT or UVT + AL + AX				(*4) (*5) (*6)
TBM				(*1)

- Notes *1 The standard type is provided with SLT. Only in the case of 24 V DC, specify the control voltage.
 *2 The second AX can be installed in place of the AL on the left pole side. When placing an order, specify the incorporation of the switches in the body.
 *3 When UVT is provided, the UVT voltage module will come in the vertical lead wire terminal block type. (SHT does not have a voltage module.)
 *4 When AL, AX or AL and AX are installed on the pole on which UVT is installed, the UVT voltage module must be separately installed.
 *5 When the accessory is provided with UVT, the UVT voltage module has a vertical lead wire terminal block. The UVT is not provided with a cassette.
 *6 SLT to be used when three or more accessories are installed on the left pole is manufactured to order.

- Remarks: 1. The encircled numbers indicate the order of installation.
 2. TBM can be installed regardless of the number of installed AL, AX, SHT and UVT.

6 Accessories 1 Internal Accessories

UL 489 Listed Circuit Breakers

Table 6-7 Table of maximum number of internal accessories

Handle of circuit breaker ● AL ○ AX ▨ SHT or UVT ➔ TBM ➔ Outgoing direction of lead wires
 Left pole → Right pole ◻ are cassette type accessories.

Model	MCCB	NF50-SVFU NF100-CVFU	NF50-SVFU NF100-CVFU	NF125-SVU NF125-HVU NF250-SVU NF250-HVU	NF225-CWU	NF-SKW	NF-SLW			
	ELCB							NV50-SVFU	NV50-SVFU NV100-CVFU	NV125-SVU NV125-HVU NV250-SVU NV250-HVU
Number of poles AL and AX (standard) switches		2 poles	3 poles	2 or 3 poles	3 poles	3 poles	3 poles	2 poles	3 poles	3 poles
Accessory	S									
AL										
AX										
SHT or UVT										
AL + AX										
AL + SHT or UVT										
AX + SHT or UVT										
AL + AX + SHT or UVT										
TBM										

- Notes
- *1 When UVT is provided, the UVT voltage module will come in the vertical lead wire terminal block type. (SHT does not have a voltage module.)
 - *2 SHT cannot be installed.
 - *3 SHT and UVT are normally installed on the right pole side. If you intend to install them on the left pole side, specify so.
 - *4 In the case where three or more accessories are installed on the left pole side and AL, AX or AL and AX are installed on the pole on which SLT, SHT or UVT is installed, the SLT will be manufactured to order.
 - *5 When AL, AX or AL and AX are installed on the pole on which UVT is installed, the UVT voltage module must be installed separately.
 - *6 UVT of NF50-SVFU and NV50-SVFU are not provided with cassettes.
 - *7 The standard type is provided with SLT. Only in the case of 24 V DC, specify the control voltage.

- Remarks:
- The encircled numbers indicate the order of installation.
 - AL and AX for minute load can be manufactured to order. (These switches have been certified only by UL and CSA. They have not been certified by TUV.)

MDU Breakers

Table 6-8-1 Table of maximum number of internal accessories

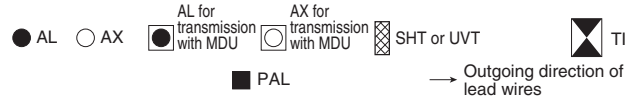

Model	NF400-SEP with MDU NF400-HEP with MDU	NF600-SEP with MDU NF600-HEP with MDU NF800-SEP with MDU NF800-HEP with MDU
Number of poles	3 or 4 poles	
switch	S	
Accessory		
AL		(*1)
AX		(*1)
SHT	(*2)	(*2)
UVT	(*3) (*4)	(*3) (*4)
AL + AX	(*1)	(*1)
AL + SHT	(*1) (*2)	(*1) (*2)
AX + SHT	(*1) (*2)	(*1) (*2)
AL + AX + SHT	(*1) (*2)	(*1) (*2)
AL + UVT	(*1) (*3) (*4) (*5)	(*1) (*3) (*4) (*5)
AX + UVT	(*1) (*3) (*4) (*5)	(*1) (*3) (*4) (*5)
AL + AX + UVT	(*1) (*3) (*4) (*5)	(*1) (*3) (*4) (*5)
PAL	(*6)	(*6)
EPAL	---	---
TI	(*6) <small>With contact outputs for PAL and OAL</small>	(*6) <small>With contact outputs for PAL and OAL</small>

- Notes *1 In the case where three or more accessories are installed on the left pole side and AL, AX or AL and AX are installed on the pole on which SLT, SHT or UVT is installed, the SLT will be manufactured to order.
 *2 SHT and UVT are normally installed on the right pole side. If you intend to install them on the left pole side, specify so. (The reset preventing UVT must be installed on the left pole side.)
 *3 The UVT voltage module is installed externally. UTV is not provided with a cassette.
 *4 UVT is normally installed on the right pole. If you intend to install it on the left pole, specify so.
 *5 When AL, AX or AL and AX are installed on the pole on which UVT is installed, the UVT voltage module must be installed separately.
 *6 The standard model has a terminal block. A 5-VA control power supply (compatible with 100 to 240 V AC/DC) is required. (In this case, another internal accessory cannot be installed on the right pole.)
- Remark: 1. The encircled numbers indicate the order of installation.

6 Accessories 1 Internal Accessories

MDU Breakers

Table 6-8-2 Table of maximum number of internal accessories

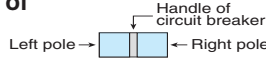

Left pole → [] ← Right pole

Handle of circuit breaker

Model	NF400-SEP with MDU NF400-HEP with MDU	NF600-SEP with MDU NF600-HEP with MDU NF800-SEP with MDU NF800-HEP with MDU
	Number of poles switch	3 or 4 poles
Accessory	S	
AL for transmission with MDU (*1)		
AX for transmission with MDU (*1)		
AL + AX for transmission with MDU (*1)		
AL + AX + AL for transmission with MDU (*1)		
AL + AX + AX for transmission with MDU (*1)		
AL + AX + AL + AX for transmission with MDU (*1)		

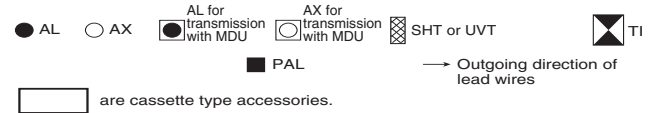

Note *1 To transmit signals from AL, AX or AL and AX, AL and/or AX for transmission with the MDU are installed on the left pole side. In this case, the lead wires of AL and/or AX for transmission with the MDU installed on the left pole side cannot be drawn out to the outside or fitted to the terminal block.

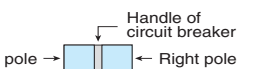

Left pole → [] ← Right pole

Handle of circuit breaker

Model	NF250-SEV with MDU NF250-HEV with MDU	NV250-SEV with MDU NV250-HEV with MDU
	Number of poles switch	3 or 4 poles
Accessory	S	
AL		
AX		
AL + AX		
SHT or UVT		
AL + or UVT		—
AX + or UVT		—
AL + AX + or UVT		—
TBM	—	
ATU	—	—
PAL		
EPAL	—	
AL for transmission with MDU (*5)		
AL for transmission with MDU AX (*5)		
AL for transmission with MDU AL + AX (*5)		
AL for transmission with MDU AL + AX + AL (*5)		—
AL for transmission with MDU AL + AX + AX (*5)		—
AL for transmission with MDU AL + AX + AL + AX (*5)		—

With contact outputs for PAL, EPAL and EAL

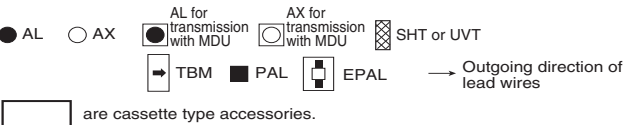

Notes *1 The second AX can be installed in place of the AL on the left pole side. When placing an order, specify the incorporation of the switches in the body.
 *2 When UVT is provided, the UVT voltage module will come in the vertical lead wire terminal block type. (SHT does not have a voltage module.)
 *3 The device is provided with SLT. Only in the case of 24 V DC, specify the control power supply. (Compatible with standard voltage from 100 to 240 V AC/DC.)
 *4 The device is provided with a terminal block. A control power supply (compatible with 100 to 240 V AC/DC) is required. (In this case, another internal accessory cannot be installed on the right pole.)
 *5 To transmit signals from AL, AX or AL and AX, AL and/or AX for transmission with the MDU are installed on the left pole side. In this case, the lead wires of AL and/or AX for transmission with the MDU installed on the left pole side cannot be drawn out to the outside or fitted to the terminal block. In the case of 225A frame circuit breakers, AL for transmission with the MDU must be installed for fault current measurement.

Remark: 1. The encircled numbers indicate the order of installation.

6 Accessories 1

5. Cassette Type Accessories

The internal accessories for major models having a frame size from 30 to 800 A come in cassettes, and they can be installed to and removed from circuit breakers by the user.

Some cassette type accessories have lead wires drawn out, and others have vertical lead wire terminal blocks (SLT). (These parts are supplied by 10 pieces for frame size from 30 to 250 A or by 1 piece for frame size from 400 to 800 A.)

■ Applicable models and kinds of cassette type accessories

	Model	Alarm switch (AL)	Auxiliary switch (AX)	Shunt tripping device (SHT)	Undervoltage tripping device (UVT)
MCCB	NF63-CV~NF250-CV, NF32-SV~NF250-SV NF63-HV~NF250-HV NF125-SGV~NF250-SGV, NF125-LGV~NF250-LGV NF125-HGV~NF250-HGV NF125-SEV, NF250-SEV, NF125-HEV, NF250-HEV NF125-RGV, NF250-RGV, NF125-UV, NF250-UV NF100-CVFU, NF125-SVU/HVU, NF250-SVU/HVU	○	○	○	○
	NF50-SVFU, NF400-CW, NF630-CW, NF800-CEW NF400-SW, NF630-SW, NF400-SEW~NF800-SEW NF800-SDW, NF400-HEW~NF800-HEW NF400-REW~NF800-REW, NF400-UEW, NF800-UEW	○	○	○	-
ELCB	NV63-CV~NV250-CV, NV32-SV~NV250-SV NV63-HV~HV250-HV NV125-SEV, NV250-SEV, NV125-HEV, NV250-HEV NV100-CVFU, NV125-SVU/HVU, NV250-SVU/HVU	○	○	○	○
	NV50-SVFU, NV400-CW, NV630-CW NV400-SW, NV630-SW, NV400-SEW~NV800-SEW NV400-HEW~NV800-HEW, NV400-REW	○	○	○	-

■ Procedure for installing cassette type accessories

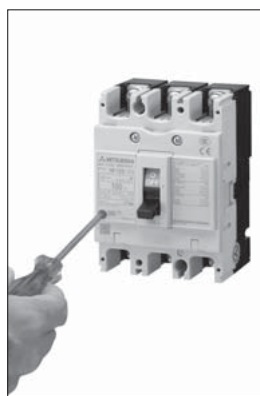

1. Press the trip button (PTT) to trip the circuit breaker.
(*1)

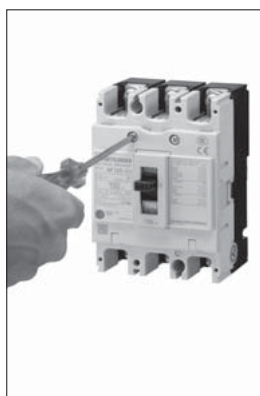

2. Loosen the cover screws.

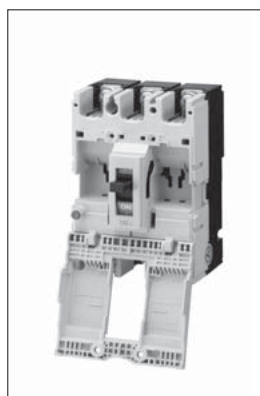

3. Open the cover.

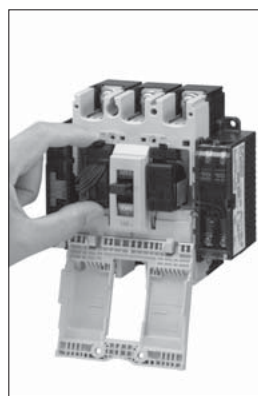

4. Install the cassette type accessory. (*2)

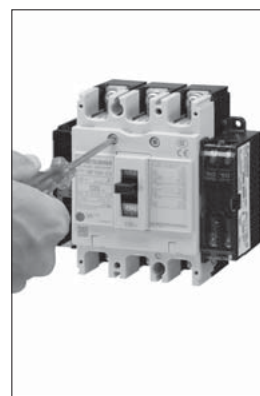

5. Close the cover, and tighten the screws.

Notes *1. When installing any cassette type accessory, set the circuit breaker to the tripped state.

*2. If the inner lid or another accessory has been installed, remove it before installing the accessory.

When any circuit breaker supplied with the inner lid is used without an accessory, fit the inner lid without fail.

Failure to do so may affect the short-circuiting performance.

Models with inner lid: NF125-SV, NF125-HV, NF125-UV
NV125-SV, NV125-HV
NF250-SV, NF250-HV,
NV250-SV, NV250-HV,
NF125-SVU, NF125-HVU, NV125-SVU, NV125-HVU
NF250-SVU, NF250-HVU, NV250-SVU, NV250-HVU

NF250-HEV, NF250-UV
NV250-HEV
NF125-SEV, NF125-HEV,
NV125-SEV, NV125-HEV,
NF400-REW, NF400-UEW
NF630-REW, NV400-REW
NF800-HEW, NF800-REW, NF800-UEW
NV800-HEW

Cautions when installing

Before installing or removing any cassette type accessory, set the circuit breaker and accessories to the no-voltage state.

Never install a cassette type accessory while the handle is in the ON or OFF position. Doing so may damage the accessory.

When installing an accessory with lead wires drawn out, apply the supplied nameplate to the circuit breaker side face.

When installing an accessory with lead wires drawn out for a frame size of 400 to 800 A, secure the lead wires along the circuit breaker side face with the supplied lead wire retainers.

Type name

Table 6-9-1

Model		Installation pole	AL	AX	AL+AX	SHT	UVTN or UVTS	
MCCB	ELCB							
NF50-SVFU	NV50-SVFU	For right pole	AL-03SVU AL-03SVURS	AX-03SVU AX-03SVURS	ALAX-03SVU ALAX-03SVURS	SHTA240-03SVUR SHTA440-03SVUR SHTD100-03SVUR SHTA240-03SVURS SHTA440-03SVURS SHTD100-03SVURS	-	
		For left pole	AL-03SVU AL-03SVULS	AX-03SVU AX-03SVULS	ALAX-03SVU ALAX-03SVULS	SHTA240-03SVUL SHTA440-03SVUL SHTD100-03SVUL SHTA240-03SVULS SHTA440-03SVULS SHTD100-03SVULS	-	
NF32-SV, NF63-CV, NF63-SV, NF63-HV NF125-CV, NF125-SV, NF125-HV NF125-SGV, NF125-LGV, NF125-HGV NF160-SGV, NF160-LGV, NF160-HGV NF125-SEV, NF125-HEV NF125-RGV, NF125-UV NF250-CV, NF250-SV, NF250-HV NF250-SGV, NF250-LGV, NF250-HGV NF250-SEV, NF250-HEV NF250-RGV, NF250-UV	NV32-SV, NV63-CV NV63-SV, NV63-HV NV125-CV, NV125-SV NV125-HV NV125-SEV, NV125-HEV NV250-CV, NV250-SV NV250-HV NV250-SEV, NV250-HEV	For right pole	AL-05SV AL-05SVRS	AX-05SV AX-05SVRS	ALAX-05SV ALAX-05SVRS	SHTA240-05SVR SHTA550-05SVR SHTD125-05SVR SHTA240-05SVRS SHTA550-05SVRS SHTD125-05SVRS	UVTNAD130-05SVR UVTNA250-05SVR UVTNA480-05SVR UVTNAD130-05SVRS UVTNA250-05SVRS UVTNA480-05SVRS	UVTSAD130-05SVR UVTSA250-05SVR UVTSA480-05SVR UVTSAD130-05SVRS UVTSA250-05SVRS UVTSA480-05SVRS
		For left pole	AL-05SV AL-05SVLS	AX-05SV AX-05SVLS	ALAX-05SV ALAX-05SVLS	SHTA240-05SVL SHTA550-05SVL SHTD125-05SVL SHTA240-05SVLS SHTA550-05SVLS SHTD125-05SVLS	UVTNAD130-05SVL UVTNA250-05SVL UVTNA480-05SVL UVTNAD130-05SVLS UVTNA250-05SVLS UVTNA480-05SVLS	UVTSAD130-05SVL UVTSA250-05SVL UVTSA480-05SVL UVTSAD130-05SVLS UVTSA250-05SVLS UVTSA480-05SVLS
NF100-CVFU NF125-SVU/HVU NF250-SVU/HVU	NV100-CVFU NV125-SVU/HVU NV250-SVU/HVU	For right pole	AL-05SVU AL-05SVURS	AX-05SVU AX-05SVURS	ALAX-05SVU ALAX-05SVURS	SHTA240-05SVUR SHTA550-05SVUR SHTD125-05SVUR SHTA240-05SVURS SHTA550-05SVURS SHTD125-05SVURS	UVTNAD130-05SVUR UVTNA250-05SVUR UVTNA480-05SVUR UVTNAD130-05SVURS UVTNA250-05SVURS UVTNA480-05SVURS	UVTSAD130-05SVUR UVTSA250-05SVUR UVTSA480-05SVUR UVTSAD130-05SVURS UVTSA250-05SVURS UVTSA480-05SVURS
		For left pole	AL-05SVU AL-05SVULS	AX-05SVU AX-05SVULS	ALAX-05SVU ALAX-05SVULS	SHTA240-05SVUL SHTA550-05SVUL SHTD125-05SVUL SHTA240-05SVULS SHTA550-05SVULS SHTD125-05SVULS	UVTNAD130-05SVUL UVTNA250-05SVUL UVTNA480-05SVUL UVTNAD130-05SVULS UVTNA250-05SVULS UVTNA480-05SVULS	UVTSAD130-05SVUL UVTSA250-05SVUL UVTSA480-05SVUL UVTSAD130-05SVULS UVTSA250-05SVULS UVTSA480-05SVULS
NF400-CW, NF400-SW, NF400-SEW NF400-HEW, NF400-REW, NF400-UEW NF630-CW, NF630-SW, NF630-SEW NF630-HEW, NF630-REW NF800-CEW, NF800-SDW, NF800-SEW NF800-HEW, NF800-REW, NF800-UEW	NV400-CW, NV400-SW NV400-SEW, NV400-HEW NV400-REW NV630-CW, NV630-SW NV630-SEW, NV630-HEW NV800-SEW, NV800-HEW	For right pole (2, or 3 poles)	-	AX-4SW AX-4SWRS AX2-4SWRS	-	SHT-4SW SHT-4SWRS	-	
		For right pole (4 poles)	-	-	-	SHT-4SWRFS SHT-8SWRFS	-	
		For left pole (2, 3 or 4 poles)	AL-4SWL AL-4SWLS AL2-4SWLS	AX-4SW AX-4SWLS AX2-4SWLS	ALAX-4SWL ALAX-4SWLS	SHT-4SW SHT-4SWLS	-	

- Remarks:
- For the possibility of installation of accessories and the installation pole, refer to the tables of maximum numbers on pages 106 to 110.
 - AL and AX for minute load can be manufactured to order.
 - Corrosion-proof cassette type AL and AX are not available. When the circuit breaker body is exposed to class 1 tropicalization, class 2 tropicalization, reinforced corrosion resistance treatment or class 2 heat resistance treatment, place an order for the circuit breaker including the accessories.
 - Cassette type accessories with SLT for right pole cannot be installed to 4-pole circuit breakers. Accessories with SLT for right pole to be used in 4-pole circuit breakers are manufactured to order.
 - Cassette type accessories with SLT cannot be installed to flush plate type circuit breakers.
 - Cassette type accessories (AL, AX and SHT) cannot be installed to circuit breakers with MG.
 - It is impossible to install a combination of a cassette type accessory with lead wires drawn out and that with SLT or a combination of cassette type accessories with SLT on the same pole.
 - It is impossible to install the cassette type AL or AX to the pole to which UVT has been installed.
 - AX and SHT with lead wires drawn out for frame size from 400 to 800 A can be installed to any of the right and left poles.
 - When installing more than one AL or AX with lead wires drawn out for frame size from 400 to 800 A to one side, install the necessary number of the accessories for one piece. The lead wires from the circuit breaker vary in length depending on the installation position.
 - Install the cassette accessories for frame size from 400 to 800 A starting from the outside of the installation positions. For the installation positions, see the installation positions shown in the following table.
 - When three pieces of more of AL and AX are installed on a circuit breaker with a frame size 400 to 800 A, the AL and AX with SLT are manufactured to order.

Installation positions of cassette type accessories for 400 to 800 A frames

Installation positions

Table 6-9-2 Installation positions of cassette type accessories

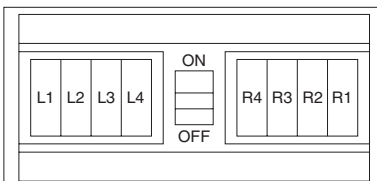

Frame (A)	400 • 600 • 630					800							
	L1	L2	L3	R2	R1	L1	L2	L3	L4	R4	R3	R2	R1
AL	○	○	-	-	-	○	○	○	-	-	-	-	-
AX	○	○	-	○	○	○	○	○	○	-	-	○ ^(*)	○
AL + AX	○	○	-	-	-	○	○	-	-	-	-	-	-
SHT	-	○	-	-	○	-	-	○	-	○ ^(*)	-	-	-

* Accessories only for Earth Leakage Circuit Breakers (NV-C, S and H), Earth Leakage Alarm Breakers (NF-Z) and single-phase 3-wire circuits (NF-N and NV-N) cannot be installed to R1, R2, R3 or R4.

Note *1 It is impossible to simultaneously install AX on R2 and SHT on R3 or R4.

Interpretation of type name

(1) Alarm switch • Auxiliary switch

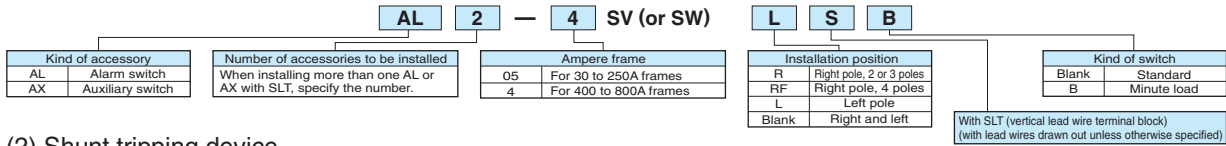

(2) Shunt tripping device
Undervoltage tripping device

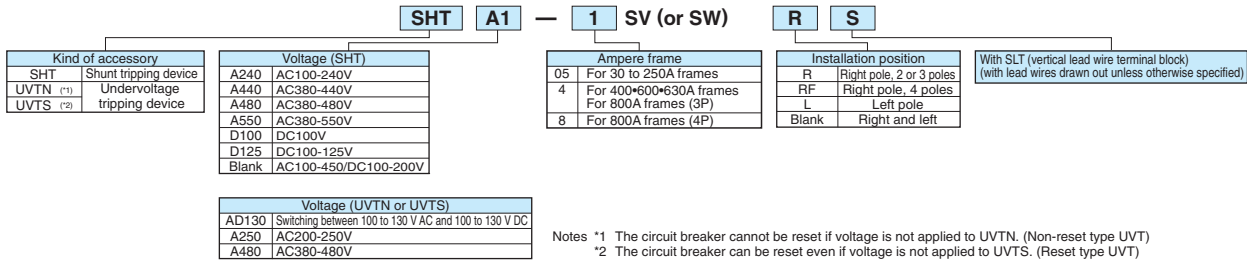

6. Shunt Trip (SHT)

■ Coil ratings (standard)

Table 6-10-1

Model	Provision of coil burnout preventing switch	Voltage (V)	Input (VA) ^(*)				Operating time ^(*) (ms)
			AC		DC		
NF50-SVFU NV50-SVFU	Provided	AC100-240 380-440 DC100			60		15 or less
NF32-SV, NF63-CV/SV/HV, NF125-SGV/LGV/HGV NF160-SGV/LGV/HGV, NF125-CV/SV/HV/SEV/HEV/RGV/UV NF250-CV/SV/HV/SEV/HEV/RGV/UV NF250-SGV/LGV/HGV NV32-SV, NV63-CV/SV/HV NV125-CV/SV/HV/SEV/HEV, NV250-CV/SV/HV/SEV/HEV NF100-CVFU, NF125-SVU/HVU, NF250-SVU/HVU NV100-CVFU, NV125-SVU/HVU, NV250-SVU/HVU		AC100-240 380-550 DC100-125	120		50		
NF225-CWU		AC100-240 380-480 DC100-125			60		
NF400-CW/SW/SEW/HEW/REW/UEW NF630-CW/SW/SEW/HEW/REW NF800-CEW/SDW/SEW/HEW/REW/UEW NV400-CW/SW/SEW/HEW/REW NV630-CW/SW/SEW/HEW NV800-SEW/HEW, NF-SKW, NF-SLW		Compatible with 100 to 450 V AC and 100 to 200 V DC	100V 200V 380V 450V	20 50 120 170	100V 200V	10 35	5-15
NF1000-SEW, NF1250-SEW/SDW NF1600-SEW/SDW		AC100-120 200-240 380-450 DC100	200 300		70 100		7-15 15-25

Notes *1 Ensure that the voltage of the operating power supply for SHT is not dropped below the allowable operating voltage (70% of the rated minimum voltage value) by the input power.
*2 The operating time is the time from when the rated voltage is applied to the shunt tripping device until the main contact of the circuit breaker starts opening.
Remark: 1. The accessory is usable at 50 Hz and 60 Hz.

■ Coil ratings (list of available special voltage coils)

Table 6-10-2

Model	VAC										VDC										Compatible with ACDC	
	24	25-27	24-48	48	50-55	60	440-480	380-550	440-550	500-550	12	24	24-36	36	36-48	48	60	110	125	220		200-250
NF32-SV, NF63-CV/SV/HV NF125-CV/SV/HV/SEV/HEV/RGV/UV NF125-SGV/LGV/HGV, F160-SGV/LGV/HGV NF250-CV/SV/HV/SEV/HEV/RGV/UV NF250-SGV/LGV/HGV NV32-SV, NV63-CV/SV/HV NV125-CV/SV/HV/SEV/HEV NV250-CV/SV/HV/SEV/HEV NF100-CVFU, NF125-SVU/HVU, NF250-SVU/HVU NV100-CVFU, NV125-SVU/HVU, NV250-SVU/HVU	-	-	○	-	-	-	-	-	-	○	-	○	-	○	-	-	-	-	-	○	-	-
NF225-CWU	-	-	○	-	-	○	-	-	-	○	-	○	-	○	-	○	-	-	-	○	-	-
NF400-CW/SW/SEW/HEW/REW/UEW NF630-CW/SW/SEW/HEW/REW NF800-CEW/SDW/SEW/HEW/REW/UEW NV400-CW/SW/SEW/HEW/REW NV630-CW/SW/SEW/HEW NV800-SEW/HEW, NF-SKW, NF-SLW	-	-	-	-	-	-	○	-	-	○	-	-	-	-	-	-	-	-	-	-	-	○
NF1000-SEW, NF1250-SEW/SDW NF1600-SEW/SDW	○	-	-	○	-	-	○	-	-	○	○	-	○	-	○	-	○	○	-	-	-	-

7. Undervoltage Trip (UVT)

(1) Specifications for UVT and coil ratings

Table 6-11

Model	Specification		Coil ratings					
	Reset type	Non-reset type	Voltage (V)		Input (VA)	Operating time (*2) (ms)		
			Standard voltage	Special voltage (*1)				
NF50-SVFU NV50-SVFU	–	○	AC/DC100-130V AC200-250V AC380-480V	AC/DC24V AC/DC48V	5	30 or less		
NF32-SV, NF63-CV/SV/HV/HRV NF125-CV/SV/HV/RGV/SEV/HEV/UV NF125-SGV/LGV/HGV, NF160-SGV/LGV/HGV NF250-CV/SV/HV/RGV/SEV/HEV/UV NF250-SGV/LGV/HGV NV32-SV, NV63-CV/SV/HV NV125-CV/SV/HV/SEV/HEV NV250-CV/SV/HV/SEV/HEV NF100-CVFU, NF125-SVU/HVU, NF250-SVU/HVU NV100-CVFU, NV125-SVU/HVU, NV250-SVU/HVU	○	○		AC/DC24V AC/DC48V AC500-600V				
NF400-CW/SW/SEW/HEW/REW/UEW NF630-CW/SW/SEW/HEW/REW NF800-CEW/SDW/SEW/HEW/REW/UEW NV400-CW/SW/SEW/HEW/REW NV630-CW/SW/SEW/HEW NV800-SEW/HEW	○ (*4)	○ (*5)		(*3) Switching between 100 to 110 and 120 to 130 AC Switching between 200 to 220 and 230 to 250 AC Switching between 380 to 415 and 440 to 480 AC Switching between 100 and 110 DC			(*3) Switching between 24/48 AC Switching between 500 to 550/600 AC Switching between 24/48DC Switching between 110/125DC	5
NF1000-SEW, NF1250-SEW NF1600-SEW	○	○		Switching between 24/48 AC Switching between 24/48DC	5	30 or less		
NF-SKW/SLW	○ (*4)	–		Switching between 110/125DC				
NF225-CWU	–	○		Switching between 24/48 AC Switching between 24/48DC Switching between 110/125DC				

Notes *1 Some special voltage models vary in voltage range.

*2 The operating time is the time from when the undervoltage tripping device is set to the no-voltage state until the main contact starts opening.

*3 The accessory is usable at 50 Hz and 60 Hz.

*4 If UVT is turned on without excitation, the circuit breaker instantaneously opens and immediately trips.

*5 Only for installation on the left pole

(2) Reset type and non-reset type UVT

■ Reset type (Refer to Table 6-12.)

The reset type UVT has a structure which does not trip a circuit breaker even if the UVT coil is not excited when the circuit breaker handle is in the OFF or reset position. Therefore, it keeps the circuit breaker in the reset state even if the coil is not excited when the breaker is reset electrically.

When the coil in the unexcited state is turned on, the circuit breaker is normally tripped. However, the major contacts of some models of circuit breakers may instantaneously close, or, on circuit breakers with AX, the AX switches may instantaneously change over. For electrical interlock, use a non-reset type UVT.

■ Non-reset type (Refer to Table 6-12.)

When the UVT coil is not excited, the circuit breaker cannot be set to the off state even if the circuit breaker is tried to be reset from the tripped state. When the coil exciting voltage restores to the reference voltage or more, the circuit breaker can be reset to the off state.

(3) Time delay UVT

- This type of UVT has a time delay in operation.
- It can prevent operation upon occurrence of instantaneous power failure.

Table 6-12

UVT module type name	Time delay	Voltage (V)	
		Standard voltage	Special voltage
U-05W	Switching among 0.1, 0.3 and 0.5 s	AC24/48 AC100-120/200-240/380-450 AC220-250/380-450/460-550 (Compatible with 50 Hz and 60 Hz) DC100-110	AC380-450/460-550/600-690 (Compatible with 50 Hz and 60 Hz) DC24/48
		AC100-120/200-240/380-450 AC220-250/380-450/460-550 (Compatible with 50 Hz and 60 Hz)	–
U-30W	Switching among 0.5, 1 and 3 s	AC100-120/200-240/380-450 AC220-250/380-450/460-550 (Compatible with 50 Hz and 60 Hz)	–

8. Lead Wire Drawing

Lead wire lateral drawing ... Available to all models

Note *1 Except for BH, BH-P, BH-S, BH-PS, BH-D6, BH-D10, BH-DN, BV-D, BV-DN and KB-D.

Remark: 1. Although the following models are applicable to lead wires drawn laterally, they are normally applicable to installation in close contact with the circuit breaker side faces. (The circuit breaker side faces have grooves.)

Lead wires drawing to load

Table 6-15

Model applicable to lead wire drawing to load (only front connection type)
NF30-CS

Specifications for lead wires

Table 6-16

Applicable model	Kind of lead wire	Lead wire thickness	Lead wire length	Example of ring mark						
NF30-CS	Heat-resistant wire	0.4mm ²	450mm	<table border="1"> <tr> <td>98/ALa (Red)</td> <td>96/ALb (Blue)</td> </tr> <tr> <td>95/ALc (Gray)</td> <td>14/AXa (Brown)</td> </tr> <tr> <td>12/AXb (Black)</td> <td>11/AXc (White)</td> </tr> </table>	98/ALa (Red)	96/ALb (Blue)	95/ALc (Gray)	14/AXa (Brown)	12/AXb (Black)	11/AXc (White)
98/ALa (Red)		96/ALb (Blue)								
95/ALc (Gray)		14/AXa (Brown)								
12/AXb (Black)	11/AXc (White)									
1000A frame or above	0.75mm ²	<table border="1"> <tr> <td>C1/S1 (Red)</td> <td>C2/S2 (Red)</td> </tr> <tr> <td>J1/UC1 (White)</td> <td>J2/UC2 (White)</td> </tr> </table>	C1/S1 (Red)	C2/S2 (Red)	J1/UC1 (White)	J2/UC2 (White)				
C1/S1 (Red)	C2/S2 (Red)									
J1/UC1 (White)	J2/UC2 (White)									
30 to 800A frames except above models	0.5mm ²	A terminal symbol is indicated on each lead wire with a ring mark.								

NF32-SV, NF63-CV/SV/HV~NF250-CV/SV/HV/UV
 NF125-SEV/HEV, NF250-SEV/HEV, NF125-RGV
 NF250-RGV, NF125-SGV/LGV/HGV~NF250-SGV/LGV/HGV
 NV32-SV, NV63-CV/SV/HV~NV250-CV/SV/HV
 NV125-SEV/HEV, NV250-SEV/HEV
 NF50-SVFU, NF100-CVFU, NF125-SVU/HVU, NF250-SVU/HVU,
 NF225-CWU
 NV100-CVFU, NV125-SVU/HVU
 NV250-SVU/HVU

(When a 4-pole model among the above models has accessories installed on the right pole side, the lead wires are 400 mm long.)

9. Lead Wire Terminal Block

(1) Vertical lead wire terminal block (SLT)

The lead wire terminal blocks for plug-in terminal blocks are available (P-LT). The drilling size of these terminal blocks differs from the standard size. Consult us for details.

For a flush plate type circuit breaker, a terminal block will be installed on the circuit breaker rear face. (Specify as FP-LT.)

Note *1 When the circuit breaker body is equipped with internal accessories and electrical operation device of motor-driven type (2) or spring charge type (2), the circuit breaker is normally provided with a lead wire terminal block.

MCCB

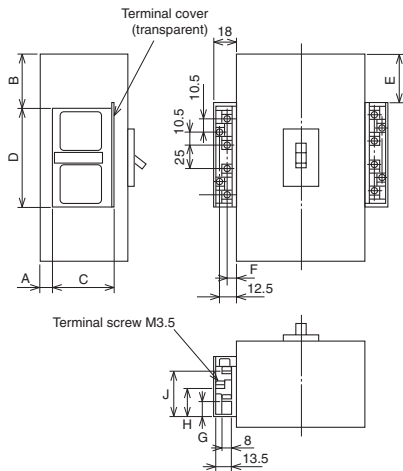

Table 6-17-1 Table of variable dimensions

Model	A	B	C	D	E	F	G	H	J
NF30-CS	4	4.5	44.5	86.5	4.5	7	10	22	34
NF32-SV, NF63-CV/SV/HV	7	26.5	54	86.5	26.5	7	14	26	38
NF125-CV/SV/HV	7	26.5	54	86.5	26.5	7	14	26	38
NF125-UV	7	87.5	54	86.5	87.5	7	14	26	38
NF250-UV	7	119	54	86.5	119	7	14	26	38
NF125-SEV/HEV/RGV, NF250-CV/SV/HV/SEV/HEV/RGV NF125-SGV/LGV/HGV, NF160-SGV/LGV/HGV NF250-SGV/LGV/HGV	7	44	54	86.5	44	7	14	26	38
NF50-SVFU	7	27.5	54	86.5	27.5	7	14	26	38
NF100-CVFU	7	28.5	54	86.5	28.5	7	14	26	38
NF125-SVU/HVU	7	47.5	54	86.5	47.5	7	14	26	38
NF225-CWU	7	37	54	86.5	37	7	14	26	38
NF400-CW/SW/SEW/HEW/REW, NF-SKW NF630-CW/SW/SEW/HEW/REW	41	79.5	54	86.5	79.5	7	14	26	38
NF800-CEW/SDW/SEW/HEW/REW, NF-SLW		88.5	54	86.5	88.5	7	14	26	38
NF1000-SEW, NF1250-SEW, NF1600-SEW	62.5	173	54	86.5	173	7	14	26	38
NF400-UEW(3P)	(*1)	138	119.5	54	86.5	119.5	7	14	26
NF400-UEW(4P), NF800-UEW	(*1)	138	135.5	54	86.5	135.5	7	14	26

Note *1 The terminal positions are different from those shown in the left figure. Consult us for details.
 Remark: 1. Terminal screw tightening torque: M3.5 ... 0.9 to 1.2 N·m

ELCB

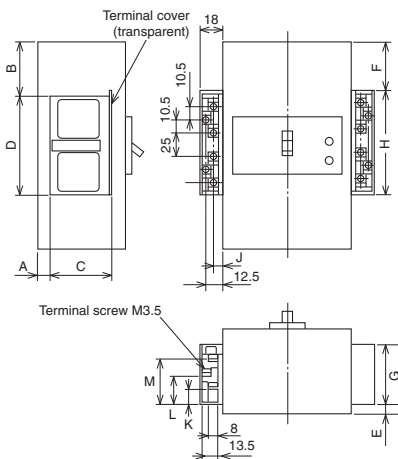

Table 6-17-2 Table of variable dimensions

Model	A	B	C	D	E	F	G	H	J	K	L	M	
NV50-SVFU	16.5	17	54	86.5	16.5	17	54	86.5	6	10.5	22.5	34.5	
NV32-SV, NV63-CV/SV/HV	7	26.5	54	86.5	7	26.5	54	86.5	7	14	26	38	
NV100-CVFU	7	36.5	54	86.5	7	36.5	54	86.5	7	14	26	38	
NV125-CV/SV/HV	7	26.5	54	86.5	7	26.5	54	86.5	7	14	26	38	
NV125-SVU/HVU	7	47.5	54	86.5	7	47.5	54	86.5	7	14	26	38	
NV125-SEV/HEV, NV250-CV/SV/HV/SEV/HEV	7	44	54	86.5	7	44	54	86.5	7	14	26	38	
NV250-SVU/HVU	7	54	54	86.5	7	54	54	86.5	7	14	26	38	
NV400-CW/SW/SEW/HEW/REW	41	79.5	54	86.5	26.5	79.5	52	92	7	14	26	38	
NV630-CW/SW/SEW/HEW, NV-SKW													
NV800-SEW/HEW	(*1)	41	88.5	54	86.5	26.5	88.5	52	92	7	14	26	38

Notes *1 The terminal positions are different from those shown in the left figure. Consult us for details.
Remarks: 1. Terminal screw tightening torque: M3.5 ... 0.9 to 1.2 N·m
2. The lead wire terminal block for TBL is provided on the right pole side. However, the lead wire terminal blocks for TBL of NV30-FA and NV50-FA are provided on the left pole side.

14-terminal SLT

SLT for installing three or more internal accessories on the left pole side

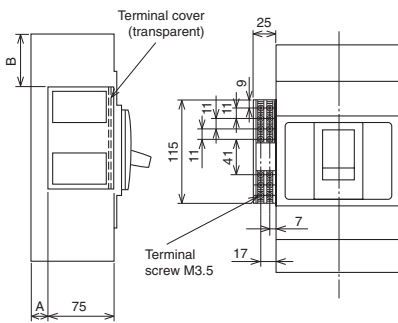

Table 6-17-3

Model		A	B
MCCB	ELCB		
NF400-CW/SW/SEW NF400-HEW/REW NF630-CW/SW/SEW NF630-HEW/REW	NV400-CW/SW/SEW NV400-HEW/REW NV630-CW/SW/SEW/HEW	20	60
NF400-UEW(3P) NF800-CEW/SDW/SEW NF800-HEW/REW	NV800-SEW/HEW	117	100
NF400-UEW(4P), NF800-UEW NF1000-SEW, NF1250-SEW NF1600-SEW		20	69
		117	116
		35	154

Remark: 1. The terminal positions are different from those shown in the left figure. Consult us for details.

10. Test Button Module (TBM)

- The test button is kept pressed while control input voltage is applied to the button. (When ELCB of time delay type is used, apply voltage for 2 seconds or more.)
- The test button module is supplied with voltage through a circuit isolated from the main circuit. It can share the control sequence with SHT of a molded case circuit breaker.
- Unlike TBL, the test button modules can be connected in parallel.
- The module is normally provided with a vertical lead wire terminal block (SLT).

Table 6-18

Model	NV32-SV NV63-CV/SV/HV NV125-CV/SV/HV NV125-SEV/HEV NV250-CV/SV/HV/SEV/HEV NV50-SVFU NV100-CVFU NV125-SVU/HVU NV250-SVU/HVU	NV400-CW/SW NV630-CW/SW NV400-SEW~NV800-SEW NV400-HEW~NV800-HEW NV400-REW
Control input	Compatible with 100 to 240 AC and 100 to 240 DC (DC24) (*1)	
Rated voltage (V)		
Control input (VA)	1.5 VA or less	1 VA or less
Reference drawing	Fig. 1	Fig. 2

Note *1 Unless otherwise specified, the module will be manufactured for 100 to 240 V AC and 100 to 240 V DC. In the case of 24 V DC, specify the voltage.
Remark: 1. The length of the lead wires to be connected to TBM1 and 2 shall be 100 m or more.

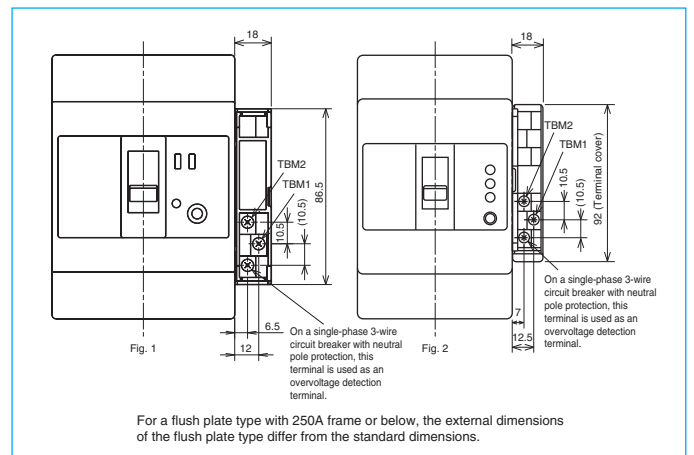

For a flush plate type with 250A frame or below, the external dimensions of the flush plate type differ from the standard dimensions.

11. Pre-Alarm Module (PAL)

The pre-alarm is a function to output an alarm when the load current exceeds the preset current value. It is helpful in securing continuous power supply and preventive maintenance.

It can be fitted to electronic circuit breakers with a frame size from 125 to 1600 A.

■ 125 and 250A frames

● Pre-alarm module (PAL module)

The standard modules have SLT. Other internal accessories cannot be installed on the right pole side.

A control power supply (compatible with 100 to 240 V AC and DC) is necessary. The control power supply voltage range is 85 to 246 V AC/DC, and the required volt-ampere is 5 VA.

Table 6-19-1

Model	Switching capacity	Contact output (1a)	Resetting method
NF125-SEV NF125-HEV NF250-SEV NF250-HEV NV125-SEV NV125-HEV NV250-SEV NV250-HEV	AC125V 2A AC250V 2A	DC 30V 2A DC100V 0.3A	Press the reset button, or turn off the control power supply.

Pre-alarm characteristics

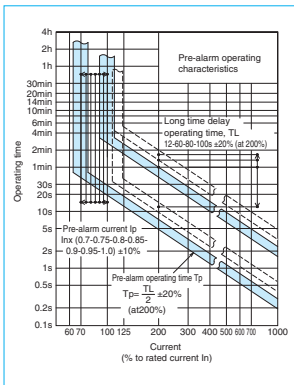

Dimensional drawing of pre-alarm module

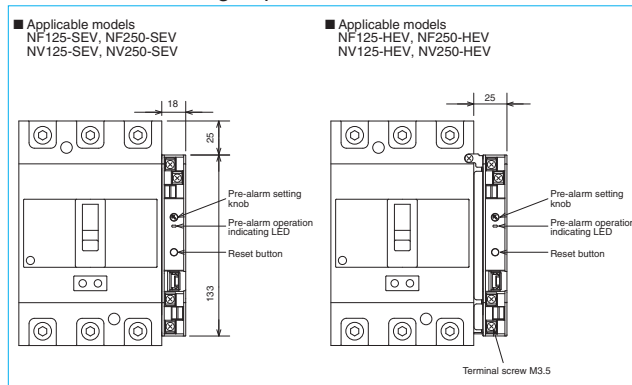

Terminal arrangement

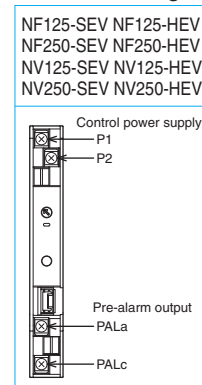

● Pre-alarm LED indication

When the load current exceeds the preset current value, the LED lamp on the pre-alarm module front panel starts blinking. When the pre-alarm output is given, the lamp stops blinking and turns on.

● Pre-alarm current setting (IP setting)

The pre-alarm current can be set to the rated current $I_n \times 0.7, 0.75, 0.8, 0.85, 0.9, 0.95$ or 1.0 with the knob on the pre-alarm module front panel.

■ 400 A frame or above

● Solid state relay (SSR) output (PAL lead)

The lead wires are drawn out. On the right pole side, only internal accessories with lead wires drawn out can be installed. A control power supply is unnecessary.

Table 6-19-2

Model	Switching capacity	Resetting method
NF400-SEW NF400-HEW NF400-REW NF400-UW NF630-SEW NF630-HEW NF630-REW NF800-CEW NF800-SEW NF800-HEW NF800-REW NF800-UW NF1000-SEW NF1250-SEW NF1600-SEW NV400-SEW NV400-HEW NV400-REW NV630-SEW NV630-HEW NV800-SEW NV800-HEW	Solid state relay (SSR) – Non-contact output AC/DC24 to 240V 20mA	When the load current becomes lower than the preset current value, the alarm is reset.

● Pre-alarm module (PAL module)

The standard modules have SLT. Other internal accessories cannot be installed on the right pole side.

A control power supply (compatible with 100 to 200 V AC) is necessary except for NF-ZEW. The control power supply voltage range is 80 to 242 V AC, and the required volt-ampere is 10 VA.

Table 6-19-3

Model	Switching capacity	Contact output (1a)	Resetting method
NF400-SEW NF400-HEW NF400-REW NF400-UW NF630-SEW NF630-HEW NF630-REW NF800-CEW NF800-SEW NF800-HEW NF800-REW NF800-UW NF1000-SEW NF1250-SEW NF1600-SEW NV400-SEW NV400-HEW NV400-REW NV630-SEW NV630-HEW NV800-SEW NV800-HEW	100 V AC or 200 V AC, 2 A		Press the reset button, or turn off the control power supply.

Pre-alarm characteristics

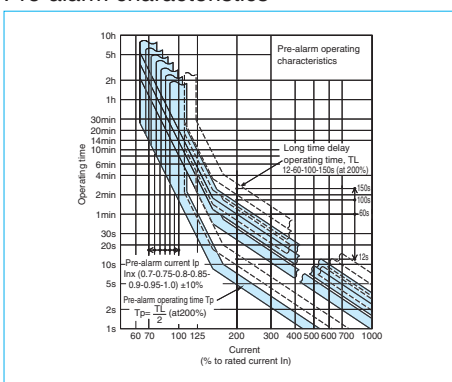

Detailed drawing of pre-alarm module

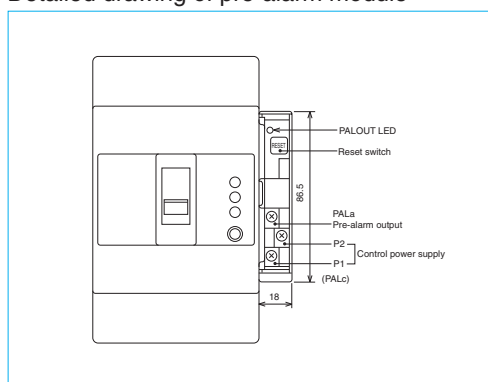

Pre-alarm module output rating

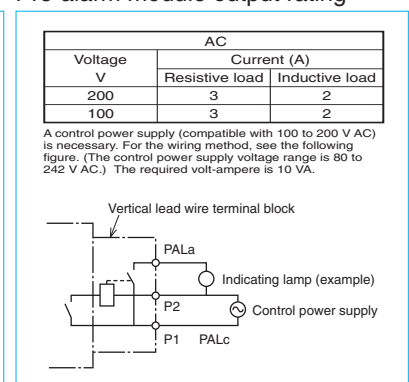

● Pre-alarm LED display (standard device)

When the load current exceeds the preset current value, the LED lamp on the circuit breaker front panel starts blinking. When the pre-alarm output is given, the lamp stops blinking and turns on.

● Pre-alarm current setting (IP setting)

The pre-alarm current can be set to the rated current $I_n \times 0.7, 0.75, 0.8, 0.85, 0.9, 0.95$ or 1.0 with the knob on the circuit breaker front panel.

● Installation procedure For details, please refer to Operating Handle Installation Manual supplied with the product.

① Installation to a breaker Install the operating handle to the circuit breaker in accordance with the following procedure.

	250A frame and below		400 to 1600A frames
Installation procedure	<p style="text-align: center;">Center of operating handle and center of circuit breaker</p> <p style="text-align: center;">2 poles 3 poles 4 poles</p> <p style="text-align: center;">Installation position of operating handle with respect to circuit breaker (Note 1)</p> <p style="text-align: center;">(In the case of F-05SV2, F-1SV2, F-05SRUL2, F-05SUL2 and F-1SUL2)</p> <p>Tighten the circuit breaker and operating handle together with the supplied two operating handle mounting screws.</p>		<p style="text-align: center;">Circuit breaker cover screws (Remove.)</p> <p style="text-align: center;">(In the case of F-4S to F-6SUL) The operating handle mounting screws are tapping screws without washers or spring washers.</p> <p style="text-align: center;">Center of operating handle and center of circuit breaker</p> <p style="text-align: center;">3 poles 4 poles</p> <p style="text-align: center;">Installation position of operating handle with respect to circuit breaker</p>
	<p>(Installation procedure)</p> <ol style="list-style-type: none"> 1) Install the circuit breaker on the panel with the two circuit breaker mounting screws through the holes (a). 2) Install the operating handle with the supplied two operating handle mounting screws through the holes (b). 		<p>(Installation procedure)</p> <ol style="list-style-type: none"> 1) Remove the circuit breaker cover screws in the same positions as the operating handle mounting holes. 2) Install the circuit breaker with the four circuit breaker mounting screws. 3) Fit the spacer(s) for installation of operating handle between the circuit breaker and operating handle. (The number of the spacers varies depending on the model.) 4) Install the operating handle with the supplied operating handle mounting screws.

Note *1 In the case of F-05SRUL2, the center of the operating handle is the same as the center of the circuit breaker.

② Installation of decorative board and retaining board

Drill holes in the door according to the drilling size shown on the previous page, and tighten the decorative board and retaining board with the supplied countersunk screws. In the case of 800A frame or below, fit the supplied packing to the position shown right.

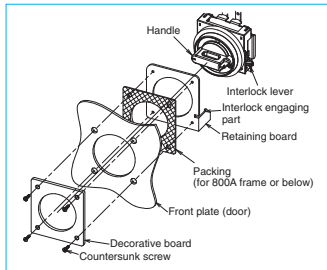

● Door locking mechanism

The panel door can be opened only when the operating handle is operated to open (reset). (On F-4S to F10SW, the door lock is held in the released state even if the handle is returned to OFF.) The door can be opened when the handle is in the ON position if the release knob is operated with a tool.

● Operation locking mechanism

Circuit breakers with a frame size of 800A or below can be locked by setting the handle in the OFF position. (Operating handles which can lock circuit breakers in the ON or OFF position can be manufactured.) Operate the locking part, and lock the handle with padlocks. Up to three padlocks can be fitted. Lockout hasps (scissors locks) can be used. If the circuit breaker trips even when the operating handle is locked in the ON position, also the operating handle indicates that it has tripped.

[F-2SUL or below: Only when one 35-mm padlock (weighing 70 g or less) is used]
 [F-4S or above: Only when one 40-mm padlock (weighing 100 g or less) is used]

To 800A frame or below, padlocks with dimension C of 3 mm to 8 mm can be applied.
 For 1000A or above, padlocks with dimension of 3 mm to 6 mm can be applied. (When using padlocks of 3 mm or less, please consult us.)

● Circuit breaker installation direction (except UL 489 listed circuit breakers)

We can supply circuit breakers on which the handles and their ON and OFF positions are in the same directions as on vertically installed circuit breakers even when they are installed horizontally. The door drilling size is identical. If you intend to install an operating handle on a horizontally installed circuit breaker, specify "Y" (horizontal installation with power supply on the left) or "Z" (horizontal installation with power supply on the right) at the end of the model name. (Ex.: F-4S Y)

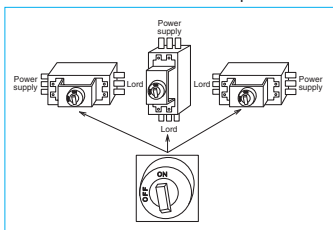

● Sealing of release knob

The use of an optional part, Release Protection "F-RCS", can prevent the panel door being opened by operating the release knob. (800A frame or below)

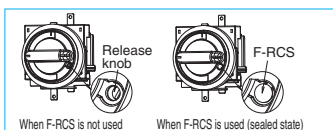

● Operation Lock Devices

(1) Padlock

Padlock Dimensions
 Use commercially available padlocks. (mm)

Applicable model	A (Nominal size)	B	C
All models	35	19	5
	40	22 or 23	5.5

Dimension C: Maximum 8mm.

(2) Lockout Devices (Scissors Lock)

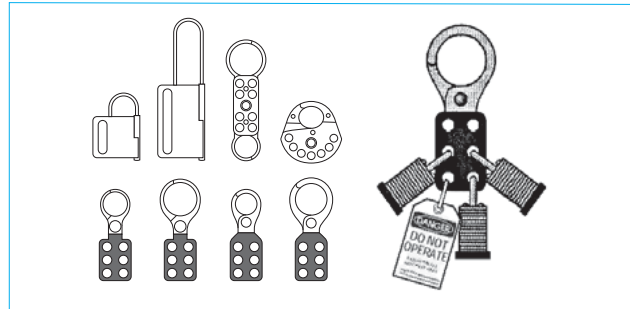

● How to order

For 800A frame or below, specify the following specification symbols together with the model name.

- Operation lock: LF Lock in OFF position
- Operation lock: LN Lock in ON or OFF position
- Door opening: DR Reset to open
- Operation lock: DF Open in OFF position
- Installation direction: Blank ... Power supply upward
- Installation direction: Y Power supply on left
- Operation lock: Z Power supply on right

For a standard product with a frame size of 1000A or above, specify the model name. When it is required to enable the operation lock only in the OFF position, specify the model name and "only lock in OFF position."

If you intend to seal the release knob, place an order for the release protection. (Lot: 10 pcs.)

● Interpretation of model name

(1) For 800A frame or below

$\frac{F}{1)} - \frac{1}{2)} \frac{SV}{3)} \frac{UL}{4)} \frac{E}{5)} \frac{2}{6)}$

- 1) F: Operating handle type name
- 2) 1: Circuit breaker group (0.5, 1, 2, 4, 6 or 8)
- 3) SV: Classification of circuit breaker (S, SV, H, U, UV, SR or SG)
- 4) UL: Blank...General product UL...UL 489 listed product
- 5) E: Blank...Standard E...For emergency stop
- 6) 2: Blank...3P or 4P 2...2P

(2) For 1000A frame or above

$\frac{F}{1)} \frac{10}{2)} \frac{SW}{3)} \frac{4P}{4)}$

- 1) F: Operating handle type name
- 2) 4: Circuit breaker A frame (10 or 120)
- 3) SW: Series name
- 4) 4P: Number of poles (4P) * Not indicated for 3P

2. V-Type Operating Handle

● Appearance (Color: Munsell N1.5)



Operating handle of door mount type consisting of operating section to be mounted on circuit breaker body and operating handle on panel door

- The handle provides an isolation function in combination with the circuit breaker body.
- Conforming to the safety regulations of EN Standard (EN 60204-1)
- Protection class (IEC 60529) IP65 as standard
- The handle can be locked only in the OFF position with up to three commercially available padlocks (35 mm or 40 mm).
- The panel door can be opened in the OFF position. In the ON and trip positions, the panel door is locked and cannot be opened. However, the door can be opened even in the ON and trip positions by operating the release part with a tool.

● Outline drawings

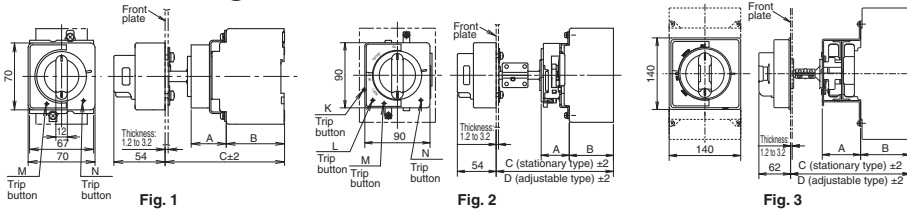

● Center of hinge and breaker

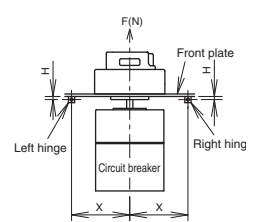

Relationship between hinges and circuit breaker handle viewed from load side of circuit breaker

● Dimensional drawings for front plate drilling

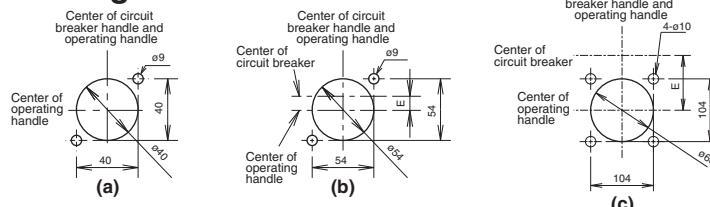

	H	X
For 30 to 250 A frames	0 or more	5H+100 or more
For 400 to 800 A frames	0 or more	8H+150 or more

* The above figure shows the relationship viewed from the load side.

● Dimensional drawings of circuit breaker mounting holes

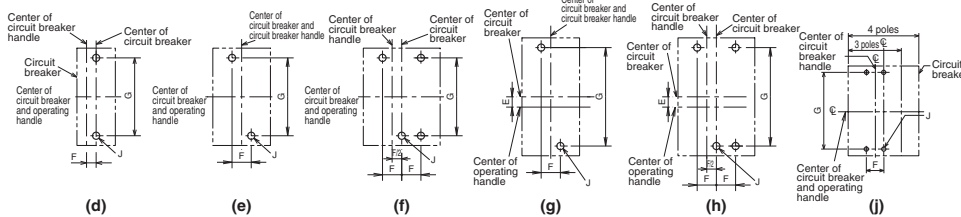

● Door lock withstand load

	F(N)
30 to 800A frames	200

Table 6-21 Summary of dimension

Type name		Applicable model		Reference drawing		Dimensions (mm)															
Stationary type	Adjustable type	MCCB	Number of poles	ELCB	Number of poles	Dimensional drawing	Drilling plan	A	B	Stationary type C	Adjustable type(*2) D (min)	Adjustable type(*2) D (max)	E	F	G	J	Trip button position (*5)				
																		V-05SV2 V-05SVE2	Adjusting unit V-AD3S is mounted on stationary type.	NF32-SV NF63-CV, NF63-SV, NF63-HV	2P
V-05SV V-05SVE	NF32-SV NF63-CV, NF63-SV, NF63-HV	3P	NV32-SV NV63-CV, NV63-SV, NV63-HV	2P, 3P	e	162	300	25	L												
V-1SV2, V-1SVE2	NF125-CV, NF125-SV	2P	-	-	d	-	-	15	N												
V-1SV V-1SVE	NF125-CV, NF125-SV	3P	NV125-CV, NV125-SV, NV125-HV	3P	e	-	-	30	L												
V-1UV V-1UVE	NF125-HV	2P, 3P	-	-	f	30.5	-	30	L												
V-2SV V-2SVE	NF125-UV	2P, 3P	-	-	g	30.5	-	30	L												
V-2UV V-2UVE	NF125-SEV, NF125-HEV, NF125-SGV NF125-LGV, NF125-HGV, NF125-RGV NF160-SGV, NF160-LGV, NF160-HGV NF250-CV, NF250-SV, NF250-HV NF250-SGV, NF250-LGV, NF250-HGV NF250-SEV, NF250-HEV, NF250-RGV	2P, 3P	NV125-SEV, NV125-HEV NV250-CV, NV250-SV, NV250-HV NV250-SEV, NV250-HEV	3P	e	37.5	-	35	K												
V-03SVUL2 V-03SVUL	NF50-SVUFU	2P	NV50-SVUFU	2P	a	39	61	125	-	-	9	82.5	M								
V-05SVUL2 V-05SVUL	NF100-CVUFU	3P	-	-	e	39	61	125	-	-	12.5	111	N								
V-1SVUL V-2SVUL V-2SUL	NF125-SVU, NF125-HVU NF250-SVU, NF250-HVU NF225-CWU	3P	NV125-SVU, NV125-HVU NV250-SVU, NV250-HVU	3P	b	39	61	125	162	300	6	30	123	L							
V-4S V-4SE V-4U V-4UE	NF400-CW/SW/SEW/HEW/REW NF630-CW/SW/SEW/HEW/REW	2P, 3P, 4P	NV400-CW/SW/SEW/HEW/REW NV630-CW/SW/SEW/HEW	3P, 4P	j	41	61	125	162	300	-	35	126	K							
V-8S V-4SUL V-6SUL	NF800-CEW/SDW/SEW/HEW/REW NF-SKW NF-SLW	2P, 3P, 4P	NV800-SEW/HEW	3P	c	76	194	288	330	397	20	44	234	M6 screw or ø7	-						

Notes
 *1 For the adjustable type, purchase the optional adjusting unit V-AD3S or V-AD3L.
 *2 The dimensions of the adjustable type models provided with the adjusting unit V-AD3S or V-AD3L are shown.
 *3 When using the operating handle for a plug-in type model with a frame size of 250A or below, specify so.
 *4 The dimensions on the front connection type are shown. For the rear connection and plug-in types, separately consult us.
 *5 The circuit breaker can be tripped by operating the trip button while the door is open. (The trip button position varies depending on the model.)
 *6 The handle cannot be used when the circuit breaker is installed on IEC 35-mm rails.

Remarks
 1. The products whose model names contain E are designed for emergency stop. The delivery category is ●. That of V-05SVE is ●.
 2. When the operating handle is fitted to NV, the test button cannot be pressed easily. If necessary, use a circuit breaker with TBL or TBM. When using an Earth Leakage Alarm Breaker, use the externally resetting type (ECA-SLT) or automatically resetting type (ARS).

● Installation procedure For details, please refer to Operating Handle Installation Manual supplied with the product.

① Installation to a breaker Install the operating handle to the circuit breaker in accordance with the following procedure.

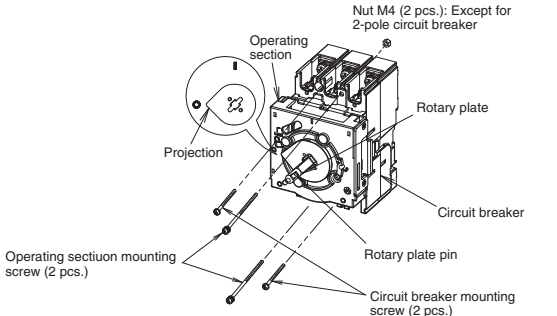
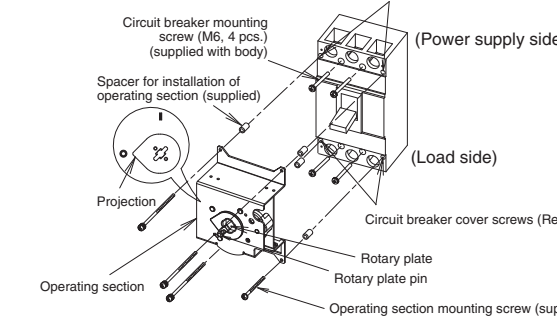
	250A frame and below	400 to 800A frames
Installation procedure	<p>(Installation procedure)</p> <p>① Operating handle for 3- or 4-pole circuit breaker Set the rotary plate of the operating section to the OFF (symbol O) position, and fit the plate to the circuit breaker with the supplied operating section mounting screws and nuts. Install the circuit breaker to the panel with the circuit breaker mounting screws (2 pcs.).</p> <p>② Operating handle for 2-pole circuit breaker Install the operating section together with the circuit breaker to the panel with the supplied operating section mounting screws (2 pcs.).</p> 	<p>(Installation procedure)</p> <p>① Remove the circuit breaker cover screws (4 pcs.) in the same positions as the operating handle mounting holes.</p> <p>② Install the circuit breaker with the circuit breaker mounting screws (4 pcs.).</p> <p>③ Fit the supplied operating section mounting spacers (4 pcs.) between the circuit breaker and operating handle.</p> <p>④ Set the rotary plate to the OFF (symbol O) position, and install the operating section to the circuit breaker with the supplied operating section mounting screws.</p> 

② Installation of operating handle section

Drill a hole in the door according to the dimensional drawing for front plate drilling given on the previous page, and install the operating handle section in accordance with the following procedure.

- Tighten the operating handle section from the back of the front plate. Temporarily tighten the screws to center the section in the hole.
- Set the handle of the operating handle section to the OFF state, tighten the front plate, and make sure that the handle can be smoothly turned to the ON and OFF positions. Turn the handle to the right and left in the OFF state, and make sure that OFF is displayed. If OFF is not displayed, move the operating handle section up and down and to the right and left for adjustment. (Take care that the operating handle section is in parallel with the circuit breaker.) Then, open the front plate, and finally tighten the screws.

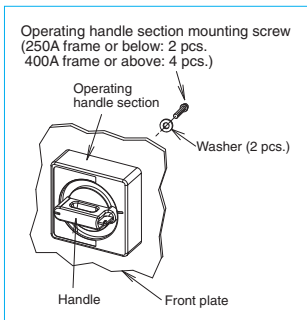

Note The adjusting unit is not applicable to 2-pole external type circuit breakers. If it is used on a 2-pole external type circuit breaker, the positions may not be correctly displayed.

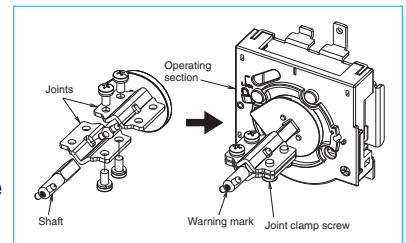

Make adjustments with the adjusting unit as stated below.

① External dimension drawing

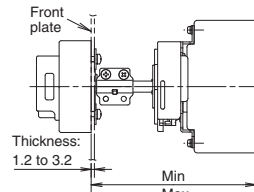

② Calculation of shaft cutting allowance

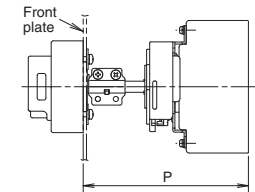

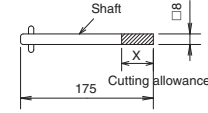
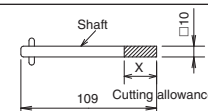
Type name	Dimensions (mm)		Cutting allowance	Calculation
	Min	Max		
V-05SV V-05SVUL	162	300		(Cutting allowance)(P max)(panel size) X = 300 mm - P
V-1SV V-1SVUL V-1SUL				
V-2SV V-2SVUL V-2SUL				
V-2SGUL				
V-4S	233	300		
V-8S				
V-4SUL V-6SUL				

Note The unit is applicable to operating handles for emergency stop (E).

● Padlocks

The user must prepare padlocks.

The dimensions of the padlocks are the same as those shown on page 129.

● How to order

Specify the model name of the operating handle.
For adjustable type, place an order for the adjustment unit.
(One lot includes 1 pc.)

250A frame or below: V-AD3S

400 to 800A frames: V-AD3L

● Interpretation of model name

(1) For 800A frame or below

$$\frac{V}{1) - \frac{1}{2) - \frac{S}{3) - \frac{UL}{4) - \frac{E}{5) - \frac{2}{6)}}$$

- 1) V: Operating handle type name
- 2) 1: Circuit breaker group (0.5, 1, 2, 4, 6 or 8)
- 3) S: Classification of circuit breaker (S, SV, H, U, UV)
- 4) UL: Blank...General product UL...UL 489 listed product
- 5) E: Blank...Standard E...For emergency stop
- 6) 2: Blank...3P or 4P 2...2P

● Door locking mechanism

The operating handle is provided with an interlock mechanism to prevent the door opening in the ON and TRIP positions. In the OFF position, the door can be opened. However, the door can be opened in the ON or TRIP position by pressing the release knob in the arrow direction with a tool (3 mm wide and 1.8 mm thick).

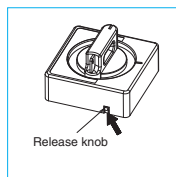

● Operation locking mechanism

① Operating handle section

Operation lock can be set only in the OFF Position. Up to three commercially available padlocks (A = 35 or 40 mm) can be fitted. Lockout hasps (scissors locks) can be used. When the operating handle section is locked with padlocks, also the door is locked.

② Operating section

The operating section can be locked so that the circuit breaker will not be turned on carelessly when the inside of the panel is inspected with the panel door open. Fit a padlock through the hole in the operating section of the operating handle.

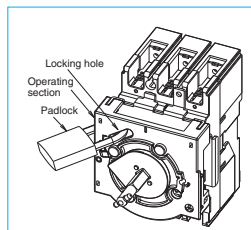

● Adjusting unit

The height from the circuit breaker mounting surface to the panel door can be adjusted by fitting the optional adjusting unit V-AD3S or V-AD3L. Cut the shaft of the adjusting unit according to the height.

3. Terminal Covers

The terminal covers are used to avoid exposure of live parts. Many kinds of terminal covers, including large terminal covers (TC-L), small terminal covers (TC-S), transparent terminal covers (TTC), rear terminal covers (BTC) and plug-in terminal covers (PTC), for various models and applications are available, and they are helpful. (The terminal covers cannot be fitted to electrically operated circuit breakers of spring charged type (2) and motor-drive type (2). The standard terminal covers can be used for the spring charged type (1). For the motor-drive type, special terminal covers can be manufactured. Consult us for details.)

● **Quick terminal covers**

These covers are very convenient because they can be fitted only by inserting them into the mounting holes in the circuit breaker body. To remove the terminal cover, shift the projections of the terminal cover with the tip of a slotted screwdriver or finger, and draw it out.

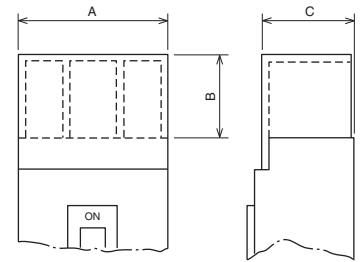

TC-L TC-S TTC

● **Table of variable dimensions**

Table 6-22 Large terminal covers (TC-L)

Type name	Color	Number of poles of circuit breaker	Applicable model		Dimensions (mm)			Contents			Appearance	Remarks
			MCCB	ELCB	A	B	C	Number of covers	Cover mounting screw	Sealing plate		
TCL-03CS2W	White	2	NF30-CS	- (*)1	43.5	25	30.5	2	-	2		
TCL-03CS3W	White	3		-	67	25	30.5	2	-	2		
TCL-05SV2 (*2)(*8)	White	2	NF32-SV NF63-CV/SV/HV	-	50	25	65.5	2	-	2		
TCL-05SV2L (*2)(*9)	White	2	NF32-SV NF63-CV/SV/HV	-	50	40	65.5	2	-	2		
TCL-05SV3 (*3)(*8)	White	3	NF32-SV NF63-CV/SV/HV	NV32-SV, NV63-HV	75	25	65.5	2	-	2		
TCL-05SV3L (*3)(*9)	White	2, 3	-	NV63-CV/SV	75	40	65.5	2	-	2		
TCL-05SV4 (*3)	White	4	NF63-SV/HV	-	100	25	65.5	2	-	2		
TCL-1SV2 (*2)	White	2	NF125-CV/SV	-	60	40	65.5	2	-	2		
TCL-1SV3 (*3)	White	3	NF125-CV/SV	NV125-CV/SV/HV	90	40	65.5	2	-	2		
TCL-1SV4 (*3)	White	2, 3	NF125-HV/UV	-	90	40	65.5	2	-	2		
TCL-2SV3 (*3)(*10)	White	4	NF125-SV/HV/UV	NV125-SV/HV	120	40	65.5	2	-	2		
	White	2, 3	NF125-SGVLGV/HGV/RGV NF160-SGVLGV/HGV NF250-SGVLGV/HGV/RGV NF250-CV/SV/HV/UV, NF250-SEV/HEV NF125-SEV/HEV	NV250-CV/SV/HV NV250-SEV/HEV NV125-SEV/HEV	105	40	65.5	2	-	2		
TCL-2SV3L (*3)(*11)	White	3	-	NV63-CV/SV	75	40	65.5	2	-	2		
	White	2, 3	NF125-SGVLGV/HGV/RGV NF160-SGVLGV/HGV NF250-SGVLGV/HGV/RGV NF250-CV/SV/HV/UV, NF250-SEV/HEV NF125-SEV/HEV	NV250-CV/SV/HV NV250-SEV/HEV NV125-SEV/HEV	105	50	65.5	2	-	2		
TCL-2SV4 (*3)(*5)	White	4	NF250-SV/HV/UV NF250-SEV/HEV NF125-SEV/HEV NF225-SWM (*)6	NV250-SV/HV NV250-SEV/HEV NV125-SEV/HEV	140	40	65.5	2	-	2		Quick type The cover can be sealed with the sealing plate.
TCL-4SW3 (*3)	White	2, 3	NF400-CW/SW/SEW NF630-CW/SW/SEW	NV400-CW/SW/SEW NV630-CW/SW/SEW	171	110	99.5	2	-	2		
	White	3	NF400-SEP with MDU (*)7 NF400-UW (*)4	-	171	110	132.5/196.5	2	-	-		
TCL-4SW4 (*3)	White	4	NF400-SW/SEW/HEW NF630-SW/SEW NF400-SEP with MDU (*)7	NV400-SEW/HEW NV630-SEW	240	110	105	2	6	-		
TCL-8SW3 (*3)	White	2, 3	NF800-CEW/SDW/SEW/HEW/REW	NV800-SEW/HEW	224	155	103.5	2	4	-		Use in combination with insulating barrier.
	White	3	NF800-SEP with MDU/HEP with MDU (*)7 NF800-SEP with MDU/HEP with MDU (*)7	-	224	155	103.5	2	4	-		
TCL-8UW3	Transparent	3	NF800-UW (*)4	-	220	155	146/194.5	2	4	-		
TCL-8SW4 (*3)	White	4	NF800-SEP with MDU/HEP with MDU (*)7 NF800-SEP with MDU/HEP with MDU (*)7	-	294	155	103.5	2	6	-		
TCL-8UW4	Transparent	4	NF400-UW, NF800-UW (*)4	-	290	155	146/194.5	2	6	-	Screw type	
TCL-10SW3	Transparent	3	NF1000-SEW NF1250-SEW/SDW	-	220	150	139	2	4	-		
TCL-10SW4	Transparent	4	NF1000-SEW NF1250-SEW/SDW	-	290	150	139	2	4	-		
TCL-03SVU2 (*3)	White	2	NF50-SVFU	NV50-SVFU	36	30	65.5	2	-	-		
TCL-03SVU3 (*3)	White	3	NF50-SVFU	NV50-SVFU	54	30	65.5	2	-	-	Quick type (Remove the existing cover from the body, and fit the terminal cover.)	
TCL-05SVU2 (*2)(*8)	White	2	NF100-CVFU	-	50	25	65.5	2	2	-		
TCL-05SVU2L (*2)(*9)	White	2	NF100-CVFU	-	50	40	65.5	2	2	-	Screw type	
TCL-05SVU3 (*3)(*8)	White	3	NF100-CVFU	NV100-CVFU	75	25	65.5	2	2	-		
TCL-05SVU3L (*3)(*9)	White	3	NF100-CVFU	NV100-CVFU	75	40	65.5	2	2	-	Screw type (Remove the existing cover from the body, and fit the terminal cover.)	
TCL-1SVU3 (*3)	White	2, 3	NF125-SVU	-	90	40	65.5	2	2	-		
TCL-2SVU3 (*3)(*10)	White	3	NF125-HVU	NV125-SVU/HVU	105	40	65.5	2	2	-	Screw type (Remove the existing cover from the body, and fit the terminal cover.)	
	White	3	NF250-SVU/HVU	NV250-SVU/HVU	105	40	65.5	2	2	-		
TCL-2SVU3L (*3)(*11)	White	3	NF250-SVU/HVU	NV250-SVU/HVU	105	50	65.5	2	2	-	Screw type (Remove the existing cover from the body, and fit the terminal cover.)	
	White	3	NF225-CWU	-	105	40	65.5	2	-	-		
TCL-2SWU3L (*3)(*11)	White	3	NF225-CWU	-	105	50	65.5	2	-	-	Quick type (Remove the existing cover from the body, and fit the terminal cover.)	
TCL-4SKW	White	3	NF-SKW	-	171	110	99.5	2	-	2		
TCL-6SLW	Transparent	3	NF-SLW	-	224	155	103.5	2	4	-	Quick type	Use in combination with insulating barrier.

Notes *1 For 2-pole NV, use TC-L for 3-pole circuit breaker.
 *2 For a circuit breaker with F or V type operating handle, specify the model name with F at the end.
 *3 (F or V type operating handle dedicated models, screws are used for fixing.)
 *4 The dimension C is the size on the power supply side and load side.
 *5 When a crimp terminal applicable to wires with a size of 117.2 to 152.05 mm² (Model 2CR-150 or CB150-S8) is used, TC-L cannot be fitted. Insulate the terminal from TC-S with insulating tube or taping.
 *6 In the case of installation on the body, specify the model name with-MDU at the end.
 *7 It cannot be installed in the case of installation on the body.

*8 Applicable to circuit breakers with rating of 75A or less (max. wire size 25 mm²)
 *9 Applicable to circuit breakers with rating of 125A or less (max. wire size 60 mm²)
 *10 Applicable to circuit breakers with rating of 200A or less (max. wire size 100 mm²)
 *11 Applicable to circuit breakers with rating of 250A or less (max. wire size 150 mm²) (Applicable to UL wire 300MCM)
 Remarks 1. The wire sizes shown in the above notes *10 to *13 are those of the 600-V vinyl insulated wires.
 2. Insulate the exposed live parts of crimp terminals with insulating tape or the like.
 3. When protection from the power supply and load sides is necessary, separately consult us.

6 Accessories 2 External Accessories

Table 6-23 Small terminal covers (TC-S)

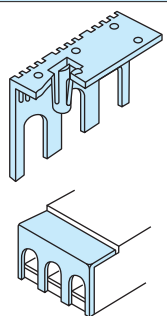
Type name	Color	Number of poles of circuit breaker	Applicable model		Dimensions (mm)			Contents			Appearance	Remarks
			MCCB	ELCB	A	B	C	Number of covers	Cover mounting screw	Sealing plate		
TCS-03CS2W	White	2	NF30-CS	-	43.5	5	30.5	2	-	2	 <p>Quick type The cover can be sealed with the sealing plate.</p>	
TCS-03CS3W	White	3		-	67	5	30.5	2	-	2		
TCS-05SV2	(*1) White	2	NF32-SV, NF63-CV/SV/HV	-	50	5	65.5	2	-	2		
TCS-05SV3	White	3	NF32-SV, NF63-CV/SV/HV	NV32-SV, NV63-HV	75	5	65.5	2	-	2		
	(*2) White	2, 3	-	NV63-CV/SV								
TCS-1SV2(*2)	White	2	NF125-CV/SV	-	60	6.5	65.5	2	-	2		
TCS-1SV3(*3)	White	3	NF125-CV/SV	NV125-CV/SV/HV	90	6.5	65.5	2	-	2		
	White	2, 3	NF125-HV/UV	-								
TCS-2SV3	(*2) White	2, 3	NF125-SGV/LGV/HGV/RGV NF160-SGV/LGV/HGV NF250-SGV/LGV/HGV/RGV NF250-CV/SV/HV/UV, NF250-SEV/HEV NF125-SEV/HEV	NV250-CV/SV/HV NV250-SEV/HEV NV125-SEV/HEV	105	6.5	65.5	2	-	2		

Notes *1 For a circuit breaker with F type operating handle, specify the model name with F at the end.
(F type operating handle dedicated models, screws are used for fixing.)
*2 The standard models can be used in combination with F and V Type Operating Handles.

Remarks 1. Small terminal covers for 4-pole circuit breakers are available.
2. Insulate the exposed live parts of crimp terminals with insulating tape or the like.

Table 6-24 Transparent terminal covers (TTC)

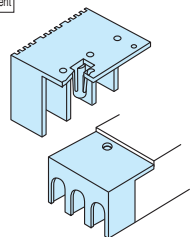
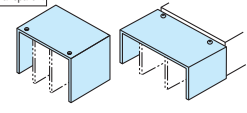
Type name	Number of poles of circuit breaker	Applicable model		Dimensions (mm)			Contents			Appearance	Remarks
		MCCB	ELCB	A	B	C	Number of covers	Cover mounting screw	Sealing plate		
TTC-03CS2	2	NF30-CS	-	43.5	25	30.5	2	-	2	 <p>Quick type The cover can be sealed with the sealing plate.</p>	
TTC-03CS3	3		-	67	25	30.5	2	-	2		
TTC-05SV2	(*1) 2	NF32-SV NF63-CV/SV/HV	-	50	25	65.5	2	-	2		
TTC-05SV3	3	NF32-SV NF63-CV/SV/HV	NV32-SV, NV63-HV	75	25	65.5	2	-	2		
	(*2) 2, 3	-	NV63-CV/SV								
TTC-1SV2	(*1) 2	NF125-CV/SV	-	60	40	65.5	2	-	2		
TTC-1SV3	3	NF125-CV/SV	NV125-CV/SV/HV	90	40	65.5	2	-	2		
	(*2) 2, 3	NF125-HV/UV	-								
TTC-2SV3	2, 3	NF125-SGV/LGV/HGV/RGV NF160-SGV/LGV/HGV NF250-SGV/LGV/HGV/RGV NF250-CV/SV/HV/UV, NF250-SEV/HEV NF125-SEV/HEV	NV250-CV/SV/HV NV250-SEV/HEV NV125-SEV/HEV	105	40	65.5	2	-	2		
	3	-	-								
TTC-4SW3	2, 3	NF400-CW/SW/SEW NF400-HEW/REW NF630-CW/SW/SEW NF630-HEW/REW	NV400-CW/SW/SEW NV400-HEW/REW NV630-CW/SW/SEW NV630-HEW	171	110	104.5	2	4	-		
	3	NF400-SEP with MDU/HEP with MDU(*4)	-								
TTC-4SW4	4	NF400-SW/SEW/HEW NF630-SW/SEW/HEW NF400-SEP with MDU/HEP with MDU(*4)	NV400-SEW/HEW NV630-SEW	240	110	104.5	2	6	-	 <p>Screw type</p>	Use in combination with insulating barrier.
TTC-8SW3	2, 3	NF800-CEW/SDW/SEW NF800-HEW/REW	NV800-SEW/HEW	224	155	103.5	2	4	-		
	3	NF800-SEP with MDU/HEP with MDU(*4) NF800-SEP with MDU/HEP with MDU(*4)	-								
TTC-8SW4	4	NF800-SEW/HEW NF800-SEP with MDU/HEP with MDU(*4) NF800-SEP with MDU/HEP with MDU(*4)	-	294	155	103.5	2	6	-		

Notes *1 For a circuit breaker with F type operating handle, specify the model name with F at the end.
(F type operating handle dedicated models, screws are used for fixing.)
*2 The standard models can be used in combination with F and V Type Operating Handles.

*3 When a crimp terminal applicable to wires with a size of 117.2 to 152.05 mm² (Model 2CR-150 or CB150-S8) is used, TTC cannot be fitted.
Use TCL-2SV3L. Or insulate the terminal from TC-S with insulating tube or taping.
*4 In the case of installation on the body, specify the model name with • MDU at the end.
*5 Applicable to circuit breakers with rating of 200A or less (max. wire size 100 mm²)

<BTC>

Fig. 1

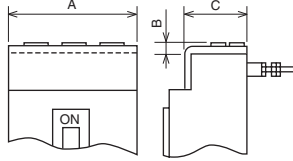
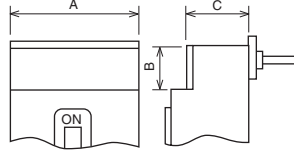

Fig. 2



<PTC>

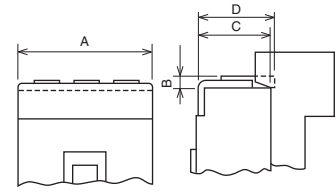

Table 6-25 Rear terminal cover (BTC)

Type name	Color	Number of poles of circuit breaker	Applicable model		Dimensions (mm)			Contents			Appearance	Remarks	
			MCCB	ELCB	A	B	C	Number of covers	Cover mounting screw	Sealing plate			
BTC-03CS2W	White	2	NF30-CS	-	43.5	6.5	30.5	2	-	2		Cover for connection block in the case of simple rear connection	
BTC-03CS3W	White	3		-	67	6.5	30.5	2	-	2			
BTC-05SV2	White	2	NF32-SV NF63-CV/SV/HV	- (*)	50	5	65.5	2	-	2		Cover for stud connection block on back in the case of rear connection type	
BTC-05SV3	White	3	NF32-SV NF63-CV/SV/HV	NV32-SV, NV63-HV	75	5	65.5	2	-	2			
BTC-1SV2	White	2, 3	-	-	60	6.5	65.5	2	-	2		Cover for stud connection block on back in the case of rear connection type	
BTC-1SV3	White	2, 3	NF125-HV/UV	-	90	6.5	65.5	2	-	2			
BTC-2SV3	White	2, 3	NF125-SGV/LGV/HGV/RGV NF160-SGV/LGV/HGV NF250-SGV/LGV/HGV/RGV NF250-CV/SV/HV/UV, NF250-SEV/HEV NF125-SEV/HEV	NV250-CV/SV/HV NV250-SEV/HEV NV125-SEV/HEV	105	6.5	65.5	2	-	2		Cover for stud connection block on back in the case of rear connection type	
BTC-4SW3	White	2, 3	NF400-CW/SW/SEW NF630-CW/SW/SEW	NV400-CW/SW/SEW NV630-CW/SW/SEW	140	42 (*)	99.5	2	-	2			
	White	3	NF400-SEP with MDU (*) NF400-UEW (*)	- (*)	140	42 (*)	132.5/ 196.5	2	-	2	Quick type The cover can be sealed with the sealing plate.		
BTC-4SW4	(*)	4	NF400-SW/SEW/HEW NF630-SW/SEW/HEW NF400-SEP with MDU/HEP with MDU (*)	NV400-SEW/HEW NV630-SEW	185	42 (*)	97.5	2	6	-		Screw type	
BTC-8SW3	(*)	3	NF800-CEW/SW/SEW/HEW/REW NF800-SEP with MDU/HEP with MDU (*) NF800-UEW (*)	NV800-SEW/HEW	210	32 (*)	97.5	2	8	-			
BTC-8SW4	(*)	4	NF800-SEW/HEW NF800-SEP with MDU/HEP with MDU (*) NF800-SEP with MDU/HEP with MDU (*) NF400-UEW, NF800-UEW (*)	- (*)	280	32 (*)	97.5	2	10	-			
					280	32 (*)	146/ 194.5	2	6	-			

Notes *1 For 2-pole ELCB, use BTC for 3-pole circuit breaker.
*2 Dimension B in Fig. 2
*3 The covers can be used for plug-in type circuit breakers. Other models are designed only for rear connection type.
*4 The dimension C is the size on the power supply side and load side.
*5 In the case of installation on the body, it can be fitted only on the power supply side.

Remarks 1.PTC-4SW3 can be used as the back terminal covers for NF400-HEW/REW, NF630-HEW/REW, NV400-HEW/REW and NV630-HEW.
2.For terminal covers for 4-pole circuit breakers not listed above, consult us.

Table 6-26 Plug-in terminal covers (PTC)

Type name	Color	Number of poles of circuit breaker	Applicable model		Dimensions (mm)				Contents			Appearance	Remarks
			MCCB	ELCB	A	B	C	D	Number of covers	Cover mounting screw	Sealing plate		
PTC-05SV2	White	2	NF32-SV NF63-CV/SV/HV	-	50	6.5	65.5	72	2	2	-		Cover for stud connection block in the case of plug-in type
PTC-05SV3	White	3	NF32-SV NF63-CV/SV/HV	NV32-SV, NV63-HV	75	6.5	65.5	72	2	2	-		
PTC-1SV2	White	2	NF125-CV/SV	-	60	6.5	65.5	-	2	4	-		Cover for stud connection block in the case of plug-in type
PTC-1SV3	White	2, 3	NF125-HV/UV	-	90	6.5	65.5	-	2	4	-		
PTC-2SV3	White	2, 3	NF125-SGV/LGV/HGV/RGV NF160-SGV/LGV/HGV NF250-SGV/LGV/HGV/RGV NF250-CV/SV/HV/UV, NF250-SEV/HEV NF125-SEV/HEV	NV250-CV/SV/HV NV250-SEV/HEV NV125-SEV/HEV	105	6.5	65.5	78.5	2	4	-	Screw type	
PTC-4SW3	(*)	2, 3	NF400-CW/SW/SEW NF630-CW/SW/SEW	NV400-HEW/REW NV630-CW/SW/SEW NF400-HEW/REW (*) NF630-HEW/REW (*)	140	42	97.5	-	2	4	-	Same as screw type of BTC	

Notes *1 The covers can be used as back terminal covers.
*2 See Fig. 2 of BTC.

Table 6-27 List of terminal covers applicable to F and V Type Operating Handles

Type name			Applicable operating handles	Number of poles of circuit breaker	Applicable model	
Large terminal covers (TC-L)	Small terminal covers (TC-S)	Transparent terminal covers (TTC)			MCCB	ELCB
TCL-05SV2F (*2)(*3) TCL-05SV2LF (*2)(*4)	TCS-05SV2F (*2)	TTC-05SV2F (*2)	F-05SV2, V-05SV2	2	NF32-SV, NF63-CV/SV/HV	– (*1)
TCL-05SV3 (*3) TCL-05SV3L (*4)	TCS-05SV3	TTC-05SV3	F-05SV, V-05SV	3 2, 3	NF32-SV, NF63-CV/SV/HV –	NV32-SV, NV63-HV NV63-CV/SV
TCL-05SV4	–	–	–	4	NF32-SV, NF63-CV/SV/HV	–
TCL-1SV2F (*2)	TCS-1SV2F (*2)	TTC-1SV2F (*2)	F-1SV2, V-1SV2	2	NF125-CV/SV	–
TCL-1SV3	TCS-1SV3	TTC-1SV3	F-1SV, V-1SV	3 2, 3	NF125-CV/SV NF125-HV/UV	NV125-CV/SV/HV –
TCL-1SV4	–	–	–	4	NF125-CV/SV/HV/UV	NV125-CV/SV/HV
TCL-2SV3 (*5) TCL-2SV3L (*6)	TCS-2SV3	TTC-2SV3	F-2SV, V-2SV	2, 3	NF250-CV/SV/HV/UV, NF250-SEV/HEV NF125-SEV/HEV	NV250-CV/SV/HV, NV250-SEV/HEV NV125-SEV/HEV
TCL-2SV4	–	–	–	4	NF250-CV/SV/HV/UV, NF250-SEV/HEV NF125-SEV/HEV	NV250-CV/SV/HV, NV250-SEV/HEV NV125-SEV/HEV
TCL-4SW3 TCL-4SP3W	–	TTC-4SW3	F-4S V-4S	2, 3	NF400-CW/SW/SEW/HEW/REW NF630-CW/SW/SEW/HEW/REW	NV400-CW/SW/SEW/HEW/REW NV630-CW/SW/SEW/HEW
TCL-4SW4	–	TTC-4SW4	–	4	NF400-SW/SEW/HEW NF630-SW/SEW/HEW	NV400-SEW/HEW NV630-SEW
TCL-8SW3	–	TTC-8SW3	F-8S V-8S	2, 3	NF800-CEW/SDW/SEW/HEW/REW	NV800-SEW/HEW
TCL-8SW4	–	TTC-8SW4	–	4	NF800-SEW/HEW	–

Notes *1 For 2-pole NV, use a terminal cover for 3-pole circuit breaker.
 *2 Only for F and V Type Operating Handles (screw type)
 *3 Applicable to circuit breakers with rating of 75A or less (max. wire size 25 mm²)
 *4 Applicable to circuit breakers with rating of 125A or less (max. wire size 60 mm²)
 *5 Applicable to circuit breakers with rating of 200A or less (max. wire size 100 mm²)
 *6 Applicable to circuit breakers with rating of 250A or less (max. wire size 150 mm²)

Remark: 1. The terminal covers for UL 489 Listed Circuit Breakers can be normally combined with F Type Operating Handles.

4. Insulating Barriers

The insulating barrier enhances the insulation between the phases of circuit breaker terminals. It also prevents accidents due to conductive foreign matter and dust, and secondary accidents when isolating a fault current.

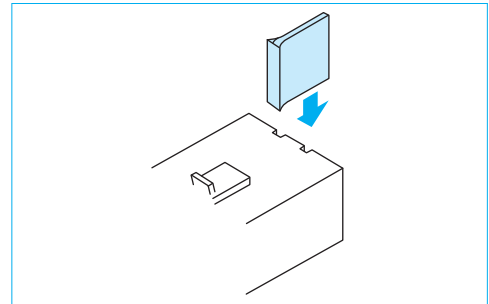

● The insulating barrier is available for the models listed in the table below.

Table 6-28

(“●” denotes optional)

Applicable model	Connecting method				
	MCCB	ELCB	Front	Rear	Flush plate
NF32-SV, NF63-CV NF125-CV, NF100-CV/U	NV32-SV, NV63-CV NV125-CV, NV100-CV/U	●	–	–	–
NF63-SV/HV NF125-SV/HV	NV63-SV/HV NV125-SV/HV	Standard attachment	–	–	–
NF125-SEV/HEV, NF125-ZEV NF250-CV/SV/HV/SEV/HEV NF125-SGV/LGV/HGV/RGV NF160-SGV/LGV/HGV NF250-SGV/LGV/HGV/RGV NF250-SEV/HEV/ZEV with MDU	NV125-SEV/HEV NV250-CV/SV/HV/SEV/HEV NV250-SEV/HEV with MDU	Standard attachment	–	–	Standard attachment
NF125-SVU NF125-HVU NF250-SVU NF250-HVU NF225-CWU	NV125-SVU NV125-HVU NV250-SVU NV250-HVU NV100-SWU	Standard attachment	–	–	–
NF400-CW/SW/SEW/HEW/REW/UEW NF630-CW/SW/SEW/HEW/REW	NV400-CW/SW/SEW/HEW/REW NV630-CW/SW/SEW/HEW	Standard attachment	●	●	Standard attachment
NF400-UEW(4P) NF800-CEW/SEW/HEW/REW/SDW	NV800-SEW/HEW	Standard attachment	●	●	●
NF800-UEW	–	Standard attachment	●	●	–
NF-SKW, NF-SLW	–	Standard attachment	–	–	–
NF1000-SEW, NF1250-SEW/SDW	–	Standard attachment	–	–	Standard attachment
NF1600-SEW/SDW	–	Standard attachment	–	–	–

Always mount the insulating barrier when it comes with the circuit breaker.

● Insulating Barrier-Front (BA-F)

Table 6-29 Summary of dimensions

Type name	Applicable model		Dimensions (mm)		Quantity per breaker			Reference diagram
	MCCB	ELCB	A	B	2P	3P	4P	
BAF-05SV	NF32-SV NF63-CV NF125-CV	NV32-SV NV63-CV NV125-CV	50	59.5	1 (*2)	2	3	
	NF63-SV/HV NF125-SV/HV/UV	NV63-SV/HV NV125-SV/HV						
BAF-2SV	NF125-SEV/HEV NF125-SGV/LGV/HGV/RGV NF160-SGV/LGV/HGV NF250-CV/SV/HV/UV/SEV/HEV NF250-SGV/LGV/HGV/RGV NF250-SEV/HEV/ZEV with MDU	NV125-SEV/HEV NV250-CV/SV/HV/SEV/HEV NV250-SEV/HEV with MDU	100	59.5	2	4	6	
	BAF-05SVU	NF100-CVFU	NV100-CVFU	50	59.5	2	4	
NF125-SVU NF125-HVU		NV125-SVU NV125-HVU	100	59.5	-	4	-	
BAF-2SVU	NF250-SVU NF250-HVU	NV250-SVU NV250-HVU						
BAF-2SWU	NF225-CWU	-	100	59.5	-	4	-	
BAF-4SW	NF400-CW/SW/SEW/HEW/REW NF630-CW/SW/SEW/HEW/REW	NV400-CW/SW/SEW/HEW/REW NV630-CW/SW/SEW/HEW	110	98.5	2	4	6	
BAF-4UW (*1)	NF400-UEW(3P)	-	110	132/ 98.5	-	4	-	
BAF-8SW	NF800-CEW/SEW/SDW/HEW/REW	NV800-SEW/HEW	110	98.5	1	2	3	
BAF-10SW	NF400-UEW(4P) NF800-UEW, NF1000-SEW NF1250-SEW/SDW	-	110	132	1	2	3	
BAF-SKW	NF-SKW	-	110	98.5	-	4	-	
BAF-SLW	NF-SLW	-	110	98.5	-	2	-	
BAF-16SW	NF1600-SEW/SDW	-	185	132	1	2	3	

Notes *1 The barriers BAF-4UW for the power supply and load sides vary in the dimension B.
*2 Not supplied with ELCB.

● Insulating Barrier-Rear (BA-B)

Table 6-30 Summary of dimensions

Type name	Applicable model		Dimensions (mm)		Quantity per breaker			Reference diagram
	MCCB	ELCB	A	B	2P	3P	4P	
BAB-4SW	NF400-CW/SW/SEW/HEW/REW NF400-UEW(3P) NF630-CW/SW/SEW/HEW/REW	NV400-CW/SW/SEW/HEW/REW NV630-CW/SW/SEW/HEW	140	74.5	-	4	6	
	BAB-8SW	NF800-CEW/SEW/SDW/HEW/REW NF400-UEW(4P) NF800-UEW						

Drilling size for use of BA-B (in the case of 3-pole circuit breaker)

NF400-CW, NF400-SW, NF400-SEW, NF400-HEW, NF400-REW, NF400-UEW NV400-CW, NV400-SW, NV400-SEW, NV400-HEW, NV400-REW NF630-CW, NF630-SW, NF630-SEW, NF630-HEW, NF630-REW NV630-CW, NV630-SW, NV630-SEW, NV630-HEW	NF800-CEW, NF800-SEW, NF800-HEW, NF800-REW, NF800-UEW NV800-SEW, NV800-HEW
<p>Power supply side Note The dimensions in brackets are those for NF400-UEW.</p> <p>Load side</p>	<p>Note The dimensions in brackets are those for NF800-UEW.</p>

The drilling size drawings show the dimensions viewed from the rear side.

● Insulating Barrier-Plug-in (BA-P)

Table 6-31 Summary of dimensions

Type name	Applicable model		Dimensions (mm)		Quantity per breaker			Reference diagram
	MCCB	ELCB	A	B	2P	3P	4P	
BAP-2SV	NF125-SEV/HEV NF125-SGV/LGV/HGV/RGV NF160-SGV/LGV/HGV NF250-CV/SV/HV NF250-SGV/LGV/HGV/RGV NF250-SEV/HEV	NV125-SEV/HEV NV250-CV/SV/HV/SEV/HEV	172	74.5	4			
BAP-4SW	NF400-CW/SW NF400-SEW/HEW/REW/UEW NF630-CW/SW NF630-SEW/HEW/REW	NV400-CW/SW NV400-SEW/HEW/REW NV630-CW/SW NV630-SEW/HEW	178	74.5		4	6	
BAP-8SW	NF800-CEW/SEW NF800-HEW/REW	NV800-SEW/HEW	172	74.5	-			
	NF1000-SEW NF1250-SEW	-	215	74.5				

● Earth fault preventing barriers (BA-G)

Table 6-32 Summary of dimensions

Type name	Applicable model		Dimensions (mm)		Quantity per breaker	Reference diagram
	MCCB	ELCB	A	B		
BAG-05SV3	NF32-SV NF63-CV/SV/HV	NV32-SV NV63-CV/SV/HV	30	75	1	<p>Earth fault preventing barrier (3 poles)</p>
BAG-1SV3	NF125-CV/SV/HV	NV125-CV/SV/HV	40	90		
BAG-2SV3	NF125-SEV/HEV NF250-CV/SV/HV/SEV/HEV NF250-SEV/HEV/ZEV with MDU	NV125-SEV/HEV NV250-CV/SV/HV/SEV/HEV NV250-SEV/HEV with MDU	63	105		
BAG-4SW3	NF400-CW/SW/SEW/HEW/REW NF630-CW/SW/SEW/HEW/REW	NV400-CW/SW/SEW/HEW/REW NV630-CW/SW/SEW/HEW	63	164		
BAG-4UW3	NF400-UEW	-	63	164		
BAG-8SW3	NF800-CEW/SEW/SDW/HEW/REW	NV800-SEW/HEW	110	210		
BAG-8UW3	NF800-UEW	-	110	210		
BAG-10SW3	NF1000-SEW NF1250-SEW/SDW	-	98	210		
BAG-16SW3	NF1600-SEW/SDW	-	150	300		

Also the earth fault preventing barriers for 2- and 4-pole circuit breakers are available.

5. Handle Lock Devices, Lock Covers, Auxiliary Handles, Card Holders

(1) Handle Lock Devices (HL and HL-S)

These devices are used to lock the circuit breakers in the ON or OFF position. If overcurrent flows while the circuit breaker is locked, it will trip. Model HL (red resin moldings) to be fitted to handles and Model HL-S to be secured on circuit breaker covers are available. (Use a commercially available padlock having the nominal size shown in the right table. If a padlock in another size is used, the device may not lock correctly.)

Padlock size (mm)

Application	A (Nominal size)	B	C
a	25	11	4
b	35	19	5
c	40	22 or 23	5.5

Table 6-33 HL

Type name	Applicable model		Reference diagram	Padlock	
	MCCB	ELCB			
HL-05FH	NF30-CS	-	Fig. 4	a	
HLN-05SV	NF32-SV, NF63-CV/SV/HV NF125-CV/SV/HV/UV, NF125-SEV/HEV NF125-SGV/LGV/HGV/RGV NF160-SGV/LGV/HGV	NV32-SV, NV63-CV/SV/HV NV125-CV/SV/HV, NV125-SEV/HEV NV250-CV/SV/HV, NV250-SEV/HEV	Fig. 1		
	NF250-CV/SV/HV/UV, NF250-SEV/HEV NF250-SGV/LGV/HGV/RGV				
	NF32-SV, NF63-CV/SV/HV NF125-CV/SV/HV/UV, NF125-SEV/HEV NF125-SGV/LGV/HGV/RGV NF160-SGV/LGV/HGV NF250-CV/SV/HV/UV, NF250-SEV/HEV NF250-SGV/LGV/HGV/RGV	NV32-SV, NV63-CV/SV/HV NV125-CV/SV/HV, NV125-SEV/HEV NV250-CV/SV/HV, NV250-SEV/HEV			
HLF-05SV	NF32-SV, NF63-CV/SV/HV NF125-CV/SV/HV/UV, NF125-SEV/HEV NF125-SGV/LGV/HGV/RGV NF160-SGV/LGV/HGV NF250-CV/SV/HV/UV, NF250-SEV/HEV NF250-SGV/LGV/HGV/RGV	NV32-SV, NV63-CV/SV/HV NV125-CV/SV/HV, NV125-SEV/HEV NV250-CV/SV/HV, NV250-SEV/HEV	Fig. 1		
HLF-05SVU	NF125-SVU/HVU NF250-SVU/HVU	NV125-SVU/HVU NV250-SVU/HVU			
HLF-2SWU	NF225-CWU	-			
HL-4CW	NF400-CW	NV400-CW	Fig. 2		c
HL-4SW	NF400-SW/SEW/HEW/REW/UEW NF630-CW/SW/SEW/HEW/REW NF800-CW/SDW/SEW/HEW/REW/UEW	NV400-SW/SEW/HEW/REW NV630-CW/SW/SEW/HEW NV800-SW/HEW			
	HL-4SP	NF-SKW/SLW			
HL	NF1000-SEW, NF1250-SEW/SDW, NF1600-SEW/SDW	-	Fig. 3		

Notes *1 When a padlock is not used, the device can be used as a lock cover (LC).
*2 Place an order for a circuit breaker body combined with the device.

Remarks 1. One lot of HL-4CW and HL-4SW contains one piece, and one lot of others contains 10 pieces.
2. HLF types are used for OFF lock, and HLN types for ON lock.

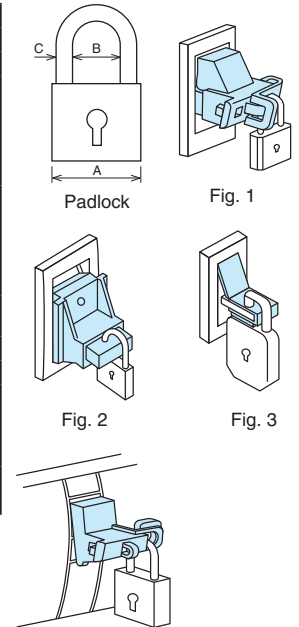

Table 6-34 HL-S

Type name	Applicable model				Dimensions (mm)						Reference diagram	Padlock
	MCCB	Number of poles	ELCB	Number of poles	A	B	C	D	E	F		
HLS-05SV2	NF32-SV, NF63-CV, NF63-SV NF63-HV	2P	-	-	32	75	50	-	-	32		
		2P	-	-			57					
HLS-05SV	NF32-SV, NF63-CV, NF63-SV NF63-HV	3P	NV32-SV, NV63-HV	3P	62.5	84	75	23	63	32		
		4P	-	-			86	-				
	NF125-CV, NF125-SV	3P	NV125-SV, NV125-HV, NV125-SV, NV125-HV	3P								
	NF125-SV, NF125-HV	2P, 3P	-	-								
	NF125-SV, NF125-HV	4P	NV125-SV, NV125-HV	4P								
	NF125-SV, NF125-HV	2P, 3P	-	-								
NF125-SV, NF125-HV	4P	-	-									
NF125-SV, NF125-HV	2P, 3P	-	-	69.5	-	-	-	-	-	1.5		
NF125-SV, NF125-HV	4P	-	-									
HLS-2SV	NF125-SGV/LGV/HGV/RGV NF160-SGV/LGV/HGV NF250-CV, NF250-SV, NF250-HV NF250-SGV/LGV/HGV/RGV	2P	NV125-SEV, NV125-HEV NV250-CV, NV250-SV, NV250-HV	3P	32	84	100	-	63	32		
		3P	NV125-SEV, NV125-HEV NV250-CV, NV250-SV, NV250-HV	3P								
	NF125-SV, NF125-HV NF125-SGV/LGV/HGV/RGV NF160-SGV/LGV/HGV NF250-CV, NF250-SV, NF250-HV NF250-SGV/LGV/HGV/RGV	4P	NV125-SEV, NV125-HEV NV250-SV, NV250-SEV, NV250-HEV	4P								
	NF125-SV, NF125-HV NF125-SGV/LGV/HGV/RGV NF160-SGV/LGV/HGV NF250-SV, NF250-HV, NF250-SEV, NF250-HEV NF250-SGV/LGV/HGV/RGV	2P, 3P 4P	- -	- -								
HLS-03SVU	NF50-SVFU	2P, 3P	NV50-SVFU	2P, 3P	-	-	-	-	-	-	Fig. 9	
HLS-05SVU2	NF100-CVFU	2P	-	-	32	75	50	-	-	32	Fig. 5	
HLS-05SVU	NF100-CVFU	3P	NV100-CVFU	3P			75					
HLS-05SVU	NF125-SVU/HVU	2P, 3P	NV125-SVU/HVU	3P	32	75	86	-	-	32	Fig. 5	
		2P, 3P	NV125-SVU/HVU	3P			86					
HLS-2SVU	NF250-SVU/HVU	3P	NV250-SVU/HVU	3P	32	84	100	-	-	32	Fig. 5	
HLS-2SWU	NF225-CWU	3P	-	3P	-	84	100	-	-	32	Fig. 6	
HLS-4SW	NF400-CW/SW/SEW/HEW/REW NF630-CW/SW/SEW/HEW/REW	2P, 3P, 4P	NV400-CW/SW/SEW/HEW/REW NV630-CW/SW/SEW/HEW	3P, 4P	-	-	-	-	-	-	Fig. 7	
		3P	-	-	-	-	-	-	-	-	-	
HLS-4UW	NF400-UEW	3P	-	-	-	-	-	-	-	-	-	
HLS-8SW	NF800-CEW/SDW/SEW/HEW/REW	2P, 3P, 4P	NV800-SEW/HEW	3P, 4P	-	-	-	-	-	-	Fig. 8	
HLS-8UW	NF400-UEW NF800-UEW	4P 3P, 4P	-	-	-	-	-	-	-	-		

Notes *1 For locking in OFF position
*2 A, B, C and D in Figs. 5 and 6 are drilling sizes in front plate.
*3 Terminal covers cannot be fitted.

6. Mechanical Interlocks (MI)

This mechanical interlock device is used to enable one of two circuit breakers to turn on. Install the device on the panel. Mechanical interlocks to be installed directly to circuit breaker bodies can be manufactured. Consult us for details.

● Front, rear and plug-in types

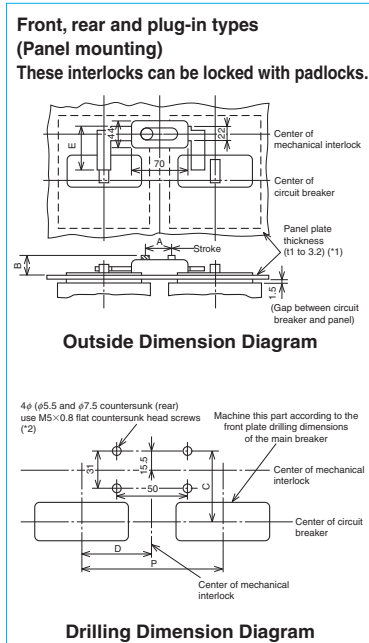

Fig. 1

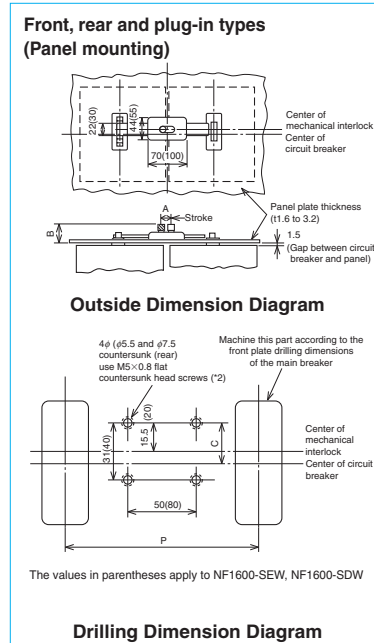

Fig. 2

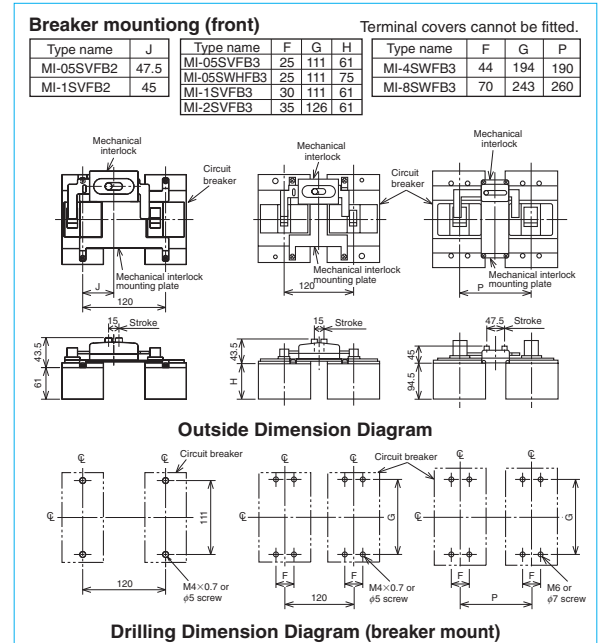

Fig. 3

Notes *1 For 400A frame or above, use a panel 1.6 to 3.2 thick.
*2 When the panel is 2.3 or more thick, countersink the panel (rear side) in φ9.5 for the four φ5.5 holes.

Table 6-38 Table of variable dimensions

Applicable model		Pitch (P) (*1)				Dimensions (mm)					Reference diagram	Breaker mount (*4) Type name 2P-3P	Reference diagram (3P)		
MCCB	ELCB (*8)	Standard		Semi-standard	Standard		t	A	B	C (*3)				D	E
		Type name	2P	3P	3P	Type name	4P								
NF32-SV, NF63-CV/SV/HV	-	MI-05SV3	120	-	-	-	-	(*2)	15	33	63	47.5	58	MI-05SVFB2	Fig. 3
NF32-SV, NF63-CV/SV/HV	NV32-SV, NV63-CV/SV/HV		-	120	-	130	MI-05SV4		120 (*6)	15	33	63	-		
NF125-CV/SV	-	MI-05SV3	120	-	-	-	-		15	33	63	45	58	MI-1SVFB2	
NF125-CV/SV/HV	NV125-CV/SV/HV		-	120	130	150	MI-1SV4		130 (*6)	15	33	63	-	58	
NF125-UV	-	MI-05SV3	-	120	150	180	MI-2SV4		150 (*6)	15	33	63	-	58	
NF125-SEV/HEV	NV125-SEV/HEV NV125-SGV/LGV/HGV/RGV NF160-SGV/LGV/HGV NF250-CV/SV/HV, NF250-SEV/HEV NF250-SGV/LGV/HGV/RGV		-	-	-	-	-	-	(*2)	25.5	-	-	-	-	-
NF125-SGV/LGV/HGV/RGV			-	-	-	-	-	-							
NF160-SGV/LGV/HGV			-	-	-	-	-	-							
NF250-CV/SV/HV			-	-	-	-	-	-							
NF250-SEV/HEV		-	-	-	-	-	-								
NF250-SGV/LGV/HGV/RGV	-	-	-	-	-	-	-	-	-	-	-	-	-	-	
NF250-UV	-	MI-05SWU3	-	120 (*6)	-	-	-	15	33	63	-	58	-	-	
NF225-CWU	-		-	-	-	-	-	-	-	-	-	-	-	-	
NF400-CW/SW/SEW/HEW/REW NF630-CW/SW/SEW/HEW/REW NF-SKW	NV400-CW/SW/SEW/HEW/REW NV630-CW/SW/SEW/HEW	MI-4SW3	190		-	210 (*5)	MI-4SW4 (*5)	250	(*2)	47.5	33	83.5	-	74	MI-4SWFB3 (*5)
NF400-UWU (3P)	-		-	190	-	-	-	-							
NF800-CEW/SDW/SEW/HEW/REW NF-SLW	NV800-SEW/HEW	MI-8SW3	220		-	240 (*5)	MI-8SW4 (*5)	290							
NF400-UWU (4P) NF800-UWU	-		-	-	220	-	-	-	-	-	60	-	-	-	-
NF1000-SEW, NF1250-SEW/SDW	-	MI-10SW3	220	-	-	MI-10SW4	290	2,3	47.5	47	37.5	-	-	-	Fig. 2
NF1600-SEW/SDW	-	MI-16SW3	315	-	-	MI-16SW4	426	(*7)	65	54.5	39	-	-	-	-





Notes *1 Specify the circuit breaker mounting pitch (P).
*2 No need to specify the panel thickness (t). (Usable panel thickness range: t = 1~3.2mm. Above 400AF, use panel thickness t = 1.6~3.2mm)
*3 For isolation purposes with 400, 600, 630 or 800A frame NF-SKW/SLW or NV-SKW, keep the C dimension deviation within ±1 mm.
*4 Terminal covers cannot be fitted. (However, TCL-4SW3 can be fitted.)
*5 Not UL 489 listed product.
*6 When UVT is provided, separately install the module.
*7 If the thickness is not 2.3, specify the panel thickness (t).
*8 For NV with TBL, use a circuit breaker with MG.

Remarks 1. When a mechanical interlock is installed on the panel, screw type terminal covers cannot be installed.
2. These devices do not provide an isolation function. However, 400, 600, 630 and 800A frame circuit breakers can be made conforming to it. (See Note 3.)
3. On a 2-pole circuit breaker obtained by removing the neutral pole conductor from a 3-pole circuit breaker, the mechanical interlock can be installed in the same manner as on a 3-pole circuit breaker.

7. Boxes for Circuit Breakers and Boxed Circuit Breakers

(1) Kinds and specifications

Table 6-39

Appearance		Closed type (S)		Dust-proof type (I)	Water-proof type (W)										
		 (*1)	 (*1)												
MCCB (*2)	NF30-CS	2, 3P	NFS-03CS	—	—										
	NF32-SV, NF63-CV/SV/HV	2P	NFS-05SV2 (*5)	—	—										
		3P	NFS-05SV	NFI-05SV	NFW-05SV										
	NF125-CV/SV	2P	NFS-1SV2 (*5)	—	—										
		3P	NFS-1SV	NFI-1SV	NFW-1SV										
	NF125-HV	2, 3P	NFS-1SV	—	NFW-1HV										
	NF125-SGV/LGV NF160-SGV/LGV NF250-SGV/LGV NF250-CV/SV, NF125/250-SEV NF125/160/250-HGV NF250-HV, NF125/250-HEV NF400-CW NF400-SW/SEW NF630-CW/SW/SEW NF800-CEW/SDW/SEW	2, 3P	—	NFS-2SV	NFI-2SV	NFW-2SV									
							—	—	NFI-4CW	NFW-4CW					
							—	—	NFI-4SW	NFW-4SW					
							—	—	NFI-6SW	NFW-6SW					
							—	—	NFI-8SW	NFW-8SW					
							ELCB (*2)	NV32-SV, NV63-CV/SV/HV	2P	NFS-05SV	—	—			
									3P	NFS-05SV	NFI-05SV	NFW-05SV			
								NV125-CV/SV NV125-HV NV250-CV/SV, NV125/250-SEV NV250-HV, NV125/250-HEV NV400-CW NV400-SW/SEW NV630-CW/SW/SEW NV800-SEW	3P	—	NFS-1SV	NFI-1SV	NFW-1SV		
NFS-2SV														NFI-2SV	NFW-2SV
—	—	NFI-4SW	NFW-4SW												
—	—	NFI-6SW	NFW-6SW												
—	—	NFI-8SW	NFW-8SW												
Operating method		Direct operation of circuit breaker handle		Operation through operating handle mechanism											
Standard paint color		Box: Munsell 5Y7/1 Operating handle: Munsell N1.5													
Protection class (IEC 60529)		IP3X		IP4X (*3)	IP65 (*4)										

Notes *1 The window frame varies depending on the model.
 *2 For 1-pole circuit breakers, boxes are not manufactured.
 *3 The protection class of NFI-1SV and NFI-2SV is IP3X.
 *4 The protection class of NFW-4CW, NFW-4SW, NFW-6SW and NFW-8SW is IP54.
 *5 The circuit breaker body is a 2-pole external type.
 Remarks: 1. Only internal accessories with lead wires drawn out can be fitted. (However, LT and SLT can be fitted on the right pole side.)
 2. The dust-proof type (I) models do not provide an isolation function.

● Selection of rated current

When selecting the rated current of circuit breaker, it is necessary to consider the temperature in the box. When the rated current is carried, the temperature in the box increases by 10 to 20K. Correct the rated current with the temperature correction curve.
 Determine the maximum working current to be 80% or less of the rated current.

● Locking

Type I and W boxed circuit breakers can be provided with locks in the following parts. Locking can prevent unnecessary operation.

① Cover and case

② ON or OFF position of operating handle

(Padlocks must be prepared by the user.
 (The dimensions of the padlocks are shown)
 on page 116.

● Interlock (only for Dust-proof type)

The cover cannot be opened while the circuit breaker is in the ON state. However, if the interlock release screw is turned, the cover is released from the locked state and can be opened even in the ON state.

● Handle operation and display

The ON, OFF or trip state of the body is displayed on each position on the decorative board.

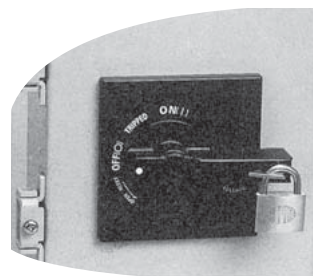

Example of Type I operating handle block

(2) External dimensions

MCCB

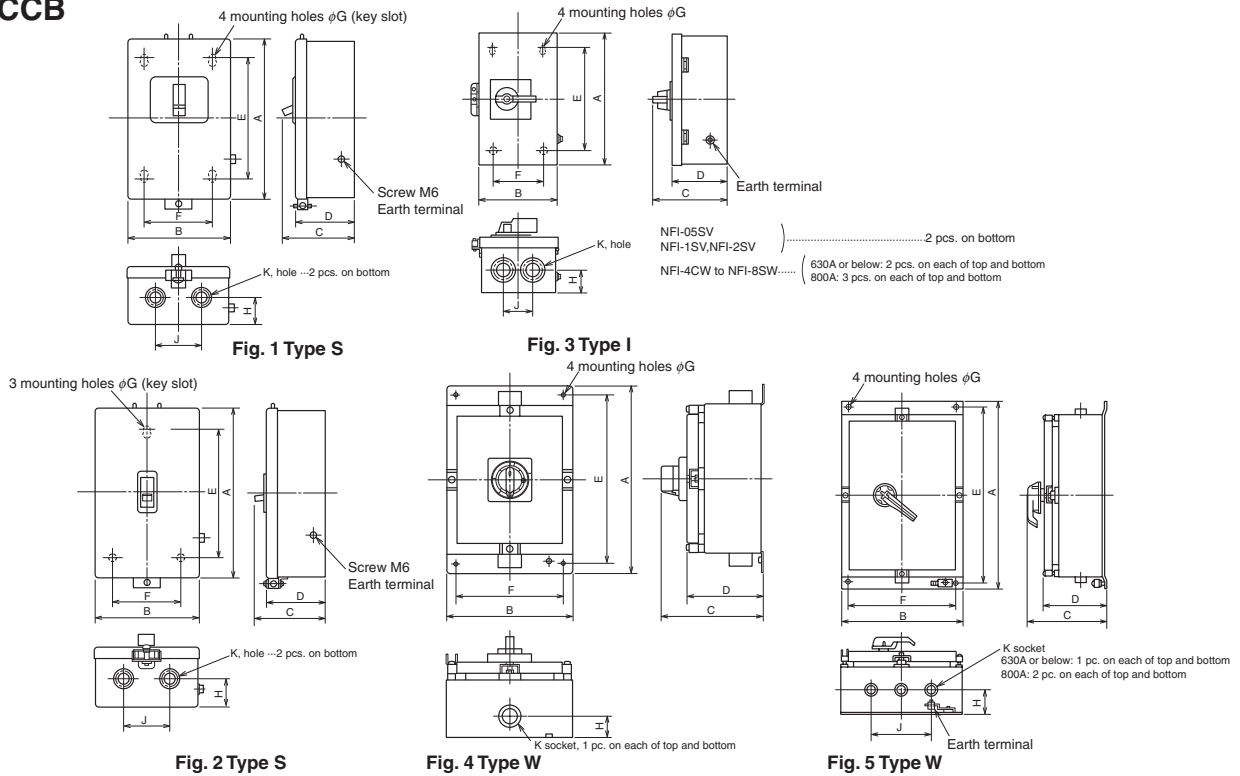

Table 6-40 Table of variable dimensions (Boxes for 4-pole circuit breakers are not manufactured.)

Note) The sockets are applicable to thick steel duct (JIS C 8305) and conduit tube thread.

Box type	Type name	Applicable Model	Fig.	Variable dimensions									
				A	B	C	D	E	F	G	H	J	K
S	NFS-03CS	NF30-CS	2	188	158	69	58	150	78	6	25	100	20, 28
	NFS-05SV2	NF32-SV, NF63-CV/SV/HV	1	260	178	98	78	202	100	7	34	100	28, 35, 44
	NFS-05SV												
	NFS-1SV2	NF125-CV/SV	1	310	178	98	78	252	100	7	34	100	28, 35, 44
	NFS-1SV	NF125-CV/SV/HV											
NFS-2SV	NF250-CV/SV, NF125/250-SEV NF125-SGV/LGV NF160-SGV/LGV NF250-SGV/LGV	1	440	247	137	116	373	170	9	52	120	50, 62, 78	
I	NFI-05SV	NF32-SV, NF63-CV/SV/HV	3	350	186	155.5	117	286	120	7	42	100	28, 35, 44
	NFI-1SV	NF125-CV/SV/HV	3	352	188	155.5	118	286	120	7	42	100	28, 35, 44
	NFI-2SV	NF250-CV/SV/HV, NF125/250-SEV/HEV NF125-SGV/LGV/HGV NF160-SGV/LGV/HGV NF250-SGV/LGV/HGV	3	442	248	162	124	373	170	9	54	120	50, 62, 78
	NFI-4CW	NF400-CW	3	730	320	244	191	650	240	11	87	120	50, 62, 78
	NFI-4SW	NF400-SW/SEW	3	730	320	244	191	650	240	11	65	120	50, 62, 78
	NFI-6SW	NF630-CW/SW/SEW	3	940	433	260	207	856	350	15	90	150	92
	NFI-8SW	NF800-CEW/SDW/SEW	3	1353	543	304	251	1270	460	15	90	320	104
W	NFW-05SV	NF32-SV, NF63-CV/SV/HV	4	390	265	214	160	350	225	9.5	45	-	28
	NFW-1SV	NF125-CV/SV	4	390	265	214	160	350	225	9.5	50	-	36
	NFW-1HV	NF125-HV	4	480	265	239	186	440	225	9.5	60	-	36
	NFW-2SV	NF250-CV/SV/HV, NF125/250-SEV/HEV NF125-SGV/LGV/HGV NF160-SGV/LGV/HGV NF250-SGV/LGV/HGV	4	550	355	264	210	510	315	11	75	-	54
	NFW-4CW	NF400-CW	5	800	355	257	220	760	315	11	85	-	70
	NFW-4SW	NF400-SW/SEW	5	800	355	257	220	760	315	11	85	-	70
	NFW-6SW	NF630-CW/SW/SEW	5	800	355	257	220	760	315	11	85	-	82
	NFW-8SW	NF800-CEW/SDW/SEW	5	1435	550	339	265	1395	515	15	100	180	104

6 Accessories 2 External Accessories

ELCB

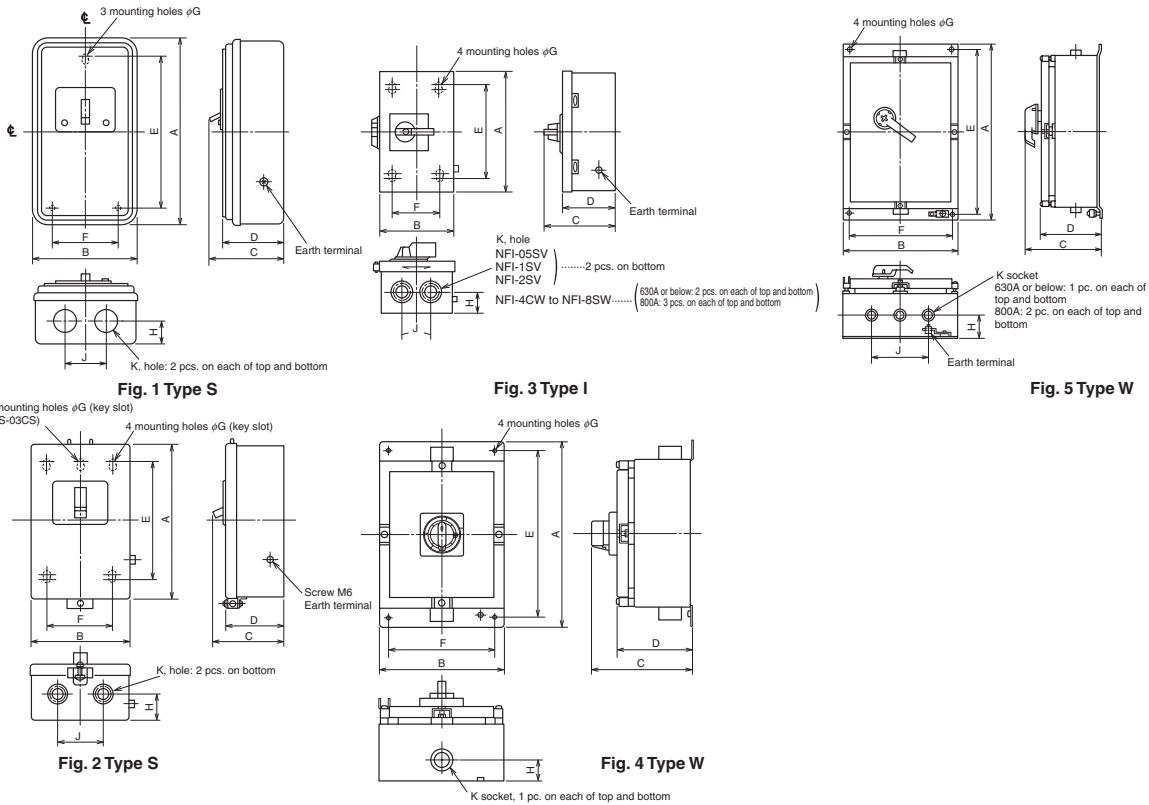

Table 6-41 Table of variable dimensions (Boxes for 4-pole circuit breakers are not manufactured.)

Note) The sockets are applicable to thick steel duct (JIS C 8305) and conduit tube thread.

Box type	Type name	Applicable Model	Variable dimensions										
			Fig.	A	B	C	D	E	F	G	H	J	K
S	NFS-05SV2	NV32-SV, NV63-CV/SV/HV	2	260	178	98	78	202	100	7	34	100	28, 35, 44
	NFS-05SV												
	NFS-1SV2	NV125-CV/SV	2	310	178	98	78	252	100	7	34	100	28, 35, 44
	NFS-1SV												
	NFS-2SV	NV250-CV/SV, NV125/250-SEV	2	440	247	137	116	373	170	9	52	120	50, 62, 78
I	NFI-05SV	NV32-SV, NV63-CV/SV/HV	3	350	186	155.5	117	286	120	7	42	100	28, 35, 44
	NFI-1SV	NV125-CV/SV/HV	3	352	188	155.5	118	286	120	7	42	100	28, 35, 44
	NFI-2SV	NV250-CV/SV/HV, NV125/250-SEV/HEV	3	442	248	162	124	373	170	9	54	120	50, 62, 78
	NFI-4CW	NV400-CW	3	730	320	244	191	650	240	11	87	120	50, 62, 78
	NFI-4SW	NV400-SW/SEW	3	730	320	244	191	650	240	11	65	120	50, 62, 78
	NFI-6SW	NV630-CW/SW/SEW	2	940	433	260	207	856	350	15	90	150	92
	NFI-8SW	NV800-SEW	3	1353	543	304	251	1270	460	15	90	320	104
		NFW-05SV	NV32-SV, NV63-CV/SV/HV	4	390	265	214	160	350	225	9.5	45	-
W	NFW-1SV	NV125-CV/SV	4	390	265	214	160	350	225	9.5	50	-	36
	NFW-1HV	NV125-HV	4	480	265	239	186	440	225	9.5	60	-	36
	NFW-2SV	NV250-CV/SV/HV, NV125/250-SEV/HEV	4	550	355	264	210	510	315	11	75	-	54
	NFW-4CW	NV400-CW	5	800	355	257	220	760	315	11	85	-	70
	NFW-4SW	NV400-SW/SEW	5	800	355	257	220	760	315	11	85	-	70
	NFW-6SW	NV630-CW/SW/SEW	5	800	355	257	220	760	315	11	85	-	82
	NFW-8SW	NV800-SEW	5	1435	550	339	265	1395	515	15	100	180	104

8. Electrical Operated Circuit Breakers and Electrical Operation Devices



Spring charge type (1)



Spring charge type (2)
Standard paint color: Munsell 5Y7/1



Motor-drive type (2)
Standard paint color: Munsell 5Y7/1

(1) Specifications

● Electrically operated circuit breakers

Table 6-42

Specify the electrical operation device together with the circuit breaker body.

Electrically operating method		Spring charge type (1)	Spring charge type (2)		Motor-drive type (2)		
MCCB	Class S, H and R	NF125-SV, NF125-HV NF125-SEV, NF125-HEV NF125-SGV/LGV/HGV/RGV NF160-SGV/LGV/HGV NF250-SV, NF250-HV NF250-SEV, NF250-HEV NF250-SGV/LGV/HGV/RGV NF125-RV, NF250-RV	NF400-SW, NF400-SEW NF400-HEW, NF400-REW NF630-SW, NF630-SEW NF630-HEW, NF630-REW NF800-SDW, NF800-SEW NF800-HEW, NF800-REW	NF1000-SEW NF1250-SEW NF1250-SDW NF1600-SEW NF1600-SDW	NF400-SW, NF400-SEW NF400-HEW, NF400-REW NF630-SW, NF630-SEW NF630-HEW, NF630-REW NF800-SDW, NF800-SEW NF800-HEW, NF800-REW	NF1000-SEW NF1250-SEW NF1250-SDW NF1600-SEW NF1600-SDW	
	Class C	NF125-CV NF250-CV	NF400-CW NF630-CW NF800-CEW	—	NF400-CW NF630-CW NF800-CEW	—	
	Class U	NF125-UV NF250-UV	NF400-UEW NF800-UEW	—	NF400-UEW NF800-UEW	—	
	Motor breakers	NF125-SV, NF250-SV	—	—	—	—	
ELCB	Class S, H and R	NV125-SV, NV125-HV NV125-SEV, NV125-HEV NV250-SV, NV250-HV NV250-SEV, NV250-HEV	NV400-SW, NV400-SEW NV400-HEW, NV400-REW NV630-SW, NV630-SEW NV630-HEW, NV800-SEW NV800-HEW	—	NV400-SW, NV400-SEW NV400-HEW, NV400-REW NV630-SW, NV630-SEW NV630-HEW, NF800-SEW NV800-HEW (*3)	—	
	Class C	NV125-CV NV250-CV	NV400-CW NV630-CW	—	NV400-CW(*3) NV630-CW	—	
	Motor breakers	NV125-SV, NV250-SV	—	—	—	—	
Rated operating voltage (V) (Allowable operating voltage range: 85 to 110%)		Compatible with 100 to 240 V AC and 100 to 250 V DC 24 V DC, 48 to 60 V DC (*1)	DC100-110, AC100-110 AC200-220(DC125, AC240)		DC100-110, AC100-110, AC200-220 (DC125, AC240)		
Operating current (Ams) Values in (): Starting current	DC	100/110V	ON OFF	0.5 (1.5)	8 1.0 (3.0)	10 1.0 (4.0)	3.0(8.0) 5.0(13.5)
		100/110V	ON OFF	0.6 (3.0)	10 1.0 (3.0)	10 1.0 (3.0)	4.0(8.0) 5.0(10.0)
	AC	200/220V	ON OFF	0.5 (2.5)	8 0.5 (1.5)	8 0.5 (1.5)	2.0(4.5) 3.5(7.0)
		Charge	ON OFF	0.05-0.1(*2) 0.6 or less (self-holding type) 1.2 or less (self-holding type)	0.05 3 or less (self-holding type)	0.07 0.5 (1.5)	0.3 or less (self-holding type)
Required transformer capacity VA		150	700		400	700	
Endurance voltage		1500V	1500V		1500V	1500V	

Notes *1 When the rated operating voltage is 24 V DC or 48 to 60 V DC, specify the voltage. If the voltage is not specified, the circuit breaker will be manufactured for 100 to 240 V AC and 100 to 250 V DC.

*2 For 24-V DC circuit breakers, the operating time at a voltage of 100% or more is shown.

*3 Models for special voltage (125 V DC or 240 V AC) are not provided with the test button.

Remarks 1. Flush plate type circuit breakers can be manufactured to order.

2. The models with voltage in parentheses are special voltage products.

3. For the spring charge type (1), use an ON-OFF operating switch for minute load.

4. For the spring charge type (1) with 3 poles, TC-S, TC-L, TTC, BTC and PTC can be used. For that with 4 poles, only TC-L can be used.

5. When the body of the spring charge type (1) breaker is an earth leakage alarm breaker, the reset button cannot be pressed. Provide such a circuit breaker with an external reset or automatic reset system (except for the electronic type).

6. When the body of the motor-drive type (2) or spring charge type (2) has internal accessories, they are normally provided with lead wire terminal blocks.

7. The types other than the spring charge type (1) do not provide an isolation function.

8. When placing an order for a CE marked product of the spring charge type (1) or spring charge type (2), specify the model name with CE.

9. The switching durability of electrically operated circuit breakers conforms to JIS.

● Electrical operation devices

The following models of Electrical Operation Devices are supplied also as separate devices. The user can install them to the circuit breaker body.

(Front connection, rear connection and plug-in types)

(When requiring a motor breaker or a CE marked product, place an order for it together with the circuit breaker body.)

Table 6-43

Electrically operating method	Spring charge type (1)	
Applicable models	NF125-CV NF125-SV NF125-HV	NV125-CV NV125-SV NV125-HV
Rated operating voltage		
Compactible to 100-240VAC/100-250VDC	MDSAD240-NF1SVJ	MDSAD240-NV1SVJ
24VDC	MDS024-NF1SVJ	MDS024-NV1SVJ
48-60VDC	MDS060-NF1SVJ	MDS060-NV1SVJ

● Cautions

- All electrical operations are based on intermittent rating. Avoid operating any device continuously 10 times or more (ON and OFF operations are counted as one time).
- Operate any device at 85 to 110% of the rated operating voltage.
- The dielectric strength of electrical operation circuits is 1500 V. When performing dielectric strength test of any of these devices and other devices, if the test voltage exceeds the rated value (1500 V), disconnect the operation power supply terminal.
- When collectively operating more than one electrical operation device, isolate the devices connecting a relay to each device.
If the control terminals are directly connected in parallel, a circuit will be formed, and the devices may not normally function.

● Automatic reset (optional)

The automatic reset type has a built-in alarm switch in the circuit breaker and is connected in such a way that the OFF operation circuit is closed when the circuit breaker trips. Therefore, when the circuit breaker trips, it is automatically reset.

However, when the circuit breaker thermally trips, it may not be automatically reset.

If an automatic reset spring charge type (1) is required, the user must wire the device in accordance with the external connection diagram shown in Fig. 1 in (3).

(2) Installation and connection (List of manufacturable)

Table 6-44

Frame (A)	Installation and connection method	Front connection type	Rear connection type	Plug-in type (*1)
50~250		○	○	○ (*2)
400~800		○	○	○
1000, 1250		○	○	○
1600		○	○	-

Notes *1 For ELCB, only 3-pole circuit breakers with a frame size of 125 to 400 A can be manufactured.
*2 In the case of 4-pole 125 A frame circuit breakers and U class, the circuit breakers are supplied as special models. Consult us for details.

Remarks: 1. All models of the front connection type are provided with bar terminals (except the spring charge type (1)).
2. 2-pole circuit breakers of all models are obtained by removing the neutral pole conductors from 3-pole circuit breakers.

(3) Structure and operation

■ Spring charge type (1)

● Electrical operation

- When the ON operation switch is closed, the relay will operate, the motor will be driven, the latch mechanism will be released, and the closing spring force will instantaneously turn on the circuit breaker.
- When the OFF operation switch is closed, the relay will operate, the motor will be driven, the circuit breaker will be turned off (reset), and, at the same time, the closing spring will be charged.

Note: The charge may not be completed because the circuit protective function operates.

● Manual operation

- After turning the MANUAL/AUTO selection switch on the cover upper surface to MANUAL, press the ON button, and the latch mechanism will be released, and the closing spring force will instantaneously turn on the circuit breaker.
- After turning the MANUAL/AUTO selection switch on the cover upper surface to MANUAL, draw out the manual handle, and move it upward and downward about 10 to 14

times. Then, the circuit breaker will be turned off (reset), and, at the same time, the closing spring will be charged. Although the circuit breaker can be turned off even if the switch is not turned to MANUAL, the selection switch should be set to MANUAL because remote operation may be accepted.

- After turning the changeover switch to MANUAL, draw out the OFF lock plate, and lock the circuit breaker in the OFF state with padlocks (to be prepared by the user). Up to three padlocks can be fitted.
φ5 to φ8 padlocks can be fitted.

Note: After the completion of manual operation (on-site operation), return the selection switch to AUTO without fail. If it is not returned, electrical operation (remote operation) cannot be performed.

● Display of tripping state

When the circuit breaker trips in the ON state, the tripping state is displayed. When it trips in the OFF state, the OFF state is kept displayed.

Note: When it trips in the OFF state, signals from AL will not be output.

● Cautions for use

- ① To the ON or OFF operation switch (to be prepared by the user), current only of 24 V DC and 15 to 30 mA flows. Use a switch for minute load.
- ② Operate the operation switch for 0.1 s or more to turn on and for 20 ms or more to turn off. If it is operated for less than the time, it may not function.
The wire to the operation switch shall be less than 100 m.
- ③ The power supply module has a built-in switching power supply. Therefore, it may interfere with communication devices near the module. In such a case, install a noise filter on the input side.
- ④ For the automatic reset type, purchase a circuit breaker with alarm switch (for minute load), and connect the signal circuit (among the terminal numbers S1, S2 and S4) as shown in Fig. 1.

If the circuit breaker in the OFF state is tripped by UVT-N or the like, it cannot be automatically reset. To reset it, it is necessary to turn it on under no current. After this operation, it will be automatically reset.

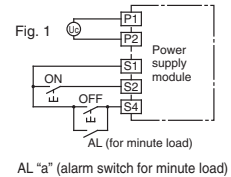

Operation circuit

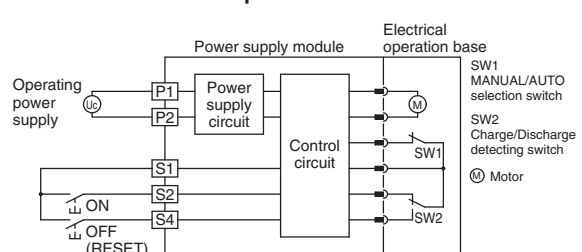

The circuit breaker is off, and the electrical operation device is in the charged state.

Symbol	Interpretation of symbol
SW1	MANUAL/AUTO selection switch
SW2	Limit switch (For spring condition detection charge/discharge)
(M)	Motor

Note *1 When power is applied, inrush current (capacitor charging current) of 60 A flows to the breaker and fuse installed on the power supply circuit for 1 ms or so. When selecting the breaker and fuse, make sure that they will not cause problems, such as blowout and malfunction.

■ **Motor-drive type (2)**

● **Electrical operation**

Forward and reverse motor rotation is changed by ball screw to switch the breaker ON and OFF (reset).

● **Manual operation**

The manual operation handle can be used to switch the breaker ON and OFF directly.

● **Cautions for use**

① In the case of a circuit breaker with UVT, if the circuit breaker trips owing to the operation of UVT, the procedure for re-closing the circuit breaker varies depending on the condition of the electrical operation device before the circuit breaker trips.

- Tripping in ON state: Reset (OFF). → Turn on.
- Tripping in OFF state: Turn on (idle tripping). → Reset (OFF). → Turn on.

(If the circuit breaker cannot be turned on (idle tripping), reset (OFF) it, and turn on.)

- When an automatic reset system is configured on a non-reset type circuit breaker with UVT, if UVT is set to the no-voltage state, the operations to turn off (reset), trip, turn off (reset) and trip are repeated.

Therefore, configure the circuit in such a way that power is disconnected from the electrical operation device before the circuit breaker is tripped by the non-reset type UVT.

- ② Current of about 0.2 A will flow to the ON-OFF switch. Use an appropriate switch.
- ③ Do not apply ON and OFF operation signals continuously. An interval of 0.5 sec or more is necessary between ON and OFF signals.
- ④ In the case of the automatic reset type device, it will perform the reset operation with an interval of 0.5 sec after NFB performs the tripping action.
- ⑤ The electrical operation device has a built-in pumping preventing circuit. Therefore, it can operate to turn off the circuit breaker while the ON operation switch is held in the closing state, but it cannot turn on continuously after turning off. To turn on, once turn off the ON operation switch, and turn on the switch. Do not apply the ON operation signal continuously.
- ⑥ The manual operating handle moves at a high speed during electrical operation. Pay attention to the handle. Keep the operation circuit power supply off during manual operation.
- ⑦ In the manual operation, surely turn the manual operating handle to the position indicated on the nameplate.

● **Operation circuit** For the automatic reset type, the connections indicated with the dashed lines are added.

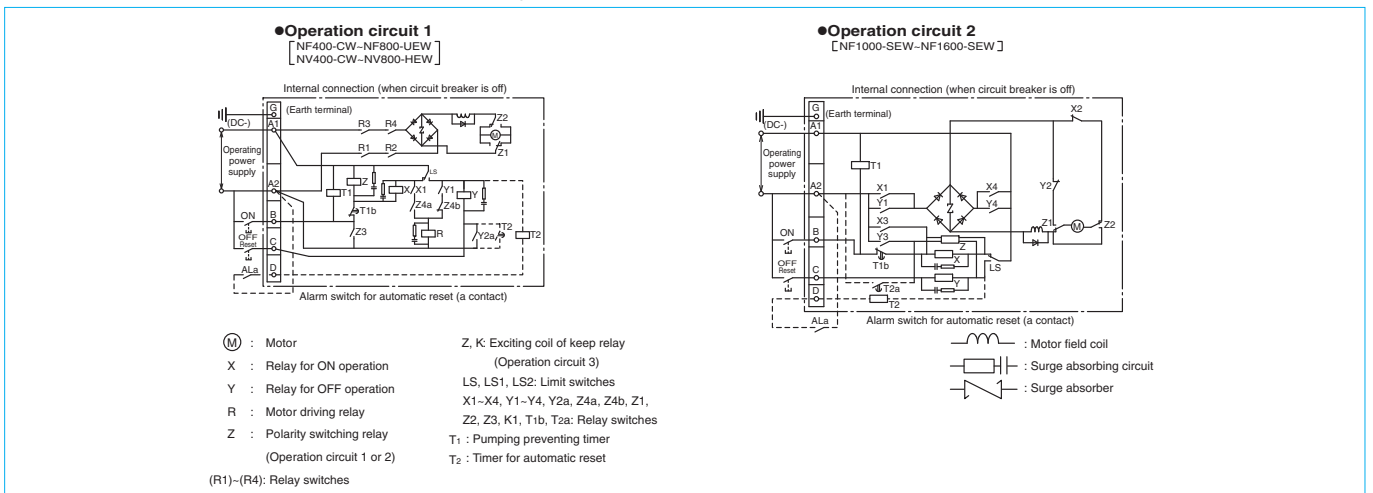

■ **Spring charge type (2)**

● **Electrical operation**

When the ON operation switch is closed, the closing coil will be excited to release the latch mechanism, and the closing spring force will instantaneously turn on the circuit breaker. When the OFF operation switch is closed, the relay will operate to start the motor, turn off (reset) the circuit breaker and, at the same time, charge the closing spring.

● **Manual operation**

- Press the ON button, and the latch mechanism will be released, and the closing spring force will instantaneously turn on the circuit breaker.
- Turning off (resetting)

Push the leaf spring, bring out the manual handle, and move the handle upward and downward more than ten times. Then, the circuit breaker will be turned off (reset), and, at the same time, the closing spring will be charged.

● **Cautions for use**

① In Before installing or removing the electrical operation device to or from the circuit breaker, trip the circuit breaker, and discharge the electrical operation device. After the device is installed to the circuit breaker, the device will not trip the circuit breaker in the OFF state even if the trip button is pressed. This is not a trouble.

The electrical operation device takes 3 seconds to turn off the circuit breaker. To open the circuit immediately by remote operation, use a circuit breaker with SHT or UVT.

- The device has a built-in pumping preventing relay.
- ② Current of about 9 A and 0.2 A will flow to the ON and OFF switches, respectively. Use appropriate switches.

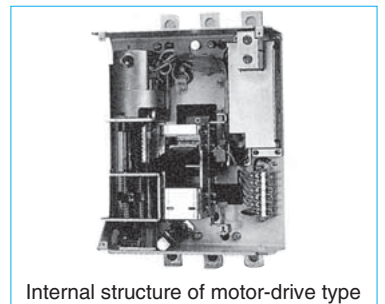
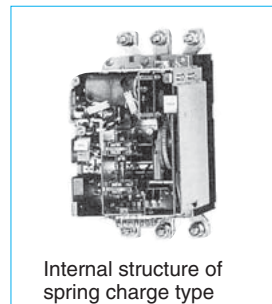

● **Operation circuit**

For the automatic reset type, the connections indicated with the dashed lines are added.

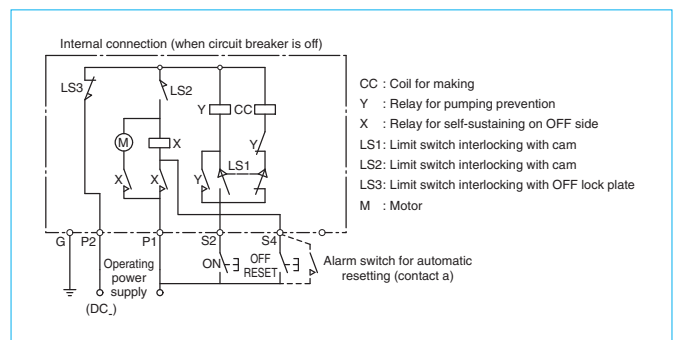

9. Distribution Board Mounting Parts, Lock Covers and Handle Caps

● BPA-type mounting base (for BH-PS and HBH-P)

Single-phase-type

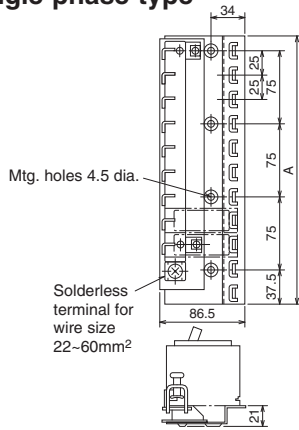

Note: Single-phase types have no central pole.

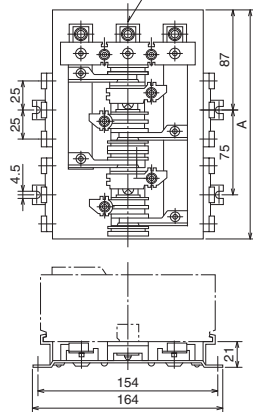

Solderless terminal for wire size :
125A 14-50mm²
250A 22-125mm²

Three-phase-type

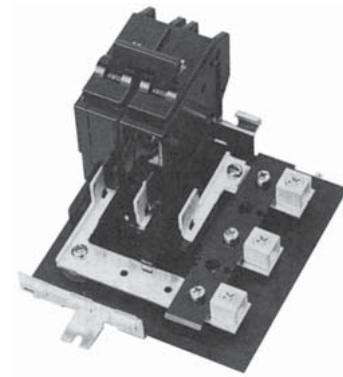

Max. no. of ways	1ph, 2w		1ph, 3w		3ph, 4w		Neutral terminal
	Main : 125A	Main : 250A	Main : 125A	Main : 250A	Main : 125A	Main : 250A	
6	BPA-1106	BPA-2106	-	-	BPA-3106	-	NT-06
9	BPA-1109	-	-	-	-	-	-
12	BPA-1112	BPA-2112	-	-	BPA-3112	-	NT-12
15	BPA-1115	-	-	-	-	-	-
18	BPA-1118	BPA-2118	BPA-2218	-	BPA-3118	BPA-3218	NT-18
24	-	BPA-2124	BPA-2224	-	BPA-3124	BPA-3224	NT-24
30	-	-	BPA-2230	-	-	BPA-3230	NT-30
36	-	-	BPA-2236	-	-	BPA-3236	NT-36
42	-	-	-	-	-	BPA-3242	NT-42

● Mounting plate (for HBH and BH-S)

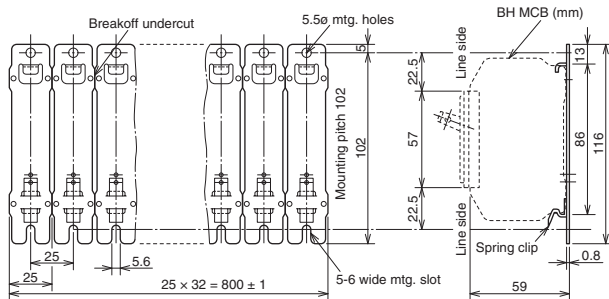

One mounting plate has 32 circuits.
One package includes 10 mounting plates (320 circuits).

● Lock covers and handle caps (for 1-pole, 2-pole and 3-pole types)

Many panelboards include some restricted-operation circuits, which must either normally remain on, such as all-night lighting or alarms, or must remain off, such as spare circuits, or circuits used in repair or construction work. Breakers for such circuits can be locked by simply installing a lock cover on the handle.

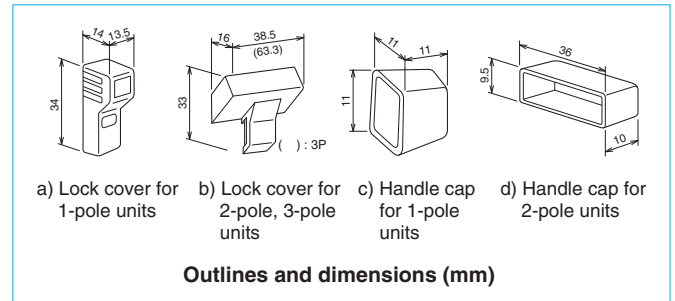

Colors available

Fig. ref.	Item	Poles	Colors		
			Red	Yellow	Green
a)	Lock cover	1	LCBH1R	LCVH1Y	—
b)		2	LCBH2R	LCBH2Y	—
b)		3	LCBH3R	LCBH3Y	—
c)	Cap	1	HC1R	HC1Y	HC1G
d)		2	HC2R	HC2Y	HC2G

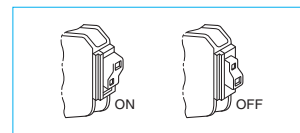

Lock cover in place (1-pole unit)

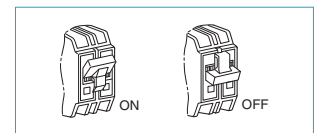

Lock cover in place (2-pole unit)

10. IEC 35-mm Rail Mounting Adapters

Table 6-45

Type name	Number of poles of circuit breaker	Applicable model		Fig.
		MCCB	ELCB	
DIN-03CS	2, 3	NF30-CS	—	Fig. 1
(Note1) DIN-05SV	2, 3	NF32-SV NF63-CV/SV/HV	NV32-SV NV63-CV/SV/HV	Fig. 2

Remark: 1. Place an order in units of 10 pieces.

● External dimension

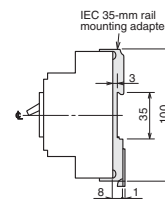

Fig. 1

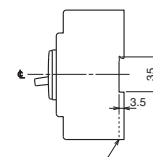

Fig. 2 Mounting hook for IEC 35mm rail [DIN-05SV]

7

Characteristics and Dimensions

1 Molded Case Circuit Breakers 142

• NF30-CS	142
• NF32-SV, NF63-CV/SV/HV	144
• NF125-CV/SV/HV	146
• NF125-UV	148
• NF250-CV/SV/HV	150
• NF250-UV	152
• NF125-SGV/LGV/HGV/RGV, NF160-SGV/LGV/HGV, NF250-SGV/LGV/HGV/RGV	154
• NF125-SEV/HEV, NF250-SEV/HEV	156
• NF400-CW/SW	158
• NF400-SEW/HEW/REW	160
• NF400-UEW	162
• NF630-CW/SW	164
• NF630-SEW/HEW/REW	166
• NF800-CEW/SEW/HEW/REW	168
• NF800-SDW	170
• NF800-UEW	172
• NF1000-SEW, NF1250-SEW	174
• NF1250-SDW	176
• NF1600-SEW	178
• NF1600-SDW	180

2 Earth Leakage Circuit Breakers 182

• NV32-SV, NV-63CV/SV/HV	182
• NV125-CV/SV/HV	184
• NV250-CV/SV/HV	186
• NV125-SEV/HEV, NV250-SEV/HEV	188
• NV400-CW/SW	190
• NV400-SEW/HEW/REW	192
• NV630-CW/SW	194
• NV630-SEW/HEW	196
• NV800-SEW/HEW	198

3 UL 489 Listed Circuit Breakers 200

• NF50-SVFU, NV50-SVFU	200
• NF100-CVFU, NV100-CVFU	202
• NF125-SVU/HVU, NV125-SVU/HVU	204
• NF225-CWU	206
• NF250-SVU/HVU, NV250-SVU/HVU	208
• NF-SKW	210
• NF-SLW	212

4 Measuring Display Unit Breakers 214

• NF250-SEV/HEV with MDU	214
• NF400-SEP/HEP with MDU	216
• NF630-SEP/HEP with MDU, NF800-SEP/HEP with MDU ...	218

5 Miniature Circuit Breakers, Residual Current Circuit Breakers, Residual Current Circuit Breakers with Overcurrent Protection and Isolating Switch 220

• BH,BH-P	220
• BH-S.....	221
• BH-PS	222
• BH-D6, BH-D10	223
• BH-DN	224
• BV-D.....	225
• BV-DN	226
• KB-D.....	227

6 Circuit Protectors 228

• CP30-BA	228
-----------------	-----

7 Electrical Operated Circuit Breakers 229

NF30-CS



NF30-CS

Model		NF30-CS		
Rated current In (A)		3, 5, 10, 15, 20, 30		
Number of poles		2	3	
Rated insulation voltage Ui (V)		500		
Rated short-circuit breaking capacity (kA)	IEC 60947-2 (Icu/Ics)	AC	690V	-
			500V	-
			415V	1.5/1.5
			380V	1.5/1.5
			240V	2.5/2
Standard Attached Parts (Front connection)			Mounting screw: M4x0.7x20 (2pcs)	

Operating Characteristics

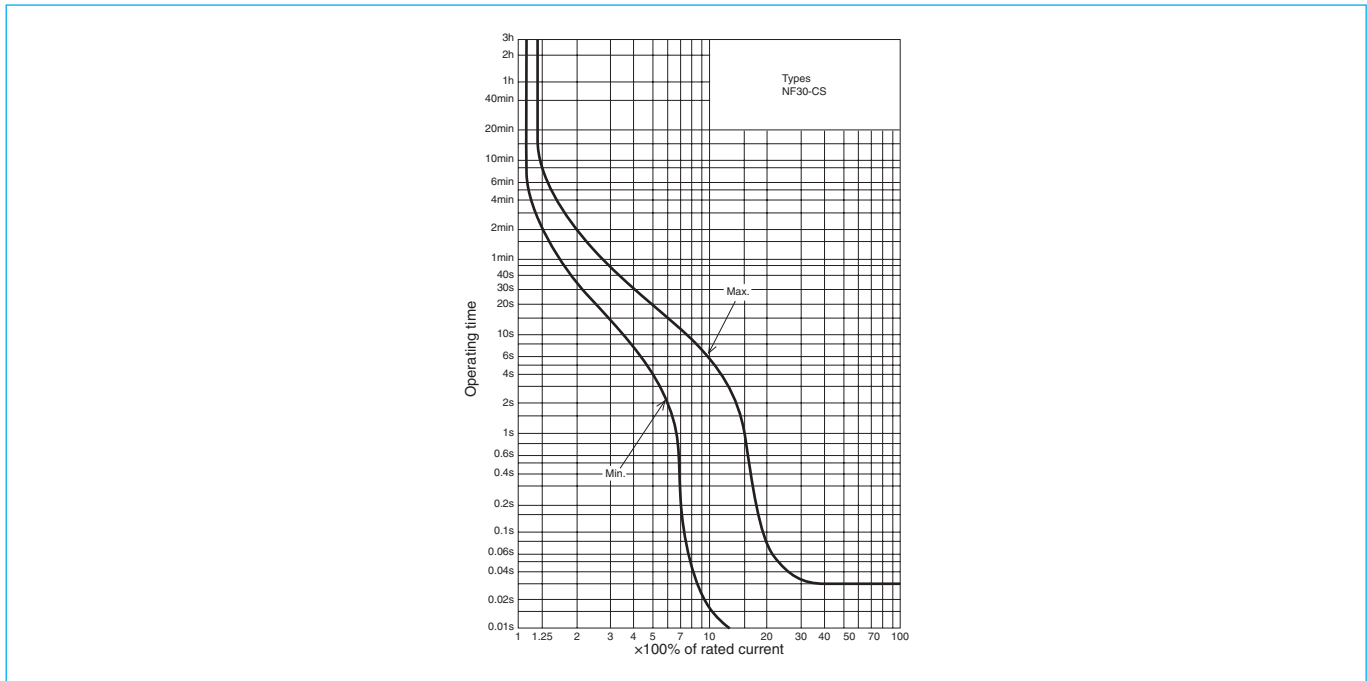

Internal Accessories

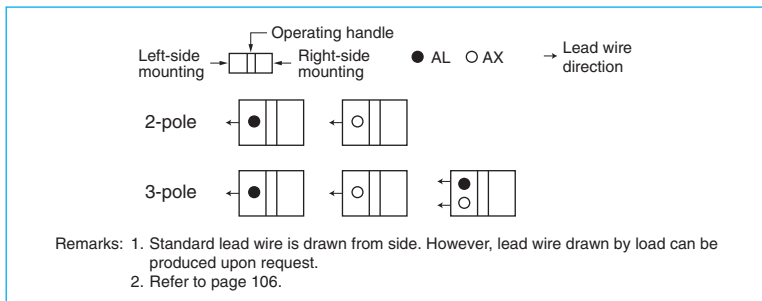

Temperature Characteristics Curve

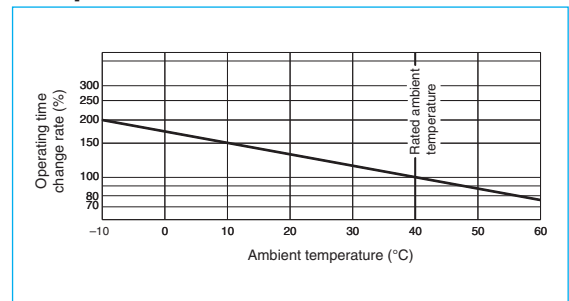

External Accessories

Accessories		Type name	Reference page
Terminal cover	Small	(TC-S) TCS-03CS3W (*1)	123
	Large	(TC-L) TCL-03CS3W (*1)	
	Rear	(BTC) BTC-03CS3W (*1)	
	Skeleton	(TTC) TTC-03CS (*1)	
Handle lock		(HL) HL-05FH	129
Lock cover		(LC) LC03CS	130
IEC 35mm rail mounting adapter		(DIN) DIN-03CS	139

Note *1 The designation depends on the number of poles. Refer to the reference page.

Outline Drawing

Front connection

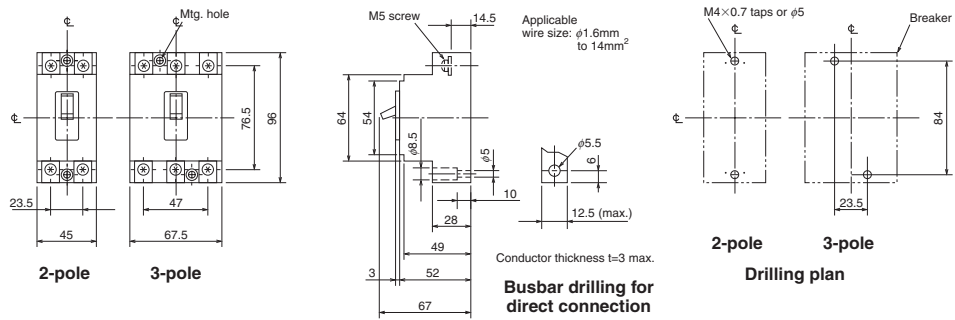

Rear connection

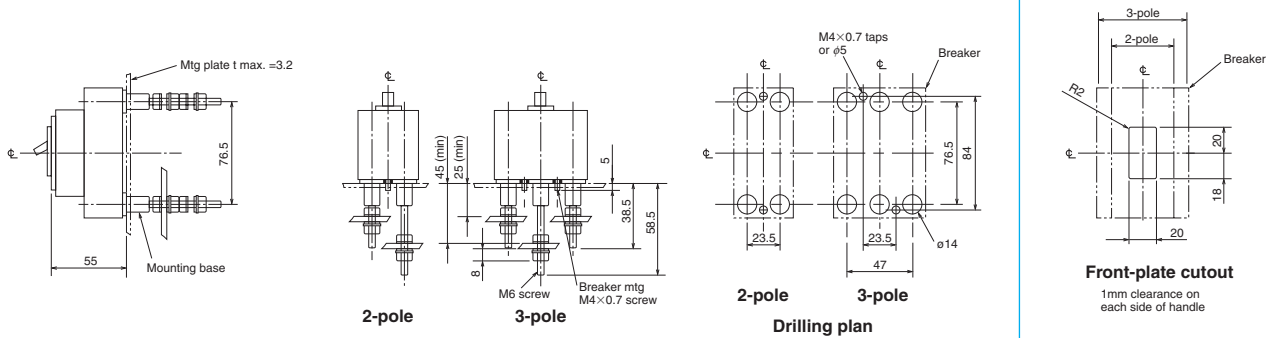

IEC Rail Mounting Adapter

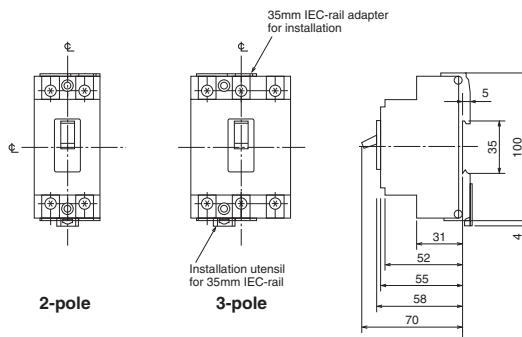

NF32-SV NF63-CV NF63-SV NF63-HV



NF63-SV

Model		NF32-SV	NF63-CV	NF63-SV	NF63-HV		
Rated current In (A)		3 4 (5) 6 10 (15) 16 20 25 (30) 32	3 4 (5) 6 10 (15) 16 20 25 (30) 32 40 50 (60) 63	3 4 (5) 6 10 (15) 16 20 25 (30) 32 40 50 (60) 63	10 (15) 16 20 25 (30) 32 40 50 (60) 63		
Number of poles		2 3	2 3	2 3 4	2 3 4		
Rated insulation voltage Ui (V)		600		600	690		
Rated short-circuit breaking capacity (kA)	IEC 60947-2 (Icu/Ics)	AC	690V	-	-	2.5/2.5	
			500V	2.5/2.5	2.5/2.5	7.5/7.5	7.5/7.5
			440V	2.5/2.5	2.5/2.5	7.5/7.5	10/8
			415V	2.5/2.5	2.5/2.5	7.5/7.5	10/8
			400V	5/5	5/5	7.5/7.5	10/8
			380V	5/5	5/5	7.5/7.5	10/8
			230V	7.5/7.5	7.5/7.5	15/15	25/19
	DC	250V (*1)	2.5/2.5	7.5/7.5	7.5/7.5		
Standard attached parts (front connection)		Mounting screw: M4x0.7x55 (2 and 3P: 2pcs, 4P: 4pcs) Insulation barrier: (2P: 1pc, 3P: 2pcs, 4P: 3pcs) (*2)					

Notes *1 Use two poles for three- and four-pole products. Not available for use with connection as shown at the bottom of page 14.
*2 Supplied with NF63-SV and NF63-HV.

Operating Characteristics

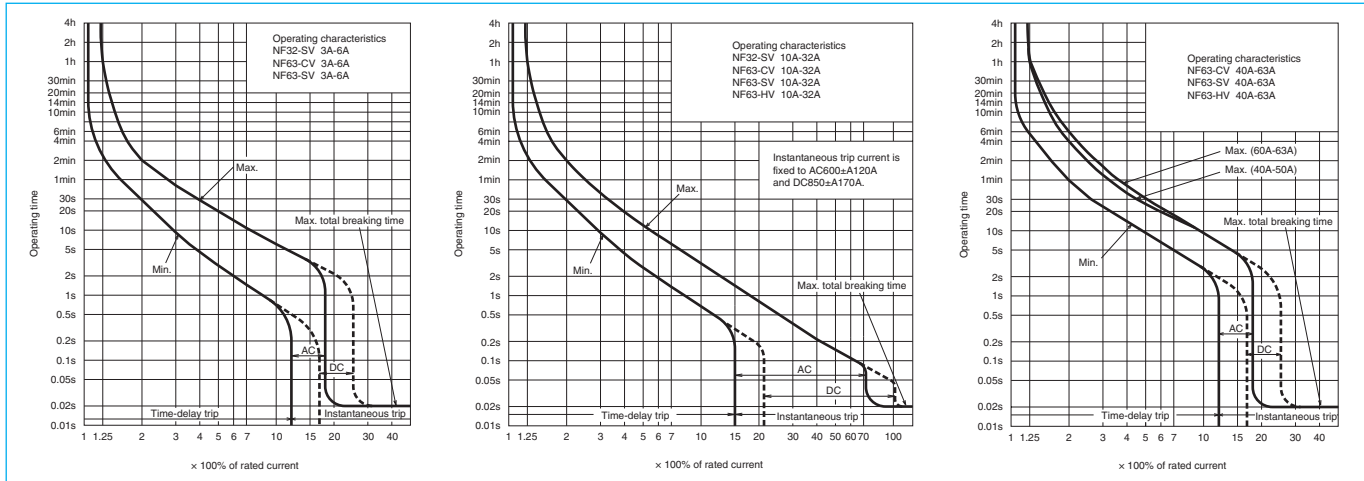

Internal Accessories

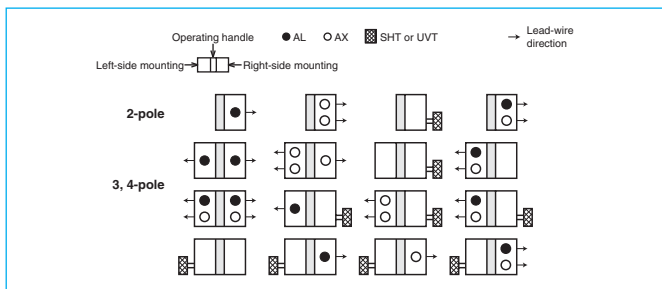

Temperature Compensation Curve

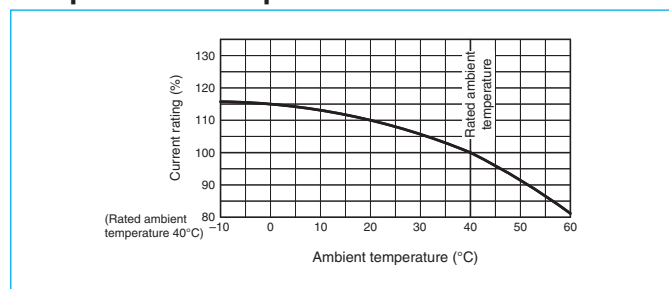

External Accessories

Accessories		Type name	Reference page	Accessories		Type name	Reference page	
Operating handle	F	2P F-05SV2	119	Mechanical interlock	MI	2, 3P MI-05SV3	131	
		3, 4P F-05SV				4P MI-05SV4		
	V	2P V-05SV2	121		Terminal cover	Small	TC-S	2P TCS-05SV2
		3, 4P V-05SV						3P TCS-05SV3
Handle lock device	LC	LC-05SV	129	Large		TC-L	2P TCL-05SV2	
	HL(*1)	HLF-05SV					2P TCL-05SV2L	
		HLN-05SV		3P TCL-05SV3				
	HL-S	HLS-05SV				4P TCL-05SV4	123	
Terminal cover	Skeleton	TTC	2P TTC-05SV2	Rear	BTC	2P BTC-05SV2		
						3P TTC-05SV3		3P BTC-05SV3
	Plug-in	PTC	2P PTC-05SV2	2P PTC-05SV2	Plug-in	PTC		2P PTC-05SV2
							3P PTC-05SV3	3P PTC-05SV3
IEC 35mm rail mounting adapters		DIN-05SV					139	

Note *1 HLF types are used for OFF lock and HLN types for ON lock.

Outline Drawing

Front connection

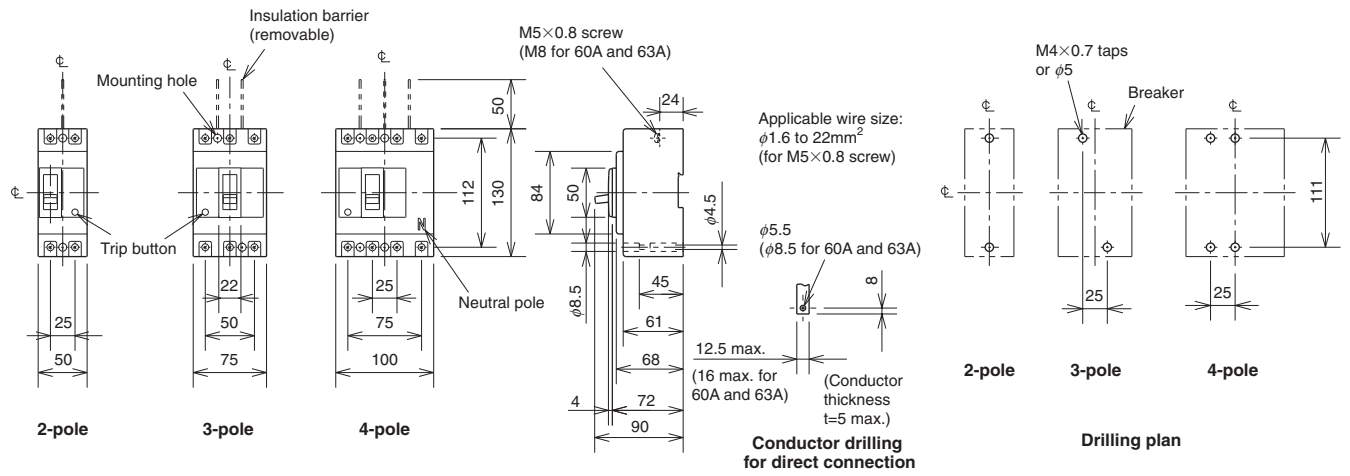

Rear connection

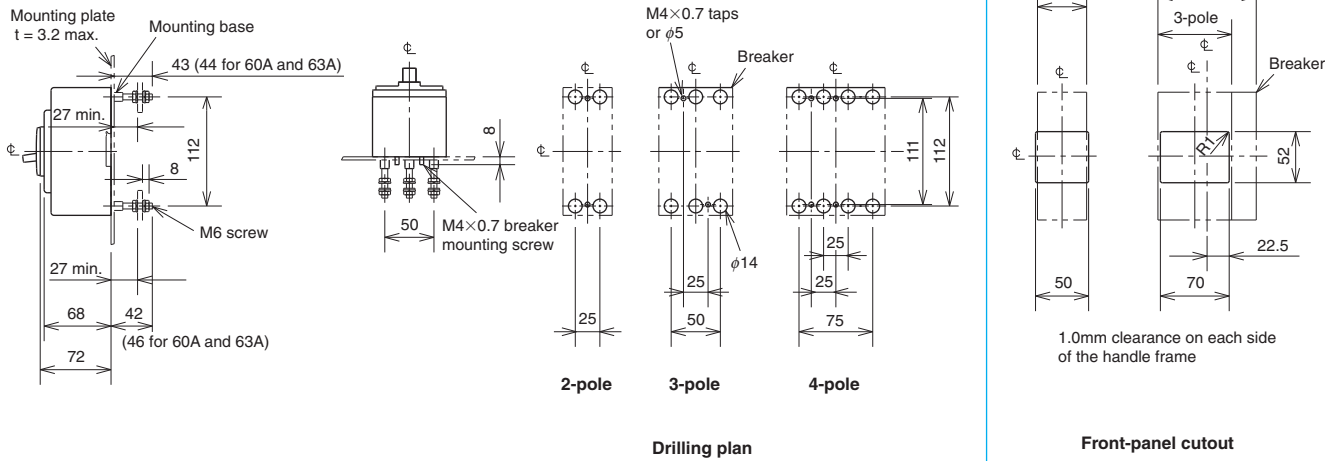

Plug-in

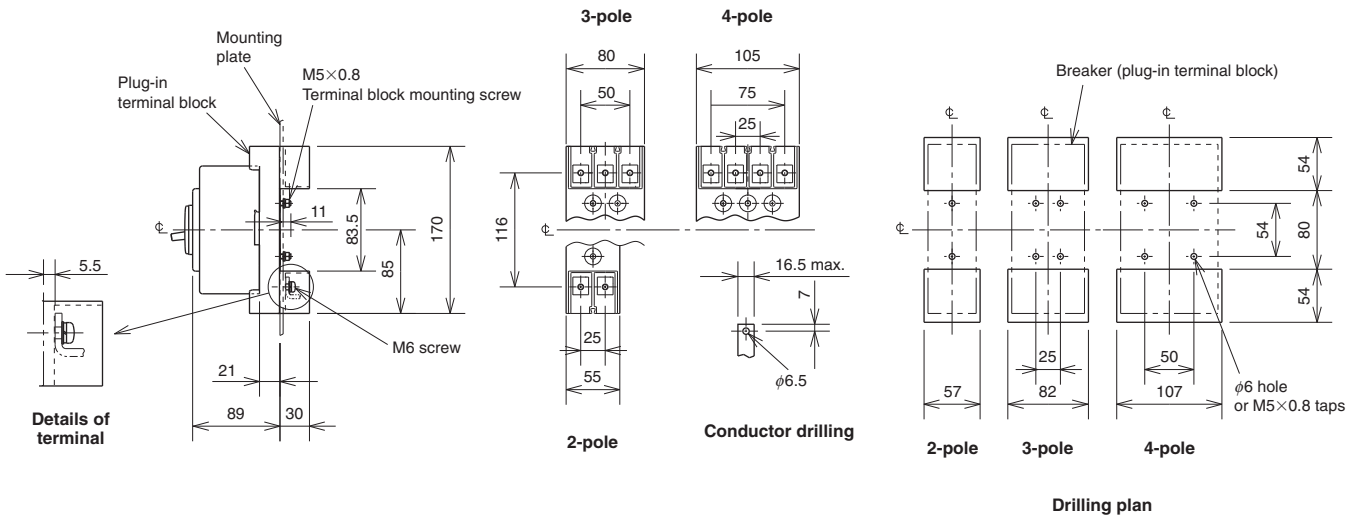

Remark: 1. Only 2-pole and 3-pole models are available for NF32-SV and NF63-CV.

NF125-CV NF125-SV NF125-HV



NF125-SV

Model		NF125-CV					NF125-SV			NF125-HV					
Rated current In (A)		50 (60) 63 (75) 80 100 125					(15) 16 20 (30) 32 40 50 (60) 63 (75) 80 100 125			(15) 16 20 (30) 32 40 50 (60) 63 (75) 80 100 125					
Number of poles		2		3			2	3		4		2	3	4	
Rated insulation voltage Ui (V)		600					690			690					
Rated short-circuit breaking capacity (kA)	IEC 60947-2 (Icu/Ics)	AC	690V		-					8/8			10/8		
			500V		7.5/4					18/18			30/23		
			440V		10/5					25/25			50/38		
			415V		10/5					30/30			50/38		
			400V		10/5					30/30			50/38		
			380V		10/5					30/30			50/38		
			230V		30/15					50/50			100/75		
Standard attached parts (front connection)		DC	250V (*1)		7.5/4					40/40			-		
				Mounting screw: M4x0.7x55 (2 and 3P: 2pcs, 4P: 4pcs) (*2) Insulation barrier: (2P: 1pc, 3P: 2pcs, 4P: 3pcs)											

Notes *1 Use two poles for three- and four-pole products.
If wired as shown at the bottom on page 14, three and four poles can be used for up to 400 and 500VDC, respectively.
*2 Supplied with NF125-SV and NF125-HV.

Operating Characteristics

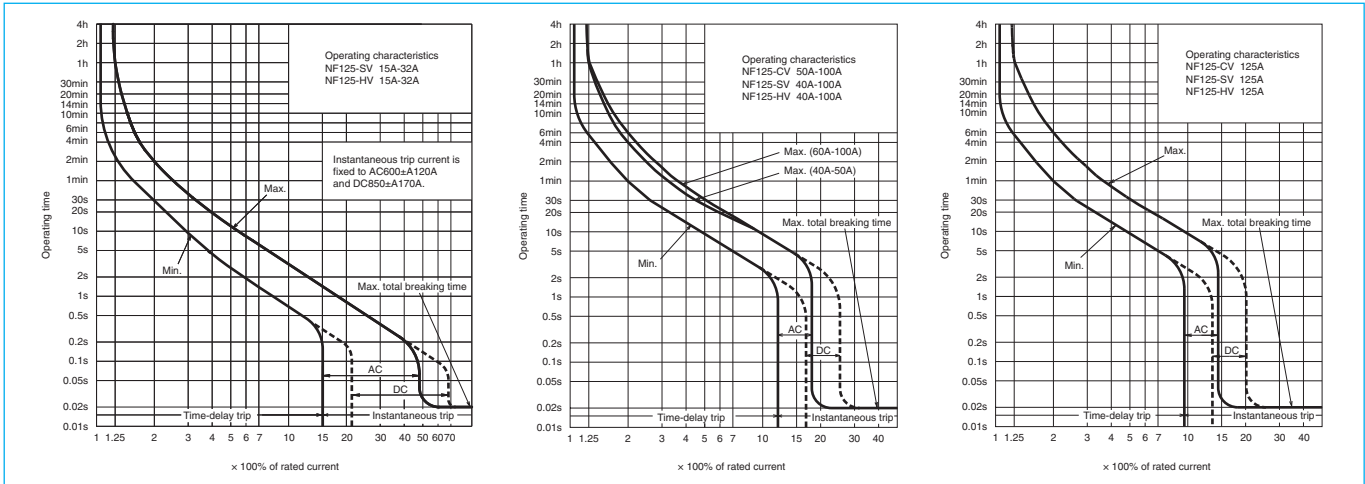

Internal Accessories

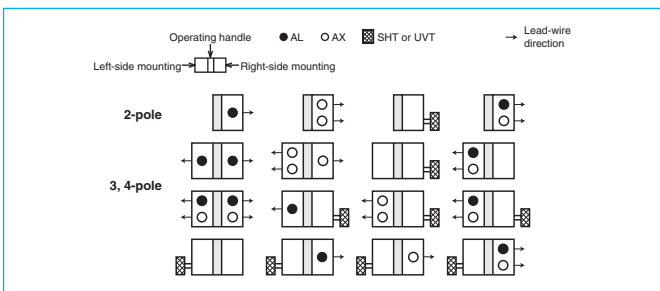

Temperature Compensation Curve

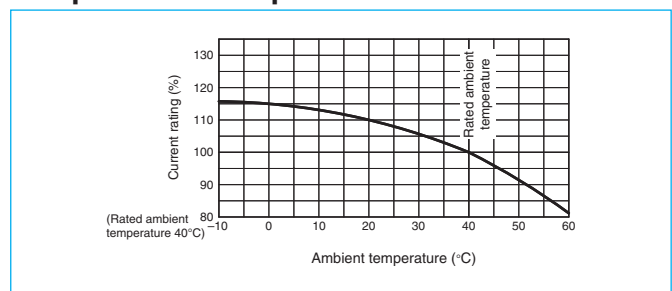

External Accessories

Accessories		Type name	Reference page	Accessories		Type name	Reference page	
Operating handle	F	2P F-1SV2	119	Mechanical interlock	MI	2, 3P MI-05SV3	131	
		3, 4P F-1SV				4P MI-05SV4		
	V	2P V-1SV2	121	Terminal cover	Small	TC-S		2P TCS-1SV2
		3, 4P V-1SV				3P TCS-1SV3		
Handle lock device	LC	LC-05SV	129		Large	TC-L	2P TCL-1SV2	
	HL(*1)	HLF-05SV				3P TCL-1SV3		
		HLN-05SV			4P TCL-1SV4			
	HL-S	HLS-05SV			Skeleton	TTC	2P TTC-1SV2	
			Rear		BTC	3P TTC-1SV3	123	
						2P BTC-1SV2		
			Plug-in	PTC	3P BTC-1SV3			
					2P PTC-1SV2			
					3P PTC-1SV3			
				Electrical operation device	(*2)		135	

Notes *1 HLF types are used for OFF lock and HLN types for ON lock.
*2 Specify the working voltage. Refer to the reference page for type name.

Outline Drawing

Front connection

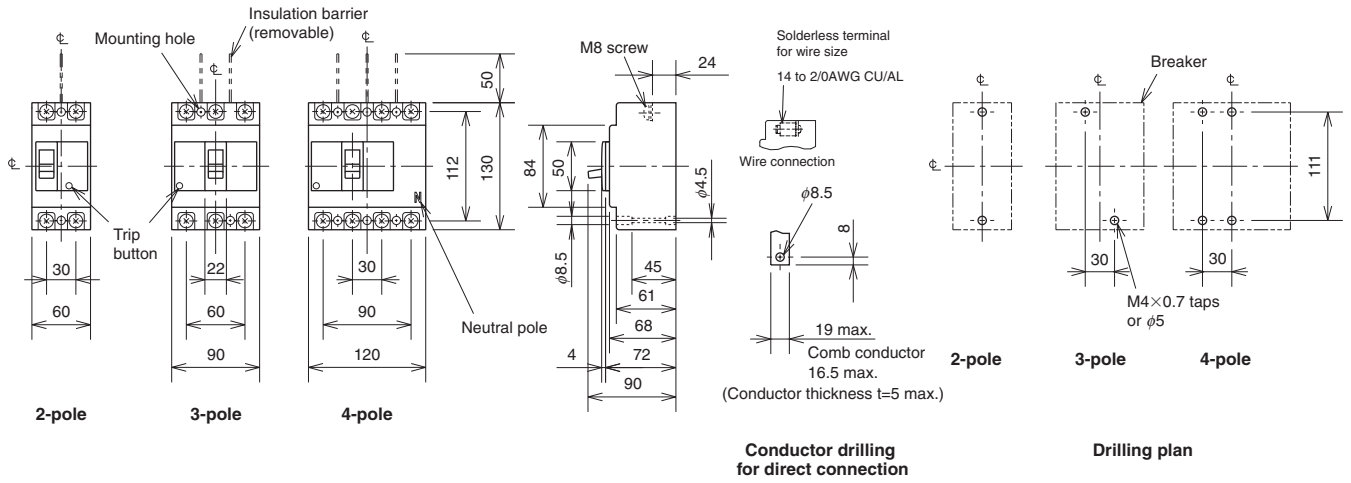

Rear connection

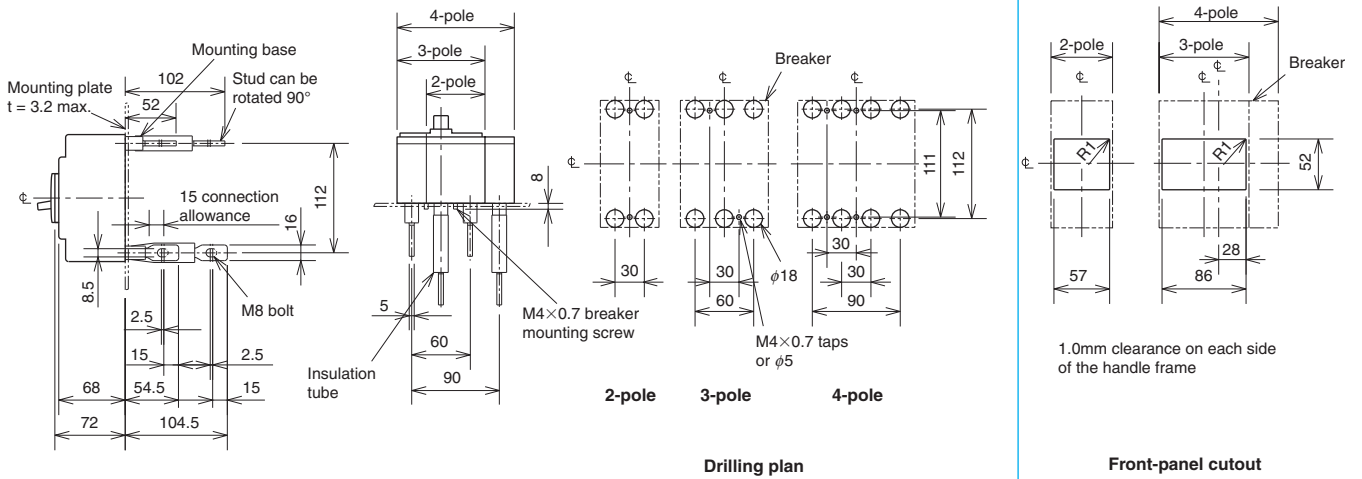

Plug-in

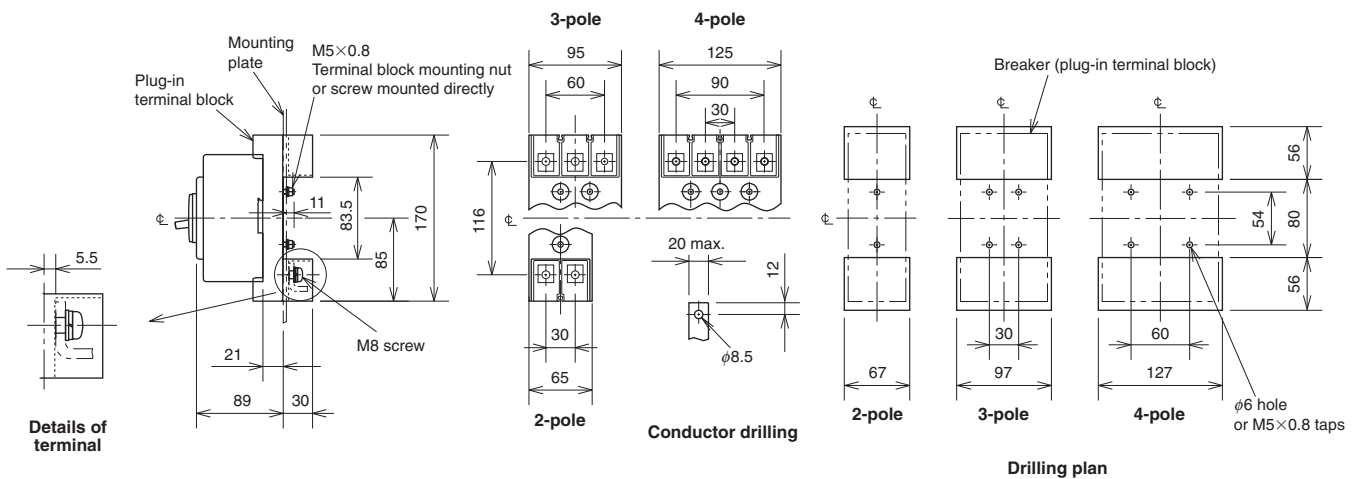

Remarks: 1. The 2-pole models of NF125-HV are 3-pole models with the central pole removed.
 2. Only 2-and 3-pole models are available for NF125-CV.

NF125-UV



NF125-UV

Model		NF125-UV				
Rated current In (A)		15	20	30	40	50
Number of poles		2		3	4	
Rated insulation voltage Ui (V)		690				
Rated short-circuit breaking capacity (kA)	IEC 60947-2 (Icu/Ics)	AC	690V	10/10		
			500V	200/200		
			440V	200/200		
			415V	200/200		
			400V	200/200		
			380V	200/200		
			230V	200/200		
	DC	250V	-			
Standard attached parts (front connection)		Mounting screw: M4x0.7x55 (2 and 3P: 2pcs, 4P: 4pcs) M4x0.7x73 (2 and 3P: 2pcs)				

Operating Characteristics

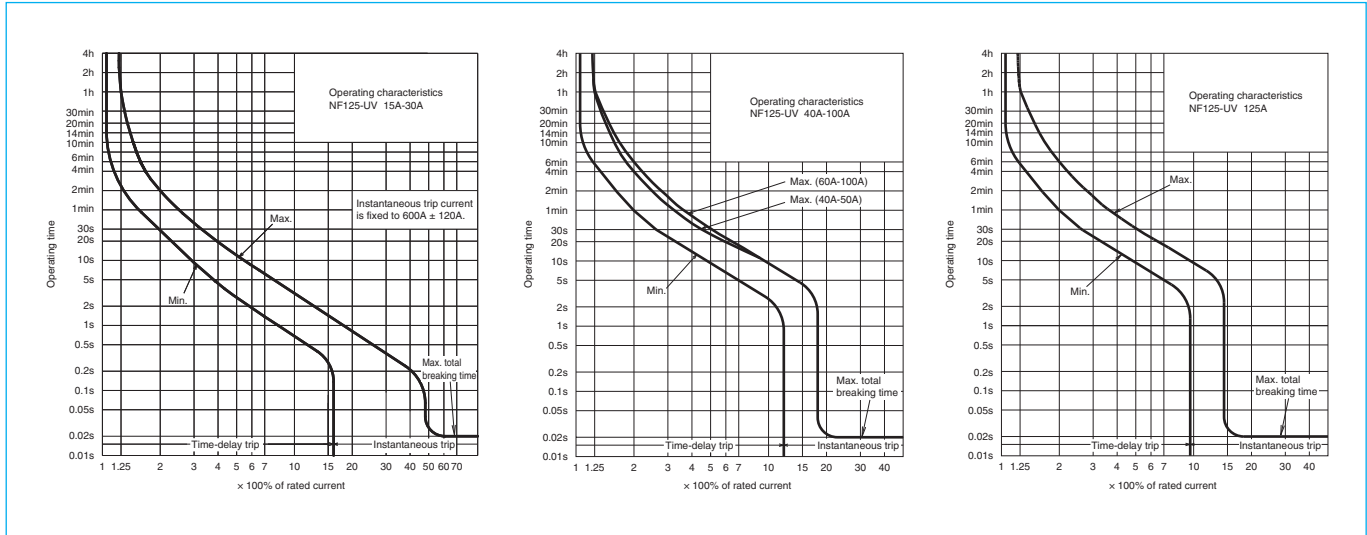

Internal Accessories

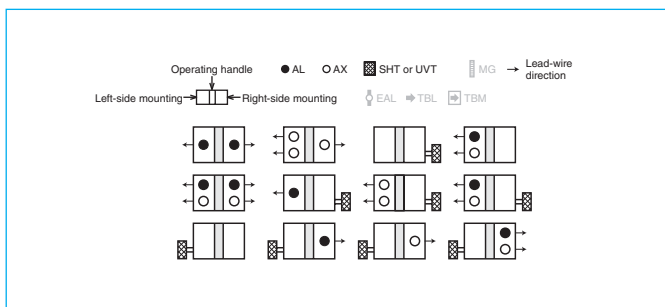

Temperature Compensation Curve

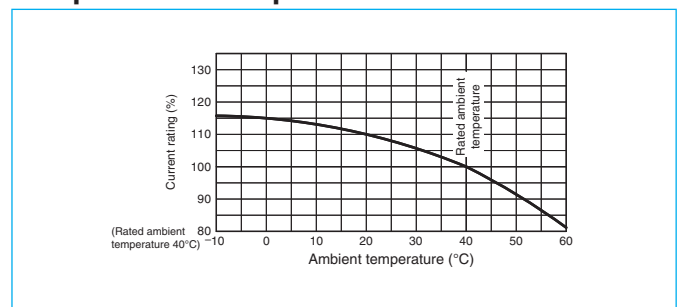

External Accessories

Accessories		Type name	Reference page	Accessories		Type name	Reference page		
Operating handle	F	F-1UV	119	Mechanical interlock	MI	2, 3P	MI-05SV3		
	V	V-1UV	121				4P	MI-05SV4	
Lock cover	LC	LC-05SV	129	Terminal cover	Small	TC-S	3P	TCS-1SV3	
Handle lock device	HL (*1)	HLF-05SV					Large	TC-L	3P
		HLN-05SV				4P			TCL-1SV4
	HL-S	HLS-05SV			Skeleton	TTC	3P	TTC-1SV3	
					Rear	BTC	3P	BTC-1SV3	
				Plug-in	PTC	3P	PTC-1SV3		
				Electrical operation device	(*2)		135		

Notes *1 HLF types are used for OFF lock and HLN types for ON lock.
*2 Specify the working voltage. Refer to the reference page for type name.

Outline Drawing

Front connection

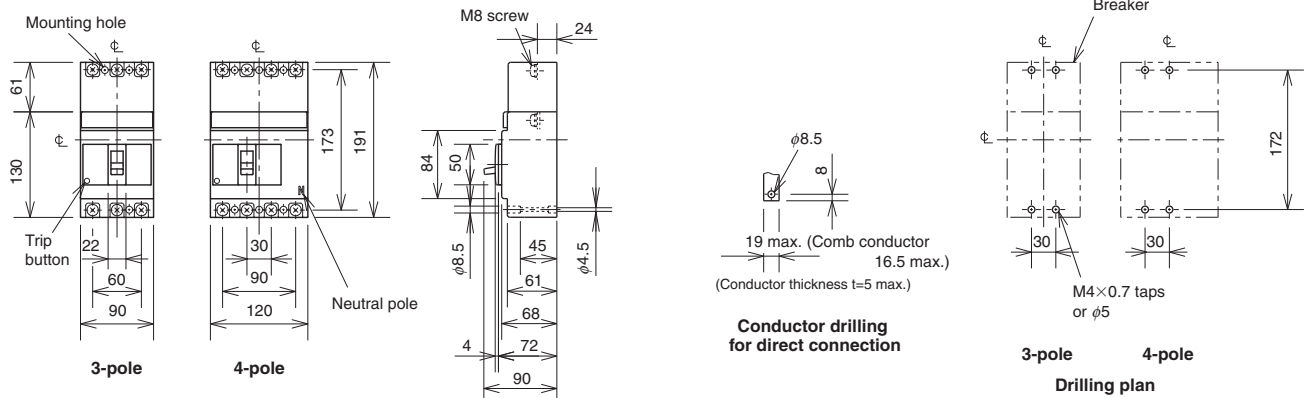

Rear connection

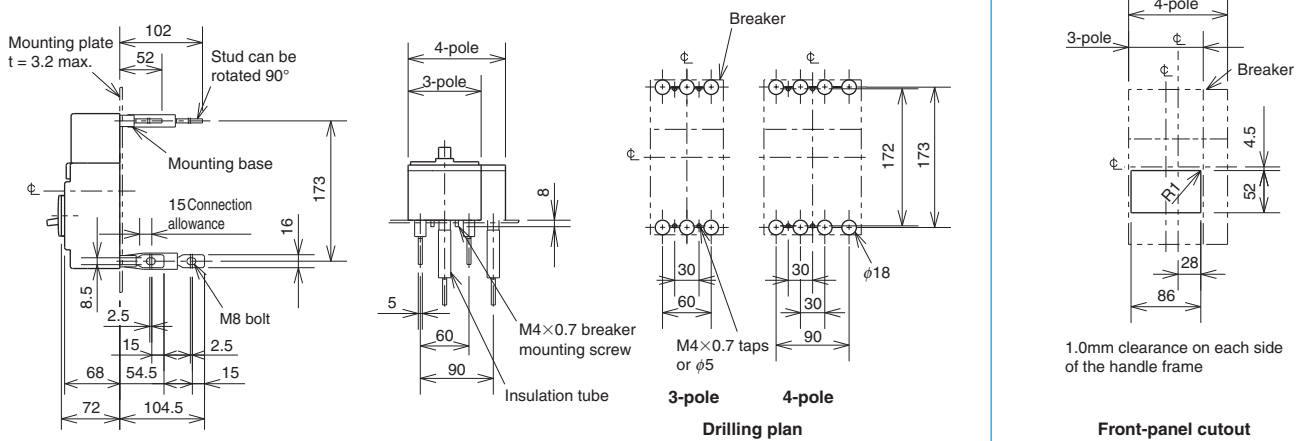

Plug-in

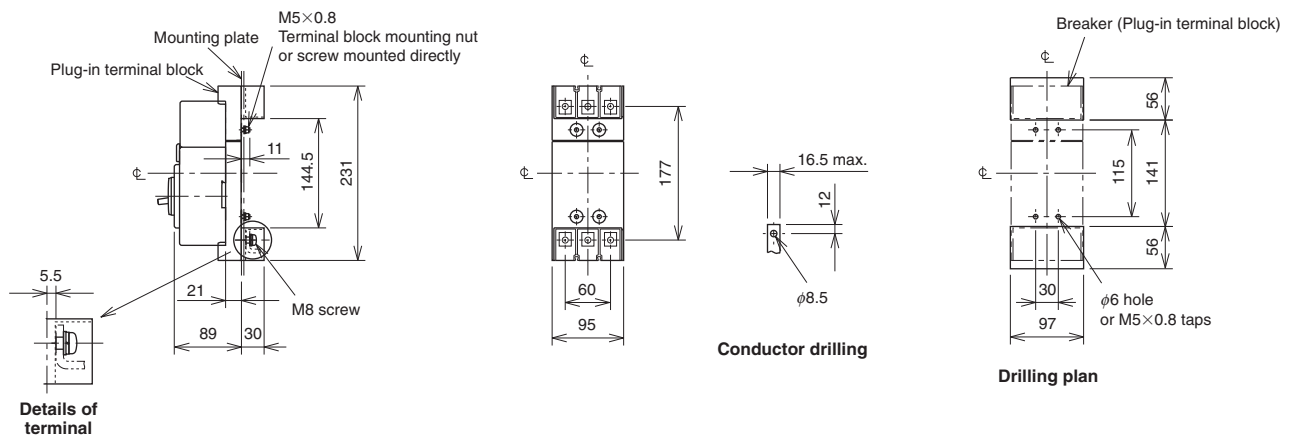

Remark: 1. 2-pole models are 3-pole models with the central pole removed.

NF250-CV NF250-SV NF250-HV



NF250-SV

Model		NF250-CV		NF250-SV			NF250-HV			
Rated current In (A)		(*1) (100) 125 150 175 200 225 250		(*1) (100) 125 150 160 175 200 225 250			125 150 160 175 200 225 250			
Number of poles		2 3		2 3 4			2 3 4			
Rated insulation voltage Ui (V)		600		690			690			
Rated short-circuit breaking capacity (kA)	IEC 60947-2 (Icu/Ics)	AC	690V	-			8/8			
			500V	10/8			30/30			
			440V	15/12			36/36			
			415V	25/19			36/36			
			400V	25/19			36/36			
			380V	25/19			36/36			
		230V	36/27			85/85				
DC (*1)	250V	15/12			20/20 (300V)			40/40 (300V)		
Standard attached parts (front connection)		Mounting screw: M4x0.7x55 (2 and 3P: 2pcs, 4P: 4pcs) Insulation barrier: (2P: 2pcs, 3P: 4pcs, 4P: 6pcs)								

Note *1 Use two poles for three- and four-pole products. In this case, do not use the neutral pole of the four-pole products. If wired as shown at the bottom of page 14, three-pole NF250-CV can be used for up to 400VDC, three-pole NF250-SV and NF250-HV up to 500VDC and four-pole products up to 600VDC.

Operating Characteristics

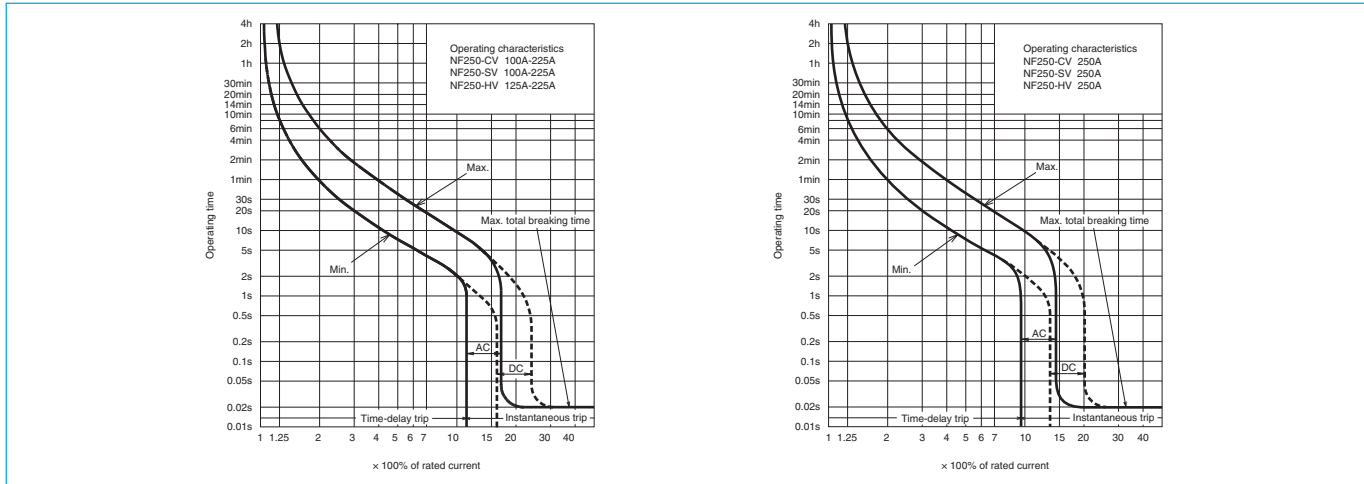

Internal Accessories

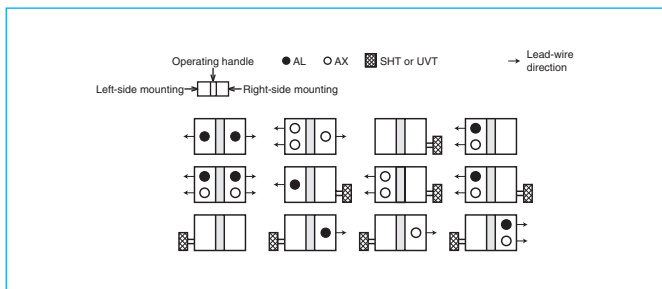

Temperature Compensation Curve

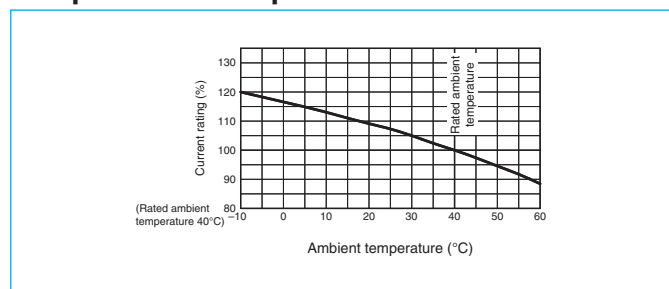

External Accessories

Accessories		Type name	Reference page	Accessories		Type name	Reference page	
Operating handle	F	F-2SV	119	Mechanical interlock	2, 3P	MI-05SV3	131	
	V	V-2SV	121		4P	MI-2SV4		
Handle lock device	LC	LC-05SV	129	Terminal cover	Small	2, 3P	TCS-2SV3	123
	HL(*1)	HLF-05SV				2, 3P	TCL-2SV3	
	HL-S	HLS-2SV			4P	TCL-2SV4		
			Skeleton		TTC	2, 3P	TTC-2SV3	
			Rear		BTC	2, 3P	BTC-2SV3	
			Plug-in	PTC	2, 3P	PTC-2SV3		
Electrical operation device						(*2)	135	

Notes *1 HLF types are used for OFF lock and HLN types for ON lock.
*2 Specify the working voltage. Refer to the reference page for type name.

NF250-UV



NF250-UV

Model		NF250-UV		
Rated current I _n (A)		125	150	175
		200	225	250
Number of poles		2	3	4
Rated insulation voltage U _i (V)		690		
Rated short-circuit breaking capacity (kA)	IEC 60947-2 (Icu/Ics)	AC	690V	15/15
			500V	200/200
			440V	200/200
			415V	200/200
			400V	200/200
			380V	200/200
		DC	250V	-
Standard attached parts (front connection)		Mounting screw: M4×0.7×55 (2 and 3P: 2pcs, 4P: 4pcs) Mounting screw: M4×0.7×73 (2 and 3P: 2pcs) Insulation barrier: (2P: 2pcs, 3P: 4pcs, 4P: 6pcs)		

Operating Characteristics

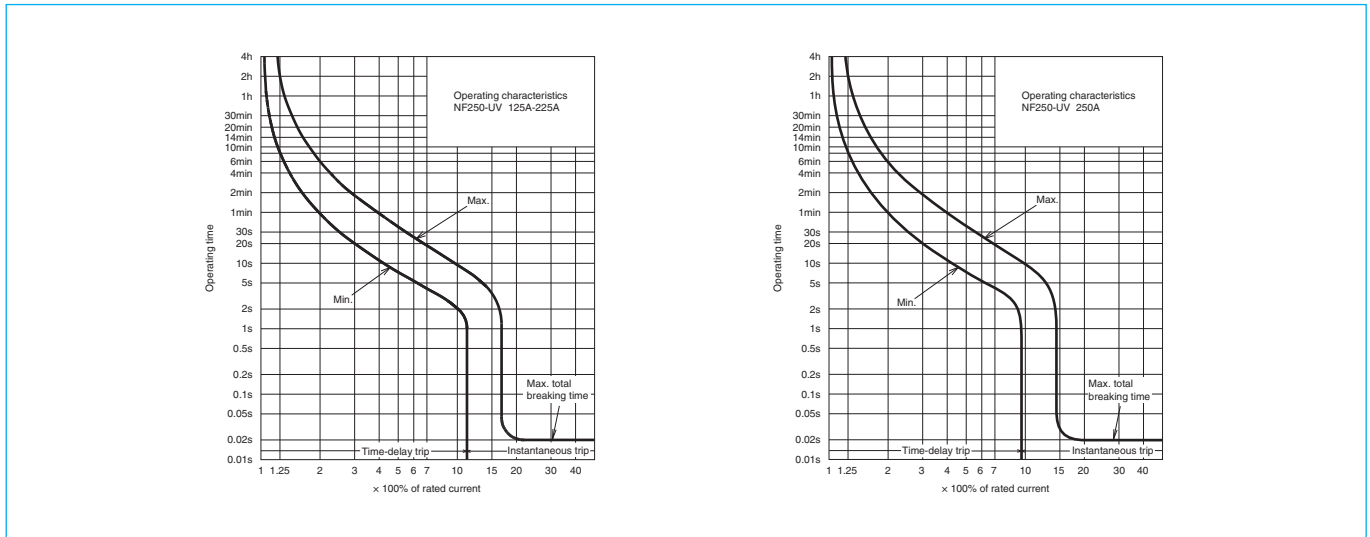

Internal Accessories

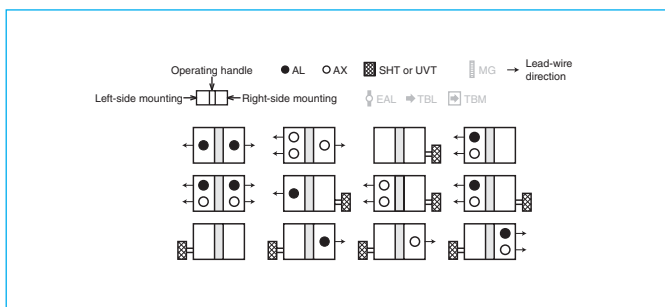

Temperature Compensation Curve

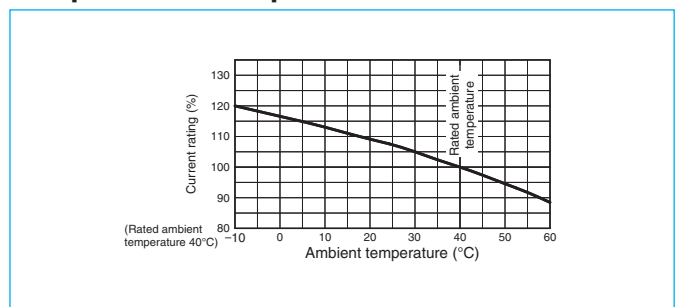

External Accessories

Accessories		Type name	Reference page	Accessories		Type name	Reference page	
Operating handle	F	F-2UV	119	Mechanical interlock	MI	2, 3P	MI-05SV3	
	V	V-2UV	121				4P	MI-2SV4
Handle lock device	LC	LC-05SV	129	Terminal cover	Small	TC-S	2, 3P	TCS-2SV3
	HL(*1)	HLF-05SV				Large	TC-L	2, 3P
		HLN-05SV					4P	TCL-2SV3L
	HL-S	HLS-2SV			Skeleton	TTC	2, 3P	TTC-2SV3
					Rear	BTC	2, 3P	BTC-2SV3
				Plug-in	PTC	2, 3P	PTC-2SV3	
				Electrical operation device		(*2)		135

Notes *1 HLF types are used for OFF lock and HLN types for ON lock.
*2 Specify the working voltage. Refer to the reference page for type name.

Outline Drawing

Front connection

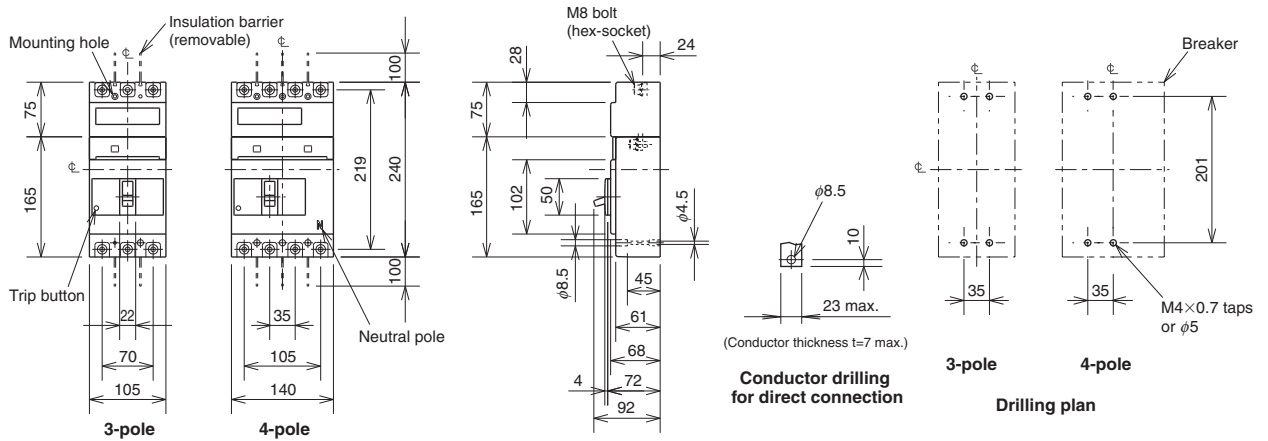

Rear connection

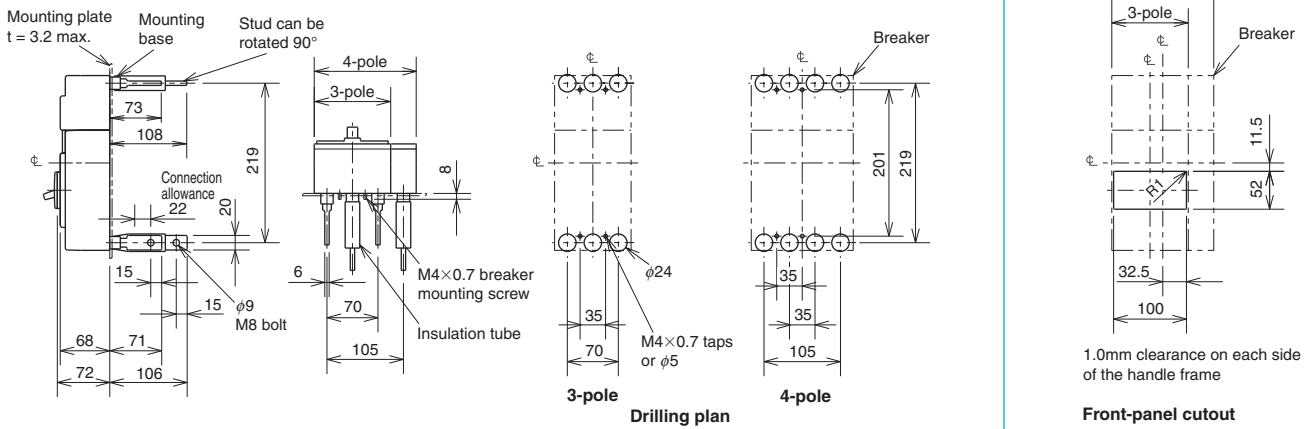

Plug-in

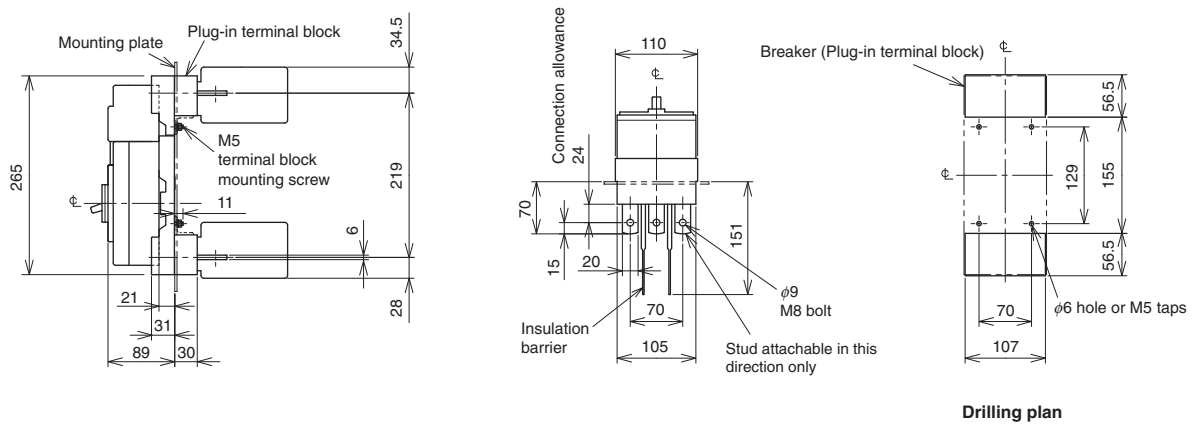

Remark: 1. 2-pole models are 3-pole models with the central pole removed.

7 Characteristics and Dimensions

Molded Case Circuit Breakers

- NF125-SGV
- NF250-SGV
- NF160-LGV
- NF125-HGV
- NF250-HGV
- NF250-RGV
- NF160-SGV
- NF125-LGV
- NF250-LGV
- NF160-HGV
- NF125-RGV



NF250-SGV

Model	NF125-SGV	NF160-SGV	NF250-SGV	NF125-LGV	NF160-LGV	NF250-LGV
Rated current In (A)	16-20, 20-25, 25-32 32-40, 35-50, 45-63 56-80, 70-100, 90-125	125-160	125-160 140-200 175-250	16-20, 20-25, 25-32 32-40, 35-50, 45-63 56-80, 70-100, 90-125	125-160	125-160 140-200 175-250
Number of poles	2 3 4	2 3 4	2 3 4	2 3 4	2 3 4	2 3 4
Rated insulation voltage Ui (V)	690	690	690	690	690	690
Rated short-circuit breaking capacity (kA) IEC 60947-2 (Icu/Ics)	AC	AC	AC	AC	AC	AC
	690V	8/8	8/8	8/8	8/8	8/8
	500V	30/30	30/30	36/36	36/36	36/36
	440V	36/36	36/36	36/36	50/50	50/50
	415V	36/36	36/36	36/36	50/50	50/50
	400V	36/36	36/36	36/36	50/50	50/50
	380V	36/36	36/36	36/36	50/50	50/50
	DC (*)	300V	20/20	20/20	20/20	20/20
Standard attached parts (front connection)	Mounting screw: M4x0.7x55 (2 and 3P: 2pcs, 4P: 4pcs) Insulation barrier: (2P: 2pcs, 3P: 4pcs, 4P: 6pcs)					

Model	NF125-HGV	NF160-HGV	NF250-HGV	NF125-RGV	NF250-RGV
Rated current In (A)	16-20, 20-25, 25-32 32-40, 35-50, 45-63 56-80, 70-100, 90-125	125-160	125-160 140-200 175-250	16-20, 20-25, 25-32 32-40, 40-50, 50-63 63-80, 80-100, 100-125	125-160 160-200 200-250
Number of poles	2 3 4	2 3 4	2 3 4	2 3	2 3
Rated insulation voltage Ui (V)	690	690	690	690	690
Rated short-circuit breaking capacity (kA) IEC 60947-2 (Icu/Ics)	AC	AC	AC	AC	AC
	690V	10/8	10/8	—	—
	500V	50/38	50/38	—	—
	440V	65/65	65/65	125/125	125/125
	415V	70/70	70/70	150/150	150/150
	400V	75/75	75/75	150/150	150/150
	380V	75/75	75/75	150/150	150/150
	DC (*)	300V	40/40	40/40	—
Standard attached parts (front connection)	Mounting screw: M4x0.7x55 (2 and 3P: 2pcs, 4P: 4pcs) Insulation barrier: (2P: 2pcs, 3P: 4pcs, 4P: 6pcs)				

Note *1 When wired as shown at the bottom of page 14, three-pole models can be used for up to 500VDC, and four-pole models for up to 600VDC.

Operating Characteristics

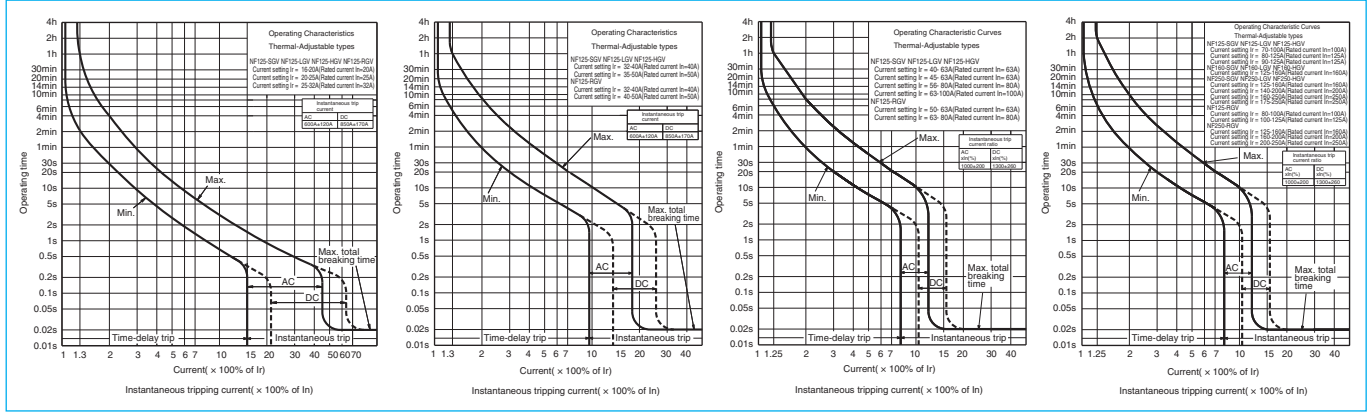

Internal Accessories

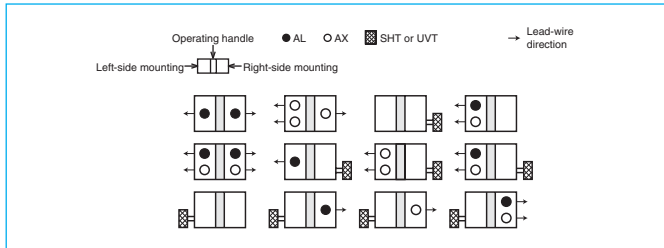

Temperature Compensation Curve

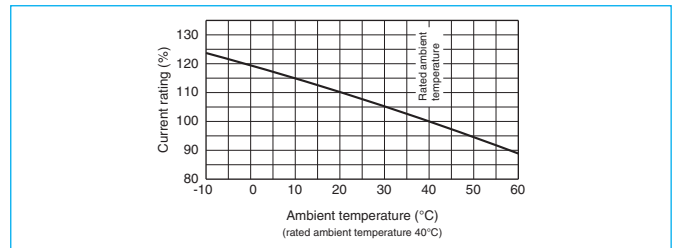

External Accessories

Accessories	Type name	Reference page	Accessories	Type name	Reference page	
Operating handle	F	F-2SV	Mechanical interlock	MI	2, 3P MI-05SV3	
	V	V-2SV		4P MI-2SV4	131	
Handle lock device	LC	LC-05SV	Terminal cover	Small	TC-S	2, 3P TCS-2SV3
	HL(*1)	HLF-05SV		2, 3P TCL-2SV3	123	
		HLN-05SV		4P TCL-2SV3L		
	HLS-2SV	4P TCL-2SV4				
		Skeleton		TTC		2, 3P TTC-2SV3
		Rear		BTC	2, 3P BTC-2SV3	
		Plug-in	PTC	2, 3P PTC-2SV3		
		Electrical operation device		(*2)	135	

Notes *1 HLF types are used for OFF lock and HLN types for ON lock.
*2 Specify the working voltage. Refer to the reference page for type name.

Outline Drawing

Front connection

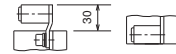
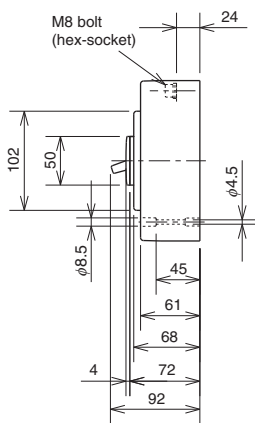
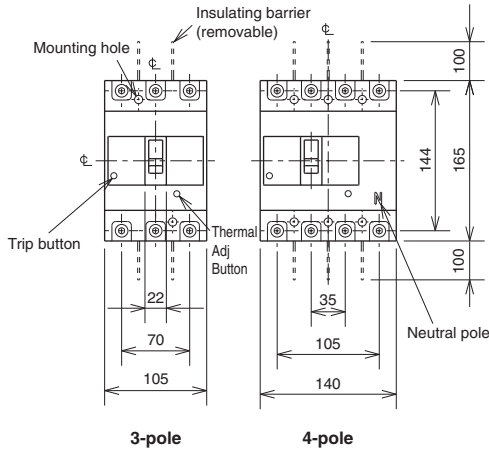

Solderless terminal for wire size
125-175A 14-95mm²
200-250A 70-125mm²
Wire connection

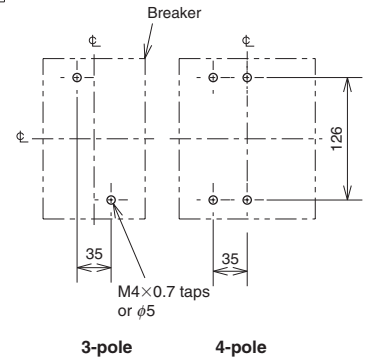
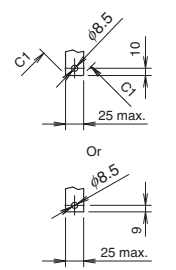

3-pole 4-pole

Conductor drilling for direct connection

Drilling plan

Rear connection

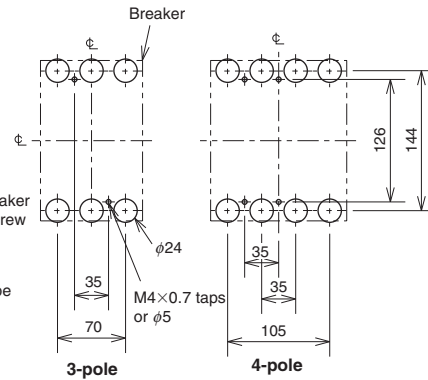
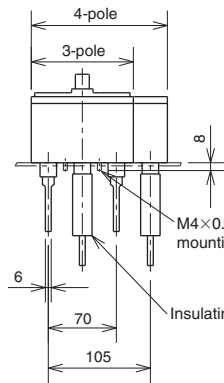
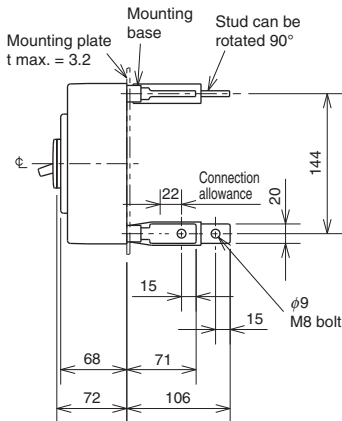

Drilling plan

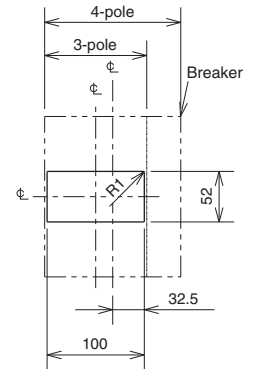

1mm clearance on each side of the handle frame

Front-panel cutout

Plug-in

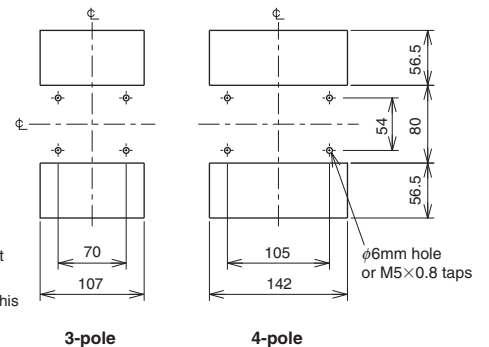
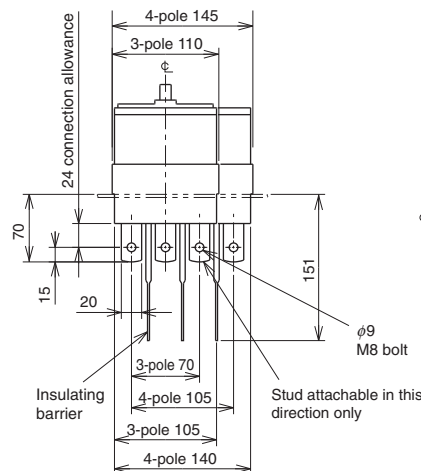
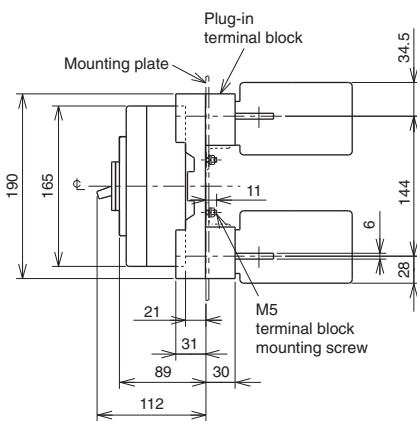

Drilling plan

Remark: 1. 2-pole models are 3-pole models with the central pole removed.

7 Characteristics and Dimensions 1

Molded Case Circuit Breakers

NF125-SEV
NF125-HEV
NF250-SEV
NF250-HEV



NF125-SEV

Model		NF125-SEV		NF125-HEV		NF250-SEV		NF250-HEV	
Rated current In (A)		32 63 125		32 63 125		160 250		160 250	
Current setting Ir (A)		16-32 32-63 63-125		16-32 32-63 63-125		80-160 125-250		80-160 125-250	
Number of poles		3 4		3 4		3 4		3 4	
Rated insulation voltage Ui (V)		690		690		690		690	
Rated short-circuit breaking capacity (kA)	IEC 60947-2 (Icu/Ics)	AC	690V	8/8	10/8	8/8	10/8		
			500V	30/30	50/38	30/30	50/38		
			440V	36/36	65/65	36/36	65/65		
			415V	36/36	70/70	36/36	70/70		
			400V	36/36	75/75	36/36	75/75		
			380V	36/36	75/75	36/36	75/75		
		DC	250V	-	-	-	-		
Standard attached parts (front connection)		Mounting screw: M4x0.7x55 (3P: 2pcs, 4P: 4pcs) Insulation barrier: (3P: 4pcs, 4P: 6pcs)							

Operating Characteristics

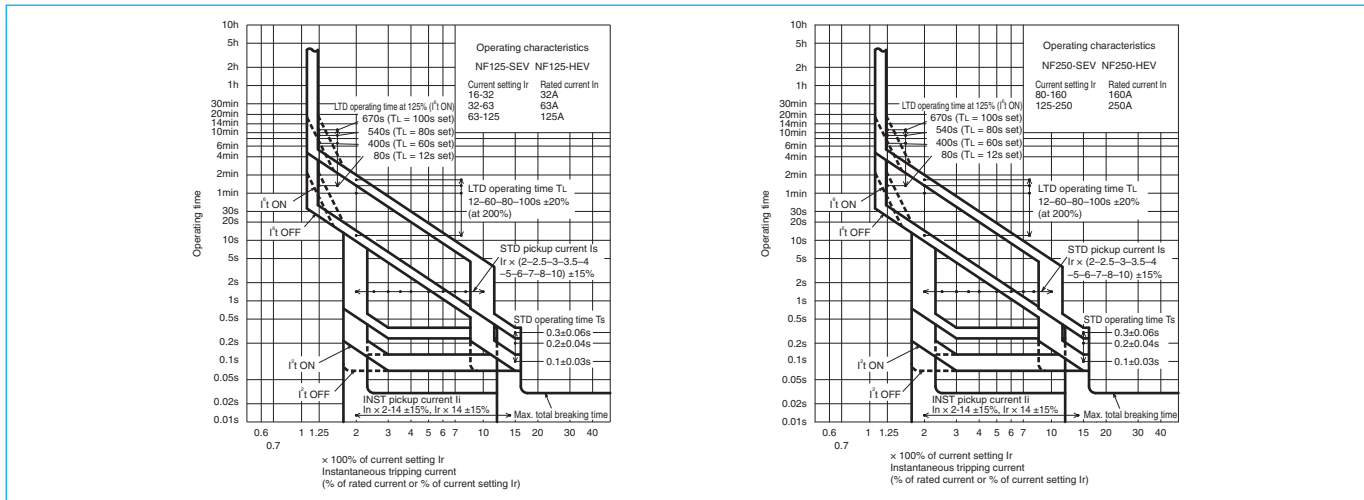

Internal Accessories

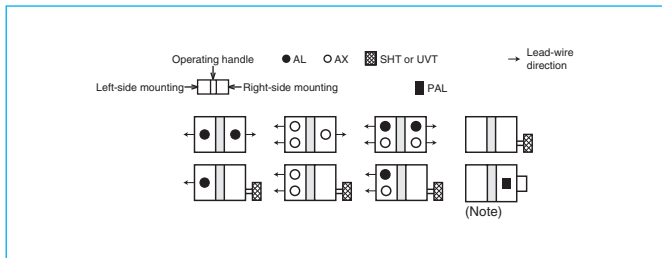

Current Reducing Curve

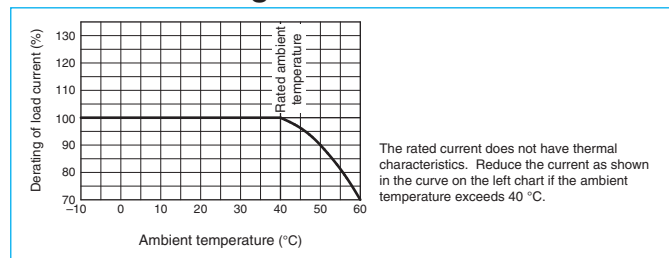

External Accessories

Accessories		Type name	Reference page	Accessories		Type name	Reference page
Operating handle	F	F-2SV	119	Mechanical interlock	MI	3P MI-05SV3	131
	V	V-2SV	121			4P MI-2SV4	
Handle lock device	LC	LC-05SV	129	Terminal cover	Small	3P TCS-2SV3	123
	HL(*1)	HLF-05SV				3P TCL-2SV3	
		HLN-05SV			3P TCL-2SV3L		
	HLS-2SV	4P TCL-2SV4					
			3P TTC-2SV3				
			3P BTC-2SV3				
			3P PTC-2SV3				
Electrical operation device						(*2)	135

Notes *1 HLF types are used for OFF lock and HLN types for ON lock.
 *2 Specify the working voltage. Refer to the reference page for type name.

Outline Drawing

Front connection

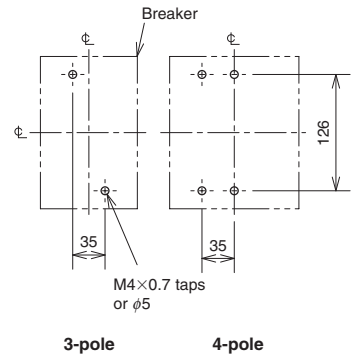
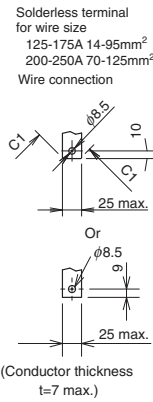
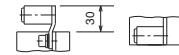
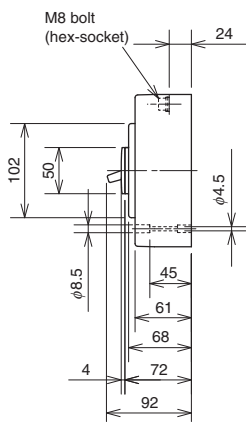
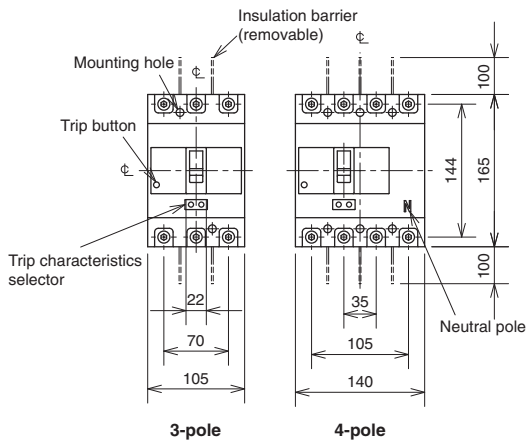

Conductor drilling for direct connection

Drilling plan

Rear connection

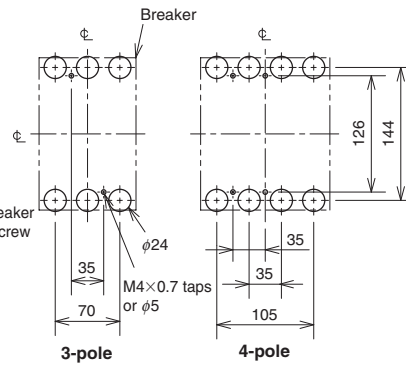
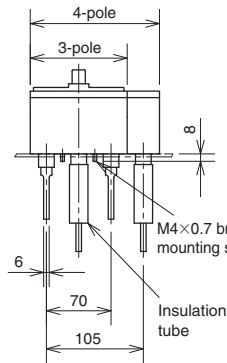
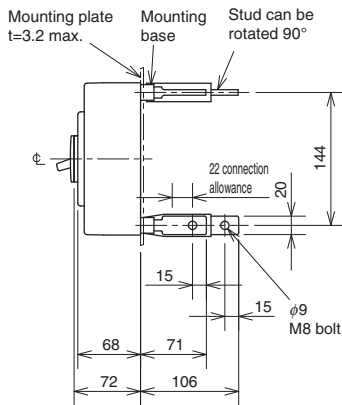

Drilling plan

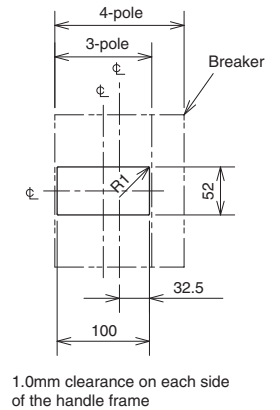

1.0mm clearance on each side of the handle frame

Front-panel cutout

Plug-in

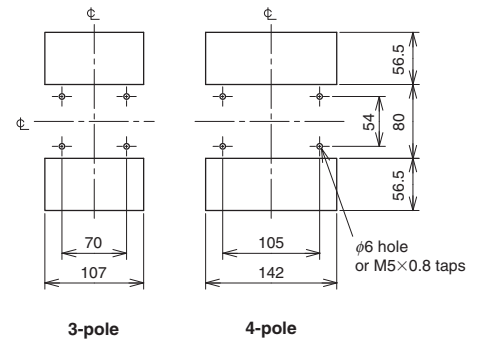
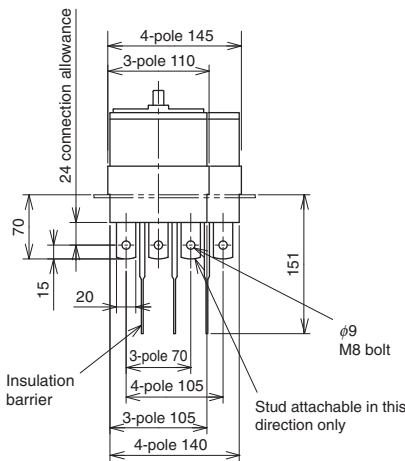
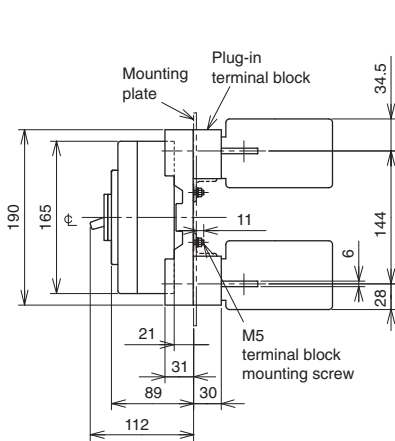

Drilling plan

NF400-CW NF400-SW



NF400-SW

Model		NF400-CW		NF400-SW		
Rated current In (A)		250	300	350	400	
Number of poles		2	3	2	3	4
Rated insulation voltage Ui (V)		690		690		
Rated short-circuit breaking capacity (kA)	IEC 60947-2 (Icu/Ics)	AC	690V	-	10/10	
			500V	15/8	30/30	
			440V	25/13	42/42	
			400V	36/18	45/45	
			230V	50/25	85/85	
		DC (*1)	250V	20/10	40/40	
Standard attached parts		Front connection	Mounting screw: M6x60 (4pcs) Insulating barrier: (2P: 2pcs, 3P: 4pcs, 4P: 6pcs)			
		Rear connection	Mounting screw: M6x72 (4pcs)			

Note *1 When wired as shown at the bottom of page 14, 3-pole models can be used for up to 400VDC, and 4-pole models for up to 500VDC.

Operating Characteristics

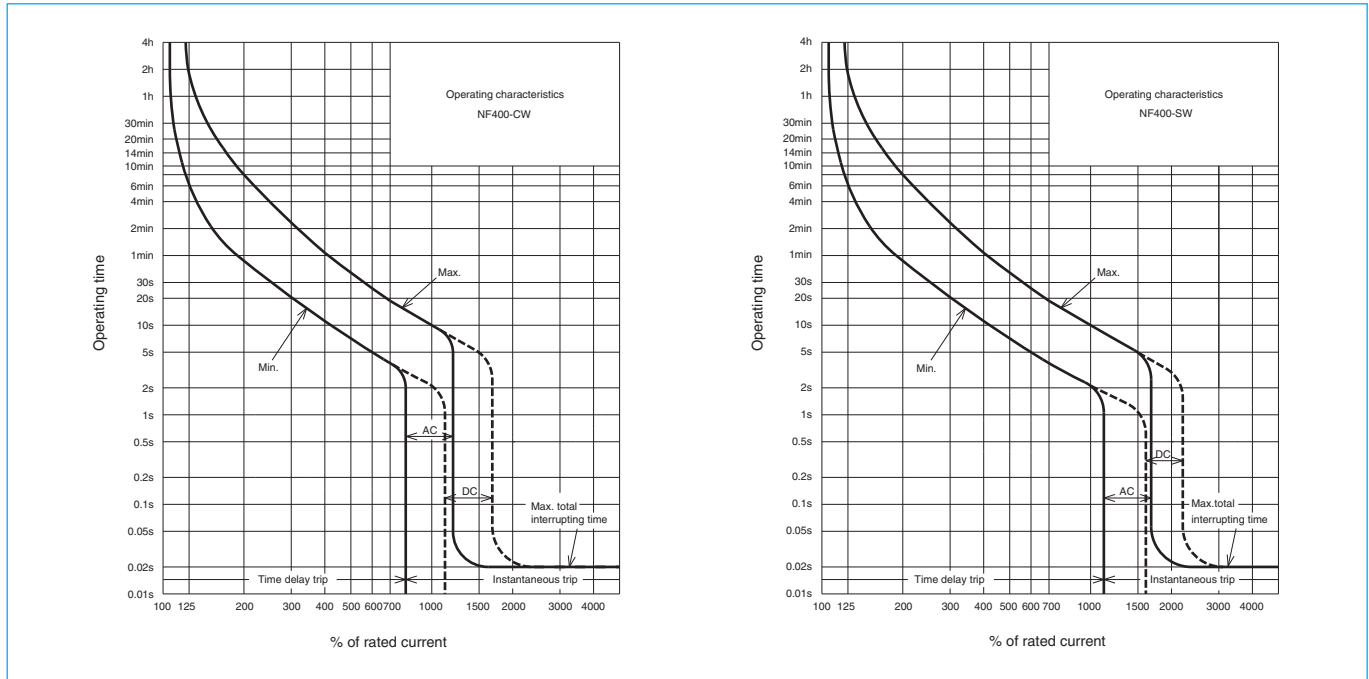

Internal Accessories

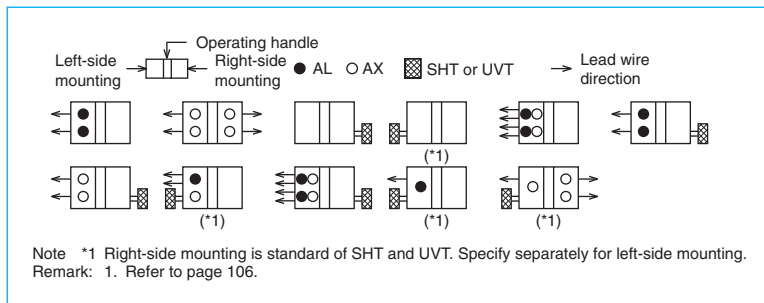

Temperature Compensation Curve

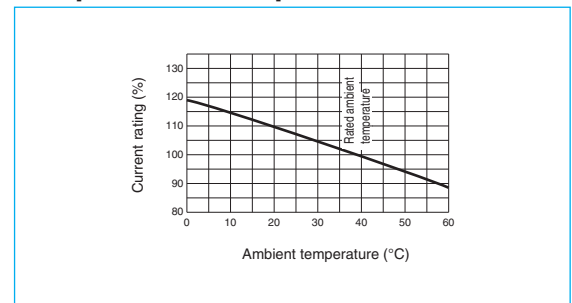

External Accessories

Accessories		Type name	Reference page	Accessories		Type name	Reference page
Operating handle	F	F-4S	119	Terminal cover	Large	TC-L 2, 3P	TCL-4SW3
	V	V-4S	121			TC-L 4P	TCL-4SW4
Mechanical interlock	MI	2, 3P	131		Skeleton	TTC 2, 3P	TTC-4SW3
		4P				MI-4SW4	TTC 4P
Auxiliary handle	HT	HT-4CW, HT-4SW	130	Rear	BTC 2, 3P	BTC-4SW3	
					BTC 4P	BTC-4SW4	
Note *1 Specify the operation method and voltage. Order in combination with the breaker unit.				Handle lock device		HL	HL-4CW, HL-4SW
					HL-S	HLS-4SW	129
				Electrical operation device	NFM	3P	(*1)
						4P	

Outline Drawing

Front connection

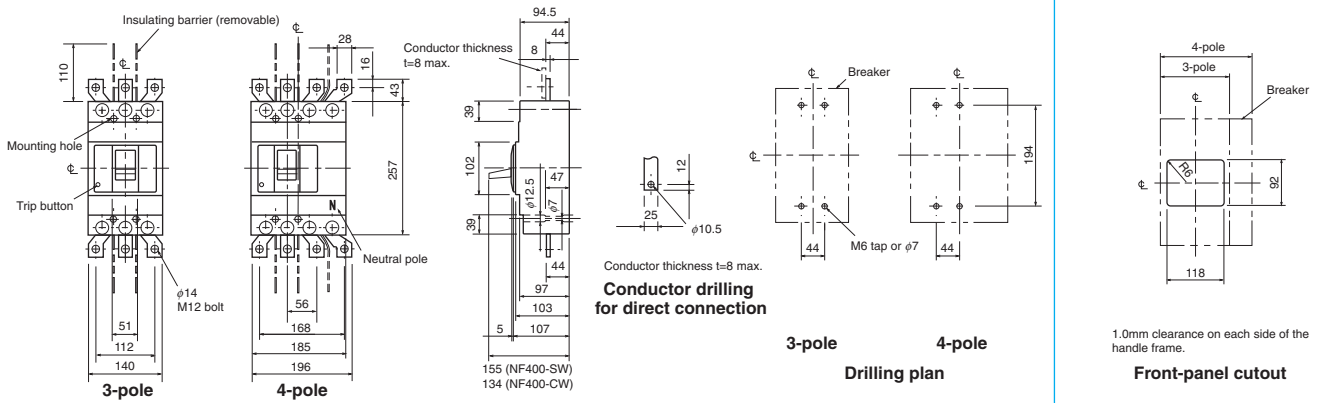

Rear connection

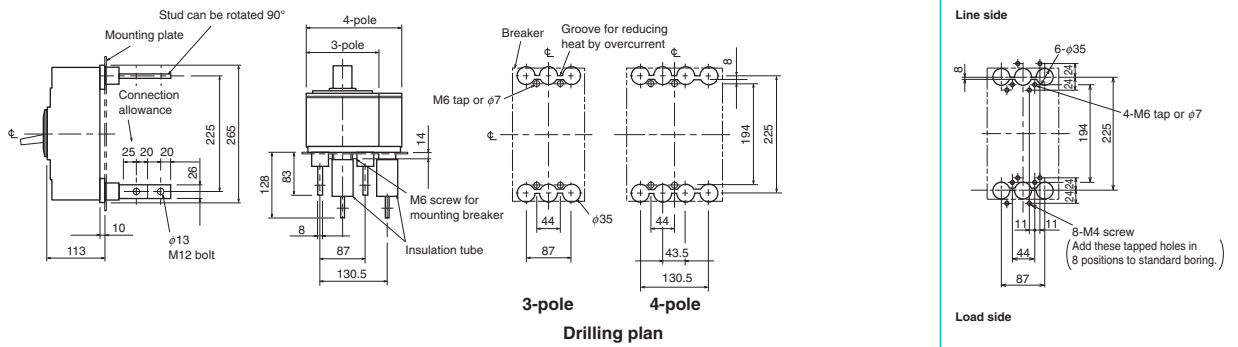

Boring dimensions for rear connection type barriers (3-pole)

Line side

Load side

Note The bore dimensional drawing shows the breaker viewed from the rear.

Plug-in

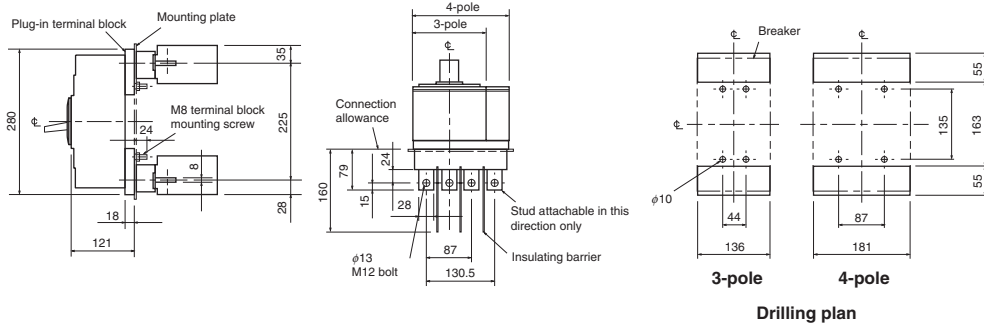

Remark: 1. 2-pole models are 3-pole models with the central pole removed.

NF400-SEW NF400-HEW NF400-REW



NF400-SEW

Model		NF400-SEW	NF400-HEW	NF400-REW		
Rated current In (A)		200-400 adjustable				
Number of poles		3	4	3		
Rated insulation voltage Ui (V)		690	690	690		
Rated short-circuit breaking capacity (kA)	IEC 60947-2 (Icu/Ics)	AC	690V	10/10	35/18	-
			500V	30/30	50/50	70/35
			440V	42/42	65/65	125/63
			400V	50/50	70/70	125/63
			230V	85/85	100/100	150/75
Standard attached parts		Front connection	Mounting screw: M6x72 (4pcs) Insulating barrier: (3P: 4pcs, 4P: 6pcs)			
		Rear connection	Mounting screw: M6x85 (4pcs)			

Operating Characteristics

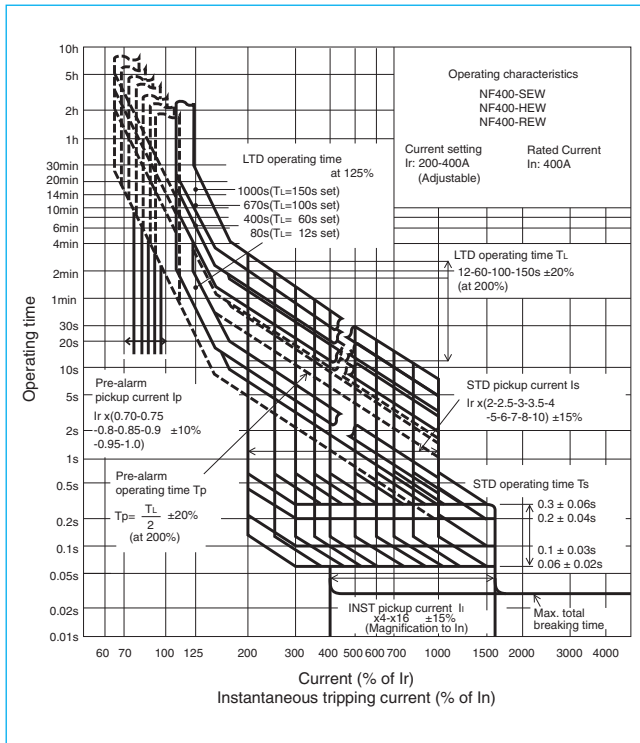

Internal Accessories

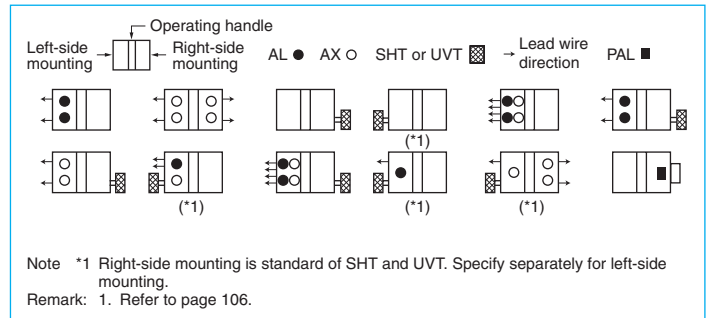

Current Reducing Curve

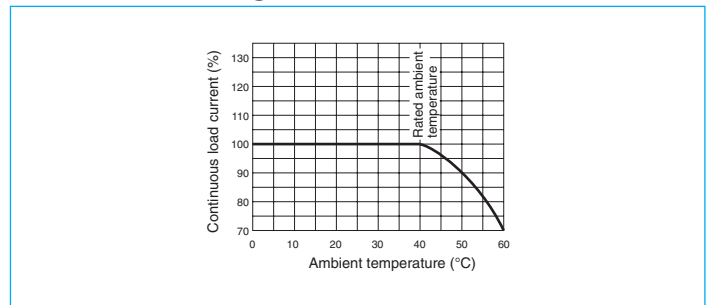

External Accessories

Accessories	Type name	Reference page	Accessories	Type name	Reference page			
Operating handle	F	F-4S	Terminal cover	Large	TC-L	3P	TCL-4SW3 (*2)	123
	V	V-4S				4P	TCL-4SW4 (*3)	
Mechanical interlock	MI	3P		Skeleton	TTC	3P	TTC-4SW3	
		4P				4P	TTC-4SW4	
Auxiliary handle	HT	3P	Rear	BTC	3P	BTC-4SW3 (*2)	129	
		4P			4P	BTC-4SW4 (*3)		
			Handle lock device	HL	HL-4SW	129		
				HL-S	HLS-4SW			
			Electrical operation device	NFM	3P	(*1)	135	
					4P			

Notes *1 Specify the operation method and voltage. Order in combination with the breaker unit.
*2 This is for NF400-SEW.
*3 This is for NF400-SEW/HEW.

Outline Drawing

Front connection

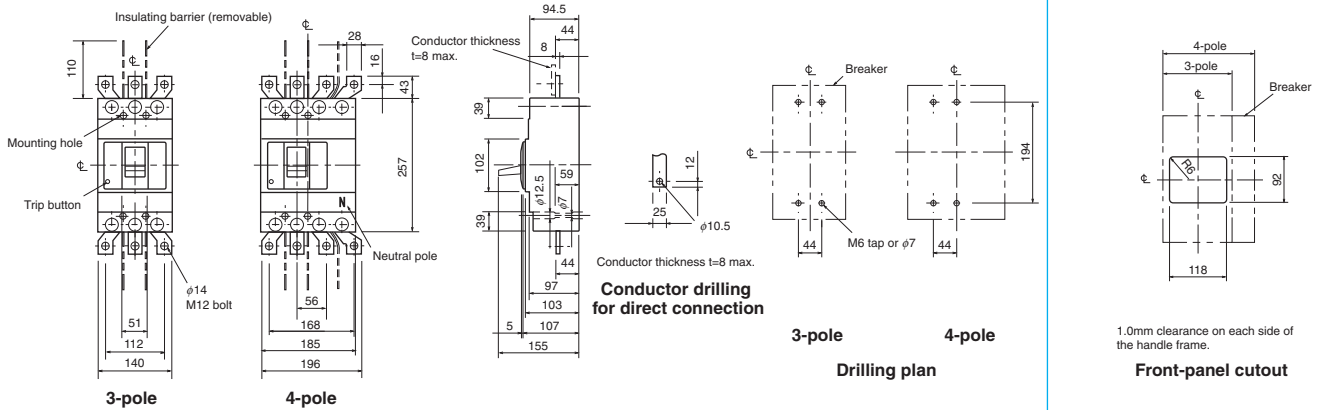

Rear connection

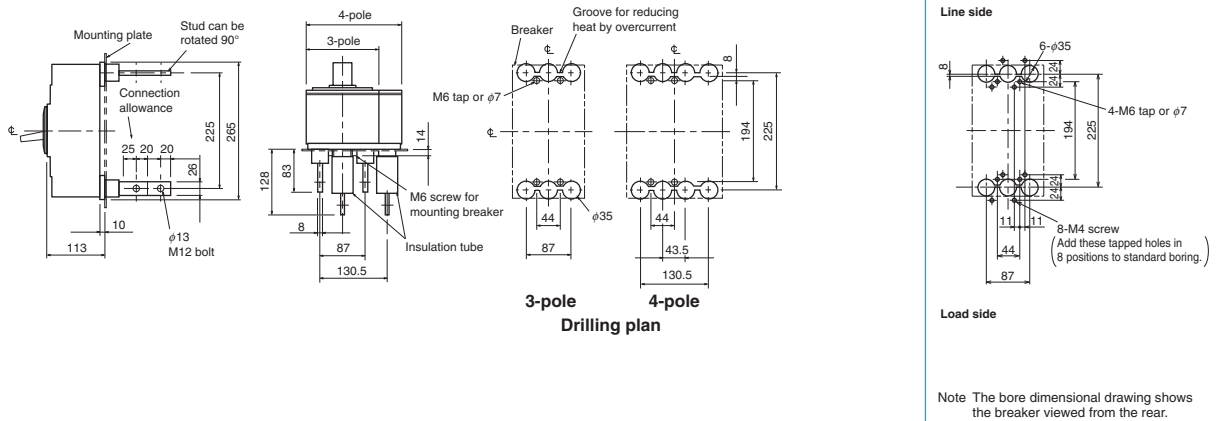

Plug-in

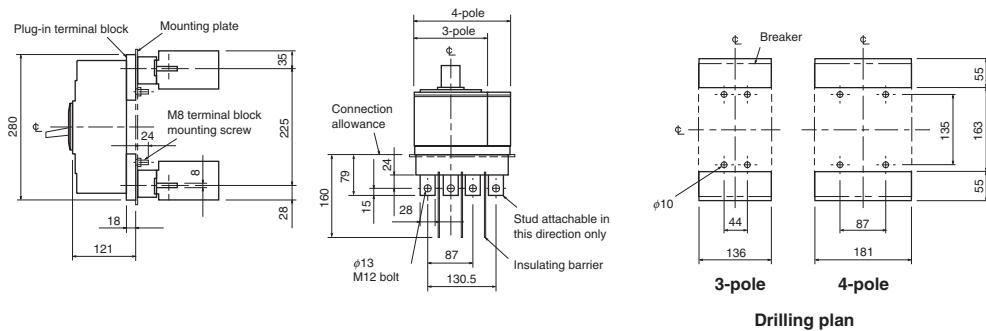

NF400-UEW



NF400-UEW

Model		NF400-UEW		
Rated current I_n (A)		200-400 adjustable		
Number of poles		3	4	
Rated insulation voltage U_i (V)		690		
Rated short-circuit breaking capacity (kA)	IEC 60947-2 (Icu/Ics)	AC	690V	-
			500V	170/170
			440V	200/200
			400V	200/200
			230V	200/200
Standard attached parts (4-pole models are provided with auxiliary handle.)		Front connection	Mounting screw: M6x65 (2pcs), M6x174 (2pcs) Insulating barrier: (3P: 4pcs)	
		Rear connection	Mounting screw: M6x72 (2pcs), M6x181 (2pcs)	

Operating Characteristics

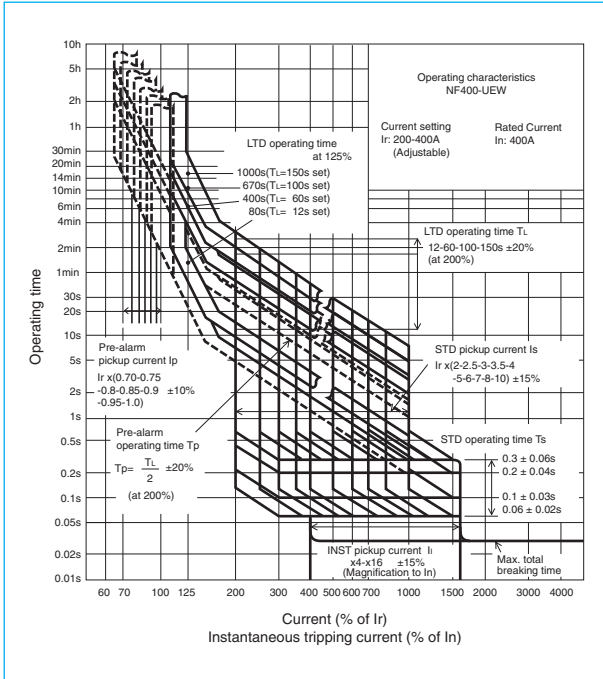

Internal Accessories

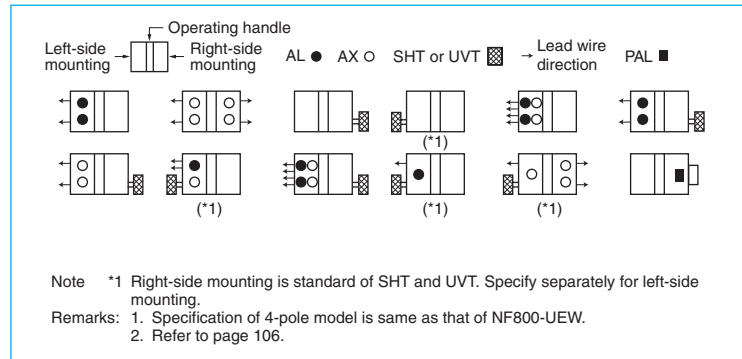

Current Reducing Curve

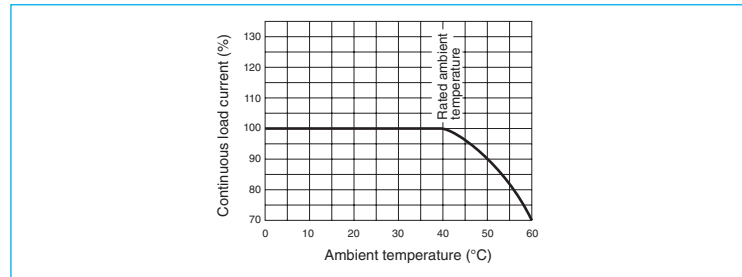

7 External Accessories

Accessories	Type name	Reference page	Accessories	Type name	Reference page				
Operating handle	F	F-4U	119	Terminal cover	Large	TC-L	3P	TCL-4SW3	123
	V	V-4U	121		Skeleton	TTC	3P	-	
Mechanical interlock	MI	MI-4SW3	131		Rear	BTC	3P	BTC-4SW3	
Auxiliary handle	HT	HT-4SW	130	Handle lock device	HL		HL-4SW	129	
					HL-S		HLS-4UW		
				Electrical operation device			(*1)	135	

Note *1 Specify the operation method and voltage. Order in combination with the breaker unit.

Remark *1 Specification of 4-pole model is same as that of NF800-UEW.

Outline Drawing

Front connection

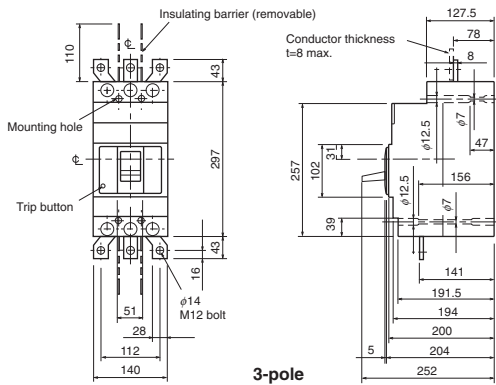

3-pole

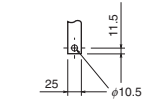

Conductor thickness t=8 max.

Conductor drilling for direct connection

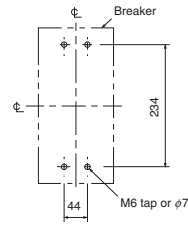

3-pole
Drilling plan

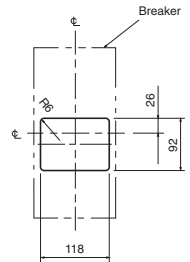

1.0mm clearance on each side of the handle frame.

Front-panel cutout

Rear connection

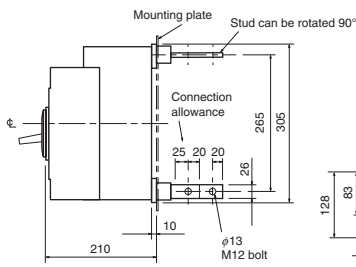

3-pole

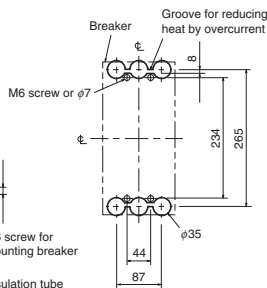

Drilling plan

Boring dimensions for rear connection type barriers (3-pole)

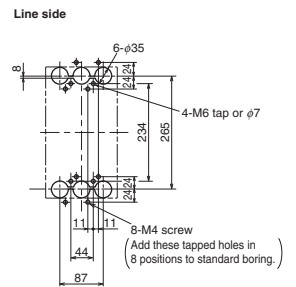

Load side

Note The bore dimensional drawing shows the breaker viewed from the rear.

Plug-in

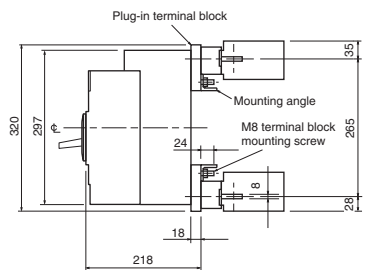

3-pole

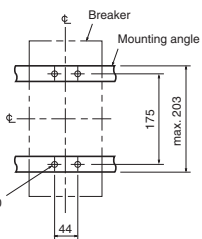
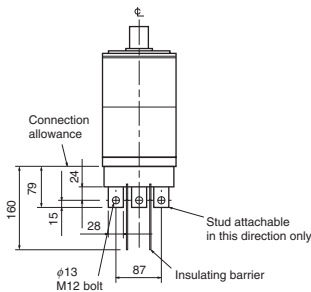

3-pole
Drilling plan

NF630-CW NF630-SW



NF630-SW

Model		NF630-CW			NF630-SW			
Rated current In (A)		500 600 630						
Number of poles		2	3		2	3	4	
Rated insulation voltage Ui (V)		690			690			
Rated short-circuit breaking capacity (kA)	IEC 60947-2 (Icu/Ics)	AC	690V	-			10/10	
			500V	18/9			30/30	
			440V	36/18			42/42	
			400V	36/18			50/50	
			230V	50/25			85/85	
		DC (*1)	250V			20/10		40/40
Standard attached parts (4-pole models are provided with auxiliary handle.)		Front connection	Mounting screw: M6x72 (4pcs) Insulating barrier: (2P: 2pcs, 3P: 4pcs, 4P: 6pcs)					
		Rear connection	Mounting screw: M6x85 (4pcs)					

Note *1 When wired as shown at the bottom of page 14, 3-pole models can be used for up to 400VDC, and 4-pole models for up to 500VDC.

Operating Characteristics

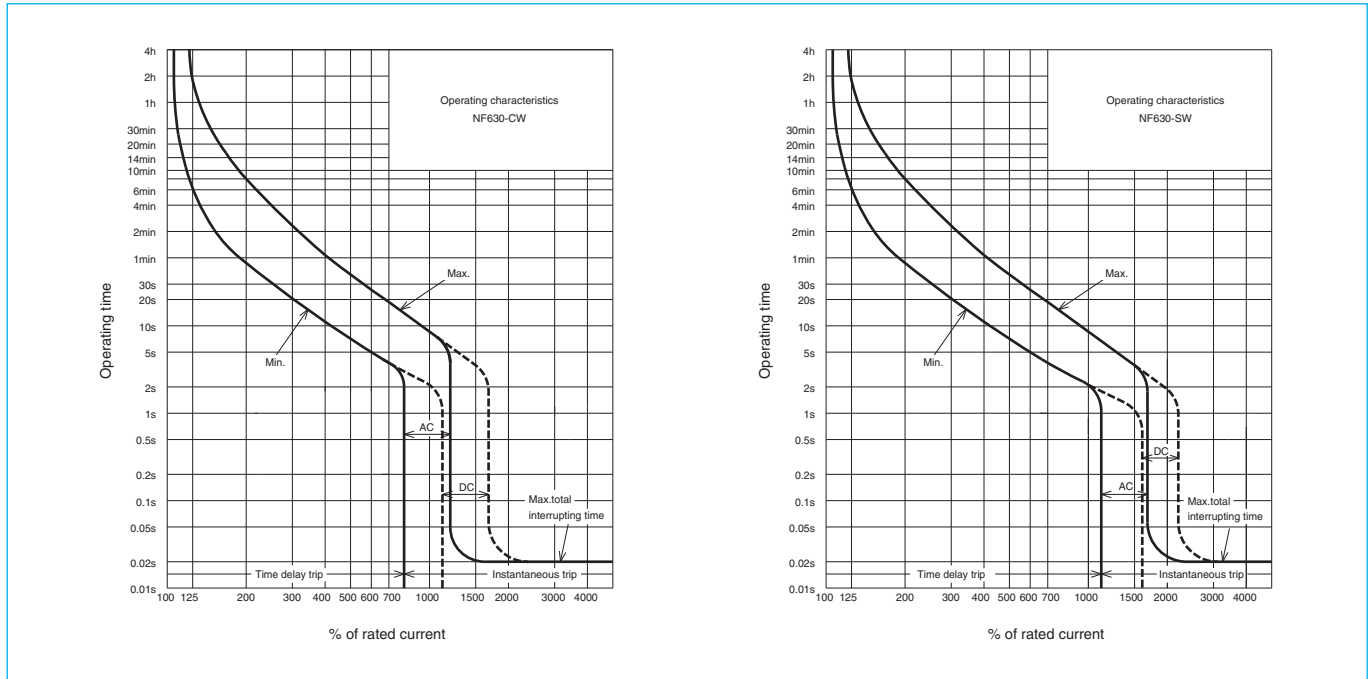

Internal Accessories

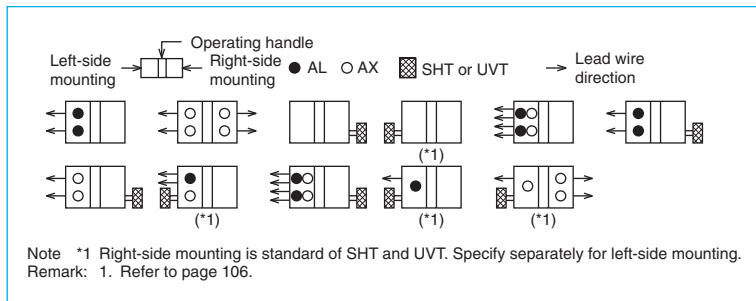

Temperature Compensation Curve

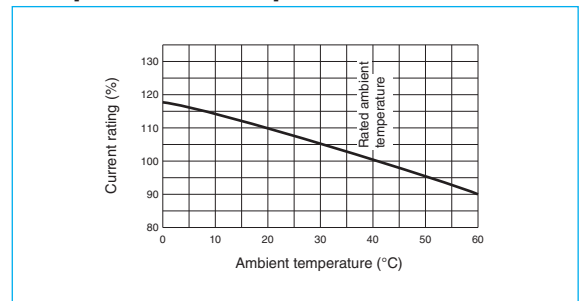

External Accessories

Accessories		Type name	Reference page	Accessories		Type name	Reference page
Operating handle	F	F-4S	119	Terminal cover	Large	TC-L 2, 3P	TCL-4SW3
	V	V-4S	121			TC-L 4P	TCL-4SW4
Mechanical interlock	MI	2, 3P	131		Skeleton	2, 3P	TTC-4SW3
		4P				TTC-4SW4	
Auxiliary handle	HT	130		Rear	2, 3P	BTC-4SW3	
					4P	BTC-4SW4	
Handle lock device				HL	HL-4SW		129
				HL-S	HLS-4SW		
Electrical operation device				NFM	3P	(*1)	135
					4P		

Outline Drawing

Front connection

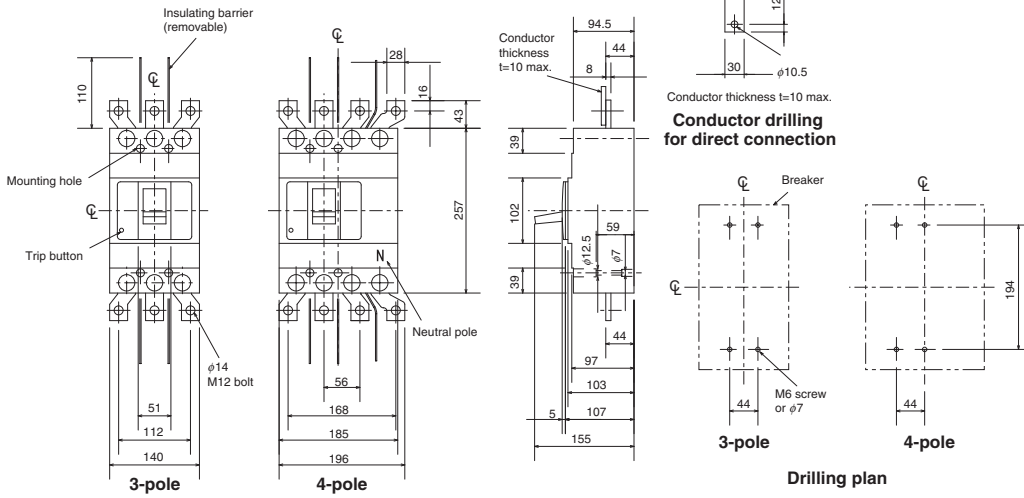

Rear connection

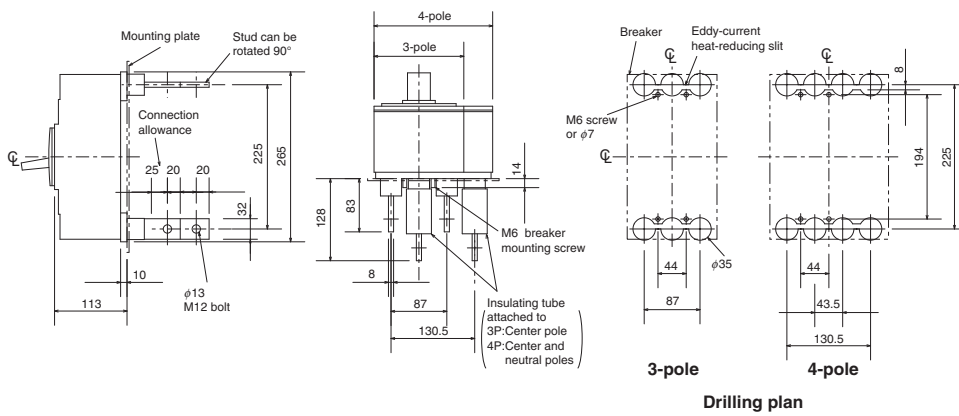

Boring dimensions for rear connection type barriers (3-pole)

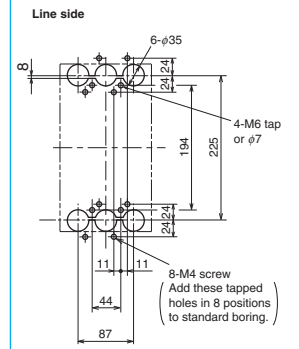

Note The bore dimensional drawing shows the breaker viewed from the rear.

Plug-in

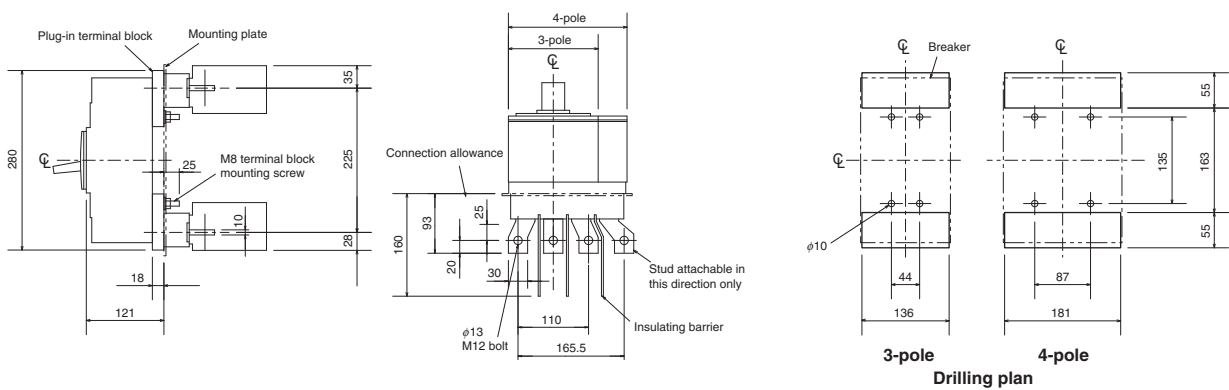

Remark: 1. 2-pole models are 3-pole models with the central pole removed.

NF630-SEW NF630-HEW NF630-REW



NF630-SEW

Model		NF630-SEW	NF630-HEW	NF630-REW		
Rated current I _n (A)		300-630 adjustable				
Number of poles		3	4	3		
Rated insulation voltage U _i (V)		690	690	690		
Rated short-circuit breaking capacity (kA)	IEC 60947-2 (Icu/Ics)	AC	690V	10/10	35/18	-
			500V	30/30	50/50	70/35
			440V	42/42	65/65	125/63
			400V	50/50	70/70	125/63
			230V	85/85	100/100	150/75
Standard attached parts (4-pole models are provided with auxiliary handle.)		Front connection	Mounting screw: M6×72 (4pcs) Insulating barrier: (3P: 4pcs, 4P: 6pcs)			
		Rear connection	Mounting screw: M6×85 (4pcs)			

Operating Characteristics

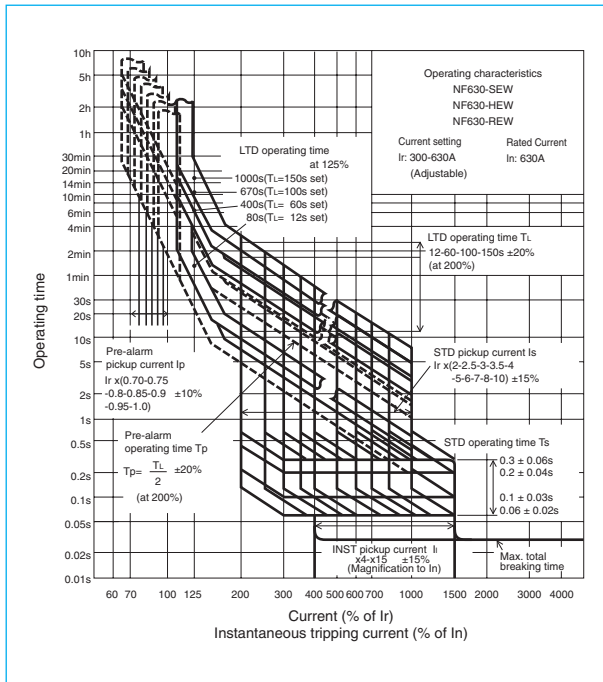

Internal Accessories

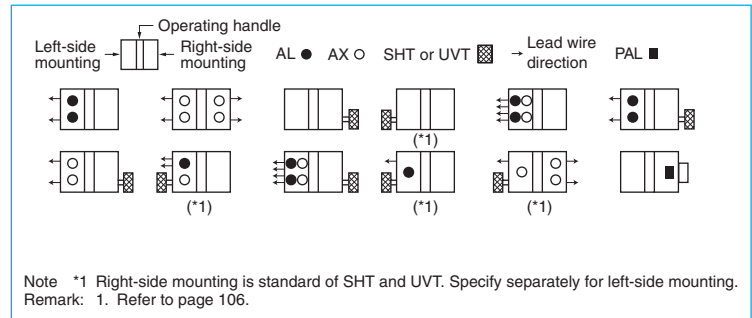

Current Reducing Curve

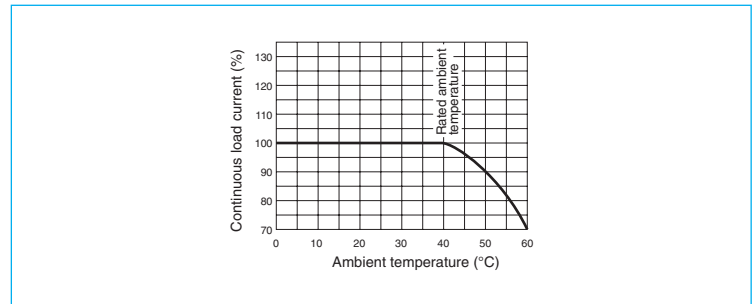

External Accessories

Accessories		Type name	Reference page	Accessories		Type name	Reference page	
Operating handle	F	F-4S	119	Terminal cover	Large	3P	TCL-4SW3 (*2)	
	V	V-4S	121			4P	TCL-4SW4 (*3)	
Mechanical interlock	MI	3P	MI-4SW3		Skeleton	TTC	3P	TTC-4SW3
		4P	MI-4SW4				4P	TTC-4SW4
Auxiliary handle	HT	HT-4SW			Rear	BTC	3P	BTC-4SW3 (*2)
							4P	BTC-4SW4 (*3)
Handle lock device				HL		HL-4SW		
				HL-S		HLS-4SW		
Electrical operation device				NFM	3P	(*1)		
					4P			

Notes *1 Specify the operation method and voltage. Order in combination with the breaker unit.
*2 This is for NF630-SEW.
*3 This is for NF630-SEW/HEW.

Outline Drawing

Front connection

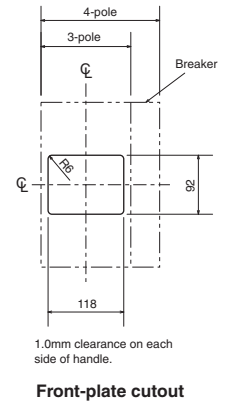
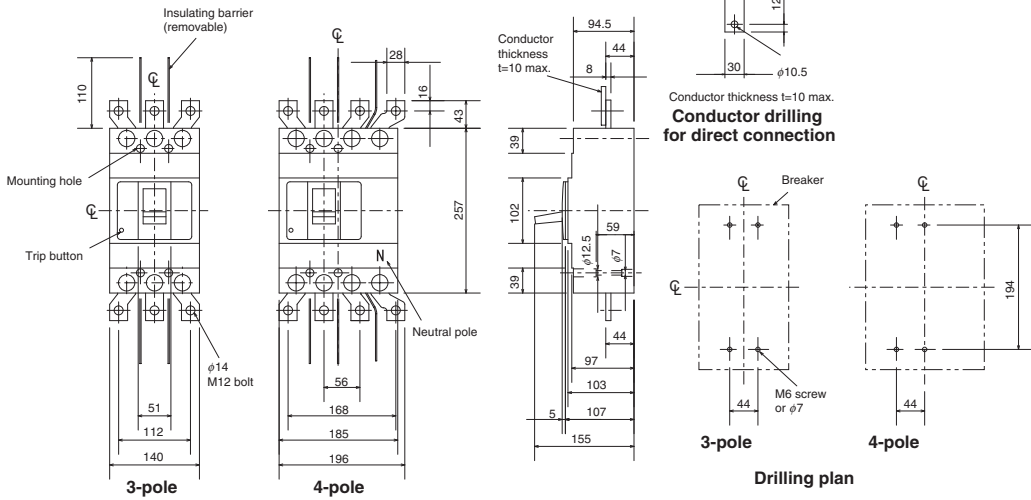

Rear connection

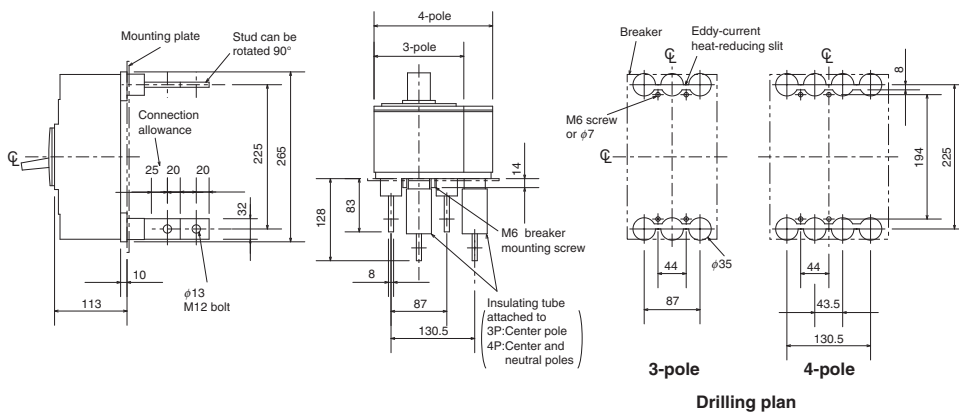

Boring dimensions for rear connection type barriers (3-pole)

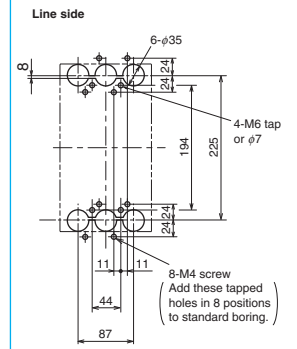

Note The bore dimensional drawing shows the breaker viewed from the rear.

Plug-in

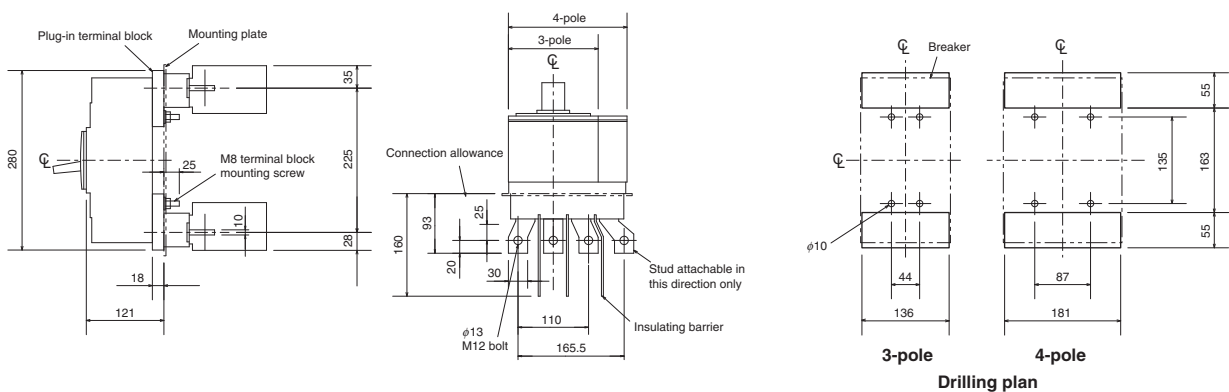

NF800-CEW NF800-SEW NF800-HEW NF800-REW



NF800-SEW

Model	NF800-CEW	NF800-SEW	NF800-HEW	NF800-REW			
Rated current In (A)	400-800 adjustable						
Number of poles	3	3, 4	3, 4	3			
Rated insulation voltage Ui (V)	690	690	690	690			
Rated short-circuit breaking capacity (kA)	IEC 60947-2 (Icu/lcs)	AC	690V	-	10/10	15/15	-
			500V	18/9	30/30	50/50	70/35
			440V	36/18	42/42	65/65	125/63
			400V	36/18	50/50	70/70	125/63
			230V	50/25	85/85	100/100	150/75
Standard attached parts (4-pole models are provided with auxiliary handle.)	Front connection	Mounting screw: M6x35 (4pcs) Insulating barrier: (3P: 2pcs, 4P: 3pcs)					
	Rear connection	Mounting screw: M6x40 (4pcs)					

Operating Characteristics

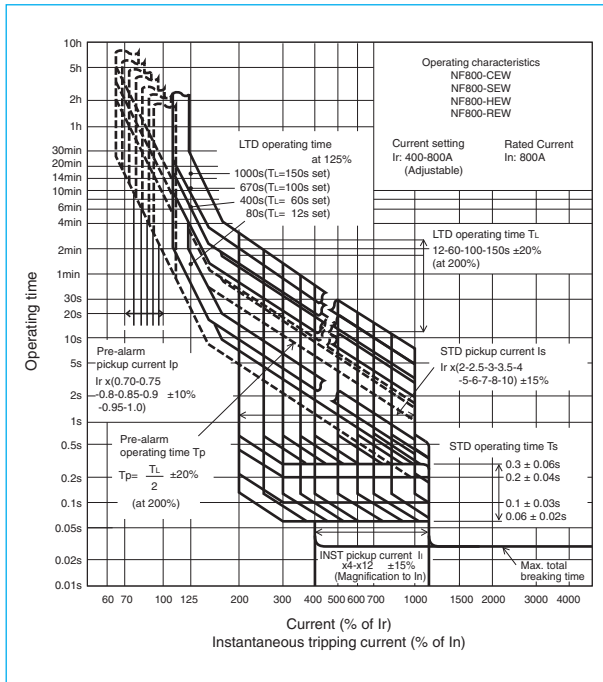

Internal Accessories

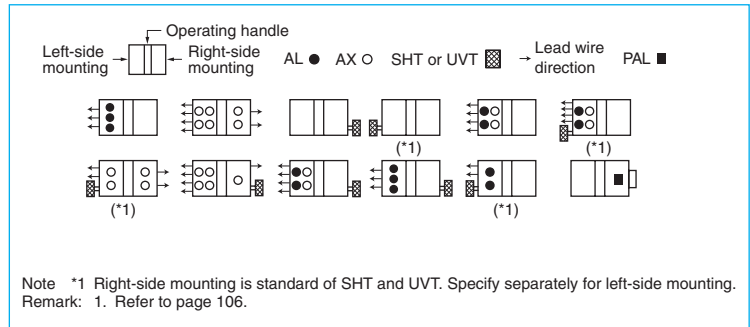

Current Reducing Curve

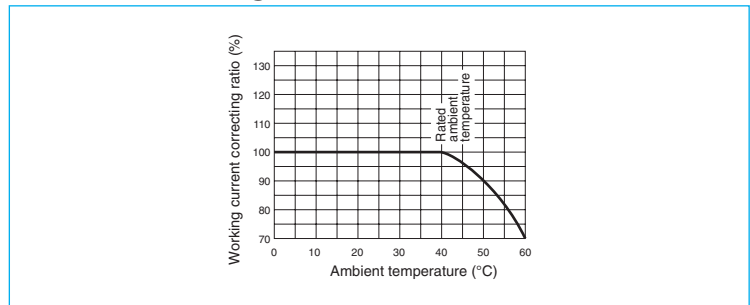

External Accessories

Accessories	Type name	Reference page	Accessories	Type name	Reference page				
Operating handle	F	F-8S	Terminal cover	Large	TC-L	3P	TCL-8SW3	123	
	V	V-8S				4P	TCL-8SW4		
Mechanical interlock	MI	3P		MI-8SW3	Skeleton	TTC	3P		TTC-8SW3
		4P		MI-8SW4			4P		TTC-8SW4
Auxiliary handle	HT	HT-4SW		Rear	BTC	3P	BTC-8SW3		
						4P	BTC-8SW4		
Handle lock device			HL		HL-4SW	HLS-8SW	129		
					HL-S				
Electrical operation device			NFM		3P	(*)	135		
					4P				

Note *1 Specify the operation method and voltage. Order in combination with the breaker unit.

NF800-SDW



NF800-SDW

Model		NF800-SDW	
Rated current I _n (A)		(700), 800	
Number of poles		2	
Rated insulation voltage U _i (V)		690	
Rated short-circuit breaking capacity (kA)	IEC 60947-2 (Icu/Ics)	DC	250V
	Time constant not larger than 10ms		
Standard attached parts (4-pole models are provided with auxiliary handle.)	Front connection	Mounting screw: M6x35 (4pcs) Insulating barrier: (2P: 1pc, 3P: 2pcs, 4P: 3pcs)	
	Rear connection	Mounting screw: M6x40 (4pcs)	

Operating Characteristics

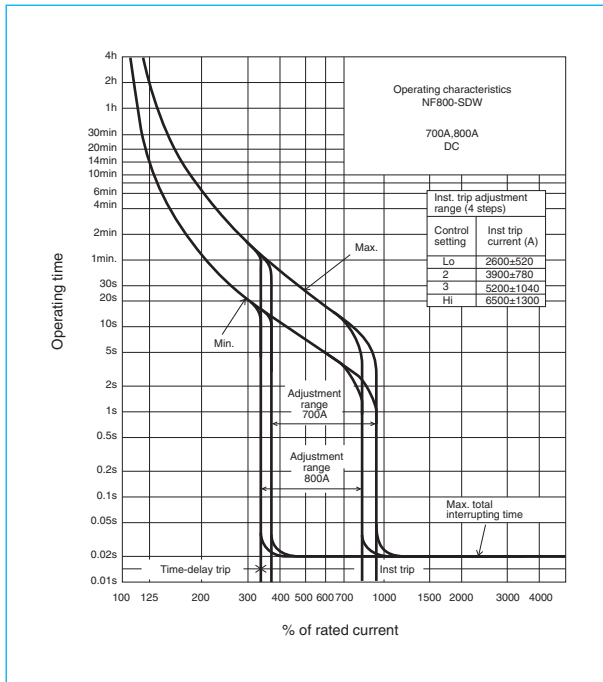

Internal Accessories

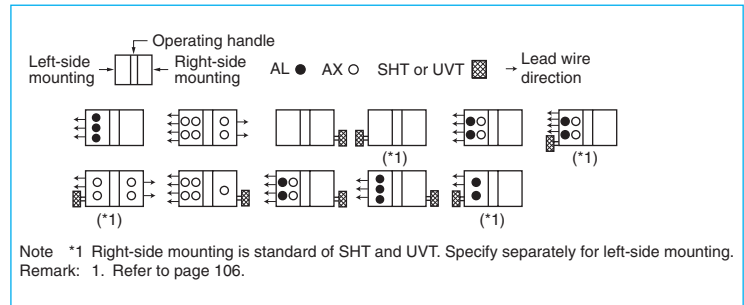

Temperature Compensation Curve

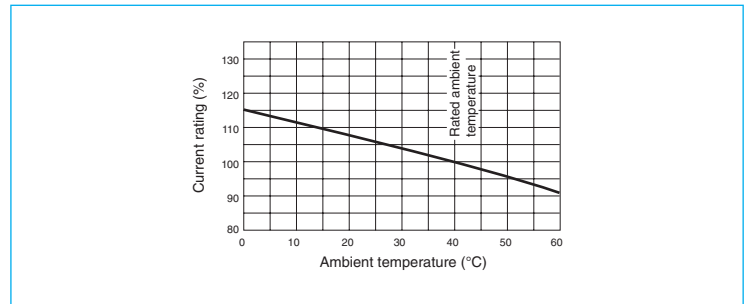

7 External Accessories

Accessories		Type name	Reference page	Accessories		Type name	Reference page	
Operating handle	F	F-8S	119	Terminal cover	Large	TC-L 2, 3P	TCL-8SW3	
	V	V-8S	121			TC-L 4P	TCL-8SW4	
Mechanical interlock	MI	2, 3P	131		Skeleton	TTC	2, 3P	TTC-8SW3
		4P					4P	TTC-8SW4
Auxiliary handle	HT	130		Rear	BTC	2, 3P	BTC-8SW3	
						4P	BTC-8SW4	
Handle lock device						HL	HL-4SW	
						HL-S	HLS-8SW	
Electrical operation device						NFM 2, 3P	(*1)	
						4P		

Note *1 Specify the operation method and voltage. Order in combination with the breaker unit.

NF800-UEW



NF800-UEW

Model		NF800-UEW		
Rated current I_n (A)		400-800 adjustable		
Number of poles		3	4	
Rated insulation voltage U_i (V)		690		
Rated short-circuit breaking capacity (kA)	IEC 60947-2 (Icu/Ics)	AC	690V	35/35
			500V	170/170
			440V	200/200
			400V	200/200
			230V	200/200
Standard attached parts (4-pole models are provided with auxiliary handle.)		Front connection	Mounting screw: 3P: M6×35, M6×132 (2pcs each) 4P: M6×35 (3pcs), M6×132 (2pcs) Insulating barrier: (3P: 2pcs, 4P: 3pcs)	
		Rear connection	Mounting screw: 3P: M6×40, M6×137 (2pcs each) 4P: M6×40 (3pcs), M6×137 (2pcs)	

Operating Characteristics

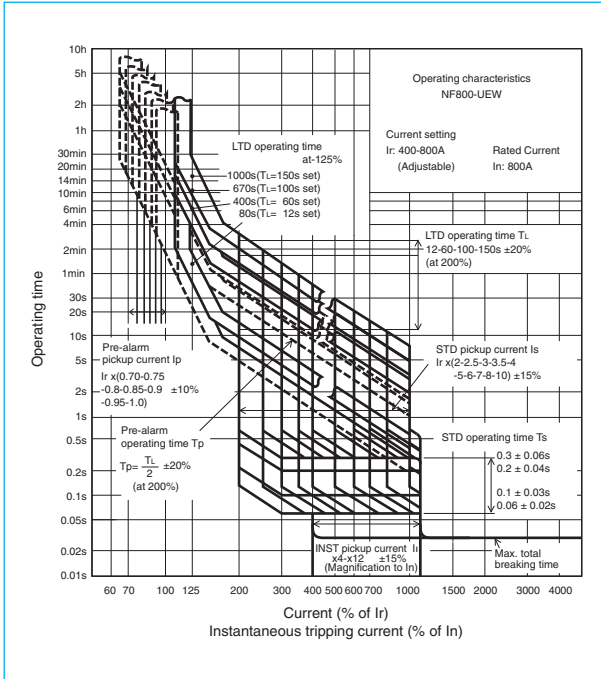

Internal Accessories

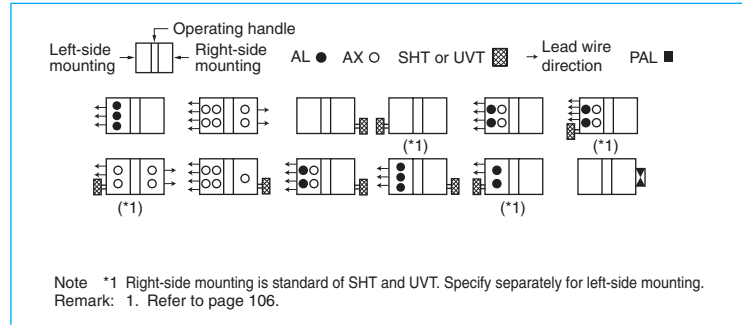

Current Reducing Curve

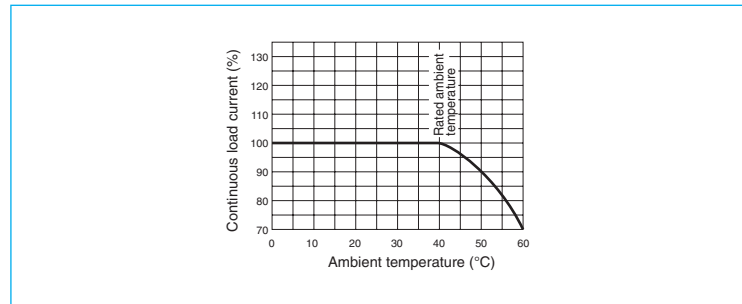

External Accessories

Accessories		Type name	Reference page	Accessories		Type name	Reference page	
Operating handle	F	F-8U	119	Terminal cover	Large	3P	TCL-8UW3	
	V	-	121			4P	TCL-8UW4	
Mechanical interlock	MI	3P	MI-8SW3		Skeleton	TTC	3P	-
		4P	MI-8SW4				4P	-
Auxiliary handle	HT	HT-4SW	130	Rear	BTC	3P	BTC-8SW3	
						4P	BTC-8SW4	
Handle lock device	HL			Handle lock device	HL		HL-4SW	
							HL-S	HLS-8UW
Electrical operation device				Electrical operation device		(*1)	135	

Note *1 Specify the operation method and voltage. Order in combination with the breaker unit.

NF1000-SEW NF1250-SEW



NF1250-SEW

Model		NF1000-SEW	NF1250-SEW		
Rated current In (A)		500-1000 Adjustable	600-1250 Adjustable		
Number of poles		3 4	3 4		
Rated insulation voltage Ui (V)		690	690		
Rated short-circuit breaking capacity (kA)	IEC 60947-2 (Icu/Ics)	AC	690V	25/13	25/13
			500V	65/33	65/33
			440V	85/43	85/43
			400V	85/43	85/43
			230V	125/63	125/63
Standard attached parts		Front connection	Mounting screw: M8x40 (4pcs) Insulating barrier: (3P: 2pcs, 4P: 3pcs) Auxiliary handle: (1pc)		
		Rear connection	Mounting screw: M8x40 (4pcs) Insulating barrier: (3P: 2pcs, 4P: 4pcs) Auxiliary handle: (1pc)		

Operating Characteristics

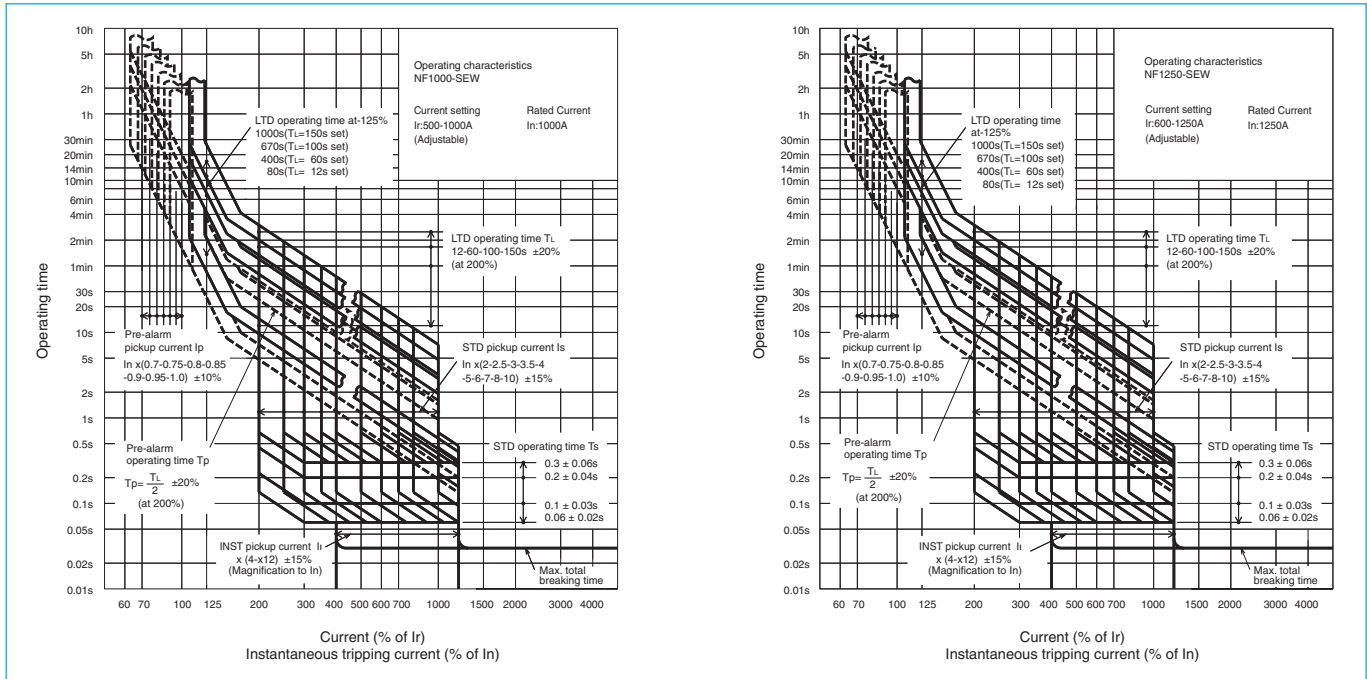

Internal Accessories

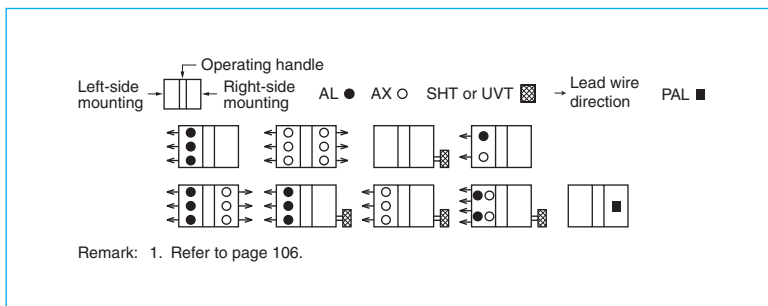

Current Reducing Curve

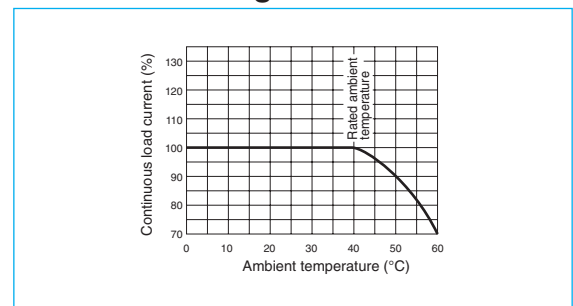

External Accessories

(An order for ☆ should be placed at the same time as an order of circuit breaker main body.)

Accessories		Type name	Reference page	Accessories		Type name	Reference page
Operating handle	F	3P F10SW	119	Auxiliary handle	HT	HT-10SW	130
		4P F10SW4P		Handle lock device	HL	HL (☆)	129
Mechanical interlock	MI	3P MI-10SW3	131	Large terminal cover	TC-L	3P TCL-10SW3	123
		4P MI-10SW4				4P TCL-10SW4	
				Electrical operation device	NFM	3P (*)	135
						4P (*)	

Note *1 Specify the operation method and voltage. Order in combination with the breaker unit.

NF1250-SDW



NF1250-SDW

Model		NF1250-SDW			
Rated current In (Amp.)		1000, 1250			
Number of poles		2			
Rated insulation voltage Ui (V)		690			
Rated short-circuit breaking capacity (kA)	IEC 60947-2 (Icu/Ics) Time constant not large than 10ms	DC	250V	40/20	
Standard Attached parts		Front connection	Mounting screw: M8×40 (4pcs) Insulating barrier: (2P: 1pc, 3P: 2pcs, 4P: 3pcs) Auxiliary handle: (1pc)		
		Rear connection	Mounting screw: M8×40 (4pcs) Insulating barrier: (3P: 2pcs, 4P: 4pcs) Auxiliary handle: (1pc)		

Operating Characteristics

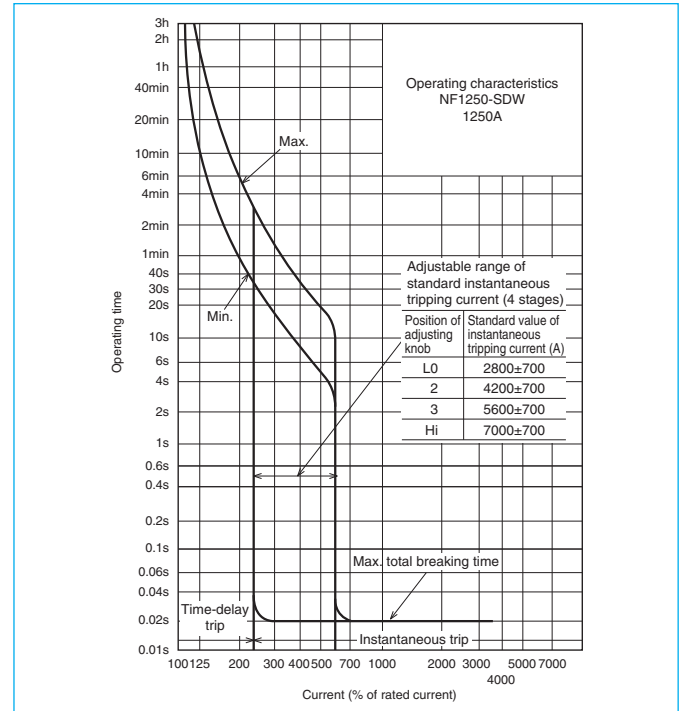
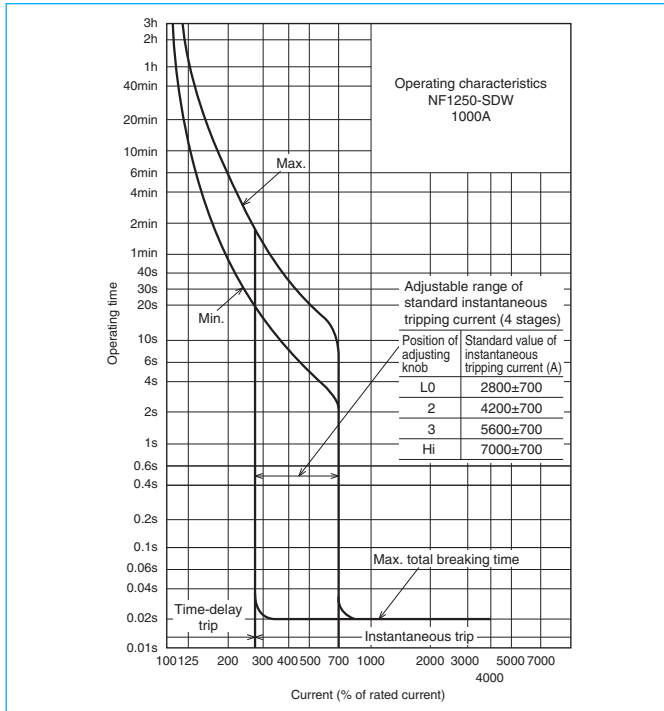

Internal Accessories

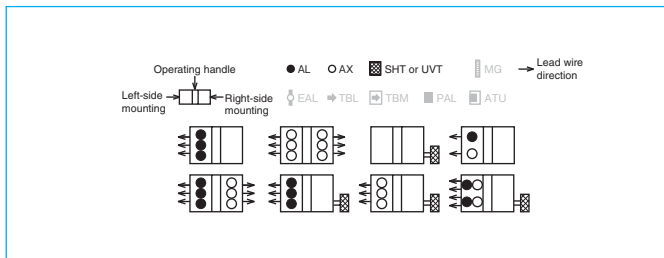

Temperature Compensation Curve

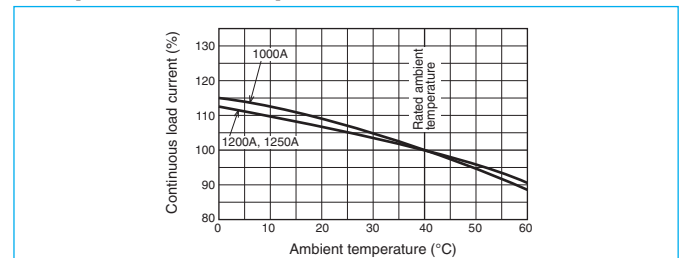

External Accessories

(An order for ☆ should be placed at the same time as an order of circuit breaker main body.)

Accessories		Type name	Reference page	Accessories		Type name	Reference page
Operating handle	F	2, 3P F10SW	119	Auxiliary handle	HT	HT-10SW	130
		4P F10SW4P		Handle lock device	HL	HL (☆)	129
Mechanical interlock	MI	2, 3P MI-10SW3	131	Large terminal cover	TC-L	2, 3P TCL-10SW3	123
		4P MI-10SW4				4P TCL-10SW4	
				Electrical operation device	NFM	2, 3P (*1)	135
						4P	

Note *1 Specify the operation method and voltage. Order in combination with the breaker unit.

NF1600-SEW



NF1600-SEW

Model		NF1600-SEW		
Rated current I_n (A)		Adjustable 800-1600		
Number of poles		3	4	
Rated insulation voltage U_i (V)		690		
Rated short-circuit breaking capacity (kA)	IEC 60947-2 (Icu/Ics)	AC	690V	25/13
			500V	65/33
			440V	85/43
			400V	85/43
			230V	125/63
Standard attached parts		Front connection	Mounting screw: M8 × 40 (4pcs) Insulating barrier: (3P: 2pcs, 4P: 3pcs) Auxiliary handle: (1pc)	
		Rear connection	Mounting screw: M8 × 40 (4pcs) Auxiliary handle: (1pc)	

Operating Characteristics

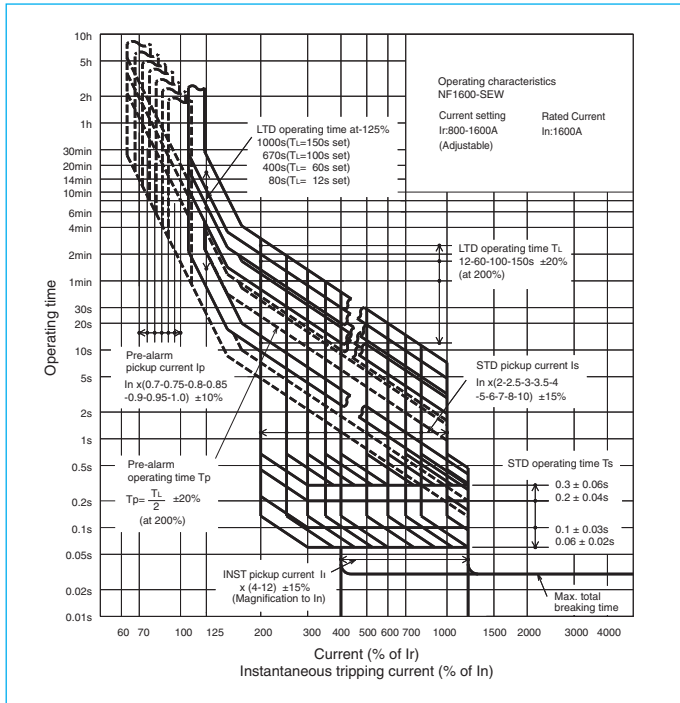

Internal Accessories

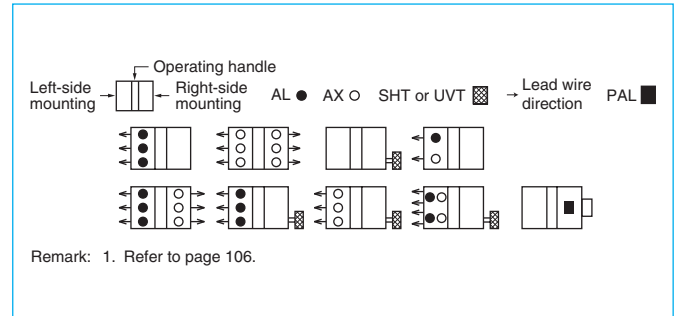

Current Reducing Curve

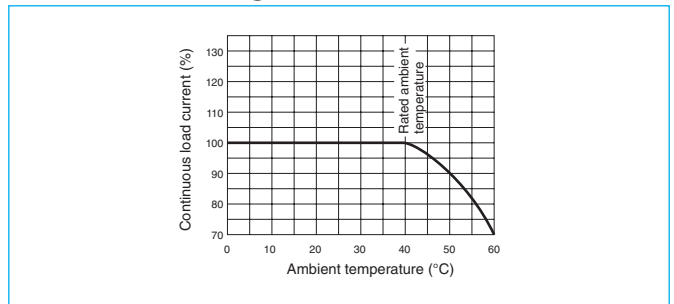

External Accessories

(An order for ☆ should be placed at the same time as an order of circuit breaker main body.)

Accessories		Type name	Reference page	Accessories		Type name	Reference page
Operating handle	F	3P F10SW	119	Auxiliary handle	HT	HT-10SW	130
		4P F10SW4P		Handle lock device	HL	HL (☆)	129
Mechanical interlock	MI	3P MI-16SW3	131	Electrical operation device	NFM	(*1)	135
		4P MI-16SW4					

Note *1 Specify the operation method and voltage. Order in combination with the breaker unit.

Outline Drawing

Front connection

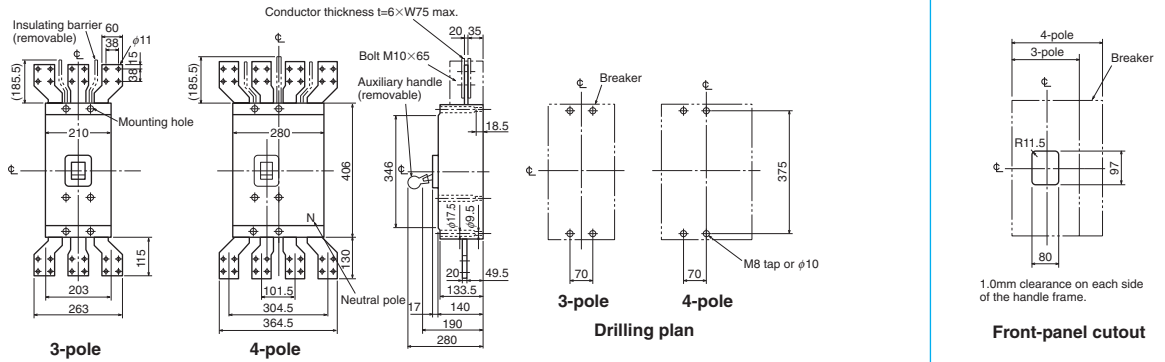

Rear connection

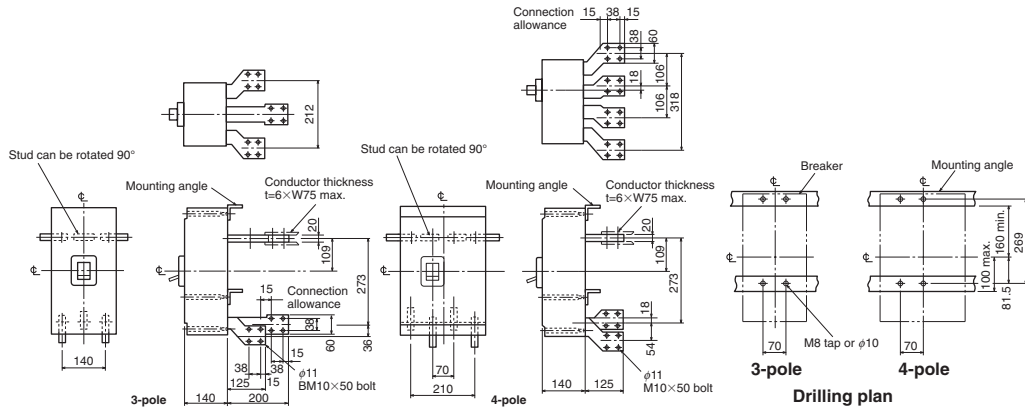

NF1600-SDW



NF1600-SDW

Model		NF1600-SDW	
Rated current In (Amp.)		1600	
Number of poles		2	
Rated insulation voltage Ui (V)		690	
Rated short-circuit breaking capacity (kA)	IEC 60947-2 (Icu/Ics) Time constant not large than 10msec	DC	250V
	40/20		
Standard Attached parts	Front connection	Mounting screw: M8×40 (4pcs) Insulating barrier: (2P: 1pc, 3P: 2pcs, 4P: 3pcs) Auxiliary handle: (1pc)	
	Rear connection	Mounting screw: M8×40 (4pcs) Auxiliary handle: (1pc)	

Operating Characteristics

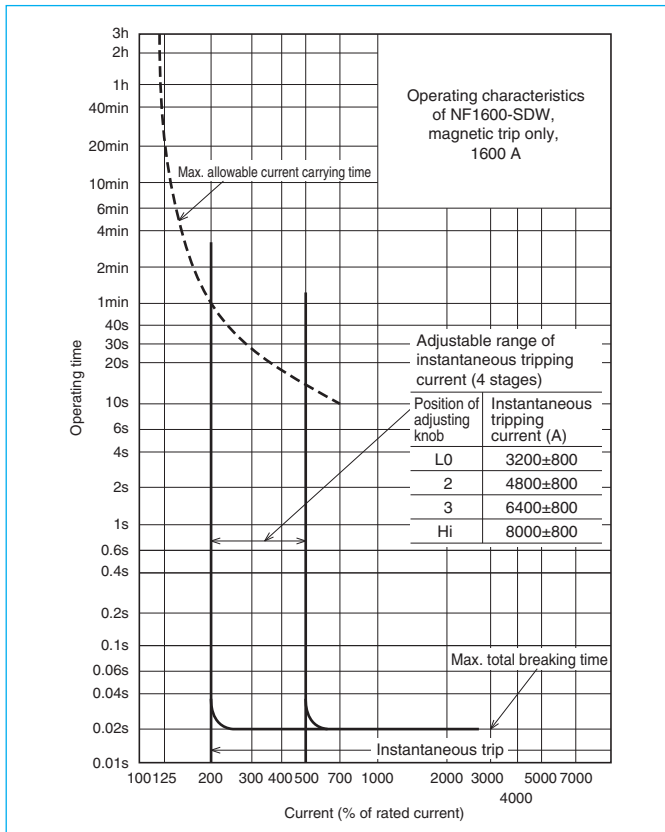

Internal Accessories

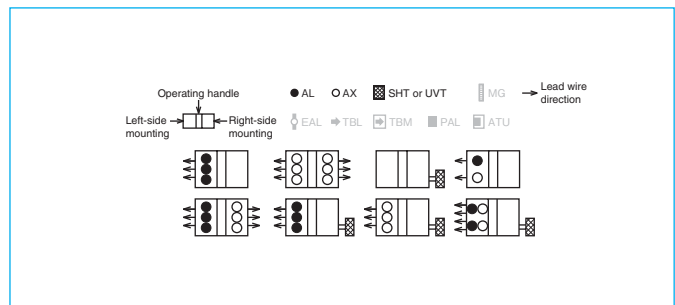

External Accessories

(An order for ☆ should be placed at the same time as an order of circuit breaker main body.)

Accessories	Type name	Reference page	Accessories	Type name	Reference page
Operating handle	F 2, 3P	F10SW	Auxiliary handle	HT	HT-10SW
	4P	F10SW4P		Handle lock device	HL
Mechanical interlock	MI 2, 3P	MI-16SW3	Electrical operation device	NFM 2, 3P	(*1)
	4P	MI-16SW4		4P	

Note *1 Specify the operation method and voltage. Order in combination with the breaker unit.

NV32-SV
NV63-CV
NV63-SV
NV63-HV



NV63-SV

Model		NV32-SV	NV63-CV	NV63-SV	NV63-HV				
Rated current I _n (A)		(5) 6 10 (15) 16 20 25 (30) 32	(5) (10) (15) 16 20 25 (30) 32 40 50 (60) 63	(5) (10) (15) 16 20 25 (30) 32 40 50 (60) 63	(15) 16 20 25 (30) 32 40 50 (60) 63				
Number of poles		3	2 3	2 3	3				
Phase line		3φ3W, 1φ2W	1φ2W	3φ3W, 1φ2W	3φ3W, 1φ2W				
Rated operational voltage U _e (V)		AC 100-440	100-240	100-240	100-440				
High-speed type	Rated current sensitivity (mA)	(15) 30 100/200/500 selectable	30	(15) 30 100/200/500 selectable	(15) 30 100/200/500 selectable				
	Max operating time (s)	at IΔn 0.1 at 5IΔn 0.04	0.1 0.04	0.1 0.04	0.1 0.04				
Time-delay type	Rated current sensitivity (mA)	-	-	-	-				
	Max operating time (s)	-	-	-	-				
	Inertial operating time (s) (or more)	-	-	-	-				
Earth-leakage indication system		Mechanical type (button)	Mechanical type (button)	Mechanical type (button)	Mechanical type (button)				
Rated short-circuit breaking capacity (kA)	IEC 60947-2 (Icu/Ics)	AC	440V	5/5	-	2.5/2.5	-	7.5/7.5	10/8
			415V	5/5	-	2.5/2.5	-	7.5/7.5	10/8
			400V	5/5	-	5/5	-	7.5/7.5	10/8
			230V	10/10	-	7.5/7.5	-	15/15	25/19
			200V	10/10	-	7.5/7.5	-	15/15	25/19
			100V	10/10	-	7.5/7.5	-	15/15	25/19
Standard attached parts (Front connection)		Mounting screw: M4×0.7×55 (2pcs) (*1)		Insulation barrier: (2P: 1pc, 3P: 2pcs)					

Note *1 Attached to NV63-SV and NV63-HV.

Operating Characteristics

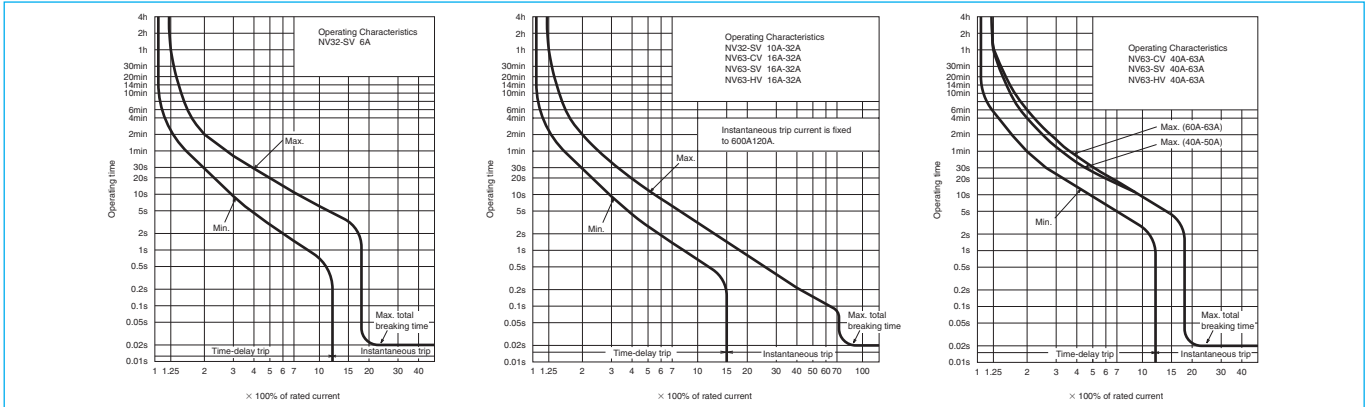

Earth leakage Tripping Characteristics

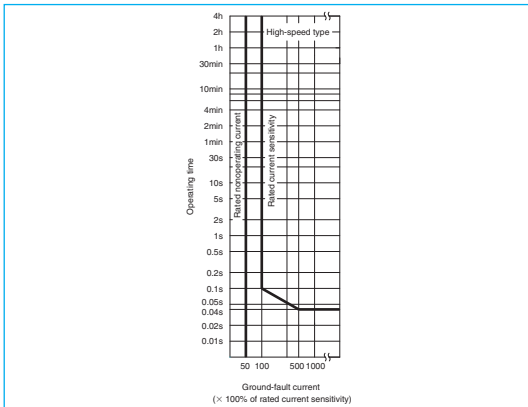

Internal Accessories

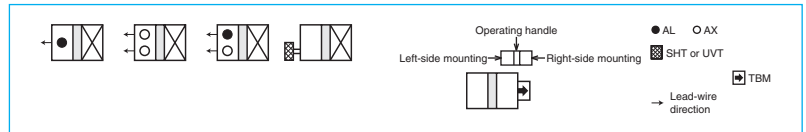

Temperature Compensation Curve

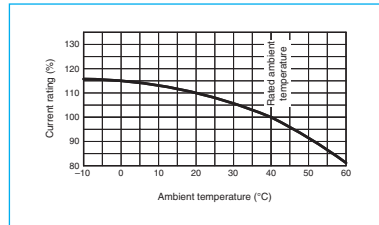

Internal Wiring Diagram

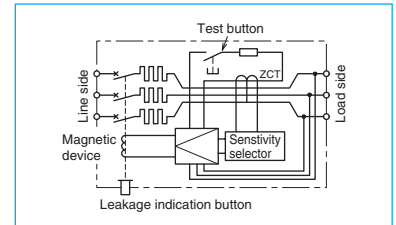

External Accessories

Accessories	Type name	Reference page	Accessories	Type name	Reference page	
Operating handle	F	F-05SV	Mechanical interlock	MI	MI-05SV3	
	V	V-05SV		121		131
Handle lock device	LC	LC-05SV	Terminal cover	Small	TC-S	TCS-05SV3
	HL (*1)	HLF-05SV		Large	TC-L	TCL-05SV3
		HLN-05SV			TC-L	TCL-05SV3L
		HLN-05SV			Skeleton	TTC
	HLS-05SV			Rear	BTC	BTC-05SV3
			Plug-in	PTC	PTC-05SV3	
IEC 35mm rail mounting adapters				DIN-05SV	139	

Note *1 HLF types are used for OFF lock and HLN types for ON lock.

Outline Drawing

Front connection

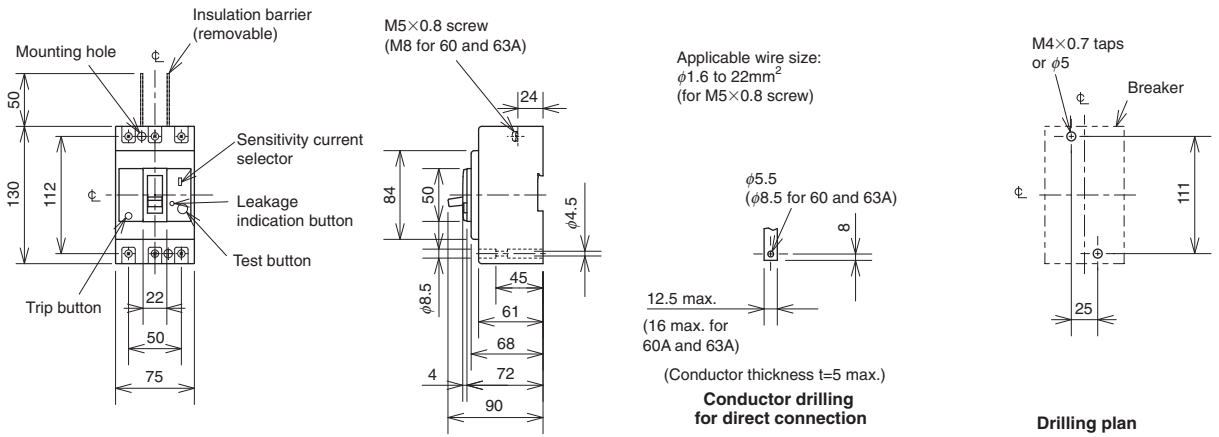

Rear connection

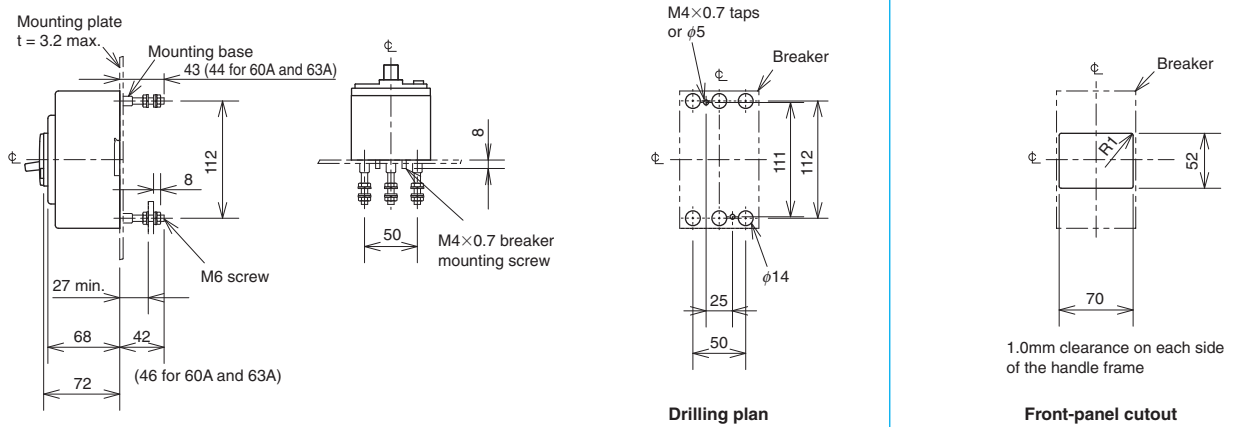

Plug-in

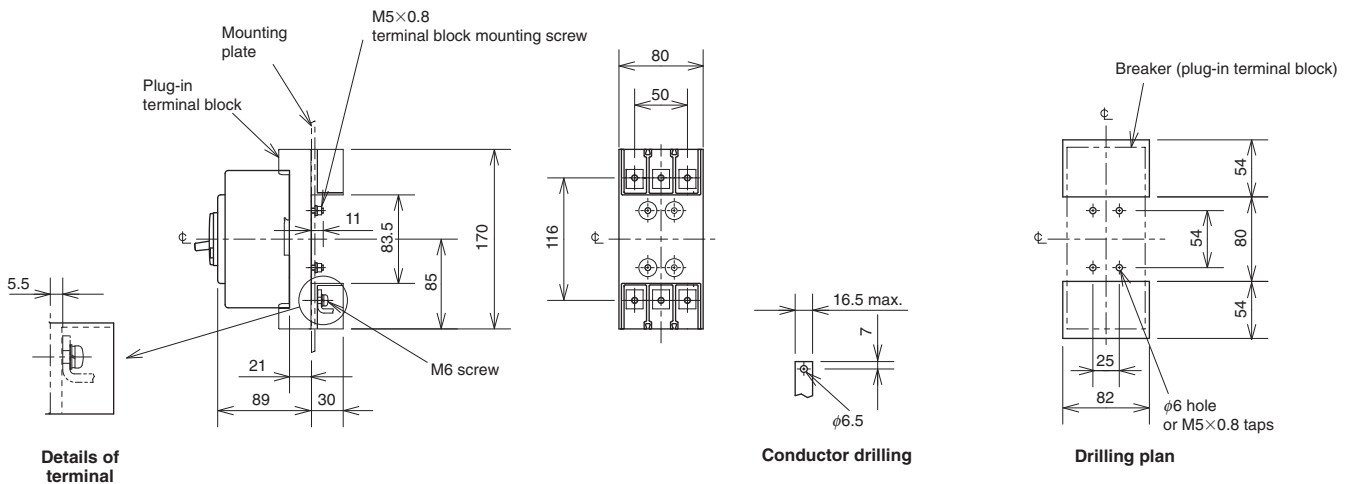

Remark: 1. 2-pole models are 3-pole models with the central pole removed.

NV125-CV NV125-SV NV125-HV



NV125-SV

Model		NV125-CV		NV125-SV		NV125-HV	
Rated current I _n (A)		(60) 63 (75) 80 100 125		(15) 16 20 30 32 40 50 (60) 63 (75) 80 100 125		(15) 16 20 (30) 32 40 50 (60) 63 75 80 100 125	
Number of poles		3		3	4	3	4
Phase line		3φ3W, 1φ2W		3φ3W, 1φ2W	3φ4W	3φ3W, 1φ2W	3φ4W
Rated operational voltage U _e (V)		AC 100-440		100-440	200-440	100-440	200-440
High-speed type	Rated current sensitivity (mA)	(15) 30 100/200/500 selectable		30 100/200/500 selectable		(30) 100/200/500 selectable	
	Max operating time (s)	at Δn		0.1		0.1	
		at 5Δn		0.04		0.04	
Time-delay type	Rated current sensitivity (mA)	(100/200/500 selectable)		(100/200/500 selectable)		(100/200/500 selectable)	
	Max operating time (s)	(0.45/1.0/2.0 selectable)		(0.45/1.0/2.0 selectable)		(0.45/1.0/2.0 selectable)	
	Inertial operating time (s) (or more)	(0.1/0.5/1.0)		(0.1/0.5/1.0)		(0.1/0.5/1.0)	
Earth-leakage indication system		Mechanical type (button)		Mechanical type (button)		Mechanical type (button)	
Rated short-circuit breaking capacity (kA)	IEC 60947-2 (Icu/lcs)	AC	440V	10/5	25/25	50/38	
			415V	10/5	30/30	50/38	
			400V	10/5	30/30	50/38	
			230V	30/15	50/50	100/75	
			200V	30/15	50/50	100/75	
			100V	30/15	50/50	100/75	-
Standard attached parts (Front connection)		Mounting screw: M4×0.7×55 (3P: 2pcs, 4P: 4pcs) (*1) Insulation barrier: (3P: 2pcs, 4P: 3pcs)					

Note *1 Attached to NV125-SV and NV125-HV.

Operating Characteristics

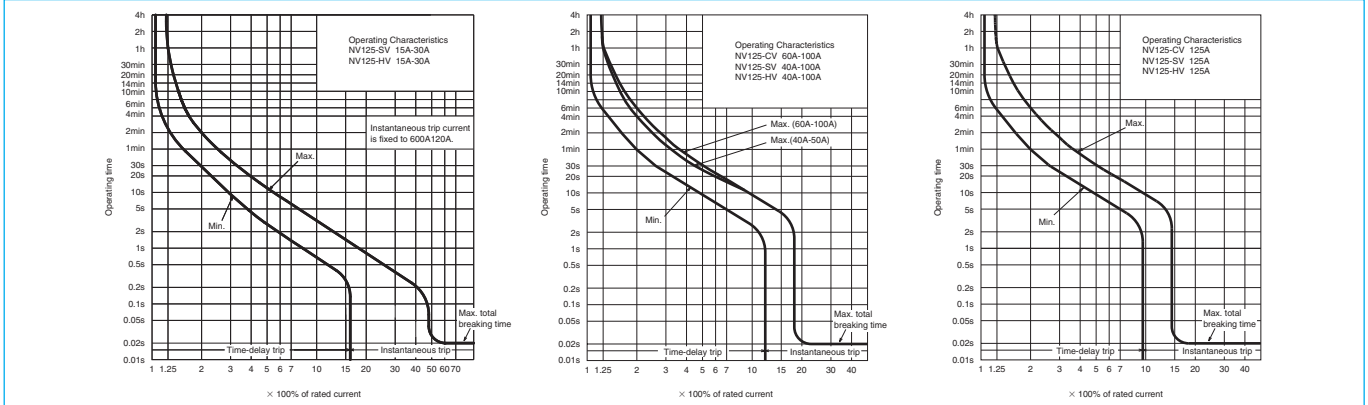

Earth leakage Tripping Characteristics

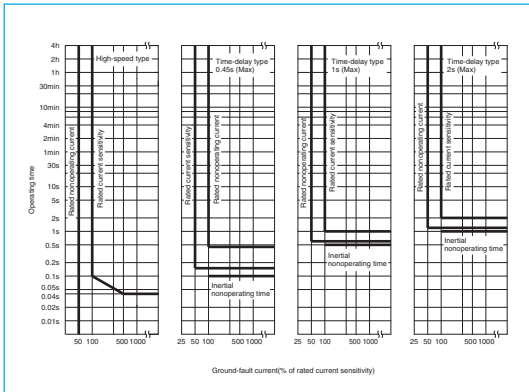

Internal Accessories

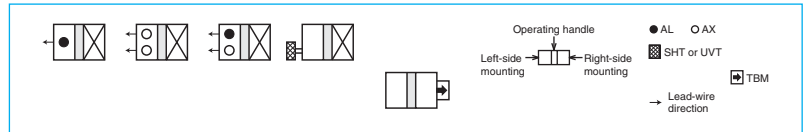

Temperature Compensation Curve

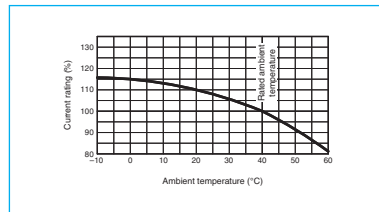

Internal Wiring Diagram

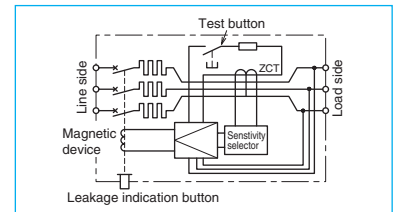

External Accessories

Accessories	Type name	Reference page	Accessories	Type name	Reference page	
Operating handle	F	F-1SV	Mechanical interlock	MI	3P MI-05SV3	
	V	V-1SV		4P MI-1SV4	131	
Handle lock device	LC	LC-05SV	Terminal cover	Small	TC-S TCS-1SV3	
	HL (*1)	HLF-05SV		3P	TCL-1SV3	123
		HLN-05SV		4P	TCL-1SV4	
HL-S	HLS-05SV	Skeleton		TTC	TTC-1SV3	
			Rear	BTC	BTC-1SV3	
			Plug-in	PTC	PTC-1SV3	
			Electrical operation device	(*2)	135	

Notes *1 HLF types are used for OFF lock and HLN types for ON lock.
*2 Specify the working voltage. Refer to the reference page for type name.

Outline Drawing

Front connection

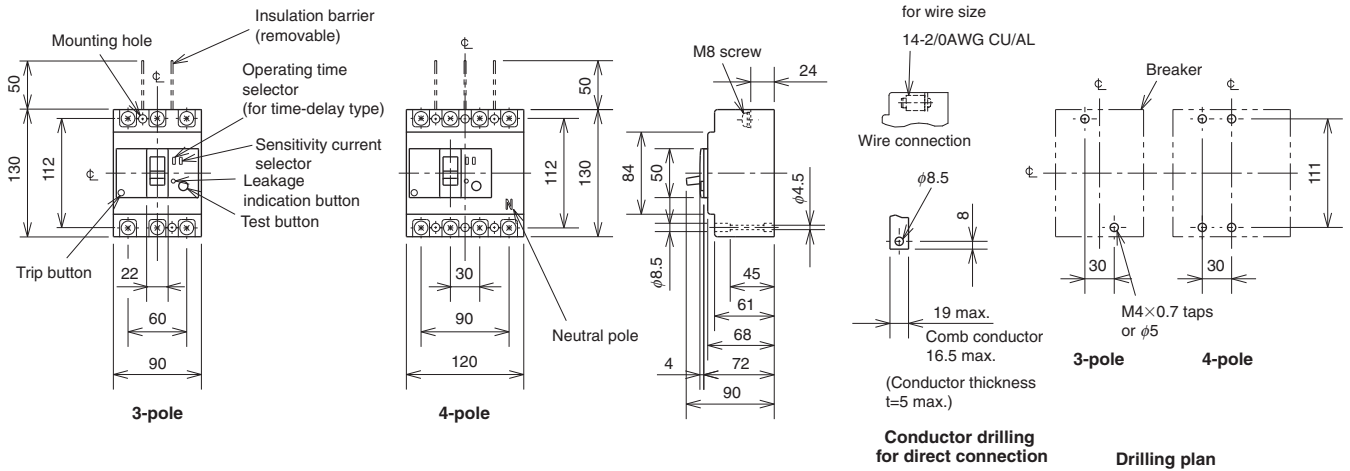

Rear connection

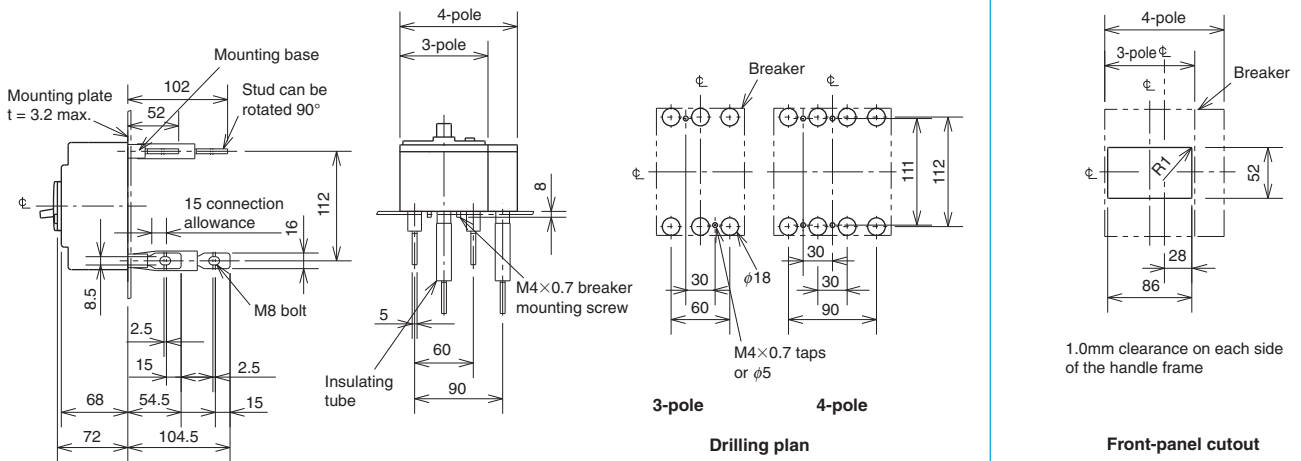

Plug-in

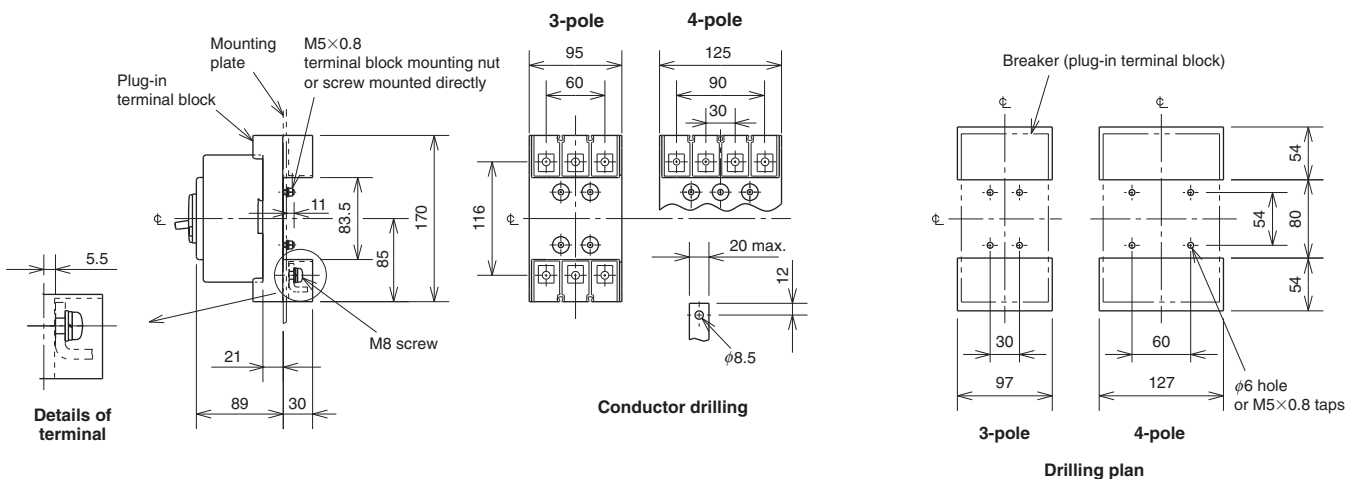

Remark: 1. Only 3-pole models are available for NV125-CV.

NV250-CV NV250-SV NV250-HV



NV250-CV

Model		NV250-CV		NV250-SV		NV250-HV		
Rated current I _n (A)		125	150 175	125 150 175	200 225 250	125 150 175	200 225 250	
Number of poles		3		3	4	3	4	
Phase line		3φ3W, 1φ2W		3φ3W, 1φ2W	3φ4W	3φ3W, 1φ2W	3φ4W	
Rated operational voltage U _e (V)		AC 100-440		100-440	200-440	100-440	200-440	
High-speed type	Rated current sensitivity (mA)	30 100/200/500 selectable		(30) 100/200/500 selectable		(30) 100/200/500 selectable		
	Max operating time (s)	at ΔI _n	0.1		0.1		0.1	
		at 5ΔI _n	0.04		0.04		0.04	
Time-delay type	Rated current sensitivity (mA)	(100/200/500 selectable)		(100/200/500 selectable)		(100/200/500 selectable)		
	Max operating time (s)	(0.45/1.0/2.0 selectable)		(0.45/1.0/2.0 selectable)		(0.45/1.0/2.0 selectable)		
	Inertial operating time (s) (or more)	(0.1/0.5/1.0)		(0.1/0.5/1.0)		(0.1/0.5/1.0)		
Earth-leakage indication system		Mechanical type (button)		Mechanical type (button)		Mechanical type (button)		
Rated short-circuit breaking capacity (kA)	IEC 60947-2 (Icu/Ics)	AC	440V	15/12	36/36	65/65		
			415V	25/19	36/36	70/70		
			400V	25/19	36/36	75/75		
			230V	36/27	85/85	100/100		
			200V	36/27	85/85	100/100		
			100V	36/27	85/85	100/100		
Standard attached parts (Front connection)		Mounting screw: M4×0.7×55 (3P: 2pcs, 4P: 4pcs)		Insulation barrier: (3P: 4pcs, 4P: 6pcs)				

Operating Characteristics

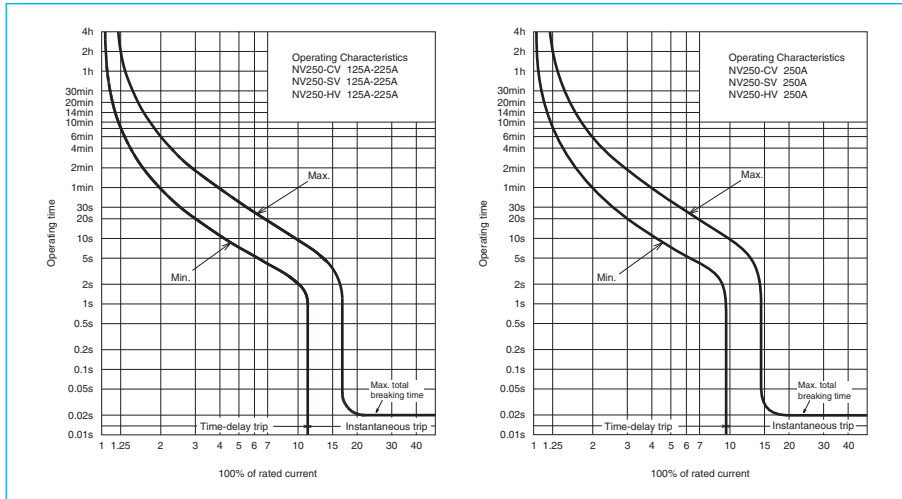

Earth leakage Tripping Characteristics

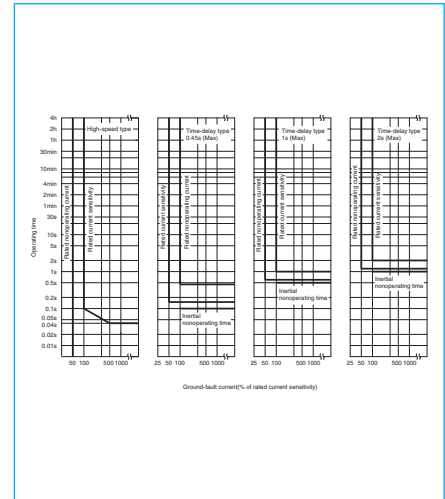

Internal Accessories

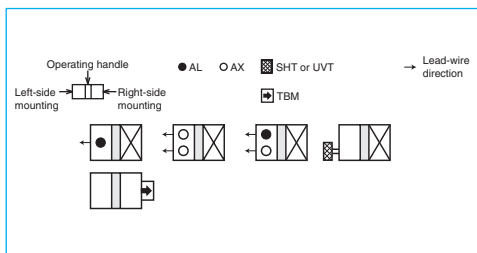

Temperature Compensation Curve

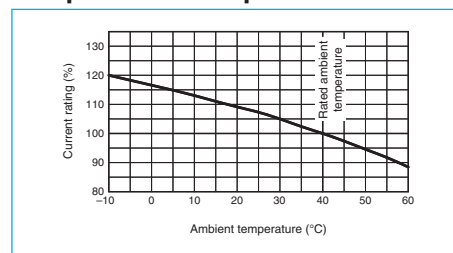

Internal Wiring Diagram

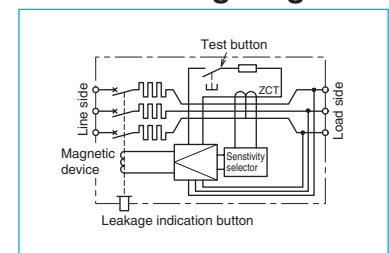

External Accessories

Accessories	Type name	Reference page	Accessories	Type name	Reference page
Operating handle	F	F-2SV	Mechanical interlock	MI	3P MI-05SV3
	V	V-2SV		4P MI-2SV4	131
Handle lock device	LC	LC-05SV	Terminal cover	Small	
	HL (*1)	HLF-05SV		3P TCL-2SV3	123
		HLN-05SV		4P TCL-2SV3L	
	HL-S	HLS-2SV		4P TCL-2SV4	
			Skeleton	3P TTC-2SV3	
			Rear	3P BTC-2SV3	
			Plug-in	3P PTC-2SV3	
			Electrical operation device	(*2)	135

Notes *1 HLF types are used for OFF lock and HLN types for ON lock.
*2 Specify the working voltage. Refer to the reference page for type name.

NV125-SEV NV125-HEV NV250-SEV NV250-HEV



NV250-SEV

Model		NV125-SEV	NV125-HEV	NV250-SEV	NV250-HEV		
Rated current In (A)		125	125	250	250		
Current setting Ir (A)		63-125		125-250	125-250		
Number of poles		3	4	3	3		
Phase line type		3φ3W, 1φ2W	3φ4W	3φ3W, 1φ2W	3φ4W		
Rated operational voltage Ui		V		440	440		
Rated operational voltage Ue (V)		AC		100-440	100-440		
High-speed type	Rated current sensitivity (mA)	(30)		(30)	(30)		
	Max operating time (s)	100/200/500 selectable		100/200/500 selectable	100/200/500 selectable		
Time-delay type	Rated current sensitivity (mA)	(100/200/500 selectable)		(100/200/500 selectable)	(100/200/500 selectable)		
	Max operating time (s)	(0.45/1.0/2.0 selectable)		(0.45/1.0/2.0 selectable)	(0.45/1.0/2.0 selectable)		
Inertial operating time (s) (or more)		(0.1/0.5/1.0)		(0.1/0.5/1.0)	(0.1/0.5/1.0)		
Earth-leakage indication system		Mechanical type (button)		Mechanical type (button)	Mechanical type (button)		
Rated short-circuit breaking capacity (kA)	IEC 60947-2 (Icu/Ics)	AC	440V	36/36	65/65	36/36	65/65
			415V	36/36	70/70	36/36	70/70
			400V	36/36	75/75	36/36	75/75
			230V	85/85	100/100	85/85	100/100
			200V	85/85	100/100	85/85	100/100
			100V	85/85	100/100	85/85	100/100
Standard attached parts (Front connection)		Mounting screw: M4×0.7×55 (3P: 2pcs, 4P: 4pcs)		Insulation barrier: (3P: 4pcs, 4P: 6pcs)			

Operating Characteristics

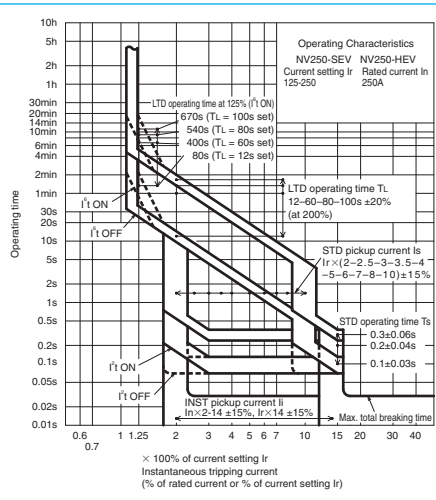
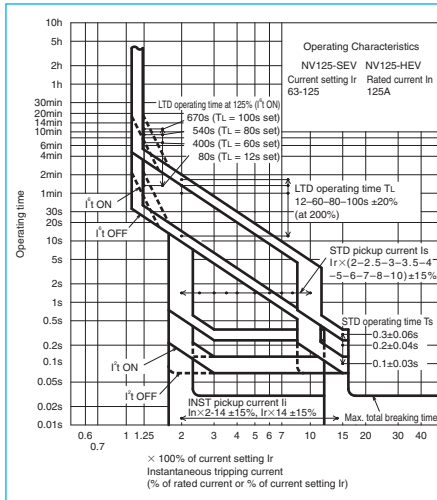

Earth leakage Tripping Characteristics

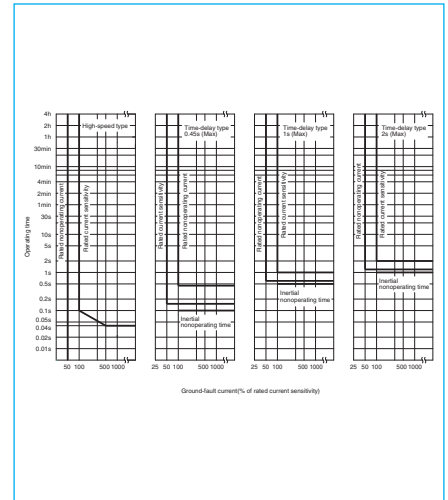

Internal Accessories

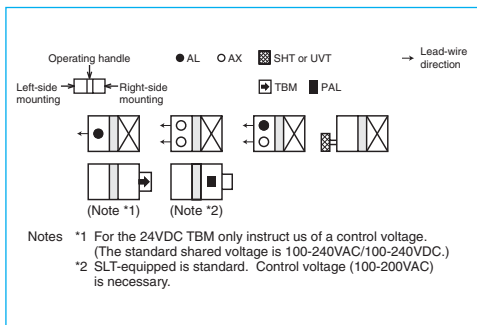

Current Reducing Curve

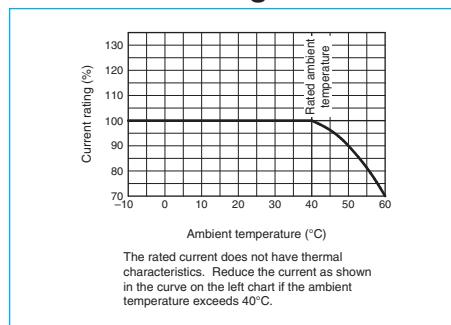

Internal Wiring Diagram

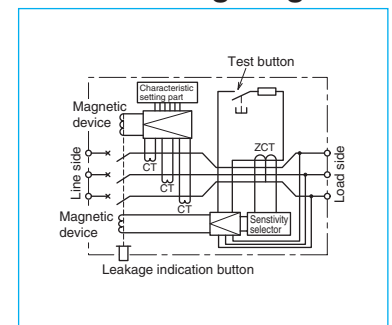

External Accessories

Accessories		Type name	Reference page	Accessories		Type name	Reference page
Operating handle	F	F-2SV	119	Mechanical interlock	3P	MI-05SV3	131
	V	V-2SV	121		4P	MI-2SV4	
Handle lock device	LC	LC-05SV	129	Terminal cover	3P	TCS-2SV3	123
	HL (*1)	HLF-05SV			3P	TCL-2SV3	
	HLN-05SV	3P			TCL-2SV3L		
HL-S	HLS-2SV	4P	TCL-2SV4				
			3P		TTC-2SV3		
			3P	BTC-2SV3			
			3P	PTC-2SV3			
				Electrical operation device	(*2)	135	

Notes *1 HLF types are used for OFF lock and HLN types for ON lock.
*2 Specify the working voltage. Refer to the reference page for type name.

Outline Drawing

Front connection

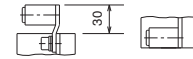
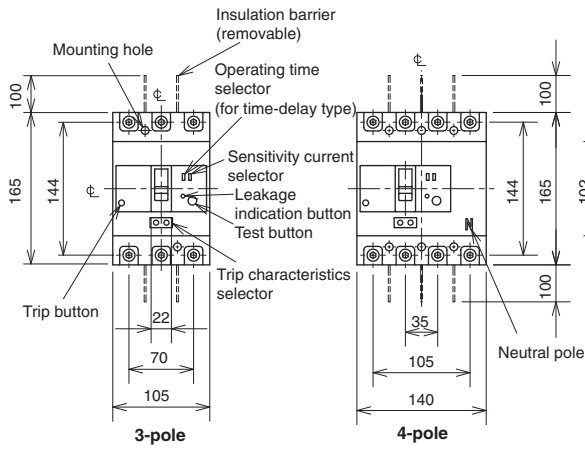

Solderless terminal for wire size
 125-175A 14-95mm²
 200-250A 70-125mm²
 Wire connection

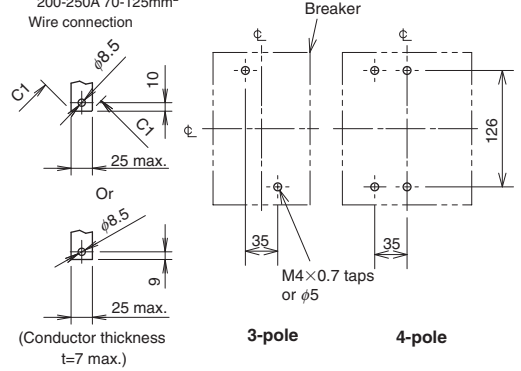

Conductor drilling for direct connection

Drilling plan

Rear connection

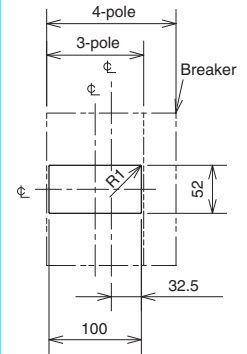
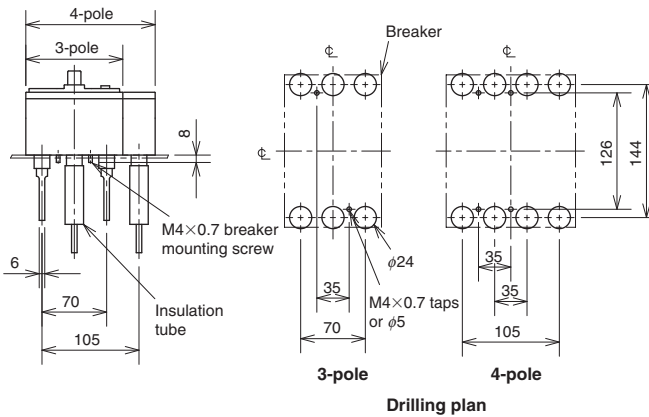
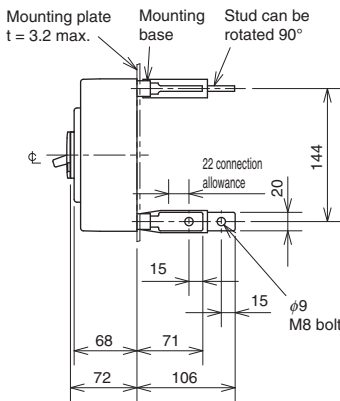

1.0mm clearance on each side of the handle frame

Front-panel cutout

Plug-in

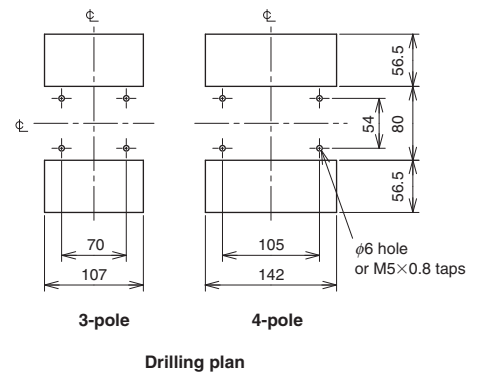
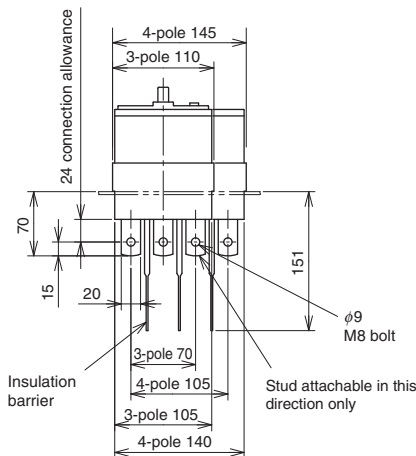
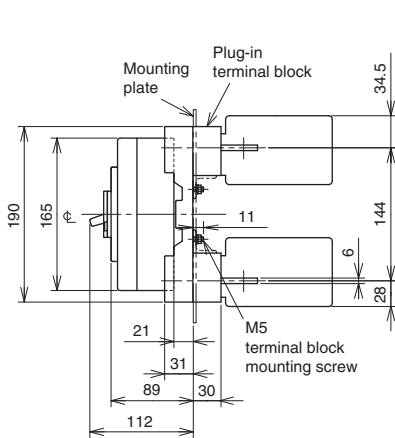

Drilling plan

Remark: 1. Only 3-pole models are available for the model of NV250-SEV and NV250-HEV.

NV400-CW NV400-SW



NV400-SW

Model	NV400-CW	NV400-SW		
Number of poles	3			
Rated operational voltage Ue (V AC) (*1)	100-440 Multi-voltage type			
Rated current In (A)	250 300 350 400			
High-speed type	Rated current sensitivity IΔn (mA)	(30) 100 · 200 · 500 Selectable		
	Max. operating time at 5IΔn (s)	0.04		
Time-delay type	Rated current sensitivity IΔn (mA)	(100 · 200 · 500 Selectable)		
	Max. operating time at 2IΔn (s)	(0.45 · 1.0 · 2.0 Selectable)		
	Inertial non-operating time at 2IΔn (s)	(0.1 · 0.5 · 1.0)		
Earth-leakage indication system		Button		
Rated short-circuit breaking capacity (kA) IEC 60947-2 (Icu/Ics) EN 60947-2	AC	440V	25/13	42/42
		400V	36/18	45/45
		230V	50/25	85/85
Standard attached parts (Front connection)		Mounting screw: M6×60 (4pcs) Insulation barrier: (4pcs)		

Note *1 Rated operational voltage of time-delay type is for 200-440V.

Operating Characteristics

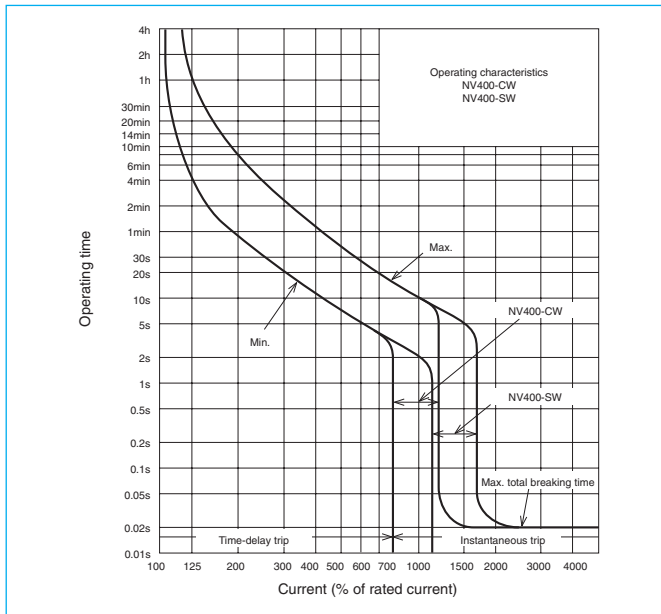

Earth Leakage Tripping Characteristics

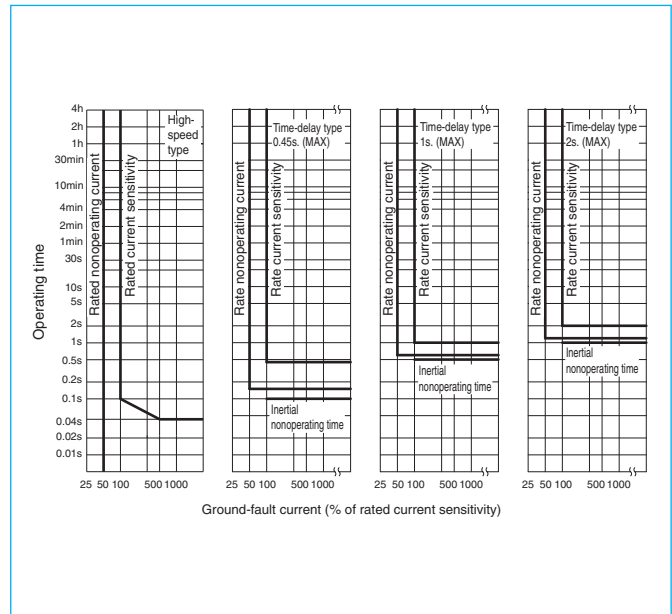

Internal Accessories

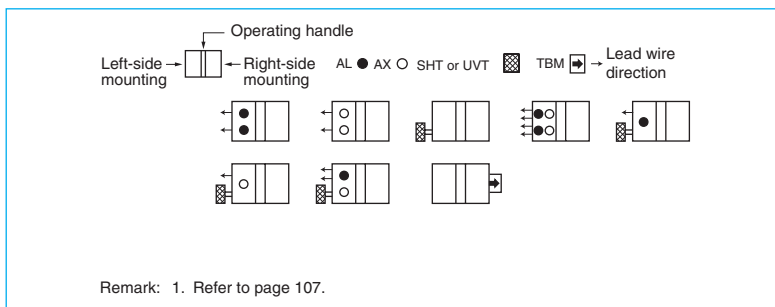

Temperature Compensation Curve

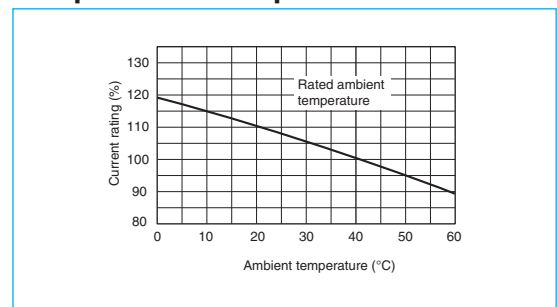

External Accessories

Accessories	Type name	Reference page	Accessories	Type name	Reference page			
Operating handle	F	F-4S	119	Auxiliary handle	HT	HT-4CW, HT-4SW	130	
	V	V-4S	121	Terminal cover	Large	TC-L	TCL-4SW3	123
Mechanical interlock	MI	MI-4SW3	131		Skeleton	TTC	TTC-4SW3	
					Rear	BTC	BTC-4SW3	
				Handle lock device	HL	HL-4CW, HL-4SW	129	
					HL-S	HLS-4SW		
				Electrical operation device	(*)1		135	

Note *1 Specify the operation method and voltage. Order in combination with the breaker unit.

Internal Wiring Diagram

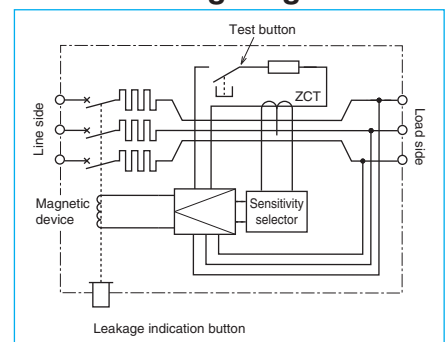

Outline Drawing

Front connection

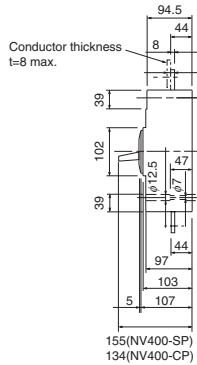
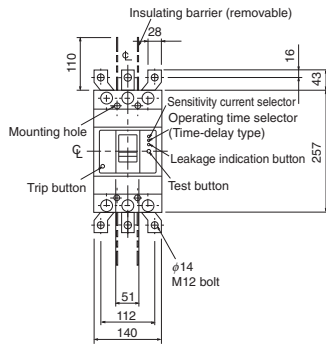

Conductor thickness $t=8$ max.
 Conductor drilling for direct connection

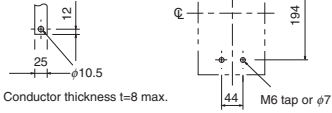

Drilling plan

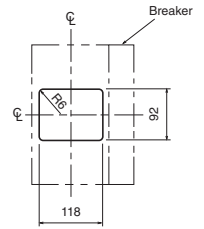

Front-panel cutout

Rear connection

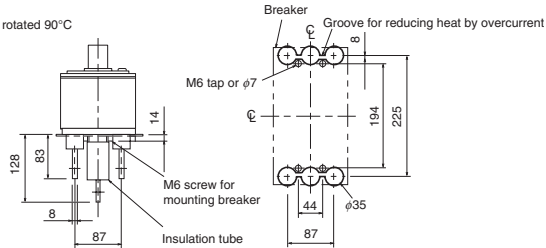
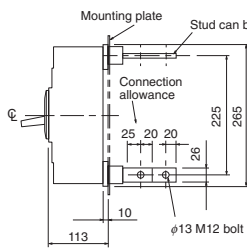

Drilling plan

Boring dimensions for rear connection type barriers (3-pole)

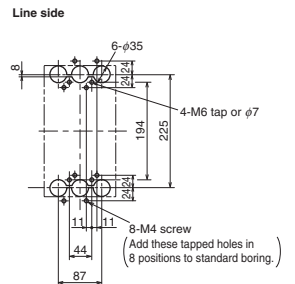

Load side

Note The bore dimensional drawing shows the breaker viewed from the rear.

NV400-SEW NV400-HEW NV400-REW



NV400-SEW

Model		NV400-SEW		NV400-HEW		NV400-REW	
Number of poles		3	4	3	4	3	
Rated operational voltage Ue (V AC) (*1)		100-440 Multi-voltage type					
Rated current In (A)		200-400 adjustable					
High-speed type	Rated current sensitivity $I\Delta n$ (mA)	(30) 100 · 200 · 500 Selectable					
	Max. operating time at $5I\Delta n$ (s)	0.04					
Time-delay type	Rated current sensitivity $I\Delta n$ (mA)	(100 · 200 · 500 Selectable)					
	Max. operating time at $5I\Delta n$ (s)	(0.45 · 1.0 · 2.0 Selectable)					
	Max. inertial non-operating time at $2I\Delta n$ (s)	(0.1 · 0.5 · 1.0)					
Earth-leakage indication system		Button					
Rated short-circuit breaking capacity (kA) IEC 60947-2 (Icu/Ics) EN 60947-2	AC	440V	42/42	65/65	125/63		
		400V	50/50	70/70	125/63		
		230V	85/85	100/100	150/75		
Standard attached parts (Front connection)		Mounting screw: M6x72 (4pcs) Insulation barrier: (3P: 4pcs, 4P: 6pcs)					

Note *1 Rated operational voltage of time-delay type is for 200-440V.

Operating Characteristics

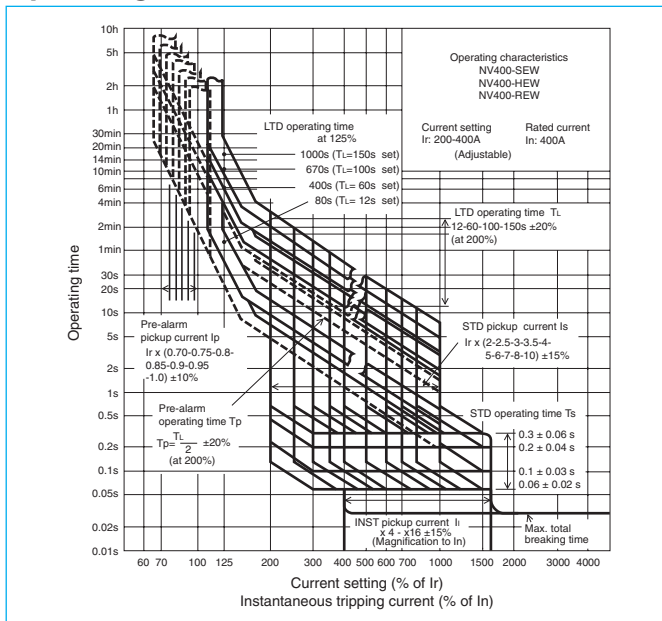

Earth Leakage Tripping Characteristics

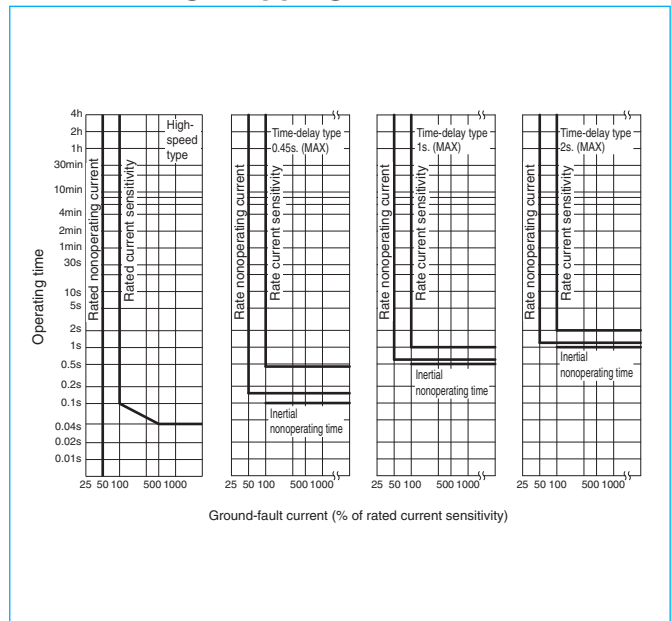

Internal Accessories

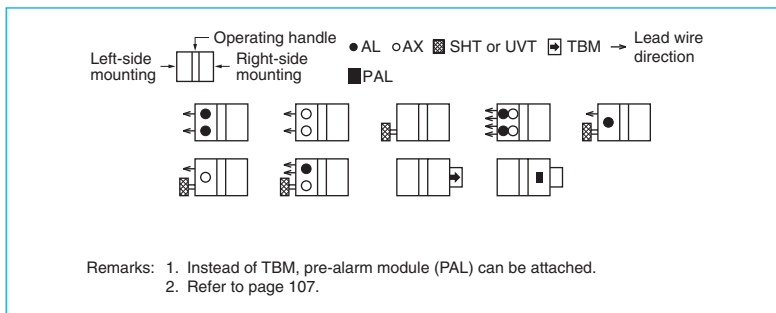

Current Reducing Curve

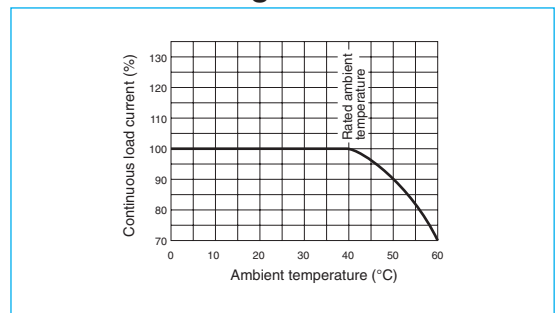

External Accessories

Accessories		Type name	Reference page	Accessories		Type name	Reference page	
Operating handle	F	F-4S	119	Auxiliary handle	HT	HT-4SW	130	
	V	V-4S	121	Terminal cover	Large	TC-L	3P TCL-4SW3 (*1) 4P TCL-4SW4 (*1)	123
Mechanical interlock	MI	3P MI-4SW3 4P MI-4SW4	131		Skeleton	TTC	3P TTC-4SW3 4P TTC-4SW4	
	Rear	BTC	3P BTC-4SW3 (*2) 4P BTC-4SW4		Handle lock device	HL	HL-4SW	
HL-S		HLS-4SW	Electrical operation device			NVM	3P (*3) 4P	

Notes *1 This is for NV400-SEW.
 *2 This is for NV400-SEW. For rear terminal cover of NV400-HEW/REW, use PTC-4SW3.
 *3 Specify the operation method and voltage. Order in combination with the breaker unit.

Internal Wiring Diagram

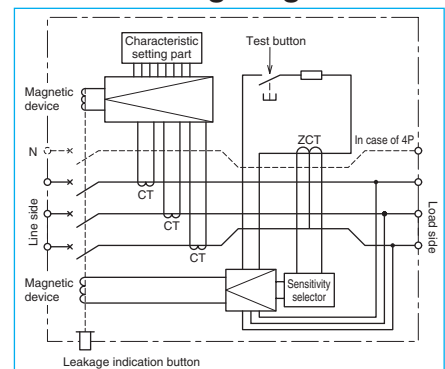

Outline Drawing

Front connection

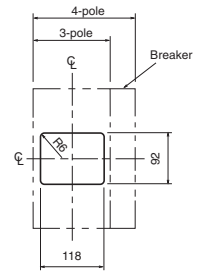
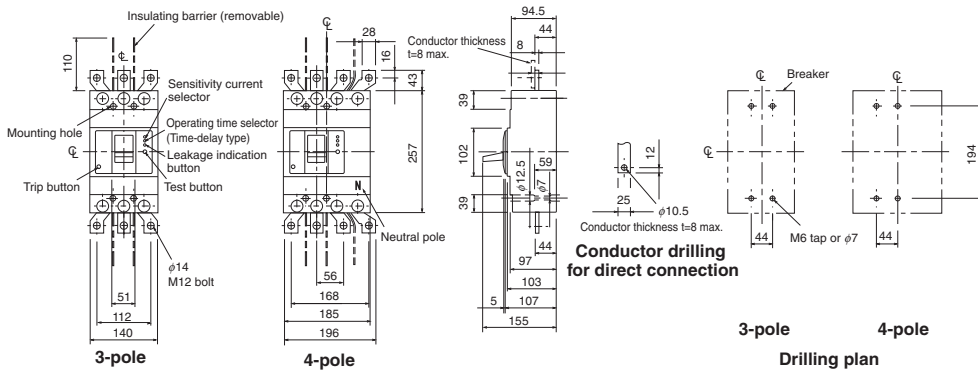

1.0mm clearance on each side of the handle frame.

Front-panel cutout

Rear connection

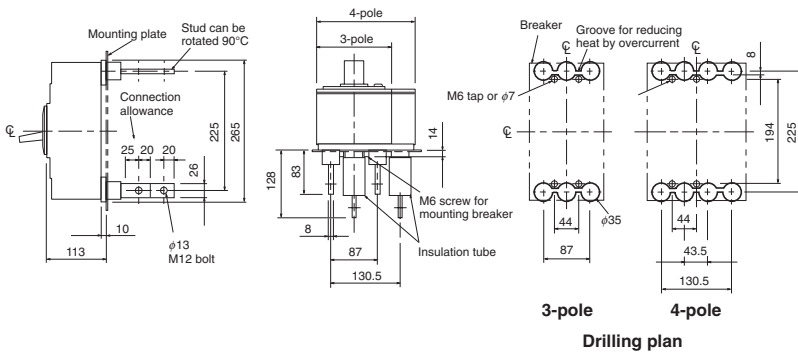

Boring dimensions for rear connection type barriers (3-pole)

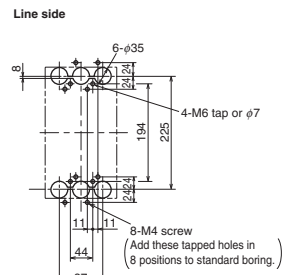

Load side

Note The bore dimensional drawing shows the breaker viewed from the rear.

NV630-CW NV630-SW



NV630-SW

Model		NV630-CW	NV630-SW
Number of poles		3	
Rated operational voltage Ue (V AC)		100-440 Multi-voltage type	
Rated current In (A)		500 600 630	
High-speed type	Rated current sensitivity IΔn (mA)	-	
	Max. operating time at 5IΔn (s)	-	
Time-delay type	Rated current sensitivity IΔn (mA)	100 · 200 · 500 Selectable	
	Max. operating time at 5IΔn (s)	0.45 · 1.0 · 2.0 Selectable	
	Max. inertial non-operating time at 2IΔn (s)	0.1 · 0.5 · 1.0	
Earth-leakage indication system		Button	
Rated short-circuit breaking capacity (kA) IEC 60947-2 (Icu/Ics) EN 60947-2	AC	440V	36/18 42/42
		400V	36/18 50/50
		230V	50/25 85/85
Standard attached parts (Front connection)		Mounting screw: M6×72 (4pcs) Insulation barrier: (4pcs)	

Operating Characteristics

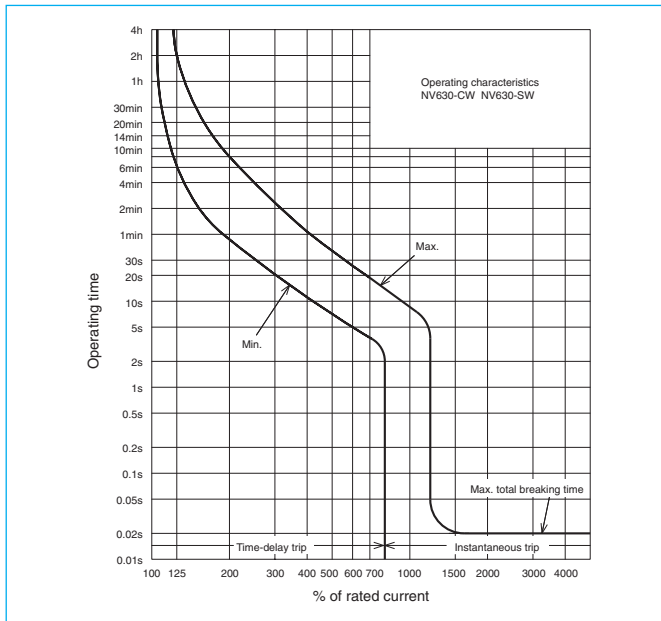

Earth Leakage Tripping Characteristics

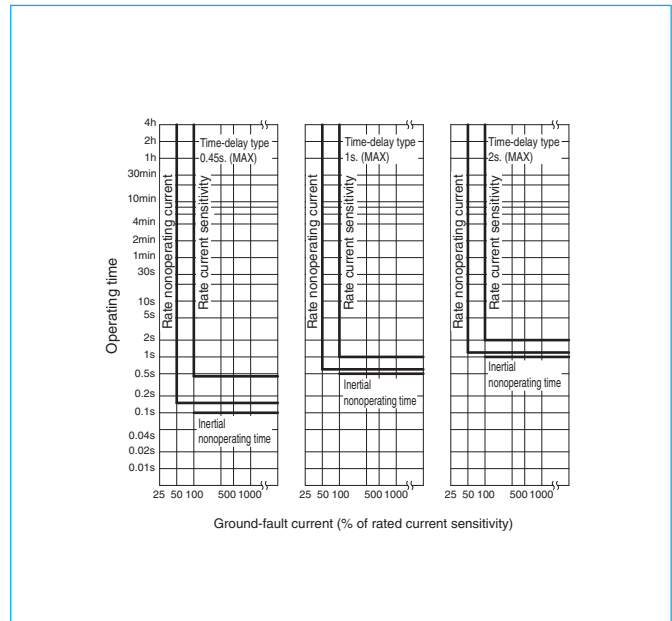

Internal Accessories

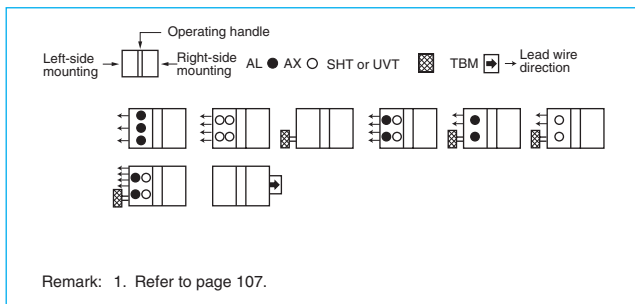

Temperature Compensation Curve

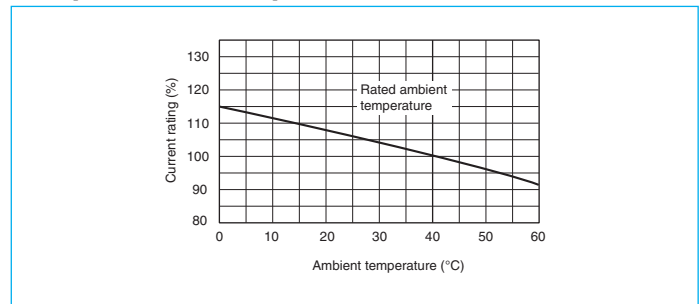

External Accessories

Accessories	Type name	Reference page	Accessories	Type name	Reference page		
Operating handle	F	F-4S	119	Auxiliary handle	HT	HT-4SW	130
	V	V-4S	121	Terminal cover	Large	TC-L	TCL-4SW3
Mechanical interlock	MI	MI-4SW3	131	Skeleton	TTC	TTC-4SW3	129
				Rear	BTC	BTC-4SW3	
				Handle lock device	HL	HL-4SW	135
			Electrical operation device	HL-S	HLS-4SW	135	
					(*1)		

Note *1 Specify the operation method and voltage. Order in combination with the breaker unit.

Internal Wiring Diagram

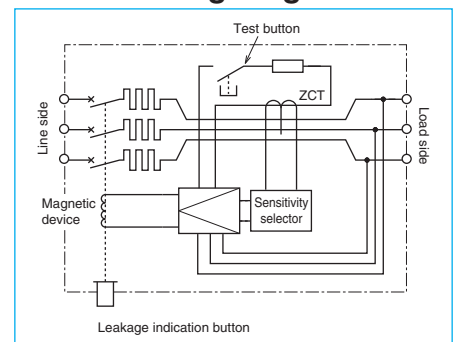

Outline Drawing

Front connection

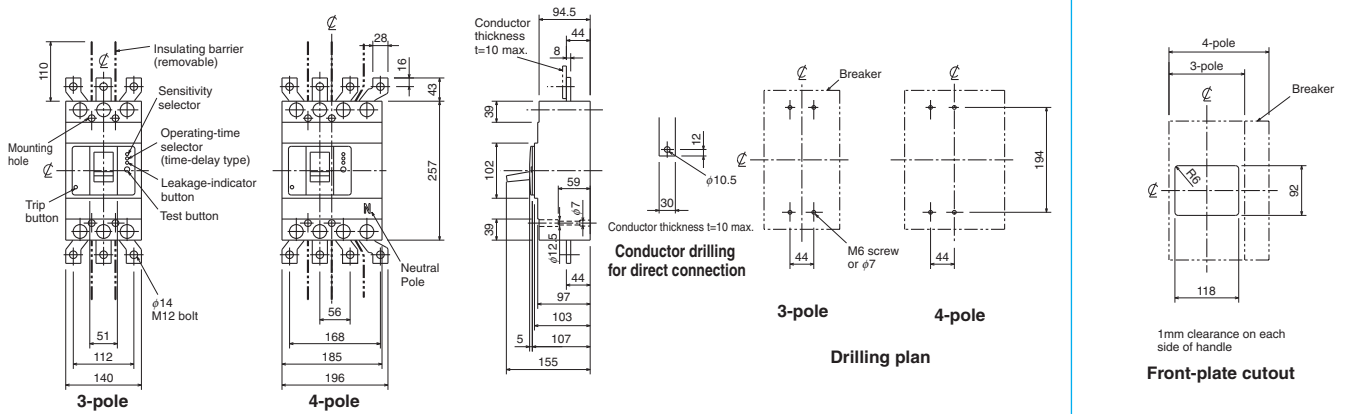

Rear connection

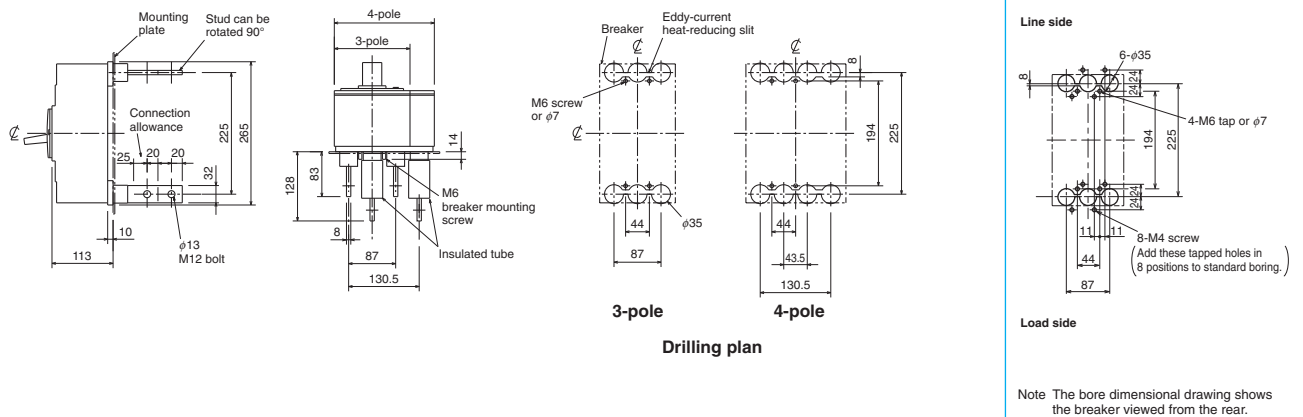

NV630-SEW NV630-HEW



NV630-SEW

Model		NV630-SEW	NV630-HEW
Number of poles		3	4
Rated operational voltage Ue (V AC) (*1)		100-440 Multi-voltage type	
Rated current In (A)		300-630 adjustable	
High-speed type	Rated current sensitivity $I\Delta n$ (mA)	-	
	Max. operating time at $5I\Delta n$ (s)	-	
Time-delay type	Rated current sensitivity $I\Delta n$ (mA)	(100 · 200 · 500 Selectable)	
	Max. operating time at $5I\Delta n$ (s)	(0.45 · 1.0 · 2.0 Selectable)	
	Max. inertial non-operating time at $2I\Delta n$ (s)	(0.1 · 0.5 · 1.0)	
Earth-leakage indication system		Button	
Rated short-circuit breaking capacity (kA) IEC 60947-2 (Icu/Ics) EN 60947-2	AC	440V	42/42
		400V	50/50
		230V	85/85
Standard attached parts (Front connection)		Mounting screw: M6x72 (4pcs) Insulation barrier: (3P: 4pcs, 4P: 6pcs)	

Note *1 Rated operational voltage of time-delay type is for 200-440V.

Operating Characteristics

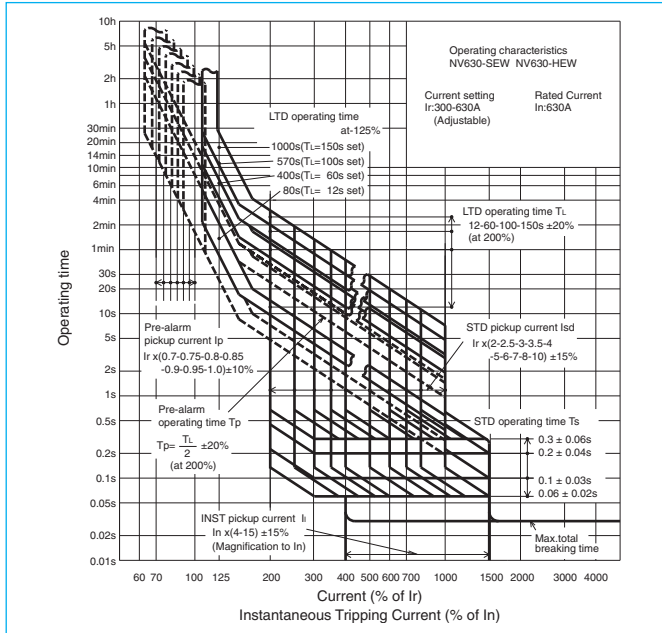

Earth Leakage Tripping Characteristics

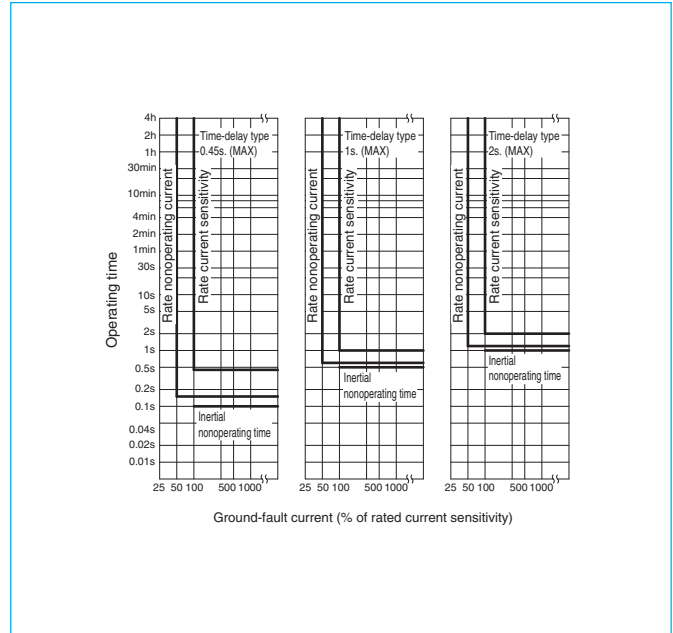

Internal Accessories

Remarks:

1. Instead of TBM, pre-alarm module (PAL) can be attached.
2. Refer to page 107.

Current Reducing Curve

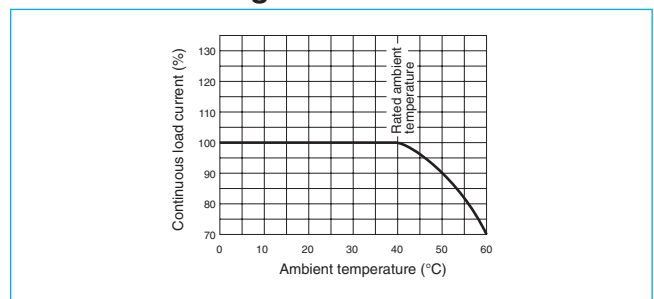

External Accessories

Accessories	Type name	Reference page	Accessories	Type name	Reference page			
Operating handle	F	F-4S	119	Auxiliary handle	HT	HT-4SW	130	
	V	V-4S	121	Terminal cover	Large	TC-L	3P	TCL-4SW3 (*1)
Mechanical interlock	MI	3P	MI-4SW3			4P	TCL-4SW4 (*1)	
		4P	MI-4SW4		Skeleton	TTC	3P	TTC-4SW3
Notes	*1 This is for NV630-SEW.		Rear		BTC	3P	BTC-4SW3 (*2)	
	*2 This is for NV630-HEW. For rear terminal cover of NV630-HEW, use PTC-4SW3.				4P	BTC-4SW4		
*3 Specify the operation method and voltage. Order in combination with the breaker unit.		Handle lock device			HL	HL-4SW	129	
		HL-S		HLS-4SW				
		Electrical operation device		NVM	3P	(*3)	135	
				4P				

Internal Wiring Diagram

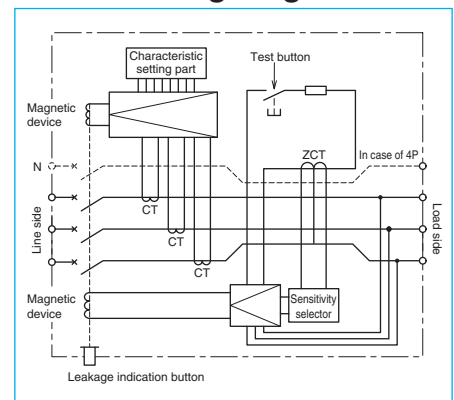

Outline Drawing

Front connection

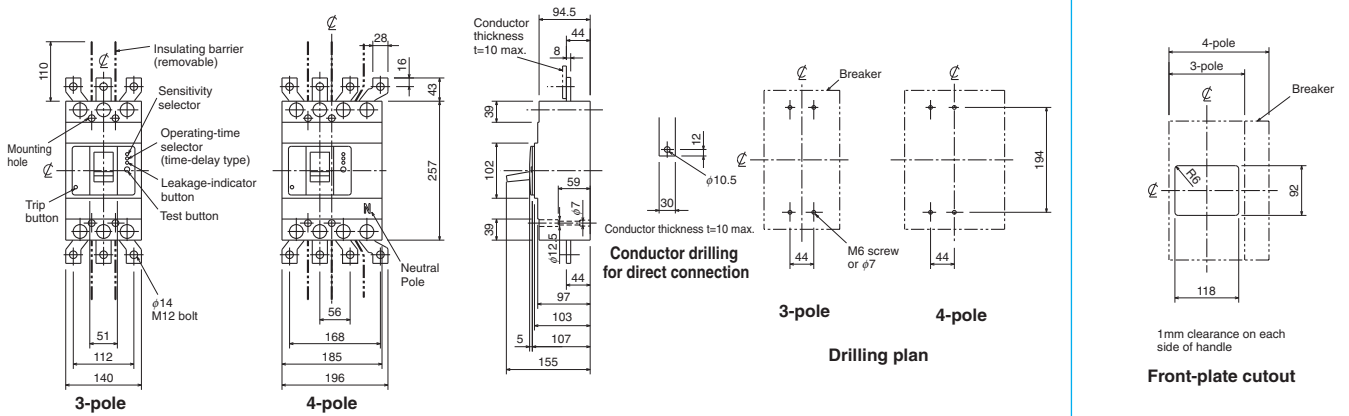

Rear connection

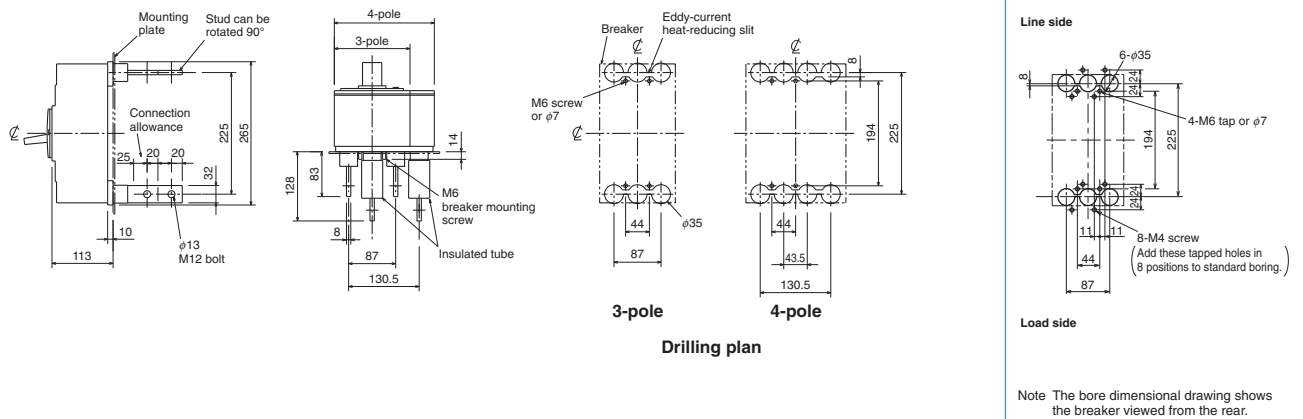

NV800-SEW NV800-HEW



NV800-SEW

Model		NV800-SEW	NV800-HEW
Number of poles		3	
Rated operational voltage Ue (V AC)		100-440 Multi-voltage type	
Rated current In (A)		400-800 adjustable	
High-speed type	Rated current sensitivity $I\Delta n$ (mA)	-	
	Max. operating time at $5I\Delta n$ (s)	-	
Time-delay type	Rated current sensitivity $I\Delta n$ (mA)	100 · 200 · 500 Selectable	
	Max. operating time at $5I\Delta n$ (s)	0.45 · 1.0 · 2.0 Selectable	
	Max. inertial non-operating time at $2I\Delta n$ (s)	0.1 · 0.5 · 1.0	
Earth-leakage indication system		Button	
Rated short-circuit breaking capacity (kA) IEC 60947-2 (Icu/Ics) EN 60947-2	AC	440V	42/42
		400V	50/50
		230V	85/85
Standard attached parts (Front connection)		Mounting screw: M6x35 (4pcs) Insulation barrier: (2pcs)	

Operating Characteristics

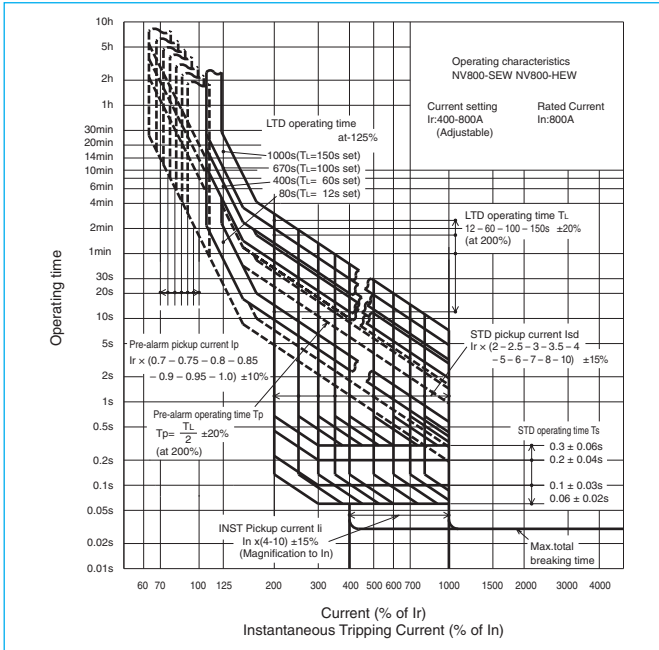

Earth Leakage Tripping Characteristics

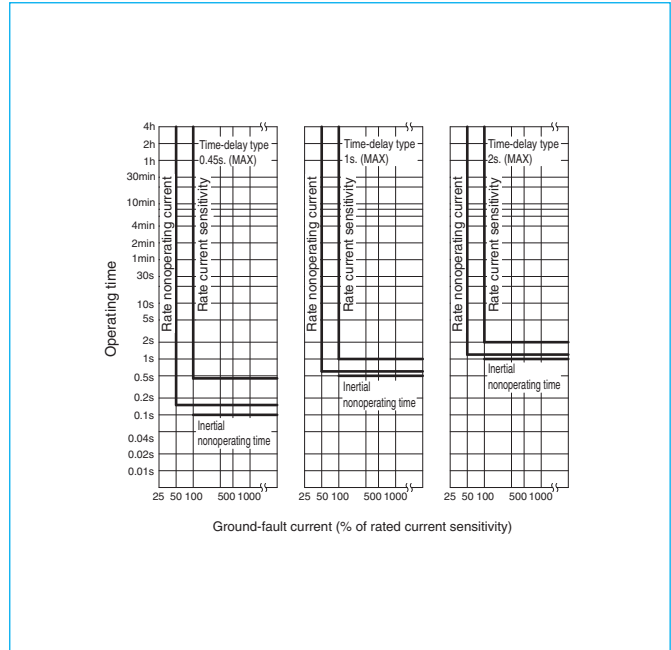

Internal Accessories

Operating handle ● AL ○ AX ■ SHT or UVT □ TBM → Lead wire direction

Left-side mounting Right-side mounting

Remarks: 1. Instead of TBM, pre-alarm module (PAL) or trip indicator (TI) can be attached.
2. Refer to page 107.

Current Reducing Curve

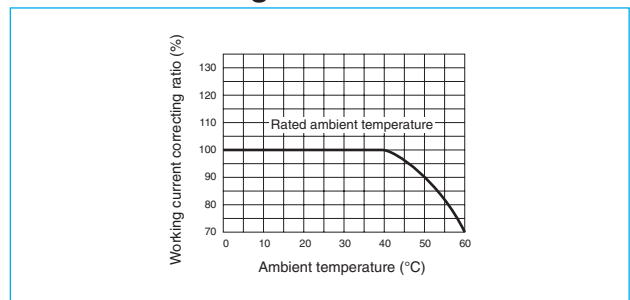

External Accessories

Accessories	Type name	Reference page	Accessories	Type name	Reference page	
Operating handle	F	F-8S	119	Auxiliary handle	HT HT-4SW 130	
	V	V-8S	121	Terminal cover	Large	TC-L TCL-8SW3
Mechanical interlock	MI	MI-8SW3	131		Skeleton	TTC TTC-8SW3
					Rear	BTC BTC-8SW3
				Handle lock device	HL HL-4SW 129	
				HL-S	HLS-8SW	
				Electrical operation device	(*1)	135

Note *1 Specify the operation method and voltage. Order in combination with the breaker unit.

Internal Wiring Diagram

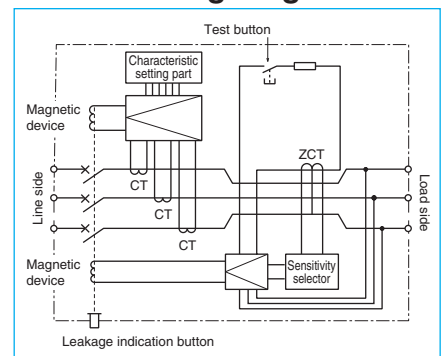

Outline Drawing

Front connection

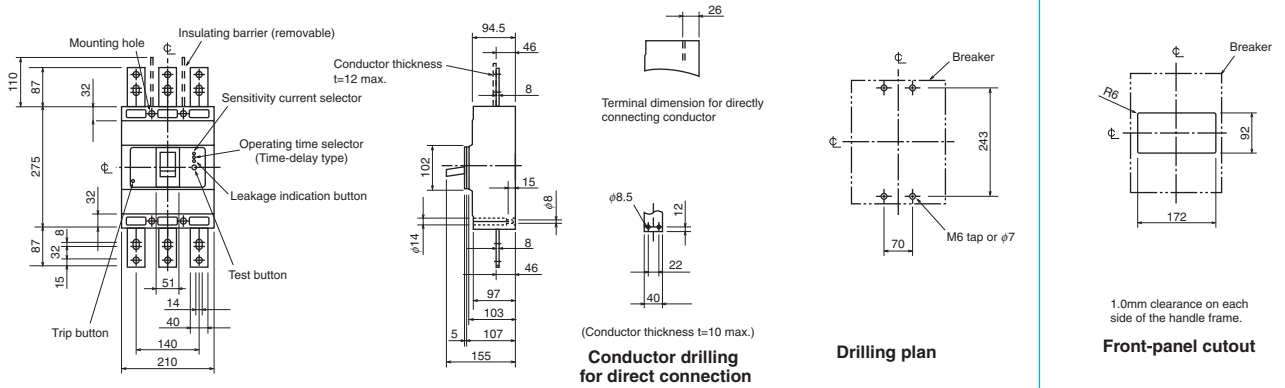

Rear connection

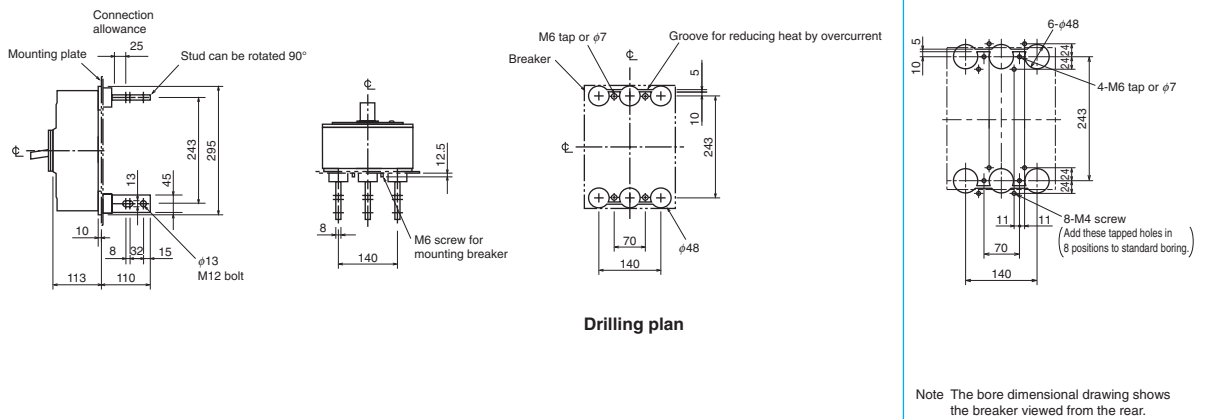

NF50-SVFU NV50-SVFU



NF50-SVFU

Model		NF50-SVFU		Model		NV50-SVFU			
Rated current I _n (A) Rated ambient temperature 40°C		(3) 5 10 15 20 30 40 50		Rated current I _n (A) Rated ambient temperature 40°C		(5) (10) 15 20 30 40 50			
		Number of poles		2	3	Number of poles		2 3	
Number of poles		2 3		Phase line		1φ2W 3φ3W 1φ2W			
Rated short-circuit breaking capacity (kA)	UL 489 CSA C22.2 No.5-02	Rated voltage VAC	240	Rated voltage VAC	UL 489		120-240		
		600Y/347V	-		IEC 60947-2 EN 60947-2	100-240	100-440		
		480V	-	High-speed type		Rated current sensitivity I _{Δn} mA		30 50 30 50 100	
		480Y/277V	-		Pick-up current UL 1053		75% of I _{Δn}		
	240V	14	Operating time (sec) within AT 5I _{Δn}		0.04 (*1)				
	120V	-	Earth-leakage indication system		Indicator window				
IEC 60947-2 EN 60947-2 (Icu/Ics)	AC	Rated insulation voltage U _i V	440	Rated short-circuit breaking capacity (kA)	UL 489 CSA C22.2 No.5-02	AC	480V	-	
		690V	-				240V	14	
		500V	-				120V	14	
		440V	7.5/4		IEC 60947-2 EN 60947-2 (Icu/Ics)	AC	440V	-	7.5/4
		415V	10/5				400V	-	10/5
		400V	10/5				230V	15/8	15/8
380V	10/5	100V	15/8	15/8					
230V	15/8	Standard attached parts (Front connection)		IEC35 rail mounting claws					

Note *1 0.1 for UL1053.
Remark: 1. The mounting screws must be prepared by the user. (Recommended size: M4×0.7×65 (2 pcs).)

Operating Characteristics

(The CE and CCC characteristics are noted differently. Contact us for more information.)

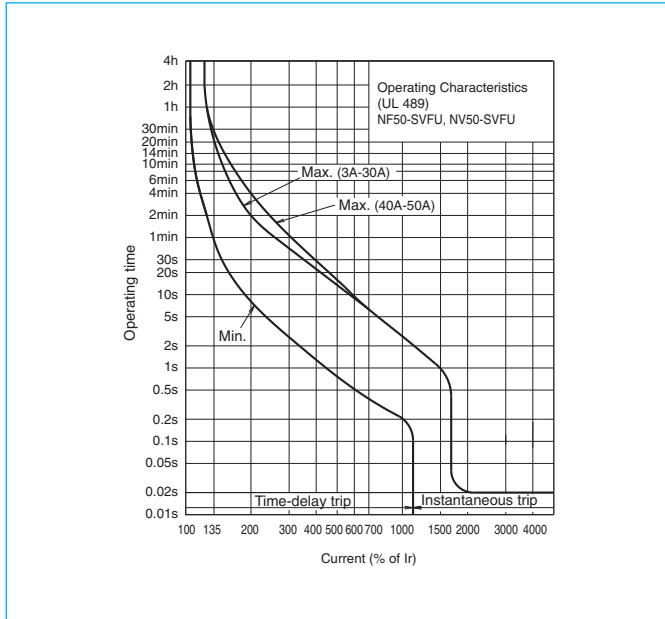

Earth Leakage Tripping Characteristics

(The CE and CCC characteristics are noted differently. Contact us for more information.)

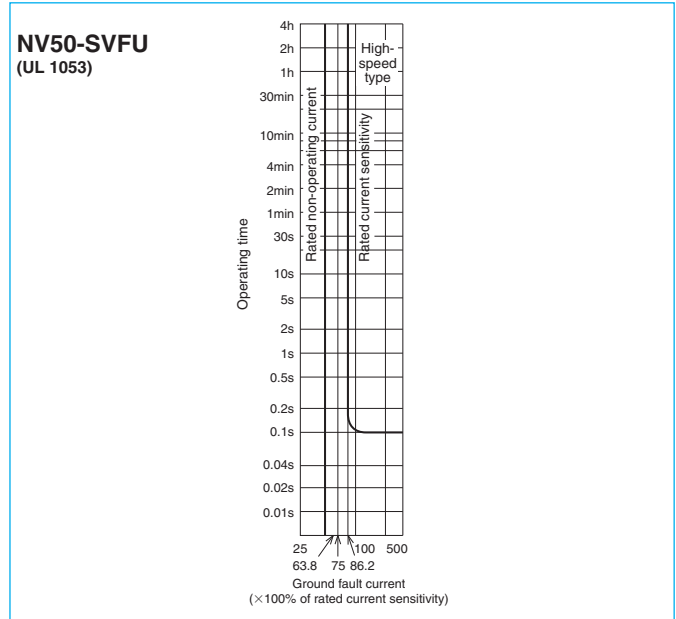

Internal Accessories

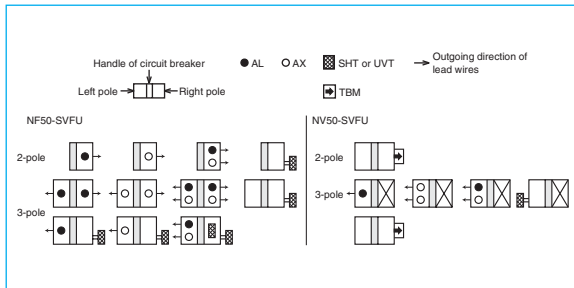

Temperature Compensation Curve

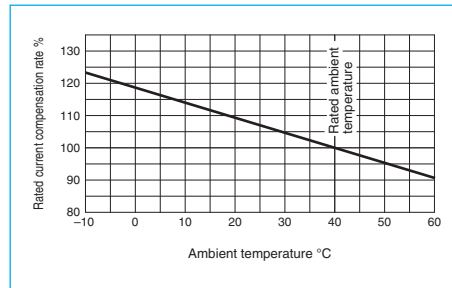

Internal Wiring Diagram

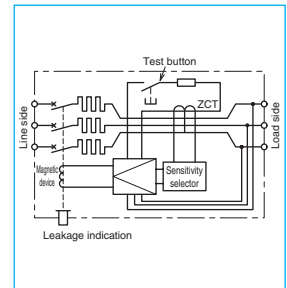

External Accessories

Accessories	Type name	Reference page	Accessories	Type name	Reference page
Operating handle	F 2P F-03SVUL2	119	Terminal cover	Large TC-L 2P TCL-03SVU2	123
	F 3P F-03SVUL			TC-L 3P TCL-03SVU3	
	V 2P V-03SVUL2	121			
	V 3P V-03SVUL				
Handle lock device	HL HLF-03SVU	129			
	HL-S HLS-03SVU				

Outline Drawing

Front connection

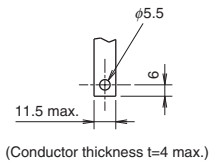
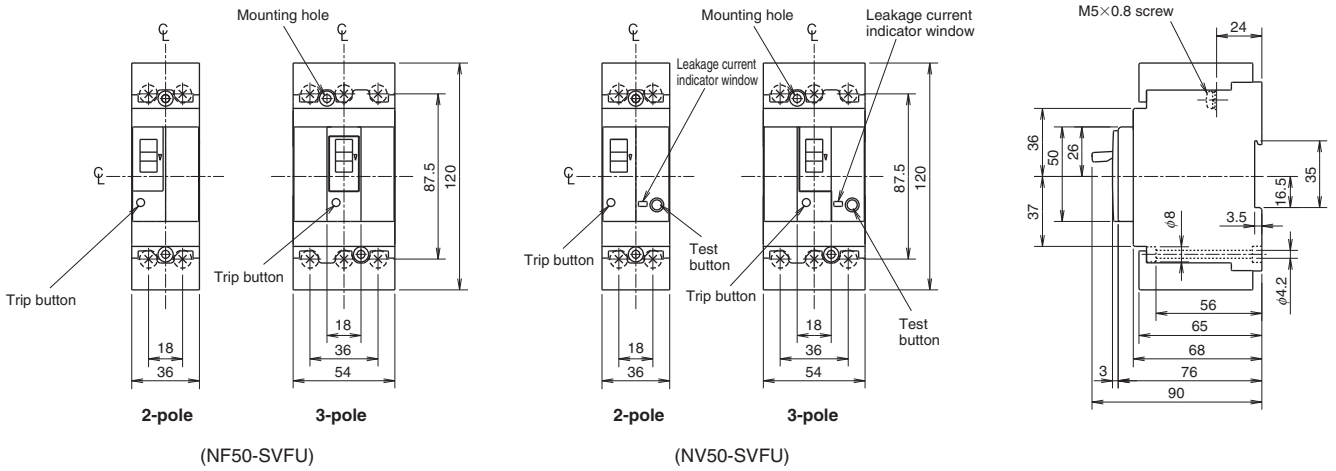

Conductor drilling for direct connection

Remarks: 1. The mounting screws are not enclosed with the breaker.
 2. The wires cannot be connected directly.

Compatible crimp terminals Tightening torque 22lb-in (2.5N-m)

Applicable wire range (*1)	Crimp terminal type (*2)		
	mm ²	AWG (#) (60°C/75°C)	
1.04-2.63	16-14	JST R2-5 2-M5	R2-5
		V2-5 V2-M5	R2-5M
2.63-4.6	12	-	R3.5-5S R3.5-5L
2.63-6.64	12-10	R5.5-5	R5.5-5
		V5.5-5	R5.5-5S R5.5-5N
6.64-10.52	8	R8-5	R8-5 R8-5S
10.52-16.78	6	R14-5	R14-5
		14-NK5	R14-5S
16.78-26.66	4	22-S5 22-S6	R22-5S

JST: Japan Solderless Terminal Mfg. Co.
 NTM: Nichifu Co., Ltd.
 Notes *1 14AWG or larger to comply with UL Standards.
 *2 When using with a wire connection, use the crimp terminal combination shown above.

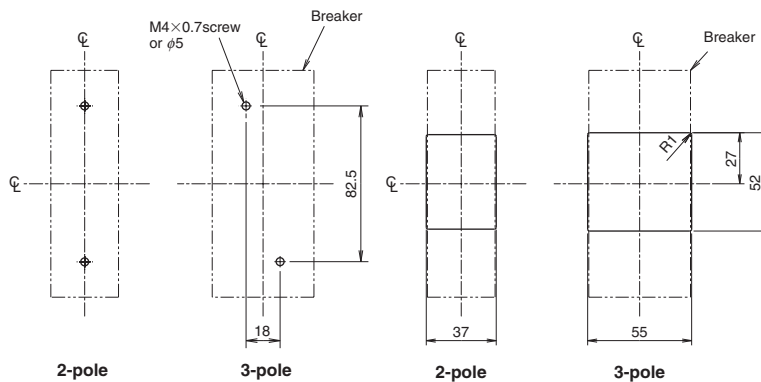

Drilling plan

Front panel drilling plan

The drilling dimensions have a 1.0 mm clearance on each side of breaker window frame.

NF100-CVFU NV100-CVFU



NF100-CVFU

Model		NF100-CVFU		Model		NV100-CVFU			
Rated current I _n (A)		60 (70) 75 (80) (90) 100		Rated current I _n (A)		60 (70) 75 (80) (90) 100			
Rated ambient temperature 40°C				Rated ambient temperature 40°C					
Number of poles		2 3		Number of poles		3			
				Phase line		3φ3W 1φ2W			
Number of poles		2 3		UL 489		120-240			
Rated short-circuit breaking capacity (kA)	UL 489 CSA C22.2 No.5-02	Rated voltage VAC	240	Rated voltage VAC	IEC 60947-2 EN 60947-2	100-440			
		600Y/347V	-			High-speed type	Rated current sensitivity I Δ n mA		30/50/ 100/200/500 selectable
		480V	-				Pick-up current UL 1053		75% of I Δ n
		480Y/277V	-				Operating time (sec) within AT 5I Δ n		0.04 (*1)
		240V	14				Earth-leakage indication system		Mechanical button
120V	-	Rated short-circuit breaking capacity (kA)		UL 489 CSA C22.2 No.5-02	AC	480V 240V 120V 440V 400V 230V 100V	- 14 14 10/5 10/5 15/8 15/8		
Rated short-circuit breaking capacity (kA)	IEC 60947-2 EN 60947-2 (I _{cu} /I _{cs})	Rated insulation voltage U _i V	600	Rated short-circuit breaking capacity (kA)	IEC 60947-2 EN 60947-2 (I _{cu} /I _{cs})	AC	IEC35 rail mounting claws, Insulating barrier		
		690V	-				(Only for type with bar terminal) Mounting screw M4×0.7×55 (2 screws)		
		500V	7.5/4						
		440V	10/5						
		415V	10/5						
		400V	10/5						
		380V	10/5						
230V	15/8								
Standard attached parts (Front connection)				IEC35 rail mounting claws, Insulating barrier (Only for type with bar terminal) Mounting screw M4×0.7×55 (2 screws)					

Note *1 0.1 for UL1053.

Operating Characteristics

(The CE and CCC characteristics are noted differently. Contact us for more information.)

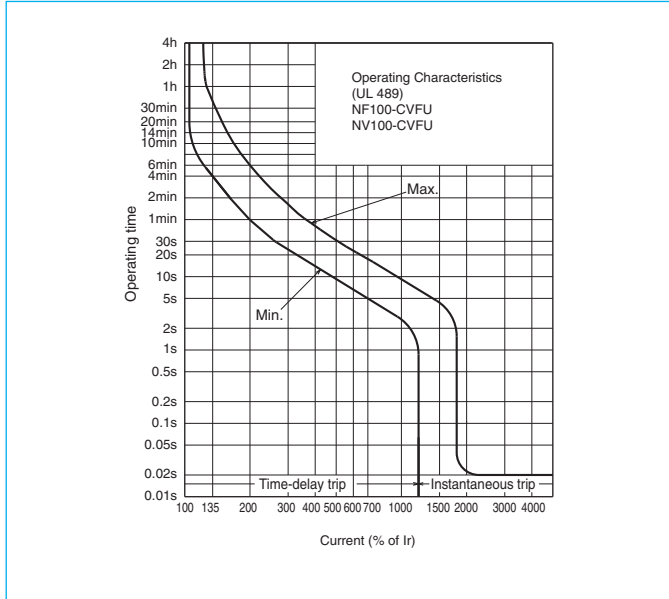

Earth Leakage Tripping Characteristics

(The CE and CCC characteristics are noted differently. Contact us for more information.)

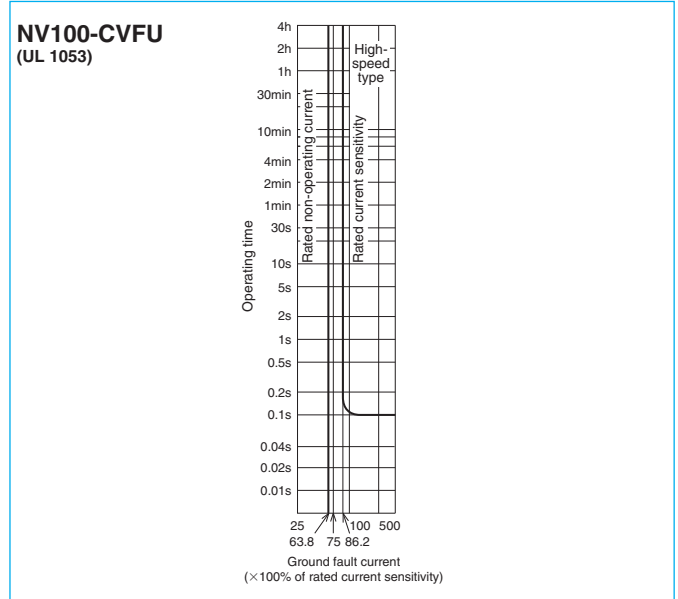

Internal Accessories

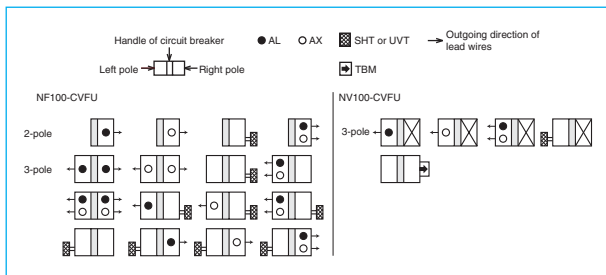

Temperature Compensation Curve

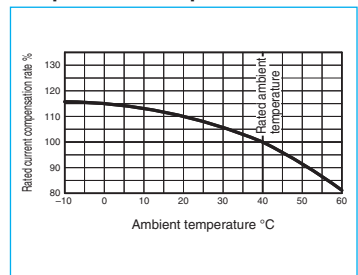

Internal Wiring Diagram

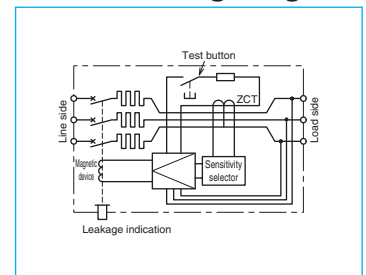

External Accessories

Accessories			Type name	Reference page	Accessories			Type name	Reference page	
Operating handle	F	2P	F-05SVUL2	119	Terminal cover	Large	TC-L	2P	TCL-05SVU2	123
		3P	F-05SVUL					2P	TCL-05SVU2L	
	V	2P	V-05SVUL2	3P				TCL-05SVU3		
		3P	V-05SVUL	3P				TCL-05SVU3L		
Handle lock device	HL		HLF-05SVU	129						
	HL-S	2P	HLS-05SVU2							
		3P	HLS-05SVU							

Outline Drawing

Front connection

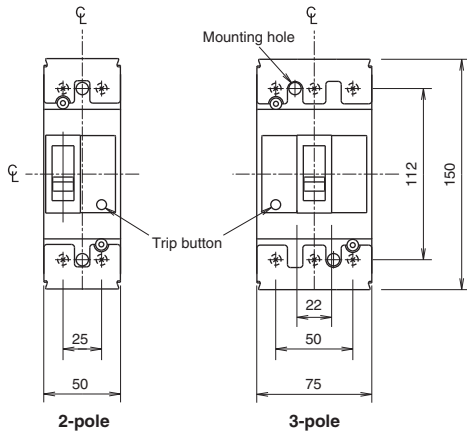

(NF100-CVFU)

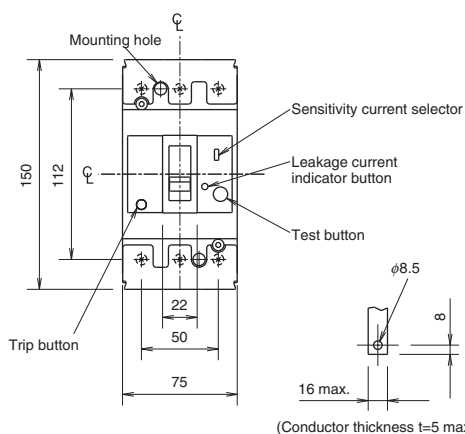

(NV100-CVFU)

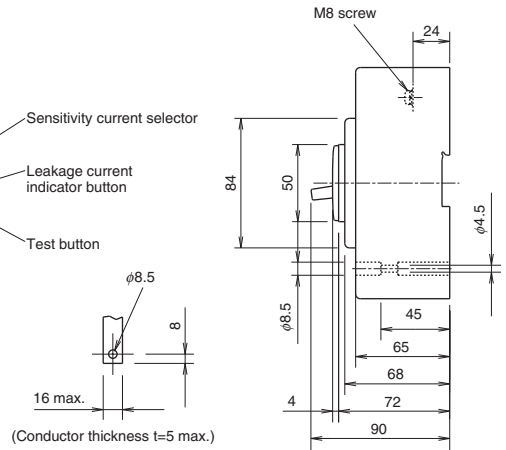

Conductor drilling for direct connection

Compatible crimp terminals Tightening torque 54lb-in (6N·m)

Applicable wire range	Crimp terminal type (*1)	
	mm ²	AWG (#) (60°C/75°C)
2.5-2.63	14	R2-8
2.63-6.64	12-10	R5.5-8
6.64-10.52	8	R8-8
10.52-16.78	6	R14-8
16.78-26.66	4	R22-8
26.66-42.42	2	38-S8
42.42-60.57	1/0	60-2BA 60-S8

JST: Japan Solderless Terminal Mfg. Co.
 NTM: Nichifu Co., Ltd.
 Note *1 When using with a wire connection, use the crimp terminal combination shown above.

Front connection(solderless terminal)

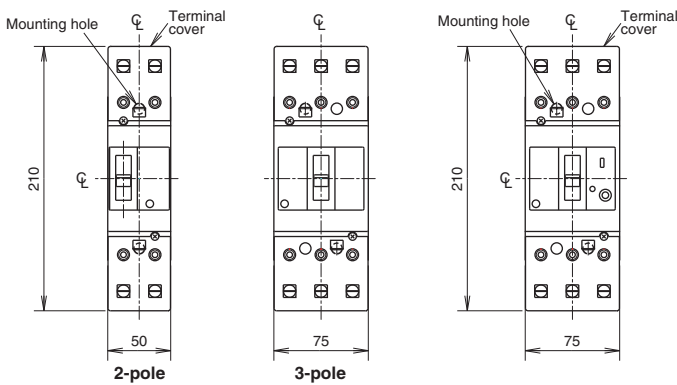

Size of screwdriver with bolting
 Please bolt with flat head screwdriver.
 The length of X : 6mm-7mm
 The length of Y : 9.5mm

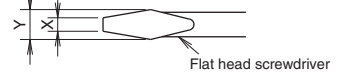

Wire size 60°C/75°C CU ONLY	Number of strands
14AWG	7
12-10AWG	7
8AWG	7
6-4AWG	7
2AWG	7
1-1/0AWG	19

The tightening torque is different according to connected wire.
 Refer to instruction manual for details.
 Remark: Periodical retightening prevents overheating by the setting of twisted strands or the stress of heating and cooling.

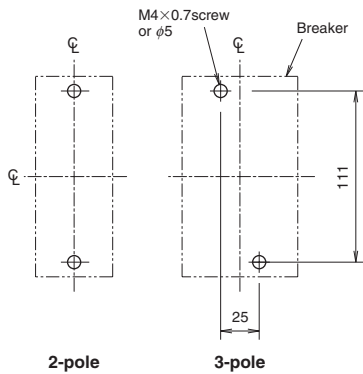

Drilling plan

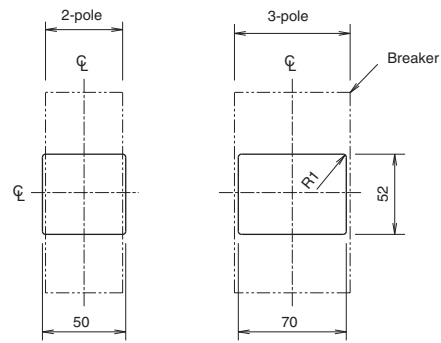

The drilling dimensions have a 1.0 mm clearance on each side of breaker window frame.

Front panel drilling plan

NF125-SVU NF125-HVU NV125-SVU NV125-HVU



NF125-HVU

Model		NF125-SVU		NF125-HVU		Model		NV125-SVU		NV125-HVU	
Rated current I _n (A) Rated ambient temperature 40°C		15 20 30 40 50 60 (70) 75 (80) (90) 100		125		15 20 30 40 50 60 (70) 75 (80) (90) 100		125			
Number of poles		2	3	2	3	3	3				
Rated short-circuit breaking capacity (kA)		UL 489 CSA C22.2 No.5-02		600Y/347V		600Y/347V		120-480		120-480	
Rated voltage VAC		480		480		600Y/347V		120-480		120-480	
AC		600Y/347V		-		18		18			
AC		480V		30		30		50		50	
AC		240V		50		50		100		100	
AC		120V		-		-		-		-	
Rated insulation voltage U _i V		690		690		690		690		690	
AC		690V		8/4		8/4		10/5		10/5	
AC		500V		18/9		18/9		25/13		25/13	
AC		440V		30/15		30/15		50/25		50/25	
AC		415V		30/15		30/15		50/25		50/25	
AC		400V		30/15		30/15		50/25		50/25	
AC		380V		30/15		30/15		50/25		50/25	
AC		230V		50/25		50/25		100/50		100/50	
Standard attached parts (Front connection)										Mounting screw M4×0.7×55 (2 screws), Insulating barrier (2P: 2pcs, 3P: 4pcs)	

Note *1 0.1 for UL1053.

Operating Characteristics (The CE and CCC characteristics are noted differently. Contact us for more information.)

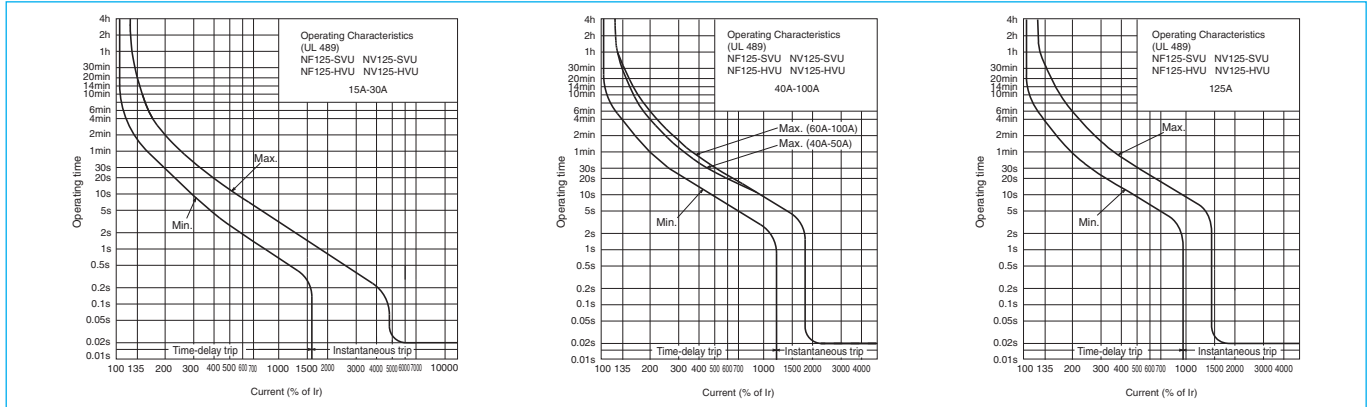

Earth Leakage Tripping Characteristics

(The CE and CCC characteristics are noted differently. Contact us for more information.)

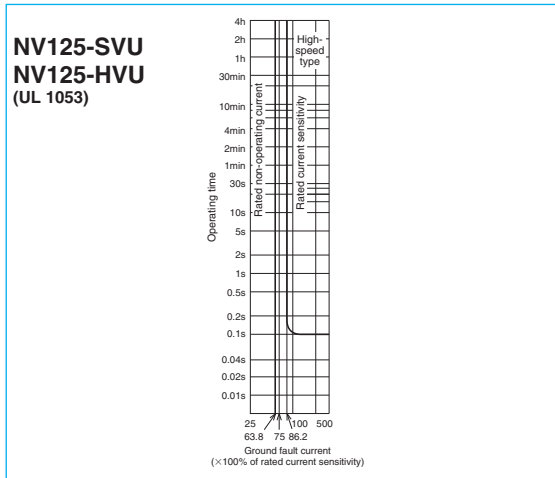

Internal Accessories

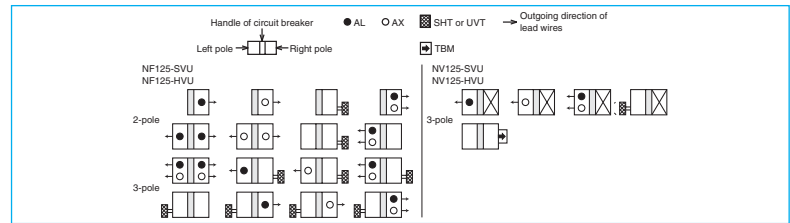

Temperature Compensation Curve Internal Wiring Diagram

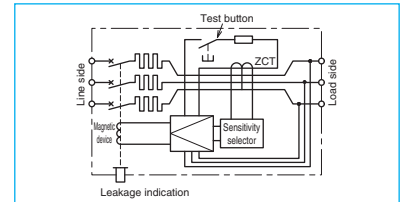
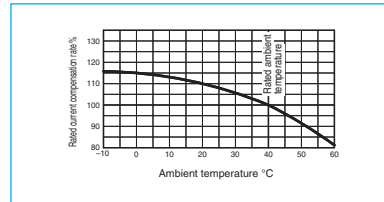

External Accessories

Accessories	Type name	Reference page	Accessories	Type name	Reference page
Operating handle	F	F-1SVUL	Terminal cover	Large	TC-L
	V	V-1SVUL		TCL-1SVU3	123
Handle lock device	HL	HLF-05SVU			
	HL-S	HLS-05SVU			

Outline Drawing

Front connection

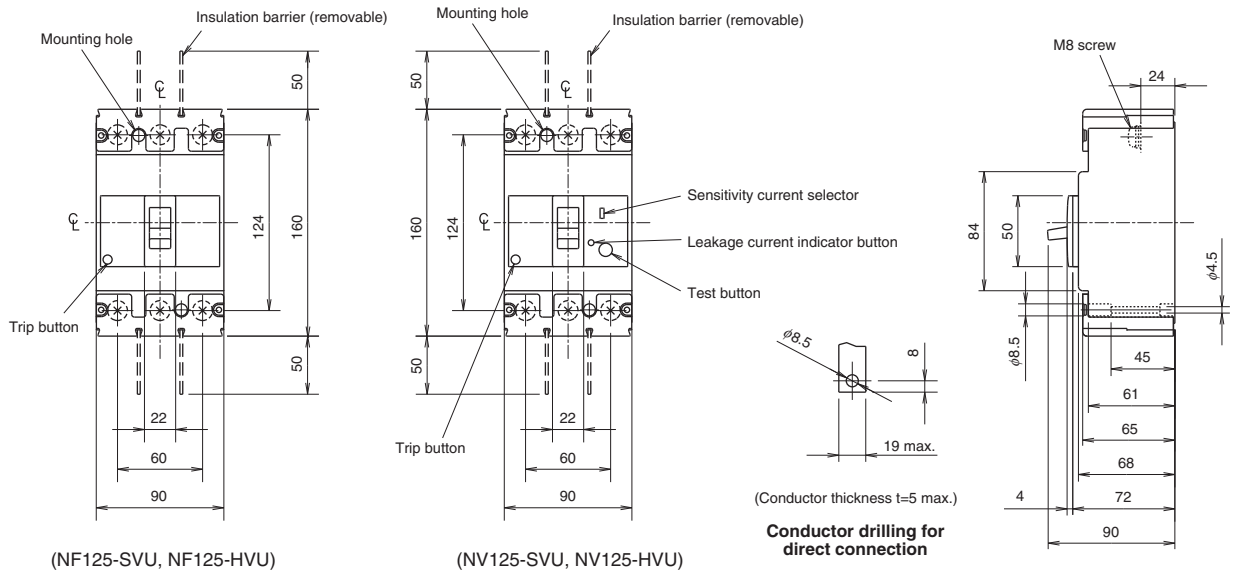

Compatible crimp terminals Tightening torque 54lb-in (6N-m)

Applicable wire range		Crimp terminal type (*1)	
mm ²	AWG (#) (60°C/75°C)	JST	NTM
2.5-2.63	14	R2-8	R2-8
2.63-6.64	12-10	R5.5-8	R5.5-8
6.64-10.52	8	R8-8	R8-8
10.52-16.78	6	R14-8	R14-8 R14-8S
16.78-26.66	4	R22-8	R22-8S
26.66-42.42	2	38-S8	R38-8S
42.42-60.57	1/0	60-2BA 60-S8	CB60-8

JST: Japan Solderless Terminal Mfg. Co.
 NTM: Nichifu Co., Ltd.
 Note *1 When using with a wire connection, use the crimp terminal combination shown above.

Front connection (solderless terminal)

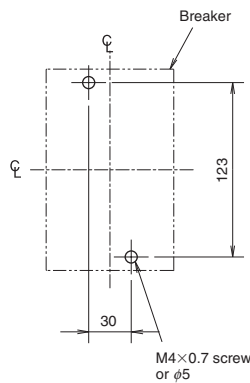
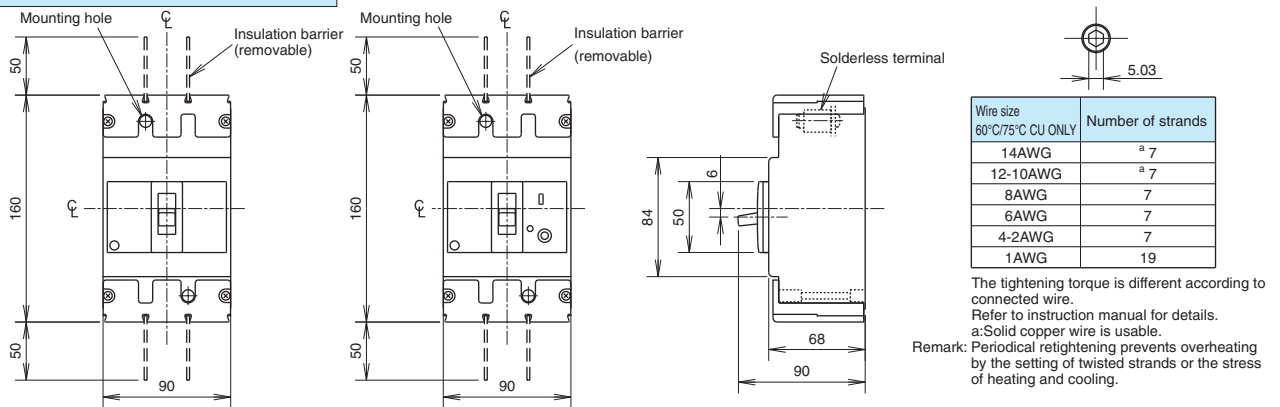

Drilling plan

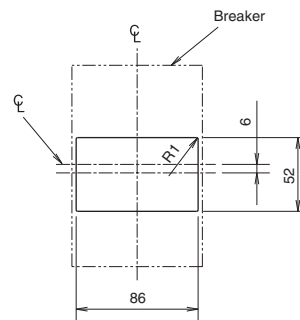

Front panel drilling plan

The drilling dimensions have a 1.0 mm clearance on each side of breaker window frame.

Remark: 1. 2-pole models are 3-pole with the central pole conductor removed.

NF225-CWU



NF225-CWU

Model		NF225-CWU		
Rated current I _n (A) at ambient temperature 40°C (IEC30°C)		125 150 175 200 225	250	
Number of poles		3		
Rated short-circuit breaking capacities (kA)	UL 489	Rated voltage (VAC)		
		AC	240V	
	IEC 60947-2 (Icu/Ics)	Rated insulation voltage U _i (V)		
		AC	500V	10/5
			440V	15/8
			400V	18/9
DC	250V	10/5 (*1)		
Standard attached parts		Mounting screw: M4×0.7×55 (2pcs), Insulation barrier: (4pcs), Terminal cover: (1 set) (*2)		

Notes *1 Use either two poles. When wired as shown at the bottom of page 32, the models can be used for up to 400 V DC.
*2 The standard configuration contains a protection cover and adopts the IP20 (finger protection) structure.

Operating Characteristics

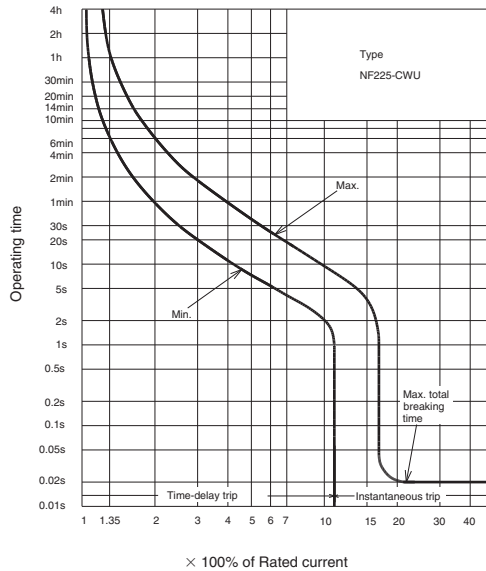

Internal Accessories

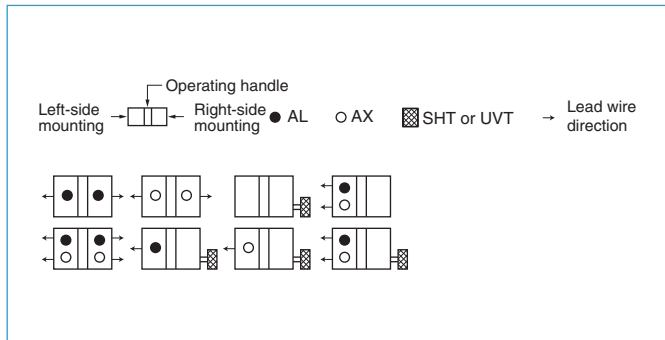

Temperature Compensation Curve

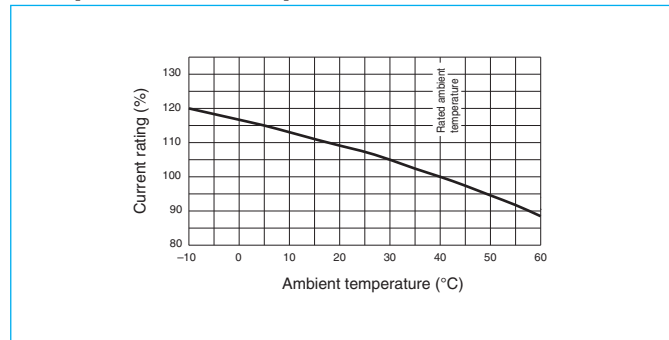

External Accessories

Accessories	Type name	Reference page	Accessories	Type name	Reference page
Operating handle	F	F-2SUL	Mechanical interlock	MI	MI-05SWU3
	V	V-2SUL			
Handle lock device	HL	HLF-2SWU	Terminal cover	Large	TC-L
					TCL-2SWU3

Outline Drawing

Front connection

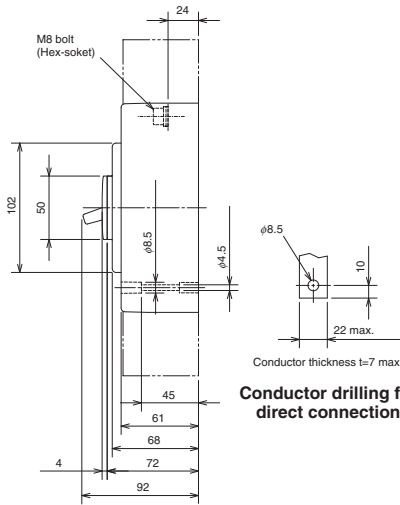
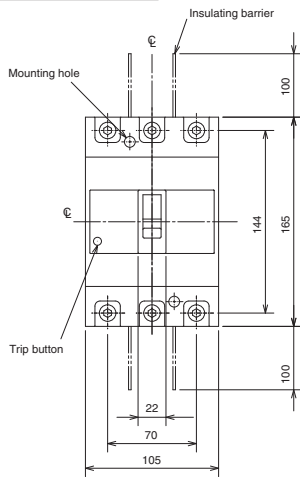

Compatible crimp terminals Tightening torque 90lb-in (10N.m)

Applicable wire range mm ²	AWG (#) (60°C/75°C)	Crimp terminal type (*2)	
		JST	NTM
16.78-26.66	4	R22-8 22-S8	R22-8S R22-8S CB22-8S
26.66-42.42	2	R38-8 38-S8	R38-8 R38-8S
42.42-60.57	1/0	R60-8 60-2BA CB60-S8	R60-8 CB60-8 CB60-8S
60.57-76.28	2/0	70-8	R70-8
76.28-96.3	3/0	80-3BA CB80-S8	
96.3-117.2	4/0	100-3BA CB100-S8	
117.2-152.05	250/300MCM	CB150-S8 (*1)	

JST: Japan Solderless Terminal Mfg. Co.
 NTM: Nichifu Co., Ltd.
 Notes *1 TCL-2SVU3L can be mounted when using CB150-S8.
 *2 When using with a wire connection, use the crimp terminal combination shown above.

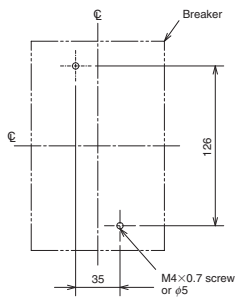

Drilling plan

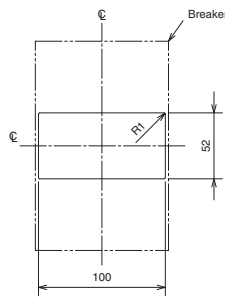

Front cover cutout

1mm clearance on each side of handle

NF250-SVU NF250-HVU NV250-SVU NV250-HVU



NF250-HVU

Model		NF250-SVU		NF250-HVU		Model		NV250-SVU		NV250-HVU			
Rated current I _n (A) Rated ambient temperature 40°C		125	150	250	125	150	250	125	150	250	125	150	250
Number of poles		3	3	3	3	3	3	3	3	3	3	3	3
Phase line		3ø3W 1ø2W		3ø3W 1ø2W		3ø3W 1ø2W		3ø3W 1ø2W		3ø3W 1ø2W		3ø3W 1ø2W	
Rated voltage VAC		480		600Y/347V		480		600Y/347V		480		600Y/347V	
Rated short-circuit breaking capacity (kA)		600Y/347V		18		18		600Y/347V		18		18	
UL 489 CSA C22.2 No.5-02		AC		480V		35		35		50		50	
IEC 60947-2 EN 60947-2 (Icu/Ics)		AC		240V		65		65		100		100	
Rated insulation voltage U _i V		690		690		690		690		690		690	
Rated current sensitivity I _{Δn} mA		30/50/ 100/200/500 selectable		30/50/ 100/200/500 selectable		30/50/ 100/200/500 selectable		30/50/ 100/200/500 selectable		30/50/ 100/200/500 selectable		30/50/ 100/200/500 selectable	
Pick-up current UL 1053		75% of I _{Δn}		75% of I _{Δn}		75% of I _{Δn}		75% of I _{Δn}		75% of I _{Δn}		75% of I _{Δn}	
Operating time s within AT 5I _{Δn}		0.04 (*1)		0.04 (*1)		0.04 (*1)		0.04 (*1)		0.04 (*1)		0.04 (*1)	
Earth-leakage indication system		Mechanical button		Mechanical button		Mechanical button		Mechanical button		Mechanical button		Mechanical button	
UL 489 CSA C22.2 No.5-02		AC		480V		35		35		50		50	
IEC 60947-2 EN 60947-2 (Icu/Ics)		AC		240V		65		65		100		100	
Rated short-circuit breaking capacity (kA)		440V		36/18		36/18		50/25		50/25		50/25	
UL 489 CSA C22.2 No.5-02		AC		400V		36/18		36/18		50/25		50/25	
IEC 60947-2 EN 60947-2 (Icu/Ics)		AC		230V		65/33		65/33		100/50		100/50	
Standard attached parts (Front connection)		Mounting screw M4×0.7×55 (2 screws), Insulating barrier (4pcs)		230V		65/33		65/33		100/50		100/50	
Standard attached parts (Front connection)		Mounting screw M4×0.7×55 (2 screws), Insulating barrier (4pcs)		100V		65/33		65/33		100/50		100/50	

Note *1 0.1 for UL1053.

Operating Characteristics (The CE and CCC characteristics are noted differently. Contact us for more information.)

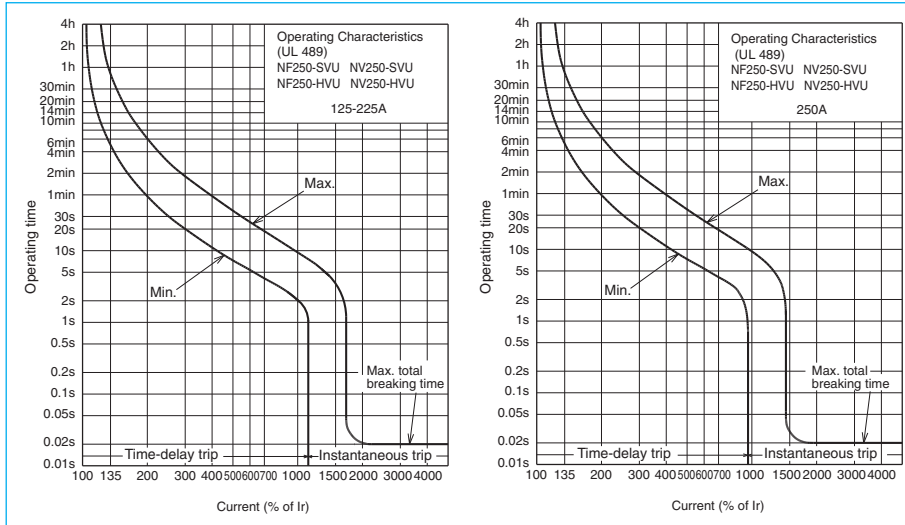

Earth Leakage Tripping Characteristics (The CE and CCC characteristics are noted differently. Contact us for more information.)

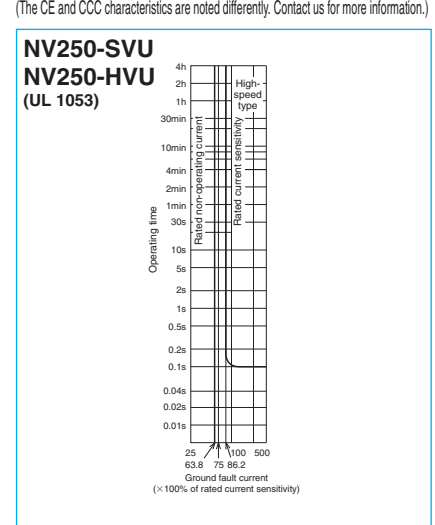

Internal Accessories

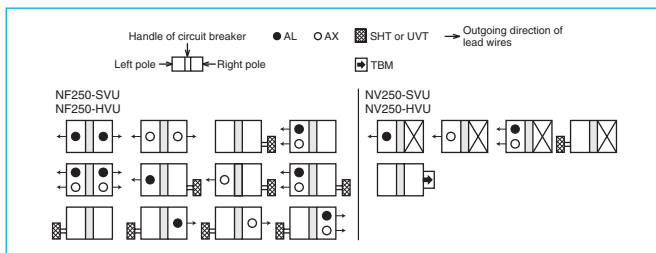

Temperature Compensation Curve

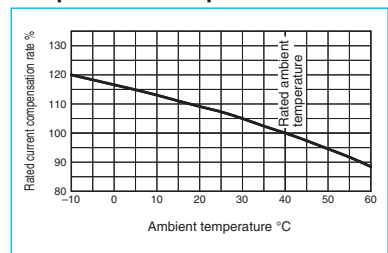

Internal Wiring Diagram

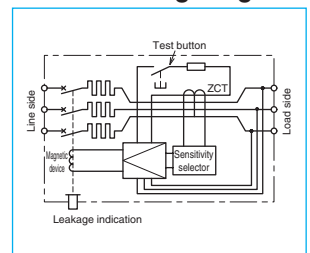

External Accessories

Accessories	Type name	Reference page	Accessories	Type name	Reference page
Operating handle	F F-2SVUL	119	Terminal cover	Large TC-L	123
	V V-2SVUL	121			
Handle lock device	HL HLF-05SVU	129			
	HL-S HLS-2SVU				

Outline Drawing

Front connection

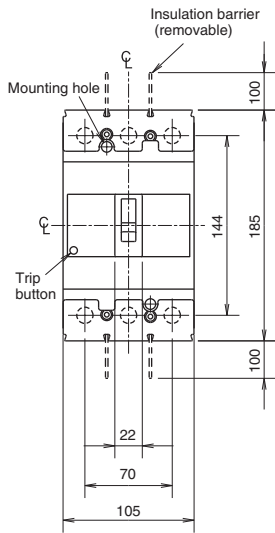

(NF250-SVU, NF250-HVU)

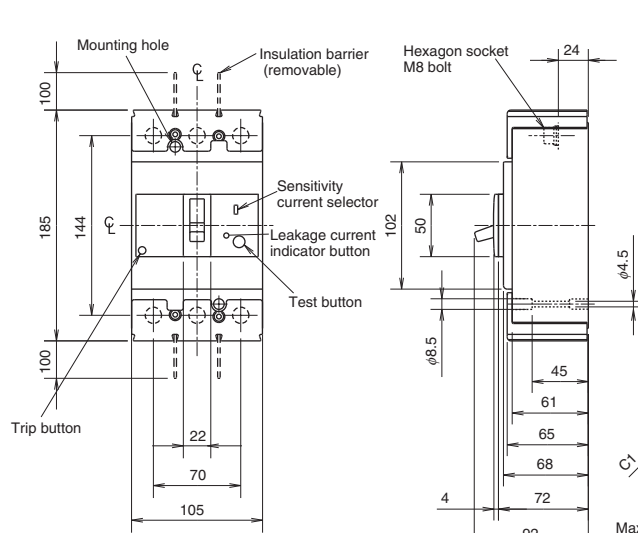

(NV250-SVU, NV250-HVU)

Compatible crimp terminals Tightening torque 90lb-in (10N.m)

Applicable wire range mm ²	AWG (#) (60°C/75°C)	Crimp terminal type (*2)	
		JST	NTM
16.78-26.66	4	R22-8 22-S8	R22-8 R22-8S CB22-8S
26.66-42.42	2	R38-8 38-S8	R38-8 R38-8S
42.42-60.57	1/0	R60-8 60-2BA CB60-S8	R60-8 CB60-8 CB60-8S
60.57-76.28	2/0	70-8	R70-8
76.28-96.3	3/0	80-3BA CB80-S8	
96.3-117.2	4/0	100-3BA CB100-S8	
117.2-152.05	250/300MCM	CB150-S8 (*1)	

JST: Japan Solderless Terminal Mfg. Co.
 NTM: Nichifu Co., Ltd.
 Notes *1 TCL-2SVU3L can be mounted when using CB150-S8.
 *2 When using with a wire connection, use the crimp terminal combination shown above.

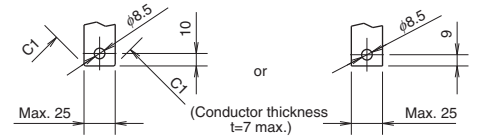

Conductor drilling for direct connection

Front connection (solderless terminal)

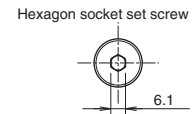
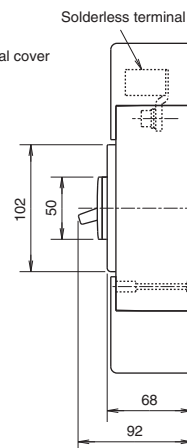
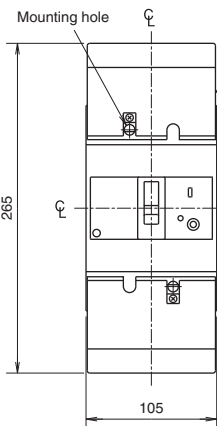
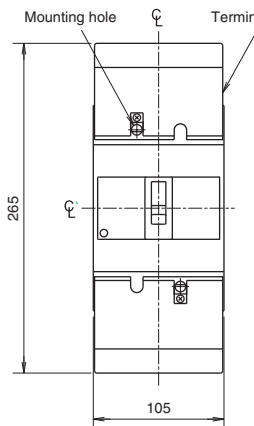

Wire size 60°C/75°C CU ONLY	Number of strands
4-2AWG	7
1-1/0AWG	19
3/0-4/0AWG	19
250-350MCM	37

The tightening torque is different according to connected wire.
 Refer to instruction manual for details.

Remark: Periodical retightening prevents overheating by the setting of twisted strands or the stress of heating and cooling.

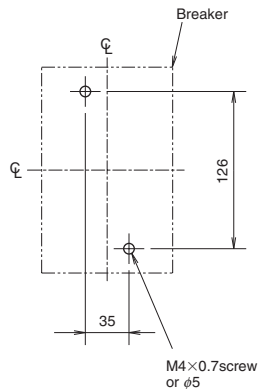

Drilling plan

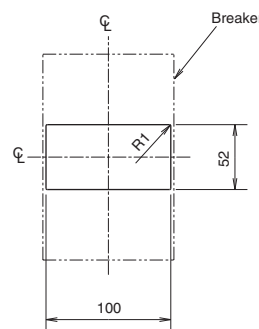

The drilling dimensions have a 1.0 mm clearance on each side of breaker window frame.

Front panel drilling plan

NF-SKW



NF-SKW

Model		NF-SKW		
Rated current I _n (A) at ambient temperature 40°C		250	300	
		350	400	
Number of poles		3		
Rated short-circuit breaking capacities (kA)	UL 489	Rated voltage (AC V)		
		AC	600Y/347V	20
			480V	35
		240V	65	
	IEC 60947-2 (Icu/Ics)	Rated insulation voltage U _i (V)		690
AC		690V	10/10 (5/5) (*1)	
		500V	30/30 (25/25) (*1)	
		440V	42/42 (36/36) (*1)	
		400V	45/45 (36/36) (*1)	
	230V	85/85 (65/65) (*1)		

Note *1 In case of solderless terminal, interrupting capacity reduces: (/).

Operating Characteristics (The CE characteristics is noted differently. Contact us for more information.)

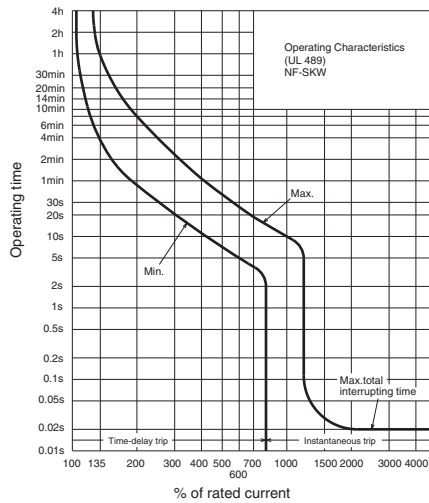

Internal Accessories

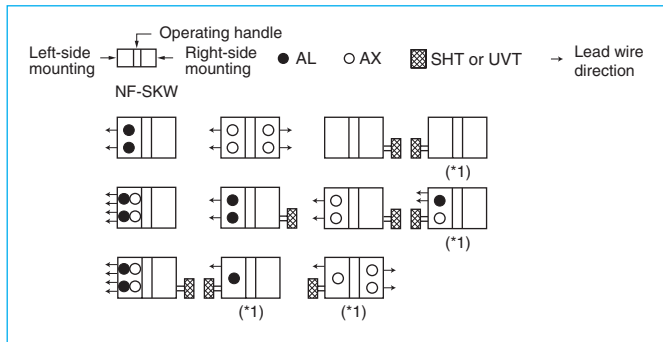

Note *1 Right-side mounting is standard of SHT and UVT. Specify separately for left-side mounting.

Temperature Compensation Curve

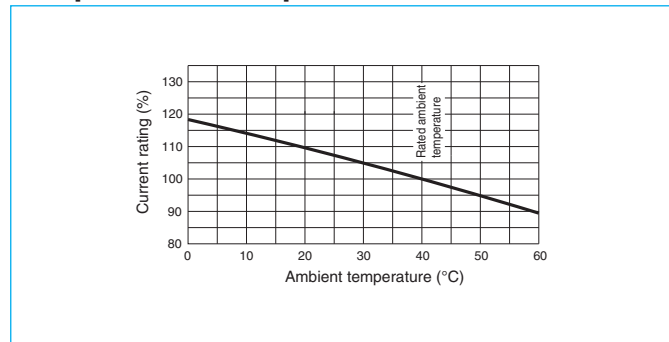

External Accessories

Accessories	Type name	Reference page	Accessories	Type name	Reference page
Operating handle	F	F-4SUL	Terminal cover	Large	TC-L
	V	V-4SUL		TCL-4SKW	123
Handle lock device	HL	HL-4SP			

Outline Drawing

Front connection (Solderless terminal)

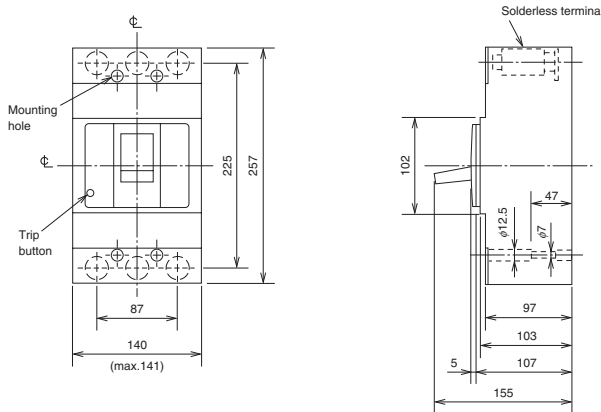

Note Do not remove solderless terminal in any case.
 Standard attached parts
 Mounting screw: M6×60 (4pcs), Insulating plate: (1pc)

Hexagon socket set screw

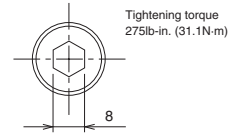

UL

Ampere ratings	Wire size	Number of strands
250A, 300A	250-350MCM CU	37
250A	350MCM AL	
350A, 400A	3/0AWG CU ONLY	19

IEC

Ampere ratings	Wire size (IEC 60228)	
	Class 2	Class 5
250A-350A	70-185mm ²	95-185mm ²
400A	150-240mm ²	150-185mm ²

Front connection (Busbar terminal)

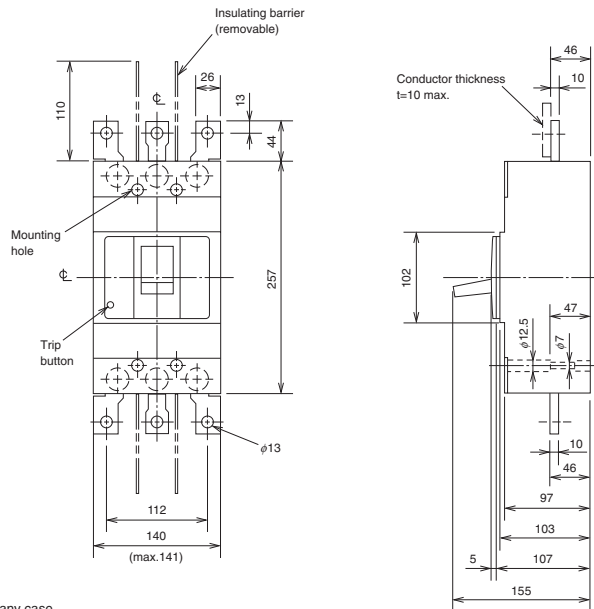

Note Do not remove busbar terminal in any case.
 Standard attached parts
 Mounting screw: M6×60 (4pcs), Insulating barrier: (4pcs), Insulating plate: (1pc)

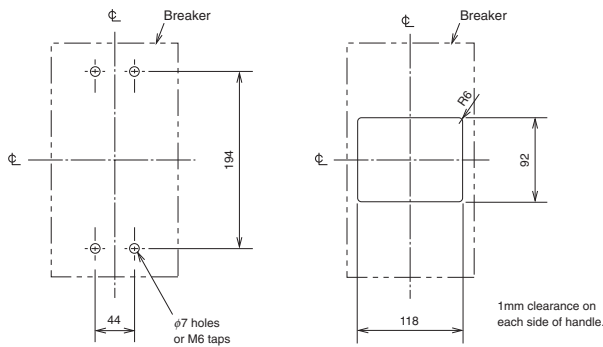

Drilling plan

Front-panel cutout

CAUTION
 When mounted in steel or cast box cover must be insulated as shown.
 58mm air gap to cover or 0.8mm fibre insulating plate extending 12.7mm out from each side of breaker.

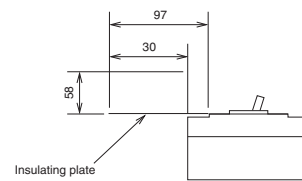

(Line)

NF-SLW



NF-SLW

Model		NF-SLW		
Rated current I _n (A) at ambient temperature 40°C		500 600		
Number of poles		3		
Rated short-circuit breaking capacities (kA)	UL 489	Rated voltage (VAC)		
		AC	600Y/347V	20
			480V	35
	240V	85		
	IEC 60947-2 (Icu/Ics)	Rated insulation voltage U _i (V)		690
		AC	690V	10/10
500V			30/30	
440V	42/42			
400V	45/45			
230V	85/85			

Operating Characteristics (The CE characteristics is noted differently. Contact us for more information.)

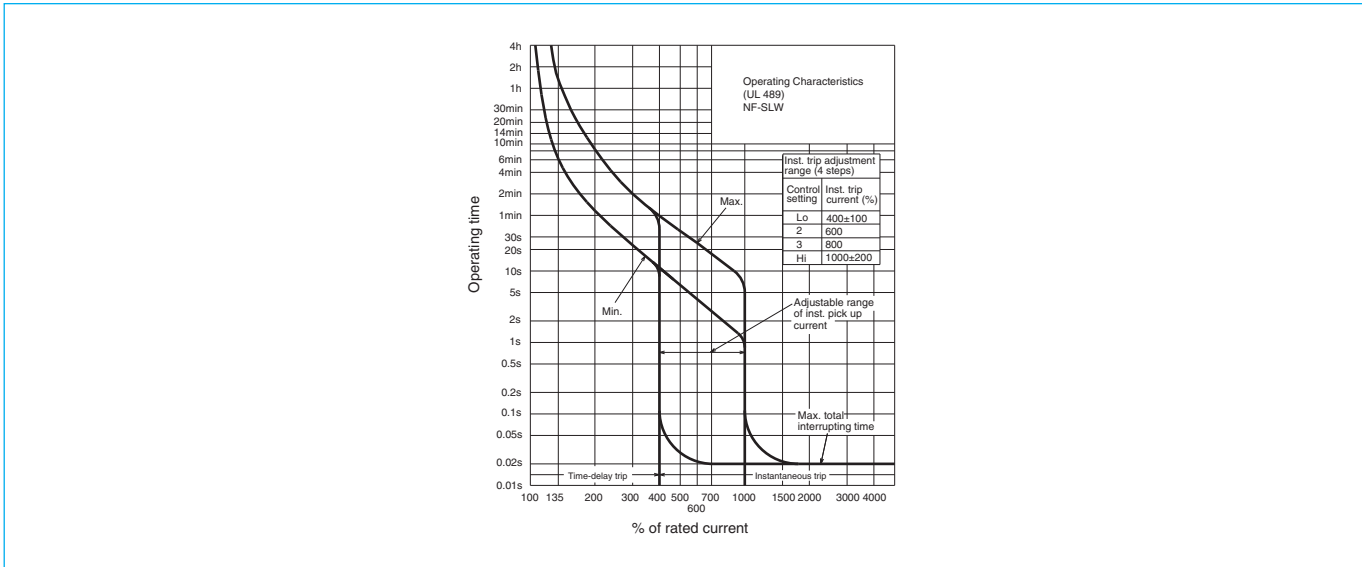

Internal Accessories

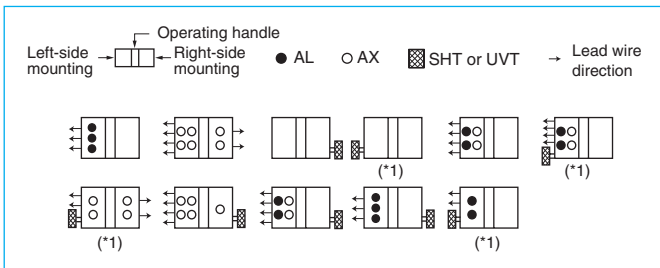

Note *1 Right-side mounting is standard of SHT and UVT. Specify separately for left-side mounting.

Temperature Compensation Curve

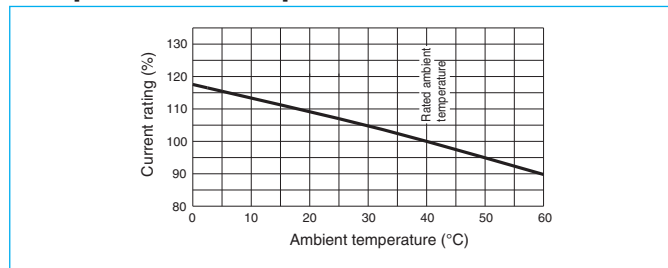

External Accessories

Accessories	Type name	Reference page	Accessories	Type name	Reference page
Operating handle	F	F-6SUL	Terminal cover	Large	TC-L
	V	V-6SUL		TCL-6SLW	123
Handle lock device	HL	HL-4SP			

Outline Drawing

Front connection (Solderless terminal)

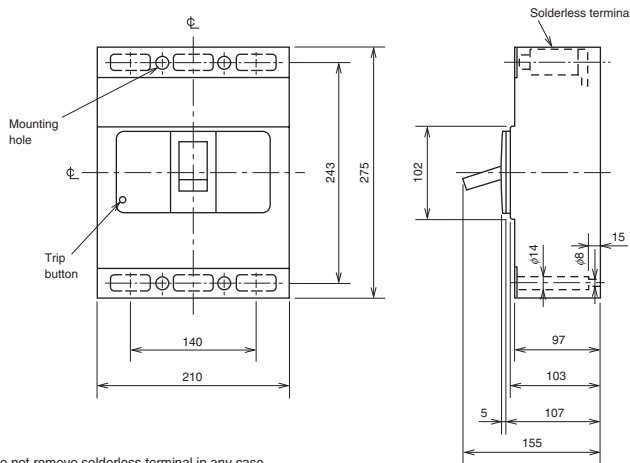

Note Do not remove solderless terminal in any case.
 Standard attached parts
 Mounting screw: M6×35 (4pcs), Insulating plate: (1pc)

Hexagon socket set screw

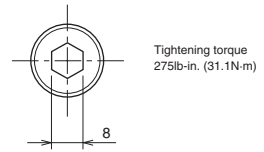

UL

Ampere ratings	Wire size	Number of strands
500A, 600A	250-350MCM CU ONLY	37

IEC

Ampere ratings	Wire size (IEC 60228)	
	Class 2	Class 5
500A, 600A	95-185mm ²	120-185mm ²

Front connection (Busbar terminal)

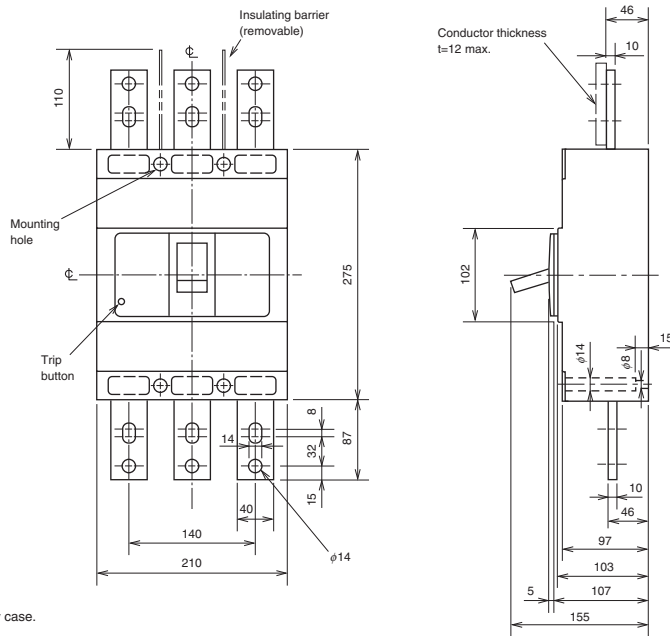

Note Do not remove busbar terminal in any case.
 Standard attached parts
 Mounting screw: M6×35 (4pcs), Insulating barrier: (2pcs), Insulating plate: (1pc)

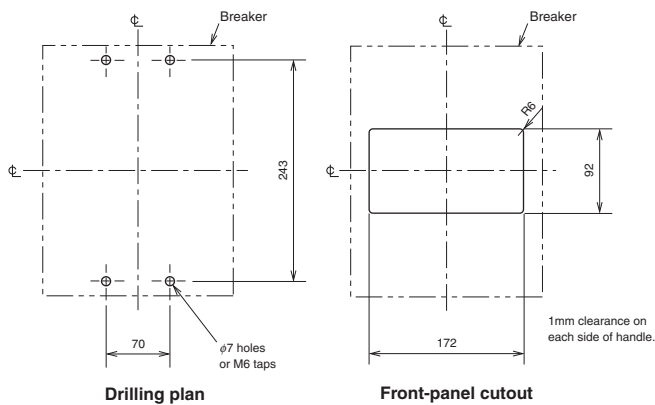

CAUTION

When mounted in steel or cast box cover must be insulated as shown.
 58mm air gap to cover or 0.8mm fibre insulating plate extending 12.7mm out from each side of breaker.

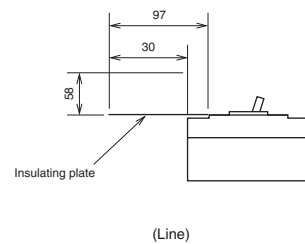

NF250-SEV with MDU NF250-HEV with MDU

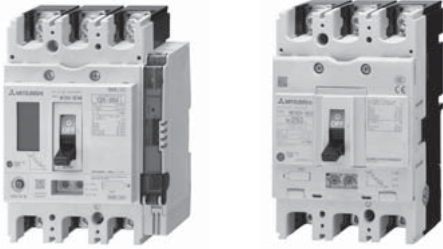

Model		NF250-SEV with MDU	NF250-HEV with MDU	
Rated current I _n (A)		250	250	
Rated ambient temperature 40°C				
Current setting I _r (A)		125-250	125-250	
Number of poles		3 4	3 4	
Rated insulation voltage U _i (V)		690	690	
Rated short-circuit breaking capacity (kA)	IEC 60947-2 (Icu/Ics)	AC 690V	8/8	10/8
		500V	18/18	30/23
		440V	36/36	50/50
		415V	36/36	70/70
		400V	36/36	75/75
		380V	36/36	75/75
		230V	85/85	100/100
		DC 250V	-	-
Standard attached parts (Front connection)		Mounting screw M4 × 0.7 × 55 (3P: 2psc, 4P: 4psc) Insulation barrier (3P: 4psc, 4P: 6psc)		
MDU accessories	Breaker mounting	MDU, Connection cable (for breaker mounting)		
	Panel mounting	MDU, Panel mounting bracket, Panel mounting screw, Connection cable (for panel mounting)		

NF250-SEV with MDU (Breaker mounting) NF250-SEV with MDU (Panel mounting)

Operating Characteristics

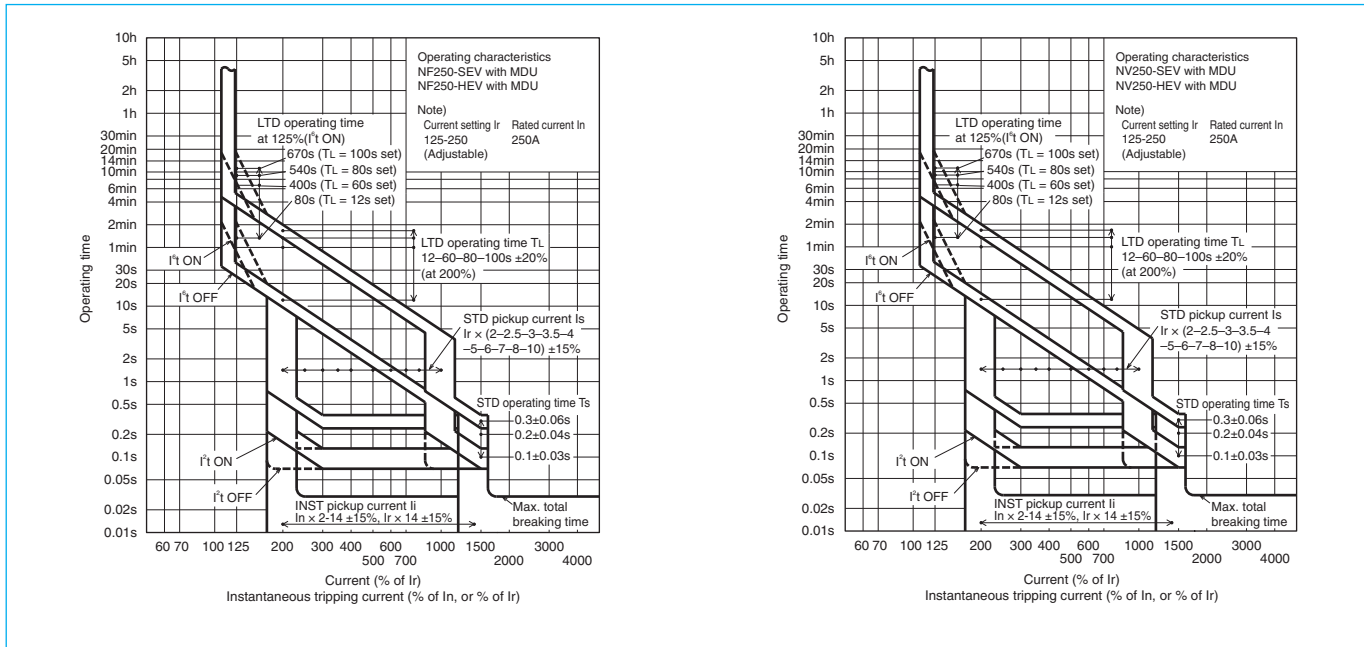

Internal Accessories

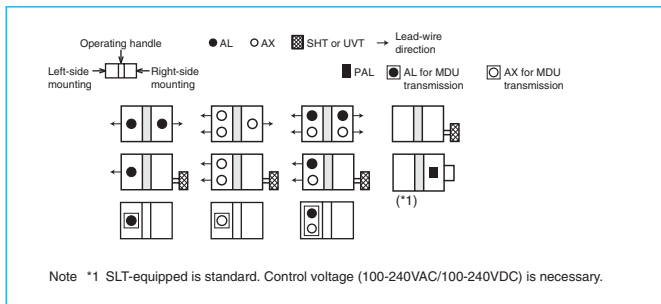

Current Reducing Curve

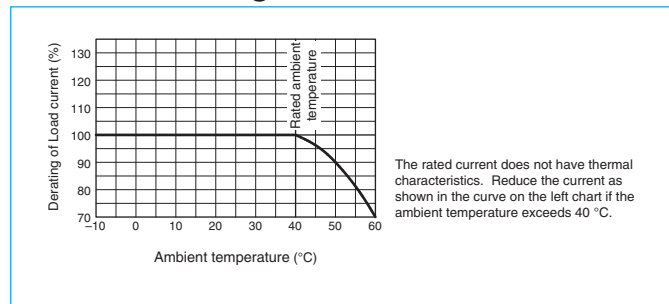

External Accessories

Accessories	Type name	Reference page	Accessories	Type name	Reference page
Operating handle (*1)	F	F-2SV	Mechanical interlock	MI (*3)	3P MI-05SV3
	V	V-2SV		4P MI-2SV4	131
Handle lock device	LC	LC-05SV	Terminal cover	Small	3P TCS-2SV3
	HL (*2)	HLF-05SV			3P TCL-2SV3
		HLN-05SV		4P TCL-2SV4	
HL-S (*1)	HLS-2SV	3P TTC-2SV3		3P BTC-2SV3	
Electrical operation device (*1)		(*4)	135		

Notes *1 Available only for the MDU panel mounting type.
*2 HLF types are used for OFF lock and HLN types for ON lock.
*3 When selecting the MDU breaker mounting, only the MI panel mounting can be manufactured.
*4 Specify the working voltage.

Outline Drawing

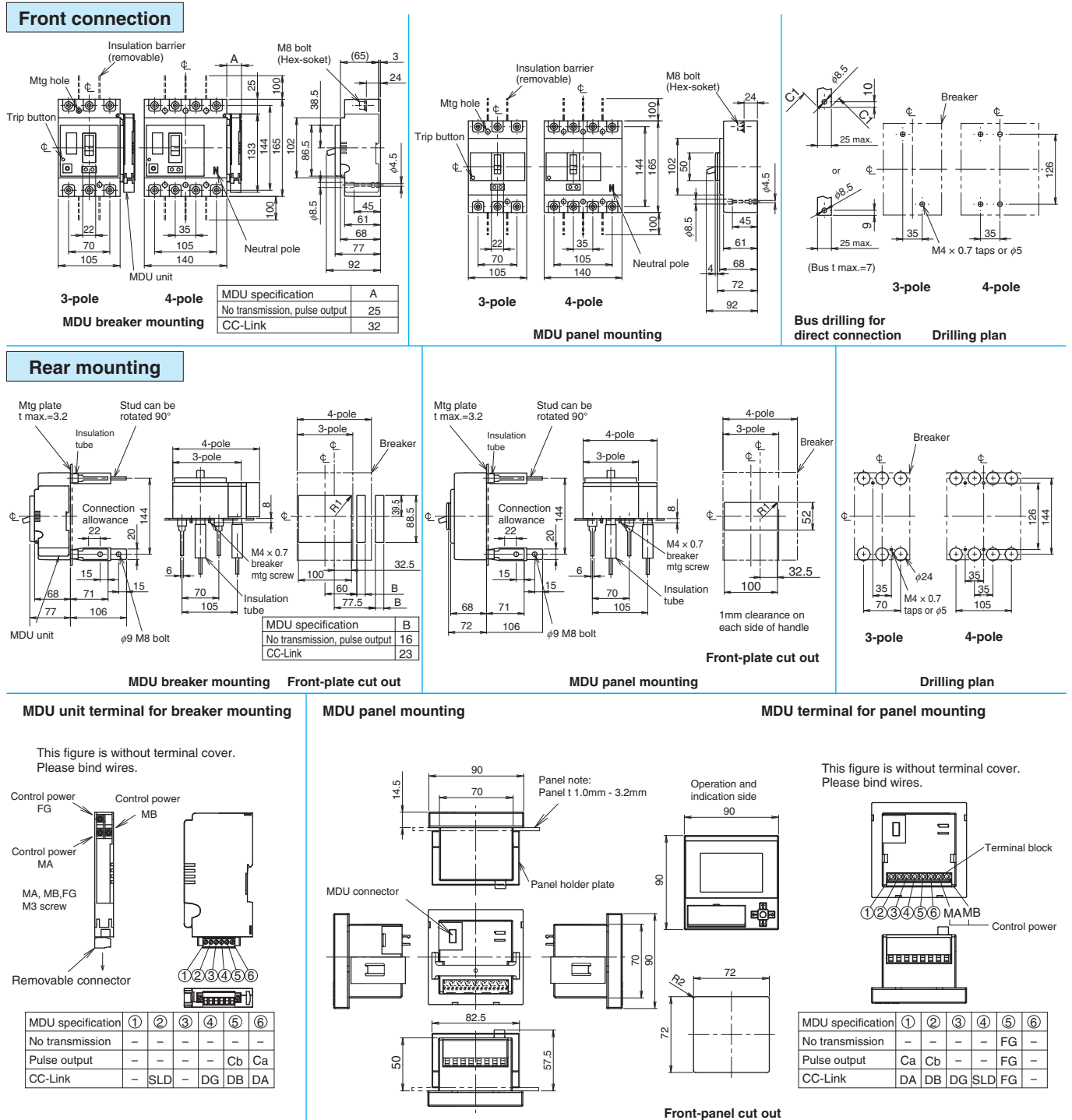

NF400-SEP with MDU NF400-HEP with MDU



NF400-SEP with MDU
(Breaker mounting)

Model		NF400-SEP with MDU	NF400-HEP with MDU	
Rated current In (A)		200 225 250 300 350 400 Adjustable		
Rated ambient temperature 40°C				
Number of poles		3	4	
Rated operational voltage Ue V		690		
Rated short-circuit breaking capacity (kA)	IEC 60947-2 (Icu/Ics)	AC	690V	10/10
			500V	30/30
			440V	42/42
			415V	45/45
			400V	45/45
			380V	45/45
			230V	85/85
			200V	85/85
Standard attached parts (Front connection)		Breaker	Mounting screw M6 × 60 (4pcs) Insulation barrier (3P: 4pcs, 4P: 6pcs)	
MDU accessories	Breaker mounting	MDU, Connection cable (for breaker mounting)		
	Panel mounting	MDU, Panel mounting bracket, Panel mounting screw, Connection cable (for panel mounting)		

Operating Characteristics

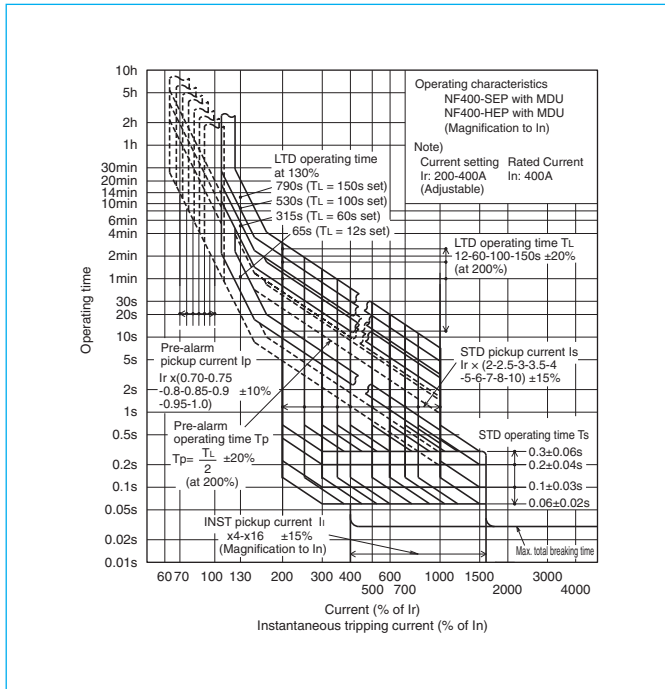

Internal Accessories

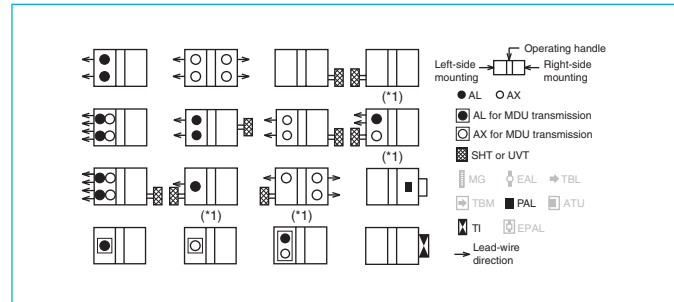

Note *1 Right side mounting is standard of SHT and UVT. Specify separately for left side mounting.

Current Reducing Curve

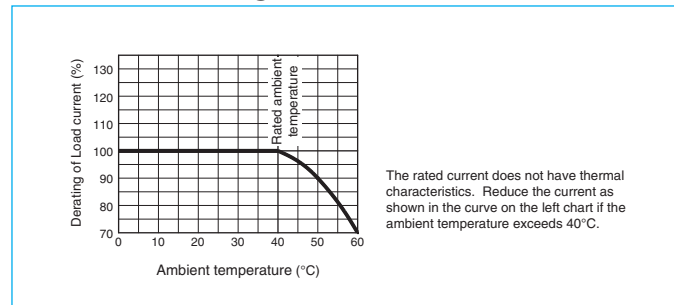

External Accessories

Accessories	Type name		Reference page	Accessories	Type name		Reference page			
	Breaker mounting	Panel mounting			Breaker mounting	Panel mounting				
Operating handle	F	-	F-4S	Large	TC-L	3P	-	TCL-4SW3 (*1)	123	
	V	-	V-4S			4P	-	TCL-4SW4 (*1)		
Handle lock device	HL	HL-4SW	S4SW	Skeleton	TTC	3P	TTC-4SW3-MDU	TTC-4SW3		
	HL-S	-	HL-4SW			4P	TTC-4SW4-MDU	TTC-4SW4		
Mechanical interlock	MI	3P	MI-4SW3	Rear	BTC	3P	BTC-4SW3 (*1)	BTC-4SW3 (*1)		
	(*2)	4P	MI-4SW4			MI-4SW3	4P	BTC-4SW4 Only line side		BTC-4SW4
Auxiliary handle	HT	HT-4SW	MI-4SW4	Electrical operation device	NFM	3P	-	(*3)		135
						4P				

Notes *1 For NF400SEP with MDU.
*2 When selecting the MDU breaker mounting, only the MI panel mounting can be manufactured.
*3 Specify the operation method and voltage. Order in combination with the breaker unit.

Outline Drawing

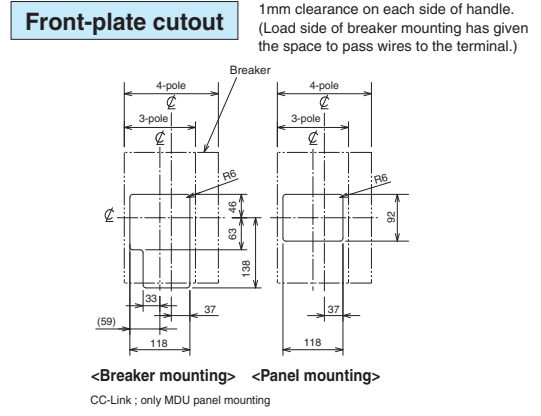
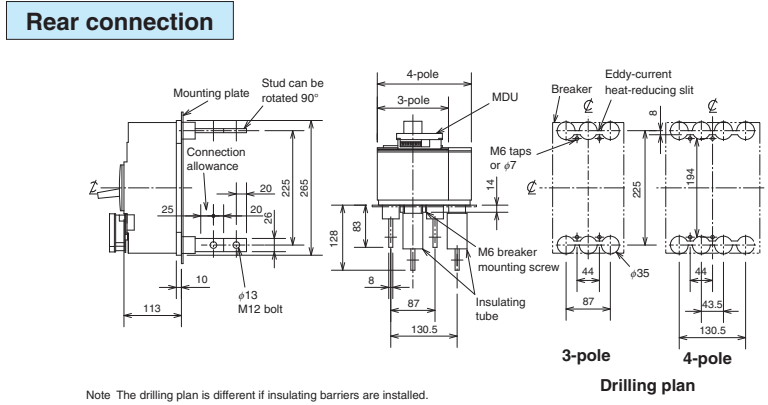
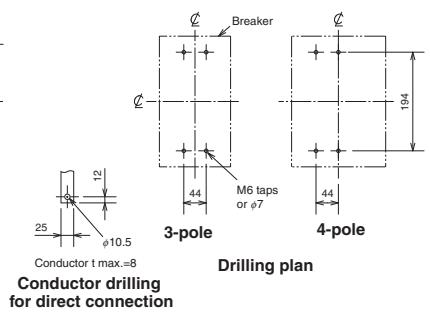
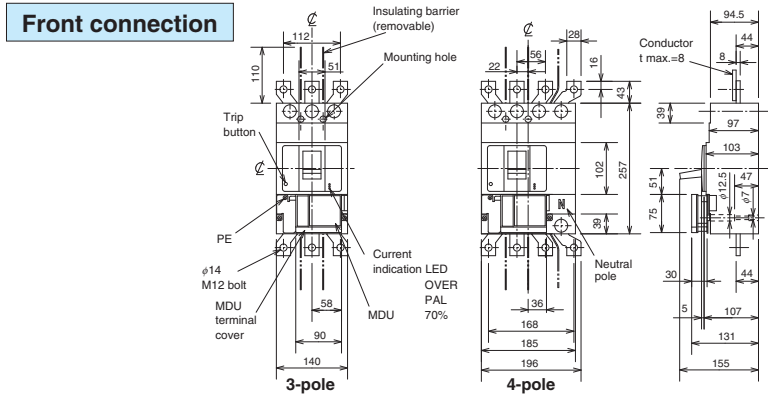

NF400-SEP, NF400-HEP with MDU (No transmission, pulse output)

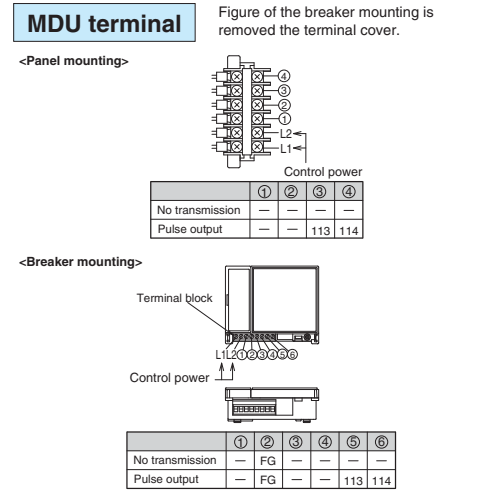
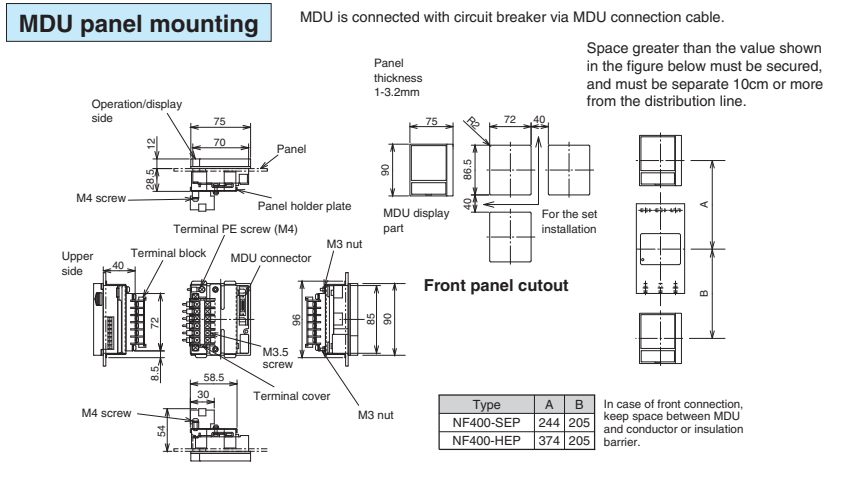

NF400-SEP, NF400-HEP with MDU (CC-Link)

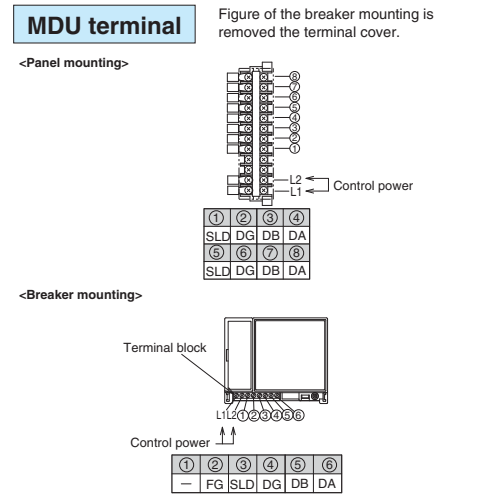
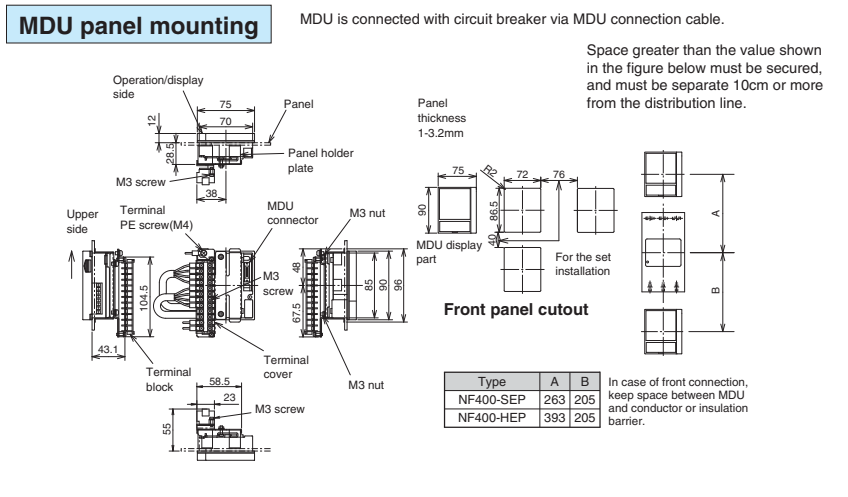

NF630-SEP with MDU NF630-HEP with MDU NF800-SEP with MDU NF800-HEP with MDU



NF630-SEP with MDU
(Breaker mounting)

Model		NF630-SEP with MDU		NF630-HEP with MDU		NF800-SEP with MDU		NF800-HEP with MDU					
Rated current In (A) Rated ambient temperature 40°C		300	350	400	500	600	630	400	450	500	600	700	800
		Adjustable											
Number of poles		3	4	3	4	3	4	3	4	3	4	3	4
Rated operational voltage Ue V		690		690		690		690		690		690	
Rated short-circuit breaking capacity (kA)	IEC 60947-2 (Icu/Ics)	AC	690V	10/10	15/15	10/10	15/15	10/10	15/15	10/10	15/15	10/10	15/15
			500V	30/30	50/50	30/30	50/50	30/30	50/50	30/30	50/50	30/30	50/50
			440V	42/42	65/65	42/42	65/65	42/42	65/65	42/42	65/65	42/42	65/65
			415V	45/45	70/70	45/45	70/70	45/45	70/70	45/45	70/70	45/45	70/70
			400V	45/45	70/70	45/45	70/70	45/45	70/70	45/45	70/70	45/45	70/70
			380V	45/45	70/70	45/45	70/70	45/45	70/70	45/45	70/70	45/45	70/70
			230V	85/85	100/100	85/85	100/100	85/85	100/100	85/85	100/100	85/85	100/100
			200V	85/85	100/100	85/85	100/100	85/85	100/100	85/85	100/100	85/85	100/100
Standard attached parts (Front connection) (*1)		Breaker		Mounting screw M6 × 35 (4pcs) Insulation barrier (3P: 2pcs, 4P: 3pcs)									
MDU accessories		Breaker mounting		MDU, Breaker mounting plate, Mounting screw for breaker mounting plate, Connection cable (for breaker mounting), MDU Mounting screw									
		Panel mounting		MDU, Panel mounting bracket, Panel mounting nut, Connection cable (for panel mounting), MDU Mounting screw									

Note *1 4-pole models are provided with auxiliary handle.

Operating Characteristics

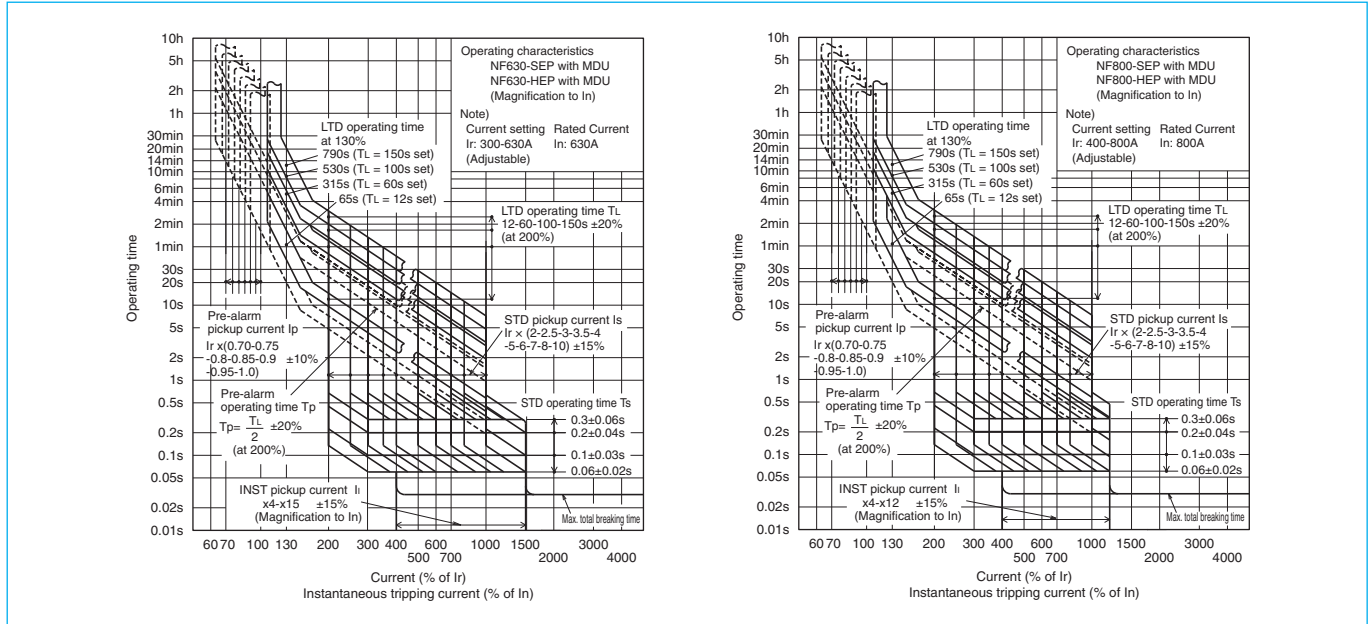

Internal Accessories

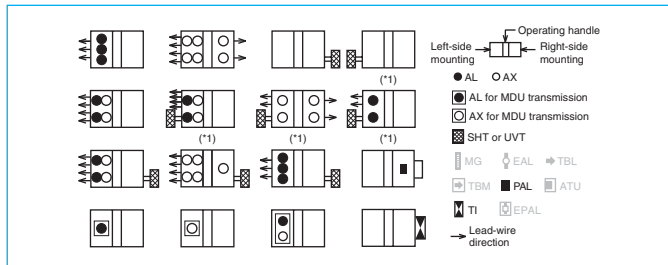

Note *1 Right side mounting is standard of SHT and UVT. Specify separately for left side mounting.

Current Reducing Curve

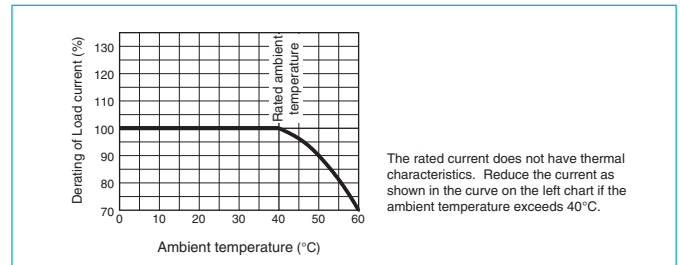

External Accessories

Accessories	Type name		Reference page	Accessories		Type name		Reference page		
	Breaker mounting	Panel mounting		Breaker mounting	Panel mounting					
Operating handle	F	-	F-8S	119	Large	TC-L	3P	-	TCL-8SW3	123
	V	-	V-8S	121			4P	-	TCL-8SW4	
Handle lock device	HL	HL-4SW	HL-4SW	129	Skeleton	TTC	3P	TTC-8SW3-MDU	TTC-8SW3	
	HL-S	-	HLS-8SW				4P	TTC-8SW4-MDU	TTC-8SW4	
Mechanical interlock	MI	3P	MI-8SW3	131	Rear	BTC	3P	BTC-8SW3	BTC-8SW3	
	(*1)	4P	MI-8SW4				MI-8SW4	4P	BTC-8SW4	BTC-8SW4
Auxiliary handle	HT	HT-4SW	HT-4SW	130	Electrical operation device	NFM	3P	-	(*2)	135
							4P			

Notes *1 When selecting the MDU breaker mounting, only the MI panel mounting can be manufactured.
*2 Specify the operation method and voltage. Order in combination with the breaker unit.

Outline Drawing

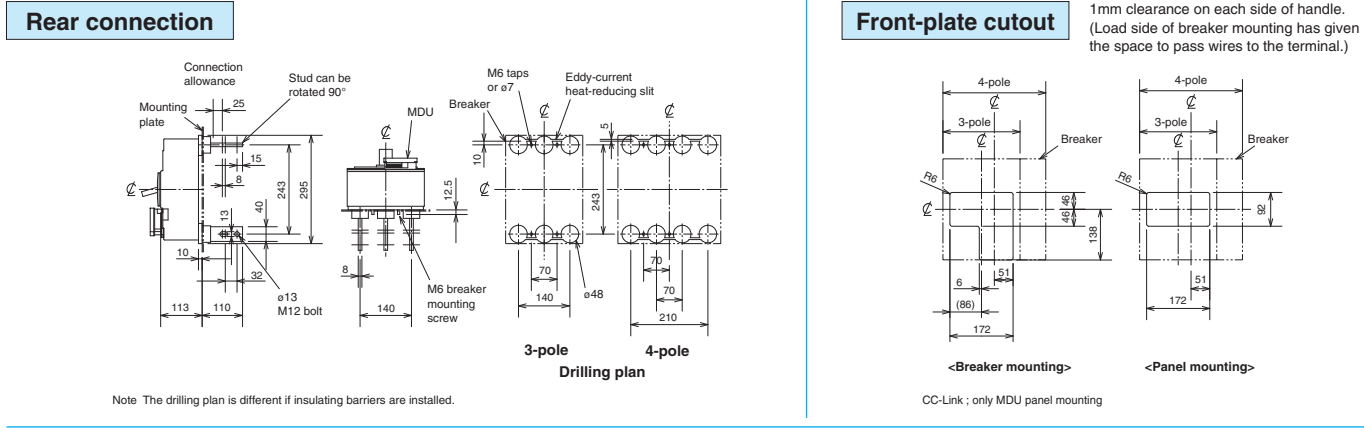
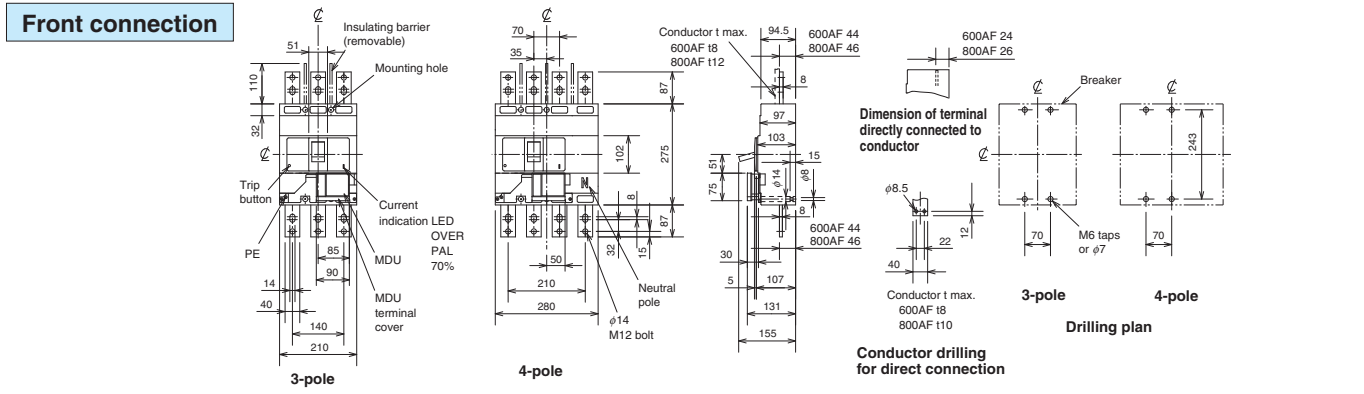

NF630-SEP, NF630-HEP, NF800-SEP, NF800-HEP with MDU (No transmission, Pulse output)

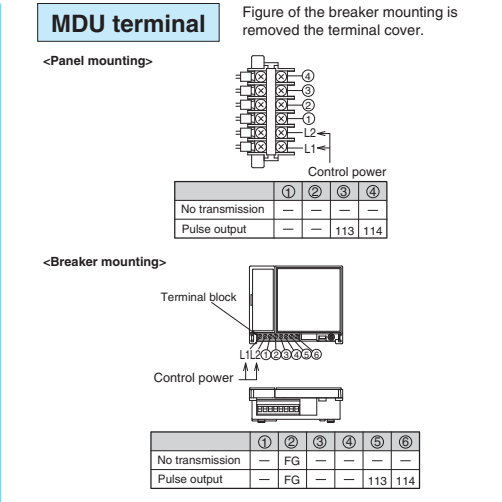
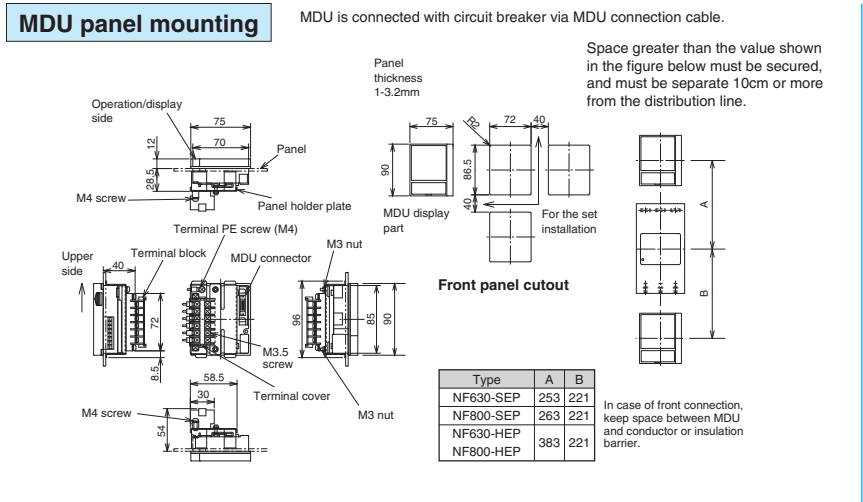

NF630-SEP, NF630-HEP, NF800-SEP, NF800-HEP with MDU (CC-Link)

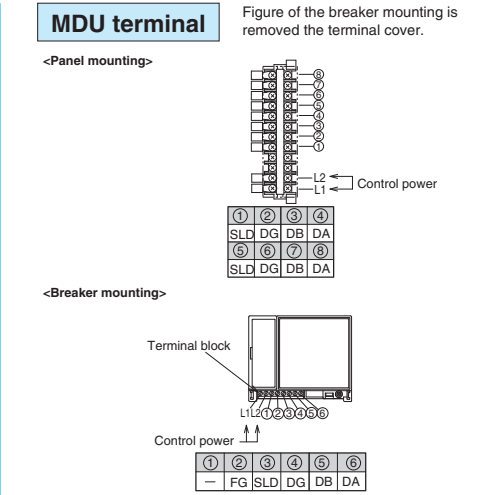
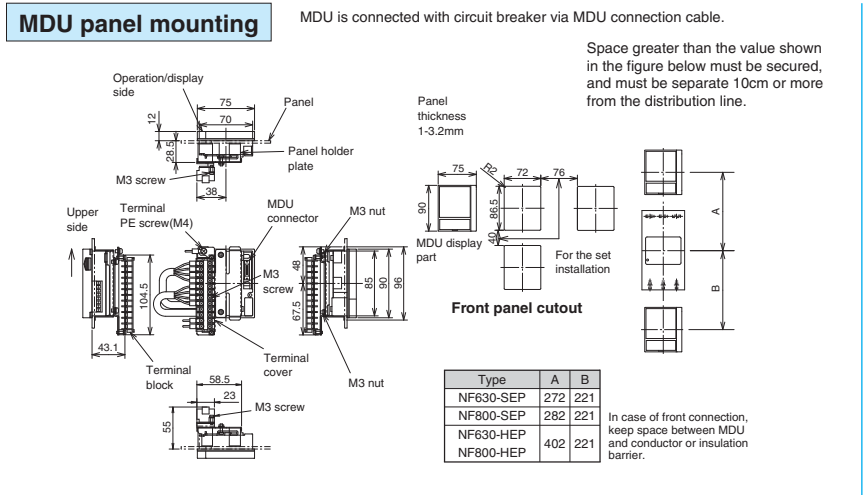

BH BH-P

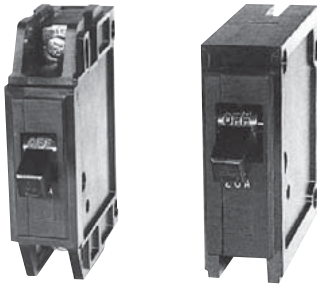

BH

BH-P

Model		BH			BH-P			
Number of poles		1	2	3	1	2	3	
Rated current (A) at ambient temperature 40°C		70	70, 100	70, 100	70	70, 100	70, 100	
Rated voltage (V)		AC	230/400			230/400		
		DC	125			125		
Rated short circuit capacity (kA)	IEC 60898	AC230/400V	3	–	3	–	–	
		AC400V	–	3	–	3	–	
	–	DC125V	1			1		

Operating Characteristics

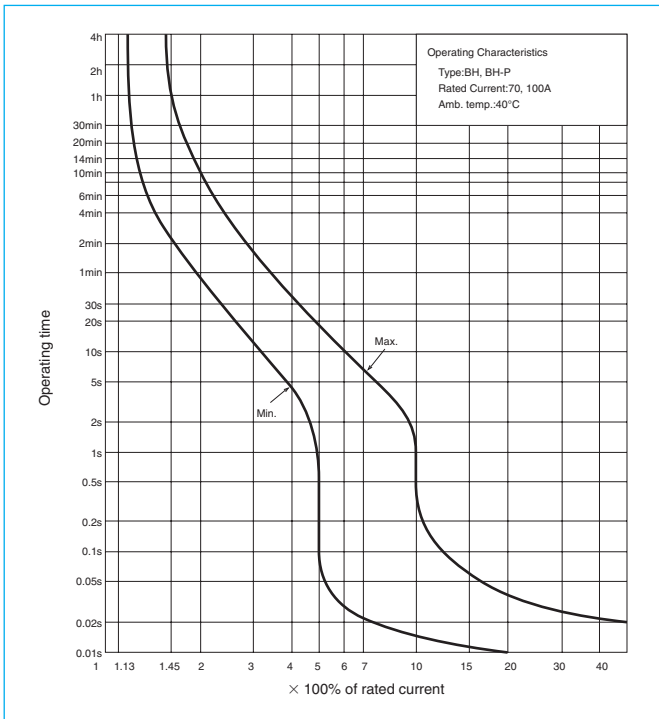

Temperature Compensation Curve

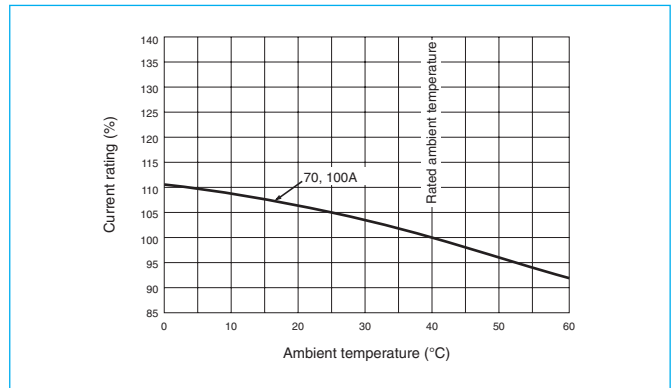

Outline Drawing

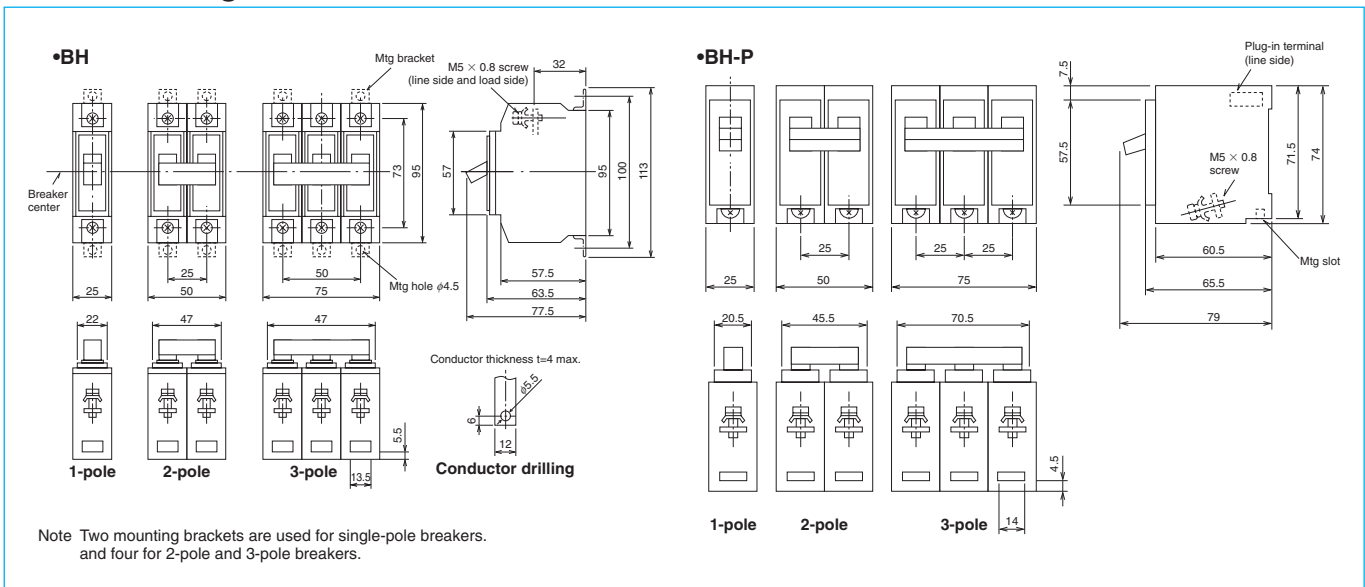

BH-S



BH-S

Model		BH-S M3			BH-S M6		
Number of poles		1	2	3	1	2	3
Rated current (A) at ambient temperature 40°C		5, 10, 15, 20, (25), 30, 40, 50, 60	10, 15, 20, (25), 30, 40, 50, 60	15, 20, (25), 30, 40, 50, 60	5, 10, 15, 20, (25), 30, 40, 50, 60	10, 15, 20, (25), 30, 40, 50, 60	15, 20, (25), 30, 40, 50, 60
Rated voltage (V)		AC	230/400	400	400	230/400	400
		DC	–	125	–	–	125
Rated short circuit capacity (kA)	IEC 60898	AC230/400V	3	–	–	6	–
		AC400V	–	3	–	–	6
	–	DC125V	–	1	–	–	1

Operating Characteristics

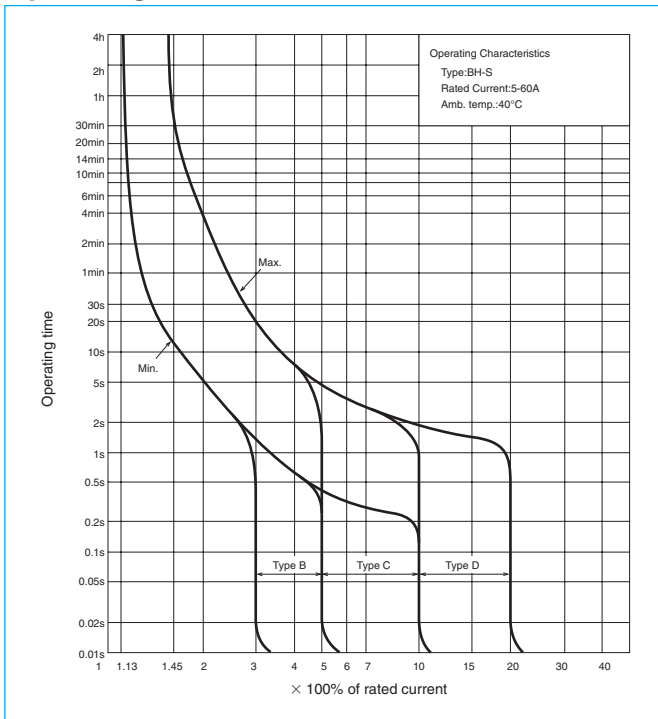

Temperature Compensation Curve

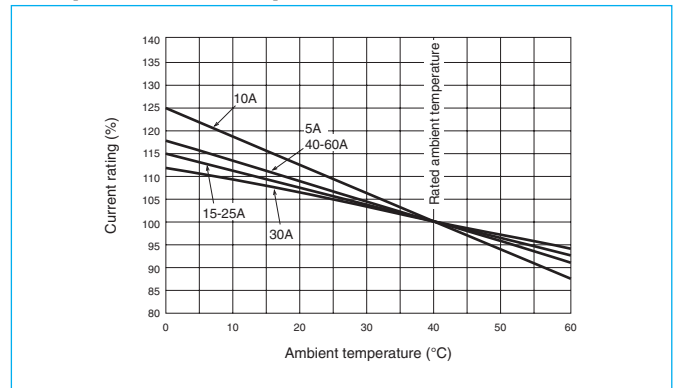

Outline Drawing

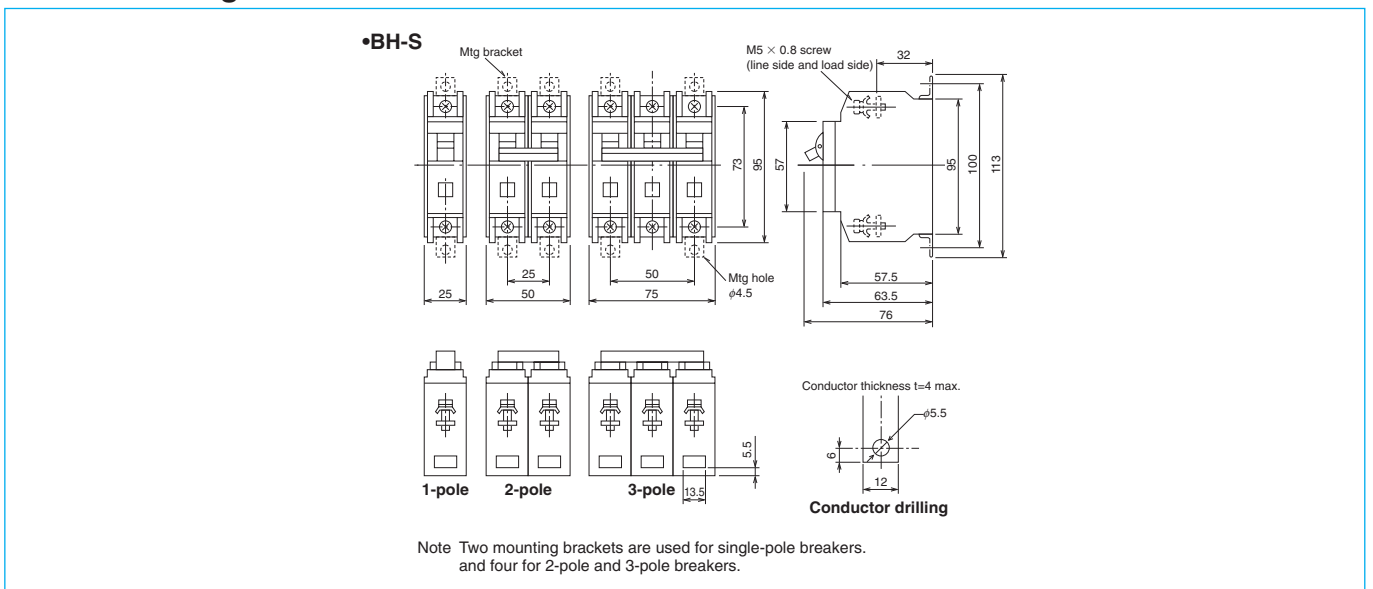

BH-PS



BH-PS

Model		BH-PS M3			BH-PS M9		
Number of poles		1	2	3	1	2	3
Rated current (A) at ambient temperature 40°C		10, 15, 20, 30, 40, 50, 60	10, 15, 20, 30, 40, 50, 60	15, 20, 30, 40, 50, 60	6, 10, 16, 20, (25), 32, 40, 50, 60	10, 16, 20, (25), 30, 40, 50, 60	10, 16, 20, (25), 32, 40, 50, 60
Rated voltage (V)		AC	230/400	400	400	230/400	400
		DC	-	125	-	-	-
Rated short circuit capacity (kA)		IEC 60898	AC230/400V	3	-	9	-
		-	AC400V	-	3	-	9
		-	DC125V	-	1	-	-

Operating Characteristics

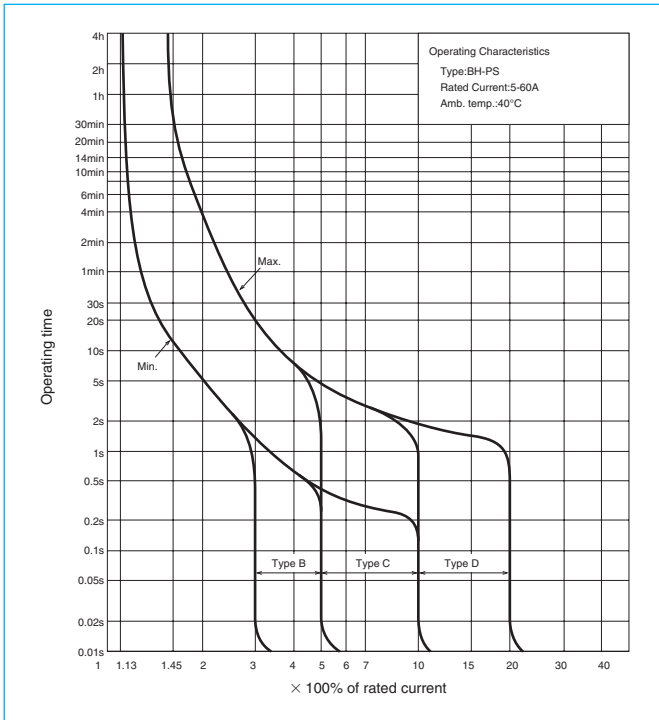

Temperature Compensation Curve

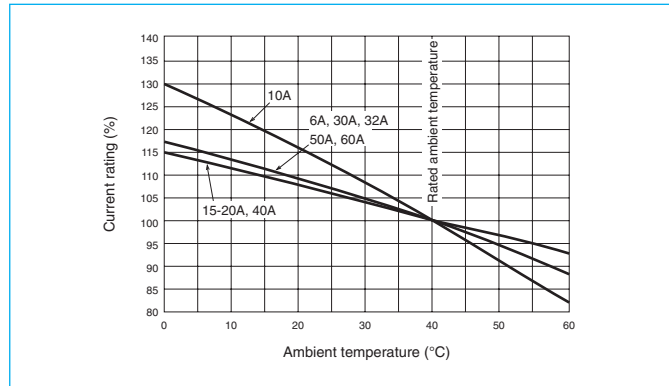

Outline Drawing

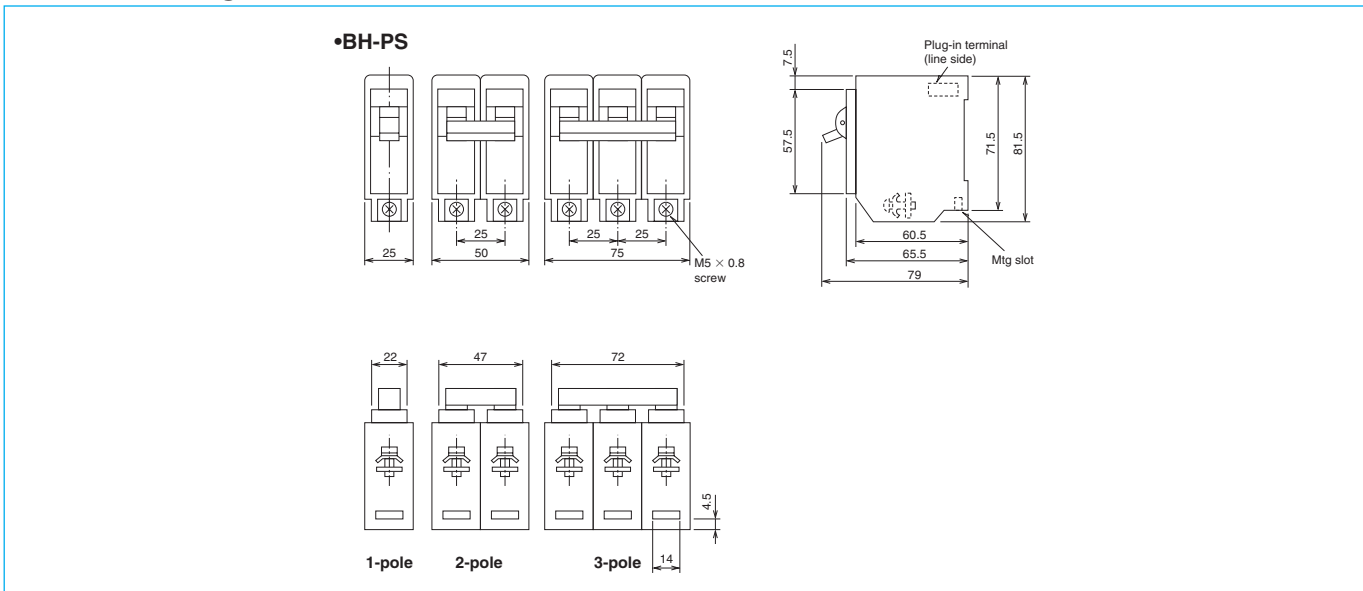

BH-D6 BH-D10



BH-D6

Model		BH-D6					BH-D10				BH-D10 (For DC)			
Number of poles (P)		1	2	3	4(3+N) (*1)	2(1+N) (*1)	1	2	3	4(3+N) (*1)	1	2		
Instantaneous tripping		Type B, C, D					Type B, C		Type B, C, D			Type B, C		
Rated insulation voltage U_i (V)		440					440					250		
Rated current I_n (A) at ambient temperature 30°C		0.5, 1, 1.6, 2, 3, 4, 6, 10, 13, 16, 20, 25, 32, 40, 50, 63					0.5, 1, 1.6, 2, 3, 4, 6, 10, 13, 16, 20, 25, 32, 40		0.5, 1, 1.6, 2, 3, 4, 6, 10, 13, 16, 20, 25, 32, 40, 50, 63				0.5, 1, 1.6, 2, 3, 4, 6, 10, 13, 16, 20, 25, 32, 40, 50, 63	
Rated short-circuit capacity (kA)	IEC60898-1 GB10963.1 (Icn)	AC	230V	6	-		6	10	-		6	-		
		230/400V	6	-		-	10	-		6	-			
	400V	-	6		-	-	10		-	6				
	IEC60898-2 GB10963.2 (Icn)	DC	125V	-					-					10
250V		-					-					-	10	

Note *1 N pole is a switched neutral pole (without overcurrent release device).

Operating Characteristics

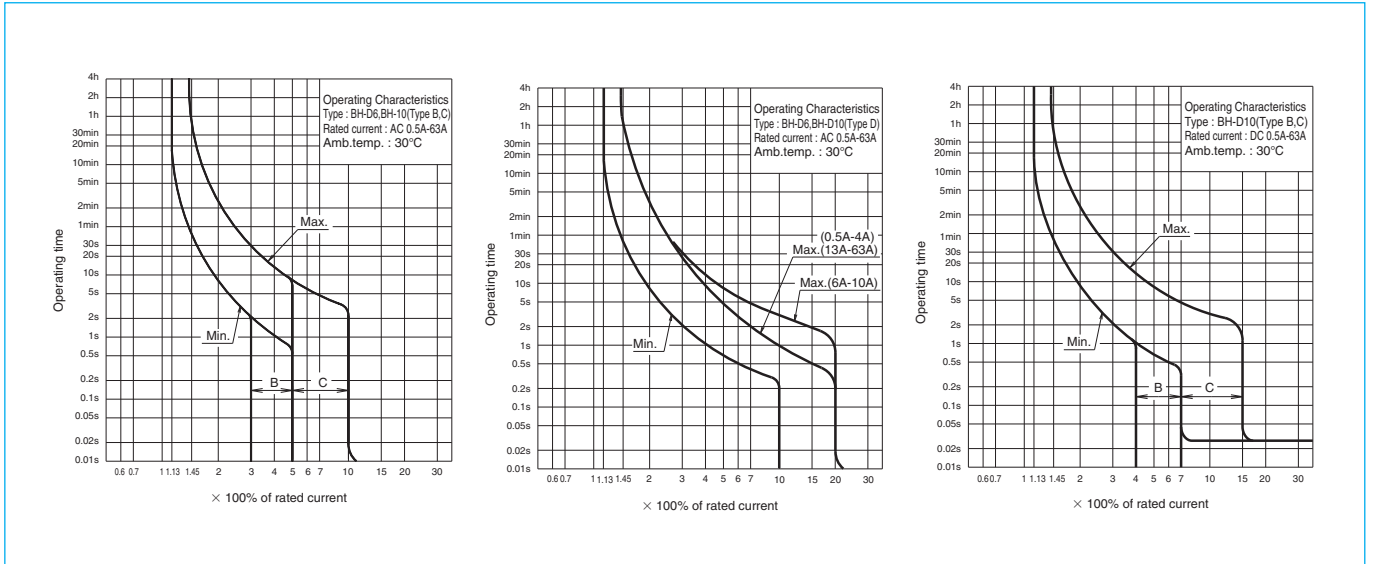

Outline Drawing

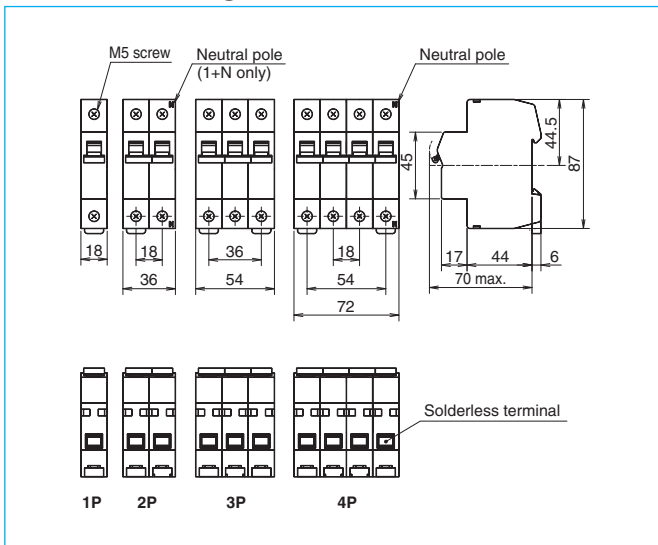

Temperature Compensation Curve

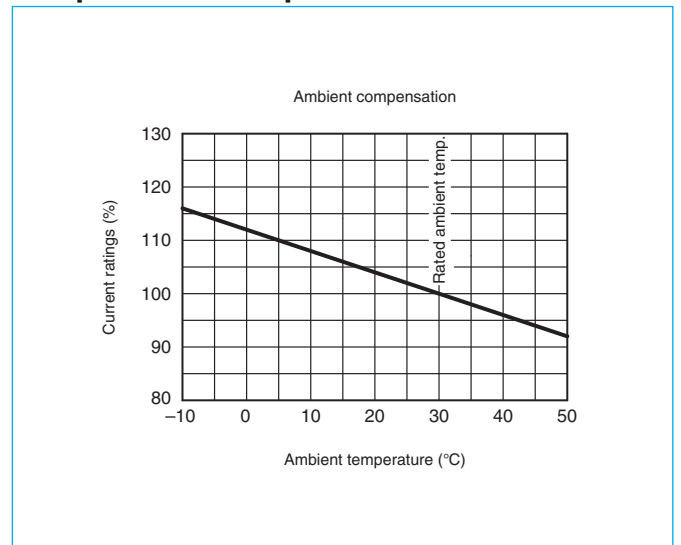

BH-DN



BH-DN

Model				BH-DN
Number of poles (P)				2 (1+N) (*1)
Instantaneous tripping				Type C
Rated insulation voltage U_i (V)				230
Rated current I_n (A) at ambient temperature 30°C				6, 10, 16, 20
Rated short-circuit capacity (kA)	IEC60898-1 GB10963.1 (I_{cn})	AC	230V	4.5

Note *1 N pole is a switched neutral pole (without overcurrent release device).

Operating Characteristics

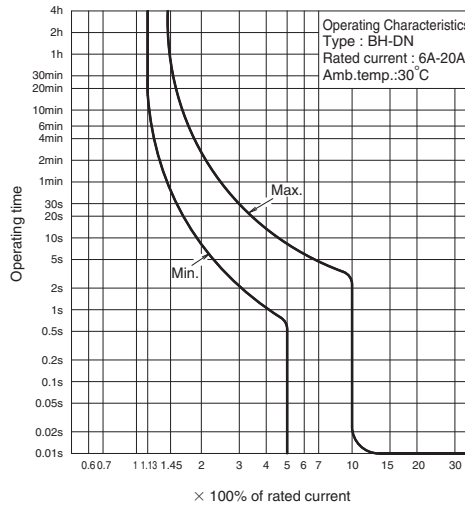

Outline Drawing

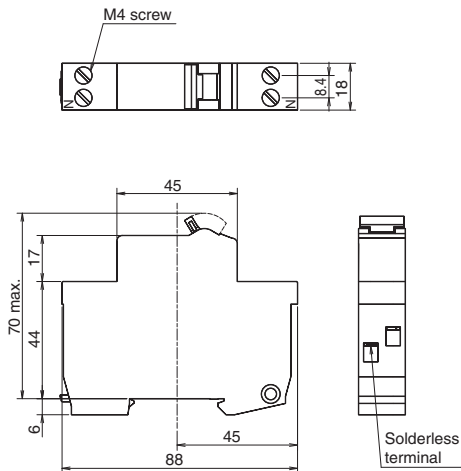

Temperature Compensation Curve

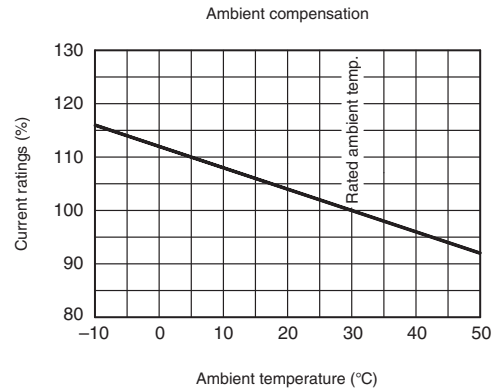

BV-D



BV-D

Model	BV-D	
Number of poles (P)	2 (1+N) (*1)	4 (3+N) (*1) (*2)
Rated operational voltage U_e (VAC)	230	230/400
Rated current I_n (A) at ambient temperature 30°C	25, 40, 63	
Rated current sensitivity $I_{\Delta n}$ (mA)	30, 300	
Max. operating time at $5I_{\Delta n}$ (s)	0.04	
Pulsating current sensitivity	Type AC	
Residual operation	Dependent on line voltage	
Rated making and breaking capacity I_m (A)	500 (In 25, 40A)	630 (In 63A)
Rated conditional short-circuit current I_{nc} (kA)	6	
Rated residual making and breaking capacity $I_{\Delta m}$ (A)	500 (In 25, 40A)	630 (In 63A)
Rated conditional residual short-circuit current $I_{\Delta c}$ (kA)	6	

Notes *1 N pole is a switched neutral pole (without overcurrent release device).
 *2 For use to three phase 4-wire type. When using, it be sure to connect the neutral wire to the neutral phase. Not available for use to three phase 3-wire type.

Operating Characteristics

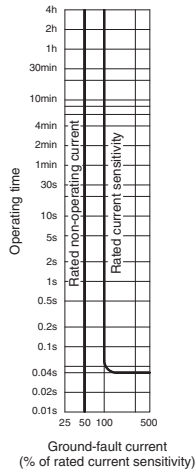

Outline Drawing

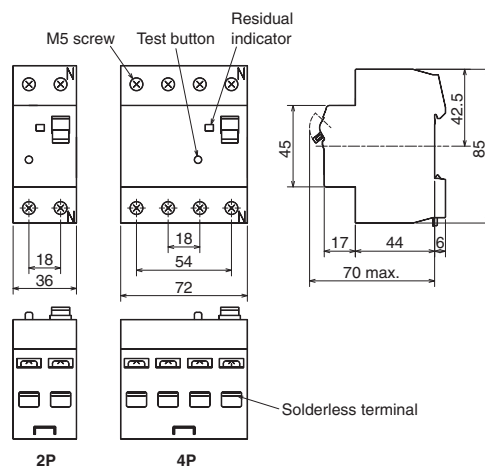

BV-DN



BV-DN

Model				BV-DN
Number of poles (P)				2 (1+N) (*1)
Rated operational voltage U _e (VAC)				230
Rated current I _n (A) at ambient temperature 30°C				6, 10, 16, 20, 25, 32, 40
Instantaneous tripping				Type C
Rated current sensitivity I _{Δn} (mA)				30, 100, 300
Max. operating time at 5I _{Δn} (s)				0.04
Pulsating current sensitivity				Type AC
Residual operation				Dependent on line voltage
Rated short-circuit capacity (kA)	IEC61009-1 GB16917.1 (Icn)	AC	230V	4.5

Note *1 N pole is a switched neutral pole (without overcurrent release device).

Operating Characteristics

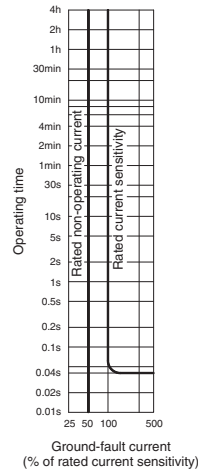
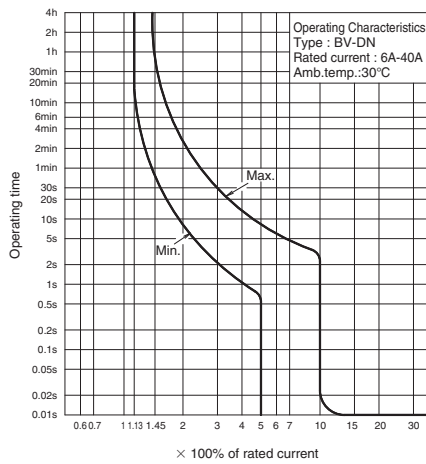

Outline Drawing

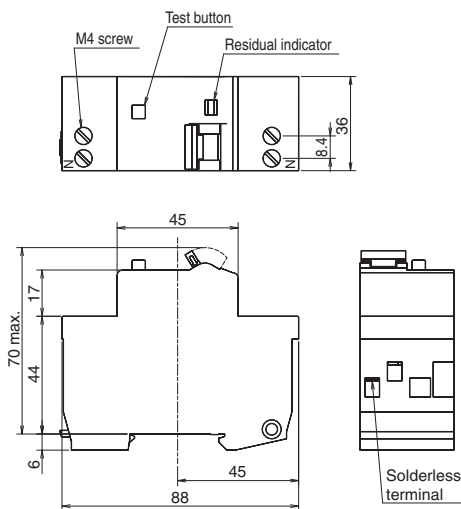

Temperature Compensation Curve

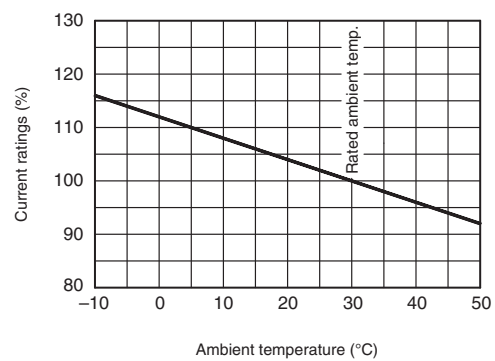

KB-D



KB-D

Model	KB-D			
Number of poles (P)	1	2	3	4 (3+N) (*1)
Utilization category	AC22A class			
Rated insulation voltage U_i (V)	250	440		
Rated voltage U_e (VAC)	230	400		
Rated current I_n (A) at ambient temperature 30°C	32, 63, 80			
Short-time withstand current (A)	20× I_n , 1sec			
Short-time making current (A)	20× I_n			

Note *1 N pole is a switched neutral pole (without overcurrent release device).

Outline Drawing

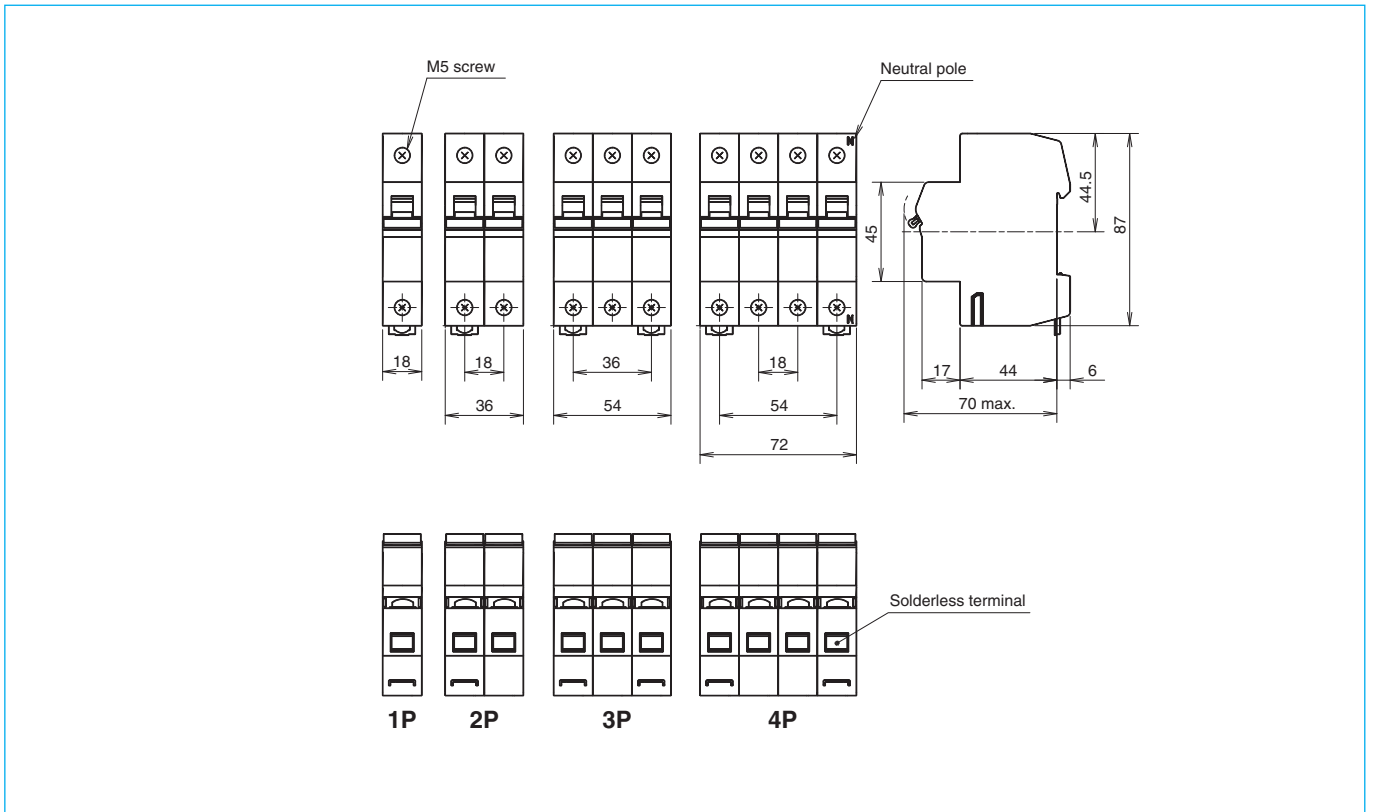

CP30-BA



CP30-BA

Frame (A)		30			
Model		CP30-BA			
Number of poles		1	2	3	
Rated impulse withstand voltage U_{imp} (kV)		2.5			
Rated current (A)		0.1, 0.25, 0.3, 0.5, 1, 2, 3, 5, 7, 10, 15, 20, 30			
Rated short-circuit capacity (kA)	UL 1077 CSA C22.2 No.235	Rated voltage (V)	AC (V)	250	
			DC (V)	65	
		AC		2.5kA at 250V	
	DC		2.5kA at 65V	2.5kA at 125V	-
	IEC 60934 EN 60934	Rated insulation voltage U_i (V)		250	
		AC		2.5kA at 230V	
DC		2.5kA at 60V	2.5kA at 120V	-	
EN 60947-2 IEC 60947-2 (Icu/Ics)	Rated insulation voltage U_i (V)		250		
	AC		2.5/2.5kA at 230V		
	DC		2.5/2.5kA at 60V	2.5/2.5kA at 120V	-
AC-DC common use		●			
Operating characteristics		Instantaneous type (I) Medium type (M),(MD) Slow type (S),(SD) Fast type (F)			
Mode of tripping		Instantaneous type (I): magnetic only Other type (M, MD, S, SD, F):hydraulic-magnetic			

Operating Characteristics

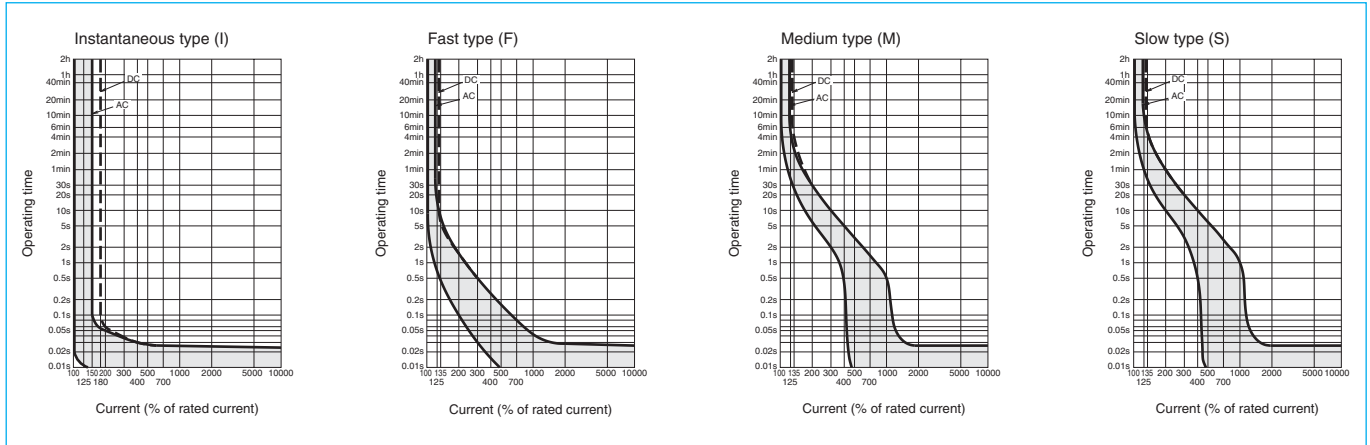

Outline Drawing

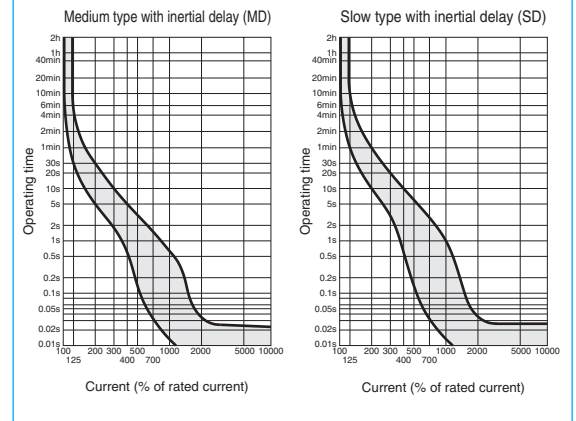
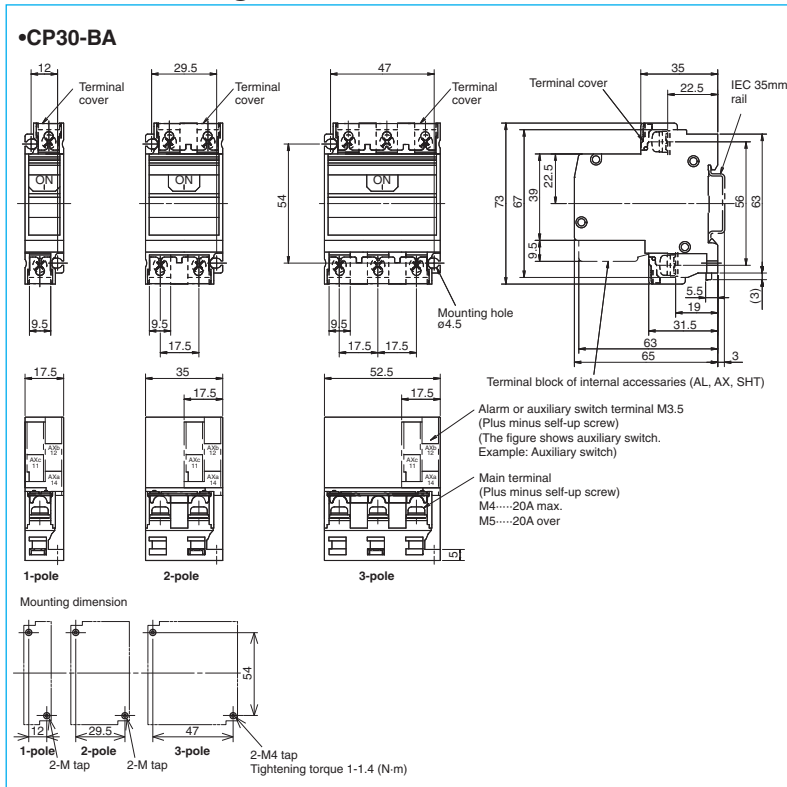

Temperature Characteristics Curve

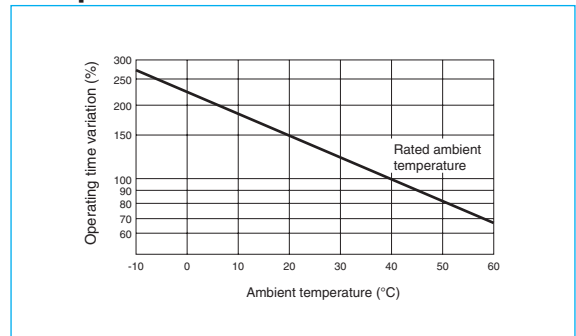

(1) Dimensions of electrical operated circuit breakers

The following concept is applied for the dimensions of the electrical operated circuit breaker. Please understand this before using this type of breaker.

Connection method	Outline dimensions listing method			
Front connection (Rear connection)	Model	Listed page	Model	Listed page
	NF125-CV/SV/HV NV125-CV/SV/HV NF125-UV NF125-SEV/HEV/RV/ZEV NF250-CV/SV/HV/SEV/HEV NF250-RV NF125-SGV/LGV/HGV/RGV NF160-SGV/LGV/HGV NF250-SGV/LGV/HGV/RGV NV125-SEV/HEV NV250-CV/SV/HV/SEV/HEV NF250-UV	229 (*1) 230 (*1)	NF400-CW/SW/SEW/HEW/REW NF630-CW/SW/SEW/HEW/REW NF400-UEW (3P) NV400-CW/SW/SEW/HEW/REW NF400-UEW (4P) NV630-CW/SW/SEW/HEW NF800-CEW/SEW/HEW/REW/SDW NF800-UEW NV800-SEW/HEW NF1000-SEW, NF1250-SEW/SDW NF1600-SEW/SDW	 230 231 232
Rear connection Plug-in	The drilling dimensions and connection related dimensions are the same as the dimensions for the breaker body. Refer to the dimension drawings of each model. Note that for the rear connection type, four mounting holes are required even for the 2-pole or 3-pole types.			

(2) Front connection (Rear connection)

NF125-CV, NF125-SV, NF125-HV
NV125-CV, NV125-SV, NV125-HV

Front connection

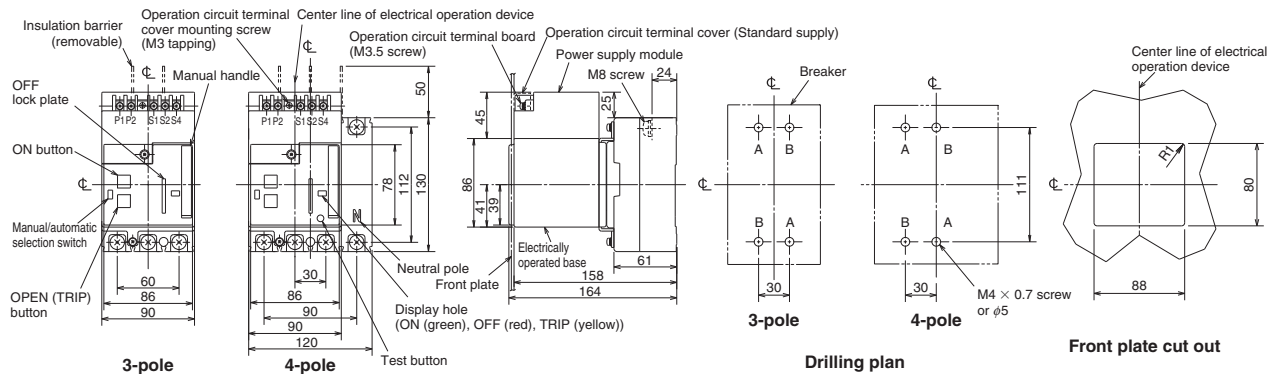

Remarks: 1. This cannot be mounted on the 2-pole breaker.
2. The test button is equipped only on the earth leakage circuit breaker.

NF125-SEV, NF125-HEV, NF125-RV
NF250-CV, NF250-SV, NF250-HV, NF250-SEV, NF250-HEV, NF250-RV
NV125-SEV, NV125-HEV
NV250-CV, NV250-SV, NV250-HV, NV250-SEV, NV250-HEV
NF125-SGV/LGV/HGV/RGV
NF160-SGV/LGV/HGV
NF250-SGV/LGV/HGV/RGV

Front connection

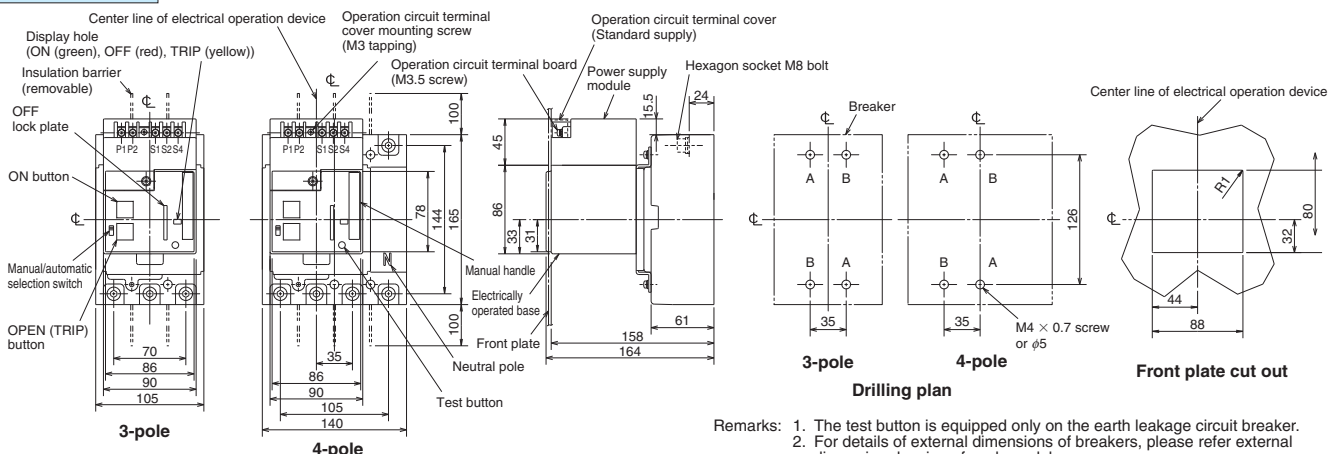

Remarks: 1. The test button is equipped only on the earth leakage circuit breaker.
2. For details of external dimensions of breakers, please refer external dimension drawing of each model.

7 Characteristics and Dimensions

Electrical Operated Circuit Breakers

NF400-CW, NF400-SW, NF400-SEW, NF400-HEW, NF400-REW, NF630-CW, NF630-SW, NF630-SEW, NF630-HEW, NF630-REW Motor drive type

Front connection

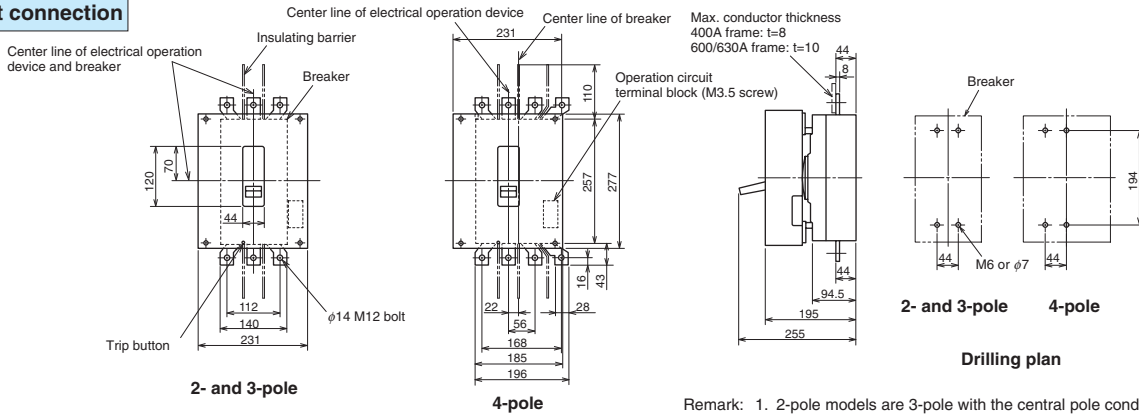

Remark: 1. 2-pole models are 3-pole with the central pole conductor removed.

NF400-UEW (3-pole) Motor drive type

Front connection

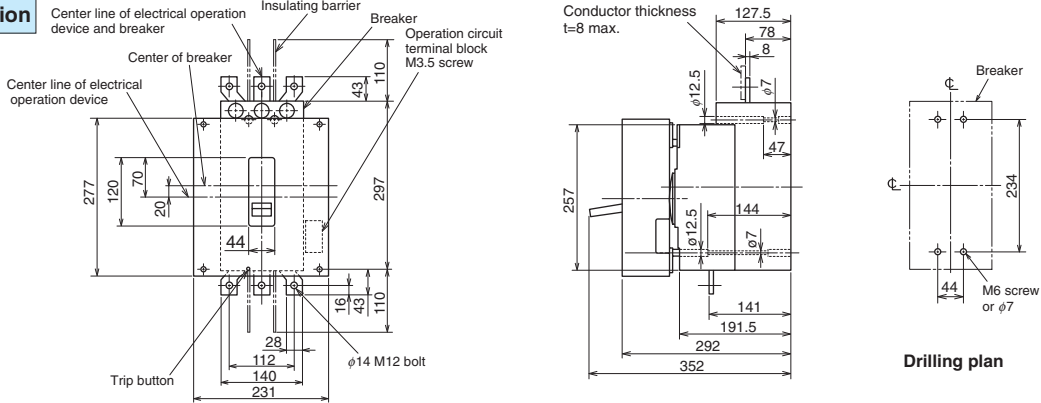

NV400-CW, NV400-SW, NV400-SEW, NV400-HEW, NV400-REW, NV630-CW, NV630-SW, NV630-SEW, NV630-HEW Motor drive type

Front connection

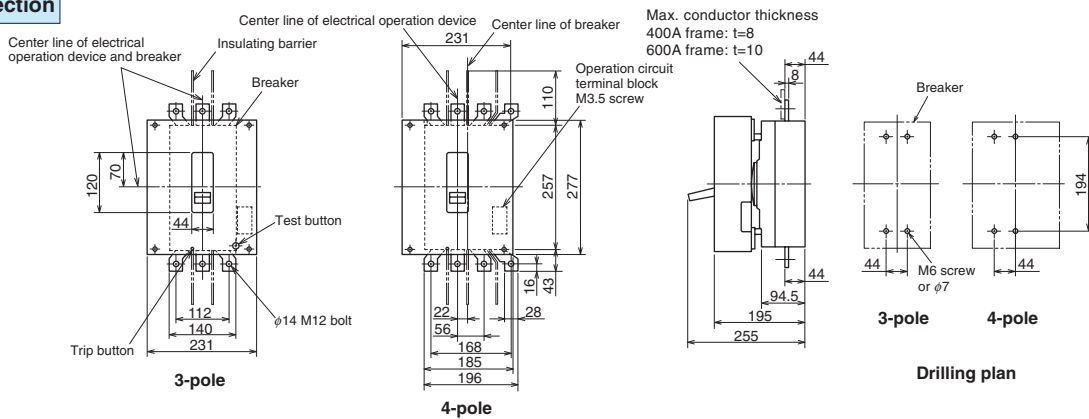

NF400-UEW (4-pole) Motor drive type

Front connection

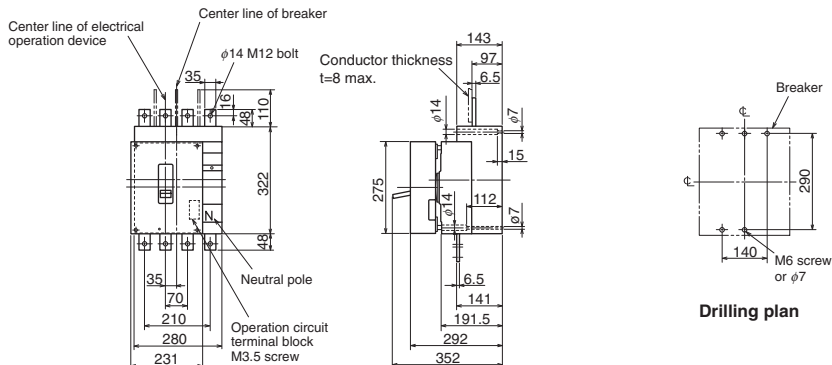

NF800-CEW, NF800-SDW, NF800-SEW, NF800-HEW, NF800-REW Motor drive type

Front connection

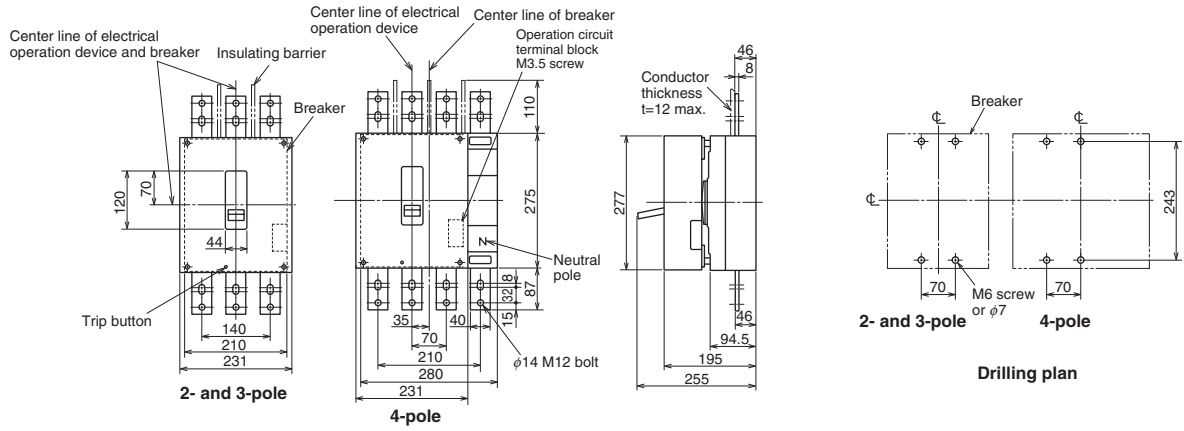

Remark: 1. 2-pole models are 3-pole with the central pole conductor removed.

NF800-U EW Motor drive type

Front connection

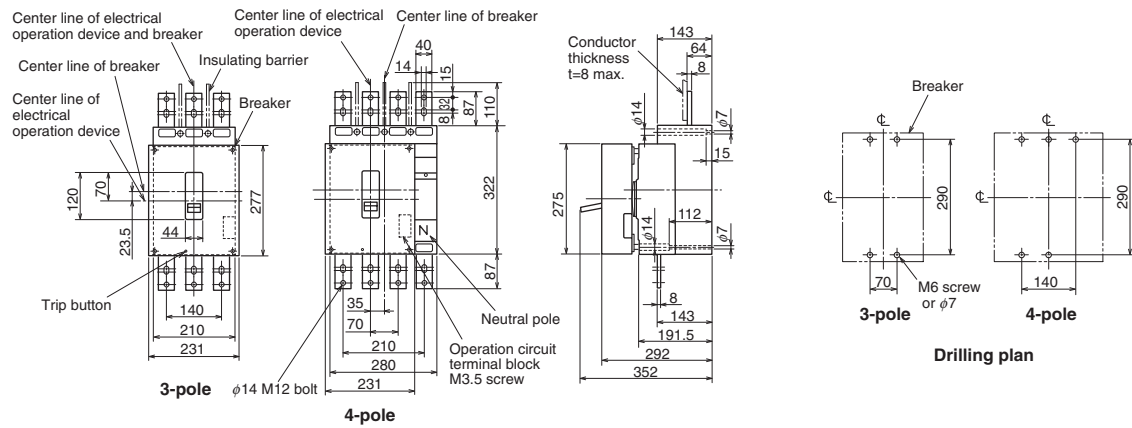

NV800-SEW, NV800-HEW Motor drive type

Front connection

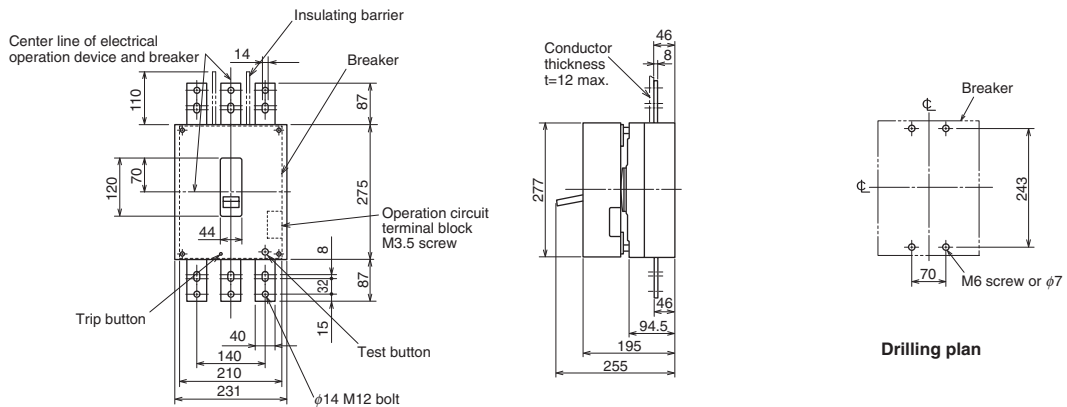

NF1000-SEW, NF1250-SEW, NF1250-SDW Motor drive type

Front connection

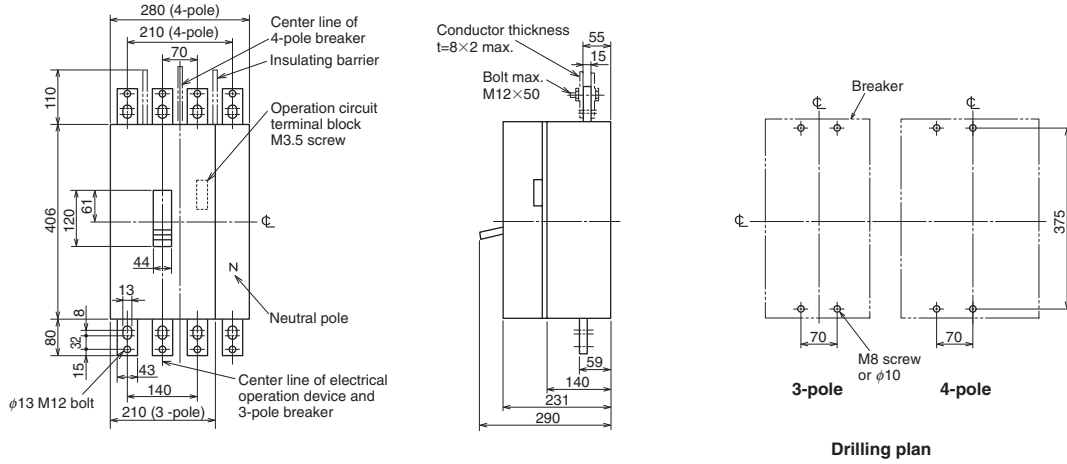

Remark: 1. 2-pole models are 3-pole with the central pole conductor removed.

NF1600-SEW, NF1600-SDW Motor drive type

Front connection

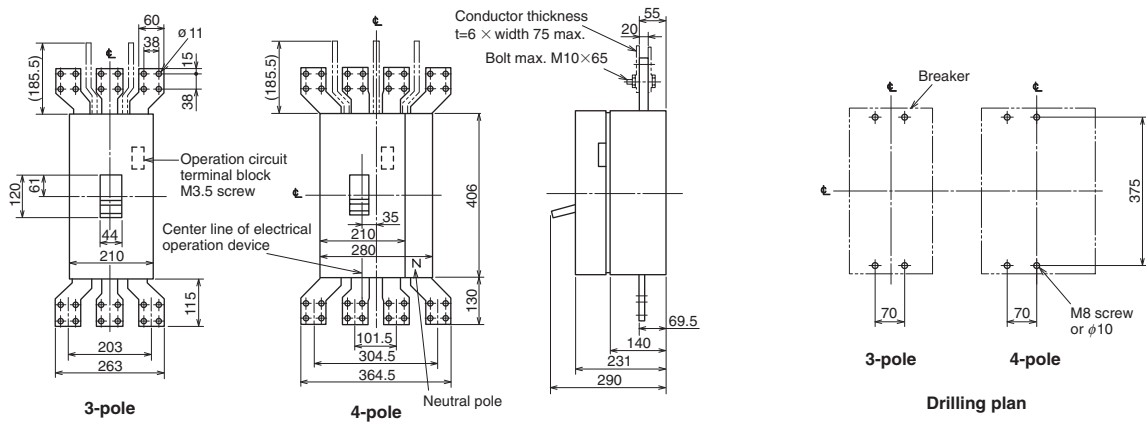

NF1600-SEW (3-pole) Motor drive type

Rear connection

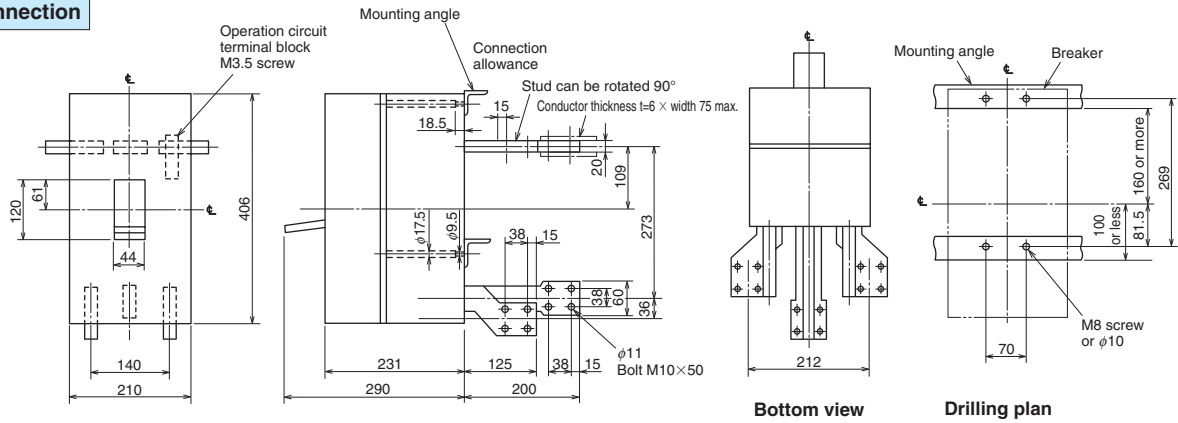

NF1600-SEW (4-pole) Motor drive type

Rear connection

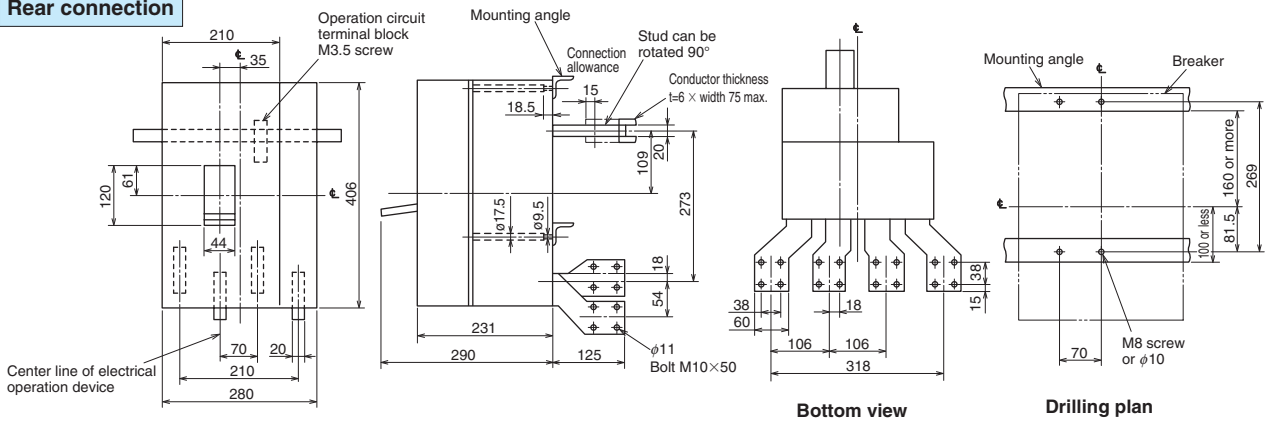

NF1600-SDW (3-pole) Motor-drive type

Rear connection

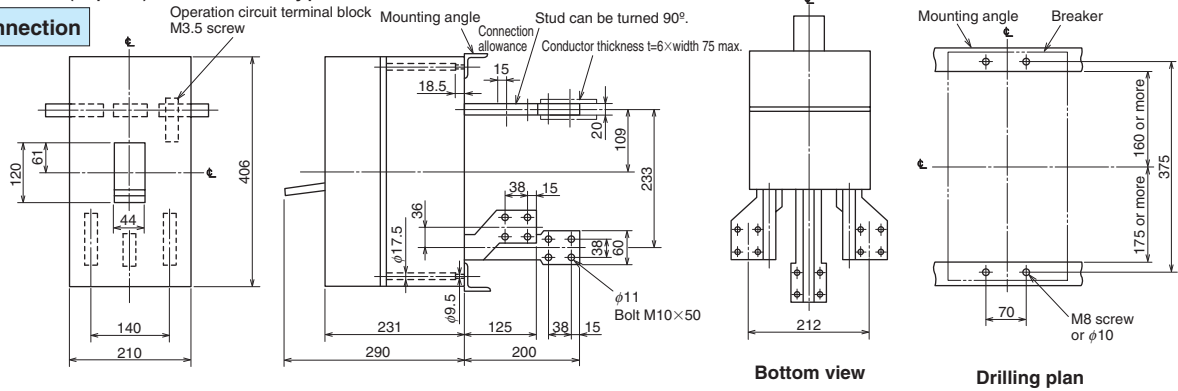

Remark: 2-pole models are 3-pole models with the central pole removed.

NF1600-SDW (4-pole) Motor-drive type

Rear connection

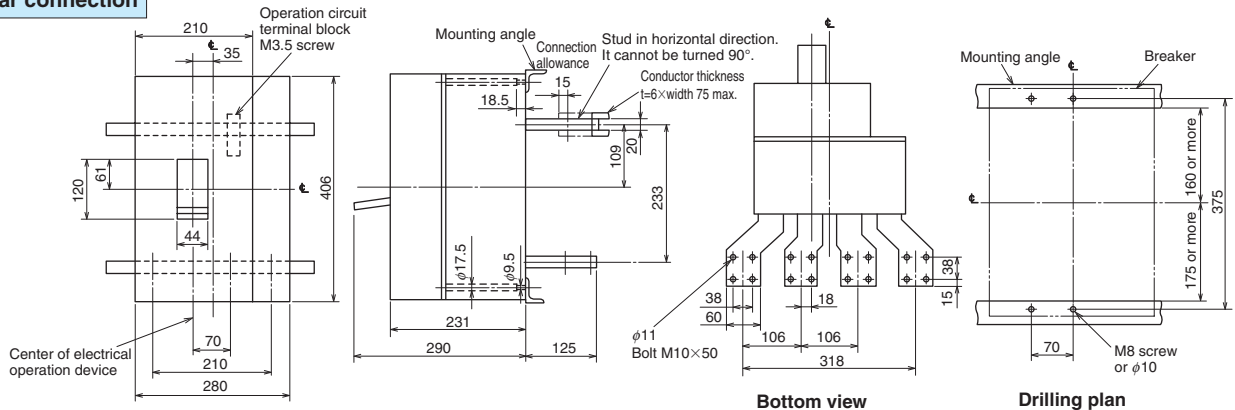

MEMO

7

8

Handling and Maintenance

1) Storage and Transportation	236
2) Standard Working Conditions	236
3) Mounting and Connections	236
4) Maintenance and Inspections	238
5) Troubleshooting	240



8 Handling and Maintenance

1. Storage and Transportation

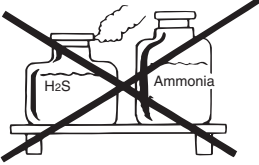
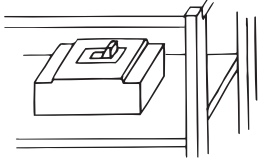
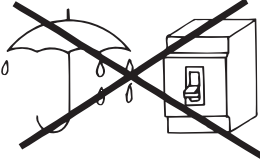
(1) Precautions for storage

<p>Avoid corrosive gases</p>  <p>Do not store the product in an atmosphere containing acidic gas or ammonia gas. H_2S 0.01ppm or less SO_2 0.05ppm or less NH_3 0.25ppm or less</p>	<p>Store in the OFF or tripped state</p>  <p>Store the breaker in the OFF state or tripped state.</p>	<p>Avoid moisture</p>  <p>Do not leave the breaker in a humid place for long periods of time.</p>
--	---	---

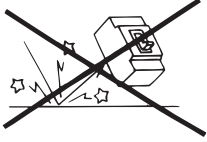
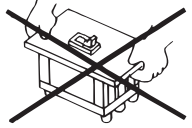
(2) Precautions for transportation

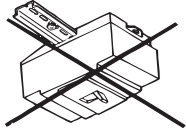
<p>Carefully pack and transport</p>  <p>Do not drop the package during transportation. When shipping the breaker, make sure to package it carefully.</p>	<p>Do not carry by holding the front and back of the flush plate</p>  <p>Do not carry the embedded type breaker by holding the front and back of the flush plate. The breaker could drop during transportation.</p>	<p>Do not carry by the lead wires</p>  <p>Do not carry the accessories by the lead wires. Excessive force will be applied on the accessories.</p>	<p>Do not transport upside down (when mounted on IEC 35mm rail)</p>  <p>Do not transport a panel containing parts mounted on an IEC 35mm rail in an upside down state.</p>
--	---	--	--

2. Standard Working Conditions

- Working ambient temperature ... $-10^{\circ}C$ to $40^{\circ}C$
 (Note that the 24-hour average value must not exceed $35^{\circ}C$)
 working current reduction rate in ambient temperature exceeding $40^{\circ}C$.
 $50^{\circ}C$... 0.9 fold
 $60^{\circ}C$... 0.7 fold
- Relative humidity ... 85% or less with no dew condensation.
- Altitude ... 2000m or less
- Atmosphere ... Free of excessive moisture, oil vapors, smoke, dust, salt, corrosive substances, vibration or impact, etc.

3. Mounting and Connections

(1) Precautions for mounting

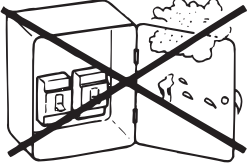
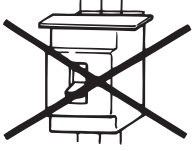
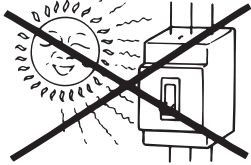
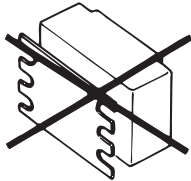
<p>Attention to dust and cutting chips!</p>  <p>Make sure that the breaker does not come in contact with rain water, oil, dust or cutting chips. Special attention must be taken to conductive materials such as scraps from drilling steel plates.</p>	<p>Do not block ventilation ports</p>  <p>Do not block the ventilation ports. The breaker performance could drop. Ensure the insulation distance for breaker mounting indicated on page 101.</p>	<p>Avoid direct sunlight</p>  <p>Make sure that the breaker is not subject to direct sunlight during use. An increase in temperature could cause malfunctions. Sunlight could also discolor the nameplate and molded case, etc.</p>	<p>Do not remove the rear cover</p>  <p>Do not remove the rear cover from the back of the base.</p>
---	--	--	---

Mounting style

Pay attention to the mounting angle of the following models as the overcurrent tripping characteristics may vary according to the mounting style. Use in a vertical direction is recommended.

- NF30-CS
- CP30-BA

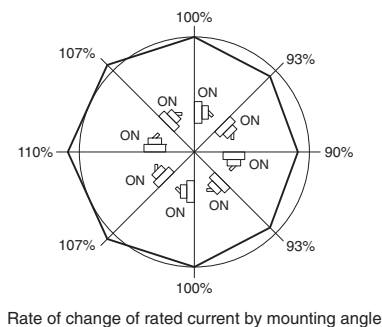

Do not wipe with thinner, detergent or chemical cloth

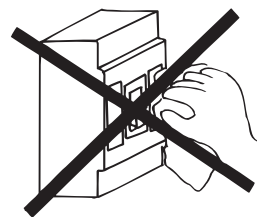

Do not use thinner, etc., to clean the surface of the breaker. Use compressed air or a dry cloth to clean.

(2) Precautions for Connections

Oiling of threads prohibited

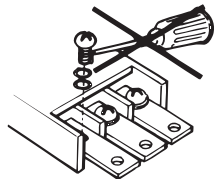

- Do not apply lubricant to the threads. Oil will decrease the friction at threads and cause the screws to loosen easily, and the unit to overheat. Excessive stress will be applied on the threads even with the standard tightening torque and can cause the screws to break.

Connect conductors parallel to each pole

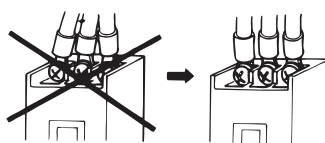

- Connect each connection conductor so it is parallel to each pole.

Do not deform studs

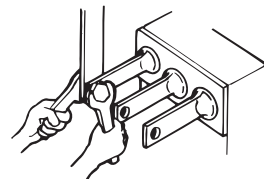

- When connecting the conductors on the rear connection type, take care not to deform the studs when tightening.

Do not connect in reverse

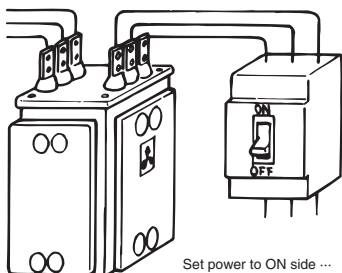

- As a rule, do not connect the power and load in reverse. If necessary, refer to the specifications and select a model which can be connected in reverse.
- An insulating barrier should be provided on both the power and load sides of the breakers when using a high voltage circuit where dew condenses easily or in a circuit which has a reverse connection in the circuit.

Securely fix conductors

- A large electromagnetic force is applied on the connected conductor according to the accident current. Use the conditions on the right as guide and securely fix (tighten) the conductors.

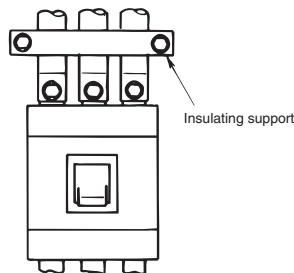

Electromagnetic force applied per 1m conductor (During 3-phase short-circuit)

Current target value kA(Pf)	Distance between conductors cm		10	20
	10	(0.4)	490	245
18	(0.3)	1860	930	
25	(0.2)	4410	2205	
35	(0.2)	8720	4360	
42	(0.2)	12545	6270	
50	(0.2)	17835	8920	
65	(0.2)	30185	15090	
85	(0.2)	51550	25775	
100	(0.2)	71540	35770	
125	(0.2)	111720	55860	

Bar Connection

- When directly connecting the conductor, refer to the outline drawings and drill the conductor.
- When connecting the conductors to a bar terminal, pay attention to the insulating distance with the ground. A ground fault prevention barrier is available as an option.

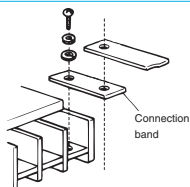

Wire retention type connection

- When directly connecting to the terminal, insert the single strand or stranded wires in straight and then tighten. A commercially-available crimp terminal or bar can be connected directly.
- When using stranded wires, split them and then tighten.

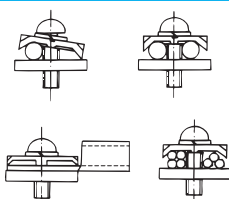

Solderless terminal connection

- Untwist the connection wires, align the core wires and then tighten. The wires will loosen up during use, and must be tightened during periodic maintenance.
- Do not solder or bind the end of the strands.
- Make sure not to catch the insulating sheath of the wire when tightening.

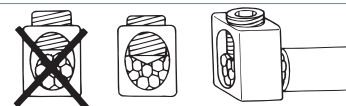

ELCB (NV) connection

- When using a single-phase 3-wire method, connect the neutral pole to the NC's center pole.
- When using a 3-pole ELCB with a single-phase 2-wire, connect to the left and right poles (poles at both sides) of ELCB.
- Never connect the ELCB units in parallel as it will create a loop circuit, and could burn the magnetic device.
- Never connect the MCCB and ELCB in parallel.

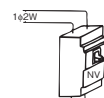
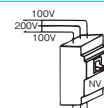

4. Maintenance and Inspections

(1) Initial inspections

After installing the MCCB and ELCB, inspect the following matters before powering the units.

Model	Inspection items	Criterion	Remarks
Common	1. Are there any excessive screws, drilling scraps, wire scraps or any other conductive materials around the terminals?	All conductive material must be removed.	
	2. Are there any cracks or damage on the cover or base?	No cracks or breaks allowed.	
	3. Is there any dew condensation on the cover, base or terminals?	No dew condensation allowed.	
	4. Measure the insulation resistance with a 500V insulation resistance tester.	5MΩ or more	Refer to Precautions ② for the ELCB.
	5. Are the connector connections tightened securely?	Must be specified tightening torque.	
ELCB	6. Are the ELCB rated voltage and circuit voltage the same?	Voltages must be the same.	
	7. Apply voltage, press the test button and check the operation.	Must trip with an earth leak.	

Precautions

① Withstand voltage test

A guide for the test is given on the following. Do not perform a withstand voltage test exceeding these levels. (Note) Test the operating circuit between the live section and ground.

(Application time: one minute)

(Unit: V)

Main circuit		Auxiliary circuit or control circuit	
Rated insulation voltage	Test voltage (effective value for alternating current)	Rated insulation voltage of operating circuit	Test voltage (effective value for alternating current)
$U_i \leq 300$	2000	$U_{is} \leq 60$	1000
$300 < U_i \leq 690$	2500	$60 < U_{is} \leq 690$	$2U_{is} + 1000$ (min. 1500)

② Insulation resistance measurement and withstand voltage test

The restrictions a and b apply to the following models.

Applicable models: Earth leakage circuit breaker, Measuring display unit breaker.

Measurement position		Test		Insulation resistance measurement		Withstand voltage test	
		ON	OFF	ON	OFF		
State of handle		○	○	○	○	○	○
Between live section of main circuit and ground		○	○	○	○	○	○
Between different poles	Line side	Between left - middle, middle - right, left - right poles		△	○	×	○
	Load side	Between left - neutral pole, middle - neutral poles, right - neutral poles		○ ^(*) (△)	○	○ ^(*) (x)	○
		Between left - middle, middle - right, left - right poles		△	△	×	×
	Between left - neutral poles, middle - neutral poles, right - neutral poles		○ ^(*) (△)	○ ^(*) (△)	○ ^(*) (x)	○ ^(*) (x)	
Between power - load side terminals		-	○	-	○		
Between main circuit live sections - operating circuit live sections		○	○	○	○		
Between operating circuit live section - ground		○	○	○	○		

Note *1 Values in parentheses apply for measuring display unit breaker.

(2) Periodic inspections

To prevent trouble and ensure the breaker operates safely for a long time, inspect the breaker one month after starting use and periodically thereafter according to the environmental conditions.

Inspection Interval Guide

1	Clean and dry environment	Once every 2 to 3 years
2	Environment with low levels of dust, corrosive gas, vapors, salt, etc.	Once a year
3	Places other than 1 or 2	Once every six months

Model	Inspection items	Criterion	Remarks
Common	1. Are any of the conductors loose?	No conductor must be loose.	If any conductor is loose, tighten again with the appropriate torque given in Tables 5-5 and 5-6 on pages 97 to 98.
	2. Is any cover or base cracked? Is any handle damaged?	There must be no cracks, damage or breaks.	
	3. Has the breaker been submerged and infiltrated with water? Is the breaker heavily dirtied by mud or dust?	There must be no infiltration of water, heavy mud or dust.	If water has infiltrated the breaker, it must be replaced with a new part or overhauled by the Mitsubishi Service Center.
	4. Has the temperature risen abnormally?	(1) Visually inspect that none of the studs on the backs of the terminals, or the breaker's tightened or molded sections are discolored from burning. (2) There must be no especially high temperature rise when the current at each phase is balanced. (Tolerable maximum value for terminal temperature rise: 60K) (3) There should be no difference on the left and right side of the base sides if the load current is balanced.	There may be a light temperature difference between the following terminals. ● Between the power side terminal and load side terminal ● Between the center pole terminal and left and right pole terminals.
	5. Can the handle be turned ON and OFF smoothly?	Should operate smoothly.	Open and close a normally closed breaker periodically.
	6. Does pressing the TRIP button result in a trip?	Must be resettable after tripping.	This will clean the contact and prevent abnormal heating.
	NV	7. Test by pressing the TEST button.	Must operate properly and close again.

(3) Inspection after Tripping

Whether the circuit breaker can be reused or must be replaced after switching off a fault current depends on the intensity of the current which was switched off.

Intensity of trip current, degree of MCCB and ELCB damage, and countermeasures

Intensity of trip current	Degree of MCCB and ELCB damage	Countermeasures
When it is clear that the circuit breaker operated within the time-delay trip range (Overcurrent up to 10 times of rated current)	No abnormality such as contamination around vent observed	Reusable 〔(The circuit breaker can function 50 times (100A or less) at overload current which is 6 times higher than rated current)〕
Relatively low short-circuit current which causes instantaneous tripping ↕ Large short-circuit current close to rated breaking capacity	Soot and dust found near vent ↕ Soot and dust found near handle, remarkable contamination found near vent Molten metal found in circuit breaker Box of box type circuit breaker is severely deformed	Reusable ↕ Replace with a new part

If the intensity of the fault current cannot be estimated, remove the MCCB and ELCB, and measure the insulation resistance. If the specified value (5MΩ) has not been reached, perform a withstand voltage test. If the withstand voltage is within the specified value, the circuit breaker can be used temporarily but it should be replaced with a new part as soon as possible. If both the insulation resistance and withstand voltage are sufficient, the circuit breaker may be judged as reusable. However, it should be checked for abnormalities, such as an abnormal rise in temperature for a set period.

- Measure the insulation resistance and perform the withstand voltage test with the procedures given in section 1 and 2 on page 238.
- Check that the ELCB operates when the test button is pressed.

(4) Guide to service life

Maintenance and inspection must be conducted according to the environment in which the circuit breaker is installed.

The service life of the circuit breaker cannot be determined just by the number of service years.

A reference to the service life is given below, but the circuit breaker must be diagnosed by a specialist for an accurate reading.

Guide to service life

Degree	Environment	Example	Guide for replacement (years)
Standard usage state	1 Place where air is always clean and dry	Dust-proof and air-conditioned electrical room	Approx. 10 to 20
	2 Indoors, where there is little dust and no corrosive gas	Circuit-breakers housed in distribution panels or boxes within an individual electric room having no dust-proofing or air-conditioning	Approx. 7 to 15
Poor environment	1 Place with gases such as sulfuric acid, hydrogen sulfide, salt and high levels of moisture, but low levels of dust	Geothermal power house, sewage treatment plants, iron and steel works, paper and pulp plants, etc.	Approx. 3 to 7
	2 Place with high levels of gas and dust which humans cannot endure for long periods of time	Chemical plants, quarries, mines, etc.	Approx. 1 to 3

Standard	Size of circuit breaker frame (A)	Number of operating cycles (times)			Number of tripping times by shunt tripping device or undervoltage tripping device, or by trip button
		Energization	No energization	Total	
JIS C 8201-2-1 Ann.2	100 or less	1500	8500	10000	10% of total operating cycles
JIS C 8201-2-2 Ann.2	More than 100, 315 or less	1000	7000	8000	
JIS C 8201-2-1 Ann.1	More than 315, 630 or less	1000	4000	5000	
JIS C 8201-2-2 Ann.1	More than 630, 2500 or less	500	2500	3000	
IEC 60947-2 (*1)	More than 2500	500	1500	2000	

Note *1 The number of trips by the ELCB test button is one-third the number of energizations.

The operating life shortens as the circuit breaker frame size increases. (Refer to above tables.)

These values may seem low, but since this circuit breaker is a protective device, it basically differs from a switch intended for frequent opening and closing.

For tripping by a shunt tripping device, the life is especially short and special consideration should be taken.

⚠ WARNING Continuing user of a circuit breaker which has reached its service life can result in the following problems. Always update the circuit breakers accordingly.

- ① Insulation fault: Risk of burning, internal short-circuit, and electric shock.
- ② Energizing fault: Burning or unnecessary operations caused by overheating of the internal parts, etc.
- ③ Operation fault: ON and OFF operation of the circuit may be disabled.
- ④ Tripping fault: Protection of the load device or wiring, etc., may be disabled.

⚠ CAUTION When the operating endurance exceeds the specified value, the above faults could occur or the internal conductor could break, overheat or burn.

5. Troubleshooting

(1) Troubleshooting for breaker unit (MCCB, ELCB)

Fault state		Cause		Countermeasures and Actions
Operation errors	Can't close	Foreign matter in switching mechanism		Remove the foreign matter
		Breaker hasn't been reset		Reset again
		Breaker can't be reset	See below(*)	See below
	(*) Can't reset Can't trip Can't turn OFF	Wear due to tripping endurance	Excessive use of shunt trip operation	Replace with new part. Change shunt trip to electric operation
		Reset mechanism is faulty	Improper adjustment	Return for repairs
		Undervoltage coil is not excited	Careless operation	Excite the coil
		Resetting time has not elapsed		Wait for bimetal to cool down
		Switching spring is broken or fatigued	Breakage caused by initial trouble	Return for repairs
			End of service life	Replace with new part
		Contact has fused because of excessive interruptive current		Replace with large capacity breaker
Broken handle	Insufficient lubricant (grease)		Return for repairs	
	Excessive power during operation		Replace handle	
	Positional relation of external operation handle and breaker is poor		Replace handle Correct positional relation	
Poor energizing	Foreign matter caught between contacts		Remove foreign matter (if cover is removable) Return for repairs (if cover is not removable)	
	Fusion at conductive section	Excessive interrupting current	Replace with new part having large interruptive capacity	
	Excessive wear of contacts	Short-circuit current cut off End of service life	Replace with new part	
Broken rated changeover screw		Excessive tightening torque (Tighten with 0.3 to 0.45N-m)		Return for repairs
Annoying operation	Operates under normal load	Ambient temperature is high	Incorrect selection (temperature compensation)	Change the selection
			Panel is sealed	Ventilate
		Excessive temperature rise	Loosening at terminal connections	Tighten
		Applied frequency is incorrect (thermal-adjustable electromagnetic type NV1000A, NV2000A frame or more)	Incorrect selection (frequency)	Replace with breaker having suitable frequency
		Load current contains high levels of high-frequency distortion		Insert a reactor and decrease distortion factor
		Measuring instrument is reading small measurement values because of distorted current		Correctly specify the rated values by using real meters with effective value
	Electronic type	Overcurrent indicator LED is ON	Rated current setting value is too low	Correct the rated current setting
			Rated current changeover screw was not tightened	Correctly tighten the rated current changeover screw Tightening torque 0.3 to 0.45N-m
	Malfunctions when starting	Failure of rated current changeover section		Return for repairs
		Heating caused by repeated starting current	Incorrect selection	Replace with breaker having higher rating
	Momentarily functions when starting	Long starting time	Incorrect selection	Replace with breaker having higher rating
		Starting current is too high		Change the instantaneous setting or replace with breaker having higher rating
		Starting rush current is too high		Change the instantaneous setting or replace with breaker having higher rating
		Excessive current during delta-star starting changeover		Change the instantaneous setting or replace with breaker having higher rating
		Excessive current due to reversible operation		Change the instantaneous setting or replace with breaker having higher rating
Rush current during instantaneous restart			Change the instantaneous setting or replace with breaker having higher rating	
Rare short-circuit of motor			Repair the motor	
Operates during use	Bimetal reset incomplete after instantaneous tripping		Allow to properly reset	
	Abnormal current passed simultaneously with closing (short-circuit closing)		Inspect the circuit and remove the cause	
	Antenna for transceiver (5W or higher) was seated against electronic type MCCB body during transmission		Use the transformer at least 1m away from the electronic type MCCB	
Short-circuit on power side		Dust is accumulated		Remove the cause or replace with new part
		Conductive matter has dropped into power side		Remove the cause or replace with new part
Temperature rise	Terminal temperature is high	Improper tightening	Improper maintenance	Tighten
		Complete electromagnetic type being used at a high frequency (400Hz, etc.)		Replace with breaker having suitable frequency
	Mold side temperature is high	Load current contains high levels of high-frequency distortion		Insert a reactor and decrease distortion factor
		Incorrect measurement resulting from touch		Measure with a measuring instrument
		Studs are loose		Tighten
Heating at stud tightening section	Contact fault between stud conductor and body terminal		Reassemble the stud	
	Groove to reduce overcurrent heating not grooved on rear connection type's steel mounting plate (400A frame and larger)		Machine grooves to reduce overcurrent heating	
No operation	No tripping at overcurrent	Selected rated current is too high		Replace with a breaker having a lower current
		Applied frequency is incorrect		Replace with breaker having suitable frequency
		Backup breaker has tripped	Backup breaker's instantaneous tripping current is too low	Lower the instantaneous electromagnetic setting Raise the electromagnetic setting for the backup breaker, or change the rating
Does not operate with tester (electronic type MCCB)	Overcurrent indication LED does not turn ON, or turns ON and then OFF before specified time	Breaker tester's battery is spent		Replace the breaker tester's battery
	Overcurrent indication LED turns ON and then OFF after specified time, but does not trip	Tripping mechanism is faulty		Return for repairs

(2) Troubleshooting for leakage operation section

Fault state		Cause	Countermeasures and Actions
Annoying operation errors	Operates simultaneously with closing (The leakage mechanism operates, such as the leakage indication button pops out)	The wiring is long creating a large ground electrostatic capacity, and causes a leakage current flow	Change the rated sensitivity current or install the ELCB near the load
		ELCB units are being used in parallel, or is incorrectly connected with a neutral wire, etc.	Use the correct wiring
	Operates during use	An excessive surge, such as inducted lightning, has infiltrated the unit	Install a surge absorber, etc., near the circuit
		Induction noise from a nearby large current bus, etc., has infiltrated the unit	Avoid sources of noise
Operation errors	Leakage operation occurs when the test button is pressed, etc., but there is not indication	LED is faulty or is at end of service life	Replace with new part
		The indicator button is improperly adjusted and does not protrude	Return for repairs
No operation	No operation takes place when the test button is pressed	Electronic circuit section is faulty	Replace with new part
		Voltage is not applied	Apply the specified voltage
		Contact continuity is faulty	Remove the foreign matter from the contact

Remarks: 1. When using a transceiver, use at least 1m away from the electronic MCCB and ELCB.

(3) Troubleshooting for accessories

Fault state		Cause		Countermeasures and Actions
NFM NVM (Electric operation device)	Operation disabled	Operation power voltage has dropped	Operation circuit wire capacity is insufficient	Use a larger operation circuit wire
			Operation power capacity is insufficient	Improve the operation power
		Resistor or motor is burned	Excessive continuous operation	Return for repairs (motor replacement)
		Connection is incorrect		Use the correct wiring
	Continuous idling	Applied voltage is incorrect		Apply the correct operation voltage
		ON and OFF circuits are operating simultaneously, operation is mistaken		Provide an interlock at the pushbutton
		For the self-holding type, the auxiliary switch contact is used for automatic reset		Use the alarm switch contact for the automatic reset contact
	One idle run when closing	Voltage ripping in the OFF state, or tripping caused by undervoltage		Turn OFF once to reset, and then turn ON again
Breaker itself has automatically cut-off and tripped				
UVT (Undervoltage tripping device)	Closing disabled	Applied frequency or voltage is incorrect		Improve the power
		Doesn't attract	voltage drop is large	Improve the voltage
	Doesn't trip even when voltage is absent	Breaker's tripping mechanism is faulty		Return for repairs
SHT (Shunt tripping device)	Doesn't trip	Insufficient voltage	Operation voltage has dropped	Improve the power
			Applied voltage is incorrect	Improve the power
		Coil is burnt	Coil is continuously excited	Return for repairs (coil replacement, installation of burn prevention auxiliary coil)
			Operation voltage has dropped causing continuous excitation	Return for repairs (coil replacement), improve power
			Burn preventing auxiliary contact is faulty	Return for repairs (coil replacement, contact repair)
			Abnormal voltage is applied	Return for repairs (coil replacement)
AL (Alarm switch) AX (Auxiliary switch) EAL (Earth leakage alarm contact) TBM (Test button module) PAL (Pre-alarm)	Malfunction	Contact fault caused by overcurrent		Return for repairs
		Incorrect connection	Connection mistaken during installation	Refer to nameplate and correct the wiring
		Microload	Incorrect selection	Return for repairs (replacement with type for microloads)
		Loose mounting screws	Insufficient tightening Vibration during transportation	Return for repairs (readjustment)

8 Handling and Maintenance

(4) Cases of unnecessary ELCB operation

Even if the ELCB is not faulty, there may be a problem in the circuit which causes frequent operation or instantaneous operation at closing. Refer to the following section and incorporate it as part of the circuit inspection and troubleshooting.

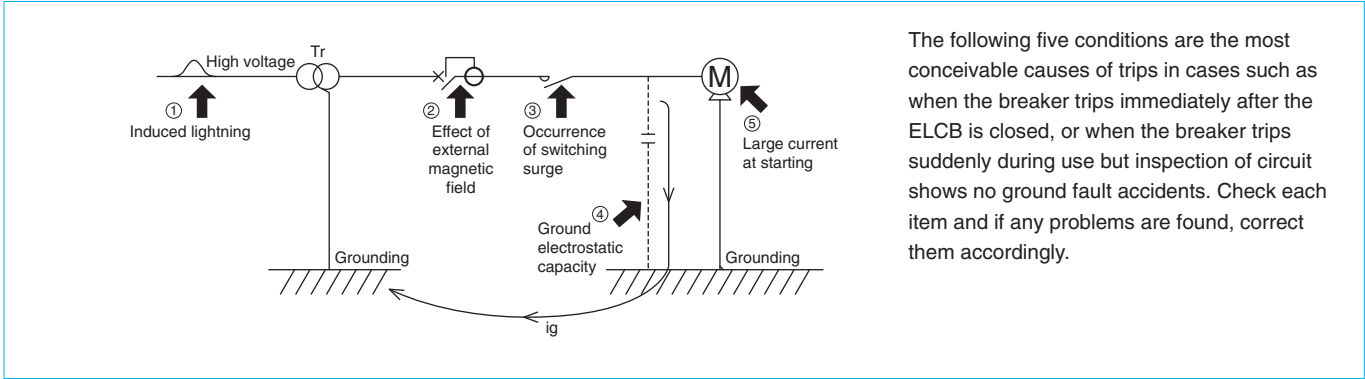

The following five conditions are the most conceivable causes of trips in cases such as when the breaker trips immediately after the ELCB is closed, or when the breaker trips suddenly during use but inspection of circuit shows no ground fault accidents. Check each item and if any problems are found, correct them accordingly.

Cause	Countermeasures
1 Induction lightning	All models incorporate a non-operating shock structure and should sufficiently withstand 7kV (JIS Standards), so unnecessary operation should not occur.
2 External magnetic field	The ZCT is equipped with a magnetic shield, and is not affected easily. However, the breaker could operate if there are large current buses reaching several thousand amperes near the ELCB, or if there is a short-circuit fault in nearby circuit. Separate the ELCB from the large current bus wires by at least 10cm.
3 Switching surge	All models incorporate a non-operating shock structure and should not operate unnecessarily. However if there is a time lag in the closing time of each pole in the magnetic switch, unnecessary operation could occur due to the relation of the ground electrostatic capacity.
4 Effect of ground electrostatic capacity	If the wires are stored in a metal conduit or metal duct wiring, the ground electrostatic capacity will increase compared to other wiring methods. This may cause the leakage current to constantly increase. If the magnetic switch chatters, etc., the leakage current may become temporarily unbalanced thus reaching a leakage current equivalent to the sensitivity current and causing unnecessary operation. Review the following matters in this case. <ol style="list-style-type: none"> 1) Shorten the load circuit line, or install the ELCB near the load (device) being used. (Install in a branch circuit.) 2) Lead the control circuit for the control device, etc., from the power on the ELCB side. 3) If the above measures are difficult or if they cause further unnecessary operation, reconsider the selected ELCB rated sensitivity current.
5 Equilibrium properties caused by large current at starting	The ZCT is made of high-grade permalloy, a material with Ni as its main element and which has outstanding residual magnetic characteristics. The periphery of the ZCT is covered with material having outstanding magnetic characteristics, creating a complete magnetic shield. This suppresses the effect of residual currents to the minimum, and prevents the breaker from unnecessarily operating even near a current of several thousand amperes. In the relay, the characteristics change if the primary conductor is bent immediately after it is passed through the ZCT. Thus, when passing a primary conductor with current of 300A or more through the ZCT, keep the conductor straight for at least 30cm on either side.

9

Appendix

1) Handle Operation Angle Dimensions	244
2) MCCB Trip Button, Instantaneous Adjustment Dial Drilling and Terminal Cover Mounting Hole Dimensions	245
3) ELCB Button and Switch Dimensions	246
4) List of Product Weights	247
5) Switching the Adjustable Items	248
6) Breaker Mounting Screw Dimensions	251
7) List of Mold Surface Temperature-rise Values	252
8) Ordering Information	253
9) Melshort 2	255
10) Low-Voltage Products Website	256

1. Handle Operation Angle Dimensions

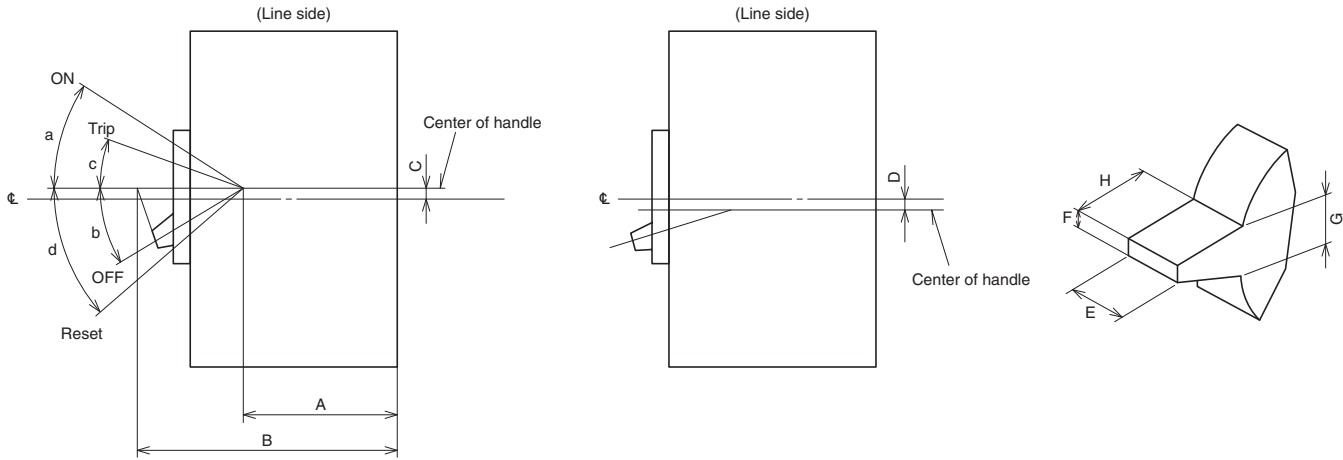

Table of dimension variations

Class	Model		Operation angle (°)				Dimensions (mm)							
			ON	OFF	Trip	Reset	A	B	C	D	E	F	G	H
	MCCB, MCB	ELCB, RCCB, RCBO	a	b	c	d	A	B	C	D	E	F	G	H
C • S • H	NF50-SVFU	NV50-SVFU	12	20	4	27	55	90	13	-	8	5	5	14
	NF32-SV	NV32-SV	15	19	5	21	40	90	2	-	12	7	7	17
	NF63-CV, NF63-SV, NF63-HV	NV63-CV, NV63-SV, NV63-HV												
	NF125-CV, NF125-SV, NF125-HV	NV125-CV, NV125-SV, NV125-HV												
	NF100-CVFU, NF125-SVU, NF125-HVU	NV100-CVFU, NV125-SVU, NV125-HVU												
	NF125-SEV, NF125-HEV	NV125-SEV, NV125-HEV	15	19	5	21	40	92	2	-	12	7	7	19
	NF250-CV, NF250-SV, NF250-HV													
	NF250-SEV, NF250-HEV													
	NF250-SGV, NF250-LGV, NF250-HGV													
	NF125-SGV, NF125-LGV, NF125-HGV													
	NF160-SGV, NF160-LGV, NF160-HGV													
	NF250-SVU, NF250-HVU													
	NF30-CS	-	21	29	1	31	47	67	10	-	8.5	4.5	6	13
	NF225-CWU	-	12	18	2	21.5	38	92	7.5	-	13.5	7	8	18.5
NF400-CW	NV400-CW	16.5	10	6.5	14.5	49	134	6.5	-	32.5	14.5	15.5	25	
NF400-SW/SEW/HEW/REW	NV400-SW/SEW/HEW/REW	16.5	10	6.5	14.5	49	155	6.5	-	32.5	13.5	15.5	46	
NF630-CW/SW/SEW/HEW/REW	NV630-CW/SW/SEW/HEW/REW													
NF-SKW	NV-SKW													
NF800-CEW/SDW/SEW/HEW/REW	NV800-SEW/HEW	16.5	10	6.5	14.5	49	155	6.5	-	32.5	13.5	15.5	46	
NF-SLW														
NF1000-SEW, NF1250-SEW	-	18	12	6	17	84	190	-	4	41.5	13.5	15	36.5	
NF1600-SEW														
R • U	NF125-RGV, NF250-RGV	-	15	19	5	21	40	92	2	-	12	7	7	19
	NF125-UV	-	15	19	5	21	40	92	-	29	12	7	7	17
	NF250-UV	-	15	19	5	21	40	92	-	35	12	7	7	19
	NF400-UEW	-	16.5	10	6.5	14.5	146	252	-	13.5	32.5	13.5	15.5	46
	NF400-UEW(4P), NF800-UEW	-	16.5	10	6.5	14.5	146	252	-	17	32.5	13.5	15.5	46
BH	BH	-	19	18	5	21	56	77.5	5	-	9.5	9.5	9.5	13
	BH-P	-	19	18	5	21	57.5	79	12	-	9.5	9.5	9.5	13
	BH-S	-	19	18	5	21	56	76.5	5	-	34.5	8	9.5	12
	BH-PS	-	19	18	5	21	57.5	78	12	-	34.5	8	9.5	12
	BH-D6, BH-D10 ^{*1}	-	41	36	-	-	63	76	9	-	-	-	-	-
	BH-DN ^{*1}	-	42	48	-	-	63	76	10	-	17	4	9.5	12
	KB-D ^{*1}	-	41	48	-	-	63	76	9	-	-	-	-	-
	-	BV-D ^{*1}	42	40	-	-	61	76	10	-	14	4	-	-
-	BV-DN ^{*1}	42	48	-	-	63	76	10	-	17	4	-	-	

Note *1 Trip is the same as the OFF position. Resetting is not required.

2. MCCB Trip Button, Instantaneous Adjustment Dial Drilling and Terminal Cover Mounting Hole Dimensions

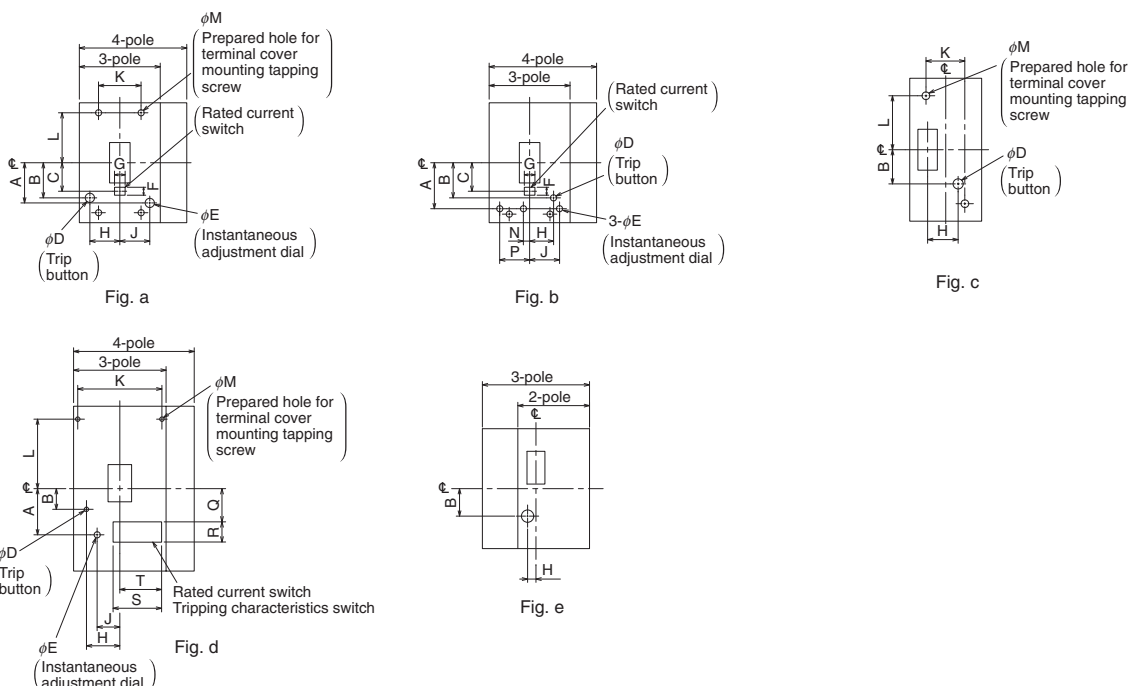

Table of dimension variations

Model	Number of poles	Fig.	A	B	C	ϕD	ϕE	F	G	H	J	K	L	ϕM	N	P	Q	R	S	T
NF50-SVFU	2, 3	e	-	14	-	6.5	-	-	-	4	-	-	-	-	-	-	-	-	-	-
NF32-SV, NF63-CV	2	c	-	20	-	6.5	-	-	-	21	-	-	-	-	-	-	-	-	-	-
NF63-SV, NF63-HV	3, 4	a	-	20	-	6.5	-	-	-	29	-	-	-	-	-	-	-	-	-	-
NF125-CV, NF125-SV, NF125-HV	2	c	-	20	-	6.5	-	-	-	21	-	-	-	-	-	-	-	-	-	-
NF100-CVFU, NF125-SVU, NF125-HVU	3, 4	a	-	20	-	6.5	-	-	-	37	-	-	-	-	-	-	-	-	-	-
NF125-UV	2, 3, 4	a	-	20	-	6.5	-	-	-	37	-	-	-	-	-	-	-	-	-	-
NF125-SEV, NF125-HEV, NF250-SV, NF250-HV	2, 3, 4	a	-	20	-	6.5	-	-	-	44	-	-	-	-	-	-	-	-	-	-
NF125-SGV, NF125-LGV, NF125-HGV																				
NF160-SGV, NF160-LGV, NF160-HGV																				
NF250-SGV, NF250-LGV, NF250-HGV																				
NF250-SVU, NF250-HVU, NF250-UV																				
NF250-SEV, NF250-HEV	3, 4	a	-	20	-	6.5	-	-	-	44	-	-	-	-	-	-	-	-	-	-
NF125-RGV	2, 3	a	-	20	-	6.5	-	-	-	44	-	-	-	-	-	-	-	-	-	-
NF250-RGV	2, 3	a	-	20	-	6.5	-	-	-	44	-	-	-	-	-	-	-	-	-	-
NF30-CS	2	b	-	14.5	-	4	-	-	-	16	-	-	-	-	-	-	-	-	-	-
	3		-	14.5	-	4	-	-	-	27.5	-	-	-	-	-	-	-	-	-	-
NF225-CWU	2, 3	a	-	15.5	-	6.5	-	-	-	43	-	-	-	-	-	-	-	-	-	-
NF400-CW	2, 3	d	-	30.5	-	6.5	-	-	-	51.5	-	125	110.5	3.5	-	-	-	-	-	-
NF400-SW, NF-SKW	2, 3	d	-	30.5	-	6.5	-	-	-	51.5	-	125	110.5	3.5	-	-	-	-	-	-
	4		-	30.5	-	6.5	-	-	-	51.5	-	125	110.5	3.5	-	-	-	-	-	-
NF400-SEW, NF400-HEW, NF400-REW	3	d	-	30.5	-	6.5	-	-	-	51.5	-	125	110.5	3.5	-	-	53	30	74	63.5
	4		-	30.5	-	6.5	-	-	-	51.5	-	125	110.5	3.5	-	-	53	30	74	63.5
NF400-UEW	3	d	-	50.5	-	6.5	-	-	-	51.5	-	125	130.5	3.5	-	-	53	30	74	63.5
	4		-	54	-	6.5	-	-	-	78.5	-	156	152	3.5	-	-	76.5	30	74	98.5
NF630-CW	2, 3	d	-	30.5	-	6.5	-	-	-	51.5	-	125	110.5	3.5	-	-	-	-	-	-
NF630-SW	2, 3	d	-	30.5	-	6.5	-	-	-	51.5	-	125	110.5	3.5	-	-	-	-	-	-
	4		-	30.5	-	6.5	-	-	-	51.5	-	125	110.5	3.5	-	-	-	-	-	-
NF630-SEW, NF630-HEW, NF630-REW	3	d	-	30.5	-	6.5	-	-	-	51.5	-	125	110.5	3.5	-	-	53	30	74	98.5
	4		-	30.5	-	6.5	-	-	-	51.5	-	125	110.5	3.5	-	-	53	30	74	98.5
NF800-CEW, NF800-SEW, NF800-HEW, NF800-REW	3	d	-	30.5	-	6.5	-	-	-	78.5	-	86	128.5	3.4	-	-	53	30	74	98.5
	4		-	30.5	-	6.5	-	-	-	78.5	-	156	128.5	3.4	-	-	53	30	74	98.5
NF800-SDW, NF-SLW	2, 3	d	74	30.5	-	6.5	10	-	-	78.5	57	86	128.5	3.4	-	-	-	-	-	-
	4		74	30.5	-	6.5	10	-	-	78.5	57	156	128.5	3.4	-	-	-	-	-	-
NF800-UEW	3	d	-	54	-	6.5	-	-	-	78.5	-	86	152	3.4	-	-	76.5	30	74	98.5
	4		-	54	-	6.5	-	-	-	78.5	-	156	152	3.4	-	-	76.5	30	74	98.5
NF1000-SEW, NF1250-SEW	3	d	-	70	-	6	-	-	-	56.5	-	199	178.5	3.4	-	-	130	30	74	89
	4		-	70	-	6	-	-	-	56.5	-	269	178.5	3.4	-	-	130	30	74	89

- Remarks:
1. The 4-pole part is available for the S and H Series 50A frame to 1600A frame (excluding NF400-REW, NF630-REW and NF800-REW).
 2. The 2-pole part for NF250-CV and larger is the same as the 3-pole part. (Including NF125-HV.)
 3. The terminal cover mounting hole shows the case for the screwed type. The breaker mounting hole is used to mount the one-touch terminal cover. Refer to the respective dimension drawings.
 4. The K dimensions are divided down the breaker center.

3. ELCB Button and Switch Dimensions

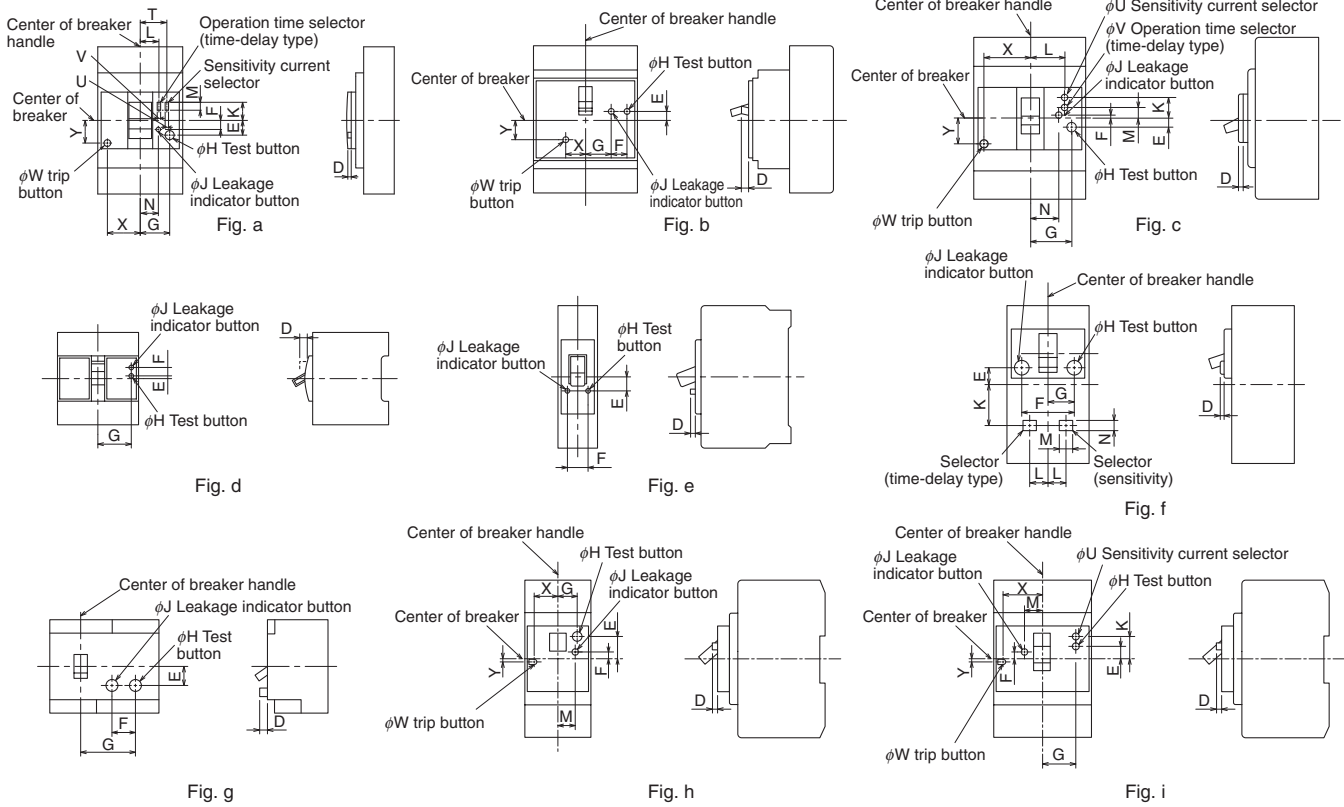

Table of dimension variations

Model	Reference drawing	Variable dimensions (mm)																	
		D		E	F	G	H	J	K	L	M	N	T	U	V	W	X	Y	
		Test button	Indicator button																
NV32-SV	Fixed type	a		13	8	26.5	9.5	4	-	-	-	16	-	-	-	6	29	20	
NV63-CV, NV63-SV, NV63-HV	Selector type								16	-	7		23.5	3	-				
NV125-CV, NV125-SV, NV125-HV	Fixed type	a	3	4	13	8	26.5	9.5	4	-	-	16	-	-	-	6	37	20	
	Selector type									16	-		7	24	3				-
	Time-delay type									16	17		7	24	3				3
NV250-CV, NV250-SV, NV250-HV	Fixed type	a		13	8	34	9.5	4	-	-	-	23.5	-	-	-	6	44	20	
	Selector type								16	-	7		31	3	-				
	Time-delay type								16	24	7		31	3	3				
NV400-CW (note2)	Fixed type	c	3	3	(2.3)	14.6	43.5	9.5	5	-	-	43.5	-	-	-	6.5	51.5	30.5	
	Selector type									30.6	43.5		-	5.5	-				
	Time-delay type									30.6	-		22.6	5.5	5.5				
NV400-SEW, NV400-HEW	Fixed type	c	3	3	(2.3)	14.6	43.5	9.5	5	-	-	43.5	-	-	-	6.5	51.5	30.5	
	Selector type									30.6	43.5		-	5.5	-				
	Time-delay type									30.6	-		22.6	5.5	5.5				
NV630-SEW, NV630-HEW	Fixed type	c	3	3	(2.3)	14.6	54.1	9.5	5	-	-	54.1	-	-	-	6.5	78.5	30.5	
	Selector type									30.6	54.1		-	5.5	-				
	Time-delay type									30.6	-		22.6	5.5	5.5				

Note *1 Dimensions shown in parentheses apply to minus direction.

4. List of Product Weights

MCCB

Model	Item	Breaker body											Accessories (weight of only accessories)							
		Front connection type				Rear connection type				Plug-in type (including plug-in frame)			Electric operated type	Boxed type			Operation handle		Mechanical interlock (MI)	
		1P	2P	3P	4P	1P	2P	3P	4P	2P	3P	4P		S	I	W	F type	V type		S type
C • S • H • M B	NF32-SV	-	0.45	0.65	-	-	0.55	0.8	-	0.8	1.2	-	-	1.5	5.0	10.2	0.4	0.45	0.6	0.17
	NF63-CV (rated current 50A or less)	-	0.45	0.65	-	-	0.55	0.8	-	0.8	1.2	-	-	1.5	5.0	10.2	0.4	0.45	0.6	0.17
	NF63-CV (rated current 60A, 63A)	-	0.5	0.7	-	-	0.6	0.85	-	0.85	1.25	-	-	1.5	5.0	10.2	0.4	0.45	0.6	0.17
	NF63-SV, NF63-HV (rated current 50A or less)	-	0.5	0.7	0.9	-	0.6	0.85	1.1	0.85	1.25	1.5	-	1.5	5.0	10.2	0.4	0.45	0.6	0.17
	NF63-SV, NF63-HV (rated current 60A, 63A)	-	0.55	0.75	1.0	-	0.65	0.9	1.2	0.9	1.3	1.6	-	1.5	5.0	10.2	0.4	0.45	0.6	0.17
	NF125-CV	-	0.6	1.0	-	-	1.0	1.5	-	1.2	1.9	-	1.3	1.8	5.1	10.2	0.4	0.45	0.6	0.17
	NF125-SV	-	0.7	0.95	1.3	-	1.1	1.5	2.0	1.3	1.9	2.4	1.3	1.8	5.1	10.2	0.4	0.45	0.6	0.17
	NF125-HV	-	0.6	1.0	1.2	-	1.0	1.5	1.9	1.2	1.9	2.3	1.3	1.8	5.1	10.5	0.4	0.45	0.6	0.17
	NF125-SEV	-	-	1.7	2.2	-	-	2.2	2.9	-	2.6	3.3	1.3	6.8	8.7	13.5	0.5	0.55	0.6	0.17
	NF125-HEV	-	-	1.7	2.2	-	-	2.2	2.9	-	2.6	3.3	1.3	6.8	8.7	13.5	0.5	0.55	0.6	0.17
	NF250-CV	-	1.3	1.5	-	-	1.7	2.2	-	3.1	3.4	-	1.3	6.8	8.7	13.5	0.5	0.55	0.6	0.17
	NF250-SV	-	1.4	1.6	2.0	-	1.8	2.3	3.0	3.2	3.5	4.5	1.3	6.8	8.7	13.5	0.5	0.55	0.6	0.17
	NF250-HV	-	1.4	1.6	2.0	-	1.8	2.3	3.0	3.2	3.5	4.5	1.3	-	8.7	13.5	0.5	0.55	0.6	0.17
	NF250-SEV	-	-	1.7	2.2	-	-	2.4	3.2	-	3.6	4.7	1.3	6.8	8.7	13.5	0.5	0.55	0.6	0.17
	NF250-HEV	-	-	1.7	2.2	-	-	2.4	3.2	-	3.6	4.7	1.3	-	8.7	13.5	0.5	0.55	0.6	0.17
	NF125-SGV	-	1.4	1.6	2.0	-	1.8	2.3	3.0	3.2	3.5	4.5	1.3	6.8	8.7	13.5	0.5	0.55	0.6	0.17
	NF125-LGV	-	1.4	1.6	2.0	-	1.8	2.3	3.0	3.2	3.5	4.5	1.3	-	8.7	13.5	0.5	0.55	0.6	0.17
	NF125-HGV	-	1.4	1.6	2.0	-	1.8	2.3	3.0	3.2	3.5	4.5	1.3	-	8.7	13.5	0.5	0.55	0.6	0.17
	NF160-SGV	-	1.4	1.6	2.0	-	1.8	2.3	3.0	3.2	3.5	4.5	1.3	6.8	8.7	13.5	0.5	0.55	0.6	0.17
	NF160-LGV	-	1.4	1.6	2.0	-	1.8	2.3	3.0	3.2	3.5	4.5	1.3	-	8.7	13.5	0.5	0.55	0.6	0.17
	NF160-HGV	-	1.4	1.6	2.0	-	1.8	2.3	3.0	3.2	3.5	4.5	1.3	-	8.7	13.5	0.5	0.55	0.6	0.17
	NF250-SGV	-	1.4	1.6	2.0	-	1.8	2.3	3.0	3.2	3.5	4.5	1.3	6.8	8.7	13.5	0.5	0.55	0.6	0.17
	NF250-LGV	-	1.4	1.6	2.0	-	1.8	2.3	3.0	3.2	3.5	4.5	1.3	-	8.7	13.5	0.5	0.55	0.6	0.17
	NF250-HGV	-	1.4	1.6	2.0	-	1.8	2.3	3.0	3.2	3.5	4.5	1.3	-	8.7	13.5	0.5	0.55	0.6	0.17
	NF30-CS	-	0.25	0.35	-	-	0.35	0.5	-	-	-	-	-	1.1	-	-	-	-	-	-
	NF400-CW	-	4.4	5.0	-	-	5.7	7.0	-	7.0	8.3	-	-	-	-	-	-	-	-	-
	NF400-SW	-	4.6	5.2	6.8	-	5.9	7.3	9.7	7.2	8.5	11.3	-	-	19	30	-	-	-	-
	NF400-SEW/HEW	-	-	6.0	7.6	-	8.1	10.5	-	9.3	12.0	-	-	-	-	-	2.0	-	-	-
	NF400-REW	-	-	6.0	-	-	8.5	-	-	9.3	-	-	-	-	-	-	-	-	-	-
	NF630-CW	-	5.2	6.0	-	-	6.5	7.9	-	7.6	9.1	-	-	-	-	-	-	-	-	-
NF630-SW	-	5.4	6.2	8.0	-	6.7	8.1	10.6	7.8	9.3	12.0	-	-	33	30	-	-	-	-	
NF630-SEW/HEW	-	-	6.5	8.3	-	8.4	10.9	-	9.6	12.3	-	-	-	-	-	-	-	-	-	
NF630-REW	-	-	6.5	-	-	8.4	-	-	9.6	-	-	-	-	-	-	-	-	-	-	
NF800-CEW	-	-	10.9	-	-	12.1	-	-	16.3	-	-	-	-	-	-	-	-	-	-	
NF800-SDW	-	9	-	-	-	10	-	-	-	-	-	-	-	48	70	2.4	-	-	-	
NF800-SEW/HEW	-	-	10.9	14.2	-	12.1	15.8	-	16.3	21.4	-	-	-	-	-	-	-	-	-	
NF800-REW	-	-	10.9	-	-	12.1	-	-	16.3	-	-	-	-	-	-	-	-	-	-	
NF1000-SEW, NF1250-SEW	-	-	23.5	30.7	-	23	30.8	-	26.6	35.5	-	10	-	48	70	3.4	-	2.0	-	
NF1600-SEW	-	-	34.5	41.2	-	30	40.7	-	-	-	-	10	-	-	-	3.4	-	-	0.55	
R • U	NF125-RGV	-	1.5	1.8	-	-	-	-	2.35	2.7	-	1.3	-	-	-	0.5	0.55	0.6	0.17	
	NF250-RGV	-	1.5	1.8	-	-	-	-	3.2	3.6	-	1.3	-	-	-	0.5	0.55	0.6	0.17	
	NF125-UV	-	1.35	1.5	1.9	-	-	-	2.2	2.4	-	1.3	-	-	-	0.5	0.55	0.6	0.17	
	NF250-UV	-	2.5	2.7	3.7	-	-	-	4.2	4.5	-	1.3	-	-	-	0.5	0.55	0.6	0.17	
	NF400-UEW	-	-	16.2	25.4	-	-	18.6	30.7	-	19.8	-	9.0	-	-	-	2.2	-	1.9	0.45
	NF800-UEW	-	-	27.6	33.7	-	-	31.2	38.4	-	-	-	9.0	-	-	-	2.7	-	-	-
BH	BH	0.15	0.31	0.47	-	-	-	-	-	-	-	-	-	-	-	-	-	-	-	
	BH-S	-	0.44	0.65	-	-	-	-	-	-	-	-	-	-	-	-	-	-	-	
	BH-P	0.13	0.26	0.38	-	-	-	-	-	-	-	-	-	-	-	-	-	-	-	
	BH-PS	-	0.35	0.53	-	-	-	-	-	-	-	-	-	-	-	-	-	-	-	
	BH-D6, BH-D10	0.15	0.3	0.45	0.55	-	-	-	-	-	-	-	-	-	-	-	-	-	-	
	BH-DN	-	0.12	-	-	-	-	-	-	-	-	-	-	-	-	-	-	-	-	
KB-D	0.09	0.18	0.27	0.36	-	-	-	-	-	-	-	-	-	-	-	-	-	-	-	
UL	NF50-SVFU	-	0.3	0.45	-	-	-	-	-	-	-	-	-	-	-	0.3	0.35	-	-	
	NF100-CVFU	-	0.6	0.85	-	-	-	-	-	-	-	-	-	-	-	0.4	0.45	-	-	
	NF125-SVU	-	0.7	0.95	-	-	-	-	-	-	-	-	-	-	-	0.4	0.5	-	0.17	
	NF125-HVU	-	-	1.0	-	-	-	-	-	-	-	-	-	-	-	0.4	0.5	-	0.17	
	NF250-SVU	-	-	1.7	-	-	-	-	-	-	-	-	-	-	-	0.5	0.55	-	0.17	
	NF250-HVU	-	-	1.7	-	-	-	-	-	-	-	-	-	-	-	0.5	0.55	-	0.17	
	NF225-CWU	-	-	1.5	-	-	-	-	-	-	-	-	-	-	-	0.5	-	0.6	0.17	
	NF-SKW	-	-	5.7	-	-	-	-	-	-	-	-	-	-	-	2.0	-	1.9	0.45	
NF-SLW	-	-	9.6	-	-	-	-	-	-	-	-	-	-	-	2.4	-	1.9	0.45		

ELCB

Model	Item	Breaker body											Accessories (weight of only accessories)							
		Front connection type				Rear connection type				Plug-in type (including plug-in frame)			Electric operated type	Boxed type			Operation handle		Mechanical interlock (MI)	
		2P	3P	4P	2P	3P	4P	2P	3P	4P	S	I		W	F type	V type	S type			
C • S • H • U L	NV32-SV	-	0.75	-	-	0.95	-	-	1.35	-	-	-	1.5	5.0	10.2	0.4	0.45	0.6	0.17	
	NV63-CV, NV63-SV (rated current 50A or less)	0.7	0.75	-	0.8	0.95	-	1.1	1.35	-	-	-	1.5	5.0	10.2	0.4	0.45	0.6	0.17	
	NV63-CV, NV63-SV (rated current 60A, 63A)	0.75	0.8	-	0.85	1.0	-	1.15	1.4	-	-	-	1.5	5.0	10.2	0.4	0.45	0.6	0.17	
	NV63-HV (rated current 50A or less)	-	0.75	-	-	0.95	-	-	1.35	-	-	-	1.5	5.0	10.2	0.4	0.45	0.6	0.17	
	NV63-HV (rated current 60A, 63A)	-	0.8	-	-	1.0	-	-	1.4	-	-	-	1.5	5.0	10.2	0.4	0.45	0.6	0.17	
	NV125-CV	-	1.0	-	-	1.5	-	-	1.9	-	-	-	1.3	1.8	5.1	10.2	0.4	0.45	0.6	0.17
	NV125-SV	-	1.1	1.4	-	1.6	2.1	-	2.0	2.5	1.3	1.8	5.1	10.2	0.4	0.45	0.6	0.17		
	NV125-HV	-	1.1	1.4	-	1.6	2.1	-	2.0	2.5	1.3	1.8	5.1	10.5	0.4	0.45	0.6	0.17		
	NV125-SEV	-	1.9	2.5	-	2.4	3.2	-	2.8	3.6	1.3	6.8	8.7	13.5	0.5	0.55	0.6	0.17		
	NV125-HEV	-	1.9	2.5	-	2.4	3.2	-	2.8	3.6	1.3	6.8	8.7	13.5	0.5	0.55	0.6	0.17		
	NV250-CV	-	1.7	-	-	2.4	-	-	3.6	3.6	1.3	6.8	8.7	13.5	0.5	0.55	0.6	0.17		
	NV250-SV	-	1.9	2.5	-	2.6	3.5	-	3.8	5.0	1.3	6.8	8.7	13.5	0.5	0.55	0.6	0.17		
	NV250-HV	-	1.8	-	-	2.5	-	-	3.7	-	1.3	6.8	8.7	13.5	0.5	0.55	0.6	0.17		
	NV50-SVFU	0.4	0.5	-	-	-	-	-	-	-	-	-	-	-	-	0.3	0.35	-	-	
	NV100-CVFU	-	0.95	-	-	-	-	-	-	-	-	-	-	-	-	0.4	0.45	-	-	
	NV125-SVU	-	1.1	-	-	-	-	-	-	-	-	-	-	-	-	0.4	0.5	-	0.17	
	NV125-HVU	-	1.1	-	-	-	-	-	-	-	-	-	-	-	-	0.4	0.5	-	0.17	
	NV250-SVU	-	1.9	-	-	-	-	-	-	-	-	-	-	-	-	0.5	0.55	-	0.17	
	NV250-HVU	-	1.9	-	-	-	-	-	-	-	-	-	-	-	-	0.5	0.55	-	0.17	
	NV400-CW	-	5.6	-	-	7.7	-	-	8.9	-	-	-	-	-	-	-	-	-	-	-
	NV400-SW	-	5.9	-	-	8	-	-	9.2	-										

5. Switching the Adjustable Items

(1) Adjustable rated current and tripping characteristics items

Adjustable item		Rated current	LTD tripping characteristics	STD tripping characteristics	Instantaneous tripping characteristics	PAL	Rated sensitivity	Rated Operating time (for time-delay type)	Rated voltage
Applicable model									
MCCB	NF125-SEV/HEV	○	○ (*2)	○ (*2)	○	○ (*1)			
	NF250-SEV/HEV	○	○ (*2)	○ (*2)	○	○ (*1)			
	NF400-SEW/HEW/REW/UEW								
	NF630-SEW/HEW/REW	○	○	○	○	○			
	NF800-CEW/SEW/HEW/REW/UEW								
	NF1000-SEW, NF1250-SEW, NF1600-SEW								
	NF800-SDW, NF-SLW				○				
	NF125-SGV/LGV/HGV NF160-SGV/LGV/HGV NF250-SGV/LGV/HGV	○							
ELCB	NV125-SEV/HEV	○	○ (*2)	○ (*2)	○	○ (*1)	○	○	
	NV250-SEV/HEV	○	○ (*2)	○ (*2)	○	○ (*1)	○	○	
	NV400-SEW/HEW/REW								
	NV630-SEW/HEW	○	○	○	○	○	○	○	
	NV800-SEW/HEW								
	NV32-SV, NV63-CV/SV/HV						○		
	NV125-CV/SV/HV NV250-CV/SV/HV NV400-CW/SW, NV630-CW						○	○	



Notes *1 Available only for models with pre-alarm module.

*2 Use the OPERATION CHECK & SETUP UNIT Y-350. Consult Mitsubishi for details.

Remarks: Unless otherwise specified, the electronic breaker is adjusted to the following settings as a default.

- (1) Rated current: maximum value
- (2) LTD tripping characteristics: maximum value
- (3) STD tripping characteristics (current, operating time): maximum value
- (4) Instantaneous tripping characteristics: maximum value
- (5) PAL: minimum value
- (6) Rated sensitivity current: maximum value
- (7) Leakage operation time (for time-delay type): maximum value

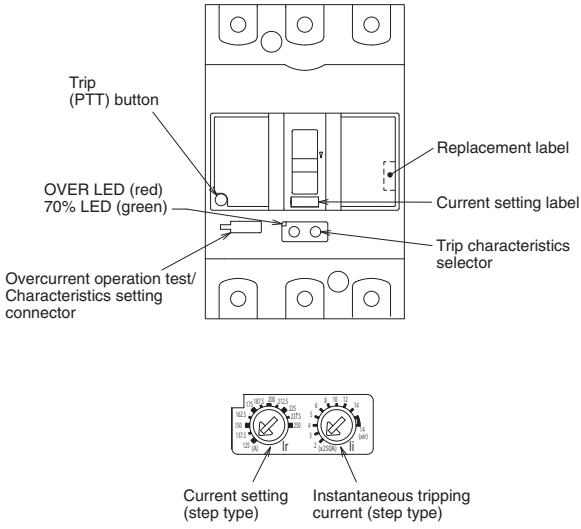
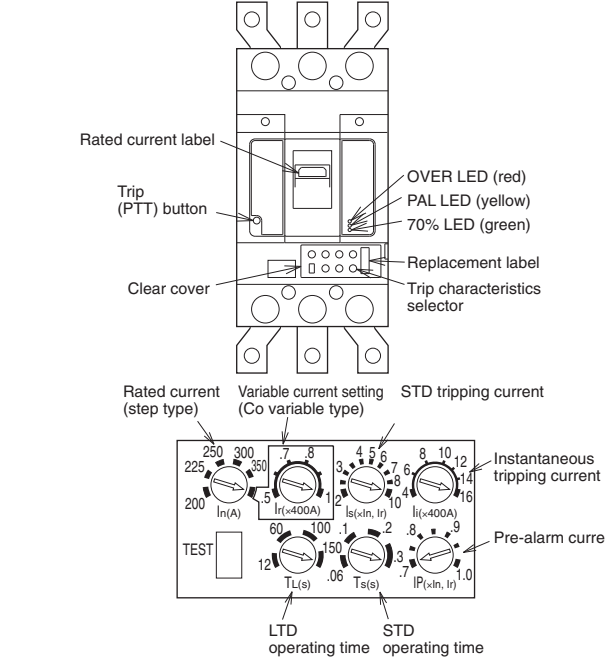
(2) Adjusting the rated current and tripping characteristics

Item	Electronic type	
Application	125 to 250A frame	400 to 1600A frame
Example of selector layout		
Example of making a selection	<p>Turn the handle to OFF before starting the settings.</p> <ol style="list-style-type: none"> Set the arrow of each characteristic's setting dial to the required scale position. Always set the dial arrow within the bold lines of the setting value. If stopped at the middle, the adjacent setting value may be applied. Use a 0.5mm thick flat-tip screwdriver with a 3mm or less tip width. Turn the screwdriver at 0.05N·m or less. From the replacement labels, select the rated current label with the same value as the setting value. Replace the rated current label. Close the cover and tighten the screw. 	<p>Turn the handle to OFF before starting the settings.</p> <ol style="list-style-type: none"> Open the clear cover. Set the arrow of each characteristic's setting dial to the required scale position. For values other than instantaneous tripping current and adjustable current settings, which can be adjusted at any time, always set the dial arrow within the bold lines of the setting value. If stopped at the middle, the adjacent setting value may be applied. Use a 0.6mm thick flat-tip screwdriver with a 4.5mm or less tip width. Turn the screwdriver at 0.05N·m or less. From the replacement labels, select the rated current label with the same value as the setting value. Replace the rated current label. Close the clear cover.
Setter and tester	<p>In case of 125 to 250A frame (Application: Electronic (effective value detection) breaker) The following items can be set and tested using the breaker test and setter Y-350.</p> <ul style="list-style-type: none"> • LTD and STD characteristics settings • Long-term operation test (variable signal) • Short-term operation test (fixed signal) *1 • Instantaneous operation test (fixed signal) • Pre-alarm operation test (variable signal) *2 <p>*1. Fixed signal which is 1.5 times the STD trip current. *2. Only for models with pre-alarm module.</p>	<p>In case of 400 to 1600A frame (Application: Electronic (effective value detection) breaker) The following items can be tested using the tester Y-250.</p> <ul style="list-style-type: none"> • Long-term operation test (variable signal) • Short-term operation test (fixed signal) • Instantaneous operation test (fixed signal) • Pre-alarm operation test (variable signal)  <p>Y-250</p>

(3) Selecting the rated voltage, rated sensitivity and operating time

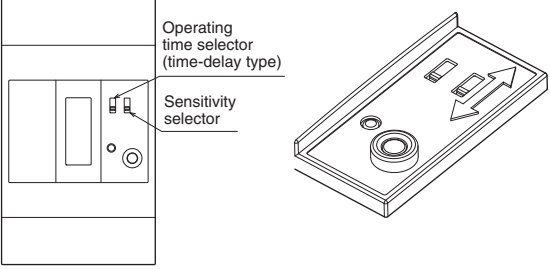
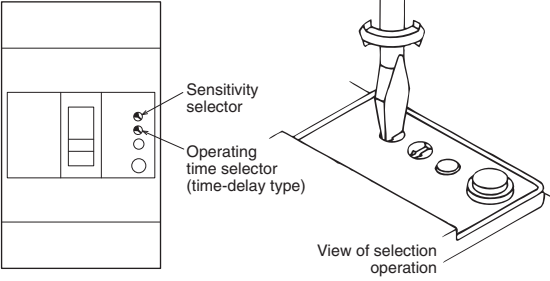
Model	Selector layout	Voltage selection	Sensitivity and operation time selection
ELCB 3-step sensitivity selector type		Use for the circuit voltage within the rated voltage.	Turn the handle to OFF before changing the selection.
		Use for the circuit voltage within the rated voltage.	Turn the handle to OFF before changing the selection.

6. Breaker Mounting Screw Dimensions

■ MCCB • MCB

Class	Model	Hole depth A	Wood screw (round wood screw) for front connection	Front connection type	Rear connection type	Plug-in type	Required quantity per unit			
							1P	2P	3P	4P
C • S • H	NF50-SVFU	56	–	M4x0.7x65 (note)	–	–	–	2	2	–
	NF32-SV, NF63-CV, NF63-SV, NF63-HV NF125-CV, NF125-SV, NF125-HV NF100-CVFU, NF125-SVU NF125-HVU	45	4.1x58	M4x0.7x55	M4x0.7x55	M4x0.7x55	–	2	2	4
	NF125-SEV, NF125-HEV NF250-CV, NF250-SV, NF250-HV NF250-SEV, NF250-HEV NF250-SVU, NF250-HVU NF125-SGV, NF125-LGV, NF125-HGV NF160-SGV, NF160-LGV, NF160-HGV NF250-SGV, NF250-LGV, NF250-HGV	45	4.1x58	M4x0.7x55	M4x0.7x55	M4x0.7x55 M4x0.7x73	–	2 (For plug-in type 4)	2	4
	NF30-CS	10	4.1x25	M4x0.7x20	M4x0.7x20	–	–	2	2	–
	NF225-CWU	45	4.1x58	M4x0.7x55	–	–	–	2 (For plug-in type 4)	2	4
	NF400-CW, NF400-SW NF-SKW	47	–	M6x60	M6x72	M6x72	–	4	4	4
	NF400-SEW, NF400-HEW, NF400-REW NF630-CW, NF630-SW, NF630-SEW NF630-HEW, NF630-REW	59	–	M6x72	M6x85	M6x85	–	4	4	4
	NF800-CEW, NF800-SEW NF800-HEW, NF800-REW, NF-SLW	15	–	M6x35	M6x40	M6x35	–	4	4	4
	NF1000-SEW, NF1250-SEW	18.5	–	M8x40	M8x40	M8x40	–	4	4	4
	NF1600-SEW	18.5	–	M8x40	M8x40	–	–	4	4	4
	NF125-RGV NF250-RGV	45	–	M4x0.7x55	M4x0.7x55	M4x0.7x55	–	2	2	–
	NF125-UV, NF250-UV	45/61	–	M4x0.7x55/73	M4x0.7x55/73	M4x0.7x55/73	–	4	4	–
	NF125-UV (4P), NF250-UV (4P)	45	–	M4x0.7x55	M4x0.7x55	M4x0.7x55	–	2	2	4
NF400-UEW (3P)	47/156	–	M6x65/174	M6x72/181	M6x72/181	–	–	4	–	
NF400-UEW (4P), NF800-UEW	15/112	–	M6x35/132	M6x40/137	M6x35/132	–	–	4	6	
BH	BH	–	–	–	–	–	–	–	–	
	BH-S	–	–	–	–	–	–	–	–	
	BH-P	–	–	–	–	–	–	–	–	
	BH-PS	–	–	–	–	–	–	–	–	
	BH-D6	–	–	–	–	–	–	–	–	
	BH-DN	–	–	–	–	–	–	–	–	
	KB-D	–	–	–	–	–	–	–	–	
	BH-D10	–	–	–	–	–	–	–	–	

Remarks: 1. The mounting shown in the  sections are enclosed with the MCCB. The mounting screws for the plug-in connection are enclosed with the plug-in terminal block.

All other mounting screws must be prepared by the user.

2. All mounting screws other than the hexagon socket bolts and hexagon bolts are P-type panhead screws.

3. For models with two types of mounting screws, the screw length differs on the supply side and load side.

4. The plug-in type is not available for NF800-UEW.

Note For the P-type panhead screw, use a type with a spring washer and flat washer (small round) combination, or a P-type panhead screw with spring washer and flat washer.

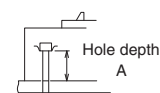

■ ELCB • RCCB • RCBO

Class	Model	Hole depth A	Wood screw (round wood screw) for front connection	Screw for steel plates (P-type panhead screw)			Required quantity per unit	
				Front connection type	Rear connection type	Plug-in type	2, 3P	4P
NV	NV50-SVFU	56	–	M4x0.7x65 (note)	–	–	2	–
	NV32-SV, NV63-CV, NV63-SV, NV63-HV NV125-CV, NV125-SV, NV125-HV NV100-CVFU, NV125-SVU, NV125-HVU	45	4.1x58	M4x0.7x55	M4x0.7x55	M4x0.7x55	2	4
	NV125-SEV, NV125-HEV NV250-CV, NV250-SV, NV250-HV NV250-SEV, NV250-HEV, NV250-SVU, NV250-HVU	45	4.1x58	M4x0.7x55	M4x0.7x55	M4x0.7x55 M4x0.7x73	2 (For plug-in type 4)	4
	NV400-CW, NV400-SW	47	–	M6x60	M6x72	M6x72	4	4
	NV400-SEW, NV400-HEW, NV400-REW NV630-CW, NV630-SW, NV630-SEW NV630-HEW	59	–	M6x72	M6x85	M6x85	4	4
	NV800-SEW, NV800-HEW	15	–	M6x35	M6x40	M6x35	4	4
	BV-D	–	–	–	–	–	–	–
	BV-DN	–	–	–	–	–	–	–

Remarks: 1. The mounting shown in the  sections are enclosed with the ELCB.

Note For the P-type panhead screw, use a type with a spring washer and flat washer (small round) combination, or a P-type panhead screw with spring washer and flat washer.

7. List of Mold Surface Temperature-rise Values

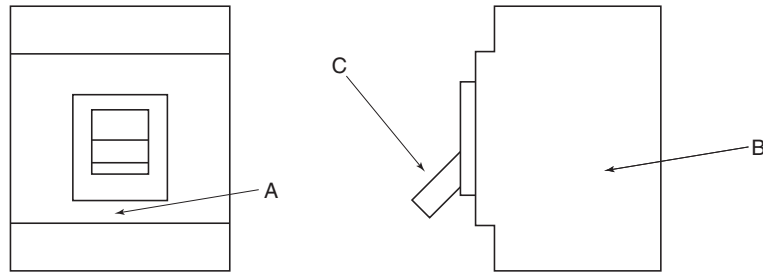

MCCB

(K)

Model	Conducting current	Measurement point				
		Cover surface (A)	Base side (B)	Handle (C)	Line terminal	Load terminal
NF32-SV	32A	14	38	12	36	37
NF63-CV	63A	15	42	14	39	44
NF63-SV	63A	15	39	12	41	44
NF63-HV	63A	15	42	12	41	49
NF125-CV	125A	13	29	9	43	42
NF125-SV	125A	14	32	10	44	40
NF125-HV	125A	16	33	11	49	42
NF250-CV	250A	19	35	13	46	45
NF250-SV	250A	20	36	13	47	45
NF250-HV	250A	20	36	13	49	46
NF30-CS	30A	18	15	5	23	33
NF125-SGV	125A	20	35	13	42	49
NF250-SGV	250A	20	36	13	49	50
NF160-SGV	160A	20	35	13	40	44

(K)

Model	Conducting current	Measurement point				
		Cover surface (A)	Base side (B)	Handle (C)	Line terminal	Load terminal
NF400-CW	400A	16	25	16	47	37
NF400-SW	400A	20	27	10	46	37
NF400-SEW	400A	14	22	9	35	31
NF400-HEW	400A	14	23	8	34	32
NF400-REW	400A	15	23	9	35	32
NF400-UW	400A	19	28	13	42	33
NF630-CW	630A	23	32	15	52	52
NF630-SW	630A	23	33	16	54	52
NF630-SEW	630A	22	31	14	51	45
NF630-HEW	630A	20	31	13	50	44
NF630-REW	630A	21	31	13	51	44
NF800-CEW	800A	21	30	13	45	40
NF800-SDW	800A	18	28	12	46	44
NF800-SEW	800A	21	30	12	45	41
NF800-HEW	800A	22	31	12	47	42
NF800-REW	800A	21	30	13	46	42
NF800-UW	800A	25	35	16	51	46

ELCB

(K)

Model	Conducting current	Measurement point				
		Cover surface (A)	Base side (B)	Handle (C)	Line terminal	Load terminal
NV32-SV	32A	15	35	11	36	41
NV63-CV	63A	17	32	13	43	41
NV63-SV	63A	17	37	13	45	47
NV63-HV	63A	17	35	13	43	43
NV125-CV	125A	13	30	13	47	43
NV125-SV	125A	14	30	15	45	43
NV125-HV	125A	14	32	14	42	43
NV250-CV	250A	21	37	14	43	44
NV250-SV	250A	21	39	18	47	43
NV250-HV	250A	23	38	17	48	43

(K)

Model	Conducting current	Measurement point				
		Cover surface (A)	Base side (B)	Handle (C)	Line terminal	Load terminal
NV400-CW	400A	22	32	11	46	41
NV400-SW	400A	23	32	12	47	42
NV400-SEW	400A	16	23	10	36	34
NV400-HEW	400A	15	22	11	35	35
NV400-REW	400A	15	22	10	36	35
NV630-CW	630A	24	34	17	54	52
NV630-SW	630A	23	33	16	53	53
NV630-SEW	630A	23	34	17	54	53
NV630-HEW	630A	22	33	17	54	52
NV800-SEW	800A	29	40	13	53	46

Notes *1 The connected wire size follows JIS C 8201 Ann.2 Standards. The temperature rise value will vary according to the size of the connected wire.

*2 This table shows the temperature-rise values. The ambient temperature must be added for the actual measurement value.

*3 These are examples of the measurement values, and are not guaranteed values. Use these as reference data.

8. Ordering Information

● Molded Case Circuit Breakers

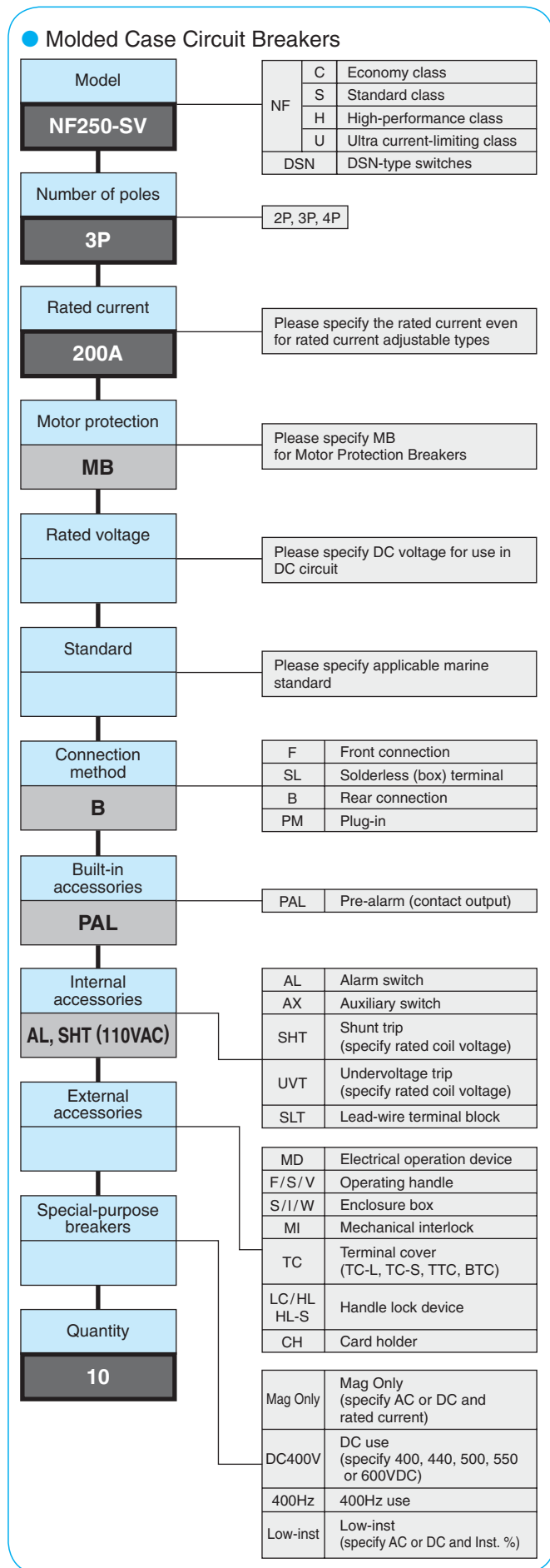

● Earth Leakage Circuit Breakers

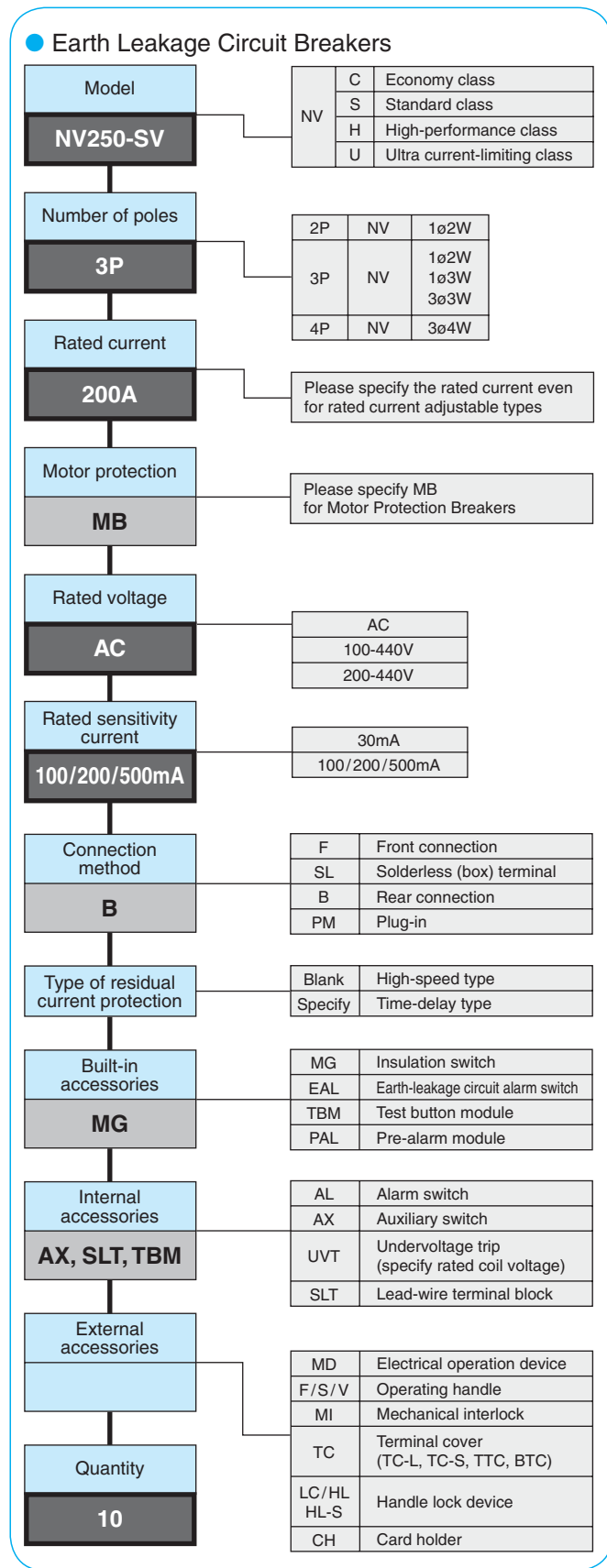

● Circuit Protector (CP30-BA)

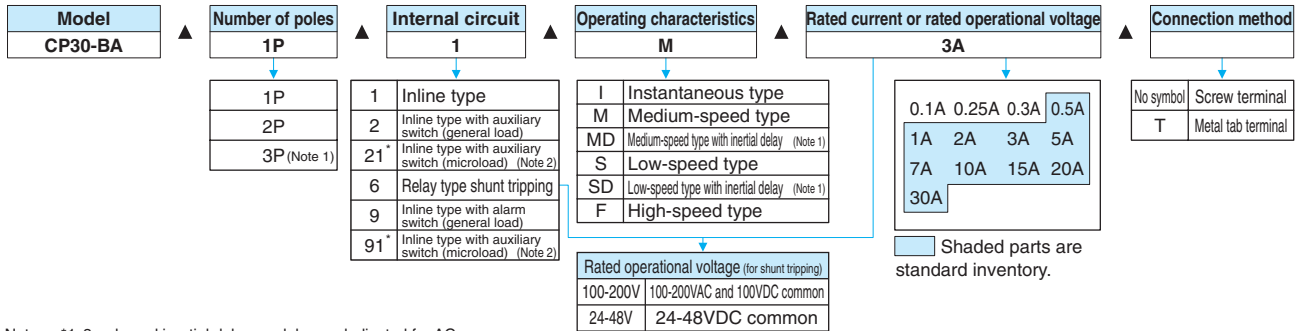

Notes *1 3-pole and inertial delay models are dedicated for AC.

2 If an auxiliary switch (AX) or alarm switch (AL) used for a 125VAC 0.5A or less circuit is required, select the microload type indicated with an asterisk.

*3 The relay type shunt trip is subject to CCC. This is a UL (cURus) and CE Marking compliant product.

Example 1. CP30-BA 1P 1-M 3A (example of inline type, medium-speed, 1-pole part, 3A, screw terminal specifications)

As a standard, this product is a UL (cURus), CCC, CE Marking compliant product.

Mandatory items are indicated with a bold box. Always specify these items.

Unless specified, all other items will be manufactured with standard Mitsubishi specifications.

● UL 489 Listed Molded Case Circuit Breakers

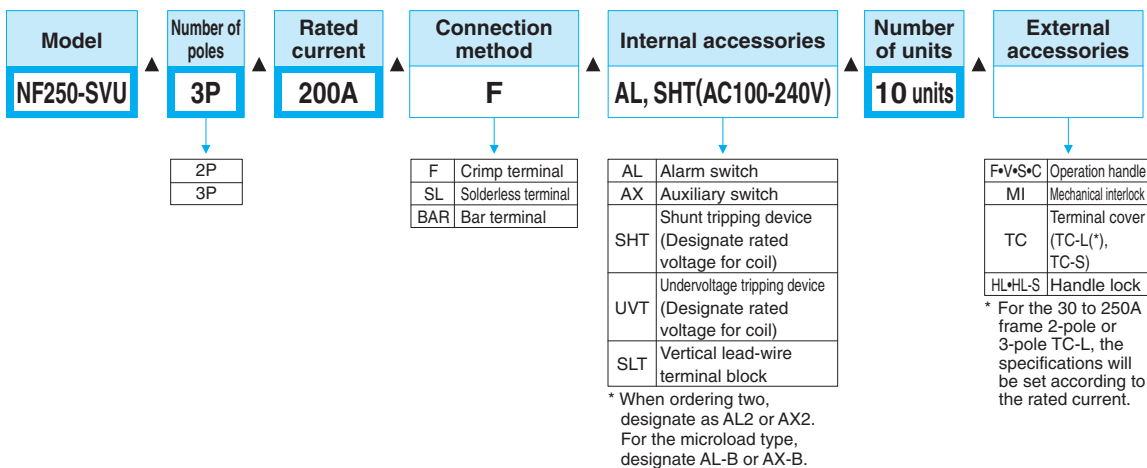

● UL 489 Listed Earth Leakage Circuit Breakers

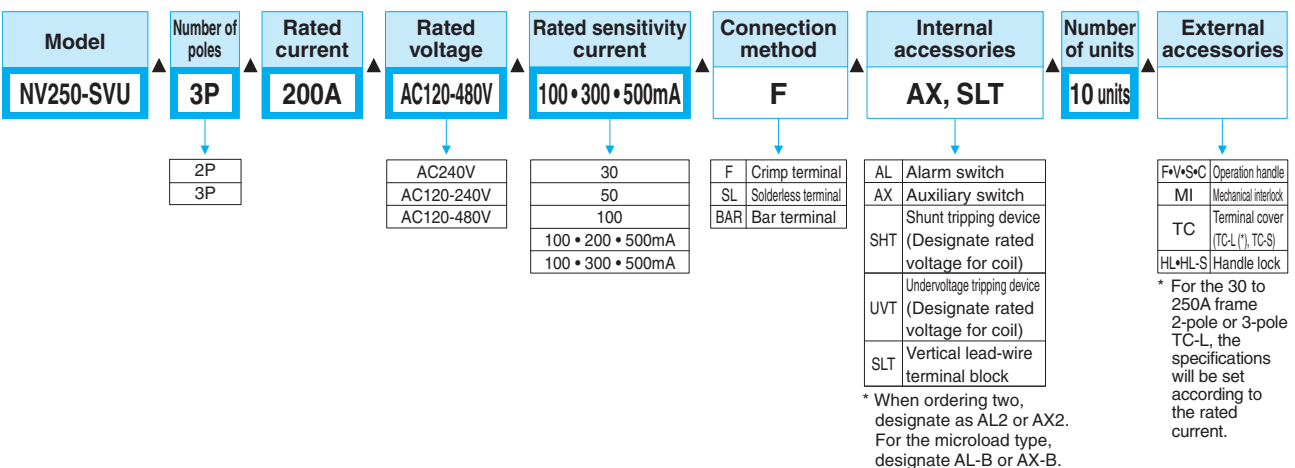

9. Melshort 2

A Smarter, Easier Way to Select Breakers

This software program ensures the easy selection of low-voltage circuit breakers according to the required rated breaking capacity and related equipment.

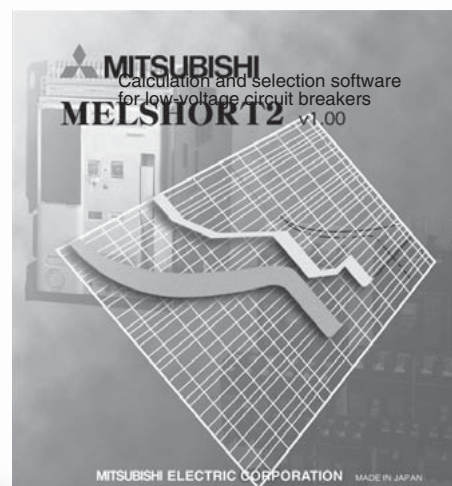
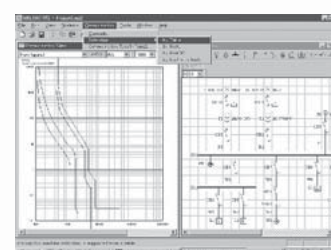
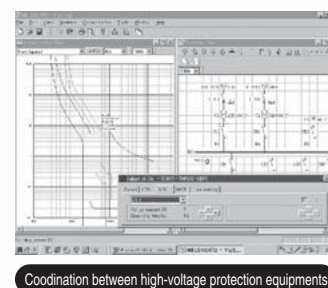
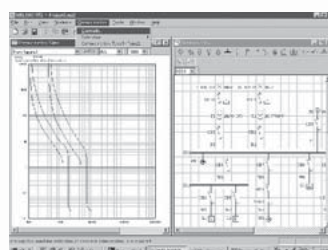
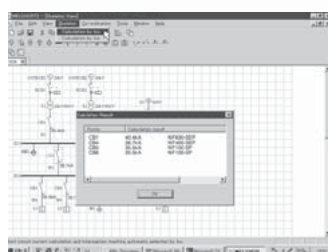
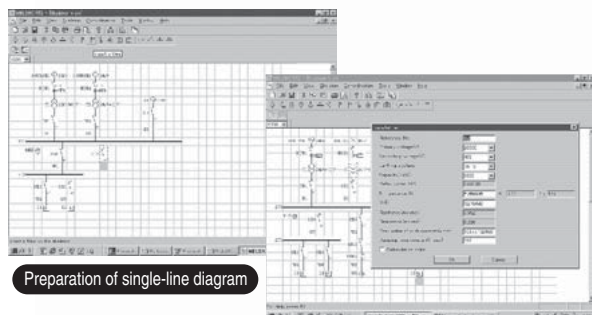

Advantages

●Contents

The program's menu allows not only short-circuit current calculations, but also the examination of various protection coordination.

- Preparation of single-line connection diagrams.
- Short-circuit calculations.
- Automatic selection of breaker type.
- Selection of breaker type for cascade interruption combination.
- Selection of breaker type for selective interruption combination.
- Examination of coordination between high-voltage protection equipment.
- Protection coordination with motor start current.

■Products Menu

Low-voltage circuit breakers:
MCCBs, ELCBs, ACBs, MCBs, Contactors,
Thermal relays, High-voltage OCRs

●Selection Efficiency Improved

Simple, accurate and fast operation is ensured as a result of being able to examine the coordination between various protection systems, and being able to select breakers interactively on the screen.

●Software Updates

Users can download the latest software updates by accessing Mitsubishi's LVS home page.

<http://www.fukuyama.melco.co.jp/lvs>

■Computer Requirements

Operating system : Windows 95/98/NT4.0/2000/XP
CPU : 166 MHz or faster
RAM memory size : min 32 MB
Free hard disk capacity : min 50 MB
Display resolution : min 640 x 480 dots
CD-ROM Drive : 2x or higher

10. Low Voltage Products Website

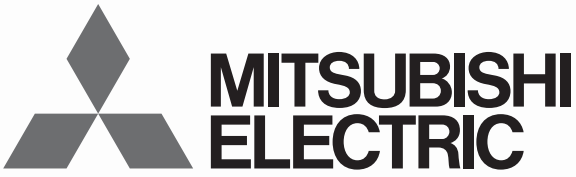

Changes for the Better

www.MitsubishiElectric.co.jp/haisei/lvs/

— Easier to Navigate, More Information Available —

Whether you are looking for information on high-performance power distribution/protection systems and energy-saving support equipment or simply interested in one of our many low-voltage power control products, we've made things easier for you to find. The website is now organized to provide enhanced usability for customers, and the latest information on our low-voltage products and systems. Please be sure to visit, check out our new look, and bookmark the site for future reference.



Four Key Features

1 Product Information

Based on past customer requests, we've increased the content to include a full product line-up, product specifications and relevant CAD data. The Products pages are divided into two categories:

Low-voltage Circuit Breakers

WS-V Series Next-generation MCCB and ELCB, AE-SW Series ACB, DIN Series MCB

Energy Measuring Devices

New S Series Multi-measuring Instruments, EcoMonitorPro Energy Measuring Unit

2 Downloads

The latest catalogs, information on certifications acquired, handling and maintenance information, and technical notes can all be downloaded free of charge. We've organized the information for maximum customer convenience, and will be updating the contents periodically.

3 News

Check here for the latest, up-to-date news on Mitsubishi Electric products such as new product releases and changes in specifications.

4 Support

Our interest is to serve you! Please contact us whenever you have a question or are in need of support. We'll reply at the earliest possible time. Committed to supporting our customers' businesses, we also provide information through Mitsubishi Electric's global network.

Empowering Industries

Product Line-up

Mitsubishi Electric manufactures intelligent high-performance low-voltage products that are renowned for their high reliability. Each product page provides product details and other information required to help you make the right decision, as well as links to other pages of related interest, such as downloadable catalogs and product certifications.

Low-voltage Products Circuit Breakers

- Air Circuit Breakers (ACB)
- Molded Case Circuit Breakers (MCCB)
- Earth Leakage Circuit Breakers (ELCB)
- Miniature Circuit Breakers (MCB)
- Measuring Display Unit Breakers
- UL 489 Listed Circuit Breakers
- Circuit Protectors
- Motor Protection Breakers

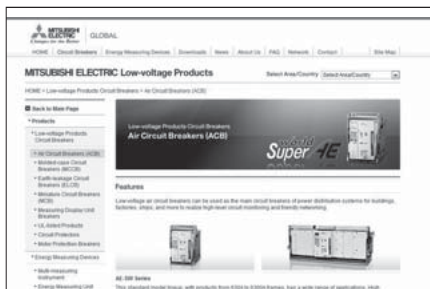

Energy Measuring Devices

- Multi-measuring Instrument
- Energy Measuring Unit

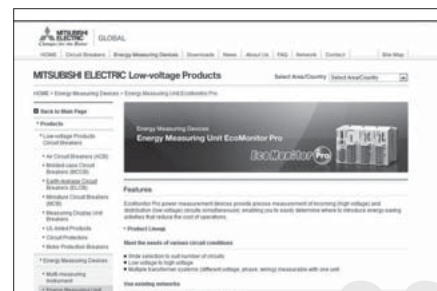
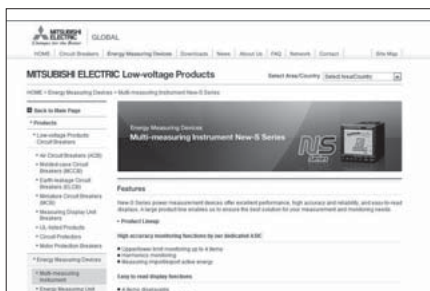

Downloads

Download useful product information in PDF format whenever you need it.

- Catalogs
- Approved certifications
- Handling and maintenance
- Technical notes

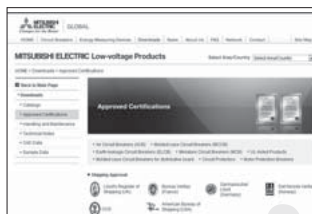

About Us

The outstanding technological expertise of the Fukuyama Works has led to its recognition as a leader in the field of power distribution control equipment. These pages provide various information on the works, including our history and manufacturing facilities.

Related Websites

Mitsubishi Electric offers a variety of FA products and systems. For further information, please visit the Mitsubishi Electric Global Website at:

Global.MitsubishiElectric.com

MITSUBISHI Molded Case Circuit Breakers & Earth Leakage Circuit Breakers

Sales Network

Country / Region	Corporation Name	Address	Telephone
Australia	Mitsubishi Electric Australia Pty. Ltd.	348 Victoria Road, Rydalmere, N.S.W. 2116, Australia	+61-2-9684-7777
Belarus	Tehnikon	Oktyabrskaya 19, Off. 705, BY-220030 Minsk, Belarus	+375(0)17210 46 26
Belgium	Koning & Hartman B.V.	Woluwelaan 31, BE-1800 Vilvoorde, Belgium	+32(0)2570240
Chile	Rhona S.A.	Vte. Agua Santa 4211 Casilla 30-D (P.O. Box) Vina del Mar, Chile	+56-32-2-320-600
China	Mitsubishi Electric Automation (China) Ltd.	Mitsubishi Electric Automation Building, No.1386 Hongqiao Road, Shanghai, 200336	+86-21-2322-3030
	Mitsubishi Electric Automation (China) Ltd. Beijing Branch	9/F, Office Tower1 Henderson Centre 18 Jianguomennei Dajie DongCheng district Beijing 100005	+86-10-6518-8830
	Mitsubishi Electric Automation (China) Ltd. ShenZhen Branch	Room 2512-2516, Great China International Exchange Square, Jintian Rd.S., Futian District, Shenzhen, 518034	+86-755-2399-8272
	Mitsubishi Electric Automation (China) Ltd. GuangZhou Branch	Room 1609, North Tower, The Hub Center, No.1068, Xing Gang East Road, Haizhu District, Guang Zhou, China 510335	+86-20-8923-6730
	Mitsubishi Electric Automation (China) Ltd. ChengDu Branch	Block B, Room 407-408, Shangri-La Center Office Building, No.9 Binjiang East Road, Chengdu, China 610021	+86-28-8446-8030
Colombia	Mitsubishi Electric Automation (Hongkong) Ltd.	10/F., Manulife Tower, 169 Electric Road, North Point, Hong Kong	+852-2887-8810
Czech Republic	Proelectrico Representaciones S.A.	Carrera 42 # 75-367 Bod 109 Itagui Colombia	+57-4-4441284
	AUTOCONT CONTROL SYSTEMS S.R.O	Technologická 374/6, CZ-708 00 Ostrava - Pustkovec	+420 595 691 150
Denmark	BEIJER ELECTRONICS A/S	LYKKEGARDSVEJ 17, DK-4000 ROSKILDE	+45(0)4675 76 66
Egypt	Cairo Electrical Group	9, Rostoum St. Garden City P.O. Box 165-11516 Maglis El-Shaab, Cairo - Egypt	+20-2-27961337
France	Mitsubishi Electric Europe B.V.	25, Boulevard des Bouvets, F-92741 Nanterre Cedex	+33(0)155 68 55 68
Germany	Mitsubishi Electric Europe B.V.	Gothaer Str. 8, 40880 Ratingen , Germany	+49(0)2102 486-0
Greece	KALAMARAKIS - SAPOUNAS S.A.	IONIAS & NEROMILOU STR., CHAMOMILOU ACHARNES, ATHENS, 13678 Greece	+30-2102 406000
	UTECO	5, MAVROGENOUS STR., 18542 PIRAEUS, Greece	+30-211-1206-900
Hungary	Meltrade Ltd.	Fertő utca 14. HU-1107 Budapest, Hungary	+36(0)1-431-9726
India	Mitsubishi Electric India Private Limited	2nd Floor, Tower A&B, Cyber Greens, DLF Cyber City, DLF Phase-III, Gurgaon - 122 022 Haryana, India	+91-124-4630300
	Milite Electric Co. Pvt. Ltd.	Plot No. 32 G/F, Sector-6 IMT, Manesar, Haryana -122050, India	+91-124-469-5300
Indonesia	P. T. Sahabat Indonesia	P.O.Box 5045 Kawasan Industri Pergudangan, Jakarta, Indonesia	+62-(0)21-6610651-9
Ireland	Mitsubishi Electric Europe B.V.	Westgate Business Park, Ballymount, IRL-Dublin 24, Ireland	+353(0)1-4198800
Israel	Gino Industries Ltd.	26, Ophir Street IL-32235 Haifa, Israel	+972(0)4-867-0656
Italy	Mitsubishi Electric Europe B.V.	Viale Colleoni 7, I-20041 Agrate Brianza (MI), Italy	+39 039-60531
Kazakhstan	Kazpromavtomatika	ul. Zhambyla 28, KAZ - 100017 Karaganda	+7-7212-501000
Korea	Mitsubishi Electric Automation Korea Co., Ltd	1480-6, Gayang-Dong, Gangseo-Gu, Seoul, Korea	+82-2-3660-9572
Lebanon	Comptoir d'Electricite Generale-Liban	Cebaco Center - Block A Autostrade Dora, P.O. Box 11-2597 Beirut - Lebanon	+961-1-240445
Lithuania	Rifas UAB	Tinklu 29A, LT-5300 Panevezys, Lithuania	+370(0)45-582-728
Malaysia	Mittrich Sdn Bhd	No.5 Jalan Pembenta U1/49, Temasya Industrial Park, Glenmarie 40150 Shah Alam, Selangor, Malaysia	+603-5569-3748
Malta	ALFATRADE LTD	99 PAOLA HILL, PAOLA PLA 1702, Malta	+356(0)21-697-816
Marocco	SCHIELE MAROC	KM 7.2 NOUVELLE ROUTE DE RABAT AIN SEBAA, 20600 Casablanca, Marocco	+212 661 45 15 96
Myanmar	Peace Myanmar Electric Co.,Ltd.	NO137/139 Botahtaung Pagoda Road, Botahtaung Town Ship 1161, Yangon, Myanmar	+95-(0)1-202589
Nepal	Watt&Volt House	KHA 2-65, Volt House Dillibazar Post Box: 2108, Kathmandu, Nepal	+977-1-4411330
Netherlands	Imtech Marine & Offshore B.V.	Sluisjesdijk 155, NL-3087 AG Rotterdam, Netherlands	+31(0)10-487-19 11
North America	Mitsubishi Electric Automation, Inc.	500 Corporate Woods Parkway, Vernon Hills, IL 60061 USA	+847-478-2100
Norway	Scanelec AS	Leivikasen 43B, NO-5179 Godvik, Norway	+47(0)55-506000
Middle East Arab Countries & Cyprus	Comptoir d'Electricite Generale-International-S.A.L.	Cebaco Center - Block A Autostrade Dora P.O. Box 11-1314 Beirut - Lebanon	+961-1-240430
Pakistan	Prince Electric Co.	2-P, GULBERG II, LAHORE - 54660 PAKISTAN	+92-(0)42-35752323 +92-(0)42-35753373
Philippines	Edison Electric Integrated, Inc.	24th Fl. Galleria Corporate Center, Edsa Cr. Ortigas Ave., Quezon City Metro Manila, Philippines	+63-(0)2-634-8691
Poland	Mitsubishi Electric Europe B.V. Polish Branch	Krakowska 50, 32-083 Balice, Poland	+48(0)12 630 47 00
Republic of Moldova	Intehsis SRL	bld. Traian 23/1, MD-2060 Kishinev, Moldova	+373(0)22-66-4242
Romania	Sirius Trading & Services SRL	RO-060841 Bucuresti, Sector 6 Aleea Lacul Morii Nr. 3	+40-(0)21-430-40-06
Russia	Mitsubishi Electric Europe B.V. Moscow Branch	52, bld. 3 Kosmodamianskaya Nab, 115054, Moscow, Russia	+7 495 721-2070
Saudi Arabia	Center of Electrical Goods	Al-Shuwayer St. Side way of Salahuddin Al-Ayoubi St. P.O. Box 15955 Riyadh 11454 - Saudi Arabia	+966-1-4770149
Singapore	Mitsubishi Electric Asia Pte. Ltd.	307 Alexandra Road, Mitsubishi Electric Building, Singapore 159943	+65-6473-2308
Slovakia	PROCONT, Presov SIMAP	Kupelna 1, SK - 08001 Presov, Slovakia Jana Derku 1671, SK - 91101 Trencin, Slovakia	+421(0)51-7580 611 + 421(0)32 743 04 72
Slovenia	Inea RBT d.o.o.	Stegne 11, SI-1000 Ljubljana, Slovenia	+386(0)1-513-8116
South Africa	CBI-electric: low voltage	Private Bag 2016, ZA-1600 Isando Gauteng, South Africa	+27-(0)11-9282000
Spain	Mitsubishi Electric Europe B.V. Spanish Branch	Carretera de Rubi 76-80, E-08190 Sant Cugat del Valles (Barcelona), Spain	+34(0)93-565-3131
Sweden	Euro Energy Components AB	Järnvägsqatan 36, S-434 24 Kungsbacka, Sweden	+46(0)300-690040
Switzerland	TriElec AG	Muehlentalstrasse 136, CH-8201 Schaffhausen	+41-(0)52-6258425
Taiwan	Setsuyo Enterprise Co., Ltd	5th Fl., No.105, Wu Kung 3rd, Wu-Ku Hsiang, Taipei, Taiwan, R.O.C.	+886-(0)2-2298-8889
Thailand	United Trading & Import Co., Ltd.	77/12 Bamrungmuang Road, Klong Mahanak Pomprab Bangkok Thailand	+66-223-4220-3
Tunisia	MOTRA Electric	3, Résidence Imen, Avenue des Martyrs Mourouj III, 2074 - El Mourouj III Ben Arous, Tunisia	+216-71 474 599
Turkey	GTS	Bayraktar Bulvarı Nutuk Sok. No:5, Posta Kutusu34384, TR-34775 Yukarı Dudullu-Uemraniye, Istanbul, Turkey	+90(0)216 526 3990
United Kingdom	Mitsubishi Electric Europe B.V.	Travellers Lane, UK-Hatfield, Herts. AL10 8XB, United Kingdom	+44(0)1707-276100
Uruguay	Fierro Vignoli S.A.	Avda. Uruguay 1274 Montevideo Uruguay	+598-2-902-0808
Venezuela	Adesco S.A.	Calle 7 La Urbina Edificio Los Robles Locales C y D Planta Baja, Caracas - Venezuela	+58-212-241-9952
Vietnam	CTY TNHH-TM SA GIANG	10th Floor, Room1006-1007,225 Tran Hung Dao St., Co Giang Ward, Dist. 1, Ho Chi Minh City, Vietnam	+84-8-838-6727/28/29

For Safety : Please read the instruction manual carefully before using the products in this catalog. Wiring and connection must be done by the person have a specialized knowledge of electric construction and wiring.



for a greener tomorrow

Eco Changes is the Mitsubishi Electric Group's environmental statement, and expresses the Group's stance on environmental management. Through a wide range of businesses, we are helping contribute to the realization of a sustainable society.



MITSUBISHI ELECTRIC CORPORATION

HEAD OFFICE: TOKYO BUILDING, 2-7-3, MARUNOUCHI, CHIYODA-KU, TOKYO 100-8310, JAPAN