

UL File No.: E122222
CSA File No.: LR39291



Features

- 100-240V AC free-voltage input, 48-125V DC type available
- Short body — 62.5mm 2.461 inch (screw terminal type)
- Front panel of IP65 type is protected against water-splash and dust
- Built-in Screw terminals
Screw terminal type is used for easy wiring and reducing additional cost for accessories.
- 0 setting instantaneous output operation
- Multiple time ranges — 1 s to 500 h (Max.)
- 8 different operation modes: (PM4H-A)
- Compliant with UL/CSA, CE and LLOYD

RoHS Directive compatibility information
<http://www.nais-e.com/>

Product types

Type	Operation mode	Contact arrangement	Time range	Protective construction	Rated operating voltage	Terminal type	Part number
PM4H-A	8 operation modes • Pulse ON-delay • Pulse Flicker • Pulse ON-flicker • Differential ON/OFF-delay (1) (2) • Signal OFF-delay • Pulse One-shot • Pulse One-cycle	Relay Timed-out 2 Form C	16 selectable ranges 1s to 500h	IP65	100 to 240V AC	11 pins	PM4HA-H-AC240VW
						Screw terminal	PM4HA-H-AC240VSW
					48 to 125V DC	11 pins	PM4HA-H-DC125VW
						Screw terminal	PM4HA-H-DC125VSW
					24V AC/DC	11 pins	PM4HA-H-24VW
						Screw terminal	PM4HA-H-24VSW
					12V DC	11 pins	PM4HA-H-DC12VW
						Screw terminal	PM4HA-H-DC12VSW
PM4H-S	Power ON-delay	Relay Timed-out 2 Form C	16 selectable ranges 1s to 500h	IP65	100 to 240V AC	11 pins	PM4HA-H-AC240V
						Screw terminal	PM4HA-H-AC240VS
					48 to 125V DC	11 pins	PM4HA-H-DC125V
						Screw terminal	PM4HA-H-DC125VS
					24V AC/DC	11 pins	PM4HA-H-24V
						Screw terminal	PM4HA-H-24VS
					12V DC	11 pins	PM4HA-H-DC12V
						Screw terminal	PM4HA-H-DC12VS
PM4H-M	5 operation modes (With instantaneous contact) • Power ON-delay • Power Flicker • Power ON-flicker • Power One-shot • Power One-cycle	Relay Timed-out 1 Form C Instantaneous 1 Form C	16 selectable ranges 1s to 500h	IP65	100 to 240V AC	8 pins	PM4HS-H-AC240VW
						Screw terminal	PM4HS-H-AC240VSW
					48 to 125V DC	8 pins	PM4HS-H-DC125VW
						Screw terminal	PM4HS-H-DC125VSW
					24V AC/DC	8 pins	PM4HS-H-24VW
						Screw terminal	PM4HS-H-24VSW
					12V DC	8 pins	PM4HS-H-DC12VW
						Screw terminal	PM4HS-H-DC12VSW
				IP50	100 to 240V AC	8 pins	PM4HS-H-AC240V
						Screw terminal	PM4HS-H-AC240VS
					48 to 125V DC	8 pins	PM4HS-H-DC125V
						Screw terminal	PM4HS-H-DC125VS
					24V AC/DC	8 pins	PM4HS-H-24V
						Screw terminal	PM4HS-H-24VS
					12V DC	8 pins	PM4HS-H-DC12V
						Screw terminal	PM4HS-H-DC12VS
IP65	100 to 240V AC	8 pins	PM4HM-H-AC240VW				
		Screw terminal	PM4HM-H-AC240VSW				
	48 to 125V DC	8 pins	PM4HM-H-DC125VW				
		Screw terminal	PM4HM-H-DC125VSW				
	24V AC/DC	8 pins	PM4HM-H-24VW				
		Screw terminal	PM4HM-H-24VSW				
	12V DC	8 pins	PM4HM-H-DC12VW				
		Screw terminal	PM4HM-H-DC12VSW				
IP50	100 to 240V AC	8 pins	PM4HM-H-AC240V				
		Screw terminal	PM4HM-H-AC240VS				
	48 to 125V DC	8 pins	PM4HM-H-DC125V				
		Screw terminal	PM4HM-H-DC125VS				
	24V AC/DC	8 pins	PM4HM-H-24V				
		Screw terminal	PM4HM-H-24VS				
	12V DC	8 pins	PM4HM-H-DC12V				
		Screw terminal	PM4HM-H-DC12VS				

If you use this timer under harsh environment, please order above sealed type (IP65 type). IP65 type — Protection dust and water jet splay on the front face.

PM4H-A/S/M

Time range

Scale		Time unit			
		sec	min	hrs	10h
Control time range	1	0.1s to 1s	0.1 min to 1 min	0.1h to 1h	1.0h to 10h
	5	0.5s to 5s	0.5 min to 5 min	0.5h to 5h	5h to 50h
	10	1.0s to 10s	1.0 min to 10 min	1.0h to 10h	10h to 100h
	50	5s to 50s	5 min to 50 min	5h to 50h	50h to 500h

PM4H-A/PM4H-S/PM4H-M
All types of PM4H timer have multi-time range.
16 time ranges are selectable.
1s to 500h (Max. range) is controlled.

Note: 0 setting is for instantaneous output operation.

Specifications

Item	Type	PM4H-A	PM4H-S	PM4H-M
Rating	Rated operating voltage	100 to 240V AC, 48 to 125V DC, 12V DC, 24V AC/DC		
	Rated frequency	50/60Hz common (AC operating type)		
	Rated power consumption	Approx. 10VA (100 to 240V AC) Approx. 2.5VA (24V AC) Approx. 1.5W (12V DC, 24V DC, 48 to 125V DC)		
	Rated control capacity	5A 250V AC (resistive load)		
	Operating mode	Pulse ON-delay Pulse Flicker Pulse ON-Flicker Differential ON/OFF-delay (1) (2) Signal OFF-delay Pulse One-shot Pulse One-cycle	Power ON-delay	Power ON-delay Power Flicker Power ON-flicker Power One-shot Power One-cycle (with instantaneous contact)
	Time range	1s to 500h (Max.) 16 time ranges switchable		
Time accuracy (Note:)	Operating time fluctuation	±0.3% (power off time change at the range of 0.1s to 1h)		
	Setting error	±5% (Full-scale value)		
	Voltage error	±0.5% (at the operating voltage changes between 85 to 110%)		
	Temperature error	±2% (at 20°C ambient temp. at the range of -10 to +50°C +14 to +122°F)		
Contact	Contact arrangement	Timed-out 2 Form C		Timed-out 1 Form C Instantaneous 1 Form C
	Contact resistance (Initial value)	Max. 100mΩ (at 1A 6V DC)		
	Contact material	Silver alloy		Au flash on Silver alloy
Life	Mechanical (contact)	2×10 ⁷		
	Electrical (contact)	10 ⁵ (at rated control capacity)		
Electrical function	Allowable operating voltage range	85 to 110% of rated operating voltage (at 20°C coil temp.)		
	Insulation resistance (Initial value)	Min. 100MΩ	Between live and dead metal parts Between input and output Between contacts of different poles Between contacts of same pole	(At 500V DC)
	Breakdown voltage (Initial value)	2,000Vrms for 1 min Between live and dead metal parts 2,000Vrms for 1 min Between input and output 2,000Vrms for 1 min Between contacts of different poles 1,000Vrms for 1 min Between contacts of same pole		
	Min. power off time	100ms		
	Max. temperature rise	55°C 131°F		65°C 149°F
Mechanical function	Vibration resistance	Functional	10 to 55Hz: 1 cycle/min double amplitude of 0.25mm (10min on 3 axes)	
		Destructive	10 to 55Hz: 1 cycle/min double amplitude of 0.375mm (1h on 3 axes)	
	Shock resistance	Functional	Min. 98m/s ² (4 times on 3 axes)	
		Destructive	Min. 980m/s ² (5 times on 3 axes)	
Operating condition	Ambient temperature	-10 to +50°C +14 to +122°F		
	Ambient humidity	30 to 85%RH (at 20°C 68°F, non-condensing)		
	Atmospheric pressure	860 to 1,060hPa		
	Ripple factor (DC type)	20%		
Others	Protective construction	IP65 on front panel (using rubber gasket ATC18002) <only for IP65 type>		
	Weight	100g 3.527 oz (Pin type) 110g 3.880 oz (Screw terminal type)		

Note: 1) Unless otherwise specified, the measurement conditions at the maximum scale time standard are specified to be the rated operating voltage (within 5% ripple factor for DC), 20°C 68°F ambient temperature, and 1s power off time.

2) For the 1s range, the tolerance for each specification becomes ±10ms.

Terminal layouts and Wiring diagrams

PM4H-A

Pin type

- Timed-out 2 Form C

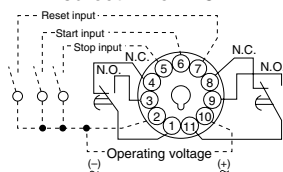

Screw terminal type

- Timed-out 2 Form C

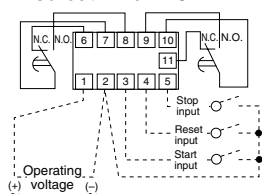

PM4H-S

Pin type

- Timed-out 2 Form C

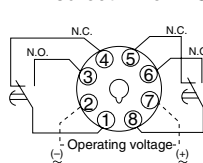

Screw terminal type

- Timed-out 2 Form C

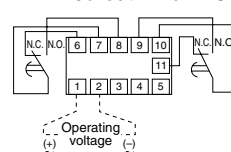

PM4H-M

Pin type

- Timed-out 1 Form C
- Instantaneous 1 Form C

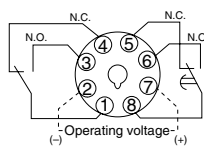

Screw terminal type

- Timed-out 1 Form C
- Instantaneous 1 Form C

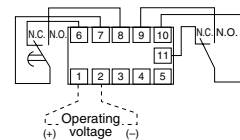

1) DC Type

Type	Pin	Screw terminal
PM4H-A	Connect the terminal ② to negative (-), and the terminal ⑩ to positive (+).	Connect the terminal ② to negative (-), and the terminal ⑩ to positive (+).
PM4H-S	Connect the terminal ② to negative (-), and the terminal ⑦ to positive (+).	
PM4H-M	Connect the terminal ② to negative (-), and the terminal ① to positive (+).	

2) Contact



- 3) Voltage should not be applied to the various inputs (reset, start, and stop) of the PM4H-A multi-range timer. These inputs should be input without voltage.

Parts name

PM4H-S



- Time range selector
 16 time settings selectable
 (1 s to 500 h)
 1s 5s 10s 50s
 1min 5min 10min 50min
 1h 5h 10h 50h
 10h 50h 100h 500h

PM4H-A

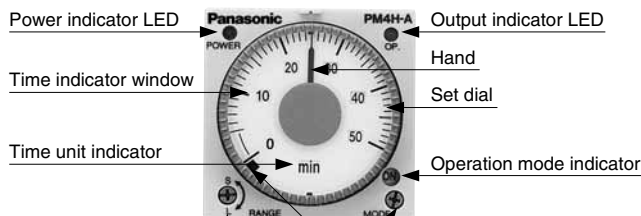

- Instantaneous output area
 When the hand is in this area,
 instantaneous operation starts.

PM4H-M



- Operation mode selector
 Selectable from
 5 operation modes
 ON : Power ON-delay
 FL : Power flicker
 FO : Power ON-flicker
 OS : Power One-shot
 OC : Power One-cycle

- Operation mode selector
 Selectable from 8 operation modes
 ON : Pulse ON-delay
 FL : Pulse Flicker
 FO : Pulse ON-flicker
 OF1 : Differential ON/OFF-delay (1)
 SF : Signal OFF-delay
 OS : Pulse One-shot
 OF2 : Differential ON/OFF-delay (2)
 OC : Pulse One-cycle

PM4H-A/S/M

Dimensions

mm inch
Tolerance: $\pm 0.5 \pm 0.020$

• PM4H-□

Screw terminal type
(Flush mount)

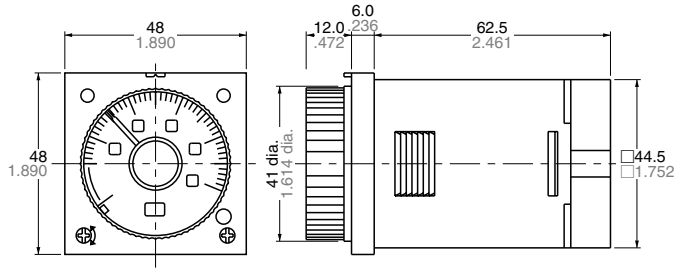

Pin type
(Flush mount/Surface mount)

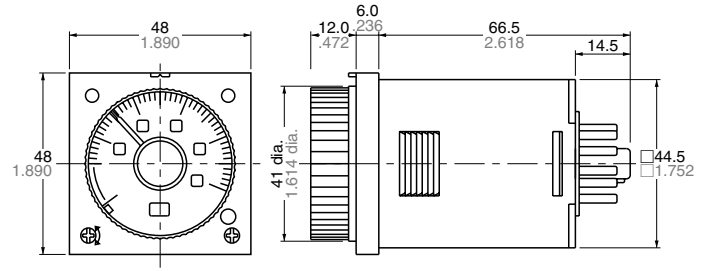

• Panel mount dimensions (with mounting frame)

Screw terminal type

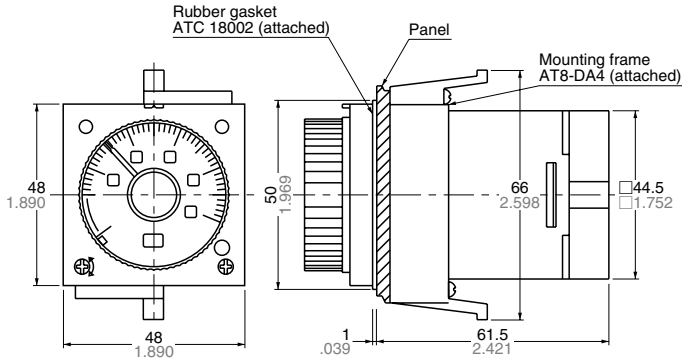

Pin type

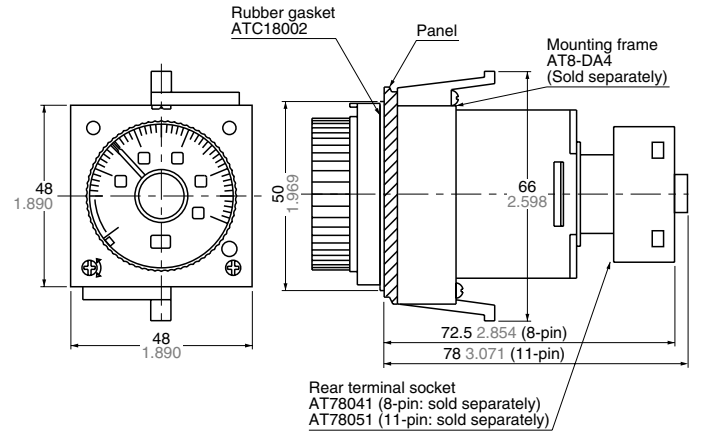

• Surface mount dimensions

Pin type

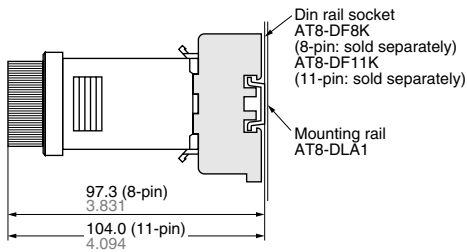

• Panel cut out dimensions

Standard cut out dimensions are shown below.
Use mounting frame (AT8-DA4) and rubber gasket (ATC18002).

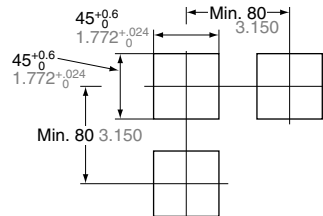

• Adjacent mounting

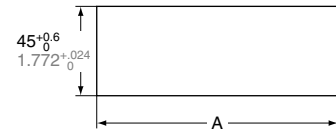

$$A = (48 \times n - 2.5) + 0.6$$

$$A = (1.890 \times n - .098) + 0.024$$

- Note) 1. The proper thickness of mounting panel is between 1 to 5mm.
2. Adjacent mount is less water-resistant.

Operation mode

PM4H-A

(* LED lighting * LED flickering
 T: Setting time $t_1, t_2, t_a, t_b < T$ $t_1 + t_2 = T$)

Operation type	Explanation	Time chart
<p>Pulse ON-delay</p> <p>(ON)</p>	<ul style="list-style-type: none"> If using a time-limit start when the power is turned on, and a reset when the power is turned off, pins ② to ⑥ (screw-tightening pins ② and ③) should be shorted ahead of time. Turn the operation mode selector switch to the (ON) position. If pins ② to ⑥ (screw-tightening pins ② and ③) are shorted (the start input is turned on) with the power supply on, the output will go on after the set time has elapsed. If the power supply is turned off, or pins ② to ⑦ (screw-tightening pins ② to ④) are shorted (the reset input is turned on), a reset is carried out. Note) During time-limited operation, the time-limited operation is stopped while the pins ② to ⑤ (screw-tightening pins ② to ⑤) are being shorted (the stop input is on). When the pins are released, time-limited operation resumes. 	<p>△Note: * LED lighting or No LED lighting</p>
<p>Pulse Flicker</p> <p>(FL)</p>	<ul style="list-style-type: none"> If using a time-limit start when the power is turned on, and a reset when the power is turned off, pins ② to ⑥ (screw-tightening pins ② and ③) should be shorted ahead of time. Turn the operation mode selector switch to the (FL) position. When pins ② to ⑥ (screw-tightening pins ② and ③) are shorted (the start input is turned on) with the power supply on, the limited time interval begins, and the output goes on after the set time has elapsed. After the output has gone on, it goes off when the set time has elapsed, and this process is subsequently repeated. If the power supply is turned off, or pins ② to ⑦ (screw-tightening pins ② to ④) are shorted (the reset input is turned on), a reset is carried out. Note) During time-limited operation, the time-limited operation is stopped while the pins ② to ⑤ (screw-tightening pins ② to ⑤) are being shorted (the stop input is on). When the pins are released, time-limited operation resumes. 	<p>△Note: * LED lighting or No LED lighting</p>
<p>Pulse ON-flicker</p> <p>(FO)</p>	<ul style="list-style-type: none"> If using a time-limit start when the power is turned on, and a reset when the power is turned off, pins ② to ⑥ (screw-tightening pins ② and ③) should be shorted ahead of time. Turn the operation mode selector switch to the (FO) position. When pins ② to ⑥ (screw-tightening pins ② and ③) are shorted (the start input is turned on) with the power supply on, the output goes on, and after the set time has elapsed, it goes off. This process is subsequently repeated. If the power supply is turned off, or pins ② to ⑦ (screw-tightening pins ② to ④) are shorted (the reset input is turned on), a reset is carried out. Note) During time-limited operation, the time-limited operation is stopped while the pins ② to ⑤ (screw-tightening pins ② to ⑤) are being shorted (the stop input is on). When the pins are released, time-limited operation resumes. 	<p>△Note: * LED lighting or No LED lighting</p>
<p>Differential ON/OFF-delay (1)</p> <p>(OF1)</p>	<ul style="list-style-type: none"> Turn the operation mode selector switch to the (OF1) position. When pins ② to ⑥ (screw-tightening pins ② and ③) are shorted (the start input is turned on) with the power supply on, the output goes on, and after the set time has elapsed, it goes off. Also, when pins ② to ⑥ are released (the start input goes off), the output goes on, and after the set time has elapsed, it goes off. If the status of pins ② to ⑥ (screw-tightening pins ② and ③) changes during the time-limit interval (the start input goes from on to off, or from off to on), the time-limit interval is restarted from the point at which the change took place. If the power supply is turned off, or pins ② to ⑦ (screw-tightening pins ② to ④) are shorted (the reset input is turned on), a reset is carried out. Note) During time-limited operation, the time-limited operation is stopped while the pins ② to ⑤ (screw-tightening pins ② to ⑤) are being shorted (the stop input is on). When the pins are released, time-limited operation resumes. 	<p>△Note: * LED lighting or No LED lighting</p>
<p>Signal OFF-delay</p> <p>(SF)</p>	<ul style="list-style-type: none"> Turn the operation mode selector switch to the (SF) position. When pins ② to ⑥ (screw-tightening pins ② and ③) are shorted (the start input is turned on) with the power supply on, the output goes on, and when pins ② to ⑥ (screw-tightening pins ② and ③) are released (the start input is turned off), the time limit interval begins. After the set time has elapsed, the output goes off. If start input is entered at any point during the time limit interval, the time limit interval is reset. Note) During time-limited operation, the time-limited operation is stopped while the pins ② to ⑤ (screw-tightening pins ② to ⑤) are being shorted (the stop input is on). When the pins are released, time-limited operation resumes. 	<p>△Note: * LED lighting or No LED lighting</p>

Note: Keep 0.1s or more for power off time.
 Keep 0.05s or more for start, stop, reset input time.

PM4H-A/S/M

Operation type	Explanation	Time chart
Pulse One-shot OS	<ul style="list-style-type: none"> If using a time-limit start when the power is turned on, and a reset when the power is turned off, pins ② to ⑥ (screw-tightening pins ② and ③) should be shorted ahead of time. Turn the operation mode selector switch to the OS position. When pins ② to ⑥ (screw-tightening pins ② and ③) are shorted (the start input is turned on) with the power supply on, the output goes on for the set time limit interval. If the power supply is turned off, or pins ② to ⑦ (screw-tightening pins ② to ④) are shorted (the reset input is turned on), a reset is carried out. Note) During time-limited operation, the time-limited operation is stopped while the pins ② to ⑤ (screw-tightening pins ② to ⑤) are being shorted (the stop input is on). When the pins are released, time-limited operation resumes. 	<p>△Note: * LED lighting or No LED lighting</p>
Differential ON/OFF-delay (2) OF2	<ul style="list-style-type: none"> Turn the operation mode selector switch to the OF2 position. When pins ② to ⑥ (screw-tightening pins ② and ③) are shorted (the start input is turned on) with the power supply on, the time limit interval begins, and after the set time interval has elapsed, the output goes on. Also, when pins ② to ⑥ are released (the start input goes off), the time limit interval begins, and after it has elapsed, the output goes off. If the status of pins ② to ⑥ (screw-tightening pins ② and ③) changes during the time-limit interval (the start input goes from on to off, or from off to on), the time limit interval is restarted from the point at which the change took place. If the power supply is turned off, or pins ② to ⑦ (screw-tightening pins ② to ④) are shorted (the reset input is turned on), a reset is carried out. Note) During time-limited operation, the time-limited operation is stopped while the pins ② to ⑤ (screw-tightening pins ② to ⑤) are being shorted (the stop input is on). When the pins are released, time-limited operation resumes. 	<p>△Note: * LED lighting or No LED lighting</p>
Pulse One-cycle OC	<ul style="list-style-type: none"> If using a time-limit start when the power is turned on, and a reset when the power is turned off, pins ② to ⑥ (screw-tightening pins ② and ③) should be shorted ahead of time. Turn the operation mode selector switch to the OC position. When pins ② to ⑥ (screw-tightening pins ② and ③) are shorted (the start input is turned on) with the power supply on, the output goes on after the set time limit interval has elapsed. After it has gone on, it goes off after one pulse (approximately 0.8 seconds). If the power supply is turned off, or pins ② to ⑦ (screw-tightening pins ② to ④) are shorted (the reset input is turned on), a reset is carried out. Note) During time-limited operation, the time-limited operation is stopped while the pins ② to ⑤ (screw-tightening pins ② to ⑤) are being shorted (the stop input is on). When the pins are released, time-limited operation resumes. 	<p>One pulse time (t): Approx. 0.8s △Note: * LED lighting or No LED lighting</p>

Note: Keep 0.1s or more for power off time.
 Keep 0.05s or more for start, stop, reset input time.

PM4H-S

(* LED lighting * LED flickering)
 T: Setting time

Operation type	Explanation	Time chart
Power ON-delay	Time limit contact relay When the power supply is turned on, the output goes on after the set time interval has elapsed. When the power supply is turned off, a reset is carried out.	

PM4H-M

Operation type	Explanation	Time chart
Power ON-delay ON Power Flicker FL Power ON-flicker FO Power One-shot OS Power One-cycle OC	Turn the operation mode selector switch to display the various operations. When the power supply is turned on, the time limit interval begins, and operation is carried out. When the power supply is turned off, a reset is carried out.	

Note: Keep 0.1s or more for power off time. PM4H-M timers do not have each input which is start, reset and stop.

PM4H SERIES MODES AND TIME SETTING

1. Operation method

1) Operation mode setting [PM4H-A type]

8 operation modes are selectable with operation mode selector.
Turn the operation mode selector with screw driver.
Operation mode is shown up through the window above the mode selector. The marks are (ON), (FL), (FO), (OF), (SF), (OS), (PF), (OC).
Turn the mode selector to the mark until you can check by clicking sound.
Confirm the mode selector position if it is correct.
If the position is not stable, the timer might mis-operate.



2) Time range setting [PM4H series common]

16 time ranges are selectable between 1s to 500h.
Turn the time range selector with the screw driver.
Clockwise turning increases the time range, and Counter-clockwise turning decrease the time range.
Confirm the range selector position if it is correct.
If the position is not stable, the timer might mis-operate.



3) Time setting [common]

To set the time, turn the set dial to a desired time within the range.
Instantaneous output will be on when the dial is set to "0".
When the instantaneous output is used, the dial should be set under "0" range. (Instantaneous output area)
When power supply is on, the time range, setting time and operation mode cannot be changed.
Turn off the power supply or a reset signal is applied to set the new operation mode.
If the position is not stable, the timer might mis-operate.

2. How to use "Set ring" [PM4H series common]

1) Fixed time setting

Set the desired time and put 2 set rings together.
Insert the rings into stopper to fix the time.

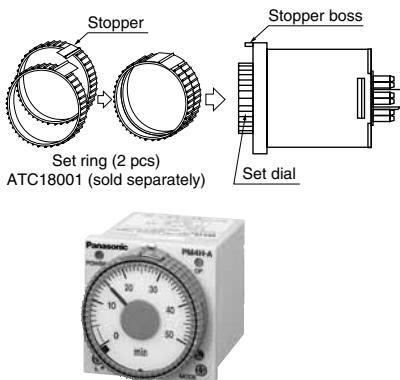

2) Time range setting

Example: Time range 20s to 30s.

① Shorter time value setting

Set the dial to 20s.
Place the stop ring at the right side of stopper.

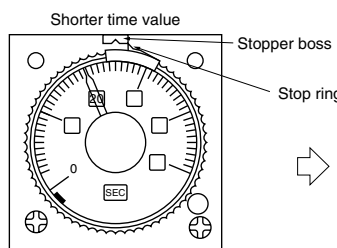

② Longer time value setting

Set the dial to 30s.
Place the stop ring at the left side of stopper.

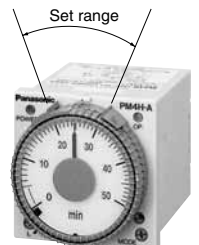
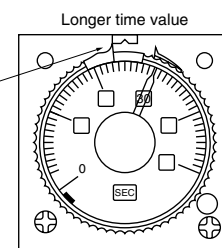

Note) The stoppers for the lower limit setting set ring and the upper limit setting set ring face the opposite directions.

Applicable standard (PM4H series common)

Safety standard	EN61812-1	Pollution Degree 2/Overvoltage Category III
EMC	(EMI)EN61000-6-4 Radiation interference electric field strength Noise terminal voltage (EMS)EN61000-6-2 Static discharge immunity	EN55011 Group1 ClassA EN55011 Group1 ClassA
	RF electromagnetic field immunity	EN61000-4-2 4 kV contact 8 kV air
	EFT/B immunity	EN61000-4-3 10 V/m AM modulation (80 MHz to 1 GHz) 10 V/m pulse modulation (895 MHz to 905 MHz)
	Surge immunity	EN61000-4-4 2 kV (power supply line) 1 kV (signal line)
	Conductivity noise immunity	EN61000-4-5 1 kV (power line)
	Power frequency magnetic field immunity	EN61000-4-6 10 V/m AM modulation (0.15 MHz to 80 MHz)
	Voltage dip/Instantaneous stop/Voltage fluctuation immunity	EN61000-4-8 30 A/m (50 Hz) EN61000-4-11 10 ms, 30% (rated voltage) 100 ms, 60% (rated voltage) 1,000 ms, 60% (rated voltage) 5,000 ms, 95% (rated voltage)