

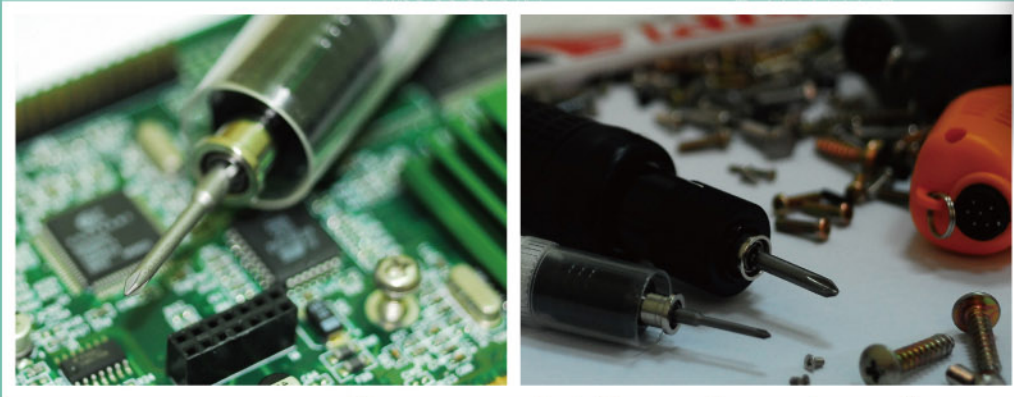

KILEWS



INNOVATION FOR SCREWS FASTENING



CATALOGUE

Index

SCREWDRIVERS MODEL TYPES DESCRIPTION	2.
TABLE OF ALL MODELS / TORQUE OF ALL MODELS	3.
BRUSHLESS MEDIUM TORQUE AC-TYPE AUTOMATIC TRIGGER AND PUSH START CLUTCH TYPE SERIES	
SK-B5 Series	4.
BRUSHLESS HIGH TORQUE AC-TYPE AUTOMATIC TRIGGER AND PUSH START CLUTCH TYPE SERIES	
SK-B6 Series	5.
POWER CONTROLLER (FOR BRUSHLESS SCREWDRIVERS)	
SKP Series SKP-12HL, SKP-32BC-60W, SKP-BE32HL(6P).....	6.
BRUSHLESS MINI TORQUE DC-TYPE AUTOMATIC TRIGGER START CLUTCH TYPE SERIES	
SKD-B100 Series	7.
BRUSHLESS LOW TORQUE DC-TYPE AUTOMATIC TRIGGER AND PUSH START CLUTCH TYPE SERIES	
SKD-BN200 Series	8.
BRUSHLESS MEDIUM TORQUE DC-TYPE AUTOMATIC TRIGGER AND PUSH START CLUTCH TYPE SERIES	
SKD-BN500 Series	9.
BRUSHLESS LOW TORQUE DC-TYPE AUTOMATIC WITH COUNTER TRIGGER AND PUSH START CLUTCH TYPE SERIES	
SKD-BE200 Series	10.
BRUSHLESS MEDIUM TORQUE DC-TYPE AUTOMATIC WITH COUNTER TRIGGER AND PUSH START CLUTCH TYPE SERIES	
SKD-BE500 Series	11.
BRUSHLESS LOW TORQUE DC-TYPE AUTOMATIC VACUUM SCREWDRIVERS	
SKD-BN200 (VACUUM TYPE) Series	12.
BRUSHLESS MEDIUM TORQUE DC-TYPE AUTOMATIC VACUUM SCREWDRIVERS	
SKD-BN500 (VACUUM TYPE) Series	13.
BRUSHLESS HIGH TORQUE DC-TYPE AUTOMATIC TRIGGER AND PUSH START CLUTCH TYPE SERIES	
SKD-BN7000 Series	14.
SCREW COUNTER (FOR BRUSHLESS SCREWDRIVERS)	
INTRODUCTION/FEATURES	15.
SCREW COUNTER vs SCREWDRIVERS	16.
SCREW COUNTER (FOR BRUSHLESS SCREWDRIVERS)	
SKP-BC32HL-100(V3.0) Counter / Power Supply / Slow-Start.....	17.
SCREW COUNTER (FOR BRUSHLESS SCREWDRIVERS)	
SKP-BC32HL Counter / Power Supply / Slow-Start.....	18.
TORQUE METERS	
KTM-15, KTM-150, KTM-250	19.
SCREW FEEDER (FOR VACUUM TYPE SCREWDRIVER AND AUTOMATION SYSTEM)	
KFA-0820 Series KFA-0820H, KFA-0820A.....	20.
SCREW FEEDER (FOR VACUUM TYPE SCREWDRIVER AND AUTOMATION SYSTEM)	
KFA-0830 / KFA-0850	21.
SCREW FEEDER	
KFR-1050	22.
ACCESSORIES	
Auxiliary Arm KP Series KP-AUX1T-B, KP-VAR, KP-VA1, KP-AUX2, KP-AUX5, KP-AUX-C/E/B/D.....	23.
ACCESSORIES	
Screwdriver I/O Signal Control Box (For Manual / PLC) · Slow Start Control Module · 90° Degree Attachment	
KL-SCBSN, KL-SSBN, KL-1, KL-2, KZ-1, KL-M-1, KL-M-2.....	24.
ACCESSORIES	
Suspension Rack, Torque Fixing Ring, Spiral Cables, TorqueAdjuster, Pistol Grip, Screw Setter, Spring Balancer Series	25.

AC-TYPE (BRUSHLESS SERIES)

S K - B 6 2 3 0 P F D

↓ ↓ ↓ ↓ ↓ ↓
 1 2 3 6 7 8

Post 1- AC-TYPE

Post 2-B: Brushless Electric Screwdriver Series

Post 3- input Voltage: "1"-AC110~120Volt 50/60Hz

"2"-AC220~240Volt 50/60Hz

Post 6-Start Type: "P"-Push Start Type; "L"-Trigger Start Type

Post 7-"F"- High Speed Type

Post 8-Bit Type

"A"-Bit in SS 5mm, Hexagon Type 

"B"-Bit in SS 6.35mm, Hexagon Type 

"C"-Bit in M3 4Ø Round Type 

"D"-Bit in M6 5Ø Round Type 



DC-TYPE (BRUSHLESS SERIES)

S K D - B N 7 0 2 2 P F D

↓ ↓ ↓ ↓ ↓
 1 2 7 8 9

Post 1-DC-TYPE

Post 2-B: Brushless Electric Screwdriver Series

N: New generation of functional intergeneration screwdriver series.

E: Built-in counter screwdrivers

Post 7-Start Type: "P"-Push Start Type; "L"-Trigger Start Type

Post 8-"F"- High Speed Type

Post 9-Bit Type

"A"-Bit in SS 5mm, Hexagon Type 

"B"-Bit in SS 6.35mm, Hexagon Type 

"C"-Bit in M3 4Ø Round Type 

"D"-Bit in M6 5Ø Round Type 



TABLE OF ALL MODELS

Page	Series	Screwdrivers						Power Model
		Model	Torque(kgf.cm)	Speed(r.p.m)	Screw Size(mm)	Features	Starting Method	
4	5	SK-B5112L/LF, SK-B5212L/LF	1.5~12	1200(2000)	1.6~3.0	AC Automatic Screwdrivers	Trigger and Push Start	
		SK-B5112P/PF, SK-B5212P/PF	2~12	1200(2000)	1.6~3.0			
		SK-B5122L/LF, SK-B5222L/LF	3~22	1200	2.3~4.0			
		SK-B5117LF/PF, SK-B5217LF/PF	3~17	2000	1.6~3.5			
5	6	SK-B6125L/P(LF/PF)	5~25	1000/2000	2.6~4.0	AC Automatic Screwdrivers	Trigger and Push Start	
		SK-B6230L/P(LF/PF)	5~30	1200/2000	2.6~4.0			
		SK-B6150L/P, SK-B6250L/P	20~50	1000/1200	4.0~5.0			
7	B100	SKD-B100L(LS4)	0.08~1.5	1000/700(280/200)	1.0~1.7	Mini Torque Brushless Screwdrivers	Trigger Start	SKP-12HL
		SKD-B103L(LS4)	0.5~3.5	1000/700(280/200)	1.0~2.3			
8 12 10	BN200/ BN200/ (VACUUM TYPE) BE200	SKD-BN203L(S5, 6, 7)	0.2~3.5	1000/700 (500/350.370/260.230/160)	1.0~2.3	Low Torque Brushless Screwdrivers	Trigger and Push Start	SKP-32HL-60W
		SKD-BN207L	0.5~7	1000/700	1.4~2.6			
		SKD-BN210L/P	1~10(2~10)	1000/700	1.6~3.0			
9 13 11	BN500/ BN500/ (VACUUM TYPE) BE500	SKD-BN512L/P(LF/PF)	1.5~12(2~12)	1000/700(2000)	1.6~3.0(1.6~3.0)	Medium/Torque Screwdrivers with Counter	Trigger and Push Start	SKP-32BC-60W SKP-BE32HL(6P) (LF/PF Use only)
		SKD-BN517LF/PF	3~17	2000	1.6~3.0			
		SKD-BN519L/P	3~19	1000/700	2.3~3.5			
14	BN700	SKD-BN7022LF/PF	5~22	2000	2.6~4.0	DC Automatic Screwdrivers	Trigger and Push Start	SKP-BE32HL(6P)
		SKD-BN7030L/P	10~30	1200/900	2.6~4.0			

TORQUE OF ALL MODELS (kgf.cm)

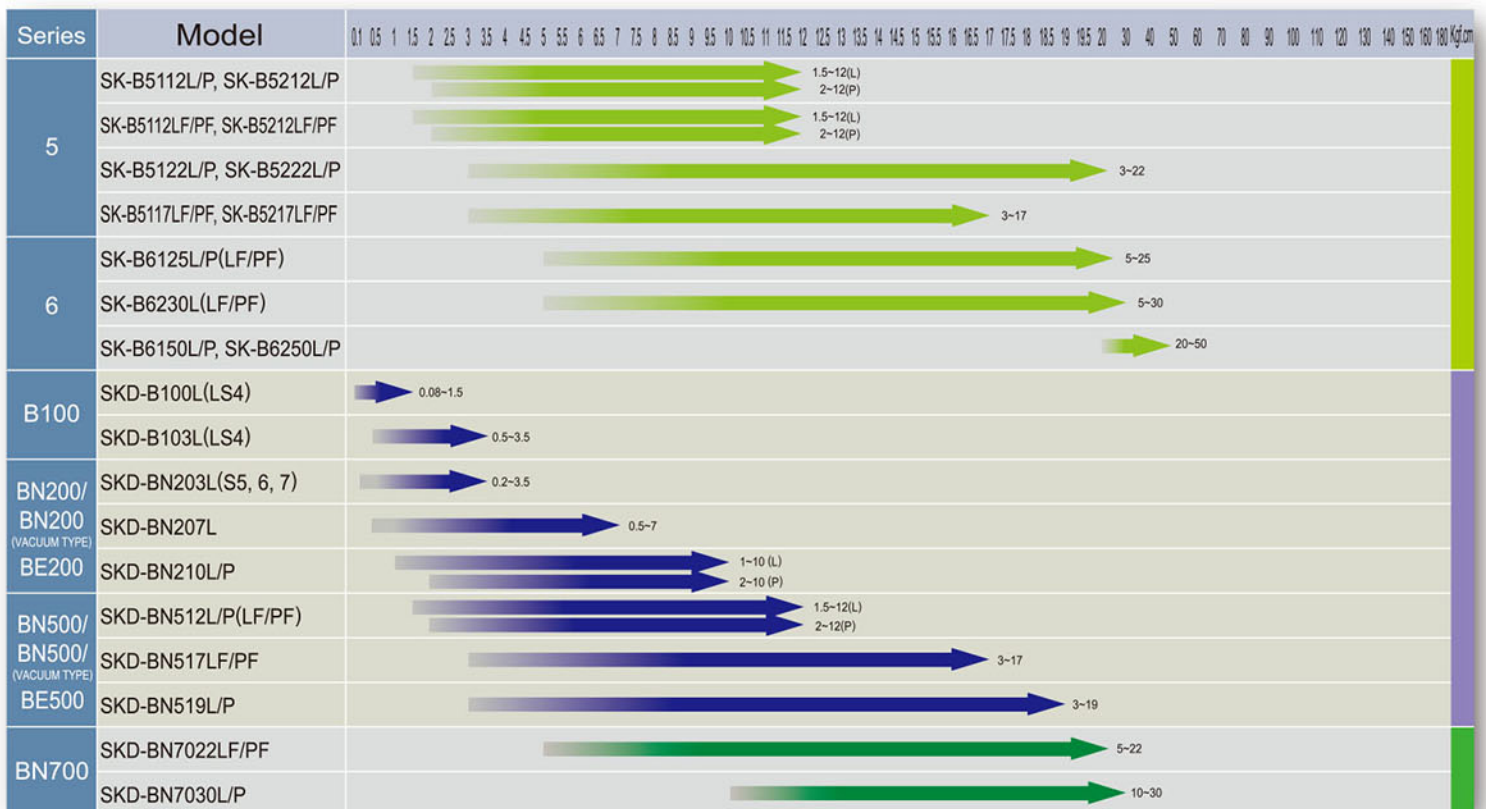

(1kgf.cm=0.098N.m, 1N.m=8.85Lbf.in, 1N.m=10.2kgf.cm)



- AC plug ; no adaptor needed.
- Torque range 1.5~22kgf.cm.
- Adopts High-Functional Brushless Motor.
- Best fit for general machine screws operation.
- High rotation speed.

External Dimension

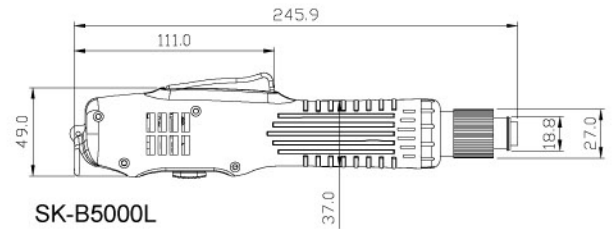

SK-B5000L

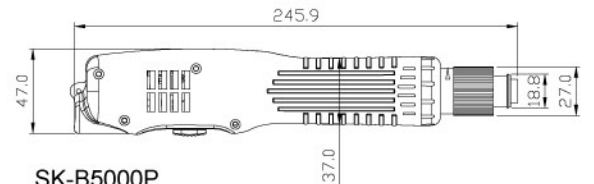

SK-B5000P

Torque Range Chart

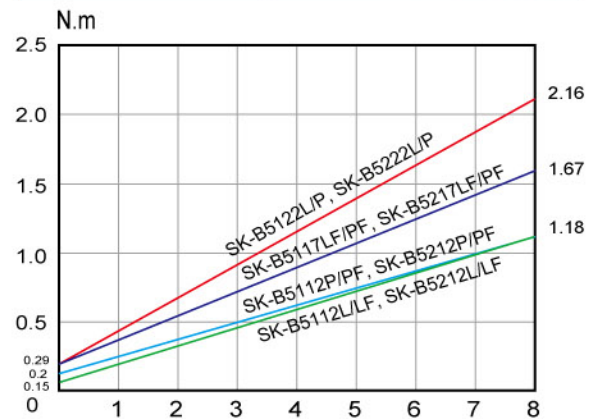

Specifications

Model		SK-B5112L SK-B5112P	SK-B5112LF SK-B5112PF	SK-B5117LF SK-B5117PF	SK-B5122L SK-B5122P	SK-B5212L SK-B5212P	SK-B5212LF SK-B5212PF	SK-B5217LF SK-B5217PF	SK-B5222L SK-B5222P
Input Voltage		AC110~120V 50/60Hz				AC220~240V 50/60Hz			
Torque	(kgf.cm)	L:1.5~12 P:2~12	L:1.5~12 P:2~12	3~17	4~22	L:1.5~12 P:2~12	L:1.5~12 P:2~12	3~17	4~22
	(Lbf.in)	L:1.33~10.44 P:1.77~10.44	L:1.33~10.44 P:1.77~10.44	2.57~14.78	3.47~19.12	L:1.33~10.44 P:1.77~10.44	L:1.33~10.44 P:1.77~10.44	2.57~14.78	3.47~19.12
	(N.m)	L:0.15~1.18 P:0.2~1.18	L:0.15~1.18 P:0.2~1.18	0.29~1.67	0.39~2.16	L:0.15~1.18 P:0.2~1.18	L:0.15~1.18 P:0.2~1.18	0.29~1.67	0.39~2.16
Repeatable Torque Accuracy(%)		±3%							
Torque Adjustment		Stepless							
Free Speed(r.p.m)		1200	2000	2000	1200	1200	2000	2000	1200
Power Consumption		0.4A				0.2A			
Screw Size Dia (mm)	Machine Screw	1.6~3.0	1.6~3.0	1.6~3.5	2.3~4.0	1.6~3.0	1.6~3.0	1.6~3.5	2.3~4.0
	Tapping Screw	1.6~2.6	1.6~2.6	1.6~3.0	2.3~3.5	1.6~2.6	1.6~2.6	1.6~3.0	2.3~3.5
Weight(g)		470							
Length(mm)		245							
ESD(Anti-Static)		-							
ETL		✓				-			
CE		-				✓			
RoHS		✓							
Bit Type		A	B	C	D				

Accessories

Torque Fixing Ring
KC-6C



Torque Adjuster
KW-3



Suspension Rack
KH-4



Spring Balancer
KL-1200



90° Degree
Attachment
KL-2
(only "L" type)



BRUSHLESS HIGH TORQUE AC-TYPE AUTOMATIC TRIGGER AND PUSH START CLUTCH TYPE SERIES

SK-B6 Series



- AC plug ; no adaptor needed.
- Torque range 5~50kgf.cm.
- Adopts High-Functional Brushless Motor.
- Best fit for general machine screws operation.
- High rotation speed.

External Dimension

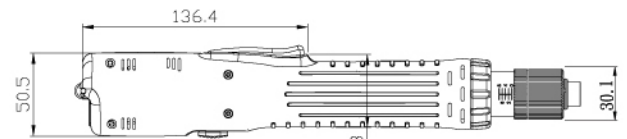

SK-B6250L

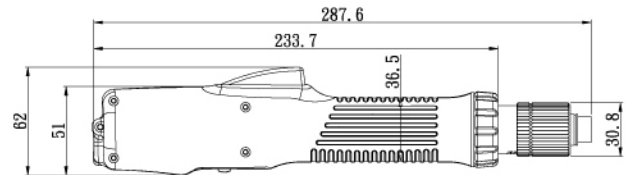

SK-B6150P

Torque Range Chart

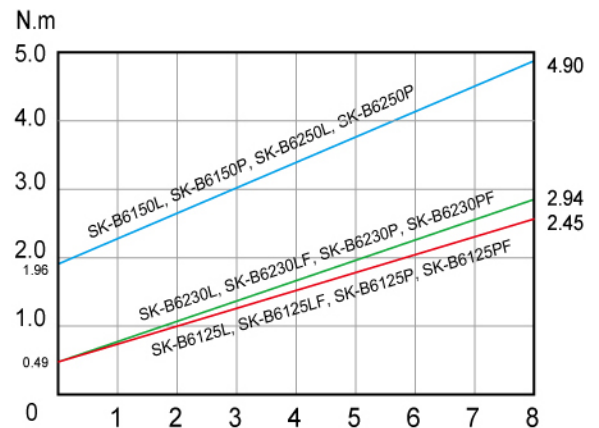

Specifications

Model		SK-B6125L SK-B6125P	SK-B6125LF SK-B6125PF	SK-B6150L SK-B6150P	SK-B6230L SK-B6230P	SK-B6230LF SK-B6230PF	SK-B6250L SK-B6250P
Input Voltage		AC110~120V 50/60Hz			AC220~240V 50/60Hz		
Torque	(kgf.cm)	5~25	5~25	20~50	10~30	10~30	20~50
	(Lbf.in)	4.34~21.68	4.34~21.68	17.35~43.37	8.67~26.02	8.67~26.02	17.35~43.37
	(N.m)	0.49~2.45	0.49~2.45	1.96~4.90	0.98~2.94	0.98~2.94	1.96~4.90
Repeatable Torque Accuracy(%)		±3%					
Torque Adjustment		Stepless					
Free Speed(r.p.m)		1000	2000	1000	1200	2000	1200
Power Consumption		0.5A			0.3A		
Screw Size Dia (mm)	Machine Screw	2.6~4.0	2.6~4.0	4.0~5.0	2.6~4.0	2.6~4.0	4.0~5.0
	Tapping Screw	2.6~3.5	2.6~3.5	≤4	2.6~3.5	2.6~3.5	≤4
Weight(g)		500			810		
Length(mm)		285			305		
ESD(Anti-Static)		-					
ETL		✓			-		
CE		-			✓		
RoHS		-			✓		
Bit Type							

Accessories

<p>Torque Fixing Ring KC-7C</p>	<p>Torque Adjuster KW-1</p>
<p>Suspension Rack KH-2</p>	<p>90° Degree Attachment KL-1(only "L" type)</p>
<p>Spring Balancer KL-1200</p>	<p>Pistol Grip LG-14 for 220V L type only</p>



External Dimension

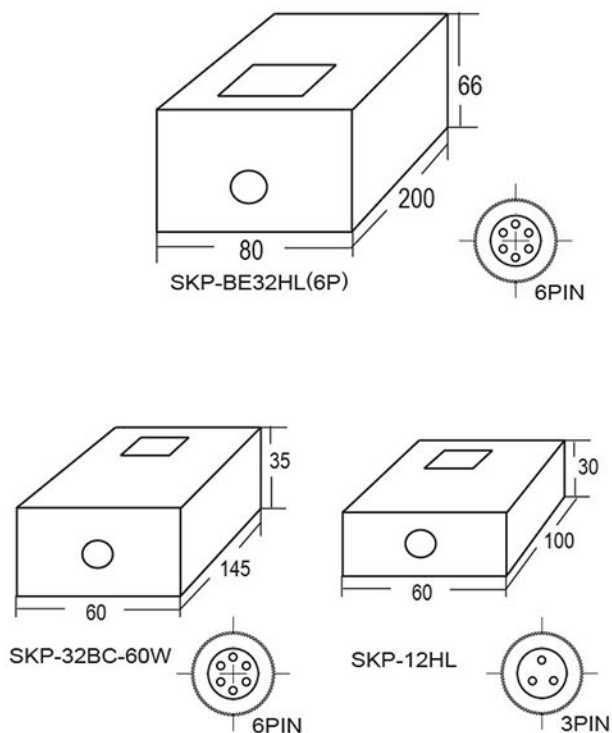

- Power switch : ON/OFF indicator. Two kinds of output voltage Hi & Lo.
- Please set the torque scale below 4 for operation when the voltage of SKP series is set as Lo or below 32V.
- Support variant plug type for different country.

Specifications

Model	SKP-12HL	SKP-32BC-60W	SKP-BE32HL(6P)
Input Voltage	AC 100-240V 50/60Hz	AC 100-240V 50/60Hz	AC 100-240V 50/60Hz
Output Voltage	LO DC 9V / HI DC 12V	LO DC 24V / HI DC 32V	LO DC 24V / HI DC 32V
Capacity	2.5A	1.8A MAX	3A MAX
Outside Dimensions	100X50X35(mm)	145X60X35(mm)	200X80X66(mm)
Weight(g)	144.5(main body)	250(main body)	460(main body)
AC Cord Length	2M with ground	2M with ground	2M with ground

Remark (optional)



Applicable Models

SKD-B100 Series

SKD-BN200 Series
SKD-BE200 Series
SKD-BN500 Series
(not included F type series)
SKD-BE500 Series
(not included F type series)

SKD-BN200 Series
SKD-BE200 Series
SKD-BN500 Series
SKD-BE500 Series
SKD-BN7000 Series

Plug Feature

(U.S.A plug)

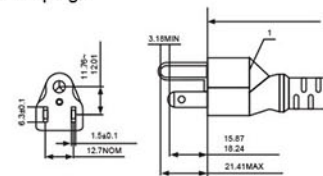

(EUROPE plug)

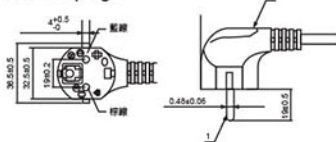

(INDIA plug)

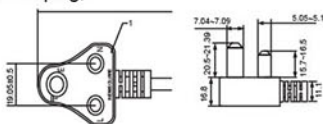

(AUSTRALIA plug)



(U.K plug)

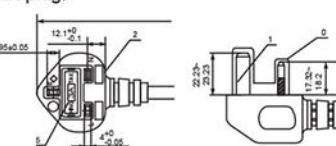

BRUSHLESS MINI TORQUE DC-TYPE AUTOMATIC TRIGGER START CLUTCH TYPE SERIES

SKD-B100 Series

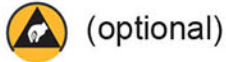

(optional)

First smallest brushless DC-12V screwdriver in the world



- Adopting the high function of innovation and brushless feature. Durable and permanent life-time. Motor maintenance is unnecessary.
- Small and light weight, noiseless, streamlined appearance, high stability and easy to use.
- First creation of the most smallest and lightest brushless feature.
- First innovation of Forward/Reverse switch modes. Screws can be loosed easily just in a moment without switching the switches' modes.
- Two lowest torque specifications: 0.08~1.5Kgf.cm / 0.5~3.5Kgf.cm. Best choice for producing high precision products, such as watches, high precision hard-driver and etc.
- Certification: ETL and CE

External Dimension

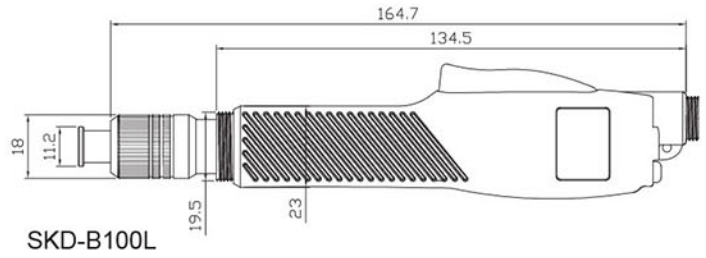

Torque Range Chart

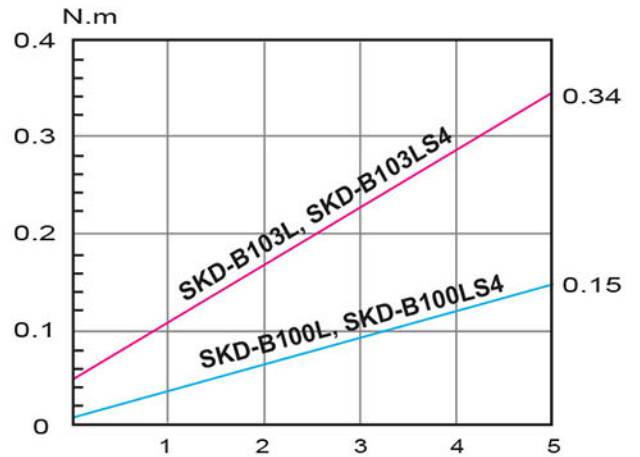

Specifications

Model		SKD-B100L	SKD-B103L	SKD-B100LS4	SKD-B103LS4
Input Voltage		DC9V or DC12V			
Torque	(kgf.cm)	0.08~1.5	0.5~3.5	0.08~1.5	0.5~3.5
	(Lbf.in)	0.07~1.33	0.44~3.01	0.07~1.33	0.44~3.01
	(N.m)	0.008~0.15	0.05~0.34	0.008~0.15	0.05~0.34
Repeatable Torque Accuracy(%)		±5%			
Torque Adjustment		Stepless			
Free Speed (r.p.m)	HI	1000	1000	280	280
	LO	700	700	200	200
Screw Size Dia (mm)	Machine Screw	1.0~1.7	1.0~2.3	1.0~1.7	1.0~2.3
	Tapping Screw	1.0~1.5	1.0~2.0	1.0~1.5	1.0~2.0
Weight(g)		170			
Length(mm)		165			
Power Controller		SKP-12HL			
ESD(Anti-Static)		✓(with black housing)			
CE		✓			
RoHS		✓			
Bit Type					



Accessories



Power Controller Specification

Model	SKP-12HL
Input Voltage	AC100~240V 50/60Hz
Output Voltage	Lo DC9V / Hi DC12V
Capacity	2.5A
Size	105X50X35
Weight	144.5g
Cord Length	2M



- Adopts High-Functional Brushless Motor, marvelous lifespan and strong durability to repair and maintenance almost needless.
- Smaller size, light weight, low noise-pollution, fashionable design, high stability and easy operation motor which gives the benefit of longer working-time. (3 years warranty on motor)
- Brushless Motor has more stable torque output : It is best to fit for operating in clean-room circumstance and no worry of pollution will be arisen.
- Best tool to assemble Watch, Laptop, Digital Camera, DVD Player, Cell Phone, Communication Equipment and High tech Products which need to be assembled in clean-room.
- CE and ETL are optional

External Dimension

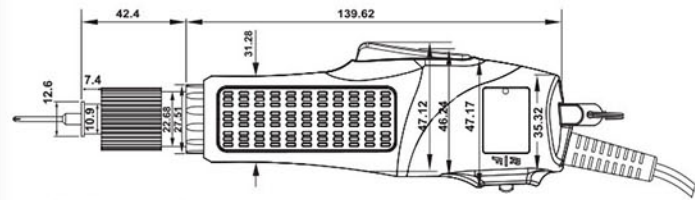

SKD-BN200L

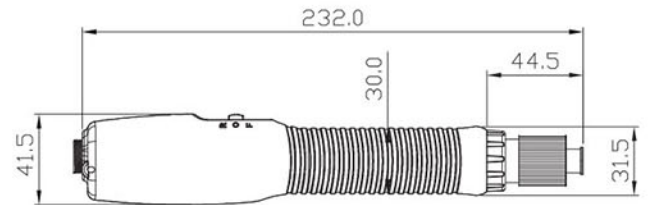

SKD-BN200P

Torque Range Chart

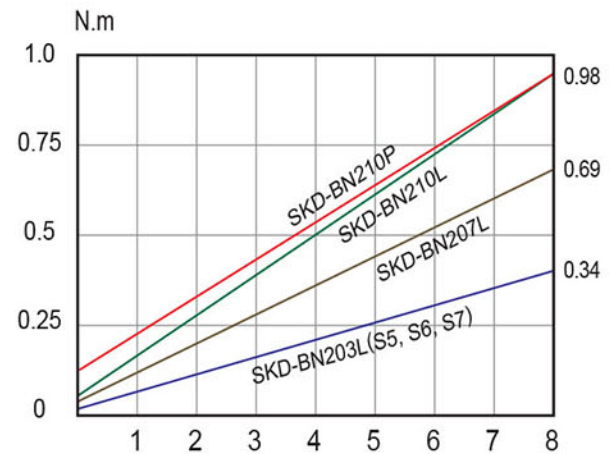

Specifications

Model		SKD-BN203L	SKD-BN203LS5	SKD-BN203LS6	SKD-BN203LS7	SKD-BN207L	SKD-BN210L/P
Input Voltage		DC24V or DC32V					
Power Consumption		25W					
Torque	(kgf.cm)	0.2~3.5	0.2~3.5	0.2~3.5	0.2~3.5	0.5~7	L: 1~10 / P: 2~10
	(Lbf.in)	0.18~3.01	0.18~3.01	0.18~3.01	0.18~3.01	0.44~6.10	L: 0.89~8.67 / P: 1.77~8.67
	(N.m)	0.02~0.34	0.02~0.34	0.02~0.34	0.02~0.34	0.05~0.69	L: 0.10~0.98 / P: 0.2~0.98
Repeatable Torque Accuracy(%)		±3%					
Torque Adjustment		Stepless					
Free Speed (r.p.m)	HI	1000	500	370	230	1000	1000
	LO	700	350	260	160	700	700
Screw Size Dia (mm)	Machine Screw	1.0~2.3	1.0~2.3	1.0~2.3	1.0~2.3	1.4~2.6	1.6~3.0
	Tapping Screw	1.0~2.0	1.0~2.0	1.0~2.0	1.0~2.0	1.4~2.3	1.6~2.6
Weight(g)		L:330 P:310					
Length(mm)		L:185 P:230					
ESD(Anti-Static)		✓ (with black housing)					
CE		✓					
RoHS		✓					
Bit Type							

Accessories



※SKD-BN203LS5 can not work with KL-SSBN slow start control module

BRUSHLESS MEDIUM TORQUE DC-TYPE AUTOMATIC TRIGGER AND PUSH START CLUTCH TYPE SERIES



SKD-BN500 Series



- Adopts High-Functional Brushless Motor, marvelous lifespan and strong durability to repair and maintenance almost needless.
- Smaller size, light weight, low noise-pollution, fashionable design, high stability and easy operation motor which gives the benefit of longer working-time. (3 years warranty on motor)
- Brushless Motor has more stable torque output : It is best to fit for operating in clean-room circumstance and no worry of pollution will be arisen.
- Best tool to assemble Watch, Laptop, Digital Camera, DVD Player, Cell Phone, Communication Equipment and High tech Products which need to be assembled in clean-room.
- CE and ETL are optional

External Dimension

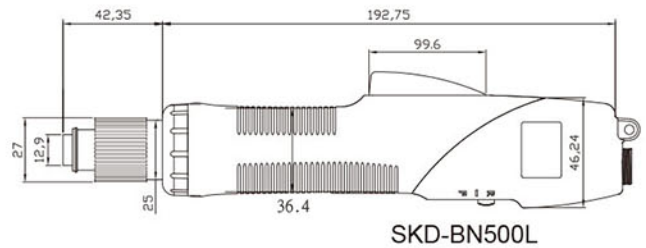

SKD-BN500L

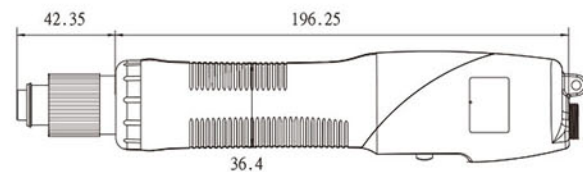

SKD-BN500P

Torque Range Chart

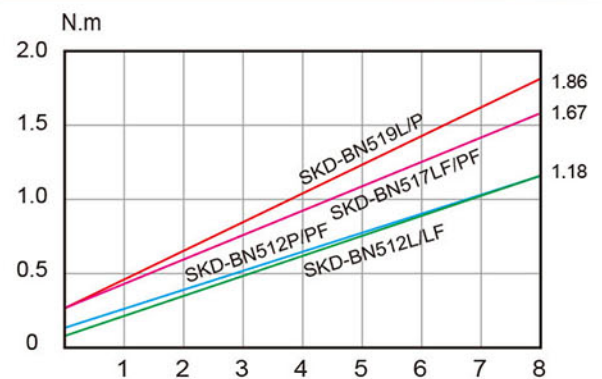

Specifications

Model		SKD-BN512L	SKD-BN512P	SKD-BN512LF	SKD-BN512PF	SKD-BN517LF/PF	SKD-BN519L/P
Input Voltage		DC24V or DC32V					
Power Consumption		55W					
Torque	(kgf.cm)	1.5~12	2~12	1.5~12	2~12	3~17	3~19
	(Lbf.in)	1.33~10.44	1.77~10.44	1.33~10.44	1.77~10.44	2.57~14.78	2.57~16.46
	(N.m)	0.15~1.18	0.2~1.18	0.15~1.18	0.2~1.18	0.29~1.67	0.29~1.86
Repeatable Torque Accuracy(%)		±3%					
Torque Adjustment		Stepless					
Free Speed (r.p.m)	HI	1000	1000	2000	2000	2000	1000
	LO	700	700	—	—	—	700
Screw Size Dia (mm)	Machine Screw	1.6~3.0	1.6~3.0	1.6~3.0	1.6~3.0	1.6~3.0	2.3~3.5
	Tapping Screw	1.6~2.6	1.6~2.6	1.6~2.6	1.6~2.6	1.6~2.6	2.3~3.0
Weight(g)		520					
Length(mm)		245					
ESD(Anti-Static)		✓ (with black housing)					
CE		✓					
RoHS		✓					
Bit Type							

Accessories

Torque Fixing Ring KC-6C 	Torque Adjuster KW-3
Suspension Rack KH-4 	Spring Balancer KL-1200
90° Degree Attachment KL-2 	Pistol Grip LG-10, PG-10
Power Controller 	

SKD-BE200 Series



- (optional)
- Brushless motor, the perfect combination of screw counter and electric screwdriver, and most fit for operating in the clean room environment.
- Torque range from 0.2~10Kgf.cm is medium & small-sized screwdrivers. Widespread and extensively applied by users.
- SKD-BE series is one compact of LED counter and electric screwdriver. Two-color housing, easy to operate, suitably used on production line and effectively control numbers of fastening screws and operation quality.
- Easy to set up, complete function, user can set up this counter according to needs of work and leave system automatically to inspect the precision of fastened screws.
- This system can set up Effective Count Number(SC), Automatic Zero(At), Slow Start Time(RC), Slow Start Speed(L0), Start Detect Time(Lt), Stop Time(Ht), Double Confirm Time after Fastening(LL), Waiting Time between Two Screws. Professional designs for the needs of users.
- Automatic Learning can complete necessary time from start to fasten, let user confirm whether it is an ideal fastening value.
- Signal output by OK ALL/OK ONE/N.G. in the screwdrivers, open collector. The user can select another wire to connect PLC if necessary.
- If start time doesn't stop as over Ht time, that means stripped or wrong screw ; If start time stops before Lt time, that means screws stuck or wrong. This function can effectively determine whether screw fastening is right or wrong.
- After setting up screws fastening, shut-off can be confirmed just one time during pre-set time.
- CE and ETL are optional

External Dimension

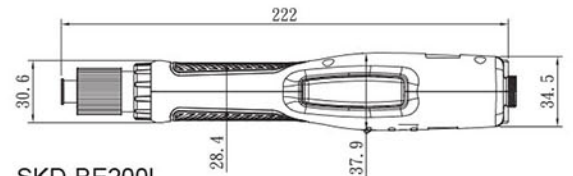

SKD-BE200L

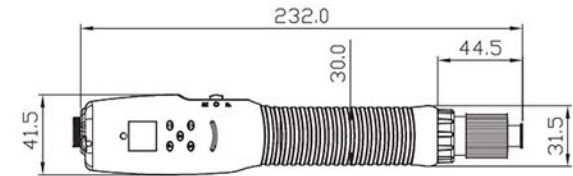

SKD-BE200P

Torque Range Chart

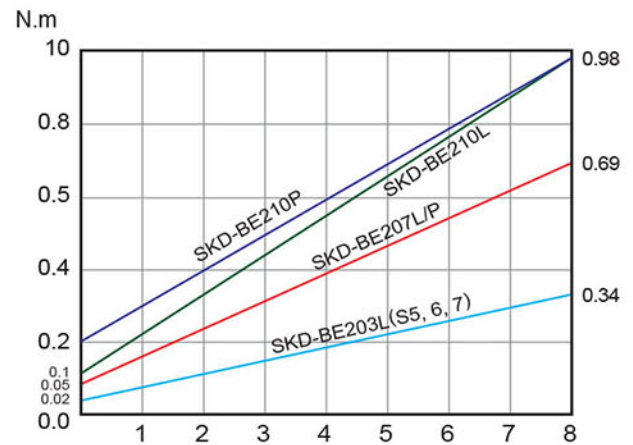

Specifications

Model		SKD-BE203L	SKD-BE203LS5	SKD-BE203LS6	SKD-BE203LS7	SKD-BE207L	SKD-BE210L/P
Input Voltage		DC24V or DC32V					
Power Consumption		25W					
Torque	(kgf.cm)	0.2~3.5	0.2~3.5	0.2~3.5	0.2~3.5	0.5~7	L: 1~10 / P: 2~10
	(Lbf.in)	0.18~3.01	0.18~3.01	0.18~3.01	0.18~3.01	0.44~6.10	L: 0.89~8.67 / P: 1.77~8.67
	(N.m)	0.02~0.34	0.02~0.34	0.02~0.34	0.02~0.34	0.05~0.69	L: 0.10~0.98 / P: 0.2~0.98
Repeatable Torque Accuracy(%)		±3%					
Torque Adjustment		Stepless					
Free Speed (r.p.m)	HI	1000	500	370	230	1000	1000
	LO	700	350	260	160	700	700
Screw Size Dia (mm)	Machine Screw	1.0~2.3	1.0~2.3	1.0~2.3	1.0~2.3	1.4~2.6	1.6~3.0
	Tapping Screw	1.0~2.0	1.0~2.0	1.0~2.0	1.0~2.0	1.4~2.3	1.6~2.6
Weight(g)		330					
Length(mm)		LC:226 / LB:240					
ESD(Anti-Static)		✓ (with black housing)					
CE		✓					
RoHS		✓					
Bit Type							

Accessories

Torque Fixing Ring KC-13C

Torque Adjuster KW-4

Suspension Rack KH-5

Spring Balancer KL-600

Power Controller SKP-32BC-60W

**Please contact with your agent for special customization version.

SKD-BE500 Series



- Brushless motor, the perfect combination of screw counter and electric screwdriver, and most fit for operating in the clean room environment.
- Torque range from 1.5~19Kgf.cm is medium & small-sized screwdrivers. Widespread and extensively applied by users.
- SKD-BE series is one compact of LED counter and electric screwdriver. Two-color housing, easy to operate, suitably used on production line and effectively control numbers of fastening screws and operation quality.
- Easy to set up, complete function, user can set up this counter according to needs of work and leave system automatically to inspect the precision of fastened screws.
- This system can set up Effective Count Number(SC), Automatic Zero(At), Start Detect Time(Lt), Stop Time(Ht), Double Confirm Time after Fastening(LL), Waiting Time between Two Screws. Professional designs for the needs of users.
- Automatic Learning can complete necessary time from start to fasten, let user confirm whether it is an ideal fastening value.
- Signal output by OK ALL/OK ONE/N.G. in the screwdrivers, open collector. The user can select another wire to connect PLC if necessary.
- If start time doesn't stop as over Ht time, that means stripped or wrong screw ; If start time stops before Lt time, that means screws stuck or wrong. This function can effectively determine whether screw fastening is right or wrong.
- After setting up screws fastening, shut-off can be confirmed just one time during pre-set time.
- CE and ETL are optional

External Dimension

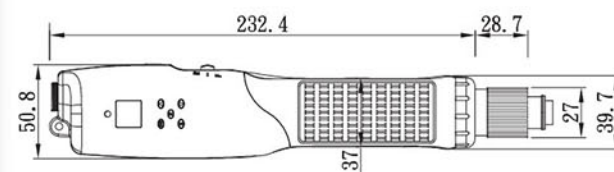

SKD-BE500P(6P)

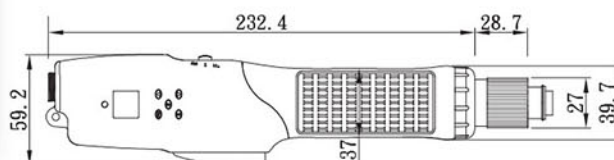

SKD-BE500L(6L)

Torque Range Chart

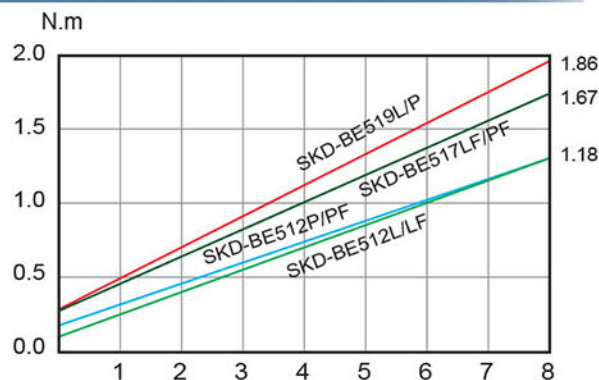

Accessories

Torque Fixing Ring KC-6C

Torque Adjuster KW-3

Suspension Rack KH-4

Spring Balancer KL-1200

Power Controller SKP-32BC-60W (not included F type series)

Pistol Grip LG-11, PG-11

SKP-BE32HL(6P)

Specifications

Model		SKD-BE512L(6P)	SKD-BE512P(6P)	SKD-BE512LF(6P)	SKD-BE512PF(6P)	SKD-BE517LF(6P)	SKD-BE517PF(6P)	SKD-BE519L(6P)	SKD-BE519P(6P)
Input Voltage		DC24V or DC32V							
Power Consumption		55W							
Torque	(kgf.cm)	1.5~12	2~12	1.5~12	2~12	3~17	3~17	3~19	3~19
	(Lbf.in)	1.33~10.44	1.77~10.44	1.33~10.44	1.77~10.44	2.57~14.78	2.57~14.78	2.57~16.46	2.57~16.46
	(N.m)	0.15~1.18	0.2~1.18	0.15~1.18	0.2~1.18	0.29~1.67	0.29~1.67	0.29~1.86	0.29~1.86
Repeatable Torque Accuracy(%)		±3%							
Torque Adjustment		Stepless							
Free Speed (r.p.m)	HI	1000	1000	2000	2000	2000	2000	1000	1000
	LO	700	700	—	—	—	—	700	700
Screw Size Dia (mm)	Machine Screw	1.6~3.0	1.6~3.0	1.6~3.0	1.6~3.0	1.6~3.0	1.6~3.0	2.3~3.5	2.3~3.5
	Tapping Screw	1.6~2.6	1.6~2.6	1.6~2.6	1.6~2.6	1.6~2.6	1.6~2.6	2.3~3.0	2.3~3.0
Weight(g)		580							
Length(mm)		270							
ESD(Anti-Static)		✓ (with black housing)							
CE		✓							
RoHS		✓							
Bit Type									

****Please contact with your agent for special customization version.**

KILEWS BRUSHLESS LOW TORQUE DC-TYPE AUTOMATIC VACUUM SCREWDRIVERS

SKD-BN200 (VACUUM TYPE) Series



- Vacuum screwdriver was taking the series of SKD-BN200L/P as reference and being created by adding the vacuum head. The main purpose is sucking the non-magnetic screws, such as plastic screws / aluminum-made screws / stainless steel screws and any other screws that does not contain magnetic.
- Any type and specification of screws can be sucked which only need to replace the head to KS-2B.
- The suction of vacuum pump is powerful; if the screws tray is using together, it will be more convenient and easy. The screws can be placed at the tray first and then sucked by the vacuum screwdriver.
- CE and ETL are optional

External Dimension

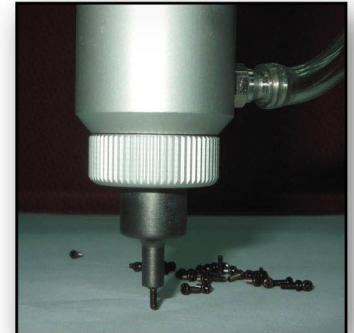
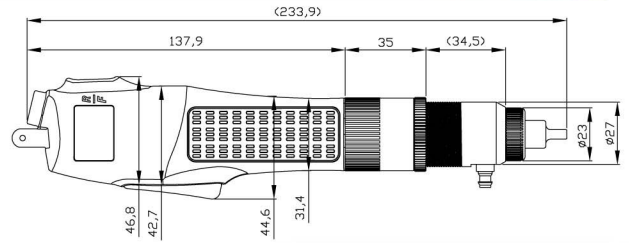

**Please contact with your agent for special customization

Specifications

Mode		SKD-BN203L(VACUUM TYPE)	SKD-BN207L(VACUUM TYPE)	SKD-BN210L(VACUUM TYPE)	SKD-BN203LS5(VACUUM TYPE)	SKD-BN203LS6(VACUUM TYPE)	SKD-BN203LS7(VACUUM TYPE)
Input Voltage		DC24V or DC32V					
Torque	(kgf.cm)	0.2~3.5	0.5~7	1~10	0.2~3.5	0.2~3.5	0.2~3.5
	(Lbf.in)	0.18~3.01	0.44~6.10	0.89~8.67	0.18~3.01	0.18~3.01	0.18~3.01
	(N.m)	0.02~0.34	0.05~0.69	0.10~0.98	0.02~0.34	0.02~0.34	0.02~0.34
Repeatable Torque Accuracy(%)		±3%					
Torque Adjustment		Stepless					
Free Speed (r.p.m)	HI	1000	1000	1000	500	370	230
	LO	700	700	700	350	260	160
Screw Size Dia (mm)	Machine Screw	1.0~2.3	1.4~2.6	1.6~3.0	1.0~2.3	1.0~2.3	1.0~2.3
	Tapping Screw	1.0~2.0	1.4~2.3	1.6~2.6	1.0~2.0	1.0~2.0	1.0~2.0
Power Consumption		25W					
Weight(g)		385					
Length(mm)		234					
ESD(Anti-Static)		✓ (with black housing)					
CE		✓					
RoHS		✓					
Power Controller		SKP-32BC-60W					
Bit Type							

BRUSHLESS MEDIUM TORQUE DC-TYPE AUTOMATIC VACUUM SCREWDRIVERS



SKD-BN500 (VACUUM TYPE) Series



- Vacuum screwdriver was taking the series of SKD-BN500L/P as reference and being created by adding the vacuum head. The main purpose is sucking the non-magnetic screws, such as plastic screws / aluminum-made screws / stainless steel screws and any other screws that does not contain magnetic.
- Any type and specification of screws can be sucked which only need to replace the head to KS-5B.
- The suction of vacuum pump is powerful; if the screws tray is using together, it will be more convenient and easy. The screws can be placed at the tray first and then sucked by the vacuum screwdriver.
- CE and ETL are optional

External Dimension

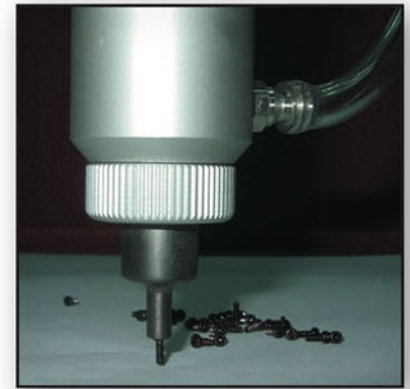
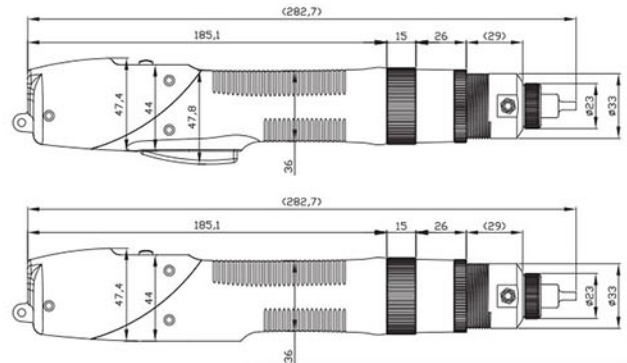

KS-5B



Bit nozzle specification

PART NO	d1	d2	D	H	Bit Dia (mm) T x D x L
P11032	2.2	3	4	1.3	00X1.5X60
P11032-1	2.7	4	5	1.5	0X2.0X60
P11032-2	3.2	4.5	5.5	2	1X2.5X60
P11032-3	3.7	5.8	6.8	3	BN200:1X3.0X60 BN500:2X3.0X60

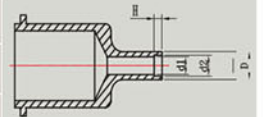

**Please contact with your agent for special customization

Specifications

Model		SKD-BN512L (VACUUM TYPE)	SKD-BN512P (VACUUM TYPE)	SKD-BN519L/P (VACUUM TYPE)	SKD-BN517L/P/PF (VACUUM TYPE)	SKD-BN512LF (VACUUM TYPE)	SKD-BN512PF (VACUUM TYPE)
Input Voltage		DC24V or DC32V					
Torque	(kgf.cm)	1.5~12	2~12	3~19	3~17	1.5~12	2~12
	(Lbf.in)	1.33~10.44	1.77~10.44	2.57~16.46	2.57~14.78	1.32~10.44	1.77~10.44
	(N.m)	0.15~1.18	0.2~1.18	0.29~1.86	0.29~1.67	0.15~1.18	0.2~1.18
Repeatable Torque Accuracy(%)		±3%					
Torque Adjustment		Stepless					
Free Speed (r.p.m)	HI	1000	1000	1000	2000	2000	2000
	LO	700	700	700	—	—	—
Screw Size Dia (mm)	Machine Screw	1.6~3.0	1.6~3.0	2.3~3.5	1.6~3.0	1.6~3.0	1.6~3.0
	Tapping Screw	1.6~2.6	1.6~2.6	2.3~3.0	1.6~2.6	1.6~2.6	1.6~2.6
Power Consumption		55W					
Weight(g)		520					
Length(mm)		283					
ESD(Anti-Static)		✓ (with black housing)					
CE		✓					
RoHS		✓					
Power Controller		SKP-32BC-60W		SKP-BE32HL(6P)			
Bit Type							



External Dimension

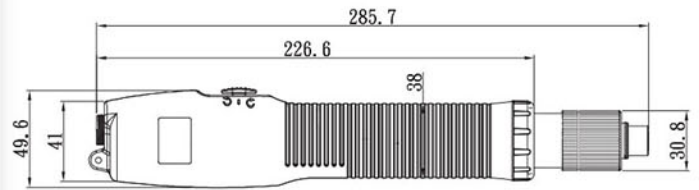

SKD-BN7000P

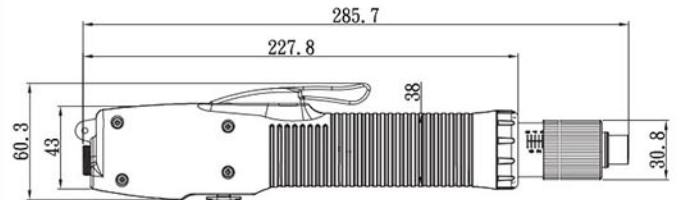

SKD-BN7000L

Torque Range Chart

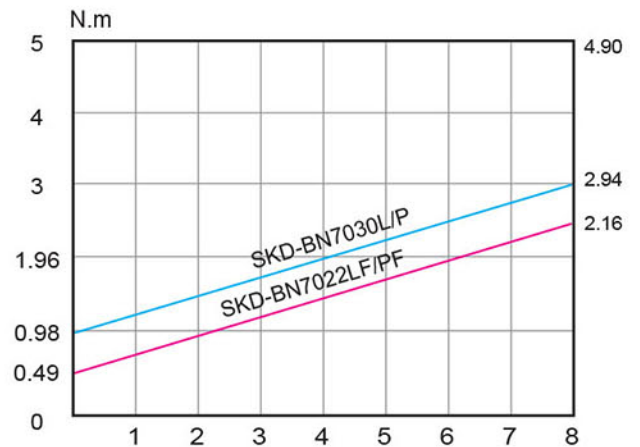

- Brushless feature is applicable in a clean-room environment. The output of torque is highly stable. It is not only a easy-operate equipment but also be operated continuously for a long period.
- One LED on the housing is to remind the operators that the screwdriver is connecting to the power controller.
- Besides, it is a non-carbon, low-noise equipment, and low voltage.
- The best choice when composing the vertical's internal parts and/or any large-size electric equipments, including home appliances, LED/LCD panels and etc.
- CE and ETL are optional

Specifications

Model		SKD-BN7022LF/PF	SKD-BN7030L/P
Input Voltage		DC24V/32V	
Power Consumption		55W	
Torque	(kgf.cm)	5~22	10~30
	(Lbf.in)	4.33~19.12	8.67~26.02
	(N.m)	0.49~2.16	0.98~2.94
Repeatable Torque Accuracy(%)		±3%	
Torque Adjustment		Stepless	
Free Speed (r.p.m)	HI	2000	1200
	LO		900
Screw Size Dia (mm)	Machine Screw	2.6~4.0	2.6~4.0
	Tapping Screw	2.6~3.5	2.6~3.5
Weight(g)		790	
Length(mm)		290	
ESD(Anti-Static)		✓(with black housing)	
CE		—	✓
RoHS		✓	
Power Controller		SKP-BE32HL(6P)	
Bit Type			

Accessories



Introduction

In order to achieve accurate counting on screw fastening and work together with PLC based process control, KILEWS integrate screw counter, power supply, and slow start function into unique device which is both power supply and screw counter as well. Our screw counters are designed more conveniently and perfectly to meet users' practicability and availability.

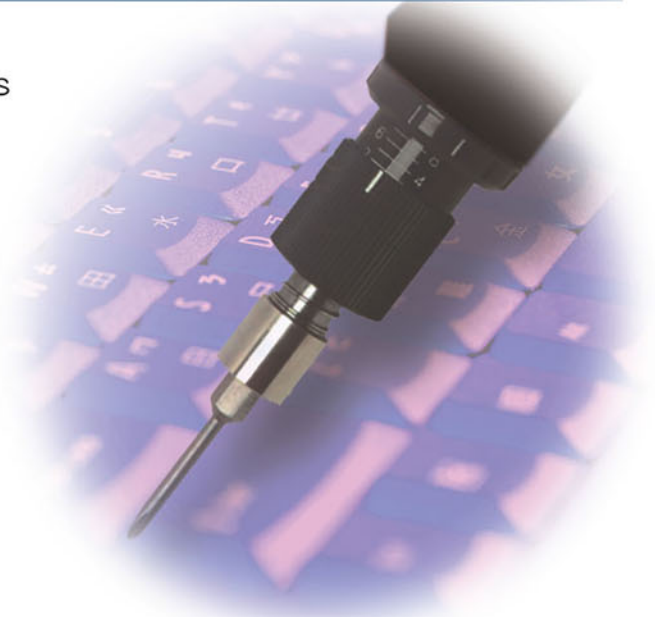

Features of SKP-BC32HL-100(V3.0)

- High / Low speed switch / Hi/Lo voltage switch protection function
- Slow start time (0.0-9.9 second)
- Slow start speed Level (L0:100%, 35%~85% L1~L9 Rated speed)
- Target reached Confirm (enable / disable)
- Input / Output function control
- External start Input Control
- External reverse Input Control
- External enable Input Control
- External confirm Input Control
- Expanding 5 sets data memory
- Auto-Learning function for time monitoring
- Before tightening reverse
- After tightening reverse
- Counting mode (count up / count down)
- Signal output (OK 1/ OK ALL / NG)
- Cancel NG signal (Use external Clear or Confirm button to cancel NG signal)
- Operation complete time
- Self locking when counter detect error (enable / disable)
- Sensor mode (Applications according to different operation use)
- Error code by monitoring
- Strong anti-interference capability

****Please contact with your agent for special customization version.**



SKP-BC32HL-100(V3.0)

SKD-BN203L

SKD-BN207L

SKD-BN210L

SKD-BN512L

SKD-BN512P

SKD-BN519L

SKD-BN519P

SKD-BN512LF

SKD-BN512PF

SKD-BN517LF

SKD-BN517PF

SKD-BN7030L

SKD-BN7030P

SKD-BN7022LF

SKD-BN7022PF





SCREW COUNTER (FOR BRUSHLESS SCREWDRIVERS) SKP-BC32HL-100(V3.0) [Counter / Power Supply / Slow-Start]

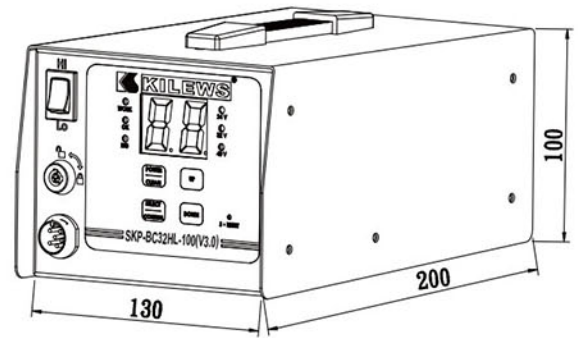

EXTERNAL DIMENSION



Specifications

Model	SKP-BC32HL-100(V3.0)
Input Voltage	AC 100~240V 50/60HZ
Output Voltage	DC 32V / 24V 1.875A
Power Consumption	60W
Count	1~99
Count method	Count-up / Count-down
Work with Sensor	ON / OFF
GATE Sensor	ON(2 Sensors) / OFF(1 Sensor)
Slow-start time adjustable	0~9.9 seconds
Slow-start speed adjustable	L0 : 100%, 35%~85% L1~L9 Rated speed
Running Time limit-LO	0.00~9.99 seconds
Running Time limit-HI	0.0~9.9 seconds
Reminder Mode	ON / OF / FF / EF with LED and buzzer
Auto ZERO	ON / OFF
External inputs	Forward / Reverse / Disable / Confirm / Sensor / Clear
External outputs	OK / NG / OK ALL
Screwdriver Control	HI / LO : Slow-Start
Outside Dimensions	200X130X100(mm)
Weight(Kg)	1.57
Accessories	Power cordX1 \ KeyX2
Remark	  
Applicable Models	SKD-BN200(Series) SKD-BN500(Series) SKD-BN7000(Series)





External Dimension

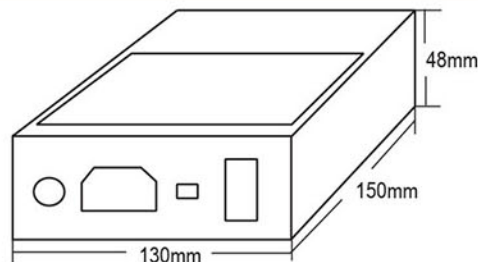

Specifications

Model		SKD-BC203L	SKD-BC207L	SKD-BC210L/P
Torque	(kgf.cm)	0.2~3.5	0.5~7	L:1~10 / P:2~10
	(Lbf.in)	0.18~3.01	0.44~6.10	L:0.89~8.67 / P:1.77~8.67
	(N.m)	0.02~0.34	0.05~0.69	L:0.10~0.98 / P:0.2~0.98
Free Speed (r.p.m)	HI	1000	1000	1000
	LO	700	700	700
Screw Size Dia (mm)	Machine Screw	1.0~2.3	1.4~2.6	1.6~3.0
	Tapping Screw	1.0~2.0	1.4~2.3	1.6~2.6
Weight(g)		L:330 P:310		
Length(mm)		L:185 P:230		

Model		SKD-BC512L	SKD-BC519L	SKD-BC512P	SKD-BC519P
Torque	(kgf.cm)	1.5~12	3~19	2~12	3~19
	(Lbf.in)	1.33~10.44	2.57~16.46	1.77~10.44	2.57~16.46
	(N.m)	0.15~1.18	0.29~1.86	0.2~1.18	0.29~1.86
Free Speed (r.p.m)	HI	1000	1000	1000	1000
	LO	700	700	700	700
Screw Size Dia (mm)	Machine Screw	1.6~3.0	2.3~3.5	1.6~3.0	2.3~3.5
	Tapping Screw	1.6~2.6	2.3~3.0	1.6~2.6	2.3~3.0
Weight(g)		520	520	520	520
Length(mm)		245	245	245	245

Specifications

Model	SKP-BC32HL
Input Voltage	AC 100V~240V 50/60Hz
Output Voltage	DC 32V/24V 1.8A/3A
Power Consumption	60W
Count	1~99
Count method	Count-up/Count-down
Work with Sensor	ON/OFF
GATE Sensor	ON(2Sensor)/OFF(1Sensor)
Slow-start time adjustable	0~9.9 seconds
Slow-start speed adjustable	L0 : 100%, 30%~80% L1~L9 Rated Speed
Running Time limit-LO	0.00~9.99 seconds
Running Time limit-HI	0.0~9.9 seconds
Reminder Mode	ON/OFF/FF/EF with LED and buzzer
Auto ZERO	ON/OFF
External inputs	Sensor/Reset
External outputs	OK/NG/OK ALL
Screwdriver Control	HI/LO : Slow-Start
Weight(kg)	0.84kg
Outside Dimensions	150X48X130(mm)
Accessories	Power cordX1 Suspension bailX2 Terminal BlockX1
Remark	

Features

- Auto detect missing screw, screw stripped, floating lock and wrong choosing of screw.
- Selectable, auto-reset or manual reset.
- Suitable for operation in the clean room.
- The most complete function system such as the setting for SL, SC, RC, SP, auto reply the output timing AT, LT, HT, LL. This is the most professional design and choice.
- Slow-start function, which is able to set slow-start time and rotation speed level from L0-L9 to control the screwdriver start from low speed to normal rotation speed.
- Auto-Learning function, to measure the time for screw fastening, is convenient when the users simulate the time of the screw fastening for the special screws.
- Expanding 5 sets data memory. The users can choose single set to operate or 5 sets to operate cyclically like as one screwdriver used as 5 in 1. It's the best choice of screws counter.
- Displaying the quantity of unfinished or fastened screws, and the users can add external sensor switch to avoid any mistake from shortage of screw fastening. And it is able to prompt user automatically while the fastening job is done as setting. Screw counting is also able to connect external devices.
- Setting output input signal (Open Collector) such function is suitable for semi or full automatic. Production line and function for contact point of relay, to prevent operator from improper operation. And make an accurate calculation by signal of sensor.
- Enable to connect with external PLC system to make production line humanistic. Calculate the screws numbers which must be fastened by computer to avoid any unnecessary neglect of screw fastening.
- This system provides DC voltage which can connect to CN1(V+) and CN5(COM) to use the voltage.
- Prevent the screw fastening mistake and can connect the sensor to detect the mistake when the screws fastening, then force to shut-down and show warning message.

TORQUE METERS

KTM-15, KTM-150, KTM-250

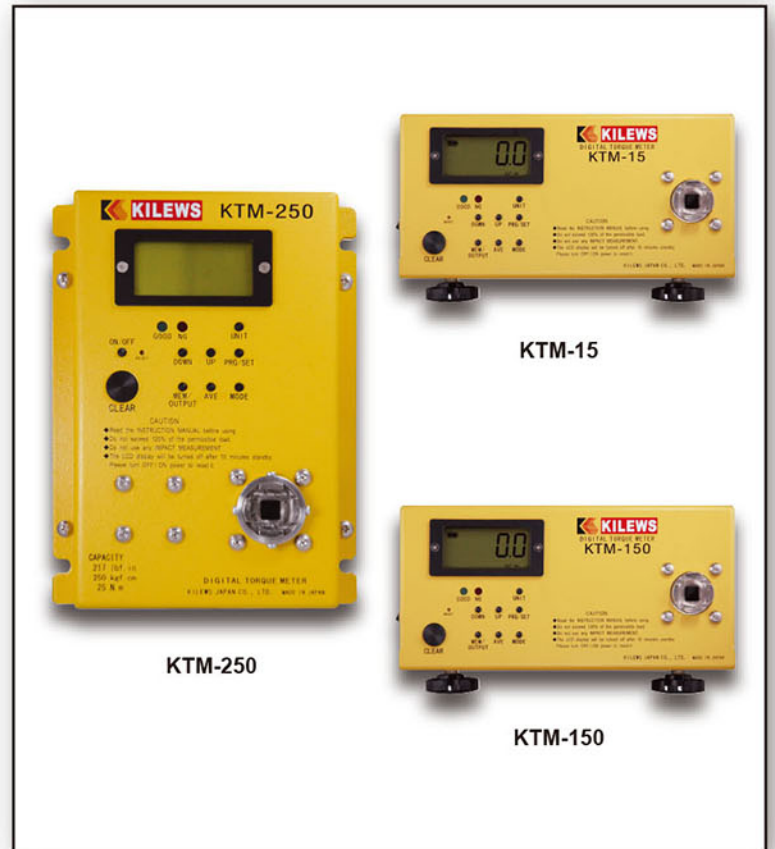

● The torque meters are directly produced in Japan, authorized by Kilews Industrial Co., Ltd. by ODM. Each product will be provided with an Adjustment Certificate and one year Warranty in normal using. Take Note! These measuring instruments could not be applied in testing the pneumatic screwdriver products and prohibited in measuring the torque exceeding maximum measuring range of torque meters.

KTM-15, KTM-150, KTM-250,

- LED can identify the test range of torque setting by needed user. If the result is not complying to torque range setting, light will be warned.
- USB connector is only used for data output : it is convenient for user to work with computer.
- Auto-zero can be selected and zero reset becomes unnecessary for user.
- Automatically test values about maximum, minimum and mean.

Specifications

Model		KTM-250	KTM-150	KTM-15
Measuring Ranges	(kgf.cm)	3.0~250.0	1.5~150.0	0.15~15.0
	(Lbf.in)	3.0~217.0	1.5~130.0	0.15~13.0
	(N.m)	0.30~25.00	0.15~15.0	0.015~1.500
Accuracy		+/- 0.5%		
Power Supply		4.8VDC (Ni-MH chargeable battery 1.2VX4 cell 1650mAh)		
Charging Time		From empty -3 hours		
Operation Time		About 12 hours		
Battery Life		Chargeable for 300 time or more. However, it varies depending on operating conditions.		
Size(mm)		160(W)X210(D)X45(H)	230(W)X125(D)X65(H)	
Weight(kg)		2.0	1.8	
Exclusive Charger		Input : AC100V~240V 50/60Hz Output : DC12V 500mA		
Accessory		Torque measuring adaptorX1 AJ-250	Torque measuring adaptorX3 AJ-150 / AJ-50 / AJ-15K	Torque measuring adaptorX2 AJ-15/ AJ-3



Features

- **WIDEST RANGE OF APPLICABLE SCREW SIZES :**
Between 0.8-2.0mm
- **MAX OF SCREWS LENGTH & HOPPER CAPACITY :**
Screw Length : Up to 5mm (under screw head)
Capacity of hopper : 4000pcs (for M1.4X4)/1200pcs (for M2.0X5)
- **APPLICABILITY OF SPECIAL SCREW TYPES :**
Screw Length : Thread Diameter (1=1, 1<1)
Thickness of screw head 0.2mm
No jamming or failure occurred with these applicable types and affect productivity.
- **BRUSHLESS MOTOR :**
Adopting durable made in Japan brushless motor.
- **ADJUSTABLE RAILWAY :**
High precision wire cut adjustable railway. Adjustable rail, screw size from 0.8mm up to 2.0mm.
- **CIRCULAR LOOP FEEDING :**
Circular loop feeding, adopting durable aluminum extruded rail.
Screws are carried on a Circular track for smooth feeding.
- **ADOPTING MULTI-FUNCTIONAL :**
Adopting multi-functional smart PCB with material shortage alert and screw taking counting function in digital display. (Please contact our service center for detail information.)
- **SIGNAL OUTPUT FUNCTION :**
With screws in position signal output function.

Prompt delivery and steady screw feeding are the important factors of a screw feeder. We have collected feedbacks from all brands users for their opinions to develop this screw feeder. We integrated our advantages with other brands and eliminated detriments that occurred on other brands. As the result, win situation is provided to both our distributors and customers. Please read operation manual before operating in order to achieve the max value of the screw feeder.

Other functions

PCB designed with short circuit and over load protection. Screw feeder and PCB grounding connection is also available. Power On/Off buzzer alert and blinking LED indicator.

Specifications

Model Name & Number	KFA-0820 Automatic Screw Feeder
Size	160(L)X82(W)X112(H) mm
Weight	1.53kg (w/o adapter)
Power Source	AC 100~240V
Switching Adaptor	DC 12V Switching Adaptor
Applicable Screw	From M0.8~M2.0
Applicable Screw Length	up to 5mm
Horizontal Delivery Speed	42~90 pcs/min (0.7~1.5 Sec)
Feeding	Chamber Blanking
Scoping Chamber Capacity	4000pcs (for M1.4X4) / 1200pcs (for M2.0X5)



SCREW FEEDER (FOR VACUUM TYPE SCREWDRIVER AND AUTOMATION SYSTEM)

KFA-0830 / KFA-0850



**KFA-0850A
(VACUUM TYPE)**

Prompt delivery and steady screw feeding are the important factors of a screw feeder. We have collected feedbacks from all brands users for their opinions to develop this screw feeder. We integrated our advantages with other brands and eliminated detriments that occurred on other brands. As the result, win situation is provided to both our distributors and customers. Please read operation manual before operating in order to achieve the max value of the screw feeder.

Features

- **WIDEST RANGE OF APPLICABLE SCREW SIZES :**
Between 0.8-3.0mm (Incl. : 1.0mm, 1.2mm, 1.4mm, 1.7mm, 2.0mm, 2.3mm, 2.6mm, 3.0mm) 8 sizes.
- **APPLICABILITY OF SPECIAL SCREW TYPES :**
Screw Length : Thread Diameter (1=1, 1<1)
Thickness of screw head 0.2mm
No jamming or failure occurred with these applicable types and affect productivity.
- **BRUSHLESS MOTOR :**
Adopting durable made in Japan brushless motor.
- **ADJUSTABLE RAILWAY :**
High precision wire cut adjustable railway. Adjustable rail, screw size from 0.8mm up to 3.0mm.
- **HORIZONTAL LINEAR FEEDING :**
Horizontal linear feeding, adopting durable aluminum extruded rail.
Screws are carried on a horizontal track for smooth feeding.
- **ADOPTING MULTI-FUNCTIONAL :**
Adopting multi-functional smart PCB with material shortage alert and screw taking counting function in digital display. (Please contact our service center for detail information.)
- **SIGNAL OUTPUT FUNCTION :**
With screws in position signal output function.



KFA-0830

Other functions

PCB designed with short circuit and over load protection. Screw feeder and PCB grounding connection is also available. Power On/Off buzzer alert and blinking LED indicator.

Specifications

Model Name & Number	KFA-0830	KFA-0850
Size	182(L)X124(W)X146(H) mm	182(L)X124(W)X150(H) mm
Weight	3.0kg (w/o adapter)	3.1kg (w/o adapter)
Power Source	AC 100~240V	
Switching Adaptor	DC 12V Switching Adaptor	
Applicable Screw	From M0.8~M3.0	From M1.2~M3.5
Applicable Screw Length	1.0~15 mm	≤12 mm
Applicable Screw Dia.	1.2~9.5 mm	—
Horizontal Delivery Speed	46~50 pcs/min (1.2~1.3 Sec)	42~90 pcs/min (0.7~1.5 Sec)
Feeding	Chamber Blanking	
Scooping Chamber Capacity	200~220 c.c	2000pcs(for M1.2) 600pcs(for M3.5)



**KFA-0850H
(PICK UP TYPE)**



Prompt delivery and steady screw feeding are the important factors of a screw feeder. We have collected feedbacks from all brands users for their opinions to develop this screw feeder. We integrated our advantages with other brands and eliminated detriments that occurred on other brands. As the result, win situation is provided to both our distributors and customers. Please read operation manual before operating in order to achieve the max value of the screw feeder.

Specifications

Model Name & Number	KFR-1050 Automatic Screw Feeder
Size	182(L)X126(W)X147(H) mm
Weight	2.5 Kg (w/o adapter)
Power Source	AC 100~240V
Switching Adaptor	DC 15V Switching Adaptor
Applicable Screw	From M1.0 to M5.0
Applicable Screw Length	Up to 19mm(under head)
Scooping Chamber Capacity	200~220 cc
Accessories (in package & box)	Allen Wrench (L Shaped 2.0 x 107 mm) X1 pc.
	Switching Adaptor x 1 Set.
	Accessory(front) (0.8 , 1.0 , 1.2 , 1.5 , 2.0 x 70 mm)X1 pc.
	Accessory(behind) (0.2 x 10 x 20 mm)X2 pcs (0.5 x 10 x 20 mm)X10 pcs.
	Stopper 2.0~5.0mmX1 pc.
	Instruction Manual
Package Size	Each Set/Box : 282(L)X142(W)X201(H)mm
	Each Carton : 450(L)X310(W)X435(H)mm
Package Weight (Including Machine)	Each Set/Box G.W : Approx 2.63 Kgs
	Each Carton G.W : Approx 16.53 Kgs(One Carton=6 Sets)

Features

- **WIDEST RANGE OF APPLICABLE SCREW SIZES :**
Between 1.0-5.0mm (Incl.: 1.0mm, 1.2mm, 1.4mm, 1.7mm, 2.0mm, 2.3mm, 2.6mm, 3.0mm, 3.5mm, 4.0mm, & 5.0mm,) 11 sizes.
- **MAX OF SCREWS LENGTH & HOPPER CAPACITY :**
Screw Length : Up to 19mm (under screw head)
Capacity of hopper : 200-220 c.c
- **APPLICABILITY OF SPECIAL SCREW TYPES :**
Screw Length Thread Diameter (1=1, 1 < 1)
Thickness of screw head 0.2mm
No jamming or failure occurred with these applicable types and affect productivity.
- **SIZE OF FEEDING RAIL IS ADJUSTABLE :**
Feeding rail can be pulled out for width adjusts to the applied sizes easily. Measurements for width adjusting can be in metric or imperial units.
- **SAVE PARTS COSTS & STOCK :**
KFR-1050 allows adjusting the width of feeding rail to serve 11 sizes screws, between 1.0mm to 5.0mm diameter. The flexibility prevents dealers from stocking up on quantities for different sizes, and reduces the cost on related accessories for users.
- **ADJUSTABLE VIBRATION INTENSITY :**
With vibration in small amplitude at high strength, it moves screws On rail to pick-up point in good order, no overlay or jamming to affect the speed of movement and productivity.
- **HUMANIZED MULTI PROGRAMMING CONTROL:**
*Individual drive system for feeding and vibrating operation.
*Setting for suitable stop time without interapt to operate.
*Equipped ground wire, socket & buzzer for operative safety and alarm signal.
*PCB controls for efficiencies of desired speed & timing on each operating step.
*Switching Adaptor allowed AC 100-240V power source for stable DC 15V output No influences and problems due to the different AC power source of factories locations.

Other functions

PCB designed with short circuit and over load protection. Screw feeder and PCB grounding connection is also available. Power On/Off buzzer alert and blinking LED indicator.



Auxiliary Arm KP Series [KP-AUX1T-B, KP-VAR, KP-VA1, KP-AUX2, KP-AUX5]
[KP-AUX-C/E/B/D]



KP-AUX1T



Auxiliary Arm

KP-AUX1T

- Provide with the rocker arm , enable to revolve on 360 degrees.
- Main shaft can be extended to maximum 830mm
- Power arm inside includes nitrogen gas stick , allow user to grab the arm easily, automatic lift up to position after finishing the work .
- Easy to assemble and Disassemble.
- Optional accessory KP-VA1, KP-VAR(90 degree adapter) is available for user to Adjust angle in accordance with the object to be fastened.

KP-AUX2, KP-AUX5

- Main shaft can be extended to maximum 340mm
- Steady bearing in horizontal direction for screwdriver to act in vertical precisely.
- Utilize KL-1200 to suspend the spring hoist vertically and capable of making adjustment at screwdriver's weight.
- Steady screwdriver with 4 sides of plate , the screwdriver head of horizontal and vertical position becomes more accurate.
- Applying to low torque , high precision screwdriver, most suitable for small objects.



KP-VAR, KP-VA1

Specifications

Model	KP-AUX1T-B	KP-AUX2	KP-AUX5
Description	Suspension Arm	Suspension Rope	Suspension Rope
Reach	50mm~830mm	50mm~340mm	50mm~340mm
Models	SK-6 Series	SKD-BN200 Series	SKD-BN500 Series SKD-BE500 Series
Remark	KP-VA1 adaptable	Spring Balancer KL-1200 adaptable	Spring Balancer KL-1200 adaptable

※ The auxiliary arm can be used only with Kilews electric screwdrivers.



Specifications

Model No.	Max torque (Nm)	A(mini/maxi) cm	Tool Ø diameter(mm)
KP-AUX-C50-1000	50	43~100	38.5~52
KP-AUX-C50-1200	50	50~120	38.5~52
KP-AUX-E50-1000	50	43~100	38.5~52
KP-AUX-E50-1200	50	50~120	38.5~52
KP-AUX-B50-1000	50	43~100	38.5~52
KP-AUX-B50-1200	50	50~120	38.5~52
KP-AUX-D50-1000	50	43~100	38.5~52
KP-AUX-D50-1200	50	50~120	38.5~52

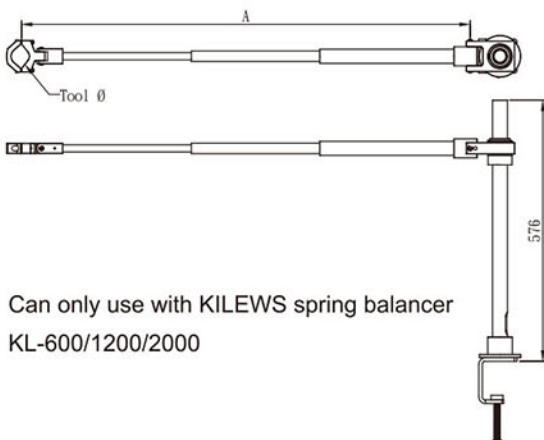
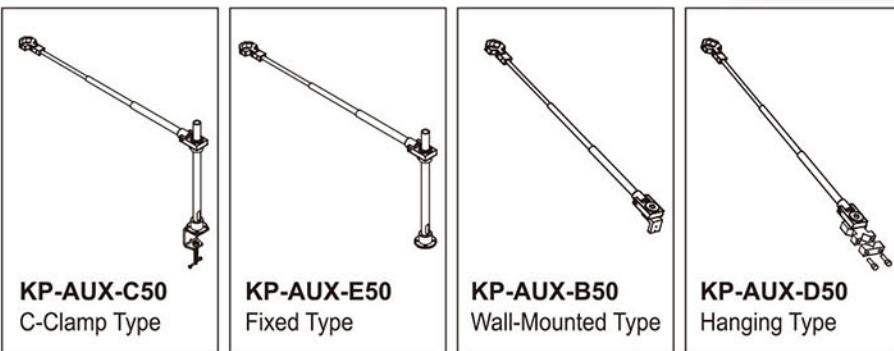

Can only use with KILEWS spring balancer KL-600/1200/2000



Screwdriver I/O Signal Control Box (For Manual / PLC) 、 Slow Start Control Module 、 90° Degree Attachment

[KL-SCBSN, KL-SSBN, KL-1, KL-2, KZ-1, KL-M-1, KL-M-2]

Screwdriver I/O Signal Control Box (For Manual / PLC)



KL-SCBSN

- Slow Start time (0.0-9.9 second)
- Slow start Speed Level (30%-100% of normal speed,L0-L9)
- Operation Time (0.0-9.9 second)
- Target Reached Confirm (enable / disable)
- Brake Signal Hold Time (start off / next start off)
- External Start Input Control
- External Reverse Input Control
- Signal output (Start,Stop,Reverse)



SHIELDED CABLE



BN SCREWDRIVER



KL-SCBSN/KL-SSBN



OR



BN series Power Controller



Slow Start Control Module

KL-SSBN

- **BYPASS** : Automatically disable slow start function when screwdriver in reverse rotation, easier to reverse screws.
- Adjustable slow start speed from 30% to 100% of normal speed, Slow start level setting from L1-L2-L3-....L9-L0
- Provide output start signal/ break signal/ forward and reverse signal with MOS relay switch
- Compatible with KILEWS Brushless DC SKD-BN series
- Slow start time can be set from 0.1 s up to 9.9 second
- Dimension : 58x95x35mm (LxWxH)

90° Degree Attachment Applicable Model

KL-1	SK-B6L Series, SKD-BN700L Series
KL-2	SKD-B5L Series, SKD-BN500L Series
KZ-1	SKD-B100 Series (only for SKD-B113LZ)
KL-M-1	SKD-B100 Series (only for SKD-B123KLM)
KL-M-2	Screwdriver should be customized

※ Only for "L" trigger start screwdrivers

90° Degree Attachment



Suspension Rack, Torque Fixing Ring, Spiral Cables, TorqueAdjuster, Pistol Grip, Screw Setter, Spring Balancer Series

	Suspension Rack	KH-2	KH-3	KH-4	KH-5	KH-2L
	Applicable Models	SKD-BN500 Series(&KC) SKD-BE500 Series(&KC)	SK-B5 Series(&KC)	SK-B5 Series SKD-BN500 Series SKD-BE500 Series	SKD-BN200Series SKD-BE200Series SKD-BN200Series(&KC) SKD-BE200Series(&KC)	SK-B6 Series(&KC) SKD-BN7000(&KC)



	Torque Fixing Ring	KC-6C(S)	KC-7C(S)	KC-9C(S)	KC-13C(S)	KC-2(S)
	Applicable Models	SK-B5 Series SKD-BN500 Series SKD-BE500 Series	SK-B6 Series	SKD-B100 Series	SKD-BN200Series SKD-BE200Series	SKD-BN7000 Series

ESD need special order (S) series.





Spiral Cables

Supplying spiral cables for all of KILEWS screwdrivers with 4pin or 6pin. (B100/B200 series are not included.)
Note: Cable can be extended up to 3M.

 <div style="display: flex; justify-content: space-around; font-size: small;"> <div style="text-align: center;">KW-1</div> <div style="text-align: center;">KW-3</div> <div style="text-align: center;">KW-4</div> </div>		Suspension Rack	KW-1	KW-3	KW-4
		Applicable Models	SK-B6 Series SKD-BN7000 Series	SK-B5 Series SKD-BN500 Series SKD-BE500 Series	SKD-BN200Series SKD-BE200Series

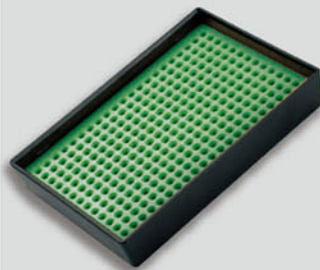
	Pistol Grip	Applicable Models
	LG-10	SKD-BN500L Series
	PG-10	SKD-BN500P Series
	LG-11	SKD-BE500L Series
	PG-11	SKD-BE500P Series
	LG-14	SK-B6 for 220V L type only

	Screw Setter	Applicable Models
	KB-1	M1.7~2.0 Screw available
	KB-2	M2.0~2.6 Screw available
	KB-3	M3.0~4.0 Screw available

	Spring Balancer	Applicable Models
	KL-600 (0.3~0.6kg)	SKD-B100 Series, SKD-BN200 Series, SKD-BE200 Series
	KL-1200 (0.6~1.5kg)	USE FOR ALL MODELS (TBN, RBN and BN900 series are not included.)



KILEWS®
SKD-B100L
DC 12V 55W
Torque 0-1.5kgf cm Flx 1000rpm
Duty cycle 1.0s On 3.0s Off
KILEWS Industrial Co., Ltd.
S/N: TP0187
MADE IN TAIWAN



KILEWS

Actual SKD-B100 series size

INNOVATION FOR SCREWS FASTENING

K2016.04R2