

# 5 Port Solenoid Valve

## Series VF1000/3000/5000

Reduced power consumption:

**0.55 W** [With power saving circuit]  
 [Starting 1.55 w Holding 0.55 w]

**1.55 W** [Standard]  
 (Conventional: 2.0 W) \* With DC light

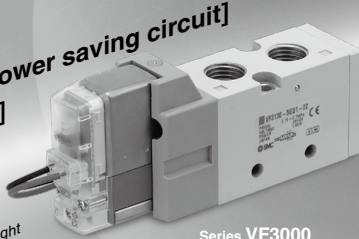

Series VF3000



Low wattage specification added  
 \* VF1000/3000

Power consumption **0.35 w** (Without light)  
**0.4 w** (With light)



### Power consumption is reduced by power saving circuit.

Power consumption is decreased by approx. 1/3 by reducing the wattage required to hold the valve in an energized state. (Effective energizing time is over 40 ms at 24 VDC.) Refer to electrical power waveform as shown below.

Electrical power waveform with power saving circuit

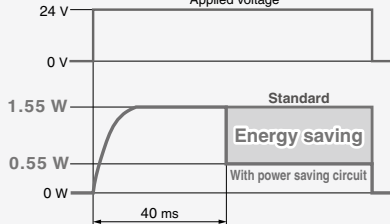

### ■ Built-in full-wave rectifier (AC)

#### ● Noise reduction

Noise is considerably reduced by changing it to DC mode with a full-wave rectifier.

#### ● Reduced apparent power

Conventional: 5.6 VA → **1.55 VA**

### ■ Built-in strainer in the pilot valve

Unexpected troubles due to foreign matter can be prevented. Note) Be sure to mount an air filter on the inlet side.

Rubber material: HNBR  
 Ozone-resistant specification  
 \* The pilot valve poppet is made of FKM.

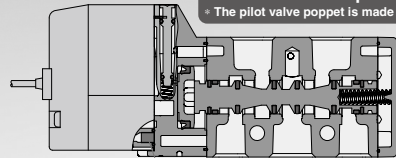

Strainer

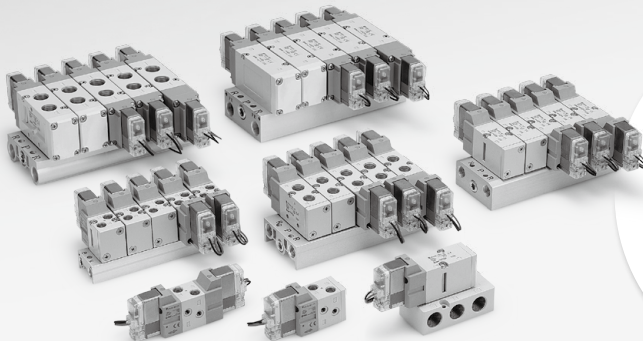



















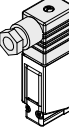



Air operated valve  
 VFA1000/3000/5000 (P2213-4)

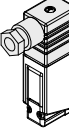

SJ
SY
SV
SYJ
SZ
VF
VP4
S0700
VQ
VQ4
VQ5
VQC
VQC4
VQZ
SQ
VFS
VFR
VQ7

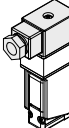
# Model Selection by Operating Conditions 1

## Solenoid Valve: Single Unit

Series	Sonic conductance C [dm <sup>3</sup> /(s·bar)]	Type of actuation	Port size	Voltage	Electrical entry	Light/Surge voltage suppressor	Manual override		
Body ported	VF1000 	2-position single <b>VF1000</b> (B)2 4(A) (EB)3 1 5(EA) (P) 	M5 x 0.8 1/8	12 VDC 24 VDC 24 VAC 100 VAC 200 VAC 110 VAC 220 VAC 240 VAC	Grommet 				
		2-position double <b>VF1000</b> (B)2 4(A) (EB)3 1 5(EA) (P) 			1/8 1/4			L-type plug connector 	
	3-position closed center (A)4 2(B) (EA)5 1 3(EB) (P) 	1/4 3/8	M-type plug connector 						
VF3000 	4.0		2-position double <b>VF1000</b> (B)2 4(A) (EB)3 1 5(EA) (P) 		1/8 1/4			DIN terminal 	DC ■ With surge voltage suppressor ■ With light/surge voltage suppressor
		3-position exhaust center (A)4 2(B) (EA)5 1 3(EB) (P) 	1/4 3/8					3-position pressure center (A)4 2(B) (EA)5 1 3(EB) (P) 	■ With surge voltage suppressor (Non-polar) ■ With light/surge voltage suppressor (Non-polar)
VF5000 	8.8	3-position closed center (A)4 2(B) (EA)5 1 3(EB) (P) 			1/4 3/8			AC ■ With light/surge voltage suppressor	Push-turn locking lever type 
Base mounted	VF3000 	2-position single (A)4 2(B) (EA)5 1 3(EB) (P) 	1/4 3/8	DIN (EN1753 01-803) terminal 					
		2-position double (A)4 2(B) (EA)5 1 3(EB) (P) 		1/4 3/8 1/2	Conduit terminal 				
	3-position closed center (A)4 2(B) (EA)5 1 3(EB) (P) 	1/4 3/8 1/2	3-position exhaust center (A)4 2(B) (EA)5 1 3(EB) (P) 						
VF5000 	9.4		3-position pressure center (A)4 2(B) (EA)5 1 3(EB) (P) 						





Page 808

Page 822

Low wattage specification page 833 Power consumption: 0.35 W (Without light) 0.4 W (With light)

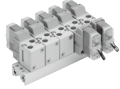
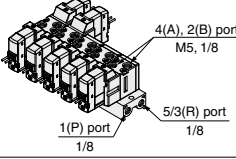
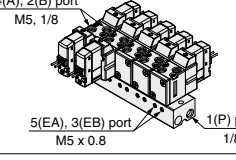
# Model Selection by Operating Conditions 2

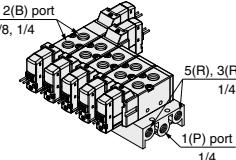
## Solenoid Valve: Manifold

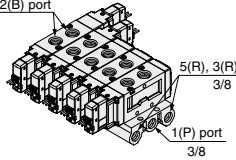
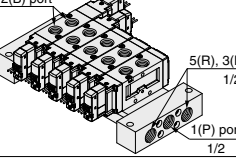
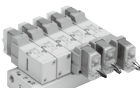
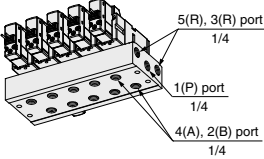
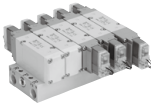
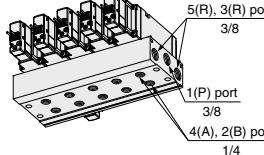
Series	EXH port type	Manifold base model	Applicable valve	Applicable stations
<b>VF1000</b> 	Common EXH	<b>VV5F1-30</b>  4(A), 2(B) port M5, 1/8 1(P) port 5/3(R) port 1/8	VF1□30 VF1□33	2 to 20 stations
	Individual EXH	<b>VV5F1-31</b>  4(A), 2(B) port M5, 1/8 5(EA), 3(EB) port M5 x 0.8 1(P) port 1/8		
<b>VF3000</b> 	Common EXH	<b>VV5F3-30</b>  4(A), 2(B) port 1/8, 1/4 5(R), 3(R) port 1/4 1(P) port 1/4	VF3□30 VF3□33	2 to 20 stations
<b>VF5000</b> 	Common EXH	<b>VV5F5-20</b>  4(A), 2(B) port 5(R), 3(R) port 3/8 1(P) port 3/8	VF5□20 VF5□23	2 to 10 stations
	Common EXH	<b>VV5F5-21</b>  4(A), 2(B) port 5(R), 3(R) port 1/2 1(P) port 1/2		2 to 15 stations
<b>VF3000</b> 	Common EXH	<b>VV5F3-40</b>  5(R), 3(R) port 1/4 1(P) port 1/4 4(A), 2(B) port 1/4	VF3□40 VF3□43	2 to 20 stations
	<b>VF5000</b> 	Common EXH	<b>VV5F5-40</b>  5(R), 3(R) port 3/8 1(P) port 3/8 4(A), 2(B) port 1/4	VF5□44

Body ported

Base mounted

Page 837

Page 848

- SJ
- SY
- SY
- SV
- SYJ
- SZ
- VF**
- VP4
- S0700
- VQ
- VQ4
- VQ5
- VQC
- VQC4
- VQZ
- SQ
- VFS
- VFR
- VQ7

# Cylinder Speed Chart ①

Use as a guide for selection.  
Please check the actual conditions with SMC Model Selection Program.

## Body Ported

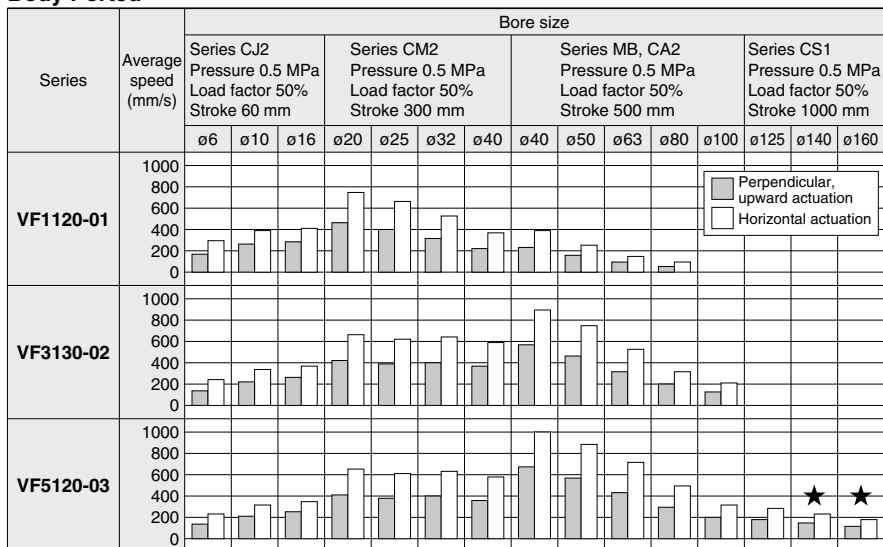

\* With ★: when using steel piping

## Base Mounted

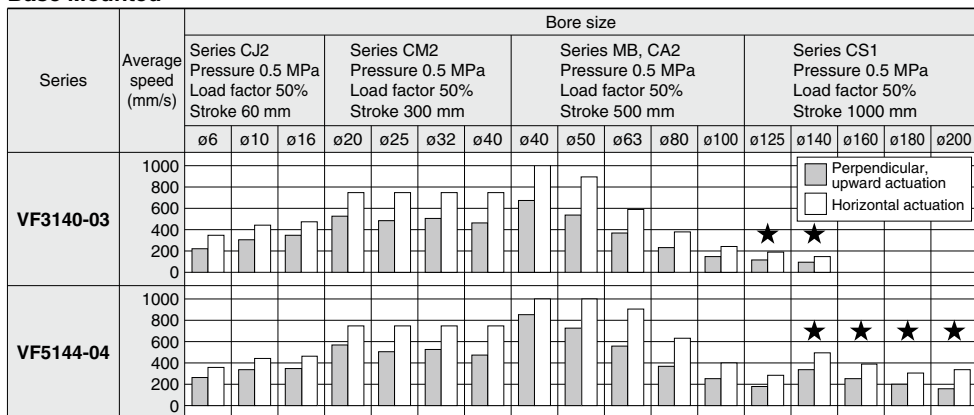

\* With ★: when using steel piping

# Cylinder Speed Chart ②

Use as a guide for selection.  
Please check the actual conditions with SMC  
Model Selection Program.

## Conditions

### Body Ported

	Body ported	Series CJ2	Series CM2	Series MB, CA2	Series CS1
VF1120-01	Tubing x Length	T0604 x 1 m	T0806 x 1 m		—
	Speed controller	AS3002F-06	AS3002F-08		—
	Silencer	AN101-01			—
VF3130-02	Tubing x Length	T0604 x 1 m	T1075 x 1 m		—
	Speed controller	AS3002F-06	AS4002F-10		—
	Silencer	AN110-01			—
VF5120-03	Tubing x Length	T0604 x 1 m	T1075 x 1 m	T1209 x 1 m	
	Speed controller	AS3002F-06	AS4002F-10	AS4002F-12	
	Silencer	AN30-03			AN302-03

### Body Ported [when using SGP (Steel Piping)]

	Body ported	Series CS1
VF5120-03	Tubing x Length	SGP10A x 1 m
	Speed controller	AS420-03
	Silencer	AN30-03

### Base Mounted

	Base mounted	Series CJ2	Series CM2	Series MB, CA2	Series CS1
VF3140-03	Tubing x Length	T0604 x 1 m	T1075 x 1 m	T1209 x 1 m	—
	Speed controller	AS3002F-06	AS4002F-10	AS4002F-12	—
	Silencer	AN30-03			—
VF5144-04	Tubing x Length	T0604 x 1 m	T1075 x 1 m	T1209 x 1 m	
	Speed controller	AS3002F-06	AS4002F-10	AS4002F-12	
	Silencer	AN40-04			

### Base Mounted [when using SGP (Steel Piping)]

	Base mounted	Series CS1
VF3140-03	Tubing x Length	SGP10A x 1 m
	Speed controller	AS420-03
	Silencer	AN30-03
VF5144-04	Tubing x Length	SGP15A x 1 m
	Speed controller	AS420-04
	Silencer	AN40-04

SJ

SY

SY

SV

SYJ

SZ

VF

VP4

S0700

VQ

VQ4

VQ5

VQC

VQC4

VQZ

SQ

VFS

VFR

VQ7

# Pilot Operated 5 Port Solenoid Valve

## Series VF1000/3000/5000

### Single Unit

Body Ported



Note) Only DIN and conduit terminal types are available with AC mode. Refer to the electrical entry for details.



#### How to Order Valve

Body ported VF 3 1 3 0 [ ] [ ] - 5 G [ ] [ ] 1 - 01 [ ] [ ] - [ ] - [ ]

**Series**

1	VF1000
3	VF3000
5	VF5000

**Type of actuation**

1	2-position single
2	2-position double
3	3-position closed center
4	3-position exhaust center
5	3-position pressure center

\* Only 1 and 2 are available with the VF1000.

**Body model**

Symbol	VF1000	VF3000	VF5000
2	○	○	○
3	○	○	○

**Pressure specifications**

Nil	Standard (0.7 MPa)
K	High-pressure type (1 MPa)

**Body option**

0: Pilot valve individual exhaust

PE port\* EA/EB port

VF1000	VF3000	VF5000
○	○	○
○	○	○

3: Main/Pilot valve common exhaust

PE port EA/EB port

VF1000	VF3000	VF5000
○	○	○
○	○	○

**Coil specifications**

Nil	Standard
T	With power saving circuit (DC only)

Note) Be sure to select the power saving circuit type when it is continuously energized for long periods of time. (Refer to page 858 for details.)

\* T type is available with DC mode only. When T is selected, only Z type of light/surge voltage suppressor is available. (Note that when the electrical entry of DIN terminal type without connector is selected, only DOS and YOS are available.)

**Rated voltage**

DC		AC (50/60 Hz)			
5	24 VDC	1	100 VAC	2	200 VAC
6	12 VDC	3	110 VAC [115 VAC]	4	220 VAC [230 VAC]
		7	240 VAC		
		B	24 VAC		

\* Refer to "Made to Order" (Page 821) when piping to PE port is required.

**Thread type**

Nil	Rc
F	G
N	NPT
T	NPTF

\* M5 is available with Nil only.

**Bracket**

Nil	Without bracket
F	With bracket

VF1000/3000 Single type  
(The bracket cannot be connected after delivered.)

VF1000 Double type only

\* Not available with the VF5000.

**Made to Order**

Nil	—
X500	Pilot exhaust port with piping thread (M3) specification (Refer to page 821.)
X600	TRIAC output specification (Refer to page 821.)

**A, B port size**

Symbol	Port size	VF1000	VF3000	VF5000
M5	M5 x 0.8	○	—	—
01	1/8	○	○	—
02	1/4	—	○	○
03	3/8	—	—	○

**Electrical entry**

Grommet	L-type plug connector	M-type plug connector	DIN terminal (IP65 compatible)	DIN (EN175301-803) terminal (IP65 compatible)	Conduit terminal (IP65 compatible)
G: Lead wire length 300 mm H: Lead wire length 600 mm	L: With lead wire (length 300 mm)	M: With lead wire (length 300 mm)	D: With connector	Y: With connector	T: Conduit terminal
G: Lead wire length 300 mm H: Lead wire length 600 mm DC Without light/surge voltage suppressor	LN: Without lead wire	MN: Without lead wire	DO: Without connector	YO: Without connector	
CE	DC	CE	CE	CE	CE
compliant	AC	—	—	—	—

\* LN and MN types are with 2 sockets.

\* Refer to page 856 when different length of lead wire for L/M-type plug connector is required.

\* Refer to page 857 for details on the DIN (EN175301-803) terminal.

Note 1) When using IP65, select the main/pilot valve common exhaust type. (Except VF1000)

Note 2) With the same specifications as the DC type, all electrical entries for the 24 VAC type are CE marking compliant.



**Manual override**

Nil: Non-locking push type	D: Push-tum locking slotted type	E: Push-tum locking lever type

**Light/Surge voltage suppressor**

Symbol	Light/Surge voltage suppressor	DC	AC
Nil	Without light/surge voltage suppressor	○	○
S	With surge voltage suppressor	○	—(Not)
Z	With light/surge voltage suppressor	○	○
R	With surge voltage suppressor (Non-polar)	○	—
U	With light/surge voltage suppressor (Non-polar)	○	—

Note) S type is not available with AC mode, since a rectifier prevents surge voltage generation.

\* In the DIN terminal type, since a light is installed in the connector, DOZ, DOU, YOZ, YOU are not available.

**Caution**

When using the surge voltage suppressor type, residual voltage will remain. Refer to page 858 for details.

# Pilot Operated 5 Port Solenoid Valve Body Ported/Single Unit *Series VF1000/3000/5000*

## Specifications



Model		VF1000	VF3000	VF5000
Fluid		Air		
Operating pressure range (MPa)	Standard	2-position single/3-position	0.15 to 0.7	
	High-pressure type	2-position double	0.1 to 0.7	
		2-position single/3-position	0.15 to 1.0	
		2-position double	0.1 to 1.0	
Ambient and fluid temperature (°C)		-10 to 50 (No freezing)		
Max. operating frequency (Hz)	2-position single/double	10	10	5
	3-position	—	3	3
Manual override		Non-locking push type Push-turn locking slotted type Push-turn locking lever type		
Pilot exhaust type		Individual exhaust, Main/Pilot valve common exhaust (Except VF1000)		
Lubrication		Not required		
Mounting orientation		Unrestricted		
Impact/Vibration resistance (m/s <sup>2</sup> ) <small>(Note)</small>		300/50		
Enclosure		Dustproof (IP65* for D, Y, T)		

(Note) Impact resistance: No malfunction occurred when it is tested in the axial direction and at the right angles to the main valve and armature in both energized and de-energized states every once for each condition. (Values at the initial period)

Vibration resistance: No malfunction occurred in a one-sweep test between 45 and 2000 Hz. Test was performed at both energized and de-energized states in the axial direction and at the right angles to the main valve and armature. (Values at the initial period)

\* Based on IEC 60529. When using IP65, select the main/pilot valve common exhaust type.



**Made to Order**  
(Refer to page 821 for details.)

Symbol	Specification
X500	Pilot exhaust port with piping thread (M3) specification
X600	TRIAC output specification

## Solenoid Specifications

Electrical entry		Grommet (G), (H) L-type plug connector (L) M-type plug connector (M) G, H, L, M	DIN terminal (D) DIN (EN175301-803) terminal (Y) Conduit terminal (T) D, Y, T	
Coil rated voltage (V)	DC	24, 12		
	AC (50/60 Hz)	24, 100, 110, 200, 220, 240		
Allowable voltage fluctuation		±10% of rated voltage*		
Power consumption (W)	DC	Standard 1.5 (With light: 1.55)	1.5 (With light: 1.75)	
	With power saving circuit	0.55 <small>(Note)</small> (With light only) (Starting 1.55 Holding 0.55)	0.75 <small>(Note)</small> (With light only) (Starting 1.75 Holding 0.75)	
Apparent power (VA)*	AC	24 V	1.5 (With light: 1.55)	1.5 (With light: 1.75)
		100 V	1.55 (With light: 1.65)	1.55 (With light: 1.7)
		110 V [115 V]		
		200 V		
		220 V [230 V]		
240 V				
Surge voltage suppressor		Diode (Non-polar type: Varistor)		
Indicator light		LED (Neon light is used for AC mode of D, Y, T.)		

\* It is in common between 110 VAC and 115 VAC, and between 220 VAC and 230 VAC.

\* Allowable voltage fluctuation is -15% to +5% of the rated voltage for 115 VAC or 230 VAC.

\* Since voltage drops due to the internal circuit in S, Z, T types (with power saving circuit), the allowable voltage fluctuation should be within the following range.

24 VDC: -7% to +10%    12 VDC: -4% to +10%

(Note) Refer to page 858 for details.

## Response Time

Series	Type of actuation		Pressure specifications	Operating pressure range (MPa)	Response time (ms) (at 0.5 MPa)			
					Without light/surge voltage suppressor	With light/surge voltage suppressor		AC
						S, Z type	R, U type	
VF1000	2-position	Single	Standard	0.15 to 0.7	20	45	23	45
		Double		0.1 to 0.7	12	12	12	12
		Single	High-pressure type	0.15 to 1.0	23	48	26	48
		Double		0.1 to 1.0	15	15	15	15
VF3000	2-position	Single	Standard	0.15 to 0.7	20	45	23	45
		Double		0.1 to 0.7	12	12	12	12
	3-position			0.15 to 0.7	30	55	33	55
	2-position	Single	High-pressure type	0.15 to 1.0	23	48	26	48
		Double		0.1 to 1.0	15	15	15	15
	3-position			0.15 to 1.0	33	58	36	58
VF5000	2-position	Single	Standard	0.15 to 0.7	30	55	33	55
		Double		0.1 to 0.7	15	15	15	15
	3-position			0.15 to 0.7	50	75	53	75
	2-position	Single	High-pressure type	0.15 to 1.0	33	58	36	58
		Double		0.1 to 1.0	18	18	18	18
	3-position			0.15 to 1.0	53	78	56	78

(Note) Based on dynamic performance test, JIS B 8375-1981. (Coil temperature: 20°C, at rated voltage)

SJ  
SY  
SY  
SV  
SYJ  
SZ  
VF  
VP4  
S0700  
VQ  
VQ4  
VQ5  
VQC  
VQC4  
VQZ  
SQ  
VFS  
VFR  
VQ7

# Series VF1000/3000/5000

## Flow-rate Characteristics/Weight

Valve model	Type of actuation		Port size		Flow-rate characteristics <sup>Note 1)</sup>						Weight (g) <sup>Note 2)</sup>	
			1, 4, 2 (P, A, B)	5, 3 (EA, EB)	1 → 4/2 (P → A/B)			4/2 → 5/3 (A/B → EA/EB)			Grommet	DIN terminal
					C [dm <sup>3</sup> / (s·bar)]	b	Cv	C [dm <sup>3</sup> / (s·bar)]	b	Cv		
VF1□20-M5	2-position	Single	M5 x 0.8		0.49	0.40	0.13	0.52	0.35	0.13	140	176
		Double			0.49	0.40	0.13	0.52	0.35	0.13	200	272
VF1□20-01	2-position	Single	1/8	M5 x 0.8	0.76	0.22	0.17	0.53	0.28	0.13	136	172
		Double			0.76	0.22	0.17	0.53	0.28	0.13	196	268
VF3□30-01	2-position	Single	1/8		3.0	0.38	0.78	2.8	0.30	0.67	182	218
		Double			3.0	0.38	0.78	2.8	0.30	0.67	243	315
	Closed center	2.4			0.31	0.64	1.8	0.37	0.46	260	332	
	3-position	Exhaust center			2.6	0.37	0.70	3.0 [2.5]	0.32 [0.28]	0.76 [0.62]	260	332
		Pressure center			3.0 [1.4]	0.42 [0.44]	0.83 [0.39]	2.4	0.27	0.59	260	332
	VF3□30-02	2-position			Single	1/4	1/8	4.0	0.36	1.0	3.1	0.32
Double			4.0	0.36	1.0			3.1	0.32	0.75	239	311
Closed center		2.4	0.45	0.68	1.9			0.37	0.47	256	328	
3-position		Exhaust center	3.0	0.42	0.82			3.1 [2.7]	0.36 [0.29]	0.79 [0.66]	256	328
		Pressure center	5.5 [1.4]	0.37 [0.50]	1.4 [0.40]			2.6	0.32	0.64	256	328
VF5□20-02		2-position	Single	1/4				7.1	0.46	1.9	7.7	0.51
	Double		7.1			0.46	1.9	7.7	0.51	2.2	368	440
	Closed center	6.7	0.46			1.8	6.6	0.41	1.8	406	478	
	3-position	Exhaust center	7.1			0.42	1.9	8.0 [7.4]	0.45 [0.47]	2.2 [2.1]	406	478
		Pressure center	6.8 [2.7]			0.51 [0.50]	2.0 [0.78]	5.7	0.37	1.4	406	478
	VF5□20-03	2-position	Single			3/8		8.8	0.44	2.4	10.0	0.49
Double			8.8	0.44	2.4			10.0	0.49	2.9	354	426
Closed center		7.5	0.43	2.0	7.5			0.38	1.9	391	463	
3-position		Exhaust center	8.3	0.40	2.2			10.0 [8.7]	0.48 [0.46]	3.0 [2.4]	391	463
		Pressure center	9.2 [3.0]	0.50 [0.49]	2.6 [0.85]			6.1	0.35	1.6	391	463

Note 1) [ ] : Normal position  
 Note 2) Values without bracket



## Construction: Body Ported

### 2-position single

Symbol  
2-position single  
VF1000

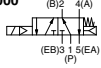

VF3000  
VF5000

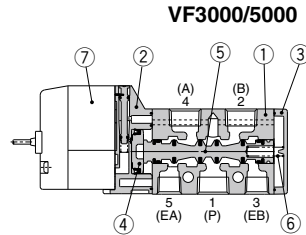
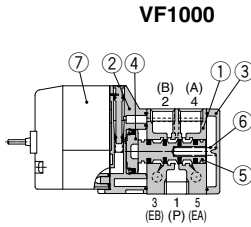
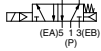

### 2-position double

Symbol  
2-position single  
VF1000

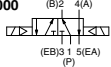

VF3000  
VF5000

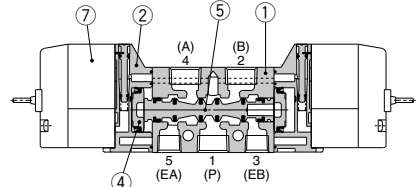
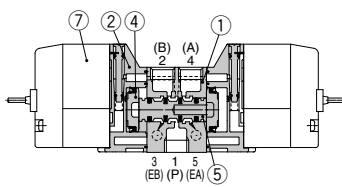
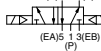

### 3-position closed center/exhaust center/pressure center

Symbol  
3-position closed center

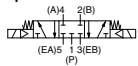

3-position exhaust center



3-position pressure center

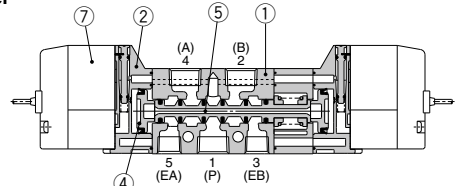

(Drawing shows a closed center type.)

## Component Parts

No.	Description	Material	Note
1	Body	Aluminum die-casted	White
2	Adapter plate	Resin	Gray
3	End plate	Resin (VF313□-F : Aluminum die-casted)	White
4	Piston	Resin	
5	Spool valve	Aluminum, HNBR	
6	Spring	Stainless steel	

## Replacement Parts

No.	Description	Part no.	Note
7	Pilot valve assembly	Refer to "How to Order Pilot Valve Assembly" on page 812.	Built-in strainer

## Bracket Assembly Part No.

Description	Part no.
Bracket (for VF1000 double)	DXT144-8-1A (With 2 mounting screws)

SJ  
SY  
SY  
SV  
SYJ  
SZ  
VF  
VP4  
S0700  
VQ  
VQ4  
VQ5  
VQC  
VQC4  
VQZ  
SQ  
VFS  
VFR  
VQ7

# Series VF1000/3000/5000

## How to Order Pilot Valve Assembly (With a gasket and two mounting screws)

### ⚠ Caution

When only the pilot valve assembly is replaced, it is not possible to change from V211 (Grommet or L/M-type) to V212 (DIN or Conduit type), or vice versa.

Valve model: VF□□□□□□ - 5 G Z □ 1 - □□□

\* Select from the below in accordance with the valve used.

#### ■ Grommet or L/M-type

V 2 1 1 □□ - 5 G Z

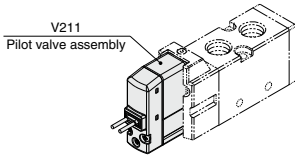

#### ● Light/Surge voltage suppressor

		DC	AC
Nil	Without light/surge voltage suppressor	○	○
S	With surge voltage suppressor	○	— <sup>(Note)</sup>
Z	With light/surge voltage suppressor	○	○
R	With surge voltage suppressor (Non-polar)	○	—
U	With light/surge voltage suppressor (Non-polar)	○	—

Note) S type is not available with AC mode, since a rectifier prevents surge voltage generation. When T is selected, only Z type of light/surge voltage suppressor is available.

### ⚠ Caution

When using the surge voltage suppressor type, residual voltage will remain. Refer to page 858 for details.

#### ● Electrical entry

G	Grommet (Lead wire length 300 mm)	
H	Grommet (Lead wire length 600 mm)	
L	L-type plug connector	With lead wire
LN		Without lead wire
LO	M-type plug connector	Without connector
M		With lead wire
MN	M-type plug connector	Without lead wire
MO		Without connector

\* LN and MN types are with 2 sockets.

\* Refer to page 856 when different length of lead wire for L/M-type plug connector is required.

#### ■ DIN or Conduit type

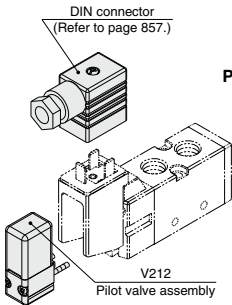

#### ● Pressure specifications

Nil	Standard (0.7 MPa)
K	High-pressure type (1 MPa)

#### ● Coil specifications

Nil	Standard
T	With power saving circuit (DC only)

\* T type is available with DC mode only.

#### ● Rated voltage

DC	
5	24 VDC
6	12 VDC

#### AC (50/60 Hz)

1	100 VAC
2	200 VAC
3	110 VAC [115 VAC]
4	220 VAC [230 VAC]
7	240 VAC
B	24 VAC

### ⚠ Caution

For V212 (DIN or Conduit type), the coil specifications (DIN and voltage (including light/surge voltage suppressor) cannot be changed by replacing the pilot valve assembly.

### ⚠ Caution

Tightening torque of the pilot valve assembly mounting screw  
M2.5: 0.32 N·m

Dimensions: Series VF1000/Body Ported

2-position single

Grommet (G) (H): VF1120-□<sup>G</sup>□□1-M5□(-F)

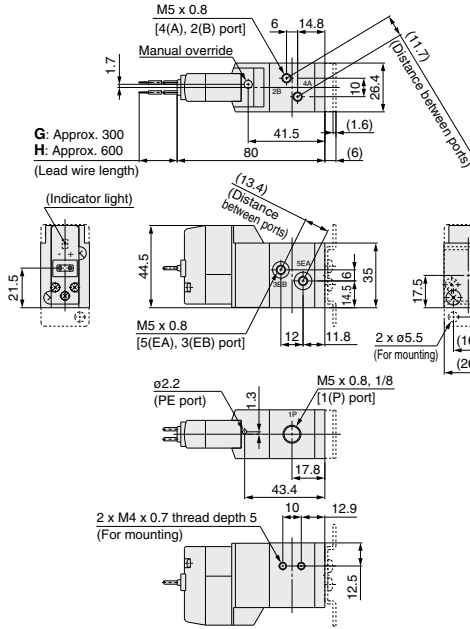

Grommet (G) (H): VF1120-□<sup>G</sup>□□1-01□(-F)

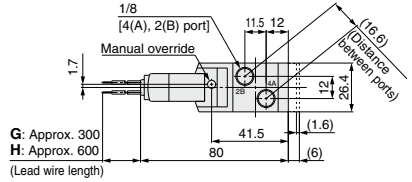

G: Approx. 300  
H: Approx. 600  
(Lead wire length)

Grommet (G) (H)  
DC without light/surge voltage suppressor

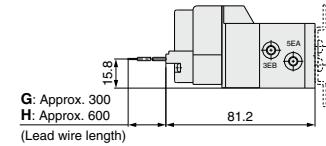

G: Approx. 300  
H: Approx. 600  
(Lead wire length)

L-type plug connector (L): VF1120-□L□□1-M5<sub>01</sub>□(-F)

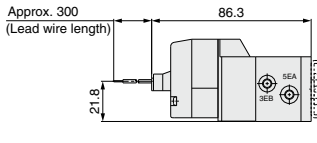

Unless otherwise indicated, dimensions are the same as Grommet (G).

DIN terminal (D) (Y): VF1120-□D□□1-M5<sub>01</sub>□(-F)

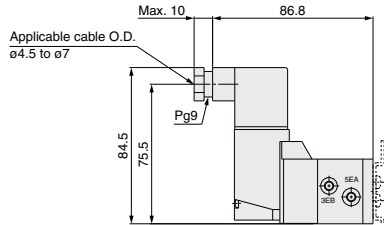

Unless otherwise indicated, dimensions are the same as Grommet (G).

M-type plug connector (M): VF1120-□M□□1-M5<sub>01</sub>□(-F)

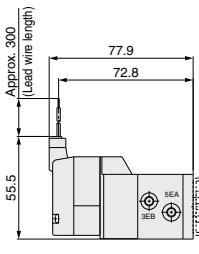

Unless otherwise indicated, dimensions are the same as Grommet (G).

Conduit terminal (T): VF1120-□T□□1-M5<sub>01</sub>□(-F)

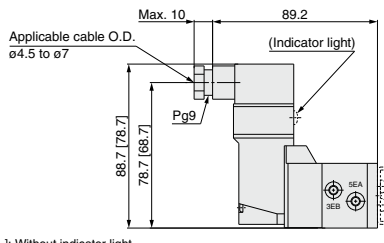

[ ]: Without indicator light  
Unless otherwise indicated, dimensions are the same as Grommet (G).

SJ
SY
SY
SV
SYJ
SZ
VF
VP4
S0700
VQ
VQ4
VQ5
VQC
VQC4
VQZ
SQ
VFS
VFR
VQ7

# Series VF1000/3000/5000

## Dimensions: Series VF1000/Body Ported

### 2-position double

Grommet (G) (H): VF1220-□<sup>G</sup>□□1-M5□

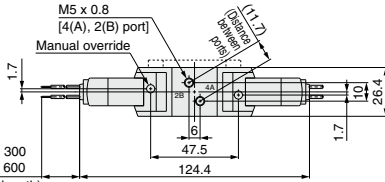

G: Approx. 300  
H: Approx. 600  
(Lead wire length)

Grommet (G) (H): VF1220-□<sup>G</sup>□□1-01□

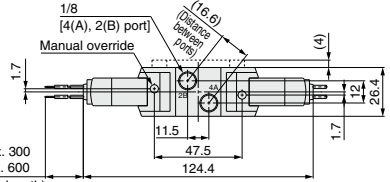

G: Approx. 300  
H: Approx. 600  
(Lead wire length)

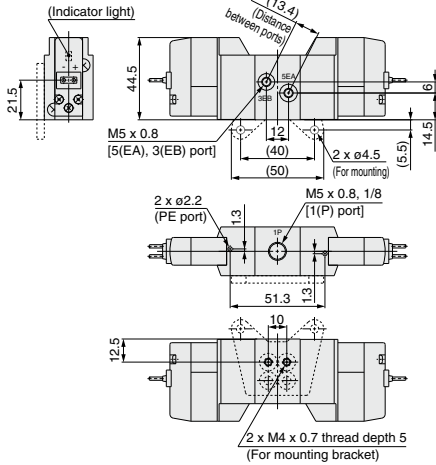

Grommet (G) (H)  
DC without light/surge voltage suppressor

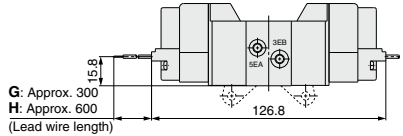

G: Approx. 300  
H: Approx. 600  
(Lead wire length)

L-type plug connector (L): VF1220-□<sup>L</sup>□□1-M5<sub>01</sub>□

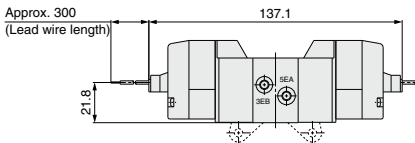

Approx. 300  
(Lead wire length)

DIN terminal (D) (Y): VF1220-□<sup>D</sup>□□1-M5<sub>01</sub>□

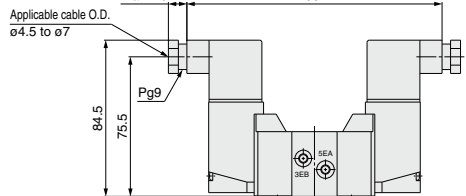

Unless otherwise indicated, dimensions are the same as Grommet (G).

M-type plug connector (M): VF1220-□<sup>M</sup>□□1-M5<sub>01</sub>□

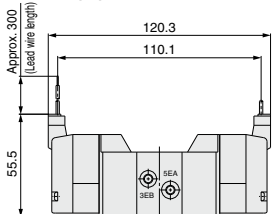

Approx. 300  
(Lead wire length)

Conduit terminal (T): VF1220-□<sup>T</sup>□□1-M5<sub>01</sub>□

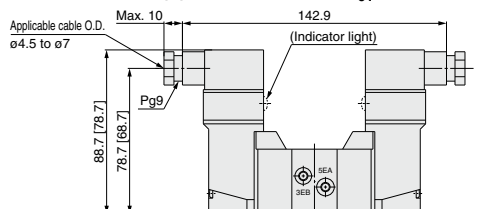

[ ]: Without indicator light  
Unless otherwise indicated, dimensions are the same as Grommet (G).

Unless otherwise indicated, dimensions are the same as Grommet (G).

**Dimensions: Series VF3000/Body Ported**

**2-position single**

**Grommet (G) (H): VF3130-□<sub>G</sub>□<sub>H</sub>□□1.01□□ (-F)**

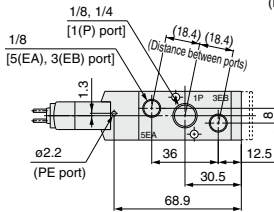
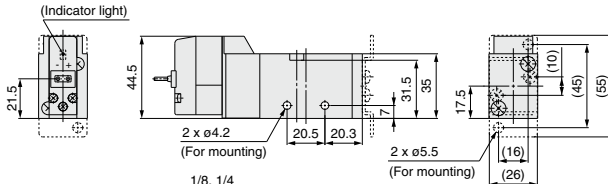
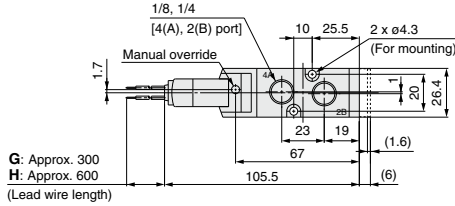

**Grommet (G) (H)**  
DC without light/surge voltage suppressor

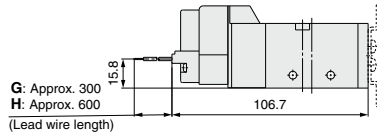

**L-type plug connector (L): VF3130-□L□□1.01□□ (-F)**

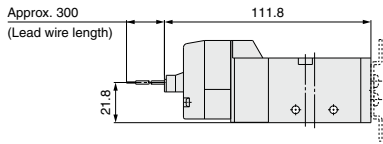

Unless otherwise indicated, dimensions are the same as Grommet (G).

**DIN terminal (D) (Y): VF3130-□<sub>D</sub>□□1.01□□ (-F)**

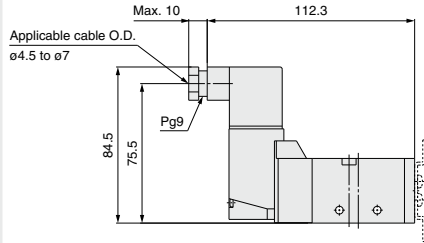

Unless otherwise indicated, dimensions are the same as Grommet (G).

**M-type plug connector (M): VF3130-□M□□1.01□□ (-F)**

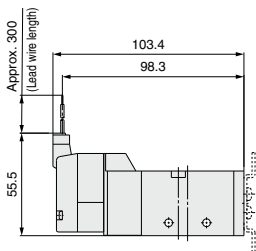

Unless otherwise indicated, dimensions are the same as Grommet (G).

**Conduit terminal (T): VF3130-□<sub>T</sub>□□1.01□□ (-F)**

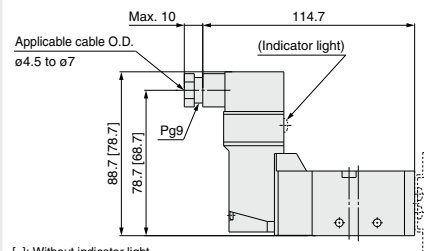

[ ]: Without indicator light  
Unless otherwise indicated, dimensions are the same as Grommet (G).

SJ
SY
SY
SV
SYJ
SZ
<b>VF</b>
VP4
S0700
VQ
VQ4
VQ5
VQC
VQC4
VQZ
SQ
VFS
VFR
VQ7

# Series VF1000/3000/5000

## Dimensions: Series VF3000/Body Ported

### 2-position double

Grommet (G) (H): VF3230-□<sup>G</sup><sub>H</sub>□□1-01□□

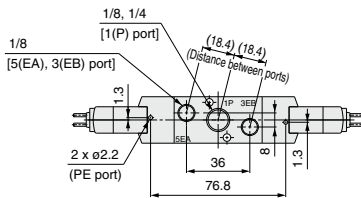
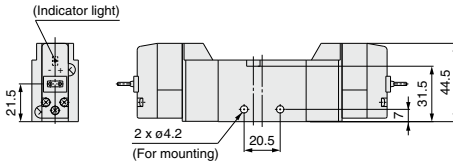
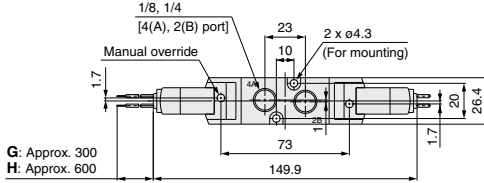

### Grommet (G) (H)

DC without light/surge voltage suppressor

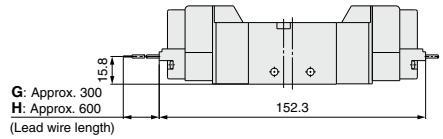

### L-type plug connector (L): VF3230-□L□□1-01□□

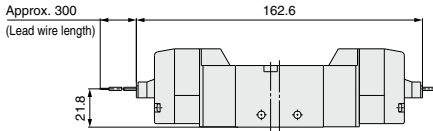

Unless otherwise indicated, dimensions are the same as Grommet (G).

### M-type plug connector (M): VF3230-□M□□1-01□□

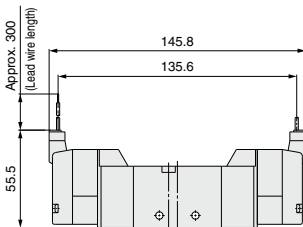

Unless otherwise indicated, dimensions are the same as Grommet (G).

### DIN terminal (D) (Y): VF3230-□<sup>D</sup><sub>Y</sub>□□1-01□□

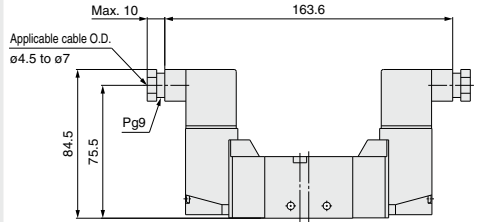

Unless otherwise indicated, dimensions are the same as Grommet (G).

### Conduit terminal (T): VF3230-□T□□1-01□□

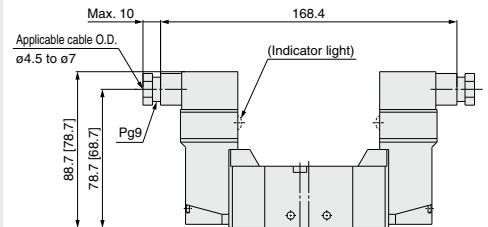

[ ]: Without indicator light

Unless otherwise indicated, dimensions are the same as Grommet (G).

**Dimensions: Series VF3000/Body Ported**

3-position closed center/exhaust center/pressure center

Grommet (G) (H): VF3<sup>3</sup><sub>5</sub>30-□□□□1-01□□

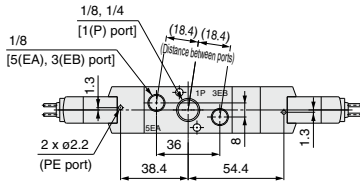
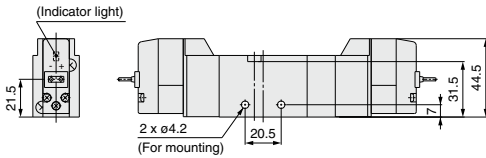
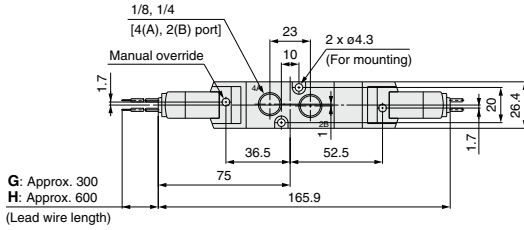

**Grommet (G) (H)**  
DC without light/surge voltage suppressor

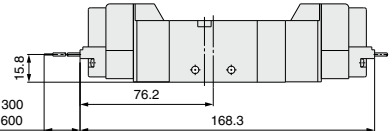

L-type plug connector (L): VF3<sup>3</sup><sub>5</sub>30-□□□□L-01□□

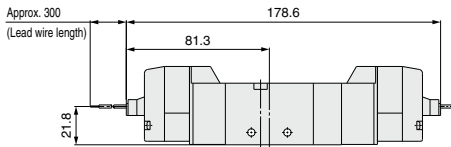

Unless otherwise indicated, dimensions are the same as Grommet (G).

M-type plug connector (M): VF3<sup>3</sup><sub>5</sub>30-□□□□M-01□□

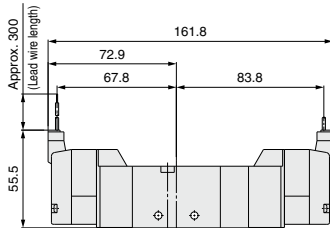

Unless otherwise indicated, dimensions are the same as Grommet (G).

DIN terminal (D) (Y): VF3<sup>3</sup><sub>5</sub>30-□□□□D-01□□

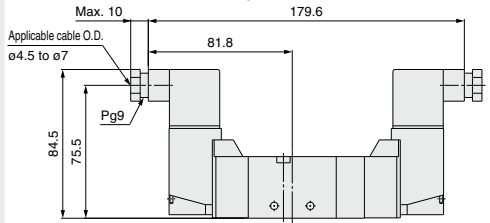

Unless otherwise indicated, dimensions are the same as Grommet (G).

Conduit terminal (T): VF3<sup>3</sup><sub>5</sub>30-□□□□T-01□□

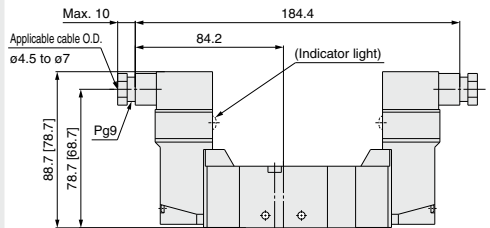

[ ]: Without indicator light  
Unless otherwise indicated, dimensions are the same as Grommet (G).

SJ
SY
SY
SV
SYJ
SZ
<b>VF</b>
VP4
S0700
VQ
VQ4
VQ5
VQC
VQC4
VQZ
SQ
VFS
VFR
VQ7

# Series VF1000/3000/5000

## Dimensions: Series VF5000/Body Ported

### 2-position single

Grommet (G) (H): VF5120-□<sup>G</sup>□<sup>H</sup>□□1-02□<sub>03</sub>□

G: Approx. 300

H: Approx. 600

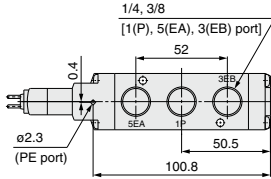
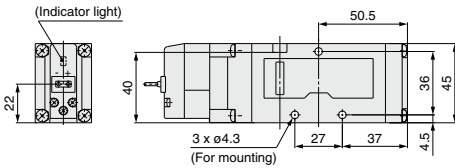
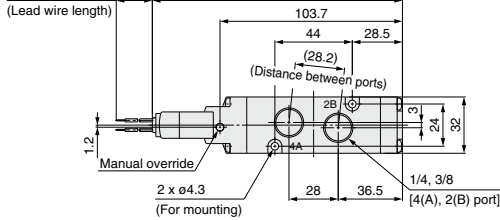

### Grommet (G) (H)

DC without light/surge voltage suppressor

G: Approx. 300

H: Approx. 600

(Lead wire length)

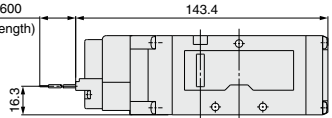

L-type plug connector (L): VF5120-□L□□1-02□<sub>03</sub>□

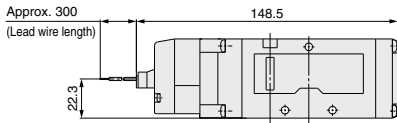

Unless otherwise indicated, dimensions are the same as Grommet (G).

DIN terminal (D) (Y): VF5120-□<sup>D</sup>□<sup>Y</sup>□□1-02□<sub>03</sub>□

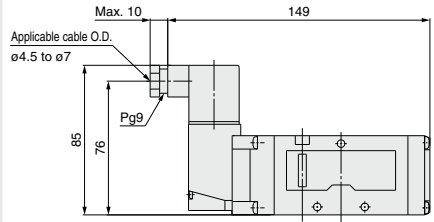

Unless otherwise indicated, dimensions are the same as Grommet (G).

M-type plug connector (M): VF5120-□M□□1-02□<sub>03</sub>□

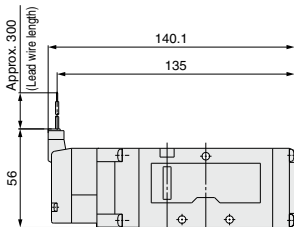

Unless otherwise indicated, dimensions are the same as Grommet (G).

Conduit terminal (T): VF5120-□T□□1-02□<sub>03</sub>□

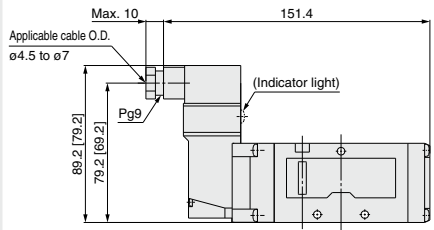

[ ]: Without indicator light

Unless otherwise indicated, dimensions are the same as Grommet (G).



**Dimensions: Series VF5000/Body Ported**

**2-position double**

**Grommet (G) (H): VF5220-□<sup>G</sup>□□1-02<sub>03</sub>□**

G: Approx. 300

H: Approx. 600

(Lead wire length)

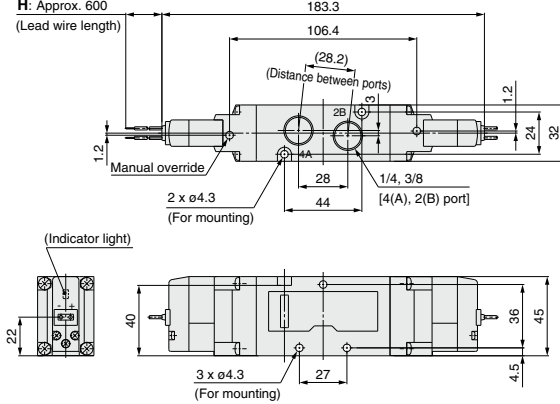

**Grommet (G) (H)**  
DC without light/surge voltage suppressor

G: Approx. 300

H: Approx. 600

(Lead wire length)

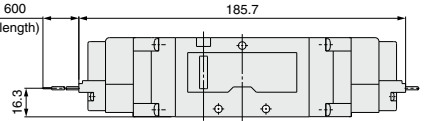
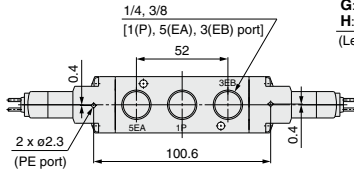

**L-type plug connector (L): VF5220-□L□□1-02<sub>03</sub>□**

Approx. 300

(Lead wire length)

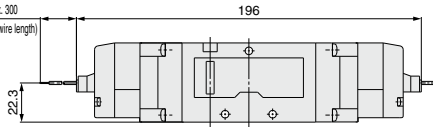

Unless otherwise indicated, dimensions are the same as Grommet (G).

**M-type plug connector (M): VF5220-□M□□1-02<sub>03</sub>□**

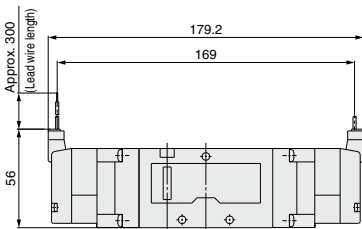

Unless otherwise indicated, dimensions are the same as Grommet (G).

**DIN terminal (D) (Y): VF5220-□<sup>D</sup>□□1-02<sub>03</sub>□**

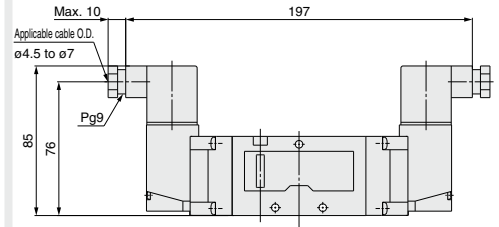

Unless otherwise indicated, dimensions are the same as Grommet (G).

**Conduit terminal (T): VF5220-□T□□1-02<sub>03</sub>□**

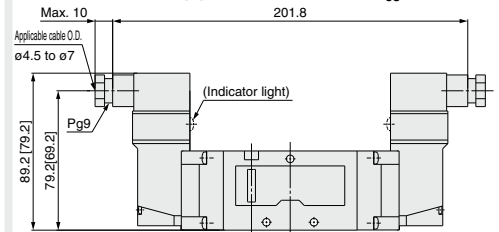

[ ]: Without indicator light

Unless otherwise indicated, dimensions are the same as Grommet (G).

SJ
SY
SY
SV
SYJ
SZ
<b>VF</b>
VP4
S0700
VQ
VQ4
VQ5
VQC
VQC4
VQZ
SQ
VFS
VFR
VQ7

# Series VF1000/3000/5000

## Dimensions: Series VF5000/Body Ported

### 3-position closed center/exhaust center/pressure center

Grommet (G) (H): VF5<sup>3</sup><sub>4</sub>20-□□□1-<sup>02</sup><sub>03</sub>□

G: Approx. 300

H: Approx. 600

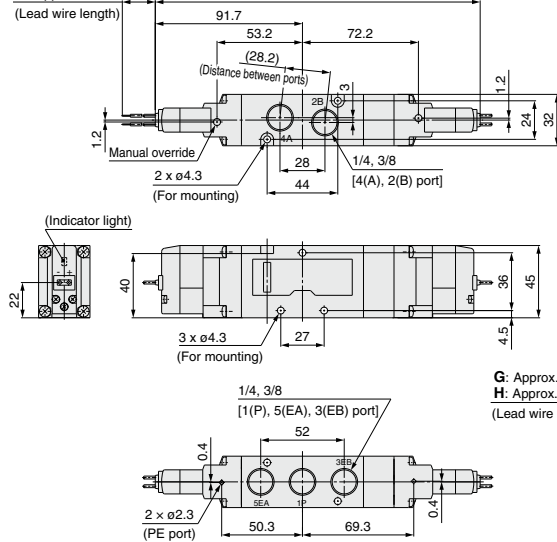

### Grommet (G) (H)

DC without light/surge voltage suppressor

G: Approx. 300

H: Approx. 600

(Lead wire length)

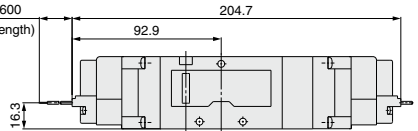

L-type plug connector (L): VF5<sup>3</sup><sub>4</sub>20-□□□1-<sup>02</sup><sub>03</sub>□

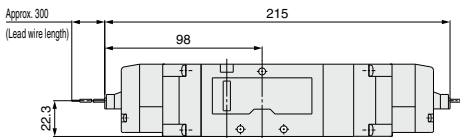

Unless otherwise indicated, dimensions are the same as Grommet (G).

DIN terminal (D) (Y): VF5<sup>3</sup><sub>4</sub>20-□□□1-<sup>02</sup><sub>03</sub>□

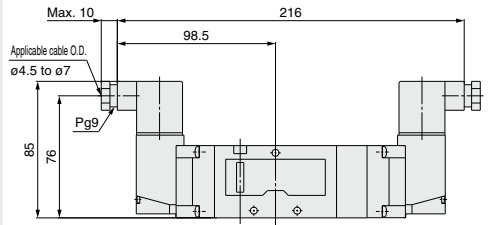

Unless otherwise indicated, dimensions are the same as Grommet (G).

M-type plug connector (M): VF5<sup>3</sup><sub>4</sub>20-□□□1-<sup>02</sup><sub>03</sub>□

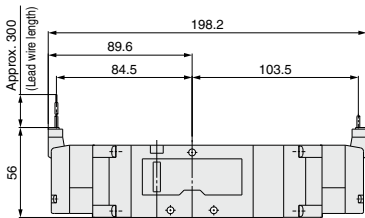

Unless otherwise indicated, dimensions are the same as Grommet (G).

Conduit terminal (T): VF5<sup>3</sup><sub>4</sub>20-□□□1-<sup>02</sup><sub>03</sub>□

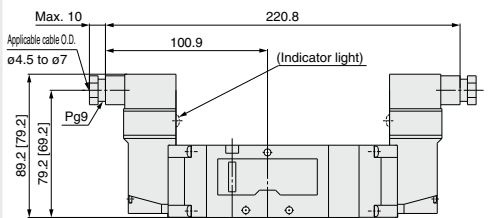

[ ]: Without indicator light

Unless otherwise indicated, dimensions are the same as Grommet (G).

# Series VF1000/3000/5000

## Made to Order

Please contact SMC for detailed dimensions, specifications, and lead times.



### 1 Body Ported Pilot Exhaust Port with Piping Thread (M3) Specification

In this specification, piping to the pilot exhaust port (PE port) is available when the valve is used in an environment where the exhaust from the pilot valve is not allowable, or intrusion of ambient dust should be prevented. Combination with low wattage specification is not possible.

#### How to Order Valve

**VF 3**   **3 0**        **1**       **X500**

Series

1	VF1000
3	VF3000
5	VF5000

Type of actuation

1	2-position single
2	2-position double
3	3-position closed center
4	3-position exhaust center
5	3-position pressure center

Body model

Symbol	VF1000	VF3000	VF5000
2	○	—	○
3	—	○	—

Note) Not available for the base mounted type.

Entry is the same as standard products. The specifications and performance are the same as those of standard products.

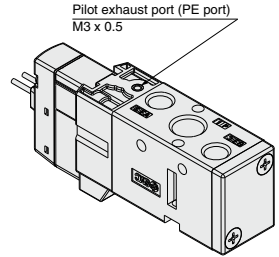

#### • 2-position single

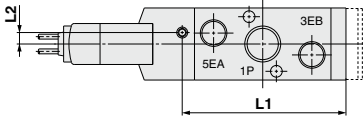

#### • 2-position double

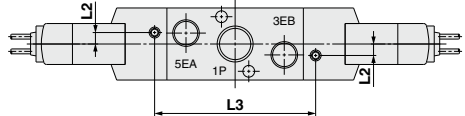

#### • 3-position closed center/exhaust center/pressure center

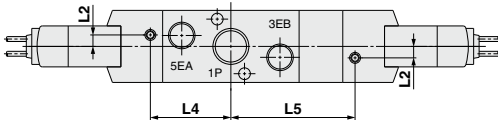

Series	L1	L2	L3	L4	L5
VF1000	34.5	4.2	33.4	—	—
VF3000	60	4.2	59	29.5	45.5
VF5000	95	3.45	89	44.5	63.5

### 2 TRIAC Output Specification

For AC type valve, use this specification when the pilot valve is not recovered even though valve power supply is turned OFF at the equipment using output unit with large leakage voltage over 8% of the rated voltage (TRIAC output such as PLC or SSR, etc.). Combination with low wattage specification is not possible.

#### How to Order Valve

**VF 3**           **1**       **X600**

Series

1	VF1000
3	VF3000
5	VF5000

Type of actuation

1	2-position single
2	2-position double
3	3-position closed center
4	3-position exhaust center
5	3-position pressure center

Entry is the same as standard products.  
Note) Rated voltage: AC type only

SJ
SY
SY
SV
SYJ
SZ
VF
VP4
S0700
VQ
VQ4
VQ5
VQC
VQC4
VQZ
SQ
VFS
VFR
VQ7

# Pilot Operated 5 Port Solenoid Valve

# Series VF3000/5000

## Single Unit

Base Mounted



Note) Only DIN and conduit terminal types are available with AC mode. Refer to the electrical entry for details.



### How to Order Valve

**Base mounted (VF1000: Not available)**

**Series**

3	VF3000
5	VF5000

\* Not available with the VF1000.

**Type of actuation**

1	2-position single
2	2-position double
3	3-position closed center
4	3-position exhaust center
5	3-position pressure center

**Body model**

**Pressure specifications**

Nil	Standard (0.7 MPa)
K	High-pressure type (1 MPa)

**Coil specifications**

Nil	Standard
T	With power saving circuit (DC only)

Note) Be sure to select the power saving circuit type when it is continuously energized for long periods of time. (Refer to page 858 for details.)

\* T type is available with DC mode only. When T is selected, only Z type of light/surge voltage suppressor is available. (Note that when the electrical entry of DIN terminal type without connector is selected, only DOS and YOS are available.)

**Rated voltage**

DC	AC (50/60 Hz)
5	1 100 VAC
2	2 200 VAC
3	3 110 VAC [115 VAC]
4	4 220 VAC [230 VAC]
7	7 240 VAC
B	B 24 VAC

**Body option**

**0: Pilot valve individual exhaust**

PE port	EA/EB port
VF3000	VF5000
○	—

**3: Main/Pilot valve common exhaust**

PE port	EA/EB port
VF3000	VF5000
○	—

**4: Pilot valve base exhaust**

PE port	VF3000	VF5000
—	—	○

**Made to Order**

Nil	—
X600	TRIAC output specification (Refer to page 821.)

**Thread type**

Nil	Rc
F	G
N	NPT
T	NPTF

**Port size (Sub-plate)**

Symbol	Port size	VF3000	VF5000
Nil	Without sub-plate	○	○
02	1/4	○	○
03	3/8	○	○
04	1/2	—	○

\* Without the sub-plate, two mounting screws and a gasket are included.

**Manual override**

Nil: Non-locking push type	D: Push-tum locking slotted type	E: Push-tum locking lever type

**Light/Surge voltage suppressor**

Symbol	Light/Surge voltage suppressor	DC	AC
Nil	Without light/surge voltage suppressor	○	○
S	With surge voltage suppressor	○	— <sup>(Note)</sup>
Z	With light/surge voltage suppressor	○	○
R	With surge voltage suppressor (Non-polar)	○	—
U	With light/surge voltage suppressor (Non-polar)	○	—

Note) S type is not available with AC mode, since a rectifier prevents surge voltage generation.

\* In the DIN terminal type, since a light is installed in the connector, DOZ, DOU, YOZ, YOU are not available.

### Electrical entry

Grommet	L-type plug connector	M-type plug connector	DIN terminal (IP65 compatible)	DIN (EN175301-803) terminal (IP65 compatible)	Conduit terminal (IP65 compatible)
<b>G:</b> Lead wire length 300 mm	<b>L:</b> With lead wire (length 300 mm)	<b>M:</b> With lead wire (length 300 mm)	<b>D:</b> With connector	<b>Y:</b> With connector	<b>T:</b> Conduit terminal
<b>H:</b> Lead wire length 600 mm					
<b>G:</b> Lead wire length 300 mm	<b>LN:</b> Without lead wire	<b>MN:</b> Without lead wire	<b>DO:</b> Without connector	<b>YO:</b> Without connector	
<b>H:</b> Lead wire length 600 mm	<b>LO:</b> Without connector	<b>MO:</b> Without connector			
<b>DC</b> Without light/surge voltage suppressor					
CE	DC	CE	CE	CE	CE
compliant	AC	—	—	—	—

Note) S type is not available with AC mode, since a rectifier prevents surge voltage generation.

\* In the DIN terminal type, since a light is installed in the connector, DOZ, DOU, YOZ, YOU are not available.

### Caution

When using the surge voltage suppressor type, residual voltage will remain. Refer to page 858 for details.

- \* LN and MN types are with 2 sockets.
- \* Refer to page 856 when different length of lead wire for L/M-type plug connector is required.
- \* Refer to page 857 for details on the DIN (EN175301-803) terminal. Note 1) When using IP65, select the main/pilot valve common exhaust type or pilot valve base exhaust type. Note 2) With the same specifications as the DC type, all electrical entries for the 24 VAC type are CE marking compliant.

# Pilot Operated 5 Port Solenoid Valve Base Mounted/Single Unit *Series VF3000/5000*

## Specifications

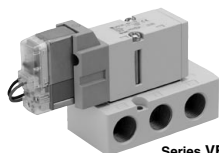

Series VF3000



Series VF5000



**Made to Order**  
(Refer to page 821 for details.)

Symbol	Specification
<b>X600</b>	TRIAC output specification

Model		VF3000	VF5000
<b>Fluid</b>		Air	
<b>Operating pressure range (MPa)</b>	<b>Standard</b>	2-position single/3-position	0.15 to 0.7
		2-position double	0.1 to 0.7
	<b>High-pressure type</b>	2-position single/3-position	0.15 to 1.0
		2-position double	0.1 to 1.0
<b>Ambient and fluid temperature (°C)</b>		-10 to 50 (No freezing)	
<b>Max. operating frequency (Hz)</b>	2-position single/double	10	5
	3-position	3	3
<b>Manual override</b>		Non-locking push type Push-turn locking slotted type Push-turn locking lever type	
<b>Pilot exhaust type</b>		Individual exhaust, Main/ Pilot valve common exhaust	Pilot valve base exhaust
<b>Lubrication</b>		Not required	
<b>Mounting orientation</b>		Unrestricted	
<b>Impact/Vibration resistance (m/s<sup>2</sup>) <small>Note</small></b>		300/50	
<b>Enclosure</b>		Dustproof (IP65* for D, Y, T)	

Note) Impact resistance: No malfunction occurred when it is tested in the axial direction and at the right angles to the main valve and armature in both energized and de-energized states every once for each condition. (Values at the initial period)

Vibration resistance: No malfunction occurred in a one-sweep test between 45 and 2000 Hz. Test was performed at both energized and de-energized states in the axial direction and at the right angles to the main valve and armature. (Values at the initial period)

\* Based on IEC 60529. When using IP65, select the main/pilot valve common exhaust type or pilot valve base exhaust type.

## Solenoid Specifications

<b>Electrical entry</b>		Grommet (G), (H) L-type plug connector (L) M-type plug connector (M) G, H, L, M	DIN terminal (D) DIN (EN175301-803) terminal (Y) Conduit terminal (T) D, Y, T
<b>Coil rated voltage (V)</b>	DC AC (50/60 Hz)	24, 12	
<b>Allowable voltage fluctuation</b>		±10% of rated voltage*	
<b>Power consumption (W)</b>	<b>Standard</b>	1.5 (With light: 1.55)	1.5 (With light: 1.75)
	<b>DC With power saving circuit</b>	0.55 <sup>Note</sup> (With light only) [Starting 1.55 Holding 0.55]	0.75 <sup>Note</sup> (With light only) [Starting 1.75 Holding 0.75]
<b>Apparent power (VA)*</b>	24 V	1.5 (With light: 1.75)	
	100 V	1.55 (With light: 1.65)	
	110 V [115 V]	1.55 (With light: 1.7)	
	200 V		
	220 V [230 V] 240 V		
<b>Surge voltage suppressor</b>		Diode (Non-polar type: Varistor)	
<b>Indicator light</b>		LED (Neon light is used for AC mode of D, Y, T.)	

\* It is in common between 110 VAC and 115 VAC, and between 220 VAC and 230 VAC.

\* Allowable voltage fluctuation is -15% to +5% of the rated voltage for 115 VAC or 230 VAC.

\* Since voltage drops due to the internal circuit in S, Z, T types (with power saving circuit), the allowable voltage fluctuation should be within the following range.

24 VDC: -7% to +10% 12 VDC: -4% to +10%

Note) Refer to page 858 for details.

## Response Time

Series	Type of actuation		Pressure specifications	Operating pressure range (MPa)	Response time (ms) (at 0.5 MPa)			
					Without light/surge voltage suppressor	With light/surge voltage suppressor		AC
						S, Z type	R, U type	
VF1000	2-position	Single	Standard	0.15 to 0.7	20	45	23	45
		Double		0.1 to 0.7	12	12	12	12
		Single	High-pressure type	0.15 to 1.0	23	48	26	48
		Double		0.1 to 1.0	15	15	15	15
VF3000	2-position	Single	Standard	0.15 to 0.7	20	45	23	45
		Double		0.1 to 0.7	12	12	12	12
	3-position		High-pressure type	0.15 to 0.7	30	55	33	55
	Single	0.15 to 1.0		23	48	26	48	
	2-position	Double	0.1 to 1.0	15	15	15	15	15
		3-position		0.15 to 1.0	33	58	36	58
VF5000	2-position	Single	Standard	0.15 to 0.7	30	55	33	55
		Double		0.1 to 0.7	15	15	15	15
	3-position		High-pressure type	0.15 to 0.7	50	75	53	75
	Single	0.15 to 1.0		33	58	36	58	
	2-position	Double	0.1 to 1.0	18	18	18	18	18
		3-position		0.15 to 1.0	53	78	56	78

Note) Based on dynamic performance test, JIS B 8375-1981. (Coil temperature: 20°C, at rated voltage)

SJ  
SY  
SV  
SYJ  
SZ  
VF  
VP4  
S0700  
VQ  
VQ4  
VQ5  
VQC  
VQC4  
VQZ  
SQ  
VFS  
VFR  
VQ7

# Series VF3000/5000

## Flow-rate Characteristics/Weight

Valve model	Type of actuation		Port size	Flow-rate characteristics <sup>Note 1)</sup>						Weight (g) <sup>Note 2)</sup>	
				1 → 4/2 (P → A/B)			4/2 → 5/3 (A/B → EA/EB)			Grommet	DIN terminal
				C [dm <sup>3</sup> /s-bar]	b	Cv	C [dm <sup>3</sup> /s-bar]	b	Cv		
VF3□40-02	2-position	Single	1/4	2.8	0.14	0.64	2.5	0.18	0.57	344 (192)	380 (228)
		Double		2.8	0.14	0.64	2.5	0.18	0.57	405 (252)	477 (324)
	3-position	Closed center		2.1	0.22	0.49	1.6	0.26	0.41	422 (270)	494 (342)
		Exhaust center		2.3	0.21	0.53	2.8 [2.1]	0.23 [0.26]	0.66 [0.50]	422 (270)	494 (342)
		Pressure center		2.9 [1.1]	0.16 [0.45]	0.67 [0.32]	2.1	0.23	0.49	422 (270)	494 (342)
VF3□40-03	2-position	Single	3/8	3.1	0.24	0.76	2.6	0.23	0.62	327 (192)	363 (228)
		Double		3.1	0.24	0.76	2.6	0.23	0.62	388 (252)	460 (324)
	3-position	Closed center		2.2	0.33	0.57	1.6	0.34	0.40	405 (270)	477 (342)
		Exhaust center		2.6	0.27	0.61	2.8 [2.3]	0.30 [0.28]	0.68 [0.55]	405 (270)	477 (342)
		Pressure center		3.4 [1.3]	0.29 [0.48]	0.80 [0.38]	2.2	0.31	0.52	405 (270)	477 (342)
VF5□44-02	2-position	Single	1/4	7.3	0.49	2.1	7.3	0.50	2.0	486 (297)	522 (333)
		Double		7.3	0.49	2.1	7.3	0.50	2.0	541 (352)	613 (424)
	3-position	Closed center		6.6	0.35	1.7	6.3	0.31	1.6	578 (390)	650 (462)
		Exhaust center		7.4	0.33	1.9	8.1 [7.4]	0.35 [0.34]	2.1 [1.9]	578 (390)	650 (462)
		Pressure center		8.0 [2.9]	0.35 [0.48]	2.1 [0.85]	5.6	0.31	1.5	578 (390)	650 (462)
VF5□44-03	2-position	Single	3/8	8.4	0.34	2.2	8.9	0.29	2.3	473 (297)	509 (333)
		Double		8.4	0.34	2.2	8.9	0.29	2.3	529 (352)	601 (424)
	3-position	Closed center		7.3	0.34	2.0	7.1	0.28	1.8	566 (390)	638 (462)
		Exhaust center		8.1	0.27	2.0	14.0 [8.3]	0.26 [0.31]	3.4 [2.2]	566 (390)	638 (462)
		Pressure center		8.1 [2.5]	0.33 [0.48]	2.0 [0.74]	5.7	0.31	1.4	566 (390)	638 (462)
VF5□44-04	2-position	Single	1/2	9.4	0.43	2.7	12.0	0.32	3.0	545 (297)	581 (333)
		Double		9.4	0.43	2.7	12.0	0.32	3.0	600 (352)	672 (424)
	3-position	Closed center		7.1	0.41	2.1	7.4	0.32	2.0	638 (390)	710 (462)
		Exhaust center		8.6	0.39	2.4	13.0 [8.9]	0.21 [0.40]	3.1 [2.5]	638 (390)	710 (462)
		Pressure center		11.0 [2.6]	0.18 [0.47]	2.6 [0.78]	6.1	0.35	1.6	638 (390)	710 (462)

Note 1) [ ]: Normal position

Note 2) ( ): Values without sub-plate

Pilot Operated 5 Port Solenoid Valve  
Base Mounted/Single Unit **Series VF3000/5000**

**Construction: Base Mounted**

**VF3000/5000**

Symbol  
2-position single

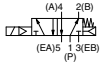

2-position single

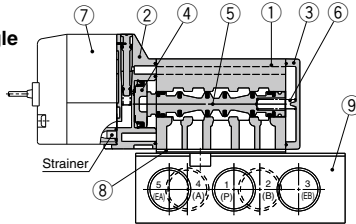

Symbol  
2-position double

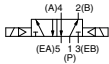

2-position double

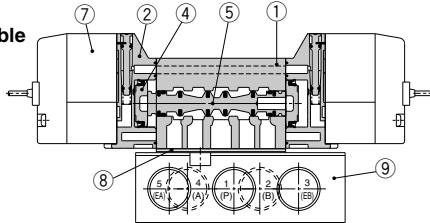

Symbol  
3-position closed center

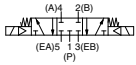

3-position closed center/exhaust center/pressure center

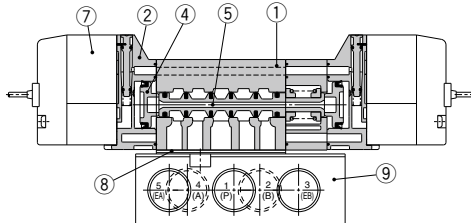

3-position exhaust center

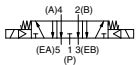

3-position pressure center

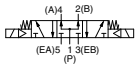

(Drawing shows a closed center type.)

Sub-plate part no.

**VF 3 000-71-1**

Series

3	VF3000
5	VF5000

Thread type

NII	Rc
F	G
N	NPT
T	NPTF

Port size

Symbol	Port size	VF3000	VF5000
1	1/4	○	○
2	3/8	○	○
3	1/2	—	○

**Component Parts**

No.	Description	Material	Note
1	Body	Aluminum die-casted	White
2	Adapter plate	Resin	Gray
3	End plate	Resin	White
4	Piston	Resin	
5	Spool valve	Aluminum, HNBR	
6	Spring	Stainless steel	

**Replacement Parts**

No.	Description	Part no.		Note
		VF3000	VF5000	
7	Pilot valve assembly	Refer to "How to Order Pilot Valve Assembly" on page 826.		Built-in strainer
8	Gasket	DXT031-30-11	DXT156-9-8	HNBR
9	Sub-plate	1/4: VF3000-71-1□ 3/8: VF3000-71-2□	1/4: VF5000-71-1□ 3/8: VF5000-71-2□ 1/2: VF5000-71-3□	Aluminum die-casted
—	Round head combination screw (1 pc.)	DXT031-44-1 (M4 x 39.5, With spring washer)	—	For mounting valve
—	Hexagon socket head cap screw (1 pc.)	—	AXT620-32-1 (M4 x 48, With spring washer)	For mounting valve

**Caution**

**Tightening Torque for Mounting Valve**

**M4: 1.4 N·m**

SJ
SY
SY
SV
SYJ
SZ
VF
VP4
S0700
VQ
VQ4
VQ5
VQC
VQC4
VQZ
SQ
VFS
VFR
VQ7

# Series VF3000/5000

## How to Order Pilot Valve Assembly (With a gasket and two mounting screws)

### ⚠ Caution

When only the pilot valve assembly is replaced, it is not possible to change from V211 (Grommet or L/M-type) to V212 (DIN or Conduit type), or vice versa.

Valve model: VF□□□□□□ - 5 G Z □ 1 - □□□□

\* Select from the below in accordance with the valve used.

#### ■ Grommet or L/M-type

V 2 1 1 □□ - 5 G Z

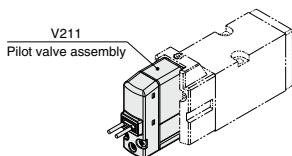

#### ● Light/Surge voltage suppressor

		DC	AC
Nil	Without light/surge voltage suppressor	<input type="radio"/>	<input type="radio"/>
S	With surge voltage suppressor	<input type="radio"/>	<input type="radio"/>
Z	With light/surge voltage suppressor	<input type="radio"/>	<input type="radio"/>
R	With surge voltage suppressor (Non-polar)	<input type="radio"/>	<input type="radio"/>
U	With light/surge voltage suppressor (Non-polar)	<input type="radio"/>	<input type="radio"/>

Note) S type is not available with AC mode, since a rectifier prevents surge voltage generation. When T is selected, only Z type of light/surge voltage suppressor is available.

### ⚠ Caution

When using the surge voltage suppressor type, residual voltage will remain. Refer to page 858 for details.

#### ● Electrical entry

G	Grommet (Lead wire length 900 mm)	
H	Grommet (Lead wire length 600 mm)	
L	L-type plug connector	With lead wire
LN		Without lead wire
LO	Without connector	
M	M-type plug connector	With lead wire
MN		Without lead wire
MO		Without connector

\* LN and MN types are with 2 sockets.

\* Refer to page 856 when different length of lead wire for L/M-type plug connector is required.

#### ■ DIN or Conduit type

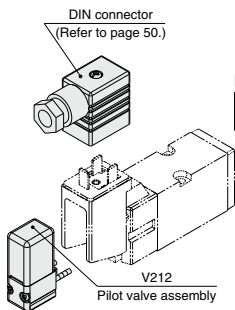

V 2 1 2 □□ - 5

#### ● Pressure specifications

Nil	Standard (0.7 MPa)
K	High-pressure type (1 MPa)

#### ● Coil specifications

Nil	Standard
T	With power saving circuit (DC only)

\* T type is available with DC mode only.

#### ● Rated voltage

DC	
5	24 VDC
6	12 VDC
AC (50/60 Hz)	
1	100 VAC
2	200 VAC
3	110 VAC [115 VAC]
4	220 VAC [230 VAC]
7	240 VAC
B	24 VAC

### ⚠ Caution

For V212 (DIN or Conduit type), the coil specifications and voltage (including light/surge voltage suppressor) cannot be changed by replacing the pilot valve assembly.

### ⚠ Caution

Tightening torque of the pilot valve assembly mounting screw

M2.5: 0.32 N·m

826



**Dimensions: Series VF3000/Base Mounted**

**2-position single**

Grommet (G) (H): VF3140-□G□□□1-02□□  
03□

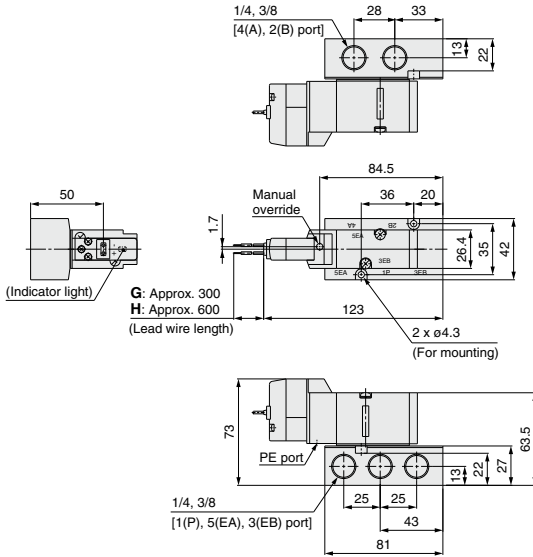

G: Approx. 300  
H: Approx. 600  
(Lead wire length)

**Grommet (G) (H)**  
DC without light/surge voltage suppressor

G: Approx. 300  
H: Approx. 600  
(Lead wire length)

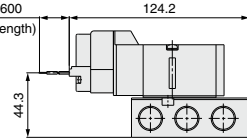

**L-type plug connector (L): VF3140-□L□□□1-02□□**  
03□

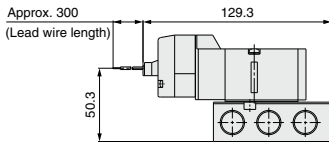

Unless otherwise indicated, dimensions are the same as Grommet (G).

**DIN terminal (D) (Y): VF3140-□D□□□1-02□□**  
03□

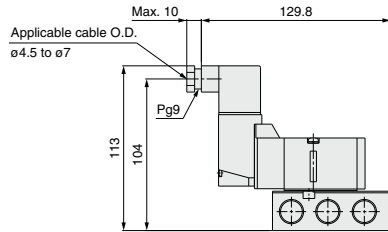

Unless otherwise indicated, dimensions are the same as Grommet (G).

**M-type plug connector (M): VF3140-□M□□□1-02□□**  
03□

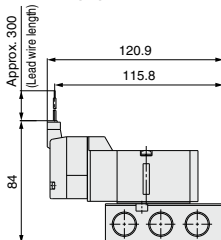

Unless otherwise indicated, dimensions are the same as Grommet (G).

**Conduit terminal (T): VF3140-□T□□□1-02□□**  
03□

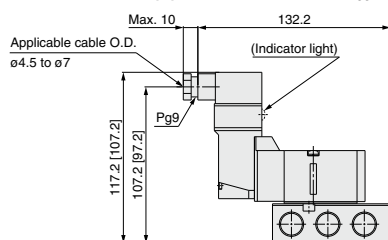

[ ]: Without indicator light  
Unless otherwise indicated, dimensions are the same as Grommet (G).

- SJ
- SY
- SY
- SV
- SYJ
- SZ
- VF
- VP4
- S0700
- VQ
- VQ4
- VQ5
- VQC
- VQC4
- VQZ
- SQ
- VFS
- VFR
- VQ7

# Series VF3000/5000

## Dimensions: Series VF3000/Base Mounted

### 2-position double

Grommet (G) (H): VF3240-□G□□1.02□□

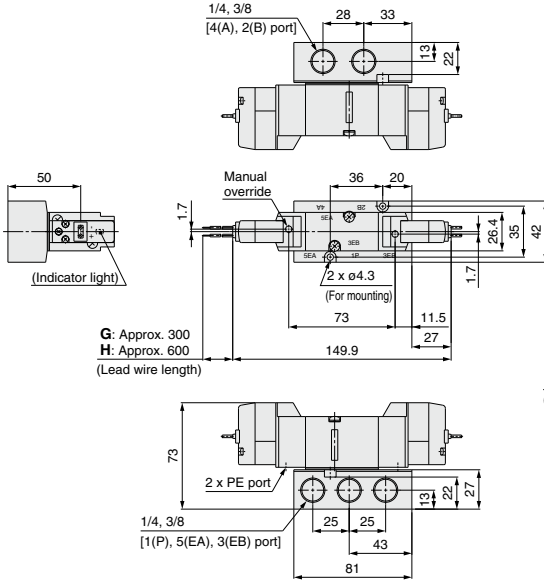

### Grommet (G) (H) DC without light/surge voltage suppressor

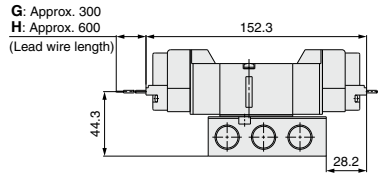

### L-type plug connector (L): VF3240-□L□□1.02□□

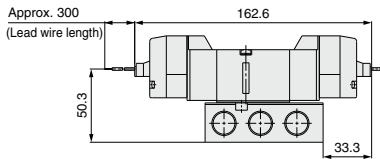

Unless otherwise indicated, dimensions are the same as Grommet (G).

### DIN terminal (D) (Y): VF3240-□D□□1.02□□

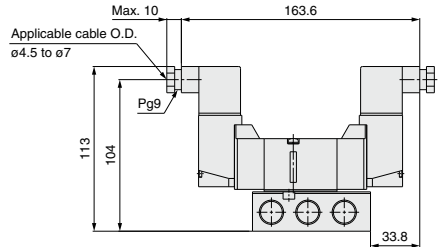

Unless otherwise indicated, dimensions are the same as Grommet (G).

### M-type plug connector (M): VF3240-□M□□1.02□□

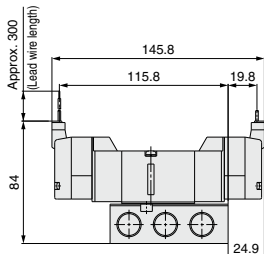

Unless otherwise indicated, dimensions are the same as Grommet (G).

### Conduit terminal (T): VF3240-□T□□1.02□□

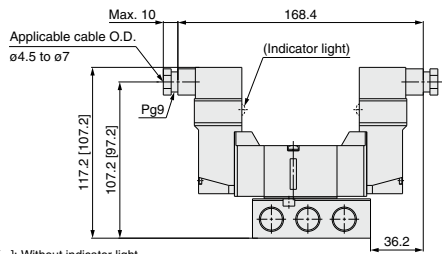

[ ]: Without indicator light  
 Unless otherwise indicated, dimensions are the same as Grommet (G).

**Dimensions: Series VF3000/Base Mounted**

3-position closed center/exhaust center/pressure center

Grommet (G) (H): VF3<sup>3</sup><sub>5</sub>40-□□G□□1-02<sub>03</sub>□

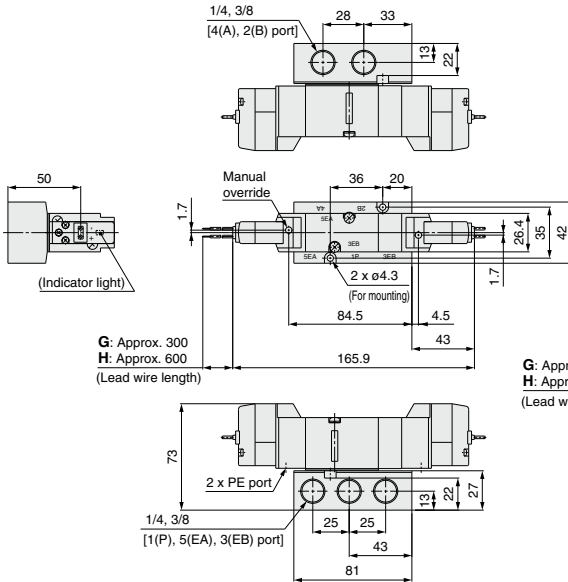

G: Approx. 300  
H: Approx. 600  
(Lead wire length)

**Grommet (G) (H)**  
DC without light/surge voltage suppressor

G: Approx. 300  
H: Approx. 600  
(Lead wire length)

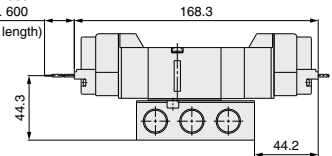

L-type plug connector (L): VF3<sup>3</sup><sub>5</sub>40-□□L□□1-02<sub>03</sub>□

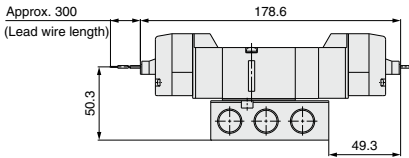

Unless otherwise indicated, dimensions are the same as Grommet (G).

DIN terminal (D) (Y): VF3<sup>3</sup><sub>5</sub>40-□□D□□1-02<sub>03</sub>□

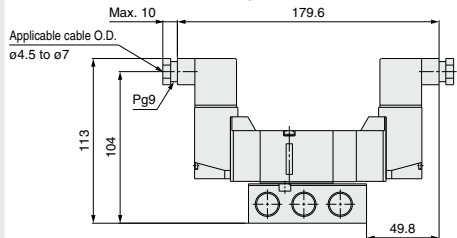

Unless otherwise indicated, dimensions are the same as Grommet (G).

M-type plug connector (M): VF3<sup>3</sup><sub>5</sub>40-□□M□□1-02<sub>03</sub>□

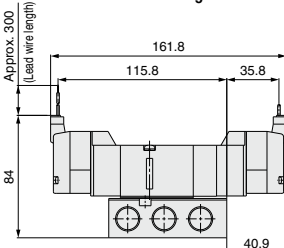

Unless otherwise indicated, dimensions are the same as Grommet (G).

Conduit terminal (T): VF3<sup>3</sup><sub>5</sub>40-□□T□□1-02<sub>03</sub>□

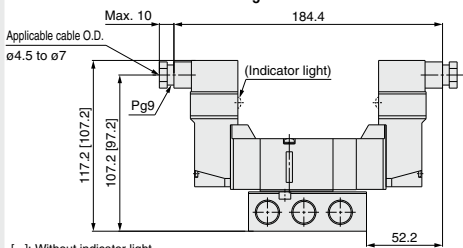

[ ]: Without indicator light  
Unless otherwise indicated, dimensions are the same as Grommet (G).

SJ
SY
SV
SYJ
SZ
VF
VP4
S0700
VQ
VQ4
VQ5
VQC
VQC4
VQZ
SQ
VFS
VFR
VQ7

# Series VF3000/5000

## Dimensions: Series VF5000/Base Mounted

### 2-position single

Grommet (G) (H): VF5144-□G□□1-<sup>02</sup>□<sub>03</sub>□<sub>04</sub>

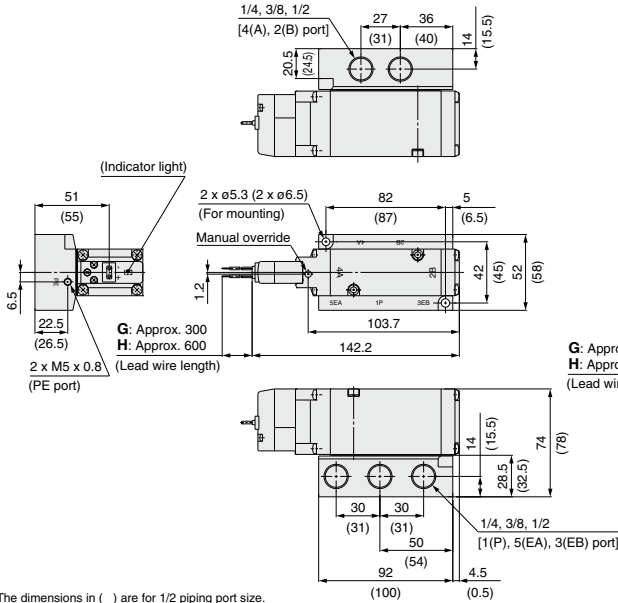

### Grommet (G) (H)

DC without light/surge voltage suppressor

G: Approx. 300

H: Approx. 600

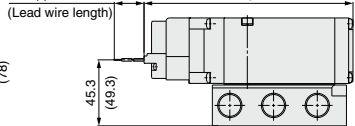

The dimensions in ( ) are for 1/2 piping port size.

L-type plug connector (L): VF5144-□L□□1-<sup>02</sup>□<sub>03</sub>□<sub>04</sub>

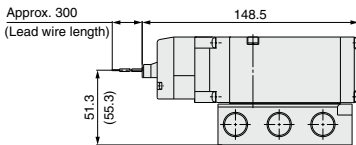

Unless otherwise indicated, dimensions are the same as Grommet (G). The dimensions in ( ) are for 1/2 piping port size.

DIN terminal (D) (Y): VF5144-□D□□1-<sup>02</sup>□<sub>03</sub>□<sub>04</sub>

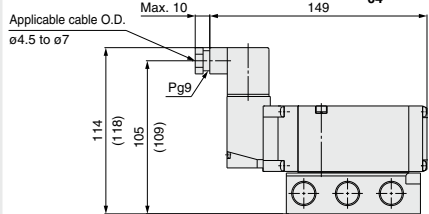

Unless otherwise indicated, dimensions are the same as Grommet (G). The dimensions in ( ) are for 1/2 piping port size.

M-type plug connector (M): VF5144-□M□□1-<sup>02</sup>□<sub>03</sub>□<sub>04</sub>

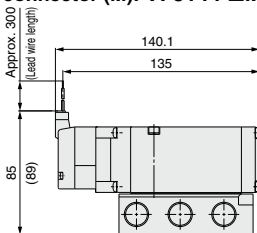

Unless otherwise indicated, dimensions are the same as Grommet (G). The dimensions in ( ) are for 1/2 piping port size.

Conduit terminal (T): VF5144-□T□□1-<sup>02</sup>□<sub>03</sub>□<sub>04</sub>

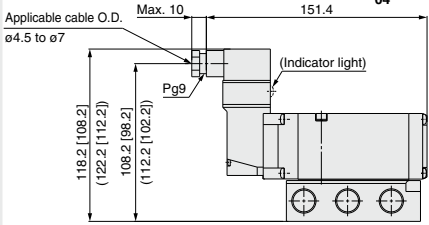

Unless otherwise indicated, dimensions are the same as Grommet (G). [ ]: Without indicator light. The dimensions in ( ) are for 1/2 piping port size.

**Dimensions: Series VF5000/Base Mounted**

**2-position double**

**Grommet (G) (H): VF5244-□□□□1-<sup>02</sup><sub>03</sub>□□<sub>04</sub>**

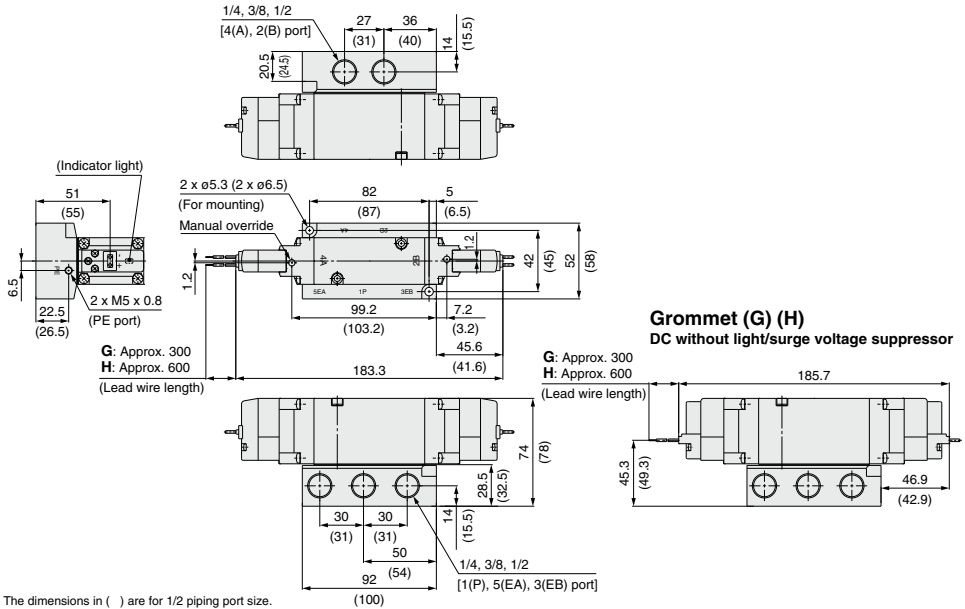

The dimensions in ( ) are for 1/2 piping port size.

**L-type plug connector (L): VF5244-□□□□1-<sup>02</sup><sub>03</sub>□□<sub>04</sub>**

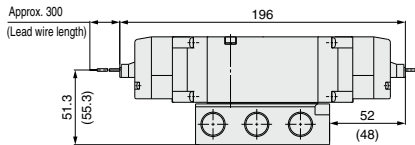

Unless otherwise indicated, dimensions are the same as Grommet (G).  
The dimensions in ( ) are for 1/2 piping port size.

**M-type plug connector (M): VF5244-□□□□1-<sup>02</sup><sub>03</sub>□□<sub>04</sub>**

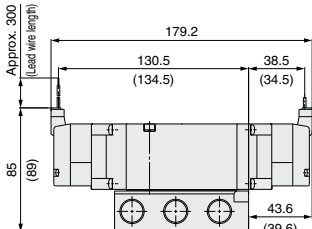

Unless otherwise indicated, dimensions are the same as Grommet (G).  
The dimensions in ( ) are for 1/2 piping port size.

**DIN terminal (D) (Y): VF5244-□□□□1-<sup>02</sup><sub>03</sub>□□<sub>04</sub>**

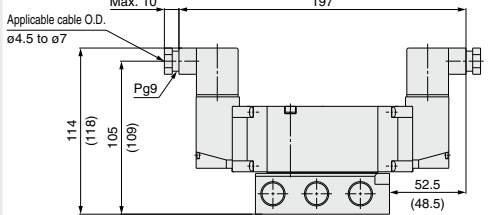

Unless otherwise indicated, dimensions are the same as Grommet (G).  
The dimensions in ( ) are for 1/2 piping port size.

**Conduit terminal (T): VF5244-□□□□1-<sup>02</sup><sub>03</sub>□□<sub>04</sub>**

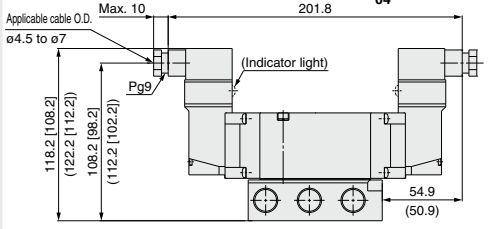

Unless otherwise indicated, dimensions are the same as Grommet (G).  
[ ] : Without indicator light  
The dimensions in ( ) are for 1/2 piping port size.

- SJ
- SY
- SY
- SV
- SYJ
- SZ
- VF
- VP4
- S0700
- VQ
- VQ4
- VQ5
- VQC
- VQC4
- VQZ
- SQ
- VFS
- VFR
- VQ7

# Series VF3000/5000

## Dimensions: Series VF5000/Base Mounted

### 3-position closed center/exhaust center/pressure center

Grommet (G) (H): VF5<sup>3</sup><sub>5</sub>44-□□□□1-02□□<sub>03</sub><sub>04</sub>

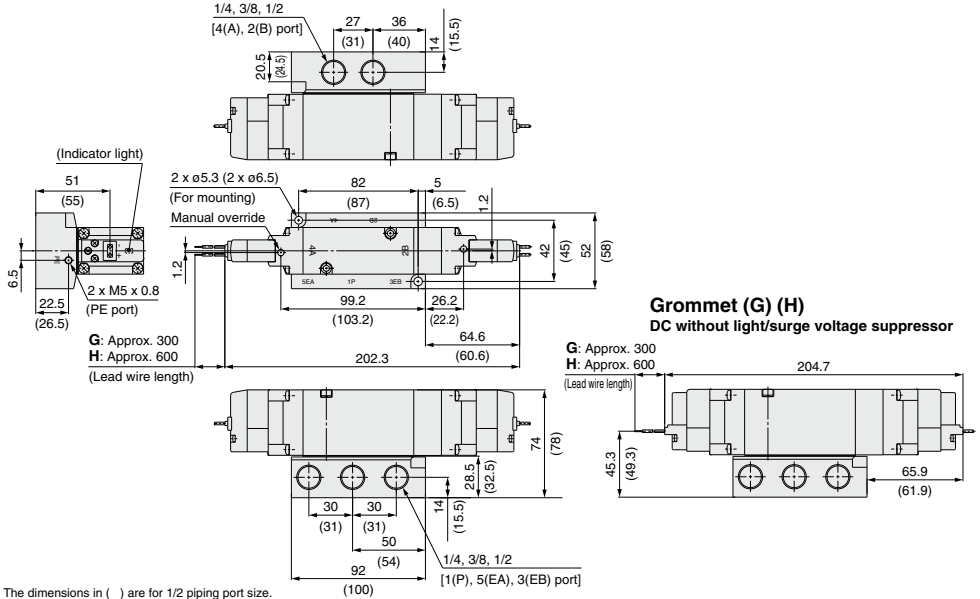

L-type plug connector (L): VF5<sup>3</sup><sub>5</sub>44-□□L□□1-02□□<sub>03</sub><sub>04</sub>

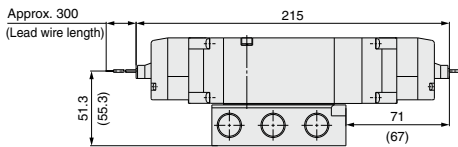

Unless otherwise indicated, dimensions are the same as Grommet (G).  
The dimensions in ( ) are for 1/2 piping port size.

DIN terminal (D) (Y): VF5<sup>3</sup><sub>5</sub>44-□□□□D□□□1-02□□<sub>03</sub><sub>04</sub>

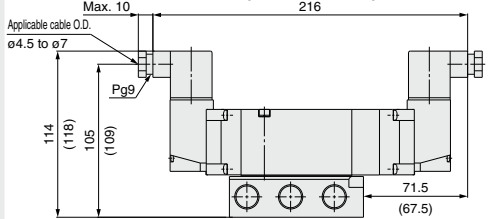

Unless otherwise indicated, dimensions are the same as Grommet (G).  
The dimensions in ( ) are for 1/2 piping port size.

M-type plug connector (M): VF5<sup>3</sup><sub>5</sub>44-□□M□□1-02□□<sub>03</sub><sub>04</sub>

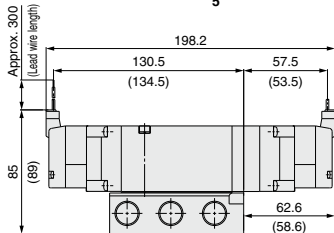

Unless otherwise indicated, dimensions are the same as Grommet (G).  
The dimensions in ( ) are for 1/2 piping port size.

Conduit terminal (T): VF5<sup>3</sup><sub>5</sub>44-□□□□T□□□1-02□□<sub>03</sub><sub>04</sub>

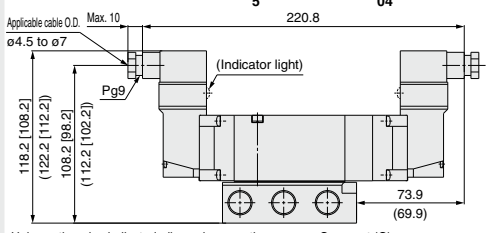

Unless otherwise indicated, dimensions are the same as Grommet (G).  
[ ] : Without indicator light  
The dimensions in ( ) are for 1/2 piping port size.

Body Ported  
Base Mounted

# Low Wattage Specification Series VF1000/3000 C €

RoHS

## How to Order Valve

VF 3 1 3 0 Y - 5 G 1 - 02

**Series**

1	VF1000
3	VF3000

**Type of actuation**

1	2-position single
2	2-position double
3	3-position closed center
4	3-position exhaust center
5	3-position pressure center

\* Only 1 and 2 are available with the VF1000.

**Body model**

		Mountable manifold		
		30	31	40
2	VF1000 Body ported	—	—	—
3	VF1000 Body ported (For manifold)	● (Note 1)	● (Note 1)	—
	VF3000 Body ported	● (Note 1)	—	—
4	VF3000 Base mounted	—	—	● (Note 2)

Note 1) Refer to page 837.

Note 2) Refer to page 848.

**Body option**

<b>0: Pilot valve individual exhaust</b>	
PE port	EA/EB port
VF1000	VF3000
○	○
<b>3: Main/Pilot valve common exhaust</b>	
PE port	EA/EB port
VF1000	VF3000
●*	○

\* Only available for body ported (for manifold) type.

**Low wattage type**

**Rated voltage**

1	100 VAC
2	200 VAC
3	110 VAC
4	220 VAC
5	24 VDC
6	12 VDC

**Bracket**

Nil	Without bracket
F	With bracket

Available with the VF1120, VF1220 and VF3130 only.

**Thread type**

Nil	Rc, M5
F	G
N	NPT
T	NPTF

**<Body ported> A, B port size**

M5	M5 x 0.8 (VF1000)
01	1/8 (VF1000, VF3000)
02	1/4 (VF3000)

**<Base mounted> Sub-plate port size**

Nil	Without sub-plate
02	Port size: 1/4
03	Port size: 3/8

**Version symbol**

**Manual override**

Nil	Non-locking push type
D	Push-turn locking slotted type
E	Push-turn locking lever type

**Light/Surge voltage suppressor and common specifications**

Nil	Without light/surge voltage suppressor	—
R	With surge voltage suppressor (DC only, Non-polar)	D and Y are not available
U	With light/surge voltage suppressor (DC only, Non-polar)	D and Y are not available
S	With surge voltage suppressor (DC only)	—
Z	With light/surge voltage suppressor	DOZ and YOZ are not available

**Electrical entry**

24 VDC, 12 VDC/100 VAC, 110 VAC, 200 VAC, 220 VAC				24 VDC, 12 VDC/100 VAC, 110 VAC, 200 VAC, 220 VAC	
Grommet		L-type plug connector	M-type plug connector	DIN terminal	
G: Lead wire length 300 mm	L: With lead wire (length 300 mm)	M: With lead wire (length 300 mm)	MN: Without lead wire	D: With connector	Y: With connector
H: Lead wire length 800 mm	LN: Without lead wire	LD: Without connector	MO: Without connector	DO: Without connector	YO: Without connector
CE compliant	DC	●	●	●	●
	AC	—	—	●	●

\* LN and MN types are with 2 sockets.

\* Y type DIN terminal complies with EN-175301-803C (former DIN 43650C). Refer to page 857 for details.

\* When using IP65, select the main/pilot valve common exhaust type. (Except VF1000)

SJ
SY
SY
SV
SYJ
SZ
VF
VP4
S0700
VQ
VQ4
VQ5
VQC
VQC4
VQZ
SQ
VFS
VFR
VQ7

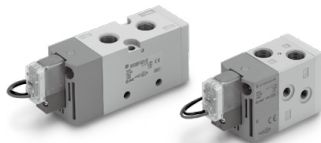

## Specifications

Model		VF1000	VF3000
<b>Fluid</b>		Air	
<b>Internal pilot operating pressure range (MPa)</b>	2-position single/3-position	0.15 to 0.7	
	2-position double	0.1 to 0.7	
<b>Ambient and fluid temperature (°C)</b>		-10 to 50 (No freezing)	
<b>Max. operating frequency (Hz)</b>	2-position single/double	5	5
	3-position	3	3
<b>Manual override</b>		Non-locking push type Push-turn locking slotted type Push-turn locking lever type	
<b>Pilot exhaust type</b>		Main/Pilot valve common exhaust	
<b>Lubrication</b>		Not required	
<b>Mounting orientation</b>		Unrestricted	
<b>Impact/Vibration resistance (m/s<sup>2</sup>)</b> <small>Note)</small>		150/30	
<b>Enclosure</b>		Dustproof (IP65* for DIN terminal)	

\* Based on IEC 60529.

Note) Impact resistance: No malfunction occurred when it is tested in the axial direction and at the right angles to the main valve and armature in both energized and de-energized states every once for each condition. (Values at the initial period)

Vibration resistance: No malfunction occurred in a one-sweep test between 45 and 2000 Hz. Test was performed at both energized and de-energized states in the axial direction and at the right angles to the main valve and armature. (Values at the initial period)

## Solenoid Specifications

Electrical entry		Grommet (G), (H) L-type plug connector (L) M-type plug connector (M)	DIN terminal (D), (Y)	
		G, H, L, M	D, Y	
<b>Coil rated voltage (V)</b>	DC	24, 12		
	AC (50/60 Hz)	100, 110, 200, 220		
<b>Allowable voltage fluctuation</b>		±10% of rated voltage*		
<b>Power consumption (W)</b>	DC	Standard		
	AC	0.35 (With light: 0.4 (With light of DIN terminal: 0.45))		
<b>Apparent power (VA)</b> *	AC	100 V	0.78 (With light: 0.81)	0.78 (With light: 0.87)
		110 V [115 V]	0.86 (With light: 0.89) [0.94 (With light: 0.97)]	0.86 (With light: 0.97) [0.94 (With light: 1.07)]
		200 V	1.18 (With light: 1.22)	1.15 (With light: 1.30)
		220 V [230 V]	1.30 (With light: 1.34) [1.42 (With light: 1.46)]	1.27 (With light: 1.46) [1.39 (With light: 1.60)]
		<b>Surge voltage suppressor</b>	Diode (DIN terminal, Non-polar type: Varistor)	
<b>Indicator light</b>		LED (Neon light is used for AC mode of DIN terminal.)		

\* It is in common between 110 VAC and 115 VAC, and between 220 VAC and 230 VAC.

\* Allowable voltage fluctuation is -15% to +5% of the rated voltage for 115 VAC or 230 VAC.

\* Since voltage drops due to the internal circuit in S and Z types, the allowable voltage fluctuation should be within the following range:  
24 VDC: -7% to +10%  
12 VDC: -4% to +10%

## Response Time

Series	Type of actuation	Response time (ms) (at 0.5 MPa)			AC
		Without light/surge voltage suppressor	With light/surge voltage suppressor		
		S, Z type	R, U type		
VF1000	2-position single	45	55	45	45
	2-position double	12	12	12	12
VF3000	2-position single	55	63	55	50
	2-position double	14	14	14	16
	3-position	100	100	90	90



Low Wattage Specification  
Body Ported/Base Mounted/Single Unit **Series VF1000/3000**

**Dimensions**

**VF1000**

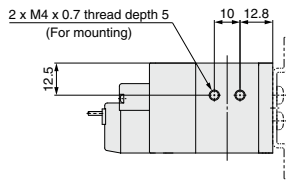
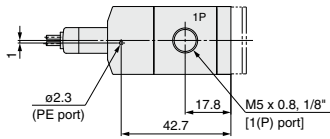
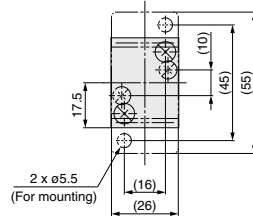
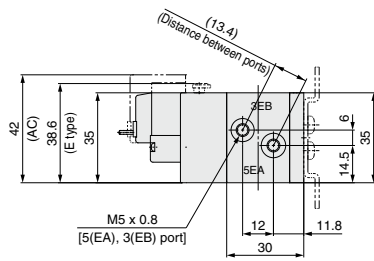
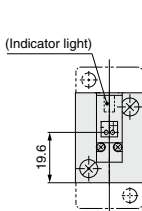
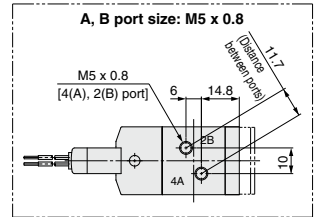
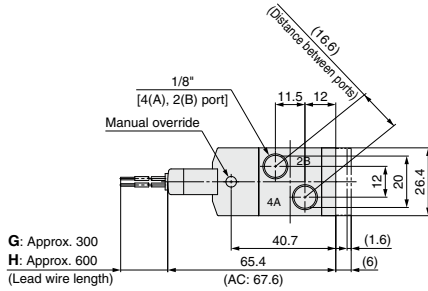

**L-type plug connector (L)**

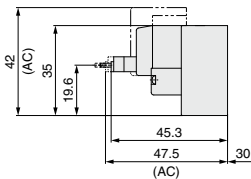

**M-type plug connector (M)**

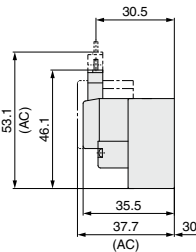

**DIN terminal (D) (Y)**

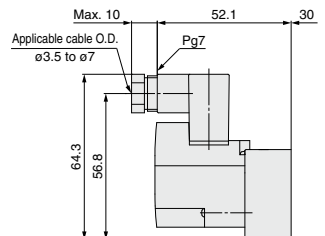

- SJ**
- SY**
- SY**
- SV**
- SYJ**
- SZ**
- VF**
- VP4**
- S0700**
- VQ**
- VQ4**
- VQ5**
- VQC**
- VQC4**
- VQZ**
- SQ**
- VFS**
- VFR**
- VQ7**

# Series VF1000/3000

## Dimensions

### VF3000

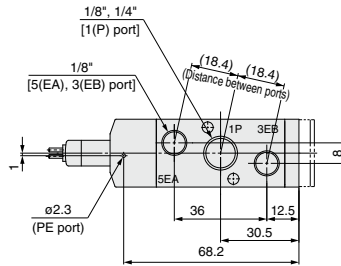
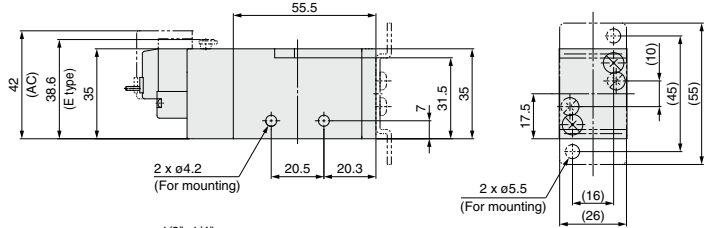
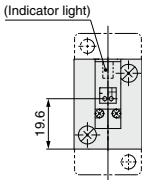
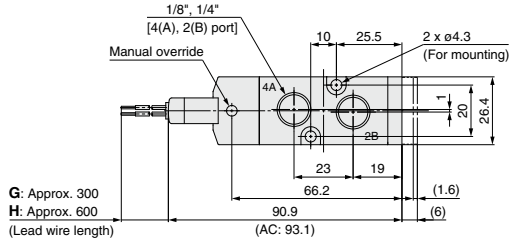

### L-type plug connector (L)

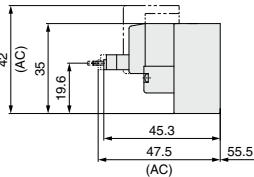

### M-type plug connector (M)

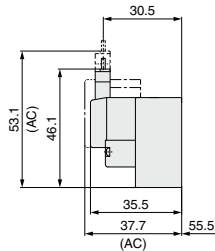

### DIN terminal (D) (Y)

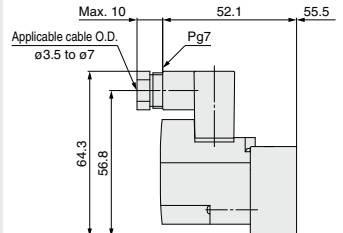

# Pilot Operated 5 Port Solenoid Valve

## Series VF1000/3000/5000

### Manifold

Body Ported

#### How to Order Manifold



Note) Only DIN and conduit terminal types are available with AC mode.  
Refer to the electrical entry for details.

#### Common exhaust

VV5F 1 - 30 - 04 1 -

Series

1	VF1000
3	VF3000
5	VF5000

#### Manifold model

Symbol	P, R port size	VF1000	VF3000	VF5000
30	1/8	○	—	—
	1/4	—	○	—
20	3/8	—	—	○
21	1/2	—	—	○

#### Stations

02	2 stations
...	...
20	20 stations

\* Up to 10 stations for VV5F5-20, and up to 15 stations for VV5F5-21.

#### Thread type

Nil	Rc
00F	G
00N	NPT
00T	NPTF

\* The A and B ports are made on the top.

#### Individual exhaust (VF1000 only)

VV5F1 - 31 - 04 3 -

Series

1	VF1000
---	--------

#### Manifold model

Symbol	P, R port size	EA, EB port size
31	1/8	M5

#### Stations

02	2 stations
...	...
20	20 stations

#### Thread type

Nil	Rc
00F	G
00N	NPT
00T	NPTF

#### Manifold model

Symbol	P, R port size	EA, EB port size
31	1/8	M5

Note) When placing an order for body ported valve as a single unit, mounting screws for manifold and gasket are not attached. Order them separately, if necessary. (Refer to page 839 for details.)

#### How to Order Valve

\* For low wattage specification, refer to "How to Order Valve" on page 833.

VF 3 1 3 0 - 5 G - 1 - 01 -

Series

1	VF1000
3	VF3000
5	VF5000

#### Type of actuation

1	2-position single
2	2-position double
3	3-position closed center
4	3-position exhaust center
5	3-position pressure center

\* Only 1 and 2 are available with the VF1000.

#### Coil specifications

Nil	Standard
T	With power saving circuit (DC only)

Note) Be sure to select the power saving circuit type when it is continuously energized for long periods of time. (Refer to page 858 for details.)  
\* T type is available with DC mode only. When T is selected, only Z type of light/surge voltage suppressor is available. (Note that when the electrical entry of DIN terminal type without connector is selected, only DOS and YOS are available.)

#### Pressure specifications

Nil	Standard (0.7 MPa)
K	High-pressure type (1 MPa)

#### Rated voltage

DC	AC (50/60 Hz)				
5	24 VDC	1	100 VAC	4	220 VAC (230 VAC)
6	12 VDC	2	200 VAC	7	240 VAC
		3	110 VAC (115 VAC)	B	24 VAC

#### Body model

Symbol	VF1000	VF3000	VF5000
2	—	—	—
3	○	○	○

Note) Manifold only.

#### Body option

0: Pilot valve individual exhaust			3: Main/Pilot valve common exhaust		
PE port	EA/EB port		PE port	EA/EB port	
VF1000	VF3000	VF5000	VF1000	VF3000	VF5000
○	○	○	○	○	○

#### Made to order

Refer to page 821 for details.  
Combination with low wattage specification is not possible.

#### Thread type

Nil	Rc
F	G
N	NPT
T	NPTF

\* M5 is available with Nil only.

#### Manual override

Nil: Non-locking push type

D: Push-turn locking slotted type

E: Push-turn locking lever type

#### Light/Surge voltage suppressor

Symbol	Light/Surge voltage suppressor	DC	AC
Nil	Without light/surge voltage suppressor	○	○
Z	With surge voltage suppressor	○	⊗(S)
S	With light/surge voltage suppressor	○	○
R	With surge voltage suppressor (Non-polar)	○	○
U	With light/surge voltage suppressor (Non-polar)	○	○

Note) S type is not available with AC mode, since a rectifier prevents surge voltage generation.

\* In the DIN terminal type, since a light is installed in the connector, DOZ, DOU, YOZ, YOU are not available.

#### Electrical entry

Grommet		L-type plug connector		M-type plug connector		DIN terminal (IP65 compatible)	DIN (EN175301-803) terminal (IP65 compatible)	Conduit terminal (IP65 compatible)
G: Lead wire length 300 mm	H: Lead wire length 600 mm	L: With lead wire (length 300 mm)	LN: Without lead wire	M: With lead wire (length 300 mm)	MN: Without lead wire	D: With connector	Y: With connector	T: Conduit terminal
		LO: Without connector		MO: Without connector		DO: Without connector	YO: Without connector	
CE	DC	CE	CE	CE	CE	CE	CE	CE

\* LN and MN types are with 2 sockets. \* Refer to page 856 when different length of lead wire for L/M-type plug connector is required.  
\* Refer to page 857 for details on the DIN (EN175301-803) terminal.  
Note 1) When using IP65, select the main/pilot valve common exhaust type.  
Note 2) With the same specifications as the DC type, all electrical entries for the 24 VAC type are CE marking compliant.

#### Caution

When using the surge voltage suppressor type, residual voltage will remain. Refer to page 858 for details.

# Series VF1000/3000/5000

## Manifold Specifications

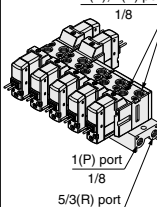
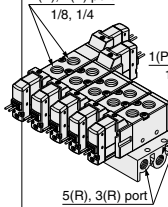
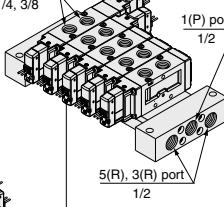
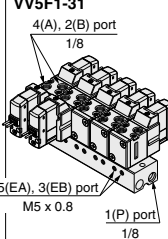
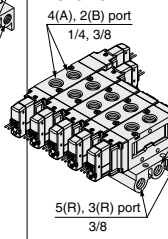
Series	VF1000		VF3000	VF5000	
Manifold base model	<b>VV5F1-30</b> 		<b>VV5F3-30</b> 	<b>VV5F5-21</b> 	
	<b>VV5F1-31</b> 		<b>VV5F5-20</b> 		
EXH port type	Common EXH	Individual EXH	Common EXH	Common EXH	Common EXH
Applicable valve model	<b>VF1□30</b> <b>VF1□33</b>		<b>VF3□30</b> <b>VF3□33</b>	<b>VF5□20</b> <b>VF5□23</b>	
Applicable stations	2 to 20 stations		2 to 20 stations	2 to 10 stations	2 to 15 stations
Manifold base Weight: W [g] Stations: n	W = 29n + 21	W = 51n + 35	W = 63n + 64	W = 97n + 80	W = 139n + 550

Note) Supply pressure to 1(P) ports and exhaust pressure from R ports on both sides for 10 stations or more (5 stations or more for the VF5000).

## How to Order Manifold Assembly

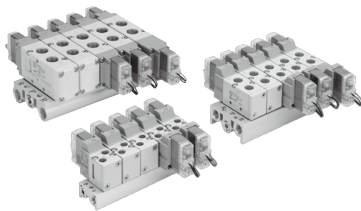

### Example (VV5F3-30)

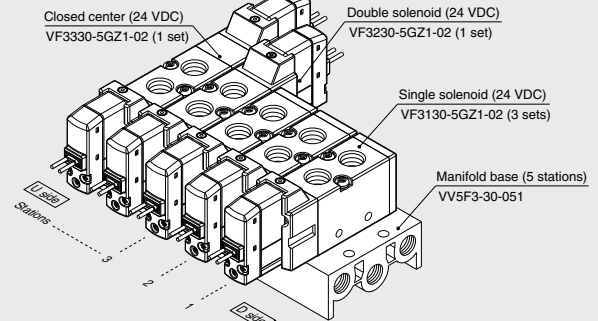

**VV5F3-30-051** ..... 1 set (Type 30, 5-station manifold base part no.)  
 \* **VF3130-5GZ1-02** ..... 3 sets (Single solenoid part no.)  
 \* **VF3230-5GZ1-02** ..... 1 set (Double solenoid part no.)  
 \* **VF3330-5GZ1-02** ..... 1 set (Closed center part no.)  
 ↳ The asterisk denotes the symbol for assembly. Prefix it to the part nos. of the solenoid valve, etc.

- The valve arrangement is numbered as the 1st station from D side.
- Under the manifold base part number, state the valves to be mounted in order from the 1st station as shown in the figure above. If the arrangement becomes complicated, specify on the manifold specification sheet.

## Manifold Options

### ■ For body ported Blanking plate assembly

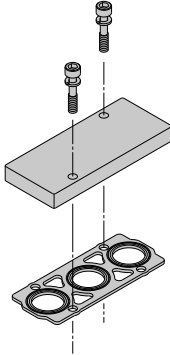

Series	Blanking plate assembly part no.
<b>VF1000</b>	DXT144-13-3A
<b>VF3000</b>	DXT031-38-5A
<b>VF5000</b>	VF5000-70-1A

### ■ Mounting screw, gasket part no.

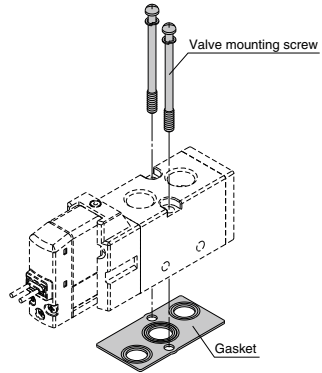

Series	Valve mounting screw (1 pc.)	Gasket
<b>VF1000</b>	Round head combination screw DXT031-44-1 (M4 x 39.5, With spring washer)	DXT144-12-2  DXT155-25-7
<b>VF3000</b>	Hexagon socket head cap screw AXT620-32-1 (M4 x 48, With spring washer)	DXT156-9-6

### ■ Individual EXH spacer assembly

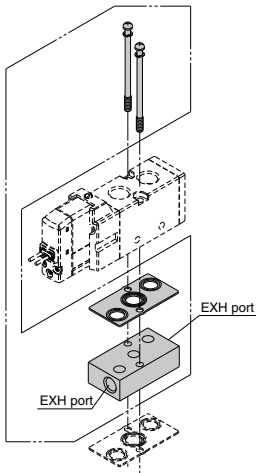

### ⚠ Caution

#### Tightening Torque for Mounting Screw

M4: 1.4 N·m

### ⚠ Warning

When mounting a valve or spacer on the manifold base or sub-plate, etc., the mounting orientation is already decided. If mounted in a wrong direction, the equipment to be connected may result in a malfunction. Refer to the dimensions for mounting.

VF **3** 000-75-1 **A**

#### Series

Symbol	Series	Port size
<b>3</b>	VF3000	1/8
<b>5</b>	VF5000	1/4

#### Thread type

Nll	Rc
<b>F</b>	G
<b>N</b>	NPT
<b>T</b>	NPTF

SJ  
SY  
SY  
SV  
SYJ  
SZ  
VF  
VP4  
S0700  
VQ  
VQ4  
VQ5  
VQC  
VQC4  
VQZ  
SQ  
VFS  
VFR  
VQ7

# Series VF1000/3000/5000

## Dimensions: Series VF1000

Type 30/VV5F1-30-□□1-□: Common exhaust  
Grommet (G) (H)

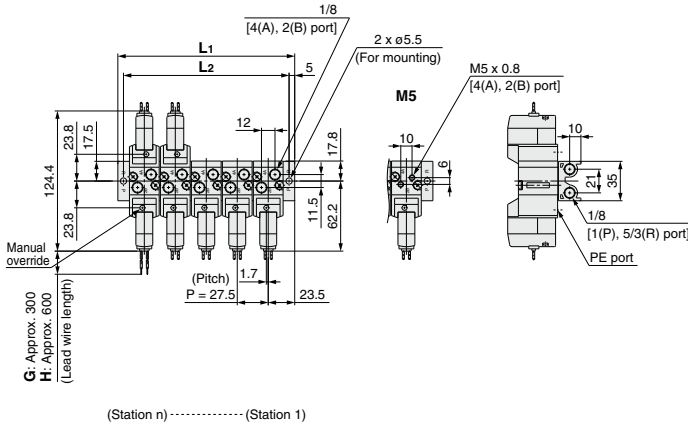

**Grommet (G) (H)**  
DC without light/  
surge voltage suppressor

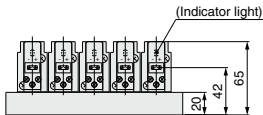
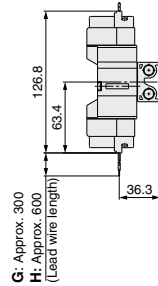

**L-type plug connector (L)**

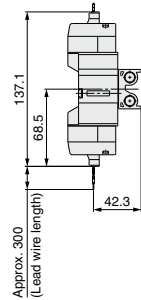

### L: Dimensions

n	2	3	4	5	6	7	8	9	10	11	12	13	14
L1	74.5	102	129.5	157	184.5	212	239.5	267	294.5	322	349.5	377	404.5
L2	64.5	92	119.5	147	174.5	202	229.5	257	284.5	312	339.5	367	394.5

n	15	16	17	18	19	20
L1	432	459.5	487	514.5	542	569.5
L2	422	449.5	477	504.5	532	559.5

Unless otherwise indicated, dimensions are the same as Grommet (G).

**M-type plug connector (M)**

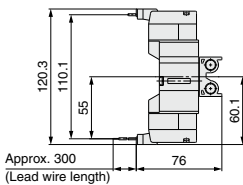

**DIN terminal (D) (Y)**

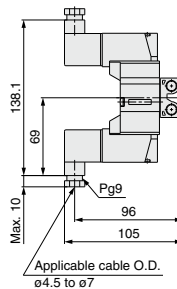

**Conduit terminal (T)**

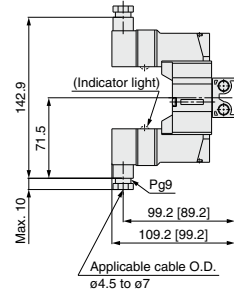

Unless otherwise indicated, dimensions are the same as Grommet (G).

Unless otherwise indicated, dimensions are the same as Grommet (G).

[ ]: Without indicator light  
Unless otherwise indicated, dimensions are the same as Grommet (G).

**Dimensions: Series VF1000**

**Type 31/VV5F1-31-□□3-□: Individual exhaust  
Grommet (G) (H)**

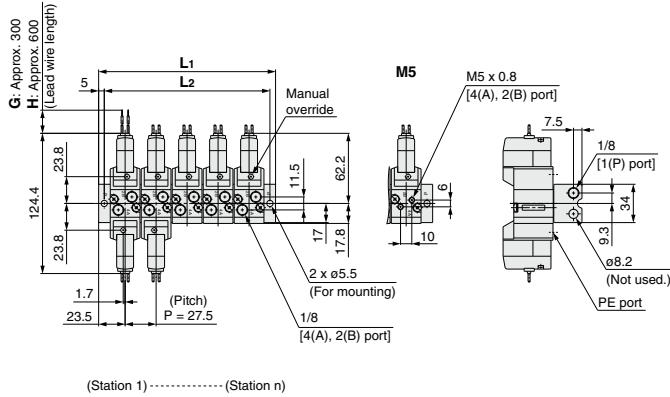

**Grommet (G) (H)  
DC without light/  
surge voltage suppressor**

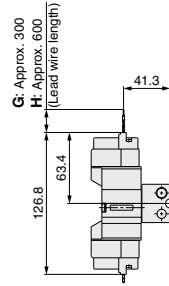

(Station 1) ..... (Station n)

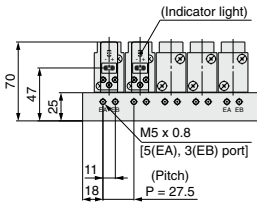

**L-type plug connector (L)**

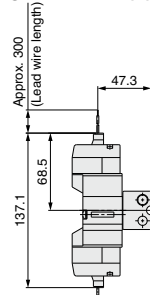

**L: Dimensions**

n: Stations

n	2	3	4	5	6	7	8	9	10	11	12	13	14
L1	74.5	102	129.5	157	184.5	212	239.5	267	294.5	322	349.5	377	404.5
L2	64.5	92	119.5	147	174.5	202	229.5	257	284.5	312	339.5	367	394.5

n	15	16	17	18	19	20
L1	432	459.5	487	514.5	542	569.5
L2	422	449.5	477	504.5	532	559.5

Unless otherwise indicated, dimensions are the same as Grommet (G).

**M-type plug connector (M)**

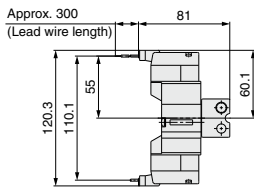

**DIN terminal (D) (Y)**

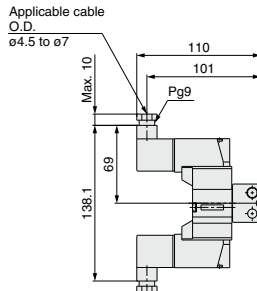

Unless otherwise indicated, dimensions are the same as Grommet (G).

Unless otherwise indicated, dimensions are the same as Grommet (G).

**Conduit terminal (T)**

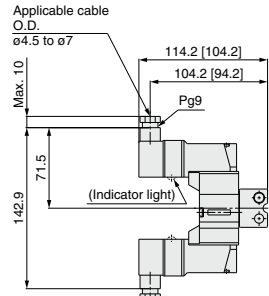

[ ]: Without indicator light  
Unless otherwise indicated, dimensions are the same as Grommet (G).

SJ
SY
SY
SV
SYJ
SZ
VF
VP4
S0700
VQ
VQ4
VQ5
VQC
VQC4
VQZ
SQ
VFS
VFR
VQ7

# Series VF1000/3000/5000

## Dimensions: Series VF3000

Type 30/VV5F3-30-□□1-□: Common exhaust  
Grommet (G) (H)

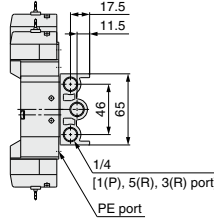
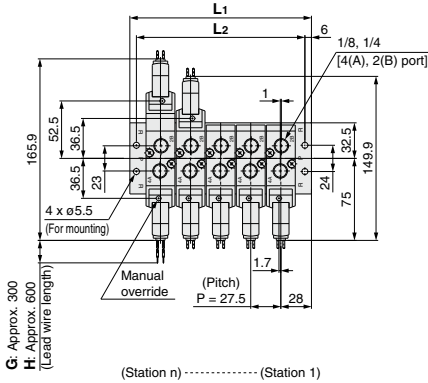

Grommet (G) (H)  
DC without light/  
surge voltage suppressor

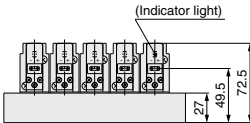
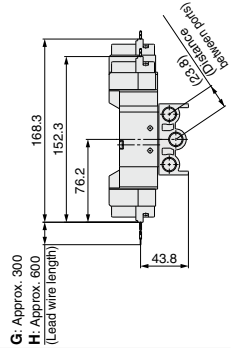

### L: Dimensions

L	n	2	3	4	5	6	7	8	9	10	11	12	13	14
L1		83.5	111	138.5	166	193.5	221	248.5	276	303.5	331	358.5	386	413.5
L2		71.5	99	126.5	154	181.5	209	236.5	264	291.5	319	346.5	374	401.5

L	n	15	16	17	18	19	20
L1		441	468.5	496	523.5	551	578.5
L2		429	456.5	484	511.5	539	566.5

### M-type plug connector (M)

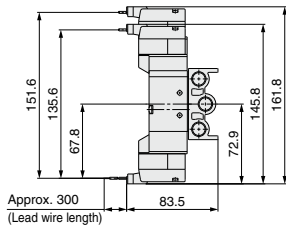

Unless otherwise indicated, dimensions are the same as Grommet (G).

### DIN terminal (D) (Y)

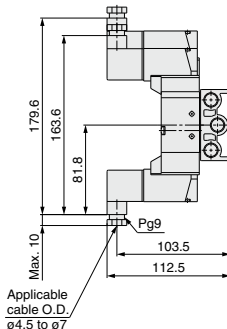

Unless otherwise indicated, dimensions are the same as Grommet (G).

### Conduit terminal (T)

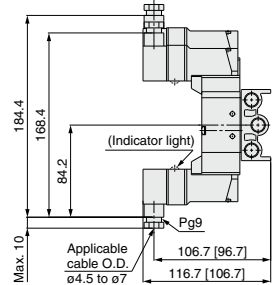

[ ]: Without indicator light  
Unless otherwise indicated, dimensions are the same as Grommet (G).



**Dimensions: Series VF3000**

Type 30/VV5F3-30-□□1-□: When the individual EXH spacer (VF3000-75-1A) is mounted.  
Grommet (G) (H)

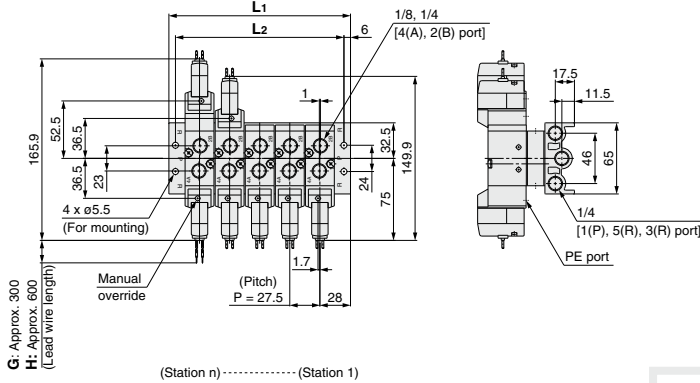

**Grommet (G) (H)**  
DC without light/  
surge voltage suppressor

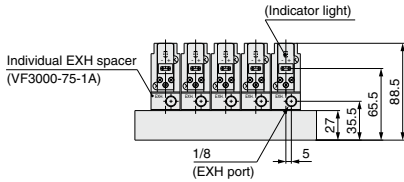
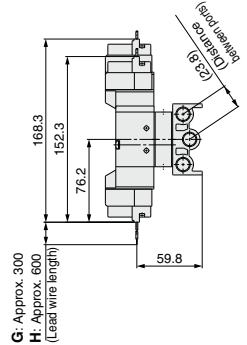

**L: Dimensions**

L	n	2	3	4	5	6	7	8	9	10	11	12	13	14
L1		83.5	111	138.5	166	193.5	221	248.5	276	303.5	331	358.5	386	413.5
L2		71.5	99	126.5	154	181.5	209	236.5	264	291.5	319	346.5	374	401.5

n: Stations

L	n	15	16	17	18	19	20
L1		441	468.5	496	523.5	551	578.5
L2		429	456.5	484	511.5	539	566.5

**L-type plug connector (L)**

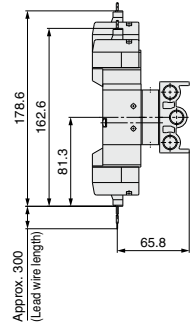

Unless otherwise indicated, dimensions are the same as Grommet (G).

**M-type plug connector (M)**

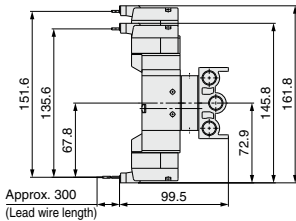

Unless otherwise indicated, dimensions are the same as Grommet (G).

**DIN terminal (D) (Y)**

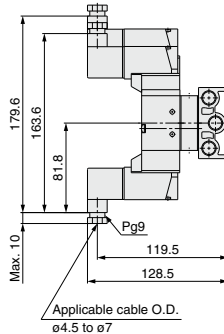

Unless otherwise indicated, dimensions are the same as Grommet (G).

**Conduit terminal (T)**

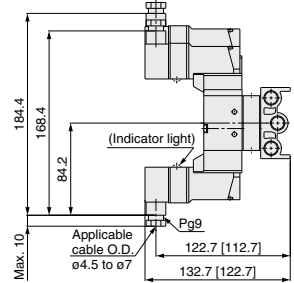

[ ]: Without indicator light  
Unless otherwise indicated, dimensions are the same as Grommet (G).

SJ
SY
SY
SV
SYJ
SZ
<b>VF</b>
VP4
S0700
VQ
VQ4
VQ5
VQC
VQC4
VQZ
SQ
VFS
VFR
VQ7

# Series VF1000/3000/5000

## Dimensions: Series VF5000

Type 20/VV5F5-20-□□1-□: Common exhaust Grommet (G)

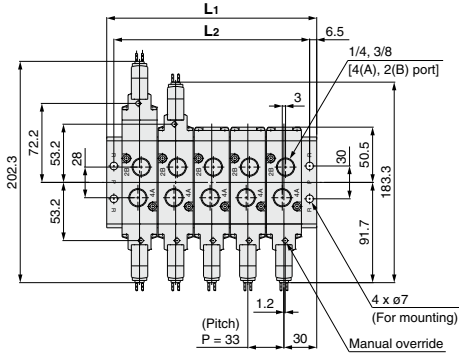

(Station n) ..... (Station 1)

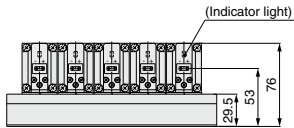

**Grommet (G) (H)**  
DC without light/  
surge voltage suppressor

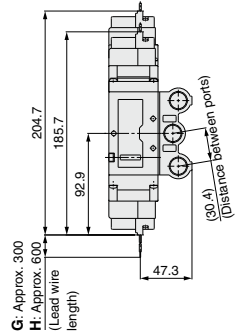
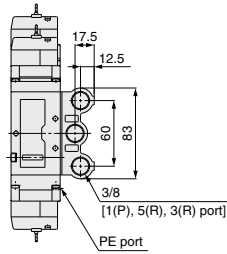

G: Approx. 300  
H: Approx. 600  
(Lead wire length)

**L-type plug connector (L)**

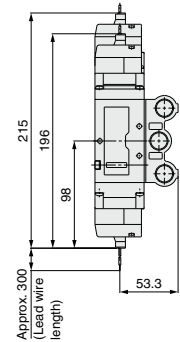

Unless otherwise indicated, dimensions are the same as Grommet (G).

### L: Dimensions

n	2	3	4	5	6	7	8	9	10
L1	93	126	159	192	225	258	291	324	357
L2	80	113	146	179	212	245	278	311	344

**M-type plug connector (M)**

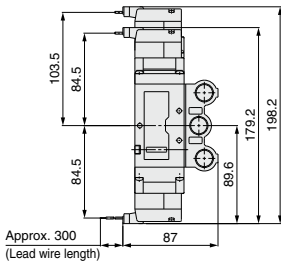

Unless otherwise indicated, dimensions are the same as Grommet (G).

**DIN terminal (D) (Y)**

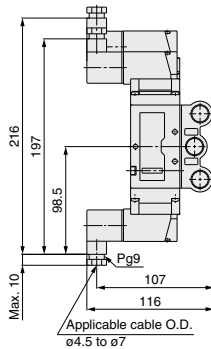

Unless otherwise indicated, dimensions are the same as Grommet (G).

**Conduit terminal (T)**

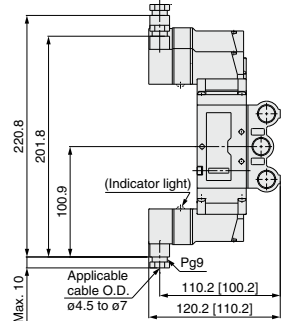

[ ]: Without indicator light  
Unless otherwise indicated, dimensions are the same as Grommet (G).

**Dimensions: Series VF5000**

Type 20/VV5F5-20-□□1-□: When the individual EXH spacer (VF5000-75-1A) is mounted.  
Grommet (G)

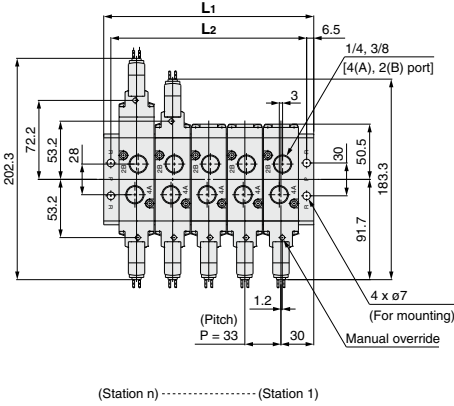

**Grommet (G) (H)**  
DC without light/  
surge voltage suppressor

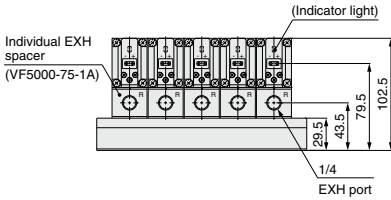
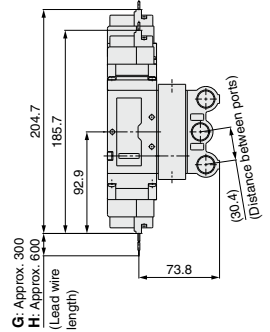

**L: Dimensions**

n	2	3	4	5	6	7	8	9	10
L1	93	126	159	192	225	258	291	324	357
L2	80	113	146	179	212	245	278	311	344

n: Stations

**L-type plug connector (L)**

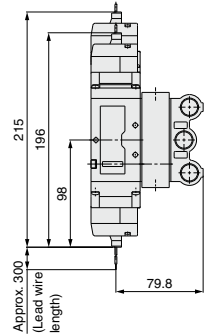

Unless otherwise indicated, dimensions are the same as Grommet (G).

**M-type plug connector (M)**

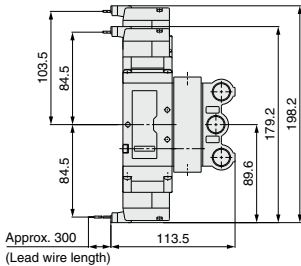

Unless otherwise indicated, dimensions are the same as Grommet (G).

**DIN terminal (D) (Y)**

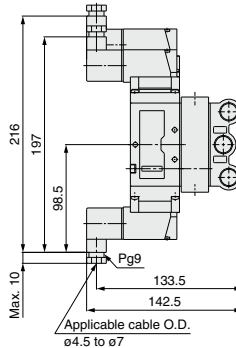

Unless otherwise indicated, dimensions are the same as Grommet (G).

**Conduit terminal (T)**

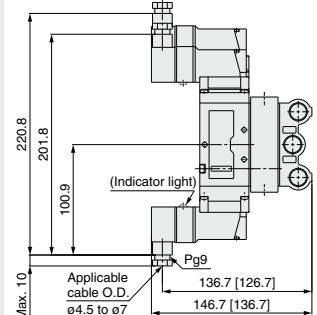

[ ]: Without indicator light  
Unless otherwise indicated, dimensions are the same as Grommet (G).

- SJ
- SY
- SV
- SYJ
- SZ
- VF**
- VP4
- S0700
- VQ
- VQ4
- VQ5
- VQC
- VQC4
- VQZ
- SQ
- VFS
- VFR
- VQ7

# Series VF1000/3000/5000

## Dimensions: Series VF5000

Type 21/VV5F5-21-□□1-□: Common exhaust  
Grommet (G)

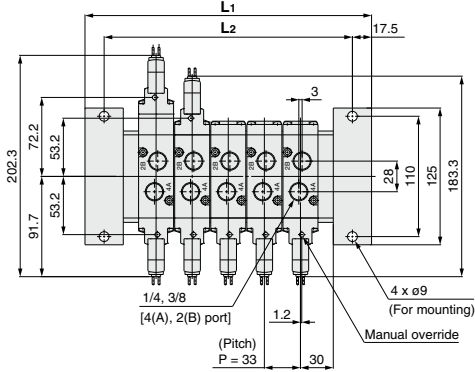

(Station n) ..... (Station 1)

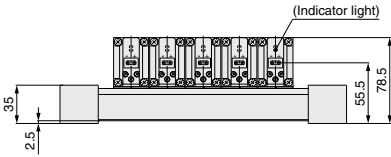

**Grommet (G) (H)**  
DC without light/  
surge voltage suppressor

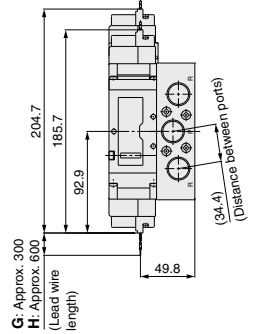
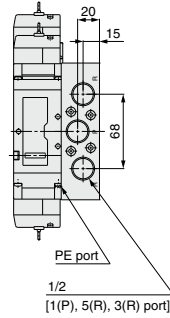

**L-type plug connector (L)**

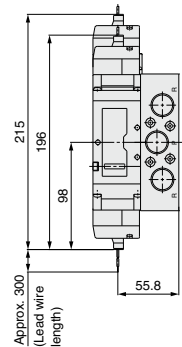

Unless otherwise indicated, dimensions are the same as Grommet (G).

### L: Dimensions

n	2	3	4	5	6	7	8	9	10	11	12	13	14	15
L1	163	196	229	262	295	328	361	394	427	460	493	526	559	592
L2	128	161	194	227	260	293	326	359	392	425	458	491	524	557

n: Stations

**M-type plug connector (M)**

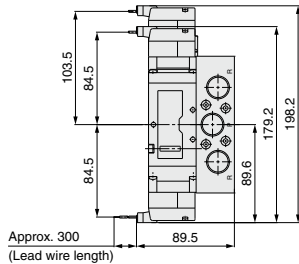

Unless otherwise indicated, dimensions are the same as Grommet (G).

**DIN terminal (D) (Y)**

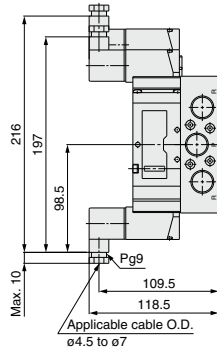

Unless otherwise indicated, dimensions are the same as Grommet (G).

**Conduit terminal (T)**

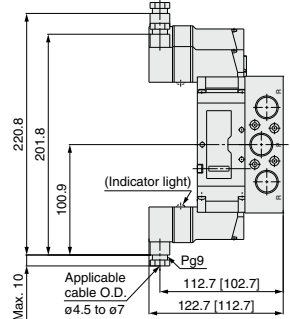

[ ]: Without indicator light  
Unless otherwise indicated, dimensions are the same as Grommet (G).

**Dimensions: Series VF5000**

Type 21/VV5F5-21-□□1-□: When the individual EXH spacer (VF5000-75-1A) is mounted.  
Grommet (G)

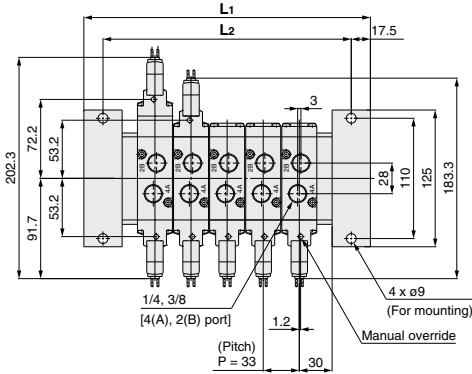

(Station n) ..... (Station 1)

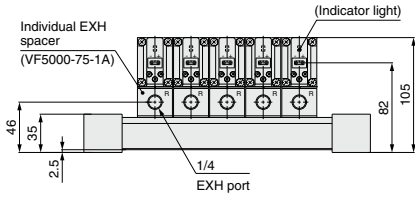

**Grommet (G) (H)**  
DC without light/  
surge voltage suppressor

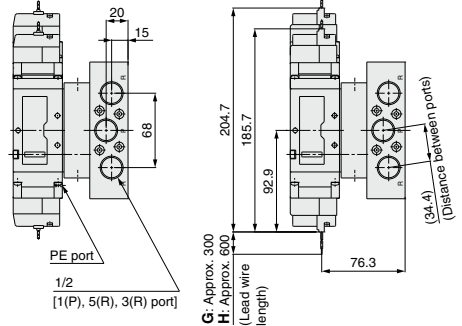

**L-type plug connector (L)**

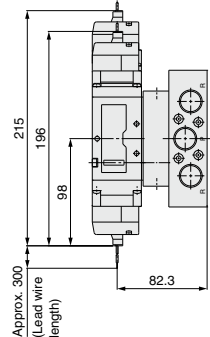

Unless otherwise indicated, dimensions are the same as Grommet (G).

**L: Dimensions**

n	2	3	4	5	6	7	8	9	10	11	12	13	14	15
L1	163	196	229	262	295	328	361	394	427	460	493	526	559	592
L2	128	161	194	227	260	293	326	359	392	425	458	491	524	557

n: Stations

**M-type plug connector (M)**

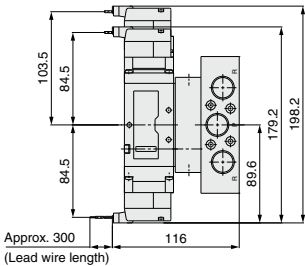

Unless otherwise indicated, dimensions are the same as Grommet (G).

**DIN terminal (D) (Y)**

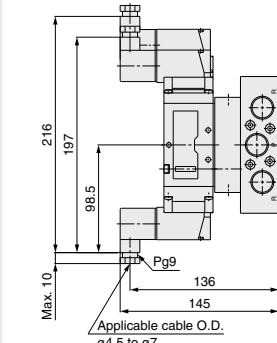

Unless otherwise indicated, dimensions are the same as Grommet (G).

**Conduit terminal (T)**

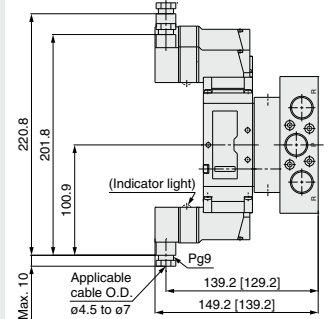

[ ]: Without indicator light  
Unless otherwise indicated, dimensions are the same as Grommet (G).

SJ
SY
SV
SYJ
SZ
<b>VF</b>
VP4
S0700
VQ
VQ4
VQ5
VQC
VQC4
VQZ
SQ
VFS
VFR
VQ7

# Pilot Operated 5 Port Solenoid Valve

# Series VF3000/5000

# Manifold

Base Mounted



(Note) Only DIN and conduit terminal types are available with AC mode.  
Refer to the electrical entry for details.

## How to Order Manifold

Common exhaust

VV5F 3 - 40 - 05 2 - 02 F

Symbol	Series	P, R port size	A, B port size
3	VF3000	1/4	1/4
5	VF5000	3/8	1/4

\* The A and B ports are made on the bottom.

Symbol	Stations
02	2 stations
:	:
20	20 stations

\* Up to 10 stations for VV5F5.

Thread type	
Nil	Rc
F	G
N	NPT
T	NPTF

## How to Order Valve (With a gasket and two mounting screws)

\* For low wattage specification, refer to "How to Order Valve" on page 833.

VF 3 1 4 0 - 5 G 1 -

Series	Symbol
3	VF3000
5	VF5000

\* Not available with the VF1000.

Type of actuation	Symbol
2-position single	1
2-position double	2
3-position closed center	3
3-position exhaust center	4
3-position pressure center	5

Body model

Body option

0: Pilot valve individual exhaust



PE port E/AEB port

VF3000 VF5000

3: Main/Pilot valve common exhaust



PE port E/AEB port

VF3000 VF5000

4: Pilot valve base exhaust



PE port

VF3000 VF5000

Pressure specifications

Nil	Standard (0.7 MPa)
K	High-pressure type (1 MPa)

Rated voltage

DC		AC (50/60 Hz)	
5	24 VDC	1	100 VAC
6	12 VDC	2	200 VAC
		3	110 VAC [115 VAC]
		4	220 VAC [230 VAC]
		7	240 VAC
		B	24 VAC

Made to Order

Refer to page 821 for details.  
Combination with low wattage specification is not possible.

Manual override

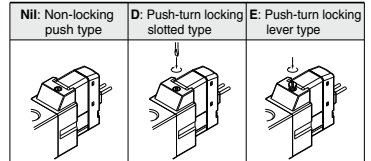

Light/Surge voltage suppressor

Symbol	Light/Surge voltage suppressor	DC	AC
Nil	Without light/surge voltage suppressor	○	○
S	With surge voltage suppressor	○	— <sup>(Note)</sup>
Z	With light/surge voltage suppressor	○	○
R	With surge voltage suppressor (Non-polar)	○	—
U	With light/surge voltage suppressor (Non-polar)	○	—

(Note) S type is not available with AC mode, since a rectifier prevents surge voltage generation.

\* In the DIN terminal type, since a light is installed in the connector, DOZ, DOU, YOZ, YOU are not available.



**Caution**  
When using the surge voltage suppressor type, residual voltage will remain. Refer to page 858 for details.

Electrical entry

Grommet	L-type plug connector	M-type plug connector	DIN terminal	DIN (EN175301-803) terminal	Conduit terminal
G: Lead wire length 300 mm H: Lead wire length 600 mm	L: With lead wire (length 300 mm) LN: Without lead wire	M: With lead wire (length 300 mm) MN: Without lead wire	D: With connector DO: Without connector	Y: With connector YO: Without connector	T: Conduit terminal
	LO: Without connector	MO: Without connector			
CE DC	CE	CE	CE	CE	CE
constant AC <sup>(Note 2)</sup>			CE	CE	CE

\* LN and MN types are with 2 sockets. \* Refer to page 856 when different length of lead wire for L/M-type plug connector is required.  
\* Refer to page 857 for details on the DIN (EN175301-803) terminal.

Note 1) When using IP65, select the main/pilot valve common exhaust or pilot valve base exhaust type.

Note 2) With the same specifications as the DC type, all electrical entries for the 24 VAC type are CE marking compliant.

## Manifold Specifications

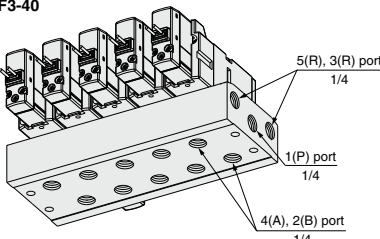
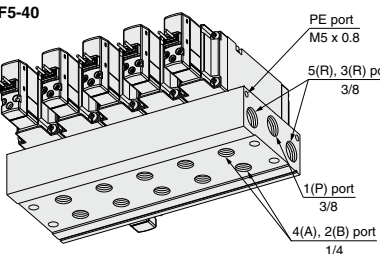
Series	Manifold base model	EXH port type	Applicable valve model	Applicable stations	Manifold base Weight: W [g] Stations: n
VF3000		Common EXH	VF3□40 VF3□43	2 to 20 stations	W = 110n + 116
VF5000		Common EXH	VF5□44	2 to 10 stations	W = 161n + 128

Note) Supply pressure to 1(P) ports and exhaust pressure from R ports on both sides for 10 stations or more (5 stations or more for the VF5000).

## How to Order Manifold Assembly

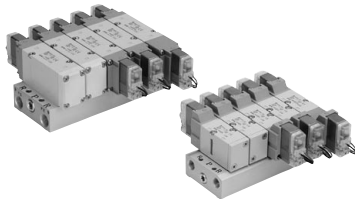

### Example (VV5F3-40)

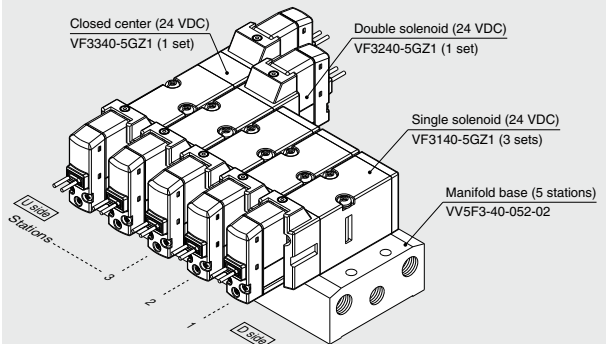

- VV5F3-40-052-02 ..... 1 set (Type 40, 5-station manifold base part no.)
- \* VF3140-5GZ1 ..... 3 sets (Single solenoid part no.)
- \* VF3240-5GZ1 ..... 1 set (Double solenoid part no.)
- \* VF3340-5GZ1 ..... 1 set (Closed center part no.)

The asterisk denotes the symbol for assembly. Prefix it to the part nos. of the solenoid valve, etc.

- The valve arrangement is numbered as the 1st station from D side.
- Under the manifold base part number, state the valves to be mounted in order from the 1st station as shown in the figure above. If the arrangement becomes complicated, specify on the manifold specification sheet.

SJ  
SY  
SY  
SV  
SYJ  
SZ  
VF  
VP4  
S0700  
VQ  
VQ4  
VQ5  
VQC  
VQC4  
VQZ  
SQ  
VFS  
VFR  
VQ7

# Series VF3000/5000

## Manifold Options

### ■ For base mounted Blanking plate assembly

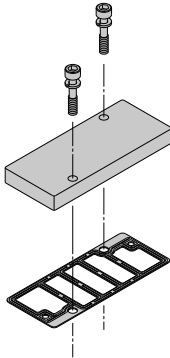

Series	Blanking plate assembly part no.
VF3000	DXT031-38-5A
VF5000	VF5000-70-2A

### ■ Individual EXH spacer assembly

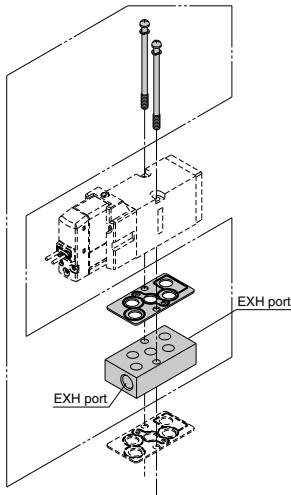

### ■ Mounting screw, gasket part no.

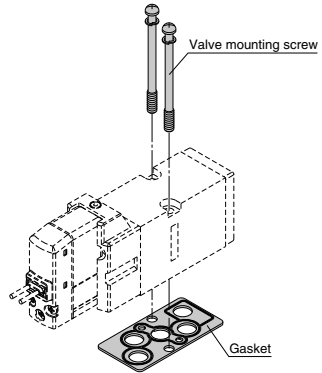

Series	Valve mounting screw (1 pc.)	Gasket
VF3000	Round head combination screw DXT031-44-1 (M4 x 39.5, With spring washer)	DXT031-30-11
VF5000	Hexagon socket head cap screw AXT620-32-1 (M4 x 48, With spring washer)	DXT156-9-8

### ⚠ Caution

#### Tightening Torque for Mounting Screw

M4: 1.4 N·m

### ⚠ Warning

When mounting a valve or spacer on the manifold base or sub-plate, etc., the mounting orientation is already decided. If mounted in a wrong direction, the equipment to be connected may result in a malfunction. Refer to the dimensions for mounting.

VF **3** 000-75-2 **A**

#### Series

Symbol	Series	Port size
3	VF3000	1/8
5	VF5000	1/4

#### Thread type

NII	Rc
F	G
N	NPT
T	NPTF



**Dimensions: Series VF3000**

**Type 40/VV5F3-40-□□2-02□: Common exhaust  
Grommet (G) (H)**

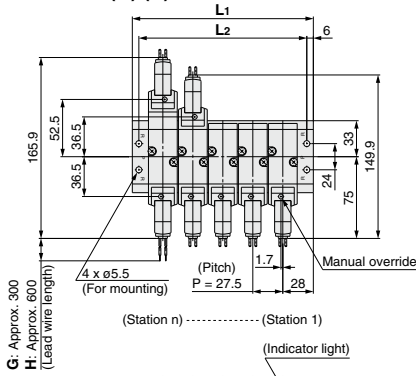

G: Approx. 300  
H: Approx. 600  
(Lead wire length)

(Station n) ..... (Station 1)

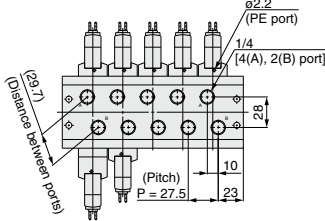
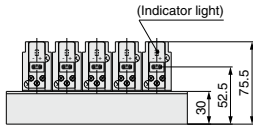

**Grommet (G) (H)  
DC without light/  
surge voltage suppressor**

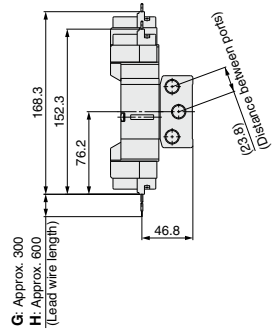

G: Approx. 300  
H: Approx. 600  
(Lead wire length)

**L: Dimensions**

n	2	3	4	5	6	7	8	9	10	11	12	13	14
L1	83.5	111	138.5	166	193.5	221	248.5	276	303.5	331	358.5	386	413.5
L2	71.5	99	126.5	154	181.5	209	236.5	264	291.5	319	346.5	374	401.5

n	15	16	17	18	19	20
L1	441	468.5	496	523.5	551	578.5
L2	429	456.5	484	511.5	539	566.5

**L-type plug connector (L)**

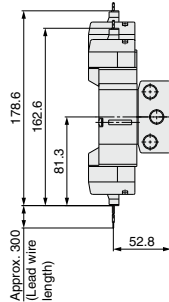

Unless otherwise indicated, dimensions are the same as Grommet (G).

**M-type plug connector (M)**

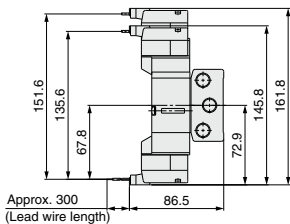

Approx. 300  
(Lead wire length)

Unless otherwise indicated, dimensions are the same as Grommet (G).

**DIN terminal (D) (Y)**

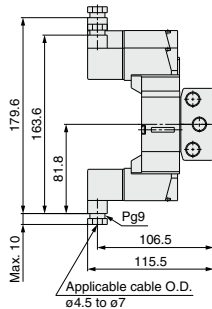

Unless otherwise indicated, dimensions are the same as Grommet (G).

**Conduit terminal (T)**

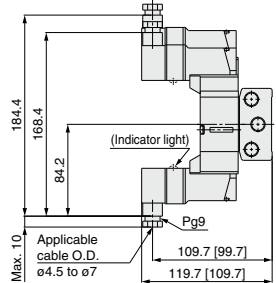

[ ]: Without indicator light  
Unless otherwise indicated, dimensions are the same as Grommet (G).

SJ
SY
SY
SV
SYJ
SZ
<b>VF</b>
VP4
S0700
VQ
VQ4
VQ5
VQC
VQC4
VQZ
SQ
VFS
VFR
VQ7

# Series VF3000/5000

## Dimensions: Series VF3000

Type 40/VV5F3-40-□□-2-02□: When the individual EXH spacer (VF3000-75-2A) is mounted.

### Grommet (G) (H)

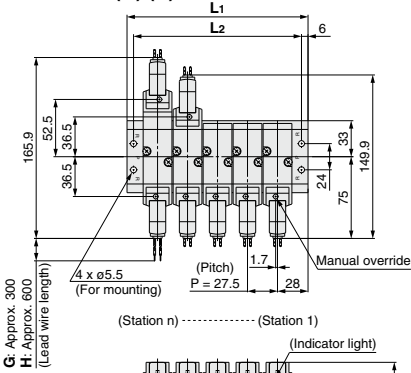

### Grommet (G) (H)

DC without light/  
surge voltage suppressor

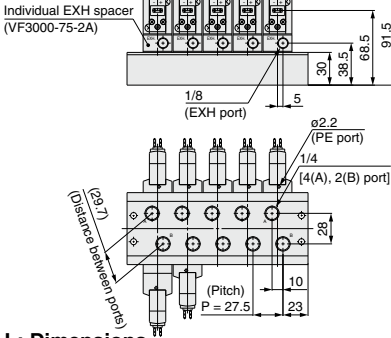
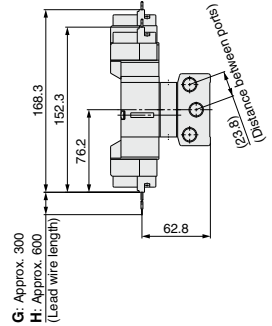
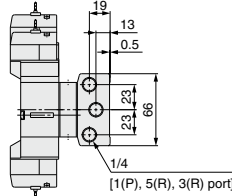

### L: Dimensions

n	2	3	4	5	6	7	8	9	10	11	12	13	14
L1	83.5	111	138.5	166	193.5	221	248.5	276	303.5	331	358.5	386	413.5
L2	71.5	99	126.5	154	181.5	209	236.5	264	291.5	319	346.5	374	401.5

n	15	16	17	18	19	20
L1	441	468.5	496	523.5	551	578.5
L2	429	456.5	484	511.5	539	566.5

### M-type plug connector (M)

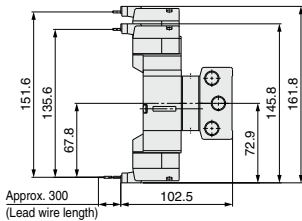

Unless otherwise indicated, dimensions are the same as Grommet (G).

### DIN terminal (D) (Y)

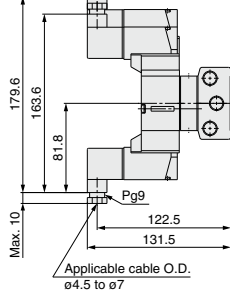

Unless otherwise indicated, dimensions are the same as Grommet (G).

### Conduit terminal (T)

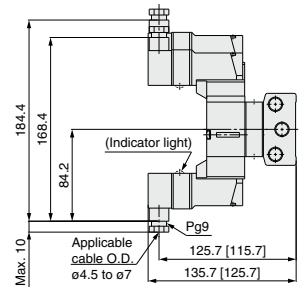

[ ]: Without indicator light  
Unless otherwise indicated, dimensions are the same as Grommet (G).

**Dimensions: Series VF5000**

**Type 40/VV5F5-40-□□2-02□: Common exhaust Grommet (G)**

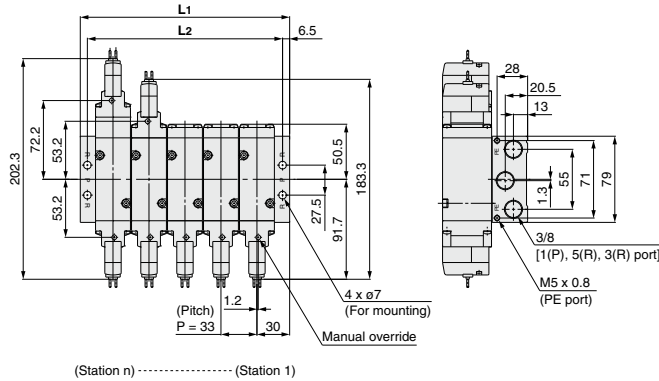

(Station n) ..... (Station 1)

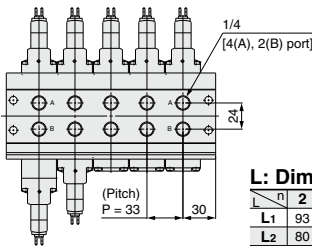
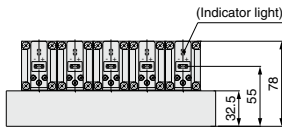

**L: Dimensions**

n	2	3	4	5	6	7	8	9	10
L1	93	126	159	192	225	258	291	324	357
L2	80	113	146	179	212	245	278	311	344

**Grommet (G) (H)**  
DC without light/  
surge voltage suppressor

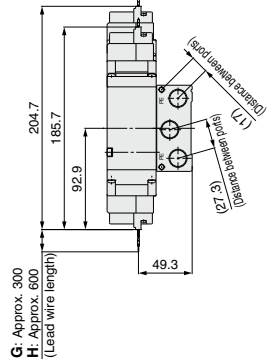

G: Approx. 300  
H: Approx. 600  
(Lead wire length)

**L-type plug connector (L)**

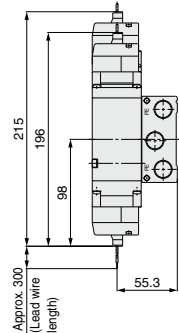

Unless otherwise indicated, dimensions are the same as Grommet (G).

**M-type plug connector (M)**

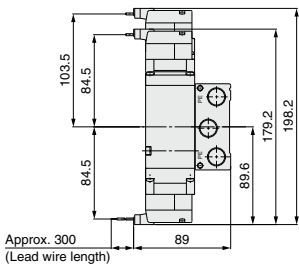

Approx. 300  
(Lead wire length)

**DIN terminal (D) (Y)**

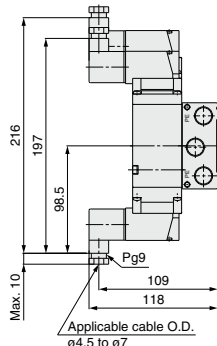

Unless otherwise indicated, dimensions are the same as Grommet (G).

**Conduit terminal (T)**

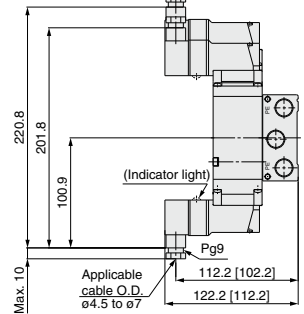

[ ]: Without indicator light  
Unless otherwise indicated, dimensions are the same as Grommet (G).

Unless otherwise indicated, dimensions are the same as Grommet (G).

SJ
SY
SY
SV
SYJ
SZ
VF
VP4
S0700
VQ
VQ4
VQ5
VQC
VQC4
VQZ
SQ
VFS
VFR
VQ7

# Series VF3000/5000

## Dimensions: Series VF5000

Type 40/VV5F5-40-□□2-02□: When the individual EXH spacer (VF5000-75-2A) is mounted.

### Grommet (G)

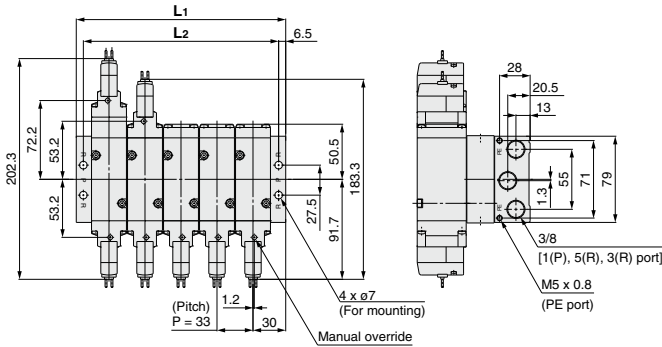

(Station n) ..... (Station 1)

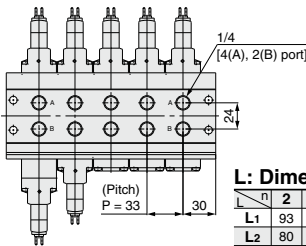
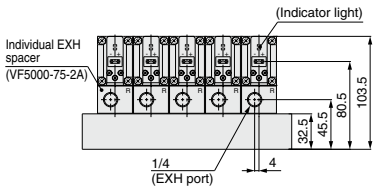

### L: Dimensions

	n	2	3	4	5	6	7	8	9	10
L1	93	126	159	192	225	258	291	324	357	
L2	80	113	146	179	212	245	278	311	344	

### Grommet (G) (H)

DC without light/  
surge voltage suppressor

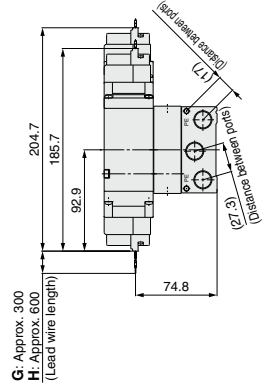

G: Approx. 300  
H: Approx. 600  
(Lead wire length)

### L-type plug connector (L)

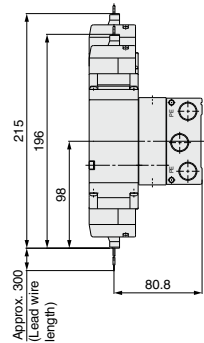

Approx. 300  
(Lead wire length)

Unless otherwise indicated, dimensions are the same as Grommet (G).

### M-type plug connector (M)

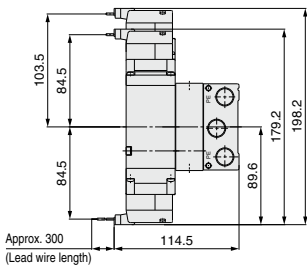

Approx. 300  
(Lead wire length)

### DIN terminal (D) (Y)

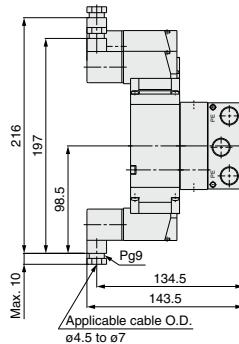

Unless otherwise indicated, dimensions are the same as Grommet (G).

### Conduit terminal (T)

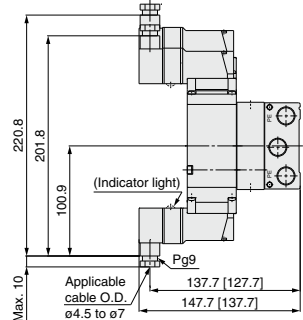

[ ]: Without indicator light  
Unless otherwise indicated, dimensions are the same as Grommet (G).

Unless otherwise indicated, dimensions are the same as Grommet (G).



# Series VF Specific Product Precautions 1

Be sure to read before handling.

Refer to front matter 53 for Safety Instructions, pages 3 to 8 for 3/4/5 Port Solenoid Valves Precautions.

## Manual Override

### ⚠ Warning

Regardless of an electric signal for the solenoid valve, the manual override is used for switching the main valve. Connected actuator is started by manual operation. Use the manual override after confirming that there is no danger.

#### ■ Non-locking push type

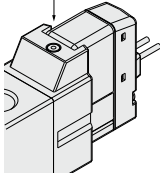

Push down on the manual override with a small screwdriver until it stops. Release the screwdriver and the manual override will return.

#### ■ Push-turn locking slotted type

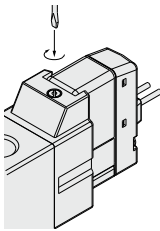

Locked position

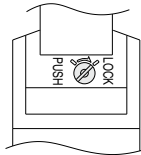

Push down on the manual override with a small flat head screwdriver until it stops. Turn it clockwise by 90° to lock it. Turn it counterclockwise to release it.

#### ■ Push-turn locking lever type

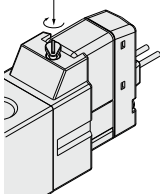

Locked position

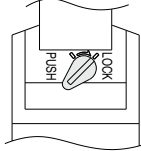

After pushing down, turn in the direction of the arrow. If it is not turned, it can be operated the same way as the non-locking push type.

### ⚠ Caution

When locking the manual override on the push-turn locking type (D or E type), be sure to push it down before turning. Turning without first pushing it down can cause damage to the manual override and other trouble such as air leakage, etc. Do not apply excessive torque when turning the locking type manual override. (0.1 N·m)

## How to Use L/M-Type Plug Connector

### ⚠ Caution

#### 1. Connector attachment/detachment

- To attach a connector, hold the lever and connector unit between your fingers and insert straight onto the pins of the solenoid valve so that the lever's pawl is pushed into the groove and locks.
- To detach a connector, remove the pawl from the groove by pushing the lever downward with your thumb, and pull the connector straight out.

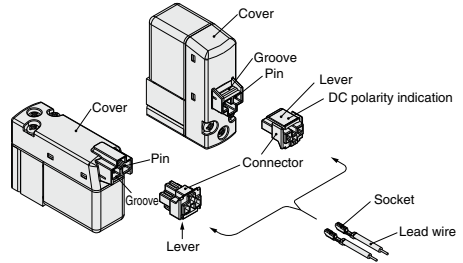

#### 2. Crimping lead wire and socket connection

Not necessary if ordering the lead wire pre-connected model. Strip 3.2 to 3.7 mm at the end of the lead wires, insert the ends of the core wires evenly into the sockets, and then crimp with a crimping tool. When this is done, take care that the coverings of the lead wires do not enter the core wire crimping area. (Please contact SMC for details on the crimping tool.)

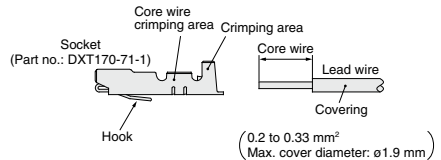

#### 3. Socket with lead wire attachment/detachment

##### • Attachment

Insert the sockets into the square holes of the connector (with +, - indication), and continue to push the sockets all the way in until they lock by hooking into the seats in the connector. (When they are pushed in, their hooks open and they are locked automatically.) Then, confirm that they are locked by pulling lightly on the lead wires.

##### • Detachment

To detach a socket from a connector, pull out the lead wire while pressing the socket's hook with a stick having a thin tip (approx. 1 mm). If the socket will be used again, first spread the hook outward.

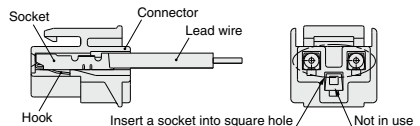

SJ
SY
SV
SVJ
SZ
VF
VP4
S0700
VQ
VQ4
VQ5
VQC
VQC4
VQZ
SQ
VFS
VFR
VQ7



# Series VF Specific Product Precautions 2

Be sure to read before handling.

Refer to front matter 53 for Safety Instructions, pages 3 to 8 for 3/4/5 Port Solenoid Valves Precautions.

## Plug Connector Lead Wire Length

### ⚠ Caution

Plug connector lead wires have a standard length of 300 mm, however, the following lengths are also available.

#### How to Order Connector Assembly

DC	: V200-30-4A-	
100 VAC	: V200-30-1A-	
200 VAC	: V200-30-2A-	
Other AC voltages	: V200-30-3A-	

Without lead wire : V200-30-A  
(With a connector and 2 sockets)

#### ● Lead wire length

Nil	300 mm
6	600 mm
10	1000 mm
15	1500 mm
20	2000 mm
25	2500 mm
30	3000 mm
50	5000 mm

### How to Order

Specify the connector assembly part number together with the part number for the plug connector type solenoid valve without connector.

(Example) Lead wire length: 2000 mm

<b>DC</b>	<b>AC</b>
VF3130-5LO1-02	VF3130-1LO1-02
V200-30-4A-20	V200-30-1A-20

## How to Use DIN Terminal Connector

The DIN terminal with an IP65 (enclosure) is protected against dust and water, however, it must not be used in water.

### ⚠ Caution

#### Connection

- 1) Loosen the set screw and pull the connector out of the solenoid valve terminal block.
- 2) After removing the set screw, insert a flat head screwdriver, etc. into the notch on the bottom of the terminal block and pry it open, separating the terminal block and the housing.
- 3) Loosen the terminal screws on the terminal block, insert the core of the lead wire into the terminal, and attach securely with the terminal screws.

In addition, when using the DC mode type with a surge voltage suppressor (polar: S and Z types), connect wires corresponding to the polarity (+ or -) that is printed on the terminal block.

- 4) Secure the cord by fastening the ground nut.

In the case of connecting wires, select cable cords carefully because if those out of the specified range ( $\phi 4.5$  to  $\phi 7$ ) are used, it will not be able to satisfy IP65 (enclosure).

Tighten the ground nut and set screw within the specified range of torque.

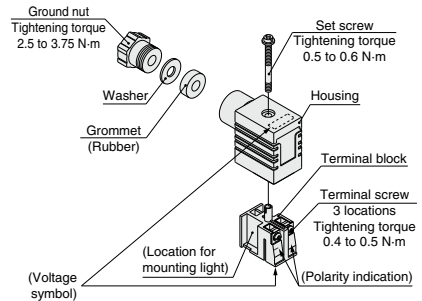

\* Refer to page 857 for the DIN connector part no.

### Changing the entry direction

After separating the terminal block and housing, the cord entry direction can be changed by attaching the housing in the opposite direction.

\* Make sure not to damage elements, etc., with the lead wires of the cord.

### Precautions

Plug in and pull out the connector vertically without tilting to one side.

### Applicable cable

Cable O.D.:  $\phi 4.5$  to  $\phi 7$

(Reference)  $0.5 \text{ mm}^2$  to  $1.5 \text{ mm}^2$ , 2-core or 3-core, equivalent to JIS C 3306

### Applicable crimped terminal

O terminal: R1.25-4M that is specified in JIS C 2805

Y terminal: 1.25-3L, which is released by JST Mfg. Co., Ltd.

Stick terminal: Size 1.5 or shorter



# Series VF Specific Product Precautions 3

Be sure to read before handling.

Refer to front matter 53 for Safety Instructions, pages 3 to 8 for 3/4/5 Port Solenoid Valves Precautions.

## DIN (EN175301-803) Terminal

Y type DIN terminal corresponds to the DIN connector with terminal pitch 10 mm, which complies with EN175301-803B. Since the terminal pitch is different from the D type DIN connector, these two types are not interchangeable.

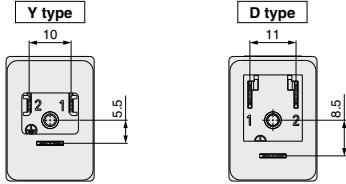

## How to Order DIN Connector

### ⚠ Caution

#### ● Without indicator light

DC, AC, Common to all voltages: V200-□-1

#### ● With indicator light

DC

Polar type (□Z) : V200-□-3-□

Non-polar type (□U) : V200-□-5-□

#### ● Rated voltage

05	24 VDC
06	12 VDC

AC (□Z) : V200-□-7-□

#### Connector specifications

	D type	Y type	Rated voltage
61	□	□	01 100/110 VAC [115 VAC]
63	□	□	02 200/220 VAC [230 VAC]
			07 240 VAC

Note) For 24 VAC, the part no. is V200-61-5-B.

## Circuit diagram with light (Built-in connector)

### DC (□Z) circuit diagram

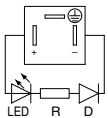

LED: Light emitting diode  
D: Protective diode  
R: Resistor

### AC (□Z) circuit diagram

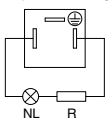

NL: Neon light, R: Resistor

### DC (□U) circuit diagram

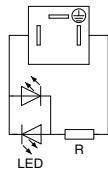

LED: Light emitting diode  
R: Resistor

Note) The 24 VAC specification is the same as those in the DC (□U) circuit diagram.

## How to Use Conduit Terminal

### ⚠ Caution

#### Connection

- Loosen the set screw and remove the terminal block cover from the terminal block.
- Loosen the terminal screws on the terminal block, insert the core of the lead wire or crimped terminal into the terminal, and attach securely with the terminal screws.

In addition, when using the DC mode type with a surge voltage suppressor (polar: S and Z types), connect wires to terminal 1 and 2 corresponding to the polarity (+ or -) as shown on the right figure.



- Secure the cord by fastening the ground nut.

In the case of connecting wires, select cable cords carefully because if those out of the specified range ( $\phi 4.5$  to  $\phi 7$ ) are used, it will not be able to satisfy IP65 (enclosure).

Tighten the ground nut and set screw within the specified range of torque.

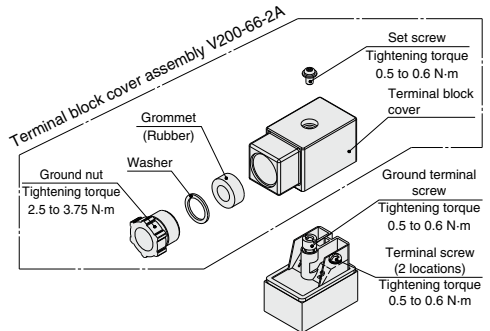

#### Applicable cable

Cable O.D.:  $\phi 4.5$  to  $\phi 7$

(Reference)  $0.5 \text{ mm}^2$  to  $1.5 \text{ mm}^2$ , 2-core or 3-core, equivalent to JIS C 3306

#### Applicable crimped terminal

O terminal: Equivalent to R1.25-3 that is specified in JIS C 2805  
Y terminal: Equivalent to 1.25-3, which is released by JST Mfg. Co., Ltd.

\* Use O terminal when a ground terminal is used.

SJ  
SY  
SV  
SYJ  
SZ  
VF  
VP4  
S0700  
VQ  
VQ4  
VQ5  
VQC  
VQC4  
VQZ  
SQ  
VFS  
VFR  
VQ7



# Series VF Specific Product Precautions 4

Be sure to read before handling.

Refer to front matter 53 for Safety Instructions, pages 3 to 8 for 3/4/5 Port Solenoid Valves Precautions.

## Light/Surge Voltage Suppressor

### ⚠ Caution

<DC>

#### ■ Polar type

With surge voltage suppressor (□S) Polarity protection diode

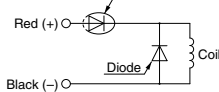

#### ● Grommet or L/M-type plug connector

With light/surge voltage suppressor (□Z)

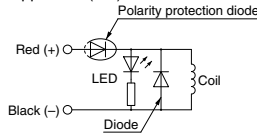

#### ● DIN or Conduit terminal

With light/surge voltage suppressor (□Z)

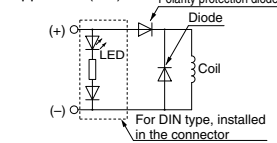

#### ■ Non-polar type

With surge voltage suppressor (□R)

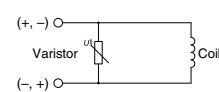

#### ● Grommet or L/M-type plug connector

With light/surge voltage suppressor (□U)

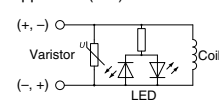

#### ● DIN or Conduit terminal

With light/surge voltage suppressor (□U)

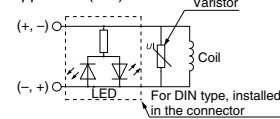

- Please connect correctly the lead wires to + (positive) and - (negative) indications on the connector. (For non-polar type, the lead wires can be connected to either one.)
- When the valve with polarity protection diode is used, the voltage will drop by approx. 1 V. Therefore, pay attention to the allowable voltage fluctuation (For details, refer to the solenoid specifications of each type of valve).
- Solenoids, whose lead wires have been pre-wired: + (positive) side red and - (negative) side black.

#### ■ With power saving circuit

Power consumption is decreased by approx. 1/3 by reducing the wattage required to hold the valve in an energized state. (Effective energizing time is over 40 ms at 24 VDC.)

Refer to the electrical power waveform as shown below.

#### <Electrical power waveform of energy saving type>

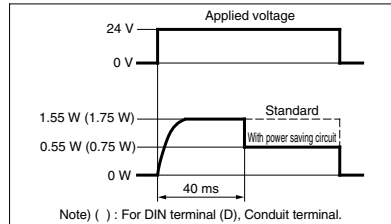

- Since the voltage will drop by approx. 0.5 V due to the transistor, pay attention to the allowable voltage fluctuation. (For details, refer to the solenoid specifications of each type of valve.)

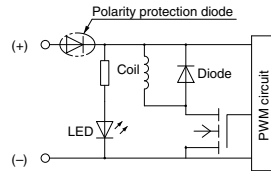

<AC>

**S type is not available, since a rectifier prevents surge voltage generation.**

#### ● Grommet or L/M-type plug connector

With light/surge voltage suppressor (□Z)

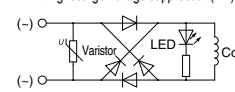

#### ● DIN or Conduit terminal

With light/surge voltage suppressor (□Z)

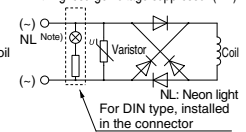

#### Residual voltage of the surge voltage suppressor

Note) If a varistor or diode surge voltage suppressor is used, there is some residual voltage to the protection element and rated voltage. Therefore, refer to the table below and pay attention to the surge voltage protection on the controller side. Also, since the response time does change, refer to the specifications on pages 809 and 823.

#### Residual Voltage

Surge voltage suppressor	DC		AC
	24 V	12 V	
S, Z	Approx. 1 V		Approx. 1 V
R, U	Approx. 47 V	Approx. 32 V	—

#### Continuous Duty

For applications such as mounting a valve on a control panel, incorporate measure to limit the heat radiation so that it is within the operating temperature range. Furthermore, do not touch it while it is being energized or right after it is energized.





# Series VF Specific Product Precautions 5

Be sure to read before handling.

Refer to front matter 53 for Safety Instructions, pages 3 to 8 for 3/4/5 Port Solenoid Valves Precautions.

## One-touch Fittings Precautions

### ⚠ Caution

When fittings are used, they may interfere with one another depending on their types and sizes. Therefore, the dimensions of the fittings to be used should first be confirmed in their respective catalogs.

Fittings whose compliance with the VF series is already confirmed are stated below. If the fitting within the applicable range is selected, there will not be any interference.

#### Applicable Fittings: Series KQ2H, KQ2S

Series	Model	Piping port	Port size	Applicable tubing O.D.							
				ø3.2	ø4	ø6	ø8	ø10	ø12	ø16	
VF1000	VF1□20-□□1-M5	4(A), 2(B)	M5	██████████							
		5(EA), 3(EB)	M5	██████████							
	VF1□20-□□1-01	4(A), 2(B)	1/8	██████████							
		5(EA), 3(EB)	M5	██████████							
	VF1□3□-□□1-M5	4(A), 2(B)	M5	██████████							
	VF1□3□-□□1-01	4(A), 2(B)	1/8	██████████							
	Type 30 manifold base	1(P), 5/3(R)	1/8	██████████							
Type 31 manifold base	1(P)	1/8	██████████								
	5(EA), 3(EB)	M5	██████████								

Series	Model	Piping port	Port size	Applicable tubing O.D.							
				ø3.2	ø4	ø6	ø8	ø10	ø12	ø16	
VF3000	VF3□3□-□□1-01	4(A), 2(B)	1/8	██████████							
		1(P), 5(EA), 3(EB)	1/8	██████████							
	VF3□3□-□□1-02	4(A), 2(B)	1/4	██████████							
		1(P), 5(EA), 3(EB)	P: 1/4, EA, EB: 1/8	██████████							
	VF3□4□-□□1-02	4(A), 2(B)	1/4	██████████							
		1(P), 5(EA), 3(EB)	1/4	██████████							
	VF3□4□-□□1-03	4(A), 2(B)	3/8	██████████							
		1(P), 5(EA), 3(EB)	3/8	██████████							
	Type 30 manifold base	1(P), 5(R), 3(R)	1/4	██████████							
	Type 40 manifold base	4(A), 2(B)	1/4	██████████							
1(P), 5(R), 3(R)		1/4	██████████								

Series	Model	Piping port	Port size	Applicable tubing O.D.							
				ø3.2	ø4	ø6	ø8	ø10	ø12	ø16	
VF5000	VF5□2□-□□1-02	4(A), 2(B)	1/4	██████████							
		1(P), 5(EA), 3(EB)	1/4	██████████							
	VF5□2□-□□1-03	4(A), 2(B)	3/8	██████████							
		1(P), 5(EA), 3(EB)	3/8	██████████							
	VF5□44-□□1-02	4(A), 2(B)	1/4	██████████							
		1(P), 5(EA), 3(EB)	1/4	██████████							
	VF5□44-□□1-03	4(A), 2(B)	3/8	██████████							
		1(P), 5(EA), 3(EB)	3/8	██████████							
	VF5□44-□□1-04	4(A), 2(B)	1/2	██████████							
		1(P), 5(EA), 3(EB)	1/2	██████████							
	Type 20 manifold base	1(P), 5(R), 3(R)	3/8	██████████							
	Type 21 manifold base	1(P), 5(R), 3(R)	1/2	██████████							
	Type 40 manifold base	4(A), 2(B)	1/4	██████████							
		1(P), 5(R), 3(R)	3/8	██████████							

SJ  
SY  
SY  
SV  
SYJ  
SZ  
VF  
VP4  
S0700  
VQ  
VQ4  
VQ5  
VQC  
VQC4  
VQZ  
SQ  
VFS  
VFR  
VQ7



# Low Wattage Specification (VF1000/3000) Specific Product Precautions 6

Be sure to read before handling.

Refer to front matter 53 for Safety Instructions, pages 3 to 8 for 3/4/5 Port Solenoid Valves Precautions.

## Manual Override

### ⚠ Warning

#### 1. Non-locking push type [Standard]

Press in the direction of the arrow.

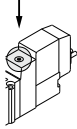

#### 2. Push-turn locking slotted type [D type]

After pushing down, turn in the direction of the arrow. If it is not turned, it can be operated the same way as the non-locking push type.

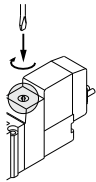

Locked position



### ⚠ Caution

When operating the D type, use a watchmakers' screwdriver and turn lightly.

[Torque: Less than 0.1 N·m]

#### 3. Push-turn locking lever type [E type]

After pushing down, turn in the direction of the arrow. If it is not turned, it can be operated the same way as the non-locking push type.

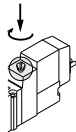

Locked position



### ⚠ Caution

When locking the manual override with the push-turn locking type (D or E type), be sure to push it down before turning.

Turning without first pushing it down can cause damage to the manual override and other trouble such as air leakage, etc.

## Solenoid Valve for 200/220 VAC Specification

### ⚠ Warning

AC specification solenoid valves with grommet or L/M-type plug connector have a built-in rectifier circuit in the pilot section to operate the DC coil. With 200/220VAC specification pilot valves, this built-in rectifier generates heat when energized. The surface may become hot depending on the energized condition; therefore, do not touch the solenoid valves.

## How to Use L/M-Type Plug Connector

### ⚠ Caution

#### 1. Connector attachment/detachment

- To attach a connector, hold the lever and connector unit between your fingers and insert straight onto the pins of the solenoid valve so that the lever's pawl is pushed into the groove and locks.
- To detach a connector, remove the pawl from the groove by pushing the lever downward with your thumb, and pull the connector straight out.

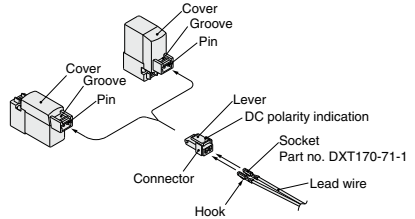

#### 2. Crimping lead wire and socket connection

Strip 3.2 to 3.7 mm at the end of the lead wires, insert the ends of the core wires evenly into the sockets, and then crimp with a crimping tool. When this is done, take care that the coverings of the lead wires do not enter the core wire crimping area.

(Please contact SMC for the dedicated crimping tools.)

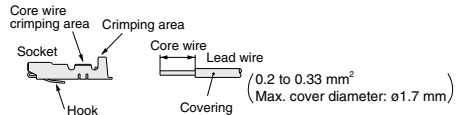

#### 3. Socket with lead wire attachment/detachment

##### • Attachment

Insert the sockets into the square holes of the connector (with +, - indication), and continue to push the sockets all the way in until they lock by hooking into the seats in the connector. (When they are pushed in, their hooks open and they are locked automatically.) Then, confirm that they are locked by pulling lightly on the lead wires.

##### • Detachment

To detach a socket from a connector, pull out the lead wire while pressing the socket's hook with a stick having a thin tip (approx. 1 mm). If the socket will be used again, first spread the hook outward.

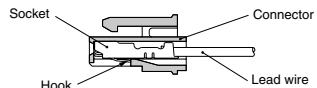



# Low Wattage Specification (VF1000/3000) Specific Product Precautions 6-1

Be sure to read before handling.

Refer to front matter 53 for Safety Instructions, pages 3 to 8 for 3/4/5 Port Solenoid Valves Precautions.

## Plug Connector Lead Wire Length

### Caution

Plug connector lead wires have a standard length of 300 mm, however, the following lengths are also available.

### How to Order Connector Assembly

DC: **SY100-30-4A-**

100 VAC: **SY100-30-1A-**

200 VAC: **SY100-30-2A-**

Other AC voltages: **SY100-30-3A-**

Without lead wire: **SY100-30-A**

(With a connector and 2 sockets)

### How to Order

Specify the connector assembly part number together with the part number for the plug connector type solenoid valve without connector.

(Example) Lead wire length: 2000 mm

<b>DC</b>	<b>AC</b>
<b>VF3130Y-5LO1-02</b>	<b>VF3130Y-1LO1-02</b>
<b>SY100-30-4A-20</b>	<b>SY100-30-1A-20</b>

● Lead wire length

<b>Nil</b>	300 mm
<b>6</b>	600 mm
<b>10</b>	1000 mm
<b>15</b>	1500 mm
<b>20</b>	2000 mm
<b>25</b>	2500 mm
<b>30</b>	3000 mm
<b>50</b>	5000 mm

SJ
SY
SV
SZ
VF
VP4
S0700
VQ
VQ4
VQ5
VQC
VQC4
VQZ
SQ
VFS
VFR
VQ7





# Low Wattage Specification (VF1000/3000) Specific Product Precautions 7

Be sure to read before handling.

Refer to front matter 53 for Safety Instructions, pages 3 to 8 for 3/4/5 Port Solenoid Valves Precautions.

## Light/Surge Voltage Suppressor

### ⚠ Caution

#### 1. L/M-type plug connector <DC>

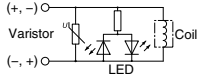

<AC>

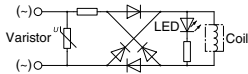

#### 2. DIN terminal <DC>

With surge voltage suppressor (DS, DOS, YS, YOS)

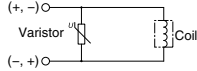

With light/surge voltage suppressor (DZ, YZ)

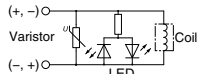

<AC>

With indicator light (DZ, YZ)

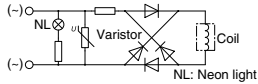

Note) If a varistor surge voltage suppressor is used, there is some residual voltage to the protection element and rated voltage. Therefore, pay attention to the surge voltage protection on the controller side.

## How to Use DIN Terminal

### 1. ISO#: Conforming to EN-175301-803C (former DIN 43650C) (Distance between pins: 8 mm)

The DIN terminal type with an IP65 (enclosure) is protected against dust and water, however, it must not be used in water.

### 2. Connection

- 1) Loosen the set screw and pull the connector out of the solenoid valve terminal block.
- 2) After removing the set screw, insert a flat head screwdriver, etc. into the notch on the bottom of the terminal block and pry it open, separating the terminal block and the housing.
- 3) Loosen the terminal screws (slotted head screw) on the terminal block, insert the core of the lead wire into the terminal according to wiring connection, and attach securely with the terminal screws.
- 4) Tighten the ground nut to secure the wire.

### 3. Changing the entry direction

After separating the terminal block and housing, the cord entry direction can be changed by attaching the housing in a different direction (four directions at 90° intervals).

\* Make sure not to damage a light, etc., with the lead wires of the cord.

## How to Use DIN Terminal

### 4. Precautions

Plug in and pull out the connector vertically without tilting to one side.

### 5. Applicable cable

Cable O.D:  $\phi 3.5$  to  $\phi 7$

(Reference) 0.5 mm<sup>2</sup>, 2-core or 3-core, equivalent to JIS C 3306

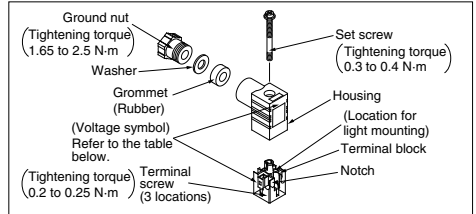

## DIN Connector Part No.

### ⚠ Caution

#### DIN terminal (D)

Without indicator light	SY100-61-1
-------------------------	------------

#### With indicator light

Rated voltage	Voltage symbol	Part no.
24 VDC	24 V	SY100-61-3-05
12 VDC	12 V	SY100-61-3-06
100 VAC	100 V	SY100-61-2-01
200 VAC	200 V	SY100-61-2-02
110 VAC	110 V	SY100-61-2-03
220 VAC	220 V	SY100-61-2-04

#### DIN terminal (Y)

##### Without indicator light

Rated voltage	Voltage symbol	Part no.
Common to all voltages	None	SY100-82-1

##### With indicator light

Rated voltage	Voltage symbol	Part no.
24 VDC	24 V	SY100-82-3-05
12 VDC	12 V	SY100-82-3-06
100 VAC	100 V	SY100-82-2-01
200 VAC	200 V	SY100-82-2-02
110 VAC (115VAC)	110 V	SY100-82-2-03
220 VAC (230 VAC)	220 V	SY100-82-2-04

### Circuit diagram with light

#### AC circuit diagram

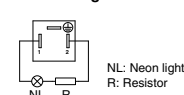

#### DC circuit diagram

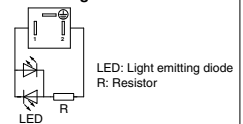

SJ

SY

SY

SV

SYJ

SZ

VF

VP4

S0700

VQ

VQ4

VQ5

VQC

VQC4

VQZ

SQ

VFS

VFR

VQ7