

SIEMENS



3WJ air circuit breakers

SINOVA The Power of **Simplicity**

Discover The Power of **Simplicity** with SINOVA

Backed by Siemens quality standards, SINOVA introduces exceptional ease of operation and cost-efficiency to electrical installations in buildings, utilities, industries, and infrastructure applications.

Our low-voltage electrical products offer protection, control, switching, and metering capabilities that help promote efficiency across the value chain, optimizing OPEX, CAPEX, and reducing environmental impact.

We are continuously driven to innovate and provide simple and reliable solutions. Inspired by efficiency and simplicity, we strive to empower industry professionals to streamline processes and complete projects quicker every time.



3WJ air circuit breakers

Product highlights



Adaptable

Our air circuit breakers feature common footprints, allowing for easy and seamless integration.



Comprehensive

With a range of up to 4000A, our air circuit breakers cater to all your standard application needs.



Customizable

We provide complete flexibility for users to choose their desired features, ensuring cost-efficient performance that meets their specific requirements.

SINOVA The Power of **Simplicity**

Safety is our top priority

Ensuring the protection of both people and plants



Plant safety

Precise protection for installations to prevent the development of ground faults. Less thermal stresses on busbar and cables.



People safety

Closer protection for installations preventing ground faults.

Plant safety

Ground fault current depends on the line-to-neutral voltage and fault loop impedance. Absolute G settings, rather than percentages of nominal current, enable users to set breaker values closer to the calculated value, which improves ground fault sensing and eliminates the risk of potential fire hazards.

Our 3WJ air circuit breakers were designed with absolute settings to address this issue.



People safety

Multiple standard features and optional features for safe operation.

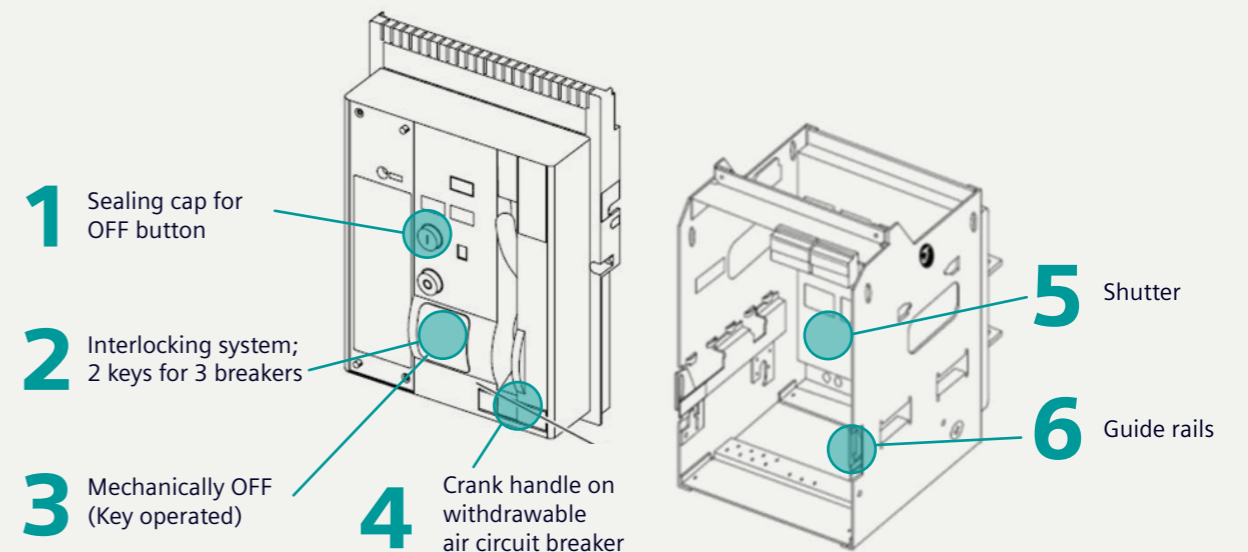

Efficiency is key

We aim to enhance plant productivity while minimizing downtime



Mechanical contact erosion indicator

Our air circuit breakers feature contact erosion indicators that allow plant operators to easily monitor the health of the breakers at regular intervals. This proactive approach enables scheduled maintenance, reduces the occurrence of unplanned shutdowns, and improves overall operational efficiency.

Unique ready to close indicator



Facilitates start-up



Safe switching on



Faster fault analysis

Customize your needs

We provide flexibility for users to choose from a wide range of accessories that best suit their specific needs and requirements.

Shunt release 	Undervoltage release 
Spring charging motor 	Operation counter 
Internal current sensor for neutral pole 	External current sensor for N-conductor 
Trip alarm switch 	Crank handle 

Note: Subsequent retrofitting is possible at any time.

Key applications

Our air circuit breakers are designed to ensure reliable and efficient protection in a wide range of settings.

Industrial

- **General manufacturing:** Motors, switchgear, control panels, and automation systems
- **Process industry:** Pumps, compressors, and control systems
- **OEM machine builders:** Conveyors, HVAC, etc.

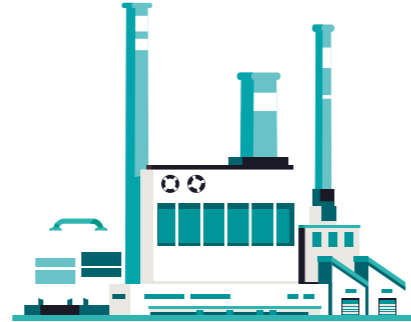

Infrastructure

- **Electrical utilities:** Feeder pillars, etc.
- **Water and wastewater treatment plants:** Pumps, valves, and control systems
- **Transportation systems:** Power distribution and signaling in railways, airports, and ports
- **Telecommunications:** Networks, base stations, and power distribution data centers
- **Road & tunnels:** Street lighting, traffic control, ventilation systems



Buildings

- **General manufacturing:** Motors, switchgear, control panels, and automation systems
- **Process industry:** Pumps, compressors, and control systems
- **OEM machine builders:** Conveyors, HVAC, etc.



Meeting the needs of all stakeholders in the project value chain

Our products are specifically designed to meet the evolving needs of all stakeholders involved in the project value chain. In today's building and industrial projects where cost-efficiency is crucial, power distribution is undergoing a paradigm shift.

With the rapid pace of changing application requirements, it is essential to have products and solutions that cater to the specific needs of each stakeholder. Our offerings address these needs, starting from the project inception phase and extending through the operation and maintenance phase of projects.



Consultants

Cost-efficient solutions, delivered with shorter lead times are the top priority of consultants today.

Our range of 3WJ air circuit breakers provides cost-efficiency by offering consultants the flexibility of configuring each product to meet specific application needs.



Contractors (EPC)

The demand for more cost-efficient, safe, and adaptable solutions is ever increasing for contractors in the installations and commissioning phase of projects.

The pre-readiness for installation at the commissioning phase is a crucial time for contractors to ensure cost optimization and risk management.

Our 3WJ air circuit breakers allow time saving during installation and enable faster commissioning with:

- The availability of how-to videos and a comprehensive CAx library
- Common footprints and complete flexibility in product selection



Panel Builders

Our 3WJ air circuit breakers are a comprehensive range that caters to all standard applications up to 4000A. Designed with common footprints to existing air circuit breaker portfolios, enabling simple and quick adaptation.

These features allow panel builders to deliver cost-efficient solutions to customers with short lead times.





End Users

Designed for today's power requirements of safety, reliability, and cost-efficiency that are of paramount importance for facility teams, our 3WJ air circuit breakers adhere to the latest international standards (IEC 60947-2). The common footprint feature helps to reduce OPEX by minimizing inventory and allowing for easy periodic upgrades with the availability of a wide range of accessories.

Product range

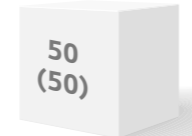
3WJ air circuit breakers

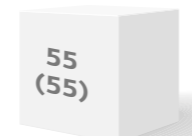
	Rated currents In max (A)	Short circuit breaking capacity I_{cu} / I_{cs} I_{cw} for 1s (kA)
Frame size I 	<ul style="list-style-type: none"> 800A 1000A 1250A 1600A 	 50 (50)
Frame size II 	<ul style="list-style-type: none"> 2000A 2500A 3200A 4000A 	 55 (55)

- ✓ 2 frame sizes
- ✓ 800A to 4000A
- ✓ Breaking capacity up to 55kA
- ✓ Suitable for up to 440V AC
- ✓ 3 pole and 4 pole
- ✓ Fixed-mounted and withdrawable design
- ✓ Withdrawable version in various termination options e.g., H-H (as standard) / H-V / V-V / V-H

ETU variants to suit all standard applications

Type	ETU350WJ	ETU360WJ
Protective functions	L-S-I	L-S-I-N-G
LCD display	✓	✓
Neutral conductor protection	-	✓
LEDs for fault annunciation	✓	✓
Overload (L)	✓	✓
Short time delayed short circuit (S)	✓	✓
Instantaneous short circuit (I)	✓	✓
Ground fault (G)	-	✓

Overview

System overview

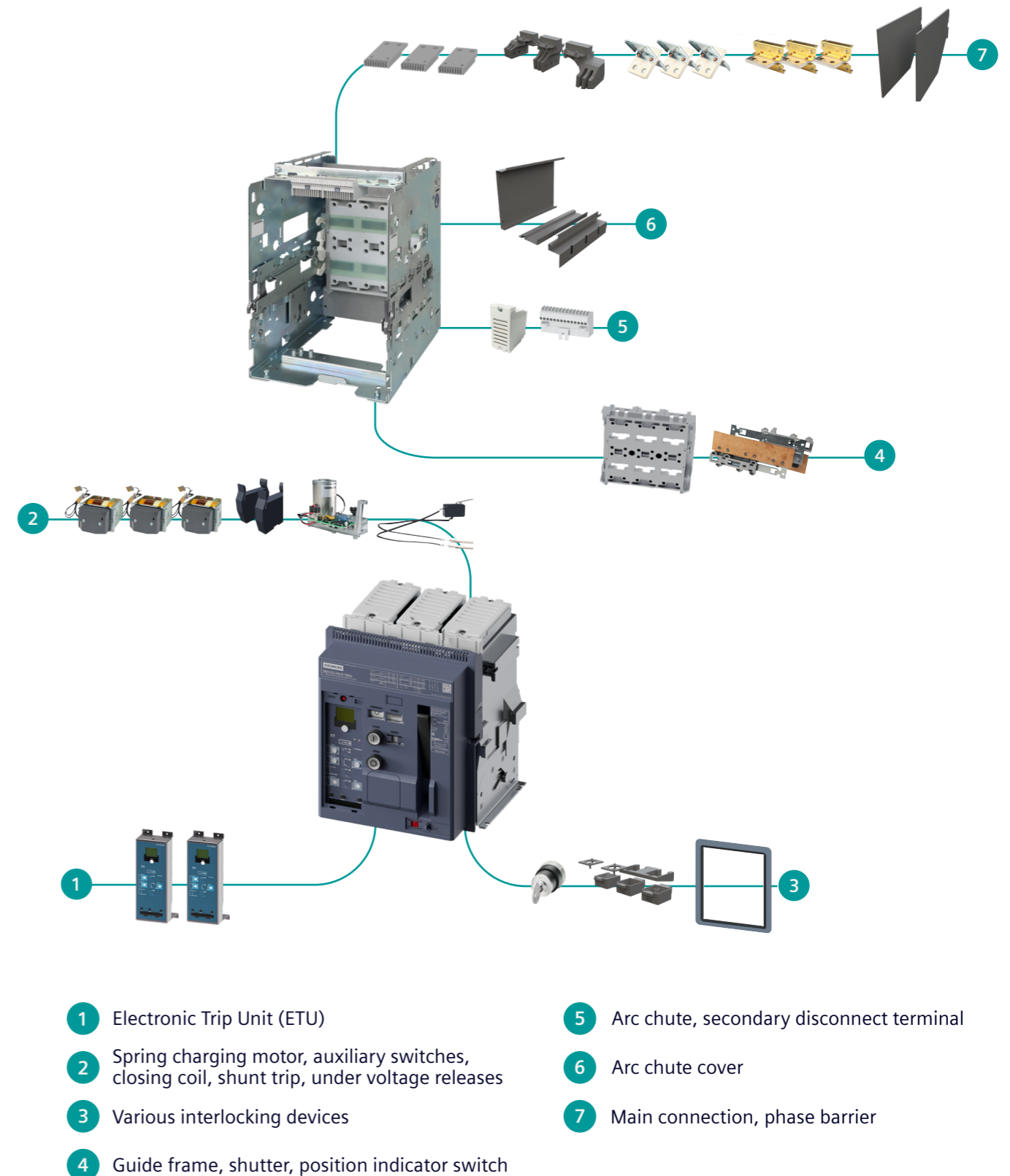

Technical specifications

3WJ air circuit breakers

The automatic circuit breakers adhere to IEC 60947-2 standards, and non-automatic circuit breakers adhere to IEC 60947-2 CBI-Y standards.



I

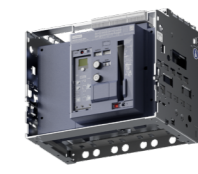

II

Frame size											
Breaker type				3WJ1108	3WJ1110	3WJ1112	3WJ1116	3WJ1220	3WJ1225	3WJ1232	3WJ1240
Rated current in at 40°C, at 50/60Hz	Main conductor	A		800	1000	1250	1600	2000	2500	3200	4000
	Neutral conductor (only 4P)	A		100%							
Rated operating voltage Ue at 50/60Hz		AC									
		V		440							
Rated impulse	Main circuits	kV		8							
	Auxiliary circuits	kV		4							
Utilization category				B							
Rated short circuit	Breaking capacity	up to									
Making capacity Icm (peak value)	S	440V AC	kA	105	105	105	105	121	121	121	121
Rated service short circuit	Breaking capacity	up to									
Breaking capacity Ics (rms value)	S	440V AC	kA	50	50	50	50	55	55	55	55
Rated ultimate short circuit	Breaking capacity	up to									
Breaking capacity Icu (rms value)	S	440V AC	kA	50	50	50	50	55	55	55	55
Permissible ambient temperatures	Operation		°C	-20...+70							
	Storage		°C	-40...+80							
Rated short-time withstand current Icw at 50/60Hz		1 secs	kA	50	50	50	50	55	55	55	55
Power loss at In With 3-phase symmetric load	Fixed-mounted		W	60	90	122	170	216	338	420	750
	Withdrawable including guide-frame		W	130	205	255	392	493	563	760	960
Endurance	Mechanical		Operating cycle	12000	12000	12000	12000	10000	10000	10000	10000
	Electrical up to 440V AC			8000	8000	8000	8000	4000	4000	4000	4000
Operating frequency	Mechanical		1/h	60							
Main conductor for minimum cross-section	Copper bars, bare		Qty mm ²	1x 60 x 10	2x 40 x 10	2x 60 x 10	2x 60 x 10	2x 100 x 10	2x 100 x 10	3x 100 x 10	4x 120 x 10
	Copper bars, bare		Qty mm ²	1x 50 x 10	2x 60 x 10	2x 40 x 10	2x 50 x 10	2x 80 x 10	2x 100 x 10	3x 100 x 10	4x 100 x 10
Auxiliary conductors (Cu)	Solid and finely stranded with end sleeves			1 x 0.5 ... 2.5mm ² ; 1 x AWG14							
Max no. of auxiliary conductors X cross-section				2 x 1.0 mm ²							

Selection & ordering data

MLFB Structure: Basic configuration for AC circuit breakers and AC non-automatic circuit breakers.

3WJ1		5	6	7	8	9	10	11	12	13	14	15	16	Z		
Switching device																
Frame size	1	1														
	2	2														
Max. rated current $I_{n\max}$	800A	■	-		0	8										
	1000A	■	-		1	0										
	1250A	■	-		1	2										
	1600A	■	-		1	6										
	2000A	-	■		2	0										
	2500A	-	■		2	5										
	3200A	-	■		3	2										
	4000A	-	■		4	0										
Breaking capacity I_{cu}/I_{cs} (kA), I_{cw} for 1s (kA) at 440V AC	Breaking capacity S	■	-		50/50kA			2								
		-	■		55/55kA			2								
AC non-automatic circuit breakers	ETU							A	A							
Circuit breakers, display with current metering																
Electronic Trip Unit (ETU)	ETU350WJ:LSI							A	E							
	ETU360WJ:LSING							A	F							
Number of poles	Fixed-mounted				3 pole					0						
					4 pole					1						
	Withdrawable	Without position signaling switch and without shutter			3 pole						3					
					4 pole						4					
		Without position signaling switch and with shutter			3 pole							5				
					4 pole							6				
Connection																
Number of mounting	Fixed-mounted ⁽¹⁾	■	■	Vertical										1		
		■	■	Horizontal										2		
		■	■	Vertical on top / horizontal at the bottom											5	
		■	■	Horizontal on top / vertical at the bottom											6	
		Withdrawable ⁽¹⁾	■	■	Without guide frame											0
			■	■	Vertical											1
	■		■	Horizontal											2	
	■		■	Vertical on top / horizontal at the bottom											5	
	■		■	Horizontal on top / vertical at the bottom											6	
	Spring charging motor (M), auxiliary switches (AUX)															
	Without spring charging motor and without auxiliary switches														0	
	Without spring charging motor but with auxiliary switches 2 NO, 2 NC				S1, S2										1	
Auxiliary switches 2 NO, 2 NC and spring charging motor				S1, S2												
Spring charging motor	24V DC													2		
Spring charging motor	110-127V AC / 110-125V DC													3		
Spring charging motor	220-240V AC / 220-250V DC													4		
Auxiliary switches 4 NO, 4 NC and spring charging motor				S5, S6												
Spring charging motor	24V DC													5		
Spring charging motor	110-127V AC / 110-125V DC													6		
Spring charging motor	220-240V AC / 220-250V DC													7		

Note:

4000A is available for fixed-mounted vertical⁽¹⁾ and withdrawal vertical⁽¹⁾. Crank Handle is not part of the standard scope of supply, to be ordered as an accessory.

Selection & ordering data

Basic configuration for AC circuit breakers and AC non-automatic circuit breakers.







3WJ1		5	6	7	8	9	10	11	12	13	14	15	16	Z
Closing coil														
Without closing coil														
Closing coil (CC)														
Closing coil														
Closing coil														
Closing coil														
Closing coil														
1st auxiliary release														
Without 1st auxiliary release														
Shunt trip (ST)														
Shunt trip														
Shunt trip														
Shunt trip														
Undervoltage release (UVR), instantaneous (≤ 80 ms), short-delay (≤ 200 ms)														
UVR														
UVR														
UVR														
UVR														
UVR														
Undervoltage release (UVR-t), can be delayed between 0.2 s and 3.2 s														
UVR-t														
UVR-t														
UVR-t														
2nd auxiliary release														
Without 2nd auxiliary release														
Shunt trip (ST), suitable for continuous duty														
Shunt trip														
Shunt trip														
Shunt trip														
Z options														
Door sealing frame (IP41)														
Trip unit cover														
Position signal switch (1x connected, 1x test, 1x disconnected)														
Position signal switch (3x connected, 2x test, 1x disconnected)														
Neutral CT for 4th Pole														
Mutual mechanical interlock - Bowden for fixed breakers with 2m bowden cable														
Mutual mechanical interlock - Bowden for drawout breakers with 2m bowden cable														
Locking systems - Castell														
Door interlock - To prevent the opening of the control cabinet door in the ON position														
Door interlock - To prevent the opening of the control cabinet door in the connected position														
5 digit operating counter														
Ready to close														
Trip signal switch														
Special packaging														

Note:

4000A is available for fixed-mounted vertical⁽¹⁾ and withdrawal vertical⁽¹⁾. Crank Handle is not part of the standard scope of supply, to be ordered as an accessory.

Selection & ordering data









Accessories

Frame size	Product image	Frame size / A	Type / Description	Article no.	List price per PU (Per Unit)
Accessory					
Trip alarm switch			1 NO Contact	3WJ9111-0AH02	
Auxiliary switch block			2NO+2NC, S1/S2	3WJ9111-0AG04	
			2NO+2NC, S6/S5	3WJ9111-0AG01	
			3NO+1NC, S60/S5	3WJ9111-0AG02	
			4NO+0NC, S60/S61	3WJ9111-0AG03	
Charging motor (M)			24V DC	3WJ9111-0AF01	
			110-127V AC / 110-125V DC	3WJ9111-0AF05	
			220-240V AC / 220-250V DC	3WJ9111-0AF06	
Closing Coil (CC)/ Shunt Trip (ST) - for continuous duty			24V DC	3WJ9111-0AD01	
			110-127V AC / 110-125V DC	3WJ9111-0AD05	
			220-240V AC / 220-250V DC	3WJ9111-0AD06	
Undervoltage Release (UVR): Instantaneous (≤8ms), Short delay (≤200ms)			24V DC	3WJ9111-0AE01	
			110...127V AC / 110...125V DC	3WJ9111-0AE05	
			220...240V AC / 220...250V DC	3WJ9111-0AE06	
			380...415V AC	3WJ9111-0AE07	
Undervoltage Release (UVR-t): with adjustable time delay of 0.2-3.2s			110...127V AC / 110...125V DC	3WJ9111-0AE15	
			220...240V AC / 220...250V DC	3WJ9111-0AE16	
			380...415V AC	3WJ9111-0AE17	
Locking provision against unauthorized closing secured open			Locking provision for Castell locks. The lock must be ordered at the manufacturer.	3WJ9111-0BA31	
			With CES lock	3WJ9111-0BA35	
Mutual mechanical interlock			Bowden cable - 2m	3WJ9111-0BB41	
			Bowden cable - 3m	3WJ9111-0BB42	
			Bowden cable - 4.5m	3WJ9111-0BB43	
			Bowden cable (2m) for fixed-mounted design is necessary for each circuit breaker. Spare-part for Z-option S55	3WJ9111-0BB21	
			Bowden cable (2m) for withdrawable design is necessary for each circuit breaker. Spare-part for Z-option R55.	3WJ9111-0BB22	

Note: The product images in this table list are for visual representation purposes only and may not reflect exact product sizes.

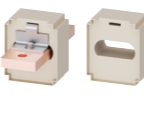
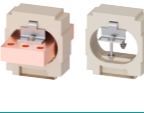
Selection & ordering data



Accessories

Frame size	Product image	Frame size / A	Type / Description	Article no.	List price per PU (Per Unit)
Accessory					
Key interlocking system			Against paralleling unsynchronized sources for 3 circuit breakers with CES lock. Interlocking in OFF position mounted to front cover 2 identical keys for 3 circuit breakers max. 2 circuit breakers closed	3WJ9111-0BA43	
Transparent cover for ETU			ETU350WJ	3WJ9111-0EM21	
			ETU360WJ		
Crank handle			For withdrawable circuit breakers	3WJ9111-0BC01	
Door sealing frame			IP41	3WJ9111-0AP01	
External current sensor for N-conductor		1	Busbar connection (Include copper bar)	3WJ9111-0AA31	
			Window type (Without copper bar)	3WJ9111-0AA21	
		2	Busbar connection (Include copper bar)	3WJ9111-0AA32	
			Window type (Without copper bar)	3WJ9111-0AA22	
2 phase barriers (1 set)		1	For 3P fixed design	3WJ9111-0AP51	
			For 3P withdrawable design	3WJ9111-0AP61	
		2	For 3P fixed design	3WJ9111-0AP52	
			For 3P withdrawable design	3WJ9111-0AP62	
3 phase barriers (1 set)		1	For 4P fixed design	3WJ9111-0AP53	
			For 4P withdrawable design	3WJ9111-0AP63	
		2	For 4P fixed design	3WJ9111-0AP54	
			For 4P withdrawable design	3WJ9111-0AP64	
Operation counter			5-digit operating cycles counter	3WJ9111-0AH04	
Ready-to-close			1 NO contact	3WJ9111-0AH01	



Note: The product images in this table list are for visual representation purposes only and may not reflect exact product sizes.

Selection & ordering data

Accessories

Frame size Accessory	Product image	Frame size / A	Type / Description	Article no.	List price per PU (Per Unit)
Sealing cap			For OFF push button	3WJ9111-0AP05	
Protective cover IP55			Not possible in combination with door sealing frame	3WJ9111-0AP03	
Position signaling switch			1x connected, 1x test, 1x disconnected	3WJ9111-0AH12	
			3x connected, 2x test, 1x disconnected	3WJ9111-0AH11	

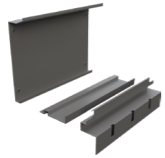
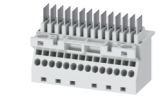
Spares

Frame size Accessory	Product image	Frame size / A	Type / Description	Article no.	List price per PU (Per Unit)
Arc chute		1	1 unit	3WJ9111-0AP31	
		2		3WJ9111-0AP32	
Arc Chute Cover		1	3 pole, fixed breaker	3WJ9111-0AP45	
			4 pole, fixed breaker	3WJ9111-0AP47	
			3 pole, withdrawable breaker	3WJ9111-0AP41	
			4 pole, withdrawable breaker	3WJ9111-0AP43	
		2	3 pole, fixed breaker	3WJ9111-0AP46	
			4 pole, fixed breaker	3WJ9111-0AP48	
Base part			3 pole, withdrawable breaker	3WJ9111-0AP42	
			4 pole, withdrawable breaker	3WJ9111-0AP44	
			For secondary disconnect terminals	3WJ9111-0AB03	
Conversion set		FS 1/3P	Converting fixed-mounted circuit breakers into withdrawable design	3WJ9111-0BC11	
		FS 1/4P		3WJ9111-0BC14	
		FS 2/3P		3WJ9111-0BC12	
		FS 2/4P		3WJ9111-0BC15	
Dummy block			For secondary disconnect terminals	3WJ9111-0AB04	

Note: The product images in this table list are for visual representation purposes only and may not reflect exact product sizes.

Selection & ordering data

Spares

Frame size Accessory	Product image	Frame size / A	Type / Description	Article no.	List price per PU (Per Unit)	
Electronic Trip Unit (ETU)		FS 1/2	ETU350WJ LSI	3WJ9111-0EE31		
		FS 1/2	ETU360WJ LSING	3WJ9111-0EE32		
Internal current sensor		1	Rogowski Coil	3WJ9111-0AA14		
		2		3WJ9111-0AA15		
Main contact system (1 pc)		1600A	-	3WJ9111-0AQ03		
		2000A		3WJ9111-0AQ11		
		2500A		3WJ9111-0AQ12		
		3200A		3WJ9111-0AQ13		
		4000A		For withdrawable design	3WJ9111-0AQ14	
				For fixed mounted design	3WJ9111-0AQ15	
		Up to 1000A		-	3WJ9111-0AQ01	
		Up to 1250A		-	3WJ9111-0AQ02	
Sliding disconnect			Secondary contact modules only for withdrawable design	3WJ9111-0AB02		
Secondary disconnect terminals			For fixed design	3WJ9111-0AB01		
Rear horizontal main connection, top or bottom		Size 1 up to 1000A	3 pieces for 3 pole in withdrawable design	3WJ9111-0AX11		
		Size 1 up to 1250A	3 pieces for 3 pole in withdrawable design	3WJ9111-0AX13		
		Size 1 up to 1600A	3 pieces for 3 pole in withdrawable design	3WJ9111-0AX15		
		Size 2 2000A	3 pieces for 3 pole in withdrawable design	3WJ9111-0AX21		
		Size 2 2500A	3 pieces for 3 pole in withdrawable design	3WJ9111-0AX23		
Size 2 3200A	3 pieces for 3 pole in withdrawable design	3WJ9111-0AX25				

Note: The product images in this table list are for visual representation purposes only and may not reflect exact product sizes.

Selection & ordering data

Spares

Frame size	Product image	Frame size / A	Type / Description	Article no.	List price per PU (Per Unit)
Accessory					
Rear horizontal main connection, top or bottom		Size 1 up to 1000A	4 pieces for 4 pole in withdrawable design	3WJ9111-0AX12	
		Size 1 up to 1250A	4 pieces for 4 pole in withdrawable design	3WJ9111-0AX14	
		Size 1 up to 1600A	4 pieces for 4 pole in withdrawable design	3WJ9111-0AX16	
		Size 2 2000A	4 pieces for 4 pole in withdrawable design	3WJ9111-0AX22	
		Size 2 2500A	4 pieces for 4 pole in withdrawable design	3WJ9111-0AX24	
		Size 2 3200A	4 pieces for 4 pole in withdrawable design	3WJ9111-0AX26	
Rear vertical main connection, top or bottom		Size 1 up to 1000A	3 pieces for 3 pole in withdrawable design	3WJ9111-0AV11	
		Size 1 up to 1250A	3 pieces for 3 pole in withdrawable design	3WJ9111-0AV13	
		Size 1 up to 1600A	3 pieces for 3 pole in withdrawable design	3WJ9111-0AV15	
		Size 1 up to 1000A	4 pieces for 4 pole in withdrawable design	3WJ9111-0AV12	
		Size 1 up to 1250A	4 pieces for 4 pole in withdrawable design	3WJ9111-0AV14	
		Size 1 up to 1600A	4 pieces for 4 pole in withdrawable design	3WJ9111-0AV16	
		Size 2 2000A	3 pieces for 3 pole in withdrawable design	3WJ9111-0AV21	
		Size 2 2500A	3 pieces for 3 pole in withdrawable design	3WJ9111-0AV23	
		Size 2 3200A	3 pieces for 3 pole in withdrawable design	3WJ9111-0AV25	
		Size 2 4000A	3 pieces for 3 pole in withdrawable design	3WJ9111-0AV31	
		Size 2 2000A	4 pieces for 4 pole in withdrawable design (Top)	3WJ9111-0AV22	
			4 pieces for 4 pole in withdrawable design (Bottom)	3WJ9111-0AV27	
		Size 2 2500A	4 pieces for 4 pole in withdrawable design	3WJ9111-0AV24	
		Size 2 3200A	4 pieces for 4 pole in withdrawable design	3WJ9111-0AV26	
		Size 2 4000A	4 pieces for 4 pole in withdrawable design	3WJ9111-0AV32	

Note: The product images in this table list are for visual representation purposes only and may not reflect exact product sizes.

Selection & ordering data

Spares

Frame size	Product image	Frame size / A	Type / Description	Article no.	List price per PU (Per Unit)
Accessory					
Vertical main connection, top or bottom		Size 1 up to 1000A	3 pieces for 3 pole in fixed mounted design	3WJ9111-0AM11	
		Size 1 up to 1250A	3 pieces for 3 pole in fixed mounted design	3WJ9111-0AM13	
		Size 1 up to 1600A	3 pieces for 3 pole in fixed mounted design	3WJ9111-0AM15	
		Size 1 up to 1000A	4 pieces for 4 pole in fixed mounted design	3WJ9111-0AM12	
		Size 1 up to 1250A	4 pieces for 4 pole in fixed mounted design	3WJ9111-0AM14	
		Size 1 up to 1600A	4 pieces for 4 pole in fixed mounted design	3WJ9111-0AM16	
		Size 2 2000A	3 pieces for 3 pole in fixed mounted design	3WJ9111-0AM21	
		Size 2 2500A	3 pieces for 3 pole in fixed mounted design	3WJ9111-0AM23	
		Size 2 3200A	3 pieces for 3 pole in fixed mounted design	3WJ9111-0AM25	
		Size 2 4000A	3 pieces for 3 pole in fixed mounted design	3WJ9111-0AM31	
		Size 2 2000A	4 pieces for 4 pole in fixed mounted design	3WJ9111-0AM22	
		Size 2 2500A	4 pieces for 4 pole in fixed mounted design	3WJ9111-0AM24	
Size 2 3200A		4 pieces for 4 pole in fixed mounted design	3WJ9111-0AM26		
Size 2 4000A		4 pieces for 4 pole in fixed mounted design	3WJ9111-0AM32		
Mechanical interlock to prevent opening of the circuit breaker compartment door			If ACB is closed - for fixed mounted design and spare part for Z-option S30	3WJ9111-0BB12	
			If ACB is closed - for withdrawable design and spare part for Z-option R30	3WJ9111-0BB13	
Shutter		1	For 3 pole	3WJ9111-0AP04	
		2	For 4 pole	3WJ9111-0AP08	
			For 3 pole	3WJ9111-0AP06	
			For 4 pole	3WJ9111-0AP11	

Note: The product images in this table list are for visual representation purposes only and may not reflect exact product sizes.

Selection & ordering data

3WJ8 guide frame for withdrawable design

Current rating	Frame size	No. of poles	Safety shutter	Terminal orientation	AUX connectors	Article no.	List price per PU (Per Unit)	
1250A	1	3P	With safety shutter	Top horizontal bottom horizontal	2	3WJ8112-2AA32-1BA1		
1250A	1	4P				3WJ8112-2AA42-1BA1		
1600A	1	3P				3WJ8116-2AA32-1BA1		
1600A	1	4P				3WJ8116-2AA42-1BA1		
2000A	2	3P				3WJ8220-2AA32-1BA1		
2000A	2	4P				3WJ8220-2AA42-1BA1		
2500A	2	3P				3WJ8225-2AA32-1BA1		
2500A	2	4P				3WJ8225-2AA42-1BA1		
3200A	2	3P				3WJ8232-2AA32-1BA1		
3200A	2	4P				3WJ8232-2AA42-1BA1		
1250A	1	3P				Top horizontal bottom vertical	3WJ8112-2AA36-1BA1	
1250A	1	4P					3WJ8112-2AA46-1BA1	
1600A	1	3P		3WJ8116-2AA36-1BA1				
1600A	1	4P		3WJ8116-2AA46-1BA1				
2000A	2	3P		3WJ8220-2AA36-1BA1				
2000A	2	4P		3WJ8220-2AA46-1BA1				
2500A	2	3P		3WJ8225-2AA36-1BA1				
2500A	2	4P		3WJ8225-2AA46-1BA1				
3200A	2	3P		3WJ8232-2AA36-1BA1				
3200A	2	4P		3WJ8232-2AA46-1BA1				
1250A	1	3P		Top vertical bottom vertical			3WJ8112-2AA31-1BA1	
1250A	1	4P					3WJ8112-2AA41-1BA1	
1600A	1	3P				3WJ8116-2AA31-1BA1		
1600A	1	4P				3WJ8116-2AA41-1BA1		
2000A	2	3P	3WJ8220-2AA31-1BA1					
2000A	2	4P	3WJ8220-2AA41-1BA1					
2500A	2	3P	3WJ8225-2AA31-1BA1					
2500A	2	4P	3WJ8225-2AA41-1BA1					
3200A	2	3P	3WJ8232-2AA31-1BA1					
3200A	2	4P	3WJ8232-2AA41-1BA1					
4000A	2	3P	3WJ8240-2AA31-1BA1					
4000A	2	4P	3WJ8240-2AA41-1BA1					

Note: Crank handle is not part of the standard scope of supply, to be ordered as an accessory.

Selection & ordering data

3WJ8 guide frame for withdrawable design

Current rating	Frame size	No. of poles	Safety shutter	Terminal orientation	AUX connectors	Article no.	List price per PU (Per Unit)	
1250A	1	3P	Without safety shutter	Top horizontal bottom horizontal	2	3WJ8112-2AA32-0BA1		
1250A	1	4P				3WJ8112-2AA42-0BA1		
1600A	1	3P				3WJ8116-2AA32-0BA1		
1600A	1	4P				3WJ8116-2AA42-0BA1		
2000A	2	3P				3WJ8220-2AA32-0BA1		
2000A	2	4P				3WJ8220-2AA42-0BA1		
2500A	2	3P				3WJ8225-2AA32-0BA1		
2500A	2	4P				3WJ8225-2AA42-0BA1		
3200A	2	3P				3WJ8232-2AA32-0BA1		
3200A	2	4P				3WJ8232-2AA42-0BA1		
1250A	1	3P				Top horizontal bottom vertical	3WJ8112-2AA36-0BA1	
1250A	1	4P					3WJ8112-2AA46-0BA1	
1600A	1	3P		3WJ8116-2AA36-0BA1				
1600A	1	4P		3WJ8116-2AA46-0BA1				
2000A	2	3P		3WJ8220-2AA36-0BA1				
2000A	2	4P		3WJ8220-2AA46-0BA1				
2500A	2	3P		3WJ8225-2AA36-0BA1				
2500A	2	4P		3WJ8225-2AA46-0BA1				
3200A	2	3P		3WJ8232-2AA36-0BA1				
3200A	2	4P		3WJ8232-2AA46-0BA1				
1250A	1	3P		Top vertical bottom vertical			3WJ8112-2AA31-0BA1	
1250A	1	4P					3WJ8112-2AA41-0BA1	
1600A	1	3P				3WJ8116-2AA31-0BA1		
1600A	1	4P				3WJ8116-2AA41-0BA1		
2000A	2	3P	3WJ8220-2AA31-0BA1					
2000A	2	4P	3WJ8220-2AA41-0BA1					
2500A	2	3P	3WJ8225-2AA31-0BA1					
2500A	2	4P	3WJ8225-2AA41-0BA1					
3200A	2	3P	3WJ8232-2AA31-0BA1					
3200A	2	4P	3WJ8232-2AA41-0BA1					
4000A	2	3P	3WJ8240-2AA31-0BA1					
4000A	2	4P	3WJ8240-2AA41-0BA1					

Note: Crank handle is not part of the standard scope of supply, to be ordered as an accessory.

SINOVA

The Power of **Simplicity**

Published by
Siemens Ltd

Smart Infrastructure
Electrical Products
R&D Building, 48,
Thane-Belapur Road
Thane 400708, India

Subject to changes and errors. The information given in this document only contains general descriptions and/or performance features which may not always specifically reflect those described, or which may undergo modification in the course of further development of the products. The requested performance features are binding only when they are expressly agreed upon in the concluded contract.

© Siemens 2023