

# Automatic Screw Feeder

## 自動ネジ供給機

# SSI-M Series

## Operation and Maintenance Manual

- Read these instructions for the proper use of this machine.
- After having read these instructions, keep them in a convenient place so you or the operator can refer to them whenever necessary.

ATTENTION : [www.ohtake-root.co.jp](http://www.ohtake-root.co.jp) is the only web site associated with our company.  
We do not have any branches in China.

各位顾客请注意! : 「[www.ohtake-root.co.jp](http://www.ohtake-root.co.jp) 是敝司唯一的官方网站,  
目前, 敝司在中国没有办事处与所谓的中国官网。」

注意! : [www.ohtake-root.co.jp](http://www.ohtake-root.co.jp) が当社唯一の HP アドレスです。  
弊社の名を騙る偽サイトにご注意下さい。現在、当社は中国国内に支店はございません。

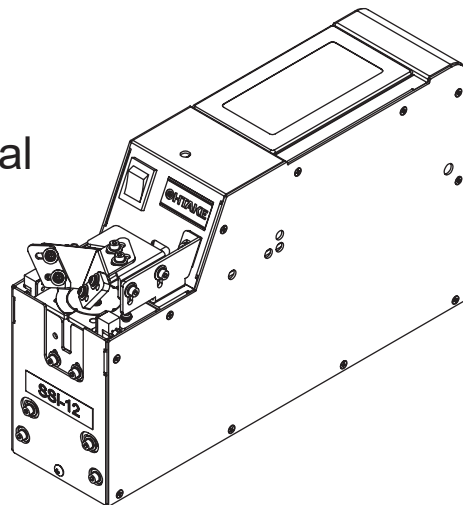

SSIMMAE01bM

# Contents

1. OVERVIEW OF THIS MACHINE -----	1	8. MISCELLANEOUS -----	27
2. BEFORE USE -----	1	9. TROUBLESHOOTING -----	29
3. OPERATING PRECAUTIONS -----	2	10. SPECIFICATIONS -----	35
4. NAMES OF MACHINE PARTS -----	5	11. EXTERNAL DIMENSIONS -----	37
5. ADJUSTMENTS AND CHECKS BEFORE USE-----	7	12. WARRANTY -----	38
6. MAINTENANCE -----	15		
7. PARTS ADJUSTMENTS AND REPLACEMENTS -----	15		

## 1. OVERVIEW OF THIS MACHINE

Thank you very much for selecting our Automatic Screw Feeder "SSI series".

This machine, with an electrical driver, can line up screws (M-1, M-3) and supplies them continuously to help make screw fastening work efficient.

Different sizes of screws can be used by changing the rail and parts of the escaper assembly.

It can be used wherever there is a power source for an AC adapter.

## 2. BEFORE USE

Please check for the following accessories before operating the machine.

- \* Instruction Manual 1 copy
- \* Hexagonal Wrench 1 piece
- \* Ground wire 1 piece
- \* AC Adapter 1 unit
- \* Screwdriver 1 piece

※ The design, performance and specifications are subject to change, without prior notice, for the sake of improvement.

### 3. OPERATING PRECAUTIONS

This manual contains safety alert symbols and signal words to help prevent injuries to the user or damage to property.

#### ◎ Indications



#### WARNING

This indicates there is a chance of death, serious injury or fire if the instructions are not followed.



#### CAUTION

This indicates there is a chance of personal injury or damage to property if the instructions are not followed.

#### ◎ Symbols indicating type of danger and preventative measures



Prohibited operation. Never do this!



Do not disassemble, modify or repair.



Do not touch with wet hands.



This indicates to stop operations.



Unplug power supply from wall outlet.



General caution.



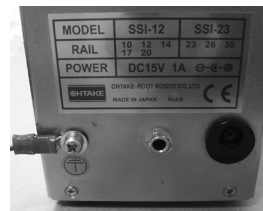







Attach the ground wire by loosening the screw near the mark  of the equipment.



the back of the main body















 WARNING

---

-  Do not disassemble the AC adapter as there is a risk of electric shock, fire or malfunction.
-  Do not damage, alter or change the power cord. Do not place heavy objects on the cord.  
 Do not pull hard on the cord or twist the cord as it could be damaged, thereby causing a risk of fire or electric shock.
-  Do not handle the AC adapter with wet hands as it could cause an electric shock.
-  When using an outlet with AC100 ~ 240V, don't overload the electrical circuit.  
 Do not modify or remodel this machine as this may cause a fire or electric shock.
-  Do not operate this machine near flammable liquids, gasses or materials as there could be a risk of fire or explosion.
-  Stop operating the machine and unplug the AC adapter from the wall outlet when you detect overheating, smoke, a pungent odor or any other unusual condition, as there may be a risk of fire or electric shock. Contact the dealer, from which you purchased the machine and have it examined and repaired.
-  In the case of a thunderstorm, stop operating the machine, turn off the power and unplug the AC adapter from the wall outlet. If there is lightning and thunder nearby, move away from the machine and do not touch it or the AC adapter.  
After the thunder stops and when it is safe to do so, check the machine. If there is any abnormality, contact your dealer.
-  When performing maintenance, changing parts or when you sense an abnormality in the machine, turn the power off and pull the AC adapter from the wall outlet.

 CAUTION

---

-  Use only the AC adapter supplied with this machine otherwise it may result in a fire or electric shock.
-  Do not install this machine in an unstable location otherwise it may fall causing damage or injury.
-  Always operate the machine with the upper cover in place, otherwise it may result in injury.
-  Do not allow any foreign material to enter the machine while in operation.  
 Do not put your fingers into the machine while in operation, otherwise an injury will result.
-  Do not operate this machine in overly humid or dusty conditions.  
 Keep the socket plug clean at all times otherwise it may cause a fire or electric shock.
-  When moving the machine, always disconnect the AC adapter from the wall outlet or it may result in damage to the cord or cause a fire or electric shock.
-  Turn off the machine and unplug the AC adapter from the wall outlet if the machine will be unused for any extended period of time.
-  Do not operate the machine with tension on the AC adapter cord.  
 Keep the cord loose and untangled.
-  Do not bend, alter or damage the rail. Do not apply any oil. It is recommended that the user clean the rail periodically.
-  Do not use any screw that is out of the specified range nor any screw that is oily or dirty.
-  When picking up screws, do not exert excessive force or shock to the screws.

## 4. NAMES OF MACHINE PARTS

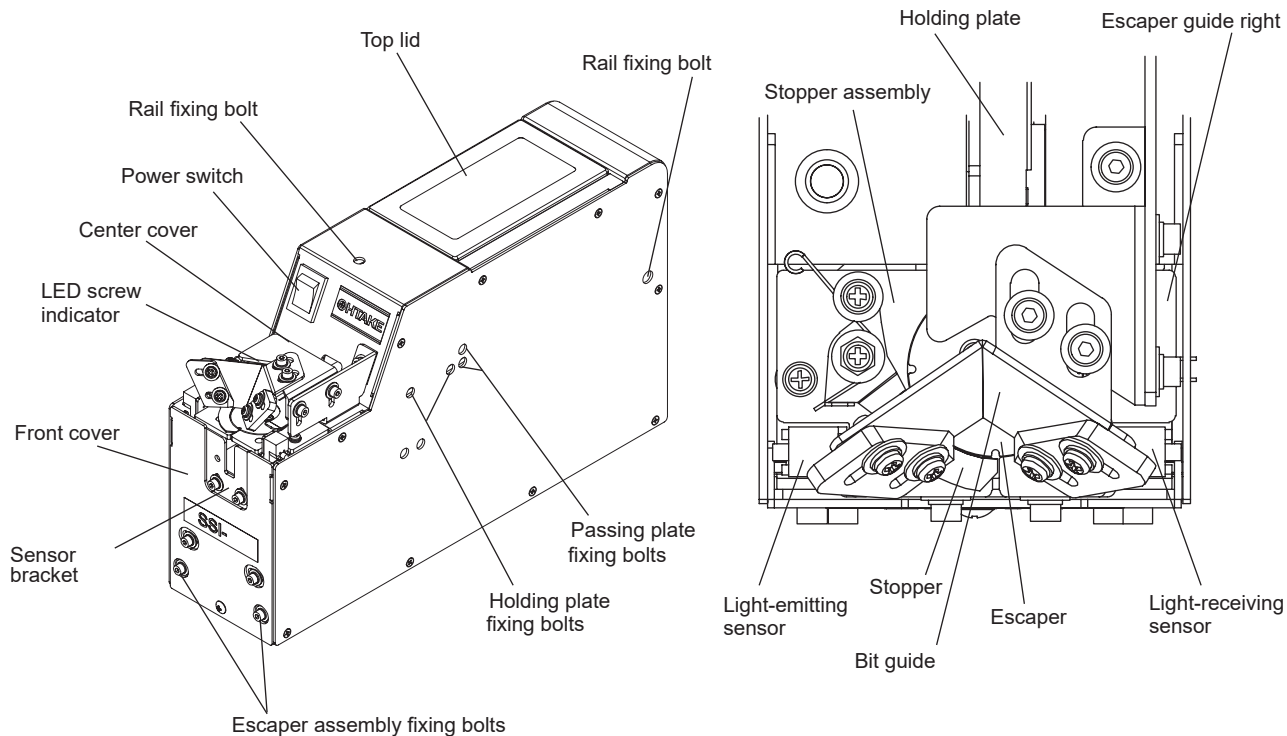

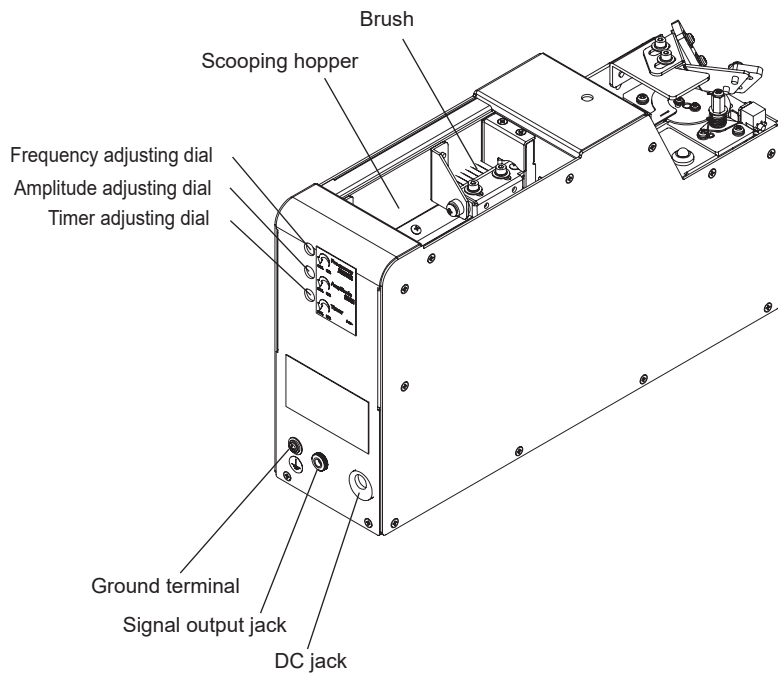

## 5. ADJUSTMENTS AND CHECKS BEFORE USE

### 5-1. Main body model number verification

Check if the machine has the parts which match the nominal diameter of the screws to be loaded. Check the model number of the rail, escaper, robot escaper guide and passing plate by referring to the following table. Before delivery, each section of the machine is checked and adjusted with panhead screws matching the nominal diameters of the model ordered. Operate the machine with the screws loaded to check that the pick up is smooth. If the height or or shape of the screw head is different or if the operation is regarded as abnormal, each section must be readjusted.

If this is the case, make the following checks and adjustments:

- Check the screw load amount
- Check and adjust the brush
- Check and adjust the passing plate
- Check and adjust the rail vibration
- Check and adjust the holding plate
- Check and adjust the timer

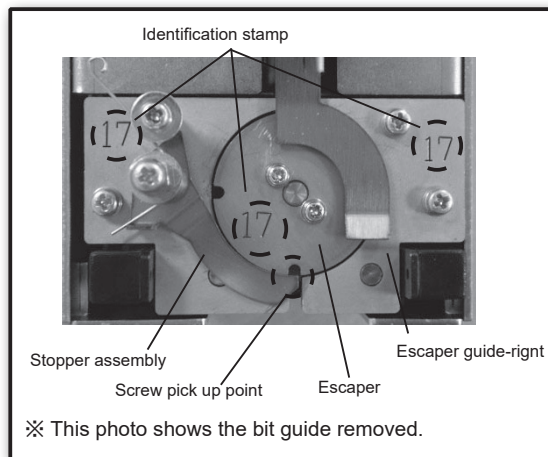

Screw feeder series	Screw feeder model	Screw size	Rail set No.	Rail model No.	Escaper model No.	Stopper assembly model No.	Escaper guide-right model No.
SSI-12M	SSI-12M10	φ 1.0	SIM10SET	SIR10	SSIE10	SSIES10	SSIEM10
	SSI-12M12	φ 1.2	SIM12SET	SIR12	SSIE12	SSIES12	SSIEM12
	SSI-12M14	φ 1.4	SIM14SET	SIR14	SSIE14	SSIES14	SSIEM14
	SSI-12M17	φ 1.7	SIM17SET	SIR17	SSIE17	SSIES17	SSIEM17
	SSI-12M20	φ 2.0	SIM20SET	SIR20	SSIE20	SSIES20	SSIEM20
SSI-23M	SSI-23M23	φ 2.3	SIM23SET	SIR23	SSIE23	SSIES23	SSIEM23
	SSI-23M26	φ 2.6	SIM26SET	SIR26	SSIE26	SSIES26	SSIEM26
	SSI-23M30	φ 3.0	SIM30SET	SIR30	SSIE30	SSIES30	SSIEM30

If the rail, escaper, stopper assembly and escaper guide-right are replaced, screws with a different nominal diameter can be accepted. After these parts are replaced, fine adjusting is required.

The respective adjusting procedures will be described in the following pages. Please read these procedures.



## 5-2. Basic Operation

The driving motor repeats a normal rotation and a reversal for about 2 seconds at a time as the scooper carries screws to the rail. The vibrator (solenoid) continuously sends screws to the front stopper to be picked up using a screwdriver.

The rail vibrates to deliver screws towards the end of the rail, then the escaper rotates to deliver screws to the pick up point. When the screws come to the stopper, the LED indicator lights up and the escaper stops rotating.

Do not overload the hopper in order to ensure a proper alignment and smooth flow of screws. (See Picture 2)

Adjust the scooping chamber to its lowest position by turning the power to the machine ON and OFF.

Fill the scooping chamber with screws up to 2mm below the rail groove.  
Do not load screws beyond the front of the sliding plate.  
Always ensure there are adequate screws for the operation.

[CAUTION] Use only the AC adapter supplied with this machine otherwise it may cause damage to the machine.

\* Amount of screws.

View from above

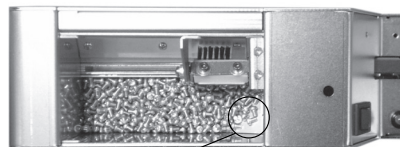

Do not load screws beyond the front of the sliding plate.

### ○Picking up screws

- Use an electric driver to pick up screws at the stopper.  
Use the bit guide to put the screwdriver down vertically into the screwhead's slots, then pull the screwdriver, horizontally, towards you as picking up the screw.
- When inserting the screwdriver into the screwhead slots, do not use excessive force as it may alter the position of the escaper or cause damage to the machine.
- To insert the screwdriver bit into the screwhead slots properly, it may be necessary to twist the driver slightly.
- Use a driver bit which corresponds with the screw's diameter.

### ○Action of the escaper

- The escaper rotates 90° clockwise, stops for a few seconds, and rotates again 90° clockwise.  
When a screw is caught in the escaper and the notch position is altered, the escaper automatically rotates counterclockwise, as a reference point run, in order to adjust the notch position and then returns to the clockwise rotation.
- This machine continues its operation when no screw is found at the screw pick up point. When a screw is delivered to the front of escaper, the scooping action will stop after a set time, if the screw is not picked up. After the screw is picked up, the machine starts operating again. This time lapse can be varied by adjusting the timer.

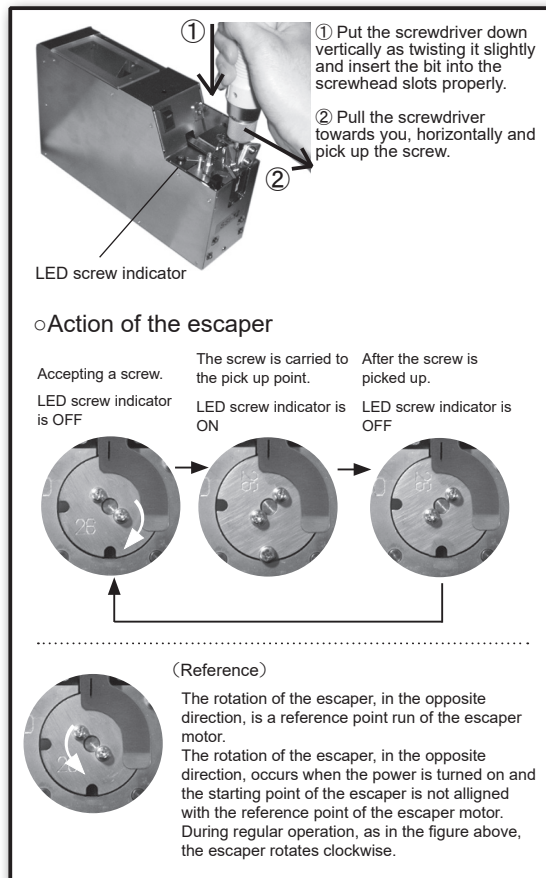

### 5-3. Brush height adjustment

**!** Turn OFF the power switch before starting replacement or adjustment.

No adjustment is necessary if the tip of the brush touches the screw head in the rail groove and rotates when the machine is turned on.

If any adjustment is necessary, loosen the brush height adjusting bolt to adjust the brush height.

Move the brush manually to check that the brush touches heads of the screws in the rail groove, with the power switched off.

If the brush position is too high, incorrectly positioned screws cannot be swept. If the brush position is too low, it may sweep out correctly positioned screws from the rail or it may stop rotating.

Brush height adjustment screws

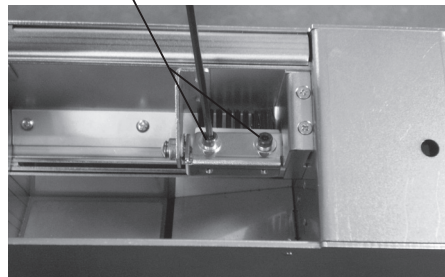

Move the brush by hand to check that the screws, in the rail groove, are in slight contact with the brush bristles and make adjustments if necessary.

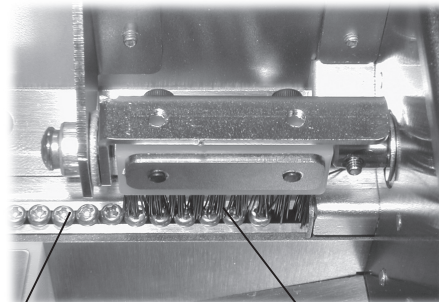

Loaded screws

Brush

## 5-4. Passing and holding plates height adjustment

❗ Turn OFF the power switch before starting replacement or adjustment.

Both the passing and holding plates are fixed to the rail.

Passing and holding plates adjustment shall be made when the rail is removed from the body. Refer to 『7-1 Rail assembly replacement』 for replacing.

If the clearance, between the passing plate and the screw head, is too high or too low, the flow of screws may be stopped.

To adjust, loosen the passing plate fixing screws and place a screw into the rail groove, just beneath the passing plate. Set the clearance of the passing plate to just above the screw head.

If the clearance, between the holding plate and the screw head, is too high or too low, the flow of screws may be stopped. Set the clearance to 0.2 ~ 0.5mm above the screw head.

After adjustment, place a screw into the rail groove in front of the passing plate and tilt the rail to see if the screw moves smoothly to the end of the rail.

Note: When screws attached with washers are used, please set the clearance slightly higher than 0.5mm. For ultra-thin or unique shaped screw heads, an additional type of passing plate is available. Please contact your dealer for more information.

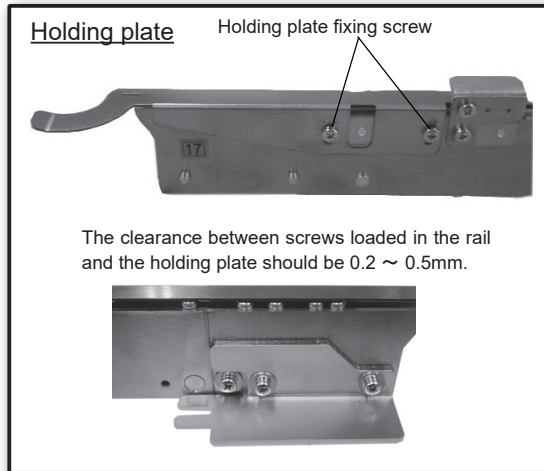
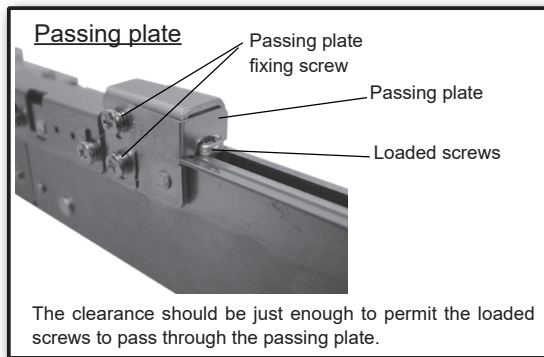

## 5-5. Rail vibration check and adjustment

The amplitude and frequency of the rail vibration can be adjusted.

The vibration has been adjusted at the factory for screws that correspond with the rail.

Put some screws into the rail groove and turn the power ON. If they are delivered smoothly, there is no need for adjustment.

The screw transport speed differs depending on screw type.

For screws with a slow transport speed, or screws that easily jump out, please make an adjustment to the vibration.

- ① Turn the amplitude adjusting dial (second hole from the top in the back of the machine) using the accompanying screwdriver. Find the point at which the rail vibrates the most. (Please be careful not to use excessive force)
  - ② Turn the frequency adjusting dial (first hole at the top), and find the point at which screws can move efficiently.
  - ③ Adjust the amplitude dial again for strength of the vibration. Find the point where screws are not vibrating too heavily so that they can travel stably on the rail, without being trapped at the passing plate or falling out from the rail. Repeat procedures above as necessary.
- If the vibration is adjusted too much, to increase the transport speed, screws may jump from the rail and fall into the machine, failing to be delivered.  
Adjust the vibration to a proper value that matches the loaded screws.

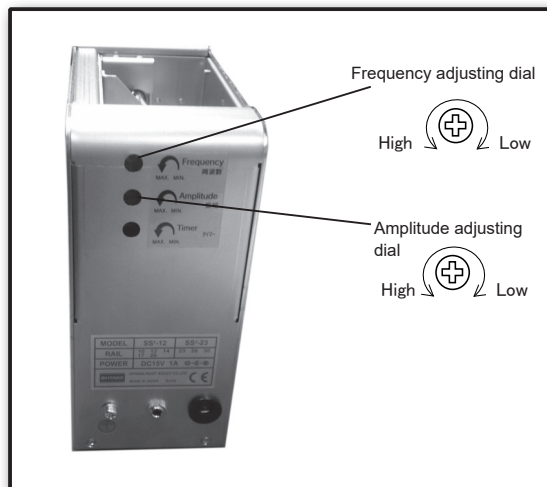



## 5-8. Bit guide check and adjustment

- Adjust the bit guide's height by loosening the attaching bolts.
- Make sure that the bit guide does not contact the screw heads.
- Use the screwdriver and hex key that are provided with this machine.
- Remember to tighten the bolts and screws after adjustment.
- After adjustment, check that the pick up of screws is smooth.

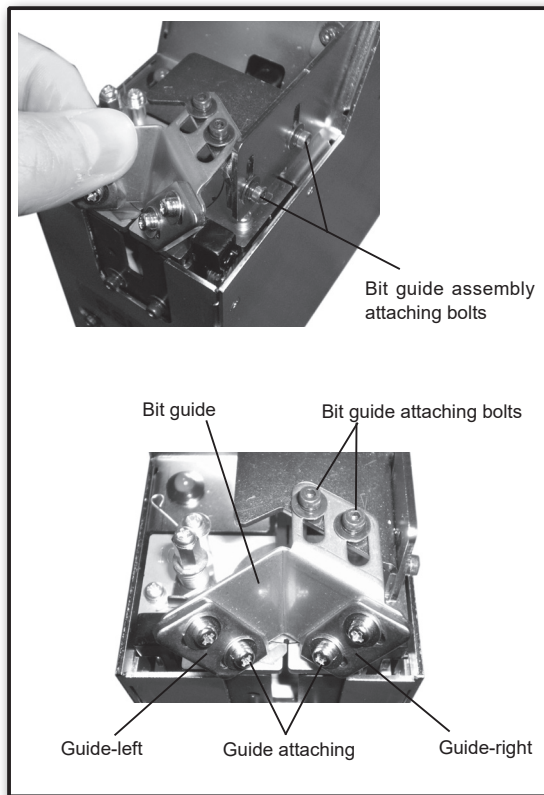

## 6. MAINTENANCE

A dirty rail groove may affect the screw transport speed.

Clean the dirty rail with a soft, clean cloth dipped in alcohol.

If cleaning is difficult, remove the rail from the machine to clean the rail groove.

Refer to the next section under 『7-1 Rail assembly replacement』 for replacing.

Before removing the rail from the machine, be sure to turn OFF the power supply and take the screws out of the hopper.

If there is any dirt or a flaw in the rail groove that may cause an impediment in use, we recommend the user to replace the rail.

## 7. PARTS ADJUSTMENTS AND REPLACEMENTS

The brush, main motor, escaper, escaper guide and drive belt are consumable parts.

When using a different diameter of screw, the following items must be replaced: rail and escaper.

These parts may be ordered separately.

The replacing and adjusting procedures are described on the next page.

When replacing any parts, a fine adjustment is required. Make these fine adjustments by reading the corresponding contents carefully.

Before replacing any parts, be sure to remove all the screws from the hopper.



## 7-1. Rail assembly replacement

- ❗ Turn OFF the power switch before starting replacement or adjustment.

Before replacing, remove all the screws from the hopper, the rail and the escaper.

If there is any dirt or flaw on the rail or in the rail groove that prevents a smooth operation, we recommend the user clean or replace the rail. Use the escaper, stopper assembly, escaper guide-right and rail assembly that correspond to the diameter of the screws to be used.

- ① Remove the bit guide assembly.

Loosen the attaching bolts (2 pcs.) and pull out the bit guide assembly.

- ② Remove the front cover.

Loosen the bolts on the front cover to remove.

- ③ Loosen the escaper assembly screws and pull out the escaper assembly.

Loosen the attaching bolts of the escaper assembly (front bottom) with the hex key. Pull out the escaper assembly, being careful not to damage the attached harness.

①

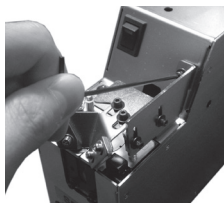

Remove the bit guide assembly.

②

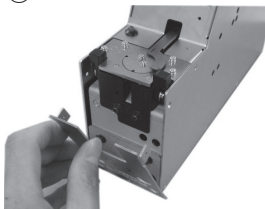

Remove the front cover.

③

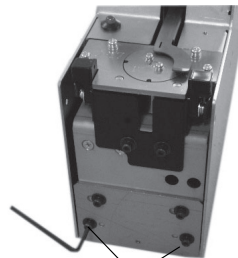

Loosen the escaper assembly bolts and pull out the escaper assembly.

Escaper assembly fixing bolts

#### ④ Replace the rail assembly.

Insert the hex key into the top cover's front and center hole to loosen the fixing bolt. Repeat this procedure with the right cover's back center hole. Pull out the rail assembly and replace it with a rail that corresponds with the screws you will be using.

Insert the new rail and tighten the rail fixing bolts.

#### ⑤ Reassembly of the escaper assembly.

Install the escaper assembly by fitting the hole, on the base, with the projection on the clamping plate.

Take care not to pinch the harness when installing.

After replacing the rail, adjustments are required.

Fix the rail so that it does not contact the escaper and make sure that screws won't fall into the gap between the escaper and rail.

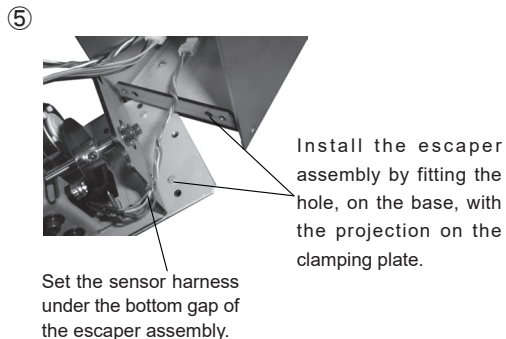
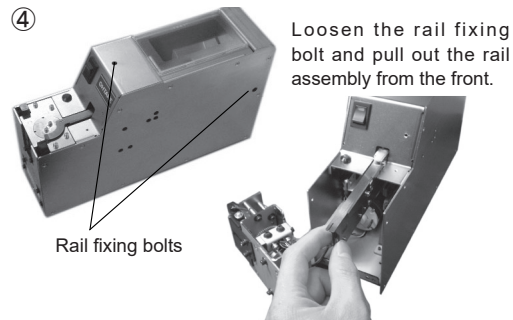

## 7-2. Escaper replacement or adjustment

- ❗ Turn OFF the power switch before replacing.  
Before replacing, remove all the screws from the hopper, the rail and the escaper.  
Turn ON the power for adjustments.

When using different diameter screws, change the rail, the escaper, stopper assembly and the escaper guide-right. After replacing, check and adjust the escaper area. When removing the escaper attaching screws, use the driver for M2 (bit No. 0). Replacing and checking is done with the bit guide removed.

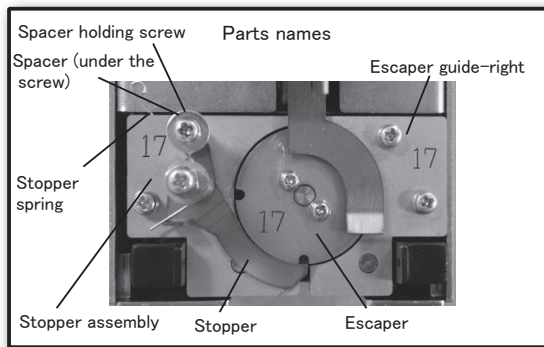

- ① Remove the escaper guide-right and the escaper.

①

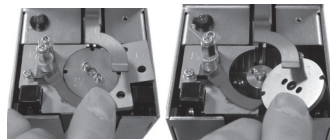

Remove the escaper guide-right and the escaper.

- ② Remove the spring, spacer and the stopper assembly.

②



Remove the stopper spring.



Remove the spacer.



Remove the stopper assembly.

### ③ Assembling the replacement parts.

After attaching the stopper assembly, hook the stopper spring under the flat washer of the spacer holding screw.

Check that the stopper returns smoothly when it's pulled and released.

When the stopper edge touches the escaper, refer to 『7-7 Stopper replacement』 to adjust it.

### ④ Notch position adjustment.

Turn the power ON while covering the sensor optical axis with a piece of paper (location shown on right). The screw sensor LED lights up and the escaper rotates to the reference point.

As the escaper stops, loosen the escaper holding screws and rotate the escaper, by hand, to align the rail groove and the escaper notch. Then tighten the escaper holding screws.

③

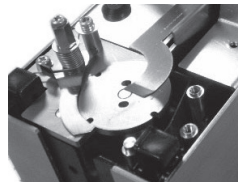

Attach the stopper assembly, the escaper and the escaper guide-right.

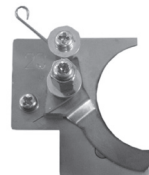

Hook the stopper spring under the flat washer of the spacer holding screw.

④

Escaper holding screws

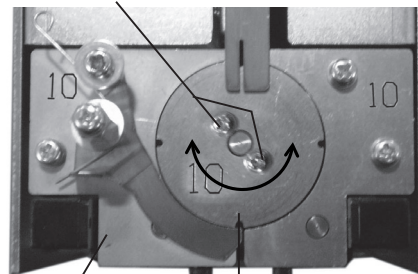

Align the rail groove and the escaper notch.

Cover the sensor optical axis to stop rotation.

### ⑤ Passing screws position check.

Check that the gaps between the rail and the escaper guide-left and right are even. If the rail touches the escaper guide, screws can't be delivered smoothly. If the gap is too wide, screws fall into the feeder.

Check that the surface of the escaper is level with, or 0.1 ~ 0.3mm lower than, the surface of the rail. If the escaper is too high or too low, screws don't enter the escaper notch properly.

Adjust the escaper bracket by loosening the attaching screws to move the bracket up/down or sideways. Tighten the screws after adjustment. In order to see clearly, pull up the holding plate, gently.

After adjusting, turn the power ON to make a reference point run.

Remove the paper from the sensor optical axis to start the escaper rotation. Check that each of the 4 notches, in each rotation, aligns with the rail groove.

When adjustments are done, attach the bit guide and do a trial run with screws to be used. If there is an abnormality, make readjustments including rail vibration and rail positioning.

⑤

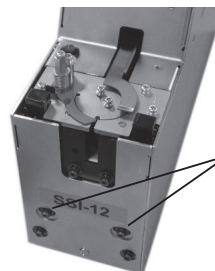

Escaper bracket attaching bolts.

Gaps between the rail and the escaper guides left/right should be even. There should be no contact.

The escaper surface is level with, or 0.1 ~ 0.3mm lower than, the rail surface.

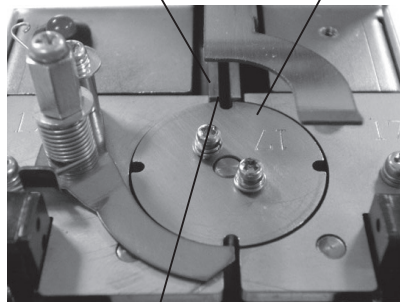

The rail groove and the escaper notch are aligned.

### 7-3. Sensor check and adjustment

Usually, there is no need to adjust the sensor as it was done when assembled in the factory.

When checking is required, take the rear cover off and check the voltage level of No. 3 and No.7 pin of IC4050. When measuring the voltage level, the metal part of the main body is the ground.

#### ○Front sensor adjustment < Pin No.7 >

The screw sensor detects whether or not there is a screw at the pick up point.

The following are irregular situations that require adjustment:

- There is no screw at the pick up point but, the LED is on and the escaper doesn't rotate.
- There's a screw at the pick up point but, the LED is not on and yet, the escaper rotates.

Turn ON the power with no screw at the pick up point.

Next, loosen the 2 sensor bracket attaching bolts and do the following:

- ① Pull the sensor bracket down and check if the light is ON and the voltage is over 4V. At this time, the escaper is stopped.
- ② Next, while checking the voltage level, slowly push the sensor bracket up which causes the voltage to decrease. When the voltage is around 0.25V ~ 1.5V tighten the sensor bracket.

When there is no screw at the pick up point, the voltage is 0.25V ~ 1.5V and the LED screw indicator is OFF.

When there is a screw at the pick up point and the voltage is over 3.5V, the LED screw indicator is ON.

This is a general standard. The borderline, whether there is a screw in position or not, is 2.5V.

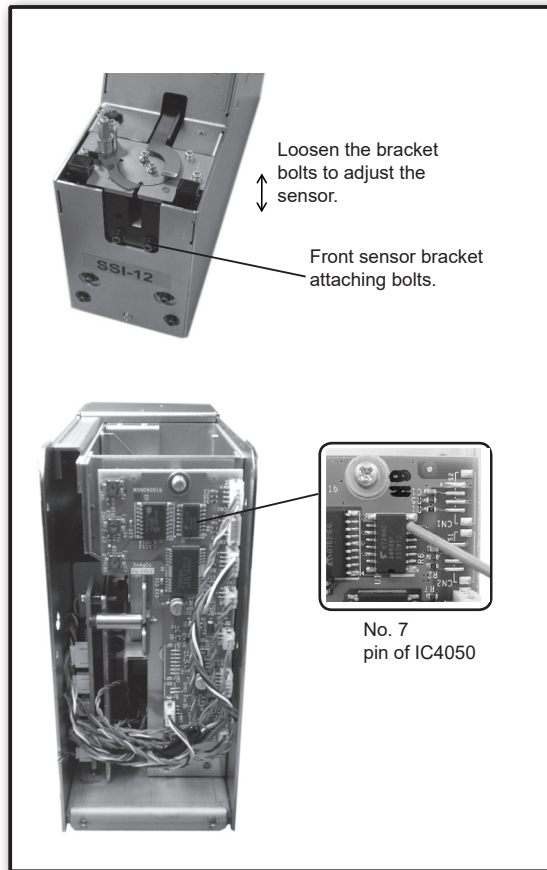

○Rail screw sensor adjustment < Pin No.3 >

The rail screw sensor detects whether or not there are any screws remaining on the rail.

The following are irregular situations that require adjustment:

- There are few screws on the rail, but the scooping block stops.
- The rail is full of screws, but the scooping block doesn't stop.

Loosen the light - receiving sensor bracket fixing bolts (2 pcs.) and adjust the sensor level by rotating the bracket. (See the picture on the right.)

0.25 – 1.5V: There are no screws remaining on the rail.

3.5V or more: There are screws on the rail.

If the voltage is 2.5V or over, the sensor judges that there are screws on the rail.

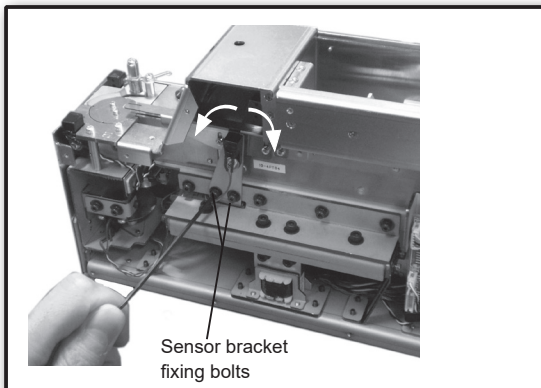

## 7-4. Brush replacement or adjustment

- ❗ Turn OFF the power switch before starting replacement or adjustment.

If the ends of the brush are worn and do not sweep off the screws that are out of alignment, replace the brush.

Optional hard-bristled brushes are available. Contact the dealer, from which you purchased this machine, for more information.

Turn the machine ON and OFF until the brush comes to a position where you can remove the brush fixing bolts.

Refer to the diagram, in the picture to the right, to replace the brush.

Refer to “5-3. Brush Height Adjustment” for adjustment.

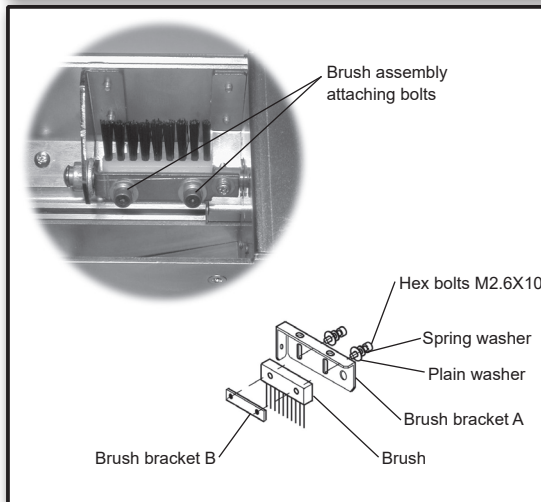

Brush Item Nos.: NSN02107 (for Model SSI-12)

NSN22001 (for Model SSI-23; option for Model SSI-12)

## 7-5. Drive belt replacement or adjustment

- ❗ Turn OFF the power switch before starting replacement or adjustment.

If the drive belt is worn, cut or slips, replace it with a new one.

- Turn the machine OFF and remove the left and center covers.
- When you remove the covers, you will see four rollers around which the drive belt is fitted.
- Remove the belt, with your fingers, as shown in the picture.
- After installing the belt, check that each part moves normally. (Refer to heading " 5. Adjustments and checks before use".)

Drive Belt Item No.: NSN03114

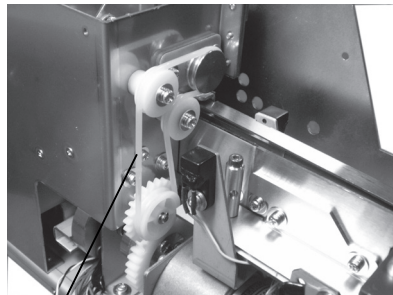

Drive belt

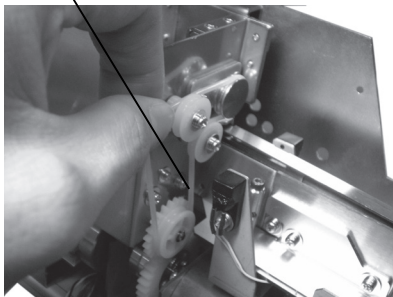



## 7-6. Main motor unit replacement

**!** Turn OFF the power switch before starting replacement.

If the motor is damaged, replace it with a new motor unit.

① ② Remove the base weight, being careful not to lose the spacers (4pcs.).

③ Remove the top center, rear, left and right covers. Loosen the clips (2pcs.) holding the cable. Remove the motor harness (blue and orange) from the circuit board.

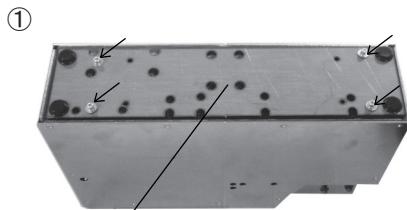

Remove the base weight.

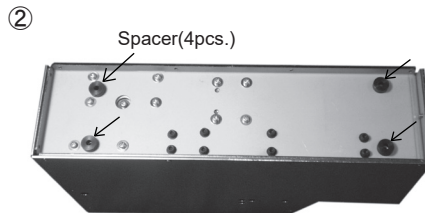

After base weight was removed.

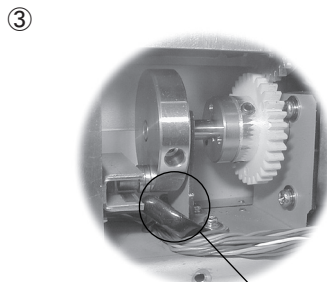

Remove the covers. Loosen the clips (2pcs.) holding the cable.

④ ⑤ Remove the motor fixing screws (4 pcs.) from the bottom of the body and pull the motor out from the body's left side.

⑥ When installing, insert the roller into the slot.

Note: When installing, take care not to pinch the wiring.

Main motor unit Item No.: NSN 03001

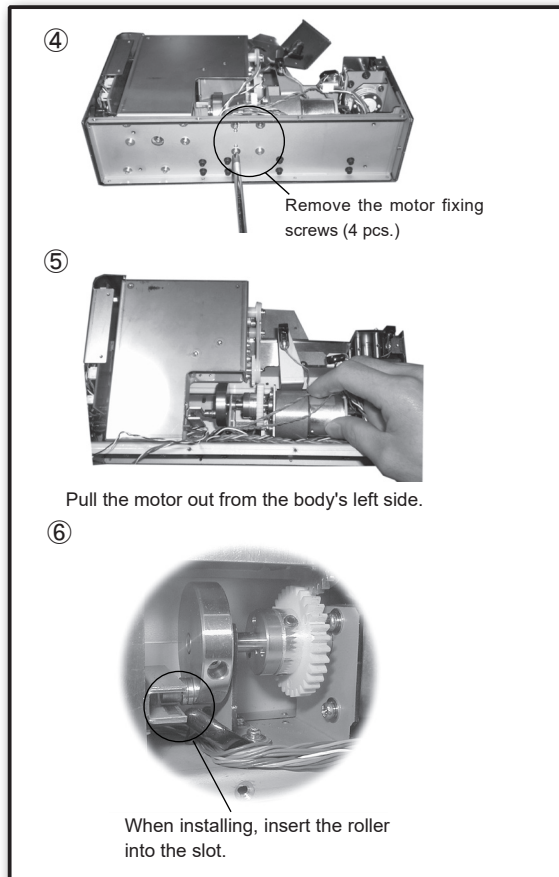

## 7- 7. Stopper replacement

**!** Turn OFF the power before replacing or adjusting.

- The stopper is a consumable part. When the stopper edge is worn or damaged, replace it. (The stopper may be replaced without removing the escaper guides.)
- Remove the stopper spring being careful that the flat washer or the spring does not fly off.
- Remove, in the following order, the flat washer, the stopper spring and the stopper.
- Install the stopper and while holding the stopper spring and flat washer, attach with the holding screw. Take care not to pinch the spring with the holding screw.
- Hook the end of the stopper spring onto the spacer holding screw. Check if the stopper moves smoothly and that there is a gap between the stopper edge and the escaper guide.
- Make sure that the stopper edge doesn't contact the escaper. If they are in contact, the rotation may be affected.
- If they touch, loosen the stopper holding screw, push the spacer towards the stopper and adjust the stopper edge position.

Part number of Stopper: SSI 10007

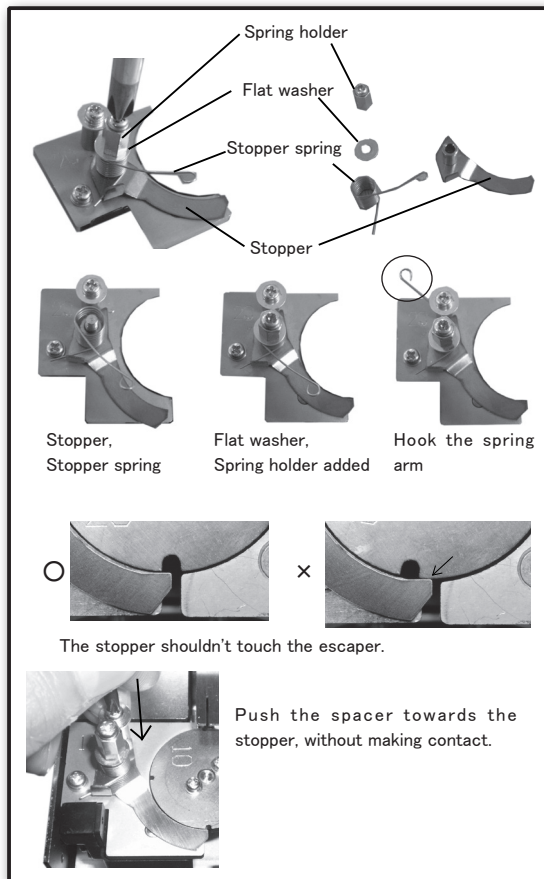

## 8. MISCELLANEOUS

### 8-1. External Output Signals

The jack, at the back of the machine, can be used in the detection of screws at the pick up point. It can also be used with standard screw counters.

[Function]: Screw present: signal high (ON)

Incoming current: shall be limited to less than 100mA

**\*\*CAUTION:** An additional resistor is required, on the external circuit, to regulate the current. **\*\***

[Capacity]: Max DC current: 100mA

External supply voltage: 5 ~24VDC (Max: 27VDC)

[Note]: Use the  $\phi 3.5$ -3 conductor miniature plug.

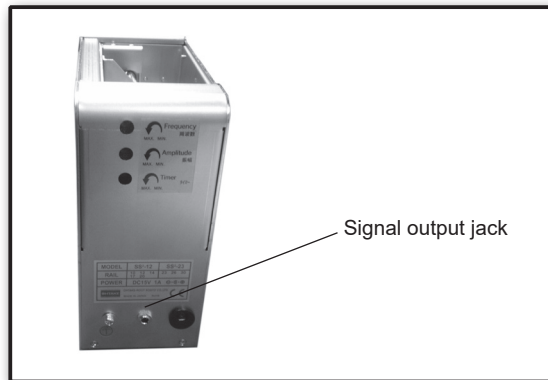

Recommended type:

Marushin Electric Mfg.Co.,Ltd.

MP-019LC (Straight type)

MP-012LN (Right angle type)

Recommended connector cable:

Marushin Electric Mfg.Co.,Ltd.

MC-35ST (Straight type)

MC-35STL (Right angle type)

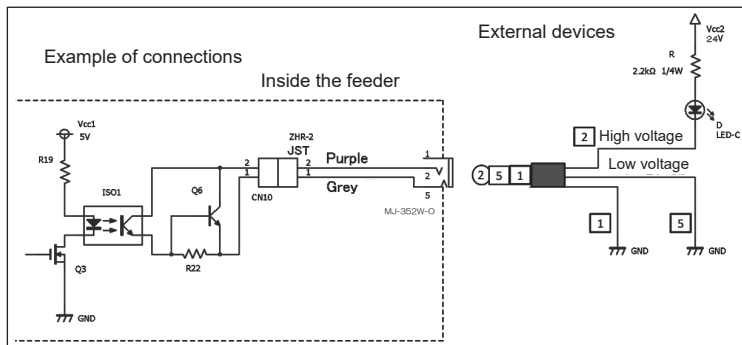

## 8-2. Anchoring the machine

When anchoring the feeder, use the holes on the bottom (M4). Keep the length of the screws, on the inside the machine, less than 8mm.

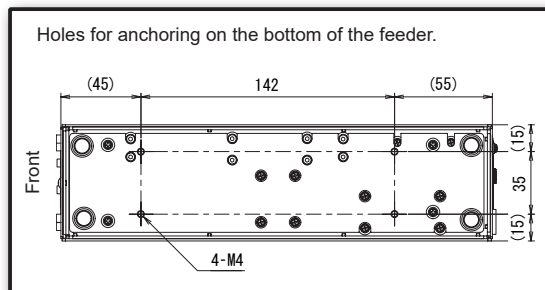

## 8-3. Overload Protective Circuit

This machine is provided with an overload protective circuit. Normally, the driving motor rotates forward, continuously feeding screws to the escaper. However, if there is an overload, at the driving section, the motor reverses rotation for a certain amount of time and then returns to the forward rotation. When the cause for overload is removed, during the reverse rotation, the driving motor returns to the forward rotation.

If the cause of the overload is not removed during the reverse rotation, the driving motor repeats the sequence of reverse rotation - forward rotation - reverse rotation - forward rotation for a certain amount of time in order to shut off power to the driving motor. During this time, the escaper operation is not stopped. When the power to the driving motor is shut off, turn OFF the power switch and remove the cause of the overload. For example, when too many screws are loaded into the scooping hopper, reduce the amount of screws to a proper level. If any screw is caught by the driving section, remove it.

After removing the cause of the overload, turn ON the power switch to operate this machine. (Power reset)

## 9. TROUBLESHOOTING



For safety, always unplug the AC adapter from the wall outlet before making any adjustments.

Problem	Cause	Corrective Measure
The machine does not run after being turned on.	<ul style="list-style-type: none"><li>○ The power is cut off.</li><li>○ No screw was picked up from the pick up point for a given period of time.</li><li>○ There are too many screws in the scooping hopper.</li><li>○ An object is stuck inside the machine.</li><li>○ AC adapter failure</li></ul>	<ul style="list-style-type: none"><li>○ Check that the AC adapter is properly connected to the power source.</li><li>○ Remove the screw from the pick up point.</li><li>○ Adjust the timer control dial.</li><li>○ Reduce the amount of screws in the scooping hopper.</li><li>○ Remove the object.</li><li>○ Consult our service section.</li></ul>
The rail does not vibrate.	<ul style="list-style-type: none"><li>○ An object (e.g. screw) is stuck between the rail and the body.</li><li>○ Even though there is no object stuck between the rail and the body, it does not vibrate.</li></ul>	<ul style="list-style-type: none"><li>○ Remove the object.</li><li>○ Check and adjust the amplitude. If the rail does not vibrate after the adjustment, contact your sales dealer for repair.</li></ul>

Problem	Cause	Corrective Measure
<p>The flow of screws has stopped.</p>	<ul style="list-style-type: none"> <li>○ The screws are the wrong size for the rail.</li> <li>○ There are not enough screws in the scooping hopper.</li> <li>○ A screw is stuck between the passing plate and the rail groove and the brush cannot remove it.</li> <li>○ A screw is stuck on the rail.</li> </ul>	<ul style="list-style-type: none"> <li>○ Use screws appropriate to the rail size.</li> <li>○ Place screws into the scooping hopper.</li> <li>○ Adjust the brush.</li> <li>○ Adjust the passing plate.</li> <li>○ Replace the drive belt.</li> <li>○ Use a hard-bristled brush.(optional)</li> <li>○ Pull up the holding plate, remove the screw and readjust the holding plate position. Be careful not to scratch the rail.</li> </ul>

Problem	Cause	Corrective Measure
Screws have fallen into the rail groove.	<ul style="list-style-type: none"> <li>○ The screws are the wrong size for the rail.</li> <li>○ The screw length is shorter than the rail groove width.</li> </ul>	<ul style="list-style-type: none"> <li>○ Use screws appropriate to the rail size.</li> <li>○ Screw may not be compatible. Please contact the dealer for more information.</li> </ul>
The screws do not flow smoothly.	<ul style="list-style-type: none"> <li>○ The gap between the holding plate and the screw head is too small.</li> <li>○ Vibration frequency is not properly adjusted.</li> <li>○ Spring washer screws are smaller than the type specified for the rail being used.</li> <li>○ There is dust, dirt, or grease on the rail.</li> <li>○ The rail vibration is insufficient.</li> <li>○ There is a screw caught between the rail and the body.</li> <li>○ The rail is in contact with the body.</li> <li>○ The motor is malfunctioning.</li> </ul>	<ul style="list-style-type: none"> <li>○ Adjust the holding plate.</li> <li>○ Adjust the vibration frequency.</li> <li>○ If the speed of the screw flow does not increase after the above adjustments, contact your sales dealer.</li> <li>○ Use screws appropriate to the rail size.</li> <li>○ Wipe the rail with a soft, clean, alcohol-soaked cloth.</li> <li>○ Check and adjust the vibration frequency.</li> <li>○ Remove the screw.</li> <li>○ If the rail touches the body, contact your sales dealer.</li> <li>○ Replace the driving motor.</li> </ul>



Problem	Cause	Corrective Measure
<p>Screws tend to pass through the passing plate in an abnormal position.</p> <p>The length of the screw thread tends to enter the passing plate.</p>	<ul style="list-style-type: none"> <li>○ The passing plate is not adjusted properly.</li> <li>○ Too many screws are in the scooping hopper.</li> </ul>	<ul style="list-style-type: none"> <li>○ Adjust the passing plate.</li> <li>○ Reduce the amount of screws to a proper level.</li> </ul>
<p>No screw flows to the pick up point.</p>	<ul style="list-style-type: none"> <li>○ Screws are stopped while still on the rail.</li> <li>• Screws cannot be transferred smoothly from the rail to the escaper.</li> </ul>	<ul style="list-style-type: none"> <li>○ Adjust the position of the holding plate.</li> <li>○ Adjust the distance between the end of the rail and the escaper.</li> </ul>
<p>The machine stops its operation suddenly.</p>	<ul style="list-style-type: none"> <li>○ The overload circuit was activated.</li> <li>○ Too many screws are in the scooping hopper.</li> <li>○ A screw is caught in the clearance.</li> <li>○ A screw, at the pick up point, could not be picked up for an extended period.</li> </ul>	<ul style="list-style-type: none"> <li>○ Turn the machine OFF and ON again.</li> <li>○ Remove the cause of overload.</li> <li>○ Remove screws to a proper level.</li> <li>○ When the machine stops, even if the screws are at a proper level, consult our service section.</li> <li>○ Remove the screw that is caught.</li> <li>○ Remove the screw.</li> </ul>

Problem	Cause	Corrective Measure
The scooping operation does not stop, though a screw is at the pick up point.	<ul style="list-style-type: none"> <li>○ The timer dial is not properly adjusted.</li> </ul>	<ul style="list-style-type: none"> <li>○ Readjust the timer dial.</li> </ul>
The escaper operation does not stop though a screw is at the pick up point.	<ul style="list-style-type: none"> <li>○ The sensor does not detect a screw.</li> </ul>	<ul style="list-style-type: none"> <li>○ Readjust the voltage of the sensor.</li> </ul>
A screw has fallen into the machine.		<ul style="list-style-type: none"> <li>○ Take the cover off and remove the screw.</li> </ul>
The noise of the machine has increased.	<ul style="list-style-type: none"> <li>○ Adjustments of the vibration frequency and the amplitude volume are unsuitable.</li> <li>○ There is insufficient grease.</li> </ul>	<ul style="list-style-type: none"> <li>○ Readjust the vibration frequency and amplitude volume.</li> <li>○ Apply grease to the movable parts. Recommended grease: BR2 Plus , Dow Corning Asia Co. Ltd.</li> </ul>

Problem	Cause	Corrective Measure
The escaper does not rotate when no screws are present, although the indicator light is on.	<ul style="list-style-type: none"> <li>○ Something is blocking the front screw sensor.</li>   <li>○ Adjustment of the front screw sensors is unsuitable.</li> </ul>	<ul style="list-style-type: none"> <li>○ Remove dust or objects obstructing the sensor's optical axis.</li> <li>○ If the escaper or stopper is damaged or worn, parts replacement is recommended.</li>   <li>○ Readjust the front screw sensors.</li> </ul>
The escaper rotates in the wrong direction.	<ul style="list-style-type: none"> <li>○ When the escaper is operating, something is preventing the escaper from rotating smoothly.</li>   <li>○ Escaper and the escaper guide are out of alignment.</li> </ul>	<ul style="list-style-type: none"> <li>○ While the escaper rotates, please check whether it is hitting the bit-guide or the rail.</li>   <li>○ If the escaper or escaper guide is damaged or worn, replacement is recommended.</li> </ul>
The escaper continues to rotate in the wrong direction.	<ul style="list-style-type: none"> <li>○ The reference point sensor may be improperly adjusted.</li> </ul>	<ul style="list-style-type: none"> <li>○ Please contact your sales dealer or our service section.</li> </ul>

## 10. SPECIFICATIONS

Power AC adapter (switching type)	Input: AC100~240V 50/60Hz Output: DC15V
Dimensions	65(W) × 242(D) × 146(H) (mm)
Weight	Approx. 3.3Kg (including rail)
Screw capacity	Approx. 40cc
Following accessories	Operation Manual 1 copy AC Adapter 1 unit Hexagonal Wrench 1 piece Screwdriver 1 piece Grounding cable 1 piece
Installation location	Level stable place
Installation and storage condition	Temperature 0~40°C Humidity 10~85% (without condensation)
Compliance standards	EMC: 2014/30/EU MD: 2006/42/EC RoHS: 2011/65/EU

### [CAUTION]

- Check if the screw's shaft diameter matches the rail groove width.
- Within the range of the screw sizes and lengths below, there may be unique screw shapes or structures not compatible with the feeder unit.
- To use a screw with a different diameter, match it with the corresponding parts mentioned in the table below.
- The rail, escaper, stopper assembly and escaper guide are available, separately, for replacement.
- The design, performance and specifications are subject to change, for the sake of improvement, without prior notice.
- The noise of this unit is less than LAeq 70 dB at a distance of 1 m.
- This product complies with EU directive. Please check the EU Declaration of Conformity for compliance standards.

Reference table of the specified screws						Screw head shape	
Screw size	Screw shaft diameter ( $\phi$ )	Screw head diameter ( $\phi$ )	Washer diameter ( $\phi$ )	Screw head thickness (mm)	Screw shaft length (mm)	No. 0 pan head	Pan head
$\phi$ 1.0	0.9~0.95	1.8~2.0	-	0.35~1.0	1.6~10	○	
$\phi$ 1.2	1.1~1.15	1.8~2.3	-	0.35~1.0	1.9~10	○	
$\phi$ 1.4	1.3~1.4	2.0~2.5	-	0.35~1.0	2.2~10	○	
$\phi$ 1.7	1.6~1.7	2.5~3.0	-	0.35~1.0	2.7~10	○	
$\phi$ 2.0	1.9~2.1	3.0~3.5	-	0.35~1.3	3.2~16		○
$\phi$ 2.3	2.2~2.4	3.5~4.0	-	0.35~1.5	3.7~16		○
$\phi$ 2.6	2.5~2.7	4.0~4.5	-	0.35~1.7	4.2~16		○
$\phi$ 3.0	2.9~3.2	5.0~5.5	-	0.35~2.0	4.8~16		○

Screw feeder series	Screw feeder model	Screw size	Rail set No.	Rail model No.	Escaper model No.	Stopper assembly model No.	Escaper guide-right model No.
SSI-12M	SSI-12M10	φ 1.0	SIM10SET	SIR10	SSIE10	SSIES10	SSIEM10
	SSI-12M12	φ 1.2	SIM12SET	SIR12	SSIE12	SSIES12	SSIEM12
	SSI-12M14	φ 1.4	SIM14SET	SIR14	SSIE14	SSIES14	SSIEM14
	SSI-12M17	φ 1.7	SIM17SET	SIR17	SSIE17	SSIES17	SSIEM17
	SSI-12M20	φ 2.0	SIM20SET	SIR20	SSIE20	SSIES20	SSIEM20
SSI-23M	SSI-23M23	φ 2.3	SIM23SET	SIR23	SSIE23	SSIES23	SSIEM23
	SSI-23M26	φ 2.6	SIM26SET	SIR26	SSIE26	SSIES26	SSIEM26
	SSI-23M30	φ 3.0	SIM30SET	SIR30	SSIE30	SSIES30	SSIEM30

Note :  
An exchange kit includes the following: rail assembly, escaper, stopper assembly, and escaper guide-right.

## ○ Replacement parts

• Rail

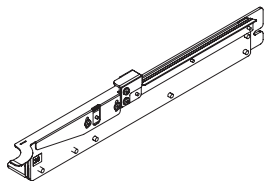

• Escaper

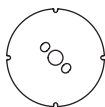

• Stopper assembly • Escaper guide-right

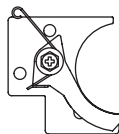

• Brush assembly  
(for SSI-12)  
NSN02107

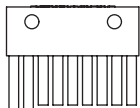

• Brush assembly  
(for SSI-23)  
NSN22001

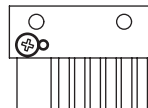

• Main motor unit  
(for SS)  
NSN03001

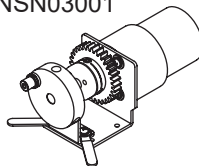

• Drive belt  
NSN03114

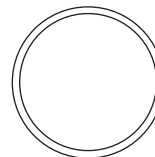

• Bit guide unit  
NSIB6103

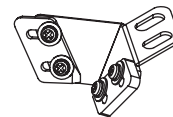

# 11. EXTERNAL DIMENSIONS

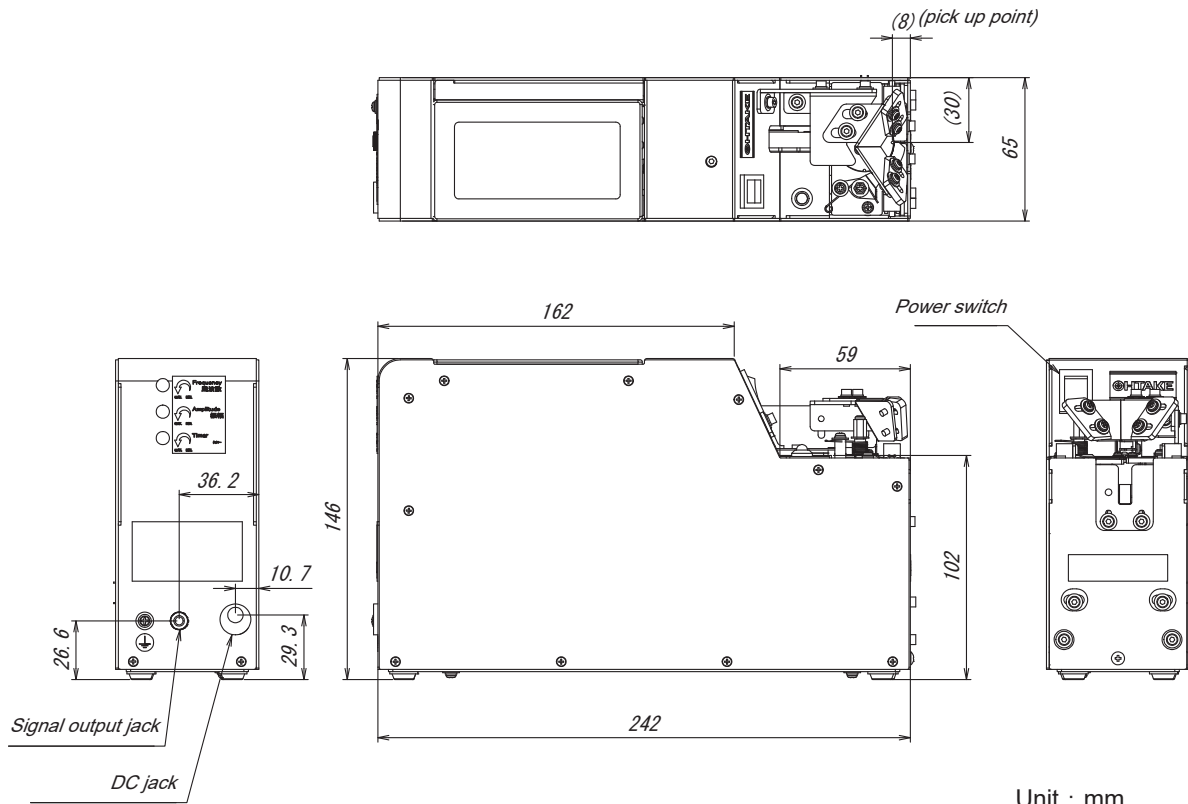

## 12. WARRANTY

For users within Japan, the effective term of warranty is for 6 months from the date of delivery.

This warranty will not be applicable to purchases or users outside of Japan.

If any problems should occur, please contact your sales dealer.

After the warranty period, there will be a charge for repairs.

In the following cases, the purchaser shall pay for parts and labor regardless of the terms of warranty:

- ① Failure due to improper handling.
- ② Failure due to product modification or improper processing.
- ③ Failure due to causes beyond control (for example earthquake or fire).
- ④ Failure attributable to any cause other than this product.
- ⑤ Consumables (brushes, main motor, escaper, stopper assembly, escaper guide-right, drive belt) and replaceable parts and replacement work expenses.

The repair parts shall be available within 5 years after purchase.

<http://www.ohtake-root.co.jp>

## 株式会社 大武・ルート工業

岩手県一関市萩荘字金ヶ崎 27 〒 021-0902  
Tel +81-191-24-3144  
Fax +81-191-24-3145

## OHTAKE-ROOT KOGYO CO.,LTD.

27 Kanegasaki Hagisho  
Ichinoseki,Iwate, 021-0902 JAPAN  
Tel +81-191-24-3144  
Fax +81-191-24-3145

「Quicher」「OHTAKE」「OHTAKE・ROOT KOGYO」 are trademarks or registered trademarks of OHTAKE・ROOT KOGYO CO.,LTD.

「Quicher(クイッチャー)」「OHTAKE」「OHTAKE・ROOT KOGYO」は、株式会社 大武・ルート工業の商標又は登録商標です。

The specifications and/or design may be altered, without notice, whenever there are changes or improvements.

改良のため、予告なくデザイン、性能、仕様等を変更することがあります。

Photocopying, reproduction or publication, in whole or in part, of this manual, without permission, is strictly prohibited by copyright law.

この取扱説明書の一部または全部の無断転載、複製を禁じます。

(as of Apr. 2021)

© Copyright OHTAKE・ROOT KOGYO CO.,LTD.

(2021年4月現在)