

Micro Programmable Controller CPM2A

The CPM2A brick-style controllers offer one of the most powerful, small-scale control solutions in the industry today. They provide 20, 30, 40 or 60 I/O point CPUs, pulse I/O for position control, multiple communications ports and a powerful instruction set.

- Expandable up to 120 I/O points
- Peripheral and RS-232C ports standard for direct connection to serial devices and programming tools
- Removable terminals
- Synchronized pulse control coordinates input devices with control devices
- Auxiliary 24 VDC supply (AC type only)
- Relay or Transistor outputs
- Analog I/O expansion modules available
- Temperature sensor input expansion modules available
- Real-time clock
- 20 kHz high-speed counter input
- Two, 10 kHz pulse outputs for position control applications



Basic Configuration

Up to three Expansion I/O Modules or Special I/O Modules can be connected to any CPM2A CPU. The mounting order does not affect the number of modules that can be mounted.

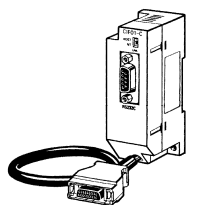

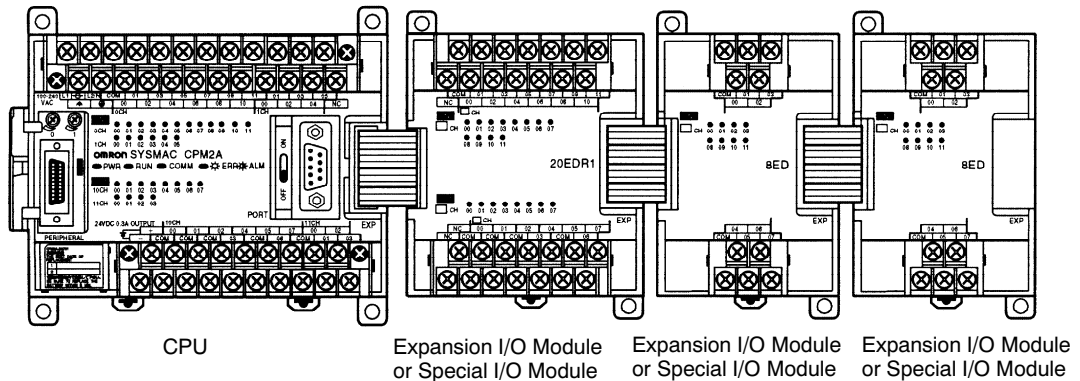

Optional Serial Communications Adapters CPM1-CIF01/CIF11 modify the Peripheral Port for use as an additional serial port.



Ordering Information

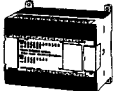
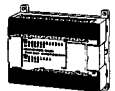
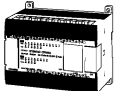
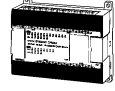
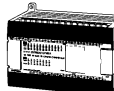

■ CPU

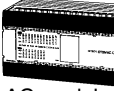
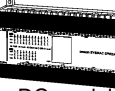
Stock Note: Shaded models are normally stocked.

Description	Input points	Output points	Power supply	Part number		
				Relay outputs	Transistor outputs	
					NPN (Sinking)	PNP (Sourcing)
CPUs with 20 I/O points  AC model  DC models	12	8	AC	CPM2A-20CDR-A	—	—
			DC	CPM2A-20CDR-D	CPM2A-20CDT-D	CPM2A-20CDT1-D
CPUs with 30 I/O points  AC model  DC models	18	12	AC	CPM2A-30CDR-A	—	—
			DC	CPM2A-30CDR-D	CPM2A-30CDT-D	CPM2A-30CDT1-D
CPUs with 40 I/O points  AC model  DC models	24	16	AC	CPM2A-40CDR-A	—	—
			DC	CPM2A-40CDR-D	CPM2A-40CDT-D	CPM2A-40CDT1-D
CPUs with 60 I/O points  AC model  DC models	36	24	AC	CPM2A-60CDR-A	—	—
			DC	CPM2A-60CDR-D	CPM2A-60CDT-D	CPM2A-60CDT1-D

■ EXPANSION I/O AND SPECIAL I/O MODULES

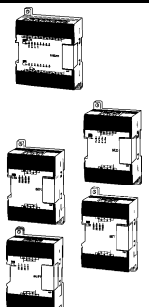
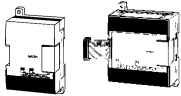
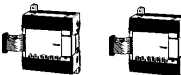
Stock Note: Shaded models are normally stocked.

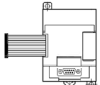
Description	Max. number of Units	Inputs	Outputs	Output type	Part number
Expansion I/O 	3 max.	12	8	Relay	CPM1A-20EDR1
				Transistor (NPN)	CPM1A-20EDT
				Transistor (PNP)	CPM1A-20EDT1
		8	—	—	CPM1A-8ED
		—	8	Relay	CPM1A-8ER
		—	8	Transistor (NPN)	CPM1A-8ET
			Transistor (PNP)	CPM1A-8ET1	
Analog I/O 	3 max.	2	1	Analog	CPM1A-MAD01
					CPM1A-MAD11
Temperature Sensor Inputs 	3 max.	2	—	Thermocouple	CPM1A-TS001
	1 (See Note.)	4	—		CPM1A-TS002
	3 max.	2	—	Platinum resistance thermometer	CPM1A-TS101
		2	1 analog		CPM1A-TS101-DA
	1 (See Note.)	4	—	CPM1A-TS102	
CompoBus/S I/O Link 	3 max.	I/O Link of 8 input bits and 8 output bits		—	CPM1A-SRT21
DeviceNet I/O Link Module 	3 max.	32 input bits from the Master and 32 output bits to the Master		—	CPM1A-DRT21
Profibus-DP Slave Module 	3 max.	16 bits (Inputs from the Master)	16 bits (Outputs to the Master)	—	CPM1A-PRT21
					Shielded twisted pair cable, available commercially

Note: If a CPM1A-TS002/102 is connected, only one other module (and not a CPM1A-TS002/102) can be connected.

■ PROGRAMMING CONSOLES AND CABLES

Stock Note: Shaded models are normally stocked.

Product	Part number
Programming console (2 m cable attached), connects directly to peripheral port	CQM1H-PRO01-E
Programming console (2 m cable attached); order CS1W-CN114 adapter for peripheral port	CQM1-PRO01-E
Programming console (Requires separate cable. See below.)	C200H-PRO27-E
Connecting cable for C200H-PRO27-E	2 m cable
	4 m cable
	C200H-CN222
	C200H-CN422





■ SUPPORT SOFTWARE

Stock Note: Shaded models are normally stocked.

Product	Functions	Part number
CX-Programmer Jr.	Windows-based programming software; reduced instruction set and networking commands.	WS02-CXPC1-EJ-V□.□
CX-Programmer	Full programming software package programs micro, small and larger controllers.	WS02-CXPC1-E-V□.□

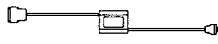
■ SERIAL COMMUNICATIONS ADAPTERS AND CABLES

Stock Note: Shaded models are normally stocked.

CPM2A port	Name	Appearance	Comments	Cable length	Part number
Peripheral	RS-232C Adapter		Cable-mounted communication adapter converts peripheral port to DB9-pin serial port.	3.3 m (10.8 ft)	CQM1-CIF02
			DIN mount communication adapter converts peripheral port to DB9-pin serial port.	3.3 m (10.8 ft)	CPM1-CIF01
RS-232C	RS-232C Cable		Program download cable from computer to Omron DB9 serial port.	2 m (6.6 ft)	C200HS-CN220-EU CBL-202*
			Communication cable to other Omron devices with DB9 serial port	3 m (9.8 ft)	C200H-CN320-EU CBL-804*
			Communication cable to other Omron devices with DB9 serial port	5 m (16.4 ft)	C200H-CN520-EU
			Communication cable for NT31C (port "B" only).	50 cm	NT31C-CN510-EU
				3 m	NT31C-CN320-EU CBL-803*
			Communication cable for NT31C (port "B" only).	5 m	NT31C-CN520-EU
			Programmable download cable from D-sub 9-pin computer port to RS-232C port.	2 m	C200H-CN229-EU CBL-202*
				2 m	XW2Z-200S
			Programmable download cable from D-sub 25-pin computer port to RS-232C port.	5 m	XW2Z-500S
Peripheral	RS-422/RS-485 Adapter		Converts CPM2A peripheral port to RS-422/RS-485 communications.	3.3 m (10.8 ft)	CPM1-CIF11

* Available in Canada only.

■ BATTERY

Stock Note: Shaded models are normally stocked.

Product	Function	Part number
Backup Battery Replacement	Backs up memory in the CPM2A CPU Unit. (One battery is already installed in the unit.)	CPM2A-BAT01

■ PROGRAM TRANSFER EQUIPMENT

Stock Note: Shaded models are normally stocked.

Product	Description	Part number
Expansion Memory Unit	Uploads and downloads program and setup memory areas to and from the controller.	CPM1-EMU01-V1
EEPROM (256 kbits)	Used with the Expansion Memory Unit	EEPROM-CPM1-EMU01

■ **MANUALS**

Product	Description	Part number
Operation manual	CPM2A operation manual	W352
Programming manual	CPM1/CPM1A/CPM2A/CPM2C/SRM1(-V2) Programming Manual	W353

Specifications

■ **GENERAL SPECIFICATIONS**

Item		CPU's with 20 I/O points	CPU's with 30 I/O points	CPU's with 40 I/O points	CPU's with 60 I/O points
Supply voltage	AC power	100 to 240 VAC, 50/60 Hz			
	DC power	24 VDC			
Operating voltage range	AC power	85 to 264 VAC			
	DC power	20.4 to 26.4 VDC			
Power consumption	AC power	60 VA max.			
	DC power	20 W max. (See separate table following this one for details)			
Inrush current	AC power	60 A max.			
	DC power	20 A max.			
External power supply (AC power supplies only)	Supply voltage	24 VDC			
	Output capacity	300 mA (See Notes 1, 2, 3.)			
Insulation resistance	20 MΩ min. (at 500 VDC) between the external AC terminals and protective earth terminals.				
Dielectric strength	2,300 VAC 50/60 Hz for 1 min between the external AC and protective earth terminals, leakage current: 10 mA max.				
Noise immunity	Conforms to IEC61000-4-4, 2 kV (power lines)				
Vibration resistance	10 to 57 Hz, 0.075-mm amplitude, 57 to 150 Hz, acceleration: 9.8 m/s ² in X, Y, and Z directions for 80 minutes each. (Time coefficient; 8 minutes × coefficient factor 10 = total time 80 minutes)				
Shock resistance	147 m/s ² three times each in X, Y, and Z directions.				
Ambient temperature	Operating: 0° to 55°C				
	Storage: -20° to 75°C				
Humidity	10% to 90% (with no condensation)				
Atmosphere	Must be free from corrosive gas				
Terminal screw size	M3				
Power interrupt time	AC power supply: 10 ms min. DC power supply: 2 ms min.				
CPU weight	AC power	650 g max.	700 g max.	800 g max.	1,000 g max.
	DC power	550 g max.	600 g max.	700 g max.	900 g max.
Expansion weight	Units with 20 I/O points: 300 g max. Units with 8 output points: 250 g max. Units with 8 input points: 200 g max. MAD01 Analog I/O Unit: 150 g max. MAD11 Analog I/O Unit: 250 g max. Temperature Sensor Units: 250 g max. CompoBus/S I/O Link Unit: 200 g max. DeviceNet I/O Link Unit: 200 g max. Profibus-DP Slave Unit: 125 g				

- Note: 1. Use the external power supply as the power supply for input devices only. (It cannot be used to drive output devices.)
 2. If the external power supply current exceeds the rated current, or there is a short-circuit, the external power supply voltage will drop and PLC operation will stop.
 3. If there are 3 CPM1A-MAD11 modules mounted to a CPM2A-60CDR-A, the current for the external power supply must not exceed 200 mA.

■ CHARACTERISTICS

Control method		Stored program method			
I/O control method		Cyclic scan with direct output (Immediate refreshing can be performed with IORF(97).)			
Programming language		Ladder diagram			
Instruction length		1 step per instruction, 1 to 5 words per instruction			
Instructions		Basic instructions: 14 Special instructions: 105 instructions, 185 variations			
Execution time		Basic instructions: 0.64 μs (LD instruction) Special instructions: 7.8 μs (MOV instruction)			
Program capacity		4,096 words			
User data memory		2,048 words			
I/O capacity	CPU Unit only	20 points	30 points	40 points	60 points
	With Expansion I/O Modules	80 points max.	90 points max.	100 points max.	120 points max.
Memory protection		HR area, AR area, program contents, read/write DM area contents, and counter values maintained during power interruptions.			
Memory backup		Flash memory: Program, read-only DM area, and PC Setup Battery backup: The read/write DM area, HR area, AR area, and counter values are backed up by a battery. (Battery life is approximately 5 years.)			
Self-diagnostic functions		CPU failure (watchdog timer), I/O bus error, and memory failure, battery error			
Program checks		No END instruction and programming errors are checked at the start of operation.			
Communications functions		Built-in peripheral port: Supports host link, peripheral bus, no-protocol, or Programming Console connections. Built-in RS-232C port: Supports Host Link, No-protocol, 1:1 Slave Unit link, 1:1 Master Unit link, or 1:1 NT Link connections.			
Functions provided by Expansion Modules		Analog I/O Module: Provides 2 analog inputs and 1 analog output. CompoBus/S I/O Link Module: Provides 8 inputs and 8 outputs as a CompoBus/S Slave. Temperature Sensor Modules: Provide 2 or 4 thermocouple inputs, or 2 or 4 temperature-resistance thermometer inputs.			

■ I/O ALLOCATION

Input bits	IR 00000 to IR 00915 (Words not used for input bits can be used for work bits.)	
Output bits	IR 01000 to IR 01915 (Words not used for output bits can be used for work bits.)	
Work bits	928 bits: IR 02000 to IR 04915 (Words IR 020 to IR 049) and IR 20000 to IR 22715 (Words IR 200 to IR 227)	
Special bits (SR area)	448 bits: SR 22800 to SR 25515 (Words IR 228 to IR 255)	
Temporary bits (TR area)	8 bits (TR0 to TR7)	
Holding bits (HR area)	320 bits: HR 0000 to HR 1915 (Words HR 00 to HR 19)	
Auxiliary bits (AR area)	384 bits: AR 0000 to AR 2315 (Words AR 00 to AR 23)	
Link bits (LR area)	256 bits: LR 0000 to LR 1515 (Words LR 00 to LR 15)	
Timers/Counters	256 timers/counters (TIM/CNT 000 to TIM/CNT 255) 1-ms timers: TMHH(--) 10-ms timers: TIMH(15) 100-ms timers: TIM 1-s/10-s timers: TIML(--) Decrementing counters: CNT Reversible counters: CNTR(12)	
Data memory	Read/Write: 2,048 words (DM 0000 to DM 2047) Error Log is contained in DM 2000 to DM 2021 Read-only: 456 words (DM 6144 to DM 6599) PC Setup: 56 words (DM 6600 to DM 6655)	
Basic in- terrupts	Interrupt processing	External interrupts: 4 (Shared by the external interrupt inputs (counter mode) and the quick-response inputs.)
	Interval timer interrupts	1 (Scheduled Interrupt Mode or Single Interrupt Mode)
High-speed counter	High-speed counter	One high-speed counter: 20 kHz single-phase or 5 kHz two-phase (linear count method) Counter interrupt: 1 (set value comparison or set-value range comparison)
	Interrupt inputs (counter mode)	Four inputs (Shared with external interrupt inputs (counter mode) and quick-response inputs.) Counter interrupts: 4 (Shared by the external interrupt inputs and quick-response inputs.)
Pulse output	Two points with no acceleration/deceleration, 10 to 10 kHz each, and no direction control. One point with waveform acceleration/deceleration, 10 to 10 kHz, and direction control. Two points with variable duty-ratio outputs using PWM(--). (Pulse outputs can be used with transistor outputs only, they cannot be used with relay outputs.)	
Synchronized pulse control	One point: A pulse output can be created by combining the high-speed counter with the pulse output and multiplying the frequency of the input pulses from the high-speed counter by a fixed factor. (This output is possible with transistor outputs only, it cannot be used with relay outputs.)	
Quick-response inputs	Four points (Min. input pulse width: 50 μs min.)	
Analog controls	2 controls, setting range: 0 to 200	
Input time constant	Can be set for all input points. (1 ms, 2 ms, 3 ms, 5 ms, 10 ms, 20 ms, 40 ms, or 80 ms; default setting: 10 ms)	
Clock function	Shows the year, month, day of the week, day, hour, minute, and second. (Battery backup)	

■ I/O SPECIFICATIONS

CPU Input

Item	Inputs	Specification
Input voltage	All	24 VDC +10%/-15%
Input impedance	IN00000 to IN00001	2.7 kΩ
	IN00002 to IN00006	3.9 kΩ
	IN00007 and up	4.7 kΩ
Input current	IN00000 to IN00001	8 mA typical
	IN00002 to IN00006	6 mA typical
	IN00007 and up	5 mA typical
ON voltage/current	IN00000 to IN00001	17 VDC min., 5 mA
	IN00002 and up	14.4 VDC min., 3 mA
OFF voltage/current	All	5.0 VDC max., 1 mA
ON delay	All	1 to 80 ms max. Default: 10 ms (See Note.)
OFF delay	All	1 to 80 ms max. Default: 10 ms (See Note.)
Circuit configuration	IN00000 to IN00001	
	IN00002 to IN00006	
	IN00007 and up	

Note: The input time constant can be set to 1, 2, 3, 5, 10, 20, 40, or 80 ms in the PLC Setup.

High-speed Counter Inputs

Inputs IN00000 through IN00002 can be used as high-speed counter inputs, as shown in the following table. The maximum count frequency is 5 kHz in differential phase mode and 20 kHz in the other modes.

Input	Function			
	Differential phase mode	Pulse + direction input mode	Up/down input mode	Increment mode
IN00000	A-phase pulse input	Pulse input	Increment pulse input	Increment pulse input
IN00001	B-phase pulse input	Direction input	Decrement pulse input	Normal input
IN00002	Z-phase pulse input/Hardware reset input (IN00002 can be used as a normal input when it is not used as a high-speed counter input.)			

Interrupt Inputs

Inputs IN00003 through IN00006 can be used as interrupt inputs (interrupt input mode or counter mode) and quick-response inputs. The minimum pulse width for these inputs is 0.05 ms.

Expansion I/O Module Input

Item	Specification
Input voltage	24 VDC +10%/-15%
Input impedance	4.7 kΩ
Input current	5 mA typical
ON voltage	14.4 VDC min.
OFF voltage	5.0 VDC max.
ON delay	1 to 80 ms max. Default: 10 ms (See note.)
OFF delay	1 to 80 ms max. Default: 10 ms (See note.)
Circuit configuration	

Note: The input time constant can be set to 1, 2, 3, 5, 10, 20, 40, or 80 ms in the PLC Setup.

OUTPUT SPECIFICATIONS (CPU AND EXPANSION I/O MODULE)

Relay Output

Item	Specification
Max. switching capacity	2 A, 250 VAC (cosφ = 1) 2 A, 24 VDC (4 A/common)
Min. switching capacity	10 mA, 5 VDC
Service life of relay	Electrical: 150,000 operations (30 VDC resistive load) 100,000 operations (240 VAC inductive load, cosφ = 4) Mechanical: 20,000,000 operations
ON delay	15 ms max.
OFF delay	15 ms max.
Circuit configuration	

Transistor Output (Sinking)

Item	Specification					
	20CDT-D	30CDT-D	40CDT-D	60CDT-D	8ET	20EDT1
Max. switching capacity	OUT01000, 01001: 4.5 to 30 VDC, 0.2 A/output OUT01002 and up: 4.5 to 30 VDC, 0.3 A/output					24 VDC ^{+10%/−5%} , 0.3 A/output
	0.8 A/common 1.6 A/Unit	0.8 A/common 2.4 A/Unit	0.8 A/common 3.2 A/Unit	0.8 A/common 4.8 A/Unit	0.9 A/common 1.8 A/Unit	0.9 A/common 1.8 A/Unit
Leakage current	0.1 mA max.					
Residual voltage	1.5 V max.					
ON delay	OUT01000 and OUT01001: 20 μs max. OUT01002 and up: 0.1 ms max.					0.1 ms max.
OFF delay	OUT01000 and OUT01001: 40 μs max. (4.5 to 26.5 V, 10 to 100 mA) 0.1 ms max. (4.5 to 30 V, 10 to 300 mA) OUT01002 and up: 1 ms max. (4.5 to 30 V, 10 to 300 mA)					1 ms max. 24 VDC ^{+10%/−5%} , 5 to 300 mA)
Fuse (See Note)	1 fuse/output					1 fuse/common
Circuit configuration						

Note: Cannot be replaced by the user.

Transistor Output (Sourcing)

Item	Specification					
	20CDT1-D	30CDT1-D	40CDT1-D	60CDT1-D	8ET1	20EDT1
Max. switching capacity	OUT01000, 01001: 4.5 to 30 VDC, 0.2 A/output OUT01002 and up: 4.5 to 30 VDC, 0.3 A/output					24 VDC ^{+10%/−5%} , 0.3 A/output
	0.8 A/common 1.6 A/Unit	0.8 A/common 2.4 A/Unit	0.8 A/common 3.2 A/Unit	0.8 A/common 4.8 A/Unit	0.9 A/common 1.8 A/Unit	0.9 A/common 1.8 A/Unit
Leakage current	0.1 mA max.					
Residual voltage	1.5 V max.					
ON delay	OUT01000 and OUT01001: 20 μs max. OUT01002 and up: 0.1 ms max.					0.1 ms max.
OFF delay	OUT01000 and OUT01001: 40 μs max. (4.5 to 26.5 V, 10 to 100 mA) 0.1 ms max. (4.5 to 30 V, 10 to 300 mA) OUT01002 and up: 1 ms max. (4.5 to 30 V, 10 to 300 mA)					1 ms max. 24 VDC ^{+10%/−5%} , 5 to 300 mA)
Fuse (See Note)	1 fuse/output					1 fuse/common
Circuit configuration						

Note: Cannot be replaced by the user.

■ ANALOG I/O MODULE

Up to 3 Expansion I/O Modules or Expansion Modules (including the CPM1A-MAD01 Analog I/O Module) can be connected to a CPM2A CPU.

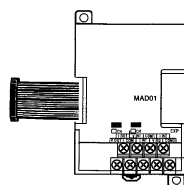

CPM1A-MAD01

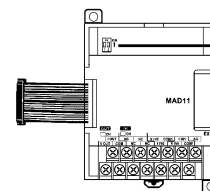

CPM1A-MAD11

Item		CPM1A-MAD01		CPM1A-MAD11	
		Voltage I/O	Current I/O	Voltage I/O	Current I/O
Analog inputs	Number of inputs	2		2 (allocated 2 words)	
	Input signal ranges	0 to 10 V or 1 to 5 V	4 to 20 mA	0 to 5 V, 1 to 5 V, 0 to 10 V, -10 to 10 V	0 to 20 mA, 4 to 20 mA
	Maximum rated input	±15 V	±30 mA	±15 V	±30 mA
	External input impedance	1 MΩ min.	250 Ω rated	1 MΩ min.	250 Ω
	Resolution	1/256		1/6,000 (full scale)	
	Overall precision	1.0% of full scale		25°C: ±0.3% of full scale	25°C: ±0.4% of full scale
				0 to 55°C: ±0.6% of full scale	0 to 55°C: ±0.8% of full scale
Converted A/D data	8-bit binary		Binary data (4-digit hexadecimal) -10 to 10 V: F448 to 0BB8 Hex full scale Other: 0000 to 1770 Hex full scale		
Analog output (See Note 1.)	Averaging	—		Supported (set for each input with DIP switch)	
	Disconnected line detection	—		Supported	
	Number of outputs	1		1 (allocated 1 word)	
	Output signal ranges	0 to 10 V or -10 to 10 V	4 to 20 mA	1 to 5 V, 0 to 10 V, -10 to 10 V	0 to 20 mA, 4 to 20 mA
	External output max. current	5 mA	—	—	—
	External output allowed load resistance	—	350 Ω	1 kΩ min.	600 Ω max.
	External output impedance	—		0.5 Ω max.	—
	Resolution	1/256 (1/512 when the output signal range is -10 to 10 V.)		1/6,000 (full scale)	
	Overall precision	1.0% of full scale		25°C: ±0.4% of full scale	
				0 to 55°C: ±0.8% of full scale	
Data setting	8-bit binary with sign bit		—		
D/A data setting	—		Binary data (4-digit hexadecimal) -10 to 10 V: F448 to 0BB8 Hex full scale Other: 0000 to 1770 Hex full scale		
Conversion time (See Note 2.)	10 ms/Unit max.		2 ms/point (6 ms/all analog I/O)		
Isolation method	Photocoupler isolation between I/O terminals and PC (There is no isolation between the analog I/O signals.)		Photocoupler isolation between analog I/O and internal circuits. (Individual analog I/O signals are not isolated.)		

- Note: 1. The voltage output and current output can be used at the same time, but the total output current cannot exceed 21 mA.
 2. The conversion time is the total time for 2 analog inputs and 1 analog output.

■ TEMPERATURE SENSOR MODULES

By connecting a Temperature Sensor Module (CPM1A-TS001/TS002/TS101/TS101A/TS102) to the CPM2A, inputs can be received from thermocouples or temperature-resistance thermometers. Inputs converted to binary data (4-digit hexadecimal) and stored in the IR area.

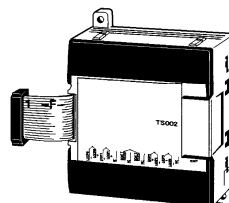

Specifications

Item	Specification		
Model	CPM1A-TS001/TS002	CPM1A-TS101/TS102	CPM1A-TS101-DA
Number of inputs	TS001: 2; TS002: 4	TS101: 2; TS102: 4	2
Input types (See Note 1)	Thermocouple types K or J, selectable	Platinum resistance thermometer types Pt100 and JPt100, selectable	
Input resolution	0.1°C in 2's complement format		
Input accuracy	±0.5% or ±2% of the stored value whichever is larger ±1 digit max. (See Note 2)	±0.5% or ±1% of the stored value whichever is larger ±1 digit max. (See Note 2)	1.0% max. full scale
Number of outputs	None	None	1
Output types	—	—	Voltage or current output
Output resolution	—	—	1/256 (0 to 10 V) 1/512 (-10 to +10 V) 1/256 (4 to 20 mA)
Output accuracy	—	—	1.0% max. full scale
Conversion cycle	250 ms for all points		60 ms max. for all points
Converted temperature data	Binary data (4-digit hexadecimal)		Binary data (8-digit hexadecimal)
Isolation method	Photocoupler isolation between I/O terminals and the PLC		

Note: 1. The same input type must be used for all inputs.

2. Accuracy for K thermocouples at temperatures less than -100°C: ±4°C ± 1 digit max.

Input Temperature Ranges

The input type is selected with a rotary switch. The ranges for each of the input types are shown in the following table.

Model	CPM1A-TS001/TS002		CPM1A-TS101/TS101-DA/TS102	
Input type	Thermocouple type K	Thermocouple type J	Platinum RTD Pt100	Platinum RTD JPt100
Range in °C	-200 to 1,300, 0.0 to 500.0	-100 to 850, 0.0 to 400.0	-200.0 to 650.0	-200.0 to 650.0
Range in °F	-300 to 2300, 0.0 to 900.0	-100 to 1500, 0.0 to 750.0	-300.0 to 1200.0	-300.0 to 1200.0

COMPOBUS/S I/O LINK MODULE

The CPM2A PLC can function as a Slave to a CompoBus/S Master Module (or SRM1 CompoBus/S Master Controller) when a CPM1A-SRT21 CompoBus/S I/O Link Module is connected. The CompoBus/S I/O Link Module establishes an I/O link of 8 inputs and 8 outputs between the Master Module and the CPM2A. Up to 3 Expansion I/O Modules or Expansion Modules can be connected to a CPM2A CPU.

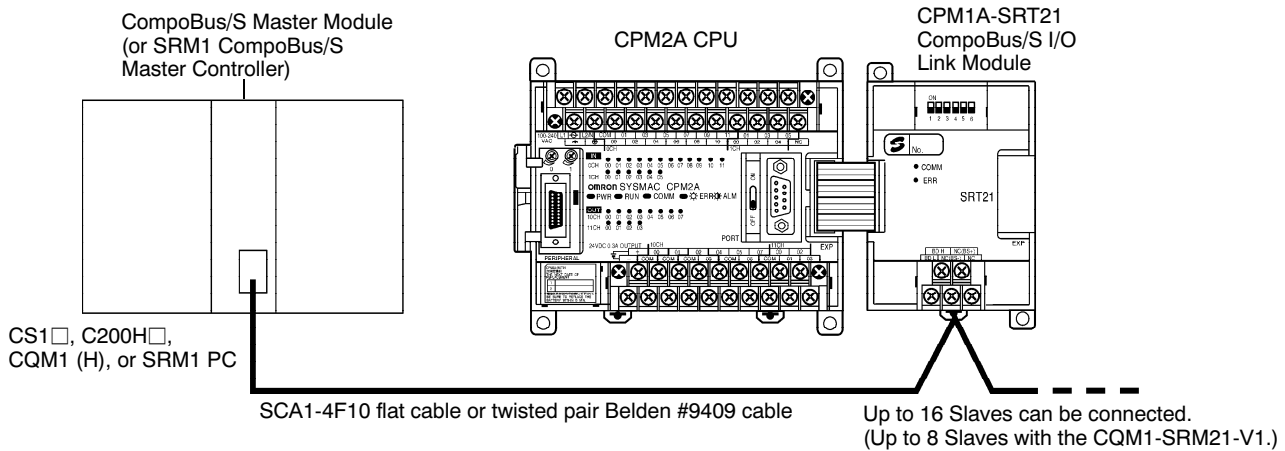

Specifications

Item	Specification
Model number	CPM1A-SRT21
Master/Slave	CompoBus/S Slave
Number of I/O bits	8 input bits, 8 output bits
Number of words occupied in CPM2A I/O memory	1 input word, 1 output word (Allocated in the same way as other Expansion I/O Units or Expansion Units)
Node number setting	Set using the DIP switch.

Note: See the CompoBus/S section of Omron's *Remote I/O and Wiring Solutions Catalog (GC RIO1)* for more details on CompoBus/S communications.

CPM1A-DRT21 DEVICENET I/O LINK MODULE

The CPM1A-DRT21 DeviceNet I/O Link Module can be connected to the CPM2A to function as a slave under a DeviceNet Master Module. This enables an I/O Link with the Master Module via 32 input and 32 output points.

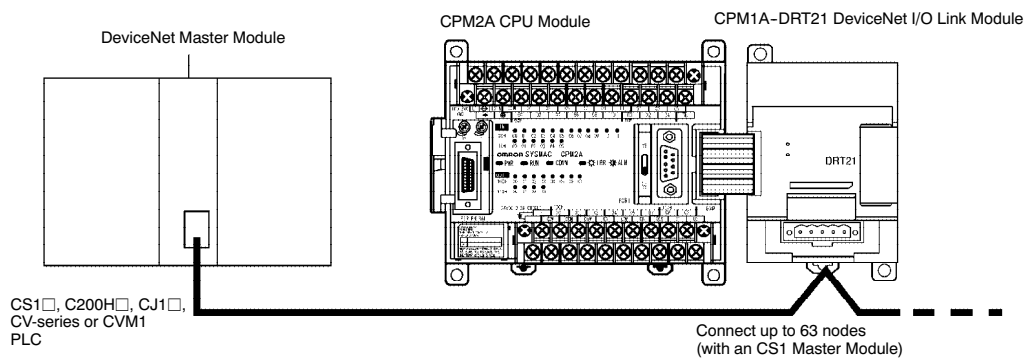

Specifications

Item	Specification
Model number	CPM1A-DRT21
Master/slave	DeviceNet slave
I/O capacity to master	32 input and 32 output points
I/O memory allocated in CPM2A	2 input words and 2 output words (same as other Expansion Units)
Node address setting	DIP switch (Set before turning ON power for the CPU Unit.)
Maximum number of nodes (depending on the PC to which Master Unit is mounted)	CS1: 63 nodes CJ1: 63 nodes CVM1/CV: 32nodes C200HX/HG/HE: 25 nodes C200HS: 16 nodes

■ PROFIBUS-DP SLAVE MODULE

The CPM2A controller can function as a Slave to a Profibus-DP Master Module when a CPM1A-PRT21 Profibus-DP Slave Module is connected. The Profibus-DP Slave Module establishes an I/O link of 16 inputs and 16 outputs between the master and the controller. A maximum of 3 Profibus-DP Slave Modules can be connected to a CPM1A or CPM2A to create I/O links for up to 96 points (48 inputs and 48 outputs).

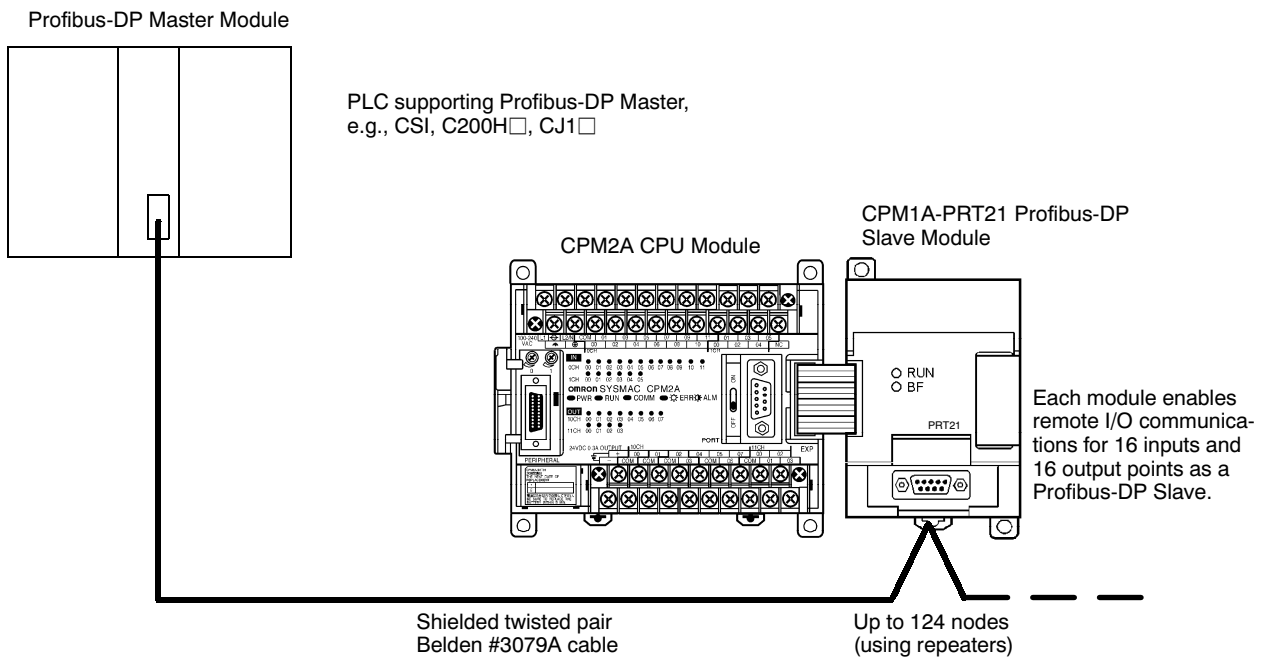

Specifications

Storage temperature	-20 to +75°C
Ambient temperature	0 to +55°C
Ambient humidity	10 to 90% (non-condensing)
EMC compliance	EN 50081-2, EN 61131-2
Current consumption	100 mA from the PLC I/O bus
Weight	125 g (typical)
Control data	From CPU to unit: none
Status data	From unit to CPU: none
I/O data (in bytes)	2 bytes input, 2 bytes output

■ COMMUNICATIONS ADAPTER

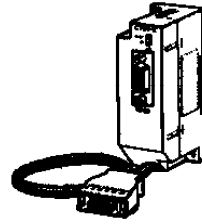

CPM1-CIF01

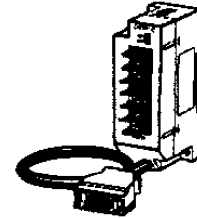

CPM1-CIF11

RS-232C Adapter and RS-422 Adapter

Part number	CPM1-CIF01		CPM1-CIF11	
Functions	Level conversion between the CMOS level (CPU side) and the RS-232C (peripheral device side)		Level conversion between the CMOS level (CPU side) and the RS-422 (peripheral device side)	
Insulation	The RS-232C (peripheral device side) is insulated by a DC/DC converter and photocoupler.		The RS-422 (peripheral device side) is insulated by a DC/DC converter and photocoupler.	
Power supply	Power is supplied by the CPU.			
Power consumption	0.3 A max.			
Transmission speed	38.4 kbits/s max.			
Vibration resistance	10 to 57 Hz with an amplitude of 0.075 mm, and 57 to 150 Hz with an acceleration of 1 G in the X, Y and Z directions for 80 minutes each (i.e. for 8 minutes each, 10 times).			
Shock resistance	1.5 G in the X, Y and Z directions 3 times each.			
Ambient temperature	Operating	0°C to 55°C (32°F to 131°F)		0°C to 55°C (32°F to 131°F)
	Storage	-20°C to 75°C (-4°F to 167°F)		-20°C to 75°C (-4°F to 167°F)
Ambient humidity	Operating	10% to 90% RH (with no condensation)		
Ambient environment	Operating	With no corrosive gas		
Weight	200 g max.			

Dimensions

Unit: mm (inch)

■ CPU

CPM2A-20CD□-□/30CD□-□

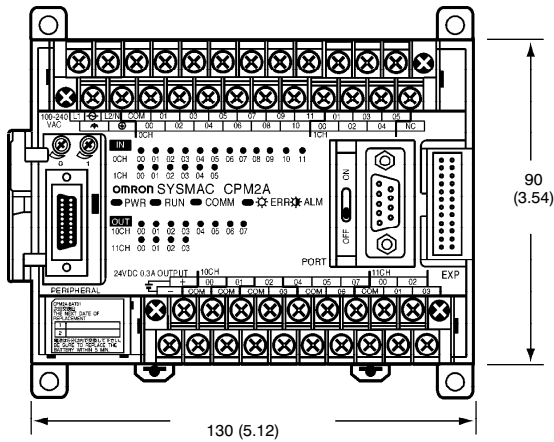

CPUs with DC Power

CPUs with AC Power

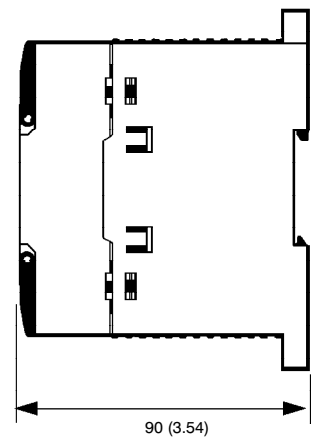
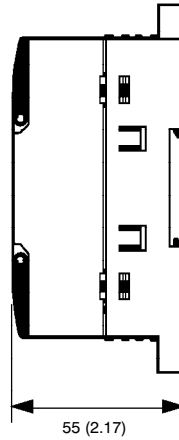

CPM2A-40CD□-□

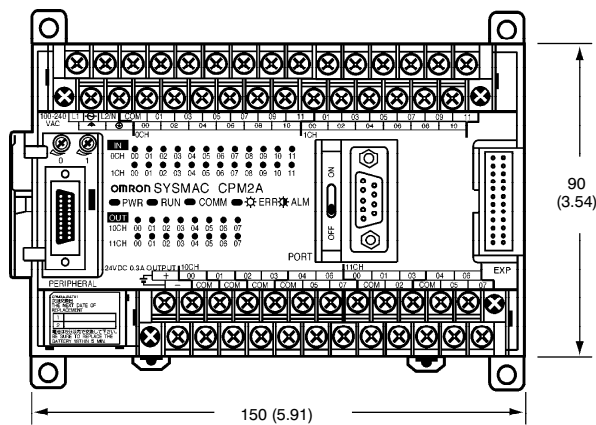

CPUs with DC Power

CPUs with AC Power

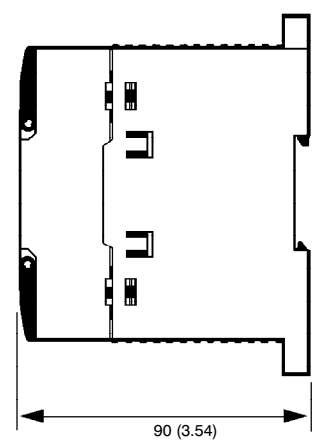
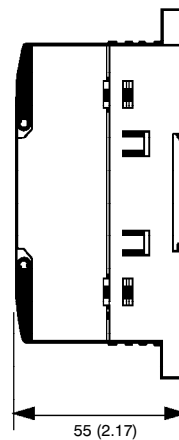

CPM2A-60CD□-□

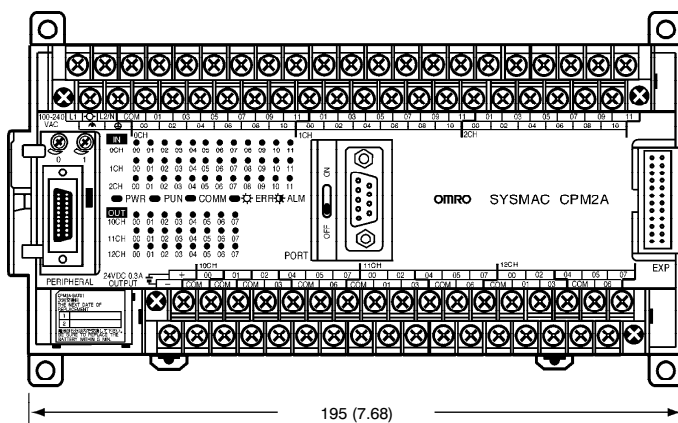

CPUs with DC Power

CPUs with AC Power

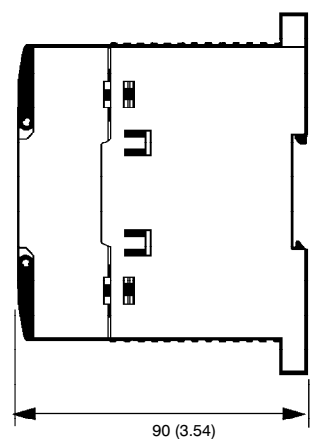
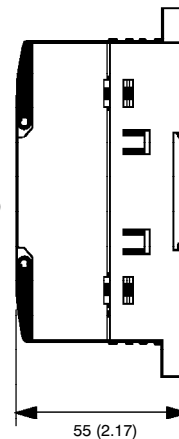

■ EXPANSION I/O AND SPECIAL I/O MODULES

CPM1A-20ED□ Expansion I/O Modules

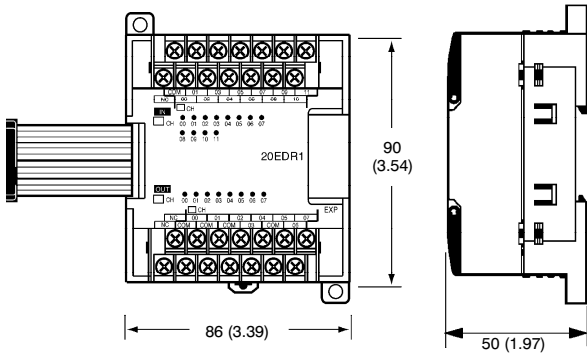

CPM1A-8□□□ Expansion I/O Modules

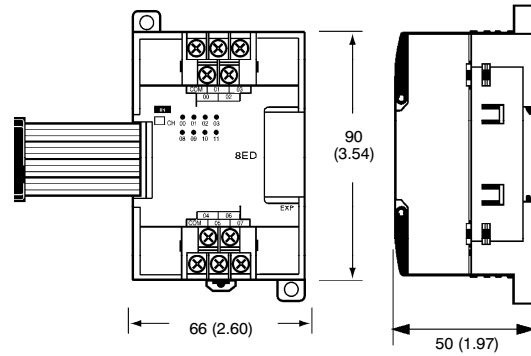

CPM1A-MAD01 Analog I/O Module

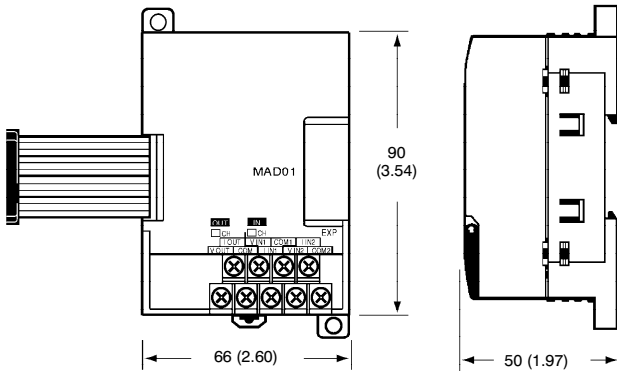

CPM1A-MAD11 Analog I/O Module

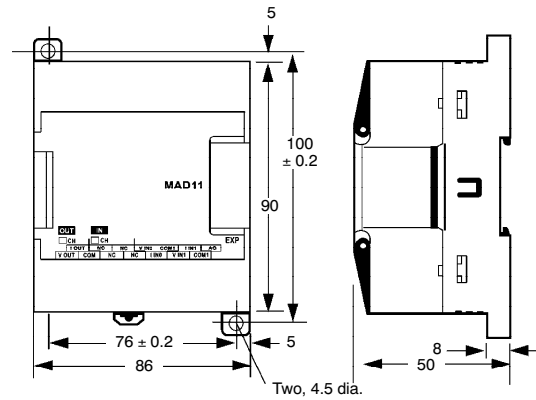

CPM1A-TS□□□ Temperature Sensor Input Modules

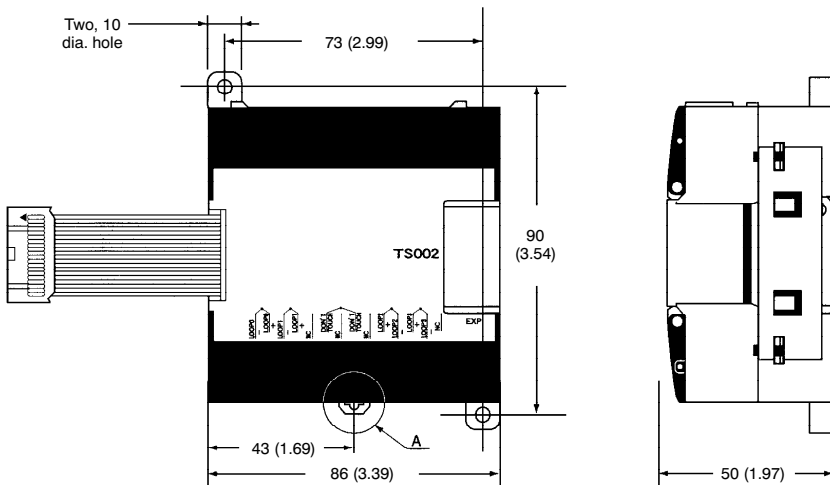

Unit: mm (inch)

CPM1A-SRT21 CompoBus/S I/O Link Module

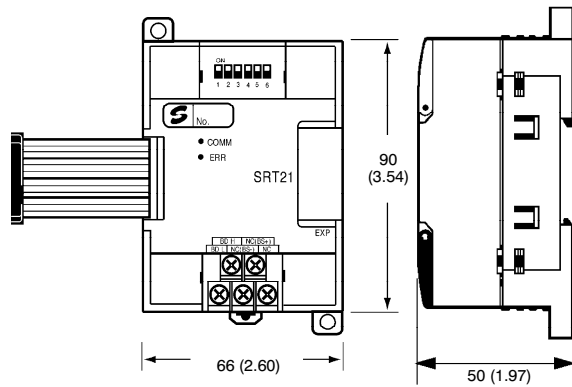

CPM1A-DRT21 DeviceNet I/O Link Module

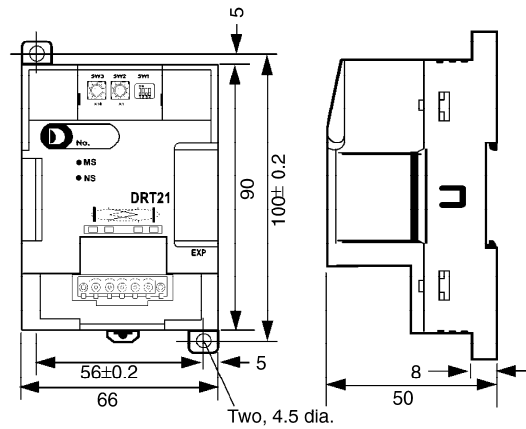

CPM1A-PRT21 Profibus-DP Slave Module

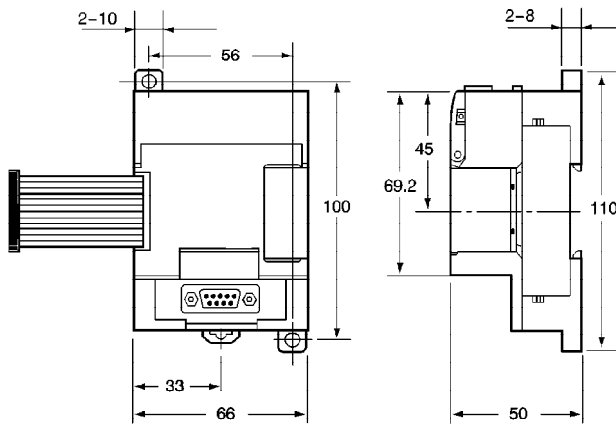

COMMUNICATION ADAPTER MODULES

CPM1-CIF01

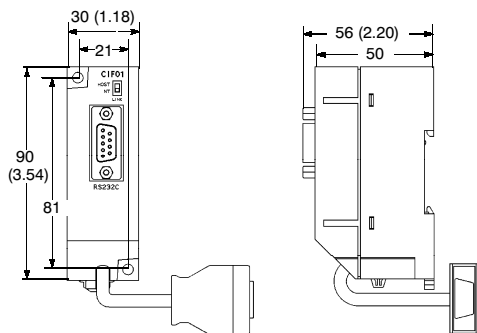

CPM1-CIF11

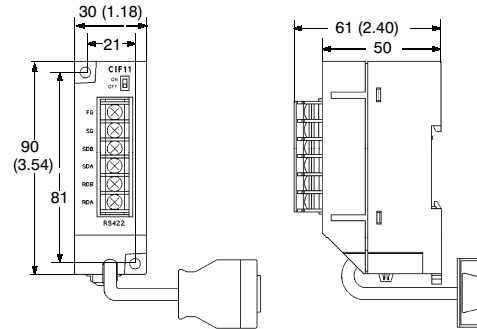

Functions

■ CONFIGURATION

The CPM2A PLCs incorporate a variety of features, including synchronized pulse control, interrupt inputs, pulse outputs, analog settings, and a clock function. Use the CPM2A CPU as a stand-alone controller for a broad range of machine control applications.

The CPM2A easily communicates with personal computers, other OMRON PLCs, and OMRON Programmable Terminals. These communications capabilities allow the user to design a low-cost distributed production system.

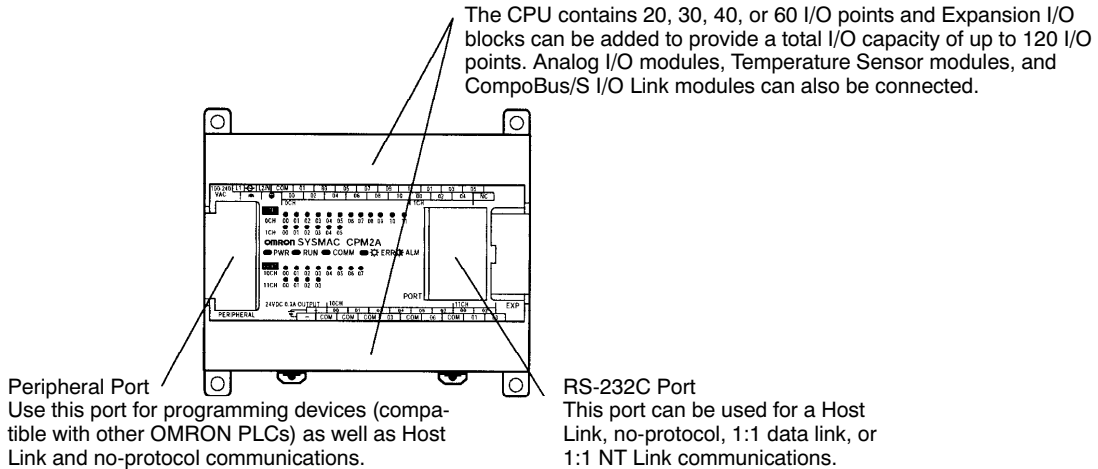

■ TIME-PROPORTIONAL CONTROL

The CPM2A performs simple-to-program, time-proportional control using up to three Analog I/O modules (maximum 6 analog inputs and 3 analog outputs) and the PID and PWM expansion instructions. These instructions set the parameters for PID control and a pulse output with variable duty ratio. For increased reliability, an open-circuit detection function can be used with the 1 to 5 VDC and 4 to 20 mA analog input settings.

For temperature monitoring applications, CPM2A accepts up to 6 inputs (two per module) from Temperature Sensor Input modules. The PID instruction can manipulate the input from either thermocouple or platinum resistance thermometer sensors.

■ DISTRIBUTED I/O CONTROL

Omron's CompoBus/S Network provides distributed CPU control based on a "PLC + compact PLC" configuration which provides improvements over distributed control based on "PLC + remote I/O" configurations. The distributed CPU control makes equipment module, so designs can be standardized, special needs can be addressed and modules can be replaced easily in the event of breakdown without affecting the main CPU.

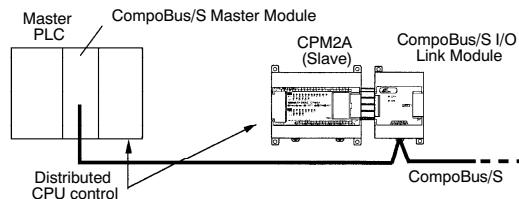

■ BUILT-IN MOTOR CONTROL CAPABILITY

Synchronized Pulse Control (transistor output models only)

Synchronized output pulse control provides an easy way to coordinate the operation of a peripheral piece of equipment with the main equipment. The output pulse frequency can be controlled as a multiple of the input pulse frequency, allowing the speed of a peripheral piece of equipment (such as a supply conveyor) to be synchronized with the speed of the main piece of equipment.

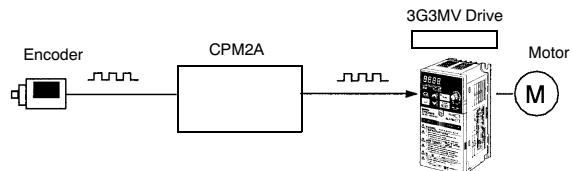

Pulses are output as a fixed multiple of the input frequency.

■ HIGH-SPEED COUNTERS AND INTERRUPTS

The CPM2A has a total of five high-speed counter inputs. The one high-speed counter input has a response frequency of 20 kHz/5 kHz, and the four interrupt inputs (in counter mode) have a response frequency of 2 kHz.

Four Input Modes

The high-speed counter can be used in any one of the four input modes: differential phase mode (5 kHz), pulse plus direction input mode (20 kHz), up/down pulse mode (20 kHz), or increment mode (20 kHz). Interrupts can be triggered when the count matches a set value or falls within a specified range.

Interrupt Inputs

The interrupt inputs (counter mode) can be used for incrementing counters or decrementing counters (2 kHz) and trigger an interrupt (executing the interrupt program) when the count matches the target value. Use this for target-value comparison or range comparison control that is unaffected by the cycle time.

Easy Position Control with Pulse Outputs (transistor output models only)

The CPM2A PLCs with transistor outputs have two outputs that can produce 10 Hz to 10 kHz pulses (single-phase outputs).

When used as single-phase pulse outputs, there can be two outputs with a frequency range of 10 Hz to 10 kHz with a fixed duty ratio or 0.1 to 999.9 Hz with a variable duty ratio (0 to 100% duty ratio).

When used as pulse plus direction or up/down pulse outputs, there can be just one output with a frequency range of 10 Hz to 10 kHz.

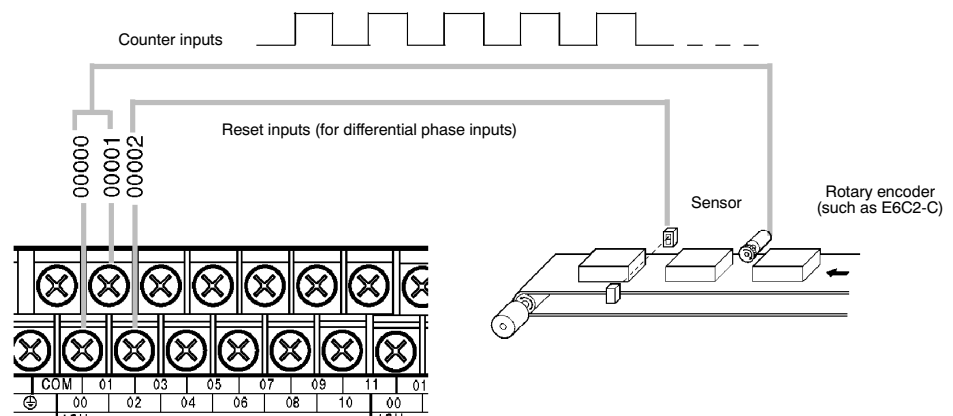

Input	Response frequency	Input mode (count value)	Control method
00000	5 kHz	Differential phase input mode (-8,388,608 to 8,388,607)	Target value comparison interrupts
00001	20 kHz	Pulse + direction input mode (-8,388,608 to 8,388,607)	Range comparison interrupts
00002		Up/down pulse input mode (-8,388,608 to 8,388,607)	
		Increment mode (0 to 16,777,215)	

■ PULSE OUTPUTS

The CPM2A has two pulse outputs. You can configure these outputs as two single-phase outputs without acceleration and deceleration, two variable duty-ratio pulse outputs, or pulse outputs with trapezoidal acceleration/deceleration (one pulse + direction output and one up/down pulse output). The pulse output's PV coordinate system can also be specified in the PLC Setup as either relative or absolute.

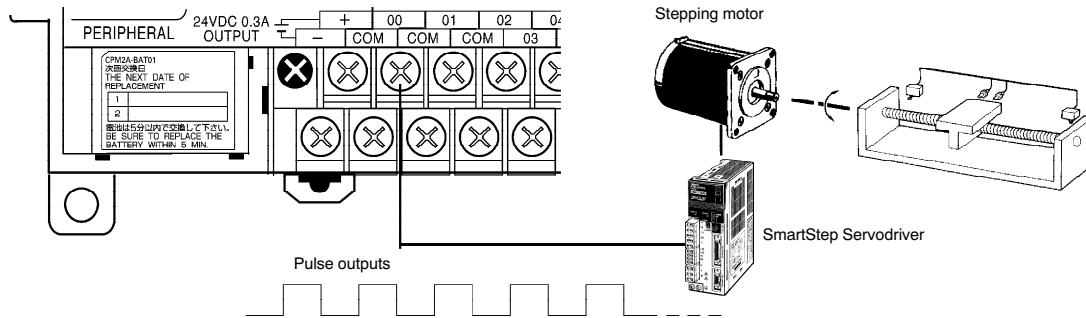

Item		Single-phase pulse output without acceleration/deceleration	Variable duty-ratio pulse output	Single-phase pulse output with trapezoidal acceleration/deceleration			
				Pulse + direction output	Up/down pulse output		
Controlling instruction(s)		PULS(65) and SPED(64)	PWM(--)	PULS(65) and ACC(--)			
Output number	01000	Pulse output 0 (See Note.)	Pulse output 0 (See Note.)	Pulse output 0	Pulse output	Pulse output 0	CW pulse output
	01001	Pulse output 1 (See Note.)	Pulse output 1 (See Note.)		Direction output		CCW pulse output
Output frequency range		10 Hz to 10 kHz	0.1 Hz to 999.9 Hz	10 Hz to 10 kHz		10 Hz to 10 kHz	
	Pitch	10 Hz	0.1 Hz	10 Hz		10 Hz	
Duty ratio		50%	0 to 100%	50%		50%	

Note: With single-phase pulse outputs, pulse outputs 0 and 1 can each be output independently.

Application Example: Adjusting Film/Paper Web Speed in Packaging and Printing

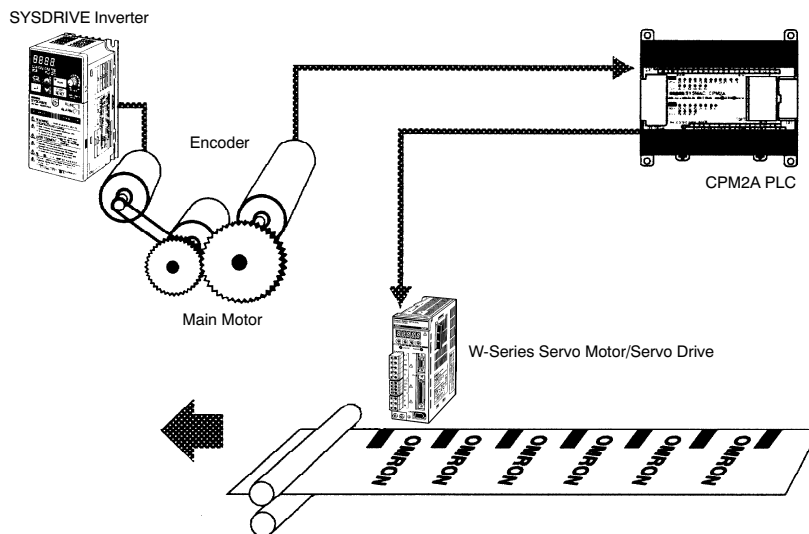

■ HIGH-SPEED INPUT CAPABILITIES FOR MACHINE CONTROL

High-speed Interrupt Input Function

There are four inputs used for interrupt inputs (shared with quick-response inputs and interrupt inputs in counter mode) with a minimum input signal width of 50 μ s and a response time of 0.3 ms. When an interrupt input goes ON, the main program is stopped and the interrupt program is executed.

Quick-response Input Function

There are four inputs used for quick-response inputs (shared with interrupt inputs and interrupt inputs in counter mode) that can reliably read input signals with a signal width as short as 50 μ s. Quick-response inputs are received into an internal buffer, so signals that change status within a cycle can be processed.

Stabilizing Input Filter Function

The input time constant for all inputs can be set to 1 ms, 2 ms, 3 ms, 5 ms, 10 ms, 20 ms, 40 ms, or 80 ms. The effects of chattering and external noise can be reduced by increasing the input time constant.

Interval Timer Interrupts

The interval timer offers a 0.5 and 319,968 ms range and can be set to generate just one interrupt (one-shot mode) or periodic interrupts (scheduled interrupt mode) to match the application.

■ OTHER FUNCTIONS

Analog Settings

There are two controls on the CPU that can be turned to change the analog settings (0 to 200 BCD) of timers and counters. These controls can be used to easily change or fine-tune machine settings such as a conveyor belt's pause time or feed rate.

Calendar/Clock

The built-in clock (accuracy within 1 minute/month) can be read from the program to show the current year, month, day, day of the week, and time. The clock can be set from a programming device (such as a Programming Console) or the time can be adjusted by rounding up or down to the nearest minute.

Long-term Timer

The long-term timer provides an easy way to control equipment scheduling. Use two instructions to set this up. The long-term timer instruction (TIML) lets you set values up to 99,990 seconds (27 hours, 46 minutes, 30 seconds) and the Seconds-to-Hours conversion instruction (HMS) lets you schedule this with other clock functions.

Communications

■ NT LINK FOR PROGRAMMABLE TERMINALS

The CPM2A can be connected directly to an OMRON NT-Series Programmable Terminal in NT Link mode (1:1) for high-speed transmission of data. No separate drivers are required. Use the RS-232C port for the NT Link connection.

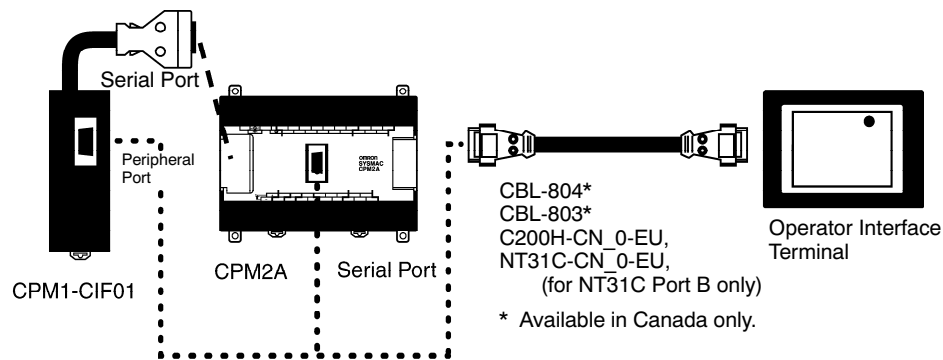

■ HOST LINK

A Host Link connection can be made through the CPM2A's RS-232C port or Peripheral port. A personal computer or Programmable Terminal connected in Host Link mode can be used for operations such as reading/writing data in the CPM2A's I/O memory or reading/changing the controller's operating mode.

1:1 Host Link Communications

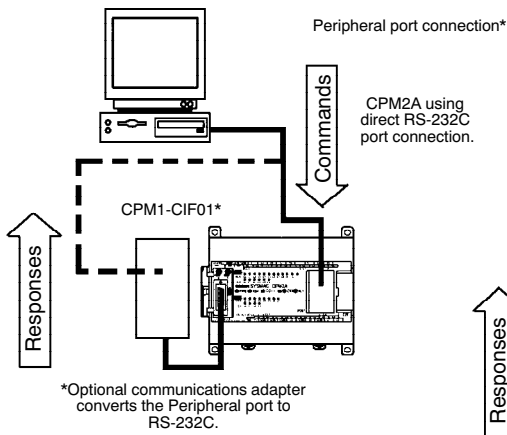

*Optional communications adapter converts the Peripheral port to RS-232C.

1:N Host Link Communications

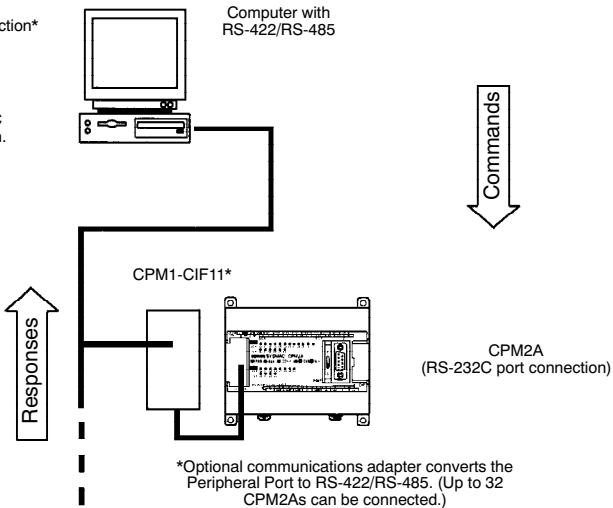

*Optional communications adapter converts the Peripheral Port to RS-422/RS-485. (Up to 32 CPM2As can be connected.)

No-Protocol Communications

The transmit TXD (48) and receive RXD (47) instructions can be used in No-Protocol mode to exchange data with standard serial devices. For example, data can be received from a bar code reader or transmitted to a serial modem. The serial devices can be connected directly to the RS-232C port or the Peripheral port using the CPM1-CIF01 serial communications adapter.

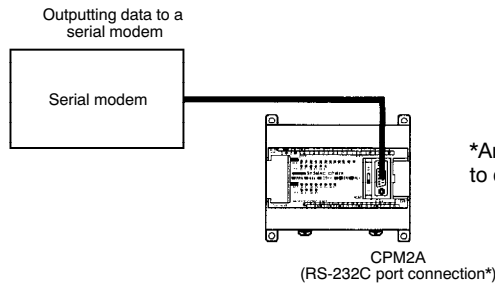
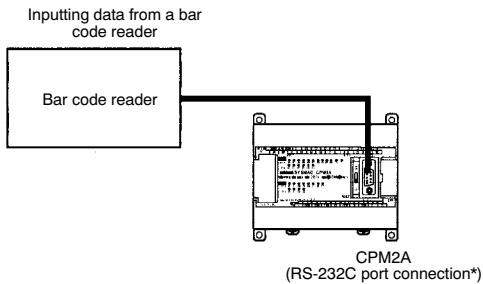

*An RS-232C Adapter is needed to connect to the Peripheral port.

■ 1:1 DATA LINKS

A CPM2A can be linked directly to another CPM2A, CQM1H, CPM1, CPM1A, CPM2C, SRM1(-V2), or a C200HS or C200HX/HG/HE programmable controller. The 1:1 PLC Link allows automatic data link connections or sharing of memory between two Omron CPUs. The controller must be connected through the RS-232C port; it cannot be connected through the Peripheral port.

Example of a 1:1 Link between CPM2As

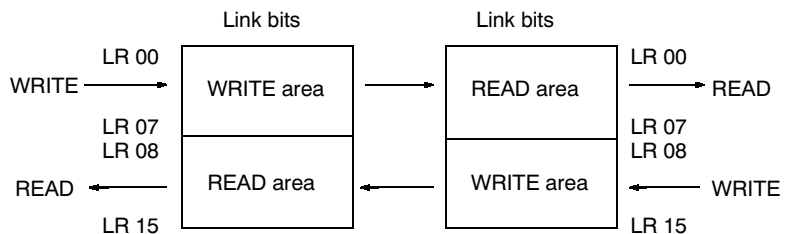
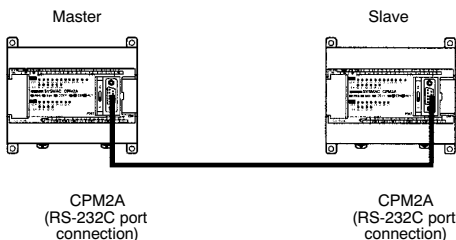

PROGRAM TRANSFER UNIT

Use Omron's EEPROM program transfer unit to update programs in machines or program multiple controllers with the same program. The CPM1-EMU01-V1 Expansion Memory Unit connects to the peripheral port of micro and small PLCs.

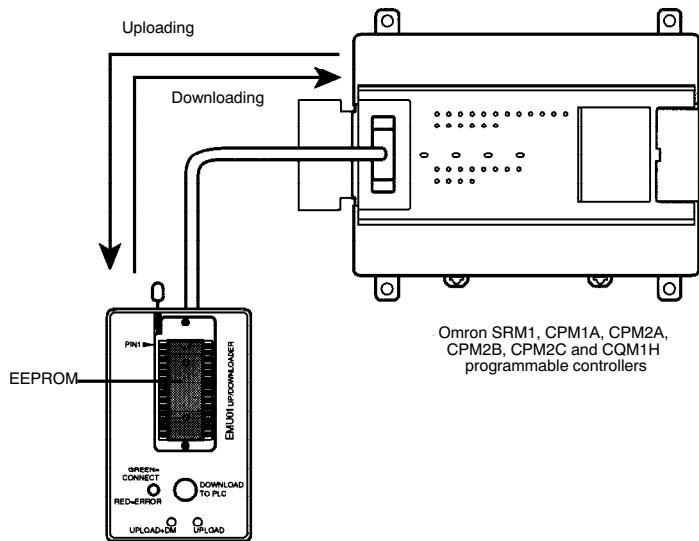

Certain Terms and Conditions of Sale

1. **Offer; Acceptance.** These terms and conditions (these "Terms") are deemed part of all catalogs, manuals or other documents, whether electronic or in writing, relating to the sale of goods or services (collectively, the "Goods") by Omron Electronics LLC and its subsidiary companies ("Seller"). Seller hereby objects to any terms or conditions proposed in Buyer's purchase order or other documents which are inconsistent with, or in addition to, these Terms. Please contact your Omron representative to confirm any additional terms for sales from your Omron company.
2. **Prices.** All prices stated are current, subject to change without notice by Seller. Buyer agrees to pay the price in effect at time of shipment.
3. **Discounts.** Cash discounts, if any, will apply only on the net amount of invoices sent to Buyer after deducting transportation charges, taxes and duties, and will be allowed only if (i) the invoice is paid according to Seller's payment terms and (ii) Buyer has no past due amounts owing to Seller.
4. **Orders.** Seller will accept no order less than \$200 net billing.
5. **Governmental Approvals.** Buyer shall be responsible for, and shall bear all costs involved in, obtaining any government approvals required for the importation or sale of the Goods.
6. **Taxes.** All taxes, duties and other governmental charges (other than general real property and income taxes), including any interest or penalties thereon, imposed directly or indirectly on Seller or required to be collected directly or indirectly by Seller for the manufacture, production, sale, delivery, importation, consumption or use of the Goods sold hereunder (including customs duties and sales, excise, use, turnover and license taxes) shall be charged to and remitted by Buyer to Seller.
7. **Financial.** If the financial position of Buyer at any time becomes unsatisfactory to Seller, Seller reserves the right to stop shipments or require satisfactory security or payment in advance. If Buyer fails to make payment or otherwise comply with these Terms or any related agreement, Seller may (without liability and in addition to other remedies) cancel any unshipped portion of Goods sold hereunder and stop any Goods in transit until Buyer pays all amounts, including amounts payable hereunder, whether or not then due, which are owing to it by Buyer. Buyer shall in any event remain liable for all unpaid accounts.
8. **Cancellation; Etc.** Orders are not subject to rescheduling or cancellation unless Buyer indemnifies Seller fully against all costs or expenses arising in connection therewith.
9. **Force Majeure.** Seller shall not be liable for any delay or failure in delivery resulting from causes beyond its control, including earthquakes, fires, floods, strikes or other labor disputes, shortage of labor or materials, accidents to machinery, acts of sabotage, riots, delay in or lack of transportation or the requirements of any government authority.
10. **Shipping; Delivery.** Unless otherwise expressly agreed in writing by Seller:
 - a. Shipments shall be by a carrier selected by Seller;
 - b. Such carrier shall act as the agent of Buyer and delivery to such carrier shall constitute delivery to Buyer;
 - c. All sales and shipments of Goods shall be FOB shipping point (unless otherwise stated in writing by Seller), at which point title to and all risk of loss of the Goods shall pass from Seller to Buyer, provided that Seller shall retain a security interest in the Goods until the full purchase price is paid by Buyer;
 - d. Delivery and shipping dates are estimates only.
 - e. Seller will package Goods as it deems proper for protection against normal handling and extra charges apply to special conditions.
11. **Claims.** Any claim by Buyer against Seller for shortage or damage to the Goods occurring before delivery to the carrier must be presented in writing to Seller within 30 days of receipt of shipment and include the original transportation bill signed by the carrier noting that the carrier received the Goods from Seller in the condition claimed.
12. **Warranties.** (a) **Exclusive Warranty.** Seller's exclusive warranty is that the Goods will be free from defects in materials and workmanship for a period of twelve months from the date of sale by Seller (or such other period expressed in writing by Seller). Seller disclaims all other warranties, express or implied. (b) **Limitations.** SELLER MAKES NO WARRANTY OR REPRESENTATION, EXPRESS OR IMPLIED, ABOUT NON-INFRINGEMENT, MERCHANTABILITY OR FITNESS FOR A PARTICULAR PURPOSE OF THE GOODS. BUYER ACKNOWLEDGES THAT IT ALONE HAS DETERMINED THAT THE GOODS WILL SUITABLY MEET THE REQUIREMENTS OF THEIR INTENDED USE. Seller further disclaims all warranties and responsibility of any type for claims or expenses based on infringement by the Goods or otherwise of any intellectual property right. (c) **Buyer Remedy.** Seller's sole obligation hereunder shall be to replace (in the form originally shipped with Buyer responsible for labor charges for removal or replacement thereof) the non-complying Good or, at Seller's election, to repay or credit Buyer an amount equal to the purchase price of the Good; provided that in no event shall Seller be responsible for warranty, repair, indemnity or any other claims or expenses regarding the Goods unless Seller's analysis confirms that the Goods were properly handled, stored, installed and maintained and not subject to contamination, abuse, misuse or inappropriate modification. Return of any goods by Buyer must be approved in writing by Seller before shipment. Seller shall not be liable for the suitability or unsuitability or the results from the use of Goods in combination with any electrical or electronic components, circuits, system assemblies or any other materials or substances or environments. Any advice, recommendations or information given orally or in writing, are not to be construed as an amendment or addition to the above warranty.
13. **Damage Limits; Etc.** SELLER SHALL NOT BE LIABLE FOR SPECIAL, INDIRECT OR CONSEQUENTIAL DAMAGES, LOSS OF PROFITS OR PRODUCTION OR COMMERCIAL LOSS IN ANY WAY CONNECTED WITH THE GOODS, WHETHER SUCH CLAIM IS BASED IN CONTRACT, WARRANTY, NEGLIGENCE OR STRICT LIABILITY. Further, in no event shall liability of Seller exceed the individual price of the Good on which liability is asserted.
14. **Indemnities.** Buyer shall indemnify and hold harmless Seller, its affiliates and its employees from and against all liabilities, losses, claims, costs and expenses (including attorney's fees and expenses) related to any claim, investigation, litigation or proceeding (whether or not Seller is a party) which arises or is alleged to arise from Buyer's acts or omissions under these Terms or in any way with respect to the Goods. Without limiting the foregoing, Buyer (at its own expense) shall indemnify and hold harmless Seller and defend or settle any action brought against Seller to the extent that it is based on a claim that any Good made to Buyer specifications infringed intellectual property rights of another party.
15. **Property; Confidentiality.** The intellectual property embodied in the Goods is the exclusive property of Seller and its affiliates and Buyer shall not attempt to duplicate it in any way without the written permission of Seller. Notwithstanding any charges to Buyer for engineering or tooling, all engineering and tooling shall remain the exclusive property of Seller. All information and materials supplied by Seller to Buyer relating to the Goods are confidential and proprietary, and Buyer shall limit distribution thereof to its trusted employees and strictly prevent disclosure to any third party.
16. **Miscellaneous.** (a) **Waiver.** No failure or delay by Seller in exercising any right and no course of dealing between Buyer and Seller shall operate as a waiver of rights by Seller. (b) **Assignment.** Buyer may not assign its rights hereunder without Seller's written consent. (c) **Amendment.** These Terms constitute the entire agreement between Buyer and Seller relating to the Goods, and no provision may be changed or waived unless in writing signed by the parties. (d) **Severability.** If any provision hereof is rendered ineffective or invalid, such provision shall not invalidate any other provision. (e) **Setoff.** Buyer shall have no right to set off any amounts against the amount owing in respect of this invoice. (f) As used herein, "including" means "including without limitation".

Certain Precautions on Specifications and Use

1. **Suitability of Use.** Seller shall not be responsible for conformity with any standards, codes or regulations which apply to the combination of the Good in the Buyer's application or use of the Good. At Buyer's request, Seller will provide applicable third party certification documents identifying ratings and limitations of use which apply to the Good. This information by itself is not sufficient for a complete determination of the suitability of the Good in combination with the end product, machine, system, or other application or use. The following are some examples of applications for which particular attention must be given. This is not intended to be an exhaustive list of all possible uses of this Good, nor is it intended to imply that the uses listed may be suitable for this Good:
 - (i) Outdoor use, uses involving potential chemical contamination or electrical interference, or conditions or uses not described in this document.
 - (ii) Energy control systems, combustion systems, railroad systems, aviation systems, medical equipment, amusement machines, vehicles, safety equipment, and installations subject to separate industry or government regulations.
 - (iii) Systems, machines and equipment that could present a risk to life or property. Please know and observe all prohibitions of use applicable to this Good.
2. **Programmable Products.** Seller shall not be responsible for the user's programming of a programmable Good, or any consequence thereof.
3. **Performance Data.** Performance data given in this catalog is provided as a guide for the user in determining suitability and does not constitute a warranty. It may represent the result of Seller's test conditions, and the user must correlate it to actual application requirements. Actual performance is subject to the Seller's Warranty and Limitations of Liability.
4. **Change in Specifications.** Product specifications and accessories may be changed at any time based on improvements and other reasons. It is our practice to change part numbers when published ratings or features are changed, or when significant construction changes are made. However, some specifications of the Good may be changed without any notice. When in doubt, special part numbers may be assigned to fix or establish key specifications for your application. Please consult with your Seller's representative at any time to confirm actual specifications of purchased Good.
5. **Errors and Omissions.** The information in this catalog has been carefully checked and is believed to be accurate; however, no responsibility is assumed for clerical, typographical or proofreading errors, or omissions.

NEVER USE THE PRODUCT FOR AN APPLICATION INVOLVING SERIOUS RISK TO LIFE OR PROPERTY WITHOUT ENSURING THAT THE SYSTEM AS A WHOLE HAS BEEN DESIGNED TO ADDRESS THE RISKS, AND THAT THE SELLER'S PRODUCT IS PROPERLY RATED AND INSTALLED FOR THE INTENDED USE WITHIN THE OVERALL EQUIPMENT OR SYSTEM.

Complete "Terms and Conditions of Sale" for product purchase and use are on Omron's website at www.omron.com/oei – under the "About Us" tab, in the Legal Matters section.

ALL DIMENSIONS SHOWN ARE IN MILLIMETERS.

To convert millimeters into inches, multiply by 0.03937. To convert grams into ounces, multiply by 0.03527.

OMRON[®]**OMRON ELECTRONICS LLC**

One Commerce Drive
Schaumburg, IL 60173

847-843-7900

For US technical support or other inquiries:

800-556-6766**OMRON CANADA, INC.**

885 Milner Avenue
Toronto, Ontario M1B 5V8

416-286-6465**OMRON ON-LINE**

Global - <http://www.omron.com>

USA - <http://www.omron.com/oei>

Canada - <http://www.omron.ca>