

- PUSHBUTTON SWITCHES
- SELECTOR SWITCHES
- EMERGENCY STOP PUSHBUTTON SWITCHES
- PILOT LIGHTS
- MULTI DISPLAY LIGHTS
- TERMINAL BLOCKS

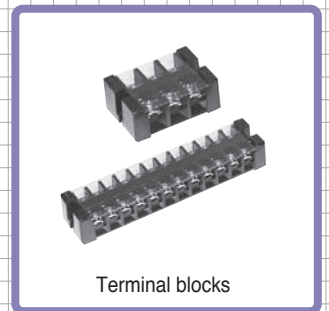

LOW
VOLTAGE
EQUIPMENT
Up to 600 Volts

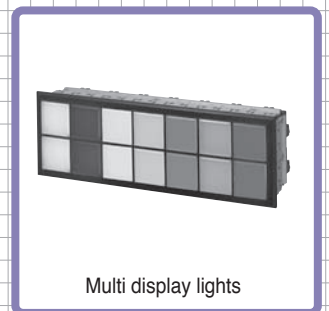
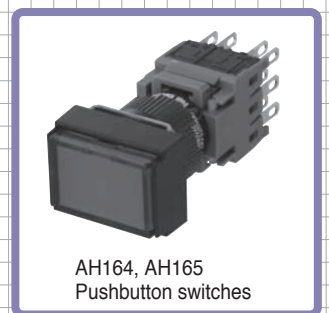

INDIVIDUAL CATALOG 04

from D&C CATALOG 20th Edition

01 02 03 **04** 05 06 07 08 09 10 11 12

minico $\varnothing 16$ Command Switches AR16•DR16, AF16•DF16

- An integrated structure with built-in contacts that can reduce control panel depth.
- A wide variety of sockets are available to simplify wiring.



Operator • Contacts

Mounting panel

Supporting smaller and thinner operator's panels

A structure that integrates operator and contacts to reduce panel-mounting depth. Terminals extending to the rear of the switch ensure easy wiring work.

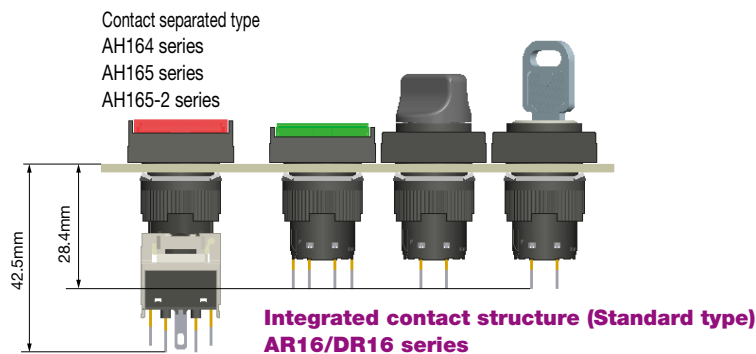

A wide variety of sockets reduce wiring work

Switches combine with a variety of sockets to simplify wiring.

● Fast-connection socket

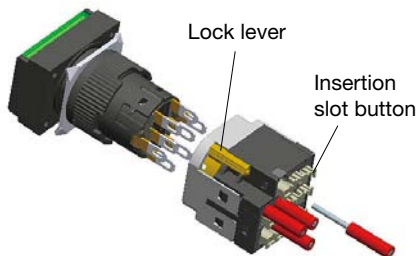

- Applicable as a fast-connection terminal switch by combining the socket with a switch.
- Easily wired by simply removing the wire sheath and inserting the wires while pressing the insertion slot button (no soldering required).
- Incorporates a branch terminal for easy branching.

● Connector socket

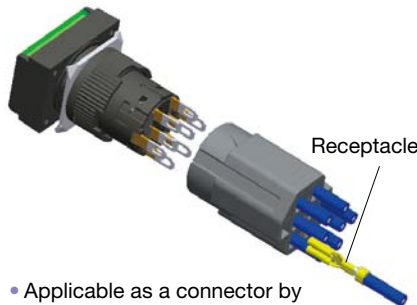

- Applicable as a connector by combining the socket with receptacles.
- The socket holds the receptacles, making it easy to connect the receptacle to the switch with a single operation.

● Socket for PC board

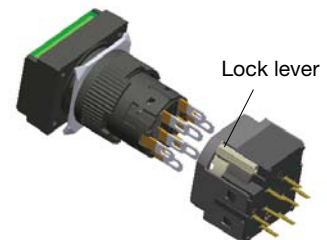

- Applicable as a switch for PC board by combining the socket with a switch.
- Pattern wiring reduces the number of wiring man-hour and helps prevent faulty wiring.

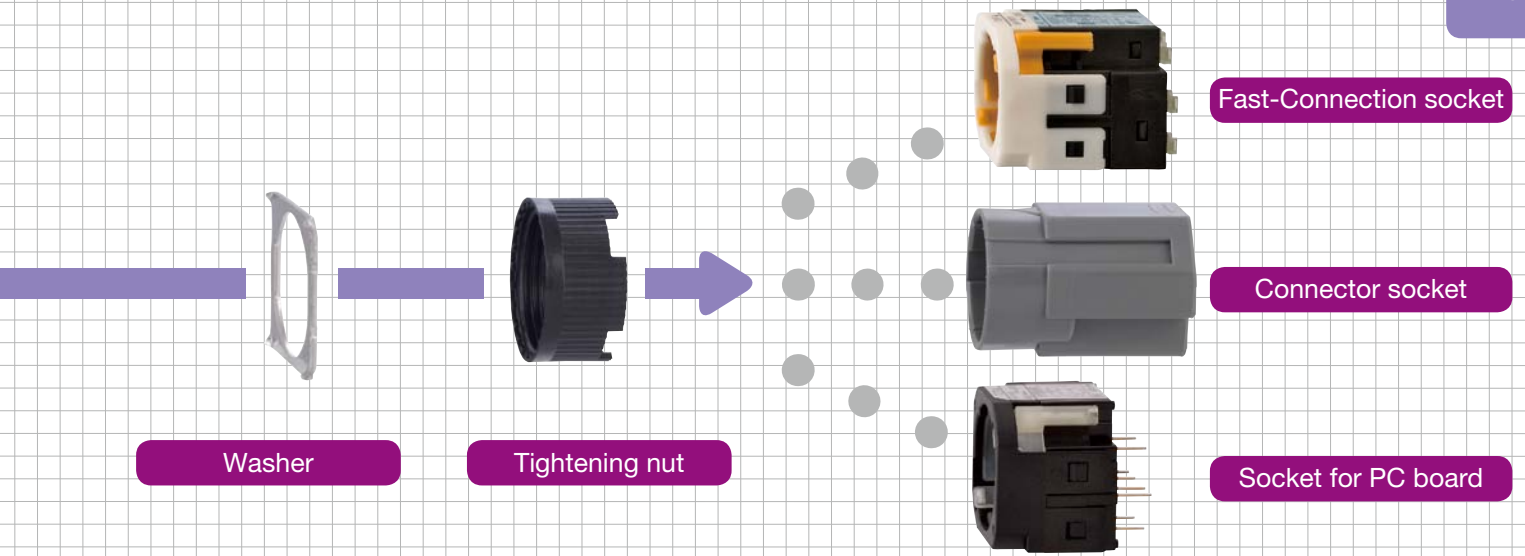

Contributes to attractive panel designs

In addition to the standard type, a thin type with a panel protrusion of only 2 mm is available, allowing high-density mounting for attractive panel designs.

Integrated contact structure (Thin type) AF16/DF16 series



- Keep in mind that the panel cutout size for the thin type depends on the operator shape. See page 04/167 for details.
- The panel depth is unified to 35.9mm.

Brighter illuminated surface

Less power consumption helps to save energy. A longer service life helps to reduce maintenance costs.



Dedicated LED lamp

Degrees of protection IP65

The operator has IP65 protection for smooth operation without adverse effects from oil, water, or dusts. Applicable to a wide variety of equipment, from machine tools to OA equipment.

Highly reliable contact mechanism

Gold-plated contacts and a snap-action mechanism enables IC-level applications (with a switching current of 1 mA at 5 V).

Meets EU RoHS requirements

Standard models meet RoHS requirements (EU Directive 2002/95/C).

Standard models meet international standards

Standard models meet UL/CSA requirements, China Compulsory Certification (CCC) standards, and TÜV EN standards, making them ideal for equipment for export.

Note: Command switches shipped as single articles to China must conform to the Product Quality Law. Check with your Fuji Electric representative.

The insertion/extraction life of the key is greatly extended

The key selector switch incorporates a pin tumbler type key (reversible type) to improve the insertion/extraction performance of the key.



- Six key types are available.
- The pin tumbler construction improves security.

The operating angle position of the selector switch can be easily changed.

The bezel is separate from the knob (key), so the operating angle position can be easily changed in 45° increments (with the AR16 series rectangular or square type only). The following figure shows a knob type example. Same applies to the key type.

- Two-position model example.

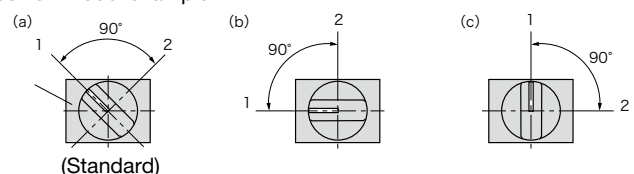

Ø22 (Ø25) AR22 and DR22 Command Switches

The use of a release arm enables easy mounting.



Operator • Contacts

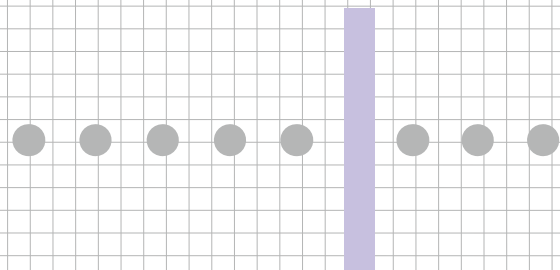

Mounting panel

Easy attachment and detachment with a release arm

The separate structure with a unique wedge mechanism enables one-step attachment and detachment of the operating section and contact section, without the use of any tool.

One-step lock!

Attachment



Push

Detachment



One Touch!

One-step release!

Contact block and transformer unit can also be added or replaced in a single step

All contact block and transformer unit are designed with snap-on mounting, so no tools are required.

One Touch!

Attachment



One Step!

Detachment



Improved work efficiency through bi-directional wiring

Terminals can be wired from two directions. This is ideal for wiring crossovers or wiring in narrow spaces. Square washers are used to enable wiring with solid wires.

Utility

Wiring from two directions



1NO

Blue



1NC

Red



Lamp terminals and Transformer Unit

Black



Color coding of contact blocks, lamp terminal and transformer unit makes wiring and checking easy.

Panel thickness need not be adjusted

Because the back surface of the operating section is mounted with a tightening nut, there is absolutely no need to adjust the panel thickness.

Also, the operator can be mounted on the panel along with a previously installed button and knob.

Easy



Mounting panel



Superior contact reliability

All the contacts are double break type and feature self-cleaning action. Every time the switch is operated, the contact surfaces are wiped with a sliding movement, thus ensuring high contact reliability even at low voltage and small current levels (5V, 5mA).

Buzzers are also available

Electronic or electromagnetic buzzers provide audible feedback on the status of the equipment. Splash-proof buzzers that conform to EN 60204-1 (degrees of protection) are also available (enclosure used in general industry: IP54).



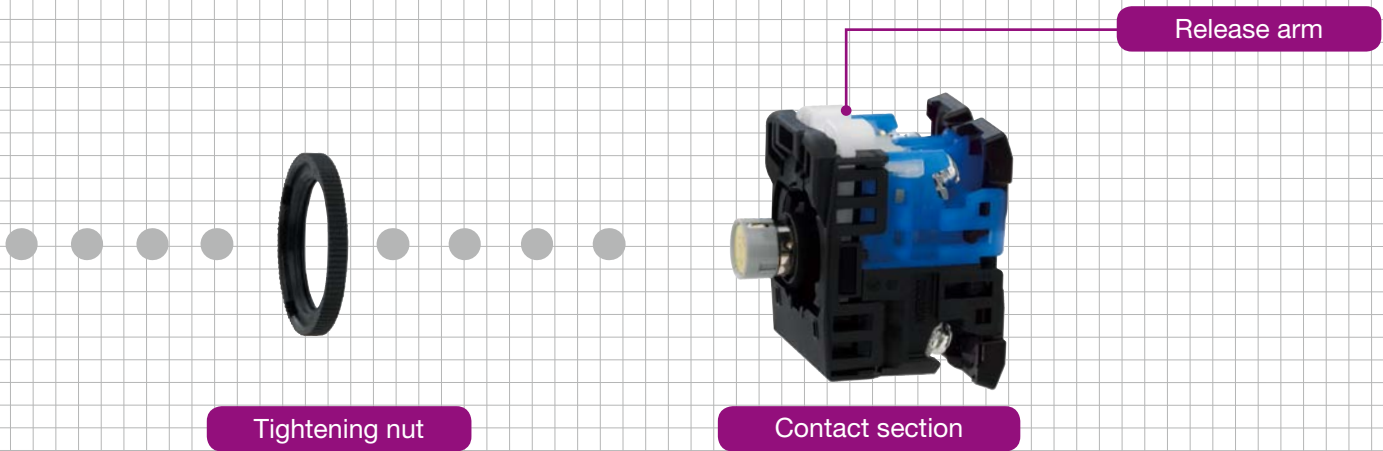

Tightening nut

Contact section

Depth of the short body

A short design enables full use of the available depth of the equipment.

Short

① The Short-body Pilot light is 21.5mm long.

Switches with IP2X-compliant terminals are also available

Switches with IP2X-compliant terminals with a finger protection structure conforming to EN 60204-1 (Protection against electric shock) are available. (A test finger that simulates a human finger does not come into contact with live parts.)

Safety

Contacts Transformer unit Lamp terminal for pilot light

Note: For details, refer to AR22 and DR22-series Special Products.

High brightness LED illuminated model, "PIKARI-KUN"

- Standard models feature (1) higher equipment grade, (2) enhanced safety that enables easy identification of the status, and (3) adoption of pure green illumination color through a major improvement in visibility (Luminance) through the adoption of four elements LED.
- Along with a significant improvement in Luminance, energy is saved through a reduction in power consumption.
- The maintenance cost is also reduced by increasing the service life.

Terminal cover for charged parts provided as a standard accessory

A terminal cover that covers the terminals is provided as a standard accessory to help prevent electric shock by reducing exposure to charged parts.

Note: Not provided on all models.

Lamp base shape facilitates easy replacement

The same lamp base shape of BA9s/13 for both high brightness LED lamps and incandescent lamps facilitates application.

Standard models meet international standards

Standard models meet UL/CSA requirements and TÜV EN standards, making them ideal for equipment for export.

Chinese CCC-compliant models are also available.

Note: For details, refer to List of Models.
See page 04/3 to 04/6

Global Standardization

Features 30 × 50 mm tight mounting

Note: Not applicable to all models.

Panel cutout dimensions of 22.3 mm and 25.5 mm diameter

By providing a projection on the tightening nut, one switch can be mounted on two different panel cutout dimensions. Therefore, switches do not need to be purchased to match the panel cutout dimensions.

Ø 22.3^{+0.4}₀ mm Ø 25.5^{+0.5}₀ mm

Units can be mounted on a 25.5-mm diameter hole simply by turning over the tightening nut.

Safety equipment

16 to 30 mm diameter

Command Switch Emergency Stop (Illuminated) Pushbutton Switches

These pushbutton switches comply with various international standards, so they can be reliably used as emergency stop devices.

Ø16 (AH165, AR16)

minico



AR16V0R

Compliance with International Standards

The emergency stop pushbuttons employ FUJI's original Trigger Action mechanism.

They are suitable for emergency stop and safety.

This mechanism prevents the contacts from moving until the button is pushed and locked.

- Provided with a Trigger Action mechanism conforming to EN 480.
- Provided with direct opening action (approved by TÜV) conforming to EN60947-5-1 and EN60947-5-5. ↻

Button section	Not pushed	Being pushed	Locked
Contact operation transitions			
NC contacts	Closed	Closed	Open

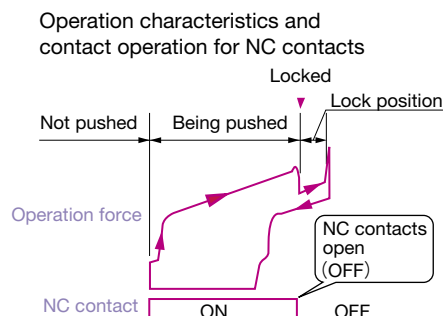

Emergency stop pushbutton switches available with an integrated contact structure

Emergency stop pushbutton switches are available with an integrated contact structure in which the operating section and contact section are combined into one unit (AH165-V, AR16V, and AR22VG). By arranging the contacts in an integrated structure, the reliability of the safety protection function is increased.

- The AR16V types feature a panel depth dimension of 28 mm for non-illuminated models and can have up to four sets of contacts.
- The AR22VGF types are equipped with a lamp circuit interlocking structure in which a lamp lights when the switch is locked.

Non-illuminated

Illuminated

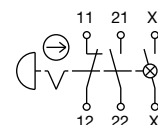

Ø22 (AR22, AM22)



AR22V0L

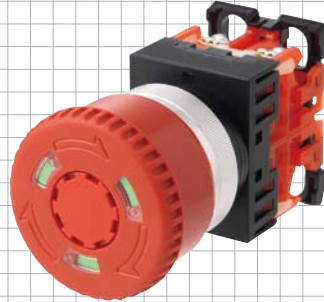

AM22VME

Ø30 (AR30)



AR30V1R

A mechanical indicator mechanism by which the operating status can be seen at a single glance is available.

In AM22VME types, the operating status is indicated mechanically in the form of green and red colors in three button display windows

Reset status (no operation being performed): **Green** Locked status (during operation): **Red**

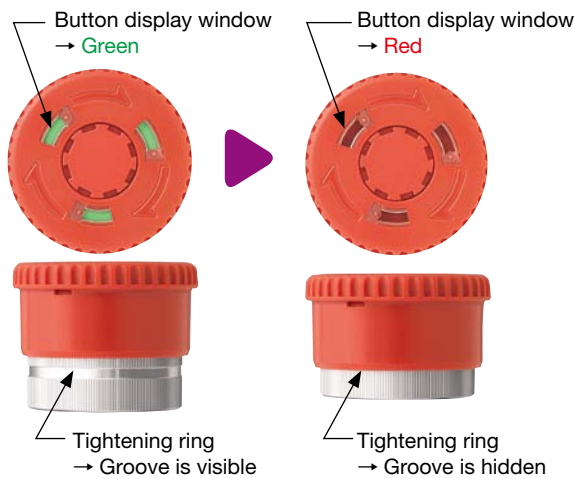

- Ideal for mechanical control panels in which display power supply is difficult to ensure.

SEMI-compliant guard rings are also available

This guard ring can be combined with our emergency stop switches to comply with the SEMI standards required for semiconductor manufacturing devices.

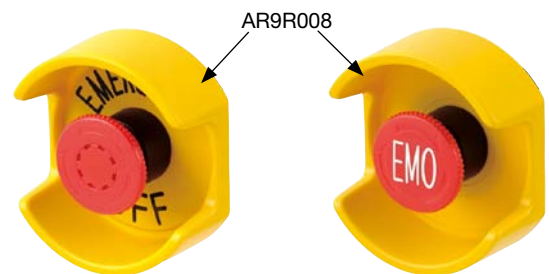

Combination of an AR9R008 guard ring with an AR22V2R switch

Combination of an AR9R008 guard ring with an AR22V3R Z286 switch

- Emergency stop switches with the "EMO" mark are available (AR22V3R Z286).
- EMERGENCY OFF labels are available.



Note: For details, refer to SEMI-compliant guard rings.

AR22V3R Z286

Standard models meet international standards

Standard models meet UL/CSA requirements and TÜV, EN Standard are available and exhibit CE marking. Chinese CCC-compliant models are also available.



Note: For details, refer to the list of models.





Emergency stop pushbutton switches with IP2X -compliant terminals are also available

Emergency stop pushbutton switches with IP2X-compliant terminals with a finger protection structure conforming to EN 60204-1 (protection against electric shock) are available. (A test finger that simulates a human finger does not come in contact with live parts.)

Note: The AR16V types is IP2X compliant when used with a terminal cover for charged parts (AR9Y262, sold separately). Switches from the AH165-V types are not IP2types compliant. For details on the AR22, 30V, Q, and AM22V types, refer to Special Products. The standard AR22V/G types are IP2X compliant.

General information

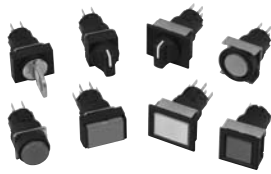

Command Series

Series	Type	Features
Command Series	AR22 and DR22 	<ul style="list-style-type: none"> • Standard models feature illumination with high brightness LEDs. • No adjusting of panel thickness is necessary. • The button and lens can be mounted on a panel while the operator is engaged. • Easy replacing contact block and transformer. • Wiring from two directions is possible. • The shortest among industrial pushbuttons. The transformer now occupies far less space. • A terminal cover are provided, assuring safety and security. • The emergency stop pushbuttons employ FUJI's original Trigger Action mechanism. They are suitable for emergency stop and safety. • Mountable even on panel cutout 25mm diameter. • AR22 and DR22 series of the ø22 Command Switches are approved by UL/CSA CCC and TÜV (EN standard). • Bearing CE markings.
	AR30 and DR30 	<ul style="list-style-type: none"> • Standard models feature illumination with high brightness LEDs. • Easy replacing contact block and transformer. • The shortest among industrial pushbuttons. The transformer now occupies far less space. • A terminal cover are provided, assuring safety and security. • The emergency stop pushbuttons employ FUJI's original Trigger Action mechanism. They are suitable for emergency stop and safety. • AR30 and DR30 series of the ø30 Command Switches are approved by UL/CSA, CCC and TÜV (EN standard). • Bearing CE markings.
	AR16 and AF16 	<ul style="list-style-type: none"> • An integrated operator component and contact mechanism that reduces control panel's depth. A unified depth of 28.4mm for the Standard type and 35.9mm for the Thin type. • Thin type and Standard types available for your control panel design. Select an optimum one to match your control panel design. • A wide variety of sockets help to reduce wiring. • Incorporating a gold-flashed SPDT or 2PDT contact mechanism with a snap-action structure that makes and breaks 1mA at 5V. • A key selector switch with a pin tumbler key and reversible type mechanism provides improved key insertion and removal (extraction) performance. • Complies with RoHS (EU Directive 2002/95/EC). • The standard AR16 and DR16, AF16 and DF16 series of the ø16 Command Switches are approved by UL/CSA, CCC and TÜV (EN standard). • Bearing CE markings.
	AH164 and AH165 AH165-2 	<ul style="list-style-type: none"> • Standard models feature illumination with high brightness LEDs. • Unified depth dimension of 24 mm for type with indicator and 42.5 mm for other types. • Application possible at 1 mA, 5 V due to gold-plated contacts and sliding structure. • Incandescent, neon and LED lamps are available. • Easy replacing contact block. • AH165-2 series are about twice as large as the AH165 series. • AH164 and AH165, AH165-2 series of the ø16 Command Switches are approved by UL/CSA, CCC and TÜV (EN standard). • Bearing CE markings.

					Page																																																							
<table border="1"> <thead> <tr> <th>Type</th> <th>AR22</th> <th colspan="3">DR22</th> </tr> </thead> <tbody> <tr> <td>Degree of protection</td> <td colspan="4">IP65</td> </tr> <tr> <td>Illuminated pushbutton switches</td> <td>●</td> <td colspan="3"></td> </tr> <tr> <td>Pushbutton switches</td> <td>●</td> <td colspan="3">—</td> </tr> <tr> <td>Emergency stop pushbutton switches</td> <td>●</td> <td colspan="3">—</td> </tr> <tr> <td>Emergency stop illuminated pushbutton switches</td> <td>●</td> <td colspan="3">—</td> </tr> <tr> <td>Selector switches</td> <td>●</td> <td colspan="3">—</td> </tr> <tr> <td>Illuminated selector switches</td> <td>●</td> <td colspan="3">—</td> </tr> <tr> <td>Joy stick selector switches</td> <td>●</td> <td colspan="3">—</td> </tr> <tr> <td>Buzzer</td> <td>—</td> <td colspan="3">● (IP00, IP54)</td> </tr> <tr> <td>Pilot lights</td> <td>—</td> <td colspan="3">●</td> </tr> </tbody> </table>					Type	AR22	DR22			Degree of protection	IP65				Illuminated pushbutton switches	●				Pushbutton switches	●	—			Emergency stop pushbutton switches	●	—			Emergency stop illuminated pushbutton switches	●	—			Selector switches	●	—			Illuminated selector switches	●	—			Joy stick selector switches	●	—			Buzzer	—	● (IP00, IP54)			Pilot lights	—	●			04/2
Type	AR22	DR22																																																										
Degree of protection	IP65																																																											
Illuminated pushbutton switches	●																																																											
Pushbutton switches	●	—																																																										
Emergency stop pushbutton switches	●	—																																																										
Emergency stop illuminated pushbutton switches	●	—																																																										
Selector switches	●	—																																																										
Illuminated selector switches	●	—																																																										
Joy stick selector switches	●	—																																																										
Buzzer	—	● (IP00, IP54)																																																										
Pilot lights	—	●																																																										
<table border="1"> <thead> <tr> <th>Type</th> <th>AR30</th> <th colspan="3">DR30</th> </tr> </thead> <tbody> <tr> <td>Degree of protection</td> <td colspan="4">IP65</td> </tr> <tr> <td>Illuminated pushbutton switches</td> <td>●</td> <td colspan="3">—</td> </tr> <tr> <td>Pushbutton switches</td> <td>●</td> <td colspan="3">—</td> </tr> <tr> <td>Emergency stop pushbutton switches</td> <td>●</td> <td colspan="3">—</td> </tr> <tr> <td>Emergency stop illuminated pushbutton switches</td> <td>●</td> <td colspan="3">—</td> </tr> <tr> <td>Selector switches</td> <td>●</td> <td colspan="3">—</td> </tr> <tr> <td>Illuminated selector switches</td> <td>●</td> <td colspan="3">—</td> </tr> <tr> <td>Joy stick selector switches</td> <td>●</td> <td colspan="3">—</td> </tr> <tr> <td>Buzzer</td> <td>—</td> <td colspan="3">● (IP00, IP54)</td> </tr> <tr> <td>Pilot lights</td> <td>—</td> <td colspan="3">●</td> </tr> </tbody> </table>					Type	AR30	DR30			Degree of protection	IP65				Illuminated pushbutton switches	●	—			Pushbutton switches	●	—			Emergency stop pushbutton switches	●	—			Emergency stop illuminated pushbutton switches	●	—			Selector switches	●	—			Illuminated selector switches	●	—			Joy stick selector switches	●	—			Buzzer	—	● (IP00, IP54)			Pilot lights	—	●			04/55
Type	AR30	DR30																																																										
Degree of protection	IP65																																																											
Illuminated pushbutton switches	●	—																																																										
Pushbutton switches	●	—																																																										
Emergency stop pushbutton switches	●	—																																																										
Emergency stop illuminated pushbutton switches	●	—																																																										
Selector switches	●	—																																																										
Illuminated selector switches	●	—																																																										
Joy stick selector switches	●	—																																																										
Buzzer	—	● (IP00, IP54)																																																										
Pilot lights	—	●																																																										
<table border="1"> <thead> <tr> <th>Type</th> <th>AR16</th> <th>DR16</th> <th>AF16</th> <th>DF16</th> </tr> </thead> <tbody> <tr> <td>Degree of protection</td> <td colspan="4">IP65</td> </tr> <tr> <td>Illuminated pushbutton switches</td> <td>●</td> <td>—</td> <td>●</td> <td>—</td> </tr> <tr> <td>Pushbutton switches</td> <td>●</td> <td>—</td> <td>●</td> <td>—</td> </tr> <tr> <td>Emergency stop pushbutton switches</td> <td>●</td> <td>—</td> <td>—</td> <td>—</td> </tr> <tr> <td>Emergency stop illuminated pushbutton switches</td> <td>●</td> <td>—</td> <td>—</td> <td>—</td> </tr> <tr> <td>Selector switches</td> <td>●</td> <td>—</td> <td>●</td> <td>—</td> </tr> <tr> <td>Pilot lights</td> <td>—</td> <td>●</td> <td>—</td> <td>●</td> </tr> </tbody> </table>					Type	AR16	DR16	AF16	DF16	Degree of protection	IP65				Illuminated pushbutton switches	●	—	●	—	Pushbutton switches	●	—	●	—	Emergency stop pushbutton switches	●	—	—	—	Emergency stop illuminated pushbutton switches	●	—	—	—	Selector switches	●	—	●	—	Pilot lights	—	●	—	●	04/129															
Type	AR16	DR16	AF16	DF16																																																								
Degree of protection	IP65																																																											
Illuminated pushbutton switches	●	—	●	—																																																								
Pushbutton switches	●	—	●	—																																																								
Emergency stop pushbutton switches	●	—	—	—																																																								
Emergency stop illuminated pushbutton switches	●	—	—	—																																																								
Selector switches	●	—	●	—																																																								
Pilot lights	—	●	—	●																																																								
<table border="1"> <thead> <tr> <th>Type</th> <th>AH164</th> <th>AH165</th> <th>AH165-2</th> </tr> </thead> <tbody> <tr> <td>Degree of protection</td> <td>IP40</td> <td>IP65</td> <td>IP65</td> </tr> <tr> <td>Illuminated pushbutton switches</td> <td>●</td> <td>●</td> <td>●</td> </tr> <tr> <td>Pushbutton switches</td> <td>●</td> <td>●</td> <td>●</td> </tr> <tr> <td>Emergency stop pushbutton switches</td> <td>—</td> <td>●</td> <td>—</td> </tr> <tr> <td>Selector switches</td> <td>●</td> <td>●</td> <td>●</td> </tr> <tr> <td>Pilot lights</td> <td>●</td> <td>●</td> <td>●</td> </tr> <tr> <td>Buzzer</td> <td>● (IP00)</td> <td>● (IP54)</td> <td>—</td> </tr> </tbody> </table>					Type	AH164	AH165	AH165-2	Degree of protection	IP40	IP65	IP65	Illuminated pushbutton switches	●	●	●	Pushbutton switches	●	●	●	Emergency stop pushbutton switches	—	●	—	Selector switches	●	●	●	Pilot lights	●	●	●	Buzzer	● (IP00)	● (IP54)	—	04/186																							
Type	AH164	AH165	AH165-2																																																									
Degree of protection	IP40	IP65	IP65																																																									
Illuminated pushbutton switches	●	●	●																																																									
Pushbutton switches	●	●	●																																																									
Emergency stop pushbutton switches	—	●	—																																																									
Selector switches	●	●	●																																																									
Pilot lights	●	●	●																																																									
Buzzer	● (IP00)	● (IP54)	—																																																									

General information

Command Series

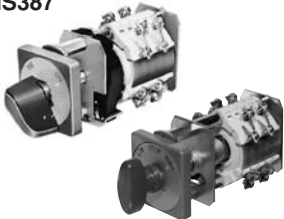
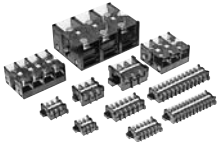
Series	Type	Features
Multi Display	AP30F and AP40F 	<ul style="list-style-type: none"> • High brightness for more vivid colors • Newly added blue and pure white LEDs improve visibility. • Transformer-free design for lighter structure and shorter depth (for 100-V and 200-V models) • Easy color and voltage changes. • Wide window size selection. A wide selection, including half-size windows. • UL/CSA-compliant models also available.
Rotary Switches	AC09, AC16 and AC32 	<ul style="list-style-type: none"> • Rotary switches with code output. • Three types of code output are available. • Select either soldered or connector connections.
Cam Type	RC310 	<ul style="list-style-type: none"> • A wide range of models available for control, instrumentation, and motor starting and with bifurcated contacts, keys, and indicators.
Panel Switches	NS387 	<ul style="list-style-type: none"> • Ideal for switching all types of electric circuits.
Terminal Blocks		<ul style="list-style-type: none"> • FUJI can supply a variety of terminal blocks for switchboard or switchgear use.

						Page																											
<table border="1"> <thead> <tr> <th>Type</th> <th>Illuminated face</th> <th>Face size</th> </tr> </thead> <tbody> <tr> <td rowspan="5">AP30F</td> <td>Half size (H)</td> <td>15×30</td> </tr> <tr> <td>Square (S)</td> <td>30×30</td> </tr> <tr> <td>Rectangular horizontally long (T)</td> <td>30×60</td> </tr> <tr> <td>Rectangular vertical long (V)</td> <td>60×30</td> </tr> <tr> <td>Mixture of S, T, V (X)</td> <td>—</td> </tr> </tbody> </table>		Type	Illuminated face	Face size	AP30F	Half size (H)	15×30	Square (S)	30×30	Rectangular horizontally long (T)	30×60	Rectangular vertical long (V)	60×30	Mixture of S, T, V (X)	—	<table border="1"> <thead> <tr> <th>Type</th> <th>Illuminated face</th> <th>Face size</th> </tr> </thead> <tbody> <tr> <td rowspan="5">AP40F</td> <td>Half size (H)</td> <td>20×40</td> </tr> <tr> <td>Square (S)</td> <td>40×40</td> </tr> <tr> <td>Rectangular horizontally long (T)</td> <td>40×80</td> </tr> <tr> <td>Rectangular vertical long (V)</td> <td>80×40</td> </tr> <tr> <td>Mixture of S, T, V (X)</td> <td>—</td> </tr> </tbody> </table>		Type	Illuminated face	Face size	AP40F	Half size (H)	20×40	Square (S)	40×40	Rectangular horizontally long (T)	40×80	Rectangular vertical long (V)	80×40	Mixture of S, T, V (X)	—	04/235	
Type	Illuminated face	Face size																															
AP30F	Half size (H)	15×30																															
	Square (S)	30×30																															
	Rectangular horizontally long (T)	30×60																															
	Rectangular vertical long (V)	60×30																															
	Mixture of S, T, V (X)	—																															
Type	Illuminated face	Face size																															
AP40F	Half size (H)	20×40																															
	Square (S)	40×40																															
	Rectangular horizontally long (T)	40×80																															
	Rectangular vertical long (V)	80×40																															
	Mixture of S, T, V (X)	—																															
<table border="1"> <thead> <tr> <th>Type</th> <th colspan="3">Type of code</th> </tr> <tr> <td></td> <th>Real binary code</th> <th>Complementary binary code</th> <th>Real gray code</th> </tr> </thead> <tbody> <tr> <td>AC09</td> <td>●</td> <td>●</td> <td>●</td> </tr> <tr> <td>AC16</td> <td></td> <td></td> <td></td> </tr> <tr> <td>AC32</td> <td></td> <td></td> <td></td> </tr> </tbody> </table>				Type	Type of code				Real binary code	Complementary binary code	Real gray code	AC09	●	●	●	AC16				AC32				04/256									
Type	Type of code																																
	Real binary code	Complementary binary code	Real gray code																														
AC09	●	●	●																														
AC16																																	
AC32																																	
<table border="1"> <thead> <tr> <th>Type</th> <th>Mounting</th> <th>Rated insulation voltage</th> <th>Rated thermal current</th> <th>Remarks</th> </tr> </thead> <tbody> <tr> <td>RC310-1</td> <td>40 x 40, mounted with 4 screws</td> <td>600V</td> <td>10A</td> <td>The following are also available: Keys, indicators, bifurcated contacts, case covers, etc.</td> </tr> </tbody> </table>					Type	Mounting	Rated insulation voltage	Rated thermal current	Remarks	RC310-1	40 x 40, mounted with 4 screws	600V	10A	The following are also available: Keys, indicators, bifurcated contacts, case covers, etc.	04/263																		
Type	Mounting	Rated insulation voltage	Rated thermal current	Remarks																													
RC310-1	40 x 40, mounted with 4 screws	600V	10A	The following are also available: Keys, indicators, bifurcated contacts, case covers, etc.																													
<table border="1"> <thead> <tr> <th>Type</th> <th>Rated thermal current</th> <th>Application</th> </tr> </thead> <tbody> <tr> <td rowspan="3">NS387</td> <td rowspan="3">15A</td> <td>Voltmeter changeover switches</td> </tr> <tr> <td>Ammeter changeover switches</td> </tr> <tr> <td>Industrial control switches</td> </tr> </tbody> </table>				Type	Rated thermal current	Application	NS387	15A	Voltmeter changeover switches	Ammeter changeover switches	Industrial control switches	04/270																					
Type	Rated thermal current	Application																															
NS387	15A	Voltmeter changeover switches																															
		Ammeter changeover switches																															
		Industrial control switches																															
<table border="1"> <thead> <tr> <th>Type</th> <th>Rated insulation voltage</th> <th>Rated thermal current</th> <th>Application</th> </tr> </thead> <tbody> <tr> <td>AYBN</td> <td>600V</td> <td>15 to 600A</td> <td>General purpose terminal blocks</td> </tr> <tr> <td>AYBS</td> <td>600V</td> <td>49 to 115A</td> <td>High quality terminal blocks</td> </tr> <tr> <td>LT4D</td> <td>660V</td> <td>20A</td> <td>Rail mounted terminal blocks with isolating switch</td> </tr> <tr> <td>SKT</td> <td>600V</td> <td>50 to 200A</td> <td>Terminal block with pressure solderless box lug type connector on one side and screw type connector on the other</td> </tr> <tr> <td>LT2E</td> <td>600V</td> <td>22 to 600A</td> <td>Rail mounted terminal blocks</td> </tr> <tr> <td>LT5</td> <td>250V</td> <td>30A</td> <td>Testing terminal and link for VT and CT circuit</td> </tr> </tbody> </table>				Type	Rated insulation voltage	Rated thermal current	Application	AYBN	600V	15 to 600A	General purpose terminal blocks	AYBS	600V	49 to 115A	High quality terminal blocks	LT4D	660V	20A	Rail mounted terminal blocks with isolating switch	SKT	600V	50 to 200A	Terminal block with pressure solderless box lug type connector on one side and screw type connector on the other	LT2E	600V	22 to 600A	Rail mounted terminal blocks	LT5	250V	30A	Testing terminal and link for VT and CT circuit	04/276	
Type	Rated insulation voltage	Rated thermal current	Application																														
AYBN	600V	15 to 600A	General purpose terminal blocks																														
AYBS	600V	49 to 115A	High quality terminal blocks																														
LT4D	660V	20A	Rail mounted terminal blocks with isolating switch																														
SKT	600V	50 to 200A	Terminal block with pressure solderless box lug type connector on one side and screw type connector on the other																														
LT2E	600V	22 to 600A	Rail mounted terminal blocks																														
LT5	250V	30A	Testing terminal and link for VT and CT circuit																														

04

Pushbuttons, Selector Switches Pilot Lights, Control Selector Switches Panel Switches, Terminal Blocks



		Page	
Command Series	AR22 and DR22	General information	04/2
		Quick reference guide	04/3
		Type number nomenclature	04/7
		Ratings and specifications	04/12
		Pushbuttons, selectors, pilot lights and buzzers.....	04/17
		Dimensions	04/40
		Notes on use	04/50
	AR30 and DR30	General information	04/55
		Quick reference guide	04/56
		Type number nomenclature	04/60
		Ratings and specifications	04/65
		Pushbuttons, selectors, pilot lights and buzzers.....	04/71
		Dimensions	04/94
		Notes on use	04/105
	AR16, DR16 and AF16, DF16	Accessories for AR22/DR22 and AR30/DR30	04/108
		Special products	04/122
		Mass (AR22/DR22 and AR30/DR30).....	04/125
		General information	04/129
		Quick reference guide	04/130
		Ratings and specifications	04/136
		Type number nomenclature	04/139
		Type numbers and dimensions (AR16 and DR16)	04/143
		Type numbers and dimensions (AF16 and DF16).....	04/154
		Panel cutout and mounting	04/167
	AH164 and AH165	Notes on use	04/169
		Accessories	04/175
		Integrated contact structure AR16V series	04/180
General information		04/186	
Quick reference guide		04/187	
Type number nomenclature		04/191	
Ratings and specifications		04/193	
AH165-2	Pushbuttons, selectors, pilot lights and buzzers.....	04/195	
	Mounting space	04/209	
	General information	04/186	
	Quick reference guide	04/187	
	Type number nomenclature	04/191	
Multi Display Lights	Ratings and specifications	04/212	
	Pushbuttons, selectors and pilot lights	04/213	
	Mounting space	04/223	
	Notes on use (AH164, AH165 and AH165-2)	04/224	
	Accessories for AH164, AH165 and AH165-2	04/227	
	Mass (AH164, AH165 and AH165-2)	04/233	
	Window layout sheet	04/254	
Rotary Switches	AC09, AC16 and AC32	General information	04/235
		Type number nomenclature	04/236
		Specifications and performance	04/237
		Dimensions	04/239
		Notes on use	04/243
Cam Type	RC310	Accessories	04/247
		Digital code output type	04/256
Panel Switches	NS387 and RC310	Control selector switches	04/263
		Instrument switches	04/270
Terminal Blocks	NS387 and RC310	Control switches	04/272
		General information	04/276
		AYBN General purpose terminal blocks	04/278
		AYBS High quality terminal blocks	04/279
		LT4D Channel mounted type terminal blocks with isolating switch	04/280
		SKT Power terminal blocks	04/281
		LT2E Rail mounted terminal blocks	04/283
Testing Terminal TT Testing terminals for VT and CT circuits.....	04/288		
Command Series		CCC approved	04/289

Discontinued

		Page
Command Series	AG22 and AG23	General information04CD/1/1
		Quick reference guide04CD/1/2
		Type number nomenclature04CD/1/4
		Ratings and specifications04CD/1/6
		Pushbuttons, pilot lights, lever switches and rocker switches04CD/1/8
		Dimensions04CD/1/12
		Notes on use04CD/1/13
		Accessories04CD/1/17
		Mass04CD/1/19
	AM22 and DM22	General information04CD/2/1
		Quick reference guide04CD/2/2
		Type number nomenclature04CD/2/4
		Ratings and specifications04CD/2/8
		Pushbuttons, selectors and pilot lights04CD/2/13
		Dimensions04CD/2/29
		Notes on use04CD/2/36
		Accessories04CD/2/39
		Special products04CD/2/46
		Mass04CD/2/49
	CCC approved04CD/2/50	
AH25	General information04CD/3/1	
	Quick reference guide04CD/3/2	
	Type number nomenclature04CD/3/5	
	Ratings and specifications04CD/3/7	
	Pushbuttons, selectors and pilot lights04CD/3/10	
	Notes on use04CD/3/27	
	Accessories04CD/3/30	
	Mass04CD/3/34	
Command box	AHX904CD/4/1	

MINIMUM ORDERS

Orders amounting to **less than ¥10,000** net per order will be charged as ¥10,000 net per order plus freight and other charges.

WEIGHTS AND DIMENSIONS

Weights and dimensions appearing in this catalog are the best information available at the time of going to press.

FUJI ELECTRIC FA has a policy of continuous product improvement, and design changes may make this information out of date.

Please confirm such details before planning actual construction.

INFORMATION IN THIS CATALOG IS SUBJECT TO CHANGE WITHOUT NOTICE.

■ Command series

AR22/DR22



AF94-320



AF94-310



AF98-88

- 22mm diameter hole
- Mountable even on panel cutout 25mm in diameter.
- Provided with newly developed release arm
- Provided with terminal cover for safety and security
- UL, CSA, TÜV and CCC approved

AH164, 165



SK-1103



SK-1138

- 16mm diameter hole, finger-sized button
- Incandescent, neon and LED lamps are available.
- Block type contact
- AH165 series is oil-tight
- UL, CSA, TÜV and CCC approved

AR30/DR30



AF95-4



AF95-6



AF98-195

- 30mm diameter hole
- Provided with terminal cover for safety and security
- UL, CSA, TÜV and CCC approved

AH165-2



AF87-211



AF87-208

- 16mm diameter hole
- AH165-2 series are about twice as large as the AH165 series
- Incandescent, neon and LED lamps are available.
- Block type contact
- AH165-2 series is oil-tight
- UL, CSA, TÜV and CCC approved

AR16/DR16, AF16/DF16



KKD07-157



KKD07-171



KKD07-183

- 16mm diameter hole, finger-sized button
- Integrated contact structure
- AR16 series is standard type.
- AF16 series is thin type.
- UL, CSA, TÜV and CCC approved

The AR22 now uses a release arm with a wedge mechanism developed by Fuji Electric FA. This enables you to mount or remove the operator and contact block without using any tools. When fitting the switch to a panel, you can ignore the panel thickness. You have only to secure the operator with a locking nut from behind the panel without any need for adjustment. The improved locking nut is capable of mounting the operator in both 22.3mm and 25.5mm dia. panel cutout holes.

■ Features

Facilitated mounting

- No adjusting of panel thickness is necessary.
- The button and lens can be mounted on a panel while the operator is engaged.
- Mountable even on a panel cutout 25.5mm in diameter.

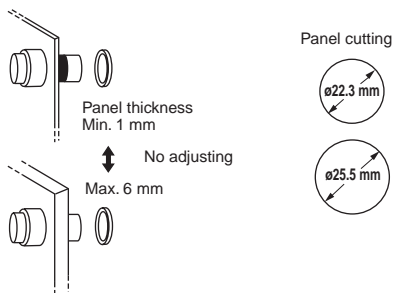

Miniaturization

- Pushbuttons and selector switches with 1NO+1NC: 41mm deep
- Pilot lights: 37mm deep
- The transformer now occupies far less space.

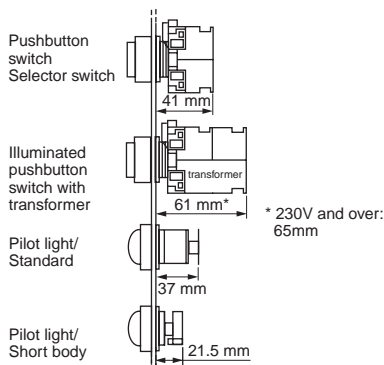

Easy replacing contact block and transformer

- Because of a snap-on mounting, replacement or addition of the contact block and transformer unit is very simple.
- The contact block is common to all the pushbuttons of this series.
- Contact block is easily replaced even when the pushbuttons are mounted closely together.
- Replacement of the contact block can be done with a screwdriver, without the need for any special tool.

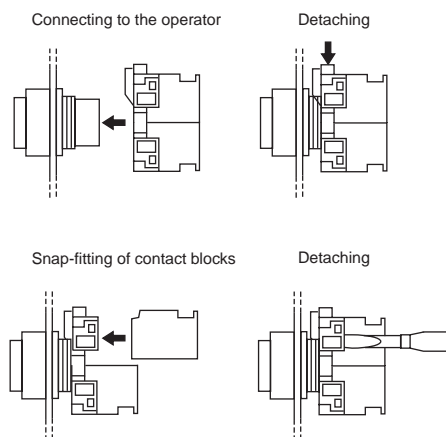

Wiring

- Wiring from two directions is possible.
- Wiring in both vertical and lateral directions facilitates wiring in narrow spaces.
- Color coding of contact blocks makes wiring easy. 1NO: Blue, 1NC: Red
- Lamp terminal and transformer unit: Black

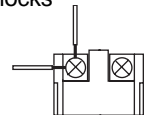

Safety

- A terminal cover is provided, assuring safety and security.
- FUJI's original Trigger Action mechanism is used in the emergency stop pushbuttons. They are suitable for emergency stop and safety. This mechanism prevents the contacts from moving until the button is pushed and locked.
- Reliability of safety functions increased by integrated operator and contact block construction. (AR22VG)

Protection

- Excellent oil-tight construction (IP65) of the operator.
- Closure of the contact block has been improved.







■ Approvals















For further information related to approved type, see page 04/3 to 04/06.

Pushbuttons/Selectors/Pilot Lights/Buzzers AR22 and DR22 Quick reference guide

■ Illuminated pushbutton switches

Operator	Type	Operator	Type	Operator	Type
Flush round head <i>See page 04/17, 04/40</i> 	AR22F0L, F5L  AF94-318	Extended with full guard (24mm dia. with openings) <i>See page 04/17, 04/40</i> 	AR22G2L, G7L  AF99-319	Flush round head with square bezel <i>See page 04/18, 04/40</i> 	AR22F0P, F5P  AF94-315
Extended round head <i>See page 04/17, 04/40</i> 	AR22E0L, E5L  AF94-317	Extended with full guard (24mm dia.) <i>See page 04/18, 04/40</i> 	AR22G1L, G6L  AF02-70	Extended round head with square bezel <i>See page 04/18, 04/40</i> 	AR22E0P, E5P  AF94-314
Mushroom head (40mm dia.) <i>See page 04/17, 04/40</i> 	AR22M0L, M5L  AF94-367	Push-lock, turn-reset (40mm dia. with white arrow) <i>See page 04/18, 04/40</i> 	AR22V5L  KKD06-335	Mushroom head with square bezel (29mm dia.) <i>See page 04/19, 04/40</i> 	AR22M4P  AF94-440
Mushroom head (29mm dia.) <i>See page 04/17, 04/40</i> 	AR22M4L, M9L  AF94-369	Flush square head <i>See page 04/18, 04/40</i> 	AR22F0M, F5M  AF97-68		
Extended with transparent full guard (24mm dia.) <i>See page 04/17, 04/40</i> 	AR22G4L, G9L  AF94-294	Extended square head <i>See page 04/18, 04/40</i> 	AR22E0M, E5M  AF94-357		

■ Pushbutton switches

Operator	Type	Operator	Type	Operator	Type
Flush round head <i>See page 04/20, 04/41</i> 	AR22F0R, F5R  AF94-320	Flush round head Symbol mark type <i>See page 04/20, 04/41</i> 	AR22FAR, FBR  AF98-193	Mushroom head (40mm dia.) <i>See page 04/20, 04/41</i> 	AR22M0R, M5R  AF94-293
Extended round head <i>See page 04/20, 04/41</i> 	AR22E0R, E5R  AF94-319	Extended round head Symbol mark type <i>See page 04/20, 04/41</i> 	AR22EAR, EBR  AF98-192	Mushroom head (29mm dia.) <i>See page 04/20, 04/41</i> 	AR22M4R, M9R  AF94-321

Note  : See page 04/289

Pushbuttons/Selectors/Pilot Lights/Buzzers

AR22 and DR22















Quick reference guide

■ Pushbutton switches

Operator	Type	Operator	Type	Operator	Type
Extended with full guard (24mm dia.) <i>See page 04/20, 04/41</i> 	AR22G3R, G8R  AF94-292	Pushbutton with selector ring (2-position) <i>See page 04/22, 04/41</i> 	AR22S1R, S2R, S3R, S6R  AF97-507	Flush round head with square bezel <i>See page 04/20, 04/41</i> 	AR22F0Y, F5Y  AF94-295
Flush with full guard (24mm dia.) <i>See page 04/20, 04/41</i> 	AR22G2R, G7R  AF02-68	Push-lock, turn-reset (40mm dia. with white arrow) <i>See page 04/20, 04/41</i> 	AR22V5R  KKD08-042	Extended round head with square bezel <i>See page 04/21, 04/41</i> 	AR22E0Y, E5Y  AF94-297
Extended with half guard <i>See page 04/20, 04/41</i> 	AR22G0R, G5R  AF96-236	Flush square head <i>See page 04/20, 04/41</i> 	AR22F0S, F5S  AF94-316	Mushroom head with square bezel (29mm dia.) <i>See page 04/21, 04/41</i> 	AR22M4Y  AF94-298
Mushroom head with full guard (40mm dia.) <i>See page 04/20, 04/41</i> 	AR22M3R, M8R  AF94-372	Extended square head <i>See page 04/20, 04/41</i> 	AR22E0S, E5S  AF94-296		

Note: AR22M8R: Not approved standard

■ Emergency stop pushbutton switches (conform to EN418)

Operator	Type	Operator	Type	Operator	Type
Push-lock, turn-reset (Soft-touch 40mm dia. with white arrow) <i>See page 04/23, 04/42</i> 	AR22V0R  KKD08-042	Push-lock, turn-reset (29mm dia.) <i>See page 04/23, 04/42</i> 	AR22V4R  KKD06-339	Unibody push-lock, turn-reset (Soft-touch 40mm dia. with white arrow) <i>See page 04/23, 04/42</i> 	AR22VGE  KKD05-023b
Push-lock, turn-reset (40mm dia.) <i>See page 04/23, 04/42</i> 	AR22V2R  KKD05-020b	Key release push-lock, turn-reset (40mm dia.) <i>See page 04/23, 04/42</i> 	AR22V7R  KKD09-020	Push-lock, turn-reset (40mm dia. with "EMO" character) <i>See page 04/120</i> 	AR22V3R-■RZ286  KKD05-261
Push-lock, turn-reset (Soft-touch 29mm dia. with white arrow) <i>See page 04/23, 04/42</i> 	AR22VSR  KKD06-346	Push-lock, pull-reset (35mm dia.) <i>See page 04/23, 04/42</i> 	AR22Q2R  KKD06-334		







Notes: Provided with the  (Direct opening action)  : *See page 04/289*

Pushbuttons/Selectors/Pilot Lights/Buzzers

AR22 and DR22

Quick reference guide

■ Emergency stop illuminated pushbutton switches (conform to EN418)



Operator	Type	Operator	Type	Operator	Type
Push-lock, turn-reset (Soft-touch 40mm dia. with white arrow) <i>See page 04/24, 04/43</i>	AR22V0L  KKD06-335	Push-lock, turn-reset (Soft-touch 40mm dia. transparent in all colors with white arrow) <i>See page 04/24, 04/43</i>	AR22VDL  KKD06-342	Push-lock, turn-reset (Soft touch 29mm dia. with white arrow) <i>See page 04/24, 04/43</i>	AR22VSL  KKD06-344
Push-lock, turn-reset (40mm dia.) <i>See page 04/24, 04/43</i>	AR22V2L  KKD06-337	Push-lock, turn-reset (40mm dia. transparent in all colors) <i>See page 04/24, 04/43</i>	AR22VAL  KKD06-340	Unibody push-lock, turn-reset (Soft-touch 40mm dia. with white arrow) <i>See page 04/24, 04/43</i>	AR22VGF  KKD05-150

Note: Provided with the  (Direct opening action)

■ Selector switches

Operator	Type	Operator	Type	Operator	Type
Knob <i>See page 04/25, 04/44</i>	AR22PR, PCR  AF94-310	Key <i>See page 04/25, 04/44</i>	AR22JR, JCR  KKD09-018	Lever with square bezel <i>See page 04/25, 04/44</i>	AR22WY, WCY  AF94-323
Lever <i>See page 04/25, 04/44</i>	AR22WR, WCR  AF94-324	Key (Long durability) <i>See page 04/25, 04/44</i>	AR22JAR  KKD09-015	Cylindrical knob with square bezel <i>See page 04/25, 04/44</i>	AR22RY, RCY  AF94-362
Cylindrical knob <i>See page 04/25, 04/44</i>	AR22RR, RCR  AF94-308	Knob with square bezel <i>See page 04/25, 04/44</i>	AR22PY, PCY  AF94-309	Key with square bezel <i>See page 04/25, 04/44</i>	AR22JY, JCY  KKD09-019

■ Illuminated selector switches

Operator	Type	Operator	Type
Knob <i>See page 04/32, 04/45</i>	AR22PL  AF94-306	Knob with square bezel <i>See page 04/32, 04/45</i>	AR22PP  AF94-318

Note  : *See page 04/289*

Pushbuttons/Selectors/Pilot Lights/Buzzers

AR22 and DR22







Quick reference guide

■ Pilot lights





Lens	Type	Lens	Type	Lens	Type
Dome	DR22D0L  AF94-333	Flush square	DR22F3M  AF94-330	Extended square	DR22E3M  AF94-380
<i>See page 04/34, 04/45</i>		<i>See page 04/34, 04/47</i>		<i>See page 04/34, 04/46</i>	
					
Extended round	DR22E3L  AF94-332	Flush square (Transparent lens)	DR22F4M  AF94-443	Flush rectangular	DR22E3N  AF96-237
<i>See page 04/34, 04/46</i>		<i>See page 04/34, 04/47</i>		<i>See page 04/34, 04/48</i>	
					
Faceted	DR22K0L  AF96-189	Flush square (12mm high frame)	DR22F5M  AF95-658	Extended round with square bezel	DR22E3P  AF94-331
<i>See page 04/34, 04/46</i>		<i>See page 04/34, 04/47</i>		<i>See page 04/34, 04/46</i>	
					

Note: With resistor unit type: Not approved standard

■ Joy stick selector switches

Handle	Type	Handle	Type	Handle	Type
Ball type	AR22A0, A5  AF97-49	Ball type with lock	AR22A1, A6  AF97-45	Rubber cap type	AR22A2, A7  AF97-56
<i>See page 04/38, 04/48</i>		<i>See page 04/38, 04/48</i>		<i>See page 04/38, 04/49</i>	
					

■ Buzzers

Sound	Type	Sound	Type	Sound	Type
Electronic sound	DR22B5 *  KKD08-053	Magnetic sound	DR22B3  AF96-376	Electronic sound (IP54)	DR22B8 *  AF96-244
<i>See page 04/39, 04/49</i>		<i>See page 04/39, 04/49</i>		<i>See page 04/39, 04/49</i>	
					

Note: * 6V AC, 110V DC types: Not approved standard

Note (C): See page 04/289

Illuminated pushbuttons

AR22 E0L – 10 E3 R □

① ② ③ ④ ⑤ ⑥

① **Product category**

AR22: 22mm-dia. illuminated pushbutton
 22mm-dia. emergency stop illuminated pushbutton

② **Operator**

- Illuminated pushbutton
- F0L: Flush round head
- F5L: Flush round head (Alternate)
- E0L: Extended round head
- E5L: Extended round head (Alternate)
- M0L: Mushroom head (40mm dia.)
- M5L: Mushroom head (40mm dia. alternate)
- M4L: Mushroom head (29mm dia.)
- M9L: Mushroom head (29mm dia. alternate)
- G4L: Extended with transparent full guard (24mm dia.)
- G9L: Extended with transparent full guard (24mm dia. alternate)
- G2L: Extended with full guard (24mm dia. with openings)
- G7L: Extended with full guard (24mm dia. with openings, alternate)
- G1L: Extended with full guard (24mm dia.)
- G6L: Extended with full guard (24mm dia. alternate)
- V5L: Push-lock, turn-reset (40mm dia. with white arrow) *1
- F0M: Flush square head
- F5M: Flush square head (Alternate)
- E0M: Extended square head
- E5M: Extended square head (Alternate)
- F0P: Flush round head with square bezel
- F5P: Flush round head with square bezel (Alternate)
- E0P: Extended round head with square bezel
- E5P: Extended round head with square bezel (Alternate)
- M4P: Mushroom head with square bezel (29mm dia.)
- Emergency stop illuminated pushbutton
- V0L: Push-lock, turn-reset (Soft-touch 40mm dia. with white arrow)
- V2L: Push-lock, turn-reset (40mm dia.)
- VDL: Push-lock, turn-reset (Soft-touch 40mm dia. transparent in all colors with white arrow)
- VAL: Push-lock, turn-reset (40mm dia. transparent in all colors)
- VSL: Push-lock, turn-reset (Soft-touch 29mm dia. with white arrow)
- VGF: Unibody push-lock, turn-reset (Soft-touch 40mm dia. with white arrow)

③ **Contact arrangement**

- | | |
|-------------|---------|
| 10: 1NO | 30: 3NO |
| 01: 1NC | 03: 3NC |
| 11: 1NO+1NC | 40: 4NO |
| 20: 2NO | 04: 4NC |
| 02: 2NC | 50: 5NO |
| 22: 2NO+2NC | 05: 5NC |

④ **Lamp voltage**

- Incandescent lamp
- 54: 5.5V AC/DC, without transformer
- C4: 15V AC/DC, without transformer
- D4: 20V AC/DC, without transformer
- E4: 24V AC/DC, without transformer
- H4: 100-110V AC, with transformer
- L4: 115-127V AC, with transformer
- M4: 200-220V AC, with transformer
- Q4: 230-254V AC, with transformer
- S4: 350-380V AC, with transformer
- T4: 400-440V AC, with transformer
- V4: 480V AC, with transformer
- W4: 500-550V AC, with transformer
- LED lamp
- A3: 6V AC, without transformer
- 63: 6V DC, without transformer
- B3: 12V AC/DC, without transformer
- C3: 15V AC/DC, without transformer
- E3: 24V AC/DC, without transformer
- H3: 100-110V AC, with transformer
- L3: 115-127V AC, with transformer
- M3: 200-220V AC, with transformer
- Q3: 230-254V AC, with transformer
- S3: 350-380V AC, with transformer
- T3: 400-440V AC, with transformer
- V3: 480V AC, with transformer
- W3: 500-550V AC, with transformer

- Neon lamp (For AR22VGF)
- H1: 110V AC, without transformer
- K1: 120V AC, without transformer
- M1: 220V AC, without transformer
- P1: 240V AC, without transformer

⑤ **Color of lens**

- | | |
|-----------|-----------|
| G: Green | Y: Yellow |
| R: Red *2 | A: Orange |
| W: White | S: Blue |

⑥ **Special product**

- Z9: Resisting water-soluble cutting oils and heat
- Z8: With a contact protection cover
- Z4: Resisting sulfuration gas
- ZB: Meeting IP2X finger-protection standards

Notes: *1 Products with no trigger action mechanism. These products cannot be used as emergency stop switches that comply with EN standards.



- *2 Button color of emergency stop illuminated switches are Red only.
- The manufacturing range varies depending on the model. For details, refer to the contents of this catalog.

Pushbuttons/Selectors/Pilot Lights/Buzzers

AR22 and DR22

Type number nomenclature

Pushbuttons

AR22 E0R – 10 R  

① ② ③ ④ ⑤ ⑥

① Product category

AR22: 22mm-dia. pushbutton
22mm-dia. emergency stop pushbutton

② Operator

- Pushbutton switch
- F0R: Flush round head
- F5R: Flush round head (Alternate)
- E0R: Extended round head
- E5R: Extended round head (Alternate)
- FAR: Flush round head (Symbol mark type)
- FBR: Flush round head (Symbol mark type, alternate)
- EAR: Extended round head (Symbol mark type)
- EBR: Extended round head (Symbol mark type, alternate)
- M0R: Mushroom head (40mm dia.)
- M5R: Mushroom head (40mm dia. Alternate)
- M4R: Mushroom head (29mm dia.)
- M9R: Mushroom head (29mm dia. Alternate)
- G3R: Extended with full guard (24mm dia.)
- G8R: Extended with full guard (24mm dia. Alternate)
- G2R: Flush with full guard (24mm dia.)
- G7R: Flush with full guard (24mm dia. Alternate)
- G0R: Extended with half guard
- G5R: Extended with half guard (Alternate)
- M3R: Mushroom head with full guard (40mm dia.)
- M8R: Mushroom head with full guard (40mm dia. Alternate)
- S1R: Push-button with selector ring (2-position)
- S2R: Push-button with selector ring (2-position)
- S3R: Push-button with selector ring (2-position)
- S6R: Push-button with selector ring (2-position)
- V5R: Push-lock, turn-reset (40mm dia. with white arrow) *1
- F0S: Flush square head
- F5S: Flush square head (Alternate)
- E0S: Extended square head
- E5S: Extended square head (Alternate)
- F0Y: Flush round head with square bezel
- F5Y: Flush round head with square bezel (Alternate)
- E0Y: Extended round head with square bezel
- E5Y: Extended round head with square bezel (Alternate)
- M4Y: Mushroom head with square bezel (29mm dia.)
 - Emergency stop pushbutton switch
- V0R: Push-lock, turn-reset (Soft-touch 40mm dia. with white arrow)
- V2R: Push-lock, turn-reset (40mm dia.)
- VSR: Push-lock, turn-reset (Soft-touch 29mm dia. with white arrow)
- V4R: Push-lock, turn-reset (29mm dia.)
- V7R: Key-release push-lock, turn-reset (40mm dia.)
- Q2R: Push-lock, pull-reset (35mm dia.)
- VGE: Unibody push-lock, turn-reset (Soft-touch 40mm dia. with white arrow)

③ Contact arrangement

10: 1NO	30: 3NO
01: 1NC	03: 3NC
11: 1NO+1NC	33: 3NO+3NC
20: 2NO	40: 4NO
02: 2NC	04: 4NC
22: 2NO+2NC	50: 5NO
	05: 5NC

④ Color of button

G: Green	Y: Yellow
R: Red ²	A: Orange
B: Black	S: Blue
W: White	C: Clear
T: Green, Red, Black (For AR22F0R)	(For AR22FAR, FBR, EAR, EBR)

⑤ Symbol mark (For AR22FAR, FBR, EAR, EBR)

Symbol mark	○	I	⊕	○	I	⊕	
Color of button	White	Black	White	Black	White	Black	Clear
Color of mark	Red		Green		Green		Black
Code	01	02	03	04	11	12	02B 04B 12B

⑥ Special product

Z9: Resisting water-soluble cutting oils and heat
Z8: With a contact protection cover
Z4: Resisting sulfuration gas
ZB: Meeting IP2X finger-protection standards

Notes: *1 Products with no trigger action mechanism. These products cannot be used as emergency stop switches that comply with EN standards.

*2 Button color of emergency stop switches are Red only.

• The manufacturing range varies depending on the model. For details, refer to the contents of this catalog.

Selector and illuminated selector switches

AR22 PL – 2 □ **10 E3 G** □ □
 ① ② ③ ④ ⑤ ⑥ ⑦ ⑧ ⑨

① **Product category**

AR22: 22mm dia. selector switch and illuminated selector switch

② **Operator**

- Selector switch
 - PR: Knob
 - PCR: Knob operated control type
 - WR: Lever
 - WCR: Lever operated control type
 - RR: Cylindrical knob
 - RCR: Cylindrical knob operated control type
 - JR: Key
 - JCR: Key operated control type
 - JAR: Key (Long durability)
 - PY: Knob with square bezel
 - PCY: Knob operated control type with square bezel
 - WY: Lever with square bezel
 - WCY: Lever operated control type with square bezel
 - RY: Cylindrical knob with square bezel
 - RCY: Cylindrical knob operated control type with square bezel
 - JY: Key with square bezel
 - JCY: Key operated control type with square bezel
- Illuminated selector switch
 - PL: Knob
 - PP: Knob with square bezel

③ **Operation**

- 2: 2-position, maintained
- 0: 2-position, spring return
- 3: 3-position, maintained
- 6: 3-position, spring/manual return (Left to center)
- 7: 3-position, spring/manual return (Right to center)
- 1: 3-position, spring return
- 4: 4-position, maintained (For AR22PCR, WCR, RCR)
- 5: 5-position, maintained (For AR22PCR, WCR, RCR)

④ **Key removable position**

- A: Left
- B: Left and right
- C: Left, right and center
- D: Right
- E: Center
- F: Right and center
- G: Left and center

⑤ **Contact arrangement**

- | | |
|-------------|-------------|
| 10: 1NO | 30: 3NO |
| 01: 1NC | 03: 3NC |
| 11: 1NO+1NC | 33: 3NO+3NC |
| 20: 2NO | 40: 4NO |
| 02: 2NC | 04: 4NC |
| 22: 2NO+2NC | 50: 5NO |
| | 05: 5NC |

Note: Control type: See page 04/29 to 04/31

⑥ **Lamp voltage**

- Incandescent lamp
 - 54: 5.5V AC/DC, without transformer
 - C4: 15V AC/DC, without transformer
 - D4: 20V AC/DC, without transformer
 - E4: 24V AC/DC, without transformer
 - H4: 100-110V AC, with transformer
 - L4: 115-127V AC, with transformer
 - M4: 200-220V AC, with transformer
 - Q4: 230-254V AC, with transformer
 - S4: 350-380V AC, with transformer
 - T4: 400-440V AC, with transformer
 - V4: 480V AC, with transformer
 - W4: 500-550V AC, with transformer
- LED lamp
 - A3: 6V AC, without transformer
 - B3: 6V DC, without transformer
 - B3: 12V AC/DC, without transformer
 - C3: 15V AC/DC, without transformer
 - E3: 24V AC/DC, without transformer
 - H3: 100-110V AC, with transformer
 - L3: 115-127V AC, with transformer
 - M3: 200-220V AC, with transformer
 - Q3: 230-254V AC, with transformer
 - S3: 350-380V AC, with transformer
 - T3: 400-440V AC, with transformer
 - V3: 480V AC, with transformer
 - W3: 500-550V AC, with transformer

⑦ **Color of knob**

- B: Black (Not available for illuminated selector switch)
- G: Green
- R: Red
- W: White (Not available for selector switch)
- Y: Yellow (Not available for selector switch)
- A: Orange (Not available for selector switch)
- S: Blue (Not available for selector switch)

⑧ **Key type No.**

A, B, C, D, E or F
 ("A" is standard)

⑨ **Special product**

- Z9: Resisting water-soluble cutting oils and heat
- Z8: With a contact protection cover
- Z4: Resisting sulfuration gas
- ZB: Meeting IP2X finger-protection standards

Note: • The manufacturing range varies depending on the model. For details, refer to the contents of this catalog.

AR22 and DR22

Type number nomenclature

Pilot lights

DR22 D0L – E3 W □

① ② ③ ④ ⑤

① **Product category**

DR22: 22mm dia. pilot light

② **Lens**

D0L: Dome

E3L: Extended round

K0L: Faceted

F3M: Flush square

F4M: Flush square (Transparent lens)

F5M: Flush square (12mm high frame)

E3M: Extended square

E3N: Flush rectangular

E3P: Extended round with square bezel

③ **Lamp voltage**

• Incandescent lamp

54: 5.5V AC/DC, without transformer

C4: 15V AC/DC, without transformer

D4: 20V AC/DC, without transformer

E4: 24V AC/DC, without transformer

H4: 100-110V AC, with transformer

L4: 115-127V AC, with transformer

M4: 200-220V AC, with transformer

Q4: 230-254V AC, with transformer

S4: 350-380V AC, with transformer

T4: 400-440V AC, with transformer

V4: 480V AC, with transformer

W4: 500-550V AC, with transformer

• LED lamp

A3: 6V AC, without transformer

63: 6V DC, without transformer

B3: 12V AC/DC, without transformer

C3: 15V AC/DC, without transformer

E3: 24V AC/DC, without transformer

H3: 100-110V AC, with transformer

L3: 115-127V AC, with transformer

M3: 200-220V AC, with transformer

Q3: 230-254V AC, with transformer

S3: 350-380V AC, with transformer

T3: 400-440V AC, with transformer

V3: 480V AC, with transformer

W3: 500-550V AC, with transformer

H7: 110V DC, with resistor unit

58: 5.5V AC/DC, short-body without transformer

C8: 15V AC/DC, short-body without transformer

D8: 20V AC/DC, short-body without transformer

E8: 24V AC/DC, short-body without transformer

H8: 100-110V AC, short-body with transformer

L8: 115-127V AC, short-body with transformer

M8: 200-220V AC, short-body with transformer

A9: 6V AC, short-body without transformer

69: 6V DC, short-body without transformer

B9: 12V AC/DC, short-body without transformer

C9: 15V AC/DC, short-body without transformer

E9: 24V AC/DC, short-body without transformer

H9: 100-110V AC, short-body with transformer

L9: 115-127V AC, short-body with transformer

M9: 200-220V AC, short-body with transformer

④ **Color of lens**

G: Green

Y: Yellow

R: Red

A: Orange

W: White

S: Blue

⑤ **Special product**

Z9: Resisting water-soluble cutting oils and heat

Z4: Resisting sulfuration gas

ZB: Meeting IP2X finger-protection standards

Note: • The manufacturing range varies depending on the model. For details, refer to the contents of this catalog.

Joy stick selector switches

AR22A 0 N – A0A0 B

① ②③ ④ ⑤

① **Product category**

AR22A: 22mm-dia. Joy stick selector switch

② **Handle**

- 0: Ball type (without lock, manual return)
- 1: Ball type with lock (manual return)
- 2: Rubber cap type (without lock, manual return)
- 5: Ball type (without lock, spring return)
- 6: Ball type with lock (spring return)
- 7: Rubber cap type (without lock, spring return)

③ **Terminal**

- N: Screw
- H: Solder/tab

④ **Contact arrangement**

Contact arrangement	Blank	1NO	1NC	1NO+1NC	2NO	2NC	2NO+2NC
Code	Screw	0	A	B	1	D	E
	Solder/tab	0	-	-	1	-	2

Operating direction code of contacts

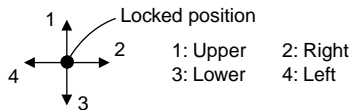

Ex. AR22A0N-A 0 A 0 B
1 2 3 4

⑤ **Handle color**

- B: Black

■ **Ordering information**

Specify the following:

1. Type number

For the CCC approved product, add the suffix **(CCC)** to the type number

Example: Pushbutton switch **AR22F0R-11B(CCC)**

Buzzers

DR22B 5 – E B

① ② ③ ④

① **Product category**

DR22B: 22mm-dia. buzzer

② **Sound**

- 5: Electronic sound
- 3: Magnetic sound
- 8: Electronic sound (IP54)

③ **Operating voltage**

- A: 6V AC (Type "5", "8")
- 6: 6V DC (Type "5", "8")
- E: 12-24V AC/DC (Type "5", "8")
- F: 35-48V AC/DC (Type "5", "8")
- H: 100-110V AC
- M: 200-220V AC
- 1: 100-110V DC (Type "5", "8")

④ **Color of head**

- B: Black

Pushbuttons/Selectors/Pilot Lights/Buzzers

AR22 and DR22

Ratings and specifications

■ Standards approved

UL508	File No. E44592
CSA C22.2 No.14	File No. LR20479 cUL File No. E44592 (For AR22VG)
TÜV: EN60947-5-1	Pushbutton, Illuminated pushbutton: R9551062, Selector, Illuminated selector: R9551060 Pilot lights: R9551061 Joy stick selector switch: R2050803 (Lever switch) Buzzer: J9950091
TÜV: EN60947-5-1 EN60947-5-5	Emergency stop pushbutton Emergency stop illuminated pushbutton : R50028146, R50028137 (For AR22VG)

■ Specifications (Indoor use)

Description	Pushbutton switch Illuminated pushbutton switch Emergency stop pushbutton switch Emergency stop illuminated pushbutton switch Selector switch Illuminated selector switch	Joy stick selector (Lever switch)	Pilot light
Rated insulation voltage	600V AC/DC *1	250V AC/DC	250V AC/DC *2
Mechanical durability	See page 04/13	250,000 operations	–
Electrical durability	500,000 operations at 220V AC 6A 1 million operations at 220V AC 3A (AR22VG type: 100,000 operations)	100,000 operations at 220V AC 1A (Res. load)	–
Operating frequency	1200 operations/hour (On-load factor: 40%) AR22VG type: 1800 operations/hour (On-load factor: 40%)		–
Dielectric strength	2500V AC, 1 minute *3	2000V AC, 1 minute *4	
Insulation resistance	100MΩ or more (500V DC megger)		
Rated impulse dielectric strength	6kV (AR22VG type: 4kV)	–	6kV
Conditional short-circuit current	1000A	1000A	–
Short-circuit protective device	Fuse 15A	Fuse 1A	–
Pollution degree	3		
Vibration	Resonance: 10 to 55Hz, double amplitude 0.1mm *5 Constant: 16.7Hz, double amplitude 3mm		
Shock	Malfunction durability: 100m/s ² *6 Mechanical durability: 500m/s ²		Mechanical durability : 500m/s ²
Ambient temperature (No condensation or no icing)	-20 to +70°C *7	-5 to +70°C	-20 to +50°C
Storage temperature	-40 to +80°C		
Humidity	45 to 85% RH (within -5 to +40°C)		
Degree of protection	IP65		

Notes: *1 Illuminated type without transformer and AR22VG type: 250V AC/DC

*2 Pilot light with transformer: 600V AC

*3 Illuminated type without transformer: 2000V AC, 1 minute (except AR22VGF type)

*4 Pilot light with transformer: 2500V AC, 1 minute

*5 Emergency stop type: 10 to 500Hz, double amplitude 0.7mm (acceleration 50m/s²), according to the test condition of EN60947-5-5 (1997)

*6 Emergency stop type: 150m/s²

*7 AR22VGE type: -20 to +60°C, illuminated type: -20 to +50°C

Pushbuttons/Selectors/Pilot Lights/Buzzers AR22 and DR22 Ratings and specifications

● Mechanical durability

Description		Operations
Pushbutton switch	Momentary action	5 million
Illuminated pushbutton switch	Alternate action	1 million
Emergency stop pushbutton switch	With selector ring	100,000
Emergency stop illuminated pushbutton	Push-lock, turn-reset	100,000
	Push-lock, pull-reset	30,000
Selector switch	Maintained 1, 2, 3, 4-contact	1 million
	Maintained 5, 6-contact	500,000
	Control type, spring return, spring/manual return	200,000
Illuminated selector switch	Maintained	
	Without transformer 1, 2, 3-contact	1 million
	4-contact	500,000
	With transformer 1, 2-contact	1 million
	3-contact	500,000
	Spring return, spring/manual return	200,000

Note: Key insertion/removal durability for selector switch key types

- Key type 10,000
- Key (Long durability) type 20,000

● Buzzers

Item	DR22B5	DR22B3	DR22B8
Rated insulation voltage	Without transformer: 60V AC/DC With transformer: 250V AC		
Sound level	90dB (0.1m) 70dB (1m)	80 to 90dB (0.1m) 60 to 70dB (1m)	80dB (0.1m) 60dB (1.0m)
Durability	1000h	200h	1000h
Frequency	2.4 to 3.3kHz		
Intermittent cycle	Approx. 170-cycle/min		
Current consumption	See the table below		
Dielectric strength	Without transformer: 1000V AC 1 minute With transformer: 2000V AC 1 minute		
Insulation resistance	100MΩ or more (500V DC megger)		
Pollution degree	3		
Vibration	Resonance: 10 to 55Hz, double amplitude 0.1mm Constant: 16.7Hz, double amplitude 3.0mm		
Shock	Mechanical durability: 500m/s ²		
Ambient temperature	-20 to +60°C (No condensation or no icing) (with resistor unit: -20 to +40°C)		
Storage temperature	-30 to +70°C		
Humidity	45 to 85%RH (within -5 to 40°C)		
Degree of protection	IP00		IP54

● Current consumption

Operational voltage	Current consumption	
	DR22B5, DR22B8	DR22B3
6V AC	70mA AC	—
6V DC	35mA DC	—
24V AC/DC	40mA AC, 25mA DC	30mA AC, 20mA DC
48V AC/DC	65mA AC, 20mA DC	—
110V AC	30mA AC	30mA AC
110V DC	30mA DC	—
220V AC	15mA AC	15mA AC

Pushbuttons/Selectors/Pilot Lights/Buzzers

AR22 and DR22

Ratings and specifications

■ **Contact ratings**
 ● **UL/CSA standards**
AC (COS ϕ =0.35)

Contact rated code	120V		240V		480V		600V	
	Making current	Breaking current	Making current	Breaking current	Making current	Breaking current	Making current	Breaking current
A600	60A	6.0A	30A	3.0A	15A	1.5A	12A	1.2A
B300 (AR22VG)	30A	3.0A	15A	1.5A	–	–	–	–

DC $T_{0.95}$ = 6P (Max. 300ms)

Description	Contact rated code	Making current · Breaking current		
		125V	250V	301V–600V
Illuminated pushbutton switch Pushbutton (Ring type selector switch: AR22S2R only) Emergency stop pushbutton switch	P600	1.1A	0.55A	0.2A
Emergency stop illuminated pushbutton switch (Except the overlap contact types)	Q300 (AR22VG)	0.55A	0.27A	–
Overlap contact types of products shown above Pushbutton (Ring type selector switch: AR22S1R, S6R only) Selector switch (2-position only, except the overlap contact types) Illuminated selector switch (2-position only, except the overlap contact types)	Q600	0.55A	0.27A	0.1A
Pushbutton (Ring type selector switch: AR22S3R only) Selector switch (2-pos./overlap contact type, 3-, 4-, 5-pos. type) Illuminated selector switch (2-pos./overlap contact type, 3-pos. type)	R300	0.22A	0.11A	–

Note: Joy stick selector switches (Lever switches): 250V AC, 5A (Res. load) 125V DC, 0.2A 24V DC, 1A (Res. load)

● **EN standard/TÜV approved**

Description	Rated operational current			
	Rated thermal current	Rated operational voltage	AC15 (Ind. load)	DC13 (Ind. load)
			Rated operational current	Rated operational current
Illuminated pushbutton switch Pushbutton (Except the selector ring type) Emergency stop pushbutton switch Emergency stop illuminated pushbutton switch Selector switch (2-position) Illuminated selector switch (2-position)	10A	24V	6.0A	4.0A (AR22VG: 1.5A)
		120V	6.0A (AR22VG: 3A)	–
		125V	–	1.3A (AR22VG: 0.3A)
		240V	6.0A (AR22VG: 3A)	–
		250V	–	0.45A (AR22VG: 0.15A)
		480V	2.5A (AR22VG: –)	–
		600V	2.0A (AR22VG: –)	–
Selector switch (3, 4, 5-position) Illuminated selector switch (3-position) Pushbutton with selector ring	10A	24V	6.0A	2.0A
		120V	6.0A	–
		125V	–	0.65A
		240V	6.0A	–
		250V	–	0.23A
		480V	2.5A	–
		600V	2.0A	–
Joy stick selector switch (Lever switch)	5A	24V	–	0.7A
		120V	0.3A	–
		125V	–	0.15A
		240V	0.3A	–

Lamp rated voltage UL/CSA standards, TÜV approved

	LED lamp	Incandescent lamp	Neon lamp
Full-voltage (without transformer)	Max. 24V AC/DC	Max. 30V AC/DC	Max. 240V AC
With transformer	Max. 550V AC (Short-body type: Max. 220V AC)		–

Pushbuttons/Selectors/Pilot Lights/Buzzers AR22 and DR22 Ratings and specifications

■ Operating characteristic (1NO+1NC)

Description	Pushbutton Illuminated pushbutton	Emergency stop pushbutton		Selector *2		
		Emergency stop illuminated pushbutton		Illuminated selector		
		Push-lock type	Push-pull type	Maintained	Spring/manual return	Spring return
Ave. required operating force	9N (Push-lock type: 20N)	30N (AR22VG: 22N)*1	45N	0.15N•m	0.13N•m	0.1N•m
Operating travel	Approx. 6mm (Push-lock type: Approx. 9mm, operation angle: Approx. 45°)	Approx. 9mm (AR22VG: Approx. 10mm, operation angle: Approx. 45°)	Approx. 9mm	2-position: Approx. 90° 3-position: Approx. 45° 4-position: Approx. 40° 5-position: Approx. 30°	3-position: Approx. 45°	2-position: Approx. 60° 3-position: Approx. 45°
Required return force	– (Push-lock type: 0.6N•m)	0.6N•m (AR22VG: 0.2N•m)	30N (pull)	0.15N•m	0.13N•m	–

Notes: *1 AR22V2R, V4R, V7R, VAL types: 45N
*2 4-position, 5-position: 2NO+2NC

■ Lamp ratings

● Illuminated pushbuttons, illuminated selectors, pilot lights

Transformer	Lamp voltage	LED			Incandescent		
		Type	Rated voltage	Consumption	Type	Rated voltage	Consumption
Without transformer	5.5V AC/DC	–	–	–	AHX135	6.3V AC/DC	0.9W
	6V AC	APX510-6□	6V AC	Green, red, orange, amber, blue: 7mA AC Yellow: 50mA AC	–	–	–
	6V DC	APX510-D6□	6V DC	Green, red, orange, amber, blue: 11mA DC Yellow: 33mA DC	–	–	–
	12V AC/DC	APX510-12□	12V AC/DC	Green, red, orange, amber, blue: 14mA AC, 11mA DC Yellow: 28mA AC, 22mA DC	–	–	–
	15V AC/DC	APX510-15□	15V AC/DC	Green, red, orange, amber, blue: 13mA AC, 11mA DC Yellow: 26mA AC, 22mA DC	AHX279	18V AC/DC	0.8W
Without transformer	20V AC/DC	–	–	–	AHX144	24V AC/DC	0.9W
	24V AC/DC	APX510-24□	24V AC/DC	12mA AC, 11mA DC	AHX129	30V AC/DC	0.8W
With transformer (Standard type: AR9T511)	110V AC	APX510-6□	6V AC	1.5VA	AHX135	6.3V AC/DC	2VA
	127V AC						2VA
	220V AC						2VA
	254V AC	APX510-6□	6V AC	2.5VA	AHX135	6.3V AC/DC	2.5VA
	380V AC						2.5VA
440V AC						2.5VA	
480V AC						2.5VA	
550V AC						2.5VA	
With resistor unit (AR9T519-H)	110V DC	APX510-24□	24V AC/DC	1.2W	–	–	–

Notes: • Short body pilot lights: 110V AC, 127V AC, 220V AC only
• Replace the □ mark by the lamp luminous color code, see page 04/16
• Except AR22VGF type

● Emergency stop illuminated pushbuttons (AR22VGF type)

Transformer	Lamp	Voltage	Type	Rated voltage	Consumption
Without transformer	LED	24V AC/DC	AR9L002-ER	24V AC/DC	12mA AC 11mA DC
	Neon	110V AC	AR9N001-HA	110V AC	0.19VA
		120V AC	AR9N001-KA	120V AC	0.21VA
		220V AC	AR9N001-MA	220V AC	0.30VA
		240V AC	AR9N001-PA	240V AC	0.30VA

Notes: Lamp base: BA9S/13

Pushbuttons/Selectors/Pilot Lights/Buzzers AR22 and DR22 Ratings and specifications

■ Lamp durability

Lamp	Durability (reference)	Judgement criterion
LED	Approx. 30000h	When brightness is less than 50% of initial value
Incandescent	Approx. 5000h (AC)	When the bulb burns out
Neon	Approx. 5000h	When a remarkable blackening appears in the glass bulb and the using becomes improper

Notes: • The operating voltage for incandescent lamps is set at 80 to 90% of the lamp's rated voltage.
• The durability of LED lamp is a mean value in all colors.

Estimated durability for LED lamps

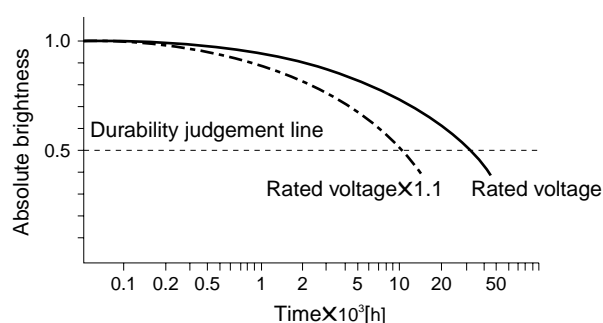

Notes: • Durability at $T_a=25^{\circ}\text{C}$
• Durability is affected by temperature, humidity, and voltage fluctuation.

■ Combination of lens color and LED or neon lamp luminous color





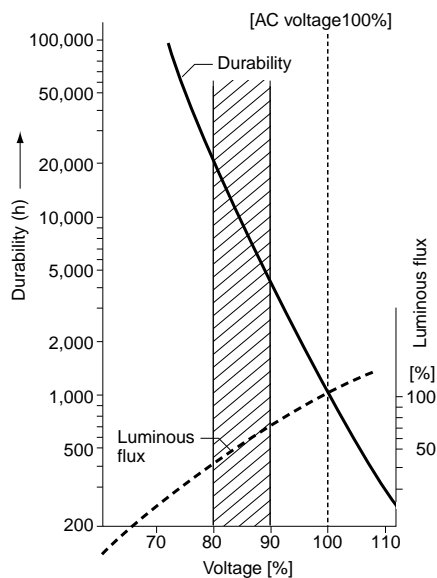

Lens Color	Code	LED or neon lamp Luminous color	Type
Green	G	Green	APX510-■G
Red	R	Red	APX510-■R
White	W	Orange	APX510-■O
Yellow	Y	Yellow	APX510-■Y
Orange *	A	Amber	APX510-■A
Blue	S	Blue	APX510-■S
Red (AR22VGF)	R	Red	AR9L002-ER
		Orange (Neon lamp)	AR9N001-■A

Notes: * DR22F4M: LED lamp color is orange. (APX510-■O)
• Replace the ■ mark by the lamp voltage code

Incandescent lamp voltage characteristics



■ Illuminated pushbutton switches

Operator	Transformer	Contact	LED lamp Momentary action Type	Alternate action Type	Incandescent lamp Momentary action Type	Alternate action Type
Flush round head  AF94-318	Without	1NO 1NC 1NO+1NC 2NO+2NC	AR22F0L-10■3□ AR22F0L-01■3□ AR22F0L-11■3□ AR22F0L-22■3□	AR22F5L-10■3□ AR22F5L-01■3□ AR22F5L-11■3□ —	AR22F0L-10■4□ AR22F0L-01■4□ AR22F0L-11■4□ AR22F0L-22■4□	AR22F5L-10■4□ AR22F5L-01■4□ AR22F5L-11■4□ —
	With	1NO 1NC 1NO+1NC	AR22F0L-10■3□ AR22F0L-01■3□ AR22F0L-11■3□	AR22F5L-10■3□ AR22F5L-01■3□ AR22F5L-11■3□	AR22F0L-10■4□ AR22F0L-01■4□ AR22F0L-11■4□	AR22F5L-10■4□ AR22F5L-01■4□ AR22F5L-11■4□
Extended round head  AF94-317	Without	1NO 1NC 1NO+1NC 2NO+2NC	AR22E0L-10■3□ AR22E0L-01■3□ AR22E0L-11■3□ AR22E0L-22■3□	AR22E5L-10■3□ AR22E5L-01■3□ AR22E5L-11■3□ —	AR22E0L-10■4□ AR22E0L-01■4□ AR22E0L-11■4□ AR22E0L-22■4□	AR22E5L-10■4□ AR22E5L-01■4□ AR22E5L-11■4□ —
	With	1NO 1NC 1NO+1NC	AR22E0L-10■3□ AR22E0L-01■3□ AR22E0L-11■3□	AR22E5L-10■3□ AR22E5L-01■3□ AR22E5L-11■3□	AR22E0L-10■4□ AR22E0L-01■4□ AR22E0L-11■4□	AR22E5L-10■4□ AR22E5L-01■4□ AR22E5L-11■4□
Mushroom head (40mm dia.)  AF94-367	Without	1NO 1NC 1NO+1NC 2NO+2NC	AR22M0L-10■3□ AR22M0L-01■3□ AR22M0L-11■3□ AR22M0L-22■3□	AR22M5L-10■3□ AR22M5L-01■3□ AR22M5L-11■3□ —	AR22M0L-10■4□ AR22M0L-01■4□ AR22M0L-11■4□ AR22M0L-22■4□	AR22M5L-10■4□ AR22M5L-01■4□ AR22M5L-11■4□ —
	With	1NO 1NC 1NO+1NC	AR22M0L-10■3□ AR22M0L-01■3□ AR22M0L-11■3□	AR22M5L-10■3□ AR22M5L-01■3□ AR22M5L-11■3□	AR22M0L-10■4□ AR22M0L-01■4□ AR22M0L-11■4□	AR22M5L-10■4□ AR22M5L-01■4□ AR22M5L-11■4□
Mushroom head (29mm dia.)  AF94-369	Without	1NO 1NC 1NO+1NC 2NO+2NC	AR22M4L-10■3□ AR22M4L-01■3□ AR22M4L-11■3□ AR22M4L-22■3□	AR22M9L-10■3□ AR22M9L-01■3□ AR22M9L-11■3□ —	AR22M4L-10■4□ AR22M4L-01■4□ AR22M4L-11■4□ AR22M4L-22■4□	AR22M9L-10■4□ AR22M9L-01■4□ AR22M9L-11■4□ —
	With	1NO 1NC 1NO+1NC	AR22M4L-10■3□ AR22M4L-01■3□ AR22M4L-11■3□	AR22M9L-10■3□ AR22M9L-01■3□ AR22M9L-11■3□	AR22M4L-10■4□ AR22M4L-01■4□ AR22M4L-11■4□	AR22M9L-10■4□ AR22M9L-01■4□ AR22M9L-11■4□
Extended with transparent full guard (24mm dia.)  AF94-294	Without	1NO 1NC 1NO+1NC 2NO+2NC	AR22G4L-10■3□ AR22G4L-01■3□ AR22G4L-11■3□ AR22G4L-22■3□	AR22G9L-10■3□ AR22G9L-01■3□ AR22G9L-11■3□ —	AR22G4L-10■4□ AR22G4L-01■4□ AR22G4L-11■4□ AR22G4L-22■4□	AR22G9L-10■4□ AR22G9L-01■4□ AR22G9L-11■4□ —
	With	1NO 1NC 1NO+1NC	AR22G4L-10■3□ AR22G4L-01■3□ AR22G4L-11■3□	AR22G9L-10■3□ AR22G9L-01■3□ AR22G9L-11■3□	AR22G4L-10■4□ AR22G4L-01■4□ AR22G4L-11■4□	AR22G9L-10■4□ AR22G9L-01■4□ AR22G9L-11■4□
Extended with full guard (24mm dia. with openings)  AF99-319	Without	1NO 1NC 1NO+1NC 2NO+2NC	AR22G2L-10■3□ AR22G2L-01■3□ AR22G2L-11■3□ AR22G2L-22■3□	AR22G7L-10■3□ AR22G7L-01■3□ AR22G7L-11■3□ —	AR22G2L-10■4□ AR22G2L-01■4□ AR22G2L-11■4□ AR22G2L-22■4□	AR22G7L-10■4□ AR22G7L-01■4□ AR22G7L-11■4□ —
	With	1NO 1NC 1NO+1NC	AR22G2L-10■3□ AR22G2L-01■3□ AR22G2L-11■3□	AR22G7L-10■3□ AR22G7L-01■3□ AR22G7L-11■3□	AR22G2L-10■4□ AR22G2L-01■4□ AR22G2L-11■4□	AR22G7L-10■4□ AR22G7L-01■4□ AR22G7L-11■4□

Note: ■ □ See page 04/19

Illuminated Pushbuttons

AR22

Operator	Transformer	Contact	LED lamp Momentary action Type	Alternate action Type	Incandescent lamp Momentary action Type	Alternate action Type
Extended with full guard (24mm dia.)  KK02-127A	Without	1NO 1NC 1NO+1NC 2NO+2NC	AR22G1L-10■3□ AR22G1L-01■3□ AR22G1L-11■3□ AR22G1L-22■3□	AR22G6L-10■3□ AR22G6L-01■3□ AR22G6L-11■3□ —	AR22G1L-10■4□ AR22G1L-01■4□ AR22G1L-11■4□ AR22G1L-22■4□	AR22G6L-10■4□ AR22G6L-01■4□ AR22G6L-11■4□ —
	With	1NO 1NC 1NO+1NC	AR22G1L-10■3□ AR22G1L-01■3□ AR22G1L-11■3□	AR22G6L-10■3□ AR22G6L-01■3□ AR22G6L-11■3□	AR22G1L-10■4□ AR22G1L-01■4□ AR22G1L-11■4□	AR22G6L-10■4□ AR22G6L-01■4□ AR22G6L-11■4□
Push-lock, turn-reset (40mm dia. with white arrow)  KKD06-335	Without	1NO 1NC 1NO+1NC 3NC	— — — —	AR22V5L-10■3□ AR22V5L-01■3□ AR22V5L-11■3□ AR22V5L-03■3□	— — — —	AR22V5L-10■4□ AR22V5L-01■4□ AR22V5L-11■4□ AR22V5L-03■4□
	With	1NO 1NC 1NO+1NC	— — —	AR22V5L-10■3□ AR22V5L-01■3□ AR22V5L-11■3□	— — —	AR22V5L-10■4□ AR22V5L-01■4□ AR22V5L-11■4□
Flush square head  AF97-68	Without	1NO 1NC 1NO+1NC 2NO+2NC	AR22F0M-10■3□ AR22F0M-01■3□ AR22F0M-11■3□ AR22F0M-22■3□	AR22F5M-10■3□ AR22F5M-01■3□ AR22F5M-11■3□ —	AR22F0M-10■4□ AR22F0M-01■4□ AR22F0M-11■4□ AR22F0M-22■4□	AR22F5M-10■4□ AR22F5M-01■4□ AR22F5M-11■4□ —
	With	1NO 1NC 1NO+1NC	AR22F0M-10■3□ AR22F0M-01■3□ AR22F0M-11■3□	AR22F5M-10■3□ AR22F5M-01■3□ AR22F5M-11■3□	AR22F0M-10■4□ AR22F0M-01■4□ AR22F0M-11■4□	AR22F5M-10■4□ AR22F5M-01■4□ AR22F5M-11■4□
Extended square head  AF94-357	Without	1NO 1NC 1NO+1NC 2NO+2NC	AR22E0M-10■3□ AR22E0M-01■3□ AR22E0M-11■3□ AR22E0M-22■3□	AR22E5M-10■3□ AR22E5M-01■3□ AR22E5M-11■3□ —	AR22E0M-10■4□ AR22E0M-01■4□ AR22E0M-11■4□ AR22E0M-22■4□	AR22E5M-10■4□ AR22E5M-01■4□ AR22E5M-11■4□ —
	With	1NO 1NC 1NO+1NC	AR22E0M-10■3□ AR22E0M-01■3□ AR22E0M-11■3□	AR22E5M-10■3□ AR22E5M-01■3□ AR22E5M-11■3□	AR22E0M-10■4□ AR22E0M-01■4□ AR22E0M-11■4□	AR22E5M-10■4□ AR22E5M-01■4□ AR22E5M-11■4□
Flush round head with square bezel  AF94-315	Without	1NO 1NC 1NO+1NC 2NO+2NC	AR22F0P-10■3□ AR22F0P-01■3□ AR22F0P-11■3□ AR22F0P-22■3□	AR22F5P-10■3□ AR22F5P-01■3□ AR22F5P-11■3□ —	AR22F0P-10■4□ AR22F0P-01■4□ AR22F0P-11■4□ AR22F0P-22■4□	AR22F5P-10■4□ AR22F5P-01■4□ AR22F5P-11■4□ —
	With	1NO 1NC 1NO+1NC	AR22F0P-10■3□ AR22F0P-01■3□ AR22F0P-11■3□	AR22F5P-10■3□ AR22F5P-01■3□ AR22F5P-11■3□	AR22F0P-10■4□ AR22F0P-01■4□ AR22F0P-11■4□	AR22F5P-10■4□ AR22F5P-01■4□ AR22F5P-11■4□
Extended round head with square bezel  AF94-314	Without	1NO 1NC 1NO+1NC 2NO+2NC	AR22E0P-10■3□ AR22E0P-01■3□ AR22E0P-11■3□ AR22E0P-22■3□	AR22E5P-10■3□ AR22E5P-01■3□ AR22E5P-11■3□ —	AR22E0P-10■4□ AR22E0P-01■4□ AR22E0P-11■4□ AR22E0P-22■4□	AR22E5P-10■4□ AR22E5P-01■4□ AR22E5P-11■4□ —
	With	1NO 1NC 1NO+1NC	AR22E0P-10■3□ AR22E0P-01■3□ AR22E0P-11■3□	AR22E5P-10■3□ AR22E5P-01■3□ AR22E5P-11■3□	AR22E0P-10■4□ AR22E0P-01■4□ AR22E0P-11■4□	AR22E5P-10■4□ AR22E5P-01■4□ AR22E5P-11■4□

Note: ■ □ See page 04/19

Operator	Trans- former	Contact	LED lamp		Incandescent lamp	
			Momentary action Type	Alternate action Type	Momentary action Type	Alternate action Type
Mushroom head with square bezel (29mm dia.)  AF94-440	Without	1NO	AR22M4P-10■3□	—	AR22M4P-10■4□	—
		1NC	AR22M4P-01■3□	—	AR22M4P-01■4□	—
		1NO+1NC	AR22M4P-11■3□	—	AR22M4P-11■4□	—
		2NO+2NC	AR22M4P-22■3□	—	AR22M4P-22■4□	—
	With	1NO	AR22M4P-10■3□	—	AR22M4P-10■4□	—
		1NO+1NC	AR22M4P-11■3□	—	AR22M4P-11■4□	—

• **Lens color**

Replace the □ mark by the lens color code

Color	Green	Red	White	Blue	Yellow	Orange
Code	G	R	W	S	Y	A

Note: AR22V5L type: Red, yellow only

• **Contact arrangements**

Contact arrangements other than above are available

Contact arrangement	1NO	1NC	1NO+1NC	2NO	2NC	3NO
Code	10	01	11	20	02	30

Contact arrangement	3NC	2NO+2NC	4NO	4NC	5NO	5NC
Code	03	22	40	04	50	05

Available numbers of contact blocks

Operation	Without transformer	With transformer
Momentary action	5-contact block	3-contact block
Alternate action Push-lock, turn-reset	3-contact block	2-contact block

• **Voltage**

Replace the ■ mark by the lamp voltage code

Transformer		Code	
		LED	Incandescent
Without transformer	6V DC	6	—
	6V AC	A	—
	5.5V AC/DC	—	5
	12V AC/DC	B	—
	15V AC/DC	C	C
	20V AC/DC 24V AC/DC	— E	D E
With transformer	100-110V AC	H	H
	115-127V AC	L	L
	200-220V AC	M	M
	230-254V AC	Q	Q
	350-380V AC	S	S
	400-440V AC	T	T
	480V AC	V	V
	500-550V AC	W	W

Pushbuttons

AR22

■ Pushbutton switches

Operator	Contact	Momentary action Type	Alternate action Type
Flush round head  <small>AF94-320</small>	1NO 1NC 1NO+1NC 2NO 2NC 2NO+2NC	AR22F0R-10 □ AR22F5R-10 □ AR22F0R-01 □ AR22F5R-01 □ AR22F0R-11 □ AR22F5R-11 □ AR22F0R-20 □ AR22F5R-20 □ AR22F0R-02 □ AR22F5R-02 □ AR22F0R-22 □ AR22F5R-22 □	
Extended round head  <small>AF94-319</small>	1NO 1NC 1NO+1NC 2NO 2NC 2NO+2NC	AR22E0R-10 □ AR22E5R-10 □ AR22E0R-01 □ AR22E5R-01 □ AR22E0R-11 □ AR22E5R-11 □ AR22E0R-20 □ AR22E5R-20 □ AR22E0R-02 □ AR22E5R-02 □ AR22E0R-22 □ AR22E5R-22 □	
Flush round head symbol mark type  <small>AF98-193</small>	1NO 1NC 1NO+1NC 2NO 2NC 2NO+2NC	AR22FAR-10C ■ AR22FBR-10C ■ AR22FAR-01C ■ AR22FBR-01C ■ AR22FAR-11C ■ AR22FBR-11C ■ AR22FAR-20C ■ AR22FBR-20C ■ AR22FAR-02C ■ AR22FBR-02C ■ AR22FAR-22C ■ AR22FBR-22C ■	
Extended round head symbol mark type  <small>AF98-192</small>	1NO 1NC 1NO+1NC 2NO 2NC 2NO+2NC	AR22EAR-10C ■ AR22EBR-10C ■ AR22EAR-01C ■ AR22EBR-01C ■ AR22EAR-11C ■ AR22EBR-11C ■ AR22EAR-20C ■ AR22EBR-20C ■ AR22EAR-02C ■ AR22EBR-02C ■ AR22EAR-22C ■ AR22EBR-22C ■	
Mushroom head (40mm dia.)  <small>AF94-293</small>	1NO 1NC 1NO+1NC 2NO 2NC 2NO+2NC	AR22M0R-10 □ AR22M5R-10 □ AR22M0R-01 □ AR22M5R-01 □ AR22M0R-11 □ AR22M5R-11 □ AR22M0R-20 □ AR22M5R-20 □ AR22M0R-02 □ AR22M5R-02 □ AR22M0R-22 □ AR22M5R-22 □	
Mushroom head (29mm dia.)  <small>AF94-321</small>	1NO 1NC 1NO+1NC 2NO 2NC 2NO+2NC	AR22M4R-10 □ AR22M9R-10 □ AR22M4R-01 □ AR22M9R-01 □ AR22M4R-11 □ AR22M9R-11 □ AR22M4R-20 □ AR22M9R-20 □ AR22M4R-02 □ AR22M9R-02 □ AR22M4R-22 □ AR22M9R-22 □	
Extended with full guard (24mm dia.)  <small>AF94-292</small>	1NO 1NC 1NO+1NC 2NO 2NC 2NO+2NC	AR22G3R-10 □ AR22G8R-10 □ AR22G3R-01 □ AR22G8R-01 □ AR22G3R-11 □ AR22G8R-11 □ AR22G3R-20 □ AR22G8R-20 □ AR22G3R-02 □ AR22G8R-02 □ AR22G3R-22 □ AR22G8R-22 □	

Note: ■ □ See page 04/21

Operator	Contact	Momentary action Type	Alternate action Type
Flush with full guard (24mm dia.)  <small>AF02-68</small>	1NO 1NC 1NO+1NC 2NO 2NC 2NO+2NC	AR22G2R-10 □ AR22G7R-10 □ AR22G2R-01 □ AR22G7R-01 □ AR22G2R-11 □ AR22G7R-11 □ AR22G2R-20 □ AR22G7R-20 □ AR22G2R-02 □ AR22G7R-02 □ AR22G2R-22 □ AR22G7R-22 □	
Mushroom head with full guard (40mm dia.)  <small>AF94-372</small>	1NO 1NC 1NO+1NC 2NO 2NC 2NO+2NC	AR22M3R-10 □ AR22M8R-10 □ AR22M3R-01 □ AR22M8R-01 □ AR22M3R-11 □ AR22M8R-11 □ AR22M3R-20 □ AR22M8R-20 □ AR22M3R-02 □ AR22M8R-02 □ AR22M3R-22 □ AR22M8R-22 □	
Extended with half guard  <small>AF96-236</small>	1NO 1NC 1NO+1NC 2NO 2NC 2NO+2NC	AR22G0R-10 □ AR22G5R-10 □ AR22G0R-01 □ AR22G5R-01 □ AR22G0R-11 □ AR22G5R-11 □ AR22G0R-20 □ AR22G5R-20 □ AR22G0R-02 □ AR22G5R-02 □ AR22G0R-22 □ AR22G5R-22 □	
Push-lock, turn-reset (40mm dia. with white arrow)  <small>KKD08-042</small>	1NO 1NC 1NO+1NC 2NO 2NC 2NO+2NC	— — — — — —	AR22V5R-10 □ AR22V5R-01 □ AR22V5R-11 □ AR22V5R-20 □ AR22V5R-02 □ AR22V5R-22 □
Flush square head  <small>AF94-316</small>	1NO 1NC 1NO+1NC 2NO 2NC 2NO+2NC	AR22F0S-10 □ AR22F5S-10 □ AR22F0S-01 □ AR22F5S-01 □ AR22F0S-11 □ AR22F5S-11 □ AR22F0S-20 □ AR22F5S-20 □ AR22F0S-02 □ AR22F5S-02 □ AR22F0S-22 □ AR22F5S-22 □	
Extended square head  <small>AF94-296</small>	1NO 1NC 1NO+1NC 2NO 2NC 2NO+2NC	AR22E0S-10 □ AR22E5S-10 □ AR22E0S-01 □ AR22E5S-01 □ AR22E0S-11 □ AR22E5S-11 □ AR22E0S-20 □ AR22E5S-20 □ AR22E0S-02 □ AR22E5S-02 □ AR22E0S-22 □ AR22E5S-22 □	
Flush round head with square bezel  <small>AF94-295</small>	1NO 1NC 1NO+1NC 2NO 2NC 2NO+2NC	AR22F0Y-10 □ AR22F5Y-10 □ AR22F0Y-01 □ AR22F5Y-01 □ AR22F0Y-11 □ AR22F5Y-11 □ AR22F0Y-20 □ AR22F5Y-20 □ AR22F0Y-02 □ AR22F5Y-02 □ AR22F0Y-22 □ AR22F5Y-22 □	

Operator	Contact	Momentary action Type	Alternate action Type
Extended round head with square bezel 	1NO	AR22E0Y-10□	AR22E5Y-10□
	1NC	AR22E0Y-01□	AR22E5Y-01□
	1NO+1NC	AR22E0Y-11□	AR22E5Y-11□
	2NO	AR22E0Y-20□	AR22E5Y-20□
	2NC	AR22E0Y-02□	AR22E5Y-02□
	2NO+2NC	AR22E0Y-22□	AR22E5Y-22□

Operator	Contact	Momentary action Type	Alternate action Type
Mushroom head with square bezel (29mm dia.) 	1NO	AR22M4Y-10□	—
	1NC	AR22M4Y-01□	—
	1NO+1NC	AR22M4Y-11□	—
	2NO	AR22M4Y-20□	—
	2NC	AR22M4Y-02□	—
	2NO+2NC	AR22M4Y-22□	—

• **Button color**

Replace the □ mark by the button color code

Color	Green	Red	White	Blue	Yellow	Orange	Black
Code	G	R	W	S	Y	A	B

Note: AR22V5R type: Red, yellow, black only

• **Available numbers of contact blocks**

Momentary action	Alternate action Push-lock, turn-reset
6-contact block	4-contact block

• **Contact arrangements**

Contact arrangements other than above are available

Contact arrangement	1NO	1NC	1NO+1NC	2NO	2NC	3NO	3NC
Code	10	01	11	20	02	30	03



Contact arrangement	2NO+2NC	4NO	4NC	5NO	5NC	3NO+3NC
Code	22	40	04	50	05	33

• **Symbol mark** (For AR22FAR, FBR, EAR, EBR)

Replace the ■ mark by the symbol mark code

Symbol mark	○	I	Ⓢ	Ⓢ	Ⓢ	Ⓢ	Ⓢ	Ⓢ
Color of button	White	Black	White	Black	White	Black	Clear	
Color of mark	Red		Green		Green		Black	
Code	01	02	03	04	11	12	02B	04B 12B

Pushbuttons AR22

Operator	Contact (The following contact is only available.)	Button color	Type	Contact operation					
				Contact block		Left 		Right 	
				Mounting position	Type	Free	Depressed	Free	Depressed
Pushbutton with selector ring (2-position)  AF94-355	2NO+2NC	Green Red Black White Yellow Orange Blue	AR22S1R-22G AR22S1R-22R AR22S1R-22B AR22S1R-22W AR22S1R-22Y AR22S1R-22A AR22S1R-22S	(1)	NC	—	—	●	—
				(2)	NC	—	—	●	—
				(3)	NO	—	●	—	●
				(4)	NO	—	●	—	●
	2NO	Green Red Black White Yellow Orange Blue	AR22S2R-20G AR22S2R-20R AR22S2R-20B AR22S2R-20W AR22S2R-20Y AR22S2R-20A AR22S2R-20S	(1)	NO	—	●	—	—
				(2)	NO	—	—	—	●
				(3)					
				(4)					
	2NO+2NC	Green Red Black White Yellow Orange Blue	AR22S2R-22G AR22S2R-22R AR22S2R-22B AR22S2R-22W AR22S2R-22Y AR22S2R-22A AR22S2R-22S	(1)	NC	●	—	■	
				(2)	NC	■		●	—
				(3)	NO	—	●	—	—
				(4)	NO	—	—	—	●
	2NO+2NC	Green Red Black White Yellow Orange Blue	AR22S3R-22G AR22S3R-22R AR22S3R-22B AR22S3R-22W AR22S3R-22Y AR22S3R-22A AR22S3R-22S	(1)	NC	—	—	■	
				(2)	NC	■		—	—
				(3)	NO	—	●	—	—
				(4)	NO	—	—	—	●
	2NO+2NC	Green Red Black White Yellow Orange Blue	AR22S6R-22G AR22S6R-22R AR22S6R-22B AR22S6R-22W AR22S6R-22Y AR22S6R-22A AR22S6R-22S	(1)	NC	●	—	—	Locked
				(2)	NC	●	—	—	
				(3)	NO	—	●	●	
				(4)	NO	—	●	●	

Note: (1) to (4): Contact block mounting position



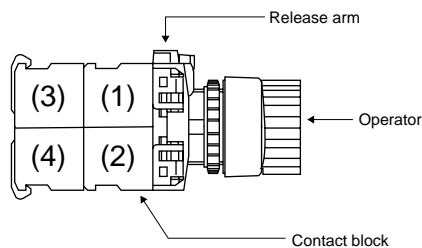

● Contact closed
— Contact open

● Position of contact block





■ Emergency stop pushbutton switches

☞ (Direct opening action), conform to EN418

Operator	Contact	Type
Push-lock, turn-reset (Soft-touch 40mm dia. With white arrow)  <small>KKD08-042</small>	1NC 1NO+1NC 2NC 3NC 2NO+2NC 4NC	AR22V0R-01R AR22V0R-11R AR22V0R-02R AR22V0R-03R AR22V0R-22R AR22V0R-04R
Push-lock, turn-reset (40mm dia.)  <small>KKD05-020b</small>	1NC 1NO+1NC 2NC 3NC 2NO+2NC 4NC	AR22V2R-01R AR22V2R-11R AR22V2R-02R AR22V2R-03R AR22V2R-22R AR22V2R-04R
Push-lock, turn-reset (Soft-touch 29mm dia. with white arrow)  <small>KKD06-346</small>	1NC 1NO+1NC 2NC 3NC 2NO+2NC 4NC	AR22VSR-01R AR22VSR-11R AR22VSR-02R AR22VSR-03R AR22VSR-22R AR22VSR-04R
Push-lock, turn-reset (29mm dia.)  <small>KKD06-339</small>	1NC 1NO+1NC 2NC 3NC 2NO+2NC 4NC	AR22V4R-01R AR22V4R-11R AR22V4R-02R AR22V4R-03R AR22V4R-22R AR22V4R-04R







Notes: • Button color : Red only
 • Contact arrangements indicated in the table can be supplied.

Operator	Contact	Type
Key release push-lock, turn-reset (40mm dia.)  <small>KKD09-020</small>	1NC 1NO+1NC 2NC 3NC 2NO+2NC 4NC	AR22V7R-01R AR22V7R-11R AR22V7R-02R AR22V7R-03R AR22V7R-22R AR22V7R-04R
Push-lock, pull-reset (35mm dia.)  <small>KKD06-334</small>	1NC 1NO+1NC 2NC	AR22Q2R-01R AR22Q2R-11R AR22Q2R-02R
Unibody push-lock, turn-reset (Soft-touch 40mm dia. with white arrow)  <small>KKD05-023b</small>	1NC 1NO+1NC 2NC	AR22VGE-01R AR22VGE-11R AR22VGE-02R

Emergency Stop Illuminated Pushbuttons AR22

Emergency stop illuminated pushbutton switches

☺ (Direct opening action), conform to EN418

Operator	Transformer	Contact	LED lamp Type	Incandescent lamp Type	Neon lamp Type
Push-lock, turn-reset (Soft-touch 40mm dia. with white arrow)  KKD06-335	Without	1NC 1NO+1NC 2NC 3NC	AR22V0L-01■3R AR22V0L-11■3R AR22V0L-02■3R AR22V0L-03■3R	AR22V0L-01■4R AR22V0L-11■4R AR22V0L-02■4R AR22V0L-03■4R	— — — —
	With	1NC 1NO+1NC 2NC	AR22V0L-01■3R AR22V0L-11■3R AR22V0L-02■3R	AR22V0L-01■4R AR22V0L-11■4R AR22V0L-02■4R	— — —
Push-lock, turn-reset (40mm dia.)  KKD06-337	Without	1NC 1NO+1NC 2NC 3NC	AR22V2L-01■3R AR22V2L-11■3R AR22V2L-02■3R AR22V2L-03■3R	AR22V2L-01■4R AR22V2L-11■4R AR22V2L-02■4R AR22V2L-03■4R	— — — —
	With	1NC 1NO+1NC 2NC	AR22V2L-01■3R AR22V2L-11■3R AR22V2L-02■3R	AR22V2L-01■4R AR22V2L-11■4R AR22V2L-02■4R	— — —
Push-lock, turn-reset (Soft-touch 40mm dia. transparent in all colors with white arrow)  KKD06-342	Without	1NC 1NO+1NC 2NC 3NC	AR22VDL-01■3R AR22VDL-11■3R AR22VDL-02■3R AR22VDL-03■3R	AR22VDL-01■4R AR22VDL-11■4R AR22VDL-02■4R AR22VDL-03■4R	— — — —
	With	1NC 1NO+1NC 2NC	AR22VDL-01■3R AR22VDL-11■3R AR22VDL-02■3R	AR22VDL-01■4R AR22VDL-11■4R AR22VDL-02■4R	— — —
Push-lock, turn-reset (40mm dia. transparent in all colors)  KKD06-340	Without	1NC 1NO+1NC 2NC 3NC	AR22VAL-01■3R AR22VAL-11■3R AR22VAL-02■3R AR22VAL-03■3R	AR22VAL-01■4R AR22VAL-11■4R AR22VAL-02■4R AR22VAL-03■4R	— — — —
	With	1NC 1NO+1NC 2NC	AR22VAL-01■3R AR22VAL-11■3R AR22VAL-02■3R	AR22VAL-01■4R AR22VAL-11■4R AR22VAL-02■4R	— — —
Push-lock, turn-reset (Soft-touch 29mm dia. with white arrow)  KKD06-344	Without	1NC 1NO+1NC 2NC 3NC	AR22VSL-01■3R AR22VSL-11■3R AR22VSL-02■3R AR22VSL-03■3R	AR22VSL-01■4R AR22VSL-11■4R AR22VSL-02■4R AR22VSL-03■4R	— — — —
	With	1NC 1NO+1NC 2NC	AR22VSL-01■3R AR22VSL-11■3R AR22VSL-02■3R	AR22VSL-01■4R AR22VSL-11■4R AR22VSL-02■4R	— — —
Unibody push-lock, turn-reset (Soft-touch 40mm dia. with white arrow)  KKD05-150	Without	1NC	AR22VGF-01E3R	—	AR22VGF-01■1R
		1NO+1NC	AR22VGF-11E3R	—	AR22VGF-11■1R
		2NC	AR22VGF-02E3R	—	AR22VGF-02■1R

Notes: • Button color: Red only • AR22VGF type: Lamp circuit contacts are provided, see page 04/43. • Contact arrangements indicated in the table can be supplied.

Voltage

Replace the ■ mark by the lamp voltage code

Transformer	Code	Code		
		LED	Incandescent	Neon
Without	6V DC	6	—	—
	6V AC	A	—	—
	5V AC/DC	—	5	—
	12V AC/DC	B	—	—
	15V AC/DC	C	—	—
	20V AC/DC	—	D	—
	24V AC/DC	E	—	—
	110V AC	—	—	H
	120V AC	—	—	K
	220V AC	—	—	M
	240V AC	—	—	P

Notes: AR22VGF: LED 24V AC/DC and neon only

Transformer	Code	Code	
		LED	Incandescent
With	100-110V AC	H	H
	115-127V AC	L	L
	200-220V AC	M	M
	230-254V AC	Q	Q
	350-380V AC	S	S
	400-440V AC	T	T
	480V AC	V	V
	500-550V AC	W	W

■ Selector switches 2-position

Operator	Operation	Knob color or key removable position	Contact	Type		Contact operation (Example)		
				Switch with round bezel	Switch with square bezel	Contact arrangement	Operator position	
							<div style="display: flex; justify-content: space-around;"> Left Right </div> <div style="display: flex; justify-content: space-around;"> </div>	
Knob <small>AF94-310</small>	Maintained	Color code: B: Black (Standard) Color other than above are available (G: Green) (R: Red)	1NO 1NC 1NO+1NC 2NO 2NC 2NO+2NC	AR22PR-210B AR22PR-201B AR22PR-211B AR22PR-220B AR22PR-202B AR22PR-222B	AR22PY-210B AR22PY-201B AR22PY-211B AR22PY-220B AR22PY-202B AR22PY-222B	1NO (1)	Upper contact 	
	each 90°						1NC (1)	Upper contact
Spring return	 60°						1NO+1NC (1)	Upper contact
								Lower contact
Lever <small>AF94-324</small>	Maintained		1NO 1NC 1NO+1NC 2NO 2NC 2NO+2NC	AR22WR-210B AR22WR-201B AR22WR-211B AR22WR-220B AR22WR-202B AR22WR-222B	AR22WY-210B AR22WY-201B AR22WY-211B AR22WY-220B AR22WY-202B AR22WY-222B	(1)	Upper contact 	
	each 90°					(2)	Lower contact 	
	Spring return	 60°				2NO+2NC (1)	Upper contact 	
						(3)	Lower contact 	
Cylindrical knob <small>AF94-308</small>	Maintained		1NO 1NC 1NO+1NC 2NO 2NC 2NO+2NC	AR22RR-210B AR22RR-201B AR22RR-211B AR22RR-220B AR22RR-202B AR22RR-222B	AR22RY-210B AR22RY-201B AR22RY-211B AR22RY-220B AR22RY-202B AR22RY-222B	(2)	Lower contact 	
	each 90°					(4)	Upper contact 	
	Spring return	 60°					Lower contact 	
							Upper contact 	
Key <small>KKD09-018</small>	Maintained	■: Key removable position (): Key type <i>See page 04/27</i>	1NO 1NC 1NO+1NC 2NO 2NC 2NO+2NC	AR22J□R-2■10() AR22J□R-2■01() AR22J□R-2■11() AR22J□R-2■20() AR22J□R-2■02() AR22J□R-2■22()	AR22JY-2■10() AR22JY-2■01() AR22JY-2■11() AR22JY-2■20() AR22JY-2■02() AR22JY-2■22()			
	each 90°							
	Spring return	 60°						

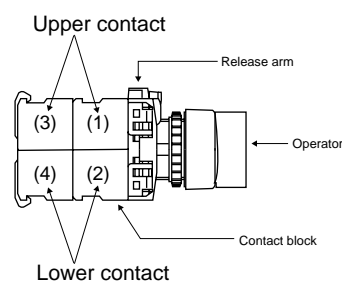

Notes: • (1) to (4): Contact block mounting position
 • ① - ②, ③ - ④: Contact block terminal No.
 • Contact arrangements: See page 04/27



● Contact closed

● **Operator**
 Replace the □ mark by the cylinder key type code
 Standard type: Blank
 Long durability type: A

Selector Switches

AR22

3-position

Operator	Operation	Knob color	Contact	Type Switch with round bezel	Switch with square bezel	Contact operation (Example)			
						Contact arrange- ment	Operation position		
							L	C	R
 AF94-310	Maintained each 45°	Color code: B: Black (Standard) Color other than above are available (G: Green) (R: Red)	1NO+1NC 2NO 2NC 2NO+2NC	AR22PR-311B AR22PR-320B AR22PR-302B AR22PR-322B	AR22PY-311B AR22PY-320B AR22PY-302B AR22PY-322B	(1) (2)	Upper contact ③ ④	Lower contact ① ②	
	Spring/manual return ⤴ each 45°		1NO+1NC 2NO 2NC 2NO+2NC	AR22PR-611B AR22PR-620B AR22PR-602B AR22PR-622B	AR22PY-611B AR22PY-620B AR22PY-602B AR22PY-622B		(1) (2)	Upper contact ③ ④	Lower contact ① ②
	Spring/manual return ⤵ each 45°		1NO+1NC 2NO 2NC 2NO+2NC	AR22PR-711B AR22PR-720B AR22PR-702B AR22PR-722B	AR22PY-711B AR22PY-720B AR22PY-702B AR22PY-722B	(1) (2)		Upper contact ③ ④	Lower contact ① ②
	Spring return ⤴ each 45°		2NO+2NC	AR22PR-122B	AR22PY-122B		(1) (2)	Upper contact ① ②	Lower contact ① ②
 AF94-324	Maintained each 45°		1NO+1NC 2NO 2NC 2NO+2NC	AR22WR-311B AR22WR-320B AR22WR-302B AR22WR-322B	AR22WY-311B AR22WY-320B AR22WY-302B AR22WY-322B	(1) (2)		Upper contact ③ ④	Lower contact ① ②
	Spring/manual return ⤴ each 45°		1NO+1NC 2NO 2NC 2NO+2NC	AR22WR-611B AR22WR-620B AR22WR-602B AR22WR-622B	AR22WY-611B AR22WY-620B AR22WY-602B AR22WY-622B		(1) (2)	Upper contact ③ ④	Lower contact ① ②
	Spring/manual return ⤵ each 45°		1NO+1NC 2NO 2NC 2NO+2NC	AR22WR-711B AR22WR-720B AR22WR-702B AR22WR-722B	AR22WY-711B AR22WY-720B AR22WY-702B AR22WY-722B	(1) (2)		Upper contact ③ ④	Lower contact ① ②
	Spring return ⤴ each 45°		2NO+2NC	AR22WR-122B	AR22WY-122B		(1) (2)	Upper contact ① ②	Lower contact ① ②
 AF94-308	Maintained each 45°		1NO+1NC 2NO 2NC 2NO+2NC	AR22RR-311B AR22RR-320B AR22RR-302B AR22RR-322B	AR22RY-311B AR22RY-320B AR22RY-302B AR22RY-322B	(1) (2)		Upper contact ③ ④	Lower contact ① ②
	Spring/manual return ⤴ each 45°		1NO+1NC 2NO 2NC 2NO+2NC	AR22RR-611B AR22RR-620B AR22RR-602B AR22RR-622B	AR22RY-611B AR22RY-620B AR22RY-602B AR22RY-622B		(1) (2)	Upper contact ③ ④	Lower contact ① ②
	Spring/manual return ⤵ each 45°		1NO+1NC 2NO 2NC 2NO+2NC	AR22RR-711B AR22RR-720B AR22RR-702B AR22RR-722B	AR22RY-711B AR22RY-720B AR22RY-702B AR22RY-722B	(1) (2)		Upper contact ③ ④	Lower contact ① ②
	Spring return ⤴ each 45°		2NO+2NC	AR22RR-122B	AR22RY-122B		(1) (2)	Upper contact ① ②	Lower contact ① ②
						(3) (4)		③ ④	③ ④

Operator	Operation	Key removable position	Contact	Type Switch with round bezel	Switch with square bezel	Contact operation (Example)			
						Contact arrangement	Operator position		
							L	C	R
 KKD09-018	Maintained each 45°	■: Key removable position (): Key type	1NO+1NC 2NO 2NC 2NO+2NC	AR22J□R-3■11() AR22J□R-3■20() AR22J□R-3■02() AR22J□R-3■22()	AR22JY-3■11() AR22JY-3■20() AR22JY-3■02() AR22JY-3■22()	1NO+1NC (1) (2)	Upper contact ③	Lower contact ①	
	Spring/manual return ① each 45°		1NO+1NC 2NO 2NC 2NO+2NC	AR22J□R-6■11() AR22J□R-6■20() AR22J□R-6■02() AR22J□R-6■22()	AR22JY-6■11() AR22JY-6■20() AR22JY-6■02() AR22JY-6■22()	(1) (2)	Upper contact ③	Lower contact ①	
	Spring/manual return ① each 45°		1NO+1NC 2NO 2NC 2NO+2NC	AR22J□R-7■11() AR22J□R-7■20() AR22J□R-7■02() AR22J□R-7■22()	AR22JY-7■11() AR22JY-7■20() AR22JY-7■02() AR22JY-7■22()	(1) (2)	Upper contact ③	Lower contact ①	
	Spring return ① each 45°		2NO+2NC	AR22J□R-1E22()	AR22JY-1E22()	2NO+2NC (1) (2) (3) (4)	Upper contact ①	Lower contact ①	

Notes: • Operator position L:Left, C:Center, R:Right
 • (1) to (4): Contact block mounting position
 • ① – ②, ③ – ④: Contact block terminal No.

● Contact closed

• Contact arrangements

Contact arrangements other than above are available







Contact arrangement	1NO	1NC	1NO+1NC	2NO	2NC	3NO	3NC
Code	10	01	11	20	02	30	03

Contact arrangement	2NO+2NC	4NO	4NC	5NO	5NC	3NO+3NC
Code	22	40	04	50	05	33

• Available numbers of contact blocks

Maintained	Spring return Spring/manual return
6-contact block	4-contact block

• Key removable positions

Code	A	B	C	D	E	F	G
Removable position							
AR22J□R-2	●	●	—	●	—	—	—
AR22J□R-0	●	—	—	—	—	—	—
AR22J□R-3	●	●	●	●	●	●	●
AR22J□R-6	—	—	—	●	●	●	—
AR22J□R-7	●	—	—	—	●	—	●
AR22J□R-1	—	—	—	—	●	—	—

●: Available —: Not available

• Position of contact block

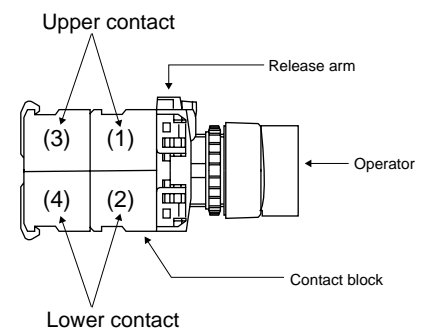

• Key code No.

Replace the () mark with one of the following key code.
 A, B, C, D, E and F
 Standard key code is A.

















• Operator

Replace the □ mark by the cylinder key type code
 Standard type: Blank
 Long durability type: A







Selector Switches AR22

■ Selector switches (control type)

3-position

Operator	Operation	Knob color or key removable position	Contact arrangement	Type	
				Switch with round bezel	Switch with square bezel
Knob  <small>AF94-435</small>	Maintained each 45°	Color code: B: Black (Standard) Color other than above are available (G: Green) (R: Red)	Replace the ■ mark by the contact arrangement code (shown on next page).	AR22PCR-3■B	AR22PCY-3■B
	Spring/manual return  each 45°			AR22PCR-6■B	AR22PCY-6■B
	Spring/manual return  each 45°			AR22PCR-7■B	AR22PCY-7■B
	Spring return  each 45°			AR22PCR-1■B	AR22PCY-1■B
Lever  <small>AF94-436</small>	Maintained each 45°		Replace the ■ mark by the contact arrangement code (shown on next page).	AR22WCR-3■B	AR22WCY-3■B
	Spring/manual return  each 45°			AR22WCR-6■B	AR22WCY-6■B
	Spring/manual return  each 45°			AR22WCR-7■B	AR22WCY-7■B
	Spring return  each 45°			AR22WCR-1■B	AR22WCY-1■B
Cylindrical knob  <small>AF94-433</small>	Maintained each 45°		Replace the ■ mark by the contact arrangement code (shown on next page).	AR22RCR-3■B	AR22RCY-3■B
	Spring/manual return  each 45°			AR22RCR-6■B	AR22RCY-6■B
	Spring/manual return  each 45°			AR22RCR-7■B	AR22RCY-7■B
	Spring return  each 45°			AR22RCR-1■B	AR22RCY-1■B
Key  <small>KKD09-016</small>	Maintained each 45°	Replace the □ mark by the key removable position code: A, B, C, D, E, F or G	Replace the ■ mark by the contact arrangement code (shown on next page).	AR22JCR-3□()	AR22JCY-3□()
	Spring/manual return  each 45°			AR22JCR-6□()	AR22JCY-6□()
	Spring/manual return  each 45°			AR22JCR-7□()	AR22JCY-7□()
	Spring return  each 45°			AR22JCR-1E■()	AR22JCY-1E■()

● Key removable positions

Code	A	B	C	D	E	F	G
Removable position							
AR22JCR-3	●	●	●	●	●	●	●
AR22JCR-6	-	-	-	●	●	●	-
AR22JCR-7	●	-	-	-	●	-	●
AR22JCR-1	-	-	-	-	●	-	-

●: Available -: Not available

● Key code No.

Replace the () mark with one of the following key code.
 A, B, C, D, E and F
 Standard key code is A.

• Contact arrangement code (Typical example)

Contact arrangement	Contact arrangement code	Contact operation				
		Contact block		Operator position		
		Mounting position	Type	Left	Center	Right
2NC	01F	(1)	NC	[Diagram: Solid bar in Center position]		
		(2)	NC	[Diagram: Solid bar in Right position]		
		-	-	-	-	-
		-	-	-	-	-
2NO+2NC	014	(1)	NC	[Diagram: Solid bar in Center position]		
		(2)	NC	[Diagram: Solid bar in Right position]		
		(3)	NO			●
		(4)	NO	●		
4NC	01J	(1)	NC	[Diagram: Solid bar in Center position]		
		(2)	NC	[Diagram: Solid bar in Right position]		
		(3)	NC	[Diagram: Solid bar in Left position]		
		(4)	NC	[Diagram: Solid bar in Right position]		
2NO+2NC	024	(1)	NC	[Diagram: Solid bar in Center position]		
		(2)	NC		●	
		(3)	NO			●
		(4)	NO	●		●
2NO+2NC	03C* (Maintained only)	(1)	NC	[Diagram: Solid bar in Center position]		
		(2)	NC			●
		(3)	NO			●
		(4)	NO	●		
2NO+2NC	044*	(1)	NC	[Diagram: Solid bar in Center position]		
		(2)	NC		●	
		(3)	NO			●
		(4)	NO	●		
2NO+2NC	054	(1)	NC	[Diagram: Solid bar in Center position]		
		(2)	NC		●	
		(3)	NO			●
		(4)	NO			●

Notes: ●: Contact closed Blank: Contact open

* There may be some overlap in the contact when switching between notches.

• Position of contact block

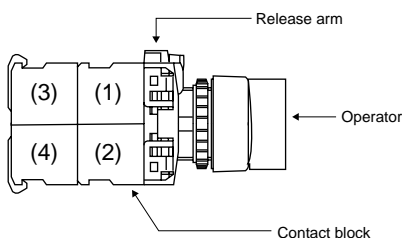

Contact arrangement	Contact arrangement code	Contact operation				
		Contact block		Operator position		
		Mounting position	Type	Left	Center	Right
2NO+2NC	064	(1)	NC		[Diagram: Solid bar in Center position]	
		(2)	NC		●	
		(3)	NO	●		
		(4)	NO	●		●
1NO+1NC	07F	(1)	NC		[Diagram: Solid bar in Center position]	
		(2)	NO			●
		-	-	-	-	-
		-	-	-	-	-
2NO+2NC	07C* (Maintained only)	(1)	NC		[Diagram: Solid bar in Center position]	
		(2)	NC			●
		(3)	NO	●		
		(4)	NO	●		
2NO+2NC	084	(1)	NC		[Diagram: Solid bar in Center position]	
		(2)	NC		●	
		(3)	NO	●		
		(4)	NO	●		
2NO+2NC	094*	(1)	NC		[Diagram: Solid bar in Center position]	
		(2)	NC		●	
		(3)	NO	●		
		(4)	NO			●
2NO+2NC	104	(1)	NC		●	
		(2)	NC		●	
		(3)	NO	●		●
		(4)	NO	●		●
2NO+2NC	11C* (Maintained only)	(1)	NC		●	
		(2)	NC			●
		(3)	NO	●		●
		(4)	NO	●		

04

Selector Switches AR22

• Contact arrangement code (Typical example)

Contact arrangement	Contact arrangement code	Contact operation				
		Contact block		Operator position		
		Mounting position	Type	Left	Center	Right
2NO+2NC	124*	(1)	NC		●	
		(2)	NC		●	
		(3)	NO	●		●
		(4)	NO	●		
2NO+2NC	134*	(1)	NC		●	
		(2)	NC		●	
		(3)	NO	●		●
		(4)	NO			●
3NO+1NC	14D* (Maintained only)	(1)	NO	●		
		(2)	NC		●	
		(3)	NO	●		
		(4)	NO			●
3NO+1NC	15A*	(1)	NO			●
		(2)	NC		●	
		(3)	NO			●
		(4)	NO	●		
2NO+2NC	164	(1)	NC		●	
		(2)	NC		●	
		(3)	NO	●		
		(4)	NO	●		
2NO+2NC	174*	(1)	NC		●	
		(2)	NC		●	
		(3)	NO	●		
		(4)	NO			●
2NO+2NC	184	(1)	NC		●	
		(2)	NC		●	
		(3)	NO			●
		(4)	NO			●

Notes: ●: Contact closed Blank: Contact open

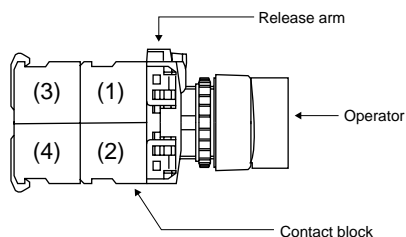

* There may be some overlap in the contact when switching between notches.

• Position of contact block



Contact arrangement	Contact arrangement code	Contact operation				
		Contact block		Operator position		
		Mounting position	Type	Left	Center	Right
2NO+2NC	194	(1)	NC		●	
		(2)	NC	●		
		(3)	NO	●		
		(4)	NO			●
4NO	20B	(1)	NO			●
		(2)	NO	●		
		(3)	NO			●
		(4)	NO	●		

4, 5-position

Operator	Contact (The following contact is only available.)	Operation	Knob color	Contact arrangement	Type	
					Switch with round bezel	Switch with square bezel
Knob  AF94-435	2NO+2NC	4-position maintained	Color code: B: Black (Standard) Color other than above are available (G: Green) (R: Red)	Replace the ■ mark by the contact arrangement code (shown below)	AR22PCR-4■B	AR22PCY-4■B
		5-position maintained			AR22PCR-5■B	AR22PCY-5■B
Lever  AF94-436	2NO+2NC	4-position maintained			AR22WCR-4■B	AR22WCY-4■B
		5-position maintained			AR22WCR-5■B	AR22WCY-5■B
Cylindrical knob  AF94-433	2NO+2NC	4-position maintained			AR22RCR-4■B	AR22RCY-4■B
		5-position maintained			AR22RCR-5■B	AR22RCY-5■B

04

● Contact arrangement code

Position	Contact arrangement	Contact arrangement code	Contact operation		Operator position				
			Contact block						
			Mounting position	Type	1	2	3	4	5
4-position	2NO+2NC	41C* (Maintained only)	(1)	NC			●		
			(2)	NC	●				
			(3)	NO		●			
			(4)	NO				●	
5-position	2NO+2NC	51C* (Maintained only)	(1)	NC				●	
			(2)	NC		●			
			(3)	NO	●				
			(4)	NO					●

● Position of contact block

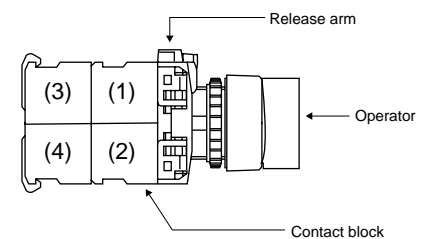

Operator position
4-position 5-position

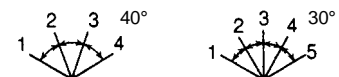





Notes: ●: Contact closed
* There may be some overlap in the contact when switching between notches.

Illuminated Selector Switches





AR22

■ Illuminated selector switches

2-position

Operator	Operation	Contact	LED lamp		Incandescent lamp		
			Transformer	Type	Transformer	Type	
Knob  <small>AF94-306</small>	Maintained	1NO 1NC 1NO+1NC 2NO+2NC	Without	AR22PL-210■□ AR22PL-201■□ AR22PL-211■□ AR22PL-222■□	Without	AR22PL-210■□ AR22PL-201■□ AR22PL-211■□ AR22PL-222■□	
			With	AR22PL-210■□ AR22PL-201■□ AR22PL-211■□ AR22PL-220■□	With	AR22PL-210■□ AR22PL-201■□ AR22PL-211■□ AR22PL-220■□	
	Spring return  60°	1NO 1NC 1NO+1NC 2NO	Without	AR22PL-010■□ AR22PL-001■□ AR22PL-011■□ AR22PL-020■□	Without	AR22PL-010■□ AR22PL-001■□ AR22PL-011■□ AR22PL-020■□	
			With	AR22PL-010■□ AR22PL-001■□ AR22PL-011■□ AR22PL-020■□	With	AR22PL-010■□ AR22PL-001■□ AR22PL-011■□ AR22PL-020■□	
	Knob with square bezel  <small>AF94-360</small>	Maintained	1NO 1NC 1NO+1NC 2NO+2NC	Without	AR22PP-210■□ AR22PP-201■□ AR22PP-211■□ AR22PP-222■□	Without	AR22PP-210■□ AR22PP-201■□ AR22PP-211■□ AR22PP-222■□
				With	AR22PP-210■□ AR22PP-201■□ AR22PP-211■□ AR22PP-220■□	With	AR22PP-210■□ AR22PP-201■□ AR22PP-211■□ AR22PP-220■□
Spring return  60°		1NO 1NC 1NO+1NC 2NO	Without	AR22PP-010■□ AR22PP-001■□ AR22PP-011■□ AR22PP-020■□	Without	AR22PP-010■□ AR22PP-001■□ AR22PP-011■□ AR22PP-020■□	
			With	AR22PP-010■□ AR22PP-001■□ AR22PP-011■□ AR22PP-020■□	With	AR22PP-010■□ AR22PP-001■□ AR22PP-011■□ AR22PP-020■□	

3-position

Operator	Operation	Contact	LED lamp		Incandescent lamp	
			Transformer	Type	Transformer	Type
Knob  <small>AF94-306</small>	Maintained	1NO+1NC 2NO+2NC	Without	AR22PL-311■□ AR22PL-322■□	Without	AR22PL-311■□ AR22PL-322■□
			With	AR22PL-311■□		AR22PL-311■□
	Spring/manual return  each 45°	1NO+1NC 1NO+1NC	Without	AR22PL-611■□ AR22PL-611■□	Without	AR22PL-611■□ AR22PL-611■□
			With	AR22PL-711■□ AR22PL-711■□	Without	AR22PL-711■□ AR22PL-711■□
Knob with square bezel  <small>AF94-360</small>	Maintained	1NO+1NC 2NO+2NC	Without	AR22PP-311■□ AR22PP-322■□	Without	AR22PP-311■□ AR22PP-322■□
			With	AR22PP-311■□		AR22PP-311■□
	Spring/manual return  each 45°	1NO+1NC 1NO+1NC	Without	AR22PP-611■□ AR22PP-611■□	Without	AR22PP-611■□ AR22PP-611■□
			With	AR22PP-711■□ AR22PP-711■□	Without	AR22PP-711■□ AR22PP-711■□

Note: □, ■ See page 04/33

- Replace the ■ mark by the following lamp voltage code

Transformer	Voltage	Code	
		LED	Incandescent
Without	5V AC/DC	—	5
	6V DC	6	—
	6V AC	A	—
	12V AC/DC	B	—
	15V AC/DC	C	C
	20V AC/DC	—	D
	24V AC/DC	E	E
With	100-110V AC	H	H
	115-127V AC	L	L
	200-220V AC	M	M
	230-254V AC	Q	Q
	350-380V AC	S	S
	400-440V AC	T	T
	480V AC	V	V
	500-550V AC	W	W

- Replace the □ mark by the following knob color code

Color	Green	Red	White	Blue	Yellow	Orange
Code	G	R	W	S	Y	A

- Up to 4-contact of contact arrangement can be made.
Available numbers of contacts are as follow.

No. of position	Operation	Without transformer	With transformer
2-position	Maintained	4-contact	3-contact
	Spring return	3-contact	2-contact
3-position	Maintained	4-contact	3-contact
	Spring/manual return	3-contact	2-contact

- Contact arrangement and operator position

2-position

Transformer	Contact arrangement	Contact block		Operator position	
		Mounting position	Type	Left	Right
With/without	1NO	(1)	NO	—	●
With/without	1NC	(1)	NC	●	—
Without	1NO+1NC	(1)	NO	—	●
		(2)	NC	●	—
With	1NO+1NC	(1)	NC	●	—
		(2)	NO	—	●
With/without	2NO	(1)	NO	—	●
		(2)	NO	—	●
Without	2NO+2NC *1	(1)	NO	—	●
		(2)	NC	●	—
		(3)	NO	—	●
		(4)	NC	●	—

Notes: *1: AR22PL-2, AR22PP-2

●: Contact closed, —: Contact open

3-position

Transformer	Contact arrangement	Contact block		Operator position		
		Mounting position	Type	Left	Center	Right
Without	1NO+1NC *1	(1)	NO	●	—	—
		(2)	NC	—	—	●
	1NO+1NC *2	(1)	NO	—	—	●
		(2)	NC	●	—	—
	2NO+2NC *3	(1)	NO	●	—	—
		(2)	NC	—	—	●
(3)	NO	●	—	—	—	
(4)	NC	—	—	—	●	
With	1NO+1NC *1	(1)	NC	—	—	●
		(2)	NO	●	—	—
	1NO+1NC *2	(1)	NC	●	—	—
		(2)	NO	—	—	●

Notes: *1: AR22PL-3, 6 AR22PP-3, 6

*3: AR22PL-3 AR22PP-3

*2: AR22PL-7, AR22PP-7

●: Contact closed, —: Contact open

- Position of contact block

Without transformer

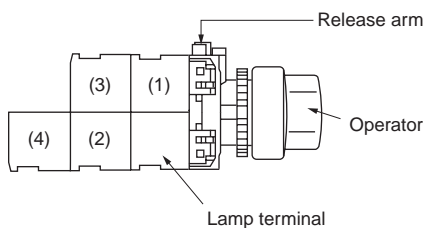

With transformer

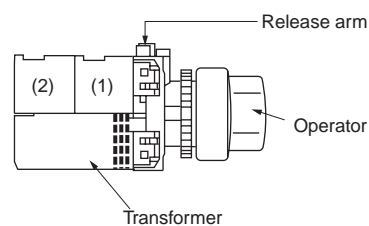

Pilot Lights DR22

■ Pilot lights/standard

Lens	Transformer	LED lamp Lamp voltage	Type	Incandescent lamp Lamp voltage	Type
Dome  <small>AF94-333</small>	Without	6V AC 6V DC 12V AC/DC 24V AC/DC	DR22D0L-A3□ DR22D0L-63□ DR22D0L-B3□ DR22D0L-E3□	5.5V AC/DC — 15V AC/DC 24V AC/DC	DR22D0L-54□ — DR22D0L-C4□ DR22D0L-E4□
	With	100–110V AC 200–220V AC	DR22D0L-H3□ DR22D0L-M3□	100–110V AC 200–220V AC	DR22D0L-H4□ DR22D0L-M4□
Extended round  <small>AF94-332</small>	Without	6V AC 6V DC 12V AC/DC 24V AC/DC	DR22E3L-A3□ DR22E3L-63□ DR22E3L-B3□ DR22E3L-E3□	5.5V AC/DC — 15V AC/DC 24V AC/DC	DR22E3L-54□ — DR22E3L-C4□ DR22E3L-E4□
	With	100–110V AC 200–220V AC	DR22E3L-H3□ DR22E3L-M3□	100–110V AC 200–220V AC	DR22E3L-H4□ DR22E3L-M4□
Faceted  <small>AF96-189</small>	Without	6V AC 6V DC 12V AC/DC 24V AC/DC	DR22K0L-A3□ DR22K0L-63□ DR22K0L-B3□ DR22K0L-E3□	5.5V AC/DC — 15V AC/DC 24V AC/DC	DR22K0L-54□ — DR22K0L-C4□ DR22K0L-E4□
	With	100–110V AC 200–220V AC	DR22K0L-H3□ DR22K0L-M3□	100–110V AC 200–220V AC	DR22K0L-H4□ DR22K0L-M4□
Flush square  <small>AF94-330</small>	Without	6V AC 6V DC 12V AC/DC 24V AC/DC	DR22F3M-A3□ DR22F3M-63□ DR22F3M-B3□ DR22F3M-E3□	5.5V AC/DC — 15V AC/DC 24V AC/DC	DR22F3M-54□ — DR22F3M-C4□ DR22F3M-E4□
	With	100–110V AC 200–220V AC	DR22F3M-H3□ DR22F3M-M3□	100–110V AC 200–220V AC	DR22F3M-H4□ DR22F3M-M4□
Flush square (Transparent lens)  <small>AF94-443</small>	Without	6V AC 6V DC 12V AC/DC 24V AC/DC	DR22F4M-A3□ DR22F4M-63□ DR22F4M-B3□ DR22F4M-E3□	5.5V AC/DC — 15V AC/DC 24V AC/DC	DR22F4M-54□ — DR22F4M-C4□ DR22F4M-E4□
	With	100–110V AC 200–220V AC	DR22F4M-H3□ DR22F4M-M3□	100–110V AC 200–220V AC	DR22F4M-H4□ DR22F4M-M4□
Flush square (12mm high frame)  <small>AF94-380</small>	Without	6V AC 6V DC 12V AC/DC 24V AC/DC	DR22F5M-A3□ DR22F5M-63□ DR22F5M-B3□ DR22F5M-E3□	5.5V AC/DC — 15V AC/DC 24V AC/DC	DR22F5M-54□ — DR22F5M-C4□ DR22F5M-E4□
	With	100–110V AC 200–220V AC	DR22F5M-H3□ DR22F5M-E3□	100–110V AC 200–220V AC	DR22F5M-H4□ DR22F5M-M4□
Extended square  <small>AF95-685</small> <small>AF94-380</small>	Without	6V AC 6V DC 12V AC/DC 24V AC/DC	DR22E3M-A3□ DR22E3M-63□ DR22E3M-B3□ DR22E3M-E3□	5.5V AC/DC — 15V AC/DC 24V AC/DC	DR22E3M-54□ — DR22E3M-C4□ DR22E3M-E4□
	With	100–110V AC 200–220V AC	DR22E3M-H3□ DR22E3M-M3□	100–110V AC 200–220V AC	DR22E3M-H4□ DR22E3M-M4□
Flush rectangular  <small>AF96-237</small>	Without	6V AC 6V DC 12V AC/DC 24V AC/DC	DR22E3N-A3□ DR22E3N-63□ DR22E3N-B3□ DR22E3N-E3□	5.5V AC/DC — 15V AC/DC 24V AC/DC	DR22E3N-54□ — DR22E3N-C4□ DR22E3N-E4□
	With	100–110V AC 200–220V AC	DR22E3N-H3□ DR22E3N-M3□	100–110V AC 200–220V AC	DR22E3N-H4□ DR22E3N-M4□
Extended round with square bezel  <small>AF94-331</small>	Without	6V AC 6V DC 12V AC/DC 24V AC/DC	DR22E3P-A3□ DR22E3P-63□ DR22E3P-B3□ DR22E3P-E3□	5.5V AC/DC — 15V AC/DC 24V AC/DC	DR22E3P-54□ — DR22E3P-C4□ DR22E3P-E4□
	With	100–110V AC 200–220V AC	DR22E3P-H3□ DR22E3P-M3□	100–110V AC 200–220V AC	DR22E3P-H4□ DR22E3P-M4□

Note: □ See page 04/37

■ Pilot lights/short-body without transformer

Lens	LED lamp		Incandescent lamp	
	Lamp voltage	Type	Lamp voltage	Type
 AF98-88	5.5V AC/DC	—	5.5V AC/DC	DR22D0L-58□
	6V AC	DR22D0L-A9□	6V AC	—
	6V DC	DR22D0L-69□	6V DC	—
	12V AC/DC	DR22D0L-B9□	15V AC/DC	DR22D0L-C8□
	24V AC/DC	DR22D0L-E9□	24V AC/DC	DR22D0L-E8□
 AF98-90	5.5V AC/DC	—	5.5V AC/DC	DR22E3L-58□
	6V AC	DR22E3L-A9□	6V AC	—
	6V DC	DR22E3L-69□	6V DC	—
	12V AC/DC	DR22E3L-B9□	15V AC/DC	DR22E3L-C8□
	24V AC/DC	DR22E3L-E9□	24V AC/DC	DR22E3L-E8□
 AF98-89	5.5V AC/DC	—	5.5V AC/DC	DR22K0L-58□
	6V AC	DR22K0L-A9□	6V AC	—
	6V DC	DR22K0L-69□	6V DC	—
	12V AC/DC	DR22K0L-B9□	15V AC/DC	DR22K0L-C8□
	24V AC/DC	DR22K0L-E9□	24V AC/DC	DR22K0L-E8□
 AF98-92	5.5V AC/DC	—	5.5V AC/DC	DR22F3M-58□
	6V AC	DR22F3M-A9□	6V AC	—
	6V DC	DR22F3M-69□	6V DC	—
	12V AC/DC	DR22F3M-B9□	15V AC/DC	DR22F3M-C8□
	24V AC/DC	DR22F3M-E9□	24V AC/DC	DR22F3M-E8□
 AF98-92	5.5V AC/DC	—	5.5V AC/DC	DR22F4M-58□
	6V AC	DR22F4M-A9□	6V AC	—
	6V DC	DR22F4M-69□	6V DC	—
	12V AC/DC	DR22F4M-B9□	15V AC/DC	DR22F4M-C8□
	24V AC/DC	DR22F4M-E9□	24V AC/DC	DR22F4M-E8□
 AF98-94	5.5V AC/DC	—	5.5V AC/DC	DR22F5M-58□
	6V AC	DR22F5M-A9□	6V AC	—
	6V DC	DR22F5M-69□	6V DC	—
	12V AC/DC	DR22F5M-B9□	15V AC/DC	DR22F5M-C8□
	24V AC/DC	DR22F5M-E9□	24V AC/DC	DR22F5M-E8□
 AF98-93	5.5V AC/DC	—	5.5V AC/DC	DR22E3M-58□
	6V AC	DR22E3M-A9□	6V AC	—
	6V DC	DR22E3M-69□	6V DC	—
	12V AC/DC	DR22E3M-B9□	15V AC/DC	DR22E3M-C8□
	24V AC/DC	DR22E3M-E9□	24V AC/DC	DR22E3M-E8□
 KK02-234B	5.5V AC/DC	—	5.5V AC/DC	DR22E3N-58□
	6V AC	DR22E3N-A9□	6V AC	—
	6V DC	DR22E3N-69□	6V DC	—
	12V AC/DC	DR22E3N-B9□	15V AC/DC	DR22E3N-C8□
	24V AC/DC	DR22E3N-E9□	24V AC/DC	DR22E3N-E8□
 AF98-91	5.5V AC/DC	—	5.5V AC/DC	DR22E3P-58□
	6V AC	DR22E3P-A9□	6V AC	—
	6V DC	DR22E3P-69□	6V DC	—
	12V AC/DC	DR22E3P-B9□	15V AC/DC	DR22E3P-C8□
	24V AC/DC	DR22E3P-E9□	24V AC/DC	DR22E3P-E8□

Note: □ See page 04/37

Pilot Lights DR22

■ Pilot lights/short-body with transformer

Lens	LED lamp		Incandescent lamp	
	Lamp voltage	Type	Lamp voltage	Type
Dome  <small>AF97-137</small>	100–110V AC	DR22D0L-H9 □	100–110V AC	DR22D0L-H8 □
	200–220V AC	DR22D0L-M9 □	200–220V AC	DR22D0L-M8 □
Extended round  <small>AF97-138</small>	100–110V AC	DR22E3L-H9 □	100–110V AC	DR22E3L-H8 □
	200–220V AC	DR22E3L-M9 □	200–220V AC	DR22E3L-M8 □
Faceted  <small>KK02-130A</small>	100–110V AC	DR22K0L-H9 □	100–110V AC	DR22K0L-H8 □
	200–220V AC	DR22K0L-M9 □	200–220V AC	DR22K0L-M8 □
Flush square  <small>AF97-134</small>	100–110V AC	DR22F3M-H9 □	100–110V AC	DR22F3M-H8 □
	200–220V AC	DR22F3M-M9 □	200–220V AC	DR22F3M-M8 □
Flush square (Transparent lens)  <small>AF97-133</small>	100–110V AC	DR22F4M-H9 □	100–110V AC	DR22F4M-H8 □
	200–220V AC	DR22F4M-M9 □	200–220V AC	DR22F4M-M8 □
Flush square (12mm high frame)  <small>AF97-136</small>	100–110V AC	DR22F5M-H9 □	100–110V AC	DR22F5M-H8 □
	200–220V AC	DR22F5M-M9 □	200–220V AC	DR22F5M-M8 □
Extended square  <small>KK02-134A</small>	100–110V AC	DR22E3M-H9 □	100–110V AC	DR22E3M-H8 □
	200–220V AC	DR22E3M-M9 □	200–220V AC	DR22E3M-M8 □
Flush rectangular  <small>KK02-235B</small>	100–110V AC	DR22E3N-H9 □	100–110V AC	DR22E3N-H8 □
	200–220V AC	DR22E3N-M9 □	200–220V AC	DR22E3N-M8 □
Extended round with square bezel  <small>AF97-135</small>	100–110V AC	DR22E3P-H9 □	100–110V AC	DR22E3P-H8 □
	200–220V AC	DR22E3P-M9 □	200–220V AC	DR22E3P-M8 □

Note: □ See page 04/37

• **Lens color**

Replace the □ mark by the following lens color code

Color	Green	Red	White	Blue	Yellow	Orange
Code	G	R	W	S	Y	A

• **Lamp voltage**



Available lamp voltage are as follow.

Description	Voltage	Code		Short-body type	
		Standard type LED	Incandescent	LED	Incandescent
Without transformer	5.5V AC/DC	–	54	–	58
	6V AC	A3	–	A9	–
	6V DC	63	–	69	–
	12V AC/DC	B3	–	B9	–
	15V AC/DC	C3	C4	C9	C8
	20V AC/DC	–	D4	–	D8
	24V AC/DC	E3	E4	E9	E8
With transformer	100-110V AC	H3	H4	H9	H8
	115-127V AC	L3	L4	L9	L8
	200-220V AC	M3	M4	M9	M8
	230-254V AC	Q3	Q4	–	–
	350-380V AC	S3	S4	–	–
	400-440V AC	T3	T4	–	–
	480V AC	V3	V4	–	–
	500-550V AC	W3	W4	–	–
With resistor unit	110V DC	H7	–	–	–

Joy Stick Selector Switches

AR22

■ Joy stick selector switches

Handle	Terminal	Operating directions	Contact arrangement	Type	
				Manual return	Spring return
Ball type without lock  <small>AF97-49</small>	Screw	↑ ↓	1NO × 2	AR22A0N-A0A0B	AR22A5N-A0A0B
			1NO + 1NC × 2	AR22A0N-1010B	AR22A5N-1010B
		↔	1NO × 4	AR22A0N-AAAAB	AR22A5N-AAAAB
			1NO + 1NC × 4	AR22A0N-1111B	AR22A5N-1111B
	Solder/tab	↑ ↓	1NO + 1NC × 2	AR22A0H-1010B	AR22A5H-1010B
			2NO + 2NC × 2	AR22A0H-2020B	AR22A5H-2020B
↔	↑ ↓	1NO + 1NC × 4	AR22A0H-1111B	AR22A5H-1111B	
		2NO + 2NC × 4	AR22A0H-2222B	AR22A5H-2222B	
Ball type with lock  <small>AF97-45</small>	Screw	↑ ↓	1NO × 2	AR22A1N-A0A0B	AR22A6N-A0A0B
			1NO + 1NC × 2	AR22A1N-1010B	AR22A6N-1010B
		↔	1NO × 4	AR22A1N-AAAAB	AR22A6N-AAAAB
			1NO + 1NC × 4	AR22A1N-1111B	AR22A6N-1111B
	Solder/tab	↑ ↓	1NO + 1NC × 2	AR22A1H-1010B	AR22A6H-1010B
			2NO + 2NC × 2	AR22A1H-2020B	AR22A6H-2020B
↔	↑ ↓	1NO + 1NC × 4	AR22A1H-1111B	AR22A6H-1111B	
		2NO + 2NC × 4	AR22A1H-2222B	AR22A6H-2222B	
Rubber cap type without lock  <small>AF97-56</small>	Screw	↑ ↓	1NO × 2	AR22A2N-A0A0B	AR22A7N-A0A0B
			1NO + 1NC × 2	AR22A2N-1010B	AR22A7N-1010B
		↔	1NO × 4	AR22A2N-AAAAB	AR22A7N-AAAAB
			1NO + 1NC × 4	AR22A2N-1111B	AR22A7N-1111B
	Solder/tab	↑ ↓	1NO + 1NC × 2	AR22A2H-1010B	AR22A7H-1010B
			2NO + 2NC × 2	AR22A2H-2020B	AR22A7H-2020B
↔	↑ ↓	1NO + 1NC × 4	AR22A2H-1111B	AR22A7H-1111B	
		2NO + 2NC × 4	AR22A2H-2222B	AR22A7H-2222B	

● Operating direction

- Directions other than those shown in the table above can be provided.
- For types AR22A□N-**1** **2** **3** **4** B, designate the contact arrangement codes for the necessary operating directions (**1**: Upper, **2**: Right, **3**: Lower, **4**: Left). Designate "0" for unnecessary directions.

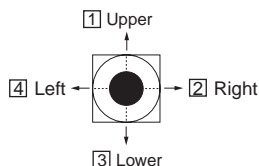



● Contact arrangement

Contact arrangement		–	1NO	1NC	1NO+1NC	2NO	2NC	2NO+2NC
Manual return Spring return	Screw	0	A	B	1	D	E	–
	Solder/Tab	0	–	–	1	–	–	2

- Spring/manual return are also available, contact FUJI.

■ Buzzers

Sound	Description	Transformer	Operating voltage	Type
 KKD08-053	<ul style="list-style-type: none"> • LED operation indicator (Red) • Intermittent/continuous sound selection • Sound level: 90dB (0.1m) 70dB (1m) 	Without	6V AC Discontinued 6V DC 12 to 24V AC/DC 35 to 48V AC/DC Discontinued	DR22B5-AB DR22B5-6B DR22B5-EB DR22B5-FB
		With	100 to 110V AC 200 to 220V AC	DR22B5-HB DR22B5-MB
		With resistor unit	100 to 110V DC Discontinued	DR22B5-1B
 AF96-376	<ul style="list-style-type: none"> • Sound volume adjustment • Sound level: 80 to 90dB (0.1m) 60 to 70dB (1m) 	Without	24V AC/DC	DR22B3-EB
		With	100 to 110V AC 200 to 220V AC	DR22B3-HB DR22B3-MB
 AF96-244	<ul style="list-style-type: none"> • Intermittent/continuous sound selection • Sound level: 80dB (0.1m) 60dB (1m) 	Without	6V AC Discontinued 6V DC 12 to 24V AC/DC 35 to 48V AC/DC Discontinued	DR22B8-AB DR22B8-6B DR22B8-EB DR22B8-FB
		With	100 to 110V AC 200 to 220V AC	DR22B8-HB DR22B8-MB
		With resistor unit	100 to 110V DC Discontinued	DR22B8-1B

- Notes:
- Intermittent/continuous sound selection (DR22B5, B8)
See the "Short-circuit terminal" in the dimensions diagram on the 04/49 page, and select as follows:
 - Short-circuit terminal mounted → Intermittent sound
 - Short-circuit terminal not mounted → Continuous sound

- Sound volume adjustment (DR22B3)
Use a flat-bladed screwdriver with a narrow tip to gently turn "Control knob" shown in the dimensions diagram on the 04/49 page, as follows.
- Clockwise → Increase sound pressure
- Counterclockwise → Decrease sound pressure

04

Pushbuttons/Selectors/Pilot Lights/Buzzers

AR22 and DR22

Dimensions

- Dimensions, mm
- Illuminated pushbutton switches

Flush/Extended

With transformer

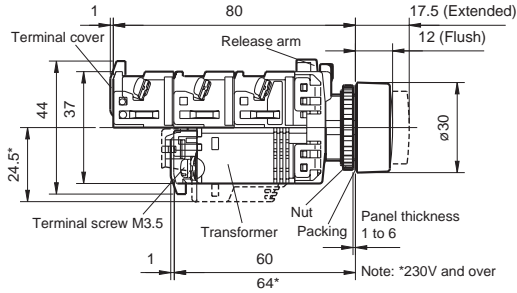

AR22F0L, F5L
AR22E0L, E5L

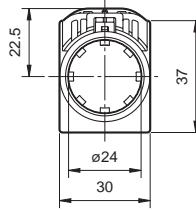

AR22F0M, F5M
AR22E0M, E5M

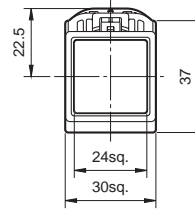

AR22F0P, F5P
AR22E0P, E5P

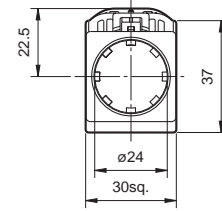

Without transformer

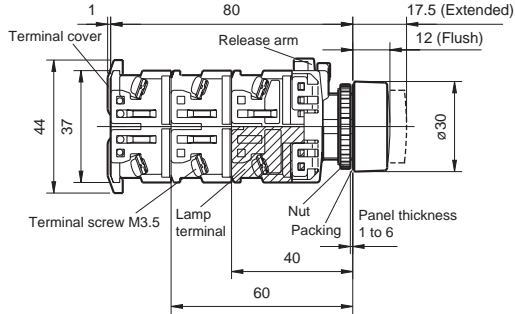

Mushroom (40mm dia.)

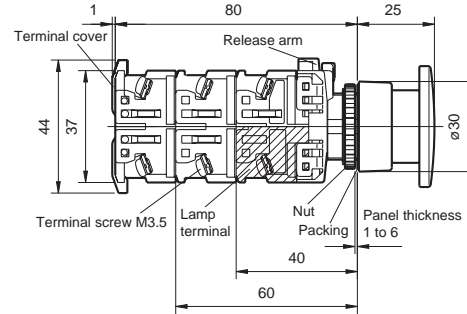

AR22M0L, M5L

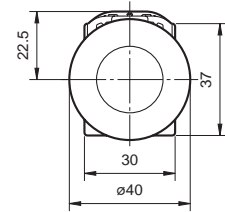

Mushroom (29mm dia.)

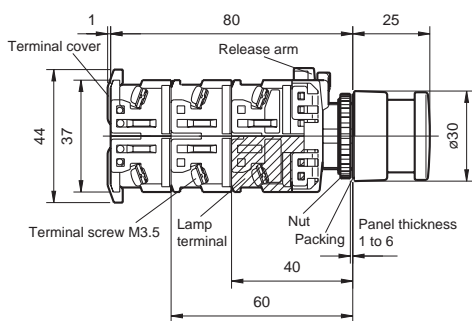

AR22M4L, M9L

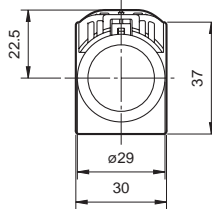

AR22M4P

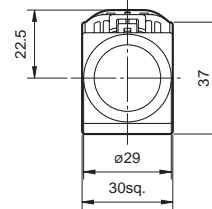

Extended with full guard

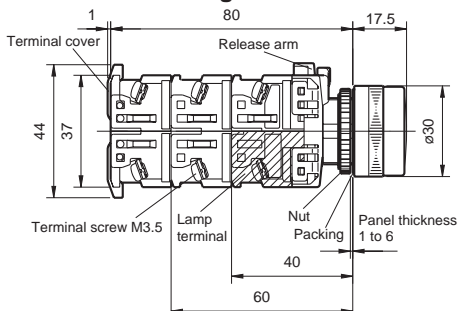

AR22G4L, G9L
AR22G1L, G6L

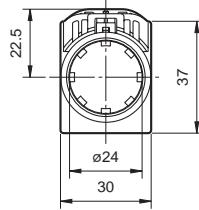

Extended with full guard (with openings)

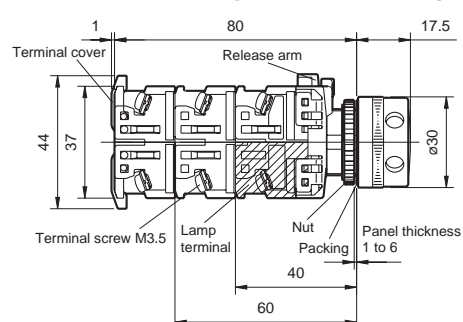

AR22G2L, G7L

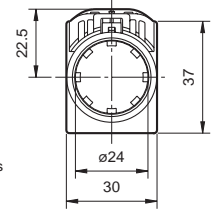

Push-lock, turn-reset

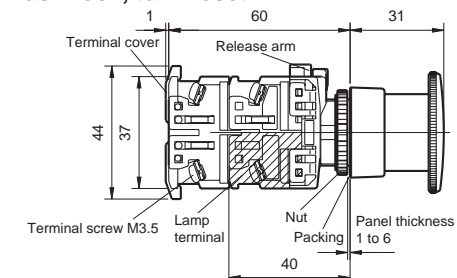

AR22V5L

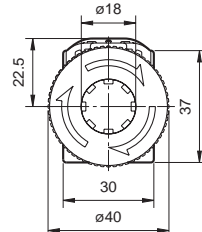

Pushbuttons/Selectors/Pilot Lights/Buzzers AR22 and DR22 Dimensions

■ Dimensions, mm
● Pushbutton switches

Flush/Extended

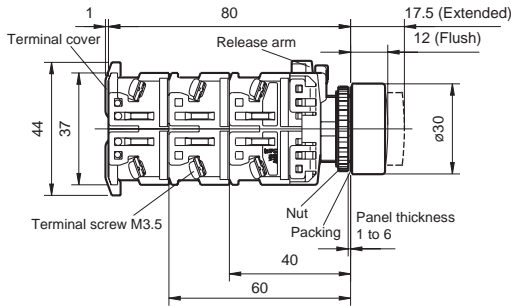

AR22F0R, F5R
AR22E0R, E5R
AR22FAR, FBR
AR22EAR, EBR

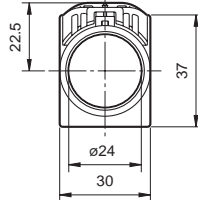

AR22F0S, F5S
AR22E0S, E5S

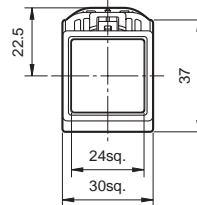

AR22F0Y, F5Y
AR22E0Y, E5Y

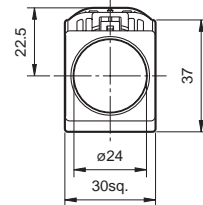

Mushroom (40mm dia.)

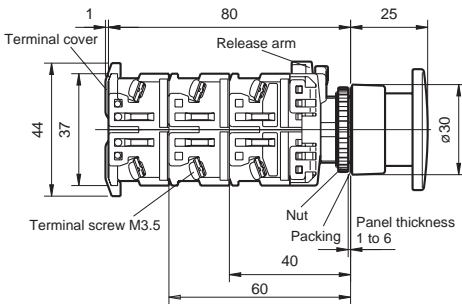

AR22M0R, M5R

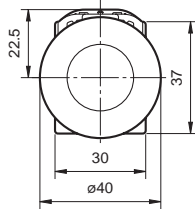

Flush/Extended with full guard

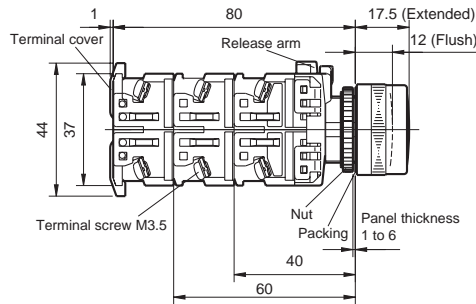

AR22G3R, G8R
AR22G2R, G7R

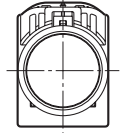

Mushroom (29mm dia.)

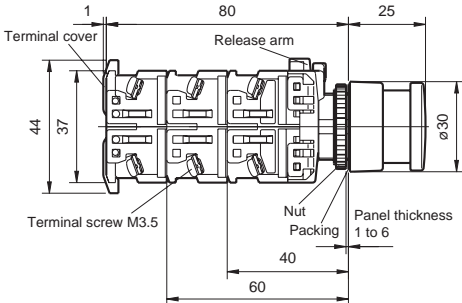

AR22M4R, M9R

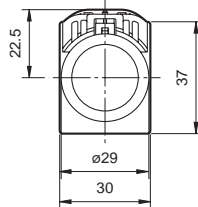

AR22M4Y

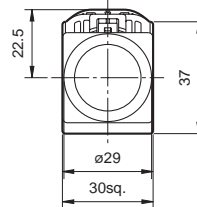

Extended with half guard

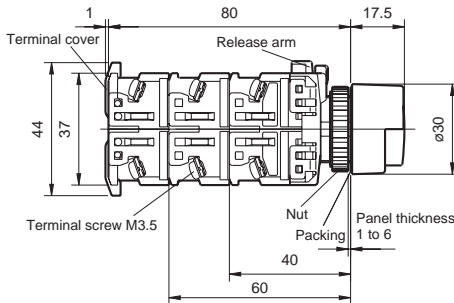

AR22G0R, G5R

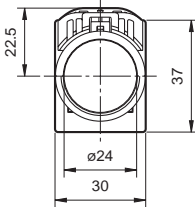

Mushroom with full guard (40mm dia.)

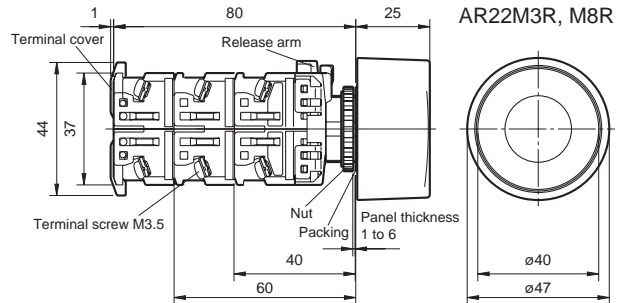

AR22M3R, M8R

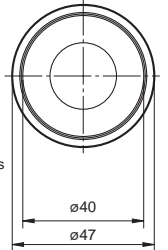

Pushbutton with selector ring

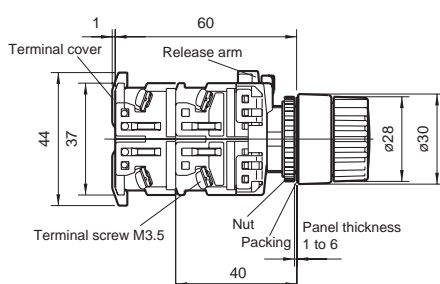

AR22S1R, S2R
AR22S3R, S6R

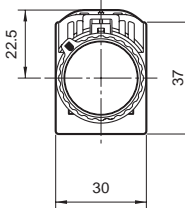

Push-lock, turn-reset

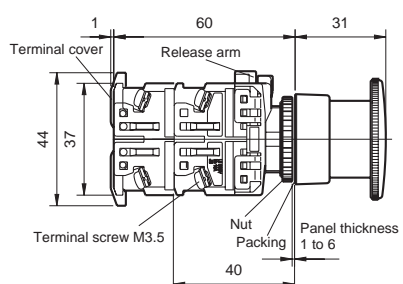

AR22V5R

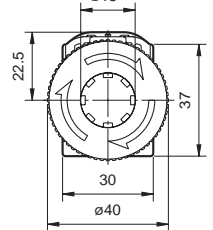

Pushbuttons/Selectors/Pilot Lights/Buzzers AR22 and DR22 Dimensions

■ Dimensions, mm

● Emergency stop pushbutton switches

Push-lock, turn-reset (40mm dia.)

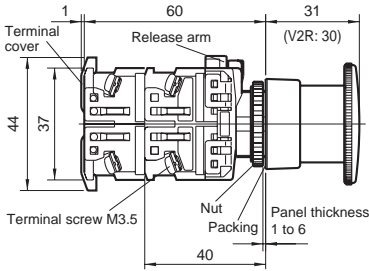

AR22V0R, V2R

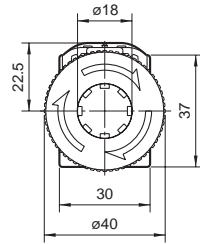

Push-lock, turn-reset (29mm dia.)

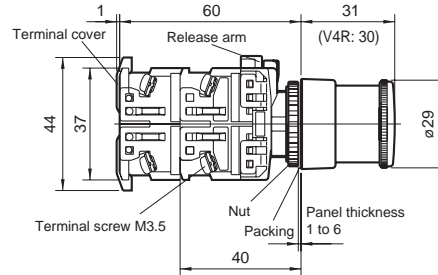

AR22VSR, V4R

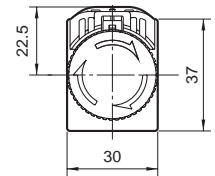

Key release push-lock, turn-reset (40mm dia.)

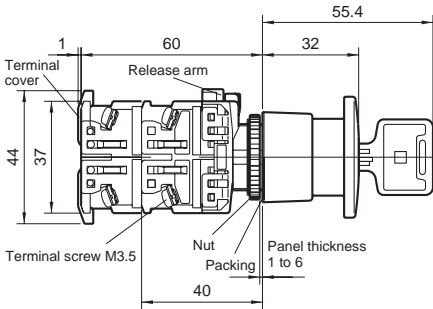

AR22V7R

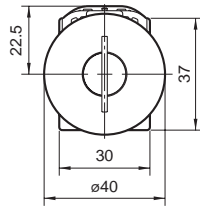

Push-lock, pull-reset (35mm dia.)

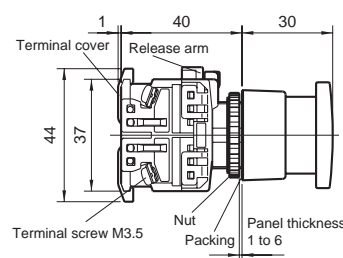

AR22Q2R

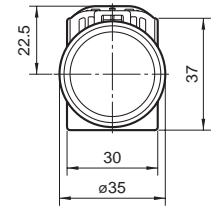

Unibody push-lock, turn-reset (40mm dia.)

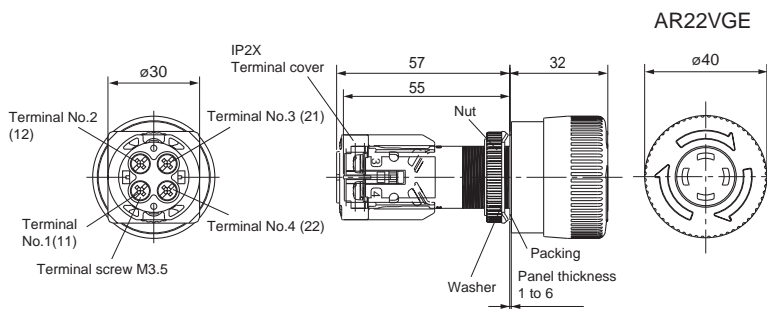

AR22VGE

Wiring diagrams

1NC

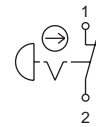

2NC

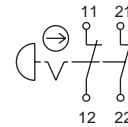

1NO+1NC

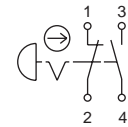

Note: Terminal No. shown in () are for contact arrangement 2NC.

■ Dimensions, mm
 ● Emergency stop illuminated pushbutton switches

Push-lock, turn-reset (40mm dia.)

With transformer

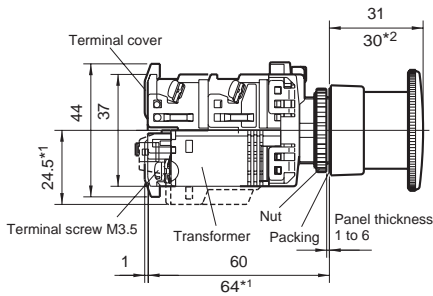

AR22V0L, V2L
 AR22VDL, VAL

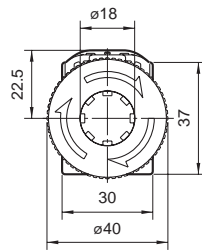

Without transformer

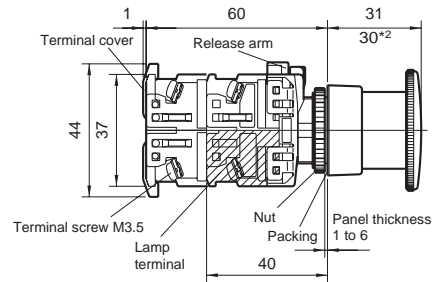

Note: *1 230V and over
 *2 AR22V2L and VAL types only

Push-lock, turn-reset (29mm dia.)

Without transformer

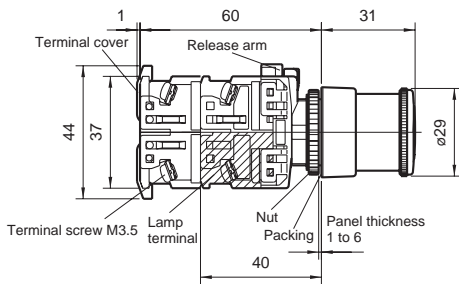

AR22VSL

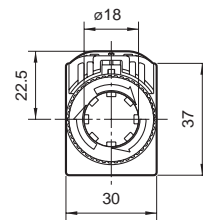

Unibody push-lock, turn-reset (40mm dia.)

Without transformer

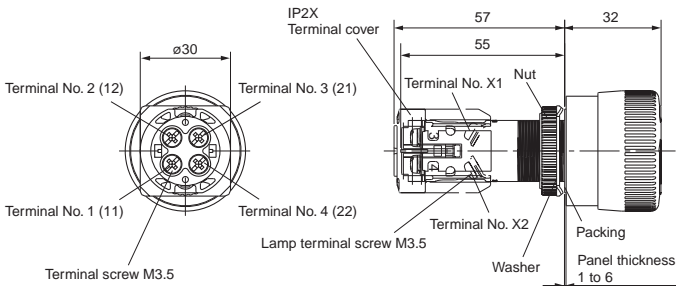

AR22VGF

Wiring diagrams

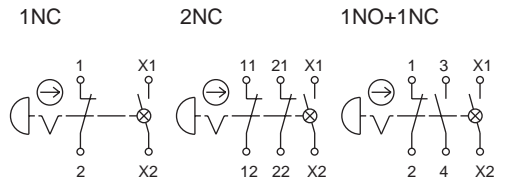

Note: Terminal No. shown in () are for contact arrangement 2NC.

Pushbuttons/Selectors/Pilot Lights/Buzzers

AR22 and DR22

Dimensions

■ Dimensions, mm
● Selector switches

Knob

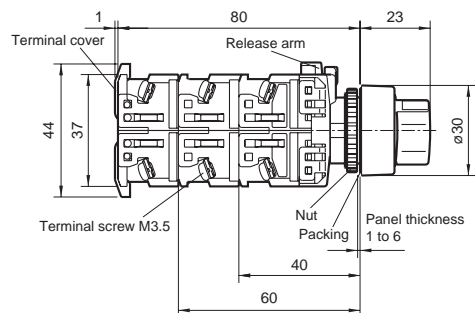

AR22PR, PCR

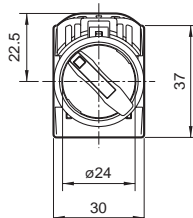

AR22PY, PCY

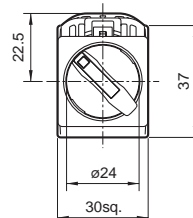

Lever

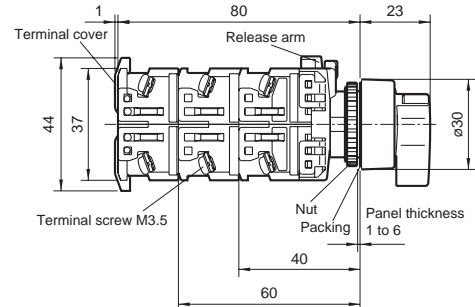

AR22WR, WCR

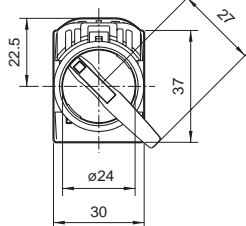

AR22WY, WCY

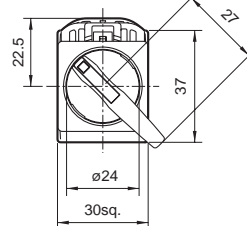

Cylindrical knob

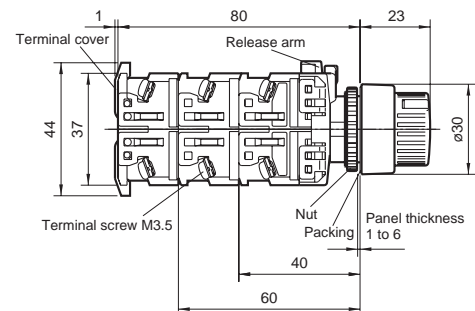

AR22RR, RCR

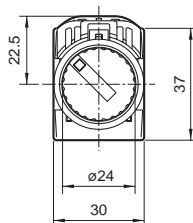

AR22RY, RCY

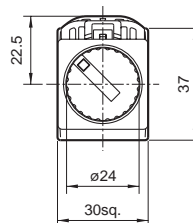

Key

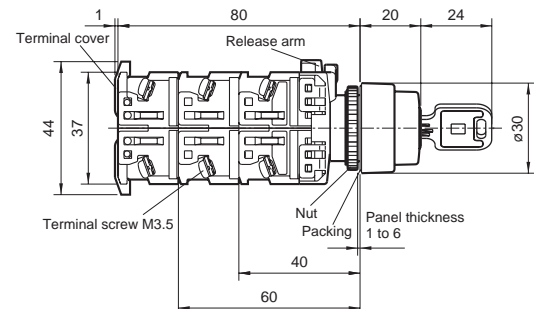

AR22JR, JCR
AR22JAR

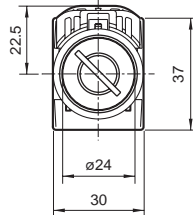

AR22JY, JCY

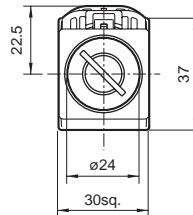

■ **Dimensions, mm**

● **Illuminated selector switches**

With transformer

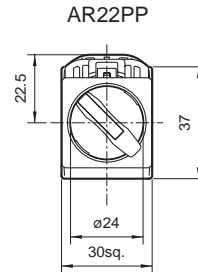
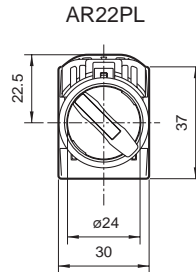
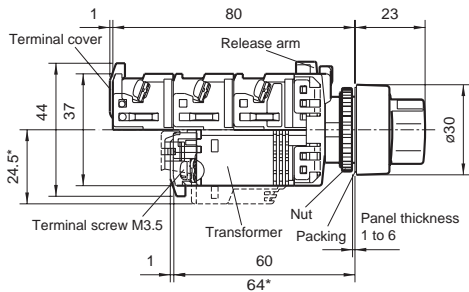

Note: * 230V and over

Without transformer

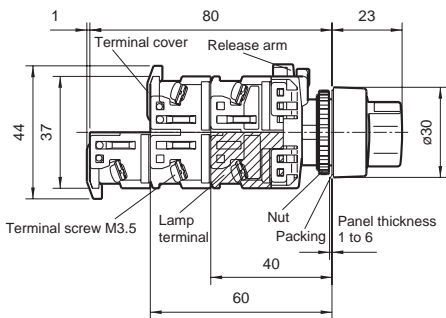

● **Pilot lights**

Dome

With transformer, with resistor unit

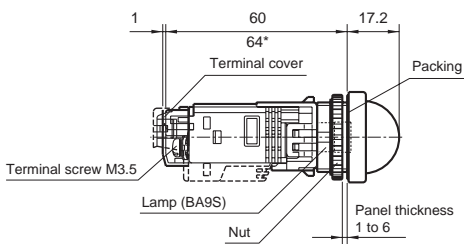

DR22D0L



Without transformer

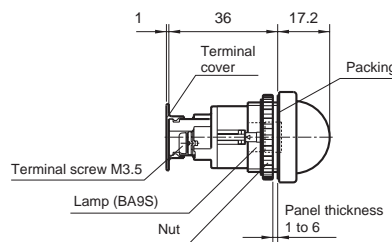

DR22D0L

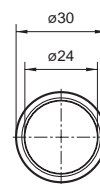

Short body/with transformer

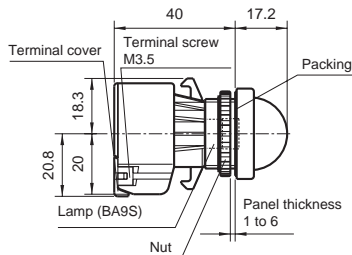

DR22D0L

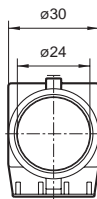

Short body/without transformer

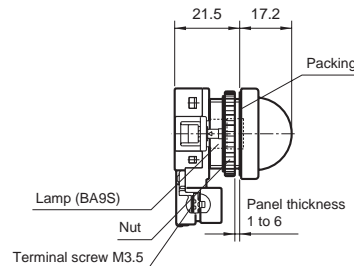

DR22D0L

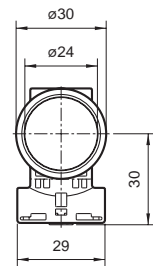

Note: * Except for the types 110V AC, 127V AC and 220V AC.

Pushbuttons/Selectors/Pilot Lights/Buzzers

AR22 and DR22

Dimensions

■ Dimensions, mm
● Pilot lights

Extended

With transformer, with resistor unit

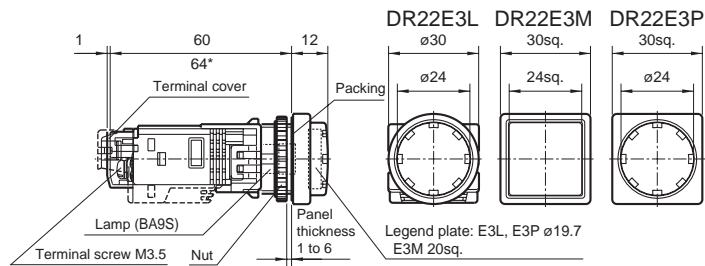

Without transformer

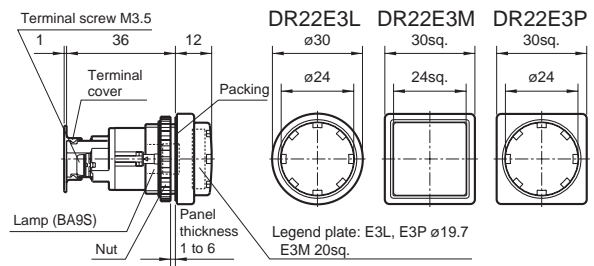

Short body/with transformer

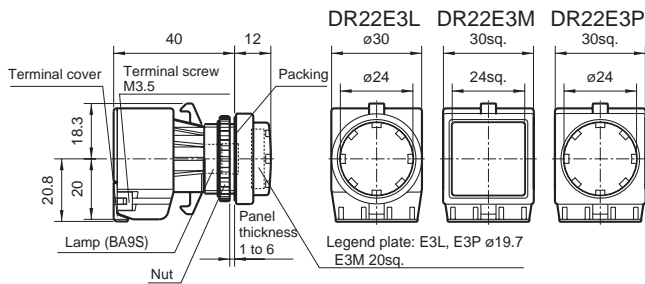

Short body/without transformer

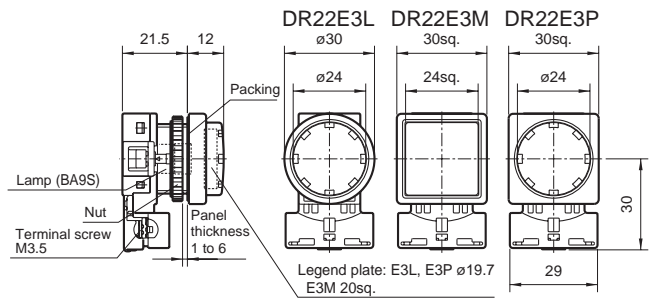

Note: * Except for the types 110V AC, 127V AC and 220V AC.

Faceted

With transformer, with resistor unit

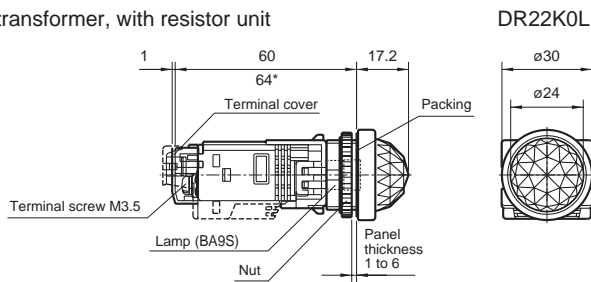

Without transformer

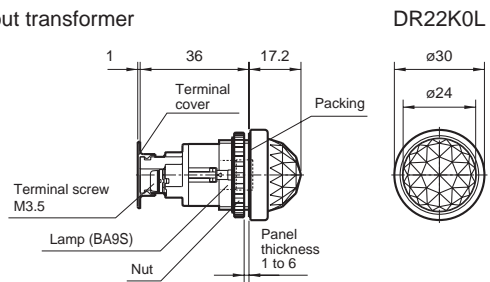

Short body/with transformer

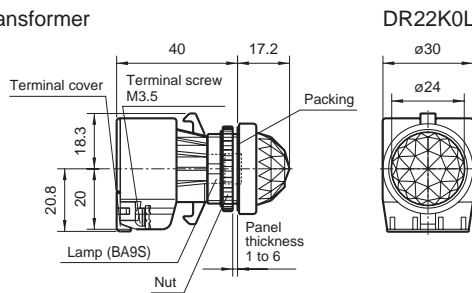

Short body/without transformer

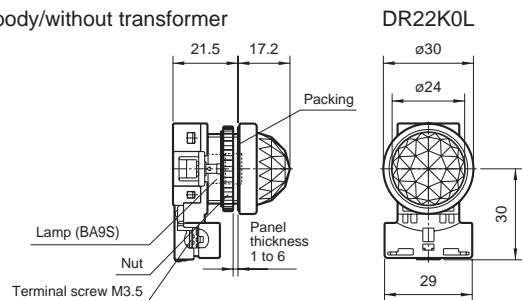

Note: * Except for the types 110V AC, 127V AC and 220V AC.

Pushbuttons/Selectors/Pilot Lights/Buzzers AR22 and DR22 Dimensions

■ Dimensions, mm ● Pilot lights

Flush

With transformer, with resistor unit DR22F3M, F4M

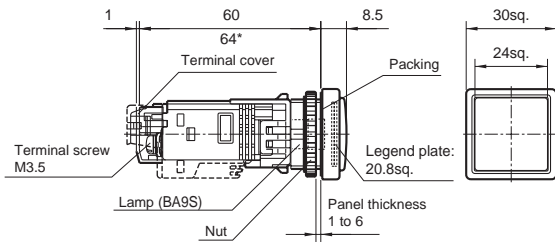

Without transformer DR22F3M, F4M

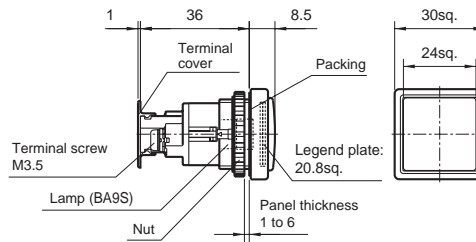

Short body/with transformer DR22F3M, F4M

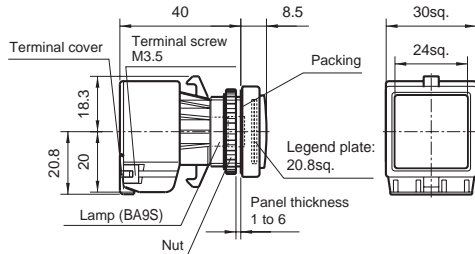

Short body/without transformer DR22F3M, F4M

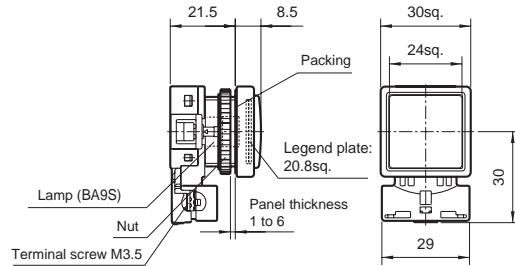

Note: * Except for the types 110V AC, 127V AC and 220V AC.

Flush (12mm high frame)

With transformer, with resistor unit DR22F5M

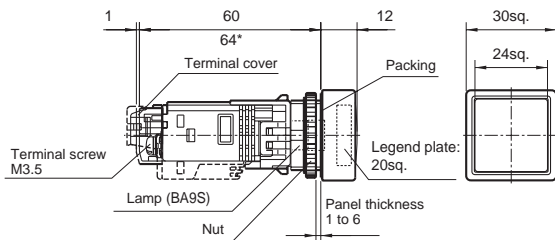

Without transformer DR22F5M

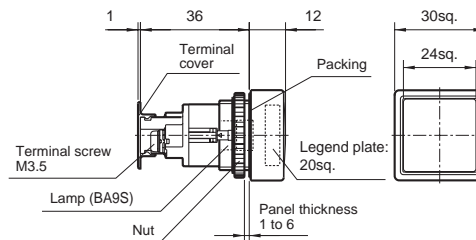

Short body/with transformer DR22F5M

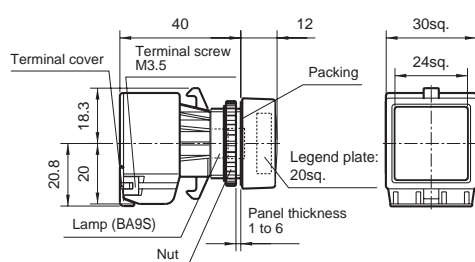

Short body/without transformer DR22F5M

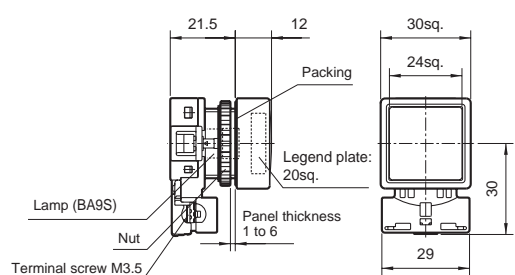

Note: * Except for the types 110V AC, 127V AC and 220V AC.

Pushbuttons/Selectors/Pilot Lights/Buzzers

AR22 and DR22

Dimensions

■ Dimensions, mm
● Pilot lights

Flush rectangular

With transformer, with resistor unit

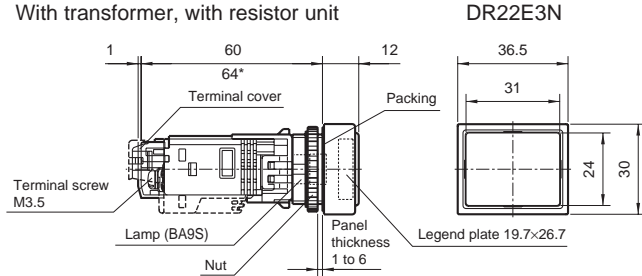

Without transformer

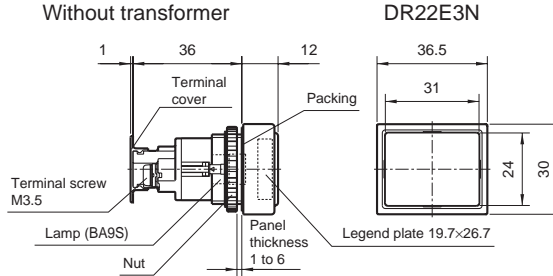

Short body/with transformer

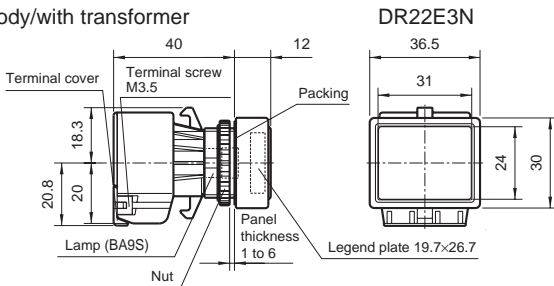

Short body/without transformer

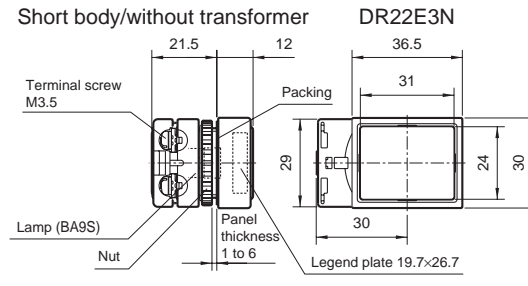

Note: * Except for the types 110V AC, 127V AC and 220V AC.

● Joy stick selector switches

Ball type without lock

Screw terminal AR22A0N, A5N

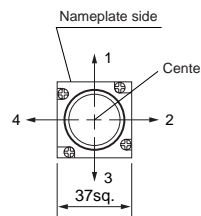
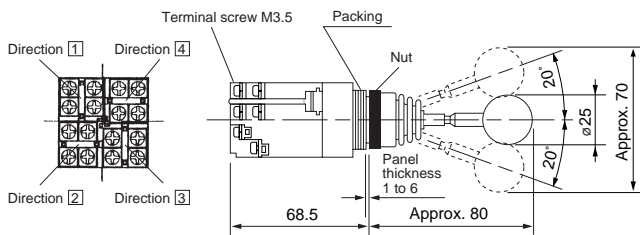

Solder/tab terminal AR22A0H, A5H

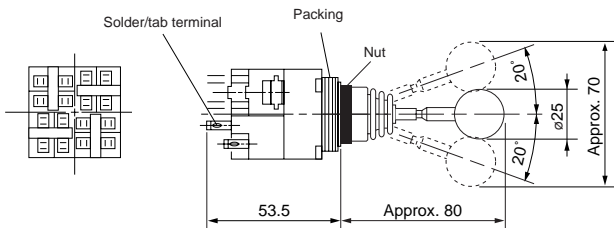

Notes * The contact arrangement is operable in the designated direction by pulling the lock piece in the central position with the fingers. The lock piece will return automatically and locks when the lock piece is released in the central position. The lock piece locks in the central position only.

Ball type with lock

Screw terminal AR22A1N, A6N

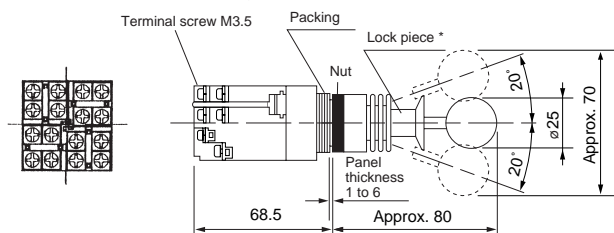

Solder/tab terminal AR22A1H, A6H

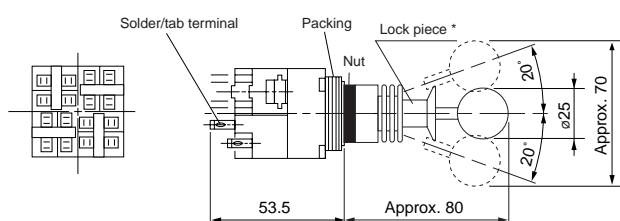

■ Dimensions, mm

● Joy stick selector switches

Rubber cap type without lock

Screw terminal AR22A2N, A7N

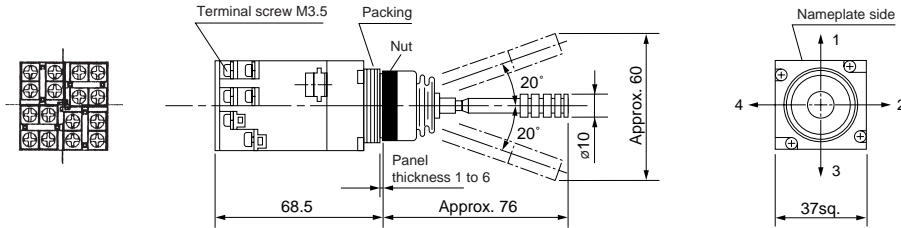

Solder/tab terminal AR22A2H, A7H

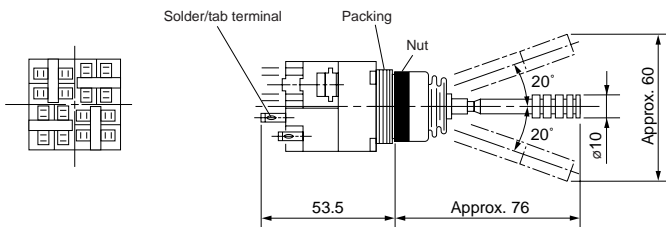

● Buzzers

Electronic sound

With transformer

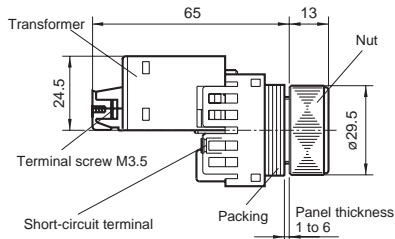

DR22B5

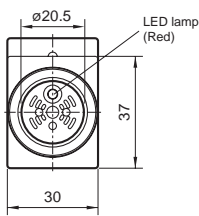

Without transformer

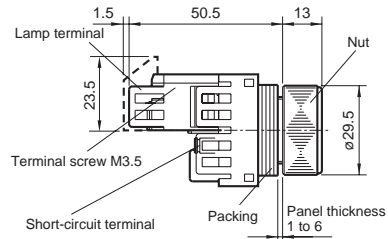

DR22B5

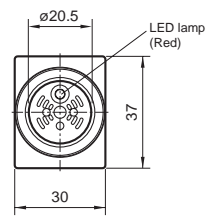

Magnetic sound

With transformer

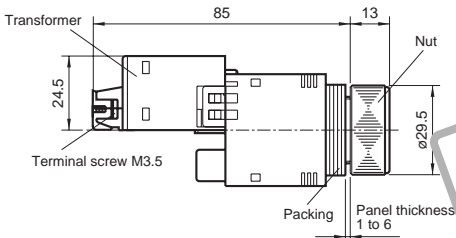

DR22B3

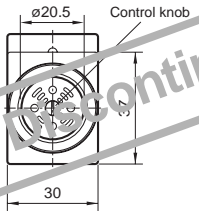

Without transformer

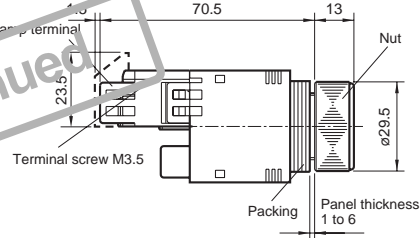

DR22B3

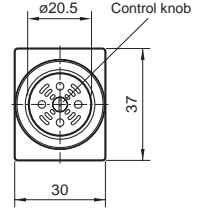

Electronic sound (IP54)

With transformer

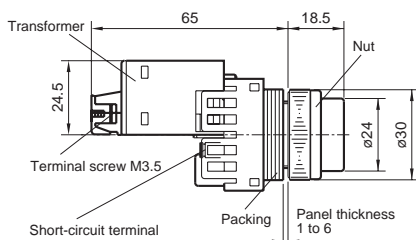

DR22B8

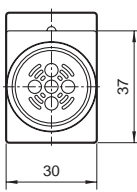

Without transformer

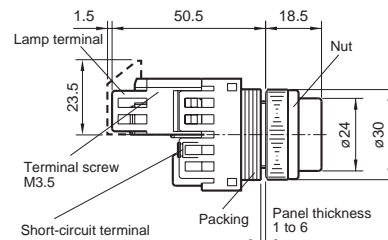

DR22B8

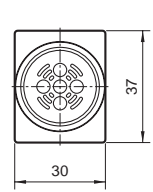

Pushbuttons/Selectors/Pilot Lights/Buzzers AR22 and DR22 Notes on use

Notes on use

■ Fit two sizes of panel cutout holes

* The unique nut with a step allows switch to be mounted in either 22.3mm- or 25.5mm-dia. holes as shown in Fig. 1 without any extra adapter.

Fig. 1 Panel cutout

The switch mounted as a $\phi 22$ mm diameter unit.

The switch mounted as a $\phi 25$ mm diameter unit.

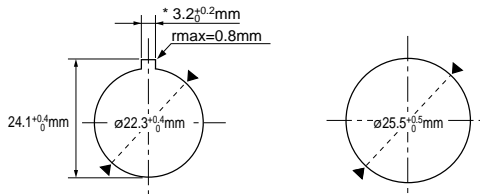

Note: * If key-washer or legend plate are not used, 3.2mm-wide location holes need not be cutout.

■ Detaching contact block from the operator

While keeping the white release arm pressed with one finger, pull-out the contact block in the direction by the arrow.

Fig. 2 Detaching contact block from the operator

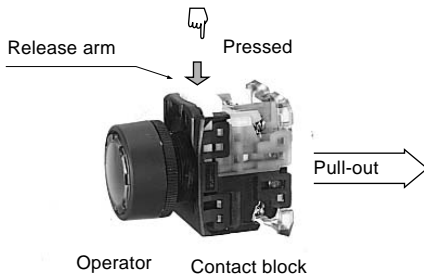

■ Mounting operator to panel

① In a 22.3mm-dia. panel cutout hole
Insert the operator into the cutout hole from the panel front as shown in the Fig. 3.
Then, fit section "A" of the AR9A004 wrench from behind the panel and secure the operator with nut. (See page 04/108 for the wrench)

Fig. 3 Mounting an operator in a 22.3mm-dia. hole

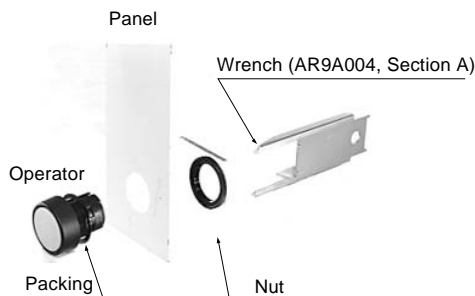

Note: Recommended tightening torque is from 1 to 1.5N•m

② In a 25.5mm-dia. panel cutout hole

As shown in Fig. 4, with the nut step-out side oriented to the panel, use the wrench to tighten the nut and secure the operator.

Fig. 4 Mounting a operator in a 25.5mm-dia. hole

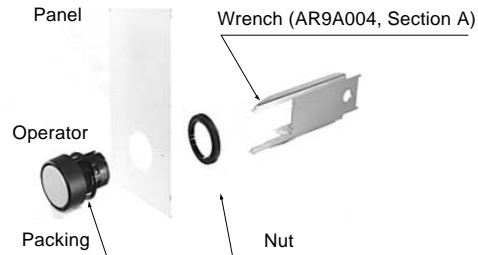

Note: 1. Recommended tightening torque is from 1 to 1.5N•m
2. Ensure that the step-out portion of the nut is correctly fitted in the cutout hole.

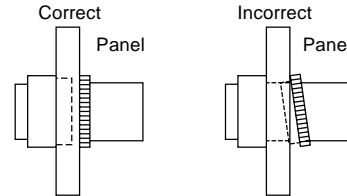

For easier mounting in the 25.5mm-dia. hole, the AR9Y718 adapter is also available separately.

Fig. 5 Mounting with an adapter and locking nut

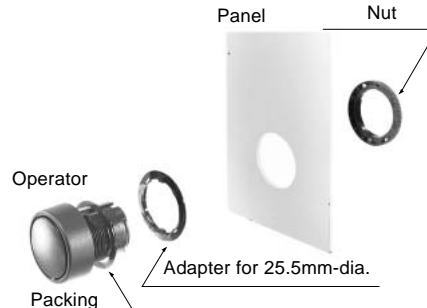

■ Mounting contact block to the operator

As shown in Fig. 6, align the protruding part of the contact block release arm with the operator groove at the ∇ mark. Then, insert the contact block into the operator until it clicks.

Fig. 6 Mounting the contact block to the operator

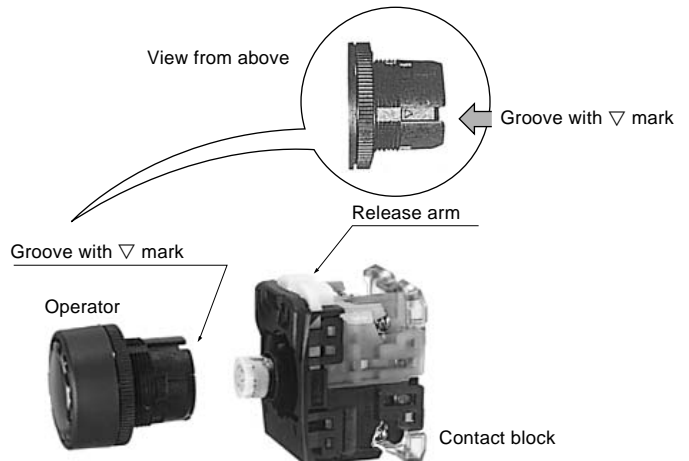

■ **VG type panel mounting**

As shown in the illustration, remove the live section cover, nut, and washer, and insert the main unit into a panel which has been cut from the front side of the panel. Place the type number AR22 facing upward, and secure the main unit with the nut using a wrench AHX701. The appropriate tightening torque is 1 to 1.5N•m.

Fig. 7

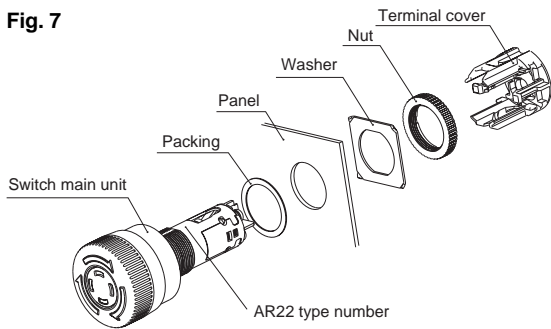

■ **Joy stick selector switch mounting on panel**

- (1) Twist and remove the ball from the operator.
- (2) Loosen the nut and remove the switch if the switch is provided with a lock.
- (3) If no locking nut is provided, loosen the nut and remove the switch after the packing part (A) shown in the illustration is stretched to the lever groove.
- (4) Mount the switch in the order opposite to removal. Set the packing to the notch on the lever as a reference. Do not separate the nut from the packing.
- (5) Use a torque wrench AR9A006 to tighten the nut from the front of the panel.

Note: Recommended tightening a torque is 1 to 1.5N•m.

Fig. 8

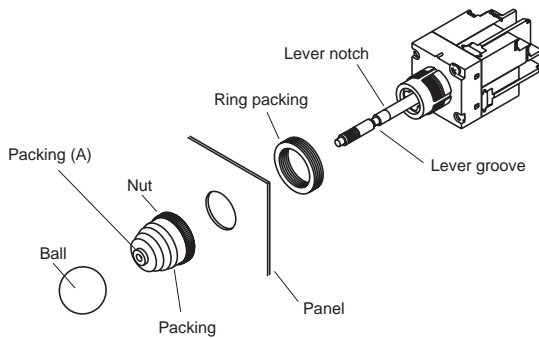

■ **Buzzer mounting on panel**

- (1) Remove the nut, and insert the main unit into the mounting hole from the back of the panel.
- (2) Tighten the buzzer using a wrench AR9A006 from the front side of the panel.

Note:

- Recommended tightening torque is 1 to 1.5N•m.
- Electronic sound (IP54) type has a all-in-one unit with nut and cap.

■ **Applicable panel thickness**

The AR22/DR22 series switches are mountable to panels with thickness as given in Table below.

Mounting condition		Applicable panel thickness (mm)	
Without accessories		1 to 6	
With accessories	Protective cover, water-proof cap, legend plate	1 to 4	
	Key washer	without hole	1 to 4
		with hole	1 to 5
	Adapter for a 25.5mm-dia. hole		1 to 5.5

- When using a joy stick selector switch and buzzer
 The applicable panel thickness is 1 to 6mm. Five 1.3mm packings (single-piece type) are included as standard equipment. Insert as many as required depending on the panel thickness, using the following table as a guide. When using a key washer, legend plate, or adapter, their thickness will have to be added to the values in the guide.

Panel thickness (mm) (plus key washer, legend plate)	Number of packings (reference)
1.0 to 1.6	5
1.6 to 2.8	4
2.8 to 3.8	3
3.8 to 4.8	2
4.8 to 6.0	1

04

Pushbuttons/Selectors/Pilot Lights/Buzzers

AR22 and DR22

Notes on use

■ Minimum mounting space, mm

(1) Minimum mounting space

Fig. 9

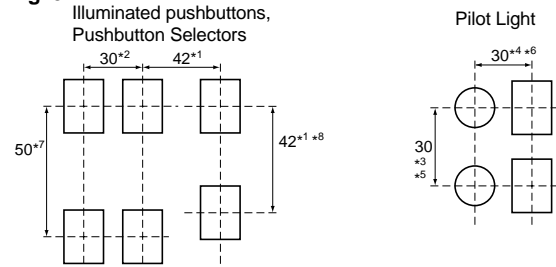

- Notes:
- *1 AR22M0□, M5□, V5□, V0□, V2□, V7R, VG□: 42mm
AR22M3R, M8R: 49mm
AR22Q2R, WR, W0R, WY, WCY: 40mm
 - *2 When mounting contact blocks at 30mm pitch, use it circuit of 380V or less.
 - *3 Short body with transformer types: 50mm.
 - *4 Rectangular types: 36.5mm (except for short body without transformer types).
 - *5 Short body without transformer types: 60mm.
 - *6 Rectangular short body without transformer types: 60mm.
 - *7 This dimension applies when transformer units or contact blocks face each other.
 - *8 This dimension applies when transformer unit or contact block is mounted on only one side.

When mounting operators on a panel, orient all ▽ marks on the operator upwards.

(The operator release arms are oriented upwards.) This aligns the terminals of all contact blocks, thus making wiring easy.

(2) Detaching contact blocks from operators

As shown in Fig. 10, insert a flat-head screw driver into the groove of the white release arm on the contact block. Then, while inserting the driver in hole A of the operator base, lower the driver grip and take out the contact block.

Fig. 10

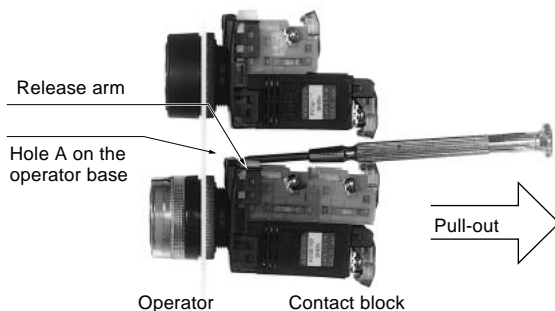

Note: Use a flat head screwdriver as shown at the right.

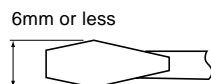

■ Products with blue and green LEDs

The LED devices on products with high-brightness (blue and green) LEDs are very sensitive to static electricity. When replacing LED lamps do not allow static electricity to come into direct contact with the metal frame on the upper side of the LED lamp. The LED device may be damaged if this part is subjected to static electricity. When installing or removing an LED lamp, it is recommended that you use the lamp changer (AHX790).

Fig. 11

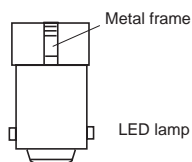

■ Wiring

(1) The terminal screws are M3.5 pan head screws. Solid wires, stranded wires, or crimp terminals can be connected.

Fig. 12

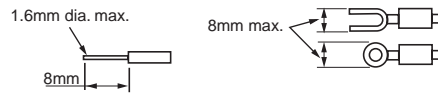

(2) Two crimp terminals can be used by putting one of them on top of the other. If fork-type crimp terminals are used in the horizontal direction, however, use ones as shown in the figure below. (i.e., Toei Tanshi's F2-3.5S or an equivalent).

Fig. 13

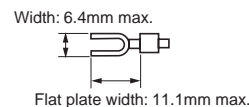

- (3) The terminal washers are a self-lifting type.
- (4) Tighten the terminal screws to a tightening torque of 0.8 to 1N•m.
- (5) Keep the terminals free of external force while wiring or after wiring, or operational failures may result.
- (6) Do not use screws other than the provided terminal screws.

Notes:

- If solid wires are connected to the lamp terminals in the horizontal direction (on the side), be sure to insert the solid wires into the square washers.
- Terminal layout., see page 04/54
- See page 04/53 for the wiring of the joy stick selector switch and VG type.

■ LED Indicator

(1) LED Lamp Malfunctioning

The LED lamp is lit by a very small level of current. Therefore, it may be erroneously lit by a leaking current from the surge absorption circuit or semiconductor circuit or due to stray capacitance between cables. In that case, provide a countermeasure (e.g., connect a resistor in parallel with the LED lamp).

• Countermeasure for Malfunctioning

The LED lamp malfunctions can be prevented by connecting a shunt resistor (R) or CR elements (a capacitor and resistor) in parallel with the LED lamp terminal. The resistance and CR values vary depending on the model and the operating conditions.

Fig. 14

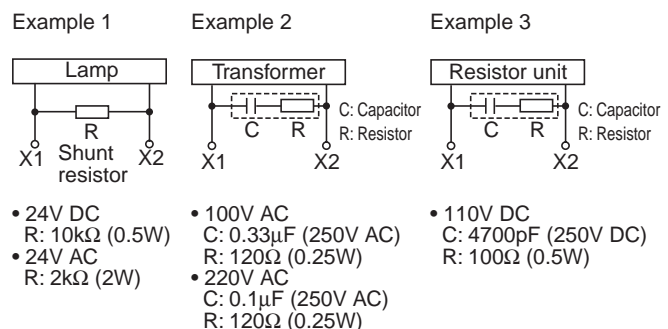

- 24V DC
R: 10kΩ (0.5W)
- 24V AC
R: 2kΩ (2W)
- 100V AC
C: 0.33μF (250V AC)
R: 120Ω (0.25W)
- 220V AC
C: 0.1μF (250V AC)
R: 120Ω (0.25W)
- 110V DC
C: 4700pF (250V DC)
R: 100Ω (0.5W)

(2) Incoming surge

High luminance LED products use an element sensitive to static electricity. They may not be lit by an abnormal voltage like surge. Please note it.

■ Joy stick selector switch

- Screw terminal wiring
- (1) The terminals use M3.5 pan head screws. Use crimp terminals to wire the terminals.

Fig. 15

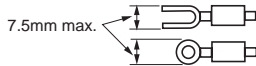

- (2) The terminal washers are a self-lifting type.
- (3) Tighten the terminal screws to a tightening torque of 0.8 to 1.0N•m. Keep the terminals free of external force during and after wiring, or operational failures may result.

• Solder (tab terminal) wiring

- (1) Pay attention to the following items when soldering the terminals.
 - Use a soldering iron with a power consumption of 30W. Use resin-core solder.
 - If a 30W soldering iron is used, finish soldering the terminals within five seconds. If a 20W soldering iron is used, finish soldering the terminals within 10 seconds. Make sure that the soldering iron tip length is at least 20mm long. Do not apply external force to the terminals. Because lead-free solder's melting point is slightly high, soldering work may be difficult. Use a soldering iron whose tip is rather large or whose calorific value is rather high.
- (2) When using adjacent terminals, use insulation tubes to prevent the terminals from short-circuiting. Utmost attention must be paid to the solder terminals if especially thick wires are used or if a large quantity of solder is used.
- (3) Connectable wires
 - Solid wire: 2 wires, 0.8mm dia. max.
 - Stranded wire: 1 wire, 0.75mm² max.
- (4) Use the 110 (2.8mm) series receptacle for the tab terminals.
- (5) Wire the tab terminals with the contact unit connected to the main unit.

• Operation

Operation shall be made after the joy stick operation lever is surely returned to the center position. Do not apply excessive force to the operation lever. The maximum permissible force is 100N.

• Use of contact blocks

If NO and NC contacts are used in the same contact block, check that there is no difference in potential. Do not connect different type of power source different in type.

■ Buzzer

- Noise
- If the application circuit is likely to generate excessively strong noise, connect a surge absorber (e.g., FUJI's ENC390D, provided that the switch is a 24V type) in parallel with the buzzer.

• Place of Use

The buzzer does not have a drip-proof construction. Do not use the buzzer in places where oil or water is sprayed or where dust accumulates. If the buzzer is a splash-proof type, it will resist sprays of water.

- Do not use the buzzer in places that are subject to an excessive amount of corrosive gas.
- Note that the buzzer is likely to sound erroneously due to leakage current or the like.

■ AR22VG type

- As shown in Fig. 16 (a), engage the tip of the wrench (AHX8003) with the groove in the center to mount or remove the locking unit. The recommended tightening torque is 0.6 to 1N•m.

- As shown in Fig. 16 (b), insert the lamp changer (AHX790) and press the lamp changer to mount or remove the lamp. Turn the lamp changer clockwise when mounting the lamp and counterclockwise when removing it.

Fig. 16

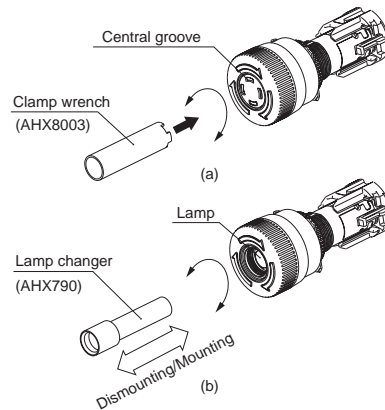

Note: The lamp and neon lamp are special models for the AR22VGF. Use only these special lamps for replacement.

• Wiring

The terminals use M3.5 pan head screws. Use crimp terminals for wiring and cover the crimp terminals with insulation tubes.

Fig. 17

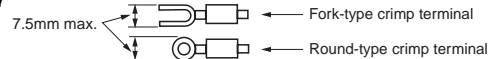

- The terminal washers are a self-lifting type.
- Tighten the terminal screws to a torque of 0.8 to 1N•m. Keep the terminals free of external force during and after wiring, or operational failures may result.
- Wiring precautions
 - (1) Use of round-type crimp terminal
 - Remove the live section cover, and half-tighten to the point parallel with the terminal rib white marks in the direction of the arrows as shown in the illustration below.
 - Mount the live section cover and tighten the terminals securely.

Fig. 18

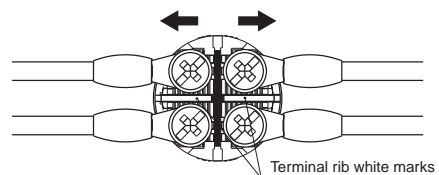

As shown in the illustration below, mount the live section cover so that the mounting legs of the cover engage with the concave parts of the main unit.

Fig. 19

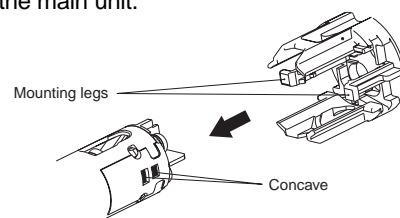

- (2) If fork-type crimp terminals are used, wiring will be possible without removing the live section cover.

Pushbuttons/Selectors/Pilot Lights/Buzzers

AR22 and DR22

Notes on use

■ Operation

- Do not use a hitting or bouncing action to operate the button, or the switch may break. Always operate the switch by hand. Do not pull mushroom head pushbuttons or alternate buttons other than the Q2.
- Do not rotate the selector ring type while the button is pressed, or the mechanism may break.
- The control type incorporates make-before-break contacts. Prepare a protection circuit for the application.
- The dial of the selector switch rotates with a light force. Do not apply force in excess of 1N•m. Please do not pull out or insert the key forcibly.
- To release the lock of the push-lock type, rotate the button clockwise as shown by the arrow. Do not pull the button, or the latch may break and the lock may fail to work.
- Do not lock the emergency stop pushbutton switch and emergency stop illuminated pushbutton switch in use. Push and lock the switch in case of an emergency only.

■ Terminal layout

Fig. 20

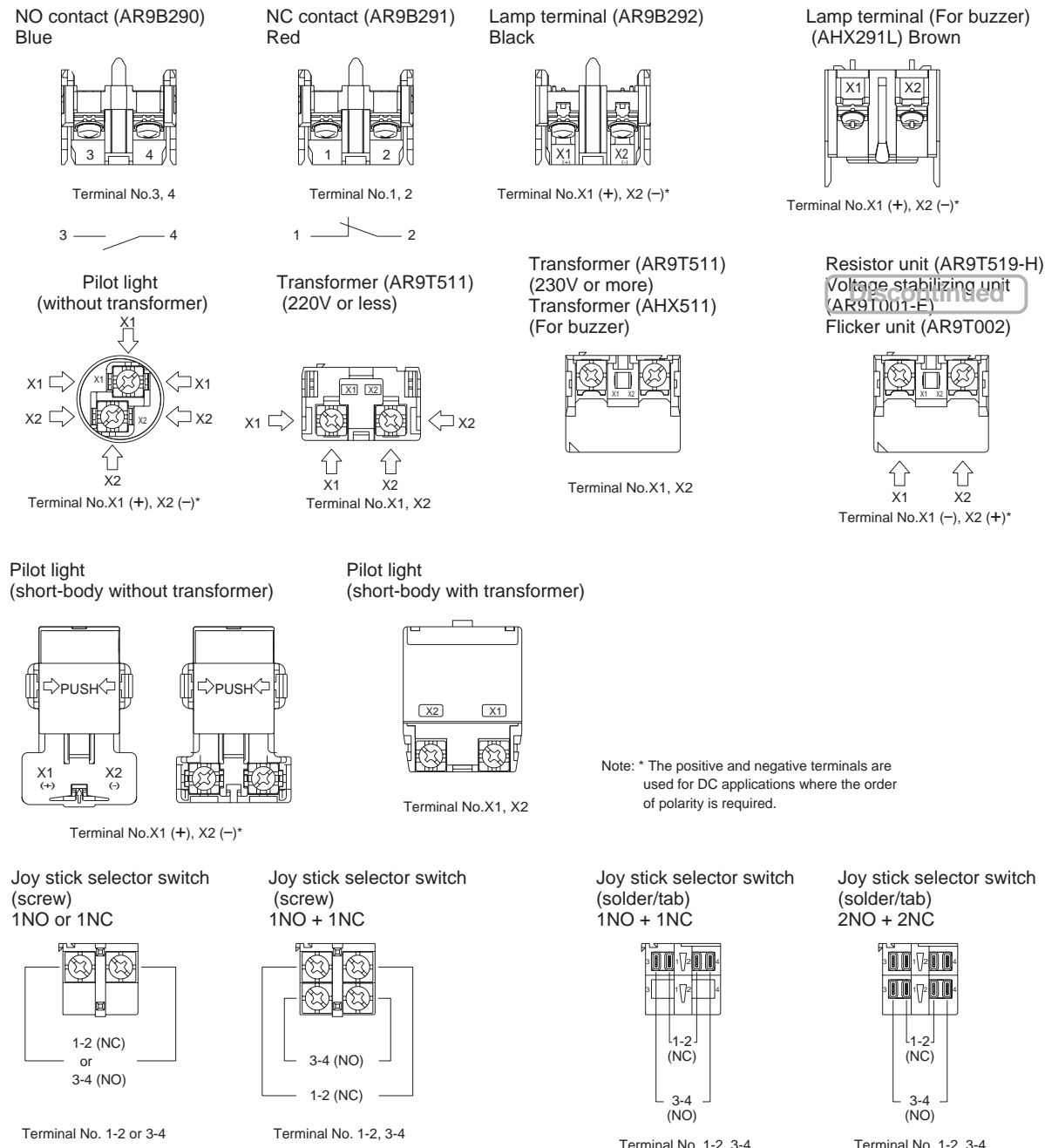

The full range of the contact blocks and transformer units suitable for the AR22 and DR22 series may also be fitted to the AR30 and DR30 series.

■ **Features**

Quick-replacement contact blocks and transformer units

The snap-on construction makes replacement and addition of contact blocks and transformer units very simple and straightforward.

Oil-and dust-proof operator module construction

The protection level of the AR30/DR30 operator modules conforms to IEC Standard IP65. The special seals protect the operator modules and switch mechanisms against oil, dust, and grime, thus ensuring high performance in dusty and moist environments.

Miniaturization

- Selector switches with 1NO+1NC: 41mm deep
- Pilot lights: 34mm deep
- The transformer now occupies far less space.

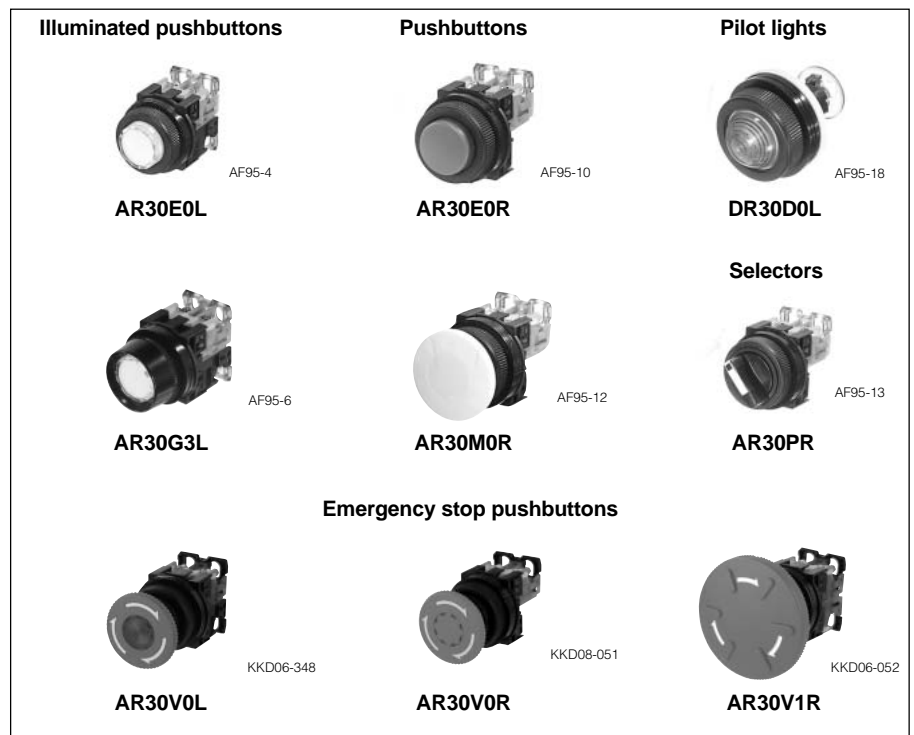
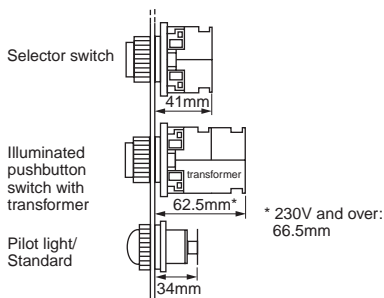

Self-cleaning contacts

All the contacts are double break type and feature self-cleaning action. Every time the switch is operated, the contact surfaces are wiped with a sliding movement, thus ensuring high contact reliability even at low voltage and small current levels (5V, 5mA).

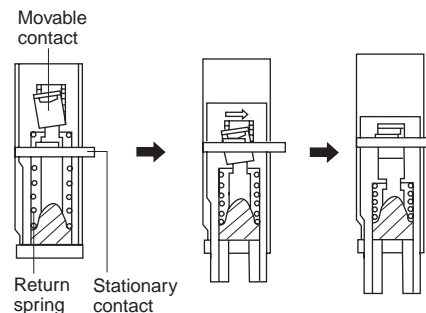

Metal nut

Safer model with metal nut is also available



Wiring

- Wiring from two directions is possible.
- Wiring in both vertical and lateral directions facilitates wiring in narrow spaces.
- Color coding of contact blocks makes wiring easy. 1NO: Blue, 1NC: Red
- Lamp terminal and transformer unit: Black

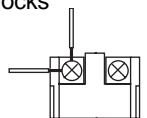

Safety

- A terminal cover is provided, assuring safety and security.
- FUJI's original Trigger Action mechanism is used in the emergency stop pushbuttons. They are suitable for emergency stop and safety. This mechanism prevents the contacts from moving until the button is pushed and locked.

Protection

- Excellent oil-tight construction (IP65) of the operator.
- Closure of the contact block has been improved.

■ **Approvals**



For further information related to approved type, see page 04/56 to 04/59.

Pushbuttons/Selectors/Pilot Lights/Buzzers

AR30 and DR30

Quick reference guide

■ Illuminated pushbutton switches

Operator	Type	Operator	Type	Operator	Type
Extended round head <i>See page 04/71, 04/94</i> 	AR30E0L, E5L  AF95-4	Extended with full guard (24mm dia. with openings) <i>See page 04/71, 04/94</i> 	AR30G2L, G7L  AF99-328	Push-lock, turn-reset (40mm dia. with white arrow) <i>See page 04/71, 04/95</i> 	AR30V5L  KKD06-348
Extended with transparent full guard (24mm dia.) <i>See page 04/71, 04/94</i> 	AR30G4L, G9L  KKD05-164	Extended with full guard (24mm dia.) <i>See page 04/71, 04/94</i> 	AR30G3L, G8L  AF95-6	Push-pull <i>See page 04/71, 04/95</i> 	AR30Q7L  AF96-185

■ Pushbutton switches

Operator	Type	Operator	Type	Operator	Type
Flush round head <i>See page 04/73, 04/96</i> 	AR30F0R, F5R  AF95-11	Mushroom head (29mm dia.) <i>See page 04/73, 04/96</i> 	AR30M4R  AF95-8	Mushroom head with full guard (35mm dia. metal nut) <i>See page 04/73, 04/96</i> 	AR30GSR  AF96-239
Extended round head <i>See page 04/73, 04/96</i> 	AR30E0R, E5R  AF95-10	Extended with full guard (24mm dia.) <i>See page 04/73, 04/96</i> 	AR30G1R, G6R  AF95-16	Giant head <i>See page 04/73, 04/97</i> 	AR30B0R  AF95-579
Flush round head Symbol mark type <i>See page 04/73, 04/96</i> 	AR30FAR, FBR  AF98-195	Extended with half guard <i>See page 04/73, 04/96</i> 	AR30G0R, G5R  AF95-9	Giant head with guard <i>See page 04/73, 04/97</i> 	AR30B1R  AF95-582
Extended round head Symbol mark type <i>See page 04/73, 04/96</i> 	AR30EAR, EBR  AF98-194	Pin lock <i>See page 04/73, 04/96</i> 	AR30GPR  AF96-240	Giant head with full guard <i>See page 04/73, 04/97</i> 	AR30B2R  AF95-580
Mushroom head (40mm dia.) <i>See page 04/73, 04/96</i> 	AR30M0R, M5R  AF95-12	Mushroom head with full guard (40mm dia.) <i>See page 04/73, 04/96</i> 	AR30M3R, M8R  AF95-17	Giant head with full guard <i>See page 04/74, 04/97</i> 	AR30B3R  AF95-581





Note: AR30M8R: Not approved standard  : *See page 04/289*

■ **Pushbutton switches**

Operator	Type	Operator	Type	Operator	Type
Pushbutton with selector ring (2-position) See page 04/75, 04/97 UL, CE, CE, CE, CE	AR30S1R, S2R, S3R, S6R  AF97-506	Push-lock, turn-reset (40mm dia. with white arrow) See page 04/74, 04/97 UL, CE, CE, CE, CE	AR30V5R  KKD08-051	Pushbutton with emergency operating cap See page 04/74, 04/97 UL, CE, CE, CE, CE	AR30FVR  AF96-187
Push, turn-lock See page 04/74, 04/97 UL, CE, CE, CE, CE	AR30N0R  AF95-583				

04

■ **Emergency stop pushbutton switches (conform to EN418)**

Operator	Type	Operator	Type	Operator	Type
Push-lock, turn-reset (Soft-touch 40mm dia. with white arrow) See page 04/76, 04/98 UL, CE, CE, CE, CE	AR30V0R  KKD08-051	Push-lock, turn-reset (65mm dia. with white arrow) See page 04/76, 04/98 UL, CE, CE, CE, CE	AR30V1R  KKD06-352	Push-lock, pull-reset (35mm dia.) See page 04/76, 04/98 UL, CE, CE, CE, CE	AR30Q2R  KKD06-347
Push-lock, turn-reset (40mm dia.) See page 04/76, 04/98 UL, CE, CE, CE, CE	AR30V2R  KKD06-353				

Notes: Provided with the  (Direct opening action)

■ **Emergency stop illuminated pushbutton switches (conform to EN418)**

Operator	Type	Operator	Type
Push-lock, turn-reset (Soft-touch 40mm dia. with white arrow) See page 04/77, 04/98 UL, CE, CE, CE, CE	AR30V0L  KKD06-348	Push-lock, turn-reset (40mm dia.) See page 04/77, 04/98 UL, CE, CE, CE, CE	AR30V2L  KKD06-350

Note: Provided with the  (Direct opening action)









 : See page 04/289

Pushbuttons/Selectors/Pilot Lights/Buzzers



AR30 and DR30

Quick reference guide



■ Selector switches

Operator	Type	Operator	Type	Operator	Type
Knob	AR30PR, PCR	Key	AR30JR, JCR	Key (Long durability)	AR30JAR
<i>See page 04/78, 04/99</i>	 AF95-13	<i>See page 04/78, 04/99</i>	 KKD09-023	<i>See page 04/78, 04/99</i>	 KKD09-021
					
Lever	AR30WR, WCR				
<i>See page 04/78, 04/99</i>	 AF95-14				
					

■ Illuminated selector switches

Operator	Type
Knob	AR30PL
<i>See page 04/87, 04/99</i>	 AF95-5
	

■ Lever type selector switches

Operator	Type
Lever (metal type)	AR30HR
<i>See page 04/85, 04/099</i>	 KKD05-115
	

■ Pilot lights







Lens	Type	Lens	Type	Lens	Type
Dome	DR30D0L	Dome with dimmer control	DR30D1L	Flush square (40mm sq. transparent lens)	DR30M4M *
<i>See page 04/89, 04/100</i>	 AF95-18	<i>See page 04/89, 04/101</i>	 AF02-63	<i>See page 04/91, 04/102</i>	 AF97-63
					
Extended round	DR30E3L	Flush square (34mm sq. transparent lens)	DR30F4M *		
<i>See page 04/89, 04/100</i>	 AF95-20	<i>See page 04/91, 04/102</i>	 AF97-65		
					
Faceted	DR30K0L	Flush rectangular (Transparent lens)	DR30F4N *		
<i>See page 04/90, 04/101</i>	 AF95-19	<i>See page 04/91, 04/102</i>	 AF97-64		
					

Note: With resistor unit and resistor types: Not approved standard







* LED 12V AC type: Not approved standard

Ⓞ : See page 04/289

■ Joy stick selector switches

Handle	Type	Handle	Type	Handle	Type
Ball type	AR30A0, A5	Ball type with lock	AR30A1, A6	Rubber cap type	AR30A2, A7
See page 04/92, 04/103	 AF97-48	See page 04/92, 04/103	 AF97-44	See page 04/92, 04/103	 AF97-57
					

■ Buzzers

Sound	Type	Sound	Type	Sound	Type
Electronic sound	DR30B5*	Magnetic sound	DR30B0	Electronic sound (IP54)	DR30B8 *
See page 04/93, 04/104	 KKD08-058	See page 04/93, 04/104	 AF96-378	See page 04/93, 04/104	 AF96-245
					
Electronic sound (economy)	DR30B6				
See page 04/93, 04/104	 KK02-17				
					

Note: * 6V AC, 110V DC types: Not approved standard

04

Pushbuttons/Selectors/Pilot Lights/Buzzers

AR30 and DR30

Type number nomenclature

Illuminated pushbuttons

AR30 E0L – 10 E3 R □

① ② ③ ④ ⑤ ⑥

① Product category

AR30: 30mm-dia. illuminated pushbutton
30mm-dia. emergency stop illuminated pushbutton

② Operator

- Illuminated pushbutton
- E0L: Extended round head
- E5L: Extended round head (Alternate)
- G4L: Extended with transparent full guard (24mm dia.)
- G9L: Extended with transparent full guard (24mm dia. alternate)
- G2L: Extended with full guard (24mm dia. with openings)
- G7L: Extended with full guard (24mm dia. with openings, alternate)
- G3L: Extended with full guard (24mm dia.)
- G8L: Extended with full guard (24mm dia. alternate)
- V5L: Push-lock, turn-reset (40mm dia. with white arrow) *1
- Q7L: Push-pull
- Emergency stop illuminated pushbutton
- V0L: Push-lock, turn-reset (Soft-touch 40mm dia. with white arrow)
- V2L: Push-lock, turn-reset (40mm dia.)

③ Contact arrangement

10: 1NO	30: 3NO
01: 1NC	03: 3NC
11: 1NO+1NC	33: 3NO+3NC
20: 2NO	40: 4NO
02: 2NC	04: 4NC
22: 2NO+2NC	50: 5NO
	05: 5NC

④ Lamp voltage

- Incandescent lamp
- 54: 5.5V AC/DC, without transformer
- C4: 15V AC/DC, without transformer
- D4: 20V AC/DC, without transformer
- E4: 24V AC/DC, without transformer
- H4: 100-110V AC, with transformer
- L4: 115-127V AC, with transformer
- M4: 200-220V AC, with transformer
- Q4: 230-254V AC, with transformer
- S4: 350-380V AC, with transformer
- T4: 400-440V AC, with transformer
- V4: 480V AC, with transformer
- W4: 500-550V AC, with transformer
- LED lamp
- A3: 6V AC, without transformer
- 63: 6V DC, without transformer
- B3: 12V AC/DC, without transformer
- C3: 15V AC/DC, without transformer
- E3: 24V AC/DC, without transformer
- H3: 100-110V AC, with transformer
- L3: 115-127V AC, with transformer
- M3: 200-220V AC, with transformer
- Q3: 230-254V AC, with transformer
- S3: 350-380V AC, with transformer
- T3: 400-440V AC, with transformer
- V3: 480V AC, with transformer
- W3: 500-550V AC, with transformer

⑤ Color of lens

G: Green	Y: Yellow
R: Red *2	A: Orange
W: White	S: Blue

⑥ Special product

Z9: Resisting water-soluble cutting oils and heat
Z8: With a contact protection cover
Z4: Resisting sulfuration gas
ZB: Meeting IP2X finger-protection standards
ZM: Metal nut

Notes: *1 Products with no trigger action mechanism. These products cannot be used as emergency stop switches that comply with EN standards.

*2 Button color of emergency stop illuminated switches are Red only.

- The manufacturing range varies depending on the model. For details, refer to the contents of this catalog.

Pushbuttons/Selectors/Pilot Lights/Buzzers

AR30 and DR30

Type number nomenclature

Pushbuttons

AR30 E0R – 10 R

① ② ③ ④ ⑤ ⑥

① Product category

AR30: 30mm-dia. pushbutton
30mm-dia. emergency stop pushbutton

② Operator

- Pushbutton switch
- F0R: Flush round head
- F5R: Flush round head (Alternate)
- E0R: Extended round head
- E5R: Extended round head (Alternate)
- FAR: Flush round head (Symbol mark type)
- FBR: Flush round head (Symbol mark type, alternate)
- EAR: Extended round head (Symbol mark type)
- EBR: Extended round head (Symbol mark type, alternate)
- M0R: Mushroom head (40mm dia.)
- M5R: Mushroom head (40mm dia. Alternate)
- M4R: Mushroom head (29mm dia.)
- G1R: Extended with full guard (24mm dia.)
- G6R: Extended with full guard (24mm dia. Alternate)
- GPR: Pin lock
- G0R: Extended with half guard
- G5R: Extended with half guard (Alternate)
- M3R: Mushroom head with full guard (40mm dia.)
- M8R: Mushroom head with full guard (40mm dia. Alternate)
- GSR: Mushroom head with full guard (35mm dia. metal nut)
- B0R: Giant head
- B1R: Giant head with guard
- B2R: Giant head with full guard
- B3R: Giant head with full guard
- S1R: Pushbutton with selector ring (2-position)
- S2R: Pushbutton with selector ring (2-position)
- S3R: Pushbutton with selector ring (2-position)
- S6R: Pushbutton with selector ring (2-position)
- N0R: Push, turn-lock
- V5R: Push-lock, turn-reset (40mm dia. with white arrow) *1
- FVR: Pushbutton with emergency operating cap
 - Emergency stop pushbutton switch
- V0R: Push-lock, turn-reset (Soft-touch 40mm dia. with white arrow)
- V2R: Push-lock, turn-reset (40mm dia.)
- V1R: Push-lock, turn-reset (Soft-touch 65mm dia. with white arrow)
- Q2R: Push-lock, pull-reset (35mm dia.)

③ Contact arrangement

10: 1NO	30: 3NO
01: 1NC	03: 3NC
11: 1NO+1NC	33: 3NO+3NC
20: 2NO	40: 4NO
02: 2NC	04: 4NC
22: 2NO+2NC	44: 4NO+4NC
	50: 5NO
	05: 5NC

④ Color of button

G: Green	Y: Yellow
R: Red ²	A: Orange
B: Black	S: Blue
W: White	C: Clear
T: Green, Red, Black (For AR30F0R)	(For AR30FAR, FBR, EAR, EBR)

⑤ Symbol mark (For AR30FAR, FBR, EAR, EBR)

Symbol mark	○	I	Ⓢ	○	I	Ⓢ
Color of button	White	Black	White	Black	White	Black
Color of mark	Red	Green	Green	Green	Black	Black
Code	01	02	03	04	11	12
					02B	04B
						12B

⑥ Special product

Z9: Resisting water-soluble cutting oils and heat
Z8: With a contact protection cover
Z4: Resisting sulfuration gas
ZB: Meeting IP2X finger-protection standards
ZM: Metal nut

Notes: *1 Products with no trigger action mechanism. These products cannot be used as emergency stop switches that comply with EN standards.
*2 Button color of emergency stop switches are Red only.
• The manufacturing range varies depending on the model. For details, refer to the contents of this catalog.

Pushbuttons/Selectors/Pilot Lights/Buzzers

AR30 and DR30

Type number nomenclature

Selector and illuminated selector switches

AR30 PL – 2 □ 10 E3 G □ □

① ② ③ ④ ⑤ ⑥ ⑦ ⑧ ⑨

① Product category

AR30: 30mm dia. selector switch and illuminated selector switch

② Operator

- Selector switch

PR: Knob

PCR: Knob operated control type

WR: Lever

WCR: Lever operated control type

JR: Key

JCR: Key operated control type

JAR: Key (Long durability)

HR: Lever (Metal type)

- Illuminated selector switch

PL: Knob

③ Operation

2: 2-position, maintained

0: 2-position, spring return

3: 3-position, maintained

6: 3-position, spring/manual return (Left to center)

7: 3-position, spring/manual return (Right to center)

1: 3-position, spring return

4: 4-position, maintained (For AR30PCR, WCR)

5: 5-position, maintained (For AR30PCR, WCR)

④ Key removable position

A: Left

B: Left and right

C: Left, right and center

D: Right

E: Center

F: Right and center

G: Left and center

⑤ Contact arrangement

10: 1NO 30: 3NO

01: 1NC 03: 3NC

11: 1NO+1NC 33: 3NO+3NC

20: 2NO 40: 4NO

02: 2NC 04: 4NC

22: 2NO+2NC 44: 4NO+4NC

50: 5NO

05: 5NC

Note: Control type: See page 04/82 to 04/84

⑥ Lamp voltage

- Incandescent lamp

54: 5.5V AC/DC, without transformer

C4: 15V AC/DC, without transformer

D4: 20V AC/DC, without transformer

E4: 24V AC/DC, without transformer

H4: 100-110V AC, with transformer

L4: 115-127V AC, with transformer

M4: 200-220V AC, with transformer

Q4: 230-254V AC, with transformer

S4: 350-380V AC, with transformer

T4: 400-440V AC, with transformer

V4: 480V AC, with transformer

W4: 500-550V AC, with transformer

- LED lamp

A3: 6V AC, without transformer

63: 6V DC, without transformer

B3: 12V AC/DC, without transformer

C3: 15V AC/DC, without transformer

E3: 24V AC/DC, without transformer

H3: 100-110V AC, with transformer

L3: 115-127V AC, with transformer

M3: 200-220V AC, with transformer

Q3: 230-254V AC, with transformer

S3: 350-380V AC, with transformer

T3: 400-440V AC, with transformer

V3: 480V AC, with transformer

W3: 500-550V AC, with transformer

⑦ Color of knob

B: Black (Not available for illuminated selector switch)

G: Green

R: Red

W: White (Not available for selector switch)

Y: Yellow (Not available for selector switch)

A: Orange (Not available for selector switch)

S: Blue (Not available for selector switch)

⑧ Key type No.

A, B, C, D, E or F

("A" is standard)

⑨ Special product

Z9: Resisting water-soluble cutting oils and heat

Z8: With a contact protection cover

Z4: Resisting sulfuration gas

ZB: Meeting IP2X finger-protection standards

ZM: Metal nut

Note: • The manufacturing range varies depending on the model. For details, refer to the contents of this catalog.

Pilot lights**DR30 D0L – E3 W □**

① ② ③ ④ ⑤

① Product category

DR30: 30mm dia. pilot light

② Lens

D0L: Dome

E3L: Extended round

K0L: Faceted

D1L: Dome with dimmer control

F4M: Flush square (34mm sq. transparent lens)

F4N: Flush rectangular (Transparent lens)

M4M: Flush square (40mm sq. transparent lens)

③ Lamp voltage

● Incandescent lamp

54: 5.5V AC/DC, without transformer

C4: 15V AC/DC, without transformer

D4: 20V AC/DC, without transformer

E4: 24V AC/DC, without transformer

H4: 100-110V AC, with transformer

L4: 115-127V AC, with transformer

M4: 200-220V AC, with transformer

Q4: 230-254V AC, with transformer

S4: 350-380V AC, with transformer

T4: 400-440V AC, with transformer

V4: 480V AC, with transformer

W4: 500-550V AC, with transformer

FQ: 50V DC, with resistor*

HQ: 110V DC, with resistor*

MQ: 220V DC, with resistor*

● LED lamp

A3: 6V AC, without transformer

63: 6V DC, without transformer

B3: 12V AC/DC, without transformer

C3: 15V AC/DC, without transformer

E3: 24V AC/DC, without transformer

H3: 100-110V AC, with transformer

L3: 115-127V AC, with transformer

M3: 200-220V AC, with transformer

Q3: 230-254V AC, with transformer

S3: 350-380V AC, with transformer

T3: 400-440V AC, with transformer

V3: 480V AC, with transformer

W3: 500-550V AC, with transformer

H7: 110V DC, with resistor unit

FR: 50V DC, with resistor*

HR: 110V DC, with resistor*

MR: 220V DC, with resistor*

● LED unit

(For DR30F4M, F4N, M4M type)

65: 6V DC, without transformer

25: 12V AC, without transformer

B5: 12V AC/DC, without transformer

E5: 24V AC/DC, without transformer

H5: 100-110V AC, with transformer

L5: 115-127V AC, with transformer

M5: 200-220V AC, with transformer

Q5: 230-254V AC, with transformer

S5: 350-380V AC, with transformer

T5: 400-440V AC, with transformer

V5: 480V AC, with transformer

W5: 500-550V AC, with transformer

HE: 110V DC, with resistor unit

Note: * DR30D0L, K0L type only

④ Color of lens or color plate

G: Green

R: Red

W: White

Y: Yellow

A: Orange

S: Blue

⑤ Special product

Z9: Resisting water-soluble cutting oils and heat

Z4: Resisting sulfuration gas

ZB: Meeting IP2X finger-protection standards

ZM: Metal nut

Note: • The manufacturing range varies depending on the model. For details, refer to the contents of this catalog.

Pushbuttons/Selectors/Pilot Lights/Buzzers

AR30 and DR30

Type number nomenclature

Joy stick selector switches

AR30A 0 N – A0A0 B

① ②③ ④ ⑤

① Product category

AR30A: 30mm-dia. Joy stick selector switch

② Handle

- 0: Ball type (without lock, manual return)
- 1: Ball type with lock (manual return)
- 2: Rubber cap type (without lock, manual return)
- 5: Ball type (without lock, spring return)
- 6: Ball type with lock (spring return)
- 7: Rubber cap type (without lock, spring return)

③ Terminal

- N: Screw
- H: Solder/tab

④ Contact arrangement

Contact arrangement	Blank	1NO	1NC	1NO+1NC	2NO	2NC	2NO+2NC	
Code	Screw	0	A	B	1	D	E	–
	Solder/tab	0	–	–	1	–	–	2

Operating direction code of contacts

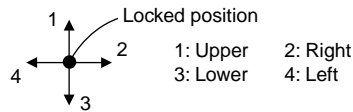

Ex. AR30A0N-A0A0B
1 2 3 4

⑤ Handle color

- B: Black

■ Ordering information

Specify the following:

1. Type number

For the CCC approved product, add the suffix **(CCC)** to the type number

Example: Pushbutton switch AR30F0R-11B**(CCC)**

Buzzers

DR30B 5 – E B

① ② ③④

① Product category

DR30B: 30mm-dia. buzzer

② Sound

- 5: Electronic sound
- 6: Electronic sound (economy)
- 0: Magnetic sound
- 8: Electronic sound (IP54)

③ Operating voltage

- A: 6V AC (Type "5", "8")
- 6: 6V DC (Type "5", "8")
- E: 12-24V AC/DC (Type "6" : 24V DC)
- F: 35-48V AC/DC (Type "5", "8")
- G: 24V AC (Type "6")
- H: 100-110V AC
- M: 200-220V AC
- 1: 100-110V DC (Type "5", "8")

④ Color of head

- B: Black

■ **Standards approved**

UL508	File No. E44592
CSA C22.2 No.14	File No. LR20479
TÜV: EN60947-5-1	Pushbutton, Illuminated pushbutton: R9551062 Selector, Illuminated selector: R9551060 Pilot lights: R9551061 Joy stick selector switch: R2050803 (Lever switch) Buzzer: J9950091
TÜV: EN60947-5-1 EN60947-5-5	Emergency stop pushbutton Emergency stop illuminated pushbutton : R50028146

■ **Specifications (Indoor use)**

Description	Pushbutton switch Illuminated pushbutton switch Emergency stop pushbutton switch Emergency stop illuminated pushbutton switch Selector switch Illuminated selector switch	Joy stick selector (Lever switch)	Pilot light
Rated insulation voltage	600V AC/DC *1	250V AC/DC	250V AC/DC *2
Mechanical durability	<i>See page 04/66</i>		
Electrical durability	500,000 operations at 220V AC 6A 1 million operations at 220V AC 3A	100,000 operations at 220V AC 1A (Res. load)	–
Operating frequency	1200 operations/hour (On-load factor: 40%)		–
Dielectric strength	2500V AC, 1 minute *3	2000V AC, 1 minute *4	
Insulation resistance	100MΩ or more (500V DC megger)	100MΩ or more (500V DC megger)	
Rated impulse dielectric strength	6kV	–	6kV
Conditional short-circuit current	1000A	1000A	–
Short-circuit protective device	Fuse 15A	Fuse 1A	–
Pollution degree	3		
Vibration	Resonance: 10 to 55Hz, double amplitude 0.1mm *5 Constant: 16.7Hz, double amplitude 3mm		
Shock	Malfunction durability: 100m/s ² *6 Mechanical durability: 500m/s ²		Mechanical durability: 500m/s ²
Ambient temperature (No condensation or no icing)	-20 to +70°C	-5 to +70°C	-20 to +50°C
Storage temperature	-40 to +80°C		
Humidity	45 to 85% RH (within -5 to +40°C)		
Degree of protection	IP65 *7		

Notes: *1 Illuminated type without transformer: 250V AC/DC

*2 Pilot light with transformer: 600V AC

*3 Illuminated type without transformer: 2000V AC, 1 minute

*4 Pilot light with transformer: 2500V AC, 1 minute

*5 Emergency stop type: 10 to 500Hz, double amplitude 0.7mm (acceleration 50m/s²), according to the test condition of EN60947-5-5 (1998)

*6 Emergency stop type: 150m/s²

*7 AR30Q7L and DR30D1L type: IP40

Pushbuttons/Selectors/Pilot Lights/Buzzers

AR30 and DR30

Ratings and specifications

● Mechanical durability

Description		Operations
Pushbutton switch	Momentary action	5 million
Illuminated pushbutton switch	Alternate action	1 million
Emergency stop pushbutton switch	With selector ring	100,000
Emergency stop illuminated pushbutton	Push-lock, turn-reset	100,000
	Push-lock, pull-reset	30,000
Selector switch	Maintained 1, 2, 3, 4-contact	1 million
	Maintained 5, 6, 7, 8-contact	500,000
	Control type, spring return, spring/manual return	200,000
Illuminated selector switch	Maintained	
	Without transformer 1, 2, 3-contact	1 million
	4-contact	500,000
	With transformer 1, 2-contact	1 million
	3-contact	500,000
	Spring return, spring/manual return	200,000

Note: Key insertion/removal durability for selector switch key types

- Key type 10,000
- Key (Long durability) type 20,000

● Buzzers

Item	DR30B5	DR30B6	DR30B0 (Discontinued)	DR30B8
Rated insulation voltage	Without transformer: 60V AC/DC With transformer: 250V AC *1			
Sound level	90dB (0.1m) 70dB (1m)			80dB (0.1m) 60dB (1.0m)
Durability	1000h		80h	1000h
Frequency	2.4 to 3.3kHz	1.9 to 2.5kHz		2.4 to 3.3kHz
Intermittent cycle	Approx. 170-cycle/min	–	–	Approx. 170-cycle/min
Current consumption	See the table below			
Dielectric strength	Without transformer: 1000V AC 1 minute With transformer: 2000V AC 1 minute *2			
Insulation resistance	100MΩ or more (500V DC megger)			
Pollution degree	3			
Vibration	Resonance: 10 to 55Hz, double amplitude 0.1mm Constant: 16.7Hz, double amplitude 3.0mm			
Shock	Mechanical durability: 500m/s ²			
Ambient temperature	–20 to +60°C (No condensation or no icing) (with resistor unit: –20 to +40°C)			
Storage temperature	–30 to +70°C			
Humidity	45 to 85%RH (within –5 to 40°C)			
Degree of protection	IP00			IP54

Note: *1 DR30B0 (without transformer): 250V AC

*2 DR30B0 (without transformer): 2000V AC 1 minute

● Current consumption

Operational voltage	Current consumption			
	DR30B5, DR30B8	DR30B6	DR30B0	
6V AC (Discontinued)	70mA AC	–	–	
6V DC	35mA DC	25mA AC	–	
24V AC	–	45mA AC	–	
24V DC	–	30mA DC	–	
24V AC/DC	40mA AC, 25mA DC	30mA AC, 20mA DC	Discontinued	
48V AC/DC (Discontinued)	65mA AC, 20mA DC	–	–	
110V AC	30mA AC	30mA AC	30mA AC	
110V DC (Discontinued)	20mA DC	–	–	
220V AC	15mA AC	15mA AC	20mA AC	

Pushbuttons/Selectors/Pilot Lights/Buzzers
AR30 and DR30
Ratings and specifications

■ **Contact ratings**
 ● **UL/CSA standards**
AC (COS $\phi=0.35$)

Contact rated code	120V		240V		480V		600V	
	Making current	Breaking current	Making current	Breaking current	Making current	Breaking current	Making current	Breaking current
A600	60A	6.0A	30A	3.0A	15A	1.5A	12A	1.2A

DC T_{0.95}= 6P (Max. 300ms)

Description	Contact rated code	Making current · Breaking current		
		125V	250V	301V–600V
Illuminated pushbutton switch Pushbutton (Ring type selector switch: AR30S2R only) Emergency stop pushbutton switch Emergency stop illuminated pushbutton switch (Except the overlap contact types)	P600	1.1A	0.55A	0.2A
Overlap contact types of products shown above Pushbutton (Ring type selector switch: AR30S1R, S6R only) Selector switch (2-position only, except the overlap contact types) Illuminated selector switch (2-position only, except the overlap contact types)	Q600	0.55A	0.27A	0.1A
Pushbutton (Ring type selector switch: AR30S3R only) Selector switch (2-pos./overlap contact type, 3-, 4-, 5-pos. type) Illuminated selector switch (2-pos./overlap contact type, 3-pos. type)	R300	0.22A	0.11A	–

Note: Joy stick selector switches (Lever switches): 250V AC, 5A (Res. load) 125V DC, 0.2A 24V DC, 1A (Res. load)

● **EN standard/TÜV approved**

Description	Rated operational current			
	Rated thermal current	Rated operational voltage	AC15 (Ind. load)	DC13 (Ind. load)
			Rated operational current	Rated operational current
Illuminated pushbutton switch Pushbutton (Except the selector ring type) Emergency stop pushbutton switch Emergency stop illuminated pushbutton switch Selector switch (2-position) Illuminated selector switch (2-position)	10A	24V	6.0A	4.0A
		120V	6.0A	–
		125V	–	1.3A
		240V	6.0A	–
		250V	–	0.45A
		480V	2.5A	–
		600V	2.0A	–
Selector switch (3, 4, 5-position) Illuminated selector switch (3-position) Pushbutton with selector ring	10A	24V	6.0A	2.0A
		120V	6.0A	–
		125V	–	0.65A
		240V	6.0A	–
		250V	–	0.23A
		480V	2.5A	–
		600V	2.0A	–
Joy stick selector switch (Lever switch)	5A	24V	–	0.7A
		120V	0.3A	–
		125V	–	0.15A
		240V	0.3A	–

Lamp rated voltage UL/CSA standards, TÜV approved

	LED lamp	Incandescent lamp
Full-voltage (without transformer)	Max. 24V AC/DC	Max. 30V AC/DC
With transformer	Max. 550V AC (Short-body type: Max. 220V AC)	

Pushbuttons/Selectors/Pilot Lights/Buzzers

AR30 and DR30

Ratings and specifications

■ Operating characteristic (1NO+1NC)

Description	Pushbutton Illuminated pushbutton	Emergency stop pushbutton		Selector *2		
		Emergency stop illuminated pushbutton		Illuminated selector		
		Push-lock type	Push-pull type	Maintained	Spring/manual return	Spring return
Ave. required operating force	9N (Push-lock type: 20N)	30N *1	45N	0.15N•m	0.13N•m	0.1N•m
Operating travel	Approx. 6mm (Push-lock type: Approx. 9mm, operation angle: Approx. 45°)	Approx. 9mm (Operation angle: Approx. 45°)	Approx. 9mm	2-position: Approx. 90° 3-position: Approx. 45° 4-position: Approx. 40° 5-position: Approx. 30°	3-position: Approx. 45°	2-position: Approx. 60° 3-position: Approx. 45°
Required return force	– (Push-lock type: 0.6N•m)	0.6N•m	30N (pull)	0.15N•m	0.13N•m	–

Notes: *1 AR30V2R type: 45N
*2 4-position, 5-position: 2NO+2NC

■ Lamp ratings

● Illuminated pushbuttons, illuminated selectors, pilot lights (round type)

Transformer	Lamp voltage	LED (lamp base: BA9S/13)			Incandescent (lamp base: BA9S/13)		
		Type	Rated voltage	Consumption	Type	Rated voltage	Consumption
Without transformer	5.5V AC/DC	–	–	–	AHX135	6.3V AC/DC	0.9W
	6V AC	APX510-6□	6V AC	Green, red, orange, amber, blue: 7mA AC Yellow: 50mA AC	–	–	–
	6V DC	APX510-D6□	6V DC	Green, red, orange, amber, blue: 11mA DC Yellow: 33mA DC	–	–	–
	12V AC/DC	APX510-12□	12V AC/DC	Green, red, orange, amber, blue: 14mA AC, 11mA DC Yellow: 28mA AC, 22mA DC	–	–	–
	15V AC/DC	APX510-15□	15V AC/DC	Green, red, orange, amber, blue: 13mA AC, 11mA DC Yellow: 26mA AC, 22mA DC	AHX279	18V AC/DC	0.8W
	20V AC/DC 24V AC/DC	– APX510-24□	– 24V AC/DC	– 12mA AC, 11mA DC	AHX144 AHX129	24V AC/DC 30V AC/DC	0.9W 0.8W
With transformer (Standard type: AR9T511)	110V AC	APX510-6□	6V AC	1.5VA	AHX135	6.3V AC/DC	2VA
	127V AC						2VA
	220V AC						2VA
	254V AC	APX510-6□	6V AC	2.5VA	AHX135	6.3V AC/DC	2.5VA
	380V AC 440V AC 480V AC 550V AC						2.5VA 2.5VA 2.5VA 2.5VA
With resistor unit (AR9T519-H)	110V DC	APX510-24□	24V AC/DC	1.2W	–	–	–

Notes: • Short body pilot lights: 110V AC, 127V AC, 220V AC only
• Replace the □ mark by the lamp luminous color code, see page 04/70

● Pilot lights with resistor

Lamp Voltage	LED (lamp base: E12/15)			Incandescent (lamp base: E12/15)		
	Type	Rated voltage	Consumption	Type	Rated voltage	Consumption
50V DC	APX507-24□ *	24V AC/DC	0.8W	AHX130	18V AC/DC	5W
110V DC			1.7W			10W
220V DC			3.3W			20W

Notes: * White: APX509-24O
• Replace the □ mark by the lamp luminous color code, see page 04/70

Pushbuttons/Selectors/Pilot Lights/Buzzers
AR30 and DR30
Ratings and specifications

• **Pilot lights (DR30F4M, F4N, M4M types)**

Transformer	Lamp voltage	LED (lamp base: BA9S/13)			Incandescent (lamp base: BA9S/13)		
		Type	Rated voltage	Consumption	Type	Rated voltage	Consumption
Without transformer	5.5V AC/DC	–	–	–	AHX135	6.3V AC/DC	0.9W
	6V DC	DR9Q005-6□	6V DC	Green, red, amber: 20mA DC White: 33mA DC Yellow: 48mA DC	–	–	–
	12V AC	DR9Q005-2□	12V AC	Red, amber: 18mA AC Green: 10mA AC White: 30mA AC Yellow: 50mA AC	–	–	–
	12V AC/DC	DR9Q005-B□	12V AC/DC	Red, amber: 22mA AC, 20mA DC Green: 13mA AC, 10mA DC White: 36mA AC, 30mA DC Yellow: 54mA AC, 48mA DC	–	–	–
	15V AC/DC	–	–	–	AHX279	20V AC/DC	0.8W
	20V AC/DC	–	–	–	AHX144	24V AC/DC	0.9W
	24V AC/DC	DR9Q005-E□	24V AC/DC	Green, red, amber: 11mA AC, 10mA DC White: 12mA AC, 11mA DC Yellow: 16mA AC, 12mA DC	AHX129	30V AC/DC	0.8W
With transformer unit (LED: AR9T557) (Incandescent: AR9T511)	110V AC	DR9Q005-2□	12V AC	3VA	AHX135	6.3V AC/DC	2VA
	127V AC						2VA
	220V AC						2VA
	254V AC						2.5VA
	380V AC						2.5VA
	440V AC						2.5VA
	480V AC						2.5VA
	550V AC						2.5VA
With resistor unit (AR9T519-H)	110V DC	DR9Q005-E□	24V AC/DC	1.4W	–	–	–

Notes: • Replace the □ mark by the lamp luminous color code, see page 04/70

04

Pushbuttons/Selectors/Pilot Lights/Buzzers

AR30 and DR30

Ratings and specifications

■ Lamp durability

Lamp	Durability (reference)	Judgement criterion
LED	Approx. 30000h	When brightness is less than 50% of initial value
Incandescent	Approx. 5000h (AC)	When the bulb burns out

Notes: •The operating voltage for incandescent lamps is set at 80 to 90% of the lamp's rated voltage.
•The durability of LED lamp is a mean value in all colors.

Estimated durability for LED lamps

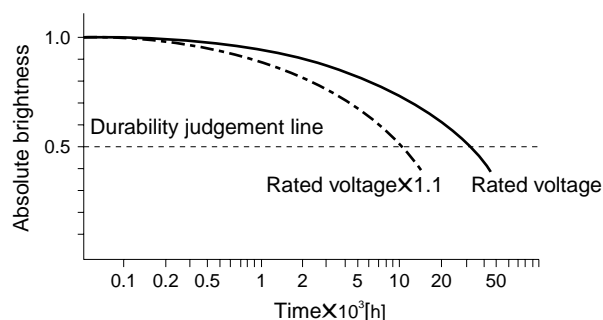

Notes: • Durability at $T_a=25^{\circ}\text{C}$
• Durability is affected by temperature, humidity, and voltage fluctuation.

Incandescent lamp voltage characteristics

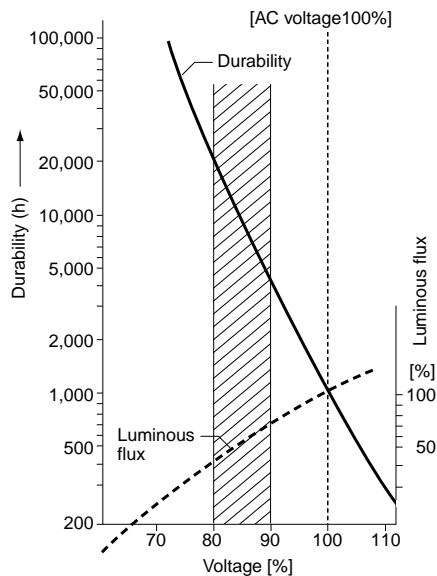

■ Combination of lens color and LED luminous color

Button color (lens or color plate)		LED lamp (high-brightness)			LED lamp (high-brightness)	
Color	Code	Luminous color	Type	Type * ¹	Luminous color	Type * ²
Green	G	Green	APX510-■G	APX507-24G	Green	DR9Q005-■G
Red	R	Red	APX510-■R	APX507-24R	Red	DR9Q005-■R
White	W	Orange	APX510-■O	APX509-24O	White	DR9Q005-■W
Yellow	Y	Yellow	APX510-■Y	APX507-24Y	Yellow	DR9Q005-■Y
Orange	A	Amber	APX510-■A	APX507-24A	Amber	DR9Q005-■A
Blue	S	Blue	APX510-■S	APX507-24S	—	—

Notes: *¹ For pilot light with resistor

*² For DR30 F4M, F4N, M4M type

• Replace the ■ mark by the lamp voltage code, see page 04/68, 04/69

■ Illuminated pushbutton switches

Operator	Trans- former	Contact	LED lamp Momentary action Type	Alternate action Type	Incandescent lamp Momentary action Type	Alternate action Type
Extended round head  AF95-4	Without	1NO 1NC 1NO+1NC 2NO+2NC	AR30E0L-10■3□ AR30E0L-01■3□ AR30E0L-11■3□ AR30E0L-22■3□	AR30E5L-10■3□ AR30E5L-01■3□ AR30E5L-11■3□ —	AR30E0L-10■4□ AR30E0L-01■4□ AR30E0L-11■4□ AR30E0L-22■4□	AR30E5L-10■4□ AR30E5L-01■4□ AR30E5L-11■4□ —
	With	1NO 1NC 1NO+1NC	AR30E0L-10■3□ AR30E0L-01■3□ AR30E0L-11■3□	AR30E5L-10■3□ AR30E5L-01■3□ AR30E5L-11■3□	AR30E0L-10■4□ AR30E0L-01■4□ AR30E0L-11■4□	AR30E5L-10■4□ AR30E5L-01■4□ AR30E5L-11■4□
Extended with transparent full guard (24mm dia.)  KKD05-164	Without	1NO 1NC 1NO+1NC 2NO+2NC	AR30G4L-10■3□ AR30G4L-01■3□ AR30G4L-11■3□ AR30G4L-22■3□	AR30G9L-10■3□ AR30G9L-01■3□ AR30G9L-11■3□ —	AR30G4L-10■4□ AR30G4L-01■4□ AR30G4L-11■4□ AR30G4L-22■4□	AR30G9L-10■4□ AR30G9L-01■4□ AR30G9L-11■4□ —
	With	1NO 1NC 1NO+1NC	AR30G4L-10■3□ AR30G4L-01■3□ AR30G4L-11■3□	AR30G9L-10■3□ AR30G9L-01■3□ AR30G9L-11■3□	AR30G4L-10■4□ AR30G4L-01■4□ AR30G4L-11■4□	AR30G9L-10■4□ AR30G9L-01■4□ AR30G9L-11■4□
Extended with full guard (24mm dia. with openings)  AF99-328	Without	1NO 1NC 1NO+1NC 2NO+2NC	AR30G2L-10■3□ AR30G2L-01■3□ AR30G2L-11■3□ AR30G2L-22■3□	AR30G7L-10■3□ AR30G7L-01■3□ AR30G7L-11■3□ —	AR30G2L-10■4□ AR30G2L-01■4□ AR30G2L-11■4□ AR30G2L-22■4□	AR30G7L-10■4□ AR30G7L-01■4□ AR30G7L-11■4□ —
	With	1NO 1NC 1NO+1NC	AR30G2L-10■3□ AR30G2L-01■3□ AR30G2L-11■3□	AR30G7L-10■3□ AR30G7L-01■3□ AR30G7L-11■3□	AR30G2L-10■4□ AR30G2L-01■4□ AR30G2L-11■4□	AR30G7L-10■4□ AR30G7L-01■4□ AR30G7L-11■4□
Extended with full guard (24mm dia.)  AF95-6	Without	1NO 1NC 1NO+1NC 2NO+2NC	AR30G3L-10■3□ AR30G3L-01■3□ AR30G3L-11■3□ AR30G3L-22■3□	AR30G8L-10■3□ AR30G8L-01■3□ AR30G8L-11■3□ —	AR30G3L-10■4□ AR30G3L-01■4□ AR30G3L-11■4□ AR30G3L-22■4□	AR30G8L-10■4□ AR30G8L-01■4□ AR30G8L-11■4□ —
	With	1NO 1NC 1NO+1NC	AR30G3L-10■3□ AR30G3L-01■3□ AR30G3L-11■3□	AR30G8L-10■3□ AR30G8L-01■3□ AR30G8L-11■3□	AR30G3L-10■4□ AR30G3L-01■4□ AR30G3L-11■4□	AR30G8L-10■4□ AR30G8L-01■4□ AR30G8L-11■4□
Push-lock, turn-reset (40mm dia. with white arrow)  KKD06-348	Without	1NO 1NC 1NO+1NC 3NC	— — — —	AR30V5L-10■3□ AR30V5L-01■3□ AR30V5L-11■3□ AR30V5L-03■3□	— — — —	AR30V5L-10■4□ AR30V5L-01■4□ AR30V5L-11■4□ AR30V5L-03■4□
	With	1NO 1NC 1NO+1NC	— — —	AR30V5L-10■3□ AR30V5L-01■3□ AR30V5L-11■3□	— — —	AR30V5L-10■4□ AR30V5L-01■4□ AR30V5L-11■4□
Push-pull (35mm dia.)  AF96-185	Without	1NO+1NC	AR30Q7L-11■3□	—	AR30Q7L-11■4□	—
	With	1NO+1NC	AR30Q7L-11■3□	—	AR30Q7L-11■4□	—

Note: ■ □ See page 04/72

Illuminated Pushbuttons

AR30

• Lens color

Replace the □ mark by the lens color code

Color	Green	Red	White	Blue	Yellow	Orange
Code	G	R	W	S	Y	A

Note: AR30V5L type: Red, yellow only

• Contact arrangements

Contact arrangements other than above are available

Contact arrangement	1NO	1NC	1NO+1NC	2NO	2NC	3NO
Code	10	01	11	20	02	30

Contact arrangement	3NC	2NO+2NC	4NO	4NC	5NO	5NC
Code	03	22	40	04	50	05

Note: AR30Q7L type: 1NO + 1NC only

Available numbers of contact blocks

Operation	Without transformer	With transformer
Momentary action	6-contact block	4-contact block
Alternate action Push-lock, turn-reset	3-contact block	2-contact block

• Contact operation (AR30Q7L)

Contact block		Button position		
No.	Type	Pull	Free	Push
(1)	NC	●		
(2)	NC	■		

● Contact closed

• Voltage

Replace the ■ mark by the lamp voltage code

Transformer		Code	
		LED	Incandescent
Without transformer	6V DC	6	—
	6V AC	A	—
	5.5V AC/DC	—	5
	12V AC/DC	B	—
	15V AC/DC	C	C
	20V AC/DC 24V AC/DC	— E	D E
With transformer	100-110V AC	H	H
	115-127V AC	L	L
	200-220V AC	M	M
	230-254V AC	Q	Q
	350-380V AC	S	S
	400-440V AC	T	T
	480V AC	V	V
	500-550V AC	W	W

• Position of contact block

AR30Q7L (without transformer)

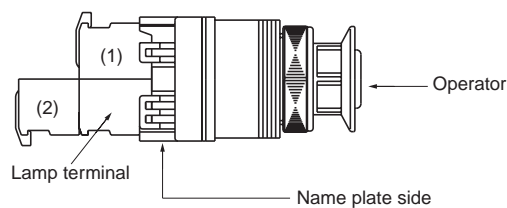



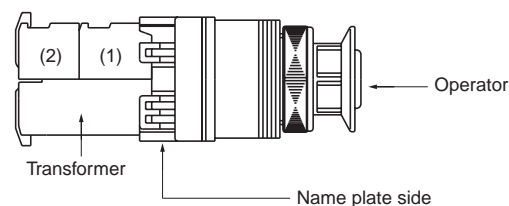



AR30Q7L (with transformer)





■ Pushbutton switches

Operator	Contact	Momentary action Type	Alternate action Type
Flush round head  AF95-11	1NO 1NC 1NO+1NC 2NO 2NC 2NO+2NC	AR30F0R-10 □ AR30F0R-01 □ AR30F0R-11 □ AR30F0R-20 □ AR30F0R-02 □ AR30F0R-22 □	AR30F5R-10 □ AR30F5R-01 □ AR30F5R-11 □ AR30F5R-20 □ AR30F5R-02 □ AR30F5R-22 □
Extended round head  AF95-10	1NO 1NC 1NO+1NC 2NO 2NC 2NO+2NC	AR30E0R-10 □ AR30E0R-01 □ AR30E0R-11 □ AR30E0R-20 □ AR30E0R-02 □ AR30E0R-22 □	AR30E5R-10 □ AR30E5R-01 □ AR30E5R-11 □ AR30E5R-20 □ AR30E5R-02 □ AR30E5R-22 □
Flush round head symbol mark type  AF98-195	1NO 1NC 1NO+1NC 2NO 2NC 2NO+2NC	AR30FAR-10C ■ AR30FAR-01C ■ AR30FAR-11C ■ AR30FAR-20C ■ AR30FAR-02C ■ AR30FAR-22C ■	AR30FBR-10C ■ AR30FBR-01C ■ AR30FBR-11C ■ AR30FBR-20C ■ AR30FBR-02C ■ AR30FBR-22C ■
Extended round head symbol mark type  AF98-194	1NO 1NC 1NO+1NC 2NO 2NC 2NO+2NC	AR30EAR-10C ■ AR30EAR-01C ■ AR30EAR-11C ■ AR30EAR-20C ■ AR30EAR-02C ■ AR30EAR-22C ■	AR30EBR-10C ■ AR30EBR-01C ■ AR30EBR-11C ■ AR30EBR-20C ■ AR30EBR-02C ■ AR30EBR-22C ■
Mushroom head (40mm dia.)  AF95-12	1NO 1NC 1NO+1NC 2NO 2NC 2NO+2NC	AR30M0R-10 □ AR30M0R-01 □ AR30M0R-11 □ AR30M0R-20 □ AR30M0R-02 □ AR30M0R-22 □	AR30M5R-10 □ AR30M5R-01 □ AR30M5R-11 □ AR30M5R-20 □ AR30M5R-02 □ AR30M5R-22 □
Mushroom head (29mm dia.)  AF95-8	1NO 1NC 1NO+1NC 2NO 2NC 2NO+2NC	AR30M4R-10 □ AR30M4R-01 □ AR30M4R-11 □ AR30M4R-20 □ AR30M4R-02 □ AR30M4R-22 □	—
Extended with full guard (24mm dia.)  AF95-16	1NO 1NC 1NO+1NC 2NO 2NC 2NO+2NC	AR30G1R-10 □ AR30G1R-01 □ AR30G1R-11 □ AR30G1R-20 □ AR30G1R-02 □ AR30G1R-22 □	AR30G6R-10 □ AR30G6R-01 □ AR30G6R-11 □ AR30G6R-20 □ AR30G6R-02 □ AR30G8R-22 □

Note: ■ □ See page 04/74

Operator	Contact	Momentary action Type	Alternate action Type
Extended with half guard  AF95-9	1NO 1NC 1NO+1NC 2NO 2NC 2NO+2NC	AR30G0R-10 □ AR30G0R-01 □ AR30G0R-11 □ AR30G0R-20 □ AR30G0R-02 □ AR30G0R-22 □	AR30G5R-10 □ AR30G5R-01 □ AR30G5R-11 □ AR30G5R-20 □ AR30G5R-02 □ AR30G5R-22 □
Pin lock  AF96-240	1NO 1NC 1NO+1NC 2NO 2NC 2NO+2NC	AR30GPR-10 □ AR30GPR-01 □ AR30GPR-11 □ AR30GPR-20 □ AR30GPR-02 □ AR30GPR-22 □	—
Mushroom head with full guard (40mm dia.)  AF95-17	1NO 1NC 1NO+1NC 2NO 2NC 2NO+2NC	AR30M3R-10 □ AR30M3R-01 □ AR30M3R-11 □ AR30M3R-20 □ AR30M3R-02 □ AR30M3R-22 □	AR30M8R-10 □ AR30M8R-01 □ AR30M8R-11 □ AR30M8R-20 □ AR30M8R-02 □ AR30M8R-22 □
Mushroom head with full guard (35mm dia. metal nut)  AF96-239	1NO 1NC 1NO+1NC 2NO 2NC 2NO+2NC	AR30GSR-10 □ AR30GSR-01 □ AR30GSR-11 □ AR30GSR-20 □ AR30GSR-02 □ AR30GSR-22 □	—
Giant head  AF95-579	1NO 1NC 1NO+1NC 2NO 2NC 2NO+2NC	AR30B0R-10 □ AR30B0R-01 □ AR30B0R-11 □ AR30B0R-20 □ AR30B0R-02 □ AR30B0R-22 □	—
Giant head with guard  AF95-582	1NO 1NC 1NO+1NC 2NO 2NC 2NO+2NC	AR30B1R-10 □ AR30B1R-01 □ AR30B1R-11 □ AR30B1R-20 □ AR30B1R-02 □ AR30B1R-22 □	—
Giant head with full guard  AF95-580	1NO 1NC 1NO+1NC 2NO 2NC 2NO+2NC	AR30B2R-10 □ AR30B2R-01 □ AR30B2R-11 □ AR30B2R-20 □ AR30B2R-02 □ AR30B2R-22 □	—

Pushbuttons AR30

Operator	Contact	Momentary action Type	Alternate action Type
Giant head with full guard  <small>AF95-581</small>	1NO	AR30B3R-10 □ —	
	1NC	AR30B3R-01 □ —	
	1NO+1NC	AR30B3R-11 □ —	
	2NO	AR30B3R-20 □ —	
	2NC	AR30B3R-02 □ —	
	2NO+2NC	AR30B3R-22 □ —	
Push, turn-lock  <small>AF95-583</small>	1NO	AR30N0R-10 □ —	
	1NC	AR30N0R-01 □ —	
	1NO+1NC	AR30N0R-11 □ —	
	2NO	AR30N0R-20 □ —	
	2NC	AR30N0R-02 □ —	
	2NO+2NC	AR30N0R-22 □ —	

• Button color

Replace the □ mark by the button color code

Color	Green	Red	White	Blue	Yellow	Orange	Black
Code	G	R	W	S	Y	A	B



Note: AR30V5R type: Red, yellow, black only

• Contact arrangements

Contact arrangements other than above are available

Contact arrangement	1NO	1NC	1NO+1NC	2NO	2NC	3NO	3NC
Code	10	01	11	20	02	30	03

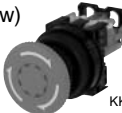
Contact arrangement	2NO+2NC	4NO	4NC	5NO	5NC	3NO+3NC	4NO+4NC
Code	22	40	04	50	05	33	44

Operator	Contact	Momentary action Type	Alternate action Type
Push-lock, turn-reset (40mm dia. with white arrow)  <small>KKD08-051</small>	1NO	—	AR30V5R-10 □
	1NC	—	AR30V5R-01 □
	1NO+1NC	—	AR30V5R-11 □
	2NO	—	AR30V5R-20 □
	2NC	—	AR30V5R-02 □
	2NO+2NC	—	AR30V5R-22 □
Pushbutton with emergency operating cap  <small>AF96-187</small>	1NO	AR30FVR-10 □	—
	1NC	AR30FVR-01 □	—
	1NO+1NC	AR30FVR-11 □	—
	2NO	AR30FVR-20 □	—
	2NC	AR30FVR-02 □	—
	2NO+2NC	AR30FVR-22 □	—



• Available numbers of contact blocks

Momentary action	Alternate action Push-lock, turn-reset
8-contact block	4-contact block

• Symbol mark (For AR30FAR, FBR, EAR, EBR)

Replace the ■ mark by the symbol mark code

Symbol mark	○	I	⊕	○	I	⊕
Color of button	White Black	White Black	White Black	Clear		
Color of mark	Red	Green	Green	Black		
Code	01 02	03 04	11 12	02B 04B 12B		

Operator	Contact (The following contact is only available.)	Button color	Type	Contact operation					
				Contact block		Left 		Right 	
				Mounting position	Type	Free	Depressed	Free	Depressed
Pushbutton with selector ring (2-position)  AF97-506	2NO+2NC	Green Red Black White Yellow Orange Blue	AR30S1R-22G AR30S1R-22R AR30S1R-22B AR30S1R-22W AR30S1R-22Y AR30S1R-22A AR30S1R-22S	(1)	NC	—	—	●	—
				(2)	NC	—	—	●	—
				(3)	NO	—	●	—	●
				(4)	NO	—	●	—	●
	2NO	Green Red Black White Yellow Orange Blue	AR30S2R-20G AR30S2R-20R AR30S2R-20B AR30S2R-20W AR30S2R-20Y AR30S2R-20A AR30S2R-20S	(1)	NO	—	●	—	—
				(2)	NO	—	—	—	●
				(3)	NO	—	●	—	—
				(4)	NO	—	—	—	●
	2NO+2NC	Green Red Black White Yellow Orange Blue	AR30S2R-22G AR30S2R-22R AR30S2R-22B AR30S2R-22W AR30S2R-22Y AR30S2R-22A AR30S2R-22S	(1)	NC	●	—	██████████	
				(2)	NC	██████████		●	—
				(3)	NO	—	●	—	—
				(4)	NO	—	—	—	●
	2NO+2NC	Green Red Black White Yellow Orange Blue	AR30S3R-22G AR30S3R-22R AR30S3R-22B AR30S3R-22W AR30S3R-22Y AR30S3R-22A AR30S3R-22S	(1)	NC	—	—	██████████	
				(2)	NC	██████████		—	—
				(3)	NO	—	●	—	—
				(4)	NO	—	—	—	●
	2NO+2NC	Green Red Black White Yellow Orange Blue	AR30S6R-22G AR30S6R-22R AR30S6R-22B AR30S6R-22W AR30S6R-22Y AR30S6R-22A AR30S6R-22S	(1)	NC	●	—	—	Locked
				(2)	NC	●	—	—	
				(3)	NO	—	●	●	
				(4)	NO	—	●	●	

Note: (1) to (4): Contact block mounting position

● Contact closed
— Contact open



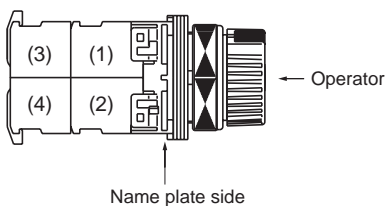

● Position of contact block



Emergency Stop Pushbuttons AR30

■ Emergency stop pushbutton switches



⇒ (Direct opening action), conform to EN418

Operator	Contact	Type
Push-lock, turn-reset (Soft-touch 40mm dia. with white arrow)  <small>KKD08-051</small>	1NC 1NO+1NC 2NC 3NC 2NO+2NC 4NC	AR30V0R-01R AR30V0R-11R AR30V0R-02R AR30V0R-03R AR30V0R-22R AR30V0R-04R
Push-lock, turn-reset (40mm dia.)  <small>KKD06-353</small>	1NC 1NO+1NC 2NC 3NC 2NO+2NC 4NC	AR30V2R-01R AR30V2R-11R AR30V2R-02R AR30V2R-03R AR30V2R-22R AR30V2R-04R
Push-lock, turn-reset (Soft-touch 65mm dia. with white arrow)  <small>KKD06-352</small>	1NC 1NO+1NC 2NC 3NC 2NO+2NC 4NC	AR30V1R-01R AR30V1R-11R AR30V1R-02R AR30V1R-03R AR30V1R-22R AR30V1R-04R
Push-lock, pull-reset (35mm dia.)  <small>KKD06-347</small>	1NC 1NO+1NC 2NC	AR30Q2R-01R AR30Q2R-11R AR30Q2R-02R

- Notes:
- Button color: Red only
 - Contact arrangements indicated in the table can be supplied.

■ Emergency stop illuminated pushbutton switches

⇒ (Direct opening action), conform to EN418

Operator	Transformer	Contact	LED lamp Type	Incandescent lamp Type
Push-lock, turn-reset (Soft-touch 40mm dia. with white arrow)  <small>KKD06-348</small>	Without	1NC 1NO+1NC 2NC 3NC	AR30V0L-01■3R AR30V0L-11■3R AR30V0L-02■3R AR30V0L-03■3R	AR30V0L-01■4R AR30V0L-11■4R AR30V0L-02■4R AR30V0L-03■4R
	With	1NC 1NO+1NC 2NC	AR30V0L-01■3R AR30V0L-11■3R AR30V0L-02■3R	AR30V0L-01■4R AR30V0L-11■4R AR30V0L-02■4R
Push-lock, turn-reset (40mm dia.)  <small>KKD06-350</small>	Without	1NC 1NO+1NC 2NC 3NC	AR30V2L-01■3R AR30V2L-11■3R AR30V2L-02■3R AR30V2L-03■3R	AR30V2L-01■4R AR30V2L-11■4R AR30V2L-02■4R AR30V2L-03■4R
	With	1NC 1NO+1NC 2NC	AR30V2L-01■3R AR30V2L-11■3R AR30V2L-02■3R	AR30V2L-01■4R AR30V2L-11■4R AR30V2L-02■4R

Notes: • Button color: Red only
• Contact arrangements indicated in the table can be supplied.

• Voltage

Replace the ■ mark by the lamp voltage code











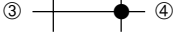

Transformer		Code	Incandescent
		LED	
Without	6V DC	6	—
	6V AC	A	—
	5V AC/DC	—	5
	12V AC/DC	B	—
	15V AC/DC	C	C
	20V AC/DC	—	D
	24V AC/DC	E	E

Transformer		Code	Incandescent
		LED	
With	100-110V AC	H	H
	115-127V AC	L	L
	200-220V AC	M	M
	230-254V AC	Q	Q
	350-380V AC	S	S
	400-440V AC	T	T
	480V AC	V	V
	500-550V AC	W	W

04

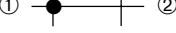
Selector Switches AR30

■ Selector switches 2-position

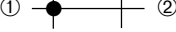
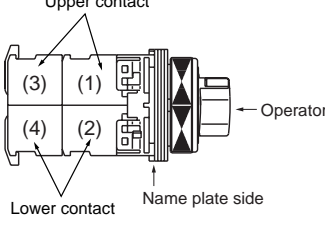
Operator	Operation	Knob color or key removable position	Contact	Type Switch with round bezel	Contact operation (Example)	
					Contact arrangement	Operator position Left Right 
 AF95-13	Maintained each 90°	Color code: B: Black (Standard) Color other than above are available (G: Green) (R: Red)	1NO 1NC 1NO+1NC 2NO 2NC 2NO+2NC	AR30PR-210B AR30PR-201B AR30PR-211B AR30PR-220B AR30PR-202B AR30PR-222B	1NO (1)	Upper contact 
	Spring return  60°				1NC (1) Upper contact 	
 AF95-14	Maintained each 90°		1NO 1NC 1NO+1NC 2NO 2NC 2NO+2NC	AR30WR-210B AR30WR-201B AR30WR-211B AR30WR-220B AR30WR-202B AR30WR-222B	1NO+1NC (1)	Upper contact 
	Spring return  60°				(2) Lower contact 	
 KKD09-023	Maintained each 90°	■: Key removable position (): Key type <i>See page 04/80</i>	1NO 1NC 1NO+1NC 2NO 2NC 2NO+2NC	AR30J□R-2■10() AR30J□R-2■01() AR30J□R-2■11() AR30J□R-2■20() AR30J□R-2■02() AR30J□R-2■22()	(3)	Upper contact 
	Spring return  60°				(2) Lower contact 	
					(4)	Lower contact 
						



Notes: • (1) to (4): Contact block mounting position
 • ① – ②, ③ – ④: Contact block terminal No.
 • Contact arrangements: *See page 04/80*

● Contact closed

• Operator

Replace the □ mark by the cylinder key type code
 Standard type: Blank
 Long durability type: A

3-position

Operator	Operation	Knob color	Contact	Type Switch with round bezel	Contact operation (Example)			
					Contact arrange- ment	Operation position		
						L	C	R
 <p style="text-align: center;">AF95-13</p>	Maintained each 45°	Color code: B: Black (Standard) Color other than above are available (G: Green) (R: Red)	1NO+1NC 2NO 2NC 2NO+2NC	AR30PR-311B AR30PR-320B AR30PR-302B AR30PR-322B	1NO+1NC (1) (2)	Upper contact ③	Lower contact ①	
	Spring/manual return ① each 45°		1NO+1NC 2NO 2NC 2NO+2NC			AR30PR-611B AR30PR-620B AR30PR-602B AR30PR-622B	Upper contact ③	Lower contact ②
	Spring/manual return ① each 45°		1NO+1NC 2NO 2NC 2NO+2NC	AR30PR-711B AR30PR-720B AR30PR-702B AR30PR-722B	Upper contact ③		Lower contact ②	
	Spring return ① each 45°		2NO+2NC		AR30PR-122B	Upper contact ①	Lower contact ①	
 <p style="text-align: center;">AF95-14</p>	Maintained each 45°		1NO+1NC 2NO 2NC 2NO+2NC	AR30WR-311B AR30WR-320B AR30WR-302B AR30WR-322B		1NO+1NC (1) (2)	Upper contact ③	Lower contact ①
	Spring/manual return ① each 45°		1NO+1NC 2NO 2NC 2NO+2NC		AR30WR-611B AR30WR-620B AR30WR-602B AR30WR-622B		Upper contact ③	Lower contact ②
	Spring/manual return ① each 45°		1NO+1NC 2NO 2NC 2NO+2NC	AR30WR-711B AR30WR-720B AR30WR-702B AR30WR-722B		Upper contact ③	Lower contact ②	
	Spring return ① each 45°		2NO+2NC		AR30WR-122B	Upper contact ①	Lower contact ①	

04

Note: • Contact arrangements: See page 04/80

● Contact closed

Selector Switches AR30

Operator	Operation	Key removable position	Contact	Type Switch with round bezel	Contact operation (Example)	
					Contact arrangement	Operator position
					L C R	L C R
					⊖ ⊕ ⊗	⊖ ⊕ ⊗
 KKD09-023	Maintained each 45°	■: Key removable position (): Key type	1NO+1NC 2NO 2NC 2NO+2NC	AR30J□R-3■11() AR30J□R-3■20() AR30J□R-3■02() AR30J□R-3■22()	1NO+1NC (1) (2)	Upper contact ③ ● ● ④ Lower contact ① ● ②
	Spring/manual return ⊕ each 45°		1NO+1NC 2NO 2NC 2NO+2NC	AR30J□R-6■11() AR30J□R-6■20() AR30J□R-6■02() AR30J□R-6■22()	1NO+1NC (1) (2)	Upper contact ③ ● ④ Lower contact ① ● ②
	Spring/manual return ⊕ each 45°		1NO+1NC 2NO 2NC 2NO+2NC	AR30J□R-7■11() AR30J□R-7■20() AR30J□R-7■02() AR30J□R-7■22()	1NO+1NC (1) (2)	Upper contact ③ ● ④ Lower contact ① ● ②
	Spring return ⊖ each 45°		2NO+2NC	AR30J□R-1E22()	2NO+2NC (1) (2) (3) (4)	Upper contact ① ● ● ② Lower contact ① ● ② ③ ● ④ ③ ● ④

Notes: • Operator position L: Left, C: Center, R: Right
• (1) to (4): Contact block mounting position
• ① – ②, ③ – ④: Contact block terminal No.

● Contact closed

• Contact arrangements

Contact arrangements other than above are available







Contact arrangement	1NO	1NC	1NO+1NC	2NO	2NC	3NO	3NC
Code	10	01	11	20	02	30	03

Contact arrangement	2NO+2NC	4NO	4NC	5NO	5NC	3NO+3NC	4NO+4NC
Code	22	40	04	50	05	33	44

• Available numbers of contact blocks

Maintained	Spring return Spring/manual return
8-contact block	4-contact block

• Key removable positions

Code	A	B	C	D	E	F	G
Removable position							
AR30J□R-2	●	●	—	●	—	—	—
AR30J□R-0	●	—	—	—	—	—	—
AR30J□R-3	●	●	●	●	●	●	●
AR30J□R-6	—	—	—	●	●	●	—
AR30J□R-7	●	—	—	—	●	—	●
AR30J□R-1	—	—	—	—	●	—	—

●: Available —: Not available

• Position of contact block

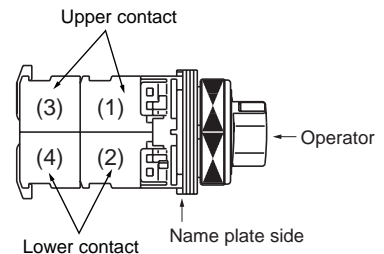



• Key code No.

Replace the () mark with one of the following key code.
A, B, C, D, E and F
Standard key code is A.







• Operator

Replace the □ mark by the cylinder key type code
Standard type: Blank
Long durability type: A

■ Selector switches (control type)
3-position

Operator	Operation	Knob color or key removable position	Contact arrangement	Type Switch with round bezel
Knob  <small>AF95-475</small>	Maintained each 45°	Color code: B: Black (Standard) Color other than above are available (G: Green) (R: Red)	Replace the ■ mark by the contact arrangement code (shown on next page).	AR30PCR-3■B
	Spring/manual return ⌚ each 45°			AR30PCR-6■B
	Spring/manual return ⌚ each 45°			AR30PCR-7■B
	Spring return ⌚ each 45°			AR30PCR-1■B
Lever  <small>KK02-140A</small>	Maintained each 45°		Replace the ■ mark by the contact arrangement code (shown on next page).	AR30WCR-3■B
	Spring/manual return ⌚ each 45°			AR30WCR-6■B
	Spring/manual return ⌚ each 45°			AR30WCR-7■B
	Spring return ⌚ each 45°			AR30WCR-1■B
Key  <small>KKD09-022</small>	Maintained each 45°	Replace the □ mark by the key removable position code: A, B, C, D, E F or G	Replace the ■ mark by the contact arrangement code (shown on next page).	AR30JCR-3□■()
	Spring/manual return ⌚ each 45°			AR30JCR-6□■()
	Spring/manual return ⌚ each 45°			AR30JCR-7□■()
	Spring return ⌚ each 45°			AR30JCR-1E■()

● Key removable positions

Code	A	B	C	D	E	F	G
Removable position							
AR30JCR-3	●	●	●	●	●	●	●
AR30JCR-6	-	-	-	●	●	●	-
AR30JCR-7	●	-	-	-	●	-	●
AR30JCR-1	-	-	-	-	●	-	-

●: Available -: Not available

● Key code No.

Replace the () mark with one of the following key code.
A, B, C, D, E and F
Standard key code is A.

Selector Switches AR30

• Contact arrangement code (Typical example)

Contact arrangement	Contact arrangement code	Contact operation				
		Contact block		Operator position		
		Mounting position	Type	Left	Center	Right
2NC	01F	(1)	NC	[Diagram: Solid bar in Center position]		
		(2)	NC	[Diagram: Solid bar in Right position]		
		-	-	-	-	-
		-	-	-	-	-
2NO+2NC	014	(1)	NC	[Diagram: Solid bar in Center position]		
		(2)	NC	[Diagram: Solid bar in Right position]		
		(3)	NO			●
		(4)	NO	●		
4NC	01J	(1)	NC	[Diagram: Solid bar in Center position]		
		(2)	NC	[Diagram: Solid bar in Right position]		
		(3)	NC	[Diagram: Solid bar in Left position]		
		(4)	NC	[Diagram: Solid bar in Right position]		
2NO+2NC	024	(1)	NC	[Diagram: Solid bar in Center position]		
		(2)	NC		●	
		(3)	NO			●
		(4)	NO	●		●
2NO+2NC	03C* (Maintained only)	(1)	NC	[Diagram: Solid bar in Center position]		
		(2)	NC			●
		(3)	NO			●
		(4)	NO	●		
2NO+2NC	044*	(1)	NC	[Diagram: Solid bar in Center position]		
		(2)	NC		●	
		(3)	NO			●
		(4)	NO	●		
2NO+2NC	054	(1)	NC	[Diagram: Solid bar in Center position]		
		(2)	NC		●	
		(3)	NO			●
		(4)	NO			●

Notes: ●: Contact closed Blank: Contact open

* There may be some overlap in the contact when switching between notches.

• Position of contact block

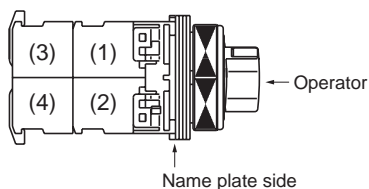

Contact arrangement	Contact arrangement code	Contact operation				
		Contact block		Operator position		
		Mounting position	Type	Left	Center	Right
2NO+2NC	064	(1)	NC		[Diagram: Solid bar in Center position]	
		(2)	NC		●	
		(3)	NO	●		
		(4)	NO	●		●
1NO+1NC	07F	(1)	NC		[Diagram: Solid bar in Center position]	
		(2)	NO			●
		-	-	-	-	-
		-	-	-	-	-
2NO+2NC	07C* (Maintained only)	(1)	NC		[Diagram: Solid bar in Center position]	
		(2)	NC			●
		(3)	NO	●		
		(4)	NO	●		
2NO+2NC	084	(1)	NC		[Diagram: Solid bar in Center position]	
		(2)	NC		●	
		(3)	NO	●		
		(4)	NO	●		
2NO+2NC	094*	(1)	NC		[Diagram: Solid bar in Center position]	
		(2)	NC		●	
		(3)	NO	●		
		(4)	NO			●
2NO+2NC	104	(1)	NC		●	
		(2)	NC		●	
		(3)	NO	●		●
		(4)	NO	●		●
2NO+2NC	11C* (Maintained only)	(1)	NC		●	
		(2)	NC			●
		(3)	NO	●		●
		(4)	NO	●		●

• Contact arrangement code (Typical example)

Contact arrangement	Contact arrangement code	Contact operation				
		Contact block		Operator position		
		Mounting position	Type	Left 	Center 	Right
2NO+2NC	124*	(1)	NC		●	
		(2)	NC		●	
		(3)	NO	●		●
		(4)	NO	●		
2NO+2NC	134*	(1)	NC		●	
		(2)	NC		●	
		(3)	NO	●		●
		(4)	NO			●
3NO+1NC	14D* (Maintained only)	(1)	NO	●		
		(2)	NC		●	
		(3)	NO	●		
		(4)	NO			●
3NO+1NC	15A*	(1)	NO			●
		(2)	NC		●	
		(3)	NO			●
		(4)	NO	●		
2NO+2NC	164	(1)	NC		●	
		(2)	NC		●	
		(3)	NO	●		
		(4)	NO	●		
2NO+2NC	174*	(1)	NC		●	
		(2)	NC		●	
		(3)	NO	●		
		(4)	NO			●
2NO+2NC	184	(1)	NC		●	
		(2)	NC		●	
		(3)	NO			●
		(4)	NO			●

Notes: ●: Contact closed Blank: Contact open

* There may be some overlap in the contact when switching between notches.

• Position of contact block

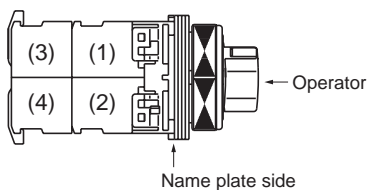



Contact arrangement	Contact arrangement code	Contact operation				
		Contact block		Operator position		
		Mounting position	Type	Left 	Center 	Right
2NO+2NC	194	(1)	NC			
		(2)	NC			
		(3)	NO	●		
		(4)	NO			●
4NO	20B	(1)	NO			●
		(2)	NO	●		
		(3)	NO			●
		(4)	NO	●		

04

Selector Switches AR30

4, 5-position

Operator	Contact (The following contact is only available.)	Operation	Knob color	Contact arrangement	Type Switch with round bezel
 AF95-475	2NO+2NC	4-position maintained	Color code: B: Black (Standard) Color other than above are available (G: Green) (R: Red)	Replace the ■ mark by the contact arrangement code (shown below)	AR30PCR-4■B
		5-position maintained			AR30PCR-5■B
 KK02-140A	2NO+2NC	4-position maintained			AR30WCR-4■B
		5-position maintained			AR30WCR-5■B

● Contact arrangement code

Position	Contact arrangement	Contact arrangement code	Contact operation		Operator position
			Contact block		
			Mounting position	Type	
4-position	2NO+2NC	41C* (Main-tained only)	(1)	NC	●
			(2)	NC	●
			(3)	NO	●
			(4)	NO	●
5-position	2NO+2NC	51C* (Main-tained only)	(1)	NC	●
			(2)	NC	●
			(3)	NO	●
			(4)	NO	●

Notes: ●: Contact closed

* There may be some overlap in the contact when switching between notches.

● Position of contact block

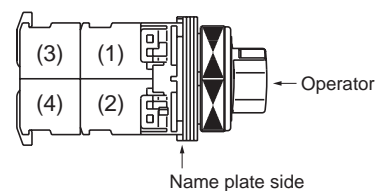

Operator position

4-position

5-position



■ Lever type selector switches
2-position

Operator	Operation	Contact	Type	Contact operation		
				Contact arrangement	Operator position	
					Left	Right
 <p>KKD05-115</p>	Maintained each 90°	1NO	AR30HR-210	1NO (1)	Upper contact ③ ——— ● ——— ④	
		1NC	AR30HR-201	1NC (1)	Upper contact ① — ● ——— ——— ②	
		1NO+1NC	AR30HR-211	1NO (1)	Upper contact ③ ——— ● ——— ④	
				1NC (2)	Lower contact ① — ● ——— ——— ②	
		2NO	AR30HR-220	1NO (1)	Upper contact ③ ——— ● ——— ④	
				1NO (2)	Lower contact ③ ——— ● ——— ④	
		2NC	AR30HR-202	1NC (1)	Upper contact ① — ● ——— ——— ②	
1NC (2)	Lower contact ① — ● ——— ——— ②					
2NO+2NC	AR30HR-222	1NO (1)	Upper contact ③ ——— ● ——— ④			
		1NO (3)	③ ——— ● ——— ④			
		1NC (2)	Lower contact ① — ● ——— ——— ②			
		1NC (4)	① — ● ——— ——— ②			

04

Notes: • Contact arrangements in the table can be supplied.





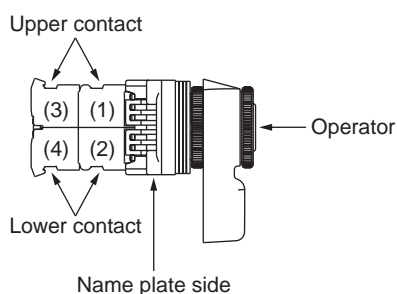



● Contact closed

● Position of contact block

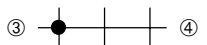
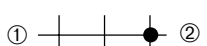

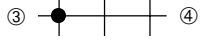
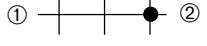
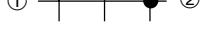
Illuminated Selector Switches AR30

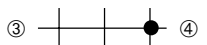
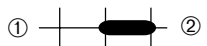
3-position

Operator	Operation	Contact	Type	Contact operation			
				Contact arrangement	Operator position		
					Left	Center	Right
							
 KKD05-114	Maintained each 45°	1NO+1NC	AR30HR-311	1NO (1) 1NC (2)	Upper contact  Lower contact 		
		2NO+2NC	AR30HR-322	1NO (1) 1NO (3) 1NC (2) 1NC (4)	Upper contact   Lower contact  		
	Spring return  each 60°	2NO+2NC	AR30HR-122	1NC (1) 1NO (3) 1NC (2) 1NO (4)	Upper contact   Lower contact  		

Notes: • Contact arrangements in the table can be supplied.



● Contact closed

• Contact arrangements. The NO contacts at (1) and (2) use special parts. Do not interchange these parts.

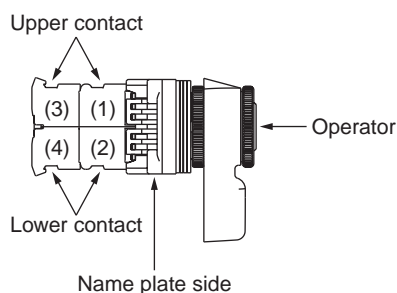
• Position of contact block





■ Illuminated selector switches
2-position

Operator	Operation	Contact	LED lamp		Incandescent lamp	
			Transformer	Type	Transformer	Type
 AF95-5	Maintained	1NO 1NC 1NO+1NC 2NO+2NC	Without	AR30PL-210■3□ AR30PL-201■3□ AR30PL-211■3□ AR30PL-222■3□	Without	AR30PL-210■4□ AR30PL-201■4□ AR30PL-211■4□ AR30PL-222■4□
			With	AR30PL-210■3□ AR30PL-201■3□ AR30PL-211■3□ AR30PL-220■3□	With	AR30PL-210■4□ AR30PL-201■4□ AR30PL-211■4□ AR30PL-220■4□
	Spring return  60°	1NO 1NC 1NO+1NC 2NO	Without	AR30PL-010■3□ AR30PL-001■3□ AR30PL-011■3□ AR30PL-020■3□	Without	AR30PL-010■4□ AR30PL-001■4□ AR30PL-011■4□ AR30PL-020■4□
			With	AR30PL-010■3□ AR30PL-001■3□ AR30PL-011■3□ AR30PL-020■3□	With	AR30PL-010■4□ AR30PL-001■4□ AR30PL-011■4□ AR30PL-020■4□

04

3-position

Operator	Operation	Contact	LED lamp		Incandescent lamp	
			Transformer	Type	Transformer	Type
 AF95-5	Maintained	1NO+1NC 2NO+2NC	Without	AR30PL-311■3□ AR30PL-322■3□	Without	AR30PL-311■4□ AR30PL-322■4□
			With	AR30PL-311■3□	With	AR30PL-311■4□
	Spring/manual return  each 45°	1NO+1NC 1NO+1NC	Without	AR30PL-611■3□ AR30PL-611■3□	Without	AR30PL-611■4□ AR30PL-611■4□
			With	AR30PL-611■3□ AR30PL-611■3□	With	AR30PL-611■4□ AR30PL-611■4□

Note: □, ■ See page 04/88

Illuminated Selector Switches AR30

- Replace the ■ mark by the following lamp voltage code

Transformer	Voltage	Code	
		LED	Incandescent
Without	5V AC/DC	—	5
	6V DC	6	—
	6V AC	A	—
	12V AC/DC	B	—
	15V AC/DC	C	C
	20V AC/DC	—	D
	24V AC/DC	E	E
With	100-110V AC	H	H
	115-127V AC	L	L
	200-220V AC	M	M
	230-254V AC	Q	Q
	350-380V AC	S	S
	400-440V AC	T	T
	480V AC	V	V
	500-550V AC	W	W

- Contact arrangement and operator position

2-position

Transformer	Contact arrangement	Contact block		Operator position	
		Mounting position	Type	Left	Right
With/without	1NO	(1)	NO	—	●
With/without	1NC	(1)	NC	●	—
Without	1NO+1NC	(1)	NO	—	●
		(2)	NC	●	—
With	1NO+1NC	(1)	NC	●	—
		(2)	NO	—	●
With/without	2NO	(1)	NO	—	●
		(2)	NO	—	●
Without	2NO+2NC *1	(1)	NO	—	●
		(2)	NC	●	—
		(3)	NO	—	●
		(4)	NC	●	—
With	2NO+2NC *1	(1)	NC	●	—
		(2)	NC	●	—
		(3)	NO	—	●
		(4)	NO	—	●

Notes: *1: AR30PL-2

●: Contact closed, —: Contact open

- Position of contact block

Without transformer

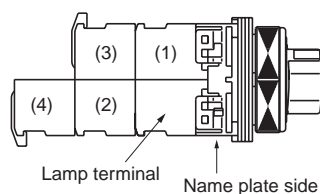

- Replace the □ mark by the following knob color code

Color	Green	Red	White	Blue	Yellow	Orange
Code	G	R	W	S	Y	A

- Up to 4-contact of contact arrangement can be made. Available numbers of contacts are as follow.

No. of position	Operation	Without transformer	With transformer
2-position	Maintained	6-contact	4-contact
	Spring return	3-contact	2-contact
3-position	Maintained	6-contact	4-contact
	Spring/manual return	3-contact	2-contact

3-position

Transformer	Contact arrangement	Contact block		Operator position		
		Mounting position	Type	Left	Center	Right
Without	1NO+1NC *1	(1)	NO	●	—	—
		(2)	NC	—	—	●
	1NO+1NC *2	(1)	NO	—	—	●
		(2)	NC	●	—	—
	2NO+2NC *3	(1)	NO	●	—	—
		(2)	NC	—	—	●
		(3)	NO	●	—	—
		(4)	NC	—	—	●
With	1NO+1NC *1	(1)	NC	—	—	●
		(2)	NO	●	—	—
	1NO+1NC *2	(1)	NC	●	—	—
		(2)	NO	—	—	●
	2NO+2NC *3	(1)	NC	—	—	●
		(2)	NC	—	—	●
		(3)	NO	●	—	—
		(4)	NO	●	—	—

Notes: *1: AR30PL-3, 6 *3: AR30PL-3





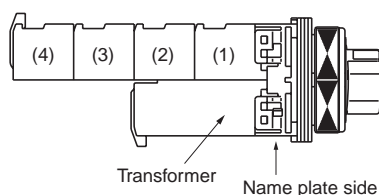

*2: AR30PL-7

●: Contact closed, —: Contact open

With transformer





■ Pilot lights/standard

Lens	Transformer	LED lamp Lamp voltage	Type	Incandescent lamp Lamp voltage	Type
 AF95-18	Without	6V AC 6V DC 12V AC/DC 24V AC/DC	DR30D0L-A3□ DR30D0L-63□ DR30D0L-B3□ DR30D0L-E3□	5.5V AC/DC — 15V AC/DC 24V AC/DC	DR30D0L-54□ — DR30D0L-C4□ DR30D0L-E4□
	With	100–110V AC 200–220V AC	DR30D0L-H3□ DR30D0L-M3□	100–110V AC 200–220V AC	DR30D0L-H4□ DR30D0L-M4□
 AF97-674	With resistor	50V DC 110V DC 220V DC	DR30D0L-FR□ DR30D0L-HR□ DR30D0L-MR□	50V DC — —	DR30D0L-FQ□ — —
	With resistor	— —	— —	110V DC 220V DC	DR30D0L-HQ□ DR30D0L-MQ□
Discontinued					
 AF95-20	Without	6V AC 6V DC 12V AC/DC 24V AC/DC	DR30E3L-A3□ DR30E3L-63□ DR30E3L-B3□ DR30E3L-E3□	5.5V AC/DC — 15V AC/DC 24V AC/DC	DR30E3L-54□ — DR30E3L-C4□ DR30E3L-E4□
	With	100–110V AC 200–220V AC	DR30E3L-H3□ DR30E3L-M3□	100–110V AC 200–220V AC	DR30E3L-H4□ DR30E3L-M4□
 AF95-19	Without	6V AC 6V DC 12V AC/DC 24V AC/DC	DR30K0L-A3□ DR30K0L-63□ DR30K0L-B3□ DR30K0L-E3□	5.5V AC/DC — 15V AC/DC 24V AC/DC	DR30K0L-54□ — DR30K0L-C4□ DR30K0L-E4□
	With	100–110V AC 200–220V AC	DR30K0L-H3□ DR30K0L-M3□	100–110V AC 200–220V AC	DR30K0L-H4□ DR30K0L-M4□
 AF97-673	With resistor	50V DC 110V DC 220V DC	DR30K0L-FR□ DR30K0L-HR□ DR30K0L-MR□	50V DC — —	DR30K0L-FQ□ — —
	With resistor	— —	— —	110V DC 220V DC	DR30K0L-HQ□ DR30K0L-MQ□
Discontinued					
 KK02-144A	Without	6V AC 6V DC 12V AC/DC 15V AC/DC 24V AC/DC	DR30D1L-A3□ DR30D1L-63□ DR30D1L-B3□ DR30D1L-C3□ DR30D1L-E3□	5.5V AC/DC — — 15V AC/DC 24V AC/DC	DR30D1L-54□ — — DR30D1L-C4□ DR30D1L-E4□
	With	100V–110V AC 200V–220V AC	DR30D1L-H3□ DR30D1L-M3□	100V–110V AC 200V–220V AC	DR30D1L-H4□ DR30D1L-M4□

Note: □ See page 04/90

Pilot Lights DR30

■ Pilot lights/short-body with transformer

Lens	LED lamp		Incandescent lamp	
	Lamp voltage	Type	Lamp voltage	Type
Dome  <small>KK02-141A</small>	100–110V AC 200–220V AC	DR30D0L-H9 □ DR30D0L-M9 □	100–110V AC 200–220V AC	DR30D0L-H8 □ DR30D0L-M8 □
Extended round  <small>KK02-142A</small>	100–110V AC 200–220V AC	DR30E3L-H9 □ DR30E3L-M9 □	100–110V AC 200–220V AC	DR30E3L-H8 □ DR30E3L-M8 □
Faceted  <small>KK02-143A</small>	100–110V AC 200–220V AC	DR30K0L-H9 □ DR30K0L-M9 □	100–110V AC 200–220V AC	DR30K0L-H8 □ DR30K0L-M8 □

● Lens color

Replace the □ mark by the following lens color code



Color	Green	Red	White	Blue	Yellow	Orange
Code	G	R	W	S	Y	A

● Lamp voltage

Available lamp voltage are as follow.

Description	Voltage	Code Standard type		Code Short-body type	
		LED	Incandescent	LED	Incandescent
Without transformer	5.5V AC/DC	–	54	–	–
	6V AC	A3	–	–	–
	6V DC	63	–	–	–
	12V AC/DC	B3	–	–	–
	15V AC/DC	C3	C4	–	–
	20V AC/DC	–	D4	–	–
	24V AC/DC	E3	E4	–	–
With transformer	100-110V AC	H3	H4	H9	H8
	115-127V AC	L3	L4	L9	L8
	200-220V AC	M3	M4	M9	M8
	230-254V AC	Q3	Q4	–	–
	350-380V AC	S3	S4	–	–
	400-440V AC	T3	T4	–	–
	480V AC	V3	V4	–	–
	500-550V AC	W3	W4	–	–
With resistor unit	110V DC	H7	–	–	–
With resistor	50V DC	FR	FQ	–	–
	110V DC	HR	HQ	–	–
	220V DC	MR	MQ	–	–

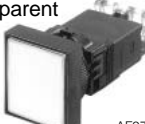
■ Pilot lights/standard

Lens	Transformer	LED unit		Incandescent lamp	
		Lamp voltage	Type	Lamp voltage	Type
Flush square (34mm sq. transparent lens)  AF97-65	Without	6V DC 15V AC/DC 24V AC/DC	DR30F4M-65 □ DR30F4M-C5 □ DR30F4M-E5 □	5.5V AC/DC 15V AC/DC 24V AC/DC	DR30F4M-54 □ DR30F4M-C4 □ DR30F4M-E4 □
	With	100–110V AC 200–220V AC	DR30F4M-H5 □ DR30F4M-M5 □	100–110V AC 200–220V AC	DR30F4M-H4 □ DR30F4M-M4 □
Flush rectangular (Transparent lens)  AF97-61	Without	6V DC 15V AC/DC 24V AC/DC	DR30F4N-65 □ DR30F4N-C5 □ DR30F4N-E5 □	5.5V AC/DC 15V AC/DC 24V AC/DC	DR30F4N-54 □ DR30F4N-C4 □ DR30F4N-E4 □
	With	100–110V AC 200–220V AC	DR30F4N-H5 □ DR30F4N-M5 □	100–110V AC 200–220V AC	DR30F4N-H4 □ DR30F4N-M4 □
Flush square (40mm sq. transparent lens)  AF97-63	Without	6V DC 15V AC/DC 24V AC/DC	DR30M4M-65 □ DR30M4M-C5 □ DR30M4M-E5 □	5.5V AC/DC 15V AC/DC 24V AC/DC	DR30M4M-54 □ DR30M4M-C4 □ DR30M4M-E4 □
	With	100–110V AC 200–220V AC	DR30M4M-H5 □ DR30M4M-M5 □	100–110V AC 200–220V AC	DR30M4M-H4 □ DR30M4M-M4 □

● Color plate

Replace the □ mark by the following color plate color code

Color	Green	Red	White	Blue*	Yellow	Orange
Code	G	R	W	S	Y	A

Note: * Incandescent lamp only



● Lamp voltage

Available lamp voltage are as follow.

Description	Voltage	Code	
		Standard type	
		LED	Incandescent
Without transformer	5.5V AC/DC	–	54
	6V AC	A5	–
	6V DC	65	–
	12V AC	25	–
	12V AC/DC	B5	–
	15V AC/DC	C5	C4
	20V AC/DC	–	D4
	24V AC/DC	E5	E4
With transformer	100-110V AC	H5	H4
	115-127V AC	L5	L4
	200-220V AC	M5	M4
	230-254V AC	Q5	Q4
	350-380V AC	S5	S4
	400-440V AC	T5	T4
	480V AC	V5	V4
	500-550V AC	W5	W4
With resistor unit	110V DC	HE	–

Joy Stick Selector Switches AR30

■ Joy stick selector switches

Handle	Terminal	Operating directions	Contact arrangement	Type	
				Manual return	Spring return
 AF97-48	Screw	↑ ↓	1NO X 2	AR30A0N-A0A0B	AR30A5N-A0A0B
			1NO + 1NC X 2	AR30A0N-1010B	AR30A5N-1010B
		↔	1NO X 4	AR30A0N-AAAAB	AR30A5N-AAAAB
			1NO + 1NC X 4	AR30A0N-1111B	AR30A5N-1111B
	Solder/tab	↑ ↓	1NO + 1NC X 2	AR30A0H-1010B	AR30A5H-1010B
			2NO + 2NC X 2	AR30A0H-2020B	AR30A5H-2020B
Solder/tab	↔	1NO + 1NC X 4	AR30A0H-1111B	AR30A5H-1111B	
		2NO + 2NC X 4	AR30A0H-2222B	AR30A5H-2222B	
 AF97-44	Screw	↑ ↓	1NO X 2	AR30A1N-A0A0B	AR30A6N-A0A0B
			1NO + 1NC X 2	AR30A1N-1010B	AR30A6N-1010B
		↔	1NO X 4	AR30A1N-AAAAB	AR30A6N-AAAAB
			1NO + 1NC X 4	AR30A1N-1111B	AR30A6N-1111B
	Solder/tab	↑ ↓	1NO + 1NC X 2	AR30A1H-1010B	AR30A6H-1010B
			2NO + 2NC X 2	AR30A1H-2020B	AR30A6H-2020B
Solder/tab	↔	1NO + 1NC X 4	AR30A1H-1111B	AR30A6H-1111B	
		2NO + 2NC X 4	AR30A1H-2222B	AR30A6H-2222B	
 AF97-57	Screw	↑ ↓	1NO X 2	AR30A2N-A0A0B	AR30A7N-A0A0B
			1NO + 1NC X 2	AR30A2N-1010B	AR30A7N-1010B
		↔	1NO X 4	AR30A2N-AAAAB	AR30A7N-AAAAB
			1NO + 1NC X 4	AR30A2N-1111B	AR30A7N-1111B
	Solder/tab	↑ ↓	1NO + 1NC X 2	AR30A2H-1010B	AR30A7H-1010B
			2NO + 2NC X 2	AR30A2H-2020B	AR30A7H-2020B
Solder/tab	↔	1NO + 1NC X 4	AR30A2H-1111B	AR30A7H-1111B	
		2NO + 2NC X 4	AR30A2H-2222B	AR30A7H-2222B	

● Operating direction

- Directions other than those shown in the table above can be provided.
- For types AR30A□N-**1** **2** **3** **4** B, designate the contact arrangement codes for the necessary operating directions (**1**: Upper, **2**: Right, **3**: Lower, **4**: Left). Designate "0" for unnecessary directions.

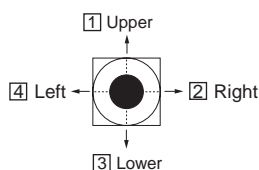



● Contact arrangement

Contact arrangement		–	1NO	1NC	1NO+1NC	2NO	2NC	2NO+2NC
Manual return Spring return	Screw	0	A	B	1	D	E	–
	Solder/Tab	0	–	–	1	–	–	2

- Spring/manual return are also available, contact FUJI .

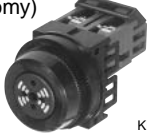
■ Buzzers

Sound	Description	Transformer	Operating voltage	Type
 KKD08-058	<ul style="list-style-type: none"> • LED operation indicator (Red) • Intermittent/continuous sound selection • Sound level: 90dB (0.1m) 70dB (1m) 	Without	6V AC Discontinued 6V DC 12 to 24V AC/DC 35 to 48V AC/DC Discontinued	DR30B5-AB DR30B5-6B DR30B5-EB DR30B5-FB
		With	100 to 110V AC 200 to 220V AC	DR30B5-HB DR30B5-MB
		With resistor unit	100 to 110V DC	DR30B5-1B
 KK02-145A	<ul style="list-style-type: none"> • Sound level: 90dB (0.1m) 70dB (1m) 	Without	6V DC 24V AC 24V DC	DR30B6-6B DR30B6-GB DR30B6-EB
		With	100 to 110V AC 200 to 220V AC	DR30B6-HB DR30B6-MB
 AF96-378	<ul style="list-style-type: none"> • Sound level: 90dB (0.1m) 70dB (1m) 	Without	100 to 110V AC 200 to 220V AC	DR30B0-HB DR30B0-ME
 AF96-245	<ul style="list-style-type: none"> • Intermittent/continuous sound selection • Sound level: 80dB (0.1m) 60dB (1m) 	Without	6V AC Discontinued 6V DC 12 to 24V AC/DC 35 to 48V AC/DC Discontinued	DR30B8-AB DR30B8-6B DR30B8-EB DR30B8-FB
		With	100 to 110V AC 200 to 220V AC	DR30B8-HB DR30B8-MB
		With resistor unit	100 to 110V DC	DR30B8-1B

Notes: • Intermittent/continuous sound selection (DR30B5, B8)
 See the "Short-circuit terminal" in the dimensions diagram on the 04/104 page, and select as follows:
 • Short-circuit terminal mounted → Intermittent sound
 • Short-circuit terminal not mounted → Continuous sound

04

Pushbuttons/Selectors/Pilot Lights/Buzzers

AR30 and DR30

Dimensions

■ Dimensions, mm

● Illuminated pushbuttons

Extended

With transformer

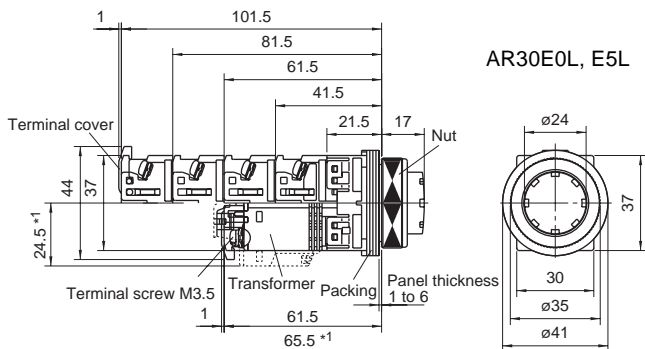

Without transformer

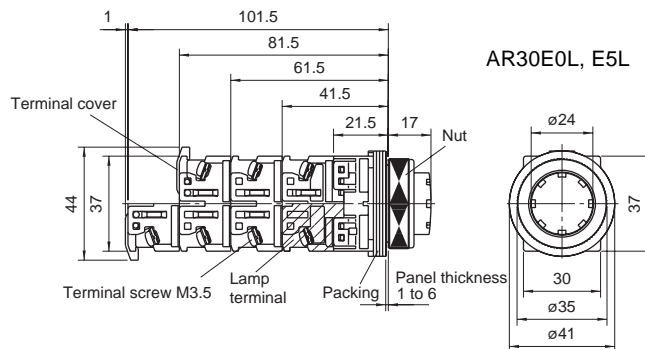

Extended with transparent full guard (24mm dia.)

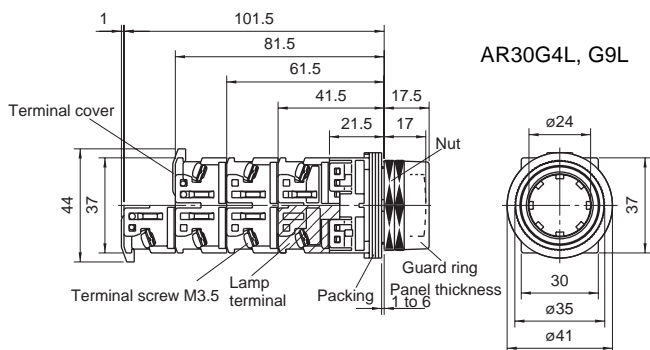

Extended with full guard (24mm dia. with openings)

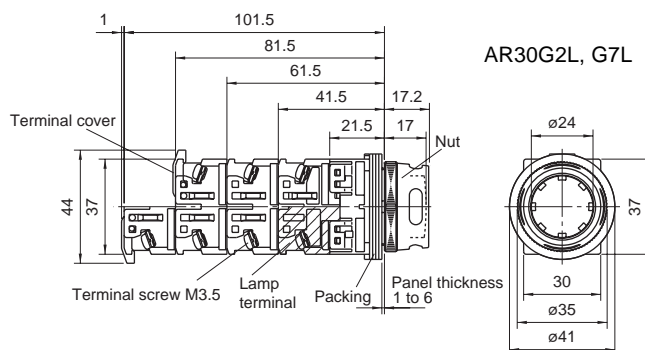

Extended with full guard (24mm dia.)

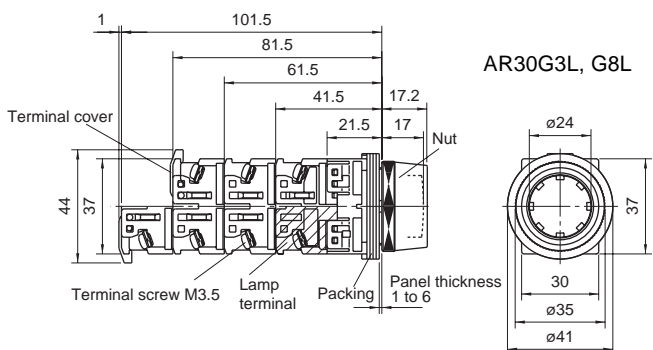

Note: *1 Except for the types 110V AC, 127V AC and 220V AC.

Pushbuttons/Selectors/Pilot Lights/Buzzers AR30 and DR30 Dimensions

■ Dimensions, mm

● Illuminated pushbuttons

Push-lock, turn-reset (40mm dia. with white arrow)

With transformer

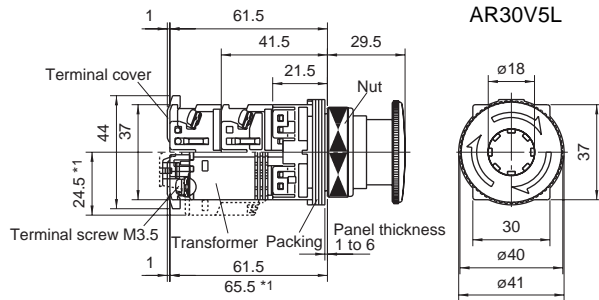

Without transformer

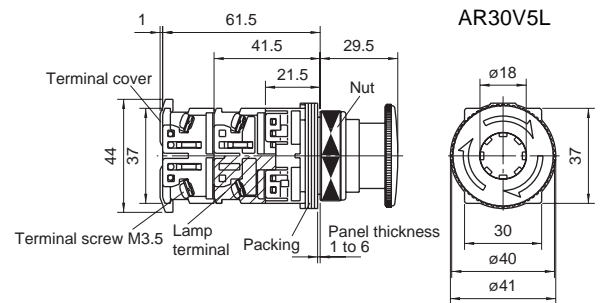

Push-pull

With transformer

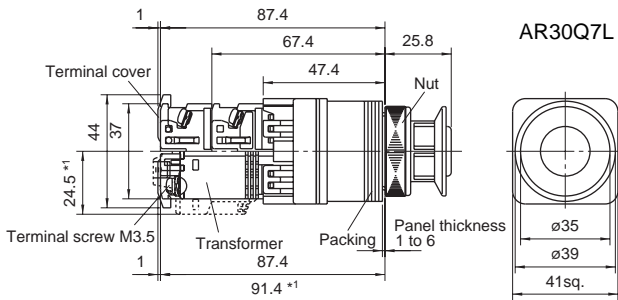

Without transformer

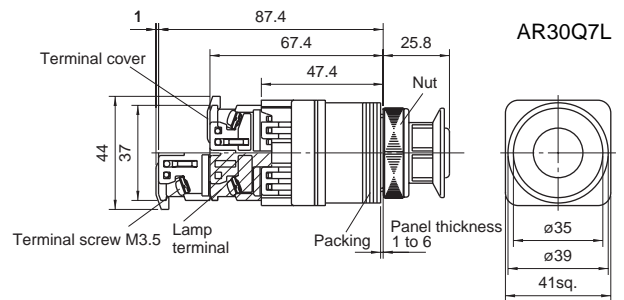

Note: *1 Except for the types 110V AC, 127V AC and 220V AC.

Pushbuttons/Selectors/Pilot Lights/Buzzers

AR30 and DR30

Dimensions

■ Dimensions, mm

● Pushbuttons

Flush/Extended

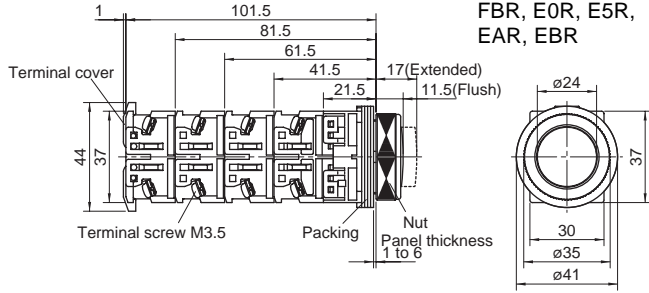

Mushroom (40mm dia.)

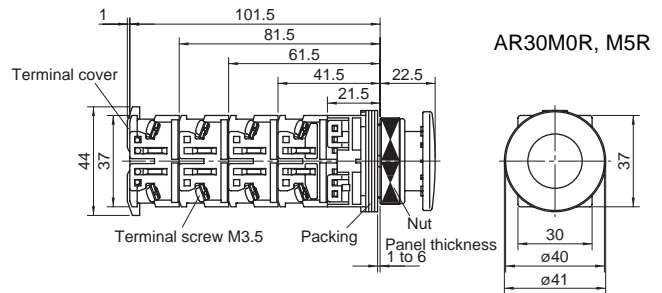

Mushroom (29mm dia.)

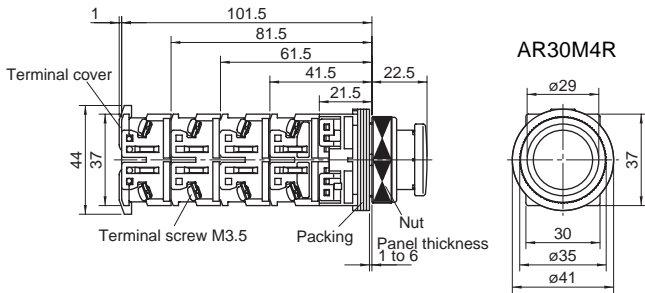

Extended with full guard (24mm dia.)

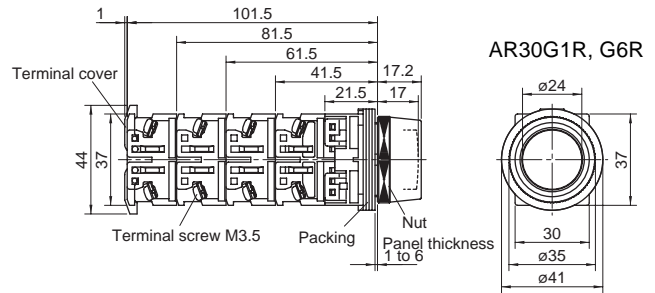

Extended with half guard

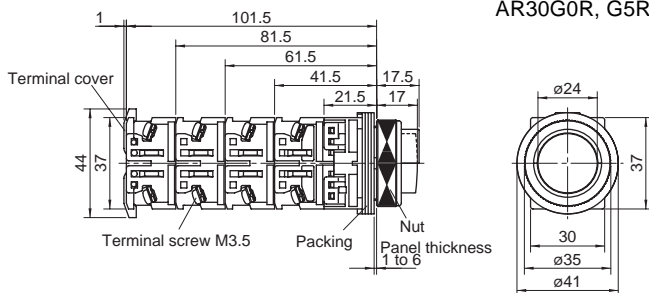

Pin lock

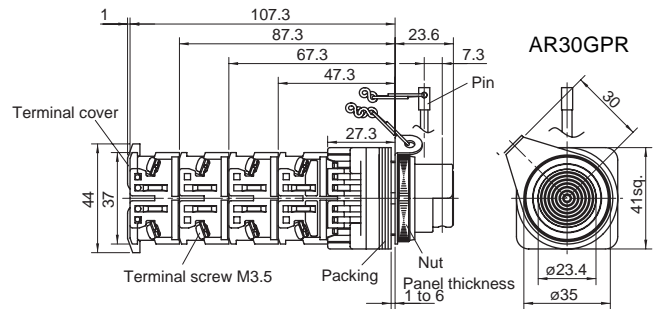

Note:
The enclosed pin can be inserted to lock the pushbutton in a pushed or not pushed state.

Mushroom with full guard (40mm dia.)

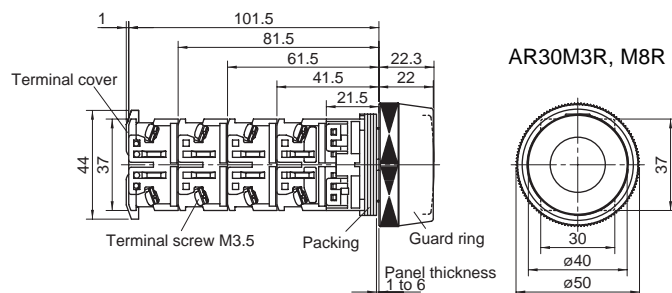

Mushroom with full guard (35mm dia. metal nut)

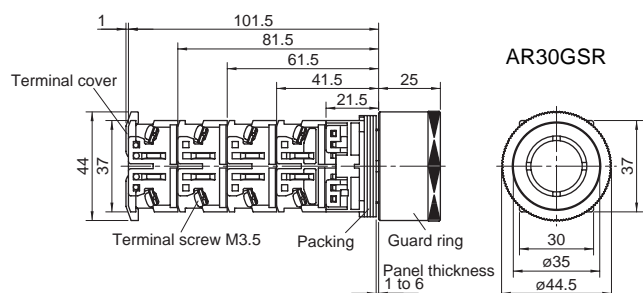

Pushbuttons/Selectors/Pilot Lights/Buzzers AR30 and DR30 Dimensions

■ Dimensions, mm

● Pushbuttons

Giant

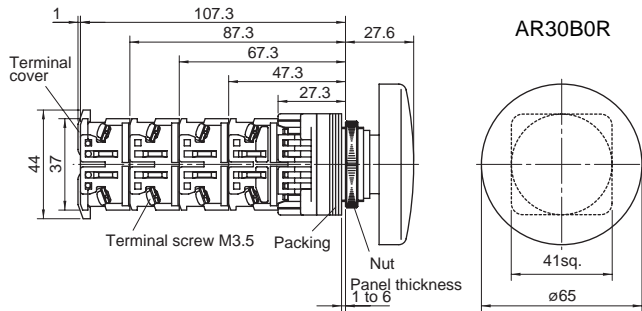

Giant with guard

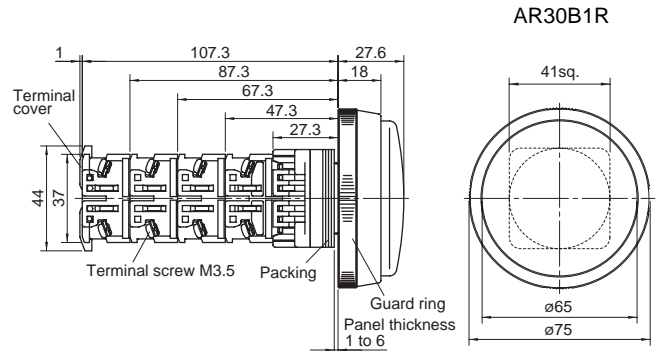

Giant with full guard

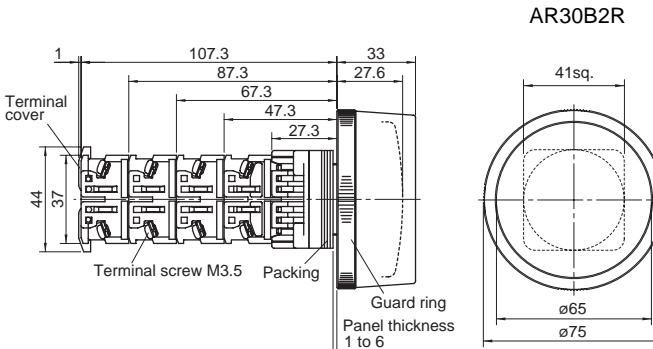

Giant with full guard

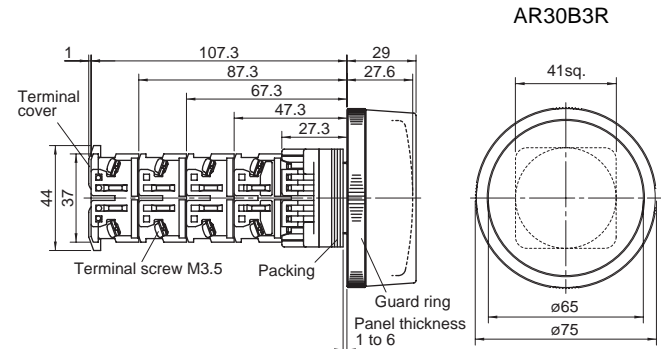

Pushbutton with selector ring (2-position)

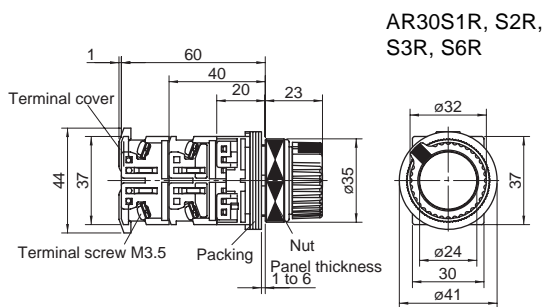

Push, turn-lock

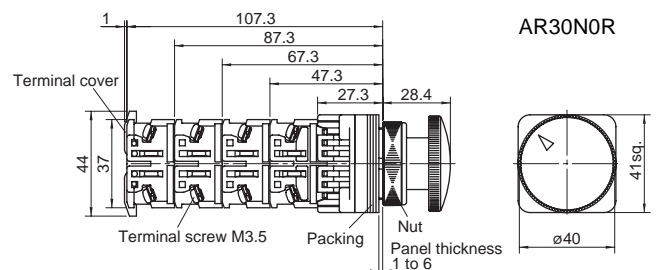

Note:
When the push button is pressed in the left position, it resets automatically (momentary operation).
When pressed and turned to the right it locks, and to the left it resets.

Push-lock, turn-reset (40mm dia. with white arrow)

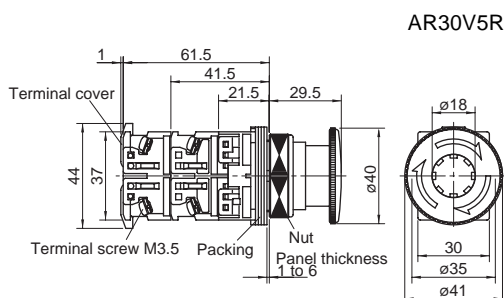

Emergency operating cap

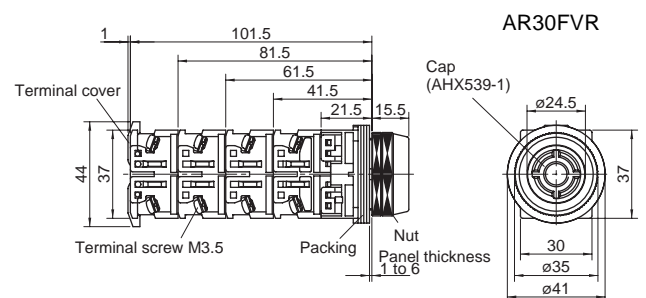

Note:
This pushbutton switch is operated while holding the cap with the fingertips.
The cap (AHX539) can be exchanged.

Pushbuttons/Selectors/Pilot Lights/Buzzers

AR30 and DR30

Dimensions

■ Dimensions, mm

● Emergency stop pushbuttons

Push-lock, turn-reset (40mm dia.)

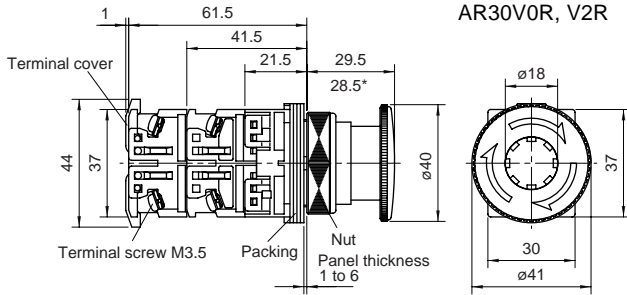

Note: * AR30V2R type

Push-lock, turn-reset (65mm dia. with white allow)

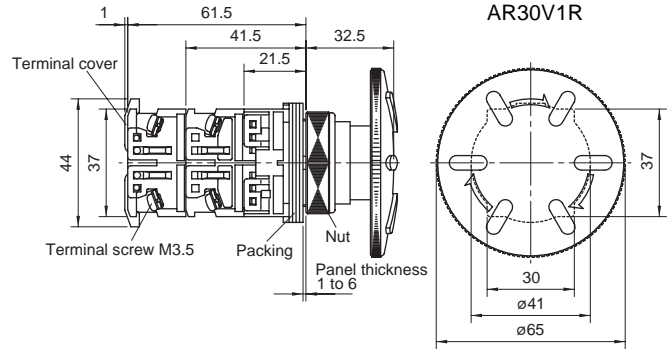

Push-lock, pull-reset (35mm dia.)

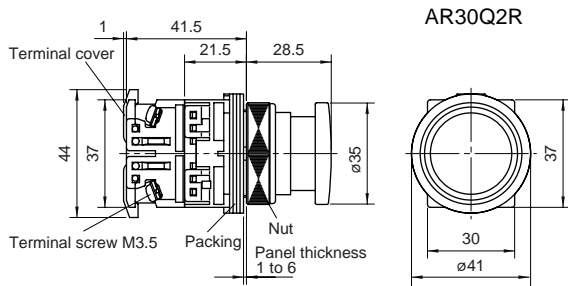

● Emergency stop illuminated pushbuttons

Push-lock, turn-reset (40mm dia.)

With transformer

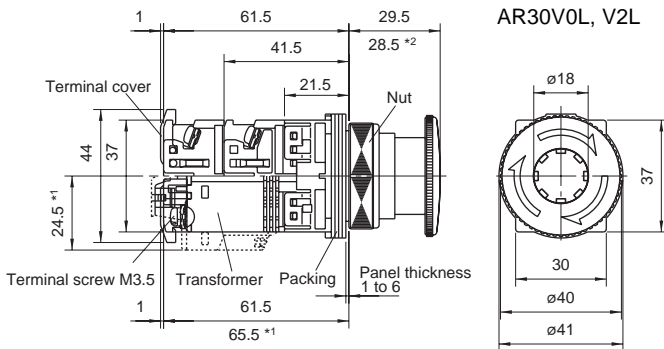

Without transformer

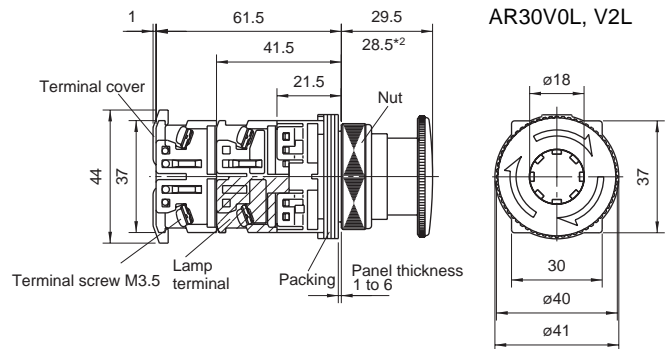

Notes: *1 Except for the types 110V AC, 127V AC and 220V AC.

*2 AR30V2L type

Pushbuttons/Selectors/Pilot Lights/Buzzers AR30 and DR30 Dimensions

■ Dimensions, mm

● Selector switches

Knob

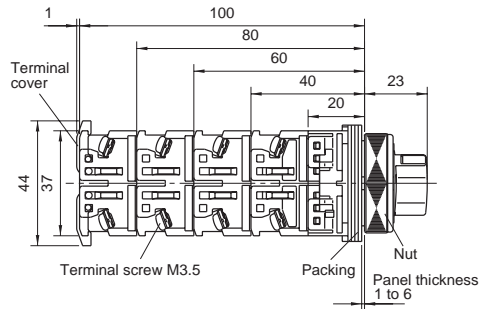

AR30PR, PCR

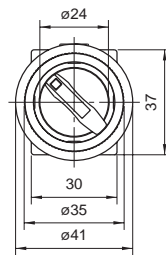

Lever

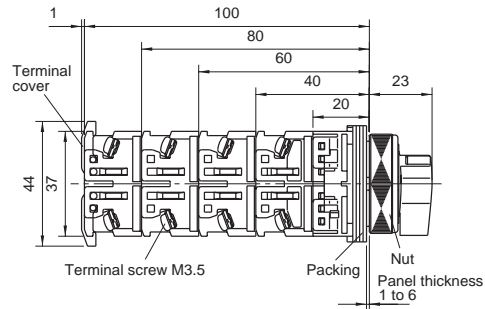

AR30WR, WCR

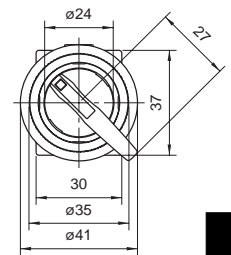

Key

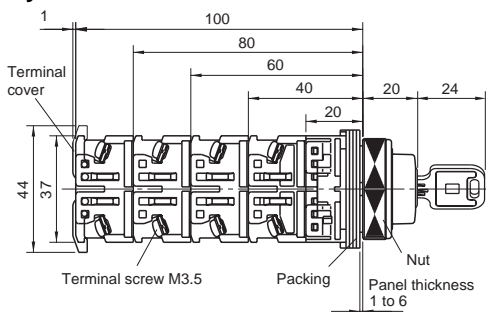

AR30JR, JCR, JAR

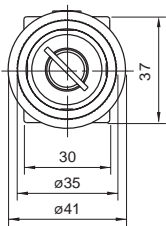

● Lever type selector switches

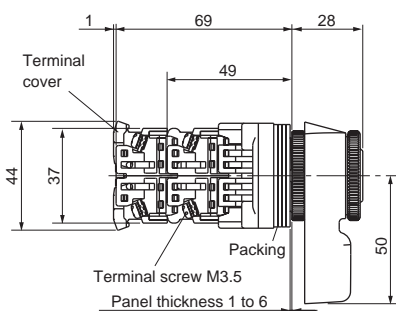

AR30HR-2

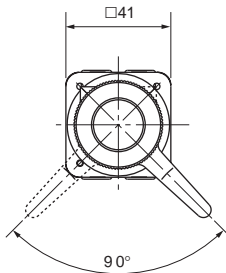

AR30HR-3

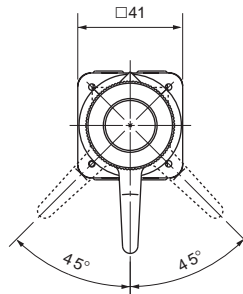

AR30HR-1

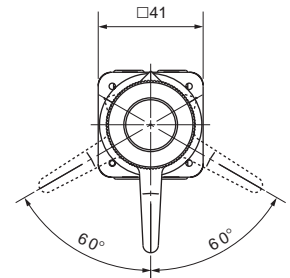

● Illuminated selector switches

Knob

With transformer

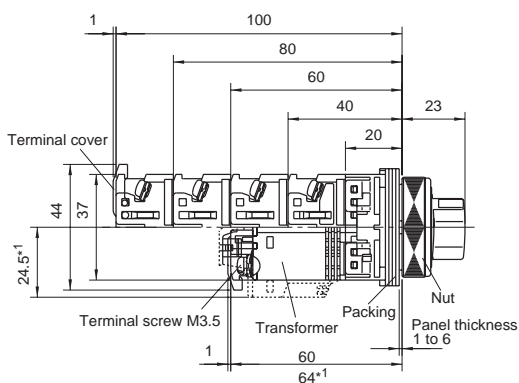

AR30PL

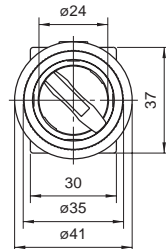

Without transformer

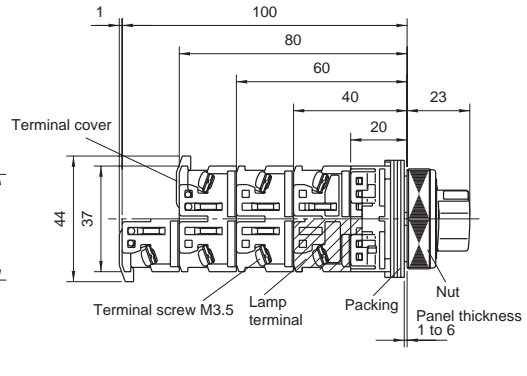

AR30PL

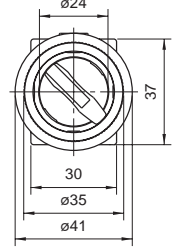

Notes: *1 Except for the types 110V AC, 127V AC and 220V AC.

Pushbuttons/Selectors/Pilot Lights/Buzzers

AR30 and DR30

Dimensions

■ Dimensions, mm

● Pilot lights

Dome

With transformer, with resistor unit

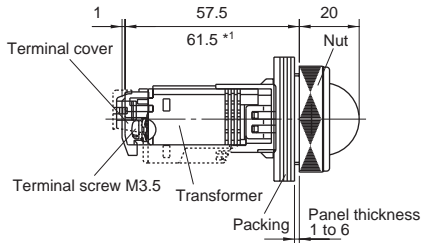

Without transformer

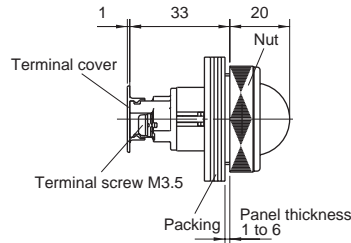

DR30D0L

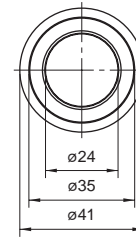

With resistor LED, incandescent (50V DC)

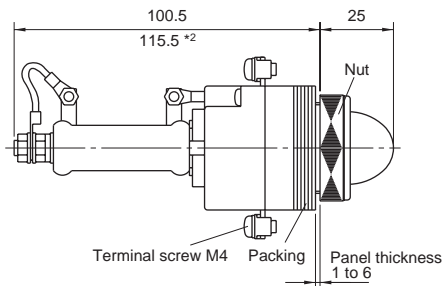

With resistor Incandescent (110, 220V DC)

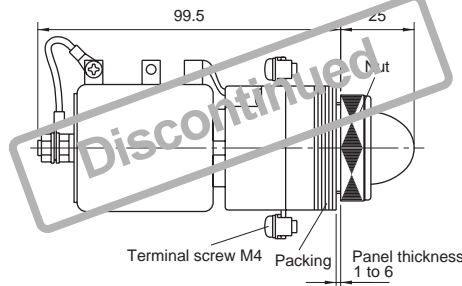

DR30D0L

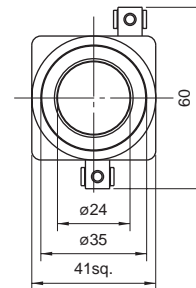

Short-body / with transformer

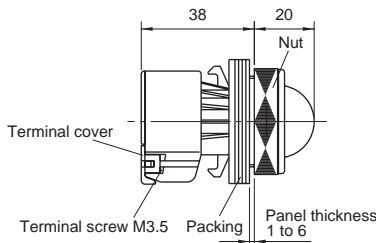

DR30D0L

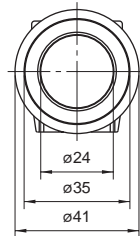

Extended

With transformer, with resistor unit

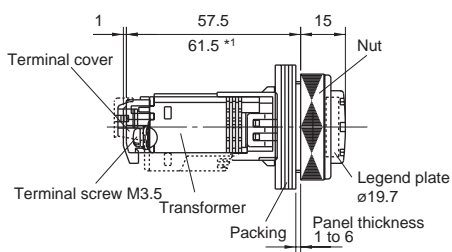

Without transformer

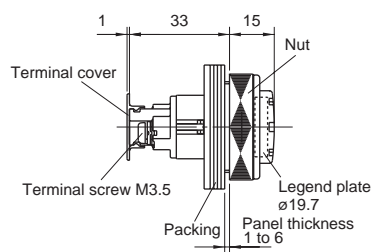

DR30E3L

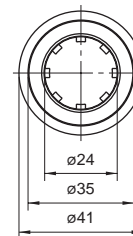

Short-body / with transformer

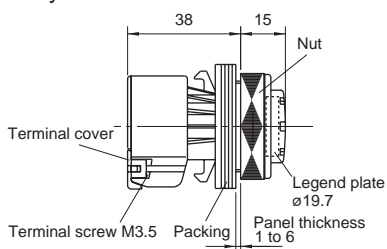

DR30E3L

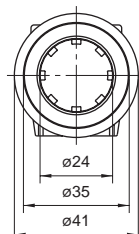

Notes: *1 Except for the types 110V AC, 127V AC and 220V AC.
*2 Incandescent (50V DC) type only

■ **Dimensions, mm**

● **Pilot lights**

Faceted

With transformer, with resistor unit

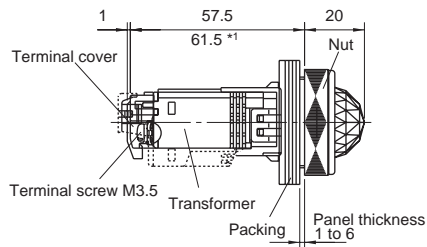

Without transformer

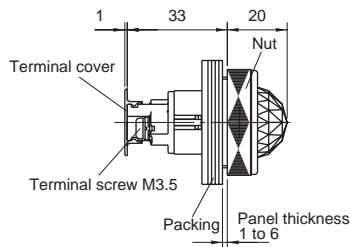

DR30K0L

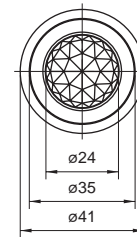

With resistor LED, incandescent (50V DC)

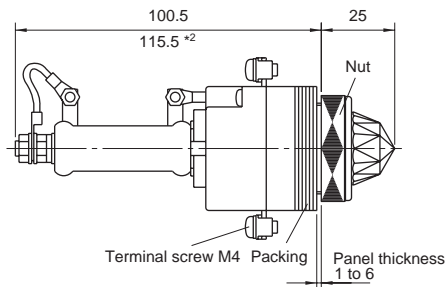

With resistor LED, incandescent (110, 220V DC)

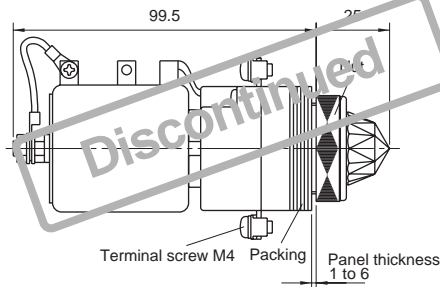

DR30K0L

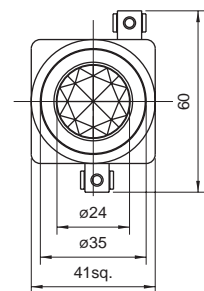

Short-body / with transformer

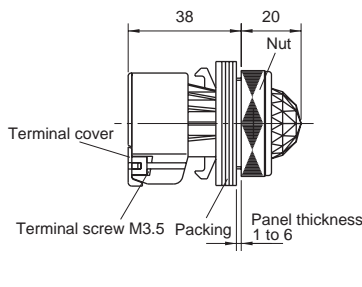

DR30K0L

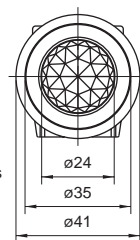

Dome with dimmer control

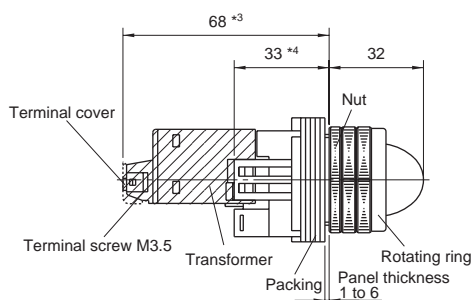

DR30D1L

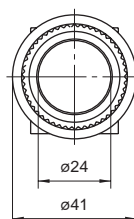

- Notes: *1 Except for the types 110V AC, 127V AC and 220V AC.
 *2 Incandescent (50V DC) type only
 *3 With transformer, with resistor unit type only
 *4 For without transformer types, add 1 mm when mounting the terminal cover.

Pushbuttons/Selectors/Pilot Lights/Buzzers

AR30 and DR30

Dimensions

■ Dimensions, mm

● Pilot lights

Flush square (34mm sq. transparent lens)

With transformer, with resistor unit

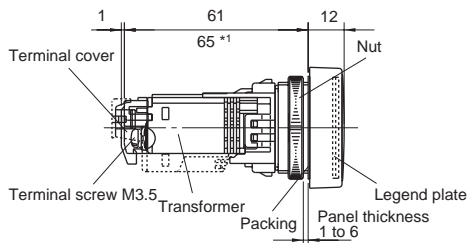

Without transformer

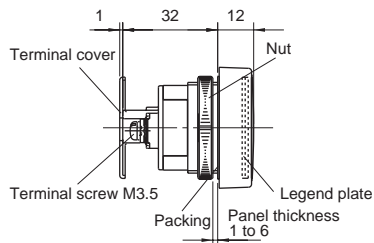

DR30F4M

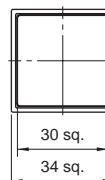

Flush rectangular (Transparent lens)

With transformer, with resistor unit

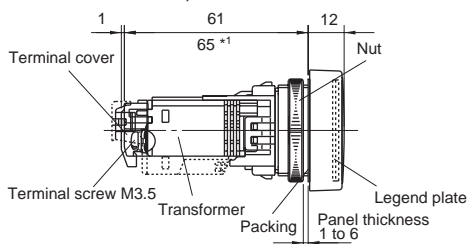

Without transformer

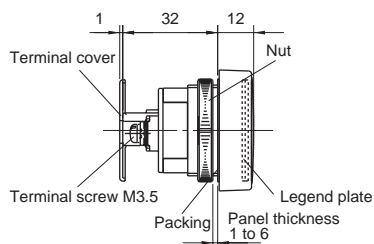

DR30F4N

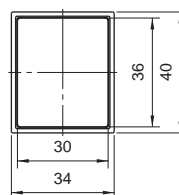

Flush square (40mm sq. transparent lens)

With transformer, with resistor unit

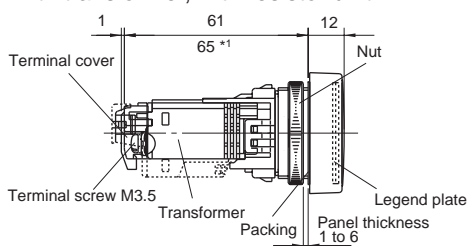

Without transformer

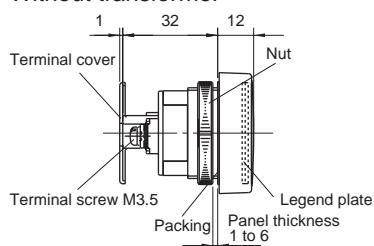

DR30M4M

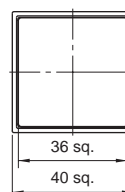

Note: *1 Except for the types 110V AC, 127V AC and 220V AC.

■ **Dimensions, mm**

● **Joy stick selector switches**

Ball type (without lock)

AR30A0N, A5N: Screw terminal

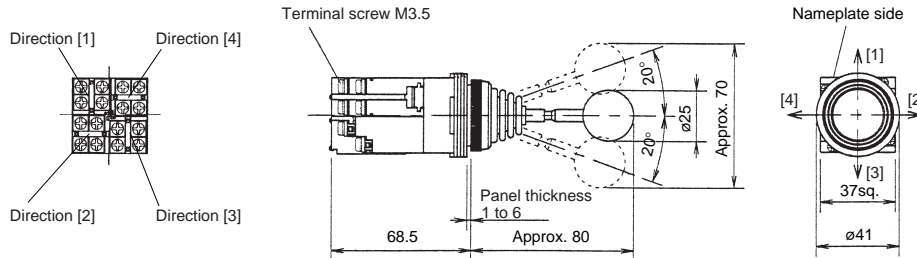

Ball type with lock

AR30A1N, A6N: Screw terminal

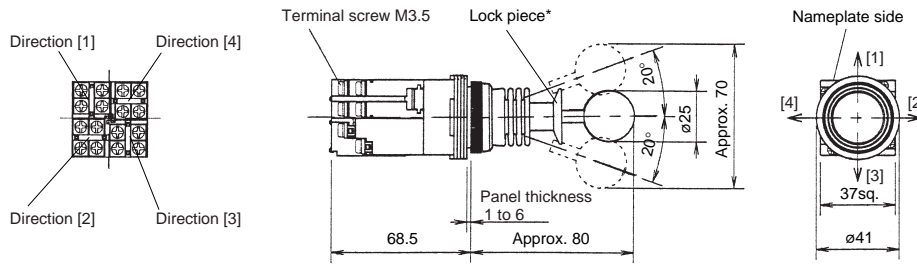

Notes * The contact arrangement is operable in the designated direction by pulling the lock piece in the central position with the fingers. The lock piece will return automatically and locks when the lock piece is released in the central position. The lock piece locks in the central position only.

Rubber cap type (without lock)

AR30A2N, A7N: Screw terminal

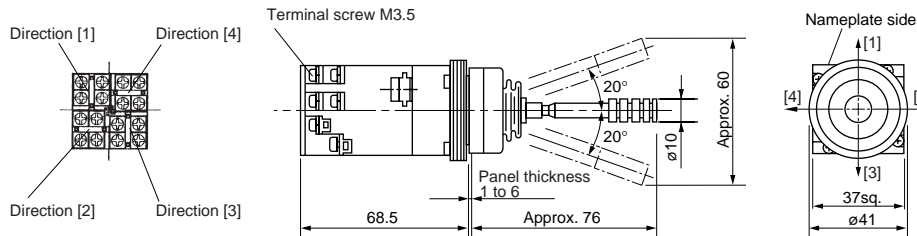

Solder/tab terminal: AR30□H

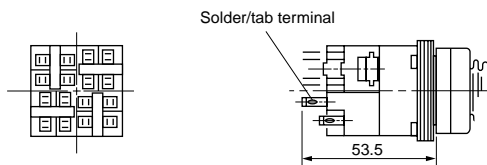

Pushbuttons/Selectors/Pilot Lights/Buzzers

AR30 and DR30

Dimensions

■ Dimensions, mm

● Buzzers

Electronic sound

With transformer

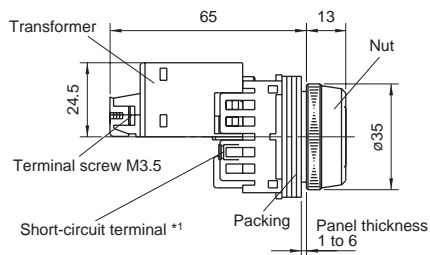

DR30B5, B6

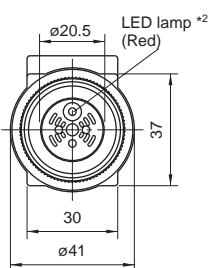

Without transformer

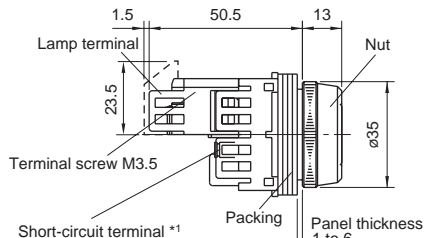

DR30B5, B6

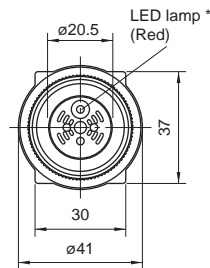

Magnetic sound

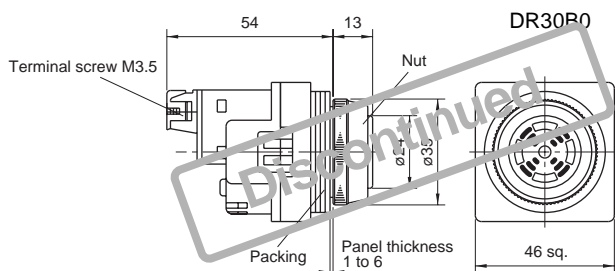

Electronic sound (IP54)

With transformer

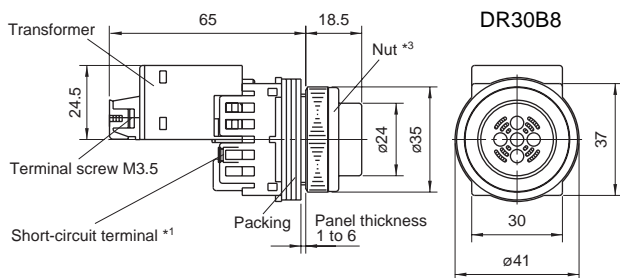

DR30B8

Without transformer

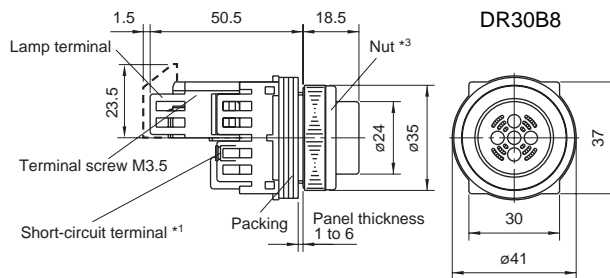

DR30B8

Notes: *1 There are no short-circuit terminals with DR30B6. (Continuous sound only)

*2 There are no LED lamps with DR30B6.

*3 The nut and cap are united with DR30B8.

Notes on use

■ **Panel cutout hole**

Fig. 1 Panel cutout hole dimensions, mm

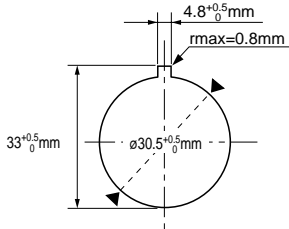

Note : If key-washer or legend plate are not used, 4.8mm-wide, location holes shown in Fig. 1 need not be cutout.

■ **Mounting operator to panel**

1. Pushbutton with a round bezel (ordinary mounting)

Insert the operator into the cutout hole from the back of the panel, and tighten the nut with the AHX001 wrench from the front of the panel to secure the operator as shown in Fig.2.

Fig. 2 Pushbutton with a round bezel

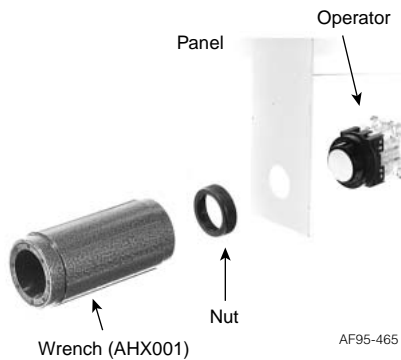

Note : Recommended tightening torque is from 1.5 to 2N•m.

2. AR30V0R, V0L, V2R, V2L, V5R, V5L

- (1) The button is removed after loosening the center button by inserting the end of the AR9A002 tightening wrench or the AR9A005 wrench (enclosed with pushbutton) into the holes in the center button and turning counterclockwise, as shown in Fig.3.
- (2) Attach the operator in the same manner as described in step 1.

Fig. 3

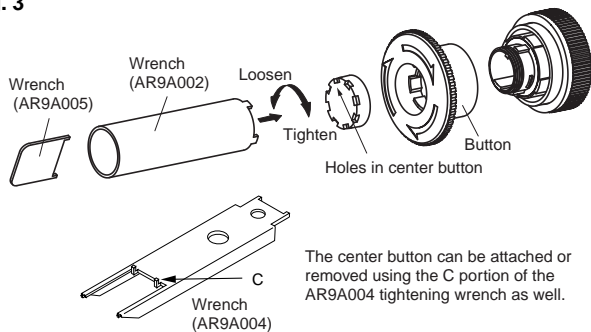

Insert the operator into the cutout hole from the back of the panel, and as shown in Fig.4, insert the pushbutton into the operator cylinder while aligning the grooves inside the pushbutton with the protrusions on the operator.

Fig. 4 Setting pushbutton to operator cylinder

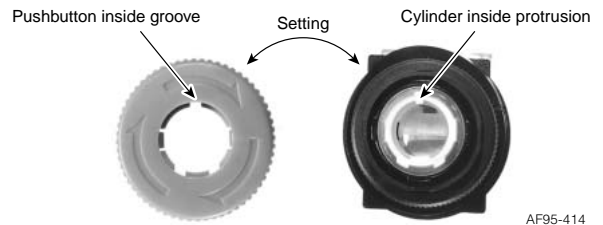

3. AR30WR, WCR

- (1) As shown in the following figure, insert the tip of a flathead screwdriver into the selector tip groove. Rotate the screwdriver in the direction indicated by the arrow until the selector tip rises, and draw out the knob.
- (2) Attach the operator in the same manner as described in step 1.
- (3) Insert the knob, with the selector tip in the floated state, into the original position of the rotation tube, and push the selector tip into place.

Fig. 5

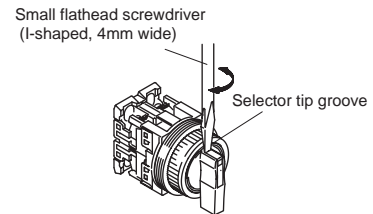

4. AR30M0R, M4R, M5R, B0R, Q7L

- (1) Loosen the button by hand.
- (2) Attach the operator in the same manner as described in step 1.
- (3) Screw in the button by hand, making sure that the button is screwed in all the way. (Recommended tightening torque: 0.3 to 0.5 N•m)

Fig. 6

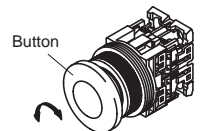

5. AR30M3R, M8R, B1R, B2R and B3R

The outer circumference of the nut is threaded, so be careful not to cut your hand on it.

- (1) Loosen and remove the guard ring by hand.
- (2) Loosen and remove the button and nut by hand.
- (3) Insert the operator into the cutout hole from the back of the panel, and tighten the nut to secure it in place. (Recommended tightening torque: 0.3 to 0.5 N•m)
- (4) Screw in the button by hand, making sure that it is screwed in all the way. (Recommended tightening torque: 0.3 to 0.5 N•m)
- (5) Loosen and remove the guard ring by hand. (Recommended tightening torque: 1.5 to 2.5 N•m)

Fig. 7

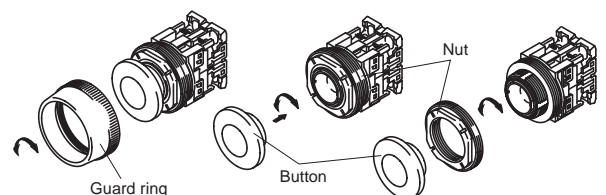

6. AR30N0R, V1R, Q2R

- (1) Loosen and remove the screw on the side of the button, taking care not to loosen the screw.
- (2) Attach the operator in the same manner as described in step 1.
- (3) Attach and secure the button in place with the screw, making sure that the head of the screw does not protrude from the side.
- (4) Recommended tightening torque: N0R, V1R 0.5 to 1.0N•m
Q2R 0.3 to 0.5N•m

Fig. 8

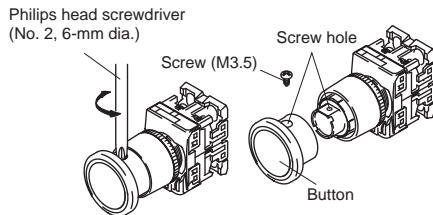

7. AR30GSR

- (1) Insert the tips of the AR9A001 wrench into the indentations around the button center, and turn the wrench to loosen and remove the button.
- (2) Loosen and remove the guard ring by hand.
- (3) Insert the switch operator into the cutout hole from the back of the panel, and secure it with the guard ring from the front of the panel. (Recommended tightening torque: 1.5 to 2.5 N•m)
- (4) Attach and secure the button with the AR9A001 wrench. (Recommended tightening torque: 0.3 to 0.5 N•m)

Fig. 9

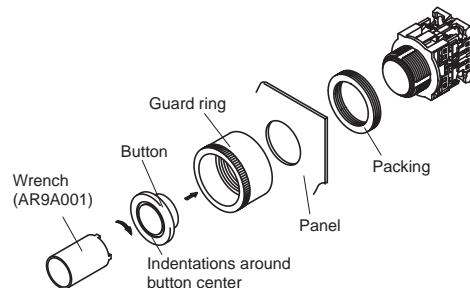

8. DR30F4M, F4N, M4M

Insert the pilot lights from the front of the panel and fix it with the AHX536 tightening wrench from the back of the panel.

- (1) Recommended tightening torque: 1 to 1.5N•m
- (2) For pilot lights with transformers and resistance units, remove the transformer or resistance unit in advance. (Fig.10)

Fig. 10

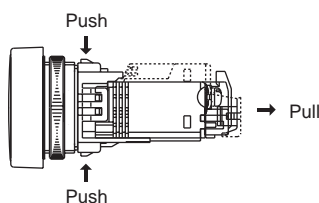

9. Mounting a 22mm-dia. command switch with a square button and a square bezel, or with a round button and a square bezel, to a panel cutout hole for a 30mm-dia. command switch using an adapter

As shown in Fig. 11, mount an adapter and packing onto a 22mm-dia. command switch (AR22, DR22 series) with a square button and a square bezel or one with a round button and a square bezel. Then, insert the switch operator into the panel cutout hole from the front of the panel. Use AR9A004 wrench section A to tighten the locking nut from behind the panel to secure the switch.

Use the adapter accessory nut for this purpose. Do not use the command switch accessory nut.

Fig. 11 Command switch with a square button and a square bezel, and command switch with a round button and a square bezel

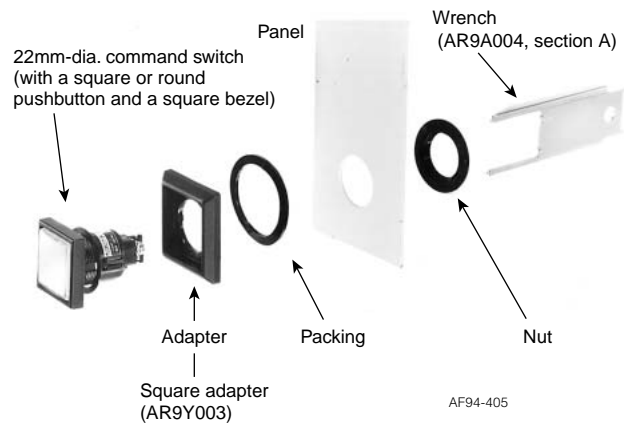

Note : • Recommended tightening torque is from 1 to 1.5N•m.
• Panel thickness: 2.5 to 5mm

This adapter can be used with the following 22mm-dia. Command switches :

- AR22F0M, F5M, E0M, E5M, F0P, F5P, E0P, E5P, M4P
- AR22F0S, F5S, E0S, E5S, F0Y, F5Y, E0Y, E5Y, M4Y
- AR22PY, PCY, WY, WCY, RY, RCY, JY, JCY, PP
- DR22F3M, F4M, F5M, E3M, E3P

10. AR30S1R, S2R, S3R, S6R

- (1) Attach the operator in the same manner as described in step 1.
- (2) Attach the rosette assembly to the operator.
- (3) Pressing the rosette from the directions indicated by the arrows, insert the selector tip in the groove.
- (4) Make sure that the selector tip is inserted completely.
- (5) To remove the rosette, use a small flathead screwdriver to remove the selector tip as described in step 3, and then remove the rosette.

Fig. 12

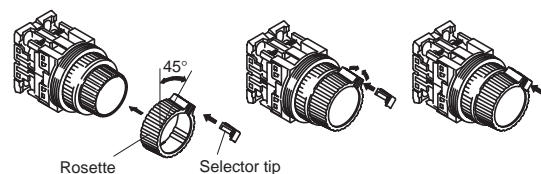

11. AR30A (joy stick selector)

- (1) Remove the clamp ring as shown in the following figure.
 - (2) Attach the operator in the same manner as described in step 1.
- Note: Even if a lock type is used, remove the clamp ring in the same manner.

Fig. 13

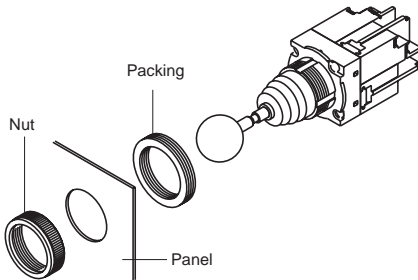

12. AR30HR

- (1) The lever is removed after loosening the nut by hand.
- (2) Loosen and remove the tightening nut by hand.
- (3) Insert the operator into the cutout hole from the back of the panel, and tighten the tightening nut with the AHX001 wrench or AR9A006 wrench from the front of panel to secure the operator as shown in Fig. 14. (Recommended tightening torque : 1.5 to 2.5N • m)
- (4) Attach the lever assembly to the operator.
- (5) Screw in the nut by hand, making sure that it is screwed in all the way.

Fig. 14

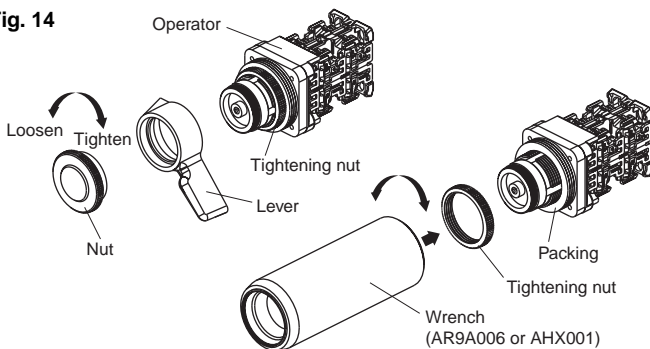

Water-proof and dust-proof cap

Applicable type: Water-proof cap AHX052
 Dust-proof cap AHX032, 033, 034, 113, 157

When attached to the panel in combination with a water-proof or dust-proof cap, the water-proof cap or dust-proof cap may sink downward and prevent the depressed button from returning to its original position.

As shown in the following figure, cut an approximately 5-mm air outlet in the portion of the ring packing touching the panel surface. Also, reduce the number of packing rings by one below the standard number. The clamp ring tightening torque is 1.5 to 2.5 N•m.

Fig. 15

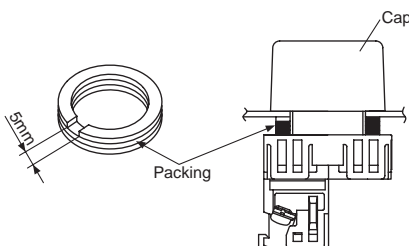

Degree of protection

The water-proof cap or dust-proof cap seals the panel surface to provide IP65 protection.

Applicable panel thickness

The AR30/DR30 series switches are mountable to panels with the thickness given in the table below.

Switch mounting condition	Applicable panel thickness
Without accessories	1 to 6mm
With accessories	AR9Y003 adapter 2.5 to 5mm

Using accessory ring-packings

Use the required number of ring-packings (1.6mm-thick, 4 pieces, resin mold).

Table below is a guideline for using the packings.

If a locking nut or legend plate is used, the thickness must be counted as an additional panel thickness.

Panel thickness vs. number of packings (reference data)

Effective panel thickness including lock-ring and legend plate thicknesses	Number of packings
1.0mm to less than 2.0mm	4
2.0mm to less than 3.6mm	3
3.6mm to less than 5.0mm	2
5.0mm to less than 6.0mm	1

Minimum mounting space, mm

The minimum mounting spaces required for AR30/DR30 command switches are given below. (Fig. 16)

Fig. 16

- Illuminated pushbutton and pushbutton
- Emergency stop illuminated pushbutton and emergency stop pushbutton
- Illuminated and non-illuminated selectors
- Pilot light

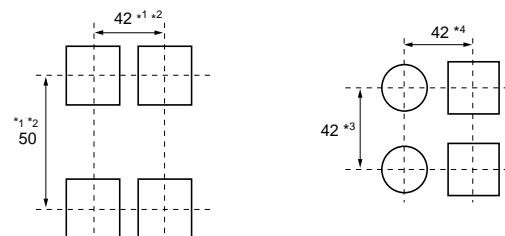

Notes: *1 AR30M3R, M8R, GSR: 55mm
 *2 AR30B□R, GPR, V1R: 80mm

Type	*3	*4
F4M	34	34
F4N (Vertical lengthwise mounting)	40	34
(Horizontal lengthwise mounting)	34	40
M4M	40	40
Pilot lights short-body with transformer	50	42
Pilot lights with resistor	80	42



Other items are the same as for the AR22 and DR22 series, see page 04/50 to 04/54.





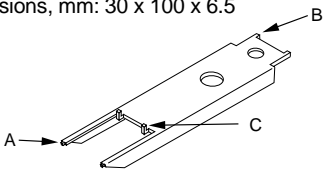

Pushbuttons/Selectors/Pilot Lights

AR22/DR22 and AR30/DR30

Accessories

■ Accessories

Description	Type
Wrench	AR9A004 Dimensions, mm: 30 x 100 x 6.5   Remarks Section "A" Use this section to tighten the nut for mounting the operator on a panel. Section "B" Use this section to tighten or remove the lens. Applicable type: AR22F0L, F5L, E0L, E5L, F0P, F5P, E0P, E5P AR22G1L, G2L, G4L, G6L, G7L, G9L DR22E3L, E3P AR30E0L, E5L, G2L, G3L, G4L, G7L, G8L, G9L DR30E3L Section "C" Fit the tabs on the section "C" in the center button, and turn the wrench to tighten or remove the button. Applicable type: AR22V (except V4R, VG type) AR30V (except V1R type)
Wrench for AR22, DR22	AR9A701 Dimensions, mm: $\varnothing 28 \times 70$ Application: AR22, DR22 nut tightening
Wrench	AHX536 Dimensions, mm: $\varnothing 32 \times 76$ Application: DR30F4M, F4N, M4M, N1, N2 nut tightening
Wrench	AR9A001 Dimensions, mm: $\varnothing 22 \times 35$ Application: AR22, DR22 round-type lens tightening AR22E0M, E5M oil-proof cap tightening AR30, DR30 round-type lens tightening AR30GSR button tightening
Wrench (for center button)	AR9A002 Dimensions, mm: $\varnothing 18 \times 60$ Application: AR22V center button tightening (except V4R, VG type) AR30V center button tightening (except V1R type)
Wrench	AHX701 Dimensions, mm: $\varnothing 25 \times 72.5$ Application: DR22N, AR22VG nut tightening

Description	Type
Wrench (for center button)	AHX8003 Dimensions, mm: $\varnothing 14 \times 50$ Attaching and removing the center button of the AR22VGF type. 
Wrench for AR22,30 and DR22, 30	AR9A006 Dimensions, mm: $\varnothing 40 \times 100$ To mount an AR22, 30 or DR22, 30 command switch to a panel, use this wrench to tighten the nut securely. It is very easy to fit this wrench onto the nut. The wrench with an inside rubber-lining can be easily used with either your right or left hand. 
Wrench for AR30, DR30	AHX001 Dimensions, mm: $\varnothing 47 \times 100$ To mount an AR30 or DR30 command switch to a panel, use this wrench to tighten the nut securely. 
Special tool	AHX321 Dimensions, mm: 42 x 130 x 6.5 For all types except pilot lights DR9A321-T Dimensions, mm: 57 x 130 x 30 For pilot lights <ul style="list-style-type: none"> This tool is used to remove contact blocks and transformer units. The AHX321 can remove round color lens of switches.  
Wrench/Lamp changer	AHX702 Dimensions, mm: $\varnothing 36 \times 55$ Use this wrench to tighten or remove the lens and lamp. Used with: Lens of DR22D0L, K0L and DR30D0L, K0L Incandescent lamp of pilot lights and illuminated pushbuttons 
Lamp changer	AHX790 Dimensions, mm: $\varnothing 14 \times 55$ <ul style="list-style-type: none"> Use this rubber wrench for mounting or removing lamps from pilot lights and illuminated pushbutton switches. This wrench can be used for both LED and incandescent lamps. One end is for the BA9S/13 lamp, and the other is for the E12/15 lamp (for use with 30mm dia. pilot lights with resistor). For 30mm dia. pilot lights with resistor, this tool can also be used to attach or remove incandescent lamps. 

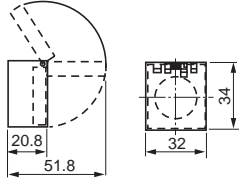
Description	Type
Protection cover	AR9E760 This cover protects against accidental operation. The cover lid is returned home with a spring force. (Packing is provided) Used with: AR22F0L, F5L, E0L, E5L, F0M, F5M, E0M, E5M, F0P, F5P, E0P, E5P AR22F0R, F5R, E0R, E5R, F0S, F5S, E0S, E5S, E0Y, E5Y, F0Y, F5Y, FAR, FBR, EAR, EBR Dimensions, mm: 

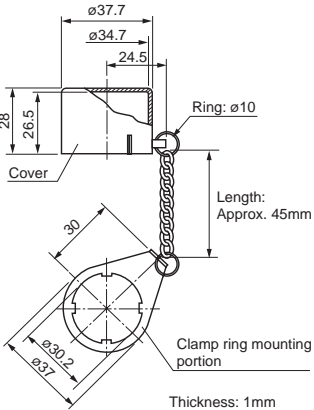

AF95-29

Cover for preventing operating errors with 30mm dia. types	AR9E538 Inadvertent operation can be prevented by fitting a transparent cover with chain in the clamp ring. Used with: AR30F0R, F5R, E0R, E5R, E0L, E5L Dimensions, mm:  Cover Ring: $\phi 10$ Length: Approx. 45mm Clamp ring mounting portion Thickness: 1mm
--	--

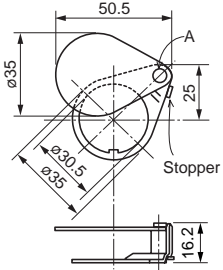

AF91-671

Cover for preventing operating errors with 30mm dia. types	AHX408 This is a metallic cover for preventing inadvertent operation. Used with: AR30F0R, F5R Dimensions, mm:  When attaching the cover to a vertical panel, if you attach it so that the portion indicated by an "A" is at the upper right, the stopper causes the cover to stop above the push button to halt further rotation. The material is steel (zinc plated).
--	--

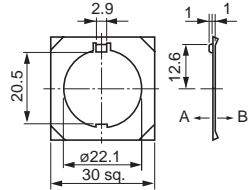

.AF93-420

Description	Type
Key washer for AR22, DR22	AR9Y715 Use this metal washer when securing a operator in a 22.3mm dia. panel cutout hole. Dimensions, mm: 



AF95-25

- When the periphery of the panel cutout has a hole to stop rotation, use with side A contacting the panel (except for Joy stick selector types).
- Even when the periphery of the panel cutout does not have a hole to stop rotation, if used with side B contacting the panel it can serve as a washer for eliminating play (except for Joy stick selector types).

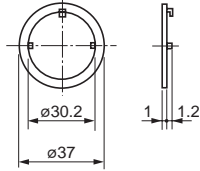
Key washer for $\phi 30$	AHX082 Use this metal washer when securing an operator in a 30.5mm dia. panel cutout hole. Dimension, mm: 
--------------------------	---



SC-1016

Operator base cover	AR9Y002 Attach this cover to the operator base of a pushbutton switch with only one contact block (1NO or 1NC) to protect against dust.
---------------------	---

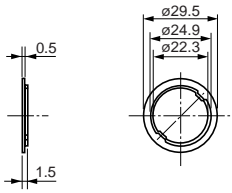

AF95-26

Adapter for AR22, DR22	AR9Y718 Use this resin adapter to mount the AR22/DR22 (switch/pilot light) in a 25.5mm dia. cutout hole on a panel. Dimensions, mm: 
------------------------	---





.AF95-28

Pushbuttons/Selectors/Pilot Lights

AR22/DR22 and AR30/DR30

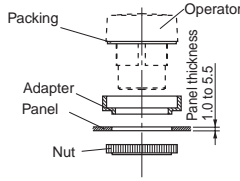
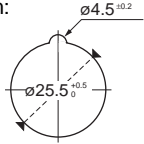
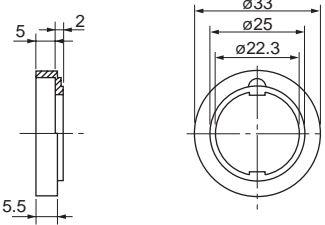
Accessories

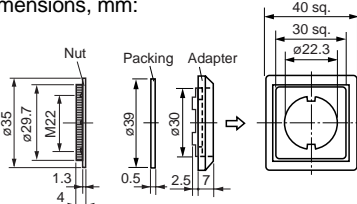
Description	Type
Adapter for AR22 and DR22 	AR9Y008 Use this resin adapter to mount the AR22/DR22 (switch/pilot light) in a 25.5mm dia. cutout hole on a panel. Mounting, mm:  Panel cutout, mm:  Equipped with device for stopping rotation Used with: AR22, DR22 round head types (except for M3R, M8R, VG□, joy stick selectors and buzzers) Dimensions, mm: 
Adapter for AR30 and DR30 	AR9Y003 Mount this adapter onto a 22mm dia. command switch with a square bezel to obtain a 30mm dia. command switch with a square/round button and a square bezel. A resin ring-packing and a nut are accessories of the adapter. Dimensions, mm:  Note: Panel thickness: 2.5 to 5mm

AF98-198

AF95-416

Description	Type
Round-frame adapter for 30mm dia. types 	AR9Y004 By using this adapter in combination with the round type 22mm dia. command switch, the 22mm dia. command switch can be used as a 30mm dia. command switch/round frame type. Used with: AR22, DR22 round types (except for M3R, M8R, VG□, Joy stick selectors, buzzers) Dimensions, mm  Note: Panel thickness: 2.5 to 5mm
Round-frame adapter for 30mm dia. type VG 	AHX958 Using this adapter in combination with model AR22VG (22mm dia.) allows mounting to a 30.5mm panel cutout hole. The attachment method is as follows. <ul style="list-style-type: none"> • The washer and nut (22.3mm dia.) originally attached to the operator will not be used, so remove them. • Attach the 22mm dia. packing (included), the 30mm dia. adapter and the 30mm dia. packing to the operator in that order, and insert the operator into the cutout hole. • From the back of the panel cutout hole, fasten the 30mm-dia. nut using the AHX701 wrench. The correct tightening torque is 1 to 1.5 N•m.  <p>*1 Adapter for 30mm dia. (AHX958)</p> Panel cutout, mm:  Dimensions, mm:  Note: Panel thickness: 1 to 6mm

KK02-100A

AF93-4

Description
Legend plate for AR22

Type
AR9P711-①②③
① Color
B: Black
A: Aluminum

This aluminum legend plate is for a 22.3mm dia. panel cutout hole. (Packing provided)

Legend	Code	
	②	③
Blank	0	0
ON	0	A
OFF	0	B
START	0	C
STOP	0	D
OFF-ON	2	A

Dimensions, mm:

SI-1033

Description
Legend plate for AR22

Type
AR9P713-①②③
① Color
B: Black
A: Partially black

This aluminum legend plate is for a 22.3mm dia. panel cutout hole. (Packing provided)

Legend	Code	
	②	③
Blank	0	0
ON	0	A
OFF	0	B
START	0	C
STOP	0	D
OFF-ON	2	A

Dimensions, mm:

AF95-114

Description
Legend plate for AR22

Type
AR9P712-①②③
① Color
B: Black
A: Partially black

This aluminum legend plate is for a 22.3mm dia. panel cutout hole. (Packing provided)

Legend	Code	
	②	③
Blank	0	0
ON	0	A
OFF	0	B
START	0	C
STOP	0	D
OFF-ON	2	A

Dimensions, mm:

SI-1032

Description
Legend plate for AR22 emergency stop

Type
AR9P719-①②
Plate color: Yellow
Letter color: Black

This aluminum legend plate is for a 22.3mm dia. panel cutout hole. (Packing provided)

Legend	Code		Letter height
	①	②	
Blank	0	0	-
EMERGENCY	5	A	7mm
STOP	5	B	13mm
EMERGENCY	5	C	13mm
OFF			

Dimensions, mm:

KK02-265A

Note: Engraving for making letters is not available.



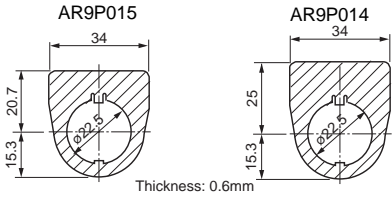

Pushbuttons/Selectors/Pilot Lights

AR22/DR22 and AR30/DR30

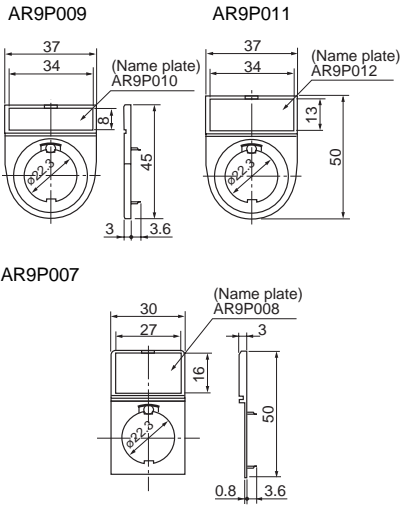

Accessories

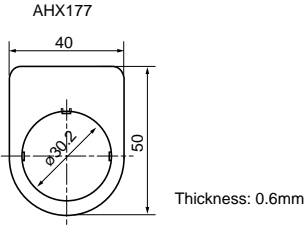
Description	Type
Legend plate for AR22 (width: 34mm)	AR9P015-B ①② : Hight 36mm AR9P014-B ①② : Hight 40.3mm
	Color: black
	Legend code ① ②
	Blank 0 0 ON 0 A OFF 0 B START 0 C STOP 0 D OFF-ON 2 A
	Optimal for use in combination with a 3-position selector switch. Legend plates are available in two types: short, 36 mm; and long, 40.3mm.
	Dimensions, mm:
	
	.AF96-190

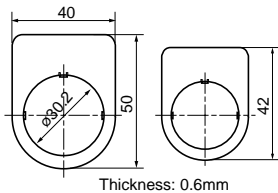
Description	Type
Legend plate with name plate for AR22	Legend plate AR9P009-B Name plate AR9P010-B ①② (34 × 8mm)
	Legend plate AR9P011-B Name plate AR9P012-B ①② (34 × 13mm)
	Legend plate AR9P007-B Name plate AR9P008-B ①② (27 × 16mm)
	Name plate Code ① ②
	ON 0 A OFF 0 B START 0 C STOP 0 D OFF-ON 2 A
	Dimensions, mm:
	
	.AF96-190

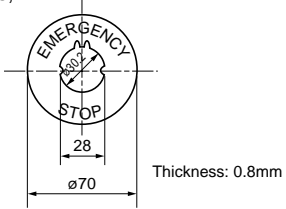
Description	Type
Legend plate for AR30	AHX177-①②③④ This legend plate is for a 30.5mm dia. panel cutout hole. ① Material and color
	Code Material Color
	S Brass Silver B Aluminum Black A Aluminum Aluminum
	② Size H: Standard S: Short size
	Legend Code ③ ④
	Blank 0 0 ON 0 A OFF 0 B START 0 C STOP 0 D OFF-ON 2 A
	Dimensions, mm:
	
	AHX177B AHX177-BS AHX177A AHX177-AS
	
	.AF89-466
	AF87-49

Description	Type
Legend plate for AR30 emergency stop	AHX720-①② This aluminum legend plate is for a 30.5mm dia. panel cutout hole. Plate color: Yellow Letter color: Black
	Legend Code Letter height ① ②
	Blank 0 0 - EMERGENCY STOP 5 A 7mm
	Dimensions, mm:
	
	Note: Engraving for making letters is not available.
	SK-598

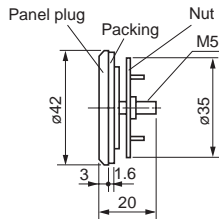

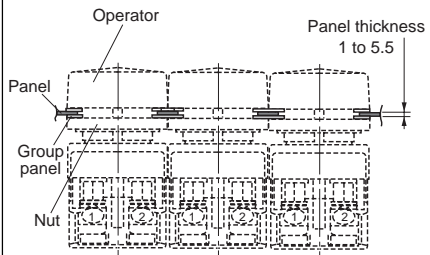
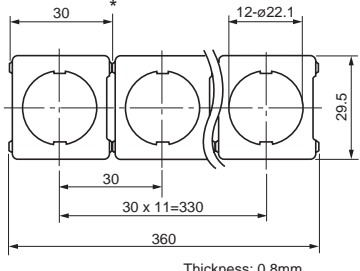

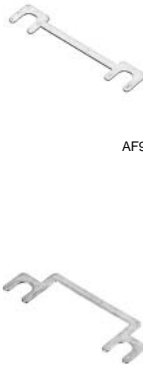
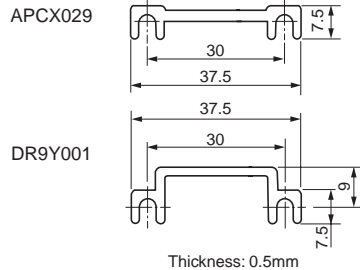
Description	Type
Panel plug for AR22 and DR22  SI-1027	Round: AHX725-B Black AHX725-H Gray Square: AHX726-B Black AHX726-H Gray Dimensions, mm: $\phi 29.5 \times 17$ (AHX725) $29.5 \text{ sq.} \times 17$ (AHX726) Use this plug to cover up unused panel cutout holes. For oil proof usage, use together with packing (AR9Y730) and a nut (AR9R744).
Panel plug for AR30 and DR30  T-1993	AHX004 Color: Silver (metal) This plug is used to cover up unused panel cutout hole. Dimensions, mm: 



Description	Type
Group panel for 22mm dia. type  AF97-233	DR9Y004 These new 22mm dia. command switch/square types can be neatly aligned side by side on this group panel at a 30mm pitch to form a uniform panel face with no misalignment between mounted switches. Depending on the number of switches to be grouped (maximum 12), the panel can be divided (by cutting at the portion indicated by an asterisk (*)). Mounting, mm: (example showing a group of three)  Dimensions, mm:  Thickness: 0.8mm

Description	Type
Jumper  AF95-153 AF95-27	APCX029 (For pilot light without transformer) DR9Y001 (For pilot light with transformer) Use this jumper to connect terminals allocated in a 30mm pitch. Rated current is 3A Dimensions, mm:  Thickness: 0.5mm

04

Pushbuttons/Selectors/Pilot Lights AR22/DR22 and AR30/DR30 Accessories





<p>Description</p> <p>Knob (for illuminated selector switch)</p>  <p style="text-align: right; font-size: small;">AF94-465</p>	<p>Type</p> <table style="width: 100%; border-collapse: collapse;"> <tr> <td style="width: 30%;">Type</td> <td>Used with</td> </tr> <tr> <td>AR9M005 □</td> <td>AR22PL, PP AR30PL</td> </tr> </table> <p>Replace the □ mark by the knob color code</p> <table style="width: 100%; border-collapse: collapse;"> <tr> <td style="width: 20%;">Color</td> <td>Green</td> <td>Red</td> <td>White</td> </tr> <tr> <td>Code</td> <td>G</td> <td>R</td> <td>W</td> </tr> </table> <hr/> <table style="width: 100%; border-collapse: collapse;"> <tr> <td style="width: 20%;">Color</td> <td>Yellow</td> <td>Orange</td> <td>Blue</td> </tr> <tr> <td>Code</td> <td>Y</td> <td>A</td> <td>S</td> </tr> </table>	Type	Used with	AR9M005 □	AR22PL, PP AR30PL	Color	Green	Red	White	Code	G	R	W	Color	Yellow	Orange	Blue	Code	Y	A	S																	
Type	Used with																																					
AR9M005 □	AR22PL, PP AR30PL																																					
Color	Green	Red	White																																			
Code	G	R	W																																			
Color	Yellow	Orange	Blue																																			
Code	Y	A	S																																			
<p>Key</p>  <p style="text-align: right; font-size: small;">KKD09-012</p>	<p>Type</p> <table style="width: 100%; border-collapse: collapse;"> <tr> <td style="width: 30%;">Type</td> <td>Used with</td> </tr> <tr> <td>AR9C022 □</td> <td>AR22JR, JCR, AR30JR, JCR,</td> </tr> <tr> <td>AR9C025 □</td> <td>AR22JAR, AR30JAR</td> </tr> </table> <p>Replace the □ mark by the key type code. Code: A, B, C, D, E or F, 6 types.</p>	Type	Used with	AR9C022 □	AR22JR, JCR, AR30JR, JCR,	AR9C025 □	AR22JAR, AR30JAR																															
Type	Used with																																					
AR9C022 □	AR22JR, JCR, AR30JR, JCR,																																					
AR9C025 □	AR22JAR, AR30JAR																																					
<p>Legend plate (for F type with round bezel)</p>  <p style="text-align: right; font-size: small;">AF94-459</p>	<p>AR9P001-W</p> <p>This part is made of acrylic resin. Use paint or thinner compatible with resin.</p> <p>Dimensions, mm: ø17.8 x 0.9</p>																																					
<p>Legend plate (for E type with round bezel)</p>  <p style="text-align: right; font-size: small;">AF94-459</p>	<p>AR9P002-W</p> <p>This part is made of acrylic resin. Use paint or thinner compatible with resin.</p> <p>Dimensions, mm: ø19.7 x 4.2</p>																																					
<p>Symbol mark plate</p>  <p style="text-align: right; font-size: small;">AF98-197</p>	<table style="width: 100%; border-collapse: collapse;"> <tr> <td style="width: 30%;">Type</td> <td>Used with</td> </tr> <tr> <td>AR9P019 □ □ ■</td> <td>AR22FAR, FBR, AR30FAR, FBR</td> </tr> <tr> <td>AR9P020 □ □ ■</td> <td>AR22EAR, EBR, AR30EAR, EBR</td> </tr> </table> <p>□ □ ■ :</p> <table style="width: 100%; border-collapse: collapse; font-size: x-small;"> <tr> <td style="width: 10%;">Symbol</td> <td>○</td> <td>∩</td> <td>⊕</td> <td>○</td> <td>∩</td> <td>⊕</td> </tr> <tr> <td>Plate</td> <td>W</td> <td>B</td> <td>W</td> <td>B</td> <td>W</td> <td>B</td> <td>Clear</td> </tr> <tr> <td>Symbol</td> <td>Red</td> <td>Green</td> <td>Green</td> <td>Black</td> <td></td> <td></td> <td></td> </tr> <tr> <td>Code</td> <td>01</td> <td>02</td> <td>03</td> <td>04</td> <td>11</td> <td>12</td> <td>02B 04B 12B</td> </tr> </table> <p>W: White, B: black</p>	Type	Used with	AR9P019 □ □ ■	AR22FAR, FBR, AR30FAR, FBR	AR9P020 □ □ ■	AR22EAR, EBR, AR30EAR, EBR	Symbol	○	∩	⊕	○	∩	⊕	Plate	W	B	W	B	W	B	Clear	Symbol	Red	Green	Green	Black				Code	01	02	03	04	11	12	02B 04B 12B
Type	Used with																																					
AR9P019 □ □ ■	AR22FAR, FBR, AR30FAR, FBR																																					
AR9P020 □ □ ■	AR22EAR, EBR, AR30EAR, EBR																																					
Symbol	○	∩	⊕	○	∩	⊕																																
Plate	W	B	W	B	W	B	Clear																															
Symbol	Red	Green	Green	Black																																		
Code	01	02	03	04	11	12	02B 04B 12B																															

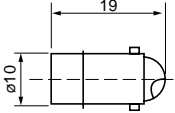

<p>Description</p> <p>Legend plate and color plate (for F type with square bezel)</p>  <p style="text-align: right; font-size: small;">AF94-460</p>	<p>• Legend plate</p> <table style="width: 100%; border-collapse: collapse;"> <tr> <td style="width: 30%;">Type</td> <td>Used with</td> </tr> <tr> <td>DR9P241-W</td> <td>AR22F0M, F5M DR22F3M, F4M</td> </tr> <tr> <td>DR9P242-WP</td> <td>DR30M4M</td> </tr> <tr> <td>DR9P242-W</td> <td>DR30M4M, LED(W)</td> </tr> <tr> <td>DR9P243-WP</td> <td>DR30F4N</td> </tr> <tr> <td>DR9P243-W</td> <td>DR30F4N, LED(W)</td> </tr> <tr> <td>DR9P244-WP</td> <td>DR30F4M</td> </tr> <tr> <td>DR9P244-W</td> <td>DR30F4M, LED(W)</td> </tr> </table> <p>Types DR9P242, 243 and 244-W are LED illuminated, and used exclusively with operators having a "W" in the type number.</p> <p>• color plate</p> <table style="width: 100%; border-collapse: collapse;"> <tr> <td style="width: 30%;">Type</td> <td>Used with</td> </tr> <tr> <td>DR9P241 □</td> <td>DR22F3M, F4M</td> </tr> <tr> <td>DR9P242 □</td> <td>DR30M4M</td> </tr> <tr> <td>DR9P243 □</td> <td>DR30F4N</td> </tr> <tr> <td>DR9P244 □</td> <td>DR30F4M</td> </tr> </table> <p>Replace the □ mark by the color code</p> <table style="width: 100%; border-collapse: collapse;"> <tr> <td style="width: 20%;">Color</td> <td>Green</td> <td>Red</td> <td>White</td> </tr> <tr> <td>Code</td> <td>G</td> <td>R</td> <td>W</td> </tr> </table> <hr/> <table style="width: 100%; border-collapse: collapse;"> <tr> <td style="width: 20%;">Color</td> <td>Yellow</td> <td>Orange</td> <td>Blue</td> </tr> <tr> <td>Code</td> <td>Y</td> <td>A</td> <td>S</td> </tr> </table> <p>This part is made of acrylic resin. Use paint or thinner compatible with resin.</p> <p>Dimensions, mm: DR9P241: 20.8 sq. x 0.8 DR9P242: 33.4 sq. x 1 DR9P243: 33.4 x 27.4 x 1 DR9P244: 27.4 sq. x 1</p>	Type	Used with	DR9P241-W	AR22F0M, F5M DR22F3M, F4M	DR9P242-WP	DR30M4M	DR9P242-W	DR30M4M, LED(W)	DR9P243-WP	DR30F4N	DR9P243-W	DR30F4N, LED(W)	DR9P244-WP	DR30F4M	DR9P244-W	DR30F4M, LED(W)	Type	Used with	DR9P241 □	DR22F3M, F4M	DR9P242 □	DR30M4M	DR9P243 □	DR30F4N	DR9P244 □	DR30F4M	Color	Green	Red	White	Code	G	R	W	Color	Yellow	Orange	Blue	Code	Y	A	S
Type	Used with																																										
DR9P241-W	AR22F0M, F5M DR22F3M, F4M																																										
DR9P242-WP	DR30M4M																																										
DR9P242-W	DR30M4M, LED(W)																																										
DR9P243-WP	DR30F4N																																										
DR9P243-W	DR30F4N, LED(W)																																										
DR9P244-WP	DR30F4M																																										
DR9P244-W	DR30F4M, LED(W)																																										
Type	Used with																																										
DR9P241 □	DR22F3M, F4M																																										
DR9P242 □	DR30M4M																																										
DR9P243 □	DR30F4N																																										
DR9P244 □	DR30F4M																																										
Color	Green	Red	White																																								
Code	G	R	W																																								
Color	Yellow	Orange	Blue																																								
Code	Y	A	S																																								
<p>Legend plate (for E type with square bezel)</p>  <p style="text-align: right; font-size: small;">AF94-460</p>	<table style="width: 100%; border-collapse: collapse;"> <tr> <td style="width: 30%;">Type</td> <td>Used with</td> </tr> <tr> <td>AR9P003-W</td> <td>AR22E0M, E5M DR22F5M, E3M</td> </tr> <tr> <td>DR9P001-W</td> <td>DR22E3N</td> </tr> </table> <p>This part is made of acrylic resin. Use paint or thinner compatible with resin.</p> <p>Dimensions, mm: AR9P003-W: 20 sq. x 4.8 DR9P001-W: 19.7 x 26.7 x 4.5</p>	Type	Used with	AR9P003-W	AR22E0M, E5M DR22F5M, E3M	DR9P001-W	DR22E3N																																				
Type	Used with																																										
AR9P003-W	AR22E0M, E5M DR22F5M, E3M																																										
DR9P001-W	DR22E3N																																										
<p>Legend sheet</p>  <p style="text-align: right; font-size: small;">AF95-34</p>	<p>AHX727</p> <p>Affix this seal to the DR9P241-□/AR9P003 legend plate for marking or labeling.</p> <p>Dimensions, mm: 20 sq. x 0.025</p>																																										

Pushbuttons/Selectors/Pilot Lights

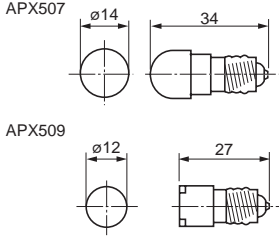

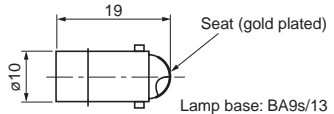

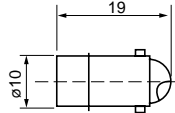

AR22/DR22 and AR30/DR30



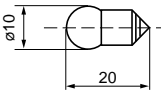

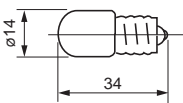



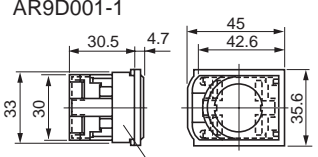

Accessories

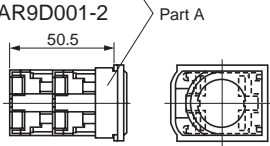
Description	Type
LED lamp  KKD06-208	Type Lamp voltage
	APX510-6 □ 6V AC
	APX510-D6 □ 6V DC
	APX510-12 □ 12V AC/DC
	APX510-15 □ 15V AC/DC
	APX510-24 □ 24V AC/DC
	Replace the □ mark by the luminous color code
	Luminous color Yellow Red Green
	Code Y R G
	Lens color Y R G
Luminous color Amber Orange Blue	
Code A O S	
Lens color A W, A* S	
* Orange is available only for the DR22F4M pilot light.	
Dimensions, mm: 	Lamp base: BA9s/13
LED lamp (for DR30 with resistor)	Type Lamp voltage
 KK02-110A	APX507-24 □ 24V AC/DC
	APX509-24O
 KK02-111A	Note: The symbol in the box indicates the color of light emitted. (See note APX510.) When the code is "W" (white), use an LED lamp ((APX.509-24O)
	Dimensions, mm:  Lamp base: E12/15
LED lamp (for AR22VGF type)	Type Lamp voltage
 KK02-109A	AR9L002-ER 24V AC/DC
	Luminous color: Red
	Dimensions, mm:  Lamp base: BA9s/13
	Do not use the LED lamp for other types.

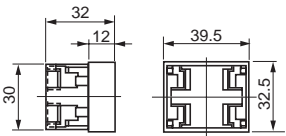
Description	Type	
Neon lamp (for AR22VGF type)  KK03-038	Type Lamp voltage	
	AR9N001-HA 110V AC	
	AR9N001-KA 120V AC	
	AR9N001-MA 220V AC	
	AR9N001-PA 240V AC	
	Luminous color: Orange	
	Dimensions, mm:	
	Do not use the LED lamp for other types.	
	LED lamp for DR30 (square type)	Type Lamp voltage
	 KKD06-208	DN6Q005-6 □ 6V DC
DN6Q005-2 □ 12V AC		
DN6Q005-B □ 12V AC/DC		
DN6Q005-E □ 24V AC/DC		
Replace the □ mark by the luminous color code		
Luminous color Yellow Red Green		
Code Y R G		
Lens color Y R G		
Luminous color Amber Orange		
Code Y W		
Lens color Y W		
Dimensions, mm: 	Lamp base: BA9s/13	
	Do not use the LED lamp for other types.	

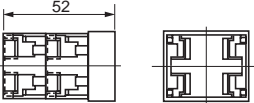
Pushbuttons/Selectors/Pilot Lights AR22/DR22 and AR30/DR30 Accessories

Description	Type															
Incandescent lamp 	<table border="1"> <thead> <tr> <th>Type</th> <th>Lamp voltage</th> <th>Rated voltage, consumption</th> </tr> </thead> <tbody> <tr> <td>AHX135</td> <td>5.5V AC/DC</td> <td>6.3V AC/DC, 1W</td> </tr> <tr> <td>AHX279</td> <td>15V AC/DC</td> <td>18V AC/DC, 1W</td> </tr> <tr> <td>AHX144</td> <td>20V AC/DC</td> <td>24V AC/DC, 1W</td> </tr> <tr> <td>AHX129</td> <td>24V AC/DC</td> <td>30V AC/DC, 1W</td> </tr> </tbody> </table>	Type	Lamp voltage	Rated voltage, consumption	AHX135	5.5V AC/DC	6.3V AC/DC, 1W	AHX279	15V AC/DC	18V AC/DC, 1W	AHX144	20V AC/DC	24V AC/DC, 1W	AHX129	24V AC/DC	30V AC/DC, 1W
	Type	Lamp voltage	Rated voltage, consumption													
	AHX135	5.5V AC/DC	6.3V AC/DC, 1W													
	AHX279	15V AC/DC	18V AC/DC, 1W													
	AHX144	20V AC/DC	24V AC/DC, 1W													
AHX129	24V AC/DC	30V AC/DC, 1W														
Dimensions, mm: 																
Lamp base: BA9s/13																
AF89-427																
Incandescent lamp (for DR30 with resistor) 	<table border="1"> <thead> <tr> <th>Type</th> <th>Lamp voltage</th> <th>Rated voltage, consumption</th> </tr> </thead> <tbody> <tr> <td>AHX130</td> <td>15V AC/DC</td> <td>18V AC/DC, 2W</td> </tr> </tbody> </table>	Type	Lamp voltage	Rated voltage, consumption	AHX130	15V AC/DC	18V AC/DC, 2W									
Type	Lamp voltage	Rated voltage, consumption														
AHX130	15V AC/DC	18V AC/DC, 2W														
Dimensions, mm: 																
Lamp base: E12/15																
KK02-115A																
Contact block (1NO) 	<table border="1"> <thead> <tr> <th>Type</th> <th>Standard</th> </tr> </thead> <tbody> <tr> <td>AR9B290</td> <td>Standard</td> </tr> <tr> <td>AR9B290-S</td> <td>Overlap</td> </tr> </tbody> </table>	Type	Standard	AR9B290	Standard	AR9B290-S	Overlap									
Type	Standard															
AR9B290	Standard															
AR9B290-S	Overlap															
Color: Blue Dimensions, mm: 19.3 x 29 x 27 Note: Terminal cover is not supplied with this.																
AF94-455																
Contact block (1NC) 	<table border="1"> <thead> <tr> <th>Type</th> <th>Standard</th> </tr> </thead> <tbody> <tr> <td>AR9B291</td> <td>Standard</td> </tr> <tr> <td>AR9B291-S</td> <td>Overlap</td> </tr> </tbody> </table>	Type	Standard	AR9B291	Standard	AR9B291-S	Overlap									
Type	Standard															
AR9B291	Standard															
AR9B291-S	Overlap															
Color: Red Dimensions, mm: 19.3 x 29 x 27 Note: Terminal cover is not supplied with this.																
AF94-455																
Lamp terminal 	<table border="1"> <thead> <tr> <th>Type</th> <th>Standard</th> </tr> </thead> <tbody> <tr> <td>AR9B292</td> <td>Standard</td> </tr> </tbody> </table>	Type	Standard	AR9B292	Standard											
Type	Standard															
AR9B292	Standard															
Color: Black Dimensions, mm: 19.3 x 29 x 27 Note: Terminal cover is not supplied with this.																
AF94-456																





Description	Type																																											
Contact protection cover 	<table border="1"> <thead> <tr> <th>Type</th> <th>Used with *</th> </tr> </thead> <tbody> <tr> <td>AR9D001-1</td> <td>AR22, 1-step contact</td> </tr> <tr> <td>AR9D001-2</td> <td>AR22, 2-step contact</td> </tr> <tr> <td>AR9D002-1</td> <td>AR30, 1-step contact</td> </tr> <tr> <td>AR9D002-2</td> <td>AR30, 2-step contact</td> </tr> </tbody> </table>	Type	Used with *	AR9D001-1	AR22, 1-step contact	AR9D001-2	AR22, 2-step contact	AR9D002-1	AR30, 1-step contact	AR9D002-2	AR30, 2-step contact																																	
	Type	Used with *																																										
	AR9D001-1	AR22, 1-step contact																																										
	AR9D001-2	AR22, 2-step contact																																										
	AR9D002-1	AR30, 1-step contact																																										
	AR9D002-2	AR30, 2-step contact																																										
	<ul style="list-style-type: none"> The contact is covered with a silicon rubber cover to keep out foreign matter such as dust, etc. Section A of the AR9D001 is separate. * See page 04/122, "AR22 □ Z8, AR30 □ Z8"																																											
	Dimensions, mm: 																																											
																																												
	KK02-117A																																											
																																												
																																												
KK02-118A																																												
																																												
																																												
																																												
																																												
Transformer unit 	<table border="1"> <thead> <tr> <th>Type</th> <th>Primary voltage</th> <th>Used with</th> </tr> </thead> <tbody> <tr> <td>AR9T511-H</td> <td>100-110V AC</td> <td rowspan="2">Standard type (except buzzers)</td> </tr> <tr> <td>AR9T511-L</td> <td>115-127V AC</td> </tr> <tr> <td>AR9T511-M</td> <td>200-220V AC</td> <td rowspan="2">DR30F4N, F4M, M4M</td> </tr> <tr> <td>AR9T511-Q</td> <td>230-254V AC</td> </tr> <tr> <td>AR9T511-S</td> <td>350-380V AC</td> <td rowspan="2">DR30F4N, F4M, M4M</td> </tr> <tr> <td>AR9T511-T</td> <td>400-440V AC</td> </tr> <tr> <td>AR9T511-V</td> <td>480V AC</td> <td rowspan="2">DR30F4N, F4M, M4M</td> </tr> <tr> <td>AR9T511-W</td> <td>500-550V AC</td> </tr> <tr> <td>AR9T557-H</td> <td>100-110V AC</td> <td rowspan="2">DR30F4N, F4M, M4M</td> </tr> <tr> <td>AR9T557-L</td> <td>115-127V AC</td> </tr> <tr> <td>AR9T557-M</td> <td>200-220V AC</td> <td rowspan="2">DR30F4N, F4M, M4M</td> </tr> <tr> <td>AR9T557-Q</td> <td>230-254V AC</td> </tr> <tr> <td>AR9T557-S</td> <td>350-380V AC</td> <td rowspan="2">DR30F4N, F4M, M4M</td> </tr> <tr> <td>AR9T557-T</td> <td>400-440V AC</td> </tr> <tr> <td>AR9T557-V</td> <td>480V AC</td> <td rowspan="2">DR30F4N, F4M, M4M</td> </tr> <tr> <td>AR9T557-W</td> <td>500-550V AC</td> </tr> </tbody> </table>	Type	Primary voltage	Used with	AR9T511-H	100-110V AC	Standard type (except buzzers)	AR9T511-L	115-127V AC	AR9T511-M	200-220V AC	DR30F4N, F4M, M4M	AR9T511-Q	230-254V AC	AR9T511-S	350-380V AC	DR30F4N, F4M, M4M	AR9T511-T	400-440V AC	AR9T511-V	480V AC	DR30F4N, F4M, M4M	AR9T511-W	500-550V AC	AR9T557-H	100-110V AC	DR30F4N, F4M, M4M	AR9T557-L	115-127V AC	AR9T557-M	200-220V AC	DR30F4N, F4M, M4M	AR9T557-Q	230-254V AC	AR9T557-S	350-380V AC	DR30F4N, F4M, M4M	AR9T557-T	400-440V AC	AR9T557-V	480V AC	DR30F4N, F4M, M4M	AR9T557-W	500-550V AC
Type	Primary voltage	Used with																																										
AR9T511-H	100-110V AC	Standard type (except buzzers)																																										
AR9T511-L	115-127V AC																																											
AR9T511-M	200-220V AC	DR30F4N, F4M, M4M																																										
AR9T511-Q	230-254V AC																																											
AR9T511-S	350-380V AC	DR30F4N, F4M, M4M																																										
AR9T511-T	400-440V AC																																											
AR9T511-V	480V AC	DR30F4N, F4M, M4M																																										
AR9T511-W	500-550V AC																																											
AR9T557-H	100-110V AC	DR30F4N, F4M, M4M																																										
AR9T557-L	115-127V AC																																											
AR9T557-M	200-220V AC	DR30F4N, F4M, M4M																																										
AR9T557-Q	230-254V AC																																											
AR9T557-S	350-380V AC	DR30F4N, F4M, M4M																																										
AR9T557-T	400-440V AC																																											
AR9T557-V	480V AC	DR30F4N, F4M, M4M																																										
AR9T557-W	500-550V AC																																											
Dimensions, mm: Up to 220 V 22.4 x 30 x 45 Over 220 V 25.3 x 29 x 48 Note: With terminal cover																																												
																																												
AF95-33																																												



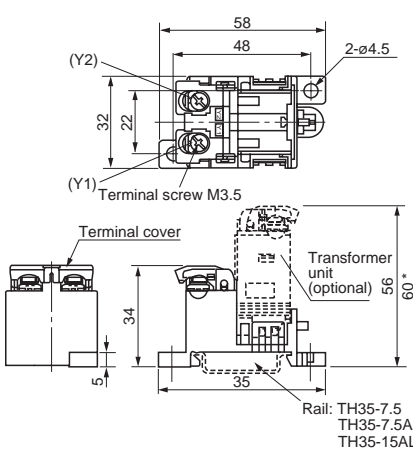

04

Pushbuttons/Selectors/Pilot Lights



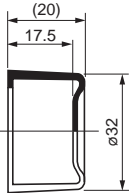

AR22/DR22 and AR30/DR30



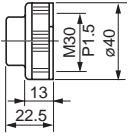
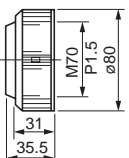

Accessories

Description	Type		
Base unit for transformer separate mounting	AR9T003 Use this base in combination with a transformer unit. This base unit can be mounted using screws or rails. Dimensions, mm 		
 KK02-118A	* Except for the types 110V AC, 127V AC and 220V AC.		
Resistor Voltage stabilizer Device for LED lamp flickering	Resistor: AR9T519-H (110V DC) Fit this resistor when using LED of 24V DC rating with 110V DC power. Voltage stabilizer: AR9T001-E This unit allows an LED lamp of 24V DC rating to be used in a circuit with voltage from 27V to 35V (AC or DC). Flickering device: 6V AC: AR9T002-A 6V DC: AR9T002-6 12 to 24V AC: AR9T002-G * 12 to 24V DC: AR9T002-E * * Used in combination with 12V, 15V, or 24V rated LED lamp. Note: With terminal cover		
 AF95-33			
Nut	Type	Used with	Dimensions, mm
 AF94-462	AR9R744	AR22, DR22*	ø29.7 x 4
 KK2-119A	DR9R001	DR30F4M DR30F4N DR30M4M	ø33.8 x 5
* Except AR22VG□, Joy stick selectors, buzzers and numerical indicators			

Description	Type													
Nut for 30mm dia. types (Resin types are black, metallic types are silver.)	AR9R001 : Resin types are black (standard) AHX088 : Metallic types are silver Used with: AR30F0R, F5R, FAR, FBR, E0R, E5R, EAR, EBR, E0L, E5L, Q7L DR30D0L, E3L, K0L AR9R002 : Resin types are black (standard) AHX093 : Metallic types are silver Used with: AR30M0R, M5R, M4R, G0R, G5R, N0R, S□R, V□R, Q2R, V□L, PR, PCR, WR, WCR, JR, JCR, JAR, PL, A□N, A□H													
 KK2-120A KK2-121A KK2-122A KK2-123A														
Water-tight cap for 22mm dia. types	AR9D797 □													
 KK2-124A	This rubber cap protects the operator and switch mechanism against dust and water. Use this cap in a dusty or moist environment. Used with: AR22E0L, E5L AR22E0R, E5R Replace the □ mark by the luminous color code. <table border="1" data-bbox="1031 1400 1276 1579"> <thead> <tr> <th>Code</th> <th>Color</th> </tr> </thead> <tbody> <tr> <td>G</td> <td>Green</td> </tr> <tr> <td>R</td> <td>Red</td> </tr> <tr> <td>B</td> <td>Black</td> </tr> <tr> <td>Y</td> <td>Yellow</td> </tr> <tr> <td>Blank</td> <td>Clear (standard)</td> </tr> </tbody> </table>		Code	Color	G	Green	R	Red	B	Black	Y	Yellow	Blank	Clear (standard)
Code	Color													
G	Green													
R	Red													
B	Black													
Y	Yellow													
Blank	Clear (standard)													
 Y-1559	Dimensions, mm: 													
Water-tight cap for 30mm dia. types	AHX052													
 Y-1559	This rubber cap protects the operator and switch mechanism against dust and water. Use this cap in a dusty or moist environment. The only color available is transparent. Used with: AR30E□R, E□L Dimensions, mm: ø36 x 22.5													

Pushbuttons/Selectors/Pilot Lights AR22/DR22 and AR30/DR30 Accessories

Description	Type																																																																
Dust-proof cap for 30mm dia. types	<table border="1"> <thead> <tr> <th>Type</th> <th>Color</th> <th>Used with</th> <th>Spec.</th> </tr> </thead> <tbody> <tr> <td>AHX032</td> <td>Red</td> <td>AR30E0R</td> <td>Oil-proof</td> </tr> <tr> <td>AHX033</td> <td>Green</td> <td></td> <td></td> </tr> <tr> <td>AHX034</td> <td>Black</td> <td></td> <td></td> </tr> <tr> <td>AHX041</td> <td>Red</td> <td>AR30F0R</td> <td>Oil-proof</td> </tr> <tr> <td>AHX042</td> <td>Green</td> <td></td> <td></td> </tr> <tr> <td>AHX043</td> <td>Black</td> <td></td> <td></td> </tr> <tr> <td>AHX157-R</td> <td>Red</td> <td>AR30B2R,</td> <td>Oil-proof</td> </tr> <tr> <td>AHX157-G</td> <td>Green</td> <td>B3R</td> <td></td> </tr> <tr> <td>AHX157-B</td> <td>Black</td> <td></td> <td></td> </tr> <tr> <td>AHX113-R</td> <td>Red</td> <td>AR30E0R</td> <td>Weather resistance</td> </tr> <tr> <td>AHX113-G</td> <td>Green</td> <td></td> <td></td> </tr> <tr> <td>AHX113-B</td> <td>Black</td> <td></td> <td></td> </tr> <tr> <td>AHX111-R</td> <td>Red</td> <td>AR30F0R</td> <td>Weather resistance</td> </tr> <tr> <td>AHX111-G</td> <td>Green</td> <td></td> <td></td> </tr> <tr> <td>AHX111-B</td> <td>Black</td> <td></td> <td></td> </tr> </tbody> </table>	Type	Color	Used with	Spec.	AHX032	Red	AR30E0R	Oil-proof	AHX033	Green			AHX034	Black			AHX041	Red	AR30F0R	Oil-proof	AHX042	Green			AHX043	Black			AHX157-R	Red	AR30B2R,	Oil-proof	AHX157-G	Green	B3R		AHX157-B	Black			AHX113-R	Red	AR30E0R	Weather resistance	AHX113-G	Green			AHX113-B	Black			AHX111-R	Red	AR30F0R	Weather resistance	AHX111-G	Green			AHX111-B	Black		
	Type	Color	Used with	Spec.																																																													
	AHX032	Red	AR30E0R	Oil-proof																																																													
	AHX033	Green																																																															
	AHX034	Black																																																															
	AHX041	Red	AR30F0R	Oil-proof																																																													
	AHX042	Green																																																															
	AHX043	Black																																																															
	AHX157-R	Red	AR30B2R,	Oil-proof																																																													
	AHX157-G	Green	B3R																																																														
	AHX157-B	Black																																																															
	AHX113-R	Red	AR30E0R	Weather resistance																																																													
	AHX113-G	Green																																																															
	AHX113-B	Black																																																															
	AHX111-R	Red	AR30F0R	Weather resistance																																																													
AHX111-G	Green																																																																
AHX111-B	Black																																																																
	SC-993																																																																
	AF89-772																																																																
<p>Dimensions, mm:</p> <p>AHX032 to 034, 041 to 043 AHX111, 113</p>  <p>AHX157</p>  <p>Used for sealing the operator from foreign debris such as dust, oil (oil-proof), and water (weather resistance) in environments where the unit is in contact with such elements.</p>																																																																	
Packing	<p>AR9Y730: AR22 and DR22 (Rubber)</p> <p>Note: Except for joystick selector switches, buzzers</p> <p>AHX282: AR30 and DR30 (Resin-standerd)</p> <p>Note: Except for DR30F4M, F4N, M4M, numerical indicators</p> <p>AHX149: AR30 and DR30 (Rubber)</p> <p>Note: Except for DR30F4M, F4N, M4M, numerical indicators</p>																																																																
	AF94-462																																																																
	KK2-125A																																																																

Description	Type												
Terminal cover	<table border="1"> <thead> <tr> <th>Type</th> <th>Used with</th> <th>Dimensions, mm</th> </tr> </thead> <tbody> <tr> <td>AR9Y305</td> <td>Contact unit Lamp terminal Transformer unit *1</td> <td>18.4 x 29 x 8.4</td> </tr> <tr> <td>DR9Y320</td> <td>Pilot lights *2 (without transformer)</td> <td>ø22 x 5.8</td> </tr> <tr> <td>DR9Y321</td> <td>DR30F4M, F4N, M4M (without transformer)</td> <td>34 sq. x 8.7</td> </tr> </tbody> </table>	Type	Used with	Dimensions, mm	AR9Y305	Contact unit Lamp terminal Transformer unit *1	18.4 x 29 x 8.4	DR9Y320	Pilot lights *2 (without transformer)	ø22 x 5.8	DR9Y321	DR30F4M, F4N, M4M (without transformer)	34 sq. x 8.7
	Type	Used with	Dimensions, mm										
AR9Y305	Contact unit Lamp terminal Transformer unit *1	18.4 x 29 x 8.4											
DR9Y320	Pilot lights *2 (without transformer)	ø22 x 5.8											
DR9Y321	DR30F4M, F4N, M4M (without transformer)	34 sq. x 8.7											
	AF94-466												
	KK2-126A												
Terminal cover	<table border="1"> <thead> <tr> <th>Type</th> <th>Used with</th> <th>Dimensions, mm</th> </tr> </thead> <tbody> <tr> <td>AHX305</td> <td>Buzzers (without transformer)</td> <td>23.5 x 27.5 x 16</td> </tr> <tr> <td>AHX426</td> <td>DR30D1L (without transformer)</td> <td>27.5 x 31 x 8</td> </tr> <tr> <td>AHX376</td> <td>DR30D1L (with transformer) Buzzers (B0 type)</td> <td>13 x 29 x 6.5</td> </tr> </tbody> </table> <p>With transformer * With short-body transformer With resistor unit</p> <p>* 230V and over</p> <p>The terminal cover is provided as standard with the applicable types listed above.</p>	Type	Used with	Dimensions, mm	AHX305	Buzzers (without transformer)	23.5 x 27.5 x 16	AHX426	DR30D1L (without transformer)	27.5 x 31 x 8	AHX376	DR30D1L (with transformer) Buzzers (B0 type)	13 x 29 x 6.5
Type	Used with	Dimensions, mm											
AHX305	Buzzers (without transformer)	23.5 x 27.5 x 16											
AHX426	DR30D1L (without transformer)	27.5 x 31 x 8											
AHX376	DR30D1L (with transformer) Buzzers (B0 type)	13 x 29 x 6.5											
	AHX305 SG-842												
	AHX426 AF92-339												
	AHX376 SG-5												

Pushbuttons/Selectors/Pilot Lights/Buzzers

AR22 Special products



Semi standard compliant guarding

■ Features

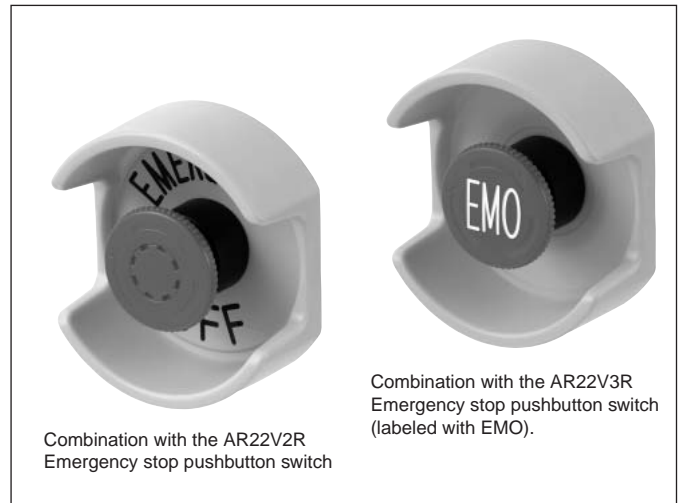
- Combine a guard ring with a Fuji electric emergency stop pushbutton switches to comply with SEMI (SEMI-S2, SEMATECH Application Guide for SEMI S2-93).
- EMERGENCY OFF legend plates are available.
- Emergency stop pushbutton switches labeled with "EMO" are available.



■ Accessories

Description	Type	Color
 (KKD05-263)	AR9R008	Yellow
Legend plate for AR9R008 emergency off  (KKD05-262)	AR9P721-5C	Yellow (Black legend)

■ Emergency stop pushbutton switches

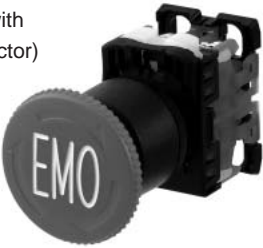
Operator	Contact	Type	Color
 (KKD05-261)	1NC	AR22V3R-01RZ286	Red (White legend)
	1NO+1NC	AR22V3R-11RZ286	
	2NC	AR22V3R-02RZ286	
	1NO+2NC	AR22V3R-12RZ286	
	3NC	AR22V3R-03RZ286	
	1NO+3NC	AR22V3R-13RZ286	
	2NO+2NC	AR22V3R-22RZ286	
	4NC	AR22V3R-04RZ286	

Note : Contact arrangements indicated in the table can be supplied.

■ Dimensions, mm

● Guardring (AR9R008)

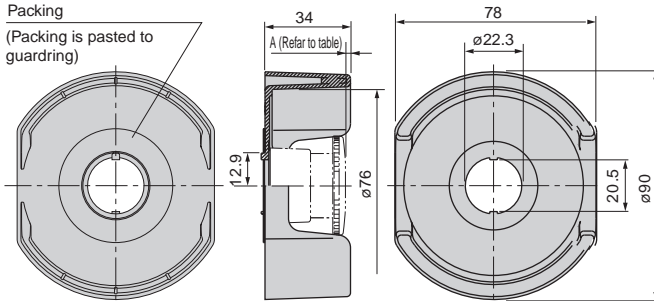

● Installation

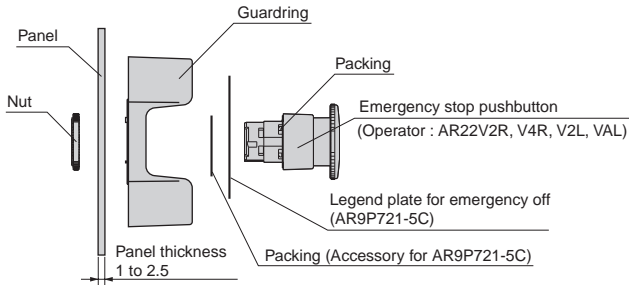

● Legend plate for emergency off (AR9P721-5C)

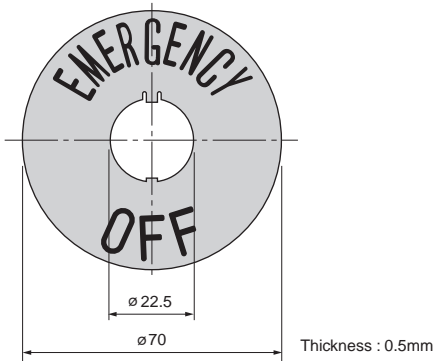

Note : • Engraving for marking letters is not available.
• Letter height : 13mm

■ Notes on use

This guardring conform to SEMI standard. Please do not use it for the emergency stops other than Semiconductor manufacturing Equipment.

■ Applicable types

AR22V2R, V4R, V2L, VAL and V3R Z286

* Dimension A (the height difference between the switch and guardring) depends on the emergency stop (Illuminated) pushbutton switch that is being used. Refer to the following table.

Type	Panel thickness	A (Reference)	
AR22V2R	1~2.5	2mm	With AR9P721-5C
AR22V4R	1~2.5	2mm	With AR9P721-5C
AR22V2L	1~2.5	2mm	With AR9P721-5C
AR22VAL	1~2.5	2mm	With AR9P721-5C
AR22V3R (Z286)	1~3.6	3mm	

● Panel cutout hole dimensions, mm

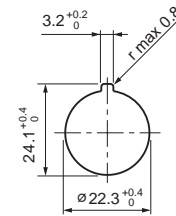

● Emergency stop pushbutton switches (AR22V3R-□□RZ286)

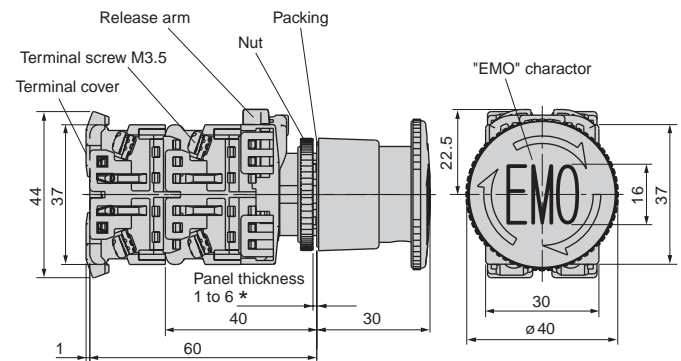

* Without accessories

Pushbuttons/Selectors/Pilot Lights/Buzzers

AR22/DR22 and AR30/DR30

Special products

Products equipped with contact protection cover

■ Features

A silicon rubber cover is provided for the contact block to keep out foreign matter such as dust, etc.
Other ratings and specifications are the same as those of the standard type.

■ Type

AR22 □ Z8

AR30 □ Z8

Specify "Z8" at the end of the type number of the standard type.

■ Dimensions

The only thing different from the standard product is the addition of a 1-mm thick silicon rubber cover around the contact block.

■ Applicable types

Type	Contact arrangement	Remarks
• Pushbuttons *1	1NO+1NC,	For use with a 1-step contact
• Emergency stop pushbuttons *2	2NO*5, 2NC	
• Selectors *3	1NO+3NC, 2NO+2NC, 3NO+1NC, 4NO*5, 4NC	For use with a 2-step contact
• Illuminated pushbuttons *4 (without transformer)	1NO*6, 1NC	For use with a 1-step contact
• Emergency stop illuminated pushbuttons*2 (without transformer)	1NO+2NC, 2NO+1NC, 3NO*6, 3NC	For use with a 2-step contact
• Illuminated selectors (without transformer)		

Notes: *1 Except for AR30B0R, B1R, B2R, B3R, N0R, and GPR.

*2 Except for unibody (VG types)

*3 Except for AR30HR

*4 Except for AR30Q7L

*5 Except for emergency stop pushbutton switch

*6 Except for emergency stop illuminated pushbutton switch

Resisting water-soluble cutting oils and heat

■ Features

Safer operation in environments exposed to water-miscible cutting fluids, machining oils, lubricating oils, cleaning oils and high humidity (up to 95%) is made possible by using materials that protect against rust and corrosion of components.
Other ratings and specifications are the same as those of the standard type.

■ Type

AR22 □ Z9, DR22 □ Z9

AR30 □ Z9, DR30 □ Z9

Specify "Z9" at the end of the type number of the standard type.

■ Dimensions

Same as those of the standard type

■ Applicable types

• AR22, DR22 series

AR 22 (Except for joy stick selectors, FAR, FBR, EAR, EBR types and VG types)

DR22 (Except for pilot lights with resistor unit and buzzers)

• AR30, DR30 series

AR30 (Except for Q7L, FAR, FBR, EAR, EBR, HR types and joy stick selectors)

DR30 (Except for D1L, F4M, F4N, M4M types, pilot lights with resistor/resistor unit and buzzers)

Meeting IP2X finger protection standards

■ Features

Conforms to EN standard EN60204-1 (protecting against electric shock). The terminal has IEC60529 degree of protection; IP2X finger protection secured (a mock human finger used in testing did not come into contact with charged parts). The contact block and lamp terminal can be easily mounted or removed with the terminal cover mounted.

■ Type

AR22 □ ZB, DR22 □ ZB

AR30 □ ZB, DR30 □ ZB

Specify "ZB" at the end of the type number of the standard type.

■ Accessories

- Contact block (plus terminal cover)
 NO contact: AR9B290-D
 NC contact: AR9B291-D
- Transformer unit (plus terminal cover)
 AR9T511-□ D

■ Ratings and specifications

- Protection degree: IP2X
- Terminal screw: M3.5
 Wiring can be done with a solid wire or fork shaped crimp terminal.

Note: Ring-type crimp terminals cannot be used.

- Other ratings and specifications are the same as those of the standard type.

■ Applicable types

- AR22, DR22 series
 AR22 (except for joy stick selectors)
 DR22: Without transformer, with transformer (except for short-body types, buzzers and numerical indicators)
- AR30, DR30 series
 AR30 (except for HR and joy stick selectors)
 DR30: Without transformer, with transformer (except for D1L, F4M, F4N, M4M types and buzzers)

Note: The terminal of the standard type VG has IP2X protection.

■ Dimensions, mm

AR22/Pushbutton switches

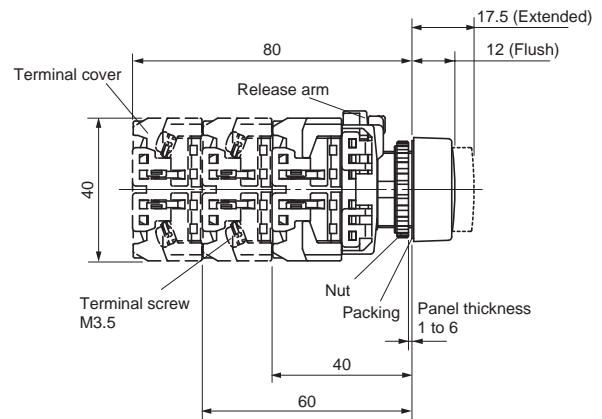

DR22/Without transformer

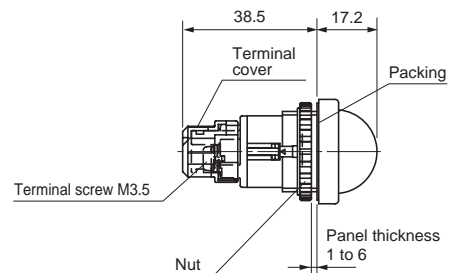

DR22/With transformer

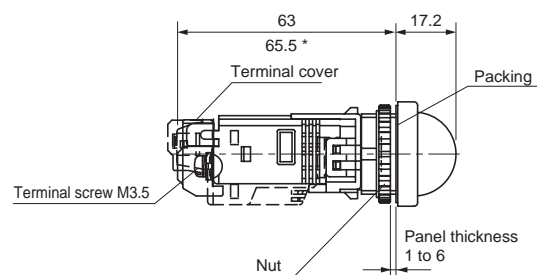

Note: * Except for the types 110V AC, 127V AC and 220V AC.

Pushbuttons/Selectors/Pilot Lights/Buzzers

AR22/DR22 and AR30/DR30

Special products

Metal nut (chrome plated) types

■ Features

The nut is a metallic ring (chrome plated).
Other ratings and specifications are the same as those of the standard model.

■ Type

AR30 ZM

DR30 ZM

Specify "ZM" at the end of the type number of the standard type.

■ Dimensions, mm

Same as those of the standard types.

■ Applicable types

• AR30, DR30 series

AR30 (except for G4L, G9L, GSR*1, GPR*1, BOR*1, and HR*1 types)

DR30 with round bezel (except for IP54 buzzer type B8)*2

Notes: *1 Standard type is a metallic ring (chrome plated).

*2 The nut of types DR30B0, B5 and B6 buzzers are resin (chrome plated).

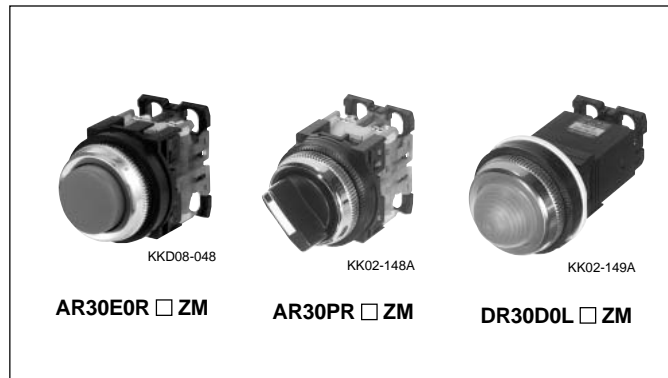

Resisting sulfuration gas

■ Features

These products can be used in environments having a concentration of hydrogen sulfide gas of 0.5 ppm or less. The metallic parts have been subjected to an anti-corrosion treatment (see note).

The contacts of the AR series are gold plated.

Note: The body is made of resin and cannot be used with gases that affect resins (plastics).

■ Type

AR22 Z4, DR22 Z4

AR30 Z4, DR30 Z4

Specify "Z4" at the end of the type number of the standard type.

■ Notes on use

- This product is resistant to light corrosive gas exposure.
- Other measures, such as covering the entire switch with a box, and the degree of protection of the panel should be taken into consideration.

■ Ratings and specifications

Hydrogen sulfide gas concentration of 0.5 ppm max.

Ambient storage temperature: 8 to 37°C

Humidity: 62 to 81%

Other ratings and specifications are the same as those of the standard type.

■ Dimensions, mm

Same as those of the standard types.

■ Applicable types

• AR22, DR22 series

AR22 (except for Joy stick selectors and VG type)

DR22 (except for pilot lights with resistor unit and buzzers)

• AR30, DR30 series

AR30 (except for HR and Joy stick selectors)

DR30 (except for F4M, F4N, M4M types, pilot lights with resistor/resistor unit and buzzers)

■ Mass, gram

● Illuminated pushbuttons

Type	Without transformer			With transformer *	
	1NO (1NC)	2NO (2NC) (1NO+1NC)	2NO+2NC	1NO (1NC)	2NO (2NC) (1NO+1NC)
AR22F0L	39	48	67	85	94
F5L	39	48	–	85	94
F0M, F0P	40	49	68	86	95
F5M, F5P	40	49	–	86	95
E0L	41	50	69	87	96
E5L	41	50	–	87	96
E0M, E0P, M4L, G1L, G2L, G4L	42	51	70	88	97
E5M, E5P, M9L, G6L, G7L, G9L	42	51	–	88	97
M4P	43	52	71	89	98
M0L	44	53	72	90	99
M5L	44	53	–	90	99
V5L	48	57	–	94	103

Note: * 230V and over : +17grams

● Pushbuttons

Type	1NO (1NC)	2NO (2NC) (1NO+1NC)	2NO+2NC
AR22F0R, FAR, F5R, FBR	27	36	55
E0R, EAR, F0S, F0Y, G0R	28	37	56
E5R, EBR, F5S, F5Y, G5R			
E0S, E0Y, M4R, G2R	29	38	57
E5S, E5Y, M9R, G7R			
M0R, M5R	31	40	59
S1R, S2R, S3R, S6R	–	43	62
M3R, M8R	44	53	72
V5R	49	58	77

● Emergency stop pushbuttons

Type	1NC	2NC (1NO+1NC)	2NO+2NC
AR22VSR	34	43	62
V0R, V4R	36	45	64
Q2R	36	45	–
V2R	38	47	66
V7R	59	68	87
VGE	61	65	–

● Emergency stop illuminated pushbuttons

Type	Without transformer		With transformer *	
	1NC	2NC (1NO+1NC)	1NC	2NC (1NO+1NC)
AR22VSL, VDL	48	57	94	103
V0L	49	58	95	104
VAL	50	59	96	105
V2L	51	60	97	106
VGF	66	70	–	–

Note: * 230V and over : +17grams

Pushbuttons/Selectors/Pilot Lights/Buzzers

AR22 and DR22

Mass

■ Mass, gram

● Pilot lights

Type	Without transformer		With transformer		With resistor unit
	Standard	Short-body	Standard *	Short-body	
DR22D0L, K0L	18	23	70	68	32
E3L, E3P, F3M, F4M	19	24	71	69	33
F5M	20	25	72	70	34
E3M	21	26	73	71	35
E3N	23	28	75	73	37

Note: * 230V and over : +17grams

● Selector switches

Type	1NO (1NC)	2NO (2NC) (1NO+1NC)	2NO+2NC
AR22PR	30	39	58
PCR	–	39	58
WR	31	40	59
WCR	–	40	59
RR, PY, WY	32	41	60
RCR, PCY, WCY	–	41	60
RY	33	42	61
RCY	–	42	61
JR, JAR	56	65	83
JCR	–	65	83
JY	57	66	84
JCY	–	66	84

● Illuminated selector switches

Type	Without transformer			With transformer *	
	1NO (1NC)	2NO (2NC) (1NO+1NC)	2NO+2NC	1NO (1NC)	2NO (2NC) (1NO+1NC)
AR22PL	42	51	70	88	97
PP	43	52	71	89	98

Note: * 230V and over : +17grams

● Joy stick selector switches

• Screw terminal types

Type	1NO x2	(1NO+1NC) x2	1NO x4	(1NO+1NC) x4
AR22A2N, A7N	89	99	116	136
A0N, A5N	99	109	126	146
A1N, A6N	112	122	139	159

• Solder/tab terminal types

Type	(1NO+1NC) x2	(2NO+2NC) x2	(1NO+1NC) x4	(2NO+2NC) x4
AR22A2H, A7H	72	75	82	88
A0H, A5H	82	85	92	98
A1H, A6H	95	98	105	111

● Buzzers

Type	Without transformer	With transformer	With resistor unit
DR22B5	50	105	52
B8	53	108	55
B3	66	121	–

■ Mass, gram

● Illuminated pushbuttons

Type	Without transformer			With transformer *	
	1NO (1NC)	2NO (2NC) (1NO+1NC)	2NO+2NC	1NO (1NC)	2NO (2NC) (1NO+1NC)
AR30E0L	49	58	77	95	104
E5L	49	58	–	95	104
G4L	50	59	78	96	105
G9L	50	59	–	96	105
V5L	56	65	–	102	111
G2L	66	75	94	112	121
G7L	66	75	–	112	121
G3L	72	81	100	118	127
G8L	72	81	–	118	127
Q7L	–	159	–	–	205

Note: * 230V and over : +17grams

● Pushbuttons

Type	1NO (1NC)	2NO (2NC) (1NO+1NC)	2NO+2NC
AR30F0R, FAR, F5R, FBR	36	45	64
E0R, EAR, G0R, E5R, EBR, G5R	37	46	65
M4R	38	47	66
M0R, M5R	40	49	68
V5R	42	51	70
S1R, S2R, S3R, S6R	–	53	72
FVR	54	63	82
G1R, G6R	59	68	87
N0R	96	105	124
GPR	116	125	144
GSR, B0R	123	132	151
M3R, M8R	126	135	154
B1R	241	250	269
B3R	279	288	307
B2R	291	300	319

● Emergency stop pushbuttons

Type	1NC	2NC (1NO+1NC)	2NO+2NC
AR30V0R	43	52	71
Q2R	45	54	–
V2R	46	55	74
V1R	60	69	88

● Emergency stop illuminated pushbuttons

Type	Without transformer		With transformer *	
	1NC	2NC (1NO+1NC)	1NC	2NC (1NO+1NC)
AR30V0L	57	66	103	112
V2L	59	68	105	114

Note: * 230V and over : +17grams

Pushbuttons/Selectors/Pilot Lights/Buzzers

AR30 and DR30

Mass

■ Mass, gram

● Pilot lights

• Without transformer type, With transformer type, With resistor unit type

Type	Without transformer	With transformer		With resistor unit
	Standard	Standard *1	Short-body	
DR30D0L, K0L	28	80	78	42
E3L	29	81	79	43
F4M *2	32 (30)	84 (82)	–	46
F4N *2	34 (30)	86 (82)	–	48
M4M *2	37 (32)	88 (84)	–	50
D1L	94	164	–	111

Notes: *1 230V and over : +17grams

*2 (): Incandescent lamp

• With resistor type

Type	50V DC	110V DC
		220V DC
DR30D0L, K0L (LED)	103	103
D0L, K0L (incandescent)	107	179

● Selector switches

Type	1NO (1NC)	2NO (2NC) (1NO+1NC)	2NO+2NC
	AR30PR, WR	41	50
PCR, WCR	–	50	69
JR, JAR	67	76	94
JCR	–	76	94
HR	125	135	153(166)

Note: () : AR30HR-122

● Illuminated selector switches

Type	Without transformer			With transformer *	
	1NO (1NC)	2NO (2NC) (1NO+1NC)	2NO+2NC	1NO (1NC)	2NO (2NC) (1NO+1NC)
AR30PL	52	61	80	98	107

Note: * 230V and over : +17grams

● Joy stick selector switches

• Screw terminal type

Type	1NO x2	(1NO+1NC) x2	1NO x4	(1NO+1NC) x4
AR30A2N, A7N	100	110	127	147
A0N, A5N	110	120	137	157
A1N, A6N	124	134	151	171

• Solder/tab terminal type

Type	(1NO+1NC) x2	(2NO+2NC) x2	(1NO+1NC) x4	(2NO+2NC) x4
AR30A2H, A7H	83	86	93	99
A0H, A5H	93	96	103	109
A1H, A6H	107	110	117	123

● Buzzers

Type	Without transformer	With transformer	With resistor unit
DR30B5, B6	47	102	49 (Except B6)
B8	48	103	50
B0	86	–	–

Command Switches AR16, DR16 and AF16, DF16 General information

- An integrated structure with built-in contacts that can reduce control panel depth.
- A wide variety of sockets are available to simplify wiring.
- Thin type and Standard types available for your control panel design. Select an optimum one to match your control panel design.

■ Features

Supporting smaller and thinner operator's panels

A structure that integrates operator and contacts to reduce panel-mounting depth. Terminals extending to the rear of the switch ensure easy wiring work.

- Standard type : 28.4mm deep
- Thin type : 35.9mm deep
- Emergency stop : 28mm deep

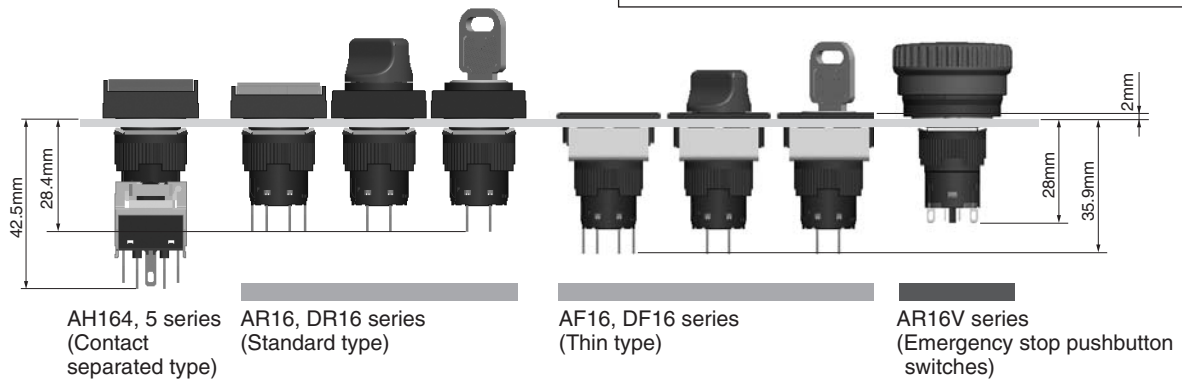
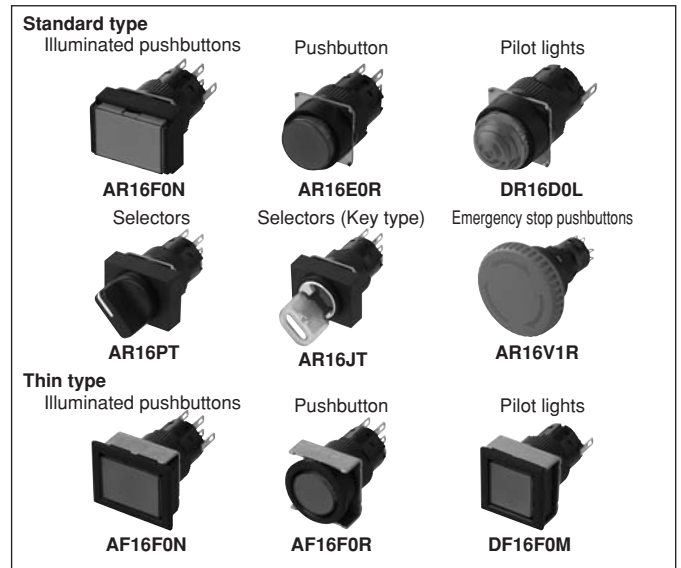

A wide variety of sockets reduce wiring work

Switches combine with a variety of sockets to simplify wiring.

- Fast-connection socket

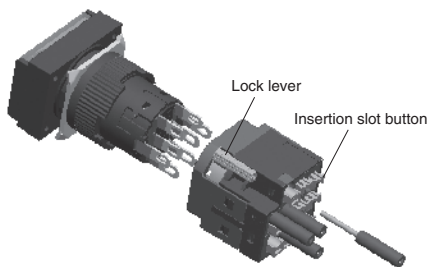

- Applicable as a fast-connection terminal switch by combining the socket with a switch.
- Easily wired by simply removing the wire sheath and inserting the wires while pressing the insertion slot button (no soldering required).
- Incorporates a branch terminal for easy branching.

- Connector socket

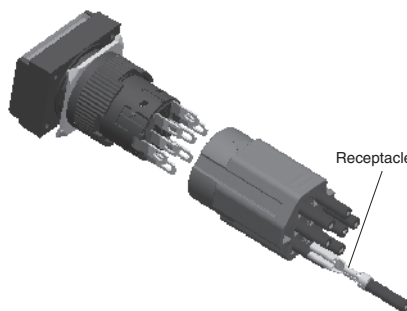

- Applicable as a connector by combining the socket with receptacles.
- The socket holds the receptacles, making it easy to connect the receptacle to the switch with a single operation.

- Socket for PC board

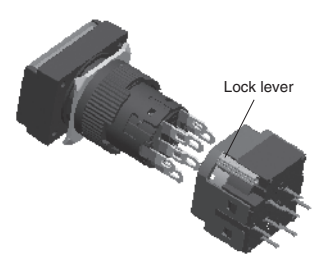

- Applicable as a switch for PC board by combining the socket with a switch.
- Pattern wiring reduces the number of wiring man-hour and helps prevent faulty wiring.

Safety

- FUJI's original Trigger Action mechanism is used in the emergency stop pushbuttons. They are suitable for emergency stop and safety. This mechanism prevents the contacts from moving until the button is pushed and locked. (See page 04/180)

Degree of protection

The operator has IP65 protection for smooth operation without adverse effects from oil, water, or dusts.

Approvals



For further information related to approved type, see page 04/130 to 04/135











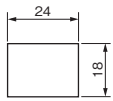
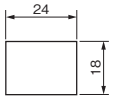

Note : commanded switches shipped as articles to China must conform to the Product Quality Law. Check with your Fuji Electric representative.

Command Switches

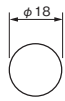
AR16, DR16 and AF16, DF16

Quick reference guide

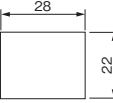
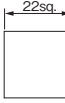
■ Illuminated pushbutton switches

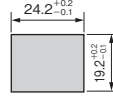
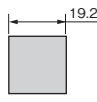
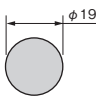
Operator		Flush rectangular		Flush rectangular with guard		Flush square		Extended round		Flush round		
Operator action		Momentary	Alternate	Momentary	Alternate	Momentary	Alternate	Momentary	Alternate	Momentary	Alternate	
Standard type	Type	AR16F0N	AR16F5N	AR16G0N	AR16G5N	AR16F0M	AR16F5M	AR16E0L	AR16E5L	—	—	
		Appearance									—	
	See page	04/143		04/143		04/143		04/143		—		
	Bezel (mm)									—		
	Panel cutting (mm)			—		—		—		—		
Thin type	Type	AF16F0N	AF16F5N	—	—	AF16F0M	AF16F5M	—	—	AF16F0L	AF16F5L	
	Appearance			—				—				
	See page	04/155		—		04/155		—		04/155		
	Bezel (mm)			—				—				
	Panel cutting (mm)			—				—				
Legend plate (mm)		19.6×13.6		19.6×13.6		13.6sq.		φ13.6		φ13.6		
Bezel color		Black										
Button color (transparent)		Green, Red, White ^{*1} , Yellow, Orange, Blue										
LED lamp	Color	Green, Red, Orange, Yellow, Amber, Blue										
	Lamp voltage	6V AC/DC, 12V AC/DC, 24V AC/DC										
Contact arrangement		SPDT, 2PDT										
Contact rating		120V AC 1A (AC-13), 24V DC 0.7A (DC-13, T _{0.95} = 21ms) 240V AC 0.7A (AC-13), 125V DC 0.15A (DC-13, T _{0.95} = 21ms)										
Mechanical durability		Momentary action: 1 million operations Alternate action: 250,000 operations										
Electrical durability		100,000 operations (220V AC 0.7A)										
Degree of protection (Operator)		IP65										
Type of terminal		Tab (#110) / solder dual-use terminal										
Accessories	Protective cover ^{*2}	○ ^{*3}	—	—	—	○ ^{*3}	—	○	—	—	—	
	Dust-proof cover	○ ^{*4}	—	—	—	○ ^{*4}	—	○	—	—	—	
	Terminal cover	○	—	○	—	○	—	○	—	○	—	
	Socket	Quick connection	○	—	○	—	○	—	○	—	○	—
		Connector use	○	—	○	—	○	—	○	—	○	—
		PC board use	○	—	○	—	○	—	○	—	○	—
Panel plug	○	—	○	—	○	—	○	—	○	—		

Notes: ^{*1} A combination of the translucent button and the white legend plate comes to white.









^{*2} The protective cover and button of the thin type are made of an integral structure.

^{*3} The protective cover of the thin type is available for momentary action only.

^{*4} Available for standard type only.

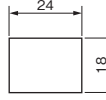
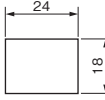
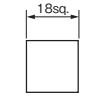
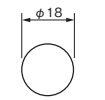
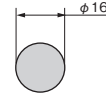
Command Switches AR16, DR16 and AF16, DF16 Quick reference guide

■ Pushbutton switches

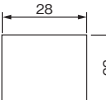
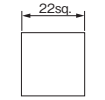
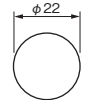
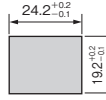
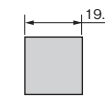
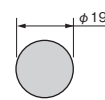
Operator		Flush rectangular		Flush rectangular with guard		Flush square		Extended round		Flush round		
Operator action		Momentary	Alternate	Momentary	Alternate	Momentary	Alternate	Momentary	Alternate	Momentary	Alternate	
Standard type	Type	AR16F0T	AR16F5T	AR16G0T	AR16G5T	AR16F0S	AR16F5S	AR16E0R	AR16E5R	–	–	
Standard type	Appearance									–		
	See page	04/145		04/145		04/145		04/145		–		
	Bezel (mm)									–		
	Panel cutting (mm)											
Thin type	Type	AF16F0T	AF16F5T	–	–	AF16F0S	AF16F5S	–	–	AF16F0R	AF16F5R	
	Appearance			–				–				
	See page	04/157				04/157				04/157		
	Bezel (mm)			–				–				
	Panel cutting (mm)			–				–				
Legend plate (mm)		19.6x13.6		19.6x13.6		13.6sq		φ13.6		φ13.6		
Button color (transparent)		Black										
Button color		Green, Red, Black ¹ , White ² , Yellow, Orange, Blue										
Contact arrangement		SPDT, 2PDT										
Contact rating		120V AC 1A (AC-13), 24V DC 0.7A (DC-13, T _{0.95} = 21ms) 240V AC 0.7A (AC-13), 125V DC 0.15A (DC-13, T _{0.95} = 21ms)										
Mechanical durability		Momentary action: 1 million operations Alternate action: 250,000 operations										
Electrical durability		100,000 operations (220V AC 0.7A)										
Degree of protection (Operator)		IP65										
Type of terminal		Tab (#110) / solder dual-use terminal										
Accessories	Protective cover ³	<input type="radio"/>	<input type="radio"/>	<input type="radio"/>	<input type="radio"/>	<input type="radio"/>	<input type="radio"/>	<input type="radio"/>	<input type="radio"/>	<input type="radio"/>	<input type="radio"/>	
	Dust-proof cover	<input type="radio"/>	<input type="radio"/>	<input type="radio"/>	<input type="radio"/>	<input type="radio"/>	<input type="radio"/>	<input type="radio"/>	<input type="radio"/>	<input type="radio"/>	<input type="radio"/>	
	Terminal cover	<input type="radio"/>	<input type="radio"/>	<input type="radio"/>	<input type="radio"/>	<input type="radio"/>	<input type="radio"/>	<input type="radio"/>	<input type="radio"/>	<input type="radio"/>	<input type="radio"/>	
	Socket	Quick connection	<input type="radio"/>	<input type="radio"/>	<input type="radio"/>	<input type="radio"/>	<input type="radio"/>	<input type="radio"/>	<input type="radio"/>	<input type="radio"/>	<input type="radio"/>	<input type="radio"/>
		Connector use	<input type="radio"/>	<input type="radio"/>	<input type="radio"/>	<input type="radio"/>	<input type="radio"/>	<input type="radio"/>	<input type="radio"/>	<input type="radio"/>	<input type="radio"/>	<input type="radio"/>
		PC board use	<input type="radio"/>	<input type="radio"/>	<input type="radio"/>	<input type="radio"/>	<input type="radio"/>	<input type="radio"/>	<input type="radio"/>	<input type="radio"/>	<input type="radio"/>	<input type="radio"/>
	Panel plug	<input type="radio"/>	<input type="radio"/>	<input type="radio"/>	<input type="radio"/>	<input type="radio"/>	<input type="radio"/>	<input type="radio"/>	<input type="radio"/>	<input type="radio"/>	<input type="radio"/>	















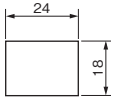

Notes: ¹ A combination of the translucent button and the black legend plate comes to black button. ⁴ The protective cover of the thin type is available for momentary action only.
² A combination of the translucent button and the white legend plate comes to white button. ⁵ Available for standard type only.
³ The protective cover and button of the thin type are made of an integral structure.

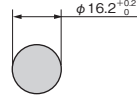
Command Switches

AR16, DR16 and AF16, DF16

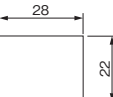

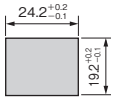
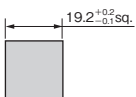











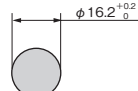

Quick reference guide

■ Pilot lights

Lens shape		Flush rectangular	Flush square	Extended round	Flush round	Dome	
Standard type	Type	DR16F0N	DR16F0M	DR16E0L	—	DR16D0L	
Standard type	Appearance	 cULus CE CCC	 cULus CE CCC	 cULus CE CCC	—	 cULus CE CCC	
	See page	04/147	04/147	04/147		04/147	
	Bezel (mm)				—		
	Panel cutting (mm)						
Thin type	Type	DF16F0N	DF16F0M	—	DF16F0L	—	
	Appearance	 cULus CE CCC	 cULus CE CCC	—	 cULus CE CCC	—	
	See page	04/159	04/159		04/159		
	Bezel (mm)			—		—	
Panel cutting (mm)			—		—		
Legend plate (mm)	19.6x13.6	13.6sq	phi13.6	phi13.6	—		
Bezel color	Black						
Button color (transparent)	Green, Red, White [†] , Yellow, Orange, Blue						
LED lamp	Color	Green, Red, Orange, Yellow, Amber, Blue					
	Lamp voltage	6V AC/DC, 12V AC/DC, 24V AC/DC					
Degree of protection (Lens)	IP65						
Type of terminal	Tab (#110) / solder dual-use terminal						
Accessories	Terminal cover	<input type="radio"/>	<input type="radio"/>	<input type="radio"/>	<input type="radio"/>	<input type="radio"/>	
	Socket	Quick connection	<input type="radio"/>	<input type="radio"/>	<input type="radio"/>	<input type="radio"/>	<input type="radio"/>
		Connector use	<input type="radio"/>	<input type="radio"/>	<input type="radio"/>	<input type="radio"/>	<input type="radio"/>
		PC board use	<input type="radio"/>	<input type="radio"/>	<input type="radio"/>	<input type="radio"/>	<input type="radio"/>
	Panel plug	<input type="radio"/>	<input type="radio"/>	<input type="radio"/>	<input type="radio"/>	<input type="radio"/>	

Note: [†] A combination of the translucent lens and the white legend plate comes to white lens (except for dome type).

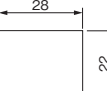
■ Selector switches (Knob type)

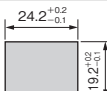
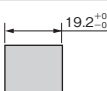
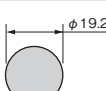





















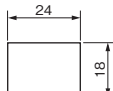

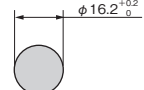



Operator		Knob with rectangular bezel	Knob with square bezel	Knob with round bezel	
No. of position		2-position, 3-position	2-position, 3-position	2-position, 3-position	
Operator action		Maintained, Spring/manual return, Spring return	Maintained, Spring/manual return, Spring return	Maintained, Spring/manual return, Spring return	
Standard type	Type	AR16PT	AR16PS	AR16PR	
	Appearance	 	 	 	
	See page	04/149	04/149	04/149	
	Bezel (mm)				
	Panel cutting (mm)				
Thin type	Type	AF16PT	AF16PS	AF16PR	
	Appearance	 	 	 	
	See page	04/161	04/161	04/161	
	Bezel (mm)				
	Panel cutting (mm)				
Bezel color		Black			
Color of knob		Black			
Contact arrangement		SPDT, 2PDT			
Contact rating		120V AC 1A (AC-13), 24V DC 0.7A (DC-13, T _{0.95} = 21ms) 240V AC 0.7A (AC-13), 125V DC 0.15A (DC-13, T _{0.95} = 21ms)			
Mechanical durability		250,000 operations			
Electrical durability		100,000 operations (220V AC 0.7A)			
Degree of protection (Operator)		IP65			
Type of terminal		Tab (#110) / solder dual-use terminal			
Accessories	Terminal cover	<input type="checkbox"/>	<input type="checkbox"/>	<input type="checkbox"/>	
	Socket	Quick connection	<input type="checkbox"/>	<input type="checkbox"/>	<input type="checkbox"/>
		Connector use	<input type="checkbox"/>	<input type="checkbox"/>	<input type="checkbox"/>
		PC board use	<input type="checkbox"/>	<input type="checkbox"/>	<input type="checkbox"/>
	Panel plug	<input type="checkbox"/>	<input type="checkbox"/>	<input type="checkbox"/>	

Command Switches





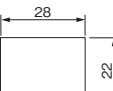

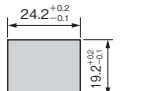
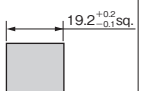
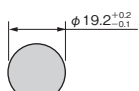

AR16, DR16 and AF16, DF16

Quick reference guide

■ Selector switches (Key type)

Operator		Key with rectangular bezel	Key with square bezel	Key with round bezel	
No. of position		2-position, 3-position	2-position, 3-position	2-position, 3-position	
Operator action		Maintained, Spring/manual return, Spring return	Maintained, Spring/manual return, Spring return	Maintained, Spring/manual return, Spring return	
Standard type	Type	AR16JT	AR16JS	AR16JR	
	Appearance	 cUL US   	 cUL US   	 cUL US   	
	See page	04/152	04/152	04/152	
	Bezel (mm)				
	Panel cutting (mm)				
Thin type	Type	AF16JT	AF16JS	AF16JR	
	Appearance	 cUL US   	 cUL US   	 cUL US   	
	See page	04/164	04/164	04/164	
	Bezel (mm)				
	Panel cutting (mm)				
Bezel color		Black			
Key removable position		Left (A), Left/Right (B), Left/Center/Right (C), Right (D), Center (E), Center/Right (F), Left/Center (G)			
No. of key types		6 (A, B, C, D, E, F)			
Contact arrangement		SPDT, 2PDT			
Contact rating		120V AC 1A (AC-13), 24V DC 0.7A (DC-13, T _{0.95} = 21ms) 240V AC 0.7A (AC-13), 125V DC 0.15A (DC-13, T _{0.95} = 21ms)			
Mechanical durability		250,000 operations			
Electrical durability		100,000 operations (220V AC 0.7A)			
Degree of protection (Operator)		IP65			
Type of terminal		Tab (#110) / solder dual-use terminal			
Accessories	Terminal cover	<input type="radio"/>	<input type="radio"/>	<input type="radio"/>	
	Socket	Quick connection	<input type="radio"/>	<input type="radio"/>	<input type="radio"/>
		Connector use	<input type="radio"/>	<input type="radio"/>	<input type="radio"/>
		PC board use	<input type="radio"/>	<input type="radio"/>	<input type="radio"/>
	Panel plug	<input type="radio"/>	<input type="radio"/>	<input type="radio"/>	

■ Emergency stop pushbutton switches

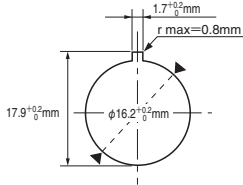
Operator	Illuminated push-lock (32mm dia)	Illuminated push-lock (40mm dia)	Push-lock (32mm dia)	Push-lock (40mm dia)
Operator action	Turn reset or pull-reset		Turn reset or pull-reset	
Type	AR16V0L	AR16V1L	AR16V0R	AR16V1R
Appearance				
See page	04/182	04/182	04/182	04/182
Button size (mm)				
Panel cutting (mm)				
Button color	Red			
LED lamp	Color	Red		
	Lamp voltage	6V AC/DC, 12V AC/DC, 24V AC/DC		
Contact arrangement	1NC, 1NO+1NC, 2NC, 1NO+2NC, 3NC, 1NO+3NC, 4NC			
Contact ratings	120V AC 0.3A (AC-15), 24V DC 0.7A (DC-13), 240V AC 0.3A (AC-15), 125V DC 0.15A (DC-13)			
Mechanical durability	100,000 operations			
Electrical durability	100,000 operations (AC-15, AC-13, AC-12, DC-13, DC-12)			
Degree of protection (Operator)	IP65			
Type of terminal	Solder use terminal			
Accessories	Terminal cover	<input type="radio"/>	<input type="radio"/>	<input type="radio"/>
	Name plate (Emergency stop)	<input type="radio"/>	<input type="radio"/>	<input type="radio"/>

04

Command Switches

AR16 and DR16, AF16 and DF16

Ratings and Specifications

■ Contact ratings

• UL/CSA

- AC (COS ϕ = 0.35)

Contact rating code	120V		240V	
	Making current	Breaking current	Making current	Breaking current
D300	3.6A	0.6A	1.8A	0.3A

• TÜV (EN60947-5-1), CCC (GB14048.5), JIS C 8201-5-1

Type of switches	Conventional free air thermal current I _{th}	Rated operational current I _e				
		Rated operational voltage U _e	AC		DC	
			AC-13 (Inductive load)	AC-12 (Resistive load)	DC-13 (Inductive load)	DC-12 (Resistive load)
Illuminated pushbutton switch Pushbutton switch Selector switch	5A	24V	–	–	0.7A ^{*)}	1A
		120V	1A	1.5A	–	–
		125V	–	–	0.15A ^{*)}	0.2A
		240V	0.7A	1A	–	–

Note: *) T_{0.95}=21ms

■ Specifications (indoor use)

Item		• Illuminated pushbutton switch, pushbutton switch	• Selector switch	• Pilot lights
Rated insulation voltage U _i		250V AC/DC		
Durability	Mechanical	Momentary action: 1 million operations Alternate action: 250,000 operations	Maintained: 250,000 operations Spring/manual return: 250,000 operations Spring return: 250,000 operations	–
	Electrical	100,000 operations (at 220V AC 0.7A)		–
Operating frequency		1200 operations/hour (On-load factor: 40%)		–
Withstand voltage	Between live section and grounding	2000V AC, 1 minute		
	Between opposite polarity live sections	2000V AC, 1 minute		
Insulation resistance		100M Ω or more (500V DC megger)		
Rated impulse withstand voltage U _{imp}		2.5kV		
Conditional short-circuit current		1000A		
Short-circuit protective device		gG 2A (IEC60269 Fuse)		
Pollution degree		3		
Vibration		Resonance: frequency 10 to 55Hz, double amplitude 1.0mm Constant: frequency 16.7Hz, double amplitude 3mm		
Shock		Malfunction durability; 100m/s ² Mechanical durability; 500m/s ²		
Operational ambient temperature		–10 to +55°C (no icing or no condensation)		
Storage temperature		–40 to +70°C		
Relative humidity (inside control panel)		45 to 85%RH (–5 to +40°C) (no icing or no condensation)		
Degree of protection of operating (displaying) section		IP65 (dust-proof, water jet proof): IEC 60529		
Degree of protection of terminal section		IP2X (Fast-connection socket: AR6S690, Connector socket: AR6S691-C or Terminal cover: AR2Y261, At the connection)		



■ Specifications (Socket)

Item	Fast-connection socket	Connector socket	Socket for PC board
Rated insulation voltage Ui	250V AC/DC		60V AC/DC
Conventional free air thermal current Ith	3A	5A	3A
Rated impulse withstand voltage Uimp	2.5kV		0.5kV
Withstand voltage (Between live section and grounding)	2000V AC, 1 minute		1000V AC, 1 minute
Insulation resistance	100MΩ or more (500V DC megger)		
Operational ambient temperature	-10 to +55°C (no icing or no condensation)		
Storage temperature	-40 to +70°C		
Relative humidity	45 to 85%RH (-5 to +40°C) (no icing or no condensation)		
Pollution degree	3		

■ Degree of protection

- The table below shows the degree of protection stipulated by IEC (International Electrotechnical Commission) standard (IEC 60529).

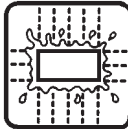
IP- 6 5

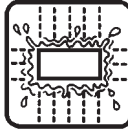
Class	Degree of protection against human contact or penetration by a foreign object		Degree of protection against ingress of water	
5		<ul style="list-style-type: none"> Normal operation secured even if the dust that can pass through screen of 75μm mesh invades. 	Protection against water jets 	<ul style="list-style-type: none"> Protected against water jet from all directions. Water projected by nozzle (6.3mm-inner dia.) from all directions at 29.4kPa for 3min at a distance of 3m.
6		<ul style="list-style-type: none"> The dust which can pass through screen of 75μm mesh shall not invade. 	Protection against powerful water 	<ul style="list-style-type: none"> Protected against powerful water jet from all directions. Water projected by nozzle (12.5mm-inner dia.) from all directions at 98kPa for 3min at a distance of 3m.

■ Contact reliability

FUJI has confirmed that the product can be used in 1mA circuit conditions at 5V AC or DC. The operable range, however, may vary depending on the operational ambient conditions and type of load.

Command Switches

AR16 and DR16, AF16 and DF16

Specifications

■ Lamp ratings and current consumption

• Illuminated pushbutton switch, Pilot lights

Applied method	Lamp operational voltage	High-brightness LED lamp		
		Type	Lamp rated voltage	Current consumption
without transformer	6V AC/DC	DR6L695-A□	6V AC/DC	Green, Blue: 11mA AC, 7.5mA DC Red, Amber: 9mA AC, 7.5mA DC Orange: 10mA AC, 8.5mA DC Yellow: 30mA AC, 26mA DC
	12V AC/DC	DR6L695-B□	12V AC/DC	Green, Red, Amber, Blue: 7.5mA AC, 7.5mA DC Orange: 9mA AC, 8.5mA DC Yellow: 11mA AC, 8.5mA DC
	24V AC/DC	DR6L695-E□	24V AC/DC	Green, Red, Amber, Blue: 7.5mA AC, 7.5mA DC Orange, Yellow: 9mA AC, 8.5mA DC

Note: A box □ indicates the luminous color. For details, see the "Combination of Illuminated pushbutton / pilot light color and LED lamp luminous color".

■ Combination of Illuminated pushbutton / pilot light color and LED lamp luminous color

Illuminated pushbutton / pilot light color (lens color)		Luminous color of high-brightness LED lamp	
Type		Type	
Green	G	Green	DR6L695-■G
Red	R	Red	DR6L695-■R
White	W	Orange	DR6L695-■W
Yellow	Y	Yellow	DR6L695-■Y
Orange	A	Amber	DR6L695-■A
Blue	S	Blue	DR6L695-■S

Note: □ A box ■ indicates the lamp operational voltage. For details, see the "Lamp ratings and current consumption".

■ LED durability

Type of lamp	Durability (reference)	Judgment criterion
LED lamp	Approx. 30000h	When the brightness is less than 50% of initial value.

Note: The durability of LED lamp is a mean value in all colors.

■ Standard approved

UL508	cUL File No.E44592
CSA C22.2 No.14	
TÜV: EN60947-5-1	Pushbutton, Illuminated pushbutton: R50116757 Selector: R50116759 Pilot lights: R50116762
CCC: GB14048.5	Switches (except pilot lights): 2003010305071068 Pilot lights: 2003010305071044

■ Standard models approved by international standards

The standard models of AR16 and DR16, AF16 and DF16 series of the ϕ 16 Command Switches meet UL / CSA requirements, China Compulsory Certification (CCC) standards, and TÜV EN standards, thus ensuring easier direct or indirect export to North America and European countries with no safety standard concerns.

Command Switches AR16 and DR16, AF16 and DF16 Type number nomenclature

• Illuminated pushbutton switches

AR16 F0N – C2 E3 G

Product category _____

Category	Code
Standard type	AR16
Thin type	AF16

Operator shape and action _____

Operator shape	Code			
	Standard type		Thin type	
	Momentary	Alternate	Momentary	Alternate
Flush rectangular	F0N	F5N	F0N	F5N
Flush rectangular with guard	G0N	G5N	–	–
Flush square	F0M	F5M	F0M	F5M
Extended round	E0L	E5L	–	–
Flush round	–	–	F0L	F5L

Contact arrangement and terminal _____

Contact arrangement	Code	Type of terminal
SPDT	C1	Tab (#110) and
2PDT	C2	solder dual-use terminal

Color of button

Color	LED color	Code
Green	Green	G
Red	Red	R
White *1	Orange	W
Yellow	Yellow	Y
Orange	Amber	A
Blue	Blue	S

Lamp operational voltage and light source

Applied method	Voltage	Code
Without transformer	6V AC/DC	A3
	12V AC/DC	B3
	24V AC/DC	E3

Note: • The button is transparent in color.
*1: A combination of the transparent lens and the white legend plate comes to white.

04

• Pushbutton switches

AR16 F0T – C2 R

Product category _____

Category	Code
Standard type	AR16
Thin type	AF16

Operator shape and action _____

Operator shape	Code			
	Standard type		Thin type	
	Momentary	Alternate	Momentary	Alternate
Flush rectangular	F0T	F5T	F0T	F5T
Flush rectangular with guard	G0T	G5T	–	–
Flush square	F0S	F5S	F0S	F5S
Extended round	E0R	E5R	–	–
Flush round	–	–	F0R	F5R

Contact arrangement and terminal _____

Contact arrangement	Code	Type of terminal
SPDT	C1	Tab (#110) and
2PDT	C2	solder dual-use terminal

Color of button

Color	Code
Green	G
Red	R
Black *1	B
White *2	W
Yellow	Y
Orange	A
Blue	S

Notes: • The button is transparent in color.
*1: A combination of the transparent button and the black legend plate comes to black.
*2: A combination of the transparent button and the white legend plate comes to white.

Note: The manufacturing range varies depending on the model. For details, see "Types and dimensions" of this catalog.

Command Switches

AR16 and DR16, AF16 and DF16

Type number nomenclature

• Pilot lights

DR16 D0L – E3 W

Product category

Category	Code
Standard type	DR16
Thin type	DF16

Lens shape

Lens shape	Code	
	Standard type	Thin type
Flush rectangular	F0N	F0N
Flush square	F0M	F0M
Extended round	E0L	–
Flush round	–	F0L
Dome	D0L	–

Color of lens

Color	LED color	Code
Green	Green	G
Red	Red	R
White *1	Orange	W
Yellow	Yellow	Y
Orange	Amber	A
Blue	Blue	S

Note: * The lens is transparent in color.
 *1: A combination of the transparent lens and the white legend plate comes to white (except for dome type).

Lamp operational voltage and light source

Applied method	Voltage	Code
Without transformer	6V AC/DC	A3
	12V AC/DC	B3
	24V AC/DC	E3

Note: The terminal used is a tab (#110) and solder dual-use terminal.

Note: The manufacturing range varies depending on the model. For details, see "Types and dimensions" of this catalog.

Command Switches AR16 and DR16, AF16 and DF16 Type number nomenclature

• Selector switches (Knob type)

Product category

Category	Code
Standard type	AR16
Thin type	AF16

Operator shape

Operator shape	Code
Knob with rectangular bezel	PT
Knob with square bezel	PS
Knob with round bezel	PR

Color of knob

Color	Code
Black	B

Contact arrangement and terminal

Contact arrangement	Code	Type of terminal
SPDT ¹	C1	Tab (#110) and solder dual-use terminal
2PDT	C2	

Note: ¹ 2-position model only available

No. of positions and operator action

No. of positions	Operator action	Code
2-position (90°)	Maintained	2
	Spring return (Right to left) ↺	0
3-position (45°)	Maintained	3
	Spring/manual return (Left to center) ↻	6
	Spring/manual return (Right to center) ↻	7
	Spring return (Left or right to center) ↻	1

AR16 PT-2 C1 B

04

• Key position and contact operation

2-position

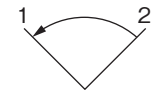
Operator action (View form the front)		Contact arrangement	Contact unit		Operator position ²	
2	0		Left	COM	1	2
 Maintained/90°	 Spring return/90°	SPDT	Left	COM	NC	●
					NO	●
		2PDT	Left	COM	NC	●
					NO	●
			Right	COM	NC	●
				NO	●	

Terminal arrangement
View from the terminal side (the back)

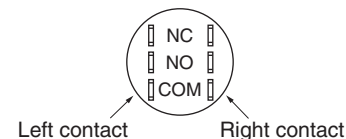

3-position

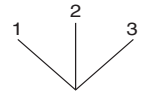
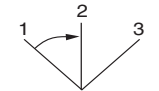
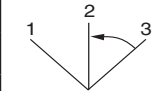
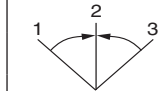
Operator action (View form the front)				Contact arrangement	Contact unit		Operator position ²		
3	6	7	1		Left	COM	1	2	3
 Maintained/each 45°	 Spring/manual return/each 45°	 Spring/manual return/each 45°	 Spring return/each 45°	2PDT	Left	COM	●		●
					Right	COM	●	●	

Note: ² ●, ■: means the contact closed (ON).

Command Switches

AR16 and DR16, AF16 and DF16

Type number nomenclature

• Selector switches (Key type)

AR16 JT-3 E C2 A

Product category _____

Category	Code
Standard type	AR16
Thin type	AF16

Operator shape _____

Operator shape	Code
Key with rectangular bezel	JT
Key with square bezel	JS
Key with round bezel	JR

No. of positions and operator action _____

No. of positions	Operator action	Code
2-position (90°)	Maintained	2
	Spring return (Right to left) ⤴	0
3-position (45°)	Maintained	3
	Spring/manual return (Left to center) ⤴	6
	Spring/manual return (Right to center) ⤵	7
	Spring return (Left or right to center) ⤴⤵	1

Types of key

Type ¹	A	B	C	D	E	F
Code	A	B	C	D	E	F

Note: ¹ "A" is standard.

Contact arrangement and terminal

Contact arrangement	Code	Type of terminal
SPDT ²	C1	Tab (#110) and solder dual-use terminal
2PDT	C2	

Note: ² 2-position model only

Key removable position

Key removable position	Applicable operator action						Code
	2	0	3	6	7	1	
Left ⤴	○	○	○	—	○	—	A
Left and right ⊗	○	—	○	—	—	—	B
Left, center and right ⊗	—	—	○	—	—	—	C
Right ⤵	○	—	○	○	—	—	D
Center ⊕	—	—	○	○	○	○	E
Center and right ⊕	—	—	○	○	—	—	F
Left and center ⊕	—	—	○	—	○	—	G

• Key position and contact operation

2-position

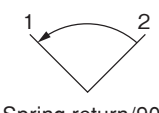
Operator action (View form the front)		Contact arrangement	Contact unit		Operator position ³	
2	0		Left	Right	1	2
 Maintained/90°	 Spring return/90°	SPDT	COM	NC	●	●
		NO	●	●		
		2PDT	COM	NC	●	●
		NO	●	●		

Terminal arrangement
View from the terminal side (the back)

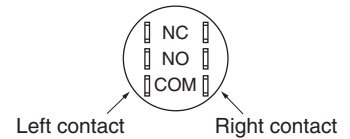

3-position

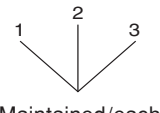
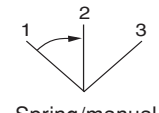
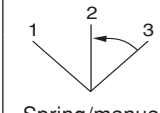
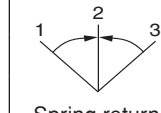
Operator action (View form the front)				Contact arrangement	Contact unit		Operator position ³		
3	6	7	1		Left	Right	1	2	3
 Maintained/each 45°	 Spring/manual return/each 45°	 Spring/manual return/each 45°	 Spring return/each 45°	2PDT	COM	NC	●	●	●
						NO	●	●	●

Note: ³ ●, ■: means the contact closed (ON).

1. Standard type, AR16 and DR16

■ Illuminated pushbutton switches (LED illuminated)

• **Type number system**

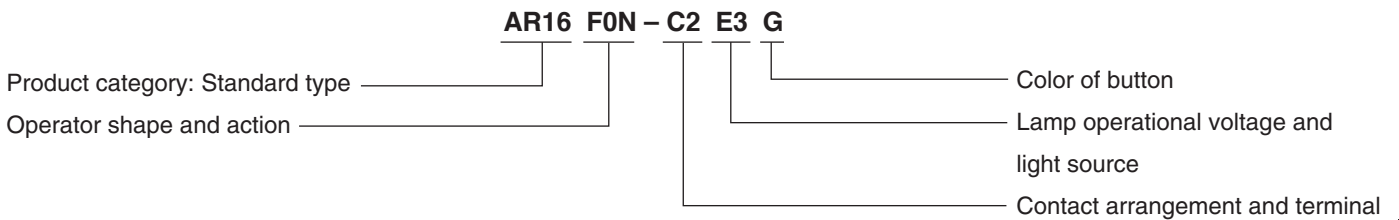

• **Type**

Operator	Appearance (Standard type)	Lamp operational voltage	Contact arrangement	Momentary action Type	Alternate action Type
Flush rectangular		6V AC/DC	SPDT	AR16F0N-C1A3□	AR16F5N-C1A3□
			2PDT	AR16F0N-C2A3□	AR16F5N-C2A3□
		12V AC/DC	SPDT	AR16F0N-C1B3□	AR16F5N-C1B3□
			2PDT	AR16F0N-C2B3□	AR16F5N-C2B3□
		24V AC/DC	SPDT	AR16F0N-C1E3□	AR16F5N-C1E3□
			2PDT	AR16F0N-C2E3□	AR16F5N-C2E3□
Flush rectangular with guard		6V AC/DC	SPDT	AR16G0N-C1A3□	AR16G5N-C1A3□
			2PDT	AR16G0N-C2A3□	AR16G5N-C2A3□
		12V AC/DC	SPDT	AR16G0N-C1B3□	AR16G5N-C1B3□
			2PDT	AR16G0N-C2B3□	AR16G5N-C2B3□
		24V AC/DC	SPDT	AR16G0N-C1E3□	AR16G5N-C1E3□
			2PDT	AR16G0N-C2E3□	AR16G5N-C2E3□
Flush square		6V AC/DC	SPDT	AR16F0M-C1A3□	AR16F5M-C1A3□
			2PDT	AR16F0M-C2A3□	AR16F5M-C2A3□
		12V AC/DC	SPDT	AR16F0M-C1B3□	AR16F5M-C1B3□
			2PDT	AR16F0M-C2B3□	AR16F5M-C2B3□
		24V AC/DC	SPDT	AR16F0M-C1E3□	AR16F5M-C1E3□
			2PDT	AR16F0M-C2E3□	AR16F5M-C2E3□
Extended round		6V AC/DC	SPDT	AR16E0L-C1A3□	AR16E5L-C1A3□
			2PDT	AR16E0L-C2A3□	AR16E5L-C2A3□
		12V AC/DC	SPDT	AR16E0L-C1B3□	AR16E5L-C1B3□
			2PDT	AR16E0L-C2B3□	AR16E5L-C2B3□
		24V AC/DC	SPDT	AR16E0L-C1E3□	AR16E5L-C1E3□
			2PDT	AR16E0L-C2E3□	AR16E5L-C2E3□

Note: • See page 04/144 for the outline dimensions.

• **Button color**

Replace the □ mark by the color code

Color	Green	Red	White	Yellow	Orange	Blue
Code	G	R	W *1	Y	A	S

Note: *1 A combination of the transparent button and the white legend plate comes to white.

Command Switches

AR16 and DR16

Type numbers and dimensions

• Dimensions, mm

Flush rectangular

AR16F0N, F5N

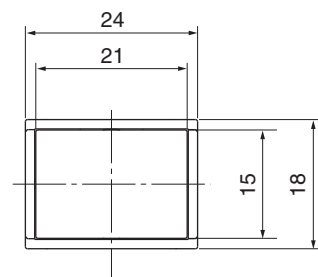
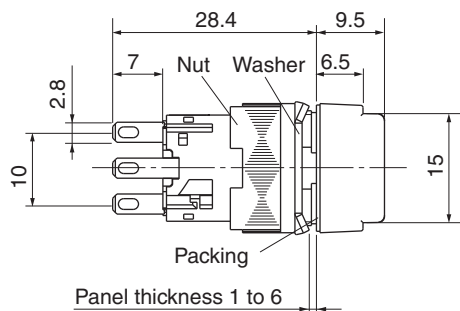
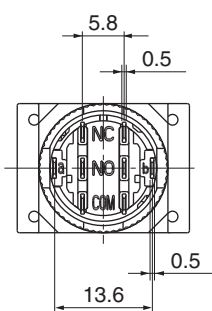

Flush rectangular with guard

AR16G0N, G5N

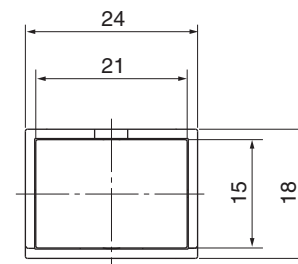
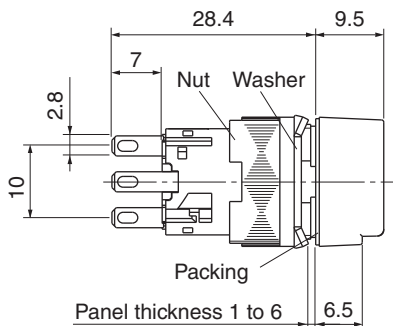
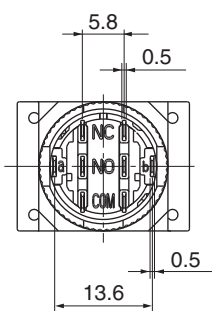

Flush square

AR16F0M, F5M

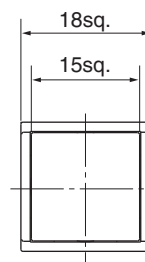
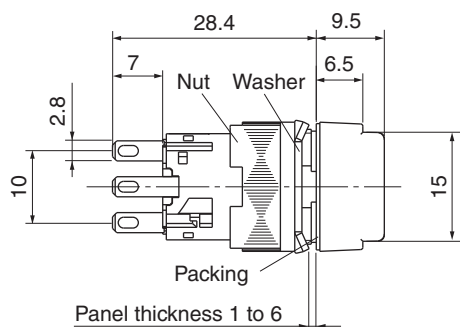
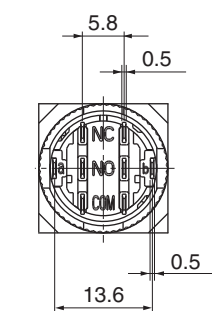

Extended round

AR16E0L, E5L

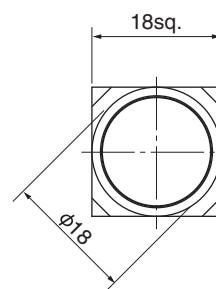
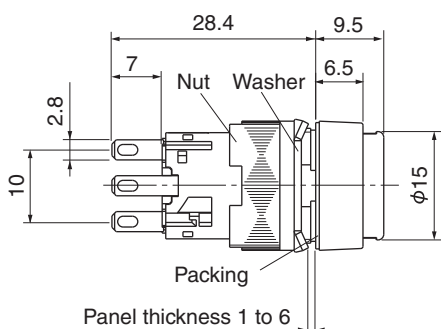
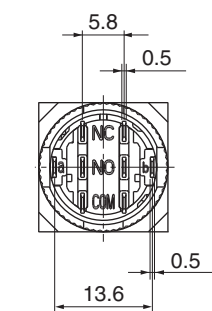

■ Pushbutton switches

• Type number system

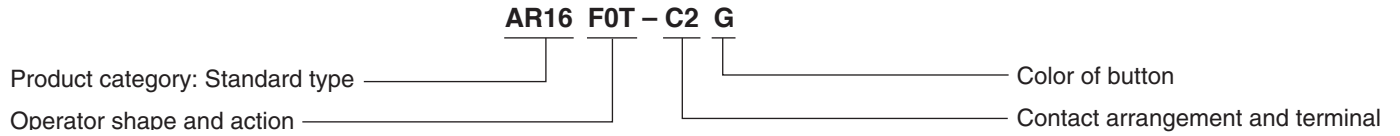

• Type

Operator	Appearance (Standard type)	Conntact arrangement	Momentary action Type	Alternate action Type
Flush rectangular	AR16F0T, F5T 	SPDT	AR16F0T-C1 □	AR16F5T-C1 □
		2PDT	AR16F0T-C2 □	AR16F5T-C2 □
Flush rectangular with guard	AR16G0T, G5T 	SPDT	AR16G0T-C1 □	AR16G5T-C1 □
		2PDT	AR16G0T-C2 □	AR16G5T-C2 □
Flush square	AR16F0S, F5S 	SPDT	AR16F0S-C1 □	AR16F5S-C1 □
		2PDT	AR16F0S-C2 □	AR16F5S-C2 □
Extended round	AR16E0R, E5R 	SPDT	AR16E0R-C1 □	AR16E5R-C1 □
		2PDT	AR16E0R-C2 □	AR16E5R-C2 □

Note: • See page 04/146 for the outline dimensions.

• Button color

Replace the □ mark by the color code

Color	Green	Red	Black	White	Yellow	Orange	Blue
Code	G	R	B * ¹	W * ²	Y	A	S

Notes: *¹ A combination of the transparent button and the black legend plate comes to black.

*² A combination of the transparent button and the white legend plate comes to white.

Command Switches

AR16 and DR16

Type numbers and dimensions

• Dimensions, mm

Flush rectangular

AR16F0T, F5T

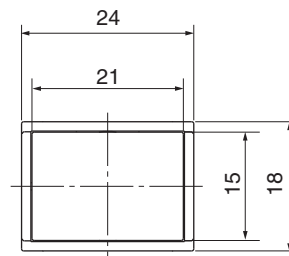
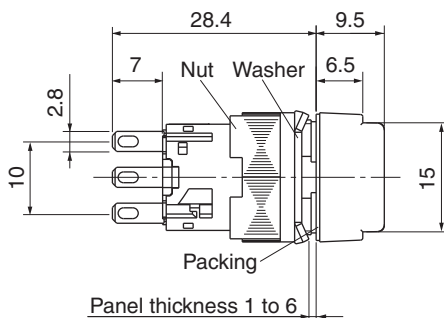
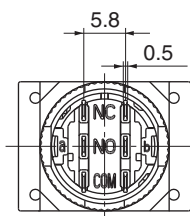

Flush rectangular with guard

AR16G0T, G5T

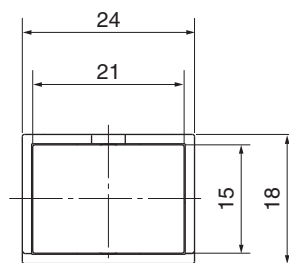
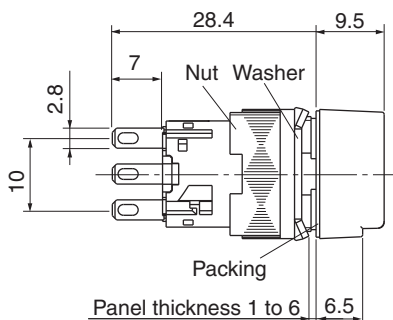
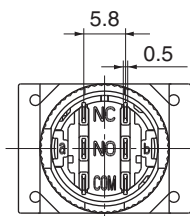

Flush square

AR16F0S, F5S

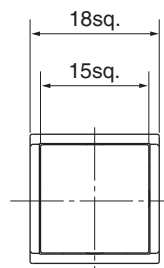
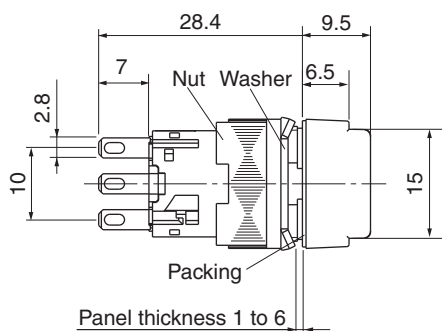
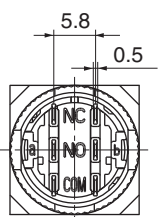

Extended round

AR16E0R, E5R

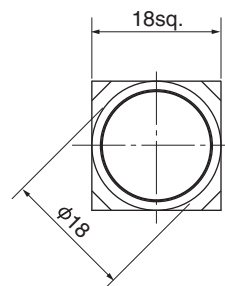
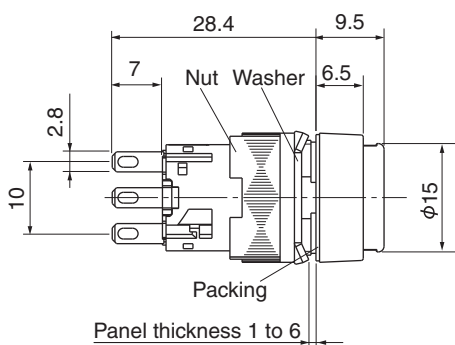
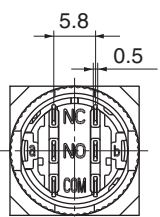

■ Pilot lights (LED illuminated)

• Type number system

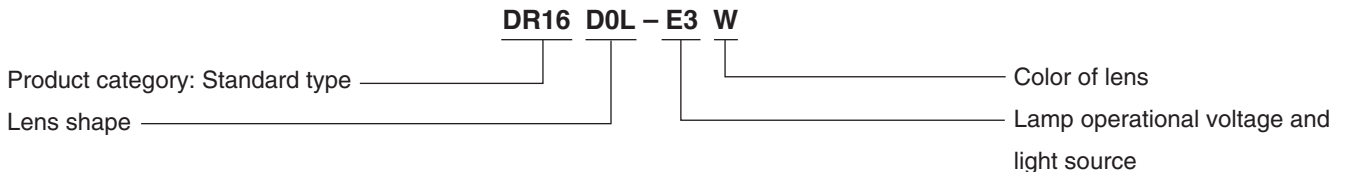

• Type

Lens	Appearance (Standard type)	LED lamp operational voltage	Type
Flush rectangular		6V AC/DC	DR16F0N-A3 □
		12V AC/DC	DR16F0N-B3 □
		24V AC/DC	DR16F0N-E3 □
Flush square		6V AC/DC	DR16F0M-A3 □
		12V AC/DC	DR16F0M-B3 □
		24V AC/DC	DR16F0M-E3 □
Extended round		6V AC/DC	DR16E0L-A3 □
		12V AC/DC	DR16E0L-B3 □
		24V AC/DC	DR16E0L-E3 □
Dome		6V AC/DC	DR16D0L-A3 □
		12V AC/DC	DR16D0L-B3 □
		24V AC/DC	DR16D0L-E3 □

Note: • See page 04/148 for the outline dimensions.

• Lens color

Replace the □ mark by the color code

Color	Green	Red	White	Yellow	Orange	Blue
Code	G	R	W *1	Y	A	S

Note: *1 A combination of the transparent lens and the white legend plate comes to white (except for dome type).

Command Switches

AR16 and DR16

Type numbers and dimensions

• Dimensions, mm

Flush rectangular
DR16F0N

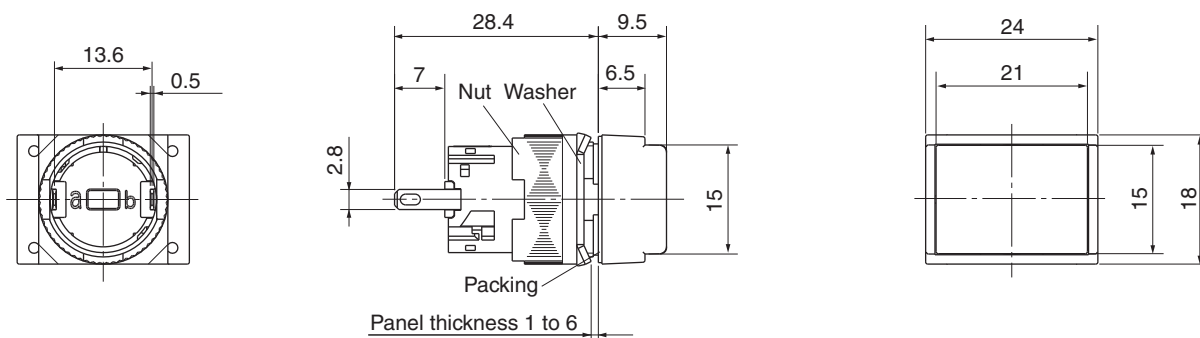

Flush square
DR16F0M

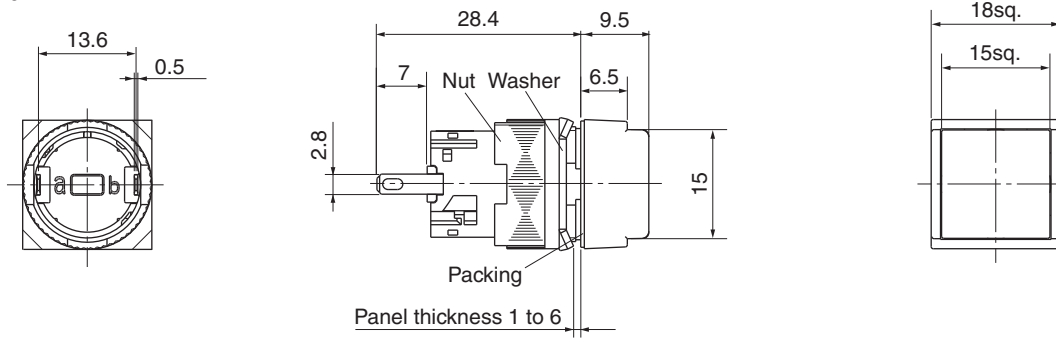

Extended round
DR16E0L

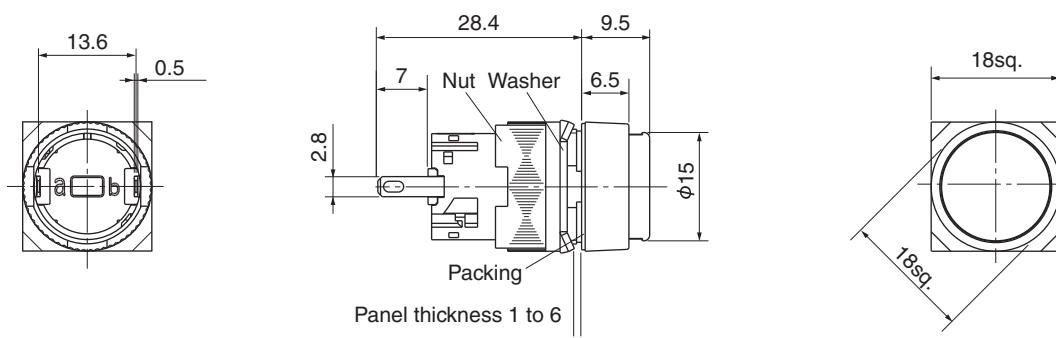

Dome
DR16D0L

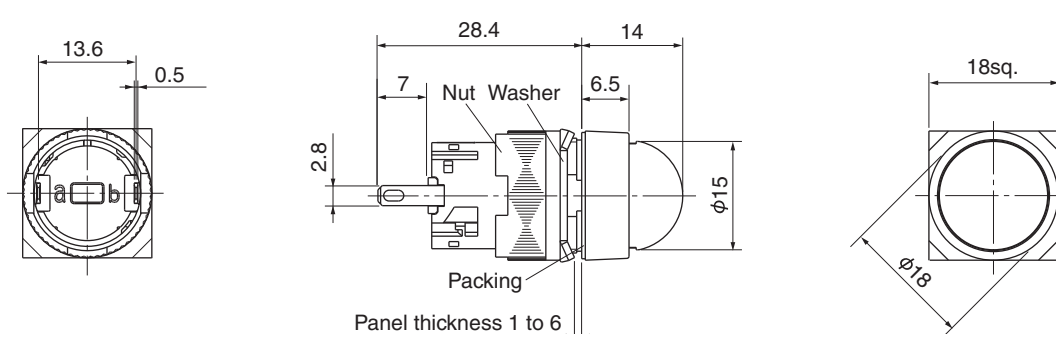



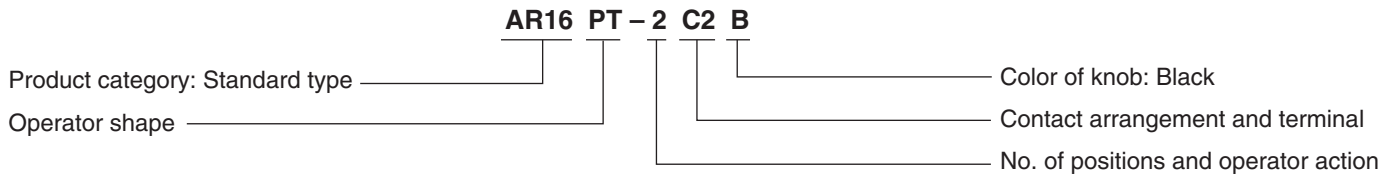

■ Selector switches (Knob type)

• Type number system

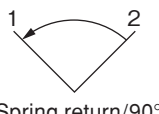

• Type

2-position

Operator and appearance (Standard type)	No. of positions	Contact arrangement	Type		Contact operation			
			 Maintained/90°	 Spring return/90°	Contact unit ¹	Operator position ²		
						1	2	
Knob with rectangular bezel/ AR16PT 	2-position	SPDT	AR16PT-2C1B	AR16PT-0C1B	Left	COM ———— NC ———— NO ————	●	
			AR16PS-2C1B	AR16PS-0C1B				●
			AR16PR-2C1B	AR16PR-0C1B				
Knob with square bezel/ AR16PS 	2-position	2PDT	AR16PT-2C2B	AR16PT-0C2B	Left	COM ———— NC ———— NO ————	●	
			AR16PS-2C2B	AR16PS-0C2B				●
Knob with round bezel/ AR16PR 	2-position	2PDT	AR16PR-2C2B	AR16PR-0C2B	Right	COM ———— NC ———— NO ————	●	●

Note: ¹ Terminal arrangement of contact (View from the terminal side (the back)).

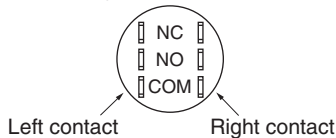

² ●: Means the contact closed (ON).









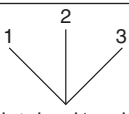
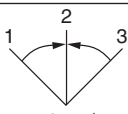
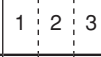

• See page 04/151 for the outline dimensions.

Command Switches

AR16 and DR16

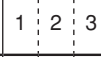
Type numbers and dimensions

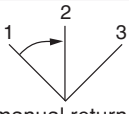
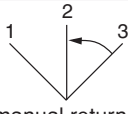
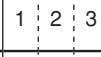
3-position

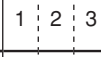
Operator and appearance (Standard type)	No. of positions	Contact arrangement	Type		Contact operation					
			 Maintained/each 45°	 Spring return/each 45°	Contact unit ¹	Operator position ²				
										
Knob with rectangular bezel/ AR16PT  Knob with square bezel/ AR16PS  Knob with round bezel/ AR16PR 	3-position	2PDT	AR16PT-3C2B	AR16PT-1C2B	Left	COM <ul style="list-style-type: none"> NC  NO  				
			AR16PS-3C2B	AR16PS-1C2B				Right	COM <ul style="list-style-type: none"> NC  NO  	
			AR16PR-3C2B	AR16PR-1C2B			Contact unit ¹			Operator position ²
						 Spring/manual return/each 45°	 Spring/manual return/each 45°			
						AR16PT-6C2B	AR16PT-7C2B	Left	COM <ul style="list-style-type: none"> NC  NO  	
						AR16PS-6C2B	AR16PS-7C2B			
			AR16PR-6C2B	AR16PR-7C2B			Contact unit ¹	Operator position ²		

Notes: ¹ Terminal arrangement of contact (View from the terminal side (the back)).

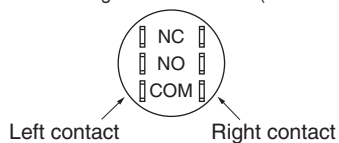

² ●, : means the contact closed (ON).
 • See page 04/151 for the outline dimensions.

• Dimensions, mm

Knob with rectangular bezel
 AR16PT

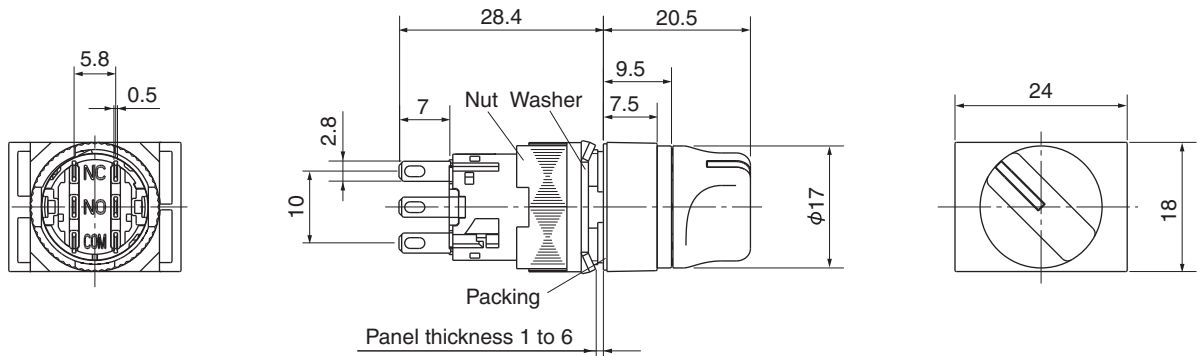

Knob with square bezel
 AF16PS

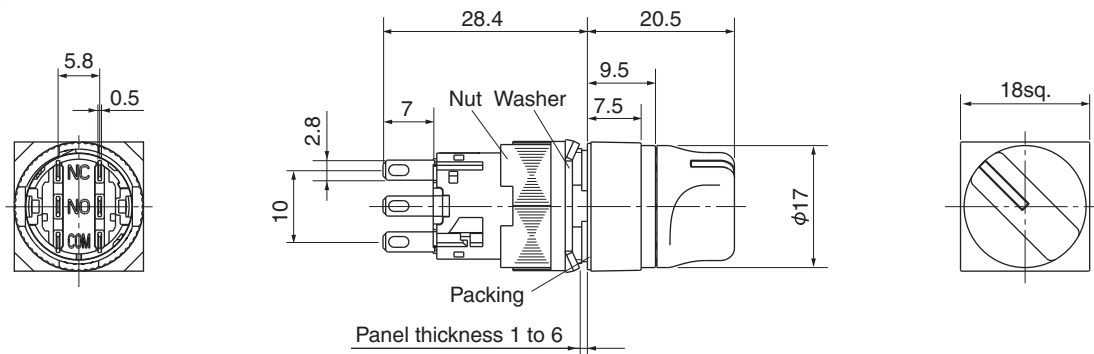

Knob with round bezel
 AF16PR

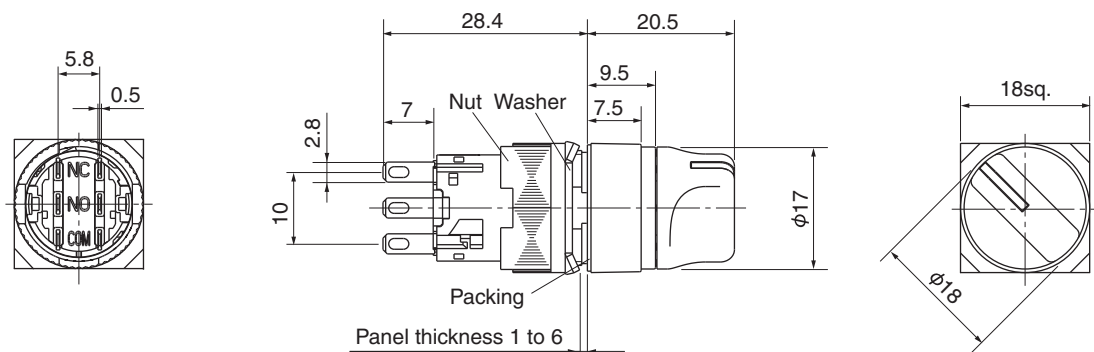

04

Command Switches

AR16 and DR16

Type numbers and dimensions

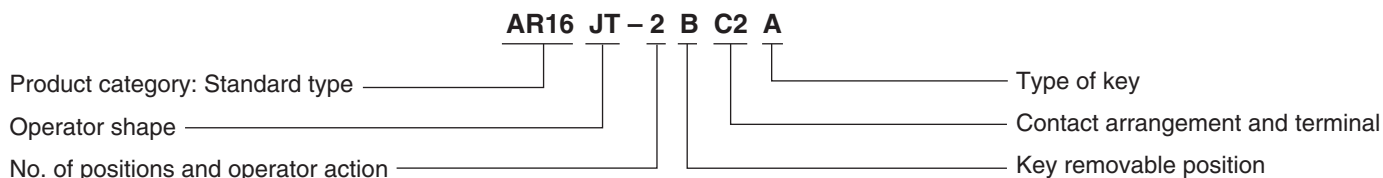

■ Selector switches (Key type)

• Type number system



• Type

2-position

Operator and appearance (Standard type)	No. of positions	Contact arrangement	Type		Contact operation			
			1 2 Maintained/90°	1 2 Spring return/90°	Contact unit ^{*1}			
						Operator position ^{*2}		
						1	2	
Key with rectangular bezel/ AR16JT 	2-position	SPDT	AR16JT-2■C1A	AR16JT-0AC1A	Left	COM	NC ●	
			AR16JS-2■C1A	AR16JS-0AC1A				
			AR16JR-2■C1A	AR16JR-0AC1A				●
Key with square bezel/ AR16JS 	2-position	2PDT	AR16JT-2■C2A	AR16JT-0AC2A	Left	COM	NC ●	
			AR16JS-2■C2A	AR16JS-0AC2A				●
Key with round bezel/ AR16JR 	2-position	2PDT	AR16JR-2■C2A	AR16JR-0AC2A	Right	COM	NC ●	
								●

Notes: *¹ Terminal arrangement of contact (View from the terminal side (the back)).

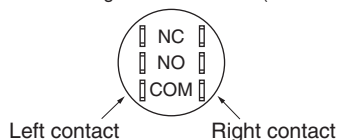

*² ●: Means the contact closed (ON).

• See page 04/154 for the outline dimensions.

• Key removable position

Specify the key removal position in the square ■ mark.

Key removable position	Applied operator action		Code
	2	0	
Left ⊙	○	○	A
Left•Right ⊗	○	—	B
Left ⊘	○	—	D

○: Available —: Not available





• Type of key

Type ^{*1}	A	B	C	D	E	F
Code	A	B	C	D	E	F

*¹ "A" is standard.

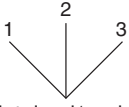
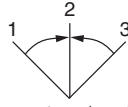
Command Switches AR16 and DR16 Type numbers and dimensions

3-position

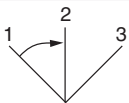
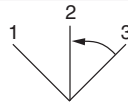
Operator and appearance (Standard type)	No. of positions	Contact arrangement	Type		Contact operation																									
			 Maintained/each 45°	 Spring return/each 45°	Contact unit ^{*1}	Operator position ^{*2}																								
						<table border="1" style="font-size: small;"> <tr> <td></td> <td></td> <td>1</td> <td>2</td> <td>3</td> </tr> </table>			1	2	3																			
		1	2	3																										
Key with rectangular bezel/ AR16JT  Key with square bezel/ AR16JS  Key with round bezel/ AR16JR 	3-position	2PDT	AR16JT-3■C2A AR16JS-3■C2A AR16JR-3■C2A	AR16JT-1EC2A AR16JS-1EC2A AR16JR-1EC2A	Left Right	<table border="1" style="font-size: x-small;"> <tr> <td rowspan="2">COM</td> <td>NC</td> <td style="text-align: center;">▬</td> <td></td> <td></td> </tr> <tr> <td>NO</td> <td></td> <td style="text-align: center;">●</td> <td></td> </tr> <tr> <td rowspan="2">COM</td> <td>NC</td> <td></td> <td style="text-align: center;">▬</td> <td></td> </tr> <tr> <td>NO</td> <td style="text-align: center;">●</td> <td></td> <td></td> </tr> </table>	COM	NC	▬			NO		●		COM	NC		▬		NO	●			<table border="1" style="font-size: x-small;"> <tr> <td></td> <td></td> <td>1</td> <td>2</td> <td>3</td> </tr> </table>			1	2	3
			COM	NC	▬																									
NO		●																												
COM	NC		▬																											
	NO	●																												
		1	2	3																										
			 Spring/manual return/each 45°	 Spring/manual return/each 45°	Left Right	<table border="1" style="font-size: x-small;"> <tr> <td rowspan="2">COM</td> <td>NC</td> <td style="text-align: center;">▬</td> <td></td> <td></td> </tr> <tr> <td>NO</td> <td></td> <td style="text-align: center;">●</td> <td></td> </tr> <tr> <td rowspan="2">COM</td> <td>NC</td> <td></td> <td style="text-align: center;">▬</td> <td></td> </tr> <tr> <td>NO</td> <td style="text-align: center;">●</td> <td></td> <td></td> </tr> </table>	COM	NC	▬			NO		●		COM	NC		▬		NO	●			<table border="1" style="font-size: x-small;"> <tr> <td></td> <td></td> <td>1</td> <td>2</td> <td>3</td> </tr> </table>			1	2	3
COM	NC	▬																												
	NO		●																											
COM	NC		▬																											
	NO	●																												
		1	2	3																										

04

Notes: *1 Terminal arrangement of contact (View from the terminal side (the back)).

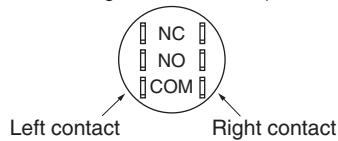

*2 ●, ▬: Means the contact closed (ON).
 • See page 04/154 for the outline dimensions.

• Key removal position

Specify the key removal position in the square ■ mark.

Key removable position	Applied operator action				Code
	3	6	7	1	
Left ◀	○	-	○	-	A
Left•Right ⊗	○	-	-	-	B
Left•Center•Right ⊗	○	-	-	-	C
Right ▶	○	○	-	-	D
Center ⊕	○	○	○	○	E
Center•Right ⊗	○	○	-	-	F
Left•Center ⊗	○	-	○	-	G

○: Available -: Not available

• Type of key

Type ^{*1}	A	B	C	D	E	F
Code	A	B	C	D	E	F

*1 "A" is standard.

Command Switches

AF16 and DF16

Type numbers and dimensions

• Dimensions, mm

Key with rectangular bezel

AR16JT

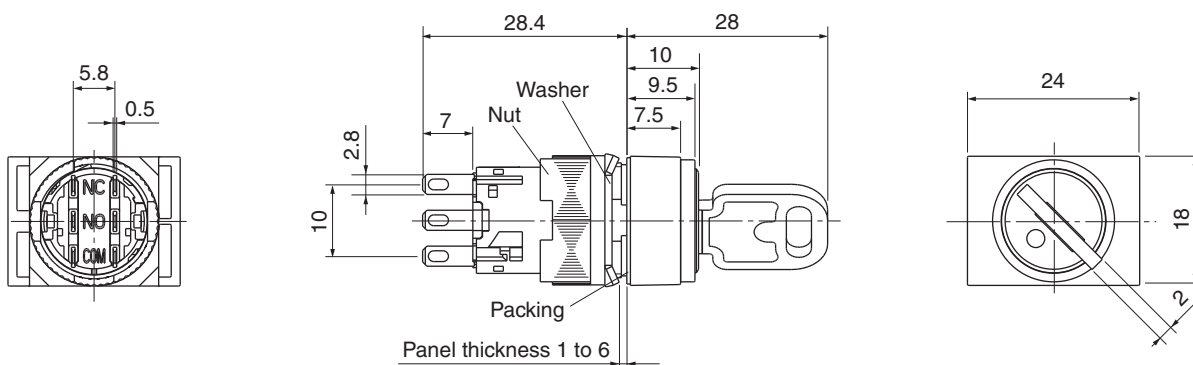

Key with square bezel

AR16JS

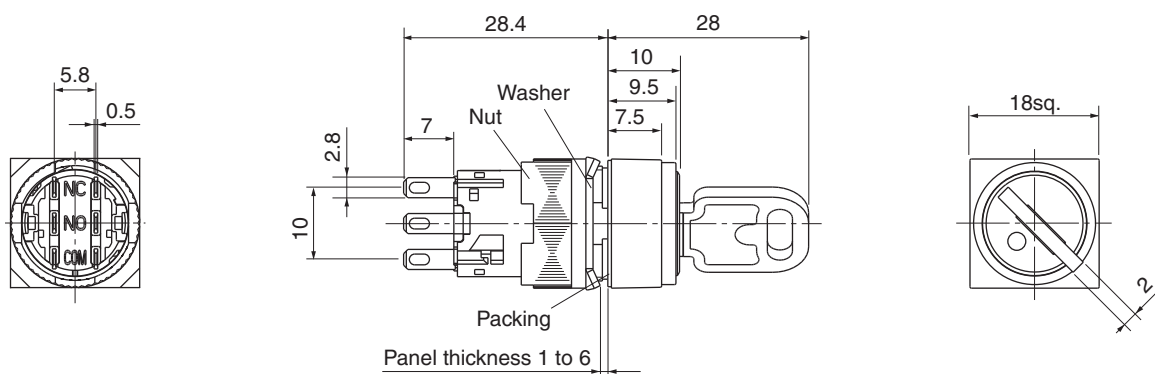

Key with round bezel

AR16JR

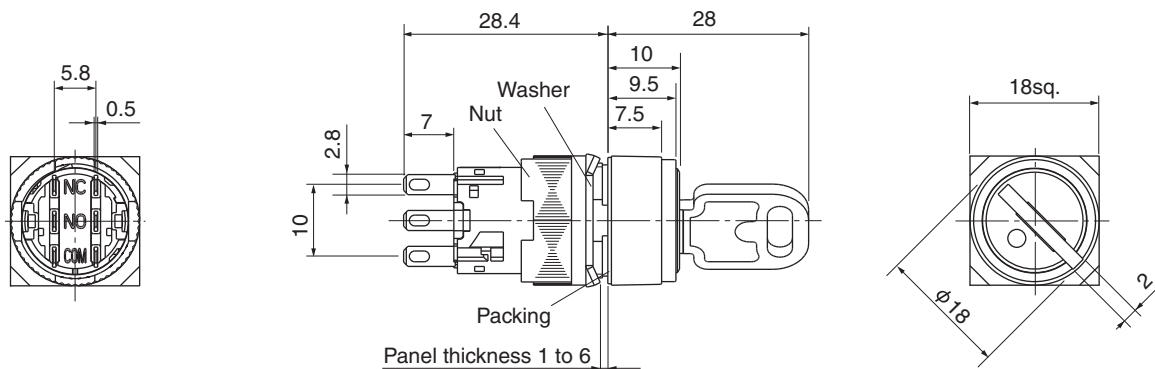

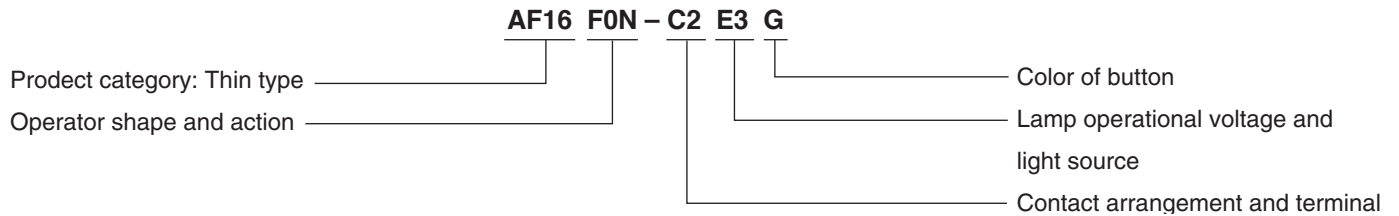

■ **Illuminated pushbutton switches (LED lamp)**

• **Type number system**



• **Type**

Operator	Appearance (Thin type)	LED lamp operational voltage	Contact arrangement	Momentary action Type	Alternate action Type
Flush rectangular		6V AC/DC	SPDT	AF16F0N-C1A3□	AF16F5N-C1A3□
			2PDT	AF16F0N-C2A3□	AF16F5N-C2A3□
		12V AC/DC	SPDT	AF16F0N-C1B3□	AF16F5N-C1B3□
			2PDT	AF16F0N-C2B3□	AF16F5N-C2B3□
		24V AC/DC	SPDT	AF16F0N-C1E3□	AF16F5N-C1E3□
			2PDT	AF16F0N-C2E3□	AF16F5N-C2E3□
Flush square		6V AC/DC	SPDT	AF16F0M-C1A3□	AF16F5M-C1A3□
			2PDT	AF16F0M-C2A3□	AF16F5M-C2A3□
		12V AC/DC	SPDT	AF16F0M-C1B3□	AF16F5M-C1B3□
			2PDT	AF16F0M-C2B3□	AF16F5M-C2B3□
		24V AC/DC	SPDT	AF16F0M-C1E3□	AF16F5M-C1E3□
			2PDT	AF16F0M-C2E3□	AF16F5M-C2E3□
Flush round		6V AC/DC	SPDT	AF16F0L-C1A3□	AF16F5L-C1A3□
			2PDT	AF16F0L-C2A3□	AF16F5L-C2A3□
		12V AC/DC	SPDT	AF16F0L-C1B3□	AF16F5L-C1B3□
			2PDT	AF16F0L-C2B3□	AF16F5L-C2B3□
		24V AC/DC	SPDT	AF16F0L-C1E3□	AF16F5L-C1E3□
			2PDT	AF16F0L-C2E3□	AF16F5L-C2E3□

Note: • The panel cutting dimensions differ depending on the operator shape of thin type model. See page 04/167.
 • For the dimensions, see page 04/156.

• **Button color**

Replace the □ mark by the color code.

Color	Green	Red	White	Yellow	Orange	Blue
Code	G	R	W *1	Y	A	S

Note: *1 A combination of the translucent button and the white legend plate comes to white lens.

Command Switches

AF16 and DF16

Type numbers and dimensions

• Dimensions, mm

Flush rectangular

AF16F0N, F5N

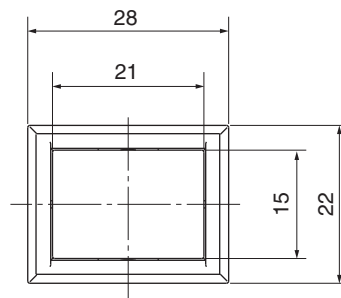
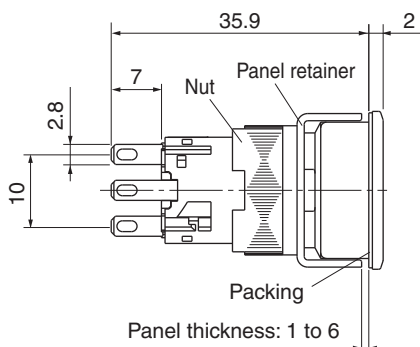
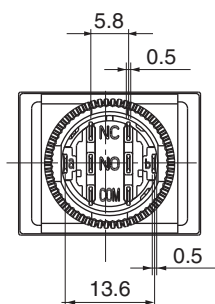

Flush square

AF16F0M, F5M

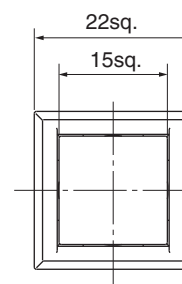
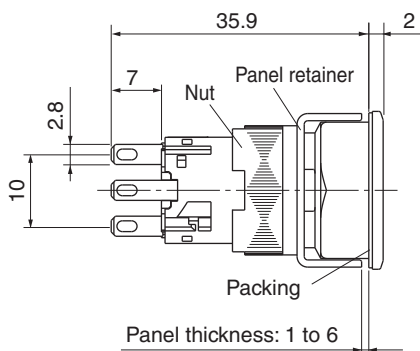
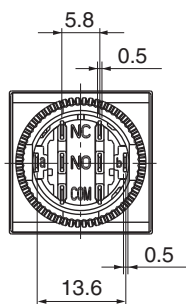

Flush round

AF16F0L, F5L

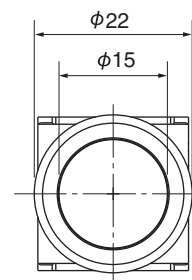
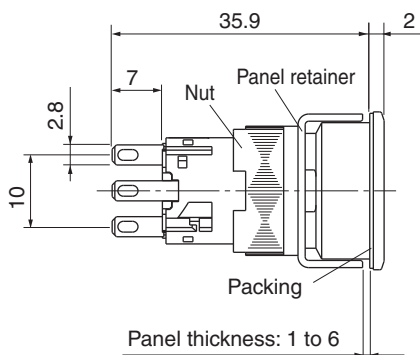
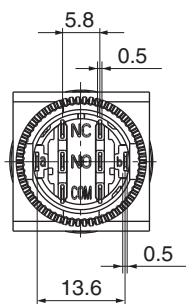

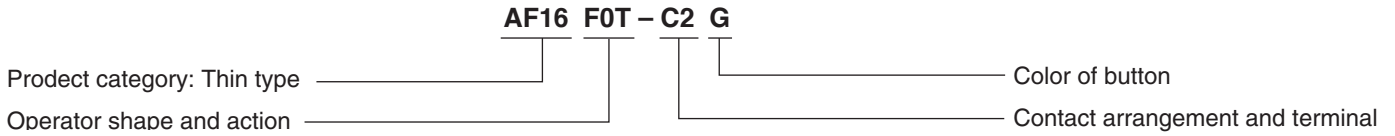

■ **Pushbutton switches**

• **Type number system**



• **Type**

Operator	Appearance (Thin type)	Contact arrangement	Momentary action Type	Alternate action Type
Flush rectangular		SPDT	AF16F0T-C1□	AF16F5T-C1□
		2PDT	AF16F0T-C2□	AF16F5T-C2□
Flush square		SPDT	AF16F0S-C1□	AF16F5S-C1□
		2PDT	AF16F0S-C2□	AF16F5S-C2□
Flush round		SPDT	AF16F0R-C1□	AF16F5R-C1□
		2PDT	AF16F0R-C2□	AF16F5R-C2□

Note: • The panel cutting dimensions differ depending on the operator shape of thin type model. See page 04/167.
 • For the dimensions, see page 04/158.

• **Button color**

Replace the □ mark by the color code.

Color	Green	Black	Red	White	Yellow	Orange	Blue
Code	G	B *1	R	W *2	Y	A	S

Notes: *1 A combination of the translucent button and the black legend plate comes to black.
 *2 A combination of the translucent button and the white legend plate comes to white.

Command Switches

AF16 and DF16

Type numbers and dimensions

• Dimensions, mm

Flush rectangular
AF16F0T, F5T

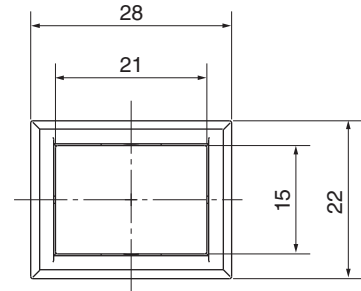
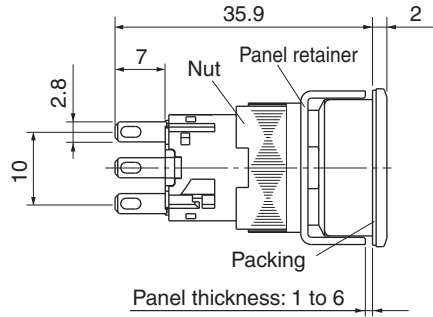
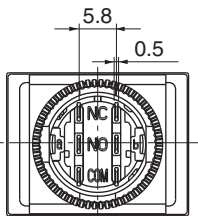

Flush square
AF16F0S, F5S

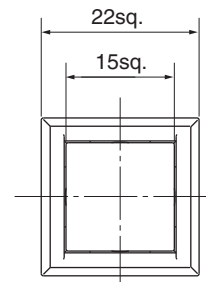
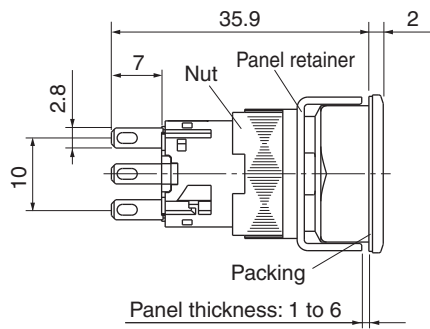
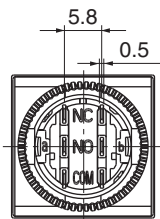

Flush round
AF16F0R, F5R

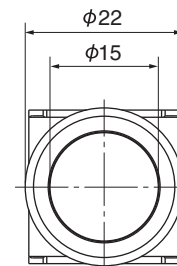
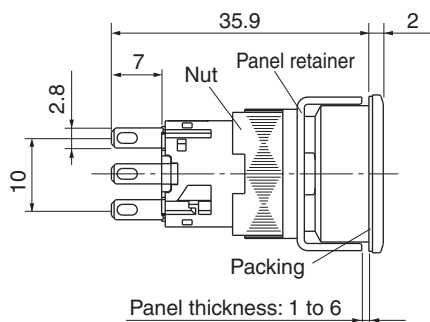
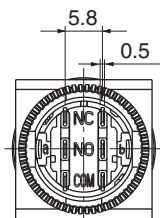

■ **Pilot lights (LED lamp)**

• **Type number system**



• **Type**

Lens	Appearance (Thin type)	LED lamp operational voltage	Type
Flush rectangular		6V AC/DC	DF16F0N-A3 □
		12V AC/DC	DF16F0N-B3 □
		24V AC/DC	DF16F0N-E3 □
Flush square		6V AC/DC	DF16F0M-A3 □
		12V AC/DC	DF16F0M-B3 □
		24V AC/DC	DF16F0M-E3 □
Flush round		6V AC/DC	DF16F0L-A3 □
		12V AC/DC	DF16F0L-B3 □
		24V AC/DC	DF16F0L-E3 □

Note: • The panel cutting dimensions differ depending on the lens shape of thin type model. See page 04/167.
 • For the dimensions, see page 04/160.

• **Lens color**

Replace the □ mark by the color code

Color	Green	Red	White	Yellow	Orange	Blue
Code	G	R	W *1	Y	A	S

Note: *1 A combination of the transparent lens and the white legend plate comes to white.

Command Switches

AF16 and DF16

Type numbers and dimensions

• Dimensions, mm

Flush rectangular
DF16F0N

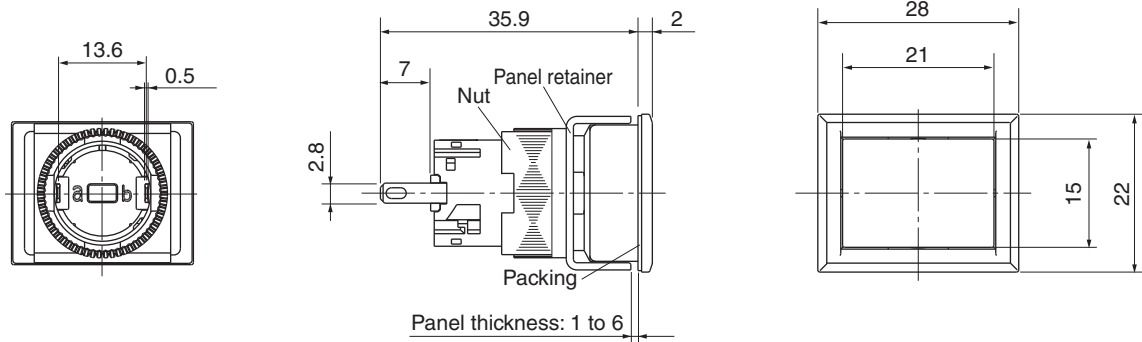

Flush square
DF16F0M

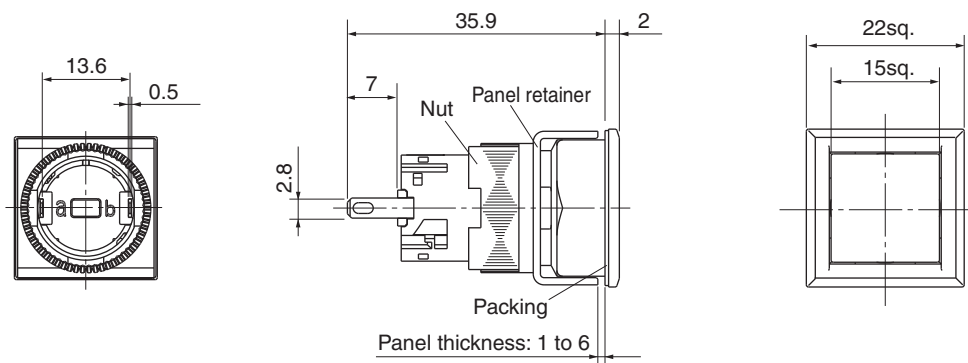

Flush round
DF16F0L

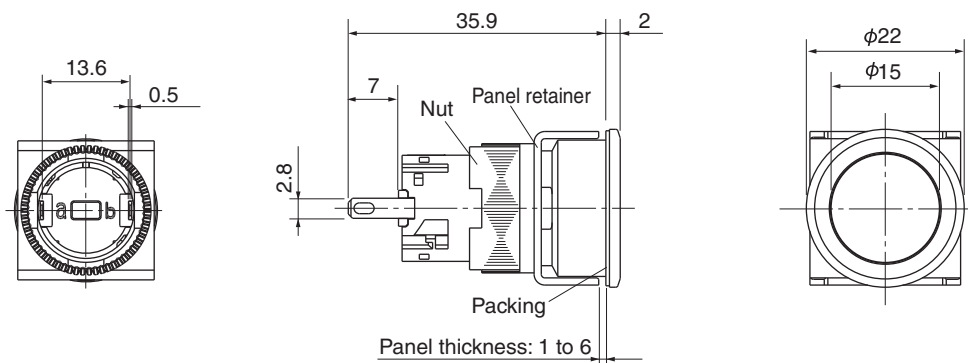



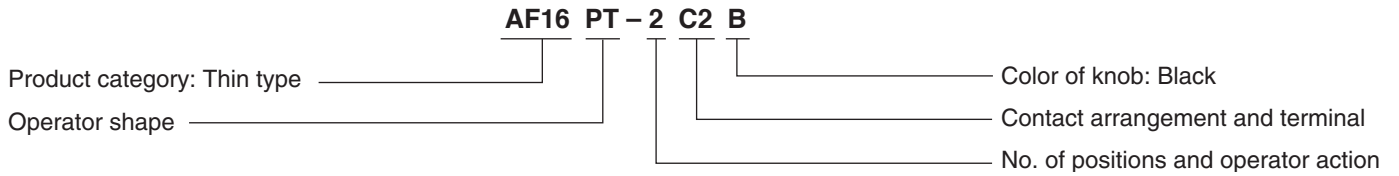

■ Selector switches (Knob type)

• Type number system

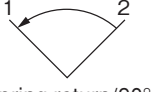

• Type
 2-position

Operator (Thin type)	Contact arrangement	Type		Contact operation			
		 Maintained/90°	 Spring return/90°	Contact unit ¹			
						Operator position ²	
						1	2
Knob with rectangular bezel/ AF16PT 	SPDT	AF16PT-2C1B	AF16PT-0C1B	Left	COM <ul style="list-style-type: none"> NC NO 	●	
		AF16PS-2C1B	AF16PS-0C1B				●
		AF16PR-2C1B	AF16PR-0C1B				
Knob with square bezel/ AF16PS 	2PDT	AF16PT-2C2B	AF16PT-0C2B	Left	COM <ul style="list-style-type: none"> NC NO 	●	
		AF16PS-2C2B	AF16PS-0C2B				●
Knob with round bezel/ AF16PR 		AF16PR-2C2B	AF16PR-0C2B	Right	COM <ul style="list-style-type: none"> NC NO 	●	●

Notes: *1 Terminal arrangement of contact (view from terminal side).

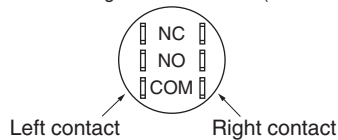

*2 ●: Contact closed.











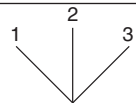
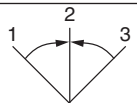

- The panel cutting dimensions differ depending on the operator shape of thin type model. See page 04/167.
- For the dimensions, see page 04/163.

Command Switches

AF16 and DF16

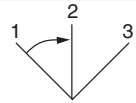
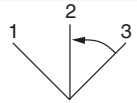
Type numbers and dimensions

3-position

Operator (Thin type)	Contact arrangement	Type		Contact operation					
		 Maintained/each 45°	 Spring return/each 45°	Contact unit ¹	Operator position ²				
					<table border="1"> <tr> <td>1</td> <td>2</td> <td>3</td> </tr> </table>	1	2	3	
1	2	3							
Knob with flush square/ AF16PT  Knob with square bezel/ AF16PS  Knob with round bezel/ AF16PR 	2PDT	AF16PT-3C2B	AF16PT-1C2B	Left	COM — NC —  — NO — 	<table border="1"> <tr> <td>1</td> <td>2</td> <td>3</td> </tr> </table>	1	2	3
		1	2				3		
		AF16PS-3C2B	AF16PS-1C2B	Right	COM — NC —  — NO — 				
		AF16PR-3C2B	AF16PR-1C2B						
				 Spring/manual return/each 45°	 Spring/manual return/each 45°		Contact unit ¹	Operator position ²	
				AF16PT-6C2B	AF16PT-7C2B		Left	COM — NC —  — NO — 	<table border="1"> <tr> <td>1</td> <td>2</td> <td>3</td> </tr> </table>
1	2	3							
AF16PS-6C2B	AF16PS-7C2B	Right	COM — NC —  — NO — 						
AF16PR-6C2B	AF16PR-7C2B								

Notes: ¹ Terminal arrangement of contact (view from terminal side).

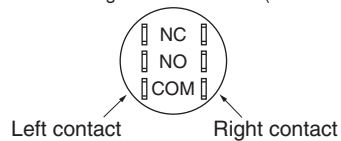

² ●, : Contact closed.

- The panel cutting dimensions differ depending on the operator shape of thin type model. See page 04/167.
- For the dimensions, see page 04/163.

• Dimensions, mm

Knob with rectangular bezel
 AF16PT

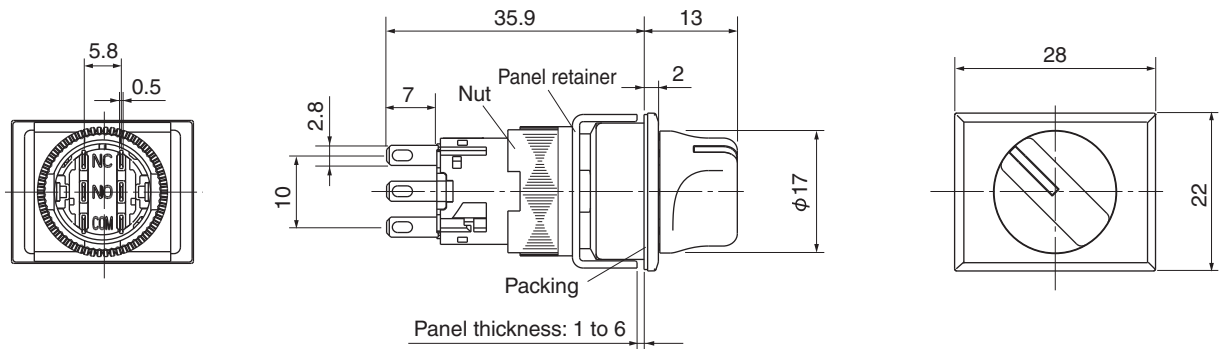

Knob with square bezel
 AF16PS

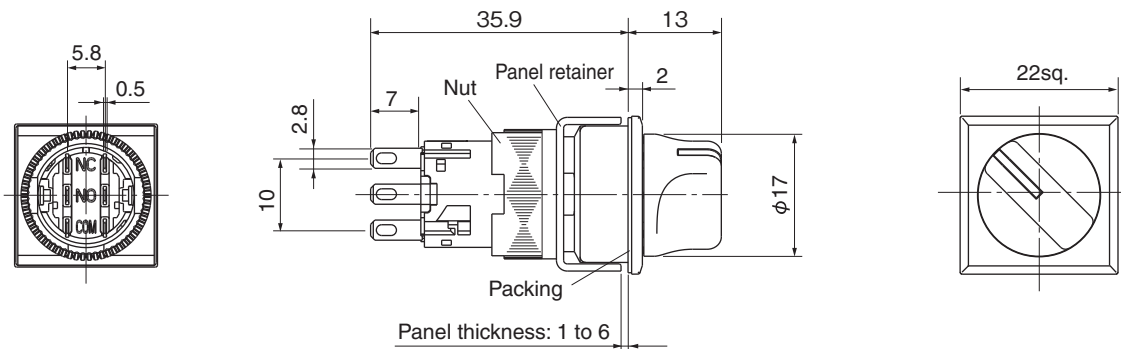

Knob
 AF16PR

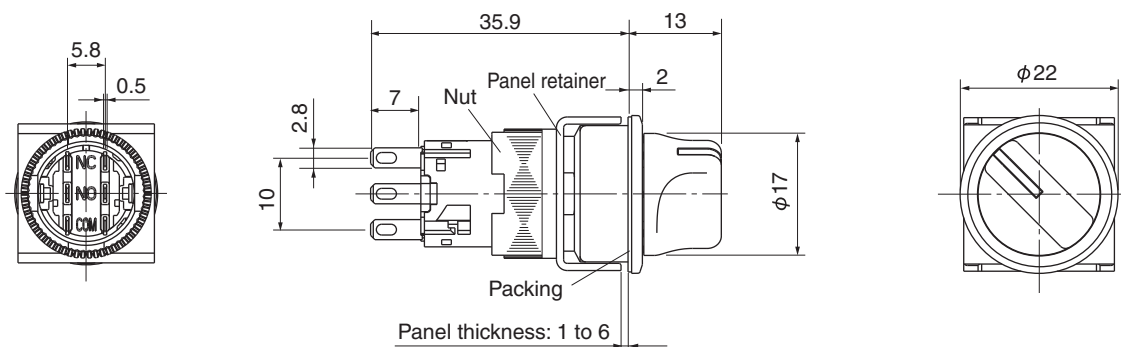

Command Switches

AF16 and DF16

Type numbers and dimensions

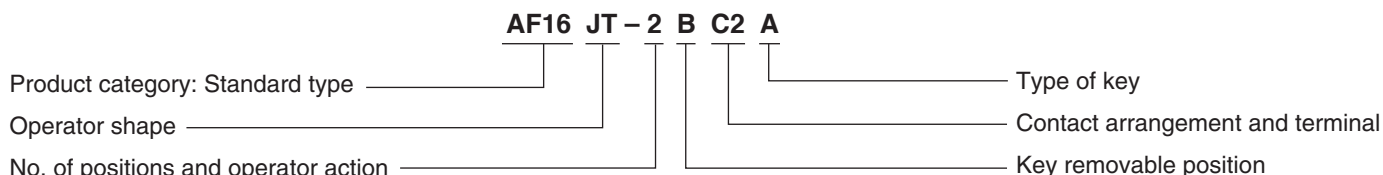

■ Selector switches (Key type)

• Type number system



• Type

2-position

Operator (Thin type)	Contact arrangement	Type		Contact operation	
		1 2 Maintained/90°	1 2 Spring return/90°	Contact unit ^{*1}	Operator position ^{*2}
					1 2
Key with rectangular bezel/ AF16JT 	SPDT	AF16JT-2■C1A	AF16JT-0AC1A	Left	COM — NC ● — NO ●
		AF16JS-2■C1A	AF16JS-0AC1A		
		AF16JR-2■C1A	AF16JR-0AC1A		
Key with square bezel/ AF16JS 	2PDT	AF16JT-2■C2A	AF16JT-0AC2A	Left	COM — NC ● — NO ●
		AF16JS-2■C2A	AF16JS-0AC2A		
Key with round bezel/ AF16JR 		AF16JR-2■C2A	AF16JR-0AC2A	Right	COM — NC ● — NO ●

Notes: *1 Terminal arrangement of contact (view from terminal side).

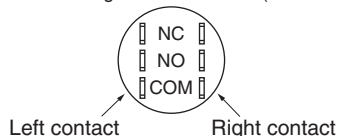

*2 ●: Contact closed.

• The panel cutting dimensions differ depending on the operator shape of thin type model. See page 04/167.

• For the dimensions, see page 04/166.

• Key removable position

Replace the ■ mark by the removable position code.

Removable position	Applied operator position		Code
	2	0	
Left ⊖	○	○	A
Left•Right ⊗	○	—	B
Left ⊕	○	—	C

○: Available —: Not available

• Type of key

Type ^{*1}	A	B	C	D	E	F
Code	A	B	C	D	E	F

*1 "A" is standard.

Command Switches AF16 and DF16 Type numbers and dimensions

3-position

Operator (Thin type)	Contact arrangement	Type		Contact operation								
		 Maintained/each 45°	 Spring return/each 45°	Contact unit ^{*1}	Operator position ^{*2}							
				<table border="1" style="width: 100%; border-collapse: collapse;"> <tr> <td style="width: 10%;"></td> <td style="width: 10%; text-align: center;">1</td> <td style="width: 10%; text-align: center;">2</td> <td style="width: 10%; text-align: center;">3</td> <td style="width: 10%;"></td> <td style="width: 10%;"></td> </tr> </table>			1	2	3			
	1	2	3									
Key with Flush square/ AF16JT Key with square bezel/ AF16JS Key with round bezel/ AF16JR 	2PDT	AF16JT-3■C2A AF16JS-3■C2A AF16JR-3■C2A	AF16JT-1EC2A AF16JS-1EC2A AF16JR-1EC2A	Left	COM <div style="display: flex; flex-direction: column; align-items: center; gap: 5px;"> NC NO </div>	<table border="1" style="width: 100%; border-collapse: collapse;"> <tr> <td style="width: 10%;"></td> <td style="width: 10%; text-align: center;">1</td> <td style="width: 10%; text-align: center;">2</td> <td style="width: 10%; text-align: center;">3</td> <td style="width: 10%;"></td> <td style="width: 10%;"></td> </tr> </table>		1	2	3		
			1	2	3							
		 Spring/manual return/each 45°	 Spring/manual return/each 45°	Right	COM <div style="display: flex; flex-direction: column; align-items: center; gap: 5px;"> NC NO </div>	<table border="1" style="width: 100%; border-collapse: collapse;"> <tr> <td style="width: 10%;"></td> <td style="width: 10%; text-align: center;">1</td> <td style="width: 10%; text-align: center;">2</td> <td style="width: 10%; text-align: center;">3</td> <td style="width: 10%;"></td> <td style="width: 10%;"></td> </tr> </table>		1	2	3		
			1	2	3							
AF16JT-6■C2A AF16JS-6■C2A AF16JR-6■C2A	AF16JT-7■C2A AF16JS-7■C2A AF16JR-7■C2A	Left	COM <div style="display: flex; flex-direction: column; align-items: center; gap: 5px;"> NC NO </div>	<table border="1" style="width: 100%; border-collapse: collapse;"> <tr> <td style="width: 10%;"></td> <td style="width: 10%; text-align: center;">1</td> <td style="width: 10%; text-align: center;">2</td> <td style="width: 10%; text-align: center;">3</td> <td style="width: 10%;"></td> <td style="width: 10%;"></td> </tr> </table>		1	2	3				
	1	2	3									
Right	COM <div style="display: flex; flex-direction: column; align-items: center; gap: 5px;"> NC NO </div>	<table border="1" style="width: 100%; border-collapse: collapse;"> <tr> <td style="width: 10%;"></td> <td style="width: 10%; text-align: center;">1</td> <td style="width: 10%; text-align: center;">2</td> <td style="width: 10%; text-align: center;">3</td> <td style="width: 10%;"></td> <td style="width: 10%;"></td> </tr> </table>		1	2	3						
	1	2	3									

04

Notes: *1 Terminal arrangement of contact (view from terminal side).

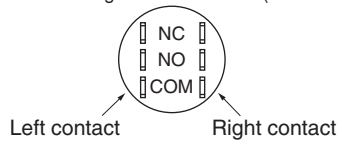

*2 ●, ■: Contact closed.

- The panel cutting dimensions differ depending on the operator shape of thin type model. See page 04/167.
- For the dimensions, see page 04/166.

• Key removable position

Replace the ■ mark by the removable position code.

Removable position	Applied operator position				Code
	3	6	7	1	
Left ◯	○	—	○	—	A
Left•Right ⊗	○	—	—	—	B
Left•Center• Right ⊗	○	—	—	—	C
Right ◯	○	○	—	—	D
Center ◯	○	○	○	○	E
Center•Right ⊗	○	○	—	—	F
Left•Center ⊗	○	—	○	—	G

○: Available —: Not available

• Type of key

Type ^{*1}	A	B	C	D	E	F
Code	A	B	C	D	E	F

*1 "A" is standard.

Command Switches

AF16 and DF16

Type numbers and dimensions

• Dimensions, mm

Key with rectangular bezel

AF16JT

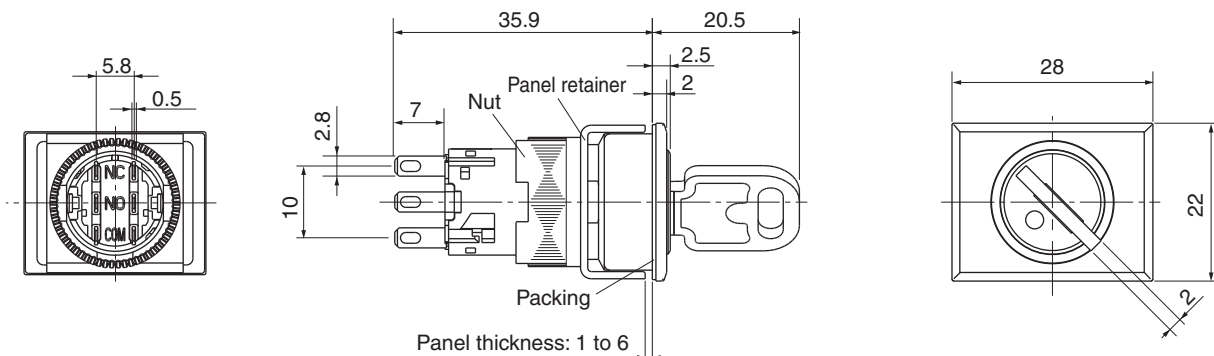

Key with square bezel

AF16JS

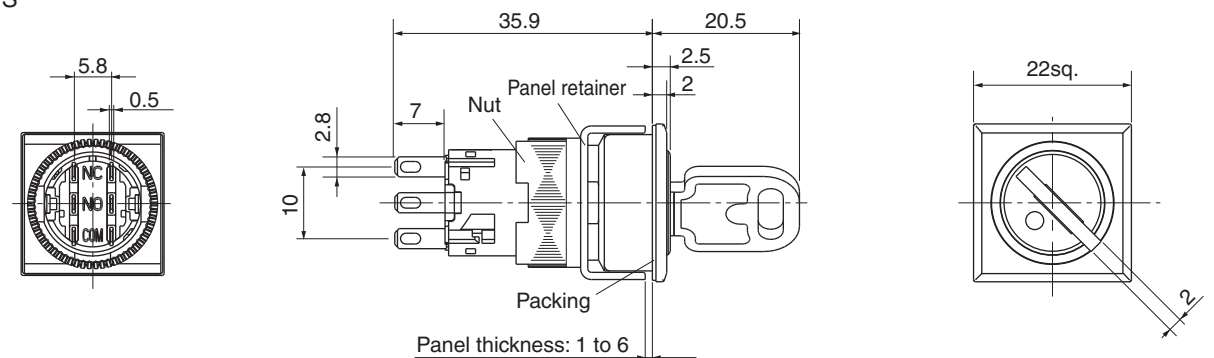

Key with round bezel

AF16JR

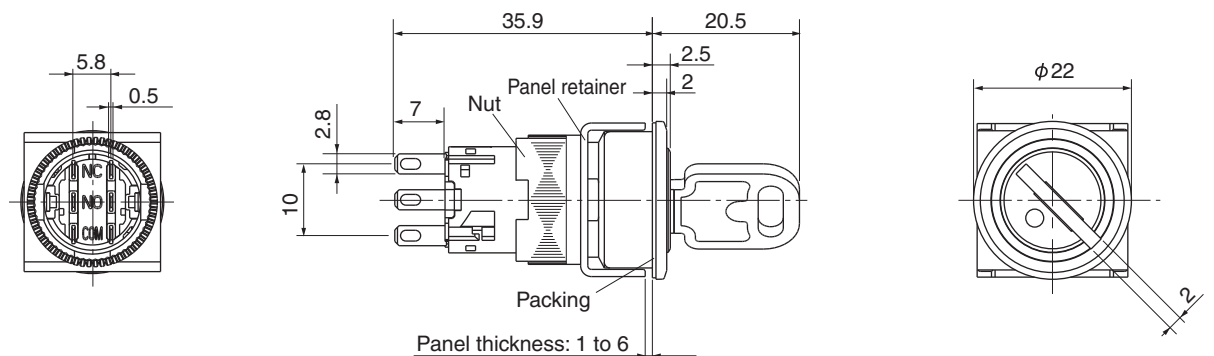

Safety Precautions

Read the Operating Instructions carefully before mounting, wiring, operating, servicing, or inspecting the command switch. Make sure that the Operating Instructions is delivered to the final user of the command switch.

- The safety precautions are classified into two levels, Warning and Caution, with meanings described as follows:

Warning : If operation is incorrect, a dangerous situation may occur, resulting in death or serious injuries.

Caution : If operation is incorrect, a dangerous situation may occur, resulting in minor to medium injuries or physical damage to equipment.

An item described under CAUTION may result in a serious accident, depending on the situation.

Warning
<ul style="list-style-type: none"> • Do not touch or approach any live part while power is supplied. An electric shock or burning may result. • Be sure to turn off the power before mounting, dismounting, wiring, or inspecting the product. An electric shock, burning from short-circuiting or equipment malfunction may result.
Caution
<ul style="list-style-type: none"> • Wire the product according to the wiring instructions in the Operating Instructions. Make sure that the size of the wires is suitable for the voltage and applied current. The wrong wiring may result in fire, accidents or malfunctions. • Treat the product as industrial waste when it is to be discarded.

■ Panel cutout, mm

- **Standard type** (common)

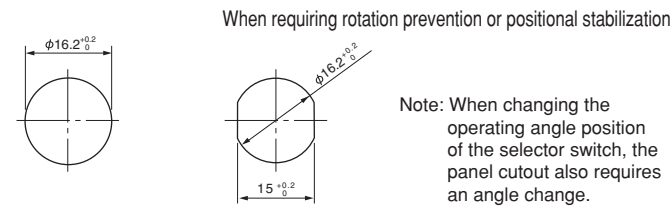

- **Thin type** (The panel cutout dimension varies depending on the operator or lens shape.)

- **Rectangular type**

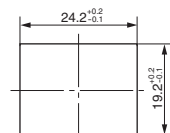

- **Square type**

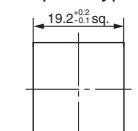

- **Round type**

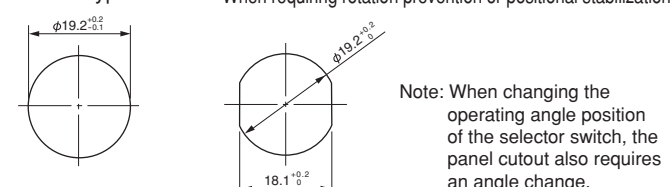

■ Installation on panel

- As shown in the figure below, insert the switch main unit into the mounting hole from the front of the panel, attach the washer and tightening nut from the back of the panel, and securely tighten the nut with the wrench (AHX601).

Note: The proper tightening torque is 0.6 to 1.0 N•m.

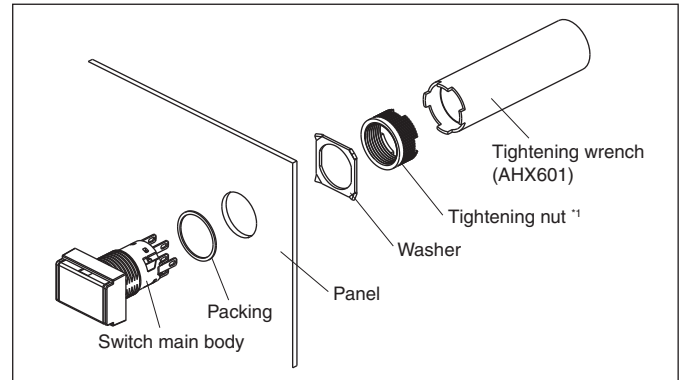

Note: *1 Do not use pliers or other improper tools to tighten the nut, or tighten it excessively. Otherwise, the nut may be damaged or the switch may malfunction.

• Thin type

- As shown in the figure below, insert the switch main unit into the mounting hole from the front of the panel, attach the panel retainer from the back of the panel, and securely tighten the nut with the wrench (AHX601).

Note: The proper tightening torque is 0.6 to 1.0 N•m.

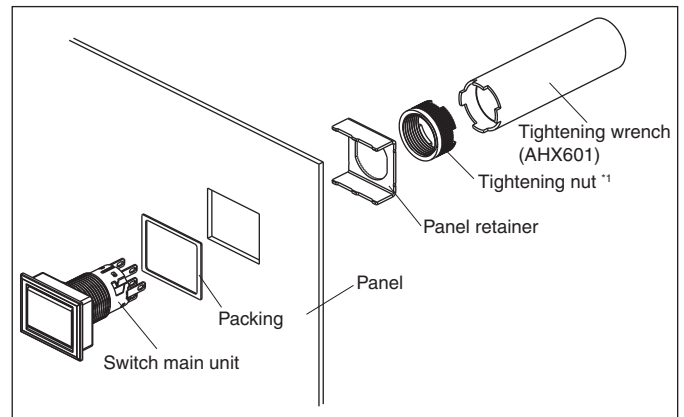

Note: *1 Do not use pliers or other improper tools to tighten the nut, or tighten it excessively. Otherwise, the nut may be damaged or the switch may malfunction.

■ Applicable panel thickness

Tables 1 and 2 show applicable panel thickness.

Table 1 Standard type (AR16/DR16 series)

Mounting condition	Applicable panel thickness, mm	
Without accessories	1 to 6	
With accessories	Protective cover	1 to 4
	Dust-tight cover	1 to 4
	Various sockets	1 to 3.2
	Terminal cover	1 to 3.2
	Protective cover + various sockets	1 to 1.6
	Protective cover + Terminal cover	1 to 1.6
	Dust-tight cover + various sockets	Cannot be used.
Dust-tight cover + Terminal cover	Cannot be used.	

Command Switches

AR16, DR16 and AF16, DF16

Panel cutout and mounting

Table 2 Thin type (AF16/DF16 series)

Mounting condition		Applicable panel thickness, mm
Without accessories		1 to 6
With accessories	Protective cover	1 to 4
	Various sockets	1 to 3.2
	Terminal cover	1 to 3.2
	Protective cover + various sockets	1 to 3.2
	Protective cover + Terminal cover	1 to 3.2

■ High-density mounting

Minimum mounting space (pitch) without accessories, mm

• Standard type (AR16/DR16 series)

Illuminated pushbuttons, pushbuttons, selectors, and pilot lights

- ① Rectangular ② Square ③ Round, dome

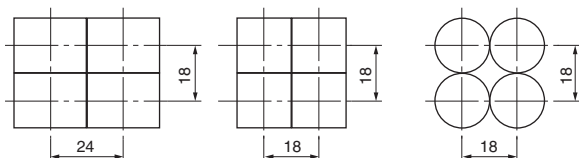

Note: Determine the mounting pitch by taking the operability and wiring work into consideration.

• Thin type (AF16/DF16 series)

Illuminated pushbuttons, pushbuttons, selectors, and pilot lights

- ① Rectangular ② Square ③ Round, dome

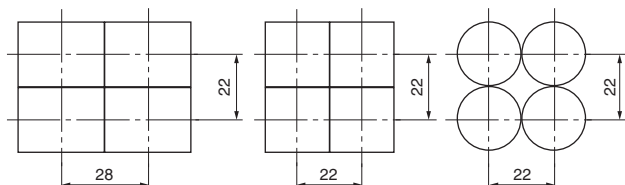

Note: Determine the mounting pitch by taking the operability and wiring work into consideration.

Minimum mounting space (pitch) with accessories, mm

- Protective cover AHX669 and AHX826

(Standard type)

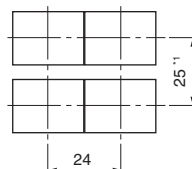

① 43: with the cover fully opened

- Protective cover AHX671

(Standard type)

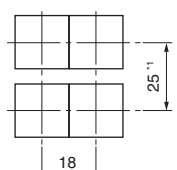

① 43: with the cover fully opened

- Protective cover AF6D826

(Thin type)

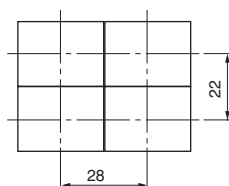

- Protective cover AF6D827

(Thin type)

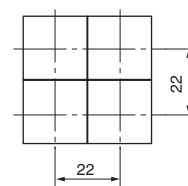

- Dust-tight cover AHX668

(Standard type)

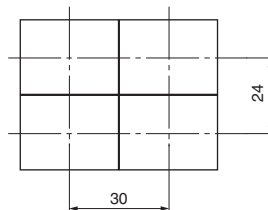

- Dust-tight cover AHX822

(Standard type)

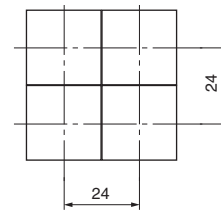

- Minimum mounting spaces (pitch) with sockets, such as Fast-Connection socket (AR6S690), connector socket (AR6S691) and PC board-use socket (AR6S692) are the same as those without accessories.

Note: Determine the mounting pitch by taking the operability and wiring workability into consideration.

Safety Precautions



Read the Operating Instructions carefully before mounting, wiring, operating, servicing, or inspecting the command switch. Make sure that the Operating Instructions is delivered to the final user of the command switch.

- The safety precautions are classified into two levels, Warning and Caution, with meanings described as follows:

 **Warning** : If operation is incorrect, a dangerous situation may occur, resulting in death or serious injuries.

 **Caution** : If operation is incorrect, a dangerous situation may occur, resulting in minor to medium injuries or physical damage to equipment.

An item described under CAUTION may result in a serious accident, depending on the situation.

 Warning
<ul style="list-style-type: none"> • Do not touch or approach any live part while power is supplied. An electric shock or burning may result. • Be sure to turn off the power before mounting, dismounting, wiring, or inspecting the product. An electric shock, burning from short-circuiting, or equipment malfunction may result.
 Caution
<ul style="list-style-type: none"> • Wire the product according to the wiring instructions in the Operating Instructions. Make sure that the size of the wires is suitable for the voltage and applied current. The wrong wiring may result in fire, accidents, or malfunctions. • Treat the product as industrial waste when it is to be discarded.

Method of replacing color lens, legend plate, and screen
Replacing color lens (screen)

- Standard type (AR16/DR16 series)

To remove the color lens, fit the color lens remover (AHX618) to the grooves in the color lens and pull out the lens, or pry the lens lightly with a small slotted screwdriver.

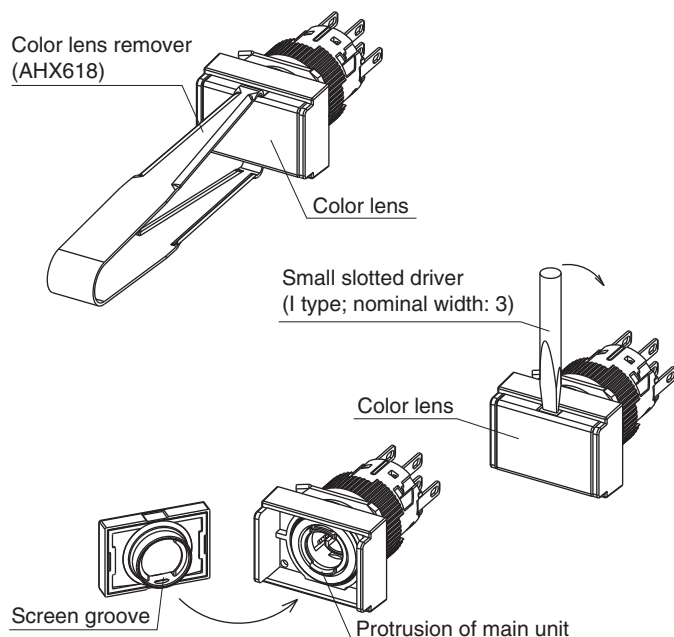

- Thin type (AF16/DF16 Series)

To remove the color lens, pry the lens lightly with a small slotted screwdriver.

If one side of the color lens is separated from the screen, further insert the screwdriver and remove the color lens together with the screen. Do not pry the packing when doing this.

To fit the color lens, align the protrusion of switch main body with the groove of the screen, and press-fit them.

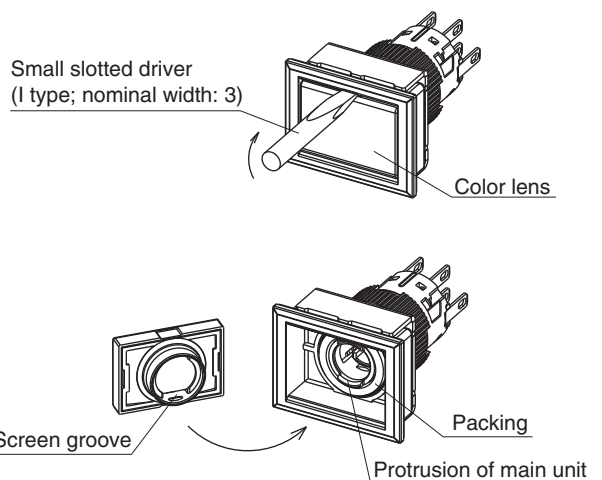

- Removing screen

Insert the tip of a small slotted screwdriver into the groove and press down the screwdriver in the direction of the arrow.

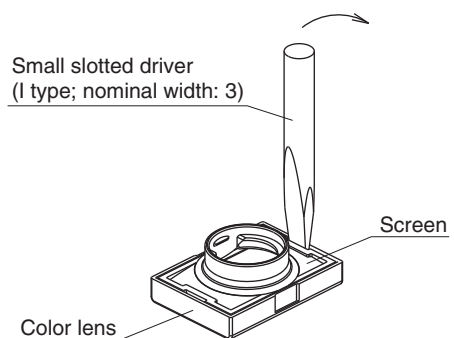

Command Switches AR16, DR16 and AF16, DF16 Notes on use

Fitting color lens to screen

• Rectangular type

Set the textured surface side of the legend plate with the screen side, then press-fit the color lens. When press-fitting, make sure that your fingers do not touch the reflective surface inside the screen.

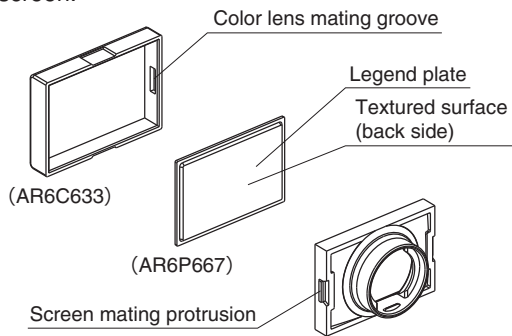

• Square type

Set the textured surface side of the legend plate with the screen side, align the screen protrusion with the color lens groove, and press-fit together. When press-fitting, make sure that your fingers do not touch the reflective surface inside the screen.

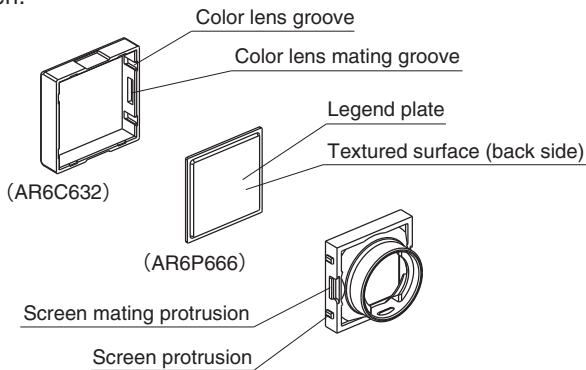

• Round type

Align the protrusion of the legend plate with the groove of the screen, also align the screen protrusion and color lens groove, and press-fit together. When press-fitting, make sure that your fingers do not touch the reflective surface inside the screen.

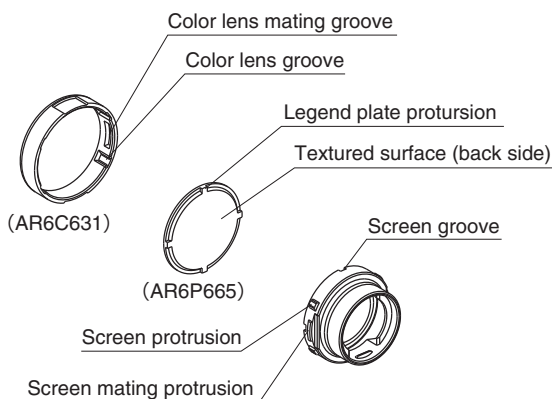

• For alternate action type of illuminated pushbutton switches and pushbutton switches, do not remove the color lenses (screens) in locked (depressed) state. The internal mechanisms may be damaged.

■ Engraving legend plate

Engrave the surface of the legend plate.

- Material: Acrylic resin
- Engraving depth: 0.5 mm max.
- Paint: Use a paint that has alcohol as its main ingredient, such as melamine paint, phthalic acid paint, or acrylic paint.

• Legend plate size

Shape	Size, mm
Rectangular	
Square	
Round	

Notes: ¹ A legend sheet may be used, provided that the external dimensions do not exceed the corresponding outer size specified in the above table and that the thickness is 0.1 mm or below. (No legend sheets are provided with the product. Please prepare on customer side.)
² Do not engrave any part other than the legend plate.

■ Changing the operating angle position of selector switch

The bezel is separated from the knob (key), which makes it easy to change the operating angle position in 45° increments (the AR16 series rectangular or square type only).

The following figures show a knob type example. The key type is the same.

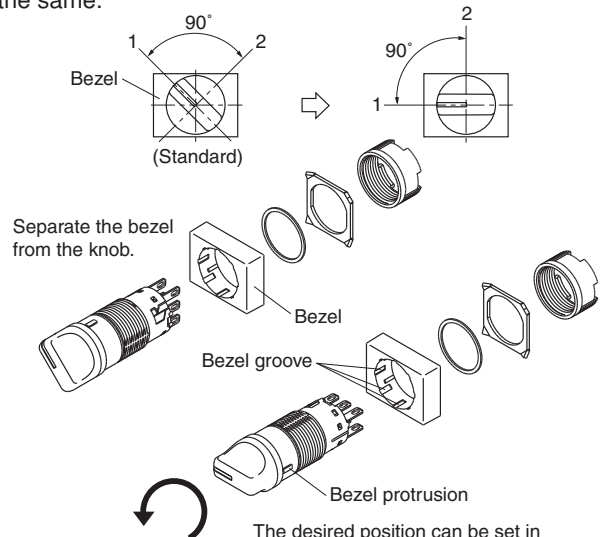

The desired position can be set in 45° intervals. Set the knob to the desired position, align the groove of the knob, and press-fit the knob.

■ Method of replacing lamp

- To remove the LED lamp, insert the lamp changer (AHX672) in the LED lamp and pull out the LED lamp.
- To mount the LED lamp, align the lamp terminal side of the main unit with the electrode side of the LED lamp, lightly hold the lamp by hand or with the head of the lamp changer (AHX672), and insert the lamp.
- The LED lamp has no polarity, so it can be powered by either AC or DC.

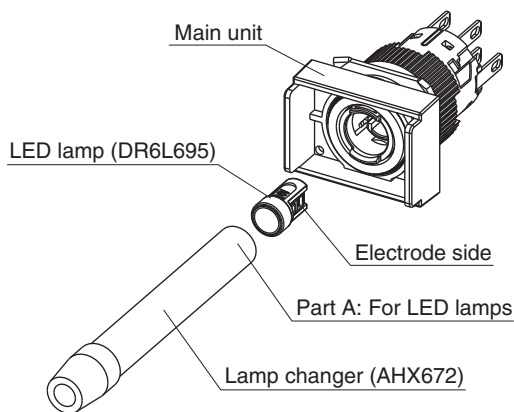

• Handling of LEDs

LED whose luminous color is green or blue is sensitive to static electricity. Be careful when handling the LED. Take thorough measures against static electricity and surges when handling the product. The following anti-electrostatic measure is recommended.

Use a wristband or anti-electrostatic glove when replacing LED lamps.

■ Wiring

- Wiring to tab terminal
 - Use 110 (2.8mm) series receptacles for tab terminals.
- Pay attention to the following points when soldering.
 - Type of solder: Use resin-core solder.
 - Use a soldering iron with a maximum power consumption of 60W (350(C) within five seconds. Make sure that the terminal is free of tension during soldering. Also, do not deform the terminal.
 - The melting point of lead-free solder is slightly high, which may make soldering difficult. Use a soldering iron that has a large soldering tip or high heat generation.
- Connectable wires
 - Two solid wires with a maximum diameter of 0.8 mm (solder)
 - One stranded wire with a maximum area of 0.75 mm² (solder)
 - Flat-type connection terminal (2.8□-1.25-5) 0.5 to 1.25mm²
 - (2.8□-0.5-5) 0.2 to 0.5mm²
- Use of contact blocks
 - When using NO and NC contacts in the same contact block, avoid connection that involves opposite polarity or wiring from different types of power supply.
- For wiring to adjacent terminals, use the terminal cover (AR6Y261) to prevent short-circuit, or an insulation tube to assure isolation. For solder terminals, caution is required if thick wires, in particular, are connected or a large quantity of solder is used.

• Terminal arrangement

Model	Circuit diagram (example)	Terminal arrangement (view from the terminal (back) side)
Illuminated pushbuttons (2PDT)		<p>[TOP] (▼) Display side</p> <p>Left-side contact Right-side contact</p>
Pushbuttons and selector switches (2PDT)		<p>[TOP] (▼) Display side</p>
Pilot lights		<p>[TOP] (▼) Display side</p>

Note: Only the left-side contact is applicable to the SPDT mechanism.

Command Switches

AR16, DR16 and AF16, DF16

Notes on use

■ LED Lamps

- LED lamp malfunctioning (incorrect lighting)

The LED lamp incorporates a circuit to prevent malfunctioning. Compared with conventional models, this LED lamp is less likely to malfunction, but it incorporates no absolute countermeasures.

A minute current (approximately 0.25 mA) turns on the LED lamp. A leakage current from the surge absorption circuit or noncontact circuit, or stray capacitance between cables, may also turn on the LED lamp.

In this case, a countermeasure (e.g., attaching a resistor in parallel with the LED lamp) is required.

- Countermeasure against malfunctioning

Malfunctioning can be prevented by connecting a shunt resistor (R) in parallel. The resistance in that case varies with the model and operating conditions.

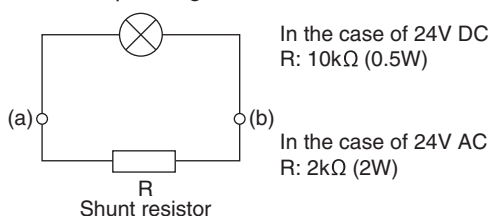

- The permissible fluctuation range for the operating voltage of the 6V model is ±5% and that for the 12V or 24V model is ±10%. If the operating voltage is always 5% or 10% higher, select a resistor that will make the operating current the same as or lower than the rated current, and connect the resistor in series to the LED lamp.

- Calculation of external resistance

Example: Connecting a 24V red LED to a 48V circuit

$$\text{External resistance } [\Omega] = \frac{\text{Circuit voltage [V]} - \text{Rated voltage [V]}}{\text{Rated current [A]}}$$

$$= \frac{48-24}{7.5 \times 10^{-3}} = 3200 [\Omega]$$

→ Therefore, use an external resistor of 3.3kΩ 1W.
(Select a resistor with sufficient wattage.)

- Surges

High-brightness LED products use elements that are sensitive to static electricity. Keep in mind that an unusual voltage, such as a surge voltage, may cause the product to malfunction.

■ Selector Switches

- Knob type

The knob can be operated by turning it lightly. Be careful to operate the knob with a torque not exceeding 1N·m.

- Key type

- Types of keys

Five types (B, C, D, E, and F) are available in addition to the standard type (type A).

Make sure that the symbol on the key coincides with the symbol on the switch.

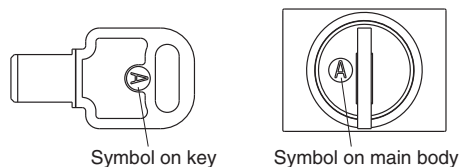

- Fully insert the key into the switch and turn the key. Do not pull on the key while turning it.
- Operate the key with a torque not exceeding 0.1N·m.
- Do not forcibly insert or extract the key.
- Do not attempt to operate the switch with the key insufficiently inserted or insert the wrong key. Otherwise, a malfunction may result.

■ Fast-connection socket

- Connectable wires

• Standed wire : 0.3 to 0.75 mm² (AWG22 to AWG18)

• Single wire : 0.5 to 1 mm dia.

• Recommended ferrule : Phoenix Contact, part number AI0, 34-8TQ

Wire size : 0.34 mm² (22 AWG)

Crimping tool : CRIMPFOX UD6-6

Note : Use a crimping tool with a hexagonal or round cross section.

Sheath external diameter: 2.8 mm dia. Max.

- Wire sheath stripping length

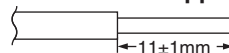

Note : If ferrules are used, securely insert the wire sheath inside a resin shell. Cut the end of the wire the same length as the ferrule or cut it at a position approximately 0.5 mm longer.

Check the length using the strip gauge on the surface of the socket displayed on the model nameplate. If standed wire is used, twist the wire so that there are no loose strands after stripping.

- Connection method

- (1) Insert the wire while pressing the button on the insertion slot with a small flat-head screwdriver (tip width of 2 mm max.). Release the button when the wire is all the way seated in the switch.
- (2) When disconnecting the wire, pull out the wire while pressing the button on the insertion slot with a small flat-head screwdriver. Cut the bare part of the wire if it was previously used, and then newly remove the sheath to reuse the wire.
- (3) Insert a single wire for each insertion slot.
- (4) Do not pull on the wires with excessive force (15 N or more) when you perform wiring. Make sure that not external force is exerted on the wires after wiring has been completed. The next time that a wire is inserted, the parts that support the wire may change shape and result in conduction failure.

- Terminal arrangement (Rear-side View)

- (1) Socket Terminal Arrangement for AR6S690-L2
- (2) Switch Terminal Arrangement for Illuminated 2PDT Contacts

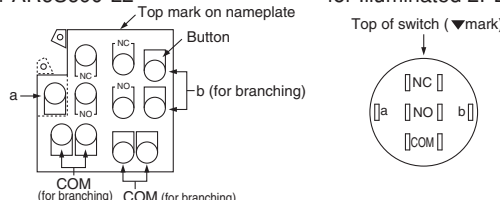

■ Connector sockets

- Connectable wires
Stranded wire: 0.5 to 0.75 mm² (20AWG to 18AWG)
- Arrange for a receptacle terminal separately.
Nichifu Co., Ltd.: CMC62895F
- Check the insertion position and insert the receptacle terminal into the socket after connecting the wires to the receptacle terminal. (The wires once connected cannot be disconnected.) Lightly pull the wires and check that the receptacle terminal is securely connected to the socket.

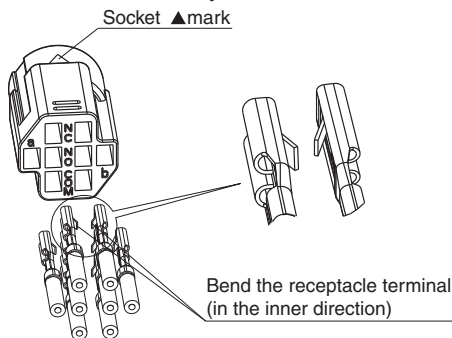

- Align the ▲ mark of the socket and the TOP (▼) mark of the switch, and put the socket and switch together.

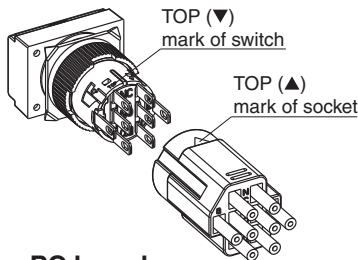

■ Socket for PC board

- Minimum mounting space (pitch), mm

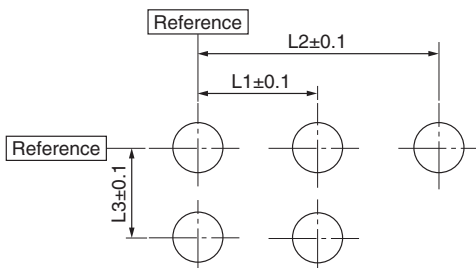

Obtain the mounting pitch based on a reference line to minimize the cumulative error.
Make sure that the centering difference between the switch and the PCB socket does not exceed 0.25 mm.

- Apply the following panel cutout dimensions (in mm) to stabilize the operator position of the switch when combined with the socket.

AR16/DR16 (common)

AF16/DF16 (round type)

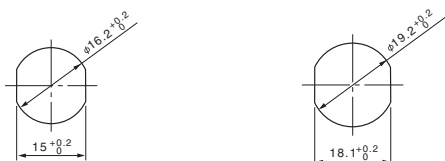

- Mount the switch to the panel. Make sure that the switch is free of any bends.

- PC board processing dimensions (in mm) as viewed from the socket mounting side.

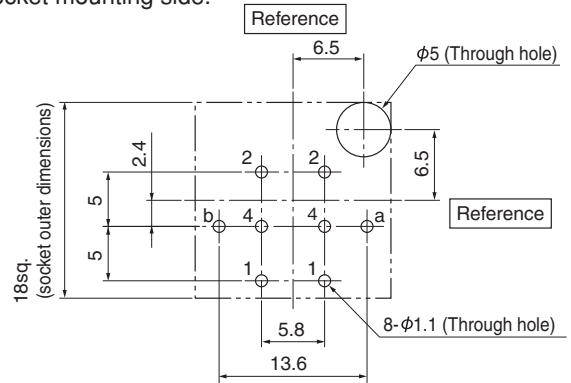

- The reference is the center of the socket (switch).
- Switch terminal arrangement (as viewed from the socket mounting side)

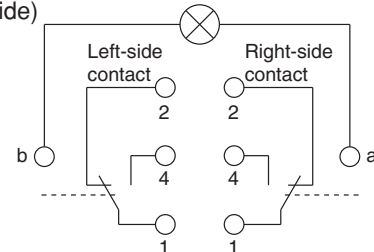

Note: The right-side contact is connected in the case of an SPDT contact.

- Insert the socket so that the lever will be located in the 5mm-diameter through hole of the PC board. Set the lever to the lock position as viewed from the socket mounting side.

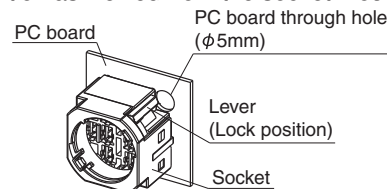

- Combine the switch-mounted panel with the socket on the PC board, and solder the socket terminal.

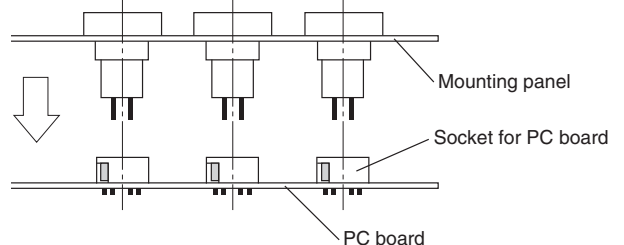

- Combine the PCB socket and the panel while making sure that the socket terminal does not fall off, and turn over the socket to do the soldering. Do not leave any space between the PC board and socket.
- After combining them, check that the lever as viewed from the soldering side is in the lock position, and solder the terminal.

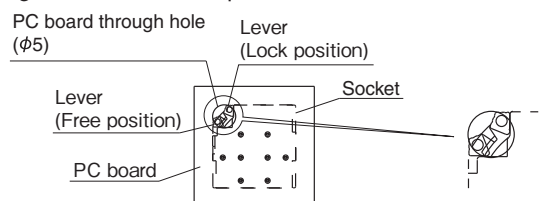

Command Switches

AR16, DR16 and AF16, DF16

Notes on use

- Pay attention to the following points when soldering.
 - Type of solder: Use resin-core solder.
 - Finish soldering at 350°C within 5 seconds.
 - Do not wash the socket.
 - Solder the socket so that no flux adheres to it.
- The melting point of lead-free solder is slightly higher than lead solder, which may make soldering difficult. Use a soldering iron with a large tip or that provides a high heat generation.
- Using a spacer between the panel and the PC board
Make sure that the distance shown in the figure below is maintained between the panel and the PC board. The spacer dimensions vary with the thickness of the mounting panel.

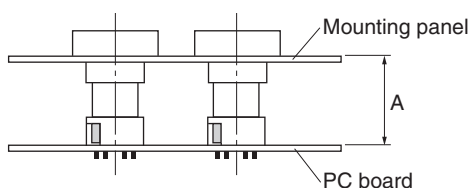

Series	A (mm)
AR16/DR16	30.2±0.2
AF16/DF16	37.7±0.2

- Mounting and removing PC board sockets
 - Removing
Push down the socket levers all the way viewed from the soldering side in the direction of the free position and remove the PC board sockets. After removal, the socket levers will return to the lock position automatically.
 - Mounting
Check that the socket lever as viewed from the soldering side is in the lock position, lightly insert the terminal and socket so their position is aligned with the switch on the panel, press the socket-mounting portion of the PC board, and securely insert the entire socket until the socket lever snaps. (Check that the lever as viewed from the soldering side is in the lock position.)
- Use the switch within the following rated voltage range when the PCB socket is used.
 - Rated insulation voltage: 60V
 - Rated operational voltage: 24V
 - Conventional free air thermal current: 3A
- Use a 1.6-mm-thick double-sided through-hole printed circuit board made of copper-plated laminated epoxy resin on a woven glass fabric base.
- In case of standard type (AR16 and DR16 series), beware that the adopted models are not allowed to attach the protective cover to some models and that the adopted models cannot be mounted to some models afterward.

■ Others

- Operation
 - Do not hit or flip the button, or the button may be damaged.
 - Be sure to operate the button by hand.
 - Do not pull the button if the switch is an alternate action type.
- High-density mounting of illuminated type
 - When continuously lighting pilot lights or pressing illuminated pushbuttons, keep in mind that the ambient temperature may exceed the rated value due to the heat radiated by the lamp.
 - Be sure to ventilate the lamp /switch if the mounting panel is not made of metal or if the mounting panel is an enclosed type.
- Usage locations
 - Be sure to use and store the product within the rated ambient temperature and humidity ranges.
 - Although the product resists ordinary cutting oils and coolant oils, do not use the unit in places where special oils may be sprayed onto the product.
 - If dusts or filings accumulate in the gap between the button and the frame, the switch may fail to operate normally. Take appropriate measures, such as using a dust-proof protective cover, if the switch is to be used in places that are subject to dusts or filings.
 - The AR16/DR16 series and AF16/DF16 series are for indoor use. Make sure that the product is not exposed to direct sunlight.
 - Do not use the product in the places that are subject to the adverse effects of ozone or corrosive gases.

Command Switches AR16, DR16 and AF16, DF16 Accessories





04

Description	Type	Dimensions, mm																													
Protective cover (for Standard type) <div style="display: flex; flex-direction: column; align-items: center; margin-top: 10px;"> <div style="margin: 5px;">KKD07-246</div> <div style="margin: 5px;">KKD07-247</div> <div style="margin: 5px;">KKD07-248</div> </div>	<table border="1" style="width: 100%; border-collapse: collapse;"> <tr> <th style="width: 30%;">Type</th> <th>Used with</th> </tr> <tr> <td>AHX669</td> <td>AR16F0N, F5N, F0T, F5T</td> </tr> <tr> <td>AXH826*</td> <td></td> </tr> <tr> <td>AHX671</td> <td>AR16F0M, F5M, F0S, F5S AR16E0L, E5L, E0R, E5R</td> </tr> </table> <p>* This cover returns to the home position with spring action to prevent accidental operation (Packing is provided). Note: The cover cannot be used with the flush rectangular with guard type models.</p>	Type	Used with	AHX669	AR16F0N, F5N, F0T, F5T	AXH826*		AHX671	AR16F0M, F5M, F0S, F5S AR16E0L, E5L, E0R, E5R	<table style="width: 100%;"> <tr> <td style="width: 33%; vertical-align: top;"> AHX669 </td> <td style="width: 33%; vertical-align: top;"> AHX826 </td> <td style="width: 33%; vertical-align: top;"> AHX671 </td> </tr> </table>	AHX669 	AHX826 	AHX671 																		
	Type	Used with																													
	AHX669	AR16F0N, F5N, F0T, F5T																													
	AXH826*																														
AHX671	AR16F0M, F5M, F0S, F5S AR16E0L, E5L, E0R, E5R																														
AHX669 	AHX826 	AHX671 																													
Protective cover (for Thin type) <div style="display: flex; flex-direction: column; align-items: center; margin-top: 10px;"> <div style="margin: 5px;">KKD07-249</div> <div style="margin: 5px;">KKD07-250</div> </div>	<table border="1" style="width: 100%; border-collapse: collapse;"> <tr> <th style="width: 30%;">Type</th> <th>Used with</th> </tr> <tr> <td>AF6D826-□</td> <td>AF16F0N, F0T</td> </tr> <tr> <td>AF6D827-□</td> <td>AF16F0M, F0S</td> </tr> </table> <p>This cover prevents accidental operation. Note: • The protective cover and the button are made of an integral structure. • Enter the color code in the square box .</p> <table border="1" style="width: 100%; border-collapse: collapse; text-align: center;"> <tr> <th style="width: 12.5%;">Color</th> <th style="width: 12.5%;">Green</th> <th style="width: 12.5%;">Red</th> <th style="width: 12.5%;">Transparent*</th> <th style="width: 12.5%;">Yellow</th> <th style="width: 12.5%;">Orange</th> <th style="width: 12.5%;">Blue</th> </tr> <tr> <th>Code</th> <td>G</td> <td>R</td> <td>C</td> <td>Y</td> <td>A</td> <td>S</td> </tr> <tr> <td>Color code of main unit</td> <td>G</td> <td>R</td> <td>W, B</td> <td>Y</td> <td>A</td> <td>S</td> </tr> </table> <p>* When the color code of the main unit is W, a combination of the transparent lens and the white legend plate comes to white. When it is B, a combination of the transparent lens and the black legend plate comes to black.</p> <ul style="list-style-type: none"> This cover returns to the home position with spring action. Not applicable to alternate models. Dimensions when connected with a push-button switch (unit: mm) 	Type	Used with	AF6D826-□	AF16F0N, F0T	AF6D827-□	AF16F0M, F0S	Color	Green	Red	Transparent*	Yellow	Orange	Blue	Code	G	R	C	Y	A	S	Color code of main unit	G	R	W, B	Y	A	S	<table style="width: 100%;"> <tr> <td style="width: 50%; vertical-align: top;"> AF6D826 </td> <td style="width: 50%; vertical-align: top;"> AF6D827 </td> </tr> </table>	AF6D826 	AF6D827
	Type	Used with																													
	AF6D826-□	AF16F0N, F0T																													
AF6D827-□	AF16F0M, F0S																														
Color	Green	Red	Transparent*	Yellow	Orange	Blue																									
Code	G	R	C	Y	A	S																									
Color code of main unit	G	R	W, B	Y	A	S																									
AF6D826 	AF6D827 																														
Dust-proof cover (for Standard type) <div style="display: flex; flex-direction: column; align-items: center; margin-top: 10px;"> <div style="margin: 5px;">KKD07-251</div> <div style="margin: 5px;">KKD07-252</div> </div>	<table border="1" style="width: 100%; border-collapse: collapse;"> <tr> <th style="width: 30%;">Type</th> <th>Used with</th> </tr> <tr> <td>AHX668</td> <td>AR16F0N, F5N, F0T, F5T</td> </tr> <tr> <td>AHX822</td> <td>AR16F0M, F5M, F0S, F5S AR16E0L, E5L, E0R, E5R</td> </tr> </table> <p>This cover seals the operator section to prevent powder or dust from invading inside the switch (Packing is provided).</p>	Type	Used with	AHX668	AR16F0N, F5N, F0T, F5T	AHX822	AR16F0M, F5M, F0S, F5S AR16E0L, E5L, E0R, E5R	<table style="width: 100%;"> <tr> <td style="width: 33%; vertical-align: top;"> AHX668 </td> <td style="width: 33%; vertical-align: top;"> AHX822 </td> <td style="width: 33%; vertical-align: top;"> </td> </tr> </table>	AHX668 	AHX822 																					
	Type	Used with																													
AHX668	AR16F0N, F5N, F0T, F5T																														
AHX822	AR16F0M, F5M, F0S, F5S AR16E0L, E5L, E0R, E5R																														
AHX668 	AHX822 																														
Terminal cover <div style="display: flex; flex-direction: column; align-items: center; margin-top: 10px;"> <div style="margin: 5px;">KKD07-253</div> </div>	<table border="1" style="width: 100%; border-collapse: collapse;"> <tr> <th style="width: 30%;">Type</th> <th>Used with</th> </tr> <tr> <td>AR6Y261</td> <td>Illuminated pushbutton switch, pushbutton switch, selector switch, pilot light</td> </tr> </table> <p>Protective cover for insulation between terminals and live parts. Note: • Dimensions when connected with a switch (pilot light) (unit: mm)</p> <p>Standard type Thin type</p> <ul style="list-style-type: none"> Wiring work should be made first, and attach the cover to the switch (pilot light). Use cables of sheath outer diameter of $\phi 2.8$mm or less. 	Type	Used with	AR6Y261	Illuminated pushbutton switch, pushbutton switch, selector switch, pilot light	<table style="width: 100%;"> <tr> <td style="width: 50%; vertical-align: top;"> </td> <td style="width: 50%; vertical-align: top;"> </td> </tr> </table>																									
	Type	Used with																													
AR6Y261	Illuminated pushbutton switch, pushbutton switch, selector switch, pilot light																														



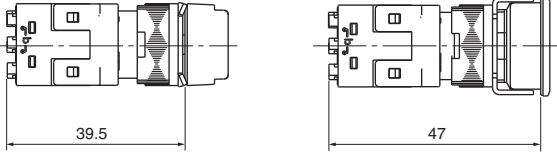
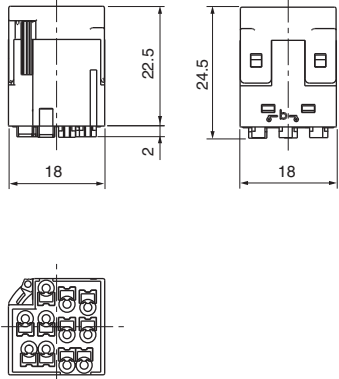

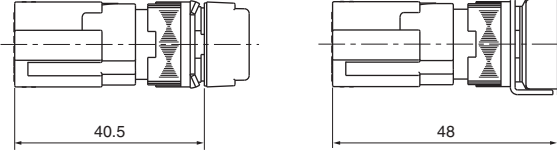
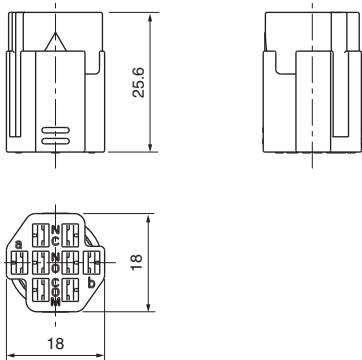

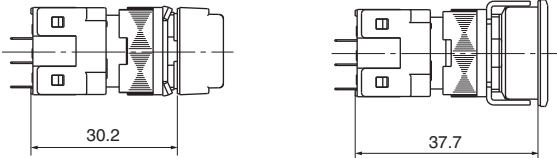
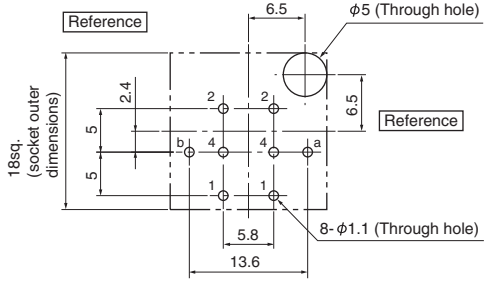
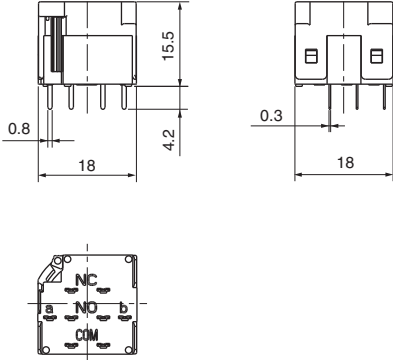

Command Switches

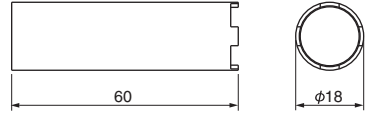
AR16, DR16 and AF16, DF16

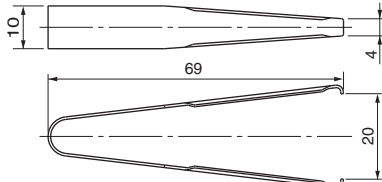
Accessories

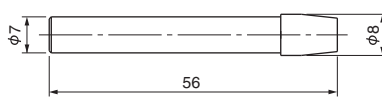
Description	Type	Dimensions, mm												
Fast-connection socket  KKD08-093	<table border="1"> <thead> <tr> <th>Type</th> <th>Used with</th> </tr> </thead> <tbody> <tr> <td>AR6S690-L1</td> <td>Illuminated pushbutton switch : SPDT</td> </tr> <tr> <td>AR6S690-L2</td> <td>Illuminated pushbutton switch : 2PDT</td> </tr> <tr> <td>AR6S690-LX</td> <td>Pilot light</td> </tr> <tr> <td>AR6S690-R1</td> <td>Pushbutton switch, selector switch : SPDT</td> </tr> <tr> <td>AR6S690-R2</td> <td>Pushbutton switch, selector switch : 2PDT</td> </tr> </tbody> </table> <p>By combining with a switch, they can be used as a Fast-connection type switch.</p> <p>Note: Dimensions when connected with a switch (pilot light) (unit:mm)</p> <p>Standard type Thin type</p> 	Type	Used with	AR6S690-L1	Illuminated pushbutton switch : SPDT	AR6S690-L2	Illuminated pushbutton switch : 2PDT	AR6S690-LX	Pilot light	AR6S690-R1	Pushbutton switch, selector switch : SPDT	AR6S690-R2	Pushbutton switch, selector switch : 2PDT	
Type	Used with													
AR6S690-L1	Illuminated pushbutton switch : SPDT													
AR6S690-L2	Illuminated pushbutton switch : 2PDT													
AR6S690-LX	Pilot light													
AR6S690-R1	Pushbutton switch, selector switch : SPDT													
AR6S690-R2	Pushbutton switch, selector switch : 2PDT													
Connector socket  KKD07-255	<table border="1"> <thead> <tr> <th>Type</th> <th>Used with</th> </tr> </thead> <tbody> <tr> <td>AR6S691-C</td> <td>Illuminated pushbutton switch, pushbutton switch, selector switch, pilot light</td> </tr> </tbody> </table> <p>By combining with receptacle terminals, this can be used as a connector.</p> <p>Note: • The receptacle terminal is not supplied. Please prepare the receptacle terminal Model No. CMC62895-F made by NICHIFU Co.,Ltd. on your side.</p> <p>• Dimensions when connected with a switch (pilot light) (unit: mm)</p> <p>Standard type Thin type</p> 	Type	Used with	AR6S691-C	Illuminated pushbutton switch, pushbutton switch, selector switch, pilot light									
Type	Used with													
AR6S691-C	Illuminated pushbutton switch, pushbutton switch, selector switch, pilot light													
Socket for PC board  KKD08-096	<table border="1"> <thead> <tr> <th>Type</th> <th>Used with</th> </tr> </thead> <tbody> <tr> <td>AR6S692</td> <td>Illuminated pushbutton switch, pushbutton switch, selector switch, pilot light</td> </tr> </tbody> </table> <p>By combining with a switch, they can be used as a switch for PC board, connection type switch.</p> <p>Note: • Dimensions when connected with a switch (pilot light) (unit: mm)</p> <p>Standard type Thin type</p>  <p>• PC board processing drawing (View from component side) (unit: mm)</p> 	Type	Used with	AR6S692	Illuminated pushbutton switch, pushbutton switch, selector switch, pilot light									
Type	Used with													
AR6S692	Illuminated pushbutton switch, pushbutton switch, selector switch, pilot light													

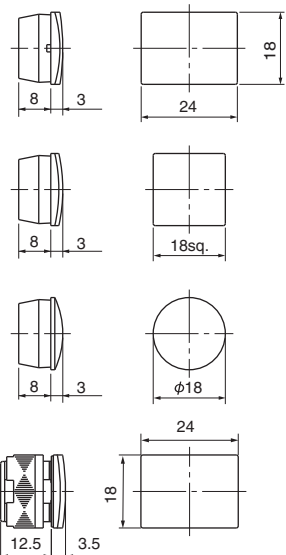

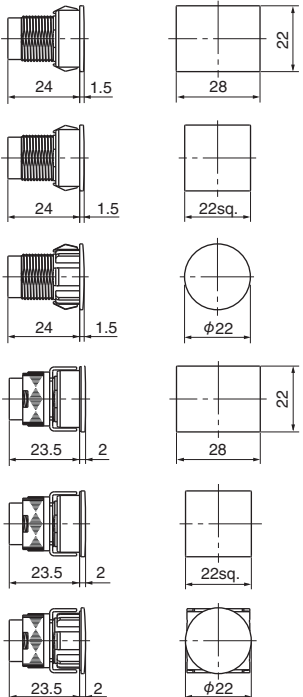



Command Switches AR16, DR16 and AF16, DF16 Accessories

Description	Type	Used with	Dimensions, mm																
Wrench  KKD07-257	AHX601	AR16 and DR16 series AF16 and DF16 series																	
Remover (for Standard type)  KKD07-258	AHX618	Illuminated pushbutton switch, pushbutton switch, pilot light																	
Lamp remover Part A →  KKD07-259	AHX672	Illuminated pushbutton switch, pilot light																	
Panel plug (for Standard type)  KKD07-260 KKD07-261 KKD07-262 KKD07-267	<table border="1"> <tr> <th>Type</th> <th>Used with</th> </tr> <tr> <td>AXH645-□</td> <td>Rectangular type Degree of protection: IP40</td> </tr> <tr> <td>AXH644-□</td> <td>Square type Degree of protection: IP40</td> </tr> <tr> <td>AXH622-□</td> <td>Round type Degree of protection: IP40</td> </tr> <tr> <td>AXH850-B^{*1}</td> <td>Rectangular type Degree of protection: IP65</td> </tr> </table> <table border="1"> <tr> <th>Type</th> <th>Black</th> <th>Gray</th> </tr> <tr> <td>Code</td> <td>B</td> <td>GY</td> </tr> </table>	Type	Used with	AXH645-□	Rectangular type Degree of protection: IP40	AXH644-□	Square type Degree of protection: IP40	AXH622-□	Round type Degree of protection: IP40	AXH850-B ^{*1}	Rectangular type Degree of protection: IP65	Type	Black	Gray	Code	B	GY	AHX645 AHX644 AHX622 AHX850-B	
Type	Used with																		
AXH645-□	Rectangular type Degree of protection: IP40																		
AXH644-□	Square type Degree of protection: IP40																		
AXH622-□	Round type Degree of protection: IP40																		
AXH850-B ^{*1}	Rectangular type Degree of protection: IP65																		
Type	Black	Gray																	
Code	B	GY																	
Panel plug (for Thin type)  KKD07-264 KKD07-266 KKD07-265 KKD07-263 KKD07-268 KKD07-269	<table border="1"> <tr> <th>Type</th> <th>Used with</th> </tr> <tr> <td>AF6Y645-B</td> <td>Rectangular type Degree of protection: IP40</td> </tr> <tr> <td>AF6Y644-B</td> <td>Square type Degree of protection: IP40</td> </tr> <tr> <td>AF6Y622-B</td> <td>Round type Degree of protection: IP40</td> </tr> <tr> <td>AF6Y850-B^{*1}</td> <td>Rectangular type Degree of protection: IP65</td> </tr> <tr> <td>AF6Y851-B^{*1}</td> <td>Square type Degree of protection: IP65</td> </tr> <tr> <td>AF6Y852-B^{*1}</td> <td>Round type Degree of protection: IP65</td> </tr> </table> *1 Packing, panel retainer, and nut are provided. Note: • The color is black only.	Type	Used with	AF6Y645-B	Rectangular type Degree of protection: IP40	AF6Y644-B	Square type Degree of protection: IP40	AF6Y622-B	Round type Degree of protection: IP40	AF6Y850-B ^{*1}	Rectangular type Degree of protection: IP65	AF6Y851-B ^{*1}	Square type Degree of protection: IP65	AF6Y852-B ^{*1}	Round type Degree of protection: IP65	AF6Y645-B AF6Y644-B AF6Y622-B AF6Y850-B AF6Y851-B AF6Y852-B			
Type	Used with																		
AF6Y645-B	Rectangular type Degree of protection: IP40																		
AF6Y644-B	Square type Degree of protection: IP40																		
AF6Y622-B	Round type Degree of protection: IP40																		
AF6Y850-B ^{*1}	Rectangular type Degree of protection: IP65																		
AF6Y851-B ^{*1}	Square type Degree of protection: IP65																		
AF6Y852-B ^{*1}	Round type Degree of protection: IP65																		

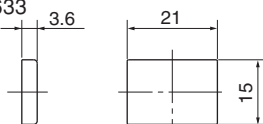
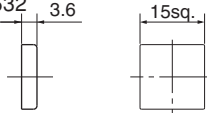
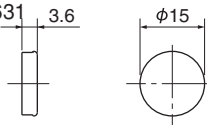
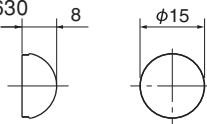
Command Switches

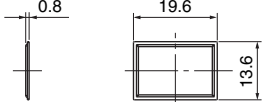
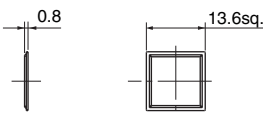
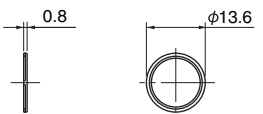
AR16, DR16 and AF16, DF16

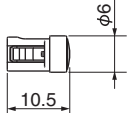
Accessories

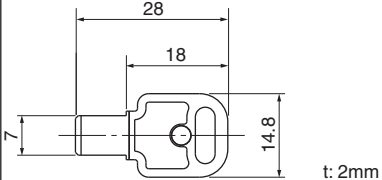
Description	Type	Dimensions, mm																															
Color lens and button 	<table border="1"> <tr> <th>Type</th> <th>Used with</th> </tr> <tr> <td>AR6C633-□</td> <td>AR16F0N, F5N, F0T, F5T, G0N, G5N, G0T, G5T DR16F0N AF16F0N, F5N, F0T, F5T, Type DF16F0N</td> </tr> <tr> <td>AR6C632-□</td> <td>AR16F0M, F5M, F0S, F5S, Type DR16F0M AF16F0M, F5M, F0S, F5S, Type DF16F0M</td> </tr> <tr> <td>AR6C631-□</td> <td>AR16E0L, E5L, E0R, E5R, Type DR16E0L AF16F0L, F5L, F0R, F5R, Type DF16F0L</td> </tr> <tr> <td>DR6C630-□</td> <td>DR16D0L</td> </tr> </table> <p>Note: Enter the color code in the square box □.</p> <table border="1"> <tr> <th>Color</th> <th>Green</th> <th>Red</th> <th>Transparent</th> <th>Yellow</th> <th>Orange</th> <th>Blue</th> </tr> <tr> <th>Code</th> <td>G</td> <td>R</td> <td>C</td> <td>Y</td> <td>A</td> <td>S</td> </tr> <tr> <th>Color code of main unit</th> <td>G</td> <td>R</td> <td>W, B</td> <td>Y</td> <td>A</td> <td>S</td> </tr> </table> <p>* When the color code of the main unit is W, a combination of the transparent lens and the white legend plate comes to white (except for dome type). When it is B, a combination of the transparent lens and the black legend plate comes to black (except for pilot light). When the dome type (DR16D0L)'s color code of the main unit is W, the lens code is W.</p>	Type	Used with	AR6C633 -□	AR16F0N, F5N, F0T, F5T, G0N, G5N, G0T, G5T DR16F0N AF16F0N, F5N, F0T, F5T, Type DF16F0N	AR6C632 -□	AR16F0M, F5M, F0S, F5S, Type DR16F0M AF16F0M, F5M, F0S, F5S, Type DF16F0M	AR6C631 -□	AR16E0L, E5L, E0R, E5R, Type DR16E0L AF16F0L, F5L, F0R, F5R, Type DF16F0L	DR6C630 -□	DR16D0L	Color	Green	Red	Transparent	Yellow	Orange	Blue	Code	G	R	C	Y	A	S	Color code of main unit	G	R	W, B	Y	A	S	AR6C633  AR6C632  AR6C631  DR6C630 
	Type	Used with																															
	AR6C633 -□	AR16F0N, F5N, F0T, F5T, G0N, G5N, G0T, G5T DR16F0N AF16F0N, F5N, F0T, F5T, Type DF16F0N																															
	AR6C632 -□	AR16F0M, F5M, F0S, F5S, Type DR16F0M AF16F0M, F5M, F0S, F5S, Type DF16F0M																															
AR6C631 -□	AR16E0L, E5L, E0R, E5R, Type DR16E0L AF16F0L, F5L, F0R, F5R, Type DF16F0L																																
DR6C630 -□	DR16D0L																																
Color	Green	Red	Transparent	Yellow	Orange	Blue																											
Code	G	R	C	Y	A	S																											
Color code of main unit	G	R	W, B	Y	A	S																											
Legend plate 	<table border="1"> <tr> <th>Type</th> <th>Used with</th> </tr> <tr> <td>AR6P667-□</td> <td>AR16F0N, F5N, F0T, F5T, G0N, G5N, G0T, G5T DR16F0N AF16F0N, F5N, F0T, F5T, Type DF16F0N</td> </tr> <tr> <td>AR6P666-□</td> <td>AR16F0M, F5M, F0S, F5S, Type DR16F0M AF16F0M, F5M, F0S, F5S, Type DF16F0M</td> </tr> <tr> <td>AR6P665-□</td> <td>AR16E0L, E5L, E0R, E5R, Type DR16E0L AF16F0L, F5L, F0R, F5R, Type DF16F0L</td> </tr> </table> <p>Note: Enter the color code in the square box □.</p> <table border="1"> <tr> <th>Type</th> <th>White</th> <th>Black</th> </tr> <tr> <th>Code</th> <td>W</td> <td>B</td> </tr> <tr> <th>Color code of main unit</th> <td>G, R, W, Y, A, S</td> <td>B</td> </tr> </table> <p>* When the color code of the main unit is W, a combination of the transparent lens and the white legend plate comes to white. When it is B, a combination of the transparent lens and the black legend plate comes to black (except for pilot light).</p>	Type	Used with	AR6P667 -□	AR16F0N, F5N, F0T, F5T, G0N, G5N, G0T, G5T DR16F0N AF16F0N, F5N, F0T, F5T, Type DF16F0N	AR6P666 -□	AR16F0M, F5M, F0S, F5S, Type DR16F0M AF16F0M, F5M, F0S, F5S, Type DF16F0M	AR6P665 -□	AR16E0L, E5L, E0R, E5R, Type DR16E0L AF16F0L, F5L, F0R, F5R, Type DF16F0L	Type	White	Black	Code	W	B	Color code of main unit	G, R, W, Y, A, S	B	AR6P667  AR6P666  AR6P665 														
	Type	Used with																															
	AR6P667 -□	AR16F0N, F5N, F0T, F5T, G0N, G5N, G0T, G5T DR16F0N AF16F0N, F5N, F0T, F5T, Type DF16F0N																															
	AR6P666 -□	AR16F0M, F5M, F0S, F5S, Type DR16F0M AF16F0M, F5M, F0S, F5S, Type DF16F0M																															
AR6P665 -□	AR16E0L, E5L, E0R, E5R, Type DR16E0L AF16F0L, F5L, F0R, F5R, Type DF16F0L																																
Type	White	Black																															
Code	W	B																															
Color code of main unit	G, R, W, Y, A, S	B																															
LED lamp 	<table border="1"> <tr> <th>Type</th> <th>Lamp operational voltage, current consumption</th> </tr> <tr> <td>DR6L695-A□</td> <td>6V AC/DC, Green, Red, Amber, blue: 7.5mA AC, 7.5mA DC Orange: AC8.5mA, DC8.5mA, Yellow: 17mA AC, 17mA DC</td> </tr> <tr> <td>DR6L695-B□</td> <td>12V AC/DC, Green, Red, Amber, blue: 7.5mA AC, 7.5mA DC Orange, Yellow: 8.5mA AC, 8.5mA DC</td> </tr> <tr> <td>DR6L695-E□</td> <td>24V AC/DC, Green, Red, Amber, blue: 7.5mA AC, 7.5mA DC Orange, Yellow: 8.5mA AC, 8.5mA DC</td> </tr> </table> <p>Note: Enter the color code in the square box □.</p> <table border="1"> <tr> <th>Color</th> <th>Green</th> <th>Red</th> <th>Orange</th> <th>Yellow</th> <th>Amber</th> <th>Blue</th> </tr> <tr> <th>Code</th> <td>G</td> <td>R</td> <td>W</td> <td>Y</td> <td>A</td> <td>S</td> </tr> <tr> <th>Color code of main unit</th> <td>G</td> <td>R</td> <td>W</td> <td>Y</td> <td>A</td> <td>S</td> </tr> </table>	Type	Lamp operational voltage, current consumption	DR6L695-A □	6V AC/DC, Green, Red, Amber, blue: 7.5mA AC, 7.5mA DC Orange: AC8.5mA, DC8.5mA, Yellow: 17mA AC, 17mA DC	DR6L695-B □	12V AC/DC, Green, Red, Amber, blue: 7.5mA AC, 7.5mA DC Orange, Yellow: 8.5mA AC, 8.5mA DC	DR6L695-E □	24V AC/DC, Green, Red, Amber, blue: 7.5mA AC, 7.5mA DC Orange, Yellow: 8.5mA AC, 8.5mA DC	Color	Green	Red	Orange	Yellow	Amber	Blue	Code	G	R	W	Y	A	S	Color code of main unit	G	R	W	Y	A	S			
	Type	Lamp operational voltage, current consumption																															
	DR6L695-A □	6V AC/DC, Green, Red, Amber, blue: 7.5mA AC, 7.5mA DC Orange: AC8.5mA, DC8.5mA, Yellow: 17mA AC, 17mA DC																															
	DR6L695-B □	12V AC/DC, Green, Red, Amber, blue: 7.5mA AC, 7.5mA DC Orange, Yellow: 8.5mA AC, 8.5mA DC																															
DR6L695-E □	24V AC/DC, Green, Red, Amber, blue: 7.5mA AC, 7.5mA DC Orange, Yellow: 8.5mA AC, 8.5mA DC																																
Color	Green	Red	Orange	Yellow	Amber	Blue																											
Code	G	R	W	Y	A	S																											
Color code of main unit	G	R	W	Y	A	S																											
Key 	<table border="1"> <tr> <th>Type</th> <th>Used with</th> </tr> <tr> <td>AR6C662-□</td> <td>AR16JT, JS, JR AF16JT, JS, JR</td> </tr> </table> <p>Note: * Enter the color code in the square box □.</p> <table border="1"> <tr> <th>Code (Key type)</th> <th>A</th> <th>B</th> <th>C</th> <th>D</th> <th>E</th> <th>F</th> </tr> </table> <p>* Two pieces per set on delivery. * Both sides of the key is same.</p>	Type	Used with	AR6C662 -□	AR16JT, JS, JR AF16JT, JS, JR	Code (Key type)	A	B	C	D	E	F																					
	Type	Used with																															
AR6C662 -□	AR16JT, JS, JR AF16JT, JS, JR																																
Code (Key type)	A	B	C	D	E	F																											

• **Standard type <AR16, DR16 series>**

1. Illuminated push button switches (g)

Type	Without transformer	
	SPDT	2PDT
AR16F0N	9.3	9.9
AR16F5N	9.3	9.9
AR16G0N	9.4	10
AR16G5N	9.4	10
AR16F0M	8.7	9.3
AR16F5M	8.7	9.3
AR16E0L	8.1	8.7
AR16E5L	8.1	8.7

2. Pushbutton switches (g)

Type	SPDT	2PDT
AR16F0T	8.5	9.1
AR16F5T	8.5	9.1
AR16G0T	8.7	9.3
AR16G5T	8.7	9.3
AR16F0S	8	8.6
AR16F5S	8	8.6
AR16E0R	7.4	8
AR16E5R	7.4	8

3. Pilot lights (g)

Type	Without transformer
DR16F0N	8.7
DR16F0M	8.1
DR16E0L	7.5
DR16D0L	7.5

4. Selector switches (knob type) (g)

Type	SPDT	2PDT
AR16PT	9.6	10.2
AR16PS	8.6	9.2
AR16PR	8.3	8.9

5. Selector switches (key type) (g)

Type	SPDT	2PDT
AR16JT	23.2	23.8
AR16JS	22.3	22.9
AR16JR	21.9	22.5

Note: The value when two keys are attached.

• **Thin type <AF16, DF16 series>**

1. Illuminated push button switches (g)

Type	Without transformer	
	SPDT	2PDT
AF16F0N	13.5	14.1
AF16F5N	13.5	14.1
AF16F0M	12.8	13.4
AF16F5M	12.8	13.4
AF16F0L	12	12.6
AF16F5L	12	12.6

2. Pushbutton switches (g)

Type	SPDT	2PDT
AF16F0T	12.7	13.3
AF16F5T	12.7	13.3
AF16F0S	12	12.6
AF16F5S	12	12.6
AF16F0R	11.3	11.9
AF16F5R	11.3	11.9

3. Pilot lights (g)

Type	Without transformer
DF16F0N	12.8
DF16F0M	12.1
DF16F0L	11.4

4. Selector switches (knob type) (g)

Type	SPDT	2PDT
AF16PT	14.2	14.8
AF16PS	13.7	14.3
AF16PR	13.1	13.7

5. Selector switches (key type) (g)

Type	SPDT	2PDT
AF16JT	27.8	28.4
AF16JS	27.3	27.9
AF16JR	26.8	27.4

Note: The value when two keys are attached.

Command Switches

AR16, DR16 and AF16, DF16

Rating and specifications/AR16V

Integrated Contacts Structure Emergency stop pushbutton switches AR16V

■ Features

- Up to four sets of contacts in a one-piece structure with a panel depth dimension of 28 mm (non-illuminated type).

Non illuminated type

Illuminated type

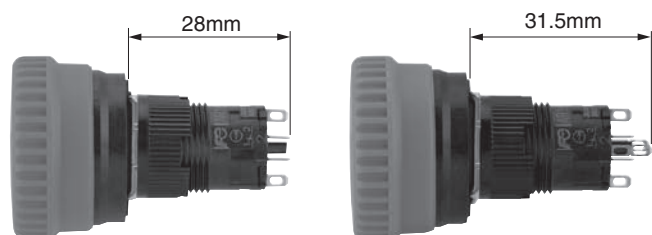

- Both pull or turn reset methods are supported.
- Two button diameters are available: 32 mm (AR16V0) and 40 mm (AR16V1).
- Safety trigger-action mechanism that prevents the contacts from operating until the switch is locked, even if people or objects accidentally come into contact with the switch.
- Direct opening mechanism for NC contacts to ensure that the contacts can be opened even in the unlikely event that they become fused. (→)
- IP65 protection for operating section.

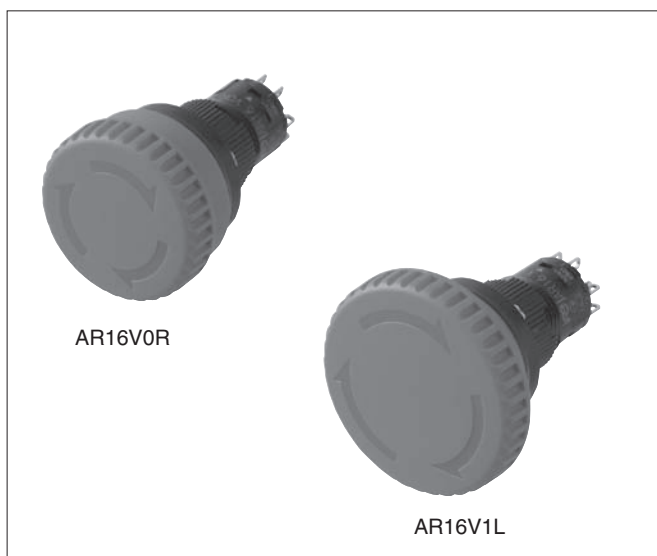

- RoHS compliance (EU Directive 2002/95/EC) is a standard feature.
- Compliance with UL/CSA standards, China Compulsory Certification (CCC) standards, and TÜV (EN standards).
- CE marking. 

■ Specifications (indoor use)

Item	AR16V	
Rated insulation voltage U_i	250V AC/DC	
Durability	Mechanical	100,000 operations
	Electrical	100,000 operations (AC-15, AC-13, AC-12, DC-13, DC-12)
Operating frequency	1200 operations / hour (On-load factor : 40%)	
Withstand voltage	Between live section and grounding	2000V AC, 1 minute
	Between opposite polarity live sections	2000V AC, 1 minute
Insulation resistance	100M Ω or more (500V DC megger)	
Rated impulse withstand voltage U_{imp}	2.5kV	
Conditional short-circuit current	1000A	
Short-circuit protective device	gG 6A (IEC60269 Fuse)	
Pollution degree	3	
Vibration	Operating extremes	: frequency 10 to 500 Hz, double amplitude 0.7mm acceleration 50m/s ²
	Damage limits	: frequency 10 to 500 Hz, double amplitude 0.7mm acceleration 50m/s ²
Shock	Malfunction durability	: 100m/s ²
	Mechanical durability	: 500m/s ²
Operational ambient temperature	-10 to +55°C (no icing or no condensation)	
Storage temperature	-40 to +70°C	
Relative humidity (inside control panel)	45 to 85%RH (-5 to 40°C) (no icing or no condensation)	
Degree of protection of operating (displaying) section	IP65 (dust-ploof, water jet proof): IEC 60529	
Degree of protection of control section	IP2X (Terminal cover : AR6Y262, At the connection)	
Terminal style	Solder terminal	
Connectable wire	0.75mm ² maximum (18AWG maximum)	

■ **Contact ratings**

• TÜV (EN60947-5-1), JIS C 8201-5-1 (1999)

Conventional free air thermal current I _{th}	Rated operational current					
	Rated operational voltage U _e	AC			DC	
		AC-12 (Resistive load)	AC-13 (Inductive load)	AC-15 (Inductive load)	DC-12 (Resistive load)	DC-13 (Inductive load)
5A	24V	—	—	—	1.0A	0.7A
	120V	1.5A	1.0A	0.3A	—	—
	125V	—	—	—	0.2A	0.15A
	240V	1.0A	0.7A	0.3A	—	—

• **UL/CSA**

• AC (COSφ=0.35)

Contact rating code	120V		240V	
	Making current	Braeking current	Making current	Braeking current
C300	15A	1.5A	7.5A	0.75A

• DC (T_{0.95}=6P)

Contact rating code	Making current · Braeking current	
	125V	250V
R300	0.22A	0.11A

■ **Contact reliability**

- FUJI has confirmed that the product can be used in 1mA circuit conditions at 5V AC or DC. The operable range, however, may vary depending on the operational ambient conditions and type of load.

■ **Operating characteristic**

Operation	Push-lock, turn-reset or pull-reset
Ave. required operating force	25N
Operating travel	Approx. 5.4mm
Operation angle	Approx. 45°
Required return force (pull-reset)	20N
Required return force (turn-reset)	0.3N · m

■ **Mass**

(g)

Type	1NC	2NC(1NO+1NC)	4NC(2NO+2NC)
AR16V0R	19.0	19.4	20.0
AR16V1R	21.1	21.5	22.1
AR16V0L	19.7	20.1	20.7
AR16V1L	21.8	22.2	22.8

■ **Standards approved**

UL508	cUL File No. E44592
CSA C22.2 No.14	
TÜV : EN60947-5-1, EN60947-5-5	R50136611

■ **Lamp rating and current consumption**

Applied method	Type of lamp	Luminous color	Lamp rated voltage	Current consumption
Without transformer	LED lamp	Red	6V AC/DC	9mA AC, 7.5mA DC
			12V AC/DC	7.5mA AC, 7.5mA DC
			24V AC/DC	7.5mA AC, 7.5mA DC



Command Switches

AR16, DR16 and AF16, DF16



Type numbers/AR16V

■ Type

- Emergency stop pushbutton switches

Operator	Contact	Type
Unibody push-lock, pull or turn-reset (32mm dia.)  (KKD08-090)	1NC	AR16V0R-01R
	1NO+1NC	AR16V0R-11R
	2NC	AR16V0R-02R
	1NO+2NC	AR16V0R-12R
	3NC	AR16V0R-03R
	1NO+3NC	AR16V0R-13R
	4NC	AR16V0R-04R
	Unibody push-lock, pull or turn-reset (40mm dia.)  (KKD08-092)	1NC
1NO+1NC		AR16V1R-11R
2NC		AR16V1R-02R
1NO+2NC		AR16V1R-12R
3NC		AR16V1R-03R
1NO+3NC		AR16V1R-13R
4NC		AR16V1R-04R

- Emergency stop illuminated pushbutton switches

Operator	Contact	LED Lamp Type
Unibody push-lock, pull or turn-reset (32mm dia.)  (KKD08-087)	1NC	AR16V0L-01■R
	1NO+1NC	AR16V0L-11■R
	2NC	AR16V0L-02■R
	1NO+2NC	AR16V0L-12■R
	3NC	AR16V0L-03■R
	1NO+3NC	AR16V0L-13■R
	4NC	AR16V0L-04■R
	Unibody push-lock, pull or turn-reset (40mm dia.)  (KKD08-091)	1NC
1NO+1NC		AR16V1L-11■R
2NC		AR16V1L-02■R
1NO+2NC		AR16V1L-12■R
3NC		AR16V1L-03■R
1NO+3NC		AR16V1L-13■R
4NC		AR16V1L-04■R

- Voltage Replace the ■mark by the lamp voltage code

Lamp voltage	Code
6V AC/DC	A3
12V AC/DC	B3
24V AC/DC	E3

Command Switches AR16, DR16 and AF16, DF16 Dimensions and Accessories/AR16V

■ Dimensions, mm

• Emergency stop pushbutton switches

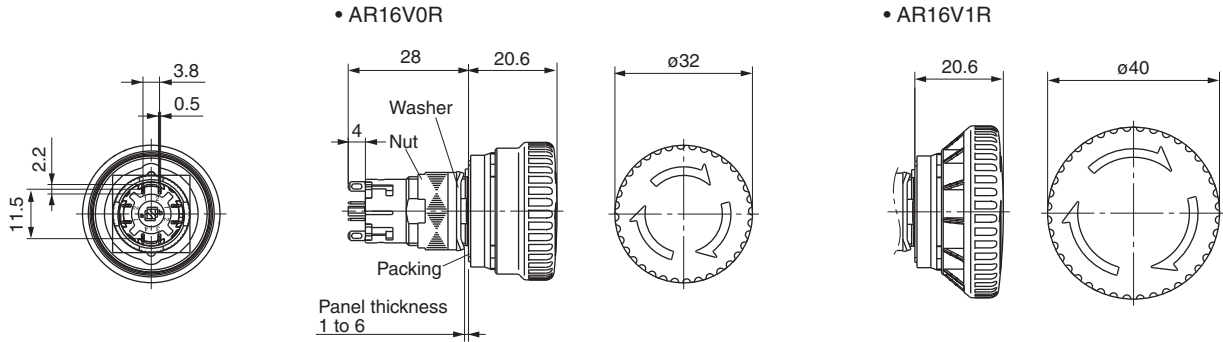

• Emergency stop illuminated pushbutton switches

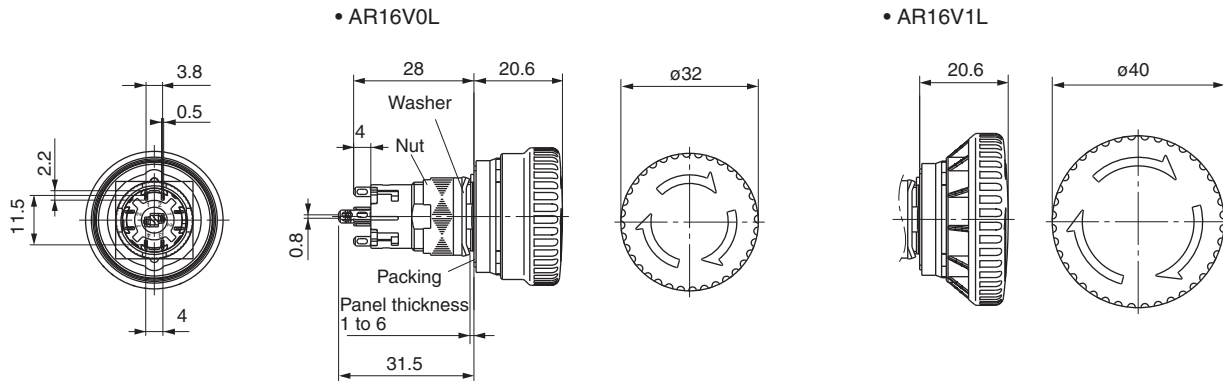

■ Accessories

Description	Type	Dimensions, mm									
<p>(KKD07-257)</p>	<p>AHX601 (AH9A601) When installing a command switch on a panel, this tool is useful for tightening the switch firmly and efficiently.</p>										
	<p>AR6Y262 Protective cover for insulation between terminals and live parts. Note : Dimensions when connected with a switch (unit : mm)</p> <p>• Wiring work should be made first , and attach the cover to the switch.</p>										
<p>Legend plate for AR16V emergency stop</p>	<p>AR6P719- *1,2</p> <table border="1"> <thead> <tr> <th>Legend</th> <th>code (*1, 2)</th> <th>Letter height</th> </tr> </thead> <tbody> <tr> <td>Black</td> <td>00</td> <td>—</td> </tr> <tr> <td>EMERGENCY STOP</td> <td>5A</td> <td>7mm</td> </tr> </tbody> </table> <p>• Plate color : Yellow • Letter color : Black</p>	Legend	code (*1, 2)	Letter height	Black	00	—	EMERGENCY STOP	5A	7mm	<p>Thickness : 0.35mm</p>
Legend	code (*1, 2)	Letter height									
Black	00	—									
EMERGENCY STOP	5A	7mm									

Command Switches AR16, DR16 and AF16, DF16 Notes on use/AR16V

■ Notes on use

Safety Precautions

Read the Operating Instructions carefully before mounting, wiring, operating, servicing, or inspecting the command switch. Make sure that the Operating Instructions is delivered to the final user of the command switch.

- The safety precautions are classified into two levels, "**WARNING** and **CAUTION**", with meanings described follows.

WARNING: Indicates a potentially hazardous situation, which, if not avoided, could result in death or serious injury.

CAUTION: Indicates a potentially hazardous situation, which, if not avoided, may result in minor or moderate injury and/or damage to the equipment.

An item described under "**CAUTION**" may result in a serious accident, depending on the situation.

WARNING

- Do not touch or approach any live part while power is supplied. An electric shock or burning may result.
- Be sure to turn off the power before mounting, dismantling, wiring, or inspecting, the product.
An electric shock, burning from short-circuiting, or equipment malfunction may result.

CAUTION

- Wire the product according to the wiring instructions in the Operating Instructions. Make sure that the size of the wires is suitable for the voltage and applied current.
The wrong wiring may result in fire, accidents, or malfunctions.
- Treat the product as industrial waste when it is to be discarded.

■ Panel cutout (mm)

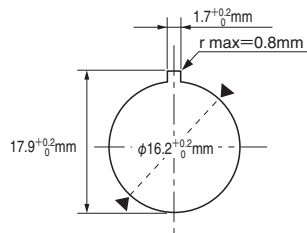

■ Applicable panel thickness

The applicable panel thickness is 1 to 6 mm. When the terminal cover (AR6Y262) is used, however, the applicable panel thickness will be 1 to 3.2 mm.

■ High-density mounting

The following minimum mounting pitch applies to high-density mounting.

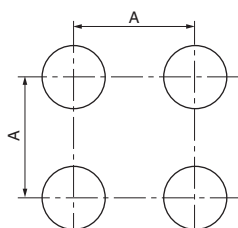

Type	Dimension A
AR16V0□	41mm min.
AR16V1	45mm min.
With AR6P719	65mm min.

Note : Determine the mounting pitch by taking the operability and wiring workability into consideration.

• Installation on panel

As shown in the figure below, insert the switch main unit into the panel cutout from the front of the panel with the top of the switch main unit (marked with an inverted triangular) facing upward. Then, use a tightening wrench (AHX601) and secure the unit with a washer and tightening nut from the rear of the panel.

Note : The proper tightening torque is 0.6 to 1.0 N · m.

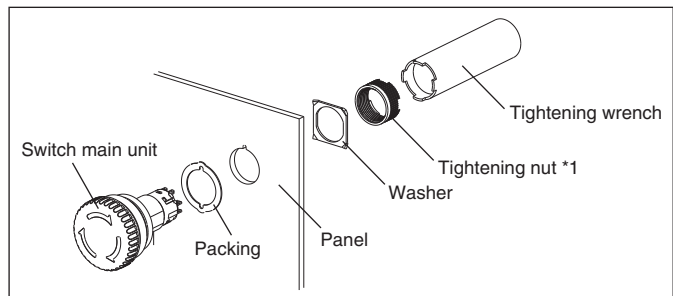
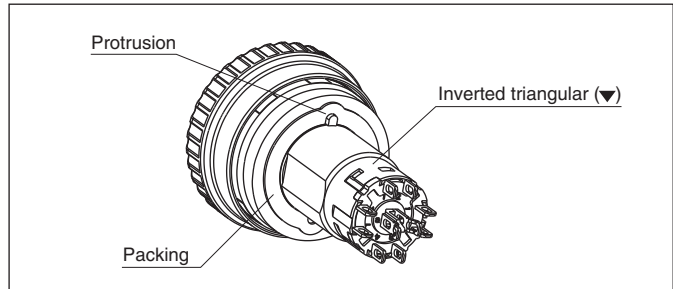

*1 : Do not use pliers or other improper tools tighten the nut, and do not tighten it excessively, or the nut may be damaged or switch may malfunction.

■ Wiring

- The wiring to this switch must be soldered. Keep the following items in mind when soldering.
 - Type of solder : Use resin-core solder.
 - Use a soldering iron with a maximum power consumption of 60W (350°C) within five seconds. Make sure that the terminals is free of tension during soldering. Also, do not deform the terminal.
- Lead-free solder has a high melting point, but the specific melting point depends on the type of lead-free solder. This may cause difficulty in soldering. Be careful not to overheat the solder if a soldering iron with a large soldering tip or a large heating capacity is used. Keep in mind that overheating the solder may result in product malfunctioning.
- Connectable wires
 - One Solid wires with a maximum diameter of 1.0mm
 - One standed wire with a maximum area of 0.75 mm²
- For wiring to adjacent terminals, use the terminal cover (AR6Y262) to prevent short-circuit, or an insulation tube to assure isolation. Care is necessary when two wires are connected together or a large quantity of solder is applied. In addition, keep in mind that overheating the tube may result in product malfunctioning if a heat-shrinking tube is used.

• Terminal arrangement

Model	Circuit diagram (example)	Terminal arrangement (view from the terminal (back) side)
Emergency stop pushbutton switches		<p>Top (marked with inverted triangular)</p> <p>Terminals 1-2 : b (NC) contact terminals Terminals 3-4 : a (NO) contact terminals Terminals a-b : Lamp terminals</p>
Emergency stop illuminated pushbutton switches		<p>Terminals 1-2 : b (NC) contact terminals Terminals 3-4 : a (NO) contact terminals Terminals a-b : Lamp terminals</p>

Note : If NO contacts are used in the contact configuration, they will be on the top of the unit (marked with the inverted triangular) and on the opposite side, regardless of the number of contacts.

■ Terminal cover (AR6Y262)

• Combination

The terminal cover must be attached in the correct direction. Make sure that the triangular on the terminal cover is aligned with the inverted triangular on the top of the unit. Also, when wiring the switch, check the alignment of these triangles and insert the wires correctly through the corresponding holes in the terminal cover.

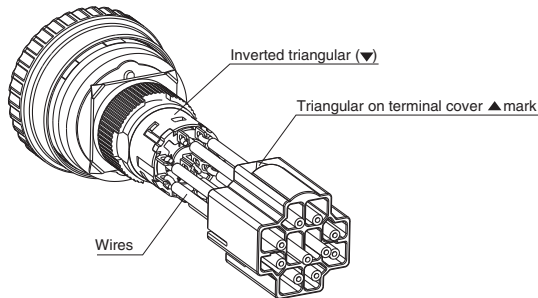

■ Nameplate (AR6P719)

• Precautions

The nameplate must be attached. Attach the nameplate to an appropriate part, such as the panel, after removing the paper from the back of the nameplate.

Before attaching the nameplate, clean the surface to which the nameplate will be attached with alcohol.

The nameplate may come off if the surface is dirty or oily.

• Attachment Procedure (Example)

Remove portions ① and ② from the center of the nameplate, align the nameplate with the panel cutout, and lightly press on the front surface of the nameplate to attach it to the panel. Then remove portions ③ and ④, and press on the entire front surface of the nameplate to complete attaching it to the panel.

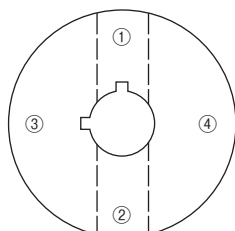

■ Others

Operation

- Do not hit or flip the button, or the button may be damaged. Be sure to operate the button by hand.
- To unlock the switch, turn the button approximately 45° clockwise (in the direction of the arrow) or pull out the button. Do not operate or handle the button with excessive force.
- Do not lock the emergency stop pushbutton switch during normal use. Push and lock the switch only in an emergency.

Storage and Usage Locations

- Be sure to use and store the product within the rated ambient temperature and humidity ranges.
- Although the product resists ordinary cutting oils and coolant oils, do not use the unit in places where special oils may be sprayed onto the product.
- If dusts or filings accumulate in the gap between the button and the frame, the switch may fail to operate normally.
- This switch are for indoor use. Make sure that the product is not exposed to direct sunlight.
- Do not use the product in the places that are subject to the adverse effects of ozone or corrosive gases.

Pushbuttons/Selectors/Pilot Lights/Buzzers

AH164, AH165 and AH165-2

General information

■ Features

Design basis

The 16mm dia. series of compact size pushbuttons are 'finger-size', and consequently take up little panel space. AH165-2 series operators are about twice as large as the AH164 and AH165 series operators for easier operation. With many types of operator available, the most suitable switch can be identified by color, shape and legend, and have a smooth, quality "snap-action". In spite of their small size they have a highly reliable mechanism, and are eminently suited for solid state and other electronic circuits. AH164, AH165 and AH165-2 series contact block holders can easily be removed manually. Moreover, the contact block can be easily attached or detached without using any special tools, thus facilitating addition or replacement of contact.

Selector switches

Selector switches can also be supplied in either knob-handle operated or key operated types.

Strong construction

The operator and contact blocks are molded from an excellent thermal resistance resin and can withstand the heat at the time of soldering. Since these pushbuttons are manufactured to industrial standards they can withstand vibration or shock thus eliminating lamp failure due to such causes as loose bases. With regard to the degree of protection, standard types which met the requirements of IP40 of IEC 60529, and oil tight types which meet the requirements of IP65 of the said, are available. This permits the application to various fields, from machine tools to OA (Office Automation) facilities.

Quality feel tough

Both the operator and contact block are precisely engineered. There is no fear of the switch malfunction even after long use and it continues to operate smoothly for its service life of about 1,000,000 operations.

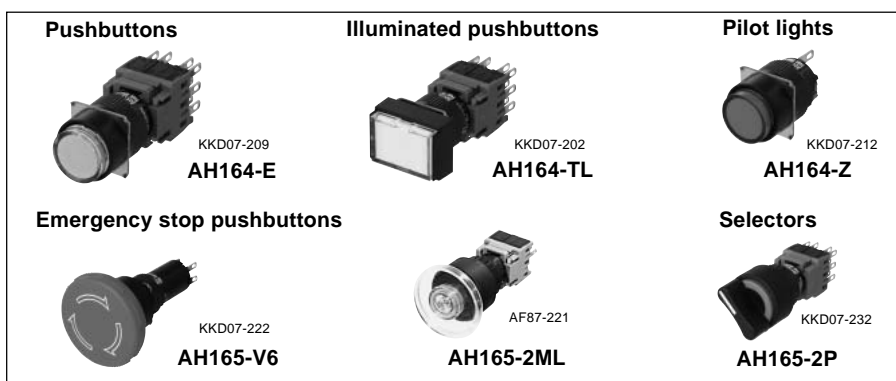

Easy color change

Color lenses fit over the inner button. The lens can easily be removed using a small screwdriver

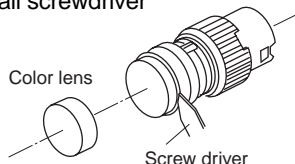

Note: The luminous color of LEDs and neon illumination types varies with the body color of the product.

Visible inscription

Button legends are printed on legend sheet, which is stuck to the legend plate on the inner button. The lettering is back lit by the switch lamp and the inscription is highly visible through the color lens. Contact FUJI for your lettering requirements.

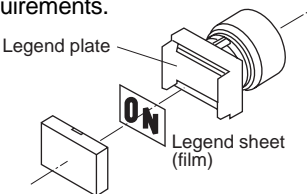

Excellent switch reliability

The switch uses a snap-action mechanism. The pushbuttons are available with either momentary or alternative actions. The snap-action switch has a double break movement which operates independently of the speed of switching. The contacts are made from gold-flashed silver. High contact reliability of 1mA at 5V AC/DC is assured. Contact blocks are available in 1NO+1NC to 3NO+3NC arrangement.

Large terminals

Solder/tab terminal is provided as standard. Wire-wrap terminal is available on request.

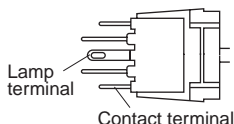

Safety

FUJI's original Trigger Action mechanism is used in the emergency stop pushbuttons. They are suitable for emergency stop and safety. This mechanism prevents the contacts from moving until the button is pushed and locked.

- Provided with a trigger action mechanism conforming to EN418.
- Provided with direct opening action (approved by TÜV) conforming to EN60947-5-1 and EN60947-5-5.

Alternate action

In the case of alternate action when the button is depressed the contacts are maintained and remain so even if the finger is removed. The button will not return to its free position. In order to remove the lock, the button must be given a second pressure before the button will return to its free position. This makes it most suitable as the switch for a power source.

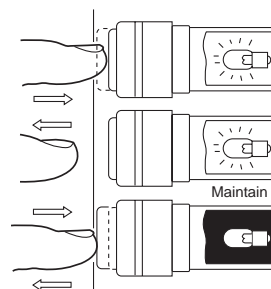

Pushbutton with finger guards

Finger guards are provided for square or rectangular type pushbuttons (SF, TF, SL and TL types) in order to prevent operational error of adjacent buttons.











Approvals



For further information related to approved type, see page 04/187 to 04/190.











AH164 (standard) / AH165 (oil-tight)

■ **Illuminated pushbutton switches**





Operator	Type	Operator	Type	Operator	Type
Extended round head <i>See page 04/195</i> 	AH164-L, L5 AH165-L, L5  KKD07-205	Flush square head <i>See page 04/195</i> 	AH164-SL, SL5 AH165-SL, SL5  KKD07-204	Flush rectangular head <i>See page 04/195</i> 	AH164-TL, TL5 AH165-TL, TL5  KKD07-202
Flush rectangular head with guard <i>See page 04/196</i> 	AH164-TGL, TGL5 AH165-TGL, TGL5  KKD07-203	Flush square head with guard <i>See page 04/196</i> 	AH164-SGL, SGL5 AH165-SGL, SGL5  KKD05-075b		

Note: Spot LED and red/green LED types: Not approved standard

■ **Pushbutton switches**

Operator	Type	Operator	Type	Operator	Type
Extended round head <i>See page 04/199</i> 	AH164-E, E5 AH165-E, E5  KKD07-209	Mushroom head <i>See page 04/199</i> 	AH164-M, M5 AH165-M, M5  KKD07-210	Flush square head <i>See page 04/199</i> 	AH164-SF, SF5 AH165-SF, SF5  KKD07-208
Flush rectangular head <i>See page 04/199</i> 	AH164-TF, TF5 AH165-TF, TF5  KKD07-206	Flush rectangular head with guard <i>See page 04/199</i> 	AH164-TGF, TGF5 AH165-TGF, TGF5  KKD05-176	Flush square head with guard <i>See page 04/199</i> 	AH164-SGF, SGF5 AH165-SGF, SGF5  KKD05-075b
Convex square head <i>See page 04/199</i> 	AH164-SM, SM5 AH165-SM, SM5  KKD05-081b	Convex rectangular head <i>See page 04/199</i> 	AH164-TM, TM5 AH165-TM, TM5  KKD05-082b	Push-lock, turn-reset (32mm dia.) ⊖ (Direct opening action) <i>See page 04/200</i> 	AH165-VR  AF91-584
Push-lock, turn-reset (40mm dia.) ⊖ (Direct opening action) <i>See page 04/200</i> 	AH165-V1R  AF91-583				

■ **Emergency stop pushbutton switches** ⊖ (Direct opening action), conform to EN418

Operator	Type	Operator	Type
Push-lock, turn-reset (32mm dia.) <i>See page 04/200</i> 	AH165-V5R  KKD07-221	Push-lock, turn-reset (40mm dia.) <i>See page 04/200</i> 	AH165-V6R  KKD07-222













Note: (CCC): *See page 04/292*

Pushbuttons/Selectors/Pilot Lights/Buzzers









AH164, AH165 and AH165-2

Quick reference guide







■ Selector switches

Operator	Type	Operator	Type	Operator	Type
Knob with rectangular bezel <i>See page 04/201</i> 	AH164-P AH165-P  KKD07-213	Knob with square bezel <i>See page 04/201</i> 	AH164-SP AH165-SP  KKD07-215	Key with rectangular bezel <i>See page 04/201</i> 	AH164-J AH165-J  KKD09-001L
Key with square bezel <i>See page 04/201, 04/204</i> 	AH164-SJ AH165-SJ  KKD09-001R	Key with rectangular bezel ⊖ (Direct opening action) <i>See page 04/202</i> 	AH165-JM  KKD09-006	Key ⊖ (Direct opening action) <i>See page 04/202</i> 	AH165-RJM  KKD09-007

■ Pilot lights

Lens	Type	Lens	Type	Lens	Type
Extended round <i>See page 04/206</i> 	AH164-Z AH165-Z  KKD07-212	Flush square <i>See page 04/206</i> 	AH164-ZS AH165-ZS  KKD05-094b	Flush rectangular <i>See page 04/206</i> 	AH164-ZT AH165-ZT  KKD07-211
Dome <i>See page 04/206</i> 	AH165-ZM  AF87-45				

■ Buzzers

Sound	Type	Sound	Type	Sound	Type
Standard <i>See page 04/208</i>	AH164-TX  AF87-317	Loud sound <i>See page 04/208</i>	AH164-TX1  AF87-44	Loud sound with volume control <i>See page 04/208</i> 	AH164-TX2B  KKD07-223
Standard sound with volume control (IP54) <i>See page 04/208</i> 	AH165-X  KKD05-096b				

Note: (CCC): *See page 04/292*

AH165-2 (oil-tight)

■ **Illuminated pushbutton switches**

Operator	Type	Operator	Type	Operator	Type
Flush round head <i>See page 04/213</i> 	AH165-2FL, 2FL5  AF87-211	Extended round head <i>See page 04/213</i> 	AH165-2EL, 2EL5  AF87-210	Mushroom head <i>See page 04/213</i> 	AH165-2ML  AF87-221
Mushroom head with square bezel <i>See page 04/213</i> 	AH165-2YML  AF87-220	Flush square head <i>See page 04/214</i> 	AH165-2SFL, 2SFL5  AF87-201	Extended square head <i>See page 04/214</i> 	AH165-2SEL, 2SEL5  AF87-200
Concave square head <i>See page 04/214</i> 	AH165-2SCL, 2SCL5  AF87-199	Push-lock, turn-reset <i>See page 04/215</i> 	AH165-2VL  AF87-219	Push-lock, turn-reset with square bezel <i>See page 04/215</i> 	AH165-2YVL  AF87-218

Note: : *See page 04/292*

■ **Pushbutton switches**













Operator	Type	Operator	Type	Operator	Type
Flush round head <i>See page 04/216</i> 	AH165-2F, 2F5  AF87-211	Extended round head <i>See page 04/216</i> 	AH165-2E, 2E5  AF87-210	Mushroom head <i>See page 04/216</i> 	AH165-2M  AF87-215
Mushroom head with square bezel <i>See page 04/216</i> 	AH165-2YM  AF87-214	Flush square head <i>See page 04/216</i> 	AH165-2SF, 2SF5  AF87-201	Concave square head <i>See page 04/216</i> 	AH165-2SCE, 2SCE5  AF87-199
Extended square head <i>See page 04/216</i> 	AH165-2SE, 2SE5  AF87-200	With selector ring <i>See page 04/217</i> 	AH165-2S2  AF87-207	With selector ring with square bezel <i>See page 04/217</i> 	AH165-2YS2  AF87-206
Push-lock, turn-reset <i>See page 04/217</i> 	AH165-2V  AF87-217	Push-lock, turn-reset with square bezel <i>See page 04/217</i> 	AH165-2YV  AF87-216		

Pushbuttons/Selectors/Pilot Lights/Buzzers

AH164, AH165 and AH165-2

Quick reference guide









■ Selector switches

Operator	Type	Operator	Type	Operator	Type
Knob	AH165-2P  KKD07-232	Knob with square bezel	AH165-2YP  KKD07-234	Key	AH165-2J  KKD09-003L
<i>See page 04/218</i> 		<i>See page 04/218</i> 		<i>See page 04/218</i> 	
Key with square bezel	AH165-2YJ  KKD09-003R	Lever	AH165-2H  AF87-209	Lever with square bezel	AH165-2SH  AF87-203
<i>See page 04/218</i> 		<i>See page 04/219</i> 		<i>See page 04/219</i> 	

■ Illuminated selector switches

Operator	Type
Knob	AH165-2PL  KKD07-240
<i>See page 04/221</i> 	

■ Pilot lights

Lens	Type	Lens	Type	Lens	Type
Flush round	AH165-2Z  AF87-213	Extended round	AH165-2ZE  AF87-212	Flush square	AH165-2SZ  AF87-205
<i>See page 04/222</i> 		<i>See page 04/222</i> 		<i>See page 04/222</i> 	
Extended square	AH165-2SZE  AF87-204				
<i>See page 04/222</i> 					

Note: (CCC): See page 04/292

Pushbuttons/Selectors/Pilot Lights/Buzzers AH164 and AH165 Type number nomenclature

■ Type number nomenclature

Pushbuttons, illuminated pushbuttons and pilot lights

AH165 - L R 11 E 3 - W
① ② ③ ④ ⑤ ⑥ ⑦

① Product category

AH164: Standard (IP40)

AH165: Oil-tight (IP65)

② Operator or lens

• Operator for illuminated pushbutton

SL: Flush square head

SL5: Flush square head (Alternate)

TL: Flush rectangular head

TL5: Flush rectangular head (Alternate)

L: Extended round head

L5: Extended round head (Alternate)

TGL: Flush rectangular head with guard

TGL5: Flush rectangular head with guard (Alternate)

SGL: Flush square head with guard

SGL5: Flush square head with guard (Alternate)

• Operator for pushbuttons

SF: Flush square head

SF5: Flush square head (Alternate)

TF: Flush rectangular head

TF5: Flush rectangular head (Alternate)

E: Extended round head

E5: Extended round head (Alternate)

TGF: Flush rectangular head with guard

TGF5: Flush rectangular head with guard (Alternate)

SGF: Flush square head with guard

SGF5: Flush square head with guard (Alternate)

M: Mushroom head

M5: Mushroom head (Alternate)

SM: Convex square head

SM5: Convex square head (Alternate)

TM: Convex rectangular head

TM5: Convex rectangular head (Alternate)

V: Push-lock, turn-reset (32mm dia.)*1 *2

V1: Push-lock, turn-reset (40mm dia.)*1 *2

• Operator for emergency stop pushbuttons

V5: Push-lock, turn-reset (32mm dia.)*2

V6: Push-lock, turn-reset (40mm dia.)*2

• Lens for pilot lights

Z: Extended round

ZS: Flush square

ZT: Flush rectangular

ZM: Dome

Note: *1 Product with no trigger action mechanism

*2 AH165 type only, direct opening action

③ Color of button or lens

Code	color	Button	LED	Incandescent	Neon
G	Green	○	○	○	○
R	Red	○	○	○	○ (Orange)
B	Black*	○	—	—	—
Y	Yellow	○	○	○	○ (Orange)
W	White	○	○ (Orange)	○	○ (Orange)
S	Blue	○	○	○	○ (Green)
O	Orange	○	○ (Amber)	○	○
RG	Red/Green	—	○	—	—

Notes: • (): indicates luminous color

• AH165-V, V1, V5, V6: Red only

* Not available for illuminated types

④ Contact arrangement

01: 1NC*1

22: 2NO+2NC

02: 2NC*1

33: 3NO+3NC*2

11: 1NO+1NC

Notes: *1 Available for AH165-V, V1, V5, V6

*2 Not available for with transformer types

⑤ Lamp voltage

Code	LED	Incandescent**2	Neon*2
AA	5V DC*2	—	—
A	6V DC*2	5V AC/DC	—
B	12V DC	12V AC/DC	—
E	24V DC	24V AC/DC	—
H	100-110V AC*1 *2	100-110V AC*1	110V AC
K	—	—	120V AC
M	200-220V AC*1 *2	200-220V AC*1	220V AC
P	—	—	240V AC

Notes: *1 With transformer (LED: 24V, Incandescent: 28V)

*2 Not available AH165-ZM

• ZM type: LED lamp only (12, 24V DC)

⑥ Type of lamp

Blank: Incandescent

1: Neon

2: Spot LED, LED (ZM types)

3: Flat LED

⑦ Terminal

Blank: Solder/tab

W: Wire-wrap

S: Soder (AH165-V, V1, V5, V6 types only)

Note: ZM types: wire-wrap terminal only (Code is blank)

Pushbuttons/Selectors/Pilot Lights/Buzzers

AH164 and AH165

Type number nomenclature

■ Type number nomenclature

Selector switches

AH165 - J 2 B 11 A - W
 ① ② ③ ④ ⑤ ⑥ ⑦

① Product category

AH164: Standard (IP40)

AH165: Oil-tight (IP65)

② Operator

• 2-position, 3-position (operating angle 90°)

SP: Knob with square bezel

P: Knob with rectangular bezel

SJ: Key with square bezel

J: Key with rectangular bezel

JM: Key with rectangular bezel (Direct opening action) *

RJM: Key (Direct opening action) *

Note: * AH165 types (2-position) only

• 3-position (operating angle 45°)

SPK: Knob with square bezel

PK: Knob with rectangular bezel

SJK: Key with square bezel

JK: Key with rectangular bezel

③ Operation

2: 2-position, maintained

0: 2-position, spring return*

3: 3-position, maintained

6: 3-position, spring/manual return (Left to center)

7: 3-position, spring/manual return (Right to center)

1: 3-position, spring return

Note: * Except for JM and RJM types

④ Color of knob or key removable position

• Color of knob

B: Black

• Key removable position

Code	2-position		3-position (operating angle 90°)				3-position (operating angle 45°)			
	2	0	1	3	6	7	1	3	6	7
A	⊗	⊗	—	⊖	—	⊖	—	⊗	—	⊗
B	⊗	—	—	⊖	—	—	—	⊗	—	—
C	—	—	—	⊕	—	—	—	⊗	—	—
D	⊗	—	—	⊖	—	—	—	⊗	—	—
E	—	—	Ⓜ	—	—	—	Ⓜ	—	—	—
F	—	—	—	—	—	—	—	⊗	—	—
G	—	—	—	—	—	—	—	⊗	—	⊗

⑤ Contact arrangement

11: 1NO+1NC

22: 2NO+2NC

33: 3NO+3NC*

Note: * Except for JM and RJM types.

⑥ Key type No.

A (standard), B, C, D, E, F

⑦ Terminal

Blank: Solder/tab

W: Wire-warp

Note: JM, RJM types: Solder/tab terminal only

Buzzers

AH164 - T X B E

① ② ③ ④

① Product category

AH164: Standard (IP00)

AH165: Splash-proof (IP54)

② Sound

TX: Standard (AH164)

TX1: Loud sound (AH164)

TX2: Loud sound with volume control (AH164)

X: Standard sound with volume control (AH165)

③ Color of head

B: Black

④ Operating voltage

AAC: 6V AC*2

ADC: 6V DC*2

A: 6V AC/DC*1

E: 12 to 24V AC/DC

F: 35 to 48V AC/DC

Notes: *1 Except for TX and TX1 types

*2 Except for TX2 and X types

Pushbuttons/Selectors/Pilot Lights/Buzzers

AH164 and AH165

Ratings and specifications

■ Standards approved

UL508	File No. E44592
CSA C22.2 No.14	File No. LR20479 (except for AH165-ZM) File No. LR84365 (for AH165-ZM)
TÜV: EN60947-5-1	Pushbutton (except for AH165-V, V1), Illuminated pushbutton: R9250087 Pushbutton (for AH165-V, V1): J9551059 Selector (except for AH165-JM, RJM): R9250088 Selector (for AH165-JM, RJM): J9551059 Pilot lights: R9250089 Buzzer: J9950092 (for AH164-TX2, AH165-X)
TÜV: EN60947-5-1 EN60947-5-5	Emergency stop pushbutton: R9950093

■ Specifications (Indoor use)

- Pushbutton switches, illuminated pushbutton switches selector switches, pilot lights

Item	AH164	AH165
Rated insulation voltage	250V AC/DC	
Ambient temperature (no condensation or no icing)	-20 to +70°C *1	-10 to +70°C *2
Humidity	45 to 85%RH (at -5 to +40°C), no condensation or no icing	
Durability (operations)	Mechanical Pushbutton switch Momentary action: 1 million Alternate action: 250,000 Push-lock, turn-reset: 100,000 Selector switch: 250,000 *3	
	Electrical 100,000 (220V AC 0.7A)	
Dielectric strength	2000V AC, 1 minute (Between lamp and contact terminals: 1500V AC, 1 minute)	
Conditional short-circuit current	1000A	
Short-circuit protective device	Fuse 1A *4	
Pollution degree	3	
Vibration	Resonance: 10 to 55Hz, double amplitude 0.1mm *5 Constant: 16.7Hz, double amplitude 3mm	
Shock	Malfunction durability: 100m/s ² *6 Mechanical durability: 500m/s ²	
Operating frequency	1200 operation/hour (on-load factor: 40%)	
Insulation resistance	100MΩ or more (500V DC megger)	
Degree of protection	IP40	IP65

Notes: *1 For illuminated pushbutton switch and pilot light: -20 to +55°C

*2 For illuminated pushbutton switch and pilot light: -10 to +55°C

*3 Key insertion/removal durability for selector switch key types: 10,000

*4 AH165-V, V1, JM, RJM, V5, V6 types: Fuse 5A

*5 Emergency stop type: 10 to 500Hz, double amplitude 0.7mm (acceleration 50m/s²), according to the test condition of EN60947-5-5 (1998)

*6 Emergency stop type: 150m/s²

● Buzzers

Item	AH164-TX	AH164-TX1
Rated insulation voltage	60V AC/DC	
Operating voltage	6V AC, 6V DC, 12 to 24V AC/DC 35 to 48V AC/DC	
Sound level	80dB (0.1m) 60dB(1m)	90dB (0.1m) 70dB(1m)
Durability	1000h	
Frequency	2 ±0.5kHz	2.4 to 3.3kHz
Intermittent cycle	Approx. 170 cycle/minute	
Current consumption	7mA(24, 48V DC) 15mA(6V DC) 20mA (6, 24V AC) 30mA (48V AC)	15mA (24, 48V DC) 25mA (6V DC) 30mA (24V AC) 40mA (48V AC) 50mA (6V AC)
Dielectric strength	1000V AC, 1 minute	
Insulation resistance	100MΩ or more (500V DC megger)	
Ambient temperature	-20 to +60°C (no condensation or no icing)	
Humidity	45 to 85%RH (at -5 to +40°C)	
Operator protection	IP00	

Item	AH164-TX2	AH165-X
Rated insulation voltage	60V AC/DC	
Operating voltage	6V AC/DC, 12 to 24V AC/DC 35 to 48V AC/DC	
Sound level	70dB to 90dB (0.1m) 50dB to 70dB (1m)	60dB to 80dB (0.1m) 40dB to 60dB (1m)
Durability	1000h	
Frequency	2 ±0.5kHz	2.4 to 3.3kHz
Intermittent cycle	Approx. 170 cycle/minute	
Current consumption	30mA (6V DC) 20mA (24, 48V DC) 40mA (6, 24, 48V AC)	
Dielectric strength	1000V AC, 1 minute	
Insulation resistance	100MΩ or more (500V DC megger)	
Ambient temperature	-20 to +60°C (no condensation or no icing)	
Humidity	45 to 85%RH (at -5 to +40°C)	
Degree of protection	IP00	IP54

Pushbuttons/Selectors/Pilot Lights/Buzzers

AH164 and AH165

Ratings and specifications

■ Contact ratings

● UL/CSA standards

Rated thermal current	Rated operational voltage	Maximum current	
		AC (Res. load)	DC (Res. load)
5A	24V 125V 250V	– – 5.0A	1.0A 0.2A –

● EN standards (TÜV approved)

Rated thermal current	Rated operational voltage	Rated operational current				
		AC 15 (Ind. load)	AC 13 (Ind. load)	AC 12 (Res. load)	DC 13 (Ind. load)	DC 12 (Res. load)
5A	24V 100 to 120V 100 to 125V 200 to 240V	– 0.3A – 0.3A	– 1.0A – 0.7A	– 1.5A – 1.0A	0.7A – 0.15A –	1.0A – 0.2A –

■ Lamp ratings

Rated operational voltage	Consumption		
	LED DC	Incandescent AC/DC	Neon AC
5V	7mA (Yellow: 28mA)	0.45W (6V)	–
6V	7mA (Yellow: 28mA)	–	–
12V	7mA	0.55W (14V)	–
24V	7mA	0.55W (28V)	–
110V	–	–	0.19VA
120V	–	–	0.21VA
220V	–	–	0.38VA
240V	–	–	0.42VA

Notes: • With transformer (LED): 2.6VA/110, 220V

• With transformer (Incandescent): 2VA/110, 220V

• For the incandescent lamps, the values in parentheses indicate the rated voltage of the lamps.

■ Contact reliability

FUJI has confirmed that the unit can be used in 1mA circuit conditions at 5V AC or DC. The operable range may vary depending on the ambient conditions and type of load.

■ Illuminated pushbutton switches/without transformer

Operator	Lamp	Voltage	Contact	Momentary action		Alternate action	
				AH164 type	AH165 (Oil-tight) type	AH164 type	AH165 (Oil-tight) type
 KKD07-205	Flat LED	24V DC	1NO+1NC 2NO+2NC 3NO+3NC	AH164-L□11E3	AH165-L□11E3	AH164-L5□11E3	AH165-L5□11E3
				AH164-L□22E3	AH165-L□22E3	AH164-L5□22E3	AH165-L5□22E3
				AH164-L□33E3	AH165-L□33E3	AH164-L5□33E3	AH165-L5□33E3
	Spot LED	24V DC	1NO+1NC 2NO+2NC 3NO+3NC	AH164-L□11E2	AH165-L□11E2	AH164-L5□11E2	AH165-L5□11E2
				AH164-L□22E2	AH165-L□22E2	AH164-L5□22E2	AH165-L5□22E2
				AH164-L□33E2	AH165-L□33E2	AH164-L5□33E2	AH165-L5□33E2
	Incandescent	24V AC/DC	1NO+1NC 2NO+2NC 3NO+3NC	AH164-L□11E	AH165-L□11E	AH164-L5□11E	AH165-L5□11E
				AH164-L□22E	AH165-L□22E	AH164-L5□22E	AH165-L5□22E
Neon	110V AC	1NO+1NC 2NO+2NC 3NO+3NC	AH164-L□11H1	AH165-L□11H1	AH164-L5□11H1	AH165-L5□11H1	
			AH164-L□22H1	AH165-L□22H1	AH164-L5□22H1	AH165-L5□22H1	
	220V AC	1NO+1NC 2NO+2NC 3NO+3NC	AH164-L□11M1	AH165-L□11M1	AH164-L5□11M1	AH165-L5□11M1	
			AH164-L□22M1	AH165-L□22M1	AH164-L5□22M1	AH165-L5□22M1	
 KKD07-204	Flat LED	24V DC	1NO+1NC 2NO+2NC 3NO+3NC	AH164-SL□11E3	AH165-SL□11E3	AH164-SL5□11E3	AH165-SL5□11E3
				AH164-SL□22E3	AH165-SL□22E3	AH164-SL5□22E3	AH165-SL5□22E3
				AH164-SL□33E3	AH165-SL□33E3	AH164-SL5□33E3	AH165-SL5□33E3
	Spot LED	24V DC	1NO+1NC 2NO+2NC 3NO+3NC	AH164-SL□11E2	AH165-SL□11E2	AH164-SL5□11E2	AH165-SL5□11E2
				AH164-SL□22E2	AH165-SL□22E2	AH164-SL5□22E2	AH165-SL5□22E2
				AH164-SL□33E2	AH165-SL□33E2	AH164-SL5□33E2	AH165-SL5□33E2
	Incandescent	24V AC/DC	1NO+1NC 2NO+2NC 3NO+3NC	AH164-SL□11E	AH165-SL□11E	AH164-SL5□11E	AH165-SL5□11E
				AH164-SL□22E	AH165-SL□22E	AH164-SL5□22E	AH165-SL5□22E
Neon	110V AC	1NO+1NC 2NO+2NC 3NO+3NC	AH164-SL□11H1	AH165-SL□11H1	AH164-SL5□11H1	AH165-SL5□11H1	
			AH164-SL□22H1	AH165-SL□22H1	AH164-SL5□22H1	AH165-SL5□22H1	
	220V AC	1NO+1NC 2NO+2NC 3NO+3NC	AH164-SL□11M1	AH165-SL□11M1	AH164-SL5□11M1	AH165-SL5□11M1	
			AH164-SL□22M1	AH165-SL□22M1	AH164-SL5□22M1	AH165-SL5□22M1	
 KKD07-202	Flat LED	24V DC	1NO+1NC 2NO+2NC 3NO+3NC	AH164-TL□11E3	AH165-TL□11E3	AH164-TL5□11E3	AH165-TL5□11E3
				AH164-TL□22E3	AH165-TL□22E3	AH164-TL5□22E3	AH165-TL5□22E3
				AH164-TL□33E3	AH165-TL□33E3	AH164-TL5□33E3	AH165-TL5□33E3
	Spot LED	24V DC	1NO+1NC 2NO+2NC 3NO+3NC	AH164-TL□11E2	AH165-TL□11E2	AH164-TL5□11E2	AH165-TL5□11E2
				AH164-TL□22E2	AH165-TL□22E2	AH164-TL5□22E2	AH165-TL5□22E2
				AH164-TL□33E2	AH165-TL□33E2	AH164-TL5□33E2	AH165-TL5□33E2
	Incandescent	24V AC/DC	1NO+1NC 2NO+2NC 3NO+3NC	AH164-TL□11E	AH165-TL□11E	AH164-TL5□11E	AH165-TL5□11E
				AH164-TL□22E	AH165-TL□22E	AH164-TL5□22E	AH165-TL5□22E
Neon	110V AC	1NO+1NC 2NO+2NC 3NO+3NC	AH164-TL□11H1	AH165-TL□11H1	AH164-TL5□11H1	AH165-TL5□11H1	
			AH164-TL□22H1	AH165-TL□22H1	AH164-TL5□22H1	AH165-TL5□22H1	
	220V AC	1NO+1NC 2NO+2NC 3NO+3NC	AH164-TL□11M1	AH165-TL□11M1	AH164-TL5□11M1	AH165-TL5□11M1	
			AH164-TL□22M1	AH165-TL□22M1	AH164-TL5□22M1	AH165-TL5□22M1	

Note: Replace the □ mark by the button color code, see page 04/196.

04

Illuminated Pushbuttons

AH164 and AH165

Operator	Lamp	Voltage	Contact	Momentary action		Alternate action	
				AH164 type	AH165 (oil-tight) type	AH164 type	AH165 (oil-tight) type
Flush rectangular head with guard  KKD07-203	Flat LED	24V DC	1NO+1NC 2NO+2NC 3NO+3NC	AH164-TGL□11E3	AH165-TGL□11E3	AH164-TGL5□11E3	AH165-TGL5□11E3
				AH164-TGL□22E3	AH165-TGL□22E3	AH164-TGL5□22E3	AH165-TGL5□22E3
	AH164-TGL□33E3	AH165-TGL□33E3	AH164-TGL5□33E3	AH165-TGL5□33E3			
	Incandescent	24V AC/DC	1NO+1NC 2NO+2NC 3NO+3NC	AH164-TGL□11E	AH165-TGL□11E	AH164-TGL5□11E	AH165-TGL5□11E
AH164-TGL□22E				AH165-TGL□22E	AH164-TGL5□22E	AH165-TGL5□22E	
Neon	110V AC	1NO+1NC 2NO+2NC 3NO+3NC	AH164-TGL□11H1	AH165-TGL□11H1	AH164-TGL5□11H1	AH165-TGL5□11H1	
			AH164-TGL□22H1	AH165-TGL□22H1	AH164-TGL5□22H1	AH165-TGL5□22H1	
	220V AC	1NO+1NC 2NO+2NC 3NO+3NC	AH164-TGL□11M1	AH165-TGL□11M1	AH164-TGL5□11M1	AH165-TGL5□11M1	
			AH164-TGL□22M1	AH165-TGL□22M1	AH164-TGL5□22M1	AH165-TGL5□22M1	
			AH164-TGL□33M1	AH165-TGL□33M1	AH164-TGL5□33M1	AH165-TGL5□33M1	
			AH164-TGL□33M1	AH165-TGL□33M1	AH164-TGL5□33M1	AH165-TGL5□33M1	
Flush square head with guard  KKD05-075b	Flat LED	24V DC	1NO+1NC 2NO+2NC 3NO+3NC	AH164-SGL□11E3	AH165-SGL□11E3	AH164-SGL5□11E3	AH165-SGL5□11E3
				AH164-SGL□22E3	AH165-SGL□22E3	AH164-SGL5□22E3	AH165-SGL5□22E3
	AH164-SGL□33E3	AH165-SGL□33E3	AH164-SGL5□33E3	AH165-SGL5□33E3			
	Incandescent	24V AC/DC	1NO+1NC 2NO+2NC 3NO+3NC	AH164-SGL□11E	AH165-SGL□11E	AH164-SGL5□11E	AH165-SGL5□11E
AH164-SGL□22E				AH165-SGL□22E	AH164-SGL5□22E	AH165-SGL5□22E	
Neon	110V AC	1NO+1NC 2NO+2NC 3NO+3NC	AH164-SGL□11H1	AH165-SGL□11H1	AH164-SGL5□11H1	AH165-SGL5□11H1	
			AH164-SGL□22H1	AH165-SGL□22H1	AH164-SGL5□22H1	AH165-SGL5□22H1	
	220V AC	1NO+1NC 2NO+2NC 3NO+3NC	AH164-SGL□11M1	AH165-SGL□11M1	AH164-SGL5□11M1	AH165-SGL5□11M1	
			AH164-SGL□22M1	AH165-SGL□22M1	AH164-SGL5□22M1	AH165-SGL5□22M1	
			AH164-SGL□33M1	AH165-SGL□33M1	AH164-SGL5□33M1	AH165-SGL5□33M1	
			AH164-SGL□33M1	AH165-SGL□33M1	AH164-SGL5□33M1	AH165-SGL5□33M1	

■ Dimensions, mm

L, L5

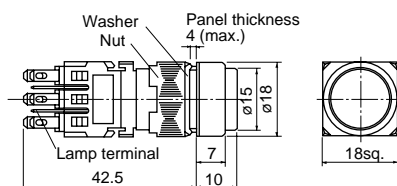

SL, SL5

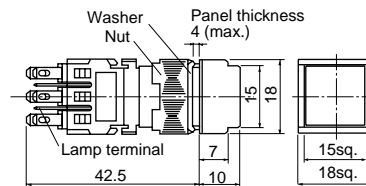

TL, TL5

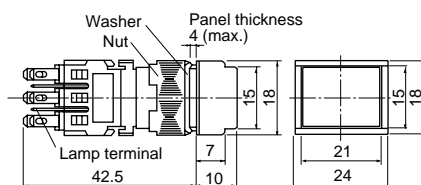

TGL, TGL5

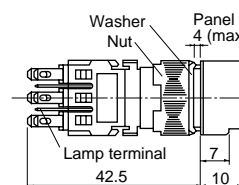

SGL, SGL5

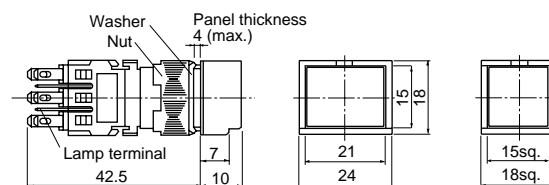

● Button color

Color	Green	Red	White	Yellow	Blue	Orange
Code	G	R	W	Y	S	O



- The color lens is made of a tinted transparent material.
- A white illuminated pushbutton is fitted with a transparent color lens. (Except the neon lamp)
- With wire-wrap pin terminals have a depth of 47mm.

● Lamp voltage

Voltages other than above are available

Code	LED	Incandescent	Neon
AA	5V DC	—	—
A	6V DC	5V AC/DC	—
B	12V DC	12V AC/DC	—
K	—	—	120V AC
P	—	—	240V AC

■ Illuminated pushbutton switches/with transformer

Operator	Lamp	Voltage	Contact	Momentary action		Alternate action	
				AH164 type	AH165 (oil-tight) type	AH164 type	AH165 (oil-tight) type
Extended round head  AF90-945	Flat LED	■ Voltage code H: 100-110V AC M: 200-220V AC	1NO+1NC	AH164-L□11■3	AH165-L□11■3	AH164-L5□11■3	AH165-L5□11■3
			2NO+2NC	AH164-L□22■3	AH165-L□22■3	AH164-L5□22■3	AH165-L5□22■3
	Incandescent		1NO+1NC	AH164-L□11■	AH165-L□11■	AH164-L5□11■	AH165-L5□11■
			2NO+2NC	AH164-L□22■	AH165-L□22■	AH164-L5□22■	AH165-L5□22■
Flush square head  AF90-946	Flat LED	■ Voltage code H: 100-110V AC M: 200-220V AC	1NO+1NC	AH164-SL□11■3	AH165-SL□11■3	AH164-SL5□11■3	AH165-SL5□11■3
			2NO+2NC	AH164-SL□22■3	AH165-SL□22■3	AH164-SL5□22■3	AH165-SL5□22■3
	Incandescent		1NO+1NC	AH164-SL□11■	AH165-SL□11■	AH164-SL5□11■	AH165-SL5□11■
			2NO+2NC	AH164-SL□22■	AH165-SL□22■	AH164-SL5□22■	AH165-SL5□22■
Flush rectangular head  AF90-947	Flat LED	■ Voltage code H: 100-110V AC M: 200-220V AC	1NO+1NC	AH164-TL□11■3	AH165-TL□11■3	AH164-TL5□11■3	AH165-TL5□11■3
			2NO+2NC	AH164-TL□22■3	AH165-TL□22■3	AH164-TL5□22■3	AH165-TL5□22■3
	Incandescent		1NO+1NC	AH164-TL□11■	AH165-TL□11■	AH164-TL5□11■	AH165-TL5□11■
			2NO+2NC	AH164-TL□22■	AH165-TL□22■	AH164-TL5□22■	AH165-TL5□22■
Flush rectangular head with guard  AF90-941	Flat LED	■ Voltage code H: 100-110V AC M: 200-220V AC	1NO+1NC	AH164-TGL□11■3	AH165-TGL□11■3	AH164-TGL5□11■3	AH165-TGL5□11■3
			2NO+2NC	AH164-TGL□22■3	AH165-TGL□22■3	AH164-TGL5□22■3	AH165-TGL5□22■3
	Incandescent		1NO+1NC	AH164-TGL□11■	AH165-TGL□11■	AH164-TGL5□11■	AH165-TGL5□11■
			2NO+2NC	AH164-TGL□22■	AH165-TGL□22■	AH164-TGL5□22■	AH165-TGL5□22■
Flush square head with guard  AF90-948	Flat LED	■ Voltage code H: 100-110V AC M: 200-220V AC	1NO+1NC	AH164-SGL□11■3	AH165-SGL□11■3	AH164-SGL5□11■3	AH165-SGL5□11■3
			2NO+2NC	AH164-SGL□22■3	AH165-SGL□22■3	AH164-SGL5□22■3	AH165-SGL5□22■3
	Incandescent		1NO+1NC	AH164-SGL□11■	AH165-SGL□11■	AH164-SGL5□11■	AH165-SGL5□11■
			2NO+2NC	AH164-SGL□22■	AH165-SGL□22■	AH164-SGL5□22■	AH165-SGL5□22■

Note: Replace the □ mark by the button color code, see page 04/198.

Illuminated Pushbuttons AH164 and AH165

■ Dimensions, mm

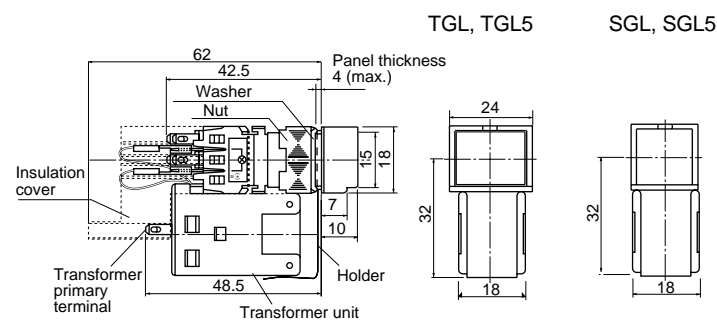
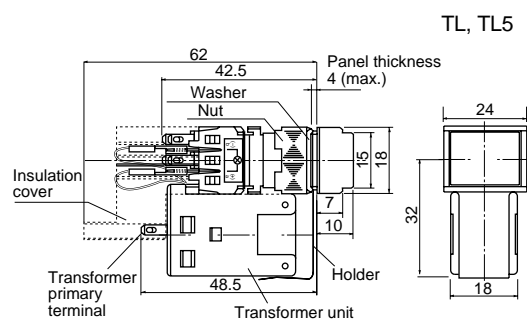
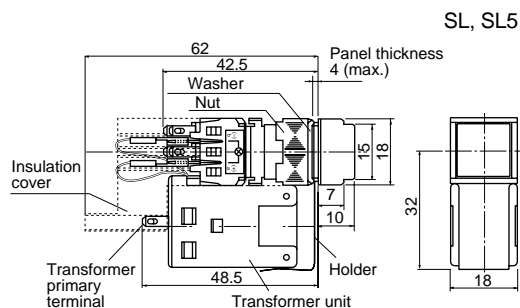
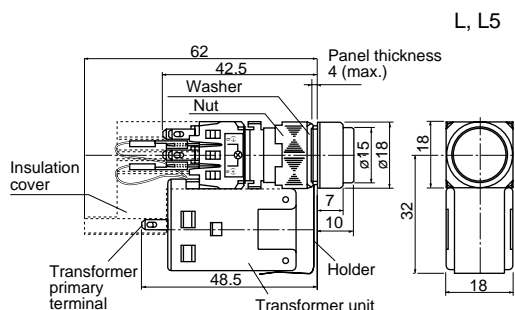









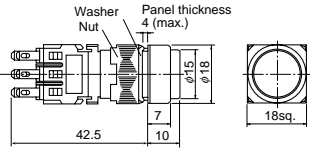

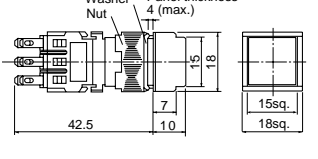

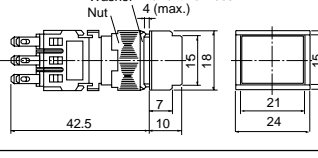

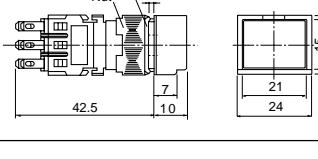
● Button color

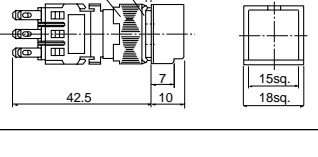
Color	Green	Red	White	Yellow	Blue	Orange
Code	G	R	W	Y	S	O

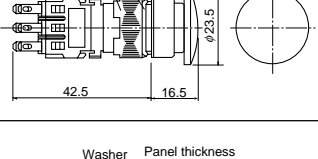
- The color lens is made of a tinted transparent material.

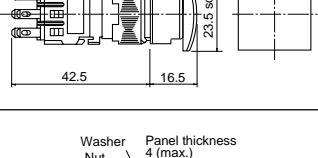
■ Pushbutton switches

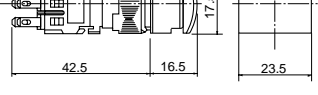
Operator	Contact	Momentary action		Alternate action		Dimensions, mm
		AH164 type	AH165 (oil-tight) type	AH164 type	AH165 (oil-tight) type	
 KKD07-209	1NO+1NC	AH164-E□11	AH165-E□11	AH164-E5□11	AH165-E5□11	
	2NO+2NC	AH164-E□22	AH165-E□22	AH164-E5□22	AH165-E5□22	
	3NO+3NC	AH164-E□33	AH165-E□33	AH164-E5□33	AH165-E5□33	
 KKD07-208	1NO+1NC	AH164-SF□11	AH165-SF□11	AH164-SF5□11	AH165-SF5□11	
	2NO+2NC	AH164-SF□22	AH165-SF□22	AH164-SF5□22	AH165-SF5□22	
	3NO+3NC	AH164-SF□33	AH165-SF□33	AH164-SF5□33	AH165-SF5□33	
 KKD07-206	1NO+1NC	AH164-TF□11	AH165-TF□11	AH164-TF5□11	AH165-TF5□11	
	2NO+2NC	AH164-TF□22	AH165-TF□22	AH164-TF5□22	AH165-TF5□22	
	3NO+3NC	AH164-TF□33	AH165-TF□33	AH164-TF5□33	AH165-TF5□33	
 KKD05-176	1NO+1NC	AH164-TGF□11	AH165-TGF□11	AH164-TGF5□11	AH165-TGF5□11	
	2NO+2NC	AH164-TGF□22	AH165-TGF□22	AH164-TGF5□22	AH165-TGF5□22	
	3NO+3NC	AH164-TGF□33	AH165-TGF□33	AH164-TGF5□33	AH165-TGF5□33	
 KKD05-075b	1NO+1NC	AH164-SGF□11	AH165-SGF□11	AH164-SGF5□11	AH165-SGF5□11	
	2NO+2NC	AH164-SGF□22	AH165-SGF□22	AH164-SGF5□22	AH165-SGF5□22	
	3NO+3NC	AH164-SGF□33	AH165-SGF□33	AH164-SGF5□33	AH165-SGF5□33	
 KKD07-210	1NO+1NC	AH164-M□11	AH165-M□11	AH164-M5□11	AH165-M5□11	
	2NO+2NC	AH164-M□22	AH165-M□22	AH164-M5□22	AH165-M5□22	
	3NO+3NC	AH164-M□33	AH165-M□33	AH164-M5□33	AH165-M5□33	
 KKD05-081b	1NO+1NC	AH164-SM□11	AH165-SM□11	AH164-SM5□11	AH165-SM5□11	
	2NO+2NC	AH164-SM□22	AH165-SM□22	AH164-SM5□22	AH165-SM5□22	
	3NO+3NC	AH164-SM□33	AH165-SM□33	AH164-SM5□33	AH165-SM5□33	
 KKD05-082b	1NO+1NC	AH164-TM□11	AH165-TM□11	AH164-TM5□11	AH165-TM5□11	
	2NO+2NC	AH164-TM□22	AH165-TM□22	AH164-TM5□22	AH165-TM5□22	
	3NO+3NC	AH164-TM□33	AH165-TM□33	AH164-TM5□33	AH165-TM5□33	

● Button color

Replace the □ mark by the following color code

Color	Green	Red	Black	White	Blue	Yellow	Orange
Code	G	R	B	W	S	Y	O



- The color lens is made of a tinted transparent material. (Except the M, SM, TM types)
- A white pushbutton is fitted with a transparent color lens. (Except the M, SM, TM types) A black pushbutton consists of a transparent color lens and an attached black legend plate. (Except M, SM, TM types)
- With wire-wrap pin terminals have a depth of 47mm.

Pushbuttons

AH165

■ Pushbutton switches

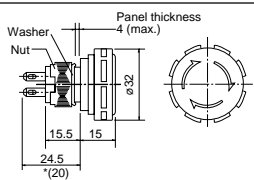
⊖ (Direct opening action)

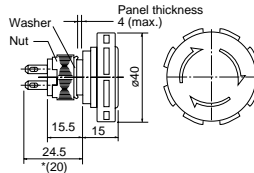

Operator	Button color	Contact	Terminal	AH165 (oil-tight) type	Dimensions, mm
Push-lock, turn-reset (32mm dia.)  <small>AF91-584</small>	Red	1NC	Solder/Tab Solder	AH165-VR01 (AH165-VR01-S)	
		2NC		AH165-VR02 (AH165-VR02-S)	
Push-lock, turn-reset (40mm dia.)  <small>AF91-583</small>	Red	1NC	Solder/Tab Solder	AH165-V1R01 (AH165-V1R01-S)	
		2NC		AH165-V1R02 (AH165-V1R02-S)	

Notes: * () For switch with solder terminal.

- Contact arrangements indicated in the table can be supplied.
- Product with no trigger action mechanism.

■ Emergency stop pushbutton switches

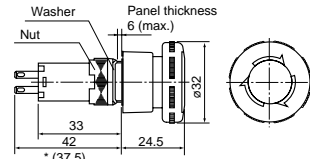

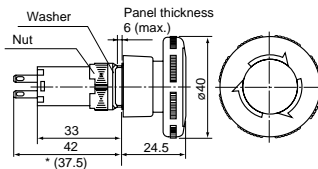







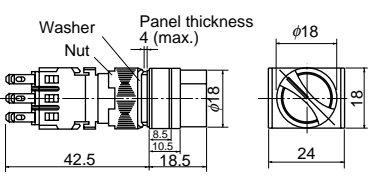

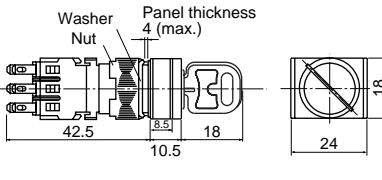
⊖ (Direct opening action), conform to EN418

Operator	Button color	Contact	Terminal	AH165 (oil-tight) type	Dimensions, mm
Push-lock, turn-reset (32mm dia.)  <small>KKD07-221</small>	Red	1NC	Solder/Tab Solder	AH165-V5R01 (AH165-V5R01-S)	
		2NC		AH165-V5R02 (AH165-V5R02-S)	
Push-lock, turn-reset (40mm dia.)  <small>KKD07-222</small>	Red	1NC	Solder/Tab Solder	AH165-V6R01 (AH165-V6R01-S)	
		2NC		AH165-V6R02 (AH165-V6R02-S)	

Notes: * () For switch with solder terminal.

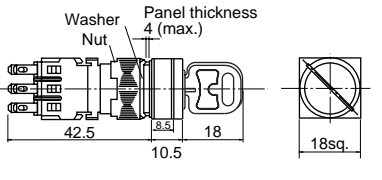
- Contact arrangements indicated in the table can be supplied.

■ Selector switches/2-position (90-degree)

Operator	Operation	Key removable position	Contact	AH164 type	AH165 (oil-tight) type	Dimensions, mm
 KKD07-213	Maintained	—	1NO+1NC 2NO+2NC 3NO+3NC	AH164-P2B11 AH164-P2B22 AH164-P2B33	AH165-P2B11 AH165-P2B22 AH165-P2B33	
	Spring return	—	1NO+1NC 2NO+2NC 3NO+3NC	AH164-P0B11 AH164-P0B22 AH164-P0B33	AH165-P0B11 AH165-P0B22 AH165-P0B33	
	Maintained	—	1NO+1NC 2NO+2NC 3NO+3NC	AH164-SP2B11 AH164-SP2B22 AH164-SP2B33	AH165-SP2B11 AH165-SP2B22 AH165-SP2B33	
Spring return	—	1NO+1NC 2NO+2NC 3NO+3NC	AH164-SP0B11 AH164-SP0B22 AH164-SP0B33	AH165-SP0B11 AH165-SP0B22 AH165-SP0B33		
 KKD09-001L	Maintained	 A	1NO+1NC	AH164-J2A11A	AH165-J2A11A	
			2NO+2NC	AH164-J2A22A	AH165-J2A22A	
			3NO+3NC	AH164-J2A33A	AH165-J2A33A	
	 B	1NO+1NC	AH164-J2B11A	AH165-J2B11A		
		2NO+2NC	AH164-J2B22A	AH165-J2B22A		
		3NO+3NC	AH164-J2B33A	AH165-J2B33A		
	 D	1NO+1NC	AH164-J2D11A	AH165-J2D11A		
		2NO+2NC	AH164-J2D22A	AH165-J2D22A		
		3NO+3NC	AH164-J2D33A	AH165-J2D33A		
Spring return	—	 A	1NO+1NC	AH164-J0A11A	AH165-J0A11A	
			2NO+2NC	AH164-J0A22A	AH165-J0A22A	
			3NO+3NC	AH164-J0A33A	AH165-J0A33A	
 KKD09-001R	Maintained	 A	1NO+1NC	AH164-SJ2A11A	AH165-SJ2A11A	
			2NO+2NC	AH164-SJ2A22A	AH165-SJ2A22A	
			3NO+3NC	AH164-SJ2A33A	AH165-SJ2A33A	
	 B	1NO+1NC	AH164-SJ2B11A	AH165-SJ2B11A		
		2NO+2NC	AH164-SJ2B22A	AH165-SJ2B22A		
		3NO+3NC	AH164-SJ2B33A	AH165-SJ2B33A		
	 D	1NO+1NC	AH164-SJ2D11A	AH165-SJ2D11A		
		2NO+2NC	AH164-SJ2D22A	AH165-SJ2D22A		
		3NO+3NC	AH164-SJ2D33A	AH165-SJ2D33A		
Spring return	—	 A	1NO+1NC	AH164-SJ0A11A	AH165-SJ0A11A	
			2NO+2NC	AH164-SJ0A22A	AH165-SJ0A22A	
			3NO+3NC	AH164-SJ0A33A	AH165-SJ0A33A	

• The operating angle range can be changed as shown below by setting the attached flange shifted by 45° in combination with the contact block.
 In this case, the minimum mounting pitch is 26mm because the contact block is shifted by 45° from the flange.

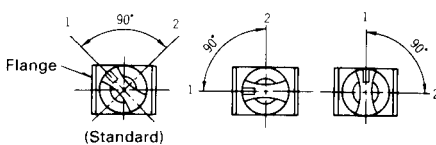

• Contact block position

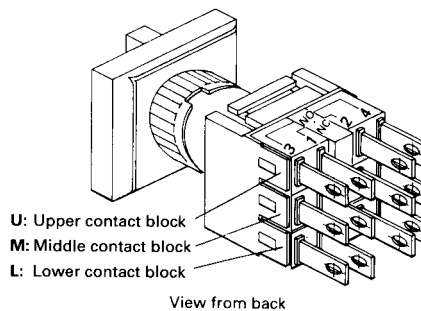

• Contact arrangement and operator position: 2-position selector switch

Contact arrangement	1NO+1NC	2NO+2NC	3NO+3NC
Operator position	Left	M 1 0 1 0 2 3 0 0 4	U L 1 0 1 0 2 3 0 0 4 3 0 0 4 L 0 4
	Right	M 1 0 1 0 2 3 0 0 4	U L 1 0 1 0 2 3 0 0 4 3 0 0 4 L 0 4

3-position selector switch













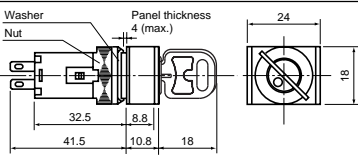



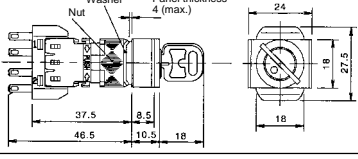

Contact arrangement	2NO+2NC	3NO+3NC
Operator position	Left	U L 1 0 1 0 2 1 0 1 0 2 3 0 0 4 3 0 0 4
	Center	U M L 1 0 1 0 2 1 0 1 0 2 1 0 1 0 2 3 0 0 4 3 0 0 4
	Right	U L 1 0 1 0 2 1 0 1 0 2 1 0 1 0 2 3 0 0 4 3 0 0 4 3 0 0 4

- There are 6 available key types; A, B, C, D, E and F. Standard key code is A.
- With wire-wrap pin terminals have a depth of 47mm.

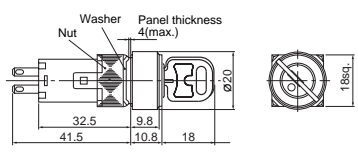
Selector Switches AH165

■ Selector switches/2-position (90-degree)

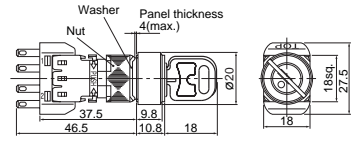

⊖ (Direct opening action)

Operator	Operation	Key removable position	Contact	AH165 (oil-tight) type	Dimensions, mm	
Key with rectangular bezel  KKD09-005L  KKD09-005R	Maintained	A 	1NO+1NC	AH165-JM2A11A		
		B 		AH165-JM2B11A		
		D 		AH165-JM2D11A		
		A 	2NO+2NC	AH165-JM2A22A		
		B 		AH165-JM2B22A		
		D 		AH165-JM2D22A		
Key with round bezel  KKD09-005L  KKD09-007R	Maintained	A 	1NO+1NC	AH165-RJM2A11A		
		B 		AH165-RJM2B11A		
		D 		AH165-RJM2D11A		
		A 	2NO+2NC	AH165-RJM2A22A		
		B 		AH165-RJM2B22A		
		D 		AH165-RJM2D22A		

• There are 6 available key types; A, B, C, D, E and F. Standard key code is A.

• Contact arrangement and operator positions:

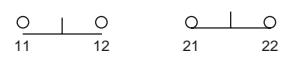
2-position selector switch



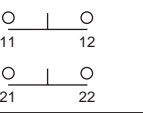
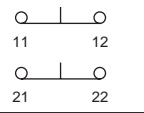
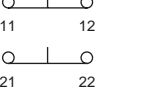
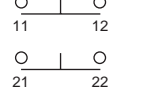

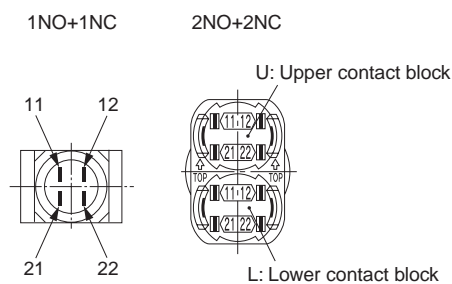

Contact arrangement	1NO+1NC	
Operator position	Left	
	Right	

Contact arrangement	2NO+2NC				
Operator position	Left	U		L	
		Right			

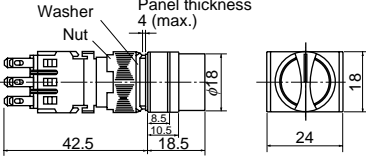
• Terminal number

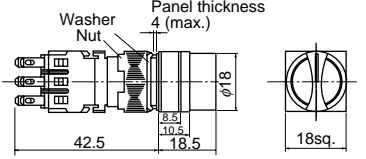

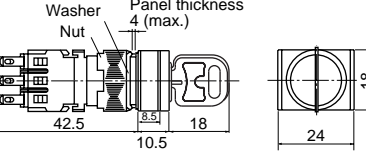
■ Selector switches/3-position (90-degree)







Operator	Operation	Key removable position	Contact	AH164 type	AH165 (oil-tight) type	Dimensions, mm		
Knob with rectangular bezel  KKD07-214	Maintained	—	2NO+2NC 3NO+3NC	AH164-P3B22 AH164-P3B33	AH165-P3B22 AH165-P3B33			
	Spring/ manual return	Ⓜ	2NO+2NC 3NO+3NC	AH164-P6B22 AH164-P6B33	AH165-P6B22 AH165-P6B33			
	Spring/ manual return	Ⓜ	2NO+2NC 3NO+3NC	AH164-P7B22 AH164-P7B33	AH165-P7B22 AH165-P7B33			
	Spring return	Ⓜ	2NO+2NC 3NO+3NC	AH164-P1B22 AH164-P1B33	AH165-P1B22 AH165-P1B33			
Knob with square bezel  KKD07-216	Maintained	—	2NO+2NC 3NO+3NC	AH164-SP3B22 AH164-SP3B33	AH165-SP3B22 AH165-SP3B33			
	Spring/ manual return	Ⓜ	2NO+2NC 3NO+3NC	AH164-SP6B22 AH164-SP6B33	AH165-SP6B22 AH165-SP6B33			
	Spring/ manual return	Ⓜ	2NO+2NC 3NO+3NC	AH164-SP7B22 AH164-SP7B33	AH165-SP7B22 AH165-SP7B33			
	Spring return	Ⓜ	2NO+2NC 3NO+3NC	AH164-SP1B22 AH164-SP1B33	AH165-SP1B22 AH165-SP1B33			
Key with rectangular bezel  KKD09-002L	Maintained*	⊖ A	2NO+2NC 3NO+3NC	AH164-J3A22A AH164-J3A33A	AH165-J3A22A AH165-J3A33A			
		Ⓜ E	2NO+2NC 3NO+3NC	AH164-J3E22A AH164-J3E33A	AH165-J3E22A AH165-J3E33A			
		⊖ D	2NO+2NC 3NO+3NC	AH164-J3D22A AH164-J3D33A	AH165-J3D22A AH165-J3D33A			
		⊕ C	2NO+2NC 3NO+3NC	AH164-J3C22A AH164-J3C33A	AH165-J3C22A AH165-J3C33A			
	Spring/ manual return	Ⓜ E	2NO+2NC 3NO+3NC	AH164-J6E22A AH164-J6E33A	AH165-J6E22A AH165-J6E33A			
		Ⓜ	⊖ D	2NO+2NC 3NO+3NC	AH164-J6D22A AH164-J6D33A		AH165-J6D22A AH165-J6D33A	
	Spring/ manual return	Ⓜ	⊖ A	2NO+2NC 3NO+3NC	AH164-J7A22A AH164-J7A33A		AH165-J7A22A AH165-J7A33A	
		Ⓜ	Ⓜ E	2NO+2NC 3NO+3NC	AH164-J7E22A AH164-J7E33A		AH165-J7E22A AH165-J7E33A	
	Spring return	Ⓜ	Ⓜ E	2NO+2NC 3NO+3NC	AH164-J1E22A AH164-J1E33A		AH165-J1E22A AH165-J1E33A	
		Key with square bezel  KKD09-002R	Maintained*	⊖ A	2NO+2NC 3NO+3NC		AH164-SJ3A22A AH164-SJ3A33A	AH165-SJ3A22A AH165-SJ3A33A
	Ⓜ E			2NO+2NC 3NO+3NC	AH164-SJ3E22A AH164-SJ3E33A		AH165-SJ3E22A AH165-SJ3E33A	
	⊖ D			2NO+2NC 3NO+3NC	AH164-SJ3D22A AH164-SJ3D33A		AH165-SJ3D22A AH165-SJ3D33A	
⊕ C	2NO+2NC 3NO+3NC			AH164-SJ3C22A AH164-SJ3C33A	AH165-SJ3C22A AH165-SJ3C33A			
Spring/ manual return	Ⓜ E		2NO+2NC 3NO+3NC	AH164-SJ6E22A AH164-SJ6E33A	AH165-SJ6E22A AH165-SJ6E33A			
	Ⓜ		⊖ D	2NO+2NC 3NO+3NC	AH164-SJ6D22A AH164-SJ6D33A	AH165-SJ6D22A AH165-SJ6D33A		
Spring/ manual return	Ⓜ		⊖ A	2NO+2NC 3NO+3NC	AH164-SJ7A22A AH164-SJ7A33A	AH165-SJ7A22A AH165-SJ7A33A		
	Ⓜ		Ⓜ E	2NO+2NC 3NO+3NC	AH164-SJ7E22A AH164-SJ7E33A	AH165-SJ7E22A AH165-SJ7E33A		
Spring return	Ⓜ		Ⓜ E	2NO+2NC 3NO+3NC	AH164-SJ1E22A AH164-SJ1E33A	AH165-SJ1E22A AH165-SJ1E33A		

- There are 6 available key types; A, B, C, D, E and F. Standard key code is A.
- Contact arrangement and operator position: *See page 04/201.*
- Spring return, spring/manual return (spring return): Operation angle 70-degree

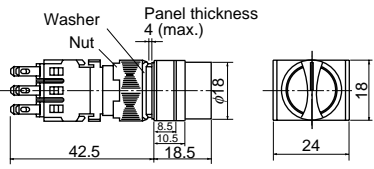
- * Available key removable position: Code B ⊖
- With wire-wrap pin terminals have a depth of 47mm.

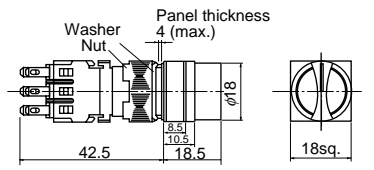
Selector Switches AH164 and AH165

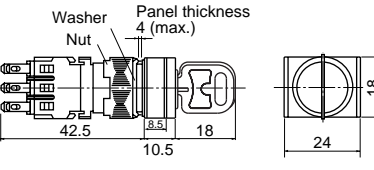
■ Selector switches/3-position (45-degree)

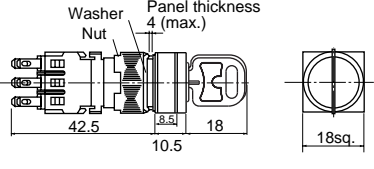
Operator	Operation	Key removable position	Contact	AH164 type	AH165 (oil-tight) type	Dimensions, mm		
Knob with rectangular bezel  KKD07-214	Maintained	—	2NO+2NC 3NO+3NC	AH164-PK3B22 AH164-PK3B33	AH165-PK3B22 AH165-PK3B33			
	Spring/ manual return	①	2NO+2NC 3NO+3NC	AH164-PK6B22 AH164-PK6B33	AH165-PK6B22 AH165-PK6B33			
	Spring/ manual return	①	2NO+2NC 3NO+3NC	AH164-PK7B22 AH164-PK7B33	AH165-PK7B22 AH165-PK7B33			
	Spring return	①	2NO+2NC 3NO+3NC	AH164-PK1B22 AH164-PK1B33	AH165-PK1B22 AH165-PK1B33			
Knob with square bezel  KKD07-216	Maintained	—	2NO+2NC 3NO+3NC	AH164-SPK3B22 AH164-SPK3B33	AH165-SPK3B22 AH165-SPK3B33			
	Spring/ manual return	①	2NO+2NC 3NO+3NC	AH164-SPK6B22 AH164-SPK6B33	AH165-SPK6B22 AH165-SPK6B33			
	Spring/ manual return	①	2NO+2NC 3NO+3NC	AH164-SPK7B22 AH164-SPK7B33	AH165-SPK7B22 AH165-SPK7B33			
	Spring return	①	2NO+2NC 3NO+3NC	AH164-SPK1B22 AH164-SPK1B33	AH165-SPK1B22 AH165-SPK1B33			
Key with rectangular bezel  KKD09-002L	Maintained	⊖ A	2NO+2NC 3NO+3NC	AH164-JK3A22A AH164-JK3A33A	AH165-JK3A22A AH165-JK3A33A			
		⓪ E	2NO+2NC 3NO+3NC	AH164-JK3E22A AH164-JK3E33A	AH165-JK3E22A AH165-JK3E33A			
		⊘ D	2NO+2NC 3NO+3NC	AH164-JK3D22A AH164-JK3D33A	AH165-JK3D22A AH165-JK3D33A			
		⊗ C	2NO+2NC 3NO+3NC	AH164-JK3C22A AH164-JK3C33A	AH165-JK3C22A AH165-JK3C33A			
	Spring/ manual return	① E	2NO+2NC 3NO+3NC	AH164-JK6E22A AH164-JK6E33A	AH165-JK6E22A AH165-JK6E33A			
		⊘ D	2NO+2NC 3NO+3NC	AH164-JK6D22A AH164-JK6D33A	AH165-JK6D22A AH165-JK6D33A			
	Spring/ manual return	⊖ A	2NO+2NC 3NO+3NC	AH164-JK7A22A AH164-JK7A33A	AH165-JK7A22A AH165-JK7A33A			
		① E	2NO+2NC 3NO+3NC	AH164-JK7E22A AH164-JK7E33A	AH165-JK7E22A AH165-JK7E33A			
	Spring return	① E	2NO+2NC 3NO+3NC	AH164-JK1E22A AH164-JK1E33A	AH165-JK1E22A AH165-JK1E33A			
		① E	2NO+2NC 3NO+3NC	AH164-JK1E22A AH164-JK1E33A	AH165-JK1E22A AH165-JK1E33A			
	Key with square bezel  KKD09-002R	Maintained	⊖ A	2NO+2NC 3NO+3NC	AH164-SJK3A22A AH164-SJK3A33A		AH165-SJK3A22A AH165-SJK3A33A	
			⓪ E	2NO+2NC 3NO+3NC	AH164-SJK3E22A AH164-SJK3E33A		AH165-SJK3E22A AH165-SJK3E33A	
⊘ D			2NO+2NC 3NO+3NC	AH164-SJK3D22A AH164-SJK3D33A	AH165-SJK3D22A AH165-SJK3D33A			
⊗ C			2NO+2NC 3NO+3NC	AH164-SJK3C22A AH164-SJK3C33A	AH165-SJK3C22A AH165-SJK3C33A			
Spring/ manual return		① E	2NO+2NC 3NO+3NC	AH164-SJK6E22A AH164-SJK6E33A	AH165-SJK6E22A AH165-SJK6E33A			
		⊘ D	2NO+2NC 3NO+3NC	AH164-SJK6D22A AH164-SJK6D33A	AH165-SJK6D22A AH165-SJK6D33A			
Spring/ manual return		⊖ A	2NO+2NC 3NO+3NC	AH164-SJK7A22A AH164-SJK7A33A	AH165-SJK7A22A AH165-SJK7A33A			
		① E	2NO+2NC 3NO+3NC	AH164-SJK7E22A AH164-SJK7E33A	AH165-SJK7E22A AH165-SJK7E33A			
Spring return		① E	2NO+2NC 3NO+3NC	AH164-SJK1E22A AH164-SJK1E33A	AH165-SJK1E22A AH165-SJK1E33A			
		① E	2NO+2NC 3NO+3NC	AH164-SJK1E22A AH164-SJK1E33A	AH165-SJK1E22A AH165-SJK1E33A			

- There are 6 available key types; A, B, C, D, E and F. Standard key code is A.
- Contact arrangement and operator position: See page 04/205.

• Key removable positions (JK, SJK)

Remvable position							
Code	A	B	C	D	E	F	G

Operation code	Key removable position
3	A, B, C, D, E, F, G
6	D, E, F
7	A, E, G
1	E

• Key code No.

There are 6 available key types; A, B, C, D, E and F.
Standard key code is A.

• Contact block position

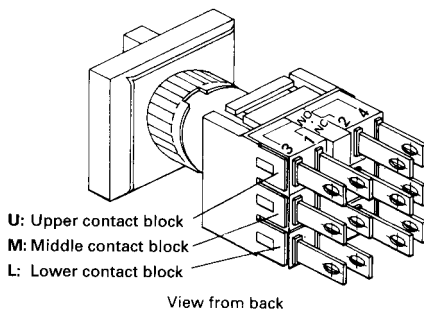





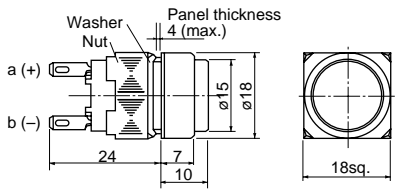

• Contact arrangement and operator position:
3-position selector switch

Contact arrange-ment		2NO+2NC	3NO+3NC
Operator position	Left ⌚	U L 1 0 1 0 2 1 0 2 3 0 0 4 3 0 0 4	U M L 1 0 1 0 2 1 0 2 1 0 2 3 0 0 4 3 0 0 4 3 0 0 4
	Center ⓪	1 0 1 0 2 1 0 1 0 2 3 0 0 4 3 0 0 4	1 0 1 0 2 1 0 1 0 2 1 0 2 3 0 0 4 3 0 0 4 3 0 0 4
	Right ⌚	1 0 1 0 2 1 0 1 0 2 3 0 0 4 3 0 0 4	1 0 1 0 2 1 0 1 0 2 1 0 2 3 0 0 4 3 0 0 4 3 0 0 4

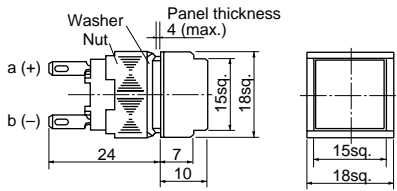
Pilot Lights AH164 and AH165

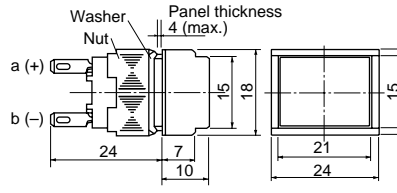
■ Pilot lights/without transformer

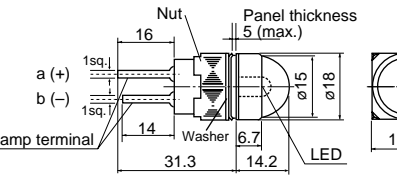
Lens	Lamp	Voltage	AH164 type	AH165 (oil-tight) type	Dimensions, mm
 SK-1139	Flat LED	24V DC	AH164-Z□E3	AH165-Z□E3	
	Spot LED	24V DC	AH164-Z□E2	AH165-Z□E2	
	Incandescent	24V AC/DC	AH164-Z□E	AH165-Z□E	
	Neon	110V AC 220V AC	AH164-Z□H1 AH164-Z□M1	AH165-Z□H1 AH165-Z□M1	
 SK-1138	Flat LED	24V DC	AH164-ZS□E3	AH165-ZS□E3	
	Spot LED	24V DC	AH164-ZS□E2	AH165-ZS□E2	
	Incandescent	24V AC/DC	AH164-ZS□E	AH165-ZS□E	
	Neon	110V AC 220V AC	AH164-ZS□H1 AH164-ZS□M1	AH165-ZS□H1 AH165-ZS□M1	
 SK-1137	Flat LED	24V DC	AH164-ZT□E3	AH165-ZT□E3	
	Spot LED	24V DC	AH164-ZT□E2	AH165-ZT□E2	
	Incandescent	24V AC/DC	AH164-ZT□E	AH165-ZT□E	
	Neon	110V AC 220V AC	AH164-ZT□H1 AH164-ZT□M1	AH165-ZT□H1 AH165-ZT□M1	
 AF87-45	LED	12V DC 24V DC	- -	AH165-ZM□B2 AH165-ZM□E2	

● Lens color

Replace the □ mark by the following lens color code

Color	Green	Red	White	Yellow	Blue	Orange
Code	G	R	W	Y	S	O

- The color lens is made of a tinted transparent material.
- A white pilot lights is fitted with a transparent color lens. (Except the neon lamp and dome).
- With wire-wrap pin terminals have a depth of 29mm. (Except for ZM type)





● Lamp voltage

Voltages other than above are available

Code	LED	Incandescent	Neon
AA	5V DC	-	-
A	6V DC	5V AC/DC	-
B	12V DC	12V AC/DC	-
K	-	-	120V AC
P	-	-	240V AC

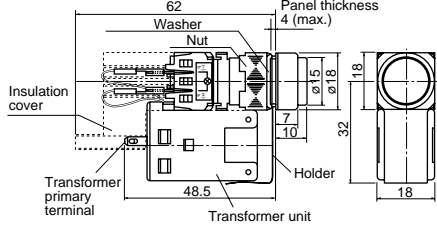
Note: Except for ZM types and red/green LED types

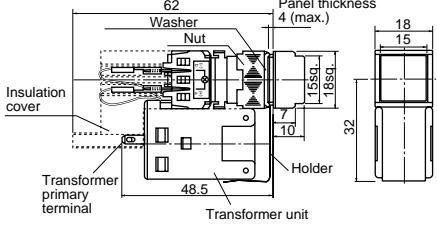
■ Pilot lights/with transformer

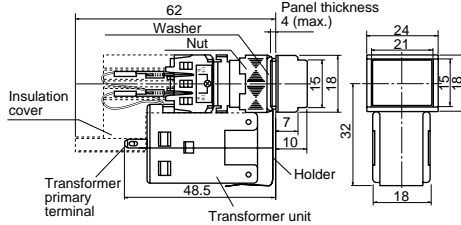
Lens	Lamp	Voltage	AH164 type	AH165 (oil-tight) type	Dimensions, mm
Extended square  AF90-944	Flat LED	■ Voltage H: 100-110V AC M: 200-220V AC	AH164-Z□■3	AH165-Z□■3	
	Incandescent		AH164-Z□■	AH165-Z□■	
Flush square  AF90-943	Flat LED	■ Voltage H: 100-110V AC M: 200-220V AC	AH164-ZS□■3	AH165-ZS□■3	
	Incandescent		AH164-ZS□■	AH165-ZS□■	
Flush rectangular  AF90-942	Flat LED	■ Voltage H: 100-110V AC M: 200-220V AC	AH164-ZT□■3	AH165-ZT□■3	
	Incandescent		AH164-ZT□■	AH165-ZT□■	

● Lens color

Replace the □ mark by the following lens color code

Color	Green	Red	White	Yellow	Blue	Orange
Code	G	R	W	Y	S	O







- The color lens is made of a tinted transparent material.
- A white pilot lights is fitted with a transparent color lens.

04

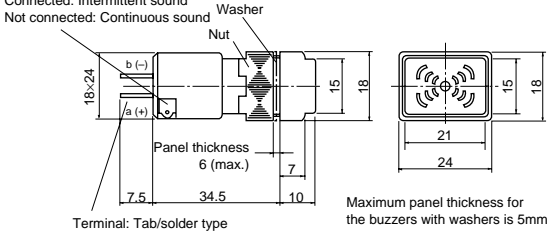
Buzzers

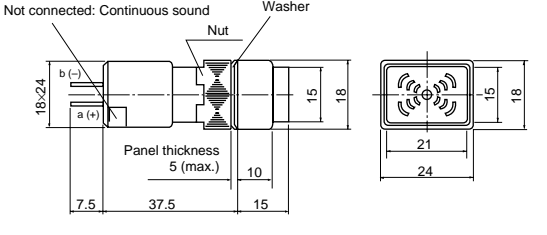
AH164 and AH165

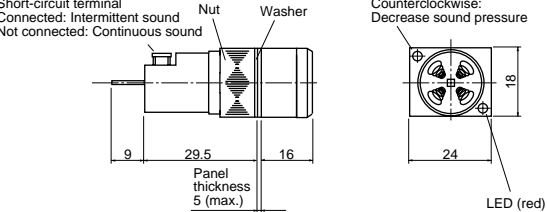
■ Buzzers

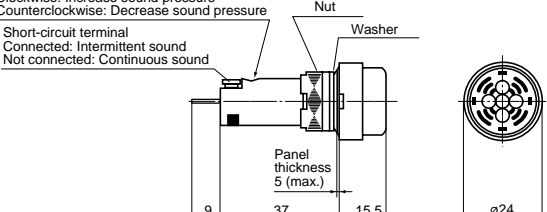
Sound	Operating voltage	Type	Dimensions, mm
Standard  AF87-317	6V AC Discontinued	AH164-TXBAAC	Short-circuit terminal Connected: Intermittent sound Not connected: Continuous sound  Maximum panel thickness for the buzzers with washers is 5mm Terminal: Tab/solder type
	6V DC	AH164-TXBADC	
	12 to 24V AC/DC	AH164-TXBE	
	35 to 48V AC/DC Discontinued	AH164-TXBF	
Loud sound  AF87-44	6V AC Discontinued	AH164-TX1BAAC	Short-circuit terminal Connected: Intermittent sound Not connected: Continuous sound 
	6V DC	AH164-TX1BADC	
	12 to 24V AC/DC	AH164-TX1BE	
	35 to 48V AC/DC Discontinued	AH164-TX1BF	
Loud sound with volume control  KKD07-223	6V AC/DC	AH164-TX2BA	Short-circuit terminal Connected: Intermittent sound Not connected: Continuous sound  Volume Clockwise: Increase sound pressure Counterclockwise: Decrease sound pressure LED (red)
	12 to 24V AC/DC	AH164-TX2BE	
	35 to 48V AC/DC Discontinued	AH164-TX2BF	
Standard sound with volume control (IP54)  KKD05-096b	6V AC/DC	AH165-XBA	Volume Clockwise: Increase sound pressure Counterclockwise: Decrease sound pressure Short-circuit terminal Connected: Intermittent sound Not connected: Continuous sound 
	12 to 24V AC/DC	AH165-XBE	
	35 to 48V AC/DC Discontinued	AH165-XBF	

Pushbuttons/Selectors/Pilot Lights/Buzzers AH164 and AH165 Mounting space

■ Mounting space, mm • Pushbuttons and pilot lights

Extended round head or lens

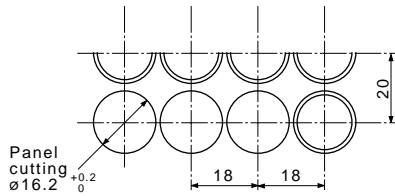

Flush square head or lens

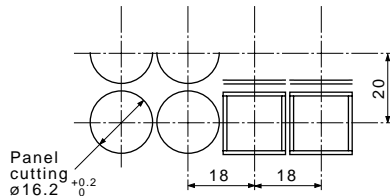

Flush rectangular head or lens

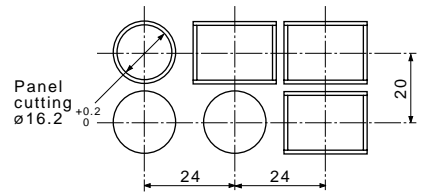

Mushroom head

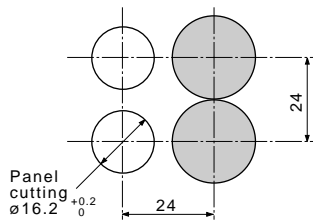

Convex square head

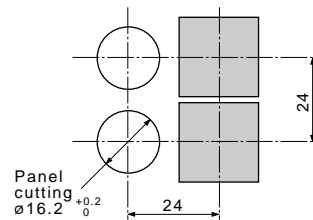

Convex rectangular head

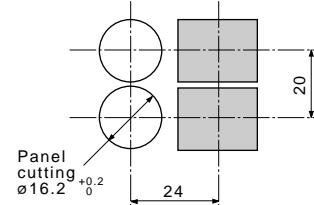

• Selector switches

• When mounting the selector switches near the pilot light

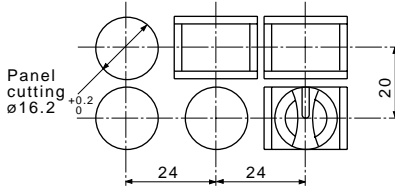

• When mounting the selector switches near each other

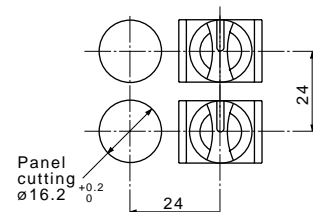

• With transformer

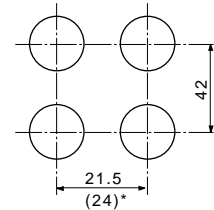

• When mounting the JM or RJM selector switches near each other (2NO+2NC only)

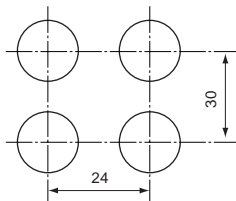

• When mounting the JM or RJM selector switches near the other selector switch, pushbutton switch and pilot lights

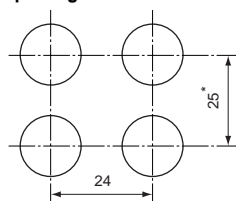

Note: * Mushroom, convex square, convex rectangular: 27

Note: * () For switch with flush rectangular head

• AH165-V, V1, V5, V6

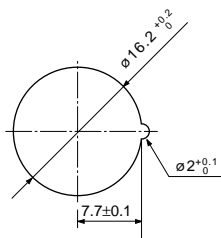

• AH165-JM, RJM

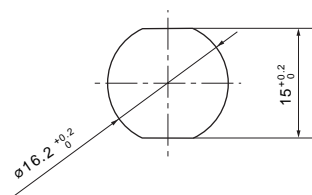

■ Terminal number

• AH164, 165

Type	Wiring	Terminal position
Illuminated pushbuttons	<p>a (+) b (-)</p>	<p>Type number display side</p>
Pushbuttons Selector switches (except for JM, RJM types)		
Pilot lights (without transformer)	<p>a (+) b (-)</p>	<p>Type number display side</p>

Pushbuttons/Selectors/Pilot Lights

AH165-2

Type number nomenclature

■ Type number nomenclature

Pushbuttons, illuminated pushbuttons and pilot lights

AH165-2 FL R 11 E 3 - W
 ① ② ③ ④ ⑤ ⑥ ⑦

① Product category

AH165-2: Oil-tight (Large operator)

② Operator or lens

• Operator for illuminated pushbutton

FL: Flush round head
 FL5: Flush round head (Alternate)
 SFL: Flush square head
 SFL5: Flush square head (Alternate)
 EL: Extended round head
 EL5: Extended round head (Alternate)
 SEL: Extended square head
 SEL5: Extended square head (Alternate)
 SCL: Concave square head
 SCL5: Concave square head (Alternate)
 ML: Mushroom head
 YML: Mushroom head with square bezel
 VL: Push-lock, turn-reset
 YVL: Push-lock, turn-reset with square bezel

• Operator for pushbuttons

F: Flush round head
 F5: Flush round head (Alternate)
 SF: Flush square head
 SF5: Flush square head (Alternate)
 E: Extended round head
 E5: Extended round head (Alternate)
 SE: Extended square head
 SE5: Extended square head (Alternate)
 SCE: Concave square head
 SCE5: Concave square head (Alternate)
 M: Mushroom head
 YM: Mushroom head with square bezel
 V: Push-lock, turn-reset
 YV: Push-lock, turn-reset with square bezel
 S2: With selector ring
 YS2: With selector ring with square bezel

• Lens for pilot lights

Z: Flush round
 SZ: Flush square
 ZE: Extended round
 SEZ: Extended square

③ Color of button or lens

Code	Color	Button	LED	Incandescent	Neon
G	Green	○	○	○	○
R	Red	○	○	○	○ (Orange)
B	Black*	○	—	—	—
Y	Yellow	○	○	○	○ (Orange)
W	White	○	○ (Orange)	○	○ (Orange)
S	Blue	○	○	○	○ (Green)
O	Orange	○	○ (Amber)	○	○

Notes: • (): indicates luminous color

* Not available for illuminated types

④ Contact arrangement (except pilot lights)

11: 1NO+1NC
 22: 2NO+2NC
 33: 3NO+3NC

⑤ Lamp voltage

Code	LED	Incandescent	Neon
AA	5V DC	—	—
A	6V DC	5V AC/DC	—
B	12V DC	12V AC/DC	—
E	24V DC	24V AC/DC	—
H	—	—	110V AC
K	—	—	120V AC
M	—	—	220V AC
P	—	—	240V AC

⑥ Type of lamp

Blank: Incandescent

1: Neon

3: Flat LED

⑦ Terminal

Blank: Solder/tab

W: Wire-wrap

■ **Type number nomenclature**

Selector switches

AH165-2 J 2 B 11 A - W
 ① ② ③ ④ ⑤ ⑥ ⑦

① **Product category**
 AH165-2: Oil-tight (Large operator)

② **Operator**
 • Knob and key type
 2-position (operating angle 90°)
 P: Knob
 YP: Knob with square bezel
 J: Key
 YJ: Key with square bezel

3-position (operating angle 45°)
 P: Knob
 YP: Knob with square bezel
 J: Key
 YJ: Key with square bezel

• Lever type
 2-position (operating angle 45°)
 H: Lever
 SH: Lever with square bezel
 Note: The operation angle is 45° on the upper and lower side.

③ **Operation**
 2: 2-position, maintained
 0: 2-position, spring return*
 3: 3-position, maintained
 6: 3-position, spring/manual return (Left to center)
 7: 3-position, spring/manual return (Right to center)
 1: 3-position, spring return
 Note: * Except for H and SH types

④ **Color of knob, lever or key removable position**

• Color of knob or lever
 B: Black

• Key removable position

Code	2-position		3-position			
	2	0	1	3	6	7
A	⊙	⊙	—	⊙	—	⊙
B	⊗	—	—	⊗	—	—
C	—	—	—	⊗	—	—
D	⊙	—	—	⊙	—	—
E	—	—	①			
F	—	—	—	⊙	—	—
G	—	—	—	⊙	—	⊙

⑤ **Contact arrangement**

11: 1NO+1NC*
 22: 2NO+2NC
 33: 3NO+3NC
 Note: * Except for 3-position

⑥ **Key type No.**

A (standard), B, C, D, E, F

⑦ **Terminal**

Blank: Solder/tab
 W: Wire-wrap

Illuminated selector switches

AH165-2 PL 2 G 11 E 3
 ① ② ③ ④ ⑤ ⑥ ⑦

① **Product category**
 AH165-2: Oil-tight (Large operator)

② **Operator**
 • 2-position (operating angle 90°)
 PL: Knob

• 3-position (operating angle 45°)
 PL: Knob

③ **Operation**

2: 2-position, maintained
 3: 3-position, maintained

④ **Color of knob**

Code	Color	LED	Incandescent	Neon
G	Green	○	○	○
R	Red	○	○	○ (Orange)
Y	Yellow	○	○	○ (Orange)
W	White	○ (Orange)	○	○ (Orange)
S	Blue	○	○	○ (Green)
O	Orange	○ (Amber)	○	○

Notes: • (): indicates luminous color
 • The part other than the arrow of the knob is black.

⑤ **Contact arrangement**

11: 1NO+1NC*
 22: 2NO+2NC
 Note: * Except for 3-position

⑥ **Lamp voltage**

Code	LED	Incandescent	Neon
AA	5V DC	—	—
A	6V DC	5V AC/DC	—
B	12V DC	12V AC/DC	—
E	24V DC	24V AC/DC	—
H	—	—	110V AC
K	—	—	120V AC
M	—	—	220V AC
P	—	—	240V AC

⑦ **Type of lamp**

Blank: Incandescent
 1: Neon
 3: Flat LED
 Note: Terminal with solder/tab only

Pushbuttons/Selectors/Pilot Lights

AH165-2

Ratings and specifications

■ Standards approved

UL508	File No. E44592
CSA C22.2 No.14	File No. LR20479 (except for AH165-2Z, 2ZE, 2SZ, 2SZE) File No. LR84365 (for AH165-2Z, 2ZE, 2SZ, 2SZE)
TÜV: EN60947-5-1	Pushbutton, illuminated pushbutton: R9250087 Selector (except for AH165-2H, SH), illuminated selector: R9250088 Selector (for AH165-2H, SH): R9250087 Pilot lights: R9250089

■ Specifications (Indoor use)

Item	AH165-2	
Rated insulation voltage	250V AC/DC	
Ambient temperature (no condensation or no icing)	-10 to +70°C *1	
Humidity	45 to 85%RH (at -5 to +40°C), no condensation or no icing	
Durability (operations)	Mechanical	Pushbutton and illuminated pushbutton switch Momentary action: 1 million Alternate action: 250,000 Push-lock, turn-reset: 100,000 With selector ring: 250,000
	Electrical	Selector and illuminated selector switch: 250,000*2 100,000 (220V AC 0.7A)
Dielectric strength	2000V AC, 1 minute (Between lamp and contact terminals: 1500V AC, 1 minute)	
Conditional short-circuit current	1000A	
Short-circuit protective device	Fuse 1A	
Pollution degree	3	
Vibration	Resonance: 10 to 55Hz, double amplitude 0.1mm Constant: 16.7Hz, double amplitude 3mm	
Shock	Malfunction durability: 100m/s ² Mechanical durability: 500m/s ²	
Operating frequency	1200 operation/hour (on-load factor: 40%)	
Insulation resistance	100MΩ or more (500V DC megger)	
Operator protection	IP65	

Notes: *1 For illuminated pushbutton, illuminated selector switch and pilot light: -10 to +55°C

*2 Key insertion/removal durability for selector switch key types: 10,000

■ Contact ratings

See page 04/194

■ Lamp ratings







Rated operational voltage	Consumption		
	LED DC	Incandescent AC/DC	Neon AC
5V	7mA (Yellow: 28mA)	0.45W (6V)	—
6V	7mA (Yellow: 28mA)	—	—
12V	7mA	0.55W (14V)	—
24V	7mA	0.55W (28V)	—
110V	—	—	0.19VA
120V	—	—	0.21VA
220V	—	—	0.38VA
240V	—	—	0.42VA

Notes: For the incandescent lamps, the values in parentheses indicate the rated voltage of the lamps.

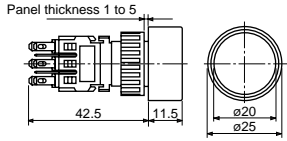
■ Contact reliability

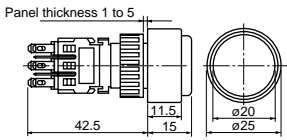
FUJI has confirmed that the unit can be used in 1mA circuit conditions at 5V AC or DC. The operable range may vary depending on the ambient conditions and type of load.

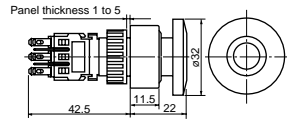
■ **Illuminated pushbutton switches**

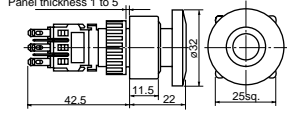



Operator	Lamp	Voltage	Contact	Momentary action	Alternate action	Dimensions, mm		
				Type	Type			
 AF87-211	Flat LED	24V DC	1NO+1NC 2NO+2NC 3NO+3NC	AH165-2FL□11E3 AH165-2FL□22E3 AH165-2FL□33E3	AH165-2FL5□11E3 AH165-2FL5□22E3 AH165-2FL5□33E3			
	Incandescent	24V AC/DC	1NO+1NC 2NO+2NC 3NO+3NC	AH165-2FL□11E AH165-2FL□22E AH165-2FL□33E	AH165-2FL5□11E AH165-2FL5□22E AH165-2FL5□33E			
	Neon	110V AC	1NO+1NC 2NO+2NC 3NO+3NC	AH165-2FL□11H1 AH165-2FL□22H1 AH165-2FL□33H1	AH165-2FL5□11H1 AH165-2FL5□22H1 AH165-2FL5□33H1			
		220V AC	1NO+1NC 2NO+2NC 3NO+3NC	AH165-2FL□11M1 AH165-2FL□22M1 AH165-2FL□33M1	AH165-2FL5□11M1 AH165-2FL5□22M1 AH165-2FL5□33M1			
	 AF87-210	Flat LED	24V DC	1NO+1NC 2NO+2NC 3NO+3NC	AH165-2EL□11E3 AH165-2EL□22E3 AH165-2EL□33E3		AH165-2EL5□11E3 AH165-2EL5□22E3 AH165-2EL5□33E3	
		Incandescent	24V AC/DC	1NO+1NC 2NO+2NC 3NO+3NC	AH165-2EL□11E AH165-2EL□22E AH165-2EL□33E		AH165-2EL5□11E AH165-2EL5□22E AH165-2EL5□33E	
Neon		110V AC	1NO+1NC 2NO+2NC 3NO+3NC	AH165-2EL□11H1 AH165-2EL□22H1 AH165-2EL□33H1	AH165-2EL5□11H1 AH165-2EL5□22H1 AH165-2EL5□33H1			
		220V AC	1NO+1NC 2NO+2NC 3NO+3NC	AH165-2EL□11M1 AH165-2EL□22M1 AH165-2EL□33M1	AH165-2EL5□11M1 AH165-2EL5□22M1 AH165-2EL5□33M1			
 AF87-221		Flat LED	24V DC	1NO+1NC 2NO+2NC 3NO+3NC	AH165-2ML□11E3 AH165-2ML□22E3 AH165-2ML□33E3	— — —		
		Incandescent	24V AC/DC	1NO+1NC 2NO+2NC 3NO+3NC	AH165-2ML□11E AH165-2ML□22E AH165-2ML□33E	— — —		
	Neon	110V AC	1NO+1NC 2NO+2NC 3NO+3NC	AH165-2ML□11H1 AH165-2ML□22H1 AH165-2ML□33H1	— — —			
		220V AC	1NO+1NC 2NO+2NC 3NO+3NC	AH165-2ML□11M1 AH165-2ML□22M1 AH165-2ML□33M1	— — —			
	 AF87-220	Flat LED	24V DC	1NO+1NC 2NO+2NC 3NO+3NC	AH165-2YML□11E3 AH165-2YML□22E3 AH165-2YML□33E3	— — —		
		Incandescent	24V AC/DC	1NO+1NC 2NO+2NC 3NO+3NC	AH165-2YML□11E AH165-2YML□22E AH165-2YML□33E	— — —		
Neon		110V AC	1NO+1NC 2NO+2NC 3NO+3NC	AH165-2YML□11H1 AH165-2YML□22H1 AH165-2YML□33H1	— — —			
		220V AC	1NO+1NC 2NO+2NC 3NO+3NC	AH165-2YML□11M1 AH165-2YML□22M1 AH165-2YML□33M1	— — —			

Note: Replace the □ mark by the following color code, see page 04/215.

Illuminated Pushbutton Switches

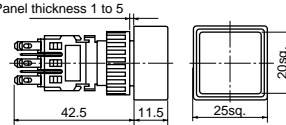

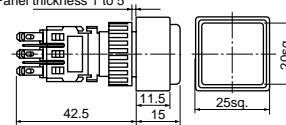
AH165-2

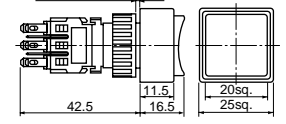
■ Illuminated pushbutton switches

Operator	Lamp	Voltage	Contact	Momentary action	Alternate action	Dimensions, mm		
				Type	Type			
 <p>AF87-201</p>	Flat LED	24V DC	1NO+1NC 2NO+2NC 3NO+3NC	AH165-2SFL□11E3 AH165-2SFL□22E3 AH165-2SFL□33E3	AH165-2SFL5□11E3 AH165-2SFL5□22E3 AH165-2SFL5□33E3			
	Incandescent	24V AC/DC	1NO+1NC 2NO+2NC 3NO+3NC	AH165-2SFL□11E AH165-2SFL□22E AH165-2SFL□33E	AH165-2SFL5□11E AH165-2SFL5□22E AH165-2SFL5□33E			
	Neon	110V AC	1NO+1NC 2NO+2NC 3NO+3NC	AH165-2SFL□11H1 AH165-2SFL□22H1 AH165-2SFL□33H1	AH165-2SFL5□11H1 AH165-2SFL5□22H1 AH165-2SFL5□33H1			
		220V AC	1NO+1NC 2NO+2NC 3NO+3NC	AH165-2SFL□11M1 AH165-2SFL□22M1 AH165-2SFL□33M1	AH165-2SFL5□11M1 AH165-2SFL5□22M1 AH165-2SFL5□33M1			
	 <p>AF87-200</p>	Flat LED	24V DC	1NO+1NC 2NO+2NC 3NO+3NC	AH165-2SEL□11E3 AH165-2SEL□22E3 AH165-2SEL□33E3		AH165-2SEL5□11E3 AH165-2SEL5□22E3 AH165-2SEL5□33E3	
		Incandescent	24V AC/DC	1NO+1NC 2NO+2NC 3NO+3NC	AH165-2SEL□11E AH165-2SEL□22E AH165-2SEL□33E		AH165-2SEL5□11E AH165-2SEL5□22E AH165-2SEL5□33E	
Neon		110V AC	1NO+1NC 2NO+2NC 3NO+3NC	AH165-2SEL□11H1 AH165-2SEL□22H1 AH165-2SEL□33H1	AH165-2SEL5□11H1 AH165-2SEL5□22H1 AH165-2SEL5□33H1			
		220V AC	1NO+1NC 2NO+2NC 3NO+3NC	AH165-2SEL□11M1 AH165-2SEL□22M1 AH165-2SEL□33M1	AH165-2SEL5□11M1 AH165-2SEL5□22M1 AH165-2SEL5□33M1			
 <p>AF87-199</p>		Flat LED	24V DC	1NO+1NC 2NO+2NC 3NO+3NC	AH165-2SCL□11E3 AH165-2SCL□22E3 AH165-2SCL□33E3	AH165-2SCL5□11E3 AH165-2SCL5□22E3 AH165-2SCL5□33E3		
		Incandescent	24V AC/DC	1NO+1NC 2NO+2NC 3NO+3NC	AH165-2SCL□11E AH165-2SCL□22E AH165-2SCL□33E	AH165-2SCL5□11E AH165-2SCL5□22E AH165-2SCL5□33E		
	Neon	110V AC	1NO+1NC 2NO+2NC 3NO+3NC	AH165-2SCL□11H1 AH165-2SCL□22H1 AH165-2SCL□33H1	AH165-2SCL5□11H1 AH165-2SCL5□22H1 AH165-2SCL5□33H1			
		220V AC	1NO+1NC 2NO+2NC 3NO+3NC	AH165-2SCL□11M1 AH165-2SCL□22M1 AH165-2SCL□33M1	AH165-2SCL5□11M1 AH165-2SCL5□22M1 AH165-2SCL5□33M1			

Note: Replace the □ mark by the following color code, see page 04/215.

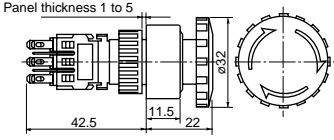
■ **Illuminated pushbutton switches**

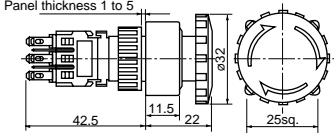
Operator	Lamp	Voltage	Contact	Type	Dimensions, mm			
 AF87-219	Push-lock, turn-reset	Flat LED	24V DC	1NO+1NC 2NO+2NC 3NO+3NC	AH165-2VL□11E3 AH165-2VL□22E3 AH165-2VL□33E3			
		Incandescent	24V AC/DC	1NO+1NC 2NO+2NC 3NO+3NC	AH165-2VL□11E AH165-2VL□22E AH165-2VL□33E			
		Neon	110V AC	1NO+1NC 2NO+2NC 3NO+3NC	AH165-2VL□11H1 AH165-2VL□22H1 AH165-2VL□33H1			
			220V AC	1NO+1NC 2NO+2NC 3NO+3NC	AH165-2VL□11M1 AH165-2VL□22M1 AH165-2VL□33M1			
	 AF87-218	Push-lock, turn-reset with square bezel	Flat LED	24V DC	1NO+1NC 2NO+2NC 3NO+3NC		AH165-2YVL□11E3 AH165-2YVL□22E3 AH165-2YVL□33E3	
			Incandescent	24V AC/DC	1NO+1NC 2NO+2NC 3NO+3NC		AH165-2YVL□11E AH165-2YVL□22E AH165-2YVL□33E	
		Neon	110V AC	1NO+1NC 2NO+2NC 3NO+3NC	AH165-2YVL□11H1 AH165-2YVL□22H1 AH165-2YVL□33H1			
			220V AC	1NO+1NC 2NO+2NC 3NO+3NC	AH165-2YVL□11M1 AH165-2YVL□22M1 AH165-2YVL□33M1			

04

• **Button color**

Replace the □ mark by the following button color code

Color	Green	Red	White	Yellow	Blue	Orange
Code	G	R	W	Y	S	O

• With wire-wrap pin terminals have a depth of 47mm.

- A white illuminated pushbutton is fitted with a transparent color lens.
- The color lens is made of a tinted transparent material.

• **Lamp voltage**











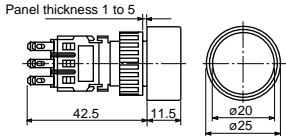

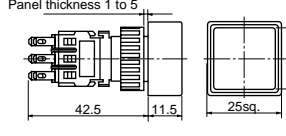
Voltages other than above are available

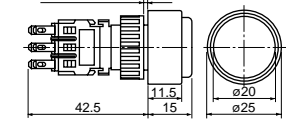
Code	LED	Incandescent	Neon
AA	5V DC	—	—
A	6V DC	5V AC/DC	—
B	12V DC	12V AC/DC	—
K	—	—	120V AC
P	—	—	240V AC

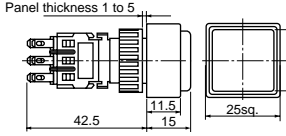
Pushbutton Switches

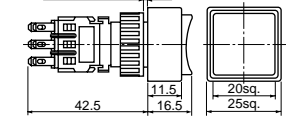

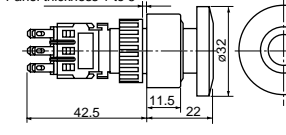

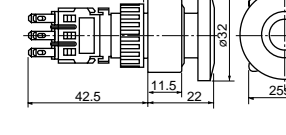

AH165-2

■ Pushbutton switches

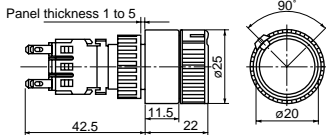
Operator	Contact	Momentary action	Alternate action	Dimensions, mm
		Type	Type	
 <p>AF87-211</p>	1NO+1NC	AH165-2F□11	AH165-2F5□11	
	2NO+2NC	AH165-2F□22	AH165-2F5□22	
	3NO+3NC	AH165-2F□33	AH165-2F5□33	
 <p>AF87-201</p>	1NO+1NC	AH165-2SF□11	AH165-2SF5□11	
	2NO+2NC	AH165-2SF□22	AH165-2SF5□22	
	3NO+3NC	AH165-2SF□33	AH165-2SF5□33	
 <p>AF87-210</p>	1NO+1NC	AH165-2E□11	AH165-2E5□11	
	2NO+2NC	AH165-2E□22	AH165-2E5□22	
	3NO+3NC	AH165-2E□33	AH165-2E5□33	
 <p>AF87-200</p>	1NO+1NC	AH165-2SE□11	AH165-2SE5□11	
	2NO+2NC	AH165-2SE□22	AH165-2SE5□22	
	3NO+3NC	AH165-2SE□33	AH165-2SE5□33	
 <p>AF87-199</p>	1NO+1NC	AH165-2SCE□11	AH165-2SCE5□11	
	2NO+2NC	AH165-2SCE□22	AH165-2SCE5□22	
	3NO+3NC	AH165-2SCE□33	AH165-2SCE5□33	
 <p>AF87-215</p>	1NO+1NC	AH165-2M□11	—	
	2NO+2NC	AH165-2M□22	—	
	3NO+3NC	AH165-2M□33	—	
 <p>AF87-214</p>	1NO+1NC	AH165-2YM□11	—	
	2NO+2NC	AH165-2YM□22	—	
	3NO+3NC	AH165-2YM□33	—	

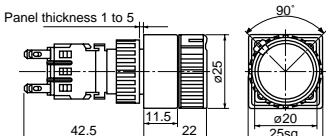
Note: Replace the □ mark by the following color code, see page 04/217.

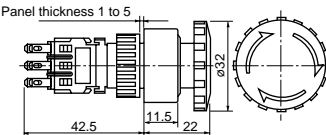
■ Pushbutton switches

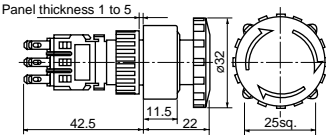
Operator	Contact	Type	Dimensions, mm
 <p>AF87-207</p>	2NO+2NC	AH165-2S2□22	
 <p>AF87-206</p>	2NO+2NC	AH165-2YS2□22	
 <p>AF87-210</p>	1NO+1NC 2NO+2NC 3NO+3NC	AH165-2V□11 AH165-2V□22 AH165-2V□33	
 <p>AF87-200</p>	1NO+1NC 2NO+2NC 3NO+3NC	AH165-2YV□11 AH165-2YV□22 AH165-2YV□33	



• Button color

Replace the □ mark by the following button color code

Color	Green	Red	Black	White	Blue	Yellow	Orange
Code	G	R	B	W	S	Y	O

• Contact arrangement and operator position

AH165-2S, 2YS

Button	Ring	Left	Right
			
Free	U	1O — 02 1O — 02	1O — 02 1O — 02
	L	3O — 04 3O — 04	3O — 04 3O — 04
Depressed	U	1O — 02 1O — 02	1O — 02 1O — 02
	L	3O — 04 3O — 04	3O — 04 3O — 04

U: Upper contact block
L: Lower contact block





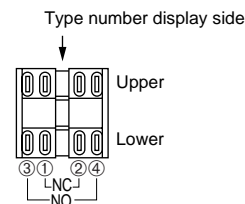

- The color lens is made of a tinted transparent material. (Except for M, YM, V, YV, types)
- A white pushbutton is fitted with a transparent color lens. A black pushbutton consists of a transparent color lens and an attached black legend plate. (Except for M, YM, V, YV, types)
- With wire-wrap pin terminals have a depth of 47mm.

• Terminal number and contact block position

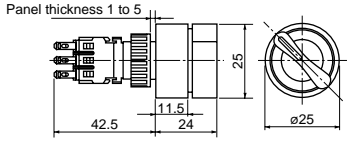

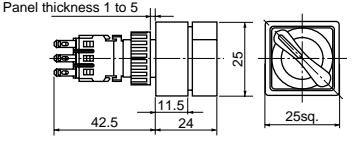
Selector Switches AH165-2

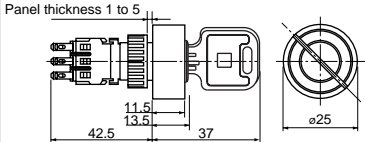
■ Selector switches/2-position (90-degree)

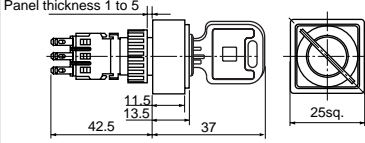
Operator	Operation	Key removable position	Contact	Type	Dimensions, mm
 KKD07-232	Maintained	—	1NO+1NC 2NO+2NC 3NO+3NC	AH165-2P2B11 AH165-2P2B22 AH165-2P2B33	
	Spring return	—	1NO+1NC 2NO+2NC 3NO+3NC	AH165-2P0B11 AH165-2P0B22 AH165-2P0B33	
 KKD07-234	Maintained	—	1NO+1NC 2NO+2NC 3NO+3NC	AH165-2YP2B11 AH165-2YP2B22 AH165-2YP2B33	
	Spring return	—	1NO+1NC 2NO+2NC 3NO+3NC	AH165-2YP0B11 AH165-2YP0B22 AH165-2YP0B33	
 KKD09-003L	Maintained	⊖ A	1NO+1NC 2NO+2NC 3NO+3NC	AH165-2J2A11A AH165-2J2A22A AH165-2J2A33A	
		⊗ B	1NO+1NC 2NO+2NC 3NO+3NC	AH165-2J2B11A AH165-2J2B22A AH165-2J2B33A	
		⊘ D	1NO+1NC 2NO+2NC 3NO+3NC	AH165-2J2D11A AH165-2J2D22A AH165-2J2D33A	
	Spring return	⊖ A	1NO+1NC 2NO+2NC 3NO+3NC	AH165-2J0A11A AH165-2J0A22A AH165-2J0A33A	
		⊗ B	1NO+1NC 2NO+2NC 3NO+3NC	AH165-2YJ2B11A AH165-2YJ2B22A AH165-2YJ2B33A	
		⊘ D	1NO+1NC 2NO+2NC 3NO+3NC	AH165-2YJ2D11A AH165-2YJ2D22A AH165-2YJ2D33A	
 KKD09-003R	Maintained	⊖ A	1NO+1NC 2NO+2NC 3NO+3NC	AH165-2YJ2A11A AH165-2YJ2A22A AH165-2YJ2A33A	
		⊗ B	1NO+1NC 2NO+2NC 3NO+3NC	AH165-2YJ2B11A AH165-2YJ2B22A AH165-2YJ2B33A	
		⊘ D	1NO+1NC 2NO+2NC 3NO+3NC	AH165-2YJ2D11A AH165-2YJ2D22A AH165-2YJ2D33A	
	Spring return	⊖ A	1NO+1NC 2NO+2NC 3NO+3NC	AH165-2YJ0A11A AH165-2YJ0A22A AH165-2YJ0A33A	
		⊗ B	1NO+1NC 2NO+2NC 3NO+3NC	AH165-2YJ0B11A AH165-2YJ0B22A AH165-2YJ0B33A	
		⊘ D	1NO+1NC 2NO+2NC 3NO+3NC	AH165-2YJ0D11A AH165-2YJ0D22A AH165-2YJ0D33A	

• The key can be removed only at the following positions:

A: ⊖ B: ⊗ D: ⊘

- For spring-return selector switches, the key can be removed at position A.
- There are 6 available key types; A, B, C, D, E and F. Standard key code is A.
- With wire-wrap pin terminals have a depth of 47mm.

• Terminal number and contact block position

Type number display side

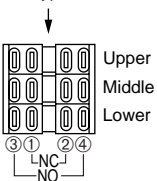

Contact arrangement (terminal No.: common)
 1NO+1NC: Middle
 2NO+2NC: Upper, lower
 3NO+3NC: Upper, middle, lower



• Contact arrangement and operator positions:

2-position

Contact arrangement	1NO+1NC	2NO+2NC	3NO+3NC
Operator position	Left	M 1O ——— 02 3O ——— 04	U 1O ——— 02 3O ——— 04 L 1O ——— 02 3O ——— 04
	Right	M 1O ——— 02 3O ——— 04	U 1O ——— 02 3O ——— 04 L 1O ——— 02 3O ——— 04

U: Upper contact block
 M: Middle contact block
 L: Lower contact block

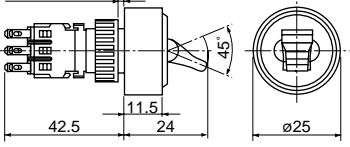
■ Selector switches/2-position

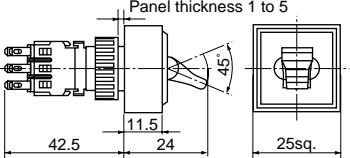
Operator	Lever color	Operation	Contact	Type	Dimensions, mm
 AF87-209	Black	Maintained	1NO+1NC 2NO+2NC 3NO+3NC	AH165-2H2B11 AH165-2H2B22 AH165-2H2B33	Panel thickness 1 to 5 
 AF87-203	Black	Maintained	1NO+1NC 2NO+2NC 3NO+3NC	AH165-2SH2B11 AH165-2SH2B22 AH165-2SH2B33	Panel thickness 1 to 5 

04

• Contact arrangement and operator position

AH165-2H, 2SH

Contact block	Lever	Up	Down
			
1NO+1NC		M 1O — O2 3O — O4	M 1O — O2 3O — O4
2NO+2NC		U — L 1O — O2 — 1O — O2 3O — O4 — 3O — O4	U — L 1O — O2 — 1O — O2 3O — O4 — 3O — O4
3NO+3NC		U — M — L 1O — O2 — 1O — O2 — 1O — O2 3O — O4 — 3O — O4 — 3O — O4	U — M — L 1O — O2 — 1O — O2 — 1O — O2 3O — O4 — 3O — O4 — 3O — O4

U: Upper contact block
M: Middle contact block
L: Lower contact block

• Terminal number and contact block position

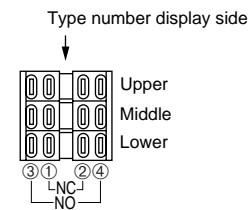





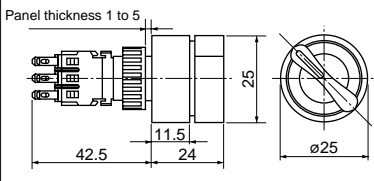

Contact arrangement (terminal No.: common)
 1NO+1NC: Middle
 2NO+2NC: Upper, lower
 3NO+3NC: Upper, middle, lower

• With wire-wrap pin terminals have a depth of 47mm.

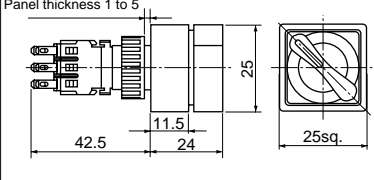
Selector Switches AH165-2

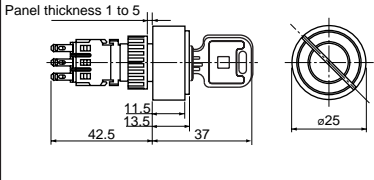
■ Selector switches/3-position (45-degree)

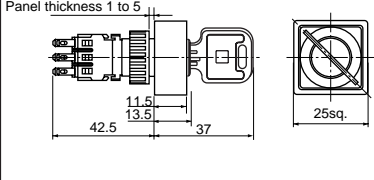
Operator	Operation	Key removable position	Contact	Type	Dimensions, mm		
 KKD07-233	Maintained	—	2NO+2NC 3NO+3NC	AH165-2P3B22 AH165-2P3B33			
	Spring/ manual return	⌚	2NO+2NC 3NO+3NC	AH165-2P6B22 AH165-2P6B33			
	Spring/ manual return	⌚	2NO+2NC 3NO+3NC	AH165-2P7B22 AH165-2P7B33			
	Spring return	⌚	2NO+2NC 3NO+3NC	AH165-2P1B22 AH165-2P1B33			
 KKD07-235	Maintained	—	2NO+2NC 3NO+3NC	AH165-2YP3B22 AH165-2YP3B33			
	Spring/ manual return	⌚	2NO+2NC 3NO+3NC	AH165-2YP6B22 AH165-2YP6B33			
	Spring/ manual return	⌚	2NO+2NC 3NO+3NC	AH165-2YP7B22 AH165-2YP7B33			
	Spring return	⌚	2NO+2NC 3NO+3NC	AH165-2YP1B22 AH165-2YP1B33			
 KKD09-003R	Maintained	⌚ A	2NO+2NC 3NO+3NC	AH165-2J3A22A AH165-2J3A33A			
		⌚ E	2NO+2NC 3NO+3NC	AH165-2J3E22A AH165-2J3E33A			
		⌚ D	2NO+2NC 3NO+3NC	AH165-2J3D22A AH165-2J3D33A			
		⌚ C	2NO+2NC 3NO+3NC	AH165-2J3C22A AH165-2J3C33A			
	Spring/ manual return	⌚ E	2NO+2NC 3NO+3NC	AH165-2J6E22A AH165-2J6E33A			
		⌚ D	2NO+2NC 3NO+3NC	AH165-2J6D22A AH165-2J6D33A			
	Spring/ manual return	⌚ A	2NO+2NC 3NO+3NC	AH165-2J7A22A AH165-2J7A33A			
		⌚ E	2NO+2NC 3NO+3NC	AH165-2J7E22A AH165-2J7E33A			
	Spring return	⌚ E	2NO+2NC 3NO+3NC	AH165-2J1E22A AH165-2J1E33A			
	 KKD09-003L	Maintained	⌚ A	2NO+2NC 3NO+3NC		AH165-2YJ3A22A AH165-2YJ3A33A	
			⌚ E	2NO+2NC 3NO+3NC		AH165-2YJ3E22A AH165-2YJ3E33A	
⌚ D			2NO+2NC 3NO+3NC	AH165-2YJ3D22A AH165-2YJ3D33A			
⌚ C			2NO+2NC 3NO+3NC	AH165-2YJ3C22A AH165-2YJ3C33A			
Spring/ manual return		⌚ E	2NO+2NC 3NO+3NC	AH165-2YJ6E22A AH165-2YJ6E33A			
		⌚ D	2NO+2NC 3NO+3NC	AH165-2YJ6D22A AH165-2YJ6D33A			
Spring/ manual return		⌚ A	2NO+2NC 3NO+3NC	AH165-2YJ7A22A AH165-2YJ7A33A			
		⌚ E	2NO+2NC 3NO+3NC	AH165-2YJ7E22A AH165-2YJ7E33A			
Spring return		⌚ E	2NO+2NC 3NO+3NC	AH165-2YJ1E22A AH165-2YJ1E33A			

• The Key can be removed at the following positions:

A: ⌚ B: ⊗ C: ⊛ D: ⊘ E: ⌚ F: ⊘ G: ⊛

For spring-return selector switches, the key can be removed only at position E. For manual/spring-return selector switches, the key can be removed at positions D, E and F for type J6, and position A, E and G for type J7.

• There are 6 available key types; A, B, C, D, E and F.

Standard key code is A.

• With wire-wrap pin terminals have a depth of 47mm.

• Contact arrangement and operator positions:

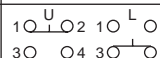
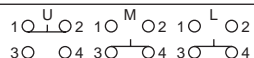
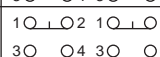
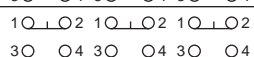
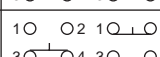
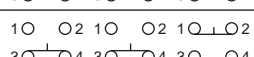
Contact arrangement	2NO+2NC	3NO+3NC
Operator position		
Left		
Center		
Right		

U: Upper contact block M: Middle contact block L: Lower contact block

• Contact block positions: See page 04/219

Fuji Electric FA Components & Systems Co., Ltd./D & C Catalog
Information subject to change without notice

■ Illuminated selector switches

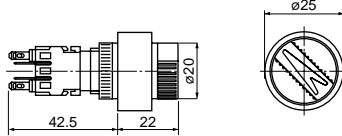
Operator	Operation	Lamp voltage	No. of positions	Contact	Type	Dimensions, mm	
 KKD07-240	Maintained	Flat LED 24V DC	2	1NO+1NC 2NO+2NC	AH165-2PL2□11E3 AH165-2PL2□22E3		
			3	2NO+2NC	AH165-2PL3□22E3		
			2	1NO+1NC 2NO+2NC	AH165-2PL2□11E AH165-2PL2□22E		
		Incandescent 24V AC/DC	3	2NO+2NC	AH165-2PL3□22E		
			2	1NO+1NC 2NO+2NC	AH165-2PL2□11H1 AH165-2PL2□22H1		
				3	2NO+2NC		AH165-2PL3□22H1
		Neon 110V AC	2	1NO+1NC 2NO+2NC	2NO+2NC		AH165-2PL2□11M1 AH165-2PL2□22M1
							3
		Neon 220V AC	2	1NO+2NC 2NO+2NC	2NO+2NC		AH165-2PL2□11M1 AH165-2PL2□22M1
							3

04

• Knob color (arrow)

Replace the □ mark by the following color code

Color	Green	Red	White	Blue	Yellow	Orange
Code	G	R	W	S	Y	O

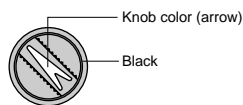

• Lamp voltage

Voltages other than above are available

Code	LED	Incandescent	Neon
AA	5V DC	—	—
A	6V DC	5V AC/DC	—
B	12V DC	12V AC/DC	—
K	—	—	120V AC
P	—	—	240V AC

• Terminal number and contact block position

Type number display side

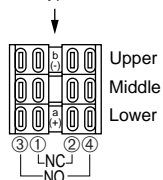

Contact arrangement (terminal No.: common)
1NO+1NC: Middle
2NO+2NC: Upper, lower

• Contact arrangement and operator positions:

2-position

Contact arrangement	1NO+1NC	2NO+2NC	
Operator position	Left (⊖)	M $\begin{matrix} 1 \text{ O } \text{---} \text{ O } 2 \\ 3 \text{ O } \quad \text{O } 4 \end{matrix}$	U $\begin{matrix} 1 \text{ O } \text{---} \text{ O } 2 \\ 3 \text{ O } \quad \text{O } 4 \end{matrix}$ L $\begin{matrix} 1 \text{ O } \text{---} \text{ O } 2 \\ 3 \text{ O } \quad \text{O } 4 \end{matrix}$
	Right (⊕)	M $\begin{matrix} 1 \text{ O } \quad \text{O } 2 \\ 3 \text{ O } \text{---} \text{ O } 4 \end{matrix}$	U $\begin{matrix} 1 \text{ O } \quad \text{O } 2 \\ 3 \text{ O } \text{---} \text{ O } 4 \end{matrix}$ L $\begin{matrix} 1 \text{ O } \quad \text{O } 2 \\ 3 \text{ O } \text{---} \text{ O } 4 \end{matrix}$







3-position

Contact arrangement	2NO+2NC	
Operator position	Left (⊖)	U $\begin{matrix} 1 \text{ O } \text{---} \text{ O } 2 \\ 3 \text{ O } \quad \text{O } 4 \end{matrix}$ L $\begin{matrix} 1 \text{ O } \quad \text{O } 2 \\ 3 \text{ O } \text{---} \text{ O } 4 \end{matrix}$
	Center (⊕)	U $\begin{matrix} 1 \text{ O } \text{---} \text{ O } 2 \\ 3 \text{ O } \quad \text{O } 4 \end{matrix}$ L $\begin{matrix} 1 \text{ O } \text{---} \text{ O } 2 \\ 3 \text{ O } \quad \text{O } 4 \end{matrix}$
Right (⊕)	U $\begin{matrix} 1 \text{ O } \quad \text{O } 2 \\ 3 \text{ O } \text{---} \text{ O } 4 \end{matrix}$ L $\begin{matrix} 1 \text{ O } \quad \text{O } 2 \\ 3 \text{ O } \text{---} \text{ O } 4 \end{matrix}$	

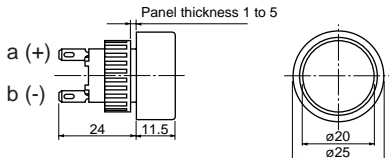
U: Upper contact block
M: Middle contact block
L: Lower contact block

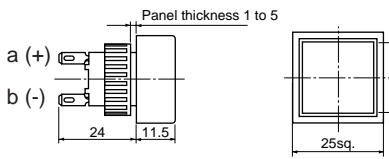
Pilot Lights AH165-2

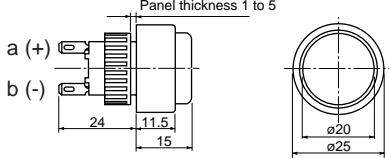
■ Pilot lights

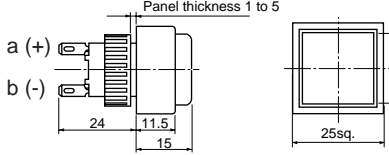
Lens	Lamp	Voltage	Type	Dimensions, mm
 AF87-213	Flat LED	24V DC	AH165-2Z□E3	
	Incandescent	24V AC/DC	AH165-2Z□E	
	Neon	110V AC	AH165-2Z□H1	
		220V AC	AH165-2Z□M1	
 AF87-205	Flat LED	24V DC	AH165-2SZ□E3	
	Incandescent	24V AC/DC	AH165-2SZ□E	
	Neon	110V AC	AH165-2SZ□H1	
		220V AC	AH165-2SZ□M1	
 AF87-212	Flat LED	24V DC	AH165-2ZE□E3	
	Incandescent	24V AC/DC	AH165-2ZE□E	
	Neon	110V AC	AH165-2ZE□H1	
		220V AC	AH165-2ZE□M1	
 AF87-204	Flat LED	24V DC	AH165-2SZE□E3	
	Incandescent	24V AC/DC	AH165-2SZE□E	
	Neon	110V AC	AH165-2SZE□H1	
		220V AC	AH165-2SZE□M1	

• Lens color

Replace the □ mark by the following lens color code

Color	Green	Red	White	Yellow	Blue	Orange
Code	G	R	W	Y	S	O

• Lamp voltage

Voltage other than above is available

Code	LED	Incandescent	Neon
AA	5V DC	—	—
A	6V DC	5V AC/DC	—
B	12V DC	12V AC/DC	—
K	—	—	120V AC
P	—	—	240V AC

- The color lens is made of a tinted transparent material.
- A white lens is fitted with a transparent color lens.
- With wire-wrap pin terminals have a depth of 29mm.

■ **Mounting space, mm**

- Illuminated pushbuttons, pushbuttons, selector switches, illuminated selector switches and pilot lights

Round head

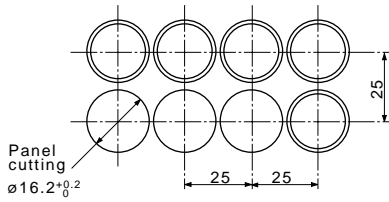

Square head

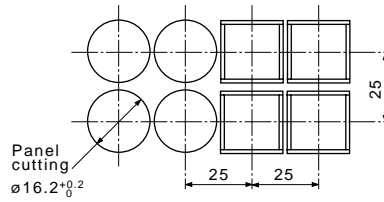

**Mushroom head
 Push-lock, turn-reset**

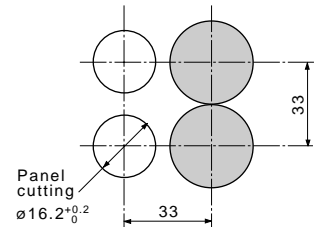

■ **Terminal number**

Type	Wiring	Terminal position
Illuminated pushbuttons, Illuminated selector switches	<p>a (+) b (-)</p> <p>① ——— ② ③ ○ ○ ④</p>	<p>Type number display side</p>
Pushbuttons Selector switches	<p>① ——— ② ③ ○ ○ ④</p>	
Pilot lights (without transformer)	<p>a (+) b (-)</p>	<p>Type number display side</p>

Pushbuttons/Selectors/Pilot Lights/Buzzers AH164, AH165 and AH165-2 Notes on use

Notes on use

■ Installation on panel

- For installation, use dedicated wrench AHX601. The appropriate tightening torque is 0.6 to 1N·cm.
- The installation sequence is as follows:
Pass the operator base through the hole in the panel and secure it by tightening the bezel. Properly position the catch arms and the catch legs of the operator base and push the contact holder onto the operator base. To remove the contact holder, pull it while pressing the catch arms inward.

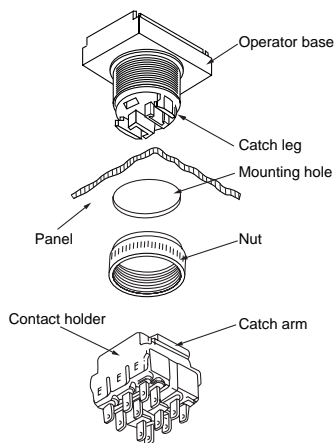

■ Mounting steps of switch with transformer

- ① Pass the switch operator through the panel hole and secure with a nut by way of the retainer metal from the front of the panel.
- ② Align the position of the catch arm of the contact block holder with that of the catch leg of the switch operator. Engage these two catches by pushing them together.
- ③ Insert and secure the transformer unit while assembling the contact block holder with the retainer metal.
- ④ Connect the receptacle terminal with lead wires extending from the transformer to the lamp terminal of the contact block holder. (Be care on the polarity of the LED. Red: +, Black: -)
- ⑤ Push in and secure the standard accessory insulation cover by aligning its position with each terminal. To replace the transformer, remove the transformer by widening the catch leg of the contact block holder. Pay attention not to excessively widen the catch leg. Mounting steps are the same as the above steps ③, ④, and ⑤.

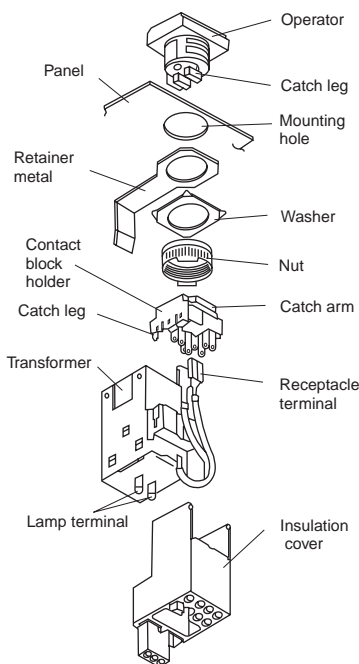

■ Installing the protection cover / dust-tight cover, guard-ring

- Be careful that the panel thickness does not exceed the following:
- Panel thickness
 - Protection cover: 2.6mm max.
 - Dust-tight cover: 2.0mm max.
 - Guard ring: 2.5mm max.

■ Operating voltage and rated voltage of incandescent lamps

Rated voltage	Operating voltage
6V	4 to 5V
14V	10 to 12V
28V (Standard)	20 to 24V

Incandescent lamps should be operated at the operating voltages if a lamp service life of 5,000 to 10,000 hours are needed. The ambient temperature must not exceed 30°C if the lamp is used at the rated voltage continuously.

■ Method of replacing lamp

- Incandescent lamps/LED lamps/neon lamps
Remove the color lens and inner button with a remover AHX618. Then draw out the lamp with a lamp changer AHX672. When installing lamps, do it manually and in the reverse order of removing.
- Products with blue and green LEDs
The LED devices on products with high-brightness (blue and green) LEDs are very sensitive to static electricity. When replacing LED lamps do not allow static electricity to come into direct contact with the metal frame on the upper side of the LED lamp. The LED device may be damaged if this part is subjected to static electricity. When installing or removing an LED lamp, it is recommended that you use the lamp changer (AHX672).

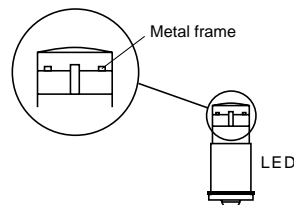

- To replace the lamp of a AH165-2 illuminated pushbutton switch (ML, VL), remove the button and draw out the oil-tight cap.

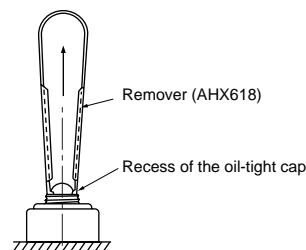

- Then, replace the lamp using a lamp changer (AHX672) and push the oil-tight cap into its original position with its engaging projection properly adjusted (see the figure below).

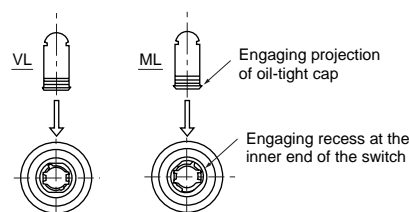

Note: Lamp of AH165-ZM type can not be replaced.

■ **Method of replacing color lens**

- To remove the color lens, insert a small screwdriver into the color lens and twist in direction of the arrow.

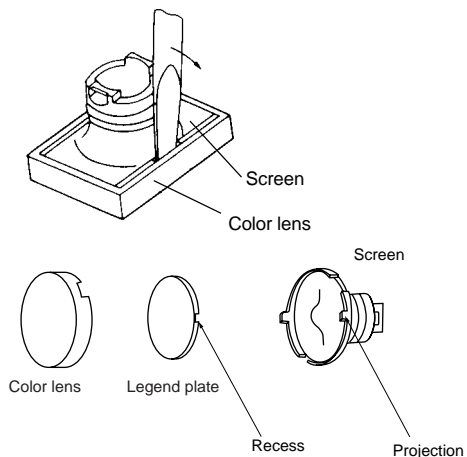

- For an AH165-2, use a small standard screwdriver or a similar tool with a flat end. If one side of the color lens is removed from the screen, insert the screwdriver or a similar tool deeper and remove the color lens together with the screen.

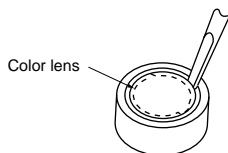

■ **Replacing pushbuttons**

In the case of alternative action type pushbutton switches and illuminated pushbutton switches, be sure not to replace the pushbuttons in their locked state. This could result in internal damage to the mechanism.

■ **Description sheet**

The Fuji description sheet is 25μm thick. If preparing custom description sheets, make sure that the thickness is 0.1mm or less.

■ **Contact block**

To replace a contact block, use removing tool AGX012. If excessive force is applied when attempting to open the support legs for the contact block holder, deformation or damage may occur.

■ **Handling precautions**

- Do not apply torque in excess of 1.0 N•m to operate the selectors switch (Type "P"). Required operating force of switches is less than 0.1 N•m.
- Do not tap on a pushbutton to turn it ON or OFF, such handling may damage it. Be sure to operate the pushbutton by hand.

■ **Key type selector switch**

- Five key types (Type B to Type F) are available besides Type A, which is the standard key type.

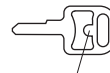

Symbol on the key



Symbol on the main unit

Be sure to use a key with a symbol which is matched with the symbol on the main unit.

- Fully insert the key into the main unit before turning the key.
- The key turning force should not exceed 0.1 N•m.
- Do not pull out or insert the key forcibly.

■ **Wiring connections**

- Use a soldering iron with a wattage of not more than 30W and a tip length of more than 20mm.

Use a rosin-core solder

With a 30W iron complete soldering within 5 seconds, or 10 seconds with a 20W iron. Do not apply external force to the terminals. Do not deform the terminals.

Because lead-free solder's melting point is slightly high, soldering work may be difficult. Use a soldering iron whose tip is rather large or whose calorie is rather high.

- Wires that can be connected
 - Two solid wires with a maximum diameter of 0.8mm (solder)
 - One stranded wire with a maximum area of 0.75mm² (solder)
- Flat connection terminal
 - (2.8□-1.25-5) 0.5 to 1.25mm²
 - (2.8□-0.5-5) 0.2 to 0.5mm²
- Using contact blocks
 - When using NO and NC contacts in the same contact block, avoid connection that involves opposite polarity or wiring from different types of power supply.
- For wiring to adjacent terminals, use insulated tubing to prevent short-circuit and to assure isolation. For solder terminals, be careful when connecting thick wires. Do not use too much solder.
- Wiring to wire-wrap pin terminals
 - Select the appropriate wire sizes and tools from the table below.

Wire size	Bit	Sleeve	Number of effective wraps
0.4mm dia.	3-A	1-B	About 8
0.5mm dia.	1-A	1-B	About 6
(0.65mm dia.)	(2-A)	(2-B)	(About 6)

Use ordinary wrapping for connection.

Wires of 0.65mm dia. must not be used on adjacent terminals. However, 0.65mm dia. wire can be mixed with 0.4 and 0.5mm dia. wires.

- Wiring to tab terminals
 - Use receptacles, No. 110.

■ **Installing lamps in close order**

When continuously lighting pilot lights or pressing illuminated pushbuttons installed in close order, care must be taken that the ambient temperature does not exceed the rated value.

Pushbuttons/Selectors/Pilot Lights/Buzzers

AH164, AH165 and AH165-2

Notes on use

■ LEDs

• LED Lamp Malfunctioning

The LED lamp is lit by a very small level of current (approximately 0.01mA). Therefore, the it may be erroneously lit by a current leaking from the surge absorption circuit or semiconductor circuit or due to stray capacitance between cables. In that case, provide a countermeasure (e.g., connect a resistor in parallel with the LED lamp).

• Countermeasure for Malfunctioning

Shunt Resistor R or CR elements connected in parallel
Lamp malfunctions can be prevented by connecting a shunt resistor (R) or CR elements (a capacitor and resistor) in parallel with the LED lamp terminal. The resistance and CR values vary depending on the model and the operating conditions.

Example 1

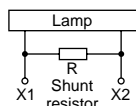

- 24V DC
R: 10kΩ (1W)

Example 2

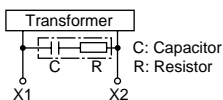

- 110V AC
C: 0.33μF (250V AC)
R: 120Ω (0.25W)
- 220V AC
C: 0.33μF (250V AC)
R: 120Ω (0.25W)

• Incoming surge

Be careful that since high luminance LED products use an element sensitive to static electricity, they may not be lit by an abnormal voltage like surge.

■ Using a flat LED in 48V DC circuit

When a flat LED lamps having a rated voltage of 24V DC is used with 48V DC circuit, connect an external resistor of 3,500Ω (1W).

■ Preventing the neon lamp from incorrectly turning ON

The neon lamp may incorrectly turn ON due to current leakage or voltage induction. In such a case, connect a shunt resistor in parallel with the lamp.

Example) 110V AC: 100k (0.25W)
220V AC: 50k (2W)

If an external surge of 3kV or more may occur, connect a surge absorption element in parallel with the lamp.

■ Operation

Do not use a hitting or bouncing action to operate the button, or the switch may break. Always operate the switch by hand.

■ Storage and operation site

- Use the unit within the rated operating ambient temperature and humidity ranges.
- Do not use the enclosed type in places where oil or water is sprayed or where dust accumulates. In places such as these, use the oil-tight type or provide a dust cover.
- The oil-tight type is evaluated with standard cutting oil and cooling oil applied. The oil-tight type cannot be used with some special oils.

■ Buzzer

• Noise







If the application circuit is likely to generate excessively strong noise, connect a surge absorber (e.g., FUJI'S ENC390D, provided that the switch is a 24V type) in parallel with the buzzer.



• Place of Use

- The buzzer does not have a drip-proof construction. Do not use the buzzer in places where oil or water is sprayed or where dust accumulates. If the buzzer is a splash-proof type, it will resist sprays of water.
- Do not use the buzzer in places that are subject to an excessive amount of corrosive gas.
 - Be careful that the buzzer is likely to sound erroneously due to leakage current or the like.

Pushbuttons/Selectors/Pilot Lights/Buzzers AH164 and AH165 Accessories

■ Accessories for AH164 and AH165



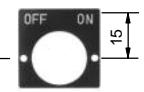
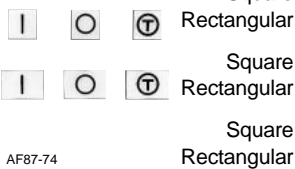

Description	Type	Color	Type					
Color chips (Round) 		L, L5, E, E5, Z	Green AHX631-G Red AHX631-R White (For Neon) AHX631-W Blue AHX631-S Yellow AHX631-Y Orange AHX631-O Clear AHX631-C					
		SF-682	For LED, Neon	Green AHX653-G				
		Color chips (Square) 		SL, SL5, SGL, SGL5, SF, SF5, SGF, SGF5, ZS	Green AHX632-G Red AHX632-R White (For Neon) AHX632-W Blue AHX632-S Yellow AHX632-Y Orange AHX632-O Clear AHX632-C			
				SF-681	For LED, Neon	Green AHX653-SG		
				Color chips (Rectangular) 		TL, TL5, TGL, TGL5, TF, TF5, TGF, TGF5, ZT	Green AHX633-G Red AHX633-R White (For Neon) AHX633-W Blue AHX633-S Yellow AHX633-Y Orange AHX633-O Clear AHX633-C	
						SF-680	For LED, Neon	Green AHX653-TG
						Mushroom head button 	M, M5	Green AHX682-G Red AHX682-R White AHX682-W Blue AHX682-S Yellow AHX682-Y Orange AHX682-O Black AHX682-B
SI-40								
Convex square head button 	SM, SM5	Green AHX683-G Red AHX683-R White AHX683-W Blue AHX683-S Yellow AHX683-Y Orange AHX683-O Black AHX683-B						
		SI-43						
		Convex rectangular head button 	TM, TM5	Green AHX684-G Red AHX684-R White AHX684-W Blue AHX684-S Yellow AHX684-Y Orange AHX684-O Black AHX684-B				
SI-44								

Description	Type	Color	Dimensions, mm
Legend sheet	Round	Type: AHX615-□ Legend: ON, OFF, UP, DOWN	
	Square	Type: AHX616-□ Legend: ON, OFF, UP, DOWN START, STOP, OPEN CLOSE, AUTO, MAN, RESET, POWER, REV, FWD, HIGH, LOW	
Legend plate (Acrylic resin) 	Round	AHX665 White AHX665-C Transparent AHX665-B Black	∅12.2 x 0.9
	Square	AHX666 White AHX666-C Transparent AHX666-B Black	12.2sq. x 0.9
	Rectangular	AHX667 White AHX667-C Transparent AHX667-B Black	12.2 x 18.2 x 0.9
Legend plate for spot LED (Acrylic resin) 	Round	AHX650	∅12.2 x 0.9
	Square	AHX651	12.2sq. x 0.9
	Rectangular	AHX652	12.2 x 18.2 x 0.9
Legend plate for selector switch (2-position) 	Type: AHX664 Legend: ON-OFF Legend: Blank		Dimensions, mm: 24sq. x 0.5
	SI-226A		
Legend plate for symbol mark 	Mark	Type	
	○	AHX666-E AHX667-E	
	⊥	AHX666-H AHX667-H	
	⊕	AHX666-T AHX667-T	
AF87-74			

Pushbuttons/Selectors/Pilot Lights/Buzzers

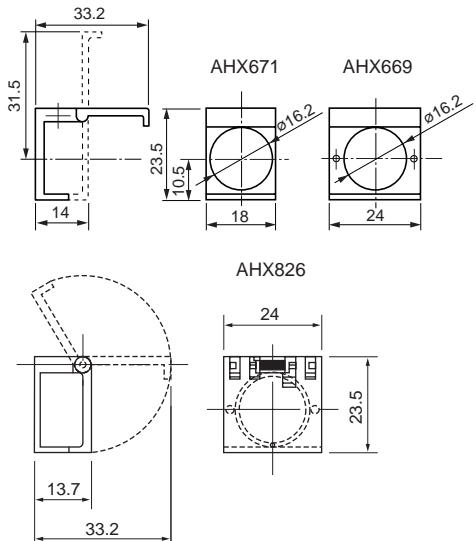
AH164 and AH165

Accessories

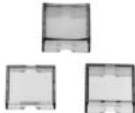

Description	Type																	
<p>Protection cover</p>  <p>KKD07-246</p> <p>KKD07-248</p> <p>KKD07-247</p>	<p>For round and square head button Type: AHX671</p> <p>For rectangular head button Type: AHX669 AHX826</p> <p>This cover protect against accidental operation. Note: Not used for illuminated pushbuttons with guard. Applicable panel thickness is 2.6mm max.</p> <p>Dimensions, mm</p> 																	
<p>Dust-tight cover</p>  <p>AF91-123, SI-41</p>	<p>For round and square head button Type: AHX822 Dimensions, mm: 24sq. x 14.2</p> <p>For rectangular head button Type: AHX668 Dimensions, mm: 24 x 30 x 14.2</p> <p>For mushroom head button Type: AHX649 Dimensions, mm: $\varnothing 30$ x 18</p> <p>These covers protect against dust. Note: Applicable panel thickness is 2.0mm max.</p>																	
<p>Guard ring</p>  <p>SI-42</p>	<table border="1"> <thead> <tr> <th>Type</th> <th>Color</th> <th>Dimensions, mm</th> </tr> </thead> <tbody> <tr> <td>AHX676-B</td> <td>Black</td> <td>$\varnothing 21$ x 12</td> </tr> <tr> <td>AHX676-GY</td> <td>Gray</td> <td></td> </tr> </tbody> </table> <p>This guard ring is used in combination with an extended round head pushbutton (L or E). Note: Applicable panel thickness is 2.5mm max. Please place an order for a packing (AHX685) separately when you intend to use for AH165 series.</p>			Type	Color	Dimensions, mm	AHX676-B	Black	$\varnothing 21$ x 12	AHX676-GY	Gray							
Type	Color	Dimensions, mm																
AHX676-B	Black	$\varnothing 21$ x 12																
AHX676-GY	Gray																	
<p>Transformer</p>  <p>AF90-949</p>	<table border="1"> <thead> <tr> <th>Voltage</th> <th>Type</th> <th>Lamp</th> </tr> </thead> <tbody> <tr> <td>100 to 110V AC</td> <td>AHX805-H</td> <td>LED</td> </tr> <tr> <td>200 to 220V AC</td> <td>AHX805-M</td> <td></td> </tr> <tr> <td>100 to 110V AC</td> <td>AHX806-H</td> <td>Incandescent</td> </tr> <tr> <td>200 to 220V AC</td> <td>AHX806-M</td> <td></td> </tr> </tbody> </table>			Voltage	Type	Lamp	100 to 110V AC	AHX805-H	LED	200 to 220V AC	AHX805-M		100 to 110V AC	AHX806-H	Incandescent	200 to 220V AC	AHX806-M	
Voltage	Type	Lamp																
100 to 110V AC	AHX805-H	LED																
200 to 220V AC	AHX805-M																	
100 to 110V AC	AHX806-H	Incandescent																
200 to 220V AC	AHX806-M																	

■ Accessories for AH165-2

Description	Type													
Color lens (Round) 	For flush head (Used with 2F, 2F5, 2FL, 2FL5, 2Z)													
	<table border="0"> <tr><td>Color</td><td>Type</td></tr> <tr><td>Green</td><td>AHX2604-G</td></tr> <tr><td>Red</td><td>AHX2604-R</td></tr> <tr><td>Yellow</td><td>AHX2604-Y</td></tr> <tr><td>Blue</td><td>AHX2604-S</td></tr> <tr><td>Orange</td><td>AHX2604-O</td></tr> <tr><td>Clear</td><td>AHX2604-C</td></tr> </table>	Color	Type	Green	AHX2604-G	Red	AHX2604-R	Yellow	AHX2604-Y	Blue	AHX2604-S	Orange	AHX2604-O	Clear
Color	Type													
Green	AHX2604-G													
Red	AHX2604-R													
Yellow	AHX2604-Y													
Blue	AHX2604-S													
Orange	AHX2604-O													
Clear	AHX2604-C													
Color lens (Square) 	For flush head (Used with 2SF, 2SF5, 2SFL, 2SFL5, 2SZ)													
	<table border="0"> <tr><td>Color</td><td>Type</td></tr> <tr><td>Green</td><td>AHX2606-G</td></tr> <tr><td>Red</td><td>AHX2606-R</td></tr> <tr><td>Yellow</td><td>AHX2606-Y</td></tr> <tr><td>Blue</td><td>AHX2606-S</td></tr> <tr><td>Orange</td><td>AHX2606-O</td></tr> <tr><td>Clear</td><td>AHX2606-C</td></tr> </table>	Color	Type	Green	AHX2606-G	Red	AHX2606-R	Yellow	AHX2606-Y	Blue	AHX2606-S	Orange	AHX2606-O	Clear
Color	Type													
Green	AHX2606-G													
Red	AHX2606-R													
Yellow	AHX2606-Y													
Blue	AHX2606-S													
Orange	AHX2606-O													
Clear	AHX2606-C													
	For extended head (Used with 2E, 2E5, 2EL, 2EL5, 2ZE)													
	<table border="0"> <tr><td>Color</td><td>Type</td></tr> <tr><td>Green</td><td>AHX2605-G</td></tr> <tr><td>Red</td><td>AHX2605-R</td></tr> <tr><td>Yellow</td><td>AHX2605-Y</td></tr> <tr><td>Blue</td><td>AHX2605-S</td></tr> <tr><td>Orange</td><td>AHX2605-O</td></tr> <tr><td>Clear</td><td>AHX2605-C</td></tr> </table>	Color	Type	Green	AHX2605-G	Red	AHX2605-R	Yellow	AHX2605-Y	Blue	AHX2605-S	Orange	AHX2605-O	Clear
Color	Type													
Green	AHX2605-G													
Red	AHX2605-R													
Yellow	AHX2605-Y													
Blue	AHX2605-S													
Orange	AHX2605-O													
Clear	AHX2605-C													
	For extended head (Used with 2SE, 2SE5, 2SEL, 2SEL5, 2SZE)													
	<table border="0"> <tr><td>Color</td><td>Type</td></tr> <tr><td>Green</td><td>AHX2607-G</td></tr> <tr><td>Red</td><td>AHX2607-R</td></tr> <tr><td>Yellow</td><td>AHX2607-Y</td></tr> <tr><td>Blue</td><td>AHX2607-S</td></tr> <tr><td>Orange</td><td>AHX2607-O</td></tr> <tr><td>Clear</td><td>AHX2607-C</td></tr> </table>	Color	Type	Green	AHX2607-G	Red	AHX2607-R	Yellow	AHX2607-Y	Blue	AHX2607-S	Orange	AHX2607-O	Clear
Color	Type													
Green	AHX2607-G													
Red	AHX2607-R													
Yellow	AHX2607-Y													
Blue	AHX2607-S													
Orange	AHX2607-O													
Clear	AHX2607-C													
	For concave head (Used with 2SCE, 2SCE5, 2SCL, 2SCL5)													
	<table border="0"> <tr><td>Color</td><td>Type</td></tr> <tr><td>Green</td><td>AHX2608-G</td></tr> <tr><td>Red</td><td>AHX2608-R</td></tr> <tr><td>Yellow</td><td>AHX2608-Y</td></tr> <tr><td>Blue</td><td>AHX2608-S</td></tr> <tr><td>Orange</td><td>AHX2608-O</td></tr> <tr><td>Clear</td><td>AHX2608-C</td></tr> </table>	Color	Type	Green	AHX2608-G	Red	AHX2608-R	Yellow	AHX2608-Y	Blue	AHX2608-S	Orange	AHX2608-O	Clear
Color	Type													
Green	AHX2608-G													
Red	AHX2608-R													
Yellow	AHX2608-Y													
Blue	AHX2608-S													
Orange	AHX2608-O													
Clear	AHX2608-C													

AF87-631

AF87-632

Description	Type															
Legend plate 	For flush head															
	<table border="0"> <tr><td>Color</td><td>Type</td><td>Used with</td></tr> <tr><td>White</td><td>AHX2609-W</td><td>Incandescent lamp, LED lamp, Pushbutton *1</td></tr> <tr><td>Clear</td><td>AHX2609-C</td><td>Neon lamp *2</td></tr> <tr><td>Black</td><td>AHX2609-B</td><td>Pushbutton *3</td></tr> </table> <p>Dimensions, mm: $\phi 18 \times 0.9$</p>	Color	Type	Used with	White	AHX2609-W	Incandescent lamp, LED lamp, Pushbutton *1	Clear	AHX2609-C	Neon lamp *2	Black	AHX2609-B	Pushbutton *3			
Color	Type	Used with														
White	AHX2609-W	Incandescent lamp, LED lamp, Pushbutton *1														
Clear	AHX2609-C	Neon lamp *2														
Black	AHX2609-B	Pushbutton *3														
	For extended head															
	<table border="0"> <tr><td>Color</td><td>Type</td><td>Used with</td></tr> <tr><td>White</td><td>AHX2610-W</td><td>Incandescent lamp, LED lamp, Pushbutton *1</td></tr> <tr><td>Clear</td><td>AHX2610-C</td><td>Neon lamp *2</td></tr> <tr><td>Black</td><td>AHX2610-B</td><td>Pushbutton *3</td></tr> </table> <p>Dimensions, mm: $\phi 18 \times 4.4$</p>	Color	Type	Used with	White	AHX2610-W	Incandescent lamp, LED lamp, Pushbutton *1	Clear	AHX2610-C	Neon lamp *2	Black	AHX2610-B	Pushbutton *3			
Color	Type	Used with														
White	AHX2610-W	Incandescent lamp, LED lamp, Pushbutton *1														
Clear	AHX2610-C	Neon lamp *2														
Black	AHX2610-B	Pushbutton *3														
	For flush square															
	<table border="0"> <tr><td>Color</td><td>Type</td><td>Used with</td></tr> <tr><td>White</td><td>AHX2611-W</td><td>Incandescent lamp, LED lamp, Pushbutton *1</td></tr> <tr><td>Clear</td><td>AHX2611-C</td><td>Neon lamp *2</td></tr> <tr><td>Black</td><td>AHX2611-B</td><td>Pushbutton *3</td></tr> </table> <p>Dimensions, mm: 17sq. x 0.9</p>	Color	Type	Used with	White	AHX2611-W	Incandescent lamp, LED lamp, Pushbutton *1	Clear	AHX2611-C	Neon lamp *2	Black	AHX2611-B	Pushbutton *3			
Color	Type	Used with														
White	AHX2611-W	Incandescent lamp, LED lamp, Pushbutton *1														
Clear	AHX2611-C	Neon lamp *2														
Black	AHX2611-B	Pushbutton *3														
	For extended square, concave square															
	<table border="0"> <tr><td>Color</td><td>Type</td><td>Used with</td></tr> <tr><td>White</td><td>AHX2612-W</td><td>Incandescent lamp, LED lamp, Pushbutton *1</td></tr> <tr><td>Clear</td><td>AHX2612-C</td><td>Neon lamp *2</td></tr> <tr><td>Black</td><td>AHX2612-B</td><td>Pushbutton *3</td></tr> </table> <p>Dimensions, mm: 17sq. x 4.4</p>	Color	Type	Used with	White	AHX2612-W	Incandescent lamp, LED lamp, Pushbutton *1	Clear	AHX2612-C	Neon lamp *2	Black	AHX2612-B	Pushbutton *3			
Color	Type	Used with														
White	AHX2612-W	Incandescent lamp, LED lamp, Pushbutton *1														
Clear	AHX2612-C	Neon lamp *2														
Black	AHX2612-B	Pushbutton *3														
AF87-631 AF87-630	<p>*1 Illuminated pushbutton switches and pilot lights with incandescent lamps or LED lamps, Pushbutton switches (excluding). *2 Illuminated pushbutton switches and pilot lights with neon lamps. *3 Pushbutton switches (black) *4 Engraved range: 17mm dia.</p>															
Mushroom head button 	For illuminated pushbuttons (Used with 2ML, 2YML)															
	<table border="0"> <tr><td>Color</td><td>Type</td></tr> <tr><td>Green</td><td>AHX2614-G</td></tr> <tr><td>Red</td><td>AHX2614-R</td></tr> <tr><td>White</td><td>AHX2614-W</td></tr> <tr><td>Yellow</td><td>AHX2614-Y</td></tr> <tr><td>Blue</td><td>AHX2614-S</td></tr> <tr><td>Orange</td><td>AHX2614-O</td></tr> </table>	Color	Type	Green	AHX2614-G	Red	AHX2614-R	White	AHX2614-W	Yellow	AHX2614-Y	Blue	AHX2614-S	Orange	AHX2614-O	
Color	Type															
Green	AHX2614-G															
Red	AHX2614-R															
White	AHX2614-W															
Yellow	AHX2614-Y															
Blue	AHX2614-S															
Orange	AHX2614-O															
	For non-illuminated pushbuttons (Used with 2M, 2YM)															
	<table border="0"> <tr><td>Color</td><td>Type</td></tr> <tr><td>Green</td><td>AHX2613-G</td></tr> <tr><td>Red</td><td>AHX2613-R</td></tr> <tr><td>White</td><td>AHX2613-W</td></tr> <tr><td>Yellow</td><td>AHX2613-Y</td></tr> <tr><td>Blue</td><td>AHX2613-S</td></tr> <tr><td>Orange</td><td>AHX2613-O</td></tr> <tr><td>Black</td><td>AHX2613-B</td></tr> </table>	Color	Type	Green	AHX2613-G	Red	AHX2613-R	White	AHX2613-W	Yellow	AHX2613-Y	Blue	AHX2613-S	Orange	AHX2613-O	Black
Color	Type															
Green	AHX2613-G															
Red	AHX2613-R															
White	AHX2613-W															
Yellow	AHX2613-Y															
Blue	AHX2613-S															
Orange	AHX2613-O															
Black	AHX2613-B															



AF87-633

04





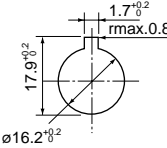

Pushbuttons/Selectors/Pilot Lights/Buzzers





AH165-2

Accessories

Description	Type																				
<p>Push-lock, turn-reset button</p>  <p>AF87-634</p>	<p>For illuminated pushbuttons (Used with 2VL, 2YVL)</p> <table border="0"> <tr> <td>Color</td> <td>Type</td> </tr> <tr> <td>Green</td> <td>AHX2616-G</td> </tr> <tr> <td>Red</td> <td>AHX2616-R</td> </tr> <tr> <td>White</td> <td>AHX2616-W</td> </tr> <tr> <td>Yellow</td> <td>AHX2616-Y</td> </tr> </table> <p>For pushbuttons (Used with 2V, 2YV)</p> <table border="0"> <tr> <td>Color</td> <td>Type</td> </tr> <tr> <td>Green</td> <td>AHX2615-G</td> </tr> <tr> <td>Red</td> <td>AHX2615-R</td> </tr> <tr> <td>Yellow</td> <td>AHX2615-Y</td> </tr> <tr> <td>Black</td> <td>AHX2615-B</td> </tr> </table>	Color	Type	Green	AHX2616-G	Red	AHX2616-R	White	AHX2616-W	Yellow	AHX2616-Y	Color	Type	Green	AHX2615-G	Red	AHX2615-R	Yellow	AHX2615-Y	Black	AHX2615-B
Color	Type																				
Green	AHX2616-G																				
Red	AHX2616-R																				
White	AHX2616-W																				
Yellow	AHX2616-Y																				
Color	Type																				
Green	AHX2615-G																				
Red	AHX2615-R																				
Yellow	AHX2615-Y																				
Black	AHX2615-B																				
<p>Dust-tight cover</p>  <p>AF87-636</p>	<p>For flush round (Used with 2F, 2FL, 2F5, 2FL5) Type: AHX2603-2</p> <p>For flush square (Used with 2SF, 2SFL, 2SF5, 2SFL5) Type: AHX2603-2S</p> <p>These covers protect against dust.</p>																				
<p>Key washer</p>  <p>AF87-635</p>	<p>Type: AHX2601</p> <p>Mounting hole, mm</p> 																				

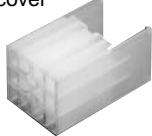
■ Accessories for AH164, AH165 and AH165-2

Description	Type																							
<p>Incandescent lamp</p>  <p>KKD06-333</p>	<table border="1"> <thead> <tr> <th>Voltage</th> <th>Type</th> </tr> </thead> <tbody> <tr> <td>6V, 0.6W</td> <td>AHX641</td> </tr> <tr> <td>14V, 0.7W</td> <td>AHX642</td> </tr> <tr> <td>28V, 0.7W</td> <td>AHX643</td> </tr> </tbody> </table>	Voltage	Type	6V, 0.6W	AHX641	14V, 0.7W	AHX642	28V, 0.7W	AHX643															
Voltage	Type																							
6V, 0.6W	AHX641																							
14V, 0.7W	AHX642																							
28V, 0.7W	AHX643																							
<p>LED lamp</p>  <p>KKD06-206</p>	<table border="1"> <thead> <tr> <th>Voltage</th> <th>Type</th> </tr> </thead> <tbody> <tr> <td>5V DC</td> <td>AHX695-5 □</td> </tr> <tr> <td>6V DC</td> <td>AHX695-6 □</td> </tr> <tr> <td>12V DC</td> <td>AHX695-12 □</td> </tr> <tr> <td>24V DC</td> <td>AHX695-24 □</td> </tr> </tbody> </table> <p>Replace the □ mark by the luminous color code Red (R), Green (G), Orange (O), Amber (A), Yellow (Y), Blue (S)</p>	Voltage	Type	5V DC	AHX695-5 □	6V DC	AHX695-6 □	12V DC	AHX695-12 □	24V DC	AHX695-24 □													
Voltage	Type																							
5V DC	AHX695-5 □																							
6V DC	AHX695-6 □																							
12V DC	AHX695-12 □																							
24V DC	AHX695-24 □																							
<p>Neon lamp</p>  <p>KKD06-306</p>	<table border="1"> <thead> <tr> <th>Voltage</th> <th>Type</th> <th>Luminous color</th> </tr> </thead> <tbody> <tr> <td rowspan="2">110V AC</td> <td>AHX655-H</td> <td>Green</td> </tr> <tr> <td>AHX654-H</td> <td>Orange</td> </tr> <tr> <td rowspan="2">120V AC</td> <td>AHX655-K</td> <td>Green</td> </tr> <tr> <td>AHX654-K</td> <td>Orange</td> </tr> <tr> <td rowspan="2">220V AC</td> <td>AHX655-M</td> <td>Green</td> </tr> <tr> <td>AHX654-M</td> <td>Orange</td> </tr> <tr> <td rowspan="2">240V AC</td> <td>AHX655-P</td> <td>Green</td> </tr> <tr> <td>AHX654-P</td> <td>Orange</td> </tr> </tbody> </table>	Voltage	Type	Luminous color	110V AC	AHX655-H	Green	AHX654-H	Orange	120V AC	AHX655-K	Green	AHX654-K	Orange	220V AC	AHX655-M	Green	AHX654-M	Orange	240V AC	AHX655-P	Green	AHX654-P	Orange
Voltage	Type	Luminous color																						
110V AC	AHX655-H	Green																						
	AHX654-H	Orange																						
120V AC	AHX655-K	Green																						
	AHX654-K	Orange																						
220V AC	AHX655-M	Green																						
	AHX654-M	Orange																						
240V AC	AHX655-P	Green																						
	AHX654-P	Orange																						
<p>Panel plug</p>  <p>KKD07-262 KKD07-261 KKD07-260</p>	<table border="1"> <thead> <tr> <th>Color</th> <th>Type</th> <th>IP</th> </tr> </thead> <tbody> <tr> <td rowspan="2">Round</td> <td>Black</td> <td>AHX622-B IP40</td> </tr> <tr> <td>Gray</td> <td>AHX622-GY IP40</td> </tr> <tr> <td rowspan="2">Square</td> <td>Black</td> <td>AHX644-B IP40</td> </tr> <tr> <td>Gray</td> <td>AHX644-GY IP40</td> </tr> <tr> <td rowspan="3">Rectangular</td> <td>Black</td> <td>AHX645-B IP40</td> </tr> <tr> <td>Gray</td> <td>AHX645-GY IP40</td> </tr> <tr> <td>Black</td> <td>AHX850-B IP65</td> </tr> </tbody> </table>	Color	Type	IP	Round	Black	AHX622-B IP40	Gray	AHX622-GY IP40	Square	Black	AHX644-B IP40	Gray	AHX644-GY IP40	Rectangular	Black	AHX645-B IP40	Gray	AHX645-GY IP40	Black	AHX850-B IP65			
Color	Type	IP																						
Round	Black	AHX622-B IP40																						
	Gray	AHX622-GY IP40																						
Square	Black	AHX644-B IP40																						
	Gray	AHX644-GY IP40																						
Rectangular	Black	AHX645-B IP40																						
	Gray	AHX645-GY IP40																						
	Black	AHX850-B IP65																						
<p>Lamp changer</p>  <p>KKD07-259</p>	<p>Type: AHX672</p> <p>If the switch is fitted with a lamp, use this tool to remove the lamp. The tool is unnecessary when installing a lamp.</p>																							
<p>Remover</p>  <p>KKD07-258</p>	<p>Type: AHX618</p> <p>This tool is used for replacing the color chips or screens.</p>																							
<p>Contact holder remover</p>  <p>SP-522</p>	<p>Type: AHX699</p> <p>This tool is used to remove a contact holder when switches are densely installed.</p>																							

Description	Type						
<p>Wrench</p>  <p>KKD07-257</p>	<p>Type: AHX601</p> <p>When installing a command switch on a panel, this tool is useful for tightening the switch firmly and efficiently.</p>						
<p>Terminal cover</p>  <p>AF87-637</p>	<p>Type: AHX2602</p> <p>This cover is used with AH164 and AH165 and AH165-2 (except pilot lights). Pass the wires through the cover, then mount the cover in position.</p>						
<p>Contact block</p>  <p>KKD06-305, KKD06-304</p>	<table border="1"> <thead> <tr> <th>Terminal</th> <th>Type</th> </tr> </thead> <tbody> <tr> <td>Solder/Tab</td> <td>AGX001</td> </tr> <tr> <td>Wire-wrap</td> <td>AGX001-W</td> </tr> </tbody> </table>	Terminal	Type	Solder/Tab	AGX001	Wire-wrap	AGX001-W
Terminal	Type						
Solder/Tab	AGX001						
Wire-wrap	AGX001-W						
<p>Dummy unit</p>  <p>SK-1141</p>	<p>Type: AGX002</p> <p>A dummy unit is used to fill the space where no contact blocks are installed. For example, two dummy units are used if 1NO+1NC contact block is installed, and one dummy unit is used if 2NO+2NC contact blocks are installed.</p>						
<p>Remover</p>  <p>SM-334</p>	<p>Type: AGX012</p> <p>This tool is used for replacing the contact blocks or dummy units.</p>						

Pushbuttons/Selectors/Pilot Lights/Buzzers

AH164, AH165 and AH165-2

Accessories

Description	Type		
Sockets	Terminal	Type	Used with
	Solder/Tab Wire-wrap PC board	AHX697-S AHX697-W AHX697-P	Pushbuttons
Sockets for LED	Terminal	Type	
	Solder/Tab Wire-wrap	AHX697-SH3 AHX697-WH3	

SM-1097

Contact arrangement is 2NO+2NC only.
Except for AH165-2PL types

SM-1098

- Contact arrangement is 2NO+2NC only.
- These sockets are used only when LED lamps rated for 24V DC are used under 110V AC/DC.
- Except for AH164, 165 and 165-2 series pilot lights or AH165-2PL type.
- When side-by-side mounting and continuous lighting, note that a socket has higher temperature over the ambient temperature.

Dimensions, mm

Solder/Tab

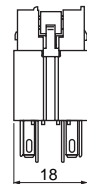
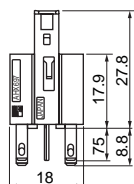

PC board mounting Pushbuttons

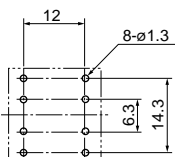

Wire-wrap

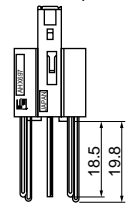

PC board

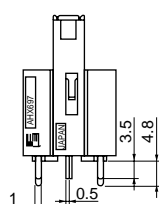

Illuminated pushbuttons

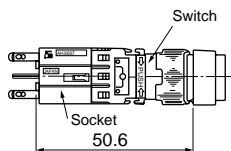
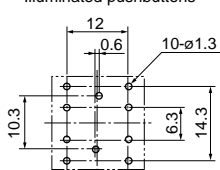

For wiring to wire-wrap pin terminals, select appropriate wire sizes and tool from the table below.

Wire size	Bit	Sleeve	Number of effective wraps
0.4mm dia.	3-A	1-B	About 8
0.5mm dia. (0.65mm dia.)	1-A (2-A)	1-B (2-B)	About 6 (About 6)

Use ordinary wrapping for connection. Wires of 0.65mm dia. must not be used on adjacent terminals. However, 0.65mm dia. wire can be mixed with 0.4mm and 0.5mm dia. wires.

■ Mass, gram
AH164 series

Type	1NO + 1NC	2NO + 2NC	3NO + 3NC
AH164-L,L5 (Without transformer)	12.5	13.5	14.5
L,L5 (With transformer)	53.5	54.5	-
SL,SL5 (Without transformer)	13.1	14.1	15.1
SL,SL5 (With transformer)	54.1	55.1	-
TL,TL5 (Without transformer)	13.9	14.9	15.9
TL,TL5 (With transformer)	54.9	55.9	-
TGL,TGL5 (Without transformer)	13.9	14.9	15.9
TGL,TGL5 (With transformer)	54.9	55.9	-
SGL,SGL5 (Without transformer)	13.1	14.1	15.1
SGL,SGL5 (With transformer)	54.1	55.1	-
AH164-E,E5	10.5	11.5	12.5
M,M5	12.5	13.5	14.5
SF,SF5	11.1	12.1	13.1
TF,TF5	11.9	12.9	13.9
TGF,TGF5	11.9	12.9	13.9
SGF,SGF5	11.1	12.1	13.1
SM,SM5	13.4	14.4	15.4
TM,TM5	13.1	14.1	15.1
AH164-P2,P0	16.1	17.1	18.1
P3,P6,P7,P1	-	17.1	18.1
PK3,PK6,PK7,PK1	-	17.1	18.1
SP2,SP0	15.8	16.8	17.8
SP3,SP6,SP7,SP1	-	16.8	17.8
SPK3,SPK6,SPK7,SPK1	-	16.8	17.8
J2,J0	30.6	31.6	32.6
J3,J6,J7,J1	-	31.6	32.6
JK3,JK6,JK7,JK1	-	31.9	32.9
SJ2,SJ0	30.3	31.3	32.3
SJ3,SJ6,SJ7,SJ1	-	31.3	32.3
SJK3,SJK6,SJK7,SJK1	-	31.6	32.6
AH164-Z (Without transformer)	6.9		
Z (With transformer)	50.9		
ZS (Without transformer)	7.5		
ZS (With transformer)	51.5		
ZT (Without transformer)	8.2		
ZT (With transformer)	52.2		
AH164-TX	16		
TX1	17.5		
TX2B	13		

AH165 series

Type	1NO + 1NC	2NO + 2NC	3NO + 3NC
AH165-L,L5 (Without transformer)	12.5	13.5	14.5
L,L5 (With transformer)	53.5	54.5	-
SL,SL5 (Without transformer)	13.1	14.1	15.1
SL,SL5 (With transformer)	54.1	55.1	-
TL,TL5 (Without transformer)	13.9	14.9	15.9
TL,TL5 (With transformer)	54.9	55.9	-
TGL,TGL5 (Without transformer)	13.9	14.9	15.9
TGL,TGL5 (With transformer)	54.9	55.9	-
SGL,SGL5 (Without transformer)	13.1	14.1	15.1
SGL,SGL5 (With transformer)	54.1	55.1	-
AH165-E,E5	10.5	11.5	12.5
M,M5	12.5	13.5	14.5
SF,SF5	11.1	12.1	13.1
TF,TF5	11.9	12.9	13.9
TGF,TGF5	11.9	12.9	13.9
SGF,SGF5	11.1	12.1	13.1
SM,SM5	13.4	14.4	15.4
TM,TM5	13.1	14.1	15.1
VR	13.4 *1	14 *2	-
V1R	14.4 *1	15 *2	-
AH165-V5R	18.1 *1	18.7 *2	-
V6R	18.9 *1	19.5 *2	-
AH165-P2,P0	16.7	17.7	18.7
P3,P6,P7,P1	-	17.7	18.7
PK3,PK6,PK7,PK1	-	17.7	18.7
SP2,SP0	16.1	17.1	18.1
SP3,SP6,SP7,SP1	-	17.1	18.1
SPK3,SPK6,SPK7,SPK1	-	17.1	18.1
J2,J0	31.2	32.2	33.2
J3,J6,J7,J1	-	32.2	33.2
JK3,JK6,JK7,JK1	-	32.5	33.5
SJ2,SJ0	30.6	31.6	32.6
SJ3,SJ6,SJ7,SJ1	-	31.6	32.6
SJK3,SJK6,SJK7,SJK1	-	31.9	32.9
AH165-JM2	30	33.9	-
RJM2	29.6	34	-
AH165-Z (Without transformer)	6.9		
Z (With transformer)	50.9		
ZS (Without transformer)	7.5		
ZS (With transformer)	51.5		
ZT (Without transformer)	8.2		
ZT (With transformer)	52.2		
ZM (Without transformer)	5.4		
AH165-X	13.7		

Note: *1 For 1NC
*2 For 2NC

Pushbuttons/Selectors/Pilot Lights/Buzzers
AH164, AH165 and AH165-2
Mass

■ Mass, gram
AH165-2 series

Type	1NO + 1NC	2NO + 2NC	3NO + 3NC
AH165-2FL,FL5	15.3	16.3	17.3
2EL,EL5	15.8	16.8	17.8
2ML	18.7	19.7	20.7
2YML	20.2	21.2	22.2
2SFL,SFL5	16.6	17.6	18.6
2SEL,SEL5	17.4	18.4	19.4
2SCL,SCL5	17.6	18.6	19.6
2VL	20.7	21.7	22.7
2YVL	21.4	22.4	23.4
AH165-2F,F5	13.4	14.4	15.4
2E,E5	13.9	14.9	15.9
2M	17.8	18.8	19.8
2YM	18.2	19.2	20.2
2SF,SF5	14.6	15.6	16.6
2SE,SE5	15.4	16.4	17.4
2SCE,SCE5	15.6	16.6	17.6
2S2	-	19	-
2YS2	-	20.6	-
2V	18	19	20
2YV	19.4	20.4	21.4
AH165-2P2,P0	16.6	17.6	18.6
2P3,P6,P7,P1	-	17.6	18.6
2YP2,YP0	18.3	19.3	20.3
2YP3,YP6,YP7,YP1	-	19.3	20.3
2J2,J0	40.9	41.9	42.9
2J3,J6,J7,J1	-	41.9	42.9
2YJ2	42.6	43.6	44.6
2YJ3,YJ6,YJ7,YJ1	-	43.6	44.6
2H	14.3	15.3	16.3
2SH	16.1	17.1	18.1
AH165-2PL2	17.4	18.4	-
2PL3	-	18.4	-
AH165-2Z	9.7		
2ZE	10.2		
2SZ	11		
2SZE	11.6		

Multi display lights F series

■ Description

Provide a bright, colorful display surface.
More user-friendly with easy wiring and windows in a wide variety of sizes.

■ Features

Lightweight (LED display, 100V or 200V AC)

Only one-third the weight of FUJI conventional models.

Wide window size selection

A wide selection, including half-size windows.

AP30F: 30 x 30mm, 30 x 60mm, 15 x 30mm

AP40F: 40 x 40mm, 40 x 80mm, 20 x 40mm

Easy color and voltage changes

LEDs (with voltage-dividing resistors or voltage-dividing capacitors and resistors) are easily replaced from the panel surface.

Save energy

A sharp reduction in power consumption.

High brightness for more vivid colors

LEDs with two to eight times the brightness of those on FUJI conventional models. Newly added blue and pure white LEDs improve visibility.

Charged-section cover

A cover for the charged section is provided as a standard accessory.

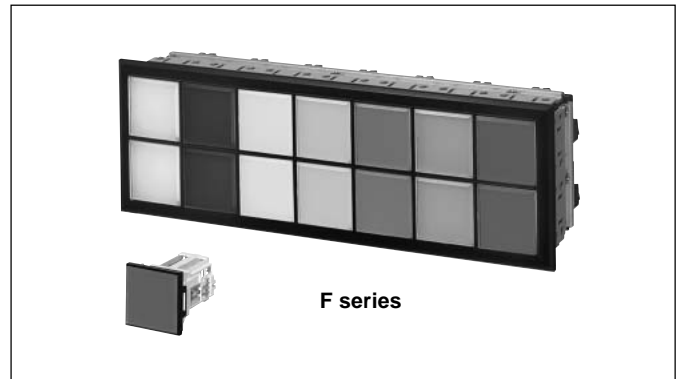

Reduced depth (AP30 series, 100V or 200V AC)

Two-thirds the depth of FUJI conventional models. And, the AP30F and AF40F feature the same depth.

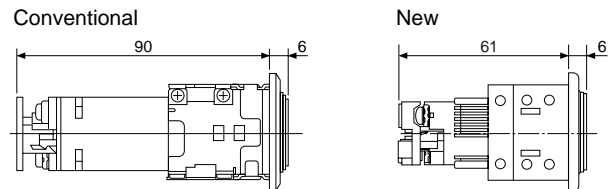

■ Configuration of AP30F/AP40F

Lens case

Lens case	AP30F	AP40F
Standard	○	○
Inclined	—	○

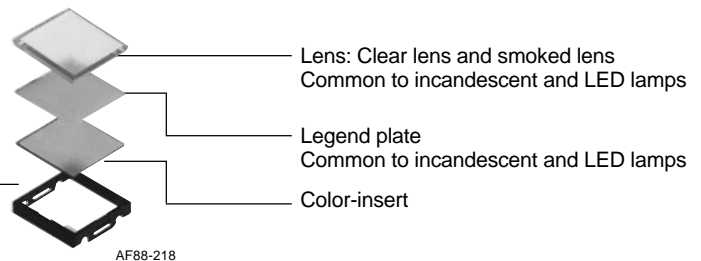

LED unit

Combination of LED luminous colors and color-inserts

LED luminous color	Color-insert	Illumination
Red	Red	Red
Green	Green	Green
Yellow	Yellow	Yellow
Amber	Orange	Orange
Orange	Clear	White
Red/green	Clear	Red/green
Blue	Blue	Blue
Pure-white	White	Pure-white

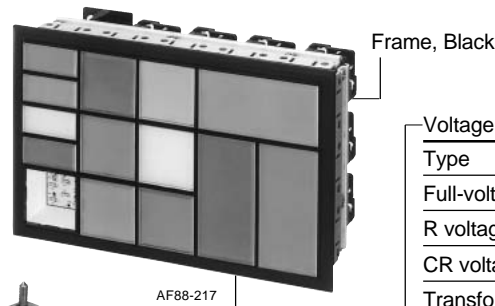
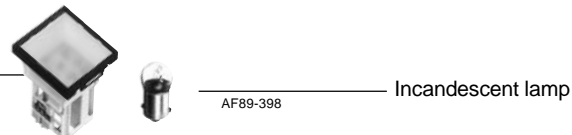

Bracket
(Standard accessories)

Voltage units

Type	LED	Incandescent
Full-voltage type	○	○
R voltage dividing	○	—
CR voltage dividing	○	—
Transformer unit	○	○
Resistor unit	—	○
Flicker unit	○	—
Voltage stabilizer unit	○	—

○ : Available
— : Not available

Multi Display Lights

AP30F and AP40F

Type number nomenclature

■ Type number nomenclature

AP30F- 04 05 □ E3-S 4 -SR (20) Z1

① ② ③ ④ ⑤ ⑥ ⑦ ⑧

① Basic type

AP30F: 30 × 30, 30 × 60, 60 × 30, 15 × 30mm (Window size)

AP40F: 40 × 40, 40 × 80, 80 × 40, 20 × 40mm

② Number of windows (=Row × Column)

	Row	Column	
AP30F	01,02,03,04,05,06,07,08,09,10 11,12,13,14,15,16,17,18,19,20	01,02,03,04,05,06,07,08,09,10 11,12,13,14,15,16,17,18,19,20	Max. 400
AP40F	01,02,03,04,05,06,07	01,02,03,04,05,06,07,08,09,10, 11,12,13,14,15	Max. 105

- Convert one rectangular window to two square windows.
- The number of windows is limited to 80 when transformer units are mounted.

③ Check terminal

C: with

Blank: without

④ Voltage unit and input voltage

AP30F series

	Incandescent	LED unit
Full-voltage type	A: 5.5V AC/DC C: 15.5V AC/DC D: 20V AC/DC E: 24V AC/DC	A3: 6V DC B3: 12V AC/DC C3: 15V AC/DC E3: 24V AC/DC ES: 24V AC/DC * F3: 48V AC/DC H3: 100-110V AC/DC L3: 115-127V AC/DC M3: 200-220V AC
Transformer unit	H: 100-110V AC L: 115-127V AC M: 200-220V AC Q: 230-254V AC S: 350-380V AC T: 400-440V AC V: 480V AC	Q3: 230-254V AC S3: 350-380V AC T3: 400-440V AC V3: 480V AC
Resistor unit	H6: 110V DC L6: 125V DC (Electric bulb 48V 1W)	—
Mixed type	X: Combination of the above three	X3: Combination of the above three types plus flicker and voltage stabilizer unit

* Short body type

AP40F series

	Incandescent	LED unit
Full-voltage type	C: 15.5V AC/DC D: 20V AC/DC E: 24V AC/DC	A3: 6V DC B3: 12V AC/DC C3: 15V AC/DC E3: 24V AC/DC ES: 24V AC/DC * F3: 48V AC/DC H3: 100-110V AC/DC L3: 115-127V AC/DC M3: 200-220V AC
Transformer unit	H: 100-110V AC L: 115-127V AC M: 200-220V AC Q: 230-254V AC S: 350-380V AC T: 400-440V AC V: 480V AC	Q3: 230-254V AC S3: 350-380V AC T3: 400-440V AC V3: 480V AC
Resistor unit	H6: 110V DC L6: 127V DC (Electric bulb 48V 2W)	—
Mixed type	X: Combination of the above three	X3: Combination of the above three types plus flicker and voltage stabilizer unit

* Short body type

Notes:

The combination of LED units and voltage units is limited as follows:

Code	Voltage unit	LED unit
E3FA	Flicker unit	24V (short body type)
E3FD		
E3C	Voltage stabilizer unit 27-35V AC/DC	24V (short body type)

- Two-color illumination face is only available for 24V AC/DC type.
- The flicker unit is available in square design only (S-type).

⑤ Shape of illuminated face

AP30F series

S: Square (30 × 30)

T: Rectangular, horizontally long (30 × 60)

V: Rectangular, vertically long (60 × 30)

H: Half-size (15 × 30) × 2

X: Mixture of S, T, and V

AP40F series

S: Square (40 × 40)

T: Rectangular, horizontally long (40 × 80)

V: Rectangular, vertically long (80 × 40)

H: Half-size (20 × 40) × 2

X: Mixture of S, T, and V

⑥ Illumination method

Blank: Single color, entire surface illumination

4: 2-color, entire surface illumination (for 24V AC/DC LEDs only)

2: 2-way rectangular-split illumination

⑦ Illuminated color

Using clear lens	Color plate (White)	Using smoked lens
R: Red	CR: Red	SR: Red
G: Green	CG: Green	SG: Green
Y: Yellow	CY: Yellow	SY: Yellow
O: Orange	CO: Orange	SO: Orange
W: White	CS: Blue	SW: White
S: Blue	RG: Red/green	SS: Blue
P: Pure-white*		

- Specify the number of windows in ().

- If two or more colors are specified using LED unit, the illuminated color ⑦ here should be blank.

* Not available for incandescent lamp

⑧ UL, CSA Approved (Option)

Using window layout sheet

Use the copies of the window layout sheet (See page 04/255) and specify for each of the window when ordering the following types.

- Types with letters on legend plate
- Types with symbol X for ④ voltage unit and input voltage
- Types with symbol X for ⑤ shape of illuminated face
- When two or more illuminated colors are specified for LED unit in ⑦.

■ Ordering information

Specify the following:

1. Type number

Multi Display Lights AP30F and AP40F Specifications and performance

■ Specifications

Type		AP30F		AP40F	
Light source		Incandescent	LED	Incandescent	LED
Size of illuminated face					
Illuminated color (types of color-insert)	Red	●	●	●	●
	Green	●	●	●	●
	Yellow	●	●	●	●
	Orange	●	●	●	●
	White	●	●	●	●
	Blue	●	●	●	●
	Pure-white	—	●	—	●
Input voltage	Full voltage	5.5, 15.5, 20 24V AC/DC	6V DC 12, 15, 24, 48, 110, 127V AC/DC 220V AC	15.5, 20 24V AC/DC	6V DC 12, 15, 24, 48, 110, 127V AC/DC 220V AC
	With transformer unit	110, 127, 220, 254, 380, 440, 480V AC 50/60Hz	254, 380, 440, 480V AC 50/60Hz	110, 127, 220, 254, 380, 440, 480V AC 50/60Hz	254, 380, 440, 480V AC 50/60Hz
	With resistor unit	110V DC 125V DC	—	110V DC 125V DC	—
	With flicker unit	—	24V DC 24V AC	—	24V DC 24V AC
	With voltage stabilizer unit	—	27 to 35V AC/DC	—	27 to 35V AC/DC
	Mixture	Combination of the above input voltages for different windows.			
Terminal		M3.5 screw with washer (self-lifting)			
No. of windows	1 to 400 *1		1 to 105 *1		
	1 to 80 *2		1 to 80 *2		
Panel thickness		1 to 6mm			

●: Available —: Not available

*1 : Without transformer unit

*2 : With transformer unit

■ Performance

Rated insulation voltage	250V AC/DC: Full voltage type, with resistor unit, with voltage stabilizer unit, R/CR dividing, with flicker unit, with transformer unit (AP30F incandescent 100 to 200V) 600V AC/DC: With transformer unit (AP30F 230 to 480V)
Dielectric strength (between unit and ground)	2000V AC 1-minute: Full voltage type, with resistor unit, with voltage stabilizer unit, R/CR dividing, with flicker unit, with transformer unit (AP30F incandescent 100 to 200V) 2500V AC 1-minute: With transformer unit (AP30F 230 to 480V)
Operating ambient temperature	−20°C to 40°C
Humidity	45 to 85%RH
Insulation resistance	100MΩ or more (500V DC megger)

Multi Display Lights

AP30F and AP40F

Specifications and performance

■ Power consumption

Light source	Operating voltage		AP30F square	AP40F square			AP30F, AP40F half size
			R, G, Y, O, W, S, P	R, Y, O, W	G, S	P	R, G, Y, O, W, S, P
LED	Full voltage	6V DC	0.26W	0.33W	0.40W	0.53W	–
		12V AC/DC	0.53W 0.56VA	0.66W 0.70VA	0.79W 0.82VA	1.06W 1.30VA	0.14W 0.16VA
		15V AC/DC	0.66W 0.69VA	0.83W 0.87VA	0.99W 1.02VA	1.32W 1.62VA	0.17W 0.18VA
		24V AC/DC	0.26W 0.34VA	0.53W 0.58VA	0.53W 0.58VA	0.53W 0.65VA	0.26W 0.29VA
		48V AC/DC	0.53W 0.67VA	0.53W 0.67VA			–
	R voltage dividing type	100-110V AC/DC 115-127V AC/DC	1.21W 1.54VA 1.40W 1.78VA	1.21W 1.54VA 1.40W 1.78VA			
CR voltage dividing type	200-220V AC	3.3VA	3.3VA				
With transformer unit	230-254V AC 350-380V AC 400-440V AC 480V AC	2.4VA	2.4VA				
With flicker unit	24V AC 24V DC	1.0VA 0.48W	1.0VA 0.48W				
Incandescent	Full voltage	5.5V AC/DC	1.0W	–			
		15.5V AC/DC	1.0W	2.0W			
		20V AC/DC 24V AC/DC					
	With transformer unit	100-110V AC 115-127V AC 200-220V AC 230-254V AC 350-380V AC 400-440V AC 480V AC	3.0VA	3.0VA			
With resistor unit	110V DC	2.0W	3.0W				

Notes: • Maximum power consumption per one square window, except for half-size window.
 • Maximum power consumption for rectangular type is twice value indicated in the table.

AP30F

■ Dimensions, mm

Front view

● S-type

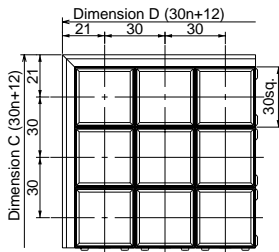

● T-type

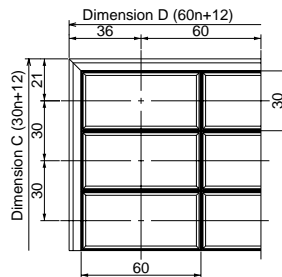

● V-type

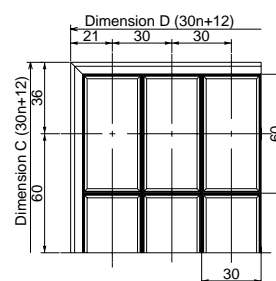

● H-type

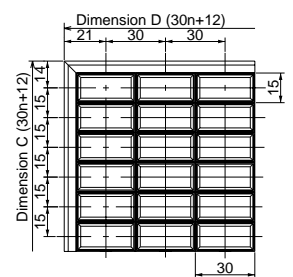

Back view

● Full-voltage type (LED)

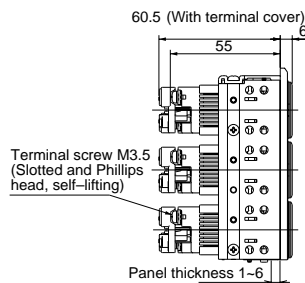
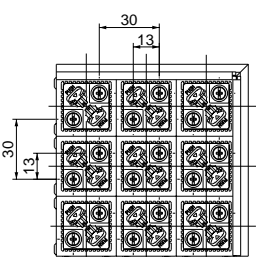

● With transformer unit (230V to 480V LED and incandescent) With resistor unit, with flicker unit, with voltage stabilizer unit

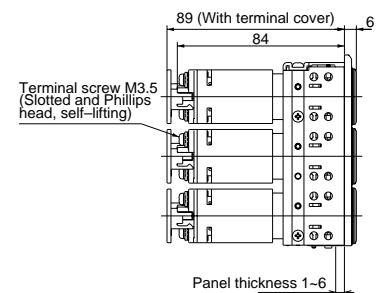
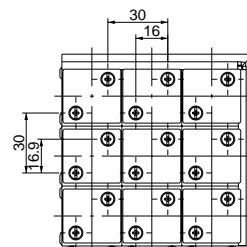

● Full-voltage type (LED, short body type)

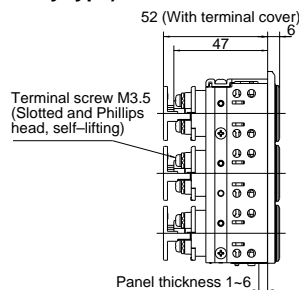
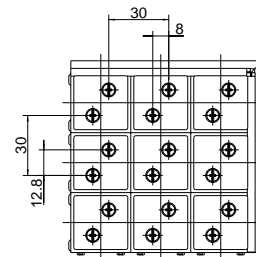

● Full-voltage type (Incandescent)

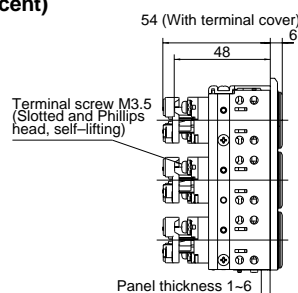
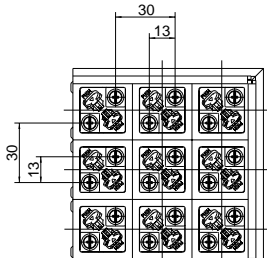

● With transformer (Incandescent, 100V to 220V)

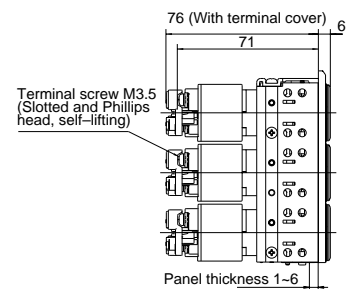
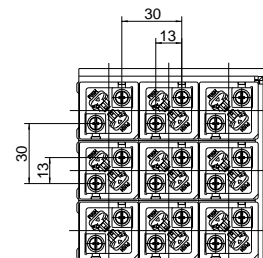

Half size (Illuminated face)

With check terminal

● Full-voltage type

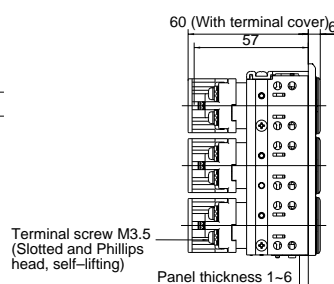
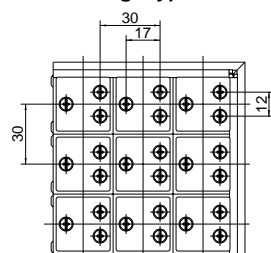

Multi Display Lights

AP30F

Dimensions

AP30F

■ Panel cutout and overall dimensions

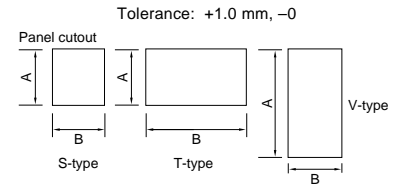

● S, H-type

Number of windows		1	2	3	4	5	6	7	8	9	10	11	12	13	14	15	16	17	18	19	20
Panel cutout	A	35	65	95	125	155	185	215	245	275	305	336	366	396	426	456	486	516	546	576	606
	B	35	65	95	125	155	185	215	245	275	305	335	365	395	425	455	485	515	545	575	605
Overall	C	42	72	102	132	162	192	222	252	282	312	342	372	402	432	462	492	522	552	582	612
	D	42	72	102	132	162	192	222	252	282	312	342	372	402	432	462	492	522	552	582	612

● T-type

Number of windows		1	2	3	4	5	6	7	8	9	10	11	12	13	14	15	16	17	18	19	20
Panel cutout	A	35	65	95	125	155	366	426	486	546	606	336	366	396	426	456	486	516	546	576	606
	B*	65	125	185	145	305	365	425	485	545	605	-	-	-	-	-	-	-	-	-	-
Overall	C	42	72	102	132	162	192	222	252	282	312	342	372	402	432	462	492	522	552	582	612
	D*	72	132	192	252	312	372	432	492	552	612	-	-	-	-	-	-	-	-	-	-

● V-type

Number of windows		1	2	3	4	5	6	7	8	9	10	11	12	13	14	15	16	17	18	19	20
Panel cutout	A*	65	125	185	245	305	366	426	486	546	606	-	-	-	-	-	-	-	-	-	-
	B	35	65	95	125	155	185	215	245	275	305	335	365	395	425	455	485	515	545	575	605
Overall	C*	72	132	192	252	312	372	432	492	552	612	-	-	-	-	-	-	-	-	-	-
	D	42	72	102	132	166	192	222	252	282	312	342	372	402	432	462	492	522	552	582	612

Note: * Indicates dimensions for rectangular windows.

■ Total numbers of windows

	T type		Number of windows (Column)																			
	V type	S.V type	1	2	3	4	5	6	7	8	9	10	-	-	-	-	-	-	-	-	-	
S.T type			1	2	3	4	5	6	7	8	9	10	11	12	13	14	15	16	17	18	19	20
Number of windows (Row)	1	1	1	2	3	4	5	6	7	8	9	10	11	12	13	14	15	16	17	18	19	20
	2	2	2	4	6	8	10	12	14	16	18	20	22	24	26	28	30	32	34	36	38	40
	3	3	3	6	9	12	15	18	21	24	27	30	33	36	39	42	45	48	51	54	57	60
	4	4	4	8	12	16	20	24	28	32	36	40	44	48	52	56	60	64	68	72	76	80
	5	5	5	10	15	20	25	30	35	40	45	50	55	60	65	70	75	80	85	90	95	100
	6	6	6	12	18	24	30	36	42	48	54	60	66	72	78	84	90	96	102	108	114	120
	7	7	7	14	21	28	35	42	49	56	63	70	77	84	91	98	105	112	119	126	133	140
	8	8	8	16	24	32	40	48	56	64	72	80	88	96	104	112	120	128	136	144	152	160
	9	9	9	18	27	36	45	54	63	72	81	90	99	108	117	126	135	144	153	162	171	180
	10	10	10	20	30	40	50	60	70	80	90	100	110	120	130	140	150	160	170	180	190	200
	11	-	11	22	33	44	55	66	77	88	99	110	121	132	143	154	165	176	187	198	209	220
	12	-	12	24	36	48	60	72	84	96	108	120	132	144	156	168	180	192	204	216	228	240
	13	-	13	26	39	52	65	78	91	104	117	130	143	156	169	182	195	208	221	234	247	260
	14	-	14	28	42	56	70	84	98	112	126	140	154	168	182	196	210	224	238	252	266	280
	15	-	15	30	45	60	75	90	105	120	135	150	165	180	195	210	225	240	255	270	285	300
	16	-	16	32	48	64	80	96	112	128	144	160	176	192	208	224	240	256	272	288	304	320
	17	-	17	34	51	68	85	102	119	136	153	170	187	204	221	238	255	272	289	306	323	340
	18	-	18	36	54	72	90	108	126	144	162	180	198	216	234	252	270	288	306	324	342	360
	19	-	19	38	57	76	95	114	133	152	171	190	209	228	247	266	285	304	323	342	361	380
	20	-	20	40	60	80	100	120	140	160	180	200	220	240	260	280	300	320	340	360	380	400

Note: For H type, count two windows as one S type window.

Examples: 1. S-type Row: 6 Column: 14 Total: 84
 2. T-type Row: 8 Column: 8 Total: 64
 3. V-type Row: 5 Column: 18 Total: 90

H type (Half size)

S type (Square type)



AP40F

■ **Dimensions, mm**

Front view

● **S-type**

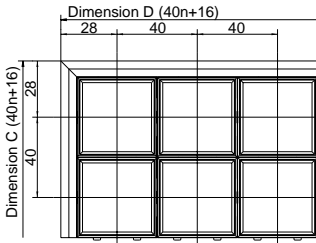

● **T-type**

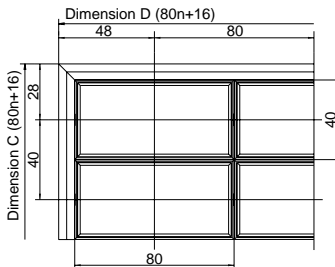

● **V-type**

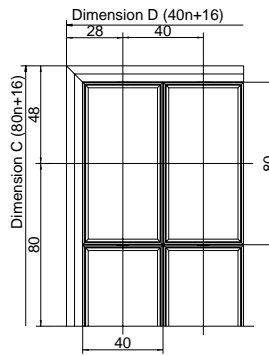

● **H-type**

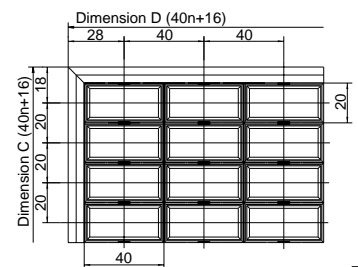

Back view

● **Full-voltage type (LED)**

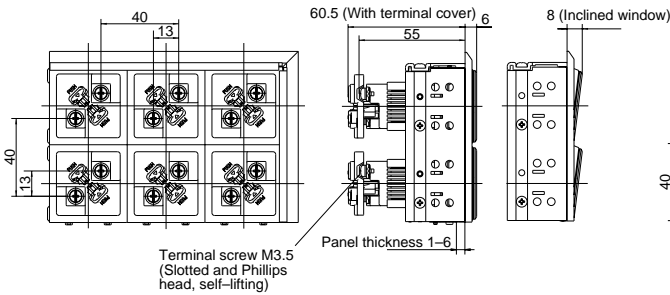

● **With transformer unit, with resistor unit, with flicker unit, with voltage stabilizer unit**

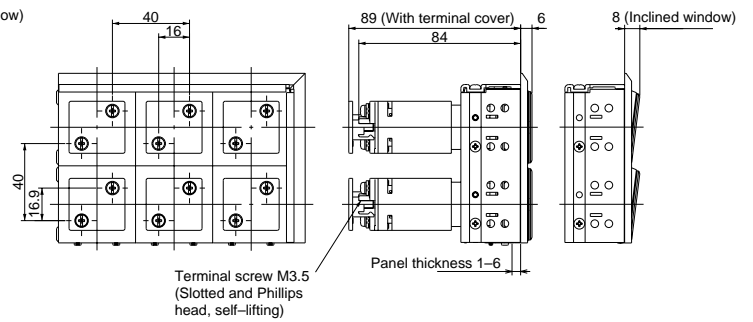

● **Full-voltage type (LED, short body type)**

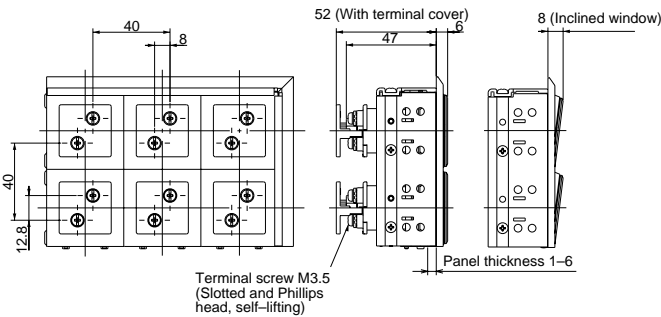

● **Full-voltage type (Incandescent)**

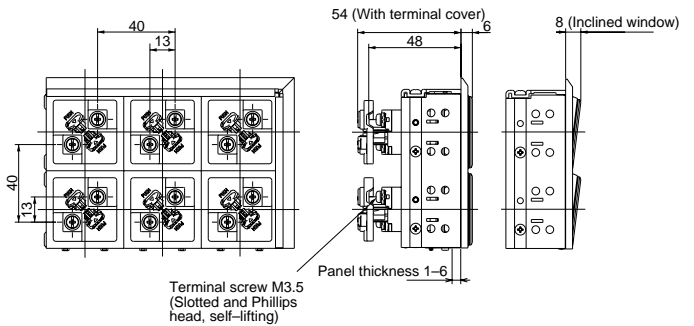

Half size (Illuminated face)

With check terminal

● **Full-voltage type**

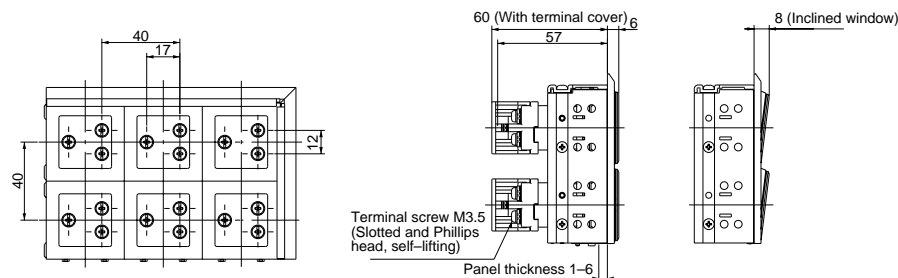

Multi Display Lights

AP40F

Dimensions

AP40F

■ Panel cutout and overall dimensions

● S, H-type

Number of windows		1	2	3	4	5	6	7	8	9	10	11	12	13	14	15
Panel cutout	A	45	85	125	165	205	245	285	—	—	—	—	—	—	—	—
	B	45	85	125	165	205	245	285	325	365	405	445	485	525	565	605
Overall	C	56	96	136	176	216	256	296	—	—	—	—	—	—	—	—
	D	56	96	136	176	216	256	296	336	376	416	456	496	536	576	616

● T-type

Number of windows		1	2	3	4	5	6	7
Panel cutout	A	45	85	125	165	205	245	285
	B*	85	165	245	325	405	485	565
Overall	C	56	96	136	176	216	256	296
	D*	96	176	256	336	416	496	576

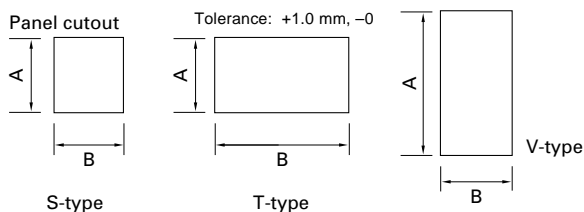

● V-type

Number of windows		1	2	3	4	5	6	7	8	9	10	11	12	13	14	15
Panel cutout	A*	85	165	245	—	—	—	—	—	—	—	—	—	—	—	—
	B	45	85	125	165	205	245	285	325	365	405	445	485	525	565	605
Overall	C*	96	176	256	—	—	—	—	—	—	—	—	—	—	—	—
	D	56	96	136	176	216	256	296	336	376	416	456	496	536	576	616

Note: * Indicates dimensions for rectangular windows.

■ Total numbers of windows

		S, V type		Number of windows (Column)																
		V type	T type	1	2	3	4	5	6	7	8	9	10	11	12	13	14	15		
S, T type				1	2	3	4	5	6	7	—									
Number of windows (Row)	1	1	1	2	3	4	5	6	7	8	9	10	11	12	13	14	15			
	2	2	2	4	6	8	10	12	14	16	18	20	22	24	26	28	30			
	3	3	3	6	9	12	15	18	21	24	27	30	33	36	39	42	45			
	4		4	8	12	16	20	24	28	32	36	40	44	48	52	56	60			
	5		5	10	15	20	25	30	35	40	45	50	55	60	65	70	75			
	6		6	12	18	24	30	36	42	48	54	60	66	72	78	84	90			
	7		7	14	21	28	35	42	49	56	63	70	77	84	91	98	105			

Note: For H Type, count two-windows as one S-type window.

H type (Half size) S type (Square type)



■ Installation

Mounting panel

- Panel thickness: 1 to 6mm
- The panel thickness must be able to support the weight of the products and wiring cables. Take particular care in deciding the panel thickness when the products are heavy.

Panel cutout

Cut the mounting panel according to the numbers of rows and columns of windows. (See the dimensions on page 04/240 and 242.)

How to install

- Insert the product into the panel cutout from the front of the mounting panel. Make sure the product top and bottom are correctly oriented. The product nameplate is stuck to the top of the product.
- Fix the brackets into the side-plate slots at the back of the panel, as shown in the figure below, and clamp the product with the bracket screws. (Tightening torque : 0.4 to 0.6N•m)

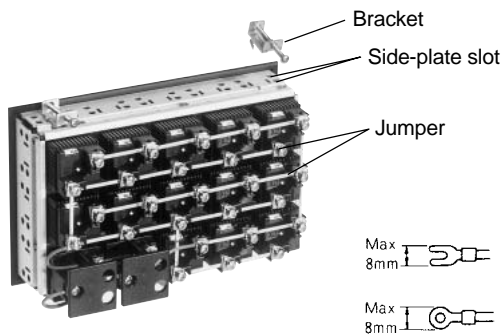

■ Wiring

Terminal size

The M3.5 terminal screw is suitable for both phillips and slotted screwdrivers. The terminal washers are the self-lifting type. Use crimp terminals. (Tightening torque : 0.8 to 1.0N•m). Double crimp terminals can be connected.

Staggered terminals

Because the terminals are staggered, jumper connection is simple. Jumpers are supplied with products as standard. Rated current of jumper : 3A

■ Mass (g)

Mass of multi display light = Voltage unit × (rows × columns) + Side plate × (rows + columns)

AP30F

Description			Mass (g)
Voltage unit	Incandescent	Full-voltage type	29
		With transformer (short)	79
		With transformer	107
		With resistor unit	52
	LED	Full-voltage type	29
		With transformer	109
		Short body type	33
		With R/CR voltage dividing type	32
		2-color all surface illumination with check terminal half size	38
		With flicker unit	54
		With voltage stabilizer unit	54
		Side plate	27

The number of brackets required depends on the type as follows

Full-voltage type and transformer type with 1 to 20 lamps

Column	AP30F	01~02	03~08	09~15	16~20
Row	AP40F	01~02	03~06	07~11	12~15
AP30F	AP40F				
01~02	01~02				
03~06	03~04				
07~10	05~07				
11~15	-				
16~20	-				

Transformer type with 21 to 50 lamps

Rows or columns	1~2	3~4	5	6~8	9	10~12	13	14~16	17	18~20
Brackets required	1	2	3	4	5	6	7	8	9	10

The transformer type with over 20 lamps is very heavy and extra brackets are required. Fit brackets at equal intervals.

Transformer type with 51 to 80 lamps

Fit brackets in all slots.

AP40F

Description			Mass (g)
Voltage unit	Incandescent	Full-voltage type	32
		With transformer	110
		With resistor unit	64
		LED	Full-voltage type
	LED	With transformer	121
		Short body type	33
		With R/CR voltage dividing type	32
		2-color all surface illumination with check terminal half size	38
		With flicker unit	67
		With voltage stabilizer unit	67
		Side plate	28

Multi Display Lights AP30F and AP40F Notes on use

■ Replacing parts

Detaching lens case

To remove a lamp, place the tip of a flat-blade screwdriver in the groove at the edge of the lens case and press it in the direction of the arrow. The tip of the screwdriver should be 4.5mm or less wide and 0.6mm or less thick.

To remove both the LED unit and lens case, place the tip of flat-blade screwdriver in one of the indents on the edges of the lens case and press it in the direction of the arrow.

When installing an LED unit, press it into the frame so that the LED unit side with the arrow faces the top side of the frame (i.e., the side with the unit type nameplate). The LED unit must be in the correct orientation when installing it.

After installing the lens case and lens, use your finger to press the lens part firmly until it stops in place. To prevent defective lighting or other problems caused by static electricity, do not press directly on the LED chip surface with your finger.

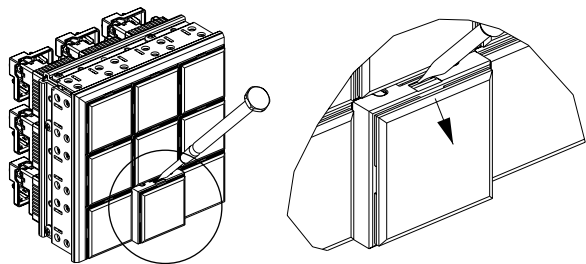

■ Replacing color inserts and legend plates

To replace a color insert and legend plate, insert a flat-blade screwdriver and press it to remove the lens.

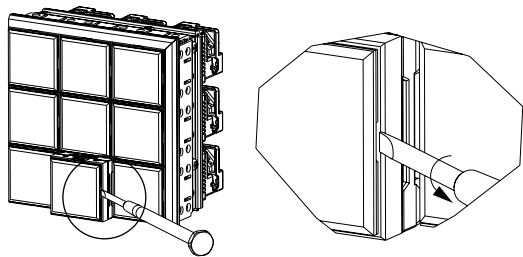

Using the specially-designed suction cup removal tool DN7Y020, replace a color insert and legend plate by applying the suction cup as shown in the diagram below.



Do not touch the chip when the color insert is removed from the LED unit and the LED chip is exposed. Defective lighting or other problems may be caused by static electricity. Install a color insert and legend plate by inserting their rough surfaces so that they face the lamp.

Replacing incandescent lamps

Insert and remove lamps using the hollow end of the lamp changer type AHX029.



LED unit color display

The operating voltage and lamp color are printed on the LED unit lamp using codes.

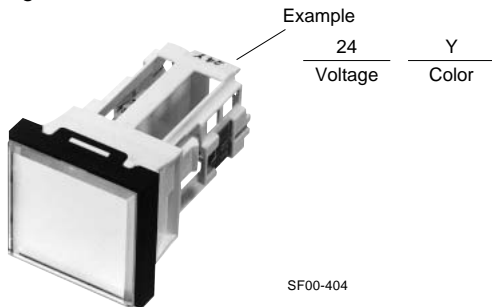

Rated voltage code \ Color code	Color code							
	R	A	W	Y	G	S	P	F
M	220R	220A	220W	220Y	220G	220S	220P	
L	127R	127A	127W	127Y	127G	127S	127P	
H	110R	110A	110W	110Y	110G	110S	110P	
F	48R	48A	48W	48Y	48G	48S	48P	
E	24R	24A	24W	24Y	24G	24S	24P	24F
C	15R	15A	15W	15Y	15G	15S	15P	
B	12R	12A	12W	12Y	12G	12S	12P	
6	6R	6A	6W	6Y	6G	6S	6P	
E (With check terminal)	24-RC	24-AC	24-WC	24-YC	24-GC	24-SC	24-PC	

Installing color inserts and legend plate

Inserting a color insert and legend plate

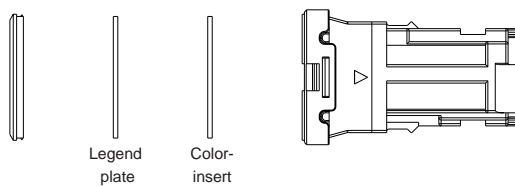

- For a color display when the lamp is OFF, insert first a color insert and then an opaque white legend plate into the lens case.
- For an opaque white display when the lamp is OFF, insert first a transparent color insert and then an opaque white legend plate into the lens case (only with LEDs).
- For smoked lenses, insert first a color insert and then an opaque white legend plate into the lens case.
- The legend plate and color inserts can be engraved.
- Do not touch the chip when the color insert is removed from the LED unit and the LED chip is exposed. Defective lighting or other problems may be caused by static electricity.

Opaque white display with the lamp off

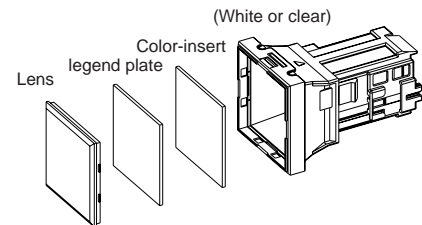

Color display with the lamp off

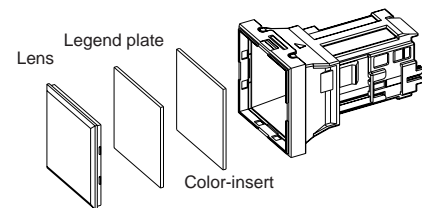

LED polarity

The terminals of all 6V DC voltage products and DC flicker units have polarity, so care is needed when installing them. X1 is the positive terminal.

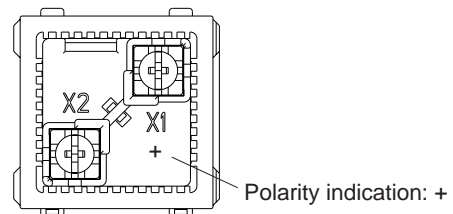

Connecting color lamps and half-size lamp windows

Terminals	Light color from two-color lamp	Half-size lamp window
X1 to X3	Green	Top
X1 to X2	Red	Bottom

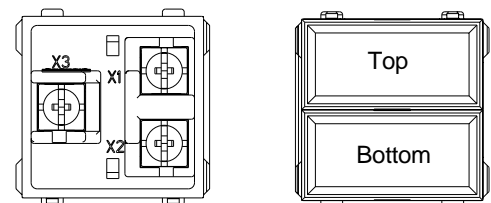

Multi Display Lights AP30F and AP40F Notes on use

Assembling lens and lens case

Assemble the lens with lens case by mating lens projections with lens case indents.

■ Other precautions

1. Transformer units

- A maximum of 80 windows can function for a unit with transformers when the windows are square.
- Transformers are designed for a load of one incandescent lamp and one LED unit. It is not possible to connect additional loads.

2. Operating voltage and the rated voltage of incandescent lamp

- Incandescent lamps can be used within the lamp's rated voltage. If you need 5,000 to 10,000 hours of service life for incandescent lamp (at AC circuit), use the lamp within the standard operating voltage. Using incandescent lamps in DC circuit greatly reduces the lamp service life due to notching phenomenon. Use LED units in DC circuit instead.

Lamp rated voltage (V AC)	Standard operating voltage (V AC)
6.3	4 to 5.5
18	12 to 15
24	16 to 20
30	20 to 24

3. Flicker units

- When two or more flicker units are used in a Multi Display Light, they may not illuminate simultaneously because of variations in flicker unit circuits.
- Flicker units can be used only with square Multi Display Lights. They cannot be used with rectangular lights.

4. Continuous lighting

- For continuous light, the duty cycle should be 50% or less. If densely packed LEDs are lit continuously with a high duty cycle, LED life will be reduced.
- With 2-color lighting on the entire surface, do not use continuous lighting when lighting 2 colors simultaneously.

5. Store and operate these units within the temperature and humidity specifications on *page 04/237*.

6. Do not use these units at outdoor.

7. Do not use these units in places where dust or cuttings will accumulate. The lights may not turn ON if dust or cuttings penetrate into the units.

■ Accessory

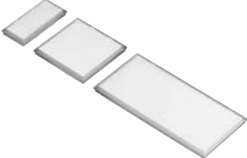
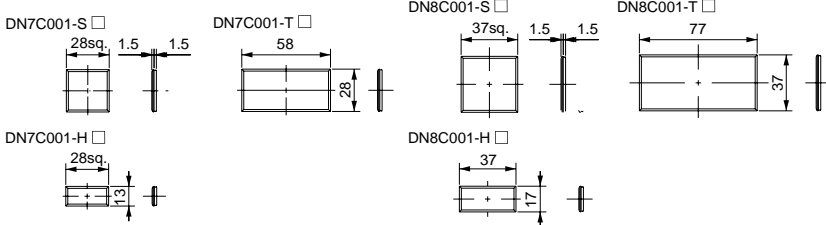
Description	Type and dimensions, mm			
Lens 	Used with		Type	
			Square(S)	Rectangular(T,V)
AP30F	Clear	DN7C001-SC	DN7C001-TC	DN7C001-HC
	Smoked	DN7C001-SS	DN7C001-TS	DN7C001-HS
AP40F	Clear	DN8C001-SC	DN8C001-TC	DN8C001-HC
	Smoked	DN8C001-SS	DN8C001-TS	DN8C001-HS
				

AF00-379

Used with	Code		Color	Type			
	LED	Incandescent		Square (S)	Rectangular (T, V)	2-way split rectangular	Half size (H)
AP30F	R	R	Red	APCX016-SR	APCX016-TR	APCX058-R	DN7P002-R
	O	O	Orange	APCX016-SO	APCX016-TO	APCX058-O	DN7P002-A
	P	W	White	APCX012-LW	APCX014-LW	APCX058-W	DN7P002-W
	G	—	Green (LED)	APCX016-SLG	APCX016-TLG	APCX058-LG	DN7P002-G
	—	G	Green (incandescent)	DN7P004-G	DN7P005-G	DN7P006-G	—
	Y	Y	Yellow	APCX016-SLY	APCX016-TLY	APCX058-LY	DN7P002-Y
	S	S	Blue	APCX016-SS	APCX016-TS	APCX058-S	DN7P002-S
	W, RG, C	—	Clear	APCX012-C	APCX014-C	APCX058-C	—
	W, C	—	Clear	—	—	—	DN7P002-C
AP40F	R	R	Red	DN8P004-R	DN8P005-R	DN8P006-R	DN8P002-R
	O	O	Orange	DN8P004-A	DN8P005-A	DN8P006-A	DN8P002-A
	W, RG, C	W	White	APCX013-LW	APCX015-LW	APCX059-W	DN8P002-W
	G	—	Green (LED)	APCX077-SG	APCX077-TG	APCX079-G	DN8P002-G
	—	G	Green (incandescent)	DN8P004-G	DN8P005-G	DN8P006-G	—
	Y	Y	Yellow	DN8P004-Y	DN8P005-Y	DN8P006-Y	DN8P002-Y
	S	S	Blue	APCX017-SS	APCX017-TS	APCX059-S	DN8P002-S
	P	—	White (LED)	APCX077-SW	APCX077-TW	APCX079-W	—
	P	—	White	—	—	—	DN8P002-W
	W, C	—	Clear	—	—	—	DN8P002-C



Legend plate

Used with	Type			
	Square (S)	Rectangular (T, V)	Half size (H)	
AP30F	Clear	APCX012-LW	APCX014-LW	DN7P002-W
	Smoked	APCX012-LWS	APCX014-LWS	DN7P002-WS
AP40F	Clear	APCX013-LW	APCX015-LW	DN8P002-W
	Smoked	APCX013-LWS	APCX015-LWS	DN8P002-WS

AP30F Square

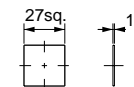

AP30F Rectangular

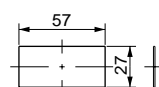

AP30F Split rectangular (Color-insert)

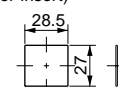

AP30F Half size

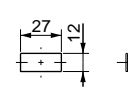

AP30F Square

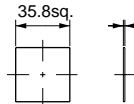

AP30F Rectangular

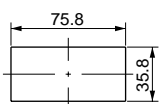

AP30F Split rectangular (Color-insert)

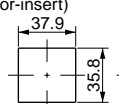



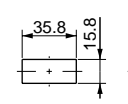



AP30F Half size

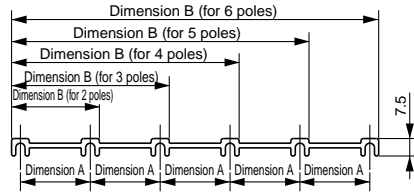

AF00-379

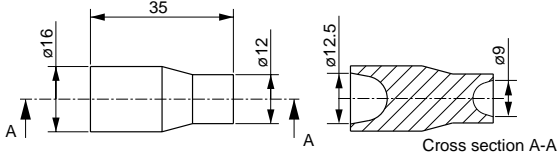
Multi Display Lights AP30F and AP40F Accessories

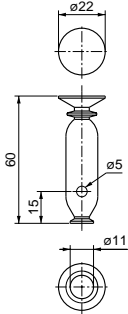
Description	Type and dimensions, mm					
Jumper  AF00-379	Used with	Type				
		2 poles	3 poles	4 poles	5 poles	6 poles
	AP30F	APCX029	DN7Y001-03	DN7Y001-04	DN7Y001-05	DN7Y001-06
	AP40F	APCX030	DN8Y001-03	DN8Y001-04	DN8Y001-05	DN8Y001-06
Jumper dimensions						
Used with	Dimension A	Dimension B				
		2 poles	3 poles	4 poles	5 poles	6 poles
AP30F series	30	37.6	67.6	97.6	127.6	157.6
AP40F series	40	47.6	87.6	127.6	167.6	207.6
						
Incandescent lamp  AF00-383	Used with	Socket type	Voltage/capacity	Type	Remarks	
	AP30F	BA9s/13 bayonet type	6.3V 1W	AHX135	Lamp with built-in transformer	
			18V 1W	AHX279	-	
			24V 1W	AHX144	-	
	30V 1W		AHX129	-		
	48V 1W		AHX407	Lamp with built-in resistor unit		
AP40F		18V 2W	AHX141	Lamp with built-in transformer		
		24V 2W	AHX142	-		
		30V 2W	AHX143	-		
		48V 2W	DN7H001	Lamp with built-in resistor unit		
<div style="display: flex; justify-content: space-around;"> <div data-bbox="622 1258 909 1292">For AP30F (except 48V 1W)</div> <div data-bbox="1005 1258 1292 1292">For AP40F, AP30F (48V 1W)</div> </div> 						
Lamp changer  T-1990	Used with	Type				
	AP30F, AP40F For incandescent lamp	AHX029				
						
Color-insert and legend plate changer  AF00-380	Type	DN7Y020				
						

Multi Display Lights AP30F and AP40F Accessories

04

Description	Type and dimensions, mm									
LED unit	Used with	Emitted color	Color-insert specification	Type						
				Square(S)	Horizontal rectangular (T)	Vertical rectangular (V)	Half size(H)			
 AF00-374	AP30F Single color All surface illumination	Red Orange White Green Yellow	Color-insert (color when light turned OFF)	DN7Q001-S1□R	DN7Q001-T1□R	DN7Q001-V1□R	DN7Q001-H1□R			
				DN7Q001-S1□A	DN7Q001-T1□A	DN7Q001-V1□A	DN7Q001-H1□A			
				DN7Q001-S1□W	DN7Q001-T1□W	DN7Q001-V1□W	DN7Q001-H1□W			
				DN7Q001-S1□G	DN7Q001-T1□G	DN7Q001-V1□G	DN7Q001-H1□G			
				DN7Q001-S1□Y	DN7Q001-T1□Y	DN7Q001-V1□Y	DN7Q001-H1□Y			
				DN7Q001-S1□S	DN7Q001-T1□S	DN7Q001-V1□S	DN7Q001-H1□S			
	Full voltage	Blue Pure-white	Color (transparent) -insert (white when light turned OFF)	DN7Q001-S1□P	DN7Q001-T1□P	DN7Q001-V1□P	DN7Q001-H1□P			
				DN7Q001-S3□R	DN7Q001-T3□R	DN7Q001-V3□R	DN7Q001-H3□R			
				DN7Q001-S3□A	DN7Q001-T3□A	DN7Q001-V3□A	DN7Q001-H3□A			
				DN7Q001-S3□G	DN7Q001-T3□G	DN7Q001-V3□G	DN7Q001-H3□G			
				DN7Q001-S3□Y	DN7Q001-T3□Y	DN7Q001-V3□Y	DN7Q001-H3□Y			
				DN7Q001-S3□S	DN7Q001-T3□S	DN7Q001-V3□S	DN7Q001-H3□S			
				AP40F Single color All surface illumination	Red Orange White Green Yellow	Color-insert (color when light turned OFF)	DN8Q001-S1□R	DN8Q001-T1□R	DN8Q001-V1□R	DN8Q001-H1□R
							DN8Q001-S1□A	DN8Q001-T1□A	DN8Q001-V1□A	DN8Q001-H1□A
DN8Q001-S1□W	DN8Q001-T1□W	DN8Q001-V1□W	DN8Q001-H1□W							
DN8Q001-S1□G	DN8Q001-T1□G	DN8Q001-V1□G	DN8Q001-H1□G							
DN8Q001-S1□Y	DN8Q001-T1□Y	DN8Q001-V1□Y	DN8Q001-H1□Y							
DN8Q001-S1□S	DN8Q001-T1□S	DN8Q001-V1□S	DN8Q001-H1□S							
Full voltage	Blue Pure-white	Color (transparent) -insert (white when light turned OFF)	DN8Q001-S1□P				DN8Q001-T1□P	DN8Q001-V1□P	DN8Q001-H1□P	
			DN8Q001-S3□R				DN8Q001-T3□R	DN8Q001-V3□R	DN8Q001-H3□R	
			DN8Q001-S3□A	DN8Q001-T3□A	DN8Q001-V3□A	DN8Q001-H3□A				
			DN8Q001-S3□G	DN8Q001-T3□G	DN8Q001-V3□G	DN8Q001-H3□G				
			DN8Q001-S3□Y	DN8Q001-T3□Y	DN8Q001-V3□Y	DN8Q001-H3□Y				
			DN8Q001-S3□S	DN8Q001-T3□S	DN8Q001-V3□S	DN8Q001-H3□S				

Notes: The LED unit is provided with a lens case and a color-insert.

Replace the □ in the type number with one of the following voltage code.

Voltage	Code	Square, horizontal/ vertical rectangular	Half size
6V DC	6	○	—
12V AC/DC	B	○	○
15V AC/DC	C	○	○
24V AC/DC	E	○	○
48V AC/DC	F	○	—
110V AC/DC	H	○	—
127V AC/DC	L	○	—
220V AC	M	○	—

○: Available —:Not available

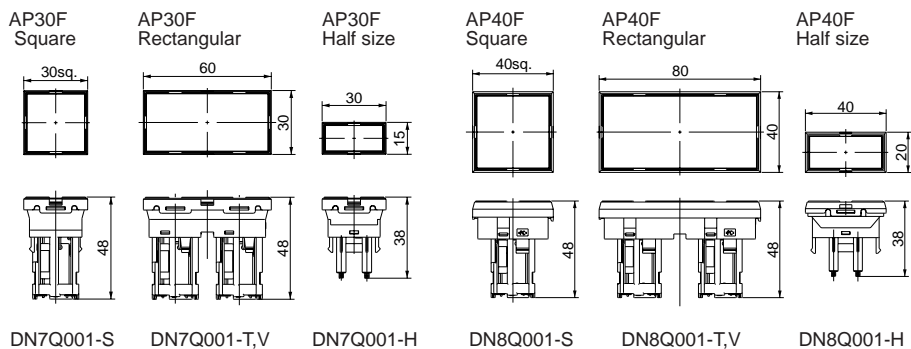

DN7Q001-S DN7Q001-T,V DN7Q001-H DN8Q001-S DN8Q001-T,V DN8Q001-H

Multi Display Lights AP30F and AP40F Accessories

Description	Type and dimensions, mm						
LED unit	Used with	Emitted color	Color-insert specification	Type			
				Square(S)	Horizontal rectangular (T)	Vertical rectangular (V)	
				AP30F LED transformer units	Red	Color-insert (color when light turned OFF)	DN7Q004-S1ER
LED short body type	Orange	DN7Q004-S1EA	DN7Q004-T1EA	DN7Q004-V1EA			
	White	DN7Q004-S1EW	DN7Q004-T1EW	DN7Q004-V1EW			
	Green	DN7Q004-S1EG	DN7Q004-T1EG	DN7Q004-V1EG			
	Yellow	DN7Q004-S1EY	DN7Q004-T1EY	DN7Q004-V1EY			
	Blue	DN7Q004-S1ES	DN7Q004-T1ES	DN7Q004-V1ES			
	Pure-white	DN7Q004-S1EP	DN7Q004-T1EP	DN7Q004-V1EP			
LED transformer units	Red	Color (transparent) -insert (white when light turned OFF)	DN7Q004-S3ER	DN7Q004-T3ER	DN7Q004-V3ER		
	Orange		DN7Q004-S3EA	DN7Q004-T3EA	DN7Q004-V3EA		
	Green		DN7Q004-S3EG	DN7Q004-T3EG	DN7Q004-V3EG		
	Yellow		DN7Q004-S3EY	DN7Q004-T3EY	DN7Q004-V3EY		
	Blue		DN7Q004-S3ES	DN7Q004-T3ES	DN7Q004-V3ES		
	Pure-white		DN7Q004-S3EP	DN7Q004-T3EP	DN7Q004-V3EP		
AP40F LED transformer units	Red		Color-insert (color when light turned OFF)	DN8Q004-S1ER	DN8Q004-T1ER	DN8Q004-V1ER	
	Orange			DN8Q004-S1EA	DN8Q004-T1EA	DN8Q004-V1EA	
	White			DN8Q004-S1EW	DN8Q004-T1EW	DN8Q004-V1EW	
	Green			DN8Q004-S1EG	DN8Q004-T1EG	DN8Q004-V1EG	
	LED short body type			Yellow	DN8Q004-S1EY	DN8Q004-T1EY	DN8Q004-V1EY
				Blue	DN8Q004-S1ES	DN8Q004-T1ES	DN8Q004-V1ES
		Pure-white		DN8Q004-S1EP	DN8Q004-T1EP	DN8Q004-V1EP	
		Red		Color (transparent) -insert (white when light turned OFF)	DN8Q004-S3ER	DN8Q004-T3ER	DN8Q004-V3ER
		Orange			DN8Q004-S3EA	DN8Q004-T3EA	DN8Q004-V3EA
		Green			DN8Q004-S3EG	DN8Q004-T3EG	DN8Q004-V3EG
	Yellow	DN8Q004-S3EY			DN8Q004-T3EY	DN8Q004-V3EY	
	Blue	DN8Q004-S3ES			DN8Q004-T3ES	DN8Q004-V3ES	
Pure-white	DN8Q004-S3EP	DN8Q004-T3EP	DN8Q004-V3EP				

Note: The LED unit is provided with a lens case and a color-insert.

Used with	Horizontal rectangular	Vertical rectangular	Remarks
AP30F	DN7Q001-T \square ■AB	DN7Q001-V \square ■AB	Full-voltage type (R/CR voltage dividing)*
2-way split illumination	DN7Q004-T \square EAB	DN7Q004-V \square EAB	Short body type for transformer unit
AP40F	DN8Q001-T \square ■AB	DN8Q001-V \square ■AB	Full-voltage type (R/CR voltage dividing)*
2-way split illumination	DN8Q004-T \square EAB	DN7Q008-V \square EAB	Short body type for transformer unit

\square : Color-insert specification codes: Colored = 2, Transparent or white: 4

■: Specify the voltage codes. See page 04/249.

●: Specifying colors for 2-way split illumination.

* For dimensions, See page 04/249.

Horizontal rectangular (T)
2-way split illumination



Vertical rectangular (V)
2-way split illumination



Specify the colors by replacing "A" and "B" with the corresponding symbols.

Red: R, Green: G, Orange: A, White: W, Yellow: Y, Blue: S, Pure white: P

Example

DN7Q001-T2ERG: AP30F horizontal rectangular type with 2-way split illumination with red on the left and green on the right.

AP30F Square

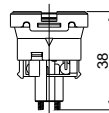
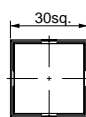

DN7Q004-S

AP30F Rectangular

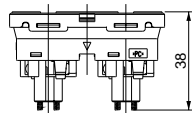
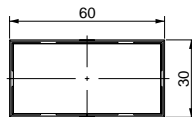

DN7Q004-T,V

AP40F Square

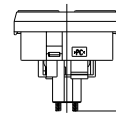
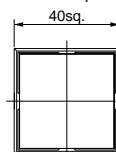

DN8Q004-S

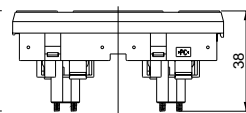
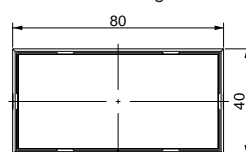

AP40F Rectangular



DN8Q004-T,V

Multi Display Lights AP30F and AP40F Accessories

04



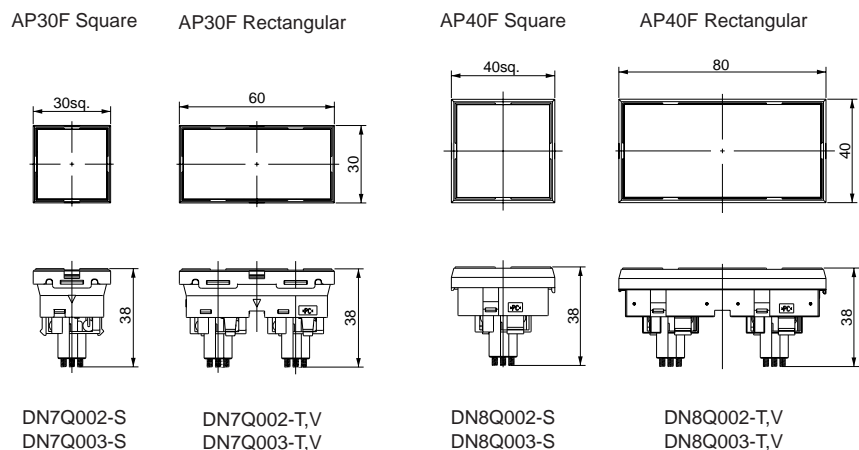

Description	Type and dimensions, mm						
LED unit	Used with	Emitted color	Color-insert specification	Type			
				Square(S)	Horizontal rectangular (T)	Vertical rectangular (V)	Half size(H)
 AF00-376  AF00-375 All surface illumination with a check terminal (full voltage only 24V type)	AP30F Single color	Red Orange White Green Yellow Blue Pure-white	Color-insert (color when light turned OFF)	DN7Q003-S1ER	DN7Q003-T1ER	DN7Q003-V1ER	-
				DN7Q003-S1EA	DN7Q003-T1EA	DN7Q003-V1EA	-
				DN7Q003-S1EW	DN7Q003-T1EW	DN7Q003-V1EW	-
				DN7Q003-S1EG	DN7Q003-T1EG	DN7Q003-V1EG	-
				DN7Q003-S1EY	DN7Q003-T1EY	DN7Q003-V1EY	-
				DN7Q003-S1ES	DN7Q003-T1ES	DN7Q003-V1ES	-
	AP30F Single color	Red Orange Green Yellow Blue	Color (transparent)-insert (white when light turned OFF)	DN7Q003-S1EP	DN7Q003-T1EP	DN7Q003-V1EP	-
				DN7Q003-S3ER	DN7Q003-T3ER	DN7Q003-V3ER	-
				DN7Q003-S3EA	DN7Q003-T3EA	DN7Q003-V3EA	-
				DN7Q003-S3EG	DN7Q003-T3EG	DN7Q003-V3EG	-
				DN7Q003-S3EY	DN7Q003-T3EY	DN7Q003-V3EY	-
				DN7Q003-S3ES	DN7Q003-T3ES	DN7Q003-V3ES	-
	AP40F Single color	Red Orange White Green Yellow Blue Pure-white	Color-insert (color when light turned OFF)	DN8Q003-S1ER	DN8Q003-T1ER	DN8Q003-V1ER	-
				DN8Q003-S1EA	DN8Q003-T1EA	DN8Q003-V1EA	-
				DN8Q004-S1EW	DN8Q003-T1EW	DN8Q003-V1EW	-
				DN8Q003-S1EG	DN8Q003-T1EG	DN8Q003-V1EG	-
				DN8Q003-S1EY	DN8Q003-T1EY	DN8Q003-V1EY	-
				DN8Q003-S1ES	DN8Q003-T1ES	DN8Q003-V1ES	-
AP40F Single color		Red Orange Green Yellow Blue	Color (transparent)-insert (white when light turned OFF)	DN8Q003-S1EP	DN8Q003-T1EP	DN8Q003-V1EP	-
				DN8Q003-S3ER	DN8Q003-T3ER	DN8Q003-V3ER	-
				DN8Q003-S3EA	DN8Q003-T3EA	DN8Q003-V3EA	-
				DN8Q003-S3EG	DN8Q003-T3EG	DN8Q003-V3EG	-
				DN8Q003-S3EY	DN8Q003-T3EY	DN8Q003-V3EY	-
				DN8Q003-S3ES	DN8Q003-T3ES	DN8Q003-V3ES	-

Note: The LED unit is provided with a lens case and a color-insert.

Used with	Emitted color	Type		
		Square(S)	Horizontal rectangular (T)	Vertical rectangular (V)
AP30F 2-color illumination	Red and green	DN7Q002-S3EF	DN7Q002-T3EF	DN7Q003-V3EF
AP40F 2-color illumination	Red and green	DN8Q002-S3EF	DN8Q002-T3EF	DN8Q003-V3EF

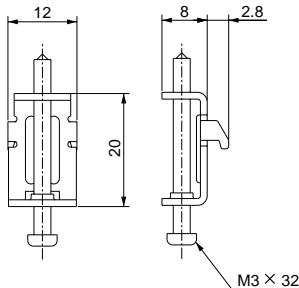

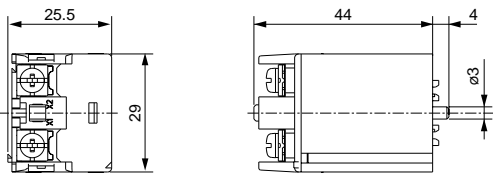

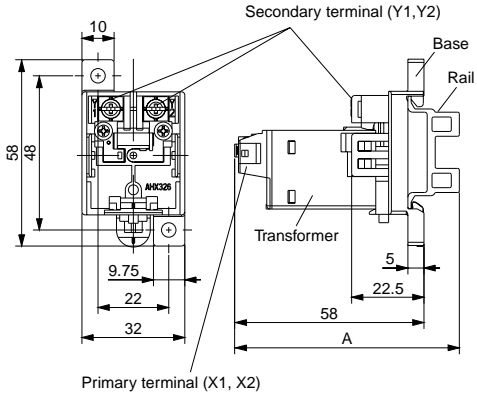







Multi Display Lights AP30F and AP40F Accessories

Description	Type and dimensions, mm																											
Mounting bracket	<table border="1"> <tr> <td>Type</td> <td colspan="6">APX111</td> </tr> </table>							Type	APX111																			
Type	APX111																											
							M3 × 32																					
AF00-384																												
Transformer unit	<table border="1"> <tr> <td>Type</td> <td colspan="6"> AX511-□ AX503-□ AX544-□ </td> </tr> </table>							Type	AX511-□ AX503-□ AX544-□																			
Type	AX511-□ AX503-□ AX544-□																											
	Note: Replace the □ mark in the type number with the voltage code.																											
SF-1111																												
Base unit for separate mounting transformer	<table border="1"> <tr> <td>Type</td> <td colspan="6">AHX326</td> </tr> </table>							Type	AHX326																			
Type	AHX326																											
	Remarks • If the power supply voltage is 100V AC or over (or more than 220V for R or CR voltage-dividing types) and the panel has limited depth or there are weight limitations, a full-voltage type can be used with a separate mounted transformer, as shown in the following table below. • A base unit is required when combining with a transformer unit. Mounting is possible using screws or rail.																											
AF89-824	<table border="1"> <tr> <td>Rail type</td> <td colspan="6">A (mm)</td> </tr> <tr> <td>TH35-15AL</td> <td colspan="6">69</td> </tr> <tr> <td>TH35-7.5, AH35-7.5AL</td> <td colspan="6">61.5</td> </tr> </table>						Rail type	A (mm)						TH35-15AL	69						TH35-7.5, AH35-7.5AL	61.5						
Rail type	A (mm)																											
TH35-15AL	69																											
TH35-7.5, AH35-7.5AL	61.5																											

■ Separate mounted transformer application table

Used with	LED specification				Incandescent specification			
	Applicable light type	Built-in unit	Transformer unit	Separate base	Applicable light type	Built-in light bulb	Transformer unit	Separate base
AP30F	AP30F-◇◆E3-● AP30F-◇◆ES-●	DN7Q001-□□□□ DN7Q004-□□□□	AHX544-□ × No. of windows	AHX326 × No. of windows	AP30F-◇◆A-●	AHX135 (6.3 V 1W bulb)	AHX511-□ × No. of windows	AHX326 × No. of windows
AP40F	AP40F-◇◆E3-● AP40F-◇◆ES-●	DN8Q001-□□□□ DN8Q004-□□□□			AP40F-◇◆C-●	AHX141 (18 V 2W bulb)	AHX503-□ × No. of windows	

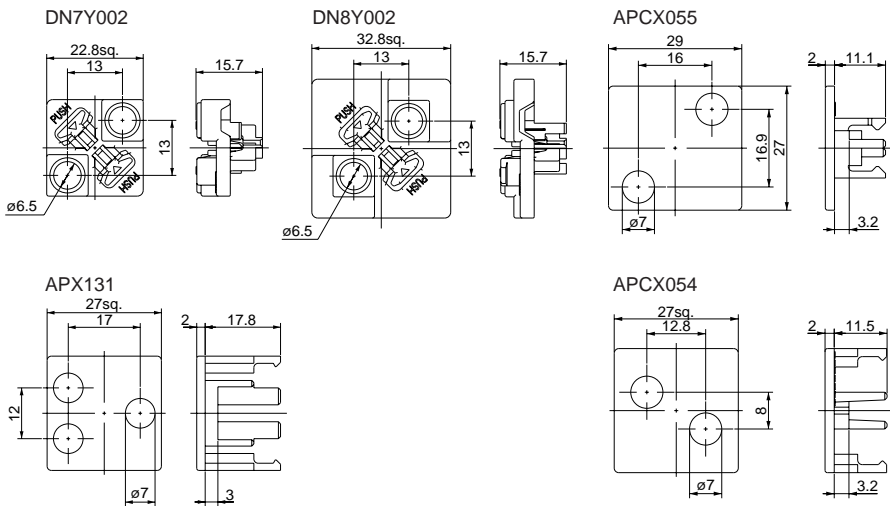
- Notes: 1. Replace ◇◆ mark by the number of basic windows. ◇◆ = vertical x horizontal
 2. Replace ● mark by the code indicating the shape of illuminated face (S, T, or V, do not specify H).
 3. The following depths are available. AP30F-◇◆E3: 60.5mm AP30F-◇◆ES: 52mm AP30F-◇◆A: 54mm
 AP40F-◇◆E3: 60.5mm AP40F-◇◆ES: 52mm AP40F-◇◆C: 54mm
 4. Refer to pages 04/249 and 04/250 for built-in unit types with LED specifications.

Description	Type and dimensions, mm						
Terminal cover	Series	Description	DN7Y002	APCX054	APX131	DN8Y002	APCX055
 AF00-389	AP30F	LED single-color, full-surface illumination					
 AF00-388		Transformer type	<input type="checkbox"/>				<input type="checkbox"/>
		Half-size, 2-color illumination			<input type="checkbox"/>		
		LED short body type		<input type="checkbox"/>			
		Incandescent lamp	<input type="checkbox"/>				
			Transformer type 110V, 220V	<input type="checkbox"/>			
		Transformer type over than 220V					<input type="checkbox"/>
 AF00-387	AP40F	LED single-color, full-surface illumination				<input type="checkbox"/>	<input type="checkbox"/>
		Transformer type					
		Half-size, 2-color illumination			<input type="checkbox"/>		
		LED short body type		<input type="checkbox"/>			
		Incandescent lamp				<input type="checkbox"/>	
			Transformer type				
 AF00-386							
 AF00-385							

Multi Display Lights AP30F and AP40F Window layout sheet

■ Window layout ordering sheet

When ordering Multi Display Lights, fill in the necessary items in this ordering sheet on Page 04/255. (It is also recommended that you make copies of the sheet for future use.)

Cases in which you should order with the ordering sheet

- When ordering a mixture of LED luminous colors
- When ordering a mixture of window sizes in the illumination face
- When ordering a mixture of two-color illumination faces
- When ordering a mixture of input voltages
- When requesting embossed characters

Filling in the ordering sheet

1. Use lines to designate the borders of the illumination face.
2. Write the color code (G, R, W, Y, O, S) for each window into the bottom row of the window. For T and V types, write the code in only one place.
3. If you are requesting embossed characters, write the characters into the table.
4. For windows requiring more than 7 (vertical) or 15 (horizontal) spaces, continue writing on a separate ordering sheet.
5. Write in two places for a two-split illumination type.
6. When using a flicker unit or a voltage stabilizer unit, write the unit code into the bottom row of the window.

Specification example

		Horizontally(Column)														
		01	02	03	04	05	06	07	08	09	10	11	12	13	14	15
Vertically(Row)	01	RUN R		STOP G												
	02	FWD W	REV W E3FD	R G	Y O											
	03	MONIT-1		MONIT-2												
	04	↑ Designate the borders of the illumination face with lines.														
	05															
	06															
	07															

Example of flicker unit voltage.

■ Window layout ordering sheet

		Horizontally(Column)														
		01	02	03	04	05	06	07	08	09	10	11	12	13	14	15
Vertically(Row)	01															
	02															
	03															
	04															
	05															
	06															
	07															

04

Rotary Switches AC09, 16 and 32

Digital code output type

Description

FUJI AC series rotary switches offer a wide choice of output codes. They feature sliding Au-flashed contacts for high contact reliability. Inhibitor and parity check circuits guard against switch malfunctions caused by error signals. With only seven connections to make, these switches are an economical solution to multiposition switching needs.

Features

- Au-flashed contacts for high contact reliability.

- The protection of operator section meets the IP65 (IEC), so these switches can be used in oil-splash environments, such as on machine tool control panels. (Except for AC32)
- A wide choice of output codes fits a broad range of applications. Available step angles are 15, 30, and 360°/26 (13.85°). Real binary code, complementary binary code, and real gray code are available.
- Switches are available with connectors or with lock rings for easy handling.
- Stopper screw positions are user selectable.



Ratings

Volts	Operational current (A) (resistive load)
50V AC	0.05
5V AC	0.5
25V DC	0.05
5V DC	0.25

Performance

Rated insulation voltage		50V
Operating temperature		-20 to +70°C
Humidity		45 to 85%RH (non condensation)
Service life	Mechanical	50,000 operations
	Electrical	50,000 operations
Dielectric strength	Between terminals	250V AC, 1 minute
	Between terminals and ground	1500V AC, 1 minute
Insulation resistance	Between terminals	500MΩ or more
	Between terminals and ground	5,000MΩ or more
Degree of protection (operator section)		AC09, AC16 : IP65 (IEC60529) AC32 : IP40 (IEC60529)

Type number nomenclature

AC 09 – C Z 0 / 25 L1 E A01 / 0007

Basic type

Mounting

- 09: M9 nut
- 16: M16 adapter
- 32: Adapter (32mm mounting pitch)

Type of code

- R: Real binary code
- C: Complementary binary code
- G: Real gray code

Angle of step

Angle	Setting position
X: 30°	0 to 11
W: 360°/13 (27.69°)	0 to 12
Y: 15°	0 to 23
Z: 360°/26 (13.85°)	0 to 25

Start position

Available step angle
0 to 11: 30°
0 to 12: 360°/13 (27.69°)
0 to 23: 15°
0 to 25: 360°/26 (13.85°)

End position

Available step angle
0 to 11: 30°
0 to 12: 360°/13 (27.69°)
0 to 23: 15°
0 to 25: 360°/26 (13.85°)

With or without lock ring

- Blank: Without lock ring
- 0007: With lock ring
- 0009: With adhesive lock ring

With or without connector

- Blank: 8-terminal, without connector
- A01: 8-terminal, with right-angle connector
- A02: 8-terminal, with straight connector
- B00: 7-terminal, without connector
- B01: 7-terminal, with right-angle connector
- B02: 7-terminal, with straight connector

With or without stopper screw

- Blank: With stopper screw
- E: Without stopper screw

Length of shaft (mm)

	AC09	AC16	AC32
L1:	16	—	14.5
L2:	18	—	16.5
L3:	20	—	18.5
L4:	22	19.5	20.5

Note: When shorter action than the maximum range of switch action is used, stopper screws are used. However, stopper screws are not used if the maximum action range is used when either 15° (symbol Y) or 360°/26 (symbol Z) is specified.

• M9 nut mounting

Angle of step	Connector	Lock ring	Type*1 *2 *3		
			Real binary code	Complementary binary code	Real gray code
30°	Without connector	Without lock ring With lock ring With adhesive lock ring	AC09-RX□□()■ AC09-RX□□()■/0007 AC09-RX□□()■/0009	AC09-CX□□()■ AC09-CX□□()■/0007 AC09-CX□□()■/0009	AC09-GX□□()■ AC09-GX□□()■/0007 AC09-GX□□()■/0009
	With right angle connector	Without lock ring With lock ring With adhesive lock ring	AC09-RX□□()■01 AC09-RX□□()■01/0007 AC09-RX□□()■01/0009	AC09-CX□□()■01 AC09-CX□□()■01/0007 AC09-CX□□()■01/0009	AC09-GX□□()■01 AC09-GX□□()■01/0007 AC09-GX□□()■01/0009
	With straight connector	Without lock ring With lock ring With adhesive lock ring	AC09-RX□□()■02 AC09-RX□□()■02/0007 AC09-RX□□()■02/0009	AC09-CX□□()■02 AC09-CX□□()■02/0007 AC09-CX□□()■02/0009	AC09-GX□□()■02 AC09-GX□□()■02/0007 AC09-GX□□()■02/0009
360°/13 (27.69°)	Without connector	Without lock ring With lock ring With adhesive lock ring	AC09-RW□□()■ AC09-RW□□()■/0007 AC09-RW□□()■/0009	AC09-CW□□()■ AC09-CW□□()■/0007 AC09-CW□□()■/0009	
	With right angle connector	Without lock ring With lock ring With adhesive lock ring	AC09-RW□□()■01 AC09-RW□□()■01/0007 AC09-RW□□()■01/0009	AC09-CW□□()■01 AC09-CW□□()■01/0007 AC09-CW□□()■01/0009	
	With straight connector	Without lock ring With lock ring With adhesive lock ring	AC09-RW□□()■02 AC09-RW□□()■02/0007 AC09-RW□□()■02/0009	AC09-CW□□()■02 AC09-CW□□()■02/0007 AC09-CW□□()■02/0009	
15°	Without connector	Without lock ring With lock ring With adhesive lock ring	AC09-RY□□()■ AC09-RY□□()■/0007 AC09-RY□□()■/0009	AC09-CY□□()■ AC09-CY□□()■/0007 AC09-CY□□()■/0009	AC09-GY□□()■ AC09-GY□□()■/0007 AC09-GY□□()■/0009
	With right angle connector	Without lock ring With lock ring With adhesive lock ring	AC09-RY□□()■01 AC09-RY□□()■01/0007 AC09-RY□□()■01/0009	AC09-CY□□()■01 AC09-CY□□()■01/0007 AC09-CY□□()■01/0009	AC09-GY□□()■01 AC09-GY□□()■01/0007 AC09-GY□□()■01/0009
	With straight connector	Without lock ring With lock ring With adhesive lock ring	AC09-RY□□()■02 AC09-RY□□()■02/0007 AC09-RY□□()■02/0009	AC09-CY□□()■02 AC09-CY□□()■02/0007 AC09-CY□□()■02/0009	AC09-GY□□()■02 AC09-GY□□()■02/0007 AC09-GY□□()■02/0009
360°/26 (13.85°)	Without connector	Without lock ring With lock ring With adhesive lock ring	AC09-RZ□□()■ AC09-RZ□□()■/0007 AC09-RZ□□()■/0009	AC09-CZ□□()■ AC09-CZ□□()■/0007 AC09-CZ□□()■/0009	AC09-GZ□□()■ AC09-GZ□□()■/0007 AC09-GZ□□()■/0009
	With right angle connector	Without lock ring With lock ring With adhesive lock ring	AC09-RZ□□()■01 AC09-RZ□□()■01/0007 AC09-RZ□□()■01/0009	AC09-CZ□□()■01 AC09-CZ□□()■01/0007 AC09-CZ□□()■01/0009	AC09-GZ□□()■01 AC09-GZ□□()■01/0007 AC09-GZ□□()■01/0009
	With straight connector	Without lock ring With lock ring With adhesive lock ring	AC09-RZ□□()■02 AC09-RZ□□()■02/0007 AC09-RZ□□()■02/0009	AC09-CZ□□()■02 AC09-CZ□□()■02/0007 AC09-CZ□□()■02/0009	AC09-GZ□□()■02 AC09-GZ□□()■02/0007 AC09-GZ□□()■02/0009

Notes:

*1 Replace the □□ marks by the Start and End positions

Step angle	30°	360°/13	15°	360°/26
Start and End positions	0 to 11	0 to 12	0 to 23	0 to 25

*2 Replace the () mark by the shaft length code
L1: 16mm L2: 18mm L3: 20mm L4: 22mm

*3 Replace the ■ mark by the connector

- Blank: 8-terminal, without connector
- A01: 8-terminal, with right angle connector
- A02: 8-terminal, with straight connector
- B00: 7-terminal, without connector
- B01: 7-terminal, with right angle connector
- B02: 7-terminal, with straight connector

Rotary Switches AC09, 16 and 32

• M16 adapter mounting

Angle of step	Connector	Type*1 *2		
		Real binary code	Complementary binary code	Real gray code
30°	Without connector With right angle connector With straight connector	AC16-RX□□L4■ AC16-RX□□L4■01 AC16-RX□□L4■02	AC16-CX□□L4■ AC16-CX□□L4■01 AC16-CX□□L4■02	AC16-GX□□L4■ AC16-GX□□L4■01 AC16-GX□□L4■02
360°/13 (27.69°)	Without connector With right angle connector With straight connector	AC16-RW□□L4■ AC16-RW□□L4■01 AC16-RW□□L4■02	AC16-CW□□L4■ AC16-CW□□L4■01 AC16-CW□□L4■02	
15°	Without connector With right angle connector With straight connector	AC16-RY□□L4■ AC16-RY□□L4■01 AC16-RY□□L4■02	AC16-CY□□L4■ AC16-CY□□L4■01 AC16-CY□□L4■02	AC16-GY□□L4■ AC16-GY□□L4■01 AC16-GY□□L4■02
360°/26 (13.85°)	Without connector With right angle connector With straight connector	AC16-RZ□□L4■ AC16-RZ□□L4■01 AC16-RZ□□L4■02	AC16-CZ□□L4■ AC16-CZ□□L4■01 AC16-CZ□□L4■02	AC16-GZ□□L4■ AC16-GZ□□L4■01 AC16-GZ□□L4■02

Notes:

*1 Replace the □□ marks by the Start and End positions

Step angle	30°	360°/13	15°	360°/26
Start and End positions	0 to 11	0 to 12	0 to 23	0 to 25

*2 Replace the ■ mark by the connector

Blank: 8-terminal, without connector
A01: 8-terminal, with right angle connector
A02: 8-terminal, with straight connector
B00: 7-terminal, without connector
B01: 7-terminal, with right angle connector
B02: 7-terminal, with straight connector

• Adaptor mounting (32mm mounting pitch)

Angle of step	Connector	Type*1 *2 *3		
		Real binary code	Complementary binary code	Real gray code
30°	Without connector With right angle connector With straight connector	AC32-RX□□()■ AC32-RX□□()■01 AC32-RX□□()■02	AC32-CX□□()■ AC32-CX□□()■01 AC32-CX□□()■02	AC32-GX□□()■ AC32-GX□□()■01 AC32-GX□□()■02
360°/13 (27.69°)	Without connector With right angle connector With straight connector	AC32-RW□□()■ AC32-RW□□()■01 AC32-RW□□()■02	AC32-CW□□()■ AC32-CW□□()■01 AC32-CW□□()■02	
15°	Without connector With right angle connector With straight connector	AC32-RY□□()■ AC32-RY□□()■01 AC32-RY□□()■02	AC32-CY□□()■ AC32-CY□□()■01 AC32-CY□□()■02	AC32-GY□□()■ AC32-GY□□()■01 AC32-GY□□()■02
360°/26 (13.85°)	Without connector With right angle connector With straight connector	AC32-RZ□□()■ AC32-RZ□□()■01 AC32-RZ□□()■02	AC32-CZ□□()■ AC32-CZ□□()■01 AC32-CZ□□()■02	AC32-GZ□□()■ AC32-GZ□□()■01 AC32-GZ□□()■02

Notes:

*1 Replace the □□ marks by the Start and End positions

Step angle	30°	360°/13	15°	360°/26
Start and End positions	0 to 11	0 to 12	0 to 23	0 to 25

*2 Replace the () mark by the shaft length

L1: 14.5mm L2: 16.5mm L3: 18.5mm L4: 20.5mm

*3 Replace the ■ mark by the connector

Blank: 8-terminal, without connector
A01: 8-terminal, with right angle connector
A02: 8-terminal, with straight connector
B00: 7-terminal, without connector
B01: 7-terminal, with right angle connector
B02: 7-terminal, with straight connector

Rotary Switches AC 09, 16 and 32

Accessories

Lead wire with connector (8-terminal)



Length of lead wire (m)	Type	Mass (g)
0.5	ACX011-805	11
1.0 (Standard)	ACX011-810	19
2.0	ACX011-820	33

Lock ring



	Type	Mass (g)
Lock ring (inserted)	ACX001	2
Lock ring (sealed)	ACX001A	5

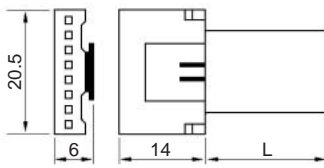

L: 0.5, 1.0, 2.0m

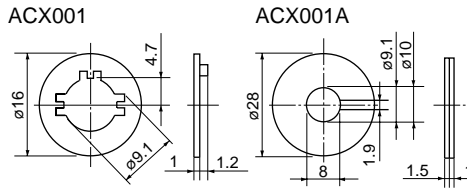

Dimensions, mm

AC09

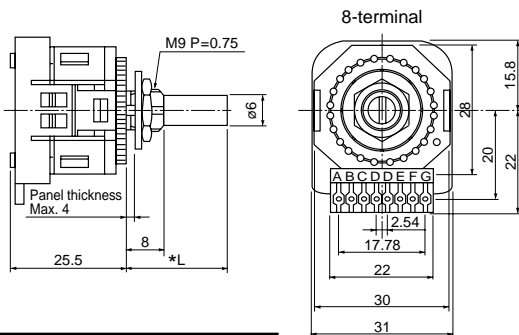

Shaft length *	L1	L2	L3	L4
	16	18	20	22
Mass (g)				
Without connector	41	42	43	44
With connector	42	43	44	45

Panel cutting

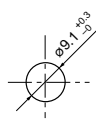

AC09 (with connector)

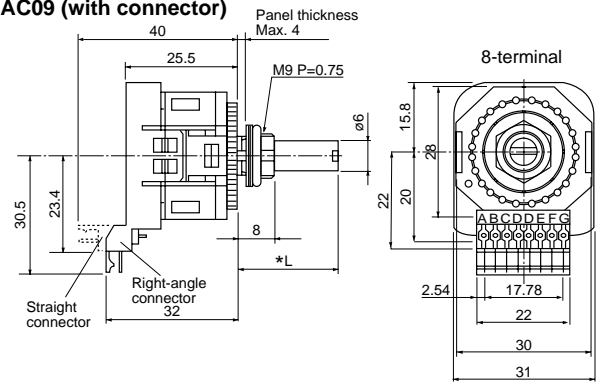

Panel cutting

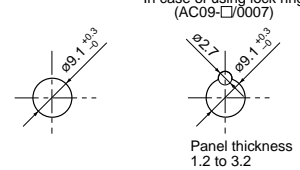

AC16

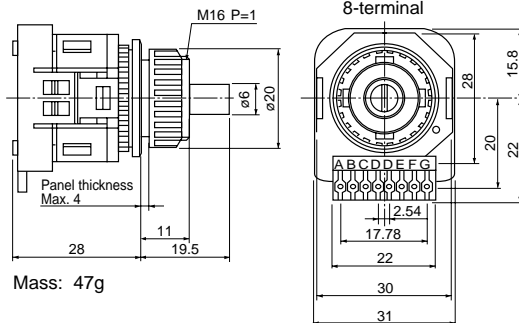

Mass: 47g

Panel cutting

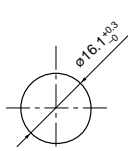

AC32

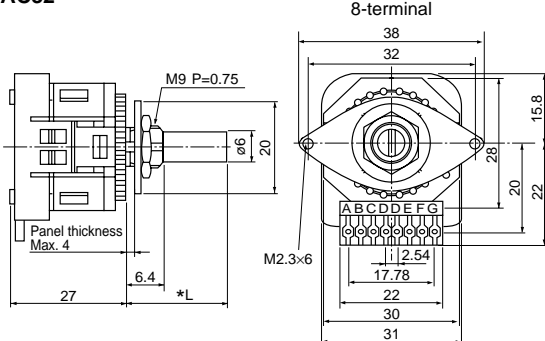

Shaft length *	L1	L2	L3	L4
	14.5	16.5	18.5	20.5
Mass (g)	47	48	49	50

Panel cutting

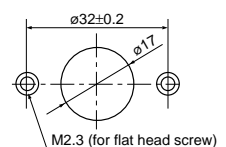

■ Installation

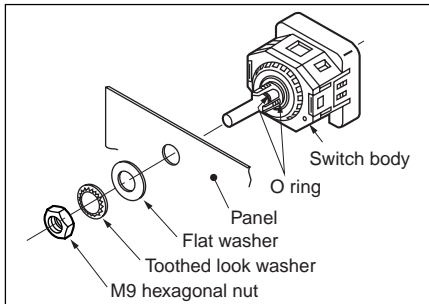

AC09

Pass the switch body through the hole from the back of the panel, and secure it by tightening the hexagonal nut with a flat washer and a toothed lock washer.

The recommended tightening torque for the hexagonal nut is 1.5 to 2N·m.

Insert the lock ring (ACX001) between the panel and the flat washer, and the adhesive lock ring (ACX001A) between the switch body and the panel.

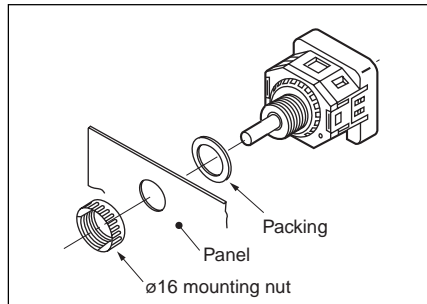

AC16

Pass the switch body with a bezel through the hole from the back of the panel, and secure it with a $\phi 16$ mounting nut. The recommended tightening torque for the nut is 0.6 to 1N·m.

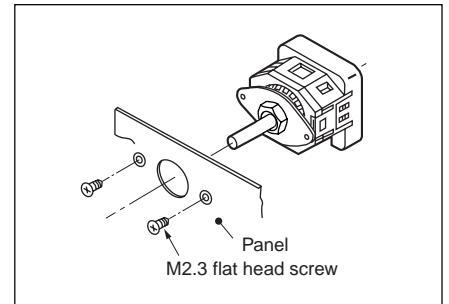

AC32

Pass the switch body through the hole from the back of the panel, and secure it with two flat head screws from the face of the panel. The recommended tightening torque for the flat head screws is 0.3 to 0.5N·m.

■ Notes on use

1. Connecting wires

Note the following points when soldering:

- The power of the soldering iron must not be over 30W.
- Use solder with resin flux core.
- Complete soldering within 5 seconds if using a 30W soldering iron, or within 10 seconds if using a 20W soldering iron.

2. Note on the case linkage

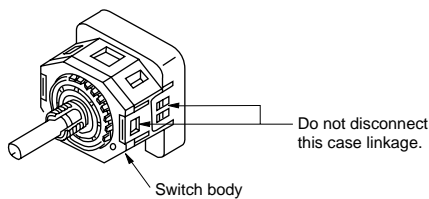

3. Number of stopper screws shipped

- AC09 and AC32
 - Step angle: 30° (symbol X)
Positions 0/11 (0 to 11): one screw. User-selectable start and stop positions: two screws (one for start position, one for end position).
 - Step angle: 15° (symbol Y)
Positions 0/22 (0 to 22): one screw. User-selectable start and stop positions: two screws (one for start position, one for end position).
 - Step angle: $360^\circ/26$ (symbol Z)
Positions 0/24 (0 to 24): one screw. User-selectable start and stop positions: two screws (one for start position, one for end position).
- AC16
Customers can specify the stopper screw positions. The switch is then shipped with stopper screws already in the specified positions.

4. Stopper screw positions

Insert stopper screws into the switch body holes marked with letters, as shown in the insertion example on the right. These tables below show that the start position stopper screw is inserted in the hole on the left of the position setting and the end positions stopper screw is inserted in the hole on the right.

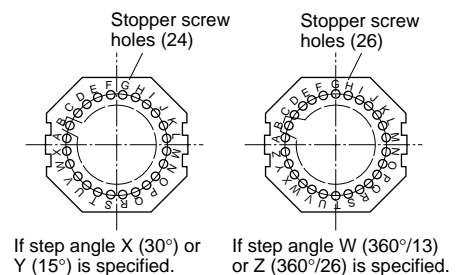

5. Installing a stopper screw

The maximum tightening torque for a stopper screw is 0.1N·m. Screw the stopper screw into position until it hits the body frame rib. Do not overtighten the screw.

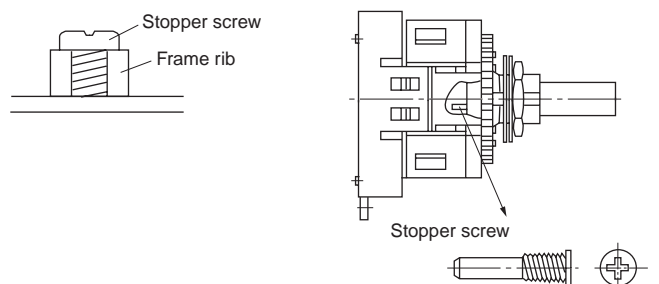

Rotary Switches

AC 09, 16 and 32

Insertion example 1

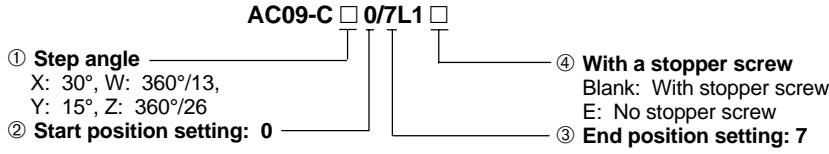

- If symbol ① (step angle) is X-----type AC09-CX0/7L1:
Insert the start side stopper screw in hole A and the end side screw in hole Q.

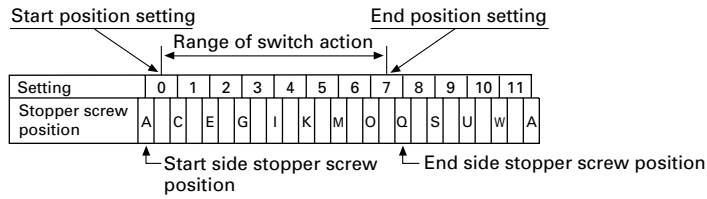

- If symbol ① (step angle) is W-----type AC09-CW0/7L1:
Insert the start side stopper screw in hole A and the end side screw in hole Q.

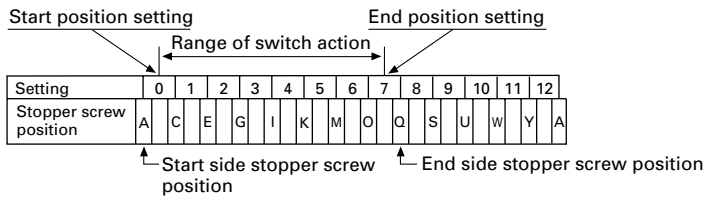

- If symbol ① (step angle) is Y-----type AC09-CY0/7L1:
Insert the start side stopper screw in hole A and the end side screw in hole J.

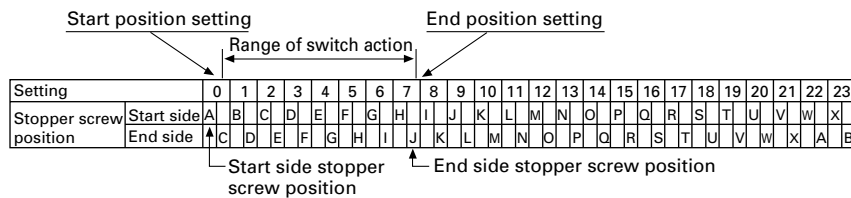

Notes: 1. If the range of action is designated as 0/22 (0 to 22), insert a stopper screw into hole A only.
2. If the range of action is designated as 0/23 (0 to 23), no stopper screws are inserted (symbol ④ is E).

- If symbol ① (step angle) is Z-----type AC09-CZ0/7L1:
Insert the start side stopper screw in hole A and the end side screw in hole J.

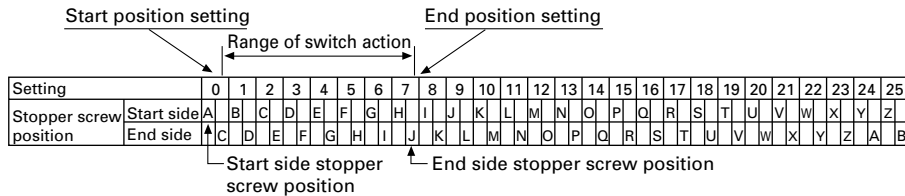

Notes: 1. If the range of action is designated as 0/24 (0 to 24), insert a stopper screw in hole A only.
2. If the range of action is designated as 0/25 (0 to 25), no stopper screws are inserted (symbol ④ is E).

Insertion example 2

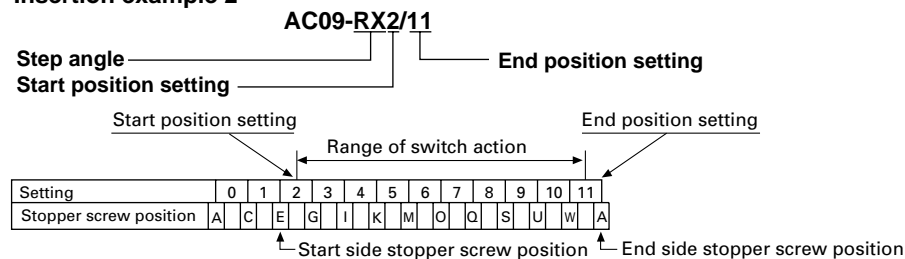

Cam-type control selector switches

■ Description

FUJI cam-type control switches are recommended for use on switchboards, control panels and switchgear because of their reliability in service. The main type is RC310 with operational current ratings of 10A.

Simplified and economical circuits can be designed around the RC310, since it can handle loads of up to 10A at 220VAC without the need of contactors. Typical examples of complex circuits based on the attractive features of these economical cam-type selector switches are given on pages 04/265 to 04/268.

FUJI is prepared to manufacture other versions to suit your particular applications, and switches with up to 12 selector positions can be made to order. RC310 switches are normally supplied with H-type handles. Alternative handle shapes available include the pistol-grip P-type, cane-handle shaped S-type and rosette shaped R-type.

Switches with a 2-12 position maintained type, 3-position center spring-return type and center spring-return type with locking device are also available.

■ Ordering information



Specify the following (See page 04/264):

1. Type number
2. Mounting method
3. Operation
4. Selector position and notch angles
5. No. of contact blocks
6. Contact arrangement
7. Handle
8. Handle colors

Example

Cam switch,
rated current 10A RC310-1
Flush mounting x
Maintained operation M
Contact arrangement 3201
(3-position, 2 contact blocks,
H type handle H
Black color handle..... B
Type number RC310x-1M3201HB

Note: "C" in the type No. nomenclature must be filled with numbers appearing in the table of "The Contact Arrangement". (page 04/265)
When requiring special arrangements not appearing in the list clearly specify the arrangement required.
Note that "C" in the type nomenclature must not be removed in this case.
RC310x-1MCHB

Type	Flush mounting x-type	Semi-flush mounting	Enclosed g-type
RC310-1	 SG-740 RC310x-1	 SG-743 RC310-1	 AF-191 RC310g-1

■ Ratings

Type	Rated thermal current (A)	Breaking capacity (A) Voltage (V)	AC	DC	DC
			Inductive	Resistive	Inductive
RC310-1	10	24	10	10	5
		110	7.5	3	1.3
		220	7.5	0.8	0.45
		440	2.5	0.4	0.2
		550	2	0.3	0.15

■ Technical data

Insulation resistance: Over 100MΩ at 500VDC
Dielectric strength: 2,500VAC. 1 minute
Ambient temperature: -5° to +60°C
Operating cycle: 600 cycles/hour

■ Life expectancy (operations)

Type	Mechanical	Electrical
RC310-1	5 million	250,000 at 220VAC 7.5A 500,000 at 220VAC 3A

■ Contact arrangement: See page 04/265.

■ Contact arrangement (typical)
(Viewed from the direction of the handle)

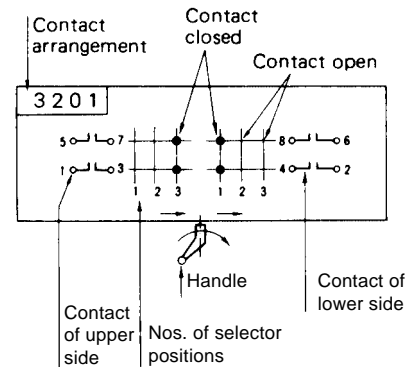

Cam Type RC310 Control selector switches

■ Type number nomenclature



RC310 series

RC310 □ - 1 □ □ □ □

Mounting
Blank: Semi-flush mounting
x: Flush mounting
g: With enclosure
Operation
Contact arrangement
See page 04/265
Handle
Handle color















● Handle color B: Black

● Operation

Model	Description
M	Maintained
A	Center spring return 
L	Center spring return with locking device (Pull to turn) 

● Selector position and notch angle

● Available

Operation	Notch angle	Position
M	90° 2 position	
	90° * 3, 4 position	 
	45° * 3-8 position	     
	30° 9-12 position	   
A	45°	
L	45°	 (With locking device)

Note: * 3 or 4-position type notch angle is normally 45 degrees. Specify when ordering other than this.

● Available

● Handle

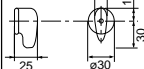
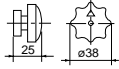
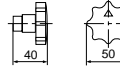
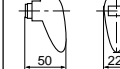
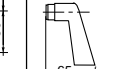
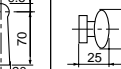
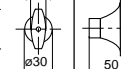
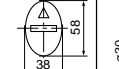
Type	Standard	Versions						
	H type	R type	W type	S type	P type	K type	D type	G type
RC310-1								

● Ratings

Type	Rated thermal current (A)	Voltage (VAC)	Number of contact blocks	Selector position and notch angle	Flush mounting (x-type) Type	Semi-flush mounting Type	Enclosed (g-type) Type
RC310-1	10	550	1	See the table above.	RC310x-1□■	RC310-1□■	RC310g-1□■
					RC310x-1□■	RC310-1□■	RC310g-1□■
					RC310x-1□■	RC310-1□■	RC310g-1□■
					RC310x-1□■	RC310-1□■	RC310g-1□■
					RC310x-1□■	RC310-1□■	RC310g-1□■
			6	RC310x-1□■	RC310-1□■	—	
				RC310x-1□■	RC310-1□■	—	
				RC310x-1□■	RC310-1□■	—	
				RC310x-1□■	RC310-1□■	—	
				RC310x-1□■	RC310-1□■	—	

Note: □: Type of operation ■: Contact arrangement – See page 04/265.

■ Contact arrangement

The following diagrams show the cam-type selector switch contact arrangement. These are only typical examples and other versions can be manufactured to meet your special requirements. Contact FUJI for details. The figures appearing on the right side indicate the contact arrangement. This information must be given when ordering.

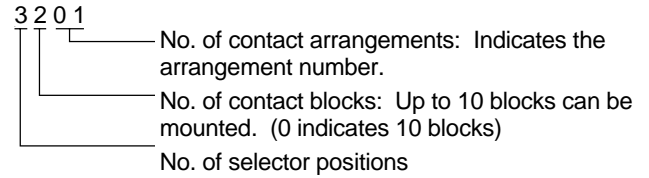

2-position 1-contact block

2101 	2102 	2103 	2104
2105 	2106 	2107 Over rap contact (early make, late break) 	2108 Over rap contact (early make, late break)

2-position 2-contact block

2201 	2202 	2203 	2204
2205 	2206 	2207 	2208

2-position 3-contact block

2301 	2302 	2303 	2304
2305 	2306 	2307 	2308

2-position 4-contact block

2401 	2402 	2403 	2404
2405 	2406 	2407 	2408

Cam Type RC310 Control selector switches

■ Contact arrangement 3-position 1-contact block

3101 	3102 	3103 	3104
3105 	3106 	3107 	3108 Notch angle : 90°
3109 	3110 	3111 	3112

3-position 2-contact block

3201 	3202 	3203 	3204
3205 	3206 	3207 	3208
3209 	3210 	3211 	3212

3-position 3-contact block

3301 	3302 	3303 	3304
3305 	3306 	3307 	3308
3309 	3310 	3311 	3312

■ Contact arrangement
4-position 2-contact block

<p>4201</p>	<p>4202</p>	<p>4203</p>	<p>4204</p>
<p>4205</p>	<p>4206</p>	<p>4207</p>	<p>4208</p>
<p>4209</p>	<p>4210</p>	<p>4211</p>	<p>4212</p>

04

4-position 3-contact block

<p>4301</p>	<p>4302</p>	<p>4303</p>	<p>4304</p>
<p>4305</p>	<p>4306</p>	<p>4307</p>	<p>4308</p>
<p>4309</p>	<p>4310</p>	<p>4311</p>	<p>4312</p>

4-position 4-contact block

<p>4401</p>	<p>4402</p>	<p>4403</p>	<p>4404</p>
<p>4405</p>	<p>4406</p>	<p>4407</p>	<p>4408</p>
<p>4409</p>	<p>4410</p>	<p>4411</p>	<p>4412</p>

Cam Type RC310 Control selector switches

■ Contact arrangement 5-position 2-contact block

<p>5201</p>	<p>5202</p>	<p>5203</p>
<p>5204</p>	<p>5205</p>	<p>5206</p>
<p>5207</p>	<p>5208</p>	<p>5209</p>

5-position 3-contact block

<p>5301</p>	<p>5302</p>	<p>5303</p>
<p>5304</p>	<p>5305</p>	<p>5306</p>
<p>5307</p>	<p>5308</p>	<p>5309</p>

5-position 4-contact block

<p>5401</p>	<p>5402</p>	<p>5403</p>
<p>5404</p>	<p>5405</p>	<p>5406</p>
<p>5407</p>	<p>5408</p>	<p>5409</p>

■ Dimensions, mm

Flush mounting
 RC310x-1

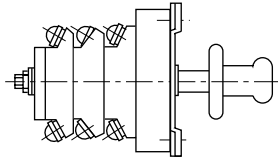

No. of contact blocks	1	2	3	4	5	6	7	8	9	10
L	39.5	51.5	63.5	75.5	87.5	99.5	111.5	123.5	135.5	147.5

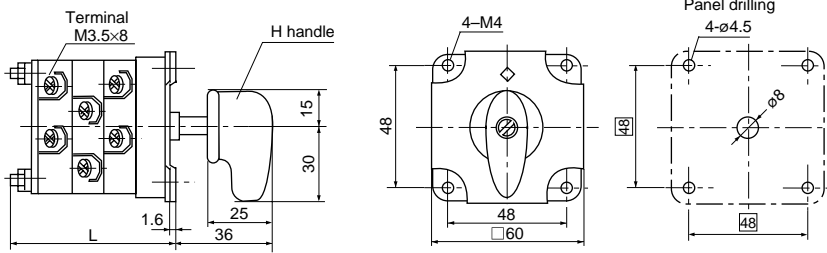

Semi-flush mounting
 RC310-1

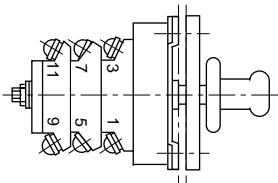

No. of contact blocks	1	2	3	4	5	6	7	8	9	10
L	39.5	51.5	63.5	75.5	87.5	99.5	111.5	123.5	135.5	147.5

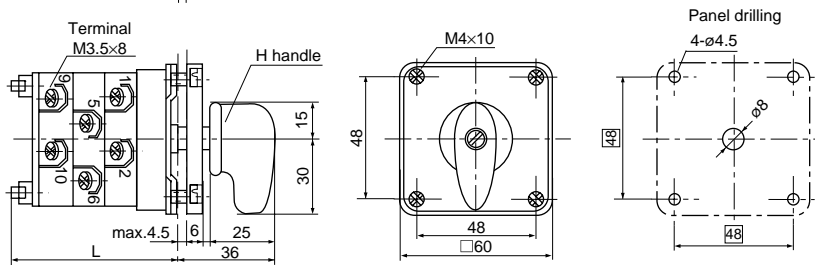

Enclosed (Up to 3-contact block)
 RC310g-1

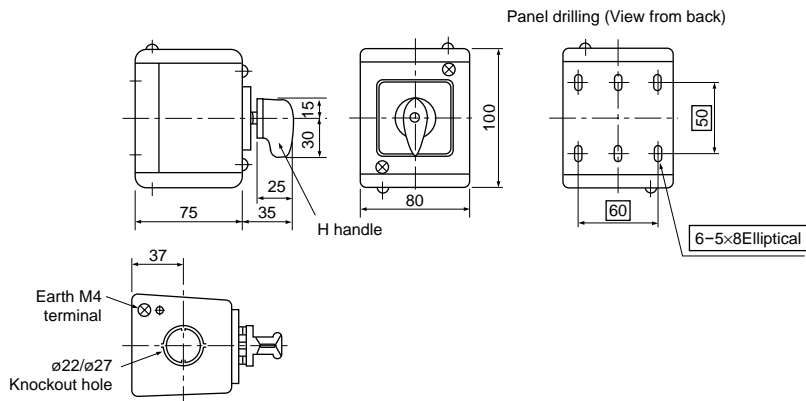

Panel Switches NS387 and RC310 Instrument switches

Voltmeter/Ammeter Changeover Switches

■ Description

These switches are used with voltmeters or ammeters in secondary PT or CT circuits. Normally, 3-phase line voltage or phase current is measured with 3 meters provided, which requires considerable switchboard or console space. Space can be saved by using NS387 and RC310 instrument switches, since the phase current or line voltage can be read with a single meter and either VS or AS (Voltmeter or Ammeter switch). FUJI AS's are precisely and ruggedly constructed, and open circuits do not occur at the time of switch-over, so eliminating the possibility of abnormal voltage trouble. NS387 is a

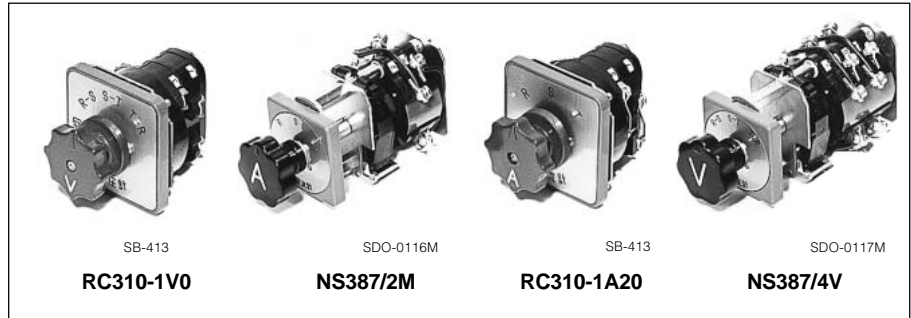

blade-type switch and RC310 is a cam-type. Both are compact in size and use highly dependable silver contacts. FUJI can also supply DC voltmeter type switches in addition to these for AC use.

■ Ordering information

Specify the following:
1. Type number

Series	Application	Type	Ordering code	No. of contact block	Legend plate *	Handle angle	With or without Off position	Mass (kg)
NS387	AC Voltmeter	NS387/4V	AC38V4N	4	R · S · S-T · T-R	2 x 45°	Without	0.5
	AC Voltmeter	NS387/4V0	AC38V4F	4	OFF · R · S · S-T · T-R	3 x 45°	With	0.5
	DC Voltmeter	NS387/2V	AC38V2N	2	I · OFF · II	2 x 45°	With	0.43
	AC Ammeter	NS387/2M	AC38A2N	2	R · S · T	2 x 45°	Without	0.43
	AC Ammeter	NS387/2M0	AC38A2F	3	OFF · R · S · T	3 x 45°	With	0.47
	AC Ammeter	NS387/3M	AC38A3N	3	R · S · T	2 x 45°	Without	0.47
	AC Ammeter	NS387/4M	AC38A43F	4	OFF · R · S · T	3 x 45°	With	0.5
RC310	AC Voltmeter	RC310-1V	AK2R1-V32	2	R · S · S-T · T-R	2 x 45°	Without	0.22
	AC Voltmeter	RC310-1V0	AK2R1-V42	2	OFF · R · S · S-T · T-R	3 x 45°	With	0.22
	AC Ammeter	RC310-1A2	AK2R1-A32	2	R · S · T	2 x 45°	Without	0.22
	AC Ammeter	RC310-1A20	AK2R1-A42	2	OFF · R · S · T	3 x 45°	With	0.22
	AC Ammeter	RC310-1A3	AK2R1-A33	3	R · S · T	2 x 45°	Without	0.25
	AC Ammeter	RC310-1A30	AK2R1-A43	3	OFF · R · S · T	3 x 45°	With	0.25

Note: * For standard type legend plate. Other types can be manufactured by request.

■ Ratings

Series	Rated thermal current (A)	Making and breaking capacity					
		AC (inductive)		DC (inductive)			
		Voltage (V)	Make (A)	Break (A)	Voltage (V)	Make (A)	Break (A)
NS387	15	110	30	3	24	60	60
		220	30	3	110	15	15
		440	20	2	220	5	5
		550	20	2	440	2.5	2.5
RC310	10	110	37.5	7.5	24	37.5	7.5
		220	37.5	7.5	110	37.5	1.3
		440	37.5	2.5	220	37.5	0.45
		550	37.5	1.5	440	37.5	0.15

■ Dimensions, mm

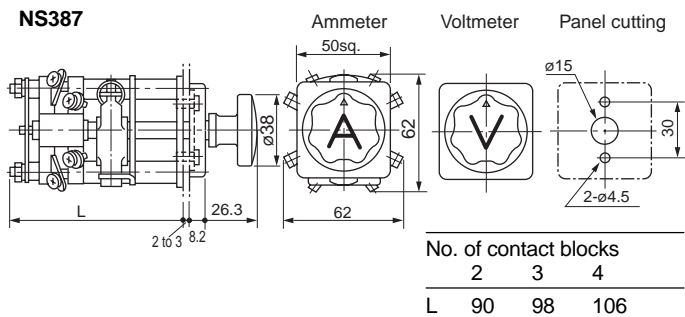

■ Handle color (standard)

NS387: Black
RC310: Black

■ Special spanner (for NS387)

Use this spanner for installation or replacement.

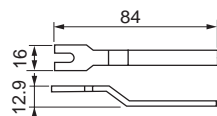

RC310

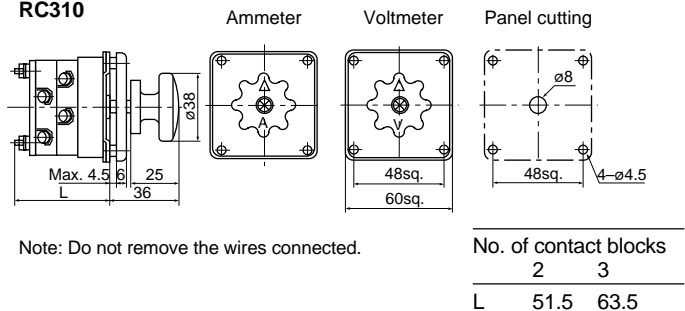

Note: Do not remove the wires connected.

■ **Wiring diagrams**

Voltmeter changeover switches

• **NS387 series**

NS387/4V

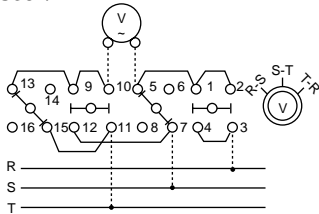

NS387/2V

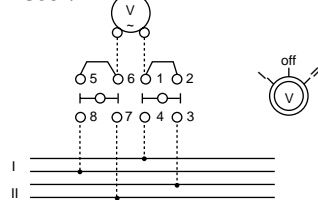

NS387/4V0

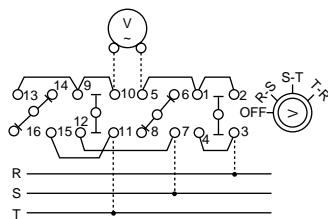

• **RC310 series**

RC310-1V

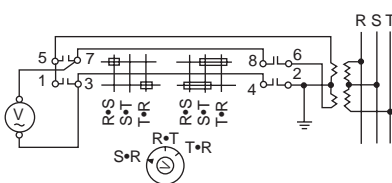

RC310-1V0

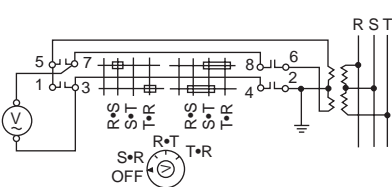

Ammeter changeover switches

• **NS387 series**

NS387/2M

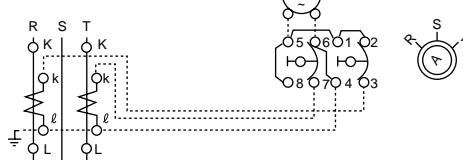

NS387/2M0

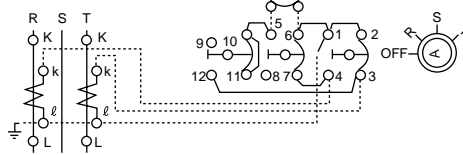

NS387/3M

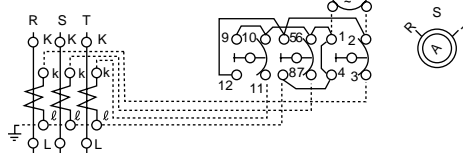

NS387/4M

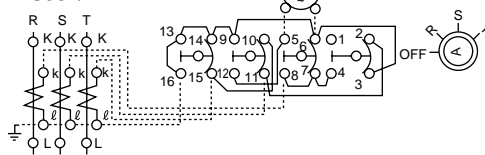

• **RC310 series**

RC310-1A2

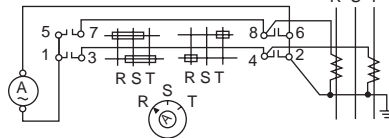

RC310-1A20

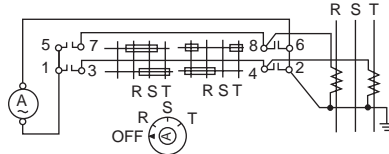

RC310-1A3

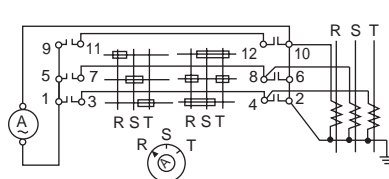

RC310-1A30

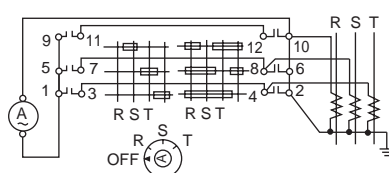

Panel Switches

NS387

Control switches

Panel switches for industrial control switchboards

■ Description

NS387 control switches are used on control panels or consoles to operate H.V. circuit breakers or disconnecting switches. These switches are small in size, dependable and take up little switchboard space. Since they have a large current capacity they can be applied to many types of control circuits.

The movable blade has both an excellent contact performance and a long service life. Switches can be supplied in center spring return for momentary action and maintained versions, with 2, 3 and 4 positions. They can be fitted with H, K or R-type standard FUJI handles. The H-type is used as an ON-OFF switch to control circuit breakers or as a disconnecting switch. The K-type is mainly for regulation use and the R-type is used for controlling the power source. In addition to the standard handles key-controlled handles are also available.

Please refer to page 04/273 of this catalog for typical contact arrangements of these panel switches. We are in a position to supply many other types of switches to meet your particular application needs.

■ Technical data

Insulation resistance: Over 25MΩ at 500V DC
Dielectric strength: 2200V AC rms, 1 minute
Durability

Mechanical: 300,000 operations
Electrical: 100,000 operations at 220V AC 5A
Allowable ambient temperature: -5° to +40°C

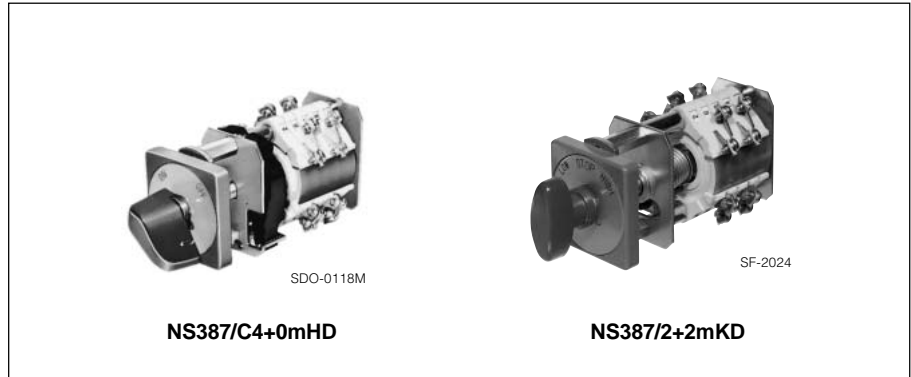
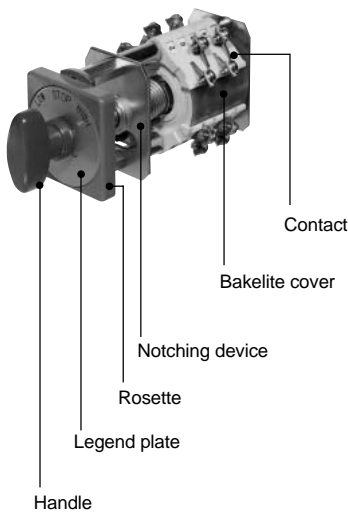

■ Ratings

Contacts	Rated thermal current (A)	Making and breaking capacity							
		DC (inductive) [W]				AC (inductive) [VA] *			
		24V	110V	220V	440V	110V	220V	440V	550V
Standard contact	15	1440	1650	1100	1100	3300	6600	8800	11000
Residual contact	15	1440	1650	550	220	-	-	-	-
Non-break contact	15	720	825	550	132	-	-	-	-

Note: * When the operated equipment is AC electromagnet, breaking capacity is the above-mentioned 10% or less the capacity of the stationary state to which the electromagnet is energized.

■ Dimensions, mm

With H, I, R, K, KP, KQ, KX, KY type handle

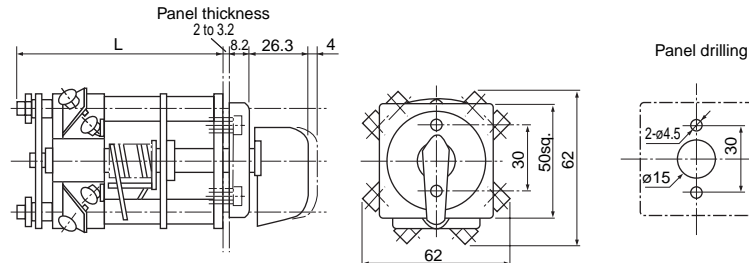

Type	No. of contact blocks					
	1	2	3	4	5	6
NS387/	82	90	98	106	114	123
NS387S/	82	90	98	106	114	123
NS387/C	82	90	98	106	114	139
NS387/A	82	90	98	106	114	123
NS387/D	82	90	98	106	114	123
Mass (kg)	0.4	0.43	0.47	0.5	0.54	0.57

■ Special spanner

Use this spanner for installation or replacement

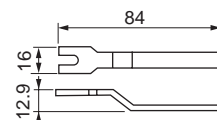

■ Ordering information

Specify the following (See page 04/273)

1. Type number
2. Letters or symbols to be printed on legend plate
3. Color of rosette (if you require other color but black standard color)
4. Color of handle
5. Options if required

■ **Type number nomenclature**

NS387 / **Basic type** / **1** + **1** + **1m** + **1m** **S1** **H1** **B** **L2**
 ① ② ③ ④ ⑤ ⑥ ⑦ ⑧

Construction

- Blank: Open type
- C: With transparent cover

Operation

- C: Maintained, 2-position
- A: Maintained, 3-position
- Blank: Spring return, 3-position

Handle locking device
 See page 04/274

Color of handle and rosette
 B: Black
 D: Dark green
 Note: The standard: Black (B).

Type of handle
 See page 04/274

With or without of micro switch
 Blank: Without
 S1: With a micro switch
 S2: With two micro switch
 Note: Specify the type of handle locking device when ordering a model equipped with a micro switch.

Note: Specify the embossed characters when ordering a model equipped with a legend plate.

Contact arrangement

Contact arrangement	Code	Contact position	Contact (varies depending on operation)			No. of combinations (varies depending on operation)		
			Blank	C	A	C	A	Blank
①	0-10	Contacts at right angles to the operating handle (in parallel to the operating handle only in the case of the 4-position changeover type)				①+③+④ ≤ 6-block	①+②+③ +④ ≤ 6-block	①+②+③ +④ ≤ 6-block
②	Blank, 1-10	The above contacts ① shifted clockwise by 45°		-		③+④ ≤ 4-block	③+④ ≤ 6-block	③+④ ≤ 4-block
③	0m-6m	Non-interrupting contacts at right angles to the operating handle (in parallel to the operating handle only in the case of the 4-position changeover type) Code "m" is added after the number of blocks.						
④	Blank, 1m-6m	The above contacts ③ shifted clockwise by 45° Code "m" is added after the number of blocks.						

Notes: • In each of the above contact forms, the symbol □ refers to the position of the operating handle.
 • If no contacts are required, leave ② and ④ blank and enter "0" for ① and ③.

• **Operation**

Operation	No. of positions	Handle position	Operation angle	Code
Maintained	2		90°	C
	3		45°	A
	4			D
Spring return	(3)			Blank
Spring / manual return	(3)			F
	(3)			E

• **Contact**

Standard contact



Non-break contact

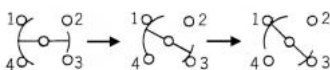

For clockwise rotation, terminals 1, 3, and 4 are conductive before the continuity of terminals 1 and 4 is interrupted. After that, only terminals 1 and 3 are conductive.

Panel Switches

NS387

Control switches

■ Operating handle

• Combination of rosette and handle

Rosette	Handle	Type of handle (refer to 2. Shape of handle, table below)
For NS387	For NS387	Without micro switch: H, I, K KP1 – KP10 KQ1 – KQ10 KX1 – KX10 KY1 – KY10 R
	For RC310	Without micro switch: P, S, D, W
		With micro switch: H, P, S, K, D, R, W

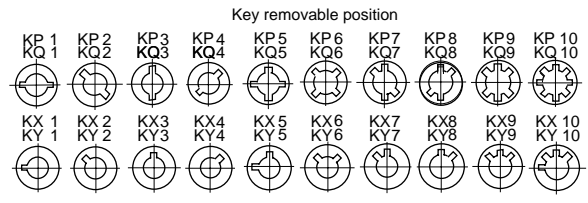

Notes: • With micro switch equipped, NS387 panel switch are provided with NS387-use rosette as standard, and with the handle for RC310-1 cam switch.
 • The large handle (P, S, D, or W) for the RC310-1 is not compatible with any other handle.

• Shape of handle



For NS387	H type 	I type 	K type 	R type 	KP type 	KQ type 	KX type 	KY type
For RC310	H type 	R type 	W type 	S type 	P type 	K type 	D type 	

• Types of handle locking

Code	Center spring return type	Maintained type
Blank	In the case of the NS387, the handle can be turned after being pulled, and the handle then returns to the center position automatically when it is released. If the handle needs to be turned without being pulled, order a model with "no handle lock". The RC310 handle can be turned without being locked.	The handle can be turned without being locked.
L1	With a handle for the RC310. The handle can be turned after being pulled, and the handle then returns to the center position automatically when it is released.	The handle can be turned after being pulled, and the handle stops at each notch when it is released.
L2	The handle can be turned without being pulled, and will return to the center position automatically when it is released. The micro switch is activated while the handle is pulled in the center position, and the switch is reset when the handle is released. The handle, however, does not turn left or right when it is pulled.	The handle can be turned after being pulled, and when it is released in any notch position, the handle will stop at that notch position. Moreover, when the handle is pulled in any notch position, the micro switch will be activated, and both the micro switch and handle will be reset when the handle is released. However, the handle cannot be switched to any other notch while it is in the pulled condition.
L3	The handle can be turned without being pulled, and will return to the center position automatically when it is released. When the handle is pulled in the left position, the lock mechanism will activate and no other notch can be selected. In that case, the handle will automatically return to the center position when it is pressed in the shaft direction.	–
L4	The handle can be turned after being pulled. When it is released, the handle will automatically return to the center position in the pulled condition. The handle will return when it is pressed in the shaft direction.	–
L5	The handle can be turned without being pulled, and will return to the center position automatically when it is released. The micro switch will be activated when the handle is pulled in the center position, and the handle will return when the handle is pressed in the shaft direction.	–

Note: If a micro switch is equipped, it will be activated when the handle is pulled.

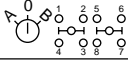
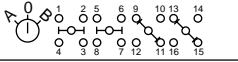
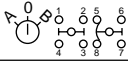
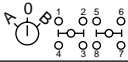
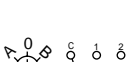
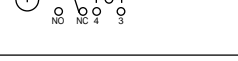
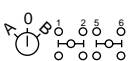
■ Assembled typical switches

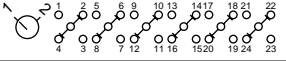
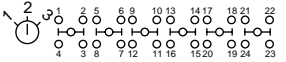
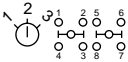
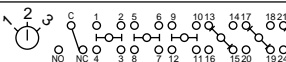
Operation	Type(example)	Contact arrangement	Description
Center spring return	NS387/2 + 0mHD		<ul style="list-style-type: none"> The handle can be turned after being pulled, and will return to the center position automatically when it is released.
	NS387/2 + 2 + 0mHB		<ul style="list-style-type: none"> The handle can be turned after being pulled, and will return to the center position automatically when it is released.
	NS387/1 + 1mHB		<ul style="list-style-type: none"> The handle can be turned after being pulled, and will return to the center position automatically when it is released.
	NS387/2 + 0mS1B		<ul style="list-style-type: none"> RC310-1 handle, equipped with a rosette. Add L1 for the pull-and-turn type.
	NS387/1 + 0mS1HDL2		<ul style="list-style-type: none"> Provided with a micro switch, RC310-1 handle, and a rosette for the NS387. The handle can be turned without being pulled, and will return to the center position automatically when it is released. The micro switch will be activated while the handle is pulled in the center position.
	NS387/5 + 0mSBL3		<ul style="list-style-type: none"> RC310-1 handle, equipped with the NS387 rosette. When the handle is pulled in the left position, it will be locked, and the handle will automatically return to the center position when it is pressed in the shaft direction.
	NS387/1 + 0mS1H1BL4		<ul style="list-style-type: none"> Equipped with a micro switch, RC310-1 handle, and a rosette for the NS387. The handle can be turned after being pulled, and will return to the center position automatically when it is released, but the handle remains in the pulled condition. The handle will be reset when it is pressed. The micro switch will be activated while the handle is pulled.
Maintained 2-position	NS387/C3 + 1mKB		—
	NS387/C6 + 0mW1D		<ul style="list-style-type: none"> RC310-1 cam switch handle, equipped with a rosette.
Maintained 3-position	NS387/A6 + 0mRB		—
	NS387/A2 + 0mH1B		<ul style="list-style-type: none"> RC310-1 cam switch handle, equipped with a rosette.
	NS387/A3 + 3 + 0mS1KDL2		<ul style="list-style-type: none"> RC310-1 cam switch handle, equipped with the NS387 rosette. The handle can be turned left or right without being pulled. The micro switch will be activated while the handle is pulled.

For other than above, contact FUJI.

04

Terminal Blocks

General Information

■ Description

FUJI can supply a variety of terminal blocks for switchboard or switchgear use. FUJI terminal blocks and end barriers are strongly constructed from a phenol resin and have adequate creepage distance and excellent insulation characteristics. Good connections are assured by convenient screw terminals and solderless box lugs. All terminal blocks are designed to carry their rated amperage without danger of overheating. FUJI terminal blocks are available in a variety of types, some of which are illustrated on this page.

AYBN type is simple to assemble and is designed to speed up installation. It is available in up to 12 poles and 600 Amps versions.

AYBS type terminal blocks are made from the highest quality phenol resin and resists tracking. Current ratings are available up to 115 Amps and 12 poles. The customer is required to assemble the channel-mounted type himself. The modular construction allows the number of blocks in a channel to be increased or decreased very easily.

In addition we can also supply the **LT4D type** which is provided with an isolating switch, and **SKT type** power terminal blocks, which are used in motor circuits, power source and similar circuits. Testing terminals type **LT5** for CT, VT secondary circuits are also available.



SB-232



SB-277

Type AYBN

General purpose terminal blocks
600 Volts 15 to 600 Amps

■ **Further information:** See page 04/277.



SB-279

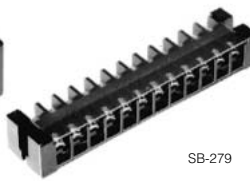

SB-279

Type AYBS

High quality terminal blocks
600 Volts 49 to 115 Amps

■ **Further information:** See page 04/279.

Type LT4D

Rail mounted terminal blocks with isolating switch
660 Volts 20 Amps

■ **Further information:** See page 04/280.

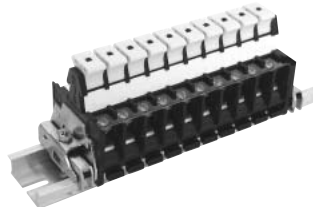

AF01-220

Type SKT

Terminal block with pressure solderless box lug type connector on one side and screw type connector on the other.

600 Volts 50 to 200 Amps

■ **Further information:** See page 04/281.



Type LT5

Testing terminal and link for VT and CT circuit
250 Volts AC/DC 30 Amps

■ **Further information:** See page 04/288.

■ Wire gauge and square

The following table shows the relationship between B.W.G., A.W.G. wire gauge and mm² cross-sections. In this catalog wire sizes are quoted in mm². Please use this table for reference.

Gauge	Square	Gauge	Square
B.W.G.	mm ²	B.W.G.	mm ²
4/0	107.2	12	6.6
3/0	104.2	10	6.0
2/0	91.6	13	5.3
0	85.2	11	4.6
1	73.2	14	4.2
2	67.5	12	3.5
3	58.6	13	3.3
4	53.5	15	2.63
5	45.6	16	2.14
6	42.4	14	2.08
7	40.9	17	1.71
8	34.0	15	1.65
9	33.6	16	1.32
10	28.7	18	1.22
11	26.7	17	1.03
12	24.5	19	0.89
13	21.2	18	0.81
14	20.9	19	0.66
15	16.8	20	0.62
16	16.4	21	0.52
17	13.8	21	0.41
18	13.3	22	0.40
19	11.1	22	0.32
20	10.5	23	0.32
21	9.1	23	0.26
22	8.3	24	0.25
23	7.3	24	0.20

B.W.G. Birmingham Wire Gauge
A.W.G. American Wire Gauge







Type LT2E

Rail mounted type terminal blocks
600 volts 22 to 600 Amps

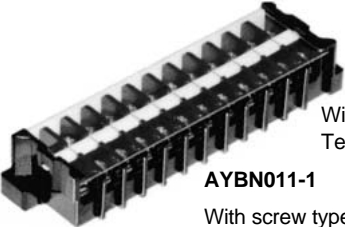
■ **Further information:** See page 04/283.

General purpose terminal blocks 600 Volts

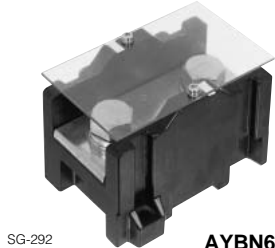
Typical illustration and description	Amps	No. of poles	With spring washer Type	Ordering code	With turtle-shaped washer Type	Ordering code
 <p>Wire size: Max. 2mm² Terminal screw: M3.5</p> <p>AYBN011-1</p> <p>With screw type connectors, marking strip and cover</p> <p>SB-277</p>	15	3 4 6	AYBN013-5 AYBN014-5 AYBN016-5	LT1N-0203B LT1N-0204B LT1N-0206B	AYBN013-1 AYBN014-1 AYBN016-1	LT1N-0203A LT1N-0204A LT1N-0206A
 <p>Wire size: Max. 5.5mm² Terminal screw: M4</p> <p>AYBN026-1</p> <p>With screw type connectors, marking strip and cover</p> <p>SB-277</p>	25	3 4 6	AYBN023-5 AYBN024-5 AYBN026-5	LT1N-0503B LT1N-0504B LT1N-0506B	AYBN023-1 AYBN024-1 AYBN026-1	LT1N-0503A LT1N-0504A LT1N-0506A
 <p>Wire size: Max. 14mm² Terminal screw: M5</p> <p>Wire size: Max. 22mm² Terminal screw: M6</p> <p>AYBN043-1</p> <p>With screw type connectors, marking strip and cover</p> <p>SB-232</p>	40	3 4	AYBN043-5 AYBN044-5	LT1N-1403B LT1N-1404B	AYBN043-1 AYBN044-1	LT1N-1403A LT1N-1404A
 <p>Wire size: Max. 60mm² Terminal screw: M8</p> <p>Wire size: Max. 100mm² Terminal screw: M10</p> <p>Wire size: Max. 200mm² Terminal screw: M12</p> <p>AYBN204-5</p> <p>With screw type connectors, marking strip and cover</p> <p>SB-277</p>	150	3 4	–	–	AYBN103-5 *1 AYBN104-5 *1	LT1N-6003B LT1N-6004B
	200	3 4	–	–	AYBN203-5 *2 AYBN204-5 *2	LT1N-1X03B LT1N-1X04B
	400	3 4	–	–	AYBN403-5 *2 AYBN404-5 *2	LT1N-2X03B LT1N-2X04B
 <p>Wire size: Max. 325mm² Terminal screw: M16</p> <p>AYBN601-5</p> <p>SG-292</p>	600	1	–	–	AYBN601-5 *2	LT1N-3X01B

Notes: *1 Cross recessed pan head screw type.
*2 Hexagonal bolt

Terminal Blocks

Type AYBN

■ Dimensions, mm

15A, 25A Terminal blocks

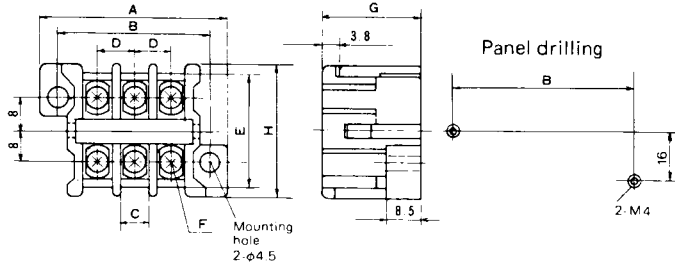

Type	No. of poles	A	B	C	D	E	F	G	H	Mass (g)
AYBN013-1, -5	3	45	37	6.9	9	28	M3.5	23.8	32	20
AYBN014-1, -5	4	54	46	6.9	9	28	M3.5	23.8	32	30
AYBN016-1, -5	6	72	64	6.9	9	28	M3.5	23.8	32	40
AYBN018-1, -5	8	90	82	6.9	9	28	M3.5	23.8	32	50
AYBN010-1, -5	10	108	100	6.9	9	28	M3.5	23.8	32	60
AYBN011-1, -5	12	126	118	6.9	9	28	M3.5	23.8	32	75
AYBN023-1, -5	3	52.5	44.5	9.9	11.5	30	M4	26.8	36	35
AYBN024-1, -5	4	64	56	9.9	11.5	30	M4	26.8	36	40
AYBN026-1, -5	6	87	79	9.9	11.5	30	M4	26.8	36	60
AYBN028-1, -5	8	110	102	9.9	11.5	30	M4	26.8	36	80
AYBN020-1, -5	10	133	125	9.9	11.5	30	M4	26.8	36	95
AYBN021-1, -5	12	156	148	9.9	11.5	30	M4	26.8	36	115

40A, 60A Terminal blocks

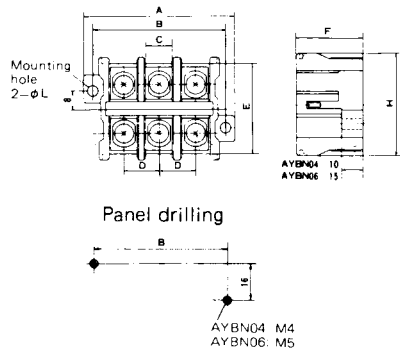

Type	No. of poles	A	B	C	D	E	F	H	L	Mass (g)
AYBN043-1, -5	3	67	59	12.4	16	40	31.8	45	φ4.5	80
AYBN044-1, -5	4	83	75	12.4	16	40	31.8	45	φ4.5	110
AYBN063-1, -5	3	90	78	16.9	20	52	39	60	φ6	160
AYBN064-1, -5	4	113	101	16.9	20	52	39	60	φ6	210

■ Ordering information

Specify the following:

1. Ordering code or type number

150A, 200A Terminal blocks

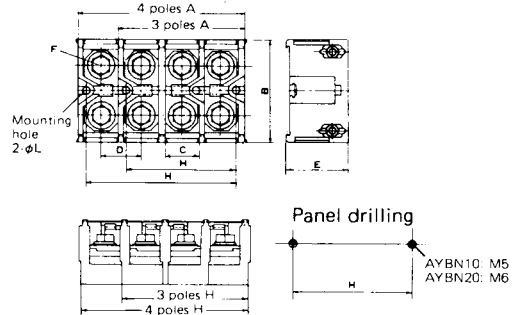

Type	No. of poles	A	B	C	D	E	F	H	L	Mass (g)
AYBN103-5	3	85	79	23	27	51	M8	72	φ6	390
AYBN104-5	4	112	79	23	27	51	M8	99	φ6	510
AYBN203-5	3	110	90	29.7	35	63	M10	96	φ7	740
AYBN204-5	4	145	90	29.7	35	63	M10	131	φ7	970

400A Terminal blocks

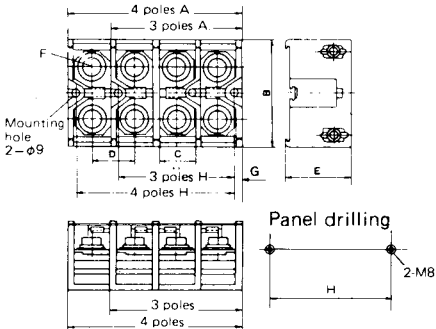

Type	No. of poles	A	B	C	D	E	F	G	H	Mass (g)
AYBN403-5	3	175	120	45	55	82	M12	9.5	156	1670
AYBN404-5	4	230	120	45	55	82	M12	9.5	211	2170

600A Terminal blocks

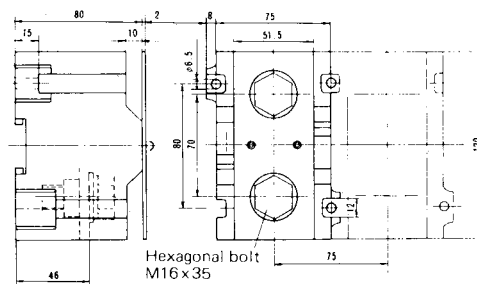

Mass: 1040g



■ Technical data

Insulation resistance: Over 100MΩ at 500V DC

Dielectric strength: 2500V AC rms. 1 minute

Ambient temperature: -20° to +40°C

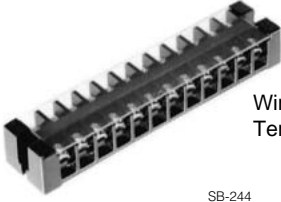
High quality terminal blocks 600 Volts

Typical illustration and description	Volts	Amps	No. of poles	With spring washer Type	Ordering code	With turtle-shaped washer Type	Ordering code
 <p>Wire size: Max. 5.5mm² Terminal screw: M4</p> <p>SB-244</p> <p>AYBS021-1</p>	600	49	6 12	AYBS026-5 AYBS021-5	LT1S-0506B LT1S-0512B	AYBS026-1 AYBS021-1	LT1S-0506A LT1S-0512A
 <p>Wire size: Max. 14mm² Terminal screw: M5</p> <p>SB-241</p> <p>AYBS044-1</p>	600	88	3 4 12	AYBS043-5 AYBS044-5 AYBS041-5	LT1S-1403B LT1S-1404B LT1S-1412B	AYBS043-1 AYBS044-1 AYBS041-1	LT1S-1403A LT1S-1404A LT1S-1412A
 <p>Wire size: Max. 22mm² Terminal screw: M6</p> <p>SB-239</p> <p>AYBS064-1</p>	600	115	3 4	AYBS063-5 AYBS064-5	LT1S-2203B LT1S-2204B	AYBS063-1 AYBS064-1	LT1S-2203A LT1S-2204A

04

■ Ordering information

Specify the following:

1. Ordering code or type number

■ Technical data

Insulation resistance: Over 100MΩ at 500V DC
Dielectric strength: 2500V AC rms 1 minute
Ambient temperature: -20° to +40°C
-20° to +60°C (at 70% ratings)

■ Dimensions, mm

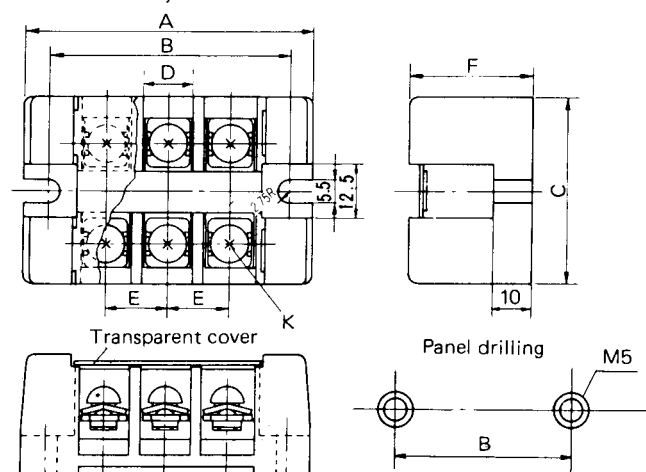

Type	No. of poles	A	B	C	D	E	F	K	Mass (g)
AYBS026-1, -5	6	101	91	40	10	13	28	M4	120(110)*
AYBS021-1, -5	12	179	169	40	10	13	28	M4	220
AYBS043-1, -5	3	72	60.5	46	12.5	15.5	32	M5	110
AYBS044-1, -5	4	88	76	46	12.5	15.5	32	M5	130
AYBS041-1, -5	12	212	200	46	12.5	15.5	32	M5	300
AYBS063-1, -5	3	89	77	60	17	21	35.5	M6	190
AYBS064-1, -5	4	110	98	60	17	21	35.5	M6	240

* For AYBS026-5 type

Terminal Blocks

Type LT4D

Channel mounted type terminal blocks with isolating switch

660 Volts 20 Amps
 Wire size: Maximum 5.5mm²
 Terminal screw: M4

These blocks are provided with isolating switches. When opening the control circuit tentatively for testing or inspection purposes please operate the switch knob. If the leads of an ammeter are connected to both ends of the terminal block and then open the switch the ammeter will then be connected in series and this will allow measurement.

Warning

Do not use this switch for secondary CT circuits. Incorrect operation could be dangerous.

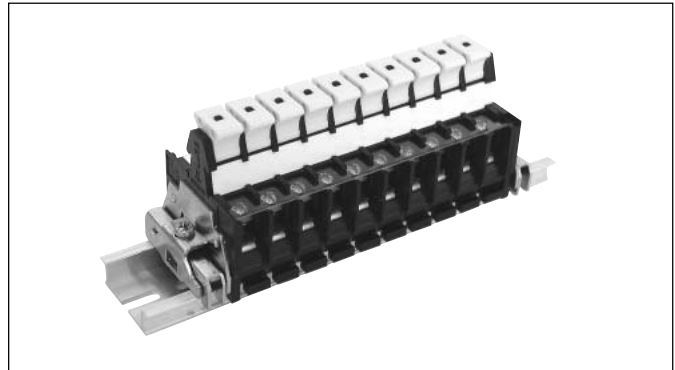

Illustration	Description	Type	Minimum quantity per order
	Terminal block section with isolating switch	LT4D-020Y	100 pcs
	End barrier	LT9D-E1	50 pcs
	End clamp kit	LT9E-T2	50 pcs
	Mounting rail	LT9E-R1	1 pcs (1m)
	Marking strip sheet	LT9D-M1	1 sheets (900mm)

Ordering information

Specify the following:

- Type number
- Quantity: *Specify in minimum quantity or multiples of minimum quantity per order.*
 Examples: *minimum quantity per order: 20 pcs. To order, 20 pcs, 40 pcs, 60 pcs, ..., 100 pcs, etc. Should be specified.*

Technical data

Insulation resistance: Over 100MΩ at 500V DC
 Dielectric strength: 2500V AC rms. 1 minute
 Ambient temperature: -20° to +60°C

Dimensions, mm

Terminal block section LT4D

mass: 50g

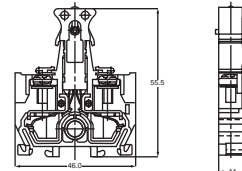

End barrier LT9D-E1

mass: 5g

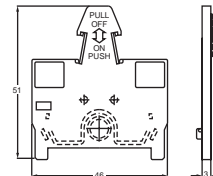

End clamp kit LT9E-T2

mass: 12g

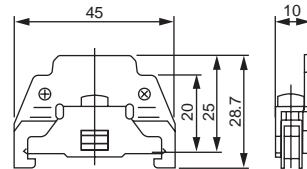

Mounting rail LT9E-R1

mass: 200g

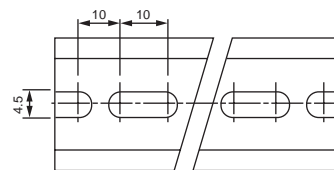

Marking strip sheet LT9D-M1

mass: 2g

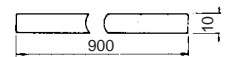

thickness :0.5mm

Assembled LT4D-020Y-□□

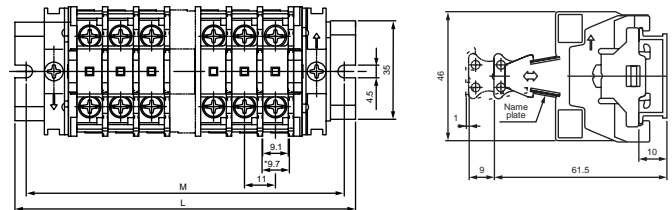

M: Mounting hole pitch
 L: Full length

No. of poles	M	L	No. of poles	M	L
8	132	140	22	292	300
10	152	172	24	312	320
12	172	180	30	372	380
			40	492	500
14	192	200	50	592	600
16	232	240	85	992	1000
18	252	260			
	272	280			

Note: 1 to 85 poles can also be assembled except those listed above.

With transparent cover power terminal blocks

600 Volts 50 to 200 Amps
Wire size: 2 to 100 mm²

- Transparent terminal cover allows the wiring configuration to be checked externally.
- Slotted hexagon head bolts that can be tightened with screwdrivers or box wrenches are used for the terminals.
- The line side and load side are provided with hinged terminal covers to ensure safety and allow easier maintenance and inspections.
- cUL approved, file No. E45457
SKT14A-3C to SKT100A-3C only.



Types and ratings

Terminal blocks

Pole	Rated insulation voltage (V AC)	Rated continuous current (A)	Wire size (mm ²)	Type	Mass (g)
3	600	50	2 to 14	SKT14A-3C	200
		100	2 to 38	SKT38A-3C	310
		150	14 to 60	SKT60A-3C	450
		200	30 to 100	SKT100A-3C	730
3 + 1 (Earth terminal)	600	50	2 to 14	SKT14A-3CG	440
		100	2 to 38	SKT38A-3CG	450
		150	14 to 60	SKT60A-3CG	690
		200	30 to 100	SKT100A-3CG	1120

Connectors

Rated voltage (V AC)	Rated continuous current (A)	Wire size (mm ²)	Type	Mass (g)
600	50	2 to 14	SKT14-S	52
	100	2 to 38	SKT38-S	55
	150	14 to 60	SKT60-S	80
	200	30 to 100	SKT100-S	135

Specifications

Insulation resistance	100MΩ or more (500V DC megger)
Withstand voltage	2500V AC 1minute
Ambient temperature	-20 to +55°C
Humidity	85%RH or less
Flammability	UL94V-2 (Cover), UL94V-0 (Frame)
Temperature rise	45K or less (JIS C 2811)

Ordering information

Specify the following:
1. Type number

Tightening torque

Type	Recommended tightening torque (N•m)		Cable pull-out (UL486A) min. force (N)	
	Line side	Load side	Min. cable	Max. cable
SKT14A-3C	5.1–6.5	11.5–15.5	222	400
SKT14A-3CG	(M6)	(M8)	(14AWG)	(8AWG)
SKT38A-3C	5.1–6.5	11.5–15.5	222	445
SKT38A-3CG	(M6)	(M8)	(14AWG)	(6AWG)
SKT60A-3C	11.5–15.5	11.5–15.5	311	623
SKT60A-3CG	(M8)	(M8)	(12AWG)	(4AWG)
SKT100A-3C	23–31	23–31	311	801
SKT100A-3CG	(M10)	(M10)	(12AWG)	(2AWG)

Terminal Blocks Type SKT

■ Dimensions, mm

• Terminal block

SKT14A-3C (Without earth terminal)

SKT14A-3CG (With earth terminal)

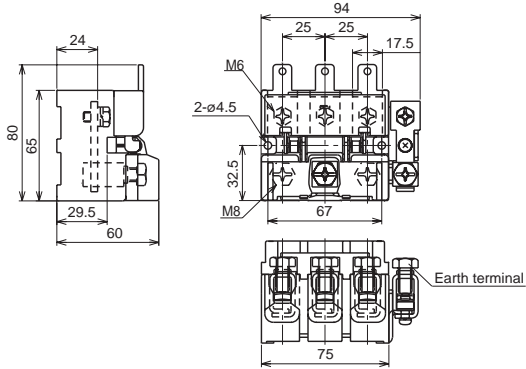

SKT38A-3C (Without earth terminal)

SKT38A-3CG (With earth terminal)

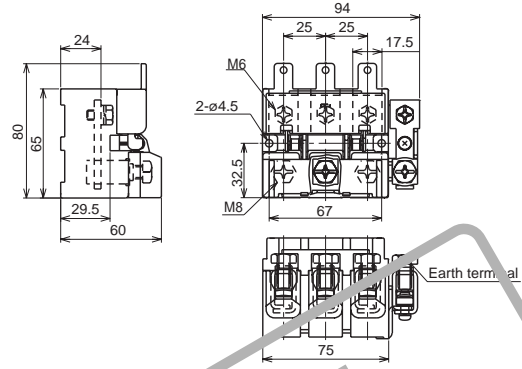

SKT60A-3C (Without earth terminal)

SKT60A-3CG (With earth terminal)

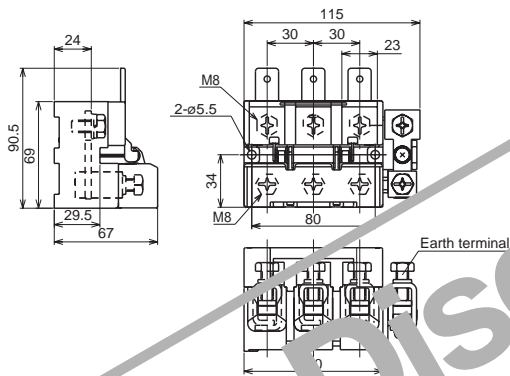

SKT100A-3C (Without earth terminal)

SKT100A-3CG (With earth terminal)

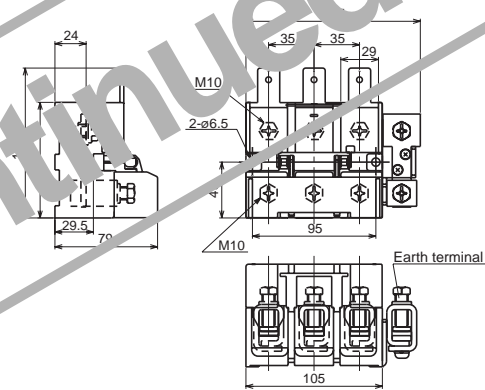

• Connector

SKT14-S

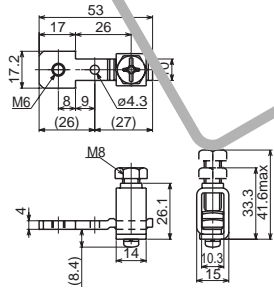

SKT38-S

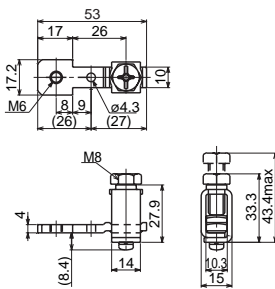

SKT60-S

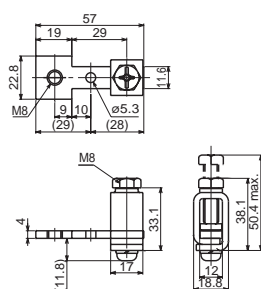

SKT100-S

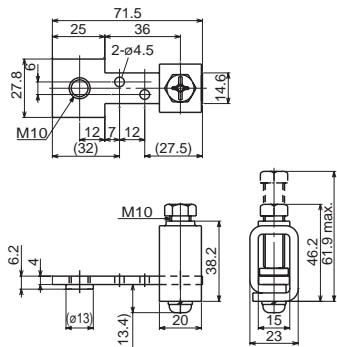

■ Features

- Any number of poles can be assembled on a 35mm DIN rail.
- A lineup of 10 models supporting screw sizes from M3.5 to M16 and a maximum current of 600A is available.
- Our standard models are approved by UL, CSA, and TÜV.
- The molded material conforms to the UL standard for self-extinguishing materials (UL94V-0).
- Mounting is performed by simply pressing the block down onto the rail (except for models LT2E-200 to 600).

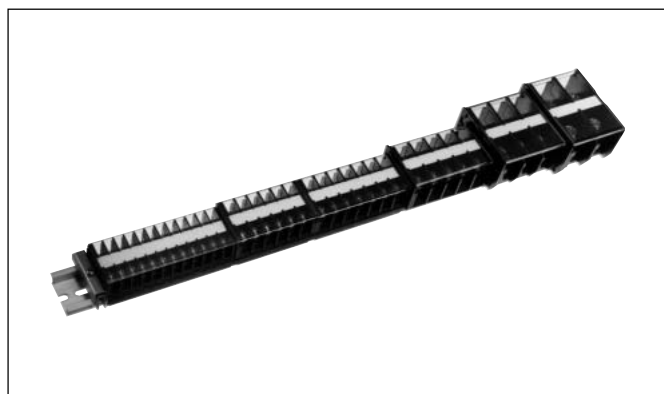

■ Specifications

Rated thermal current (A)	Terminal screw	Applicable wire size and maximum current	Terminal block	End barrier	Cover	Legend plate	End clamp	Rail
22	M3.5	1.25mm ² -16A 2mm ² -22A	LT2E-020	LT9E-E1	LT9E-C1	LT9E-M1	LT9E-T1	LT9E-R1 LT9E-R2
30	M4	1.25mm ² -16A 2mm ² -22A 3.5mm ² -30A	LT2E-030	LT9E-E2	LT9E -C2			
40	M4	3.5mm ² -30A 5.5mm ² -40A	LT2E-040	LT9E-E3				
75	M5	5.5mm ² -40A 8mm ² -50A 14mm ² -75A	LT2E-080	LT9E-E4	LT9E-C3			
95	M6	8mm ² -50A 14mm ² -75A 22mm ² -95A	LT2E-090	LT9E-E5	LT9E-C4			
160	M8	22mm ² -95A 38mm ² -130A 60mm ² -160A	LT2E-150	LT9E-E6	LT9E-C5			
200	M10	38mm ² -130A 60mm ² -160A 100mm ² -200A	LT2E-200	LT9E-E7	LT9E-C6 (Standard provided) LT9E-C7	LT9E-M3 (Standard provided)	LT9E-T2	
300	M10	60mm ² -160A 100mm ² -240A 150mm ² -300A	LT2E-300	LT9E-E7	LT9E-C8 (Standard provided) LT9E-C9			
400	M12	100mm ² -240A 150mm ² -310A 200mm ² -400A	LT2E-400	LT9E-E7	LT9E-C10 (Standard provided) LT9E-C11			
600	M16	150mm ² -310A 200mm ² -400A 325mm ² -600A	LT2E-600	LT9E-E7	LT9E-C12 (Standard provided) LT9E-C13			

Terminal Blocks Type LT2E

■ Performance

Rated insulation voltage	600V
Ambient operating conditions	Temperature -25 to 60°C (with no icing or condensation) Relative humidity 45% to 85%
Temperature rise	Temperature rise in conducting metal is less than 35K.
Insulation resistance	200MΩ between charged parts, and between charged parts and the metal mounting plate (Measured at 500V DC megger.)
Dielectric strength	2,500V AC (1 min)
Applicable standards	Conforms to JIS C 2811

■ Material

Main body	PPE (modified polyphenylene ether resin) (black) UL94V-0
Conductive plate	C2680R (Ni-plated)
Terminal screws	SWRM (Zn-plated)
Side panel	PPE (modified polyphenylene ether resin) (black) UL94V-0
Cover	PC (translucent polycarbonate resin) UL94V-0
Legend plate	PVC (white)

■ Dimensions, mm

● Terminal blocks

LT2E-020

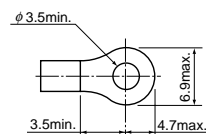
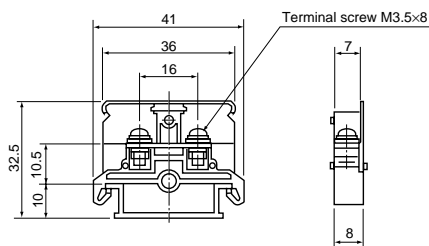

Applicable crimp terminal

LT2E-030

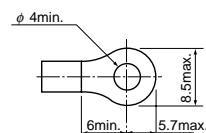
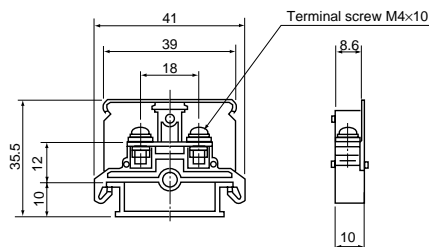

Applicable crimp terminal

LT2E-040

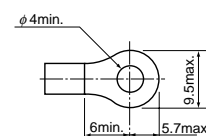
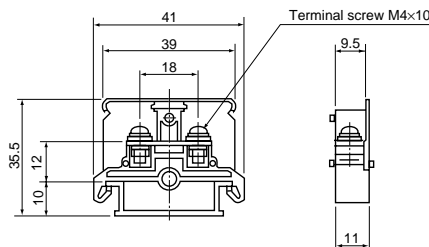

Applicable crimp terminal

LT2E-080

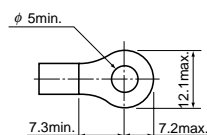
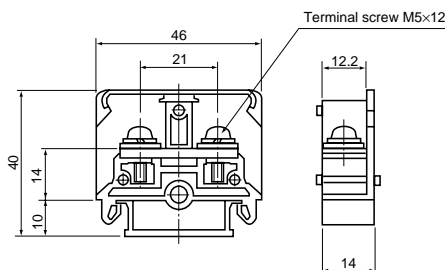

Applicable crimp terminal

● Terminal blocks

LT2E-090

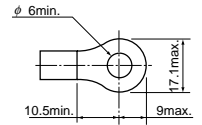
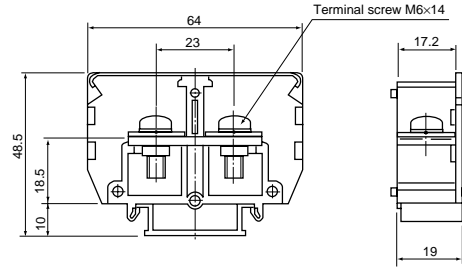

Applicable crimp terminal

LT2E-150

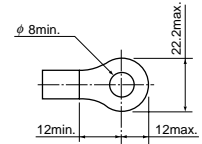
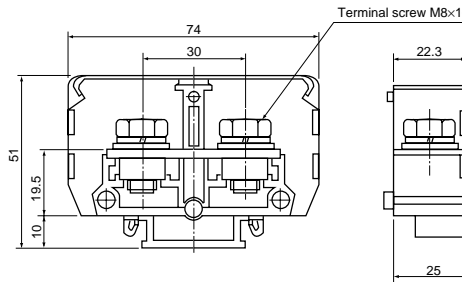

Applicable crimp terminal

LT2E-200



(Cover, supplied with a legend plate)

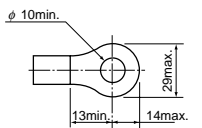
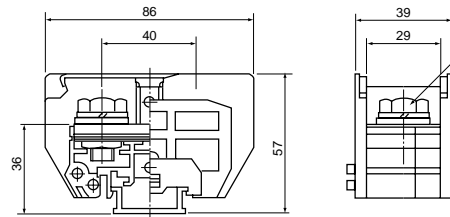

Applicable crimp terminal

LT2E-300



(Cover, supplied with a legend plate)

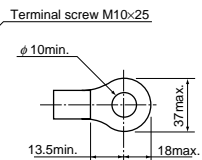
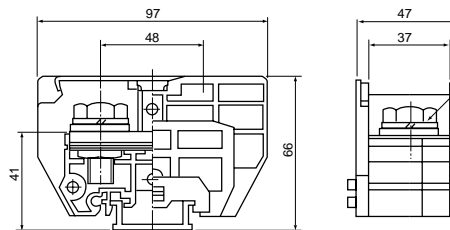

Applicable crimp terminal

LT2E-400



(Cover, supplied with a legend plate)

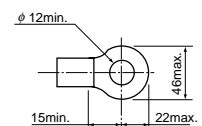
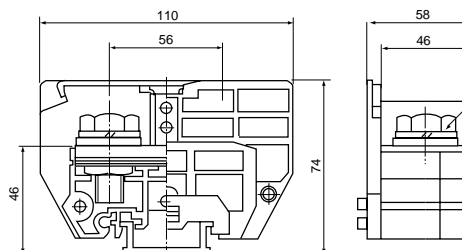

Applicable crimp terminal

LT2E-600



(Cover, supplied with a legend plate)

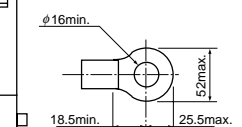
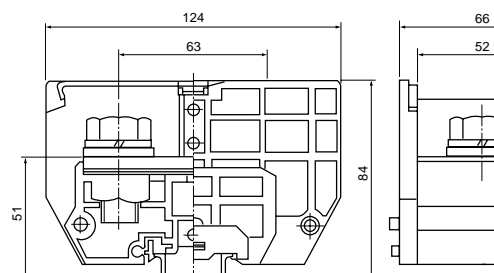

Applicable crimp terminal

Terminal Blocks Type LT2E

● End barriers

LT9E-E1



Sold in units of 100.

LT9E-E2



Sold in units of 100.

LT9E-E3



Sold in units of 100.

LT9E-E4



Sold in units of 50.

LT9E-E5



Sold in units of 20.

LT9E-E6



Sold in units of 10.

LT9E-E7

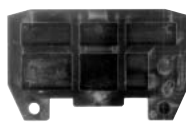

Sold in units of 1.

● Covers

LT9E-C1



Length: 1m
Sold in units of 20.

LT9E-C2



Length: 1m
Sold in units of 20.

LT9E-C3



Length: 1m
Sold in units of 20.

LT9E-C4



Length: 1m
Sold in units of 20.

LT9E-C5



Length: 1m
Sold in units of 20.

LT9E-C6

Standard cover
(Standard provided)



Sold in units of 1.

LT9E-C7

Special cover



Sold in units of 1.

LT9E-C8

Standard cover
(Standard provided)



Sold in units of 1.

LT9E-C9

Special cover

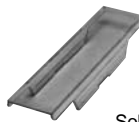

Sold in units of 1.

LT9E-C10

Standard cover
(Standard provided)



Sold in units of 1.

LT9E-C11

Special cover

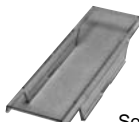

Sold in units of 1.

LT9E-C12

Standard cover
(Standard provided)



Sold in units of 1.

LT9E-C13

Special cover



Sold in units of 1.

● Legend plates

LT9E-M1

Material: PVC

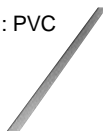

Dimensions
(0.5t×10W×1200L)
Sold in units of 50

LT9E-M3

Material: PVC

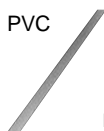

Dimensions
(0.5t×12W×900L)
Sold in units of 50

● End clamps

LT9E-T1

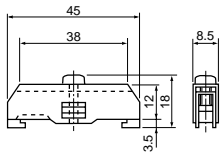

Sold in units of 100.

LT9E-T2

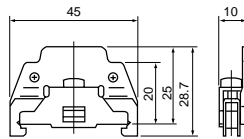

Sold in units of 50.

● Mounting rails

LT9E-R1
LT9E-R2



Material: aluminum A6063

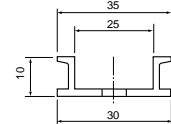
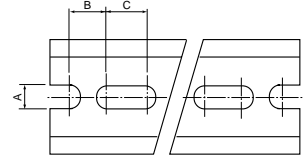

Type	A	B	C	Length	Sold in units
LT9E-R1	4.5	10	10	1000mm	100
LT9E-R2				2000mm	50

04

■ Application to products satisfying international standards

Dielectric strength: 2,200V AC for 1 min.
Operating temperature range: -25 to 60°C

Type	Standard	Rated insulation voltage (V)	Rated continuous current (A)	Applicable wire size for stranded wires (AWG)	International standards
LT2E-020	UL E45457	600	20	20-14	UL approved CSA approved TÜV approved
	CSA 109308-M-001		20	20-14	
	TÜV R9551146		22	20-14	
LT2E-030	UL E45457	600	30	18-12	
	CSA 109308-M-001		30	18-12	
	TÜV R9551147		30	18-12	
LT2E-040	UL E45457	600	40	18-10	
	CSA 109308-M-001		40	18-10	
	TÜV R9551148		40	18-10	
LT2E-080	UL E45457	600	75	10-6	
	CSA 109308-M-001		75	10-6	
	TÜV J9551159		75	12-6	
LT2E-090	UL E45457	600	95	8-4	
	CSA 109308-M-001		95	8-4	
	TÜV J9551160		95	10-4	
LT2E-150	UL E45457	600	150	4-2/0	
	CSA 109308-M-001		150	4-2/0	
	TÜV J9551161		160	6-2/0	
LT2E-200	UL E45457	600	200	2-4/0	
	CSA 109308-M-001		200	2-4/0	
	TÜV J9551162		660	2-250	
LT2E-300	UL E45457	600	300	2/0-300	
	CSA 109308-M-001		300	2/0-300	
	TÜV J9551163		660	1/0-300	
LT2E-400	UL E45457	600	400	4/0-350	
	CSA 109308-M-001		400	4/0-350	
	TÜV J9551164		660	3/0-500	
LT2E-600	UL E45457	600	550	300-600	
	CSA 109308-M-001		550	300-600	
	TÜV J9551165		660	250-600	

Note: The values in the above table are for when standard wires and crimp terminals are used for connection. Use the terminal block together with the crimp terminals and wires approved for the desired standard.

Testing Terminals Type LT5

Testing terminals for VT, CT circuit – For panel mounting

250 Volts AC or DC, 30 Amps
Wire size: Maximum 8mm²

These terminals are used in VT and CT secondary circuits.
These are used to test protective relays or meters or for carrying out calibration.

■ Ordering information

Specify the following:

1. Ordering code or type number
2. Quantity: One pack (10 pcs) is minimum.

■ Technical data

Insulation resistance: Over 100MΩ at 500V DC

Dielectric strength: 2000V AC rms. 1 minute

Ambient temperature: -25° to +50°C

■ Applications

VT circuit

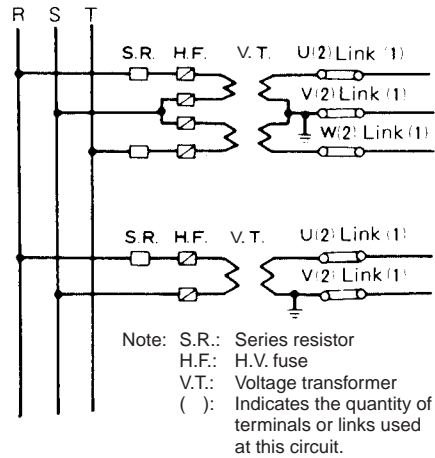

CT circuit

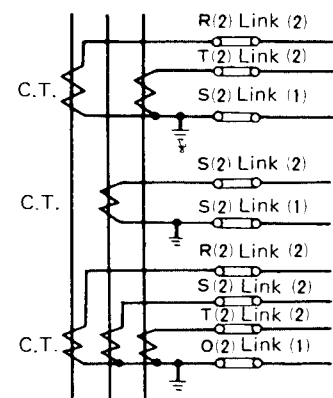

Note: C.T.: Current transformer
(): Indicates the quantity of terminals or links used at this circuit.

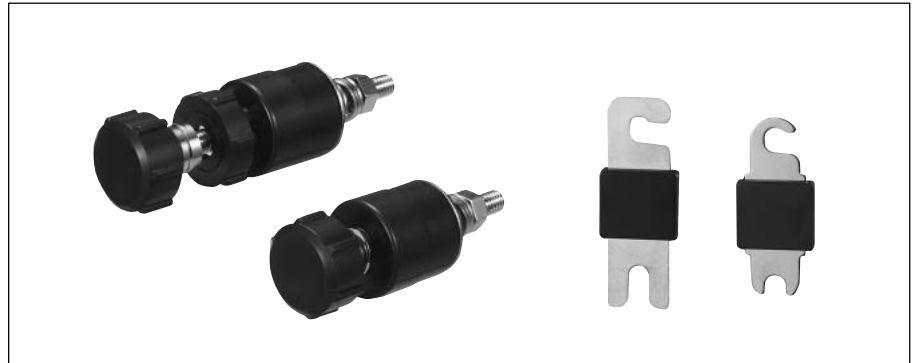



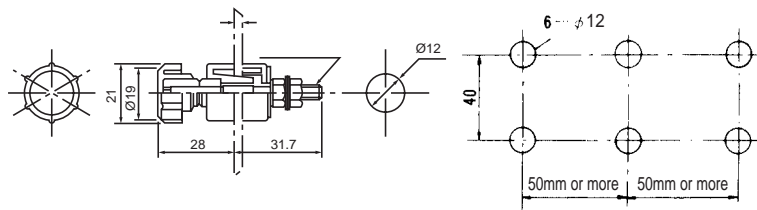

Illustration	Description	Etched letters (Standard)	Type
 SDO-0095M	VT circuit Black	U V W O -	LT5S-B2 LT5S-B3 LT5S-B4 LT5S-B1 LT5S-B
 SB-260	CT circuit Black	R S T O -	LT5D-B5 LT5D-B6 LT5D-B7 LT5D-B1 LT5D-B
 Q-482	Link, black		LT95S-B1
 SDO-0099M	Link, black (small type)		LT95S-B2

■ Dimensions, mm

LT5S – for VT circuits Mass: 30g



LT5D – for CT circuits Mass: 50g

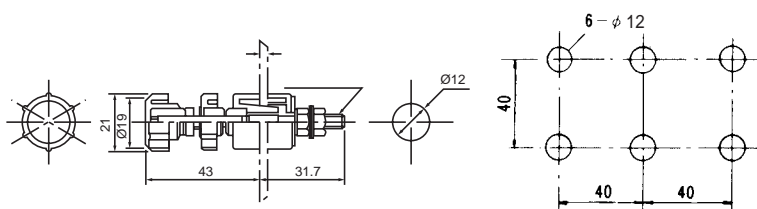

LT95S – Link

Mass: 10g

LT95S – B1

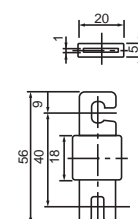

LT95S – B2

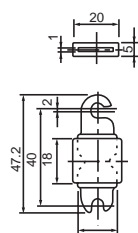

■ CCC approved

● AR22/DR22 and AD30/DR30 series

Pushbutton switches

Bezel	Operator	Type			
		AR22		AR30	
		Momentary action	Alternate action (Turn-reset for V5R)	Momentary action	Alternate action (Turn-reset for V5R)
Round bezel	Flush round head	AR22F0R	AR22F5R	AR30F0R	AR30F5R
	Extended round head	AR22E0R	AR22E5R	AR30E0R	AR30E5R
	Flush round head (symbol mark type)	AR22FAR	AR22FBR	AR30FAR	AR30FBR
	Extended round head (symbol mark type)	AR22EAR	AR22EBR	AR30EAR	AR30EBR
	Extended with half guard	AR22G0R	AR22G5R	AR30G0R	AR30G5R
	Extended with full guard (24mm dia.)	AR22G3R	AR22G8R	AR30G1R	AR30G6R
	Flush with full guard (24mm dia.)	AR22G2R	–	–	–
	Mushroom head with full guard (40mm dia.)	AR22M3R	–	AR30M3R	AR30M8R
	Mushroom head with full guard (35mm dia. metal nut)	–	–	AR30GSR	–
	Mushroom head (29mm dia.)	AR22M4R	AR22M9R	AR30M4R	–
	Mushroom head (40mm dia.)	AR22M0R	AR22M5R	AR30M0R	AR30M5R
	Giant head	–	–	AR30B0R	–
	Giant head with guard	–	–	AR30B1R	–
	Giant head with full guard	–	–	AR30B2R	–
	Giant head with full guard	–	–	AR30B3R	–
Push-lock, turn-reset (40mm dia, with white arrow)	–	AR22V5R	–	AR30V5R	
Square bezel	Flush square head	AR22F0S	AR22F5S	–	–
	Extended square head	AR22E0S	AR22E5S	–	–
	Flush round head	AR22F0Y	AR22F5Y	–	–
	Extended round head	AR22E0Y	AR22E5Y	–	–
	Mushroom head	AR22M4Y	–	–	–
Certificate No.		2003010305063372		2003010305063384	

Note: Certified contact of AR22 type: Momentary action: within 6 contacts
Alternate action : within 4 contacts
Certified contact of AR30 type: Momentary action: within 8 contacts
Alternate action : within 4 contacts

Ring selection type pushbutton switches

Bezel	Operator	Type	
		AR22	AR30
Round bezel	With selector ring	AR22S1R	AR30S1R
		AR22S2R	AR30S2R
		AR22S3R	AR30S3R
		AR22S6R	AR30S6R
Certificate No.		2003010305063372	2003010305063384

Note: Certified contact: 2NO+2NC (S2R: 2NO is also certified)

Emergency stop pushbutton switches

Bezel	Operator	Type			
		AR22		AR30	
		With white arrow (soft-touch)	No white arrow	With white arrow (soft-touch)	No white arrow
Round bezel	Push-lock, turn-reset (29mm dia.)	AR22VSR	AR22V4R	–	–
	Push-lock, turn-reset (40mm dia.)	AR22V0R	AR22V2R	AR30V0R	AR30V2R
	Push-lock, turn-reset (65mm dia.)	–	–	AR30V1R	–
	Key-release push-lock, turn-reset (40mm dia.)	–	AR22V7R	–	–
	Push-lock, pull-reset (35mm dia.)	–	AR22Q2R	–	AR30Q2R
	Unibody push-lock, turn-reset (40mm dia.)	AR22VGE	–	–	–
Certificate No.		2003010305063372 (except for AR22VGE) 2005010305156646 (for AR22VGE)		2003010305063384	

Notes: • Certified contact: 1NC, 1NO+1NC, 2NC, 3NC, 2NO+2NC, 4NC (except for Q2R, VGE type)
• Certified contact of Q2R, VGE type: 1NC, 1NO+1NC and 2NC only
• Certified button color: red (R) only

Illuminated pushbutton switches

Bezel	Operator	Type			
		AR22		AR30	
		Momentary	Alternate	Momentary	Alternate
Round bezel	Flush round head	AR22F0L	AR22F5L	–	–
	Extended round head	AR22E0L	AR22E5L	AR30E0L	AR30E5L
	Mushroom head (29mm dia.)	AR22M4L	AR22M9L	–	–
	Mushroom head (40mm dia.)	AR22M0L	AR22M5L	–	–
	Extended with transparent full guard (24mm dia.)	AR22G4L	AR22G9L	AR30G4L	AR30G9L
	Extended with full guard (24mm dia. with openings)	AR22G2L	AR22G7L	AR30G2L	AR30G7L
	Extended with full guard (24mm dia.)	AR22G1L	AR22G6L	AR30G3L	AR30G8L
	Push-lock, turn-reset (40mm dia. with white arrow)	–	–	–	AR30V5L
Square bezel	Flush square head	AR22F0M	AR22F5M	–	–
	Extended square head	AR22E0M	AR22E5M	–	–
	Flush round head	AR22F0P	AR22F5P	–	–
	Extended round head	AR22E0P	AR22E5P	–	–
	Mushroom head	AR22M4P	–	–	–
Certificate No.	2003010305063372		2003010305063384		
Specifications	<ul style="list-style-type: none"> · Contact <li style="padding-left: 20px;">Without transformer <li style="padding-left: 40px;">Momentary action: within 5 contacts <li style="padding-left: 40px;">Alternate action: within 3 contacts <li style="padding-left: 20px;">With transformer <li style="padding-left: 40px;">Momentary action: within 3 contacts <li style="padding-left: 40px;">Alternate action: within 2 contacts 		<ul style="list-style-type: none"> · Contact <li style="padding-left: 20px;">Without transformer <li style="padding-left: 40px;">Momentary action: within 6 contacts <li style="padding-left: 40px;">Alternate action: within 3 contacts <li style="padding-left: 20px;">With transformer <li style="padding-left: 40px;">Momentary action: within 4 contacts <li style="padding-left: 40px;">Alternate action: within 2 contacts 		
		<ul style="list-style-type: none"> · Color of button <li style="padding-left: 20px;">Green, red, white, yellow, orange, blue · Light source <li style="padding-left: 20px;">LED lamp, incandescent lamp · Operating voltage of lamp <li style="padding-left: 20px;">Without transformer <li style="padding-left: 40px;">LED: 6V AC, 6V DC, 12V AC/DC <li style="padding-left: 40px;">Incandescent lamp: 5.5V AC/DC, 20V AC/DC <li style="padding-left: 20px;">LED, incandescent lamp: 15V AC/DC, 24V AC/DC <li style="padding-left: 20px;">With transformer <li style="padding-left: 40px;">LED, incandescent lamp: 100-110V AC, 115-127V AC, 200-220V AC, 230-254V AC, 350-380V AC, 400-440V AC, 480V AC, 500-550V AC 			

Emergency stop illuminated pushbutton switches

Bezel	Operator	Type			
		AR22		AR30	
		With white arrow (soft-touch)	No white arrow	With white arrow (soft-touch)	No white arrow
Round bezel	Push-lock, turn-reset (29mm dia.)	AR22VSL	–	–	–
	Push-lock, turn-reset (40mm dia.)	AR22V0L	AR22V2L	AR30V0L	AR30V2L
	Push-lock, turn-reset (40mm dia. transparent in all colors)	AR22VDL	AR22VAL	–	–
	Unibody push-lock, turn-reset (40mm dia.)	AR22VGF	–	–	–
Certificate No.	2003010305063372 (except for AR22VGF)		2003010305063384		
	2005010305156646 (for AR22VGF)				

- Notes:
- Certified contact without transformer: 1NC, 1NO+1NC, 2NC, 3NC (except for VGF type)
 - Certified contact with transformer: 1NC, 1NO+1NC, 2NC (except for VGF type)
 - Certified contact of VGF type: 1NC, 1NO+1NC and 2NC only,
 - Certified lamp voltage of VGF type: LED lamp: 24V AC/DC, neon lamp: 110, 120, 220, 240V AC
 - Certified button color: red (R) only

Selector switches

Bezel	Operator	Type			
		AR22		AR30	
		Standard type	Control type	Standard type	Control type
Round bezel	Knob	AR22PR	AR22PCR	AR30PR	AR30PCR
	Lever	AR22WR	AR22WCR	AR30WR	AR30WCR
	Cylindrical knob	AR22RR	AR22RCR	–	–
	Key	AR22JR	AR22JCR	AR30JR	AR30JCR
	Key (long durability)	AR22JAR	–	AR30JAR	–
Square bezel	Knob	AR22PY	AR22PCY	–	–
	Lever	AR22WY	AR22WCY	–	–
	Cylindrical knob	AR22RY	AR22RCY	–	–
	Key	AR22JY	AR22JCY	–	–
Certificate No.		2003010305063372		2003010305063384	

Note: Certified contact of AR22 type: Maintained: within 6 contacts
Control type, spring return and spring / manual return: within 4 contacts
Certified contact of AR30 type: Momentary action: within 8 contacts
Control type, spring return and spring / manual return: within 4 contacts

Illuminated selector switches

Bezel	Operator	Type	
		AR22	AR30
		Standard type	Standard type
Round bezel	Knob	AR22PL	AR30PL
Square bezel	Knob	AR22PP	–
Certificate No.		2003010305063372	2003010305063384

Notes: • Certified contact of AR22 type :
Without transformer
Maintained : within 4 contacts
Spring return and spring / manual return: within 3 contacts
With transformer
Maintained : within 3 contacts
Spring return and spring / manual return: within 2 contacts

• Certified contact of AR30 type :
Without transformer
Maintained : within 6 contacts
Spring return and spring / manual return: within 3 contacts
With transformer
Maintained : within 4 contacts
Spring return and spring / manual return: within 2 contacts

Pilot lights

Bezel	Lens	Type	
		DR22	DR30
Round bezel	Dome	DR22D0L	DR30D0L
	Extended round	DR22E3L	DR30E3L
	Faceted	DR22K0L	DR30K0L
Square bezel	Flush square	DR22F3M	–
	Flush square (Transparent lens)	DR22F4M	DR30F4M
	Flush square (12mm high frame)	DR22F5M	–
	Extended square	DR22E3M	–
	Flush rectangular	DR22E3N	–
	Flush rectangular (Transparent lens)	–	DR30F4N
	Flush square large type (Transparent lens)	–	DR30M4M
	Extended round	DR22E3P	–
Certificate No.		2003010305063383	2003010305063487

Notes: • Certified lamp: both LED and incandescent lamp
• Certified transformer type: standard and short-body
• Except for with resistor/resistor unit

Item with degree of protection IP2X (IP20)

Type	Certificate No.
AR22 □ZB	2003010305063372
AR30 □ZB	2003010305063384
DR22 □ZB	2003010305063383
DR30 □ZB	2003010305063487

Notes: • Certified for all types listed on the table in page 04/289 to 04/291 except for unibody push-lock, turn-reset (40mm dia.) types of emergency stop illuminated pushbutton switches and short-body transformer of pilot light.
• The terminal section of standard emergency stop illuminated pushbutton switches has degree of protection, IP2X.

● AH164, 165, 165-2 series

Pushbutton switches

Operator	Type					
	AH164		AH165		AH165-2	
	Momentary action	Alternate action	Momentary action	Alternate action (Turn-reset for V, V1)	Momentary action	Alternate action (Turn-reset for 2V, 2YV)
Flush round head	–	–	–	–	AH165-2F	AH165-2F5
Extended round head	AH164-E	AH164-E5	AH165-E	AH165-E5	AH165-2E	AH165-2E5
Extended square head	–	–	–	–	AH165-2SE	AH165-2SE5
Extended square concave head	–	–	–	–	AH165-2SCE	AH165-2SCE5
Flush square head	AH164-SF	AH164-SF5	AH165-SF	AH165-SF5	AH165-2SF	AH165-2SF5
Flush rectangular head	AH164-TF	AH164-TF5	AH165-TF	AH165-TF5	–	–
Flush square head with guard	AH164-SGF	AH164-SGF5	AH165-SGF	AH165-SGF5	–	–
Flush rectangular head with guard	AH164-TGF	AH164-TGF5	AH165-TGF	AH165-TGF5	–	–
Mushroom head (round bezel)	–	–	–	–	AH165-2M	–
Mushroom head (square bezel)	–	–	–	–	AH165-2YM	–
Mushroom head	AH164-M	AH164-M5	AH165-M	AH165-M5	–	–
Convex square head	AH164-SM	AH164-SM5	AH165-SM	AH165-SM5	–	–
Convex rectangular head	AH164-TM	AH164-TM5	AH165-TM	AH165-TM5	–	–
Push-locked (round bezel)	–	–	–	AH165-V	–	AH165-2V
Push-locked large type	–	–	–	AH165-V1	–	–
Push-locked (square bezel)	–	–	–	–	–	AH165-2YV
Certificate No.	2003010305071068					

- Notes:
- Certified contact: 1NO+1NC, 2NO+2NC, 3NO+3NC. AH165-V and -V1: 1NC and 2NC only.
 - Certified button color: all in manufactured range of corresponding type. AH165-V and -V1: red (R) only.
 - Certified terminal shape: for soldering and tab, and for wrapping. AH165-V and -V1: soldering and tab only.

Ring selection type pushbutton switches

Operator	Type
	AH165-2
With selector ring (round bezel)	AH165-2S2
With selector ring (square bezel)	AH165-2YS2
Certificate No.	2003010305071068

Note: Certified contact: 2NO+2NC

Emergency stop pushbutton switches

Operator	Type
	AH165
Push-lock, turn-reset (ø32)	AH165-V5
Push-lock, turn-reset (ø40)	AH165-V6
Certificate No.	2003010305071068

- Notes:
- Certified contact: 1NC and 2NC only
 - Certified button color: red (R) only
 - Certified terminal shape: soldering and tab only

Illuminated pushbutton switches

Operator	Type					
	AH164		AH165		AH165-2	
	Momentary action	Alternate action	Momentary action	Alternate action	Momentary action	Alternate action (Turn-reset for 2VL, 2YVL)
Flush round head	–	–	–	–	AH165-2FL	AH165-2FL5
Extended round head	AH164-L	AH164-L5	AH165-L	AH165-L5	AH165-2EL	AH165-2EL5
Extended square head	–	–	–	–	AH165-2SEL	AH165-2SEL5
Concave square head	–	–	–	–	AH165-2SCL	AH165-2SCL5
Flush square head	AH164-SL	AH164-SL5	AH165-SL	AH165-SL5	AH165-2SFL	AH165-2SFL5
Flush rectangular head	AH164-TL	AH164-TL5	AH165-TL	AH165-TL5	–	–
Flush square head with guard	AH164-SGL	AH164-SGL5	AH165-SGL	AH165-SGL5	–	–
Flush rectangular head with guard	AH164-TGL	AH164-TGL5	AH165-TGL	AH165-TGL5	–	–
Mushroom head (round bezel)	–	–	–	–	AH165-2ML	–
Mushroom head (square bezel)	–	–	–	–	AH165-2YML	–
Push-locked (round bezel)	–	–	–	–	–	AH165-2VL
Push-locked (square bezel)	–	–	–	–	–	AH165-2YVL
Certificate No.	2003010305071068					

Notes: • Certified contact: 1NO+1NC, 2NO+2NC, 3NO+3NC
 • Certified terminal shape: for soldering and tab, and for wrapping.
 • Certified lamp: LED, incandescent lamp and neon

• Certified operating lamp voltage: 6, 12 and 24V DC (LED)/ 5, 12, 15 and 24V AC/DC (incandescent lamp) / 110, 120, 220 and 240V AC (neon) /110, 220V AC (LED and incandescent lamps with transformer)
 • The spot LED type have not been approved.

Selector switches (Standard)

Operator	Type		
	AH164	AH165	AH165-2
Knob (round bezel)	–	–	AH165-2P
Knob (rectangular bezel)	AH164-P	AH165-P	–
Knob (square bezel)	AH164-SP	AH165-SP	AH165-2YP
Key (round bezel)	–	–	AH165-2J
Key (rectangular bezel)	AH164-J	AH165-J	–
Key (square bezel)	AH164-SJ	AH165-SJ	AH165-2YJ
Key, 45-degree notch (rectangular bezel)	AH164-JK	AH165-JK	–
Certificate No.	2003010305071068		

Notes: • Certified contact: 1NO+1NC, 2NO+2NC, 3NO+3NC
 • Certified terminal shape: for soldering and tab, and for wrapping

Selector switches (Direct opening action)

Operator	Type
Key (rectangular bezel)	AH165-JM2
Key (round bezel)	AH165-RJM2
Certificate No.	2003010305071068

Notes: • Certified contact: 1NO+1NC, 2NO+2NC
 • Certified position quantity: 2-position only.
 Certified returning method: maintained only.

Illuminated selector switches

Operator	Type
knob (round bezel)	AH165-2PL
Certificate No.	2003010305071068

Notes: • Certified contact: 1NO+1NC, 2NO+2NC
 • Certified operating lamp voltage: 6, 12 and 24V DC (LED)/ 5, 12, 15 and 24V AC/DC (incandescent lamp)

Pilot lights

Lens	Type		
	AH164	AH165	AH165-2
Flush round	–	–	AH165-2Z
Extended round	AH164-Z	AH165-Z	AH165-2ZE
Extended square	–	–	AH165-2SZE
Flush square	AH164-ZS	AH165-ZS	AH165-2SZ
Flush rectangular	AH164-ZT	AH165-ZT	–
Certificate No.	2003010305071044		

Notes: • Certified lamp: LED, incandescent lamp and neon
 • Certified operating lamp voltage: 6, 12 and 24V DC (LED)/ 5, 12, 15 and 24V AC/DC (incandescent lamp)/ 110, 120, 220 and 240V AC (neon) /110, 220V AC (LED and incandescent lamps with transformer)
 • The spot LED type have not been approved.

Illuminated Switches/Pilot Lights

AG22 and AG23

General information

■ Description

AG series Command Switches are designed to be installed in a square or rectangular hole. AG23 series are 25 x 32mm rectangular type while AG22 series are 25mm regular square type. Either of them comprises illuminated pushbutton switch and pilot light. The illuminated pushbutton switches are available either in momentary action or alternative action. Moreover, their light sources are also available in either incandescent lamp or LED lamp. These AG series Command Switches are highly suitable for use with instrumentation panels or control panels. Their contacts use Au-flashed Ag contacts and adopt a sliding mechanism, thus ensuring a high contact reliability. The color inserts for indicators are available up to 4-way split types. Each indicator is provided with 5-color inserts and the color you desire can be easily replace.

■ Features

● Excellent contact reliability

These switches combine Au-flashed Ag contact and sliding mechanism features so as to ensure a high contact reliability even when used with low-voltage, small current circuits of 5V 1mA range. Therefore, they allow direct input to IC's. Moreover, their contacts are a double-break type, thus permitting their application to 240V AC circuits.

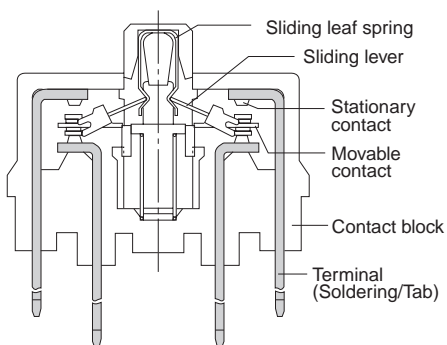

● Terminals are both use of soldering and tab terminal types

They are subjected to "solder plated" so as to permit accurate soldering.

● Contact can be added or replaced

The contact block comprises 1NO and 1NC. In AG23 series the contact arrangement is available up to 4NO+4NC and in AG22 series up to 2NO+2NC.

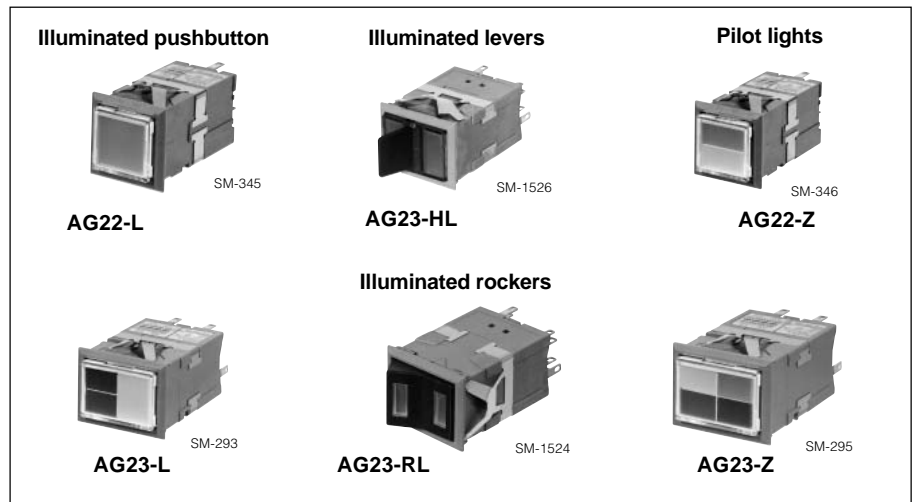

● Small in depth and compactly built

Both AG22 and AG23 series Command Switches are as small as 52mm in depth and their buttons are extruded only 5mm from the panel surface.

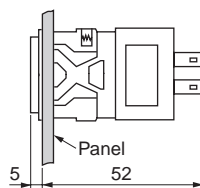

● The color inserts are available in max. 4-way split

The 4-color inserts can be positioned in any of the four quarters of the total display area. 6 combinations are available.

In these switches with incandescent lamp, their lens colors can be replaced with one from the "colored plate kit" which is provided for illuminated pushbutton switches or pilot lights.

■ Construction

AG23 (Incandescent lamp)

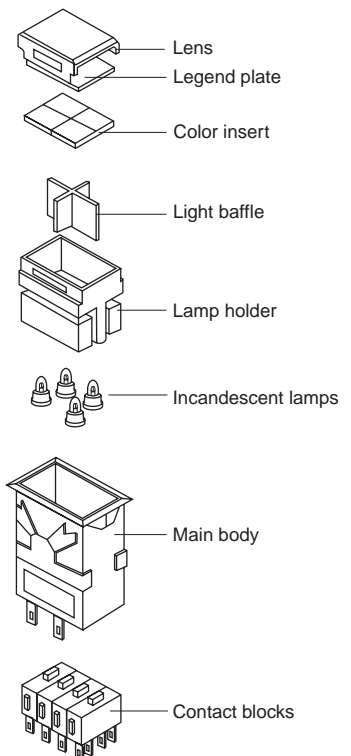

■ Approvals



For further information related to approved type, see page 04CD/1/2 to 04CD/1/3.





Illuminated Switches/Pilot Lights

AG22 and AG23





Quick reference guide

AG22 series

■ Illuminated pushbutton switches Incandescent lamp

Indicator split See page 04CD/1/8	
A: <input type="checkbox"/>	B: <input type="checkbox"/>
AG22-LAX   SP-1099	AG22-LBX   SP-1120





LED lamp: Indicators

Indicator split See page 04CD/1/9	
A: <input type="checkbox"/>	B: <input type="checkbox"/>
AG22-LA□3   SP-1101	AG22-LB□3   SP-1121





LED lamp: Contact unit

AG22-L□	See page 04CD/1/9
	 SP-1100

■ Pilot lights Incandescent lamp

Indicator split See page 04CD/1/8	
A: <input type="checkbox"/>	B: <input type="checkbox"/>
AG22-ZAX   SP-1099	AG22-ZBX   SP-1120

LED lamp: Indicators













Indicator split See page 04CD/1/9	
A: <input type="checkbox"/>	B: <input type="checkbox"/>
AG22-ZA□3   SP-1101	AG22-ZB□3   SP-1121

LED lamp: Contact socket













AG22-Z6	See page 04CD/1/9
	 SP-1100

AG23 series

■ Illuminated pushbutton switches Incandescent lamp

Indicator split See page 04CD/1/8					
A: <input type="checkbox"/>	B: <input type="checkbox"/>	C: <input type="checkbox"/>	D: <input type="checkbox"/>	E: <input type="checkbox"/>	F: <input type="checkbox"/>
AG23-LAX   SP-1102	AG23-LBX   SP-1105	AG23-LCX   SP-1116	AG23-LDX   SP-1114	AG23-LEX   SP-1112	AG23-LFX   SP-1118

LED lamp: Indicators













Indicator split See page 04CD/1/9					
A: <input type="checkbox"/>	B: <input type="checkbox"/>	C: <input type="checkbox"/>	D: <input type="checkbox"/>	E: <input type="checkbox"/>	F: <input type="checkbox"/>
AG23-LA□3   SP-1122	AG23-LB□3   SP-1104	AG23-LC□3   SP-1117	AG23-LD□3   SP-1115	AG23-LE□3   SP-1113	AG23-LF□3   SP-1119

LED lamp: Contact unit













AG23-L□	See page 04CD/1/9
	 SP-1103

Illuminated Switches/Pilot Lights AG22 and AG23 Quick reference guide

■ Pilot lights Incandescent lamp

Indicator split						<i>See page 04CD/1/8</i>
A: <input type="checkbox"/>	B: <input type="checkbox"/>	C: <input type="checkbox"/>	D: <input type="checkbox"/>	E: <input type="checkbox"/>	F: <input type="checkbox"/>	
AG23-ZAX   SP-1102	AG23-ZBX   SP-1105	AG23-ZCX   SP-1116	AG23-ZDX   SP-1114	AG23-ZEX   SP-1112	AG23-ZFX   SP-1118	





LED lamp: Indicators

Indicator split						<i>See page 04CD/1/9</i>
A: <input type="checkbox"/>	B: <input type="checkbox"/>	C: <input type="checkbox"/>	D: <input type="checkbox"/>	E: <input type="checkbox"/>	F: <input type="checkbox"/>	
AG23-ZA□ 3   SP-1112	AG23-ZB□ 3   SP-1104	AG23-ZC□ 3   SP-1117	AG23-ZD□ 3   SP-1115	AG23-ZE□ 3   SP-1113	AG23-ZF□ 3   SP-1119	





LED lamp: Socket

AG23-Z6   SP-1103	<i>See page 04CD/1/9</i>
--	--------------------------

■ Illuminated lever switches

2-position	3-position	<i>See page 04CD/1/10</i>
Maintained, Spring return	Spring/manual return	
AG23-HL□   SP-1108	AG23-HL□   SP-1108	

■ Illuminated rocker switches

2-position	3-position	<i>See page 04CD/1/11</i>
Maintained, Spring return	Spring/manual return	
AG23-RL□   SP-1107	AG23-RL□   SP-1107	

Illuminated Switches/Pilot Lights

AG22 and AG23

Type number nomenclature

■ Type number nomenclature

● Illuminated pushbutton switch (Incandescent lamp)

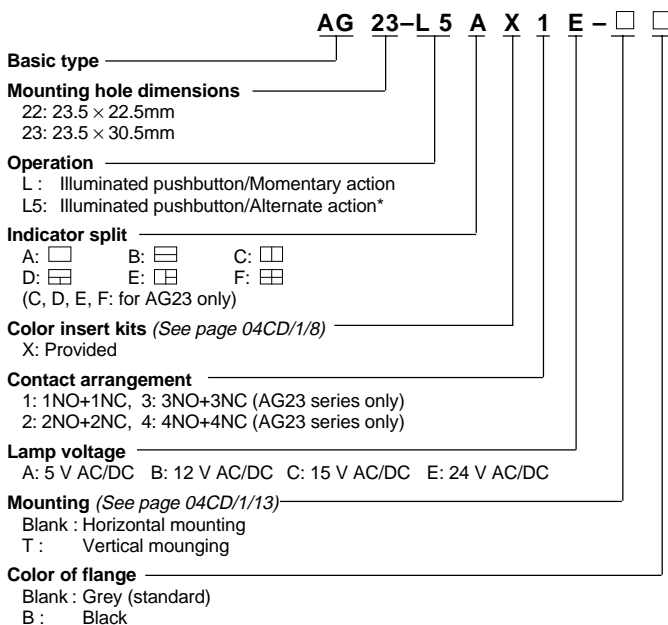

● Illuminated pushbutton switch (LED lamp)

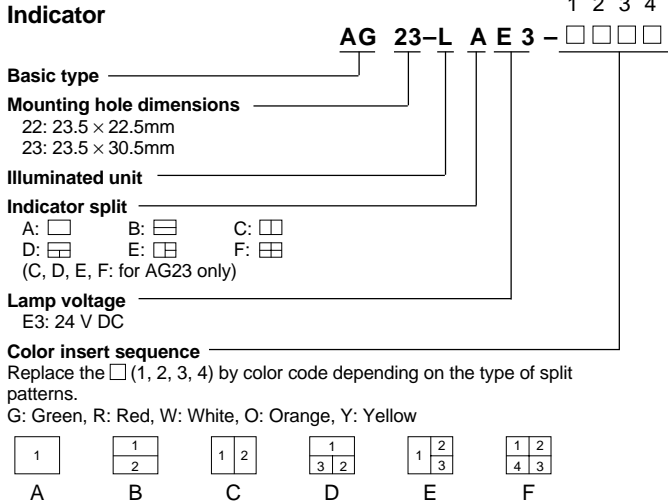

Contact unit

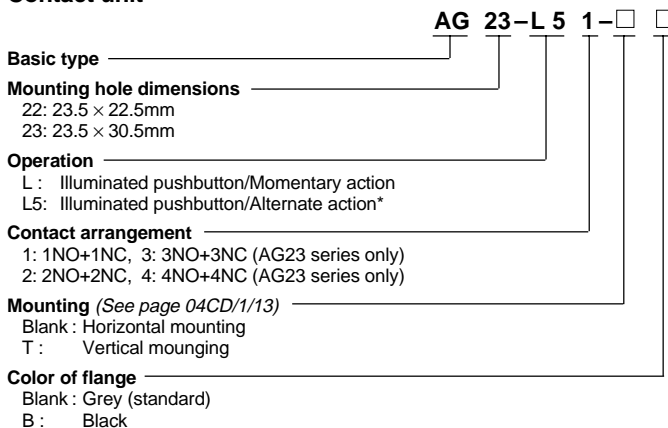

● Pilot light (Incandescent lamp)

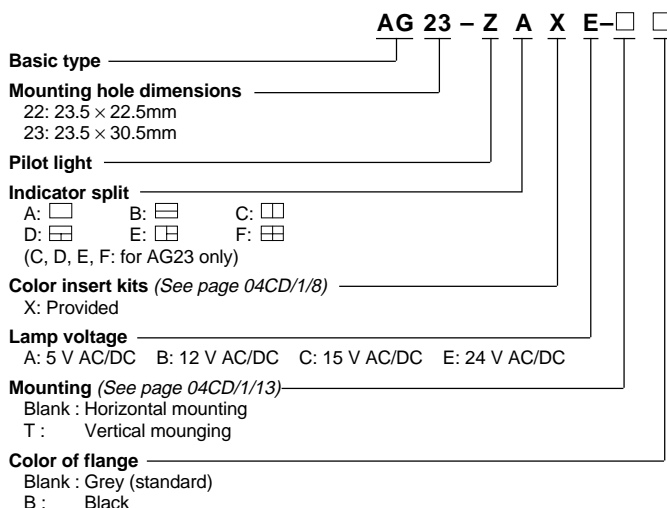

● Pilot light (LED lamp)

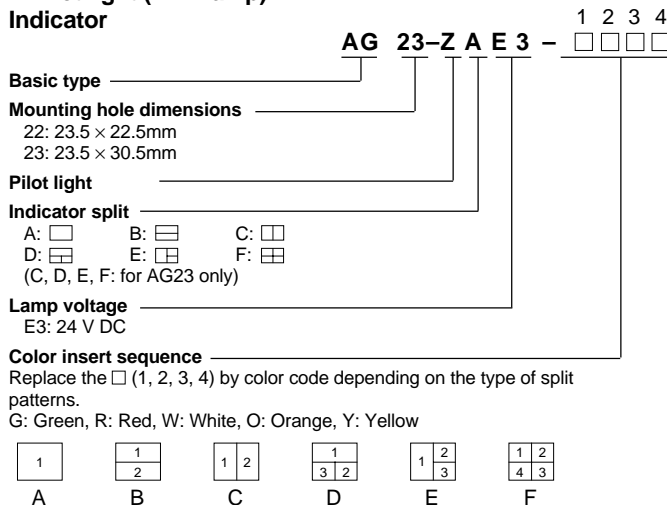

Socket

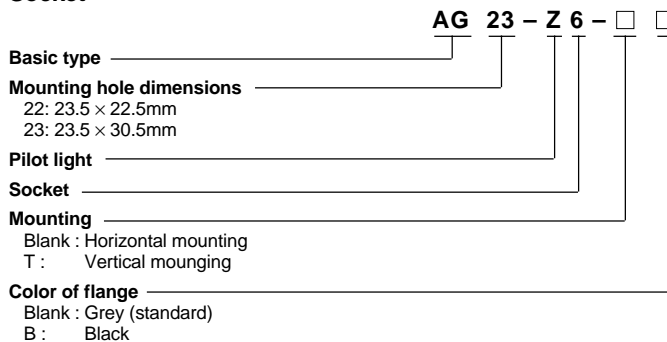

Notes: * When the button is depressed the contacts are maintained and remain so even if the finger is removed. The button will not return to its free position. In order to remove the lock, the button must be given a second pressure before the button will return to its free position.

Illuminated Switches/Pilot Lights

AG22 and AG23

Type number nomenclature

● Illuminated lever switch and illuminated rocker switch

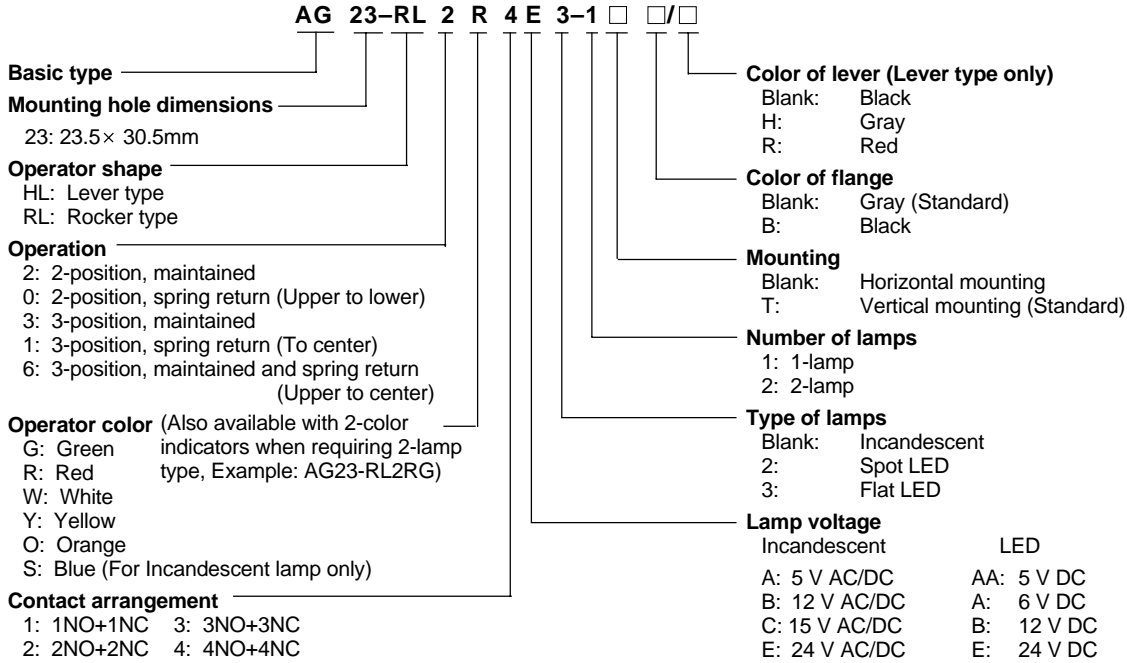

Illuminated Switches/Pilot Lights

AG22 and AG23

Ratings and specifications

■ Standards approved

UL508	File No. E44592
CSA C22.2 No.14	File No. LR20479

■ Specifications (Indoor use)

Item	Illuminated pushbutton switch	Illuminated lever switch Illuminated rocker switch	Pilot light
Rated insulation voltage	250V AC/DC		
Ambient temperature (no condensation or no icing)	-5 to +40°C		
Humidity	45 to 85%RH (at -5 to +40°C), no condensation or no icing		
Durability (operations)	Mechanical	1NO+1NC, 2NO+2NC Momentary action: 1 million Alternate action: 250,000 3NO+3NC*, 4NO+4NC*: 100,000	100,000
	Electrical	100,000 (220V AC 0.7A)	
Dielectric strength	2000V AC, 1 minute (Between lamp and contact terminals: 1500V AC, 1 minute)		
Pollution degree	3		
Vibration	Resonance: 10 to 55Hz, double amplitude 0.1mm Constant: 16.7Hz, double amplitude 3mm		
Shock	Malfunction durability: 100m/s ² Mechanical durability: 500m/s ²		Mechanical durability: 500m/s ²
Insulation resistance	100MΩ or more (500V DC megger)		
Degree of protection	IP40		

Notes: * AG23 type only.

■ Contact ratings

● UL/CSA standards

Rated thermal current	Rated operational voltage	Maximum current	
		AC (Res. load)	DC (Res. load)
5A	24V	—	1.0A
	125V	—	0.2A
	250V	5.0A	—

● NECA C 4521 standards

Rated thermal current	Rated operational voltage	Rated operational current				
		AC 15 (Ind. load)	AC 13 (Ind. load)	AC 12 (Res. load)	DC 13* (Ind. load)	DC 12 (Res. load)
5A	24V	—	—	—	0.7A	1.0A
	110V	0.3A	1.0A	1.5A	—	—
	220V	0.3A	0.7A	1.0A	0.15A	0.2A

Notes: * T_{0.95} = 21ms

■ Contact reliability

FUJI has confirmed that the unit can be used in 1mA circuit conditions at 5V AC or DC. The operable range may vary depending on the ambient conditions and type of load.

Illuminated Switches/Pilot Lights
AG22 and AG23
Ratings and specifications

■ **Power consumption**
 ● AG22, 23











Operating Voltage (V)	LED Lamp [w/split]						Incandescent lamp [W/1-lamp]
	Illuminated pushbutton switch, pilot light				Lever switch, rocker switch		
	0-split	2-split	3-split	4-split	1-lamp	2-lamp	
5	—	—	—	—	0.04*1	0.04*1	0.45
6	—	—	—	—	0.05*2	0.05*2	—
12	—	—	—	—	0.09	0.09	0.55
24	0.36	0.36	0.36	0.36	0.17	0.17	0.55

*1 Yellow: 0.14w/split

*2 Yellow: 0.17w/split

Illuminated pushbutton Switches/Pilot Lights AG22 and AG23

■ Illuminated pushbutton switches (Incandescent lamp) Momentary action

Description	Color insert split	1NO+1NC *1 *2 *3	2NO+2NC *1 *2 *3
		Type	Type
 SM-346 AG22-L	A 	AG22-LAX1 ■(-)□	AG22-LAX2 ■(-)□
	B 	AG22-LBX1 ■(-)□	AG22-LBX2 ■(-)□
 SM-293 AG23-L	A 	AG23-LAX1 ■(-)□	AG23-LAX2 ■(-)□
	B 	AG23-LBX1 ■(-)□	AG23-LBX2 ■(-)□
	C 	AG23-LCX1 ■(-)□	AG23-LCX2 ■(-)□
	D 	AG23-LDX1 ■(-)□	AG23-LDX2 ■(-)□
	E 	AG23-LEX1 ■(-)□	AG23-LEX2 ■(-)□
	F 	AG23-LFX1 ■(-)□	AG23-LFX2 ■(-)□

Notes:

*1

Replace the ■ mark by the lamp voltage code

A: 5V AC/DC

B: 12V AC/DC

C: 15V AC/DC

E: 24V AC/DC

*2

Replace the () mark by the mounting angle code

Blank: Horizontal mounting

T: Vertical mounting

*3











Replace the □ mark by the flange color code

Blank: Gray (Standard)

B: Black







For AG23 type illuminated pushbutton switch, 3NO+3NC and 4NO+4NC are also available.

Alternate action











Description	Color insert split	1NO+1NC *1 *2 *3	2NO+2NC *1 *2 *3
		Type	Type
 SM-345 AG22-L5	A 	AG22-L5AX1 ■(-)□	AG22-L5AX2 ■(-)□
	B 	AG22-L5BX1 ■(-)□	AG22-L5BX2 ■(-)□
 SM-295 AG23-L5	A 	AG23-L5AX1 ■(-)□	AG23-L5AX2 ■(-)□
	B 	AG23-L5BX1 ■(-)□	AG23-L5BX2 ■(-)□
	C 	AG23-L5CX1 ■(-)□	AG23-L5CX2 ■(-)□
	D 	AG23-L5DX1 ■(-)□	AG23-L5DX2 ■(-)□
	E 	AG23-L5EX1 ■(-)□	AG23-L5EX2 ■(-)□
	F 	AG23-L5FX1 ■(-)□	AG23-L5FX2 ■(-)□

■ Color insert kits

Illuminated pushbutton switches and pilot lights with an incandescent lamp comprise the following number of green, red, white, orange and blue inserts, legend plates and light baffle plates.

Color insert split	Color insert			Light baffle			Legend plate
	Full	Half	Quarter	Half	Quarter		
A 	5	-	-	-	-	-	1
B 	-	5	-	1	-	-	1
C 	-	-	5	-	1	-	1
D 	-	5	-	5	1	-	1
E 	-	-	5	5	-	1	1
F 	-	-	-	10	1	-	2

■ Pilot lights (Incandescent lamp)

Description	Color insert split	1NO+1NC *1 *2 *3
		Type
 SM-346 AG22-Z	A 	AG22-ZAX ■(-)□
	B 	AG22-ZBX ■(-)□
 SM-294 AG23-Z	A 	AG23-ZAX ■(-)□
	B 	AG23-ZBX ■(-)□
	C 	AG23-ZCX ■(-)□
	D 	AG23-ZDX ■(-)□
	E 	AG23-ZEX ■(-)□
	F 	AG23-ZFX ■(-)□

■ Wiring diagrams

AG22 (2NO+2NC)

• Terminal arrangement

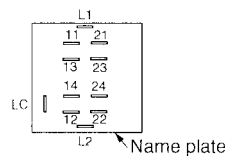

AG23 (4NO+4NC)

• Terminal arrangement

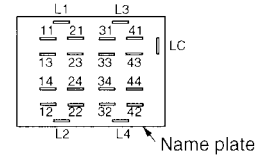

View from terminal side

■ Dimensions, mm

AG22

• Body

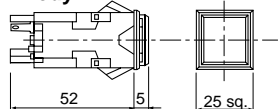

AG23

• Body

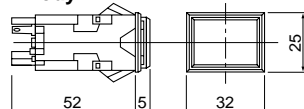

• Barrier

Center barrier
AGX008-C

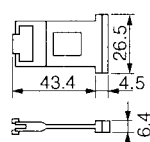

End barrier
AGX008-E

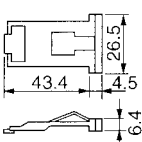

• Barrier

Long center barrier
AGX003-LC

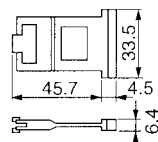

Long end barrier
AGX003-LE

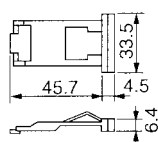

Short center barrier
AGX003-SC

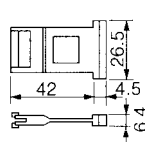



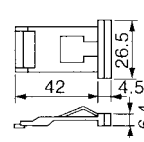







Short end barrier
AGX003-SE





■ Illuminated pushbutton switches (LED lamp)

● Indicators











Description	Color insert split	Type*1 *2
 AG22-L	A 	AG22-LA ■-△
	B 	AG22-LB ■-△△
 AG23-L	A 	AG23-LA ■-△
	B 	AG23-LB ■-△△
	C 	AG23-LC ■-△△
	D 	AG23-LD ■-△△△
	E 	AG23-LE ■-△△△
	F 	AG23-LF ■-△△△△

● Contact unit

Description	Contact	Momentary action Type*3*4	Alternate action Type*3*4
 AG22-L	1NO+1NC	AG22-L1 - () <input type="checkbox"/>	AG22-L51 - () <input type="checkbox"/>
	2NO+2NC	AG22-L2 - () <input type="checkbox"/>	AG22-L52 - () <input type="checkbox"/>
 AG23-L	1NO+1NC	AG23-L1 - () <input type="checkbox"/>	AG23-L51 - () <input type="checkbox"/>
	2NO+2NC	AG23-L2 - () <input type="checkbox"/>	AG23-L52 - () <input type="checkbox"/>
	3NO+3NC	AG23-L3 - () <input type="checkbox"/>	AG23-L53 - () <input type="checkbox"/>
	4NO+4NC	AG23-L4 - () <input type="checkbox"/>	AG23-L54 - () <input type="checkbox"/>

■ Pilot lights (LED lamp)

● Indicators

Description	Color insert split	Type*1 *2
 AG22-Z	A 	AG22-ZA ■-△
	B 	AG22-ZB ■-△△
 AG23-Z	A 	AG23-ZA ■-△
	B 	AG23-ZB ■-△△
	C 	AG23-ZC ■-△△
	D 	AG23-ZD ■-△△△
	E 	AG23-ZE ■-△△△
	F 	AG23-ZF ■-△△△△

■ Wiring diagrams (Lamp circuit)

AG22

● Incandescent lamp

Full face

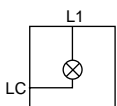

● LED lamp

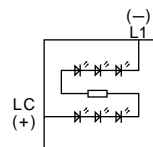

2-way

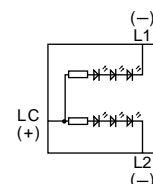
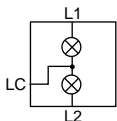

View from terminal side

AG23

● Incandescent lamp

Full face

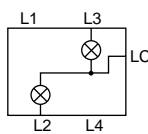

2, 3, 4 - way split

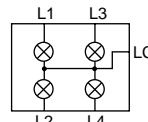

● LED lamp (24V)

Full face

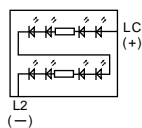

2-way Horizontal split

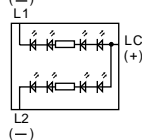

2 - way Vertical split

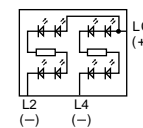

3 - way split (Half at top)

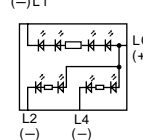

3 - way split (Half at left)

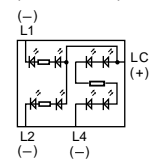

4 - way split

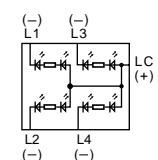

Notes:

- *1 Replace the ■ mark by the lamp voltage code.
E3: 24V DC
- *2 Replace the △ mark by color code depending on the type of split patterns.
G: Green, R: Red, W: White, O: Orange, Y: Yellow
(For color insert sequence, see page 04CD/1/4)
- *3 Replace the () mark by the mounting code.
Blank: Horizontal mounting
T: Vertical mounting
- *4 Replace the □ mark by the flange color code.
Blank: Gray, B: Blank

■ Ordering information

Example

● Indicator



AG23 series	AG23
Illuminated pushbutton	L
4-way split color insert	F
LED lamp 24V DC (Anode common)	E3
Color sequence	1: Green 2: Red 3: White 4: Orange
 GRWO

Type number AG23-LFE3-GRWO

● Contact unit



Momentary action	L
Contact block 2NO+2NC	2
Horizontal mounting	Blank
Color of flange Gray	Blank
Type number	AG23-L2

● Sockets



Description	Type code*3*4
 AG22-Z6	AG22-Z6 - () <input type="checkbox"/>
 AG23-Z6	AG23-Z6 - () <input type="checkbox"/>

Illuminated lever Switches AG23

■ Illuminated lever switches/Incandescent lamps

Description	Contact block	No. of lamp	Operation	2-position Type*	3-position Type*
 SP-1108	1NO+1NC	1	Maintained	AG23-HL2△1■-1()□/▲	—
		2		AG23-HL2△1■-2()□/▲	—
	2NO+2NC	1		AG23-HL2△2■-1()□/▲	AG23-HL3△2■-1()□/▲
		2		AG23-HL2△2■-2()□/▲	AG23-HL3△2■-2()□/▲
	3NO+3NC	1		AG23-HL2△3■-1()□/▲	AG23-HL3△3■-1()□/▲
		2		AG23-HL2△3■-2()□/▲	AG23-HL3△3■-2()□/▲
 SP-1108	1NO+1NC	1	Spring return	AG23-HL0△1■-1()□/▲	—
		2		AG23-HL0△1■-2()□/▲	—
	2NO+2NC	1		AG23-HL0△2■-1()□/▲	AG23-HL1△2■-1()□/▲
		2		AG23-HL0△2■-2()□/▲	AG23-HL1△2■-2()□/▲
	3NO+3NC	1		AG23-HL0△3■-1()□/▲	AG23-HL1△3■-1()□/▲
		2		AG23-HL0△3■-2()□/▲	AG23-HL1△3■-2()□/▲
2NO+2NC	1	Spring/ manual return	—	AG23-HL6△2■-1()□/▲	
	2		—	AG23-HL6△2■-2()□/▲	
3NO+3NC	1		—	AG23-HL6△3■-1()□/▲	
	2		—	AG23-HL6△3■-2()□/▲	

■ Illuminated lever switches/LED lamps

Description	Contact block	No. of lamp	Operation	2-position Type*	3-position Type*	
 KK04-047A	1NO+1NC	1	Maintained	AG23-HL2△1■2-1()□/▲	—	
		2		AG23-HL2△1■2-2()□/▲	—	
		2NO+2NC		1	AG23-HL2△2■2-1()□/▲	AG23-HL3△2■2-1()□/▲
	2			AG23-HL2△2■2-2()□/▲	AG23-HL3△2■2-2()□/▲	
	3NO+3NC	1		AG23-HL2△3■2-1()□/▲	AG23-HL3△3■2-1()□/▲	
		2		AG23-HL2△3■2-2()□/▲	AG23-HL3△3■2-2()□/▲	
	1NO+1NC	1		Spring return	AG23-HL0△1■2-1()□/▲	—
		2			AG23-HL0△1■2-2()□/▲	—
		2NO+2NC			1	AG23-HL0△2■2-1()□/▲
2	AG23-HL0△2■2-2()□/▲		AG23-HL1△2■2-2()□/▲			
3NO+3NC	1	AG23-HL0△3■2-1()□/▲	AG23-HL1△3■2-1()□/▲			
	2	AG23-HL0△3■2-2()□/▲	AG23-HL1△3■2-2()□/▲			
 SP-1108	1NO+1NC	1	Maintained		AG23-HL2△1■3-1()□/▲	—
		2			AG23-HL2△1■3-2()□/▲	—
		2NO+2NC			1	AG23-HL2△2■3-1()□/▲
	2			AG23-HL2△2■3-2()□/▲	AG23-HL3△2■3-2()□/▲	
	3NO+3NC	1		AG23-HL2△3■3-1()□/▲	AG23-HL3△3■3-1()□/▲	
		2		AG23-HL2△3■3-2()□/▲	AG23-HL3△3■3-2()□/▲	
	1NO+1NC	1		Spring return	AG23-HL0△1■3-1()□/▲	—
		2			AG23-HL0△1■3-2()□/▲	—
		2NO+2NC			1	AG23-HL0△2■3-1()□/▲
2	AG23-HL0△2■3-2()□/▲		AG23-HL1△2■3-2()□/▲			
3NO+3NC	1	AG23-HL0△3■3-1()□/▲	AG23-HL1△3■3-1()□/▲			
	2	AG23-HL0△3■3-2()□/▲	AG23-HL1△3■3-2()□/▲			
2NO+2NC	1	Spring/ manual return	—		AG23-HL6△2■3-1()□/▲	
	2		—		AG23-HL6△2■3-2()□/▲	
3NO+3NC	1		—		AG23-HL6△3■3-1()□/▲	
	2		—	AG23-HL6△3■3-2()□/▲		



- * • Replace the △ mark by the lamp color codes.
 G: Green R: Red W: White Y: Yellow O: Orange
 S: Blue (Incandescent Lamp only)
 • Replace the ■ mark by the lamp voltage codes
 Incandescent A: 5V AC/DC B: 12V AC/DC C: 15V AC/DC E: 24V AC/DC
 LED AA: 5V DC A: 6V DC B: 12V DC E: 24V DC

- Replace the () mark by the mounting angle code.
 Blank: Horizontal mounting
 T: Vertical mounting
 • Replace the □ mark by the flange color codes.
 Blank: Gray (Standard) B: Black
 • Replace the ▲ mark by the lever color codes.
 Blank: Black (Standard) H: Gray R: Red

■ Illuminated rocker switches/Incandescent lamps

Description	Contact block	No. of lamp	Operation	2-position Type*	3-position Type*
 SP-1107	1NO+1NC	1 2	Maintained	AG23-RL2△1■-1()□ AG23-RL2△1■-2()□	— —
	2NO+2NC	1 2		AG23-RL2△2■-1()□ AG23-RL2△2■-2()□	AG23-RL3△2■-1()□ AG23-RL3△2■-2()□
	3NO+3NC	1 2		AG23-RL2△3■-1()□ AG23-RL2△3■-2()□	AG23-RL3△3■-1()□ AG23-RL3△3■-2()□
	1NO+1NC	1 2	Spring return	AG23-RL0△1■-1()□ AG23-RL0△1■-2()□	— —
	2NO+2NC	1 2		AG23-RL0△2■-1()□ AG23-RL0△2■-2()□	AG23-RL1△2■-1()□ AG23-RL1△2■-2()□
	3NO+3NC	1 2		AG23-RL0△3■-1()□ AG23-RL0△3■-2()□	AG23-RL1△3■-1()□ AG23-RL1△3■-2()□
	2NO+2NC	1 2	Spring/ manual return	—	AG23-RL6△2■-1()□ AG23-RL6△2■-2()□
	3NO+3NC	1 2		—	AG23-RL6△3■-1()□ AG23-RL6△3■-2()□

■ Illuminated rocker switches/LED lamps

Description	Contact block	No. of lamp	Operation	2-position Type*	3-position Type*
 KK04-048A	1NO+1NC	1 2	Maintained	AG23-RL2△1■2-1()□ AG23-RL2△1■2-2()□	— —
	2NO+2NC	1 2		AG23-RL2△2■2-1()□ AG23-RL2△2■2-2()□	AG23-RL3△2■2-1()□ AG23-RL3△2■2-2()□
	3NO+3NC	1 2		AG23-RL2△3■2-1()□ AG23-RL2△3■2-2()□	AG23-RL3△3■2-1()□ AG23-RL3△3■2-2()□
	1NO+1NC	1 2	Spring return	AG23-RL0△1■2-1()□ AG23-RL0△1■2-2()□	— —
	2NO+2NC	1 2		AG23-RL0△2■2-1()□ AG23-RL0△2■2-2()□	AG23-RL1△2■2-1()□ AG23-RL1△2■2-2()□
	3NO+3NC	1 2		AG23-RL0△3■2-1()□ AG23-RL0△3■2-2()□	AG23-RL1△3■2-1()□ AG23-RL1△3■2-2()□
	2NO+2NC	1 2	Spring/ manual return	—	AG23-RL6△2■2-1()□ AG23-RL6△2■2-2()□
	3NO+3NC	1 2		—	AG23-RL6△3■2-1()□ AG23-RL6△3■2-2()□
	 SP-1107	1NO+1NC	1 2	Maintained	AG23-RL2△1■3-1()□ AG23-RL2△1■3-2()□
2NO+2NC		1 2	AG23-RL2△2■3-1()□ AG23-RL2△2■3-2()□		AG23-RL3△2■3-1()□ AG23-RL3△2■3-2()□
3NO+3NC		1 2	AG23-RL2△3■3-1()□ AG23-RL2△3■3-2()□		AG23-RL3△3■3-1()□ AG23-RL3△3■3-2()□
1NO+1NC		1 2	Spring return	AG23-RL0△1■3-1()□ AG23-RL0△1■3-2()□	— —
2NO+2NC		1 2		AG23-RL0△2■3-1()□ AG23-RL0△2■3-2()□	AG23-RL1△2■3-1()□ AG23-RL1△2■3-2()□
3NO+3NC		1 2		AG23-RL0△3■3-1()□ AG23-RL0△3■3-2()□	AG23-RL1△3■3-1()□ AG23-RL1△3■3-2()□
2NO+2NC		1 2	Spring/ manual return	—	AG23-RL6△2■3-1()□ AG23-RL6△2■3-2()□
3NO+3NC		1 2		—	AG23-RL6△3■3-1()□ AG23-RL6△3■3-2()□

* • Replace the △ mark by the lamp color codes
G: Green R: Red W: White Y: Yellow O: Orange
S: Blue (Incandescent Lamp only)

• Replace the ■ mark by the lamp voltage codes
Incandescent A: 5V AC/DC B: 12V AC/DC C: 15V AC/DC E: 24V AC/DC
LED AA: 5V DC A: 6V DC B: 12V DC E: 24V DC

• Replace the () mark by the mounting angle code
Blank: Horizontal mounting
T: Vertical mounting

• Replace the □ mark by the flange color codes
Blank: Gray (Standard) B: Black

Illuminated lever Switches/Illuminated rocker Switches

AG23

Dimensions

■ Dimensions, mm

Lever switches

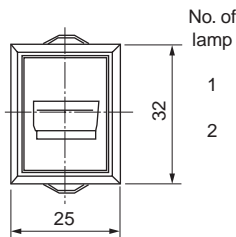
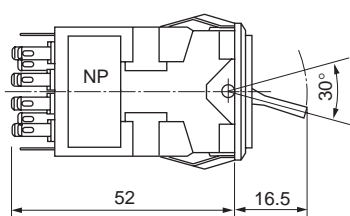

Rocker switches

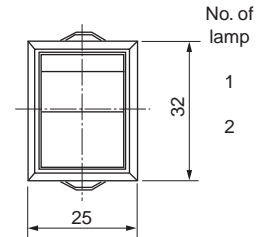
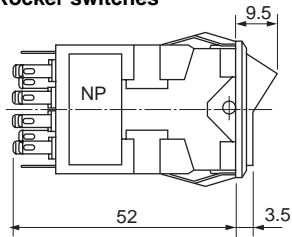

■ Wiring diagrams (AG23 4NO+4NC)

● Terminal arrangement

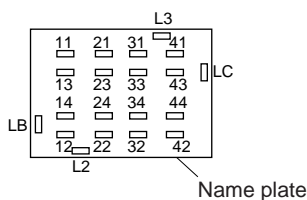

■ Wiring diagrams (Lamp circuit)

● Incandescent lamp

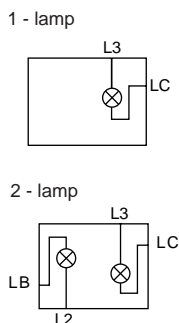

● LED lamp

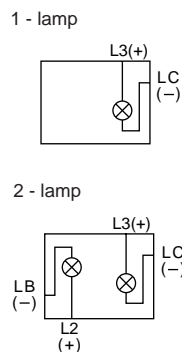

■ Contact arrangement

Operator position	1NO+1NC	2NO+2NC	3NO+3NC	4NO+4NC
2-position				
3-position				

Note: The operator position shown is where the nameplate-stuck-surface is positioned toward you.



Notes on use

■ **Mounting the Switches (Pilot lights)**

Mounting the switches by inserting them into place in the front of the mounting panel.
 The switches will be held in position by the mounting springs.



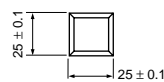
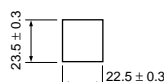
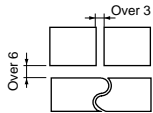
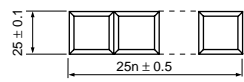
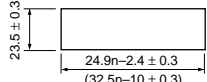
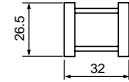
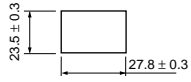
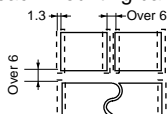

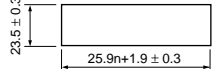

■ **Panel cutting**

● **AG 22**

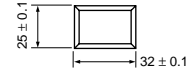
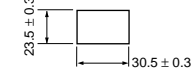
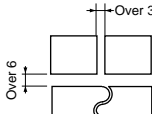
Description		Mounting design	Panel cutting	Remarks
Flange mounting	Individual mounting (Horizontal)			Panel cutting space between rows of units 
	Manifold mounting (Horizontal)			
Barrier mounting	Individual mounting (Horizontal)			Panel cutting space between rows of units Dotted line indicates the position of each mounting barrier 
	Manifold mounting (Horizontal)			

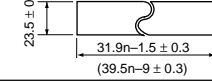
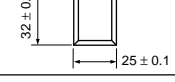
Notes • n: Number of mounted unit Max 10 Panel thickness: 1 to 5 mm (with dust covers: 1 to 4 mm)
 • For vertical mounting, contact FUJI
 • The dimensions in parentheses are for tandem mounting of switches with dust covers.

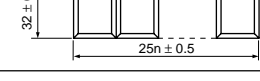
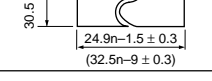
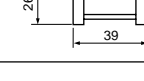
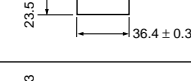
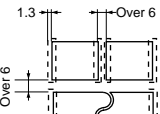
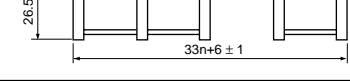
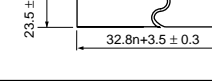
● **AG 23**

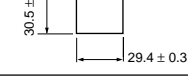
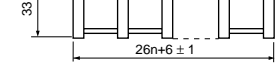
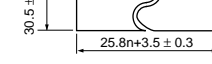
Description		Mounting design	Panel cutting	Remarks
Flange mounting	Individual mounting (Horizontal)			Panel cutting space between rows of units 
	Manifold mounting (Horizontal)			
	Individual mounting (Vertical)			
	Manifold mounting (Vertical)			
Barrier mounting	Individual mounting (Horizontal)			Panel cutting space between rows of units Dotted line indicates the position of each mounting barrier 
	Manifold mounting (Horizontal)			
	Individual mounting (Vertical)			
	Manifold mounting (Vertical)			

Notes • n: Number of mounted unit Max10 Panel thickness: 1 to 5 mm (with dust covers: 1 to 4 mm)
 • The dimensions in parentheses are for tandem mounting of switches with dust covers.

Illuminated Switches/Pilot Lights

AG22 and AG23

Notes on use

■ Installing or removing switches

- To install switches in the standard mounting or barrier-isolated single-unit mounting method, insert the switches one at a time from the front of the panel.
- Installing the main bodies of the switches
If the mounting panel is vertical, install the switches with their nameplates positioned at the bottom. If the mounting panel is horizontal, install the switches with their nameplates positioned on this side.
- If the mounting panel is thin (1 to 2 mm thick), make panel cutouts smaller.

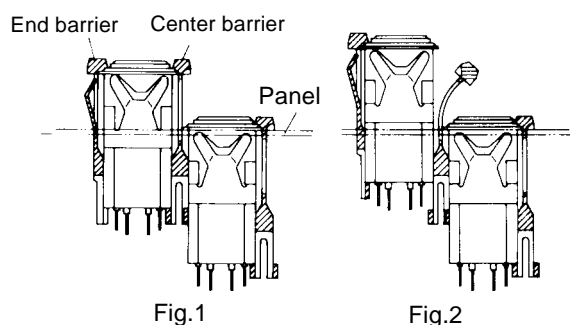

- When the barrier-isolated tandem-mounting method is employed, you can sequentially install switches one by one. For the final one, place a part of the center barrier in the mounting hole beforehand, and then insert the switch into the mounting hole so that the end barrier is in close contact with the main body of the switch (procedure: Fig.2 to Fig.1)
- To remove a switch which has been installed in the standard mounting or barrier-isolated single-unit mounting method, push out the switch by pushing it from the back of the panel while holding the panel by pushing it inward.
- To remove switches which have been installed in the barrier-isolated tandem-mounting method, proceed as follows: disengage the rear of the barrier on both sides of the switch to be removed so that the barriers are attached to the switch and, push the switch outward from the back of the panel while holding the front of the mounting panel firm, and take out the switch by opening the barriers by bending them to both sides on the front side of the panel (procedure: Fig.1 to Fig.2)

■ Operating voltage and rated voltage of incandescent lamps

Rated voltage	Operating voltage
6V	4 to 5V
14V	10 to 12V
18V	12 to 15V
28V (Standard)	20 to 24V

Incandescent lamps should be operated at the operating voltages if a lamp service life of 5,000 to 10,000 hours are needed. The ambient temperature must not exceed 30°C if the lamp is used at the rated voltage continuously.

■ Removing the lighting unit...AG23 (Oblong)

To remove the lighting unit, refer to the illustrations given in the below. (Especially when removing the unit installed on a panel)

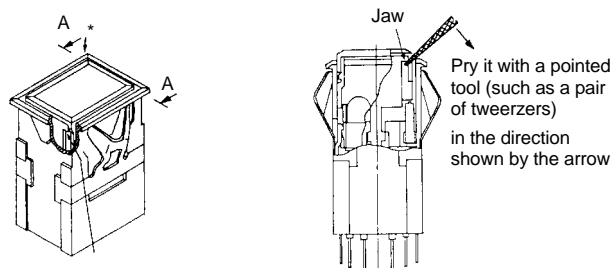

Remarks*The unit has two jaws at lower left as indicated with the asterisks

Cross section A-A (main components only)

■ Lamp replacement (For illuminated pushbutton and pilot lights)

To replace a lamp, pull out the entire lighting unit and replace the lamp from the back of the lamp holder. Install the lighting unit so that it conforms with the contact end inside the switch main-body. The inserting force must not be greater than 60N.

■ Installing the lighting section

Install the lighting unit aligning the "TOP" display on the lighting unit and switch main-body as shown in the below.

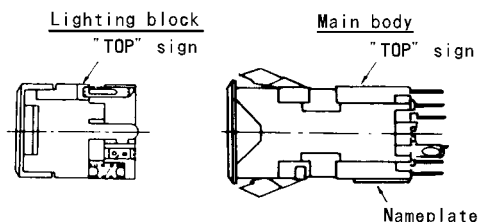

Do not push the internal mechanism of the switch main body while the lamp unit has been removed. Deformation of contact piece for the lamp may result in poor lighting or malfunction.

■ Replacing the lamp (Lever type or rocker type)

To remove the lamp, remove the lens by using a screwdriver or other pointed tool (see the illustrations in the below) and then pull out the lamp by using a lamp remover (Type AHX672). To install the lamp, insert it with your fingers and then put back the lens.

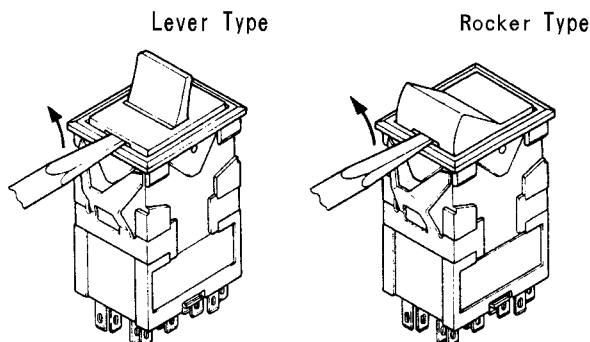

Illuminated Switches/Pilot Lights AG22 and AG23 Notes on use

■ Removeing or installing the lens

To remove the lens, slide it horizontally. To install the lens, align it with the lamp house and insert it from the top.

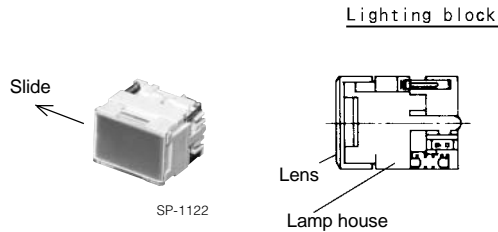

■ Installing the color plate and nameplate

Install the color plate and Nameplate in the lens section with their grained surfaces directed inward.

■ Removeing or installing the nameplate (Lever type)

To remove the nameplate from the lens, press the studs of the lens against a flat plane so that the lens is widened slightly, and insert a screwdriver or other pointed tool into the groove of the nameplate. (See the illustration in the below.)

To install the nameplate into the cover, put the end of the nameplate in the cover and then press the nameplate into the cover by pinching them with your fingers. (See the illustration in the below.)

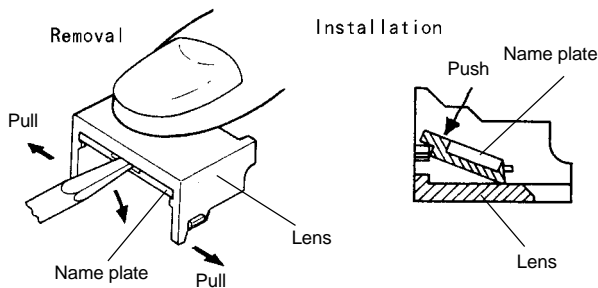

■ Contact block

To replace a contact block, use removing tool AGX012. If excessive force is applied when attempting to open the support legs for the contact block holder, deformation or damage may occur.

■ Contacts configuration modifications

Note that there are certain restrictions on contact configuration modifications.

No modifications other than those below are available. Although it is not impossible to modify a switch with 3a3b or 4a4b into that with 2a2b, do not attempt this modification because the layout of the contacts of the former differs from that of the latter.

Caution: never remove any of the contact units or dummy units which are located at both ends. If you do, the main units of the switches may be damaged, may become unable to be installed, or other troubles may result.

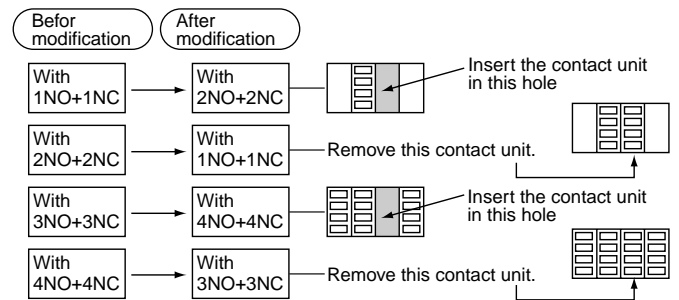

■ Wiring connections

• Use a soldering iron with a wattage of not more than 30W and a tip length of more than 20mm.

Use a rosin-core solder

With a 30W iron complete soldering within 5 seconds, or 10 seconds with a 20W iron. Do not apply external force to the terminals. Do not deform the terminals.

Because lead-free solder's melting point is slightly high, soldering work may be difficult. Use a soldering iron whose tip is rather large or whose calorie is rather high.

• Wires that can be connected

Two solid wires with a maximum diameter of 0.8mm (solder)

One stranded wire with a maximum area of 0.75mm² (solder)

• Using contact blocks

When using NO and NC contacts in the same contact block, avoid connection that involves opposite polarity or wiring from different types of power supply.

• For wiring to adjacent terminals, use insulated tubing to prevent short-circuit and to assure isolation. For solder terminals, be careful when connecting thick wires. Do not use too much solder.

■ Installing lamps in close order

When continuously lighting pilot lights or pressing illuminated pushbuttons installed in close order, care must be taken that the ambient temperature does not exceed the rated value.

■ Alternate types

AG23-L5

AG22-L5

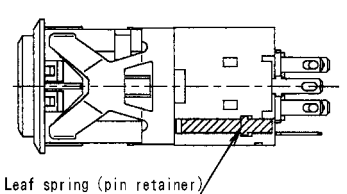
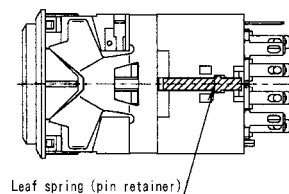

Do not open/close the switch with its leaf spring held pressed. If you do, the alternate mechanism can be damaged.

Illuminated Switches/Pilot Lights

AG22 and AG23

Notes on use

■ Dismounting the switch (Main body)

- ① To remove the main body of a rectangular command switch installed on a panel, bend the mounting springs and push them outside of the main body. If it is densely packed with other devices, use the removing tool (Type AGX013) for ease of removal.
- ② For how to use the removing tool, see the illustration in the below. Insert the tool from back of the switch (main-body) and then push out the switch.

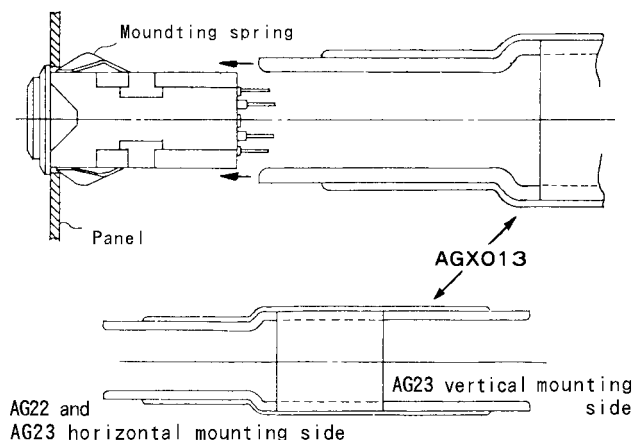

■ Operation

Do not use a hitting or bouncing action to operate the button, or the switch may break. Always operate the switch by hand.





■ Storage and operating environment



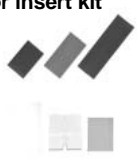

Observe the operating ambient temperature and humidity specifications indicated in the catalog or other related material. Do not use the switches in a location where they are exposed to being splashed with oil or water. The location must not be dusty.

- If it is inevitable that the installed switches will be exposed to dust or metallic particles caused by factory installation work or other tasks, cover the switches with suitable sheets to protect them.
- If using the switches in a dusty atmosphere cannot be avoided protect the switches with dust covers.

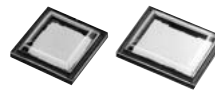
Illuminated Switches/Pilot Lights AG22 and AG23 Accessories

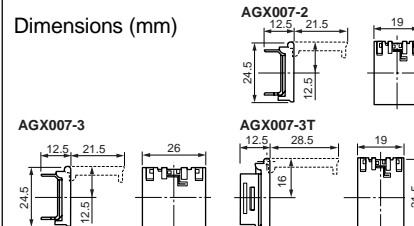
■ Accessories

Description	Type																																													
Barrier  <small>SM-337</small>  <small>SM-313</small>	<table border="1"> <thead> <tr> <th></th> <th>Color</th> <th>Type</th> </tr> </thead> <tbody> <tr> <td>For AG22</td> <td></td> <td></td> </tr> <tr> <td>Center</td> <td>Black</td> <td>AGX008-CB</td> </tr> <tr> <td>-barrier</td> <td>Gray</td> <td>AGX008-CH</td> </tr> <tr> <td>End-barrier</td> <td>Black</td> <td>AGX008-EB</td> </tr> <tr> <td></td> <td>Gray</td> <td>AGX008-EH</td> </tr> <tr> <td>For AG23</td> <td></td> <td></td> </tr> <tr> <td>Long center</td> <td>Black</td> <td>AGX003-LCB</td> </tr> <tr> <td>-barrier</td> <td>Gray</td> <td>AGX003-LCH</td> </tr> <tr> <td>Long end</td> <td>Black</td> <td>AGX003-LEB</td> </tr> <tr> <td>-barrier</td> <td>Gray</td> <td>AGX003-LEH</td> </tr> <tr> <td>Short center</td> <td>Black</td> <td>AGX003-SCB</td> </tr> <tr> <td>-barrier</td> <td>Gray</td> <td>AGX003-SCH</td> </tr> <tr> <td>Short end</td> <td>Black</td> <td>AGX003-SEB</td> </tr> <tr> <td>-barrier</td> <td>Gray</td> <td>AGX003-SEH</td> </tr> </tbody> </table>		Color	Type	For AG22			Center	Black	AGX008-CB	-barrier	Gray	AGX008-CH	End-barrier	Black	AGX008-EB		Gray	AGX008-EH	For AG23			Long center	Black	AGX003-LCB	-barrier	Gray	AGX003-LCH	Long end	Black	AGX003-LEB	-barrier	Gray	AGX003-LEH	Short center	Black	AGX003-SCB	-barrier	Gray	AGX003-SCH	Short end	Black	AGX003-SEB	-barrier	Gray	AGX003-SEH
	Color	Type																																												
For AG22																																														
Center	Black	AGX008-CB																																												
-barrier	Gray	AGX008-CH																																												
End-barrier	Black	AGX008-EB																																												
	Gray	AGX008-EH																																												
For AG23																																														
Long center	Black	AGX003-LCB																																												
-barrier	Gray	AGX003-LCH																																												
Long end	Black	AGX003-LEB																																												
-barrier	Gray	AGX003-LEH																																												
Short center	Black	AGX003-SCB																																												
-barrier	Gray	AGX003-SCH																																												
Short end	Black	AGX003-SEB																																												
-barrier	Gray	AGX003-SEH																																												
Bezel  <small>SM-354</small>	<table border="1"> <thead> <tr> <th></th> <th>Color</th> <th>Type</th> </tr> </thead> <tbody> <tr> <td>For AG22</td> <td>Black</td> <td>AGX010-2B</td> </tr> <tr> <td></td> <td>Gray</td> <td>AGX010-2H</td> </tr> <tr> <td>For AG23</td> <td>Black</td> <td>AGX010-3B</td> </tr> <tr> <td></td> <td>Gray</td> <td>AGX010-3H</td> </tr> </tbody> </table>		Color	Type	For AG22	Black	AGX010-2B		Gray	AGX010-2H	For AG23	Black	AGX010-3B		Gray	AGX010-3H																														
	Color	Type																																												
For AG22	Black	AGX010-2B																																												
	Gray	AGX010-2H																																												
For AG23	Black	AGX010-3B																																												
	Gray	AGX010-3H																																												
Color insert kit  <p>This kit contains green, red, white, orange and blue color-inserts, legend plates and light baffle plates. See page 04CD/1/8</p>	<table border="1"> <thead> <tr> <th></th> <th>Split</th> <th>Type</th> </tr> </thead> <tbody> <tr> <td>For AG22-L, Z</td> <td>Full face</td> <td>AGX019-2A</td> </tr> <tr> <td></td> <td>2-way split</td> <td>AGX019-2B</td> </tr> <tr> <td>For AG23-L, Z</td> <td>Full face</td> <td>AGX019-3A</td> </tr> <tr> <td></td> <td>2-way split</td> <td>AGX019-3B</td> </tr> <tr> <td></td> <td>3-way split</td> <td>AGX019-3C</td> </tr> <tr> <td></td> <td>4-way split</td> <td>AGX019-3E</td> </tr> <tr> <td></td> <td>4-way split</td> <td>AGX019-3F</td> </tr> </tbody> </table>		Split	Type	For AG22-L, Z	Full face	AGX019-2A		2-way split	AGX019-2B	For AG23-L, Z	Full face	AGX019-3A		2-way split	AGX019-3B		3-way split	AGX019-3C		4-way split	AGX019-3E		4-way split	AGX019-3F																					
	Split	Type																																												
For AG22-L, Z	Full face	AGX019-2A																																												
	2-way split	AGX019-2B																																												
For AG23-L, Z	Full face	AGX019-3A																																												
	2-way split	AGX019-3B																																												
	3-way split	AGX019-3C																																												
	4-way split	AGX019-3E																																												
	4-way split	AGX019-3F																																												
Legend plate  <small>SM-355</small>	<table border="1"> <thead> <tr> <th></th> <th>Color</th> <th>Type</th> </tr> </thead> <tbody> <tr> <td>For AG22-L, Z</td> <td>Clear*</td> <td>AGX009-2C</td> </tr> <tr> <td></td> <td>White</td> <td>AGX009-2W</td> </tr> <tr> <td>For AG23-L, Z</td> <td>Clear*</td> <td>AGX009-3C</td> </tr> <tr> <td></td> <td>White</td> <td>AGX009-3W</td> </tr> </tbody> </table> <p>*:Standard Dimension (mm) • 15sq.×1 (AGX009-2) • 15×23×1 (AGX009-3)</p>		Color	Type	For AG22-L, Z	Clear*	AGX009-2C		White	AGX009-2W	For AG23-L, Z	Clear*	AGX009-3C		White	AGX009-3W																														
	Color	Type																																												
For AG22-L, Z	Clear*	AGX009-2C																																												
	White	AGX009-2W																																												
For AG23-L, Z	Clear*	AGX009-3C																																												
	White	AGX009-3W																																												
Dust-tight cover  <small>SM-1528</small>	<table border="1"> <thead> <tr> <th>Type</th> <th>Used with</th> </tr> </thead> <tbody> <tr> <td>AGX011-3</td> <td>AG23-L</td> </tr> <tr> <td>AGX011-2</td> <td>AG22-L</td> </tr> </tbody> </table>	Type	Used with	AGX011-3	AG23-L	AGX011-2	AG22-L																																							
Type	Used with																																													
AGX011-3	AG23-L																																													
AGX011-2	AG22-L																																													

Description	Type															
Protection cover  <small>SM-375</small>	<table border="1"> <thead> <tr> <th></th> <th>Type</th> </tr> </thead> <tbody> <tr> <td>For AG22-L</td> <td>AGX007-2</td> </tr> <tr> <td>For AG23-L</td> <td>AGX007-3</td> </tr> <tr> <td></td> <td>AGX007-3T</td> </tr> </tbody> </table> <p>(vertical mounting) The cover protects against accidental operation. The cover lid is returned home with a spring force.</p> <p>Dimensions (mm)</p> 		Type	For AG22-L	AGX007-2	For AG23-L	AGX007-3		AGX007-3T							
	Type															
For AG22-L	AGX007-2															
For AG23-L	AGX007-3															
	AGX007-3T															
Panel plug  <small>SM-338</small>	<table border="1"> <thead> <tr> <th></th> <th>Color</th> <th>Type</th> </tr> </thead> <tbody> <tr> <td>For AG22</td> <td>Black</td> <td>AGX006-2B</td> </tr> <tr> <td></td> <td>Gray</td> <td>AGX006-2H</td> </tr> <tr> <td>For AG23</td> <td>Black</td> <td>AGX006-3B</td> </tr> <tr> <td></td> <td>Gray</td> <td>AGX006-3H</td> </tr> </tbody> </table>		Color	Type	For AG22	Black	AGX006-2B		Gray	AGX006-2H	For AG23	Black	AGX006-3B		Gray	AGX006-3H
	Color	Type														
For AG22	Black	AGX006-2B														
	Gray	AGX006-2H														
For AG23	Black	AGX006-3B														
	Gray	AGX006-3H														
Contact block  <small>KKD06-305</small>	<p>AGX001</p> <p>Soldering/Tab use</p>															
Dummy unit 	<p>AGX002</p> <p>The dummy unit installs in the part which does not use the contact unit.</p>															

Illuminated Switches/Pilot Lights

AG22 and AG23

Accessories

Description	Type			
Lens For AG23-HL  SP-124	Type		Color	Split
	Incandescent, Flat LED	Spot LED		
	AGX034-R	AGX038-R	Red	Two-way split
	AGX034-G	AGX038-G	Green	
	AGX034-W	AGX038-W	White	
	AGX034-Y	AGX038-Y	Yellow	
	AGX034-S^{*1}	—	Blue	
	AGX034-O	AGX038-O	Orange	
AGX034-B^{*2}	—	Black		
^{*1} Used with the incandescent lamp only ^{*2} Used with non illuminated side of spot LED(1-lamp types)				

Description	Type			
Lens For AG23-RL   SP-123	Type		Color	Split
	Incandescent, Flat LED	Spot LED		
	AGX032-R	—	Red	Full face
	AGX032-G	—	Green	
	AGX032-W	—	White	
	AGX032-Y	—	Yellow	
	AGX032-S^{*1}	—	Blue	
	AGX032-O	—	Orange	
	AGX033-R	AGX037-R	Red	Two-split
	AGX033-G	AGX037-G	Green	
	AGX033-W	AGX037-W	White	
	AGX033-Y	AGX037-Y	Yellow	
	AGX033-S^{*1}	—	Blue	
	AGX033-O	AGX037-O	Orange	
	AGX033-B^{*2}	—	Black	
^{*1} Used with the incandescent lamp only ^{*2} Used with non illuminated side of spot LED(1-lamp types)				

Description	Type
Legend plate For AG23-HL  SP-115	AGX036-W Dimension (mm) 8.5×16.5×2

Description	Type
Legend plate For AG23-RL  SP-116	AGX035-W Dimension (mm) 9.5×16×8.5

Description	Type
Remover  SM-334, 335	For contact unit AGX012 For body AGX013

Description	Type
Remover  SP-1142	AGX039 This tool is used to remove the indicator of illuminated pushbutton or pilot light.

Description	Type
Lamp changer For AG23-HL, RL  AF02-117	Type: AHX672 If the switch is fitted with a lamp, use this tool to remove the lamp. The tool is unnecessary when installing a lamp.

Incandescent lamp	Voltage	Type
	6V, 0.6W 14V, 0.7W 18V, 0.7W 28V, 0.7W	AHX641 AHX642 AHX612 AHX643

Socket AGX005	Terminal	Type	Contact arrangement	Used with
	 AF02-129	Solder/tab	AGX005-S	1a1b
Wire wrap		AGX005-W	2a2b	
PC board		AGX005-P		AG23
Solder/tab		AGX004-2S	1a1b	
Wire wrap		AGX004-2W	2a2b	
PC board		AGX004-2P		
Solder/tab	AGX004-4S	3a3b		
Wire wrap	AGX004-4W	4a4b		
PC board	AGX004-4P			

AGX004			
For wiring to wire-wrap pin terminals, select appropriate wire sizes and tool from the table below.			
Wire size	Bit	Sleeve	Number of effective wraps
0.4mm dia.	3-A	1-B	About 8
0.5mm dia.	1-A	2-B	About 6
(0.65mm dia.)	(2-A)	(2-B)	(About 6)

Use ordinary wrapping for connection. Wires of 0.65mm dia. must not be used on adjacent terminals. However, 0.65mm dia. wire can be mixed with 0.4mm and 0.5mm dia. wires.

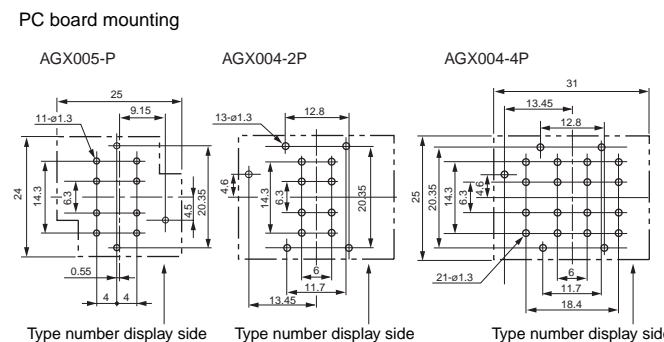
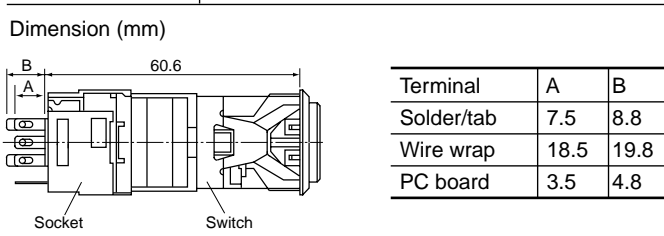

Illuminated Switches/Pilot Lights
AG22 and AG23
Mass

■ Mass, gram

Lamp type	Illuminated pushbuttons	1NO	2NO	3NO	4NO	Pilot lights		Illuminated rocker and lever switches		1NO	2NO	3NO	4NO
		+ 1NC	+ 2NC	+ 3NC	+ 4NC					+ 1NC	+ 2NC	+ 3NC	+ 4NC
Incandescent lamp	AG22-LA, L5A	21.5	22.5	–	–	AG22-ZA	18.5	AG23-RL-1	26	27	28	29	
	B, L5B	22.5	23.5	–	–	B	19.3	AG23-RL-2	28	29	30	31	
	AG23-LA, L5A	27	28	29	30	AG23-ZA	23.5	AG23-HL-1	26	27	28	29	
	B, L5B	29.2	30.2	31.2	32.2	B	25.7	AG23-HL-2	28	29	30	31	
	C, L5C	29.2	30.2	31.2	32.2	C	25.7						
	D, L5D	29.4	30.4	31.4	32.4	D	25.9						
	E, L5E	29.4	30.4	31.4	32.4	E	25.9						
F, L5F	29.5	30.5	31.5	32.5	F	26							
LED lamp	*1AG22-LA, L5A	21.8	22.8	–	–	*2AG22-ZA	19	AG23-RL-2-1	25	26	27	28	
	B, L5B	22.2	23.2	–	–	B	19	AG23-RL-2-2	27.5	28.5	29.5	30.5	
	*2AG23-LA, L5A	27.5	28.5	29.5	30.5	*2AG23-ZA	24	AG23-RL-3-1	25.5	27.2	27.5	28.5	
	B, L5B	28	29	30	31	B	24.5	AG23-RL-3-2	28	29	30	31	
	C, L5C	28	29	30	31	C	24.5	AG23-HL-2-1	25	26	27	28	
	D, L5D	28.2	29.2	30.2	31.2	D	24.7	AG23-HL-2-2	27.5	28.5	29.5	30.5	
	E, L5E	28.2	29.2	30.2	31.2	E	24.7	AG23-HL-3-1	25.5	26.5	27.5	28.5	
F, L5F	28.3	29.3	30.3	31.3	F	24.8	AG23-HL-3-2	28	29	30	31		

L5: Alternate action

*1 Combined indicators and contact unit.

*2 Combined indicators and sockets.

Pushbuttons/Selectors/Pilot Lights AM22 and DM22 General information

The full range of the contact blocks and transformer units suitable for the AR22 and DR22 series may also be fitted to the AM22 and DM22 series.

■ Features

Quick-replacement contact blocks and transformer units

The snap-on construction makes replacement and addition of contact blocks and transformer units very simple and straightforward.

Oil-and dust-proof operator module construction

The protection level of the AM22/DM22 operator modules conforms to IEC Standard IP65. The special seals protect the operator modules and switch mechanisms against oil, dust, and grime, thus ensuring high performance in dusty and moist environments.

Miniaturization

- Pushbutton and selector switches with 1NO+1NC: 40mm deep
Pilot lights: 35mm deep
- The transformer now occupies far less space.

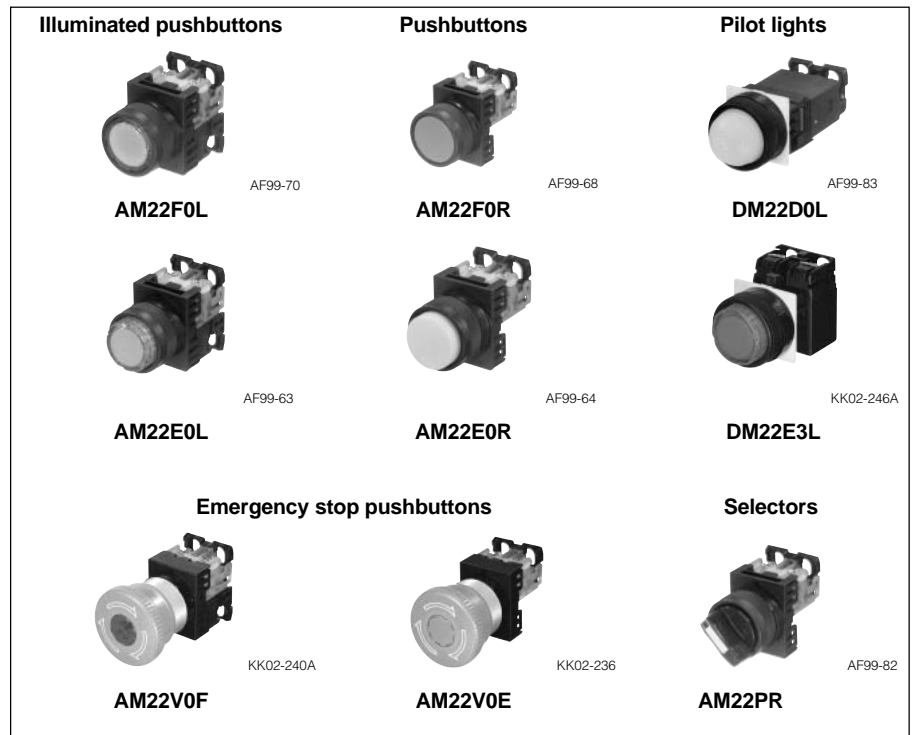
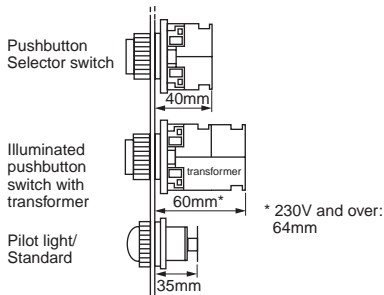

Self-cleaning contacts

All the contacts are double break type and feature self-cleaning action. Every time the switch is operated, the contact surfaces are wiped with a sliding movement, thus ensuring high contact reliability even at low voltage and small current levels (5V, 5mA).

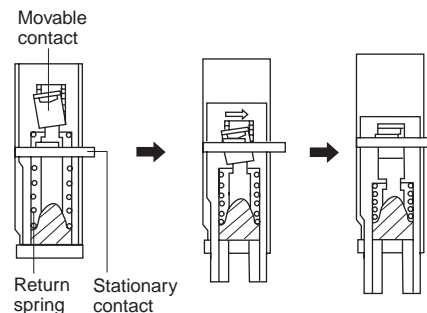

Metal nut

Safer model with metal nut is also available



Wiring

- Wiring from two directions is possible.
- Wiring in both vertical and lateral directions facilitates wiring in narrow spaces.
- Color coding of contact blocks makes wiring easy.
1NO: Blue, 1NC: Red
Lamp terminal and transformer unit: Black

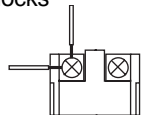

Safety

- A terminal cover is provided, assuring safety and security.
- FUJI's original Trigger Action mechanism is used in the emergency stop pushbuttons. They are suitable for emergency stop and safety. This mechanism prevents the contacts from moving until the button is pushed and locked.

Protection

- Excellent oil-tight construction (IP65) of the operator.
- Closure of the contact block has been improved.

■ Approvals















For further information related to approved type, see page 04CD/2/2 to 04CD/2/3.

Pushbuttons/Selectors/Pilot Lights







AM22 and DM22

Quick reference guide







■ Illuminated pushbutton switches

Operator	Type	Operator	Type	Operator	Type
Flush round head <i>See page 04CD/2/13, 04CD/2/29</i> 	AM22F0L, F5L  AF99-70	Mushroom head (40mm dia.) <i>See page 04CD/2/13, 04CD/2/29</i> 	AM22M0L, M5L  AF99-59	Extended with transparent full guard <i>See page 04CD/2/14, 04CD/2/29</i> 	AM22G4L, G9L  AF99-66
Extended round head <i>See page 04CD/2/13, 04CD/2/29</i> 	AM22E0L, E5L  AF99-63	Mushroom head (29mm dia.) <i>See page 04CD/2/13, 04CD/2/29</i> 	AM22M4L, M9L  AF99-61	Extended with full guard (With openings) <i>See page 04CD/2/14, 04CD/2/29</i> 	AM22G2L, G7L  AF99-69

■ Pushbutton switches

Operator	Type	Operator	Type	Operator	Type
Flush round head <i>See page 04CD/2/15, 04CD/2/30</i> 	AM22F0R, F5R  AF99-68	Mushroom head (40mm dia.) <i>See page 04CD/2/15, 04CD/2/30</i> 	AM22M0R, M5R  AF99-58	Extended with full guard (24mm dia.) <i>See page 04CD/2/15, 04CD/2/30</i> 	AM22G3R, G8R  AF99-65
Extended round head <i>See page 04CD/2/15, 04CD/2/30</i> 	AM22E0R, E5R  AF99-64	Mushroom head (29mm dia.) <i>See page 04CD/2/15, 04CD/2/30</i> 	AM22M4R  AF99-67	Mushroom head with full guard (40mm dia.) <i>See page 04CD/2/15, 04CD/2/30</i> 	AM22M3R, M8R  AF99-89

■ Emergency stop pushbutton switches (conform to EN418)

Operator	Type	Operator	Type	Operator	Type
Push-lock, turn-reset (40mm dia. with white arrow) <i>See page 04CD/2/16, 04CD/2/31</i> 	AM22V0E  KK02-236A	Push-lock, turn-reset (29mm dia. with white arrow) <i>See page 04CD/2/16, 04CD/2/31</i> 	AM22V5E  KK02-237A	Push-lock, turn-reset (40mm dia. with mechanical indicator) <i>See page 04CD/2/16, 04CD/2/31</i> 	AW22VME  KKD07-091







Note  : See page 04CD/2/50

Pushbuttons/Selectors/Pilot Lights

AM22 and DM22







Quick reference guide

■ Emergency stop illuminated pushbutton switches (conform to EN418)



Operator	Type	Operator	Type	Operator	Type
Push-lock, turn-reset (40mm dia. with white arrow)	AM22V0F	Push-lock, turn-reset (29mm dia. with white arrow)	AM22VSF	Push-lock, turn-reset (40mm dia. transparent in all colors with white arrow)	AM22VDF
<i>See page 04CD/2/17, 04CD/2/32</i>	 KK02-339A	<i>See page 04CD/2/17, 04CD/2/32</i>	 KK02-241A	<i>See page 04CD/2/17, 04CD/2/32</i>	 KK02-243A
					

Note: Provided with the  (Direct opening action)







■ Selector switches

Operator	Type	Operator	Type	Operator	Type
Knob	AM22PR, PCR	Lever	AM22WR, WCR	Key	AM22JR, JCR
<i>See page 04CD/2/18, 04CD/2/33</i>	 AF99-82	<i>See page 04CD/2/18, 04CD/2/33</i>	 AF99-76	<i>See page 04CD/2/18, 04CD/2/33</i>	 KKD09-014
					

■ Illuminated selector

Operator	Type
Knob	AM22PL
<i>See page 04CD/2/25, 04CD/2/34</i>	 AF99-79
	

■ Pilot lights

Operator	Type	Operator	Type	Operator	Type
Dome	DM22D0L	Extended round	DM22E3L	Faceted	DM22K0L
<i>See page 04CD/2/27, 04CD/2/34</i>	 AF99-88	<i>See page 04CD/2/27, 04CD/2/35</i>	 AF99-85	<i>See page 04CD/2/27, 04CD/2/35</i>	 AF99-87
					

Notes: With resistor unit type: Not approved standard

 : See page 04CD/2/50

Pushbuttons/Selectors/Pilot Lights

AM22 and DM22

Type number nomenclature

Illuminated pushbuttons

AM22 E0L – 10 E3 R □

① ② ③ ④ ⑤ ⑥

① Product category

AM22: 22mm-dia. illuminated pushbutton
22mm-dia. emergency stop illuminated pushbutton

② Operator

- Illuminated pushbutton

F0L: Flush round head
F5L: Flush round head (Alternate)
E0L: Extended round head
E5L: Extended round head (Alternate)
M0L: Mushroom head (40mm dia.)
M5L: Mushroom head (40mm dia. alternate)
M4L: Mushroom head (29mm dia.)
M9L: Mushroom head (29mm dia. alternate)
G4L: Extended with transparent full guard
G9L: Extended with transparent full guard (Alternate)
G2L: Extended with full guard (With openings)
G7L: Extended with full guard (With openings, alternate)

- Emergency stop illuminated pushbutton

V0F: Push-lock, turn-reset (40mm dia. with white arrow)
VSF: Push-lock, turn-reset (29mm dia. with white arrow)
VDF: Push-lock, turn-reset (40mm dia. transparent in all colors with white arrow)

③ Contact arrangement

10: 1NO	30: 3NO
01: 1NC	03: 3NC
11: 1NO+1NC	33: 3NO+3NC
20: 2NO	40: 4NO
02: 2NC	04: 4NC
22: 2NO+2NC	50: 5NO
	05: 5NC

④ Lamp voltage

- Incandescent lamp *1

54: 5.5V AC/DC, without transformer
C4: 15V AC/DC, without transformer
D4: 20V AC/DC, without transformer
E4: 24V AC/DC, without transformer
H4: 100-110V AC, with transformer
L4: 115-127V AC, with transformer
M4: 200-220V AC, with transformer
Q4: 230-254V AC, with transformer
S4: 350-380V AC, with transformer
T4: 400-440V AC, with transformer
V4: 480V AC, with transformer
W4: 500-550V AC, with transformer- LED lamp

A3: 6V AC, without transformer
63: 6V DC, without transformer *1
B3: 12V AC/DC, without transformer *1
C3: 15V AC/DC, without transformer *1
E3: 24V AC/DC, without transformer
H3: 100-110V AC, with transformer
L3: 115-127V AC, with transformer
M3: 200-220V AC, with transformer
Q3: 230-254V AC, with transformer
S3: 350-380V AC, with transformer
T3: 400-440V AC, with transformer
V3: 480V AC, with transformer
W3: 500-550V AC, with transformer

⑤ Color of lens

G: Green	Y: Yellow
R: Red *2	A: Orange
W: White	S: Blue

⑥ Special product

Z9: Resisting water-soluble cutting oils and heat
Z8: With a contact protection cover
Z4: Resisting sulfuration gas
ZB: Meeting IP2X finger-protection standards
ZM: Metal nut

Notes: *1 Except for emergency stop illuminated pushbutton.

*2 Button color of emergency stop illuminated switches are Red only.

• The manufacturing range varies depending on the model. For details, refer to the contents of this catalog.

Pushbuttons

AM22 E0R – 10 R □

① ② ③ ④ ⑤

① Product category

AM22: 22mm-dia. pushbutton

② Operator

- Pushbutton switch
- F0R: Flush round head
F5R: Flush round head (Alternate)
E0R: Extended round head
E5R: Extended round head (Alternate)
M0R: Mushroom head (40mm dia.)
M5R: Mushroom head (40mm dia. alternate)
M4R: Mushroom head (29mm dia.)
G3R: Extended with full guard (24mm dia.)
G8R: Extended with full guard (24mm dia. alternate)
M3R: Mushroom head with full guard (40mm dia.)
M8R: Mushroom head with full guard (40mm dia. alternate)
- Emergency stop pushbutton switch
- V0E: Push-lock, turn-reset (40mm dia. with white arrow)
V5E: Push-lock, turn-reset (29mm dia. with white arrow)
VME: Push-lock, turn-reset (40mm dia. with mechanical indicator)

③ Contact arrangement

10: 1NO	30: 3NO
01: 1NC	03: 3NC
11: 1NO+1NC	33: 3NO+3NC
20: 2NO	40: 4NO
02: 2NC	04: 4NC
22: 2NO+2NC	44: 4NO+4NC
	50: 5NO
	05: 5NC

④ Color of button

G: Green	Y: Yellow
R: Red*	A: Orange
B: Black	S: Blue
W: White	
T: Green, Red, Black (For AM22F0R)	

⑤ Special product

Z9: Resisting water-soluble cutting oils and heat
Z8: With a contact protection cover
Z4: Resisting sulfuration gas
ZB: Meeting IP2X finger-protection standards
ZM: Metal nut

Notes: * Button color of emergency stop switches are Red only.

- The manufacturing range varies depending on the model. For details, refer to the contents of this catalog.

Pushbuttons/Selectors/Pilot Lights

AM22 and DM22

Type number nomenclature

Selector and illuminated selector switches

AM22 PL – 2 □ 10 E3 G □ □

① ② ③ ④ ⑤ ⑥ ⑦ ⑧ ⑨

① Product category

AM22: 22mm dia. selector switch and illuminated selector switch

② Operator

- Selector switch

PR: Knob

PCR: Knob operated control type

WR: Lever

WCR: Lever operated control type

JR: Key

JCR: Key operated control type

- Illuminated selector switch

PL: Knob

③ Operation

2: 2-position, maintained

0: 2-position, spring return

3: 3-position, maintained

6: 3-position, spring/manual return (Left to center)

7: 3-position, spring/manual return (Right to center)

1: 3-position, spring return

4: 4-position, maintained (For AM22PCR, WCR)

5: 5-position, maintained (For AM22PCR, WCR)

④ Key removable position

A: Left

B: Left and right

C: Left, right and center

D: Right

E: Center

F: Right and center

G: Left and center

⑤ Contact arrangement

10: 1NO 30: 3NO

01: 1NC 03: 3NC

11: 1NO+1NC 33: 3NO+3NC

20: 2NO 40: 4NO

02: 2NC 04: 4NC

22: 2NO+2NC 44: 4NO+4NC

50: 5NO

05: 5NC

Note: Control type: See page 04CD/2/22 to 04CD/2/24

⑥ Lamp voltage

- Incandescent lamp

54: 5.5V AC/DC, without transformer

C4: 15V AC/DC, without transformer

D4: 20V AC/DC, without transformer

E4: 24V AC/DC, without transformer

H4: 100-110V AC, with transformer

L4: 115-127V AC, with transformer

M4: 200-220V AC, with transformer

Q4: 230-254V AC, with transformer

S4: 350-380V AC, with transformer

T4: 400-440V AC, with transformer

V4: 480V AC, with transformer

W4: 500-550V AC, with transformer

- LED lamp

A3: 6V AC, without transformer

63: 6V DC, without transformer

B3: 12V AC/DC, without transformer

C3: 15V AC/DC, without transformer

E3: 24V AC/DC, without transformer

H3: 100-110V AC, with transformer

L3: 115-127V AC, with transformer

M3: 200-220V AC, with transformer

Q3: 230-254V AC, with transformer

S3: 350-380V AC, with transformer

T3: 400-440V AC, with transformer

V3: 480V AC, with transformer

W3: 500-550V AC, with transformer

⑦ Color of knob

B: Black (Not available for illuminated selector switch)

G: Green

R: Red

W: White (Not available for selector switch)

Y: Yellow (Not available for selector switch)

A: Orange (Not available for selector switch)

S: Blue (Not available for selector switch)

⑧ Key type No.

A, B, C, D, E or F

("A" is standard)

⑨ Special product

Z9: Resisting water-soluble cutting oils and heat

Z8: With a contact protection cover

Z4: Resisting sulfuration gas

ZB: Meeting IP2X finger-protection standards

ZM: Metal nut

Notes: •The manufacturing range varies depending on the model. For details, refer to the contents of this catalog.

Pilot lights

DM22 D0L – E3 W □

① ② ③ ④ ⑤

① Product category

DM22: 22mm dia. pilot light

② Lens

D0L: Dome

E3L: Extended round

K0L: Faceted

③ Lamp voltage

• Incandescent lamp

54: 5.5V AC/DC, without transformer

C4: 15V AC/DC, without transformer

D4: 20V AC/DC, without transformer

E4: 24V AC/DC, without transformer

H4: 100-110V AC, with transformer

L4: 115-127V AC, with transformer

M4: 200-220V AC, with transformer

Q4: 230-254V AC, with transformer

S4: 350-380V AC, with transformer

T4: 400-440V AC, with transformer

V4: 480V AC, with transformer

W4: 500-550V AC, with transformer

• LED lamp

A3: 6V AC, without transformer

63: 6V DC, without transformer

B3: 12V AC/DC, without transformer

C3: 15V AC/DC, without transformer

E3: 24V AC/DC, without transformer

H3: 100-110V AC, with transformer

L3: 115-127V AC, with transformer

M3: 200-220V AC, with transformer

Q3: 230-254V AC, with transformer

S3: 350-380V AC, with transformer

T3: 400-440V AC, with transformer

V3: 480V AC, with transformer

W3: 500-550V AC, with transformer

H7: 110V DC, with resistor unit

H8: 100-110V AC/DC, short-body with transformer

L8: 115-127V AC/DC, short-body with transformer

M8: 200-220V AC/DC, short-body with transformer

H9: 100-110V AC, short-body with transformer

L9: 115-127V AC, short-body with transformer

M9: 200-220V AC, short-body with transformer

④ Color of lens

G: Green

Y: Yellow

R: Red

A: Orange

W: White

S: Blue

⑤ Special product

Z9: Resisting water-soluble cutting oils and heat

Z4: Resisting sulfuration gas

ZB: Meeting IP2X finger-protection standards

ZM: Metal nut

Notes: • The manufacturing range varies depending on the model. For details, refer to the contents of this catalog.

Pushbuttons/Selectors/Pilot Lights

AM22 and DM22

Ratings and specifications

■ Standards approved

UL508	File No. E44592
CSA C22.2 No.14	File No. LR20479
TÜV: EN60947-5-1	Pushbutton, Illuminated pushbutton: R9551062 Selector, Illuminated selector: R9551060 Pilot lights: R9551061
TÜV: EN60947-5-1 EN60947-5-5	Emergency stop pushbutton Emergency stop illuminated pushbutton : R50028146

■ Specifications (Indoor use)

Description	Pushbutton switch Illuminated pushbutton switch Emergency stop pushbutton switch Emergency stop illuminated pushbutton switch Selector switch Illuminated selector switch	Pilot light
Rated insulation voltage	600V AC/DC *1	
Mechanical durability	See page 04CD/2/9	
Electrical durability	500,000 operations at 220V AC 6A 1 million operations at 220V AC 3A	
Operating frequency	1200 operations/hour (On-load factor: 40%)	
Dielectric strength	2500V AC, 1 minute *2	
Insulation resistance	100MΩ or more (500V DC megger)	
Rated impulse dielectric strength	6kV	
Conditional short-circuit current	1000A	—
Short-circuit protective device	Fuse 15A	—
Pollution degree	3	
Vibration	Resonance: 10 to 55Hz, double amplitude 0.1mm *3 Constant: 16.7Hz, double amplitude 3mm	
Shock	Malfunction durability: 100m/s ² *4 Mechanical durability: 500m/s ²	Mechanical durability: 500m/s ²
Ambient temperature (No condensation or no icing)	-10 to +70°C, *5 (Illuminated type: -10 to +50°C *6)	-10 to +50°C
Storage temperature	-40 to +80°C	
Humidity	45 to 85% RH (within -5 to +40°C)	
Degree of protection	IP65	

Notes: *1 Illuminated type without transformer: 250V AC/DC

*2 Illuminated type without transformer: 2000V AC, 1 minute

*3 Emergency stop type: 10 to 500Hz, double amplitude 0.7mm (acceleration 50m/s²), according to the test condition of EN60947-5-5 (1997)

*4 Emergency stop type: 150m/s²

*5 AM22V0E, VSE type: -20 to +60°C

*6 AM22V0F, VDF, VSF type: -20 to +50°C

Pushbuttons/Selectors/Pilot Lights
AM22 and DM22
Ratings and specifications

● **Mechanical durability**

Description		Operations
Pushbutton switch	Momentary action	5 million
Illuminated pushbutton switch	Alternate action	1 million
Emergency stop pushbutton switch		300,000
Emergency stop illuminated pushbutton		
Selector switch	Maintained 1, 2, 3, 4-contact	1 million
	Maintained 5, 6, 7, 8-contact	500,000
	Control type, spring return, spring/manual return	200,000
Illuminated selector switch	Maintained	
	Without transformer 1, 2, 3-contact	1 million
	4-contact	500,000
	With transformer 1, 2-contact	1 million
	3-contact	500,000
	Spring return, spring/manual return	200,000

Notes: Key insertion/removal durability for selector switch key types
 • Key type 10,000

Pushbuttons/Selectors/Pilot Lights

AM22 and DM22

Ratings and specifications

■ **Contact ratings**
 ● **UL/CSA standards**
AC (COS ϕ =0.35)

Contact rated code	120V		240V		480V		600V	
	Making current	Breaking current	Making current	Breaking current	Making current	Breaking current	Making current	Breaking current
A600	60A	6.0A	30A	3.0A	15A	1.5A	12A	1.2A

DC $T_{0.95}$ = 6P (Max. 300ms)

Description	Contact rated code	Making current · Breaking current		
		125V	250V	301V–600V
Illuminated pushbutton switch Pushbutton (Except the overlap contact types)	P600	1.1A	0.55A	0.2A
Overlap contact types of products shown above Pushbutton Selector switch (2-position only, except the overlap contact types) Illuminated selector switch (2-position only, except the overlap contact types) Emergency stop pushbutton switch Emergency stop illuminated pushbutton switch	Q600	0.55A	0.27A	0.1A
Selector switch (2-pos./overlap contact type, 3-, 4-, 5-pos. type) Illuminated selector switch (2-pos./overlap contact type, 3-pos. type)	R300	0.22A	0.11A	–

● **EN standard/TÜV approved**

Description	Rated operational current			
	Rated thermal current	Rated operational voltage	AC15 (Ind. load)	DC13 (Ind. load)
			Rated operational current	Rated operational current
Illuminated pushbutton switch Pushbutton Selector switch (2-position) Illuminated selector switch (2-position)	10A	24V	6.0A	4.0A
		120V	6.0A	–
		125V	–	1.3A
		240V	6.0A	–
		250V	–	0.45A
		480V	2.5A	–
		600V	2.0A	–
Selector switch (3, 4, 5-position) Illuminated selector switch (3-position) Emergency stop pushbutton switch Emergency stop illuminated pushbutton switch	10A	24V	6.0A	2.0A
		120V	6.0A	–
		125V	–	0.65A
		240V	6.0A	–
		250V	–	0.23A
		480V	2.5A	–
		600V	2.0A	–

Lamp rated voltage UL/CSA Standards, TÜV approved

	LED lamp	Incandescent lamp
Full-voltage (without transformer)	Max. 24V AC/DC	Max. 30V AC/DC
With transformer	Max. 550V AC (Short-body type: Max. 220V AC)	

Pushbuttons/Selectors/Pilot Lights AM22 and DM22 Ratings and specifications

■ Operating characteristic (1NO+1NC)

Description	Pushbutton Illuminated pushbutton	Emergency stop pushbutton Emergency stop illuminated pushbutton Push-lock type	Selector *		
			Illuminated selector		
Ave. required operating force	9N	22N	Maintained 0.15N•m	Spring/manual return 0.13N•m	Spring return 0.1N•m
Operating travel	Approx. 6mm	Approx. 9mm (Operation angle: Approx. 60°)	2-position: Approx. 90° 3-position: Approx. 45° 4-position: Approx. 40° 5-position: Approx. 30°	3-position: Approx. 45°	2-position: Approx. 60° 3-position: Approx. 45°
Required return force	–	0.25N•m	0.15N•m	0.13N•m	–

Note: * 4-position, 5-position : 2NO+2NC

■ Lamp ratings

● Illuminated pushbuttons, illuminated selectors, pilot lights

Transformer	Lamp voltage	LED (lamp base: BA9S/13)			Incandescent (lamp base: BA9S/13)		
		Type	Rated voltage	Consumption	Type	Rated voltage	Consumption
Without transformer	5.5V AC/DC	–	–	–	AHX135	6.3V AC/DC	0.9W
	6V AC	APX510-6□	6V AC	Green, red, orange, amber, blue: 7mA AC Yellow: 50mA AC	–	–	–
	6V DC	APX510-D6□	6V DC	Green, red, orange, amber, blue: 11mA DC Yellow: 33mA DC	–	–	–
	12V AC/DC	APX510-12□	12V AC/DC	Green, red, orange, amber, blue: 14mA AC, 11mA DC Yellow: 28mA AC, 22mA DC	–	–	–
	15V AC/DC	APX510-15□	15V AC/DC	Green, red, orange, amber, blue: 13mA AC, 11mA DC Yellow: 26mA AC, 22mA DC	AHX279	18V AC/DC	0.8W
	20V AC/DC 24V AC/DC	– APX510-24□	– 24V AC/DC	– 12mA AC, 11mA DC	AHX144 AHX129	24V AC/DC 30V AC/DC	0.9W 0.8W
With transformer (Standard type: AR9T511)	110V AC	APX510-6□	6V AC	1.5VA	AHX135	6.3V AC/DC	2VA
	127V AC						2VA
	220V AC						2VA
	254V AC	APX510-6□	6V AC	2.5VA	AHX135	6.3V AC/DC	2.5VA
	380V AC 440V AC 480V AC 550V AC						2.5VA 2.5VA 2.5VA 2.5VA
With resistor unit (AR9T519-H)	110V DC	APX510-24□	24V AC/DC	1.2W	–	–	–

- Notes:
- Short body pilot lights: 110V AC, 127V AC, 220V AC only
 - Replace the □ mark by the lamp luminous color code, see page 04CD/2/12
 - Except AM22V0F, VDF, VSF type

Pushbuttons/Selectors/Pilot Lights

AM22 and DM22

Ratings and specifications

• Emergency stop illuminated pushbutton switches

Transformer	Lamp voltage	LED		
		Type	Rated voltage	Consumption
Without transformer	6V AC	AR9L001-6R	6V AC	9mA AC
	24V AC/DC	AR9L001-24R	24V AC/DC	15mA AC, 14mA DC
With transformer (Type: AM9T511)	110V AC	AR9L001-6R	6V AC	1.5VA
	127V AC			
	220V AC			
	254V AC			3.0VA
	380V AC			
	440V AC			
480V AC				
550V AC				

■ Lamp durability

Lamp	Durability (reference)	Judgement criterion
LED	Approx. 30000h	When brightness is less than 50% of initial value
Incandescent	Approx. 5000h (AC)	When the bulb burns out

Note: • The operating voltage for incandescent lamps is set at 80 to 90% of the lamp's rated voltage.
• The durability of LED lamp is a mean value in all colors.

Estimated durability for LED lamps

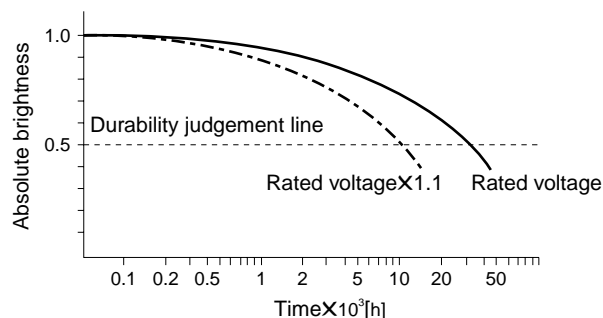

Notes: • Durability at $T_a=25^\circ\text{C}$
• Durability is affected by temperature, humidity, and voltage fluctuation.

Incandescent lamp voltage characteristics

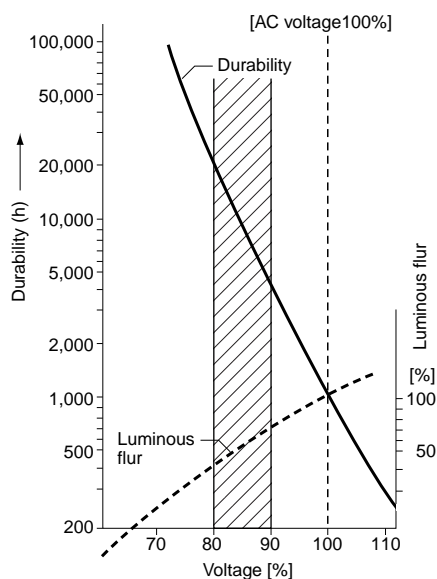





■ Combination of lens color and LED lamp luminous color

Button Color	Code	LED lamp	
		Luminous color	Type
Green	G	Green	APX510-■G
Red	R	Red	APX510-■R
White	W	Orange	APX510-■O
Yellow	Y	Yellow	APX510-■Y
Orange	A	Amber	APX510-■A
Blue	S	Blue	APX510-■S
Red	R	Red	AR9L001-■R

(AM22V0F, VDF, VSF)

Note: Replace the ■ mark by Lamp voltage. See page 04CD/2/11

■ Illuminated pushbutton switches



Operator	Transformer	Contact	LED lamp Momentary action Type	Alternate action Type	Incandescent lamp Momentary action Type	Alternate action Type
Flush round head  AF99-70	Without	1NO 1NC 1NO+1NC 2NO 2NC 2NO+2NC	AM22F0L-10■3□ AM22F0L-01■3□ AM22F0L-11■3□ AM22F0L-20■3□ AM22F0L-02■3□ AM22F0L-22■3□	AM22F5L-10 ■3□ AM22F5L-01 ■3□ AM22F5L-11 ■3□ AM22F5L-20 ■3□ AM22F5L-02 ■3□ —	AM22F0L-10 ■4□ AM22F0L-01 ■4□ AM22F0L-11 ■4□ AM22F0L-20 ■4□ AM22F0L-02 ■4□ AM22F0L-22 ■4□	AM22F5L-10 ■4□ AM22F5L-01 ■4□ AM22F5L-11 ■4□ AM22F5L-20 ■4□ AM22F5L-02 ■4□ —
	With	1NO 1NC 1NO+1NC 2NO 2NC	AM22F0L-10■3□ AM22F0L-01■3□ AM22F0L-11■3□ AM22F0L-20■3□ AM22F0L-02■3□	AM22F5L-10 ■3□ AM22F5L-01 ■3□ AM22F5L-11 ■3□ AM22F5L-20 ■3□ AM22F5L-02 ■3□	AM22F0L-10 ■4□ AM22F0L-01 ■4□ AM22F0L-11 ■4□ AM22F0L-20 ■4□ AM22F0L-02 ■4□	AM22F5L-10 ■4□ AM22F5L-01 ■4□ AM22F5L-11 ■4□ AM22F5L-20 ■4□ AM22F5L-02 ■4□
Extended round head  AF99-63	Without	1NO 1NC 1NO+1NC 2NO 2NC 2NO+2NC	AM22E0L-10■3□ AM22E0L-01■3□ AM22E0L-11■3□ AM22E0L-20■3□ AM22E0L-02■3□ AM22E0L-22■3□	AM22E5L-10 ■3□ AM22E5L-01 ■3□ AM22E5L-11 ■3□ AM22E5L-20 ■3□ AM22E5L-02 ■3□ —	AM22E0L-10 ■4□ AM22E0L-01 ■4□ AM22E0L-11 ■4□ AM22E0L-20 ■4□ AM22E0L-02 ■4□ AM22E0L-22 ■4□	AM22E5L-10 ■4□ AM22E5L-01 ■4□ AM22E5L-11 ■4□ AM22E5L-20 ■4□ AM22E5L-02 ■4□ —
	With	1NO 1NC 1NO+1NC 2NO 2NC	AM22E0L-10■3□ AM22E0L-01■3□ AM22E0L-11■3□ AM22E0L-20■3□ AM22E0L-02■3□	AM22E5L-10 ■3□ AM22E5L-01 ■3□ AM22E5L-11 ■3□ AM22E5L-20 ■3□ AM22E5L-02 ■3□	AM22E0L-10 ■4□ AM22E0L-01 ■4□ AM22E0L-11 ■4□ AM22E0L-20 ■4□ AM22E0L-02 ■4□	AM22E5L-10 ■4□ AM22E5L-01 ■4□ AM22E5L-11 ■4□ AM22E5L-20 ■4□ AM22E5L-02 ■4□
Mushroom head (40mm dia.)  AF99-59	Without	1NO 1NC 1NO+1NC 2NO 2NC 2NO+2NC	AM22M0L-10■3□ AM22M0L-01■3□ AM22M0L-11■3□ AM22M0L-20■3□ AM22M0L-02■3□ AM22M0L-22■3□	AM22M5L-10 ■3□ AM22M5L-01 ■3□ AM22M5L-11 ■3□ AM22M5L-20 ■3□ AM22M5L-02 ■3□ —	AM22M0L-10 ■4□ AM22M0L-01 ■4□ AM22M0L-11 ■4□ AM22M0L-20 ■4□ AM22M0L-02 ■4□ AM22M0L-22 ■4□	AM22M5L-10 ■4□ AM22M5L-01 ■4□ AM22M5L-11 ■4□ AM22M5L-20 ■4□ AM22M5L-02 ■4□ —
	With	1NO 1NC 1NO+1NC 2NO 2NC	AM22M0L-10■3□ AM22M0L-01■3□ AM22M0L-11■3□ AM22M0L-20■3□ AM22M0L-02■3□	AM22M5L-10 ■3□ AM22M5L-01 ■3□ AM22M5L-11 ■3□ AM22M5L-20 ■3□ AM22M5L-02 ■3□	AM22M0L-10 ■4□ AM22M0L-01 ■4□ AM22M0L-11 ■4□ AM22M0L-20 ■4□ AM22M0L-02 ■4□	AM22M5L-10 ■4□ AM22M5L-01 ■4□ AM22M5L-11 ■4□ AM22M5L-20 ■4□ AM22M5L-02 ■4□
Mushroom head (29mm dia.)  AF99-61	Without	1NO 1NC 1NO+1NC 2NO 2NC 2NC+2NC	AM22M4L-10■3□ AM22M4L-01■3□ AM22M4L-11■3□ AM22M4L-20■3□ AM22M4L-02■3□ AM22M4L-22■3□	AM22M9L-10 ■3□ AM22M9L-01 ■3□ AM22M9L-11 ■3□ AM22M9L-20 ■3□ AM22M9L-02 ■3□ —	AM22M4L-10 ■4□ AM22M4L-01 ■4□ AM22M4L-11 ■4□ AM22M4L-20 ■4□ AM22M4L-02 ■4□ AM22M4L-22 ■4□	AM22M9L-10 ■4□ AM22M9L-01 ■4□ AM22M9L-11 ■4□ AM22M9L-20 ■4□ AM22M9L-02 ■4□ —
	With	1NO 1NC 1NO+1NC 2NO 2NC	AM22M4L-10■3□ AM22M4L-01■3□ AM22M4L-11■3□ AM22M4L-20■3□ AM22M4L-02■3□	AM22M9L-10 ■3□ AM22M9L-01 ■3□ AM22M9L-11 ■3□ AM22M9L-20 ■3□ AM22M9L-02 ■3□	AM22M4L-10 ■4□ AM22M4L-01 ■4□ AM22M4L-11 ■4□ AM22M4L-20 ■4□ AM22M4L-02 ■4□	AM22M9L-10 ■4□ AM22M9L-01 ■4□ AM22M9L-11 ■4□ AM22M9L-20 ■4□ AM22M9L-02 ■4□

Note: ■ □ See page 04CD/2/14

Illuminated Pushbuttons

AM22

■ Illuminated pushbutton switches

Operator	Trans- former	Contact	LED lamp		Incandescent lamp	
			Momentary action Type	Alternate action Type	Momentary action Type	Alternate action Type
Extended with transparent full guard (24mm dia.)  AF99-66	Without	1NO	AM22G4L-10■ 3□	AM22G9L-10■ 3□	AM22G4L-10■ 4□	AM22G9L-10■ 4□
		1NC	AM22G4L-01■ 3□	AM22G9L-01■ 3□	AM22G4L-01■ 4□	AM22G9L-01■ 4□
		1NO+1NC	AM22G4L-11■ 3□	AM22G9L-11■ 3□	AM22G4L-11■ 4□	AM22G9L-11■ 4□
		2NO	AM22G4L-20■ 3□	AM22G9L-20■ 3□	AM22G4L-20■ 4□	AM22G9L-20■ 4□
		2NC	AM22G4L-02■ 3□	AM22G9L-02■ 3□	AM22G4L-02■ 4□	AM22G9L-02■ 4□
		2NO+2NC	AM22G4L-22■ 3□	—	AM22G4L-22■ 4□	—
	With	1NO	AM22G4L-10■ 3□	AM22G9L-10■ 3□	AM22G4L-10■ 4□	AM22G9L-10■ 4□
		1NC	AM22G4L-01■ 3□	AM22G9L-01■ 3□	AM22G4L-01■ 4□	AM22G9L-01■ 4□
		1NO+1NC	AM22G4L-11■ 3□	AM22G9L-11■ 3□	AM22G4L-11■ 4□	AM22G9L-11■ 4□
		2NO	AM22G4L-20■ 3□	AM22G9L-20■ 3□	AM22G4L-20■ 4□	AM22G9L-20■ 4□
		2NC	AM22G4L-02■ 3□	AM22G9L-02■ 3□	AM22G4L-02■ 4□	AM22G9L-02■ 4□
		2NO+2NC	AM22G4L-22■ 3□	—	AM22G4L-22■ 4□	—
Extended with full guard (24mm dia. with openings)  AF99-69	Without	1NO	AM22G2L-10■ 3□	AM22G7L-10■ 3□	AM22G2L-10■ 4□	AM22G7L-10■ 4□
		1NC	AM22G2L-01■ 3□	AM22G7L-01■ 3□	AM22G2L-01■ 4□	AM22G7L-01■ 4□
		1NO+1NC	AM22G2L-11■ 3□	AM22G7L-11■ 3□	AM22G2L-11■ 4□	AM22G7L-11■ 4□
		2NO	AM22G2L-20■ 3□	AM22G7L-20■ 3□	AM22G2L-20■ 4□	AM22G7L-20■ 4□
		2NC	AM22G2L-02■ 3□	AM22G7L-02■ 3□	AM22G2L-02■ 4□	AM22G7L-02■ 4□
		2NO+2NC	AM22G2L-22■ 3□	—	AM22G2L-22■ 4□	—
	With	1NO	AM22G2L-10■ 3□	AM22G7L-10■ 3□	AM22G2L-10■ 4□	AM22G7L-10■ 4□
		1NC	AM22G2L-01■ 3□	AM22G7L-01■ 3□	AM22G2L-01■ 4□	AM22G7L-01■ 4□
		1NO+1NC	AM22G2L-11■ 3□	AM22G7L-11■ 3□	AM22G2L-11■ 4□	AM22G7L-11■ 4□
		2NO	AM22G2L-20■ 3□	AM22G7L-20■ 3□	AM22G2L-20■ 4□	AM22G7L-20■ 4□
		2NC	AM22G2L-02■ 3□	AM22G7L-02■ 3□	AM22G2L-02■ 4□	AM22G7L-02■ 4□
		2NO+2NC	AM22G2L-22■ 3□	—	AM22G2L-22■ 4□	—

● Lens color

Replace the □ mark by the lens color code

Color	Green	Red	White	Blue	Yellow	Orange
Code	G	R	W	S	Y	A

● Contact arrangements

Contact arrangements other than above are available

Contact arrangement	1NO	1NC	1NO+1NC	2NO	2NC	3NO
Code	10	01	11	20	02	30

Contact arrangement	3NC	2NO+2NC	4NO	4NC	5NO	5NC	3NO+3NC
Code	03	22	40	04	50	05	33

Available numbers of contact blocks



Operation	Without transformer	With transformer
Momentary action	6-contact block	4-contact block
Alternate action	3-contact block	2-contact block



● Voltage

Replace the ■ mark by the lamp voltage code

Transformer		Code	
		LED	Incandescent
Without transformer	6V DC	6	—
	6V AC	A	—
	5.5V AC/DC	—	5
	12V AC/DC	B	—
	15V AC/DC	C	C
	20V AC/DC 24V AC/DC	— E	D E
With transformer	100-110V AC	H	H
	115-127V AC	L	L
	200-220V AC	M	M
	230-254V AC	Q	Q
	350-380V AC	S	S
	400-440V AC	T	T
	480V AC	V	V
500-550V AC	W	W	

■ Pushbutton switches

Operator	Contact	Momentary action Type	Alternate action Type
Flush round head  AF99-68	1NO 1NC 1NO+1NC 2NO 2NC 2NO+2NC	AM22F0R-10 □ AM22F0R-01 □ AM22F0R-11 □ AM22F0R-20 □ AM22F0R-02 □ AM22F0R-22 □	AM22F5R-10 □ AM22F5R-01 □ AM22F5R-11 □ AM22F5R-20 □ AM22F5R-02 □ AM22F5R-22 □
Extended round head  AF99-64	1NO 1NC 1NO+1NC 2NO 2NC 2NO+2NC	AM22E0R-10 □ AM22E0R-01 □ AM22E0R-11 □ AM22E0R-20 □ AM22E0R-02 □ AM22E0R-22 □	AM22E5R-10 □ AM22E5R-01 □ AM22E5R-11 □ AM22E5R-20 □ AM22E5R-02 □ AM22E5R-22 □
Mushroom head (40mm dia.)  AF99-58	1NO 1NC 1NO+1NC 2NO 2NC 2NO+2NC	AM22M0R-10 □ AM22M0R-01 □ AM22M0R-11 □ AM22M0R-20 □ AM22M0R-02 □ AM22M0R-22 □	AM22M5R-10 □ AM22M5R-01 □ AM22M5R-11 □ AM22M5R-20 □ AM22M5R-02 □ AM22M5R-22 □

Operator	Contact	Momentary action Type	Alternate action Type
Mushroom head (29mm dia.)  AF99-67	1NO 1NC 1NO+1NC 2NO 2NC 2NO+2NC	AM22M4R-10 □ AM22M4R-01 □ AM22M4R-11 □ AM22M4R-20 □ AM22M4R-02 □ AM22M4R-22 □	— — — — — —
Extended with full guard (24mm dia.)  AF99-65	1NO 1NC 1NO+1NC 2NO 2NC 2NO+2NC	AM22G3R-10 □ AM22G3R-01 □ AM22G3R-11 □ AM22G3R-20 □ AM22G3R-02 □ AM22G3R-22 □	AM22G8R-10 □ AM22G8R-01 □ AM22G8R-11 □ AM22G8R-20 □ AM22G8R-02 □ AM22G8R-22 □
Mushroom head with full guard (40mm dia.)  AF99-89	1NO 1NC 1NO+1NC 2NO 2NC 2NO+2NC	AM22M3R-10 □ AM22M3R-01 □ AM22M3R-11 □ AM22M3R-20 □ AM22M3R-02 □ AM22M3R-22 □	AM22M8R-10 □ AM22M8R-01 □ AM22M8R-11 □ AM22M8R-20 □ AM22M8R-02 □ AM22M8R-22 □

● Button color

Replace the □ mark by the button color code

Color	Green	Red	White	Blue	Yellow	Orange	Black
Code	G	R	W	S	Y	A	B

● Available numbers of contact blocks

Momentary action	Alternate action
8-contact block	4-contact block

● Contact arrangements

Contact arrangements other than above are available

Contact arrangement	1NO	1NC	1NO+1NC	2NO	2NC	3NO	3NC
Code	10	01	11	20	02	30	03



Contact arrangement	2NO+2NC	4NO	4NC	5NO	5NC	3NO+3NC	4NO+4NC
Code	22	40	04	50	05	33	44

Emergency stop pushbuttons

AM22

■ Emergency stop pushbutton switches



☞ (Direct opening action), conform to EN418

Operator	Contact	T y p e
Push-lock, turn-reset (40mm dia. with white arrow)  <small>KK02-236A</small>	1NC 1NO+1NC 2NC 3NC 2NO+2NC 4NC	AM22V0E-01R AM22V0E-11R AM22V0E-02R AM22V0E-03R AM22V0E-22R AM22V0E-04R
Push-lock, turn-reset (29mm dia. with white arrow)  <small>KK02-237A</small>	1NC 1NO+1NC 2NC 3NC 2NO+2NC 4NC	AM22VSE-01R AM22VSE-11R AM22VSE-02R AM22VSE-03R AM22VSE-22R AM22VSE-04R
Push-lock, turn-reset (40mm dia. with mechanical indicator)  <small>KKD07-091</small>	1NC 1NO+1NC 2NC 3NC 2NO+2NC 4NC	AM22VME-01R AM22VME-11R AM22VME-02R AM22VME-03R AM22VME-22R AM22VME-04R

- Notes:
- Button color: Red only
 - Used with AR9B290-S for NO contact.
 - Contact arrangements indicated in the table can be supplied.

■ **Emergency stop illuminated pushbutton switches**

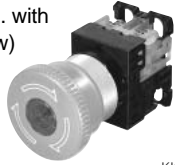
⇒ (Direct opening action), conform to EN418

Operator	Transformer	Contact	LED lamp Type
Push-lock, turn-reset (40mm dia. with white arrow)  <small>KK02-240A</small>	Without	1NC 1NO+1NC 2NC 3NC	AM22V0F-01 ■ 3R AM22V0F-11 ■ 3R AM22V0F-02 ■ 3R AM22V0F-03 ■ 3R
	With	1NC 1NO+1NC 2NC	AM22V0F-01 ■ 3R AM22V0F-11 ■ 3R AM22V0F-02 ■ 3R
Push-lock, turn-reset (29mm dia. with white arrow)  <small>KK02-241A</small>	Without	1NC 1NO+1NC 2NC 3NC	AM22VSF-01 ■ 3R AM22VSF-11 ■ 3R AM22VSF-02 ■ 3R AM22VSF-03 ■ 3R
	With	1NC 1NO+1NC 2NC	AM22VSF-01 ■ 3R AM22VSF-11 ■ 3R AM22VSF-02 ■ 3R
Push-lock, turn-reset (40mm dia. transparent in all colors with white arrow)  <small>KK02-243A</small>	Without	1NC 1NO+1NC 2NC 3NC	AM22VDF-01 ■ 3R AM22VDF-11 ■ 3R AM22VDF-02 ■ 3R AM22VDF-03 ■ 3R
	With	1NC 1NO+1NC 2NC	AM22VDF-01 ■ 3R AM22VDF-11 ■ 3R AM22VDF-02 ■ 3R

- Notes:
- Button color: Red only
 - Contact arrangements indicated in the table can be supplied.
 - Used with AR9B290-S for NO contact.

● **Voltage**







Replace the ■ mark by the lamp voltage code

Transformer		Code LED
Without	6V AC	A
	24V AC/DC	E

Transformer		Code LED
With	100–110V AC	H
	115–127V AC	L
	200–220V AC	M
	230–254V AC	Q
	350–380V AC	S
	400–440V AC	T
	480V AC	V
	500–550V AC	W

Selector Switches AM22



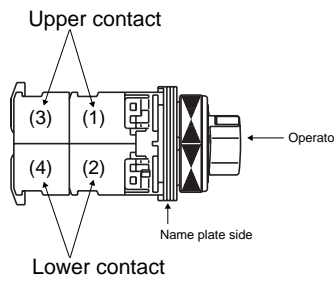







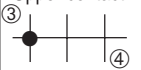



■ Selector switches 2-position

Operator	Operation	Knob color or key removable position	Contact	Type Switch with round bezel	Contact operation (Example)		
					Contact arrangement	Operator position	
						Left	Right
Knob  AF99-82	Maintained each 90°	B: Black (Standard) Color other than above are available (G: Green) (R: Red)	1NO 1NC 1NO+1NC 2NO 2NC 2NO+2NC	AM22PR-210B AM22PR-201B AM22PR-211B AM22PR-020B AM22PR-202B AM22PR-222B	1NO (1)	Upper contact ③ — — ● — ④	
	Spring return  60°		1NO 1NC 1NO+1NC 2NO 2NC 2NO+2NC	AM22PR-010B AM22PR-001B AM22PR-011B AM22PR-020B AM22PR-002B AM22PR-022B	1NC (1)	Upper contact ① — ● — — ②	
Lever  AF99-76	Maintained each 90°		1NO 1NC 1NO+1NC 2NO 2NC 2NO+2NC	AM22WR-210B AM22WR-201B AM22WR-211B AM22WR-220B AM22WR-202B AM22WR-222B	1NO+1NC (1)	Upper contact ③ — — ● — ④	
	Spring return  60°		1NO 1NC 1NO+1NC 2NO 2NC 2NO+2NC	AM22WR-010B AM22WR-001B AM22WR-011B AM22WR-020B AM22WR-002B AM22WR-022B	(2)	Lower contact ① — ● — — ②	
Key  KKD09-014	Maintained each 90°	■: Key removable position (): Key type <i>See page 04CD/2/20</i>	1NO 1NC 1NO+1NC 2NO 2NC 2NO+2NC	AM22JR-2■10() AM22JR-2■01() AM22JR-2■11() AM22JR-2■20() AM22JR-2■02() AM22JR-2■22()	(3)	Upper contact ③ — — ● — ④	
	Spring return  60°		1NO 1NC 1NO+1NC 2NO 2NC 2NO+2NC	AM22JR-0A10() AM22JR-0A01() AM22JR-0A11() AM22JR-0A20() AM22JR-0A02() AM22JR-0A22()	(2)	Lower contact ① — ● — — ②	
					(4)	① — ● — — ②	
							

Notes: • (1) to (4): Contact block mounting position
 • ① – ②, ③ – ④: Contact block terminal No.
 • Contact arrangements: *See page 04CD/2/20*

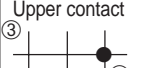
● Contact closed



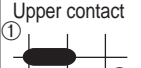







3-position

Operator	Operation	Knob color	Contact	Type Switch with round bezel	Contact operation (Example)			
					Contact arrange- ment	Operation position		
						L	C	R
 <p style="text-align: center;">AF99-82</p>	Maintained each 45°	Color code: B: Black (Standard) Color other than above are available (G: Green) (R: Red)	1NO+1NC 2NO 2NC 2NO+2NC	AM22PR-311B AM22PR-320B AM22PR-302B AM22PR-322B	1NO+1NC (1) (2)	Upper contact 	Lower contact 	
	Spring/manual return  each 45°		1NO+1NC 2NO 2NC 2NO+2NC			AM22PR-611B AM22PR-620B AM22PR-602B AM22PR-622B	1NO+1NC (1) (2)	Upper contact 
	Spring/manual return  each 45°		1NO+1NC 2NO 2NC 2NO+2NC	AM22PR-711B AM22PR-720B AM22PR-702B AM22PR-722B	1NO+1NC (1) (2)			Upper contact 
	Spring return  each 45°		2NO+2NC			AM22PR-122B	2NO+2NC (1) (2)	Upper contact 
 <p style="text-align: center;">AF99-76</p>	Maintained each 45°		1NO+1NC 2NO 2NC 2NO+2NC	AM22WR-311B AM22WR-320B AM22WR-302B AM22WR-322B	1NO+1NC (1) (2)			Upper contact 
	Spring/manual return  each 45°		1NO+1NC 2NO 2NC 2NO+2NC			AM22WR-611B AM22WR-620B AM22WR-602B AM22WR-622B	1NO+1NC (1) (2)	Upper contact 
	Spring/manual return  each 45°		1NO+1NC 2NO 2NC 2NO+2NC	AM22WR-711B AM22WR-720B AM22WR-702B AM22WR-722B	1NO+1NC (1) (2)			Upper contact 
	Spring return  each 45°		2NO+2NC			AM22WR-122B	2NO+2NC (1) (2)	Upper contact 

Note: • Contact arrangements: See page 04CD/2/20

● Contact closed

Selector Switches AM22

Operator	Operation	Key removable position	Contact	Type Switch with round bezel	Contact operation (Example)	
					Contact arrangement	Operator position L C R ⊖ ⊕ ⊗
 KKD09-014	Maintained each 45°	■: Key removable position (): Key type	1NO+1NC 2NO 2NC 2NO+2NC	AM22JR-3■11() AM22JR-3■20() AM22JR-3■02() AM22JR-3■22()	1NO+1NC (1) (2)	Upper contact  Lower contact 
	Spring/manual return ⊕ each 45°		1NO+1NC 2NO 2NC 2NO+2NC	AM22JR-6■11() AM22JR-6■20() AM22JR-6■02() AM22JR-6■22()	1NO+1NC (1) (2)	Upper contact  Lower contact 
	Spring/manual return ⊕ each 45°		1NO+1NC 2NO 2NC 2NO+2NC	AM22JR-7■11() AM22JR-7■20() AM22JR-7■02() AM22JR-7■22()	1NO+1NC (1) (2)	Upper contact  Lower contact 
	Spring return ⊖ each 45°		2NO+2NC	AM22JR-1E22()	2NO+2NC (1) (2) (3) (4)	Upper contact  Lower contact   

Notes: • Operator position L: Left, C: Center, R: Right
 • (1) to (4): Contact block mounting position
 • ① - ②, ③ - ④: Contact block terminal No.

● Contact closed

• Contact arrangements

Contact arrangements other than above are available







Contact arrangement	1NO	1NC	1NO+1NC	2NO	2NC	3NO	3NC
Code	10	01	11	20	02	30	03

Contact arrangement	2NO+2NC	4NO	4NC	5NO	5NC	3NO+3NC	4NO+4NC
Code	22	40	04	50	05	33	44

• Available numbers of contact blocks

Maintained	Spring return Spring/manual return
8-contact block	4-contact block

• Key removable positions

Code	A	B	C	D	E	F	G
Removable position							
AM22JR-2	●	●	-	●	-	-	-
AM22JR-0	●	-	-	-	-	-	-
AM22JR-3	●	●	●	●	●	●	●
AM22JR-6	-	-	-	●	●	●	-
AM22JR-7	●	-	-	-	●	-	●
AM22JR-1	-	-	-	-	●	-	-

●: Available -: Not available

• Position of contact block

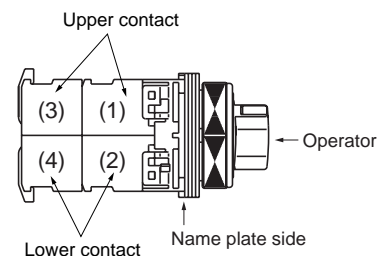













• Key code No.

Replace the () mark with one of the following key code.







A, B, C, D, E and F

Standard key code is A.

■ Selector switches (control type)
3-position

Operator	Operation	Knob color or key removable position	Contact arrangement	Type Switch with round bezel
Knob  <small>KK02-248A</small>	Maintained each 45°	Color code: B: Black (Standard) Color other than above are available (G: Green) (R: Red)	Replace the ■ mark by the contact arrangement code (shown on next page).	AM22PCR-3■B
	Spring/manual return  each 45°			AM22PCR-6■B
	Spring/manual return  each 45°			AM22PCR-7■B
	Spring return  each 45°			AM22PCR-1■B
Lever  <small>KK02-249A</small>	Maintained each 45°		Replace the ■ mark by the contact arrangement code (shown on next page).	AM22WCR-3■B
	Spring/manual return  each 45°			AM22WCR-6■B
	Spring/manual return  each 45°			AM22WCR-7■B
	Spring return  each 45°			AM22WCR-1■B
Key  <small>KKD09-013</small>	Maintained each 45°	Replace the □ mark by the key removable position code: A, B, C, D, E F or G	Replace the ■ mark by the contact arrangement code (shown on next page).	AM22JCR-3□■()
	Spring/manual return  each 45°			AM22JCR-6□■()
	Spring/manual return  each 45°			AM22JCR-7□■()
	Spring return  each 45°			AM22JCR-1E■()

● Key removable positions

Code	A	B	C	D	E	F	G
Removable position							
AM22JCR-3	●	●	●	●	●	●	●
AM22JCR-6	-	-	-	●	●	●	-
AM22JCR-7	●	-	-	-	●	-	●
AM22JCR-1	-	-	-	-	●	-	-

●: Available -: Not available

● Key code No.

Replace the () mark with one of the following key code.
A, B, C, D, E and F
Standard key code is A.

Selector Switches AM22

• Contact arrangement code (Typical example)

Contact arrangement	Contact arrangement code	Contact operation				
		Contact block		Operator position		
		Mounting position	Type	Left	Center	Right
2NC	01F	(1)	NC			
		(2)	NC			
		-	-	-	-	-
		-	-	-	-	-
2NO+2NC	014	(1)	NC			
		(2)	NC			
		(3)	NO			●
		(4)	NO	●		
4NC	01J	(1)	NC			
		(2)	NC			
		(3)	NC			
		(4)	NC			
2NO+2NC	024	(1)	NC			
		(2)	NC		●	
		(3)	NO			●
		(4)	NO	●		●
2NO+2NC	03C* (Maintained only)	(1)	NC			
		(2)	NC			●
		(3)	NO			●
		(4)	NO	●		
2NO+2NC	044*	(1)	NC			
		(2)	NC		●	
		(3)	NO			●
		(4)	NO	●		
2NO+2NC	054	(1)	NC			
		(2)	NC		●	
		(3)	NO			●
		(4)	NO			●

Notes: ●: Contact closed Blank: Contact open

* These may be some overlap in the contact when switching between notches.

• Position of contact block

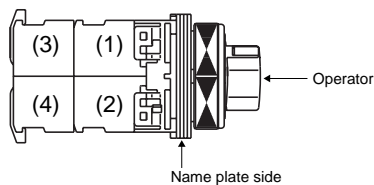

Contact arrangement	Contact arrangement code	Contact operation				
		Contact block		Operator position		
		Mounting position	Type	Left	Center	Right
2NO+2NC	064	(1)	NC			
		(2)	NC		●	
		(3)	NO	●		
		(4)	NO	●		●
1NO+1NC	07F	(1)	NC			
		(2)	NO			●
		-	-	-	-	-
		-	-	-	-	-
2NO+2NC	07C* (Maintained only)	(1)	NC			
		(2)	NC			●
		(3)	NO	●		
		(4)	NO	●		
2NO+2NC	084	(1)	NC			
		(2)	NC		●	
		(3)	NO	●		
		(4)	NO	●		
2NO+2NC	094*	(1)	NC			
		(2)	NC		●	
		(3)	NO	●		
		(4)	NO			●
2NO+2NC	104	(1)	NC		●	
		(2)	NC		●	
		(3)	NO	●		●
		(4)	NO	●		●
2NO+2NC	11C* (Maintained only)	(1)	NC		●	
		(2)	NC			●
		(3)	NO	●		●
		(4)	NO	●		●

● Contact arrangement code (Typical example)

Contact arrangement	Contact arrangement code	Contact operation				
		Contact block		Operator position		
		Mounting position	Type	Left 	Center 	Right
2NO+2NC	124*	(1)	NC		●	
		(2)	NC		●	
		(3)	NO	●		●
		(4)	NO	●		
2NO+2NC	134*	(1)	NC		●	
		(2)	NC		●	
		(3)	NO	●		●
		(4)	NO			●
3NO+1NC	14D* (Maintained only)	(1)	NO	●		
		(2)	NC		●	
		(3)	NO	●		
		(4)	NO			●
3NO+1NC	15A*	(1)	NO			●
		(2)	NC		●	
		(3)	NO			●
		(4)	NO	●		
2NO+2NC	164	(1)	NC		●	
		(2)	NC		●	
		(3)	NO	●		
		(4)	NO	●		
2NO+2NC	174*	(1)	NC		●	
		(2)	NC		●	
		(3)	NO	●		
		(4)	NO			●
2NO+2NC	184	(1)	NC		●	
		(2)	NC		●	
		(3)	NO			●
		(4)	NO			●

Notes: ●: Contact closed Blank: Contact open
* These may be some overlap in the contact when switching between notches.

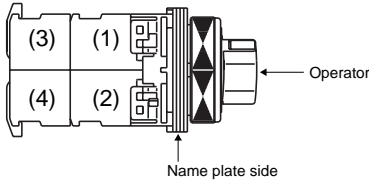

● Position of contact block



Contact arrangement	Contact arrangement code	Contact operation				
		Contact block		Operator position		
		Mounting position	Type	Left 	Center 	Right
2NO+2NC	194	(1)	NC		●	
		(2)	NC	●		
		(3)	NO	●		
		(4)	NO			●
4NO	20B	(1)	NO			●
		(2)	NO	●		
		(3)	NO			●
		(4)	NO	●		

Selector Switches AM22

4, 5-position

Operator	Contact (The following contact is only available.)	Operation	Knob color	Contact arrangement	Type Switch with round bezel
 KK02-248A	2NO+2NC	4-position maintained	Color code: B: Black (Standard) Color other than above are available (G: Green) (R: Red)	Replace the ■ mark by the contact arrangement code (shown below)	AM22PCR-4■B
		5-position maintained			AM22PCR-5■B
 KK02-249A	2NO+2NC	4-position maintained			AM22WCR-4■B
		5-position maintained			AM22WCR-5■B

● Contact arrangement code

Position	Contact arrangement	Contact arrangement code	Contact operation		Operator position
			Contact block		
			Mounting position	Type	
4-position	2NO+2NC	41C* (Main-tained only)	(1)	NC	●
			(2)	NC	●
			(3)	NO	●
			(4)	NO	●
5-position	2NO+2NC	51C* (Main-tained only)	(1)	NC	●
			(2)	NC	●
			(3)	NO	●
			(4)	NO	●

Notes: ●: Contact closed

* There may be some overlap in the contact when switching between notches.

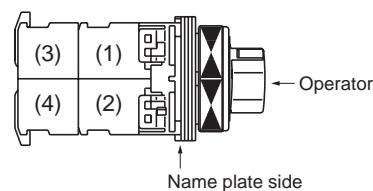

● Position of contact block



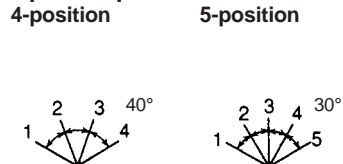

Operator position



■ Illuminated selector switches
2-position

Operator	Operation	Contact	LED lamp		Incandescent lamp	
			Transformer	Type	Transformer	Type
Knob  AF99-79	Maintained	1NO 1NC 1NO+1NC 2NO 2NO+2NC	Without	AM22PL-210■3□ AM22PL-201■3□ AM22PL-211■3□ AM22PL-020■3□ AM22PL-222■3□	Without	AM22PL-210■4□ AM22PL-201■4□ AM22PL-211■4□ AM22PL-020■4□ AM22PL-222■4□
			With	AM22PL-210■3□ AM22PL-201■3□ AM22PL-211■3□ AM22PL-220■3□	With	AM22PL-210■4□ AM22PL-201■4□ AM22PL-211■4□ AM22PL-220■4□
	Spring return  60°	1NO 1NC 1NO+1NC 2NO	Without	AM22PL-010■3□ AM22PL-001■3□ AM22PL-011■3□ AM22PL-020■3□	Without	AM22PL-010■4□ AM22PL-001■4□ AM22PL-011■4□ AM22PL-020■4□
			With	AM22PL-010■3□ AM22PL-001■3□ AM22PL-011■3□ AM22PL-020■3□	With	AM22PL-010■4□ AM22PL-001■4□ AM22PL-011■4□ AM22PL-020■4□

3-position

Operator	Operation	Contact	LED lamp		Incandescent lamp	
			Transformer	Type	Transformer	Type
Knob  AF99-79	Maintained	1NO+1NC 2NO+2NC	Without	AM22PL-311■3□ AM22PL-322■3□	Without	AM22PL-311■4□ AM22PL-322■4□
			With	AM22PL-311■3□	With	AM22PL-311■4□
	Spring/manual return  each 45°	1NO+1NC 1NO+1NC	Without	AM22PL-611■3□ AM22PL-611■3□	Without	AM22PL-611■4□ AM22PL-611■4□
			With	AM22PL-711■3□ AM22PL-711■3□	With	AM22PL-711■4□ AM22PL-711■4□

Note: □, ■ See page 04CD/2/26

Illuminated Selector Switches AM22

- Replace the ■ mark by the following lamp voltage code

Transformer	Voltage	Code	
		LED	Incandescent
Without	5V AC/DC	—	5
	6V DC	6	—
	6V AC	A	—
	12V AC/DC	B	—
	15V AC/DC	C	C
	20V AC/DC	—	D
	24V AC/DC	E	E
With	100-110V AC	H	H
	115-127V AC	L	L
	200-220V AC	M	M
	230-254V AC	Q	Q
	350-380V AC	S	S
	400-440V AC	T	T
	480V AC	V	V
	500-550V AC	W	W

- Contact arrangement and operator position

2-position

Transformer	Contact arrangement	Contact block		Operator position	
		Mounting position	Type	Left	Right
With/without	1NO	(1)	NO	—	●
With/without	1NC	(1)	NC	●	—
Without	1NO+1NC	(1)	NO	—	●
		(2)	NC	●	—
With	1NO+1NC	(1)	NC	●	—
		(2)	NO	—	●
With/without	2NO	(1)	NO	—	●
		(2)	NO	—	●
Without	2NO+2NC *1	(1)	NO	—	●
		(2)	NC	●	—
		(3)	NO	—	●
		(4)	NC	●	—
With	2NO+2NC *1	(1)	NC	●	—
		(2)	NC	●	—
		(3)	NO	—	●
		(4)	NO	—	●

Notes: *1: AM22PL-2

●: Contact closed, —: Contact open

- Position of contact block

Without transformer

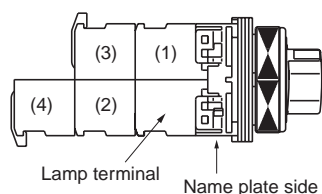

With transformer

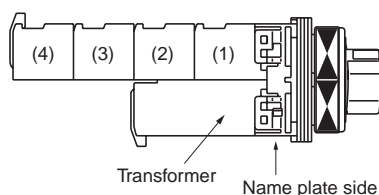

- Replace the □ mark by the following knob color code

Color	Green	Red	White	Blue	Yellow	Orange
Code	G	R	W	S	Y	A

- Up to 4-contact of contact arrangement can be made. Available numbers of contacts are as follow.

No. of position	Operation	Without transformer	With transformer
2-position	Maintained	6-contact	4-contact
	Spring return	3-contact	2-contact
3-position	Maintained	6-contact	4-contact
	Spring/manual return	3-contact	2-contact

3-position



Transformer	Contact arrangement	Contact block		Operator position		
		Mounting position	Type	Left	Center	Right
Without	1NO+1NC *1	(1)	NO	●	—	—
		(2)	NC	—	—	●
	1NO+1NC *2	(1)	NO	—	—	●
		(2)	NC	●	—	—
	2NO+2NC *3	(1)	NO	●	—	—
		(2)	NC	—	—	●
		(3)	NO	●	—	—
		(4)	NC	—	—	●
With	1NO+1NC *1	(1)	NC	—	—	●
		(2)	NO	●	—	—
	1NO+1NC *2	(1)	NC	●	—	—
		(2)	NO	—	—	●
	2NO+2NC *3	(1)	NC	—	—	●
		(2)	NC	—	—	●
		(3)	NO	●	—	—
		(4)	NO	●	—	—

Notes: *1: AM22PL-3, 6 *3: AM22PL-3



*2: AM22PL-7

●: Contact closed, —: Contact open

■ Pilot lights/standard

Lens	Transformer	LED lamp		Incandescent lamp	
		Lamp voltage	Type	Lamp voltage	Type
 AF99-88	Without	6V AC 6V DC 12V AC/DC 24V AC/DC	DM22D0L-A3 <input type="checkbox"/> DM22D0L-63 <input type="checkbox"/> DM22D0L-B3 <input type="checkbox"/> DM22D0L-E3 <input type="checkbox"/>	5.5V AC/DC — 15V AC/DC 24V AC/DC	DM22D0L-54 <input type="checkbox"/> — DM22D0L-C4 <input type="checkbox"/> DM22D0L-E4 <input type="checkbox"/>
	With	100–110V AC 200–220V AC	DM22D0L-H3 <input type="checkbox"/> DM22D0L-M3 <input type="checkbox"/>	100–110V AC 200–220V AC	DM22D0L-H4 <input type="checkbox"/> DM22D0L-M4 <input type="checkbox"/>
 AF99-85	Without	6V AC 6V DC 12V AC/DC 24V AC/DC	DM22E3L-A3 <input type="checkbox"/> DM22E3L-63 <input type="checkbox"/> DM22E3L-B3 <input type="checkbox"/> DM22E3L-E3 <input type="checkbox"/>	5.5V AC/DC — 15V AC/DC 24V AC/DC	DM22E3L-54 <input type="checkbox"/> — DM22E3L-C4 <input type="checkbox"/> DM22E3L-E4 <input type="checkbox"/>
	With	100–110V AC 200–220V AC	DM22E3L-H3 <input type="checkbox"/> DM22E3L-M3 <input type="checkbox"/>	100–110V AC 200–220V AC	DM22E3L-H4 <input type="checkbox"/> DM22E3L-M4 <input type="checkbox"/>
 AF99-87	Without	6V AC 6V DC 12V AC/DC 24V AC/DC	DM22K0L-A3 <input type="checkbox"/> DM22K0L-63 <input type="checkbox"/> DM22K0L-B3 <input type="checkbox"/> DM22K0L-E3 <input type="checkbox"/>	5.5V AC/DC — 15V AC/DC 24V AC/DC	DM22K0L-54 <input type="checkbox"/> — DM22K0L-C4 <input type="checkbox"/> DM22K0L-E4 <input type="checkbox"/>
	With	100–110V AC 200–220V AC	DM22K0L-H3 <input type="checkbox"/> DM22K0L-M3 <input type="checkbox"/>	100–110V AC 200–220V AC	DM22K0L-H4 <input type="checkbox"/> DM22K0L-M4 <input type="checkbox"/>

■ Pilot lights/short-body with transformer

Lens	LED lamp		Incandescent lamp	
	Lamp voltage	Type	Lamp voltage	Type
 KK02-245A	100–110V AC 200–220V AC	DM22D0L-H9 <input type="checkbox"/> DM22D0L-M9 <input type="checkbox"/>	100–110V AC 200–220V AC	DM22D0L-H8 <input type="checkbox"/> DM22D0L-M8 <input type="checkbox"/>
 KK02-246A	100–110V AC 200–220V AC	DM22E3L-H9 <input type="checkbox"/> DM22E3L-M9 <input type="checkbox"/>	100–110V AC 200–220V AC	DM22E3L-H8 <input type="checkbox"/> DM22E3L-M8 <input type="checkbox"/>
 KK02-247A	100–110V AC 200–220V AC	DM22K0L-H9 <input type="checkbox"/> DM22K0L-M9 <input type="checkbox"/>	100–110V AC 200–220V AC	DM22K0L-H8 <input type="checkbox"/> DM22K0L-M8 <input type="checkbox"/>

Note: See page 04CD/2/28

Pilot Lights DM22

• Lens color

Replace the □ mark by the following lens color code

Color	Green	Red	White	Blue	Yellow	Orange
Code	G	R	W	S	Y	A

• Lamp voltage

Available lamp voltage are as follow.

Description	Voltage	Code		Short-body type	
		Standard type LED	Incandescent	LED	Incandescent
Without transformer	5.5V AC/DC	–	54	–	–
	6V AC	A3	–	–	–
	6V DC	63	–	–	–
	12V AC/DC	B3	–	–	–
	15V AC/DC	C3	C4	–	–
	20V AC/DC	–	D4	–	–
	24V AC/DC	E3	E4	–	–
With transformer	100-110V AC	H3	H4	H9	H8
	115-127V AC	L3	L4	L9	L8
	200-220V AC	M3	M4	M9	M8
	230-254V AC	Q3	Q4	–	–
	350-380V AC	S3	S4	–	–
	400-440V AC	T3	T4	–	–
	480V AC	V3	V4	–	–
	500-550V AC	W3	W4	–	–
With resistor unit	110V DC	H7	–	–	–

Pushbuttons/Selectors/Pilot Lights AM22 and DM22 Dimensions

- Dimensions, mm
- Illuminated pushbutton switches

Flush/Extended

AM22F0L, F5L, E0L, E5L
With transformer

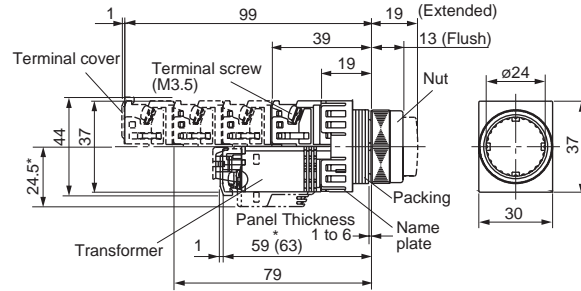

Without transformer

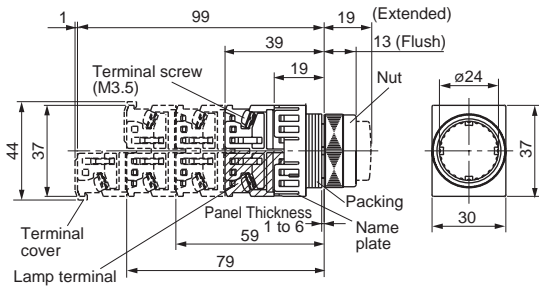

Mushroom (40mm dia.) AM22M0L, M5L

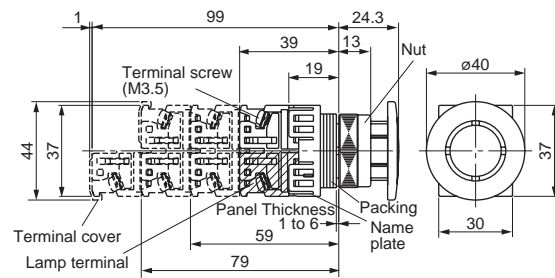

Mushroom (29mm dia.) AM22M4L, M9L

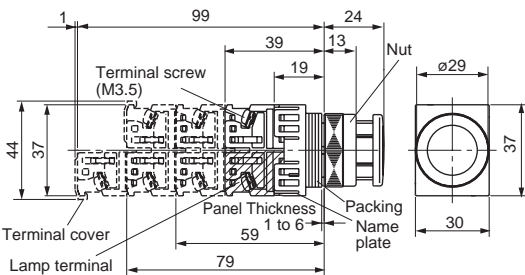

Extended with transparent full guard AM22G4L, G9L

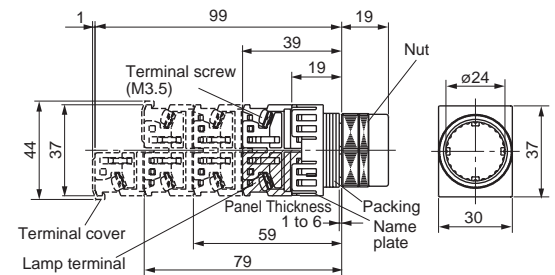

Extended with full guard (with openings) AM22G2L, G7L

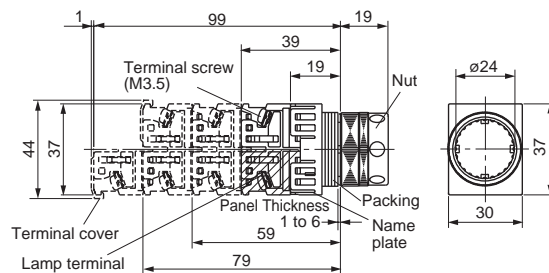

Note: * Except for the types 110V AC, 127V AC and 220V AC.

Pushbuttons/Selectors/Pilot Lights

AM22 and DM22

Dimensions

- Dimensions, mm
- Pushbutton switches

Flush/Extended

AM22F0R, F5R
AM22E0R, E5R

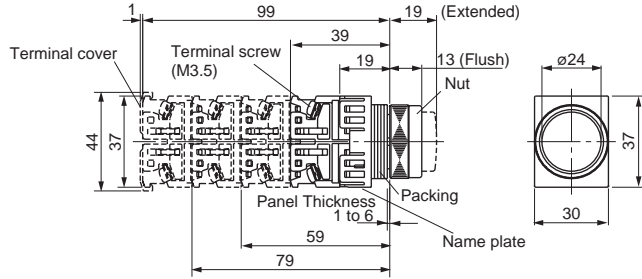

Mushroom (40mm dia.)

AM22M0R, M5R

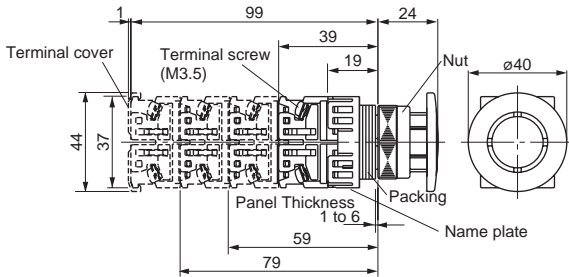

Mushroom (29mm dia.)

AM22M4R

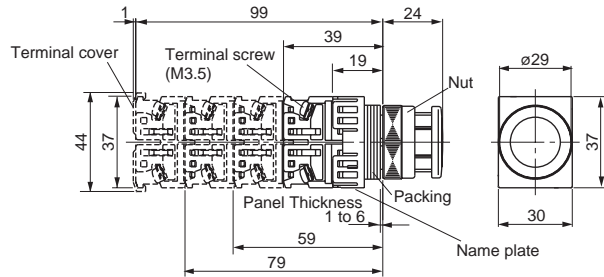

Extended with full guard (24mm dia.)

AM22G3R, G8R

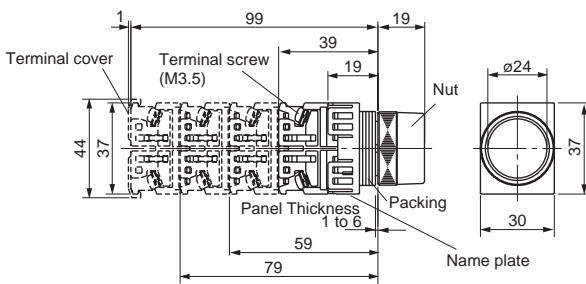

Mushroom with full guard (40mm dia.)

AM22M3R, M8R

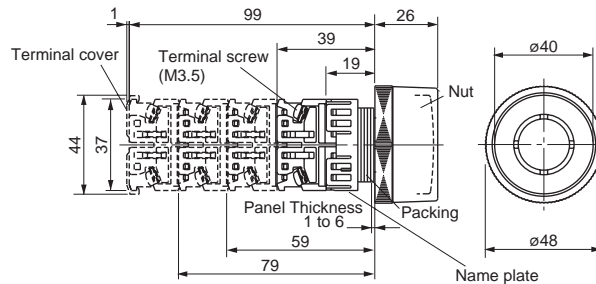

■ Dimensions, mm

● Emergency stop pushbutton switches

Push-lock, turn-reset (40mm dia. with white arrow)
 AM22V0E

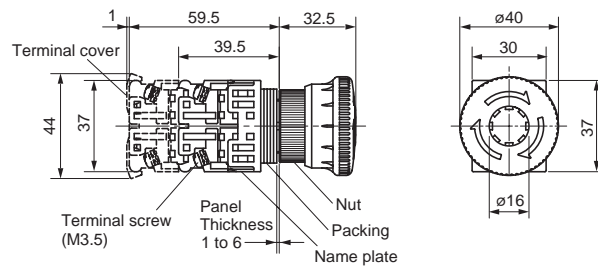

Push-lock, turn-reset (29mm dia. with white arrow)
 AM22VSE

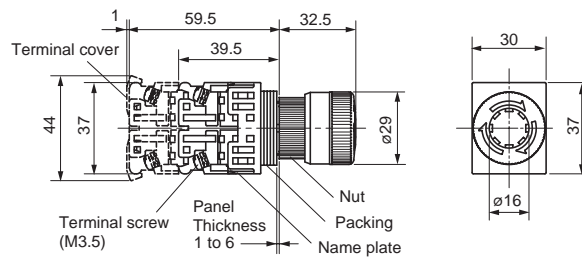

Push-lock, turn-reset (40mm dia. with mechanical indicator)
 AM22VME

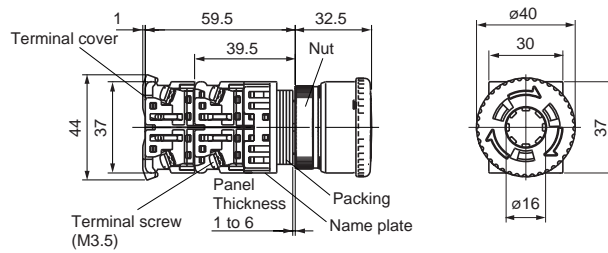

Pushbuttons/Selectors/Pilot Lights

AM22 and DM22

Dimensions

■ Dimensions, mm

● Emergency stop illuminated pushbutton switches

Push-lock, turn-reset (40mm dia. with white arrow)

AM22V0F

With transformer

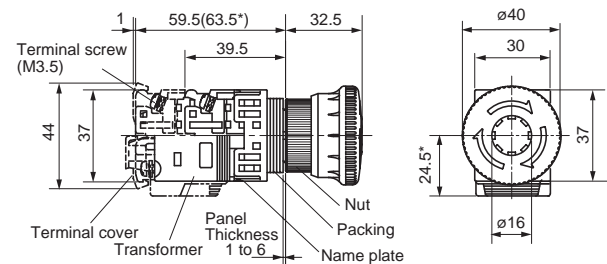

Without transformer

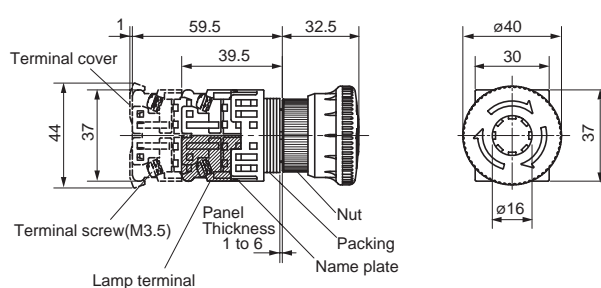

Push-lock, turn-reset (29mm dia. with white arrow)

AM22VSF

Without transformer

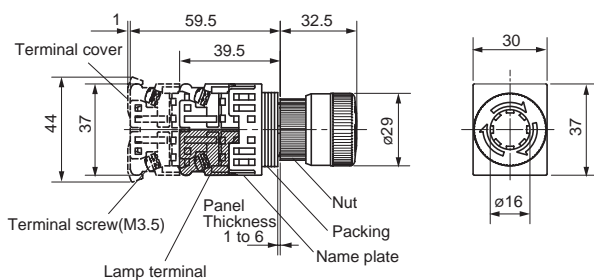

Push-lock, turn-reset (40mm dia. transparent in all colors with white arrow)

AM22VDF

Without transformer

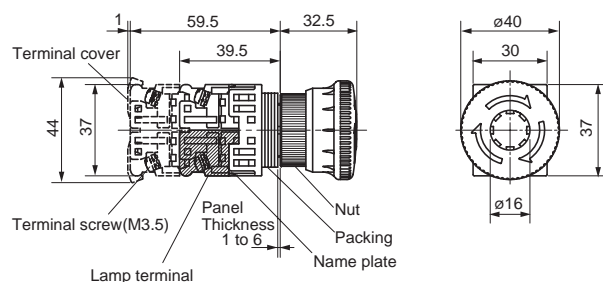

Note: * Except for the types 110V AC, 127V AC and 220V AC.

■ Dimensions, mm
 ● Selector switches

Knob

AM22PR, PCR

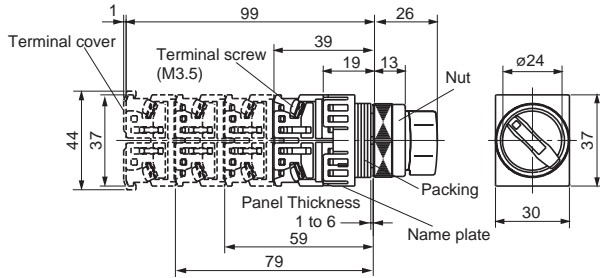

Lever

AM22WR, WCR

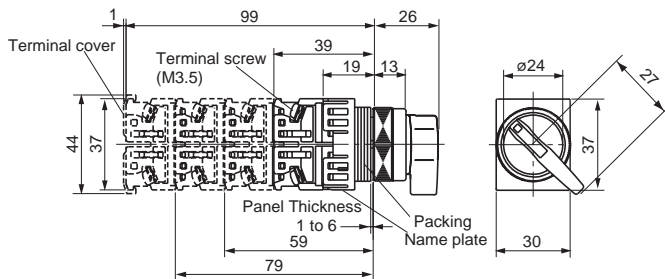

Key

AM22JR, JCR

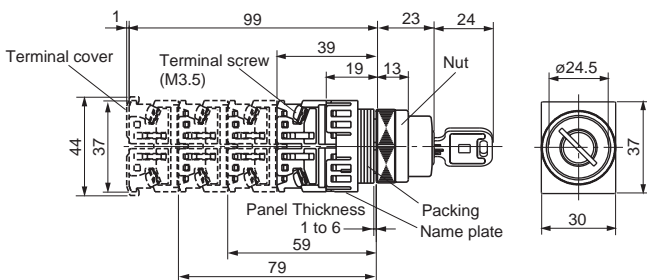

Pushbuttons/Selectors/Pilot Lights

AM22 and DM22

Dimensions

■ Dimensions, mm

● Illuminated selector switches

Knob AM22PL

With transformer

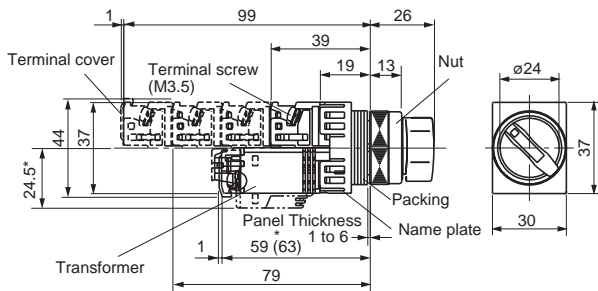

Without transformer

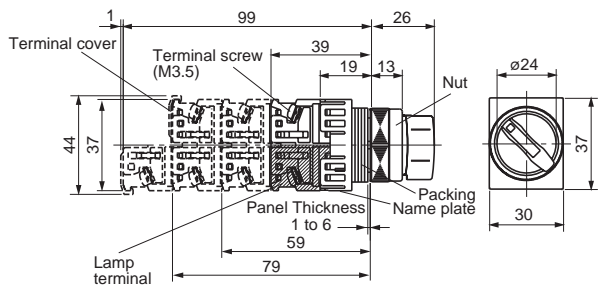

● Pilot lights

Dome DM22D0L

With transformer, with resistor unit

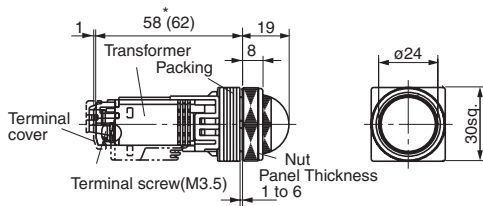

Without transformer

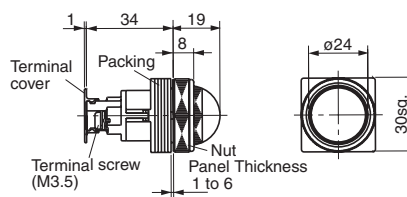

Short body/with transformer

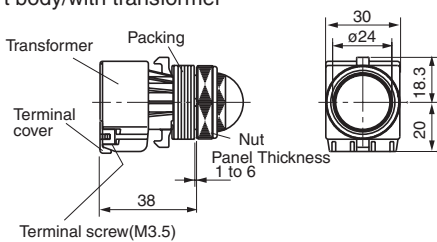

Note: * Except for the types 110V AC, 127V AC and 220V AC.

■ Dimensions, mm
 ● Pilot lights

Extended DM22E3L

With transformer, with resistor unit

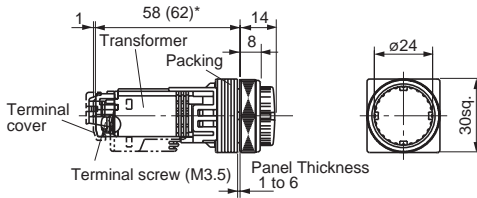

Without transformer

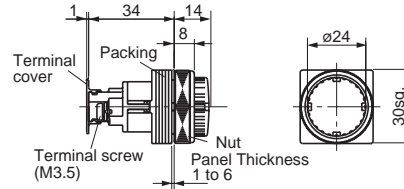

Short body/with transformer

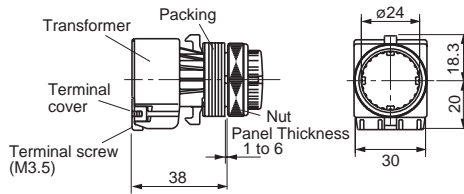

Faceted DM22K0L

With transformer, with resistor unit

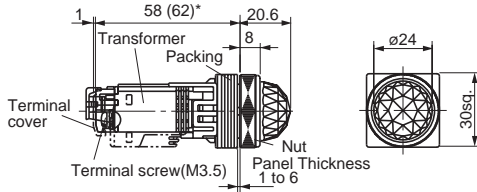

Without transformer

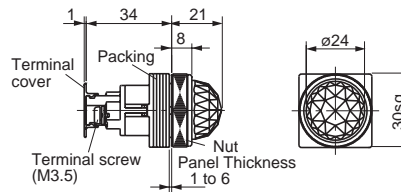

Short body/with transformer

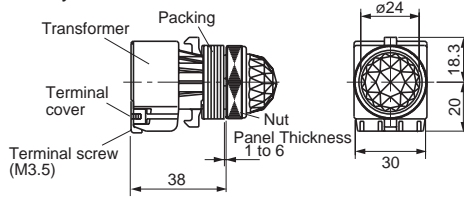

Note: * Except for the types 110V AC, 127V AC and 220V AC.

Pushbuttons/Selectors/Pilot Lights

AM22 and DM22

Notes on use

Notes on use

■ Panel cutout hole

Fig. 1 Panel cutout hole dimensions, mm

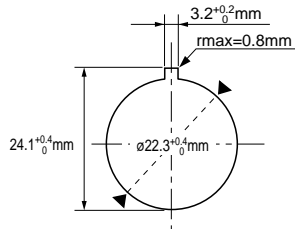

Note : If key-washer or legend plate are not used, 3.2mm-wide location holes shown in Fig. 1 need not be cutout.

■ Mounting operator to panel

1. Pushbutton with a round bezel (ordinary mounting)

Insert the operator into the cutout hole from the back of the panel, and tighten the nut with the AR9A006 wrench from the front of the panel to secure the operator as shown in Fig.2.

Fig. 2 Pushbutton with a round bezel

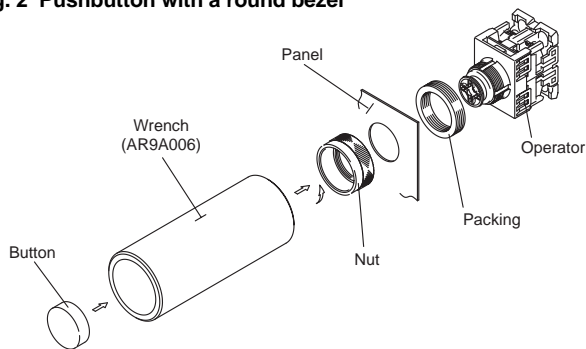

AF95-465

Note : Recommended tightening torque is from 1.0 to 1.5N·m.

2. Mounting Procedure for the M3R and M8R

• Insert the operator through the cutout hole from behind the panel and secure it by the guard ring from the front of the panel.

Note: The correct tightening torque is 1.0 to 1.5 N·m.

• Use the wrench (AR9A001) to mount the button.

Note: The correct tightening torque is 0.5 to 1.0 N·m.

Fig. 3

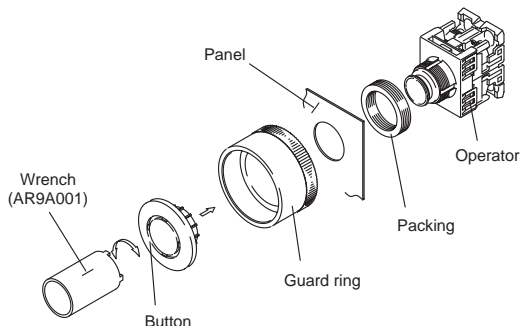

■ Method for changing the button, lens, and nameplate

● AM22F0R, F5R, E0R, E5R, G3R, G8R

- To remove the button, insert a small flat-tip screwdriver in the groove around the periphery of the button, and gently pry it off working the screwdriver around the entire periphery.
- To attach the button, align the I-shaped protrusion on the back side of the button with the cross-shaped groove on the plunger and push the button in.

Fig. 4a

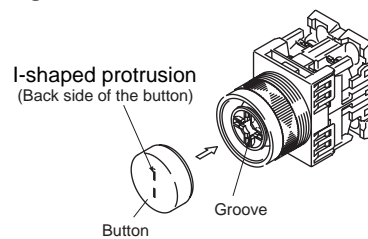
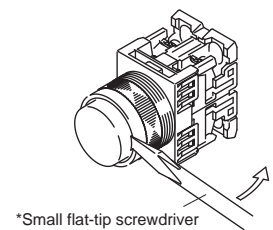
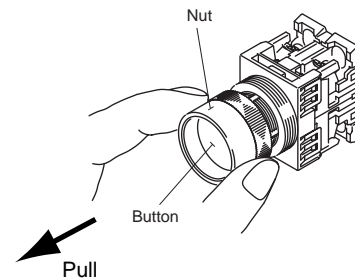

Fig. 4b



- In case of G3R, G8R: Loosen and pull the nut, and the button will come off.

Fig. 5



● AM22M0R, M5R, M4R, M0L, M4L, M5L, M9L

• The button is threaded. Attach it and remove it by hand. When attaching the button, make sure that it is screwed in completely.

Note: The correct tightening torque is 0.5 to 1.0 N·m.

• For illuminated pushbutton switches, insert the groove of the nameplate onto the protrusion on the plunger and push in the nameplate.

Fig. 6

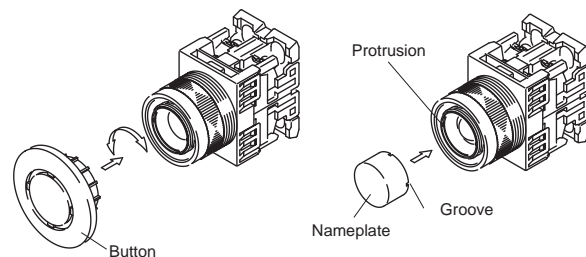

● **AM22V0E, VSE, VME, V0F, VDF, VSF**

As shown in Fig.7, engage the tips of the AM9A008 wrench into the indentations around the pushbutton center button, and turn the wrench to loosen and remove the pushbutton center button, then remove the pushbutton.

Note: The correct tightening torque is 0.5 to 1.0N•m.

Fig. 7

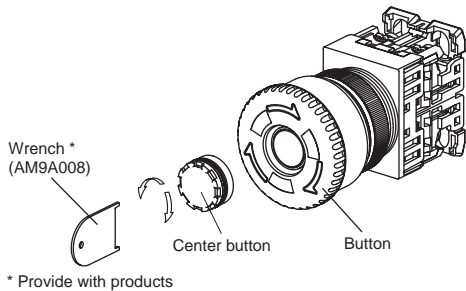

Insert the operator into the cutout hole from the back of the panel, and as shown in Fig.8, insert the pushbutton into the operator cylinder while aligning the grooves inside the pushbutton with the protrusions on the operator.

Note: The correct tightening torque is 0.5 to 1.0N•m.

Fig. 8 Setting pushbutton to operator cylinder

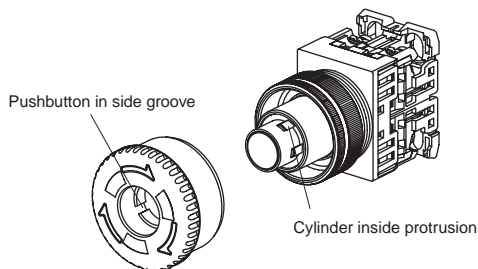

● **AM22F0L, F5L, E0L, E5L, G4L, G9L, G2L, DM22E3L**

Engage the protrusions on the front end of the wrench (AR9A001) with the groove on the lens and screw on the lens.

Note: The correct tightening torque is 0.5 to 1.0 N•m.

● **Attaching the nameplate**

Insert the groove of the nameplate onto the protrusion on the plunger.

Fig. 9

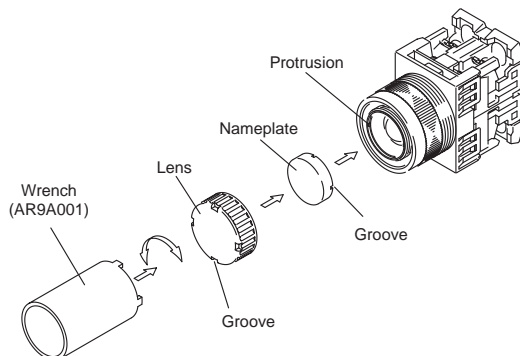

● **DM22D0L, K0L**

Push the end of the wrench (AHX702) onto the lens and turn the wrench to attach or remove the lens.

Note: The correct tightening torque is 0.5 to 1.0 N•m.

Fig. 10

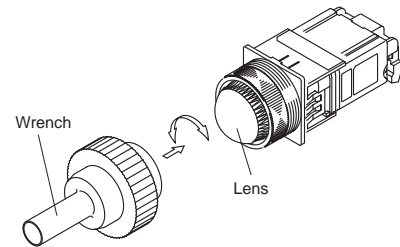

● **AM22PR, PCR, WR, WCR**

- (1) As shown in the following figure, insert the tip of a small flathead screwdriver into the selector tip groove. Rotate the screwdriver in the direction indicated by the arrow until the selector tip rises, and draw out the knob.
- (2) Attach the operator in the same manner as described in step 1.
- (3) Insert the knob, with the selector tip in the floated state, into the original position of the rotation tube, and push the selector tip into place.

Fig. 11a

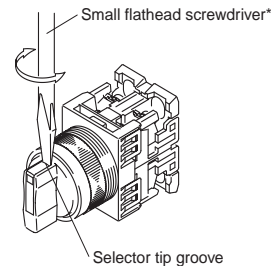
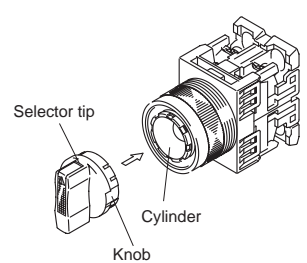

Fig. 11b



● **AM22PL**

To remove an illuminated switch, insert a small flathead screwdriver or the like into the groove around the periphery of the knob and pry it off.

Fig. 12a

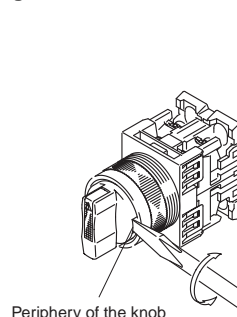
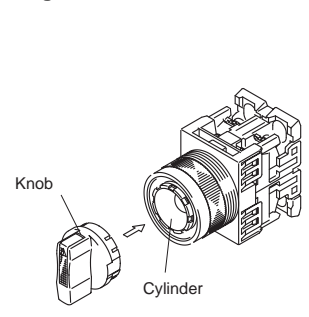

Fig. 12b



*Use a small flathead screwdriver with a head that is about 4 mm wide.

Pushbuttons/Selectors/Pilot Lights

AM22 and DM22

Notes on use

● AM22JR, JCR

- For key type switches, the decorative cover and nut are threaded. Removing the decorative cover enables the nut to be removed. Make sure to tighten the decorative cover so that there is no play.

Note: The correct tightening torque is 0.3 to 0.5 N•m.

Fig. 13

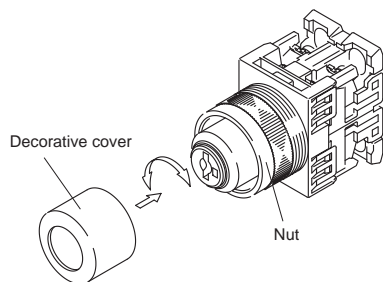

■ Water-proof and dust-proof cap

Applicable type: Water-proof cap AHX797
Dust-proof cap AM9D797

When attached to the panel in combination with a water-proof or dust-proof cap, the water-proof cap or dust-proof cap may sink downward and prevent the depressed button from returning to its original position.

As shown in the following figure, cut an approximately 5-mm air outlet in the portion of the ring packing touching the panel surface. Also, reduce the number of packing rings by one below the standard number. The clamp ring tightening torque is 1 to 1.5 N•m.

Fig. 14

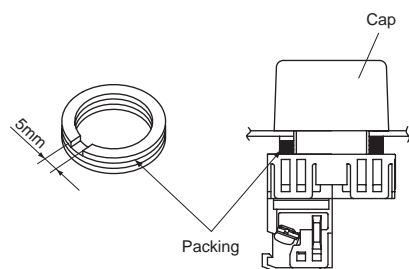

Degree of protection

The water-proof cap or dust-proof cap seals the panel surface to provide IP65 protection.

- AM9D797 : Air outlet groove packing provided.

■ Using accessory ring-packings

Use the required number of ring-packings (1.3mm-thick, 5 pieces, resin mold).

Table below is a guideline for using the packings.

If a locking nut or legend plate is used, the thickness must be counted as an additional panel thickness.

Panel thickness vs. number of packings (reference data)

Effective panel thickness including lock-ring and legend plate thicknesses	Number of packings
1.0mm to less than 1.6mm	
1.6mm to less than 2.8mm	
2.8mm to less than 3.8mm	
3.8mm to less than 4.8mm	
4.8mm to less than 6.0mm	

■ Minimum mounting space, mm

The minimum mounting spaces required for AM22•DM22 command switches are given below. (Fig. 15)

Fig. 15

- Illuminated pushbutton and pushbutton
- Emergency stop illuminated pushbutton and emergency stop pushbutton
- Illuminated and non-illuminated selectors
- Pilot light

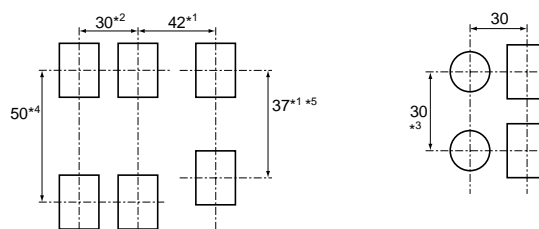

Notes: *1 • AM22M0L, M5L, M0R, M5R, V0E, V0F, VDF: 42
• AM22M3R, M8R: 49
• AM22WR, WCR: 40

*2 When mounting contact blocks at 30mm pitch, use it circuit of 380V or less.





*3 Short body with transformer types: 50mm.

*4 This dimension applies when transformer units or contact blocks face each other.

*5 This dimension applies when transformer unit or contact block is mounted on only one side.

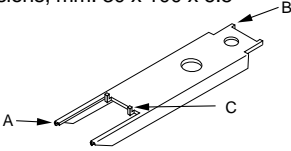
Other items are the same as for the AR22 and DR22 series, see page 04/53 to 04/57

■ Accessories





Discription	Type
<p>Wrench</p>  <p>KK02-261</p>	<p>AR9A004 Dimensions, mm: 30 x 100 x 6.5</p>  <p>Section "B" Use this section to tighten or remove the lens. Applicable type: AM22M3R, M8R, F0L, F5L, E0L, E5L, G4L, G9L, G2L, G7L, DM22E3L</p> <p>Remarks Section "A" : (For AR22 nut tightening)</p> <p>Section "C" : (For AR22V□□, AR30V□□ center button tightening)</p>
<p>Wrench</p>  <p>KKD07-096</p>	<p>AM9A008 Dimensions, mm: 16 x 23 x 0.8</p> <p>Application: AM22V□□ center button</p>
<p>Wrench</p>  <p>KK02-098A</p>	<p>AR9A001 Dimensions, mm: $\varnothing 22 \times 35$</p> <p>Application: AM22M3R, M8R, F0L, F5L, E0L, E5L, G4L, G9L, G2L, G7L, DM22E3L lens tightening</p>
<p>Wrench for $\varnothing 22, \varnothing 30$</p>  <p>For $\varnothing 22$ For $\varnothing 30$</p> <p>AF96-241</p>	<p>AR9A006 Dimensions, mm: $\varnothing 40 \times 100$</p> <p>Application: AM22, DM22 nut tightening</p>
<p>Wrench</p>  <p>SI-303</p>	<p>AHX701 Dimensions, mm: $\varnothing 25 \times 72.5$</p> <p>Application: To mount on Protection cover (AM9D762), use this wrench to tighten the nut.</p>



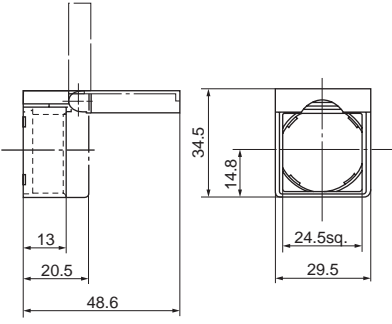
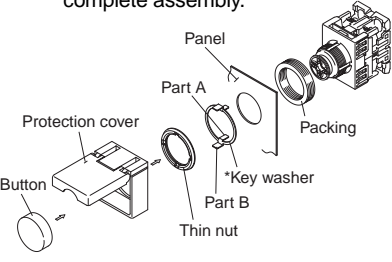

Discription	Type
<p>Special tool</p>  <p>AHX321</p>  <p>SG-873 DR9A321-T AF95-21</p>	<p>AHX321 Dimensions, mm: 42 x 130 x 6.5 For all types except pilot lights</p> <p>DR9A321-T Dimensions, mm: 57 x 130 x 30 For pilot lights</p> <ul style="list-style-type: none"> • This tool is used to remove contact blocks and transformer units. • The AHX321 can remove round color lens of switches.
<p>Wrench/Lamp changer</p>  <p>SI-1030</p>	<p>AHX702 Dimensions, mm: $\varnothing 36 \times 55$</p> <p>Use this wrench to tighten or remove the lens and lamp.</p> <p>Used with: Lens of DM22D0L, K0L Incandescent lamp of pilot lights and illuminated pushbuttons</p>
<p>Lamp changer</p>  <p>For BA9S/13 lamp</p> <p>(For E12/15 lamp)</p> <p>AF95-22</p>	<p>AHX790 Dimensions, mm: $\varnothing 14 \times 55$</p> <ul style="list-style-type: none"> • Use this rubber wrench for mounting or removing LED lamps from pilot lights and illuminated pushbutton switches.
<p>Lamp changer (for AM22 V□F type)</p>  <p>KK02-261</p>	<p>AM9A009 Dimensions, mm: $\varnothing 8 \times 50$</p> <ul style="list-style-type: none"> • Application AM22V0F, VSF, VDF

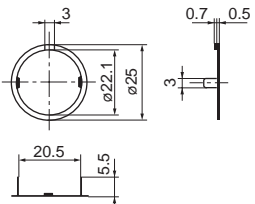
Pushbuttons/Selectors/Pilot Lights

AM22 and DM22

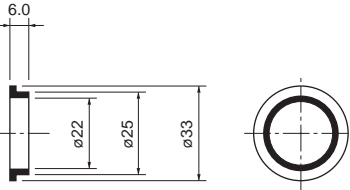
Accessories

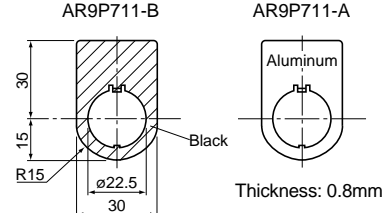
<p>Discription</p> <p>Protection cover</p>  <p>SP183</p>	<p>Type</p> <p>AM9D762</p> <p>This cover protects against accidental operation.</p> <p>Used with: AM22F□R, E□R AM22F□L, E□L</p> <p>Dimensions, mm:</p>  <p>Notes : Assemble in the following order.</p> <ol style="list-style-type: none"> 1. Remove the tightening ring. 2. Set protrusion A of the retaining washer in the groove of the operator. 3. Use the wrench (AHX701) to tighten the thin nut. 4. Align protrusion B of the retaining washer with the groove of the protective cover, and press the protective cover onto the thin nut. 5. Mount the button and lens to complete assembly.  <p>*Provided</p>
<p>Key washer</p>  <p>SP-214</p>	<p>Type</p> <p>AHX715</p> <p>Use this metal washer when securing an operator.</p> <p>Dimension, mm:</p> 
<p>Operator base cover</p>  <p>AF95-26</p>	<p>Type</p> <p>AR9Y002</p> <p>Attach this cover to the operator base of a pushbutton switch with only one contact block (1NO or 1NC) to protect against dust.</p>

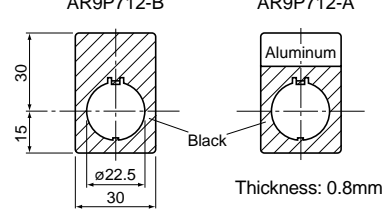
<p>Discription</p> <p>Adapter</p>  <p>SK-596</p>	<p>Type</p> <p>AHX718</p> <p>Use this adapter to mount a 22-mm-diameter command switch to a 25-mm-diameter cutout hole. Note that a 25-mm-diameter packing (AHX283, resin) must be purchased separately and used with the adapter.</p> <p>Dimensions, mm:</p>  <p>Panel cutout: $\phi 25.5^{+0.5}_0$ mm</p>																								
<p>Legend plate</p>  <p>SI-1033</p>	<p>Type</p> <p>AR9P711-①②③</p> <p>① Color B: Black A: Aluminum</p> <p>This aluminum legend plate is for a 22.3mm dia. panel cutout hole. (Packing provided)</p> <table border="1"> <thead> <tr> <th>Legend</th> <th colspan="2">Code</th> </tr> <tr> <th></th> <th>②</th> <th>③</th> </tr> </thead> <tbody> <tr> <td>Blank</td> <td>0</td> <td>0</td> </tr> <tr> <td>ON</td> <td>0</td> <td>A</td> </tr> <tr> <td>OFF</td> <td>0</td> <td>B</td> </tr> <tr> <td>START</td> <td>0</td> <td>C</td> </tr> <tr> <td>STOP</td> <td>0</td> <td>D</td> </tr> <tr> <td>OFF-ON</td> <td>2</td> <td>A</td> </tr> </tbody> </table> <p>Dimensions, mm:</p>  <p>Thickness: 0.8mm</p>	Legend	Code			②	③	Blank	0	0	ON	0	A	OFF	0	B	START	0	C	STOP	0	D	OFF-ON	2	A
Legend	Code																								
	②	③																							
Blank	0	0																							
ON	0	A																							
OFF	0	B																							
START	0	C																							
STOP	0	D																							
OFF-ON	2	A																							
<p>Legend plate</p>  <p>SI-1032</p>	<p>Type</p> <p>AR9P712-①②③</p> <p>① Color B: Black A: Partially black</p> <p>This aluminum legend plate is for a 22.3mm dia. panel cutout hole. (Packing provided)</p> <table border="1"> <thead> <tr> <th>Legend</th> <th colspan="2">Code</th> </tr> <tr> <th></th> <th>②</th> <th>③</th> </tr> </thead> <tbody> <tr> <td>Blank</td> <td>0</td> <td>0</td> </tr> <tr> <td>ON</td> <td>0</td> <td>A</td> </tr> <tr> <td>OFF</td> <td>0</td> <td>B</td> </tr> <tr> <td>START</td> <td>0</td> <td>C</td> </tr> <tr> <td>STOP</td> <td>0</td> <td>D</td> </tr> <tr> <td>OFF-ON</td> <td>2</td> <td>A</td> </tr> </tbody> </table> <p>Dimensions, mm:</p>  <p>Thickness: 0.8mm</p>	Legend	Code			②	③	Blank	0	0	ON	0	A	OFF	0	B	START	0	C	STOP	0	D	OFF-ON	2	A
Legend	Code																								
	②	③																							
Blank	0	0																							
ON	0	A																							
OFF	0	B																							
START	0	C																							
STOP	0	D																							
OFF-ON	2	A																							

Pushbuttons/Selectors/Pilot Lights AM22 and DM22 Accessories

Discription	Type																					
Legend plate	AR9P713-①②③ This aluminum legend plate is for a 22.3mm dia. panel cutout hole. (Packing provided)																					
	① Color B: Black A: Partially black																					
	<table border="1"> <thead> <tr> <th>Legend</th> <th>Code ②</th> <th>③</th> </tr> </thead> <tbody> <tr> <td>Blank</td> <td>0</td> <td>0</td> </tr> <tr> <td>ON</td> <td>0</td> <td>A</td> </tr> <tr> <td>OFF</td> <td>0</td> <td>B</td> </tr> <tr> <td>START</td> <td>0</td> <td>C</td> </tr> <tr> <td>STOP</td> <td>0</td> <td>D</td> </tr> <tr> <td>OFF-ON</td> <td>2</td> <td>A</td> </tr> </tbody> </table>	Legend	Code ②	③	Blank	0	0	ON	0	A	OFF	0	B	START	0	C	STOP	0	D	OFF-ON	2	A
Legend	Code ②	③																				
Blank	0	0																				
ON	0	A																				
OFF	0	B																				
START	0	C																				
STOP	0	D																				
OFF-ON	2	A																				
	Dimensions, mm: 																					

AF95-114

Discription	Type																								
Legend plate for emergency stop	AR9P719-①② This aluminum legend plate is for a 22.3mm dia. panel cutout hole. (Packing provided)																								
	Plate color: Yellow Letter color: Black																								
	<table border="1"> <thead> <tr> <th>Legend</th> <th>Code ①</th> <th>②</th> <th>Letter hight</th> </tr> </thead> <tbody> <tr> <td>Blank</td> <td>0</td> <td>0</td> <td>-</td> </tr> <tr> <td>EMERGENCY</td> <td>5</td> <td>A</td> <td>7mm</td> </tr> <tr> <td>STOP</td> <td>5</td> <td>B</td> <td>13mm</td> </tr> <tr> <td>EMERGENCY</td> <td>5</td> <td>C</td> <td>13mm</td> </tr> <tr> <td>OFF</td> <td></td> <td></td> <td></td> </tr> </tbody> </table>	Legend	Code ①	②	Letter hight	Blank	0	0	-	EMERGENCY	5	A	7mm	STOP	5	B	13mm	EMERGENCY	5	C	13mm	OFF			
Legend	Code ①	②	Letter hight																						
Blank	0	0	-																						
EMERGENCY	5	A	7mm																						
STOP	5	B	13mm																						
EMERGENCY	5	C	13mm																						
OFF																									
	Dimensions, mm: 																								

KK02-265A

Note: Engraving for making letters is not available.

Discription	Type																					
Legend plate (width: 34mm)	AR9P015-B①② : High 36mm AR9P014-B①② : High 40.3mm																					
	Color: black																					
	<table border="1"> <thead> <tr> <th>Legend</th> <th>code ①</th> <th>②</th> </tr> </thead> <tbody> <tr> <td>Blank</td> <td>0</td> <td>0</td> </tr> <tr> <td>ON</td> <td>0</td> <td>A</td> </tr> <tr> <td>OFF</td> <td>0</td> <td>B</td> </tr> <tr> <td>START</td> <td>0</td> <td>C</td> </tr> <tr> <td>STOP</td> <td>0</td> <td>D</td> </tr> <tr> <td>OFF-ON</td> <td>2</td> <td>A</td> </tr> </tbody> </table>	Legend	code ①	②	Blank	0	0	ON	0	A	OFF	0	B	START	0	C	STOP	0	D	OFF-ON	2	A
Legend	code ①	②																				
Blank	0	0																				
ON	0	A																				
OFF	0	B																				
START	0	C																				
STOP	0	D																				
OFF-ON	2	A																				
	Optimal for use in combination with a 3-position selector switch. Legend plates are available in two types: short, 36 mm; and long, 40.3mm.																					
	Dimensions, mm: 																					

.AF96-190



Discription	Type																		
Legend plate with name plate	AR9P009-B AR9P010-B ①② (34 × 8mm)																		
	AR9P011-B AR9P012-B ①② (34 × 13mm)																		
	AR9P007-B AR9P008-B ①② (27 × 16mm)																		
	<table border="1"> <thead> <tr> <th>Name plate</th> <th>Code ①</th> <th>②</th> </tr> </thead> <tbody> <tr> <td>ON</td> <td>0</td> <td>A</td> </tr> <tr> <td>OFF</td> <td>0</td> <td>B</td> </tr> <tr> <td>START</td> <td>0</td> <td>C</td> </tr> <tr> <td>STOP</td> <td>0</td> <td>D</td> </tr> <tr> <td>OFF-ON</td> <td>2</td> <td>A</td> </tr> </tbody> </table>	Name plate	Code ①	②	ON	0	A	OFF	0	B	START	0	C	STOP	0	D	OFF-ON	2	A
Name plate	Code ①	②																	
ON	0	A																	
OFF	0	B																	
START	0	C																	
STOP	0	D																	
OFF-ON	2	A																	
	Dimensions, mm: 																		



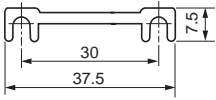
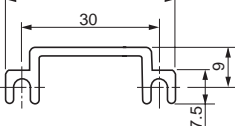

.AF96-190

Pushbuttons/Selectors/Pilot Lights

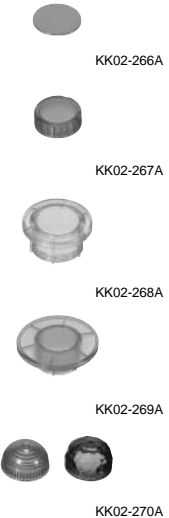





AM22 and DM22





Accessories

Discription	Type																																
Panel plug	<p>Round: AHX725-B Black AHX725-H Gray</p> <p>Square: AHX726-B Black AHX726-H Gray</p> <p>Dimensions, mm: $\varnothing 29.5 \times 17$ (AHX725) $29.5 \text{ sq.} \times 17$ (AHX726)</p> <p>Use this plug to cover up unused panel cutout holes. For oil proof usage, use together with packing (AR9Y730) and a nut (AR9R744).</p>																																
	SI-1027																																
Jumper	<p>APCX029 (For pilot light without transformer) DR9Y001 (For pilot light with transformer)</p> <p>Use this jumper to connect terminals allocated in a 30mm pitch. Rated current is 3A</p> <p>Dimensions, mm</p> <p>APCX029 </p> <p>DR9Y001 </p> <p>Thickness: 0.5mm</p>																																
	AF95-153 AF95-27																																
Lens for illuminated pushbutton switch and pilot lights	<table border="1"> <thead> <tr> <th>Type</th> <th>Used with</th> </tr> </thead> <tbody> <tr> <td>AR9C011-□*</td> <td>AM22F0L, F5L</td> </tr> <tr> <td>AM9C012-□*</td> <td>AM22E0L, E5L, G4L, G9L, G2L, G7L, DM22E3L</td> </tr> <tr> <td>AM9C015-□</td> <td>AM22M4L, M9L</td> </tr> <tr> <td>AM9C016-□</td> <td>AM22M0L, M5L</td> </tr> <tr> <td>DM9C011-□</td> <td>DM22D0L</td> </tr> <tr> <td>DM9C012-□</td> <td>DM22K0L</td> </tr> </tbody> </table> <p>Replace the □ mark by the lens color code</p> <table border="1"> <thead> <tr> <th>Color</th> <th>Green</th> <th>Red</th> <th>Clear</th> <th>Yellow</th> </tr> </thead> <tbody> <tr> <td>Code</td> <td>G</td> <td>R</td> <td>C</td> <td>Y</td> </tr> </tbody> </table> <table border="1"> <thead> <tr> <th>Color</th> <th>Orange</th> <th>Blue</th> <th>White</th> </tr> </thead> <tbody> <tr> <td>Code</td> <td>A</td> <td>S</td> <td>W</td> </tr> </tbody> </table> <p>Notes: * When the code is "W" (white), use a lens of clear color.</p>	Type	Used with	AR9C011 -□*	AM22F0L, F5L	AM9C012 -□*	AM22E0L, E5L, G4L, G9L, G2L, G7L, DM22E3L	AM9C015 -□	AM22M4L, M9L	AM9C016 -□	AM22M0L, M5L	DM9C011 -□	DM22D0L	DM9C012 -□	DM22K0L	Color	Green	Red	Clear	Yellow	Code	G	R	C	Y	Color	Orange	Blue	White	Code	A	S	W
Type	Used with																																
AR9C011 -□*	AM22F0L, F5L																																
AM9C012 -□*	AM22E0L, E5L, G4L, G9L, G2L, G7L, DM22E3L																																
AM9C015 -□	AM22M4L, M9L																																
AM9C016 -□	AM22M0L, M5L																																
DM9C011 -□	DM22D0L																																
DM9C012 -□	DM22K0L																																
Color	Green	Red	Clear	Yellow																													
Code	G	R	C	Y																													
Color	Orange	Blue	White																														
Code	A	S	W																														
	KK02-266A KK02-267A KK02-268A KK02-269A KK02-270A																																

Discription	Type																												
Lens for pushbutton switch	<table border="1"> <thead> <tr> <th>Type</th> <th>Used with</th> </tr> </thead> <tbody> <tr> <td>AM9C001-□</td> <td>AM22F0R, F5R</td> </tr> <tr> <td>AM9C003-□</td> <td>AM22E0R, E5R, G3R, G8R</td> </tr> <tr> <td>AM9C006-□</td> <td>AM22M4R</td> </tr> <tr> <td>AM9C007-□</td> <td>AM22M0R, M3R, M5R, M8R</td> </tr> </tbody> </table> <p>Replace the □ mark by the lens color code</p> <table border="1"> <thead> <tr> <th>Color</th> <th>Green</th> <th>Red</th> <th>Black</th> <th>White</th> </tr> </thead> <tbody> <tr> <td>Code</td> <td>G</td> <td>R</td> <td>B</td> <td>W</td> </tr> </tbody> </table> <table border="1"> <thead> <tr> <th>Color</th> <th>Yellow</th> <th>Orange</th> <th>Blue</th> </tr> </thead> <tbody> <tr> <td>Code</td> <td>Y</td> <td>A</td> <td>B</td> </tr> </tbody> </table>	Type	Used with	AM9C001 -□	AM22F0R, F5R	AM9C003 -□	AM22E0R, E5R, G3R, G8R	AM9C006 -□	AM22M4R	AM9C007 -□	AM22M0R, M3R, M5R, M8R	Color	Green	Red	Black	White	Code	G	R	B	W	Color	Yellow	Orange	Blue	Code	Y	A	B
Type	Used with																												
AM9C001 -□	AM22F0R, F5R																												
AM9C003 -□	AM22E0R, E5R, G3R, G8R																												
AM9C006 -□	AM22M4R																												
AM9C007 -□	AM22M0R, M3R, M5R, M8R																												
Color	Green	Red	Black	White																									
Code	G	R	B	W																									
Color	Yellow	Orange	Blue																										
Code	Y	A	B																										
	KK02-266A KK02-268A KK02-269A																												
Center button (for AM22V□□ type)	<table border="1"> <thead> <tr> <th>Type</th> <th>Used with</th> </tr> </thead> <tbody> <tr> <td>AM9C034-R</td> <td>AM22V0E, VSE</td> </tr> <tr> <td>AM9C035-R</td> <td>AM22V0F, VSF, VDF</td> </tr> </tbody> </table> <p>Center button color: Red only</p>	Type	Used with	AM9C034-R	AM22V0E, VSE	AM9C035-R	AM22V0F, VSF, VDF																						
Type	Used with																												
AM9C034-R	AM22V0E, VSE																												
AM9C035-R	AM22V0F, VSF, VDF																												
	KK02-267A																												
Push-lock, turn-reset button (for AM22V□□ type)	<table border="1"> <thead> <tr> <th>Type</th> <th>Used with</th> </tr> </thead> <tbody> <tr> <td>AM9C036-R</td> <td>AM22V0E, V0F</td> </tr> <tr> <td>AM9C037-R</td> <td>AM22VSE, VSF</td> </tr> <tr> <td>AM9C040-R</td> <td>AM22VDF</td> </tr> </tbody> </table> <p>Button color: Red only</p>	Type	Used with	AM9C036-R	AM22V0E, V0F	AM9C037-R	AM22VSE, VSF	AM9C040-R	AM22VDF																				
Type	Used with																												
AM9C036-R	AM22V0E, V0F																												
AM9C037-R	AM22VSE, VSF																												
AM9C040-R	AM22VDF																												
	KK02-271A KK02-270A KK02-272A																												
Knob	<table border="1"> <thead> <tr> <th>Type</th> <th>Used with</th> </tr> </thead> <tbody> <tr> <td>AR9M006-□</td> <td>AM22PR, PCR</td> </tr> </tbody> </table> <p>Replace the □ mark by the knob color code</p> <table border="1"> <thead> <tr> <th>Color</th> <th>Black</th> <th>Green</th> <th>Red</th> </tr> </thead> <tbody> <tr> <td>Code</td> <td>B</td> <td>G</td> <td>R</td> </tr> </tbody> </table>	Type	Used with	AR9M006 -□	AM22PR, PCR	Color	Black	Green	Red	Code	B	G	R																
Type	Used with																												
AR9M006 -□	AM22PR, PCR																												
Color	Black	Green	Red																										
Code	B	G	R																										
	AF95-43																												

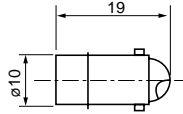
Pushbuttons/Selectors/Pilot Lights AM22 and DM22 Accessories

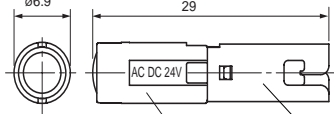

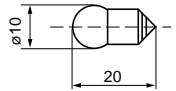

Discription	Type																				
Lever  <small>AF95-42</small>	<table border="1"> <thead> <tr> <th>Type</th> <th>Used with</th> </tr> </thead> <tbody> <tr> <td>AR9M007-□</td> <td>AM22WR, WCR</td> </tr> </tbody> </table> <p>Replace the □ mark by the lever color code</p> <table border="1"> <thead> <tr> <th>Color</th> <th>Black</th> <th>Green</th> <th>Red</th> </tr> </thead> <tbody> <tr> <th>Code</th> <td>B</td> <td>G</td> <td>R</td> </tr> </tbody> </table>	Type	Used with	AR9M007- □	AM22WR, WCR	Color	Black	Green	Red	Code	B	G	R								
Type	Used with																				
AR9M007- □	AM22WR, WCR																				
Color	Black	Green	Red																		
Code	B	G	R																		
Knob (for illuminated selector switch)  <small>AF94-465</small>	<table border="1"> <thead> <tr> <th>Type</th> <th>Used with</th> </tr> </thead> <tbody> <tr> <td>AR9M005-□</td> <td>AM22PL</td> </tr> </tbody> </table> <p>Replace the □ mark by the knob color code</p> <table border="1"> <thead> <tr> <th>Color</th> <th>Green</th> <th>Red</th> <th>White</th> </tr> </thead> <tbody> <tr> <th>Code</th> <td>G</td> <td>R</td> <td>W</td> </tr> </tbody> </table> <table border="1"> <thead> <tr> <th>Color</th> <th>Yellow</th> <th>Orange</th> <th>Blue</th> </tr> </thead> <tbody> <tr> <th>Code</th> <td>Y</td> <td>A</td> <td>S</td> </tr> </tbody> </table>	Type	Used with	AR9M005- □	AM22PL	Color	Green	Red	White	Code	G	R	W	Color	Yellow	Orange	Blue	Code	Y	A	S
Type	Used with																				
AR9M005- □	AM22PL																				
Color	Green	Red	White																		
Code	G	R	W																		
Color	Yellow	Orange	Blue																		
Code	Y	A	S																		
Key  <small>KKD09-012</small>	<table border="1"> <thead> <tr> <th>Type</th> <th>Used with</th> </tr> </thead> <tbody> <tr> <td>AR9C022-□</td> <td>AM22JR, JCR</td> </tr> </tbody> </table> <p>Replace the □ mark by the key type code. Code: A, B, C, D, E or F, 6 types.</p>	Type	Used with	AR9C022- □	AM22JR, JCR																
Type	Used with																				
AR9C022- □	AM22JR, JCR																				
Legend plate  <small>AF94-459</small>	<table border="1"> <thead> <tr> <th>Type</th> <th>Used with</th> </tr> </thead> <tbody> <tr> <td>AR9P001-W</td> <td>AM22F0L, F5L</td> </tr> </tbody> </table> <p>This part is made of acrylic resin. Use paint or thinner compatible with resin.</p> <p>Dimensions, mm: $\varnothing 17.8 \times 0.9$</p>	Type	Used with	AR9P001-W	AM22F0L, F5L																
Type	Used with																				
AR9P001-W	AM22F0L, F5L																				
Legend plate  <small>KK02-273A</small>	<table border="1"> <thead> <tr> <th>Type</th> <th>Used with</th> </tr> </thead> <tbody> <tr> <td>AR9P002-W</td> <td>AM22E0L, E5L, G4L, G9L, G2L, G7L</td> </tr> </tbody> </table> <p>This part is made of acrylic resin. Use paint or thinner compatible with resin.</p> <p>Dimensions, mm: $\varnothing 17.8 \times 4.5$</p>	Type	Used with	AR9P002-W	AM22E0L, E5L, G4L, G9L, G2L, G7L																
Type	Used with																				
AR9P002-W	AM22E0L, E5L, G4L, G9L, G2L, G7L																				
Legend plate  <small>KK02-273A</small>	<table border="1"> <thead> <tr> <th>Type</th> <th>Used with</th> </tr> </thead> <tbody> <tr> <td>AM9P024-W</td> <td>AM22M0L, M5L, M4L, M9L</td> </tr> </tbody> </table> <ul style="list-style-type: none"> This part is made of acrylic resin. Use paint or thinner compatible with resin. Dimensions, mm: $\varnothing 17.8 \times 10.2$ 	Type	Used with	AM9P024-W	AM22M0L, M5L, M4L, M9L																
Type	Used with																				
AM9P024-W	AM22M0L, M5L, M4L, M9L																				





Discription	Type																																				
LED lamp  <small>KKD06-208</small>	<table border="1"> <thead> <tr> <th>Type</th> <th>Lamp voltage</th> </tr> </thead> <tbody> <tr> <td>APX510-6 □</td> <td>6V AC</td> </tr> <tr> <td>APX510-D6 □</td> <td>6V DC</td> </tr> <tr> <td>APX510-12 □</td> <td>12V AC/DC</td> </tr> <tr> <td>APX510-15 □</td> <td>15V AC/DC</td> </tr> <tr> <td>APX510-24 □</td> <td>24V AC/DC</td> </tr> </tbody> </table> <p>Replace the □ mark by the luminous color code</p> <table border="1"> <thead> <tr> <th>Luminous color</th> <th>Yellow</th> <th>Red</th> <th>Green</th> </tr> </thead> <tbody> <tr> <th>Code</th> <td>Y</td> <td>R</td> <td>G</td> </tr> <tr> <th>Lens color</th> <td>Y</td> <td>R</td> <td>G</td> </tr> </tbody> </table> <table border="1"> <thead> <tr> <th>Luminous color</th> <th>Amber</th> <th>Orange</th> <th>Blue</th> </tr> </thead> <tbody> <tr> <th>Code</th> <td>A</td> <td>O</td> <td>S</td> </tr> <tr> <th>Lens color</th> <td>A</td> <td>W</td> <td>S</td> </tr> </tbody> </table> <p>Dimensions, mm:</p>  <p>Lamp base: BA9s/13</p>	Type	Lamp voltage	APX510-6 □	6V AC	APX510-D6 □	6V DC	APX510-12 □	12V AC/DC	APX510-15 □	15V AC/DC	APX510-24 □	24V AC/DC	Luminous color	Yellow	Red	Green	Code	Y	R	G	Lens color	Y	R	G	Luminous color	Amber	Orange	Blue	Code	A	O	S	Lens color	A	W	S
Type	Lamp voltage																																				
APX510-6 □	6V AC																																				
APX510-D6 □	6V DC																																				
APX510-12 □	12V AC/DC																																				
APX510-15 □	15V AC/DC																																				
APX510-24 □	24V AC/DC																																				
Luminous color	Yellow	Red	Green																																		
Code	Y	R	G																																		
Lens color	Y	R	G																																		
Luminous color	Amber	Orange	Blue																																		
Code	A	O	S																																		
Lens color	A	W	S																																		
LED lamp (for AM22V0F, VSF, VDF type)  <small>KK02-273A</small>	<table border="1"> <thead> <tr> <th>Type</th> <th>Lamp voltage</th> </tr> </thead> <tbody> <tr> <td>AR9L001-6R</td> <td>6V AC</td> </tr> <tr> <td>AR9L001-24R</td> <td>24V AC/DC</td> </tr> </tbody> </table> <p>Luminous color: Red only</p> <p>Dimensions, mm:</p>  <p>Holder (24V: gray) (6V: white) Lamp base</p>	Type	Lamp voltage	AR9L001-6R	6V AC	AR9L001-24R	24V AC/DC																														
Type	Lamp voltage																																				
AR9L001-6R	6V AC																																				
AR9L001-24R	24V AC/DC																																				
Incandescent lamp  <small>KKD06-307</small>	<table border="1"> <thead> <tr> <th>Type</th> <th>Lamp voltage</th> <th>Rated voltage, consumption</th> </tr> </thead> <tbody> <tr> <td>AHX135</td> <td>5.5V AC/DC</td> <td>6.3V AC/DC, 1W</td> </tr> <tr> <td>AHX279</td> <td>15V AC/DC</td> <td>18V AC/DC, 1W</td> </tr> <tr> <td>AHX144</td> <td>20V AC/DC</td> <td>24V AC/DC, 1W</td> </tr> <tr> <td>AHX129</td> <td>24V AC/DC</td> <td>30V AC/DC, 1W</td> </tr> </tbody> </table> <p>Dimensions, mm:</p>  <p>Lamp base: BA9s/13</p>	Type	Lamp voltage	Rated voltage, consumption	AHX135	5.5V AC/DC	6.3V AC/DC, 1W	AHX279	15V AC/DC	18V AC/DC, 1W	AHX144	20V AC/DC	24V AC/DC, 1W	AHX129	24V AC/DC	30V AC/DC, 1W																					
Type	Lamp voltage	Rated voltage, consumption																																			
AHX135	5.5V AC/DC	6.3V AC/DC, 1W																																			
AHX279	15V AC/DC	18V AC/DC, 1W																																			
AHX144	20V AC/DC	24V AC/DC, 1W																																			
AHX129	24V AC/DC	30V AC/DC, 1W																																			

Pushbuttons/Selectors/Pilot Lights

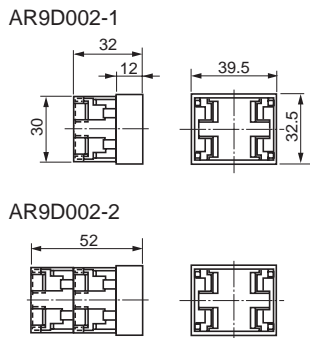



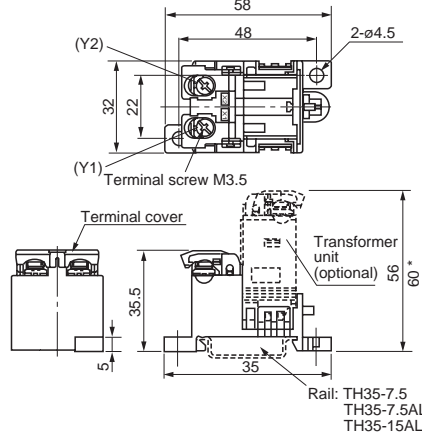



AM22 and DM22







Accessories

Discription Contact block (1NO)  AF94-455	Type AR9B290 Standard AR9B290-S Overlap Color: Blue Dimensions, mm: 19.3 x 29 x 27 Note: Terminal cover is not supplied with this.
Discription Contact block (1NC)  AF94-455	Type AR9B291 Standard AR9B291-S Overlap Color: Red Dimensions, mm: 19.3 x 29 x 27 Note: Terminal cover is not supplied with this.
Discription Lamp terminal  AF94-456	AR9B292 Color: Black Dimensions, mm: 19.3 x 29 x 27 Note: Terminal cover is not supplied with this.
Discription Contact protection cover  KK02-118A	Type Used with* AR9D002-1 AM22, 1step contact AR9D002-2 AM22, 2step contact <ul style="list-style-type: none"> The contact is covered with a silicon rubber cover to keep out foreign matter such as dust, etc. * See page 04CD/2/46(AM22□Z8 types) Dimensions, mm: 

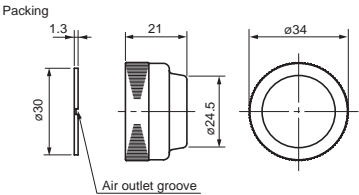
Discription Transformer unit  AF94-457  AF95-33	<table border="1"> <thead> <tr> <th>Type</th> <th>Primary voltage</th> <th>Used with</th> </tr> </thead> <tbody> <tr> <td>AR9T511-H</td> <td>100-110V AC</td> <td rowspan="11">Standard type</td> </tr> <tr> <td>AR9T511-L</td> <td>115-127V AC</td> </tr> <tr> <td>AR9T511-M</td> <td>200-220V AC</td> </tr> <tr> <td>AR9T511-Q</td> <td>230-254V AC</td> </tr> <tr> <td>AR9T511-S</td> <td>350-380V AC</td> </tr> <tr> <td>AR9T511-T</td> <td>400-440V AC</td> </tr> <tr> <td>AR9T511-V</td> <td>480V AC</td> </tr> <tr> <td>AR9T511-W</td> <td>500-550V AC</td> </tr> <tr> <td>AM9T511-H</td> <td>100-110V AC</td> <td rowspan="7">AM22V0F, VDF, VSF</td> </tr> <tr> <td>AM9T511-L</td> <td>115-127V AC</td> </tr> <tr> <td>AM9T511-M</td> <td>200-220V AC</td> </tr> <tr> <td>AM9T511-Q</td> <td>230-254V AC</td> </tr> <tr> <td>AM9T511-S</td> <td>350-380V AC</td> </tr> <tr> <td>AM9T511-T</td> <td>400-440V AC</td> </tr> <tr> <td>AM9T511-V</td> <td>480V AC</td> </tr> <tr> <td>AM9T511-W</td> <td>500-550V AC</td> </tr> </tbody> </table> Dimensions, mm: Up to 220 V 22.4 x 30 x 45 Over 220 V 25.3 x 29 x 48 Note: With terminal cover	Type	Primary voltage	Used with	AR9T511-H	100-110V AC	Standard type	AR9T511-L	115-127V AC	AR9T511-M	200-220V AC	AR9T511-Q	230-254V AC	AR9T511-S	350-380V AC	AR9T511-T	400-440V AC	AR9T511-V	480V AC	AR9T511-W	500-550V AC	AM9T511-H	100-110V AC	AM22V0F, VDF, VSF	AM9T511-L	115-127V AC	AM9T511-M	200-220V AC	AM9T511-Q	230-254V AC	AM9T511-S	350-380V AC	AM9T511-T	400-440V AC	AM9T511-V	480V AC	AM9T511-W	500-550V AC
Type	Primary voltage	Used with																																				
AR9T511-H	100-110V AC	Standard type																																				
AR9T511-L	115-127V AC																																					
AR9T511-M	200-220V AC																																					
AR9T511-Q	230-254V AC																																					
AR9T511-S	350-380V AC																																					
AR9T511-T	400-440V AC																																					
AR9T511-V	480V AC																																					
AR9T511-W	500-550V AC																																					
AM9T511-H	100-110V AC		AM22V0F, VDF, VSF																																			
AM9T511-L	115-127V AC																																					
AM9T511-M	200-220V AC																																					
AM9T511-Q	230-254V AC																																					
AM9T511-S	350-380V AC																																					
AM9T511-T	400-440V AC																																					
AM9T511-V	480V AC																																					
AM9T511-W	500-550V AC																																					
Discription Base unit for transformer separate mounting  KK02-118A	AR9T003 Use this base in combination with a transformer unit. This base unit can be mounted using screws or rails. Dimensions, mm  * Except for the types 110V AC, 127V AC and 220V AC.																																					
Discription Resistor Voltage stabilizer Device for LED lamp flickering  AF95-33	Resistor: AR9T519-H (110V DC) Fit this resistor when using LED of 24V DC rating with 110V DC power. Voltage stabilizer: AR9T001-E This unit allows an LED lamp of 24V DC rating to be used in a circuit with voltage from 27V to 35V (AC or DC). Flickering device: 6V AC: AR9T002-A 6V DC: AR9T002-6 12 to 24V AC: AR9T002-G * 12 to 24V DC: AR9T002-E * * Used in combination with 12V, 15V, or 24V rated LED lamp. Note: With terminal cover																																					

Pushbuttons/Selectors/Pilot Lights AM22 and DM22 Accessories

Discription	Type
Nut  KK02-274A  KK02-275A  KK02-276A	Type Used with AM9R744 *1 AM22F0R, F5R, E0R, E5R, M0R, M5R, M4R, F0L, F5L, E0L, E5L, M0L, M5L, M4L, M9L, PR, PCR, WR, WCR, JR, JCR, PL DM9R744 *1 DM22D0L, E3L, K0L AM9R057 *3 AM22V0E, V0F, VDF AM9R057 *2 AM22F0R, F5R, E0R, E5R, M4R, F0L, F5L, E0L, E5L, M4L, M9L, PR, PCR, WR, WCR, JR, JCR, PL AM9R058 *3 AM22VSE, VSF DM9R057 *2 DM22D0L, E3L, K0L
	*1 Resin types are black (standard) *2 Aluminum types are silver *3 Aluminum types are silver (standard)
	Type Used with AM9R003 *1 AM22G4L, G9L AM9R054 *2 AM22G3R, G8R AM9R056 *2 AM22G2L, G7L AM9R223 *2 AM22M3R, M8R
	*1 Resin types are transparent *2 Resin types are black
	Guard-ring  AM9R003  AM9R054 KK02-277A  AM9R056 KK02-274A  AM9R223 KK02-278A
Nut  AF94-462	AR9R744 For AHX725*, 726* * When use the panel plug as IP65, then use with packing(AR9Y730)
Water-tight cap  SK-594	AHX797 This rubber cap protects the operator and switch mechanism against dust and water. Use this cap in a dusty or moist environment. The only color available is transparent. Used with: AM22E0R, E5R, E0L, E5L Dimensions, mm: $\phi 36 \times 22.5$

Discription	Type									
Dust-proof cap  KK02-279A	AM9D797 -□ Replace the □ mark by the cap color code <table border="1"> <tr> <th>Color</th> <th>Green</th> <th>Red</th> <th>Black</th> </tr> <tr> <th>Code</th> <td>G</td> <td>R</td> <td>B</td> </tr> </table>	Color	Green	Red	Black	Code	G	R	B	
	Color	Green	Red	Black						
Code	G	R	B							
	Dimensions, mm: Packing 1.3, 21, $\phi 34$, $\phi 24.5$, $\phi 30$ Air outlet groove									
Packing  AHX730 SI-299  AHX283 AF94-462  AR9Y730 SF-1113	AHX730: For all AM22 and DM22 (Resin) Note: 5 pieces of packing per delivery AHX283: For AHX728 (Resin) Note: 4 pieces of packing per delivery AR9Y730: For AHX725*, 726* (Rubber) * When use the panel plug as IP65, then use with nut (AR9R744)									
Terminal cover  AF94-466	<table border="1"> <thead> <tr> <th>Type</th> <th>Used with</th> <th>Dimensions, mm</th> </tr> </thead> <tbody> <tr> <td>AR9Y305</td> <td>Contact unit Lamp terminal Transformer unit *</td> <td>18.4 x 29 x 8.4</td> </tr> <tr> <td>DR9Y320</td> <td>Pilot lights (without transformer)</td> <td>$\phi 22 \times 5.8$</td> </tr> </tbody> </table> <p>* Rated up to 220V. The terminal cover is provided as standard with the applicable types listed above. (Except for contact block alone and lamp terminal alone)</p>	Type	Used with	Dimensions, mm	AR9Y305	Contact unit Lamp terminal Transformer unit *	18.4 x 29 x 8.4	DR9Y320	Pilot lights (without transformer)	$\phi 22 \times 5.8$
Type	Used with	Dimensions, mm								
AR9Y305	Contact unit Lamp terminal Transformer unit *	18.4 x 29 x 8.4								
DR9Y320	Pilot lights (without transformer)	$\phi 22 \times 5.8$								
Terminal cover  SG-5	<table border="1"> <thead> <tr> <th>Type</th> <th>Used with</th> <th>Dimensions, mm</th> </tr> </thead> <tbody> <tr> <td>AHX376</td> <td>With transformer * With short-body transformer With resistor unit</td> <td>13 x 29 x 6.5</td> </tr> </tbody> </table> <p>* Use types that exceed the standard 220V rating for products with standard type transformer. The terminal cover is provided as standard with the applicable types listed above.</p>	Type	Used with	Dimensions, mm	AHX376	With transformer * With short-body transformer With resistor unit	13 x 29 x 6.5			
Type	Used with	Dimensions, mm								
AHX376	With transformer * With short-body transformer With resistor unit	13 x 29 x 6.5								

Pushbuttons/Selectors/Pilot Lights

AM22 and DM22

Special products

Products equipped with contact protection cover

■ Features

A silicon rubber cover is provided for the contact block to keep out foreign matter such as dust, etc.
Other ratings and specifications are the same as those of the standard type.

■ Type

AM22 □ Z8

Specify "Z8" at the end of the type number of the standard type.

■ Dimensions

The only thing different from the standard product is the addition of a 1-mm thick silicon rubber cover around the contact block.

■ Applicable types

Type	Contact arrangement	Remarks
<ul style="list-style-type: none"> • Pushbuttons • Emergency stop pushbuttons • Selectors 	1NO+1NC, 2NO*1, 2NC	For use with a 1-step contact
	1NO+3NC, 2NO+2NC, 3NO+1NC, 4NO*1, 4NC	For use with a 2-step contact
<ul style="list-style-type: none"> • Illuminated pushbuttons (without transformer) 	1NO*2, 1NC	For use with a 1-step contact
<ul style="list-style-type: none"> • Emergency stop illuminated pushbuttons (without transformer) 	1NO+2NC, 2NO+1NC, 3NO*2, 3NC	For use with a 2-step contact
<ul style="list-style-type: none"> • Illuminated selectors (without transformer) 		

Notes: *1 Except for emergency stop pushbutton switch

*2 Except for emergency stop illuminated pushbutton switch

Resisting water-soluble cutting oils and heat

■ Features

Safer operation in environments exposed to water-miscible cutting fluids, machining oils, lubricating oils, cleaning oils and high humidity (up to 95%) is made possible by using materials that protect against rust and corrosion of components.
Other ratings and specifications are the same as those of the standard type.

■ Type

AM22 □ Z9, DM22 □ Z9

Specify "Z9" at the end of the type number of the standard type.

■ Dimensions

Same as those of the standard type

■ Applicable types

• AM22, DM22 series

AM22 (Except for emergency stop pushbutton switch and emergency stop illuminated pushbutton switch)

DM22 (Except for pilot lights with resistor unit)

Meeting IP2X finger protection standards

■ Features

Conforms to EN standard EN60204-1 (protecting against electric shock). The terminal has IEC60529 degree of protection; IP2X finger protection secured (a mock human finger used in testing did not come into contact with charged parts). The contact block and lamp terminal can be easily mounted or removed with the terminal cover mounted.

■ Type

AM22 □ ZB, DM22 □ ZB

Specify "ZB" at the end of the type number of the standard type.

■ Accessories

- Contact block (plus terminal cover)
 NO contact: AR9B290-□ D
 NC contact: AR9B291-□ D
- Transformer unit (plus terminal cover)
 AR9T511-□ D

■ Ratings and specifications

- Protection degree: IP2X
- Terminal screw: M3.5
 Wiring can be done with a solid wire or fork shaped crimp terminal.

Note: Ring-type crimp terminals cannot be used.

- Other ratings and specifications are the same as those of the standard type.

■ Applicable types

AM22

DM22: Without transformer, with transformer (except for short-body types)

■ Dimensions, mm

AM22/Pushbutton switches

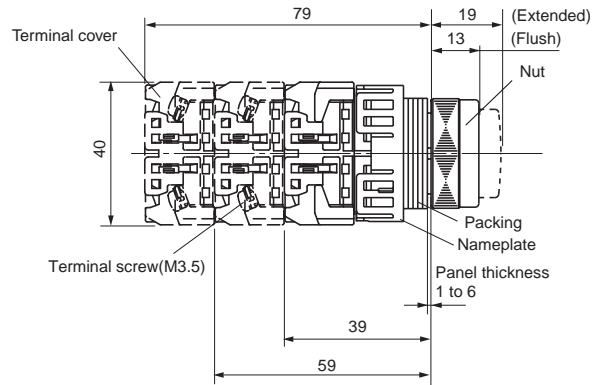

DM22/Without transformer

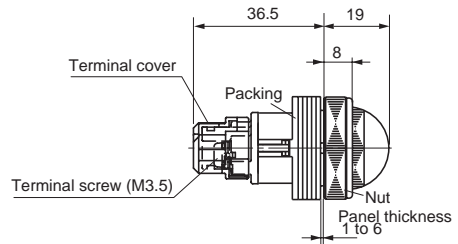

DM22/With transformer

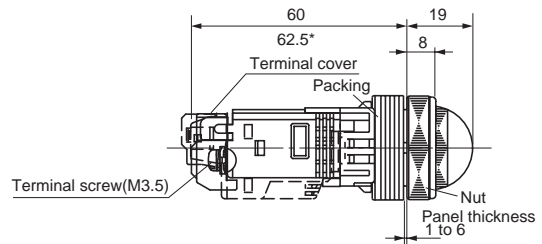

Note : * Except for the types 110V AC, 127V AC and 220V AC.

Pushbuttons/Selectors/Pilot Lights

AM22 and DM22

Special products

Metal nut (aluminum) types

■ Features

The nut is an aluminum ring.
Other ratings and specifications are the same as those of the standard model.

■ Type

AM22 □ ZM

DM22 □ ZM

Specify "ZM" at the end of the type number of the standard type.

■ Dimensions, mm

Same as those of the standard types.

■ Applicable types

AM22 (except for G4L, G9L, M3R, M8R, V□E*, V□F* types)
DM22 with round bezel

Note: * Standard type is a metallic ring (chrome plated).



Resisting sulfuration gas

■ Features

These products can be used in environments having a concentration of hydrogen sulfide gas of 0.5 ppm or less. The metallic parts have been subjected to an anti-corrosion treatment (see note).

The contacts of the AM series are gold plated.

Note: The body is made of resin and cannot be used with gases that affect resins (plastics).

■ Type

AM22 □ Z4, DM22 □ Z4

Specify "Z4" at the end of the type number of the standard type.

■ Notes on use

- This product is resistant to light corrosive gas exposure.
- Other measures, such as covering the entire switch with a box, and the degree of protection of the panel should be taken into consideration.

■ Ratings and specifications

Hydrogen sulfide gas concentration of 0.5 ppm max.

Ambient storage temperature: 8 to 37°C

Humidity: 62 to 81%

Other ratings and specifications are the same as those of the standard type.

■ Dimensions, mm

Same as those of the standard types.

■ Applicable types

AM22

DM22 (except for pilot lights with resistor unit)

(except for emergency stop pushbutton switch and emergency stop illuminated pushbutton switch)

■ Mass, gram

• Pushbutton switches

Type	1-contact	2-contact	4-contact
F0R	28	38	57
F5R			
E0R	29	39	58
E5R			
G3R, M4R	31	41	60
G8R			
M0R	33	43	62
M5R			
M3R	49	59	78
M8R			

• Illuminated pushbutton switches

Type	Without transformer			With transformer*	
	1-contact	2-contact	4-contact	1-contact	2-contact
F0L	42	51	70	88	97
F5L	42	51	–	88	97
E0L	43	53	72	89	99
E5L	43	53	–	89	99
M4L, G4L, G2L	44	54	73	90	100
M9L, G9L, G7L	44	54	–	90	100
M0L	45	55	74	91	101
M5L	45	55	–	91	101

• Emergency stop pushbutton switches

Type	1-contact	2-contact	4-contact
VSE	42	52	71
V0E	51	61	80
VME	53	63	82

• Emergency stop illuminated pushbutton switches

Type	Without transformer		With transformer*	
	1-contact	2-contact	1-contact	2-contact
VSF	53	62	99	108
VDF	60	69	106	115
V0F	62	71	108	117

• Pilot lights

Type	Without transformer	With transformer		With resistor unit
	Standard	Standard*	Short body	
D0L	22	74	72	36
E3L, K0L	23	75	73	37

• Selector switches

Type	1-contact	2-contact	4-contact
PR	33	43	62
PCR	–	43	62
WR	34	44	63
WCR	–	44	63
JR	58	68	87
JCR	–	68	87

• Illuminated selector switches

Type	Without transformer			With transformer*	
	1-contact	2-contact	4-contact	1-contact	2-contact
PL	44	54	73	90	100

Note: *230V and over : +17grams

■ CCC approved

● AM22/DM22 series

Pushbutton switches

Bezel	Operator	Type	
		AM22	
		Momentary action	Alternate action (Turn-reset for V5R)
Round bezel	Flush round head	AM22F0R	AM22F5R
	Extended round head	AM22E0R	AM22E5R
	Extended with full guard (24mm dia.)	AM22G3R	AM22G8R
	Mushroom head with full guard (40mm dia.)	AM22M3R	AM22M8R
	Mushroom head (29mm dia.)	AM22M4R	–
	Mushroom head (40mm dia.)	AM22M0R	AM22M5R
Certificate No.		2003010305063372	

Note: • Certified contact: Momentary action: within 8 contacts
Alternate action: within 4 contacts

Emergency stop pushbutton switches

Bezel	Operator	Type	
		AM22	
Round bezel	Push-lock, turn-reset (29mm dia.)	AM22VSE	
	Push-lock, turn reset (40mm dia.)	AM22V0E	
	Push-lock, turn-reset (40mm dia.)	AM22VME	
Certificate No.		2003010305063372	

Notes: • Certified contact: 1NC, 1NO+1NC, 2NC, 3NC, 2NO+2NC, 4NC
• Certified button color: red (R) only

Illuminated pushbutton switches

Bezel	Operator	Type	
		AM22	
		Momentary	Alternate
Round bezel	Flush round head	AM22F0L	AM22F5L
	Extended round head	AM22E0L	AM22E5L
	Mushroom head (29mm dia.)	AM22M4L	AM22M9L
	Mushroom head (40mm dia.)	AM22M0L	AM22M5L
	Extended with transparent full guard (24mm dia.)	AM22G4L	AM22G9L
	Extended with full guard (24mm dia. with openings)	AM22G2L	AM22G7L
Certificate No.		2003010305063372	

Specifications	<ul style="list-style-type: none"> · Contact <ul style="list-style-type: none"> Without transformer <ul style="list-style-type: none"> Momentary action: within 6 contacts Alternate action: within 3 contacts With transformer <ul style="list-style-type: none"> Momentary action: within 4 contacts Alternate action: within 2 contacts · Color of button <ul style="list-style-type: none"> Green, red, white, yellow, orange, blue · Light source <ul style="list-style-type: none"> LED lamp, incandescent lamp · Operating voltage of lamp <ul style="list-style-type: none"> Without transformer <ul style="list-style-type: none"> LED: 6V AC, 6V DC, 12V AC/DC Incandescent lamp: 5.5V AC/DC, 20V AC/DC LED, incandescent lamp: 15V AC/DC, 24V AC/DC With transformer <ul style="list-style-type: none"> LED, incandescent lamp: 100-110V AC, 115-127V AC, 200-220V AC, 230-254V AC, 350-380V AC, 400-440V AC, 480V AC, 500-550V AC
----------------	---

Emergency stop illuminated pushbutton switches

Bezel	Operator	Type
		AM22
Round bezel	Push-lock, turn-reset (29mm dia.)	AM22VSF
	Push-lock, turn reset (40mm dia.)	AM22V0F
	Push-lock, turn-reset (40mm dia. transparent in all colors)	AM22VDF
Certificate No.		2003010305063372

- Notes:
- Certified contact without transformer: 1NC, 1NO+1NC, 2NC, 3NC
 - Certified contact with transformer: 1NC, 1NO+1NC, 2NC
 - Certified light source: LED lamp only
 - Certified operating lamp voltage: Without transformer: 6A AC, 24V AC/DC
With transformer: 100-110V AC, 115-127V AC, 200-220V AC, 230-254V AC, 350-380V AC, 400-440V AC, 480V AC, 500-550V AC
 - Certified button color: red (R) only

Selector switches

Bezel	Operator	Type	
		AM22	
		Standard type	Control type
Round bezel	Knob	AM22PR	AM22PCR
	Lever	AM22WR	AM22WCR
	Key	AM22JR	AM22JCR
Certificate No.		2003010305063372	

- Note:
- Certified contact:
Maintained: within 8 contacts
Control type, spring return and spring/manual return: within 4 contacts

Illuminated selector switches

Bezel	Operator	Type
		AM22
		Standard type
Round bezel	Knob	AM22PL
Certificate No.		2003010305063372

- Notes:
- Certified contact: Without transformer
Maintained: within 6 contacts
Spring return and spring/manual return: within 3 contacts
 - With transformer
Maintained: within 4 contacts
Spring return and spring/manual return: within 2 contacts
 - Certified lamp: both LED and incandescent lamp

Pilot lights

Bezel	Lens	Type
		DM22
Round bezel	Dome	DM22D0L
	Extended round	DM22E3L
	Faceted	DM22K0L
Certificate No.		2003010305063383

- Notes:
- Certified lamp: both LED and incandescent lamp
 - Certified transformer type: standard and short-body
 - Except for with resistor unit

Item with degree of protection IP2X (IP20)

Type	Certificate No.
AM22□ ZB	2003010305063372
DM22□ ZB	2003010305063383

- Note: Certified for all types listed in the above items
except for short-body transformer of pilot light.

Features

■ **Oil and dust-proof construction**

Protection complies with IEC Standard IP65. Special seals keep out oil, water, dust, and chips. This gives FUJI switches superior performance where dampness and dirt are likely to cause trouble. FUJI recommended where reliability is important.

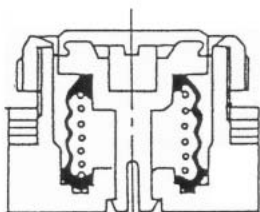

■ **Slide-action self-cleaning contacts**

All contacts are double-break and self-cleaning. With each operation, the contact surfaces are wiped by sliding that ensures positive engagement and excellent conductivity even in very low level circuits (5V, 5mA) and in corrosive environments.

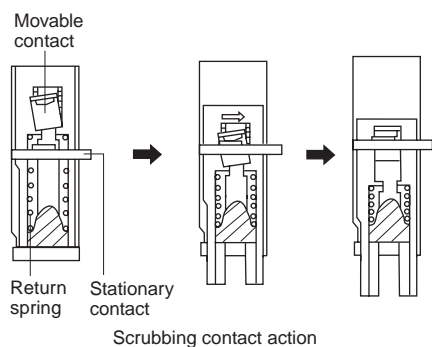

■ **Snap-on contact blocks and transformer**

The contact blocks are easily snapped on, without using screws. Light transformers can also be mounted without tools.

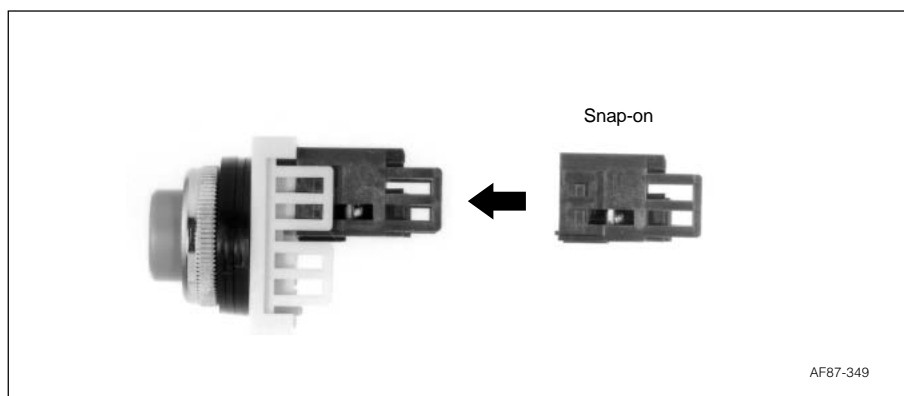

■ **A wide variety of operators**

Pushbuttons, illuminated pushbuttons, 2- or 3-position selector switches, and key-operated selector switches, etc. Choose the one you need.

■ **Contact blocks available up to 4NO+4NC**

The AH25 series controls from one to eight control blocks in combination. Each contact block contains a set of 1NO or 1NC contacts.

■ **Terminal covers**

Terminal covers make mounting safe. These covers can be used to indicate device numbers.

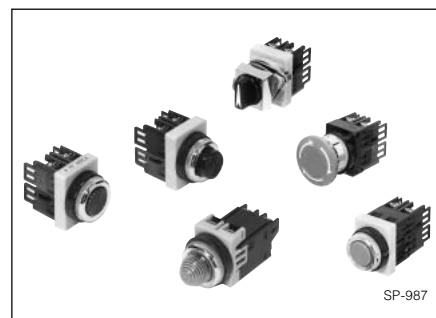
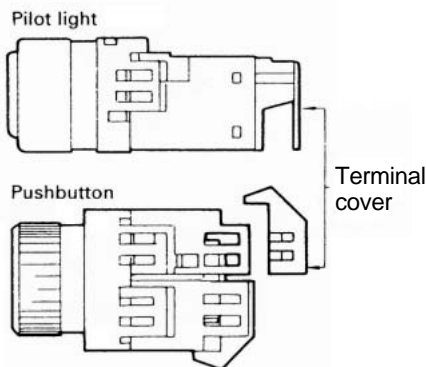

SP-987

■ **Easily replaced color tips**

Only a screwdriver is needed to replace the buttons. A wide variety of colors available to suit to your needs.



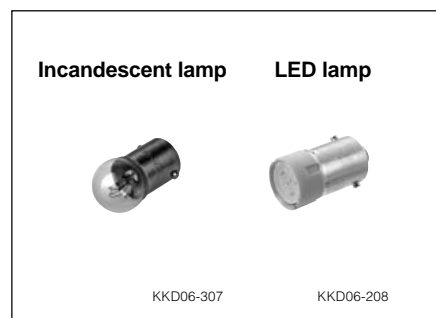

■ **Bright, long-life lamp**

LED lamps that have a longer service life than standard incandescent lamps are available. FUJI LED lamps are bright and can be used with both AC and DC, much the same way as incandescent lamps.



■ **Approvals**

UL listed 
 CSA certified 

For further information related to approved type, see page 04CD/3/2 to 04CD/3/4



Pushbuttons/Selectors/Pilot Lights

AH25



Quick reference guide

■ Pushbutton switches

Type	Description	Type	Description
AH25-F Flush round head  AF87-312 	The button surface is flush with the locking nut. Momentary type. <i>See page 04CD/3/10</i>	AH25-M Mushroom head  SG-185 	Mushroom head button. Momentary type. <i>See page 04CD/3/10</i>
AH25-F5 Flush round head /Alternate action  SG-166 	The button surface is flush with the locking nut. Push-ON/push-OFF type. <i>See page 04CD/3/10</i>	AH25-M5 Mushroom head /Alternate action  SG-183 	Mushroom head button. Push-ON/push-OFF type. <i>See page 04CD/3/10</i>
AH25-E Extended round head  AF87-314 	The button surface projects 7mm from the locking nut. Momentary type. <i>See page 04CD/3/10</i>	AH25-V Push-lock, turn-reset  AF89-414 	Locked when the button is pushed. To reset turn the button to the right. <i>See page 04CD/3/11</i>
AH25-E5 Extended round head /Alternate action  SG-175 	The button surface projects 7mm from the locking nut. Push-ON/push-OFF type. <i>See page 04CD/3/10</i>	AH25-U Wobble stick  SG-202 	The contact works when the lever is moved in any direction. Spring return action. <i>See page 04CD/3/11</i>
AH25-G Extended with half guard  SG-171 	The upper half of the button has a guard ring to help prevent operating errors. Momentary type. <i>See page 04CD/3/10</i>	AH25-SF Flush square head  SG-208 	The button surface is flush with the guard. Momentary type. Operator protection conforms to IP40. <i>See page 04CD/3/11</i>
AH25-G5 Extended with half guard /Alternate action  SG-172 	The upper half of the button has a guard ring to help prevent operating errors. Push-ON/push-OFF type. <i>See page 04CD/3/10</i>	AH25-SF5 Flush square head /Alternate action  SG-210 	The button surface is flush with the guard. Push-ON/push-OFF type. Operator protection conforms to IP40. <i>See page 04CD/3/11</i>
AH25-G1 Extended with full guard  AF87-179 	The button has a guard ring to help prevent operating errors. Momentary type. <i>See page 04CD/3/10</i>	AH25-SE Extended square head  SG-206 	The button surface projects 7mm from the guard. Momentary type. Operator protection conforms to IP40. <i>See page 04CD/3/11</i>
AH25-G6 Extended with full guard /Alternate action  SG-176 	The button has a guard ring to help prevent operating errors. Push-ON/push-OFF type. <i>See page 04CD/3/10</i>	AH25-SE5 Extended square head /Alternate action  SG-207 	The button surface projects 7mm from the guard. Push-ON/push-OFF type. Operator protection conforms to IP40. <i>See page 04CD/3/11</i>

Type	Description
AH25-S1, S2, S3, S4, S5, S6 Pushbutton with selector ring (2-position)  	Turning the ring to the left or right changes over the contact. <i>See page 04CD/3/13</i>

■ Mechanically interlocked pushbutton switches

Type	Description
AH25-□/□ Mechanically interlocked  	Two buttons are interlocked by a lever. When one is ON, the other is OFF. <i>See page 04CD/3/14</i>

■ Illuminated pushbutton switches















Type	Description	Type	Description
AH25-L Extended round head  	The surface of the illuminated button projects about 15mm from the locking nut. Momentary type. <i>See page 04CD/3/15</i>	AH25-L4 Extend with transparent full guard  	The illuminated button has a guard ring to help prevent operating errors. Momentary action. <i>See page 04CD/3/15</i>
AH25-L5 Extended round head /Alternate action  	The surface of the illuminated button projects about 15mm from the locking nut. <i>See page 04CD/3/15</i>	AH25-VL Push-lock, turn-reset  	Locked when the illuminated button is pushed. To reset, turn the button to the right. <i>See page 04CD/3/16</i>
AH25-L2 Extended with full guard (With openings)  	The illuminated button has a guard ring to help prevent operating errors. Momentary type. <i>See page 04CD/3/15</i>	AH25-SL Extended square head  	The illuminated button projects about 8mm from the guard. Momentary type. Operator protection conforms to IP40. <i>See page 04CD/3/16</i>
AH25-L6 Extended with full guard (With openings) /Alternate action  	The illuminated button has a guard ring to help prevent operating errors. Push-ON/push-OFF type. <i>See page 04CD/3/15</i>	AH25-SL5 Extended square head / Alternate action  	The illuminated button projects about 8mm from the guard. Push-ON/push-OFF type. Operator protection conforms to IP40. <i>See page 04CD/3/16</i>
AH25-L3 Extended with full guard  	The illuminated button has a guard ring to help prevent operating errors. Momentary action. <i>See page 04CD/3/15</i>	AH25-SL1 Flush square head  	The illuminated button has a built-in legend plate. Momentary type. Operator protection conforms to IP40. <i>See page 04CD/3/16</i>
AH25-L7 Extended with full guard /Alternate action  	The illuminated button has a guard ring to help prevent operating errors. Push-ON/push-OFF type. <i>See page 04CD/3/15</i>	AH25-SL6 Flush square head/ Alternate action  	The illuminated button has a built-in legend plate. Push-ON/push-OFF type. Operator protection conforms to IP40. <i>See page 04CD/3/16</i>

Pushbuttons/Selectors/Pilot Lights





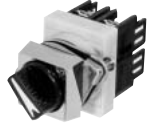





AH25

Quick reference guide

■ Selector switches

Type	Description	Type	Description
AH25-P Knob   SG-188	This switch works when the knob is turned. Operating positions : 2 or 3 Operating : Maintained, spring return, and spring/manual return. <i>See page 04CD/3/18</i>	AH25-SJ Key with square bezel   SG-226	This switch works with a key inserted. Operator protection conforms to IP40. Operating positions : 2 or 3 Operating : Maintained. <i>See page 04CD/3/18</i>
AH25-PC Knob operated control type   AF89-596	21 types of operation are available using a cam for performing complex controls. <i>See page 04CD/3/22</i>	AH25-PW Lever   SP-1007	The lever extends out 13mm from the knob. Operating positions : 2 or 3 Operating : Maintained, spring return, and spring/manual return. <i>See page 04CD/3/18</i>
AH25-J Key   SG-233	This switch works when the key is inserted. Operating positions : 2 or 3 Operating : Maintained, spring return, and spring/manual return. <i>See page 04CD/3/18</i>	AH25-PL Illuminated knob   AF89-622	Illuminated switch with a lamp built into the knob. Operating positions : 2 or 3 Operating : Maintained. <i>See page 04CD/3/23</i>
AH25-SP Knob with square bezel   SG-196	This switch works when the knob is turned. Operator protection conforms to IP40. Operating positions : 2 or 3 Operating : Maintained. <i>See page 04CD/3/18</i>	—	—

■ Pilot lights

Type	Description	Type	Description
AH25-ZM* Dome   SF-1095	This pilot light uses a round transparent colored lens. <i>See page 04CD/3/25</i>	AH25-ZN Flush square with legend plate   SF-1092	This pilot light has a built-in square legend plate on which characters and symbols can be marked. Operator protection conforms to IP40. <i>See page 04CD/3/25</i>
AH25-ZK* Faceted   SF-1094	This pilot light uses a faceted transparent colored lens. <i>See page 04CD/3/25</i>	AH25-ZM□8, □9 Dome (Short-body with transformer)   SH-971	This pilot light has a short-body transformer. <i>See page 04CD/3/25</i>
AH25-ZS Extended square   SF-1093	This pilot light uses a square lens. Operator protection conforms to IP40. <i>See page 04CD/3/25</i>	—	—

Note: * With resistor unit types: Not approved standard

■ **Type number nomenclature**
Pushbuttons

AH25 - E R 11

① ② ③ ④

① **Product category**

AH25: 25mm-dia. pushbutton

② **Operator**

F: Flush round head
F5: Flush round head(Alternate action)
E: Extended round head
E5: Extended round head(Alternate action)
G: Extended with half guard
G5: Extended with half guard (Alternate action)
G1: Extended with full guard
G6: Extended with full guard (Alternate action)
M: Mushroom head
M5: Mushroom head (Alternate action)
V: Push-lock, turn-reset
U: Wobble stick
SF: Flush square head
SF5: Flush square head (Alternate action)
SE: Extended square head
SE5: Extended square head (Alternate action)
S1-S6: Pushbutton with selector ring (2-position)

③ **Color of button**

G: Green D: Dark green
R: Red Y: Yellow
W: White B: Black*
S: Sky-blue O: Orange

*AH25-U type: ball color Black only.

④ **Contact arrangement**

10: 1NO 30: 3NO
01: 1NC 03: 3NC
11: 1NO+1NC 33: 3NO+3NC
20: 2NO 40: 4NO
02: 2NC 04: 4NC
22: 2NO+2NC 44: 4NO+4NC

Mechanically interlocked pushbutton switches

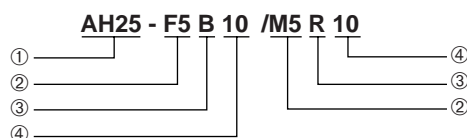

① **Product category**

AH25: 25mm-dia. interlocked pushbutton

② **Combination of operator and operation mode**

• Latched/Latched
F5/F5: Flush (Push-locked)/Flush (Push-locked)
F5/E5: Flush (Push-locked)/Extended (Push-locked)
M5/M5: Mushroom (Push-locked)/Mushroom (Push-locked)
• Latched/Unlatched
F5/F: Flush (Push-locked)/Flush (Momentary)
E5/E: Extended (Push-locked)/Extended (Momentary)
M5/M: Mushroom (Push-locked)/Mushroom (Momentary)

③ **Button color**

G: Green
R: Red
B: Black
D: Dark green
Y: Yellow
W: White
S: Sky-blue
O: Orange

④ **Contact arrangement**

10: 1NO
01: 1NC
11: 1NO+1NC
20: 2NO
02: 2NC

Illuminated pushbuttons

AH25 - L5 G 11 H 3

① ② ③ ④ ⑤ ⑥

① **Product category**

AH25: 25mm-dia. illuminated pushbutton

② **Operator**

L: Extended round head
L5: Extended round head (Alternate action)
L2: Extended with full guard (With openings)
L6: Extended with full guard (With openings alternate action)
L3: Extended with full guard
L7: Extended with full guard (Alternate action)
L4: Extended with transparent full guard
VL: Push-lock, turn-reset
SL: Extended square head
SL5: Extended square head (Alternate action)
SL1: Flush square head
SL6: Flush square head (Alternate action)

③ **Color of lens**

G: Green S: Sky-blue*
R: Red Y: Yellow
W: White O: Orange

* For LED lamp: Not available

④ **Contact arrangement**

10: 1NO 30: 3NO
01: 1NC 03: 3NC
11: 1NO+1NC 33: 3NO+3NC
20: 2NO 40: 4NO
02: 2NC 04: 4NC
22: 2NO+2NC 44: 4NO+4NC

⑤ **Lamp voltage**

• Without transformer:

	Incandescent	LED
Blank	5.5V	-
A	-	6V AC
AD	-	6V DC
B	-	12V AC/DC
C	15V AC/DC	15V AC/DC
D	20V AC/DC	-
E	24V AC/DC	24V AC/DC

• With transformer:

	Incandescent	LED
H	100-110V AC	100-110V AC
L	115-127V AC	115-127V AC
M	200-220V AC	200-220V AC
Q	230-254V AC	230-254V AC
S	350-380V AC	350-380V AC
T	400-440V AC	400-440V AC
V	480V AC	480V AC
W	500-550V AC	500-550V AC

⑥ **Type of lamp**

Blank: Incandescent lamp
3: LED lamp

Note: • The manufacturing varies depending on the model. For details, refer to the contents of this catalog

Pushbuttons/Selectors/Pilot Lights

AH25

Type number nomenclature

Selector and illuminated selector switches

AH25 - PL 3 □ G 22 E 3 □

① ② ③ ④ ⑤ ⑥ ⑦ ⑧ ⑨

① Product category

AH25: 25mm-dia. selector and illuminated selector switch

② Operator

P: Knob
 PC: Knob operated control type
 J: Key
 SP: Knob with square bezel
 SJ: Key with square bezel
 PW: Lever
 PL: Illuminated knob

③ Operating

2: 2-position, maintained
 0: 2-position, spring return (Right to left)
 3: 3-position, maintained
 6: 3-position, spring/manual return (Left to center)
 7: 3-position, spring/manual return (Right to center)
 1: 3-position, center spring return
 Blank: 3-position, maintained (Control type only)

④ Key removable position

A: Left
 B: Left and right
 C: Left, center and right
 D: Right
 E: Center
 F: Center and right
 G: Center and left

⑤ Color of knob

B: Black *¹ G: Green
 R: Red Y: Yellow*³
 W: White*³ O: Orange*³
 S: Sky-blue*^{2,3}

*¹ Except for illuminated type
 *² For LED lamp: Not available
 *³ Illuminated type only

⑥ Contact arrangement

10: 1NO 30: 3NO
 01: 1NC 03: 3NC
 11: 1NO+1NC 33: 3NO+3NC
 20: 2NO 40: 4NO
 02: 2NC 04: 4NC
 22: 2NO+2NC 44: 4NO+4NC

Note: Control type: See page 04CD/3/22

⑦ Lamp voltage

• Without transformer:

	Incandescent	LED
Blank	5.5V AC/DC	-
A	-	6V AC
AD	-	6V DC
B	-	12V AC/DC
C	15V AC/DC	15V AC/DC
D	20V AC/DC	-
E	24V AC/DC	24V AC/DC

• With transformer:

	Incandescent	LED
H	100-110V AC	100-110V AC
L	115-127V AC	115-127V AC
M	200-220V AC	200-220V AC
Q	230-254V AC	230-254V AC
S	350-380V AC	350-380V AC
T	400-440V AC	400-440V AC
V	480V AC	480V AC
W	500-550V AC	500-550V AC

⑧ Type of lamp

Blank: Incandescent lamp
 3: LED lamp

⑨ Key code No.

A, B, C, D, E or F

Pilot lights

AH25 - ZM W Q 3

① ② ③ ④ ⑤

① Product category

AH25: 25mm-dia. pilot light

② Lens

ZM: Dome
 ZK: Faceted
 ZS: Extended square*
 ZN: Flush square with legend plate*

* Incandescent lamp only

③ Color of lens

G: Green S: Sky-blue*
 R: Red Y: Yellow
 W: White O: Orange

* For LED lamp: Not available

④ Lamp voltage

• Without transformer:

	Incandescent	LED
Blank	5.5V AC/DC	-
A	-	6V AC
AD	-	6V DC
B	-	12V AC/DC
C	15V AC/DC	15V AC/DC
D	20V AC/DC	-
E	24V AC/DC	24V AC/DC

• With transformer:

	Incandescent	LED
H	-	110V DC*
H	100-110V AC	100-110V AC
L	115-127V AC	115-127V AC
M	200-220V AC	200-220V AC
Q	230-254V AC	230-254V AC
S	350-380V AC	350-380V AC
T	400-440V AC	400-440V AC
V	480V AC	480V AC
W	500-550V AC	500-550V AC

* With resistor unit only

⑤ Type of lamp

Blank: Incandescent lamp
 8: Incandescent lamp/Short-body with transformer
 3: LED lamp
 7: LED lamp/With resistor unit
 9: LED lamp/Short-body with transformer

Note: • The manufacturing varies depending on the model. For details, refer to the contents of this catalog

Pushbuttons/Selectors/Pilot Lights AH25 Ratings and specifications

■ Standards approved

UL508	File No. E44592
CSA C22.2 No.14	File No. LR20479

■ Specifications (Indoor use)

Description	Pushbutton switch Illuminated pushbutton switch Mechanically interlocked pushbutton switch Selector switch Illuminated selector switch	Pilot light
Rated insulation voltage	600V AC/DC *1	
Mechanical durability	<i>See the table below</i>	–
Electrical durability	500,000 operations at 220V AC 6A 1 million operations at 220V AC 3A	–
Operating frequency	1800 operations/hour (On-load factor: 40%)	–
Dielectric strength	2500V AC, 1 minute *2	
Insulation resistance	100MΩ or more (500V DC megger)	
Pollution degree	3	
Vibration	Resonance: 10 to 55Hz, double amplitude 0.1mm Constant: 16.7Hz, double amplitude 3mm	
Shock	Malfunction durability: 100m/s ² Mechanical durability: 500m/s ²	Mechanical durability: 500m/s ²
Ambient temperature (No condensation or no icing)	-20 to +70°C (Illuminated type: -20 to +50°C)	-20 to +50°C
Storage temperature	-40 to +80°C	
Humidity	45 to 85% RH (within -5 to +40°C)	
Degree of protection	IP65*3	

Notes: *1 Illuminated type without transformer: 250V AC/DC

*2 Illuminated type without transformer: 1500V AC, 1 minute

*3 Square type : IP40

● Mechanical durability

Description		Operations
Pushbutton switch	Momentary action	5 million
Illuminated pushbutton switch	Alternate action	1 million
	With selector ring	200,000
	Push-lock, turn-reset	100,000
Mechanically interlocked pushbutton switch	Latched/Latched, Latched/Unlatched	100,000
Selector switch	Maintained, spring return, spring/manual return Control type	1 million 200,000
Illuminated selector switch	Maintained, spring return, spring/manual return	1 million

Note: Key insertion/removal durability for selector switch key types

- Key type 10,000

Pushbuttons/Selectors/Pilot Lights

AH25

Ratings and Specifications

■ Contact ratings

• UL/CSA standards

Voltage [V]	Application		Continuous current [A]	AC(COS ϕ =0.35 or less)	
	UL	CSA		Make [A]	Break [A]
110-120	●		10	60	6.0
120		●			
220-240	●			30	3.0
240		●			
440-480	●			15	1.5
480		●			
550-600	●			12	1.2
600		●			

Voltage [V]	Application		DC
	UL	CSA	Make and break currents [A]
115-125	●		1.1
115		●	
230-250	●		0.55

Note: AH25-J3, -J5, -P3, -P1, -S1, -S3, -S4, -S5 types cannot be used in DC circuit.

• NECA standards

Description	Rated thermal current (A)	AC		DC		
		Voltage (V)	Operational current (A) AC15(Ind.)	Voltage (V)	Operational current (A)	
					DC13(Ind.)	DC12(Res.)
Pushbutton switch	10	24	6	24	6	6
Illuminated pushbutton switch		110	6	110	1.3	2.5
Selector switch (2-position)		220	6	220	0.45	1
		440	2.5	—	—	—
		550	2	—	—	—
Selector switch (3-position)	10	24	3	24	3	3
Pushbutton switch with selector ring		110	3	110	0.65	1.3
Pushbutton switch with selector lever		220	3	220	0.23	0.5
		440	1.3	—	—	—
		550	1	—	—	—

■ Contact reliability

The AH25 command switches can be used in low level circuit of 5V AC/DC, 5mA. The operating environment and the types of load, however, may affect the operating range.

Pushbuttons/Selectors/Pilot Lights AH25 Ratings and specifications

■ Lamp ratings

● Illuminated pushbuttons, illuminated selectors, pilot lights

Transformer	Lamp voltage	LED (lamp base: BA9S/13)			Incandescent (lamp base: BA9S/13)		
		Type	Rated voltage	Consumption	Type	Rated voltage	Consumption
Without transformer	5.5V AC/DC	— —	—	—	AHX135	6.3V AC/DC	0.9W
	6V AC	APX508-6□ APX510-6□	6V AC	Green, red, orange, amber: 7mA AC Yellow: 50mA AC	—	—	—
	6V DC	APX508-D6□ APX510-D6□	6V DC	Green, red, orange, amber: 11mA DC Yellow: 33mA DC	—	—	—
	12V AC/DC	APX508-12□ APX510-12□	12V AC/DC	Green, red, orange, amber: 14mA AC, 11mA DC Yellow: 28mA AC, 22mA DC	—	—	—
	15V AC/DC	APX508-15□ APX510-15□	15V AC/DC	Green, red, orange, amber: 13mA AC, 11mA DC Yellow: 26mA AC, 22mA DC	AHX279	18V AC/DC	0.8W
	20V AC/DC 24V AC/DC	— — APX508-24□ APX510-24□	— 24V AC/DC	— 12mA AC, 11mA DC	AHX144 AHX129	24V AC/DC 30V AC/DC	0.9W 0.8W
With transformer	110V AC	APX508-6□ APX510-6□	6V AC	1.5VA	AHX135	6.3V AC/DC	2VA
	127V AC						2VA
	220V AC						2VA
	254V AC	APX508-6□ APX510-6□	6V AC	2.5VA	AHX135	6.3V AC/DC	2.5VA
	380V AC						2.5VA
	440V AC						2.5VA
	480V AC 550V AC						2.5VA 2.5VA
With resistor unit	110V DC	APX508-24□ APX510-24□	24V AC/DC	1.2W	—	—	—

Note: Replace the □ mark by the lamp luminous color code.

■ Lamp durability

Lamp	Durability (reference)	Judgement criterion
LED	Approx. 30000h	When brightness is less than 50% of initial value
Incandescent	Approx. 5000h (AC)	When the bulb burns out

Note: • The operating voltage for incandescent lamps is set at 80 to 90% of the lamp's rated voltage.
• The durability of LED lamp is a mean value in all colors.

Estimated durability for LED lamps

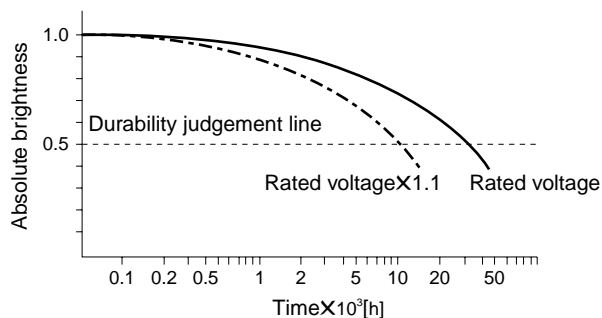

Notes: • Durability at Ta=25°C
• Durability is affected by temperature, humidity, and voltage fluctuation.

Incandescent lamp voltage characteristics

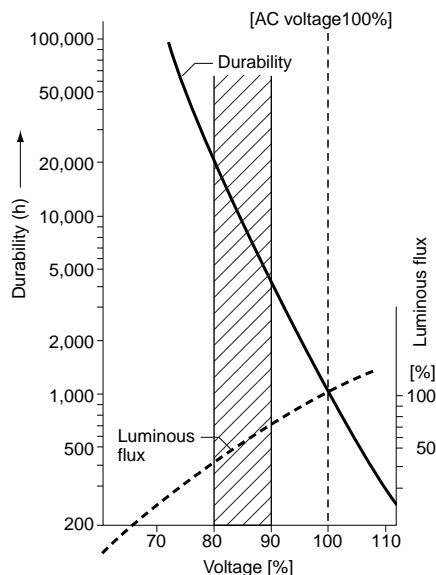







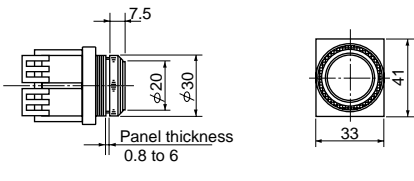

■ Combination of lens color and LED luminous color

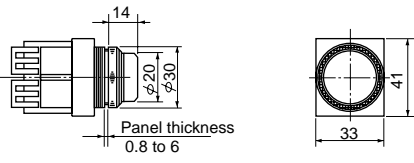
Lens color (lens or color plate)		LED lamp (high-brightness)		
Color	Code	Luminous color	Type	Type *1
Green	G	Green	APX510-■G	APX508-■G
Red	R	Red	APX510-■R	APX508-■R
White	W	Orange	APX510-■O	APX510-■O
Yellow	Y	Yellow	APX510-■Y	APX508-■Y
Orange	A	Amber	APX510-■A	APX508-■A

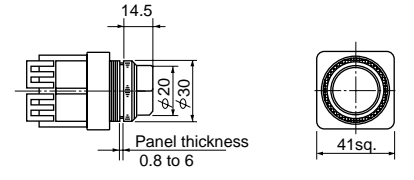
Notes: *1 For pilot lights
• Replace the ■ mark by the lamp voltage code

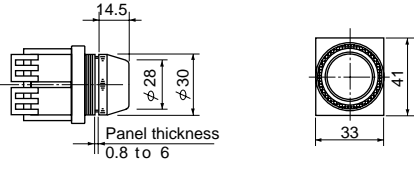
Pushbuttons AH25

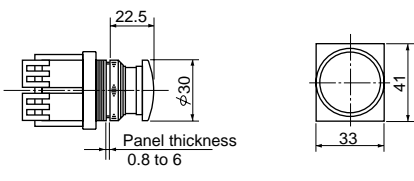
Operator	Contact	Momentary action Type	Alternate action Type	Operator dimensions,mm
Flush round head  AF87-312	1NO 1NC 1NO+1NC 2NO 2NC 2NO+2NC	AH25-F □ 10 AH25-F □ 01 AH25-F □ 11 AH25-F □ 20 AH25-F □ 02 AH25-F □ 22	AH25-F5 □ 10 AH25-F5 □ 01 AH25-F5 □ 11 AH25-F5 □ 20 AH25-F5 □ 02 AH25-F5 □ 22	
Extended round head  AF87-314	1NO 1NC 1NO+1NC 2NO 2NC 2NO+2NC	AH25-E □ 10 AH25-E □ 01 AH25-E □ 11 AH25-E □ 20 AH25-E □ 02 AH25-E □ 22	AH25-E5 □ 10 AH25-E5 □ 01 AH25-E5 □ 11 AH25-E5 □ 20 AH25-E5 □ 02 AH25-E5 □ 22	
Extended with half guard  SG-171	1NO 1NC 1NO+1NC 2NO 2NC 2NO+2NC	AH25-G □ 10 AH25-G □ 01 AH25-G □ 11 AH25-G □ 20 AH25-G □ 02 AH25-G □ 22	AH25-G5 □ 10 AH25-G5 □ 01 AH25-G5 □ 11 AH25-G5 □ 20 AH25-G5 □ 02 AH25-G5 □ 22	
Extended with full guard  SG-179	1NO 1NC 1NO+1NC 2NO 2NC 2NO+2NC	AH25-G1 □ 10 AH25-G1 □ 01 AH25-G1 □ 11 AH25-G1 □ 20 AH25-G1 □ 02 AH25-G1 □ 22	AH25-G6 □ 10 AH25-G6 □ 01 AH25-G6 □ 11 AH25-G6 □ 20 AH25-G6 □ 02 AH25-G6 □ 22	
Mushroom head  SG-185	1NO 1NC 1NO+1NC 2NO 2NC 2NO+2NC	AH25-M □ 10 AH25-M □ 01 AH25-M □ 11 AH25-M □ 20 AH25-M □ 02 AH25-M □ 22	AH25-M5 □ 10 AH25-M5 □ 01 AH25-M5 □ 11 AH25-M5 □ 20 AH25-M5 □ 02 AH25-M5 □ 22	

Notes: • □ See page 04CD/3/11
 • Contact block dimensions: See page 04CD/3/12

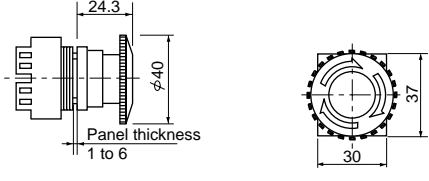
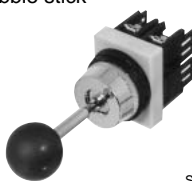
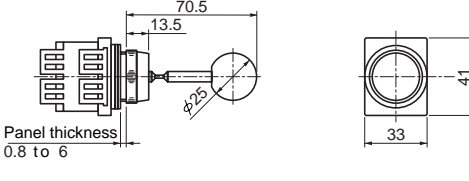
Operator	Contact	Momentary action Type	Operator dimensions,mm
Push-lock, turn-reset  <small>AF89-414</small>	1NO 1NC 1NO+1NC 2NO 2NC 2NO+2NC	AH25-V □10 AH25-V □01 AH25-V □11 AH25-V □20 AH25-V □02 AH25-V □22	
Wobble stick  <small>SG-202</small>	1NO 1NC 1NO+1NC 2NO 2NC 2NO+2NC	AH25-UB10 AH25-UB01 AH25-UB11 AH25-UB20 AH25-UB02 AH25-UB22	

Notes: • AH25-U type: ball color Black only.
 *1 Alternate action type.

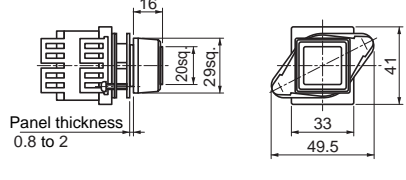
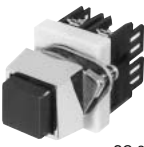
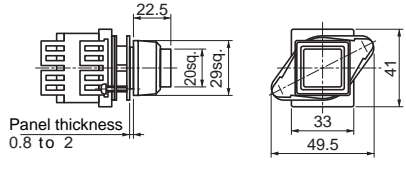
Operator	Contact	Momentary action Type	Alternate action Type	Operator dimensions,mm
Flush square head  <small>SG-208</small>	1NO 1NC 1NO+1NC 2NO 2NC 2NO+2NC	AH25-SF □10 AH25-SF □01 AH25-SF □11 AH25-SF □20 AH25-SF □02 AH25-SF □22	AH25-SF5 □10 AH25-SF5 □01 AH25-SF5 □11 AH25-SF5 □20 AH25-SF5 □02 AH25-SF5 □22	
Extended square head  <small>SG-206</small>	1NO 1NC 1NO+1NC 2NO 2NC 2NO+2NC	AH25-SE □10 AH25-SE □01 AH25-SE □11 AH25-SE □20 AH25-SE □02 AH25-SE □22	AH25-SE5 □10 AH25-SE5 □01 AH25-SE5 □11 AH25-SE5 □20 AH25-SE5 □02 AH25-SE5 □22	

• Button color

Replace the □ mark by the following button color code

Button color	Green	Red	Black	Yellow	White
Code	G	R	B	Y	W

Button color	Dark green	Sky-blue	Orange
Code	D	S	O

Note: AH25-V type: Red, yellow, black only.

- Up to 8-contact block of the contact arrangement can be made.
 For alternate action type, up to 4-contact block of the contact arrangement can be made. (Except for AH25-V type)
- AH25-V type: Up to 4-contacts can be made.
- Contact block dimensions: See page 04CD/3/12

Pushbuttons AH25

• Contact block dimensions, mm

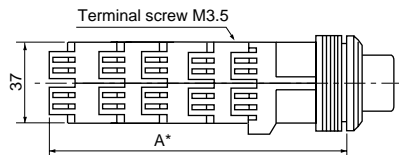



- Up to 8-contact block of the contact arrangement can be made. For alternate action type, up to 4-contact block of the contact arrangement can be made.

AH25

Contact block		1NO, 1NC,	3NO, 3NC,	3NO+3NC	4NO+4NC
		2NO, 2NC, 1NO+1NC	4NO, 4NC, 2NO+2NC		
A	Operator				
	F,E,M,G,G1	45	67	89	111
*	F5,E5,M5,G5,G6	67	89	–	–
	V	48.5	70.5	–	–
	U	43.5	65.5	87.5	109.5
	SF,SE	46.5	68.5	90.5	112.5
	SF5,SE5	68.5	90.5	–	–

* When attaching the terminal cover, the dimension of externals increase 1.5mm.

Operator	Type	Contact operation					
		Contact block		Left 		Right 	
		Mounting position	Type	Free	Depressed	Free	Depressed
Pushbutton with selector ring 2-position 2NO+2NC  SI-55	AH25-S1 □ 22	(1)	NC	—	—	●	—
		(2)	NC	—	—	●	—
		(3)	NO	—	●	—	●
		(4)	NO	—	●	—	●
	AH25-S2 □ 22	(1)	NC	●	—	██████████	
		(2)	NC	██████████		●	—
		(3)	NO	—	●	—	—
		(4)	NO	—	—	—	●
	AH25-S3 □ 22	(1)	NC	—	—	██████████	
		(2)	NC	██████████		—	—
		(3)	NO	—	●	—	—
		(4)	NO	—	—	—	●
	AH25-S4 □ 22	(1)	NC	—	—	██████████	
		(2)	NC	—	—	●	—
		(3)	NO	—	●	—	—
		(4)	NO	—	●	—	●
	AH25-S5 □ 22	(1)	NC	●	—	—	—
		(2)	NC	●	—	—	—
		(3)	NO	—	●	—	●
		(4)	NO	—	●	—	●
	AH25-S6 □ 22	(1)	NC	●	—	—	Locked
		(2)	NC	●	—	—	
		(3)	NO	—	●	●	
		(4)	NO	—	●	●	

Note: (1) to (4) contact block mounting position

● Contact closed
— Contact open

• Button color

Replace the □ mark by the following button color code

Button color	Green	Red	Black	Yellow	White
Code	G	R	B	Y	W

Button color	Dark green	Sky-blue	Orange
Code	D	S	O

- The contact arrangement is 2NO+2NC only.
- The terminals are on the upper and lower positions.
- To turn selector ring of the S3 type right/left, the contacts in the upper and lower contact blocks overlap.

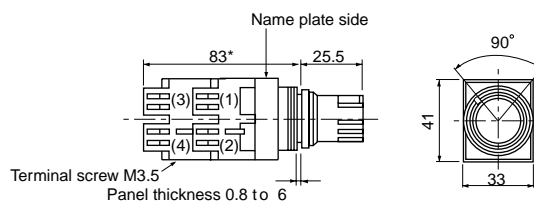

• Dimensions, mm



* When attaching the terminal cover, the dimension of externals increase 1.5mm.

Pushbuttons AH25

■ Mechanically interlocked pushbutton switches

Exterior view	Operator	Contact block	Cat. No.
 AF89-610	Flush/Flush	1NO/1NO 1NO+1NC/1NO+1NC	AH25-F5 □10/F5 □10 AH25-F5 □11/F5 □11
	Flush/Extended	1NO/1NO 1NO+1NC/1NO+1NC	AH25-F5 □10/E5 □10 AH25-F5 □11/E5 □11
	Flush/Mushroom	1NO/1NO 1NO+1NC/1NO+1NC	AH25-F5 □10/M5 □10 AH25-F5 □11/M5 □11
	Latched/Unlatched	Flush/Flush	1NO/1NO 1NO+1NC/1NO+1NC
 AF89-615	Flush/Extended	1NO/1NO 1NO+1NC/1NO+1NC	AH25-F5 □10/E □10 AH25-F5 □11/E □11
	Flush/Mushroom	1NO/1NO 1NO+1NC/1NO+1NC	AH25-F5 □10/M □10 AH25-F5 □11/M □11

• Button color

Replace the □ mark by the following button color code

Button color	Green	Red	Black	Yellow	White
Code	G	R	B	Y	W

Button color	Dark green	Sky-blue	Orange
Code	D	S	O

• Up to 2-contacts can be made.

• Dimensions, mm



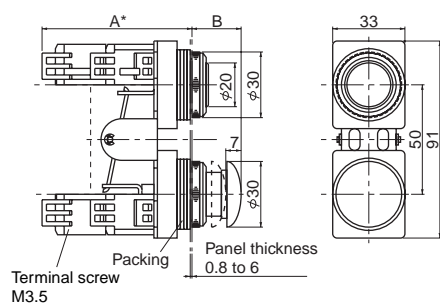

AH25-□/□

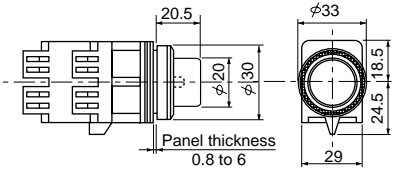

Contact arrangement	1NO, 1NC	1NO+1NC 2NO, 2NC
A*	46.5	68.5

* When attaching the terminal cover, the deimension of externals increase 1.5mm.

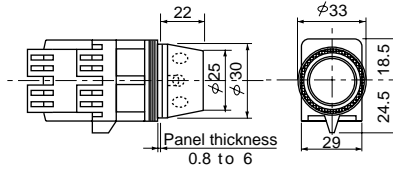
Button	F, F5	E, E5	M, M5
B	7.5	14	22.5

Operator	Contact	Momentary action Type	Alternate action Type	Operator dimensions, mm
Extended round head  <small>SG-150</small>	1NO 1NC 1NO+1NC 2NO 2NC 2NO+2NC	AH25-L □ 10 ■ AH25-L □ 01 ■ AH25-L □ 11 ■ AH25-L □ 20 ■ AH25-L □ 02 ■ AH25-L □ 22 ■	AH25-L5 □ 10 AH25-L5 □ 01 AH25-L5 □ 11 AH25-L5 □ 20 AH25-L5 □ 02 AH25-L5 □ 22	
Extended with full guard (With openings)  <small>10-267</small>	1NO 1NC 1NO+1NC 2NO 2NC 2NO+2NC	AH25-L2 □ 10 ■ AH25-L2 □ 01 ■ AH25-L2 □ 11 ■ AH25-L2 □ 20 ■ AH25-L2 □ 02 ■ AH25-L2 □ 22 ■	AH25-L6 □ 10 AH25-L6 □ 01 AH25-L6 □ 11 AH25-L6 □ 20 AH25-L6 □ 02 AH25-L6 □ 22	
Extended with full guard  <small>AF89-604</small>	1NO 1NC 1NO+1NC 2NO 2NC 2NO+2NC	AH25-L3 □ 10 ■ AH25-L3 □ 01 ■ AH25-L3 □ 11 ■ AH25-L3 □ 20 ■ AH25-L3 □ 02 ■ AH25-L3 □ 22 ■	AH25-L7 □ 10 AH25-L7 □ 01 AH25-L7 □ 11 AH25-L7 □ 20 AH25-L7 □ 02 AH25-L7 □ 22	
Extended with transparent full guard  <small>-605</small>	1NO 1NC 1NO+1NC 2NO 2NC 2NO+2NC	AH25-L4 □ 10 ■ AH25-L4 □ 01 ■ AH25-L4 □ 11 ■ AH25-L4 □ 20 ■ AH25-L4 □ 02 ■ AH25-L4 □ 22 ■	- - - - - -	

• Lens color

Replace the □ mark by the following lens color code

Button color	Green	Red	Yellow	White	Sky-blue	Orange
Code	G	R	Y	W	S	O

For illuminated pushbutton with LED lamp, sky-blue is not available.
 Lens are transparent colored plastic.

- Contact block dimensions: See page 04/19.
- Up to 8-contact block of contact arrangement can be made.
 For switches with transformers or alternate action switches, up to 4-contact block can be made.



• Voltage

Replace the ■ mark by the lamp voltage code

Transformer		Code	
		LED	Incandescent
Without transformer	6V DC	AD3	—
	6V AC	A3	—
	5.5V AC/DC	—	Blank
	12V AC/DC	B3	—
	15V AC/DC	C3	C
	20V AC/DC	—	D
With transformer	24V AC/DC	E3	E
	100-110V AC	H3	H
	115-127V AC	L3	L
	200-220V AC	M3	M
	230-254V AC	Q3	Q
	350-380V AC	S3	S
	400-440V AC	T3	T
480V AC	V3	V	
500-550V AC	W3	W	

Illuminated Pushbuttons

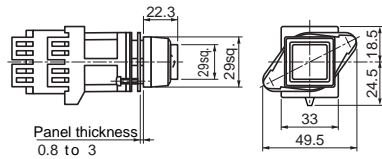
AH25

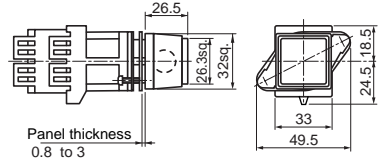
Operator	Contact	Momentary action Type	Alternate action Type	Operator dimensions, mm
Extended square head  SG-144	1NO	AH25-SL□10■	AH25-SL5□10■	 Panel thickness 0.8 to 3
	1NC	AH25-SL□01■	AH25-SL5□01■	
	1NO+1NC	AH25-SL□11■	AH25-SL5□11■	
	2NO	AH25-SL□20■	AH25-SL5□20■	
	2NC	AH25-SL□02■	AH25-SL5□02■	
	2NO+2NC	AH25-SL□22■	AH25-SL5□22■	
Flush square head  SG-139	1NO	AH25-SL1□10■	AH25-SL6□10■	 Panel thickness 0.8 to 3
	1NC	AH25-SL1□01■	AH25-SL6□01■	
	1NO+1NC	AH25-SL1□11■	AH25-SL6□11■	
	2NO	AH25-SL1□20■	AH25-SL6□20■	
	2NC	AH25-SL1□02■	AH25-SL6□02■	
	2NO+2NC	AH25-SL1□22■	AH25-SL6□22■	

Notes: For SL,SL1,SL5 and SL6,switches with incandescent lamp only.

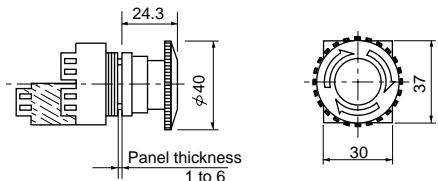
Operator	Contact	Type	Operator dimensions,mm
Push-lock, turn-reset  AF89-413	1NO	AH25-VL□10■	 Panel thickness 1 to 6
	1NC	AH25-VL□01■	
	1NO+1NC	AH25-VL□11■	
	2NO	AH25-VL□20■	
	2NC	AH25-VL□02■	
	2NO+2NC	AH25-VL□22■	

• Lens color

Replace the □ mark by the following lens color code

Button color	Green	Red	Yellow	White	Sky-blue	Orange
Code	G	R	Y	W	S	O

AH25-VL type : Red, yellow only

For illuminated pushbutton with LED lamp,sky-blue is not available.

Lens are transparent colored plastic.

- Contact block dimensions: See page 04CD/3/19.
- Up to 8-contact block of contact arrangement can be made. For switches with transformers or alternate action switches,up to 4-contact block can be made. (Except AH25-VL type)
- AH25-VL type without transformer: Up to 4-contacts
AH25-VL type with transformer: Up to 2-contacts

• Voltage

Replace the ■ mark by the lamp voltage code

Transformer		Code	
		LED	Incandescent
Without transformer	6V DC	AD3	—
	6V AC	A3	—
	5.5V AC/DC	—	Blank
	12V AC/DC	B3	—
	15V AC/DC	C3	C
	20V AC/DC	—	D
	24V AC/DC	E3	E
With transformer	100-110V AC	H3	H
	115-127V AC	L3	L
	200-220V AC	M3	M
	230-254V AC	Q3	Q
	350-380V AC	S3	S
	400-440V AC	T3	T
	480V AC	V3	V
	500-550V AC	W3	W

• **Contact block dimensions, mm**

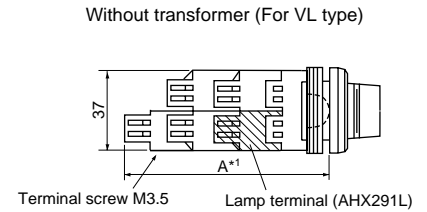
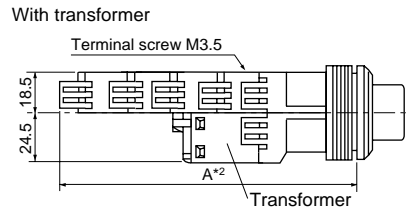
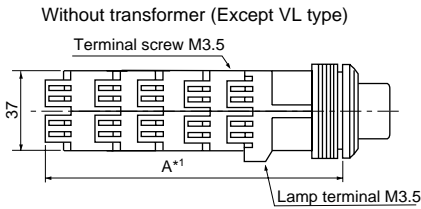

Without transformer

Contact block \ Operator		1NO, 1NC		2NO, 2NC, 1NO+1NC		3NO, 3NC		4NO, 4NC, 2NO+2NC		3NO+3NC		4NO+4NC	
A	L	64.5		86.5		108.5		130.5					
	*1 L5	86.5		108.5		-		-					
	L2,L3,L4	63.5		85.5		107.5		129.5					
	L6,L7	85.5		107.5		-		-					
	VL	48.5	70.5	70.5	92.5	-		-					
	SL,SL1	66		88		110		132					
	SL5,SL6	88		110		-		-					

With transformer

Contact block \ Operator		1NO, 1NC		2NO, 2NC 1NO+1NC		3NO, 3NC		4NO, 4NC 2NO+2NC	
A	L	81	86.5	108.5	130.5				
	*2 L5	103	108.5	130.5	152.5				
	L2,L3,L4	80	85.5	107.5	129.5				
	L6,L7	102	107.5	129.5	151.5				
	VL	62	70.5	-	-				
	SL,SL1	83	88	110	132				
	SL5,SL6	105	110	132	154				

Notes: • Up to 8-contact block of contact arrangement can be made.

For switches with transformers or alternate action switches, up to 4-contact block of contact arrangement can be made. (Except AH25-VL)













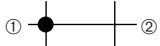

- Type AH25-VL without transformer: 4 contact Max.
- with transformer: 2 contact Max.

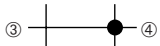
*1 When attaching the terminal cover, the dimension of externals increase 1.5mm.

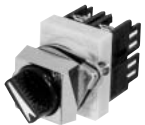
*2 When attaching the terminal cover, the dimension of externals increase 1.5mm. (Except for 1NO and 1NC)

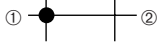
Selector Switches AH25

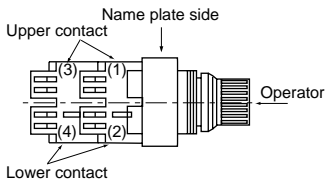
• 2-position

Operator	Operation	Contact	Type	Contact operation (Example)		
				Contact arrangement	Operator position	
					Left	Right
 SG-188	Maintained	1NO 1NC 1NO+1NC 2NO 2NO+2NC	AH25-P2 □ 10 AH25-P2 □ 01 AH25-P2 □ 11 AH25-P2 □ 20 AH25-P2 □ 22	1NO (1)	Upper contact 	
	each 90°			1NC (1)	Upper contact 	
	Spring return  90°	1NO 1NC 1NO+1NC 2NO 2NO+2NC	AH25-P0 □ 10 AH25-P0 □ 01 AH25-P0 □ 11 AH25-P0 □ 20 AH25-P0 □ 22	1NO+1NC (1)	Upper contact 	
 SP-1007	Maintained	1NO 1NC 1NO+1NC 2NO 2NO+2NC	AH25-PW2 □ 10 AH25-PW2 □ 01 AH25-PW2 □ 11 AH25-PW2 □ 20 AH25-PW2 □ 22	(2)	Lower contact 	
	each 90°			2NO+2NC	Upper contact 	
	Spring return  90°	1NO 1NC 1NO+1NC 2NO 2NO+2NC	AH25-PW0 □ 10 AH25-PW0 □ 01 AH25-PW0 □ 11 AH25-PW0 □ 20 AH25-PW0 □ 22	(3)	Lower contact 	
 SG-196	Maintained	1NO 1NC 1NO+1NC 2NO 2NO+2NC	AH25-SP2 □ 10 AH25-SP2 □ 01 AH25-SP2 □ 11 AH25-SP2 □ 20 AH25-SP2 □ 22	(2)	Upper contact 	
	each 90°			(4)	Lower contact 	
 SG-233	Maintained	1NO 1NC 1NO+1NC 2NO 2NO+2NC	AH25-J2 ■ 10() AH25-J2 ■ 01() AH25-J2 ■ 11() AH25-J2 ■ 20() AH25-J2 ■ 22()			
	each 90°					
 SG-226	Maintained	1NO 1NC 1NO+1NC 2NO 2NO+2NC	AH25-SJ2 ■ 10() AH25-SJ2 ■ 01() AH25-SJ2 ■ 11() AH25-SJ2 ■ 20() AH25-SJ2 ■ 22()			
	each 90°					

Notes: • (1) to (4): Contact block mounting position

• ①-②, ③-④: Contact block terminal No.

• □, ■, () and contact arrangements: See page 04CD/3/19

• **Operator dimensions, mm**

AH25-P

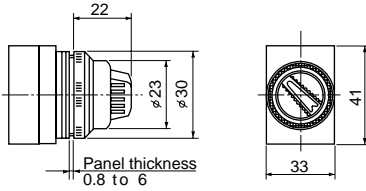

AH25-SP

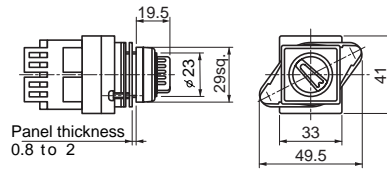

AH25-PW

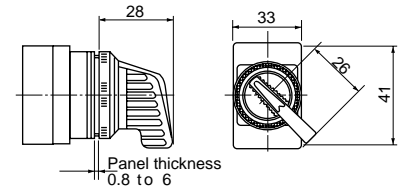

AH25-J

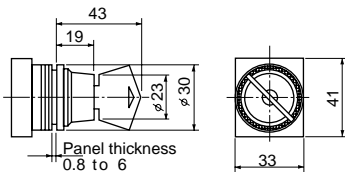

AH25-SJ

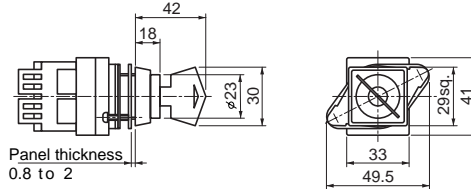

• **Contact block dimensions, mm**

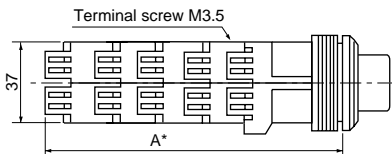

		Contact block			
		1NO, 1NC, 2NO, 2NC, 1NO+1NC	3NO, 3NC, 4NO, 4NC, 2NO+2NC	3NO+3NC	4NO+4NC
A *	AH25 P0, P2, PW0, PW2	53.5	75.5	97.5	119.5
	SP2	55.5	77.5	99.5	121.5
	SJ2	52.5	74.5	96.5	118.5
	J0, J2	51.5	73.5	95.5	117.5

Notes: * When attaching the terminal cover, the dimension of externals increase 1.5mm.

• Up to 8-contact block of the contact arrangement can be made.

• **Knob color**

Replace the □ mark by the following knob color code

Knob color	Green	Red	Black
Code	G	R	B

The standard knob color is black.

• **Key code No.**

Replace the ■ with the key code No. A, B, C, D, E or F. Standard key code is A.

• **Key removable positions**

Replace the () mark by the following code No.

Code	A	D	B
Removable position			
J2	●	●	●
J0	●	—	—
SJ2	●	●	●

● : Available —: Not available

Selector Switches AH25

• 3-position

Operator	Operation	Contact	AH25 Type
 SG-193	Maintained each 45°	1NO+1NC 2NO+2NC	AH25-P3 □ 11 AH25-P3 □ 22
	Spring/manual return ⌚ each 45°	1NO+1NC 2NO+2NC	AH25-P5 □ 11 AH25-P5 □ 22
	Spring/manual return ⌚ each 45°	1NO+1NC 2NO+2NC	AH25-P6 □ 11 AH25-P6 □ 22
	Spring return ⌚ each 60°	2NO+2NC	AH25-P1 □ 22
 AF89-602	Maintained each 45°	1NO+1NC 2NO+2NC	AH25-PW3 □ 11 AH25-PW3 □ 22
	Spring/manual return ⌚ each 45°	1NO+1NC 2NO+2NC	AH25-PW5 □ 11 AH25-PW5 □ 22
	Spring/manual return ⌚ each 45°	1NO+1NC 2NO+2NC	AH25-PW6 □ 11 AH25-PW6 □ 22
	Spring return ⌚ each 60°	2NO+2NC	AH25-PW1 □ 22
 AF88-599	Maintained each 45°	1NO+1NC 2NO+2NC	AH25-SP3 □ 11 AH25-SP3 □ 22
 SG-364	Maintained each 45°	1NO+1NC 2NO+2NC	AH25-J3 ■ 11() AH25-J3 ■ 22()
	Spring/manual return ⌚ each 45°	1NO+1NC 2NO+2NC	AH25-J5 ■ 11() AH25-J5 ■ 22()
	Spring/manual return ⌚ each 45°	1NO+1NC 2NO+2NC	AH25-J6 ■ 11() AH25-J6 ■ 22()
 AF89-609	Maintained each 45°	1NO+1NC 2NC+2NC	AH25-SJ3 ■ 11() AH25-SJ3 ■ 22()

Notes: • □, ■, () and contact arrangements: See page 04CD/3/21
• Operator dimensions: See page 04CD/3/19

• Contact block dimensions, mm

		Operator	Contact block			
			1NO, 1NC 2NO, 2NC 1NO+1NC	3NO, 3NC 4NO, 4NC 2NO+2NC	3NO+3NC	4NO+4NC
A	AH25	P3, P5, P6, PW3, PW5, PW6	53.5	75.5	97.5	119.5
		SP3	55.5	77.5	99.5	121.5
		SJ3	52.5	74.5	96.5	118.5
		J3, J5, J6	51.5	73.5	95.5	117.5
		P1, PW1	-	75.5	-	-
		J1	-	73.5	-	-

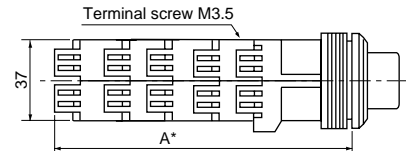

Notes : * When attaching the terminal cover, the dimension of externals increase 1.5mm.
 • Up to 8-contact block of the contact arrangement can be made.
 For spring return switches, up to 4-contact block can be made.

• Key removable positions

Replace the () mark by the following code No.

Code	A	B	C	D	E	F	G
Removable position							
J3, SJ3	●	●	●	●	●	●	●
J5	-	-	-	●	●	●	-
J6	●	-	-	-	●	-	●

●: Available -: Not available

• Contact operation (Example)

3-position

Type	Contact arrangement	Operator position					
		L	C	R	L	C	R
P3, PW3, SP3, J3, SJ3, P5, PW5, J5	1NO+1NC (1) (2)						
P6, PW6, J6	1NO+1NC (1) (2)						
P1, PW1	2NO+2NC (1) (2) (3) (4)						

● Contact closed

Note: ①-②, ③-④ : Contact block terminal No.
 • Up to 8-contact block of the contact arrangement can be made.
 For P1, PW1 types, up to 4-contact block can be made.

• Position of contact block

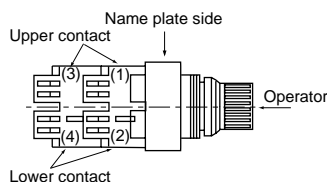

• Key code No.

Replace the ■ with the key code No. A, B, C, D, E or F.
 Standard key code is A.

• Knob color

Replace the □ mark by the following knob color code

Knob color	Green	Red	Black
Code	G	R	B

The standard knob color is black.







Selector Switches AH25



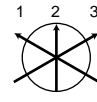
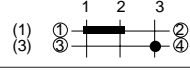
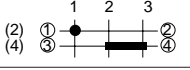
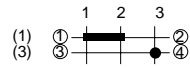
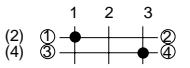
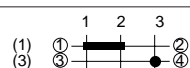
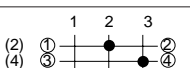
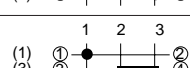
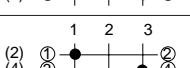
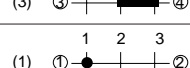
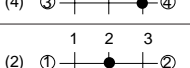

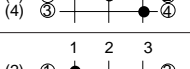
■ Selector switches (control type)

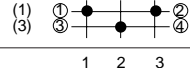
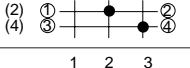
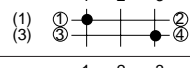
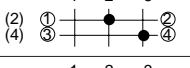
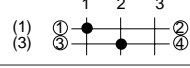
3-position

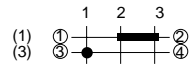
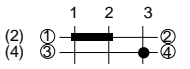
Operator	Operation	Knob color or key removable position	Contact arrangement (2NO+2NC only)	Type
 AF89-596	Maintained each 60°	Color code: B: Black (Standard) Color other than above are available (G: Green) (R: Red)	Replace the ■ mark by type arrangement code (shown on under table).	AH25-PCB■
				AH25-PCR■
				AH25-PCG■

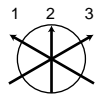
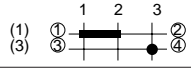
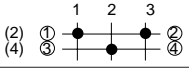
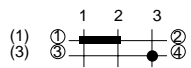
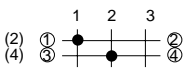
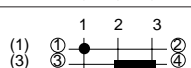
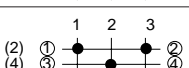
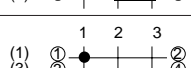
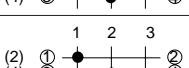
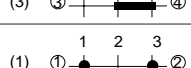
Contact operation (2NO+2NC)

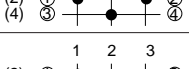
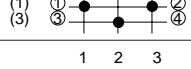
Code	Operation	Contact operation	
		Upper contact	Lower contact
012	 each 60°		
032			
052			
072			
092			
112			
132			
152			
172			
192			
212			

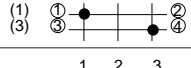
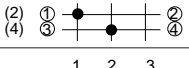
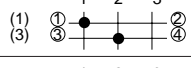
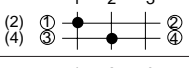
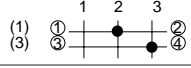
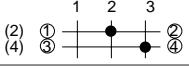
Code	Operation	Contact operation	
		Upper contact	Lower contact
022	 each 60°		
042			
062			
082			
102			
122			
142			
162			
182			
202			

● Contact closed

Notes : • (1) to (4) : Contact block mounting position

• ①-②, ③-④ : Contact block terminal No.

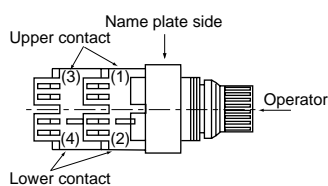

• Dimensions, mm

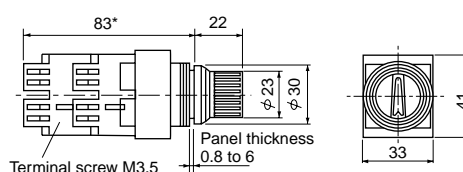

* When attaching the terminal cover, the dimension of externals increase 1.5mm.

• 2-position

Operator	Operation	Contact	Type
 AF89-622	Maintained each 90°	1NO+1NC	AH25-PL2 □ 11 ■
		2NO+2NC	AH25-PL2 □ 22 ■
	Spring return 90°	1NO+1NC	AH25-PL0 □ 11 ■
		2NO+2NC	AH25-PL0 □ 22 ■

• Operator dimensions, mm

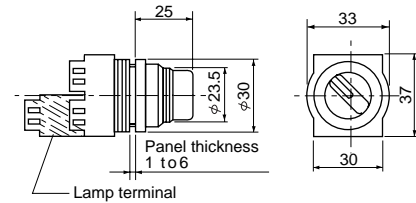

• 3-position

Operator	Operation	Contact	Type
 AF89-415	Maintained each 45°	1NO+1NC	AH25-PL3 □ 11 ■
		2NO+2NC	AH25-PL3 □ 22 ■
	Manual/ spring return each 45°	1NO+1NC	AH25-PL6 □ 11 ■
		2NO+2NC	AH25-PL6 □ 22 ■
	Manual/ spring return each 45°	1NO+1NC	AH25-PL7 □ 11 ■
		2NO+2NC	AH25-PL7 □ 22 ■

Notes: • □, ■ and contact arrangements: See page 04CD/3/24
• 3-position, spring return type is not available.

• Contact block dimensions, mm

Switch: with transformer

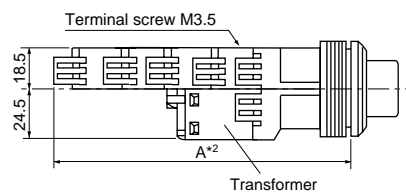

Switch: without transformer

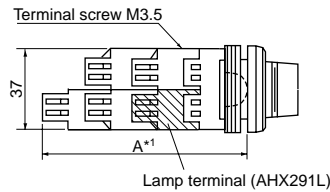

Operator		Contact block	1NO, 1NC	1NO+1NC 2NO, 2NC	3NO, 3NC	2NO+2NC 4NO, 4NC	3NO+3NC
			A	A*1	A*2	A	A
AH25	Without transformer		48.5	70.5	70.5	92.5	114.5
	With transformer	-PL	62	70.5	92.5	114.5	—

Notes: • *1 When attaching the terminal cover, the dimension of external increase 1.5mm.
• *2 When attaching the terminal cover, the dimension of external increase 1.5mm. (Except for 1NO and 1NC)

Illuminated Selector Switches AH25

- Replace the □ mark by the following lamp voltage code

Transformer	Voltage	Code	
		LED	Incandescent
Without	5.5V AC/DC	–	Blank
	6V DC	AD3	–
	6V AC	A3	–
	12V AC/DC	B3	–
	15V AC/DC	C3	C
	20V AC/DC	–	D
	24V AC/DC	E3	E
With	100-110V AC	H3	H
	115-127V AC	L3	L
	200-220V AC	M3	M
	230-254V AC	Q3	Q
	350-380V AC	S3	S
	400-440V AC	T3	T
	480V AC	V3	V
	500-550V AC	W3	W

- Contact arrangement and operator position

2-position

Transformer	Contact arrangement	Contact block		Operator position	
		Mounting position	Type	Left	Right
With/without	1NO	(1)	NO	–	●
With/without	1NC	(1)	NC	●	–
Without	1NO+1NC	(1)	NO	–	●
		(2)	NC	●	–
With	1NO+1NC	(1)	NC	●	–
		(2)	NO	–	●
With/without	2NO	(1)	NO	–	●
		(2)	NO	–	●
Without	2NO+2NC *1	(1)	NO	–	●
		(2)	NC	●	–
		(3)	NO	–	●
		(4)	NC	●	–
With	2NO+2NC *1	(1)	NC	●	–
		(2)	NC	●	–
		(3)	NO	–	●
		(4)	NO	–	●

Notes: *1: AH25-PL2

● : Contact closed, – : Contact open

- Position of contact block

Without transformer

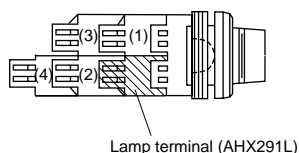

- Replace the □ mark by the following knob color code

Color	Green	Red	White	Sky-blue	Yellow	Orange
Code	G	R	W	S	Y	O

For illuminated selector switch with LED lamp, sky-blue is not available.

- Up to 4-contact of contact arrangement can be made.
Available numbers of contacts are as follow.

No. of position	Operation	Without transformer	With transformer
2-position	Maintained	6-contact	4-contact
	Spring return	4-contact	4-contact
3-position	Maintained	6-contact	4-contact
	Spring/manual return	6-contact	4-contact

3-position

Transformer	Contact arrangement	Contact block		Operator position			
		Mounting position	Type	Left	Center	Right	
Without	1NO+1NC *1	(1)	NO	●	–	–	
		(2)	NC	–	–	●	
	1NO+1NC *2	(1)	NO	–	–	●	
		(2)	NC	●	–	–	
	2NO+2NC *3	(1)	NO	●	–	–	
		(2)	NC	–	–	●	
With	1NO+1NC *1	(1)	NC	–	–	●	
		(2)	NO	●	–	–	
		1NO+1NC *2	(1)	NC	●	–	–
			(2)	NO	–	–	●
	2NO+2NC *3	(1)	NC	–	–	●	
		(2)	NC	–	–	●	
		(3)	NO	●	–	–	
		(4)	NO	●	–	–	

Notes: *1: AH25-PL3, PL6 *3: AH25-PL3

*2: AH25-PL7

● : Contact closed, – : Contact open

With transformer

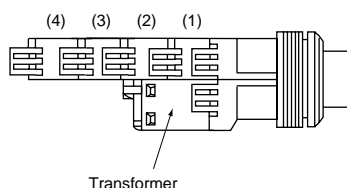

● Incandescent lamp

Lens	Lamp voltage		Type
Dome  SF-1095	Without transformer	15V DC	AH25-ZM □
		24V DC	AH25-ZM □ E
Faceted  SF-1094	Without transformer	15V DC	AH25-ZK □
		24V DC	AH25-ZK □ E
Extended square  SF-1093	Without transformer	15V DC	AH25-ZS □
		24V DC	AH25-ZS □ E
Flush square, with legend plate  SF-1092	Without transformer	15V DC	AH25-ZN □
		24V DC	AH25-ZN □ E
Dome/short-body with transformer  SH-971	With transformer	110V AC	AH25-ZM □ H8
		220V AC	AH25-ZM □ M8





● Lens color

Replace the □ mark by the following lens color code

Button color	Green	Red	Yellow	White	Sky-blue	Orange
Code	G	R	Y	W	S	O

Pilot light with LED lamp, sky-blue is not available.

● LED lamp

Lens	Lamp voltage		Type
Dome  SF-1095	Without transformer	12V DC	AH25-ZM □ B3
		24V DC	AH25-ZM □ E3
Faceted  SF-1094	Without transformer	12V DC	AH25-ZK □ B3
		24V DC	AH25-ZK □ E3
Dome/ short-body with transformer  SH-971	With transformer	110V AC	AH25-ZM □ H3
		220V AC	AH25-ZM □ M3
Dome/ short-body with transformer  SH-971	With transformer	110V AC	AH25-ZK □ H3
		220V AC	AH25-ZK □ M3
Dome/ short-body with transformer  SH-971	With transformer	110V AC	AH25-ZM □ H9
		220V AC	AH25-ZM □ M9

● Voltage

Available lamp voltage are as follow.

Description	Voltage	Code	
		Standard type	
		LED	Incandescent
Without transformer	5.5V AC/DC	–	Blank
	6V AC	A3	–
	6V DC	AD3	–
	12V AC/DC	B3	–
	15V AC/DC	C3	C
	20V AC/DC	–	D
	24V AC/DC	E3	E
With transformer	100-110V AC	H3	H
	115-127V AC	L3	L
	200-220V AC	M3	M
	230-254V AC	Q3	Q
	350-380V AC	S3	S
	400-440V AC	T3	T
	480V AC	V3	V
	500-550V AC	W3	W
With resistor unit	110V DC	H7	–

Pilot Lights AH25

■ Dimensions, mm

Type	Without transformer	With transformer	
AH25-ZM			
AH25-ZM□8			
AH25-ZK			
AH25-ZS			
AH25-ZN			

Note: *1 Same as the resistor unit type.

*2 When attaching the terminal cover, the dimension of externals increase 1.0mm.

Notes on use

■ **Mounting space, mm**

• **Switch**

F, F5, E, E5, G, G5, G1, G6, M, M5, U, S1~S6, SF, SF5, SE, SE5, L, L5, L3, L2, L4, SL, SL5, SL1, SL6, P, PW, SP, J, SJ, PC, PL

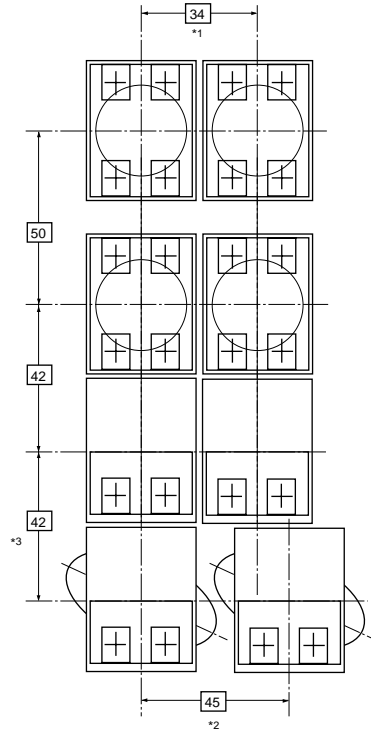

*1 G, G5 type: 42

*2 This dimension applies SF, SF5, SE, SE5, SL, SL5, SL1, SL6, SP, SJ types.

*3 L, SL type: 44 (not meet with the live section.)

• **Push-lock type**

V, VL

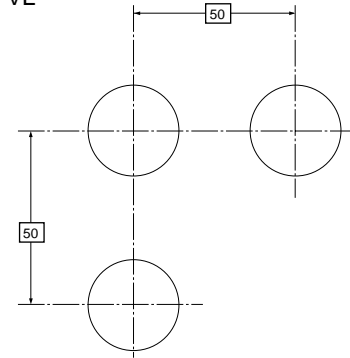

• **Pilot light**

ZM, ZK, ZS, ZN

Without transformer

With transformer

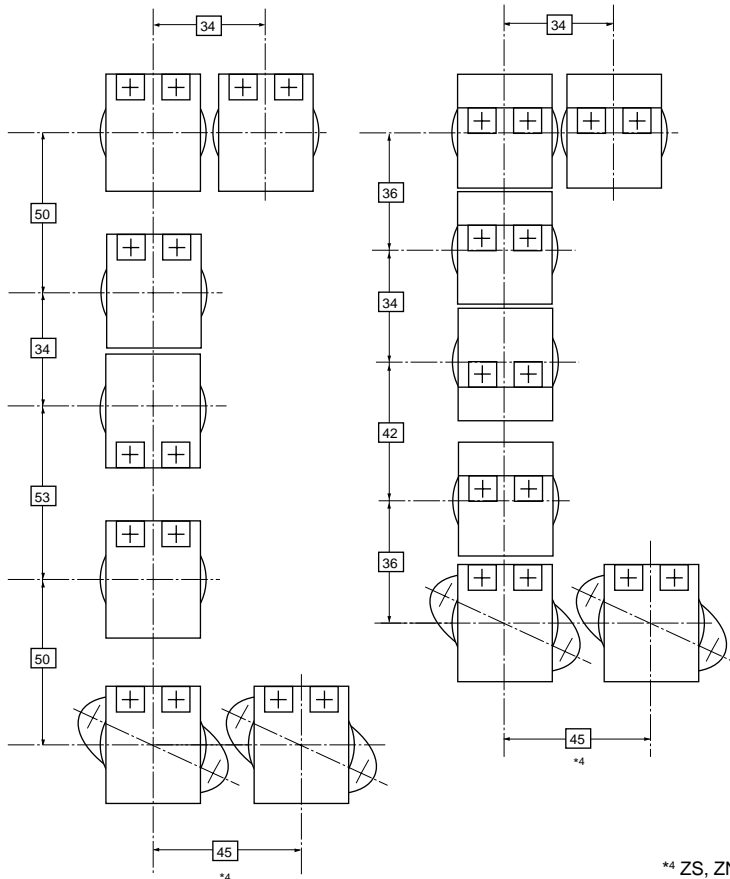

■ **Panel cutout hole**

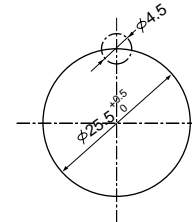

Note: If key-washer or legend plate are not used, 4.5mm dia. location holes sown and the same pilot light type ZS, ZN need not cutout.

*4 ZS, ZN type: In case of horizontal mounting

Pushbuttons/Selectors/Pilot Lights

AH25

Notes on use

■ Replace buttons

(1) To replace AH25 type F, E and G buttons with a different color, insert a flat-blade screwdriver into the groove on the button. To install them, align the button projection and the recess on the inner button and press them together firmly.

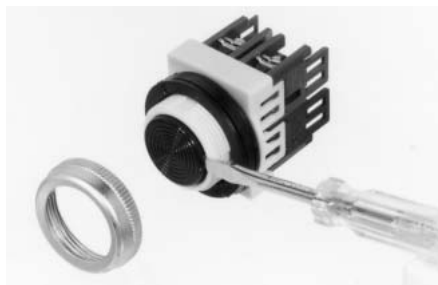

(2) To replace the color tip of AH25 type G (with half guard), do not make the trip groove face the guard.



(3) For AH25-M, V, VL, remove the button and mount the switch to the panel.

a) Tighten the button completely. The button stroke is adjusted only when it is completely tightened. If tightening is insufficient, stroke increases and destroys the contact.

■ Replace the contact block

(1) AH25 contacts can be increased with snap-fitting contact block. To add a contact block, push the additional contact block straight in until it clicks. When adding more than two contact blocks, join the slots on both sides and make sure that the contact blocks facing each other are not open. After addition or replacement, operate the switches a few times to check that they work correctly.

(2) To remove a contact block, use a screwdriver to slightly open the mounting leg, and remove the contact block from the side of the opening leg. When two contact blocks are mounted release one a little, and then the other, and remove both at the same time. The same thing goes for transformers joined to contact blocks. Be careful not to force the mounting leg. Using a special tool (AHX321), the units can be removed more easily.

b) Determine the panel thickness and number of adjustment packings with the table.

Do not adjust the button stroke with a liner under the button.

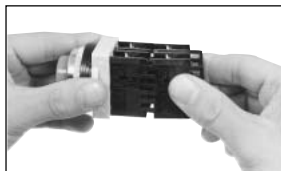
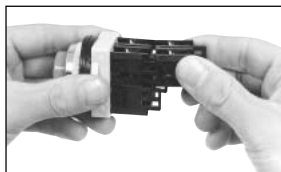
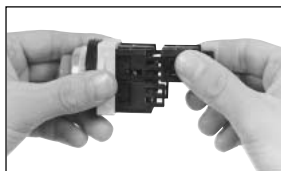
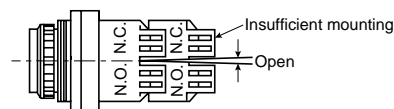

■ Exchange of transformer

(1) A transformer can be easily snap-fitted to an AH25 pilot light. When a transformer is added to a pilot light without a transformer, attach a cover to the terminal of the pilot light to avoid wiring errors.

(2) The capacity of the transformer is set for the lamp. No other load can be applied.



■ Water-proof and dust-proof cap

Applicable type:

Water-proof cap AHX106, 155
Dust-proof cap AHX025, 026, 027
AHX046, 047, 048
AHX105, 112, 114

When attached to the panel in combination with a water-proof or dust-proof cap, the water-proof cap or dust-proof cap may sink downward and prevent the depressed button from returning to its original position. As shown in the following figure, cut an approximately 5-mm air outlet in the portion of the ring packing touching the panel surface. Also, reduce the number of packing rings by one below the standard number. The clamp ring tightening torque is 1.5 to 2.5 N•m.

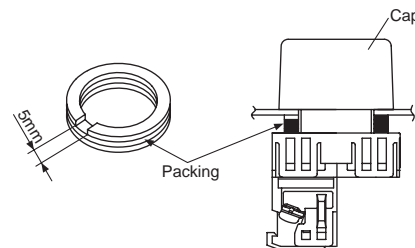

■ Degree of protection

The water-proof cap or dust-proof cap seals the panel surface to provide IP65 protection.

■ Adjustment packing

Four 1.6mm packings (molded as one) are included. Based on the thickness of the mounting panel, adjust the number as shown in the table. To mount to a panels thinner than 1.6mm, one 1.6mm packing is needed (Purchased separately).

Mounting panel thickness and number of packings (reference)

Mounting panel thickness (mm)	Number of packings
0.8 to 2.0	5
2.0 to 3.2	4
3.2 to 4.5	3
4.5 to 6.0	2

Notes:

- When using a key washer or legend plate, decrement one from the numbers in the above table.
- When more than four packings are needed, these are bought separately.

■ **Terminal layout**

Notes: * The positive and negative terminals are used for 6V DC applications.

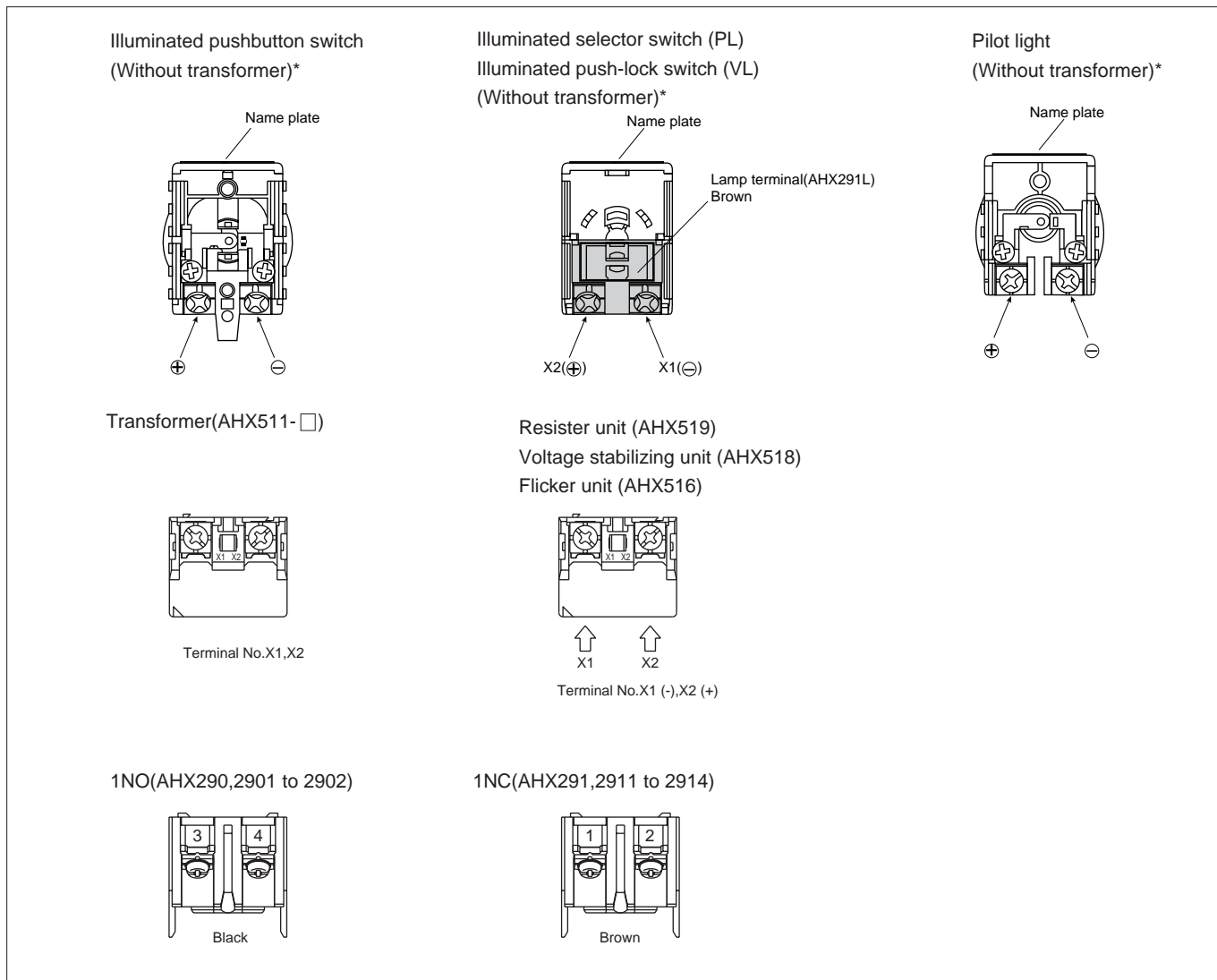

Other items are the same as for the AR22 and DR22 series, see page 04/53 to 04/57.





Pushbuttons/Selectors/Pilot Lights

AH25





Accessories



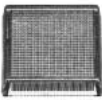

■ Accessories

Description	Type
 <p>T-1995</p>	AHX001
 <p>T-1993</p>	AHX003 Color: Silver (metal) Dimensions, mm <div style="display: flex; align-items: center;">  <div style="margin-left: 10px;"> <p>Panel plug</p> <p>Packing Nut</p> <p>φ31</p> <p>φ35</p> <p>M5</p> <p>3</p> <p>1</p> <p>20</p> </div> </div>
 <p>SC993</p>  <p>SC992</p>	F type Red AHX046 Dimensions, mm Green AHX047 φ34×17.3 Black AHX048 E type Red AHX025 Dimensions, mm Green AHX026 φ34×17.3 Black AHX027 M type Red AHX105-R Dimensions, mm Green AHX105-G φ45×25 Black AHX105-B Yellow AHX105-Y White AHX105-W
 <p>SC-993</p>	F type Red AHX112-R Dimensions, mm Green AHX112-G φ34×17.3 Black AHX112-B E type Red AHX114-R Dimensions, mm Green AHX114-G φ34×17.3 Black AHX114-B
 <p>Y-1559</p>	E type AHX106 Dimensions, mm φ31×18 L type AHX155 Dimensions, mm φ31×25.5 Note: The only color available is transparent.
 <p>AHX029 Y-1990</p>  <p>AHX790 AF95-22</p>	AHX029 For Incandescen lamp AHX790 For LED lamp

Description	Type																										
 <p>Y-1541</p>  <p>Y-1542</p>	Standard F, F5, S1-S6 type AHX061-□ E, E5, G, G5, G1, AHX062-□ G6 type Engraving F, F5, S1-S6 type AHX063-□ E, E5, G, G5, AHX064-□ G1, G6 type Replace the □ mark by the following color code. <table border="1" style="width: 100%; text-align: center;"> <tr> <td>Button color</td> <td>Green</td> <td>Red</td> <td>Black</td> </tr> <tr> <td>Code</td> <td>G</td> <td>R</td> <td>B</td> </tr> </table> <table border="1" style="width: 100%; text-align: center;"> <tr> <td>Button color</td> <td>Dark green</td> <td>Yellow</td> <td>White</td> </tr> <tr> <td>Code</td> <td>D</td> <td>Y</td> <td>W</td> </tr> </table> <table border="1" style="width: 100%; text-align: center;"> <tr> <td>Button color</td> <td>Sky-blue</td> <td>Orange</td> </tr> <tr> <td>Code</td> <td>S</td> <td>O</td> </tr> </table>	Button color	Green	Red	Black	Code	G	R	B	Button color	Dark green	Yellow	White	Code	D	Y	W	Button color	Sky-blue	Orange	Code	S	O				
Button color	Green	Red	Black																								
Code	G	R	B																								
Button color	Dark green	Yellow	White																								
Code	D	Y	W																								
Button color	Sky-blue	Orange																									
Code	S	O																									
 <p>SC-1094</p>	M, M5 type AHX065-□ Replace the □ mark by the following color code. <table border="1" style="width: 100%; text-align: center;"> <tr> <td>Button color</td> <td>Green</td> <td>Red</td> <td>Black</td> </tr> <tr> <td>Code</td> <td>G</td> <td>R</td> <td>B</td> </tr> </table> <table border="1" style="width: 100%; text-align: center;"> <tr> <td>Button color</td> <td>Dark green</td> <td>Yellow</td> <td>White</td> </tr> <tr> <td>Code</td> <td>D</td> <td>Y</td> <td>W</td> </tr> </table> <table border="1" style="width: 100%; text-align: center;"> <tr> <td>Button color</td> <td>Sky-blue</td> <td>Orange</td> </tr> <tr> <td>Code</td> <td>S</td> <td>O</td> </tr> </table>	Button color	Green	Red	Black	Code	G	R	B	Button color	Dark green	Yellow	White	Code	D	Y	W	Button color	Sky-blue	Orange	Code	S	O				
Button color	Green	Red	Black																								
Code	G	R	B																								
Button color	Dark green	Yellow	White																								
Code	D	Y	W																								
Button color	Sky-blue	Orange																									
Code	S	O																									
 <p>SC-1012</p>	Type Used with AHX066-□ F, F5 type AHX067-□ E, E5 type Note: Replace the □ mark by the following color code. <table border="1" style="width: 100%; text-align: center;"> <tr> <td>Symbol mark</td> <td>○</td> <td> </td> </tr> <tr> <td>Symbol mark color</td> <td>Red</td> <td>Green</td> </tr> <tr> <td>Button</td> <td>White</td> <td>Black</td> <td>White</td> <td>Black</td> </tr> <tr> <td>Code</td> <td>E</td> <td>F</td> <td>H</td> <td>J</td> </tr> </table> <table border="1" style="width: 100%; text-align: center;"> <tr> <td>Symbol mark</td> <td>⊕</td> </tr> <tr> <td>Symbol mark color</td> <td>Green</td> </tr> <tr> <td>Button</td> <td>White</td> <td>Black</td> </tr> <tr> <td>Code</td> <td>T</td> <td>U</td> </tr> </table>	Symbol mark	○		Symbol mark color	Red	Green	Button	White	Black	White	Black	Code	E	F	H	J	Symbol mark	⊕	Symbol mark color	Green	Button	White	Black	Code	T	U
Symbol mark	○																										
Symbol mark color	Red	Green																									
Button	White	Black	White	Black																							
Code	E	F	H	J																							
Symbol mark	⊕																										
Symbol mark color	Green																										
Button	White	Black																									
Code	T	U																									
 <p>AF87-522</p>	V type AHX769-□ VL type AHX755-□ Replace the □ mark by the following color code. <table border="1" style="width: 100%; text-align: center;"> <tr> <td>Button color</td> <td>Red</td> <td>Black*</td> <td>Yellow</td> </tr> <tr> <td>Code</td> <td>R</td> <td>B</td> <td>Y</td> </tr> </table> * Except VL type.	Button color	Red	Black*	Yellow	Code	R	B	Y																		
Button color	Red	Black*	Yellow																								
Code	R	B	Y																								

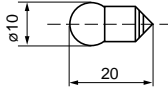
Pushbuttons/Selectors/Pilot Lights AH25 Accessories

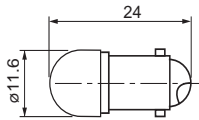
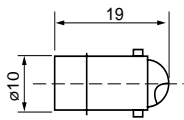
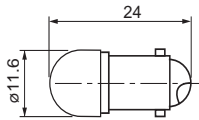
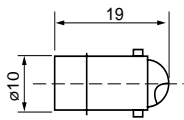
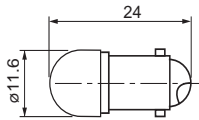
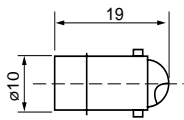





Description	Type																		
Illuminated pushbutton  AF88-613	L, L5, L2, L6, L3, L7, L4 type Green AHX068-G, LG* Red AHX068-R, LR* Clear AHX068-C Orange AHX068-O Yellow AHX068-Y Sky-blue AHX068-S White AHX068-W, LW* *For LED lamp only																		
Pilot light round lens  SC-1001	ZM type Green AHX123-G, LG* Red AHX123-R, LR* Clear AHX123-C Orange AHX123-O Yellow AHX123-Y Sky-blue AHX123-S White AHX123-W, LW* *For LED lamp only																		
Pilot light faceted lens  SC-1002	ZK type Green AHX124-G, LG* Red AHX124-R, LR* Clear AHX124-C Orange AHX124-O Yellow AHX124-Y Sky-blue AHX124-S White AHX124-W, LW* *For LED lamp only																		
Pilot light square lens  SC-1009	ZS type Green AHX125-G Red AHX125-R Clear AHX125-C Orange AHX125-O Yellow AHX125-Y Sky-blue AHX125-S White AHX125-W																		
Pilot light and illuminated pushbutton square lens  SC-1011	ZN, SL1, SL6 type AHX126-□ Replace the □ mark by the following color code. <table border="1" style="width: 100%; text-align: center;"> <tr> <td>Lens color</td> <td>Green</td> <td>Red</td> <td>Clear</td> <td>Sky-blue</td> </tr> <tr> <td>Code</td> <td>G</td> <td>R</td> <td>C</td> <td>S</td> </tr> </table> <table border="1" style="width: 100%; text-align: center;"> <tr> <td>Lens color</td> <td>Orange</td> <td>Yellow</td> <td>White</td> </tr> <tr> <td>Code</td> <td>O</td> <td>Y</td> <td>W</td> </tr> </table>	Lens color	Green	Red	Clear	Sky-blue	Code	G	R	C	S	Lens color	Orange	Yellow	White	Code	O	Y	W
Lens color	Green	Red	Clear	Sky-blue															
Code	G	R	C	S															
Lens color	Orange	Yellow	White																
Code	O	Y	W																
Legend plate  SF-1114	ZN, SL1, SL6 type AHX241-W Dimensions, mm 21.7sq.x2																		





Description	Type																																																											
Incandescent lamp  KKD06-307	<table border="1"> <thead> <tr> <th>Type</th> <th>Lamp voltage</th> <th>Rated voltage, consumption</th> </tr> </thead> <tbody> <tr> <td>AHX135</td> <td>5.5V AC/DC</td> <td>6.3V AC/DC, 1W</td> </tr> <tr> <td>AHX279</td> <td>15V AC/DC</td> <td>18V AC/DC, 1W</td> </tr> <tr> <td>AHX144</td> <td>20V AC/DC</td> <td>24V AC/DC, 1W</td> </tr> <tr> <td>AHX129</td> <td>24V AC/DC</td> <td>30V AC/DC, 1W</td> </tr> </tbody> </table> <p>Dimensions, mm:</p>  <p>Lamp base: BA9s/13</p>	Type	Lamp voltage	Rated voltage, consumption	AHX135	5.5V AC/DC	6.3V AC/DC, 1W	AHX279	15V AC/DC	18V AC/DC, 1W	AHX144	20V AC/DC	24V AC/DC, 1W	AHX129	24V AC/DC	30V AC/DC, 1W																																												
Type	Lamp voltage	Rated voltage, consumption																																																										
AHX135	5.5V AC/DC	6.3V AC/DC, 1W																																																										
AHX279	15V AC/DC	18V AC/DC, 1W																																																										
AHX144	20V AC/DC	24V AC/DC, 1W																																																										
AHX129	24V AC/DC	30V AC/DC, 1W																																																										
LED lamp 	<table border="1"> <thead> <tr> <th>Type</th> <th>Lamp voltage</th> <th>Used with</th> </tr> </thead> <tbody> <tr> <td>APX508-6 □</td> <td>6V AC</td> <td>Pilot Lights*</td> </tr> <tr> <td>APX508-D6 □</td> <td>6V DC</td> <td></td> </tr> <tr> <td>APX508-12 □</td> <td>12V AC/DC</td> <td></td> </tr> <tr> <td>APX508-15 □</td> <td>15V AC/DC</td> <td></td> </tr> <tr> <td>APX508-24 □</td> <td>24V AC/DC</td> <td></td> </tr> <tr> <td>APX510-6 □</td> <td>6V AC</td> <td>Illuminated pushbuttons,</td> </tr> <tr> <td>APX510-D6 □</td> <td>6V DC</td> <td>Illuminated</td> </tr> <tr> <td>APX510-12 □</td> <td>12V AC/DC</td> <td>selectors</td> </tr> <tr> <td>APX510-15 □</td> <td>15V AC/DC</td> <td></td> </tr> <tr> <td>APX510-24 □</td> <td>24V AC/DC</td> <td></td> </tr> </tbody> </table> <p>* When the pilot lights code is "W" (white), use an LED lamp (APX510-■O)</p> <p>Replace the □ mark by the luminous color code</p> <table border="1" style="width: 100%; text-align: center;"> <tr> <td>Luminous color</td> <td>Yellow</td> <td>Red</td> <td>Green</td> </tr> <tr> <td>Code</td> <td>Y</td> <td>R</td> <td>G</td> </tr> <tr> <td>Lens color</td> <td>Y</td> <td>R</td> <td>G</td> </tr> </table> <table border="1" style="width: 100%; text-align: center;"> <tr> <td>Luminous color</td> <td>Amber</td> <td>Orange</td> <td>Blue</td> </tr> <tr> <td>Code</td> <td>A</td> <td>O</td> <td>S</td> </tr> <tr> <td>Lens color</td> <td>O</td> <td>W</td> <td>S</td> </tr> </table> <p>Dimensions, mm:</p> <table style="width: 100%;"> <tr> <td style="text-align: center;">  APX508 </td> <td style="text-align: center;">  APX510 </td> </tr> </table> <p>Lamp base: BA9s/13</p>	Type	Lamp voltage	Used with	APX508-6 □	6V AC	Pilot Lights*	APX508-D6 □	6V DC		APX508-12 □	12V AC/DC		APX508-15 □	15V AC/DC		APX508-24 □	24V AC/DC		APX510-6 □	6V AC	Illuminated pushbuttons,	APX510-D6 □	6V DC	Illuminated	APX510-12 □	12V AC/DC	selectors	APX510-15 □	15V AC/DC		APX510-24 □	24V AC/DC		Luminous color	Yellow	Red	Green	Code	Y	R	G	Lens color	Y	R	G	Luminous color	Amber	Orange	Blue	Code	A	O	S	Lens color	O	W	S	 APX508	 APX510
Type	Lamp voltage	Used with																																																										
APX508-6 □	6V AC	Pilot Lights*																																																										
APX508-D6 □	6V DC																																																											
APX508-12 □	12V AC/DC																																																											
APX508-15 □	15V AC/DC																																																											
APX508-24 □	24V AC/DC																																																											
APX510-6 □	6V AC	Illuminated pushbuttons,																																																										
APX510-D6 □	6V DC	Illuminated																																																										
APX510-12 □	12V AC/DC	selectors																																																										
APX510-15 □	15V AC/DC																																																											
APX510-24 □	24V AC/DC																																																											
Luminous color	Yellow	Red	Green																																																									
Code	Y	R	G																																																									
Lens color	Y	R	G																																																									
Luminous color	Amber	Orange	Blue																																																									
Code	A	O	S																																																									
Lens color	O	W	S																																																									
 APX508	 APX510																																																											
Contact block  SG-370	<table border="1"> <tbody> <tr> <td>1NO</td> <td>AHX290</td> </tr> <tr> <td>1NC</td> <td>AHX291</td> </tr> </tbody> </table> <p>Note: Some models use dedicated contact blocks, so this may not be used. Contact FUJI.</p>	1NO	AHX290	1NC	AHX291																																																							
1NO	AHX290																																																											
1NC	AHX291																																																											



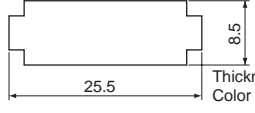

Pushbuttons/Selectors/Pilot Lights

AH25

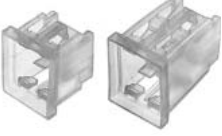
Accessories

Description	Type	Used with	
 SG-370	AHX291L	VL, PL	
	Lamp terminal: for without transformer		
 SI-8	100 to 110V AC	AHX511-H	
	115 to 127V AC	AHX511-L	
	200 to 220V AC	AHX511-M	
	230 to 254V AC	AHX511-Q	
	350 to 380V AC	AHX511-S	
	400 to 440V AC	AHX511-T	
	480V AC	AHX511-V	
500 to 550V AC	AHX511-W		
 SH-183	100 to 110V AC	AHX513-H	
	115 to 127V AC	AHX513-L	
	200 to 220V AC	AHX513-M	
	230 to 254V AC	AHX513-Q	
	350 to 380V AC	AHX513-S	
	400 to 440V AC	AHX513-T	
	480V AC	AHX513-V	
500 to 550V AC	AHX513-W		
 AF89-824	AHX326	Combining the base unit with a standard transformer makes a separate mounting type transformer. It can be mounted to the panel with screw or rails.	
	* Not approved Secondary side terminal cover need to order.		
 AHX305 SG-842	AHX305	Contact block, lamp terminal unit	23.5×27.5×16
	AHX426	Pilot lights (without transformer)	27.5×31×8
	AHX376	Transformer	13×29×6.5
	AHX426	Short-body transformer	
 AHX426 AF92-339		Resistor unit	
	AHX376		
 AHX376 SG-5	The terminal cover is provided as standard with the applicable types listed above.		

Description	Type	Used with
 SG-842	AHX306	Illuminated type
	For pilot lights and AH326 (base unit)	
Dimensions, mm		
		
Thickness: 0.5mm Color : Black		
 SC-1016	AHX083	
	Key washer	
 SF-1113	Rubber	AHX151
	Resin (Standard)	AHX283
Use rubber packing for mounting on plastic panels or panels painted with natural dry paint.		
 SC-1148	For F, E, L, L5 type	Red AHX094 Black AHX095 White AHX096 Dark green AHX097 * Chrome-plate AHX098
	For ZM, ZK type	Chrome-plate AHX098-1
	For P, J, M, S1-S6, G, G5	Red AHX099 Black AHX100 White AHX101 Dark green AHX102 * Chrome-plate AHX103
	Note: Chrome-plated products marked with asterisk (*) are made of metal.	
	For F, E	AHX050
	For M, P	AHX051
	Note: The locking nut is made of aluminum	
	For G1, G6 type	AHX055
	For L2, L6 type	AHX058
	For L3, L7 type	AHX059
For L4 type	AHX060	
 SH-154	AHX323	In combination with this cap, the knob operated selector switch can be used as a dust-proof type.
	Dust-tight cap for knob operated selector switch	
 SG-1050 SG-1051	Used with	AHX315
	AH25	(1NO+1NC)
	F, E, G1, M, U	AHX316
	S1-S6, SF, SE,	(2NO+2NC)
	P, PW, J, PC	
	SJ, SP	

Description	Type									
Locking attachment for E type  AF89-613	AHX053 Locks the button as it is pressed, easily attached and removed with the nut.									
Special tool  SG-873	AHX321 This is a special tool for removing contact blocks and transformers. It can also remove round color lens.									
Legend plate (Standard)  Y-1545	<table border="1"> <thead> <tr> <th colspan="2">AHX351()</th> </tr> <tr> <th>Pushbutton switch</th> <th>Selector switch</th> </tr> </thead> <tbody> <tr> <td>ON</td> <td rowspan="4">OFF-ON</td> </tr> <tr> <td>OFF</td> </tr> <tr> <td>START</td> </tr> <tr> <td>STOP</td> </tr> </tbody> </table> <p>Note: Put in the () ordering word as shown in the upper table Example: In case of STOP AHX351(STOP)</p>	AHX351()		Pushbutton switch	Selector switch	ON	OFF-ON	OFF	START	STOP
AHX351()										
Pushbutton switch	Selector switch									
ON	OFF-ON									
OFF										
START										
STOP										
Legend plate (Unprinted)  AF-87-49	<table> <tr> <td>Unprinted aluminum</td> <td>AHX351-A</td> </tr> <tr> <td>Unprinted aluminum, short size</td> <td>AHX351-AS</td> </tr> <tr> <td>Black</td> <td>AHX351-B</td> </tr> <tr> <td>Black, short size</td> <td>AHX351-BS</td> </tr> </table>	Unprinted aluminum	AHX351-A	Unprinted aluminum, short size	AHX351-AS	Black	AHX351-B	Black, short size	AHX351-BS	
Unprinted aluminum	AHX351-A									
Unprinted aluminum, short size	AHX351-AS									
Black	AHX351-B									
Black, short size	AHX351-BS									

Pushbuttons/Selectors/Pilot Lights

AH25

Mass

■ Mass, gram

AH25 series

Type	1NO (1NC)	2NO (2NC) (1NO+1NC)	2NC + 2NO	3NC + 3NO	4NC + 4NO
AH25- F	42	56	80	104	128
E	44	58	82	106	130
M	48	62	86	110	134
G	51	65	89	113	137
G1	53	67	91	115	139
SF	80	94	118	142	166
SE	82	96	120	144	168
U	80	94	118	142	166
S1-S6	-	-	133	-	-
V	55	69	93	-	-
AH25- F5	59	73	97	-	-
E5	61	75	99	-	-
M5	65	79	103	-	-
G5	68	82	106	-	-
G6	70	84	108	-	-
SF5	97	111	135	-	-
SE5	99	113	137	-	-
AH25- L	61	75	99	123	147
L • T	131	143	167	-	-
L2	74	88	112	136	160
L2 • T	144	156	180	-	-
L3	78	92	116	140	164
L3 • T	148	160	184	-	-
L4	57	71	95	119	143
L4 • T	127	139	163	-	-
SL	99	113	137	161	185
SL • T	169	181	205	-	-
SL1	80	94	118	142	166
SL1 • T	150	162	186	-	-
VL	72	84	108	-	-
VL • T	129	141	-	-	-
AH25- L5	81	95	119	-	-
L5 • T	151	163	187	-	-
L6	94	108	132	-	-
L6 • T	164	176	200	-	-
L7	98	112	136	-	-
L7 • T	168	180	204	-	-
SL5	116	130	154	-	-
SL5 • T	186	198	222	-	-
SL6	97	111	135	-	-
SL6 • T	167	179	203	-	-

Type	1NO (1NC)	2NO (2NC) (1NO+1NC)	2NC + 2NO	3NC + 3NO	4NC + 4NO
AH25- P2, P0	62	76	100	124	148
P3, P5, P6	-	76	100	124	148
P1	-	128	152	-	-
PW2, PW0	67	81	105	129	153
PW3, PW5, PW6	-	81	105	129	153
PW1	-	133	157	-	-
SP2	89	103	127	151	175
SP3	-	103	127	151	175
PC	-	-	108	-	-
J2, J0	88	102	126	150	174
J3, J5, J6	-	102	126	150	174
SJ2	115	129	153	177	201
SJ3	-	129	153	177	201
AH25- PL2, PL0	71	83	107	131	-
PL2, PL0 • T	128	140	164	-	-
PL3, PL6, PL7	-	83	107	131	-
PL3, PL6, PL7 • T	-	140	164	-	-

AH25- ZM	29
ZM • T	99
ZM□8, □9	101
ZK	29
ZK • T	99
ZS	62
ZS • T	132
ZN	62
ZN • T	132

Note • T: With transformer

Type	1NO(1NC)/1NO(1NC)	2NO(2NC)/2NO(2NC) 1NO+1NC/1NO+1NC
AH25- F5/F5	151	175
F5/E5	153	177
F5/M5	157	181

■ **Description**

- **Enclosed type**
Enclosed type steel boxes finished respectively with one to five holes. Rounded, smooth design. Selectable from the 22mm, 25mm, and 30mm dia. series command switches according to the application.
- **Dust protected type, protected against water jets**
Made of lightweight, strong aluminum die-casting. Rounded, smooth design. Series of models finished respectively with one to four holes. (Note: Only 22 dia. series models incorporate four holes.)

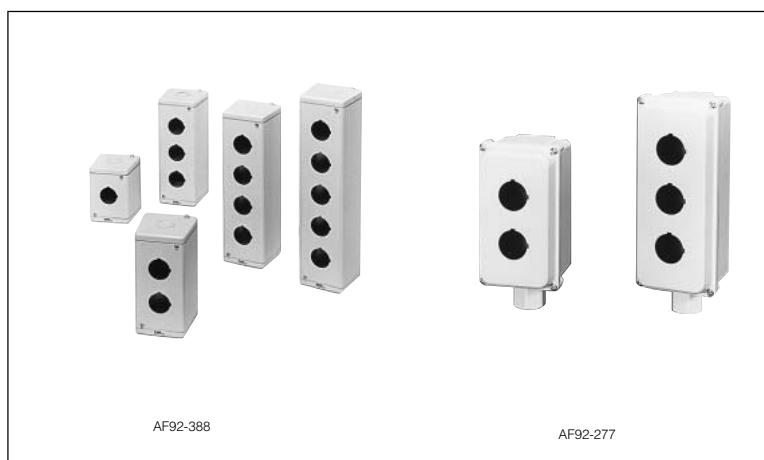

■ **Type number nomenclature**

AHX 9 0 1 A
① ② ③ ④

① **Product category**
AHX: Type

② **Size of mounting hole**
2: 22mm dia. series
1: 25mm dia. series
0: 30mm dia. series
9: without hole

③ **Number of mounting hole**

- **Enclosed type**
 - 1: 1 hole*1
 - 2: 2 holes
 - 3: 3 holes
 - 4: 4 holes
 - 5: 5 holes
- **Dust protected type, protected against water jets**
 - 1: 1 hole*2
 - 2: 2 holes
 - 3: 3 holes
 - 4: 4 hole*3
 - 9: 1 hole*1

Notes: *1 Dedicated box with one hole
*2 Same as the box for two holes in external dimension
*3 Only 22mm dia. series can be manufactured

④ **Degree of protection**

- A: Enclosed type
- W: Dust protected type, protected against water jets

Degree of Protection	Type	
Enclosed-type	AHX9□1A	
	AHX9□2A	
	AHX9□3A	
	AHX9□4A	
	AHX9□5A	
Dust protected type, protected against water jets	Dedicated box with one hole.	AHX929W
		AHX919W
		AHX909W
		AHX9□1W
		AHX9□2W
		AHX9□3W
		AHX924W

Replace the □ mark the Size of mounting hole code

Command boxes

AHX9

■ Specifications

Description	Enclosed type	Dust protected type, protected against water jets
Degree of Protection	IP40(IEC 60529)	IP65(IEC 60529)
Material	Steel	Aluminum die cast
Ambient temperature (No condensation or no icing)	-25 to +50°C	
Humidity	45 to 85% RH(with in -5 to +40°C)	
Applicable type *1	22, 25, 30mm dia.Command switch series AK22, RC310-F Cam type selector switch 30mm dia. short-body type meter	See the description in the below: Mountable switches and degree of protection
Depth	73mm	84mm
Laed hole	Knockout hole (22mm dia. top side , 27mm dia. bottom side)	
Options	Mounting bracket: A mounting bracket is available, with which the command box can be mounted vertical or at an angle of 15 (see page 04CD/4/4)	
	Command boxes incorporating switches are available	

Note: *1 Check the effective depth of the box when selecting mountable switches.

■ Mountable switches and degree of protection (Dust protected type, protected against water jets)

The degree of protection of the command box is IP65, which, however, changes according to the device to which the command box is mounted. Check the depth of the command box when selecting the device. Consult your Fuji Electric FA representative when using the command box outdoors (e.g., plating factory yards, seashores, and places exposed to special cutting oil).

Conforms to IEC standard IP65 (Dust protected type, protected against water jets)

●25mm dia. 30mm dia. series pushbuttons.*

Note: *Except for conform to IEC standard IP40 (Enclosed type)

Pushbutton switches, illuminated pushbutton switches, selector switches, pilot lights, and joy stick selector switches.

●22mm dia. series pushbuttons.

Pushbutton switches, illuminated pushbutton switches, selector switches, pilot lights, and joy stick selector switches.

●Cam switch

AK22 series (22mm dia.), RC310F series (30mm dia.).

Conforms to IEC standard IP40 (Enclosed type)

●25mm dia. series pushbuttons.

Sqare head pushbutton switch, illuminated sqare head pushbutton switch, sqare head selector switches, sqare head pilot lights, sqare head pilot lights with legend plate.

●30mm dia. series pushbuttons.

Illuminated pushbutton switches(push-pull type), pilot lights with dome with dimmer control.

Note on use

■ **Precautions for panel (wall) mounting (Dust protected type, protected against water jets)**

● Do not insert M4 screws into the waterproof bushings that are press-fit into the four mounting holes of the casing and hit the screws with a hammer, or otherwise the screws will break through the waterproof bushings (see fig. 1).

● Insert the screws into the panel mounting holes and secure the screws with nuts (see fig. 2). The waterproof performance of the casing remains unchanged when the screws are inserted into the bushings.

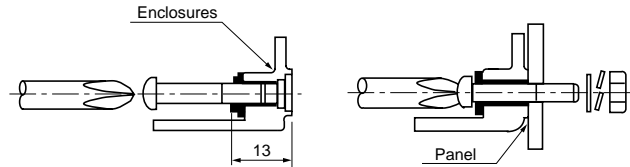
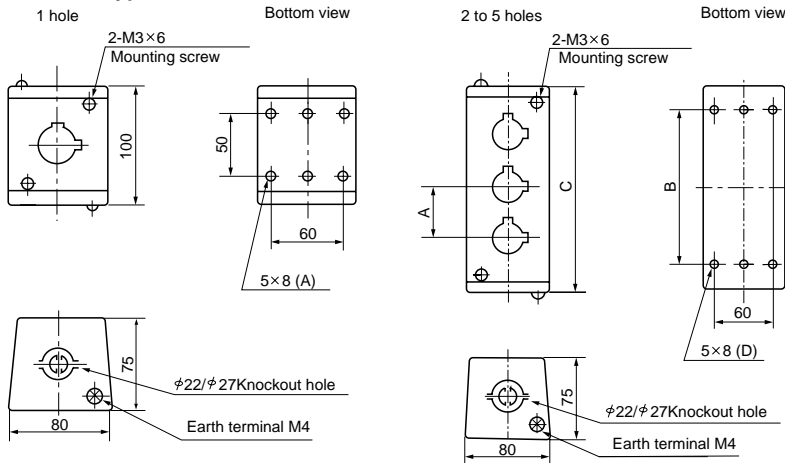

Fig.1

Fig.2

■ **Dimensions, mm:**

● **Enclosed type**



Number of holes	Dimension : mm		
	A	B	C
2	50	100	150
3	50	150	200
4	50	200	250
5	50	250	300

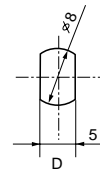

● **Dust protected type, protected against water jets**

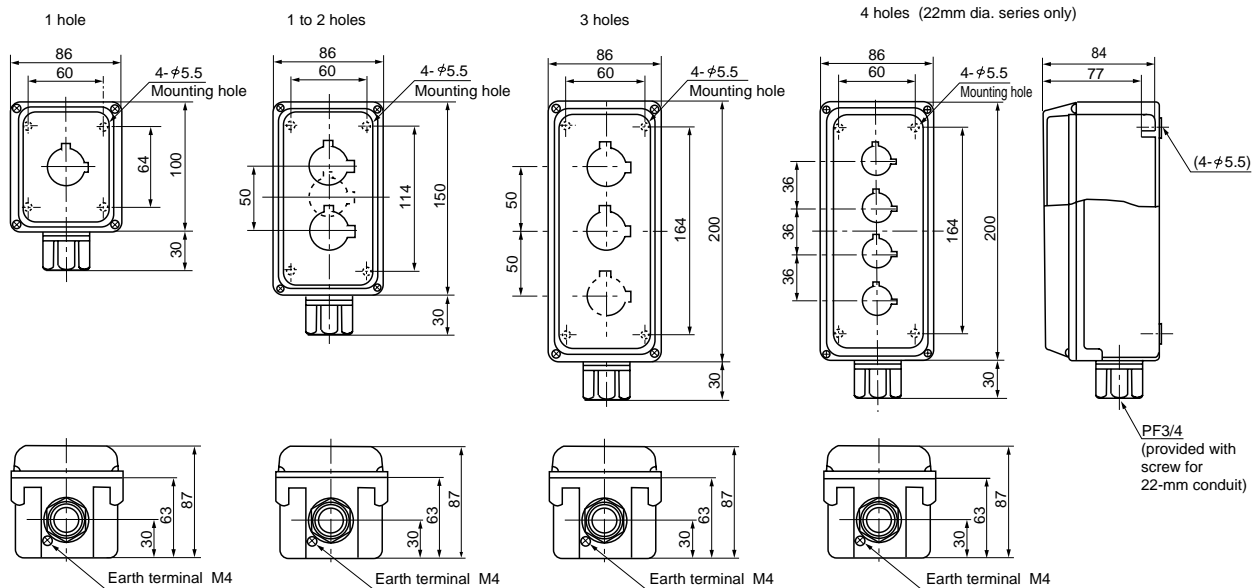

● **Panel drilling (Enclosed type, Dust protected type, protected against water jets)**

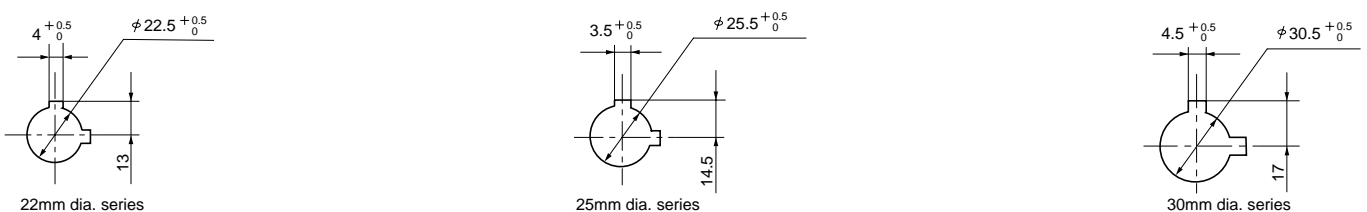

Command boxes

AHX9

■ Accessories (for Enclosed type)

● Mounting bracket

Number of holes	Mounting method	Type
1	Vertical type	AJ91S
	Angle type	AJ91K
2	Vertical type	AJ92S
	Angle type	AJ92K
3	Vertical type	AJ93S
	Angle type	AJ93K
4	Vertical type	AJ94S
	Angle type	AJ94K
5	Vertical type	AJ95S
	Angle type	AJ95K

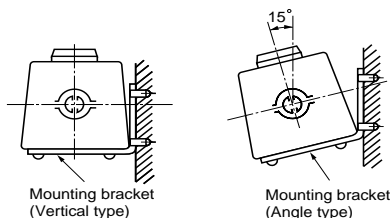

Dimensions, mm:

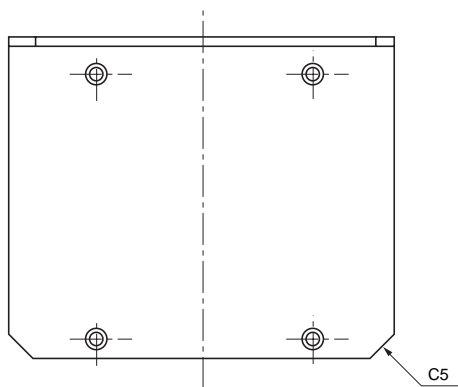

Type	Dimension:mm		
	A	B	C°
AJ91S	90	50	90
AJ91K	90	50	105
AJ92S	140	100	90
AJ92K	140	100	105
AJ93S	190	150	90
AJ93K	190	150	105
AJ94S	240	200	90
AJ94K	240	200	105
AJ95S	290	250	90
AJ95K	290	250	105

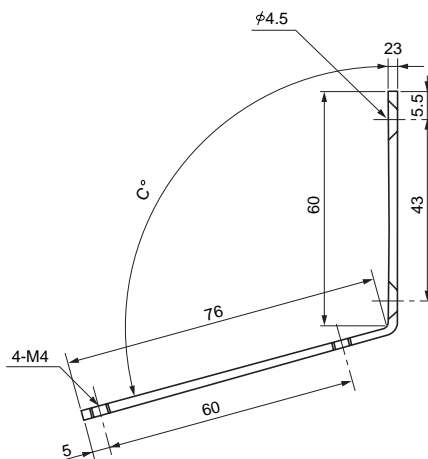
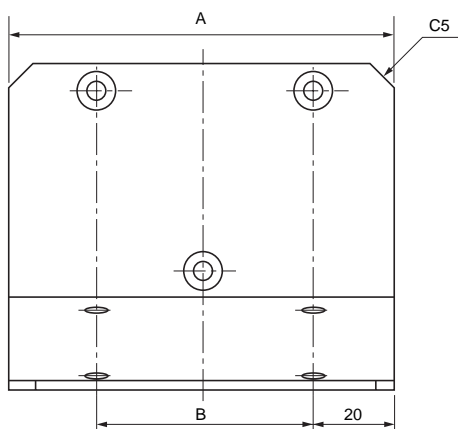

■ Mass, gram

Type	Mass	Type	Mass	Type	Mass
AHX901A	300	AHX923A	520	AHX924W	610
AHX902A	410	AHX924A	660	AHX992W	490
AHX903A	500	AHX925A	780	AHX993W	620
AHX904A	650	AHX901W	480	AHX909W	390
AHX905A	770	AHX902W	480	AHX919W	390
AHX911A	300	AHX903W	600	AHX929W	390
AHX912A	410	AHX911W	490	AHX999W	400
AHX913A	510	AHX912W	490	AHX991A	310
AHX914A	660	AHX913W	590	AHX992A	420
AHX915A	770	AHX921W	490	AHX993A	520
AHX921A	300	AHX922W	490	AHX994A	670
AHX922A	410	AHX923W	610	AHX995A	790

Catalog Disclaimer

The information contained in this catalog does not constitute an express or implied warranty of quality, any warranty of merchantability or fitness for a particular purpose is hereby disclaimed.

Since the user's product information, specific use application, and conditions of use are all outside of Fuji Electric FA Components & Systems' control, **it shall be the responsibility of the user to determine the suitability of any of the products mentioned for the user's application.**

One Year Limited Warranty

The products identified in this catalog shall be sold pursuant to the terms and conditions identified in the "Conditions of Sale" issued by Fuji Electric FA with each order confirmation.

Except to the extent otherwise provided for in the Conditions of Sale issued by Fuji Electric FA, Fuji Electric FA warrants that the Fuji Electric FA products identified in this catalog shall be free from significant defects in materials and workmanship provided the product has not been: 1) repaired or altered by others than Fuji Electric FA; 2) subjected to negligence, accident, misuse, or damage by circumstances beyond Fuji Electric FA's control; 3) improperly operated, maintained or stored; or 4) used in other than normal use or service. This warranty shall apply only to defects appearing within one (1) year from the date of shipment by Fuji Electric FA, and in such case, only if such defects are reported to Fuji Electric FA within thirty (30) days of discovery by purchaser. Such notice should be submitted in writing to Fuji Electric FA at 5-7, Nihonbashi Odemma-cho, Chuo-ku, Tokyo, Japan. The sole and exclusive remedy with respect to the above warranty whether such claim is based on warranty, contract, negligence, strict liability or any other theory, is limited to the repair or replacement of such product or, at Fuji Electric FA's option reimbursement by Fuji Electric FA of the purchase price paid to Fuji Electric FA for the particular product. **Fuji Electric FA does not make any other representations or warranties, whether oral or in writing, expressed or implied, including but not limited to any warranty regarding merchantability or fitness for a particular purpose.** Except as provided in the Conditions of Sale, no agent or representative of Fuji Electric FA is authorized to modify the terms of this warranty in writing or orally.

In no event shall Fuji Electric FA be liable for special, indirect or consequential damages, including but not limited to, loss of use of the product, other equipment, plant and power system which is installed with the product, loss of profits or revenues, cost of capital, or claims against the purchaser or user of the product by its customers resulting from the use of information, recommendations and descriptions contained herein. The purchaser agrees to pass on to its customers and users, in writing at the time inquiries and orders are received by buyer, Fuji Electric FA's warranty as set forth above.

Caution "Safety precautions"

- Operate (keep) in the environment specified in the operating instructions and manual. High temperature, high humidity, condensation, dust, corrosive gases, oil, organic solvents, excessive vibration or shock might cause electric shock, fire, erratic operation or failure.
- Follow the regulations of industrial wastes when the product is to be discarded.
- The products covered in this catalog have not been designed or manufactured for use in equipment or systems which, in the event of failure, can lead to loss of human life.
- If you intend to use the products covered in this catalog for special applications, such as for nuclear energy control, aerospace, medical, or transportation, please consult your Fuji Electric FA agent.
- Be sure to provide protective measures when using the product covered in these catalogs in equipment which, in the event of failure, may lead to loss of human life or other grave results.
- Follow the directions of the operating instructions when mounting the product.

D&C CATALOG DIGEST INDEX

Individual
catalog No.

LOW VOLTAGE PRODUCTS Up to 600 Volts

01 Magnetic Contactors and Starters
Thermal Overload Relays, Solid-state Contactors

02 Manual Motor Starters and Contactors
Combination Starters

03 Industrial Relays, Industrial Control Relays
Annunciator Relay Unit, Time Delay Relays

04 Pushbuttons, Selector Switches, Pilot Lights
Rotary Switches, Cam Type Selector Switches
Panel Switches, Terminal Blocks, Testing Terminals

05 Limit Switches, Proximity Switches
Photoelectric Switches

06 Molded Case Circuit Breakers
Air Circuit Breakers

07 Earth Leakage Circuit Breakers
Earth Leakage Protective Relays

08 Circuit Protectors
Low Voltage Current-Limiting Fuses

09 Measuring Instruments, Arresters, Transducers
Power Factor Controllers
Power Monitoring Equipment (F-MPC)

10 AC Power Regulators
Noise Suppression Filters
Control Power Transformers

HIGH VOLTAGE PRODUCTS Up to 36kV

11 Disconnecting Switches, Power Fuses
Air Load Break Switches
Instrument Transformers — VT, CT

12 Vacuum Circuit Breakers, Vacuum Magnetic Contactors
Protective Relays

INDIVIDUAL CATALOG **04**

from D&C CATALOG 20th Edition

Fuji Electric FA Components & Systems Co., Ltd.

5-7, Nihonbashi Odemma-cho, Chuo-ku, Tokyo, 103-0011, Japan

URL <http://www.fujielectric.co.jp/fcs/eng>

Information in this catalog is subject to change without notice.