



Contactor AC 24 V 50/60 HZ AC3 3 kW 400 V AUX contacts: 1 NO 3-pole, size S00 screw terminal

product brand name	SIRIUS
product designation	Power contactor
product type designation	3RT6
General technical data	
size of contactor	S00
product extension auxiliary switch	Yes
power loss [W] for rated value of the current	
• at AC in hot operating state per pole	0.42 W
• without load current share typical	1.05 W
type of calculation of power loss depending on pole	quadratic
insulation voltage rated value	690 V
degree of pollution	3
surge voltage resistance rated value	6 kV
maximum permissible voltage for protective separation between coil and main contacts according to EN 60947-1	400 V
shock resistance at rectangular impulse	
• at AC	6,7g / 5 ms, 4,2g / 10 ms
shock resistance with sine pulse	
• at AC	10,5g / 5 ms, 6,6g / 10 ms
mechanical service life (operating cycles)	
• of contactor typical	30 000 000
• of the contactor with added auxiliary switch block typical	10 000 000
Substance Prohibition (Date)	05/01/2012
Ambient conditions	
installation altitude at height above sea level maximum	2 000 m
ambient temperature	
• during operation	-25 ... +60 °C
• during storage	-55 ... +80 °C
Main circuit	
number of poles for main current circuit	3
number of NO contacts for main contacts	3
number of NC contacts for main contacts	0
operating voltage	
• at AC-3 rated value maximum	690 V
• at AC-3e rated value maximum	690 V
operational current	
• at AC-1 up to 690 V	
— at ambient temperature 40 °C rated value	18 A
— at ambient temperature 60 °C rated value	16 A
• at AC-3	

<ul style="list-style-type: none"> — at 400 V rated value — at 690 V rated value ● at AC-3e <ul style="list-style-type: none"> — at 400 V rated value — at 690 V rated value 	<p>7 A</p> <p>4.9 A</p> <p>7 A</p> <p>4.9 A</p>
connectable conductor cross-section in main circuit at AC-1	
<ul style="list-style-type: none"> ● at 60 °C minimum permissible ● at 40 °C minimum permissible 	<p>2.5 mm²</p> <p>2.5 mm²</p>
operational current for approx. 200000 operating cycles at AC-4	
<ul style="list-style-type: none"> ● at 400 V rated value ● at 690 V rated value 	<p>2.6 A</p> <p>1.8 A</p>
operating power	
<ul style="list-style-type: none"> ● at AC-1 <ul style="list-style-type: none"> — at 230 V rated value — at 230 V at 60 °C rated value — at 400 V at 60 °C rated value — at 690 V at 60 °C rated value ● at AC-3 <ul style="list-style-type: none"> — at 230 V rated value — at 400 V rated value — at 690 V rated value ● at AC-3e <ul style="list-style-type: none"> — at 400 V rated value — at 690 V rated value 	<p>6.3 kW</p> <p>6 kW</p> <p>10.5 kW</p> <p>18 kW</p> <p>1.5 kW</p> <p>3 kW</p> <p>4 kW</p> <p>3 kW</p> <p>4 kW</p>
operating power for approx. 200000 operating cycles at AC-4	
<ul style="list-style-type: none"> ● at 400 V rated value ● at 690 V rated value 	<p>1.15 kW</p> <p>1.15 kW</p>
no-load switching frequency	
<ul style="list-style-type: none"> ● at AC 	10 000 1/h
operating frequency	
<ul style="list-style-type: none"> ● at AC-1 maximum ● at AC-3 maximum ● at AC-3e maximum ● at AC-4 maximum 	<p>1 000 1/h</p> <p>750 1/h</p> <p>750 1/h</p> <p>250 1/h</p>
Control circuit/ Control	
type of voltage of the control supply voltage	AC
control supply voltage at AC	
<ul style="list-style-type: none"> ● at 50 Hz rated value ● at 60 Hz rated value 	<p>24 V</p> <p>24 V</p>
operating range factor control supply voltage rated value of magnet coil at AC	
<ul style="list-style-type: none"> ● at 50 Hz ● at 60 Hz 	<p>0.8 ... 1.1</p> <p>0.85 ... 1.1</p>
apparent pick-up power of magnet coil at AC	
<ul style="list-style-type: none"> ● at 50 Hz ● at 60 Hz 	<p>27 VA</p> <p>31.7 VA</p>
inductive power factor with closing power of the coil	
<ul style="list-style-type: none"> ● at 50 Hz ● at 60 Hz 	<p>0.8</p> <p>0.81</p>
apparent holding power of magnet coil at AC	
<ul style="list-style-type: none"> ● at 50 Hz ● at 60 Hz 	<p>4.2 VA</p> <p>4.8 VA</p>
inductive power factor with the holding power of the coil	
<ul style="list-style-type: none"> ● at 50 Hz ● at 60 Hz 	<p>0.25</p> <p>0.25</p>
Auxiliary circuit	
number of NC contacts for auxiliary contacts instantaneous contact	0
number of NO contacts for auxiliary contacts instantaneous	1

contact	
operational current at AC-12 maximum	10 A
operational current at AC-15	
• at 230 V rated value	10 A
• at 400 V rated value	3 A
• at 690 V rated value	1 A
operational current at DC-12	
• at 24 V rated value	6 A
• at 110 V rated value	3 A
• at 220 V rated value	1 A
operational current at DC-13	
• at 24 V rated value	6 A
• at 110 V rated value	1 A
• at 220 V rated value	0.3 A
contact reliability of auxiliary contacts	1 faulty switching per 100 million (17 V, 1 mA)

UL/CSA ratings

yielded mechanical performance [hp] for 3-phase AC motor at 460/480 V rated value	3 hp
---	------

Short-circuit protection

design of the fuse link	
• for short-circuit protection of the main circuit	
— with type of coordination 1 required	gL/gG LV HRC 3NA, DIAZED 5SB, NEOZED 5SE: 35 A
— with type of assignment 2 required	gL/gG LV HRC 3NA, DIAZED 5SB, NEOZED 5SE: 20 A
• for short-circuit protection of the auxiliary switch required	fuse gL/gG: 10 A

Installation/ mounting/ dimensions

mounting position	+/-180° rotation possible on vertical mounting surface; can be tilted forward and backward by +/- 22.5° on vertical mounting surface
• fastening method	screw and snap-on mounting onto 35 mm DIN rail according to DIN EN 50022
• fastening method side-by-side mounting	Yes
height	57.5 mm
width	45 mm
depth	73 mm
required spacing with side-by-side mounting at the side	0 mm

Connections/ Terminals

type of electrical connection	
• for main current circuit	screw-type terminals
• for auxiliary and control circuit	screw-type terminals
type of connectable conductor cross-sections for main contacts	
• solid or stranded	2x (0,5 ... 1,5 mm ²), 2x (0,75 ... 2,5 mm ²), 2x 4 mm ²
• finely stranded with core end processing	2x (0,5 ... 1,5 mm ²), 2x (0,75 ... 2,5 mm ²)
type of connectable conductor cross-sections	
• for auxiliary contacts	
— solid or stranded	2x (0,5 ... 1,5 mm ²), 2x (0,75 ... 2,5 mm ²), 2x 4 mm ²
— finely stranded with core end processing	2x (0,5 ... 1,5 mm ²), 2x (0,75 ... 2,5 mm ²)
• for AWG cables for auxiliary contacts	2x (20 ... 16), 2x (18 ... 14), 2x 12

Electrical Safety

protection class IP on the front according to IEC 60529	IP20
touch protection on the front according to IEC 60529	finger-safe, for vertical contact from the front

Approvals Certificates

General Product Approval



[Confirmation](#)



EMV	other	Environment
-----	-------	-------------



[Confirmation](#)

[Environmental Confirmations](#)

Further information

Service&Support (Manuals, Certificates, Characteristics, FAQs,...)
<https://support.industry.siemens.com/cs/products?pnid=16027&lc=en-CN>

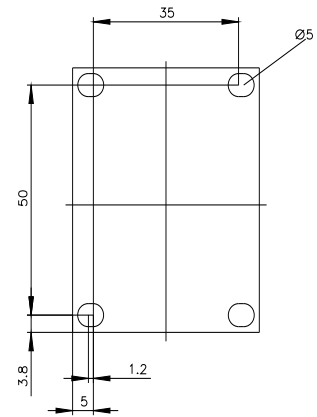
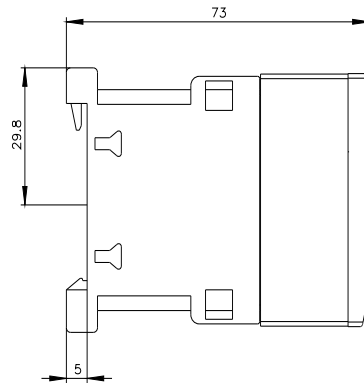
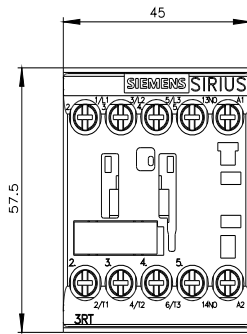

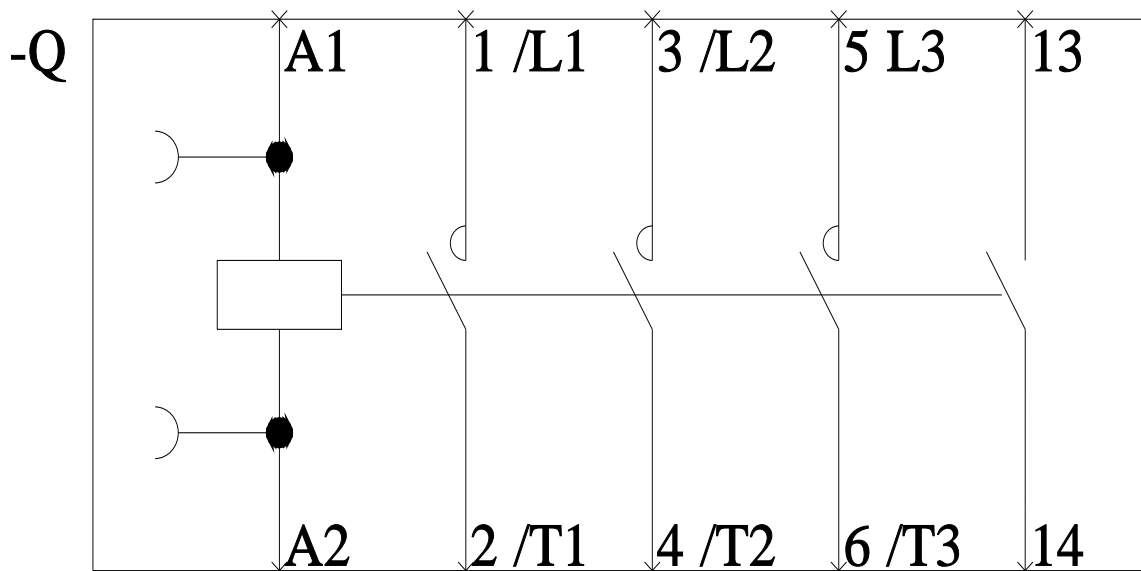
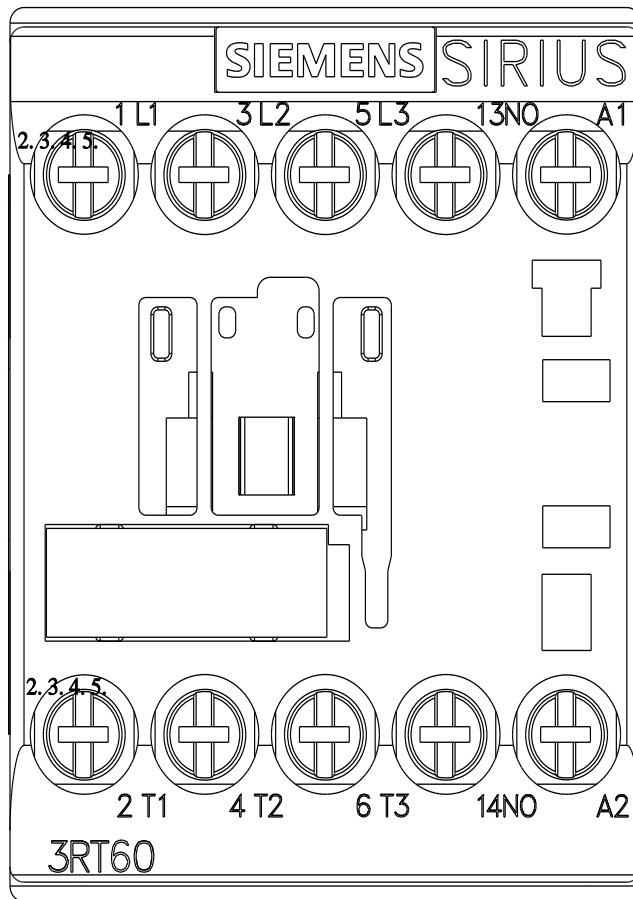

last modified:

7/14/2023



Contactor AC 220 V 50/60 HZ AC3 3 kW 400 V AUX contacts: 1 NC 3-pole, size S00 screw terminal

product brand name	SIRIUS
product designation	Power contactor
product type designation	3RT6
General technical data	
size of contactor	S00
product extension auxiliary switch	Yes
power loss [W] for rated value of the current	
• at AC in hot operating state per pole	0.42 W
• without load current share typical	1.05 W
type of calculation of power loss depending on pole	quadratic
insulation voltage rated value	690 V
degree of pollution	3
surge voltage resistance rated value	6 kV
maximum permissible voltage for protective separation between coil and main contacts according to EN 60947-1	400 V
shock resistance at rectangular impulse	
• at AC	6,7g / 5 ms, 4,2g / 10 ms
shock resistance with sine pulse	
• at AC	10,5g / 5 ms, 6,6g / 10 ms
mechanical service life (operating cycles)	
• of contactor typical	30 000 000
• of the contactor with added auxiliary switch block typical	10 000 000
Substance Prohibition (Date)	05/01/2012
Ambient conditions	
installation altitude at height above sea level maximum	2 000 m
ambient temperature	
• during operation	-25 ... +60 °C
• during storage	-55 ... +80 °C
Main circuit	
number of poles for main current circuit	3
number of NO contacts for main contacts	3
number of NC contacts for main contacts	0
operating voltage	
• at AC-3 rated value maximum	690 V
• at AC-3e rated value maximum	690 V
operational current	
• at AC-1 up to 690 V	
— at ambient temperature 40 °C rated value	18 A
— at ambient temperature 60 °C rated value	16 A
• at AC-3	

— at 400 V rated value	7 A
— at 690 V rated value	4.9 A
● at AC-3e	
— at 400 V rated value	7 A
— at 690 V rated value	4.9 A
connectable conductor cross-section in main circuit at AC-1	
● at 60 °C minimum permissible	2.5 mm ²
● at 40 °C minimum permissible	2.5 mm ²
operational current for approx. 200000 operating cycles at AC-4	
● at 400 V rated value	2.6 A
● at 690 V rated value	1.8 A
operating power	
● at AC-1	
— at 230 V rated value	6.3 kW
— at 230 V at 60 °C rated value	6 kW
— at 400 V at 60 °C rated value	10.5 kW
— at 690 V at 60 °C rated value	18 kW
● at AC-3	
— at 230 V rated value	1.5 kW
— at 400 V rated value	3 kW
— at 690 V rated value	4 kW
● at AC-3e	
— at 400 V rated value	3 kW
— at 690 V rated value	4 kW
operating power for approx. 200000 operating cycles at AC-4	
● at 400 V rated value	1.15 kW
● at 690 V rated value	1.15 kW
no-load switching frequency	
● at AC	10 000 1/h
operating frequency	
● at AC-1 maximum	1 000 1/h
● at AC-3 maximum	750 1/h
● at AC-3e maximum	750 1/h
● at AC-4 maximum	250 1/h
Control circuit/ Control	
type of voltage of the control supply voltage	AC
control supply voltage at AC	
● at 50 Hz rated value	220 V
● at 60 Hz rated value	220 V
operating range factor control supply voltage rated value of magnet coil at AC	
● at 50 Hz	0.8 ... 1.1
● at 60 Hz	0.85 ... 1.1
apparent pick-up power of magnet coil at AC	
● at 50 Hz	27 VA
● at 60 Hz	31.7 VA
inductive power factor with closing power of the coil	
● at 50 Hz	0.8
● at 60 Hz	0.81
apparent holding power of magnet coil at AC	
● at 50 Hz	4.2 VA
● at 60 Hz	4.8 VA
inductive power factor with the holding power of the coil	
● at 50 Hz	0.25
● at 60 Hz	0.25
Auxiliary circuit	
number of NC contacts for auxiliary contacts instantaneous contact	1
number of NO contacts for auxiliary contacts instantaneous	0

contact	
operational current at AC-12 maximum	10 A
operational current at AC-15	
• at 230 V rated value	10 A
• at 400 V rated value	3 A
• at 690 V rated value	1 A
operational current at DC-12	
• at 24 V rated value	6 A
• at 110 V rated value	3 A
• at 220 V rated value	1 A
operational current at DC-13	
• at 24 V rated value	6 A
• at 110 V rated value	1 A
• at 220 V rated value	0.3 A
contact reliability of auxiliary contacts	1 faulty switching per 100 million (17 V, 1 mA)
UL/CSA ratings	
yielded mechanical performance [hp] for 3-phase AC motor at 460/480 V rated value	3 hp
Short-circuit protection	
design of the fuse link	
• for short-circuit protection of the main circuit	
— with type of coordination 1 required	gL/gG LV HRC 3NA, DIAZED 5SB, NEOZED 5SE: 35 A
— with type of assignment 2 required	gL/gG LV HRC 3NA, DIAZED 5SB, NEOZED 5SE: 20 A
• for short-circuit protection of the auxiliary switch required	fuse gL/gG: 10 A
Installation/ mounting/ dimensions	
mounting position	+/-180° rotation possible on vertical mounting surface; can be tilted forward and backward by +/- 22.5° on vertical mounting surface
fastening method	screw and snap-on mounting onto 35 mm DIN rail according to DIN EN 50022
• side-by-side mounting	Yes
height	57.5 mm
width	45 mm
depth	73 mm
required spacing with side-by-side mounting at the side	0 mm
Connections/ Terminals	
type of electrical connection	
• for main current circuit	screw-type terminals
• for auxiliary and control circuit	screw-type terminals
type of connectable conductor cross-sections for main contacts	
• solid or stranded	2x (0,5 ... 1,5 mm ²), 2x (0,75 ... 2,5 mm ²), 2x 4 mm ²
• finely stranded with core end processing	2x (0,5 ... 1,5 mm ²), 2x (0,75 ... 2,5 mm ²)
type of connectable conductor cross-sections	
• for auxiliary contacts	
— solid or stranded	2x (0,5 ... 1,5 mm ²), 2x (0,75 ... 2,5 mm ²), 2x 4 mm ²
— finely stranded with core end processing	2x (0,5 ... 1,5 mm ²), 2x (0,75 ... 2,5 mm ²)
• for AWG cables for auxiliary contacts	2x (20 ... 16), 2x (18 ... 14), 2x 12
Electrical Safety	
protection class IP on the front according to IEC 60529	IP20
touch protection on the front according to IEC 60529	finger-safe, for vertical contact from the front
Approvals Certificates	
General Product Approval	



[Confirmation](#)



EMV

other

Environment



[Confirmation](#)

[Environmental Confirmations](#)

Further information

Service&Support (Manuals, Certificates, Characteristics, FAQs,...)
<https://support.industry.siemens.com/cs/products?pnid=16027&lc=en-CN>

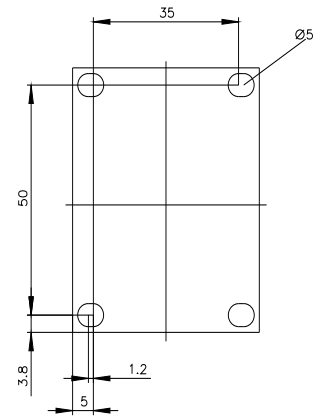
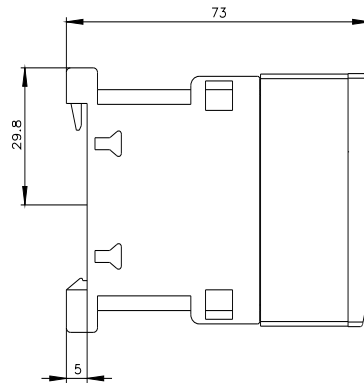
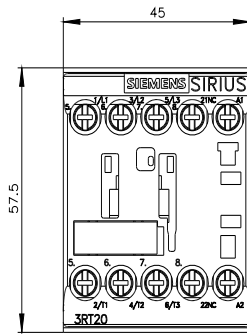

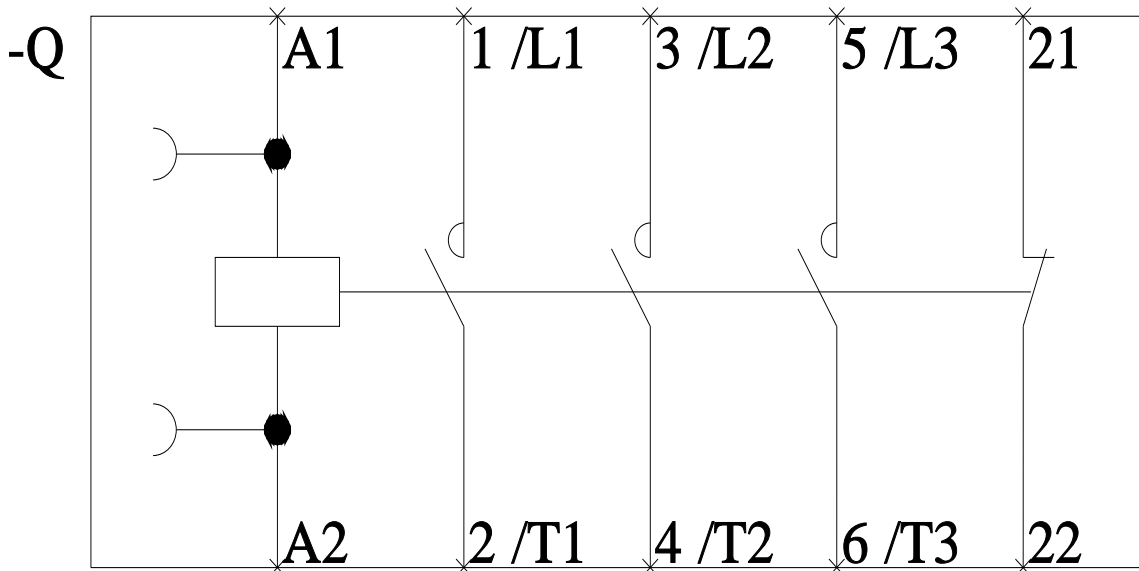
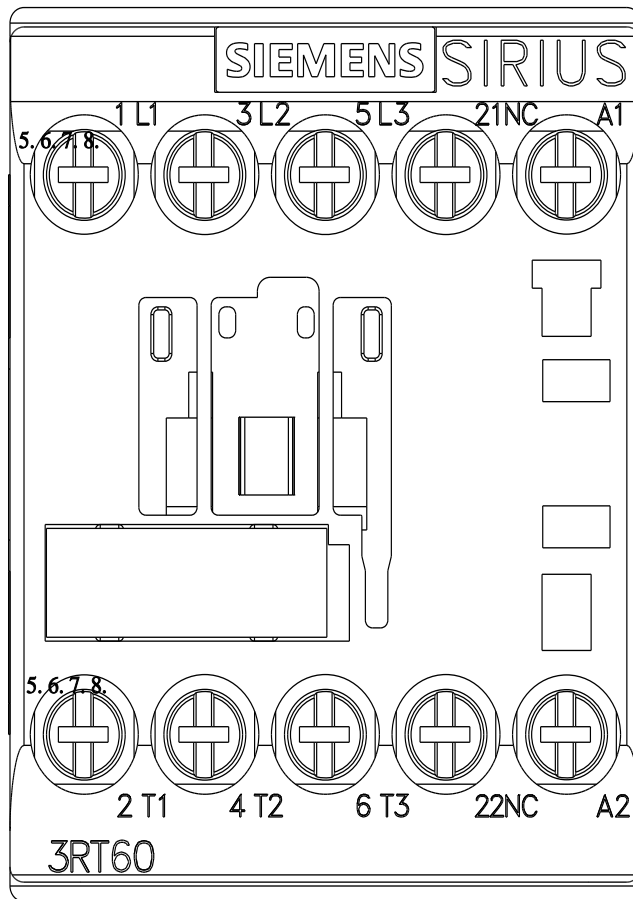

last modified:

7/14/2023



Contactor DC 24 V AC3 3 kW 400 V AUX contacts: 1 NO 3-pole, size S00 screw terminal

product brand name	SIRIUS
product designation	Power contactor
product type designation	3RT6
General technical data	
size of contactor	S00
product extension auxiliary switch	Yes
power loss [W] for rated value of the current	
• at AC in hot operating state per pole	0.42 W
• without load current share typical	4 W
type of calculation of power loss depending on pole	quadratic
insulation voltage rated value	690 V
degree of pollution	3
surge voltage resistance rated value	6 kV
maximum permissible voltage for protective separation between coil and main contacts according to EN 60947-1	400 V
shock resistance at rectangular impulse	
• at DC	6,7g / 5 ms, 4,2g / 10 ms
shock resistance with sine pulse	
• at DC	10,5g / 5 ms, 6,6g / 10 ms
mechanical service life (operating cycles)	
• of contactor typical	30 000 000
• of the contactor with added auxiliary switch block typical	10 000 000
Substance Prohibition (Date)	05/01/2012
Ambient conditions	
installation altitude at height above sea level maximum	2 000 m
ambient temperature	
• during operation	-25 ... +60 °C
• during storage	-55 ... +80 °C
Main circuit	
number of poles for main current circuit	3
number of NO contacts for main contacts	3
number of NC contacts for main contacts	0
operating voltage	
• at AC-3 rated value maximum	690 V
• at AC-3e rated value maximum	690 V
operational current	
• at AC-1 up to 690 V	
— at ambient temperature 40 °C rated value	18 A
— at ambient temperature 60 °C rated value	16 A
• at AC-3	

— at 400 V rated value	7 A
— at 690 V rated value	4.9 A
● at AC-3e	
— at 400 V rated value	7 A
— at 690 V rated value	4.9 A
connectable conductor cross-section in main circuit at AC-1	
● at 60 °C minimum permissible	2.5 mm ²
● at 40 °C minimum permissible	2.5 mm ²
operational current for approx. 200000 operating cycles at AC-4	
● at 400 V rated value	2.6 A
● at 690 V rated value	1.8 A
operating power	
● at AC-1	
— at 230 V rated value	6.3 kW
— at 230 V at 60 °C rated value	6 kW
— at 400 V at 60 °C rated value	10.5 kW
— at 690 V at 60 °C rated value	18 kW
● at AC-3	
— at 230 V rated value	1.5 kW
— at 400 V rated value	3 kW
— at 690 V rated value	4 kW
● at AC-3e	
— at 400 V rated value	3 kW
— at 690 V rated value	4 kW
operating power for approx. 200000 operating cycles at AC-4	
● at 400 V rated value	1.15 kW
● at 690 V rated value	1.15 kW
no-load switching frequency	
● at DC	10 000 1/h
operating frequency	
● at AC-1 maximum	1 000 1/h
● at AC-3 maximum	750 1/h
● at AC-3e maximum	750 1/h
● at AC-4 maximum	250 1/h
Control circuit/ Control	
type of voltage of the control supply voltage	DC
control supply voltage at DC rated value	24 V
closing power of magnet coil at DC	4 W
holding power of magnet coil at DC	4 W
Auxiliary circuit	
number of NC contacts for auxiliary contacts instantaneous contact	0
number of NO contacts for auxiliary contacts instantaneous contact	1
operational current at AC-12 maximum	10 A
operational current at AC-15	
● at 230 V rated value	10 A
● at 400 V rated value	3 A
● at 690 V rated value	1 A
operational current at DC-12	
● at 24 V rated value	6 A
● at 110 V rated value	3 A
● at 220 V rated value	1 A
operational current at DC-13	
● at 24 V rated value	6 A
● at 110 V rated value	1 A
● at 220 V rated value	0.3 A
contact reliability of auxiliary contacts	1 faulty switching per 100 million (17 V, 1 mA)
UL/CSA ratings	

yielded mechanical performance [hp] for 3-phase AC motor at 460/480 V rated value	3 hp
---	------

Short-circuit protection

design of the fuse link <ul style="list-style-type: none"> for short-circuit protection of the main circuit <ul style="list-style-type: none"> with type of coordination 1 required with type of assignment 2 required for short-circuit protection of the auxiliary switch required 	gL/gG LV HRC 3NA, DIAZED 5SB, NEOZED 5SE: 35 A gL/gG LV HRC 3NA, DIAZED 5SB, NEOZED 5SE: 20 A fuse gL/gG: 10 A
--	--

Installation/ mounting/ dimensions

mounting position	+/-180° rotation possible on vertical mounting surface; can be tilted forward and backward by +/- 22.5° on vertical mounting surface
<ul style="list-style-type: none"> fastening method fastening method side-by-side mounting 	screw and snap-on mounting onto 35 mm DIN rail according to DIN EN 50022 Yes
height	57.5 mm
width	45 mm
depth	73 mm
required spacing with side-by-side mounting at the side	0 mm

Connections/ Terminals

type of electrical connection <ul style="list-style-type: none"> for main current circuit for auxiliary and control circuit 	screw-type terminals screw-type terminals
type of connectable conductor cross-sections for main contacts <ul style="list-style-type: none"> solid or stranded finely stranded with core end processing 	2x (0,5 ... 1,5 mm²), 2x (0,75 ... 2,5 mm²), 2x 4 mm² 2x (0,5 ... 1,5 mm²), 2x (0,75 ... 2,5 mm²)
type of connectable conductor cross-sections <ul style="list-style-type: none"> for auxiliary contacts <ul style="list-style-type: none"> solid or stranded finely stranded with core end processing for AWG cables for auxiliary contacts 	2x (0,5 ... 1,5 mm²), 2x (0,75 ... 2,5 mm²), 2x 4 mm² 2x (0,5 ... 1,5 mm²), 2x (0,75 ... 2,5 mm²) 2x (20 ... 16), 2x (18 ... 14), 2x 12

Electrical Safety

protection class IP on the front according to IEC 60529	IP20
touch protection on the front according to IEC 60529	finger-safe, for vertical contact from the front

Approvals Certificates

General Product Approval



[Confirmation](#)



EMV	other	Dangerous Good	Environment
-----	-------	----------------	-------------



[Confirmation](#)

[Transport Information](#)

[Environmental Confirmations](#)

Further information

Service&Support (Manuals, Certificates, Characteristics, FAQs,...)
<https://support.industry.siemens.com/cs/products?pnid=16027&lc=en-CN>

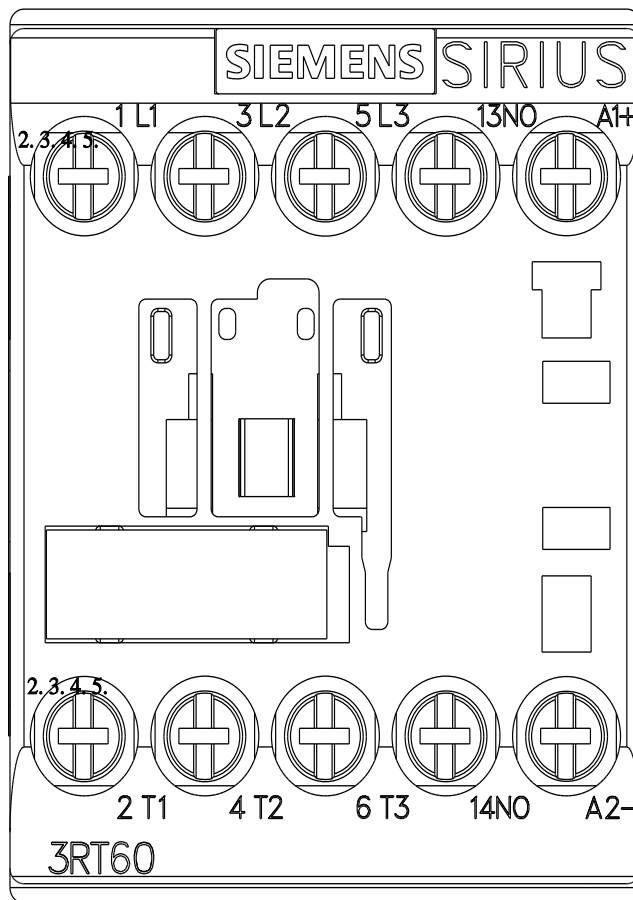
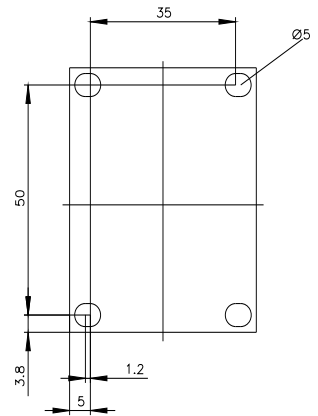
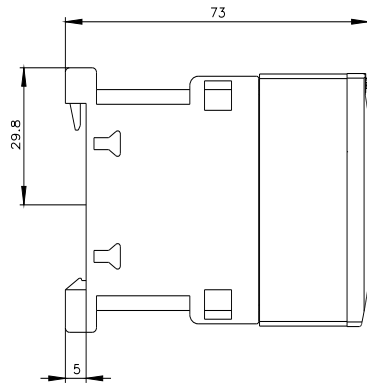
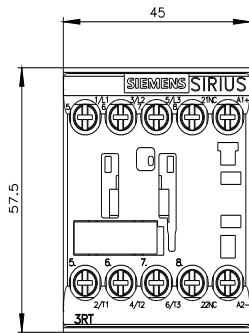

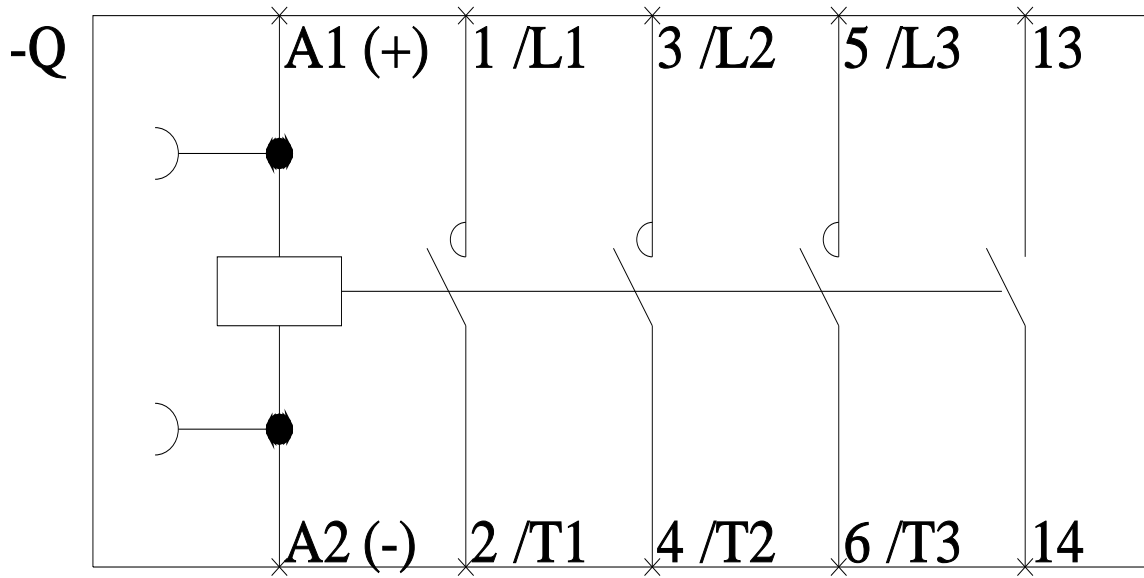

last modified:

7/14/2023 



Contactor DC 24 V AC3 3 kW 400 V AUX contacts: 1 NC 3-pole, size S00 screw terminal

product brand name	SIRIUS
product designation	Power contactor
product type designation	3RT6
General technical data	
size of contactor	S00
product extension auxiliary switch	Yes
power loss [W] for rated value of the current	
• at AC in hot operating state per pole	0.42 W
• without load current share typical	4 W
type of calculation of power loss depending on pole	quadratic
insulation voltage rated value	690 V
degree of pollution	3
surge voltage resistance rated value	6 kV
maximum permissible voltage for protective separation between coil and main contacts according to EN 60947-1	400 V
shock resistance at rectangular impulse	
• at DC	6,7g / 5 ms, 4,2g / 10 ms
shock resistance with sine pulse	
• at DC	10,5g / 5 ms, 6,6g / 10 ms
mechanical service life (operating cycles)	
• of contactor typical	30 000 000
• of the contactor with added auxiliary switch block typical	10 000 000
Substance Prohibition (Date)	05/01/2012
Ambient conditions	
installation altitude at height above sea level maximum	2 000 m
ambient temperature	
• during operation	-25 ... +60 °C
• during storage	-55 ... +80 °C
Main circuit	
number of poles for main current circuit	3
number of NO contacts for main contacts	3
number of NC contacts for main contacts	0
operating voltage	
• at AC-3 rated value maximum	690 V
• at AC-3e rated value maximum	690 V
operational current	
• at AC-1 up to 690 V	
— at ambient temperature 40 °C rated value	18 A
— at ambient temperature 60 °C rated value	16 A
• at AC-3	

<ul style="list-style-type: none"> — at 400 V rated value — at 690 V rated value ● at AC-3e <ul style="list-style-type: none"> — at 400 V rated value — at 690 V rated value 	<ul style="list-style-type: none"> 7 A 4.9 A 7 A 4.9 A
connectable conductor cross-section in main circuit at AC-1	
<ul style="list-style-type: none"> ● at 60 °C minimum permissible ● at 40 °C minimum permissible 	<ul style="list-style-type: none"> 2.5 mm² 2.5 mm²
operational current for approx. 200000 operating cycles at AC-4	
<ul style="list-style-type: none"> ● at 400 V rated value ● at 690 V rated value 	<ul style="list-style-type: none"> 2.6 A 1.8 A
operating power	
<ul style="list-style-type: none"> ● at AC-1 <ul style="list-style-type: none"> — at 230 V rated value — at 230 V at 60 °C rated value — at 400 V at 60 °C rated value — at 690 V at 60 °C rated value ● at AC-3 <ul style="list-style-type: none"> — at 230 V rated value — at 400 V rated value — at 690 V rated value ● at AC-3e <ul style="list-style-type: none"> — at 400 V rated value — at 690 V rated value 	<ul style="list-style-type: none"> 6.3 kW 6 kW 10.5 kW 18 kW 1.5 kW 3 kW 4 kW 3 kW 4 kW
operating power for approx. 200000 operating cycles at AC-4	
<ul style="list-style-type: none"> ● at 400 V rated value ● at 690 V rated value 	<ul style="list-style-type: none"> 1.15 kW 1.15 kW
no-load switching frequency	
<ul style="list-style-type: none"> ● at DC 	10 000 1/h
operating frequency	
<ul style="list-style-type: none"> ● at AC-1 maximum ● at AC-3 maximum ● at AC-3e maximum ● at AC-4 maximum 	<ul style="list-style-type: none"> 1 000 1/h 750 1/h 750 1/h 250 1/h
Control circuit/ Control	
type of voltage of the control supply voltage	DC
control supply voltage at DC rated value	
<ul style="list-style-type: none"> ● 	24 V
closing power of magnet coil at DC	4 W
holding power of magnet coil at DC	4 W
Auxiliary circuit	
number of NC contacts for auxiliary contacts instantaneous contact	1
number of NO contacts for auxiliary contacts instantaneous contact	0
operational current at AC-12 maximum	10 A
operational current at AC-15	
<ul style="list-style-type: none"> ● at 230 V rated value ● at 400 V rated value ● at 690 V rated value 	<ul style="list-style-type: none"> 10 A 3 A 1 A
operational current at DC-12	
<ul style="list-style-type: none"> ● at 24 V rated value ● at 110 V rated value ● at 220 V rated value 	<ul style="list-style-type: none"> 6 A 3 A 1 A
operational current at DC-13	
<ul style="list-style-type: none"> ● at 24 V rated value ● at 110 V rated value ● at 220 V rated value 	<ul style="list-style-type: none"> 6 A 1 A 0.3 A
contact reliability of auxiliary contacts	1 faulty switching per 100 million (17 V, 1 mA)

UL/CSA ratings	
yielded mechanical performance [hp] for 3-phase AC motor at 460/480 V rated value	3 hp
Short-circuit protection	
design of the fuse link	
<ul style="list-style-type: none"> • for short-circuit protection of the main circuit <ul style="list-style-type: none"> — with type of coordination 1 required — with type of assignment 2 required • for short-circuit protection of the auxiliary switch required 	gL/gG LV HRC 3NA, DIAZED 5SB, NEOZED 5SE: 35 A gL/gG LV HRC 3NA, DIAZED 5SB, NEOZED 5SE: 20 A fuse gL/gG: 10 A
Installation/ mounting/ dimensions	
mounting position	+/-180° rotation possible on vertical mounting surface; can be tilted forward and backward by +/- 22.5° on vertical mounting surface
fastening method	screw and snap-on mounting onto 35 mm DIN rail according to DIN EN 50022
<ul style="list-style-type: none"> • side-by-side mounting 	Yes
height	57.5 mm
width	45 mm
depth	73 mm
required spacing with side-by-side mounting at the side	0 mm
Connections/ Terminals	
type of electrical connection	
<ul style="list-style-type: none"> • for main current circuit • for auxiliary and control circuit 	screw-type terminals screw-type terminals
type of connectable conductor cross-sections for main contacts	
<ul style="list-style-type: none"> • solid or stranded • finely stranded with core end processing 	2x (0,5 ... 1,5 mm ²), 2x (0,75 ... 2,5 mm ²), 2x 4 mm ² 2x (0.5 ... 1.5 mm ²), 2x (0.75 ... 2.5 mm ²)
type of connectable conductor cross-sections	
<ul style="list-style-type: none"> • for auxiliary contacts <ul style="list-style-type: none"> — solid or stranded — finely stranded with core end processing • for AWG cables for auxiliary contacts 	2x (0.5 ... 1.5 mm ²), 2x (0.75 ... 2.5 mm ²), 2x 4 mm ² 2x (0.5 ... 1.5 mm ²), 2x (0.75 ... 2.5 mm ²) 2x (20 ... 16), 2x (18 ... 14), 2x 12
Electrical Safety	
protection class IP on the front according to IEC 60529	IP20
touch protection on the front according to IEC 60529	finger-safe, for vertical contact from the front
Approvals Certificates	
General Product Approval	



[Confirmation](#)



EG-Konf.



CCC



UL



EMV	Marine / Shipping	other	Dangerous Good	Environment
-----	-------------------	-------	----------------	-------------



RCM

[CCS \(China Classification Society\)](#)

[Confirmation](#)

[Transport Information](#)

[Environmental Confirmations](#)

Further information

Service&Support (Manuals, Certificates, Characteristics, FAQs,...)
<https://support.industry.siemens.com/cs/products?pnid=16027&lc=en-CN>

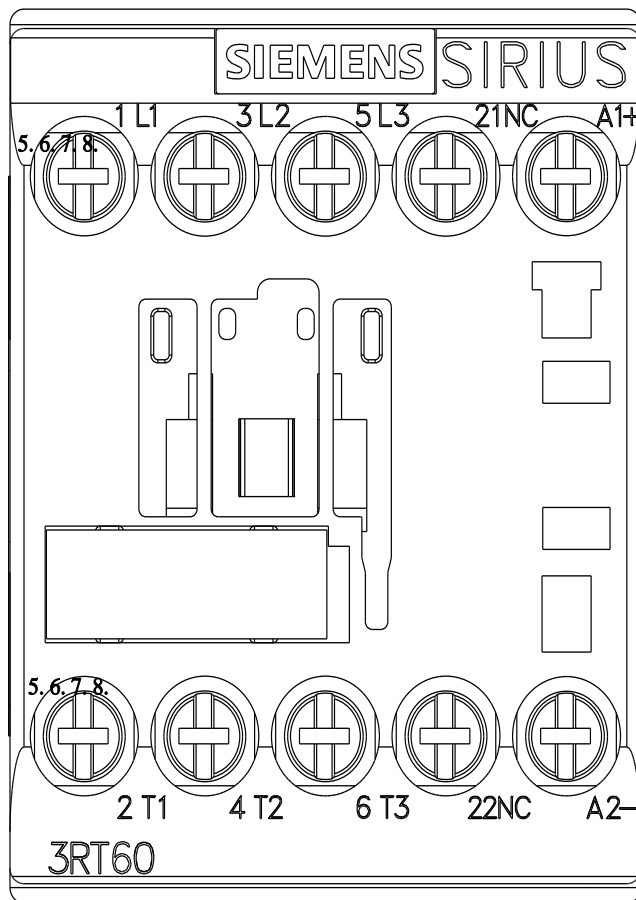
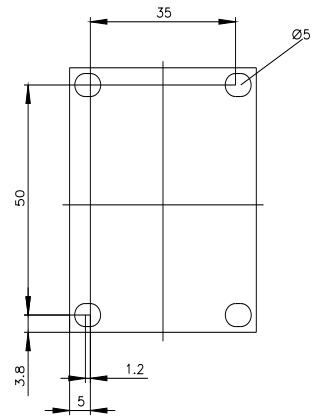
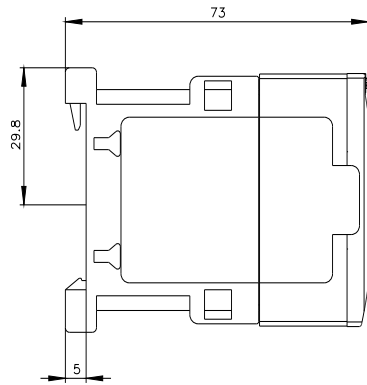
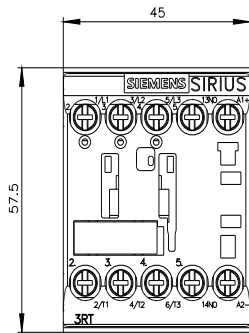

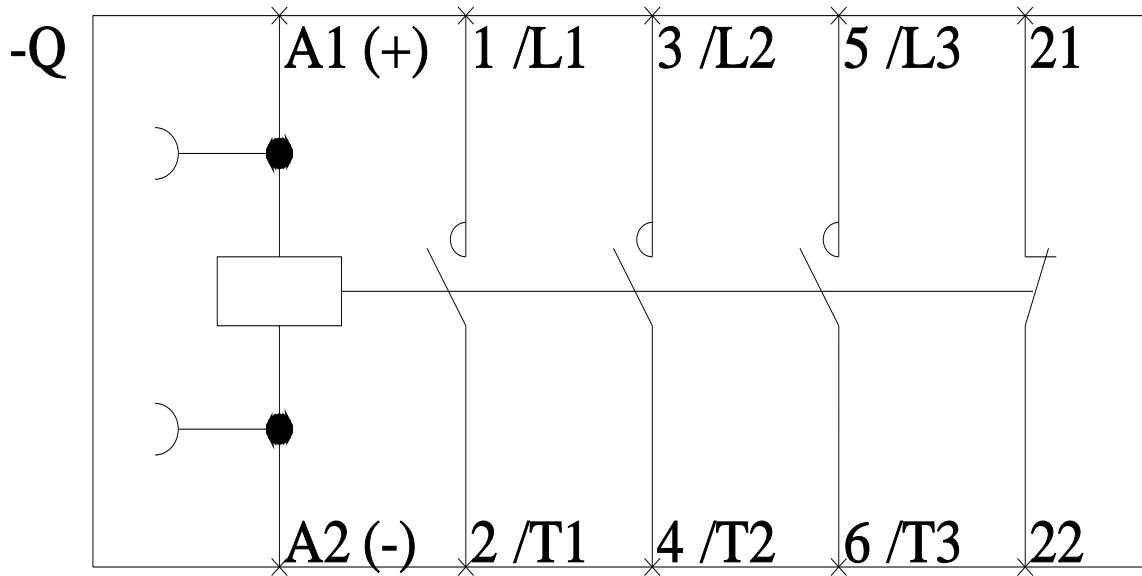

last modified:

7/14/2023 



Contactor AC 24 V 50/60 HZ AC3 4 kW 400 V AUX contacts: 1 NO 3-pole, size S00 screw terminal

product brand name	SIRIUS
product designation	Power contactor
product type designation	3RT6
General technical data	
size of contactor	S00
product extension auxiliary switch	Yes
power loss [W] for rated value of the current	
• at AC in hot operating state per pole	0.7 W
• without load current share typical	1.05 W
type of calculation of power loss depending on pole	quadratic
insulation voltage rated value	690 V
degree of pollution	3
surge voltage resistance rated value	6 kV
maximum permissible voltage for protective separation between coil and main contacts according to EN 60947-1	400 V
shock resistance at rectangular impulse	
• at AC	6,7g / 5 ms, 4,2g / 10 ms
shock resistance with sine pulse	
• at AC	10,5g / 5 ms, 6,6g / 10 ms
mechanical service life (operating cycles)	
• of contactor typical	30 000 000
• of the contactor with added auxiliary switch block typical	10 000 000
Substance Prohibition (Date)	05/01/2012
Ambient conditions	
installation altitude at height above sea level maximum	2 000 m
ambient temperature	
• during operation	-25 ... +60 °C
• during storage	-55 ... +80 °C
Main circuit	
number of poles for main current circuit	3
number of NO contacts for main contacts	3
number of NC contacts for main contacts	0
operating voltage	
• at AC-3 rated value maximum	690 V
• at AC-3e rated value maximum	690 V
operational current	
• at AC-1 up to 690 V	
— at ambient temperature 40 °C rated value	22 A
— at ambient temperature 60 °C rated value	20 A
• at AC-3	

<ul style="list-style-type: none"> — at 400 V rated value — at 690 V rated value ● at AC-3e <ul style="list-style-type: none"> — at 400 V rated value — at 690 V rated value 	9 A 6.7 A 9 A 6.7 A
connectable conductor cross-section in main circuit at AC-1	
<ul style="list-style-type: none"> ● at 60 °C minimum permissible ● at 40 °C minimum permissible 	2.5 mm ² 4 mm ²
operational current for approx. 200000 operating cycles at AC-4	
<ul style="list-style-type: none"> ● at 400 V rated value ● at 690 V rated value 	4.1 A 3.3 A
operating power	
<ul style="list-style-type: none"> ● at AC-1 <ul style="list-style-type: none"> — at 230 V rated value — at 230 V at 60 °C rated value — at 400 V at 60 °C rated value — at 690 V at 60 °C rated value ● at AC-3 <ul style="list-style-type: none"> — at 230 V rated value — at 400 V rated value — at 690 V rated value ● at AC-3e <ul style="list-style-type: none"> — at 400 V rated value — at 690 V rated value 	7.5 kW 7.5 kW 13 kW 22 kW 2.2 kW 4 kW 5.5 kW 4 kW 5.5 kW
operating power for approx. 200000 operating cycles at AC-4	
<ul style="list-style-type: none"> ● at 400 V rated value ● at 690 V rated value 	2 kW 2.5 kW
no-load switching frequency	
<ul style="list-style-type: none"> ● at AC 	10 000 1/h
operating frequency	
<ul style="list-style-type: none"> ● at AC-1 maximum ● at AC-3 maximum ● at AC-3e maximum ● at AC-4 maximum 	1 000 1/h 750 1/h 750 1/h 250 1/h
Control circuit/ Control	
type of voltage of the control supply voltage	AC
control supply voltage at AC	
<ul style="list-style-type: none"> ● at 50 Hz rated value ● at 60 Hz rated value 	24 V 24 V
operating range factor control supply voltage rated value of magnet coil at AC	
<ul style="list-style-type: none"> ● at 50 Hz ● at 60 Hz 	0.8 ... 1.1 0.85 ... 1.1
apparent pick-up power of magnet coil at AC	
<ul style="list-style-type: none"> ● at 50 Hz ● at 60 Hz 	27 VA 31.7 VA
inductive power factor with closing power of the coil	
<ul style="list-style-type: none"> ● at 50 Hz ● at 60 Hz 	0.8 0.81
apparent holding power of magnet coil at AC	
<ul style="list-style-type: none"> ● at 50 Hz ● at 60 Hz 	4.2 VA 4.8 VA
inductive power factor with the holding power of the coil	
<ul style="list-style-type: none"> ● at 50 Hz ● at 60 Hz 	0.25 0.25
Auxiliary circuit	
number of NC contacts for auxiliary contacts instantaneous contact	0
number of NO contacts for auxiliary contacts instantaneous	1

contact	
operational current at AC-12 maximum	10 A
operational current at AC-15	
• at 230 V rated value	10 A
• at 400 V rated value	3 A
• at 690 V rated value	1 A
operational current at DC-12	
• at 24 V rated value	6 A
• at 110 V rated value	3 A
• at 220 V rated value	1 A
operational current at DC-13	
• at 24 V rated value	6 A
• at 110 V rated value	1 A
• at 220 V rated value	0.3 A
contact reliability of auxiliary contacts	1 faulty switching per 100 million (17 V, 1 mA)

UL/CSA ratings

yielded mechanical performance [hp] for 3-phase AC motor at 460/480 V rated value	5 hp
---	------

Short-circuit protection

design of the fuse link	
• for short-circuit protection of the main circuit	
— with type of coordination 1 required	gL/gG LV HRC 3NA, DIAZED 5SB, NEOZED 5SE: 35 A
— with type of assignment 2 required	gL/gG LV HRC 3NA, DIAZED 5SB, NEOZED 5SE: 20 A
• for short-circuit protection of the auxiliary switch required	fuse gL/gG: 10 A

Installation/ mounting/ dimensions

mounting position	+/-180° rotation possible on vertical mounting surface; can be tilted forward and backward by +/- 22.5° on vertical mounting surface
• fastening method	screw and snap-on mounting onto 35 mm DIN rail according to DIN EN 50022
• fastening method side-by-side mounting	Yes
height	57.5 mm
width	45 mm
depth	73 mm
required spacing with side-by-side mounting at the side	0 mm

Connections/ Terminals

type of electrical connection	
• for main current circuit	screw-type terminals
• for auxiliary and control circuit	screw-type terminals
type of connectable conductor cross-sections for main contacts	
• solid or stranded	2x (0,5 ... 1,5 mm ²), 2x (0,75 ... 2,5 mm ²), 2x 4 mm ²
• finely stranded with core end processing	2x (0,5 ... 1,5 mm ²), 2x (0,75 ... 2,5 mm ²)
type of connectable conductor cross-sections	
• for auxiliary contacts	
— solid or stranded	2x (0,5 ... 1,5 mm ²), 2x (0,75 ... 2,5 mm ²), 2x 4 mm ²
— finely stranded with core end processing	2x (0,5 ... 1,5 mm ²), 2x (0,75 ... 2,5 mm ²)
• for AWG cables for auxiliary contacts	2x (20 ... 16), 2x (18 ... 14), 2x 12

Electrical Safety

protection class IP on the front according to IEC 60529	IP20
touch protection on the front according to IEC 60529	finger-safe, for vertical contact from the front

Approvals Certificates

General Product Approval



[Confirmation](#)



EMV	other	Environment
-----	-------	-------------



[Confirmation](#)

[Environmental Confirmations](#)

Further information

Service&Support (Manuals, Certificates, Characteristics, FAQs,...)
<https://support.industry.siemens.com/cs/products?pnid=16027&lc=en-CN>

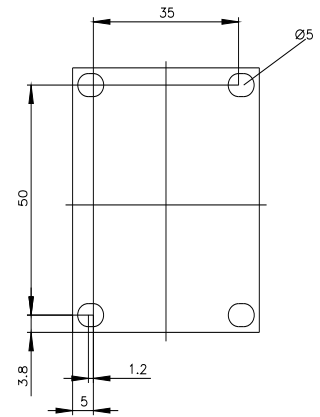
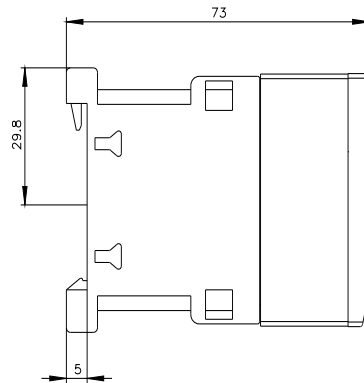
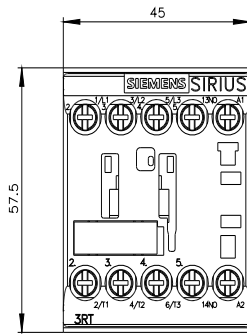

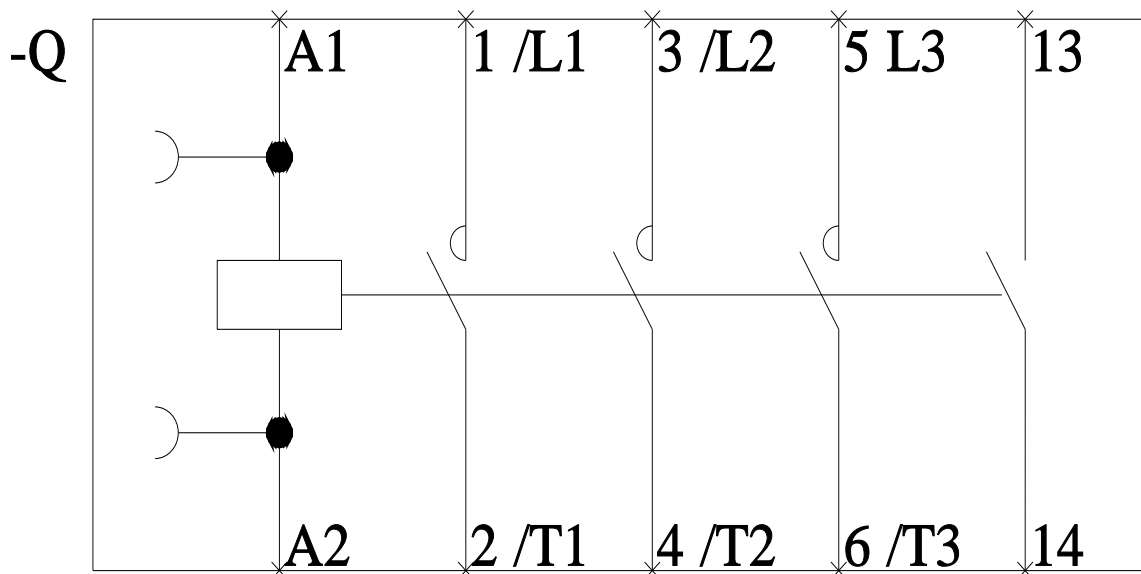
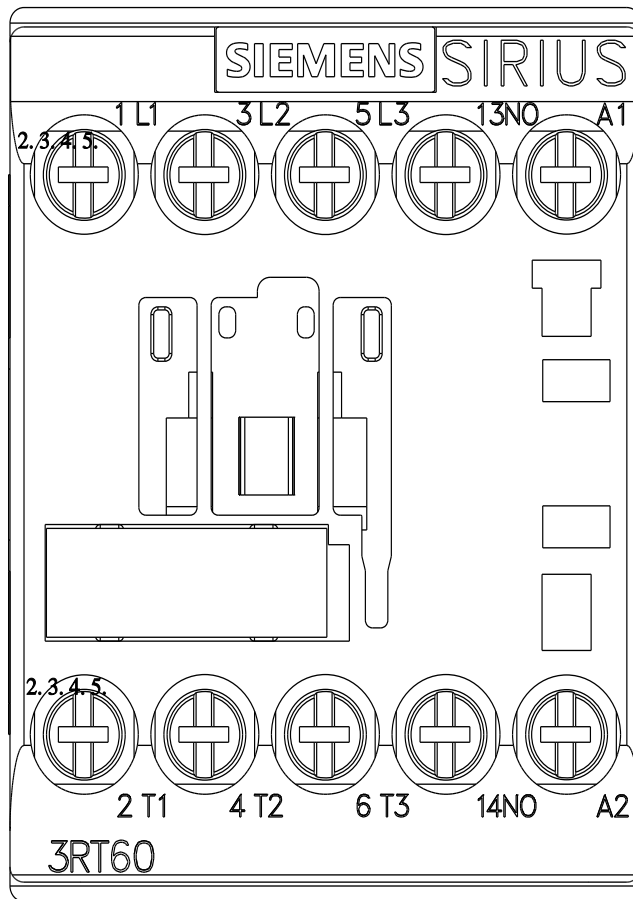

last modified:

7/14/2023



Contactor AC 220 V 50/60 HZ AC3 4 kW 400 V AUX contacts: 1 NO 3-pole, size S00 screw terminal

product brand name	SIRIUS
product designation	Power contactor
product type designation	3RT6
General technical data	
size of contactor	S00
product extension auxiliary switch	Yes
power loss [W] for rated value of the current	
• at AC in hot operating state per pole	0.7 W
• without load current share typical	1.05 W
type of calculation of power loss depending on pole	quadratic
insulation voltage rated value	690 V
degree of pollution	3
surge voltage resistance rated value	6 kV
maximum permissible voltage for protective separation between coil and main contacts according to EN 60947-1	400 V
shock resistance at rectangular impulse	
• at AC	6,7g / 5 ms, 4,2g / 10 ms
shock resistance with sine pulse	
• at AC	10,5g / 5 ms, 6,6g / 10 ms
mechanical service life (operating cycles)	
• of contactor typical	30 000 000
• of the contactor with added auxiliary switch block typical	10 000 000
Substance Prohibition (Date)	05/01/2012
Ambient conditions	
installation altitude at height above sea level maximum	2 000 m
ambient temperature	
• during operation	-25 ... +60 °C
• during storage	-55 ... +80 °C
Main circuit	
number of poles for main current circuit	3
number of NO contacts for main contacts	3
number of NC contacts for main contacts	0
operating voltage	
• at AC-3 rated value maximum	690 V
• at AC-3e rated value maximum	690 V
operational current	
• at AC-1 up to 690 V	
— at ambient temperature 40 °C rated value	22 A
— at ambient temperature 60 °C rated value	20 A
• at AC-3	

— at 400 V rated value	9 A
— at 690 V rated value	6.7 A
● at AC-3e	
— at 400 V rated value	9 A
— at 690 V rated value	6.7 A
connectable conductor cross-section in main circuit at AC-1	
● at 60 °C minimum permissible	2.5 mm ²
● at 40 °C minimum permissible	4 mm ²
operational current for approx. 200000 operating cycles at AC-4	
● at 400 V rated value	4.1 A
● at 690 V rated value	3.3 A
operating power	
● at AC-1	
— at 230 V rated value	7.5 kW
— at 230 V at 60 °C rated value	7.5 kW
— at 400 V at 60 °C rated value	13 kW
— at 690 V at 60 °C rated value	22 kW
● at AC-3	
— at 230 V rated value	2.2 kW
— at 400 V rated value	4 kW
— at 690 V rated value	5.5 kW
● at AC-3e	
— at 400 V rated value	4 kW
— at 690 V rated value	5.5 kW
operating power for approx. 200000 operating cycles at AC-4	
● at 400 V rated value	2 kW
● at 690 V rated value	2.5 kW
no-load switching frequency	
● at AC	10 000 1/h
operating frequency	
● at AC-1 maximum	1 000 1/h
● at AC-3 maximum	750 1/h
● at AC-3e maximum	750 1/h
● at AC-4 maximum	250 1/h
Control circuit/ Control	
type of voltage of the control supply voltage	AC
control supply voltage at AC	
● at 50 Hz rated value	220 V
● at 60 Hz rated value	220 V
operating range factor control supply voltage rated value of magnet coil at AC	
● at 50 Hz	0.8 ... 1.1
● at 60 Hz	0.85 ... 1.1
apparent pick-up power of magnet coil at AC	
● at 50 Hz	27 VA
● at 60 Hz	31.7 VA
inductive power factor with closing power of the coil	
● at 50 Hz	0.8
● at 60 Hz	0.81
apparent holding power of magnet coil at AC	
● at 50 Hz	4.2 VA
● at 60 Hz	4.8 VA
inductive power factor with the holding power of the coil	
● at 50 Hz	0.25
● at 60 Hz	0.25
Auxiliary circuit	
number of NC contacts for auxiliary contacts instantaneous contact	0
number of NO contacts for auxiliary contacts instantaneous	1

contact	
operational current at AC-12 maximum	10 A
operational current at AC-15	
• at 230 V rated value	10 A
• at 400 V rated value	3 A
• at 690 V rated value	1 A
operational current at DC-12	
• at 24 V rated value	6 A
• at 110 V rated value	3 A
• at 220 V rated value	1 A
operational current at DC-13	
• at 24 V rated value	6 A
• at 110 V rated value	1 A
• at 220 V rated value	0.3 A
contact reliability of auxiliary contacts	1 faulty switching per 100 million (17 V, 1 mA)

UL/CSA ratings

yielded mechanical performance [hp] for 3-phase AC motor at 460/480 V rated value	5 hp
---	------

Short-circuit protection

design of the fuse link	
• for short-circuit protection of the main circuit	
— with type of coordination 1 required	gL/gG LV HRC 3NA, DIAZED 5SB, NEOZED 5SE: 35 A
— with type of assignment 2 required	gL/gG LV HRC 3NA, DIAZED 5SB, NEOZED 5SE: 20 A
• for short-circuit protection of the auxiliary switch required	fuse gL/gG: 10 A

Installation/ mounting/ dimensions

mounting position	+/-180° rotation possible on vertical mounting surface; can be tilted forward and backward by +/- 22.5° on vertical mounting surface
• fastening method	screw and snap-on mounting onto 35 mm DIN rail according to DIN EN 50022
• fastening method side-by-side mounting	Yes
height	57.5 mm
width	45 mm
depth	73 mm
required spacing with side-by-side mounting at the side	0 mm

Connections/ Terminals

type of electrical connection	
• for main current circuit	screw-type terminals
• for auxiliary and control circuit	screw-type terminals
type of connectable conductor cross-sections for main contacts	
• solid or stranded	2x (0,5 ... 1,5 mm ²), 2x (0,75 ... 2,5 mm ²), 2x 4 mm ²
• finely stranded with core end processing	2x (0,5 ... 1,5 mm ²), 2x (0,75 ... 2,5 mm ²)
type of connectable conductor cross-sections	
• for auxiliary contacts	
— solid or stranded	2x (0,5 ... 1,5 mm ²), 2x (0,75 ... 2,5 mm ²), 2x 4 mm ²
— finely stranded with core end processing	2x (0,5 ... 1,5 mm ²), 2x (0,75 ... 2,5 mm ²)
• for AWG cables for auxiliary contacts	2x (20 ... 16), 2x (18 ... 14), 2x 12

Electrical Safety

protection class IP on the front according to IEC 60529	IP20
touch protection on the front according to IEC 60529	finger-safe, for vertical contact from the front

Approvals Certificates

General Product Approval



[Confirmation](#)



EMV	other	Environment
-----	-------	-------------



[Confirmation](#)

[Environmental Confirmations](#)

Further information

Service&Support (Manuals, Certificates, Characteristics, FAQs,...)
<https://support.industry.siemens.com/cs/products?pnid=16027&lc=en-CN>

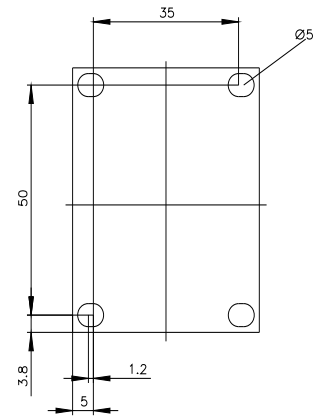
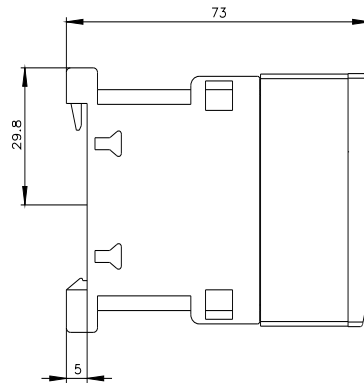
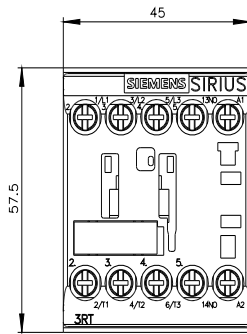

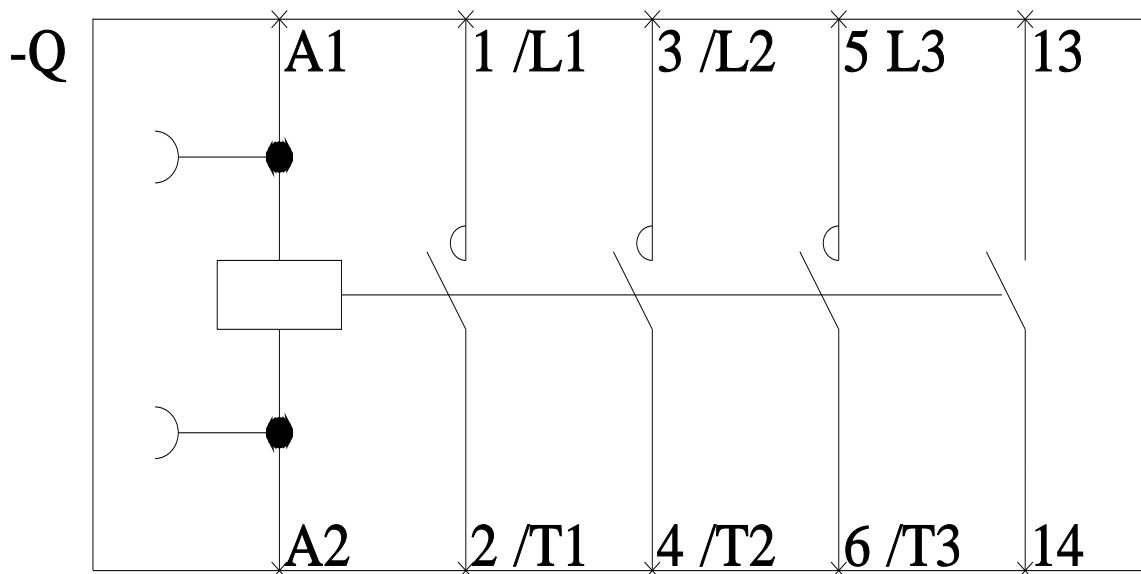
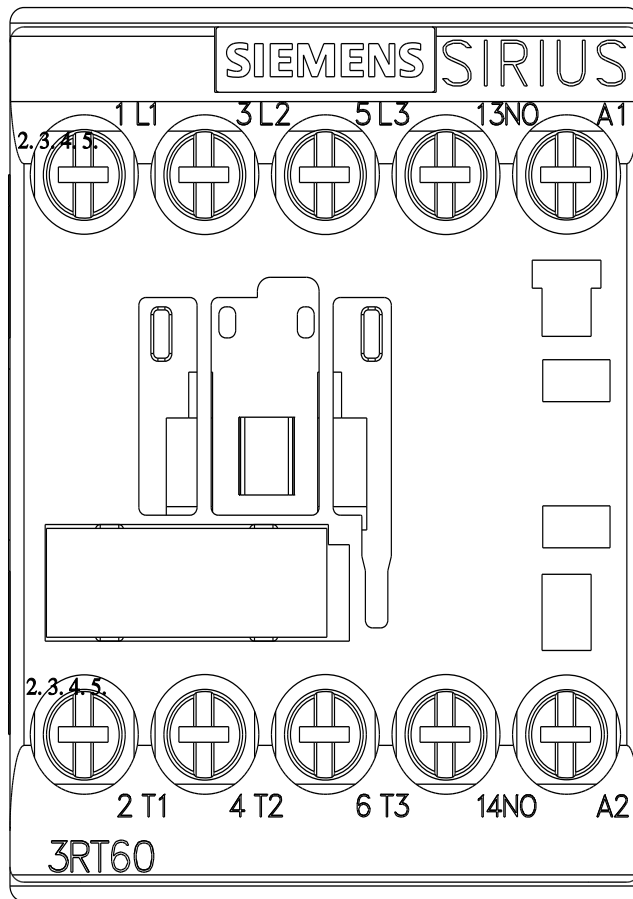

last modified:

7/14/2023



Contactor AC 220 V 50/60 HZ AC3 4 kW 400 V AUX contacts: 1 NC 3-pole, size S00 screw terminal

product brand name	SIRIUS
product designation	Power contactor
product type designation	3RT6
General technical data	
size of contactor	S00
product extension auxiliary switch	Yes
power loss [W] for rated value of the current	
• at AC in hot operating state per pole	0.7 W
• without load current share typical	1.05 W
type of calculation of power loss depending on pole	quadratic
insulation voltage rated value	690 V
degree of pollution	3
surge voltage resistance rated value	6 kV
maximum permissible voltage for protective separation between coil and main contacts according to EN 60947-1	400 V
shock resistance at rectangular impulse	
• at AC	6,7g / 5 ms, 4,2g / 10 ms
shock resistance with sine pulse	
• at AC	10,5g / 5 ms, 6,6g / 10 ms
mechanical service life (operating cycles)	
• of contactor typical	30 000 000
• of the contactor with added auxiliary switch block typical	10 000 000
Substance Prohibition (Date)	05/01/2012
Ambient conditions	
installation altitude at height above sea level maximum	2 000 m
ambient temperature	
• during operation	-25 ... +60 °C
• during storage	-55 ... +80 °C
Main circuit	
number of poles for main current circuit	3
number of NO contacts for main contacts	3
number of NC contacts for main contacts	0
operating voltage	
• at AC-3 rated value maximum	690 V
• at AC-3e rated value maximum	690 V
operational current	
• at AC-1 up to 690 V	
— at ambient temperature 40 °C rated value	22 A
— at ambient temperature 60 °C rated value	20 A
• at AC-3	

<ul style="list-style-type: none"> — at 400 V rated value — at 690 V rated value ● at AC-3e <ul style="list-style-type: none"> — at 400 V rated value — at 690 V rated value 	9 A 6.7 A 9 A 6.7 A
connectable conductor cross-section in main circuit at AC-1 <ul style="list-style-type: none"> ● at 60 °C minimum permissible ● at 40 °C minimum permissible 	 2.5 mm ² 4 mm ²
operational current for approx. 200000 operating cycles at AC-4 <ul style="list-style-type: none"> ● at 400 V rated value ● at 690 V rated value 	4.1 A 3.3 A
operating power <ul style="list-style-type: none"> ● at AC-1 <ul style="list-style-type: none"> — at 230 V rated value — at 230 V at 60 °C rated value — at 400 V at 60 °C rated value — at 690 V at 60 °C rated value ● at AC-3 <ul style="list-style-type: none"> — at 230 V rated value — at 400 V rated value — at 690 V rated value ● at AC-3e <ul style="list-style-type: none"> — at 400 V rated value — at 690 V rated value 	 7.5 kW 7.5 kW 13 kW 22 kW 2.2 kW 4 kW 5.5 kW 4 kW 5.5 kW
operating power for approx. 200000 operating cycles at AC-4 <ul style="list-style-type: none"> ● at 400 V rated value ● at 690 V rated value 	2 kW 2.5 kW
no-load switching frequency <ul style="list-style-type: none"> ● at AC 	10 000 1/h
operating frequency <ul style="list-style-type: none"> ● at AC-1 maximum ● at AC-3 maximum ● at AC-3e maximum ● at AC-4 maximum 	1 000 1/h 750 1/h 750 1/h 250 1/h
Control circuit/ Control	
type of voltage of the control supply voltage	AC
control supply voltage at AC <ul style="list-style-type: none"> ● at 50 Hz rated value ● at 60 Hz rated value 	220 V 220 V
operating range factor control supply voltage rated value of magnet coil at AC <ul style="list-style-type: none"> ● at 50 Hz ● at 60 Hz 	0.8 ... 1.1 0.85 ... 1.1
apparent pick-up power of magnet coil at AC <ul style="list-style-type: none"> ● at 50 Hz ● at 60 Hz 	27 VA 31.7 VA
inductive power factor with closing power of the coil <ul style="list-style-type: none"> ● at 50 Hz ● at 60 Hz 	0.8 0.81
apparent holding power of magnet coil at AC <ul style="list-style-type: none"> ● at 50 Hz ● at 60 Hz 	4.2 VA 4.8 VA
inductive power factor with the holding power of the coil <ul style="list-style-type: none"> ● at 50 Hz ● at 60 Hz 	0.25 0.25
Auxiliary circuit	
number of NC contacts for auxiliary contacts instantaneous contact	1
number of NO contacts for auxiliary contacts instantaneous	0

contact	
operational current at AC-12 maximum	10 A
operational current at AC-15	
• at 230 V rated value	10 A
• at 400 V rated value	3 A
• at 690 V rated value	1 A
operational current at DC-12	
• at 24 V rated value	6 A
• at 110 V rated value	3 A
• at 220 V rated value	1 A
operational current at DC-13	
• at 24 V rated value	6 A
• at 110 V rated value	1 A
• at 220 V rated value	0.3 A
contact reliability of auxiliary contacts	1 faulty switching per 100 million (17 V, 1 mA)

UL/CSA ratings

yielded mechanical performance [hp] for 3-phase AC motor at 460/480 V rated value	5 hp
---	------

Short-circuit protection

design of the fuse link	
• for short-circuit protection of the main circuit	
— with type of coordination 1 required	gL/gG LV HRC 3NA, DIAZED 5SB, NEOZED 5SE: 35 A
— with type of assignment 2 required	gL/gG LV HRC 3NA, DIAZED 5SB, NEOZED 5SE: 20 A
• for short-circuit protection of the auxiliary switch required	fuse gL/gG: 10 A

Installation/ mounting/ dimensions

mounting position	+/-180° rotation possible on vertical mounting surface; can be tilted forward and backward by +/- 22.5° on vertical mounting surface
• fastening method	screw and snap-on mounting onto 35 mm DIN rail according to DIN EN 50022
• fastening method side-by-side mounting	Yes
height	57.5 mm
width	45 mm
depth	73 mm
required spacing with side-by-side mounting at the side	0 mm

Connections/ Terminals

type of electrical connection	
• for main current circuit	screw-type terminals
• for auxiliary and control circuit	screw-type terminals
type of connectable conductor cross-sections for main contacts	
• solid or stranded	2x (0,5 ... 1,5 mm ²), 2x (0,75 ... 2,5 mm ²), 2x 4 mm ²
• finely stranded with core end processing	2x (0,5 ... 1,5 mm ²), 2x (0,75 ... 2,5 mm ²)
type of connectable conductor cross-sections	
• for auxiliary contacts	
— solid or stranded	2x (0,5 ... 1,5 mm ²), 2x (0,75 ... 2,5 mm ²), 2x 4 mm ²
— finely stranded with core end processing	2x (0,5 ... 1,5 mm ²), 2x (0,75 ... 2,5 mm ²)
• for AWG cables for auxiliary contacts	2x (20 ... 16), 2x (18 ... 14), 2x 12

Electrical Safety

protection class IP on the front according to IEC 60529	IP20
touch protection on the front according to IEC 60529	finger-safe, for vertical contact from the front

Approvals Certificates

General Product Approval



[Confirmation](#)



EMV	other	Environment
-----	-------	-------------



[Confirmation](#)

[Environmental Confirmations](#)

Further information

Service&Support (Manuals, Certificates, Characteristics, FAQs,...)
<https://support.industry.siemens.com/cs/products?pnid=16027&lc=en-CN>

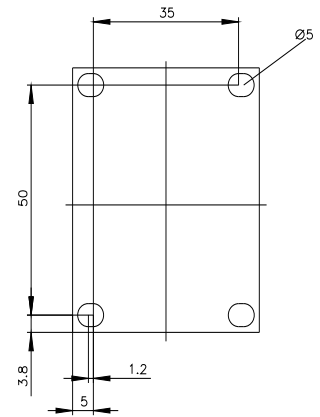
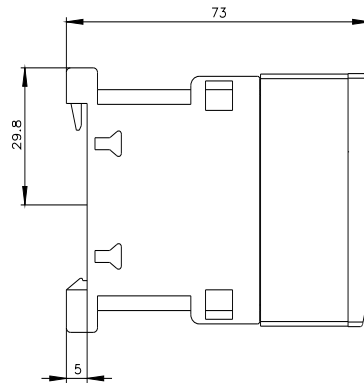
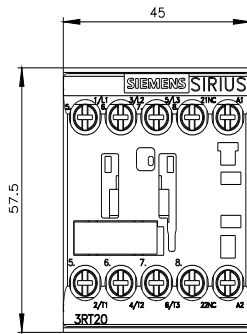

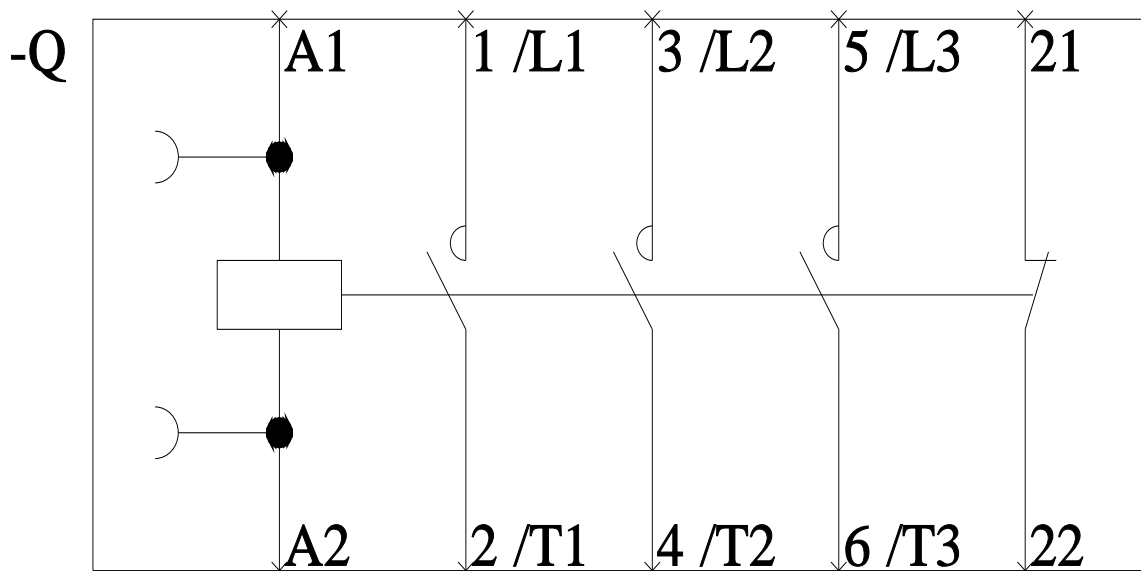
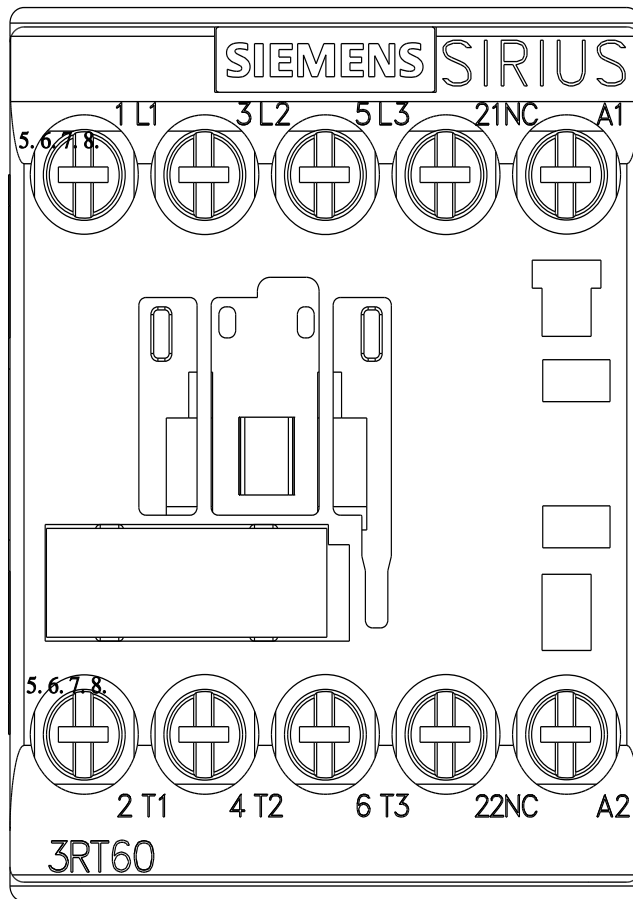

last modified:

7/14/2023



Contactor AC 230 V 50/60 HZ AC3 4 kW 400 V AUX contacts: 1 NC 3-pole, size S00 screw terminal

product brand name	SIRIUS
product designation	Power contactor
product type designation	3RT6
General technical data	
size of contactor	S00
product extension auxiliary switch	Yes
power loss [W] for rated value of the current	
• at AC in hot operating state per pole	0.7 W
• without load current share typical	1.05 W
type of calculation of power loss depending on pole	quadratic
insulation voltage rated value	690 V
degree of pollution	3
surge voltage resistance rated value	6 kV
maximum permissible voltage for protective separation between coil and main contacts according to EN 60947-1	400 V
shock resistance at rectangular impulse	
• at AC	6,7g / 5 ms, 4,2g / 10 ms
shock resistance with sine pulse	
• at AC	10,5g / 5 ms, 6,6g / 10 ms
mechanical service life (operating cycles)	
• of contactor typical	30 000 000
• of the contactor with added auxiliary switch block typical	10 000 000
Substance Prohibition (Date)	05/01/2012
Ambient conditions	
installation altitude at height above sea level maximum	2 000 m
ambient temperature	
• during operation	-25 ... +60 °C
• during storage	-55 ... +80 °C
Main circuit	
number of poles for main current circuit	3
number of NO contacts for main contacts	3
number of NC contacts for main contacts	0
operating voltage	
• at AC-3 rated value maximum	690 V
• at AC-3e rated value maximum	690 V
operational current	
• at AC-1 up to 690 V	
— at ambient temperature 40 °C rated value	22 A
— at ambient temperature 60 °C rated value	20 A
• at AC-3	

— at 400 V rated value	9 A
— at 690 V rated value	6.7 A
● at AC-3e	
— at 400 V rated value	9 A
— at 690 V rated value	6.7 A
connectable conductor cross-section in main circuit at AC-1	
● at 60 °C minimum permissible	2.5 mm ²
● at 40 °C minimum permissible	4 mm ²
operational current for approx. 200000 operating cycles at AC-4	
● at 400 V rated value	4.1 A
● at 690 V rated value	3.3 A
operating power	
● at AC-1	
— at 230 V rated value	7.5 kW
— at 230 V at 60 °C rated value	7.5 kW
— at 400 V at 60 °C rated value	13 kW
— at 690 V at 60 °C rated value	22 kW
● at AC-3	
— at 230 V rated value	2.2 kW
— at 400 V rated value	4 kW
— at 690 V rated value	5.5 kW
● at AC-3e	
— at 400 V rated value	4 kW
— at 690 V rated value	5.5 kW
operating power for approx. 200000 operating cycles at AC-4	
● at 400 V rated value	2 kW
● at 690 V rated value	2.5 kW
no-load switching frequency	
● at AC	10 000 1/h
operating frequency	
● at AC-1 maximum	1 000 1/h
● at AC-3 maximum	750 1/h
● at AC-3e maximum	750 1/h
● at AC-4 maximum	250 1/h
Control circuit/ Control	
type of voltage of the control supply voltage	AC
control supply voltage at AC	
● at 50 Hz rated value	230 V
● at 60 Hz rated value	230 V
operating range factor control supply voltage rated value of magnet coil at AC	
● at 50 Hz	0.8 ... 1.1
● at 60 Hz	0.85 ... 1.1
apparent pick-up power of magnet coil at AC	
● at 50 Hz	27 VA
● at 60 Hz	31.7 VA
inductive power factor with closing power of the coil	
● at 50 Hz	0.8
● at 60 Hz	0.81
apparent holding power of magnet coil at AC	
● at 50 Hz	4.2 VA
● at 60 Hz	4.8 VA
inductive power factor with the holding power of the coil	
● at 50 Hz	0.25
● at 60 Hz	0.25
Auxiliary circuit	
number of NC contacts for auxiliary contacts instantaneous contact	1
number of NO contacts for auxiliary contacts instantaneous	0

contact	
operational current at AC-12 maximum	10 A
operational current at AC-15	
• at 230 V rated value	10 A
• at 400 V rated value	3 A
• at 690 V rated value	1 A
operational current at DC-12	
• at 24 V rated value	6 A
• at 110 V rated value	3 A
• at 220 V rated value	1 A
operational current at DC-13	
• at 24 V rated value	6 A
• at 110 V rated value	1 A
• at 220 V rated value	0.3 A
contact reliability of auxiliary contacts	1 faulty switching per 100 million (17 V, 1 mA)
UL/CSA ratings	
yielded mechanical performance [hp] for 3-phase AC motor at 460/480 V rated value	5 hp
Short-circuit protection	
design of the fuse link	
• for short-circuit protection of the main circuit	
— with type of coordination 1 required	gL/gG LV HRC 3NA, DIAZED 5SB, NEOZED 5SE: 35 A
— with type of assignment 2 required	gL/gG LV HRC 3NA, DIAZED 5SB, NEOZED 5SE: 20 A
• for short-circuit protection of the auxiliary switch required	fuse gL/gG: 10 A
Installation/ mounting/ dimensions	
mounting position	+/-180° rotation possible on vertical mounting surface; can be tilted forward and backward by +/- 22.5° on vertical mounting surface
fastening method	screw and snap-on mounting onto 35 mm DIN rail according to DIN EN 50022
• side-by-side mounting	Yes
height	57.5 mm
width	45 mm
depth	73 mm
required spacing with side-by-side mounting at the side	0 mm
Connections/ Terminals	
type of electrical connection	
• for main current circuit	screw-type terminals
• for auxiliary and control circuit	screw-type terminals
type of connectable conductor cross-sections for main contacts	
• solid or stranded	2x (0,5 ... 1,5 mm ²), 2x (0,75 ... 2,5 mm ²), 2x 4 mm ²
• finely stranded with core end processing	2x (0,5 ... 1,5 mm ²), 2x (0,75 ... 2,5 mm ²)
type of connectable conductor cross-sections	
• for auxiliary contacts	
— solid or stranded	2x (0,5 ... 1,5 mm ²), 2x (0,75 ... 2,5 mm ²), 2x 4 mm ²
— finely stranded with core end processing	2x (0,5 ... 1,5 mm ²), 2x (0,75 ... 2,5 mm ²)
• for AWG cables for auxiliary contacts	2x (20 ... 16), 2x (18 ... 14), 2x 12
Electrical Safety	
protection class IP on the front according to IEC 60529	IP20
touch protection on the front according to IEC 60529	finger-safe, for vertical contact from the front
Approvals Certificates	
General Product Approval	



[Confirmation](#)



EMV

other

Environment



[Confirmation](#)

[Environmental Confirmations](#)

Further information

Service&Support (Manuals, Certificates, Characteristics, FAQs,...)
<https://support.industry.siemens.com/cs/products?pnid=16027&lc=en-CN>

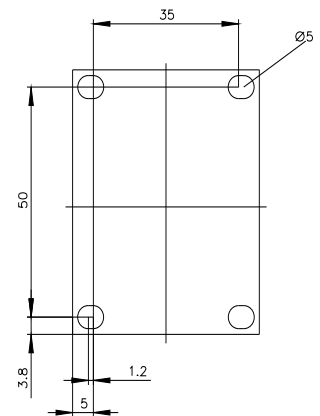
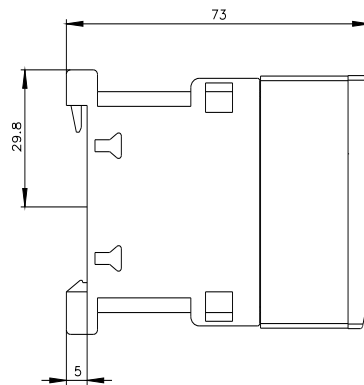
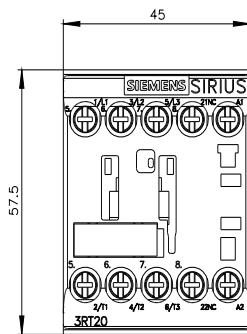

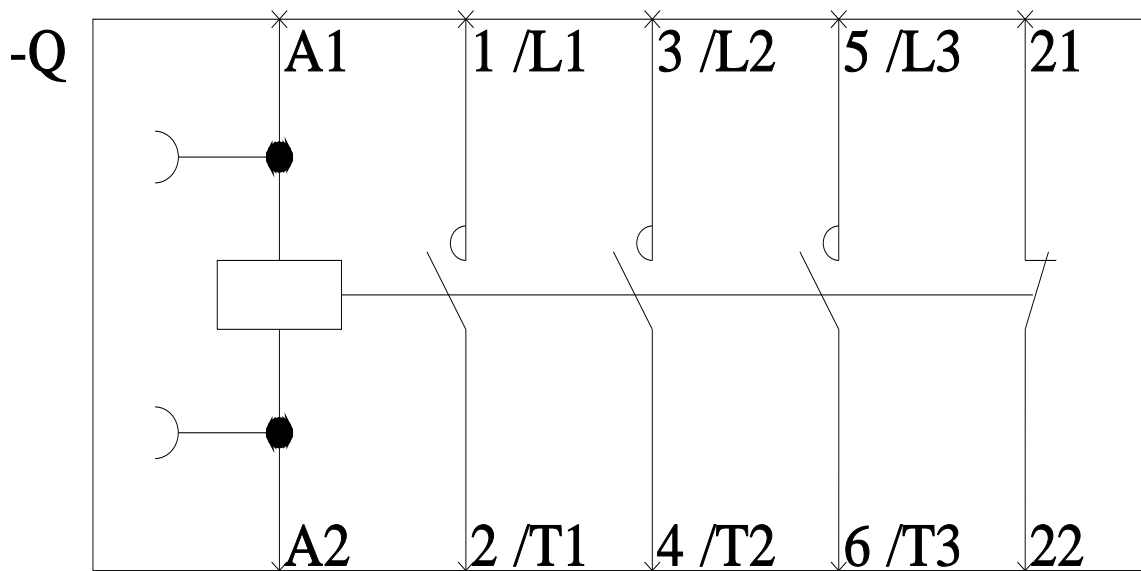
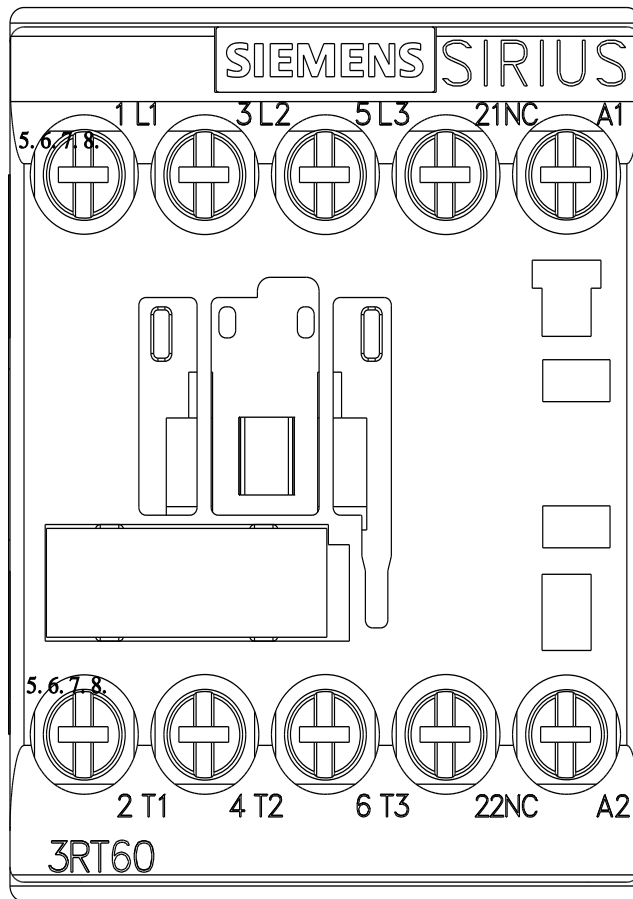

last modified:

7/14/2023



Contactor DC 24 V AC3 4 kW 400 V AUX contacts: 1 NO 3-pole, size S00 screw terminal

product brand name	SIRIUS
product designation	Power contactor
product type designation	3RT6
General technical data	
size of contactor	S00
product extension auxiliary switch	Yes
power loss [W] for rated value of the current	
• at AC in hot operating state per pole	0.7 W
• without load current share typical	4 W
type of calculation of power loss depending on pole	quadratic
insulation voltage rated value	690 V
degree of pollution	3
surge voltage resistance rated value	6 kV
maximum permissible voltage for protective separation between coil and main contacts according to EN 60947-1	400 V
shock resistance at rectangular impulse	
• at DC	6,7g / 5 ms, 4,2g / 10 ms
shock resistance with sine pulse	
• at DC	10,5g / 5 ms, 6,6g / 10 ms
mechanical service life (operating cycles)	
• of contactor typical	30 000 000
• of the contactor with added auxiliary switch block typical	10 000 000
Substance Prohibition (Date)	05/01/2012
Ambient conditions	
installation altitude at height above sea level maximum	2 000 m
ambient temperature	
• during operation	-25 ... +60 °C
• during storage	-55 ... +80 °C
Main circuit	
number of poles for main current circuit	3
number of NO contacts for main contacts	3
number of NC contacts for main contacts	0
operating voltage	
• at AC-3 rated value maximum	690 V
• at AC-3e rated value maximum	690 V
operational current	
• at AC-1 up to 690 V	
— at ambient temperature 40 °C rated value	22 A
— at ambient temperature 60 °C rated value	20 A
• at AC-3	

— at 400 V rated value	9 A
— at 690 V rated value	6.7 A
● at AC-3e	
— at 400 V rated value	9 A
— at 690 V rated value	6.7 A
connectable conductor cross-section in main circuit at AC-1	
● at 60 °C minimum permissible	2.5 mm ²
● at 40 °C minimum permissible	4 mm ²
operational current for approx. 200000 operating cycles at AC-4	
● at 400 V rated value	4.1 A
● at 690 V rated value	3.3 A
operating power	
● at AC-1	
— at 230 V rated value	7.5 kW
— at 230 V at 60 °C rated value	7.5 kW
— at 400 V at 60 °C rated value	13 kW
— at 690 V at 60 °C rated value	22 kW
● at AC-3	
— at 230 V rated value	2.2 kW
— at 400 V rated value	4 kW
— at 690 V rated value	5.5 kW
● at AC-3e	
— at 400 V rated value	4 kW
— at 690 V rated value	5.5 kW
operating power for approx. 200000 operating cycles at AC-4	
● at 400 V rated value	2 kW
● at 690 V rated value	2.5 kW
no-load switching frequency	
● at DC	10 000 1/h
operating frequency	
● at AC-1 maximum	1 000 1/h
● at AC-3 maximum	750 1/h
● at AC-3e maximum	750 1/h
● at AC-4 maximum	250 1/h
Control circuit/ Control	
type of voltage of the control supply voltage	DC
control supply voltage at DC rated value	24 V
closing power of magnet coil at DC	4 W
holding power of magnet coil at DC	4 W
Auxiliary circuit	
number of NC contacts for auxiliary contacts instantaneous contact	0
number of NO contacts for auxiliary contacts instantaneous contact	1
operational current at AC-12 maximum	10 A
operational current at AC-15	
● at 230 V rated value	10 A
● at 400 V rated value	3 A
● at 690 V rated value	1 A
operational current at DC-12	
● at 24 V rated value	6 A
● at 110 V rated value	3 A
● at 220 V rated value	1 A
operational current at DC-13	
● at 24 V rated value	6 A
● at 110 V rated value	1 A
● at 220 V rated value	0.3 A
contact reliability of auxiliary contacts	1 faulty switching per 100 million (17 V, 1 mA)
UL/CSA ratings	

yielded mechanical performance [hp] for 3-phase AC motor at 460/480 V rated value	5 hp
---	------

Short-circuit protection

design of the fuse link <ul style="list-style-type: none"> for short-circuit protection of the main circuit <ul style="list-style-type: none"> with type of coordination 1 required with type of assignment 2 required for short-circuit protection of the auxiliary switch required 	gL/gG LV HRC 3NA, DIAZED 5SB, NEOZED 5SE: 35 A gL/gG LV HRC 3NA, DIAZED 5SB, NEOZED 5SE: 20 A fuse gL/gG: 10 A
--	--

Installation/ mounting/ dimensions

mounting position	+/-180° rotation possible on vertical mounting surface; can be tilted forward and backward by +/- 22.5° on vertical mounting surface
<ul style="list-style-type: none"> fastening method fastening method side-by-side mounting 	screw and snap-on mounting onto 35 mm DIN rail according to DIN EN 50022 Yes
height	57.5 mm
width	45 mm
depth	73 mm
required spacing with side-by-side mounting at the side	0 mm

Connections/ Terminals

type of electrical connection <ul style="list-style-type: none"> for main current circuit for auxiliary and control circuit 	screw-type terminals screw-type terminals
type of connectable conductor cross-sections for main contacts <ul style="list-style-type: none"> solid or stranded finely stranded with core end processing 	2x (0,5 ... 1,5 mm²), 2x (0,75 ... 2,5 mm²), 2x 4 mm² 2x (0,5 ... 1,5 mm²), 2x (0,75 ... 2,5 mm²)
type of connectable conductor cross-sections <ul style="list-style-type: none"> for auxiliary contacts <ul style="list-style-type: none"> solid or stranded finely stranded with core end processing for AWG cables for auxiliary contacts 	2x (0,5 ... 1,5 mm²), 2x (0,75 ... 2,5 mm²), 2x 4 mm² 2x (0,5 ... 1,5 mm²), 2x (0,75 ... 2,5 mm²) 2x (20 ... 16), 2x (18 ... 14), 2x 12

Electrical Safety

protection class IP on the front according to IEC 60529	IP20
touch protection on the front according to IEC 60529	finger-safe, for vertical contact from the front

Approvals Certificates

General Product Approval



[Confirmation](#)



EMV	other	Dangerous Good	Environment
-----	-------	----------------	-------------



[Confirmation](#)

[Transport Information](#)

[Environmental Confirmations](#)

Further information

Service&Support (Manuals, Certificates, Characteristics, FAQs,...)
<https://support.industry.siemens.com/cs/products?pnid=16027&lc=en-CN>

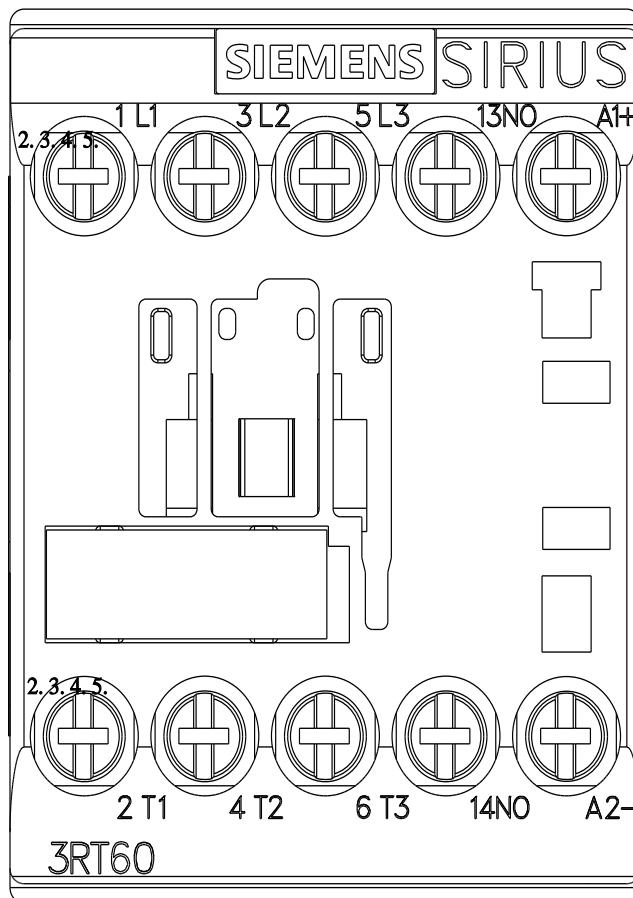
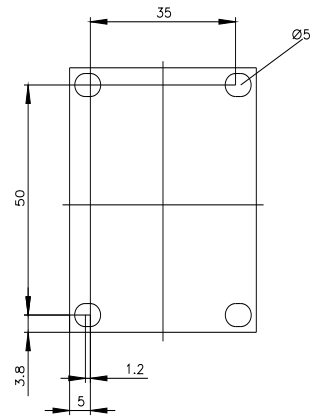
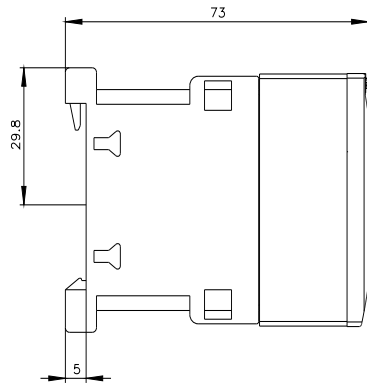
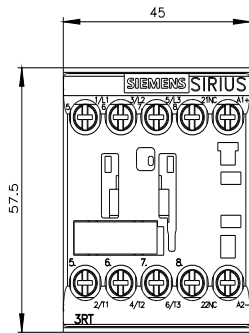

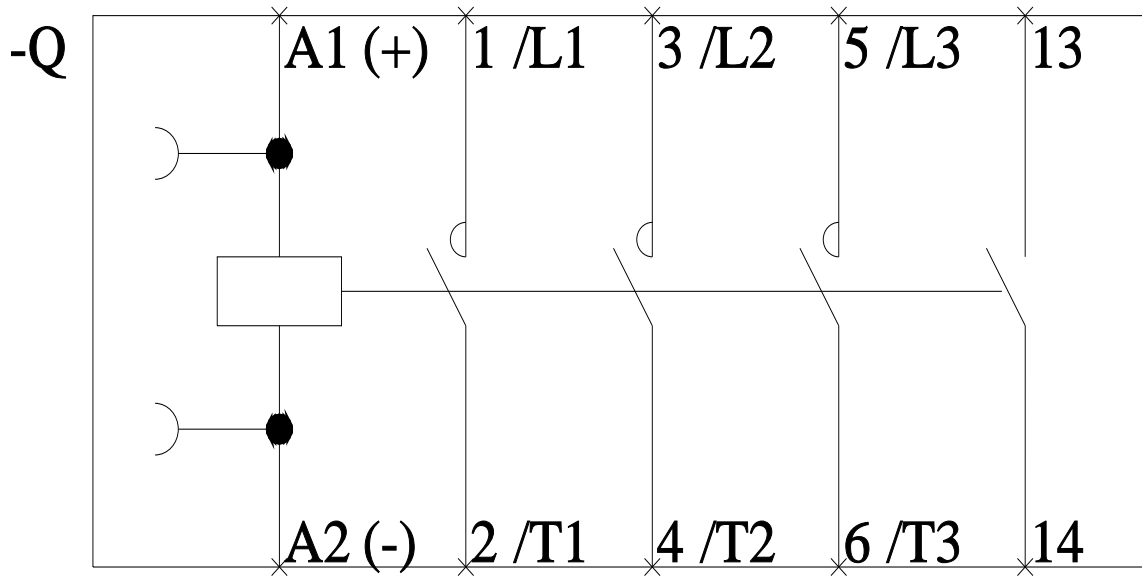

last modified:

7/14/2023 



Contactor DC 24 V AC3 4 kW 400 V AUX contacts: 1 NC 3-pole, size S00 screw terminal

product brand name	SIRIUS
product designation	Power contactor
product type designation	3RT6
General technical data	
size of contactor	S00
product extension auxiliary switch	Yes
power loss [W] for rated value of the current	
• at AC in hot operating state per pole	0.7 W
• without load current share typical	4 W
type of calculation of power loss depending on pole	quadratic
insulation voltage rated value	690 V
degree of pollution	3
surge voltage resistance rated value	6 kV
maximum permissible voltage for protective separation between coil and main contacts according to EN 60947-1	400 V
shock resistance at rectangular impulse	
• at DC	6,7g / 5 ms, 4,2g / 10 ms
shock resistance with sine pulse	
• at DC	10,5g / 5 ms, 6,6g / 10 ms
mechanical service life (operating cycles)	
• of contactor typical	30 000 000
• of the contactor with added auxiliary switch block typical	10 000 000
Substance Prohibition (Date)	05/01/2012
Ambient conditions	
installation altitude at height above sea level maximum	2 000 m
ambient temperature	
• during operation	-25 ... +60 °C
• during storage	-55 ... +80 °C
Main circuit	
number of poles for main current circuit	3
number of NO contacts for main contacts	3
number of NC contacts for main contacts	0
operating voltage	
• at AC-3 rated value maximum	690 V
• at AC-3e rated value maximum	690 V
operational current	
• at AC-1 up to 690 V	
— at ambient temperature 40 °C rated value	22 A
— at ambient temperature 60 °C rated value	20 A
• at AC-3	

— at 400 V rated value	9 A
— at 690 V rated value	6.7 A
● at AC-3e	
— at 400 V rated value	9 A
— at 690 V rated value	6.7 A
connectable conductor cross-section in main circuit at AC-1	
● at 60 °C minimum permissible	2.5 mm ²
● at 40 °C minimum permissible	4 mm ²
operational current for approx. 200000 operating cycles at AC-4	
● at 400 V rated value	4.1 A
● at 690 V rated value	3.3 A
operating power	
● at AC-1	
— at 230 V rated value	7.5 kW
— at 230 V at 60 °C rated value	7.5 kW
— at 400 V at 60 °C rated value	13 kW
— at 690 V at 60 °C rated value	22 kW
● at AC-3	
— at 230 V rated value	2.2 kW
— at 400 V rated value	4 kW
— at 690 V rated value	5.5 kW
● at AC-3e	
— at 400 V rated value	4 kW
— at 690 V rated value	5.5 kW
operating power for approx. 200000 operating cycles at AC-4	
● at 400 V rated value	2 kW
● at 690 V rated value	2.5 kW
no-load switching frequency	
● at DC	10 000 1/h
operating frequency	
● at AC-1 maximum	1 000 1/h
● at AC-3 maximum	750 1/h
● at AC-3e maximum	750 1/h
● at AC-4 maximum	250 1/h
Control circuit/ Control	
type of voltage of the control supply voltage	DC
control supply voltage at DC rated value	
●	24 V
closing power of magnet coil at DC	4 W
holding power of magnet coil at DC	4 W
Auxiliary circuit	
number of NC contacts for auxiliary contacts instantaneous contact	1
number of NO contacts for auxiliary contacts instantaneous contact	0
operational current at AC-12 maximum	10 A
operational current at AC-15	
● at 230 V rated value	10 A
● at 400 V rated value	3 A
● at 690 V rated value	1 A
operational current at DC-12	
● at 24 V rated value	6 A
● at 110 V rated value	3 A
● at 220 V rated value	1 A
operational current at DC-13	
● at 24 V rated value	6 A
● at 110 V rated value	1 A
● at 220 V rated value	0.3 A
contact reliability of auxiliary contacts	1 faulty switching per 100 million (17 V, 1 mA)

UL/CSA ratings	
yielded mechanical performance [hp] for 3-phase AC motor at 460/480 V rated value	5 hp
Short-circuit protection	
design of the fuse link	
<ul style="list-style-type: none"> for short-circuit protection of the main circuit <ul style="list-style-type: none"> with type of coordination 1 required with type of assignment 2 required for short-circuit protection of the auxiliary switch required 	gL/gG LV HRC 3NA, DIAZED 5SB, NEOZED 5SE: 35 A gL/gG LV HRC 3NA, DIAZED 5SB, NEOZED 5SE: 20 A fuse gL/gG: 10 A
Installation/ mounting/ dimensions	
mounting position	+/-180° rotation possible on vertical mounting surface; can be tilted forward and backward by +/- 22.5° on vertical mounting surface
fastening method	screw and snap-on mounting onto 35 mm DIN rail according to DIN EN 50022
<ul style="list-style-type: none"> side-by-side mounting 	Yes
height	57.5 mm
width	45 mm
depth	73 mm
required spacing with side-by-side mounting at the side	0 mm
Connections/ Terminals	
type of electrical connection	
<ul style="list-style-type: none"> for main current circuit for auxiliary and control circuit 	screw-type terminals screw-type terminals
type of connectable conductor cross-sections for main contacts	
<ul style="list-style-type: none"> solid or stranded finely stranded with core end processing 	2x (0,5 ... 1,5 mm ²), 2x (0,75 ... 2,5 mm ²), 2x 4 mm ² 2x (0,5 ... 1,5 mm ²), 2x (0,75 ... 2,5 mm ²)
type of connectable conductor cross-sections	
<ul style="list-style-type: none"> for auxiliary contacts <ul style="list-style-type: none"> solid or stranded finely stranded with core end processing for AWG cables for auxiliary contacts 	2x (0,5 ... 1,5 mm ²), 2x (0,75 ... 2,5 mm ²), 2x 4 mm ² 2x (0,5 ... 1,5 mm ²), 2x (0,75 ... 2,5 mm ²) 2x (20 ... 16), 2x (18 ... 14), 2x 12
Electrical Safety	
protection class IP on the front according to IEC 60529	IP20
touch protection on the front according to IEC 60529	finger-safe, for vertical contact from the front
Approvals Certificates	
General Product Approval	



[Confirmation](#)



EMV	other	Dangerous Good	Environment
-----	-------	----------------	-------------



[Confirmation](#)

[Transport Information](#)

[Environmental Confirmations](#)

Further information

Service&Support (Manuals, Certificates, Characteristics, FAQs,...)
<https://support.industry.siemens.com/cs/products?pnid=16027&lc=en-CN>

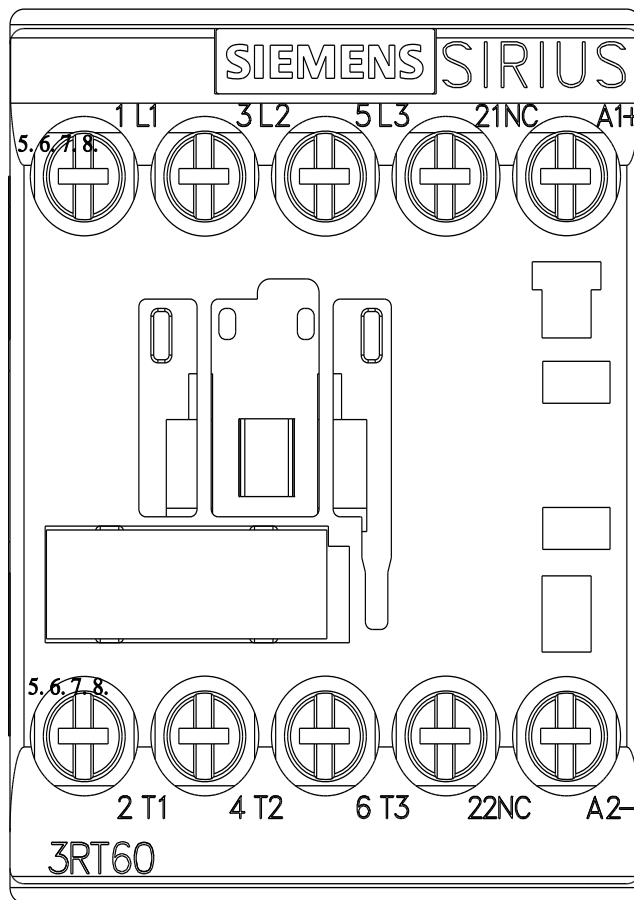
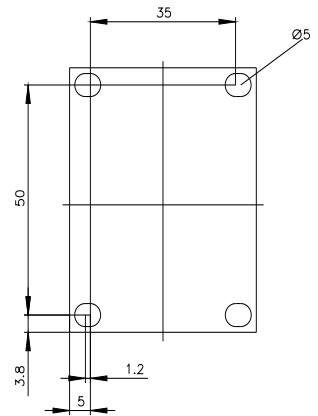
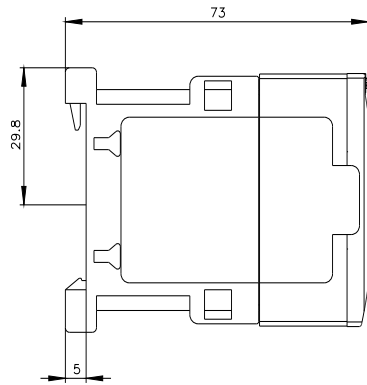
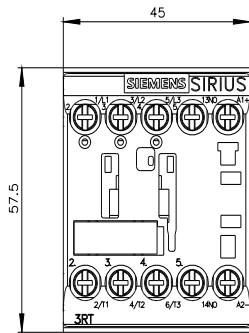

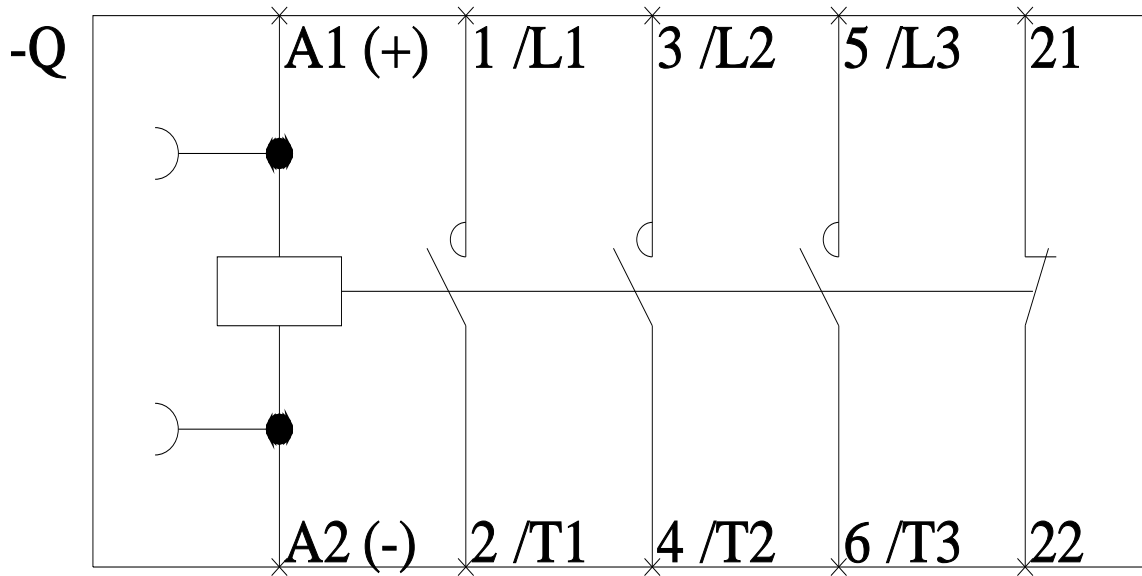

last modified:

7/14/2023 



Contactor AC 24 V 50/60 HZ AC3 5.5 kW 400 V AUX contacts: 1 NC 3-pole, size S00 screw terminal

product brand name	SIRIUS
product designation	Power contactor
product type designation	3RT6
General technical data	
size of contactor	S00
product extension auxiliary switch	Yes
power loss [W] for rated value of the current	
• at AC in hot operating state per pole	1.24 W
• without load current share typical	1.42 W
type of calculation of power loss depending on pole	quadratic
insulation voltage rated value	690 V
degree of pollution	3
surge voltage resistance rated value	6 kV
maximum permissible voltage for protective separation between coil and main contacts according to EN 60947-1	400 V
shock resistance at rectangular impulse	
• at AC	7,3g / 5 ms, 4,7g / 10 ms
shock resistance with sine pulse	
• at AC	11,4g / 5 ms, 7,3g / 10 ms
mechanical service life (operating cycles)	
• of contactor typical	30 000 000
• of the contactor with added auxiliary switch block typical	10 000 000
Substance Prohibition (Date)	05/01/2012
Ambient conditions	
installation altitude at height above sea level maximum	2 000 m
ambient temperature	
• during operation	-25 ... +60 °C
• during storage	-55 ... +80 °C
Main circuit	
number of poles for main current circuit	3
number of NO contacts for main contacts	3
number of NC contacts for main contacts	0
operating voltage	
• at AC-3 rated value maximum	690 V
• at AC-3e rated value maximum	690 V
operational current	
• at AC-1 up to 690 V	
— at ambient temperature 40 °C rated value	22 A
— at ambient temperature 60 °C rated value	20 A
• at AC-3	

<ul style="list-style-type: none"> — at 400 V rated value — at 690 V rated value 	12 A 6.7 A
<ul style="list-style-type: none"> ● at AC-3e <ul style="list-style-type: none"> — at 400 V rated value — at 690 V rated value 	12 A 6.7 A
connectable conductor cross-section in main circuit at AC-1	
<ul style="list-style-type: none"> ● at 60 °C minimum permissible ● at 40 °C minimum permissible 	2.5 mm ² 4 mm ²
operational current for approx. 200000 operating cycles at AC-4	
<ul style="list-style-type: none"> ● at 400 V rated value ● at 690 V rated value 	4.1 A 3.3 A
operating power	
<ul style="list-style-type: none"> ● at AC-1 <ul style="list-style-type: none"> — at 230 V rated value — at 230 V at 60 °C rated value — at 400 V at 60 °C rated value — at 690 V at 60 °C rated value ● at AC-3 <ul style="list-style-type: none"> — at 230 V rated value — at 400 V rated value — at 690 V rated value ● at AC-3e <ul style="list-style-type: none"> — at 400 V rated value — at 690 V rated value 	7.5 kW 7.5 kW 13 kW 22 kW 3 kW 5.5 kW 5.5 kW 5.5 kW 5.5 kW
operating power for approx. 200000 operating cycles at AC-4	
<ul style="list-style-type: none"> ● at 400 V rated value ● at 690 V rated value 	2 kW 2.5 kW
no-load switching frequency	
<ul style="list-style-type: none"> ● at AC 	10 000 1/h
operating frequency	
<ul style="list-style-type: none"> ● at AC-1 maximum ● at AC-3 maximum ● at AC-3e maximum ● at AC-4 maximum 	1 000 1/h 750 1/h 750 1/h 250 1/h
Control circuit/ Control	
type of voltage of the control supply voltage	AC
control supply voltage at AC	
<ul style="list-style-type: none"> ● at 50 Hz rated value ● at 60 Hz rated value 	24 V 24 V
operating range factor control supply voltage rated value of magnet coil at AC	
<ul style="list-style-type: none"> ● at 50 Hz ● at 60 Hz 	0.8 ... 1.1 0.85 ... 1.1
apparent pick-up power of magnet coil at AC	
<ul style="list-style-type: none"> ● at 50 Hz ● at 60 Hz 	37 VA 43 VA
inductive power factor with closing power of the coil	
<ul style="list-style-type: none"> ● at 50 Hz ● at 60 Hz 	0.8 0.8
apparent holding power of magnet coil at AC	
<ul style="list-style-type: none"> ● at 50 Hz ● at 60 Hz 	5.7 VA 6.5 VA
inductive power factor with the holding power of the coil	
<ul style="list-style-type: none"> ● at 50 Hz ● at 60 Hz 	0.25 0.25
Auxiliary circuit	
number of NC contacts for auxiliary contacts instantaneous contact	1
number of NO contacts for auxiliary contacts instantaneous	0

contact	
operational current at AC-12 maximum	10 A
operational current at AC-15	
• at 230 V rated value	10 A
• at 400 V rated value	3 A
• at 690 V rated value	1 A
operational current at DC-12	
• at 24 V rated value	6 A
• at 110 V rated value	3 A
• at 220 V rated value	1 A
operational current at DC-13	
• at 24 V rated value	6 A
• at 110 V rated value	1 A
• at 220 V rated value	0.3 A
contact reliability of auxiliary contacts	1 faulty switching per 100 million (17 V, 1 mA)
UL/CSA ratings	
yielded mechanical performance [hp] for 3-phase AC motor at 460/480 V rated value	7.5 hp
Short-circuit protection	
design of the fuse link	
• for short-circuit protection of the main circuit	
— with type of coordination 1 required	gL/gG LV HRC 3NA, DIAZED 5SB, NEOZED 5SE: 35 A
— with type of assignment 2 required	gL/gG LV HRC 3NA, DIAZED 5SB, NEOZED 5SE: 20 A
• for short-circuit protection of the auxiliary switch required	fuse gL/gG: 10 A
Installation/ mounting/ dimensions	
mounting position	+/-180° rotation possible on vertical mounting surface; can be tilted forward and backward by +/- 22.5° on vertical mounting surface
fastening method	screw and snap-on mounting onto 35 mm DIN rail according to DIN EN 50022
• side-by-side mounting	Yes
height	57.5 mm
width	45 mm
depth	73 mm
required spacing with side-by-side mounting at the side	0 mm
Connections/ Terminals	
type of electrical connection	
• for main current circuit	screw-type terminals
• for auxiliary and control circuit	screw-type terminals
type of connectable conductor cross-sections for main contacts	
• solid or stranded	2x (0,5 ... 1,5 mm ²), 2x (0,75 ... 2,5 mm ²), 2x 4 mm ²
• finely stranded with core end processing	2x (0,5 ... 1,5 mm ²), 2x (0,75 ... 2,5 mm ²)
type of connectable conductor cross-sections	
• for auxiliary contacts	
— solid or stranded	2x (0,5 ... 1,5 mm ²), 2x (0,75 ... 2,5 mm ²), 2x 4 mm ²
— finely stranded with core end processing	2x (0,5 ... 1,5 mm ²), 2x (0,75 ... 2,5 mm ²)
• for AWG cables for auxiliary contacts	2x (20 ... 16), 2x (18 ... 14), 2x 12
Electrical Safety	
protection class IP on the front according to IEC 60529	IP20
touch protection on the front according to IEC 60529	finger-safe, for vertical contact from the front
Approvals Certificates	
General Product Approval	



[Confirmation](#)



EMV	other	Environment
-----	-------	-------------



[Confirmation](#)

[Environmental Confirmations](#)

Further information

Service&Support (Manuals, Certificates, Characteristics, FAQs,...)
<https://support.industry.siemens.com/cs/products?pnid=16027&lc=en-CN>

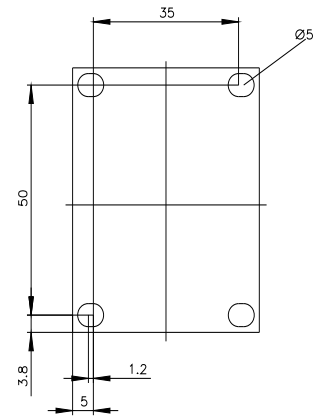
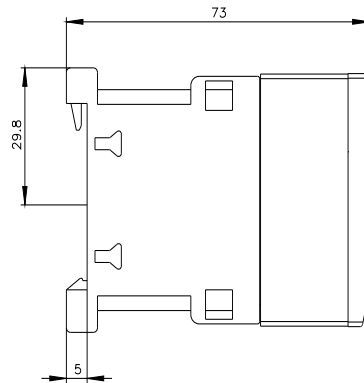
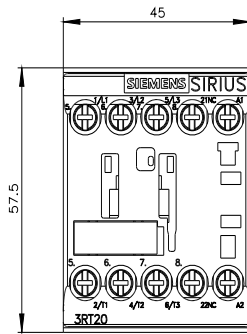

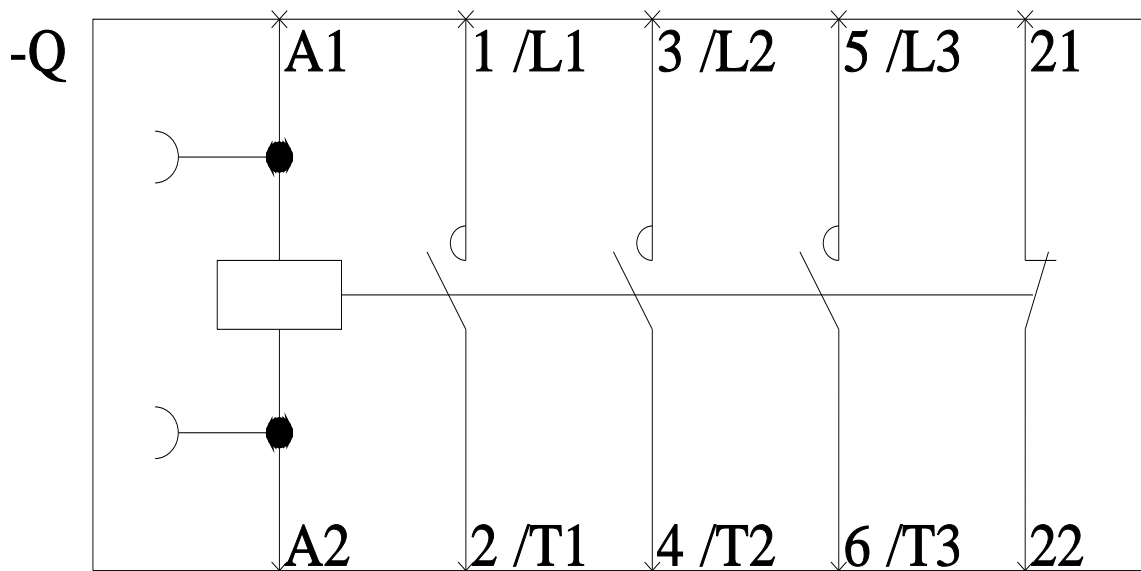
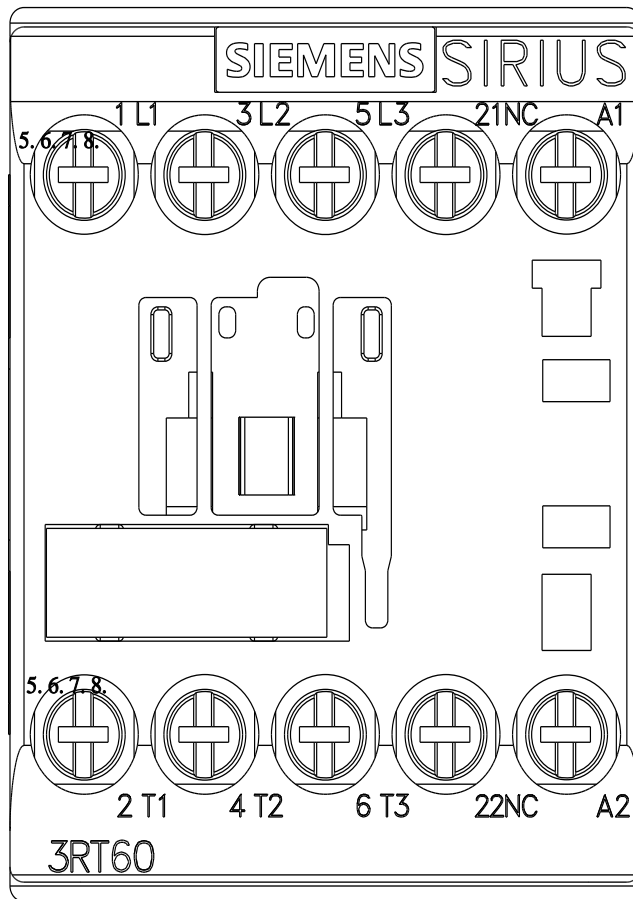

last modified:

7/14/2023



Contactor AC 220 V 50/60 HZ AC3 5.5 kW 400 V AUX contacts: 1 NO 3-pole, size S00 screw terminal

product brand name	SIRIUS
product designation	Power contactor
product type designation	3RT6
General technical data	
size of contactor	S00
product extension auxiliary switch	Yes
power loss [W] for rated value of the current	
• at AC in hot operating state per pole	1.24 W
• without load current share typical	1.42 W
type of calculation of power loss depending on pole	quadratic
insulation voltage rated value	690 V
degree of pollution	3
surge voltage resistance rated value	6 kV
maximum permissible voltage for protective separation between coil and main contacts according to EN 60947-1	400 V
shock resistance at rectangular impulse	
• at AC	7,3g / 5 ms, 4,7g / 10 ms
shock resistance with sine pulse	
• at AC	11,4g / 5 ms, 7,3g / 10 ms
mechanical service life (operating cycles)	
• of contactor typical	30 000 000
• of the contactor with added auxiliary switch block typical	10 000 000
Substance Prohibition (Date)	05/01/2012
Ambient conditions	
installation altitude at height above sea level maximum	2 000 m
ambient temperature	
• during operation	-25 ... +60 °C
• during storage	-55 ... +80 °C
Main circuit	
number of poles for main current circuit	3
number of NO contacts for main contacts	3
number of NC contacts for main contacts	0
operating voltage	
• at AC-3 rated value maximum	690 V
• at AC-3e rated value maximum	690 V
operational current	
• at AC-1 up to 690 V	
— at ambient temperature 40 °C rated value	22 A
— at ambient temperature 60 °C rated value	20 A
• at AC-3	

<ul style="list-style-type: none"> — at 400 V rated value — at 690 V rated value 	12 A 6.7 A
<ul style="list-style-type: none"> ● at AC-3e <ul style="list-style-type: none"> — at 400 V rated value — at 690 V rated value 	12 A 6.7 A
connectable conductor cross-section in main circuit at AC-1	
<ul style="list-style-type: none"> ● at 60 °C minimum permissible ● at 40 °C minimum permissible 	2.5 mm ² 4 mm ²
operational current for approx. 200000 operating cycles at AC-4	
<ul style="list-style-type: none"> ● at 400 V rated value ● at 690 V rated value 	4.1 A 3.3 A
operating power	
<ul style="list-style-type: none"> ● at AC-1 <ul style="list-style-type: none"> — at 230 V rated value — at 230 V at 60 °C rated value — at 400 V at 60 °C rated value — at 690 V at 60 °C rated value ● at AC-3 <ul style="list-style-type: none"> — at 230 V rated value — at 400 V rated value — at 690 V rated value ● at AC-3e <ul style="list-style-type: none"> — at 400 V rated value — at 690 V rated value 	7.5 kW 7.5 kW 13 kW 22 kW 3 kW 5.5 kW 5.5 kW 5.5 kW 5.5 kW
operating power for approx. 200000 operating cycles at AC-4	
<ul style="list-style-type: none"> ● at 400 V rated value ● at 690 V rated value 	2 kW 2.5 kW
no-load switching frequency	
<ul style="list-style-type: none"> ● at AC 	10 000 1/h
operating frequency	
<ul style="list-style-type: none"> ● at AC-1 maximum ● at AC-3 maximum ● at AC-3e maximum ● at AC-4 maximum 	1 000 1/h 750 1/h 750 1/h 250 1/h
Control circuit/ Control	
type of voltage of the control supply voltage	AC
control supply voltage at AC	
<ul style="list-style-type: none"> ● at 50 Hz rated value ● at 60 Hz rated value 	220 V 220 V
operating range factor control supply voltage rated value of magnet coil at AC	
<ul style="list-style-type: none"> ● at 50 Hz ● at 60 Hz 	0.8 ... 1.1 0.85 ... 1.1
apparent pick-up power of magnet coil at AC	
<ul style="list-style-type: none"> ● at 50 Hz ● at 60 Hz 	37 VA 43 VA
inductive power factor with closing power of the coil	
<ul style="list-style-type: none"> ● at 50 Hz ● at 60 Hz 	0.8 0.8
apparent holding power of magnet coil at AC	
<ul style="list-style-type: none"> ● at 50 Hz ● at 60 Hz 	5.7 VA 6.5 VA
inductive power factor with the holding power of the coil	
<ul style="list-style-type: none"> ● at 50 Hz ● at 60 Hz 	0.25 0.25
Auxiliary circuit	
number of NC contacts for auxiliary contacts instantaneous contact	0
number of NO contacts for auxiliary contacts instantaneous	1

contact	
operational current at AC-12 maximum	10 A
operational current at AC-15	
• at 230 V rated value	10 A
• at 400 V rated value	3 A
• at 690 V rated value	1 A
operational current at DC-12	
• at 24 V rated value	6 A
• at 110 V rated value	3 A
• at 220 V rated value	1 A
operational current at DC-13	
• at 24 V rated value	6 A
• at 110 V rated value	1 A
• at 220 V rated value	0.3 A
contact reliability of auxiliary contacts	1 faulty switching per 100 million (17 V, 1 mA)

UL/CSA ratings

yielded mechanical performance [hp] for 3-phase AC motor at 460/480 V rated value	7.5 hp
---	--------

Short-circuit protection

design of the fuse link	
• for short-circuit protection of the main circuit	
— with type of coordination 1 required	gL/gG LV HRC 3NA, DIAZED 5SB, NEOZED 5SE: 35 A
— with type of assignment 2 required	gL/gG LV HRC 3NA, DIAZED 5SB, NEOZED 5SE: 20 A
• for short-circuit protection of the auxiliary switch required	fuse gL/gG: 10 A

Installation/ mounting/ dimensions

mounting position	+/-180° rotation possible on vertical mounting surface; can be tilted forward and backward by +/- 22.5° on vertical mounting surface
• fastening method	screw and snap-on mounting onto 35 mm DIN rail according to DIN EN 50022
• fastening method side-by-side mounting	Yes
height	57.5 mm
width	45 mm
depth	73 mm
required spacing with side-by-side mounting at the side	0 mm

Connections/ Terminals

type of electrical connection	
• for main current circuit	screw-type terminals
• for auxiliary and control circuit	screw-type terminals
type of connectable conductor cross-sections for main contacts	
• solid or stranded	2x (0,5 ... 1,5 mm ²), 2x (0,75 ... 2,5 mm ²), 2x 4 mm ²
• finely stranded with core end processing	2x (0,5 ... 1,5 mm ²), 2x (0,75 ... 2,5 mm ²)
type of connectable conductor cross-sections	
• for auxiliary contacts	
— solid or stranded	2x (0,5 ... 1,5 mm ²), 2x (0,75 ... 2,5 mm ²), 2x 4 mm ²
— finely stranded with core end processing	2x (0,5 ... 1,5 mm ²), 2x (0,75 ... 2,5 mm ²)
• for AWG cables for auxiliary contacts	2x (20 ... 16), 2x (18 ... 14), 2x 12

Electrical Safety

protection class IP on the front according to IEC 60529	IP20
touch protection on the front according to IEC 60529	finger-safe, for vertical contact from the front

Approvals Certificates

General Product Approval



[Confirmation](#)



EMV	other	Environment
-----	-------	-------------



[Confirmation](#)

[Environmental Confirmations](#)

Further information

Service&Support (Manuals, Certificates, Characteristics, FAQs,...)
<https://support.industry.siemens.com/cs/products?pnid=16027&lc=en-CN>

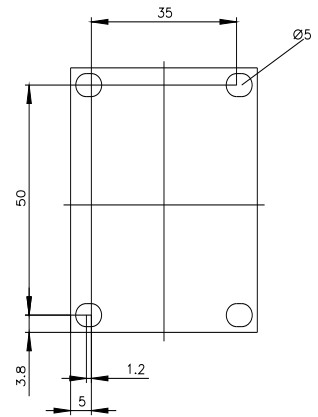
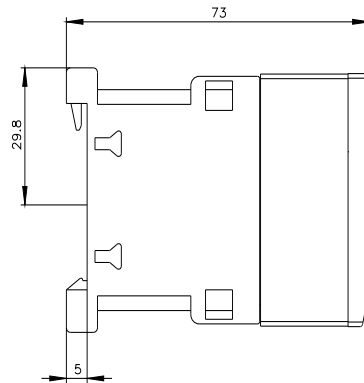
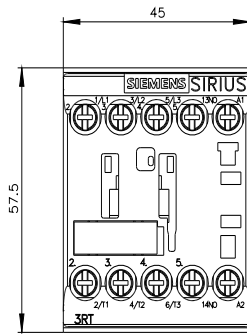

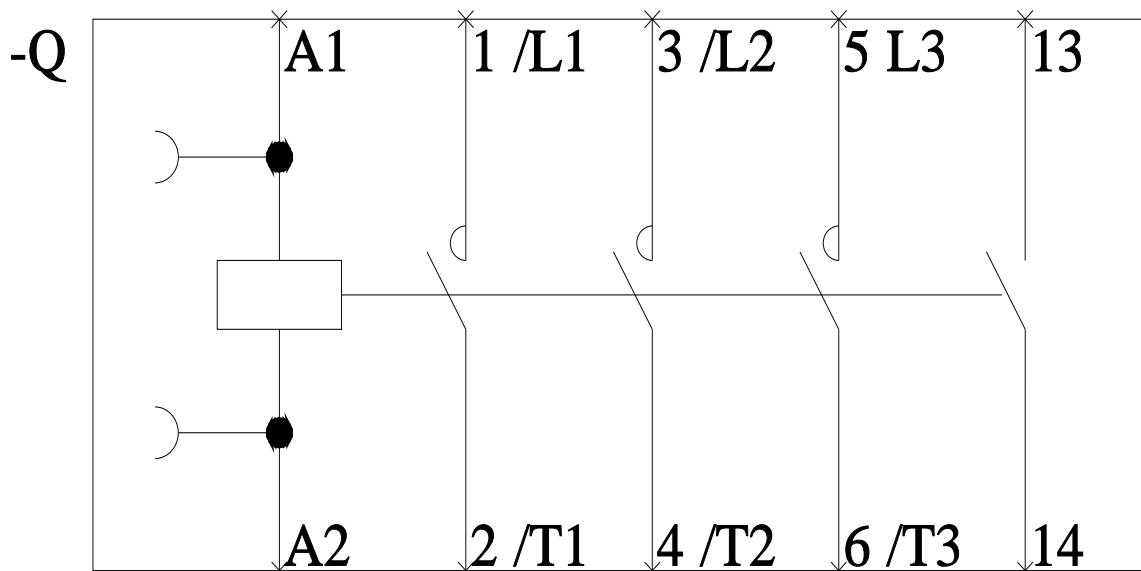
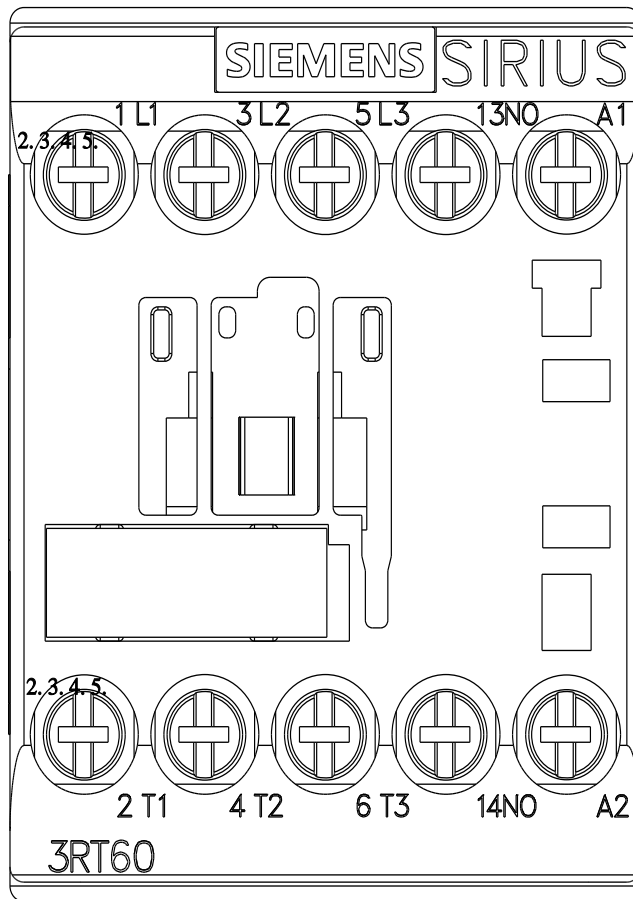

last modified:

7/14/2023



Contactor AC 220 V 50/60 HZ AC3 5.5 kW 400 V AUX contacts: 1 NC 3-pole, size S00 screw terminal

product brand name	SIRIUS
product designation	Power contactor
product type designation	3RT6
General technical data	
size of contactor	S00
product extension auxiliary switch	Yes
power loss [W] for rated value of the current	
• at AC in hot operating state per pole	1.24 W
• without load current share typical	1.42 W
type of calculation of power loss depending on pole	quadratic
insulation voltage rated value	690 V
degree of pollution	3
surge voltage resistance rated value	6 kV
maximum permissible voltage for protective separation between coil and main contacts according to EN 60947-1	400 V
shock resistance at rectangular impulse	
• at AC	7,3g / 5 ms, 4,7g / 10 ms
shock resistance with sine pulse	
• at AC	11,4g / 5 ms, 7,3g / 10 ms
mechanical service life (operating cycles)	
• of contactor typical	30 000 000
• of the contactor with added auxiliary switch block typical	10 000 000
Substance Prohibition (Date)	05/01/2012
Ambient conditions	
installation altitude at height above sea level maximum	2 000 m
ambient temperature	
• during operation	-25 ... +60 °C
• during storage	-55 ... +80 °C
Main circuit	
number of poles for main current circuit	3
number of NO contacts for main contacts	3
number of NC contacts for main contacts	0
operating voltage	
• at AC-3 rated value maximum	690 V
• at AC-3e rated value maximum	690 V
operational current	
• at AC-1 up to 690 V	
— at ambient temperature 40 °C rated value	22 A
— at ambient temperature 60 °C rated value	20 A
• at AC-3	

<ul style="list-style-type: none"> — at 400 V rated value — at 690 V rated value 	12 A 6.7 A
<ul style="list-style-type: none"> ● at AC-3e <ul style="list-style-type: none"> — at 400 V rated value — at 690 V rated value 	12 A 6.7 A
connectable conductor cross-section in main circuit at AC-1	
<ul style="list-style-type: none"> ● at 60 °C minimum permissible ● at 40 °C minimum permissible 	2.5 mm ² 4 mm ²
operational current for approx. 200000 operating cycles at AC-4	
<ul style="list-style-type: none"> ● at 400 V rated value ● at 690 V rated value 	4.1 A 3.3 A
operating power	
<ul style="list-style-type: none"> ● at AC-1 <ul style="list-style-type: none"> — at 230 V rated value — at 230 V at 60 °C rated value — at 400 V at 60 °C rated value — at 690 V at 60 °C rated value ● at AC-3 <ul style="list-style-type: none"> — at 230 V rated value — at 400 V rated value — at 690 V rated value ● at AC-3e <ul style="list-style-type: none"> — at 400 V rated value — at 690 V rated value 	7.5 kW 7.5 kW 13 kW 22 kW 3 kW 5.5 kW 5.5 kW 5.5 kW 5.5 kW
operating power for approx. 200000 operating cycles at AC-4	
<ul style="list-style-type: none"> ● at 400 V rated value ● at 690 V rated value 	2 kW 2.5 kW
no-load switching frequency	
<ul style="list-style-type: none"> ● at AC 	10 000 1/h
operating frequency	
<ul style="list-style-type: none"> ● at AC-1 maximum ● at AC-3 maximum ● at AC-3e maximum ● at AC-4 maximum 	1 000 1/h 750 1/h 750 1/h 250 1/h
Control circuit/ Control	
type of voltage of the control supply voltage	AC
control supply voltage at AC	
<ul style="list-style-type: none"> ● at 50 Hz rated value ● at 60 Hz rated value 	220 V 220 V
operating range factor control supply voltage rated value of magnet coil at AC	
<ul style="list-style-type: none"> ● at 50 Hz ● at 60 Hz 	0.8 ... 1.1 0.85 ... 1.1
apparent pick-up power of magnet coil at AC	
<ul style="list-style-type: none"> ● at 50 Hz ● at 60 Hz 	37 VA 43 VA
inductive power factor with closing power of the coil	
<ul style="list-style-type: none"> ● at 50 Hz ● at 60 Hz 	0.8 0.8
apparent holding power of magnet coil at AC	
<ul style="list-style-type: none"> ● at 50 Hz ● at 60 Hz 	5.7 VA 6.5 VA
inductive power factor with the holding power of the coil	
<ul style="list-style-type: none"> ● at 50 Hz ● at 60 Hz 	0.25 0.25
Auxiliary circuit	
number of NC contacts for auxiliary contacts instantaneous contact	1
number of NO contacts for auxiliary contacts instantaneous	0

contact	
operational current at AC-12 maximum	10 A
operational current at AC-15	
<ul style="list-style-type: none"> • at 230 V rated value • at 400 V rated value • at 690 V rated value 	10 A 3 A 1 A
operational current at DC-12	
<ul style="list-style-type: none"> • at 24 V rated value • at 110 V rated value • at 220 V rated value 	6 A 3 A 1 A
operational current at DC-13	
<ul style="list-style-type: none"> • at 24 V rated value • at 110 V rated value • at 220 V rated value 	6 A 1 A 0.3 A
contact reliability of auxiliary contacts	1 faulty switching per 100 million (17 V, 1 mA)
UL/CSA ratings	
yielded mechanical performance [hp] for 3-phase AC motor at 460/480 V rated value	7.5 hp
Short-circuit protection	
design of the fuse link	
<ul style="list-style-type: none"> • for short-circuit protection of the main circuit <ul style="list-style-type: none"> — with type of coordination 1 required — with type of assignment 2 required • for short-circuit protection of the auxiliary switch required 	gL/gG LV HRC 3NA, DIAZED 5SB, NEOZED 5SE: 35 A gL/gG LV HRC 3NA, DIAZED 5SB, NEOZED 5SE: 20 A fuse gL/gG: 10 A
Installation/ mounting/ dimensions	
mounting position	+/-180° rotation possible on vertical mounting surface; can be tilted forward and backward by +/- 22.5° on vertical mounting surface
fastening method	screw and snap-on mounting onto 35 mm DIN rail according to DIN EN 50022
<ul style="list-style-type: none"> • side-by-side mounting 	Yes
height	57.5 mm
width	45 mm
depth	73 mm
required spacing with side-by-side mounting at the side	0 mm
Connections/ Terminals	
type of electrical connection	
<ul style="list-style-type: none"> • for main current circuit • for auxiliary and control circuit 	screw-type terminals screw-type terminals
type of connectable conductor cross-sections for main contacts	
<ul style="list-style-type: none"> • solid or stranded • finely stranded with core end processing 	2x (0,5 ... 1,5 mm ²), 2x (0,75 ... 2,5 mm ²), 2x 4 mm ² 2x (0,5 ... 1,5 mm ²), 2x (0,75 ... 2,5 mm ²)
type of connectable conductor cross-sections	
<ul style="list-style-type: none"> • for auxiliary contacts <ul style="list-style-type: none"> — solid or stranded — finely stranded with core end processing • for AWG cables for auxiliary contacts 	2x (0,5 ... 1,5 mm ²), 2x (0,75 ... 2,5 mm ²), 2x 4 mm ² 2x (0,5 ... 1,5 mm ²), 2x (0,75 ... 2,5 mm ²) 2x (20 ... 16), 2x (18 ... 14), 2x 12
Electrical Safety	
protection class IP on the front according to IEC 60529	IP20
touch protection on the front according to IEC 60529	finger-safe, for vertical contact from the front
Approvals Certificates	
General Product Approval	



[Confirmation](#)



EMV

other

Environment



[Confirmation](#)

[Environmental Confirmations](#)

Further information

Service&Support (Manuals, Certificates, Characteristics, FAQs,...)
<https://support.industry.siemens.com/cs/products?pnid=16027&lc=en-CN>

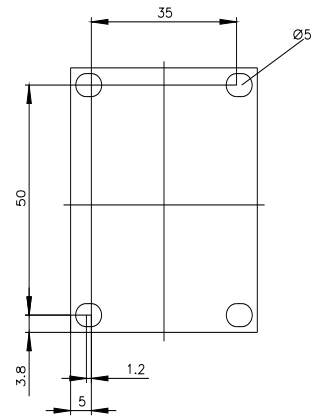
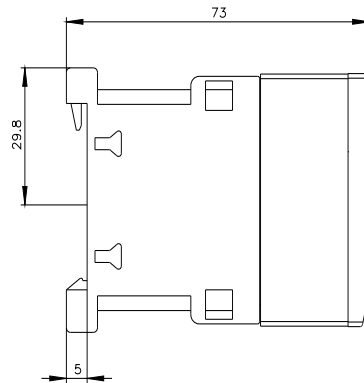
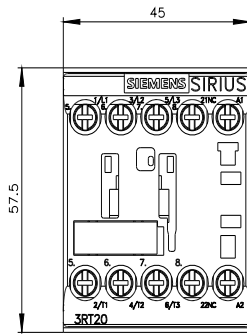

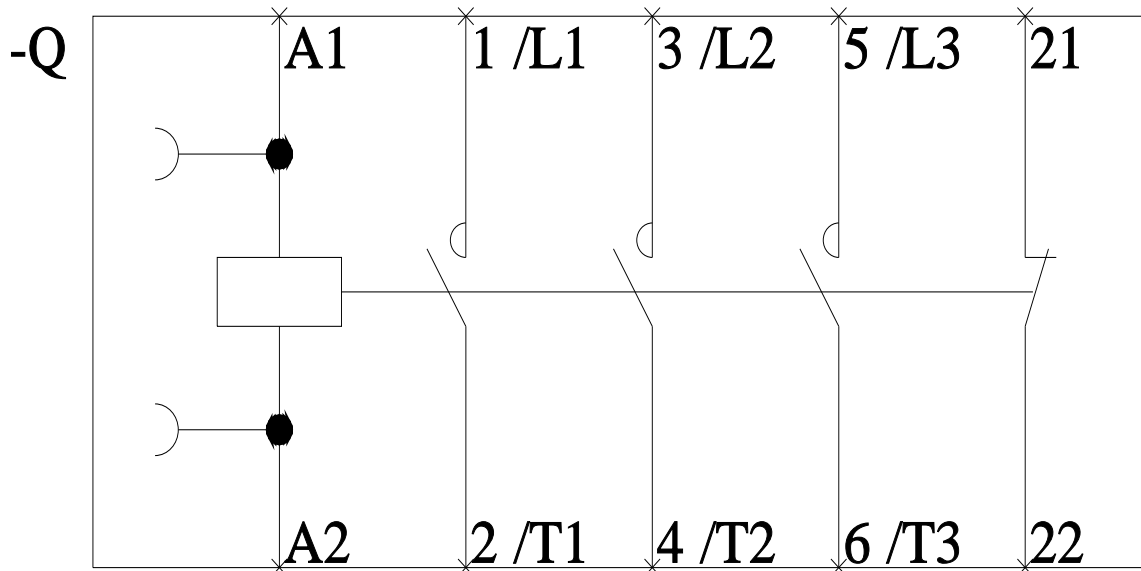
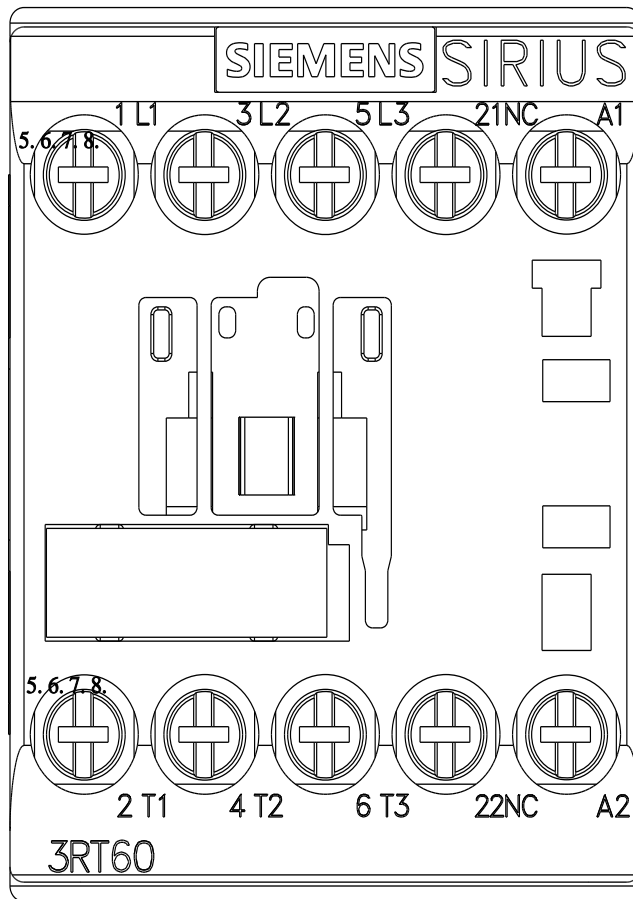

last modified:

7/14/2023 



Contactor AC 24 V 50/60 HZ AC3 7.5 kW 400 V AUX contacts 1 NO 3-pole, size S00 screw terminal

product brand name	SIRIUS
product designation	Power contactor
product type designation	3RT6
General technical data	
size of contactor	S00
product extension auxiliary switch	Yes
power loss [W] for rated value of the current	
• at AC in hot operating state per pole	2.2 W
• without load current share typical	1.42 W
type of calculation of power loss depending on pole	quadratic
insulation voltage rated value	690 V
degree of pollution	3
surge voltage resistance rated value	6 kV
maximum permissible voltage for protective separation between coil and main contacts according to EN 60947-1	400 V
shock resistance at rectangular impulse	
• at AC	7,3g / 5 ms, 4,7g / 10 ms
shock resistance with sine pulse	
• at AC	11,4g / 5 ms, 7,3g / 10 ms
mechanical service life (operating cycles)	
• of contactor typical	30 000 000
• of the contactor with added auxiliary switch block typical	10 000 000
Substance Prohibition (Date)	05/01/2012
Ambient conditions	
installation altitude at height above sea level maximum	2 000 m
ambient temperature	
• during operation	-25 ... +60 °C
• during storage	-55 ... +80 °C
Main circuit	
number of poles for main current circuit	3
number of NO contacts for main contacts	3
number of NC contacts for main contacts	0
operating voltage	
• at AC-3 rated value maximum	690 V
• at AC-3e rated value maximum	690 V
operational current	
• at AC-1 up to 690 V	
— at ambient temperature 40 °C rated value	22 A
— at ambient temperature 60 °C rated value	20 A
• at AC-3	

— at 400 V rated value	16 A
— at 690 V rated value	8.9 A
● at AC-3e	
— at 400 V rated value	16 A
— at 690 V rated value	8.9 A
connectable conductor cross-section in main circuit at AC-1	
● at 60 °C minimum permissible	2.5 mm ²
● at 40 °C minimum permissible	4 mm ²
operational current for approx. 200000 operating cycles at AC-4	
● at 400 V rated value	5.5 A
● at 690 V rated value	4.4 A
operating power	
● at AC-1	
— at 230 V rated value	7.5 kW
— at 230 V at 60 °C rated value	7.5 kW
— at 400 V at 60 °C rated value	13 kW
— at 690 V at 60 °C rated value	22 kW
● at AC-3	
— at 230 V rated value	4 kW
— at 400 V rated value	7.5 kW
— at 690 V rated value	7.5 kW
● at AC-3e	
— at 400 V rated value	7.5 kW
— at 690 V rated value	7.5 kW
operating power for approx. 200000 operating cycles at AC-4	
● at 400 V rated value	2.5 kW
● at 690 V rated value	3.5 kW
no-load switching frequency	
● at AC	10 000 1/h
operating frequency	
● at AC-1 maximum	1 000 1/h
● at AC-3 maximum	750 1/h
● at AC-3e maximum	750 1/h
● at AC-4 maximum	250 1/h
Control circuit/ Control	
type of voltage of the control supply voltage	AC
control supply voltage at AC	
● at 50 Hz rated value	24 V
● at 60 Hz rated value	24 V
operating range factor control supply voltage rated value of magnet coil at AC	
● at 50 Hz	0.8 ... 1.1
● at 60 Hz	0.85 ... 1.1
apparent pick-up power of magnet coil at AC	
● at 50 Hz	37 VA
● at 60 Hz	43 VA
inductive power factor with closing power of the coil	
● at 50 Hz	0.8
● at 60 Hz	0.8
apparent holding power of magnet coil at AC	
● at 50 Hz	5.7 VA
● at 60 Hz	6.5 VA
inductive power factor with the holding power of the coil	
● at 50 Hz	0.25
● at 60 Hz	0.25
Auxiliary circuit	
number of NC contacts for auxiliary contacts instantaneous contact	0
number of NO contacts for auxiliary contacts instantaneous	1

contact	
operational current at AC-12 maximum	10 A
operational current at AC-15	
• at 230 V rated value	10 A
• at 400 V rated value	3 A
• at 690 V rated value	1 A
operational current at DC-12	
• at 24 V rated value	6 A
• at 110 V rated value	3 A
• at 220 V rated value	1 A
operational current at DC-13	
• at 24 V rated value	6 A
• at 110 V rated value	1 A
• at 220 V rated value	0.3 A
contact reliability of auxiliary contacts	1 faulty switching per 100 million (17 V, 1 mA)

UL/CSA ratings

yielded mechanical performance [hp] for 3-phase AC motor at 460/480 V rated value	10 hp
---	-------

Short-circuit protection

design of the fuse link	
• for short-circuit protection of the main circuit	
— with type of coordination 1 required	gL/gG LV HRC 3NA, DIAZED 5SB, NEOZED 5SE: 35 A
— with type of assignment 2 required	gL/gG LV HRC 3NA, DIAZED 5SB, NEOZED 5SE: 20 A
• for short-circuit protection of the auxiliary switch required	fuse gL/gG: 10 A

Installation/ mounting/ dimensions

mounting position	+/-180° rotation possible on vertical mounting surface; can be tilted forward and backward by +/- 22.5° on vertical mounting surface
• fastening method	screw and snap-on mounting onto 35 mm DIN rail according to DIN EN 50022
• fastening method side-by-side mounting	Yes
height	57.5 mm
width	45 mm
depth	73 mm
required spacing with side-by-side mounting at the side	0 mm

Connections/ Terminals

type of electrical connection	
• for main current circuit	screw-type terminals
• for auxiliary and control circuit	screw-type terminals
type of connectable conductor cross-sections for main contacts	
• solid or stranded	2x (0,5 ... 1,5 mm ²), 2x (0,75 ... 2,5 mm ²), 2x 4 mm ²
• finely stranded with core end processing	2x (0,5 ... 1,5 mm ²), 2x (0,75 ... 2,5 mm ²)
type of connectable conductor cross-sections	
• for auxiliary contacts	
— solid or stranded	2x (0,5 ... 1,5 mm ²), 2x (0,75 ... 2,5 mm ²), 2x 4 mm ²
— finely stranded with core end processing	2x (0,5 ... 1,5 mm ²), 2x (0,75 ... 2,5 mm ²)
• for AWG cables for auxiliary contacts	2x (20 ... 16), 2x (18 ... 14), 2x 12

Electrical Safety

protection class IP on the front according to IEC 60529	IP20
touch protection on the front according to IEC 60529	finger-safe, for vertical contact from the front

Approvals Certificates

General Product Approval



[Confirmation](#)



EMV	other
-----	-------



[Confirmation](#)

Further information

Service&Support (Manuals, Certificates, Characteristics, FAQs,...)
<https://support.industry.siemens.com/cs/products?pnid=16027&lc=en-CN>

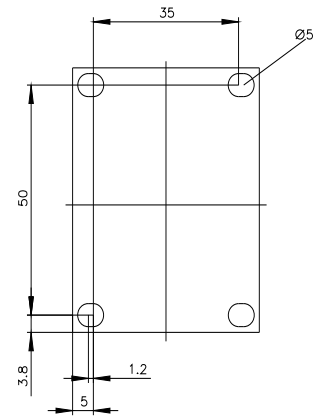
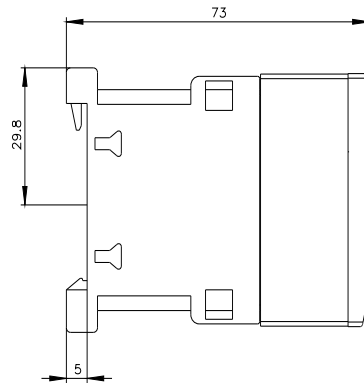
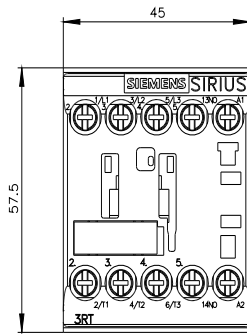

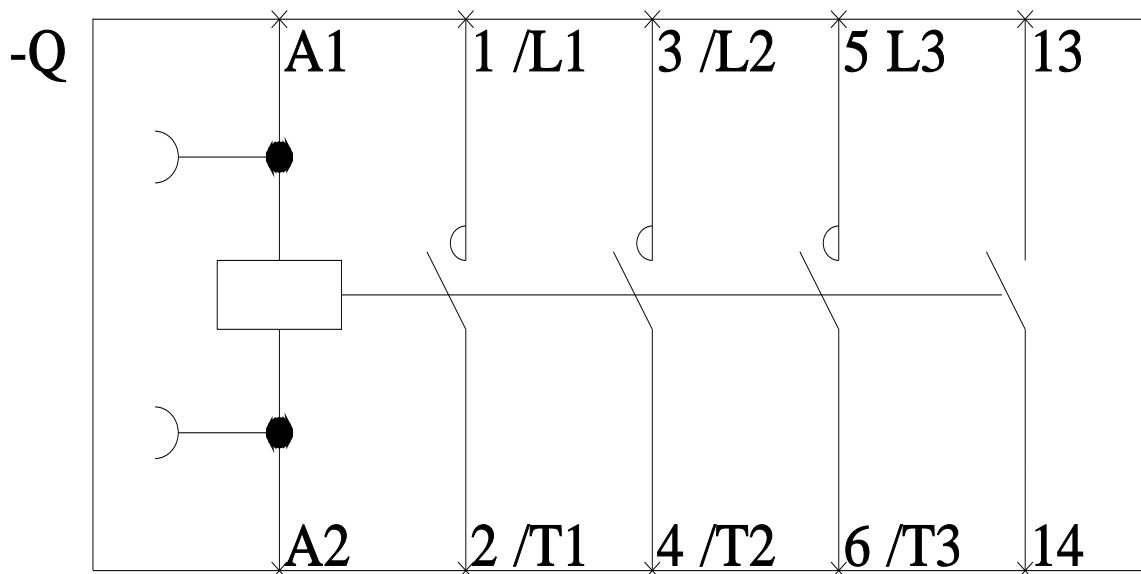
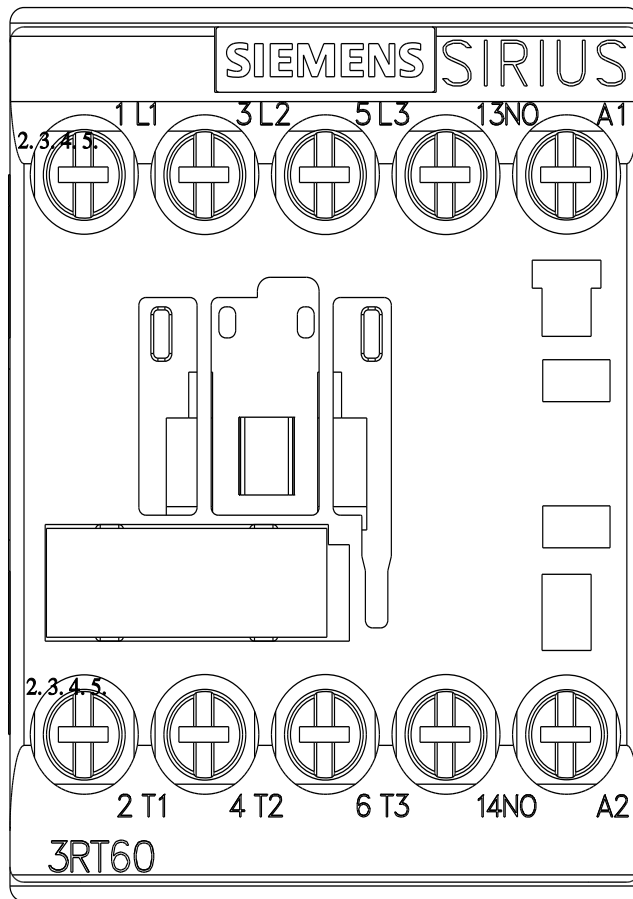



Contactor AC 220 V 50/60 HZ AC3 4 kW 400 V AUX contacts 1 NO +1 NC 3-pole, size S0 screw terminal

product brand name	SIRIUS
product designation	Power contactor
product type designation	3RT6
General technical data	
size of contactor	S0
product extension auxiliary switch	Yes
power loss [W] for rated value of the current	
• at AC in hot operating state per pole	0.4 W
• without load current share typical	1.97 W
type of calculation of power loss depending on pole	quadratic
insulation voltage rated value	690 V
degree of pollution	3
surge voltage resistance rated value	6 kV
maximum permissible voltage for protective separation between coil and main contacts according to EN 60947-1	400 V
shock resistance at rectangular impulse	
• at AC	7,5g / 5 ms, 4,7g / 10 ms
shock resistance with sine pulse	
• at AC	11,8g / 5 ms, 7,4g / 10 ms
mechanical service life (operating cycles)	
• of contactor typical	10 000 000
• of the contactor with added auxiliary switch block typical	10 000 000
Substance Prohibition (Date)	05/01/2012
Ambient conditions	
installation altitude at height above sea level maximum	2 000 m
ambient temperature	
• during operation	-25 ... +60 °C
• during storage	-55 ... +80 °C
Main circuit	
number of poles for main current circuit	3
number of NO contacts for main contacts	3
number of NC contacts for main contacts	0
operating voltage	
• at AC-3 rated value maximum	690 V
• at AC-3e rated value maximum	690 V
operational current	
• at AC-1 up to 690 V	
— at ambient temperature 40 °C rated value	40 A
— at ambient temperature 60 °C rated value	35 A
• at AC-3	

— at 400 V rated value	9 A
— at 690 V rated value	9 A
● at AC-3e	
— at 400 V rated value	9 A
— at 690 V rated value	9 A
connectable conductor cross-section in main circuit at AC-1	
● at 60 °C minimum permissible	10 mm ²
● at 40 °C minimum permissible	10 mm ²
operational current for approx. 200000 operating cycles at AC-4	
● at 400 V rated value	4.1 A
● at 690 V rated value	3.3 A
operating power	
● at AC-1	
— at 230 V rated value	13.3 kW
— at 230 V at 60 °C rated value	13.3 kW
— at 400 V at 60 °C rated value	23 kW
— at 690 V at 60 °C rated value	40 kW
● at AC-3	
— at 230 V rated value	2.2 kW
— at 400 V rated value	4 kW
— at 690 V rated value	7.5 kW
● at AC-3e	
— at 400 V rated value	4 kW
— at 690 V rated value	7.5 kW
operating power for approx. 200000 operating cycles at AC-4	
● at 400 V rated value	2 kW
● at 690 V rated value	2.5 kW
no-load switching frequency	
● at AC	5 000 1/h
operating frequency	
● at AC-1 maximum	1 000 1/h
● at AC-3 maximum	1 000 1/h
● at AC-3e maximum	1 000 1/h
● at AC-4 maximum	300 1/h
Control circuit/ Control	
type of voltage of the control supply voltage	AC
control supply voltage at AC	
● at 50 Hz rated value	220 V
● at 60 Hz rated value	220 V
operating range factor control supply voltage rated value of magnet coil at AC	
● at 50 Hz	0.8 ... 1.1
● at 60 Hz	0.85 ... 1.1
apparent pick-up power of magnet coil at AC	
● at 50 Hz	68 VA
● at 60 Hz	67 VA
inductive power factor with closing power of the coil	
● at 50 Hz	0.72
● at 60 Hz	0.74
apparent holding power of magnet coil at AC	
● at 50 Hz	7.9 VA
● at 60 Hz	6.5 VA
inductive power factor with the holding power of the coil	
● at 50 Hz	0.25
● at 60 Hz	0.28
Auxiliary circuit	
number of NC contacts for auxiliary contacts instantaneous contact	1
number of NO contacts for auxiliary contacts instantaneous	1

contact	
operational current at AC-12 maximum	10 A
operational current at AC-15	
• at 230 V rated value	10 A
• at 400 V rated value	3 A
• at 690 V rated value	1 A
operational current at DC-12	
• at 24 V rated value	6 A
• at 110 V rated value	3 A
• at 220 V rated value	1 A
operational current at DC-13	
• at 24 V rated value	6 A
• at 110 V rated value	1 A
• at 220 V rated value	0.3 A
contact reliability of auxiliary contacts	1 faulty switching per 100 million (17 V, 1 mA)
UL/CSA ratings	
yielded mechanical performance [hp] for 3-phase AC motor at 460/480 V rated value	5 hp
Short-circuit protection	
design of the fuse link	
• for short-circuit protection of the main circuit	
— with type of coordination 1 required	gL/gG LV HRC 3NA, DIAZED 5SB, NEOZED 5SE: 63 A
— with type of assignment 2 required	gL/gG LV HRC 3NA, DIAZED 5SB, NEOZED 5SE: 25 A
• for short-circuit protection of the auxiliary switch required	fuse gL/gG: 10 A
Installation/ mounting/ dimensions	
mounting position	+/-180° rotation possible on vertical mounting surface; can be tilted forward and backward by +/- 22.5° on vertical mounting surface
fastening method	screw and snap-on mounting onto 35 mm DIN rail according to DIN EN 50022
• side-by-side mounting	Yes
height	85 mm
width	45 mm
depth	97 mm
required spacing with side-by-side mounting at the side	0 mm
Connections/ Terminals	
type of electrical connection	
• for main current circuit	screw-type terminals
• for auxiliary and control circuit	screw-type terminals
type of connectable conductor cross-sections for main contacts	
• solid or stranded	2x (1 ... 2.5 mm ²), 2x (2.5 ... 10 mm ²)
• finely stranded with core end processing	2x (1 ... 2.5 mm ²), 2x (2.5 ... 6 mm ²), 1x 10 mm ²
type of connectable conductor cross-sections	
• for auxiliary contacts	
— solid or stranded	2x (0.5 ... 1.5 mm ²), 2x (0.75 ... 2.5 mm ²)
— finely stranded with core end processing	2x (0.5 ... 1.5 mm ²), 2x (0.75 ... 2.5 mm ²)
• for AWG cables for auxiliary contacts	2x (20 ... 16), 2x (18 ... 14)
Electrical Safety	
protection class IP on the front according to IEC 60529	IP20
touch protection on the front according to IEC 60529	finger-safe, for vertical contact from the front
Approvals Certificates	
General Product Approval	



[Confirmation](#)



EMV	other	Environment
-----	-------	-------------



[Confirmation](#)

[Environmental Con-
firmations](#)

Further information

Service&Support (Manuals, Certificates, Characteristics, FAQs,...)

<https://support.industry.siemens.com/cs/products?pnid=16027&lc=en-CN>

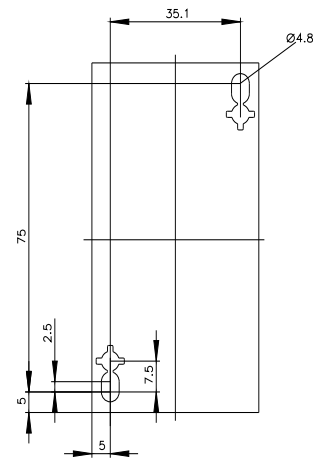
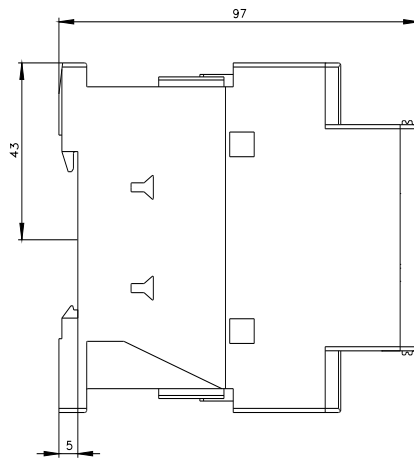
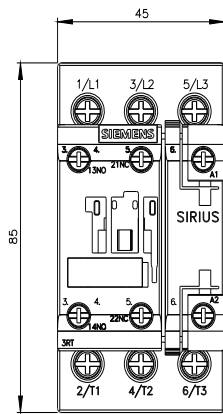

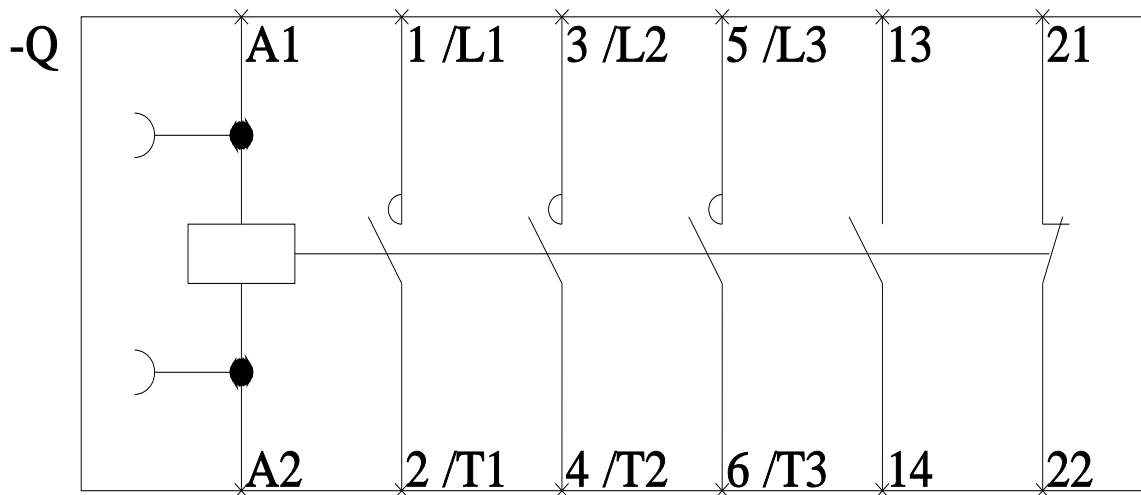
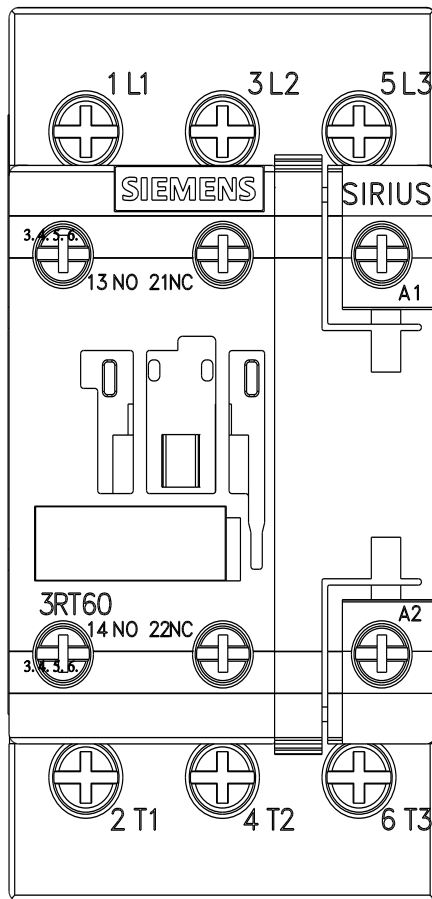



Contactor AC 220 V 50/60 HZ AC3 5.5 kW 400 V AUX contacts 1 NO +1 NC 3-pole, size S0 screw terminal

product brand name	SIRIUS
product designation	Power contactor
product type designation	3RT6
General technical data	
size of contactor	S0
product extension auxiliary switch	Yes
power loss [W] for rated value of the current	
• at AC in hot operating state per pole	0.5 W
• without load current share typical	1.97 W
type of calculation of power loss depending on pole	quadratic
insulation voltage rated value	690 V
degree of pollution	3
surge voltage resistance rated value	6 kV
maximum permissible voltage for protective separation between coil and main contacts according to EN 60947-1	400 V
shock resistance at rectangular impulse	
• at AC	7,5g / 5 ms, 4,7g / 10 ms
shock resistance with sine pulse	
• at AC	11,8g / 5 ms, 7,4g / 10 ms
mechanical service life (operating cycles)	
• of contactor typical	10 000 000
• of the contactor with added auxiliary switch block typical	10 000 000
Substance Prohibition (Date)	05/01/2012
Ambient conditions	
installation altitude at height above sea level maximum	2 000 m
ambient temperature	
• during operation	-25 ... +60 °C
• during storage	-55 ... +80 °C
Main circuit	
number of poles for main current circuit	3
number of NO contacts for main contacts	3
number of NC contacts for main contacts	0
operating voltage	
• at AC-3 rated value maximum	690 V
• at AC-3e rated value maximum	690 V
operational current	
• at AC-1 up to 690 V	
— at ambient temperature 40 °C rated value	40 A
— at ambient temperature 60 °C rated value	35 A
• at AC-3	

<ul style="list-style-type: none"> — at 400 V rated value — at 690 V rated value ● at AC-3e <ul style="list-style-type: none"> — at 400 V rated value — at 690 V rated value 	12 A 9 A 12 A 9 A
connectable conductor cross-section in main circuit at AC-1 <ul style="list-style-type: none"> ● at 60 °C minimum permissible ● at 40 °C minimum permissible 	10 mm ² 10 mm ²
operational current for approx. 200000 operating cycles at AC-4 <ul style="list-style-type: none"> ● at 400 V rated value ● at 690 V rated value 	5.5 A 5.5 A
operating power <ul style="list-style-type: none"> ● at AC-1 <ul style="list-style-type: none"> — at 230 V rated value — at 230 V at 60 °C rated value — at 400 V at 60 °C rated value — at 690 V at 60 °C rated value ● at AC-3 <ul style="list-style-type: none"> — at 230 V rated value — at 400 V rated value — at 690 V rated value ● at AC-3e <ul style="list-style-type: none"> — at 400 V rated value — at 690 V rated value 	13.3 kW 13.3 kW 23 kW 40 kW 3 kW 5.5 kW 7.5 kW 5.5 kW 7.5 kW
operating power for approx. 200000 operating cycles at AC-4 <ul style="list-style-type: none"> ● at 400 V rated value ● at 690 V rated value 	2.6 kW 4.6 kW
no-load switching frequency <ul style="list-style-type: none"> ● at AC 	5 000 1/h
operating frequency <ul style="list-style-type: none"> ● at AC-1 maximum ● at AC-3 maximum ● at AC-3e maximum ● at AC-4 maximum 	1 000 1/h 1 000 1/h 1 000 1/h 300 1/h
Control circuit/ Control	
type of voltage of the control supply voltage	AC
control supply voltage at AC <ul style="list-style-type: none"> ● at 50 Hz rated value ● at 60 Hz rated value 	220 V 220 V
operating range factor control supply voltage rated value of magnet coil at AC <ul style="list-style-type: none"> ● at 50 Hz ● at 60 Hz 	0.8 ... 1.1 0.85 ... 1.1
apparent pick-up power of magnet coil at AC <ul style="list-style-type: none"> ● at 50 Hz ● at 60 Hz 	68 VA 67 VA
inductive power factor with closing power of the coil <ul style="list-style-type: none"> ● at 50 Hz ● at 60 Hz 	0.72 0.74
apparent holding power of magnet coil at AC <ul style="list-style-type: none"> ● at 50 Hz ● at 60 Hz 	7.9 VA 6.5 VA
inductive power factor with the holding power of the coil <ul style="list-style-type: none"> ● at 50 Hz ● at 60 Hz 	0.25 0.28
Auxiliary circuit	
number of NC contacts for auxiliary contacts instantaneous contact	1
number of NO contacts for auxiliary contacts instantaneous	1

contact	
operational current at AC-12 maximum	10 A
operational current at AC-15	
<ul style="list-style-type: none"> • at 230 V rated value • at 400 V rated value • at 690 V rated value 	10 A 3 A 1 A
operational current at DC-12	
<ul style="list-style-type: none"> • at 24 V rated value • at 110 V rated value • at 220 V rated value 	6 A 3 A 1 A
operational current at DC-13	
<ul style="list-style-type: none"> • at 24 V rated value • at 110 V rated value • at 220 V rated value 	6 A 1 A 0.3 A
contact reliability of auxiliary contacts	1 faulty switching per 100 million (17 V, 1 mA)
UL/CSA ratings	
yielded mechanical performance [hp] for 3-phase AC motor at 460/480 V rated value	7.5 hp
Short-circuit protection	
design of the fuse link	
<ul style="list-style-type: none"> • for short-circuit protection of the main circuit <ul style="list-style-type: none"> — with type of coordination 1 required — with type of assignment 2 required • for short-circuit protection of the auxiliary switch required 	gL/gG LV HRC 3NA, DIAZED 5SB, NEOZED 5SE: 63 A gL/gG LV HRC 3NA, DIAZED 5SB, NEOZED 5SE: 25 A fuse gL/gG: 10 A
Installation/ mounting/ dimensions	
mounting position	+/-180° rotation possible on vertical mounting surface; can be tilted forward and backward by +/- 22.5° on vertical mounting surface
fastening method	screw and snap-on mounting onto 35 mm DIN rail according to DIN EN 50022
<ul style="list-style-type: none"> • side-by-side mounting 	Yes
height	85 mm
width	45 mm
depth	97 mm
required spacing with side-by-side mounting at the side	0 mm
Connections/ Terminals	
type of electrical connection	
<ul style="list-style-type: none"> • for main current circuit • for auxiliary and control circuit 	screw-type terminals screw-type terminals
type of connectable conductor cross-sections for main contacts	
<ul style="list-style-type: none"> • solid or stranded • finely stranded with core end processing 	2x (1 ... 2.5 mm ²), 2x (2.5 ... 10 mm ²) 2x (1 ... 2.5 mm ²), 2x (2.5 ... 6 mm ²), 1x 10 mm ²
type of connectable conductor cross-sections	
<ul style="list-style-type: none"> • for auxiliary contacts <ul style="list-style-type: none"> — solid or stranded — finely stranded with core end processing • for AWG cables for auxiliary contacts 	2x (0.5 ... 1.5 mm ²), 2x (0.75 ... 2.5 mm ²) 2x (0.5 ... 1.5 mm ²), 2x (0.75 ... 2.5 mm ²) 2x (20 ... 16), 2x (18 ... 14)
Electrical Safety	
protection class IP on the front according to IEC 60529	IP20
touch protection on the front according to IEC 60529	finger-safe, for vertical contact from the front
Approvals Certificates	
General Product Approval	



[Confirmation](#)



EMV	other	Environment
-----	-------	-------------



[Confirmation](#)

[Environmental Confirmations](#)

Further information

Service&Support (Manuals, Certificates, Characteristics, FAQs,...)
<https://support.industry.siemens.com/cs/products?pnid=16027&lc=en-CN>

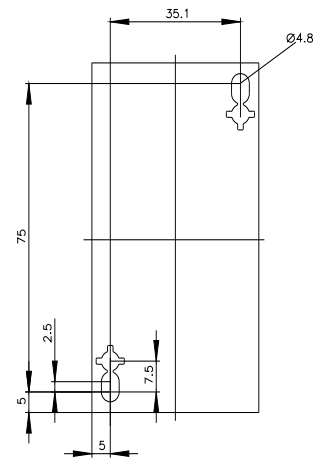
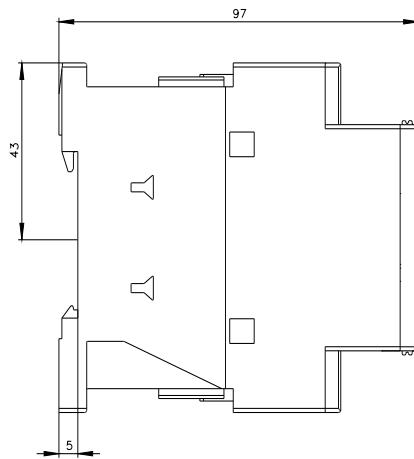
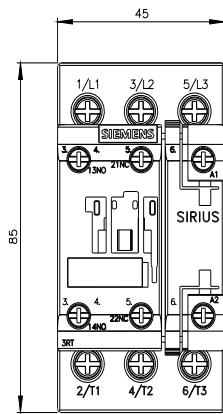

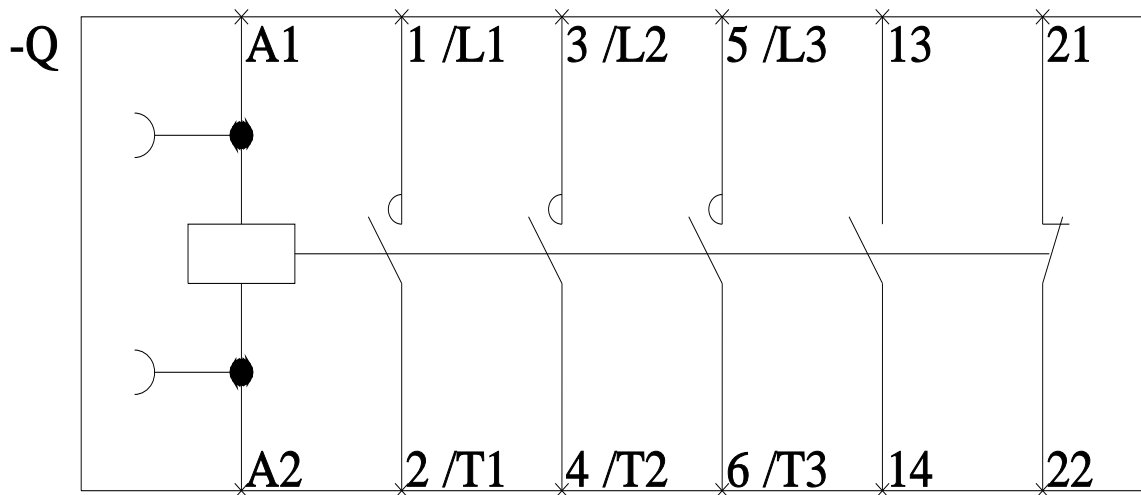
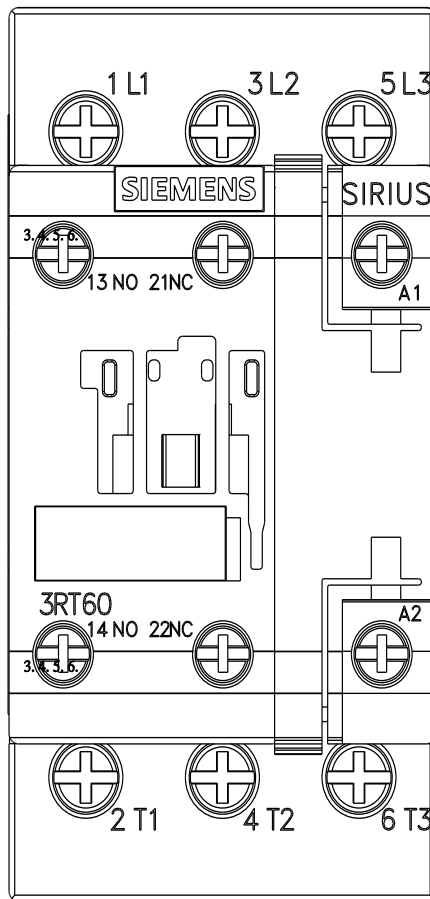



Contactor AC 220 V 50/60 HZ AC3 7.5 kW 400 V AUX contacts 1 NO +1 NC 3-pole, size S0 screw terminal

product brand name	SIRIUS
product designation	Power contactor
product type designation	3RT6
General technical data	
size of contactor	S0
product extension auxiliary switch	Yes
power loss [W] for rated value of the current	
• at AC in hot operating state per pole	0.9 W
• without load current share typical	1.97 W
type of calculation of power loss depending on pole	quadratic
insulation voltage rated value	690 V
degree of pollution	3
surge voltage resistance rated value	6 kV
maximum permissible voltage for protective separation between coil and main contacts according to EN 60947-1	400 V
shock resistance at rectangular impulse	
• at AC	7,5g / 5 ms, 4,7g / 10 ms
shock resistance with sine pulse	
• at AC	11,8g / 5 ms, 7,4g / 10 ms
mechanical service life (operating cycles)	
• of contactor typical	10 000 000
• of the contactor with added auxiliary switch block typical	10 000 000
Substance Prohibition (Date)	05/01/2012
Ambient conditions	
installation altitude at height above sea level maximum	2 000 m
ambient temperature	
• during operation	-25 ... +60 °C
• during storage	-55 ... +80 °C
Main circuit	
number of poles for main current circuit	3
number of NO contacts for main contacts	3
number of NC contacts for main contacts	0
operating voltage	
• at AC-3 rated value maximum	690 V
• at AC-3e rated value maximum	690 V
operational current	
• at AC-1 up to 690 V	
— at ambient temperature 40 °C rated value	40 A
— at ambient temperature 60 °C rated value	35 A
• at AC-3	

<ul style="list-style-type: none"> — at 400 V rated value — at 690 V rated value ● at AC-3e <ul style="list-style-type: none"> — at 400 V rated value — at 690 V rated value 	17 A 13 A 17 A 13 A
connectable conductor cross-section in main circuit at AC-1	
<ul style="list-style-type: none"> ● at 60 °C minimum permissible ● at 40 °C minimum permissible 	10 mm ² 10 mm ²
operational current for approx. 200000 operating cycles at AC-4	
<ul style="list-style-type: none"> ● at 400 V rated value ● at 690 V rated value 	7.7 A 7.7 A
operating power	
<ul style="list-style-type: none"> ● at AC-1 <ul style="list-style-type: none"> — at 230 V rated value — at 230 V at 60 °C rated value — at 400 V at 60 °C rated value — at 690 V at 60 °C rated value ● at AC-3 <ul style="list-style-type: none"> — at 230 V rated value — at 400 V rated value — at 690 V rated value ● at AC-3e <ul style="list-style-type: none"> — at 400 V rated value — at 690 V rated value 	13.3 kW 13.3 kW 23 kW 40 kW 4 kW 7.5 kW 11 kW 7.5 kW 11 kW
operating power for approx. 200000 operating cycles at AC-4	
<ul style="list-style-type: none"> ● at 400 V rated value ● at 690 V rated value 	3.5 kW 6 kW
no-load switching frequency	
<ul style="list-style-type: none"> ● at AC 	5 000 1/h
operating frequency	
<ul style="list-style-type: none"> ● at AC-1 maximum ● at AC-3 maximum ● at AC-3e maximum ● at AC-4 maximum 	1 000 1/h 1 000 1/h 1 000 1/h 300 1/h
Control circuit/ Control	
type of voltage of the control supply voltage	AC
control supply voltage at AC	
<ul style="list-style-type: none"> ● at 50 Hz rated value ● at 60 Hz rated value 	220 V 220 V
operating range factor control supply voltage rated value of magnet coil at AC	
<ul style="list-style-type: none"> ● at 50 Hz ● at 60 Hz 	0.8 ... 1.1 0.85 ... 1.1
apparent pick-up power of magnet coil at AC	
<ul style="list-style-type: none"> ● at 50 Hz ● at 60 Hz 	68 VA 67 VA
inductive power factor with closing power of the coil	
<ul style="list-style-type: none"> ● at 50 Hz ● at 60 Hz 	0.72 0.74
apparent holding power of magnet coil at AC	
<ul style="list-style-type: none"> ● at 50 Hz ● at 60 Hz 	7.9 VA 6.5 VA
inductive power factor with the holding power of the coil	
<ul style="list-style-type: none"> ● at 50 Hz ● at 60 Hz 	0.25 0.28
Auxiliary circuit	
number of NC contacts for auxiliary contacts instantaneous contact	1
number of NO contacts for auxiliary contacts instantaneous	1

contact	
operational current at AC-12 maximum	10 A
operational current at AC-15	
• at 230 V rated value	10 A
• at 400 V rated value	3 A
• at 690 V rated value	1 A
operational current at DC-12	
• at 24 V rated value	6 A
• at 110 V rated value	3 A
• at 220 V rated value	1 A
operational current at DC-13	
• at 24 V rated value	6 A
• at 110 V rated value	1 A
• at 220 V rated value	0.3 A
contact reliability of auxiliary contacts	1 faulty switching per 100 million (17 V, 1 mA)

UL/CSA ratings

yielded mechanical performance [hp] for 3-phase AC motor at 460/480 V rated value	10 hp
---	-------

Short-circuit protection

design of the fuse link	
• for short-circuit protection of the main circuit	
— with type of coordination 1 required	gL/gG LV HRC 3NA, DIAZED 5SB, NEOZED 5SE: 63 A
— with type of assignment 2 required	gL/gG LV HRC 3NA, DIAZED 5SB, NEOZED 5SE: 25 A
• for short-circuit protection of the auxiliary switch required	fuse gL/gG: 10 A

Installation/ mounting/ dimensions

mounting position	+/-180° rotation possible on vertical mounting surface; can be tilted forward and backward by +/- 22.5° on vertical mounting surface
• fastening method	screw and snap-on mounting onto 35 mm DIN rail according to DIN EN 50022
• fastening method side-by-side mounting	Yes
height	85 mm
width	45 mm
depth	97 mm
required spacing with side-by-side mounting at the side	0 mm

Connections/ Terminals

type of electrical connection	
• for main current circuit	screw-type terminals
• for auxiliary and control circuit	screw-type terminals
type of connectable conductor cross-sections for main contacts	
• solid or stranded	2x (1 ... 2.5 mm ²), 2x (2.5 ... 10 mm ²)
• finely stranded with core end processing	2x (1 ... 2.5 mm ²), 2x (2.5 ... 6 mm ²), 1x 10 mm ²
type of connectable conductor cross-sections	
• for auxiliary contacts	
— solid or stranded	2x (0.5 ... 1.5 mm ²), 2x (0.75 ... 2.5 mm ²)
— finely stranded with core end processing	2x (0.5 ... 1.5 mm ²), 2x (0.75 ... 2.5 mm ²)
• for AWG cables for auxiliary contacts	2x (20 ... 16), 2x (18 ... 14)

Electrical Safety

protection class IP on the front according to IEC 60529	IP20
touch protection on the front according to IEC 60529	finger-safe, for vertical contact from the front

Approvals Certificates

General Product Approval



[Confirmation](#)



EMV	other
-----	-------



[Confirmation](#)

Further information

Service&Support (Manuals, Certificates, Characteristics, FAQs,...)

<https://support.industry.siemens.com/cs/products?pnid=16027&lc=en-CN>

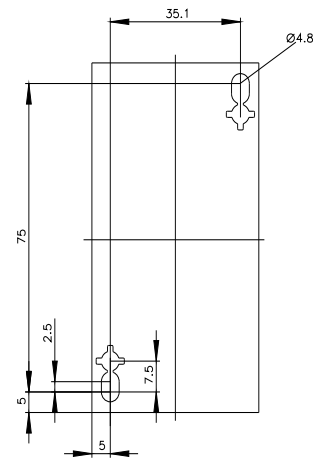
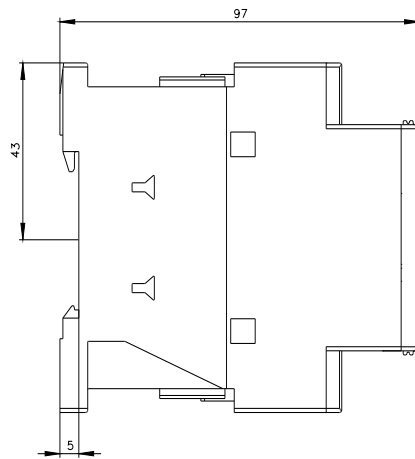
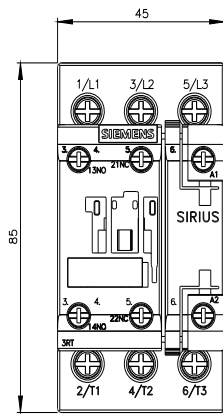

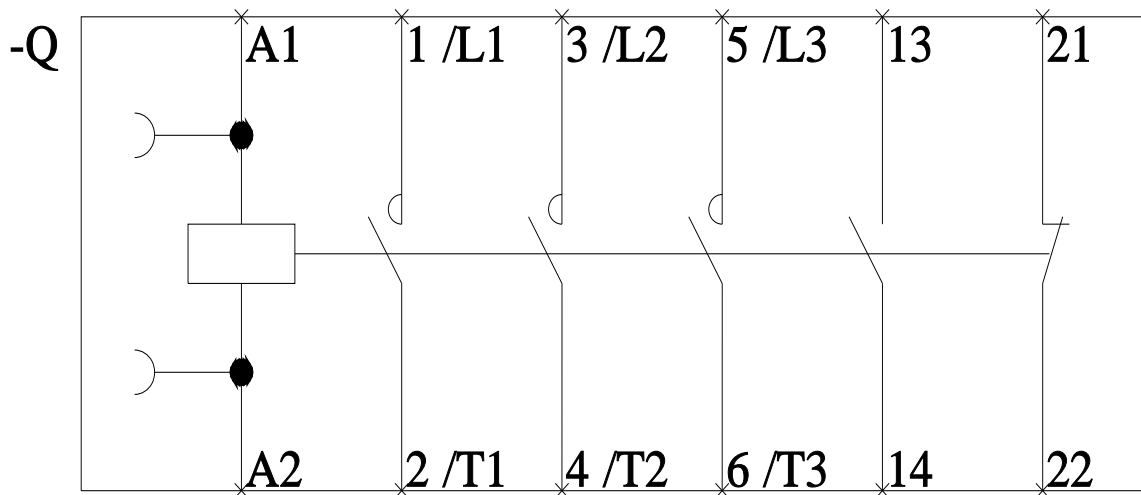
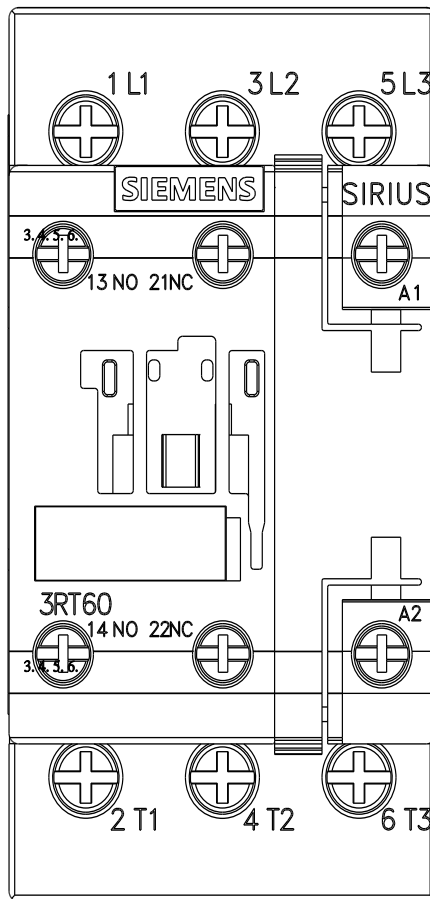



Contactor AC 110 V 50/60 HZ AC3 11 kW 400 V AUX contacts 1 NO +1 NC 3-pole, size S0 screw terminal

product brand name	SIRIUS
product designation	Power contactor
product type designation	3RT6
General technical data	
size of contactor	S0
product extension auxiliary switch	Yes
power loss [W] for rated value of the current	
• at AC in hot operating state per pole	1.9 W
• without load current share typical	2.62 W
type of calculation of power loss depending on pole	quadratic
insulation voltage rated value	690 V
degree of pollution	3
surge voltage resistance rated value	6 kV
maximum permissible voltage for protective separation between coil and main contacts according to EN 60947-1	400 V
shock resistance at rectangular impulse	
• at AC	8,3g / 5 ms, 5,3g / 10 ms
shock resistance with sine pulse	
• at AC	13,5g / 5 ms, 8,3g / 10 ms
mechanical service life (operating cycles)	
• of contactor typical	10 000 000
• of the contactor with added auxiliary switch block typical	10 000 000
Substance Prohibition (Date)	05/01/2012
Ambient conditions	
installation altitude at height above sea level maximum	2 000 m
ambient temperature	
• during operation	-25 ... +60 °C
• during storage	-55 ... +80 °C
Main circuit	
number of poles for main current circuit	3
number of NO contacts for main contacts	3
number of NC contacts for main contacts	0
operating voltage	
• at AC-3 rated value maximum	690 V
• at AC-3e rated value maximum	690 V
operational current	
• at AC-1 up to 690 V	
— at ambient temperature 40 °C rated value	40 A
— at ambient temperature 60 °C rated value	35 A
• at AC-3	

<ul style="list-style-type: none"> — at 400 V rated value — at 690 V rated value ● at AC-3e <ul style="list-style-type: none"> — at 400 V rated value — at 690 V rated value 	25 A 13 A 25 A 13 A
connectable conductor cross-section in main circuit at AC-1 <ul style="list-style-type: none"> ● at 60 °C minimum permissible ● at 40 °C minimum permissible 	10 mm ² 10 mm ²
operational current for approx. 200000 operating cycles at AC-4 <ul style="list-style-type: none"> ● at 400 V rated value ● at 690 V rated value 	9 A 9 A
operating power <ul style="list-style-type: none"> ● at AC-1 <ul style="list-style-type: none"> — at 230 V rated value — at 230 V at 60 °C rated value — at 400 V at 60 °C rated value — at 690 V at 60 °C rated value ● at AC-3 <ul style="list-style-type: none"> — at 230 V rated value — at 400 V rated value — at 690 V rated value ● at AC-3e <ul style="list-style-type: none"> — at 400 V rated value — at 690 V rated value 	13.3 kW 13.3 kW 23 kW 40 kW 5.5 kW 11 kW 11 kW 11 kW 11 kW
operating power for approx. 200000 operating cycles at AC-4 <ul style="list-style-type: none"> ● at 400 V rated value ● at 690 V rated value 	4.4 kW 7.7 kW
no-load switching frequency <ul style="list-style-type: none"> ● at AC 	5 000 1/h
operating frequency <ul style="list-style-type: none"> ● at AC-1 maximum ● at AC-3 maximum ● at AC-3e maximum ● at AC-4 maximum 	1 000 1/h 750 1/h 750 1/h 250 1/h
Control circuit/ Control	
type of voltage of the control supply voltage	AC
control supply voltage at AC <ul style="list-style-type: none"> ● at 50 Hz rated value ● at 60 Hz rated value 	110 V 110 V
operating range factor control supply voltage rated value of magnet coil at AC <ul style="list-style-type: none"> ● at 50 Hz ● at 60 Hz 	0.8 ... 1.1 0.85 ... 1.1
apparent pick-up power of magnet coil at AC <ul style="list-style-type: none"> ● at 50 Hz ● at 60 Hz 	81 VA 79 VA
inductive power factor with closing power of the coil <ul style="list-style-type: none"> ● at 50 Hz ● at 60 Hz 	0.72 0.74
apparent holding power of magnet coil at AC <ul style="list-style-type: none"> ● at 50 Hz ● at 60 Hz 	10.5 VA 8.5 VA
inductive power factor with the holding power of the coil <ul style="list-style-type: none"> ● at 50 Hz ● at 60 Hz 	0.25 0.28
Auxiliary circuit	
number of NC contacts for auxiliary contacts instantaneous contact	1
number of NO contacts for auxiliary contacts instantaneous	1

contact	
operational current at AC-12 maximum	10 A
operational current at AC-15	
• at 230 V rated value	10 A
• at 400 V rated value	3 A
• at 690 V rated value	1 A
operational current at DC-12	
• at 24 V rated value	6 A
• at 110 V rated value	3 A
• at 220 V rated value	1 A
operational current at DC-13	
• at 24 V rated value	6 A
• at 110 V rated value	1 A
• at 220 V rated value	0.3 A
contact reliability of auxiliary contacts	1 faulty switching per 100 million (17 V, 1 mA)

UL/CSA ratings

yielded mechanical performance [hp] for 3-phase AC motor at 460/480 V rated value	15 hp
---	-------

Short-circuit protection

design of the fuse link	
• for short-circuit protection of the main circuit	
— with type of coordination 1 required	gL/gG LV HRC 3NA, DIAZED 5SB, NEOZED 5SE: 100 A
— with type of assignment 2 required	gL/gG LV HRC 3NA, DIAZED 5SB, NEOZED 5SE: 35 A
• for short-circuit protection of the auxiliary switch required	fuse gL/gG: 10 A

Installation/ mounting/ dimensions

mounting position	+/-180° rotation possible on vertical mounting surface; can be tilted forward and backward by +/- 22.5° on vertical mounting surface
• fastening method	screw and snap-on mounting onto 35 mm DIN rail according to DIN EN 50022
• fastening method side-by-side mounting	Yes
height	85 mm
width	45 mm
depth	97 mm
required spacing with side-by-side mounting at the side	0 mm

Connections/ Terminals

type of electrical connection	
• for main current circuit	screw-type terminals
• for auxiliary and control circuit	screw-type terminals
type of connectable conductor cross-sections for main contacts	
• solid or stranded	2x (1 ... 2.5 mm ²), 2x (2.5 ... 10 mm ²)
• finely stranded with core end processing	2x (1 ... 2.5 mm ²), 2x (2.5 ... 6 mm ²), 1x 10 mm ²
type of connectable conductor cross-sections	
• for auxiliary contacts	
— solid or stranded	2x (0.5 ... 1.5 mm ²), 2x (0.75 ... 2.5 mm ²)
— finely stranded with core end processing	2x (0.5 ... 1.5 mm ²), 2x (0.75 ... 2.5 mm ²)
• for AWG cables for auxiliary contacts	2x (20 ... 16), 2x (18 ... 14)

Electrical Safety

protection class IP on the front according to IEC 60529	IP20
touch protection on the front according to IEC 60529	finger-safe, for vertical contact from the front

Approvals Certificates

General Product Approval



[Confirmation](#)



EMV	other	Environment
-----	-------	-------------



[Confirmation](#)

[Environmental Con-
firmations](#)

Further information

Service&Support (Manuals, Certificates, Characteristics, FAQs,...)
<https://support.industry.siemens.com/cs/products?pnid=16027&lc=en-CN>

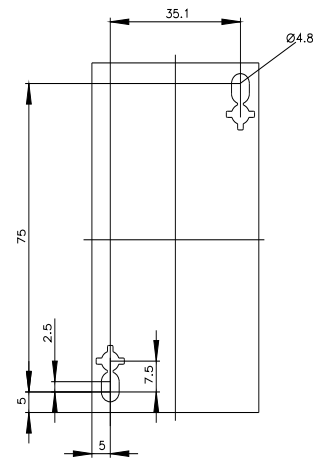
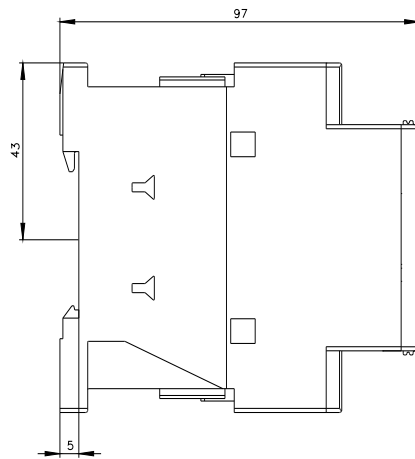
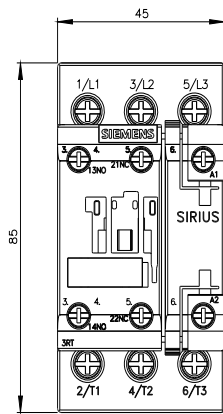

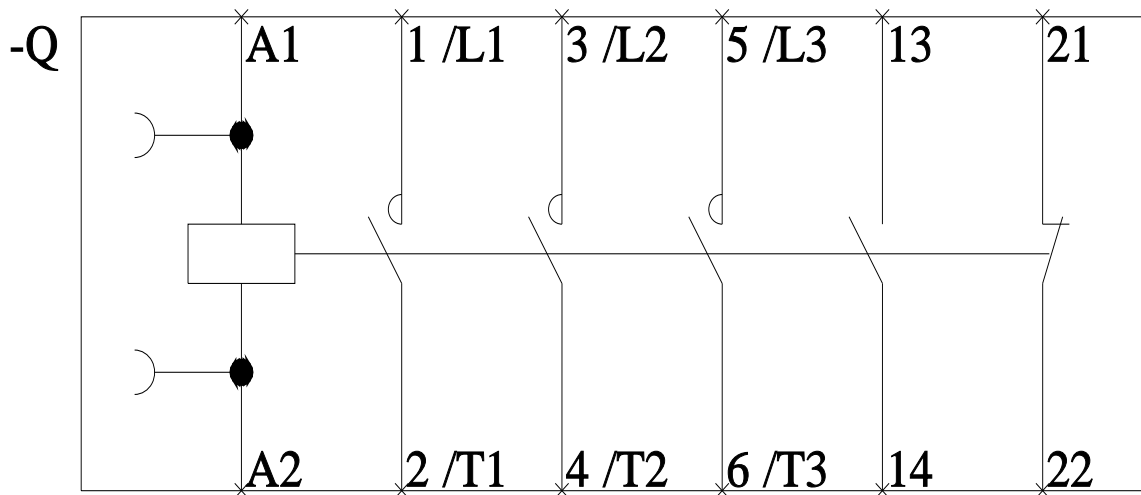
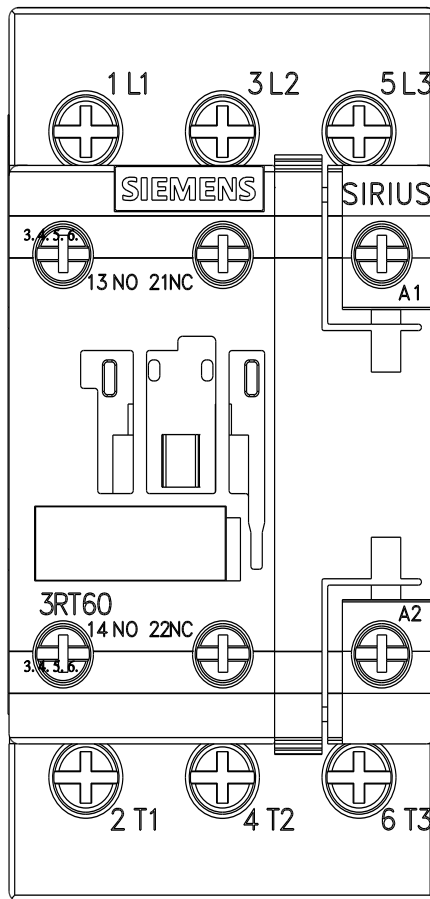



Contactor AC 220 V 50/60 HZ AC3 11 kW 400 V AUX contacts 1 NO +1 NC 3-pole, size S0 screw terminal

product brand name	SIRIUS
product designation	Power contactor
product type designation	3RT6
General technical data	
size of contactor	S0
product extension auxiliary switch	Yes
power loss [W] for rated value of the current	
• at AC in hot operating state per pole	1.9 W
• without load current share typical	2.62 W
type of calculation of power loss depending on pole	quadratic
insulation voltage rated value	690 V
degree of pollution	3
surge voltage resistance rated value	6 kV
maximum permissible voltage for protective separation between coil and main contacts according to EN 60947-1	400 V
shock resistance at rectangular impulse	
• at AC	8,3g / 5 ms, 5,3g / 10 ms
shock resistance with sine pulse	
• at AC	13,5g / 5 ms, 8,3g / 10 ms
mechanical service life (operating cycles)	
• of contactor typical	10 000 000
• of the contactor with added auxiliary switch block typical	10 000 000
Substance Prohibition (Date)	05/01/2012
Ambient conditions	
installation altitude at height above sea level maximum	2 000 m
ambient temperature	
• during operation	-25 ... +60 °C
• during storage	-55 ... +80 °C
Main circuit	
number of poles for main current circuit	3
number of NO contacts for main contacts	3
number of NC contacts for main contacts	0
operating voltage	
• at AC-3 rated value maximum	690 V
• at AC-3e rated value maximum	690 V
operational current	
• at AC-1 up to 690 V	
— at ambient temperature 40 °C rated value	40 A
— at ambient temperature 60 °C rated value	35 A
• at AC-3	

<ul style="list-style-type: none"> — at 400 V rated value — at 690 V rated value ● at AC-3e <ul style="list-style-type: none"> — at 400 V rated value — at 690 V rated value 	25 A 13 A 25 A 13 A
connectable conductor cross-section in main circuit at AC-1 <ul style="list-style-type: none"> ● at 60 °C minimum permissible ● at 40 °C minimum permissible 	10 mm ² 10 mm ²
operational current for approx. 200000 operating cycles at AC-4 <ul style="list-style-type: none"> ● at 400 V rated value ● at 690 V rated value 	9 A 9 A
operating power <ul style="list-style-type: none"> ● at AC-1 <ul style="list-style-type: none"> — at 230 V rated value — at 230 V at 60 °C rated value — at 400 V at 60 °C rated value — at 690 V at 60 °C rated value ● at AC-3 <ul style="list-style-type: none"> — at 230 V rated value — at 400 V rated value — at 690 V rated value ● at AC-3e <ul style="list-style-type: none"> — at 400 V rated value — at 690 V rated value 	13.3 kW 13.3 kW 23 kW 40 kW 5.5 kW 11 kW 11 kW 11 kW 11 kW
operating power for approx. 200000 operating cycles at AC-4 <ul style="list-style-type: none"> ● at 400 V rated value ● at 690 V rated value 	4.4 kW 7.7 kW
no-load switching frequency <ul style="list-style-type: none"> ● at AC 	5 000 1/h
operating frequency <ul style="list-style-type: none"> ● at AC-1 maximum ● at AC-3 maximum ● at AC-3e maximum ● at AC-4 maximum 	1 000 1/h 750 1/h 750 1/h 250 1/h
Control circuit/ Control	
type of voltage of the control supply voltage	AC
control supply voltage at AC <ul style="list-style-type: none"> ● at 50 Hz rated value ● at 60 Hz rated value 	220 V 220 V
operating range factor control supply voltage rated value of magnet coil at AC <ul style="list-style-type: none"> ● at 50 Hz ● at 60 Hz 	0.8 ... 1.1 0.85 ... 1.1
apparent pick-up power of magnet coil at AC <ul style="list-style-type: none"> ● at 50 Hz ● at 60 Hz 	81 VA 79 VA
inductive power factor with closing power of the coil <ul style="list-style-type: none"> ● at 50 Hz ● at 60 Hz 	0.72 0.74
apparent holding power of magnet coil at AC <ul style="list-style-type: none"> ● at 50 Hz ● at 60 Hz 	10.5 VA 8.5 VA
inductive power factor with the holding power of the coil <ul style="list-style-type: none"> ● at 50 Hz ● at 60 Hz 	0.25 0.28
Auxiliary circuit	
number of NC contacts for auxiliary contacts instantaneous contact	1
number of NO contacts for auxiliary contacts instantaneous	1

contact	
operational current at AC-12 maximum	10 A
operational current at AC-15	
• at 230 V rated value	10 A
• at 400 V rated value	3 A
• at 690 V rated value	1 A
operational current at DC-12	
• at 24 V rated value	6 A
• at 110 V rated value	3 A
• at 220 V rated value	1 A
operational current at DC-13	
• at 24 V rated value	6 A
• at 110 V rated value	1 A
• at 220 V rated value	0.3 A
contact reliability of auxiliary contacts	1 faulty switching per 100 million (17 V, 1 mA)
UL/CSA ratings	
yielded mechanical performance [hp] for 3-phase AC motor at 460/480 V rated value	15 hp
Short-circuit protection	
design of the fuse link	
• for short-circuit protection of the main circuit	
— with type of coordination 1 required	gL/gG LV HRC 3NA, DIAZED 5SB, NEOZED 5SE: 100 A
— with type of assignment 2 required	gL/gG LV HRC 3NA, DIAZED 5SB, NEOZED 5SE: 35 A
• for short-circuit protection of the auxiliary switch required	fuse gL/gG: 10 A
Installation/ mounting/ dimensions	
mounting position	+/-180° rotation possible on vertical mounting surface; can be tilted forward and backward by +/- 22.5° on vertical mounting surface
fastening method	screw and snap-on mounting onto 35 mm DIN rail according to DIN EN 50022
• side-by-side mounting	Yes
height	85 mm
width	45 mm
depth	97 mm
required spacing with side-by-side mounting at the side	0 mm
Connections/ Terminals	
type of electrical connection	
• for main current circuit	screw-type terminals
• for auxiliary and control circuit	screw-type terminals
type of connectable conductor cross-sections for main contacts	
• solid or stranded	2x (1 ... 2.5 mm ²), 2x (2.5 ... 10 mm ²)
• finely stranded with core end processing	2x (1 ... 2.5 mm ²), 2x (2.5 ... 6 mm ²), 1x 10 mm ²
type of connectable conductor cross-sections	
• for auxiliary contacts	
— solid or stranded	2x (0.5 ... 1.5 mm ²), 2x (0.75 ... 2.5 mm ²)
— finely stranded with core end processing	2x (0.5 ... 1.5 mm ²), 2x (0.75 ... 2.5 mm ²)
• for AWG cables for auxiliary contacts	2x (20 ... 16), 2x (18 ... 14)
Electrical Safety	
protection class IP on the front according to IEC 60529	IP20
touch protection on the front according to IEC 60529	finger-safe, for vertical contact from the front
Approvals Certificates	
General Product Approval	



[Confirmation](#)



EMV

other

Environment



[Confirmation](#)

[Environmental Confirmations](#)

Further information

Service&Support (Manuals, Certificates, Characteristics, FAQs,...)
<https://support.industry.siemens.com/cs/products?pnid=16027&lc=en-CN>

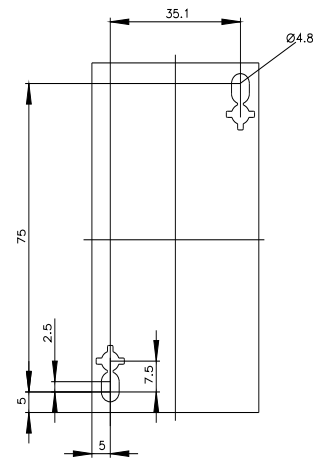
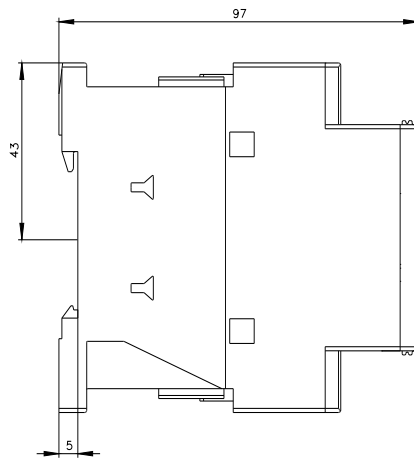
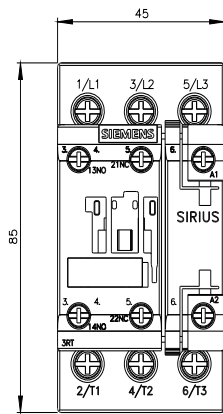

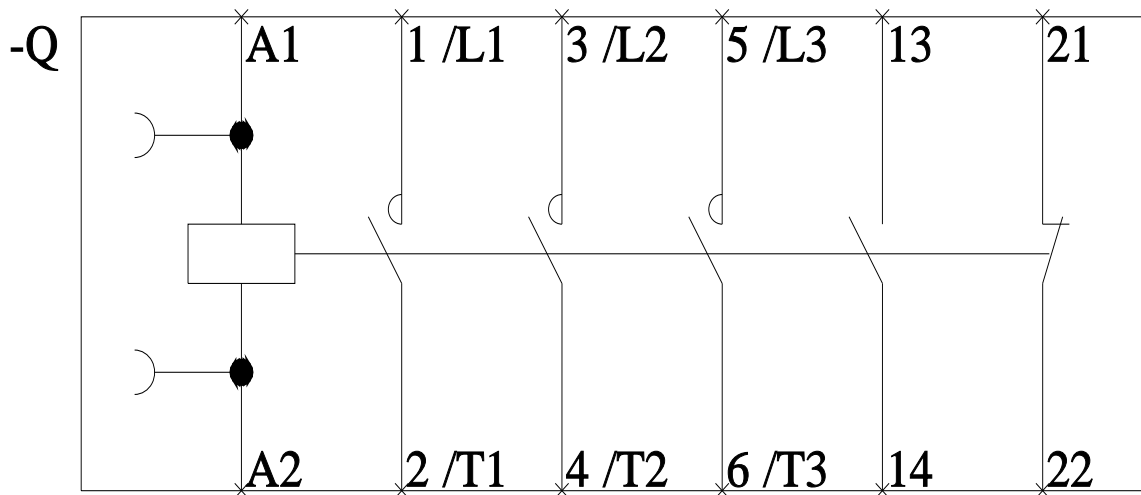
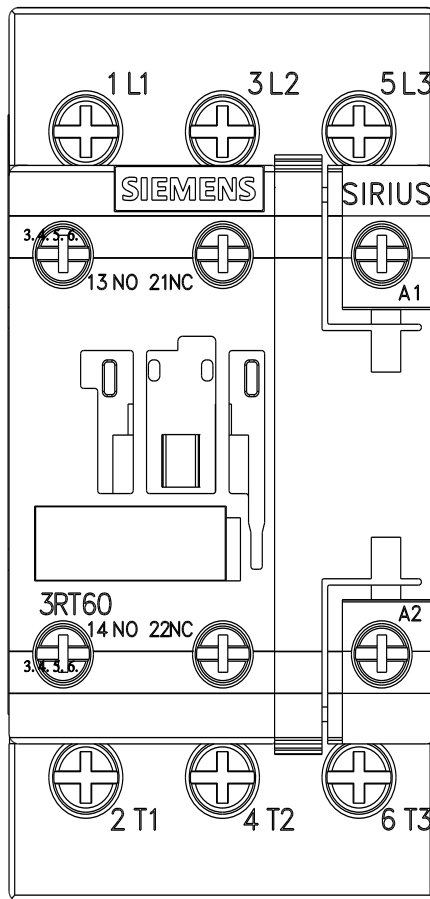



Contactor DC 24 V AC3 11 kW 400 V AUX contacts 1 NO +1 NC 3-pole, size S0 screw terminal

product brand name	SIRIUS
product designation	Power contactor
product type designation	3RT6
General technical data	
size of contactor	S0
product extension auxiliary switch	Yes
power loss [W] for rated value of the current	
• at AC in hot operating state per pole	1.9 W
• without load current share typical	5.9 W
type of calculation of power loss depending on pole	quadratic
insulation voltage rated value	690 V
degree of pollution	3
surge voltage resistance rated value	6 kV
maximum permissible voltage for protective separation between coil and main contacts according to EN 60947-1	400 V
shock resistance at rectangular impulse	
• at DC	10g / 5 ms, 7,5g / 10 ms
shock resistance with sine pulse	
• at DC	15g / 5 ms, 10g / 10 ms
mechanical service life (operating cycles)	
• of contactor typical	10 000 000
• of the contactor with added auxiliary switch block typical	10 000 000
Substance Prohibition (Date)	05/01/2012
Ambient conditions	
installation altitude at height above sea level maximum	2 000 m
ambient temperature	
• during operation	-25 ... +60 °C
• during storage	-55 ... +80 °C
Main circuit	
number of poles for main current circuit	3
number of NO contacts for main contacts	3
number of NC contacts for main contacts	0
operating voltage	
• at AC-3 rated value maximum	690 V
• at AC-3e rated value maximum	690 V
operational current	
• at AC-1 up to 690 V	
— at ambient temperature 40 °C rated value	40 A
— at ambient temperature 60 °C rated value	35 A
• at AC-3	

— at 400 V rated value	25 A
— at 690 V rated value	13 A
● at AC-3e	
— at 400 V rated value	25 A
— at 690 V rated value	13 A
connectable conductor cross-section in main circuit at AC-1	
● at 60 °C minimum permissible	10 mm ²
● at 40 °C minimum permissible	10 mm ²
operational current for approx. 200000 operating cycles at AC-4	
● at 400 V rated value	9 A
● at 690 V rated value	9 A
operating power	
● at AC-1	
— at 230 V rated value	13.3 kW
— at 230 V at 60 °C rated value	13.3 kW
— at 400 V at 60 °C rated value	23 kW
— at 690 V at 60 °C rated value	40 kW
● at AC-3	
— at 230 V rated value	5.5 kW
— at 400 V rated value	11 kW
— at 690 V rated value	11 kW
● at AC-3e	
— at 400 V rated value	11 kW
— at 690 V rated value	11 kW
operating power for approx. 200000 operating cycles at AC-4	
● at 400 V rated value	4.4 kW
● at 690 V rated value	7.7 kW
no-load switching frequency	
● at AC	5 000 1/h
● at DC	1 500 1/h
operating frequency	
● at AC-1 maximum	1 000 1/h
● at AC-3 maximum	750 1/h
● at AC-3e maximum	750 1/h
● at AC-4 maximum	250 1/h
Control circuit/ Control	
type of voltage of the control supply voltage	DC
control supply voltage at DC rated value	
●	24 V
closing power of magnet coil at DC	5.9 W
holding power of magnet coil at DC	5.9 W
Auxiliary circuit	
number of NC contacts for auxiliary contacts instantaneous contact	1
number of NO contacts for auxiliary contacts instantaneous contact	1
operational current at AC-12 maximum	10 A
operational current at AC-15	
● at 230 V rated value	10 A
● at 400 V rated value	3 A
● at 690 V rated value	1 A
operational current at DC-12	
● at 24 V rated value	6 A
● at 110 V rated value	3 A
● at 220 V rated value	1 A
operational current at DC-13	
● at 24 V rated value	6 A
● at 110 V rated value	1 A
● at 220 V rated value	0.3 A

contact reliability of auxiliary contacts	1 faulty switching per 100 million (17 V, 1 mA)
UL/CSA ratings	
yielded mechanical performance [hp] for 3-phase AC motor at 460/480 V rated value	15 hp
Short-circuit protection	
design of the fuse link	
<ul style="list-style-type: none"> ● for short-circuit protection of the main circuit <ul style="list-style-type: none"> — with type of coordination 1 required — with type of assignment 2 required ● for short-circuit protection of the auxiliary switch required 	gL/gG LV HRC 3NA, DIAZED 5SB, NEOZED 5SE: 100 A gL/gG LV HRC 3NA, DIAZED 5SB, NEOZED 5SE: 35 A fuse gL/gG: 10 A
Installation/ mounting/ dimensions	
mounting position	+/-180° rotation possible on vertical mounting surface; can be tilted forward and backward by +/- 22.5° on vertical mounting surface
fastening method	screw and snap-on mounting onto 35 mm DIN rail according to DIN EN 50022
<ul style="list-style-type: none"> ● side-by-side mounting 	Yes
height	85 mm
width	45 mm
depth	107 mm
required spacing with side-by-side mounting at the side	0 mm
Connections/ Terminals	
type of electrical connection	
<ul style="list-style-type: none"> ● for main current circuit ● for auxiliary and control circuit 	screw-type terminals screw-type terminals
type of connectable conductor cross-sections for main contacts	
<ul style="list-style-type: none"> ● solid or stranded ● finely stranded with core end processing 	2x (1 ... 2.5 mm ²), 2x (2.5 ... 10 mm ²) 2x (1 ... 2.5 mm ²), 2x (2.5 ... 6 mm ²), 1x 10 mm ²
type of connectable conductor cross-sections	
<ul style="list-style-type: none"> ● for auxiliary contacts <ul style="list-style-type: none"> — solid or stranded — finely stranded with core end processing ● for AWG cables for auxiliary contacts 	2x (0.5 ... 1.5 mm ²), 2x (0.75 ... 2.5 mm ²) 2x (0.5 ... 1.5 mm ²), 2x (0.75 ... 2.5 mm ²) 2x (20 ... 16), 2x (18 ... 14)
Electrical Safety	
protection class IP on the front according to IEC 60529	IP20
touch protection on the front according to IEC 60529	finger-safe, for vertical contact from the front
Approvals Certificates	
General Product Approval	



[Confirmation](#)



EG-Konf.



CCC



UL



EMV

other

Dangerous Good



RCM

[Confirmation](#)

[Transport Information](#)

Further information

Service&Support (Manuals, Certificates, Characteristics, FAQs,...)
<https://support.industry.siemens.com/cs/products?pnid=16027&lc=en-CN>

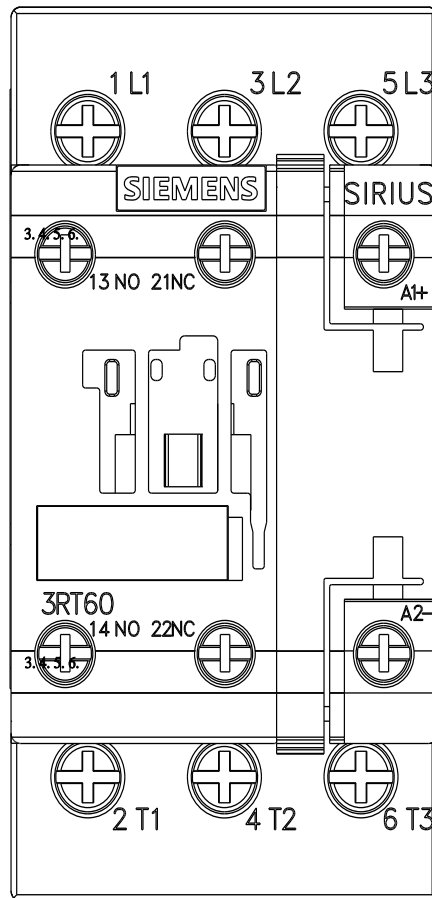
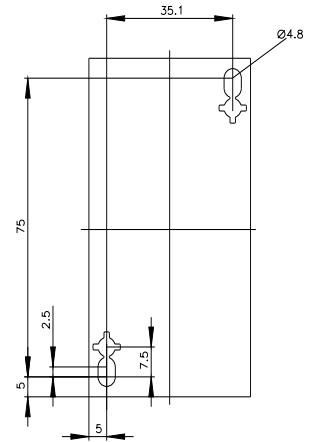
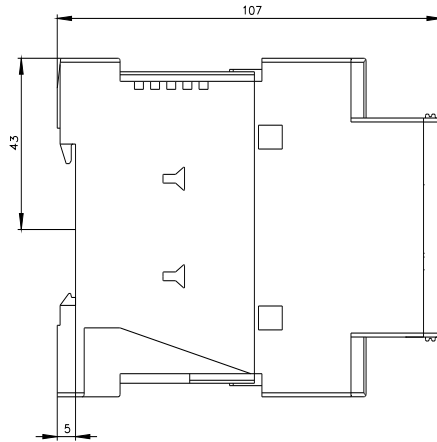
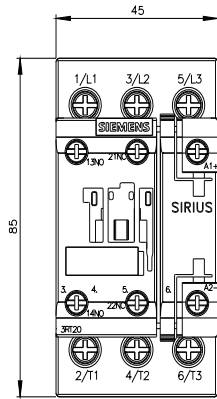

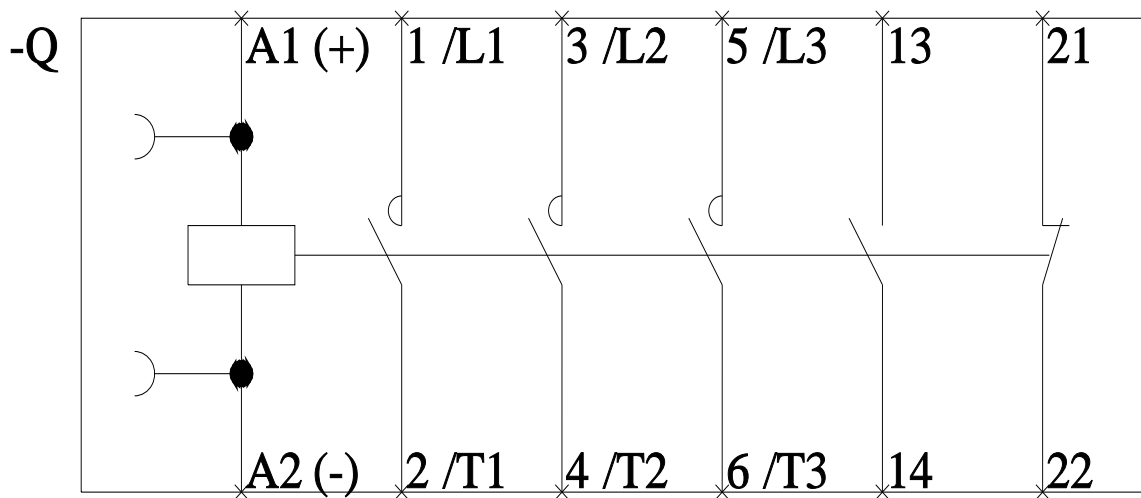

last modified:

7/14/2023 



Contactor AC 220 V 50 HZ AC3 15 kW 400 V AUX contacts 1 NO +1 NC 3-pole, size S0 screw terminal

product brand name	SIRIUS
product designation	Power contactor
product type designation	3RT6
General technical data	
size of contactor	S0
product extension auxiliary switch	Yes
power loss [W] for rated value of the current	
• at AC in hot operating state per pole	2.7 W
• without load current share typical	2.45 W
type of calculation of power loss depending on pole	quadratic
insulation voltage rated value	690 V
degree of pollution	3
surge voltage resistance rated value	6 kV
maximum permissible voltage for protective separation between coil and main contacts according to EN 60947-1	400 V
shock resistance at rectangular impulse	
• at AC	8,3g / 5 ms, 5,3g / 10 ms
shock resistance with sine pulse	
• at AC	13,5g / 5 ms, 8,3g / 10 ms
mechanical service life (operating cycles)	
• of contactor typical	10 000 000
• of the contactor with added auxiliary switch block typical	10 000 000
Substance Prohibition (Date)	05/01/2012
Ambient conditions	
installation altitude at height above sea level maximum	2 000 m
ambient temperature	
• during operation	-25 ... +60 °C
• during storage	-55 ... +80 °C
Main circuit	
number of poles for main current circuit	3
number of NO contacts for main contacts	3
number of NC contacts for main contacts	0
operating voltage	
• at AC-3 rated value maximum	690 V
• at AC-3e rated value maximum	690 V
operational current	
• at AC-1 up to 690 V	
— at ambient temperature 40 °C rated value	50 A
— at ambient temperature 60 °C rated value	42 A
• at AC-3	

<ul style="list-style-type: none"> — at 400 V rated value — at 690 V rated value ● at AC-3e <ul style="list-style-type: none"> — at 400 V rated value — at 690 V rated value 	32 A 21 A 32 A 21 A
connectable conductor cross-section in main circuit at AC-1 <ul style="list-style-type: none"> ● at 60 °C minimum permissible ● at 40 °C minimum permissible 	10 mm ² 10 mm ²
operational current for approx. 200000 operating cycles at AC-4 <ul style="list-style-type: none"> ● at 400 V rated value ● at 690 V rated value 	12 A 12 A
operating power <ul style="list-style-type: none"> ● at AC-1 <ul style="list-style-type: none"> — at 230 V rated value — at 230 V at 60 °C rated value — at 400 V at 60 °C rated value — at 690 V at 60 °C rated value ● at AC-3 <ul style="list-style-type: none"> — at 230 V rated value — at 400 V rated value — at 690 V rated value ● at AC-3e <ul style="list-style-type: none"> — at 400 V rated value — at 690 V rated value 	16 kW 15.5 kW 27.5 kW 47.5 kW 7.5 kW 15 kW 18.5 kW 15 kW 18.5 kW
operating power for approx. 200000 operating cycles at AC-4 <ul style="list-style-type: none"> ● at 400 V rated value ● at 690 V rated value 	6 kW 10.3 kW
no-load switching frequency <ul style="list-style-type: none"> ● at AC 	5 000 1/h
operating frequency <ul style="list-style-type: none"> ● at AC-1 maximum ● at AC-3 maximum ● at AC-3e maximum ● at AC-4 maximum 	1 000 1/h 750 1/h 750 1/h 250 1/h
Control circuit/ Control	
type of voltage of the control supply voltage	AC
control supply voltage at AC <ul style="list-style-type: none"> ● at 50 Hz rated value 	220 V
operating range factor control supply voltage rated value of magnet coil at AC <ul style="list-style-type: none"> ● at 50 Hz 	0.8 ... 1.1
apparent pick-up power of magnet coil at AC <ul style="list-style-type: none"> ● at 50 Hz 	77 VA
inductive power factor with closing power of the coil <ul style="list-style-type: none"> ● at 50 Hz 	0.82
apparent holding power of magnet coil at AC <ul style="list-style-type: none"> ● at 50 Hz 	9.8 VA
inductive power factor with the holding power of the coil <ul style="list-style-type: none"> ● at 50 Hz 	0.25
Auxiliary circuit	
number of NC contacts for auxiliary contacts instantaneous contact	1
number of NO contacts for auxiliary contacts instantaneous contact	1
operational current at AC-12 maximum	10 A
operational current at AC-15 <ul style="list-style-type: none"> ● at 230 V rated value ● at 400 V rated value ● at 690 V rated value 	10 A 3 A 1 A

operational current at DC-12	
<ul style="list-style-type: none"> • at 24 V rated value • at 110 V rated value • at 220 V rated value 	<p>6 A</p> <p>3 A</p> <p>1 A</p>
operational current at DC-13	
<ul style="list-style-type: none"> • at 24 V rated value • at 110 V rated value • at 220 V rated value 	<p>6 A</p> <p>1 A</p> <p>0.3 A</p>
contact reliability of auxiliary contacts	1 faulty switching per 100 million (17 V, 1 mA)
UL/CSA ratings	
yielded mechanical performance [hp] for 3-phase AC motor at 460/480 V rated value	20 hp
Short-circuit protection	
design of the fuse link	
<ul style="list-style-type: none"> • for short-circuit protection of the main circuit <ul style="list-style-type: none"> — with type of coordination 1 required — with type of assignment 2 required • for short-circuit protection of the auxiliary switch required 	<p>gL/gG LV HRC 3NA, DIAZED 5SB, NEOZED 5SE: 100 A</p> <p>gL/gG LV HRC 3NA, DIAZED 5SB, NEOZED 5SE: 35 A</p> <p>fuse gL/gG: 10 A</p>
Installation/ mounting/ dimensions	
mounting position	+/-180° rotation possible on vertical mounting surface; can be tilted forward and backward by +/- 22.5° on vertical mounting surface
fastening method	screw and snap-on mounting onto 35 mm DIN rail according to DIN EN 50022
<ul style="list-style-type: none"> • side-by-side mounting 	Yes
height	85 mm
width	45 mm
depth	97 mm
required spacing with side-by-side mounting at the side	0 mm
Connections/ Terminals	
type of electrical connection	
<ul style="list-style-type: none"> • for main current circuit • for auxiliary and control circuit 	<p>screw-type terminals</p> <p>screw-type terminals</p>
type of connectable conductor cross-sections for main contacts	
<ul style="list-style-type: none"> • solid or stranded • finely stranded with core end processing 	<p>2x (1 ... 2.5 mm²), 2x (2.5 ... 10 mm²)</p> <p>2x (1 ... 2.5 mm²), 2x (2.5 ... 6 mm²), 1x 10 mm²</p>
type of connectable conductor cross-sections	
<ul style="list-style-type: none"> • for auxiliary contacts <ul style="list-style-type: none"> — solid or stranded — finely stranded with core end processing • for AWG cables for auxiliary contacts 	<p>2x (0.5 ... 1.5 mm²), 2x (0.75 ... 2.5 mm²)</p> <p>2x (0.5 ... 1.5 mm²), 2x (0.75 ... 2.5 mm²)</p> <p>2x (20 ... 16), 2x (18 ... 14)</p>
Electrical Safety	
protection class IP on the front according to IEC 60529	IP20
touch protection on the front according to IEC 60529	finger-safe, for vertical contact from the front
Approvals Certificates	
General Product Approval	



[Confirmation](#)



EMV	other	Environment
-----	-------	-------------



[Confirmation](#)

[Environmental Confirmations](#)

Further information

Service&Support (Manuals, Certificates, Characteristics, FAQs,...)
<https://support.industry.siemens.com/cs/products?pnid=16027&lc=en-CN>

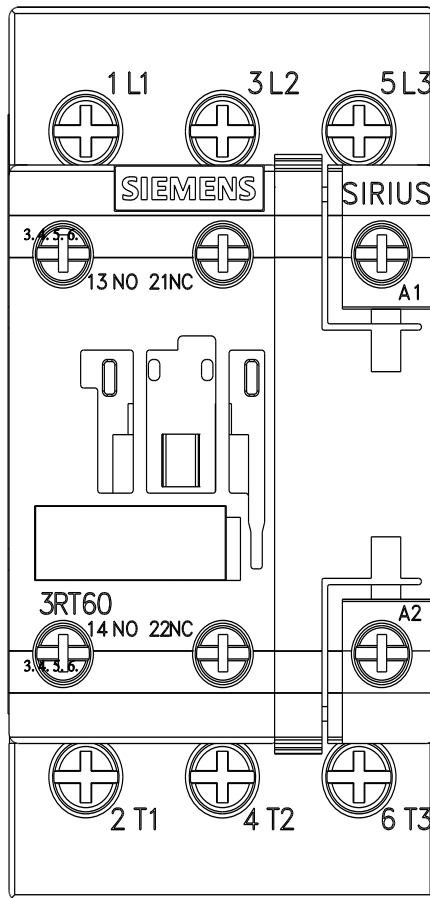
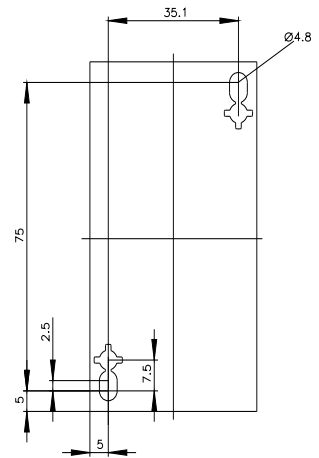
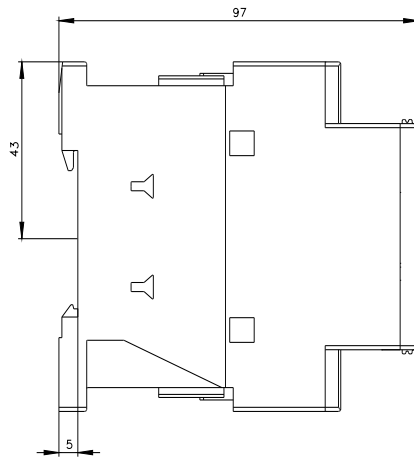
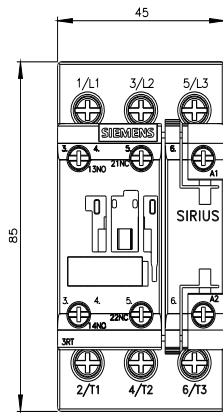

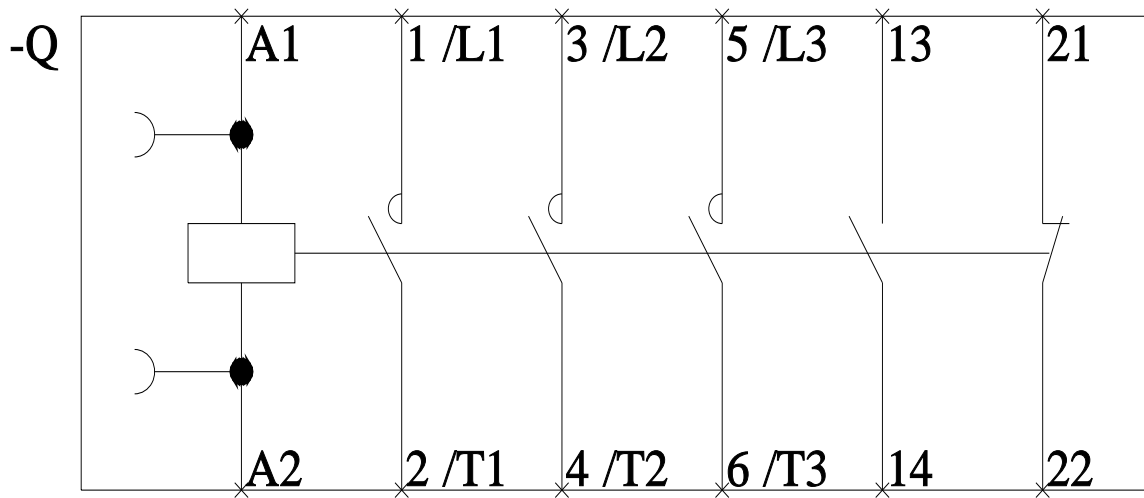

last modified:

7/14/2023 



Contactor AC 220 V 50/60 HZ AC3 15 kW 400 V AUX contacts 1 NO +1 NC 3-pole, size S0 screw terminal

product brand name	SIRIUS
product designation	Power contactor
product type designation	3RT6
General technical data	
size of contactor	S0
product extension auxiliary switch	Yes
power loss [W] for rated value of the current	
• at AC in hot operating state per pole	2.7 W
• without load current share typical	2.62 W
type of calculation of power loss depending on pole	quadratic
insulation voltage rated value	690 V
degree of pollution	3
surge voltage resistance rated value	6 kV
maximum permissible voltage for protective separation between coil and main contacts according to EN 60947-1	400 V
shock resistance at rectangular impulse	
• at AC	8,3g / 5 ms, 5,3g / 10 ms
shock resistance with sine pulse	
• at AC	13,5g / 5 ms, 8,3g / 10 ms
mechanical service life (operating cycles)	
• of contactor typical	10 000 000
• of the contactor with added auxiliary switch block typical	10 000 000
Substance Prohibition (Date)	05/01/2012
Ambient conditions	
installation altitude at height above sea level maximum	2 000 m
ambient temperature	
• during operation	-25 ... +60 °C
• during storage	-55 ... +80 °C
Main circuit	
number of poles for main current circuit	3
number of NO contacts for main contacts	3
number of NC contacts for main contacts	0
operating voltage	
• at AC-3 rated value maximum	690 V
• at AC-3e rated value maximum	690 V
operational current	
• at AC-1 up to 690 V	
— at ambient temperature 40 °C rated value	50 A
— at ambient temperature 60 °C rated value	42 A
• at AC-3	

<ul style="list-style-type: none"> — at 400 V rated value — at 690 V rated value ● at AC-3e <ul style="list-style-type: none"> — at 400 V rated value — at 690 V rated value 	32 A 21 A 32 A 21 A
connectable conductor cross-section in main circuit at AC-1	
<ul style="list-style-type: none"> ● at 60 °C minimum permissible ● at 40 °C minimum permissible 	10 mm ² 10 mm ²
operational current for approx. 200000 operating cycles at AC-4	
<ul style="list-style-type: none"> ● at 400 V rated value ● at 690 V rated value 	12 A 12 A
operating power	
<ul style="list-style-type: none"> ● at AC-1 <ul style="list-style-type: none"> — at 230 V rated value — at 230 V at 60 °C rated value — at 400 V at 60 °C rated value — at 690 V at 60 °C rated value ● at AC-3 <ul style="list-style-type: none"> — at 230 V rated value — at 400 V rated value — at 690 V rated value ● at AC-3e <ul style="list-style-type: none"> — at 400 V rated value — at 690 V rated value 	16 kW 15.5 kW 27.5 kW 47.5 kW 7.5 kW 15 kW 18.5 kW 15 kW 18.5 kW
operating power for approx. 200000 operating cycles at AC-4	
<ul style="list-style-type: none"> ● at 400 V rated value ● at 690 V rated value 	6 kW 10.3 kW
no-load switching frequency	
<ul style="list-style-type: none"> ● at AC 	5 000 1/h
operating frequency	
<ul style="list-style-type: none"> ● at AC-1 maximum ● at AC-3 maximum ● at AC-3e maximum ● at AC-4 maximum 	1 000 1/h 750 1/h 750 1/h 250 1/h
Control circuit/ Control	
type of voltage of the control supply voltage	AC
control supply voltage at AC	
<ul style="list-style-type: none"> ● at 50 Hz rated value ● at 60 Hz rated value 	220 V 220 V
operating range factor control supply voltage rated value of magnet coil at AC	
<ul style="list-style-type: none"> ● at 50 Hz ● at 60 Hz 	0.8 ... 1.1 0.85 ... 1.1
apparent pick-up power of magnet coil at AC	
<ul style="list-style-type: none"> ● at 50 Hz ● at 60 Hz 	81 VA 79 VA
inductive power factor with closing power of the coil	
<ul style="list-style-type: none"> ● at 50 Hz ● at 60 Hz 	0.72 0.74
apparent holding power of magnet coil at AC	
<ul style="list-style-type: none"> ● at 50 Hz ● at 60 Hz 	10.5 VA 8.5 VA
inductive power factor with the holding power of the coil	
<ul style="list-style-type: none"> ● at 50 Hz ● at 60 Hz 	0.25 0.28
Auxiliary circuit	
number of NC contacts for auxiliary contacts instantaneous contact	1
number of NO contacts for auxiliary contacts instantaneous	1

contact	
operational current at AC-12 maximum	10 A
operational current at AC-15	
• at 230 V rated value	10 A
• at 400 V rated value	3 A
• at 690 V rated value	1 A
operational current at DC-12	
• at 24 V rated value	6 A
• at 110 V rated value	3 A
• at 220 V rated value	1 A
operational current at DC-13	
• at 24 V rated value	6 A
• at 110 V rated value	1 A
• at 220 V rated value	0.3 A
contact reliability of auxiliary contacts	1 faulty switching per 100 million (17 V, 1 mA)

UL/CSA ratings

yielded mechanical performance [hp] for 3-phase AC motor at 460/480 V rated value	20 hp
---	-------

Short-circuit protection

design of the fuse link	
• for short-circuit protection of the main circuit	
— with type of coordination 1 required	gL/gG LV HRC 3NA, DIAZED 5SB, NEOZED 5SE: 100 A
— with type of assignment 2 required	gL/gG LV HRC 3NA, DIAZED 5SB, NEOZED 5SE: 35 A
• for short-circuit protection of the auxiliary switch required	fuse gL/gG: 10 A

Installation/ mounting/ dimensions

mounting position	+/-180° rotation possible on vertical mounting surface; can be tilted forward and backward by +/- 22.5° on vertical mounting surface
• fastening method	screw and snap-on mounting onto 35 mm DIN rail according to DIN EN 50022
• fastening method side-by-side mounting	Yes
height	85 mm
width	45 mm
depth	97 mm
required spacing with side-by-side mounting at the side	0 mm

Connections/ Terminals

type of electrical connection	
• for main current circuit	screw-type terminals
• for auxiliary and control circuit	screw-type terminals
type of connectable conductor cross-sections for main contacts	
• solid or stranded	2x (1 ... 2.5 mm ²), 2x (2.5 ... 10 mm ²)
• finely stranded with core end processing	2x (1 ... 2.5 mm ²), 2x (2.5 ... 6 mm ²), 1x 10 mm ²
type of connectable conductor cross-sections	
• for auxiliary contacts	
— solid or stranded	2x (0.5 ... 1.5 mm ²), 2x (0.75 ... 2.5 mm ²)
— finely stranded with core end processing	2x (0.5 ... 1.5 mm ²), 2x (0.75 ... 2.5 mm ²)
• for AWG cables for auxiliary contacts	2x (20 ... 16), 2x (18 ... 14)

Electrical Safety

protection class IP on the front according to IEC 60529	IP20
touch protection on the front according to IEC 60529	finger-safe, for vertical contact from the front

Approvals Certificates

General Product Approval



[Confirmation](#)



EMV	other	Environment
-----	-------	-------------



[Confirmation](#)

[Environmental Confirmations](#)

Further information

Service&Support (Manuals, Certificates, Characteristics, FAQs,...)

<https://support.industry.siemens.com/cs/products?pnid=16027&lc=en-CN>

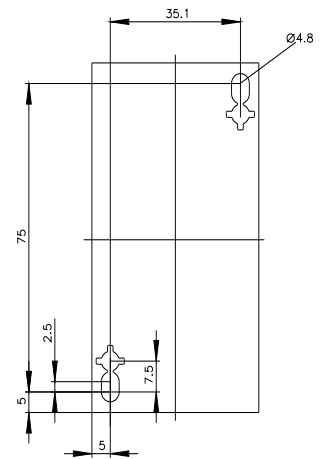
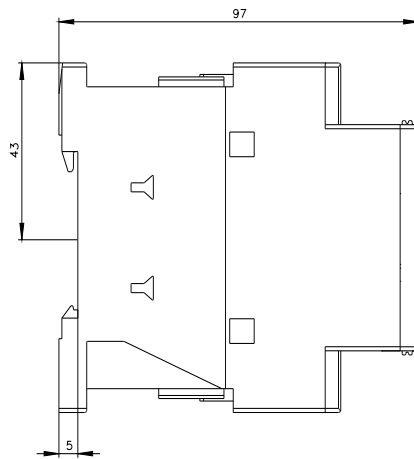
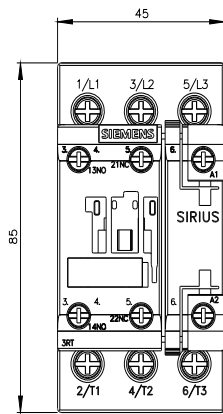

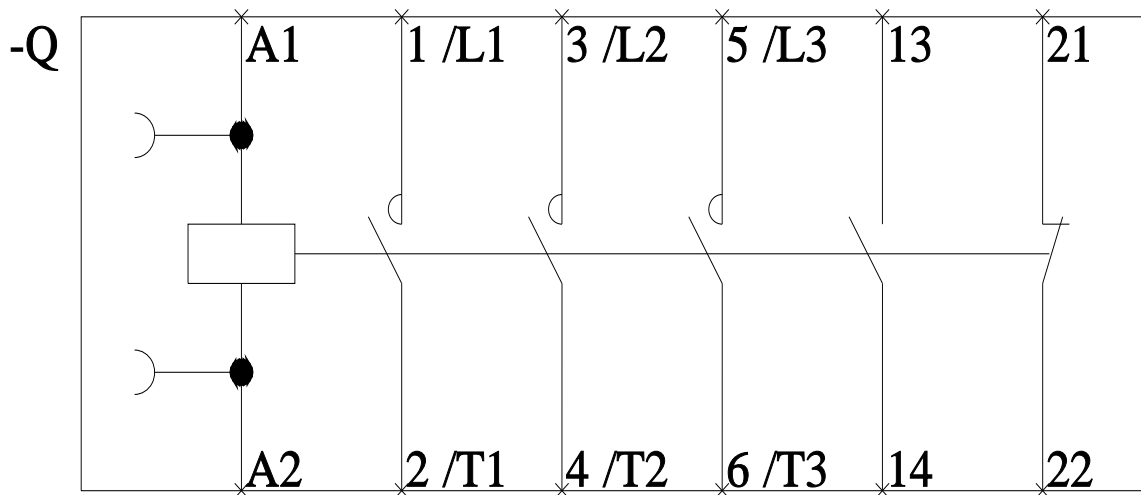
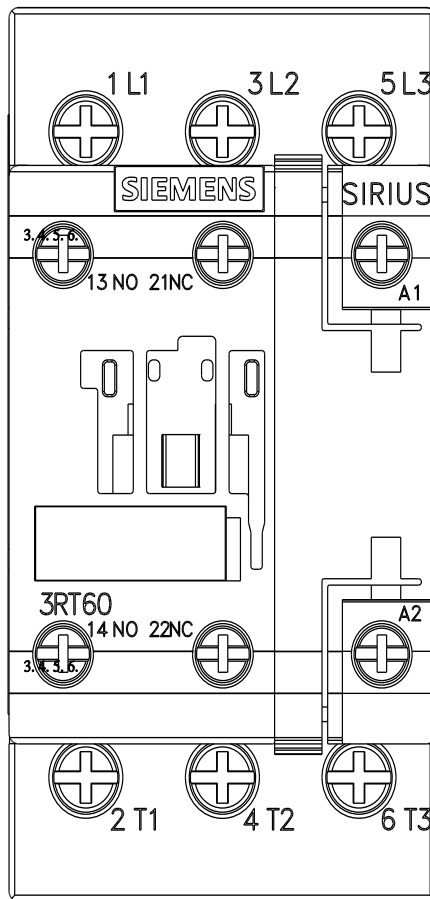

last modified:

7/14/2023



Contactor AC 220V 50/60 HZ AC3 18,5 kW 400 V AUX contacts 1 NO +1 NC 3-pole, size S0 screw terminal

product brand name	SIRIUS
product designation	Power contactor
product type designation	3RT6
General technical data	
size of contactor	S0
product extension auxiliary switch	Yes
power loss [W] for rated value of the current	
• at AC in hot operating state per pole	3.8 W
• without load current share typical	2.62 W
type of calculation of power loss depending on pole	quadratic
insulation voltage rated value	690 V
degree of pollution	3
surge voltage resistance rated value	6 kV
maximum permissible voltage for protective separation between coil and main contacts according to EN 60947-1	400 V
shock resistance at rectangular impulse	
• at AC	8,3g / 5 ms, 5,3g / 10 ms
shock resistance with sine pulse	
• at AC	13,5g / 5 ms, 8,3g / 10 ms
mechanical service life (operating cycles)	
• of contactor typical	10 000 000
• of the contactor with added auxiliary switch block typical	10 000 000
Substance Prohibition (Date)	05/01/2012
Ambient conditions	
installation altitude at height above sea level maximum	2 000 m
ambient temperature	
• during operation	-25 ... +60 °C
• during storage	-55 ... +80 °C
Main circuit	
number of poles for main current circuit	3
number of NO contacts for main contacts	3
number of NC contacts for main contacts	0
operating voltage	
• at AC-3 rated value maximum	690 V
• at AC-3e rated value maximum	690 V
operational current	
• at AC-1 up to 690 V	
— at ambient temperature 40 °C rated value	50 A
— at ambient temperature 60 °C rated value	42 A
• at AC-3	

<ul style="list-style-type: none"> — at 400 V rated value — at 690 V rated value ● at AC-3e <ul style="list-style-type: none"> — at 400 V rated value — at 690 V rated value 	38 A 21 A 38 A 21 A
connectable conductor cross-section in main circuit at AC-1 <ul style="list-style-type: none"> ● at 60 °C minimum permissible ● at 40 °C minimum permissible 	10 mm ² 10 mm ²
operational current for approx. 200000 operating cycles at AC-4 <ul style="list-style-type: none"> ● at 400 V rated value ● at 690 V rated value 	12 A 12 A
operating power <ul style="list-style-type: none"> ● at AC-1 <ul style="list-style-type: none"> — at 230 V rated value — at 230 V at 60 °C rated value — at 400 V at 60 °C rated value — at 690 V at 60 °C rated value ● at AC-3 <ul style="list-style-type: none"> — at 230 V rated value — at 400 V rated value — at 690 V rated value ● at AC-3e <ul style="list-style-type: none"> — at 400 V rated value — at 690 V rated value 	16 kW 15.5 kW 27.5 kW 47.5 kW 11 kW 18.5 kW 18.5 kW 18.5 kW 18.5 kW
operating power for approx. 200000 operating cycles at AC-4 <ul style="list-style-type: none"> ● at 400 V rated value ● at 690 V rated value 	6 kW 10.3 kW
no-load switching frequency <ul style="list-style-type: none"> ● at AC 	5 000 1/h
operating frequency <ul style="list-style-type: none"> ● at AC-1 maximum ● at AC-3 maximum ● at AC-3e maximum ● at AC-4 maximum 	1 000 1/h 750 1/h 750 1/h 250 1/h
Control circuit/ Control	
type of voltage of the control supply voltage	AC
control supply voltage at AC <ul style="list-style-type: none"> ● at 50 Hz rated value ● at 60 Hz rated value 	220 V 220 V
operating range factor control supply voltage rated value of magnet coil at AC <ul style="list-style-type: none"> ● at 50 Hz ● at 60 Hz 	0.8 ... 1.1 0.85 ... 1.1
apparent pick-up power of magnet coil at AC <ul style="list-style-type: none"> ● at 50 Hz ● at 60 Hz 	81 VA 79 VA
inductive power factor with closing power of the coil <ul style="list-style-type: none"> ● at 50 Hz ● at 60 Hz 	0.72 0.74
apparent holding power of magnet coil at AC <ul style="list-style-type: none"> ● at 50 Hz ● at 60 Hz 	10.5 VA 8.5 VA
inductive power factor with the holding power of the coil <ul style="list-style-type: none"> ● at 50 Hz ● at 60 Hz 	0.25 0.28
Auxiliary circuit	
number of NC contacts for auxiliary contacts instantaneous contact	1
number of NO contacts for auxiliary contacts instantaneous	1

contact	
operational current at AC-12 maximum	10 A
operational current at AC-15	
• at 230 V rated value	10 A
• at 400 V rated value	3 A
• at 690 V rated value	1 A
operational current at DC-12	
• at 24 V rated value	6 A
• at 110 V rated value	3 A
• at 220 V rated value	1 A
operational current at DC-13	
• at 24 V rated value	6 A
• at 110 V rated value	1 A
• at 220 V rated value	0.3 A
contact reliability of auxiliary contacts	1 faulty switching per 100 million (17 V, 1 mA)

UL/CSA ratings

yielded mechanical performance [hp] for 3-phase AC motor at 460/480 V rated value	25 hp
---	-------

Short-circuit protection

design of the fuse link	
• for short-circuit protection of the main circuit	
— with type of coordination 1 required	gL/gG LV HRC 3NA, DIAZED 5SB, NEOZED 5SE: 100 A
— with type of assignment 2 required	gL/gG LV HRC 3NA, DIAZED 5SB, NEOZED 5SE: 35 A
• for short-circuit protection of the auxiliary switch required	fuse gL/gG: 10 A

Installation/ mounting/ dimensions

mounting position	+/-180° rotation possible on vertical mounting surface; can be tilted forward and backward by +/- 22.5° on vertical mounting surface
• fastening method	screw and snap-on mounting onto 35 mm DIN rail according to DIN EN 50022
• fastening method side-by-side mounting	Yes
height	85 mm
width	45 mm
depth	97 mm
required spacing with side-by-side mounting at the side	0 mm

Connections/ Terminals

type of electrical connection	
• for main current circuit	screw-type terminals
• for auxiliary and control circuit	screw-type terminals
type of connectable conductor cross-sections for main contacts	
• solid or stranded	2x (1 ... 2.5 mm ²), 2x (2.5 ... 10 mm ²)
• finely stranded with core end processing	2x (1 ... 2.5 mm ²), 2x (2.5 ... 6 mm ²), 1x 10 mm ²
type of connectable conductor cross-sections	
• for auxiliary contacts	
— solid or stranded	2x (0.5 ... 1.5 mm ²), 2x (0.75 ... 2.5 mm ²)
— finely stranded with core end processing	2x (0.5 ... 1.5 mm ²), 2x (0.75 ... 2.5 mm ²)
• for AWG cables for auxiliary contacts	2x (20 ... 16), 2x (18 ... 14)

Electrical Safety

protection class IP on the front according to IEC 60529	IP20
touch protection on the front according to IEC 60529	finger-safe, for vertical contact from the front

Approvals Certificates

General Product Approval



[Confirmation](#)



EMV	other	Environment
-----	-------	-------------



[Confirmation](#)

[Environmental Confirmations](#)

Further information

Service&Support (Manuals, Certificates, Characteristics, FAQs,...)

<https://support.industry.siemens.com/cs/products?pnid=16027&lc=en-CN>

