

MITSUBISHI

Changes for the Better

Graphic Operation Terminal
Training Manual

GOT1000 basic course

(for GT Designer2)
Version2

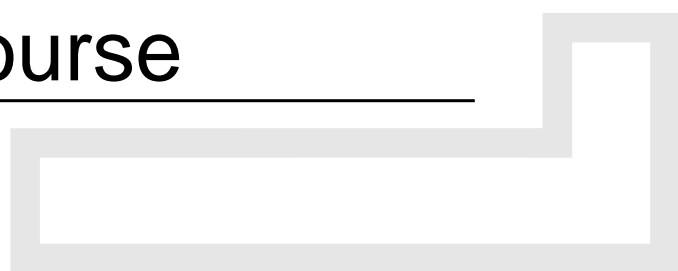

● Safety Precautions ●

(Make sure to read before training)

When designing a system, always read the relevant manuals and give due consideration to safety. In addition, pay careful attention to the following points for proper handling during training.

[Precautions during training]

Danger

- To prevent electric shock, do not touch the terminal block while the power is supplied.
- When opening the safety cover, turn off the power, or make sure that it is sufficiently safe.

Caution

- Follow the instructor's directions during training.
- Do not remove training machine units or change wiring without permission. Doing so could cause a breakdown, faulty operation, injury, or fire.
- Turn the power OFF before mounting or removing a unit. Doing so while the current is ON could cause a breakdown or electric shock.
- If the training machine emits a strange odour or sound, press the "Power Switch" or the "Emergency Switch" to stop the machine.
- If any trouble occurs, contact the instructor right away.

Revision History

* The textbook number is indicated on the back cover in the lower left corner.

Print date	* Textbook number	Revision details
Mar, 2006	SH(NA)-080632ENG-A	First edition printing

This textbook does not grant any guarantee or license for the use of the industrial property rights or other rights. Mitsubishi Electric Corporation bears no responsibility for any problems involving property rights which may occur as a result of using the information in this textbook.

Introduction

About the manuals.....	(5)
System configuration in this text.....	(7)

Chapter 1 What is the GOT?	1- 1 to 1-12
----------------------------	--------------

1.1 About the GOT	1- 1
1.2 Procedures for monitoring the PLC CPU by GOT	1- 1
1.3 GOT features.....	1- 2
1.4 GOT function list.....	1- 4
1.5 Applicable connection type between the GOT and the PLC CPU	1- 6
1.6 Equipments required for using GOT	1- 9

Chapter 2 About GOT Operation	2- 1 to 2-10
-------------------------------	--------------

2.1 Summary of operation	2- 1
2.2 Entering numerals into PLC	2- 3
2.2.1 Numerical input function.....	2- 3
2.2.2 How to operate numerical input	2- 4
2.3 Switching the screen displayed.....	2- 5
2.3.1 The screen type.....	2- 5
2.3.2 Screen switching device.....	2- 6
2.3.3 Base screen switching with the sequence program	2- 7
2.3.4 Base screen switching with the touch switch	2- 8
2.3.5 Window screen display and switching	2- 9

Chapter 3 About GT Designer2	3- 1 to 3- 6
------------------------------	--------------

3.1 About GT Designer2.....	3- 1
3.2 GT Designer 2 screen configuration and features.....	3- 1
3.3 How to use the online manual.....	3- 4
3.3.1 Reading the online manual from the product CD-ROM	3- 4
3.3.2 Reading the online manual with the GT Designer2 Help	3- 6

Chapter 4 From GOT Screen Creation to the Test	4- 1 to 4-30
--	--------------

4.1 Procedures up to using GOT	4- 1
4.2 Screen creation	4- 2
4.2.1 Project creation.....	4- 2
4.2.2 Communication settings.....	4- 7
4.2.3 Screen switching device settings	4-10
4.2.4 Data reading	4-13
4.2.5 Saving the project data.....	4-15
4.3 Data transfer (PC to GOT)	4-16

4.3.1 Connection from PC to GOT	4-16
4.3.2 About data types transferred to the GOT	4-17
4.3.3 Communication settings	4-18
4.3.4 OS installation	4-19
4.3.5 Screen data download	4-21
4.4 Connection to PLC CPU (bus connection)	4-23
4.4.1 Bus connection unit mounting	4-23
4.4.2 Connecting the cable	4-24
4.5 Checking that GOT is communicating normally with the PLC	4-25
4.5.1 Checking the OS	4-25
4.5.2 Checking that the GOT recognizes the connected equipment	4-26
4.5.3 System alarm	4-28
4.6 Executing the monitor	4-29

Chapter 5 Drawing Fundamentals	5- 1 to 5-56
--------------------------------	--------------

5.1 Before creating the screen	5- 2
5.1.1 Operations before creating the screen	5- 2
5.1.2 Figure drawing	5- 3
5.2 Text settings	5-18
5.3 Numerical input/numerical display settings	5-20
5.3.1 Numerical input settings	5-20
5.3.2 Numerical display settings	5-24
5.4 Lamp display settings	5-25
5.5 Touch switch settings	5-27
5.5.1 Bit switch settings	5-27
5.6 Operation check 1	5-33
5.7 Comment display settings	5-35
5.7.1 About the comment display	5-35
5.7.2 Comment display settings by bit device	5-37
5.8 Window screen creation	5-40
5.9 System alarm settings	5-44
5.9.1 System alarm settings	5-44
5.9.2 Go to screen switch settings	5-49
5.10 Operation check 2	5-52
5.11 Training device list and sequence program	5-55
5.12 Method for checking devices using the created screen data	5-56

Chapter 6 About Debug	6- 1 to 6-26
-----------------------	--------------

6.1 Extended Function and Option OS	6- 1
6.2 Training screen creation	6- 3
6.2.1 Screen creation training	6- 3
6.2.2 Project download	6- 5
6.2.3 Training device list and sequence program	6- 6

6.3 Ladder monitor function.....	6- 7
6.3.1 About the ladder monitor function	6- 7
6.3.2 Operation check (1).....	6- 9
6.3.3 Method for starting the ladder monitor function	6-10
6.3.4 Method for factor search operation	6-14
6.3.5 Training screen modification	6-16
6.3.6 Operation check (2).....	6-16
6.4 System monitor function.....	6-17
6.4.1 About the system monitor function.....	6-17
6.4.2 Method for starting the system monitor.....	6-18
6.4.3 Operation check (device monitor operation).....	6-20

Appendices	Appendix 1 to Appendix 42
------------	---------------------------

Appendix 1 Alarm history display function	Appendix 1
Appendix 1.1 About the alarm	Appendix 1
Appendix 1.2 About the alarm history display function	Appendix 3
Appendix 1.3 Settings screen example.....	Appendix 7
Appendix 1.4 Alarm history display function settings.....	Appendix 8
Appendix 1.5 Alarm history display function switch settings.....	Appendix 10
Appendix 1.6 Detail display window screen creation	Appendix 14
Appendix 1.7 Operation check	Appendix 16
Appendix 2 Data transfer to GOT by memory card	Appendix 17
Appendix 2.1 Overall procedure.....	Appendix 17
Appendix 3 About the FA transparent function	Appendix 19
Appendix 3.1 System configuration.....	Appendix 19
Appendix 3.2 Procedures up to accessing.....	Appendix 20
Appendix 3.3 About the restrictions.....	Appendix 24
Appendix 4 About Boot OS installation	Appendix 26
Appendix 5 Screen data upload	Appendix 28
Appendix 6 Glossary	Appendix 30

Introduction

This textbook is a "basic edition".

Practice how to use Mitsubishi Graphic Operation Terminal exercising the training in this textbook.

[Basic edition]

Learn basic subjects relating to Mitsubishi graphic operation terminal skills.

Course content:

1. GOT1000 series function, performance and system configuration
2. GOT basic operation and setup procedures
3. Figure and basic object function
(Text, numerical display, numerical input, lamp display, comment display, touch switch, etc.)
4. Ladder monitor and system monitor function

[Practice edition]

Learn efficient methods to create control screens using Mitsubishi Graphic Operation Terminal.

Course content:

1. GOT operation and GT Designer2 basic operation
2. How to use advanced object functions
(Layer, graph, comment display, language switching, original library, parts movement, alarm function)

About the manuals

Manual Selection

The GOT manuals are classified according to objectives.
 Refer to the following table and then read the manuals suited to understand GOT main unit and software handling, operation, and functions.

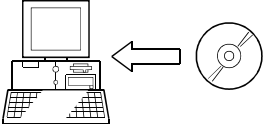
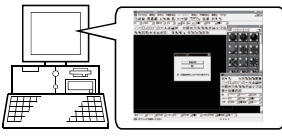
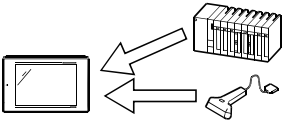
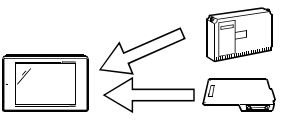
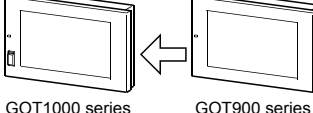
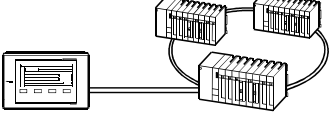
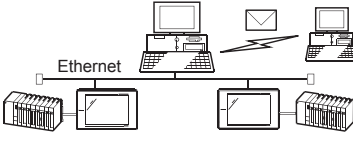
Objective	Reference
 <ul style="list-style-type: none"> Using GOT for the first time Learning about the GOT drawing by using GT Designer2 	This textbook and the relevant manual (1)
 <ul style="list-style-type: none"> Installing each GOT software in the personal computer Running each software Learning how to use the online manual 	The relevant manual (1)
 <ul style="list-style-type: none"> Learning GT Designer2 screen configuration, how to customize the screens, and how to from create project data up to transfer data <hr/> <ul style="list-style-type: none"> Learning the specifications and settings of each GT Designer2 object function 	The relevant manual (1) The relevant manual (2)
 <ul style="list-style-type: none"> Confirming the applicable connection types for GOT Confirming the system configuration for each connection type Confirming the setting method for the unit to be used Confirming the wiring diagram of connection cable for the unit to be used 	The relevant manual (3)
 <ul style="list-style-type: none"> Confirming the GOT specifications, system configuration, system equipment, parts names, setup and wiring method, maintenance and inspection method; error code specifications, part names, system equipment, and setup method Mounting each type of unit on the GOT 	The relevant manual (4)
 <p>GOT1000 series GOT900 series</p> <ul style="list-style-type: none"> Converting the monitor screen data created with GOT900 series and Digital Electronics Corporation's package into GOT1000 series data 	The relevant manual (5)
 <ul style="list-style-type: none"> Using the function of GOT main unit and using the GOT debug to check the status of the target CPU, special function module, and network 	The relevant manual (6)
 <p>Ethernet</p> <ul style="list-style-type: none"> By Using a personal computer, reading and writing the data stored on the PC card and the PLC CPU devices monitored by GOT Sending the error occurrence and restored data of alarm history display function to personal computer or mobile phone by email By using the GOT, reading and writing PLC CPU devices monitored by the other GOT 	The relevant manual (7)

Relevant manuals

The following table lists the relevant manuals for this product.
Refer to this table as needed.

	Manual Title	Manual Number (Model name code)
(1)	GT Designer2 Version2 Basic Operation/Data Transfer Manual (For GOT1000 Series) Explanation of GT Designer2 installation operations, basic operations for drawing, and method of data transfer to GOT1000 (Sold separately)*	SH-080529ENG (1D7M24)
(2)	GT Designer2 Version2 Screen Design Manual (For GOT1000 Series) 1/3 GT Designer2 Version2 Screen Design Manual (For GOT1000 Series) 2/3 GT Designer2 Version2 Screen Design Manual (For GOT1000 Series) 3/3 Explanation of the specifications and settings of all GOT1000 Series Object Function (Sold separately)*	SH-080530ENG (1D7M25)
(3)	GOT1000 Series Connection Manual (1/2)GOT1000 Series Connection Manual (2/2) Explanation of the Applicable System Configuration and cable making method for the GOT1000 Series Connection Types (Sold separately)*	SH-080532ENG (1D7M26)
(4)	GT15 User's Manual Explanation of Hardware Including All GT15 Main Body Parts Names, External Dimensions, Installation, Electrical Wiring, Specifications, and an Introduction to Optional Equipment (Sold separately)*	SH-080528ENG (1D7M23)
(5)	GT Converter2 Version2 Operating Manual Explanation of GT Converter2 operation methods (Sold separately)*	SH-080533ENG (1D7M27)
(6)	GOT1000 Series Extended/Option Functions Manual Explanation of the extended/option functions that can be used in the GOT1000 Series (Sold separately)*	SH-080544ENG (1D7M32)
(7)	GOT1000 Series Gateway Functions Manual Explanation of System Configuration, and Setting Method for the Gateway Function Specifications (Sold separately)*	SH-080545ENG (1D7M33)

*Stored in GT Works2 and GT Designer2, in PDF Format.

System Configuration in this Textbook

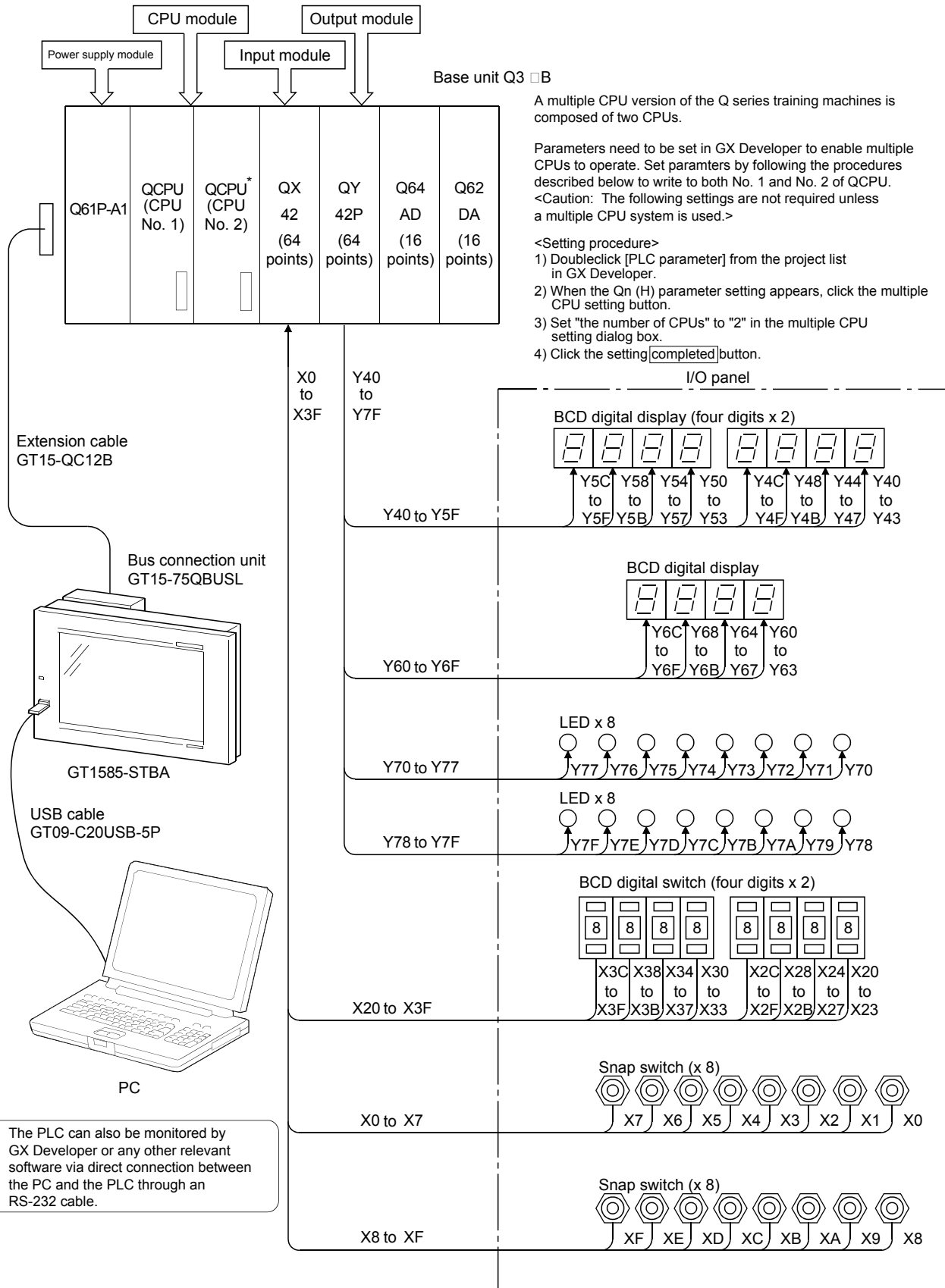

Notes

Chapter 1 What is the GOT?

1.1 About the GOT

The GOT (Graphic Operation Terminal) can be used as an electronic operation panel that enables such as switch operation, lamp display, data display, and message display on the monitor screen, which had been conventionally implemented with a control box.

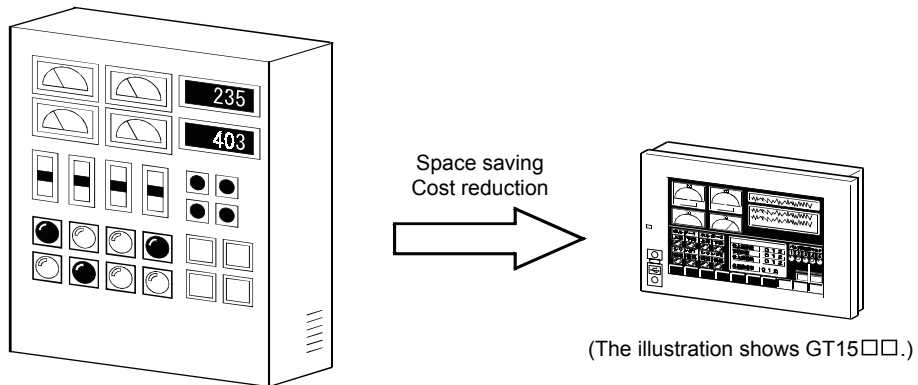

1.2 Procedures for monitoring the PLC CPU by GOT

- 1) Create a screen to be displayed in GOT using GT Designer2, software for creating monitor screens.

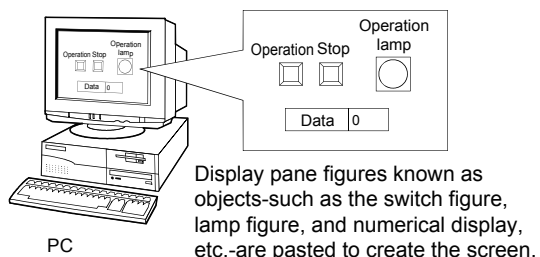

- 2) Transfer the created monitor screen data to GOT.

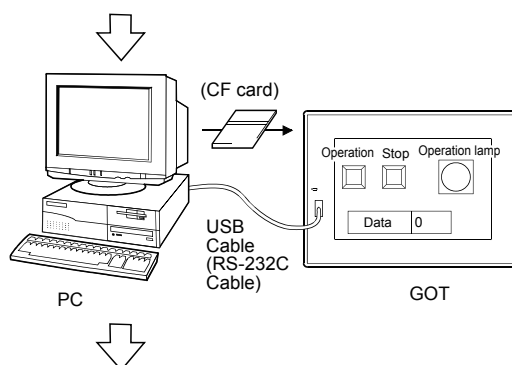

- 3) Start monitoring after connecting to PLC CPU.

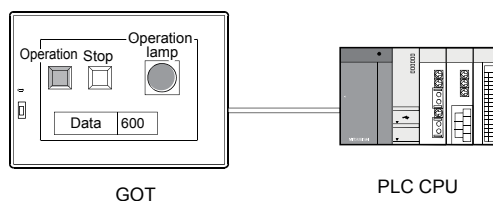

1.3 GOT features

- (1) With its 256 colors, the color screen provides a sharp, clear display that yields a vivid, top quality image.
Further, with the multi-color display board, 65,536-color display is available.
(For GT15 only)
- (2) With a memory card, high-speed data transfer of OS and screen data between personal computer and GOT is available.
The CF card interface is standard equipment, so by mounting a memory card made for OS or screen data created on a personal computer, high-speed data can be exchanged. (Data can also be transferred via USB, RS-232, or Ethernet.)

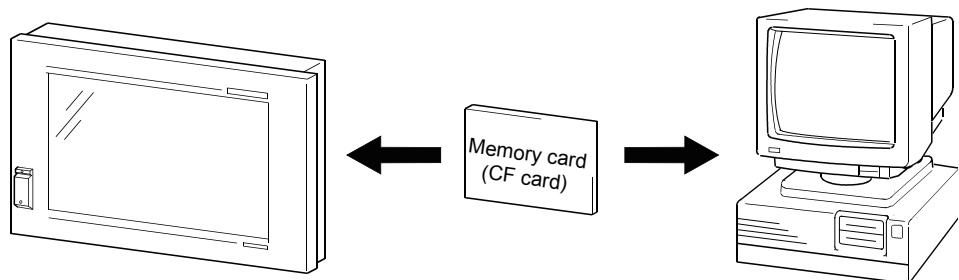

- (3) USB interface as standard equipment
The USB interface is provided as standard equipment.
The interface is located at the front, so the cable can be connected without opening the panel.
Data transferring time is reduced to approximately 1/20 compared with previous communication: RS-232. And setup time is also reduced significantly.
- (4) For various connection types
Beginning with bus connection that allows for high-speed communication, GOT supports various connection types—including direct CPU, computer link, CC-Link, MELSECNET/10, and Ethernet connections. Select the connection type to suit the system.
- (5) Heavy-duty body for an extreme environment or operation
Because the GOT display complies with IP67 standards for waterproof and dustproof, it can be used in various environments.
- (6) Alarm function
When any breakdown or malfunction occur, the alarm messages are displayed.
A history of the date, time, and frequency which the error occurred is held. The occurrence status can be displayed as a graph or saved to a memory card.
Errors can be classified into groups or levels to help organize the error information.

(7) Parts overlay (Layer function)

With the layer function, parts(objects/figures) can be superimposed, which increases design flexibility.

For example, fluctuating numeric values and graphs, trend graphs and bar graphs, image data and pointers can be superimposed and displayed together.

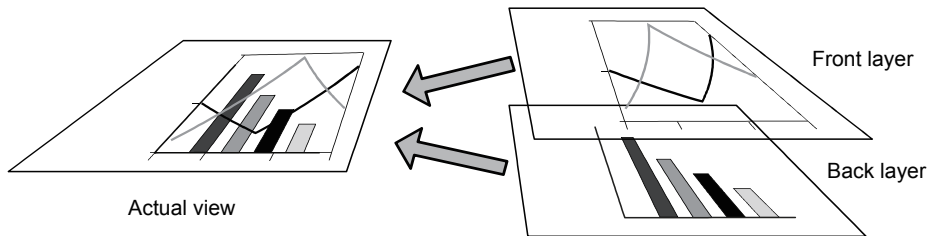

(8) Expressive font variation

Two types of fonts are available: Mincho and Gothic.

TrueType fonts and Windows® fonts are also available to display from small characters to large characters truly.

(9) Language switching function

The comment display created every language can be switched according to the device value.

Screens which all the characters on the screen switch to Japanese, English, and Korean are easy to create with a touch switch.

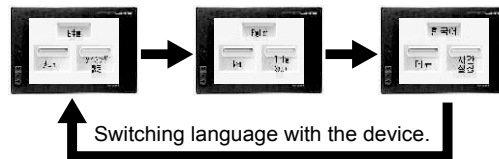

(10) Debug with enhanced compatibility with Mitsubishi PLC

All debug functions can be used to install the extended function OS to GOT from GT Designer2.

Function Name	Description
Ladder Monitor Function	The sequence program can be monitored in ladder format. The primary source of coil ON/OFF status, the device, and contact point can be searched.
System monitor function	Controller devices can be monitored and modified. A function designed to increase the efficiency of maintenance operations so that maintenance can be performed to resolve trouble with the controller system.
Network Monitor Function	As MELSECNET line conditions are displayed, communication conditions can be checked by GOT only.
Intelligent Module Monitor Function	The data of the intelligent function module buffer memory can be monitored and changed using a dedicated screen. The I/O module signal condition can also be monitored.
Servo Amplifier Monitor Function	The parameter settings and reference/diagnosis of the error history for the servo amplifier connected by GOT can be performed.
CNC Monitor Function	The Position Display Monitor, Alarm Diagnosis Monitor, Tool Offset/Param, Program Monitor, and APLC release screen that are equal to those of MELDAS dedicated display device can be displayed on the MELDAS connected to GOT.
Q Motion Monitor Function	The Q motion controller CPU Servo Monitor and parameter settings can be performed on the GOT screen.
List Editor for A/List Editor for FX	MELSEC-A series, FX series sequence program can be edited in list (instruction word) format. Program changes can be made without peripheral.

1.4 GOT function list

The table below shows the list function for each GOT model.

Item		Specifications			
		GT1575-STBA, GT1575-STBD	GT1575-VTBA, GT1575-VTBD	GT1575-VNBA, GT1575-VNBD	GT1572-VNBA, GT1572-VNBD
Display section*1	Type	TFT color liquid crystal (LCD of high intensity and wide angle view)		TFT color liquid crystal	
	Screen size	10.4"			
	Resolution	800×600dots	640×480dots		
	Display size	211(8.31)(W)×158(6.22)(H)[mm](inch)			
	Display character	16-dot standard font: 50 characters × 37 lines 12-dot standard font: 66 characters × 50 lines	16-dot standard font:40 characters × 30 lines 12-dot standard font:53 characters × 40 lines		
	Display color	256color/65536color*2		256color	16color
	Display angle	Left/Right:50 degrees Top :35 degrees Bottom :45 degrees	Left/ Right/Top/ Bottom: 85 degrees	Left/Right :45 degrees Top :30 degrees Bottom :20 degrees	
	Intensity of LCD only	280[cd/m ²]	380[cd/m ²]	200[cd/m ²]	
	Intensity adjustment	8-level adjustment		4-level adjustment	
	Life	Approx. 50,000 h (Operating ambient temperature:25°C)	Approx. 41,000 h (Operating ambient temperature:25°C)		
Backlight		Cold cathode fluorescent tube (replaceable) backlight shutoff detection function is included. Backlight off/screen saving time can be set.			
	Life*3	Approx. 40,000 h or longer (Time when display luminance reaches 50% at the operating ambient temperature of 25°C)			
Touch panel	Number of touch keys	1,900 objects/screen (Matrix structure of 38 lines × 50 columns)	1,200 objects/screen (Matrix structure of 30 lines × 40 columns)		
	Key size	Minimum 16 × 16 dots (per key)			
	Number of objects that can be simultaneously touched	Maximum of 2 objects			
	Life	1 million times or more (operating force 0.98 max.)			
Human sensor	Detection length	None			
	Detection range	None			
	Detection delay time	None			
Memory*4	C drive	Built-in flash memory 9Mbytes (for storing project data and OS)		Built-in flash memory 5Mbytes (for storing project data and OS)	
	Life (Number of write times)	100,000 times			
Batery		GT-15BAT lithium battery (Option)			
	Backup target	Clock data and maintenance time notification data			
	Life	Approx. 5 years (Operating ambient temperature of 25°C)			

(Continued to next page)

Item	Specifications			
	GT1575-STBA, GT1575-STBD	GT1575-VTBA, GT1575-VTBD	GT1575-VNBA, GT1575-VNBD	GT1572-VNBA, GT1572-VNBD
Built-in interface	RS-232	RS-232, 1ch Transmission speed:115,200/57,600/38,400/19,200/9,600/4,800 bps Connector shape:D-sub 9-pin (Male) Application:For communicating with a controller or connecting a personal computer (Project data upload/download, OS installation, FA transparent function)		
	USB	USB (Full Speed 12 Mbps), 1ch Connector shape:Mini-B Application:For connecting a personal computer (Project data upload/download, OS installation and FA transparent function)		
	CF card	Compact flash slot, 1ch Connector shape: TYPE I Application: Data transfer, data storage		
	Option function board	For option function board mounting, 1ch		
	Multi-color display board	For multi-color display board mounting, 1ch	Cannot be used. (Even installed, 65536 colors will not be displayed.)	
	Communication unit/ Option unit	For communication unit/option unit mounting, 2ch		
Buzzer output	Single tone (tone length adjustable)			
Protective structure	Outside the enclosure: IP67*5 Inside the enclosure: IP2X			
External dimensions (Excluding USB environmental protective cover)	303(11.93)(W)×214(8.43)(H)×49(1.93)(D)[mm](inch)			
Panel cutting dimensions	289(11.38)(W)×200(7.87)(H)[mm](inch)			
Weight	2.4 kg (mounting fixtures are not included)	2.3 kg (mounting fixtures are not included)		
	Compatible software package (GT Designer2 Version)	GT1575-STBA: 2.04E or later GT1575-STBD: 2.17T or later	GT1575-VTBA: 2.04E or later GT1575-VTBD: 2.17T or later	2.17T or later

*1 Bright dots (always lit) and dark dots (unlit) may appear on a liquid crystal display panel. It is impossible to completely avoid this symptom, as the liquid crystal display comprises of a great number of display elements. Please note that these dots appear due to its characteristic and are not caused by product defect.

*2 Full-color display (66536 colors) is available when the multi-color display board is mounted. (☞ 8.4 Multi-Color Display Board)

*3 The GOT screen saving/backlight off function prevents images from becoming permanently etched on the display screen and increases the backlight life.

*4 ROM in which new data can be written without deleting the written data.

*5 Compliant with IP67 when the USB environmental protection cover is attached. Compliant with IP2X at the USB interface only when a USB cable is connected. Note that this does not guarantee all users' operation environment.

1.5 Applicable connection type between the GOT and the PLC CPU

The GOT can perform monitoring by connecting it to the PLC using the following connection types.

Therefore, the connection type suitable for the system configuration or usage can be selected.

(1) Bus connection

Bus connection is a method using an extension connector of a base unit to connect a GOT (connection by I/O bus). This connection type enables the fastest response to a PLC CPU among all GOT connection types.

By occupying one stage of the extension base unit, up to maximum 5 GOTs can be connected.

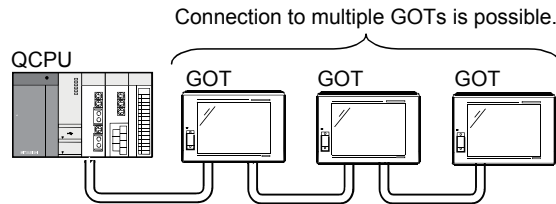

(2) Direct CPU connection

Direct CPU connection is a method using a RS-232C/RS-422 to connect a GOT.

Because no other equipment is required to connect the GOT to the PLC, this is the most economical connection type.

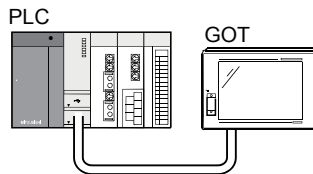

(3) Computer link connection

Computer link connection is a method using a computer link module or a serial communication module mounted together with a PLC CPU.

Connection of multiple GOTs is available depending on the model type of the computer link module or the serial communication module mounted with the PLC CPU.

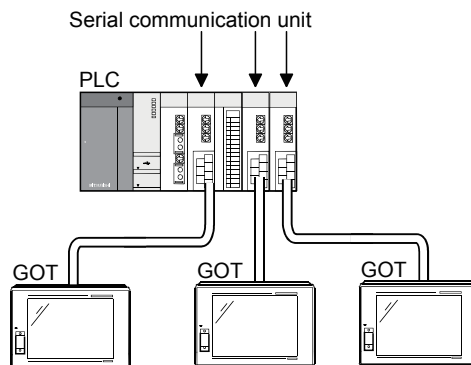

(4) MELSECNET/10 connection

GOT can be connected to the network as a normal station of the MELSECNET/10 (PLC to PLC network).

The cyclic data of the MELSECNET/10 (PLC to PLC network) and devices of the PLC CPU within the same network can be monitored.

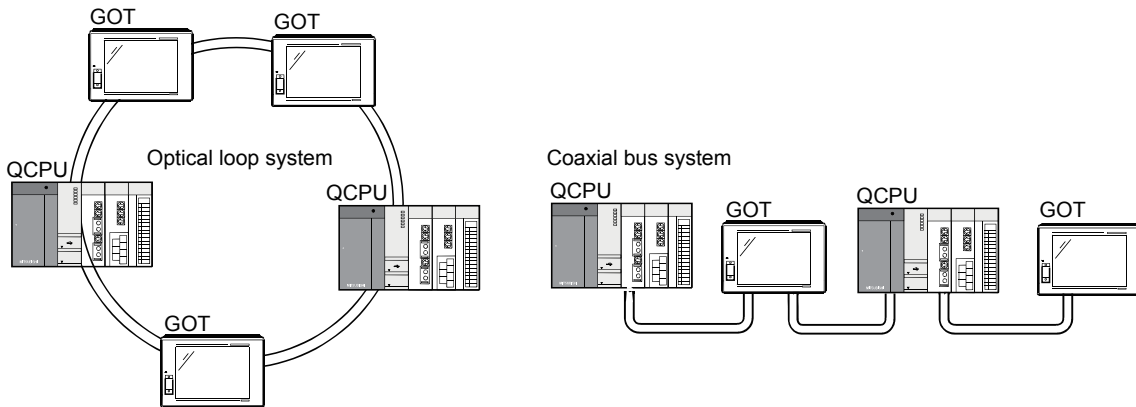

(5) CC-Link connection

GOT can be connected to the network as an intelligent device station of the CC-Link System.

The cyclic data of the CC-Link System and devices of the PLC CPU on the master or local station can be monitored.

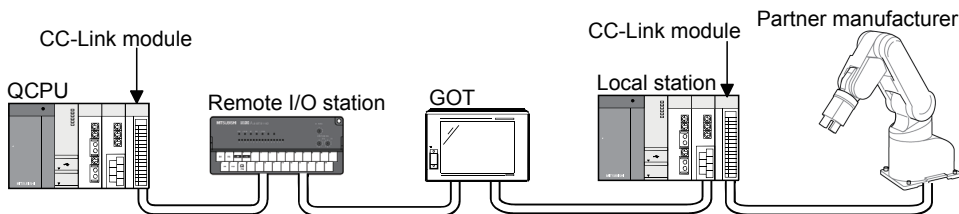

(6) Ethernet connection

GOT can be connected to the Ethernet connection (UDP/IP communications).

The networks can be configured with commercially available products such as hubs and cables.

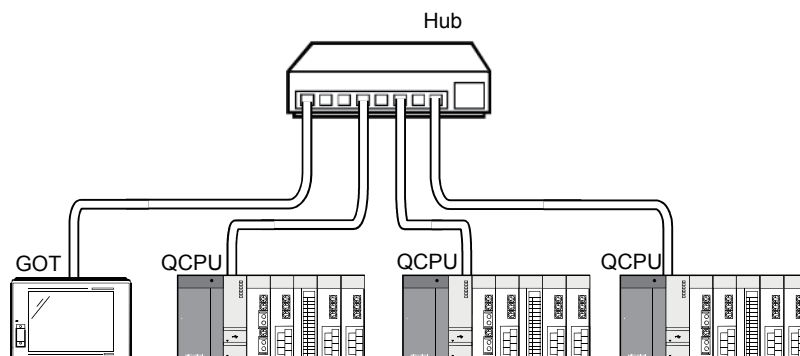

- (7) Applicable connections with third party PLCs
 GOT can be connected to third party PLCs.
 The system construction without regarding to PLC manufacture is available.
 Refer to the product catalogue or manual about PLC models that can be connected.
- (8) Connection to equipment other than the PLC
- Microcomputer
 Data can be read and written from a personal computer, microcomputer board, PLC to GOT virtual devices.
 - Bar-code reader
 The data read with the bar-code reader can be written to PLC CPU.
 - Temperature controller, Inverter, Servo amplifier, CNC
 The controllers can be monitored and changed the parameters.
- (9) Multi-channel function
 The GOT which installs multiple communication drivers can be monitored up to maximum 4 (4 channels) controllers (PLC CPU, temperature controller, inverter, etc.).

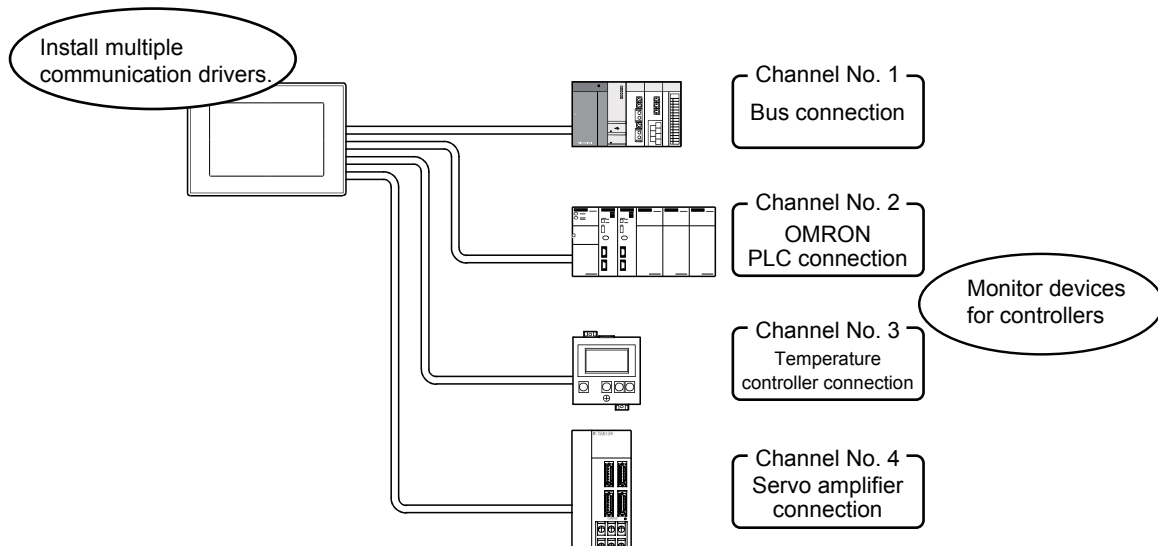

1.6 Equipments required for using GOT

The equipment required to connect the GOT to the PLC CPU is shown below.

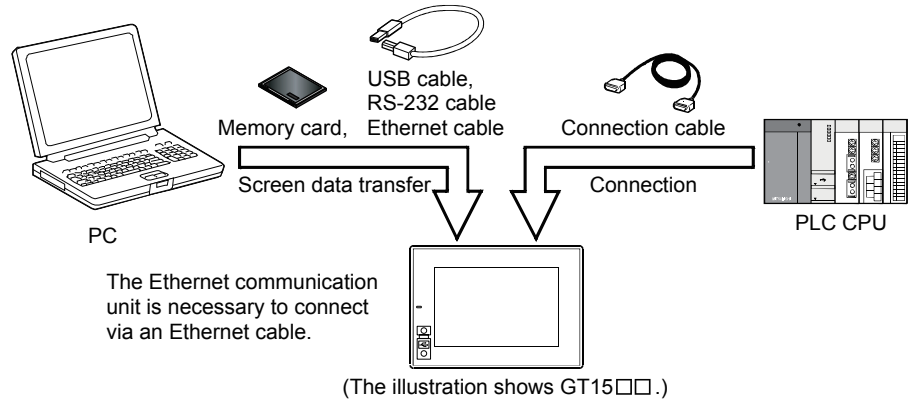

Equipment Name	Application
[1] Personal computer	Writing the screen data to GOT.
[2] GT Designer2	Software to create screen data
[3] USB/Cable	Cable to connect with the personal computer and GOT *1
[4] Communication Unit	Unit to connect the PLC CPU connection cable *1
[5] Connection Cable	Cable to connect with the GOT and PLC CPU *2

*1 The communication unit varies depending on the PLC connection type. When connecting to the PLC with the RS-232 port built-in on GOT (direct CPU connection, computer link connection, etc.), the communication unit is not required.

*2 The connection cable varies depending on the connection type.

The connection cables used for each connection type are shown below.

Connection Type	Connection Cable *1
Bus Connection	Bus Connection Cable
Direct CPU Connection	
For RS-232 Connection	RS-232 Cable
For RS-422 Connection	RS-422 Cable RS-232/422 Conversion Cable
Computer Link Connection	
For RS-232 Connection	RS-232 Cable
For RS-422 Connection	RS-422 Cable RS-232/422 Conversion Cable
CC-Link Connection	CC-Link Dedicated Cable
MELSECNET/10 Connection	
For Optical Fiber Cable Connection	Optical Fiber Cable
For Coaxial Cable Connection	Coaxial Cable
Ethernet Connection	Ethernet Cable

*1 The connection cables are exclusive products.

(Only the Ethernet connection cable is commercially available.)

● Personal computer

The personal computer is for creating and downloading the GOT1000 screen data.

Item	Description
PC	PC/AT compatible personal computer on which Windows® will operate
OS	Microsoft® Windows® 98 operating system English version Microsoft® Windows® Millennium Edition operating system English version Microsoft® Windows® Workstation 4.0 operating system English version *2 Microsoft® Windows® 2000 Professional operating system English version *2 Microsoft® Windows® XP Professional operating system English version *1 *2 Microsoft® Windows® XP Home Edition operating system English version *1 *2
Computer	Refer to *3 below.
CPU	
Required Memory	
Hard Disk Space	For Installation: 300MB or more For execution: 100MB or more
Disk Drive	CD-ROM Disk Drive
Display Color	High Color (16 bits) or more
Display	Resolution 800 × 600 dots or more
Others	Internet Explorer Ver 5.0 or later must be installed. Mouse, Keyboard, Printer and CD-ROM Driver should be compatible with the above OS.

*1 "Compatibility mode", "Fast user switching", "Changing desktop themes (font)" and "Remote desktop" are not supported.

*2 The Administrator authority is required to install GT Designer2 into Windows NT® Workstation 4.0, Windows® 2000 Professional, Windows® XP Professional or Windows® XP Home Edition.

The Administrator authority is also required to use GT Designer2 on Windows® XP Professional or Windows® XP Home Edition.

*3 The PC performance requirements are shown below, according to the operating system to be used.

Operating System	Performance required for personal computer	
	CPU	Required Memory
Microsoft® Windows® 98 operating system English version	Pentium® 200MHz or higher	64MB or more
Microsoft® Windows® Millennium Edition operating system English version	Pentium® 200MHz or higher	64MB or more
Microsoft® Windows® NT® Workstation 4.0 operating system English version	Pentium® 200MHz or higher	64MB or more
Microsoft® Windows® 2000 Professional operating system English version	Pentium® 200MHz or higher	64MB or more
Microsoft® Windows® XP Professional operating system English version Microsoft® Windows® XP Home Edition operating system English version	Pentium II® 300MHz or higher	128MB or more

● GT Works2 and GT Designer2 (CD-ROM)

Products included		Product Name	GT Works2 Version <input type="checkbox"/>	GT Designer2 Version <input type="checkbox"/>
GT Designer2	Creates screens for the GOT1000 series and GOT900 series.		<input type="radio"/>	<input type="radio"/>
GT SoftGOT2	Enables to operate as the GOT-A900 series on the personal computer.(The License key or License FD is required to use this software.)		<input type="radio"/>	<input type="radio"/>
GT Simulator2	Enables the simulation of GOT-A900 series or GOT1000 series operation on a personal computer by connecting with GX simulator or PLC CPU.		<input type="radio"/>	—
GT Converter2	Converts the project data for GOT-800 series or Digital Electronics Corporation's package data into a GT Designer2 format file. GT Converter2 is not required to convert the project data for GOT900 series to those for GOT1000 series.		<input type="radio"/>	<input type="radio"/>

Notes

Chapter 2 GOT Operation

GOT enables reading and writing to PLC CPU device memory (bit, word) with the switches, lamp display, numerical display/input, message display, etc. on the GOT screen.

2.1 Summary of operation

With GT Designer2, display pane figures called objects: —such as the switch figure, lamp figure, and numerical display, etc., —are pasted on the GOT screen.

GOT functions can be executed by setting operation functions of the PLC CPU device memory (bit, word) to each pasted object.

This chapter explains the GOT operation in connection with the PLC CPU when the switch (touch switch) or numerical display are set as shown below.

<System example>

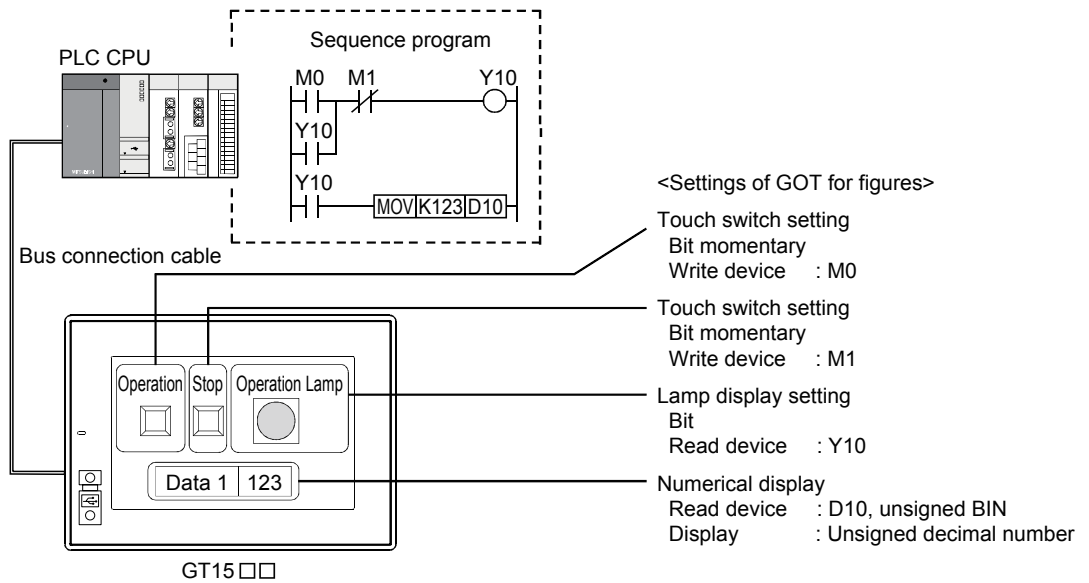

<Action description>

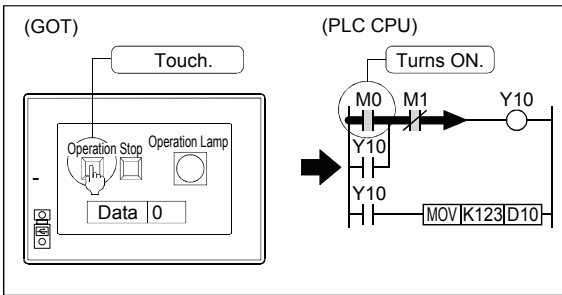

- (1) While the touch switch "Operation" on the GOT is being touched, the bit device "M0" has been ON.

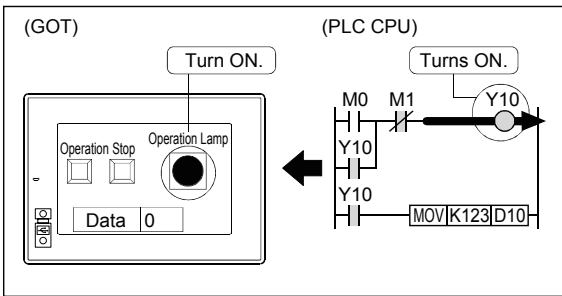

- (2) When the bit device "M0" turns ON, the bit device "Y10" turns ON.

Also, the ON figure is displayed on Operation Lamp in which the monitor device has been set to the bit device "Y10".

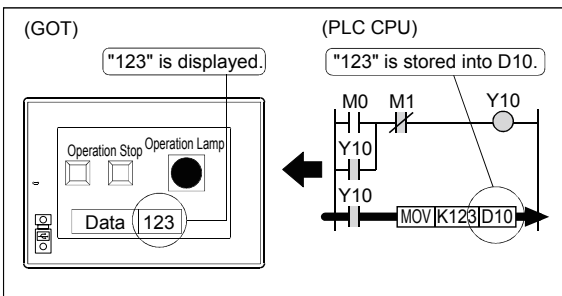

- (3) As the bit device "Y10" has been ON, "123" is stored into the word device "D10".

"123" is also displayed in the numerical display on the GOT in which the monitor device has been set to the word device "D10".

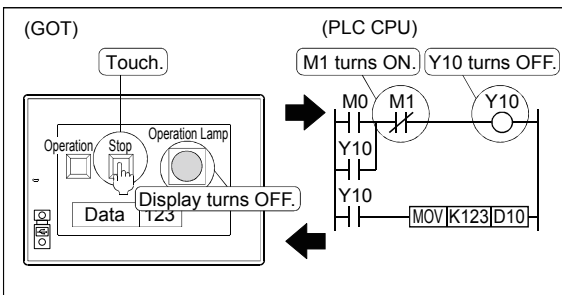

- (4) While the touch switch "Stop" on the GOT is being touched, the PLC CPU bit device "M1" has been ON. The PLC CPU bit device "Y10" turns OFF, and Operation Lamp turns OFF.

2.2 Entering numerical values into PLC CPU

2.2.1 Numerical input function

The function that writes an arbitrary numerical value into a specified word device. While not inputting the numerical value, current value of the numerical input has been displayed.

The Key window of the GOT is used to input numerical values.

Input the numerical value by displaying the below key window whose is prepared in GOT. (User-created key window is also available.)

Numerical input key window

For entering decimal numbers

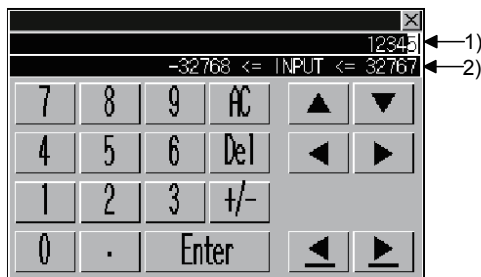

For entering hexadecimal numbers



- 1): Numbers are displayed as you enter them.
- 2): Input range for data is displayed.

Point
User-created key window for numerical input is created by registering the window as the key window.
The registered key window is displayed instead of the standard key window.
Refer to GT Designer2 Version2 Screen Design Manual chapter 4 for details of user-created key window.

2.2.2 How to operate numerical input

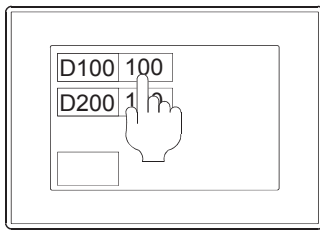

Touch the numerical input to be input.

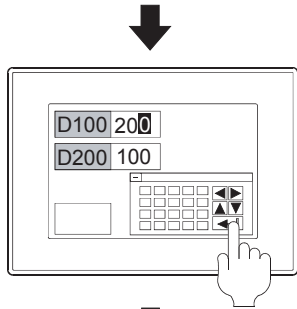

Input the numerical value on the key window to be displayed.
To store the value, touch RET key.

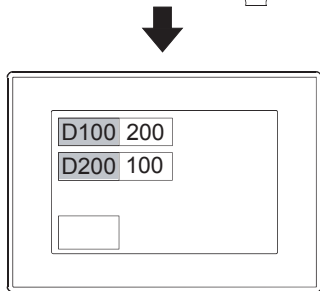

The input numerical value is reflected (D100: 100 → 200), and the key window is closed.

Point

The display and operation of the cursor and key window for numerical input can be changed through settings.

(1) Display or non-display of the cursor, and key window

- When establishing conditions or switching screens, the cursor and key window are displayed, and when establishing the operating conditions, the cursor and window key are not displayed.
- The key window is displayed on touch input and not displayed at pressing RET key.

(2) Cursor key operations

The input order can be set to the multiple numerical input.

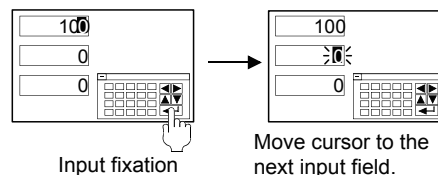

Refer to GT Designer2 Version2 Screen Design Manual chapter 4 for the operation setting methods of cursor and key window for numerical input.

2.3 Switching the screen to be displayed

2.3.1 The screen type

The GOT1000 comprises the following screen types.

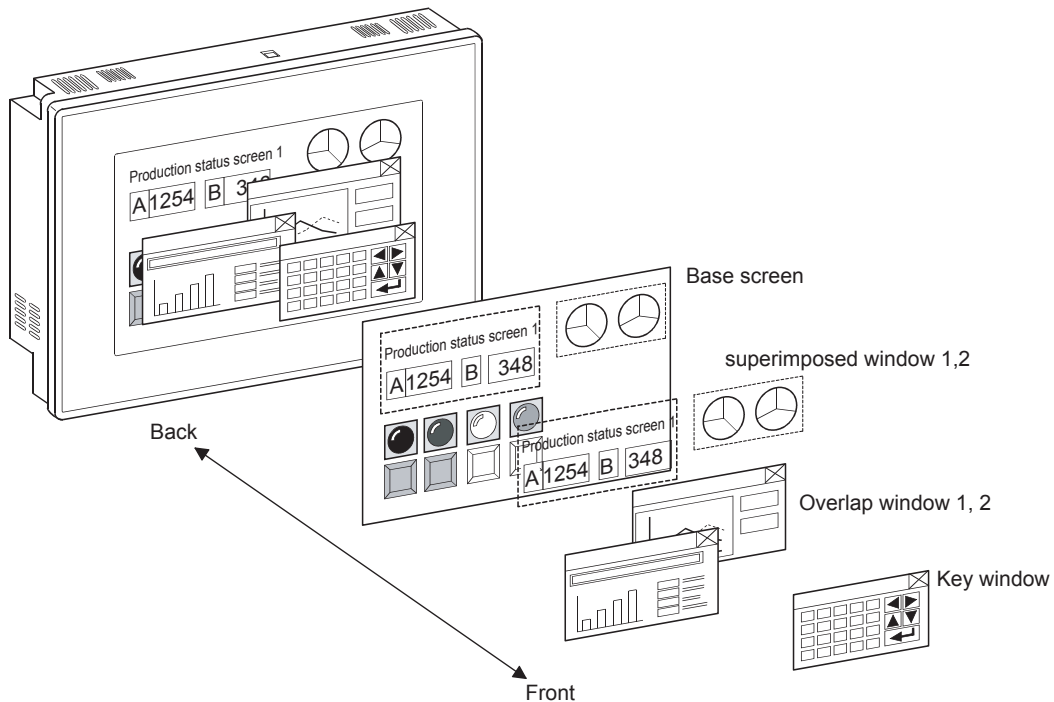

- (1) Base screen
The basic screen display on the GOT.
- (2) Window screen
A screen overlapped the base screen.
The following screen types are available.
 - Overlap window :
A window overlapped the base screen is displayed. This type of window can be moved and closed manually.
Maximum of two screens can be displayed.
 - Superimposed window :
A window superimposed the base screen is displayed. By switching a superimposed window, the corresponding part of the base screen can be changed. Maximum of two screens can be displayed.
 - Key window :
A pop-up window on the base screen is displayed when inputting numerical values.
Two key types window: default key window and user-created key window are available.

Remarks
<ul style="list-style-type: none"> Maximum of 32767 screens of both the base screen and the window screen can be created. Maximum of 4096 base screens and 1024 window screens can be displayed on the GOT. Refer to GT Designer2 Version2 Screen Design Manual chapter 2 for settings including window screen display position.

2.3.2 Screen switching device

The screen switching device is set to switch the base screens or to display the window screen on the GOT.

Device types for screen switching are as follows.

- Device for base screen switching
- Device for overlap window1 switching
- Device for overlap window2 switching
- Device for superimposed window1 switching
- Device for superimposed window2 switching

(1) Switching base screens

Switch base screens by setting a base screen No. to the device for base screen switching.

Example: When the switching device for base screen is D100.

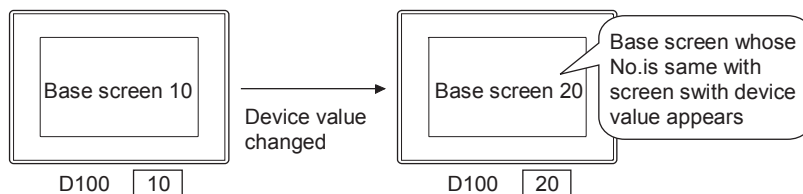

(2) Displaying or non-displaying window screen

Switch window screens by setting a window screen No. to the device for window screen switching. It stores 0 and then erases the window screens.

Example: When the switching device for window screen is D120

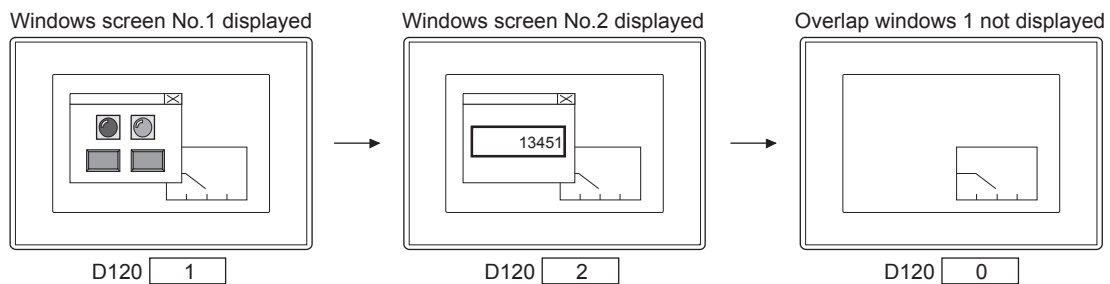

Remarks
<ul style="list-style-type: none"> Refer to section 4.2.3 for setting methods of screen switching device.

2.3.3 Base screen switching with the sequence program

GOT display screen is switched when the screen switching device value is written with the sequence program.

Example: When the switching device for base screen is D0

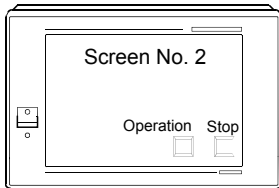
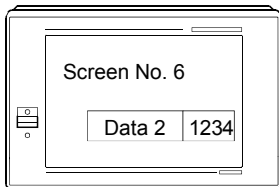
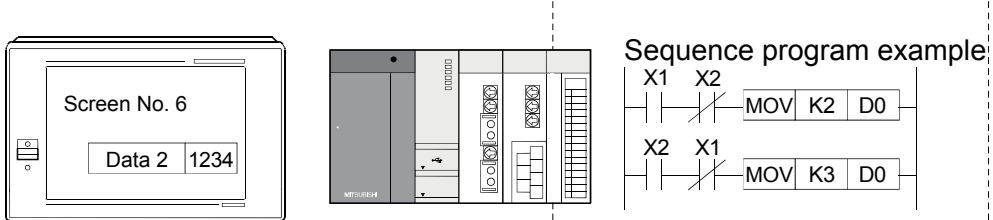

The current value of D0 is stored six because the GOT displays screen No. 6.
Turn on X1 with the sequence program, and D0 value is changed to two.

The GOT displays screen No. 2 because D0 value is changed to two.

2.3.4 Base screen switching with the touch switch

GOT display screen is switched when the screen switching device value is written with the touch switch.

Example: In the case of device for base screen switching: D0

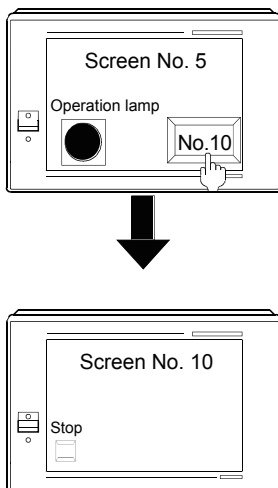
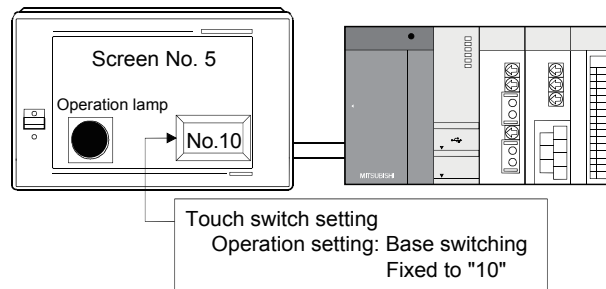

The current value of D0 is stored five because the GOT displays screen No. 5.

Set both of X1 and X2 in OFF with sequence program, and touch No. 10 touch switch.

The GOT displays screen No. 10 because the current value of D0 is changed to 10 with the touch switch.

2.3.5 Window screen display and switching

The window screen is displayed by writing the same No. as the window No. of the screen to be displayed into the switching device used in overlap windows 1, 2. Two types of writing in the screen switching device are available : writing with the sequence program, and writing with the GOT touch switch.

Point	When "zero" is written in the screen switching device, the window screen is not displayed.
-------	--

Example: When the switching device for base screen is D0, and that for overlap window 1 is D1.

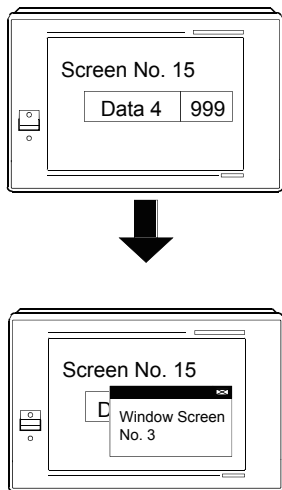
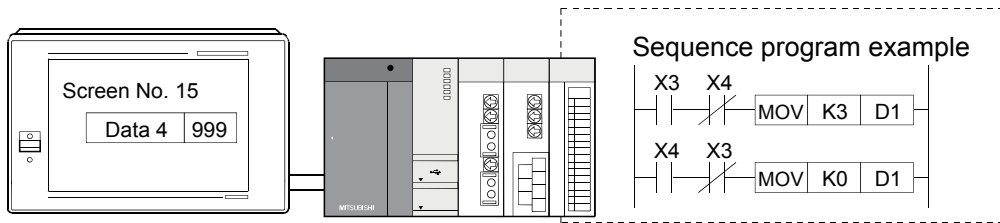

The current values of the switching device are the below because the GOT displays only base screen No. 15.

D0 = "15"

D1 = "0"

Turn ON X3 with the sequence program, and D1 value is changed to three.

The GOT displays window screen No. 3 because D1 value is changed to three.

When closing the window screen, operate either of the following methods.

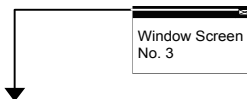

- Touch in the upper right corner of the window screen.
- Write "zero" as the D1 value in the overlap window1 screen switching device.

Notes

Chapter 3 About GT Designer2

3.1 About GT Designer2

The screens displayed in the GOT are designed with the GT Designer2. Drawing is to place or set figures and objects on the GT Designer 2 screen. The created screens and system data required for GOT operation are transferred to the GOT by GT Designer2.

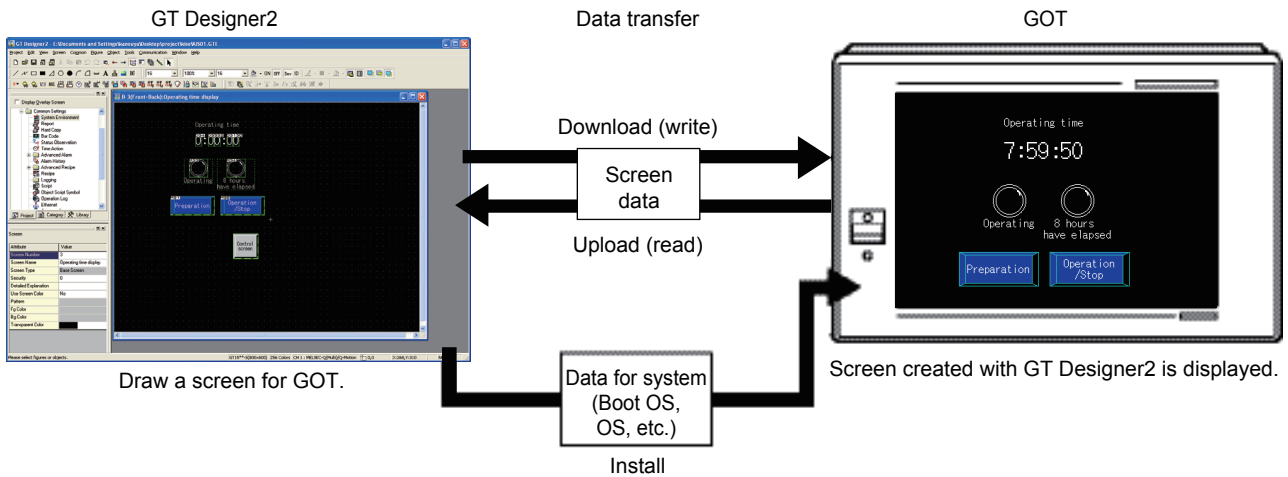

3.2 GT Designer 2 screen configuration and features

This chapter describes screen configuration and features of the GT Designer2.

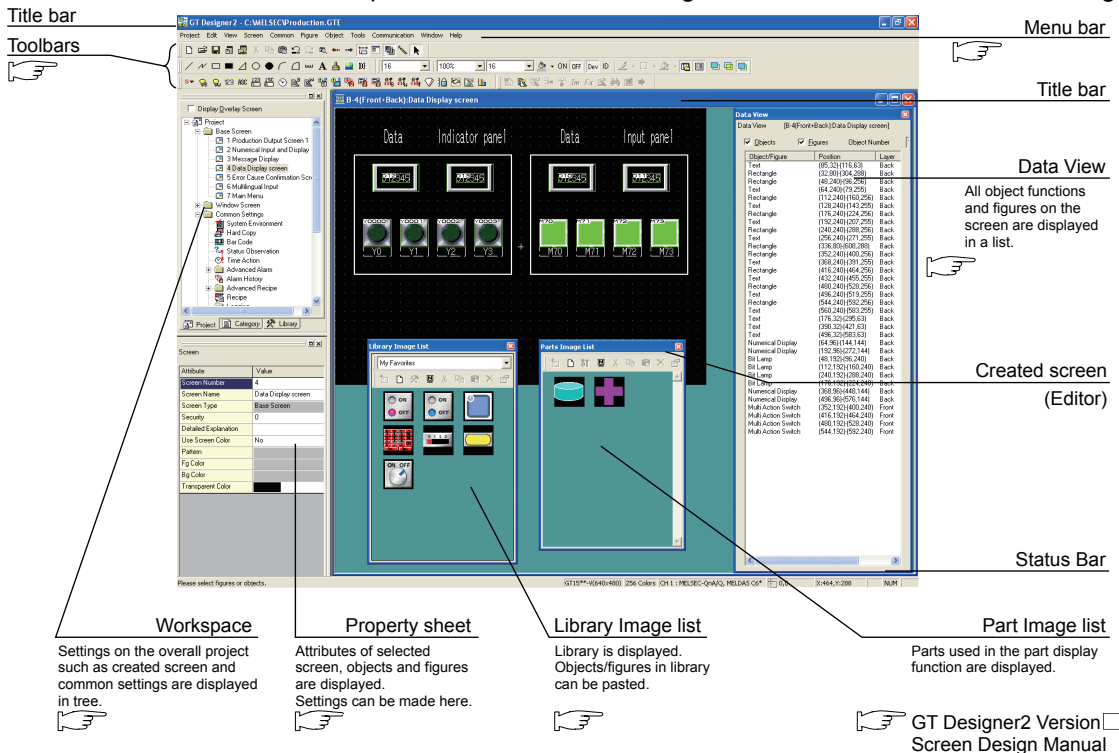

- (1) Easy understanding of the overall project (workspace)
The overall project settings are displayed in a tree structure.
It is convenient to confirm the settings, to check progress of work, and to copy the screen.
- (2) Management of objects according to application (category)
The overall project settings are displayed in a tree structure according to application (category).
Classification for each application allows simple management of objects.
- (3) Shortest setting without opening dialog box (property sheet)
Without opening the dialog boxes for the selected objects and figures, all setting items and setting details are displayed in a list.

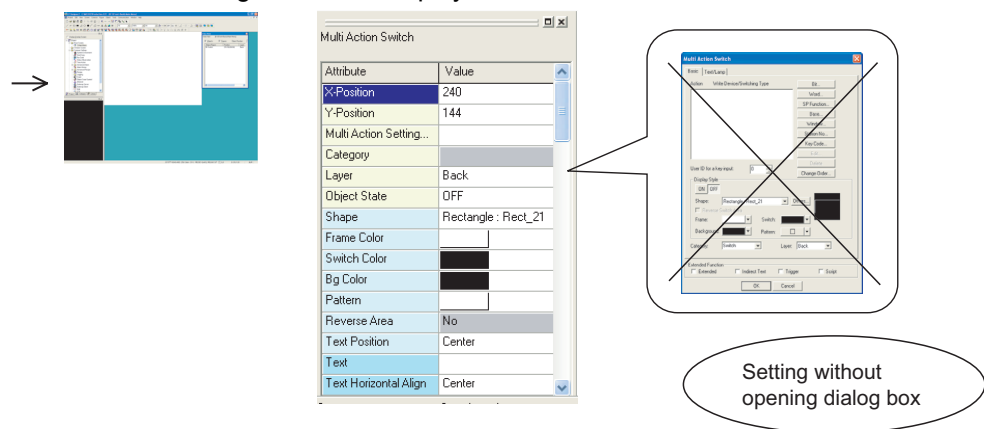

- (4) Registration of frequently used parts (library registration)
Frequently used objects and figures can be registered.
Registered objects or figures can be dragged and pasted onto the screen.
- (5) Data View
The Data View displays all objects and figures arranged on the screen in a list.
- (6) Wizard application supporting required settings (new project wizard)
When creating a new project, an interactive wizard appears.
By following the interactive wizard, the settings required for the GOT1000 can be completed.

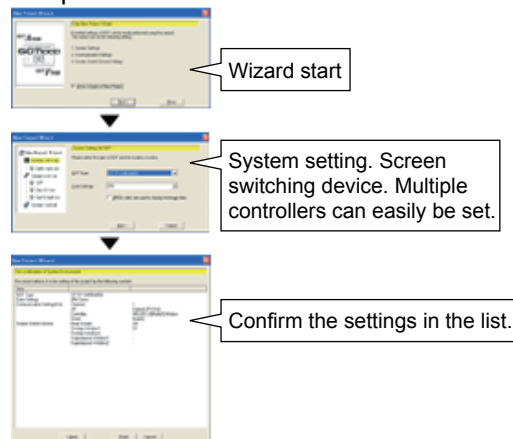

- (7) Easy confirmation of images with preview.
Display images that are the same as those for GOT (language switching, security level changing, object ON/OFF setting, etc.) can be displayed and confirmed with GT Designer2.

Example: Switch the language

Column No.		
Comment No.	1	2
1	メニュー	Menu
2	タイミング設定	Timing Setup

Comment Group Column No.

Select column No. of comment group to display.

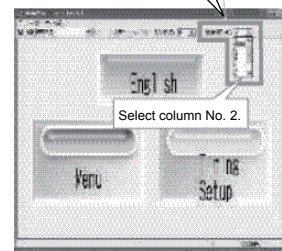
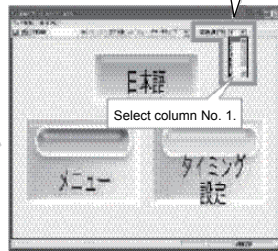

3.3 How to use the online manual

The online manual is contained in the product CD-ROM in PDF data.
To view the PDF data, Adobe® Acrobat® Reader® must have been installed in the personal computer.

3.3.1 Reading the online manual from the product CD-ROM

(1) Operation procedures



- 1) Click GT Manual 1000 in the GT Manual Menu.

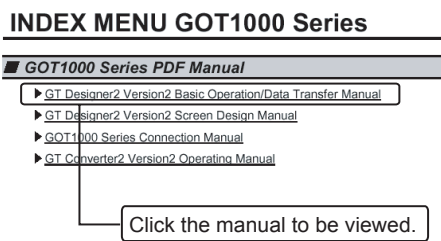

- 2) As the INDEX MENU screen is displayed, click the manual to be viewed.

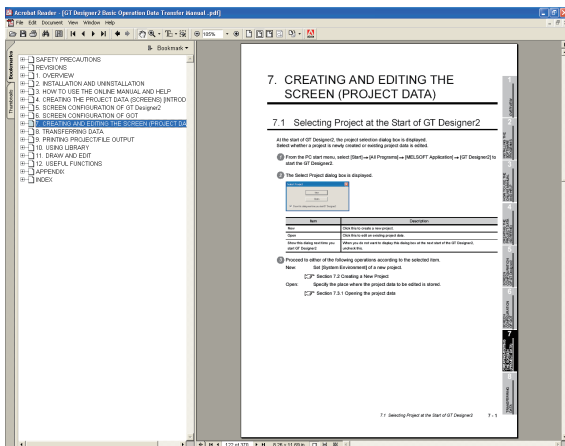

- 3) The selected manual is displayed.

Remarks

The online manual can be viewed from the Start menu or GT Designer2 Help after installation of the GT Manual to the personal computer.
Refer to the next page for how to view it from Help.

(GT series)

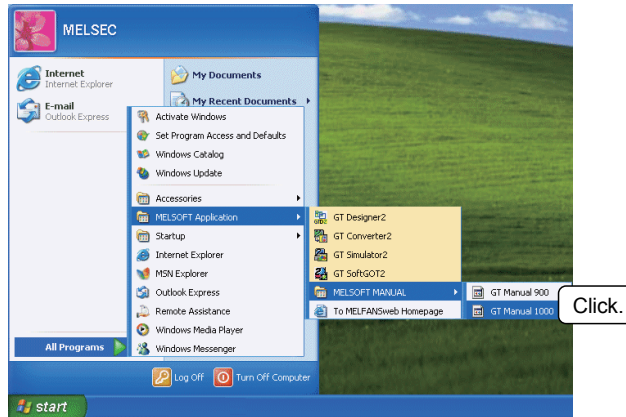

3.3.2 Reading the online manual from the GT Designer2 Help

With Help, the GT Designer2 PDF manuals can be viewed and the software version can be checked.

- (1) Operation procedures
 - 1) Click on each Help menu.

Item	Description
[Basic Operation/Data Transfer Manual]	Displays the GT Designer2 Version Basic Operation/Data Transfer Manual.
[Screen Design Manual]	Displays the first/second volume of the GT Designer2 Version Screen Design Manual.
[Index]	Displays the PDF manual list.
[About GTD2...]	The GT Designer2 version can be confirmed.
[Connect to MELFANSweb...]	Connects to the Mitsubishi Electric FA Equipment Technology Information Service MELFANSweb.

- (2) PDF manual viewing procedure (only when selecting [Index])
 - 1) After the (1) operation, the following screen is displayed, click the manual to be referenced.

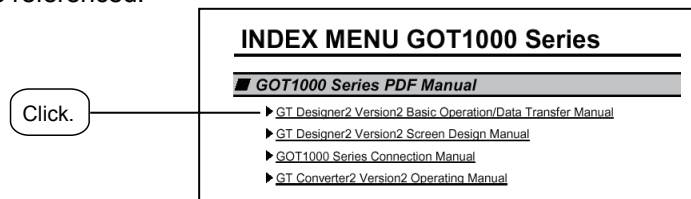

- 2) The selected manual is displayed.
(For details on using Adobe® Acrobat® Reader®, refer to Help in Adobe® Acrobat® Reader®.)

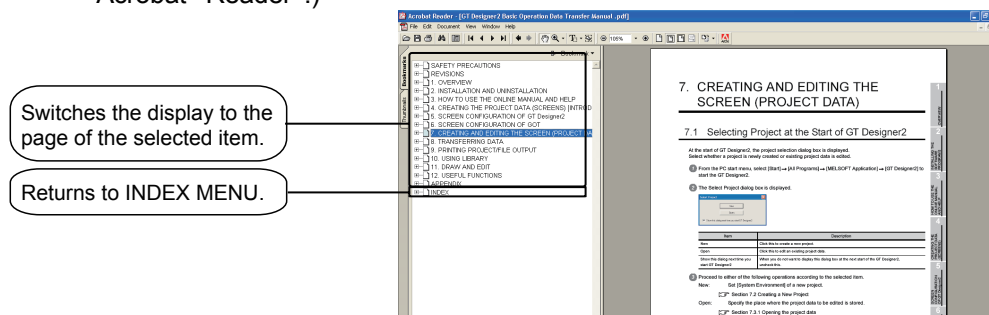

Chapter 4 From GOT Screen Creation up to the Test

4.1 Preparation before using the GOT

The procedures up to monitor the PLC by the GOT is described in this section.

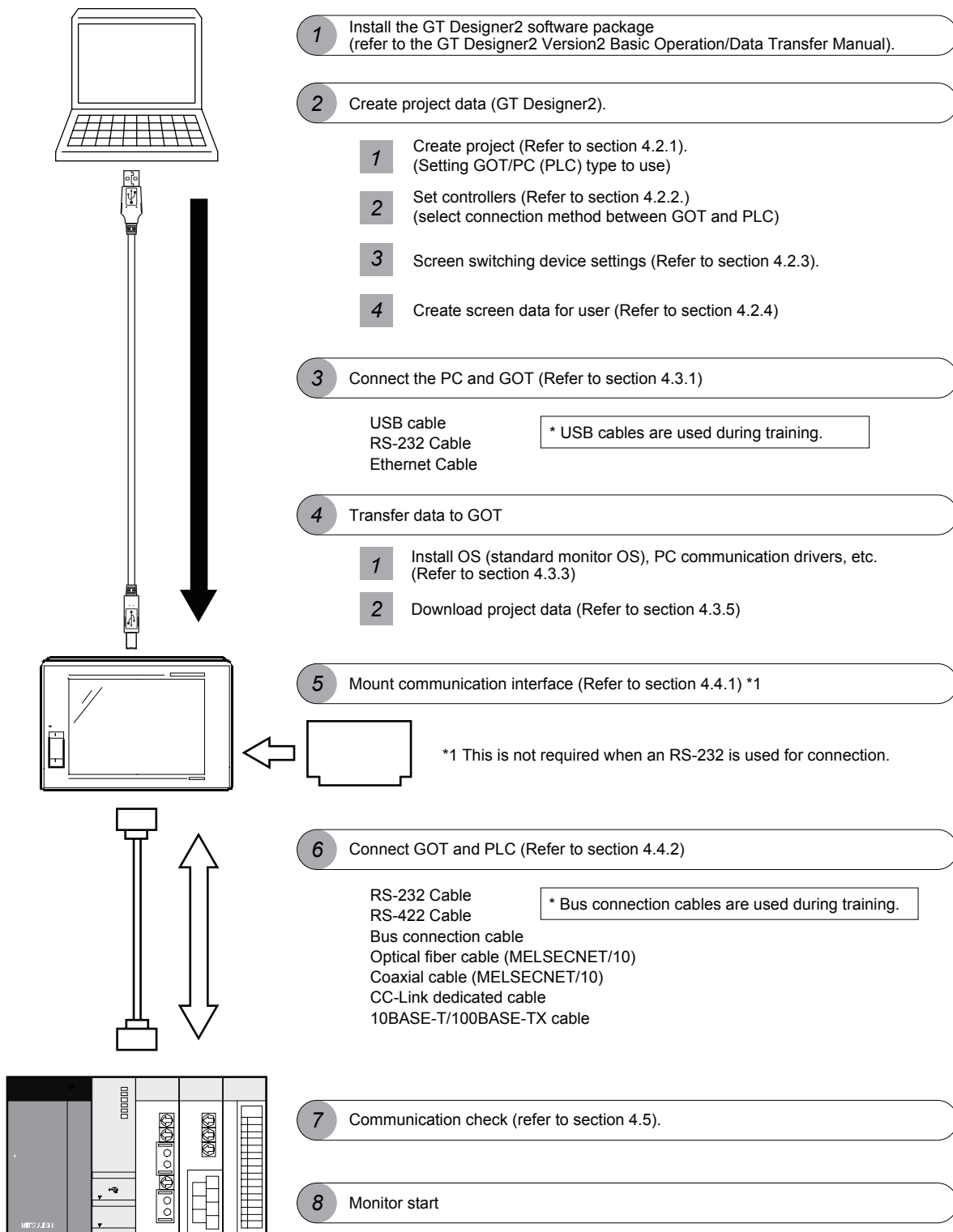

4.2 Screen creation

4.2.1 Project creation

Projects comprise all the data and settings displayed in one GOT.

The screens displayed in the GOT and connection method with the PLC are set in a project wizard.

In this section, the settings for the type of GOT used for training and the type of PLC connected to the GOT are described.

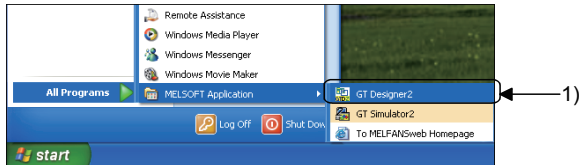

- 1) Click [Start] → [All Programs] → [MELSOFT Application] → [GT Simulator2] menus to run GT Designer2.

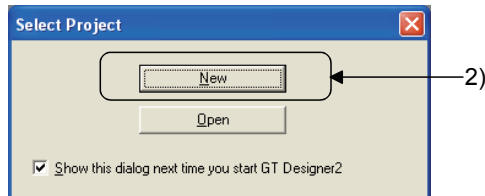

- 2) The screen on the left is displayed when GT Simulator2 is started.

Click the **New** button.

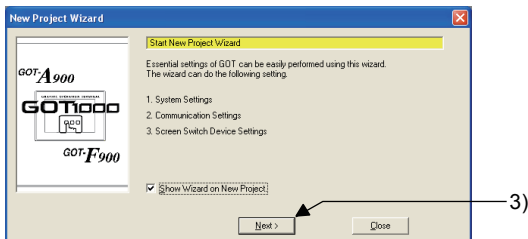

- 3) The initial screen of the Start New Project Wizard is displayed. (When no new wizard appears, go to section 4.2.2.)

Click the **Next** button.

Various settings that can be made on the project wizard are described on the following pages.

(1) System settings for GOT

The GOT type to be used and the color are set.

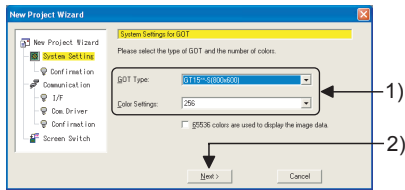

- 1) When the left screen appears, set the GOT type and the color as follows.
GOT type: GT15**-(800 × 600)
Color setting: 256 colors

- 2) After the selection is made, click the **Next** button.

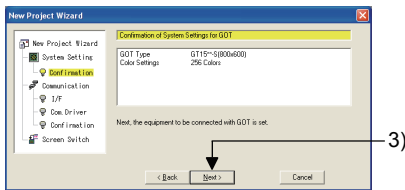

- 3) The left screen is displayed.
Confirm the settings.

Click the **Next** button.

(2) Communication Settings

The connection method for the device to be connected to GOT is set.

(The settings made here can be changed later.)

For details on communication settings, refer to section 4.2.2.

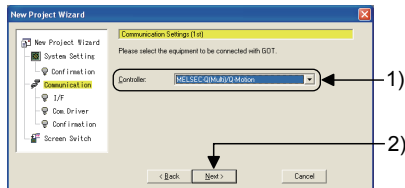

- 1) When the left screen appears, set the device to be connected as follows.
Controller: MELSEC-Q (multi)/Q motion
(The training machine is a multiple CPU system, so select the multiple CPU system.)

- 2) Click the **Next** button.

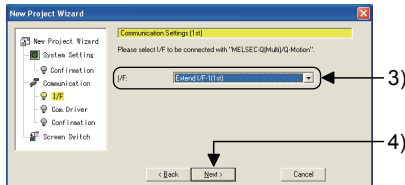

- 3) When the left screen appears, set the connection I/F as follows.
I/F: Extended I/F-1 (first stage)

- 4) Click the **Next** button.



(Next page)

(From previous page)

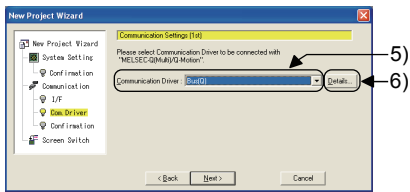

- 5) When the left screen appears, set the communication driver as follows.
Communication driver: Bus connection Q
<Note: Always change default setting from "A/QnA/QCPU, QJ71C24" to Bus connection Q. >

- There are two types of bus connection communication drivers. Select a driver that matches the PLC to be connected.
Bus connection Q : With connection to the QCPU
Bus connection A/QnA : With connection to the ACP, QnACPU

- 6) Click the **Details...** button.

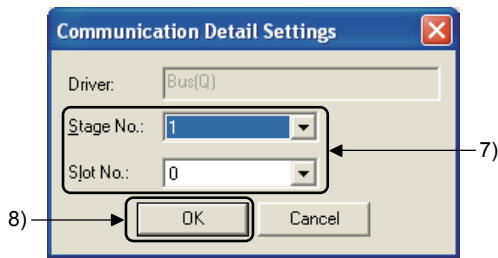

- 7) When the left screen appears, set the Stage No. and Slot No. as follows.
Stage No.: 1
Slot No.: 0

- 8) Click the **OK** button.

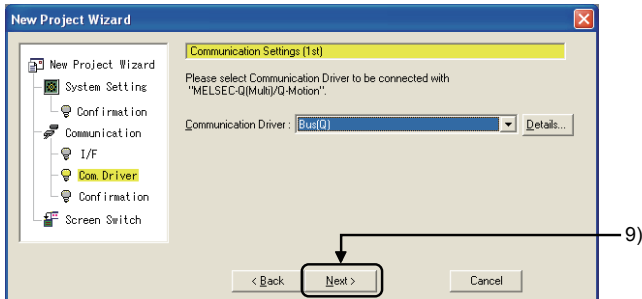

- 9) Click the **Next** button.



(Next page)

(From previous page)

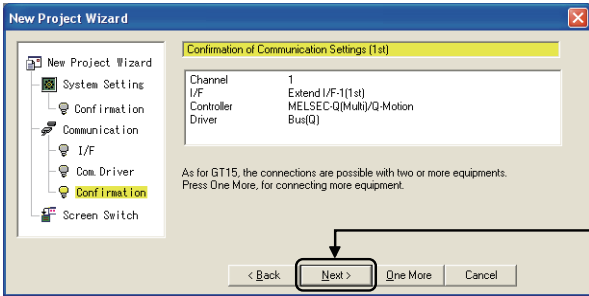

10) The left screen is displayed.
Confirm the settings.

Click the **Next** button.

(3) Setting of Screen Switch Device

The device for switching the screens displayed on GOT is set.

(The settings made here can be changed later.)

Refer to section 4.2.3 for details on screen switching device settings.

For details on screen switch device settings, refer to ~.

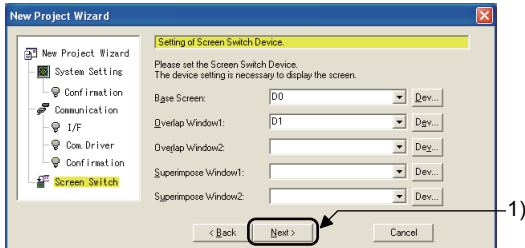

1) When the left screen appears, the screen switching device is set as follows.

Base screen: D0

Overlap window 1: D1

Overlap window 2: - (no setting)

Superimpose window 1: - (no setting)

Superimpose window 2: - (no setting)

Click the **Next** button.

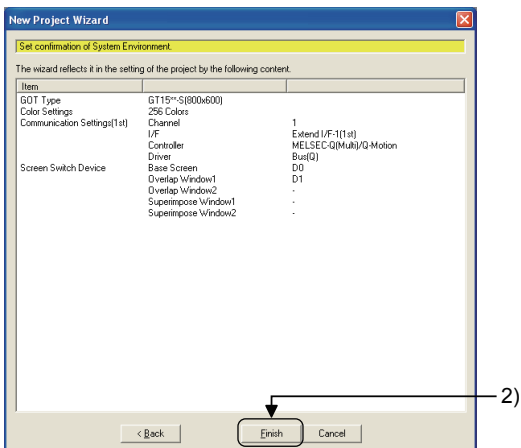

2) The left screen is displayed.
Confirm the settings.

Click the **Finish** button.



(Next page)

(From previous page)



(4) Screen property

The base screen is created.

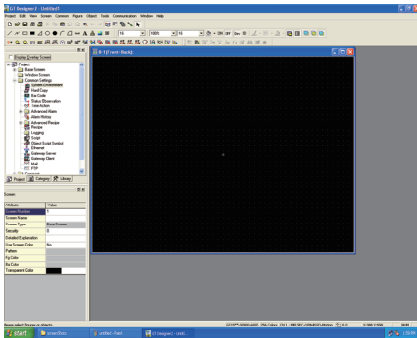
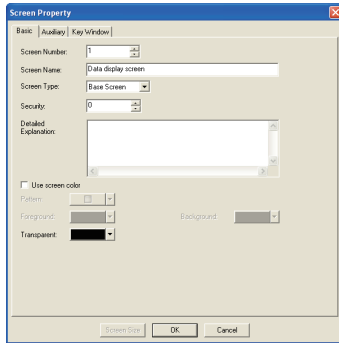

- 1) The Screen Property dialog box is displayed. Set the base screen1 title.
- 2) Enter a character string as the screen name. Enter "Base Screen" here.
- 3) Click the **OK** button.
- 4) Base screen1 is created. The screen is ready for drawing.

Point

Up to 32 characters can be entered as a screen name, regardless of whether they are one-byte or two-byte characters.

Remarks

(1) The GOT/PC type and screen names can be changed
GOT/PC type and screen title settings can be changed in the project workspace.

- Changing the GOT/PC type
- Changing the screen name

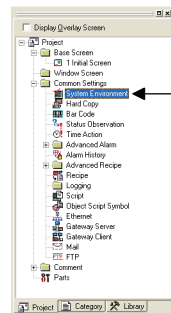

Double click

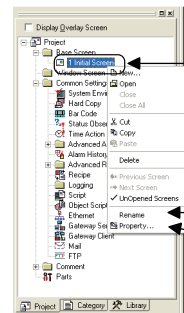

1) Right click

2) Update the screen title.

- Change directly.
- Screen properties Changing with dialog box

(2) Refer to chapter 7 of the GT Designer2 Version2 Basic Operation/Data Transfer Manual for details on GOT/PC type and screen name settings.

4.2.2 Communication Settings

Point

Settings described in this section are not required when settings are made on the new project wizard (Section 4.2.1).

The GOT and PLC CPU communication settings are performed.

When the GOT is used first, set the channel No. of the communication interface and the communication driver, and download the settings to the GOT.

This section explains about using a bus connection between the GOT and CPU.

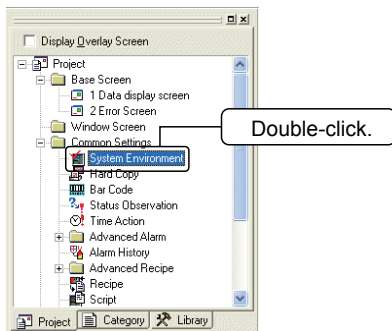

- 1) Double-click [Common Settings] → [System Environment] menu in the project workspace.

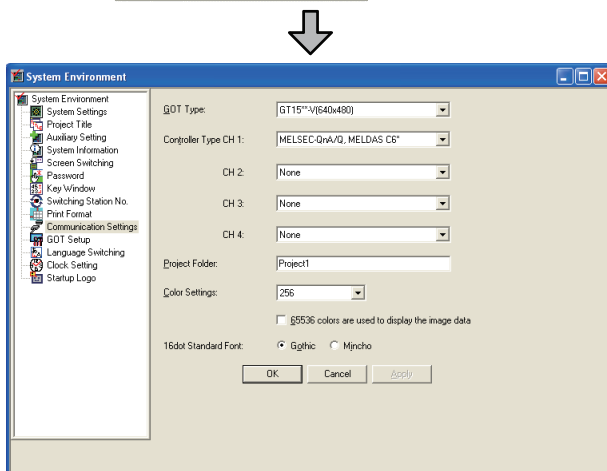

- 2) When the System Environment screen appears, double-click [Communication Settings].

(Next page)

(From previous page)

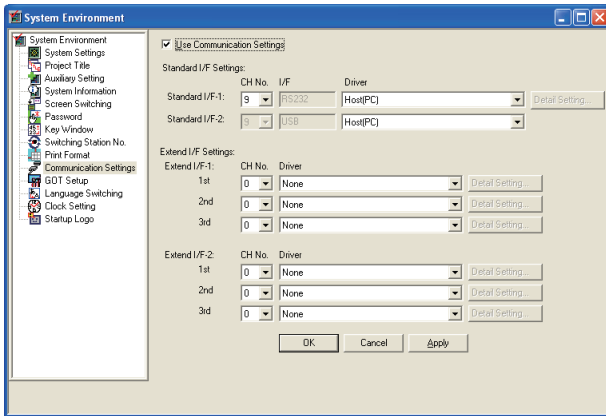

(3) When the left screen appears, check [Use Communication Settings].
With the Communication Settings, perform the following settings.

1) Standard I/F Settings

Settings are performed for the communication interface on the GOT (Standard I/F-1:R-232, Standard I/F-2:USB).

- CH No. Select a CH No. that matches the usage.

0 : not used

1 to 4 : FA device, for microcomputer connection (The communication settings must be made according to the channel No. to be connected)

8 : For bar code reader connection

9 : For host (PC) connection (default)

- I/F Communication interface type is (2 types) displayed.

RS232 : For communication with PC (GT Designer2), PLC, and microcomputer.

USB : For communication with PC (GT Designer2). (default)

- Driver..... Select the PC communication driver to be installed in the GOT.

- Detail setting....

Perform the settings including driver baud rate, data size, etc.

2) Extend I/F Settings (first stage to third stage)

Settings are performed for the communication unit in the GOT extend interface.



(Next page)

(From previous page)



- CH No. Select a CH No. that matches the usage.
 0 : not used
 1 to 4 : FA device, for microcomputer settings (settings to match the channel No. for connecting the controller)
 * : Gateway function, for Ethernet download
- Driver..... Select the PC communication driver to be installed in the GOT.
- Detail setting..... Perform settings including driver stage No., slot No., etc.

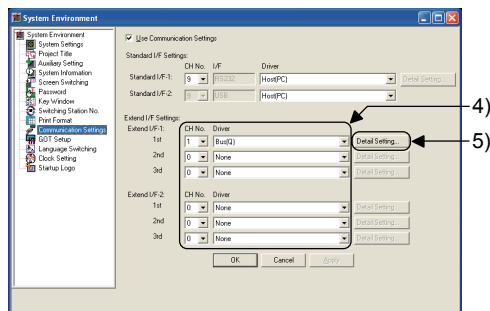

- 4) Extend I/F Settings.
 Set the 1st stage extend I/F1-1 as described below.
 (Settings for this item have already been performed in the new project wizard described in section 4.2.1.)
 CH No.: 1
 Driver: Bus connection Q

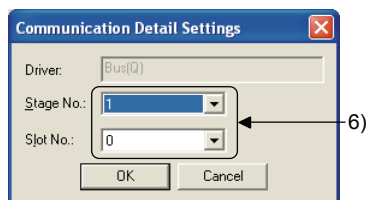

- 5) Click the **Detail Setting...** button.
- 6) When the left screen appears, set the stage No. and slot No. as follows.
 (Settings for this item have already been performed in the new project wizard described in section 4.2.1.)
 Stage No.: 1
 Slot No.: 0

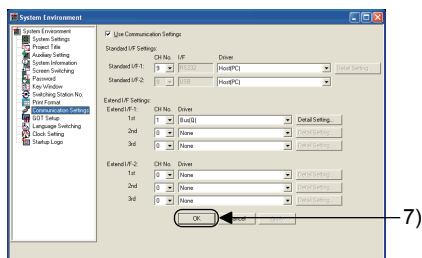

- 7) Click the **OK** button.

Point	<p>Settings including QCPU (Q mode) Stage No. and Slot No.</p> <p>With a bus connection, the PLC CPU recognizes the GOT as a 16 I/O point intelligent function module.</p> <p>A free PLC CPU I/O slot is allocated to the GOT, but when the PLC CPU connected is a QCPU, no free basic base/extended base I/O slot can be allocated.</p> <p>On communication settings, build one stage(16 points ×10 slot allotment) for GOT connection, so that the GOT can be allocated to an I/O slot.</p>
-------	--

Remarks	<ul style="list-style-type: none"> • Refer to chapter 3 of the GT Designer2 Version2 Screen Design Manual for details on Communication Settings. • Controller settings can also be performed with the GOT Utility. Refer to the GOT1000 Connection Manual for details on Utility Communication Settings.
---------	--

4.2.3 Screen switching device settings

This section explains screen switching device settings.

Set the base screen switching device to "D0", and the Overlap window1 screen switching device to "D1".

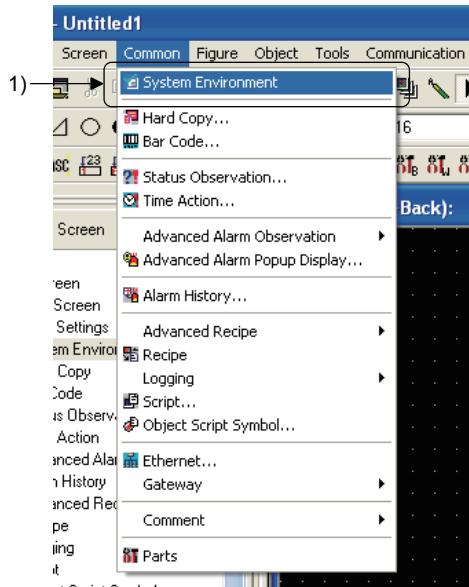

- 1) Click on the [Common] – [System Environment] menu.

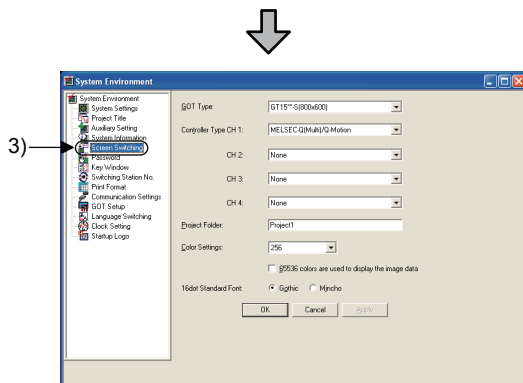

- 2) The System Environment dialog box is displayed.
- 3) Double click [Screen Switching].

(Next page)

(From the previous page)

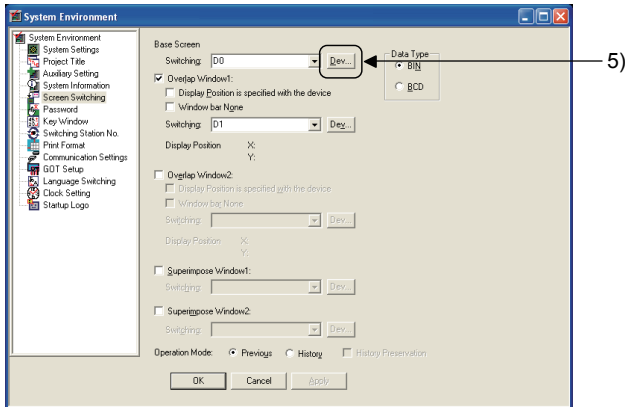

4) The screen switches.

5) Click the **Dev...** button and set the base screen switching device.

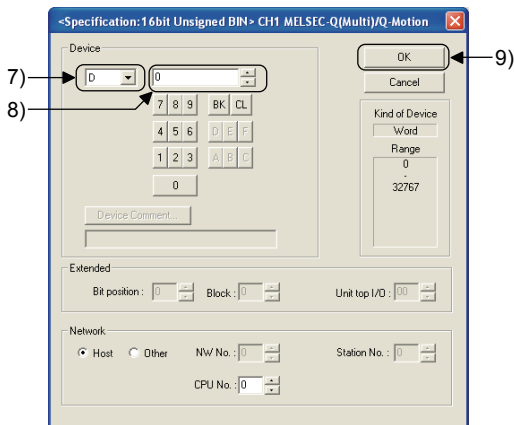

6) The device dialog box is displayed.

7) Click **D** and set to "D".

8) Click **0** and set to "0".

9) After settings are completed, click the **OK** button.

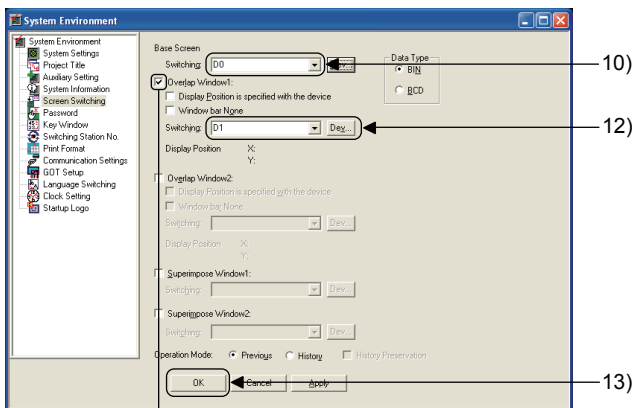

10) Check that "D0" is set in the "switching device".

11) Check "Overlap window 1" and set the Overlap 1 screen switching device.

12) Click the **Dev...** button and set the "screen switching device" to "D1".

13) Click the **OK** button.

11)

Remarks
<ul style="list-style-type: none">• Screen switching device settings <p>With the screen switching device, refer to the following to set the devices to be used.</p> <ol style="list-style-type: none">1) GOT internal device (GD) It is recommended to use this device only for switching the screen with the touch switch (screen switching switch). Screen switching cannot be controlled by the PLC CPU. With the screen switching device, the internal device (GD100) is set by default.2) PLC CPU device (D,W, etc.) It is recommended to use this device to control screen switching from the PLC CPU. <p>Screen switching can also be performed by the touch switch (screen switching switch).</p>

4.2.4 Data reading

In this section, training is performed using screen data prepared beforehand.
(Specific creation methods for screen data are explained in chapter 5.)

Remarks
The settings for the data to be read, "school.GTE", are the same as the settings described in sections 4.2.1 and 4.2.2.

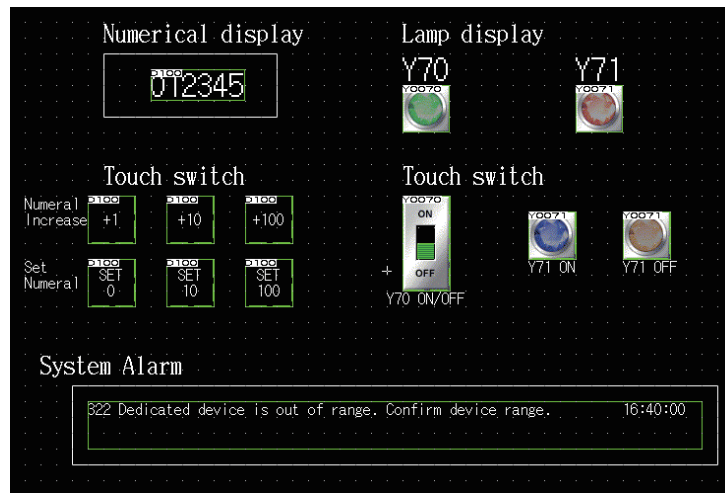

The screen (project data) is read.

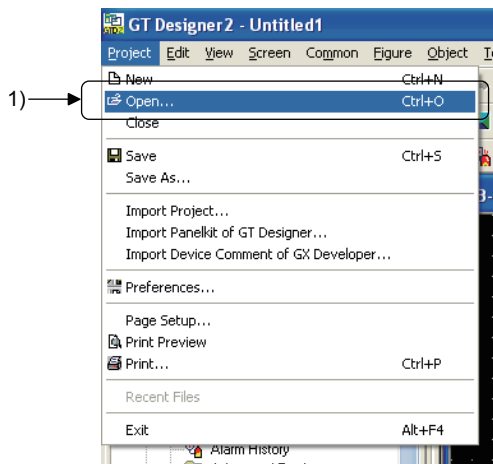

- 1) Click on the [Project] – [Open] menu.

↓
(Next page)

(From previous page)

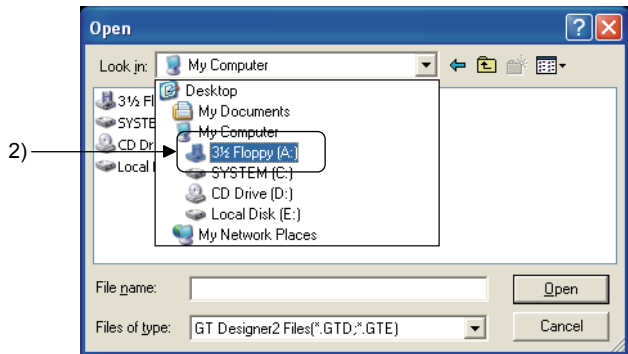

- 2) When the dialog box appears, click , and then click "3½ Floppy [A:]".

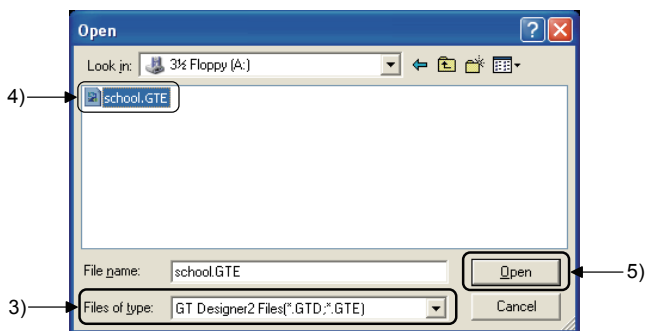

- 3) Select the file format of the screen data file to be opened. Select the "GT Designer2 Files (*.GTD, *.GTE)".
- 4) Select school.GTE
- 5) Click the **Open** button. The screen data is read.

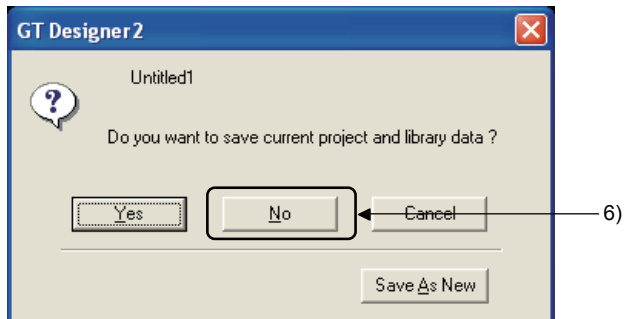

- 6) As the dialog box to confirm whether to save the project data created this time appears, click the **No** button.

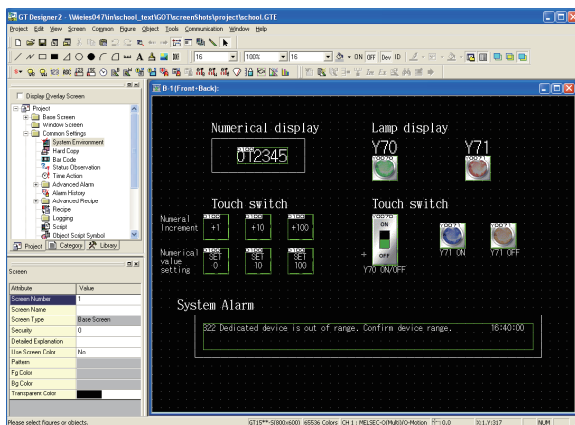

- 7) The screen is read.

4.2.5 Saving the project data

This section explains operations to save the created project data.

This section explains with an example of saving to a floppy disk (A drive).

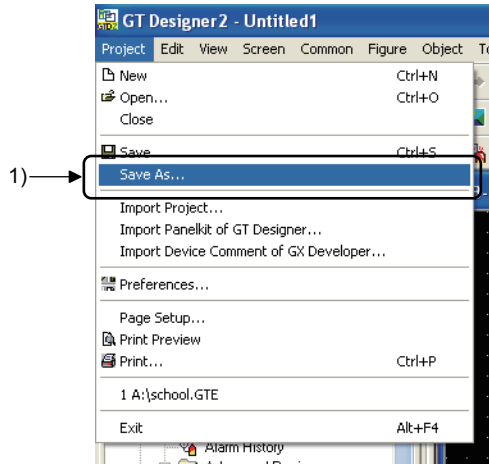

- 1) Click on the [Project] – [Save As] menu.

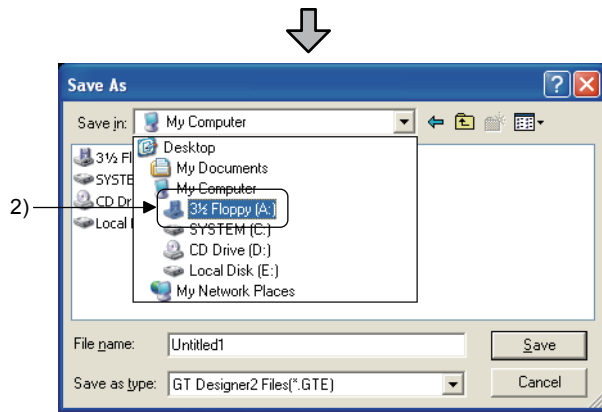

- 2) When the dialog box appears, click and then click "3½ Floppy [A:]".

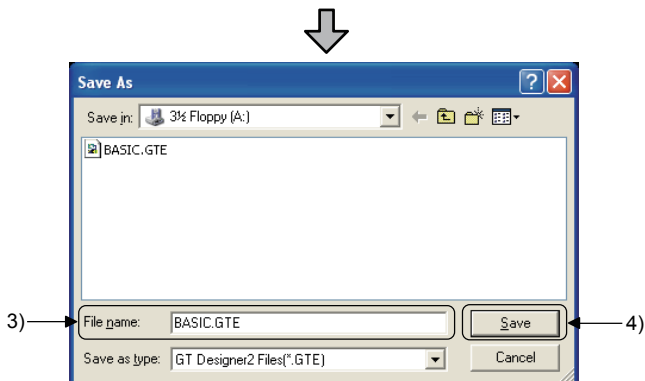

- 3) Enter the file name (project name) of the screen data file to be saved.
Enter "BASIC" here.
- 4) Click the button to save the screen data.

Point

When the project data is saved, not only the created screen, but also common settings such as connection settings, parts Information, etc., are saved in one file. If saved files are copied onto another PC, they can be used as they are. However, only the user-made library information is saved in a separate file, so when using the user-made library information, it is necessary to make a separate copy of the library data. For details on saving the library, refer to the GT Designer2 Version2 Basic Operation/Data Transfer Manual.

4.3 Data transfer (PC to GOT)

This section explains procedures for writing data created on GT Designer2 to the GOT.

4.3.1 Connection from PC to GOT

Connect the PC and GOT.

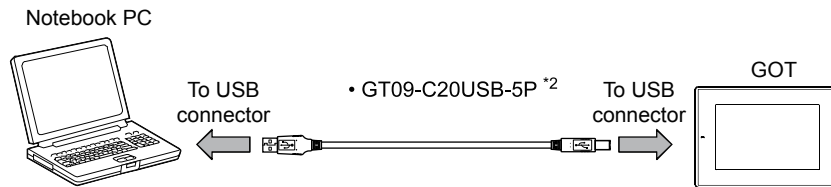

Remarks		
To connect the personal computer and GOT, RS-232 or Ethernet can be used in addition to the USB cable. Use of the USB cable enables the data to be transferred at higher speed and reduces the operation time as compared with RS-232 communication. *1		
*1 Download reference value: (GT15)		
Connection method	USB (12Mbps)	RS-232 (115Kbps)
Project Data size		
1MB	20 sec	2 min 30 sec

*2 When using the RS-232 cable, use the GT01-C30R2-9S.

This diagram is identical to the one above, showing the connection between a Notebook PC and a GOT using a GT09-C20USB-5P USB cable. The cable is labeled "To USB connector" at both ends.

4.3.2 About data types transferred to the GOT

To operate the GOT, it is necessary to transfer the following types of data to the GOT.

Data type	Outline	Data transfer timing
Boot OS	The program needed to control GOT hardware, and during communication between GOT and PCs. Boot OS is installed in the GOT at factory shipment so installation is not usually necessary.	<ul style="list-style-type: none"> When returning the settings of the GOT main unit to the factory settings (normally, installation is not required)
OS	The GOT monitoring function, OS/screen data installation, OS/screen data deletion, touch key control, system screen/guidance display function and other features for controlling the GOT are installed.	<ul style="list-style-type: none"> When using GOT for the first time When changing the functions to be used (Extended function, Option OS) and communication format After an OS upgrade
Standard monitor OS (Required)	The programs that operate the GOT, e.g. interface control, OS/screen data installation, OS/project data deletion, touch key control, and screen/guidance display functions.	
Communication driver (Required)	The PC communication driver performs communication between the GOT and the PLC CPU. Always select and install a PC communication driver that is appropriate for the connection type.	
Extended function OS	Needs to be installed when the extended function *1 is used.	
Option OS	Needs to be installed when functions *2 available by connecting an option function board (including a board with extension memory) or a multi-color display board are used.	
Project data (Required)	Data for user-made monitor screens, such as screen data, comments, common settings, etc.	<ul style="list-style-type: none"> When using GOT for the first time When changing screens and settings
Special data	Data used by the extended function (intelligent module/Q motion/servo amplifier monitor, etc.).	<ul style="list-style-type: none"> When changing the functions to be used
Resource data	All types of data created in the GOT main unit, such as recipe file, alarm log file, etc.	<ul style="list-style-type: none"> Varies depending on each GOT function

*1 Extended functions included the following.

- System monitor
- Bar code

*2 Option functions include the following.

- Advanced recipe function
- List editor function
- Gateway function
- Recipe function
- Standard font (Chinese: Simplified, traditional)
- Multi-channel function
- Logging function
- Object script
- Network monitor function
- Intelligent module monitor function
- Maintenance report function
- Kana-kanji conversion function
- Ladder monitor function
- Servo amplifier monitor function
- CNC monitor function
- Q motion monitor function

Point
<p>With GOT, data exchange between the PC and GOT is expressed in the following terms.</p> <ul style="list-style-type: none"> • Download : Writing the project data created by PC to the GOT. • Upload : Reading the GOT project data on a PC. • Install : Writing the system data required to run GOT (BootOS, OS) to GOT.

4.3.3 Communication settings

Settings for communication between the PC and the GOT are performed.

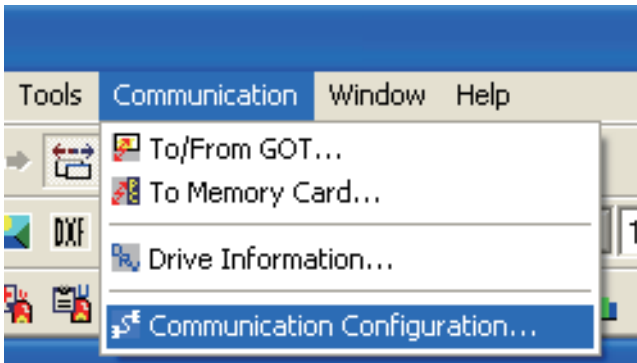

- 1) Click on the [Communication] – [Communication configuration...] menu.



Communication configuration dialog box

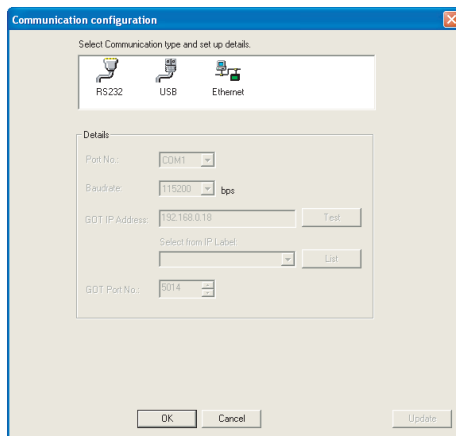

- 2) When the dialog box appears, set the communication type to "USB".
(In training, to connect the PC and GOT with the USB cable)

- 3) Click the **OK** button.

4.3.4 OS installation

This section explains operations for installing the communication driver and OS in the GOT as preparation before monitoring.
This section explains with an example.

Point

The GOT does not include the monitor OS for monitoring or the driver for communication.

Therefore, it is necessary to perform this operation only once before the first monitoring.

It is not necessary after the first time. However, when the OS is updated or the communication method is changed, this operation is required. (Installation is completed on the training machine, so overwriting is necessary.)

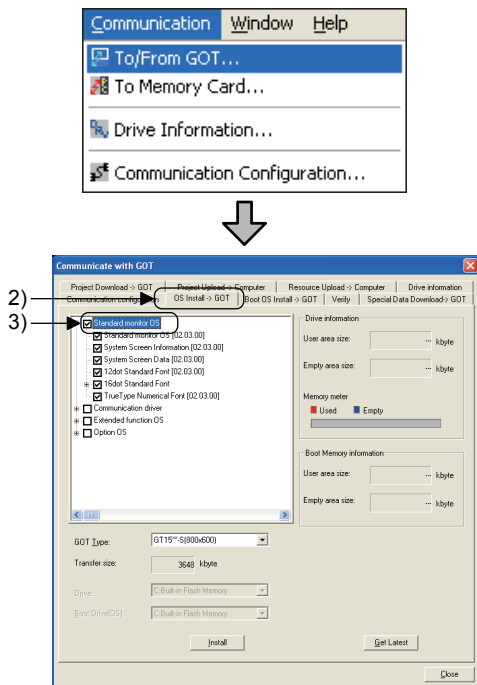

1) Click on the [Communication] – [To/From GOT] menu.

2) When the dialog box appears, click the [OS installation → GOT] tab.

3) Select the standard monitor OS.
The standard monitor OS is a program that performs monitor function control.

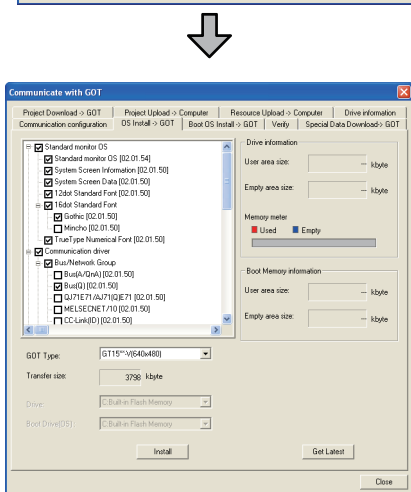

4) Select the communication driver.
The communication driver performs communication between the GOT and the PLC CPU.
Select the communication driver corresponding to the connection type.

Check the "Q BUS" in the "BUS/network Group" of the "communication driver".

5) Click the **Install** button.

↓
(Next page)

(From previous page)

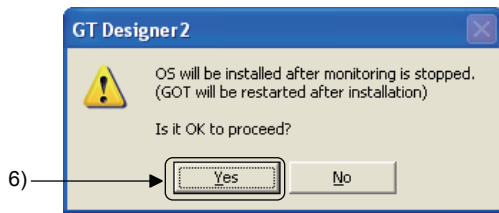

6) When the **Yes** button is clicked, OS installation is executed.

7) After OS installation is completed, click the **Close** button to close the dialog box.

Point
(1) Installing the OS If the Standard monitor OS is not installed in the GOT (Boot OS is installed at time of shipment), install the Communication drivers, Extended functions OS, and Option OS after installing the Standard monitor OS.
(2) Downloading Project data and Special data When the OS (Standard monitor OS, Communication driver, Extended function OS, Option OS) used by GT Designer2 to which Project data and Special data is downloaded is newer than the OS installed in the GOT, new functions may be unavailable. Reinstalling the OS is recommended when downloading Project data and Special data to the GOT main unit.
(3) Installing the OS The version numbers (both the major and minor version) of each OS (Standard monitor OS, Communication driver, Extended function OS, Option OS) must be the same. If their version numbers are different, the GOT will not operate.
(Example1) Standard monitor OS : [01.00.00] Communication driver : [01.00.00] Extended function OS : [01.00.00] Option OS : [01.00.00] GOT is operated.
(Example2) Standard monitor OS : [01.00.00] Communication driver : [02.00.00] Extended function OS : [01.00.00] Option OS : [01.00.00] GOT is not operated.

4.3.5 Screen data download

This section explains operations for downloading the created screen data to the GOT.

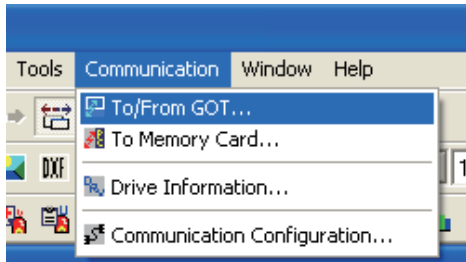

- 1) Click on the [Communication] – [To/From GOT] menu.

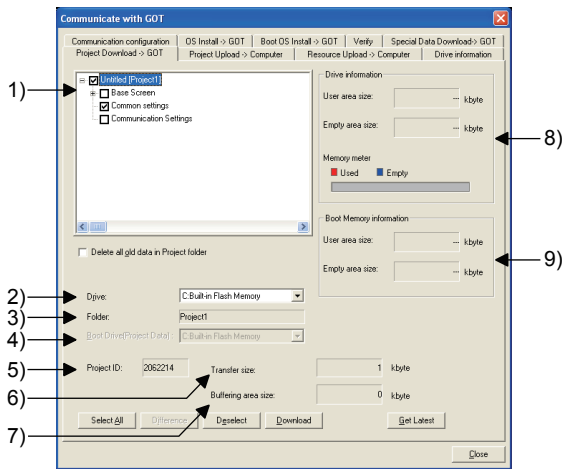

- 2) The dialog box appears and the project configuration is displayed as a tree.

- 1) Project Download -> GOT:
The project configuration is displayed as a tree. Check the item to be downloaded.
- 2) Drive name:
Select the download destination of the project data.
(A drive: Standard CF Card (only with GOT mounted), C drive: Built-in Flash Memory)

- 3) Folder name:
Displays the storage destination folder of the project data. Set the folder name in "System Settings" of the "System Environment" window.

- 4) Boot drive (Project Data):
Displays the drive in which the project data will be started. (Displays the drive name set as Drive.)

- 5) Project ID:
Project data ID number is displayed. With the project ID, downloaded project data is saved so that it is not mixed with any other data.

- 6) Transfer size:
The size of the data to be downloaded on the GOT is displayed.

- 7) Buffering area size:
Displays the total buffering area size capacity to be used by such as advanced alarms.

- 8) Drive information:
Displays the user area size, empty area size, and memory meter of the selected drive.

- 9) Boot memory information:
Displays the user area size and empty area size.



(Next page)

(From previous page)

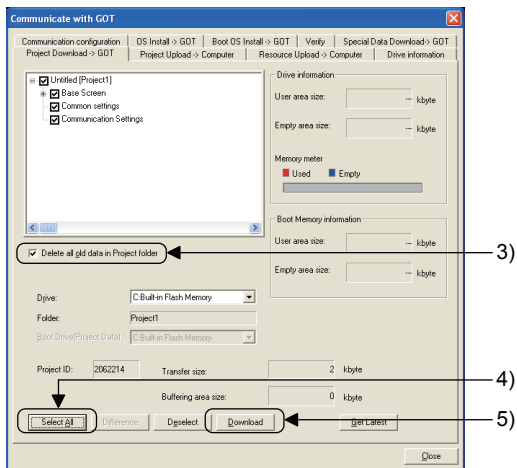

- 3) Check "Delete all old data in Project folder". When there is already screen data downloaded on the GOT, do not download the screen data described in this section.
- 4) Select the data to be downloaded on the GOT. Click the **Select All** button to download all the data.
- 5) Click the **Download** button.

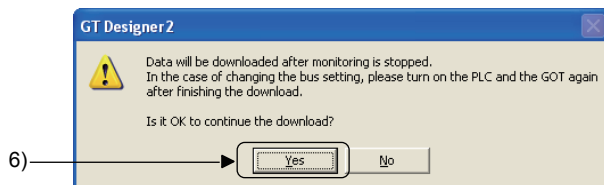

- 6) When the **Yes** button is clicked, screen data is downloaded.

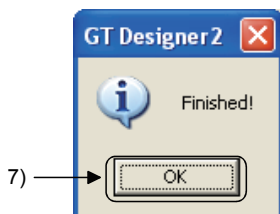

- 7) When download is completed and a completion message appears, click the **OK** button. The GOT automatically restarts when download is completed.

4.4 Connection to PLC CPU (bus connection)

4.4.1 Bus connection unit mounting

For bus communication, a bus connection unit must be mounted to the GOT.

This section explains the installation procedures for the bus communication unit onto the GOT.

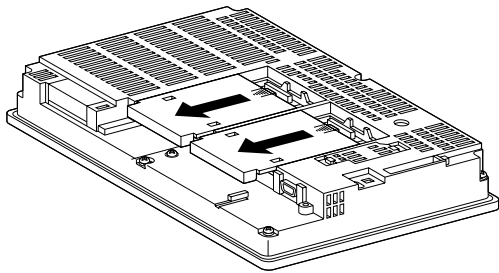

- 1) Power OFF the GOT.
- 2) Remove the expansion unit covers (I/F-1 side and I/F-2 side) of the GOT rear face.

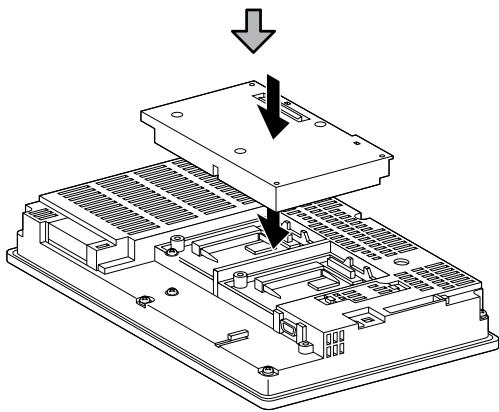

- 3) Install the communication unit in the expansion unit interface of the GOT rear face. (When the expansion unit is installed to GOT, remove the installed extension unit. Do not touch the board of the GOT when installing the communication unit.)

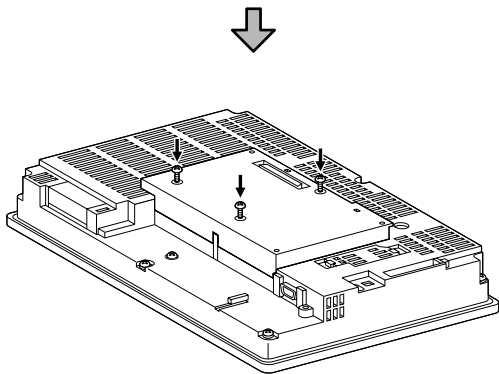

- 4) After the installation, tighten the mounting screws (4 places) in the specified torque range (0.36 to 0.48N·m).

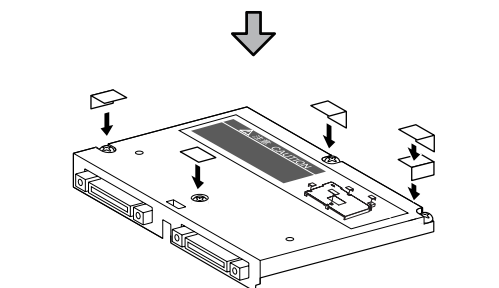

- 5) After installing the mounting screw, apply the supplied seal in order to avoid receiving static electricity.

4.4.2 Connecting the cable

This section explains connection procedures for connecting the GOT and PLC CPU with the bus connection cable.

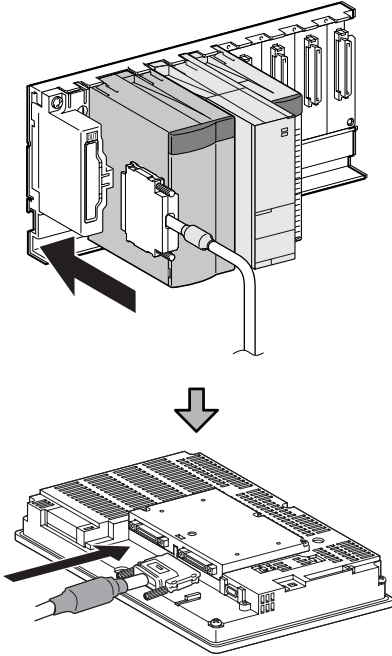

- 1) Power OFF the PLC CPU and GOT.
- 2) Connect the bus connection cable to the PLC module.
- 3) Connect the bus connection cable to the bus connector (IN side) on the bus connection unit mounted on the GOT.

4.5 Checking that GOT is communicating normally with the PLC

4.5.1 Checking the OS

With the GT Designer2, check that the OS is properly installed on the GOT.

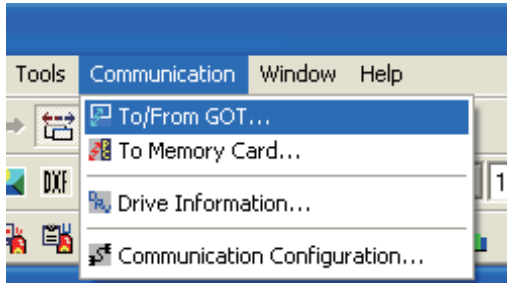

- 1) Click on the [Communication] – [To/From GOT] menu.

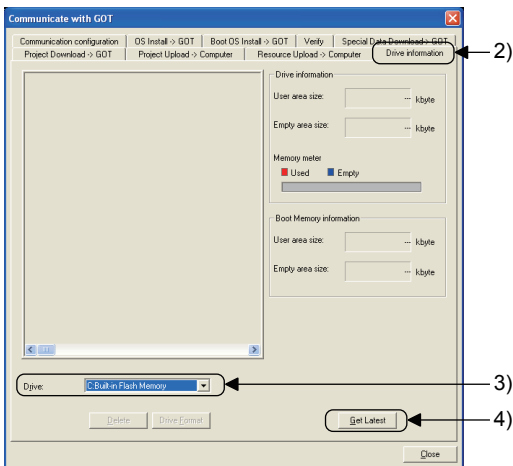

- 2) When the Communicate with GOT dialog box appears, click the [Drive Information] tab.
- 3) Select C: Built-in Flash Memory
- 4) Click the [Get Latest] button.

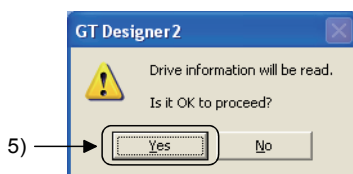

- 5) When the confirmation dialog box appears, click the [Yes] button.

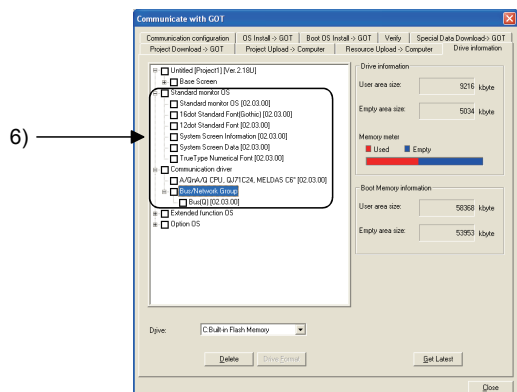

- 6) The dialog box appears and a list of the items installed on the drive is displayed as a tree.

When the following is confirmed, the OS is properly installed on the GOT.

- Standard monitor OS
- Communication driver: Bus connection Group

4.5.2 Checking that the GOT recognizes the connected equipment

Check, that the GOT recognizes the connected equipment with the GOT utility.
To avoid problems, always perform checks.

- 1) Power ON the GOT.
- 2) When the screen downloaded in section 4.3.3 appears, touch the screen as shown on the left.

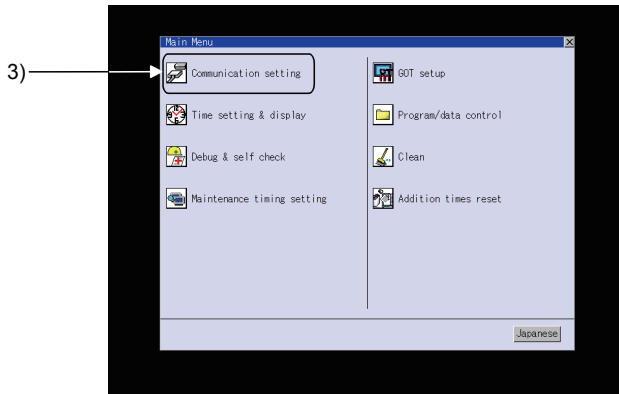
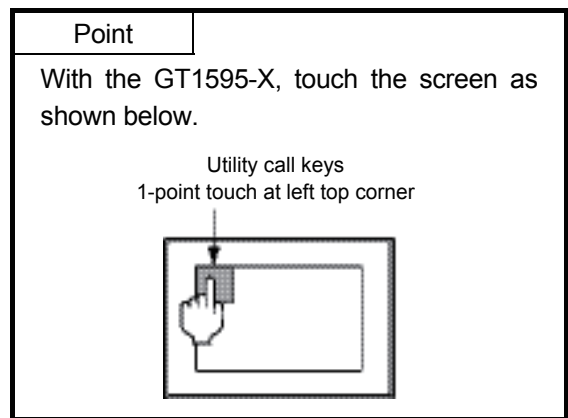
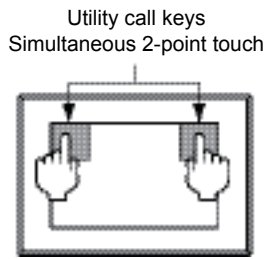

- 3) When the utility is displayed, touch "Main Menu" → "Communication Settings".

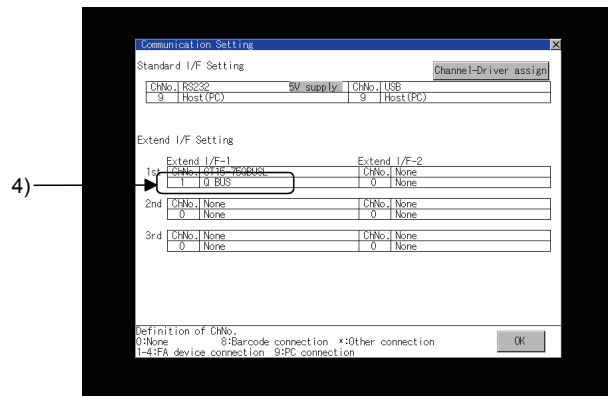

- 4) When "Communication Setting" is displayed, check that "ChNo1" in Extend I/F Setting is set to [Q BUS].

Point

When the target communication driver is not set, perform one of the following operations.

(1) Change the communication driver settings

- 1) Touch the Channel - Driver assign button in the "Communication Settings" screen.
- 2) In the "Channel - Driver assign" screen, touch the Change assignment button.
- 3) When the communication driver installed in the GOT is displayed, touch the target communication driver and touch the OK button.

The GOT automatically restarts after this setting is executed.

If project data has been downloaded, the GOT starts monitoring of the controller after restarting.

Execute this setting after carefully confirming the safety.

(2) Reinstall with the GT Designer2

With the above operation (1), when the target communication driver is not installed, install it from the GT Designer2.

4.5.3 System alarm

The system alarm is a function used to display error codes and error messages when error occurs in the PLC, GOT, servo amplifier, communication system, etc.

Error messages displayed in the system alarm do not need to be registered. (They are registered in GOT.)

If the system alarm is set in the screen beforehand, displaying system alarm allows a user to check how the error occurred and its cause.

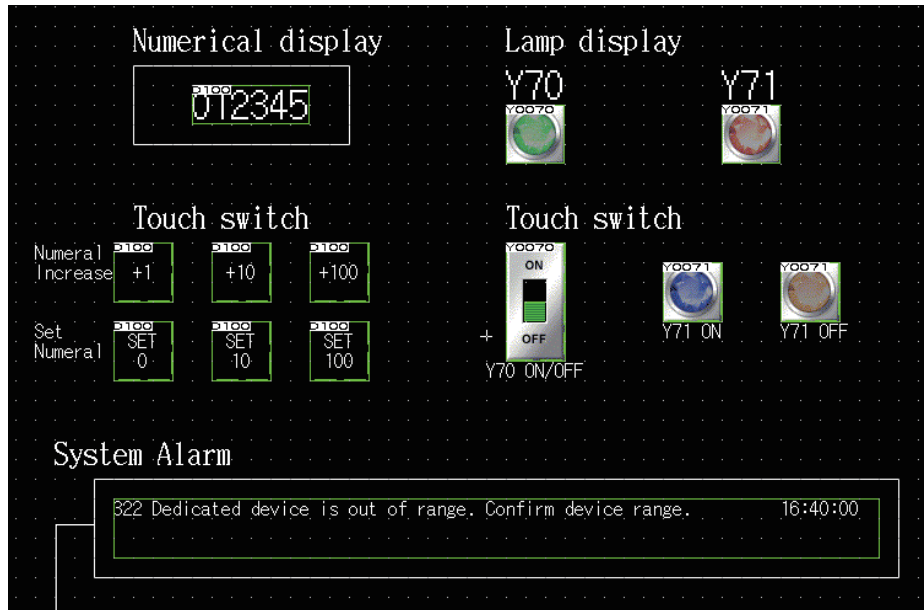

System Alarm display area

- Under normal conditions

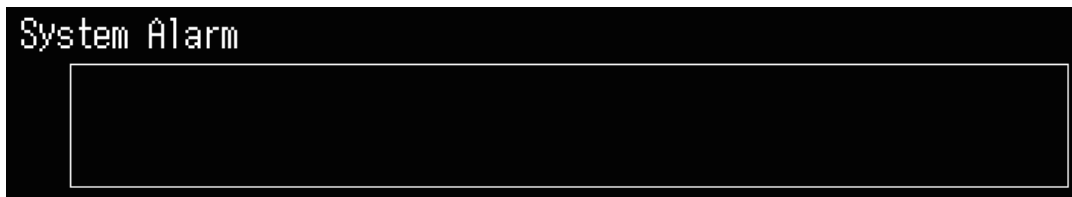

When nothing appears in the System Alarm, communication is normal.

- When an error occurs



When an error message appears in the System Alarm, check whether there is a cable disconnection, check the mounting condition of the communication unit, and check the condition of the PLC.

4.6 Executing the monitor

Operate the screen downloaded to the GOT, and monitor the PLC.

GOT Operation Image

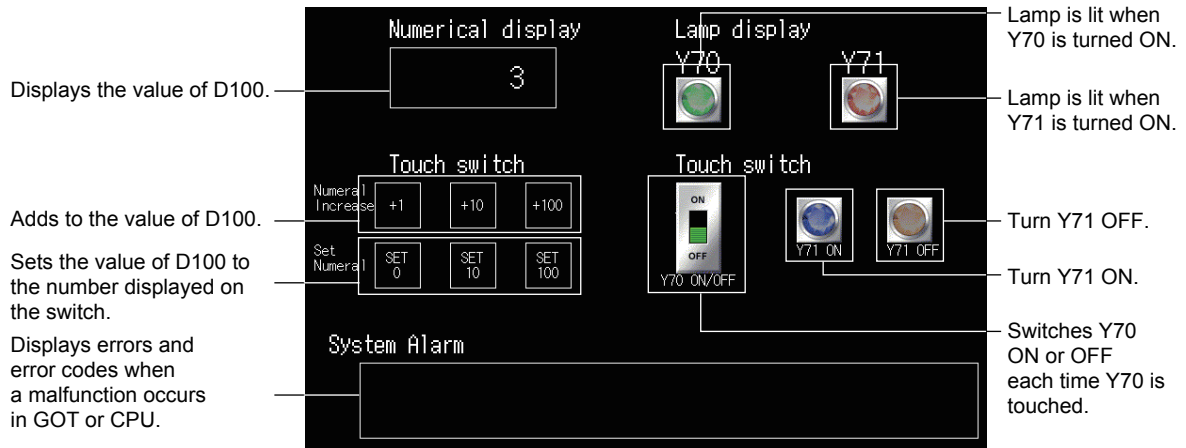

(1) Monitoring/changing the bit device (X0, X1) values

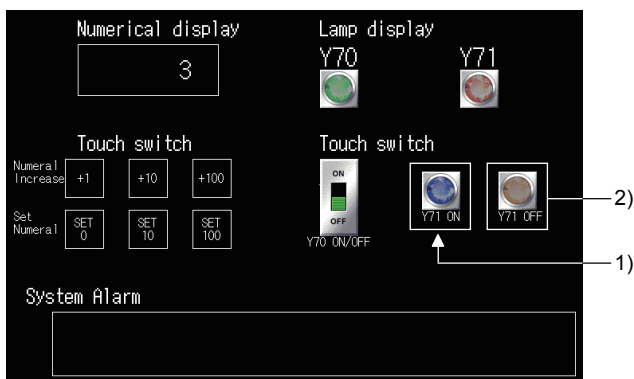

- 1) When the Y71 ON switch is touched, the Y71 comes ON.
- 2) When the Y71 OFF switch is touched, the Y71 goes OFF.

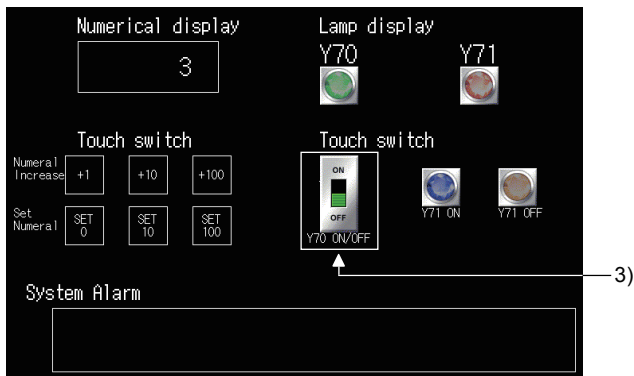

- 3) Each time the Y70 ON/OFF switch is touched, the Y70 goes ON/OFF.

(2) Monitoring/changing the word device (D100) values

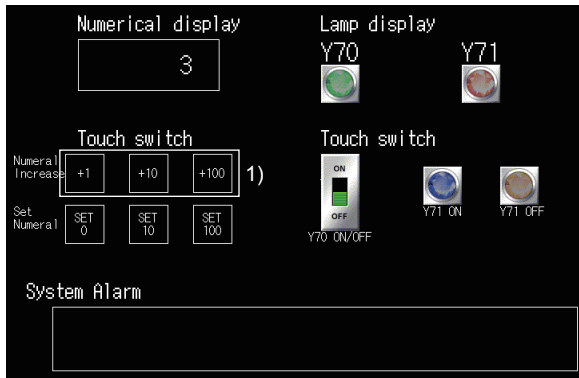

- 1) Each time the Numeral Increase switch is touched, the D100 value increases.

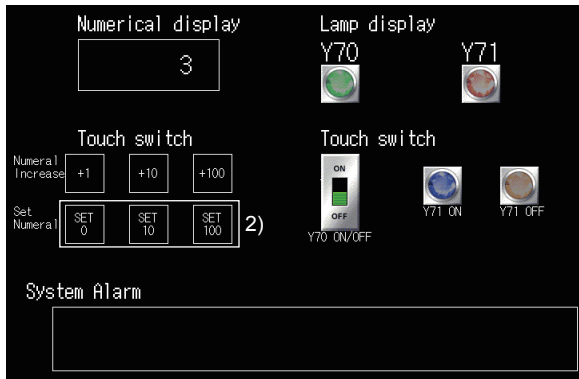

- 2) When the Set Numeral switch is touched, the D100 value is set.

(3) Displaying the error message

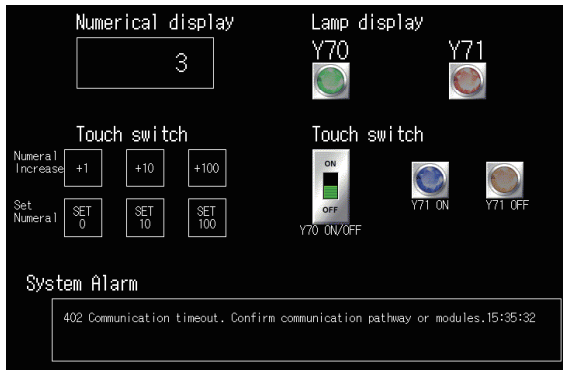

- 1) Power OFF the training machine and power OFF the PLC.
- 2) The error message appears in the system alarm.

Notes

Chapter 5 Drawing Fundamentals

This Chapter 5 explains how to create screens on the GOT.
The screen data created in this chapter works with the sequence program described in section 5.11.

[Screens to be created]

Screens to be created in this chapter and a summary of screen switching are as follows:

"↔" refers to the screen switching (page switching) operation.

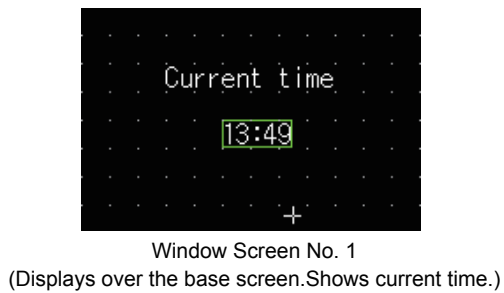
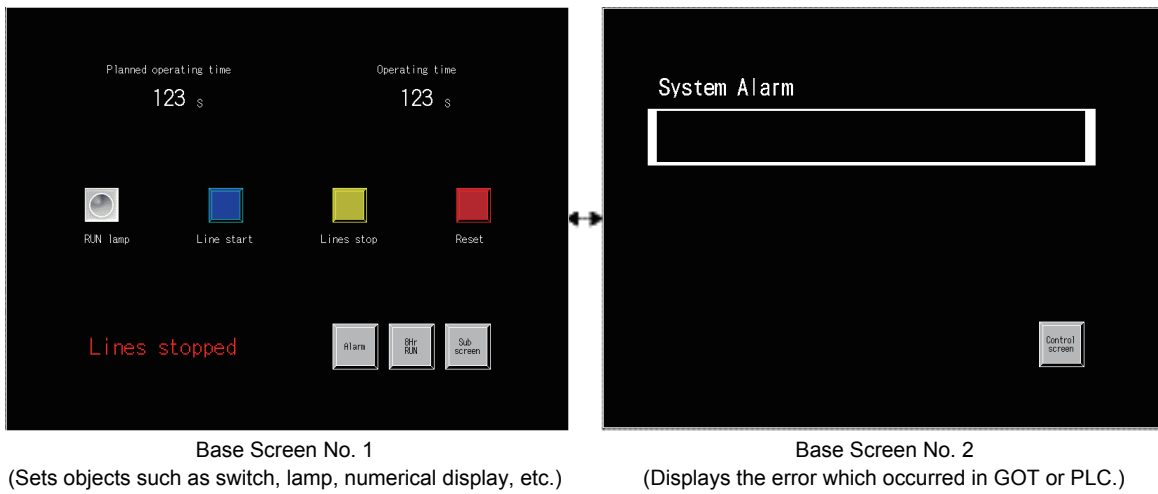

5.1 Before creating the screen

5.1.1 Operations before creating the screen

Set the project using the New Project Wizard in the following manner:

(1) System Settings for GOT

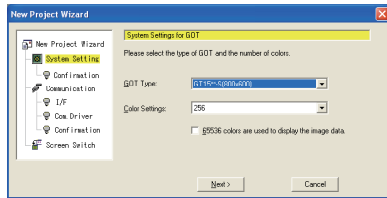

GOT Type: GT15**-S (800 x 600)
Color Settings: 256 colors

(2) Confirmation

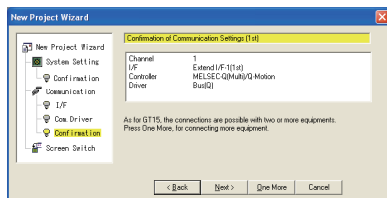

Controller: MELSEC-Q (multiple) / Q motion
I/F: Extended I/F (first stage)
Communication driver: Bus connection/Q

(3) Setting of screen Switch Device

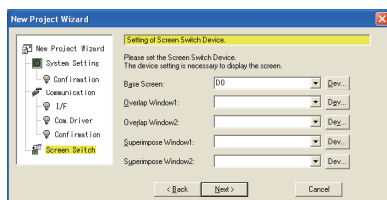

Base screen: D0

(4) Screen property

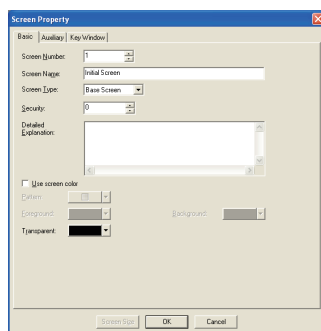

Enter "Initial Screen".

(5) Saving project data Save the project data.

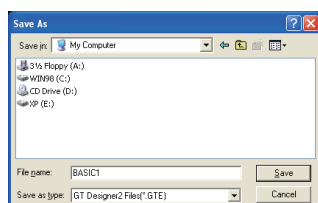





















Select the [Project] - [Save As] menu to save the project named "BASIC1".

5.1.2 Figure drawing

This section describes how to draw figures and how to edit the figures arranged on the screen.

(1) Types of drawable figures

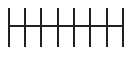
The following figures can be drawn on GT Designer2:

Shape	Drawing example	Operation Procedures
Line		<ul style="list-style-type: none"> •  (Line) • [Figure] - [Line] menu
Line free form		<ul style="list-style-type: none"> •  (Line FreeForm) • [Figure] - [Line FreeForm] menu
Rectangle	 	<ul style="list-style-type: none"> •  (Rectangle) • [Figure] - [Rectangle] menu •  (Rectangle (Filled)) • [Figure] - [Rectangle (Filled)] menu
Polygon		<ul style="list-style-type: none"> •  (Polygon) • [Figure] - [Polygon] menu
Circle (including ellipse)	 	<ul style="list-style-type: none"> •  (Circle) • [Figure] - [Circle] menu •  (Circle (Filled)) • [Figure] - [Circle (Filled)] menu
Arc (including elliptic arc)		<ul style="list-style-type: none"> •  (Arc) • [Figure] - [Arc] menu
Sector		<ul style="list-style-type: none"> •  (Sector) • [Figure] - [Sector] menu
Scale		<ul style="list-style-type: none"> •  (Scale) • [Figure] - [Scale] menu

(2) Drawing line, rectangle, and circle

This section describes how to draw a line using an example.

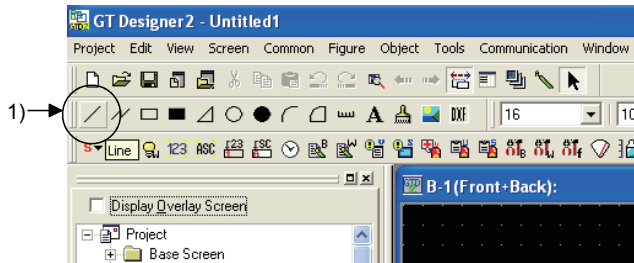

- 1) Click  on the toolbar (Figure).

Drawing rectangle: Click .

Drawing circle: Click .

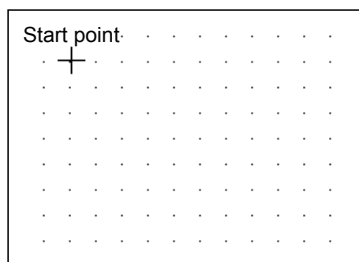

- 2) Click the left mouse button at the starting point for drawing a line.

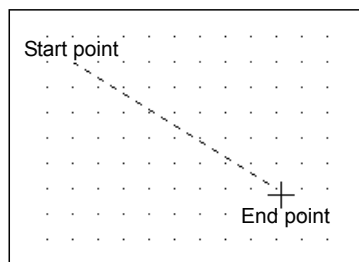

- 3) Drag and move the cursor to the end point.

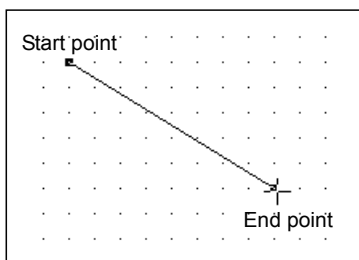



- 4) Release the left mouse button to draw a line.

(3) Drawing polygon and line free form

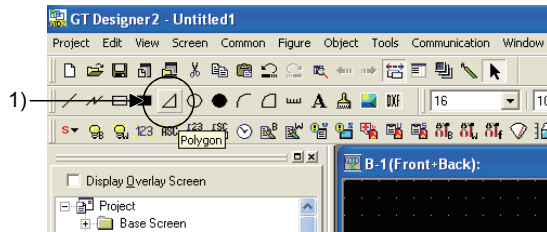
This section describes how to draw a polygon using an example.



1) Click  on the toolbar (Figure).

Drawing line free form: Click .

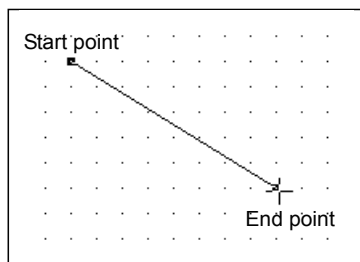

2) Click the left mouse button at the starting point for drawing a polygon.

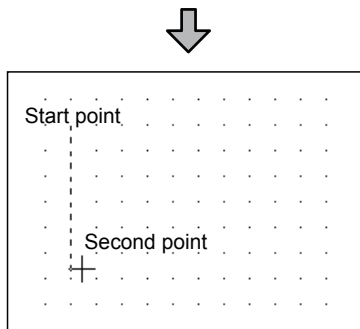

3) Drag and move the cursor to the second vertex.

4) Release the left mouse button to determine the second point.

(Next page)

(From previous page)

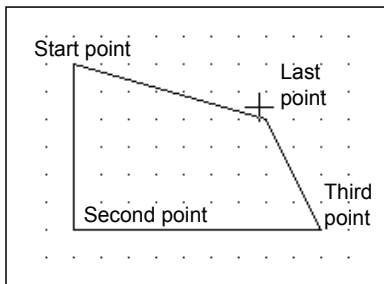
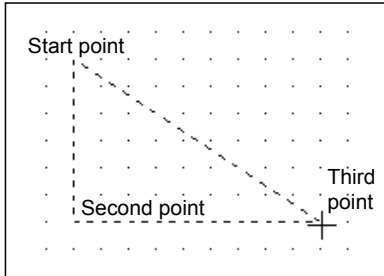



5) Click the left mouse button at the third vertex. Repeat this procedure to increase the number of vertices.

6) Double-click at the last vertex to form a polygon.

(4) Drawing arc and sector

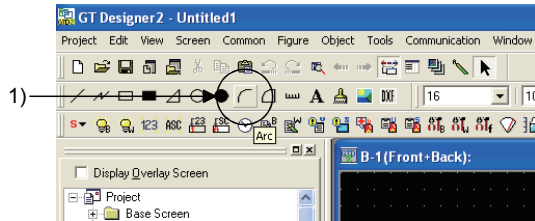
This section describes how to draw an arc using an example.



1) Click  on the toolbar (Figure).

Drawing sector: Click .

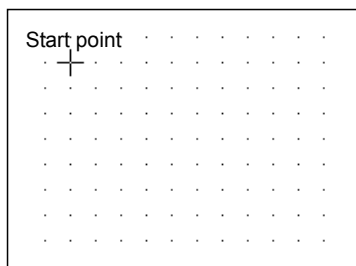

2) Click the left mouse button at the starting point for drawing an arc.

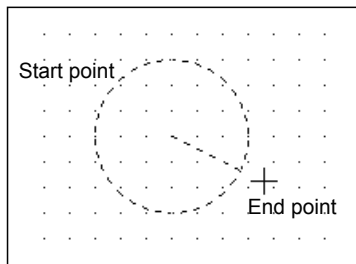

3) Drag and move the cursor to the end point.

4) Release the left mouse button. A line from the center of the circle is drawn.



(Next page)

(From previous page)

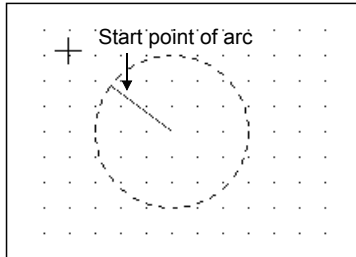

5) Drag and move the cursor to define the starting point of arc.

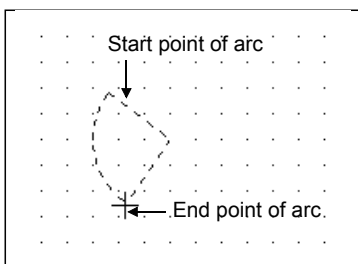

6) Click the mouse to determine the starting point of arc.

7) Drag and move the cursor to define the end point of arc.

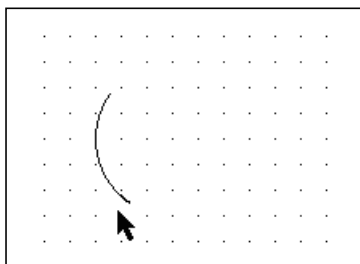

8) Click to form an arc.

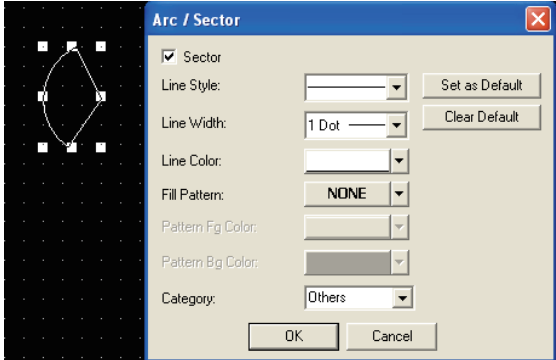
Remarks
<p>Drawing sector</p> <p>Double-click the drawn arc and check [Sector] in the Arc/Sector dialog box to draw a sector.</p> 

(5) Text settings

This section describes how to set a text (input a text).

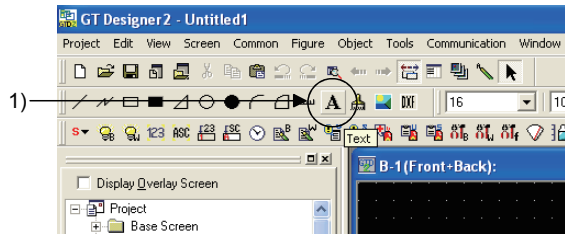

- 1) Click **A** on the toolbar (Figure).

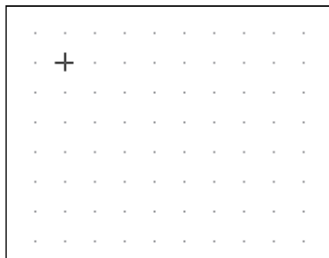

- 2) Click the left mouse button at the starting point for placing a text.

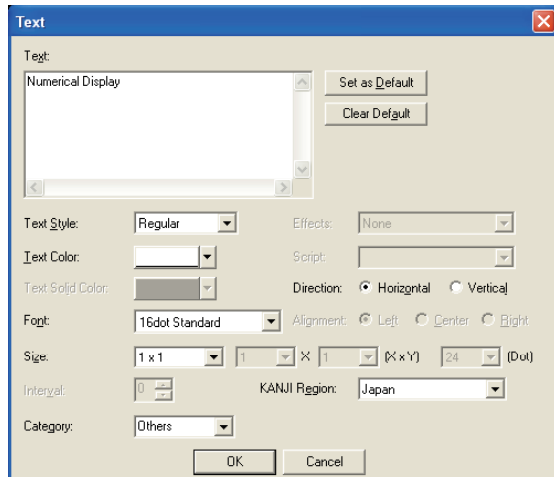

- 3) The dialog box is displayed.
- 4) Start the font - end processor (FEP) used to enter Japanese characters.



(Next page)

(From previous page)

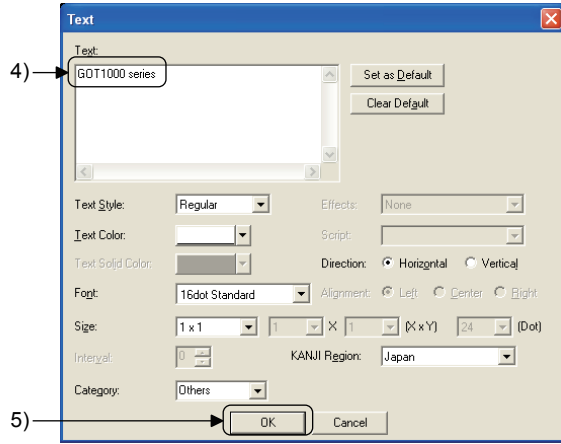

- 5) Enter a character string. Enter "GOT1000 series" here.
- 6) After entering the character string, click the **OK** button.

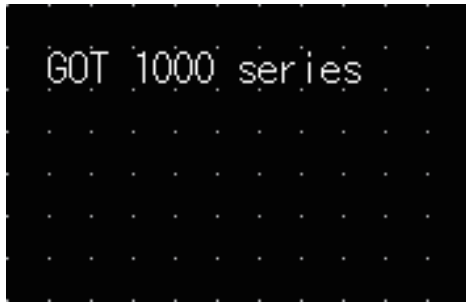

- 7) The character string is displayed.

(6) Selecting data for editing

This section describes how to select the desired figure/object for editing.

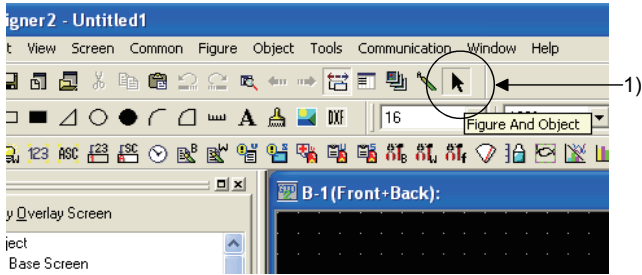

1) Click  on the toolbar (Main).

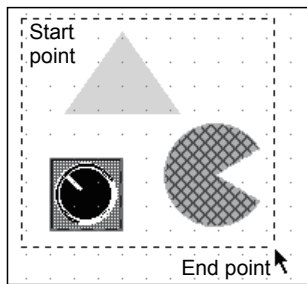

2) To select data, first click the left mouse button at the starting point to drag and move the cursor to the end point, and then release the left mouse button to include all the data necessary.

(7) Changing attribute

Change the attribute of the created figure on the property sheet.

This section describes how to change the color for a circle using an example.

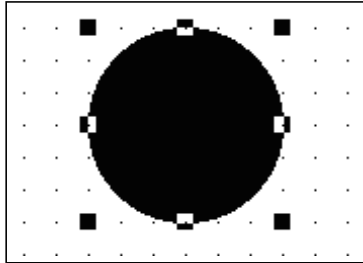

3) →

Circle	
Attribute	Value
X-Position	144
Y-Position	144
Line Style	
Line Width	1 Dot
Line Color	
Fill Pattern	
Pattern Fg Color	Black
Pattern Bg Color	Black
Category	Others

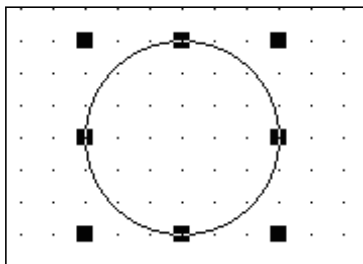

1) Select the figure.

2) Change the attribute on the property sheet.

3) Change the pattern figure color of a circle from black to white.

4) The changes made are reflected on the figure.

To change attributes other than the pattern figure color, use the following items of the property sheet.

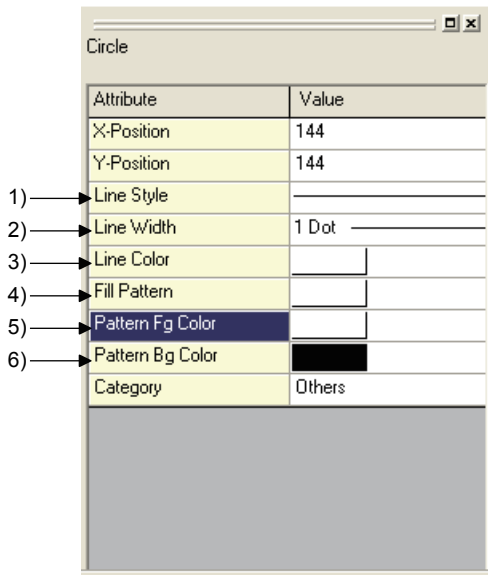

- 1) Line Style
Select a line style of the figure.
- 2) Line Width
Select a line width.
- 3) Line Color
Select a line color.
- 4) Fill Pattern
Select a filling pattern for the figure.
- 5) Pattern Fg color
Select a fill color of the figure.
- 6) Pattern Bg Color
Select a background color for the figure.
- 7) Text Color (only when text is selected)
Select a text color.
- 8) Text Style (only when text is selected)
Select a text style.
- 9) Text Solid Color (only when text is selected)
Select a text solid color.

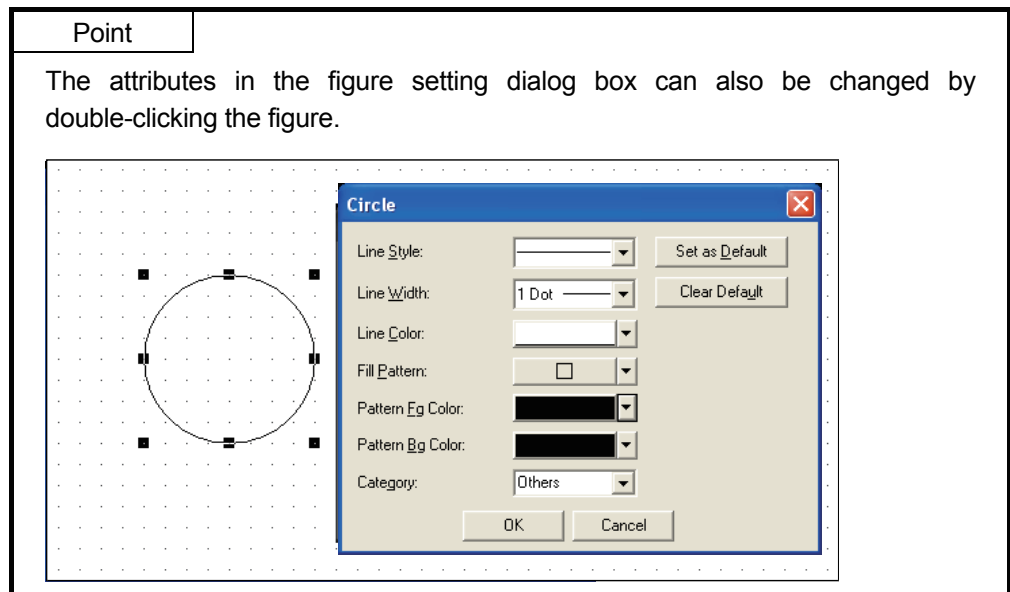

(8) Size change

This section describes how to expand/reduce the size of figure/object.

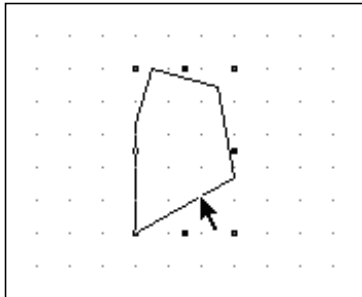

- 1) Select a figure/object of which the size needs to be changed.

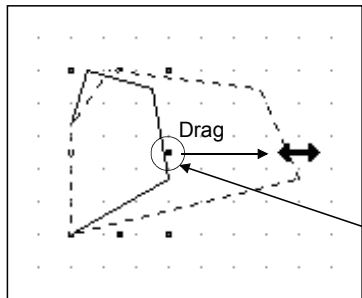

- 2) Click the left mouse button on the handle (■) on the direction to which the figure is expanded/reduced, and then drag the cursor.

This is the handle.

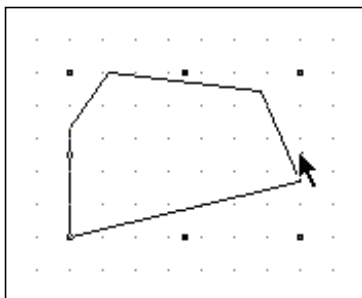

- 3) Release the left mouse button to complete the size change of figure.

Point
Size changes as follows are possible using Shift key or Ctrl key.
<ul style="list-style-type: none">• Shift key : Proportional transformation• Ctrl key : Concentric transformation

(9) Moving selected data

This section describes how to move the figure/object.

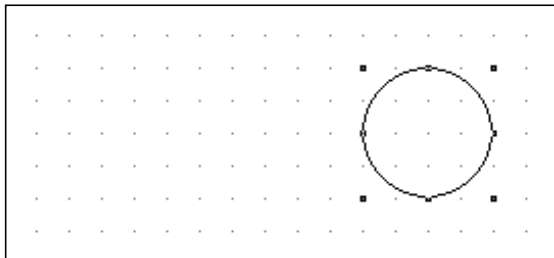
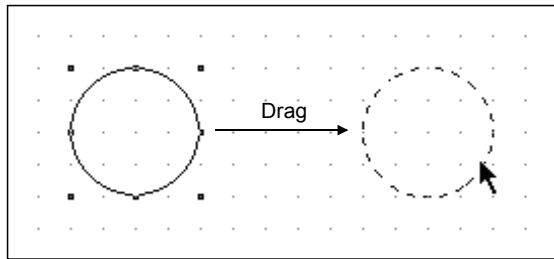
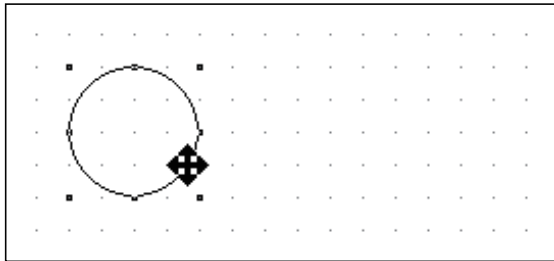
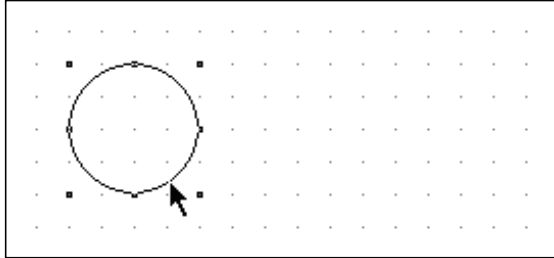

1) Select the figure/object to be moved.

2) Move the cursor to the figure/object to be moved to change the cursor shape into .

3) Click the left mouse button and drag the figure/object to the desired position.

4) Release the left mouse button to determine the position for displaying the figure/object.

(10) Cutting/copying and pasting selected data

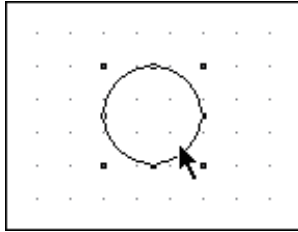

This section describes how to cut, copy, and paste the figure/object.

(a) Cut and paste

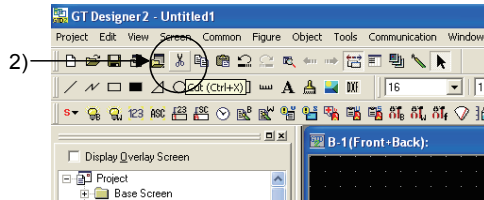

1) Select the desired figure/object.



2) For cutting, click  on the toolbar (Main)
(for copying, click ).

Point

- Similar operations can also be performed by using the following keys cut/copy can also be performed by using the following keys.
For cutting: **Ctrl** key + **X** key
For copying: **Ctrl** key + **C** key
- Figure/object can be deleted by using **Delete** key. The deleted figure/object cannot be "pasted", but can be "undone".

(b) Pasting

This section describes how to paste the cut or copied figure/object using an example.

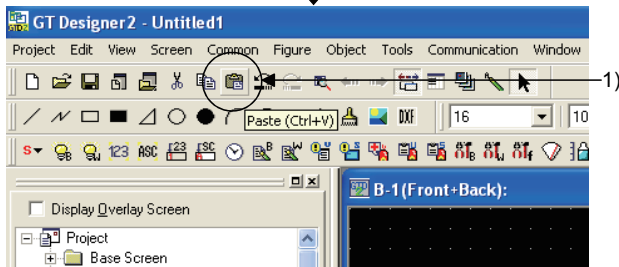

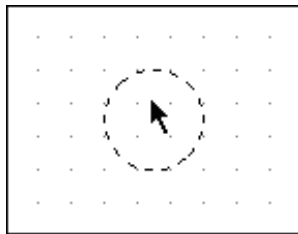

- 1) Click  on the toolbar (Main).

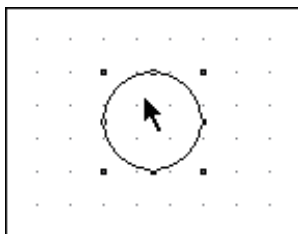

- 2) As a frame for display range appears, move it to the desired position.



- 3) Click the mouse button to paste the cut figure/object.

Point
• Pasting can also be performed by using  +  keys.

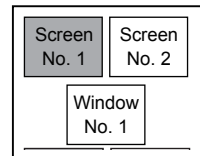

5.2 Text settings

This section describes how to create actual screens.

The following characters will be placed on Base Screen No.1.

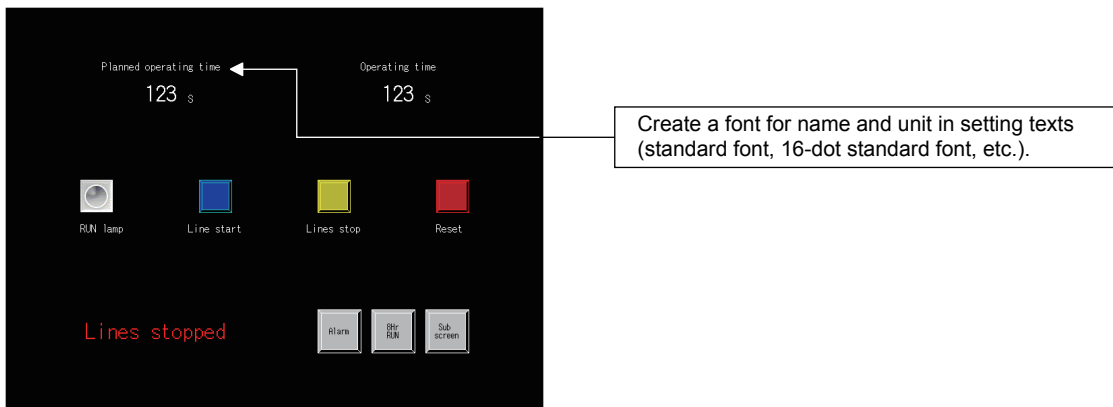

- (1) Click  on the toolbar (Figure), and then click any place on the drawing screen.
- (2) The Text dialog box appears.
Enter "Planned operating time on the Text dialog box".

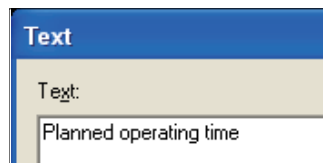

Point	<ul style="list-style-type: none"> • Texts can be entered with up to 512 characters. A text can be entered on multiple lines. • To start a new line (line feed), press the  key at the end of the current line.
-------	--

(3) Set the attributes for the entered characters.

In [Text Style], the text display format can be selected.

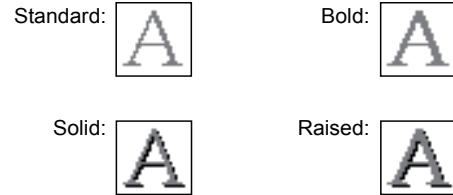
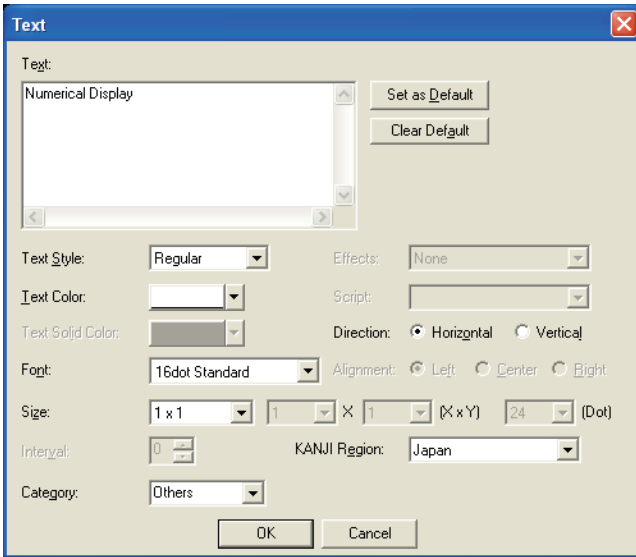

In [Font], one of the followings can be selected:

Font type/Image	Font type/Image
6 x 8 dots (Gothic)	6x8dot
Standard font	12dot Standard(Gothic)
	16dot Standard(Mincho/Gothic)
	16dot Standard(Mincho)
	12dot HQ Mincho
HQ font (Size 2 x 2 or more)	12dot HQ Gothic
	16dot HQ Mincho
	16dot HQ Gothic
TrueType font (Font size, dot specification)	TrueType Mincho
	TrueType Gothic
Windows® font (Font type specification, Font size, Font size, dot specification)	TrueType font and OpenType font displayable on the personal computer (other than vertical font)
	Windows font

(4) Click the **OK** button.
 "Planned operating time" is displayed on the screen.



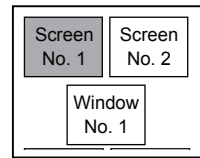

5.3 Numerical input/numerical display settings

This function is used to display or write the data stored in the devices of the controller.

In this section, create a numerical display showing the operating time, and a numerical input for entering the planned operating time.

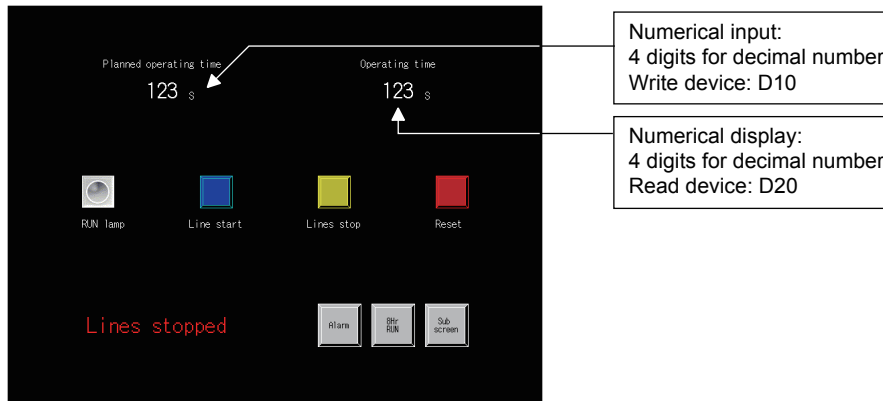

5.3.1 Numerical input settings

Making the settings of numerical input (D10)

- (1) Click  on the toolbar (Object), and then click any place on the drawing screen.

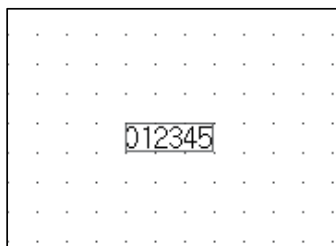

- 1) Move the cursor on to the screen, determine the position for display, and then click the mouse button.
- 2) Click the right mouse button to cancel the placement mode (+) of the cursor.

Remarks

(1) Placement of object

The cursor changes to the placement mode (+) when the menu/icon for setting an object is selected.

By clicking the mouse on the drawing screen on object is placed. To place the same type of object in a row, repeat clicking the mouse. The placement mode can be cancelled by using the right click, or [ESC] key.

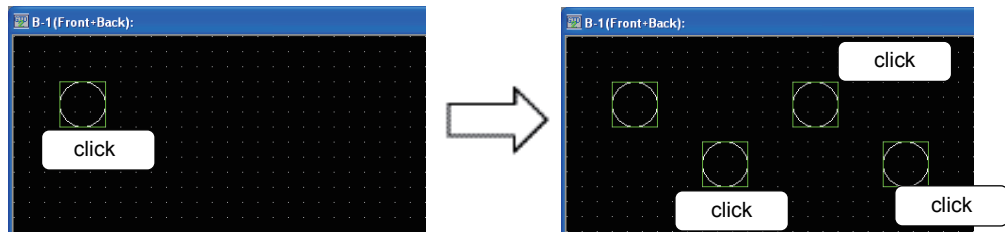

(2) Object size change

This section describes how to change the size of arranged object.

- 1) Select the object to be changed in size.
- 2) Position the cursor on the sizing handle, click and drag it to change the object size.

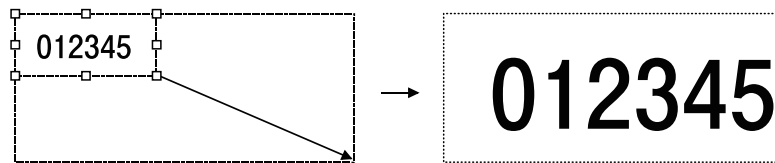

(2) Making basic settings

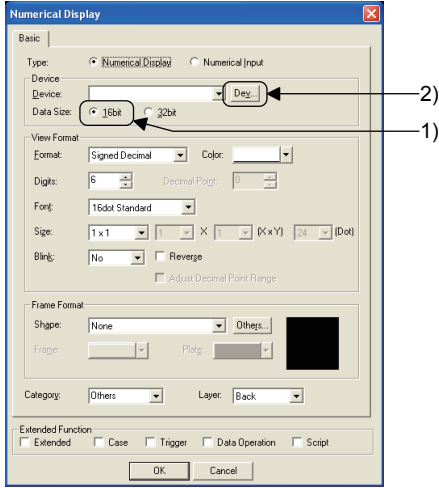

- 1) Select "16-bit" for [Data Size].
- 2) Click the **Dev...** button.

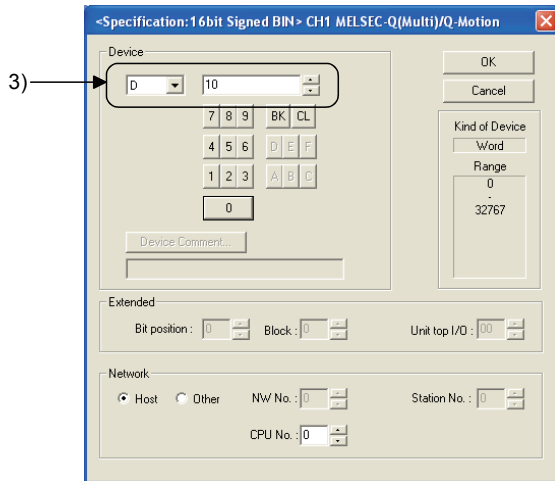

- 3) Set "D10" for [Device].
- 4) After setting is completed, click the **OK** button.

(3) Setting the display format (to handle decimal number in a range of 0 - 9999)

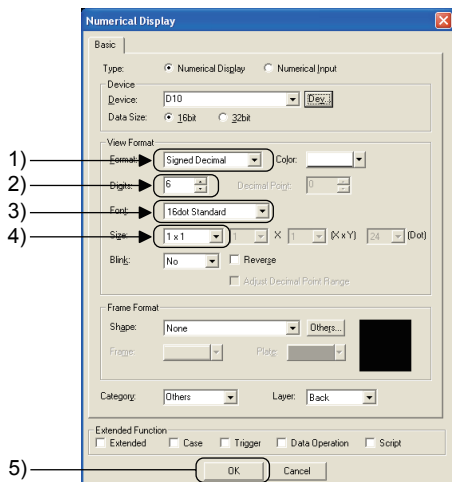

- 1) Set [Format] to "Signed Decimal".
- 2) Set [Digits] to "6".
- 3) Set [Font] to "16dot Standard".
- 4) Set [Size] to "1 × 1".
- 5) Click the **OK** button.

(4) Making settings on the screen

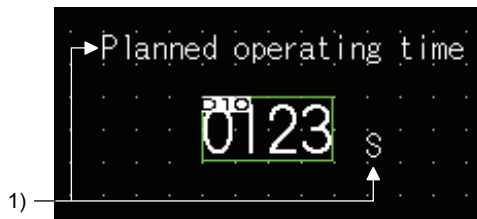

- 1) On the figure drawing screen, create characters for title and unit.

This completes the settings of the numerical input.

5.3.2 Numerical display settings

Making the settings of numerical display (D20)

- (1) Click  on the toolbar (Object), and then click any place in the drawing screen.
- (2) Double-click the numerical display, and make the settings as follows: (the same procedures as those described in section 5.3.1)

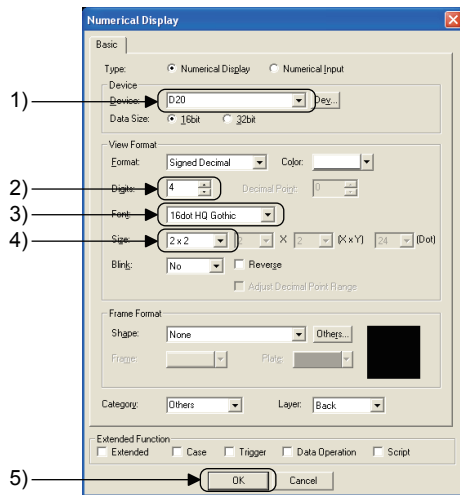

- 1) Set "D20" for [Device].
- 2) Select "4" for [Digits].
- 3) Select "16dot HQ Gothic" for [Font].
- 4) Set [Size] to "2 x 2".
- 5) Click the  button.

- (3) Making settings on the screens (the same procedures as those described in section 5.3.1)

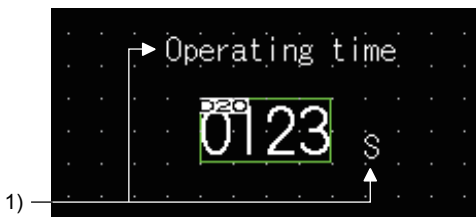

- 1) On the figure drawing screen, create characters for title and unit.

This completes the settings of the numerical display.

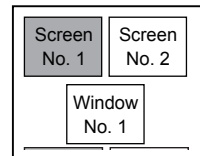

5.4 Lamp display settings

This function is used to turn on/off the lamp depending on the bit device condition (on/off) or the value of word device.

In this section, create a lamp display which turns on when Y7A is ON.

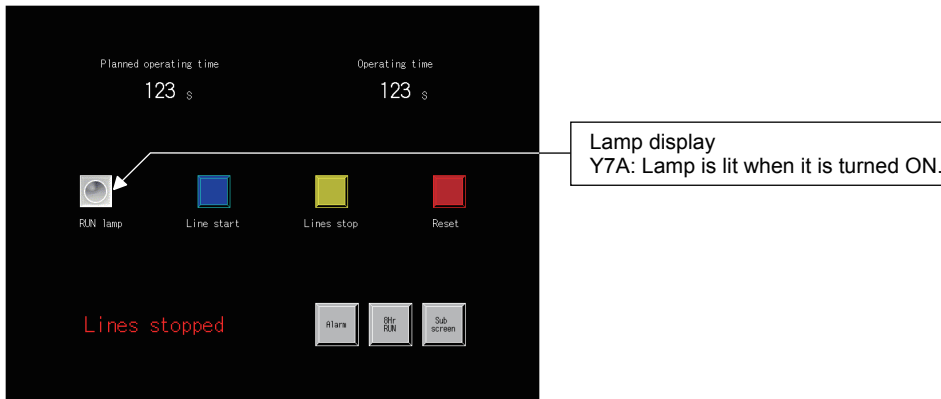

(1) Reading a lamp figure from the library

Read a lamp figure previously prepared in GT Designer2 from the library.

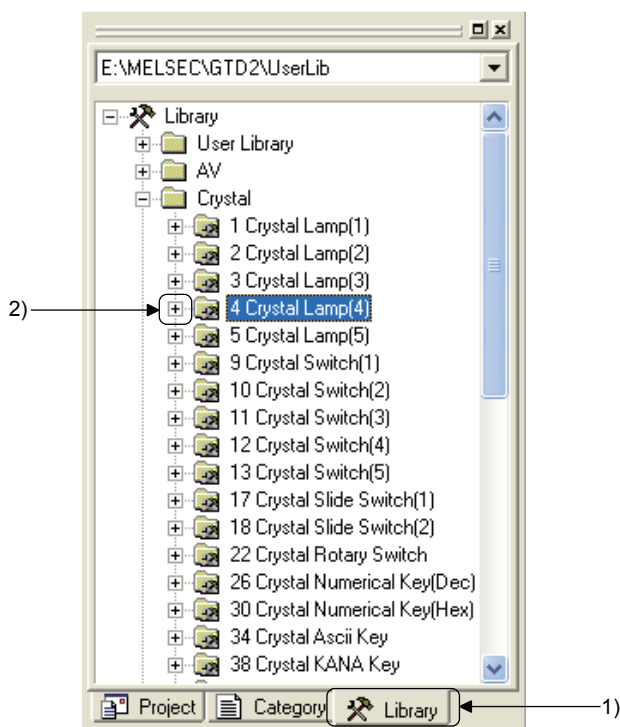

1) Click the [Library] tab in the workspace.

2) Click of [crystal] in the tree structure to open the folder, and double-click the "4 Crystal lamp (4)".

↓
(Next page)

(From previous page)

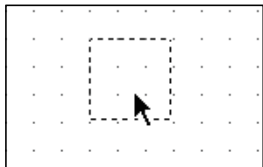
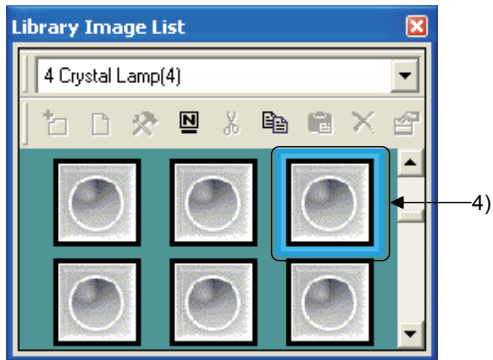

(2) Lamp display settings

- 3) As the [Library Image List] dialog box appears, click "12 CNF006_G".
(Clicking the  button displays the image name.)

- 4) On the screen, click the mouse button to place the lamp.

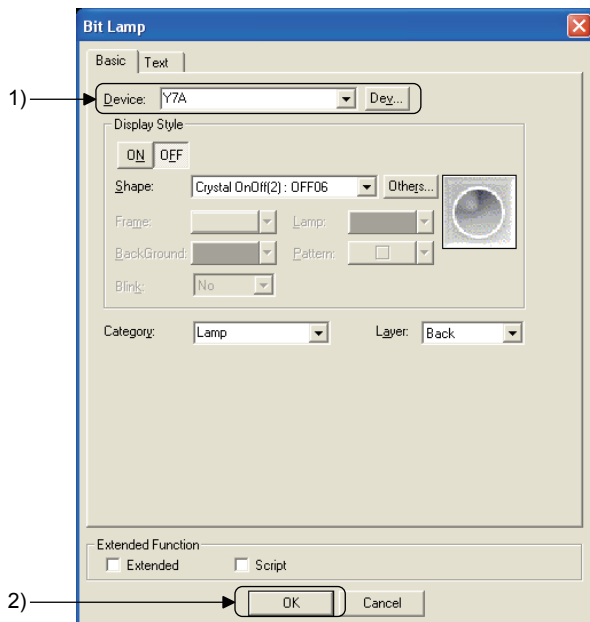

(3) Making settings on the screen

- 1) Set [Device] to "Y7A".
- 2) When setting is done, click the  button.



- 1) On the figure drawing screen, create characters for title.
This completes the settings of the lamp display.

5.5 Touch switch settings

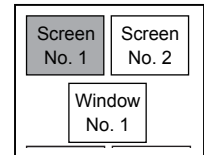

Make the settings for the switches which behave as follows when touched.

- Bit Switch : Turns bit device ON/OFF when touched.
- Go To Screen Switch : Switches base screen/window screen when touched.

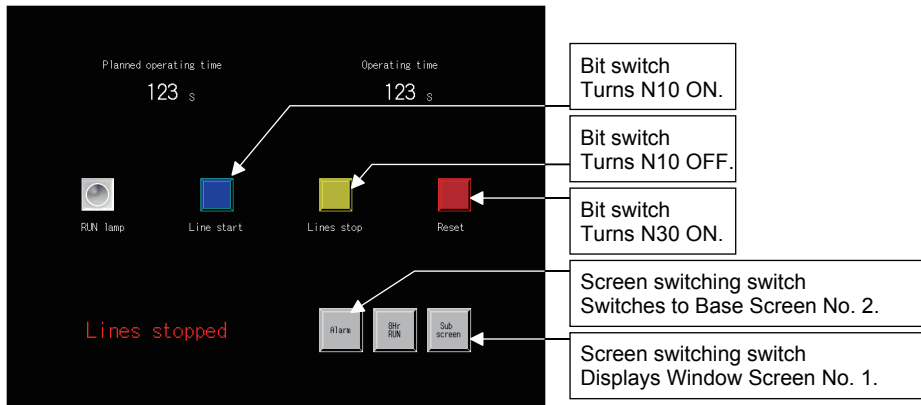

5.5.1 Bit switch settings

Creating a touch switch which turns the bit device (M10) ON when touched.

(1) Place a touch switch.

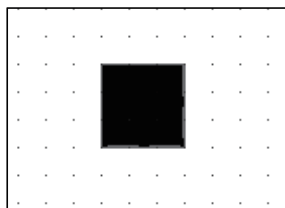
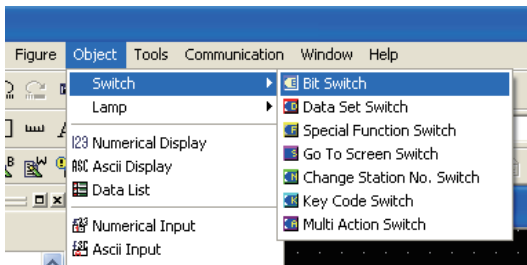

- 1) Click on the [Object] - [Switch] - [Bit Switch] menu.
- 2) Move the cursor to the position where the touch switch is placed, and click the mouse button.
- 3) The touch switch is placed.
- 4) Click the right mouse button in the area other than the touch switch to cancel the placement mode (+) of the cursor.
- 5) Double-click the placed touch switch.

(2) Bit switch settings

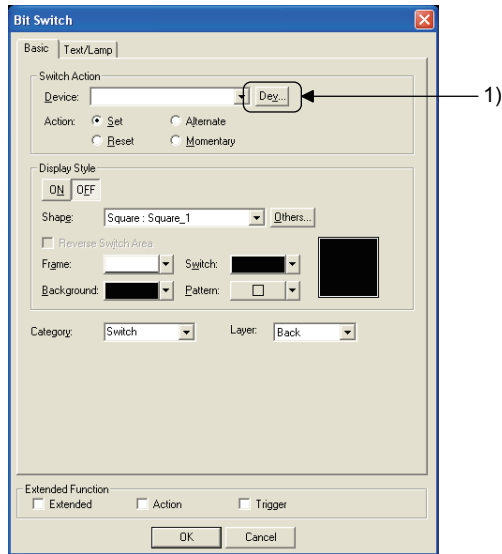

1) Click the **Dev...** button in [Switch Action].

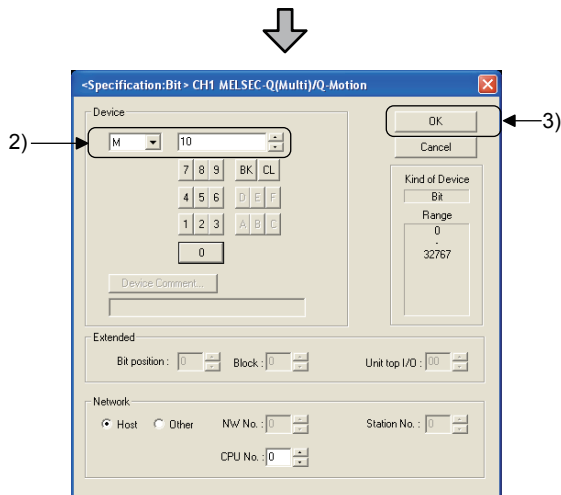

2) As the [Device] dialog box appears, set the device to "M10".

3) After setting is completed, click the **OK** button.

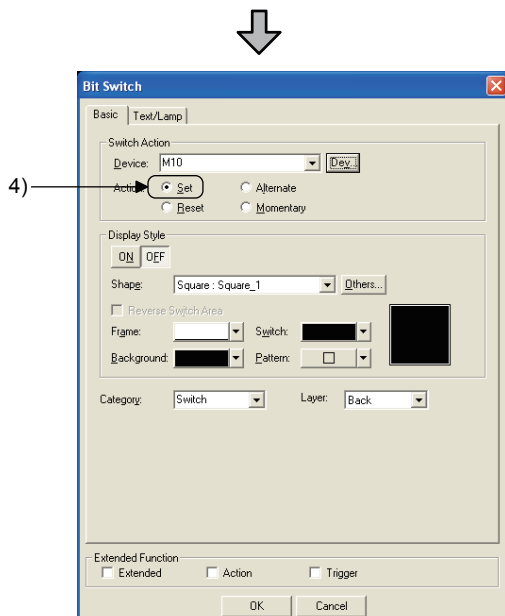

4) Select [Action].

[Action] determines how the bit device will behave when touched.

"Set": turns ON when touched

"Reset": turns OFF when touched

"Alternate": toggles ON/OFF when touched

"Momentary": turns on while being touched

(turns OFF when released)

Select "Set" here.

(3) Setting a display style

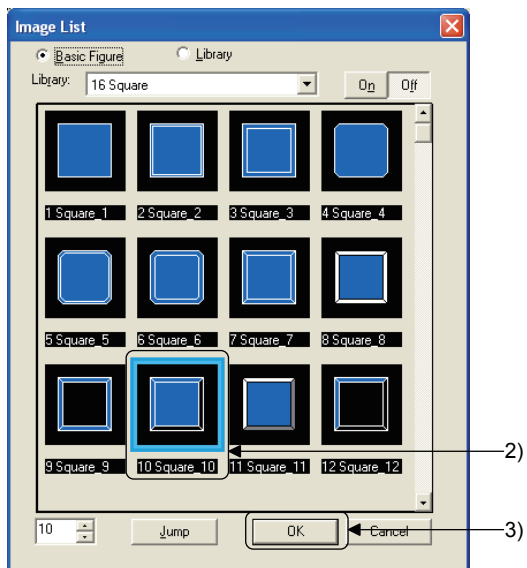
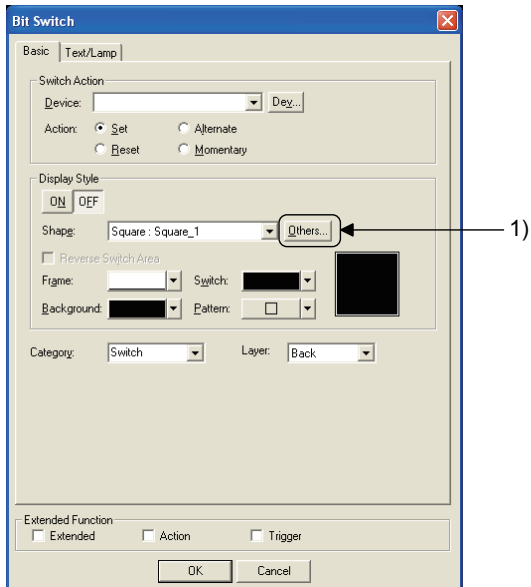

(Next page)

(From previous page)

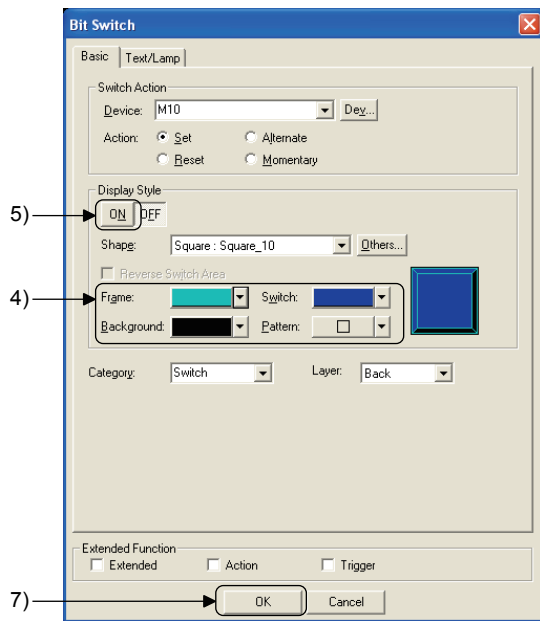

4) Set the display style for OFF as follows:
[Frame]: dark aqua
[Switch]: dark blue
[Background]: black
[Pattern]:

5) After setting is completed, click the button to set the display style of ON.

6) Set the display style of ON in the same way as that of OFF.

7) Click the button.

(4) Creating other bit switches

Create a new switch by copying and pasting the switch created in step 2.

Copy and paste a switch as described below.

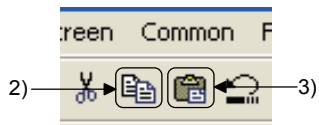
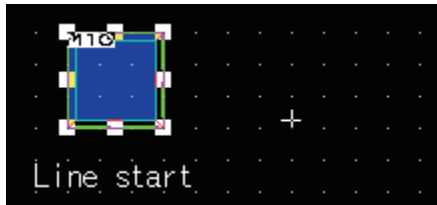

1) Click the source switch and select it.

2) Click  on the toolbar (Main).

3) Click  on the toolbar (Main).

4) As a frame for display range appears, move it to the desired position.

5) Click the mouse button to paste the cut switch.

Point

For the copied touch switch, note that the size of touch switch figure and the effective area (where reactive to touch operation) of touch switch may not exactly overlap.

In such cases, adjust the effective area of touch switch as instructed below.

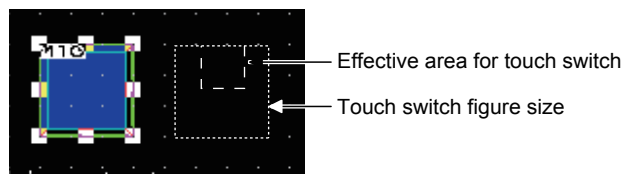

1) Right-click the mouse and select [Enable Two Tracker Mode] in menu.

2) Change the size of the touch switch effective area so that it overlaps the touch switch figure size.

The touch switch effective area can be changed in 16 dot unit.

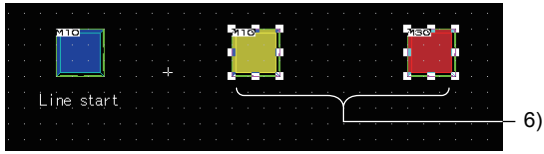

- 6) Create two switches as described in (5) above.
- 7) Change the settings of switch created by copying/pasting as follows:

Switch name	Setting items		Set data
Line stop switch	Operation setting	Operation	Reset (M10)
	Frame	Color (the same color for OFF/ON)	yellow
	Switch	Color (the same color for OFF/ON)	dark yellow
Reset switch	Device	Device	Set (M30)
	Frame	Color (the same color for OFF/ON)	red
	Switch	Color (the same color for OFF/ON)	dark red

(5) Naming the switches

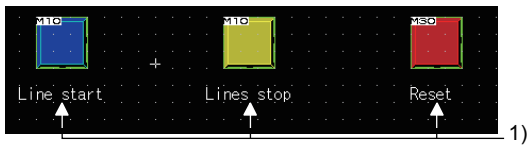

- 1) On the figure drawing screen, name the three created switches.

This completes the settings of the bit switch.

5.6 Operation check 1

Display the download screen of the project (select the [Communication] → [To/From GOT...] menu).

After checking [Delete all old data in Project folder] in the [Project Download → GOT] tab, click the Download button to download all the data to the GOT.

Reset the PLC CPU using the RESET key switch, and then switch to RUN.

Check if each switch of the initial screen (No.1) functions properly here.

(1) Test 1

Perform the following tests in screen No. 1.

Item		Test object	Planned operating time (numerical input)
		Touch operation	
Result of operation	Screen state	When a key window screen appears, enter the numeric value (15), and then press <u>Enter</u> of the key window.	
	Write device	D10	

(2) Test 2

Perform the following tests in screen No. 1.

Item		Test object	Line start switch	Operation lamp	Operating time (numerical display)
		Touch operation *1		Touch	—————
Result of operation	Screen state	The switch is pressed.	The lamp is on till the planned operating time.	Count up till the planned operating time.	
	Write device	M10: ON	—————	D20	
	Read device	—————	Y7A: ON	—————	

*1 The line will not start when the operating time exceeds the planned operating time.

(3) Test 3

Perform the following tests in screen No. 1.

Item		Test object	Line stop switch	Operation lamp	Operating time (numerical display)
		Touch operation		It is touched while the operation lamp is on.	_____
Result of operation	Screen state	The switch is pressed.	The lamp is off.	Count stops.	
	Write device	M10: ON	_____	_____	
	Read device	_____	Y7A: OFF	D20	

(4) Test 4

Perform the following tests in screen No. 1.

Item		Test object	Reset switch	Operation lamp	Operating time (numerical display)
		Touch operation		Touch	_____
Result of operation	Screen state	The switch is pressed.	The lamp is off.	The operating time becomes "0".	
	Write device	M30: ON	_____	_____	
	Read device	_____	Y7A: OFF	D20	

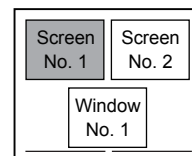

5.7 Comment display settings

Two types of messages (comments) are displayed depending on the condition of devices.

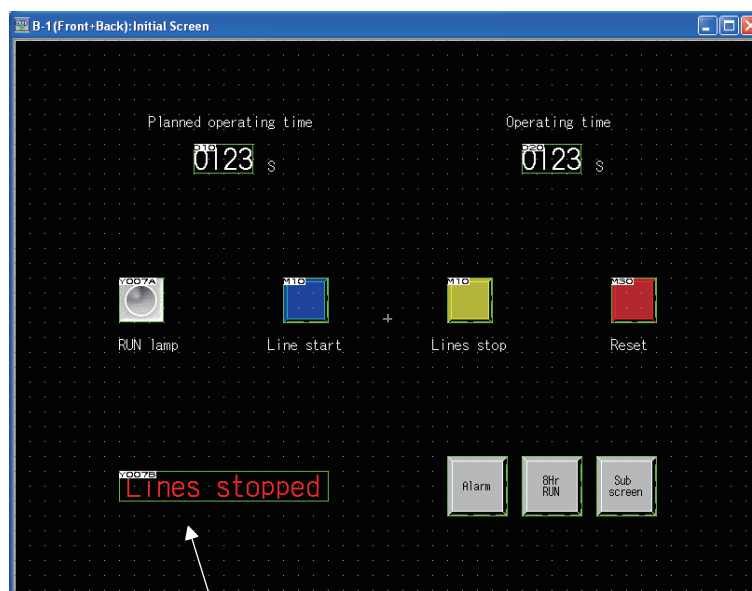

Describes the line operation (Y7B: ON/OFF) of comment display in the form of comment.
 With Y7B ON, "line in operation" is displayed.
 With Y7B OFF, "line stopped" is displayed.

5.7.1 About the comment display

There are the following two types of comment display.

(1) Comment display (bit)

It is the function to display the comment corresponding to the ON/OFF status of bit device.

The following two comments are switched back and forth for displaying.

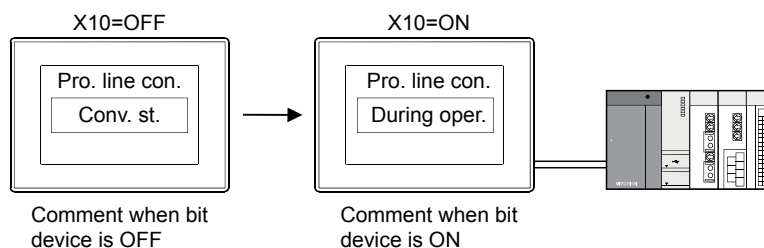

(2) Comment display (word)

It is the function to display the comment corresponding to word device value.

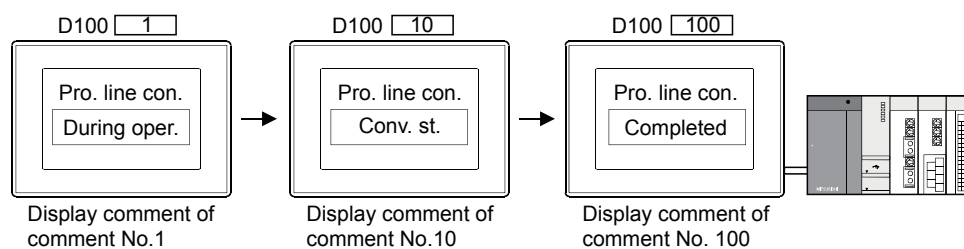

Remarks

The comment to be displayed by comment display needs to be registered in advance.

5.7.2 Comment display settings by bit device

- (1) Click  on the toolbar (Object) to place a comment on the object screen.
- (2) Comment display function settings

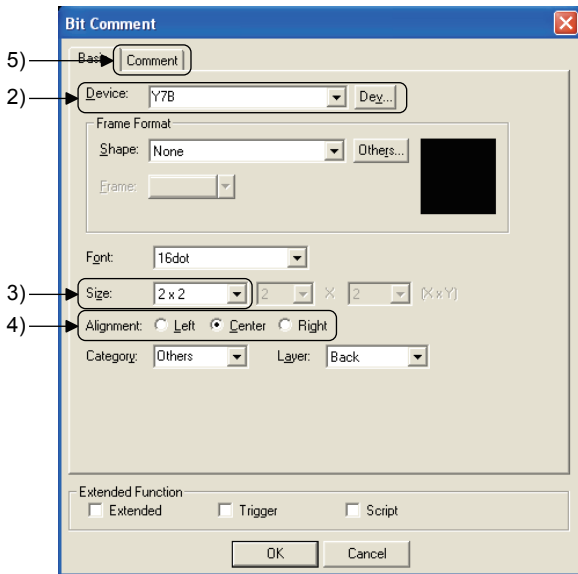

- 1) Double-click the comment box placed on the object screen.
The Bit comment (bit) dialog box is displayed.
- 2) Click the **Dev...** button to set the device to "Y7B".
- 3) Set [Size] to "2 × 2".
- 4) Set [Alignment] to "Center".
- 5) Click the [Comment] tab.

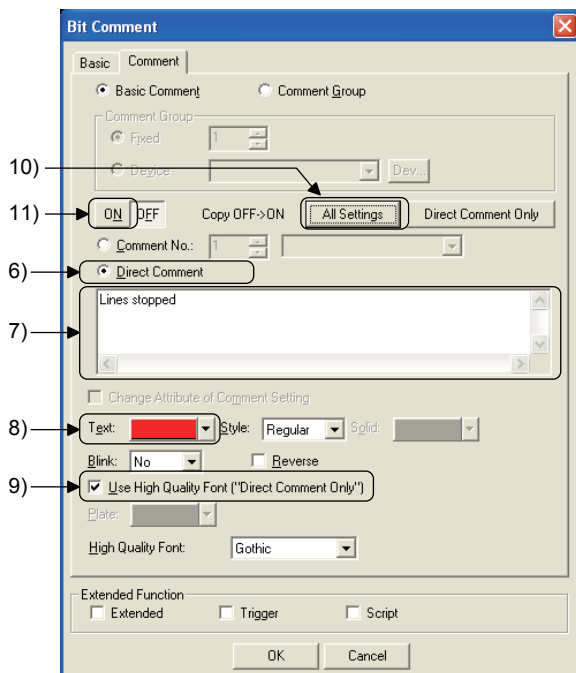

- 6) Select the comment type to be displayed when the device is OFF.
Select "Direct Comment".
- 7) Enter comments to be displayed when the device is OFF.
Enter "Lines stopped".
- 8) Select red for [Text].
- 9) Check [Use High Quality Font ("Direct Comment Only")].
(Texts will be displayed more clearly when high quality font is used.)
- 10) Click the **All Settings** button of [Copy OFF → ON].
- 11) Click the **ON** button.



(Next page)

(From previous page)

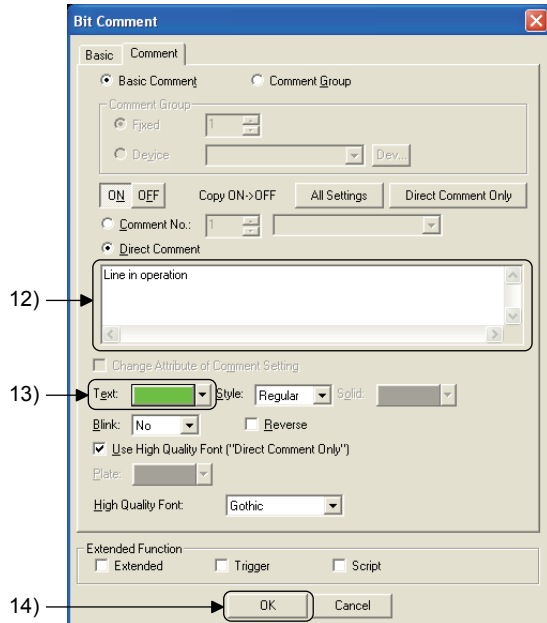

12) Set comments to be displayed when the device is ON.
Enter "Line in operation".

13) Select green for [Text].

14) Click the **OK** button.

Point
(1) A comment can be created with 1 to 512 characters.
(2) Comments can be created on multiple lines. Comments are displayed in the GOT as follows:

(3) Settings on object screen

Adjust the size of object frame so that all the comments are displayed.
Create a frame for the comments.

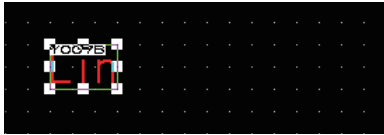

1) As the cursor changes to a re-sizing cursor when it is moved over to the handle, click the left mouse button and drag it to the desired size for displaying.

2) When the display area is determined, release the left mouse button.

3) Create a frame for comments using text.
This completes the settings of the comment display by a bit device.

Point

- The display condition for set comments can be displayed switching between ON and OFF by pressing the "ON/OFF of object function" button on the toolbar (Display setting).



- Adjust the size of display area when the comments vary in length depending on its ON/OFF condition as follows:
(Example) In case of ON, [Alarm: The water level is at upper limit].
In case of OFF, [lower limit].
Adjust the size of display area to be able to display a longer comment by switching comment displays with the "ON/OFF of object function" button of toolbar (Display setting).

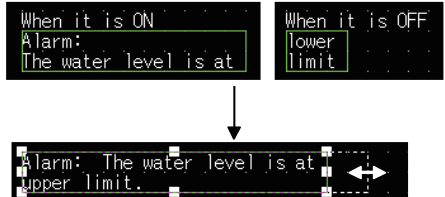

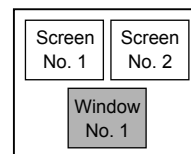

5.8 Window screen creation

Create a screen displayed over the base screen.

Window screen No. 1 is displayed in Overlap window 1 here.



Displays the clock.

(1) Making the settings of screen switch device

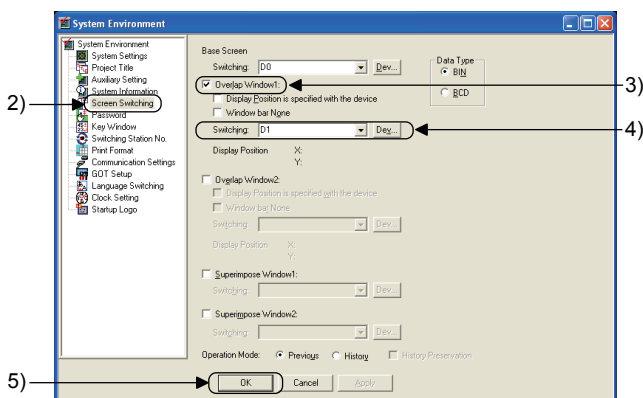

1) Select the [Common] - [System Environment] menu.

2) As the System Environment dialog box is displayed, double-click [Screen Switching].

3) Check [Overlap Window1].

4) Click the **Dev...** button to set the device to "D1".

5) Click the **OK** button.

This completes the settings of the screen switching device.

(2) Creating window screen

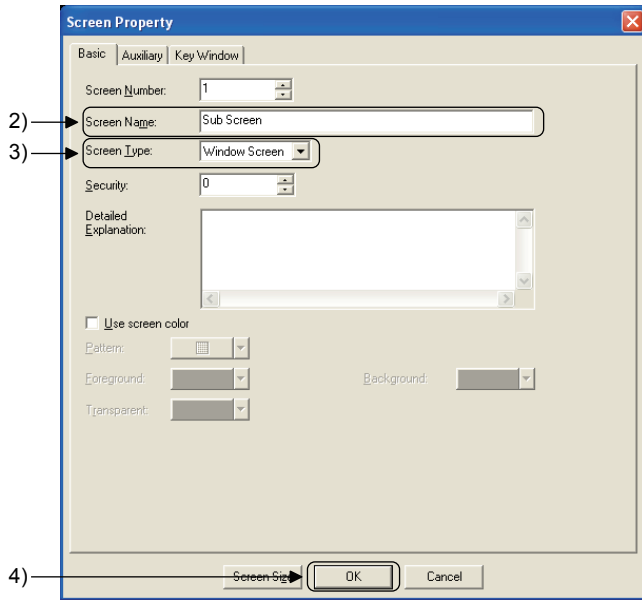

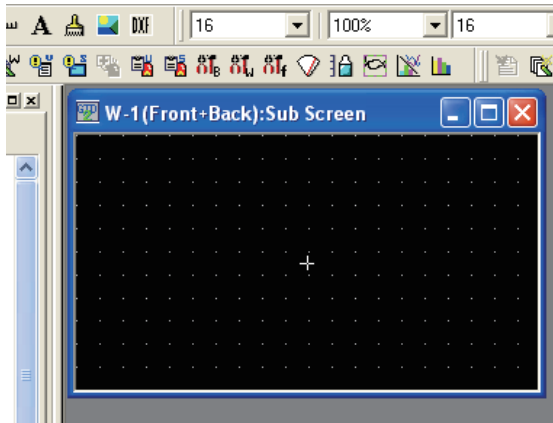

- 1) Select the [Screen] - [New Screen] - [Window Screen] menu.
- 2) Enter "Sub screen" for [Screen Name].
- 3) As a dialog box appears, check that the "Window Screen" is selected on [Screen Type].
- 4) Click the **OK** button.

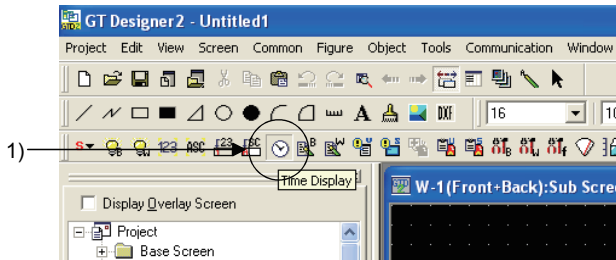

Window screen No. 1 is displayed on the screen.

(3) Setting the time displayed on the window screen
The current date and time is displayed on the GOT.



1) Click  on the toolbar (Object).



2) Move the cursor and click in the upper left point for displaying the clock.

3) Click the right mouse button to complete positioning.

4) Double-click the time display which has been placed.

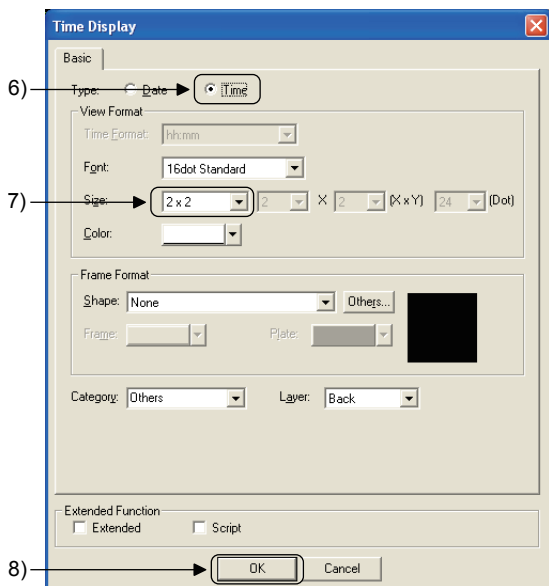

5) The Time Display dialog box is displayed.

6) Select "Time" for [Type].
(Format) (Display example: 13:48)
Hour: Minute 13:48

7) Set [Size] to "2 × 2".

8) Click the  button.

Point

(1) Date and time displayed by time display function

The time display function represents the date and time of the GOT maintained by the internal clock function.

The clock function sets the clock to be used as standard for adjusting the time between the GOT and PLC CPU.

The way of adjusting the time between the GOT and PLC CPU differs as follows depending on the clock to be used as standard :

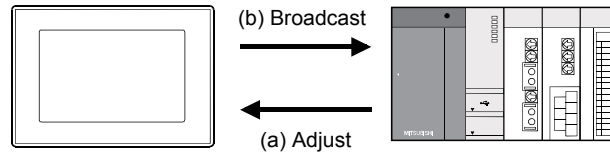

(a) Using the time of clock data in PLC CPU as standard (time adjustment)
Set the clock data of GOT to the time of clock data in PLC CPU.

(b) Using the time of clock data in GOT as standard (broadcast)
Set the clock data of PLC CPU to the time of clock data in GOT.
A battery is required for the clock data to be maintained while the power to GOT is off.

(2) Change in settings of clock function

The settings of clock function can be changed using the clock setting function provided in GT Designer2 or Utility function.

Refer to chapter 2 of the GT Designer2 Version2 Screen Design Manual for details on time display function.

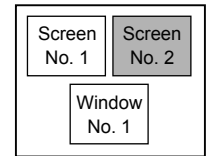

5.9 System alarm settings

Create Base Screen No. 2 and set the system alarm.

Refer to section 4.5.3 for details for system alarms.

The following screen will be created in Base Screen No.2.

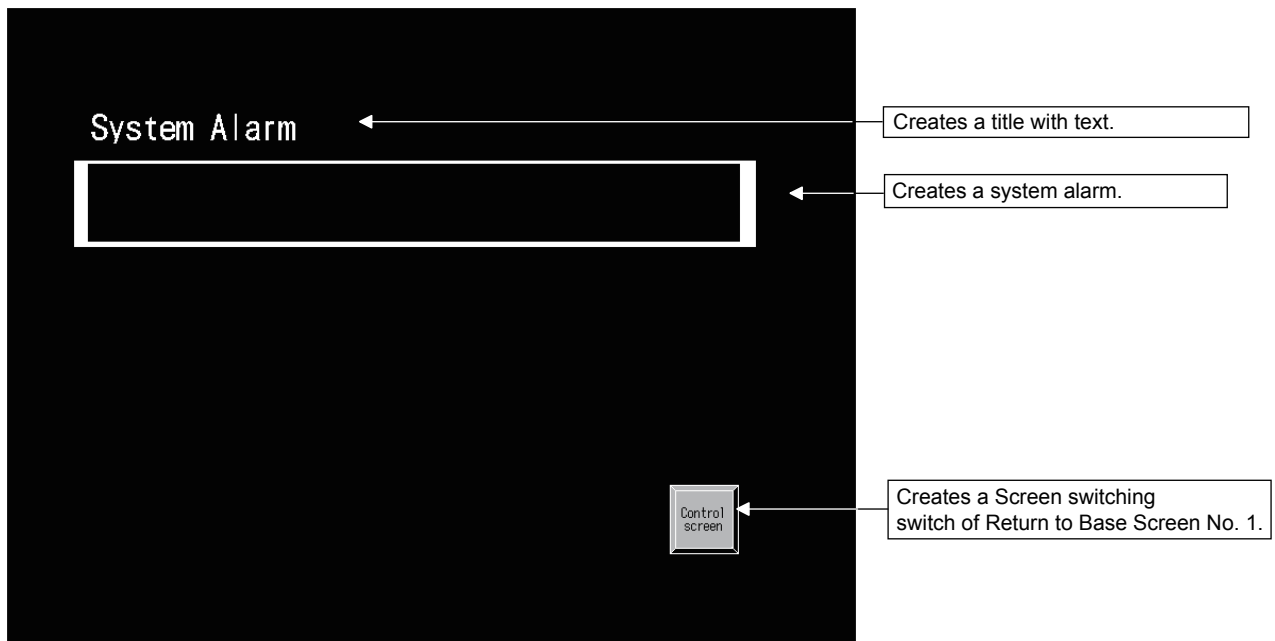

5.9.1 System alarm settings

(1) Creating Base Screen No.2

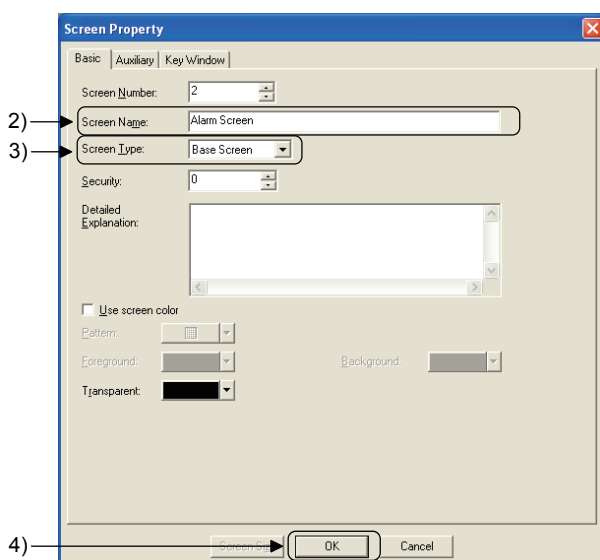

1) Select the [Screen] - [New Screen] - [Base Screen] menu.

2) Enter "Alarm screen" for [Screen Name].

3) As a dialog box appears, check that the "Base Screen" is selected on [Screen Type].

4) Click the **OK** button.

↓
(Next page)

(From previous page)

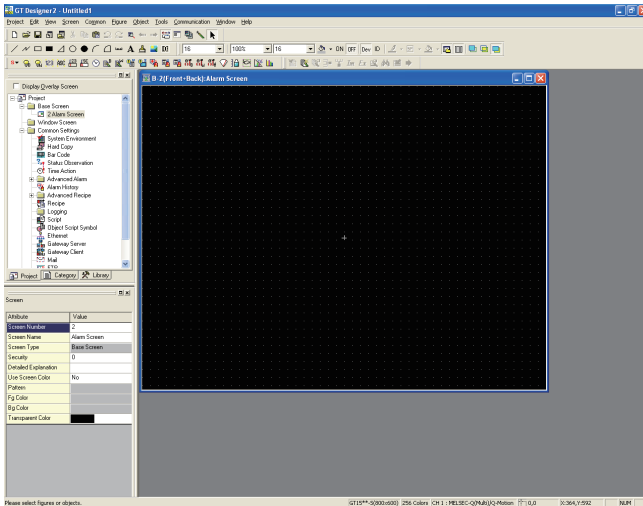

Window screen No. 2 is displayed on the screen.

(2) Setting a system alarm.

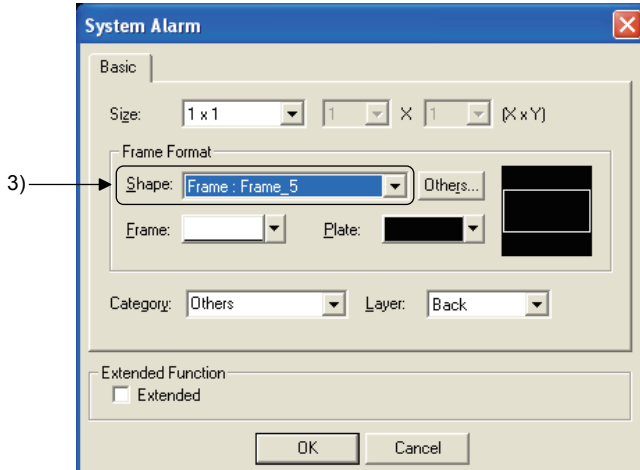

- 1) Click  on the toolbar (Object) to place a system alarm on the object screen.
- 2) Double-click the system alarm which has been placed.
The System Alarm dialog box is displayed.
- 3) Set shape for the system alarm.
Select "Frame_5" for [Shape].
- 4) Click the **OK** button.

(3) Adjust the system alarm size.

Adjust the size of system alarm so that all the system alarms are displayed.



- 1) Position the cursor over the handle, click and drag it to the desired size for displaying the system alarm.
- 2) When the object and shape are adjusted, adjustment is completed.

Point
<p>An adjustment of display area is required as illustrated below to keep part of alarm message from dropping out of the frame.</p> <div style="border: 1px solid black; padding: 5px; width: fit-content;"><p>400 Unable to communicate with CPU 9 AC down error 803 Transient error</p></div> <p style="margin-left: 200px;">} Set in three lines.</p> <p>Error message (Max. 64 digits) The time of the alarms occurred (Fixed eight digits) Enlarge the size until the time of the alarms occurred is displayed on the right edge.</p>

Remarks
<p>Size change of object with shape</p> <p>(1) Method of changing size</p> <ol style="list-style-type: none">1) Select the object to be changed in size.2) Position the cursor over the sizing handle, click and drag it to change the desired size. <div style="display: flex; align-items: center; justify-content: center;"><div style="border: 1px dashed black; padding: 5px; margin-right: 20px;"><p>322 Dedicated</p></div><div style="margin-right: 20px;">→</div><div style="border: 1px dashed black; padding: 5px;"><p>322 Dedicated device is out of range.</p></div></div>

Remarks

(2) Misalignment of object and figure

(a) Centering the object in the figure

Right click on the object to be realigned.

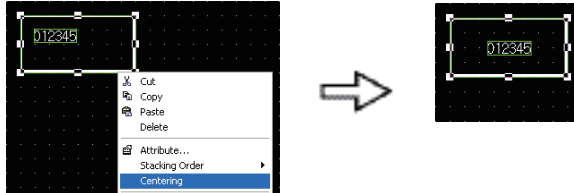

Right-click the mouse and select [Centering] in menu.

(b) Moving the object to any position within the figure

The position of object and shape can be changed separately as instructed below.

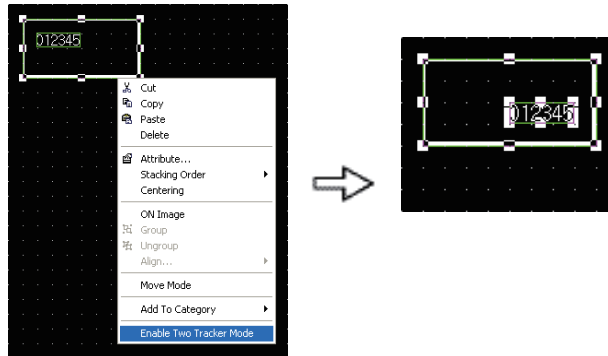

Right-click the mouse and select [Enable Two Tracker Mode] in menu.

Move the object to change the position.

(c) Moving the object to any position within the figure

The position of object and shape can be changed separately as instructed below.

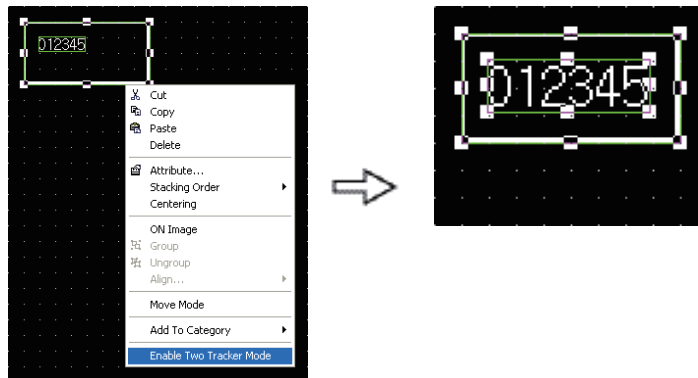

Right-click the mouse and select [Enable Two Tracker Mode] in menu.

Drag the object to change its size.

- (4) Creating a title text for the system alarm
Enter "System alarm" in Text.



5.9.2 Go to screen switch settings

Create a switch which can switch a base screen to another or display a window screen by touch operation.

(1) Placing a Go To Screen Switch.

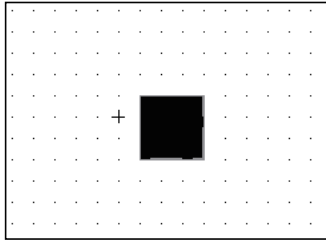

- 1) Display Base Screen No. 1.
- 2) Select the [Object] - [Switch] - [Go To Screen Switch] menu.
- 3) Move the cursor to the position where the Go To Screen Switch is placed, and click the mouse button.
- 4) Click the right mouse button in the area other than the touch switch to complete the positioning of object.
- 5) Double-click the touch switch which has been placed.

(2) Setting operation of Go To Screen Switch.

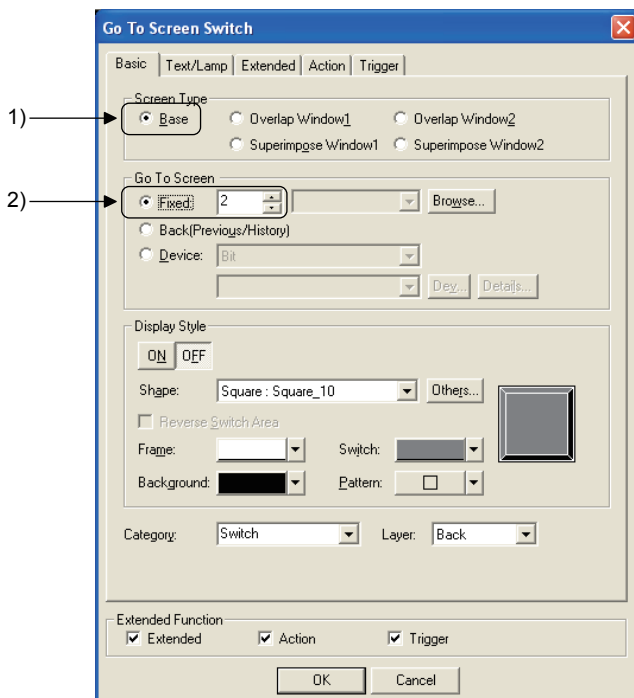

- 1) Check that "Base" is selected in [Screen Type].
 - 2) Pressing the switch in [Go To Screen] determines the screen to display.
 - "Fixed": switch to the Base Screen whose screen No. is specified.
 - "Back (Previous/history)": switch to previously displayed Base screen. Up to 10 screens can be switched according to the history.
 - "Device": switch to the Base Screen whose screen No. is specified depending on the ON/OFF condition of the specified bit device. (this is useful for returning to the previously displayed screen)
- Here select "Fixed", and set "2" to switch to Base Screen No. 2.

(3) Setting the display (figure, color) of Go To Screen Switch.

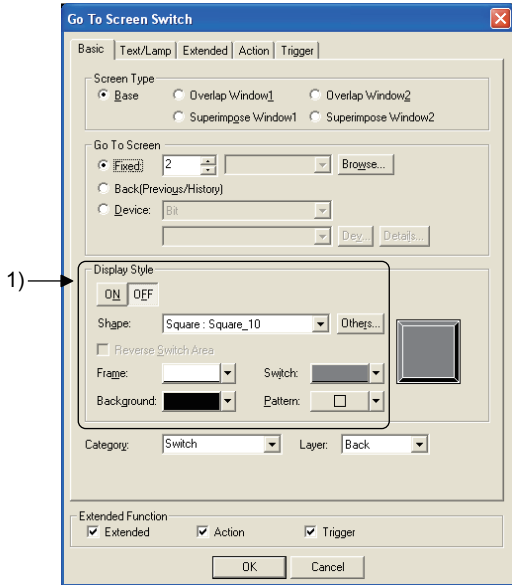

- 1) Set the Display Style of Go To Screen Switch as follows:
 "Shape": 10 square_10 (specified in **Others...**)
 [Frame]: white
 [Switch]: Gray
 [Background]: black
 [Pattern]: □

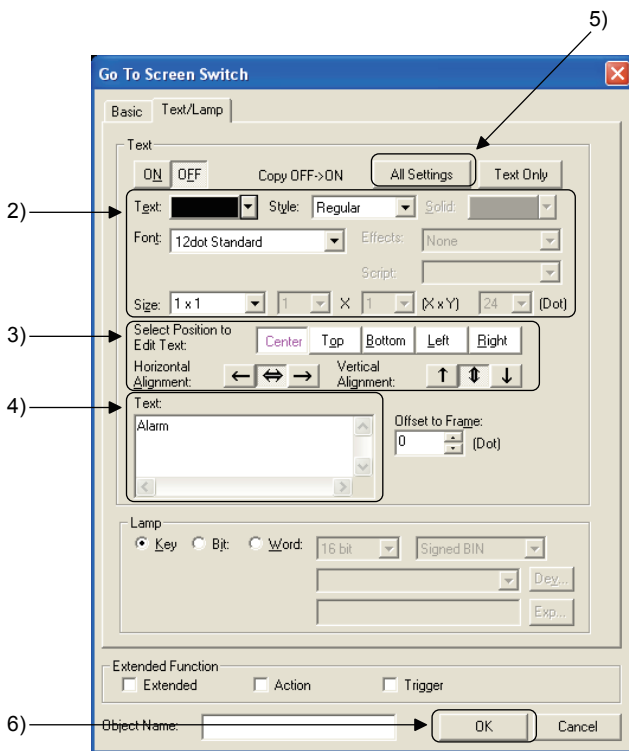

- 2) In the [Text/Lamp] tab, set the text to be displayed in the switch as follows:
 [Font]: 12dot Standard
 [Text]: black
 [Style]: Regular
 [Size]: 1 x 1
- 3) Set the display position of text as follows:
 [Select Position to Edit Text]: Center
 [Horizontal Alignment]: ←→
 [Vertical Alignment]: ⇕

The position of the texts used for switches and lamps can be selected among the following display positions:

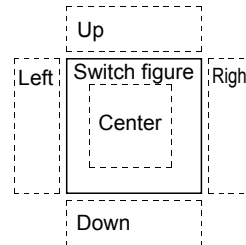

- 4) Enter texts as follows in the text entry area:
 "Alarm"
- 5) Click the **All Settings** of [Copy OFF → ON] to apply the OFF settings to the ON settings for texts.
- 6) Click the **OK** button to complete the settings.

- (4) Create Go To Screen Switch which displays Window Screen No. 1.
Copy and paste the Go To Screen Switch to Base Screen No. 2 created above.
Make the settings of display and operation for the copied Go To Screen Switch as follows:

Setting items		Set data
Basic tab	Screen Type	Overlap Window 1
	Go To Screen	Fixed 1
Text/Lamp tab	Text (the same for OFF/ON)	Sub screen

When setting is done, click the button.

- (5) Create Go To Screen Switch for Window Screen No. 2.
Copy and paste the Go To Screen Switch created for Base Screen No. 1 on to Base Screen No. 2.
Make the settings of display and operation for the pasted Go To Screen Switch as follows:

Setting items		Set data
Basic tab	Go To Screen	Fixed 1
Text/Lamp tab	Text (the same for OFF/ON)	Control screen

When setting is done, click the button. This completes the settings of Go to Screen Switch.

5.10 Operation check 2

Display the download screen of the project, and download all the data to the GOT.
 Reset the PLC CPU using the RESET key switch, and then switch to RUN.
 Check if the comment display in screen No.1 is properly displayed, and that the overlap window (Window Screen No. 1) appears correctly here.

(1) Test 1

Perform the following tests in screen No. 1.

Item		Test object	
		Planned operating time (numerical input)	
Touch operation		Touch the numerical input area.	
Result of operation	Screen state	When a key window screen appears, enter the numeric value (15), and then press <u>Enter</u> of the key window.	
	Write device	D10	

(2) Test 2

Perform the following tests in screen No. 1.

Item		Test object	
		Line stop switch	Comment display
Touch operation		Touch	_____
Result of operation	Screen state	The switch is pressed.	Comment "Line operating" appears.
	Write device	M10: ON	_____
	Read device	_____	Y7B: ON

(3) Test 3

Perform the following tests in screen No. 1.

Item		Test object	Line stop switch	Comment display
Touch operation			It is touched while the operation lamp is on.	_____
Result of operation	Screen state		The switch is pressed.	Comment "Line stopped" appears.
	Write device		M10: OFF	_____
	Read device		_____	Y7B: OFF

(4) Test 4

Perform the following tests in screen No. 1.

Item		Test object	Alarm switch
1) Touch operation			Touch
Result of operation	Screen state		Switch to Base Screen No. 2.
	Write device		2→D0
	Read device		_____

(5) Test 5

Perform the following tests in screen No. 2.

Item		Test object	System Alarm
1) Operations in the training machine			Power off the Q series training machine (After confirming Test 5, power back ON the Q series training machine.)
Result of operation	Screen state		The following alarm message appears: "402 Communication timeout. Confirm communication pathway or modules."
	Write device		_____
	Read device		_____

(6) Test 6

Perform the following tests in screen No. 2.

Item		Test object	Control screen switch
1)	Touch operation		Touch
Result of operation	Screen state		Switch to Base Screen No. 1.
	Write device		1→D0
	Read device		_____

(7) Test 7

Perform the following tests in screen No. 1.

Item		Test object	Sub screen switch
1)	Touch operation		Touch
Result of operation	Screen state		Window screen No. 1 displayed.
	Write device		1→D1
	Read device		_____

(8) Test 8

Window screen No. 1 closes.

Item		Test object	Window screen
1)	Touch operation		Touch  in the upper right corner.
Result of operation	Screen state		Window screen No. 1 closes.
	Write device		0→D1
	Read device		_____

(9) Test 9

Perform the following tests in screen No. 1.

Test object		Window screen
Item		
1)	Touch operation	Touch  in the upper right corner.
Result of operation	Screen state	Window screen No. 1 closes.
	Write device	0→D1
	Read device	_____

5.11 Training device list and sequence program

(1) Training device list

Device	Signal name	GOT operation	Device	Signal name	GOT operation
M10	Line Start/Stop	W	D10	Numerical input	W
M30	Reset	W	D20	Numerical display	R
Y7A	Operation lamp	R	D0	Base screen switching	W
Y7B	Comment display	R	D1	Window screen switching	W

R: Reading W: Writing

Point
To identify the device used for the project data being edited, the Device List function of GT Designer2 will be useful. Refer to section 5.12 of this text for details.

(2) Training sequence program

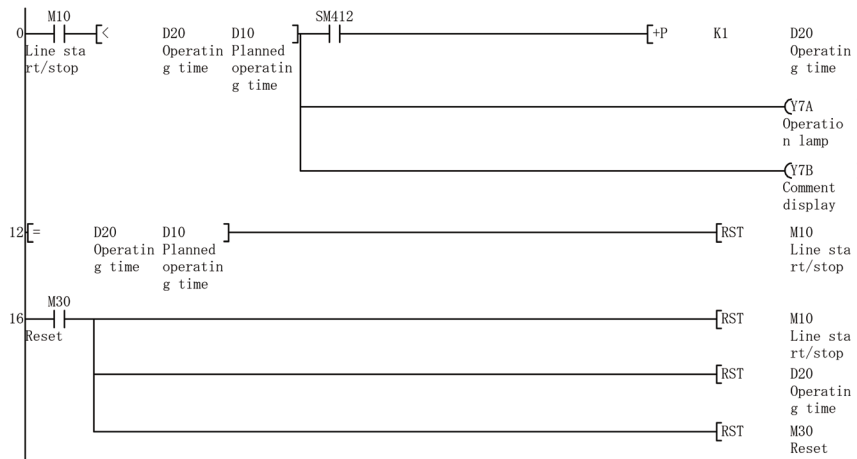

* SM412 is a special relay that makes turn ON/OFF the CPU module OS at the interval of 1 second.

5.12 Method for checking devices using the created screen data

To identify the device used for the created screen data, the Device List function of GT Designer2 will be useful.

Display a list of devices used for the screen data created during this training here.

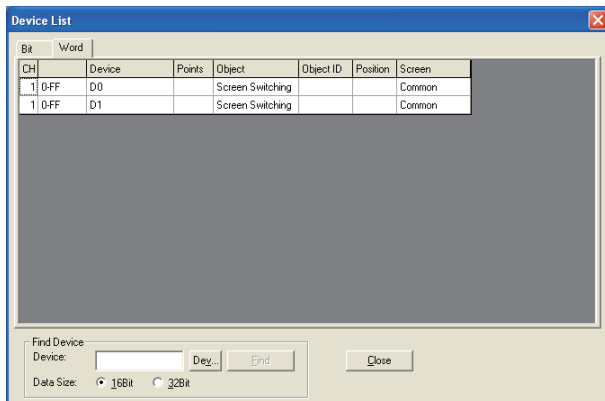
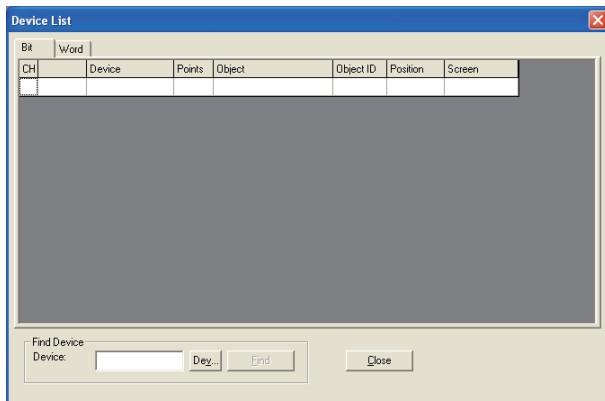
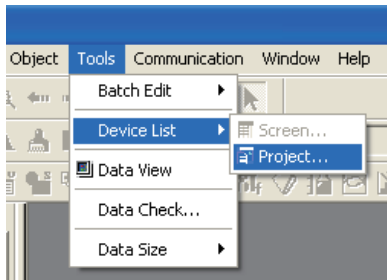

A device list can be displayed in either one of the following two ways:

- a list grouped by the project data
- a list grouped by one screen

Select a list from the project data in order to display a list of devices for the set of created data here.

Click the [Tools] - [Device List] - [Project] menu.

The Device List dialog box is displayed.

As a list of bit devices is shown right after the Device List dialog box appears, check what bit devices are included in the list.

Click the [Word] tab to see a list of word devices.

A list of word devices is displayed.

Point

When the desired device is not shown in the list, click the **Find** button to specify the appropriate device.

Refer to chapter 12 of the GT Designer2 Version Basic Operation/Data Transfer Manual for details on this setting.

Chapter 6 About Debug

This chapter describes the debug function used for troubleshooting and maintenance of the PLC system.

6.1 Extended Function and Option OS

The Extended function OS or the Option OS is the function enabled by installing the option function board, or the extended function OS/option OS in the GOT.

(1) Difference between Extended function OS and Option OS

Extended function OS	Functions available by installing an Extended function OS (An option function board is not required.)
Option OS	Functions available by mounting an option function board or installing an option OS (Some option functions do not require an option OS.)

(2) List of extended/option functions

Function Name		Description
Extended function	System monitor	Functions to monitor or change the PLC CPU devices
	Bar code	Functions to store the data read with a bar code reader connected to the GOT into the PLC in the ASCII data
Option OS	Multi-color display	Functions capable of displaying 65536 colors
	Recipe	Functions to store device values in the GOT, and use the data from the GOT to read or write to devices such as a PLC
	Advanced recipe	
	Standard font (Chinese: Simplified, Traditional) (Simplified Chinese [GB] Mincho) (Traditional Chinese [BIG5] Gothic)	Functions to display Chinese fonts in the GOT
	Maintenance time notification	Functions to automatically count the energization time in the backlight, and notify the maintenance time in two stages
	MELSEC-Q/QnA ladder monitor	Functions capable of monitoring sequence programs and searching devices and defects
	MELSEC-A ladder monitor	
	MELSEC-FX ladder monitor	
	Gateway (Server, Client)	Functions that a single PC or GOT collects and monitors the data of PLC which is monitored by multiple GOTs.
	Gateway (Mail)	
	Gateway (FTP server)	
	Network monitor function	Function to monitor the network status of MELSECNET/H, MELSECNET/10, etc.

Function Name	Description
Intelligent module monitor function	Function to monitor and change the data of intelligent function module buffer memory using a dedicated screen
List editor for MELSEC-A	Function for displaying/editing sequence program read out from ACPU in the list mode
List editor for MELSEC-FX	Function to display / edit the sequence program read out from the FXCPU in the list mode
Servo Amplifier Monitor Function	Function to monitor the servo amplifier and also to change parameters, execute test run, etc.
Q Motion Monitor Function	Function to execute servo monitor and parameter setting for motion controller CPU (Q series)
CNC Monitor Function	Function to monitor position display, alarm diagnosis and program and to check tool offset data at the same level as with the dedicated MELDAS display unit
Multi-channel function *	Function to monitor multiple controllers with a single unit of GOT

* Installation of an option OS is not required.

(3) Installation of Extended function OS/Option OS

This section explains how to install an Extended function OS/Option OS.

In this section, a ladder monitor and a system monitor, which are required to do exercises provided in sections 6.3 and 6.4, will be installed.

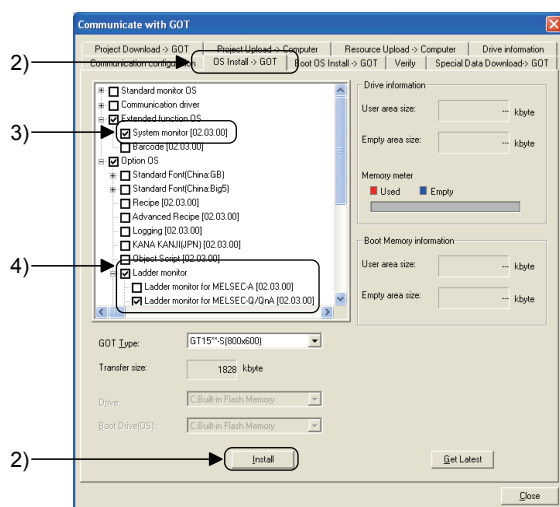
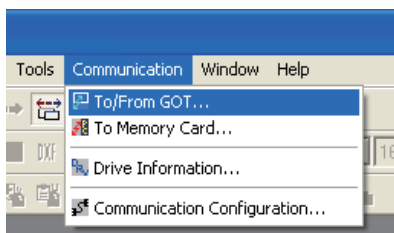

1) Click on the [Communication] - [To/From GOT...] menu.

2) When the dialog box appears, click the [OS Installation → GOT] tab.

3) Check [Extended function OS] - [System monitor].

4) Check [Option OS] - [Ladder monitor] - [Ladder monitor for MELSEC-Q/QnA].

5) Click the **Install** button.

6.2 Training screen creation

Add the following Base Screen No. 3 to the screen created in chapter 5.

Base Screen No. 3

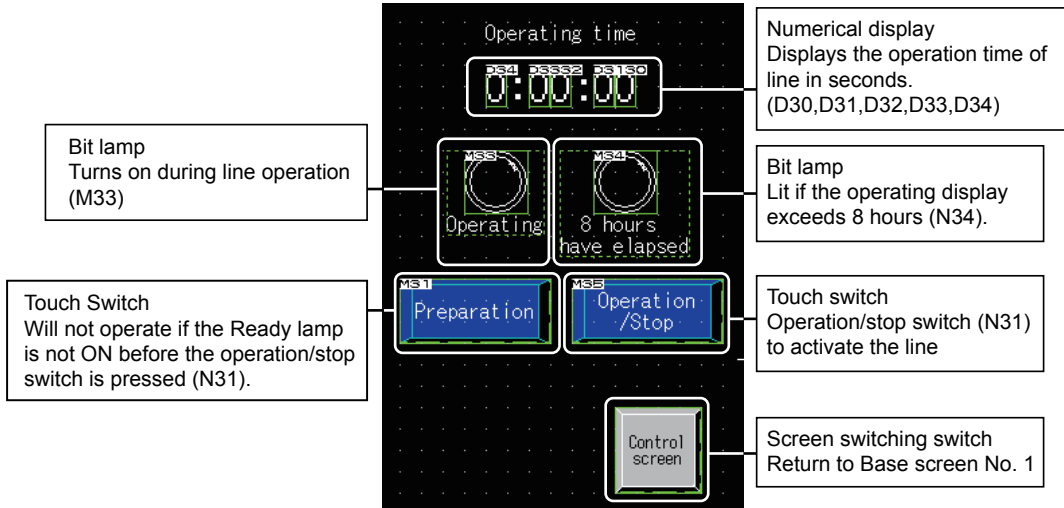

[Operation of Base Screen No. 3]

- 1) When the **Preparation** switch and the **Operation/Stop** switch turn ON, the operation will start, and the lamp will be lit.
- 2) As the operation gets started, the operating time starts counting. When the operation time is over 8 hours, the lamp turns ON.

6.2.1 Screen creation training

(1) Creating and setting Base Screen No. 3

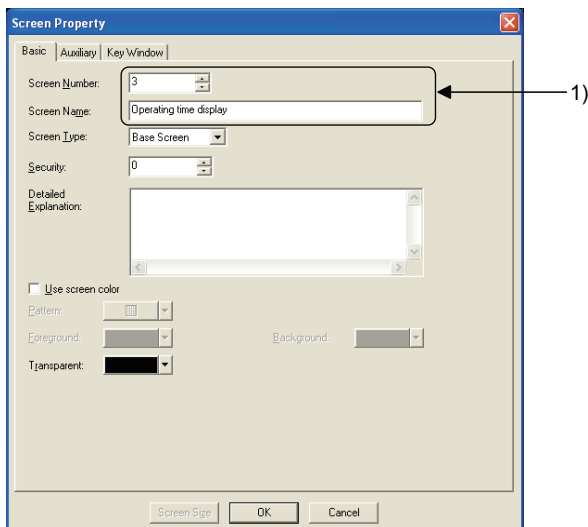

- 1) Create a base screen as follows:

Screen number: 3

Screen Name: Operating time display



(Next page)

(From previous page)

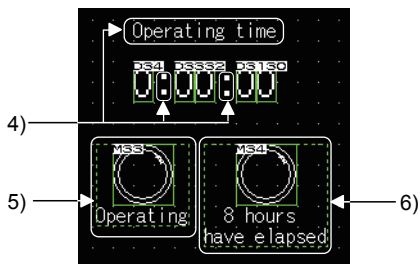
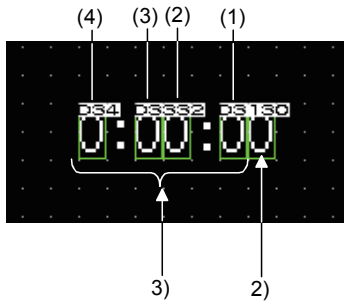

(Next page)

- 2) Place the numerical display, and make the settings as follows:

[Basic tab]

Device: D30

Number of display digits: 1

Size: 2x2

- 3) Copy and paste the numerical display created in 2), and make the settings as follows:

(1) Device setting "D31"

(2) Device setting "D32"

(3) Device setting "D33"

(4) Device setting "D34"

- 4) Create characters with text.

- 5) Create a display lamp with the following settings using the same procedure for creating a lamp display in section 5.4.

[Basic tab]

Device: M33

Figure: Circle: Circle_3

Lamp color (when it is ON): red

[Text/Lamp tab]

Display position: Bottom

Text: Operating

Copy OFF → ON (All Settings)

- 6) Copy and paste the lamp created in 5), and make the settings as follows:

[Basic tab]

Device: M34

[Text/Lamp tab]

Text: 8 hours have elapsed.

Copy OFF → ON (All Settings)

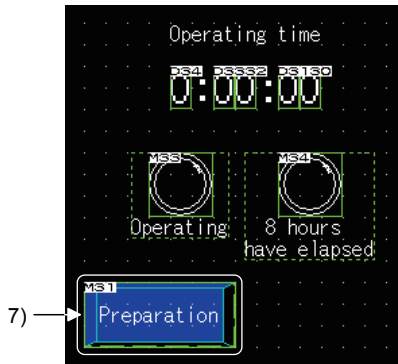

- 7) Copy and paste the touch switch created in section 5.5, change the width size, and make the settings as follows:

[Basic tab]

Device: M31

Operation: Alternate

Switch color (when it is ON): red

[Text/Lamp tab]

Text: Preparation

Copy OFF → ON

Lamp function: Bit, M31

[Operating Condition]

Trigger Type: OFF

Device: M32

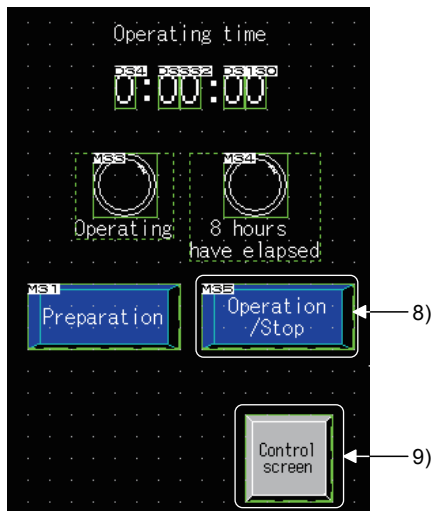

- 8) Copy and paste the switch created in 7), and change the settings as follows:

[Basic tab]

Device: M35

[Text/Lamp tab]

Text: Operation/Stop

Copy OFF → ON

Lamp function: Bit, M35

[Operating Condition]

Trigger Type: ON

Device: M31

- 9) Copy and paste the Go To Screen Switch (control screen) of Base Screen No. 2.

(2) Setting Base Screen No.1

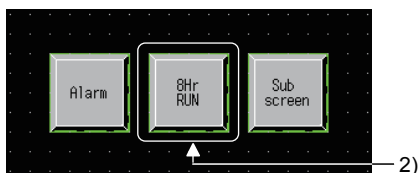

- 1) Copy the Go To Screen Switch (alarm) of Base Screen No. 1, and change the settings as follows:

[Basic tab]

Switching Screen: Fixed screen 3

[Text/Lamp tab]

Text: Operation screen

Copy OFF → ON

6.2.2 Project download

Display the download screen of the project, and download all the data to the GOT. Reset the PLC CPU using the RESET key switch, and then switch to RUN.

6.2.3 Training device list and sequence program

(1) Training device list

Device	Signal name	GOT operation	Device	Signal name	GOT operation
M31	Preparation	W	D30	1 sec	R
M32	Operation/Stop	W	D31	10 secs	R
M33	Operating	R	D32	1 min	R
M34	8 hours have elapsed.	R	D33	10 mins	R
			D34	1 hour	R
T30	Timer	R			
			D100	Base screen switching	W
			D200	Window screen switching	W

R: Reading W: Writing

Point

To identify the device used for the project data being edited, the Device List function of GT Designer2 will be useful.

Refer to section 5.12 of this manual for details.

(2) Training sequence program

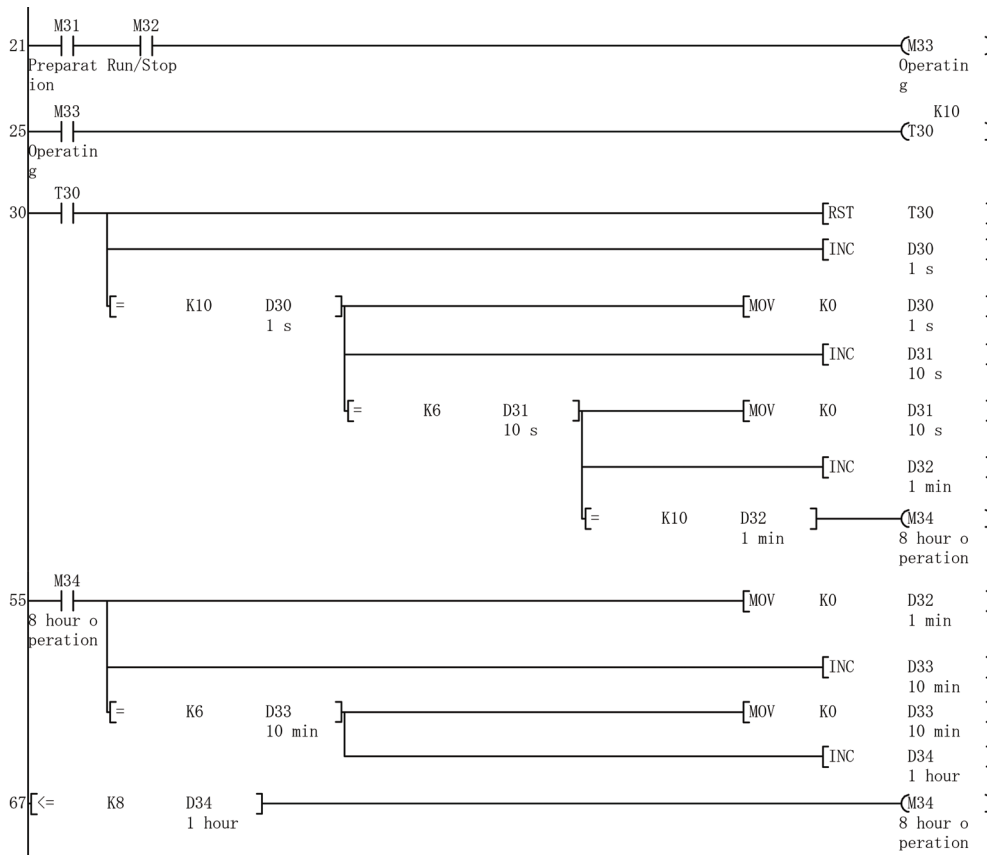

6.3 Ladder monitor function

6.3.1 About the ladder monitor function

(1) Features

This is the function to monitor PLC CPU programs in the ladder diagram format. Switching the display format (decimal number/hexadecimal number) or displaying the device comment (comment written to the PLC CPU) is possible. It is also possible to search for a contact causing a malfunction, which may lead to a reduction of factor analysis time.

Display screen for ladder monitor function

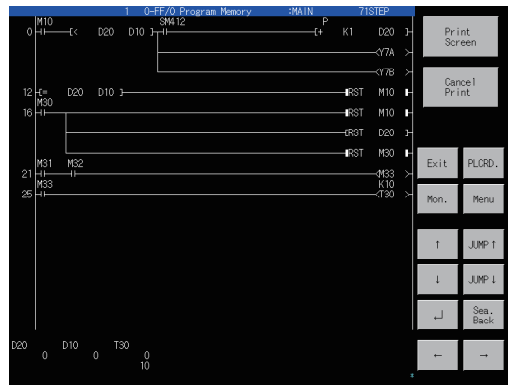

(2) Functions available with QCPU ladder monitor

Function		Description
Search operation	Dev. Sea.	Displays a ladder block containing the specified device.
	Cont. Sea.	Displays a ladder block containing the specified contact.
	Coil. Sea.	Displays a ladder block containing the specified coil.
	Step. Sea.	Displays a ladder block with the specified step number.
	End. Sea.	Displays the last ladder block of sequence program.
	Defect search	Searches the ladder for conductive/non-conductive status of the contact point that turned on or off the coil on the ladder.
	Touch search	Searches for coils of the same device when the contact shown on the screen of ladder monitor function is touched, and for contacts of the same device when the coil is touched.
Display switching		Changes displays of decimal number, and hexadecimal number for word device, and displays of device comment.
Test operation		Changes device values, etc.
Hard copy		Saves screens of ladders in the BMP or JPEG format.

(3) Hardware and OS required for ladder monitor

The following hardware and OS are required to use the ladder monitor.

Required option function board	Extended function /Option OS	Capacity for user area (calculated value for data capacity)
One of the followings: GT15- QFNB GT15- QFNB16M GT15- QFNB32M GT15- QFNB48M	MELSEC-Q/QnA Ladder monitor for MELSEC-Q/QnA (Option OS)	1082k bytes

6.3.2 Operation check (1)

Perform the following operation checks for screen No.3 created in section 6.2.

(1) Test

Perform the following tests in screen No. 3.

Test object		Operation
Item		
1)	Touch operation	Touch Ready, and then touch Operation/Stop.
Result of operation	Screen state	(Under normal conditions) The Operating lamp turns ON, and the operating time starts counting. <div style="text-align: center;">↓</div> (Current operations) The Operating lamp does not turn ON, and the operating time does not start counting.

Screen No. 3 is not working properly.

A cause of the error will be determined using the ladder monitor.

6.3.3 Method for starting the ladder monitor function

Utility call keys
Simultaneous 2-point touch

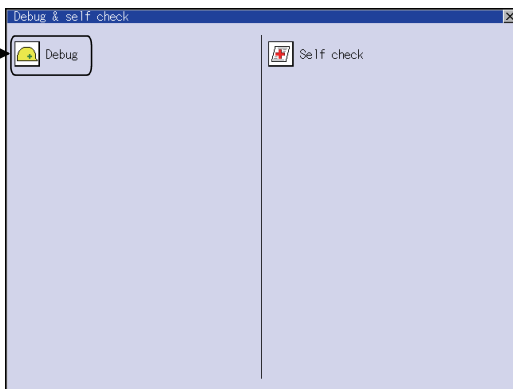
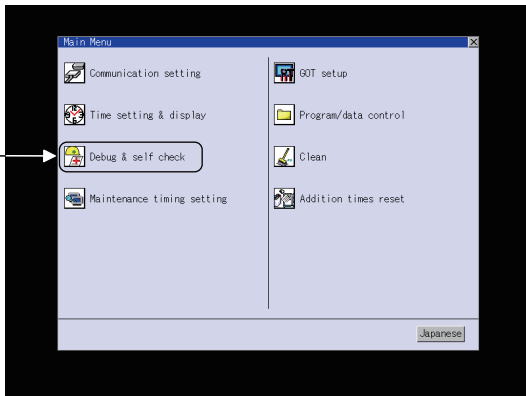
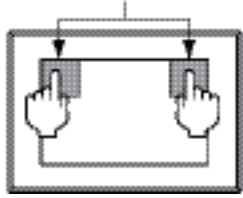

(Next page)

1) Touch the upper left and upper right corners on the GOT monitor screen at the same time.

2) When the utility is displayed, touch [Main Menu] → [Debug & self check].

3) Touch [Debug].

(From previous page)



4) Touch [Ladder Monitor].

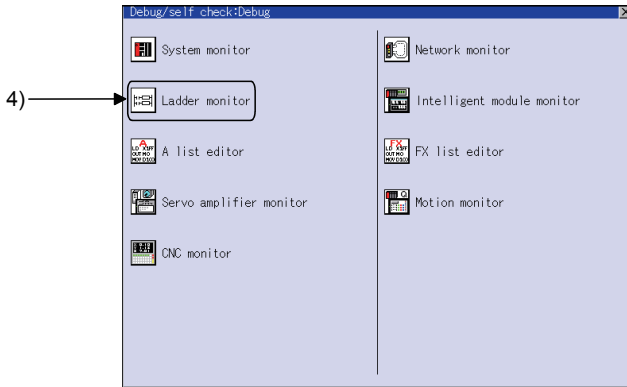

5) Touch **NO** when the screen as shown left appears.

Otherwise, go to step 7).



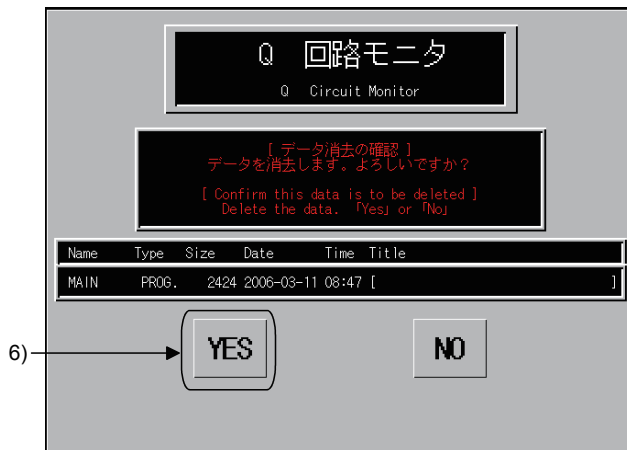

6) Touch **YES** when the screen as shown left appears.

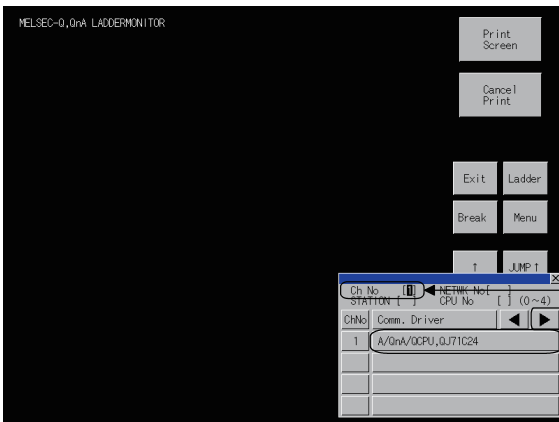

(Next page)

(From previous page)



- 7) The channel setting window appears.
 - (1) Displays the names of communication drivers installed in the GOT.
 - (2) The channel No. is fixed to "1".
- 8) Touch  to move the cursor to network No. [0].

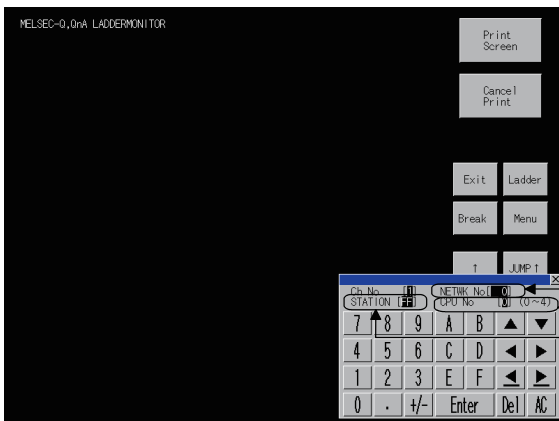

- 9) Set the network No. to [0].
- 10) Set the station No. to [FF], and touch the **Enter** key.
- 11) Set the CPU No. to [0], and touch the **Enter** key.

DEL key : Used to delete a character of the entered information.

AC key : Used to delete all characters indicated by the cursor.

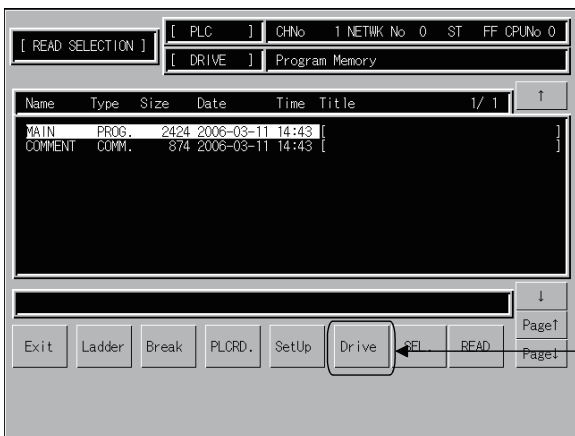

- 12) Touch the **Drive** key when the screen as shown left appears.



(Next page)

(From previous page)



- 13) When the drive selection window appears, enter [0] in the drive (applicable memory) and touch the **Enter** key.

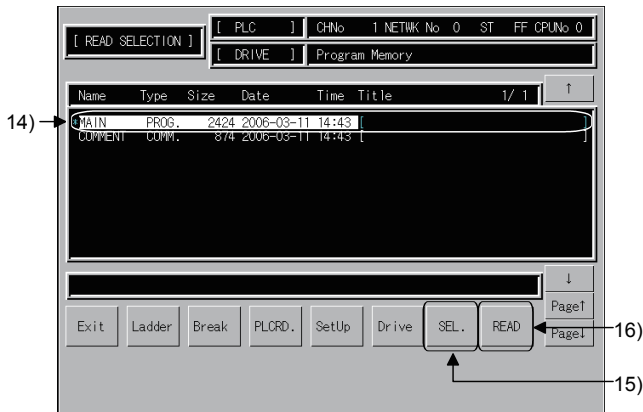

- 14) As a list of files in the program memory appears, select the ladder to be read using the down/up arrow keys (**↑**/**↓**).

- 15) Touch the **Select** key.

- 16) Touch the **Read** key.

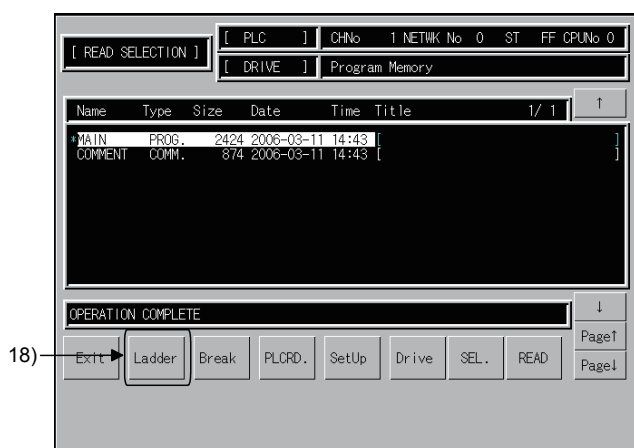

- 17) The reading of the sequence program is completed.

- 18) Touch the **Ladder** key.



(Next page)

(From previous page)

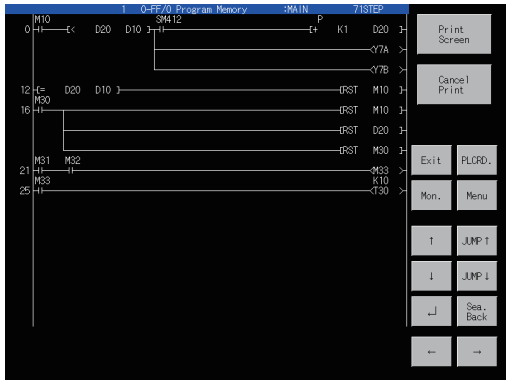

19) The sequence program is displayed, and the ladder monitor function becomes available.

6.3.4 Method for factor search operation

The factor search function searches the ladder for the conductive/non-conductive status of the contact point that turned on or off the coil when the ladder is monitored. This section explains the operation procedures.

1) Touch the **monitor** key.

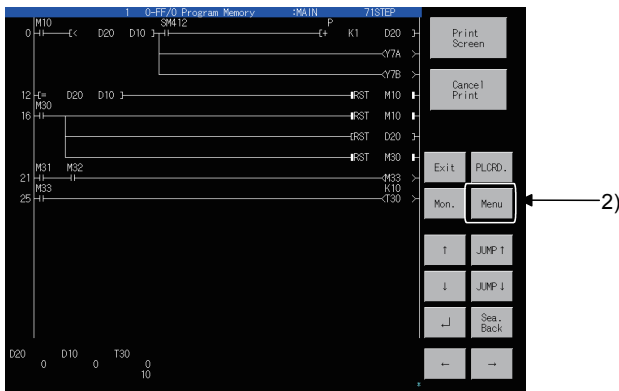
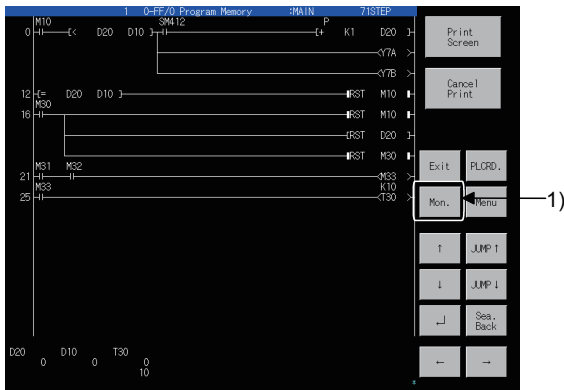

2) Touch the **Menu** key.



(Next page)

(From previous page)

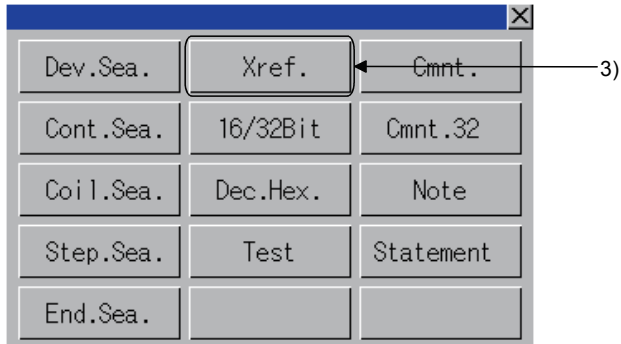

- 3) When the Menu window appears, touch the **Xref.** key.



- 4) Touch the **M** key for the device name to select it, and touch **▶** to move the cursor.



- 5) Set the device number to "33".
- 6) Touch the **Enter** key.

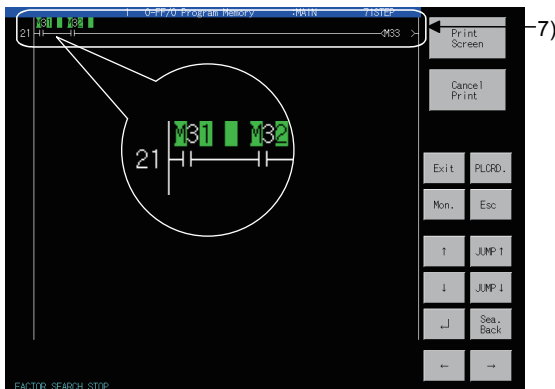

- 7) A search for the device begins, and the research result is displayed.

To cancel a factor search, touch the **Esc** key. During a factor search, all key operations except **Esc** and **Exit** keys are invalid.

<Factor search Result>

The reason why M33 does not turn ON is that M32 is not ON.

6.3.5 Training screen modification

Check the settings of touch switch (Operation/Stop) that turns on M31.

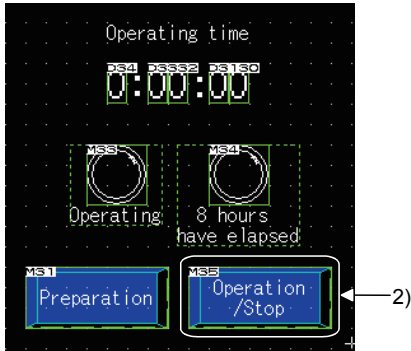

1) Check the settings of touch switch (Operation/Stop) for Base Screen No.3. M35 was mistakenly assigned, instead of M32, for the device to be turned ON.

2) Change the settings of the Operation/Stop switch as follows:

- [Basic tab]
- Device: M35 → M32
- [Text/Lamp tab]
- Lamp: Bit, M35 → M32
- Copy OFF → ON

6.3.6 Operation check (2)

Display the download screen of the project, and download all the data to the GOT. Reset the PLC CPU using the RESET key switch, and then switch to RUN.

(1) Test

Perform the following tests in screen No. 3.

Item		Test object	Operation
		1) Touch operation	
Result of operation	Screen state	The Operating lamp turns ON, and the operating time starts counting.	
2) Touch operation		Touch Operation/Stop.	
Result of operation	Screen state	The Operating lamp turns OFF, and the operating time stops.	

Check the Operating lamp turns ON, and that the operating time counts up. The correction of drawing data is completed.



Set the Ready switch OFF to perform the operation check in section 6.4.1.

6.4 System monitor function

6.4.1 About the system monitor function

(1) Features

This function is able to monitor and test the devices of the PLC CPU, and the buffer memory of intelligent function modules.

(2) Monitoring method available with system monitor function

Monitoring method	Description
Device monitor	The device monitor is a function to register devices to be monitored in advance and monitor only registered devices.
Batch monitor	The batch monitor function monitors up to 16 PLC CPUs from the device number specified by the user in a single window.
T/C monitor	The TC monitor function monitors the present value, set value, contact point, and coil of up to 8 PLC CPU timers (T)/counters (C) from the device number specified by the user in a single window.
Buffer memory monitor	The Buffer memory monitor function monitors up to 16 devices from the initial device number in the buffer memory of the intelligent function module specified by the user in a single window.

(3) Test operations

With the system monitor function, the following data changes are possible by performing test operations.

- Testing a bit device
A device specified by the user is turned ON and OFF.
- Testing a word device
A specified value is written to a device specified by the user. (Real number data is not allowed.)
- Testing a timer/counter
Specified values are written as the present and set values of a device specified by the user.
- Testing buffer memory
A specified value is written to buffer memory specified by the user.

Test menu screen

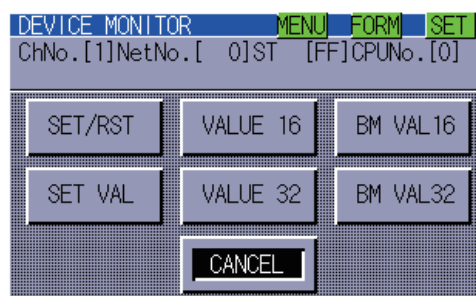

(4) Hardware and OS required for system monitor function

The following hardware and OS are required to use the system monitor.

Required option function board	Extended function / option OS	Capacity for user area (calculated value for data capacity)
—	System monitor (extended function)	746k bytes

6.4.2 Method for starting the system monitor

Utility call keys
Simultaneous 2-point touch

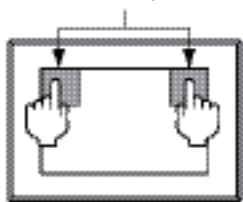

- 1) Touch the upper left and upper right corners on monitor screen of the GOT main unit at the same time.

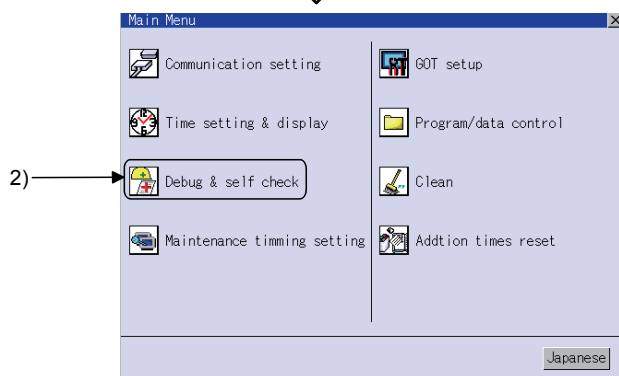

- 2) When the utility is displayed, touch [Main Menu] - [Debug & self check].

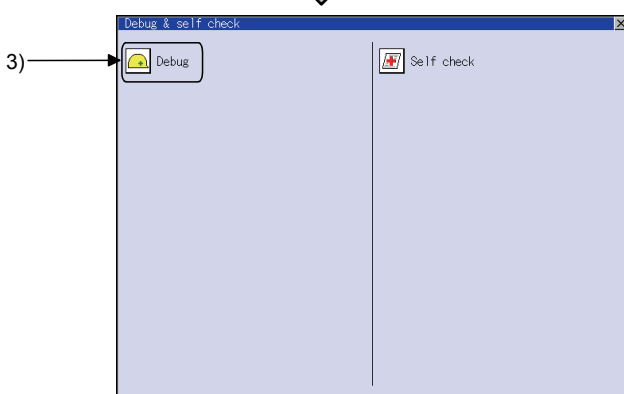

- 3) Touch [Debug].

(Next page)

(From previous page)

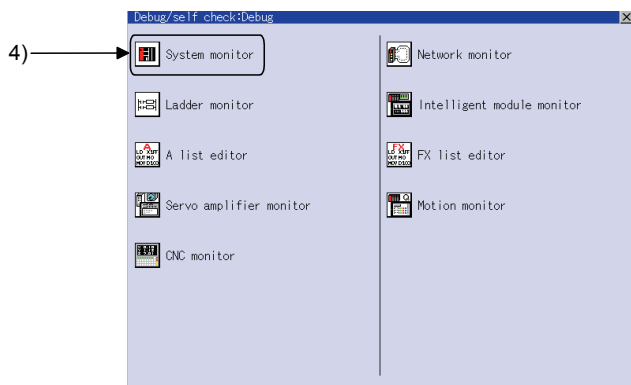

4) Touch [System Monitor].

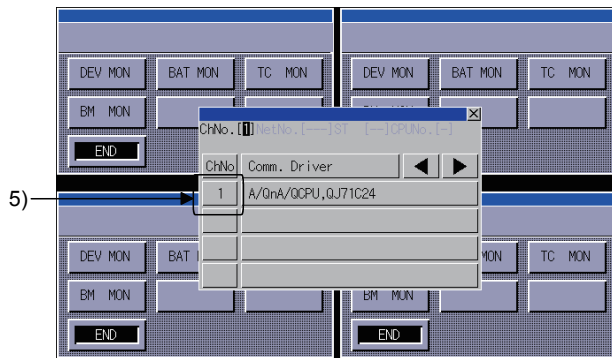

5) When the channel setting window appears, touch the "1" key.



6) The functional change menu of system monitor is displayed.

6.4.3 Operation check (device monitor operation)

In this section, the following operation checks are performed regarding the training screen created in section 6.2 using the device monitor of the system monitor function.

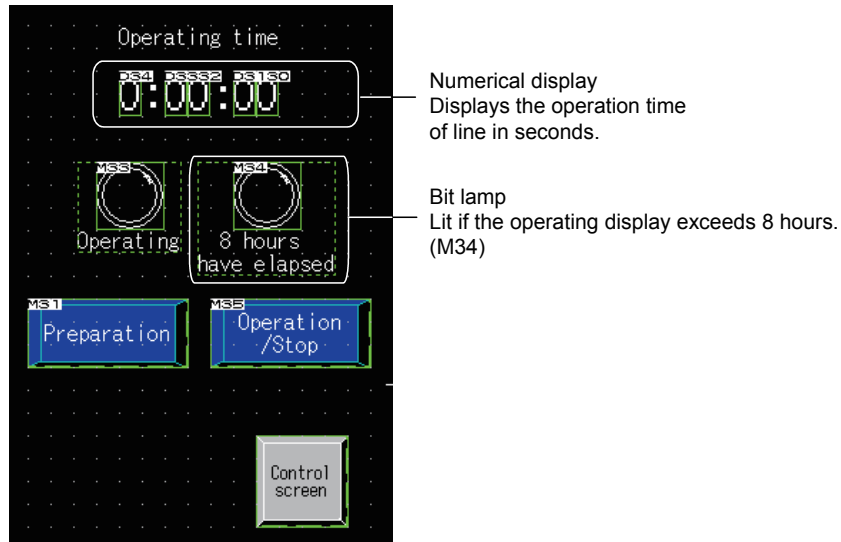

(1) Device registration procedure for device monitor



- 1) Display the functional change menu using the procedure described in section 6.4.2.
- 2) Touch the **Device Monitor** key.

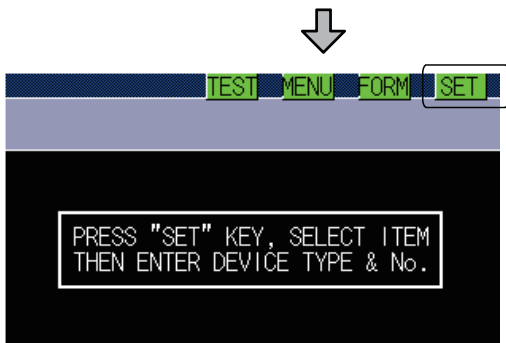

- 3) Touch the **Set** key when the screen as shown left appears.

The registered devices are displayed when there are devices already registered.

(Next page)

(From previous page)



4) Touch the **ENTRY** key.



5) When the device registration screen appears, touch the **▶** key, move the cursor to the device name, and touch "D".

6) Touch the **▶** key, and move the cursor to the device number.



7) Set the device number to "30".

8) Touch the **Enter** key.



9) Register the device.



(Next page)

(From previous page)

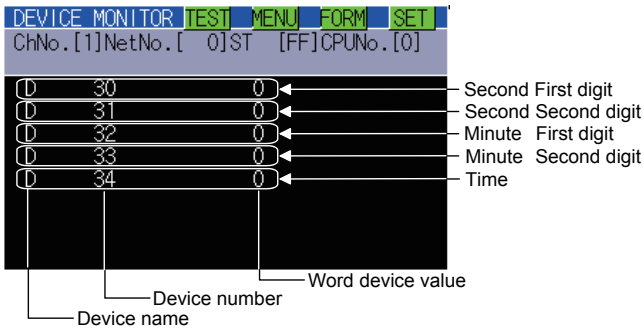

- 10) When registration is complete, return to the device registration screen.
- 11) Touch the **AC** key to clear the device value.
- 12) Set the device number to "31" and touch the **Enter** key to register the device.
- 13) Repeat the procedures for devices "D32", "D33", and "D34".
- 14) When registration is complete, touch **X** to exit the device registration screen.
- 15) Go back to the device monitor screen, and the monitor just registered is being monitored.

(2) Operation procedure for test operation

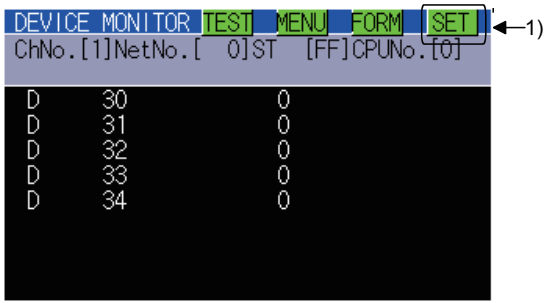

1) Touch the **SET** key on the device monitor screen.



2) Touch the **TEST** key.

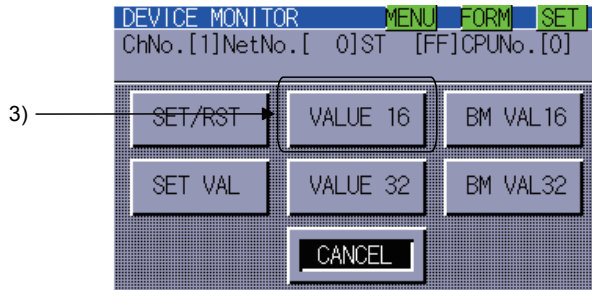

3) When the Test menu screen appears, touch the **VALUE 16** key.



4) When the setting key window appears, make the settings as follows and touch the **Enter** key.

Device name: "D"
 Device number: "30"
 Value: "0"



(Next page)

(From previous page)



5) Touch the  key, and move the cursor to the device number.

6) Make the settings as follows and touch the Enter key.

Device name: "D"
Device number: "31"
Value: "5"



7) Repeat the procedures, and, set the value of "D32" to "9", set the value of "D33" to "5", and set the value of "D34" to "7".

8) When setting is complete, touch  to exit the setting key window.

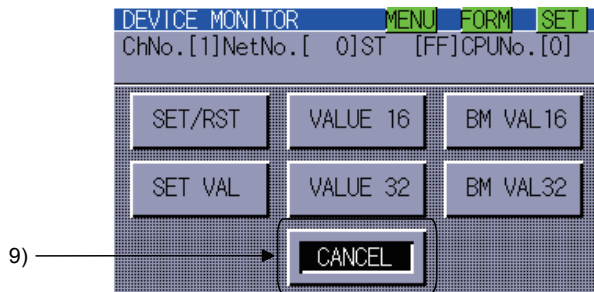

9) When the Test menu screen appears, touch the CANCEL key.

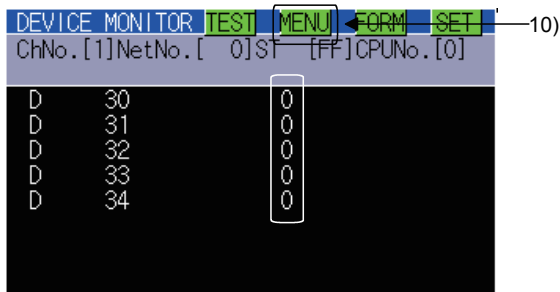

10) Go back to the device monitor screen, check that the value just entered is properly displayed, and touch the MENU key.



(Next page)

(From previous page)

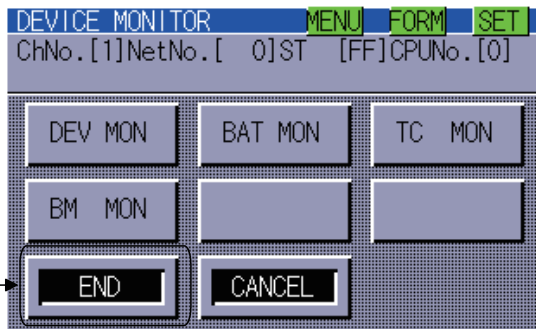

11) Touch the **END** key.

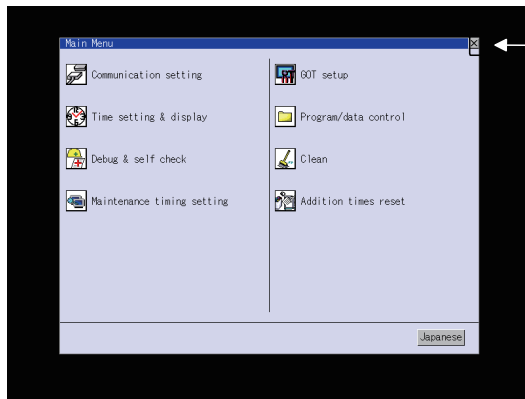

12) When the Main menu screen appears, touch **X**.

(3) Operation check

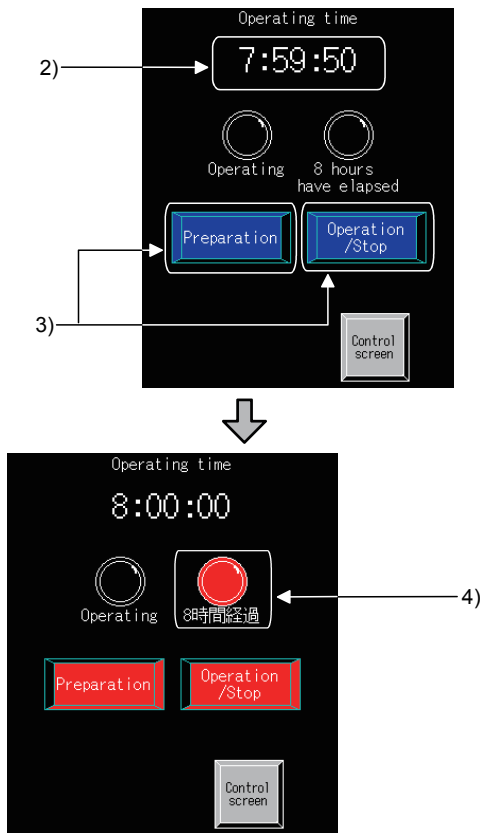

- 1) Display Base screen No. 3.
- 2) Check that the operating time indicates 7:59:50.
- 3) Touch the **Preparation** switch, and then touch the **Operation/Stop** switch to start counting the operating time.
- 4) When the operating time exceeds 8 hours, check if the lamp turns ON.

Appendix

Appendix 1 Alarm history display function

Appendix 1.1 About the alarm

This is the function to display the user-created comment, and an error of GOT, PLC, and network as an alarm message.

This chapter explains the functions that display following alarms.

(1) Alarm types

The GOT can detect the alarms as shown below.

(a) Displaying the user-created comment as an alarm message

The function that displays the user-created comments as alarm messages when an alarm occurs.

(user alarm, advanced user alarm, alarm history display)

Suitable for the case in which the alarm, which is created by the user, needs to be displayed.

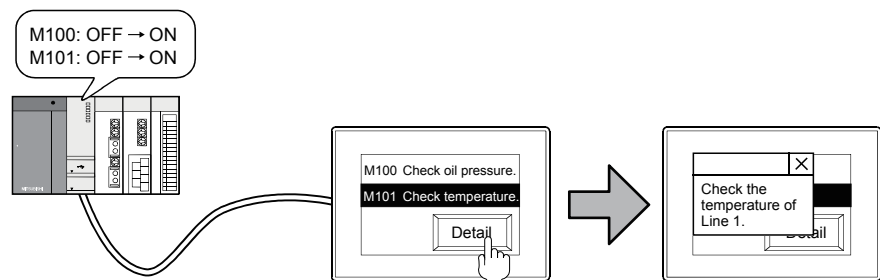

(b) Displaying an error of GOT, PLC, or network as an alarm

It is possible to display the error code and error message when an error occurs on the GOT, PLC or, network. (system alarm, advanced system alarm)

This is used to display an error of GOT, PLC, or network.

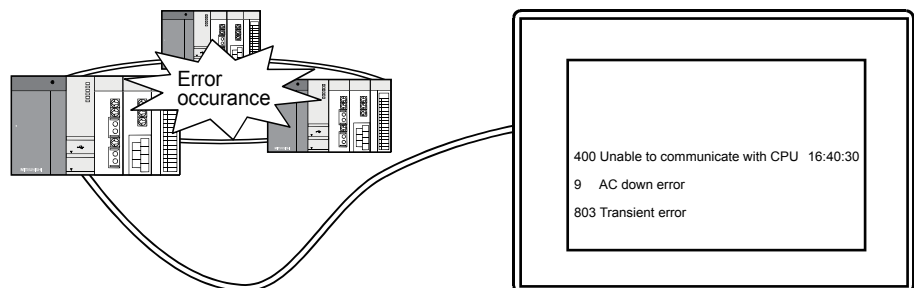

(1) Alarm function types

There are two types of alarm: alarm function and advanced alarm function.

The advanced alarm function, an extended function of alarm, is only used with the GT15.

○: Function ×: No Function

Function Name			Alarm Types		Display Method	
			System Alarm	User-Created Alarm	Displays by the Screen Unit	Popup Display *1
Alarm Function	Alarm List Display	Displays alarms that are currently occurring.	○	○	○	×
	Alarm History	Displays a history list of alarms that occurred in the table.	×	○	○	×
Advanced Alarm Function	Advanced User Alarm (Advanced Alarm Observation)	Detects the alarms created by the user, and saves the alarm history. An alarm that occurred can be displayed either by the screen unit or in the popup display.	×	○	○	○
	Advanced System Alarm (Advanced Alarm Observation)	Detects an error of GOT, PLC, or network, and saves the error history. An alarm that occurred can be displayed either by the screen unit or in the popup display.	○	×	○	○

*1: An alarm pops up whenever an alarm occurs regardless of the display screen.

Remarks
<p>This text describes the alarm history display function.</p> <p>Refer to GT Designer2 Version2 Screen Design Manual chapter 8 for the other functions.</p>

Appendix 1.2 About the alarm history display function

(1) The alarm history display function

The alarm occurrence time and comments are stored and displayed in a history list when conditions of the device specified for alarm detection are met (Bit OFF to ON/word device range).

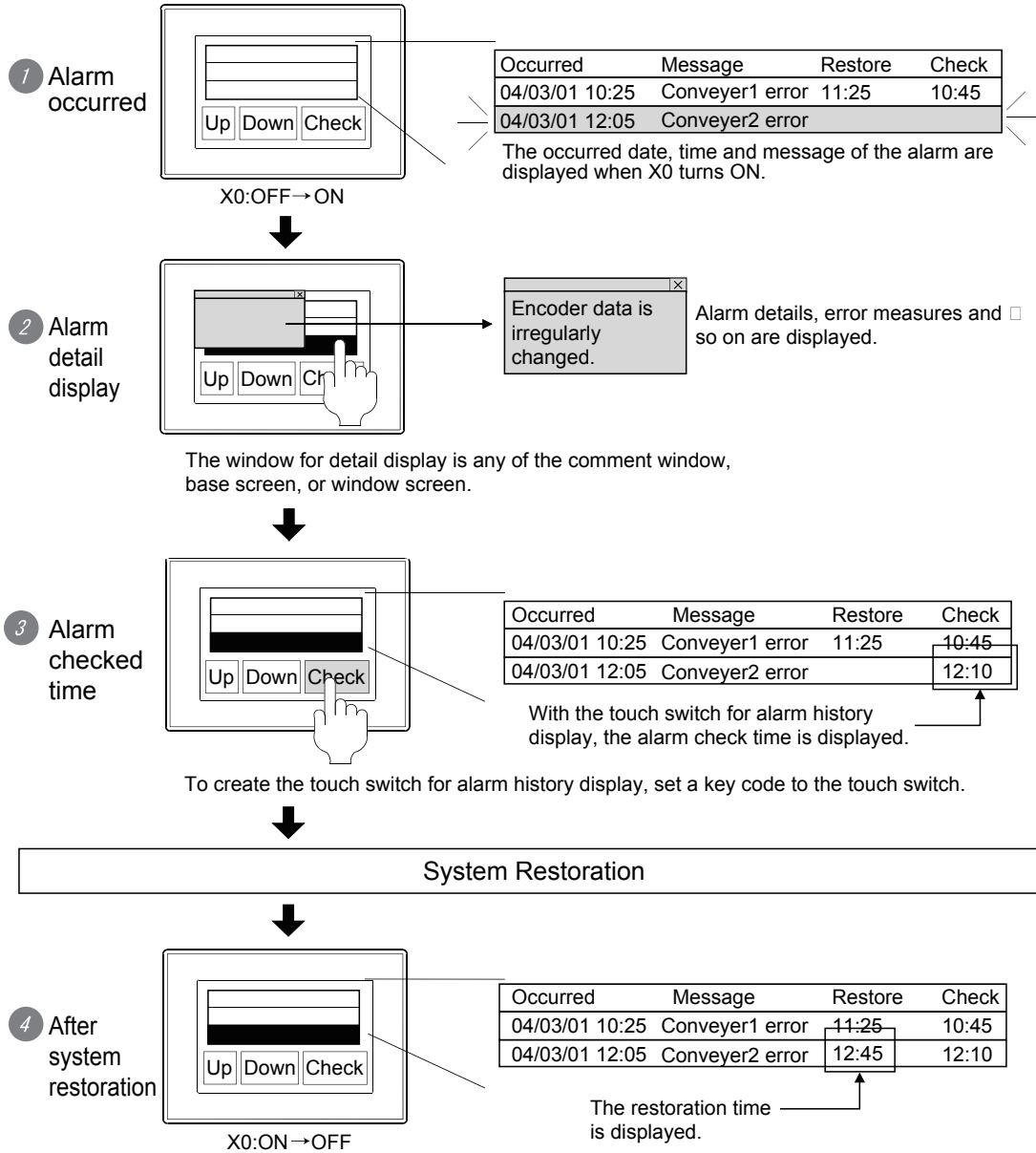

(2) Alarm collection mode

Select either of the two collection modes, historical mode or cumulative mode.

- Historical mode

In this mode, alarm contents are added to the memory built-in on GOT each time alarms occur. (Each alarm occurrence is added to the history.)

Up to the following number of alarms can be stored depending on the units:

- For GT15: 3072 alarms
- For GT11: 2048 alarms

- Cumulative mode

Latest alarm status, alarm occurrence frequencies and times, are counted and collected.

When an alarm occurs, the following information can be collected and displayed.

Occurred	Message	Restore	Check	Cumulate	Count
04/06/01 20:00	Pwr. module error	-	-	-	1
04/06/01 18:30	Oil pressure error	-	18:50	-	2
04/06/01 16:10	Drive module error	16:30	16:20	00:20	2

1)
2)
3)
4)
5)
6)

- | | |
|---|---|
| <p>1) Occurrence date and time
The date/time of alarm occurrence is displayed.</p> <p>2) Comment
The comment assigned to an alarm is displayed when an alarm occurs.</p> <p>3) Restoration date and time
The date/time of alarm restoration is displayed.</p> | <p>4) Check date and time
The date/time when an alarm occurred was checked is displayed.</p> <p>5) Cumulative Time (cumulative mode only)
Total of alarm occurrence time including alarms which occurred in the past is displayed.</p> <p>6) Frequency of occurrences (cumulative mode only)
The alarm occurrence frequency is displayed.</p> |
|---|---|

(3) Maximum number of device points and types of monitor devices being monitored

(a) Types of monitor devices

- Bit device
- Bit device (bit of word)
- Word device (alarm is occurred when the device value falls in the specified range)

(b) Maximum number of monitored points

GT15

- Bit device : 3072 points
- Word device (16-bit) : 1024 points
- Word device (32-bit) : 512 points

GT11

- Up to 256 points regardless of the types of device being monitored

Point	<p>Specifying monitor devices randomly to monitor bit devices A bit device and a bit device (bit of word) cannot be mixed when specifying monitor devices randomly.</p>
-------	---

(4) Restrictions and setting positions when using this function

Only one set device and its device name can be monitored for each project.

Although an alarm history display function can be set for each object in each base screen, the device being monitored is all the same.

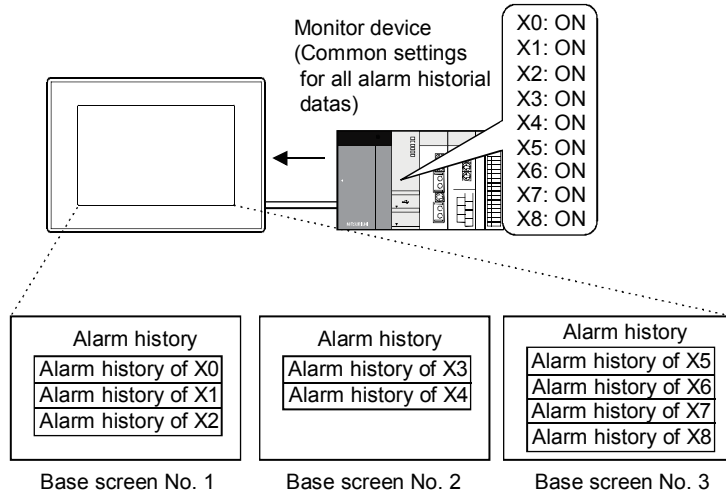

Different settings for the number of row and frame color are available for each alarm history.

(5) Collecting and holding alarm history data

(a) Collecting alarm history data

The GOT collects alarm history data at any time and saves the data in the GOT.

Alarm history data is constantly collected and updated even while the monitor screen not including alarm history display is being displayed.

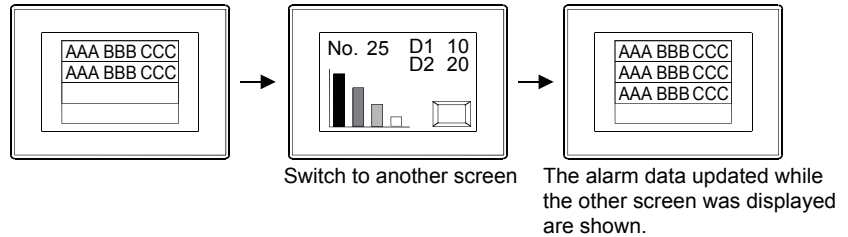

(b) Deleting alarm history data

All alarm history data is deleted by power-off or reset of the GOT.

Alarm history data can be cleared either on a one-by-one basis or in a bundle using the key (touch switch) for alarm history switch.

(c) Holding alarm history data under power failure

Alarm history data can be held even if the GOT is powered off by saving the data to the memory card.

The last state just before the GOT power is turned OFF can be displayed when the GOT is started again.

d) When the number of alarms occurred has exceeded the upper limit (when the collection mode is "Historical")

In the case where "When number of alarm occurrences exceeds set value, delete oldest alarm occurrences" was check-marked on the Option (common) tab, if the number of alarms occurred has exceeded the upper limit, the older alarms are deleted from the oldest one.

[Upper limit in total number of alarms occurred]

- For GT15: 3072 alarms
- For GT11: 2048 alarms

Remarks
Alarm history data can be read and edited in the spreadsheet software in the PC by saving it in the CSV format in the memory card.

(6) Display method of details

Details of the device which encountered an error can be displayed in either one of the following three formats (Comment Window, Window Screen, or Base Screen):

1) Display the detail display screen by one touch operation

Occurrence	Message	Restore	Check
02/02/01 10:25	Line 1 error	11:25	10:45
02/02/01 12:05	Line 2 error		12:28
02/02/01 12:35	Line 3 error		



2) Display the detail display screen by key input from the touch switch

Occurrence	Message	Restore	Check
02/02/01 10:25	Line 1 error	11:25	10:45
02/02/01 12:05	Line 2 error		12:28
02/02/01 12:35	Line 3 error		



Comment window is displayed (Window screen for alarm history).

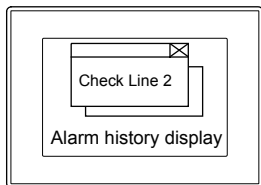

The specified comment is displayed.
 Details and corrective actions are registered in advance as comments.

Window screen is displayed (Overlap window).

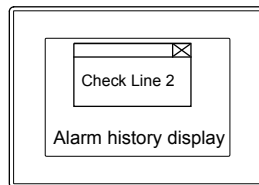

The specified base screen or window screen is displayed.
 Details and corrective actions are drawn in advance in the window and base screens.

Base screen is displayed.

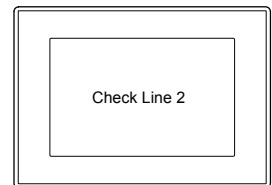

Remarks
Refer to chapter 8 of the GT Designer2 Version2 Screen Design Manual for details on the other functions.

Appendix 1.3 Settings screen example

This section describes screen setting examples that display detailed information using window screens by touching the error messages for bit device ON state (error state), such as "Comment No.1 to No.4", "Occurred Date", "Time", or "Restored Time", or the occurrence Message on the alarm history screen when the bit devices "X2 to X5" are turned ON.

Screen example to be created

The screenshot shows an 'Alarm History' screen with a table of error records and a control panel at the bottom. Callouts describe the following elements:

- Alarm history display screen**: Points to the table of error records.
- Touch switch (for confirmation)**: (The date/time when alarm was checked is displayed.) Points to the 'CHECK' column in the table.
- Touch switch (for deleting history)**: (A list of selected alarms is erased.) Points to the 'DELETE' column in the table.
- Touch switch (for scrolling up or down)**: (The listing is scrolled up or down when the alarm history amounts to more than 10 items.) Points to the 'Up' and 'Down' buttons in the control panel.
- Touch switch (for showing/hiding cursor)**: Points to the 'Cursor ON' and 'Cursor OFF' buttons in the control panel.

OCURRED	MESSAGE	REST.	CHECK
06/02/15 11:25:24	Error 1	11:25	11:25
06/02/15 11:25:24	Error 2	11:25	11:25
06/02/15 11:25:24	Error 3	11:25	11:25
06/02/15 11:25:24	Error 4	11:25	11:25
06/02/15 11:25:24		11:25	11:25
06/02/15 11:25:24		11:25	11:25
06/02/15 11:25:24		11:25	11:25
06/02/15 11:25:24		11:25	11:25
06/02/15 11:25:24		11:25	11:25
06/02/15 11:25:24		11:25	11:25
06/02/15 11:25:24		11:25	11:25

Control Panel Buttons:

- Cursor ON / Cursor OFF
- Up / Down
- Check / Check all
- Delete / Delete all
- Detail / Reset
- Save / Ladder
- Upper hierarchy / Lower hierarchy

Screen creation example of window for detail display

The screenshot shows a detail display window with the following content:

Malfunction 1 Action

Check limit switch 1.

+

Appendix 1.4 Alarm history display function settings

(1) Select the [Object] - [Alarm History] menu.

(2) Placement of alarm history display

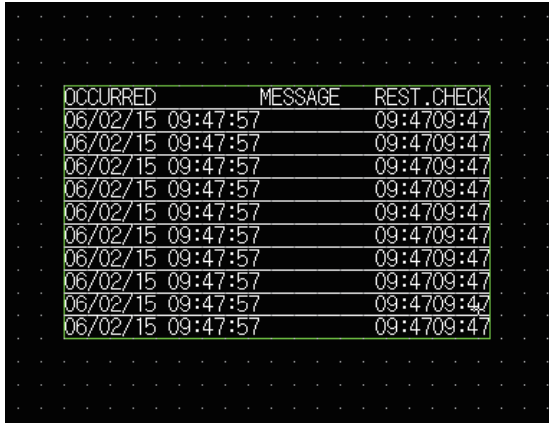

1) Move the cursor to the desired position where the alarm history to be placed, and click the mouse button.

2) Double-click the alarm history display which has been placed.
The Alarm History dialog box is displayed.

(3) Common settings for alarm history ([Device (Common)]/[Option (Common)] tab)
Common settings for alarm history are set for each project.
Settings for individual base screen are not necessary.

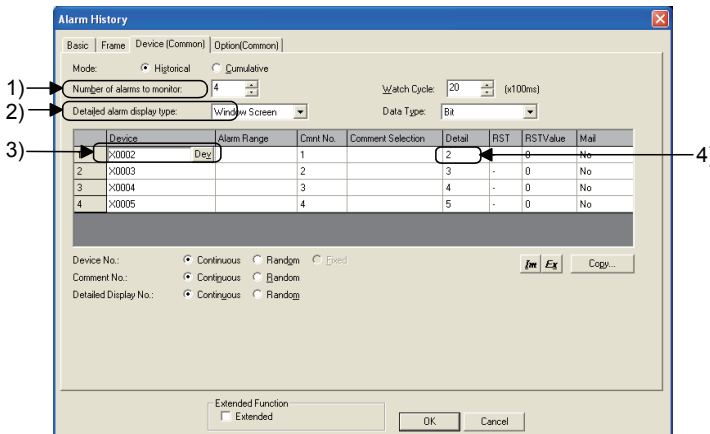

1) Set a device to be monitored.
In this case, set [Number of alarms to monitor] to "4" since alarms are set at four bit signals, "X2 to X5".

2) Select "Window screen" for [Detailed alarm display type].

3) Select the top of list, click the **Dev** button to set the monitor device to "X2".
Devices X3 to X5 are consecutively assigned.

4) Set "2" for in [Detail].
The window screen No. to display the detail appears.

Point

(1) The settings whose tab names are marked with (Common) in the dialog box are common settings in project.

Basic | Frame | Device (Common) | Option (Common)

Project common setting
(Only one setting can be set through the project.)

(2) Common settings for alarm history display can also be set by the following operations.

- Select the [Common Settings] → [Alarm History] menu.
- Select the [Project] → [Common Settings] → [Alarm History.] of the project workspace.

- (3) Settings for alarm history display ([Basic]/[Frame]/[Option] tab)
Set the display format (number of rows/frame for alarm) for alarm history display specified for each base screen.

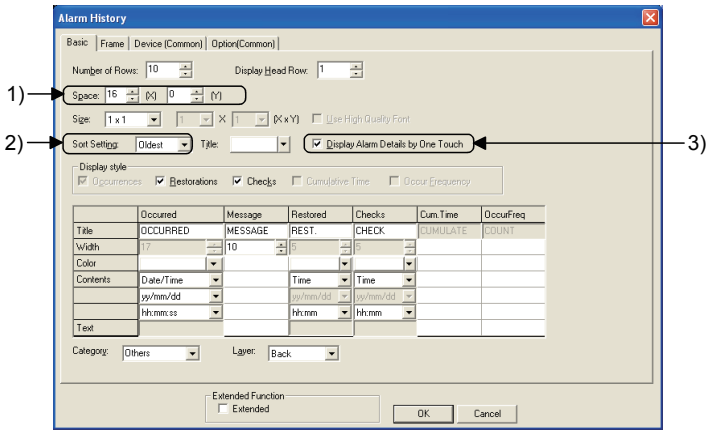

- 1) Set "16 x 0" for [Space].
- 2) Set "Oldest" for [sort setting].
- 3) Check [One Touch] when window screen is used for detail display.

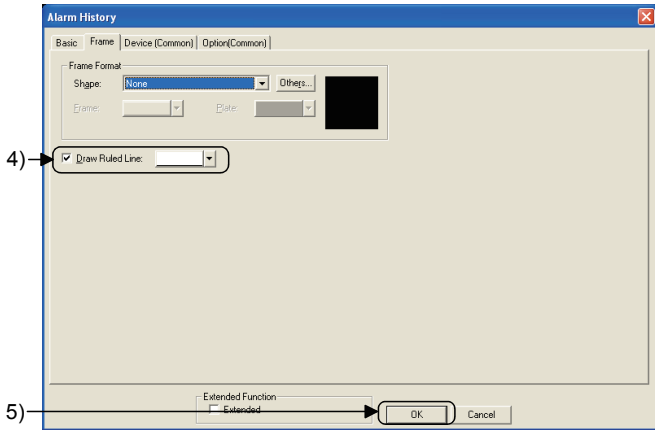

- 4) Check [Draw Ruled Line] to set it to white.
- 5) Click the **OK** button.

- (4) Settings of comments No.1 to No.4
Set the comments No.1 to No.4 as follows:

Comment No.	Comment	Text	Rev	Blink	HQ	Style	Solid
1	accident 1	<input type="checkbox"/>	No	No	<input type="checkbox"/>	Regular	<input type="checkbox"/>
2	accident 2	<input type="checkbox"/>	No	No	<input type="checkbox"/>	Regular	<input type="checkbox"/>
3	accident 3	<input type="checkbox"/>	No	No	<input type="checkbox"/>	Regular	<input type="checkbox"/>
4	accident 4	<input type="checkbox"/>	No	No	<input type="checkbox"/>	Regular	<input type="checkbox"/>

Make the settings as indicated.

Appendix 1.5 Alarm history display function switch settings

Set the touch switches used for displaying/moving the cursor for alarm history display and detail display of alarm contents.

- (1) Place a touch switch for alarm history display on the screen.
Set the touch switch for alarm history display by reading it out from the GT Designer2 library since it is registered there.

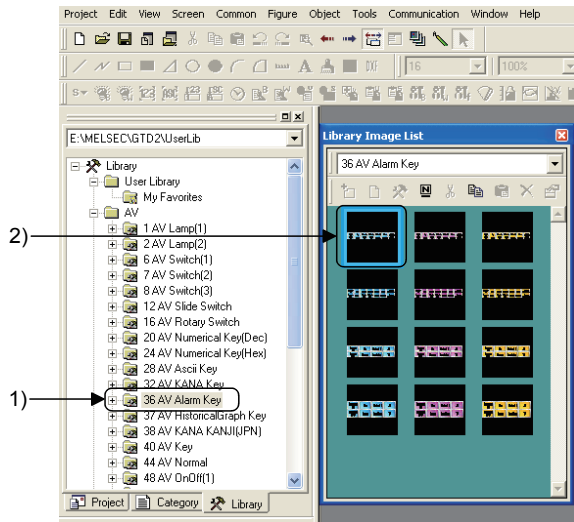

- 1) Double-click the [AV alarm key] of [AV] in the [Library] workspace.
- 2) When the Library Image list window appears, select "ADALM01_B".

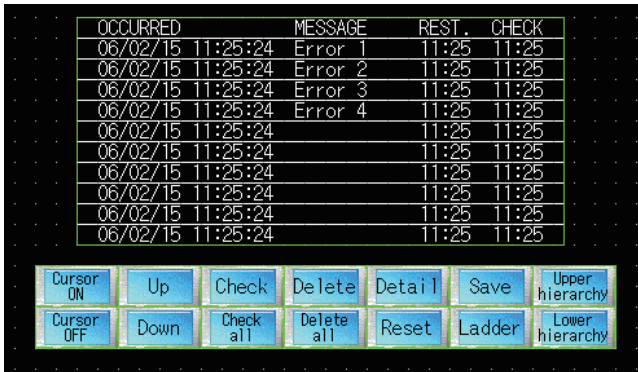

- 3) Move the cursor to the position where the touch switch for alarm history display is placed, and click the mouse button.

(2) Settings and functions of touch switch for alarm history display

The type of touch switch for alarm history display can be changed with the value of [Key Code] of touch switch.

The following describes the procedures for changing the functions of the touch switch for alarm history pasted in the previous page.

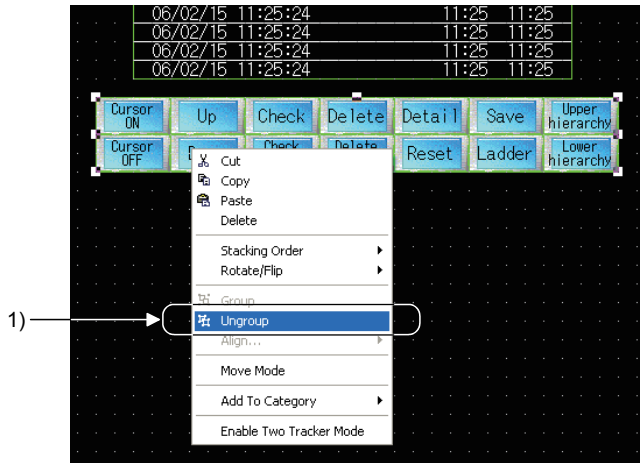

- 1) Click the right mouse button, and select [Ungroup].

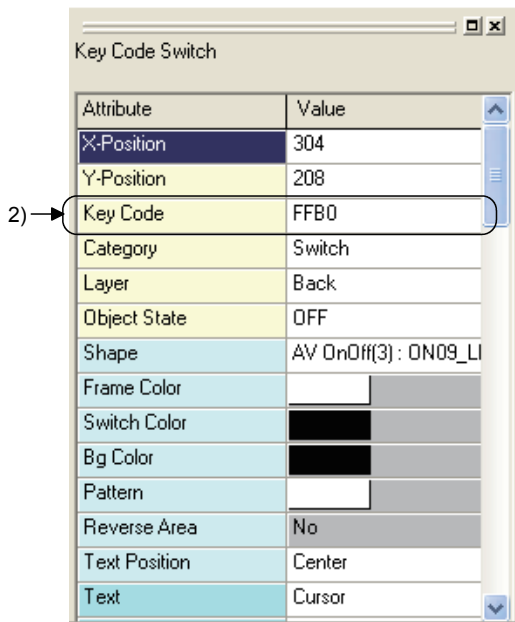

- 2) Change the value of key code using the property sheet.

The types and the key codes for touch switches for alarm history display are listed in the following table.

Switch name	Functions	Key code
Show cursor	Show cursor	FFB0H
Hide cursor	Hide cursor	FFB1H
Move upward	Move cursor upward (add page break when cursor is hidden)	FFB2H
Move downward	Move cursor downward (add page break when cursor is hidden)	FFB3H
Check *1	Display date/time of selected data (check)	FFB4H
Check all	Display date/time of all data (check all)	FFB5H
Delete *1	Clear the selected alarm data which has been restored (delete)	FFB6H
Delete All	Clear all alarm data which has been restored (delete all)	FFB7H
Detail	Display detail	FFB8H
Reset *1	Reset the specified device	FFB9H
Save	Save alarm contents to Memory Card	FFBBH
Ladder	Start the ladder monitor function to search an alarm device	FFBCH
Upper hierarchy	Switch for advanced alarm display. This cannot be used in the alarm history display function.	FFC2H
Lower hierarchy	Switch for advanced alarm display. This cannot be used in the alarm history display function.	FFB8H

*1 This should be used with a switch for show/hide cursor.

Remarks

A touch switch for alarm history display can be created using the touch switch (key code switch) for key code.

With a key code switch, the key code is automatically set when the desired function is selected.

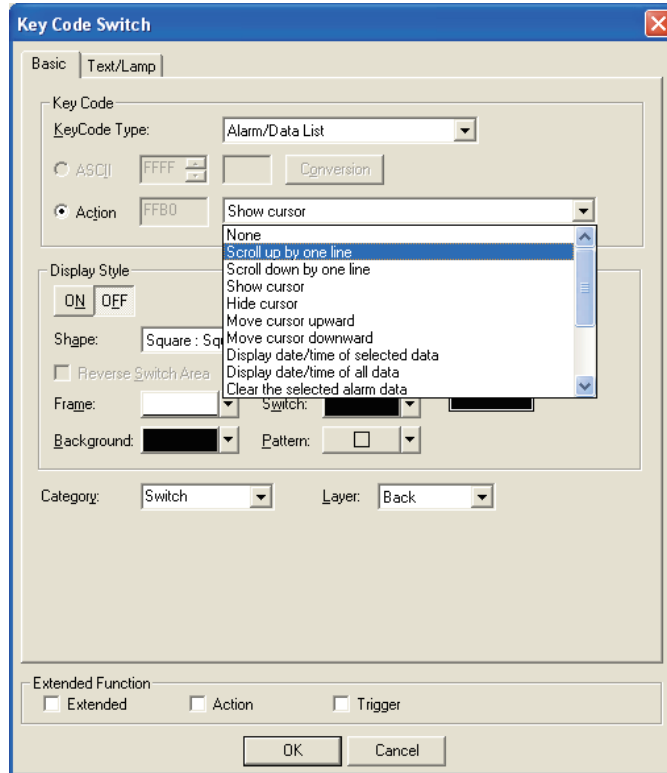

Touch switch (key code switch)

Appendix 1.6 Detail display window screen creation

Creating window screens No. 2 to No.5 for detail display.

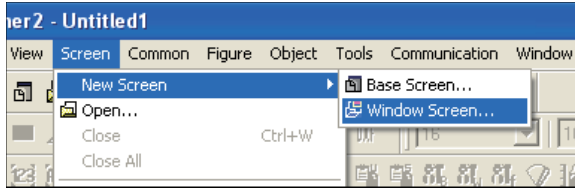

- 1) Select the [Screen] - [New Screen] - [Window Screen] menu.

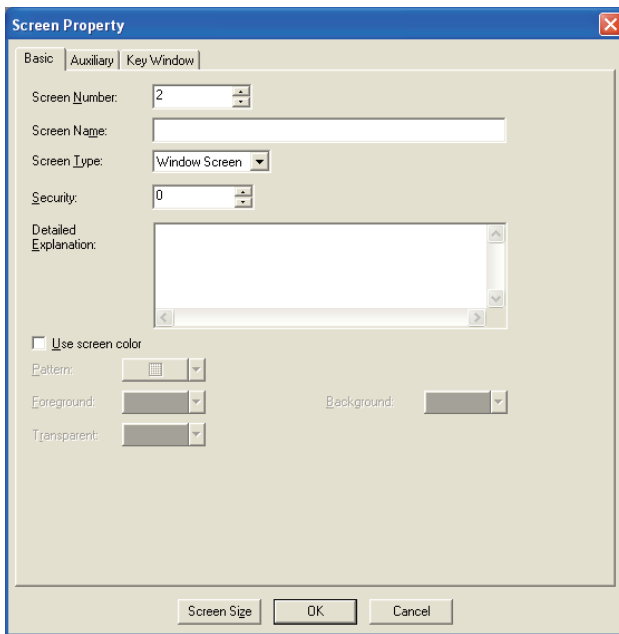

- 2) The Screen Property dialog box is displayed. Set [Screen Number] to "2".

- 3) Click the button.

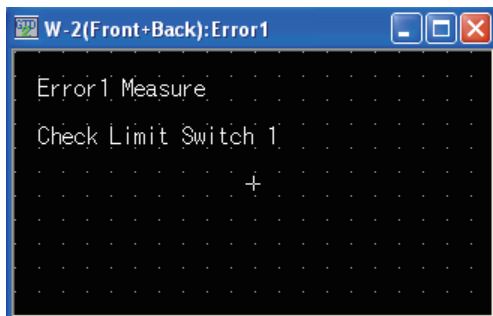

- 4) Window screen No.2 is displayed on the screen.

- 5) Set the text as indicated in the left on the window screen.

- 6) Select the [Screen] - [Close] menu.



(Next page)

(From previous page)



Window Screen No. 3

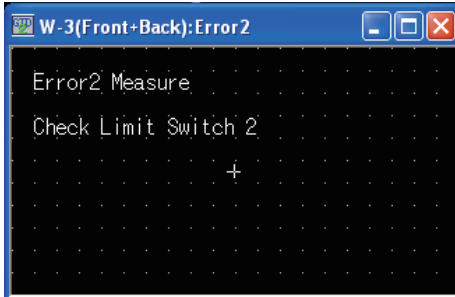

7) Repeat steps 1) to 6) to create Window Screen No.3 to Window Screen No.5 as shown in the left.

8) This completes the setting of switch for alarm history display.

Window Screen No. 4

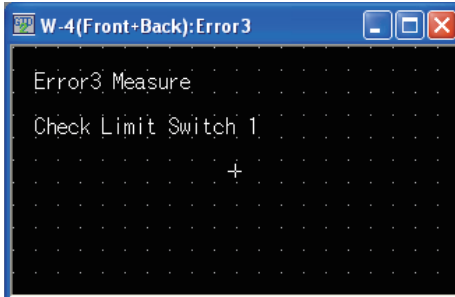

Window Screen No. 5

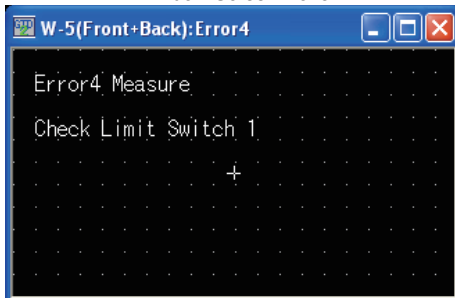

Appendix 1.7 Operation check

Download all the data to the GOT from the download screen of monitor data.
 Reset the PLC CPU using the RESET key switch, and then switch to RUN.
 Check if the alarm history display function of Screen No.4 works properly here.

(1) Test 1

Perform the following tests in screen No.4.

Item	Test object	Alarm History	Touch switch						
			Show cursor	Move upward/downward	Check	Delete			
1)	PLC test switches (X2, X3, X4, X5)	Turns each switch ON.							
	Screen state	X2 ON: Displays "Malfunction 1"	—	—	—	—			
		X3 ON: Displays "Malfunction 2"	—	—	—	—			
		X4 ON: Displays "Malfunction 3"	—	—	—	—			
		X5 ON: Displays "Malfunction 4"	—	—	—	—			
2)	First touch operation	Touch each error occurrence line.	—	—	—	—			
	Display/Action	Displays detail display window screens No.2 to 5.	—	—	—	—			
	Write device	D1:2 ~ 5	—	—	—	—			
3)	Second touch operation	—	Touch	—	—	—			
	Display/Action	The cursor is displayed.	—	—	—	—			
4)	Third touch operation	—	—	Touch	—	—			
	Display/Action	Move the cursor to "Malfunction 1".	—	—	—	—			
5)	Forth touch operation	—	—	—	Touch	—			
	Display/Action	Time when the confirmation switch is touched in "check" is displayed.	—	—	—	—			
6)	PLC test switch (X2)	Turns X2 OFF.							
	Screen state	Time when X2 is turned OFF is displayed in [Restore] of "Malfunction 1"	—	—	—	—			
7)	Fifth touch operation	—	—	—	—	Touch			
	Display/Action	Display in "Malfunction 1" is deleted.	—	—	—	—			

Appendix 2 Data transfer to GOT by memory card

It is possible to download the OS installation data and the screen data from a memory card to the GOT by writing the OS and project data to the card.

Use of memory card to transfer data to GOT conveniently eliminates the necessity to carry the personal computer and cable when downloading the project to multiple GOTs.

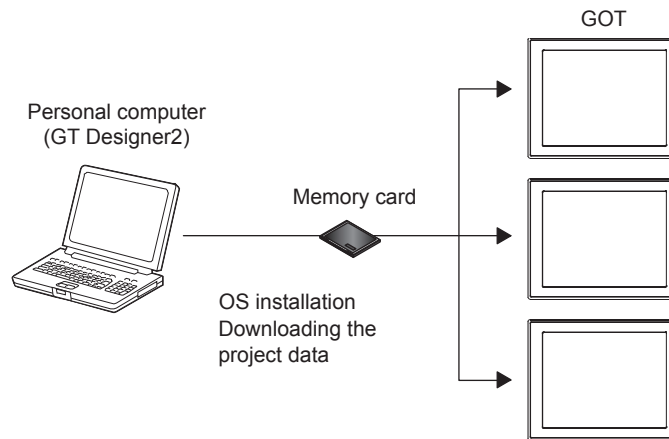

Appendix 2.1 Overall procedure

This section describes an overall procedures for data transfer to the GOT using a memory card.

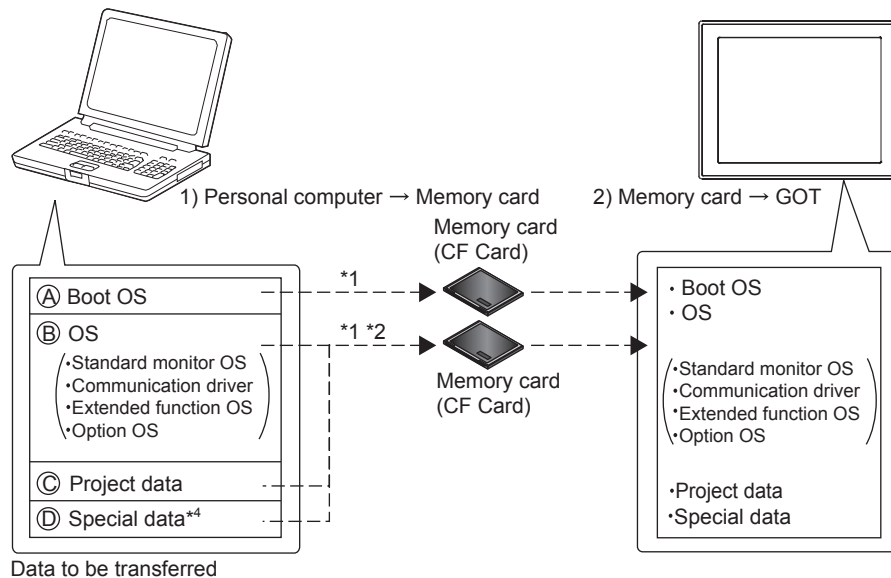

*1 Data A and B or C or D cannot be transferred to the same memory card.

*2 Depending on the capacity of the memory card, data B, C and D can be transferred simultaneously.

*3 GT□□ only

1) Personal computer → Memory card

Various data (Boot OS, OS, project data, special data) installed in the personal computer is written into the memory card using GT Designer2.

Refer to the GT Designer2 Version2 Basic Operation/Data Transfer Manual for details on writing data to the memory card.

2) Memory → GOT

The data can be installed/downloaded into the GOT in either of the following two methods.

- How to Install while the GOT is powered ON
Refer to the GT Designer2 Version2 Basic Operation/Data Transfer Manual for the installation method.
- Installation by the utility (program/data control) function of the GOT
Refer to the GT15 User's Manual/GT11 User's Manual for the installation method.

Point	
	<p>Precautions for data transfer</p> <p>(1) Memory card When downloading/installing the various types of data (Boot OS, OS, project data, special data) into a memory card, do not store any other data into that memory card. The other data are all erased at the time of download/installation. Storing the Boot OS data and the other data (OS, project data, and special data) in the same memory card should also be avoided.</p> <p>(2) Data stored in GOT When the Boot OS and OS are installed, the project data stored in the project folder in the GOT is deleted. When it is necessary to back up the project data, upload the data to the PC or memory card (CF Card) before installing the OS.</p> <p>(3) Precautions in installing Boot OS and OS Boot OS/OS installation cannot be interrupted. Note that the GOT may become non-functional if one of the following is performed during installation:</p> <ul style="list-style-type: none">• Remove the CF card.• Power off the GOT.• Press the reset button of the GOT.

Appendix 3 About the FA transparent function

The FA transparent function allows the sequence programs of the Mitsubishi PLC to be read, written and monitored via GOT when the GOT is connected both to Mitsubishi GOT and to a personal computer.

Debugging, starting up, and adjustment of the sequence program can be carried out through the USB port equipped in front of GOT, which requires no cumbersome steps like panel opening or reconnection of cables.

(The operations above can be performed through RS-232.)

Appendix 3.1 System configuration

System configuration for the FA transparent function is shown below.

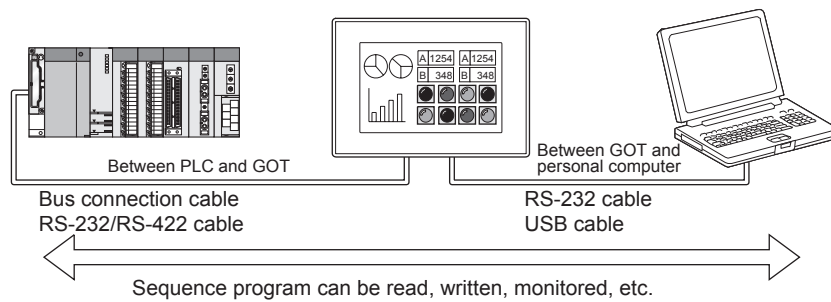

Appendix 3.2 Procedures up to accessing

This section describes the system configurations using the following connection examples:

- Connection between the PC and GOT: USB connection
- Connection between GOT and PLC: Bus connection

The following shows the procedure before accessing.

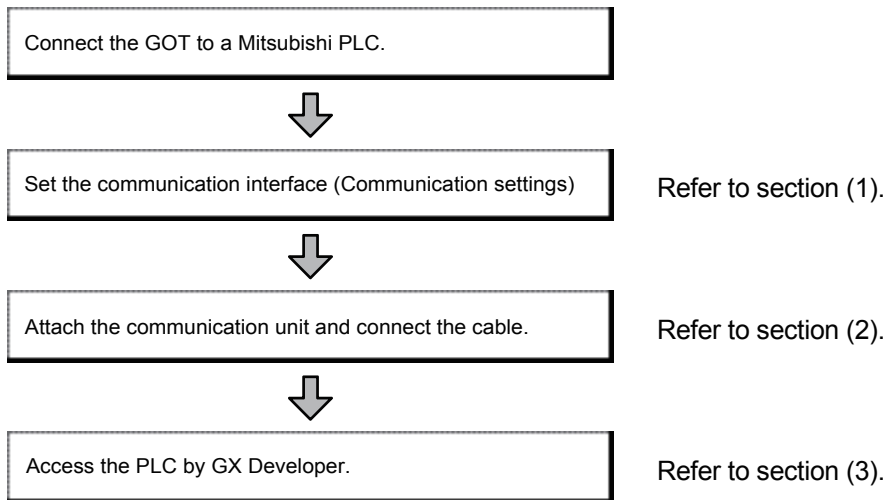

(1) Setting communication interface (Communication settings)

Set the communication interface of the GOT at [Communication settings] in GT Designer2.

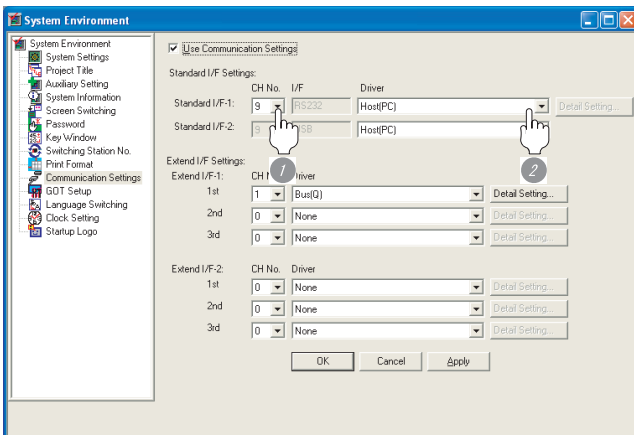

- 1) Set [CH No.] of [Standard I/F-1] to "9".
- 2) Set [Driver] of [Standard I/F-1] to "Host(PC)".

(2) Cable connection

1) Connection method for bus connection cable

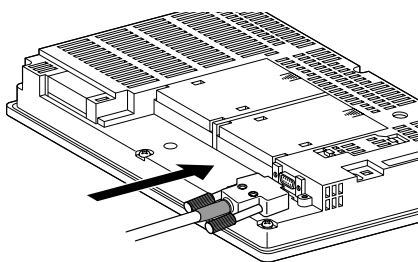

Connect the bus connection cable to the bus connection unit on the GOT.

2) Connection method for USB cable

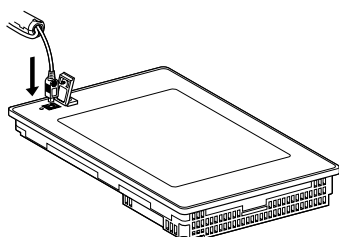

Connect the USB cable to the USB interface on the GOT.

(3) Access the PLC by GX Developer.

The following describes the procedures for monitoring the PLC by GX Developer using the FA transparent function.

Refer to the GX Developer Version □ Operating Manual for details on operation procedures for GX Developer.

(a) Connecting to PLC

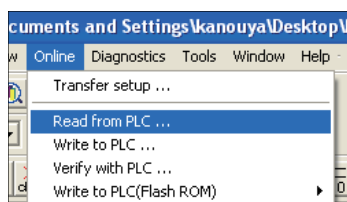

1) Click [Online] → [Read from PLC] in GX Developer.

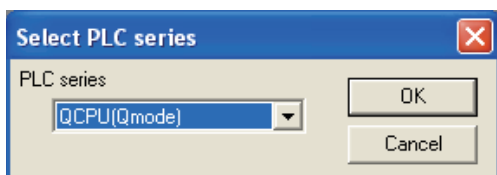

2) Set [PLC Series] of [Select PLC series] to "QCPU (Q mode)".

(Next page)

(From previous page)

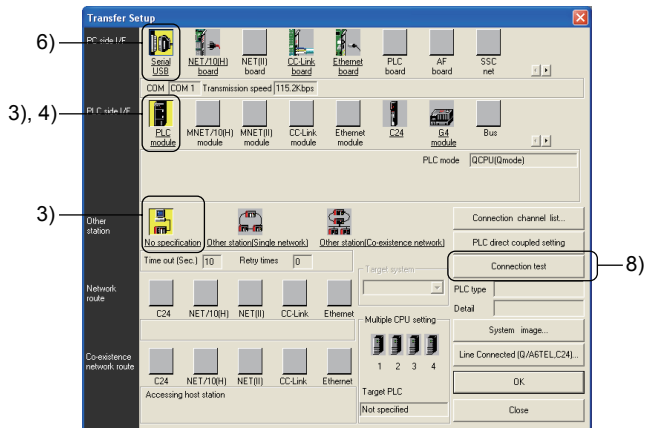

- 3) Set [Connection Setup].
PC side I/F: Serial USB
PLC side I/F: PLC module
Other station: No specification
- 4) Double-click [CPU module] of PLC side I/F to display [PLC side I/F Detailed setting of PLC module].

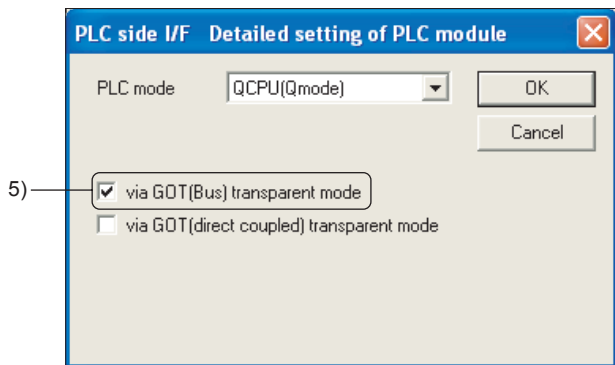

- 5) Check [via GOT(Bus) transparent mode] in [PLC side I/F Detailed setting of CPU module], and click the **OK** button.

Check [via GOT (direct connection) transparent mode] when connecting PC and GOT with the RS-232 cable.

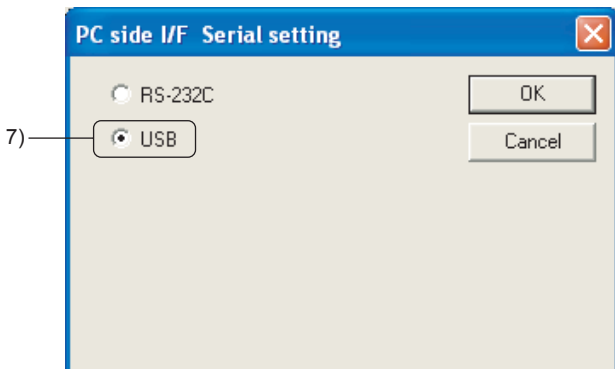

- 6) Go back to [Connection Setup], double-click [Serial USB] of PC side I/F to display [PC side I/F Serial Setting].
- 7) Check [USB] in [PC side I/F Serial Setting] and click the **OK** button.

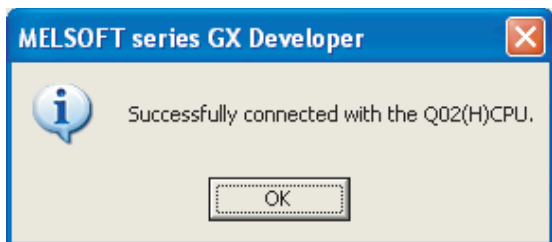

- 8) Go back to [Connection Setup], click the **Connection test** button, and check that the connection to QCPU is established.

(b) Monitoring PLC by GX Developer

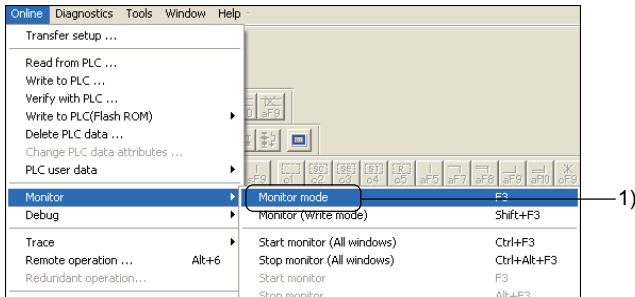

- 1) In GX Developer, select the [Online] → [Monitor] → [Monitor Mode] menu.

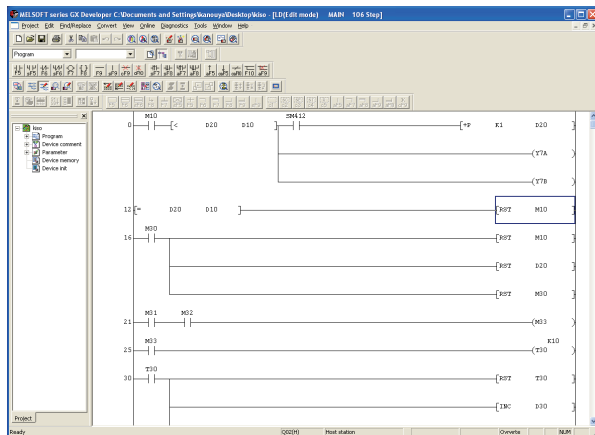

- 2) Monitoring of PLC starts.

Appendix 3.3 About the restrictions

This section describes the restrictions of the FA transparent function.

Refer to the GOT1000 Series Connection Manual and GT Designer2 Version2 Screen Design Manual for details on the specifications and cautions in using the FA transparent function.

(1) GOT interface required to use the FA transparent function

Connect the personal computer, to which GX Developer or any other relevant software has been installed, to the RS-232 interface or USB interface of the GOT. When performing the FA transparent function, use either RS-232 interface or USB interface of the GOT. Using both of them to perform the FA transparent function concurrently is not allowed.

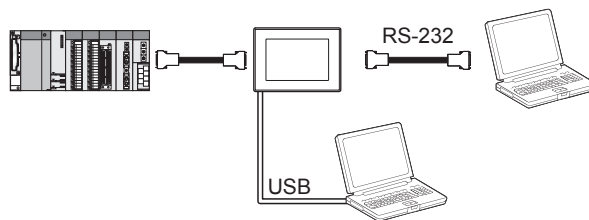

(2) When multiple GOTs are bus-connected

When multiple GOTs are bus-connected, the FA transparent function can be used on each GOT. However, note that the monitoring performance of each GOT slows down as the number of monitoring GOTs and personal computers increases.

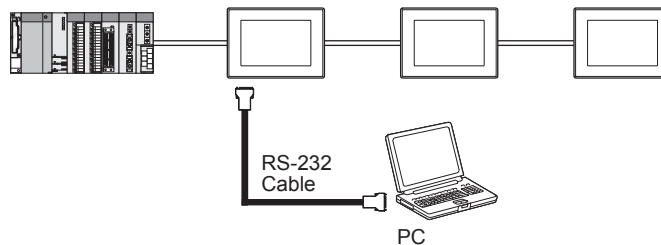

(3) When the FA transparent function is used in a bus connection

When the FA transparent function is used in a bus connection, the following GX Developer functions cannot be executed.

Unsupported GX Developer functions	Remarks
<ul style="list-style-type: none"> • Remote Reset • Remote system reset 	—
<ul style="list-style-type: none"> • Remote RUN • Remote STOP • Remote PAUSE • Remote STEP-RUN • Remote latch clear • Write clock data • Clear malfunction log 	Inexecutable only when all stations/groups has been specified.

(4) Software available on one personal computer

When multiple kinds of software are activated on one personal computer, only one of them is available for communications using the FA transparent function.

Do not concurrently perform any communications using the FA transparent function. (Offline operation with each software is available.)

Do not perform communications with the GOT (e.g. downloading project data) from GT Designer2 during communications using the FA transparent function.

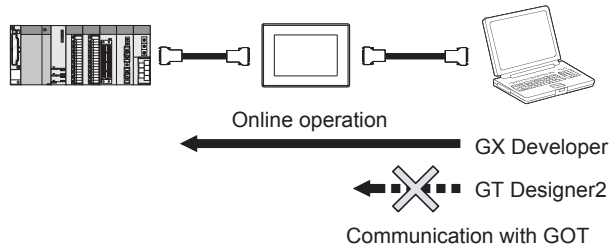

Appendix 4 Boot OS installation

This section describes the procedures for installing the Boot OS in the GOT.

Point
<p>(1) Boot OS is installed in the GOT at factory shipment so installation is not usually necessary. However, if functions not supported by the Boot OS version are used in the GOT (such as the version upgrade function of GT Designer2, etc.), Boot OS must be upgraded. To return the GOT to factory shipment state, install Boot OS to initialize it.</p> <p>(2) When Boot OS is installed, the currently installed OS and Project data are automatically deleted. If Project data backup is necessary, upload it to a PC or memory card (CF card) before installing Boot OS.</p>

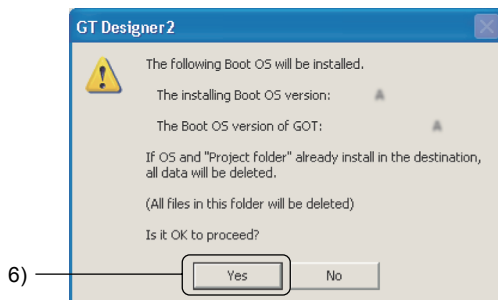
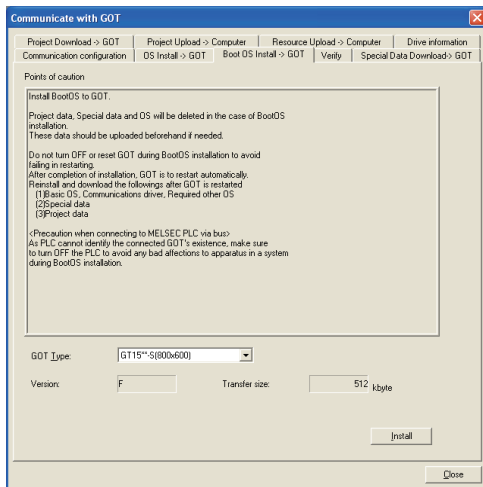
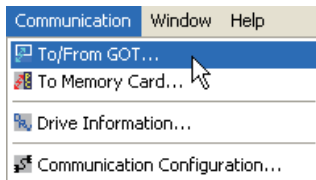

1) Click on the [Communication] - [To/From GOT...] menu.

2) When the dialog box appears, click the [Boot OS Install → GOT] tab.

3) Select the GOT type in which the Boot OS will be installed.

4) Click the **Install** button.

6) When the **Yes** button is clicked, Boot OS installation is executed.

7) After Boot OS installation is completed, click the **Close** button to close the dialog box.

Point

Checking method for the version of Boot OS and OS

The versions of Boot OS or OS currently installed in the GOT can be displayed to check if installation of Boot OS or OS is required.

- 1) Touch **Main Menu** → **OS information** in the Utility screen of GOT.
- 2) As the **[Program/data control: OS information]** screen appears, touch the folder to check the version.
 - **G1BOOT**: For Boot OS version check
 - **G1SYS**: For OS version check

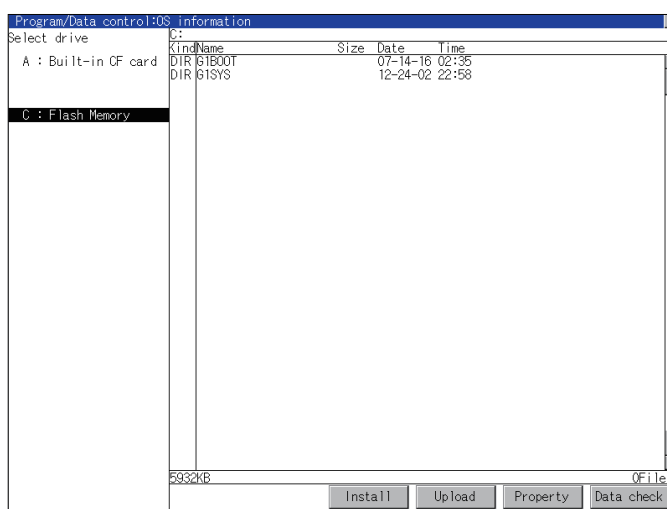

- 3) Touch the **Property** button, and the versions of the selected Boot OS and OS are displayed.

Example: When OS is selected

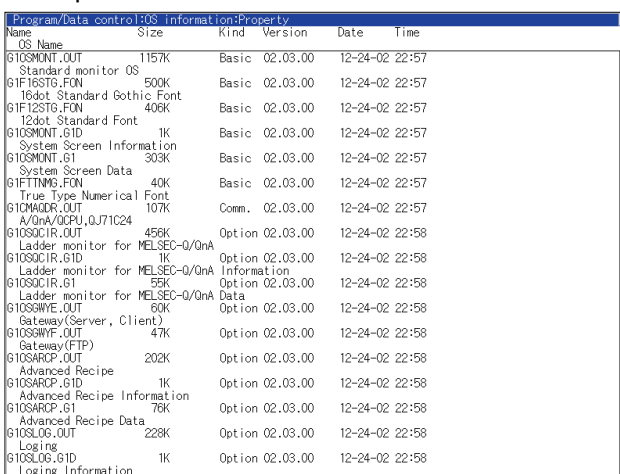

The following is displayed depending on the types of files:

- Boot : Boot OS
- Basic : Standard monitor OS
- Communication : Communication driver
- Option : Option OS

Appendix 5 Screen data upload

This section describes the procedures for saving the screen data being written to the built-in memory of GOT, as a GT Designer2 file.

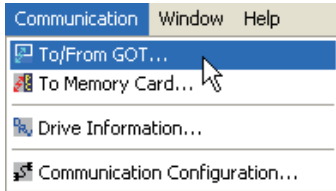

- 1) Click on the [Communication] - [To/From GOT...] menu.

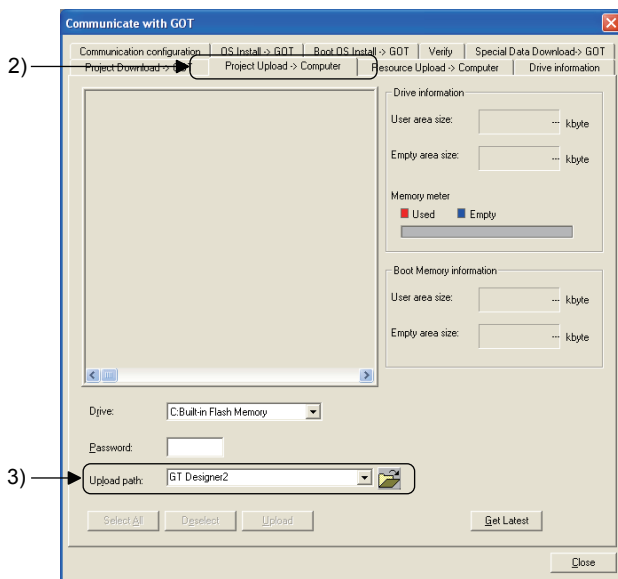

- 2) When the dialog box appears, click the [Project Upload -> Computer] tab.
- 3) Specify the destination to save the screen data for uploading. Click .

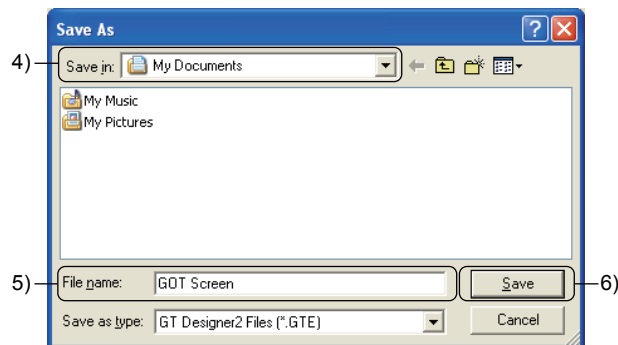

- 4) As the Save As dialog box appears, select "C:¥My Document".
- 5) Specify the file name. Enter "GOT Screen" here.
- 6) Click the **Save** button.



(Next page)

(From previous page)

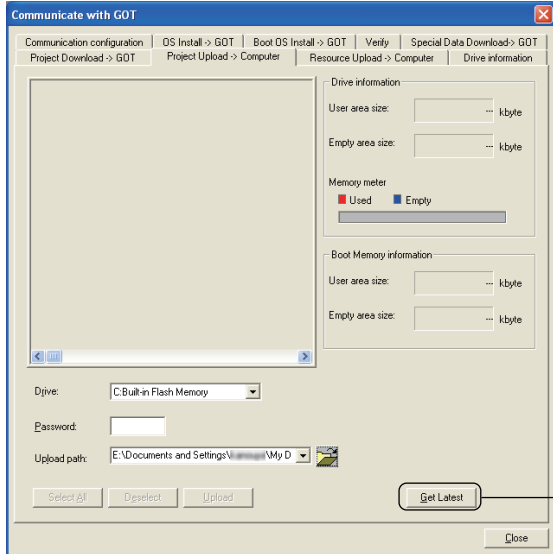

7) Click the **Get Latest** button.

8) As the confirmation that the drive information was acquired appears, click **Yes**.

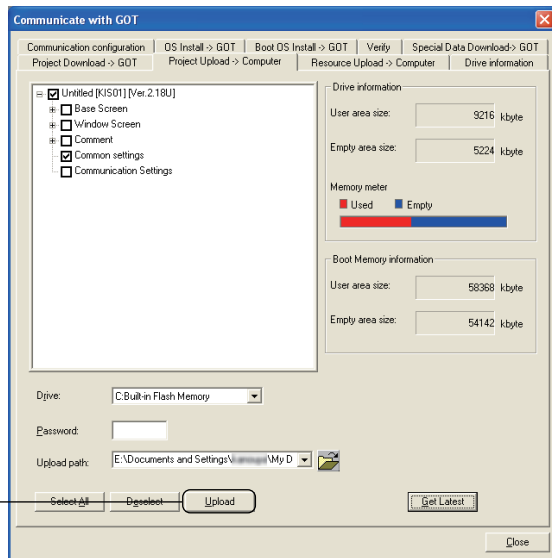

9) Click the **Upload** button.

9)

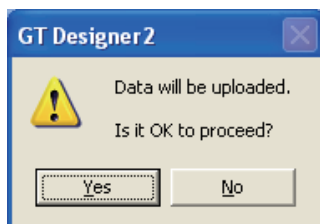

10) When the **Yes** button is clicked, screen data is uploaded.

When the upload is completed, confirm the data in "My Document".

Appendix 6 Glossary

This glossary explains the terms used in this document.

All entries are in alphabetical order

—— A ——

Access key

A key used instead of selecting menu items for GT Designer2 or other applications

The underlined letter in a menu item shows its access key.

Address

A position in memory

The PLC has various devices, including data registers (D) and internal memory (M). The positions in these memories are called addresses.

Addresses are expressed in decimal or hexadecimal format.

Hexadecimal format: X, Y, B, W

Decimal format: All addresses other than the above

Alignment

The figures and objects in the selected area are aligned with the specified method.

Besides up/down/left/right and center, there is also top-justified or left-justified alignment.

With top-justified alignment, all the figures including the most upper left and the most right bottom figures in the alignment area are justified. This is useful for uniform-interval layout of numbers in tables and other objects.

ALT (alternate)

Operation name for GT Designer2 touch switches

When a touch switch on the screen is touched, the current status of the bit device is toggled between ON and OFF.

ASCII display

ASCII code is a standard American code system. Many computer systems use ASCII codes to express information.

With a GOT, character string data (e.g., ABC) is input and displayed.

Character string data can be written to buffer memory in special function module and word devices.

Attribute (change)

The polyline/fill pattern/text status are called attributes. Changing the status of an attribute is called attribute change.

- Polyline: Line style/line width/color
- Pattern: Line style/color
- Text: Font, vertical magnification ratio/horizontal magnification ratio/direction/style/background color/color

— B —

Backlight

This is a fluorescent lamp that shines light from the rear of an LCD in order to display with the LCD.

Base screen

The screen displayed over the entire GOT display area
The base screen comprises figure and object settings.

Basic monitor

The general name for the basic GOT functions
This means the basic functions of an electronic operation panel, such as switch and lamp functions and number data and message display.

Bit device

Located in the PLC device, and transmits information with one bit.
In a GOT, each bit of a word device can be used as a bit device.

Bit map (BMP)

This is a file format for storing pixel images and is indicated with the extension (.BMP).
In a GOT, bit maps can be used as figure or part data.
BMP files can be output with image scanners or commercially available graphics software.

Blink

Makes the display go on and off repeatedly and cyclically

Buffer memory (BM)

Memory unique to PLC special function module it can be read and written directly from a GOT.

Bus connection

Connection of the GOT to the PLC base with an extension cable
This connection is through the I/O bus. The GOT can be used with about the same responsiveness as a conventional pushbutton.

— C —

Cascade (menu)

When a GT Designer2 menu is selected, the menu is selected is displayed lined up from top to bottom.

When an item in this vertical menu is selected, a horizontal menu is displayed on the left. This state is called cascade display.

Click

Moving the cursor to the desired position on the screen, then pressing the mouse button once is called clicking.

Pressing the mouse button twice in a row quickly is called double clicking.

Moving the mouse cursor to the desired position holding down the mouse button, then releasing the mouse button is called dragging.

Communication driver

This is one type of software (OS) for communicating with the PLC.

There is a dedicated communication driver for each communication format (bus connection, direct CPU connection, etc.), so always install it on the GOT with the OS installation function.

Counter (C)

This is a device that counts how many times the input came ON and switches the contact ON when the set value is reached.

To clear a counter value, it is necessary to reset the counter with a reset command.

Cyclic communication

This is a function for data communication between stations on the same network with MELSEC.

This function uses the link relay (B), link register (W), link input (X), and link output (Y) devices. A GOT directly connected to MELSECNET can use B and W as its own station devices.

—— D ——

Data register (D)

This is a PLC register for storing numbers. It is also called a D register.

A data register can handle 16-bit or 32-bit data.

With some PLC types, the data registers can handle not only integers, but real numbers as well.

The GOT has dedicated GD registers.

Default value

This is the initial value.

Device

This is the general name for memory in the PLC CPU.

There are various devices, such as input (X), output (Y), and data register (D), for various applications.

Display conditions (write conditions)

Operating (displaying or writing) only when the set conditions are met.

There are the following eight types of conditions.

- Ordinary: Always display.
- Rising: Only display when the specified device comes ON.
- Falling: Only display when the specified device comes ON.
- While ON: Always display while the specified device is ON.
- While OFF: Always display while the specified device is OFF.
- Sampling: Display with the specified cycle unit (1-3600 seconds).
- Cycle during ON: For each specified cycle (1-3600 seconds), always display if the specified device is ON.
- Cycle during OFF: For each specified cycle (1-3600 seconds), always display if the specified device is OFF.

Display Method

The display color, operations, etc. can be changed for each specified range.

The display area corresponding to monitor device value is specified by a comparison expression.

Download

To transfer screen data from the GT Designer2 PC to a GOT.

Since data can be transferred divided by screen unit, comment, and part, you can download just the screen data you need for the circumstances. The reverse operation, of picking up screen data, is called uploading.

— E —

Edge trigger

A trigger that updates the data display when the rising or falling edge of the specified bit is detected.

Even if the trigger is not generated, the data can be forcibly displayed ON at the first time after the screen is switched.

Edit Vertex

This is an editing function for changing the position of vertices of polygons or consecutive straight lines after drawing.

EL

Electro Luminescence; an orange/black monochrome display device

One type of display element

The same as LCDs, ELs have low brightness and are eye friendly.

EN Standard

Indicates a product that conforms with EC directives.

The EN Standard is one standard in EC directives (laws).

There are three main relevant EC directives: EMC directives, low-voltage directives, and mechanical directives. The EN Standard is the standard used for products meeting these directives. (e.g., safety)

Extension cable

This cable connects the PLC extension base (basic base) and the GOT when the PLC and GOT are connected with a bus connection.

Extension file register (R)

These are file register extension registers in the PLC memory cassette.

The extension file register capacity is set with parameters.

The capacity that can be set depends on the CPU used and the memory cassette capacity.

Indicated with R with MELSEC-A.

Indicated with R and ZR with MELSEC-QnA.

—— F ——

Falling (trigger)

This is the status when the device goes from ON to OFF.

With a GOT, the condition established just once at the fall is called a falling trigger.

Be aware that after the device falls, if the time until it comes ON is short, sometimes the fall cannot be detected and display is not possible.

By setting "initial display", the falling can be forcibly established once even if no trigger is generated when the screen is switched.

File register (R)

These are extension registers for when data registers (D) are insufficient.

The file register capacity is set with parameters.

The capacity that can be set depends on the CPU used and the memory cassette capacity.

Free location touch switch

Free location touch switches are so called because they are touch switches with a minimum of 16-by-16 dots (one double-byte character worth), and they can be located freely per dot.

The enabled/disabled area can be specified and the switch can also be protected conditionally.

—— G ——

Graphic operation terminal

The name of the Mitsubishi Electric display unit.

The name GOT is an acronym for Graphic Operation Terminal.

—— H ——

Handle

This is the small filled square displayed on the rectangle surrounding a figure when a figure is selected. Moving the mouse cursor here changes the shape of the cursor.

If the mouse is moved with the left mouse button held down, the figure size can be changed.

By holding down Shift key while the above operation, the figure size can be changed while maintaining the aspect ratio.

—— I ——

Icon

In Windows, a picture selected (by double-clicking it with the mouse) in order to execute an application such as GT Designer2

Install

To register application software on a PC or GOT

The GOT OS is installed on the GOT from GT Designer2.

This function is called the OS installation and is executed by selecting [Communications] - [Communicate with GOT] from the menu.

In an OS installation, it is possible to install only the necessary elements of each of the following functions.

- Standard monitor OS

- Communication driver

- Option OS (standard fonts (Chinese, simplified characters), recipes)

<Note>

At least one connection type driver for connecting with the PLC must be installed.

Instantaneous power failure

A power failure of extremely short duration.

The PLC/GOT do not treat a power failure lasting less than 20 ms as a power failure.

A power failure lasting longer than this results in initial processing the same as when the power is first switched ON.

Interlock

This is a block that prevents the system from shifting to the next operation until the operation being executed is completed. Interlocks are used to prevent devices from going out of control or being destroyed.

Normally, interlocks are put in place using bit devices.

Such signals are called interlock conditions.

With a GOT, two types of interlocks can be set: display conditions and write conditions.

Display condition: An operation condition check based on an edge trigger or level trigger

Display method: A check based on the display range or write range

IP65F

IP is the abbreviation for International Protection; this indicates a product that conforms with IEC standard 529.

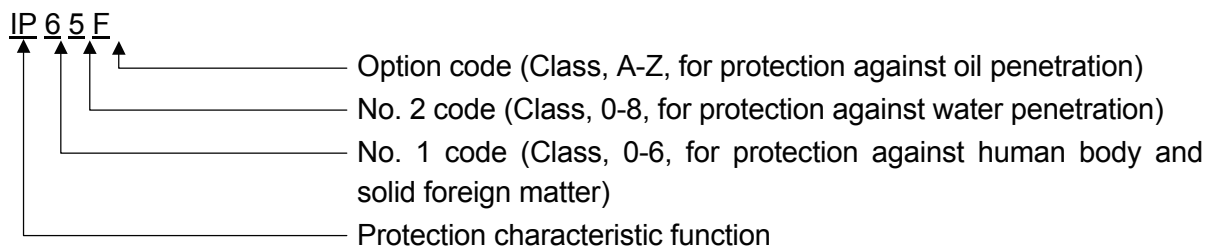

The degree of IP65 protection

No. 1 code = 6: No dust penetrates.

No. 2 code = 5: Is not harmed by direct spraying of water, for example at locations cleaned periodically.

Option code = F: Is not harmed by oil drops or application of oil, for example at locations cleaned periodically.

ISO9001

ISO9000 covers a series of standards from the International Standard Organization. These are international standards prescribing quality system requirements with the objective of assuring quality to customers.

ISO9000 covers four standards: ISO9001, ISO9002, ISO9003, and ISO9004.

The GOT1000 has received ISO9001 certification.

—— K ——

Key window

This is a window for which the number input keys are set.

There are decimal and hexadecimal system number key windows, so there is no need to set (create) the number keys on the screen.

—— L ——

Layer

This is a function that divides a single screen into two structures, the front screen and the back screen, making it possible to set objects for each layer separately.

Objects set for the front screen layer and back screen layer respectively can also be displayed overlaid.

Layer processing

Name of operation processing for screen switching

Since the screen switching is layered, it can be executed automatically without setting the layer structure.

Level trigger

A trigger that always updates the data display timing only when the specified bit is ON or when it is OFF.

Library

A library comprises figures and objects and is a group of information having one meaning.

The individual group information becomes a template.

A screen can be created by pasting the templates on the screen in the appropriate combination.

—— M ——

Maximize button

The maximize button is at the right of the window title bar. Clicking this button expands the GT Designer2 or other application to be displayed over the entire screen (maximized display).

Maximize display

This is the act of displaying GT Designer2 or some other application over the entire screen or the state in which the application is so displayed.

Memory card (CF card)

Since screen data can be stored on a memory card, a memory card is used for high-speed copying of screen data to other GOTs.

If an alarm log is stored to a memory card, this alarm log can be displayed even after the power is switched OFF, then ON again.

Menu bar

The menu bar is positioned one row beneath the application window title bar.

Message display

Displays explanations of operations, functions, etc. for the processing (function) selected by the user.

Momentary

This is a function that switches ON the specified bit device only during touch switch input.

This function can also switch ON specified bits of buffer memory or word devices.

Multi-language type

A GOT supports about 26,000 different characters for the writing systems of various nations as standard, so it can be used in the nations of the world.

Japanese, Korean, Chinese, or the like characters can be input with the Front-End Processor (FEP) for that language.

Multi-task real-time OS

A multi-task OS executes multiple tasks on a computer simultaneously.

Through the use of such an OS, a GOT can control communications, display, input, etc., all in real time.

— N —

Number keys

These are the keys for inputting numbers 0-9.

A GOT has system number key windows, so there is no need to set (create) the number keys on the screen.

— O —

Object

With the GOT1000, the desired functions will be available by pasting switch figures, lamp figures, numeric display frame figures, etc, with GT Designer2 to set the compatibility between PLC device memory (bit, word) and operation functions.

The setting targets are called objects.

Operating ambient temperature

This is the operating ambient temperature range after the device power is switched ON.

Since the PLC is normally installed in a control panel, the temperature mentioned above means in the control panel.

Pay attention to the fact that part of the GOT is in the control panel and part is outside the control panel, and those parts have different operating ambient temperature. (See below.)

Display section: 0 to 50°C

Other than display section: 0 to 55°C

Operating System (OS)

Generally, this means the basic software for computers, etc. This is the software for running programs created by the user.

In the PLC, the OS is for running the sequence programs and in the GOT, the OS is the program for operating the screen or touch switches as set and is supplied by Mitsubishi Electric.

Ordinary trigger

A trigger that constantly updates the data display.

Ordinary write

To update the contents displayed when there is any change in the data, rather than using a trigger in the display or input state as the trigger for data display or input.

See "Trigger write".

Output (Y)

This signal outputs the results of PLC calculations to the outside with ON/OFF.

The device name is expressed with Y.

The PLC output unit has relays, triacs, and transistors.

Overlap window

A pop-up screen that appears over the base screen.

Up to two overlap window screens can be displayed on one base screen.

—— P ——

Parts

Parts comprise figures and are used with the "parts display" and "parts movement" functions.

The figures that can be used in parts include text and image data.

Parts movement (locus display)

This operation erases the parts (figures) displayed just before, moves the parts to the specified new position (according to the coordinate device value), and displays it there.

With parts movement, it is also possible to remain the parts displayed just before the movement.

Such display is called parts locus display.

Password

The GOT1000 has two types.

Screen data upload/download password

Security function password

Periodic trigger

A trigger that updates the data display timing each time it is specified

Project (file)

The collection of all the information displayed on a single GOT is called a project.

A project comprises screen information, parts information, etc.

This information (project) is created in one file.

However, the library information only is created in a separate file.

—— R ——

Recipe

The recipe function writes and reads the values of devices specified by the PLC CPU according to the specification conditions (device ON/OFF).

The read-out data can be saved in a CSV-format file on a PC card for editing on a PC.

RISC chip

A RISC (Reduced Instruction Set Computer) is a computer whose central processing can execute high-frequency processing in a concentrated manner and at high speed through the analysis of high-level language programs.

Such a CPU narrows the number and types of commands to increase speed and is appropriate for equipment processing large volumes of data at high speed, such as workstations.

Rising (trigger)

This is the status when the devices goes from OFF to ON.

With a GOT, the condition established just once at the rise is called a rising trigger.

Be aware that after the device rises, if the time until it goes OFF is short, sometimes the rise cannot be detected and display is not possible.

By setting "initial display", the rising can be forcibly established once even if no trigger is generated when the screen is switched.

RST (reset)

To initialize the PLC (the same as when it is switched from OFF to ON)

With MELSEC, all coils except latch devices go OFF, and timers, counters, and data registers go to 0.

A command reset switches OFF all coils that are ON.

—— S ——

Screen

There are two types of screens: the base screen and the window screen.

The screen comprises objects and figures.

Screen Name

With GT Designer2, the project title and screen title can be set.

Project title: Comprises the title information, detailed information, and author name.

Screen title: Comprises the title information and detailed information.

Screen preview

This function can reproduce the screen display image or other displays on GT Designer2.

Screen saver function

This is a function that turns off the display on the GOT display if it goes untouched for a certain period of time.

While the display is OFF, the display can be switched to ON by touching any on the screen.

In this case, the touch switch being pressed does not operate.

Screen switching

This switches between the GOT base screen and window screen.

To switch between the screens, the word device for base and for window screen switching must be set.

In addition to the PLC word devices, GOT dedicated devices (GD) in the GOT can also be used.

Script function

The script functions are functions designed to control the GOT display with the GOT's original programs.

Controlling the GOT display with the GOT side script drastically reduces the load on the system side (e.g. PLC CPU, microcomputer) display.

Self check

This is a function with which the GOT (CPU) detects its own errors.

This function tests the GOT hardware, communications, memory, display, etc.

Serial communication

This is a method of communication that sends the data per bit along one line as the time goes by.

Serial communication unit

The module that provides the functions for connecting with the PLC and a computer (GOT or personal computer) and for reading/writing PLC devices.

When connecting the GOT1000, a communications module for the GOT is required.

Set

To switch ON the bit device or the specified bit of the word device of the PLC

The signal switched ON remains ON until it is reset.

Setting value



This is the setting value for a PLC timer (T) or counter (C) and is the numeric value used as the goal.

In sequence programs, setting values can be set with fixed values or specified indirectly.

With a GOT, setting values can be monitored and changed from the system monitor screen.

Shortcut keys

Shortcut keys are keys or combinations of keys that allow operations without opening the menu.

Shortcut keys operate combining alphanumeric keys with  key or  key.

Special (D)/(SD)

These are registers with determined applications in the PLC.

A variety of information can be viewed, including PLC CPU information and MELSECNET information.

The QCPU and QnACPU have dedicated SD devices.

With the ACPU, these are D9000- .

Special internal relay (M)/special relay (SM)

These are internal relays (M) with determined applications in the PLC.

A variety of information can be viewed, including PLC CPU information and MELSEC information.

QCPU and QnACPU have dedicated SM devices.

With the ACPU, these are M9000- .

Status display bar

The status display bar is the bottom line of the GT Designer2 display. It displays guidance, cursor information, position information, etc.

STN

STN (Super Twisted Nematic) liquid crystal

A simple matrix type LCD that seals liquid crystals between multiple transparent electrodes lined up vertically and horizontally and that displays the desired image by applying signal voltage to the electrodes to control the liquid crystal array state at the intersections. Pixels are switched ON/OFF by twisting liquid crystal molecules and by aligning them into straight lines.

The GOT1000 can display 256 colors or 16 tones of monochrome (black and white).

System information

This function transmits the GOT status (screen number being displayed, error number, etc.) to the PLC, and outputs information (GOT error resets etc.) from the PLC to the GOT. This function is set to a word device.

A read device reads information to the GOT.

A write device writes information from the GOT.

—— T ——

Template

Templates are for easily saving and reading figures and objects.

Text file

This is a file containing only letters, numbers, and symbols.

A comment can be output to a text file, edited with an editor, and the edited file can be input.

Since object settings and other GOT screen information can be output to a text file with the print function, it is also possible to read this file into a word processor and create an original document.

TFT

A color liquid crystal display using TFTs (Thin Film Transistors)

Thin-film transistors are laid out at the intersection of transparent electrodes lined up vertically and horizontally. This is an active-matrix type of LCD in which the liquid crystal is driven by these thin-film transistors so laid out.

The response is fast. For color display, there are three TFTs for each pixel, and the light from each TFT is passed through a red, green, or blue color filter.

Compared to simple matrix LCDs, there is no tendency to low contrast, and the number of scanning lines can be increased, and intermediate tone expression is also easy, so this type of LCD can display with high quality. On the other hand, the structure is complex, resulting in high cost.

On the GOT1000, display is 256 colors/ 65536 colors.

Timer (T)

This is a device that has the function of operating the timer coil after the specified time (timer setting value). The objective is to delay or hold an operation.

There are two types of timers: 10ms and 100ms.

The timer has a contact, coil, current value, and setting value. On the GOT monitor screen, all of these except the setting value can be monitored and written.

The setting value can be monitored/written with the system monitor function.

Tool bar

This is a list of buttons etc. for menu items used relatively frequently.

The following types of GT Designer2 toolbars are available.

Tool bar (Standard): The standard group of functions such as New or Save

Tool bar (View): A group of functions for setting the display, such as screen zoom or grid color

Tool bar (Figures): A group of functions for setting figures such as straight line or text

Tool bar (Objects): A group of functions for setting objects such as touch switches

Tool bar (Figure edit): A group of functions for editing figures, such as front line display or flip horizontal

Tool bar (Alignment): A group of functions for arranging the positions of figures and objects

Tool bar (Figure drawing): A group of functions for setting display attributes such as the line style or pattern foreground color

Tool bar (Communications): A group of functions for data transfer between a GOT and PC card

Tool bar (Comment): A group of functions for setting the comment function

Touch switch

By pressing the screen, screen switching or writing to a device can be performed.

The minimum size is a unit of one double-byte character (16 by 16 dots).

Transfer format OS program

See "Install".

Transparent function

When connecting a GOT and PLC CPU with direct CPU connection or a bus connection, connecting a PC or other peripheral device allows the sequence programs of the CPU to be read, written and monitored.

Trigger write

Operating (displaying or writing) only when the set conditions are met.

These conditions are called trigger conditions. See "Ordinary write".

U

Unicode system

Unicode is an international standard for character codes.

The advantage of the Unicode system is that it provides a completely universal means for multi-nationalizing applications.

Upload

To read screen data from the GOT using GT Designer2

The read-out screen data can be re-edited, then transferred back (downloaded) to the GOT

—— W ——

Window screen

A pop-up screen that appears over the base screen.

A window screen can be closed by touching the button at the top right of the window screen.

The top row on the window is the window screen move key. If this move key is touched, and another location is touched, the window screen is moved so that its top left coordinate is at the location touched.

The same as for the base screen, all objects can be set on the window screen.

If a touch switch on the base screen is overlaid by the window screen, that switch is disabled.

Word device

Of the PLC devices, word devices are those that transmit information with 16 bits (one word).

With a GOT, word devices can be handled with 16 bits or 32 bits.

As data types, word devices support signed integers, unsigned integers, and real numbers.

Word device set

This is a function that writes the specified value to a word device when there is input at a touch switch.

The specification type can be selected from fixed value, value of another word device, and fixed value added to (or subtracted from) the current device value.

Notes

Graphic Operation Terminal Training Manual

GOT1000 basic course(for GT Designer2 Version2)

MODEL	SCHOOL-GOT1000-BSC-E
MODEL CODE	1D7M59
SH(NA)-080632ENG-A(0603)MEE	



HEAD OFFICE : TOKYO BUILDING, 2-7-3 MARUNOUCHI, CHIYODA-KU, TOKYO 100-8310, JAPAN
NAGOYA WORKS : 1-14, YADA-MINAMI 5-CHOME, HIGASHI-KU, NAGOYA, JAPAN

When exported from Japan, this manual does not require application to the Ministry of Economy, Trade and Industry for service transaction permission.

Specifications subject to change without notice.