

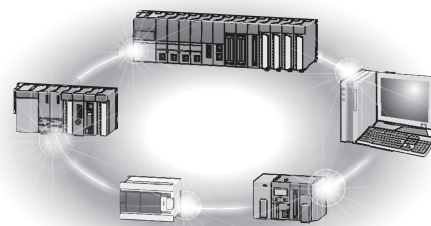

Mitsubishi Programmable Controller

High-Speed Counter Module Type AJ65BT-D62/AJ65BT-D62D/AJ65BT-D62D-S1 User's Manual



● SAFETY PRECAUTIONS ●

(Read these precautions before using this product.)

Before using this product, please read this manual and the relevant manuals carefully and pay full attention to safety to handle the product correctly.

The precautions given in this manual are concerned with this product only. For the safety precautions of the programmable controller system, refer to the user's manual for the CPU module used.

In this manual, the safety precautions are classified into two levels: "⚠ WARNING" and "⚠ CAUTION".



Indicates that incorrect handling may cause hazardous conditions, resulting in death or severe injury.



Indicates that incorrect handling may cause hazardous conditions, resulting in minor or moderate injury or property damage.

Items marked with an exclamation point in a triangle ⚠ could also cause severe consequences, depending on the circumstances, if not handled properly.

They indicate information that should be taken seriously and observed conscientiously.

Manuals supplied with the products should be stored carefully where they can be accessed whenever necessary, and should always be passed on to the end user along with the equipment.

[Design Precautions]

⚠ WARNING

- When a communication error occurs in data link, the faulty station will result in the following status. Using the communication status information, configure up an interlock circuit in the sequence program to make the system safe.
Misoutput or misoperation may cause an accident.
(1) General-purpose inputs from this module all switch off.
(2) General-purpose outputs from this module all switch off.
- Some module failures may keep input/output on or off. Provide an external monitoring circuit for I/O signals which may lead to serious accidents.

⚠ CAUTION

- Do not bundle control lines or communication cables with main circuit or power lines or lay them near these lines.
As a guideline, separate the cables at least 100mm.
Not doing so could result in noise that would cause erroneous operation.

[Security Precautions]

WARNING

- To maintain the security (confidentiality, integrity, and availability) of the programmable controller and the system against unauthorized access, denial-of-service (DoS) attacks, computer viruses, and other cyberattacks from external devices via the network, take appropriate measures such as firewalls, virtual private networks (VPNs), and antivirus solutions.

[Installation Precautions]

CAUTION

- Use the module in an environment that conforms to the general specifications in the manual. Otherwise, an electric shock, fire, misoperation or product damage or deterioration can occur.
- Securely fix the module using the DIN rail or mounting screws and fully tighten the mounting screws within the specified torque range.
Undertightening can cause a drop or misoperation.
Overtightening can cause a drop or misoperation due to damaged screws or module.
- Do not touch the conductive areas of the module directly.
Otherwise, the module can misoperate or fail.

[Wiring Precautions]

WARNING

- Before starting mounting, wiring or other work, always switch power off externally in all phases. Otherwise, an electric shock, product damage or misoperation may occur.
- When switching power on or starting operation after mounting, wiring or other work, always install the supplied terminal cover to the product. Otherwise, you may get an electric shock.

CAUTION

- Be sure to shut off all phases of the external power supply used by the system before installation or wiring.
Not doing so can cause the product to be damaged or malfunction.
- Ground the FG terminal to the protective ground conductor dedicated to the programmable controller.
Failure to do so may result in electric shock or malfunction.
- Use applicable solderless terminals and tighten them with the specified torque. If any solderless spade terminal is used, it may be disconnected when the terminal screw comes loose, resulting in failure.
- Before wiring the module, confirm the rated voltage and terminal arrangement of the product. A fire or failure can occur if the power supply connected is different from the rating or wiring is incorrect.
- Tighten the terminal screws within the specified torque range.
Undertightening can cause a short circuit or misoperation.
Overtightening can cause a short circuit or misoperation due to damaged screws or module.
- Ensure that foreign matters such as chips and wire off-cuts do not enter the module.
They can cause a fire, failure or misoperation.

[Wiring Precautions]

CAUTION

- Always secure the wires or cables connected to the module, e.g. run them in conduits or clamp them.
Otherwise, the module or cables can be damaged due to dangling, moved or accidentally pulled cables or misoperation can occur due to improper cable connection.
- Do not install the control lines or communication cables together with the main circuit lines or power cables.
Failure to do so may result in malfunction due to noise.
- Do not hold the cable part when unplugging the communication or power cable connected to the module.
When the cable is fitted with a connector, hold the connector of the cable part connected to the module.
When the cable is not fitted with a connector, loosen the screw in the cable part connected to the module. If you pull the cable connected to the module, the module or cable can be damaged or misoperation can occur due to improper cable connection.

[Starting and Maintenance Precautions]

WARNING

- Do not touch the terminals while power is on.
This can cause misoperation.
- Before starting cleaning or terminal screw retightening, always switch power off externally in all phases.
Otherwise, a module failure or misoperation can occur.

[Starting and Maintenance Precautions]

CAUTION

- Do not touch the terminals while the power is on.
Doing so may cause malfunction.
- Do not drop or apply strong shock to the module.
Failure to do so may damage the module.
- Do not disassemble or modify the module.
This can cause a failure, misoperation, injury or fire.
- The module case is made of resin. Do not drop it or give it hard impact.
This can damage the module.
- Be sure to shut off all phases of the external power supply used by the system before mounting or dismounting the module to or from the panel.
Not doing so can cause the module to fail or malfunction.
- Do not install/remove the terminal block more than 50 times after the first use of the product.
(IEC 61131-2 compliant)
- Before handling the module, always touch grounded metal, etc. to discharge static electricity from the human body.
Failure to do so can cause the module to fail or malfunction.
- The pulse/external input voltage setting pins must be set after switching power off externally in all phases.
Otherwise, the module can fail or misoperate.

[Precautions Regarding Product Disposal]

CAUTION

- When disposing of the product, handle it as industrial waste.

• CONDITIONS OF USE FOR THE PRODUCT •

- (1) Mitsubishi programmable controller ("the PRODUCT") shall be used in conditions;
- i) where any problem, fault or failure occurring in the PRODUCT, if any, shall not lead to any major or serious accident; and
 - ii) where the backup and fail-safe function are systematically or automatically provided outside of the PRODUCT for the case of any problem, fault or failure occurring in the PRODUCT.

- (2) The PRODUCT has been designed and manufactured for the purpose of being used in general industries.

MITSUBISHI SHALL HAVE NO RESPONSIBILITY OR LIABILITY (INCLUDING, BUT NOT LIMITED TO ANY AND ALL RESPONSIBILITY OR LIABILITY BASED ON CONTRACT, WARRANTY, TORT, PRODUCT LIABILITY) FOR ANY INJURY OR DEATH TO PERSONS OR LOSS OR DAMAGE TO PROPERTY CAUSED BY the PRODUCT THAT ARE OPERATED OR USED IN APPLICATION NOT INTENDED OR EXCLUDED BY INSTRUCTIONS, PRECAUTIONS, OR WARNING CONTAINED IN MITSUBISHI'S USER, INSTRUCTION AND/OR SAFETY MANUALS, TECHNICAL BULLETINS AND GUIDELINES FOR the PRODUCT.

("Prohibited Application")

Prohibited Applications include, but not limited to, the use of the PRODUCT in;

- Nuclear Power Plants and any other power plants operated by Power companies, and/or any other cases in which the public could be affected if any problem or fault occurs in the PRODUCT.
- Railway companies or Public service purposes, and/or any other cases in which establishment of a special quality assurance system is required by the Purchaser or End User.
- Aircraft or Aerospace, Medical applications, Train equipment, transport equipment such as Elevator and Escalator, Incineration and Fuel devices, Vehicles, Manned transportation, Equipment for Recreation and Amusement, and Safety devices, handling of Nuclear or Hazardous Materials or Chemicals, Mining and Drilling, and/or other applications where there is a significant risk of injury to the public or property.

Notwithstanding the above, restrictions Mitsubishi may in its sole discretion, authorize use of the PRODUCT in one or more of the Prohibited Applications, provided that the usage of the PRODUCT is limited only for the specific applications agreed to by Mitsubishi and provided further that no special quality assurance or fail-safe, redundant or other safety features which exceed the general specifications of the PRODUCTS are required. For details, please contact the Mitsubishi representative in your region.

- (3) Mitsubishi Electric shall have no responsibility or liability for any problems involving programmable controller trouble and system trouble caused by DoS attacks, unauthorized access, computer viruses, and other cyberattacks.

REVISIONS

*The manual number is given on the bottom left of the back cover.

Print Date	*Manual Number	Revision
Oct.,1997	IB(NA)-66823-A	First edition
Mar.,2000	IB(NA)-66823-B	Contents of 3.4 greatly changed Output signal list in 3.7 (2) modified Partial correction made to POINT in 7.3 Partial addition made to contents of 10.2 Partial addition made to Appendix 1 Partial correction made to 4.2.1 (2) Partial correction made to 11.3 (4)
Dec.,2003	IB(NA)-66823-C	Addition Conformation to the EMC Directive and Low Voltage Instruction Product configuration Partial Correction SAFETY PRECAUTIONS, About the Manuals, Section 2.1, 2.2, 3.1, 3.2, 3.4, 3.8, 4.2.1, 4.3, 4.4.1, 4.4.2, 9.1, 9.5, 11.3 Delete Section 1.2, 3.3, 3.4
Jul.,2005	IB(NA)-66823-D	Partial Correction SAFETY PRECAUTIONS, Section 3.5, 4.3, 4.4.6, 5.3, 9.1, 9.3, 9.4, 9.5
Mar.,2006	IB(NA)-66823-E	Partial Correction SAFETY PRECAUTIONS, Conformation to the EMC Directive and Low Voltage Instruction, Section 10.6.4
Sep.,2006	IB(NA)-66823-F	Partial Correction SAFETY PRECAUTIONS Addition Section 11.4 Section number change Section 11.4 → 11.5
Apr., 2012	IB(NA)-66823-G	Partial Correction SAFETY PRECAUTIONS, MANUALS, COMPLIANCE WITH EMC AND LOW VOLTAGE DIRECTIVES, GENERAL NAME AND ABBREVIATION, Chapter 1, Section 1.1, 2.1, 2.2, 3.1, 3.2, 3.3, 3.4, 3.5, 3.6, 3.8, 4.1, 4.2.1, 4.3, 4.4, 4.5, 4.6.1, 4.6.3, 4.6.4, 4.6.5, 5.1, 5.2, 5.3, 6.1, 6.1.1, 7.1, 7.2, 7.3, 8.1, 8.1.1, 9.1, 9.1.2, 9.3, 9.4, 10.2, 10.3.1 to 10.3.8, 10.4.1 to 10.4.8, 10.5.1 to 10.5.8, 10.6.1 to 10.6.8, 11.1, 11.4, Appendix 1, WARRANTY Addition CONDITIONS OF USE FOR THE PRODUCT Delete Section 4.6.1 Section number change Section 4.6.2 → 4.6.1, 4.6.3 → 4.6.2, 4.6.4 → 4.6.3, 4.6.5 → 4.6.4, 4.6.6 → 4.6.5

Print Date	*Manual Number	Revision
Oct.,2014	IB(NA)-66823-H	Partial Correction GENERAL NAME AND ABBREVIATION, Section 3.1, 3.2, 3.4, 4.3, 11.1, 11.3, 11.4, Appendix 1
Apr., 2024	IB(NA)-66823-I	Partial Correction SAFETY PRECAUTIONS, CONDITIONS OF USE FOR THE PRODUCT, Section 3.5, 4.6.1

Japanese Manual Version SH-3637-I

This manual confers no industrial property rights or any right of any other kind, nor does it confer any patent licenses. Mitsubishi Electric Corporation cannot be held responsible for any problems involving industrial property rights which may occur as a result of using the contents noted in this manual.

© 1997 MITSUBISHI ELECTRIC CORPORATION

INTRODUCTION

Thank you for purchasing the Mitsubishi Electric MELSEC-A series programmable controllers.
Please read this manual carefully so that equipment is used to its optimum.
A copy of this manual should be forwarded to the end user.

CONTENTS

SAFETY PRECAUTIONS	A- 1
CONDITIONS OF USE FOR THE PRODUCT	A- 6
REVISIONS	A- 7
INTRODUCTION	A- 9
MANUALS	A-12
COMPLIANCE WITH EMC AND LOW VOLTAGE DIRECTIVES	A-12
GENERAL NAME AND ABBREVIATION	A-13
PACKING LIST	A-14

1. INTRODUCTION	1- 1 to 1- 3
1.1 Features	1- 3
2. SYSTEM CONFIGURATION	2- 1 to 2- 2
2.1 Overall Configuration	2- 1
2.2 Applicable System	2- 2
3. SPECIFICATIONS	3- 1 to 3- 18
3.1 General Specifications	3- 1
3.2 Performance Specifications	3- 2
3.3 Functions	3- 8
3.4 Interfaces with External Devices	3- 9
3.5 I/O Signals Transferred to/from the Master Module	3-12
3.6 Remote Register Allocation	3-14
3.7 Applicable Encoders	3-15
3.8 Data Link Processing Times	3-16
4. INSTALLATION AND PRE-OPERATION SETTING PROCEDURE	4- 1 to 4- 16
4.1 Pre-Operation Setting Procedure	4- 1
4.2 Installation	4- 2
4.2.1 Handling instructions	4- 2
4.2.2 Installation environment	4- 3
4.3 Part Names and Settings	4- 4
4.4 Station Number Setting	4- 8
4.5 Orientation of Module Installation	4- 8
4.6 Wiring	4- 9
4.6.1 Connection of cables with the modules	4- 9
4.6.2 Instructions for wiring pulse generator	4-10
4.6.3 Wiring examples of pulse generators	4-11

4.6.4 Wiring examples of controller and external input (PRESET, F.START) terminals	4-14
4.6.5 Wiring examples of external output (EQU1, EQU2) terminals	4-15

5. PULSE INPUT AND COUNTING METHOD	5- 1 to 5- 4
---	---------------------

5.1 1-phase pulse input.....	5- 2
5.2 2-phase pulse input.....	5- 3
5.3 Reading the Present Value.....	5- 4

6. EXECUTING THE COINCIDENCE OUTPUT FUNCTION	6- 1 to 6- 3
---	---------------------

6.1 Coincidence Output Function	6- 1
6.1.1 Coincidence output function operation	6- 2

7. EXECUTING THE PRESET FUNCTION	7- 1 to 7- 3
---	---------------------

7.1 Preset Function	7- 1
7.2 Preset Using the Sequence Program.....	7- 2
7.3 Preset by External Control Signal	7- 3

8. EXECUTING THE RING COUNTER FUNCTION	8- 1 to 8- 4
---	---------------------

8.1 Ring Counter Function	8- 1
8.1.1 Ring counter function operation.....	8- 3
8.1.2 Count range.....	8- 4

9. SELECTING AND EXECUTING THE COUNTER FUNCTION	9- 1 to 9- 11
--	----------------------

9.1 Selecting the Counter Function	9- 1
9.1.1 Reading the counter function selection count value	9- 3
9.1.2 Counting errors.....	9- 4
9.2 Count Disable Function	9- 5
9.3 Latch Counter Function	9- 7
9.4 Sampling Counter Function	9- 8
9.5 Periodic Pulse Counter Function	9-10

10. PROGRAMMING	10- 1 to 10- 55
------------------------	------------------------

10.1 Programming Procedures.....	10- 1
10.2 Condition of Program Example	10- 1
10.3 Program Example when QCPU (Q mode) is Used	10- 5
10.3.1 Program example of coincidence output function.....	10- 6
10.3.2 Program example of preset with sequence program.....	10- 7
10.3.3 Program example of preset with external control signal.....	10- 8
10.3.4 Program example of ring counter function	10- 9
10.3.5 Program example of count disable function.....	10-10
10.3.6 Program example of latch counter function	10-11
10.3.7 Program example of sampling counter function	10-12
10.3.8 Program example of frequency pulse counter function	10-13
10.4 Program Example when QnACPU is Used.....	10-14

10.4.1	When preset is made by sequence program	10-15
10.4.2	Program example of preset with sequence program.....	10-16
10.4.3	Program example of preset with external control signal.....	10-17
10.4.4	Program example of ring counter function	10-18
10.4.5	Program example of count disable function.....	10-19
10.4.6	Program example of latch counter function	10-20
10.4.7	Program example of sampling counter function	10-21
10.4.8	Program example of frequency pulse counter function	10-22
10.5	Program Example when ACPU/QCPU (A Mode) is Used (Dedicated Command).....	10-23
10.5.1	Program example of coincidence output function.....	10-23
10.5.2	Program example of preset with sequence program.....	10-26
10.5.3	Program example of preset with external control signal.....	10-28
10.5.4	Program example of ring counter function	10-30
10.5.5	Program example of count disable function.....	10-32
10.5.6	Program example of latch counter function	10-34
10.5.7	Program example of sampling counter function	10-36
10.5.8	Program example of frequency pulse counter function	10-38
10.6	Program Example when ACPU/QCPU (A Mode) is Used (From/To Command).....	10-40
10.6.1	Program example of coincidence output function.....	10-40
10.6.2	Program example of preset with sequence program.....	10-42
10.6.3	Program example of preset with external control signal.....	10-44
10.6.4	Program example of ring counter function	10-46
10.6.5	Program example of count disable function.....	10-48
10.6.6	Program example of latch counter function	10-50
10.6.7	Program example of sampling counter function	10-52
10.6.8	Program example of frequency pulse counter function	10-54

11. TROUBLESHOOTING	11- 1 to 11- 5
----------------------------	-----------------------

11.1	Count Value Is Incorrect	11- 1
11.2	Count Operation Is Not Performed.....	11- 1
11.3	How to Check an Error with the LED Lamps	11- 2
11.4	When SW0088 to SW008B (fuse blown status) of master station is turned ON.....	11- 3
11.5	If Communication Error Occurs between Master Station and This Module.....	11- 4

APPENDICES	Appendix- 1 to Appendix- 4
-------------------	-----------------------------------

Appendix 1	Directions for Use	Appendix- 1
Appendix 2	Outline Drawing	Appendix- 3

MANUALS

The manuals related to this product are listed below.
Please place an order as needed.

Related Manuals

Manual Name	Manual No. (Model Code)
CC-Link System Master · Local Module type AJ61BT11/A1SJ61BT11 User's Manual Describes the system configuration, performance specifications, functions, handling, wiring and troubleshooting of the AJ61BT11 and A1SJ61BT11. (Option)	IB-66721 (13J872)
CC-Link System Master · Local Module type AJ61QBT11/A1SJ61QBT11 User's Manual Describes the system configuration, performance specifications, functions, handling, wiring and troubleshooting of the AJ61QBT11 and A1SJ61QBT11. (Option)	IB-66722 (13J873)
CC-Link System Master/Local Module User's Manual Describes the system configuration, performance specifications, functions, handling, wiring and troubleshooting of the CC-Link module (Option)	SH-080394E (13JR64)
MELSEC-L CC-Link System Master/Local Module User's Manual Describes the system configuration, performance specifications, functions, handling, wiring and troubleshooting of the L26CPU-BT and LJ61BT11 (Option)	SH-080895ENG (13JZ41)
Type AnSHCPU/AnACPU/AnUCPU/QCPU-A (A Mode) Programming Manual (Dedicated Instructions) Describes the instructions extended for the AnSHCPU/AnACPU/AnUCPU. (Option)	IB-66251 (13J742)

COMPLIANCE WITH EMC AND LOW VOLTAGE DIRECTIVES

(1) Method of ensuring compliance

To ensure that Mitsubishi programmable controllers maintain EMC and Low Voltage Directives when incorporated into other machinery or equipment, certain measures may be necessary. Please refer to one of the following manuals.

- User's manual for the CPU module or head module used
- Safety Guidelines

(This manual is included with the CPU module, base unit, or head module.)

The CE mark on the side of the programmable controller indicates compliance with EMC and Low Voltage Directives.

(2) Additional measures

To ensure that this product maintains EMC and Low Voltage Directives, please refer to one of the manuals listed under (1).

GENERAL NAME AND ABBREVIATION

Unless otherwise specified, this manual describes the AJ65BT-D62/AJ65BT-D62D/AJ65BT-D62D-S1 type high-speed counter module using general name and abbreviation described below:

General name/abbreviation	Description of general name and abbreviation
GX Developer GX Works2	Product name of the software package for the MELSEC programmable controllers
ACPU	General name of A0J2CPU, A0J2HCPU, A1CPU, A2CPU, A2CPU-S1, A3CPU, A1SCPU, A1SCPUC24-R2, A1SHCPU, A1SJCPU, A1SJCPU-S3, A1SJHCPU, A1NCP, A2NCP, A2NCP-S1, A3NCP, A3MCP, A3HCP, A2SCP, A2HCP, A2ACP, A2ACP-S1, A3ACP, A2UCP, A2UCP-S1, A2ACP, A2ACP-S1, A2UHCP-S1, A3UCP and A4UCP
QnACPU	General name of Q2ACP, Q2ACP-S1, Q2ASCP, Q2ASCP-S1, Q2ASHCP, Q2ASHCP-S1, Q3ACP, Q4ACP and Q4RCP
QCPU (A mode)	General name of QO2CPU-A, QO2HCP-A and QO6HCP-A
QCPU (Q mode)	General name of Q00JCP, Q00CP, Q01CP, Q02CP, Q02HCP, Q06HCP, Q12HCP, Q25HCP, Q02PHCP, Q06PHCP, Q12PHCP, Q25PHCP, Q12PRHCP, Q25PRHCP, Q00UJCP, Q00UCP, Q01UCP, Q02UCP, Q03UDCP, Q04UDHCP, Q06UDHCP, Q10UDHCP, Q13UDHCP, Q20UDHCP, Q26UDHCP, Q03UDECP, Q04UDEHCP, Q06UDEHCP, Q10UDEHCP, Q13UDEHCP, Q20UDEHCP, Q26UDEHCP, Q50UDEHCP, Q100UDEHCP, Q03UDVCP, Q04UDVCP, Q06UDVCP, Q13UDVCP, and Q26UDVCP
LCPU	General name of L02SCP, L02CP, L02CP-P, L06CP, L26CP, L26CP-BT, and L26CP-PBT
Master station	Station that controls the data link system. 1 station is required for 1 system.
Local station	Station with programmable controller CPU that communicates with the master station and other local station.
Remote I/O station	Station that handles bit information only. (Input/output is performed with external devices.) (AJ65BTB1-16D, AJ65SBTB1-16D, etc.)
Remote device station	Station that handles bit information and word information. (Input/output with external devices, analog data conversion)
Remote station	General name of remote I/O station and remote device station. It is controlled by master station.
Intelligent device station	Station (e.g. AJ65BT-R2) that can perform transient transmission. (Including local station)
Master module	General name for modules that can be used as the master station
Local module	General name for modules that can be used as the local station
Remote module	General name of AJ65BTB1-16D, AJ65SBTB1-16D, AJ65BT-64AD, AJ65BT-64DAV, AJ65BT-64DAI, A852GOT, etc.
SB	Link special relay (for CC-Link) Bit information that indicates master station/local station module operation status and data link status. It is indicated by SB for convenience.
SW	Link special register (for CC-Link) 16 bit information that indicates master station/local station modul operation status and data link status. It is indicated by SW for convenience.
RX	Remote input (for CC-Link) Bit information input from the remote station to the master station. It is indicated by RX for convenience.
RY	Remote output (for CC-Link) Bit information output from the master station to the remote station. It is indicated by RY for convenience.
RWw	Remote register (write area for CC-Link) 16-bit information output from the master station to the remote device station. It is indicated by RWw for convenience.
RWr	Remote register (read area for CC-Link) 16-bit information input from the remote device station to the master station. It is indicated by RWr for convenience.

PACKING LIST

The following items are included in the package of this product.

Product name	Quantity
AJ65BT-D62 type high-speed counter module	1
AJ65BT-D62D type high-speed counter module	
AJ65BT-D62D-S1 type high-speed counter module	
AJ65BT-D62/AJ65BT-D62D/AJ65BT-D62D-S1 type high-speed counter module user's manual (Hardware)	1

1. INTRODUCTION

This user's manual describes specifications, handling, and programming of the AJ65BT-D62/ D62D/ D62D-S1 high-speed counter modules (hereafter abbreviated as high-speed counter module) to be used in a CC-Link system.

The high-speed counter module can import and count pulses of a pulse generator which cannot be imported by a programmable controller CPU.

The high-speed counter module can detect and count up to 400,000 pulses per second.

The high-speed counter module is available in the following three different types.

Item		AJ65BT-D62	AJ65BT-D62D	AJ65BT-D62D-S1
Type		DC input sink output type	Differential input sink output type	
External input	Preset	5/12/24VDC 2 to 15mA		Differential input
	Function start			5/12/24VDC 2 to 5mA
Max. counting speed		Max. 200kPPS	Max. 400kPPS	
CC-Link station type		Remote device station		
Counting range		24-bit binary (0 to 16777215)		
Counting switch-over		200k/10k	1 phase: 400k 2 phases: 300k/10k	

The high-speed counter module counts 1-phase and 2-phase pulse inputs as described below.

- 1-phase pulse input multiplied by one.....Counts on the leading edge or trailing edge of a pulse.
- 1-phase pulse input multiplied by twoCounts on the leading edge and trailing edge of a pulse.
- 2-phase pulse input multiplied by one.....Counts on the leading edge or trailing edge of a phase A pulse.
- 2-phase pulse input multiplied by twoCounts on the leading edge and trailing edge of a phase A pulse.
- 2-phase pulse input multiplied by four.....Counts on the leading edge and trailing edge of phase A and phase B pulses.

The following diagram outlines how the high-speed counter module operates.

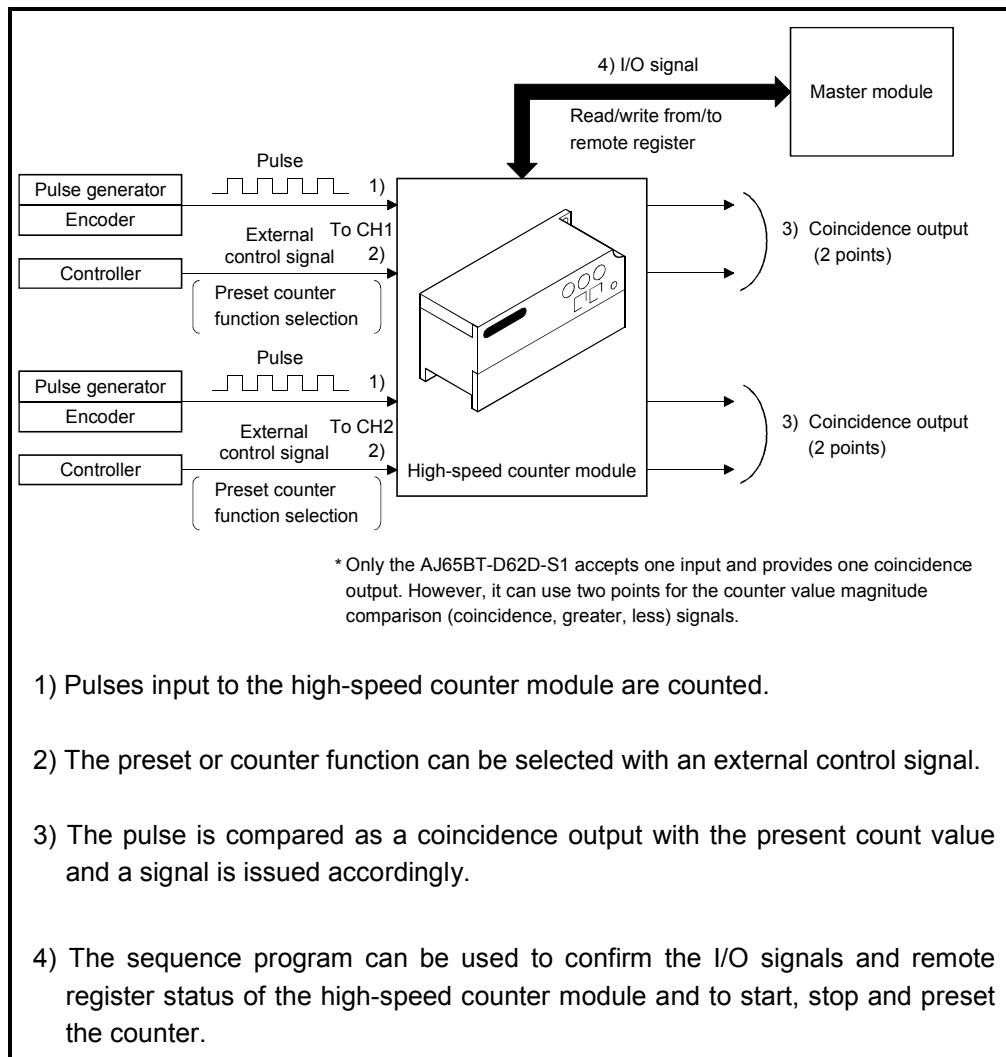

1.1 Features

The high-speed counter module has the following features.

- (1) Pulses can be counted in a wide range from 0 to 16777215.
The count value is stored in 24-bit binary.
- (2) Count value can be multiplied.
Multiplication by either one or two can be selected for 1-phase pulse inputs, or multiplication by one, two or four for 2-phase pulse inputs.
- (3) Maximum counting speed can be switched.
Since the maximum counting speed of either 400k (200k for the D62) or 10k can be selected, pulses can be counted without errors on gentle leading and trailing edges.
- (4) Coincidence output is available.
ON/OFF signals are issued according to the comparison between the preset output status of a selected channel and the present counter value.
One module can accept two inputs and issues two outputs to one input, which can serve as upper and lower limit signals.
The AJ65BT-D62D-S1 accepts one input and provides one coincidence output.
Note that it can use two points for counter value (coincidence, greater, less) signals.
- (5) Ring counter function is available.
Counting repeats between the preset value and the ring counter value, and this function is effective in controlling fixed-pitch feed.
- (6) Four counter functions are available.
Any of the following functions can be selected and used.
 - (a) Latch counter function Latches the present counter value in response to an input signal.
 - (b) Sampling counter function Counts incoming pulses within the preset period of time starting from a signal input.
 - (c) Periodic pulse counter function Stores the present and previous counter values at preset intervals during a signal input.
 - (d) Count disable function Stops pulse counting with an input signal entered while the count enable command is on.
- (7) The preset function or counter function selection can be executed using external control signals.
 - (a) Applying voltage to the PRESET (Preset) terminal executes the preset function.
 - (b) Applying voltage to the F.START (Function start) terminal executes counter function selection and the selected function.These functions are used to eliminate the influence of scan time.

2. SYSTEM CONFIGURATION

This chapter describes a system configuration using the high-speed counter module.

2.1 Overall Configuration

The overall configuration using the high-speed counter module is shown below.

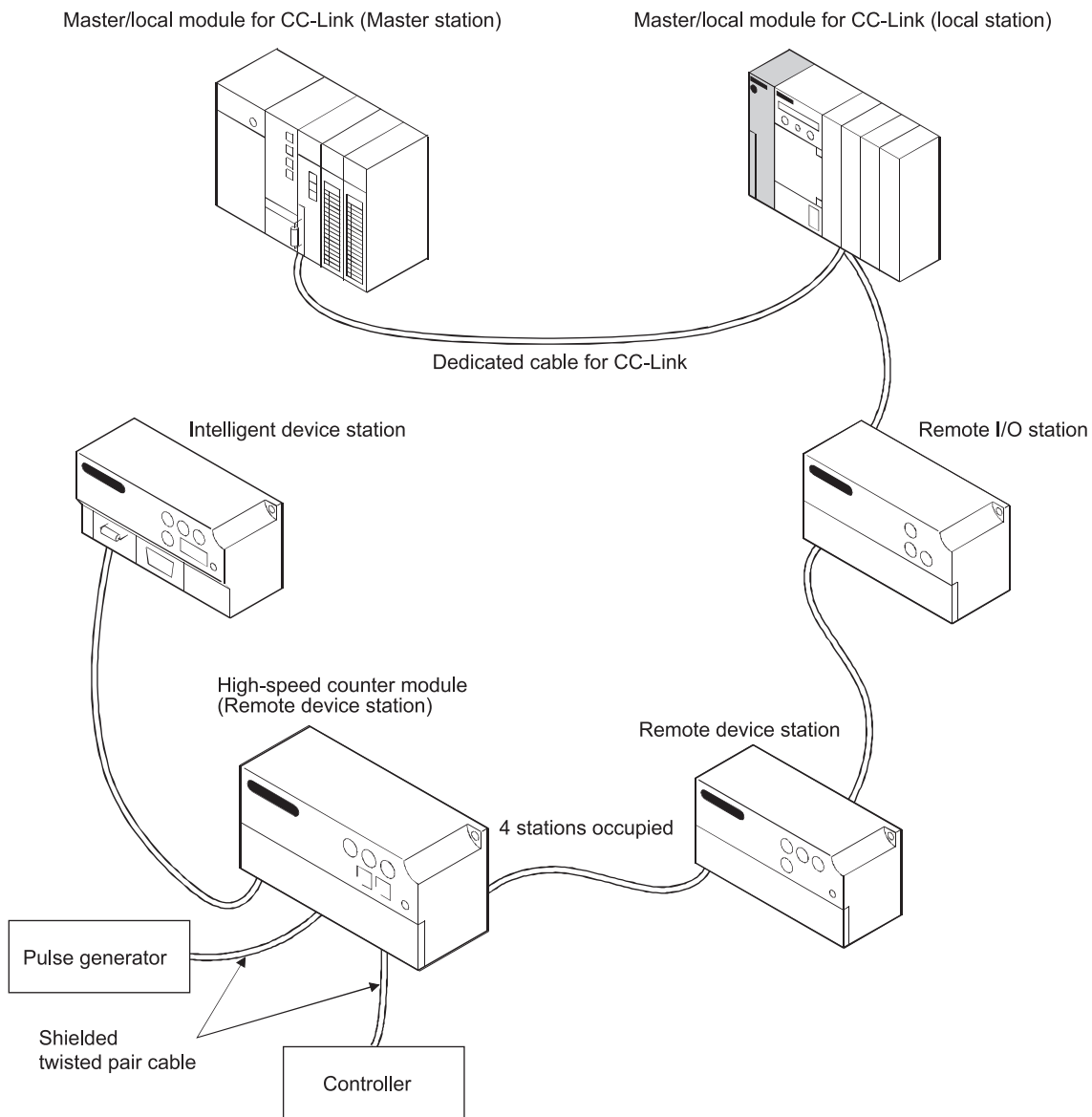

2.2 Applicable System

Application system is described.

(1) Applicable master module

For available master modules, visit the CC-Link Partner Associations (CLPA) website at:

<http://www.cc-link.org/>

REMARK

Check the specifications of the master module before use.

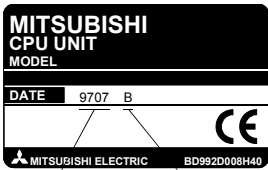
POINT
<p>When AJ61BT11, A1SJ61BT11, AJ61QBT11 and A1SJ61QBT11 are used, be sure to use the type with the number (9707 B or later) in the date column of the rating nameplate shown below. The system cannot be used with the module which does not indicate "9707 B" in the date column.</p> <p style="text-align: center;"><Large type></p> <div style="display: flex; justify-content: space-around; align-items: center;"> <div style="text-align: center;">  <p>Manufacturing year and month Function version</p> </div> <div style="text-align: center;"> <p><Small type></p>  <p>Manufacturing year and month Function version</p> </div> </div>

(2) Limitations for use of dedicated command (RLPA, RRPA) for CC-Link

The dedicated command (RLPA, RRPA) for CC-Link may not be used depending on the programmable controller CPU and the master module.

For details of limitations, refer to the A series master module user's manual (Detail) and the AnSHCPU/AnACPU/AnUCPU programming manual (Dedicated command).

Dedicated commands other than RLPA and RRPA cannot be used on the high-speed counter module.

Refer to Section 10.5 for a program example using dedicated command (RLPA, RRPA).

3. SPECIFICATIONS

3.1 General Specifications

The following table lists the general specifications of the high-speed counter module.(common to the AJ65BT-D62, AJ65BT-D62D and AJ65BT-D62D-S1)

Item	Specifications					
Operating ambient temperature	0 to 55°C					
Storage ambient temperature	-20 to 75°C					
Operating ambient humidity	10 to 90%RH, non-condensing					
Storage ambient humidity						
Vibration resistance	Compliant with JIS B 3502 and IEC 61131-2	Under intermittent vibration	Frequency	Acceleration	Amplitude	Sweep Count
			5 to 8.4Hz	—	3.5mm	10 times each in X, Y, Z directions
		Under continuous vibration	8.4 to 150Hz	9.8m/s ²	—	
			5 to 8.4Hz	—	1.75mm	—
8.4 to 150Hz	4.9m/s ²	—	—			
Shock resistance	Compliant with JIS B 3502 and IEC 61131-2 (147 m/s ² , 3 times each in 3 directions X, Y, Z)					
Operating atmosphere	No corrosive gas					
Operating altitude* ¹	0 to 2000m					
Installation location	Inside control panel					
Overvoltage category* ²	II or less					
Pollution degree* ³	2 or less					

*1 Do not use or store the programmable controller under pressure higher than the atmospheric pressure of altitude 0m. Doing so may cause malfunction. When using the programmable controller under pressure, please consult your local Mitsubishi Electric representative.

*2 This indicates the section of the power supply to which the equipment is assumed to be connected between the public electrical power distribution network and the machinery within premises. Category II applies to equipment for which electrical power is supplied from fixed facilities. The surge voltage withstand level for up to the rated voltage of 300V is 2500V.

*3 This index indicates the degree to which conductive material is generated in terms of the environment in which the equipment is used.

Pollution level 2 is when only non-conductive pollution occurs. A temporary conductivity caused by condensing must be expected occasionally.

3.2 Performance Specifications

The following table gives the performance specifications of the high-speed counter module.

(1) Performance specifications of the AJ65BT-D62

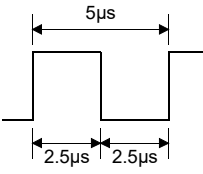
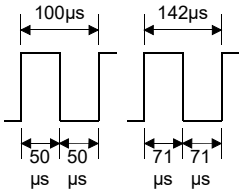
Item		Specifications	
Counting speed setting switch		HIGH position	LOW position
Number of channels		2 channels	
Count input signal	Phase	1-phase input, 2-phase input	
	Signal level (φ A, φ B)	5VDC 12VDC 24VDC } 2 to 5mA	
Counter	Counting speed (max.)*	1-phase input	200kPPS
		2-phase input	200kPPS
	Counting range	24-bit binary, 0 to 16777215	
	Type	UP/DOWN preset counter and ring counter functions	
	Minimum pulse width that can be counted (Adjust rise/fall time of input to 2.5μs or less. Duty ratio: 50%)		
Coincidence output	Comparison range	24-bit binary	
	Comparison result	Set value < count value, set value = count value, set value > count value	
External input	Preset	5/12/24VDC, 2 to 5mA	
	Function start	5/12/24VDC, 2 to 5mA	
	Response time	OFF→ON 0.5ms or less ON→OFF 3ms or less	
External output	Coincidence output	2A/1 common	
	Response time	0.1ms or less	
CC-Link station type		Remote device station	
Number of stations occupied		4 stations	
Connection cable		Dedicated cable for CC-Link	
Withstanding voltage		500VAC for 1 minute across all DC external terminals and grounding terminal.	
Insulation resistance		10MΩ or more across all DC external terminals and grounding terminal using a 500VDC insulation resistance tester.	
Noise immunity		Measure using a noise simulator of noise voltage 500Vp-p, noise width 1μs and noise frequency 25 to 60Hz.	
Terminal block		27-pin terminal block (M3.5×7 screws)	
Applicable cable size		0.75 to 2.00mm ²	
Applicable crimping terminal		RAV1.25-3, RAV2-3.5 (conforming to JIS C2805)	
Module mounting screws		Screws of M4×0.7mm×16mm or larger (tightening torque range: 0.78 to 1.18N·m) DIN rail may also be used for mounting.	
Applicable DIN rails		TH35-7.5Fe, TH35-7.5Al, (conforming to JIS C2812)	
External power supply		18 to 28.8VDC	
		Current consumption: 70 mA (for 24VDC)	
Permissible instantaneous power failure time		1ms	
Weight		0.41kg	

*Counting speed is influenced by pulse rise time and fall time. Countable speeds are as follows.

Note that counting of a pulse having long rise and fall times may result in miscounting.

Counting Speed Setting Switch	HIGH		LOW	
	1-phase input	2-phase input	1-phase input	2-phase input
Rise/fall time				
t=2μs or less	200kPPS	200kPPS	10kPPS	7kPPS
t=25μs or less	10kPPS	10kPPS	1kPPS	700PPS
t=500μs	—	—	500PPS	250PPS

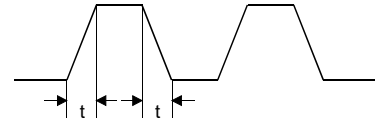

(2) Performance specifications of the AJ65BT-D62D

Item		Specifications	
Counting speed setting switch		HIGH position	LOW position
Number of channels		2 channels	
Count input signal	Phase	1-phase input, 2-phase input	
	Signal level ($\phi A, \phi B$)	EIA Standard RS-422-A differential type line driver level {equivalent to AM26LS31 (Japan Texas Instruments make)}	
Counter	Counting speed (max.)*	1-phase input	400kPPS
		2-phase input	300kPPS
	Counting range	24-bit binary, 0 to 16777215	
	Type	UP/DOWN preset counter and ring counter functions	
	Minimum pulse width that can be counted (Adjust rise/fall time of input to 0.1 μ s or less. Duty ratio: 50%)	<p>(1-phase input) (2-phase input) (1-phase input) (2-phase input)</p>	
Coincidence output	Comparison range	24-bit binary	
	Comparison result	Set value < count value, set value = count value, set value > count value	
External input	Preset	5/12/24VDC, 2 to 5mA	
	Function start	OFF \rightarrow ON 0.5ms or less ON \rightarrow OFF 3ms or less	
	Response time	OFF \rightarrow ON 0.5ms or less ON \rightarrow OFF 3ms or less	
External output	Coincidence output	2A/1 common	
	Response time	0.1ms or less	
CC-Link station type		Remote device station	
Number of stations occupied		4 stations	
Connection cable		Dedicated cable for CC-Link	
Withstanding voltage		500VAC for 1 minute across all DC external terminals and grounding terminal.	
Insulation resistance		10M Ω or more across all DC external terminals and grounding terminal using a 500VDC insulation resistance tester.	
Noise immunity		Measure using a noise simulator of noise voltage 500Vp-p, noise width 1 μ s and noise frequency 25 to 60Hz.	
Terminal block		27-pin terminal block (M3.5 \times 7 screws)	
Applicable cable size		0.75 to 2.00mm ²	
Applicable crimping terminal		RAV1.25-3, RAV2-3.5 (conforming to JIS C2805)	
Module mounting screws		Screws of M4 \times 0.7mm \times 16mm or larger (tightening torque range: 0.78 to 1.18N \cdot m) DIN rail may also be used for mounting.	
Applicable DIN rails		TH35-7.5Fe, TH35-7.5Al, (conforming to JIS C2812)	
External power supply		18 to 28.8VDC	
		Current consumption: 100mA (for 24VDC)	
Permissible instantaneous power failure time		1ms	
Weight		0.42kg	

*Counting speed is influenced by pulse rise time and fall time. Countable speeds are as follows.

Note that counting of a pulse having long rise and fall times may result in miscounting.

Counting Speed Setting Switch	HIGH		LOW	
	1-phase input	2-phase input	1-phase input	2-phase input
Rise/fall time				
t=0.1μs or less	400kPPS	300kPPS	—	—
t=1.25μs or less	200kPPS	200kPPS	10kPPS	7kPPS
t=12.5μs or less	20kPPS	20kPPS	1kPPS	700PPS
t=250μs	—	—	500PPS	250PPS

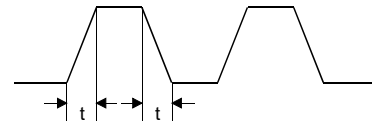

(3) Performance specifications of the AJ65BT-D62D-S1

Item		Specifications	
Counting speed setting switch		HIGH position	LOW position
Number of channels		2 channels	
Count input signal	Phase	1-phase input, 2-phase input	
	Signal level (φ A, φ B)	EIA Standard RS-422-A differential type line driver level {equivalent to AM26LS31 (Japan Texas Instruments make)}	
Counter	Counting speed (max.)*	1-phase input	400kPPS
		2-phase input	300kPPS
	Counting range	24-bit binary, 0 to 16777215	
	Type	UP/DOWN preset counter and ring counter functions	
Minimum pulse width that can be counted (Adjust rise/fall time of input to 0.1μs or less. Duty ratio: 50%)			
Coincidence output	Comparison range	24-bit binary	
	Comparison result	Set value < count value, set value = count value, set value > count value	
External input	Preset	EIA Standard RS-422-A differential type line driver level {equivalent to AM26LS31 (Japan Texas Instruments make)}	
	Function start	5/12/24VDC, 2 to 5mA	
	Response time	OFF→ON 0.5ms or less ON→OFF 3ms or less	
External output	Coincidence output	2A/1 common	
	Response time	0.1ms or less	
CC-Link station type		Remote device station	
Number of stations occupied		4 stations	
Connection cable		Dedicated cable for CC-Link	
Withstanding voltage		500VAC for 1 minute across all DC external terminals and grounding terminal.	
Insulation resistance		10MΩ or more across all DC external terminals and grounding terminal using a 500VDC insulation resistance tester.	
Noise immunity		Measure using a noise simulator of noise voltage 500Vp-p, noise width 1μs and noise frequency 25 to 60Hz.	
Terminal block		27-pin terminal block (M3.5×7 screws)	
Applicable cable size		0.75 to 2.00mm ²	
Applicable crimping terminal		RAV1.25-3, RAV2-3.5 (conforming to JIS C2805)	
Module mounting screws		Screws of M4×0.7mm×16mm or larger (tightening torque range: 0.78 to 1.18N·m) DIN rail may also be used for mounting.	
Applicable DIN rails		TH35-7.5Fe, TH35-7.5Al, (conforming to JIS C2812)	
External power supply		18 to 28.8VDC	
		Current consumption: 120mA (for 24VDC)	
Permissible instantaneous power failure time		1ms	
Weight		0.42kg	

*Counting speed is influenced by pulse rise time and fall time. Countable speeds are as follows.

Note that counting of a pulse having long rise and fall times may result in miscounting.

Counting Speed Setting Switch	HIGH		LOW	
	1-phase input	2-phase input	1-phase input	2-phase input
Rise/fall time				
t=0.1μs or less	400kPPS	300kPPS	—	—
t=1.25μs or less	200kPPS	200kPPS	10kPPS	7kPPS
t=12.5μs or less	20kPPS	20kPPS	1kPPS	700PPS
t=250μs	—	—	500PPS	250PPS

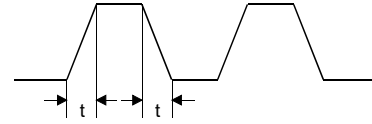

3.3 Functions

The following table lists the high-speed counter module functions.

Name		Description	Refer To
Coincidence output function		Outputs an ON/OFF signal in a specified output status, comparing it with the present value.	Section 6.1
Preset function		Counting alternates between the preset value and the ring counter value. The preset operation can be done either by a sequence program or by an external preset input.	Section 7.1
Ring counter function		Counting alternates between the preset value and the ring counter.	Section 8.1
Counter function selection	Count disable function	Stops counting pulses while the count enable command is ON.	Section 9.2
	Latch counter function	Stores the present value of the counter into the remote registers when the signal of the counter function selection start command is input.	Section 9.3
	Sampling counter function	After the signal of the counter function selection start command is input, input pulses are counted during a preset sampling period and stored into the remote registers.	Section 9.4
	Periodic pulse counter function	While the signal of the counter function selection start command is input, input pulses are stored into the remote registers at preset intervals.	Section 9.5

POINT
(1) These functions can be used together. However, only one function can be selected from the counter function selection.
(2) The preset function and counter function selection can be executed not only through a sequence program, but also through external input. <ul style="list-style-type: none"> • To use the preset function, apply voltage to the PRESET terminal. • To use a function from the counter function selection, apply voltage to the F.START terminal.

3.4 Interfaces with External Devices

The following tables give lists of the interfaces of the high-speed counter module with external devices.

(1) Interfaces of the AJ65BT-D62 with external devices

Input/Output	Internal Circuit	Terminal Number *1	Signal Name	ON/OFF	Input Voltage (Guaranteed)	Operating Current (Guaranteed)	
Input		8 (15)	Phase A pulse input 24V	ON	21.6 to 26.4V	2 to 5mA	
				OFF	5V or less	0.1mA or less	
			Phase A pulse input 12V	ON	10.8 to 13.2V	2 to 5mA	
				OFF	4V or less	0.1mA or less	
			Phase A pulse input 5V	ON	4.5 to 5.5V	2 to 5mA	
				OFF	2V or less	0.1mA or less	
		9 (16)	Phase A pulse input COM				
		10 (17)		Phase B pulse input 24V	ON	21.6 to 26.4V	2 to 5mA
					OFF	5V or less	0.1mA or less
				Phase B pulse input 12V	ON	10.8 to 13.2V	2 to 5mA
OFF	4V or less				0.1mA or less		
Phase B pulse input 5V	ON			4.5 to 5.5V	2 to 5mA		
	OFF			2V or less	0.1mA or less		
11 (18)	Phase B pulse input COM						
Input		12 (19)	Preset input 24V	ON	21.6 to 26.4V	2 to 5mA	
				OFF	5V or less	0.1mA or less	
			Preset input 12V	ON	10.8 to 13.2V	2 to 5mA	
				OFF	4V or less	0.1mA or less	
			Preset input 5V	ON	4.5 to 5.5V	2 to 5mA	
				OFF	2V or less	0.1mA or less	
13 (20)	COM	Response time	OFF→ON 0.5ms or less	ON→OFF 3ms or less			
Input		14 (21)	Function start input 24V	ON	21.6 to 26.4V	2 to 5mA	
				OFF	5V or less	0.1mA or less	
			Function start input 12V	ON	10.8 to 13.2V	2 to 5mA	
				OFF	4V or less	0.1mA or less	
			Function start input 5V	ON	4.5 to 5.5V	2 to 5mA	
				OFF	2V or less	0.1mA or less	
—	—	Response time	OFF→ON 0.5ms or less	ON→OFF 3ms or less			
Output		22 (24)	EQU1	Operating voltage 10.2 to 30V		Rated current 0.5A/point	
		Max. inrush current 4A 10ms					
		23 (25)	EQU2	Max. voltage drop at ON 1.5V		Response time OFF→ON 0.1ms or less ON→OFF 0.1ms or less	
		Input voltage 10.2 to 30V					
26	12/24V	Current consumption 8mA(TYP 24VDC)					
27	0V						

*1...The number within parentheses represents the terminal number of channel 2.

(2) Interfaces of the AJ65BT-D62D with external devices

Input/Output	Internal Circuit	Terminal Number*1	Signal Name	ON/OFF	Input Voltage (Guaranteed)	Operating Current (Guaranteed)
Input		8 (15)	Phase A pulse input	EIA Standard RS-422-A line receiver (AM26C32 (manufactured by Texas Instruments Japan Limited.) or equivalent) The specifications of line receiver are as follows: • VIT+ differential input ON voltage (H level threshold voltage): 0.1V • VIT- differential input OFF voltage (L level threshold voltage): -0.1V • Vhys hysteresis voltage (VIT+ - VIT-): 60mV (A current type line driver cannot be used.)		
		9 (16)	Phase \bar{A} pulse input			
		10 (17)	Phase B pulse input			
		11 (18)	Phase \bar{B} pulse input			
Input		12 (19)	Preset input 24V	ON	21.6 to 26.4V	2 to 5mA
				OFF	5V or less	0.1mA or less
			Preset input 12V	ON	10.8 to 13.2V	2 to 5mA
			OFF	4V or less	0.1mA or less	
	Preset input 5V	ON	4.5 to 5.5V	2 to 5mA		
		OFF	2V or less	0.1mA or less		
		13 (20)	COM	Response time	OFF→ON 0.5ms or less	ON→OFF 3ms or less
Input		14 (21)	Function start input 24V	ON	21.6 to 26.4V	2 to 5mA
				OFF	5V or less	0.1mA or less
			Function start input 12V	ON	10.8 to 13.2V	2 to 5mA
			OFF	4V or less	0.1mA or less	
	Function start input 5V	ON	4.5 to 5.5V	2 to 5mA		
		OFF	2V or less	0.1mA or less		
		—	—	Response time	OFF→ON 0.5ms or less	ON→OFF 3ms or less
Output		22 (24)	EQU1	Operating voltage 10.2 to 30V Rated current 0.5A/point Max. inrush current 4A 10ms Max. voltage drop at ON 1.5V		
		23 (25)	EQU2	Response time OFF→ON 0.1ms or less ON→OFF 0.1ms or less		
		26	12/24V	Input voltage 10.2 to 30V		
		27	0V	Current consumption 8mA(TYP 24VDC)		

*1...The number within parentheses represents the terminal number of channel 2.

(3) Interfaces of the AJ65BT-D62D-S1 with external devices

Input/Output	Internal Circuit	Terminal Number *1	Signal Name	ON/OFF	Input Voltage (Guaranteed)	Operating Current (Guaranteed)
Input		8 (16)	Phase A pulse input	EIA Standard RS-422-A line receiver (AM26C32 (manufactured by Texas Instruments Japan Limited.) or equivalent) The specifications of line receiver are as follows: • VIT+ differential input ON voltage (H level threshold voltage): 0.1V • VIT- differential input OFF voltage (L level threshold voltage): -0.1V • V _{hys} hysteresis voltage (VIT+ - VIT-): 60mV (A current type line driver cannot be used.)		
		9 (17)	Phase \bar{A} pulse input			
		10 (18)	Phase B pulse input			
		11 (19)	Phase \bar{B} pulse input			
Input		12 (20)	Preset input			
		13 (21)	$\bar{\text{Preset}}$ input			
Input		14 (22)	Function start input 24V	ON	21.6 to 26.4V	2 to 5mA
				OFF	5V or less	0.1mA or less
			Function start input 12V	ON	10.8 to 13.2V	2 to 5mA
				OFF	4V or less	0.1mA or less
			Function start input 5V	ON	4.5 to 5.5V	2 to 5mA
				OFF	2V or less	0.1mA or less
		15 (23)	Function start input COM	Response time	OFF→ON 0.5ms or less	ON→OFF 3ms or less
Output		24 (25)	EQU1	Operating voltage	10.2 to 30V	
				Rated current	0.5A/point	
				Max. inrush current	4A 10ms	
				Max. voltage drop at ON	1.5V	
				Response time		
				OFF→ON	0.1ms or less	
				ON→OFF	0.1ms or less	
		26	12/24V	Input voltage	10.2 to 30V	
		27	0V	Current consumption	8mA(TYP 24VDC)	

*1...The number within parentheses represents the terminal number of channel 2.

3.5 I/O Signals Transferred to/from the Master Module

This section explains the input/output signals (RX, RY) of the high-speed counter module transferred to/from the master module.

(1) Input signals

The following table lists the input signals of the high-speed counter module transmitted to the master module.

Input Signals		Signal Name	Description	Refer To
CH1	CH2	High-speed counter module → master module		
RXn0	RXn4	Counter value greater (point No. 1)	Turned on if the counter value is greater than the set value No. 1.	Section 6.1
RXn1	RXn5	Counter value coincidence (point No. 1)	Latched on if the counter value is equal to the set value No. 1 turned off by the coincidence signal reset command.	Section 6.1 Section 8.1
RXn2	RXn6	Counter value less (point No. 1)	Turned on when the counter value is less than the set value No. 1.	Section 6.1
RXn3	RXn7	External preset command detection	Latched on when the preset request is given from external input. Turned off by the external preset detection reset command.	Section 7.3
RXn8	RXnB	Counter value greater (point No. 2)	Turned on if the counter value is greater than the set value No. 2.	Section 6.1
RXn9	RXnC	Counter value coincidence (point No. 2)	Latched on if the counter value is equal to the set value No. 2 turned off by the coincidence signal reset command.	
RXnA	RXnD	Counter value less (point No. 2)	Turned on when the counter value is less than the set value No. 2.	
RXnE	RXnF	———	Unusable	———
RX(n+1)0	RX(n+1)2	Preset completion	Turned on on completion of the preset function executed when the preset command $\{(RY(n+1)1(RY(n+1)8))\}$ turns on. Turned off when the preset command switches from ON to OFF.	Section 7.2
RX(n+1)1	RX(n+1)3	Counter function detection	Turned on at counter function start (execution) when the counter function selection start command $\{(RY(n+1)6(RY(n+1)D))\}$ turns on. Turned off when the counter function selection start command switches from ON to OFF.	Section 9.2 Section 9.3 Section 9.4 Section 9.5
RX(n+1)4 to RX(n+1)7		———	Unusable	———
RX(n+1)8		Initial data processing request flag	Turned on by the high-speed counter module to request initial data setting after power-on or hardware reset. Turned off on initial data processing completion (when initial data processing completion flag $(RY(N+7)8)$ turns on).	
RX(n+1)9 to RX(n+1)A		———	Unusable	
RX(n+1)B		Remote ready	Turned on when the high-speed counter module is in the ready state on completion of initial data setting after power-on or hardware reset.	
RX(n+1)C to RX(n+1)F		———	Unusable	

n: Address assigned to the master station by station number setting.

POINT
The unusable devices are used in the system and should not be used by the user. If any of them is used by the user, normal operation cannot be guaranteed.

(2) Output signals

The following table lists the output signals transmitted by the master module to the high-speed counter module.

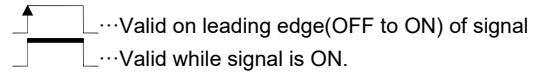

Input Signals		Signal Name Master module → high-speed counter module	Operation Timing*	Description	Refer To
CH1	CH2				
RYn0 to RYnF		—	—	Unusable	—
RY(n+1)0	RY(n+1)7	Point No. 1 coincidence signal reset command		Resets the ring counter value coincidence signal (latch) and the coincidence output No. 1 signal to the external device.	Section 6.1 Section 8.1
RY(n+1)1	RY(n+1)8	Preset command		Performs preset value write.	Section 7.2
RY(n+1)2	RY(n+1)9	Coincidence signal enable		Turn on this signal to output the counter value coincidence signal to the external device.	Section 6.1
RY(n+1)3	RY(n+1)A	Down count command		Down count is performed when this signal is on in the 1-phase mode.	Chapter 5
RY(n+1)4	RY(n+1)B	Count enable		Turn on this signal to enable count operation.	Chapters 6 to 9
RY(n+1)5	RY(n+1)C	—	—	Unusable	—
RY(n+1)6	RY(n+1)D	Counter function selection start command		Starts (executes) counter function selection.	Chapter 9
RY(n+1)E to RY(n+1)F		—	—	Unusable	—
RY(n+2)0	RY(n+2)2	External preset detection reset command		Resets external preset detection.	Section 7.3
RY(n+2)1	RY(n+2)3	Point No. 2 coincidence signal reset command		Resets the point No. 2 coincidence signal.	Section 6.1 Section 8.1
RY(n+2)4 to RY(n+7)7		—	—	Unusable	—
RY(n+7)8		Initial data processing completion flag		Turned on after completion of initial data processing performed after power-on or hardware reset.	
RY(n+7)9 to RY(n+7)F		—	—	Unusable	—

n: Address assigned to the master station by station number setting.

*For the output signal whose operation timing is "", use the corresponding input signal as an interlock for turning off that output signal.

(Example) Preset command operation

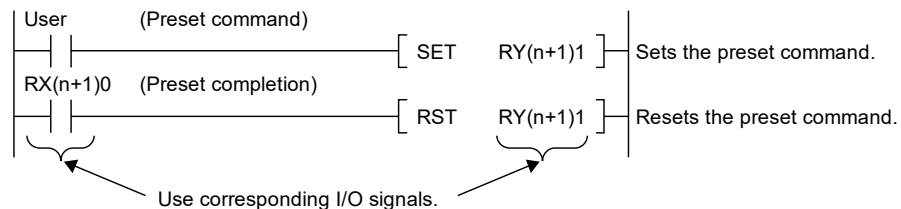

POINT

The unusable devices are used in the system and should not be used by the user.

If any of them is used by the user, normal operation cannot be guaranteed.

3.6 Remote Register Allocation

The following table gives the assignment of the remote registers in the high-speed counter module.

The initial values of the remote registers are set when power is switched on or the programmable controller CPU is reset.

Transmission Direction	Addresses		Description	Initial Value	Read/Write	Refer To
	CH1	CH2				
Write area of master station ↓ High-speed counter module	RWwm	RWwm+8	----- Preset value setting area ----- (L) (H)	0	Write only	Section 7.2 Section 7.3
	RWwm+1	RWwm+9				
	RWwm+2	RWwm+A	Pulse input mode/function selection register/ external output hold or clear setting area*1			Chapter 5 Chapter 9
	RWwm+3	RWwm+B	----- Coincidence output point No. 1 ----- (L) (H)			Chapter 6
	RWwm+4	RWwm+C				
	RWwm+5	RWwm+D	Sampling/cycle time setting area			Section 9.4 Section 9.5
	RWwm+6	RWwm+E	----- Coincidence output point No. 2 ----- (L) (H)			Chapter 6
	RWwm+7	RWwm+F				
High-speed counter module ↓ Read area of master station	RWrn	RWrn+8	----- Present value storage area ----- (L) (H)	0	Read only	Section 5.3
	RWrn+1	RWrn+9				
	RWrn+2	RWrn+A	Latch count value/sampling count (L) value/periodic pulse count previous value storage area (H)			Section 9.3 Section 9.4 Section 9.5
	RWrn+3	RWrn+B				
	RWrn+4	RWrn+C	----- Periodic pulse count present value ----- (L) (H)			Section 9.5
	RWrn+5	RWrn+D				
	RWrn+6		Sampling/periodic counter flag storage area (for both CH1 and CH2)			Section 9.4 Section 9.5
	RWrn+7 RWrn+E RWrn+F		Unusable			-----

m, n: Addresses assigned to the master station by station number setting.

*1 External output hold or clear setting is used for both CH1 and CH2.

The value set to the remote register of CH1 is valid.

*2 In the AJ65BT-D62D-S1, external output (coincidence output) does not switch on-off if coincidence output No. 2 is set. However, the counter value magnitude comparison (coincidence, greater, less) output signals (X signals) switch on-off as ordinarily.

POINT
The unusable remote registers are used in the system and should not be used by the user. If any of them is used by the user, normal operation cannot be guaranteed.

3.7 Applicable Encoders

The following encoders may be connected to the high-speed counter module.

(1) Encoders connectable to the AJ65BT-D62

(a) Open collector type encoder

(b) CMOS output type encoder

(Make sure that the output voltage of the encoder complies with the specifications of the module.)

(2) Encoder connectable to the AJ65BT-D62D and AJ65BT-D62D-S1

(a) Line driver output type encoder

(Make sure that the output voltage of the encoder complies with the specifications of the module.)

POINT

The following type of encoder cannot be used.

- | |
|---|
| <ul style="list-style-type: none">• TTL output type encoder |
|---|

3.8 Data Link Processing Times

In the high-speed counter module, it takes data link processing time described in this section to execute each function. For link scan time, refer to the user's manual for the master module used. As an example, this section explains processing times at *1 to *4 in a coincidence output operation. (The master module is the QJ61BT11 in asynchronous mode.)

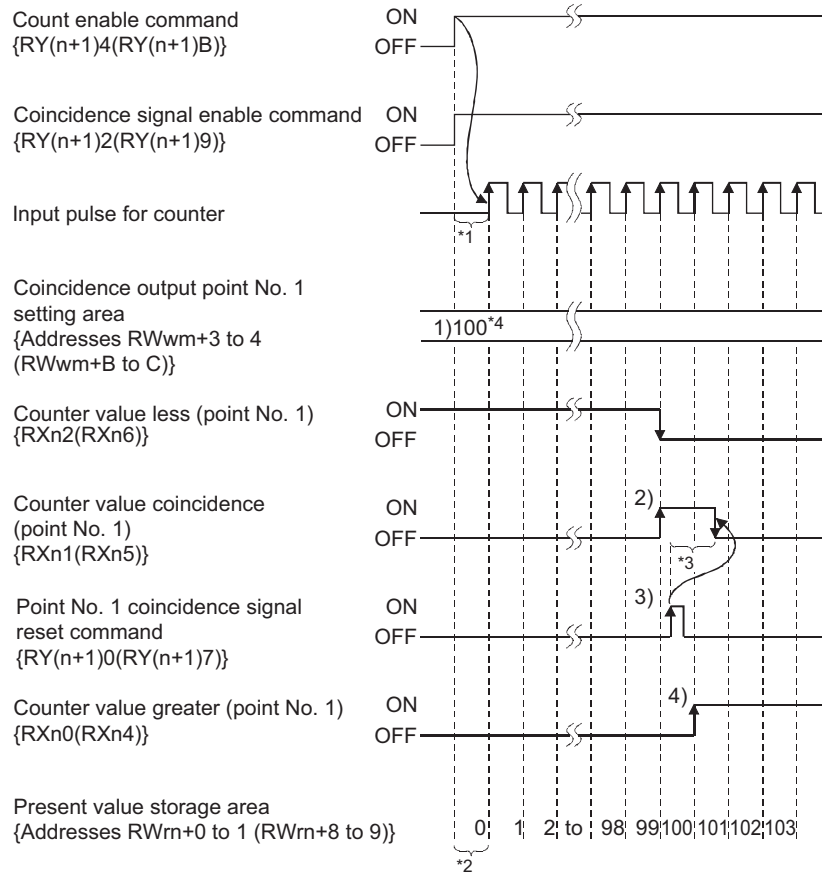

- *1 Master station (RY) → remote device station (RY) processing time (Normal value)
The following is the processing time takes for the remote device station to start pulse input when the count enable signal {RY(n+1)A (RY(n+1)B)} is turned on.

[Formula]

$$SM+LS \times 1 + \text{remote_device_station_processing_time}(1\text{ms}) \text{ [ms]}$$

high-speed counter module

SM: Scan time of master station sequence program
LS : Link scan time

- *2 Master station (RWr) ← remote device station (RWr) processing time (Normal value)
The following is the processing time takes for the master station to read the counter value counted at the remote station.

[Formula]

$$SM+LS \times 1 + \text{remote_device_station_processing_time}(1\text{ms}) \text{ [ms]}$$

high-speed counter module

SM: Scan time of master station sequence program
LS : Link scan time

- *3 Master station (RX) ← remote device station (RX) processing time (Normal value)
The following is the processing time takes for the remote device station to receive a coincidence signal reset command and for the master station to receive information that the counter value coincidence (point No. 1) signal {RXn1 (RXn5)} turned off at the remote station.
* The time takes to transmit the coincidence signal reset command to the remote station is not included.

[Formula]

$$SM+LS \times 1 + \text{remote_device_station_processing_time}(1\text{ms}) \text{ [ms]}$$

high-speed counter module

SM: Scan time of master station sequence program
LS : Link scan time

*4 Master station (RWw) → remote device station (RWw) processing time

The following is the transmission time to set coincidence output point No.1 set value at the remote device station.

[Formula]

$$\text{SM} + \text{LS} \times 1 + \text{remote device station processing time(1ms)} \text{ [ms]}$$

high-speed counter module

SM: Scan time of master station sequence program

LS : Link scan time

4. INSTALLATION AND PRE-OPERATION SETTING PROCEDURE

This chapter describes the pre-operation procedure of the high-speed counter module, the names and settings of each part, and the wiring method.

4.1 Pre-Operation Setting Procedure

Use the following procedure to make pre-operation setting for the high-speed counter module.

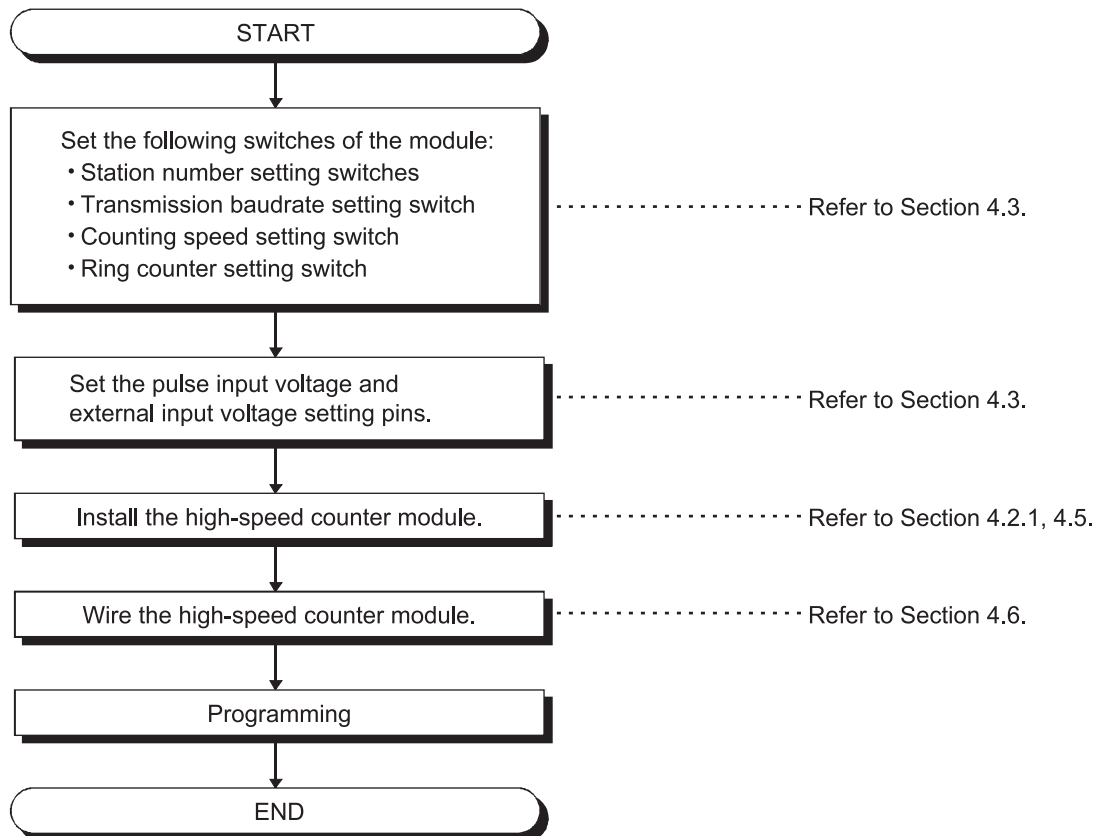

4.2 Installation

This section gives the handling instructions to be followed from unpacking to installation of the high-speed counter module and its installation environment.

4.2.1 Handling instructions

This section gives the handling instructions of the high-speed counter module.



WARNING

- Do not touch any terminal while power is on. Failure to do so may cause malfunction.



CAUTION

- Securely fix the module using the DIN rail or mounting screws and fully tighten the mounting screws within the specified torque range. Undertightening can cause a drop or misoperation. Overtightening can cause a drop or misoperation due to damaged screws or module.
- Do not touch the conductive areas of the module directly. Otherwise, the module can misoperate or fail.
- Tighten the terminal screws within the specified torque range. Undertightening the terminal screws can cause short circuit or malfunction. Overtightening can damage the screw and/or module, resulting in drop, short circuit, or malfunction.
- Ensure that foreign matters such as chips and wire off-cuts do not enter the module. They can cause a fire, failure or misoperation.
- Do not disassemble or modify the module. This can cause a failure, misoperation, injury or fire.
- Do not drop or apply strong shock to the module. Failure to do so may damage the module.
- Before mounting or dismounting the module to or from an enclosure, always switch power off externally in all phases. Otherwise, the module can fail or misoperate.
- When disposing of the product, handle it as industrial waste.

(1) Tighten the terminal screws and fixing screws of the module within the following ranges

Screw Location	Tightening Torque Range
Module mounting screw (M4 screw)	0.78 to 1.18N·m
Terminal block terminal screw (M3.5 screw)	0.59 to 0.88N·m
Terminal block mounting screw (M4 screw)	0.78 to 1.18N·m

(2) When using the DIN rail adapter, note the following in mounting the DIN rail.

(a) Applicable DIN rail type (conforming to JIS C2812)

TH35-7.5Fe

TH35-7.5Al

(b) DIN rail mounting screw pitch

When mounting the DIN rail, tighten screws in 200mm or less pitch.

4.2.2 Installation environment

CAUTION





When installing the module, avoid the following environment. If the environment of the module used is outside the range of general specifications, an electric shock, fire, misoperation or product damage or deterioration can occur

- Ambient temperature outside the range 0 to 55°C
- Ambient humidity outside the range 10 to 90%RH
- Condensation due to sudden temperature changes
- Corrosive or combustible gasses
- Dust, conductive powder (e.g. metal filings), oil mist, salt and organic solvent
- Direct sunlight
- Strong power and magnetic fields
- Vibration and impact

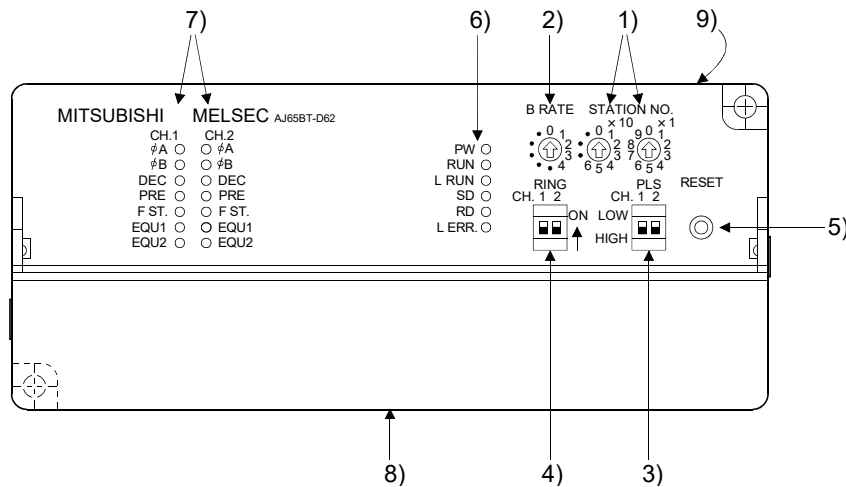
4.3 Part Names and Settings

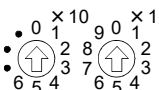
This section gives the names and settings of the high-speed counter module controls.



Number	Name	Description														
1)	Station number setting switches STATION NO. 	Used to set the station number of the high-speed counter module between 1 and 61. Use "x10" to set the tens. Use "x1" to set the modules. (Factory setting: 00)														
2)	Transmission baud rate setting switch B RATE 	Used to set the transmission speed of the high-speed counter module. (For data link) <table border="1" data-bbox="670 1142 1412 1444"> <thead> <tr> <th>Number to Be Set</th> <th>Transmission Baud rate</th> </tr> </thead> <tbody> <tr> <td>0</td> <td>156kbps (factory setting)</td> </tr> <tr> <td>1</td> <td>625kbps</td> </tr> <tr> <td>2</td> <td>2.5Mbps</td> </tr> <tr> <td>3</td> <td>5Mbps</td> </tr> <tr> <td>4</td> <td>10Mbps</td> </tr> <tr> <td>Other than 0 to 4</td> <td>Unused (If the value set is other than 0 to 4, the L ERR. LED lights up to indicate a communication error.)</td> </tr> </tbody> </table>	Number to Be Set	Transmission Baud rate	0	156kbps (factory setting)	1	625kbps	2	2.5Mbps	3	5Mbps	4	10Mbps	Other than 0 to 4	Unused (If the value set is other than 0 to 4, the L ERR. LED lights up to indicate a communication error.)
Number to Be Set	Transmission Baud rate															
0	156kbps (factory setting)															
1	625kbps															
2	2.5Mbps															
3	5Mbps															
4	10Mbps															
Other than 0 to 4	Unused (If the value set is other than 0 to 4, the L ERR. LED lights up to indicate a communication error.)															
3)	Counting speed setting switch PLS CH. 1 2 LOW HIGH 	LOW position: Up to 10kPPS can be counted for 1-phase input or up to 7kPPS for 2-phase input. HIGH position: Up to 400(200)kPPS can be counted for 1-phase input or up to 300 (200)kPPS for 2-phase input. Values in parentheses are those for use of the AJ65BT-D62. (Factory setting: HIGH position)														
4)	Ring counter setting switch RING CH. 1 2 ON 	Used to select whether the ring counter function is used or not. When using the ring counter: ON When not using the ring counter: OFF (Factory setting: OFF position)														
5)	Reset switch RESET 	Hardware reset Used to initialize the remote registers in the high-speed counter module. By turning this switch on, the initial data processing flag switches on.														

Number	Name	Description																																																												
6)	LED indicators PW ○ RUN ○ L RUN ○ SD ○ RD ○ L ERR. ○	<table border="1"> <tr> <td>PW</td> <td>On: Power on Off: Power off</td> </tr> <tr> <td>RUN</td> <td>On: Normal operation Off: 24VDC power off or WDT error</td> </tr> <tr> <td>L RUN</td> <td>On: Normal communication Off: Communication break (time excess error)</td> </tr> <tr> <td>SD</td> <td>Lit to indicate data transmission</td> </tr> <tr> <td>RD</td> <td>Lit to indicate data receive</td> </tr> <tr> <td>L ERR.</td> <td>On: Communication data error (CRC error) Flashing at constant interval: Station number settings and baud rate settings are changed during power supply. Flashing at non-constant interval: Termination resistor is not provided or the unit or the dedicated cable for CC-Link is subject to noise. Off: Normal communication</td> </tr> </table>	PW	On: Power on Off: Power off	RUN	On: Normal operation Off: 24VDC power off or WDT error	L RUN	On: Normal communication Off: Communication break (time excess error)	SD	Lit to indicate data transmission	RD	Lit to indicate data receive	L ERR.	On: Communication data error (CRC error) Flashing at constant interval: Station number settings and baud rate settings are changed during power supply. Flashing at non-constant interval: Termination resistor is not provided or the unit or the dedicated cable for CC-Link is subject to noise. Off: Normal communication																																																
		PW	On: Power on Off: Power off																																																											
		RUN	On: Normal operation Off: 24VDC power off or WDT error																																																											
		L RUN	On: Normal communication Off: Communication break (time excess error)																																																											
		SD	Lit to indicate data transmission																																																											
		RD	Lit to indicate data receive																																																											
L ERR.	On: Communication data error (CRC error) Flashing at constant interval: Station number settings and baud rate settings are changed during power supply. Flashing at non-constant interval: Termination resistor is not provided or the unit or the dedicated cable for CC-Link is subject to noise. Off: Normal communication																																																													
7)	LED indicators CH.1 CH.2 ϕ A ○ ○ ϕ A ϕ B ○ ○ ϕ B DEC ○ ○ DEC PRE ○ ○ PRE F ST. ○ ○ F ST. EQU1 ○ ○ EQU1 EQU2 ○ ○ EQU2	<table border="1"> <tr> <td>ϕ A</td> <td>Lit to indicate that voltage is being applied to the phase A pulse input terminal.</td> </tr> <tr> <td>ϕ B</td> <td>Lit to indicate that voltage is being applied to the phase B pulse input terminal.</td> </tr> <tr> <td>DEC</td> <td>Lit to indicate down count.</td> </tr> <tr> <td>PRE</td> <td>Lit to indicate that voltage is applied to the PRESET terminal, and remains lit. Turns off on the trailing edge of the external preset detection reset command.</td> </tr> <tr> <td>F ST.</td> <td>Lit to indicate that voltage is being applied to the F.START terminal.</td> </tr> <tr> <td>EQU1</td> <td>Lit to indicate that the coincidence output setting No. 1 is equal to the counter value.</td> </tr> <tr> <td>EQU2</td> <td>Lit to indicate that the coincidence output setting No. 2 is equal to the counter value.</td> </tr> </table> <p style="text-align: right;">(The AJ65BT-D62D-S1 does not have this LED.)</p>	ϕ A	Lit to indicate that voltage is being applied to the phase A pulse input terminal.	ϕ B	Lit to indicate that voltage is being applied to the phase B pulse input terminal.	DEC	Lit to indicate down count.	PRE	Lit to indicate that voltage is applied to the PRESET terminal, and remains lit. Turns off on the trailing edge of the external preset detection reset command.	F ST.	Lit to indicate that voltage is being applied to the F.START terminal.	EQU1	Lit to indicate that the coincidence output setting No. 1 is equal to the counter value.	EQU2	Lit to indicate that the coincidence output setting No. 2 is equal to the counter value.																																														
		ϕ A	Lit to indicate that voltage is being applied to the phase A pulse input terminal.																																																											
		ϕ B	Lit to indicate that voltage is being applied to the phase B pulse input terminal.																																																											
		DEC	Lit to indicate down count.																																																											
		PRE	Lit to indicate that voltage is applied to the PRESET terminal, and remains lit. Turns off on the trailing edge of the external preset detection reset command.																																																											
		F ST.	Lit to indicate that voltage is being applied to the F.START terminal.																																																											
		EQU1	Lit to indicate that the coincidence output setting No. 1 is equal to the counter value.																																																											
		EQU2	Lit to indicate that the coincidence output setting No. 2 is equal to the counter value.																																																											
8)	Terminal block	<p>Pin-to-signal correspondences are indicated below.</p> <p>For the AJ65BT-D62</p> <table border="1"> <thead> <tr> <th>Pin Number</th> <th>Signal name</th> <th>Pin Number</th> <th>Signal name</th> </tr> </thead> <tbody> <tr> <td>1</td> <td>DA</td> <td>15</td> <td rowspan="5">CH2</td> </tr> <tr> <td>2</td> <td>DB</td> <td>16</td> <td>ϕ A</td> </tr> <tr> <td>3</td> <td>DG</td> <td>17</td> <td>ϕ B</td> </tr> <tr> <td>4</td> <td>SLD</td> <td>18</td> <td>PRESET</td> </tr> <tr> <td>5</td> <td>24V</td> <td>19</td> <td>COM</td> </tr> <tr> <td>6</td> <td>F.G.</td> <td>20</td> <td>F.START</td> </tr> <tr> <td>7</td> <td>24G</td> <td>21</td> <td rowspan="2">CH1</td> </tr> <tr> <td>8</td> <td rowspan="2">CH1</td> <td>22</td> <td>EQU1</td> </tr> <tr> <td>9</td> <td>ϕ A</td> <td>23</td> <td>EQU2</td> </tr> <tr> <td>10</td> <td>ϕ B</td> <td>24</td> <td>CH2</td> </tr> <tr> <td>11</td> <td>PRESET</td> <td>25</td> <td>EQU1</td> </tr> <tr> <td>12</td> <td>COM</td> <td>26</td> <td>12/24V</td> </tr> <tr> <td>13</td> <td>F.START</td> <td>27</td> <td>COM</td> </tr> <tr> <td>14</td> <td></td> <td></td> <td></td> </tr> </tbody> </table>	Pin Number	Signal name	Pin Number	Signal name	1	DA	15	CH2	2	DB	16	ϕ A	3	DG	17	ϕ B	4	SLD	18	PRESET	5	24V	19	COM	6	F.G.	20	F.START	7	24G	21	CH1	8	CH1	22	EQU1	9	ϕ A	23	EQU2	10	ϕ B	24	CH2	11	PRESET	25	EQU1	12	COM	26	12/24V	13	F.START	27	COM	14			
Pin Number	Signal name	Pin Number	Signal name																																																											
1	DA	15	CH2																																																											
2	DB	16		ϕ A																																																										
3	DG	17		ϕ B																																																										
4	SLD	18		PRESET																																																										
5	24V	19		COM																																																										
6	F.G.	20	F.START																																																											
7	24G	21	CH1																																																											
8	CH1	22		EQU1																																																										
9		ϕ A	23	EQU2																																																										
10	ϕ B	24	CH2																																																											
11	PRESET	25	EQU1																																																											
12	COM	26	12/24V																																																											
13	F.START	27	COM																																																											
14																																																														

Number	Name	Description																																																																																																																																																																								
8)	Terminal block	<p>For the AJ65BT-D62D</p> <table border="1" data-bbox="671 360 1410 909"> <thead> <tr> <th>Pin Number</th> <th colspan="2">Signal name</th> <th>Pin Number</th> <th colspan="2">Signal name</th> </tr> </thead> <tbody> <tr> <td>1</td> <td colspan="2">DA</td> <td>15</td> <td rowspan="3">CH2</td> <td>ϕA</td> </tr> <tr> <td>2</td> <td colspan="2">DB</td> <td>16</td> <td>\overline{A}</td> </tr> <tr> <td>3</td> <td colspan="2">DG</td> <td>17</td> <td>ϕB</td> </tr> <tr> <td>4</td> <td colspan="2">SLD</td> <td>18</td> <td rowspan="3">CH2</td> <td>\overline{B}</td> </tr> <tr> <td>5</td> <td colspan="2">24V</td> <td>19</td> <td>PRESET</td> </tr> <tr> <td>6</td> <td colspan="2">F.G.</td> <td>20</td> <td>COM</td> </tr> <tr> <td>7</td> <td colspan="2">24G</td> <td>21</td> <td colspan="2">F.START</td> </tr> <tr> <td>8</td> <td rowspan="7">CH1</td> <td>ϕA</td> <td>A</td> <td>22</td> <td rowspan="2">CH1</td> <td>EQU1</td> </tr> <tr> <td>9</td> <td>\overline{A}</td> <td>23</td> <td rowspan="2">CH2</td> <td>EQU2</td> </tr> <tr> <td>10</td> <td rowspan="2">ϕB</td> <td>B</td> <td>24</td> <td>EQU1</td> </tr> <tr> <td>11</td> <td>\overline{B}</td> <td>25</td> <td>EQU2</td> </tr> <tr> <td>12</td> <td colspan="2">PRESET</td> <td>26</td> <td colspan="2">12/24V</td> </tr> <tr> <td>13</td> <td colspan="2">COM</td> <td>27</td> <td colspan="2">COM</td> </tr> <tr> <td>14</td> <td colspan="2">F.START</td> <td></td> <td colspan="2"></td> </tr> </tbody> </table> <p>For the AJ65BT-D62D-S1</p> <table border="1" data-bbox="671 1010 1410 1585"> <thead> <tr> <th>Pin Number</th> <th colspan="2">Signal name</th> <th>Pin Number</th> <th colspan="2">Signal name</th> </tr> </thead> <tbody> <tr> <td>1</td> <td colspan="2">DA</td> <td>16</td> <td rowspan="3">CH2</td> <td>ϕA</td> </tr> <tr> <td>2</td> <td colspan="2">DB</td> <td>17</td> <td>\overline{A}</td> </tr> <tr> <td>3</td> <td colspan="2">DG</td> <td>18</td> <td>ϕB</td> </tr> <tr> <td>4</td> <td colspan="2">SLD</td> <td>19</td> <td rowspan="3">CH2</td> <td>\overline{B}</td> </tr> <tr> <td>5</td> <td colspan="2">24V</td> <td>20</td> <td>PRESET</td> </tr> <tr> <td>6</td> <td colspan="2">F.G.</td> <td>21</td> <td>$\overline{\text{PRESET}}$</td> </tr> <tr> <td>7</td> <td colspan="2">24G</td> <td>22</td> <td colspan="2">F.START</td> </tr> <tr> <td>8</td> <td rowspan="7">CH1</td> <td>ϕA</td> <td>A</td> <td>23</td> <td rowspan="2">CH1</td> <td>EQU1</td> </tr> <tr> <td>9</td> <td>\overline{A}</td> <td>24</td> <td rowspan="2">CH2</td> <td>EQU1</td> </tr> <tr> <td>10</td> <td rowspan="2">ϕB</td> <td>B</td> <td>25</td> <td colspan="2">12/24V</td> </tr> <tr> <td>11</td> <td>\overline{B}</td> <td>26</td> <td colspan="2">COM</td> </tr> <tr> <td>12</td> <td colspan="2">PRESET</td> <td>27</td> <td colspan="2"></td> </tr> <tr> <td>13</td> <td colspan="2">$\overline{\text{PRESET}}$</td> <td></td> <td colspan="2"></td> </tr> <tr> <td>14</td> <td colspan="2">F.START</td> <td></td> <td colspan="2"></td> </tr> </tbody> </table>	Pin Number	Signal name		Pin Number	Signal name		1	DA		15	CH2	ϕA	2	DB		16	\overline{A}	3	DG		17	ϕB	4	SLD		18	CH2	\overline{B}	5	24V		19	PRESET	6	F.G.		20	COM	7	24G		21	F.START		8	CH1	ϕA	A	22	CH1	EQU1	9	\overline{A}	23	CH2	EQU2	10	ϕB	B	24	EQU1	11	\overline{B}	25	EQU2	12	PRESET		26	12/24V		13	COM		27	COM		14	F.START					Pin Number	Signal name		Pin Number	Signal name		1	DA		16	CH2	ϕA	2	DB		17	\overline{A}	3	DG		18	ϕB	4	SLD		19	CH2	\overline{B}	5	24V		20	PRESET	6	F.G.		21	$\overline{\text{PRESET}}$	7	24G		22	F.START		8	CH1	ϕA	A	23	CH1	EQU1	9	\overline{A}	24	CH2	EQU1	10	ϕB	B	25	12/24V		11	\overline{B}	26	COM		12	PRESET		27			13	$\overline{\text{PRESET}}$					14	F.START				
		Pin Number	Signal name		Pin Number	Signal name																																																																																																																																																																				
1	DA		15	CH2	ϕA																																																																																																																																																																					
2	DB		16		\overline{A}																																																																																																																																																																					
3	DG		17		ϕB																																																																																																																																																																					
4	SLD		18	CH2	\overline{B}																																																																																																																																																																					
5	24V		19		PRESET																																																																																																																																																																					
6	F.G.		20		COM																																																																																																																																																																					
7	24G		21	F.START																																																																																																																																																																						
8	CH1	ϕA	A	22	CH1	EQU1																																																																																																																																																																				
9		\overline{A}	23	CH2		EQU2																																																																																																																																																																				
10		ϕB	B		24	EQU1																																																																																																																																																																				
11			\overline{B}	25	EQU2																																																																																																																																																																					
12		PRESET		26	12/24V																																																																																																																																																																					
13		COM		27	COM																																																																																																																																																																					
14		F.START																																																																																																																																																																								
Pin Number	Signal name		Pin Number	Signal name																																																																																																																																																																						
1	DA		16	CH2	ϕA																																																																																																																																																																					
2	DB		17		\overline{A}																																																																																																																																																																					
3	DG		18		ϕB																																																																																																																																																																					
4	SLD		19	CH2	\overline{B}																																																																																																																																																																					
5	24V		20		PRESET																																																																																																																																																																					
6	F.G.		21		$\overline{\text{PRESET}}$																																																																																																																																																																					
7	24G		22	F.START																																																																																																																																																																						
8	CH1	ϕA	A	23	CH1	EQU1																																																																																																																																																																				
9		\overline{A}	24	CH2		EQU1																																																																																																																																																																				
10		ϕB	B		25	12/24V																																																																																																																																																																				
11			\overline{B}	26	COM																																																																																																																																																																					
12		PRESET		27																																																																																																																																																																						
13		$\overline{\text{PRESET}}$																																																																																																																																																																								
14		F.START																																																																																																																																																																								

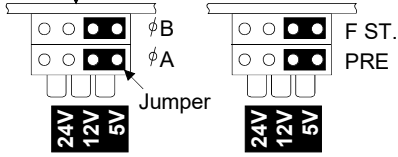
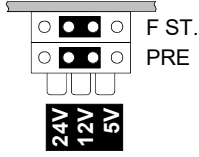
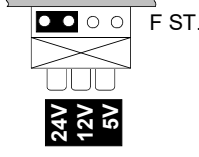
Number	Name	Description
9)	Pulse/external input voltage setting pins	<p>The also applies to CH2.</p> <p>AJ65BT-D62 Circuit board CH.1</p>  <p>(Jumper connected to 5V)</p> <p>AJ65BT-D62D CH.1</p>  <p>(Jumper connected to 12V)</p> <p>AJ65BT-D62D-S1 CH.1</p>  <p>(Jumper connected to 24V)</p> <p>(Factory setting: 24V)</p>

4.4 Station Number Setting

The buffer memory addresses of the master module, where the remote I/O signals and read/write data are stored, are determined by the station number setting of the high-speed counter module.

For details, refer to the user's manual (details) of the used master module.

4.5 Orientation of Module Installation

The following shows the possible orientation for high-speed counter module installation.

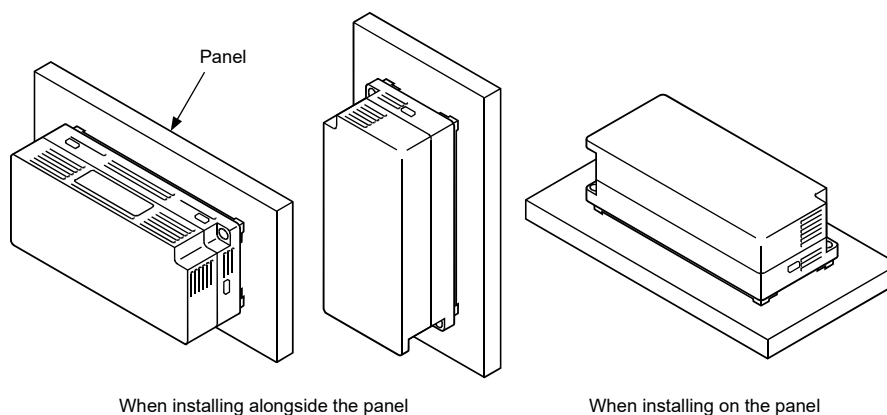

4.6 Wiring

4.6.1 Connection of cables with the modules

The following diagram shows the wiring of the master module, remote module and high-speed counter module with dedicated cable for CC-Link.

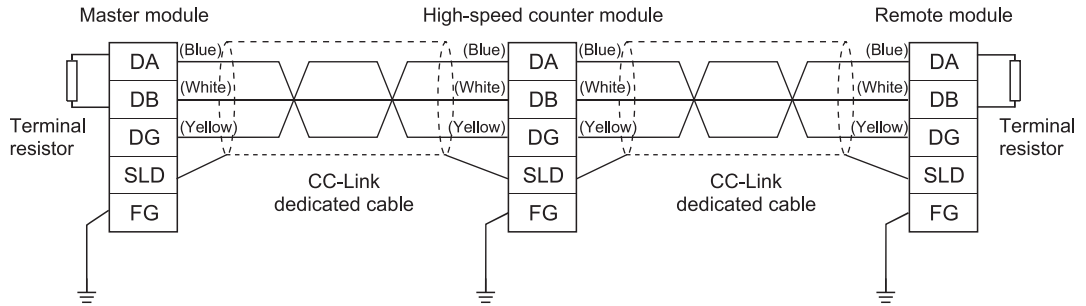

POINT

The "terminal resistors" supplied with the master module must be connected to the modules at both ends of data link. (Connect them across DA-DB.)

4.6.2 Instructions for wiring pulse generator

When connecting a pulse generator to the high-speed counter module, take the following precautions.

- (1) When using high speed pulse inputs, take the following precautions against noise
 - (a) Always use shielded twisted cables. Also provide Class 3 grounding.
 - (b) Do not run a twisted pair cable in parallel with any power line, I/O line, etc. which may generate noise. It is necessary to run the twisted pair cable at least 150mm away from the above lines and over the shortest possible distance
- (2) For a 1-phase input, always connect the count input pulse to phase A.
- (3) If the high-speed counter module picks up noise, it will count incorrectly.
- (4) The diagram below indicates the type of precautions required to prevent the wiring from picking up noise.

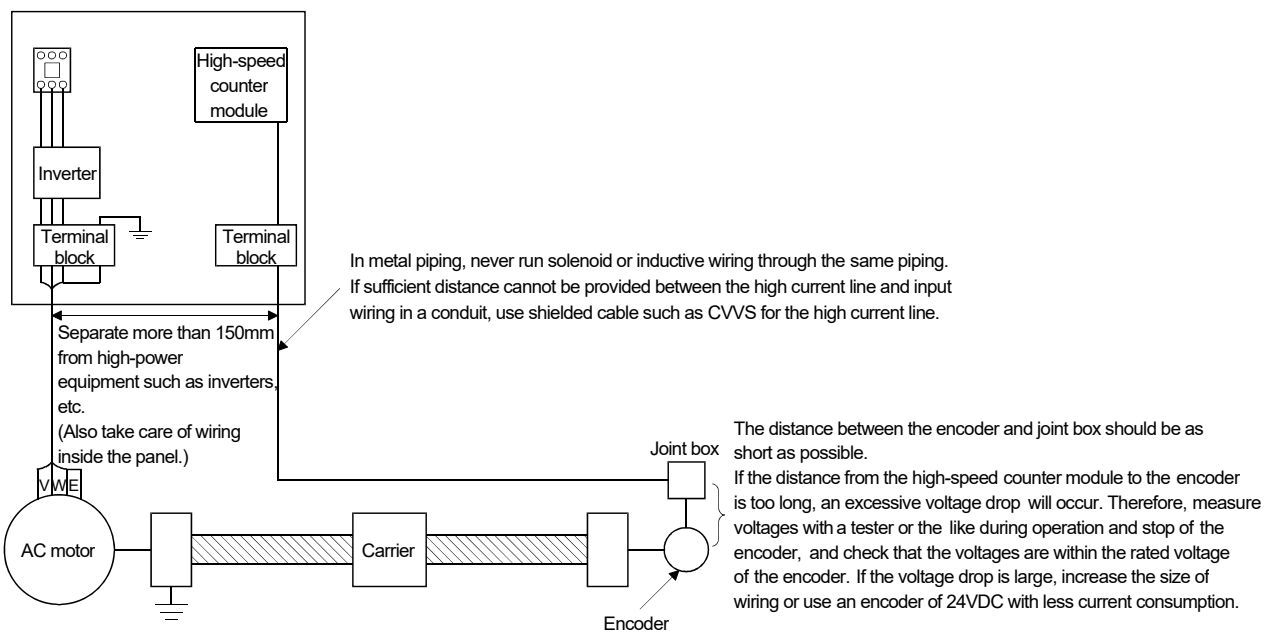

· Ground the twisted shield cable on the encoder side (joint box). (This is a connection example for 24V sink load.)

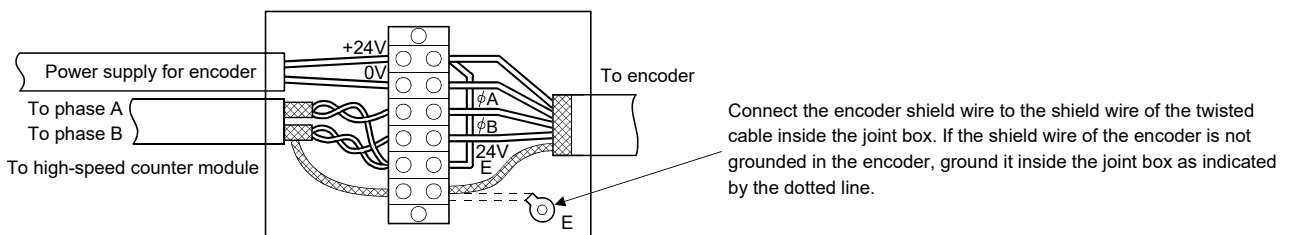

4.6.3 Wiring examples of pulse generators

(1) Pulse generator is open collector output type (24VDC)

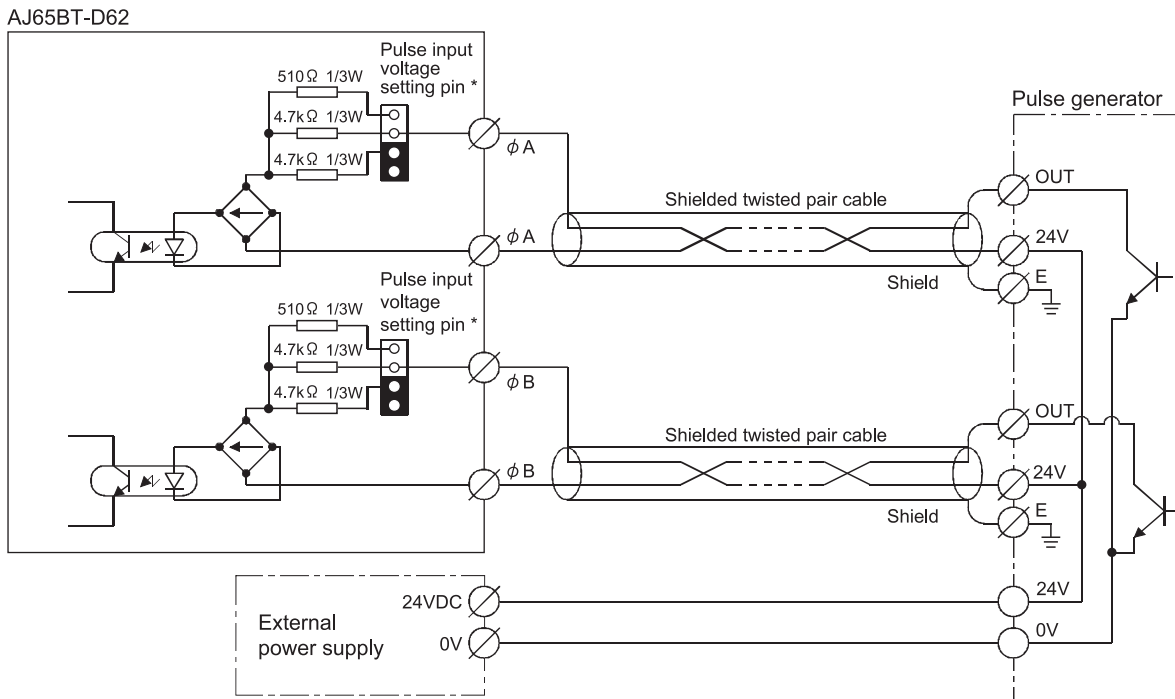

POINT
<p>When wiring the AJ65BT-D62 and encoder, separate the power supply and signal lines as shown below.</p> <p>Incorrect Wiring Example</p> <p>Since the same twisted wire is used for both the encoder signal and power supply, the canceling effect will reduce and electro-magnetic induction may occur.</p>

REMARK

*Set the pulse input voltage setting pins in the position.

(2) Pulse generator is voltage output type (5VDC)

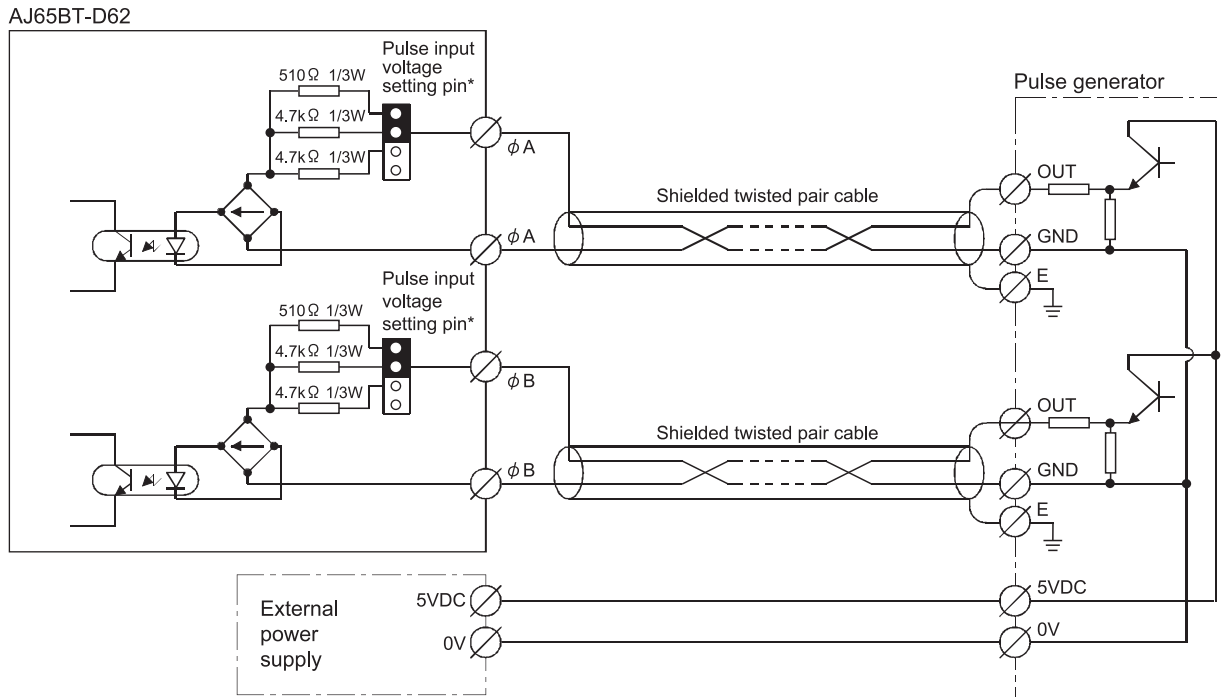

REMARK

*.....Set the pulse input voltage setting pins in the  position.

(3) Pulse generator is line driver (equivalent to AM26LS31)

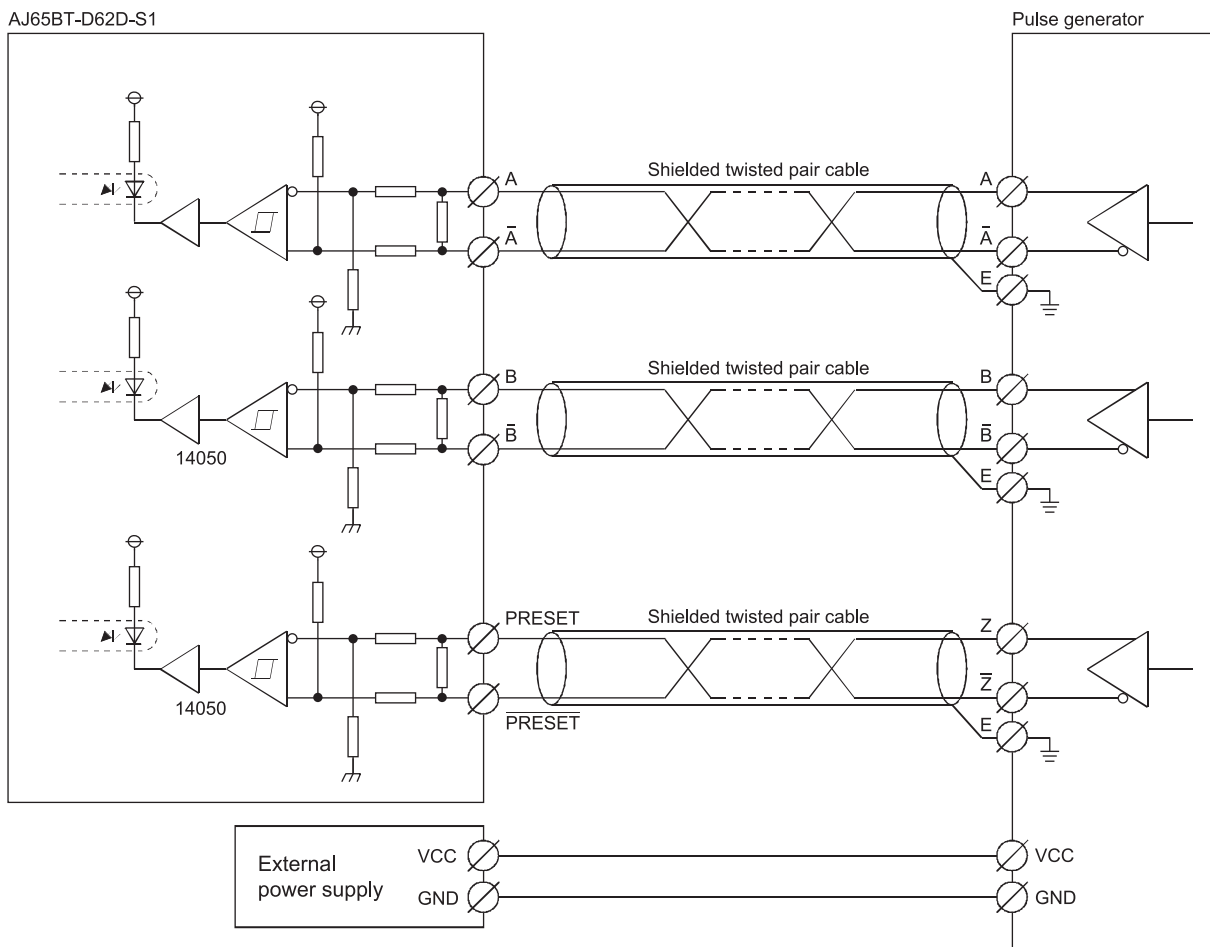
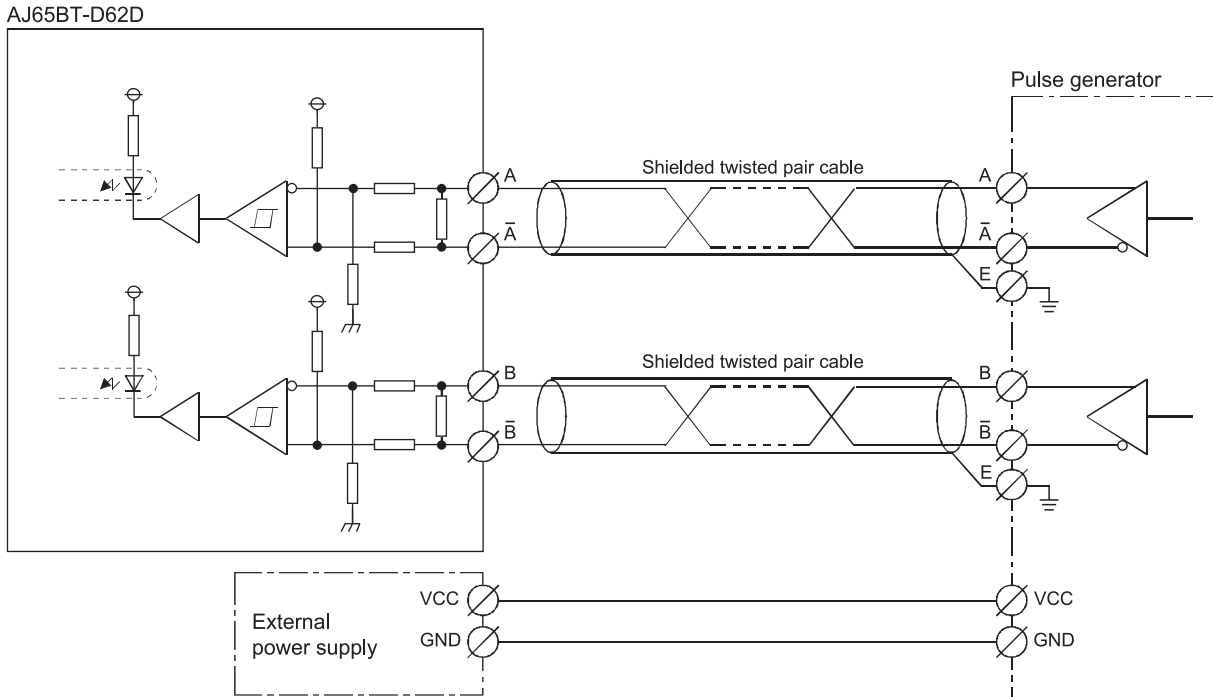

4.6.4 Wiring examples of controller and external input (PRESET, F.START) terminals

(1) Controller (sink load type) is 12V

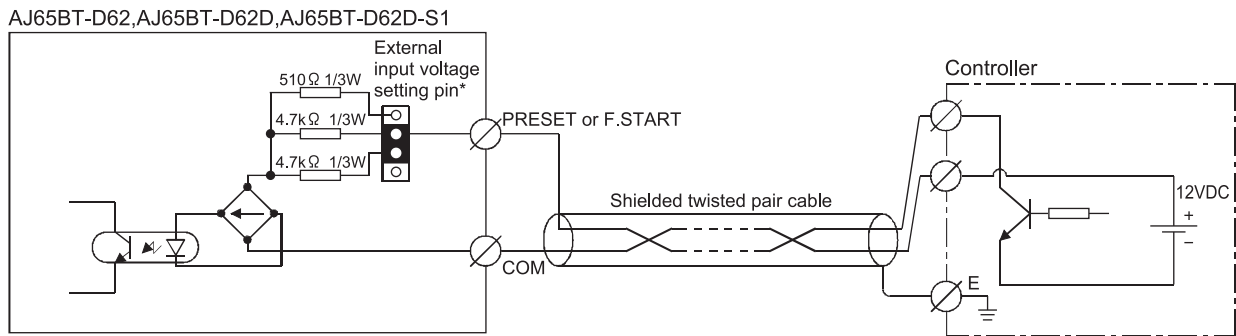

- Internal circuit is set to PRESET.
- AJ65BT-D62D-S1 has F.START only.

(2) Controller (source load type) is 5V

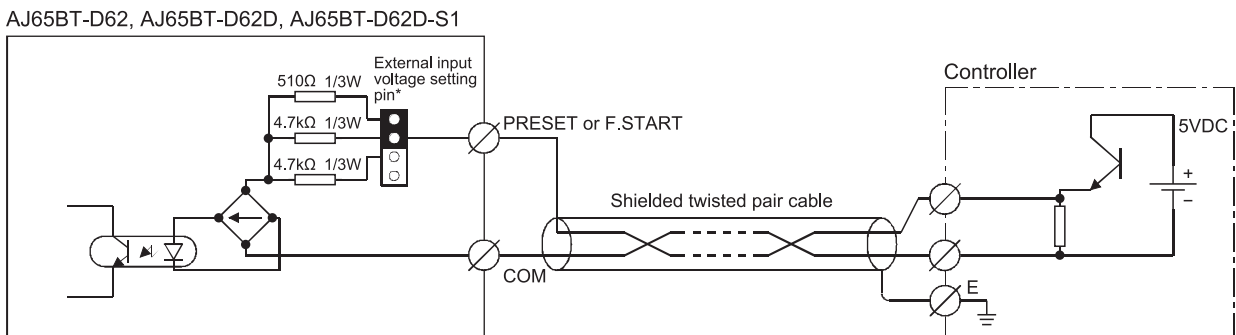

- Internal circuit is set to PRESET.
- AJ65BT-D62D-S1 has F.START only.

REMARK

*Set the external input voltage setting pins in the  position.

CAUTION

- Set the pulse/external input voltage setting pins correctly after confirming the rated voltage of the external power supply. Miss-wiring (wrong setting) can cause a fire or failure.
- The pulse/external input voltage setting pins must be set after switching power off externally in all phases. Otherwise, the module can fail or misoperate.
- Set the jumper to the pulse/external input voltage setting pins in the correct inserting orientation. Otherwise, a failure can occur.

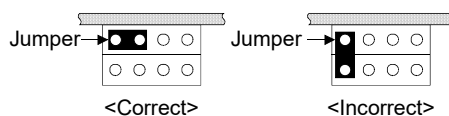

4.6.5 Wiring examples of external output (EQU1, EQU2) terminals

When using the EQU terminals, a 10.2VDC to 30VDC external power supply is required to activate the internal photocoupler. Connection methods are as follows.

(1) AJ65BT-D62, AJ65BT-D62D

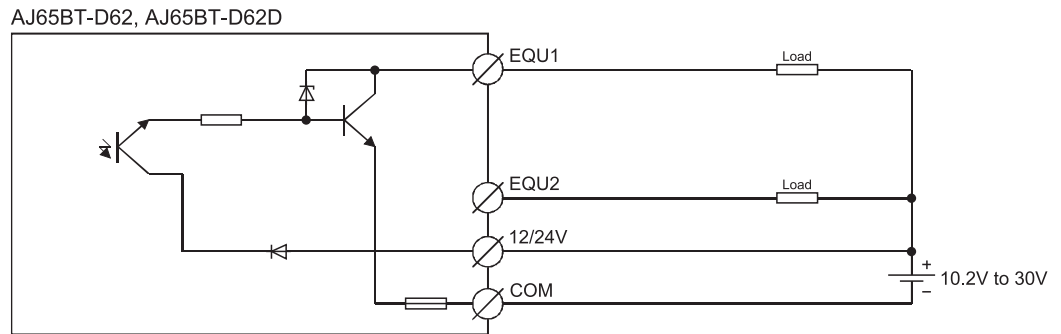

(2) AJ65BT-D62D-S1

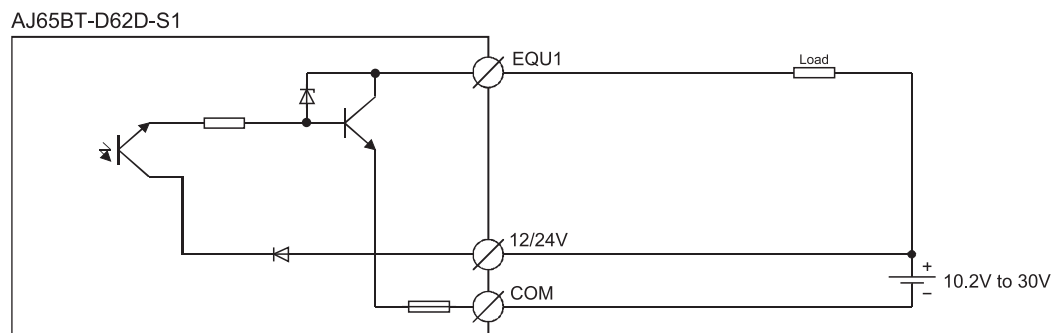

POINT
<p>Even when not using an EQU terminal, wire the 12/24V terminal (pin number: 26) and the COM terminal (pin number: 27) to an external power supply.</p> <p>If they are not wired, SW0088 to SW008B (fuse blown status) of the master module would be on.</p>

5. PULSE INPUT AND COUNTING METHOD

This chapter describes the pulse input and counting modes of the high-speed counter module.

(1) The pulse input mode is classified into 1-phase pulse input and 2-phase pulse input. 1-phase pulse input is subdivided into multiplication by one and multiplication by two, whereas 2-phase pulse input covers multiplication by one, two and four.

The following table indicates the pulse input modes and count timing.

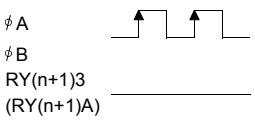
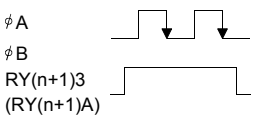
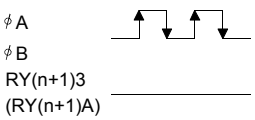
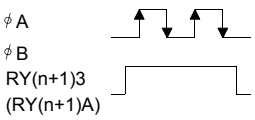
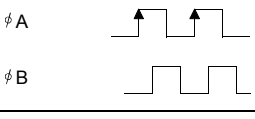
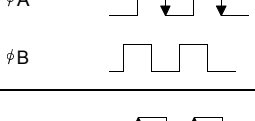
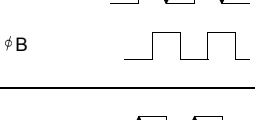
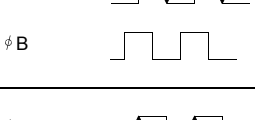
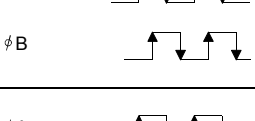
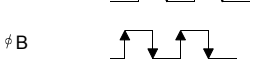
Pulse Input Mode	Count Timing		
1-phase, multiplied by one	Up counting	ϕA 	Counts a pulse on leading edge of phase ϕA . Phase ϕB and RY(n+1)3 (RY(n+1)A) are off.
	Down counting	ϕA 	Counts a pulse on trailing edge of phase ϕA . Phase ϕB or RY(n+1)3 (RY(n+1)A) is on.
1-phase, multiplied by two	Up counting	ϕA 	Counts a pulse on leading and trailing edges of phase ϕA . Phase ϕB and RY(n+1)3 (RY(n+1)A) are off.
	Down counting	ϕA 	Counts a pulse on leading and trailing edges of phase ϕA . Phase ϕB or RY(n+1)3 (RY(n+1)A) is on.
2-phase, multiplied by one	Up counting	ϕA 	Counts a pulse on leading edge of phase ϕA . Count increases in response to phase difference between phases ϕA and ϕB .
	Down counting	ϕA 	Counts a pulse on trailing edge of phase ϕA . Count decreases in response to phase difference between phases ϕA and ϕB .
2-phase, multiplied by two	Up counting	ϕA 	Counts a pulse on leading and trailing edges of phase ϕA . Count increases in response to phase difference between phases ϕA and ϕB .
	Down counting	ϕA 	Counts a pulse on leading and trailing edges of phase ϕA . Count decreases in response to phase difference between phases ϕA and ϕB .
2-phase, multiplied by four	Up counting	ϕA 	Counts a pulse on leading and trailing edges of phases ϕA and ϕB . Count increases in response to phase difference between phases ϕA and ϕB .
	Down counting	ϕA 	Counts a pulse on leading and trailing edges of phases ϕA and ϕB . Count decreases in response to phase difference between phases ϕA and ϕB .

(2) Even if the pulse input mode is changed, counting will start from the value at the time the mode is changed.

5.1 1-phase pulse input

In 1-phase pulse input, multiplication by one or two can be selected for counting.

(1) Relationship between phase A pulse input and down count command

The following diagram shows the relationship between phase A pulse input and down count command.

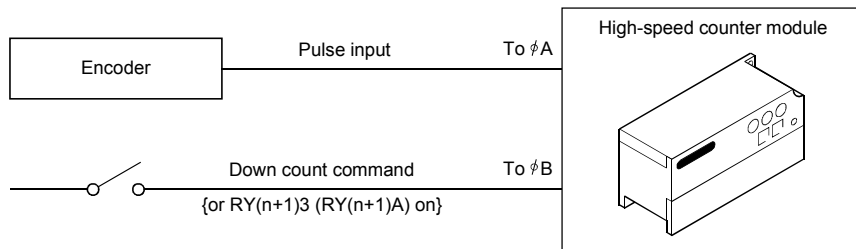

(2) Counting mode setting

To use this counting mode, set the following value to the lower 8 bits of the remote register {address RWwm+2 (RWwm+A)} using the sequence program.

When the value set is not the following set value, the initial value (1-phase multiplication by one) is set.

Counting Mode	Set Value
1-phase multiplication by one	00H
1-phase multiplication by two	01H

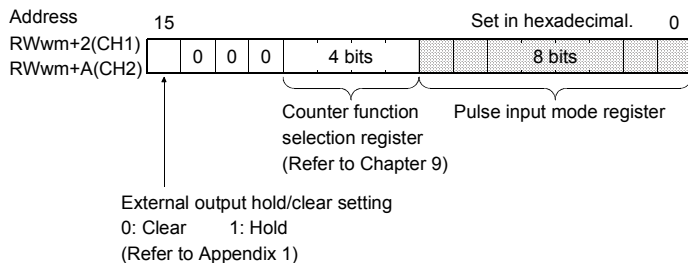

[Sequence program example]

- Counting in 1-phase, multiplied-by-two mode

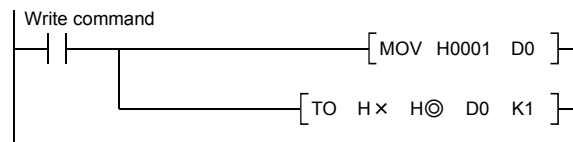

× : First I/O number of master module
 ⊙ : Corresponding station register address of master module buffer memory

POINT	Exercise care when setting the pulse input mode, since the upper 8 bits are used for the counter function selection register and external output hold/clear setting.
--------------	--

5.2 2-phase pulse input

In 2-phase pulse input, the counting mode can be selected from multiplication by one, two and four.

(1) Relationship between phase A pulse input and phase B pulse input

The following diagram shows the relationship between phase A pulse input and phase B pulse input.

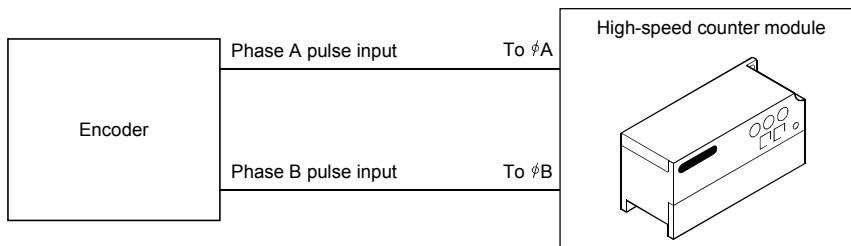

(2) Counting mode setting

To use this counting mode, set the following value to the lower 8 bits of the remote register {address RWwm+2 (RWwm+A)} using the sequence program. When the value set is not the following set value, the initial value (1-phase multiplication by one) is set.

Counting Mode	Setting
2-phase multiplication by one	02H
2-phase multiplication by two	03H
2-phase multiplication by four	04H

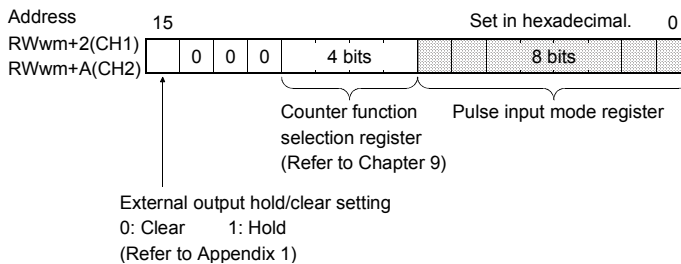

[Sequence program example]

- Counting in 1-phase, multiplied-by-two mode

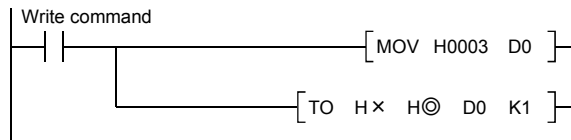

x: First I/O number of master module
 ⊙: Corresponding station register address of master module buffer memory

POINT

Exercise care when setting the pulse input mode, since the upper 8 bits are used for the counter function selection register and external output hold/clear setting.

5.3 Reading the Present Value

This section gives details on the present value stored in the present value storage area {addresses RWrn+0 to 1 (addresses RWrn+8 to 9)} and how to read it.

- (1) The present value storage area stores the present value at a time when any counter function is executed.

When each function of latch counter, sampling counter or periodic pulse counter is executed, the count value will be stored, aside from the present value storage buffer memory, in the remote registers indicated below.

Description		Latch Count Value/ Sampling Count Value/Periodic Pulse Count Previous Value	Periodic Pulse Count Present Value
Remote register addresses	CH1	RWrn+2 to 3	RWrn+4 to 5
	CH2	RWrn+A to B	RWrn+C to D

- (2) The present value (0 to 16777215) is stored in 24-bit binary in the present value storage area.
- (3) In up counting, the present value storage area returns to 0 when the count value exceeds 16777215.
In down counting, the present value storage area returns to 16777215 when the count value exceeds 0.

6. EXECUTING THE COINCIDENCE OUTPUT FUNCTION

This chapter describes the coincidence output function.

6.1 Coincidence Output Function

The coincidence output function issues a signal when a preset count value is compared with and matches the present counter value.

You can set two coincidence output points.

To use the coincidence output function, set the coincidence signal enable command {RY(n+1)2 (RYn+1)9} to ON.

[Remote registers used]

Address	Description
RWwm+3	---- CH1 coincidence output point No. 1 setting area - (L)- (H)
RWwm+4	
RWwm+6	---- CH1 coincidence output point No. 2 setting area - (L)- (H)
RWwm+7	
RWwm+B	---- CH2 coincidence output point No. 1 setting area - (L)- (H)
RWwm+C	
RWwm+E	---- CH2 coincidence output point No. 2 setting area - (L)- (H)
RWwm+F	

*In the AJ65BT-D62D-S1, its external output (coincidence output) does not switch on-off if the coincidence output No. 2 is set. However, the counter value comparison (coincidence, greater, less) output signals (X signals) switch on-off as ordinarily.

[Example of using the coincidence output function]

In a machining line system, machining operations are performed in response to the corresponding coincidence outputs to turn out products.

- 1) Materials are carried on a belt conveyor.
- 2) Material positions are identified as the present count values determined by the pulses sent to the high-speed module.
- 3) As soon as the materials reach the specified positions, the relevant machining operations are performed in response to the coincidence outputs (EQU1, EQU2) from the high-speed counter module.

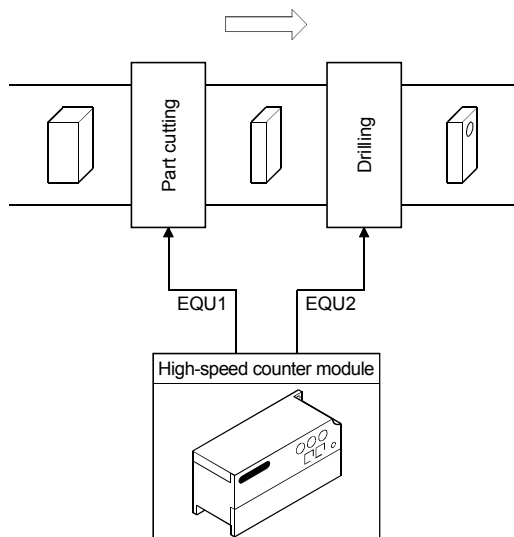

6.1.1 Coincidence output function operation

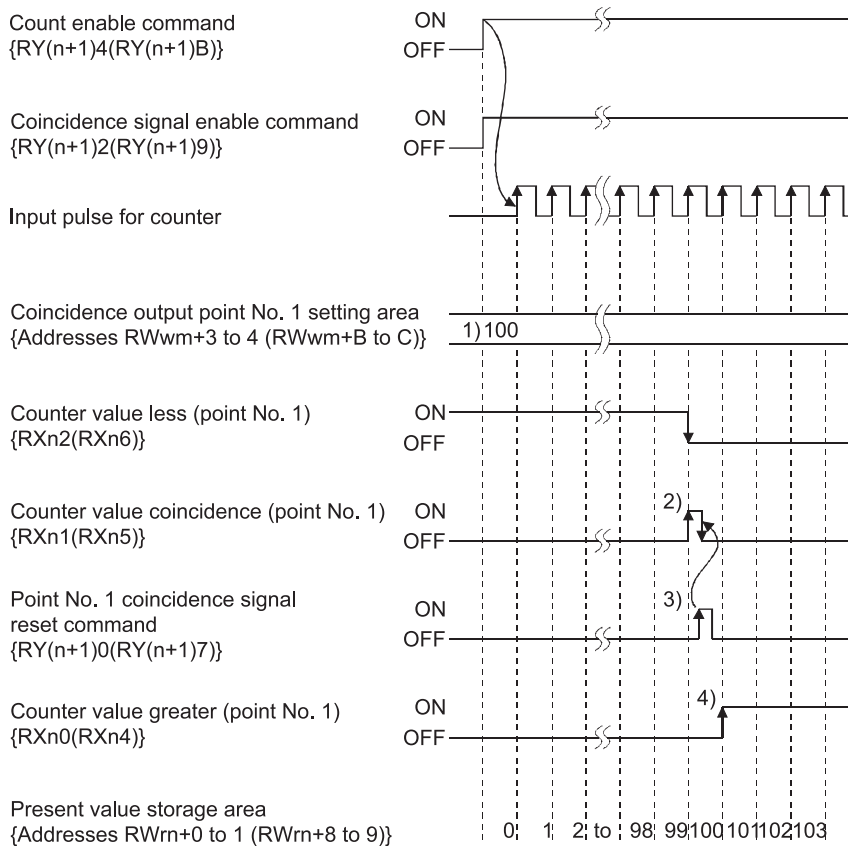

- 1)Write a value in advance in 24-bit binary to the coincidence output point No. 1 setting area {addresses RWwm+3 to 4 (RWwm+B to C)}.
- 2)When the counter value reaches the set coincidence output point value, the counter value less signal switches off and the counter value coincidence signal switches on.
- 3)The coincidence signal reset command is switched on to reset the counter value coincidence signal.
If the counter value coincidence signal remains on, the next coincident signal cannot be issued.
- 4)When the counter value becomes greater than the set coincidence signal output point value, the counter value greater signal switches on.

POINT	<ul style="list-style-type: none"> • For the coincidence output function, preset a coincidence output point and reset coincidence output before turning on the coincidence signal enable command. <p>If the coincidence signal enable command is turned on without the operation above, coincidence output occurs since the coincidence output point and the count value are the same in the initial state.</p> <ul style="list-style-type: none"> • If the following time is not satisfied for the execution of the point No.2 coincidence output reset command, the point No. 2 coincidence output reset command will not switch on-off. <div style="text-align: center; margin: 10px 0;"> <p style="font-size: small;">*1..... 10 link scans+2 sequence scans</p> </div> <p>As the point No. 2 coincidence output reset command is only valid on the leading edge (OFF→ON) of the signal, always make sure that the point No. 2 signal is off before executing the command.</p>
--------------	--

7. EXECUTING THE PRESET FUNCTION

This chapter explains the preset function.

7.1 Preset Function

The preset function is used to rewrite the counter's present value into any value. This new value is called the preset value.

The preset function can be used when a pulse count is started from the set value.

The preset function is available in two modes: "preset by the sequence program (preset command {RY(n+1)1 (RY(n+1)8})" and "preset from the external control signal (by applying a voltage to the external terminal)".

[Remote registers used]

Address	Description
RWwm+0	CH1 Preset value setting area - (L) - (H)
RWwm+1	
RWwm+8	CH2 Preset value setting area - (L) - (H)
RWwm+9	

[Example of using the preset function]

By using the preset function, the production count can be continued from the previous day.

- 1) Production amount of the previous day is preset from the programmable controller CPU to the high-speed counter module.
- 2) Products are carried on a conveyor.
- 3) Production amount is counted using the pulse input from the photoelectric switch.
- 4) At the end of daily production, the counter value in the present value storage area is stored to the word device (D, W, etc.) in the programmable controller CPU latch range.

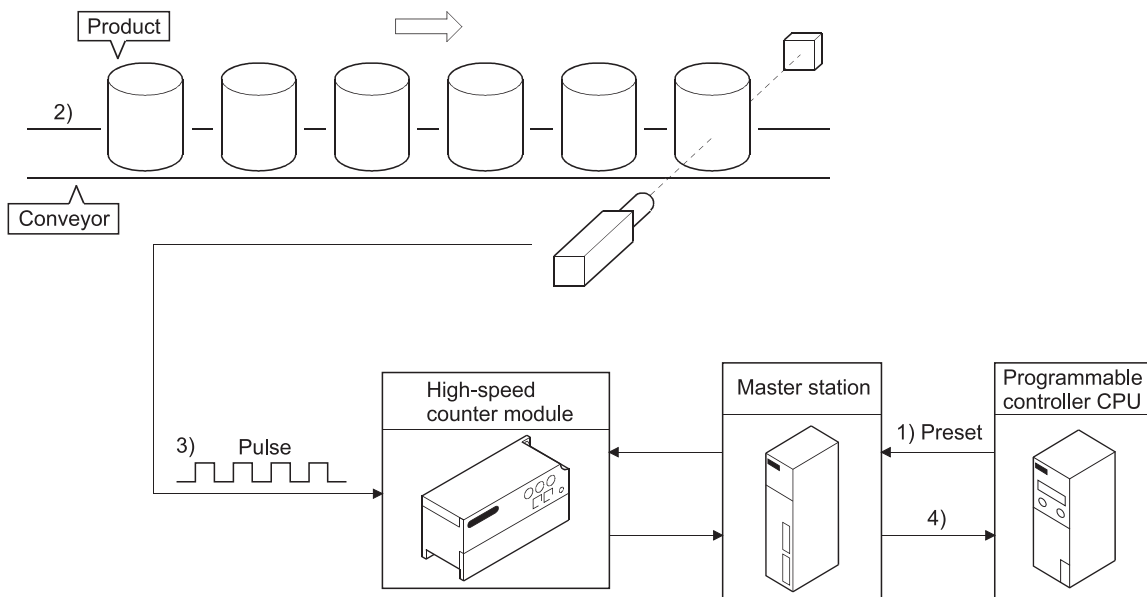

7.2 Preset Using the Sequence Program

Turn on the preset command $\{RY(n+1)1 (RY(n+1)8)\}$ in the sequence program to execute the preset function.

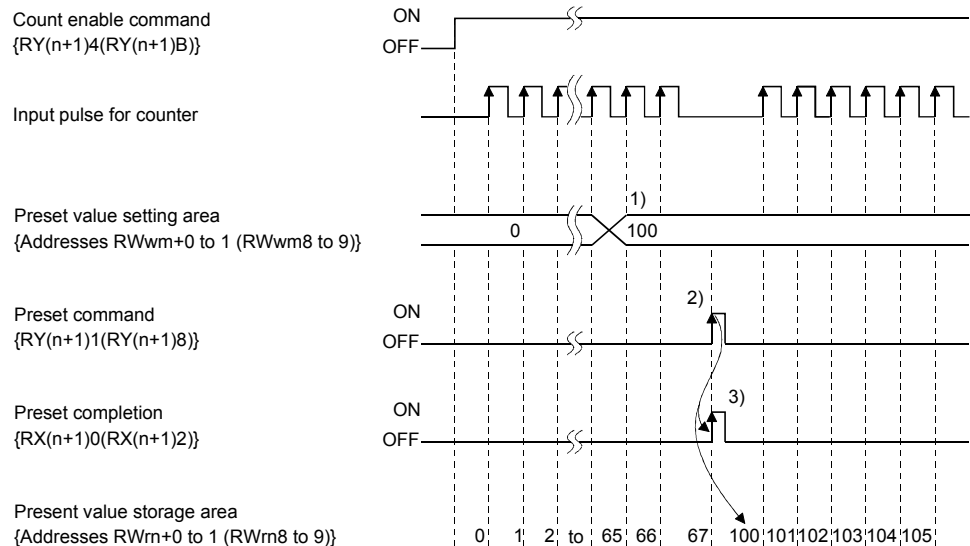

- 1)Write any value in advance in 24-bit binary to the preset value setting area $\{addresses RWwm+0 to 1 (RWwm+8 to 9)\}$.
- 2)On the leading edge (OFF \rightarrow ON) of the preset command $\{RY(n+1)1 (RY(n+1)8)\}$, the value in the preset value setting area is preset to the present value storage area. Preset can be executed independently of whether the count enable command $\{RY(n+1)1 (RY(n+1)8)\}$ is on or off.
- 3)When the preset function is executed by the preset command $\{RY(n+1)1 (RY(n+1)8)\}$ switched on, the preset completion signal $\{RY(n+1)1 (RY(n+1)8)\}$ switches on. When the preset command switches off, the preset completion signal also switches off.

7.3 Preset by External Control Signal

A voltage is applied to the external input PRESET terminal to execute preset.

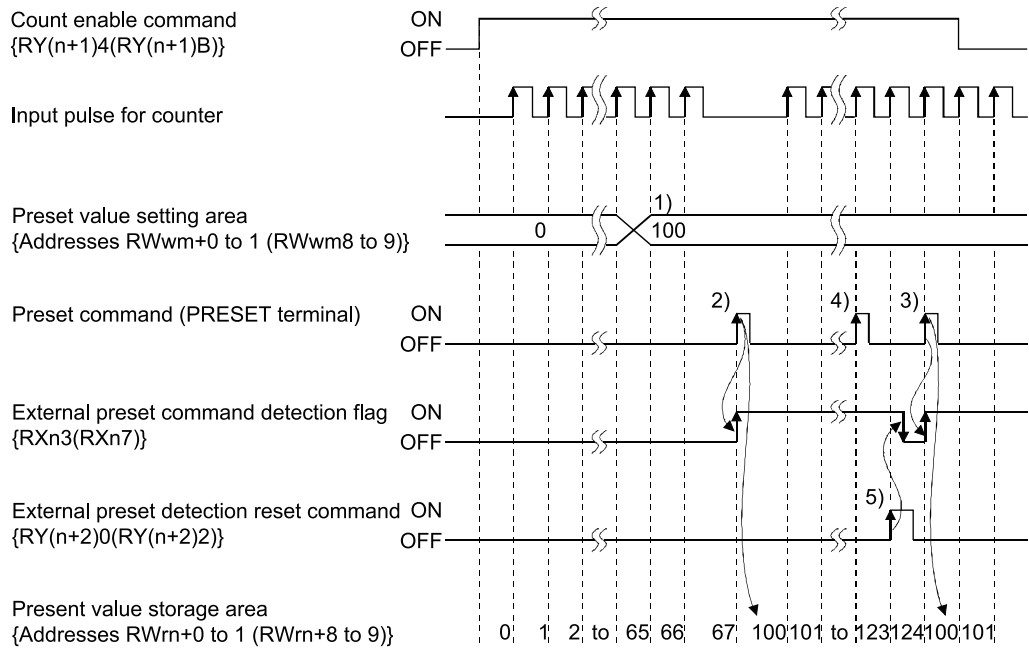

- 1) Write any value in advance in 24-bit binary to the preset value setting area {addresses RWwm+0 to 1 (RWwm8 to 9)}.
- 2) When the preset command switches on (voltage is applied to the PRESET terminal), the value in the preset value setting area is preset to the present value storage area.
- 3) Preset can be executed independently of whether the count enable command {RY(n+1)4 (RY(n+1)B)} is on or off.

POINT
<ul style="list-style-type: none"> • For the preset function through external input, reset external preset detection (5) in the figure above) every time after the execution of the preset function is completed. Doing so allows the next external input. • While the external preset command detection {RXn3 (RXn7)} is on (4) in the figure above), the next execution of the preset function through external input or a sequence program is not allowed. • If the following time is not satisfied for the execution of the external preset detection reset command , the external preset detection reset command will not switch on-off. <div style="text-align: center;"> <p>External preset detection reset command {RY(n+2)0(RY(n+2)2)}</p> <p>*1..... 10 link scans+2 sequence scans</p> </div>

8. EXECUTING THE RING COUNTER FUNCTION

This chapter describes the ring counter function.

8.1 Ring Counter Function

The ring counter function repeats counting between the preset value set by the ring counter command and the ring counter value.

The ring counter function can be used for control such as fixed-pitch feed.

When using the ring counter, preset the ring counter setting switch of the high-speed counter module to ON. Also, set the preset value and ring counter value to the remote registers.

[Remote registers used]

Address	Description
RWwm+0	CH1 Preset value setting area (L)
RWwm+1	(H)
RWwm+3	CH1 Coincidence output point No. 1 setting area (L)
RWwm+4	(H)
RWwm+8	CH2 Preset value setting area (L)
RWwm+9	(H)
RWwm+B	CH2 Coincidence output point No. 2 setting area (L)
RWwm+C	(H)

[Example of using the ring counter function]

In a system where a sheet is cut to the specified size, set the ring counter value to roller-feed a sheet in fixed pitch and cut it to the given length.

- 1) Set the preset and ring counter values to execute the ring counter function.
- 2) The motor is run to rotate the rollers.
- 3) The motor is stopped as soon as the given length of the sheet is fed by the rollers.
- 4) The sheet is cut.
- 5) The operations in steps 2) to 4) are repeated.

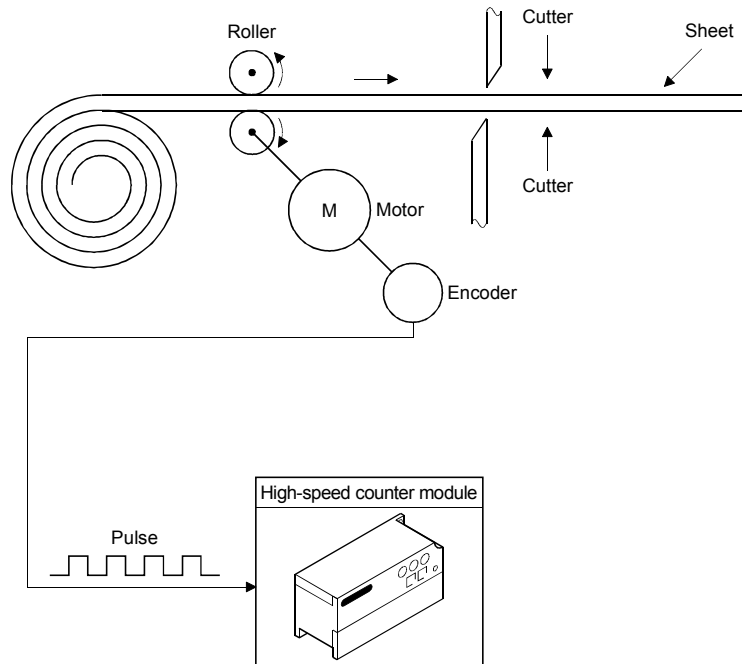

8.1.1 Ring counter function operation

When using the ring counter function, preset the ring counter setting switch of the high-speed counter module to ON.

Also set the preset value and ring count value to the remote registers.

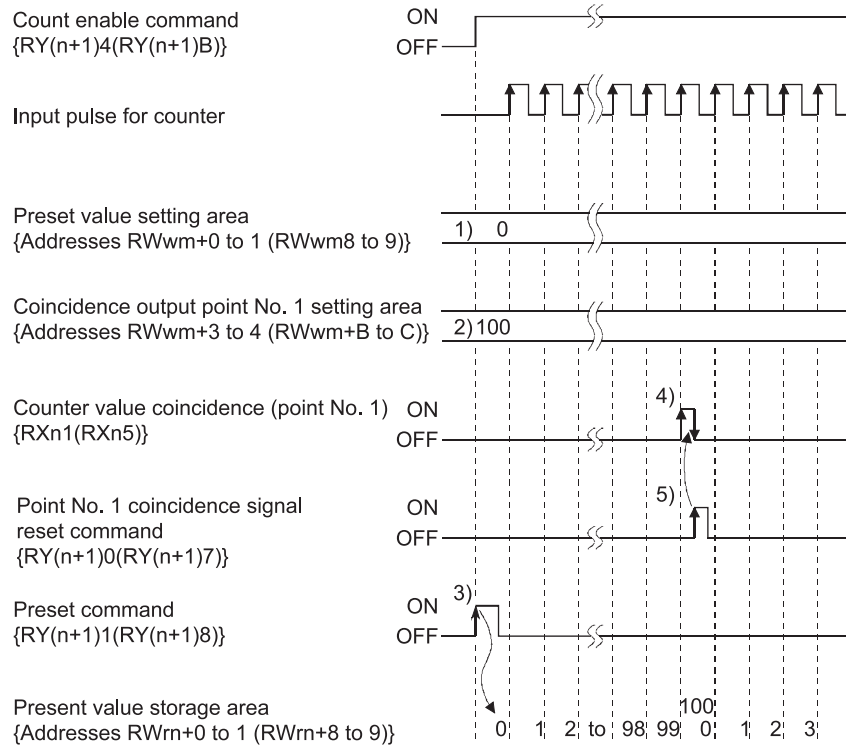

- 1) Write a preset value in advance in 24-bit binary to the preset value setting area {addresses $RWwm+0$ to $1 (RWwm8$ to $9)$ }.
- 2) Write a ring counter value in advance in 24-bit binary to the coincidence output point No. 1 setting area {addresses $RWwm+3$ to $4 (RWwm+B$ to $C)$ }.
- 3) On the leading edge (OFF→ON) of the preset command $\{RY(n+1)1 (RY(n+1)8)\}$, the value in the preset value setting area is preset to the present value storage area. Preset can be executed independently of whether the count enable command $\{RY(n+1)4 (RY(n+1)B)\}$ is on or off.
- 4) When the counter value reaches the ring counter value, the counter value coincidence signal switches on to execute presetting. When the present value is read at the execution of presetting, the ring counter value or preset value is read.
- 5) Reset the counter value coincidence signal by turning on the point No. 1 coincidence signal reset command.
If the counter value coincidence signal is on, a value cannot be preset for the next operation.

8.1.2 Count range

As shown below, the count range of the ring counter function differs depending on the relationship between the preset value, ring counter value, present value and counting mode (up/down count).

(1) If $\text{preset value} \leq \text{present value} \leq \text{ring counter value}$

The following operation is performed if the ring counter function is executed at the preset value of 0, ring counter value of 2000, and present value of 500.

1) In up count, the present value returns to the preset value (0) as soon as it is counted up to the ring counter value (2000)

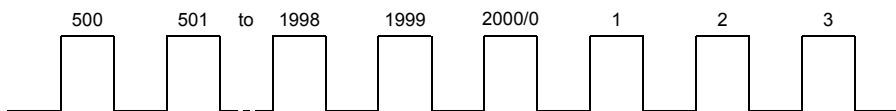

2) In down count, the present value returns to the maximum value (16777215) when it is counted down to the preset value (0).

Then, when the present value is counted down to the ring counter value (2000), it returns to the preset value(0).

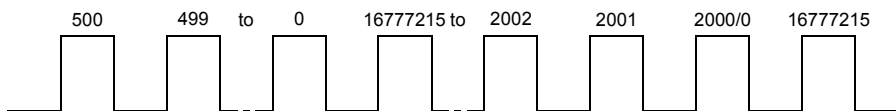

(2) If $\text{preset value} \leq \text{ring counter value} \leq \text{present value}$

The following operation is performed if the ring counter function is executed at the preset value of 0, ring counter value of 2000, and present value of 3000.

1) In up count, the present value returns to the minimum value (0) when it is counted up to the maximum value (16777215).

Then, when the present value is counted up to the ring counter value (2000), it returns to the preset value(0).

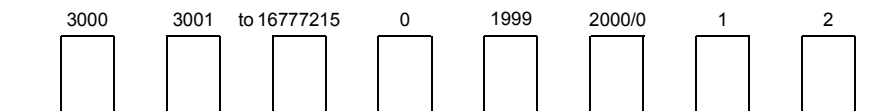

2) In down count, the present value returns to the preset value (0) as soon as it is counted down to the ring counter value (2000).

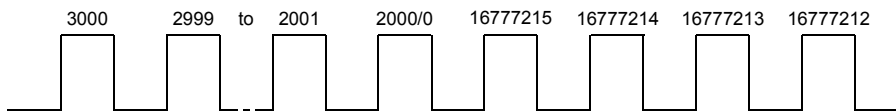

POINT
<ul style="list-style-type: none"> • Do not write the preset and ring counter values during execution of the ring counter function. If they are written, the ring counter operation may not be performed properly. • Note that the ring counter function is not activated when the following expression is satisfied. Ring counter cycle \leq 10-link scan time+2-sequence scan time

9. SELECTING AND EXECUTING THE COUNTER FUNCTION

9.1 Selecting the Counter Function

Select and execute one of the following four counter functions.

Execute the selected function by switching on the counter function selection start command or by applying a voltage to the external F.START terminal.

1) Count disable function.....Refer to Section 9.2

Inputs the signal while the count enable command is ON to stop pulse counting.

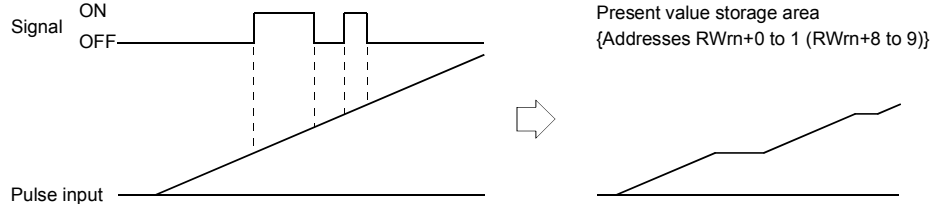

2) Latch counter function.....Refer to Section 9.3

Latches the present value of the counter at the input of the signal.

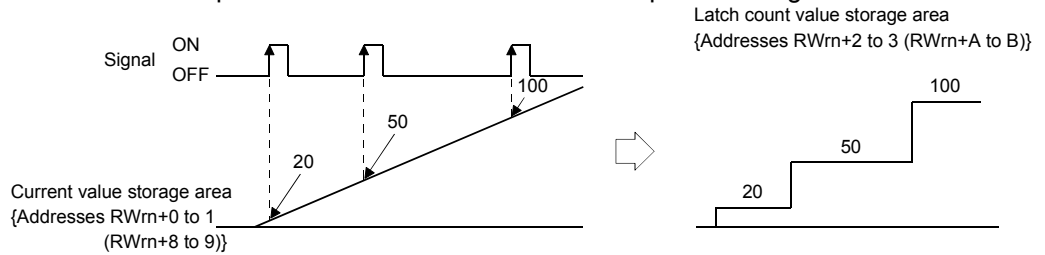

3) Sampling counter function.....Refer to Section 9.4

Counts pulses entered during a preset time (T) which begins with the input of the signal.

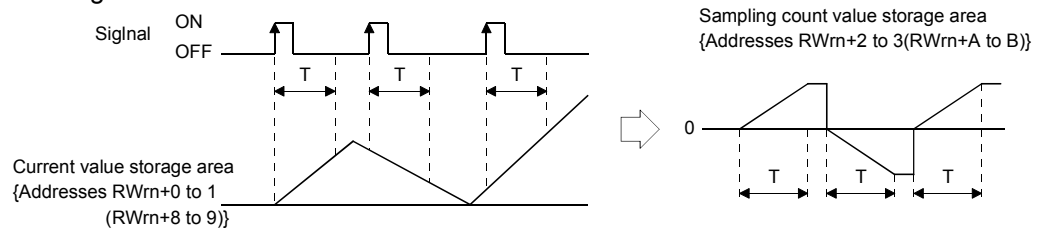

4) Periodic pulse counter function.....Refer to Section 9.5

Stores the present and previous counter values at preset intervals (T) while the signal is entered.

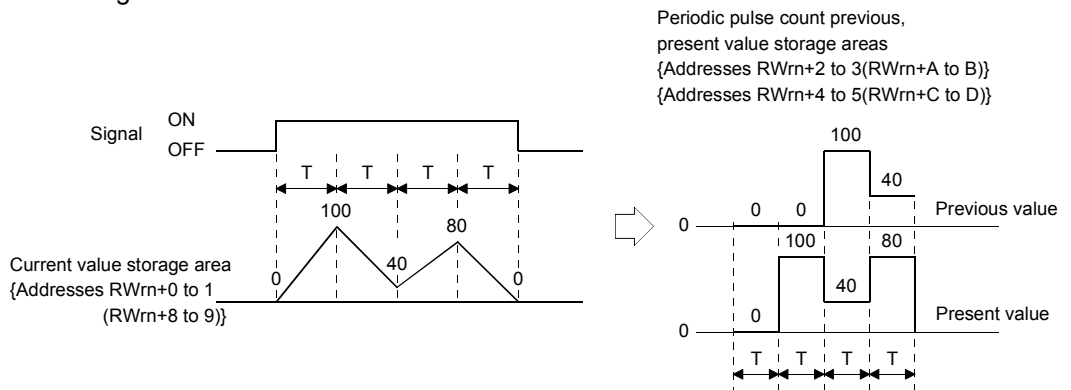

- (1) Select any of the counter functions by writing a value to the lower 4 bits in the upper bits of the remote register {address RWwm+2 (RWwm+A)}.
 When the value set is other than the following set value, the initial value (count disable function selection) is set.
 However, when changing the counter function, make sure that the counter function selection start command {RY(n+1)6 (RY(n+1)D)} and F.START terminal are off.

Counter Function Selection	Set Value
Count disable function	0H
Latch counter function	1H
Sampling counter function	2H
Periodic pulse counter function	3H

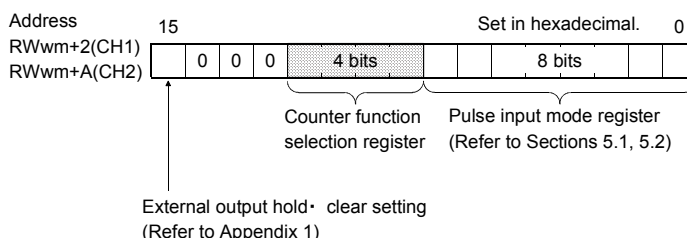

- (2) A selected function can be executed using the counter function selection start command {RY(n+1)6 (RY(n+1)D)} or the F.START terminal (external input). The signal input earlier is prioritized.
- (3) Set the time for the sampling counter function and periodic counter function between 1 and 65535 in 10ms increments.
 The unit of time is 10 [ms] and the precision is less than 1 count.

Example: When 420 is set to the sampling/interval time setting area {address RWwm+5 (RWwm+D)}
 $420 \times 10 = 4200[\text{ms}]$

POINT	The sampling and interval time values are set to the same address of the remote register, but the value set is that of the function selected.
-------	---

9.1.1 Reading the counter function selection count value

The counter function selection count value is the count value at a time when a counter function selection is made.

This section describes how to read the counter function selection count value.

- (1) The counter function selection count values are stored in the following remote registers.

Description		Latch Count Value/ Sampling Count Value/Periodic Pulse Count Previous Value	Periodic Pulse Count Present Value
Remote register	CH1	RWrn+2 to 3	RWrn+4 to 5
	CH2	RWrn+A to B	RWrn+C to D

- (2) The counter function selection count value (0 to 16777215) is stored in 24-bit binary.
- (3) In up count, the counter function selection count value returns to 0 when it exceeds 1677715.
In down count, the counter function selection count value returns to 1677715 when it exceeds 0.

POINT	The latch count value, sampling count value and periodic pulse count previous value are stored in the same address but the value stored is the count value selected.
-------	--

9.1.2 Counting errors

When the selected function is executed through external input (applying voltage to the F.START terminal) or a sequence program (turning on the counter function selection start command), a count error occurs.

(1) For external input, there is the following count delay range.

[Maximum count delay]

1[ms]×pulse input speed [PPS]×multiplication number [count]

[Minimum count delay]

0.1[ms]×pulse input speed [PPS]×multiplication number [count]

(2) When a counter function selection is made by the sequence program, the number of pulses counted during one sequence scan plus three link scans is added to the counting delay in above (1).

(3) The internal clock error is calculated as follows.

$$\frac{\text{Set time}}{10000} \times \text{pulse input speed [PPS]} \times \text{multiplication number [count]}$$

POINT

It is recommended to use the external input to make a counter function selection.

9.2 Count Disable Function

This function stops the counting operation while the count enable command is on. The following chart shows the relationships between the count enable command, the counter function selection start command and the counter's present value.

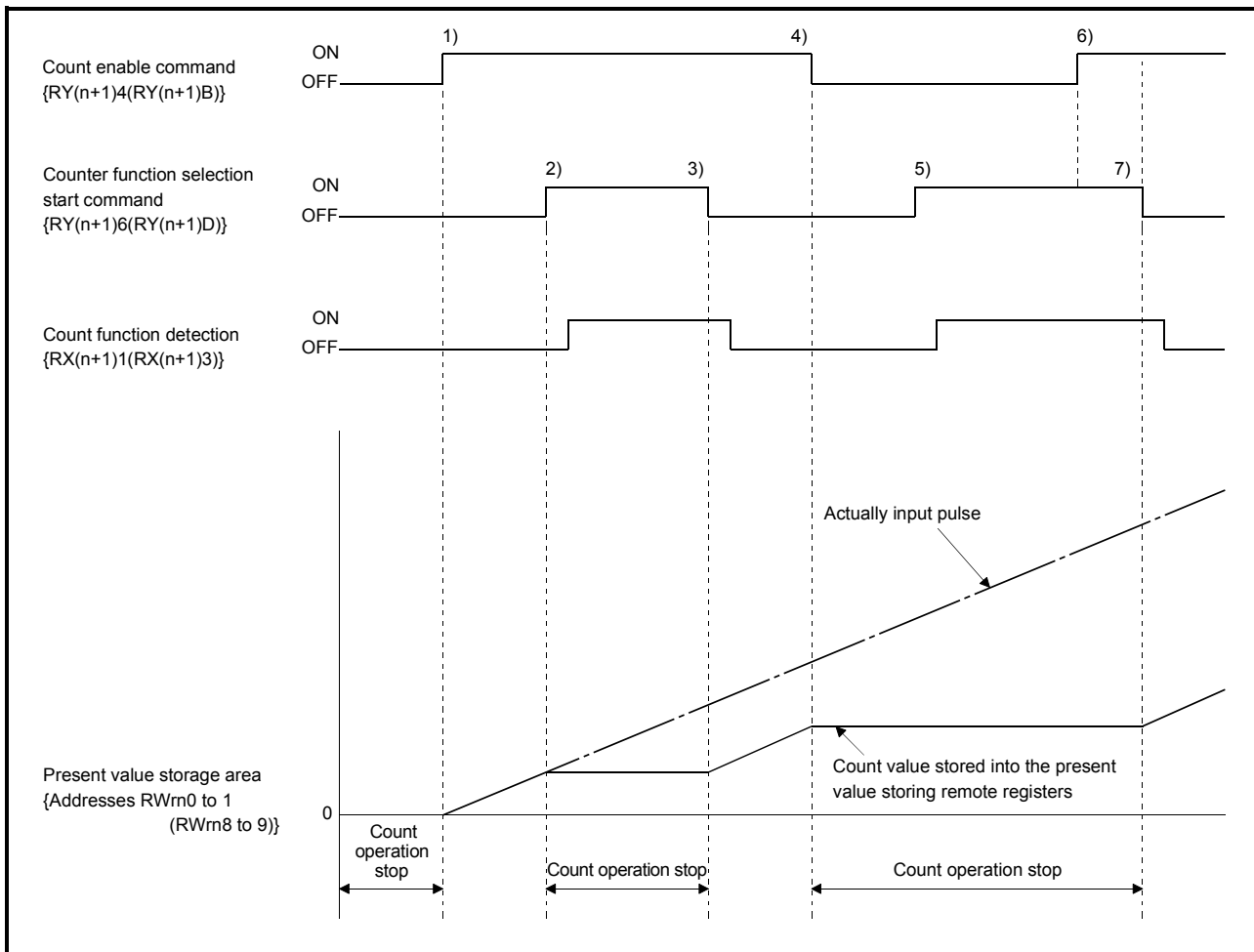

- 1) Count operation starts when the count enable command {RY(n+1)4 (RY(n+1)B} switches on.
- 2) Count operation stops when the counter function selection start command {RY(n+1)6 (RY(n+1)D), F.START terminal} switches on. Also, the counter function detection {RX(n+1)1 (RX(n+1)3)} switches on when the counter function selection start command {RY(n+1)6 (RY(n+1)D)} switches on.
- 3) Count operation resumes when the counter function selection start command {RY(n+1)6 (RY(n+1)D), F.START terminal} switches off. Also, the counter function detection {RX(n+1)1 (RX(n+1)3)} switches off when the counter function selection start command {RY(n+1)6 (RY(n+1)D)} switches off.
- 4) Count operation stops when the count enable command {RY(n+1)4 (RY(n+1)B} switches off.

- 5)Since the count enable command {RY(n+1)4 (RY(n+1)B} is off, count operation stops independently of whether the counter function selection start command {RY(n+1)6 (RY(n+1)D, F.START terminal)}.
- 6)If the count enable command {RY(n+1)4 (RY(n+1)B} is switched on, count operation remains stopped since the counter function selection start command {RY(n+1)6 (RY(n+1)D), F.START terminal} is on.
- 7)Count operation resumes when the counter function selection start command {RY(n+1)6 (RY(n+1)D), F.START terminal} switches off.

9.3 Latch Counter Function

This function latches the counter's present value at a time when the signal is input. The following chart shows the relationships between the counter's present value, counter function selection start command and latch count value storage area.

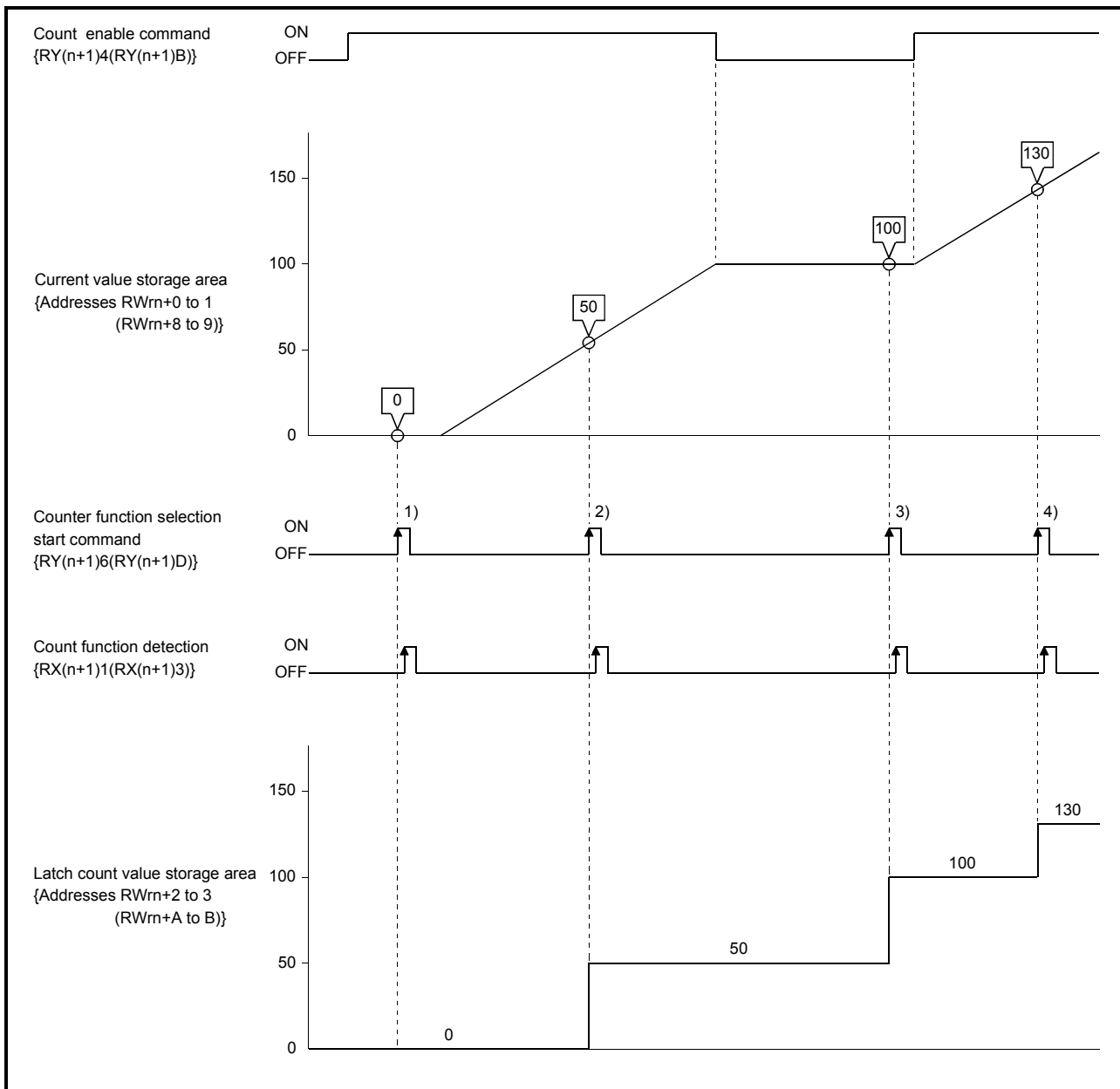

On the leading edges 1) to 4) of the counter function selection start command {RY(n+1)6 (RY(n+1)D), F.START terminal}, the counter's present value is stored into the latch count value storage area {addresses RWrn2 to 3 (RWrnA to B)}.

The latch counter function is executed regardless of the ON/OFF status of the count enable command {RY(n+1)4 (RY(n+1)B)}. Also, turning on the counter function selection start command {RY(n+1)6 (RY(n+1)D)} turns on the counter function detection signal {RX(n+1)1(RX(n+1)3)}. Turning off the counter function selection start command {RY(n+1)6 (RY(n+1)D)} turns off the counter function detection signal {RX(n+1)1(RX(n+1)3)}.

9.4 Sampling Counter Function

This function counts pulses input during a preset sampling period.

The following chart shows the relationships between the signals of the sampling counter function, remote registers and others.

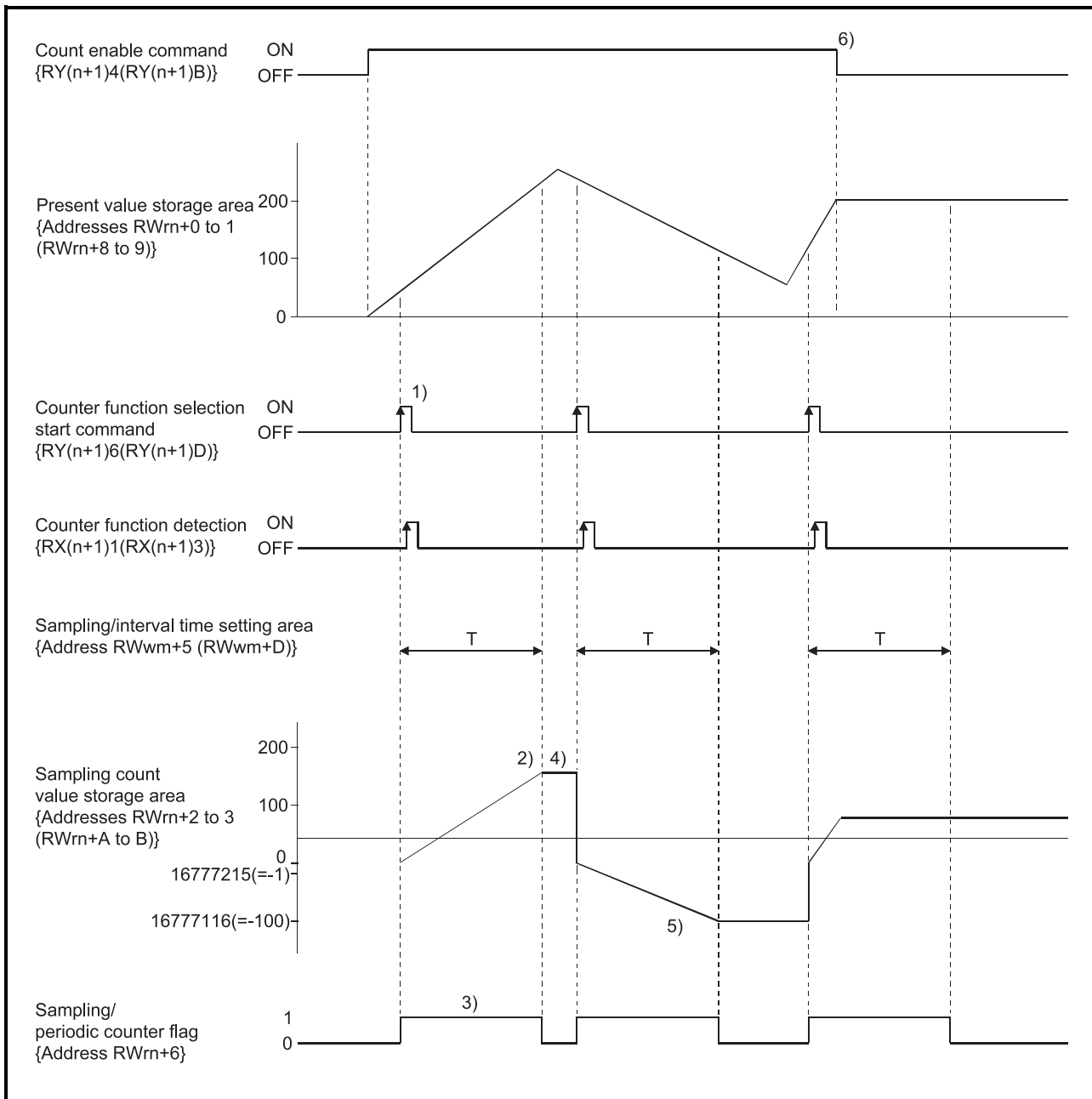

1) On the leading edge of the counter function selection start command {RY(n+1)6 (RY(n+1)D), F.START terminal}, pulses input are counted from 0. Also, the counter detection function signal {RX(n+1)1 (RX(n+1)3)} switches on when the counter function selection start command {RY(n+1)6 (RY(n+1)D)} switches on, and the counter detection signal {RX(n+1)1 (RX(n+1)3)} switches off when the counter function selection start command {RY(n+1)6 (RY(n+1)D)} switches off.

- 2) Counting stops when the preset sampling time elapses.
- 3) While the sampling counter function is being executed, the following value is stored into the sampling/periodic counter flag storage area.

Operating Status	During Execution at CH1 Only	During Execution at CH2 Only	During Execution at CH1 and CH2
Remote register address (RWm+6)	K1	K2	K3

- 4) If the sampling counter function ends, the value in the sampling count value storage area is held.
- 5) When the counter value reaches 0 when values are counted down, the high-speed counter module continues to count down from the maximum positive value since negative values cannot be counted. The counter value at the end of a sampling cycle is stored. For details, refer to Section 8.1.2 (2).
- 6) The sampling counter function is executed independently of whether the count enable command {RY(n+1)4 (RY(n+1)B)} is on or off.

9.5 Periodic Pulse Counter Function

This function stores the present and previous counter values in the corresponding periodic pulse count present and previous value storage areas at preset intervals (T). The unit of frequency is 10 ms and the precision is less than 1 count. The following chart shows the relationships between the signals, remote registers and others.

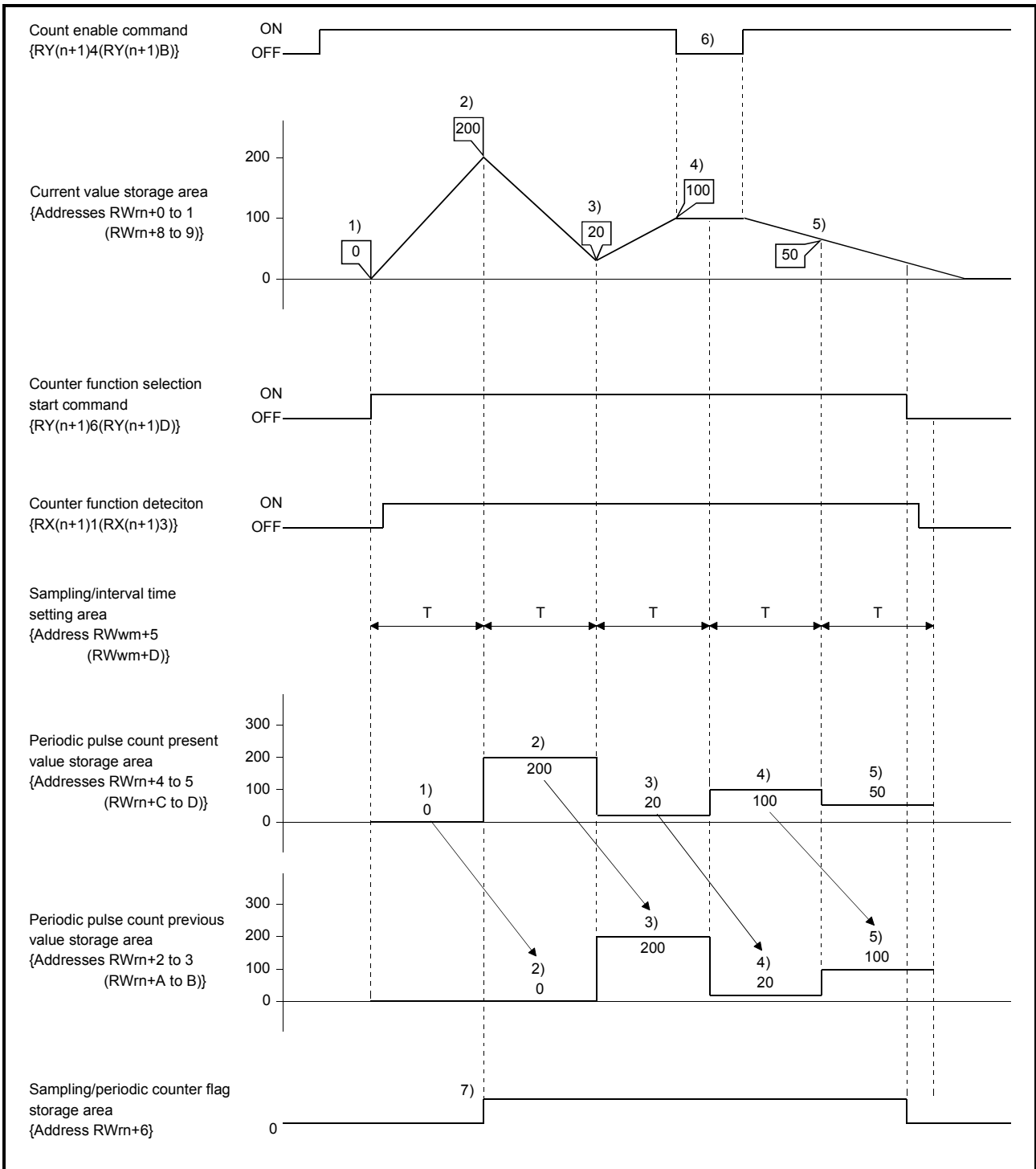

- 1) The counter's present value 0 is stored into the periodic pulse count present value storage area {addresses RWrn+4 to 5 (RWrn+C to D)} (hereinafter called the present value storage area).
- 2) The counter's present value 200 is stored into the present value storage area. The count value 0 stored until then is stored into the periodic pulse count previous value storage area {addresses RWrn+2 to 3 (RWrn+A to B)} (hereinafter called the previous value storage area).
- 3) The counter's present value 20 is stored into the present value storage area. The count value 200 stored until then is stored into the previous value storage area.
- 4) The counter's present value 100 is stored into the present value storage area. The count value 20 stored until then is stored into the previous value storage area.
- 5) The counter's present value 50 is stored into the present value remote register. The count value 100 stored until then is stored into the previous value storage area.
- 6) The periodic pulse counter function is executed independently of whether the count enable command {RY(n+1)4 (RY(n+1)B)} is on or off.
- 7) While the periodic pulse counter function is being executed, the following value is stored into the sampling/periodic counter flag storage area.

Operating Status	During Execution at CH1 Only	During Execution at CH2 Only	During Execution at CH1 and CH2
Remote register address (RWrn+6)	K1	K2	K3

10. PROGRAMMING

Program examples such as programming procedure, current value reading and various function settings of the high-speed counter module are described. When program examples introduced in this chapter are used in the actual system, make sure that the control on the system concerned is acceptable. Refer to the applicable master module user's manual (Detail) for the master module, Section 3.6 for the remote register and the AnSHCPU/AnACPU/AnUCPU programming manual (Dedicated command) for details of dedicated command.

10.1 Programming Procedures

Create the high-speed counter module program with the procedures below:

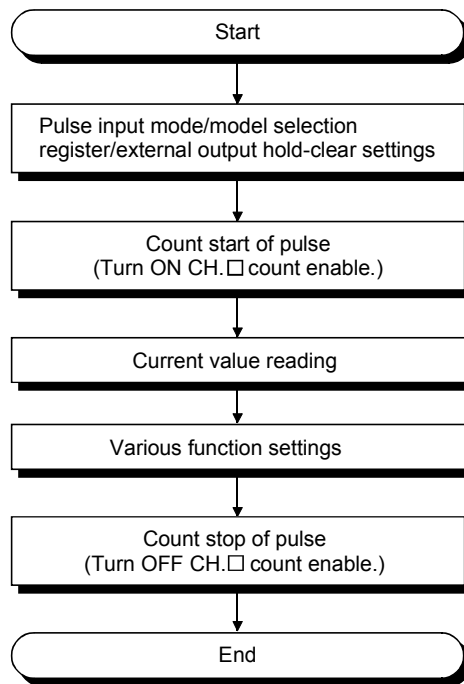

10.2 Condition of Program Example

Program examples in this chapter are created under the conditions below:

(1) System configuration

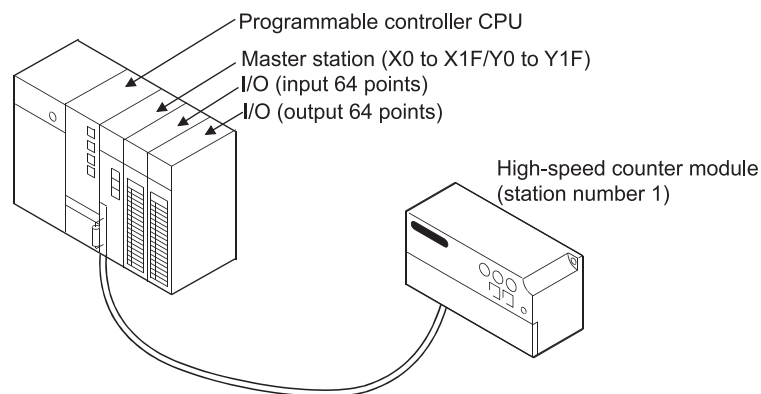

(2) Relation of programmable controller CPU, master module and high-speed counter module

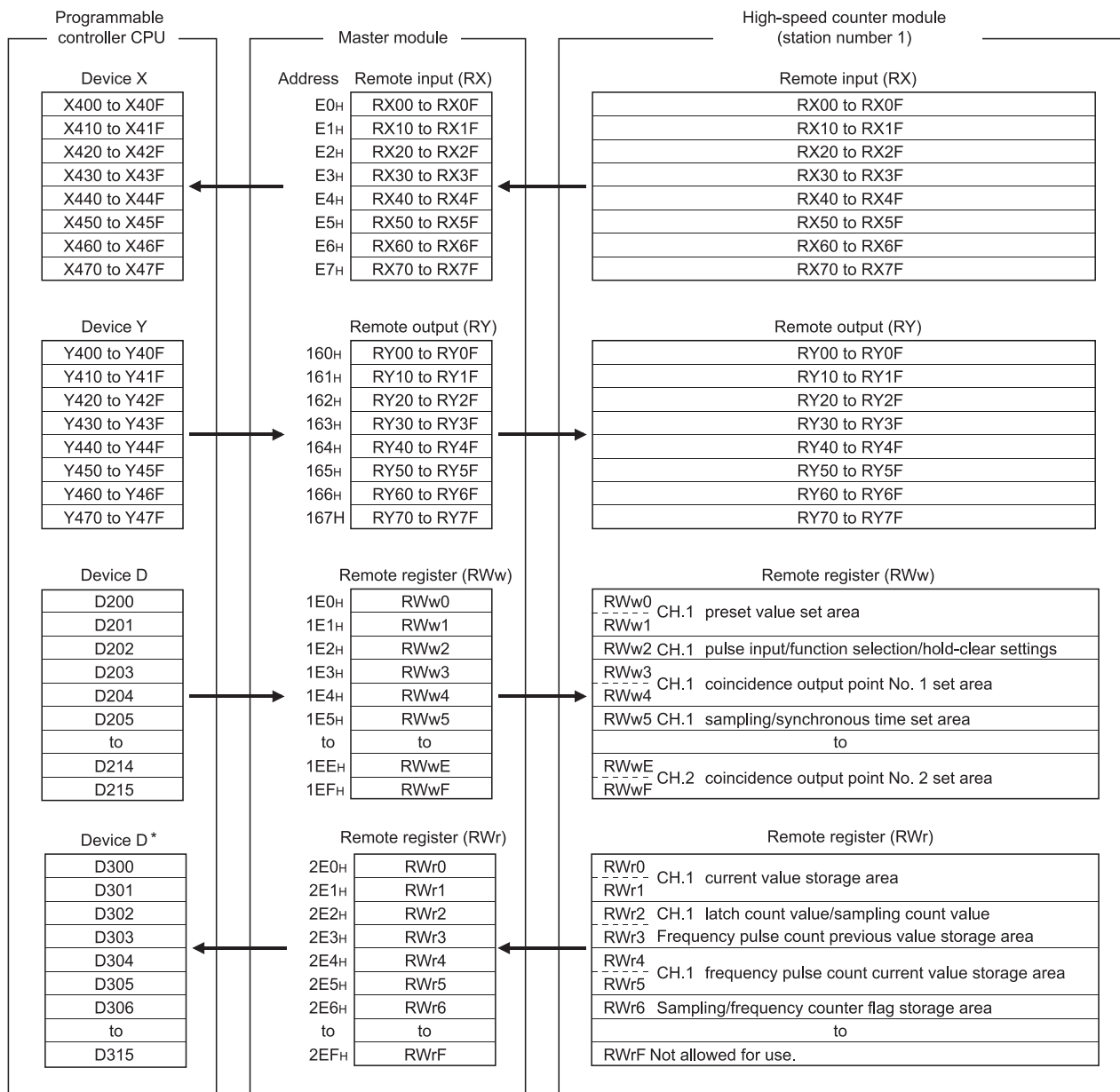

* In the program example (Refer to Section 10.5) using RRPA command (automatic refresh parameter setting) in ACPUR/QCPU (A mode), RWr0 to RWr6 are assigned to D456 to D462.

POINT

A device used in program examples in this chapter may not be used depending on your CPU module. Refer to your CPU module user's manual for the range of device setting.
 For example, devices of X100 and Y100 or later cannot be used for A1SCPU. Use devices of B or M.

(3) Set description

Set description of program examples for each function is shown below:

(a) Program example of coincidence output function

Set item	Set description
CH. 1 pulse input mode/function selection register/external output hold-clear settings (RWw2)	2-phase 2 multiplex
CH. 1 coincidence output point No. 1 set area (RWw3, RWw4)	100

(b) Program example for preset execution with sequence program

Set item	Set description
CH. 1 pulse input mode/function selection register/external output hold-clear settings (RWw2)	2-phase 2 multiplex
CH. 1 preset value set area (RWw0, RWw1)	100

(c) Program example for preset execution with external control signal

Set item	Set description
CH. 1 pulse input mode/function selection register/external output hold-clear settings (RWw2)	2-phase 2 multiplex
CH. 1 preset value set area (RWw0, RWw1)	100

(d) Program example of ring counter function

Set item	Set description
CH. 1 pulse input mode/function selection register/external output hold-clear settings (RWw2)	2-phase 2 multiplex
CH. 1 sampling/frequency time set area (RWw6)	20000ms

(e) Program example of count disable function

Set item	Set description
CH. 1 pulse input mode/function selection register/external output hold-clear settings (RWw2)	2-phase 2 multiplex

(f) Program example of latch counter function

Set item	Set description
CH. 1 pulse input mode/function selection register/external output hold-clear settings (RWw2)	2-phase 2 multiplex, latch counter function

(g) Program example of sampling counter function

Set item	Set description
CH. 1 pulse input mode/function selection register/external output hold-clear settings (RWw2)	2-phase 2 multiplex, sampling counter function
CH. 1 sampling/frequency time set area (RWw5)	20000ms

(h) Program example of frequency pulse counter function

Set item	Set description
CH. 1 pulse input mode/function selection register/external output hold-clear settings (RWw2)	2-phase 2 multiplex, frequency pulse counter function
CH. 1 sampling/frequency time set area (RWw5)	5000ms

10.3 Program Example when QCPU (Q mode) is Used

The network parameter and the automatic refresh parameter are set by the GX Developer.

(1) Parameter settings

(a) Network parameter settings

1	
Start I/O No	0000
Operational setting	Operational settings
Type	Master station
Master station data link type	PLC parameter auto start
Mode	Remote net(Ver.1 mode)
All connect count	1
Remote input[Rx]	
Remote output[Ry]	
Remote register[Rw/r]	
Remote register[Rw/w]	
Ver.2 Remote input[Rx]	
Ver.2 Remote output[Ry]	
Ver.2 Remote register[Rw/r]	
Ver.2 Remote register[Rw/w]	
Special relay[SB]	
Special register[SW]	
Retrv count	3
Automatic reconnection station count	1
Stand by master station No.	
PLC down select	Stop
Scan mode setting	Asynchronous
Delay information setting	0
Station information setting	Station information
Remote device station initial setting	Initial settings
Interrupt setting	Interrupt settings

Station No.	Station type	Expanded cyclic setting	Exclusive station count	Remote station points	Reserve/invalid station select	Intelligent buffer select(word)		
						Send	Receive	Automatic
1/1	Remote device station	single	Exclusive station 4	128 points	No setting			

(b) Automatic refresh parameter settings

1	
Start I/O No	0000
Operational setting	Operational settings
Type	Master station
Master station data link type	PLC parameter auto start
Mode	Remote net(Ver.1 mode)
All connect count	1
Remote input[Rx]	X400
Remote output[Ry]	Y400
Remote register[Rw/r]	D300
Remote register[Rw/w]	D200
Ver.2 Remote input[Rx]	
Ver.2 Remote output[Ry]	
Ver.2 Remote register[Rw/r]	
Ver.2 Remote register[Rw/w]	
Special relay[SB]	SB0
Special register[SW]	SW0
Retrv count	3
Automatic reconnection station count	1
Stand by master station No.	
PLC down select	Stop
Scan mode setting	Asynchronous
Delay information setting	0
Station information setting	Station information
Remote device station initial setting	Initial settings
Interrupt setting	Interrupt settings

POINT
<p>The remote device station initialization step registration function cannot be used.</p> <p>When the remote device station initialization step registration instruction (SB000D) is turned OFF after initialization processing, the remote register value set in the initialization step registration is cleared. Set the pulse input mode/function selection register/external output hold-clear in the sequence program.</p> <p>For program examples in this chapter, the pulse input mode/function selection register/external output hold-clear are set in the sequence program.</p>

10.3.1 Program example of coincidence output function

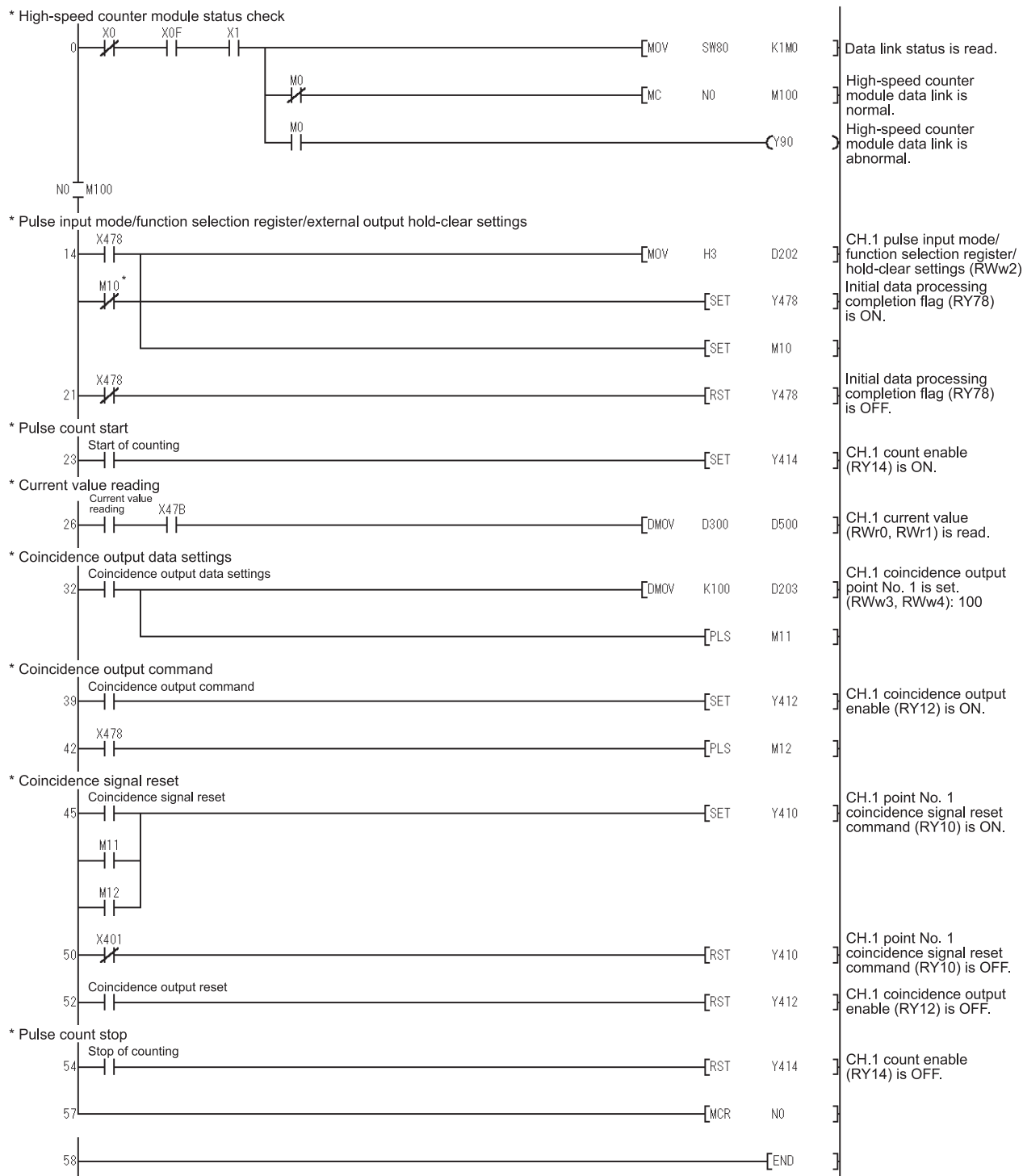

* When the programmable controller CPU is reset, the pulse input mode/function selection register/external output hold-clear settings are reset.

10.3.2 Program example of preset with sequence program

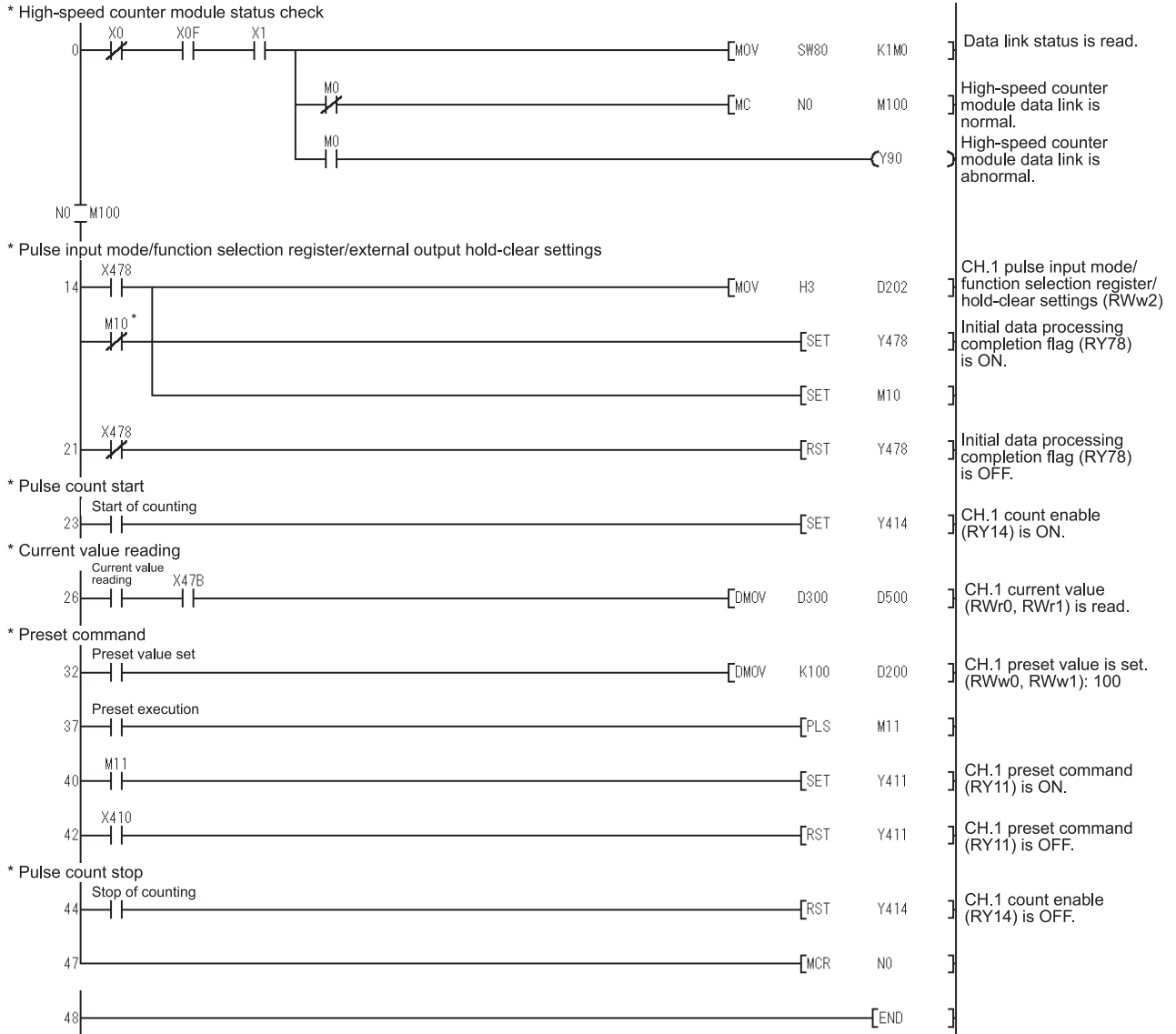

* When the programmable controller CPU is reset, the pulse input mode/function selection register/external output hold-clear settings are reset.

10.3.3 Program example of preset with external control signal

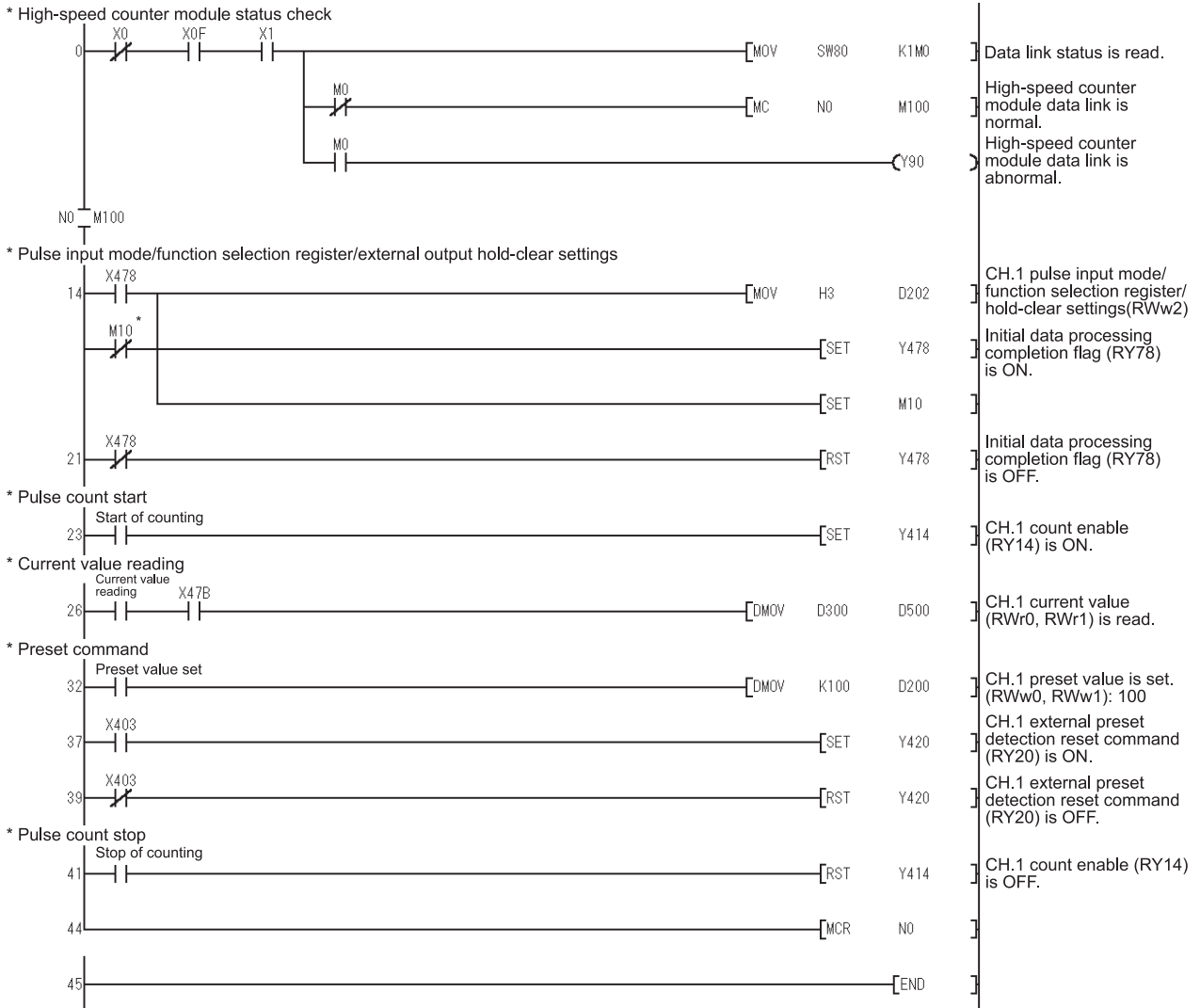

* When the programmable controller CPU is reset, the pulse input mode/function selection register/external output hold-clear settings are reset.

10.3.4 Program example of ring counter function

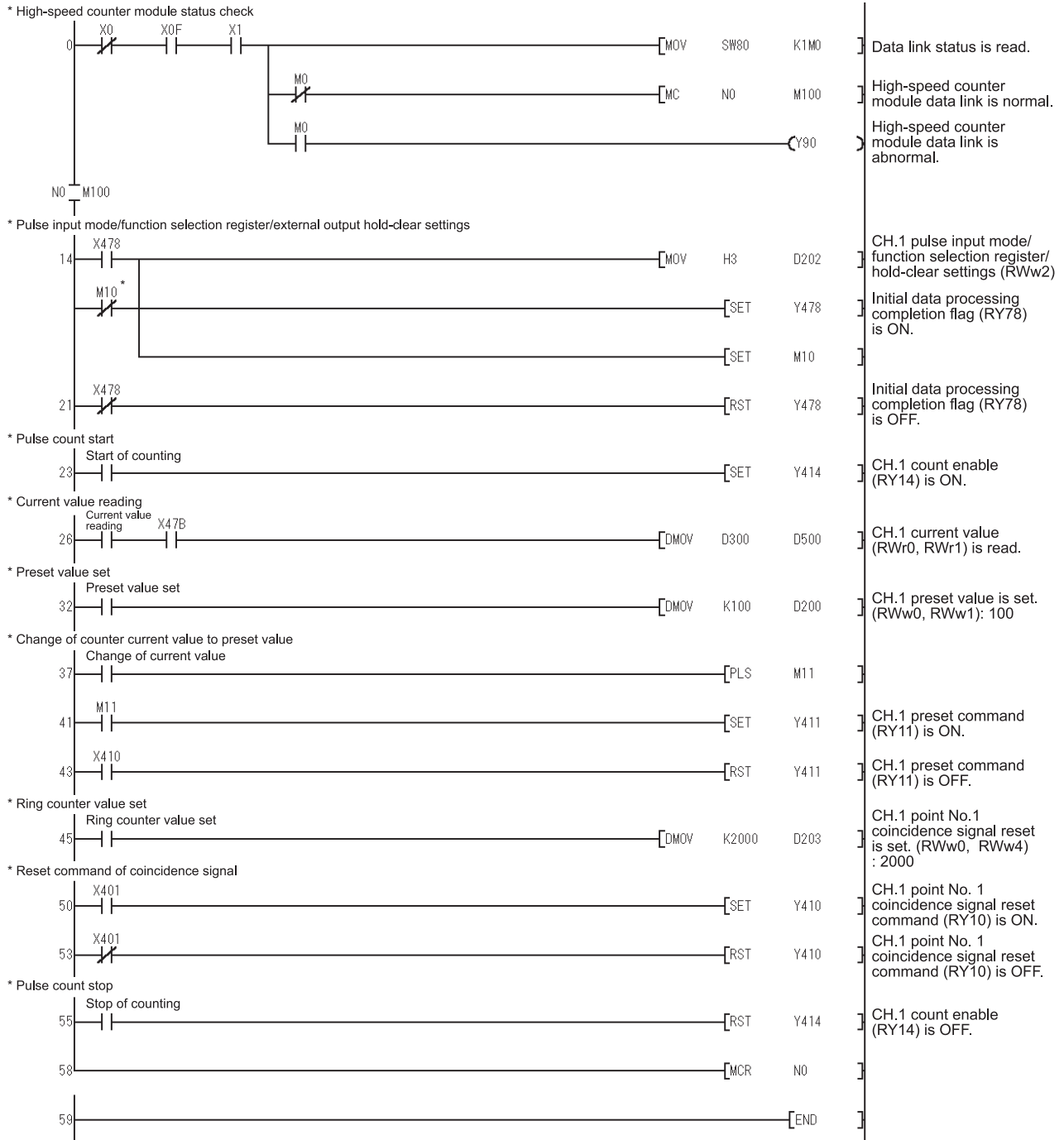

* When the programmable controller CPU is reset, the pulse input mode/function selection register/external output hold-clear settings are reset.

10.3.5 Program example of count disable function

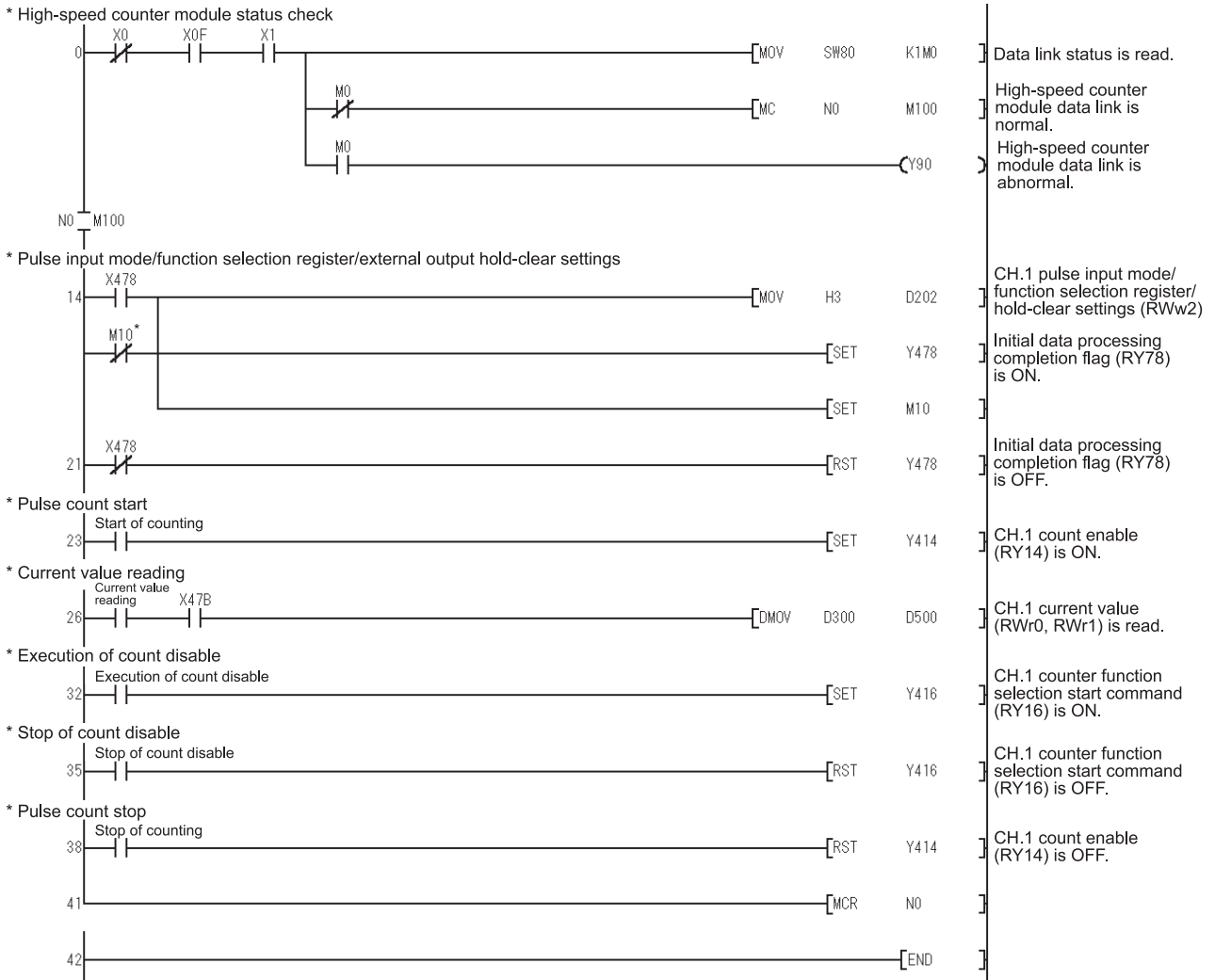

* When the programmable controller CPU is reset, the pulse input mode/function selection register/external output hold-clear settings are reset.

10.3.6 Program example of latch counter function

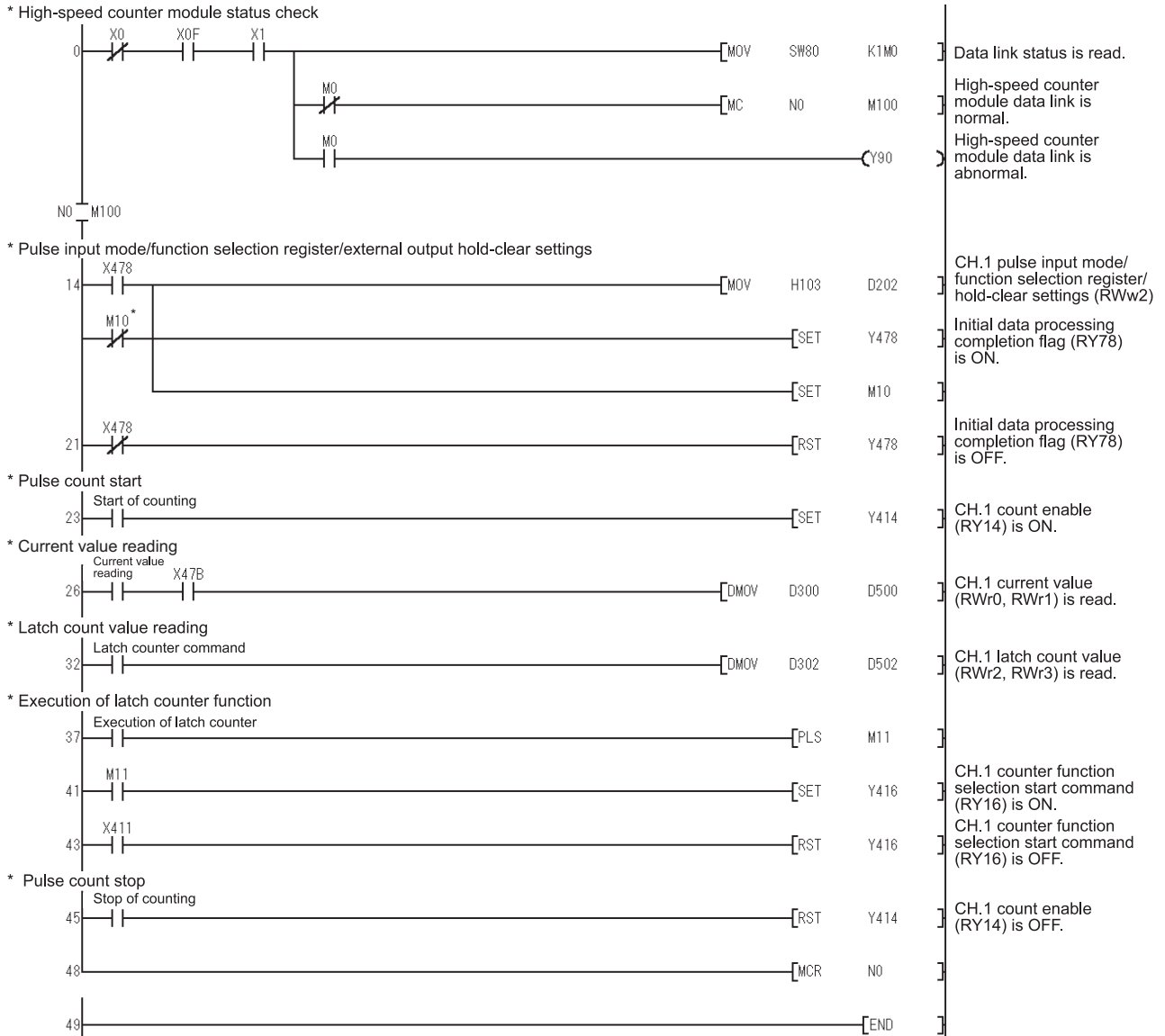

* When the programmable controller CPU is reset, the pulse input mode/function selection register/external output hold-clear settings are reset.

10.3.7 Program example of sampling counter function

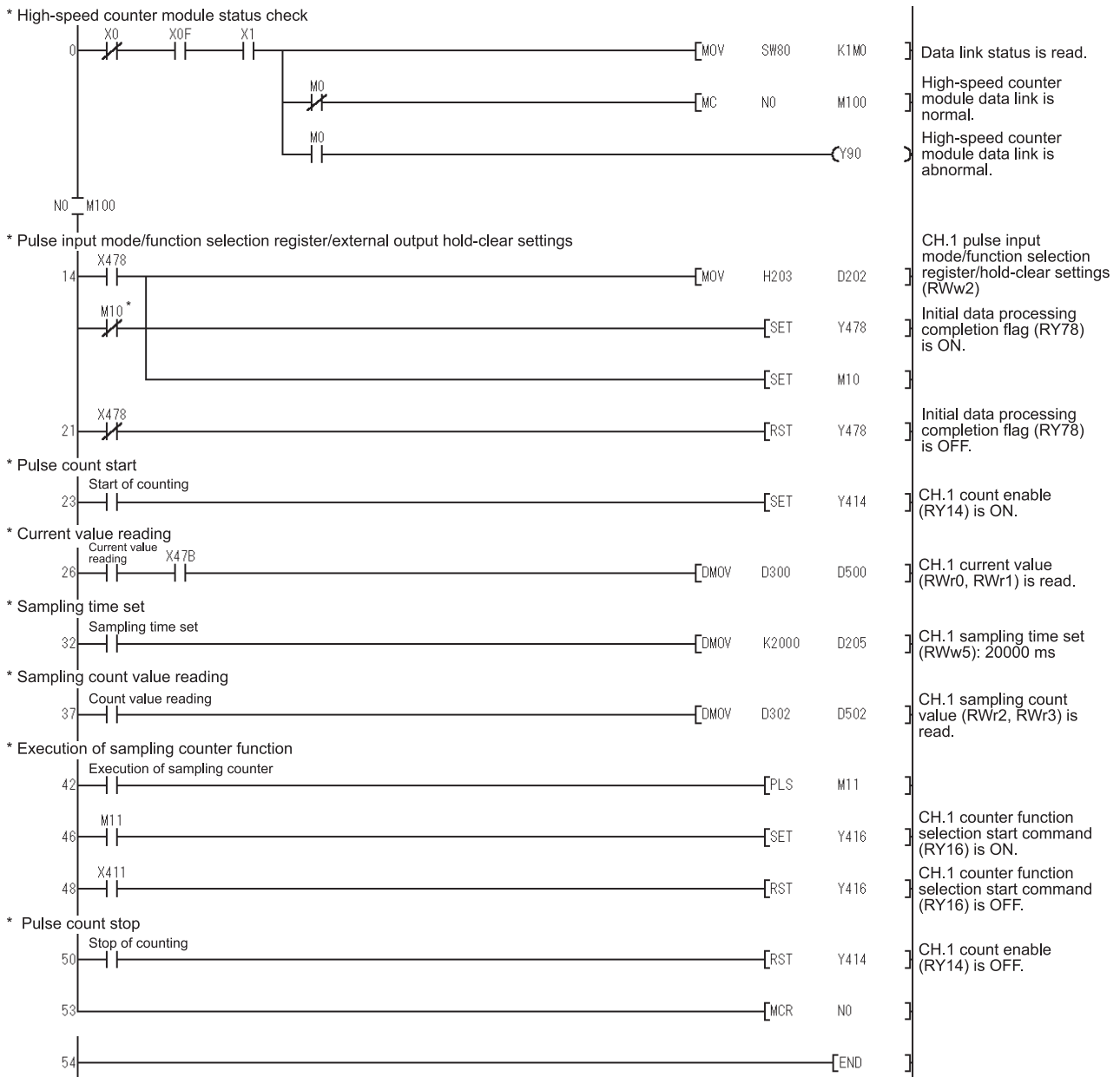

* When the programmable controller CPU is reset, the pulse input mode/function selection register/external output hold-clear settings are reset.

10.3.8 Program example of frequency pulse counter function

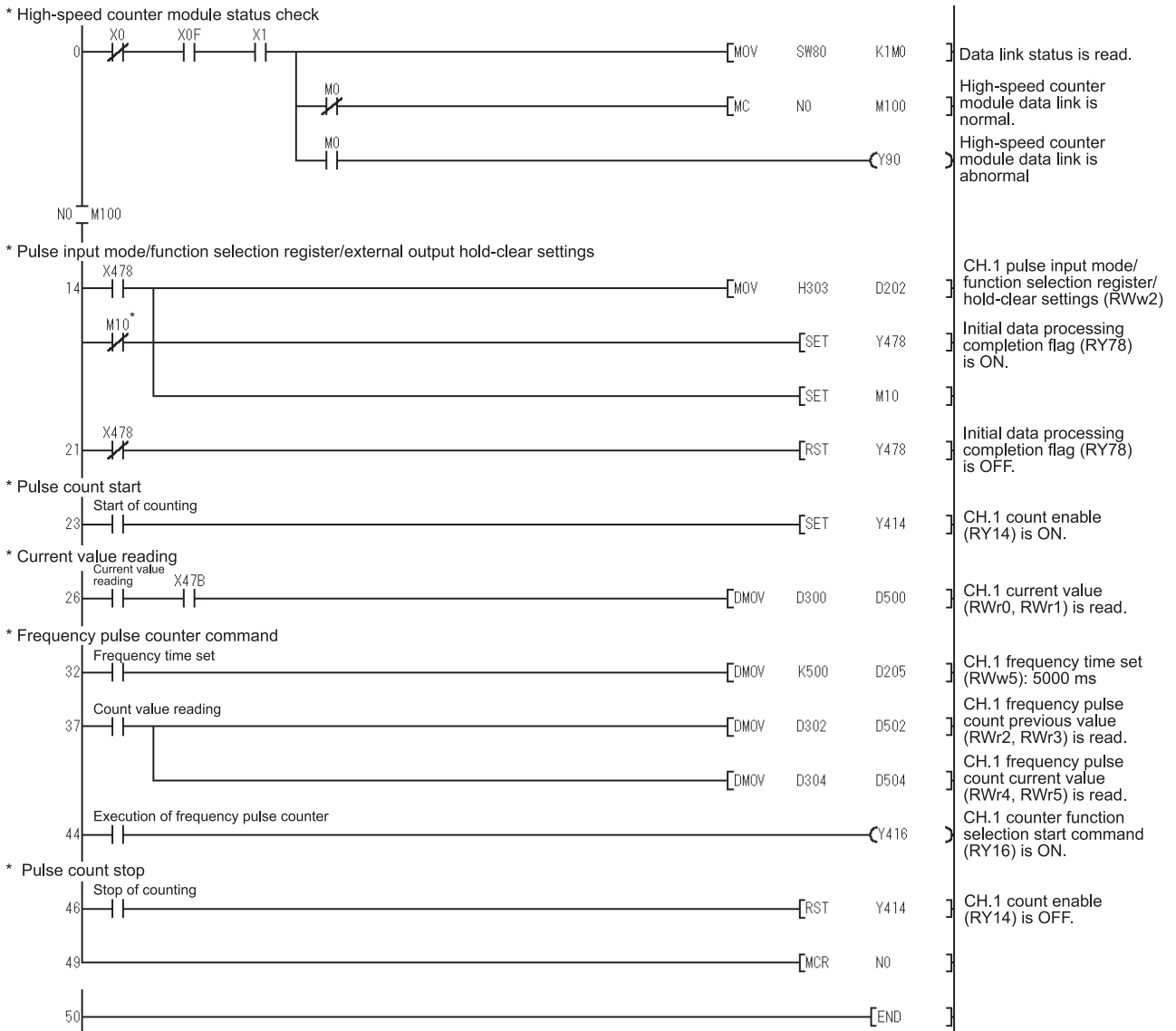

* When the programmable controller CPU is reset, the pulse input mode/function selection register/external output hold-clear settings are reset.

10.4 Program Example when QnACPU is Used

The network parameter and the automatic refresh parameter are set by the GX Developer.

(1) Parameter settings

(a) Network parameter settings

	1
Start I/O No.	0000
Type	Master station
All connect count	1
Remote input(RX)	
Remote output(RY)	
Remote register(RWr)	
Remote register(RWw)	
Special relay(SB)	
Special register(SW)	
Retry count	3
Automatic reconnection station count	1
Wait master station No.	0
PLC down select	Stop
Scan mode setting	Asynchronously
Delay information setting	0
Station information setting	Station information

Station No.	Station type	Exclusive station count	Reserve/invalid station select	Intelligent buffer select(word)		
				Send	Receive	Automatic
1/1	Remote device station	Exclusive station 4	No setting			

(b) Automatic refresh parameter settings

	1
Start I/O No.	0000
Operational setting	Operational settings
Type	Master station
Master station data link type	PLC parameter auto start
Mode	Remote net(Ver.1 mode)
All connect count	1
Remote input(RX)	X400
Remote output(RY)	Y400
Remote register(RWr)	D300
Remote register(RWw)	D200
Ver.2 Remote input(RX)	
Ver.2 Remote output(RY)	
Ver.2 Remote register(RWr)	
Ver.2 Remote register(RWw)	
Special relay(SB)	SB0
Special register(SW)	SW0
Retry count	3
Automatic reconnection station count	1
Stand by master station No.	
PLC down select	Stop
Scan mode setting	Asynchronous
Delay information setting	0
Station information setting	Station information
Remote device station initial setting	Initial settings
Interrupt setting	Interrupt settings

10.4.1 When preset is made by sequence program

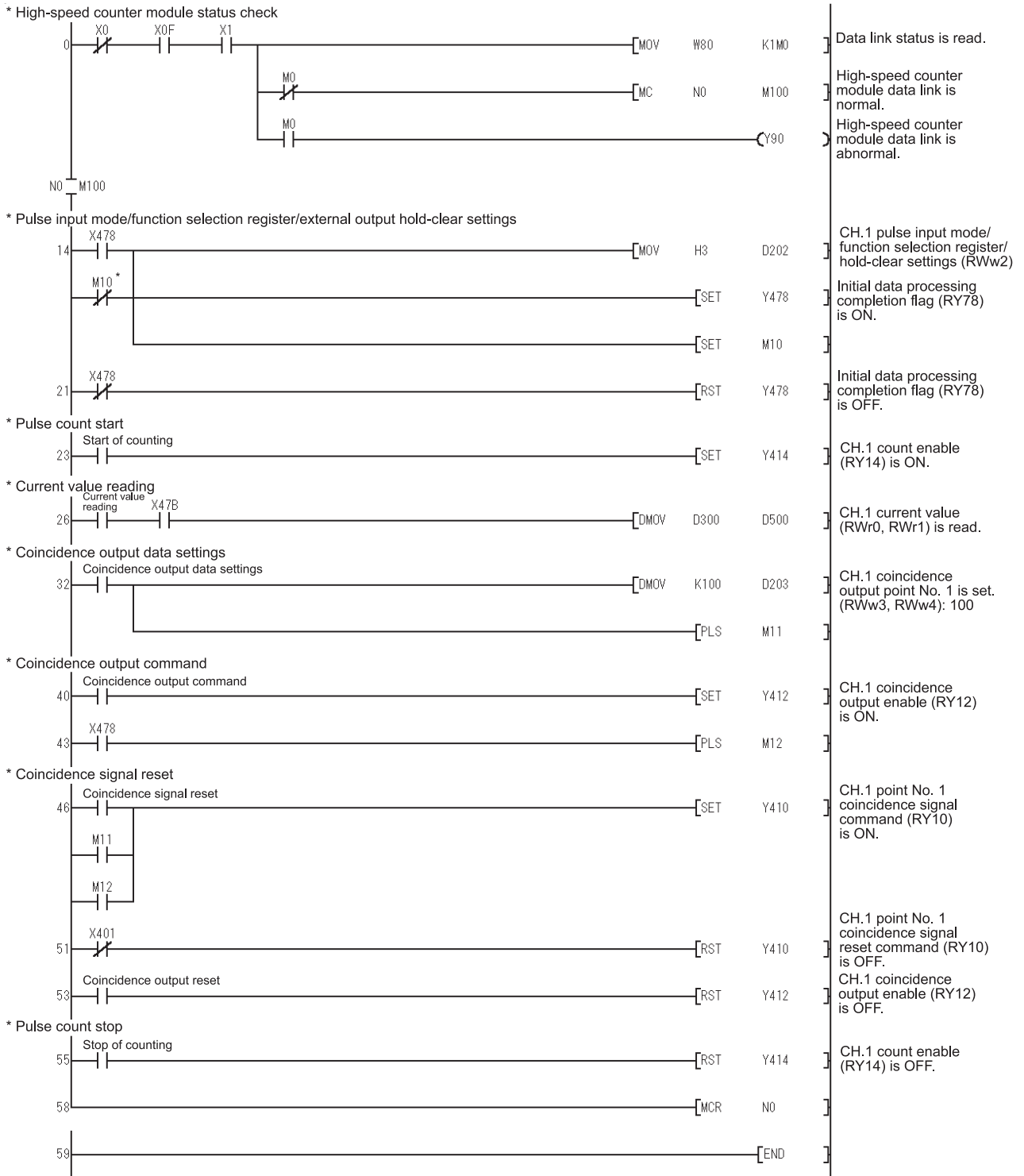

* When the programmable controller CPU is reset, the pulse input mode/function selection register/external output hold-clear settings are reset.

10.4.2 Program example of preset with sequence program

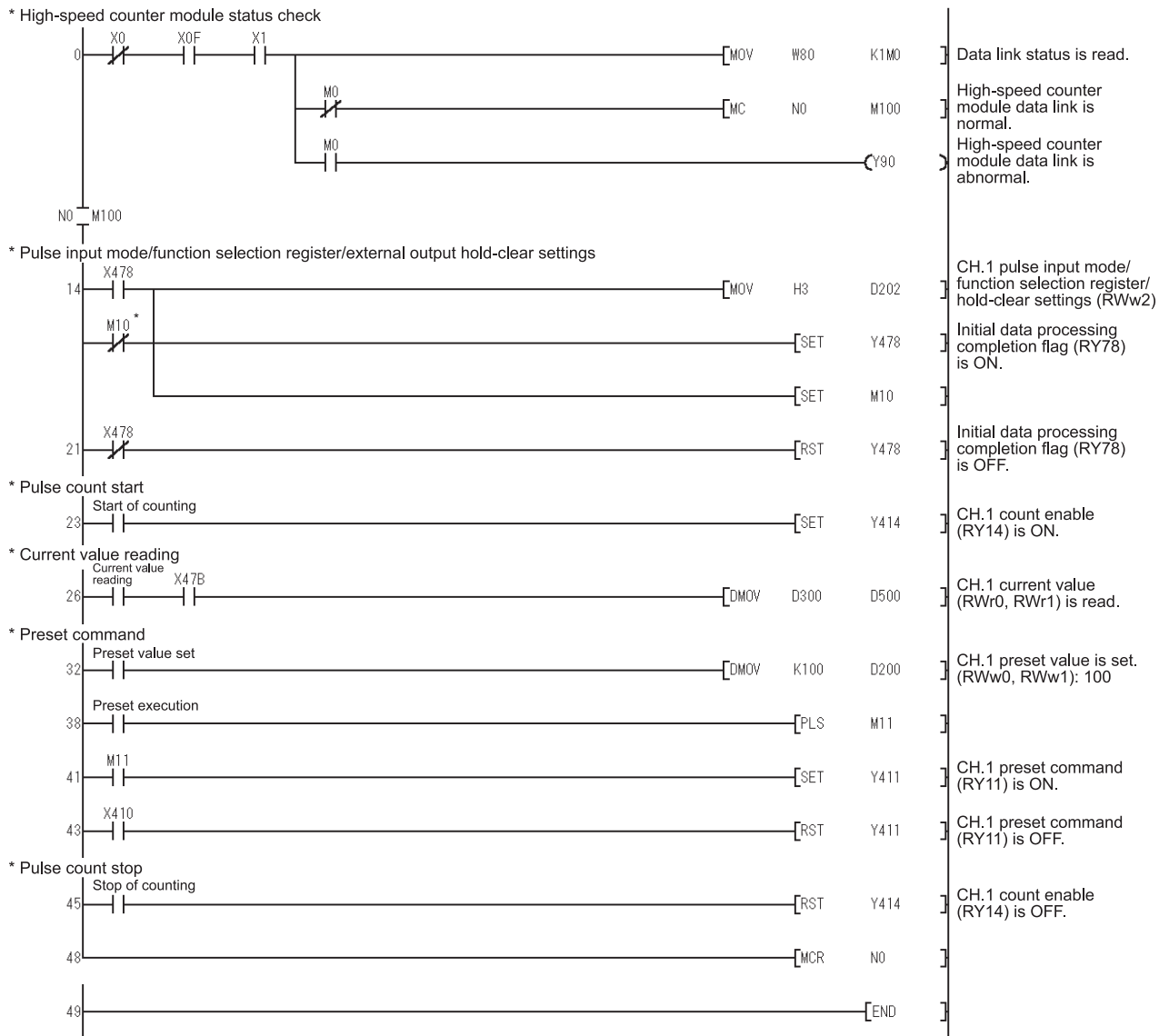

* When the programmable controller CPU is reset, the pulse input mode/function selection register/external output hold-clear settings are reset.

10.4.3 Program example of preset with external control signal

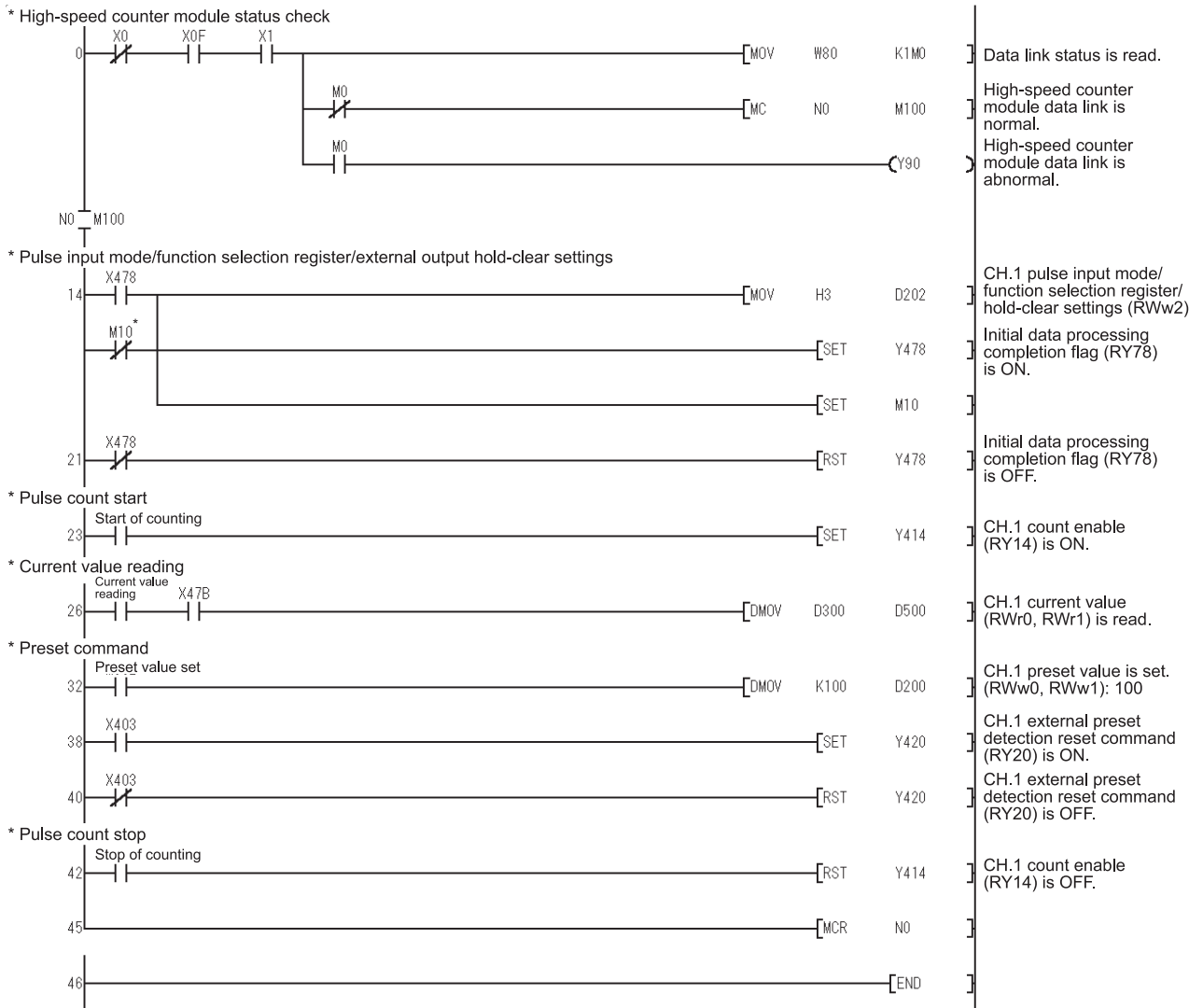

* When the programmable controller CPU is reset, the pulse input mode/function selection register/external output hold-clear settings are reset.

10.4.4 Program example of ring counter function

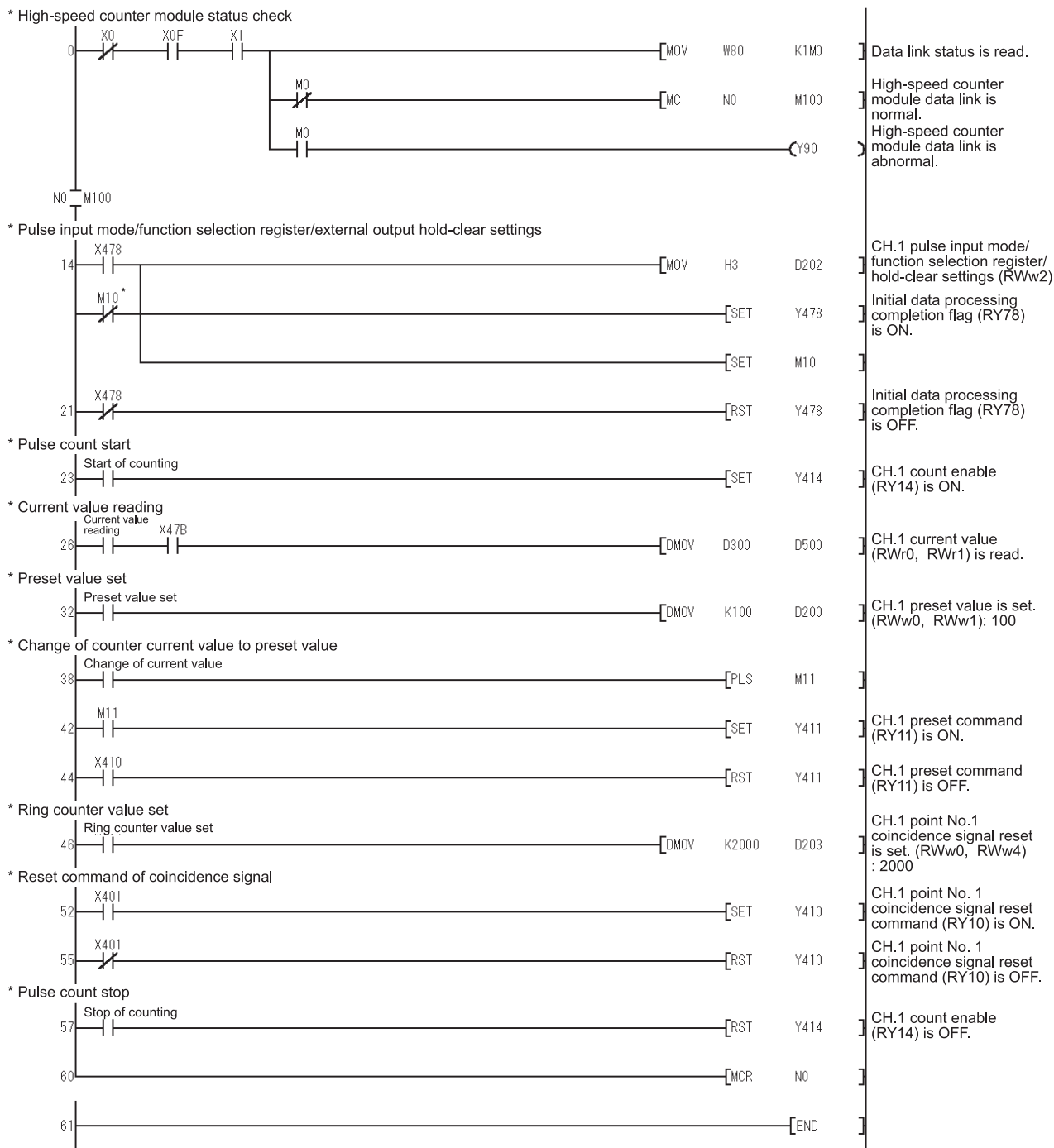

* When the programmable controller CPU is reset, the pulse input mode/function selection register/external output hold-clear settings are reset.

10.4.5 Program example of count disable function

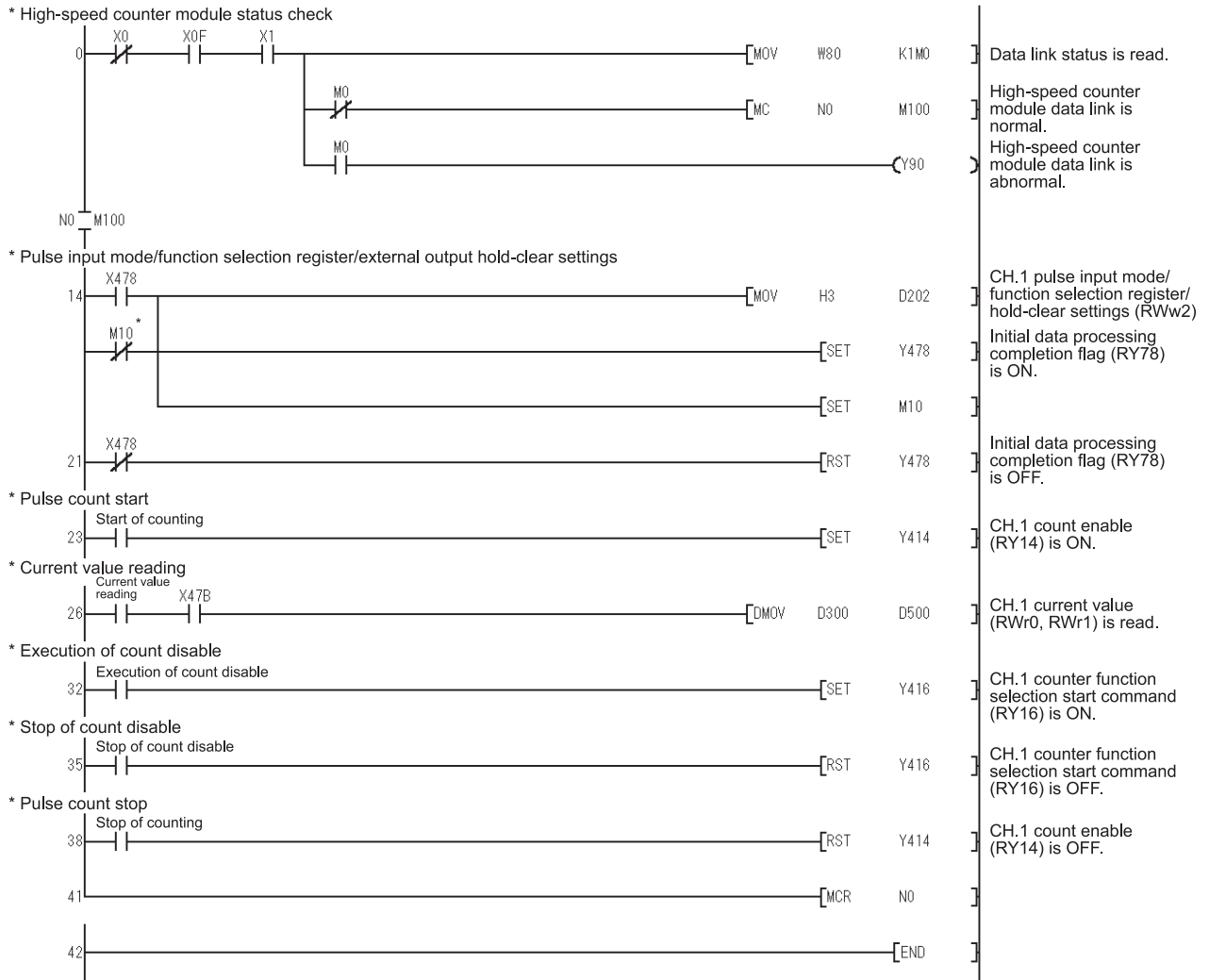

* When the programmable controller CPU is reset, the pulse input mode/function selection register/external output hold-clear settings are reset.

10.4.6 Program example of latch counter function

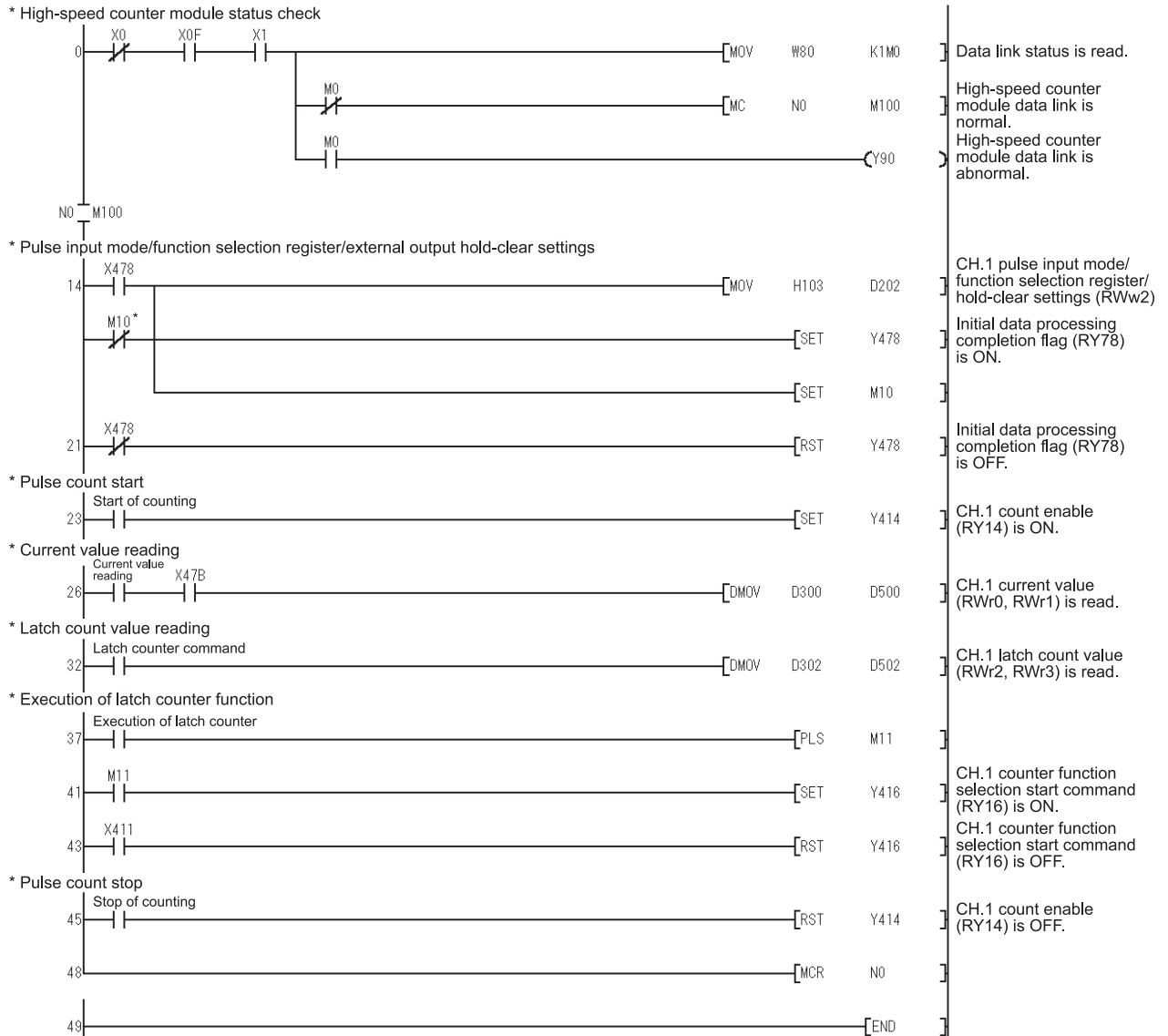

* When the programmable controller CPU is reset, the pulse input mode/function selection register/external output hold-clear settings are reset.

10.4.7 Program example of sampling counter function

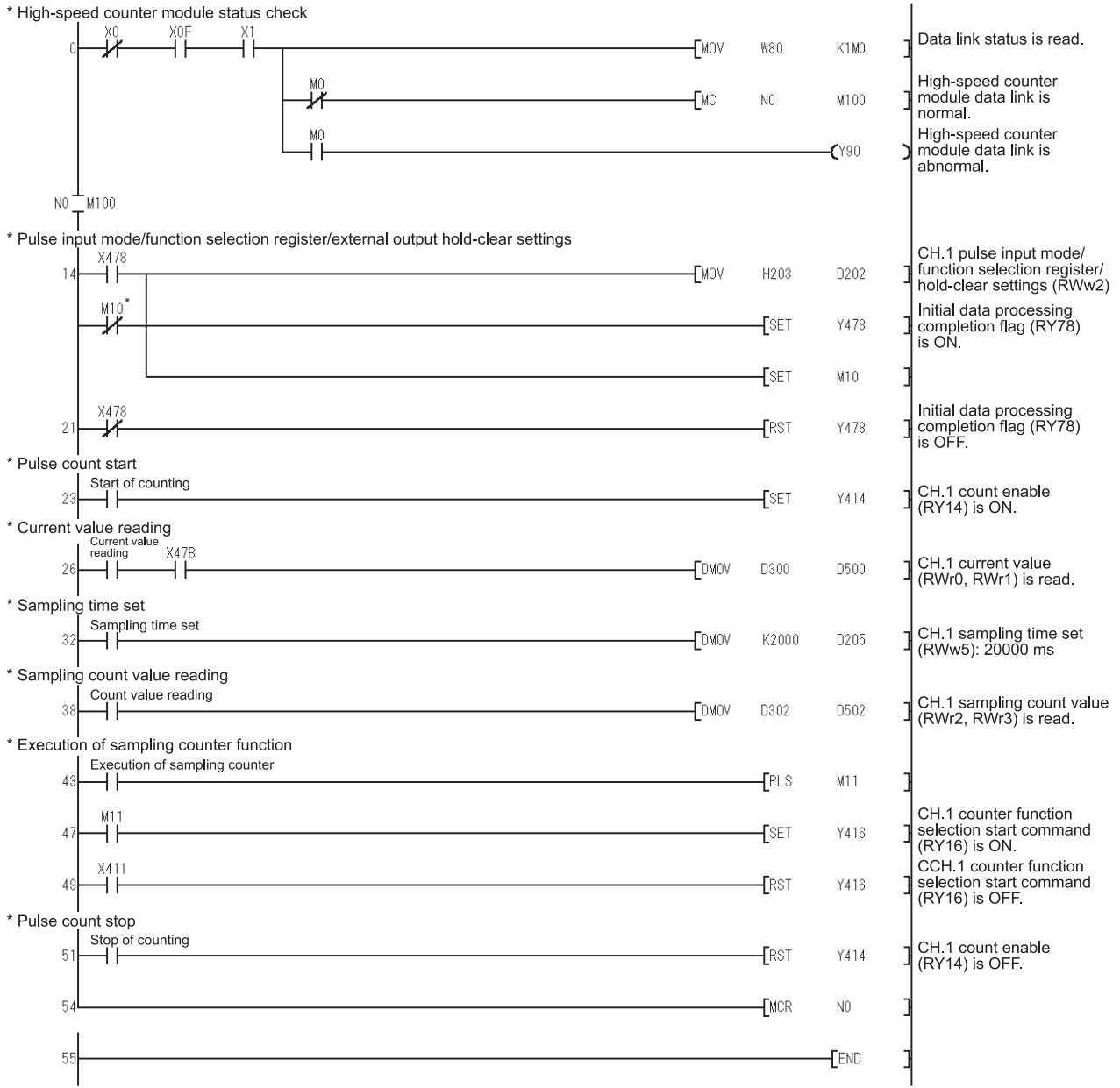

* When the programmable controller CPU is reset, the pulse input mode/function selection register/external output hold-clear settings are reset.

10.4.8 Program example of frequency pulse counter function

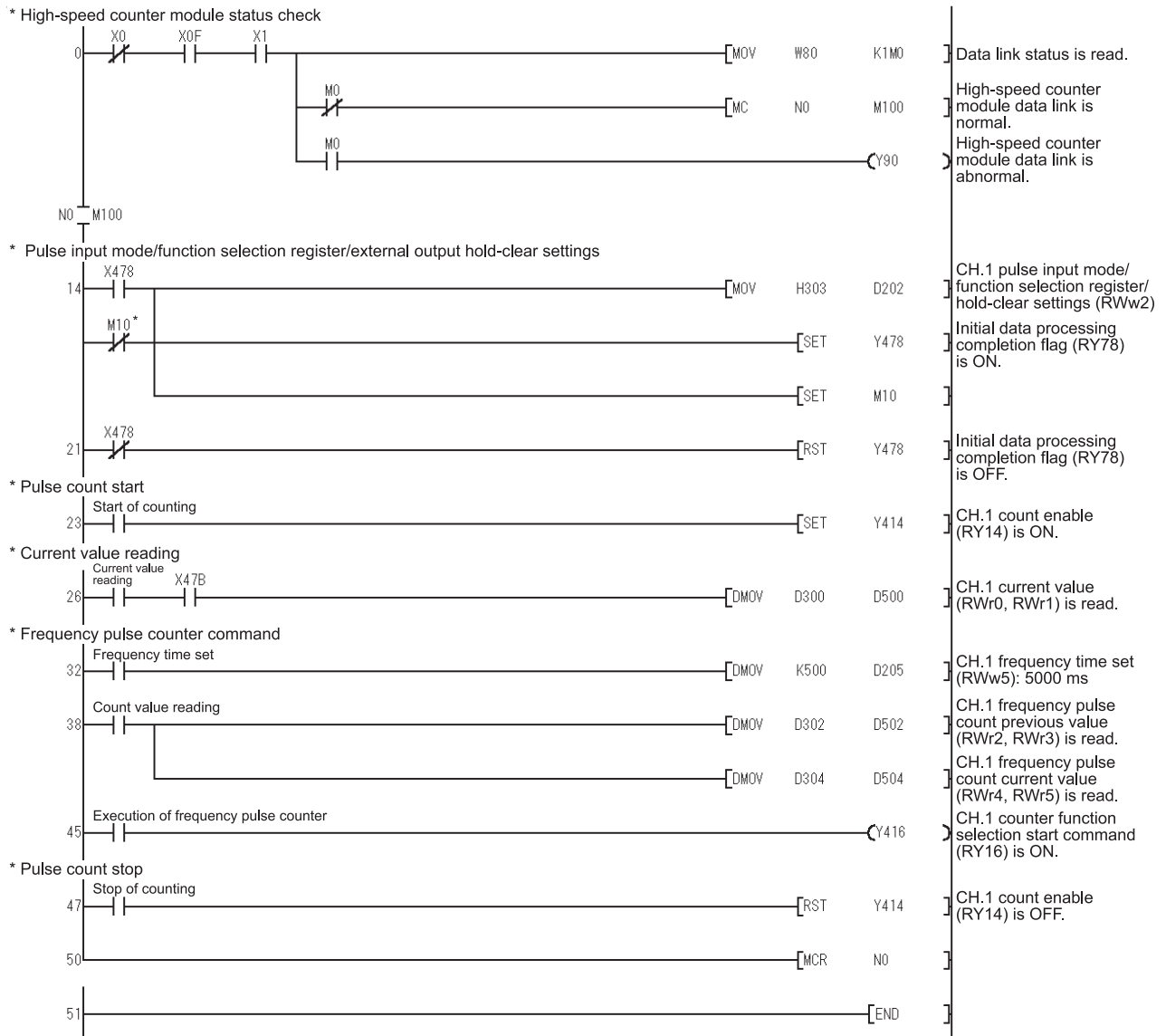

* When the programmable controller CPU is reset, the pulse input mode/function selection register/external output hold-clear settings are reset.

10.5 Program Example when ACPU/QCPU (A Mode) is Used (Dedicated Command)

The network parameter and the automatic refresh parameter are set by the sequence program.

10.5.1 Program example of coincidence output function

* Network parameter settings with dedicated command RLPA

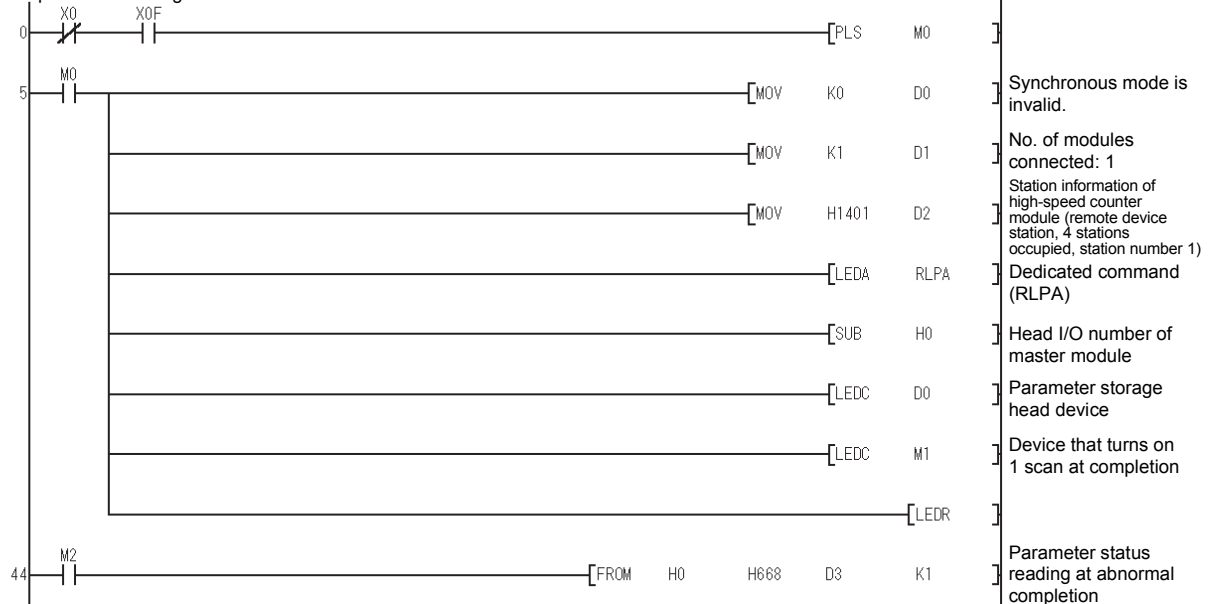

* Automatic refresh parameter settings with dedicated command RRPA

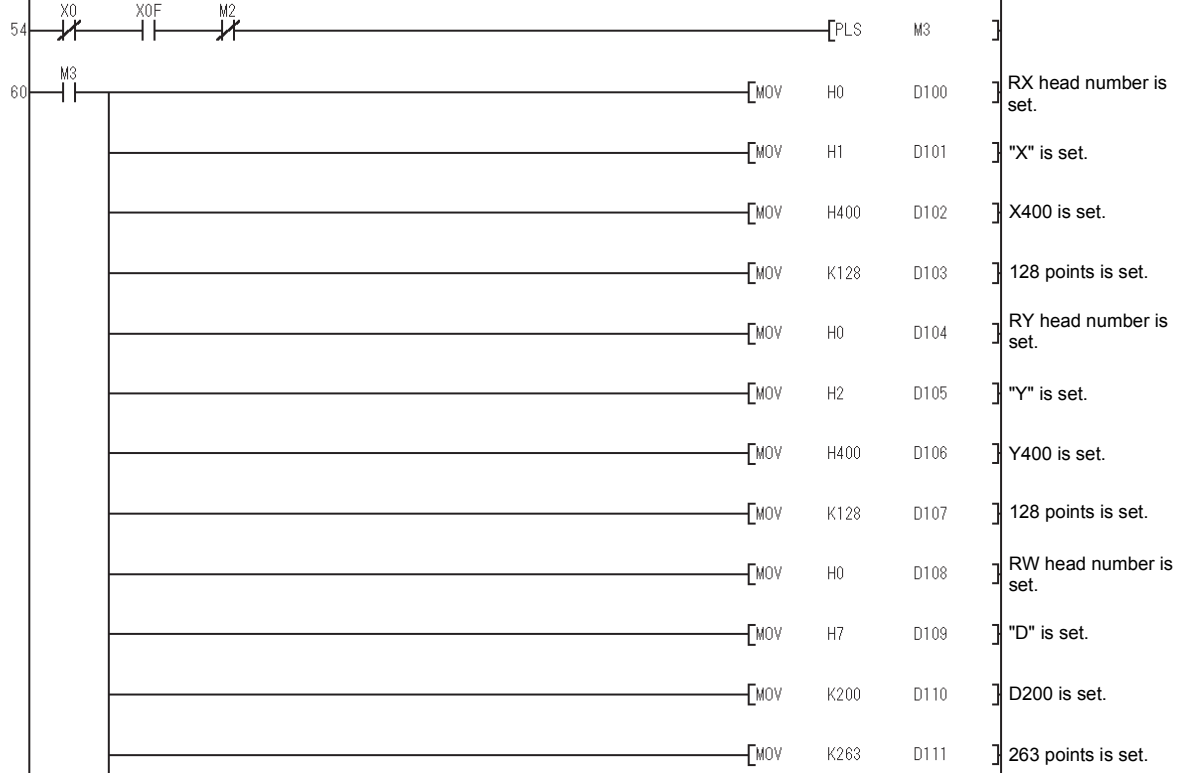

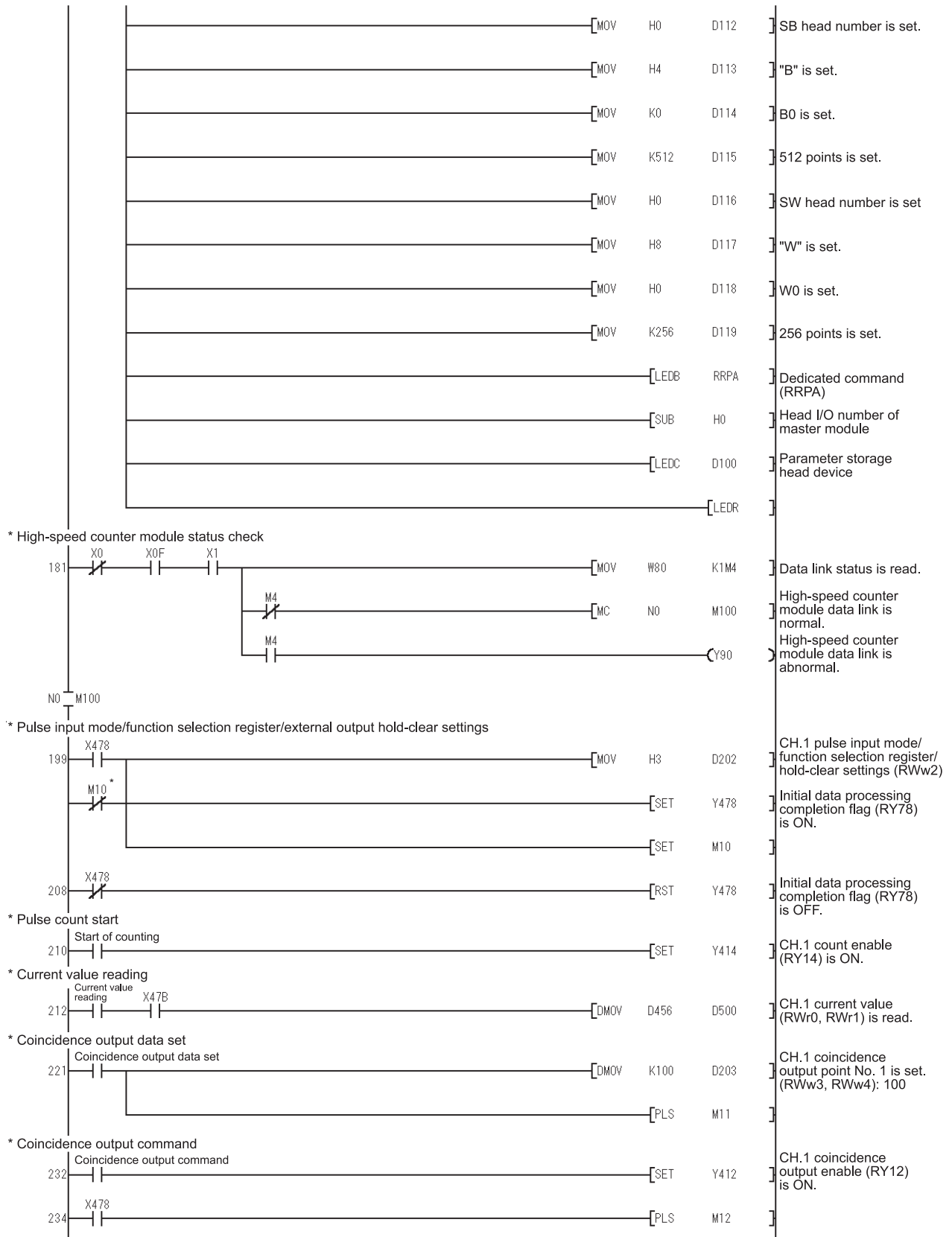

* When the programmable controller CPU is reset, the pulse input mode/function selection register/external output hold-clear settings are reset.

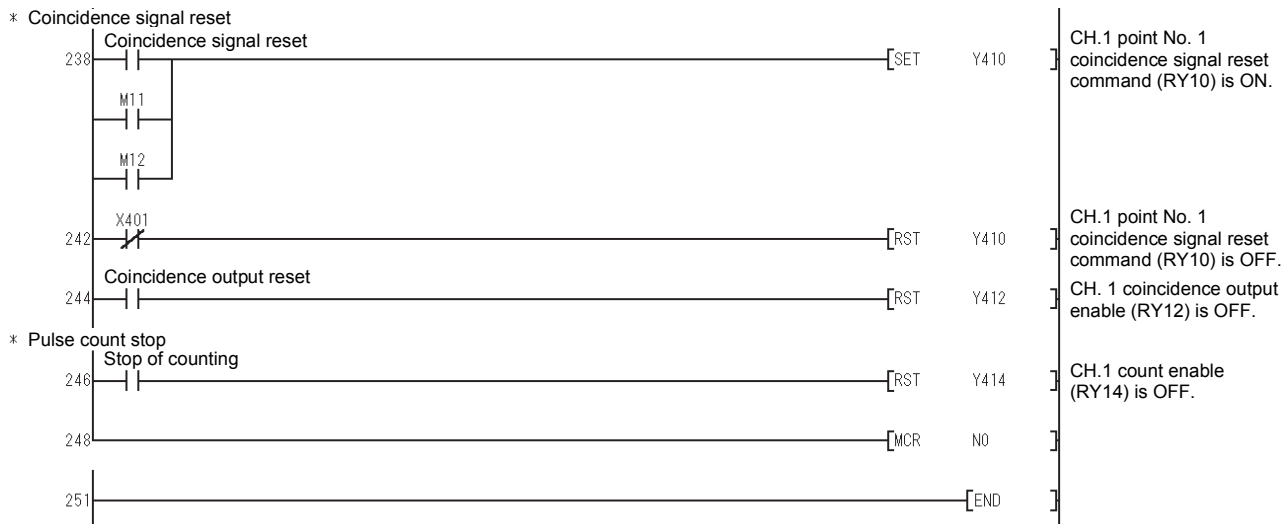

10.5.2 Program example of preset with sequence program

* Network parameter settings with dedicated command RLPA

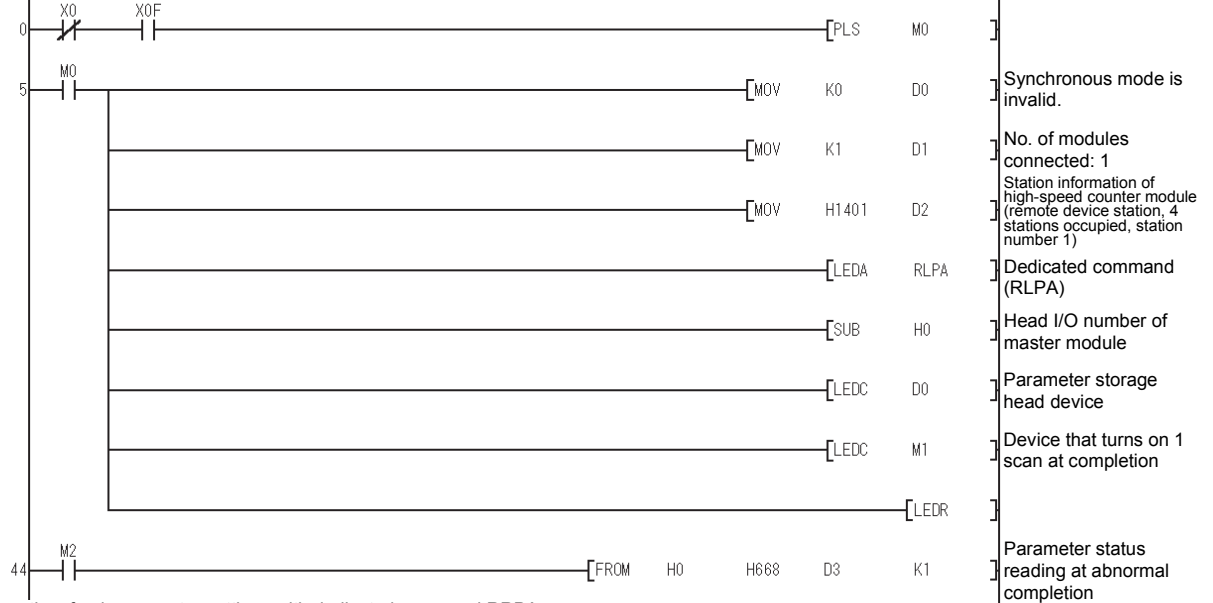

* Automatic refresh parameter settings with dedicated command RRPA

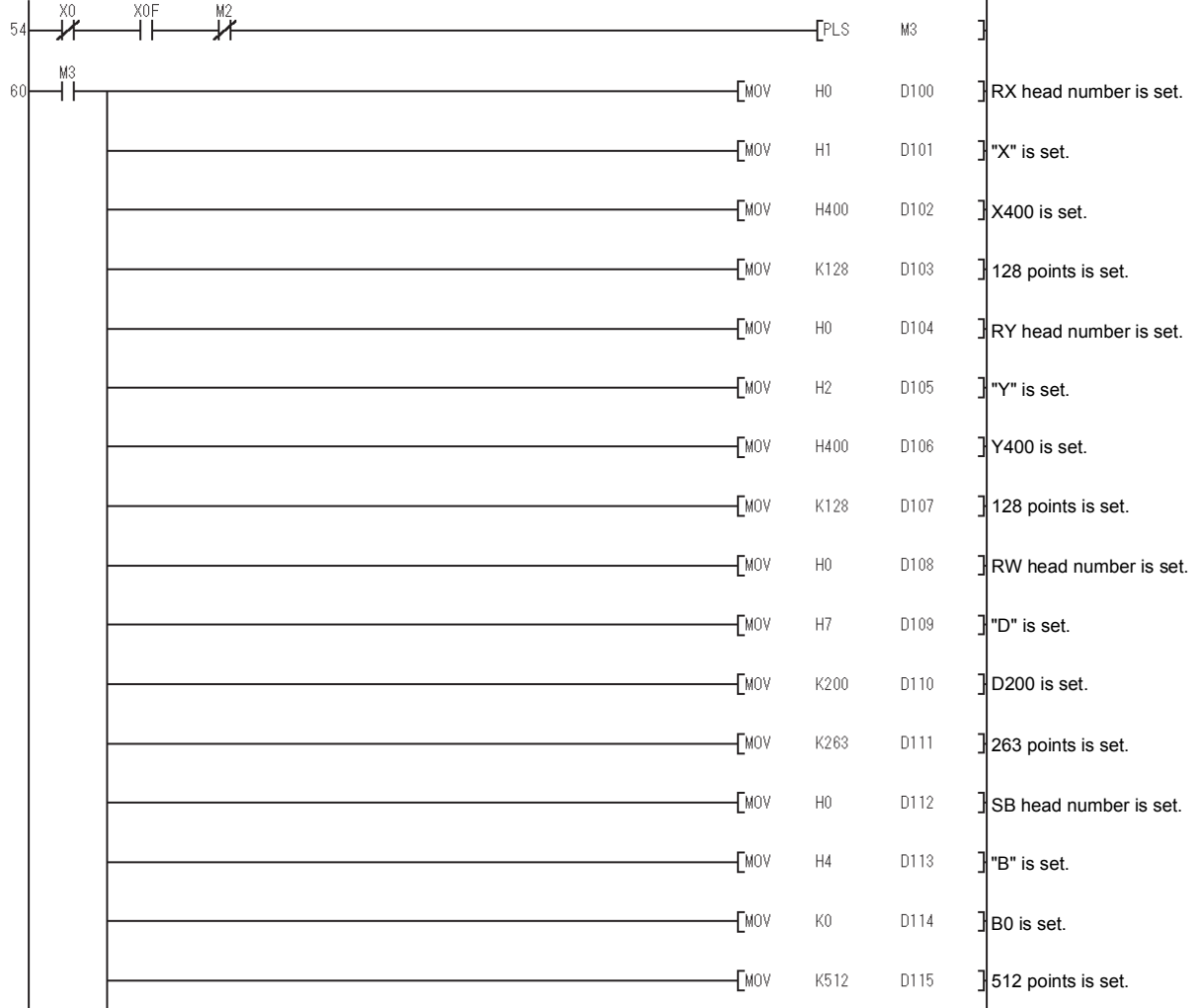

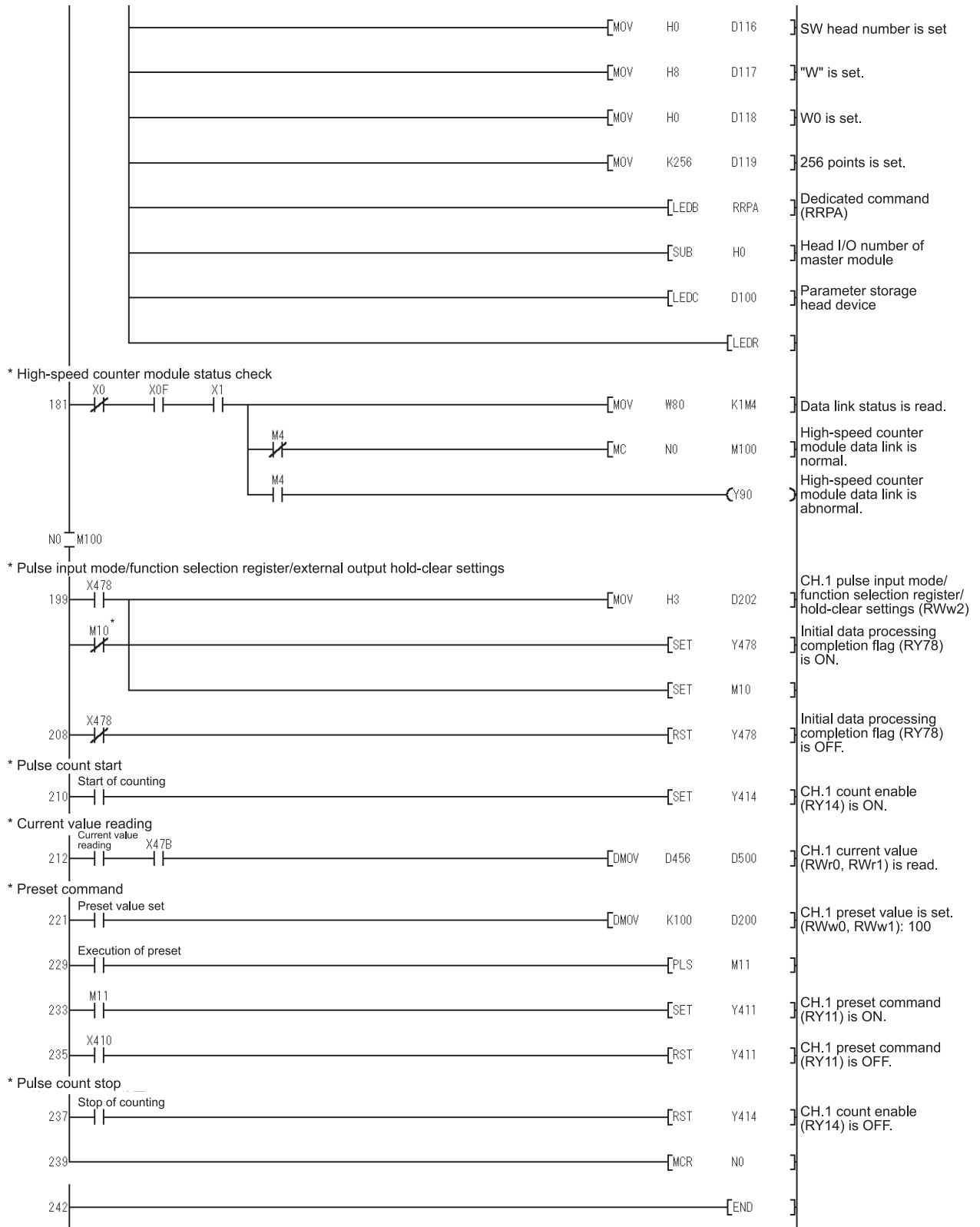

* When the programmable controller CPU is reset, the pulse input mode/function selection register/external output hold-clear settings are reset.

10.5.3 Program example of preset with external control signal

* Network parameter settings with dedicated command RLPA

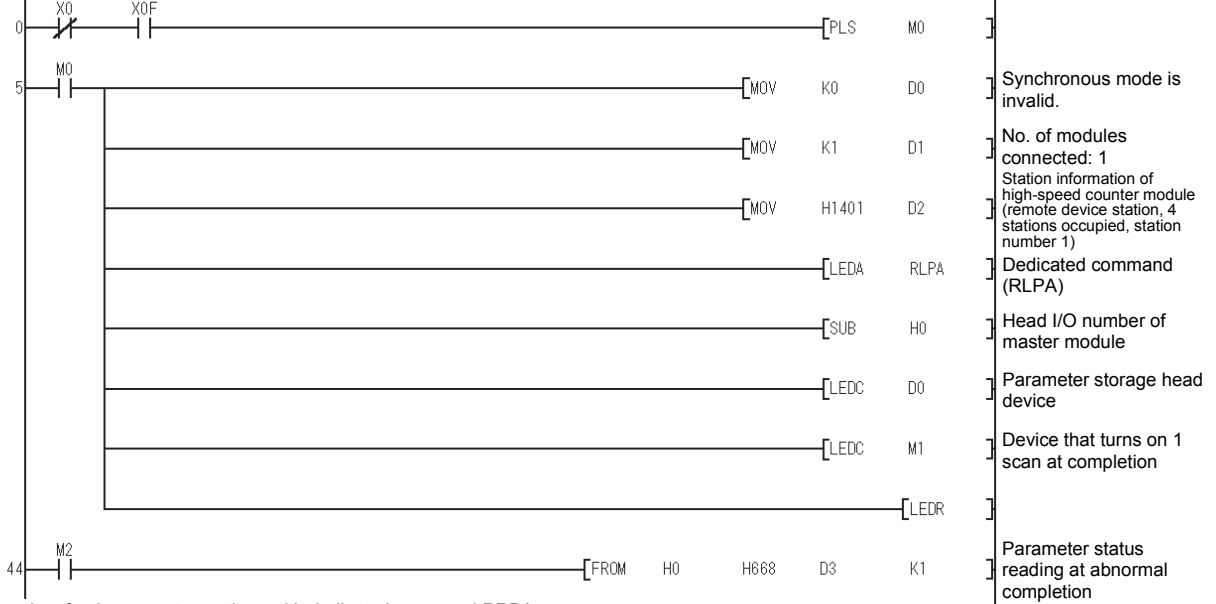

* Automatic refresh parameter settings with dedicated command RRPA

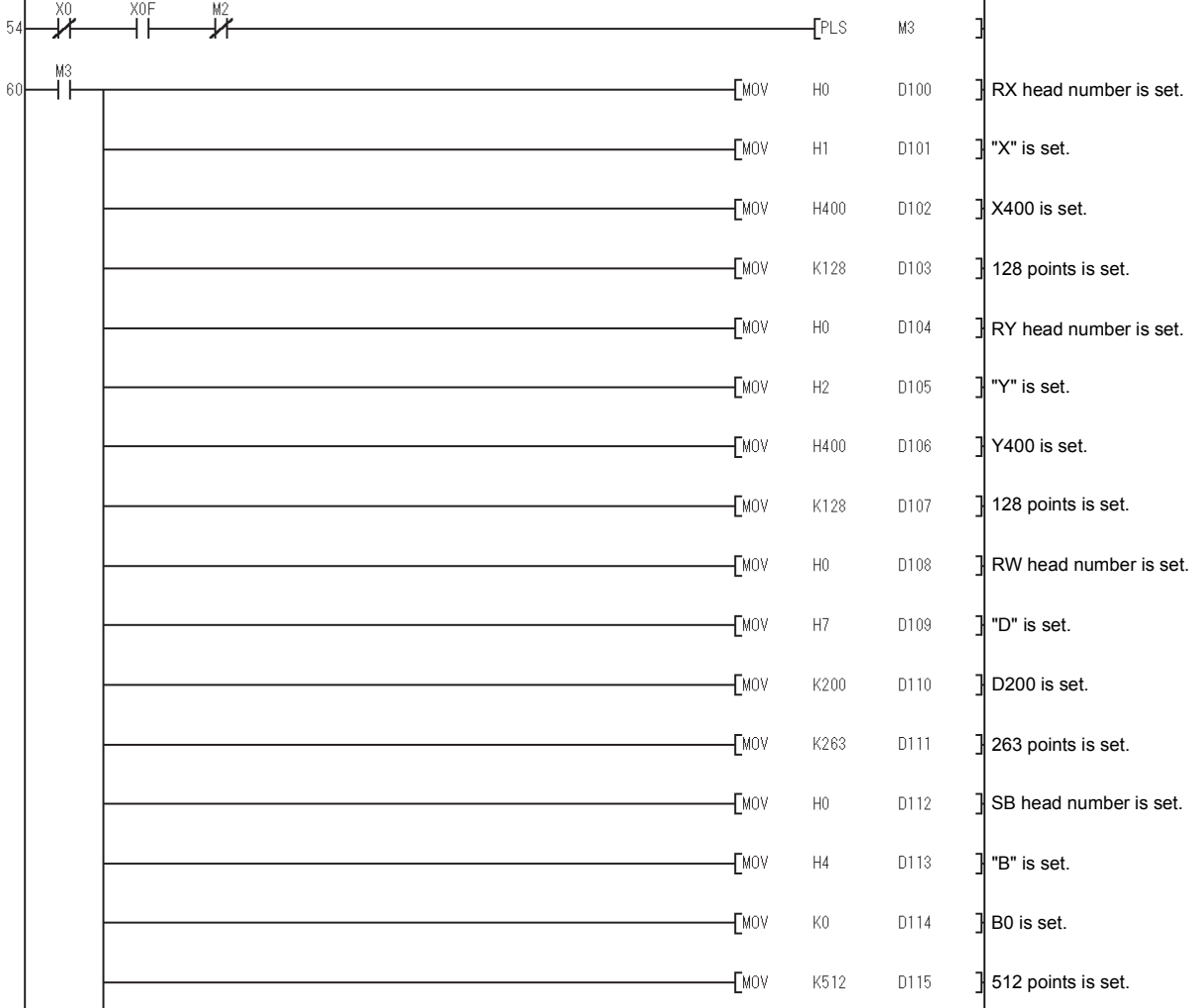

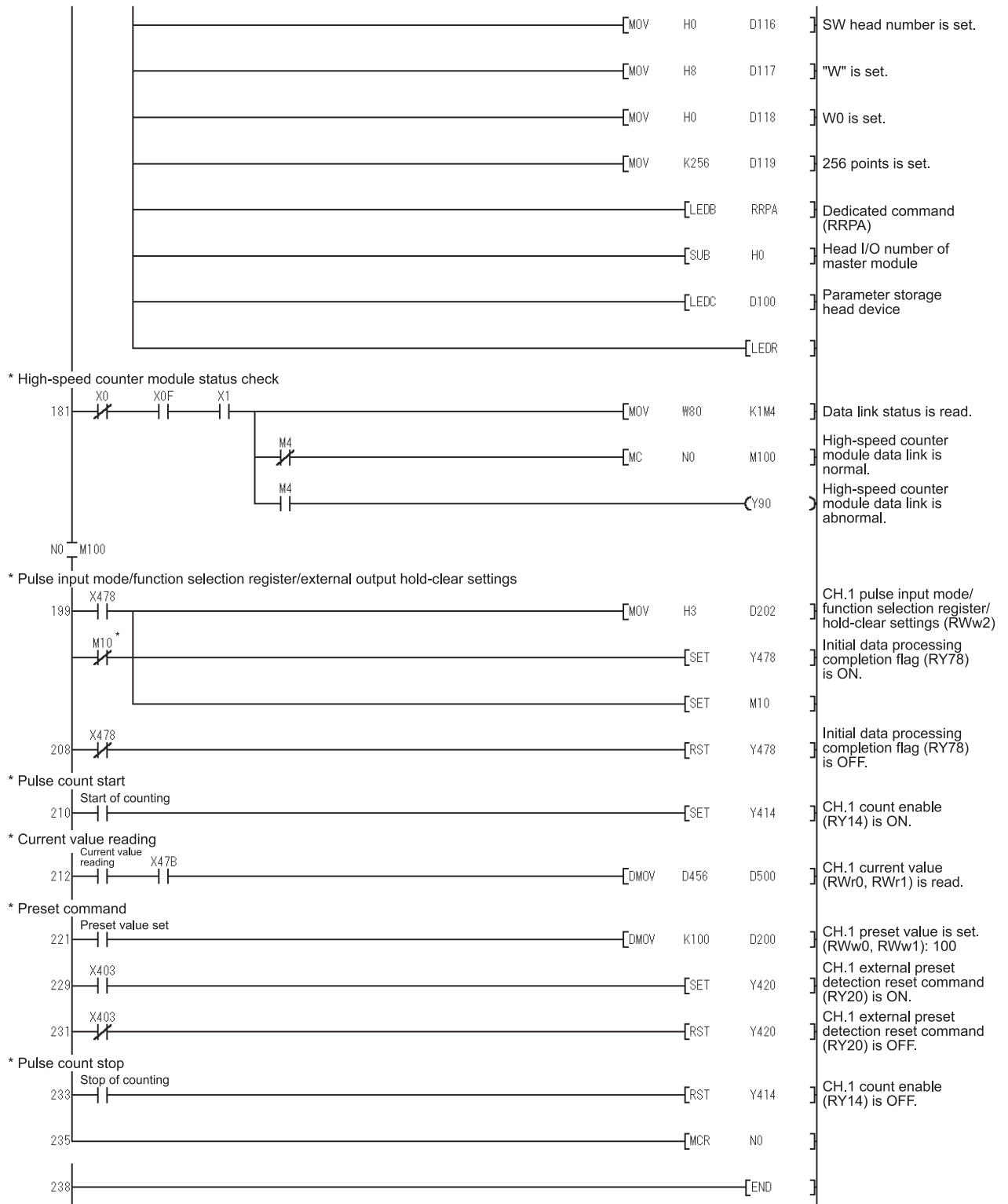

* When the programmable controller CPU is reset, the pulse input mode/function selection register/external output hold-clear settings are reset.

10.5.4 Program example of ring counter function

* Network parameter settings with dedicated command RLPA

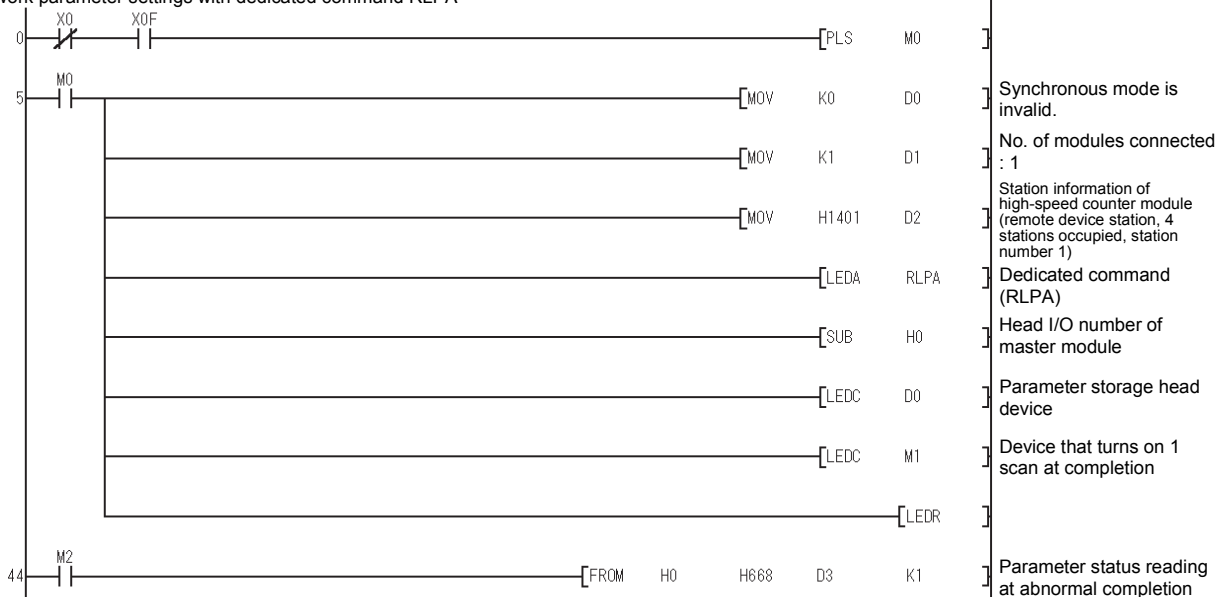

Synchronous mode is invalid.
 No. of modules connected : 1
 Station information of high-speed counter module (remote device station, 4 stations occupied, station number 1)
 Dedicated command (RLPA)
 Head I/O number of master module
 Parameter storage head device
 Device that turns on 1 scan at completion
 Parameter status reading at abnormal completion

* Automatic refresh parameter settings with dedicated command RRPA

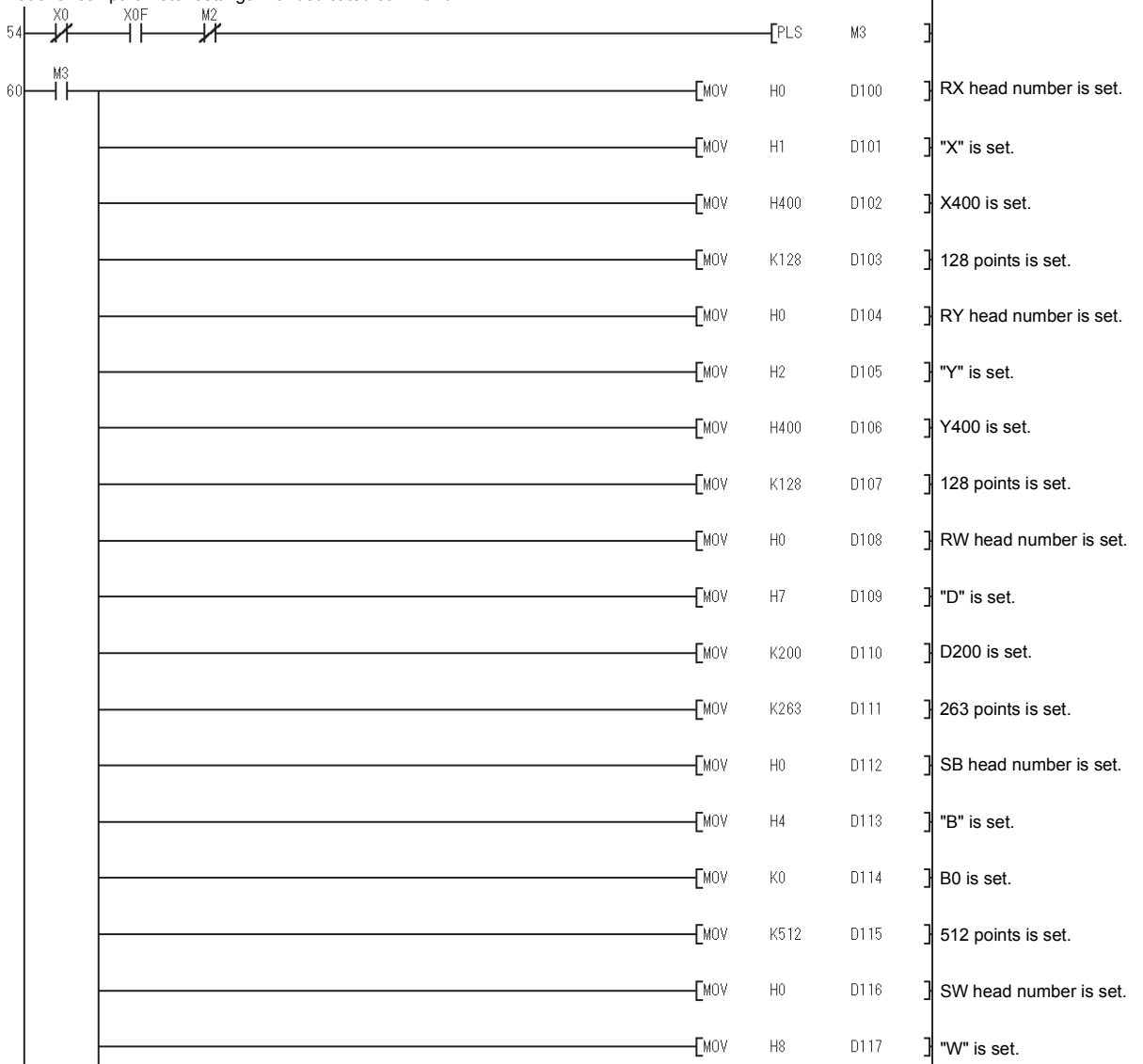

RX head number is set.
 "X" is set.
 X400 is set.
 128 points is set.
 RY head number is set.
 "Y" is set.
 Y400 is set.
 128 points is set.
 RW head number is set.
 "D" is set.
 D200 is set.
 263 points is set.
 SB head number is set.
 "B" is set.
 B0 is set.
 512 points is set.
 SW head number is set.
 "W" is set.

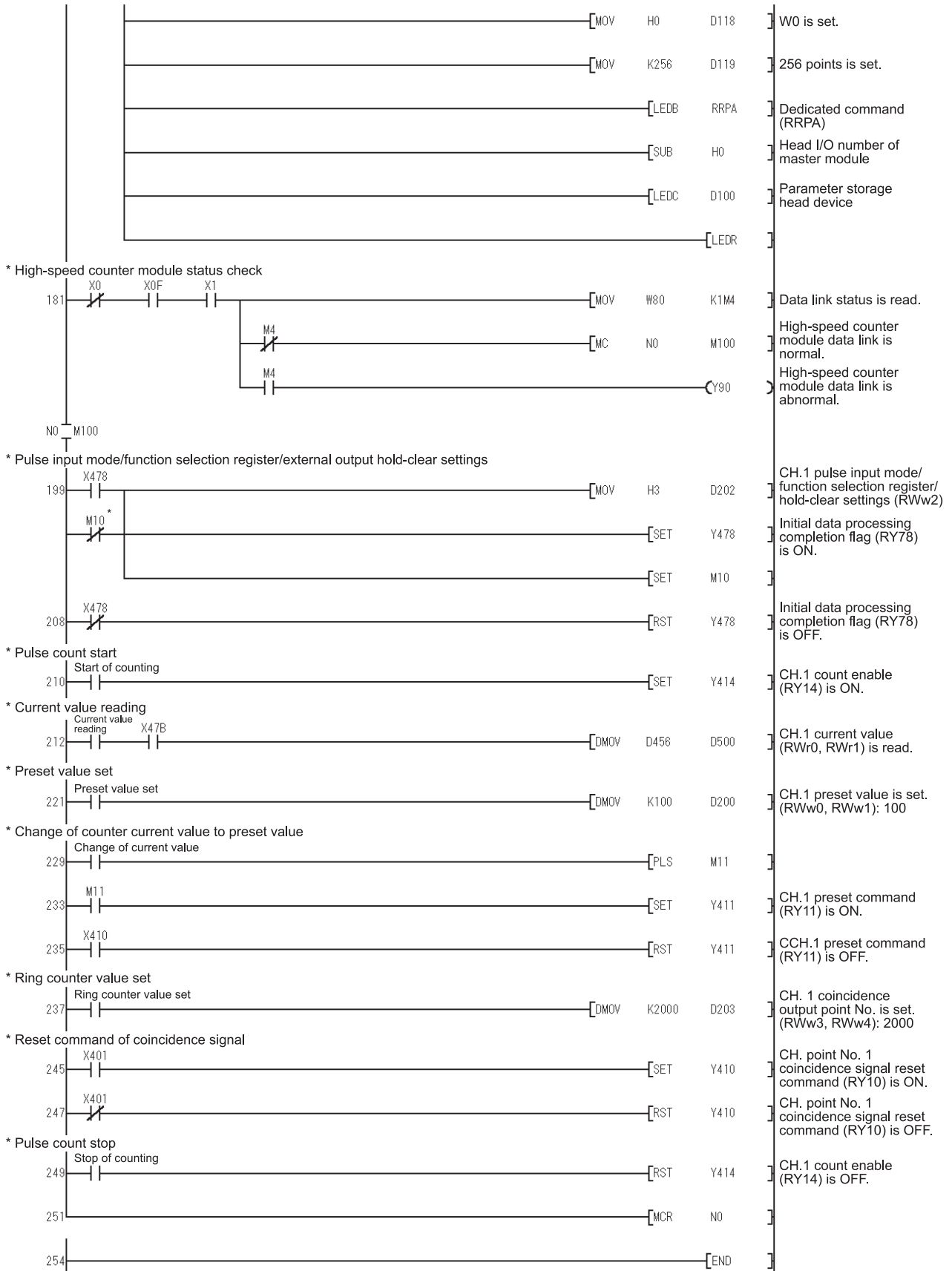

* When the programmable controller CPU is reset, the pulse input mode/function selection register/external output hold-clear settings are reset.

10.5.5 Program example of count disable function

* Network parameter settings with dedicated command RLPA

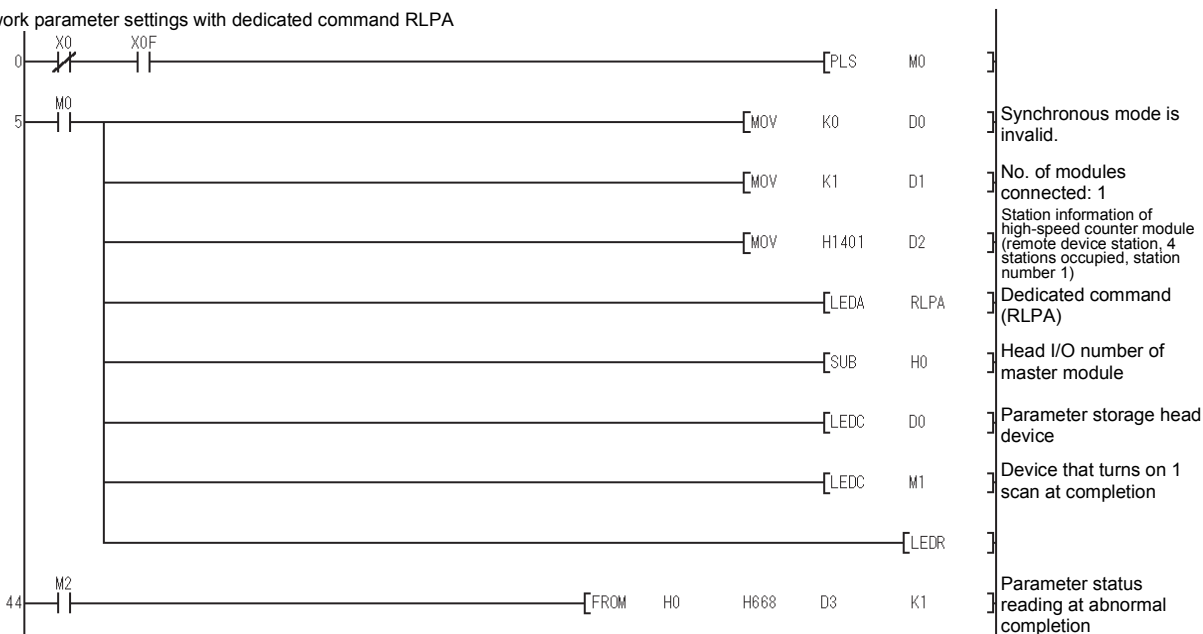

* Automatic refresh parameter settings with dedicated command RRPA

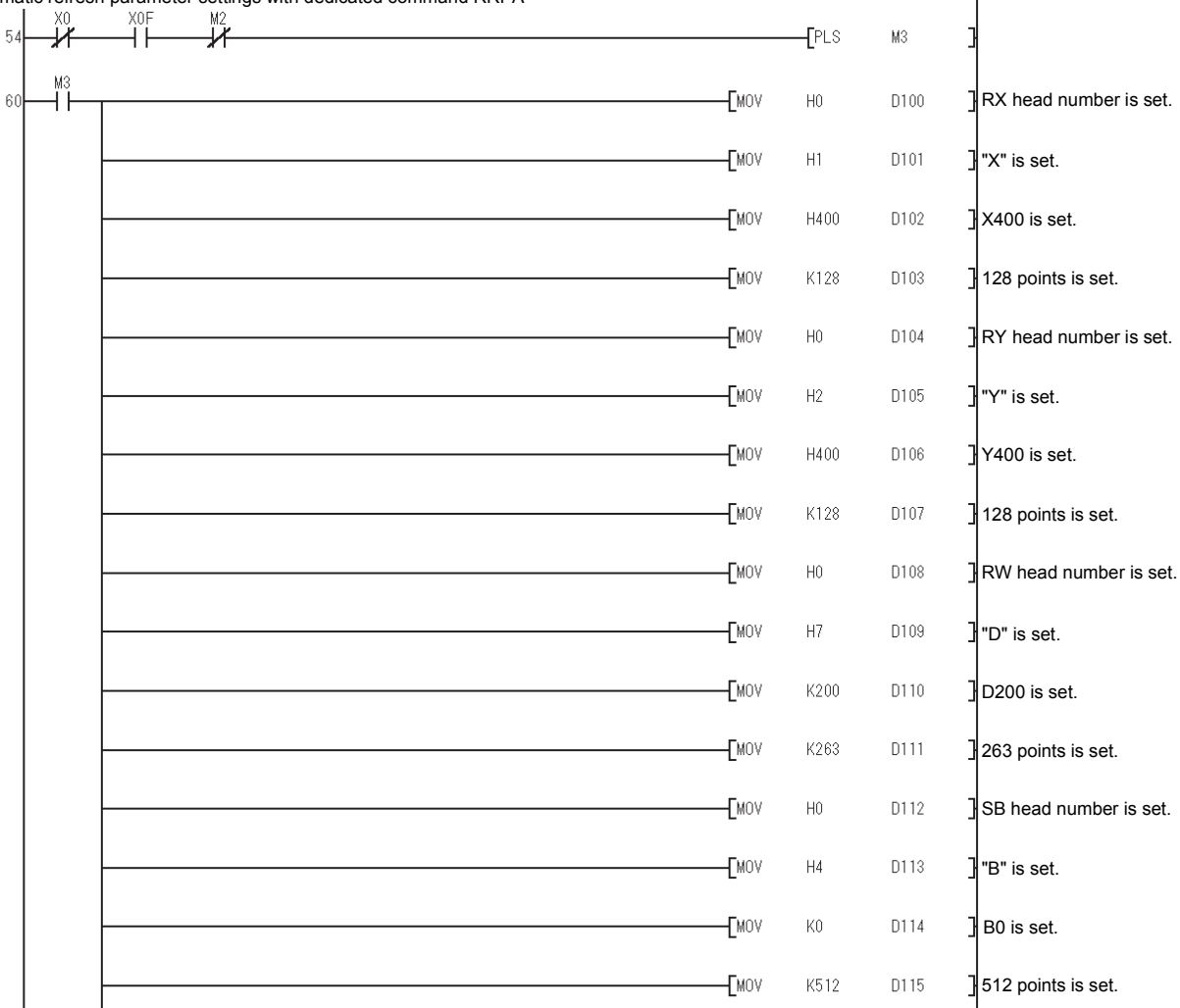

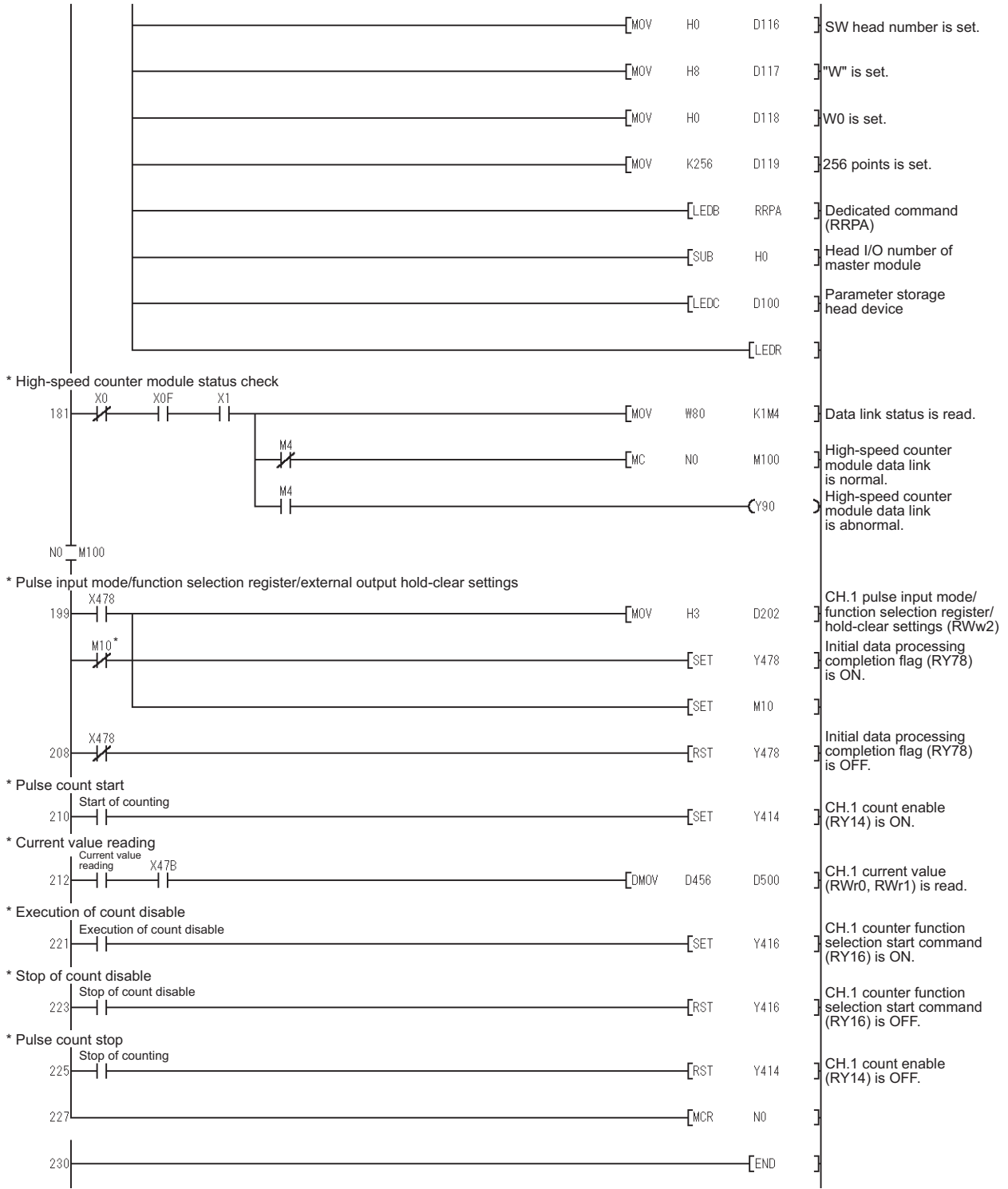

10.5.6 Program example of latch counter function

* Network parameter settings with dedicated command RLPA

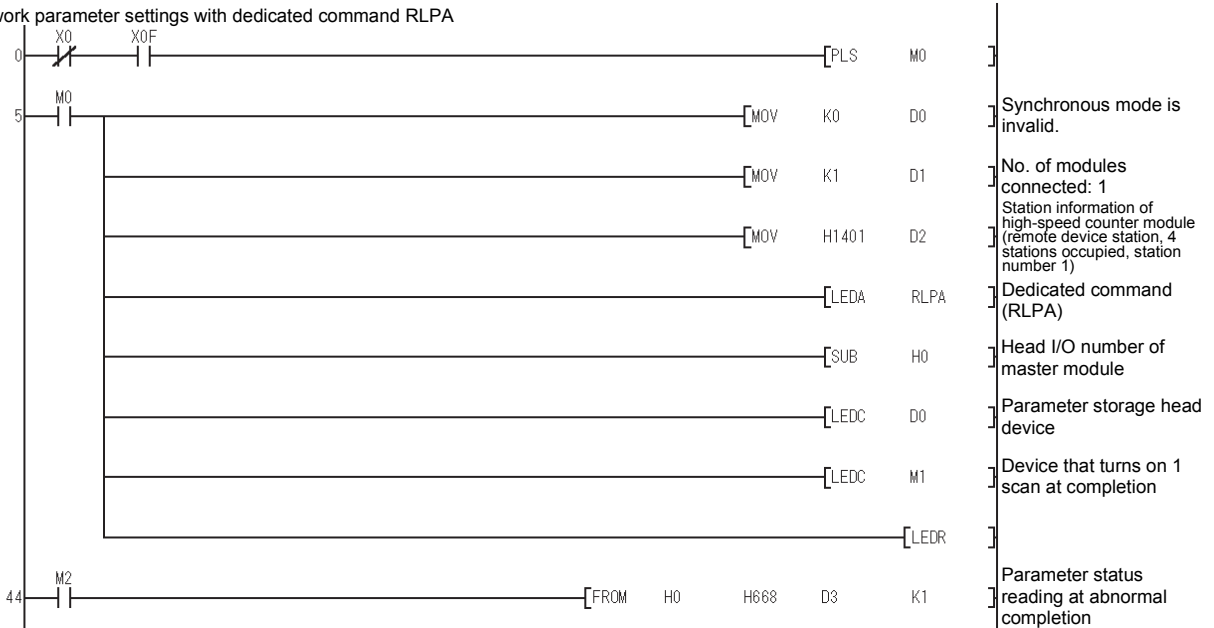

* Automatic refresh parameter settings with dedicated command RRPA

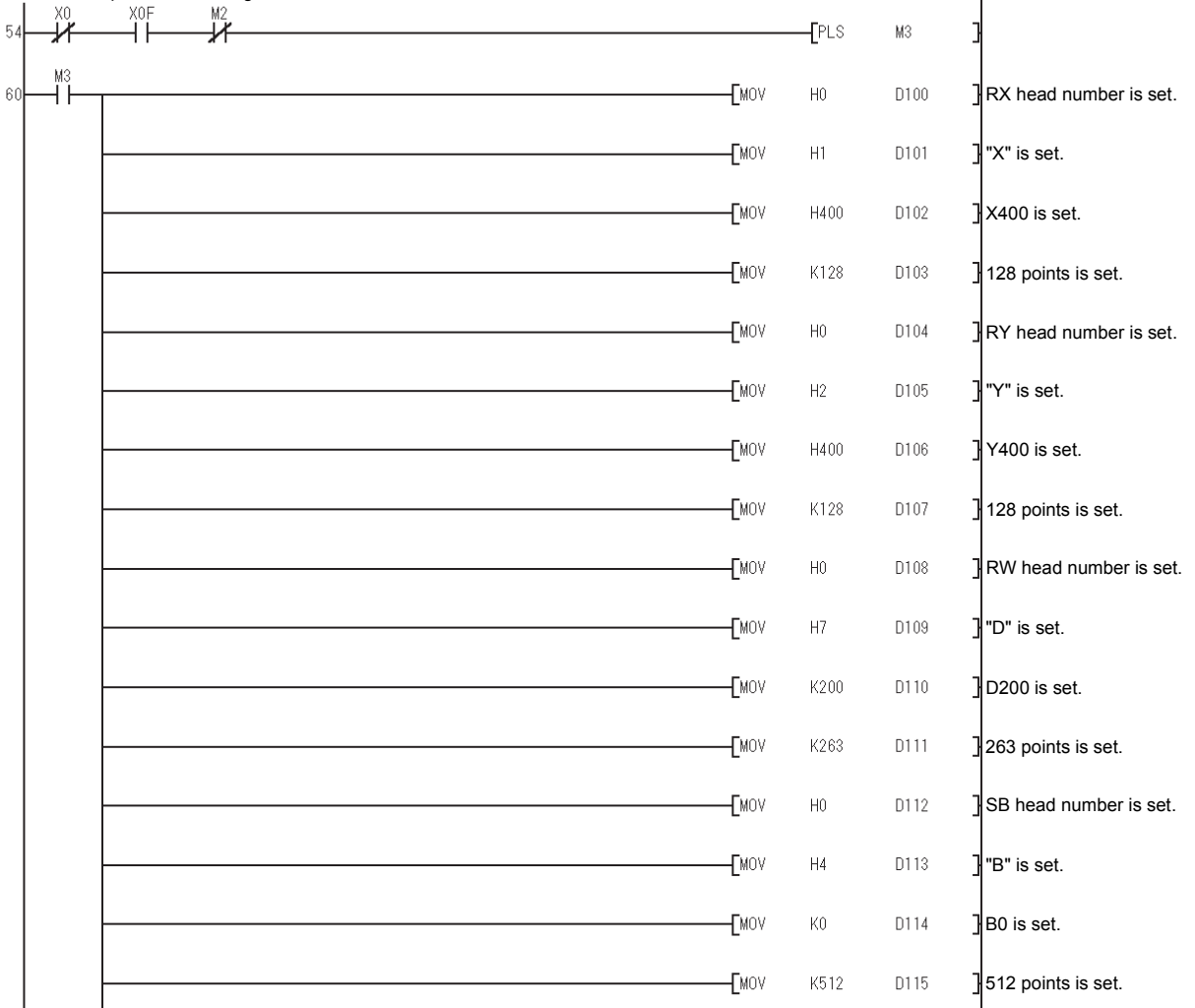

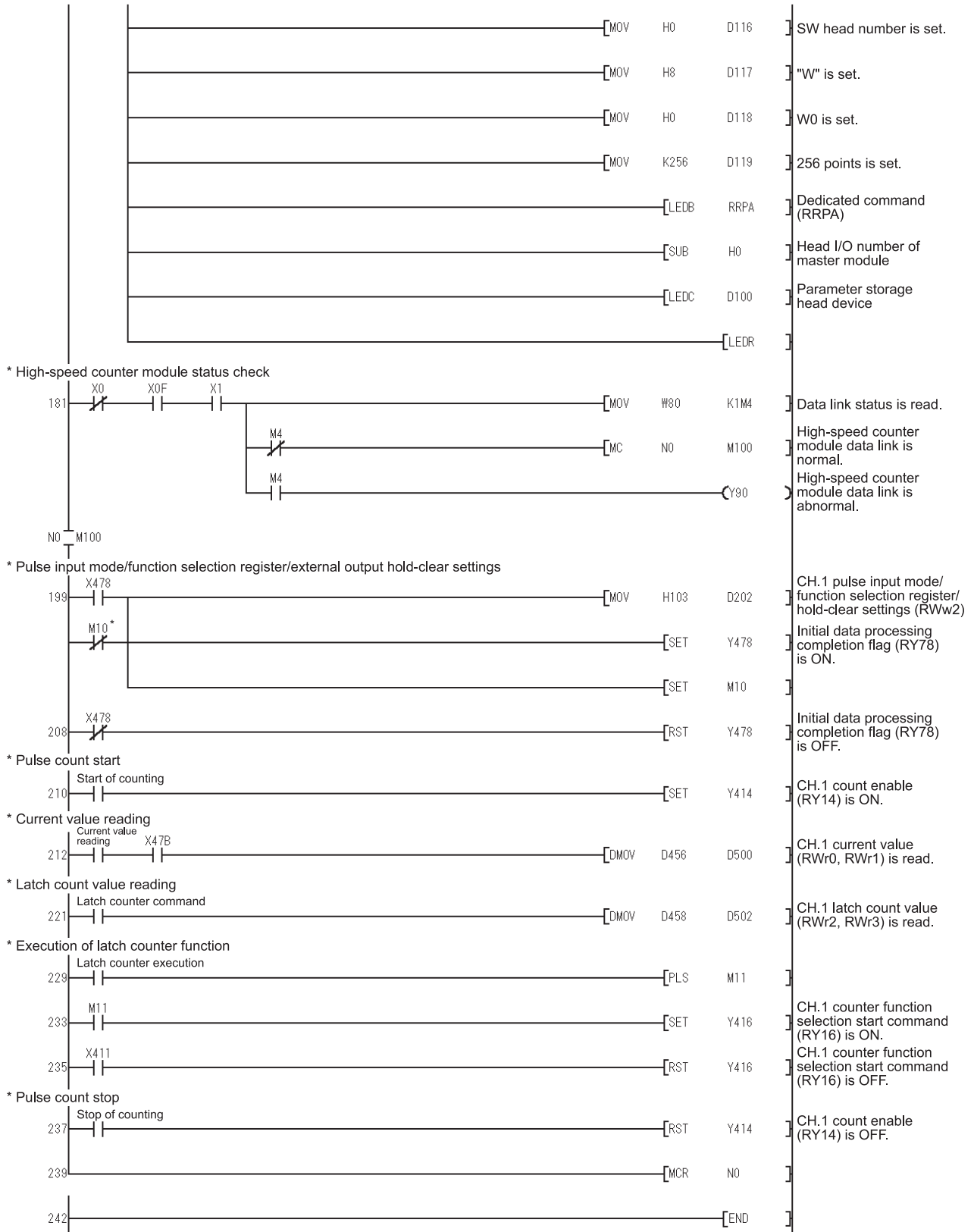

* When the programmable controller CPU is reset, the pulse input mode/function selection register/external output hold-clear settings are reset.

10.5.7 Program example of sampling counter function

* Network parameter settings with dedicated command RLPA

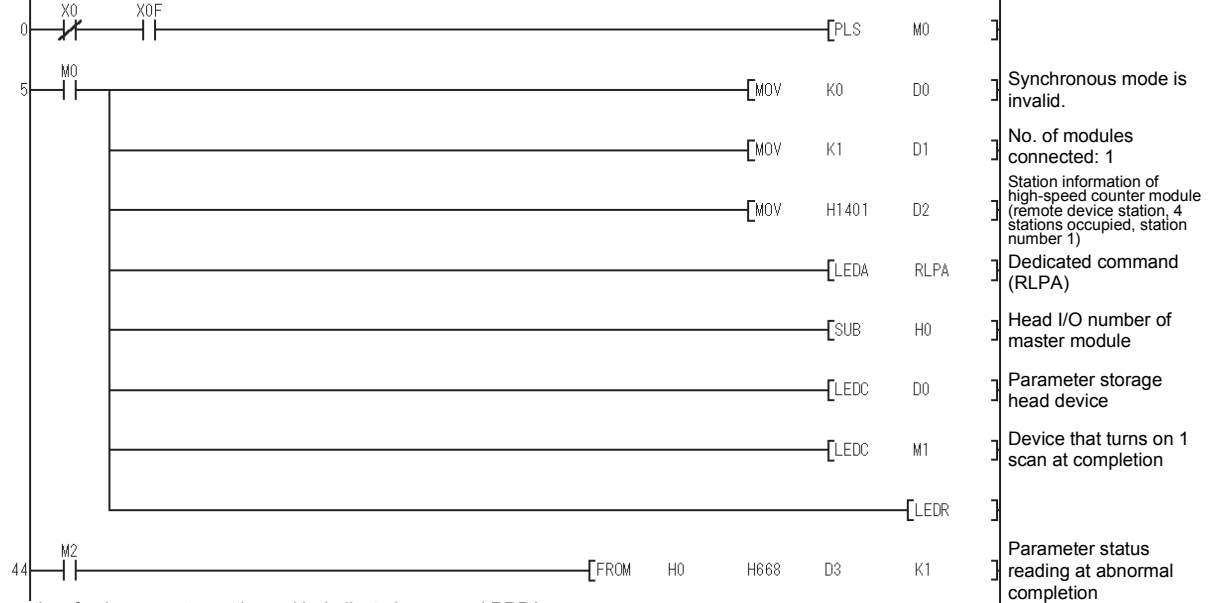

* Automatic refresh parameter settings with dedicated command RRPA

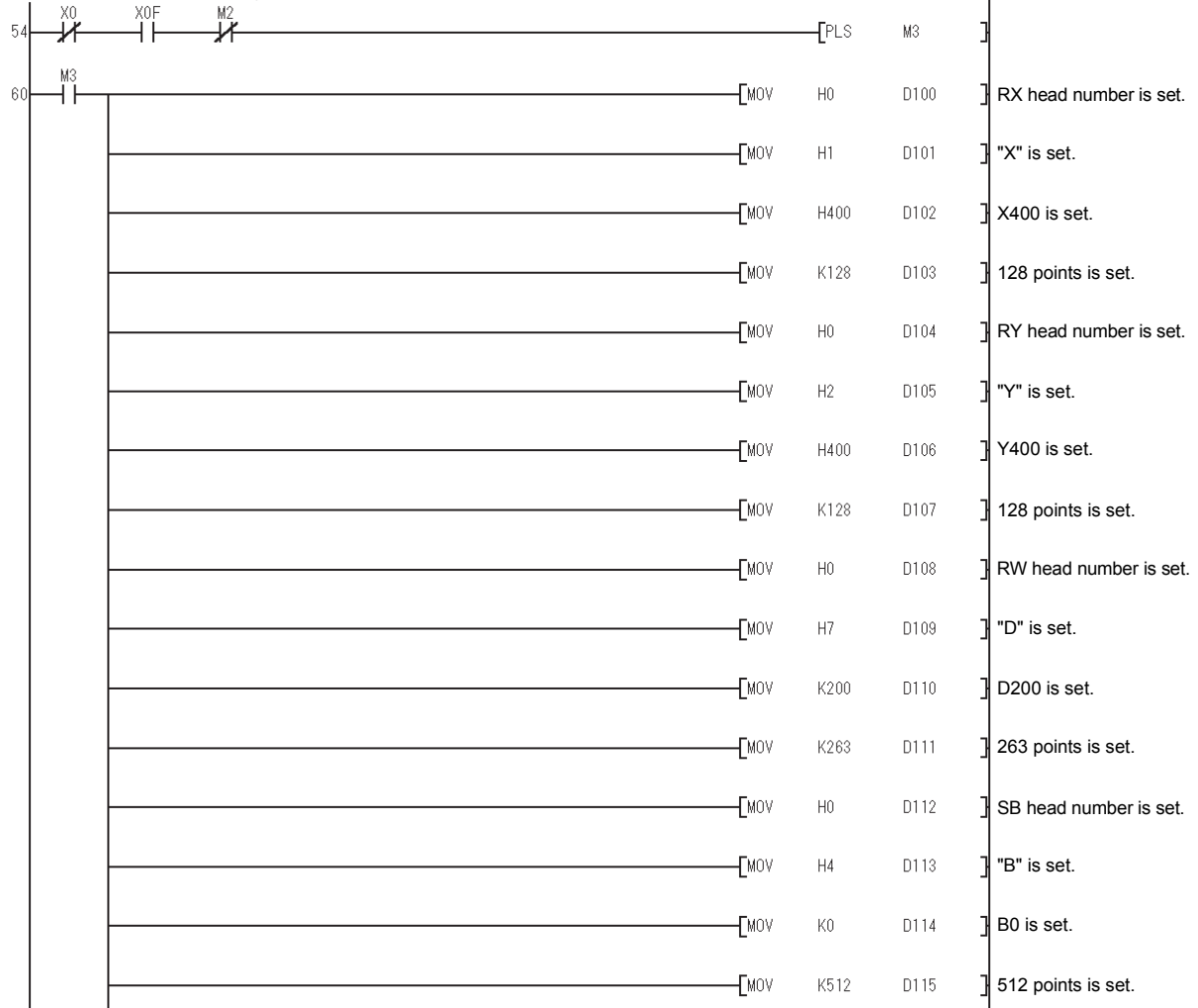

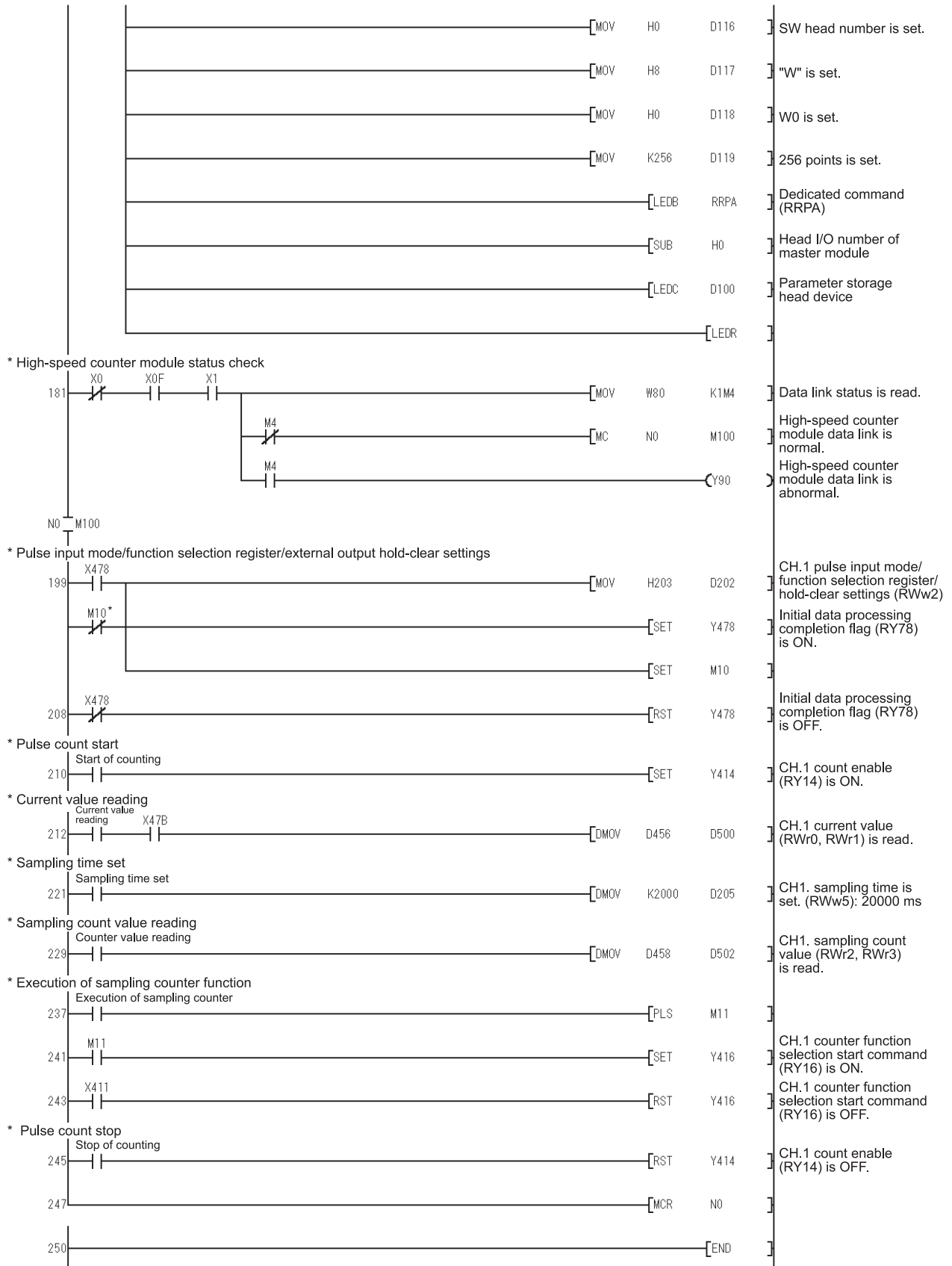

* When the programmable controller CPU is reset, the pulse input mode/function selection register/external output hold-clear settings are reset.

10.5.8 Program example of frequency pulse counter function

* Network parameter settings with dedicated command RLPA

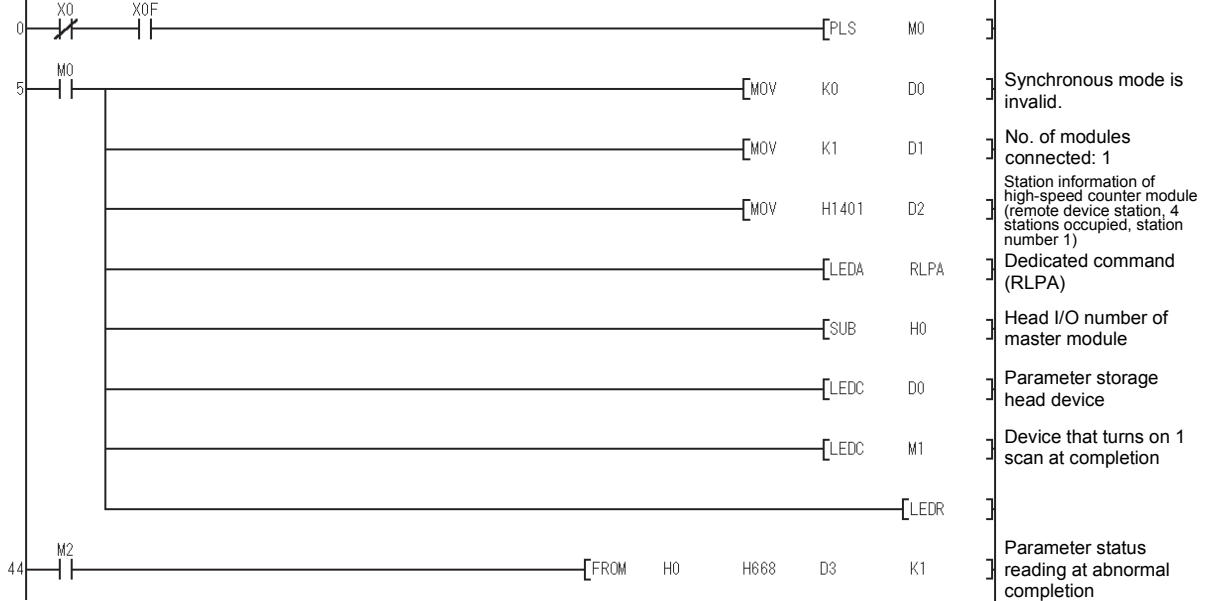

* Automatic refresh parameter settings with dedicated command RRPA

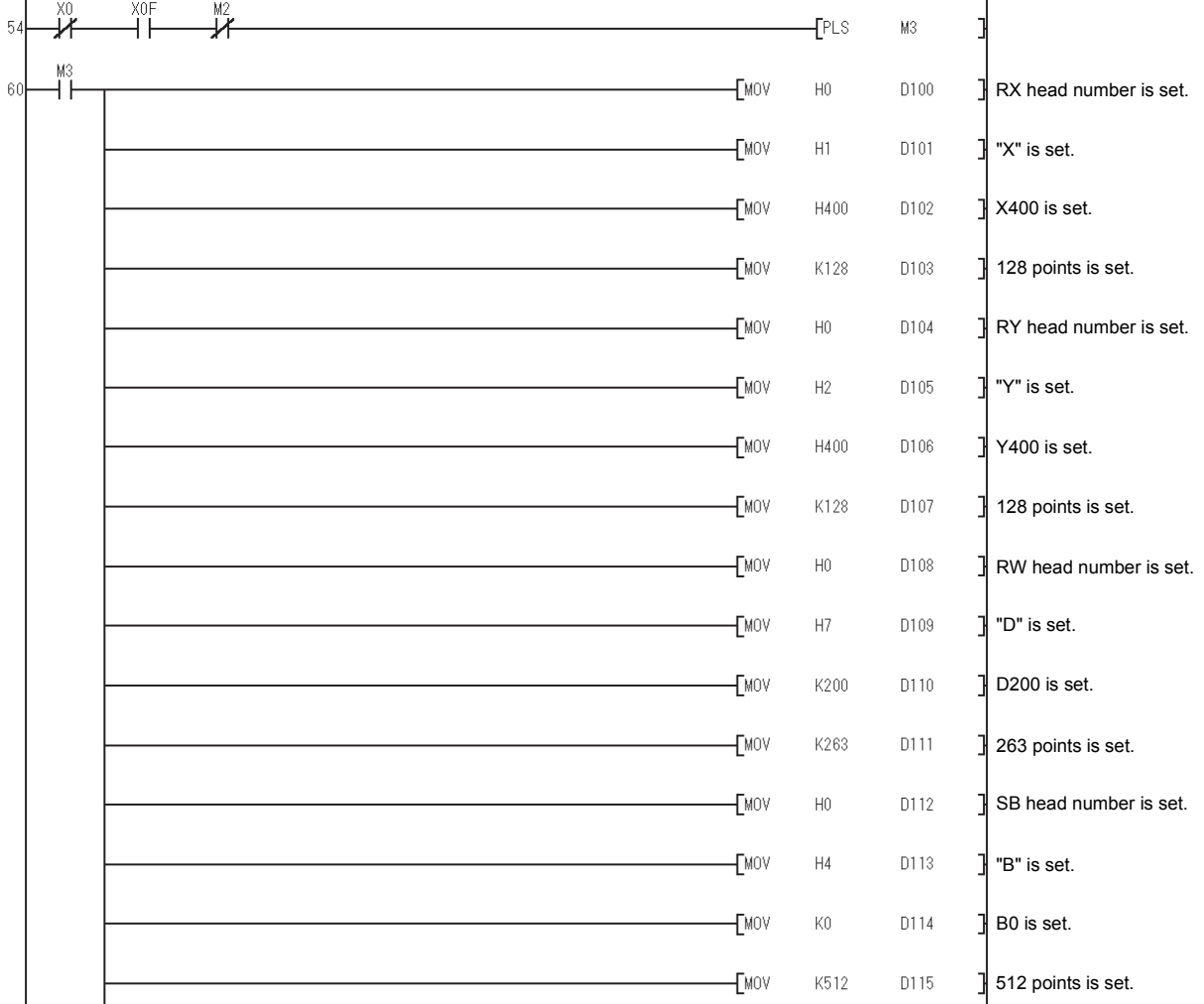

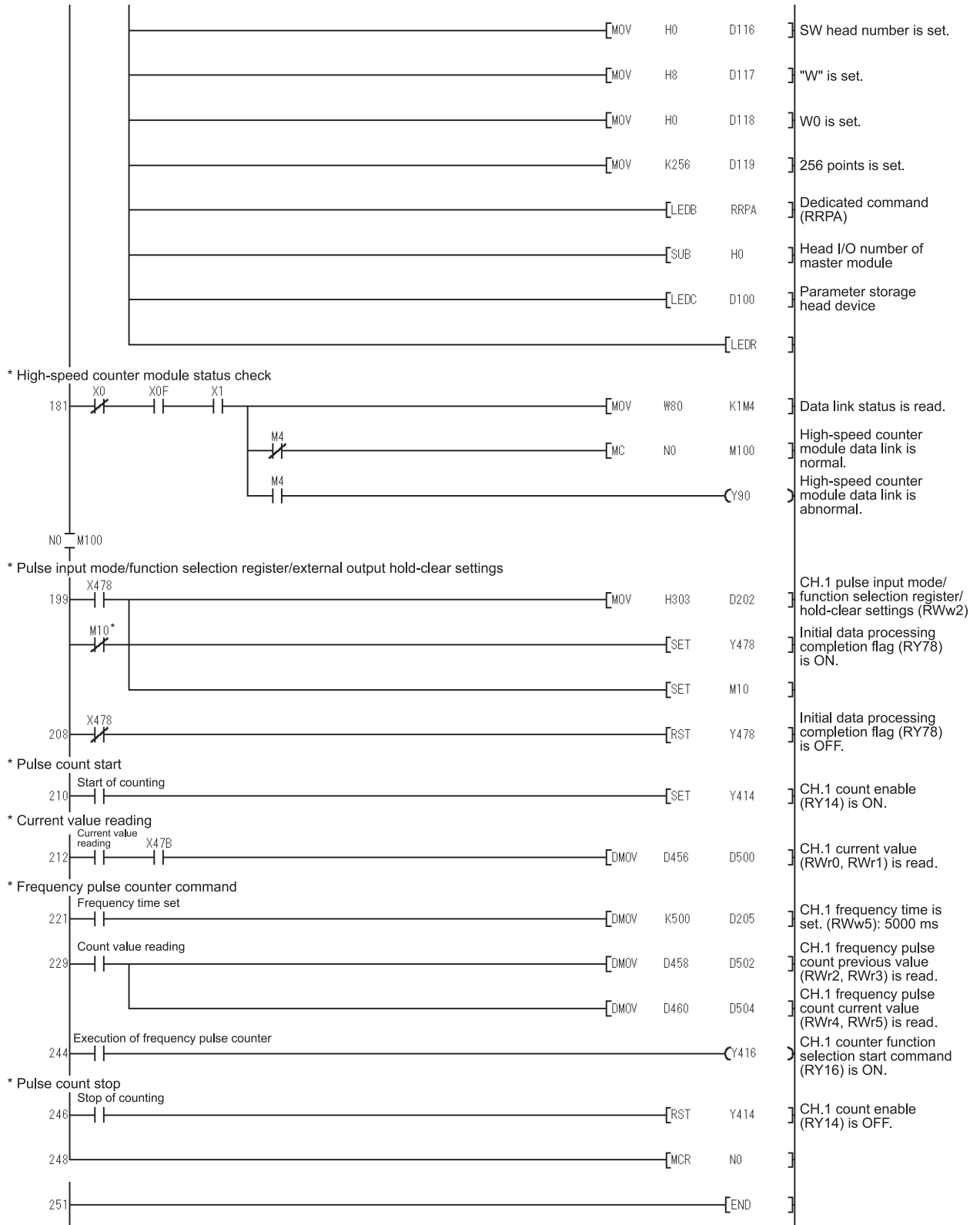

* When the programmable controller CPU is reset, the pulse input mode/function selection register/external output hold-clear settings are reset.

10.6 Program Example when ACPU/QCPU (A Mode) is Used (From/To Command)

Network parameters are set by the sequence program.

10.6.1 Program example of coincidence output function

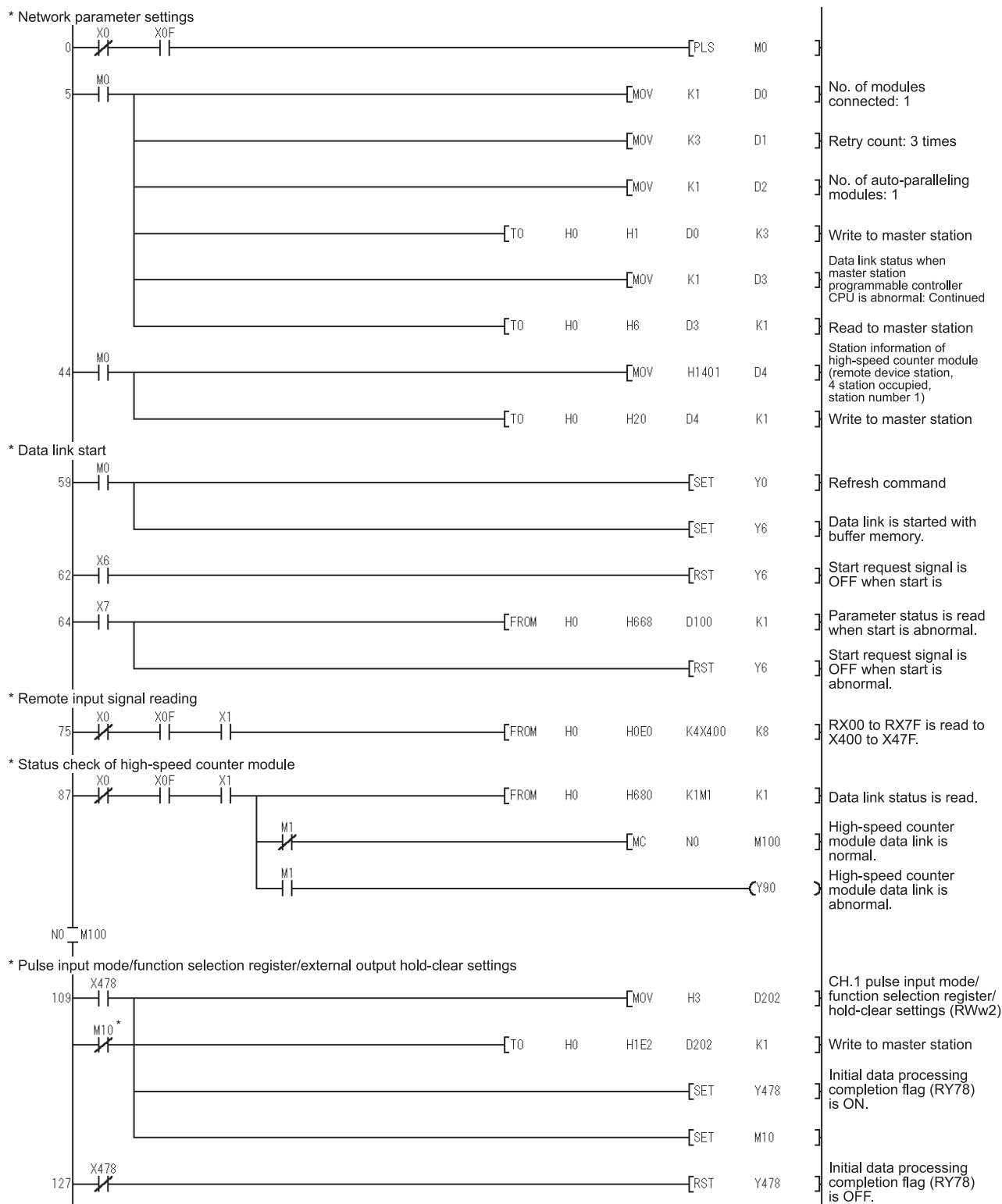

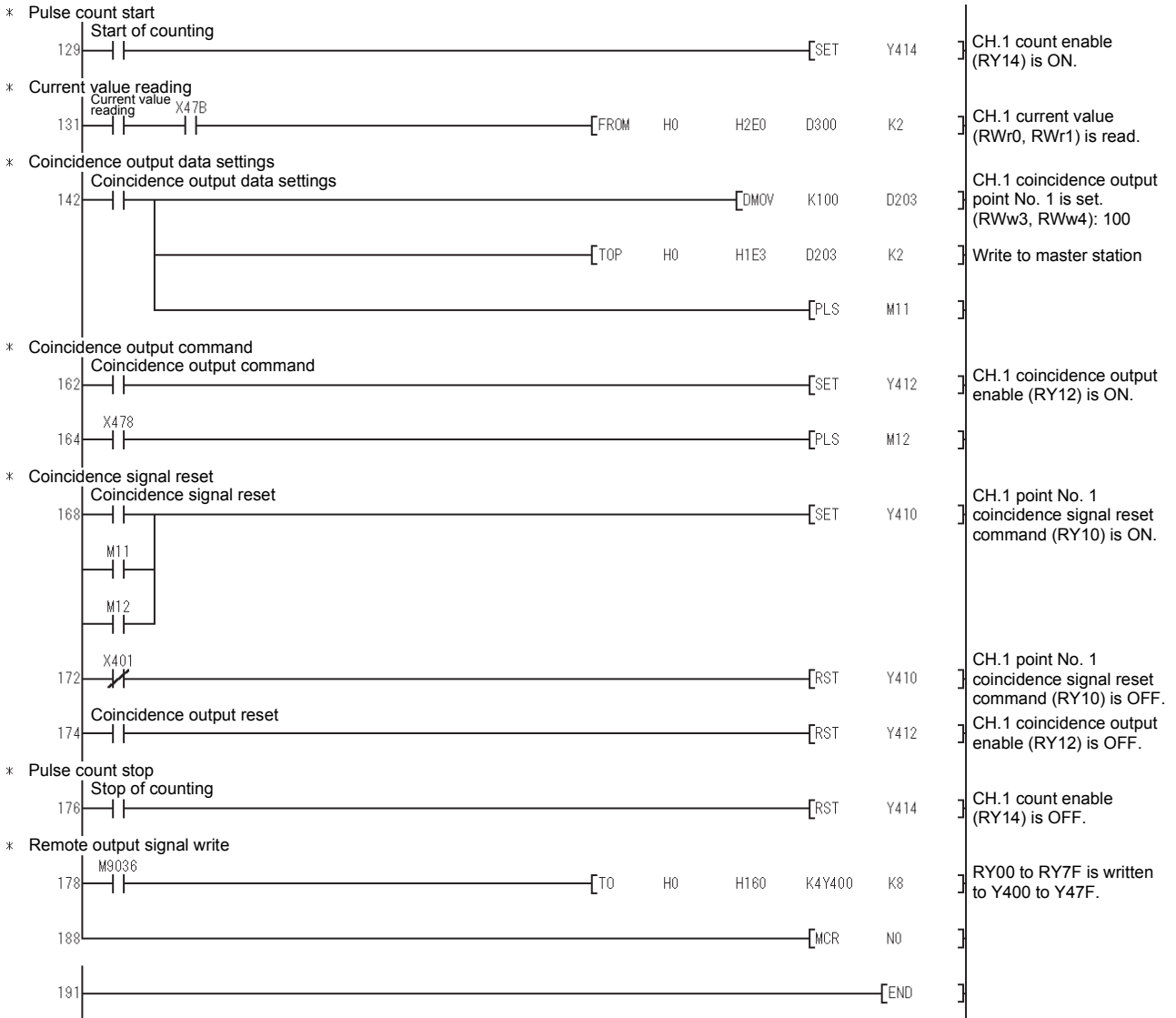

10.6.2 Program example of preset with sequence program

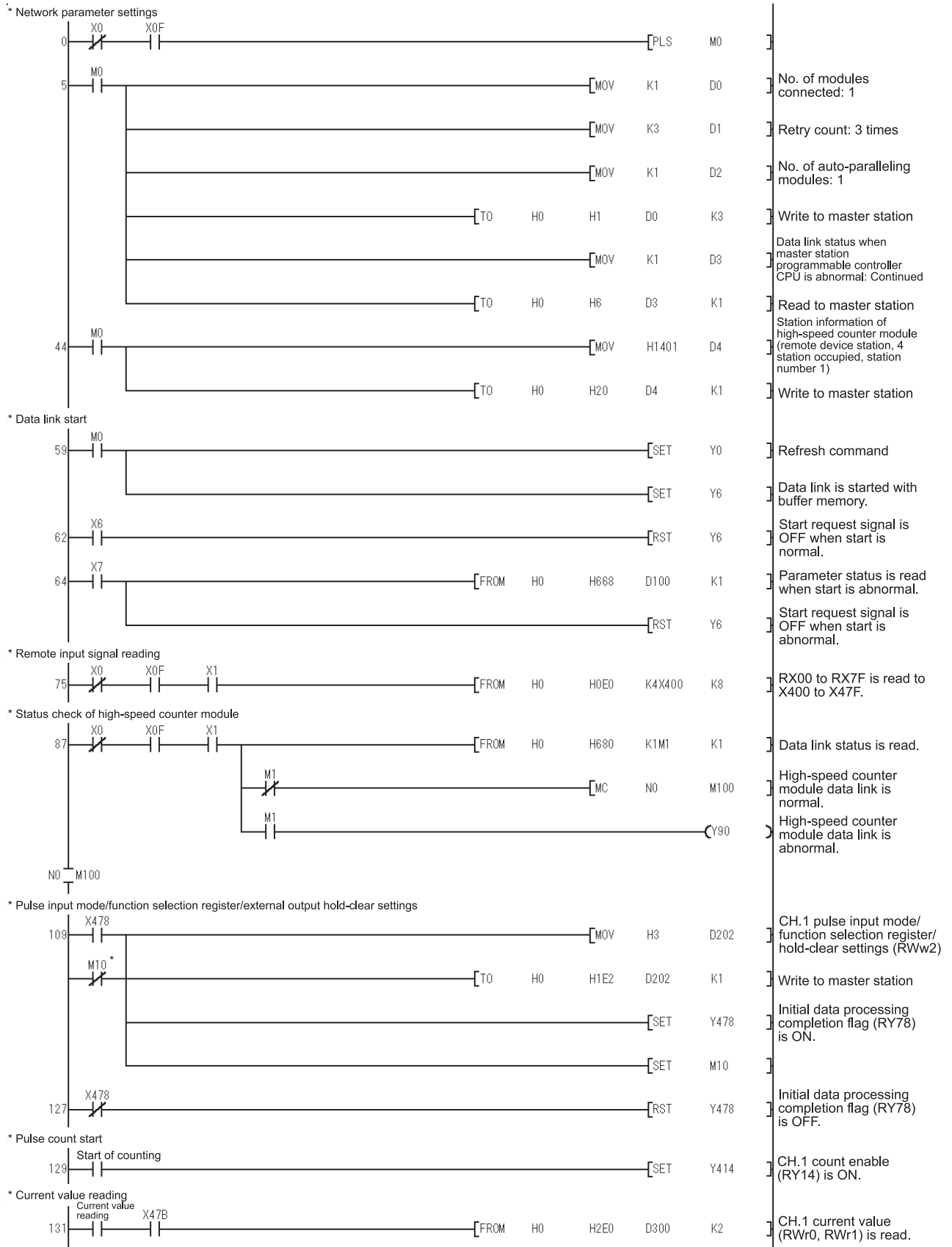

* When the programmable controller CPU is reset, the pulse input mode/function selection register/external output hold-clear settings are reset.

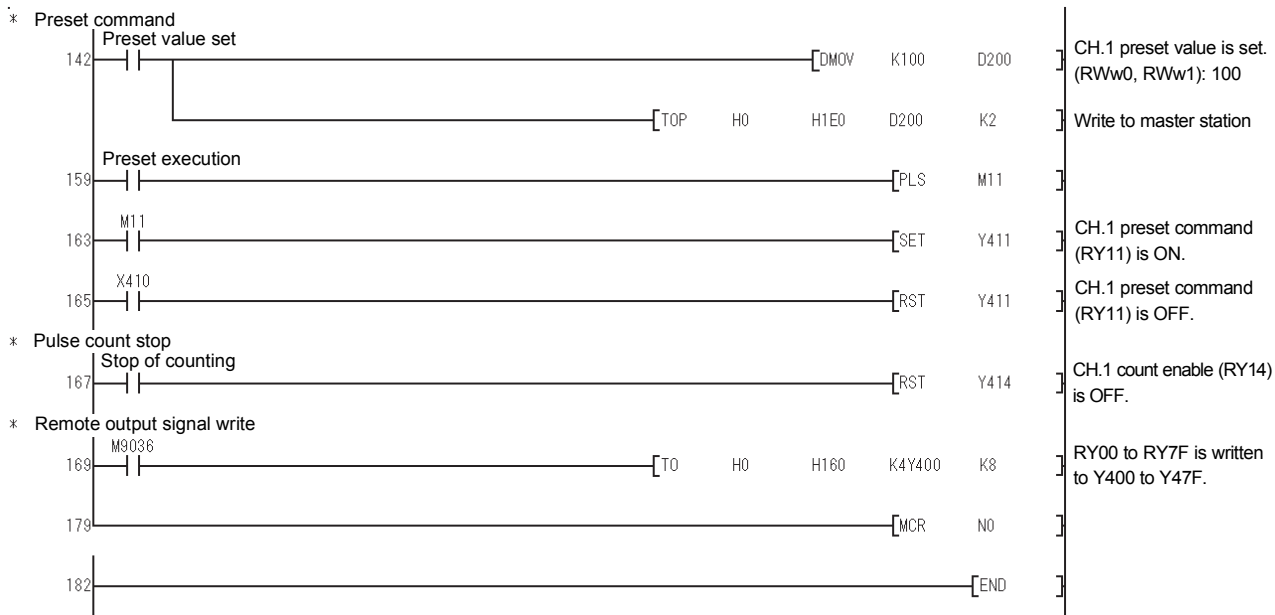

10.6.3 Program example of preset with external control signal

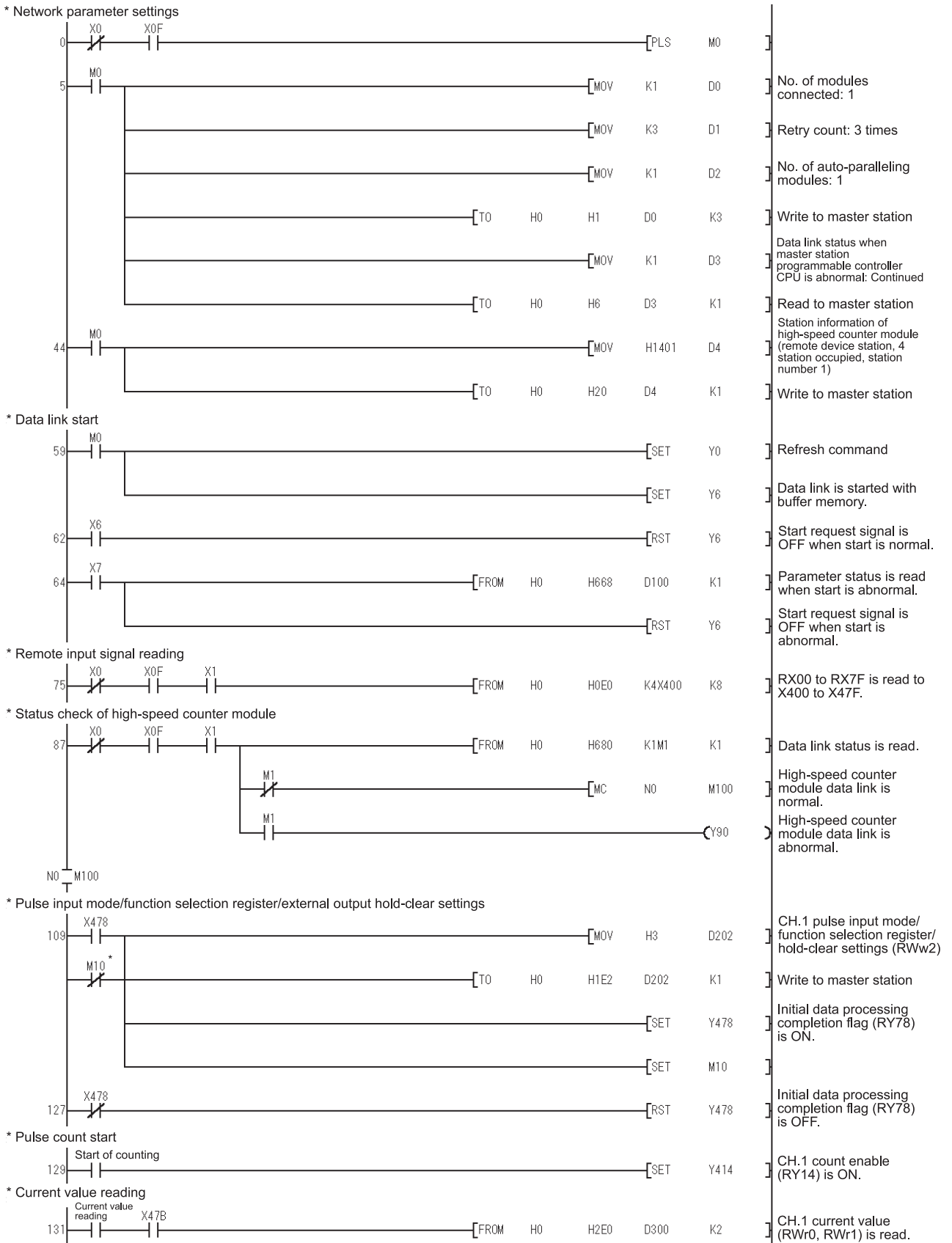

* When the programmable controller CPU is reset, the pulse input mode/function selection register/external output hold-clear settings are reset.

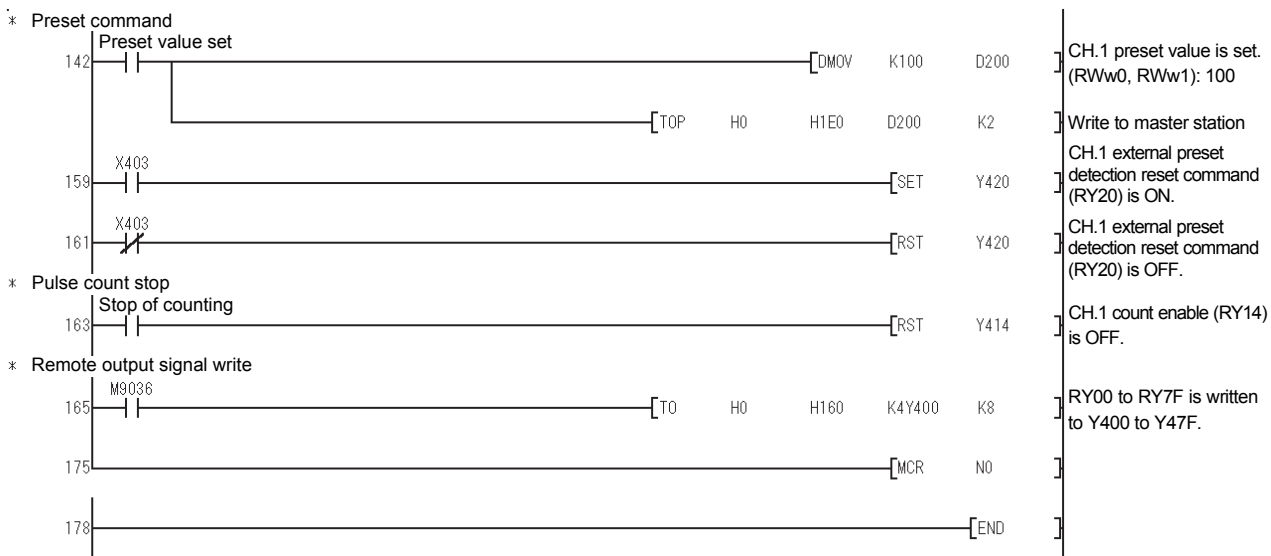

10.6.4 Program example of ring counter function

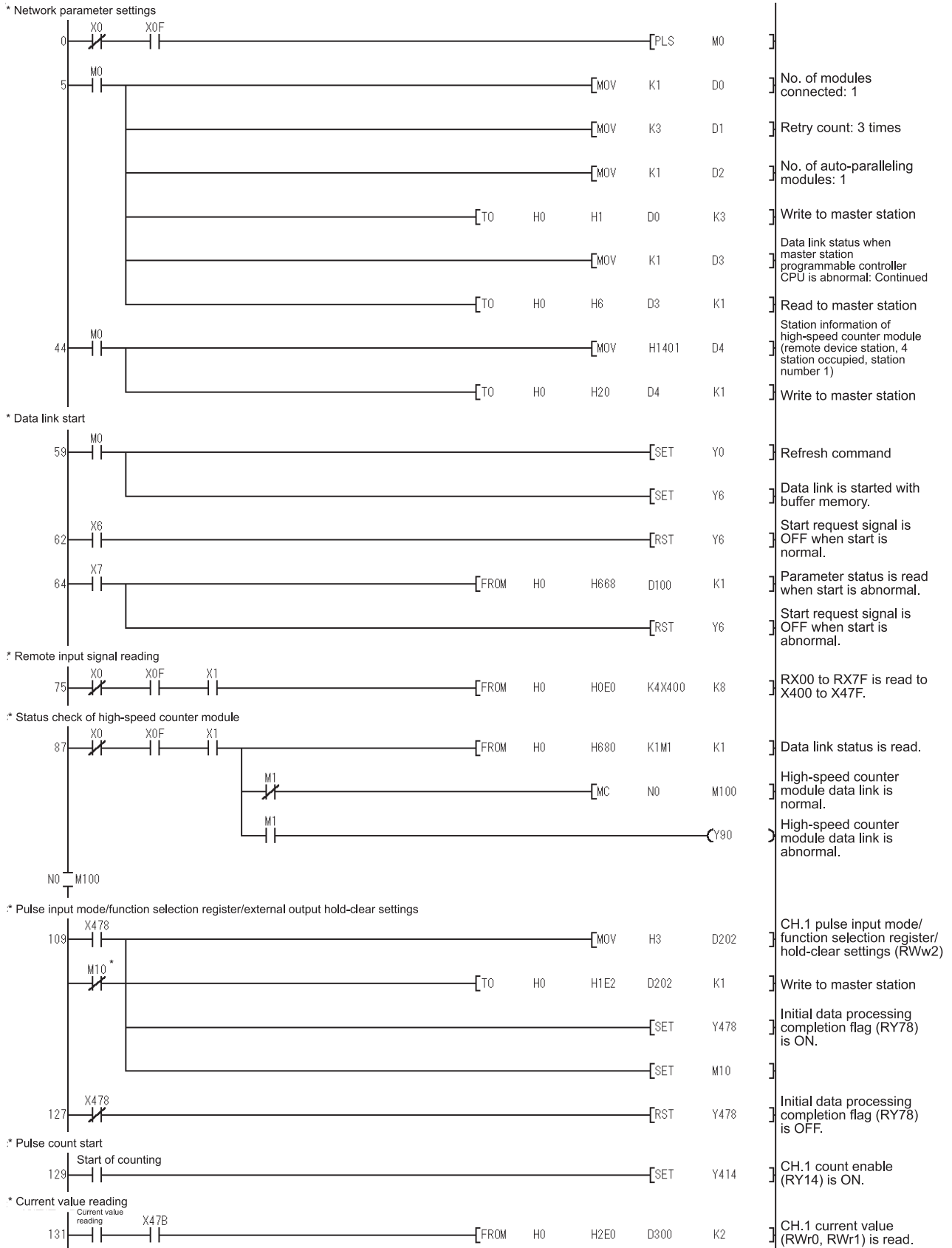

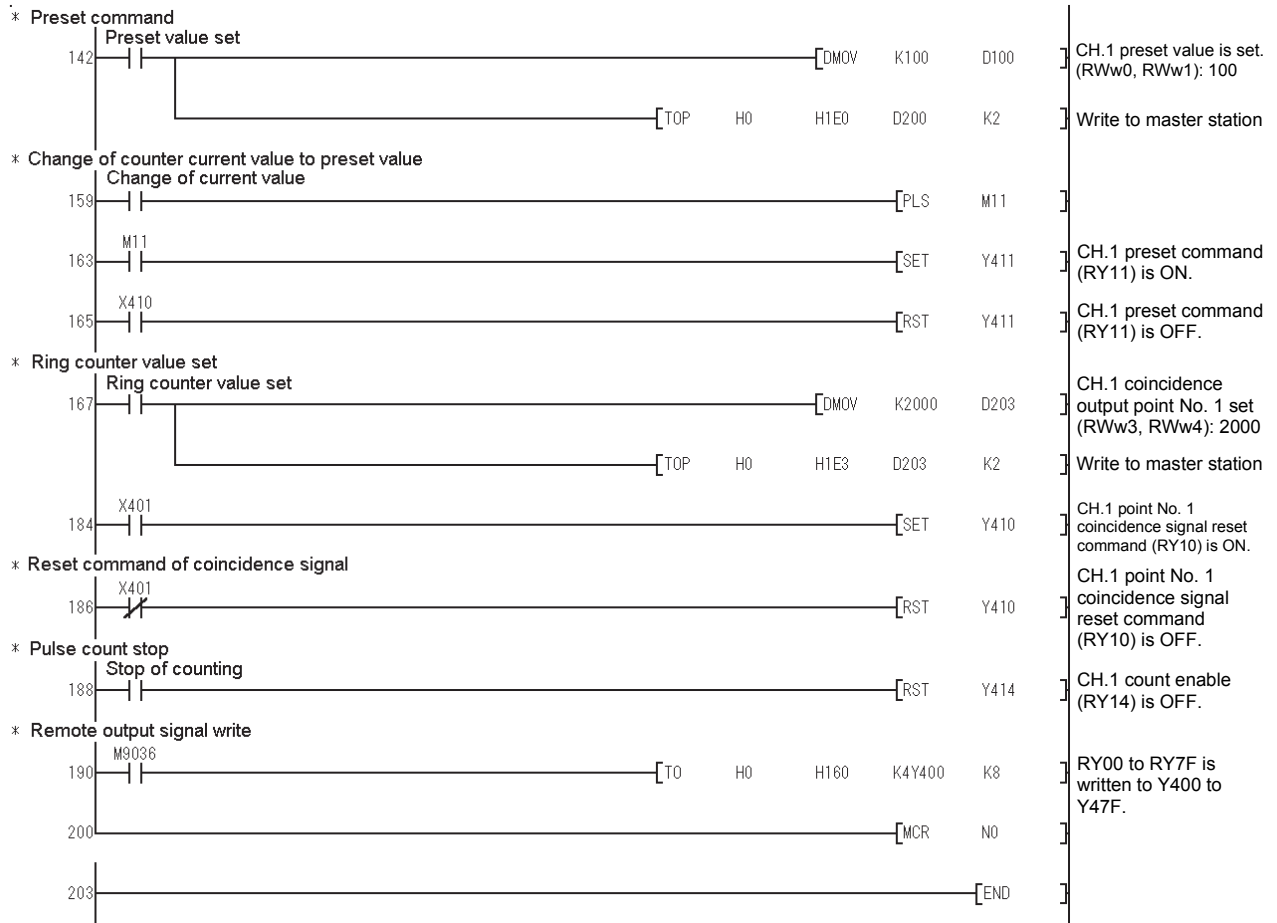

10.6.5 Program example of count disable function

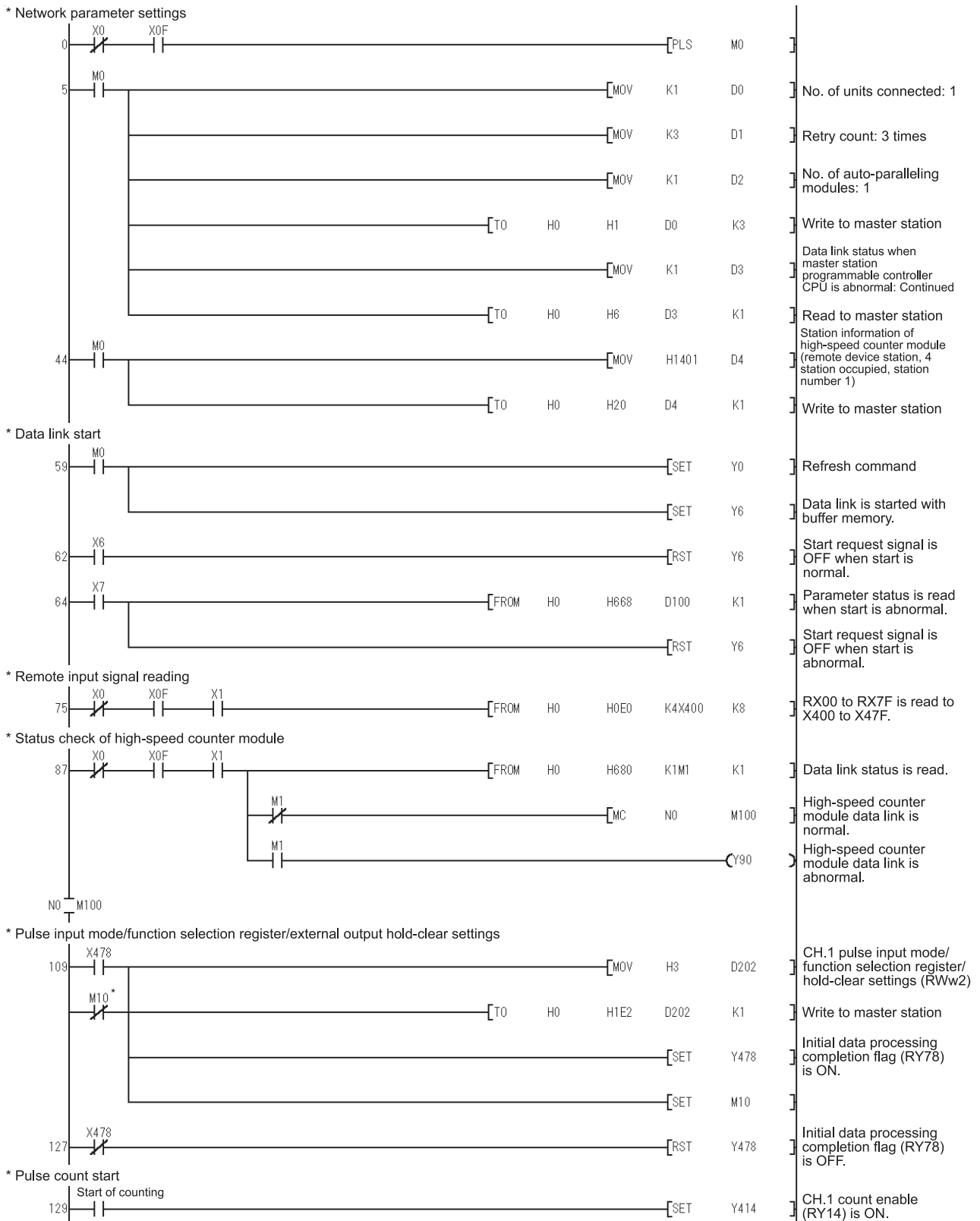

* When the programmable controller CPU is reset, the pulse input mode/function selection register/external output hold-clear settings are reset.

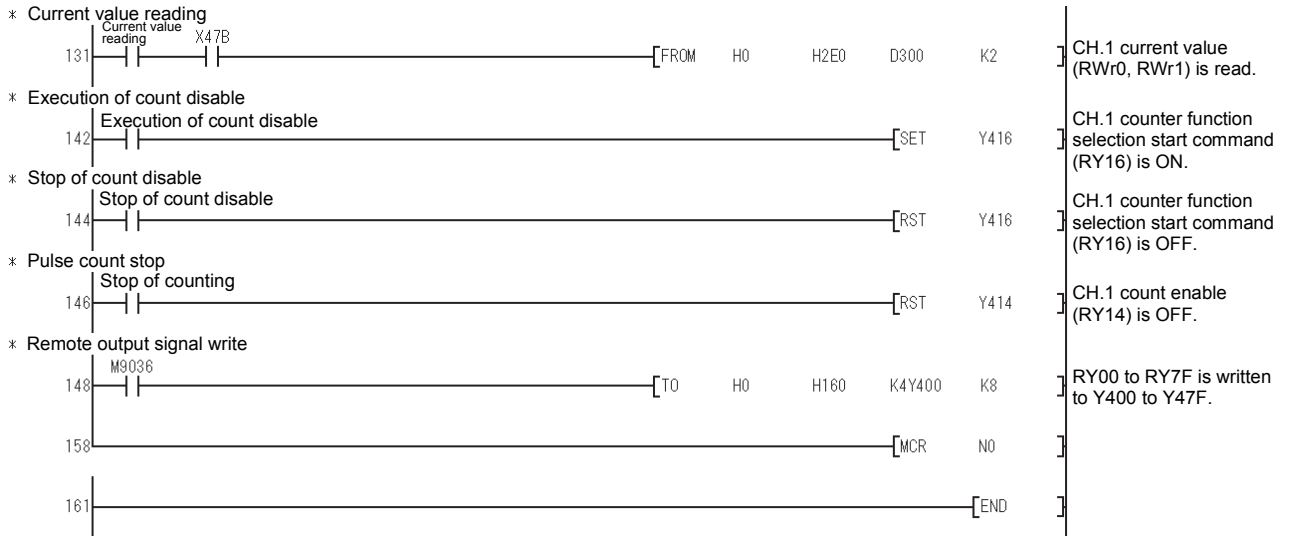

10.6.6 Program example of latch counter function

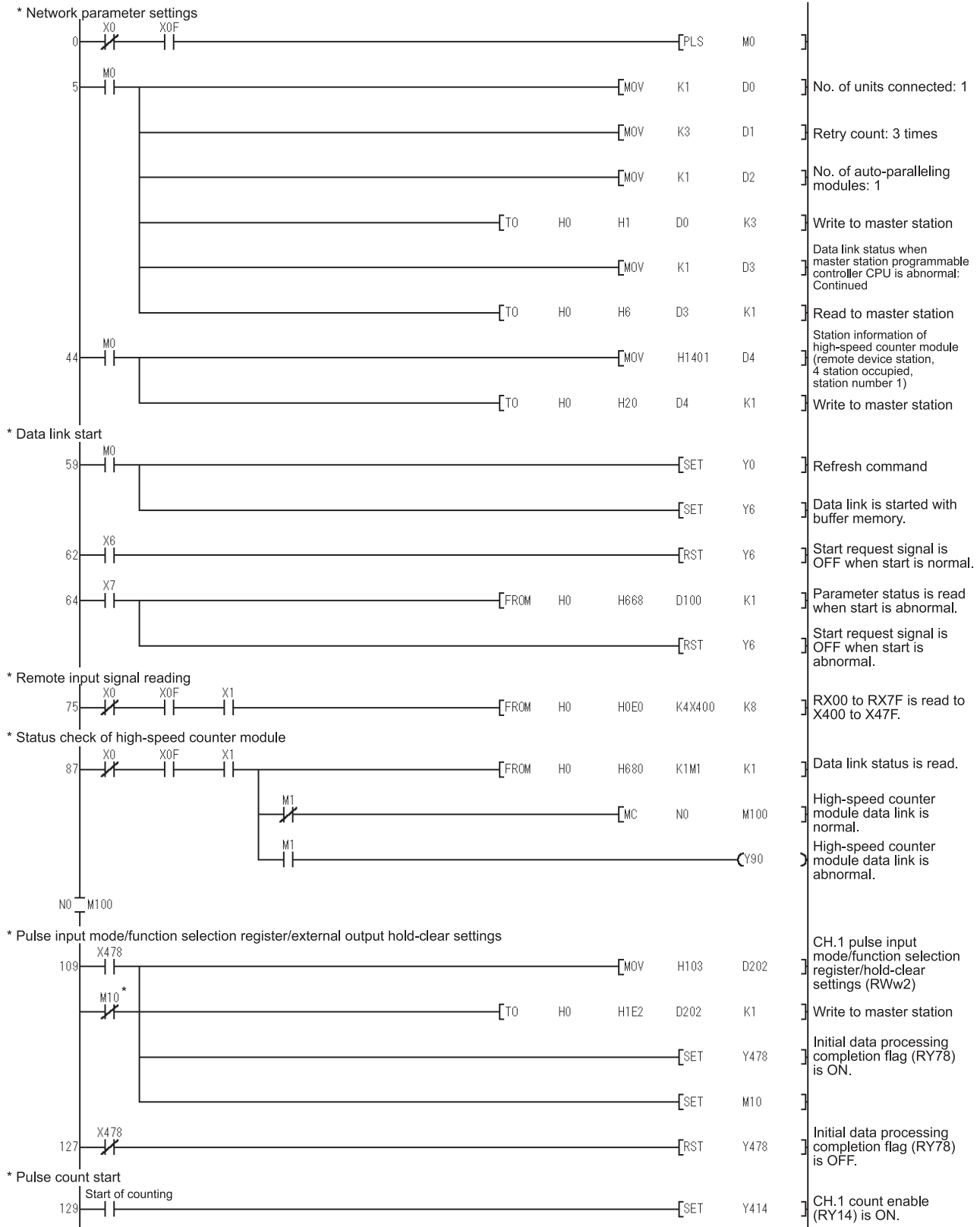

* When the programmable controller CPU is reset, the pulse input mode/function selection register/external output hold-clear settings are reset.

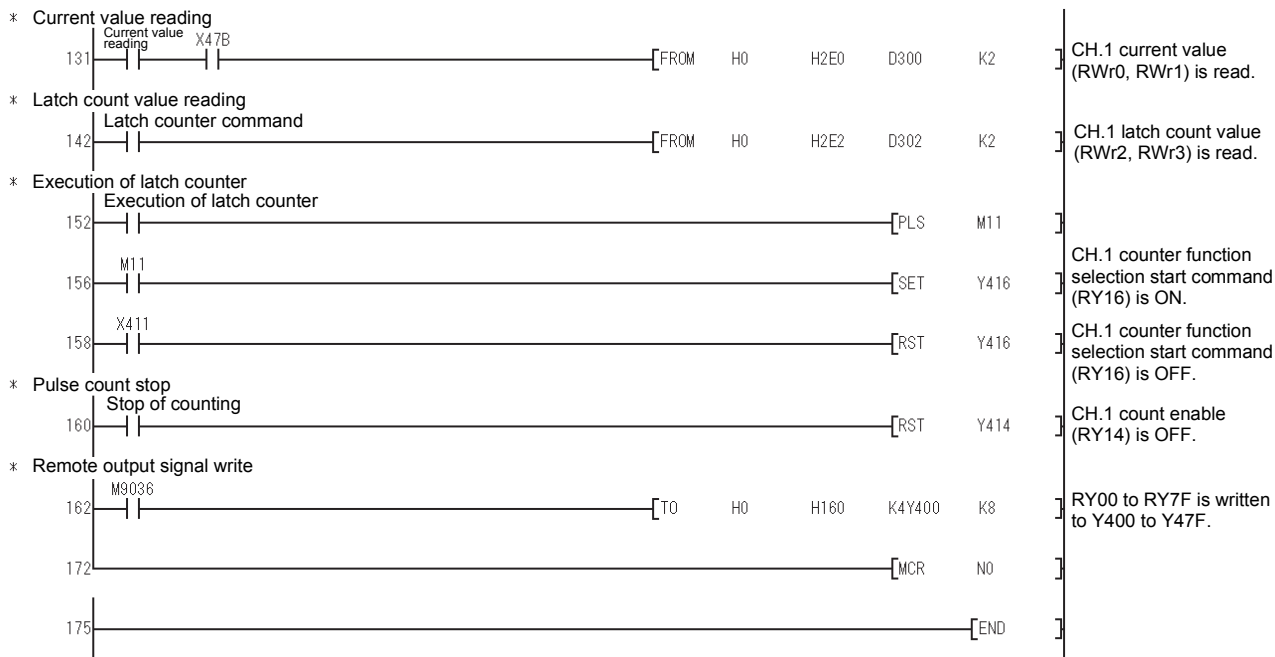

10.6.7 Program example of sampling counter function

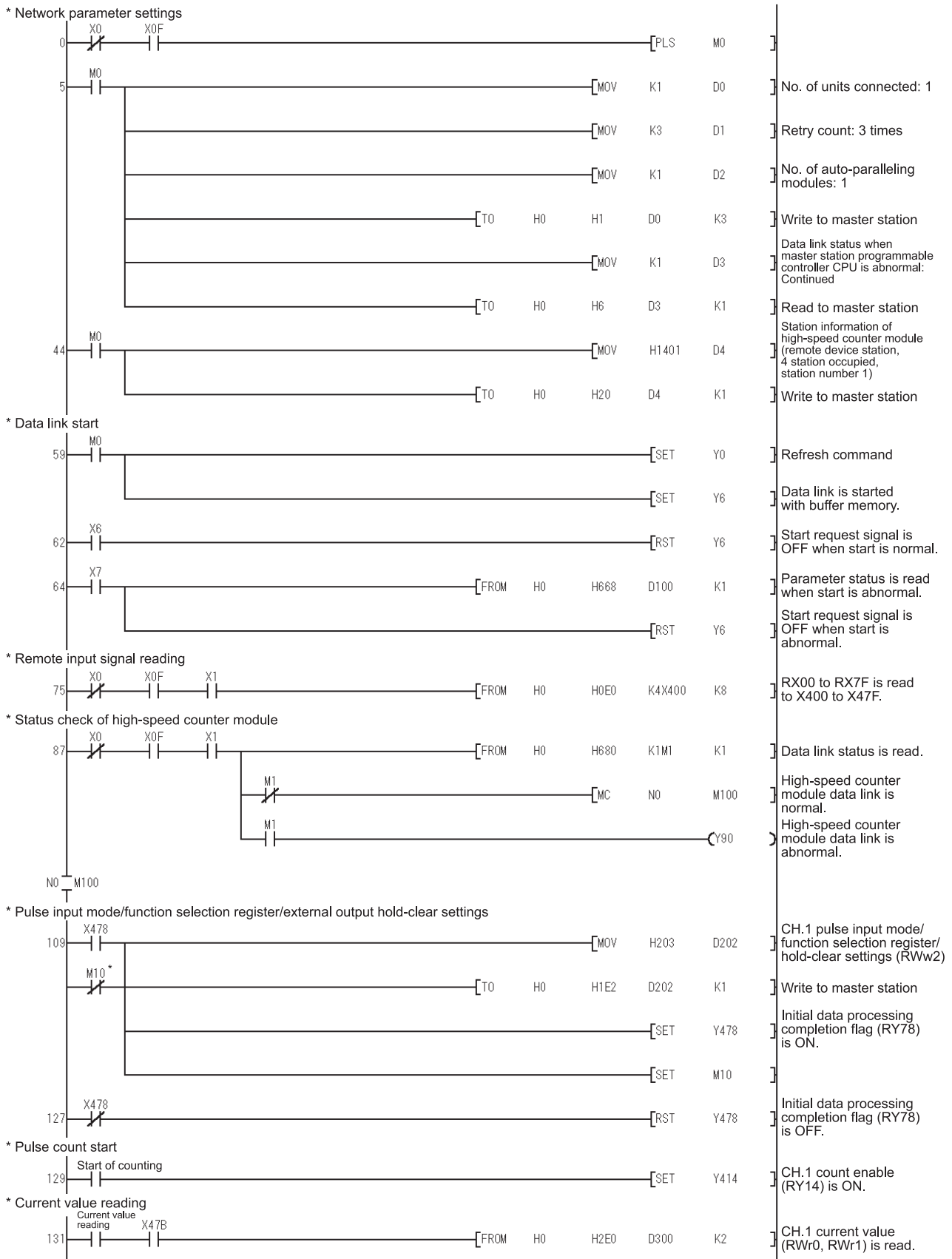

* When the programmable controller CPU is reset, the pulse input mode/function selection register/external output hold-clear settings are reset.

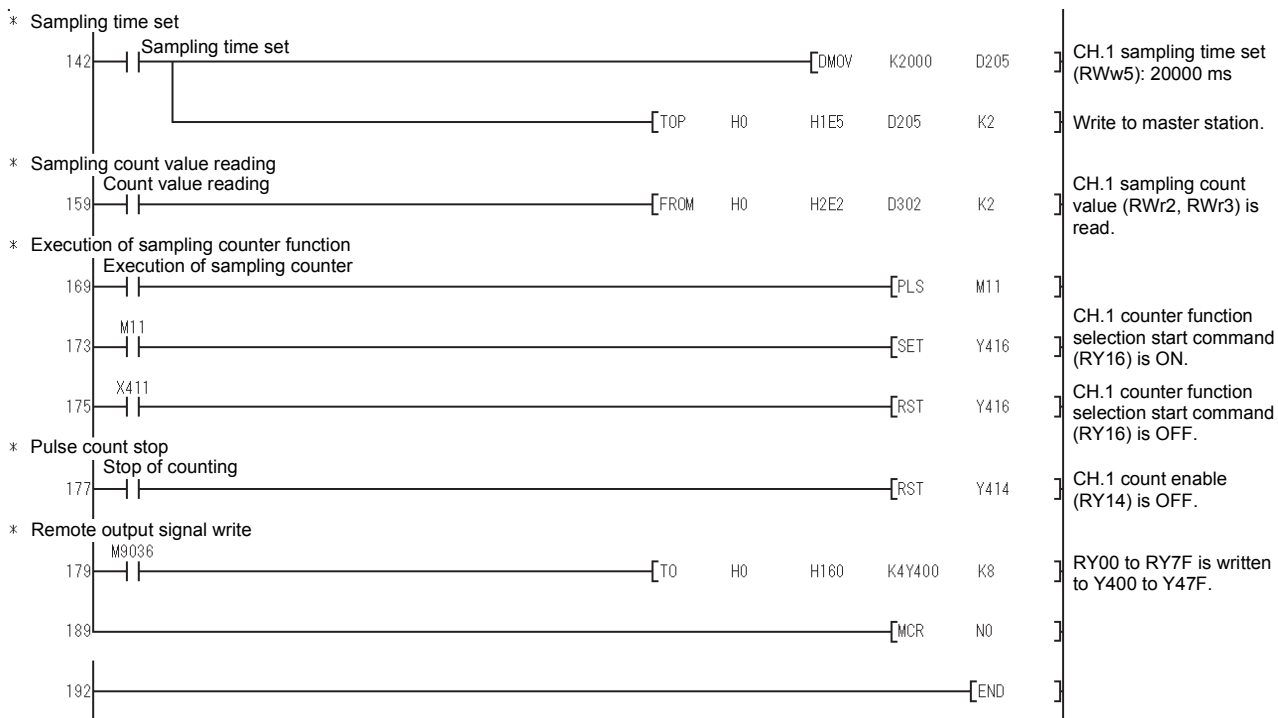

10.6.8 Program example of frequency pulse counter function

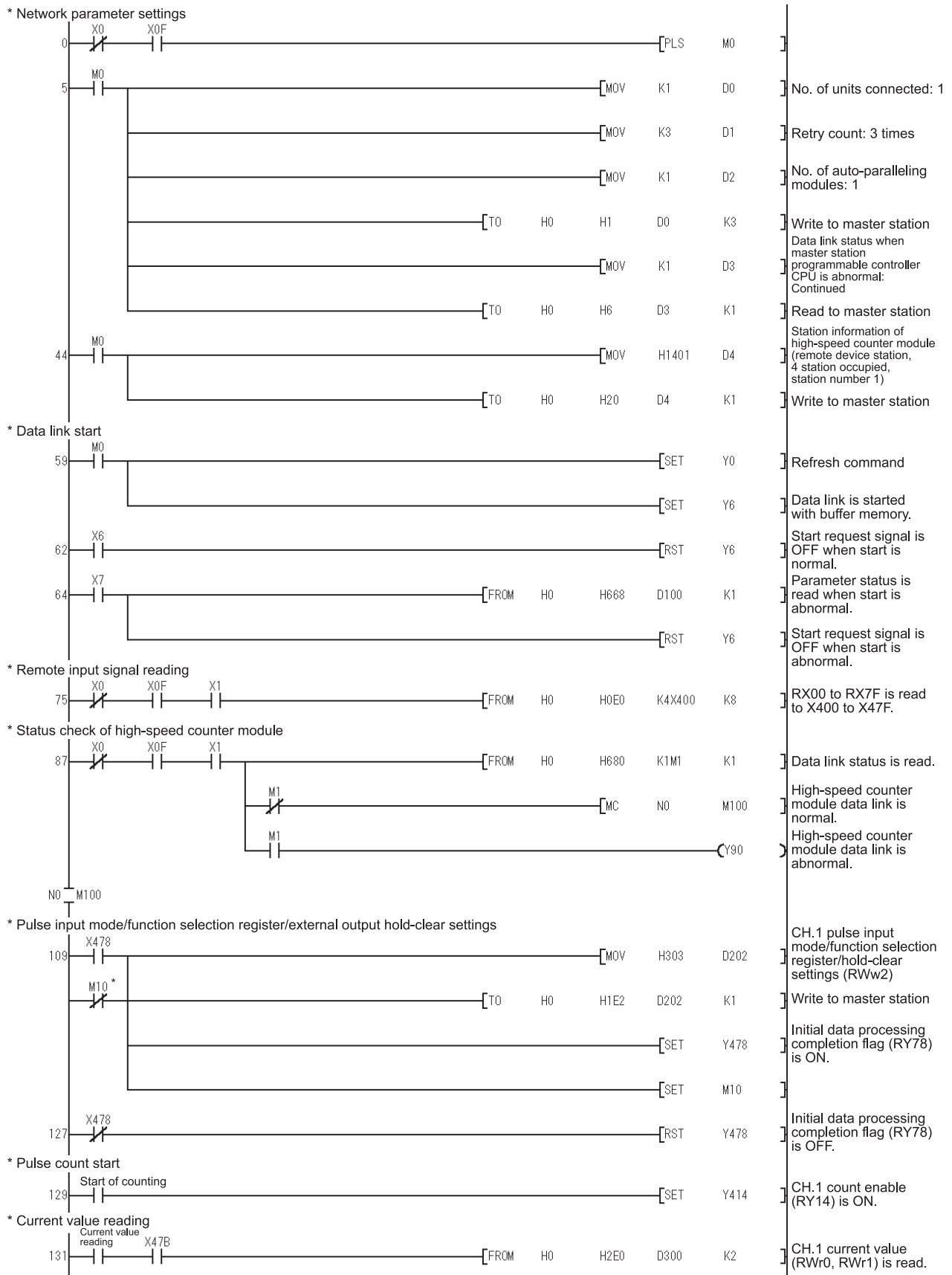

* When the programmable controller CPU is reset, the pulse input mode/function selection register/external output hold-clear settings are reset.

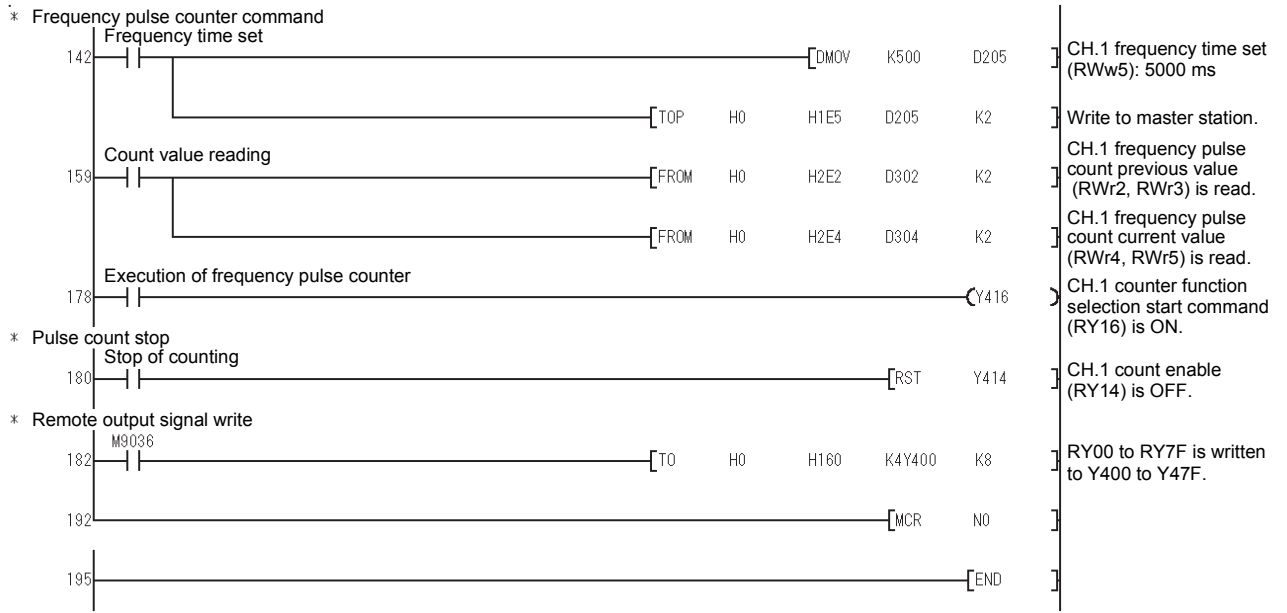

11. TROUBLESHOOTING

11.1 Count Value Is Incorrect

The following table lists check items for use when the count value is incorrect.

Check Item	Corrective Action
Is the pulse input mode consistent with the pulse input setting in the remote register?	Make the pulse input mode consistent with the pulse input setting in the remote register.
Is the sequence program data processed in 24-bit binary?	Correct the sequence program so that the data is processed in 24-bit binary.
Is the terminal for pulse input wired using a shielded twisted pair cable?	Use a shielded twisted pair cable for to wire a terminal for pulse input.
Does noise enter through the ground of the high-speed counter module?	<ul style="list-style-type: none"> • Disconnect the high-speed counter module from the ground. • If the high-speed counter module is in contact with the ground, separate it from the ground.
Have adequate measures been taken against noise in the panel or noise resulting from the other equipment?	Provide CR surge suppression to magnetic switches, etc.
Is sufficient distance provided between heavy current equipment and counter input line?	Wire the pulse input line independently, and separate in-panel wiring 150mm or more from power line.
Is the count value the same at CH1 and CH2 after the same count value was entered?	If the count values are different, the hardware is faulty. Please consult your local Mitsubishi representative.
Does the input pulse waveform match the performance specifications?	Monitor and confirm the pulse waveform using a synchroscope. If the waveform does not match the specifications, enter pulses of a correct waveform.

11.2 Count Operation Is Not Performed

The following table lists check items for use when count operation is not performed.

Check Item	Corrective Action
Is the external wiring of phases ϕ A and ϕ B correct?	Check the external wiring and make correction.
When a voltage is applied directly to the pulse input terminals of phases ϕ A and ϕ B, are the LEDs of phases ϕ A and ϕ B lit?	<ul style="list-style-type: none"> • If they are lit, check the external wiring and pulse generator and make correction. • If they are not lit, the hardware is faulty. Please consult your local Mitsubishi representative.
Is the count enable command {RY(n+1)4 (RY(n+1)B} on?	Switch on the count enable command {RY(n+1)4 (RY(n+1)B} using the sequence program.
Does the master module indicate an error?	If the master module is in error, refer to the troubleshooting procedure of the manual of the master module used and make operation normal.
Is the counter function selection start command {RY(n+1)6 (RY(n+1)D)} on or a voltage applied to the F.START terminal?	When the count disable function has been set by the counter function selection, switch off {RY(n+1)6 (RY(n+1)D)} or F.START terminal.

11.3 How to Check an Error with the LED Lamps

This section describes how to check an error using the LED lamps of the high-speed counter module.

For errors related to the programmable controller CPU and master module, refer to the programmable controller CPU and master module user's manuals.

(1) If the RUN LED of the high-speed counter module goes off

Cause	Corrective Action
Watchdog timer error occurred.	Switch on power of the high-speed counter module again ^{*1} . If the RUN LED is not lit after power is switched on again, the hardware may be faulty. Please consult your local Mitsubishi representative.

(2) If the L RUN LED of the high-speed counter module goes off

Cause	Corrective Action
Watchdog timer error occurred.	Switch on power of the high-speed counter module again ^{*1} . If the L RUN LED is not lit after power is switched on again, the hardware may be faulty. Please consult your local Mitsubishi representative.
Cable is broken or shorted.	Check for a broken or shorted cable among transmission cables and repair it.
Master station stopped link.	Check for an error at master station.
24V power is not supplied to the high-speed counter module or voltage is insufficient.	Check the 24V power voltage.
Station number was repeated.	Switch power on again ^{*1} after correcting the station number setting of the module of which station number was repeated.
Switch setting is outside the permissible range (station number 0 or not less than 62, transmission speed 5 to 9).	Correct the switching setting and switch power on again ^{*1} .

(3) If the L ERR. LED of the high-speed counter module flickers

Cause	Corrective Action
Station number or transmission speed switch setting was changed during normal operation.	Return the station number or transmission speed switch setting to the old value and switch power on again ^{*1} . If the L RUN LED is not lit after power is switched on again, the hardware may be faulty. Please consult your local Mitsubishi representative.
Station number or transmission speed switch is faulty	If the L ERR. LED begins to flicker even though switch setting was not changed during operation, the hardware may be faulty. Please consult your local Mitsubishi representative.

(4) If the L ERR. LED of the high-speed counter module is lit

Cause	Corrective Action
Switch setting is outside the permissible range (station number 0 or not less than 62, transmission speed 5 to 9).	Correct the switching setting and switch power on again*1.
Terminal resistor is not connected.	Confirm that terminal resistor is connected. If not connected, connect it and switch power on again*1.
Module or transmission cable is affected by noise.	<ul style="list-style-type: none"> • Connect both ends of the shielded wire of the Dedicated cable for CC-Link to ground (class D grounding) via SLD and FG of each module. • Securely connect the FG terminal of the module to ground. • Securely ground the piping when running cables in piping.

*1: Switch power on again: Switch power on again or turn on the reset switch.

11.4 When SW0088 to SW008B (fuse blown status) of master station is turned ON

If the fuse of the high-speed counter module is blown, it can be confirmed by monitoring the link special registers for other station fuse blown status in the master station.

Cause	Corrective Action
External power supply is not wired	<p>Wire an external power supply to the high-speed counter module.</p> <p>When using the external output (EQU1 to EQU2) terminals, wire an 10.2VDC to 30VDC external power supply as it is needed.</p> <p>Even when not using external output terminals (EQU1 to EQU2), wire the 12/24V terminal (pin number: 26) and the COM terminal (pin number: 27) to an external power supply. (Refer to Section 4.6.5)</p>
Fuse is blown	<p>The coincidence output function signal is not output. (Fuse for external power supply which operates the internal photocoupler when the EQU terminals are used)</p> <p>The fuse cannot be changed by the user. Please consult your local Mitsubishi representative.</p>

11.5 If Communication Error Occurs between Master Station and This Module

If any repeated station number bit in any of the link special registers SW0098 to SW009B (repeated station number status) switches on, check the high-speed counter module of the corresponding station number in the following flowchart.

Troubleshooting flowchart used when the "ERR." LED of the master station flickers

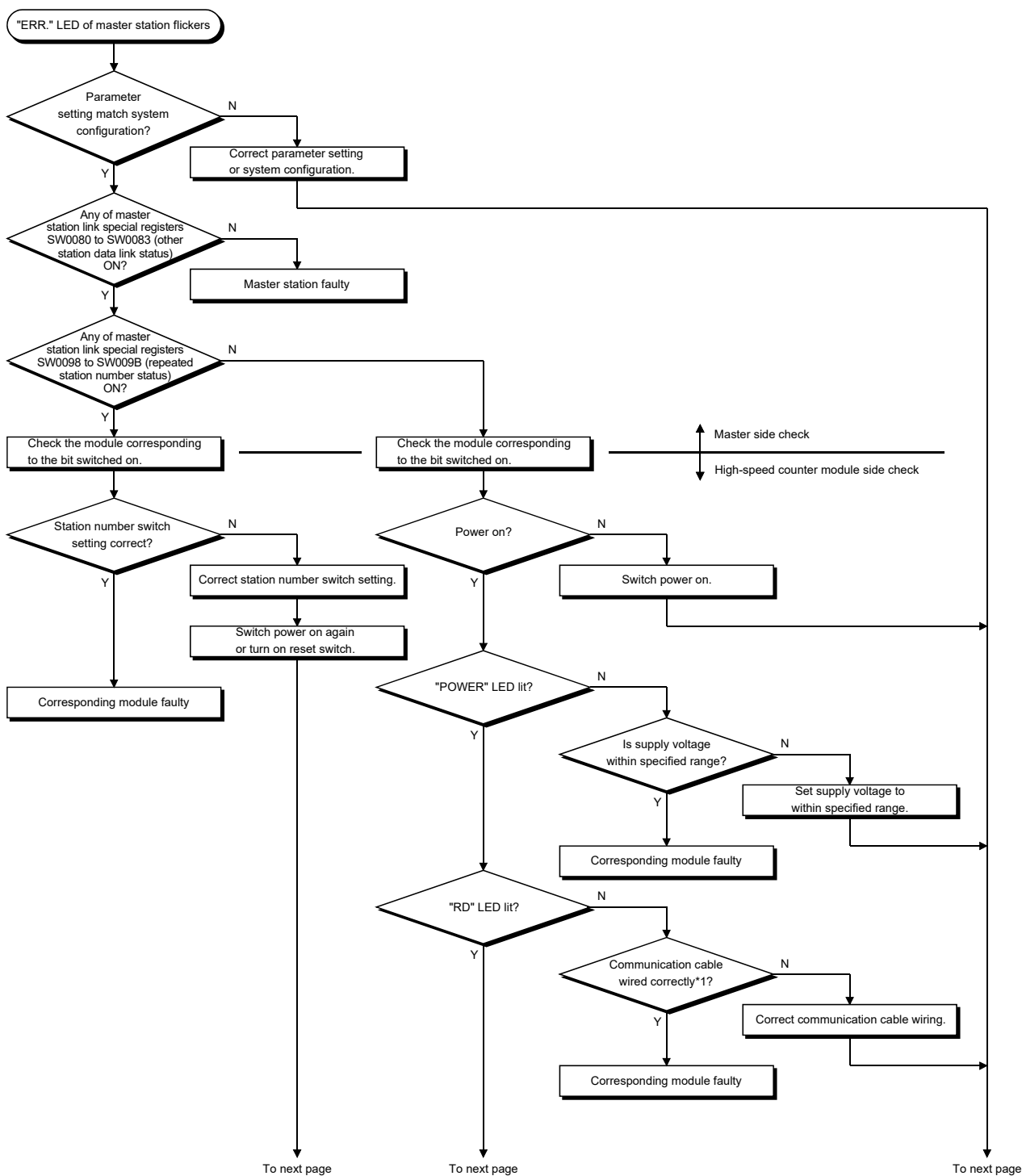

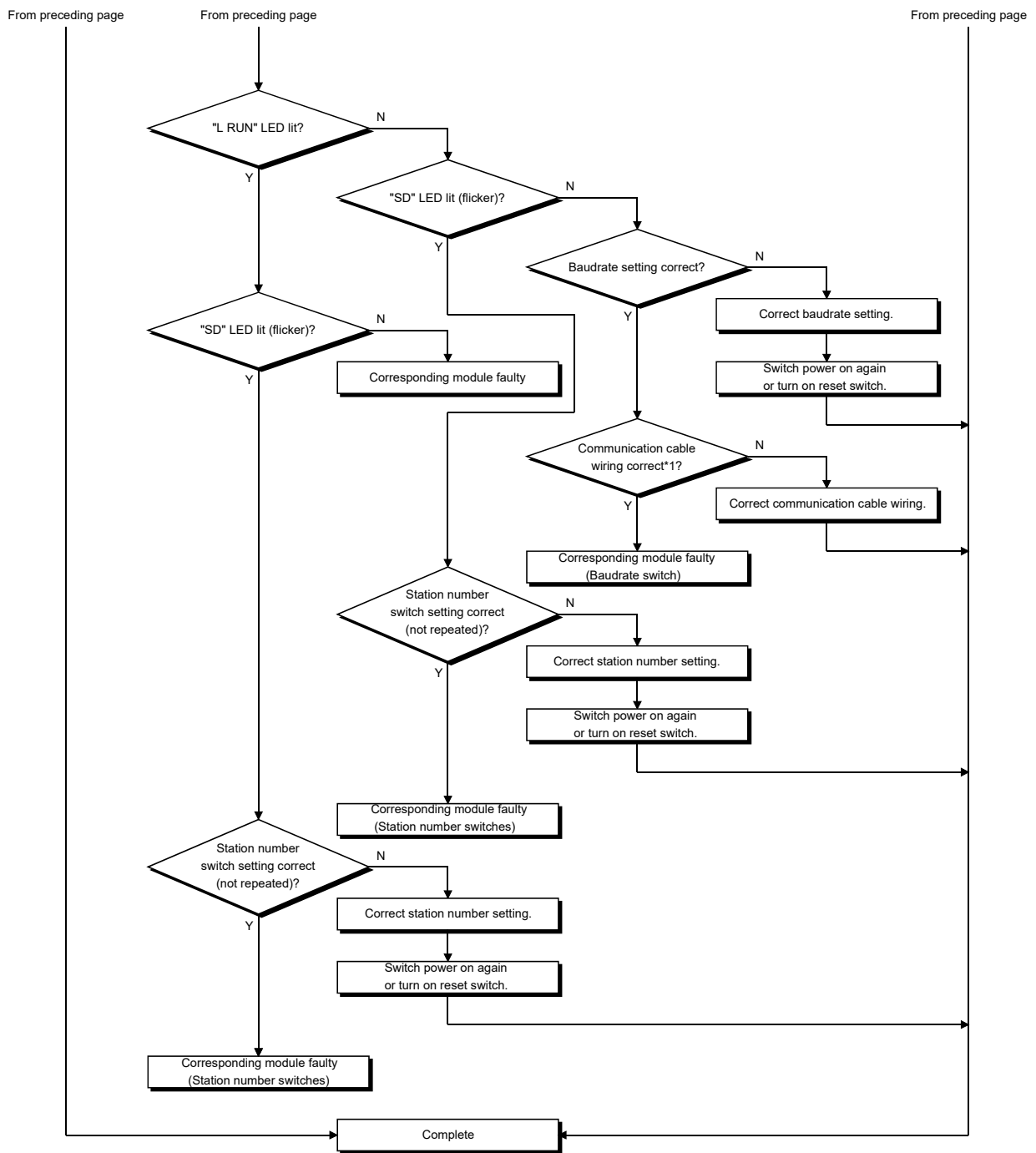

*1: Check for short circuit, reverse connection, wire breakage, no terminal resistor, improper FG connection, improper overall distance and improper interstation distance.

APPENDICES

Appendix 1 Directions for Use

- (1) For the master station, you can select whether data is cleared or held when a communication error or WDT error occurs or when remote device power switches off, using the condition setting switch. Make setting according to the system.

*The above error can be confirmed by monitoring the link special registers for other station communication status in the master station. When the error has occurred, the status of the corresponding station is stored into the following area in bit pattern.

SW0080 to SW0083: Data link status (0: normal, 1: data link error occurrence)
 SW0084 to SW0087: WDT error status (0: normal, 1: WDT error occurrence)

- (2) For the remote device station, you can select whether the external output (coincidence) status is held or cleared when a communication error, programmable controller CPU stop or master station reset is detected, using the external output hold/clear setting area of the remote register {most significant bit of address RWwn+2}. As the external output hold/clear setting is used for both CH1 and CH2, set it to the remote register of CH1.

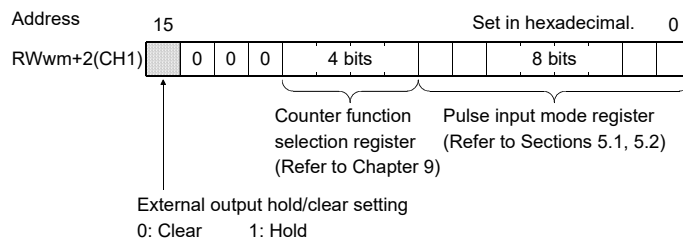

- (3) When a hardware reset or WDT error occurs, the external output (coincidence output) is forcibly switched off.

- (4) If the fuse of the high-speed counter module is blown, it can be confirmed by monitoring the link special registers for other station fuse blown status in the master station.

SW0088 to SW008B: Fuse blown status (0: normal, 1: fuse blown)

If the "fuse blown" bit is set, check the following once.

Cause	Corrective Action
External power supply is not wired	Wire an external power supply to the high-speed counter module. When using the external output (EQU1 to EQU2) terminals, wire an 10.2VDC to 30VDC external power supply as it is needed. Even when not using external output terminals (EQU1 to EQU2), wire the 12/24V terminal (pin number: 26) and the COM terminal (pin number: 27) to an external power supply. (Refer to Section 4.6.5)
Fuse is blown	The coincidence output function signal is not output. (Fuse for external power supply which operates the internal photocoupler when the EQU terminals are used) The fuse cannot be changed by the user. Please consult your local Mitsubishi representative.

Appendix 2 Outline Drawing

The following is the outline drawing of the AJ65BT-D62.
 (This applies also to the AJ65BT-D62D and AJ65BT-D62D-S1.)

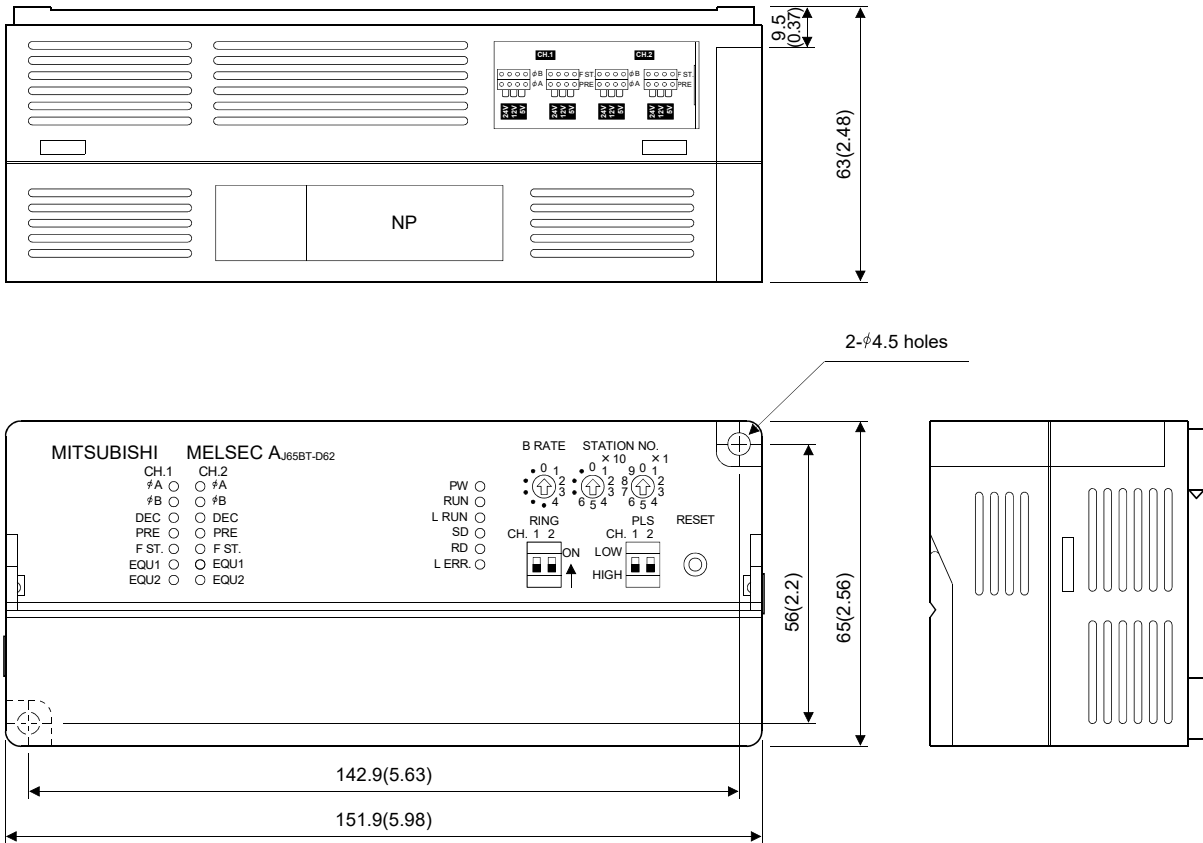

Unit: mm

MEMO

WARRANTY

Please confirm the following product warranty details before using this product.

1. Gratis Warranty Term and Gratis Warranty Range

If any faults or defects (hereinafter "Failure") found to be the responsibility of Mitsubishi occurs during use of the product within the gratis warranty term, the product shall be repaired at no cost via the sales representative or Mitsubishi Service Company.

However, if repairs are required onsite at domestic or overseas location, expenses to send an engineer will be solely at the customer's discretion. Mitsubishi shall not be held responsible for any re-commissioning, maintenance, or testing on-site that involves replacement of the failed module.

[Gratis Warranty Term]

The gratis warranty term of the product shall be for one year after the date of purchase or delivery to a designated place. Note that after manufacture and shipment from Mitsubishi, the maximum distribution period shall be six (6) months, and the longest gratis warranty term after manufacturing shall be eighteen (18) months. The gratis warranty term of repair parts shall not exceed the gratis warranty term before repairs.

[Gratis Warranty Range]

- (1) The range shall be limited to normal use within the usage state, usage methods and usage environment, etc., which follow the conditions and precautions, etc., given in the instruction manual, user's manual and caution labels on the product.
- (2) Even within the gratis warranty term, repairs shall be charged for in the following cases.
 1. Failure occurring from inappropriate storage or handling, carelessness or negligence by the user. Failure caused by the user's hardware or software design.
 2. Failure caused by unapproved modifications, etc., to the product by the user.
 3. When the Mitsubishi product is assembled into a user's device, Failure that could have been avoided if functions or structures, judged as necessary in the legal safety measures the user's device is subject to or as necessary by industry standards, had been provided.
 4. Failure that could have been avoided if consumable parts (battery, backlight, fuse, etc.) designated in the instruction manual had been correctly serviced or replaced.
 5. Failure caused by external irresistible forces such as fires or abnormal voltages, and Failure caused by force majeure such as earthquakes, lightning, wind and water damage.
 6. Failure caused by reasons unpredictable by scientific technology standards at time of shipment from Mitsubishi.
 7. Any other failure found not to be the responsibility of Mitsubishi or that admitted not to be so by the user.

2. Onerous repair term after discontinuation of production

- (1) Mitsubishi shall accept onerous product repairs for seven (7) years after production of the product is discontinued. Discontinuation of production shall be notified with Mitsubishi Technical Bulletins, etc.
- (2) Product supply (including repair parts) is not available after production is discontinued.

3. Overseas service

Overseas, repairs shall be accepted by Mitsubishi's local overseas FA Center. Note that the repair conditions at each FA Center may differ.

4. Exclusion of loss in opportunity and secondary loss from warranty liability

Regardless of the gratis warranty term, Mitsubishi shall not be liable for compensation of damages caused by any cause found not to be the responsibility of Mitsubishi, loss in opportunity, lost profits incurred to the user by Failures of Mitsubishi products, special damages and secondary damages whether foreseeable or not, compensation for accidents, and compensation for damages to products other than Mitsubishi products, replacement by the user, maintenance of on-site equipment, start-up test run and other tasks.

5. Changes in product specifications

The specifications given in the catalogs, manuals or technical documents are subject to change without prior notice.

TRADEMARKS

Microsoft, Microsoft Access, Excel, Visual Basic, Visual C++, Windows, Windows NT, Windows Vista, and Windows XP are trademarks of the Microsoft group of companies.

Celeron, Intel, and Pentium are either registered trademarks or trademarks of Intel Corporation in the United States and/or other countries.

The company names, system names and product names mentioned in this manual are either registered trademarks or trademarks of their respective companies.

In some cases, trademark symbols such as [™] or [®] are not specified in this manual.

IB(NA)-66823-I(2404)MEE

MODEL: AJ65BT-D62-U-E

MODEL CODE: 13JL45

MITSUBISHI ELECTRIC CORPORATION

HEAD OFFICE: TOKYO BLDG., 2-7-3, MARUNOUCHI, CHIYODA-KU, TOKYO 100-8310, JAPAN
NAGOYA WORKS: 1-14, YADA-MINAMI 5-CHOME, HIGASHI-KU, NAGOYA 461-8670, JAPAN

When exported from Japan, this manual does not require application to the
Ministry of Economy, Trade and Industry for service transaction permission.

Specifications subject to change without notice.