

Instruction Manual

ION BAR ASR-A Series

Controller ASM-C

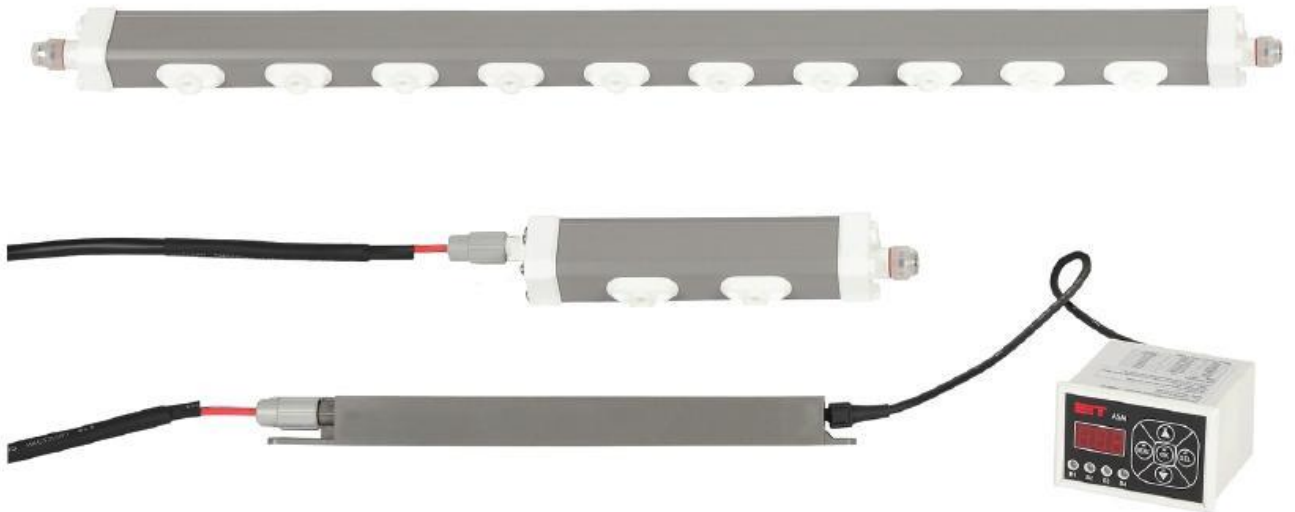

Read this instruction manual before using the product in order to achieve maximum performance.

Keep this instruction manual within your reach after reading so that it can be used at any time.

ASM controller can be used for both ASM and ASR series.

Be sure to set the ASM-C output frequency under 30Hz with ASR -A series.

CONTENTS

1. Product Introduction		3 Page
1.1 Features	1.2 Specification	
1.3 Dimensions	1.4 Performance	
1.5 Package contents	1.6 Part names	
1.7 Cautions		
2. Installation & Connection		11 Page
2.1 Installation location	2.2 Purging and moving into CR	
2.3 Wiring diagram	2.4 Installing and connecting main body	
2.5 Connecting multiple bars	2.6 Check list after installation	
3. Settings		19 Page
3.1 Setting control values	3.2 Explanation on menu options	
4. Maintenance		21 Page
4.1 Necessity of maintenance	4.2 Cleaning and replacement of emitters	
APPENDIX		23 Page
Trouble shooting		
Warranty		

※ Notice

Before installation, please read carefully 1.7 Cautions , 2. Installation & Connection and Warranty in Appendix.

1.1 Features

Welcome to become a DIT customer!

ASR-A series is a slim bar ionizer designed to be more convenient to monitor and control the product by separating its controller and HVPS(High Voltage Power Supply), while keeping the outstanding performance of ASG-A series.

ASR-A Series is,

- Bar, controller and HVPS can be installed separately.
(Up to 4 bars can be connected to 1 controller)
- ASR-A is able to be applied to narrow space as slim bar type
- Safe from fire by using piezo-ceramic for.
- Able to keep stable Ion Balance due to its patented **Auto-Balancing function**.

1.2 Specifications

Series name		ASR - A		Air	Type	CDA, N2
Length		Min 150 ~ Max 3000 mm (increasing by 50mm)			Pressure	0.05 ~ 0.5MPa (under 0.3MPa recommended)
Ion generating method		Corona discharge			Flow	2.0L/min(±10%) per 1 emitter (at 0.1MPa)
Voltage application method		Pulsed AC			Air tube diameter	∅6 (outside)
Input Voltage		DC24V±10%		Material		Main body: ABS / Emitter pin: Tungsten
Input Current		MAX. 2.4A (Controller) MAX. 300mA (1Bar=3000mm)		Display (ASM-C)		Alarm LED(Green/Red) 4ea, 3-Digit(Error and Status display)
Output Voltage		±5.5 kVp-p [Fixed]		Controllable factors (ASM-C)		Frequency, Duty level, Ion on/off, Address, Communication speed, Password, Resetting, Tip cleaning period setting
Output Frequency		1.0~60Hz[adjustable]				
Ion Balance		Under average ±30V		Power consumption		MAX.17W (1BAR) MAX.57W (4BAR)
Weight (g)	BAR	Min : 300g(ASR-A150), Max : 3Kg(ASR-A300)		Ambient temperature		0℃ ~ +50℃(32~113°F)
	Controller	Max : 100g		Relative humidity		35~85%RH(No dewing)
Ozone generation		Under 0.005ppm				

※ Specification can be changed without notice for performance improvement.

1.3 Dimensions

<Bar>

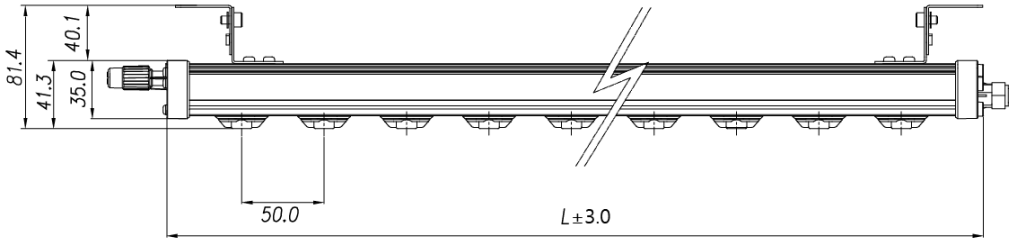

<Front view>

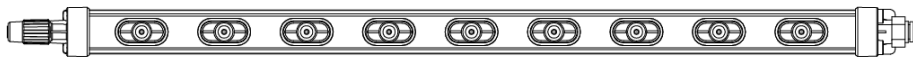

<Bottom view>

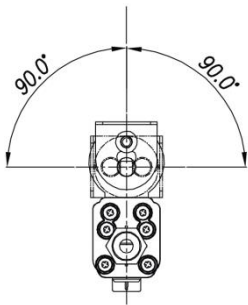

<Side view>



<Bracket rotation>

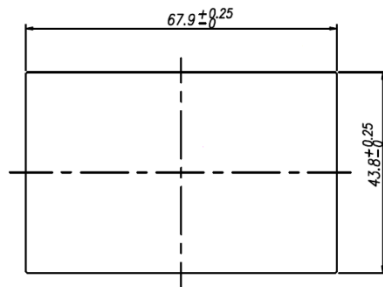

<Panel cut-out>

<HVPS>

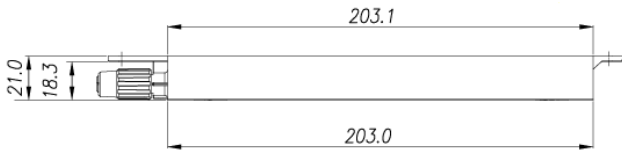

<HVPS Front view>

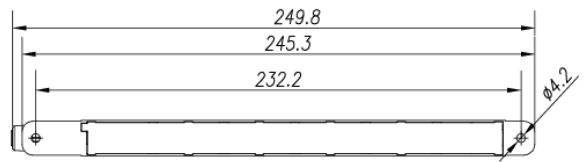

<HVPS Top view>

<Controller>

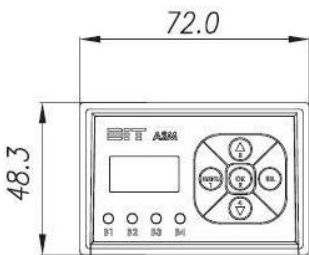

<Controller Front view>

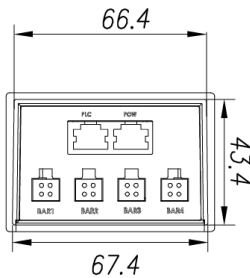

<Controller Rear view>

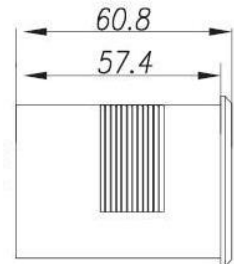

<Controller Side view>

1.3 Dimensions

<Bracket>

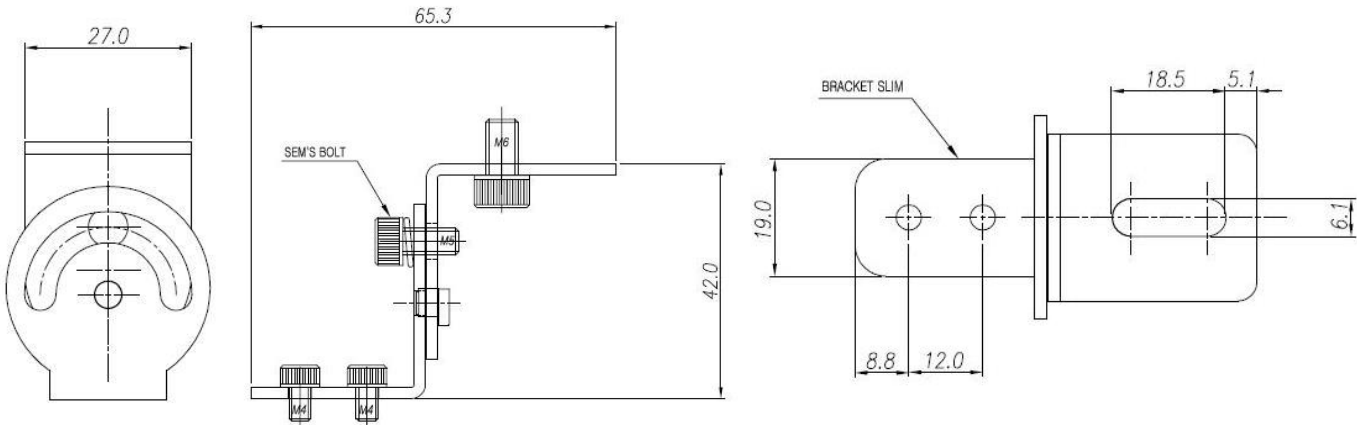

<Number of emitters & Length by Model>

Model	Number of emitters(EA)	Length(mm)	Model	Number of emitters(EA)	Length(mm)
ASR-A015	2	146	ASR-A140	27	1396
ASR-A020	3	196	ASR-A150	29	1496
ASR-A025	4	246	ASR-A160	31	1596
ASR-A030	5	296	ASR-A170	33	1696
ASR-A035	6	346	ASR-A180	35	1796
ASR-A040	7	396	ASR-A190	37	1896
ASR-A045	8	446	ASR-A200	39	1996
ASR-A050	9	496	ASR-A210	41	2096
ASR-A055	10	546	ASR-A220	43	2196
ASR-A060	11	596	ASR-A230	45	2296
ASR-A070	13	696	ASR-A240	47	2396
ASR-A080	15	796	ASR-A250	49	2496
ASR-A090	17	896	ASR-A260	51	2596
ASR-A100	19	996	ASR-A270	53	2696
ASR-A110	21	1096	ASR-A280	55	2796
ASR-A120	23	1196	ASR-A290	57	2896
ASR-A130	25	1296	ASR-A300	59	2996

1.4 Performance

- ※ Discharge time: the time necessary for static elimination
- Relation between discharge time and distance(Distance: mm, discharge Time: sec) : below graph shows the discharge time according to the distance measured in product's side and front.(Product: ASR-A060W/Place: DIT Test-Room)

Relation between Depth Direction and Decay Time

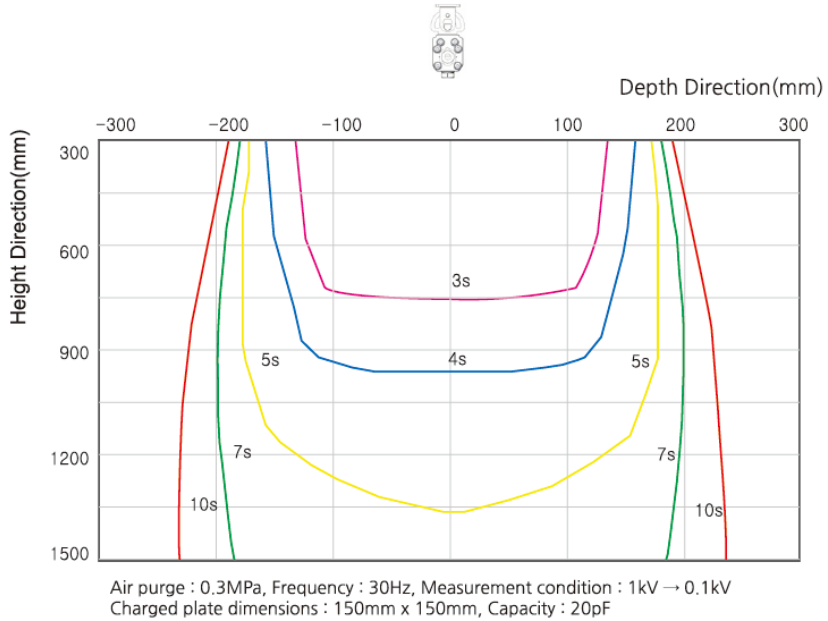

Relation between Width Direction and Decay Time

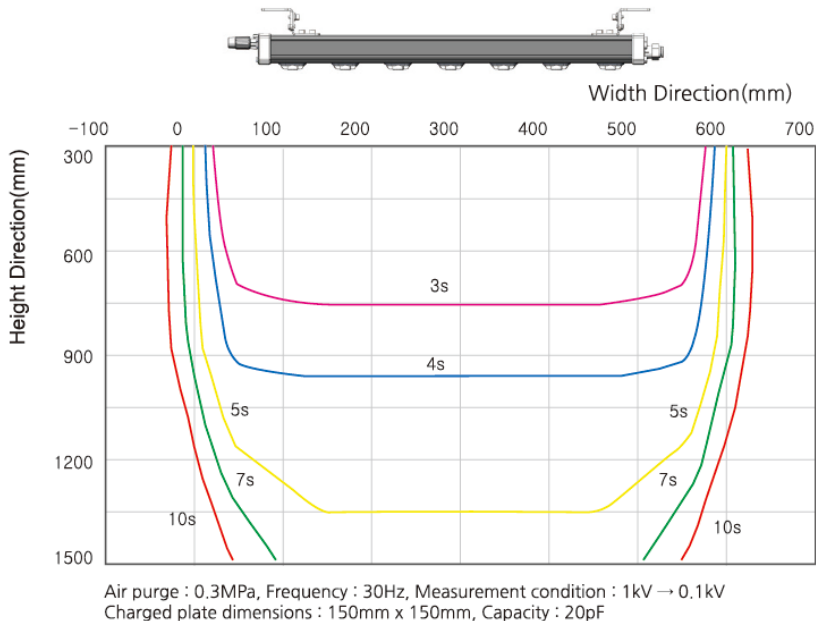

1.5 Package Contents

< Package >

(1) BAR Package

① Main body(power supply separated)



② Fixing screws



※ Contact to the seller for customizing
(Basic hexagon head bolt M4X6mm)

(2) Controller package

① Controller



② Controller bracket

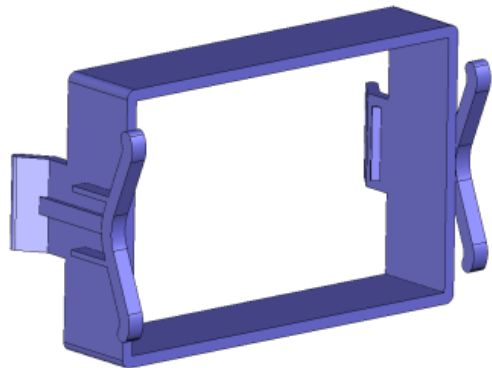



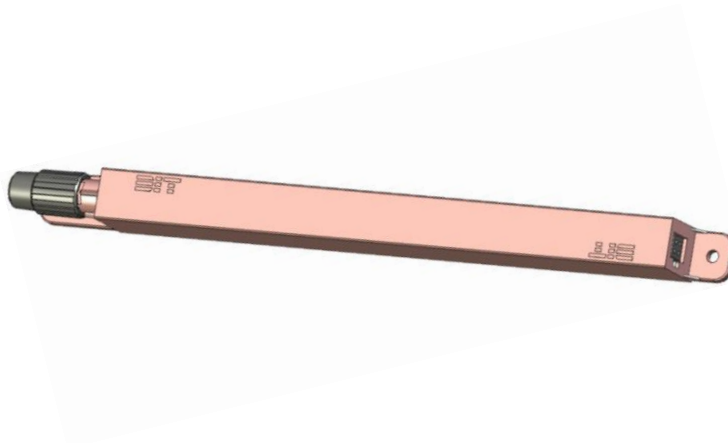

(3) High-Voltage Power Supply[HVPS]

① HVPS



1.5 Package Contents

< Option >

Trade name	Order code	Image	Notes
Ion Emitter Kit for Replacement	ASU-P01		10pcs / 1 set
RJ45 Cable(8pin) [Connecting Controller and Power/PLC]	ASU-R018A		1m
	ASU-R028A		2m
	ASU-R038A		3m
	ASU-R048A		4m
	ASU-R058A		5m
	ASU-R108A		10m
4PIN CONNECTOR CABLE [Connecting Bar and Controller]	ASU-C01		1m
	ASU-C02		2m
	ASU-C03		3m
	ASU-C04		4m
	ASU-C05		5m
	ASU-C10		10m
	ASU-C15		15m
High-Voltage용 Shield CABLE [Connecting HVPS-Bar]	ASU-H03		0.3m
	ASU-H05		0.5m
	ASU-H10		1m
Bracket	ASU-BA		Ceiling mount
	ASU-BB		Floor mount

1.6 Part Names

<BAR Part>

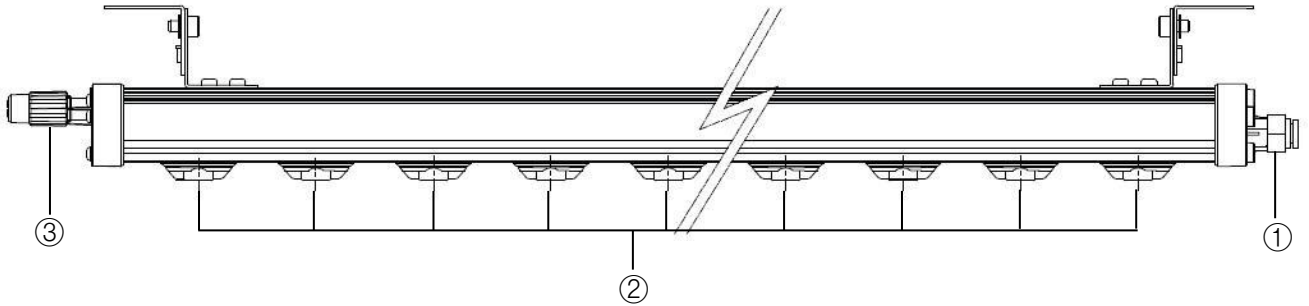

① Air feeding entrance ② Ion emitters ③ HVPS Connector

<HVPS Part>



① HVPS Connector ② HVPS-Controller Connector(4PIN)

<Controller Part>

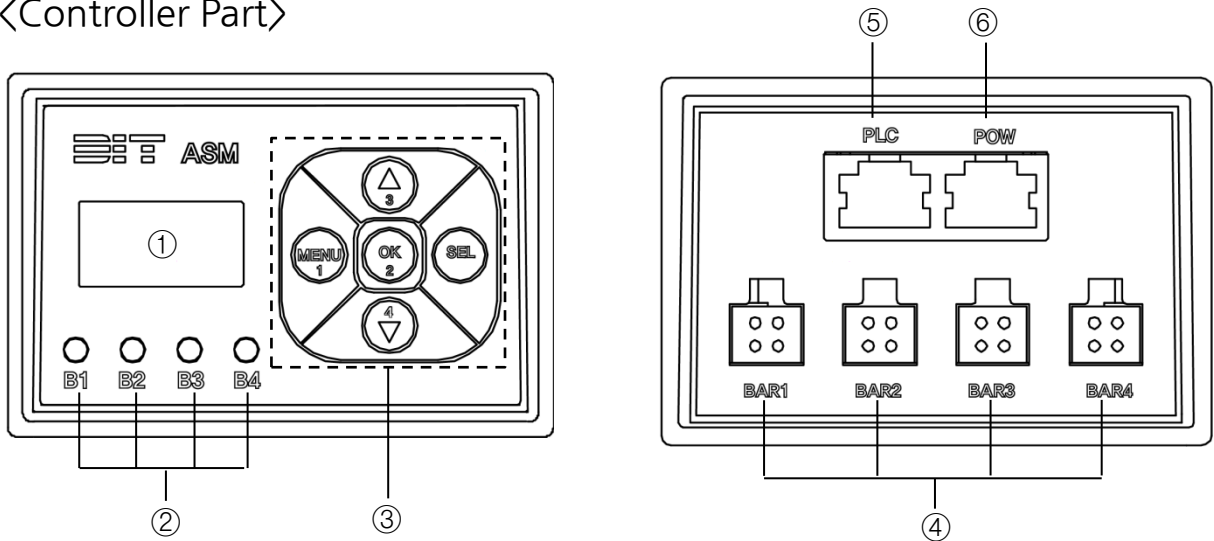

① DISPLAY ② Status Display LED of Ion Bars ③ Menu Button
 ④ HVPS-Controller Connector(4PIN) ⑥ Power Connector[RJ45(8pin)]
 ⑤ PLC Control & Alarm Signal Connector[RJ45(8pin)]

1.7 Cautions

Please be well informed of the cautions below before installation.

- Safety

- ◆ To avoid the risk of electric shock or product malfunction, keep fingers and metallic objects away from the unit during operation.
- ◆ Make sure that there is adequate ventilation when using the unit in an enclosed space because static elimination using Corona Discharge method generally generate a small quantity of ozone.
- ◆ To avoid the risk of electric shock, be sure to turn the power off during the maintenance.
- ◆ To avoid the risk of injury, do not touch the emitter pin directly with your hands.
- ◆ Disconnect from power supply and remove all the air in the unit before installing or moving.
- ◆ To avoid explosion, do not install the Unit in a place surrounded with volatile material or a lot of particles.

- Power supply

- ◆ Use a DC power supply at voltage of 24V+-10%
- ◆ Be sure to use a stabilized DC power supply.

- Installation

- ◆ Don't use any other parts not enclosed in the package.
- ◆ Do not install in regions affected by strong electric magnetic fields.
- ◆ Keep appropriate distance between two units to avoid mutual interference.(refer 11page)
- ◆ Do not connect power cable to PLC connector.
- ◆ Be careful not to apply excessive force on air feeding entrance or side cover, especially when installing the Unit vertically.

- Air feeding

- ◆ Remove impurities like water or oil from the air in compressor by using filters or clean dry air (CDA) before use.
- ◆ Install the unit after making sure that there is no foreign material in the air passage of the product.

Non-observance of the above and **Warning!** in this manual may lead to injury or product malfunction. DIT doesn't take any responsibility for the damage if the Unit is used in a manner that differs from the specification in this manual or if the Unit is modified by yourself.

2.1 Installation Location

- Provide enough space between the static elimination bar and surrounding walls as shown in the figures below.

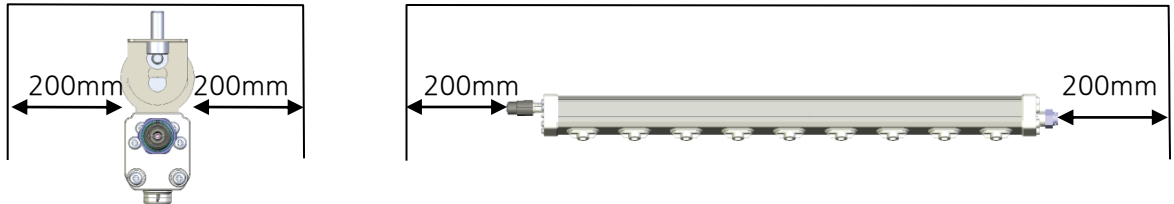

- If two ASR-A units are used, refer to the following illustration and separate the static elimination bars properly.

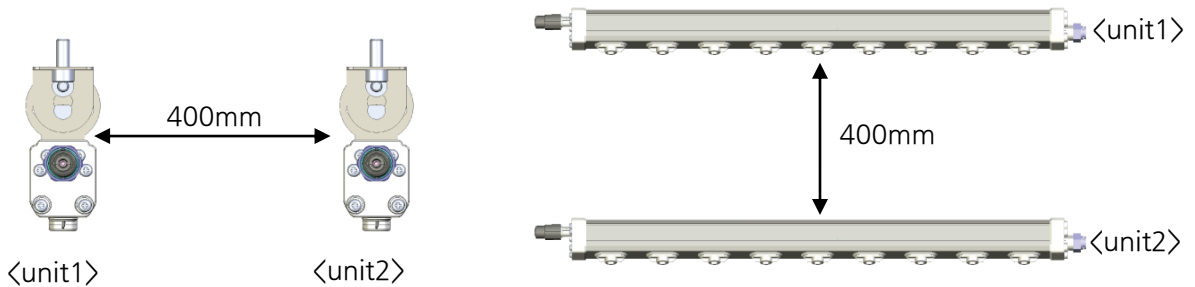

- Keep at least 20cm distance between the Unit and the static charged object.

2.2 Purging and moving into CR(Clean Room)

< Purging >

ASR-A series is packaged after purging in our clean room to remove dust. However, if needed, execute purging process according to the below.

- 1) Install the unit.
- 2) Feed the Unit CDA or N₂ gas at about pressure of 3Bar(0.3MPa)
- 3) After purging for a period of time, check the particle level with a counter to make sure that it is suitable for Clean Class.

<Moving the Unit into clean room>









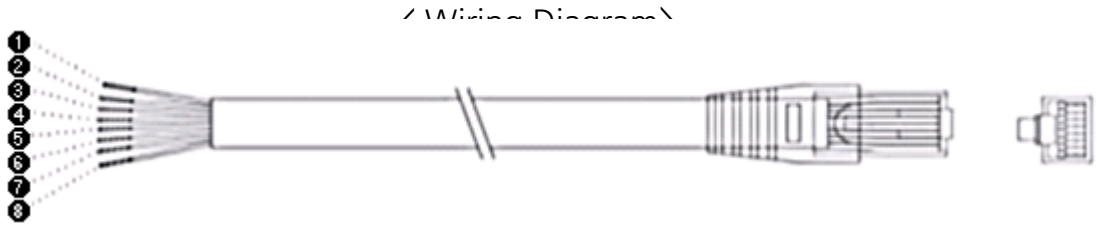







We recommend doing the below process before moving the Unit into a clean room.

- 1) Remove the wrapping paper outside the clean room.
- 2) Clean the outside of the plastic wrap with cleansing solution.
- 3) Moving the Unit into clean room using a pass box.
- 4) Remove the plastic wrap before installation.

※ If you have your own process for Clean Class, you can apply it.

2.3 Wiring diagram



Usage	PIN No.	Color	Connection & Usage	
Power cable	①	Black 	Power Supply Ground, Field Ground	
	②	Brown 	Power Supply Ground, Field Ground	
	③	Red 	Power Supply Ground, Field Ground	
	④	Orange 	+24 DC Power Supply	
	⑤	Yellow 	+24 DC Power Supply	
	⑥	Green 	+24 DC Power Supply	
	⑦	Blue 	Communication TX(-) Signal	
	⑧	Violet 	Communication TX(+) Signal	
PLC cable	①	Black 	PLC Circuit BAR1 Ion On/Off	
	②	Brown 	PLC Circuit BAR2 Ion On/Off	
	③	Red 	PLC Circuit BAR1 Ion Alarm Signal	
	④	Orange 	PLC Circuit BAR2 Ion Alarm Signal	
	⑤	Yellow 	PLC Circuit BAR3 Ion Alarm Signal	
	⑥	Green 	PLC Circuit BAR4 Ion Alarm Signal	
	⑦	Blue 	PLC Circuit BAR3 Ion On/Off	
	⑧	Violet 	PLC Circuit BAR4 Ion On/Off	

2.3 Wiring Diagram

- Connection when not using PLC and RS-485

- 1) Connect the black, brown and red wires to a power and field ground.
- 2) Connect the orange, yellow and green wires to DC 24V.
- 3) To avoid short, cut the blue and violet wires shortly and tapping them with deliberation

Operation status		Display sign	LED lighting	PLC Alarm
Disconnection to Ionizer		nc#	Lights-out	High
Ion On	PLC On	Io#	Green light	Low
Ion On	PLC off			
Ion off	PLC On			
Ion off	PLC off	If#	Green light blinking	High
HVPS failure/malfunction		Er#	Red light	
Alarm for Emitter Tip Cleaning Period		tc#	Green light	

'#' sign means each port from B1 to B4.

- Connection when using PLC

1. Connect the power cable in the same way as described above (Connection when not using PLC and RS-485) .
2. Distinguish each alarm wire and on/off wire per bar number when using PLC (Please refer to <PLC cable according to the number of connected bars> in the next page).
 - 1) Connect the on/off wire to the ground, the same point of the black, brown and red wires of power cable, which makes PLC work.
 - 2) If you open the on/off wire, PLC doesn't work.
(Please refer to the <ASM-P Series PLC Circuit Diagram> in the next page)
 - 3) The alarm signal wire is for an alarm signal.
 - Normal condition: 0V output
 - Abnormal condition: 24V(4.2mA) output
 - Setting Load: Set the output current under 100mA

2.3 Wiring Diagram

<ASM- C Series PLC Circuit Diagram>

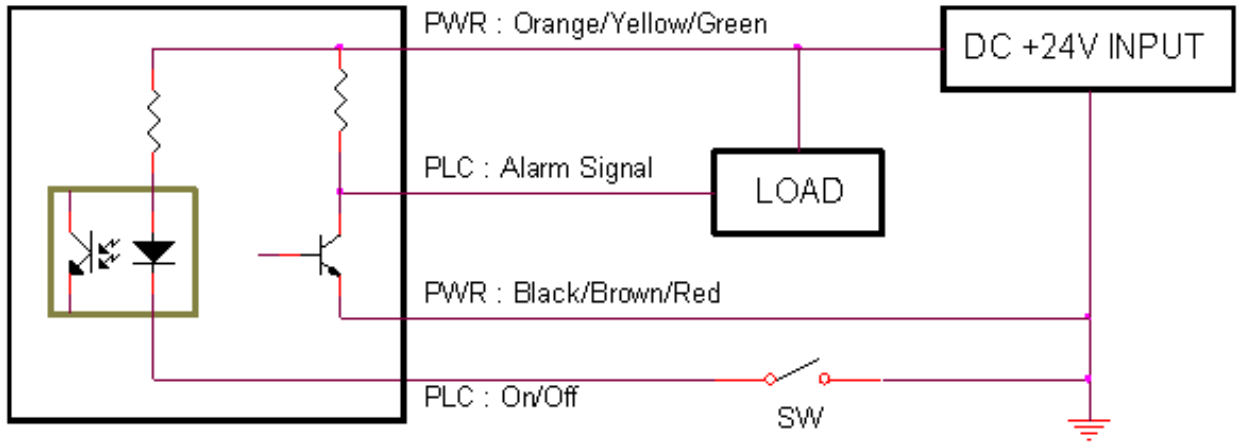

<PLC cable according to the number of connected bars>

BAR	BAR 1	BAR 2	BAR 3	BAR 4
On / Off	① Black	② Brown	⑦ Blue	⑧ Violet
Alarm Signal	③ Red	④ Orange	⑤ Yellow	⑥ Green

※ Refer to the above color list for wiring when connecting bars.

- Connection when using an adaptor

- 1) Connect the black, brown and red wires to the adaptor (-)

Make sure that either one of the lines should be connected to an earthed part of the machine.

- 2) Connect the orange, yellow and green wires to the adaptor (+)

- 3) To avoid short, cut the other 2 wires shortly and tapping them with deliberation.

2.4 Installing and connecting main body

< Installation order >

- ① Assemble the brackets firmly into a main body

Warning!!

If you fix the unit without using the brackets in package, be careful the weight not to be applied on the side cover, which can result in air leakage.

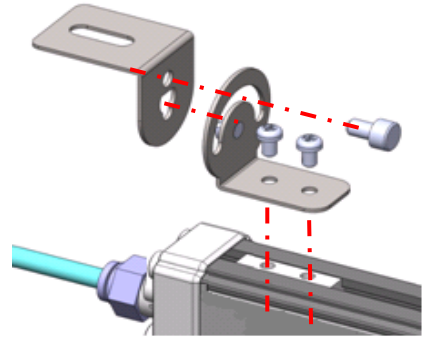

- ② Fix the main body with M5 screws.

Warning!!

Before fixing the main body, make sure that you comply all the precautions (p10.) and location guide(p.11)

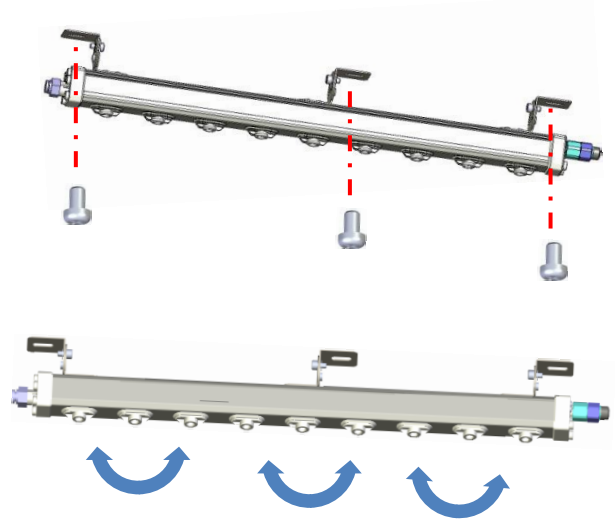

- ③ You can change main body angle up to 180 degree.

- ④ Fix the controller on the external panel of equipment or flat spot.

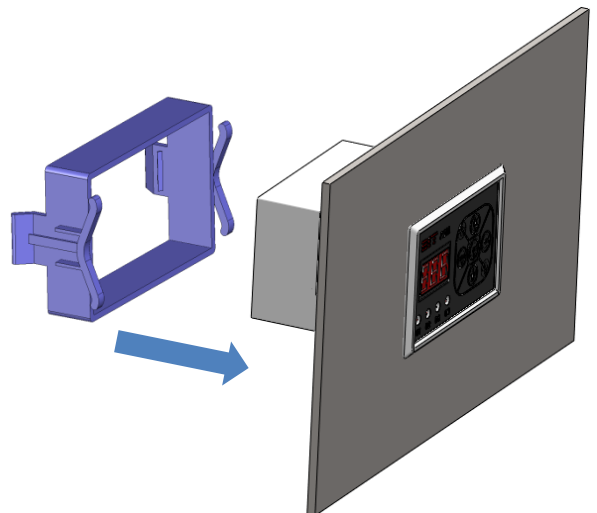

2.4 Installing and connecting main body

- ⑤ Connect RJ-45 power cable (A or B types) to power connector of the controller by pushing the cable until you hear 'tic' sound.

Warning!!

- Make sure that you understand the connection diagram(P.11) and make connections accordingly.
- If the power cable is connected to PLC connector, the device can be damaged.
- For guaranteed performance, make sure that GND line of the power cable should be earthed.

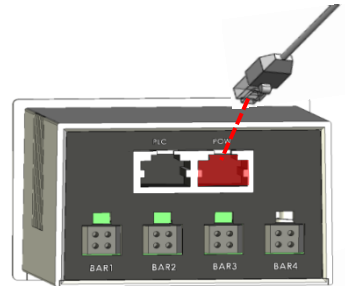
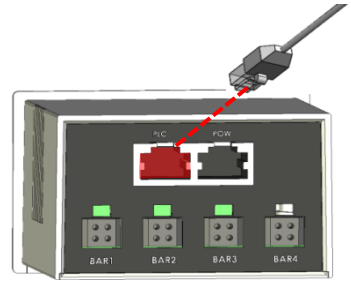

- ⑥ Connect the PLC cable to PLC connector of controller by pushing the cable until you hear 'tic' sound.

Warning!!

- Make sure that you understand the connection diagram(P.11) and make connections accordingly.

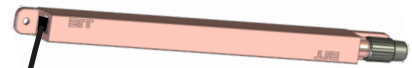

- ⑦ Connect a bar and a HVPS using 4pin connector cable.



- ⑧ GND wire of HVPS cable should be connected to GND terminal of Ion bar after connecting high voltage cable between HVPS and BAR.



- ⑨ Feed the air
6 mm diameter tube is used in ASR-A. Connect tube by pushing it through air fitting until you hear 'click' sound.



Warning!!

- Make sure that air pressure should be lower than 0.5 MPa.
- Air pressure lower than 0.3 MPa is recommended.
- Flow rate and cleanness of supplied air is crucial for performance and cleaning cycle of the device.

2.5 Connecting multiple bars

- Up to 4 bars can be connected to 1 controller in ASR-A Series.
- Electric power : Electric power(DC24V) is transferred to HVPS via controller.
 Detached HVPS of Ion bar supplies high voltage to the emitter pin.
- Telecomm : Controller collects the status of bars and transfers it through RS-485.
 [Telecomm Information : status of alarm and tip-cleaning]
 [Telecomm Control Item : Ion on/off, Ion output frequency, Ion balance]

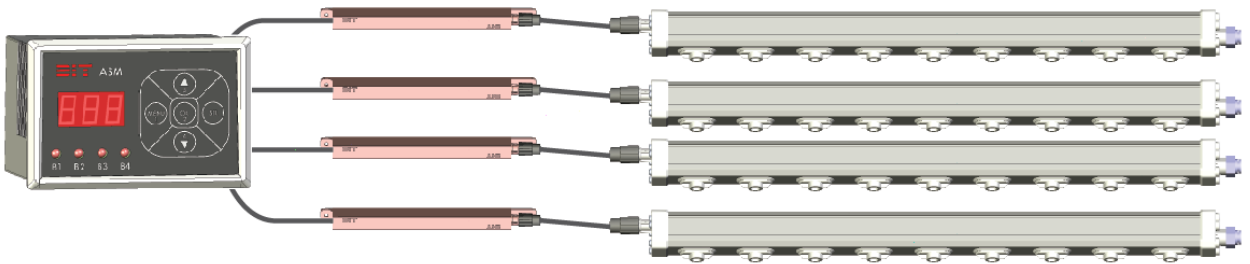

Warning!!

- If the power cable is connected to PLC connector, the device can be damaged.
- If you are to use cables other than ones provided by DIT, please consult us or our agency.
- When connecting multiple bars, make sure that sufficient air and proper power in specification on page 3 are supplied.
- Do not contact 4pin connector cable with a bar except for the connected point.
- Do not disconnect 4 pin connector cable from controller when it is powered.
 It causes the product malfunction.

2.6 Check list after installation

Recheck the below list before operating the Unit.

- (1) Make sure that power and air feeding tube are properly connected. Check if proper air flow and power are supplied to the unit. Excessive or deficient air and electric power may cause damage to the device.
- (2) Check operation environment that may cause malfunction, failure or shortening the life of the device such as strong magnetic or heat sources.
- (3) Check if there are any metallic objects in the vicinity of the device, (<5 cm), or within the operating distance. Metallic objects nearby hinder ion generation and ion moving to targets.
- (4) Check if emitters are installed correctly. Operation without an emitter may seriously damage the device or cause malfunction of it.
- (5) Check if the device is loaded with excessive weight or subject to shock. Excessive load or shock to the device may cause serious damage such as malfunction or air leakage by broken(bent) air duct.

Our ASR-A Series is an ionization device using Corona Discharge method. Ion emission and ion balance are affected by operation environment, please make yourself familiar to the device, instruction and cautions before using the device.

3.1 Setting control values

- Concurrent Control Menu - Use to control all the bars connected to a controller concurrently.
- Individual Control Menu - Use to control a specific bar connected to a controller.

Saved values on the Individual Control Menu mode will not be affected even if the values are changed on Concurrent Control Menu mode later.

Operation	How to control	Controllable items
Entering Concurrent Control Menu	Press "Menu" at a standby screen	Ion / FrE* / bAL** / tiP/ PAS Com Int Adr
Entering Individual Control Menu	1. Press "SEL" 2. Press a button of the bar to control. 3. Press "OK"	Ion tiP bAL* FrE **
Selecting control items / Changing setting values	Press "▲" or "▼"	
Entering a control item list	Press "OK"	
Setting and saving a value	Press "OK"	
Returning to the initial screen	Press "Menu" on the Menu mode	
Moving a cursor to upper digit	Holding "▼" and press "▲"	Adr, bAL, FrE, PAS
Moving a cursor to lower digit	Holding "▲" and press "▼"	Adr, bAL, FrE, PAS

※ Menu is activated only when **ASM-A/ASR-A(AC Pulsed ionizers)** is connected.

3.2 Explanation on menu options

Menu	Explanation	Notes
Adr	Setting Address	Assigning "A01" - "A10" is allowed (up to 10 units).
Ion	Ion On/Off	When ion output is "oFF", alarm LED is changed to the blinking green and "IF#" is displayed on FND.
FrE*:	Setting Frequency	This menu is not activated for ASM-P. Frequency output may range from 1.0 to 60.0. "1.0 ~ 10.0": adjustment possible by 1.0 (increase/decrease) "10.0 ~ 60.0": adjustment possible by 5.0 (increase/decrease)
Bal**	Setting Ion Balance	This menu is not activated for ASM-P. Ion balance can set a range from 35.0 to 65.0.
tIP	Setting Emitter Pin Cleaning Period	If "Yes" is chosen to start cleaning cycle, "tc#" will be displayed, when the end of cleaning cycle is reached. After cleaning emitter pins, reset the cleaning cycle. Cleaning cycle is set by week as a unit, up to five weeks; t01~t52
PAS	Setting Password	Once a password is set, it is not available to enter the main "Menu" without password. Password can be a three digit number, any number between 000 and 999.
Com	Setting Communication Speed	Communication Speed is measured in BPS(bit per second) Selection can be made among below seven speeds. 2.4k / 4.8k / 9.6k / 19.2k / 38.4k / 57.6k / 115k
Int:	Restoring initial factory settings	Factory setup is as follows. Adr : "A01" Ion : "on" FrE : "30.0" bAL : "50.0" PAS : "oFF" Com : " 9.6" tIP : "no"

※ Menu is activated only when **ASM-A/ASR-A(AC Pulsed ionizers)** is connected.

4.1 Necessity of maintenance

- Necessity of emitter pin cleaning and emitter replacement

In general, when static controllers are continuously in operation for a long period, dust and dirt are accumulated around the emitter pin, called “fuzzy-ball”. Depending on operating environment, ‘fuzzy-ball’ grows to block normal ion emission and results in deterioration in performance of static controller.

An emitter pin (inside a emitter) is a sharp, pin-shaped object, made from tungsten. ASR-A Series produces ions using Corona Discharge method. Thus, during an operation, high voltage is applied on its emitter pin, which rounds the sharp pin away as the time goes on. A rounded emitter pin cannot produce ion as well as the sharp one.

For these reasons, emitter and emitter pin should be cleaned and replaced periodically. If not cleaned, and replaced properly, worn-out emitter pin with fuzzy-balls, may deteriorate the quality and performance of your production. Make sure that emitter (and emitter pin) should be cleaned and replaced on a regular basis.

- Recommended cleaning cycle under the circumstance below : **Every 6 months**

- Temperature : 22 °C[a higher temperature may lengthen the cycle]
- Humidity : 50%[a higher humidity may lengthen the cycle]
- Clean Class : 10,000 Class [a lower Class index may lengthen the cycle]
- Quality of Supplied Air : CDA[purer air may lengthen the cycle]

- ※ The conditions listed above are for general environment, Actual result may slightly vary depending on the user’s working environment.
Six months cleaning cycle is based on test conditions used by DIT. Please compare DIT’s conditions and your working environment and adjust it and set up cleaning cycle accordingly.

4.2 Cleaning and replacement of emitters

- How to clean an emitter

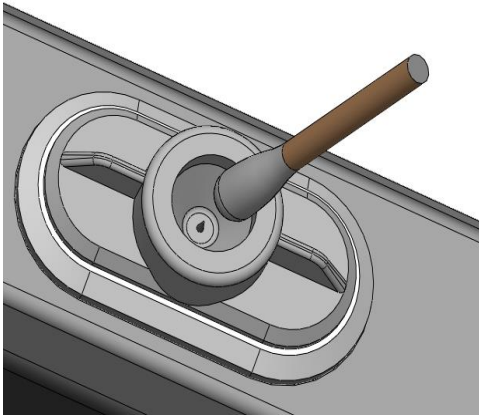

- ① Prepare soft brush or cotton swab with alcohol. (No acetone)
- ② Power off the device and stop the air feeding.
- ③ Wipe out the white 'Fuzzy ball' on the end of the emitter pin softly enough not to damage or scratch it.
- ④ Power on the device and feed the air
- ⑤ After 5 ~ 10 minutes, check the device performance with and measuring instrument.

- How to replace an emitter

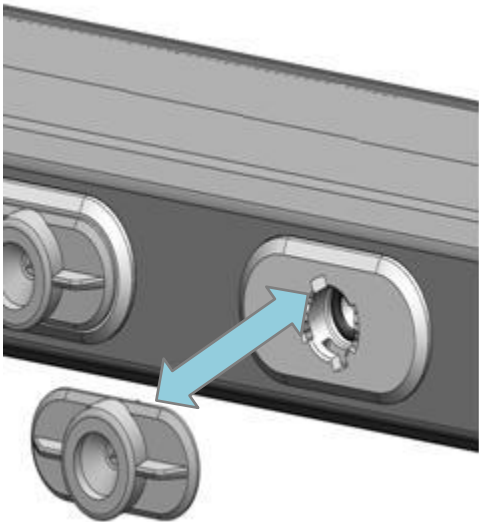

- ① Prepare a new emitter for replacement.
- ② Power off the device and stop the air input.
- ③ Rotate the emitter assembled in the Unit counterclockwise
- ④ Pull the emitter to separate it from the Unit
- ⑤ Insert a new emitter and rotate it clockwise to fix it firmly.
- ⑥ Power on the device and feed the air
- ⑦ After 5 ~ 10 minutes, check the device performance with and measuring instrument.

Trouble shooting

Problems	Check Points
FND is not displayed	<ol style="list-style-type: none"> 1) Check that the power cable is connected correctly. 2) When it dose not work even though the cable connection is correct, contact to our sales agent..
Alarm LED is blinking in red/ Er1/2/3/4 is shown on standby screen (Error message is displayed on FND)	HVPS/Circuit error or an error due to Protection circuit operation. If it is the same even after re-booting, contact to our sales agent.
Alarm LED is blinking in green	Ion off. Check the status of ion generation on a menu.
Ion balance is swing between + and -	<ol style="list-style-type: none"> 1) Some swing is natural because of Auto Balancing function 2) Clean the emitter pin or replace the emitter
Slight unknown smell during operation	Normal state caused by high voltage discharge
Smell of burning during operation	<ol style="list-style-type: none"> 1) Turn off the power immediately. 2) Contact to our sales agent.
“TC” is displayed on FND	It alarms for tip cleaning period. Change the settings of tip cleaning on the menu mode or the specific menu option.
“NC” is displayed on FND	NC1,2,3,4: Ion Bar connection error. Check that the connection is correct.

※ If you cannot solve the problem with the direction above or have other problems not described above, please call the manufacturer or leave a message on our website (www.dongiltech.co.kr).

Quality assurance team : +82 31 299 5466

Technology Market Solution

DIT Technology Application Experts are focused on delivering solutions for the Semiconductor, Electronic Assembly, Photovoltaic, Flat Panel Display, Disk Drive, Cleanroom. You can be sure of receiving maximum performance and reliability. We provide cost effective, innovative products best suited to your application needs.

Warranty

We, Dong Il Technology Ltd. Manufactured this product under a strict quality control system and warrants it for 1 year of period from the shipment date.

However, we don't have any responsibility for

- 1) Any damage if the product is used in a way different from that is explained in this manual or remade by users arbitrarily.
- 2) Any damage led by improper usage. We recommend the installation circumstances in this manual, but that is just a recommendation and users are responsible for understanding the product's specification and judgment of suitability of usage.
- 3) Direct or indirect damage led by the product malfunction.