

MOTOR CONTROL

Magnetic Contactors and Thermal Overload Relays

SK Series



Magnetic Contactor and Thermal Overload Relay

SK Series





Supporting the market for motor drive circuits such as inverters and servos

With the recent increased popularity of inverters and servo amplifiers, more companies are using magnetic contactors as primary side switches for drive control devices as well as using them as direct input motor drives (AC-3 category).

The SK Series was created to fill the need for magnetic contactors with optimized performance and specifications required for this kind of application.

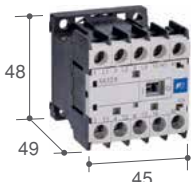
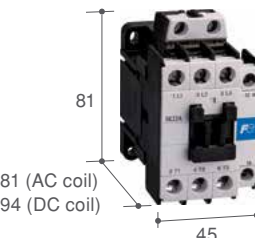
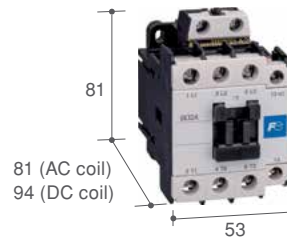

SK Series Lineup

Motor ratings AC-3, AC400V	SK06: 2.2 kW SK09: 4 kW SK12: 5.5 kW	SK18: 7.5 kW SK22: 11 kW	SK32: 15 kW
Magnetic Contactor Size (mm)			
Type	<div style="background-color: #e67e22; color: white; padding: 2px; text-align: center; margin-bottom: 2px;">SK06</div> <div style="background-color: #e67e22; color: white; padding: 2px; text-align: center; margin-bottom: 2px;">SK09</div> <div style="background-color: #e67e22; color: white; padding: 2px; text-align: center;">SK12</div>	<div style="background-color: #e67e22; color: white; padding: 2px; text-align: center; margin-bottom: 2px;">SK18</div> <div style="background-color: #e67e22; color: white; padding: 2px; text-align: center;">SK22</div>	<div style="background-color: #e67e22; color: white; padding: 2px; text-align: center;">SK32</div>
	+	+	+
Thermal Overload Relay Size (mm)			
Type	<div style="background-color: #e67e22; color: white; padding: 2px; text-align: center;">TK12</div>	<div style="background-color: #e67e22; color: white; padding: 2px; text-align: center;">TK25</div>	<div style="background-color: #e67e22; color: white; padding: 2px; text-align: center;">TK26</div>

Compared to our previous products, the size is drastically reduced (SK18 to SK32 types)

AC-operated type

- Optimized product specifications and performance for use as primary side switches in drive gears, such as inverters and servo amplifiers.

The series has been downsized to some of the smallest sizes in the world.

[Comparison with previous products]

Volume ratio: Reduced by 15 to 38%

Width: Reduced by 8 to 11 mm

Depth: Reduced by 15 mm (for SK32A type)

DC operated type

- The depth of DC operated SK18G through SK32G models has also been drastically reduced.

[Comparison with previous products]

Volume ratio: Reduced by 13 to 23%

Width: Reduced by 8 to 11 mm

Depth: Reduced by 14 to 28 mm

The depth of the DC-operated types has been reduced.

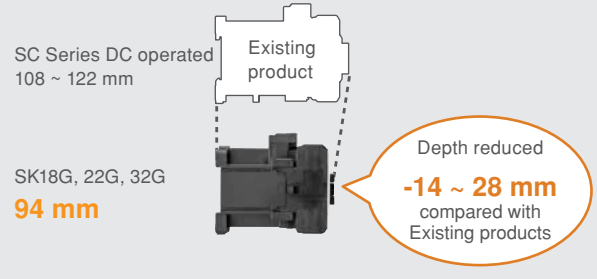

Unified width of 45 mm for SK06 to SK22 types

- The width is unified to 45 mm for SK06 to SK22 types, which is the same width as that of the BM3 series of manual motor starters. It is easier to compose a combination starter now that can realize a more compact motor starter circuit.

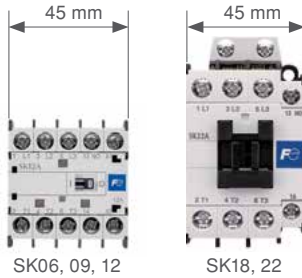

It is possible to compose a combination starter more easily.

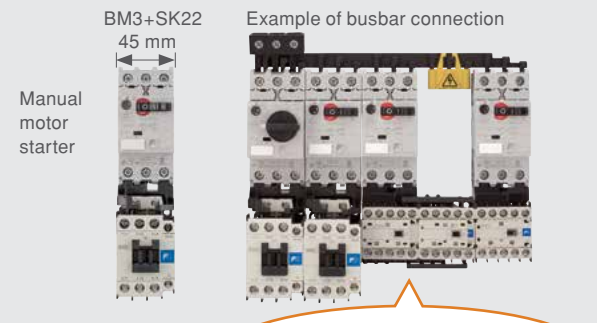

SK06 to SK22 contactors can be linked with a single busbar system

Low power consumption

- Direct drive through PLC transistor output has been expanded to motors rated 6.5 kW (200V AC).

[DC operated type]

The SK18G through SK32G models use the same high efficiency polarized electromagnets used in the SK06L through SK12L models, making it possible to directly drive all models through transistor output (rated for 24 V DC, 0.1 A).

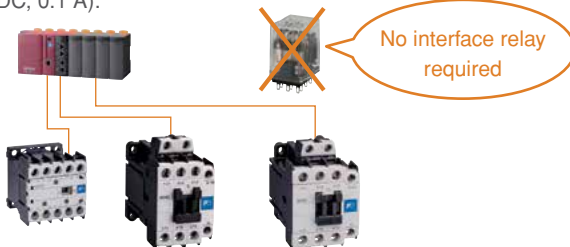

Magnet power consumption

For SK18/22/32

[DC Coil]

Standard DC coil : 2.4W

Low-power DC coil : 1.2W



86% of previous models

* Up to two auxiliary contactscan be added.

Comparison with FUJI SJ Series

Magnet power consumption

For SK18/22/32

[DC Coil]

Standard DC coil : 2.4W

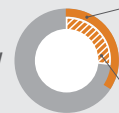

SK18, 22 Compared with conventional products

34%

SK32 Compared with conventional products

27%

Comparison with FUJI SC Series

Standard Compliance

- Being accredited with most of the mainstream international standards, our products can be exported to any destination.

Product	Type	Compliant Standards			Certified Standards				EC Directives	Certifying Body
		IEC	EN	JIS	UL	CSA	GB	KC	CE Marking	TÜV
		International	Europe	Japan	USA	Canada	China	Korea	Europe	Germany
Magnetic Contactors	SK□A	●	●	●	●	●	●	●*1	●	●
	SK□G	●	●	●	●	●	●	●*1	●	●
	SK□L	●	●	●	●	●	●	●*1	●	●
Thermal Overload Relays	TK12,TK25,TK26	●	●	●	●	●	●	-	●	●

Note:Legend ●: Compliance with standard models. *1 Single contacts (H) for auxiliary contact use have not been certified.

Catalog Disclaimer

The information contained in this catalog does not constitute an express or implied warranty of quality, any warranty of merchantability or fitness for a particular purpose is hereby disclaimed.

Since the user's product information, specific use application, and conditions of use are all outside of Fuji Electric FA Components & Systems' control, **it shall be the responsibility of the user to determine the suitability of any of the products mentioned for the user's application.**

One Year Limited Warranty

The products identified in this catalog shall be sold pursuant to the terms and conditions identified in the "Conditions of Sale" issued by Fuji Electric FA with each order confirmation.

Except to the extent otherwise provided for in the Conditions of Sale issued by Fuji Electric FA, Fuji Electric FA warrants that the Fuji Electric FA products identified in this catalog shall be free from significant defects in materials and workmanship provided the product has not been: 1) repaired or altered by others than Fuji Electric FA; 2) subjected to negligence, accident, misuse, or damage by circumstances beyond Fuji Electric FA's control; 3) improperly operated, maintained or stored; or 4) used in other than normal use or service. This warranty shall apply only to defects appearing within one (1) year from the date of shipment by Fuji Electric FA, and in such case, only if such defects are reported to Fuji Electric FA within thirty (30) days of discovery by purchaser. Such notice should be submitted in writing to Fuji Electric FA at 5-7, Nihonbashi Odemma-cho, Chuo-ku, Tokyo, Japan. The sole and exclusive remedy with respect to the above warranty whether such claim is based on warranty, contract, negligence, strict liability or any other theory, is limited to the repair or replacement of such product or, at Fuji Electric FA's option reimbursement by Fuji Electric FA of the purchase price paid to Fuji Electric FA for the particular product. **Fuji Electric FA does not make any other representations or warranties, whether oral or in writing, expressed or implied, including but not limited to any warranty regarding merchantability or fitness for a particular purpose.** Except as provided in the Conditions of Sale, no agent or representative of Fuji Electric FA is authorized to modify the terms of this warranty in writing or orally.

In no event shall Fuji Electric FA be liable for special, indirect or consequential damages, including but not limited to, loss of use of the product, other equipment, plant and power system which is installed with the product, loss of profits or revenues, cost of capital, or claims against the purchaser or user of the product by its customers resulting from the use of information, recommendations and descriptions contained herein. The purchaser agrees to pass on to its customers and users, in writing at the time inquiries and orders are received by buyer, Fuji Electric FA's warranty as set forth above.

Safety Considerations

- Operate (keep) in the environment specified in the operating instructions and manual. High temperature, high humidity, condensation, dust, corrosive gases, oil, organic solvents, excessive vibration or shock might cause electric shock, fire, erratic operation or failure.
- For safe operation, before using the product read the instruction manual or user manual that comes with the product carefully or consult the Fuji sales representative from which you purchased the product.
- Products introduced in this catalog have not been designed or manufactured for such applications in a system or equipment that will affect human bodies or lives.
- Customers, who want to use the products introduced in this catalog for special systems or devices such as for atomic-energy control, aerospace use, medical use, passenger vehicle, and traffic control, are requested to consult with Fuji Electric FA.
- Customers are requested to prepare safety measures when they apply the products introduced in this catalog to such systems or facilities that will affect human lives or cause severe damage to property if the products become faulty.
- For safe operation, wiring should be conducted only by qualified engineers who have sufficient technical knowledge about electrical work or wiring.
- Follow the regulations of industrial wastes when the product is to be discarded.
- For further questions, please contact your Fuji sales representative or Fuji Electric FA.

Magnetic-Contactors SK Series









	Page
Standard Models	6
Production Models	8
Type Number Nomenclature (Magnetic Contactors, Thermal Overload Relays and Auxiliary Relays)	9
Ratings	
Main Circuit Ratings	11
Auxiliary Circuit Ratings	12
Operating Coil Voltages	13
Operating Coil Characteristics	14
Performances	15
AC-3 Breaking Current and Electrical Durability	15
AC-1 Breaking Current and Electrical Durability	16
Protective Coordination	
Coordination with Short-circuit Protection Devices (SCPD) (Based on IEC and JIS Standards)	17
UL approved Short-circuit Current Ratings (SCCR)	21
Application to IE3 (Premium Efficiency) Motors	27
Normal Operating Conditions and Mounting	28
Wiring	30
Handling	32
Magnetic Contactors	
Features	34
Ordering Information	34
Ratings and Types	34
Dimensions and Connection Diagrams	36
Reversing Magnetic Contactors	
Features	38
Ordering Information	38
Ratings and Types	38
Dimensions and Connection Diagrams	40
Main contact 4-pole magnetic contactor	42
Magnetic contactor with tab terminal	43
PC board mounting magnetic contactor	44
Thermal Overload Relays	
Features	45
Ordering Information	45
Ratings and Types	45
Ampere Setting Range Specification Codes	45
Auxiliary Circuit Ratings	46
Operating Characteristics (Specifications)	46
Operating Characteristics Curves (Average Values)	47
Dimensions and Connection Diagrams	48
Optional Unit	
Type Numbers and Product Codes	49
Auxiliary Contact Blocks	50
Mechanical Interlock Unit and Power Connection Kit for Reversing	54
Main Circuit Surge Suppression Unit and Separate Installation Unit	55
Coil Surge Suppression Units and Operation Indicator Lamps	57
Thermal Overload Relay Reset Releases	59
Separate Mounting Unit for Thermal Overload Relay	60
Link Module and Power Connection Kit for Reversing (Insert)	62
Auxiliary Relays	64



Magnetic-Contactors









Standard Models

■ Standard Models

Series			SK Series		
Frame			06	09	12
Magnetic Contactor appearance			 (KKD14-157)		
Thermal Overload Relay appearance			 (KKD14-166)		
Type	Magnetic Contactors	AC-operated types	SK06A	SK09A	SK12A
		DC-operated types (2.4W)	SK06G	SK09G	SK12G
		DC-operated types (1.2W)	SK06L	SK09L	SK12L
	Thermal Overload Relay	TK12			
Rated insulation voltage (IEC)			690V	690V	690V
Rated impulse withstand voltage (IEC)			6kV	6kV	6kV
Rated frequency			50-60Hz	50-60Hz	50-60Hz
Main circuit ratings	3-phase squirrel-cage motor capacity [kW] AC-3 IEC60947-4-1	200-240V	1.5kW	2.2kW	3kW
		380-440V	2.2kW	4kW	5.5kW
		500-550V	3kW	4kW	5.5kW
		600-690V	3kW	4kW	4kW
	Rated current I _e [A] AC-3	200-240V	6A	9A	12A
		380-440V	6A	9A	12A
		500-550V	5A	7A	9A
		600-690V	3.5A	5A	5A
	Conventional free air thermal current (Rated continuous current) I _{th} [A]		20A	20A	20A
	Performances	Operating cycles per hour [times/hour]		1800	1800
Durability		Mechanical	10 million	10 million	10 million
		Electrical (AC-3)	1 million	1 million	1 million
Dimensions W×H×D [mm]			45×48×49	45×48×49	45×48×49
Options	Auxiliary Contact Blocks	Front mounting (2-pole)	☉		
		Front mounting (4-pole) *1	☉		
	Mechanical Interlock Unit		☉		
	Coil Surge Suppression Unit		☉		
	Main Circuit Surge Suppression Unit		☉		
Standards			    		

Note: *1 These products cannot be combined with the SK□L.

Standard Models



Series		SK Series			
Frame		18	22	32	
Magnetic Contactor appearance		 (KKD14-083)		 (KKD14-179)	
Thermal Overload Relay appearance		 (KKD14-095)		 (KKD14-113)	
Type	Magnetic Contactors	AC-operated types	SK18A	SK22A	SK32A
		DC-operated types (2.4W)	SK18G	SK22G	SK32G
DC-operated types (1.2W)		—	—	—	
Thermal Overload Relay		TK25		TK26	
Rated insulation voltage (IEC)		690V	690V	690V	
Rated impulse withstand voltage (IEC)		6kV	6kV	6kV	
Rated frequency		50-60Hz	50-60Hz	50-60Hz	
Main circuit ratings	3-phase squirrel-cage motor capacity [kW] AC-3 IEC60947-4-1	200-240V	4.5kW	5.5kW	7.5kW
		380-440V	7.5kW	11kW	15kW
		500-550V	7.5kW	11kW	15kW
		600-690V	7.5kW	7.5kW	11kW
	Rated current I _e [A] AC-3	200-240V	18A	22A	32A
380-440V		18A	22A	32A	
500-550V		13A	17A	24A	
600-690V		9A	9A	15A	
Conventional free air thermal current (Rated continuous current) I _{th} [A]		32A	32A	40A	
Performances	Operating cycles per hour [times/hour]		1800	1800	1200
	Durability	Mechanical	5 million	5 million	5 million
		Electrical (AC-3)	1 million	1 million	1 million
Dimensions W×H×D [mm]	AC-operated		45×81×81	45×81×81	53×81×81
	DC-operated		45×81×94	45×81×94	53×81×94
Options	Auxiliary Contact Blocks	Front mounting (2-pole)	⊙		
		Front mounting (4-pole)	—		
		Side-mounting	⊙		
	Mechanical Interlock Unit		⊙		
	Coil Surge Suppression Unit		⊙		
Main Circuit Surge Suppression Unit		⊙			
Standards		    			



Magnetic-Contactors

Standard Models and Production Models

■ Thermal Overload Relays

Thermal Overload Relay appearance	 (KKD14-166)	 (KKD14-095)	 (KKD14-113)
Type	TK12	TK25	TK26
Protection	Overload and phase-loss protection		
Ampere setting range The heating element code is given in brackets.	0.1-0.15A [P10] 0.13-0.2A [P13] 0.18-0.27A [P18] 0.24-0.36A [P24] 0.34-0.52A [P34]	0.48-0.72A [P48] 0.64-0.96A [P64] 0.8-1.2A [P80] 0.95-1.45A [P95] 1.1-1.65A [1P1]	1.4-2.1A [1P4] 1.7-2.6A [1P7] 2.2-3.4A [2P2] 2.8-4.2A [2P8] 4-6A [004]
		5-7.5A [005] 6-9A [006] 7-10.5A [007] 9-13A [009] 12-18A [012]*1	16-22A [016]*1 20-26A [020]*2 26-32A [026]*2

Note: *1 For TK25, TK26 only.
*2 For TK26 only.

■ Production Models

Magnetic Contactors and Magnetic Starters

Product	Type *1	Frame size						
		06	09	12	18	22	32	
Magnetic Contactors	AC-operated types	SK □ A	○	○	○	○	○	○
	DC-operated types (standard)	SK □ G	○	○	○	○	○	○
	DC-operated types (low power consumption)	SK □ L	○	○	○	—	—	—
Reversing Contactors	AC-operated types	SK □ AR	○	○	○	○	○	○
	DC-operated types (standard)	SK □ GR	○	○	○	○	○	○
	DC-operated types (low power consumption)	SK □ LR	○	○	○	—	—	—

Note: *1 In the □ mark, is replaced with the frame size.



Magnetic-Contactors

Type Number Nomenclature

■ Type Number Nomenclature

● Type Number Nomenclature (Type Number = Product Code)

• Magnetic Contactors

SK 12 A H R - 2 01 W

Basic type number

Mini-Contactor

Frame size

06, 09, 12, 18, 22 or 32

Operating method

- A : AC-operated type
- G : DC-operated type (2.4W)
- L : DC-operated type (1.2W) SK06, 09, 12

Auxiliary contact

- Blank : Bifurcated contact
- H : Single button contact

Non-reversing or reversing

- Blank : Non-reversing
- R : Reversing

Reversing conductor

- W : Wire
- M : Molded SK06, 09, 12 (Only for Combination Starter)

Note: Specify this for a reversing model.

Auxiliary contact arrangement

- 10 : 1NO
- 01 : 1NC

Coil voltage

AC operation		
	E	24V AC
	F	48V AC
	1	100V AC
	H	110V AC
	K	120V AC
	2	200V AC
	M	220V AC
	P	240V AC
	S	380V AC
	4	400V AC
	T	440V AC
	5	500V AC
DC operation		
2.4W (G)	B	12V DC
	E	24V DC
	F	48V DC
	G	60V DC
	1	100V DC
	H	110V DC
	K	120V DC
	2	200V DC
	Y	210V DC
	M	220V DC
1.2W (L)	B	12V DC
	E	24V DC
	F	48V DC

Note: Products cannot be manufactured for all possible type numbers.

• Thermal Overload Relays

TK 12 W A - 009

Basic type number

TK : 2E Thermal Overload Relay (with phase-loss detection)

Frame size

12, 25, 26

Mounting

W : On-contactor mounting (* TK12 only)

Reset method

- Blank : Manual reset (standard)
- A : Automatic reset

Ampere setting range

- P10 : 0.1-0.15A
- P13 : 0.13-0.2A
- P18 : 0.18-0.27A
- P24 : 0.24-0.36A
- P34 : 0.34-0.52A
- P48 : 0.48-0.72A
- P64 : 0.64-0.96A
- P80 : 0.8-1.2A
- P95 : 0.95-1.45A
- 1P1 : 1.1-1.65A
- 1P4 : 1.4-2.1A
- 1P7 : 1.7-2.6A
- 2P2 : 2.2-3.4A
- 2P8 : 2.8-4.2A
- 004 : 4-6A
- 005 : 5-7.5A
- 006 : 6-9A
- 007 : 7-10.5A
- 009 : 9-13A
- 012 : 12-18A
- 016 : 16-22A
- 020 : 20-26A
- 026 : 26-32A



Auxiliary Relays

■ Type Number Nomenclature

- Type Number Nomenclature
 - SK-Series Auxiliary Relays

SKH4 A H - 1 22

Basic type

SK-Series Auxiliary Relay

Operating method

- A : AC-operated types
- G : DC-operated types (2.4W)
- L : DC-operated types (1.2W)

Auxiliary contact

- Blank : Bifurcated contact
- H : Single button contact

Auxiliary contact arrangement

- 40 : 4NO
- 31 : 3NO+1NC
- 22 : 2NO+2NC

Coil voltage

AC operation			
		E	24V AC
		F	48V AC
		1	100V AC
		H	110V AC
		K	120V AC
		2	200V AC
		M	220V AC
		P	240V AC
		S	380V AC
		4	400V AC
		T	440V AC
		5	500V AC
DC operation			
2.4W (G)		B	12V DC
		E	24V DC
		F	48V DC
		G	60V DC
		1	100V DC
		H	110V DC
		K	120V DC
		2	200V DC
		Y	210V DC
		M	220V DC
1.2W (L)		B	12V DC
		E	24V DC
		F	48V DC



Ratings

■ Main Circuit Ratings

● IEC-conformance Ratings (IEC 60947-4-1, EN 60947-4-1, and VDE 0660)

Type	Max. motor capacity [kW]				Operational current [A]				Conventional free air thermal current [A] (Rated thermal current)
	3-phase squirrel-cage motor (AC-3)				3-phase squirrel-cage motor (AC-3)				
	200-240V	380-440V	500-550V	600-690V	200-240V	380-440V	500-550V	600-690V	
SK06	1.5	2.2	3	3	6	6	5	3.5	20
SK09	2.2	4	4	4	9	9	7	5	20
SK12	3	5.5	5.5	4	12	12	9	5	20
SK18	4.5	7.5	7.5	7.5	18	18	13	9	32
SK22	5.5	11	11	7.5	22	22	17	9	32
SK32	7.5	15	15	11	32	32	24	15	40

Note: AC-3 electrical durability: 1,000,000 operations

● UL/CSA-conformance Ratings (UL60947-4-1A^{*1} and CSA C22.2)

Type	Max. motor capacity [HP]				Operational current [A]				Rated continuous current [A]
	3-phase motor				3-phase motor				
	200V	220-240V	440-480V	550-600V	200V	220-240V	440-480V	550-600V	
SK06	1-1/2	2	3	5	6.9	6.8	4.8	6.1	20
SK09	2	3	5	5	7.8	9.6	7.6	6.1	20
SK12	3	3	5	5	11	9.6	7.6	6.1	20
SK18	5	5	10	7-1/2	17.5	15.2	14	9	32
SK22	5	7-1/2	15	10	17.5	22	21	11	32
SK32	7-1/2	10	20	15	25.3	28	27	17	40

Type	Max. motor capacity [HP]			Operational current [A]			Rated continuous current [A]
	Single-phase motor			Single-phase motor			
	110-120V	200V	220-240V	110-120V	200V	220-240V	
SK06	1/2	3/4	1	9.8	7.9	8	20
SK09	3/4	1	1-1/2	13.8	9.2	10	20
SK12	1	1-1/2	2	16	11.5	12	20
SK18	1	2	2	16	13.8	12	32
SK22	1-1/2	3	3	20	19.6	17	32
SK32	2	3	5	24	19.6	28	40

Note: Use wires that are rated for 75°C.

*1 The standard for Industrial Control Equipment UL 508 has been harmonized with the relevant product standards of the IEC standard for Low-Voltage Switchgear and Controlgear IEC 60947.



■ Auxiliary Circuit Ratings

● IEC-conformance Ratings (Standard Models: Bifurcated Contact)

Type	Conventional free air thermal current [A] (Rated thermal current)	Making and breaking current (AC)	Rated operational current [A]						Minimum voltage and current
			AC rated operational voltage [V]	AC-15 (Ind. load)	AC-12 (Res. load)	DC rated operational voltage [V]	DC-13 (Ind. load)	DC-12 (Res. load)	
SK06 SK09 SK12 SKH4	10	30	100-120	3	6	24	2	3	5V DC, 3mA
		30	200-240	3	6	48	1	2	
		10	380-440	1	6	110	0.3	1.5	
		5	500-600	0.5	3	220	0.2	0.5	
SK18 SK22 SK32	10	60	100-120	6	10	24	3	5	5V DC, 3mA
		30	200-240	3	8	48	1.5	3	
		15	380-440	1.5	5	110	0.55	2.5	
		12	500-600	12	5	220	0.27	1	

Note: The failure level is 10^{-7} for a normal environment without dust, dirt, or corrosive gas.
The ratings of additional auxiliary contacts are the same as those given above.

● IEC-conformance Ratings (Single Button Contact)

Type	Conventional free air thermal current [A] (Rated thermal current)	Making and breaking current (AC)	Rated operational current [A]						Minimum voltage and current
			AC rated operational voltage [V]	AC-15 (Ind. load)	AC-12 (Res. load)	DC rated operational voltage [V]	DC-13 (Ind. load)	DC-12 (Res. load)	
SK06□H SK09□H SK12□H SKH4□H	10	60	100-120	6	10	24	4	8	24V DC, 10mA
		60	200-240	6	10	48	1	3.5	
		60	380-440	6	10	110	0.5	2.5	
		30	500-600	3	5	220	0.25	0.8	
SK18□H SK22□H SK32□H	10	60	100-120	6	10	24	5	10	24V DC, 10mA
		60	200-240	6	10	48	1.5	5	
		40	380-440	4	10	110	0.7	4	
		40	500-600	4	10	220	0.27	1	

Note: The failure level is 10^{-7} for a normal environment without dust, dirt, or corrosive gas.
The ratings of additional auxiliary contacts are the same as those given above.

● UL/CSA-conformance Ratings (Bifurcated Contact or Single Button Contact)

Type	Rated continuous current [A]	Rated operational current [A]						Rating code	
		AC			DC			AC	DC
		Rated operational voltage [V]	Making	Breaking	Rated operational voltage [V]	Making	Breaking		
SK06 SK09 SK12 SK18 SK22 SK32 SKH4	10	120	60	6	125	0.55	0.55	A600	Q300
		240	30	3					
		480	15	1.5	250	0.27	0.27		
		600	12	1.2					

■ Operating Coil Voltages

● AC-operated Types

Type	Order voltage	Code	Coil voltage and frequency
SK06A SK09A SK12A SK18A SK22A SK32A	24V AC	E	24V 50Hz / 24-26V 60Hz
	48V AC	F	48V 50Hz / 48-52V 60Hz
	100V AC	1	100V 50Hz / 100-110V 60Hz
	110V AC	H	100-110V 50Hz / 110-120V 60Hz
	120V AC	K	110-120V 50Hz / 120-130V 60Hz
	200V AC	2	200V 50Hz / 200-220V 60Hz
	220V AC	M	200-220V 50Hz / 220-240V 60Hz
	240V AC	P	220-240V 50Hz / 240-260V 60Hz
	380V AC	S	346-380V 50Hz / 380-420V 60Hz
	400V AC	4	380-400V 50Hz / 400-440V 60Hz
	440V AC	T	415-440V 50Hz / 440-480V 60Hz
500V AC	5	480-500V 50Hz / 500-550V 60Hz	

● DC-operated Types (2.4W)

Type	Order voltage	Code	Coil voltage
SK06G SK09G SK12G SK18G SK22G SK32G	12V DC	B	12V DC
	24V DC	E	24V DC
	48V DC	F	48V DC
	60V DC	G	60V DC
	100V DC	1	100V DC
	110V DC	H	110V DC
	120V DC	K	120V DC
	200V DC	2	200V DC
	210V DC	Y	210V DC
	220V DC	M	220V DC

● DC-operated Types (1.2W)

Type	Order voltage	Code	Coil voltage
SK06L SK09L SK12L	12V DC	B	12V DC
	24V DC	E	24V DC
	48V DC	F	48V DC



■ Operating Coil Characteristics

● AC-operated Types

Type	Power consumption [VA]				Watt loss [W]		Pick-up voltage [V]		Drop-out voltage [V]		Operating times [ms]	
	Inrush		Sealed		200V 50Hz	220V 60Hz	50Hz	60Hz	50Hz	60Hz	Coil ON → Contact ON	Coil OFF → Contact OFF
	200V 50Hz	220V 60Hz	200V 50Hz	220V 60Hz								
SK06A SK09A SK12A	22	25	4.5	4.5	1.2	1.3	122-135	128-138	80-89	83-96	17-26	8-11
SK18A SK22A	90	95	9	9	2.7	2.8	118-136	130-146	75-106	88-120	9-20	5-16
SK32A	90	95	9	9	2.7	2.8	118-136	130-146	75-106	88-120	9-20	5-16

Note 1. The characteristics are for the following coil ratings: 200V, 50Hz/200 to 220V, 60Hz.

Note 2. The electromagnet capacity is the same even when the rated coil voltage is not 200V AC.

Note 3. The operating times are for 200V AC, 50Hz.

Note 4. The pick-up voltage and drop-out voltage for a 100V (100V AC, 50 Hz/100 to 110V, 60Hz) coil are approximately half of the values that are given in the above table.

Note 5. The values in the above table are examples for a cold status at 20°C.

● DC-operated Types (2.4W)

Type	Power consumption [W]		Time constant [ms]	Pick-up voltage [V]	Drop-out voltage [V]	Operating times [ms]	
	Inrush	Sealed	Sealed			Coil ON → Contact ON	Coil OFF → Contact OFF
	24V	24V					
SK06G SK09G SK12G	2.4	2.4	20	10-11	4-6	22-24	5-6
SK18G SK22G	2.4	2.4	33	15-16	3.5-5	65-72	18-23
SK32G	2.4	2.4	33	15-16	3.5-5	65-72	18-23

Note 1. The characteristics are for the following coil rating: 24V DC.

Note 2. The electromagnet capacity is the same even when the rated coil voltage is not 24V DC.

Note 3. The values in the above table are examples for a cold status at 20°C.

Note 4. This operating time is based on a reference value and it is not a guaranteed operating time.

● DC-operated Types (1.2W)

Type	Power consumption [W]		Time constant [ms]	Pick-up voltage [V]	Drop-out voltage [V]	Operating times [ms]	
	Inrush	Sealed	Sealed			Coil ON → Contact ON	Coil OFF → Contact OFF
	24V	24V					
SK06L SK09L SK12L	1.2	1.2	20	13-14	4-5	30-33	8-9

Note 1. The characteristics are for the following coil rating: 24V DC.

Note 2. The electromagnet capacity is the same even when the rated coil voltage is not 24V DC.

Note 3. The values in the above table are examples for a cold status at 20°C.

Note 4. This operating time is based on a reference value and it is not a guaranteed operating time.

■ Performances

Type	Rated operational voltage [V]	Rated operational current [A]	Making/breaking current [A]		Operating cycles per hour [times/hour]	Durability (Operations)	
			Making	Breaking		Mechanical	Electrical
SK06	220	6	72	60	1800	10 million	1 million
	440	6	72	60			
SK09	220	9	108	90			
	440	9	108	90			
SK12	220	12	144	120			
	440	12	144	120			
SK18	220	18	216	180	1200	5 million	
	440	18	180	144			
SK22	220	22	264	220			
	440	22	220	176			
SK32	220	32	320	260			
	440	32	320	256			

■ AC-3 Breaking Current and Electrical Durability

● SK06 to SK32

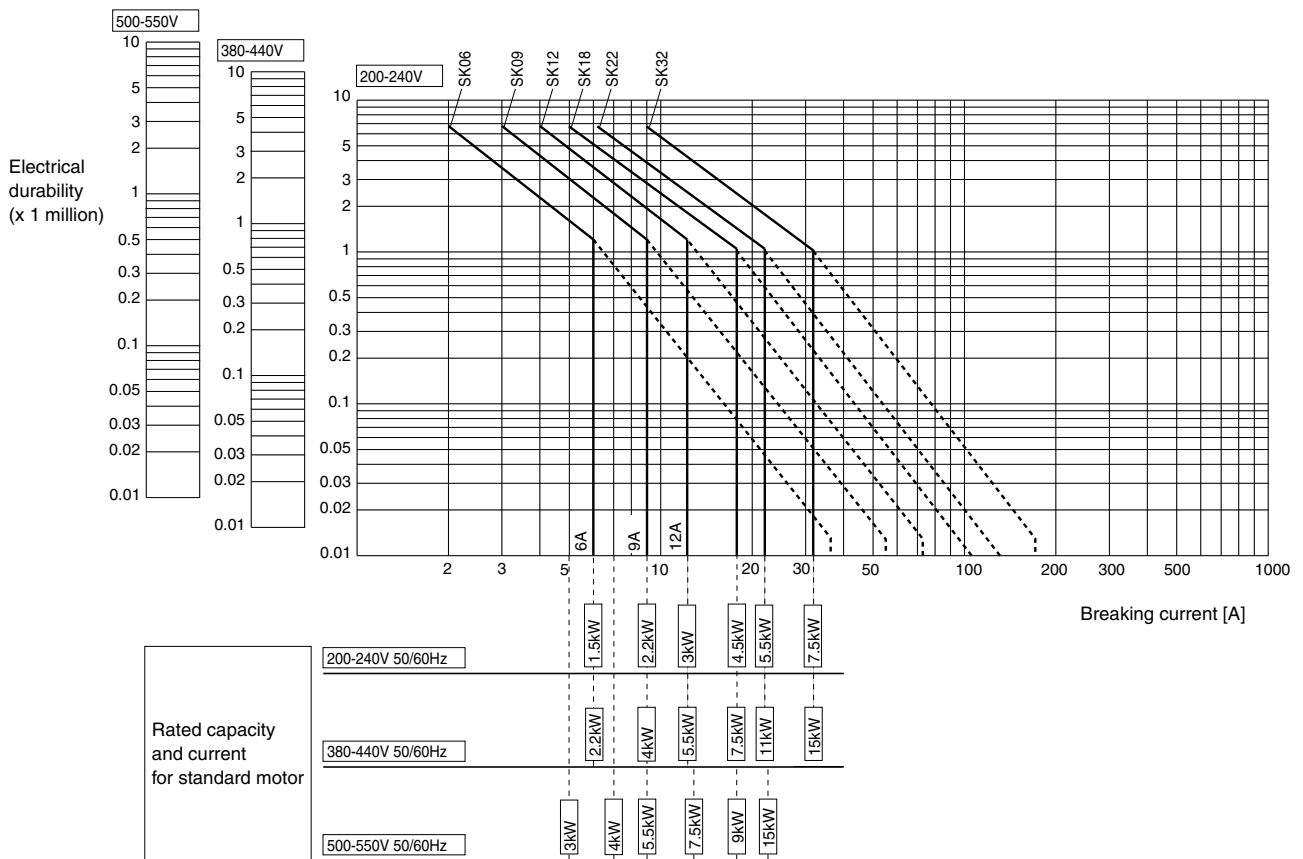



■ AC-1 Breaking Current and Electrical Durability

- SK06 to SK32

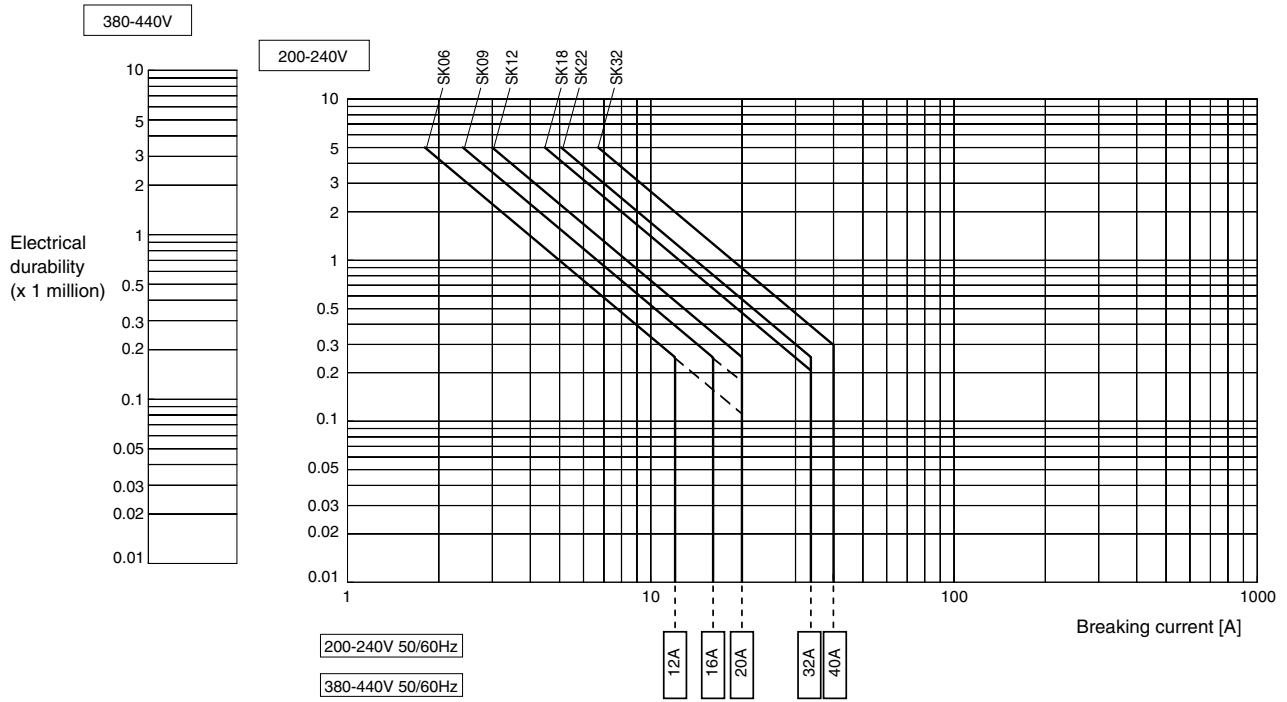



■ Coordination with Short-circuit Protection Devices (SCPD) (Based on IEC Standards)

● Prospective Short-circuit Current "r" (240V and 440V)

Magnetic Contactor	Thermal Overload Relay		Coordination type						
			Type 1		Type 2			FUJI Low-voltage Current-limiting Fuse	
	Type	Ampere setting range [A]	Short-circuit current "r" [kA]	Molded Case Circuit Breaker / Earth Leakage Circuit Breaker	Short-circuit current "r" [kA]	Fuse (IEC 60269-1 gG and gM) rating (A)	Type	Rating [A]	
SK06	TK12	0.34-0.52	1	BW32SAG EW32SAG BW32SBG EW32SBG	3	1	2	BLA003	3
		0.48-0.72	1			3	4	BLA005	5
		0.64-0.96	1			5	4	BLA005	5
		0.8-1.2	1			5	4	BLA005	5
		0.95-1.45	1			10	16	BLA020	20
		1.1-1.65	1			10	16	BLA020	20
		1.4-2.1	1			20	16	BLA020	20
		1.7-2.6	1			20	16	BLA020	20
		2.2-3.4	1			20	16	BLA020	20
		2.8-4.2	1			20	16	BLA020	20
		4-6	1			20	16	BLA020	20
		SK09	TK12			0.34-0.52	1	BW32SAG EW32SAG BW32SBG EW32SBG	3
0.48-0.72	1			3	4	BLA005	5		
0.64-0.96	1			5	4	BLA005	5		
0.8-1.2	1			5	4	BLA005	5		
0.95-1.45	1			10	16	BLA020	20		
1.1-1.65	1			10	16	BLA020	20		
1.4-2.1	1			20	16	BLA020	20		
1.7-2.6	1			20	16	BLA020	20		
2.2-3.4	1			20	16	BLA020	20		
2.8-4.2	1			20	16	BLA020	20		
4-6	1			20	16	BLA020	20		
5-7.5	1			20	16	BLA020	20		
6-9	1	20	16	BLA020	20				
SK12	TK12	0.34-0.52	1	BW32SAG EW32SAG BW32SBG EW32SBG	3	1	2	BLA003	3
		0.48-0.72	1			3	4	BLA005	5
		0.64-0.96	1			5	4	BLA005	5
		0.8-1.2	1			5	4	BLA005	5
		0.95-1.45	1			10	16	BLA020	20
		1.1-1.65	1			10	16	BLA020	20
		1.4-2.1	1			20	16	BLA020	20
		1.7-2.6	1			20	16	BLA020	20
		2.2-3.4	1			20	16	BLA020	20
		2.8-4.2	1			20	16	BLA020	20
		4-6	1			20	16	BLA020	20
		5-7.5	1			20	16	BLA020	20
6-9	1	20	16	BLA020	20				
7-10.5	1	20	16	BLA020	20				
9-13	1	30	16	BLA020	20				
SK06	-		1	BW32SAG	30	1	16	BLA020	20
SK09	-		1	EW32SAG		1	16	BLA020	20
SK12	-		1	BW32SBG		1	16	BLA020	20



Magnetic-Contactors

Protective Coordination

● Prospective Short-circuit Current “r” (240V and 440V)

Magnetic Contactor	Thermal Overload Relay		Coordination type						
			Type 1		Type 2				
	Type	Ampere setting range [A]	Short-circuit current “r” [kA]	Molded Case Circuit Breaker / Earth Leakage Circuit Breaker		Short-circuit current “r” [kA]	Fuse (IEC 60269-1 gG and gM) rating (A)	FUJI Low-voltage Current-limiting Fuse	
			Type	Rating [A]			Type	Rating [A]	
SK18	TK25	0.34-0.52	3	BW50SAG EW50SAG BW50SBG EW50SBG	3	3	2	BLA003	3
		0.48-0.72	3		3	3	4	BLA005	5
		0.64-0.96	3		5	3	4	BLA005	5
		0.8-1.2	3		5	3	16	BLA020	20
		0.95-1.45	3		10	3	20	BLA030	30
		1.1-1.65	3		10	3	20	BLA030	30
		1.4-2.1	3		20	3	20	BLA030	30
		1.7-2.6	3		20	3	20	BLA030	30
		2.2-3.4	3		20	3	20	BLA030	30
		2.8-4.2	3		20	3	20	BLA030	30
		4-6	3		20	3	20	BLA030	30
		5-7.5	3		20	3	20	BLA030	30
		6-9	3		20	3	20	BLA030	30
		7-10.5	3		20	3	25	BLA040	40
		9-13	3		30	3	25	BLA040	40
12-18	3	30	3	40	BLA060	60			
SK22	TK25	0.34-0.52	3	BW50SAG EW50SAG BW50SBG EW50SBG	3	3	2	BLA003	3
		0.48-0.72	3		3	3	4	BLA005	5
		0.64-0.96	3		5	3	4	BLA005	5
		0.8-1.2	3		5	3	16	BLA020	20
		0.95-1.45	3		10	3	20	BLA030	30
		1.1-1.65	3		10	3	20	BLA030	30
		1.4-2.1	3		20	3	20	BLA030	30
		1.7-2.6	3		20	3	20	BLA030	30
		2.2-3.4	3		20	3	20	BLA030	30
		2.8-4.2	3		20	3	20	BLA030	30
		4-6	3		20	3	20	BLA030	30
		5-7.5	3		20	3	20	BLA030	30
		6-9	3		20	3	20	BLA030	30
		7-10.5	3		20	3	25	BLA040	40
		9-13	3		30	3	25	BLA040	40
12-18	3	30	3	40	BLA060	60			
16-22	3	50	3	50	BLA075	75			
SK32	TK26	0.34-0.52	3	BW50SAG EW50SAG BW50SBG EW50SBG	3	3	2	BLA003	3
		0.48-0.72	3		3	3	4	BLA005	5
		0.64-0.96	3		5	3	4	BLA005	5
		0.8-1.2	3		5	3	16	BLA020	20
		0.95-1.45	3		10	3	20	BLA030	30
		1.1-1.65	3		10	3	20	BLA030	30
		1.4-2.1	3		20	3	20	BLA030	30
		1.7-2.6	3		20	3	20	BLA030	30
		2.2-3.4	3		20	3	20	BLA030	30
		2.8-4.2	3		20	3	20	BLA030	30
		4-6	3		20	3	20	BLA030	30
		5-7.5	3		20	3	20	BLA030	30
		6-9	3		20	3	20	BLA030	30
		7-10.5	3		20	3	25	BLA040	40
		9-13	3		30	3	25	BLA040	40
		12-18	3		30	3	40	BLA060	60
		16-22	3		50	3	50	BLA075	75
		20-26	3		50	3	50	BLA075	75
26-32	3	BW63SAG EW63SAG BW63SBG EW63SBG	63	3	50	BLA075	75		
SK18	-	-	3	BW50SAG EW50SAG	50	3	50	BLA075	75
SK22	-	-	3	BW50SAG BW50SBG EW50SBG	50	3	50	BLA075	75
SK32	-	-	3	BW63SAG EW63SAG BW63SBG EW63SBG	63	3	50	BLA075	75

● Rated conditional short-circuit current I_q (240V)

Magnetic Contactor	Thermal Overload Relay		Coordination type						
			Type 1			Type 2			
	Type	Ampere setting range [A]	Short-circuit current "I _q " [kA]	Molded Case Circuit Breaker / Earth Leakage Circuit Breaker		Short-circuit current "I _q " [kA]	Fuse (IEC 60269-1 gG and gM) rating (A)	FUJI Low-voltage Current-limiting Fuse	
			Type	Rating [A]			Type	Rating [A]	
SK06	TK12	0.34-0.52	25	BW50RAG EW50RAG	3	50	2	BLA003	3
		0.48-0.72	25		3	50	4	BLA005	5
		0.64-0.96	25		5	50	4	BLA005	5
		0.8-1.2	25		5	50	4	BLA005	5
		0.95-1.45	25		10	50	16	BLA020	20
		1.1-1.65	25		10	50	16	BLA020	20
		1.4-2.1	25		10	50	20	BLA030	30
		1.7-2.6	25		10	50	20	BLA030	30
		2.2-3.4	25		10	50	20	BLA030	30
		2.8-4.2	25		10	50	20	BLA030	30
		4-6	25		10	50	20	BLA030	30
		10	50		20	BLA030	30		
SK09	TK12	0.34-0.52	25	BW50RAG EW50RAG	3	50	2	BLA003	3
		0.48-0.72	25		3	50	4	BLA005	5
		0.64-0.96	25		5	50	4	BLA005	5
		0.8-1.2	25		5	50	4	BLA005	5
		0.95-1.45	25		10	50	16	BLA020	20
		1.1-1.65	25		10	50	16	BLA020	20
		1.4-2.1	25		10	50	20	BLA030	30
		1.7-2.6	25		10	50	20	BLA030	30
		2.2-3.4	25		10	50	20	BLA030	30
		2.8-4.2	25		10	50	20	BLA030	30
		4-6	25		10	50	20	BLA030	30
		5-7.5	25		30	50	20	BLA030	30
6-9	25	30	50	20	BLA030	30			
SK12	TK12	0.34-0.52	25	BW50RAG EW50RAG	3	50	2	BLA003	3
		0.48-0.72	25		3	50	4	BLA005	5
		0.64-0.96	25		5	50	4	BLA005	5
		0.8-1.2	25		5	50	4	BLA005	5
		0.95-1.45	25		10	50	16	BLA020	20
		1.1-1.65	25		10	50	16	BLA020	20
		1.4-2.1	25		10	50	20	BLA030	30
		1.7-2.6	25		10	50	20	BLA030	30
		2.2-3.4	25		10	50	20	BLA030	30
		2.8-4.2	25		10	50	20	BLA030	30
		4-6	25		10	50	20	BLA030	30
		5-7.5	25		30	50	20	BLA030	30
		6-9	25		30	50	20	BLA030	30
		7-10.5	25		30	50	20	BLA030	30
		9-13	25		30	50	20	BLA030	30
SK06	-	-	25	BW50RAG EW50RAG	30	50	20	BLA030	30
SK09	-	-	25		50	20	BLA030	30	
SK12	-	-	25		50	20	BLA030	30	



Magnetic-Contactors

Protective Coordination

● Rated conditional short-circuit current I_q (240V)

Magnetic Contactor	Thermal Overload Relay		Coordination type						
			Type 1			Type 2			
	Type	Ampere setting range [A]	Short-circuit current "I _q " [kA]	Molded Case Circuit Breaker / Earth Leakage Circuit Breaker		Short-circuit current "I _q " [kA]	Fuse (IEC 60269-1 gG and gM) rating (A)	FUJI Low-voltage Current-limiting Fuse	
			Type	Rating [A]			Type	Rating [A]	
SK18	TK25	0.34-0.52	10	BW50RAG EW50RAG	3	50	2	BLA003	3
		0.48-0.72	10		3	50	4	BLA005	5
		0.64-0.96	10		5	50	4	BLA005	5
		0.8-1.2	10		5	50	4	BLA005	5
		0.95-1.45	10		10	50	16	BLA020	20
		1.1-1.65	10		10	50	16	BLA020	20
		1.4-2.1	10		10	50	20	BLA030	30
		1.7-2.6	10		10	50	20	BLA030	30
		2.2-3.4	10		10	50	20	BLA030	30
		2.8-4.2	10		10	50	20	BLA030	30
		4-6	10		10	50	20	BLA030	30
		5-7.5	10		30	50	20	BLA030	30
		6-9	10		30	50	20	BLA030	30
		7-10.5	10		30	50	20	BLA030	30
		9-13	10		30	50	25	BLA040	40
		12-18	10		30	50	25	BLA040	40
SK22	TK25	0.34-0.52	10		3	50	2	BLA003	3
		0.48-0.72	10		3	50	4	BLA005	5
		0.64-0.96	10		5	50	4	BLA005	5
		0.8-1.2	10		5	50	4	BLA005	5
		0.95-1.45	10		10	50	16	BLA020	20
		1.1-1.65	10		10	50	16	BLA020	20
		1.4-2.1	10		10	50	20	BLA030	30
		1.7-2.6	10		10	50	20	BLA030	30
		2.2-3.4	10		10	50	20	BLA030	30
		2.8-4.2	10		10	50	20	BLA030	30
		4-6	10		10	50	20	BLA030	30
		5-7.5	10		30	50	20	BLA030	30
		6-9	10		30	50	20	BLA030	30
		7-10.5	10		30	50	20	BLA030	30
		9-13	10		30	50	25	BLA040	40
		12-18	10		30	50	25	BLA040	40
16-22	10		50	50	25	BLA040	40		
SK32	TK26	0.34-0.52	10		3	50	2	BLA003	3
		0.48-0.72	10		3	50	4	BLA005	5
		0.64-0.96	10		5	50	4	BLA005	5
		0.8-1.2	10		5	50	4	BLA005	5
		0.95-1.45	10		10	50	16	BLA020	20
		1.1-1.65	10		10	50	16	BLA020	20
		1.4-2.1	10		10	50	20	BLA030	30
		1.7-2.6	10		10	50	20	BLA030	30
		2.2-3.4	10		10	50	20	BLA030	30
		2.8-4.2	10		10	50	20	BLA030	30
		4-6	10		10	50	20	BLA030	30
		5-7.5	10		30	50	20	BLA030	30
		6-9	10		30	50	20	BLA030	30
		7-10.5	10		30	50	20	BLA030	30
		9-13	10		30	50	25	BLA040	40
		12-18	10		30	50	25	BLA040	40
16-22	10		50	50	40	BLA060	60		
20-26	10		50	50	50	BLA060	60		
26-32	10		BW63RAG EW63RAG	63	50	50	BLA060	60	
SK18	-	-	10	BW50RAG EW50RAG	50	50	25	BLA040	40
SK22	-	-	10	BW50RAG EW50RAG		50	25	BLA040	40
SK32	-	-	10	BW63RAG EW63RAG	63	50	50	BLA075	75

■ UL approved Short-circuit Current Ratings (SCCR)

● Combination of Breaker and Fuse (UL60947-4-1 Type C)

Magnetic Starter		Short-circuit Current Ratings (SCCR)									
Thermal Overload Relay		240V AC			240V AC			600V AC			
Magnetic Contactor Type	Type	Ampere setting range [A]	SCCR [kA]	Circuit breaker		SCCR [kA]	Circuit breaker		SCCR [kA]	Circuit breaker	Current-limiting fuse
				Max. rated current [A]	UL489-certified Molded Case Circuit Breaker / Earth Leakage Circuit Breaker		Max. rated current [A]	UL489-certified Molded Case Circuit Breaker / Earth Leakage Circuit Breaker		Max. rated current [A]	Max. rated current [A]
SK06	TK12	0.1-0.15	18	15	BW50RBGU	25	15	BW125JAGU	5	-	30
		0.13-0.2	18	15	EW50RBGU	25	15	BW125RAGU	5	-	30
		0.18-0.27	18	15		25	15	EW125JAGU	5	-	30
		0.24-0.36	18	15		25	15	EW125RAGU	5	-	30
		0.3-0.45	18	15		25	15		5	-	30
		0.34-0.52	18	15		25	15		5	-	30
		0.48-0.72	18	15		25	15		5	-	30
		0.64-0.96	18	15		25	15		5	-	30
		0.8-1.2	18	15		25	15		5	-	30
		0.95-1.45	18	20		25	15		5	-	30
		1.1-1.65	18	20		25	15		5	-	30
		1.4-2.1	18	20		25	20		5	-	30
		1.7-2.6	18	20		25	20		5	-	30
		2.2-3.4	18	20		25	20		5	-	30
		2.8-4.2	18	20		25	20		5	-	30
4-6	18	20		25	20		5	-	30		
SK09	TK12	0.1-0.15	18	15	BW50RBGU	25	15	BW125JAGU	5	-	30
		0.13-0.2	18	15	EW50RBGU	25	15	BW125RAGU	5	-	30
		0.18-0.27	18	15		25	15	EW125JAGU	5	-	30
		0.24-0.36	18	15		25	15	EW125RAGU	5	-	30
		0.3-0.45	18	15		25	15		5	-	30
		0.34-0.52	18	15		25	15		5	-	30
		0.48-0.72	18	15		25	15		5	-	30
		0.64-0.96	18	15		25	15		5	-	30
		0.8-1.2	18	15		25	15		5	-	30
		0.95-1.45	18	20		25	15		5	-	30
		1.1-1.65	18	20		25	15		5	-	30
		1.4-2.1	18	20		25	20		5	-	30
		1.7-2.6	18	20		25	20		5	-	30
		2.2-3.4	18	20		25	20		5	-	30
		2.8-4.2	18	20		25	20		5	-	30
4-6	18	20		25	20		5	-	30		
5-7.5	18	20		25	20		5	-	30		
6-9	18	20		25	20		5	-	30		
SK12	TK12	0.1-0.15	18	15	BW50RBGU	25	15	BW125JAGU	5	-	30
		0.13-0.2	18	15	EW50RBGU	25	15	BW125RAGU	5	-	30
		0.18-0.27	18	15		25	15	EW125JAGU	5	-	30
		0.24-0.36	18	15		25	15	EW125RAGU	5	-	30
		0.3-0.45	18	15		25	15		5	-	30
		0.34-0.52	18	15		25	15		5	-	30
		0.48-0.72	18	15		25	15		5	-	30
		0.64-0.96	18	15		25	15		5	-	30
		0.8-1.2	18	15		25	15		5	-	30
		0.95-1.45	18	20		25	15		5	-	30
		1.1-1.65	18	20		25	15		5	-	30
		1.4-2.1	18	20		25	20		5	-	30
		1.7-2.6	18	20		25	20		5	-	30
		2.2-3.4	18	20		25	20		5	-	30
		2.8-4.2	18	20		25	20		5	-	30
4-6	18	20		25	20		5	-	30		
5-7.5	18	20		25	20		5	-	30		
6-9	18	20		25	20		5	-	30		
7-10.5	18	20		25	20		5	-	30		
9-13	18	30		25	30		5	-	30		
SK06	-	-	18	30	BW50RBGU	25	30	BW125JAGU	5	-	30
SK09	-	-	18	30	EW50RBGU	25	30	BW125RAGU	5	-	30
SK12	-	-	18	30		25	30	EW125JAGU	5	-	30
								EW125RAGU			



Magnetic-Contactors

Protective Coordination

● Combination of Breaker and Fuse (UL60947-4-1 Type C) (Continued)

Magnetic Starter			Short-circuit Current Ratings (SCCR)										
Magnetic Contactor		Thermal Overload Relay	240V AC				480V AC				600V AC		
Type	Type	Ampere setting range [A]	SCCR [kA]	Circuit breaker		SCCR [kA]	Circuit breaker		SCCR [kA]	Circuit breaker	Current-limiting fuse		
				Max. rated current [A]	UL489-certified Molded Case Circuit Breaker / Earth Leakage Circuit Breaker		Max. rated current [A]	UL489-certified Molded Case Circuit Breaker / Earth Leakage Circuit Breaker				Max. rated current [A]	
SK18	TK25	0.1-0.15	35	15	BW125JAGU EW125JAGU	35	15	BW125RAGU EW125RAGU	5	-	30		
		0.13-0.2	35	15		35	15		5	-	30		
		0.18-0.27	35	15		35	15		5	-	30		
		0.24-0.36	35	15		35	15		5	-	30		
		0.34-0.52	35	15		35	15		5	-	30		
		0.48-0.72	35	15		35	15		5	-	30		
		0.64-0.96	35	15		35	15		5	-	30		
		0.8-1.2	35	15		35	15		5	-	30		
		0.95-1.45	35	15		35	15		5	-	30		
		1.1-1.65	35	15		35	15		5	-	30		
		1.4-2.1	35	20		35	20		5	-	30		
		1.7-2.6	35	20		35	20		5	-	30		
		2.2-3.4	35	20		35	20		5	-	30		
		2.8-4.2	35	20		35	20		5	-	30		
		4-6	35	20		35	20		5	-	30		
		5-7.5	35	20		35	20		5	-	30		
		6-9	35	20		35	20		5	-	30		
		7-10.5	35	20		35	20		5	-	30		
		9-13	35	30		35	30		5	-	30		
		12-18	35	30		35	30		5	-	50		
			25	40	10	40							
SK22	TK25	0.1-0.15	35	15	BW125JAGU EW125JAGU	35	15	BW125RAGU EW125RAGU	5	-	30		
		0.13-0.2	35	15		35	15		5	-	30		
		0.18-0.27	35	15		35	15		5	-	30		
		0.24-0.36	35	15		35	15		5	-	30		
		0.34-0.52	35	15		35	15		5	-	30		
		0.48-0.72	35	15		35	15		5	-	30		
		0.64-0.96	35	15		35	15		5	-	30		
		0.8-1.2	35	15		35	15		5	-	30		
		0.95-1.45	35	15		35	15		5	-	30		
		1.1-1.65	35	15		35	15		5	-	30		
		1.4-2.1	35	20		35	20		5	-	30		
		1.7-2.6	35	20		35	20		5	-	30		
		2.2-3.4	35	20		35	20		5	-	30		
		2.8-4.2	35	20		35	20		5	-	30		
		4-6	35	20		35	20		5	-	30		
		5-7.5	35	20		35	20		5	-	30		
		6-9	35	20		35	20		5	-	30		
		7-10.5	35	20		35	20		5	-	30		
		9-13	35	30		35	30		5	-	30		
		12-18	35	30		35	30		5	-	50		
			25	40	10	40							
			16-22	35	30	35	30	BW125JAGU EW125JAGU	5	-	50		
				25	50	10	50	BW125JAGU EW125JAGU					

● Combination of Breaker and Fuse (UL60947-4-1 Type C) (Continued)

Magnetic Starter			Short-circuit Current Ratings (SCCR)										
Magnetic Contactor		Thermal Overload Relay	240V AC				480V AC				600V AC		
Type	Type	Ampere setting range [A]	SCCR [kA]	Circuit breaker		SCCR [kA]	Circuit breaker		SCCR [kA]	Circuit breaker	Current-limiting fuse		
				Max. rated current [A]	UL489-certified Molded Case Circuit Breaker / Earth Leakage Circuit Breaker		Max. rated current [A]	UL489-certified Molded Case Circuit Breaker / Earth Leakage Circuit Breaker				Max. rated current [A]	Max. rated current [A]
SK32	TK26	0.1-0.15	35	15	BW125JAGU EW125JAGU	35	15	BW125RAGU EW125RAGU	5	-	30		
		0.13-0.2	35	15		35	15		5	-	30		
		0.18-0.27	35	15		35	15		5	-	30		
		0.24-0.36	35	15		35	15		5	-	30		
		0.34-0.52	35	15		35	15		5	-	30		
		0.48-0.72	35	15		35	15		5	-	30		
		0.64-0.96	35	15		35	15		5	-	30		
		0.8-1.2	35	15		35	15		5	-	30		
		0.95-1.45	35	15		35	15		5	-	30		
		1.1-1.65	35	15		35	15		5	-	30		
		1.4-2.1	35	20		35	20		5	-	30		
		1.7-2.6	35	20		35	20		5	-	30		
		2.2-3.4	35	20		35	20		5	-	30		
		2.8-4.2	35	20		35	20		5	-	30		
		4-6	35	20		35	20		5	-	30		
		5-7.5	35	20		35	20		5	-	30		
		6-9	35	20		35	20		5	-	30		
		7-10.5	35	20		35	20		5	-	30		
		9-13	35	30		35	30		5	-	30		
		12-18	35	30		35	30		5	-	50		
				25		40	10		40				
			16-22	35		30	35		30	5	-	50	
				25		50	10		50				
		20-26	35	30		35	30		5	-	50		
			25	50		10	50						
		26-32	35	30		35	30		5	-	50		
			25	50		10	60		BW125JAGU EW125JAGU				
		SK18	-	-		35	30		BW125JAGU EW125JAGU	35	30	BW125RAGU EW125RAGU	5
25	50				10	50	BW125JAGU EW125JAGU						
SK22	-	-	35	30	BW125JAGU EW125JAGU	35	30	BW125RAGU EW125RAGU	5	50	50		
			25	50		10	50					BW125JAGU EW125JAGU	
SK32	-	-	35	30	BW125JAGU EW125JAGU	35	30	BW125RAGU EW125RAGU	5	70	70		
		-	25	60		10	60					BW125JAGU EW125JAGU	



Magnetic-Contactors

Protective Coordination

● Combinations with Manual Motor Starter (UL60947-4-1 Type F)

Magnetic Contactor type	AC480Y/277V		Short-circuit Current Rating (SCCR) [kA]
	Combined MMS Type	Ampere setting range [A]	
SK06	BM3RS□-P40	0.25-0.4	65
	BM3RS□-P63	0.4-0.63	65
	BM3RS□-001	0.63-1	65
	BM3RS□-1P6	1-1.6	65
	BM3RS□-2P5	1.6-2.5	50
	BM3RS□-004	2.5-4	50
	BM3RS□-6P3	4-6.3	50
	BM3RH□-P40	0.25-0.4	65
	BM3RH□-P63	0.4-0.63	65
	BM3RH□-001	0.63-1	65
	BM3RH□-1P6	1-1.6	65
	BM3RH□-2P5	1.6-2.5	65
	BM3RH□-004	2.5-4	65
	BM3RH□-6P3	4-6.3	65
SK09	BM3RS□-P40	0.25-0.4	65
	BM3RS□-P63	0.4-0.63	65
	BM3RS□-001	0.63-1	65
	BM3RS□-1P6	1-1.6	65
	BM3RS□-2P5	1.6-2.5	50
	BM3RS□-004	2.5-4	50
	BM3RS□-6P3	4-6.3	50
	BM3RS□-010	6.3-10	25
	BM3RH□-P40	0.25-0.4	65
	BM3RH□-P63	0.4-0.63	65
	BM3RH□-001	0.63-1	65
	BM3RH□-1P6	1-1.6	65
	BM3RH□-2P5	1.6-2.5	65
	BM3RH□-004	2.5-4	65
BM3RH□-6P3	4-6.3	65	
BM3RH□-010	6.3-10	25	
SK12	BM3RS□-P40	0.25-0.4	65
	BM3RS□-P63	0.4-0.63	65
	BM3RS□-001	0.63-1	65
	BM3RS□-1P6	1-1.6	65
	BM3RS□-2P5	1.6-2.5	50
	BM3RS□-004	2.5-4	50
	BM3RS□-6P3	4-6.3	50
	BM3RS□-010	6.3-10	25
	BM3RS□-013	9-13	25
	BM3RH□-P40	0.25-0.4	65
	BM3RH□-P63	0.4-0.63	65
	BM3RH□-001	0.63-1	65
	BM3RH□-1P6	1-1.6	65
	BM3RH□-2P5	1.6-2.5	65
BM3RH□-004	2.5-4	65	
BM3RH□-6P3	4-6.3	65	
BM3RH□-010	6.3-10	25	
BM3RH□-013	9-13	10	

Note 1: When you use it as Type F, you need to use both a short-circuit alarm contact block BZOTKUAB and a load-side terminal cover BZOTCRE (in case of round crimped terminal type, use BZORTCRE instead).

Magnetic Contactor type	AC480Y/277V		Short-circuit Current Rating (SCCR) [kA]
	Combined MMS		
	Type	Ampere setting range [A]	
SK18	BM3RS□-P40	0.25-0.4	65
	BM3RS□-P63	0.4-0.63	65
	BM3RS□-001	0.63-1	65
	BM3RS□-1P6	1-1.6	65
	BM3RS□-2P5	1.6-2.5	65
	BM3RS□-004	2.5-4	65
	BM3RS□-6P3	4-6.3	65
	BM3RS□-010	6.3-10	25
	BM3RS□-013	9-13	25
	BM3RS□-016	11-16	25
	BM3RS□-020	14-20	25
	BM3RH□-P40	0.25-0.4	65
	BM3RH□-P63	0.4-0.63	65
	BM3RH□-001	0.63-1	65
	BM3RH□-1P6	1-1.6	65
	BM3RH□-2P5	1.6-2.5	65
	BM3RH□-004	2.5-4	65
	BM3RH□-6P3	4-6.3	65
	BM3RH□-010	6.3-10	65
	BM3RH□-013	9-13	65
BM3RH□-016	11-16	65	
BM3RH□-020	14-20	65	
SK22	BM3RS□-P40	0.25-0.4	65
	BM3RS□-P63	0.4-0.63	65
	BM3RS□-001	0.63-1	65
	BM3RS□-1P6	1-1.6	65
	BM3RS□-2P5	1.6-2.5	65
	BM3RS□-004	2.5-4	65
	BM3RS□-6P3	4-6.3	65
	BM3RS□-010	6.3-10	25
	BM3RS□-013	9-13	25
	BM3RS□-016	11-16	25
	BM3RS□-020	14-20	25
	BM3RS□-025	19-25	25
	BM3RH□-P40	0.25-0.4	65
	BM3RH□-P63	0.4-0.63	65
	BM3RH□-001	0.63-1	65
	BM3RH□-1P6	1-1.6	65
	BM3RH□-2P5	1.6-2.5	65
	BM3RH□-004	2.5-4	65
	BM3RH□-6P3	4-6.3	65
	BM3RH□-010	6.3-10	65
	BM3RH□-013	9-13	65
	BM3RH□-016	11-16	65
	BM3RH□-020	14-20	65
	BM3RH□-025	19-25	50



Magnetic Contactor type	AC480Y/277V		Short-circuit Current Rating (SCCR) [kA]
	Combined MMS		
	Type	Ampere setting range [A]	
SK32	BM3RS□-P40	0.25-0.4	65
	BM3RS□-P63	0.4-0.63	65
	BM3RS□-001	0.63-1	65
	BM3RS□-1P6	1-1.6	65
	BM3RS□-2P5	1.6-2.5	65
	BM3RS□-004	2.5-4	65
	BM3RS□-6P3	4-6.3	65
	BM3RS□-010	6.3-10	25
	BM3RS□-013	9-13	25
	BM3RS□-016	11-16	25
	BM3RS□-020	14-20	25
	BM3RS□-025	19-25	25
	BM3RS□-032	24-32	25
	BM3RH□-P40	0.25-0.4	65
	BM3RH□-P63	0.4-0.63	65
	BM3RH□-001	0.63-1	65
	BM3RH□-1P6	1-1.6	65
	BM3RH□-2P5	1.6-2.5	65
	BM3RH□-004	2.5-4	65
	BM3RH□-6P3	4-6.3	65
	BM3RH□-010	6.3-10	65
	BM3RH□-013	9-13	65
	BM3RH□-016	11-16	65
	BM3RH□-020	14-20	65
	BM3RH□-025	19-25	50
	BM3RH□-032	24-32	50

■ Applications for IE3 (premium efficiency) motors

IE3 (premium efficiency) motors have a 15 to 30% larger starting current compared with conventional motors.

(There are cases they may require a longer starting time.)

● Selecting magnetic contactors

If the starting current is increased, the make/break durability of magnetic contactors is affected.

The life expectancy of magnetic contactors used in motors (AC-3 rating) is based on a starting current that is six times the rated current. If a starting current becomes larger than this (especially if it exceeds ten times the rated value), the make/break durability could be significantly reduced, or contact welding could occur. For this reason, be sure to confirm the motor's starting current and the rating of the magnetic contactor.

[What to do for a large starting current]

Choose a product while making sure that the starting current does not exceed 10 times that of the rating (AC-3) of the magnetic contactor.

There are cases where the motor's rated current could increase. In this case, choose a product while making sure it is within the range of the magnetic contactor's AC-3 rating.

● Selecting thermal relays

A larger starting current could cause it to enter the operating range of the thermal overload relay, resulting in unnecessary operation (area b in the diagram).

Therefore, be sure to confirm this matter for IE3 motor applications.

[What to do for a large starting current]

Measure 1: Raise the pick-up current value for the dial reading of the thermal overload relay to around within 5%.

Measure 2: Use a time delay thermal overload relay (class 20 or class 30).

Note 1: For Measures 1 and 2, confirm compatibility with the thermal characteristics of the electric motor.

Note 2: If the motor's rated current also increases, configure the thermal overload relay setting in accordance with the motor's rated current.

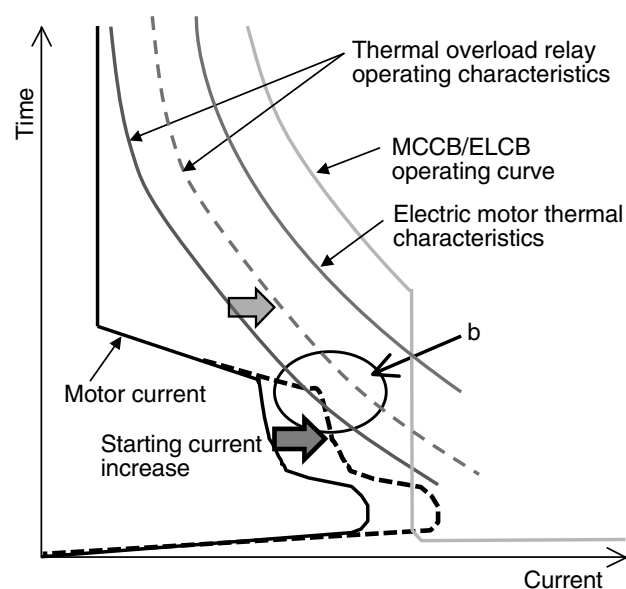



Magnetic-Contactors

Normal Operating Conditions and Mounting

■ Normal Operating Conditions and Correct Mounting

● Standard Operating Conditions

Ambient temperature *1	-10 to 55°C with no sudden temperature changes resulting in condensation or icing (The average temperature over a 24-hour period must not exceed 35°C.)
Ambient humidity	45% to 85% RH (with no condensation)
Altitude	2,000 m max.
Atmosphere	No excessive dust, smoke, corrosive gasses, inflammable gases, steam, or salts
Storage temperature	-40 to 60°C
Vibration resistance	10 to 55Hz, 15m/s ²
Shock resistance	50m/s ²
Mounting	Screw mounting 35mm-wide top hat rail (Refer to the rail mounting in the next item.)

Mounting angle	Appearance						
	Mounting direction	Standard mounting	Angled mounting	Side mounting		Horizontal mounting	Ceiling mounting
		-	30°	Upper coil side	Lower coil side	Upper terminal side	Lower terminal side
	SK06, 09, 12A □ SKH4A □	○	○	○	*3	○	○
	SK18, 22, 32A □	○	○	*5 Right and left sides available		× *6	×
	SK06, 09, 12G □ SKH4G □	○	○	*4	○	○	○
	SK18, 22, 32G □	○	○	*5 Right and left sides available		× *6	×
	SK06, 09, 12L □ SKH4L □	○	○	*4	○	○	○
	SK06, 09, 12A □W	○	○	*7	*3, *7	*7	*7
	SK18, 22, 32A □W	○	○	*5, *7 Right and left sides available		× *6, *7	×
	SK06, 09, 12G □W	○	○	*4, *7	*7	*7	*7
	SK18, 22, 32G □W	○	○	*5, *7 Right and left sides available		× *6, *7	×
	SK06, 09, 12L □W	○	○	*4, *7	*7	*7	*7

Mounting gaps *2 Provide the mounting gaps and arc space that are given in the following table when you mount the product.

Type	A [mm]	B [mm]	C [mm]
SK06, 09, 12	0	10	2
SK18, 22, 32	0	10	0

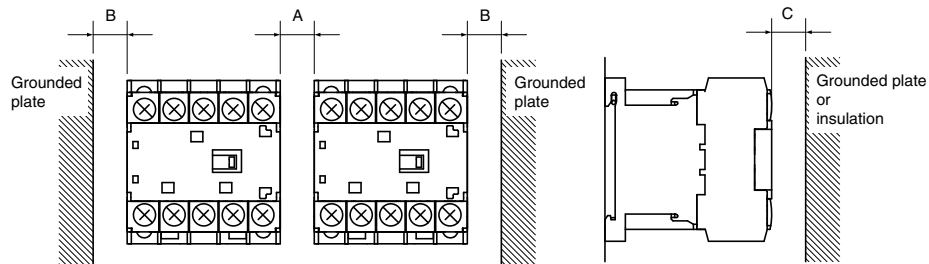

Note *1: The ambient temperature is the temperature near the product during operation.

Note *2: If Magnetic Starters are used in combination with Thermal Overload Relays and the products are used with continuous through current without providing gaps, temperature increases will reduce the life of the coil. Also, the characteristics of the Thermal Overload Relays will vary somewhat from the mutual thermal effects between the heaters. When using the products under these conditions, separate the products from each other by at least 5 mm (dimension A).

Note *3: The allowable power fluctuation range is 0.9 Us to 1.1 Us.

Note *4: The drop-out voltage is 0.05 Us to 0.7 Us.

Note *5: The mechanical durability and operating cycles per hour are reduced to 80% of those of standard installations.

Note *6: The standard type cannot be used in horizontal installations. Use the "Z109 type" instead, which was designed specifically for horizontal installations. The mechanical durability, electrical durability, and operating cycles per hour are reduced to 80% of those of standard types.

Note *7: The operational limiting current of the thermal overload relay will vary slightly.

(Note) Use screw mounting for mounting to ceilings.

● Rail Mounting

The SK06 to SK12 Magnetic Motors and Starters can be mounted to 35mm-wide support rails. Secure the rail with the mounting pitch that is shown in the figure at the right.

Example of Applicable Rail: TH35-15AL

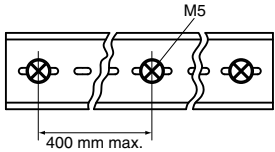

● Mounting Rail

Type	TH35-15AL
Material	Aluminum
External dimensions	

Follow the procedures below to mount or remove the product on the rail.

For SK06 through SK12 models

[Mounting]

- ① Tilt the product at about 10° from mounting surface to the rail, hang the hook at the power supply side on the rail, and softly push the product down.
- ② Press the product to the rail.
- ③ Raise the product and hang the hook at the load side on the rail.
- ④ Shake the product a little to confirm that the hook at the load side is hung on the rail.

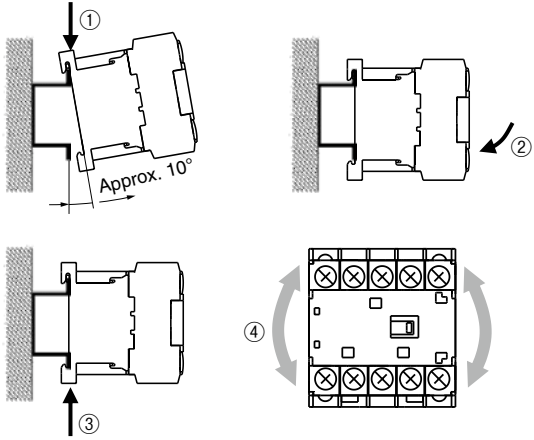

[Removing]

- ① Hold the product at the top and bottom, press it downward to remove the hook at the bottom of the product.
- ② Remove the product.

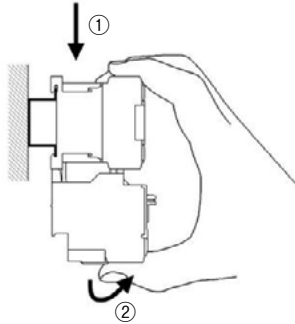

For SK18, SK22, and SK32 models

[Mounting]

- ① Catch the hook on the power supply side of the product to the rail.
- ② Press the product to the rail.

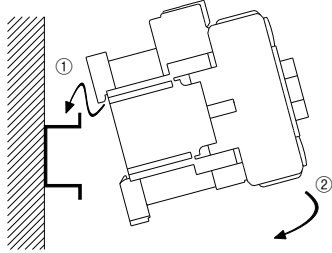

[Removing]

- ① Use a screwdriver or other tool to move the slider downward.
- ② Remove the product.

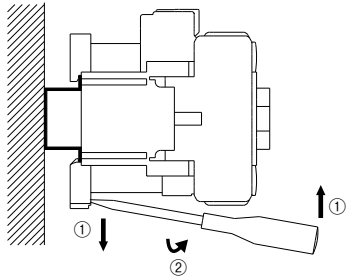

● Voltage Fluctuation Range in Control Circuits and Voltage Drop

- SK06A to SK32A (AC Operation)
Drop-out voltage (operating voltage): 85% to 110% of rated voltage
However, there is an official rated inrush voltage, but usage is possible without contact welding even if the voltage drops to 75% of the rating when the main contacts close.
- SK06G to SK32G, SK06L to SK12L (DC Operation)
Drop-out voltage (operating voltage): 85% to 110% of rated voltage at ambient temperature of 55°C and 80% to 110% of rated voltage at ambient temperature of 40°C.
However, there is an official rated inrush voltage, but usage is possible without contact welding even if the voltage drops to 75% of the rating when the main contacts close.



■ Wiring

● Wiring and Terminal Processing

Make all connections correctly according to the connection diagram. For the SK06 to SK32, you can use solid wires, stranded wires, or crimped terminals for the main terminals, auxiliary terminals, and coil terminals.

● Tightening Torque

If the Magnetic Contactor or Switch is not mounted completely, the shock when the Contactor or Switches is turned ON may cause the contacts to jump or may reduce the durability. Also, if wires are not tightened sufficiently, they may become hot or loose, resulting in a fire, short-circuit, electric shock or some other potentially dangerous situation. Be sure to tighten the wires to the torque that is specified in the following table.

● Terminals, Wire Sizes, and Tightening Torque

- 1) Terminals can be wired with solid wires, stranded wires, or crimped terminals can be used to connect the terminals. To use round crimped terminals, remove the terminal cover before you connect them to the terminals.
- 2) The connectable wire sizes and tightening torque are given in the following table.

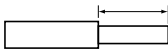
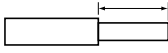
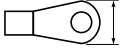
				Main terminals		Control and auxiliary terminals
				SK06 to SK12 types	SK18 to SK32 types	
				TK12 type	TK25, TK26 types	
Direct connection	Solid wire	[mm]	1 wire x (Ø1.2 to 2)	1 wire x (Ø1.2 to 2.6)	1 wire x (Ø1.2 to 2)	
			2 wires x (Ø1.2 to 1.6)	2 wires x (Ø1.2 to 1.6)	2 wires x (Ø1.2 to 1.6)	
		2 wires x (Ø1.6 to 2)	2 wires x (Ø1.6 to 2)	2 wires x (Ø1.6 to 2)		
		[AWG]	1 wire x (16 to 12)	1 wire x (16 to 10)	1 wire x (16 to 12)	
	Stranded wires	[mm ²]	2 wires x (16 to 14)	2 wires x (16 to 14)	2 wires x (16 to 14)	
			2 wires x (14 to 12)	2 wires x (14 to 12)	2 wires x (14 to 12)	
		[AWG]	1 wire x (0.75 to 2.5)	1 wire x (0.75 to 5.5)	1 wire x (0.75 to 2.5)	
			2 wires x (0.75 to 1.5)	2 wires x (0.75 to 1)	2 wires x (0.75 to 1.5)	
	2 wires x (1.5 to 2.5)	2 wires x (1 to 1.5)	2 wires x (1.5 to 2.5)	2 wires x (1.5 to 2.5)		
		2 wires x (2.5 to 4)				
Sheath stripping length [mm]		9 to 10	10 to 11	9 to 10		
Flexible stranded wires with sleeves	[mm ²]	1 wire x (0.75 to 2.5)	1 wire x (0.75 to 2.5)	1 wire x (0.75 to 2.5)		
		2 wires x (0.75 to 1.5)	2 wires x (0.75 to 1)	2 wires x (0.75 to 1.5)		
	[AWG]	2 wires x (1.5 to 2.5)	2 wires x (1 to 1.5)	2 wires x (1.5 to 2.5)		
		2 wires x (1.5 to 2.5)	2 wires x (1.5 to 2.5)	2 wires x (1.5 to 2.5)		
Sleeve length [mm]		10	12	10		
Terminal connection	Stranded wires or flexible stranded wires	[mm ²]	0.75 to 4	0.75 to 10	0.75 to 2.5	
		[AWG]	18 to 10	18 to 8	18 to 14	
	Largest crimped terminal [mm]		7.7	9.7	7.7	
Terminal screw size		M3.5	M4	M3.5		
Tightening tool		Phillips H2 screwdriver Flat-blade screwdriver, I-1x5.5xL, Type B				
Flat-blade screwdriver, 1x5.5xL, type B	[N·m]	0.8 to 1.0	1.2 to 1.5	0.8 to 1.0		

Note 1. Flexible stranded wires without sleeves cannot be used. Attach sleeves before connecting the wires.

- 0.75 to 4mm² (AWG 18 to 12) stranded wire: 7 strands or less
- Flexible stranded wire: More strands than given above.

Note 2. Use DIN 46228-compliant sleeves.

- For 1.5 to 2.5mm² (AWG 16 to 14) wires, use sleeves without insulating sheaths.
- You will not be able to insert the sleeves for some crimping tools. Use a Phoenix Contact CRIMPFOX 6 crimping tool or the equivalent.
- Observe manufacture instructions on the wire sheath stripping lengths.

Note 3. For compliance with UL or CSA standards, you must use AWG 14 or 12 wires. Also, you must use solid wires, or use stranded or flexible stranded wires with crimped terminals or sleeves.

Note 4. Two crimped terminals can be connected.

Note 5. Do not connect anything to terminals that are not wired.

Note 6. After you bend or otherwise arrange the connected wires after wiring, make sure that the tightening torque is still correct.

Note 7. If 18 A or higher will continuously flow through a Magnetic Contactor in an environment that exceeds 40°C, wiring with 4mm² or AWG 12 wires.

●Connection with peripheral units

(1) AC operated type (SK□A)

A surge suppression device is not embedded in the AC operated type operating coils. Use an optional coil-surge suppression unit, if needed. For information about the choice of coil-surge suppression units, see the catalog.

(2) DC operated type (SK□G, SK□L)

A surge suppression device (varistor) is embedded in DC operated type operating coils. Therefore, there is no need to connect a surge suppression circuit externally to a normal sequential circuit. (Table 1) Connect the operating coil terminal to various pieces of DC output equipment according to Table 2.

Be careful that an operating coil terminal has A1 (plus) or A2 (minus) polarity.

Table 1 : Varistor voltage of DC operated type

Coil voltage code	Coil voltage [V]	Varistor voltage [V]
B	12	39
E	24	
F	48	
G	60	
1	100	
H	110	470
K	120	
2	200	
Y	210	
M	220	

Table 2 : Connection between operating coil terminal of DC operated type and a peripheral unit

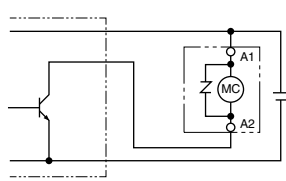
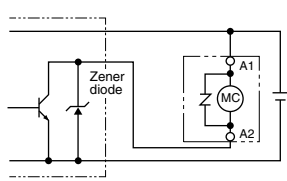
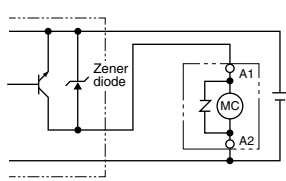
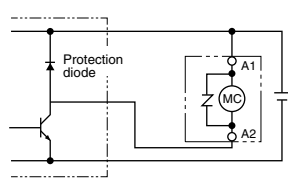
Output type of equipment	No protection diode	With protection diode		
Connection method				
Equipment example	Various DC output models	NPN output photoelectric sensor, proximity switch, etc.	NPN output photoelectric sensor, proximity switch, etc.	Programmable controller, etc.
Cautions	The dielectric strength of output transistor should be at least the coil surge voltage plus output supply voltage.	-	-	Prolongs the returning time for the protection diode.

■ Applications for special environments

● Tropical wetland and cold region processing

If magnetic contactors and switches are exported or used in tropical wetlands or cold regions as single units or integrated within boards or the like, even standard products can be used under the following conditions. Special specification products should be used in more severe usage conditions.

Ambient conditions		Standard product	Products for tropical wetlands and cold regions
Temperature	In operation	-10 to +55°C	-25 to +55°C *
	In transport	-40 to +65°C	-45 to +65°C
	In storage		
Relative humidity		85% or less	95% or less

(Note 1) Conditions assume that there's no dew condensation nor freezing due to drastic temperature change.

(Note 2) Temperature and humidity refer to the panel inside temperature.

* Thermal overload relays: Up to -10°C.

■ Handling

● Handling magnetic contactors

[Important points for inspections]

The contacts and operating coils of SK Series magnetic contactors cannot be replaced.

Only the terminal cover, terminal screws, and flexible conductors (electric wires) can be disassembled or removed.



● Handling Thermal Overload Relays

1) Adjusting the Current [Figure 1]

Turn the adjustment dial within the scale so that the total load current of the motor aligns with the triangle mark. Performance may not be dependable if the dial is set outside of the range of the scale.

2) Operation Indication [Figure 1]

When the Thermal Overload Relay operates, the white trip indicator will disappear in the operation indication window. (The white indicator will not be hidden if the Thermal Overload Relay is tripped in auto-reset status.)

3) Sequence Check [Figure 1]

You can perform a sequence check by pressing the white trip indicator in the direction of the arrow.

4) Reset Method [Figure 1]

When the Thermal Overload Relay operates, remove the cause of the error (e.g., an overload) and then press the reset button. (The Thermal Overload Relay will not reset unless it has cooled sufficiently.)

5) Auto-reset Status and Two-wire Circuits

If the Thermal Overload Relay is in auto-reset status for a 2-wire circuit and the Thermal Overload Relay resets automatically, the motor will restart operation automatically. Take adequate precautions for this.

6) Changing between Manual Resetting and Auto Resetting [Figure 2]

Use the following procedure to change between manual resetting and auto resetting. Reverse the procedure to change between auto resetting and manual resetting.

- ① Open the front cover.
- ② Use a screwdriver or similar device to press the reset button and turn it 90° clockwise.
- ③ Make sure that the reset button remains in the pressed state.
- ④ Close the front cover.

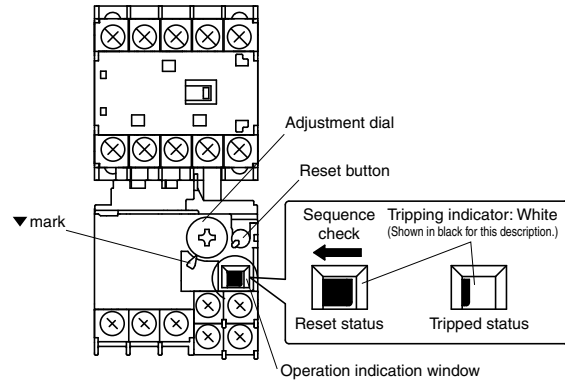

Figure 1

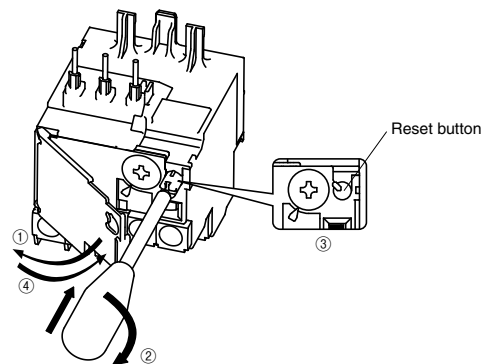
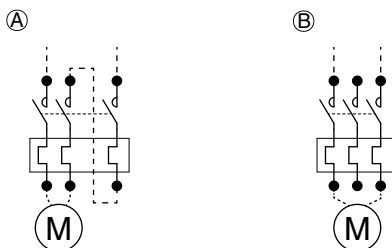

Figure 2

● Application in Single-phase Motor Circuits and DC Motor Circuits

The TK12 Thermal Overload Relays are equipped with open-phase protection. If current does not flow on all phases, the reduced operating current may cause the TK12 to operate unnecessarily. If you use the TK12 in a single-phase motor circuit or DC motor circuit, perform either (A) or (B).

- (A) Connect the wiring so that series current flows to all of the poles.
- (B) Set the adjustment dial to a setting that is 5% to 10% higher than normal.



● Ambient Temperature Compensation Characteristics

Changes in the ambient environment will affect the operation of the Thermal Overload Relay. The operational current will be higher at lower temperatures and lower at higher temperatures, i.e., compensation of operating characteristics will not be complete. Adjust the current according to the application environment. The compensation coefficient for adjusting the current depends on the ambient temperature, as shown in Figure 3. If the ambient temperature in the application changes greatly, e.g., by 20°C, use the following example as a guide to calculate the adjusted current value after compensation.

Example: Calculation Method for Dial Adjustment
at an Ambient Temperature of 55°C

$$\frac{\text{Dial current at } 20^{\circ}\text{C}}{\text{Compensation coefficient at ambient temperature of } 55^{\circ}\text{C}} = \text{Dial current at ambient temperature of } 55^{\circ}\text{C}$$

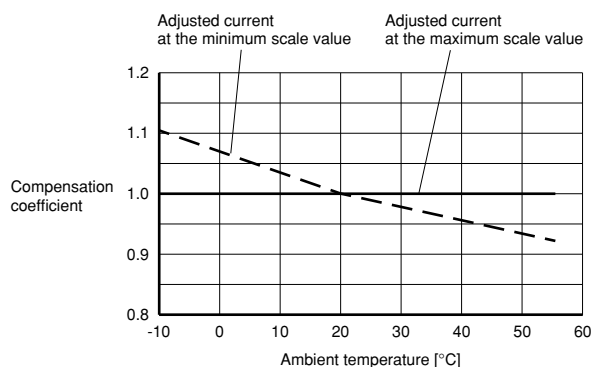

Figure 3

● Mounting the Thermal Overload Relay to and Removing It from the Magnetic Contactor

I. Mounting [Figure 4]

- 1) Loosen terminals 2, 4, and 6 on the Magnetic Contactor.
- 2) Insert the posts on the Thermal Overload Relay into the holes on the Magnetic Contactor in the direction shown by the arrows.
- 3) Insert the main circuit section of the Thermal Overload Relay on the right sides of the terminal screws.
- 4) Tighten the terminal screws on the Magnetic Contactor to the specified torque.

II. Removing [Figure 4]

- 1) Loosen the terminal screws on the Magnetic Contactor.
- 2) Move the Thermal Overload Relay left and right and pull it free from the Magnetic Contactor.

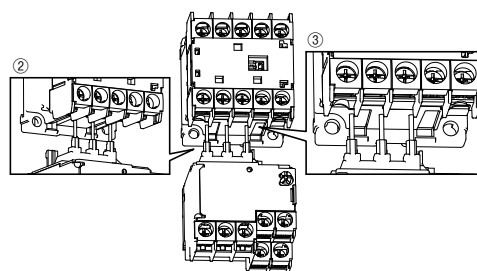

Figure 4

■ Refresh recommendation

The main contacts, mechanical components, and other parts in Fuji magnetic contactors and switches have a wear life expectancy based on the number of times they are switched. Coil electric wires and electronic components in electronic units have a life expectancy based on degradation over time according to the environment and conditions they are used in.

We recommend refreshing Fuji magnetic contactors and switches when they reach the specified number of times switched as noted in the user's manual or catalog, or roughly 10 years from the manufacture date under standard usage conditions as noted in the "Survey Concerning Recommended Refresh Periods for Low Voltage Devices" report published by The Japan Electrical Manufacturers' Association (JEMA).

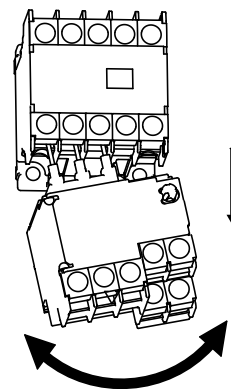

Figure 5



Magnetic Contactors

■ Features

- International safety standards for standard models (IEC, GB, JIS, UL, and CSA).
- Models available with AC or DC operating coils (DC: 2.4W and 1.2W models only).
- Many optional units.
 - Auxiliary Contact Blocks (2-pole or 4-pole)
 - Coil Surge Suppression Units
 - Interlock Units
- Easier Thermal Overload Relay wiring.
The terminal arrangement separates main circuit wires and auxiliary circuit wires for easier wiring.



■ Ordering Information (Types)

- Magnetic Contactors

SK 06 A H - E 10
① ② ③ ④ ⑤ ⑥

- ① Series
- ② Frame size
- ③ Operating coil specification
- ④ Auxiliary contact specification
- ⑤ Coil voltage specification
- ⑥ Auxiliary contact arrangement

■ Ratings and Types

- Magnetic Contactors SK06, 09, 12

Frame size ②	Max. motor capacity [kW]			Rated operational current [A]			Conventional free air thermal current [A]		Operating coil specification ③	Auxiliary contact specification ④	Auxiliary contact arrangement ⑥	Type	
	3-phase squirrel-cage motor (AC-3)			3-phase squirrel-cage motor (AC-3)			Resistive load (AC-1)						
	200-240V	380-440V	500-550V	200-240V	380-440V	500-550V	200-240V	380-440V	(Rated thermal current)				
6A [06]	1.5	2.2	3	6	6	5	12	12	20	AC-operated [A]	Bifurcated [blank] Single [H]	1NO [10] 1NC [01]	SK06A-□▲
										DC-operated (2.4W) [G]	Bifurcated [blank] Single [H]		SK06AH-□▲
										DC-operated (1.2W) [L]	Bifurcated [blank] Single [H]		SK06G-□▲
9A [09]	2.2	4	4	9	9	7	16	16	20	AC-operated [A]	Bifurcated [blank] Single [H]	1NO [10] 1NC [01]	SK06GH-□▲
										DC-operated (2.4W) [G]	Bifurcated [blank] Single [H]		SK06L-□▲
										DC-operated (1.2W) [L]	Bifurcated [blank] Single [H]		SK06LH-□▲
12A [12]	3	5.5	5.5	12	12	9	20	20	20	AC-operated [A]	Bifurcated [blank] Single [H]	1NO [10] 1NC [01]	SK09A-□▲
										DC-operated (2.4W) [G]	Bifurcated [blank] Single [H]		SK09AH-□▲
										DC-operated (1.2W) [L]	Bifurcated [blank] Single [H]		SK09G-□▲
12A [12]	3	5.5	5.5	12	12	9	20	20	20	AC-operated [A]	Bifurcated [blank] Single [H]	1NO [10] 1NC [01]	SK09GH-□▲
										DC-operated (2.4W) [G]	Bifurcated [blank] Single [H]		SK09L-□▲
										DC-operated (1.2W) [L]	Bifurcated [blank] Single [H]		SK09LH-□▲
12A [12]	3	5.5	5.5	12	12	9	20	20	20	AC-operated [A]	Bifurcated [blank] Single [H]	1NO [10] 1NC [01]	SK12A-□▲
										DC-operated (2.4W) [G]	Bifurcated [blank] Single [H]		SK12AH-□▲
										DC-operated (1.2W) [L]	Bifurcated [blank] Single [H]		SK12G-□▲
12A [12]	3	5.5	5.5	12	12	9	20	20	20	AC-operated [A]	Bifurcated [blank] Single [H]	1NO [10] 1NC [01]	SK12GH-□▲
										DC-operated (2.4W) [G]	Bifurcated [blank] Single [H]		SK12L-□▲
										DC-operated (1.2W) [L]	Bifurcated [blank] Single [H]		SK12LH-□▲

Note 1. "□" in the type column is replaced with the coil voltage code.

Note 2. "▲" in the type column is replaced with the auxiliary contact arrangement code.

Note 3. Numbers and letters in brackets [] are used in the product code.

● Magnetic Contactors SK18, 22, 32

Frame size ②	Max. motor capacity [kW]			Rated operational current [A]					Conventional free air thermal current [A] (Rated thermal current)	Operating coil specification ③	Auxiliary contact specification ④	Auxiliary contact arrangement ⑥	Type
	3-phase squirrel-cage motor (AC-3)			3-phase squirrel-cage motor (AC-3)			Resistive load (AC-1)						
	200-240V	380-440V	500-550V	200-240V	380-440V	500-550V	200-240V	380-440V					
18A [18]	4.5	7.5	7.5	18	32	32	32	32	32	AC-operated [A]	Bifurcated [blank] Single [H]	1NO [10] 1NC [01]	SK18A-□▲
										DC-operated (2.4W) [G]	Bifurcated [blank] Single [H]		SK18AH-□▲ SK18G-□▲ SK18GH-□▲
22A [22]	5.5	11	11	22	32	32	32	32	32	AC-operated [A]	Bifurcated [blank] Single [H]	SK22A-□▲ SK22AH-□▲ SK22G-□▲ SK22GH-□▲	
										DC-operated (2.4W) [G]	Bifurcated [blank] Single [H]		
32A [32]	7.5	15	15	32	40	40	40	40	40	AC-operated [A]	Bifurcated [blank] Single [H]	SK32A-□▲ SK32AH-□▲ SK32G-□▲ SK32GH-□▲	
										DC-operated (2.4W) [G]	Bifurcated [blank] Single [H]		

Note 1. "□" in the type column is replaced with the coil voltage code.

Note 2. "▲" in the type column is replaced with the auxiliary contact arrangement code.

Note 3. Numbers and letters in brackets [] are used in the product code.

● Coil voltage ⑤

AC-operated	Order Voltage	24	48	100	110	120	200	220	240	380	400	440	500
	Product code	E	F	1	H	K	2	M	P	S	4	T	5
DC-operated (2.4W)	Order Voltage	12	24	48	60	100	110	120	200	210	220		
	Product code	B	E	F	G	1	H	K	2	Y	M		
DC-operated (1.2W)	Order Voltage	12	24	48									
	Product code	B	E	F									



Magnetic-Contactors

Magnetic Contactors

■ Dimensions, mm

● Magnetic Contactors SK06, SK09, SK12

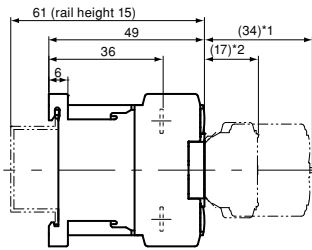

Note:
*1 With SZ1KA auxiliary contact blocks.
*2 With SZ1FA auxiliary contact blocks.

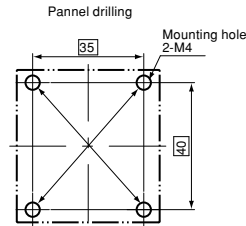
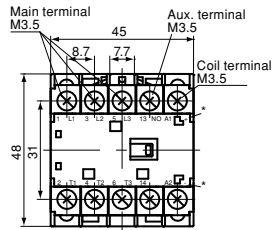

Use the two mounting holes on a diagonal

Aux. contact	Contact arrangement
1NO	
1NC	

*: For DC-operated

Mass:
0.14kg (For AC-operated)
0.17kg (For DC-operated)

SK18A, SK22A

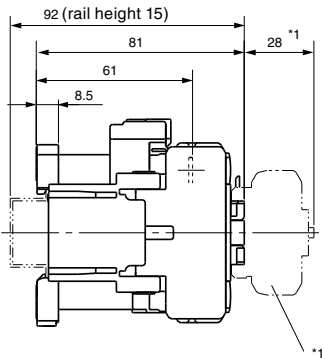

Note:
*1 With front mounting auxiliary contact block
*2 With side mounting auxiliary contact block

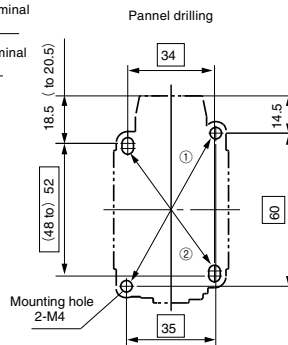
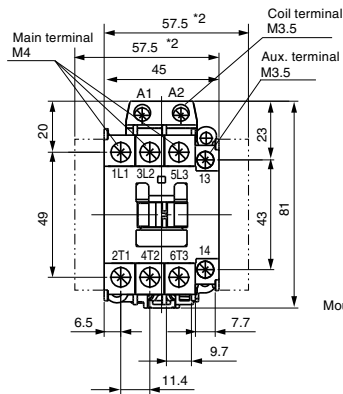

Use the two mounting holes on a diagonal
① 35 x 60
② 34 x (48 to) 52: Convertible with SC-4-0, SC-4-1

Aux. contact	Contact arrangement
1NO	
1NC	

Mass: 0.34kg

SK18G, SK22G

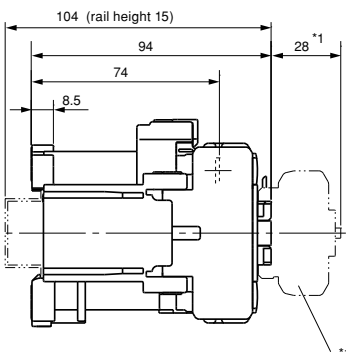

Note:
*1 With front mounting auxiliary contact block
*2 With side mounting auxiliary contact block

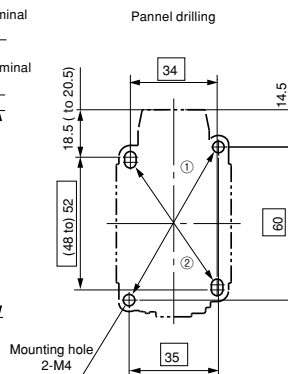
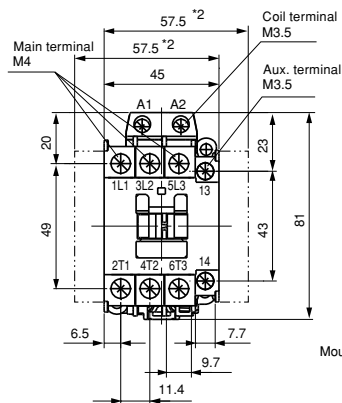

Use the two mounting holes on a diagonal
① 35 x 60
② 34 x (48 to) 52: Convertible with SC-4-0/G, SC-4-1/G

Aux. contact	Contact arrangement
1NO	
1NC	

Mass: 0.43kg

SK32A

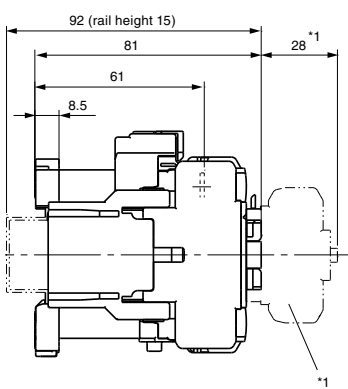

Note:
 *1 With front mounting auxiliary contact block
 *2 With side mounting auxiliary contact block

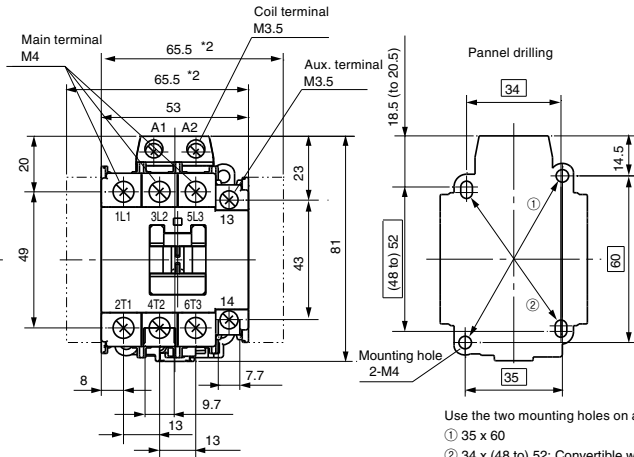

Use the two mounting holes on a diagonal
 ① 35 x 60
 ② 34 x (48 to) 52: Convertible with SC-4-0, SC-4-1

Aux. contact	Contact arrangement
1NO	
1NC	

Mass: 0.37kg

SK32G

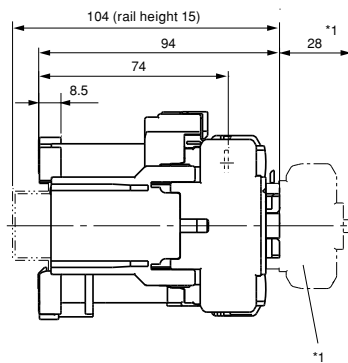

Note:
 *1 With front mounting auxiliary contact block
 *2 With side mounting auxiliary contact block

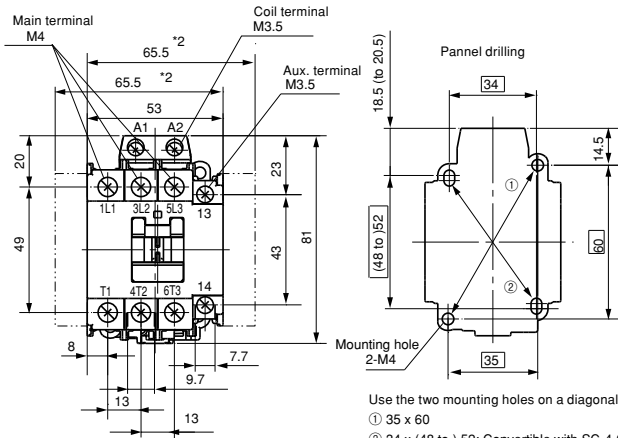

Use the two mounting holes on a diagonal
 ① 35 x 60
 ② 34 x (48 to) 52: Convertible with SC-4-0, SC-4-1

Aux. contact	Contact arrangement
1NO	
1NC	

Mass: 0.48kg



Reversing Magnetic Contactors

■ Features

- Ideal for forward/reverse motor operation and plugging.
- Mechanical interlock provided as a standard feature.

■ Ordering Information (Types)

● Reversing Magnetic Contactors

SK 06 A H R - E 10 W
 ① ② ③ ④ ⑤ ⑥ ⑦ ⑧

- ① Series
- ② Frame size
- ③ Operating coil specification
- ④ Auxiliary contact specification
- ⑤ Reversing
- ⑥ Coil voltage specification
- ⑦ Auxiliary contact arrangement
- ⑧ Reversing connection



■ Ratings and Types

● Reversing Magnetic Contactors SK06, SK09, SK12

Frame size ②	Max. motor capacity [kW]			Rated operational current [A]					Conventional free air thermal current [A] (Rated thermal current)	Operating coil specification ③	Auxiliary contact specification ④	Auxiliary contact arrangement ⑦	Type
	3-phase squirrel-cage motor (AC-3)			3-phase squirrel-cage motor (AC-3)			Resistive load (AC-1)						
	200-240V	380-440V	500-550V	200-240V	380-440V	500-550V	200-240V	380-440V					
6A [06]	1.5	2.2	3	6	6	5	12	12	20	AC-operated [A]	Bifurcated [blank] Single [H]	1NO x 2 [10] 1NC x 2 [01]	SK06AR-□▲W
										DC-operated (2.4W) [G]	Bifurcated [blank] Single [H]		SK06GR-□▲W
										DC-operated (1.2W) [L]	Bifurcated [blank] Single [H]		SK06LHR-□▲W
9A [09]	2.2	4	4	9	9	7	16	16	20	AC-operated [A]	Bifurcated [blank] Single [H]	1NO x 2 [10] 1NC x 2 [01]	SK09AR-□▲W
										DC-operated (2.4W) [G]	Bifurcated [blank] Single [H]		SK09GR-□▲W
										DC-operated (1.2W) [L]	Bifurcated [blank] Single [H]		SK09LHR-□▲W
12A [12]	3	5.5	5.5	12	12	9	20	20	20	AC-operated [A]	Bifurcated [blank] Single [H]	1NO x 2 [10] 1NC x 2 [01]	SK12AR-□▲W
										DC-operated (2.4W) [G]	Bifurcated [blank] Single [H]		SK12GR-□▲W
										DC-operated (1.2W) [L]	Bifurcated [blank] Single [H]		SK12LHR-□▲W

Note 1. "□" in the type column is replaced with the coil voltage code.

Note 2. "▲" in the type column is replaced with the auxiliary contact arrangement code.

Note 3. Numbers and letters in brackets [] are used in the product code.

Note 4. An electrical interlock is not implemented on Magnetic Contactors with an auxiliary contact arrangement of 1NOx2. When using these Magnetic Contactors, always implement an electrical interlock in the external control circuits to prevent short-circuit faults when power is turned ON.

Note 5. An electrical interlock is implemented in the auxiliary circuit configurations of the Magnetic Contactor. If you need to use an auxiliary contact, add an option Auxiliary Contact Blocks.

● Reversing Magnetic Contactors SK18, SK22, SK,32

Frame size ②	Max. motor capacity [kW]			Rated operational current [A]					Conventional free air thermal current [A] (Rated thermal current)	Operating coil specification ③	Auxiliary contact specification ④	Auxiliary contact arrangement ⑦	Type
	3-phase squirrel-cage motor (AC-3)			3-phase squirrel-cage motor (AC-3)			Resistive load (AC-1)						
	200-240V	380-440V	500-550V	200-240V	380-440V	500-550V	200-240V	380-440V					
18A [18]	4.5	7.5	7.5	18	18	13	32	32	32	AC-operated [A]	Bifurcated [blank] Single [H]	1NO x 2 [10] 1NC x 2 [01]	SK18AR-□▲W
										DC-operated (2.4W) [G]	Bifurcated [blank] Single [H]		SK18AHR-□▲W
22A [22]	5.5	11	11	22	22	17	32	32	32	AC-operated [A]	Bifurcated [blank] Single [H]		SK22AR-□▲W
										DC-operated (2.4W) [G]	Bifurcated [blank] Single [H]		SK22AHR-□▲W
32A [32]	7.5	15	15	32	32	24	40	40	40	AC-operated [A]	Bifurcated [blank] Single [H]		SK32AR-□▲W
										DC-operated (2.4W) [G]	Bifurcated [blank] Single [H]		SK32AHR-□▲W

Note 1. "□" in the type column is replaced with the coil voltage code.

Note 2. "▲" in the type column is replaced with the auxiliary contact arrangement code.

Note 3. Numbers and letters in brackets [] are used in the product code.

Note 4. An electrical interlock is not implemented on Magnetic Contactors with an auxiliary contact arrangement of 1NOx2. When using these Magnetic Contactors, always implement an electrical interlock in the external control circuits to prevent short-circuit faults when power is turned ON.

Note 5. An electrical interlock is implemented in the auxiliary circuit configurations of the Magnetic Contactor. If you need to use an auxiliary contact, add an option Auxiliary Contact Blocks.

● Coil voltage ⑥

AC-operated	Order Voltage	24	48	100	110	120	200	220	240	380	400	440	500
	Product code	E	F	1	H	K	2	M	P	S	4	T	5
DC-operated (2.4W)	Order Voltage	12	24	48	60	100	110	120	200	210	220		
	Product code	B	E	F	G	1	H	K	2	Y	M		
DC-operated (1.2W)	Order Voltage	12	24	48									
	Product code	B	E	F									



Magnetic-Contactors

Reversing Magnetic Contactors

■ Dimensions, mm

● Magnetic Contactors

SK06□R, SK09□R, SK12□R

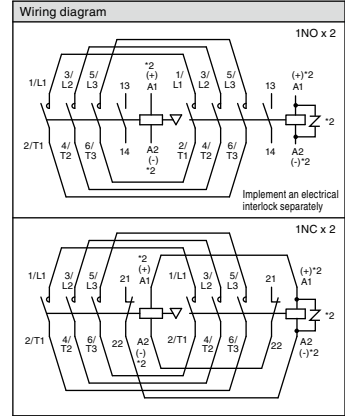
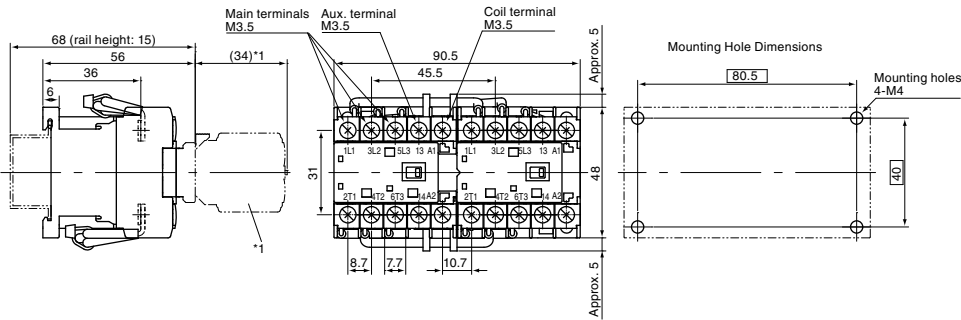

[NOTE]

- *1 With Auxiliary Contact Blocks
- *2 For DC-operated types.

Mass: 0.32kg (AC-operated type)
0.38kg (DC-operated type)

SK18AR, SK22AR

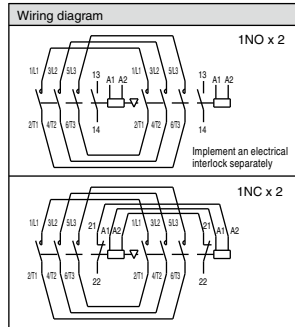
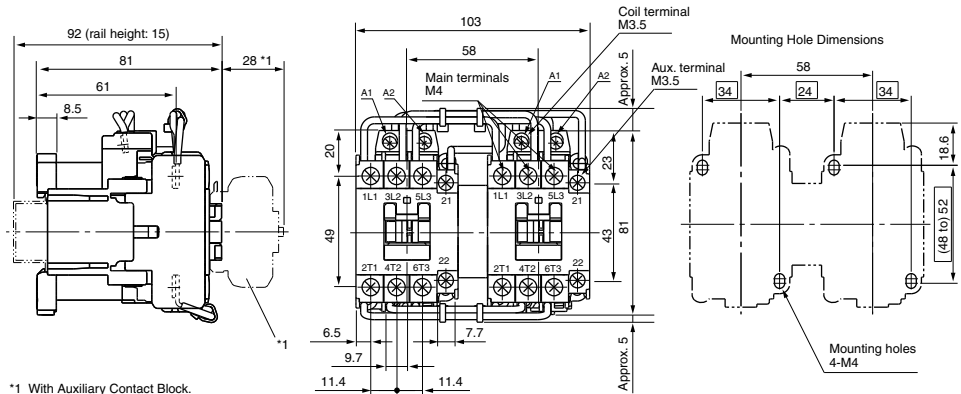

*1 With Auxiliary Contact Block.

Mass: 0.73kg

SK18GR, SK22GR

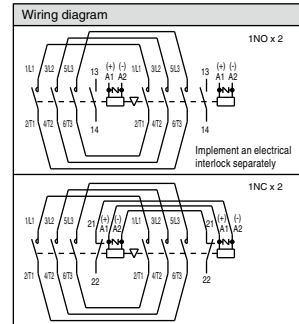
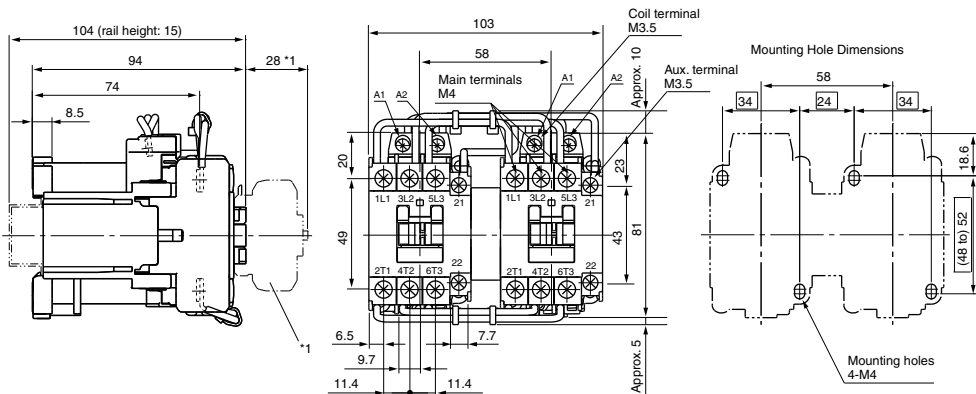

*1 With Auxiliary Contact Block.

Mass: 0.9kg

■ Dimensions, mm

SK32AR

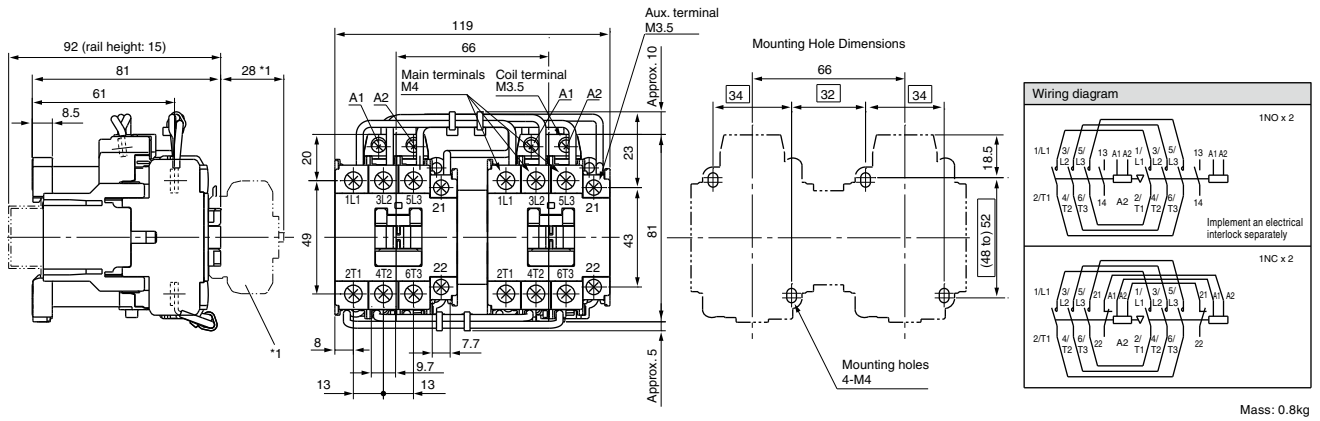

*1 With Auxiliary Contact Block.

SK32GR

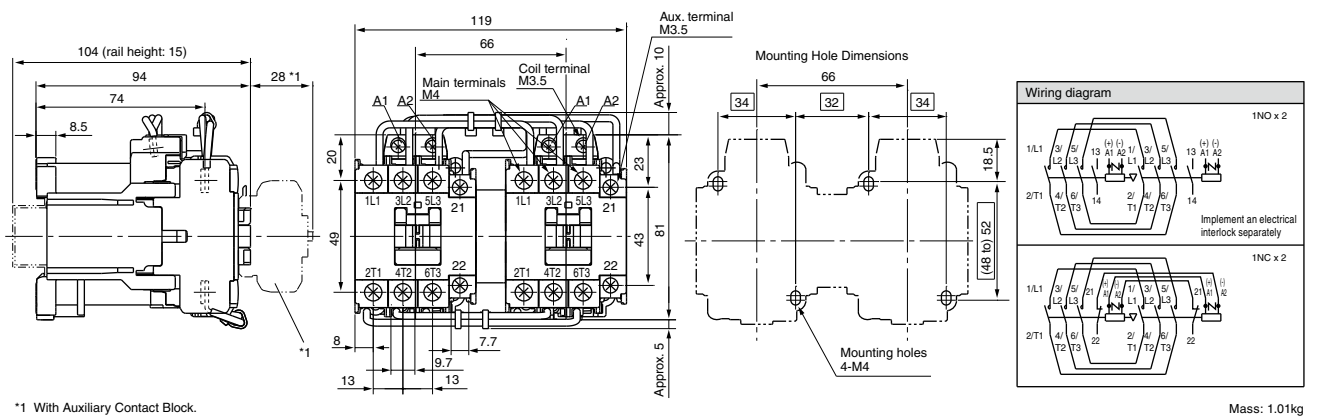

*1 With Auxiliary Contact Block.



Magnetic-Contactors

Main contact 4-pole magnetic contactor

Main contact 4-pole magnetic contactor

■ Features

- Perfect for applications where four wires are required for the main circuit
- 4NO product and 2NO2NC product main contacts are available
- The operation coil is a low consumption unit with a power consumption of 1.2 W.



SK12FL

■ Ordering Information (Types)

- Main contact 4-pole magnetic contactor

SK12EL - E

① ②

- ① Basic types
- ② Coil voltage specification

- Coil voltage specification code

Coil voltage ②	Code	Coil specification
12V DC	B	
24V DC	E	

(Note 1) The allowable power fluctuation range is 85 to 110% of the rated voltage.
 (Note 2) Be careful, as operating coil terminals have polarity.

■ Ratings and Types

Main contact (NO)						Main contact (NC)		Conventional free air thermal current [A] (Rated thermal current)	Main contact arrangement	Type			
Max. motor capacity [kW]		Rated operational current [A]				Rated operational current [A]							
3-phase squirrel-cage motor (AC-3)			3-phase squirrel-cage motor (AC-3)			Resistive load (AC-1)							
200-240V	380-440V	500-550V	200-240V	380-440V	500-550V	200-240V	380-440V	200-240V	380-440V	500-550V	20	4NO	SK12EL-□
3	5.5	5.5	12	12	9	20	20	10	10	5			

(Note 1) This product is not equipped with auxiliary contacts. If necessary, combine it with a 2-pole auxiliary contact block product.
 (Note 2) It cannot be combined with a 4-pole auxiliary contact block product.

■ Performance

Type	Rated operational voltage [V]	Rated operational current [A]	Making/breaking current [A]		Operating cycles per hour [times hour]	Durability (Operations)		Performance indication
			Making	Breaking		Mechanical	Electrical	
SK12EL-□	220	12	144	120	1800	1000	100	AC-3-0-0-0
SK12FL-□	440	12	144	120				

■ Dimensions, mm

SK12EL
SK12FL

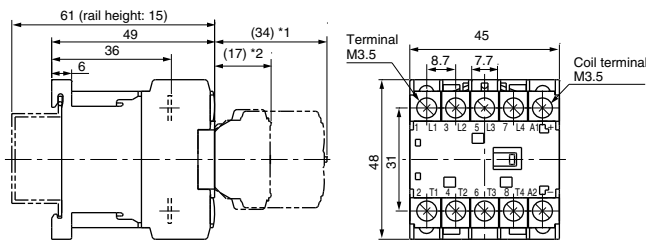

*1 When an auxiliary contact block (SZ1KA20, 11, 02) was installed
 *2 When an auxiliary contact block (SZ1FA11) was installed

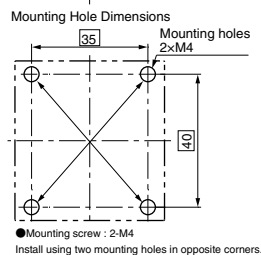

● Mounting screw : 2-M4
 Install using two mounting holes in opposite corners.

Type (Contact arrangement)	Contact arrangement diagram
SK12EL (4A)	
SK12FL (2A2B)	

Mass: 0.14kg (AC operated)
0.17kg (DC operated)



Magnetic-Contactors

Magnetic contactor with tab terminal

Magnetic contactor with tab terminal

■ Features

- This magnetic contactor supports tab terminal connections.
- Can be applied to three-phase motors (AC 230 V, 3 kW).
- The operation coil has a low power consumption of 1.2 W.
- High life expectancy type, with an electrical life expectancy of 1,000,000 operations
- Built-in operation coil switch surge suppression function.

■ Ordering Information (Types)

- Magnetic contactor with tab terminal

SK121L - E 10

① ② ③

- ① Basic types
- ② Coil voltage specification
- ③ Auxiliary contact arrangement



SK121L

- Coil voltage specification code

Coil voltage ②	Code	Coil specification
12V DC	B	
24V DC	E	

(Note 1) The allowable power fluctuation range is 85 to 110% of the rated voltage.
 (Note 2) Be careful, as operating coil terminals have polarity.

■ Ratings and Types

Max. motor capacity [kW]			Rated operational current [A]			Conventional free air thermal current [A] (Rated thermal current)	Auxiliary contact arrangement	Type
3-phase squirrel-cage motor (AC-3)			3-phase squirrel-cage motor (AC-3)					
200-240V	380-440V	500-550V	200-240V	380-440V	500-550V			
3	5.5	5.5	12	12	9	15	1NO 1NC	SK121L

■ Performance

Type	Rated operational voltage [V]	Rated operational current [A]	Making/breaking current [A]		Operating cycles per hour [times hour]	Durability (Operations)		Performance indication
			Making	Breaking		Mechanical	Electrical	
SK121L	220	12	120	96	1800	1000	100	AC-3-0-0-0
	440	12	120	96				

■ Connection terminal

IEC 61210 "Flat quick-connect terminations for electrical copper" Size: 6.3mm
 [Recommended terminal]

- Manufacturer : JST
- Product code : FVDHDF1.25-250B (Applicable wire : 1.0 to 1.65mm²)
 FVDHDF2-250B (Applicable wire : 1.65 to 2.63mm²)
 (250 series)

■ Dimensions, mm

SK121L

61.6 (When rail height is 15)

49.6

45

0.8

16.4

48

35

49

4.15

8.7

8.7

8.7

10.6

Panel drilling diagram

Mounting hole 2×M4

35

40

● Mounting screw: 2-M4
 Mount using two mounting holes that are in a diagonal line.

Auxiliary contact	Contact arrangement diagram
1NO	
1NC	

Mass: 0.17kg



Magnetic-Contactors

PC board mounting magnetic contactor

PC board mounting magnetic contactor

■ Features

- Includes a terminal for installing PC boards.
- Capable of directly driving a 3-phase motor (AC 230 V, 2.2 kW) without an interface relay, using programmable controller or detector transistor output (1.2 W).

■ Ordering Information (Types)

- PC board mounting magnetic contactor

SK092L - E 10

① ② ③

- ① Basic types
- ② Coil voltage specification
- ③ Auxiliary contact arrangement

■ Ratings and Types

Max. motor capacity [kW]		Rated operational current [A]			Conventional free air thermal current [A]	Auxiliary contact arrangement	Type
3-phase squirrel-cage motor (AC-3)		3-phase squirrel-cage motor (AC-3)		Resistive load (AC-1)			
200-240V	380-440V	200-240V	380-440V	200-240V	9	1NO	SK092L
2.2	4	9	9	9		1NC	

● Coil voltage specification code

Coil voltage ②	Code	Coil specification
12V DC	B	
24V DC	E	

- (Note 1) The allowable power fluctuation range is 85 to 110% of the rated voltage.
- (Note 2) Be careful, as operating coil terminals have polarity.

(Recommended example)
PC board

Conductor thickness: 70 [μm]
Conductor width: 6 [mm]
Conductor cross-section area: 0.42 [mm²]

⚠ CAUTION Wiring

- When installing directly to a PC board (SK092L model) Take enough current-carrying capacity for the PC board conductor.

• Precautions for PC board mounting

No measures have been taken to prevent solder, flux, or other materials from entering the magnetic contactor. If solder, flux, or other materials enter the magnetic contactor, it could cause insulation deterioration, contact failures, or other problems.

Follow the precautions below for PC board mounting:

- Solder by hand. Make sure that solder, flux, or other materials do not enter the magnetic contactor.
- Use non-corrosive flux (for example, rosin-based flux).
- Do not wash after soldering. If it must be washed, only wash the solder surface to prevent the wash solution from entering the magnetic contactor. Use an alcohol-based wash solution.
- Do not coat. If the coating agent enters the magnetic contactor, it could cause contact failures.
- After soldering, do not lift the PC board up by the magnetic contactor.

■ Performance

Type	Rated operational voltage [V]	Rated operational current [A]	Making/breaking current [A]		Operating cycles per hour [times hour]	Durability (Operations)		Performance indication
			Making	Breaking		Mechanical	Electrical	
SK092L	220	9	90	72	1800	1000	100	AC-3-0-0-0
	440	9	90	72				

■ Dimensions, mm

SK092L

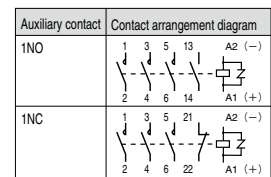
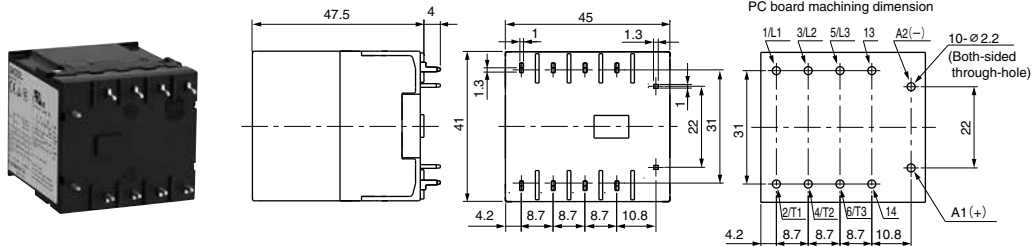



Magnetic-Contactors

Thermal Overload Relay

Thermal Overload Relay

■ Features

- International safety standards for standard models (IEC, GB, JIS, UL, and CSA).
- A terminal cover and dial cover are provided as standard features.
- Highly reliable 1NO1NC isolated auxiliary contacts to enable using NC and NO contacts at different potentials.
- Easily switch between manual and automatic reset.
- Parallel arrangement of main terminals and auxiliary terminals for easier wiring.

■ Ratings and Types

Type
TK12W□-■■■■
TK25□-■■■■
TK26□-■■■■

Note. "□" in the type column is replaced with the reset method code.
 "■■■■" is replaced by the specified code for the current setting range.

■ Ampere Setting Range Specification Codes

Type			Ampere setting range (A)	Ordering code	Applicable magnetic contactors					
TK12	TK25	TK26	0.1 - 0.15	P10	SK06	SK09	SK12	SK18	SK22	SK32
			0.13 - 0.2	P13						
			0.18 - 0.27	P18						
			0.24 - 0.36	P24						
			0.34 - 0.52	P34						
			0.48 - 0.72	P48						
			0.64 - 0.96	P64						
			0.8 - 1.2	P80						
			0.95 - 1.45	P95						
			1.1 - 1.65	1P1						
			1.4 - 2.1	1P4						
			1.7 - 2.6	1P7						
			2.2 - 3.4	2P2						
			2.8 - 4.2	2P8						
			4 - 6	004						
			5 - 7.5	005						
			6 - 9	006						
			7 - 10.5	007						
			9 - 13	009						
			-	-						
-	-	-	16 - 22	016	-	-	-	-	-	
-	-	-	20 - 26	020	-	-	-	-	-	
-	-	-	26 - 32	026	-	-	-	-	-	

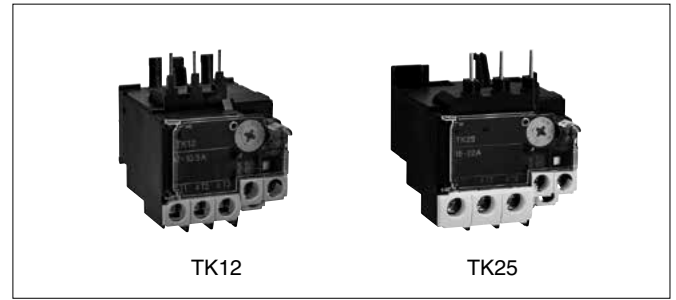

■ Ordering Information (Types)

- Thermal Overload Relay

TK 12 W A - 009

① ② ③ ④ ⑤

① Type

② Frame size

③ Mounting * TK12 only

④ Reset method

⑤ Ampere setting range *

* Refer to Heat Element Rating Specification Codes.



■ Auxiliary Circuit Ratings

● Ratings for IEC Standard Compliance

Type	Conventional free air thermal current [A] (Rated continuous current)	Rated operational current [A]					Minimum voltage and current
		Rated operational voltage [V]	AC-15 (Ind. load)		DC-13 (Ind. load)		
			NC contacts	NO contacts	NC contacts	NO contacts	
TK12	5	24	3 (0.5)	3 (0.5)	1.1(0.3)	1.1 (0.3)	DC5V, 3mA
		100-120	2.5 (0.5)	2.5 (0.5)	0.28	0.28	
		200-240	2 (0.5)	1.5 (0.5)	0.14	0.14	
		380-440	1 (0.5)	0.75 (0.5)	–		
		500-600	0.6 (0.5)	0.6 (0.5)	–		
TK25 TK26	5	24	3 (0.5)	3 (0.5)	1.1(0.3)	1.1 (0.3)	DC5V, 3mA
		100-120	2.5 (0.5)	2.5 (0.5)	0.28	0.28	
		200-240	2 (0.5)	2 (0.5)	0.14	0.14	
		380-440	1 (0.5)	1 (0.5)	–		
		500-600	0.6 (0.5)	0.6 (0.5)	–		

Numbers in brackets () are for automatic reset.

● Ratings for UL and CSA Standard Compliance

Type	Rated continuous current [A]	Rated operational current [A]						Rating code	
		AC			DC			AC	DC
		Rated operational voltage [V]	Making	Breaking	Rated operational voltage [V]	Making	Breaking		
TK12 TK25 TK26	5	120	30	3	125	0.22	0.22	B600	R300
		240	15	1.5					
		480	7.5	0.75	250	0.11	0.11		
		600	6	0.6					

■ Operating Characteristics (Specifications)

● 3-pole Circuits

Standard	Operating limit		Overload (hot start)	Locked rotor (cold start)	Ambient temperature
	Non-tripping	Tripping			
IEC 60947-4-1	105% I _e (for less than 2h)	120% I _e (for less than 2h)	Tripping class 10A: 150% I _e for less than 2min	Tripping class 10A: 720% I _e for 2 to 10 s max.	20°C

● 2-pole Circuits

Standard	Phase-loss protection	Non-tripping	Operation (hot start)	Ambient temperature
IEC 60947-4-1	Provided.	2-pole: 100% I _e 1-pole: 90% I _e	{ 2-pole: 115% I _e (for less than 2h) 1-pole: 0% I _e	20°C

■ Operating Characteristics Curves (Average Values)

● Tripping Class 10A

TK12, TK25, TK26 series, Ambient temperature: 20°C

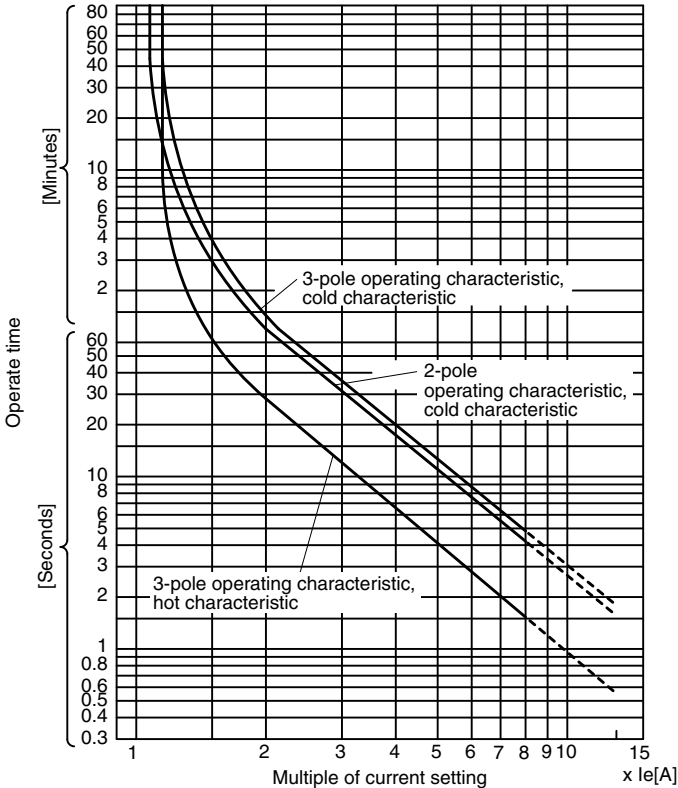



Magnetic-Contactors

Thermal Overload Relay

■ Dimensions, mm

- Thermal Overload Relay TK12

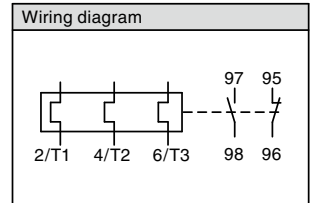
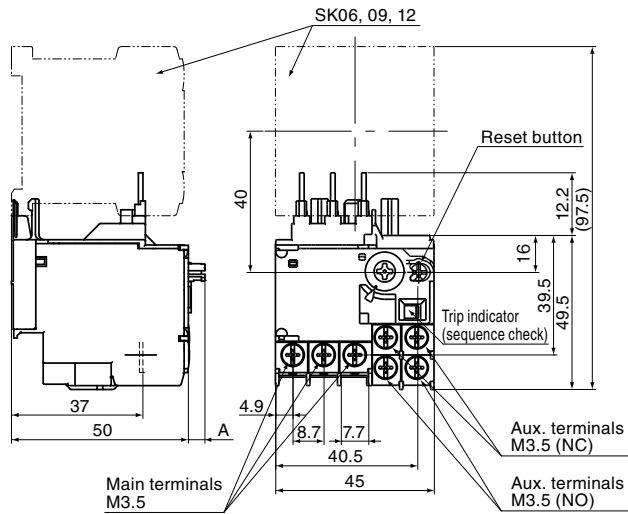

Mass : 0.1kg

Dimension A
 - Manually reset state: 5mm
 - Automatically reset state: 2mm

TK25

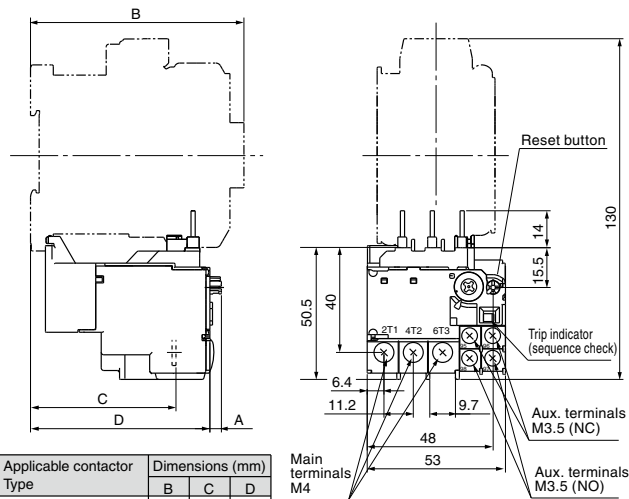

Applicable contactor Type	Dimensions (mm)		
	B	C	D
SK18A SK22A	81	55.5	68.5
SK18G SK22G	94	68.5	81.5

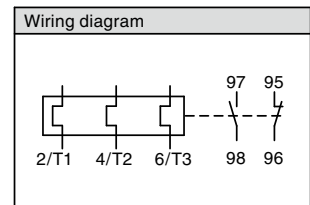

Mass: 0.11kg

Dimension A
 - Manually reset state: 5mm
 - Automatically reset state: 2mm

TK26

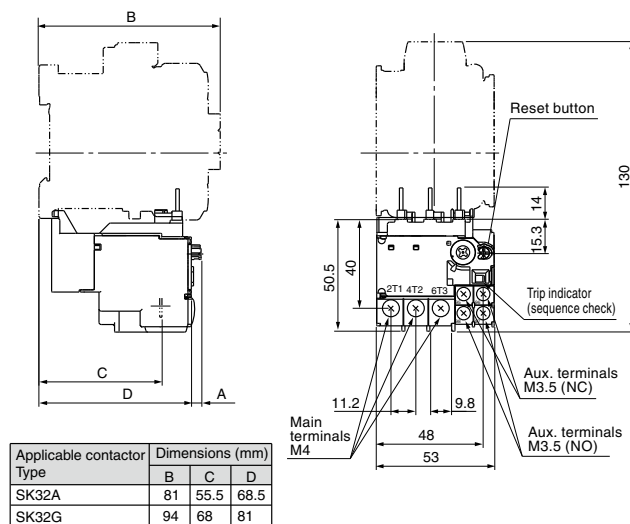

Applicable contactor Type	Dimensions (mm)		
	B	C	D
SK32A	81	55.5	68.5
SK32G	94	68	81

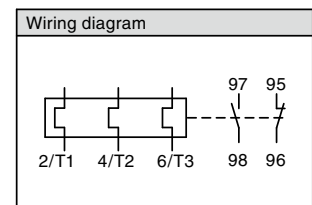

Mass: 0.11kg

Dimension A
 - Manually reset state: 5mm
 - Automatically reset state: 2mm



Optional unit

■ Type Numbers and Product Codes

Product name	Type	Specification	Used with		
Auxiliary Contact Blocks (Front mounting, Bifurcated Contact)	SZ1KA40	Contact arrangement: 4NO	SK06 to SK12 *1 SKH4 *1		
	SZ1KA31	Contact arrangement: 3NO+1NC			
	SZ1KA22	Contact arrangement: 2NO+2NC			
	SZ1KA13	Contact arrangement: 1NO+3NC			
	SZ1KA04	Contact arrangement: 4NC			
	SZ-A20	Contact arrangement: 2NO			
	SZ-A11	Contact arrangement: 1NO+1NC		SK18, SK22, SK32 *3	
	SZ-A02	Contact arrangement: 2NC			
	SZ-A111	Make-before-break contact: 1NO+1NC			
	Auxiliary Contact Blocks (Front mounting, Single Button Contact)	SZ1KA20		Contact arrangement: 2NO	SK06 to SK12 SKH4
		SZ1KA11		Contact arrangement: 1NO+1NC	
		SZ1KA02		Contact arrangement: 2NC	
		SZ1KA40H		Contact arrangement: 4NO	
SZ1KA31H		Contact arrangement: 3NO+1NC			
SZ1KA22H		Contact arrangement: 2NO+2NC			
SZ1KA13H		Contact arrangement: 1NO+3NC			
SZ1KA04H		Contact arrangement: 4NC			
SZ1KA20H		Contact arrangement: 2NO	SK06 to SK12 SKH4		
SZ1KA11H		Contact arrangement: 1NO+1NC			
SZ1KA02H	Contact arrangement: 2NC	SK18, SK22, SK32 *3			
SZ-A20H	Contact arrangement: 2NO				
SZ-A11H	Contact arrangement: 1NO+1NC				
Auxiliary Contact Blocks (Small Front mounting, Bifurcated Contact)	SZ1FA11	Contact arrangement: 1NO+1NC	SK06 to SK12 SKH4		
	SZ1FA11H	Contact arrangement: 1NO+1NC			
Auxiliary Contact Blocks (Small Front mounting, Single Button Contact)	SZ-AS1	Contact arrangement: 1NO+1NC	SK18, SK22, SK32 *3		
Auxiliary Contact Blocks (Side mounting)	SZ-AS1H	Contact arrangement: 1NO+1NC			
Mechanical Interlock Units	SZ1KRM	Reversing assembly and mechanical interlock	SK06 to SK12 SK18, SK22, SK32		
	SZ-RM				
Reversing Connection Kit (wiring)	SZ1KRW1W	Reversing Connection Kit for main circuit	SK06 to SK12		
	SZ-RW22		SK18, SK22		
	SZ-RW23		SK32		
	SZ1KRW1E		SK06 to SK12		
Main Circuit Surge Suppression Unit *2	SZ-ZM1	Front mounting Built-in CR (3-phase motor, 240V, 0.1 to 3.7kw)	SK18		
	SZ-ZM2	Side mounting Built-in CR (3-phase motor, 240V, 0.1 to 3.7kw)	SK06 to SK12 *2 SK18		
	SZ-ZM3E	Front mounting Built-in CR (3-phase motor, 240V, 0.1 to 15kw)	SK18, SK22, SK32		
	SZ-ZM4E	Side mounting Built-in CR (3-phase motor, 240V, 0.1 to 15kw)	SK06 to SK12 *2 SK18, SK22, SK32		
	SZ-ZMH	For Main Circuit Surge Suppression Unit SZ-ZM2	SZ-ZM2		
Separate Installation Unit (for Main Circuit Surge Suppression Unit)					
Coil Surge Suppression Units (surge suppression only)	SZ1KZ1	Built-in varistor: 24 to 48V AC	SK06 to SK12 *4 SKH4		
	SZ1KZ2	Built-in varistor: 48 to 125V AC			
	SZ1KZ3	Built-in varistor: 100 to 250V AC	SK06G to SK12G SK06L to SK12L SKH4G, SKH4L *4		
	SZ1KZ6	Built-in diode: 24 to 125V DC			
	SZ-Z1	Built-in varistor: 24 to 48V AC			
	SZ-Z2	Built-in varistor: 100 to 250V AC			
	Coil Surge Suppression Units (with Operation Indicator Lamps)	SZ-Z3	Built-in varistor: 380 to 440V AC	SK18A, SK22, SK32A	
		SZ-Z4	Built-in CR: 24 to 48V AC	SK18, SK22, SK32 *4	
		SZ-Z5	Built-in CR: 100 to 250V AC		
		SZ1KZ4	Built-in varistor and LED: 24 to 48V AC/DC	SK06 to SK12 *4 SKH4	
SZ1KZ5		Built-in varistor and LED: 48 to 125V AC/DC			
SZ-Z6		Built-in varistor and LED: 24 to 48V AC/DC	SK18, SK22, SK32 *4		
SZ-Z7		Built-in varistor and LED: 100 to 240V AC/DC			
SZ-Z8		Built-in CR and LED: 24 to 48V AC/DC			
Operation Indicator Units	SZ-Z9	Built-in CR and LED: 100 to 240V AC/DC			
	SZ1KL1	Built-in LED: 12 to 24V AC/DC	SK06 to SK12 SKH4		
	SZ1KL2	Built-in LED: 24 to 48V AC/DC			
SZ1KL3	Built-in LED: 48 to 125V AC/DC				
Thermal Overload Relay Separate Installation Unit	TZ1H12N	For separate installation type thermal overload relay assembly	TK12		
	TZ1H26N		TK26		
Thermal Overload Relay Reset Releases	SZ-R1	Release length: 300mm	TK12, TK25, TK26		
	SZ-R2	Release length: 500mm			
	SZ-R3	Release length: 700mm			
Link Module	BZ0LRK12AA	Links to Manual Motor Starter	SK06 to SK12		
	BZ0LRK22AA		SK18, SK22		
	BZ0LRK32AA		SK32		
	BZ0LRKACA		SK18A, SK22A, SK32A		
Spacer			SK06 to SK12		
Reversing Connection Unit (Insert)	SZ1KRW1M	Reversing Connection Unit (Insert) for main circuit			

*1 These options cannot be used with 1.2W DC Magnetic Contactors and Starters from SK06 to SK12L and SKH4L Auxiliary Relays.

*2 Use the SZ-ZM2 Main Circuit Surge Suppression Unit together with the SZ-ZMH Standalone Installation Unit.

*3 You can add another auxiliary contact unit when side mounting it.

*4 DC operated SK□G type and SK□L type have a built-in varistor in the main unit.



Auxiliary Contact Blocks

■ Features

- Easily add on auxiliary contacts.
- You can add auxiliary contacts without increasing the footprint to contribute to control panel downsizing.
- Many different contact variations in two external sizes.
- Models with double contacts are available for high reliability to achieve a minimum operating voltage and current of 5V DC, 3mA.

■ Ordering Information (Types)

- Auxiliary Contact Blocks

SZ1KA22

① Type

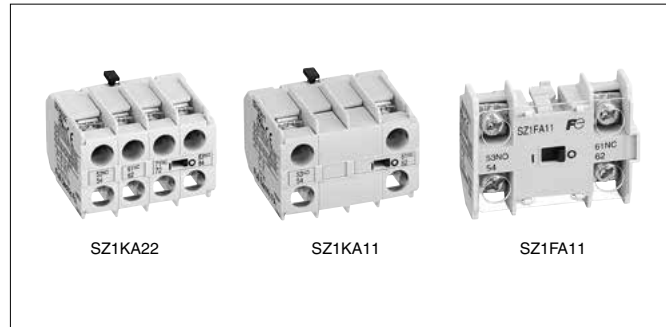

■ Ordering Information (Types)

Product name	Number of contacts	Contact arrangement	Mounting	Used with	Type
Auxiliary Contact Blocks with Bifurcated Contacts	4	4NO	Front mounting	SK06 to SK12 *1 SKH4 *1	SZ1KA40
		3NO+1NC			SZ1KA31
		2NO+2NC			SZ1KA22
		1NO+3NC			SZ1KA13
		4NC			SZ1KA04
	2	2NO	Front mounting	SK06 to SK12 SKH4	SZ1KA20
		1NO+1NC			SZ1KA11
		2NC			SZ1KA02
	2	2NO	Front mounting	SK18, 22, 32	SZ-A20
		1NO1NC			SZ-A11
		2NC			SZ-A02
	Auxiliary Contact Blocks with Single Contacts	4	4NO	Front mounting	SK06 to SK12 *1 SKH4 *1
3NO+1NC			SZ1KA31H		
2NO+2NC			SZ1KA22H		
1NO+3NC			SZ1KA13H		
4NC			SZ1KA04H		
2		2NO	Front mounting	SK06 to SK12 SKH4	SZ1KA20H
		1NO+1NC			SZ1KA11H
		2NC			SZ1KA02H
2		2NO	Front mounting	SK18, 22, 32	SZ-A20H
		1NO1NC			SZ-A11H
		2NC			SZ-A02H
Small Auxiliary Contact Block with Bifurcated Contacts		2	1NO+1NC	Front mounting	SK06 to SK12 SKH4
Small Auxiliary Contact Block with Single Contacts	2	1NO+1NC	Front mounting	SK06 to SK12 SKH4	SZ1FA11H
Make-before-break Auxiliary Contact (Bifurcated Contact)	2	1NO1NC	Front mounting	SK18, 22, 32	SZ-A111
Auxiliary Contact Block (Bifurcated Contact)	2	1NO1NC	Side Mounting	SK18, 22, 32	SZ-AS1
Auxiliary Contact Block (Single Contact)	2	1NO1NC	Side Mounting	SK18, 22, 32	SZ-AS1H

*1 These options cannot be used with 1.2W DC Magnetic Contactors and Starters from SK06 to SK12L and 1.2W SKH4L Auxiliary Relays.

■ Ratings

Type	Conventional free air thermal current (Rated continuous current) [A]	Making and breaking current (AC) [A]	Rated operational current [A]						Minimum voltage and current
			AC			DC			
			Rated operational voltage [V]	Ind. load (AC-15)	Res. load (AC-12)	Rated operational voltage [V]	Ind. load (DC-13)	Res. load (DC-12)	
SZ1KA□ SZ1FA□ (Bifurcated contacts)	10	30	AC100 - 120	3	6	24 DC	2	3	5V DC, 3mA
			AC200 - 240	3	6	48 DC	1	2	
			AC380 - 440	1	6	110 DC	0.3	1.5	
			AC500 - 600	0.5	3	220 DC	0.2	0.5	
SZ1KA□H SZ1FA□H (Single contacts)	10	60	AC100 - 120	6	10	24 DC	4	8	24V DC, 10mA
			AC200 - 240	6	10	48 DC	1	3.5	
			AC380 - 440	6	10	110 DC	0.5	2.5	
			AC500 - 600	3	5	220 DC	0.25	0.8	
SZ-A□ SZ-AS1 (Bifurcated contacts)	10	60	AC100 - 120	6	10	24 DC	3	5	5V DC, 3mA
			AC200 - 240	3	8	48 DC	1.5	3	
			AC380 - 440	1.5	5	110 DC	0.55	2.5	
			AC500 - 600	1.2	5	220 DC	0.27	1	
SZ-A□H SZ-AS1H (Single contacts)	10	60	AC100 - 120	6	10	24 DC	5	10	24V DC, 10mA
			AC200 - 240		10	48 DC	1.5	5	
			AC380 - 440	4	10	110 DC	0.7	4	
			AC500 - 600		10	220 DC	0.27	1	

■ Dimensions, mm

- SZ1KA40
- SZ1KA31
- SZ1KA22
- SZ1KA13
- SZ1KA04
- SZ1KA40H
- SZ1KA31H
- SZ1KA22H
- SZ1KA13H
- SZ1KA04H

4-pole

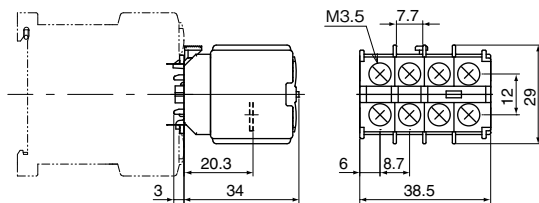

Mass: 34g

Type	Contact arrangement
SZ1KA40 SZ1KA40H	4NO
SZ1KA31 SZ1KA31H	3NO+1NC
SZ1KA22 SZ1KA22H	2NO+2NC
SZ1KA13 SZ1KA13H	1NO+3NC
SZ1KA04 SZ1KA04H	4NC

- SZ1KA20
- SZ1KA11
- SZ1KA02
- SZ1KA20H
- SZ1KA11H
- SZ1KA02H

2-pole

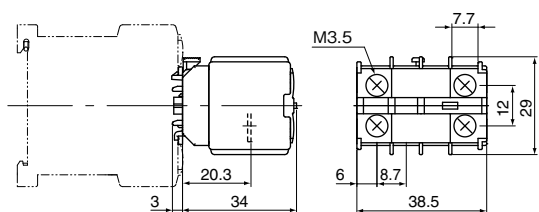

Mass: 29g

Type	Contact arrangement
SZ1KA20 SZ1KA20H	2NO
SZ1KA11 SZ1KA11H	1NO+1NC
SZ1KA02 SZ1KA02H	2NC

- SZ1FA11
- SZ1FA11H

Small, 2-pole

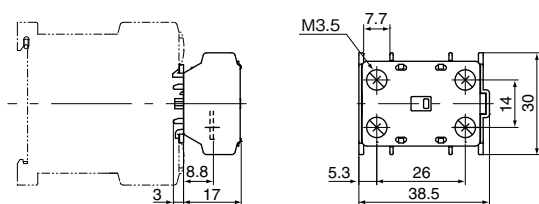

Mass: 17g

Type	Contact arrangement
SZ1FA11 SZ1FA11H	1NO+1NC



Magnetic-Contactors

Auxiliary Contact Blocks

■ Dimensions, mm

• Front mounting

- SZ-A20
- SZ-A11
- SZ-A02
- SZ-A111

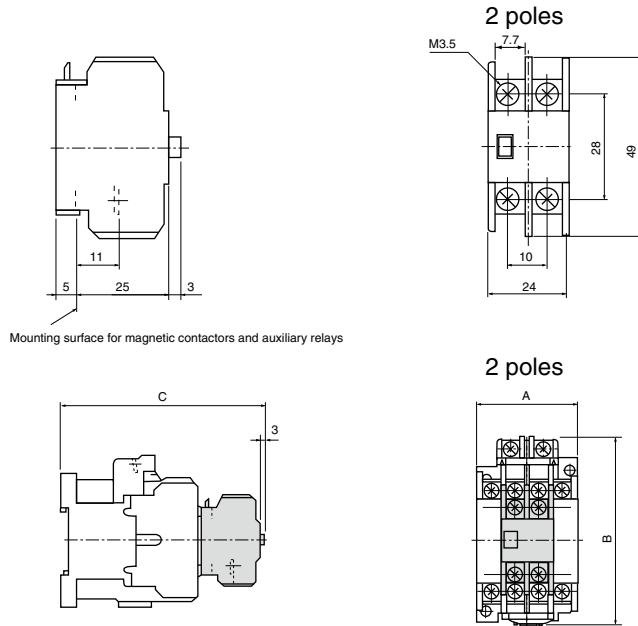

Mounting surface for magnetic contactors and auxiliary relays

(Note) Auxiliary contact block (4-pole) mounting cannot be performed. Only 2-pole mounting can be performed. It also cannot be used together with a side mounting auxiliary contact block.

Type	Contact arrangement	Mass [g]
SZ-A20 SZ-A20H	2NO 53 63 54 64	20
SZ-A11 SZ-A11H	1NO1NC 53 61 54 62	20
SZ-A02 SZ-A02H	2NC 51 61 52 62	20
SZ-A111	1NO1NC 57 65 58 66	20

Dimension table

Magnetic contactor coordination type		Dimension [mm]			Mass [kg]
Type	No. of auxiliary contacts (main unit)	A	B	C	
SK18A, 22A	1	45	81	109	0.36
SK18G, 22G	1	45	81	122	0.44
SK32A	1	53	81	109	0.39
SK32G	1	53	81	122	0.5

• Side mounting

- SZ-AS1
- SZ-AS1H

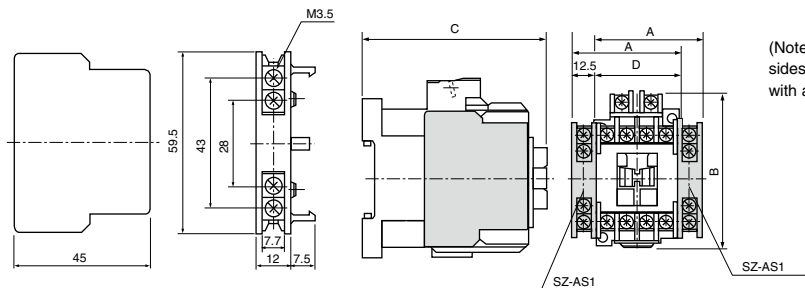

(Note) One can be mounted on one side. Mounting on both sides cannot be performed, and it cannot be used together with a side mounting auxiliary contact block.

Dimension table

Magnetic contactor coordination type		Dimension [mm]				Mass [kg]
Type	No. of auxiliary contacts (main unit)	A	B	C	D	
SK18A, 22A	1	57.5	81	81	45	0.37
SK18G, 22G	1	57.5	81	94	45	0.45
SK32A	1	65.5	81	81	53	0.4
SK32G	1	65.5	81	94	53	0.51

Type	Contact arrangement	Mass [g]
SZ-AS1 SZ-AS1H	1NO1NC 53 61 54 62	28
For left surface mounting SZ-AS1 SZ-AS1H	1NO1NC 71 83 72 84	28
For right surface mounting		

■ Mounting and removing

[SK06/09/12 models]

● Front mounting type (SZ1KA□ and SZ1FA□)

Mounting

- (1) Insert the hook from ① into the mounting groove on the main unit, then move it in direction ②.
(When the hook has caught, a click sound will be heard.)
- (2) After mounting, confirm that the auxiliary contact block is fixed firmly in place.

Removing

- (1) Press hook ③ on the unit with your finger, then move it in the opposite direction it was mounted in.

SZ1KA□

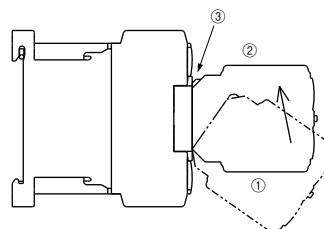

SZ1FA□

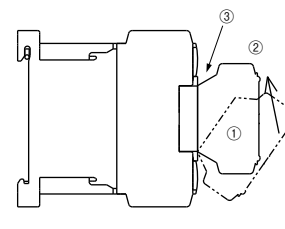

[SK18/22/32 models]

● Front mounting type (SZ-A□)

Mounting

- (1) Attach the block unit to the main unit in the direction of ①, and move it in the direction of ② until the hook of the block unit is caught in the mounting groove of the main unit.
- (2) After mounting, press the moving section of the block unit to ensure that the block unit moves smoothly.

Removing

- (1) Pull up the hook and move it in the direction of ③.

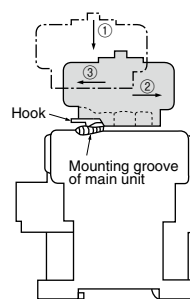

Side mounting type (SZ-AS1)

● Mounting

- (1) While pressing the contact support in the direction of ①, insert the moving section (boss) of the block unit into the moving section (dent) of the main unit, and move it in the direction of ② until the hook of the block unit is caught in the mounting groove of the main unit.
- (2) After mounting, press the moving section of the main unit to ensure that the block unit moves smoothly.

● Removing

Follow the procedure below to remove the unit from the product.

- (1) Insert a tool such as a flathead screwdriver into gap ①, then press the tool in direction ② to release the hook.

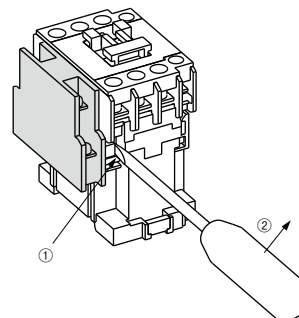
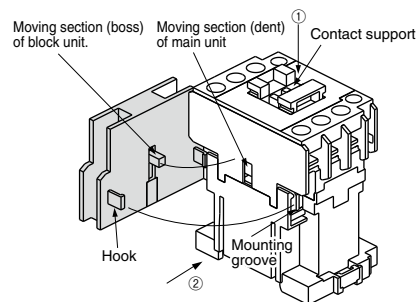



Mechanical Interlock Unit and Power Connection Kit for Reversing

■ Features

- Mechanically prevent two Magnetic Contactors from turning ON at the same time.
- Combine a Reversing Connection Kit with an Interlock Unit to easily configure a Reversing Magnetic Contactors.
- Mounting two Magnetic Contactors on the front surface reduces the mounting footprint and contributes to downsizing control panels.

■ Types

- **Mechanical Interlock Unit:** Joins two Magnetic Contactors to mechanically lock them.

Product name	Used with	Type
Mechanical Interlock Unit	SK06, SK09, SK12	SZ1KRM
	SK18, SK22, SK32	SZ-RM

- **Power Connection Kit for Reversing:** Used to reverse the circuit wiring between the main circuit terminals.

Product name	Wire size	Number of conductors per set	Used with	Type
Power Connection Kit for Reversing	AWG14 (1.6 dia.)	• One set for power supply side • One set for load side	SK06, SK09, SK12	SZ1KRW1W
		• For power supply side control • For load side control	SK06, SK09, SK12	SZ1KRW1E
		• One set for power supply side • One set for load side	SK18, SK22	SZ-RW22
			SK32	SZ-RW23

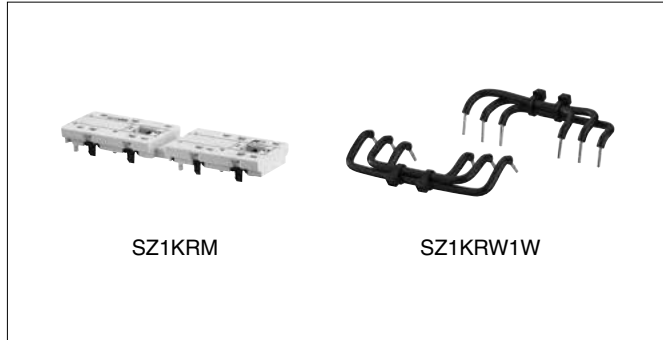

■ Dimensions, mm

- **Mechanical Interlock Unit**

·SZ1KRM

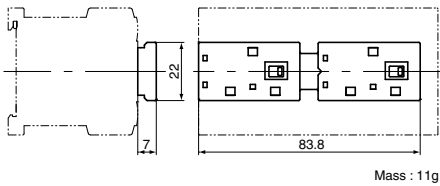

Mass: 11g

·SZ-RM

· Interlock

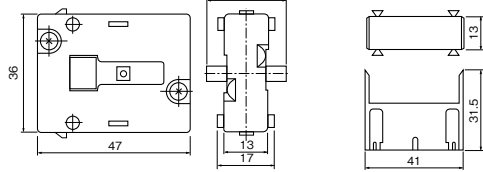

Mass: 25g

(Note 1) The interlock unit is formed from an interlock and a joint block.
(Note 2) Refer to the sections on reversing type magnetic contactors and switches on pages 33 to 35 for dimensions combined with magnetic contactors.

■ Mounting Procedures

- **Interlock Unit: SZ1KRM**

- (1) Connect two Magnetic Contactors with the two connection pieces ①.
- (2) Move the moveable projections ② on the Interlock Unit to the right side.
- (3) Insert the Interlock Unit directly from the top so that it is aligned with the projections ③ on the moveable portion on the Magnetic Contactors.
- (4) After you mount the Interlock Unit, slide the projection on the indicator window on the right side and then on the left side to confirm that they move smoothly.

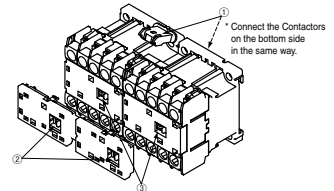

- **Interlock Unit: SZ-RM**

- (1) Match the projecting part ① with the movable part of the mechanical interlock unit with the small square opening part ② of the movable part (contact support) of the contactor, and the round boss ③ of the mechanical interlock unit with the recessed part ④ on the side of the contactor. Secure the interlock mechanical interlock unit from both sides through the contactor.
- (2) Insert the ribs ⑤ of the joint block into the guides ⑥ of the contactor and fit the window ⑧ of the joint block into the projecting part ⑦ of the mechanical interlock unit.
- (3) After connection, push and release the movable parts (contact supports) of the forwarding and reversing contactors one turn at a time to see that they move smoothly.
- (4) To remove, use a screwdriver to remove the window ⑧ of the joint block from the projecting part ⑦ of the mechanical interlock unit and remove the joint block.

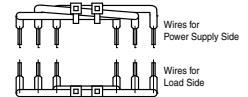
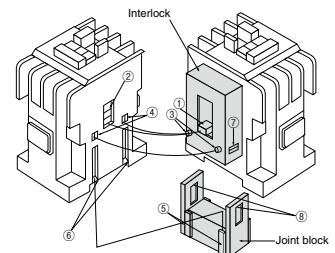

- **Power Connection Kit for Reversing**

- Connect the Kit to the main circuit terminals. There are wires for the power supply side and wires for the load side. Be sure to connect them to the correct sides.

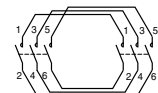

⚠ Caution Precaution for Correct Use

- When the Magnetic Contactors are switched rapidly, use an electrically interlock, such as a delay relay, to ensure a switching time of at least 15ms for the contacts of the two Magnetic Contactors.



Main Circuit Surge Suppression Unit and Separate Installation Unit

■ Features

- Absorbs the surge voltage that is generated from three-phase motors when the Magnetic Contactor is switched to suppress the effects of surge voltage.
- Combination with a Separate Installation Unit enables both screw mounting and DIN rail mounting. (The SZ-ZM2 Main Circuit Surge Suppression Unit must be used with a Separate Installation Unit to secure it.)

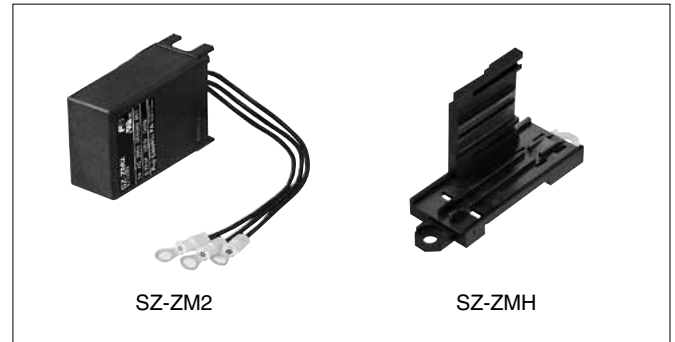

■ Ratings and Types

Product name	Mounting	Rated voltage and frequency	CR time constant	Applicable 3-phase motor	Applicable model	Type
Main Circuit Surge Suppression Unit	Front mounting	250V AC, 50/60Hz	C=0.22 μ F R=100	200 to 240V AC 0.1 to 3.7kW	SK18	SZ-ZM1
	Side mounting				SK06 to18	SZ-ZM2
	Front mounting	250V AC, 50/60Hz	C=0.33 μ F R=47	200 to 240V AC 0.1 to 15kW	SK18, 22, 32	SZ-ZM3E
	Side mounting				SK06 to 32	SZ-ZM4E
Separate Installation Unit	Screw mounting	—	—	—	SZ-ZM2	SZ-ZMH
	DIN rail mounting	—	—	—	SZ-ZM4E	

- Application of the SK Series (SK06/09/12) is possible through combined usage of SZ-ZM2 or SZ-ZM4E and a separate installation unit.
- SZ-ZM3E and SZ-ZM4E are for lead tip sleeve use (\varnothing 1.1 mm).

■ Performances

Item	Performance	
Dielectric strength	Between terminals	Rated voltage \times 230% for 1 min
	Between terminals and Unit outer case	Rated voltage \times 2 + 1,000V for 1 min
Insulation resistance	Between terminals	2,000M Ω min.
	Between terminals and Unit outer case	2,000M Ω min. per terminal
Electrostatic capacity tolerance (at 1kHz)	\pm 10%	
Durability	1 million operations	

■ Main Circuit Surge Suppression Characteristics

(220V AC, 2.2kW motor)

- Without Main Circuit Surge Suppression Unit
- With Main Circuit Surge Suppression Unit

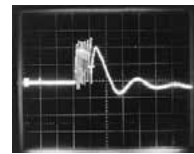

(No.CP-485)

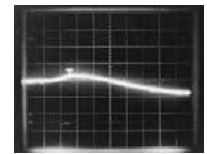

(No.CP-486)

■ Mounting Procedures

● SZ-ZM1, ZM3E

- (1) To install, force the unit onto the contactor from the direction of arrow ① and move it in the direction of arrow ②. Check that the pawl of the unit fits into the groove of the contactor.
- (2) To remove, raise the pawl of the unit and move the unit in the direction reverse that of installation.
- (3) Connect lead wires to Load-side terminals 2, 4 and 6 of the contactor. Lead wires can be connected to any of these terminals. Tighten with tightening torque described in instruction for magnetic contactor.

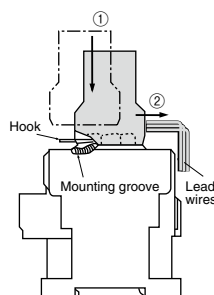

● SZ-ZM2, ZM4E

- (1) To install, push the projecting part of the unit into the groove from under the contactor until it stops.
- (2) To remove, slide the unit downward.
- (3) Connect lead wires to Load-side terminals 2, 4 and 6 of the contactor. Lead wires can be connected to any of these terminals. Tighten with tightening torque described in instruction for magnetic contactor.

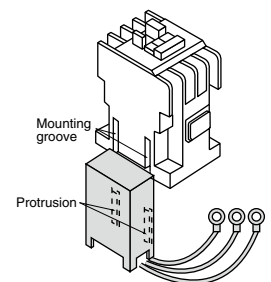

⚠ Caution Precaution for Correct Use

- Do not use the Main Circuit Surge Suppression Unit near inverter circuits or in other locations where a large harmonic component is present.



Magnetic-Contactors

Main Circuit Surge Suppression Unit and Separate Installation Unit

■ Wiring Diagram

- Connection with magnetic starter

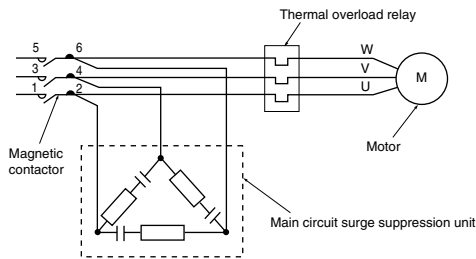

■ Dimensions, mm

- Front mounting (SZ-ZM1, ZM3E)

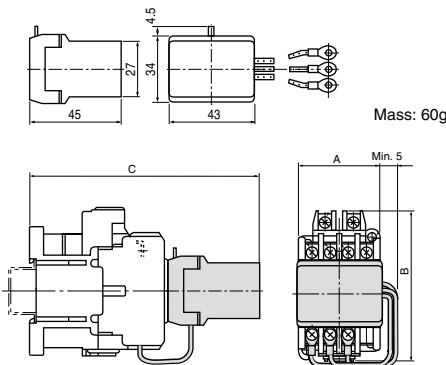

Dimension table

Type	Dimension (mm)		
	A	B	C
SK18A + SZ-ZM1	45	81	121
SK18G + SZ-ZM1	45	81	134
SK22A + SZ-ZM3E	45	81	121
SK22G + SZ-ZM3E	45	81	134
SK32A + SZ-ZM3E	53	81	121
SK32G + SZ-ZM3E	53	81	134

(Note) SZ-ZM3E model is for lead tip sleeve use (Ø1.1 mm).

- Side mounting (SZ-ZM2, ZM4)

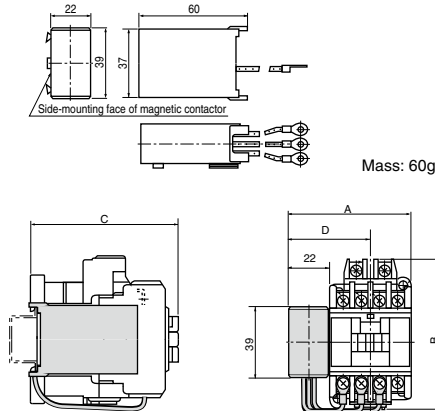

Dimension table

Type	Dimension (mm)			
	A	B	C	D
SK18A + SZ-ZM2	67	81	81	44.5
SK18G + SZ-ZM2	67	81	94	44.5
SK22A + SZ-ZM4E	67	81	81	44.5
SK22G + SZ-ZM4E	67	81	94	44.5
SK32A + SZ-ZM4E	75	81	81	44.5
SK32G + SZ-ZM4E	75	81	94	44.5

(Note 1) SZ-ZM4E model is for lead tip sleeve use (Ø1.1 mm).

(Note 2) Side mounting-type main circuit surge suppression units can be mounted to either the left or right side of the magnetic contactor.

- Separate installation unit (SZ-ZMH)

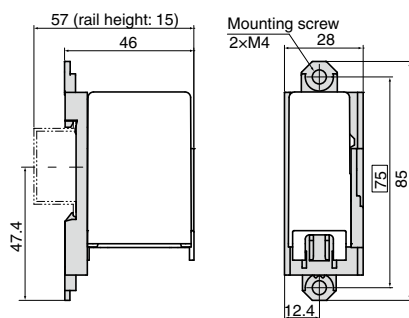

- Mounting

Line up protrusion ① on the side of the main circuit surge suppression unit with the mounting groove on the inner wall of the separate mounting unit, then press hard in the direction of the arrow until a click is heard.

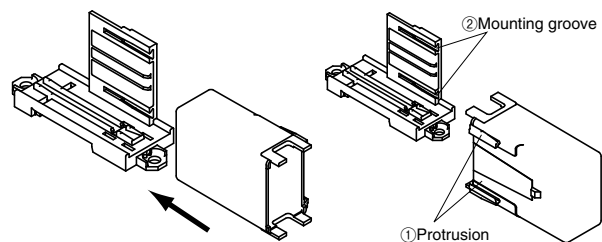



Coil Surge Suppression Units and Operation Indicator Lamps

■ Features

- The Main Circuit Surge Absorber Unit absorbs the surge voltage that is generated when the coil in a Magnetic Contactor turns OFF. This suppresses malfunctioning of electronic circuits.
- The Operation Indicator Unit indicates with an LED when voltage is applied to the coil terminals.

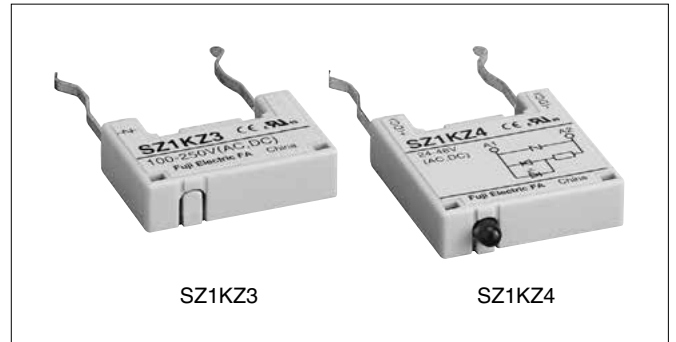



■ Ratings and Types

Product name	Surge suppression element	Specification	Operation indicator lamp	Applicable model		Control circuit voltage		Type
				AC-operated type	DC-operated type	AC	DC	
Coil Surge Suppression Units	Varistor	Varistor voltage: 100V	-	SK06A SK09A SK12A	-	24-48V	Not required. ①	SZ1KZ1
		Varistor voltage: 240V	LED (red)			48-125V		
		Varistor voltage: 470V				100-250V		
		Varistor voltage: 100V				24-48V	Not required. ①	SZ1KZ4
	Varistor voltage: 240V	48-125V						
Diode	-	-	-	SK06G, L SK09G, L SK12G, L	-	12-125V	SZ1KZ5	
Operation Indicator Units	-	-	LED (red)	SK06A SK09A SK12A	SK06G, L SK09G, L SK12G, L	12-24V	12-24V	SZ1KZ6
	-	-	-	-	-	24-48V	24-48V	SZ1KL1
	-	-	-	-	-	48-125V	48-125V	SZ1KL2
Coil Surge Suppression Units	Varistor	Varistor voltage: 100V	-	SK18A SK22A SK32A	-	24-48V	Not required ①	SZ-Z1
		Varistor voltage: 470V	-			100-250V		
		Varistor voltage: 910V	-			380-440V		
	CR	0.22μF, 22	-	SK18G SK22G SK32G	-	24-48V	24-48V	SZ-Z3
		0.1μF, 220	-			100-250V	100-250V	SZ-Z4
	Varistor	Varistor voltage: 100V	LED (red)	-	-	24-48V	Not required ①	SZ-Z5
		Varistor voltage: 470V	LED (red)			100-250V		
	CR	0.22μF, 22	LED (red)	SK18G SK22G SK32G	-	24-48V	24-48V	SZ-Z6
		0.1μF, 220	LED (red)			100-250V	100-250V	SZ-Z7

Note: ① A varistor is built into the SK□G and SK□L for DC operation.

Note: ② This type of unit is used for AC-operated contactors only.

■ Coil Surge Suppression Characteristics

Product	Application	Characteristics (200V AC coil)
Without Surge Suppression Unit	A sharp surge voltage is generated from the coil due to coil inductance as a result of the rapid change in voltage when the coil turns OFF. This becomes noise to surrounding electronic devices, and can cause malfunctions and circuit destruction.	SK12A  (0.1ms/div, 1kV/div)
Models with varistors built in	When the surge voltage reaches a certain level, current flows to the varistor that is connected in parallel with the coil. This serves to control the peak surge voltage. Varistors can be applied to either AC or DC. The suppressed surge voltage is approximately the varistor voltage.	SK12A + SZ1KZ3  (2ms/div, 200V/div)



Magnetic-Contactors

Coil Surge Suppression Units and Operation Indicator Lamps

■ Mounting methods

- SZ1KZ1 to 6, SZ1KL1 to 3

(1) Insert the Unit into the mounting holes in the Magnetic Contactor.
The Unit must be oriented properly top to bottom. Do not mount the Unit backwards.

· Mounting to Non-reversing Magnetic Contactors

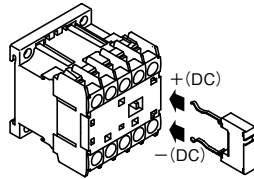

· Mounting to Reversing Magnetic Contactors

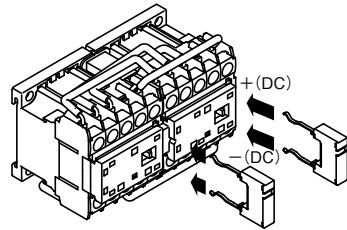

- SZ-Z1 to Z9, SZ-Z31 to Z37, SZ-Z41 to Z45

(1) Insert the terminals on the unit into coil terminals A1 and A2, then press the protrusion for fixing the unit in place into the groove on the magnetic contactor main unit to mount it.
Tighten the unit terminals along with the operating circuit electric wires.

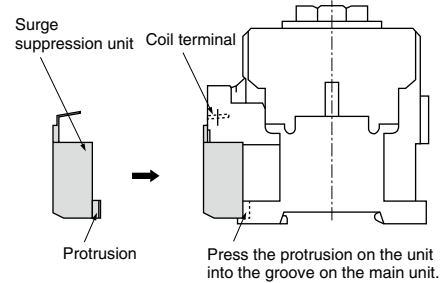

■ Dimensions, mm

- SZ1KZ1 to SZ1KZ3, SZ1KZ6
(Coil Surge Suppression Units)

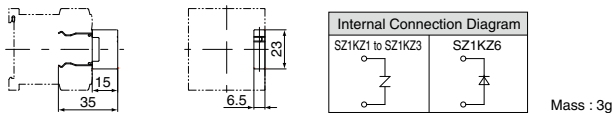

- SZ-Z1, Z2, Z3 (Varistor built-in type)
- SZ-Z4, Z5 (CR built-in type)

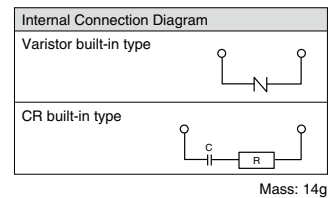
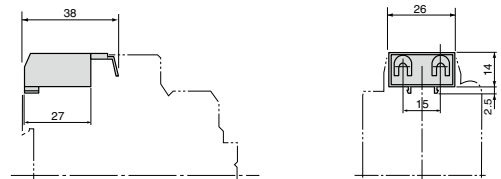

- SZ1KZ4 and SZ1KZ5
(Coil Surge Suppression Units with Operation Indicator Lamps)

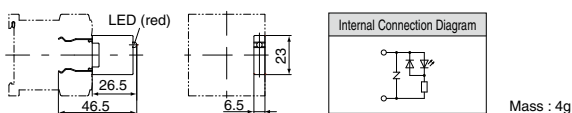

- SZ-Z6, Z7 types (varistor built-in type, with LED indicator)
- SZ-Z8, Z9 types (CR built-in type, with LED indicator)

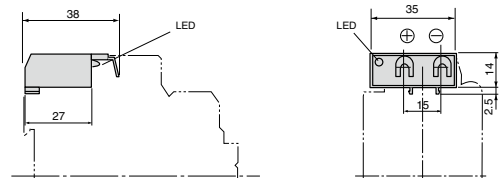

(Note 1) For DC operated units, pay careful attention to the polarity.

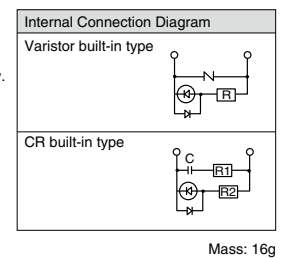

- SZ1KL1 to SZ1KL3
(Operation Indicator Units)

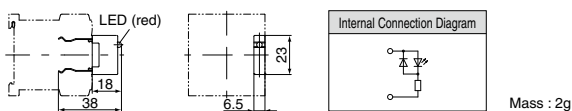



Thermal Overload Relay Reset Releases

■ Features

- A Reset Release is used to enable resetting a Thermal Relay from the front surface of the panel or from a remote location.



■ Ratings and Types

Product name	Release length [mm]	Mass [g]	Used with	Type
Thermal Overload Relay Reset Releases	300	30	2E Thermal Overload Relay	SZ-R1
	500	40	TK12, TK25 and TK26 (Packaged together with Reset Releases for the TR-0N and 5-1N.)	SZ-R2
	700	50		SZ-R3

■ Mounting Procedure

● SZ-R1, R2, R3

(1) Remove the front cover.

The cover can be easily removed as shown in the figure if you hold the cover near the hinges and pull strongly.

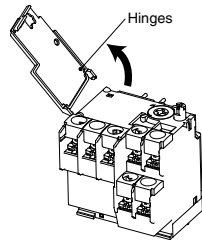

(2) Insert the tab ① on the mounting base into the hole in the Thermal Relay and then latch the tabs ② and ③. To remove the mounting base, use a fine screwdriver to disengage tabs ② and ③.

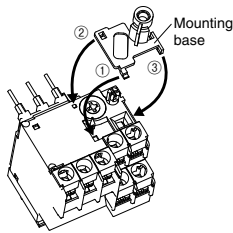

(3) Tighten the male thread ④ on the Release in the female thread ⑤ on the mounting base. Remove the nut ⑥ from the Release, insert the Release through the panel from the back of the panel, and tighten the nut ⑥ from the front of the panel to secure the Release.

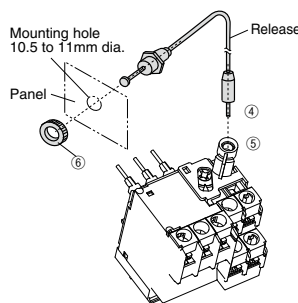

■ Dimensions, mm

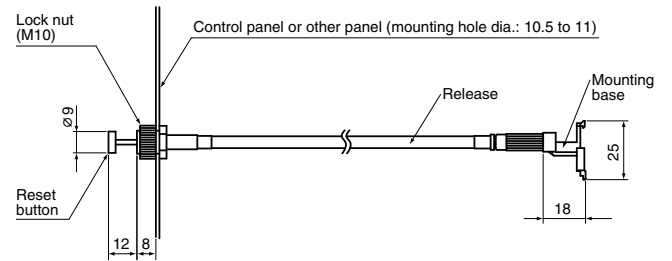

⚠ Caution Precaution for Correct Use

- When mounting the Release, do not allow the lead to bend within 25mm from the panel and within 35mm of the mounting base.
- Do not bend the lead of the Release to a radius of less than 15mm. (Refer to the figure on the right.)
- Prepare a mounting hole with a diameter of 10.5 to 11mm.

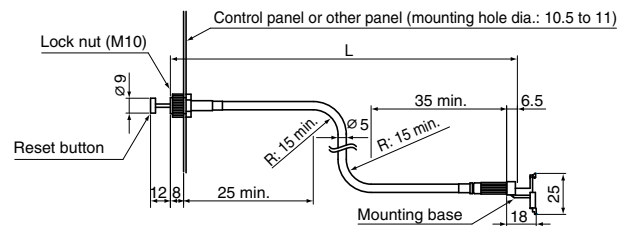



Separate Mounting Unit for Thermal Overload Relay

■ Features

- By combining this unit with a thermal overload relay for a magnetic starter, it can be used as a thermal overload relay for separate mounting.
- Screw mounting and rail mounting using an IEC top hat type of rail (35 mm width) are available.



■ Ordering Information (Types)

- Separate Mounting Unit for Thermal Overload Relay

TZ1H26N Note: An order can also be made with the product type code.

① Type

■ Types

Product name	Applicable thermal overload relay	Type
Separate Mounting Unit for Thermal Overload Relay	TK12	TZ1H12N
	TK26	TZ1H26N

■ Mounting Procedure

- (1) Fully loosen the terminal screws of the separate mounting unit.
- (2) Insert the connecting wires of the thermal overload relay, along the insertion guide of the separate mounting unit (Figure 1).
- (3) Press the thermal overload relay in the direction of the arrow, and confirm that the lower section of the thermal overload relay is securely engaged with the hooks (2 locations) of the separate mounting unit (Figure 2).

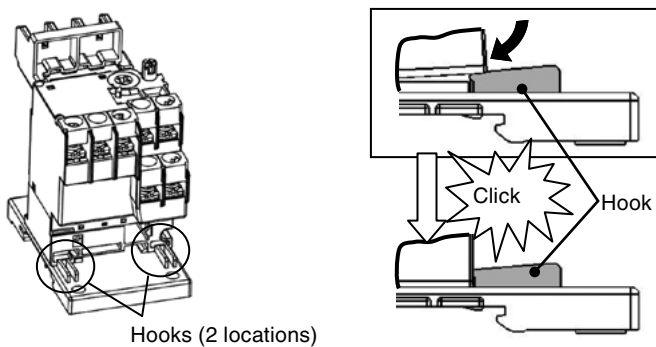
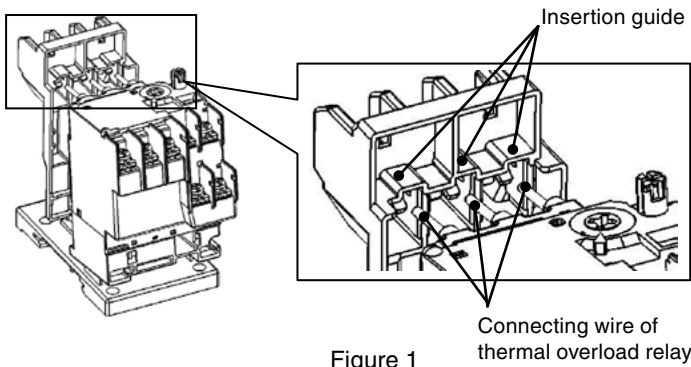

■ Dimensions

● TZ1H12N

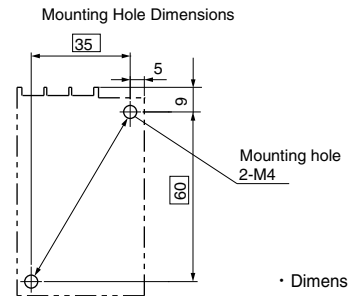
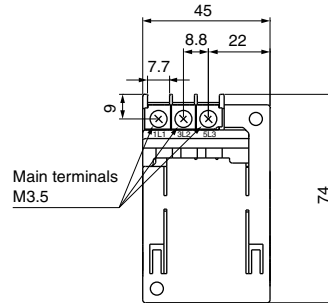
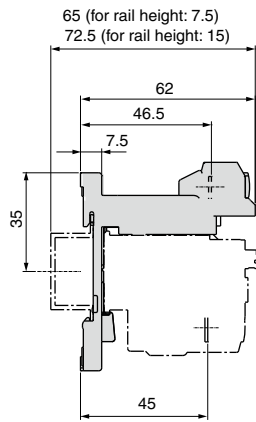

- Dimension for mounting: 35 x 60
- Mounting screw: 2-M4

Mass: 30g

● TZ1H26N

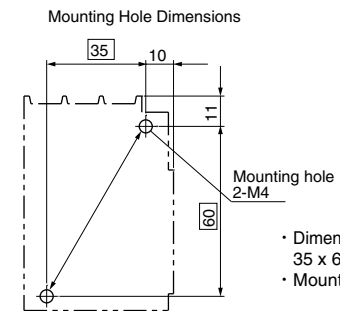
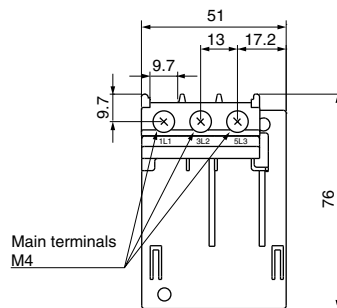
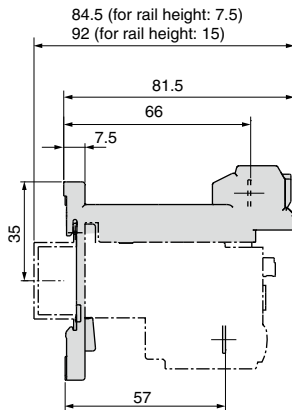

- Dimension for mounting: 35 x 60
- Mounting screw: 2-M4

Mass: 40g



Link Module and Power Connection Kit for Reversing (Insert)

■ Features

- Connect a Manual Motor Starter and a Magnetic Contactor directly through a Link Module.
- A Reversing Connection Kit (Insert) for Combination Starters has joined the lineup.

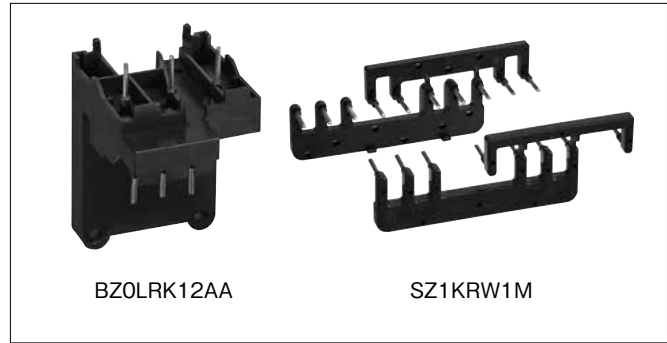





BZ0LRK12AA

SZ1KRW1M

■ Types

- Link Module/Spacer : Electrically and mechanically connects a Manual Motor Starter and Magnetic Contactor.

Link Module (for SK06, SK09, SK12)	Applicable MMS	Applicable Magnetic Contactors	Type
 Photo No. KKD11-101	BM3RSB BM3RHB	SK06, SK09, and SK12	BZ0LRK12AA
 Photo No. KKD15-219	BM3RSB BM3RHB BM3RSR BM3RHR	SK18A, SK18G SK22A, SK22G	BZ0LRK22AA
 Photo No. KKD15-221		SK32A, SK32G	BZ0LRK32AA
 Photo No. KKD15-223	-	SK18A SK22A SK32A	BZ0LRKACA

- Power Connection Kit for Reversing (Insert): Used to reverse the circuit wiring between the main circuit terminals.

Wire size	Number of conductors per set	Applicable MMS	Applicable types	Type
1.6 dia.	·One set for power supply side ·One set for load side	BM3RSB BM3RHB	SK06, SK09, and SK12	SZ1KRW1M

● Combination Starter Configuration Table

Applicable MMS	Applicable magnetic contactor	Operating coil	Link module	Spacer
BM3RSB BM3RHB BM3RSR BM3RHR	SK06A, SK06G, SK06L SK09A, SK09G, SK09L SK12A, SK12G, SK12L	AC DC	BZ0LRK12AA	-
	SK18A SK22A	AC *1	BZ0LRK22AA	BZ0LRKACA
	SK18G SK22G	DC		-
	SK32A SK32G	AC *1 DC	BZ0LRK32AA	BZ0LRKACA

*1 For an AC coil product (AC-operated type), a spacer is necessary besides a link module.

Note: When combining with SK18, SK22 or SK32 types, you can use only an MMS with the changed slider. When ordering an MMS with the changed slider, please order this item with "NEW" appended to the product type code.

■ Dimensions, mm

● Link Module BZOLRK12AA

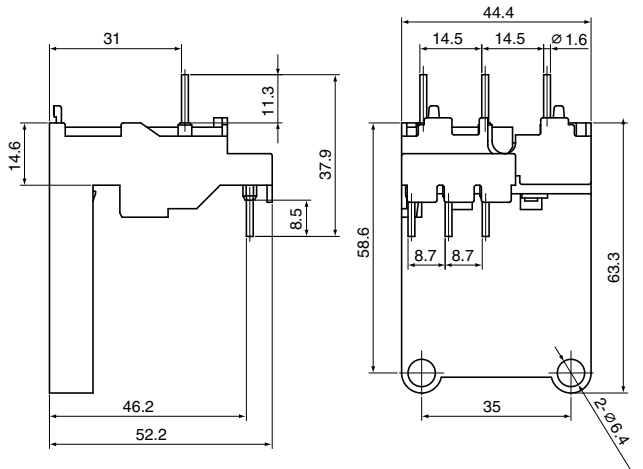

Mass : 25g

● Link Module BZOLRK22AA

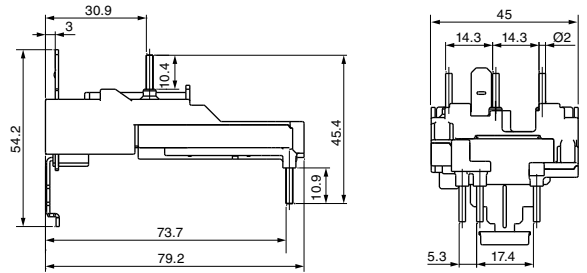

Mass: 35g

● Link Module BZOLRK32AA

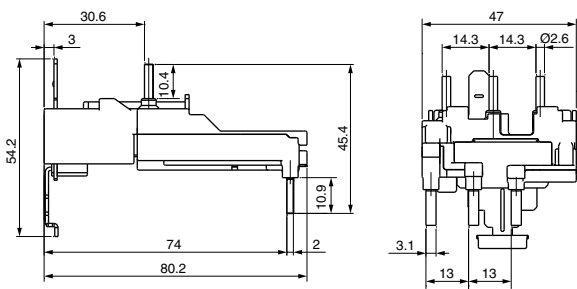

Mass: 41g

● Spacer BZOLRKACA

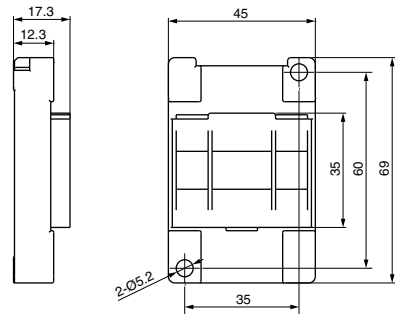

Mass: 20g

● Power Connection Kit for Reversing (Insert) SZKRW1H

[Insert for Power Supply Side]

[Insert for Load Side]

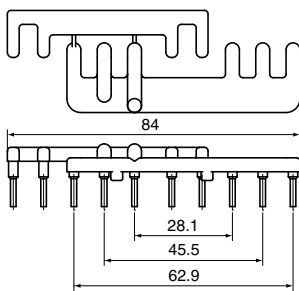

Mass : 17g

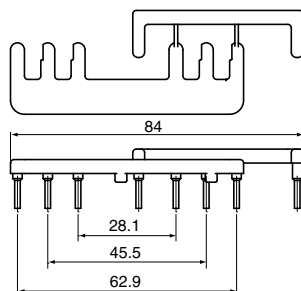

Mass : 13g



The dotted line indicates wiring for an electrical interlock when the integrated auxiliary contact is 1NC x 2. When the integrated auxiliary contact is 1NO x 2 or when wiring is not necessary, only the main circuit should be used by separating this section.



■ Features

- International safety standards for standard models (IEC, GB, JIS, UL, and CSA).
- Models available with AC, DC, or low-power DC operating coils.
- Bifurcated contact for more reliable contact for micro-loads of 3mA at 5V DC.
- Models with high-capacity contacts (single button contact) are also available.
- Configure a wide range of contacts in combination with Auxiliary Contact Blocks.



■ Ordering Information (Types)

- Auxiliary Relays

SKH4 A H - E 22

① ② ③ ④ ⑤

① Series ② Operating coil ③ Contact specification ④ Coil voltage specification ⑤ Contact arrangement

■ Ratings

Refer to Auxiliary Contact Ratings on page 11.

■ Types

Operating coil specification ②	Contact specification ③	Coil voltage specification ④	Contact arrangement ⑤	Type
AC-operated types [A]	Bifurcated contact [blank]	24V [E] 120V [K] 380V [S]	4NO	SKH4A-□40
		48V [F] 200V [2] 400V [4]	3NO+1NC	SKH4A-□31
		100V [1] 220V [M] 440V [T]	2NO+2NC	SKH4A-□22
	Single button contact [H]	110V [H] 240V [P] 500V [5]	4NO	SKH4AH-□40
			3NO+1NC	SKH4AH-□31
			2NO+2NC	SKH4AH-□22
DC-operated types (2.4W) [G]	Bifurcated contact [blank]	12V [B] 100V [1] 210V [Y]	4NO	SKH4G-□40
		24V [E] 110V [H] 220V [M]	3NO+1NC	SKH4G-□31
		48V [F] 120V [K]	2NO+2NC	SKH4G-□22
	Single button contact [H]	60V [G] 200V [2]	4NO	SKH4GH-□40
			3NO+1NC	SKH4GH-□31
			2NO+2NC	SKH4GH-□22
DC-operated types (1.2W) [L]	Bifurcated contact [blank]	12V [B]	4NO	SKH4L-□40
		24V [E]	3NO+1NC	SKH4L-□31
		48V [F]	2NO+2NC	SKH4L-□22
	Single button contact [H]		4NO	SKH4LH-□40
			3NO+1NC	SKH4LH-□31
			2NO+2NC	SKH4LH-□22

Note. "□" in the type column is replaced with the coil voltage code.

■ Performances

● Durability (Based on IEC 60947-5-1)

Type	Number of contacts	Operating cycles per hour [times/hour]	Mechanical durability	Electrical durability					
				AC-15		AC-12		DC-13	DC-12
				220V	440V	220V	440V	220V	220V
SKH4	4	1800	10 million	500,000	500,000	250,000	250,000	250,000	500,000

■ Combinations with Auxiliary Contact Blocks

SK-Series Auxiliary Relays and Auxiliary Contacts Blocks can be combined as shown in the following table. Other combinations are not possible.

Auxiliary Contact Block	Type	SZ1KA40	SZ1KA31	SZ1KA22	SZ1KA13	SZ1KA04	SZ1KA20	SZ1KA11	SZ1KA02	SZ1FA11
		SZ1KA40H	SZ1KA31H	SZ1KA22H	SZ1KA13H	SZ1KA04H	SZ1KA20H	SZ1KA11H	SZ1KA02H	SZ1FA11H
Auxiliary Relay type	Auxiliary contact arrangement	4NO	3NO+1NC	2NO+2NC	1NO+3NC	4NC	2NO	1NO+1NC	2NC	1NO+1NC
	Combined auxiliary contact arrangement									
SKH4A SKH4AH SKH4G SKH4GH	4NO	8NO	7NO+1NC	6NC+2NC	5NO+3NC	4NO+4NC	6NO	5NO+1NC	4NO+2NC	5NO+1NC
	3NO+1NC	7NO+1NC	6NO+2NC	5NO+3NC	4NO+4NC	3NO+5NC	5NO+1NC	4NO+2NC	3NO+3NC	4NO+2NC
	2NO+2NC	6NO+2NC	5NO+3NC	4NO+4NC	3NO+5NC	2NO+6NC	4NO+2NC	3NO+3NC	2NO+4NC	3NO+3NC
SKH4L SKH4LH	4NO	—	—	—	—	—	6NO	5NO+1NC	4NO+2NC	5NO+1NC
	3NO+1NC	—	—	—	—	—	5NO+1NC	4NO+2NC	3NO+3NC	4NO+2NC
	2NO+2NC	—	—	—	—	—	4NO+4NC	3NO+3NC	2NO+4NC	3NO+3NC

■ Linked Contact Compliance (Compliance with Requirements of IEC60947-5-1 Annex L)

Auxiliary Relay type	Auxiliary Contact Block	No Auxiliary Contact Block	SZ1KA□		SZ1FA11	SZ1KA□H		SZ1FA11H
			4-pole	2-pole		4-pole	2-pole	
SKH4A SKH4AH		○	×	×	×	×	×	×
SKH4G SKH4GH		○	×	×	○	○	○	○
SKH4L SKH4LH		○	—	○	○	—	○	○

○ : Complies.

× : Does not comply.

■ Dimensions, mm

SKH4

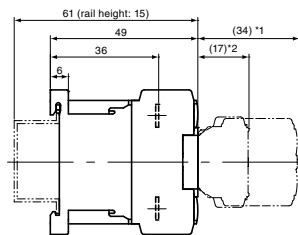

[NOTE]
*1: With SZ1KA□ Auxiliary Contact Blocks.
*2: With SZ1FA□ Auxiliary Contact Blocks.

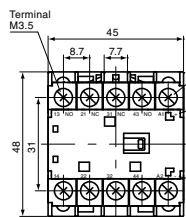

Mounting Hole Dimensions

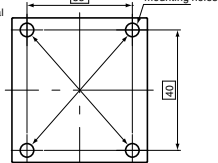

Mounting screws: 2-M4 screws
Mount the Auxiliary Relay with two mounting holes in diagonally opposed corners.

Auxiliary contacts	Contact arrangement
4NO	
3NO+1NC	
2NO+2NC	

※ For DC-operated types.
Mass : 0.14kg (SKH4A)
0.17kg (SKH4G and SKH4L)



■ MEMO

Safety Considerations

- Operate (keep) in the environment specified in the operating instructions and manual. High temperature, high humidity, condensation, dust, corrosive gases, oil, organic solvents, excessive vibration or shock might cause electric shock, fire, erratic operation or failure.
- For safe operation, before using the product read the instruction manual or user manual that comes with the product carefully or consult the Fuji sales representative from which you purchased the product.
- Products introduced in this catalog have not been designed or manufactured for such applications in a system or equipment that will affect human bodies or lives.
- Customers, who want to use the products introduced in this catalog for special systems or devices such as for atomic-energy control, aerospace use, medical use, passenger vehicle, and traffic control, are requested to consult with Fuji Electric FA.
- Customers are requested to prepare safety measures when they apply the products introduced in this catalog to such systems or facilities that will affect human lives or cause severe damage to property if the products become faulty.
- For safe operation, wiring should be conducted only by qualified engineers who have sufficient technical knowledge about electrical work or wiring.
- Follow the regulations of industrial wastes when the product is to be discarded.
- For further questions, please contact your Fuji sales representative or Fuji Electric FA.

 **Fuji Electric FA Components & Systems Co., Ltd.**

5-7, Nihonbashi Odemma-cho, Chuo-ku, Tokyo, 103-0011, Japan

URL <http://www.fujielectric.co.jp/fcs/eng>