

SIEMENS



3MT7, 3MH7, 3MU7 & 3MV8

contactors, overload relays &
motor starter protectors

SINOVA The Power of **Simplicity**

Discover The Power of **Simplicity** with SINOVA

Backed by Siemens quality standards, SINOVA introduces exceptional ease of operation and cost-efficiency to electrical installations in buildings, utilities, industries, and infrastructure applications.

Our low-voltage electrical products offer protection, control, switching, and metering capabilities that help promote efficiency across the value chain, optimizing OPEX, CAPEX, and reducing environmental impact.

We are continuously driven to innovate and provide simple and reliable solutions. Inspired by efficiency and simplicity, we strive to empower industry professionals to streamline processes and complete projects quicker every time.

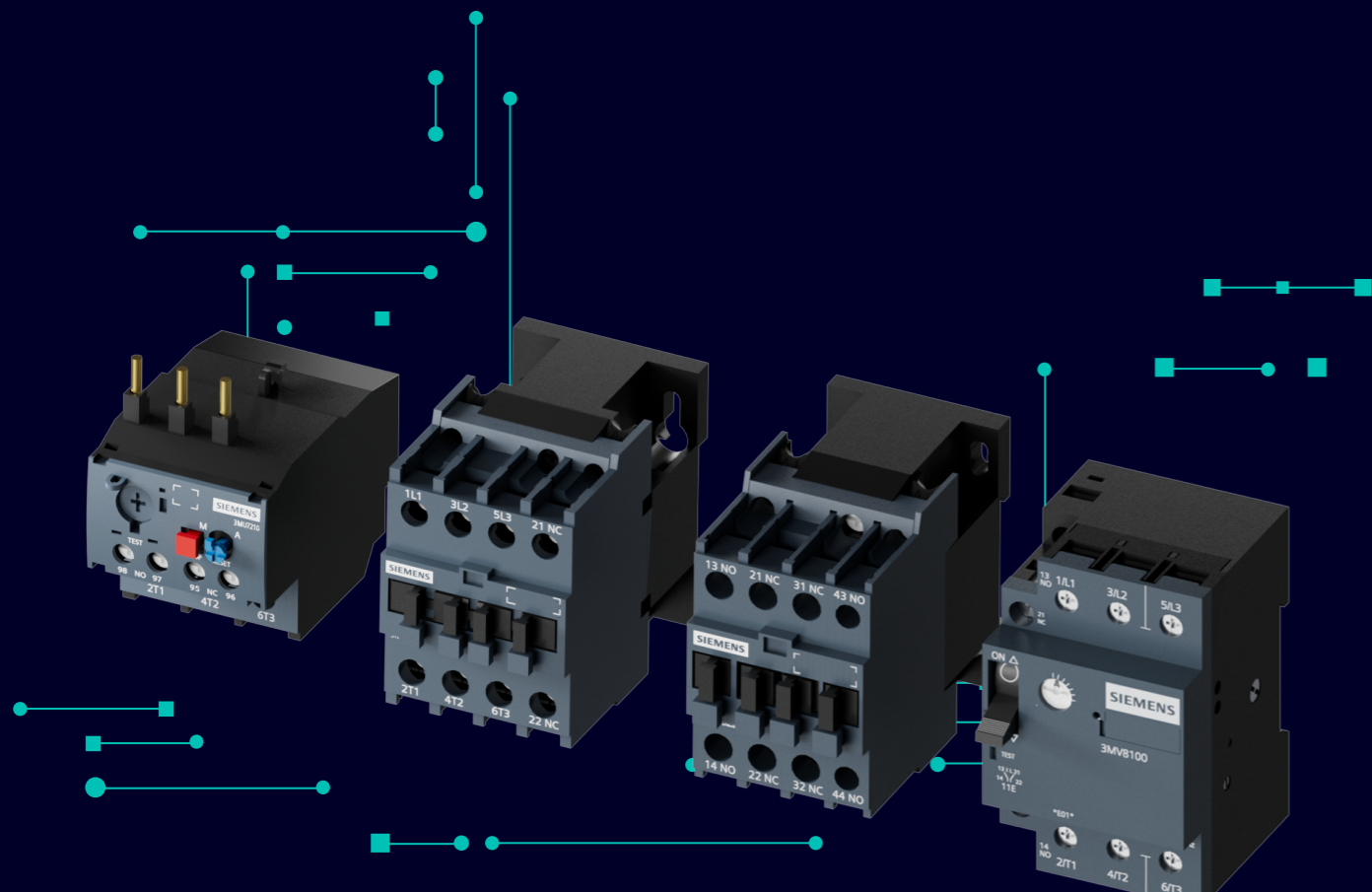

SINOVA control

Experience the power of simplicity with our SINOVA control range of electrical protection products.

Our range of control products ensures efficient control and minimizes downtime with the help of our reliable contactors and motor protection devices. Additionally, our motor starter protectors prevent damage to your motors, fans, and pumps from overloads or short circuits. Experience the assurance of Siemens quality, made simple with exact product features to meet your specific needs.

SINOVA The Power of **Simplicity**

Index

Product highlights	6
3MH7 contactor relays	7
3MT7 3 pole power contactors	19
3MU7 thermal overload relays	53
3MV8 motor starter protectors	70
Type-2 coordination charts	81

SINOVA The Power of **Simplicity**

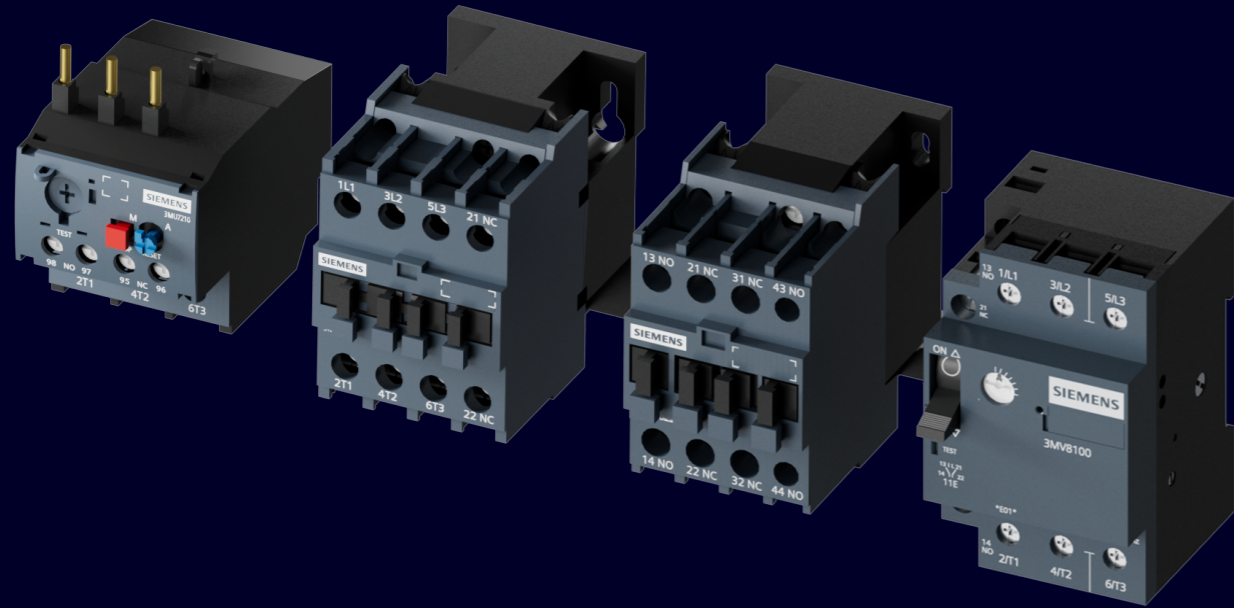

3MT7, 3MH7, 3MU7 & 3MV8
 contactors, overload relays & motor starter protectors

Product highlights



Adaptable

Our contactors and overload relays are designed to easily fit into various panel designs, catering to your control and protection requirements.



Trustworthy

Our contactors and overload relays ensure reliable motor protection with tested Type-2 coordinated feeder solutions.



Assurance

Our contactors and overload relays are compliant with IEC 60947-4-1 and IEC 60947-5-1 standards, RoHS compliant, CE certified, and type-tested under the CB scheme.



Consistent design

Our contactors and overload relays are uniform in design aesthetic and compatible with accessories across the product ranges.

SINOVA The Power of **Simplicity**

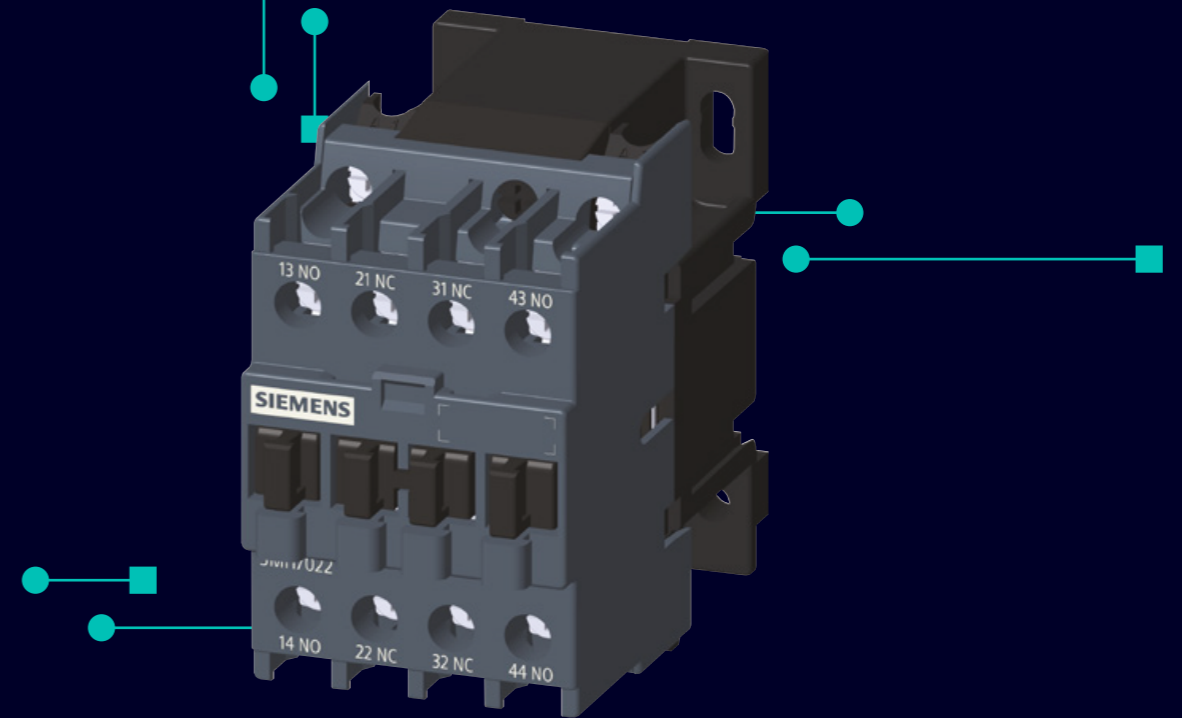

3MH7 contactor relays

Overview	8
Technical specifications	9
Selection & ordering data	12
Wiring diagrams	14
Dimension drawings	16

SINOVA The Power of **Simplicity**

Overview

3MH7 contactor relays are the foremost solution for your control circuit needs. These contactor relays are the cost-efficient and reliable choice of switching devices for controlling and signaling.



Article number scheme

Product version	Article no.									
Contactor relays	3MH7	0	□	□	-	□	□	□	□	0
Number of NO contacts	e.g. 2 = 2 NO		2							
Number of NC contacts	e.g. 2 = 2 NC		2							
Type of electrical connection	1= Screw terminals				1					
Coil circuit	A= AC coil circuit						A			
Rated control supply voltage	e.g. P0 = 230V AC, 50Hz						P	0		
Example	3MH7	0	2	2	-	1	A	P	0	0

Note:
The above scheme shows an overview of the product versions for understanding of the logic behind the article number. For your orders refer to selection and ordering data.

Technical specifications

3MH7 contactor relays

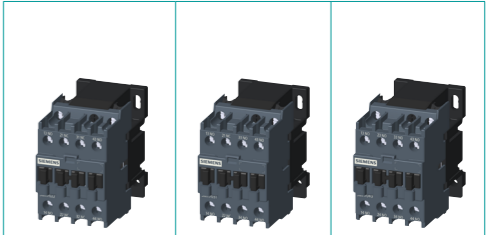

Type	3MH7022	3MH7031	3MH7040
General data			
Dimension (W x H x D)			
• Basic unit	mm	45 x 74.4 x 81.8	
Mounting position	22.5° inclination forward and backward, and 360° rotation, in relation to normal vertical mounting plane		
Mechanical service life			
• Basic unit	Operating cycles	10,000,000	
• Basic unit with mounted auxiliary switch	Operating cycles	10,000,000	
Rated insulation voltage U_i (pollution degree 3)	V	1000	
Rated impulse withstand voltage U_{imp}	kV	6	
Permissible ambient temperature			
During operation	°C	-5 ... +55	
During storage	°C	-25 ... +70	
Relative air humidity	%	10 ... 95	
Degree of protection IP on the front	IP20		
Installation altitude at height above sea level, maximum	m	2000	
Short circuit protection			
With fuse links of operational class gG:	A	10	

Technical specifications

3MH7 contactor relays

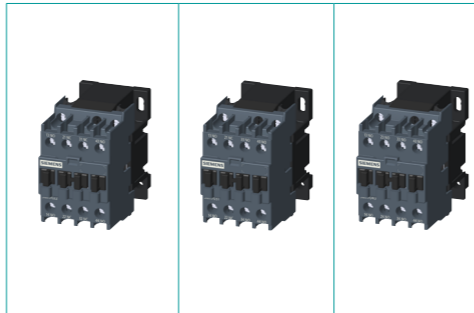

Type		3MH7022	3MH7031	3MH7040
Conductor cross-sections				
Auxiliary conductors and coil terminals		1 x (1.0 ... 4.0 mm ²); 2 x (1.0 ... 4.0 mm ²)		
Solid or stranded	mm ²	1 x (1.0 ... 2.5 mm ²); 2 x (1.0 ... 1.5 mm ²)		
Finely stranded with end sleeve	mm ²	M3.5		
• Terminal screw		1.2		
- Tightening torque	Nm			
Control				
Solenoid coil operating range		0.85 ... 1.1 x U _s		
• AC operation	at 50Hz at 60Hz	0.85 ... 1.1 x U _s		
Power consumption of the solenoid coil		70 / 0.75		
• AC operation, 50Hz		11 / 0.3		
- Closing	VA/p.f.			
- Closed	VA/p.f.			
• AC operation, 50Hz wide band		90 / 0.75		
- Closing	VA/p.f.			
- Closed	VA/p.f.	15 / 0.3		
• AC operation, 50/60Hz		80 / 0.75		
- Closing	VA/p.f.			
- Closed	VA/p.f.	12 / 0.3		
Operating times within operating range		7 ... 22		
• AC operation		5 ... 20		
- Closing delay	ms			
- Opening delay	ms			

Technical specifications

3MH7 contactor relays

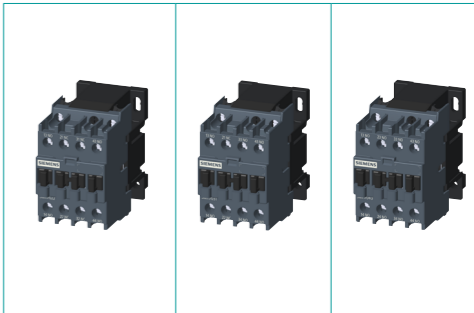

Type		3MH7022	3MH7031	3MH7040
Rated data of the auxiliary contacts				
Number of NO contacts		2	3	4
Number of NC contacts		2	1	0
Load rating with AC				
• Rated operational currents I_e				
- AC-12	690V	A	10	
- AC-15 at rated operational voltage U _e	230V	A	6	
	400V	A	3	
	500V	A	2	
	690V	A	1	
• Load rating with DC (1 conducting path)				
- DC-12, at rated operational voltage U _e	24V	A	6	
	110V	A	3	
	220V	A	1	
- DC-13, at rated operational voltage U _e	24V	A	6	
	110V	A	1	
	220V	A	0.3	
	440V	A	0.14	
	600V	A	0.1	
Switching frequency	Operating cycles/hour			
• Rated operation for utilization category				
	AC-12/DC-12	1/h	800	
	AC-15	1/h	800	
	DC-131/h	1/h	800	
• No load switching frequency		1/h	1800	

Selection & ordering data

3MH7 contactor relays

 3MH7031-1A..0	Operational current AC-15 at 230V AC	Contacts		Article no.	List price per PU (Per Unit)
		NO	NC		
	6A	4	0	3MH7040-1A..0	
	6A	3	1	3MH7031-1A..0	
6A	2	2	3MH7022-1A..0		

.. Please enter coil codes from table below.

Coil code (AC)											
Frequency	24V	36V	48V	110V	220V	230V	380V	400V	415V	165-273V	353-455V
50Hz	B0	G0	H0	F0	M0	P0	Q0	V0	R0	S0	T0
50/60Hz	C2	G2	H2	F2	N2	L2	Q2	V2	R2	-	-

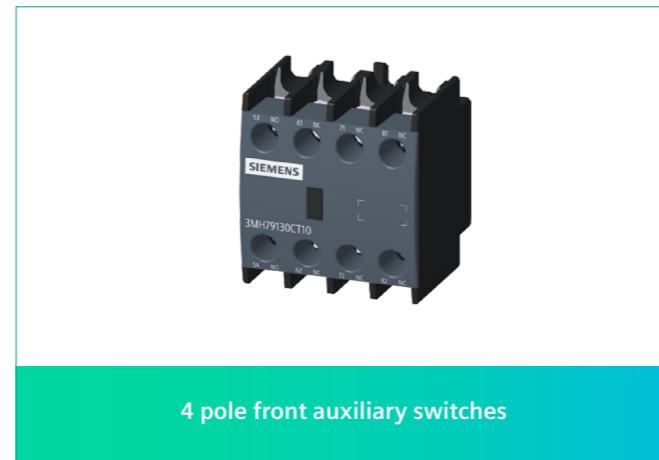

Accessories



Please refer to the next page for more information on accessories.

Selection & ordering data

3MH7 contactor relays | Accessories for contactors

Auxiliary switches							
Product image	No. of auxiliary contacts		Mounting position	Compatible contactor	Maximum mountable auxiliary switches	Article no.	List price per PU (Per Unit)
	NO	NC					
 1 pole & 2 pole front auxiliary switches	1	-	Front	Contactor relays	1	3MH7910-OCT10	
	-	1				3MH7901-OCT10	
	2	-				3MH7920-OCT10	
	1	1				3MH7911-OCT10	
	-	2				3MH7902-OCT10	
	4	-				3MH7940-OCT10	
 4 pole front auxiliary switches	3	1				3MH7931-OCT10	
	2	2				3MH7922-OCT10	
	1	3				3MH7913-OCT10	
	-	4				3MH7904-OCT10	
	2	-	First left or first right		2	3MH7920-OCL10	
1	1	3MH7911-OCL10					

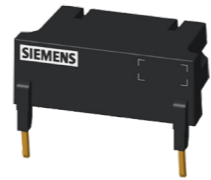
Surge suppressor					
Product image	Voltage	Mounting position	Compatible contactor	Article no.	List price per PU (Per Unit)
	24-48V AC 50/60Hz	Between A1-A2 coil terminals	3MH7 and 3MT7 Size 0, 1, 2, 3, 4	3MT7900-1SC21	
	110-240V AC 50/60Hz			3MT7900-1SL21	
	380-440V AC 50/60Hz			3MT7900-1SV21	

Wiring diagrams

3MH7 contactor relays

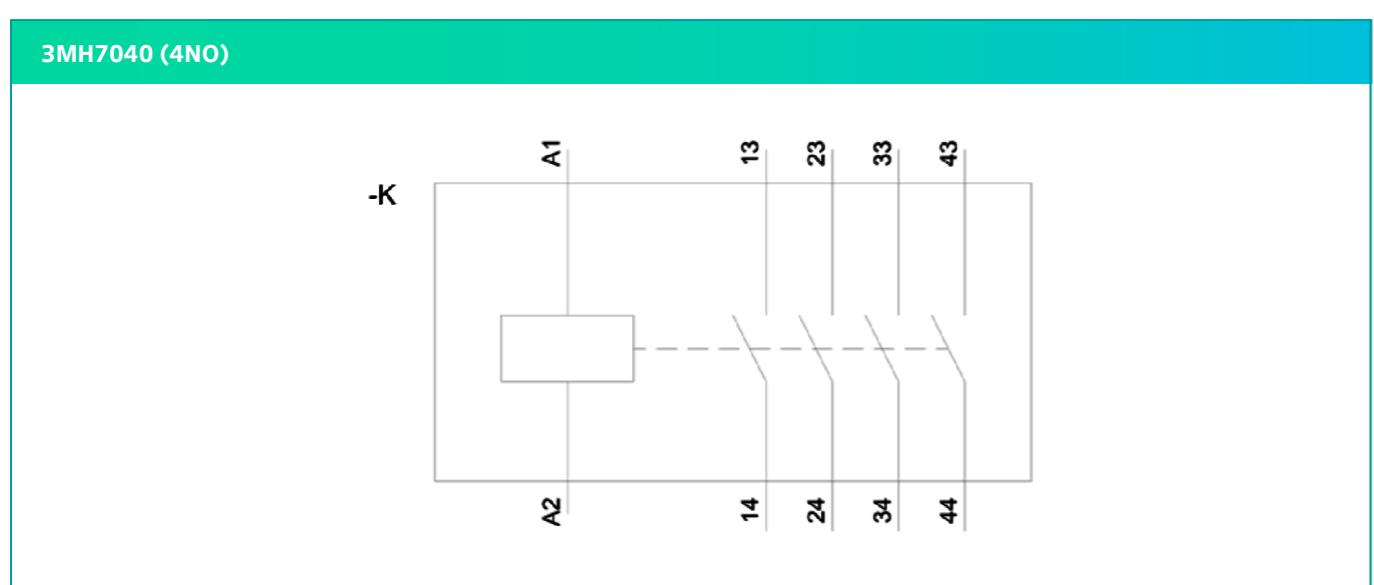
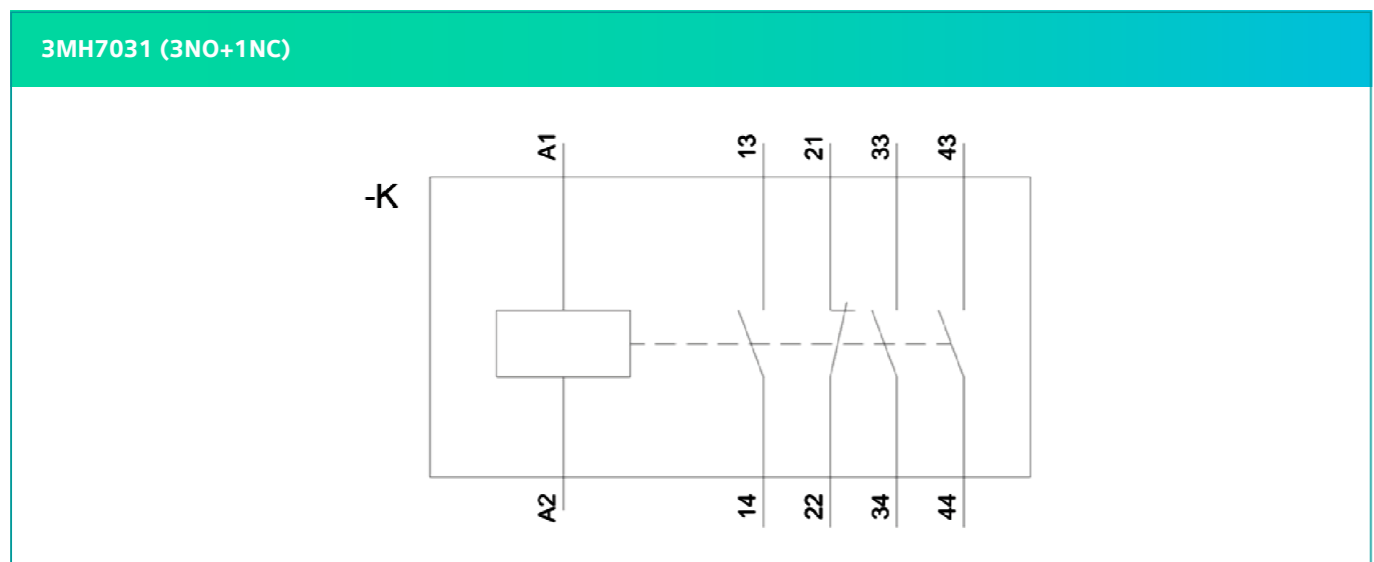
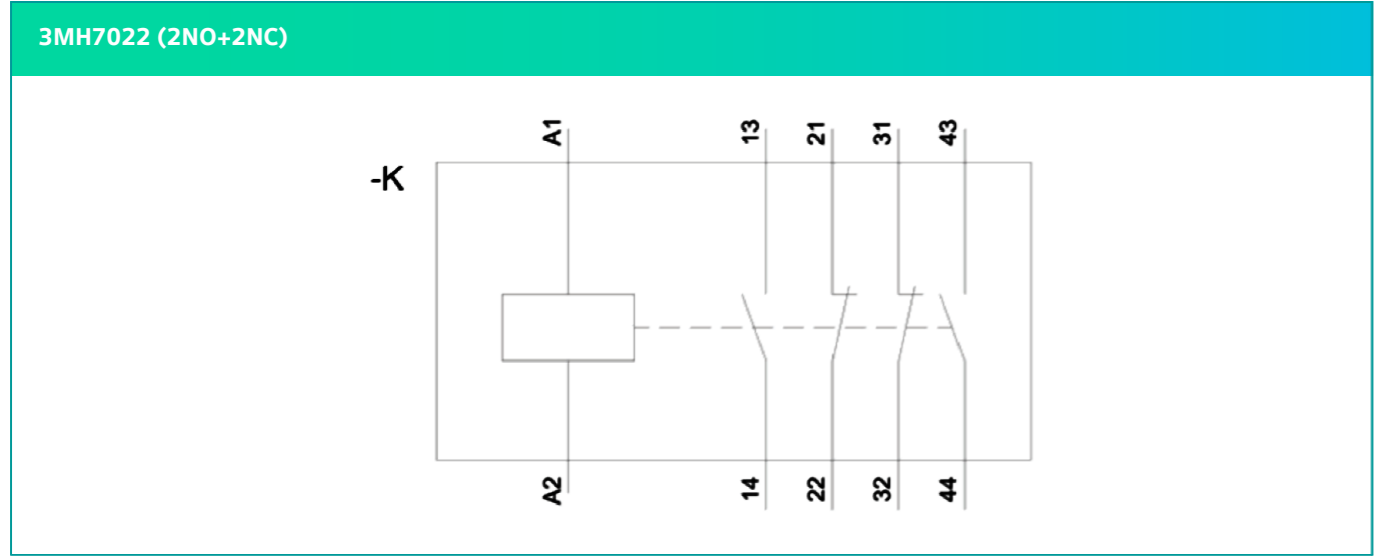

Wiring diagrams

Accessories

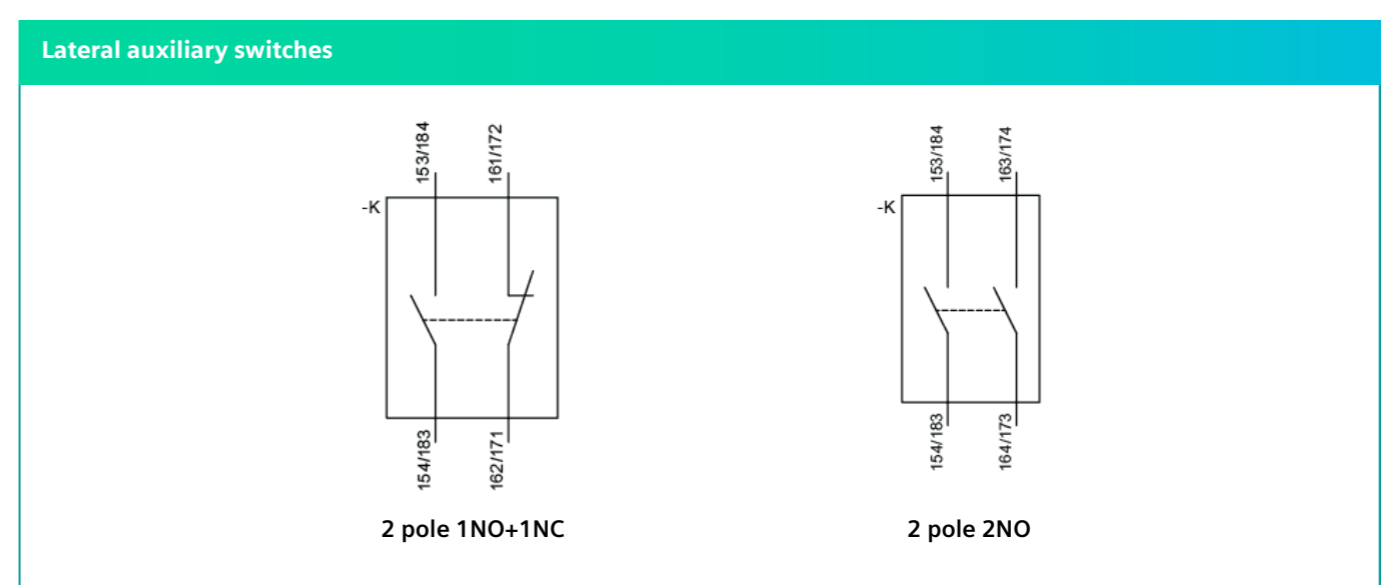
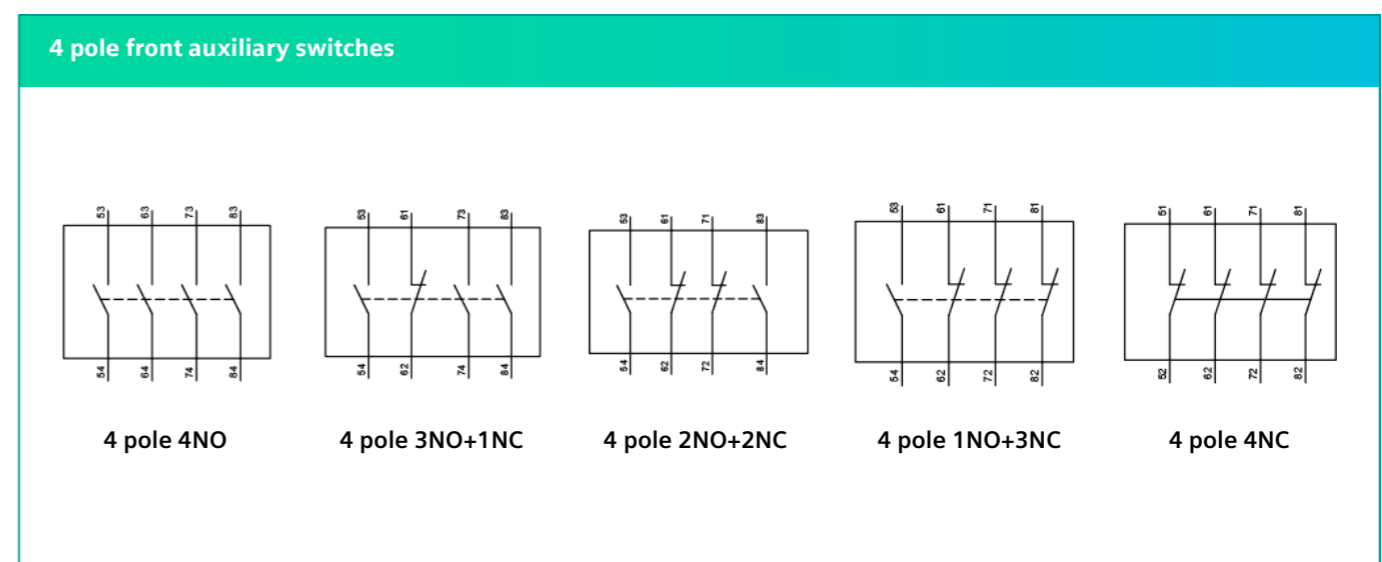
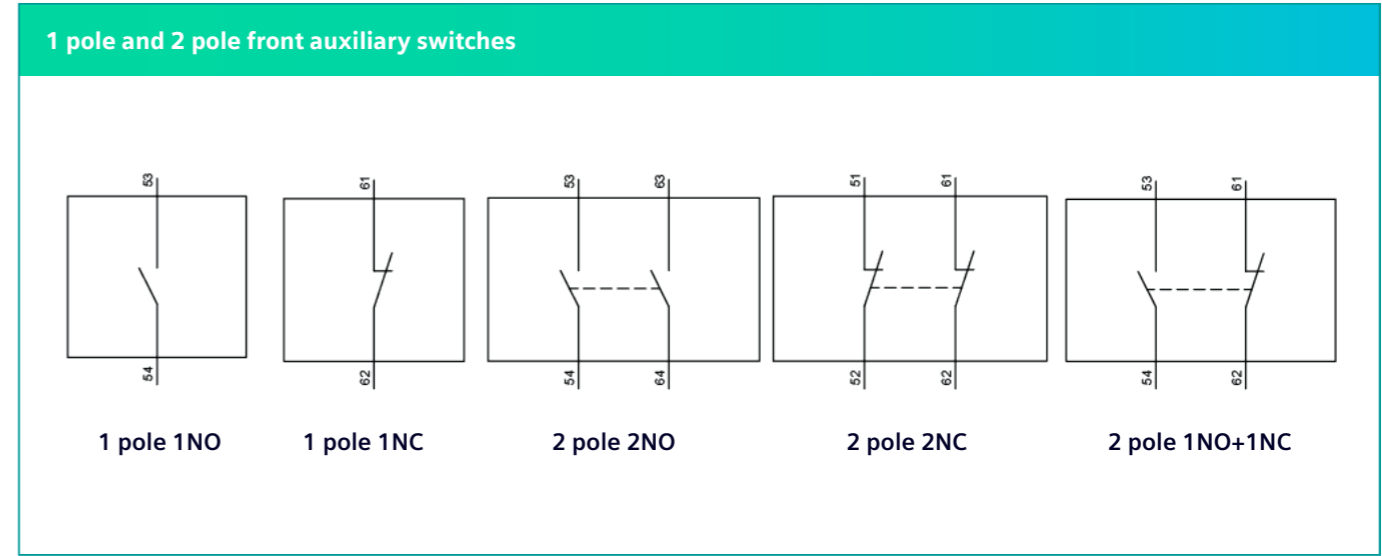

Dimension drawings

3MH7 contactor relays

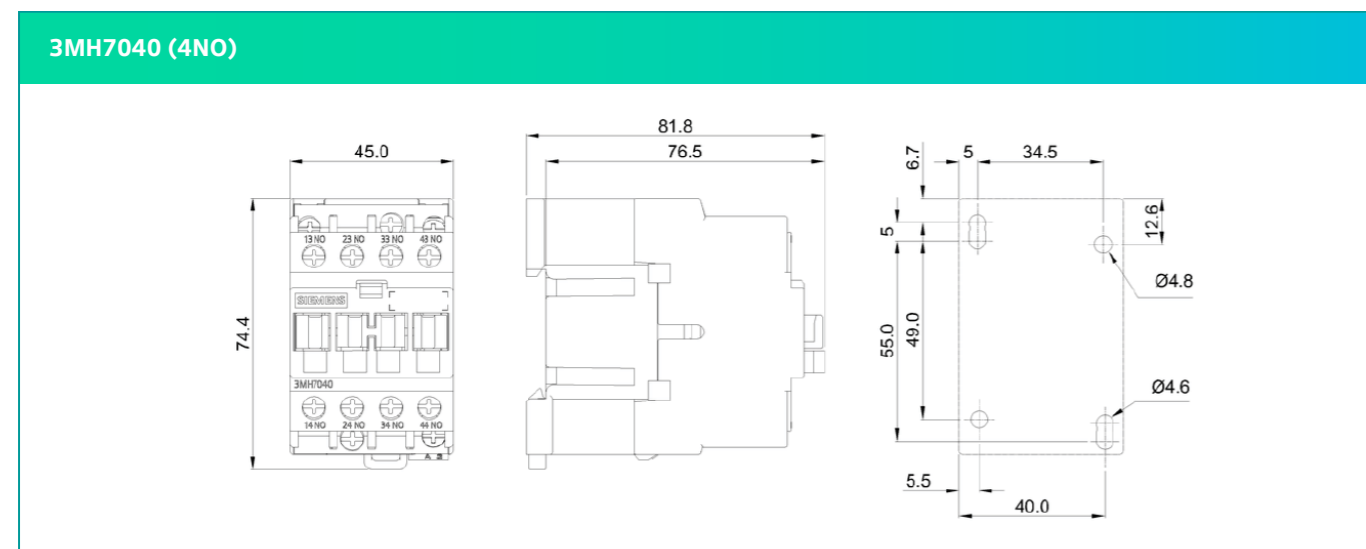
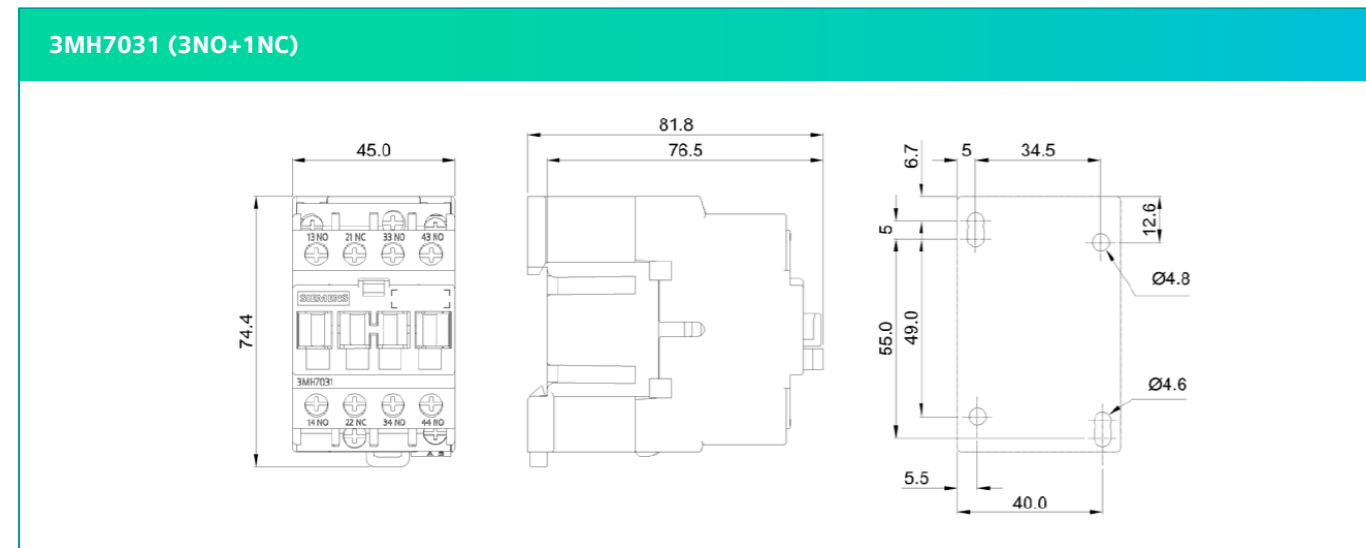
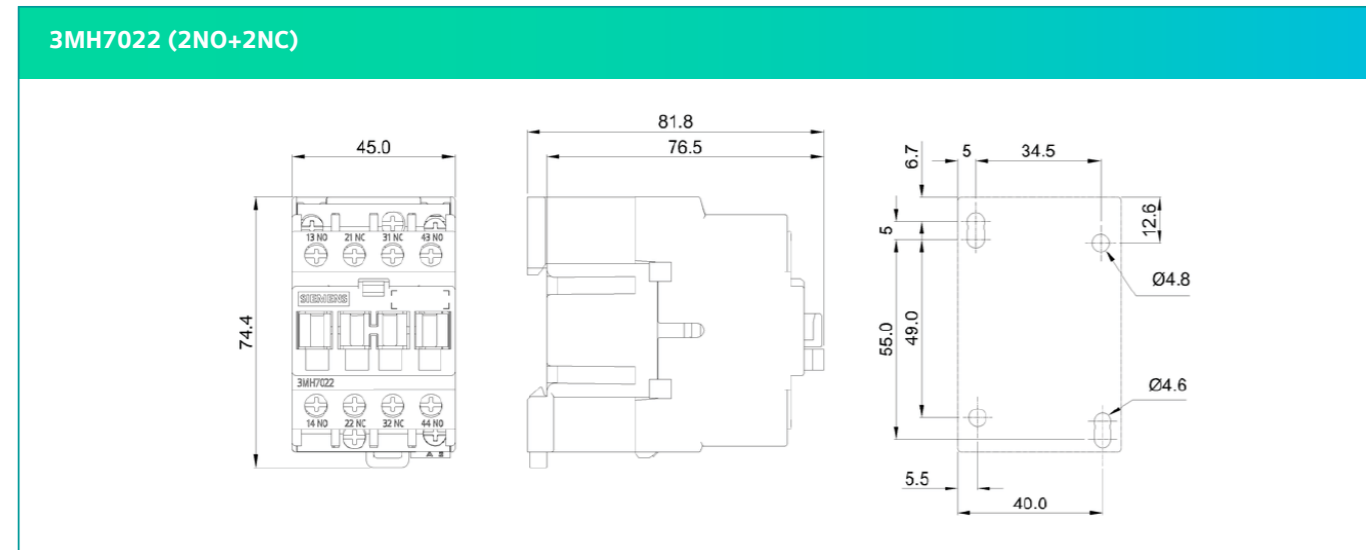

Note: All dimensions are in mm.

Dimension drawings

Accessories

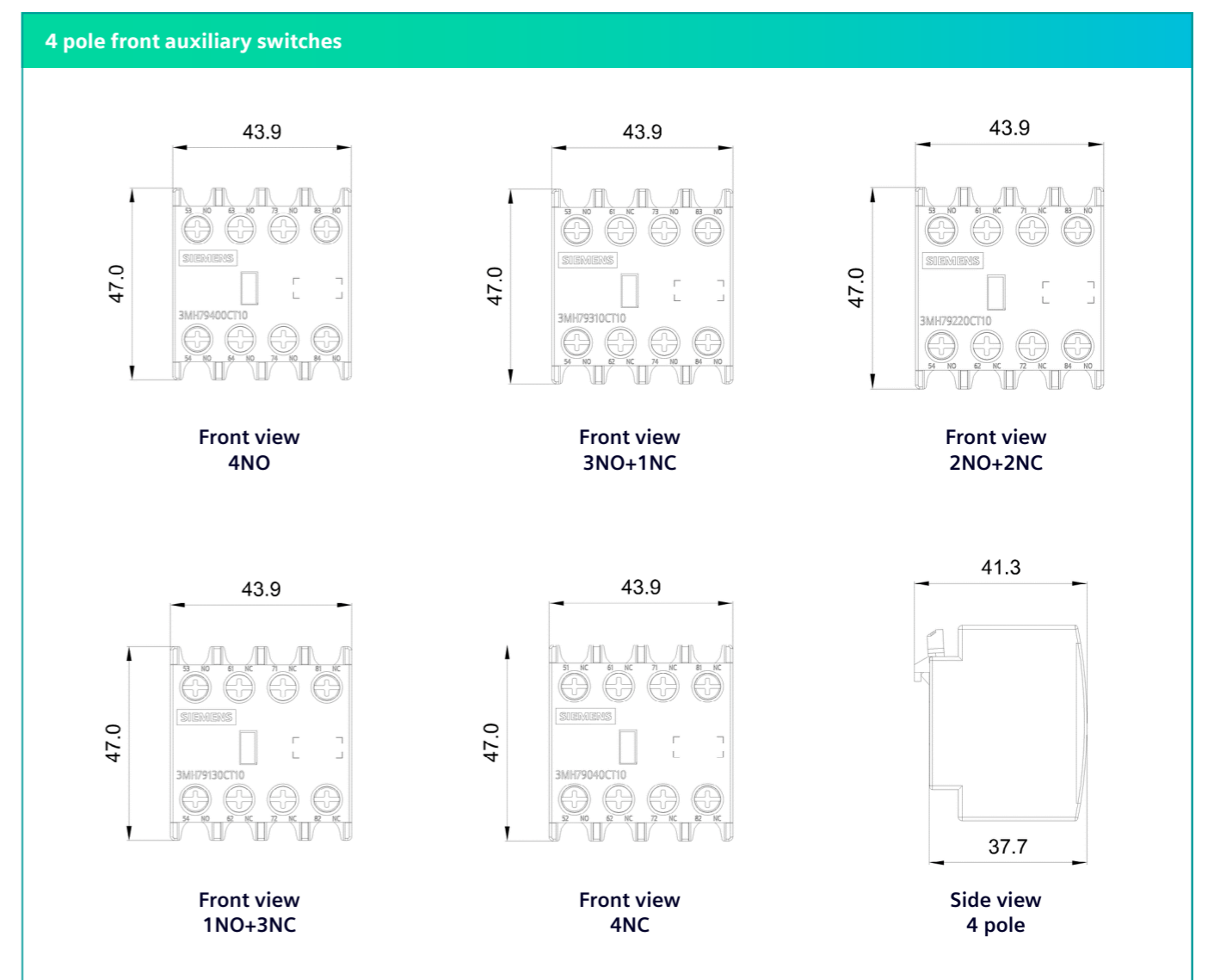
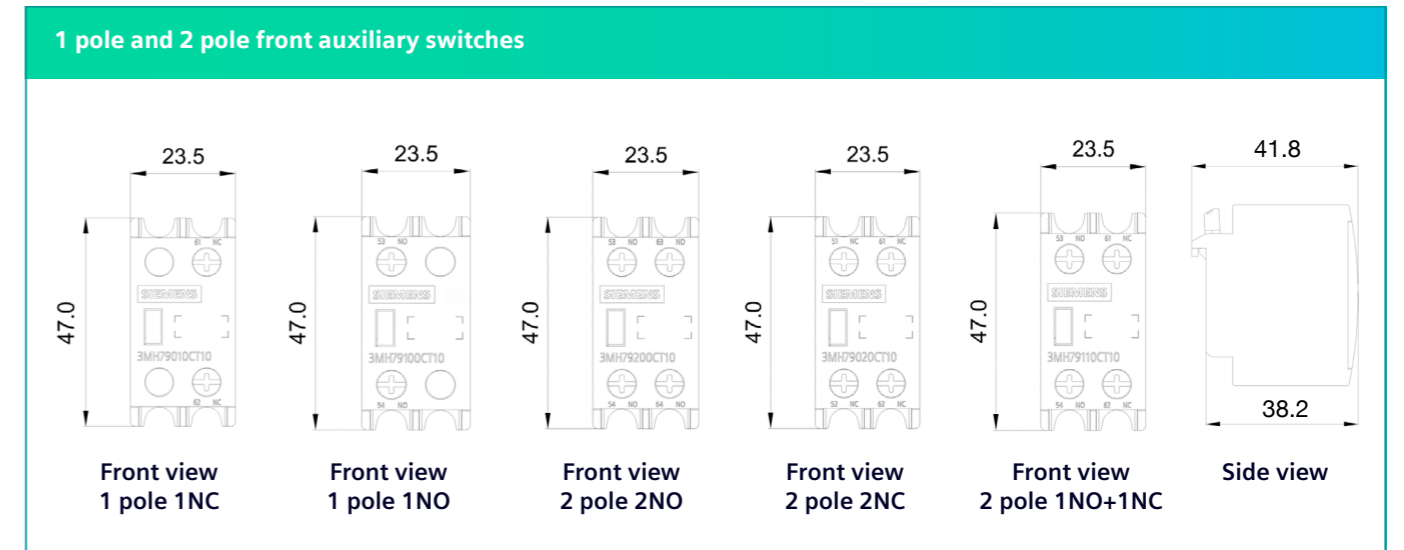

Note: All dimensions are in mm.

Dimension drawings

Accessories

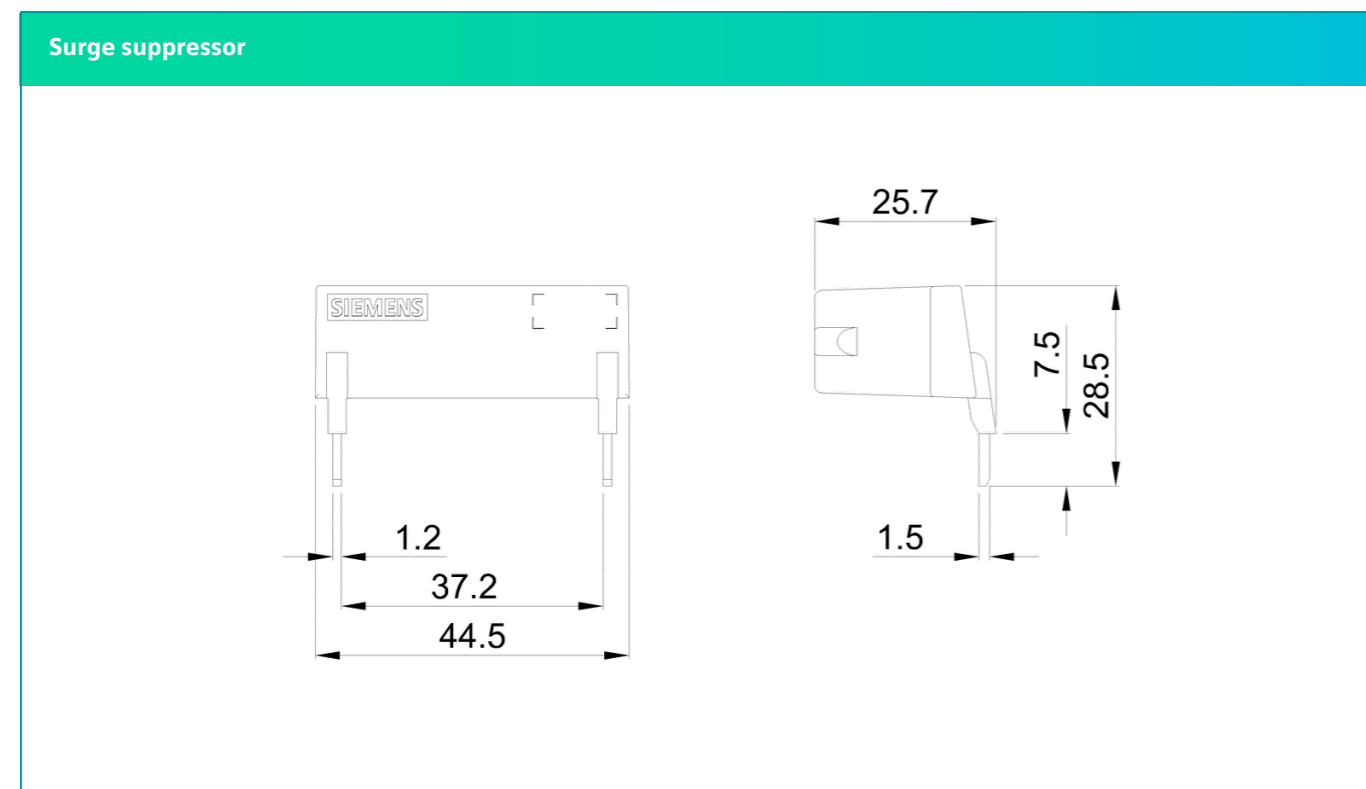
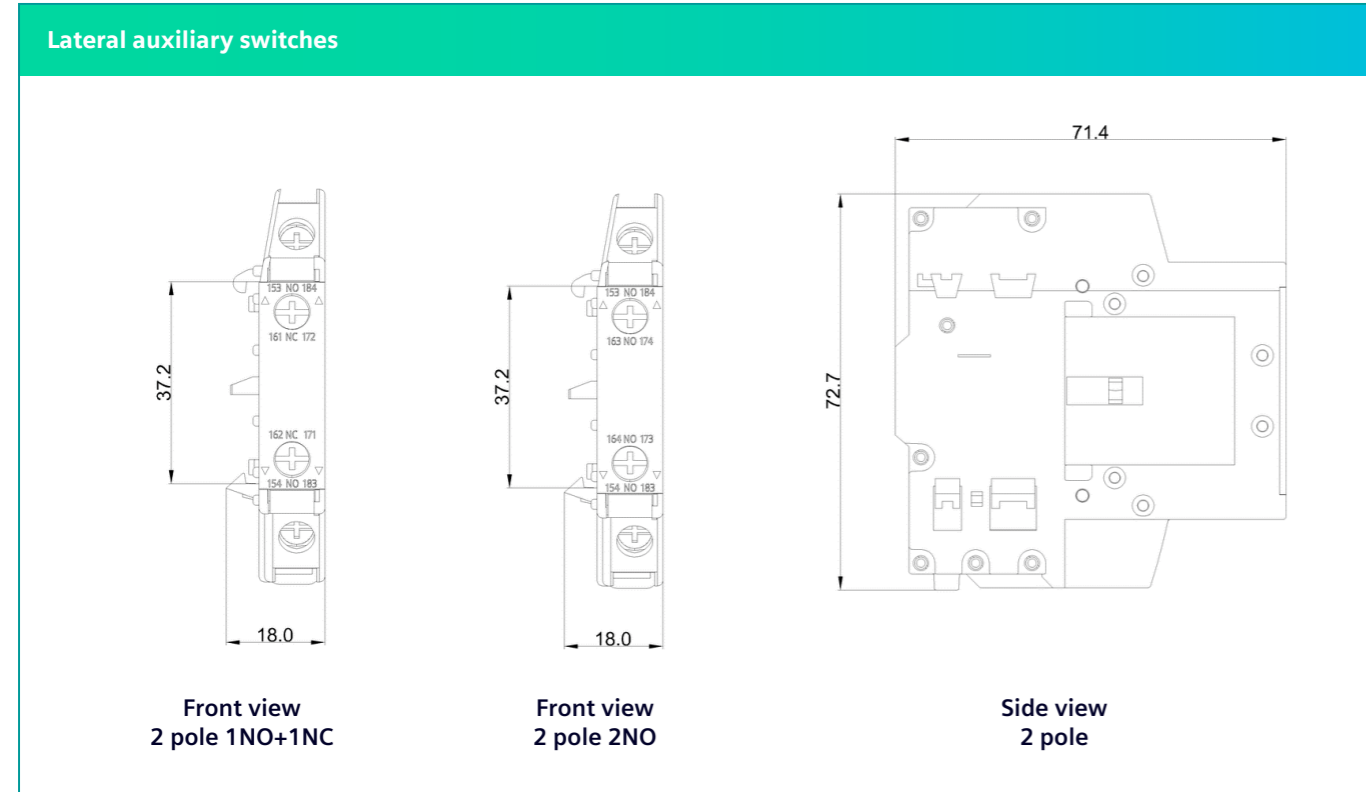

Note: All dimensions are in mm.

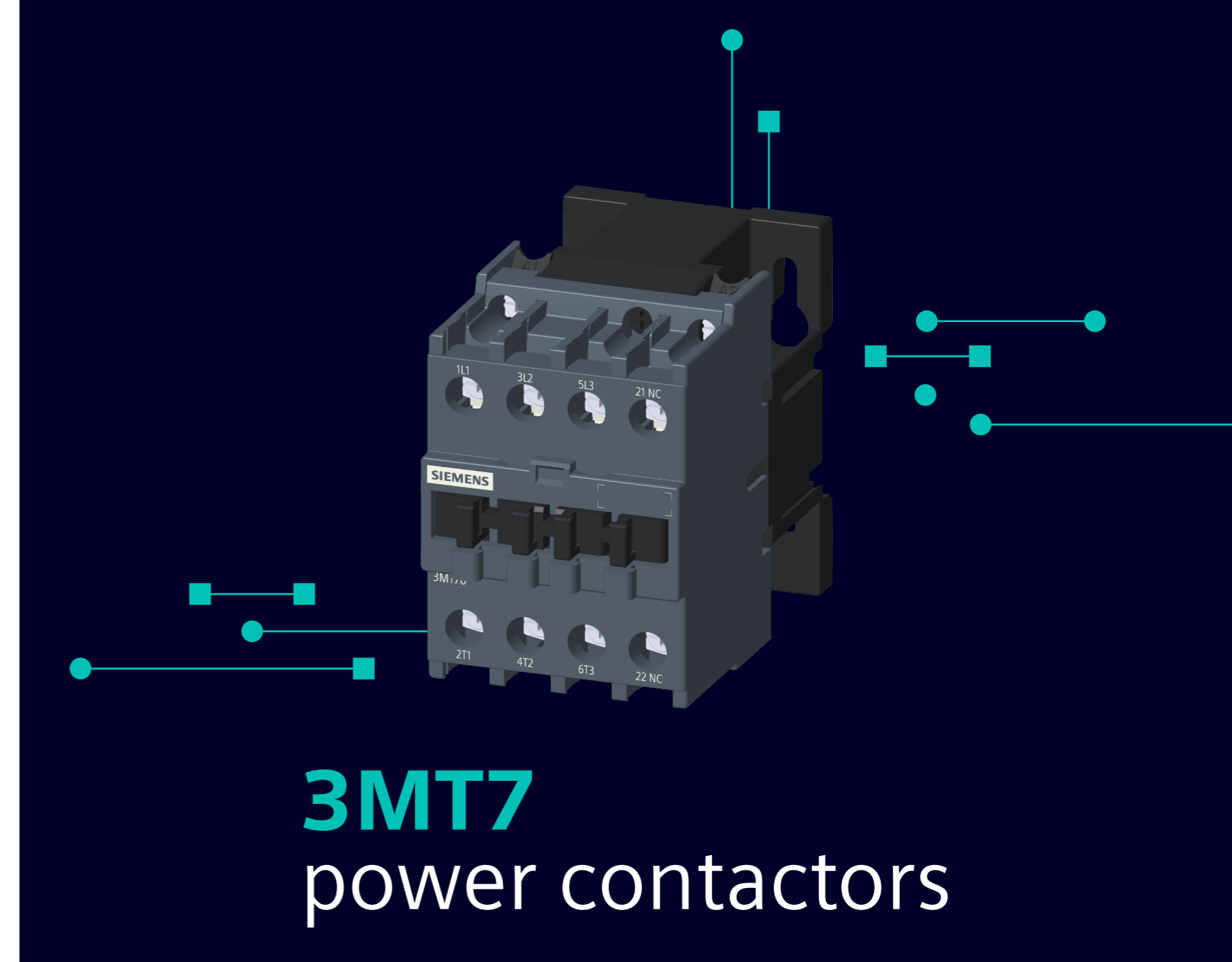

Overview	21
Technical specifications	24
Selection & ordering data	34
Wiring diagrams	41
Dimension drawings	45

SINOVA The Power of **Simplicity**

Overview

Our 3MT7 3 pole power contactor range is a cost-efficient and reliable solution for a variety of switching applications. This comprehensive range of contactors provides an optimum selection for industrial and infrastructure applications.

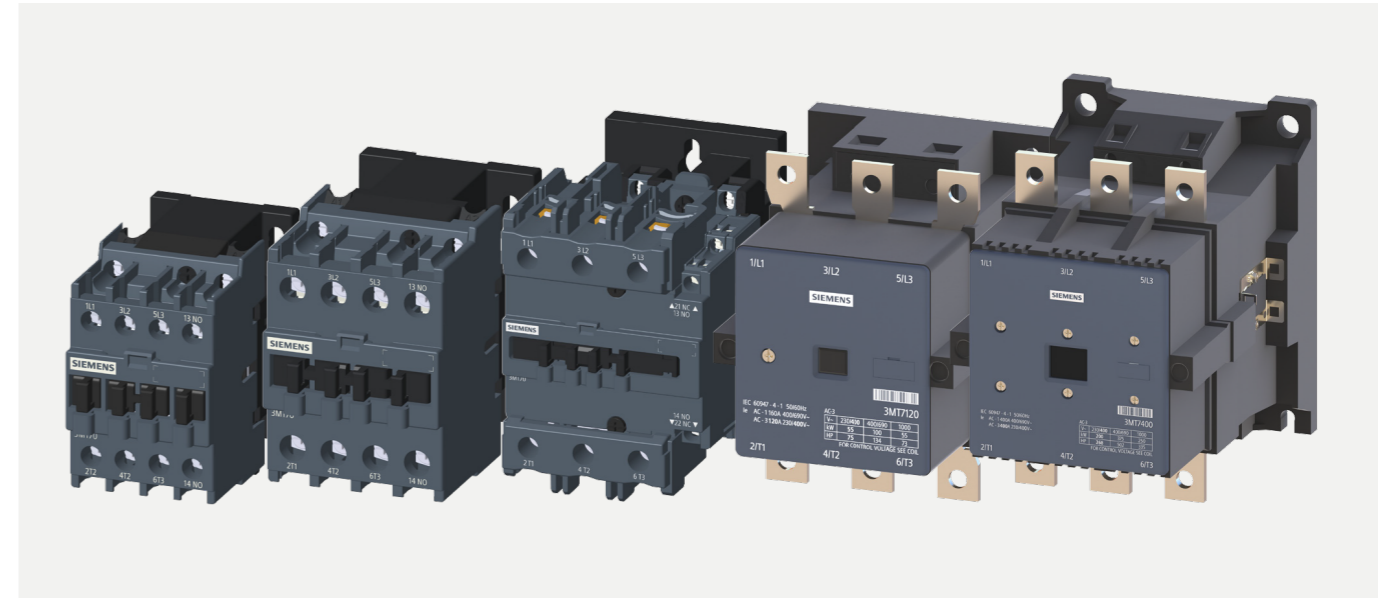

Article number scheme













Product version		Article no.												
3 pole power contactor	3MT7	<input type="checkbox"/>	<input type="checkbox"/>	<input type="checkbox"/>	-	A	<input type="checkbox"/>	<input type="checkbox"/>	<input type="checkbox"/>	-	0			
AC-3 current rating at 415V	e.g. 012 = 12 A	0	1	2										
Size	e.g. 0 = Size 0				0									
Type of electrical connection	A= Screw terminals					A								
Number of NO contacts	e.g. 1 = 1 NO							1						
Number of NC contacts	e.g. 0 = 0 NC								0					
Coil circuit	A = AC coil circuit												A	
Rated control supply voltage	e.g. P0 = 230V AC, 50Hz													P 0
Example		3MT7	0	1	2	-	0	A	A	1	0	-	0	A P 0

Note:

The above scheme shows an overview of the product versions to understand the logic behind the article number. For your orders, refer to the selection and ordering data.





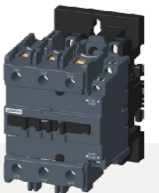

Overview of ratings and sizes

3MT7 power contactors

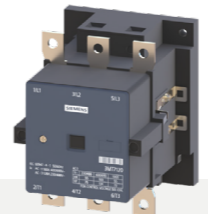
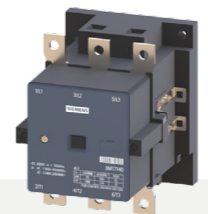
Size 0				
1NO or 1NC	6A	9A	12A	
Size 1				
1NO or 1NC	18A	22A		
Size 2				
1NO or 1NC	25A	32A	38A	40A
Size 3				
1NO + 1NC	40A	50A	65A	
Size 4				
1NO + 1NC	80A	95A		

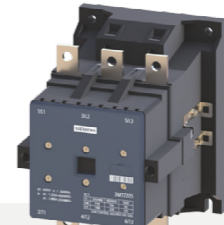
Overview of ratings and sizes

3MT7 power contactors

Size 5		
	120A	140A
Size 6		
	170A	205A
Size 7		
	250A	300A
Size 8		
	400A	

Technical specifications





3MT7 3 pole power contactors 6A to 95A



Type	3MT7006-0	3MT7010-0	3MT7012-0	3MT7018-1	3MT7022-1	3MT7025-2	3MT7032-2	3MT7038-2	3MT7040-2	3MT7040-3	3MT7050-3	3MT7065-3	3MT7080-4	3MT095-4		
Size	0	0	0	1	1	2	2	2	2	3	3	3	4	4		
General data																
Dimension (W x H x D)																
• Basic unit	W	mm	45	45.5	56	74.5	84.5									
	H	mm	74.4	74.5	82.9	127.4	127.4									
	D	mm	81.8	86.8	95	112.6	121.3									
Mounting position	22.5° inclination forward and backward, and 360° rotation, in relation to normal vertical mounting plane					22.5° inclination forward and backward, and 360° rotation, in relation to normal vertical mounting plane										
Rated insulation voltage U_i (pollution degree 3)																
• Main circuit	V	1000								1000						
• Auxiliary circuit	V	1000								1000						
Rated impulse withstand voltage U_{imp}																
• Main circuit	kV	6								6		8				
• Auxiliary circuit	kV	6								6		6				
Permissible ambient temperature																
During operation	°C	-5 ... +55								-5 ... +55						
During storage	°C	-25 ... +70								-25 ... +70						
Relative air humidity	%	10 ... 95								10 ... 95						
Degree of protection IP on the front			IP20								IP20					
Installation altitude at height above sea level, maximum	m	2000								2000						
Short circuit protection																
Main circuit																
• Fuse links, operational class gG																
- Type of coordination "1"	A	32	32	32	40	40	50	50	63	63	80	100	100	160	160	
- Type of coordination "2"	A	25	25	25	32	32	40	40	50	50	63	80	80	125	125	
Auxiliary circuit																
• Fuse links, operational class gG	A	10					10									





Technical specifications

3MT7 3 pole power contactors 6A to 95A

															
Type		3MT7006-0	3MT7010-0	3MT7012-0	3MT7018-1	3MT7022-1	3MT7025-2	3MT7032-2	3MT7038-2	3MT7040-2	3MT7040-3	3MT7050-3	3MT7065-3	3MT7080-4	3MT095-4
Size		0	0	0	1	1	2	2	2	2	3	3	3	4	4
Conductor cross-sections															
Main conductors															
Solid or stranded	mm ²	1 x (1 ... 4 mm ²); 2 x (1 ... 4 mm ²)			1 x (1.5 ... 6 mm ²); 2 x (1.5 ... 6 mm ²)		1 x (1.5 ... 10 mm ²); 2 x (1.5 ... 6 mm ²)			1 x (2.5 ... 25 mm ²); 2 x (2.5 ... 16 mm ²)			1 x (4 ... 50 mm ²); 2 x (4 ... 35 mm ²)		
Finely stranded with end sleeve	mm ²	1 x (1 ... 4 mm ²); 2 x (1 ... 1.5 mm ²)			1 x (1 ... 6 mm ²); 2 x (1 ... 2.5 mm ²)		1 x (1.5 ... 10 mm ²); 2 x (1.5 ... 4 mm ²)			1 x (2.5 ... 25 mm ²); 2 x (2.5 ... 10 mm ²)			1 x (4 ... 50 mm ²); 2 x (4 ... 16 mm ²)		
• Terminal screw - Tightening torque	Nm	M3.5 1.2			M3.5 1.7		M4 1.85			M8 5			M10 9		
Auxiliary conductors and coil terminals															
Solid or stranded	mm ²	1 x (1.0 ... 4.0 mm ²); 2 x (1.0 ... 4.0 mm ²)			1 x (1.5 ... 4.0 mm ²); 2 x (1.5 ... 4.0 mm ²)		1 x (1.5 ... 4.0 mm ²); 2 x (1.5 ... 4.0 mm ²)			1 x (1.0 ... 4.0 mm ²); 2 x (1.0 ... 4.0 mm ²)					
Finely stranded with end sleeve	mm ²	1 x (1.0 ... 2.5 mm ²); 2 x (1.0 ... 1.5 mm ²)			1 x (1.5 ... 4.0 mm ²); 2 x (1.5 ... 4.0 mm ²)		1 x (1.5 ... 4.0 mm ²); 2 x (1.5 ... 4.0 mm ²)			1 x (1.0 ... 2.5 mm ²); 2 x (1.0 ... 1.5 mm ²)					
• Terminal screw - Tightening torque	Nm	M3.5 1.2			M4 1.85		M3.5 1.2			M3.5 1.2					
Control															
Solenoid coil operating range															
• AC operation	at 50Hz at 60Hz	0.85 ... 1.1 x Us 0.85 ... 1.1 x Us			0.85 ... 1.1 x Us 0.85 ... 1.1 x Us		0.85 ... 1.1 x Us 0.85 ... 1.1 x Us			0.85 ... 1.1 x Us 0.85 ... 1.1 x Us					
Power consumption of the solenoid coil (maximum)															
• AC operation, 50Hz															
- Closing	VA/p.f.	70 / 0.75			100 / 0.75		230 / 0.75			44 / 0.3					
- Closed	VA/p.f.	11 / 0.3			15 / 0.3		15 / 0.3			-					
• AC operation, 50Hz wide band															
- Closing	VA/p.f.	90 / 0.75			120 / 0.75		-			-					
- Closed	VA/p.f.	15 / 0.3			15 / 0.3		-			-					
• AC operation, 50/60Hz															
- Closing	VA/p.f.	80 / 0.75			110 / 0.75		280 / 0.75			41 / 0.3					
- Closed	VA/p.f.	12 / 0.3			15 / 0.3		-			-					
Operating times within operating range															
• AC operation															
- Closing delay	ms	9 ... 25			12 ... 27		17 ... 29			17 ... 38					
- Opening delay	ms	4 ... 15			5 ... 22		6 ... 15			5 ... 23					

Technical specifications

3MT7 3 pole power contactors 6A to 95A

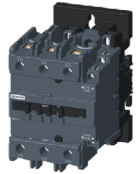
															
Type	3MT7006-0	3MT7010-0	3MT7012-0	3MT7018-1	3MT7022-1	3MT7025-2	3MT7032-2	3MT7038-2	3MT7040-2	3MT7040-3	3MT7050-3	3MT7065-3	3MT7080-4	3MT095-4	
Size	0	0	0	1	1	2	2	2	2	3	3	3	4	4	
Rated data for main contacts															
Load rating with AC															
• Utilization category AC-1															
- Rated operational currents I_e At 40 °C up to 690V	A	25	25	25	32	32	40	40	50	50	60	80	80	125	125
Utilization categories AC-3															
- Rated operational currents I_e at 400V, 55 °C	A	6	9	12	18	22	25	32	38	40	40	50	65	80	95
- Rated operational currents I_e at 690V, 55 °C	A	4	5.2	6.7	10.4	12.8	13	16	18.2	18.2	24	24	32	47	47
Rated operating power															
• Operating power at AC-3 at 400V	kW	2.2	4	5.5	7.5	11	11	15	18.5	18.5	18.5	22	30	37	45
• Operating power at AC-3 at 690V	kW	3	5.5	5.5	7.5	11	11	15	15	15	22	22	30	45	45
Power loss per pole	W	2.5	2.5	2.5	3.1	3.1	3.6	5.2	5.2	5.2	5.4	7.4	6.4	13.7	13.7
Mechanical service life (in million)															
• Basic unit	Operating cycles	10	10	10	10	10	10	10	10	10	5	5	5	3	3
Switching frequency in operating cycles/hour															
• No load switching frequency	1/h	1800	1800	1800	1800	1800	1800	1800	1800	1800	1200	1200	1200	1200	1200
• Switching frequency AC-1	1/h	600	600	600	600	600	600	600	600	600	600	600	600	600	600
• Switching frequency AC-3	1/h	750	750	750	750	750	750	600	600	600	600	600	600	400	400
Rated data for auxiliary contacts															
Number of auxiliary contacts		1NO or 1NC				1NO or 1NC				1NO + 1NC					
Load rating with AC															
• Rated operational currents I_e															
- AC-12	690V A	10				10				10					
- AC-15 at rated operational voltage U_e	230V A	6				6				6					
	400V A	3				3				3					
	500V A	2				2				2					
	690V A	1				1				1					
• Load rating with DC (1 conducting path)															
- DC-12, at rated operational voltage U_e	24V A	6				6				6					
	110V A	3				3				3					
	220V A	1				1				1					
- DC-13, at rated operational voltage U_e	24V A	6				6				6					
	110V A	1				1				1					
	220V A	0.3				0.3				0.3					
	440V A	0.14				0.14				0.14					
	600V A	0.1				0.1				0.1					





Technical specifications

3MT7 3 pole power contactors 120A to 400A

Type	3MT7120		3MT7140		3MT7170		3MT7205		3MT7250		3MT7300		3MT7400		
Size	5		5		6		6		7		7		8		
General data															
Dimension (W x H x D)															
Basic unit		W	mm	120	120	135	135	150	150	160					
		H	mm	150	150	180	180	205	205	204					
		D	mm	152	152	185	185	198	198	222					
Mounting position		22.5° inclination forward and backward, and 90° to right / 90° to left, in relation to normal vertical mounting plane, i.e., coil terminals always on top side					22.5° inclination forward and backward, and 90° to right / 90° to left, in relation to normal vertical mounting plane, i.e., coil terminals always on top side								
Rated insulation voltage U_i (pollution degree 3)		V		1000		1000		1000		1000					
Rated impulse withstand voltage U_{imp}		kV		8		8		8		8					
Permissible ambient temperature		°C		-5 ... +55		-5 ... +55		-5 ... +55		-5 ... +55					
During operation		°C		-25 ... +70		-25 ... +70		-25 ... +70		-25 ... +70					
Relative air humidity		%		10-95		10-95		10-95		10-95					
Degree of protection IP				IP00		IP00		IP00		IP00					
Installation altitude at height above sea level, maximum		m		2000		2000		2000		2000					
Short circuit protection															
Basic unit															
• Fuse links, operational class gG															
- Type of coordination "1"		A		400		400		400		400		500		630	
- Type of coordination "2"		A		200		250		250		250		400		500	
Conductor cross-sections															
Main conductors															
Stranded wire with cable lug		mm ²		2x (50 ... 120 mm ²)		2x (50 ... 120 mm ²)		2x (50 ... 120 mm ²)		2x (50 ... 120 mm ²)		2x (70 ... 240 mm ²)		2x (70 ... 240 mm ²)	
Finely stranded with cable lug		mm ²		2x (35 ... 95 mm ²)		2x (35 ... 95 mm ²)		2x (35 ... 95 mm ²)		2x (35 ... 95 mm ²)		2x (50... 240 mm ²)		2x (50... 240 mm ²)	
Terminal bar (max. width)		mm ²		2x(20x3) mm		2x(20x3) mm		2x(20x3) mm		2x(20x3) mm		2x(25x5) mm		2x(25x5) mm	
Terminal screw				M8 x 25		M8 x 25		M8 x 25		M8 x 25		M10 x 30		M10 x 30	
Tightening torque		Nm		10 ... 14 Nm		10 ... 14 Nm		10 ... 14 Nm		10 ... 14 Nm		14 ... 24 Nm		14 ... 24 Nm	
Control															
Solenoid coil operating range															
• AC operation		at 50Hz		0.85 to 1.1 x U_s		0.85 to 1.1 x U_s		0.85 to 1.1 x U_s		0.85 to 1.1 x U_s		0.85 to 1.1 x U_s		0.85 to 1.1 x U_s	
		at 60Hz		0.85 to 1.1 x U_s		0.85 to 1.1 x U_s		0.85 to 1.1 x U_s		0.85 to 1.1 x U_s		0.85 to 1.1 x U_s		0.85 to 1.1 x U_s	

Technical specifications

3MT7 3 pole power contactors 120A to 400A

Type								
Type		3MT7120	3MT7140	3MT7170	3MT7205	3MT7250	3MT7300	3MT7400
General data								
Power consumption of the solenoid coil (maximum)								
• AC operation, 50Hz								
- Closing	VA/p.f.	550 / 0.45		910 / 0.38		1440 / 0.34		2450 / 0.21
- Closed	VA/p.f.	40 / 0.24		65 / 0.26		95 / 0.24		115 / 0.33
• AC operation, 50/60Hz								
- Closing	VA/p.f.	660 / 0.45		1080 / 0.38		1780 / 0.32		3050 / 0.32
- Closed	VA/p.f.	56 / 0.24		80 / 0.27		122 / 0.23		165 / 0.29
Operating times within operating range								
• AC operation								
- Closing delay	ms	22-37		25-40		25-40		25-40
- Opening delay	ms	8-30		10-30		10-30		8-30
Rated data for main contacts								
Load rating with AC								
Utilization category AC-1								
Rated operational currents I_e at 400V, 40°C	A	160	160	210	220	300	300	400
Utilization categories AC-3								
Rated operational currents I_e at 400V	A	120	140	170	205	250	300	400
Rated operational currents I_e at 690V	A	110	100	170	170	250	250	400
Rated operating power								
Operating power at AC-3 at 400V	kW	55	75	90	110	132	160	200
Operating power at AC-3 at 690V	kW	100	110	156	156	235	235	375
Mechanical service life (in million)								
Basic unit	Operating cycles	3			3			
Switching frequency in operating cycles hour								
No load switching frequency	Cycles/h	5000	5000	5000	5000	3000	3000	3000
Switching frequency AC-1	Cycles/h	800	800	800	750	800	750	700
Switching frequency AC-3	Cycles/h	750	750	700	500	700	500	500

Selection & ordering data





3MT7 power contactors

Size	Rated data					Article no.	List price per PU (Per Unit)
	AC-3 at 400V at 55°C	Ratings of three-phase motors at 50Hz and 400V	AC-1 at 690V at 40°C	Auxiliary contacts			
	A	kW	A	NO	NC		
Size 0 	6	2.2	25	1	-	3MT7006-0AA10-0A..	
	6	2.2	25	-	1	3MT7006-0AA01-0A..	
	9	4	25	1	-	3MT7010-0AA10-0A..	
	9	4	25	-	1	3MT7010-0AA01-0A..	
	12	5.5	25	1	-	3MT7012-0AA10-0A..	
	12	5.5	25	-	1	3MT7012-0AA01-0A..	
Size 1 	18	7.5	32	1	-	3MT7018-1AA10-0A..	
	18	7.5	32	-	1	3MT7018-1AA01-0A..	
	22	11	32	1	-	3MT7022-1AA10-0A..	
	22	11	32	-	1	3MT7022-1AA01-0A..	
Size 2 	25	11	40	1	-	3MT7025-2AA10-0A..	
	25	11	40	-	1	3MT7025-2AA01-0A..	
	32	15	40	1	-	3MT7032-2AA10-0A..	
	32	15	40	-	1	3MT7032-2AA01-0A..	
	38	18.5	50	1	-	3MT7038-2AA10-0A..	
	38	18.5	50	-	1	3MT7038-2AA10-0A..	
	40	18.5	50	1	-	3MT7040-2AA10-0A..	
	40	18.5	50	-	1	3MT7040-2AA10-0A..	
Size 3 	40	18.5	60	1	1	3MT7040-3AA11-0A..	
	50	22	80	1	1	3MT7050-3AA11-0A..	
	65	30	80	1	1	3MT7065-3AA11-0A..	
Size 4 	80	37	125	1	1	3MT7080-4AA11-0A..	
	95	45	125	1	1	3MT7095-4AA11-0A..	

Note: .. Please enter coil voltage from "Coil code (AC)" table on page no. 40.





Selection & ordering data

3MT7 power contactors

Size	Rated data					Article no.	List price per PU (Per Unit)
	AC-3 at 400V at 55°C	Ratings of three-phase motors at 50Hz and 400V	AC-1 at 690V at 40°C	Auxiliary contacts			
	A	kW	A	NO	NC		
Size 5 	120	55	160	-	-	3MT7120-5AA00-0A..	
	140	75	160	-	-	3MT7140-5AA00-0A..	
Size 6 	170	90	210	-	-	3MT7170-6AA00-0A..	
	205	110	220	-	-	3MT7205-6AA00-0A..	
Size 7 	250	132	300	-	-	3MT7250-7AA00-0A..	
	300	160	300	-	-	3MT7300-7AA00-0A..	
Size 8 	400	200	400	-	-	3MT7400-8AA00-0A..	

Selection & ordering data

Spare top housing

Size	AC-3 at 400V at 55°C	Ratings of three-phase motors at 50Hz and 400V	AC-1 at 690V at 40°C	Auxiliary contacts		Article no.	List price per PU (Per Unit)
	A	kW	A	NO	NC		
Size 0 	6	2.2	25	1	-	3MT7906-0HA10	
	6	2.2	25	-	1	3MT7906-0HA01	
	9	4	25	1	-	3MT7910-0HA10	
	9	4	25	-	1	3MT7910-0HA01	
	12	5.5	25	1	-	3MT7912-0HA10	
	12	5.5	25	-	1	3MT7912-0HA01	
Size 1 	18	7.5	32	1	-	3MT7918-1HA10	
	18	7.5	32	-	1	3MT7918-1HA01	
	22	11	32	1	-	3MT7922-1HA10	
	22	11	32	-	1	3MT7922-1HA01	
Size 2 	25	11	40	1	-	3MT7925-2HA10	
	25	11	40	-	1	3MT7925-2HA01	
	32	15	40	1	-	3MT7932-2HA10	
	32	15	40	-	1	3MT7932-2HA01	
	38	18.5	50	1	-	3MT7938-2HA10	
	38	18.5	50	-	1	3MT7938-2HA01	
	40	18.5	50	1	-	3MT7940-2HA10	
	40	18.5	50	-	1	3MT7940-2HA01	
Size 3 	40	18.5	60	1	1	3MT7940-3HA11	
	50	22	80	1	1	3MT7950-3HA11	
	65	30	80	1	1	3MT7965-3HA11	
Size 4 	80	37	125	1	1	3MT7980-4HA11	
	95	45	125	1	1	3MT7995-4HA11	

Selection & ordering data

Spare contact kit

Main contact kits for Size 5, 6, 7, 8 contactors (Set of 6 fixed & 3 moving contacts)			
For contactors	AC-3 rating	Article no.	List price per PU (Per Unit)
3MT71205AA000A..	120A	3MT7912-OKA00	
3MT71405AA000A..	140A	3MT7914-OKA00	
3MT71706AA000A..	170A	3MT7917-OKA00	
3MT72056AA000A..	205A	3MT7920-5KA00	
3MT72507AA000A..	250A	3MT7925-OKA00	
3MT73007AA000A..	300A	3MT7930-OKA00	
3MT74008AA000A..	400A	3MT7940-OKA00	

Accessories

Pneumatic timer Compatible with 3MT7 3 pole power contactors Size 0, 1, 2, 3, 4							
Product image	No. of auxiliary contacts		Mounting position	Function	Timing	Article no.	List price per PU (Per Unit)
	NO	NC			Seconds		
ON delay pneumatic timer 	1	1	Top	ON delay	0.1-3	3MT7900-OPN10	
					0.1-30	3MT7900-OPN20	
					10-180	3MT7900-OPN30	
OFF delay pneumatic timer 	1	1	Top	OFF delay	0.1-3	3MT7900-OPF10	
					0.1-30	3MT7900-OPF20	
					10-180	3MT7900-OPF30	



Selection & ordering data



Accessories

Auxiliary switches Compatible with 3MT7 3 pole power contactors							
Product image	No. of auxiliary contacts		Mounting position	Compatible contactor	Maximum mountable auxiliary switches	Article no.	List price per PU (Per Unit)
	NO	NC					
1 pole & 2 pole front auxiliary switches 	1	-	Front	Size 0, 1, 2, 3, 4	1	3MH7910-0CT10	
	-	1				3MH7901-0CT10	
	2	-				3MH7920-0CT10	
	1	1				3MH7911-0CT10	
	-	2				3MH7902-0CT10	
	4	-				3MH7940-0CT10	
4 pole front auxiliary switches 	3	1	Front	Size 0, 1, 2, 3, 4	1	3MH7931-0CT10	
	2	2				3MH7922-0CT10	
	1	3				3MH7913-0CT10	
	-	4				3MH7904-0CT10	
	2	-				3MH7920-0CL10	
	1	1				3MH7911-0CL10	
Lateral auxiliary switches 	1	1	First left or first right	Size 5, 6, 7, 8	2	3MH79110CL21	
	1	1			2	3MH79110CL22	
	1	1	Second left or second right	Size 5, 6, 7, 8	2	3MH79110CL21	
	1	1			2	3MH79110CL22	

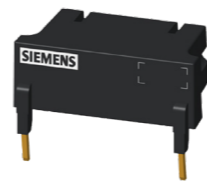
Selection & ordering data

Accessories

Surge suppressor Compatible with SINOVA 3MT7 3 pole power contactors					
Product image	Voltage	Mounting position	Compatible contactor	Article no.	List price per PU (Per Unit)
Surge suppressor 	24-48V AC 50/60Hz	Between A1-A2 coil terminals	Size 0, 1, 2, 3, 4	3MT7900-1SC21	
	110-240V AC 50/60Hz			3MT7900-1SL21	
	380-440V AC 50/60Hz			3MT7900-1SV21	
Surge suppressor 	Less than 48V	Between A1-A2 coil terminals	Size 5, 6, 7, 8	3MT79002SC22	
	48 - 127V			3MT79002SF22	
	127 - 240V			3MT79002SL22	
	240 - 400V			3MT79002SV02	
	400 - 600V			3MT79002SR02	

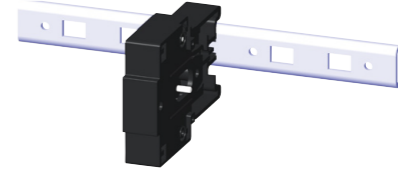
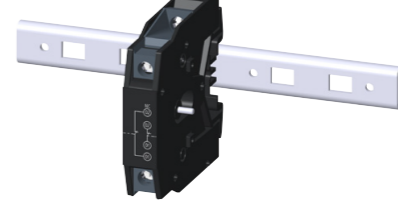
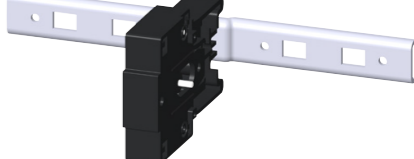
Interlock For 3MT7 3 pole power contactors					
	Mechanical interlock		Electro-mechanical interlock		
Suitable for contactors Size 0, 1, 2	 3MT7900-1XM01	Suitable for contactor Size 3	 3MT7900-1XE01	 3MT7900-1XM02	 3MT7900-1XE02
	 3MT7900-1XM03				
Suitable for contactor Size 4					

Selection & ordering data

Accessories

Mechanical Interlock For 3MT7 3 pole power contactors			
Product image	Contactor	Article no.	List price per PU (Per Unit)
	Size 5	3MT7900-1XM04	
	Size 6	3MT7900-1XM05	
	Size 7	3MT7900-1XM06	
	Size 8	3MT7900-1XM07	
	Size 5 / Size 6	3MT7900-1XM45	
	Size 6 / Size 7	3MT7900-1XM56	

Spares

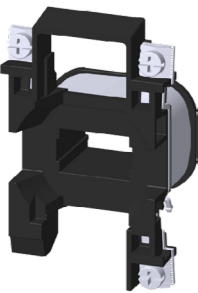
Product image	Size of contactor	Article no.	List price per PU (Per Unit)
	Size 0, 1	3MT79000L..1	
	Size 2	3MT79000L..2	
	Size 3, 4	3MT79000L..3	
	Size 5	3MT79000L..5	
	Size 6	3MT79000L..6	
	Size 7	3MT79000L..7	
	Size 8	3MT79000L..8	

.. Please enter coil codes from table below

Coil code (AC)												
Frequency	24V	36V	48V	110V	220V	230V	380V	400V	415V	165-273V*	353-455V*	550V
50Hz	B0	G0 [#]	H0	F0	M0	P0	Q0	V0	R0	S0	T0	A5 [®]
50/60Hz	C2	G2 [#]	H2 [#]	F2	N2	L2	Q2	V2 [#]	R2 [#]	-	-	-

Note:

*T0 and S0 wide band coils are available up to Size 2 contactors

[#]Not available for Size 5, 6, 7 and 8 contactors

[®]Available only for Size 5, 6, 7 and 8 contactors

Wiring diagrams

3MT7 power contactors

Size 0, Size 1, Size 2 (1NO version)

Size 0: 6A / 9A / 12A
Size 1: 18A / 22A
Size 2: 25A / 32A / 38A / 40A

Size 0, Size 1, Size 2 (1NC version)

Size 0: 6A / 9A / 12A
Size 1: 18A / 22A
Size 2: 25A / 32A / 38A / 40A

Wiring diagrams

3MT7 power contactors

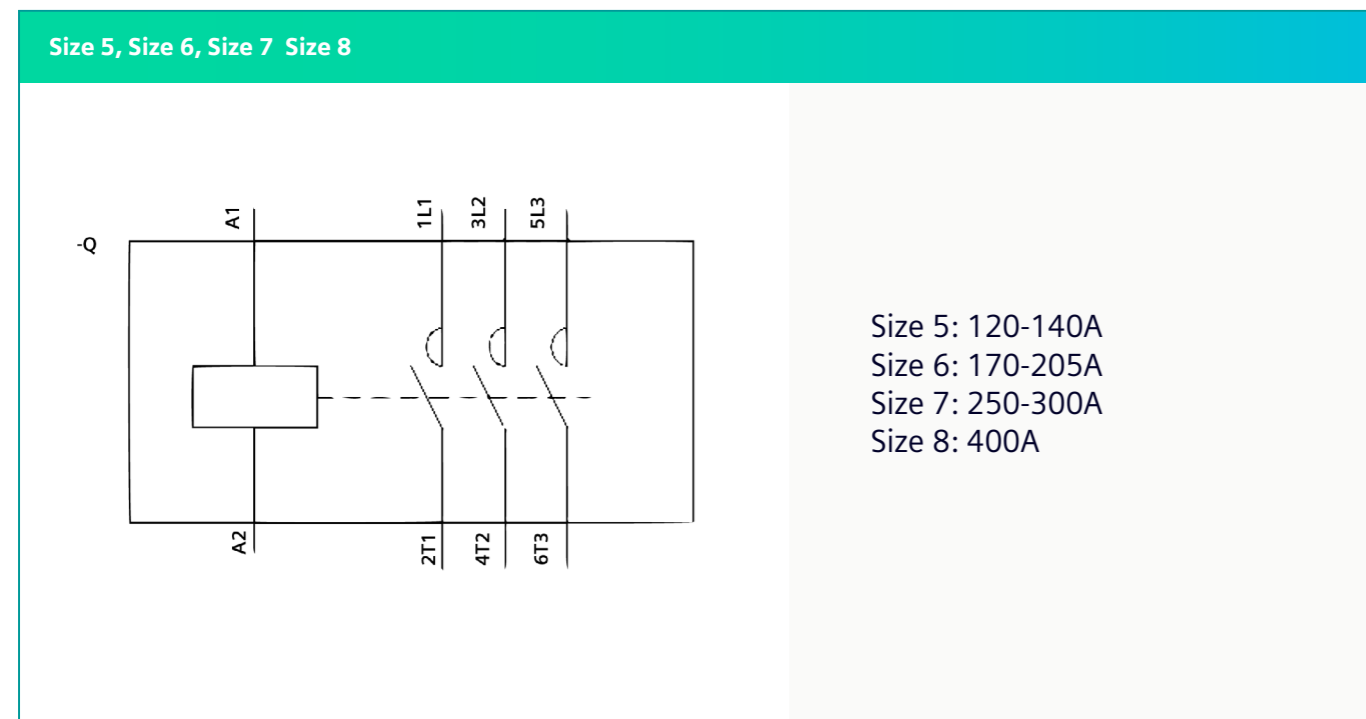
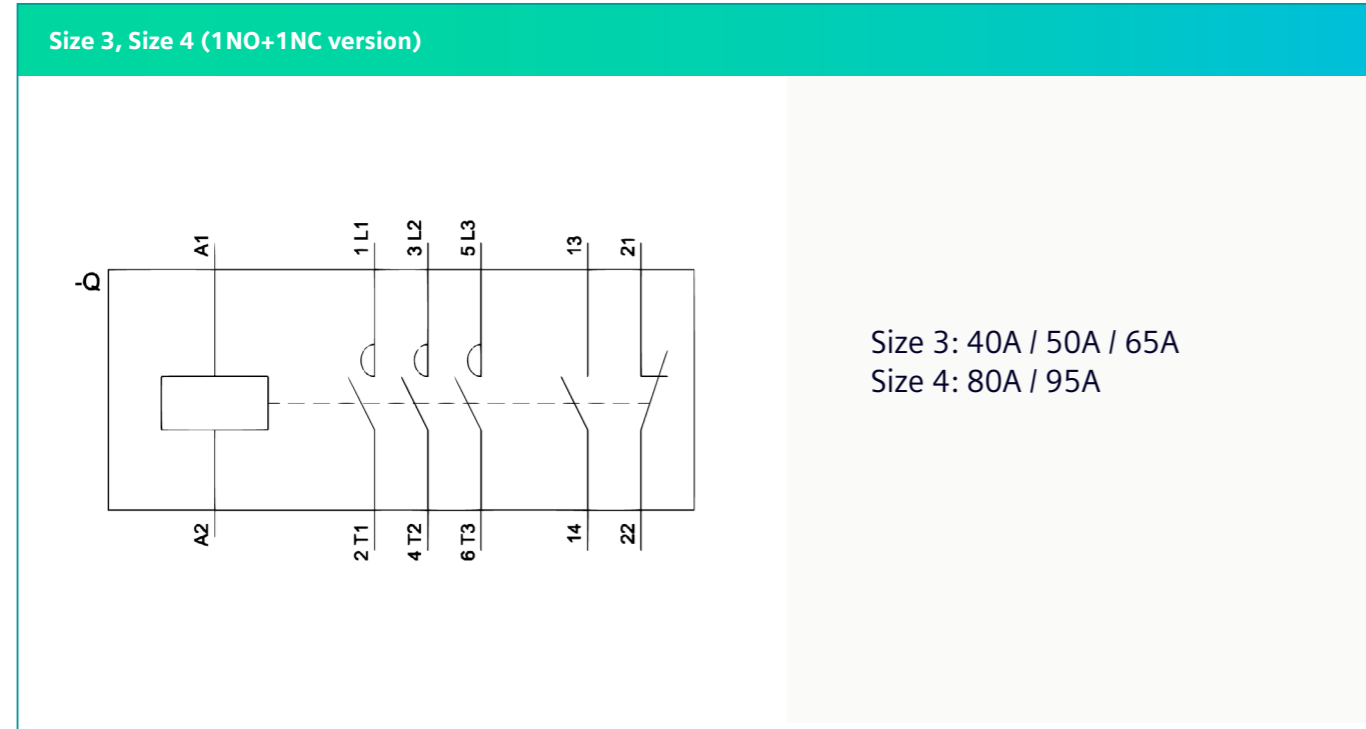

Wiring diagrams

Accessories

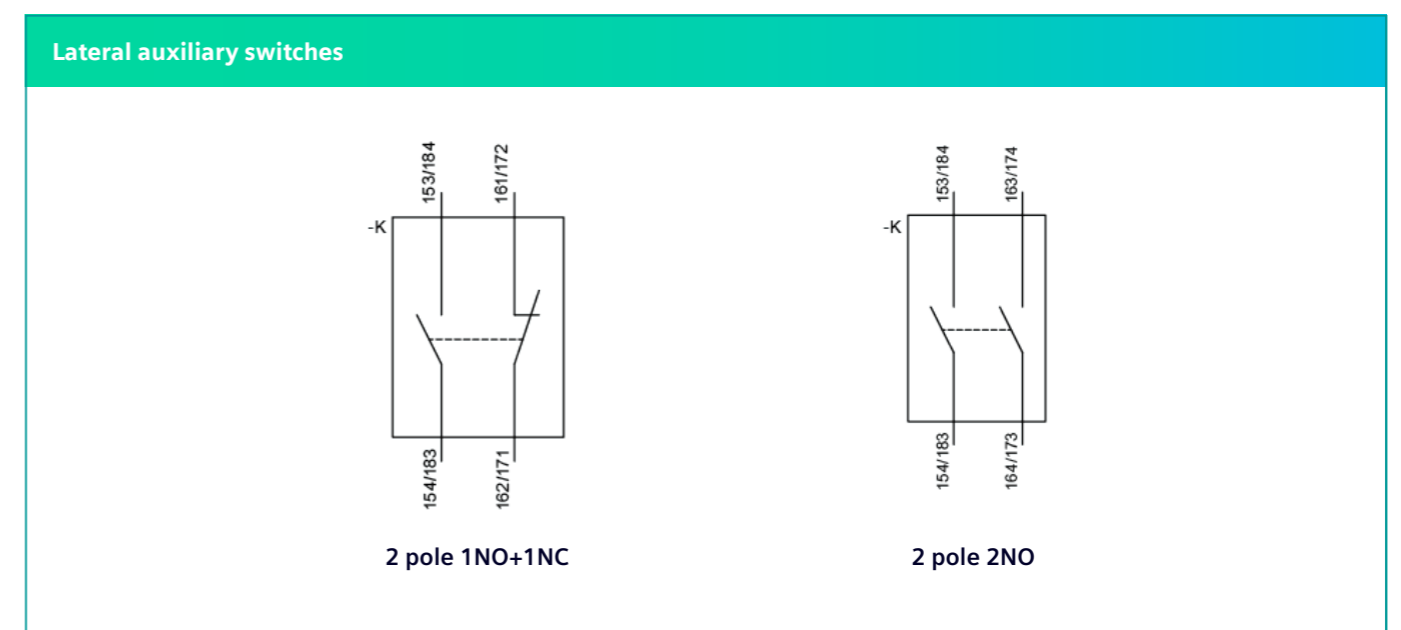
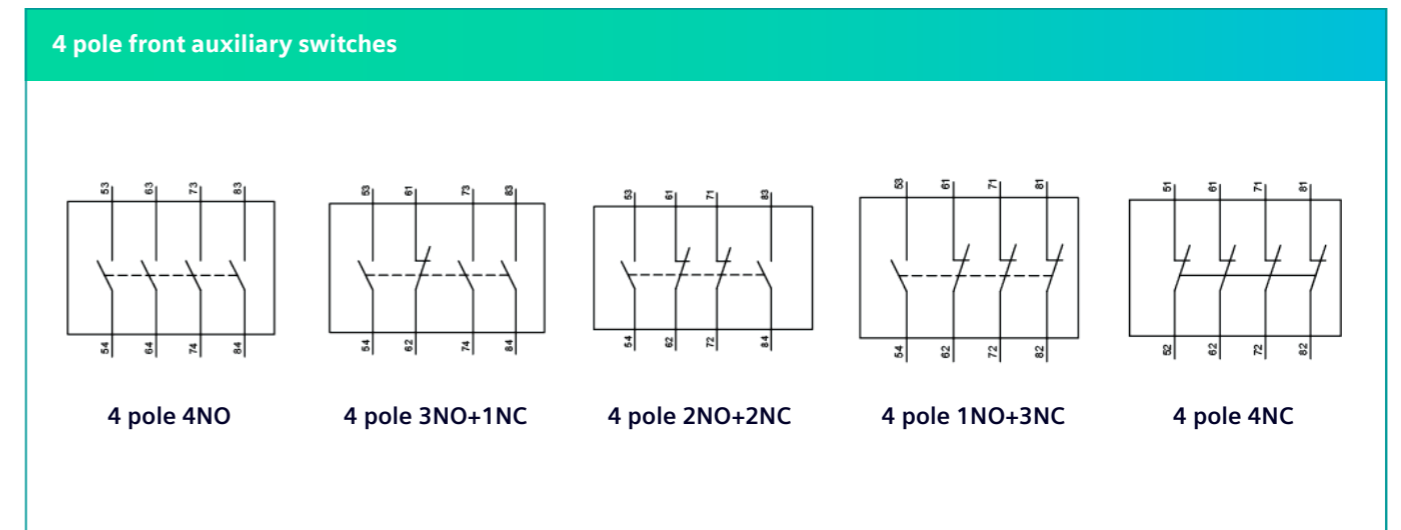
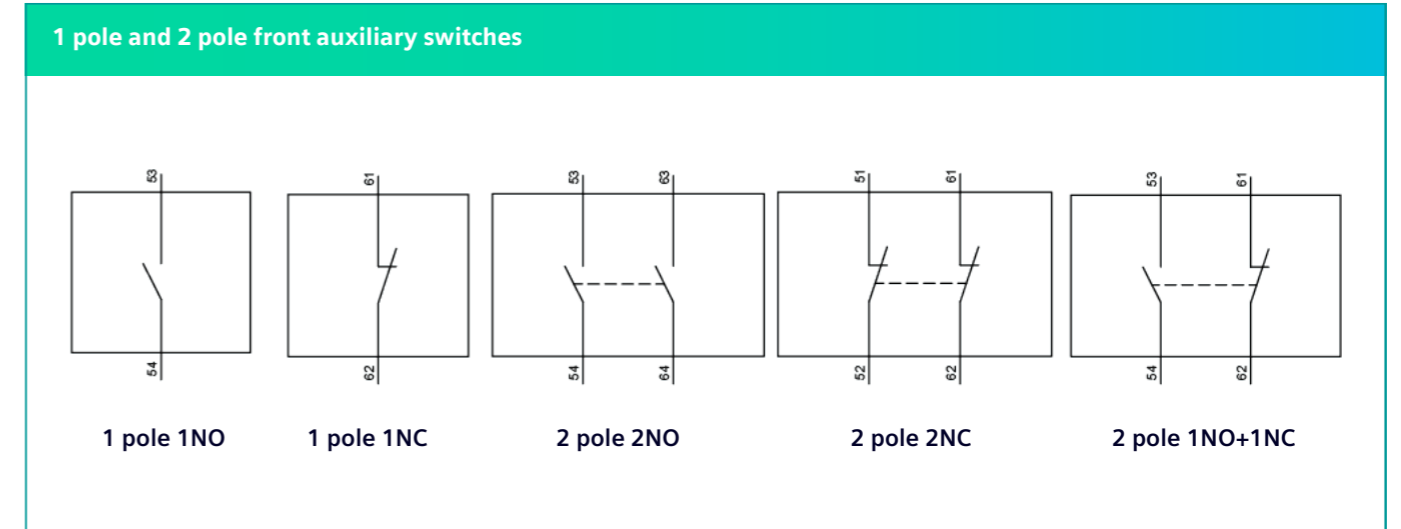

Wiring diagrams

Accessories

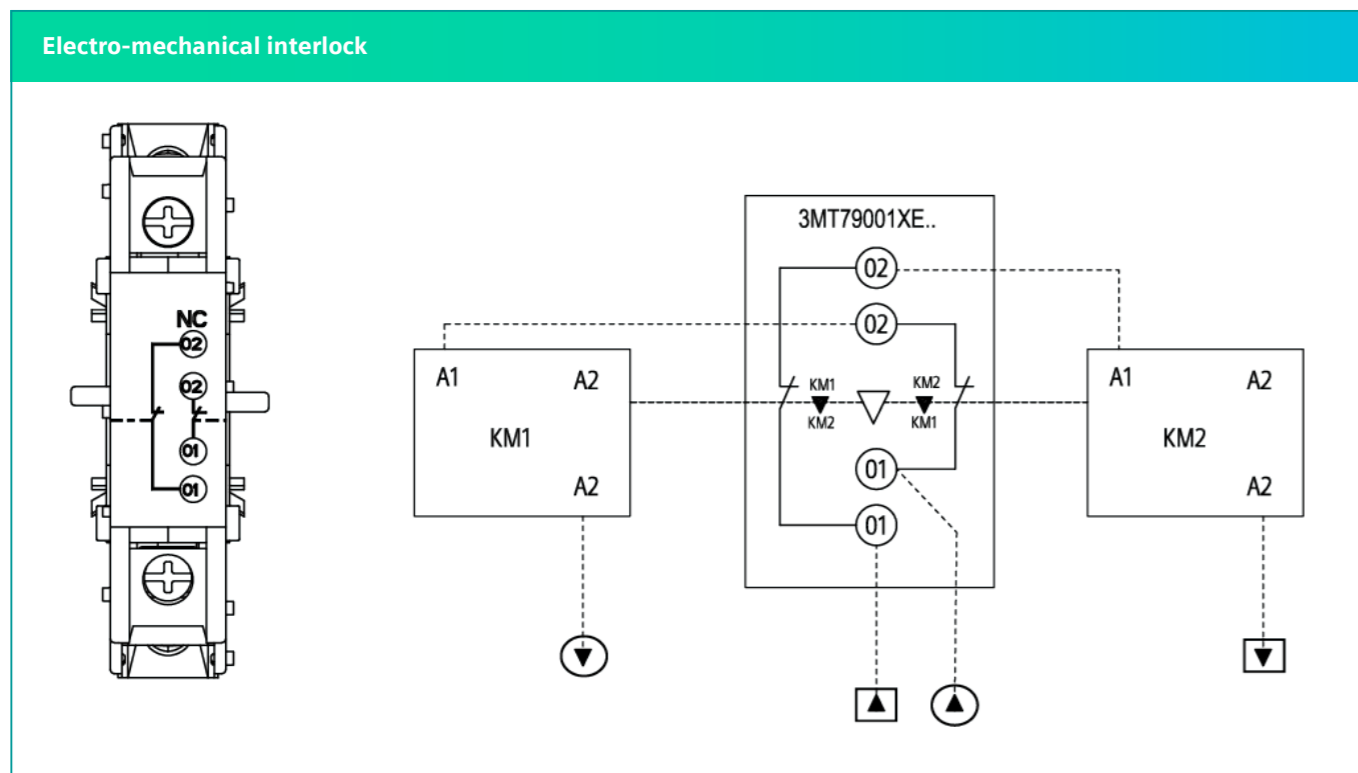
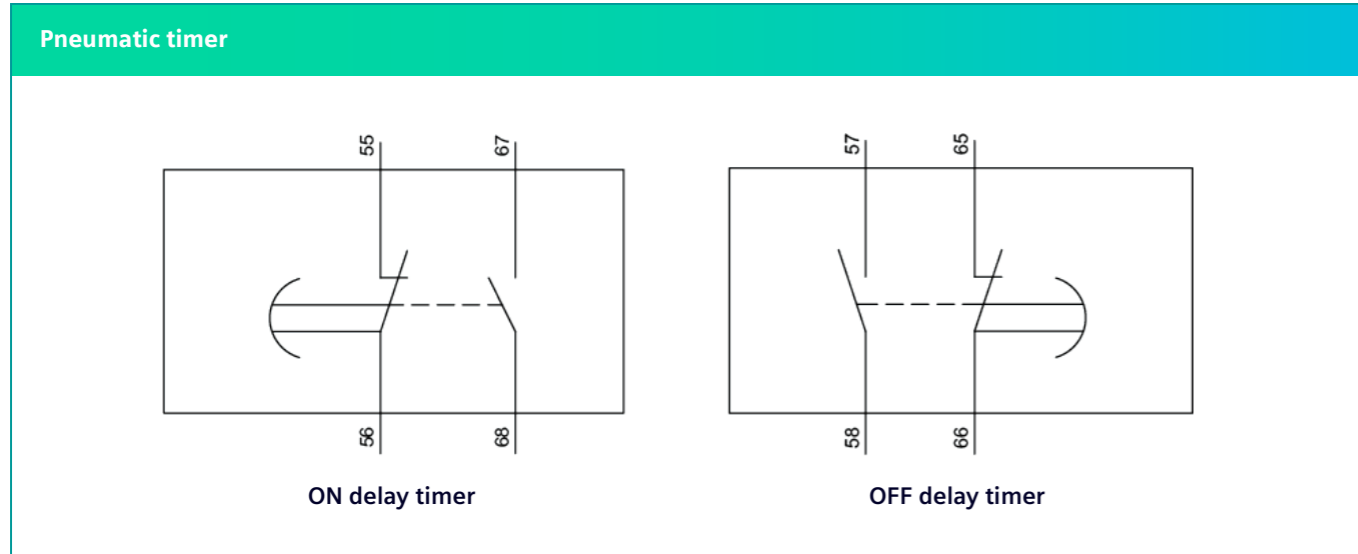

Dimension drawings

Contactor

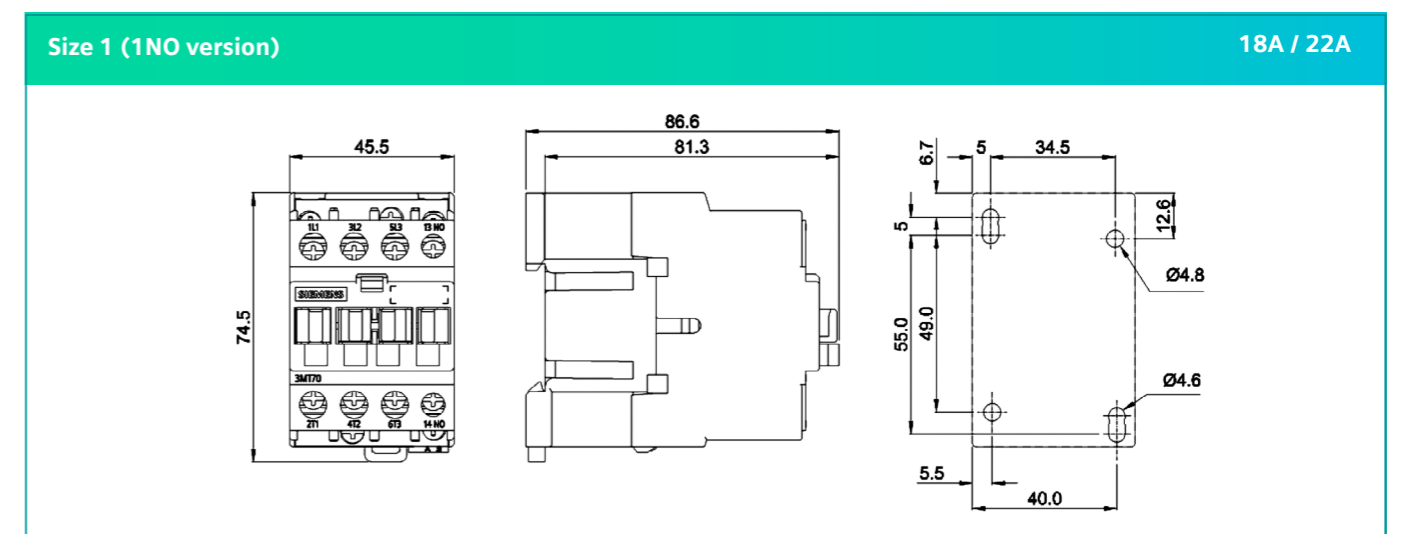
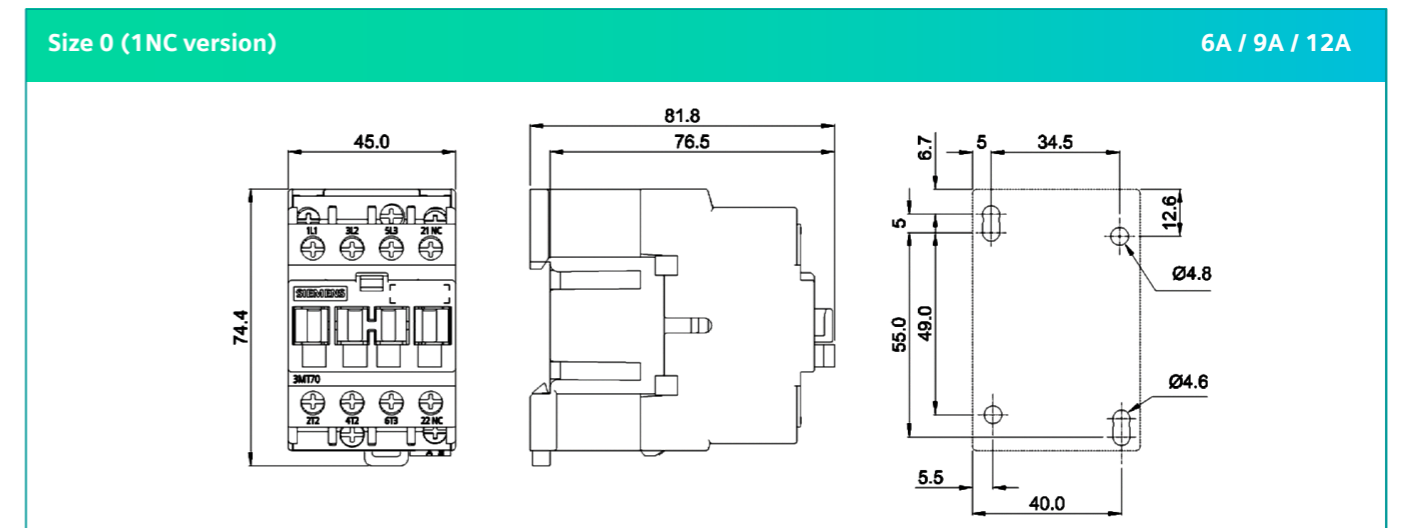
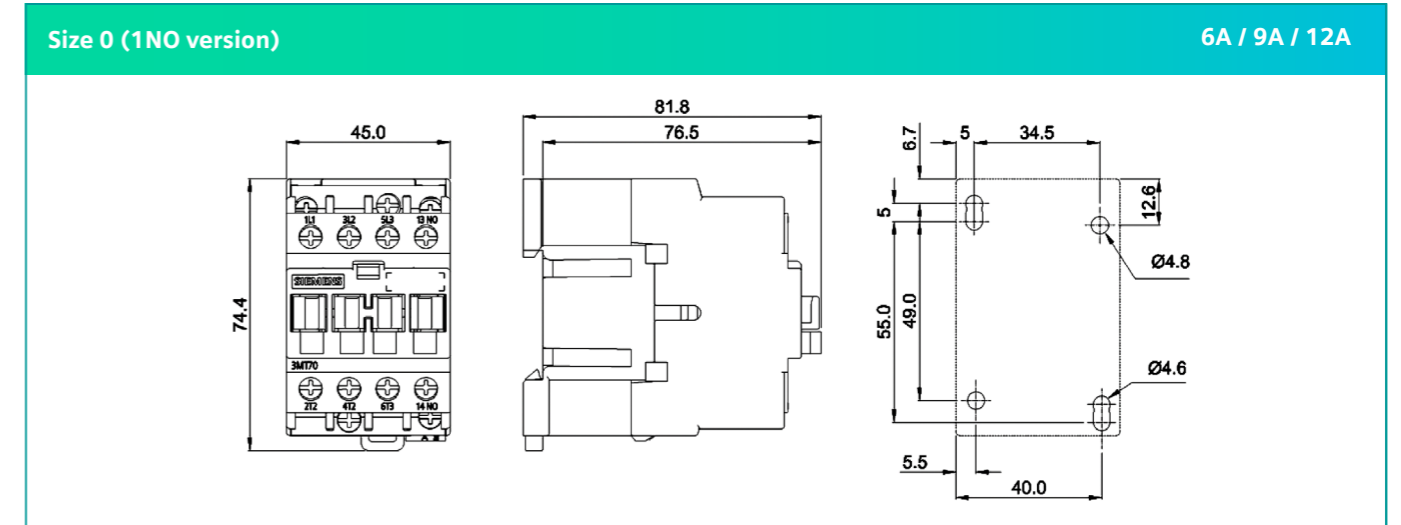

Note: All dimensions are in mm.

Dimension drawings

Contactors

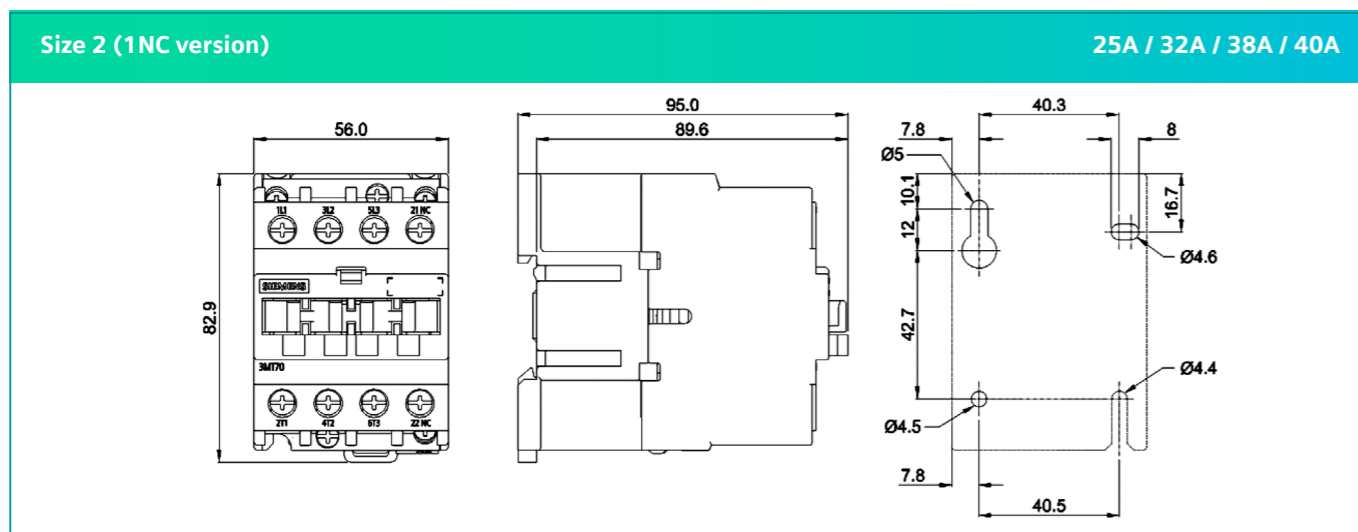
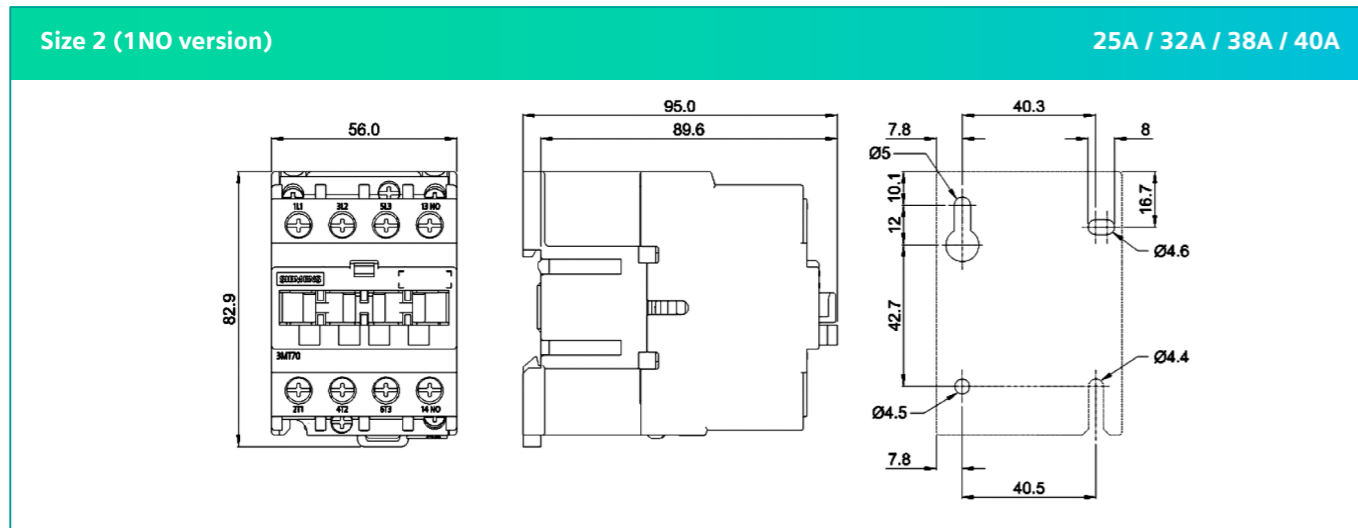
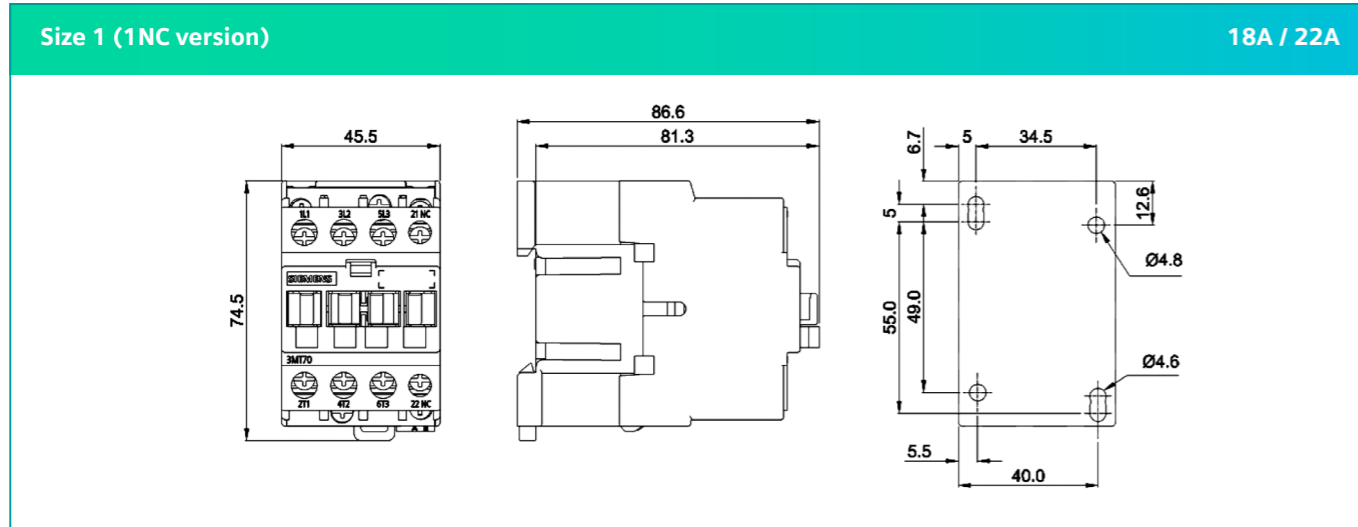

Note: All dimensions are in mm.

Dimension drawings

Contactors

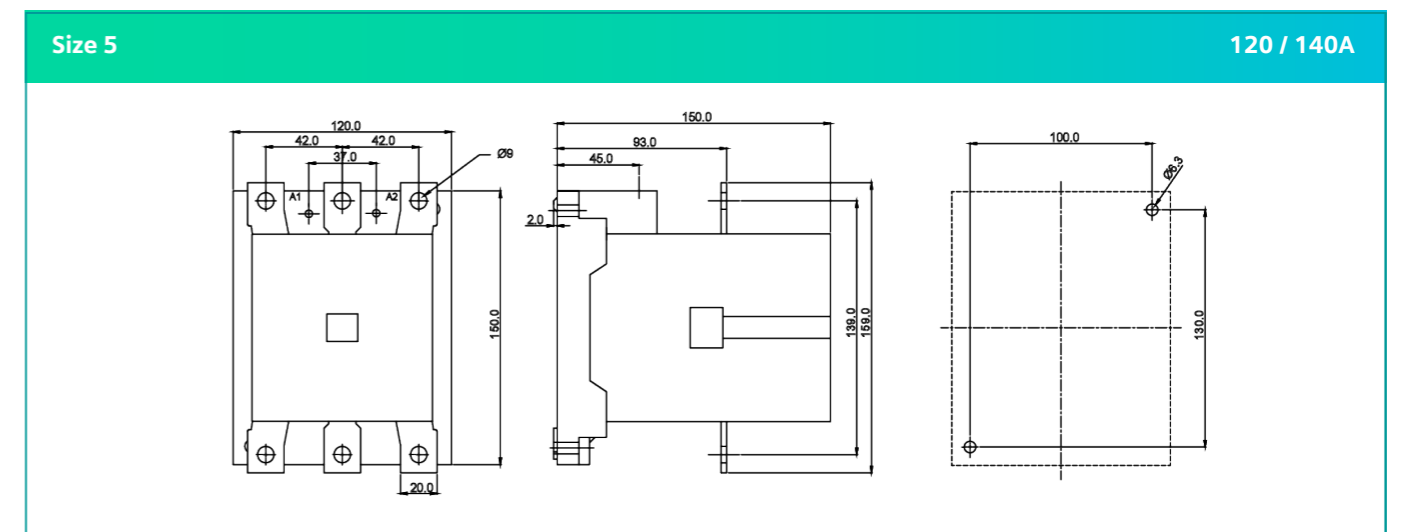
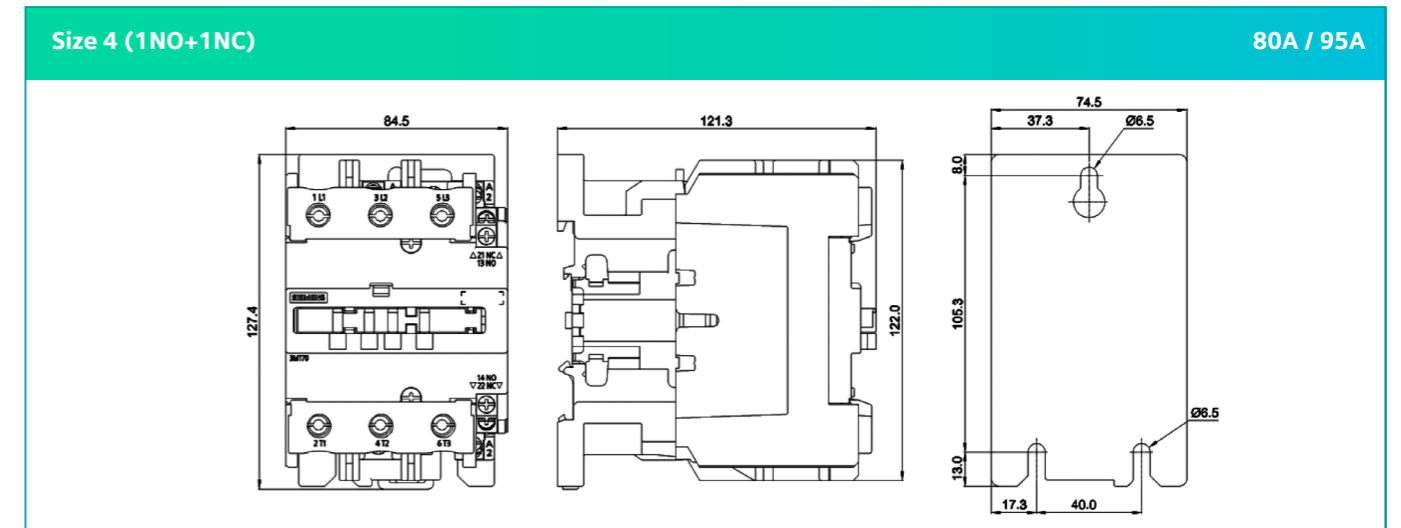
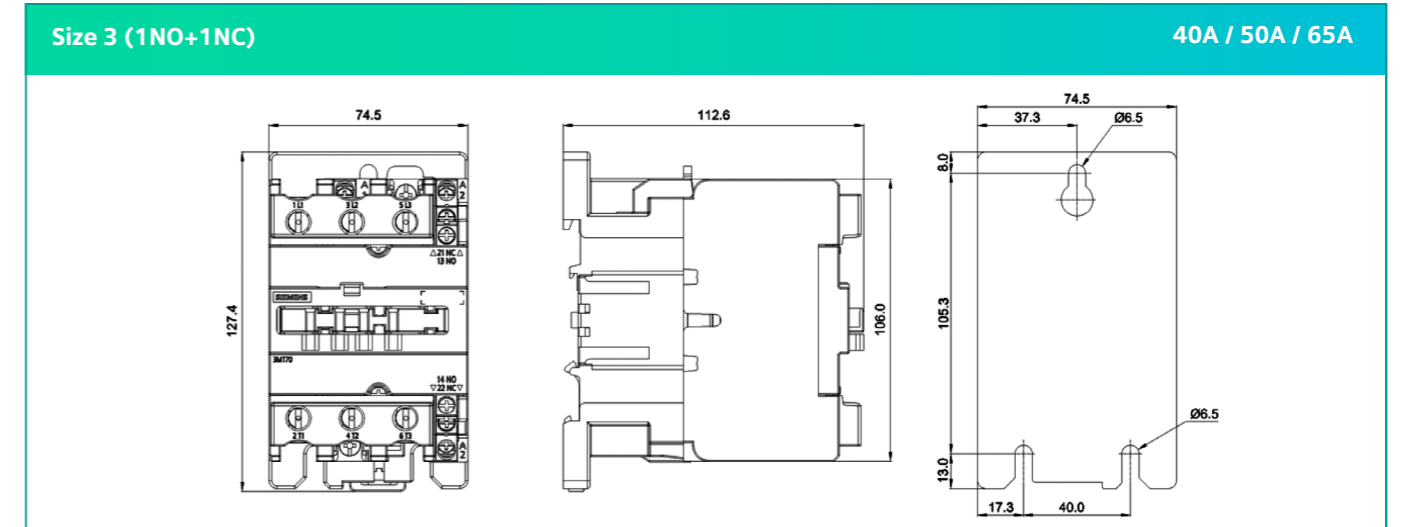

Note: All dimensions are in mm.

Dimension drawings

Contactors

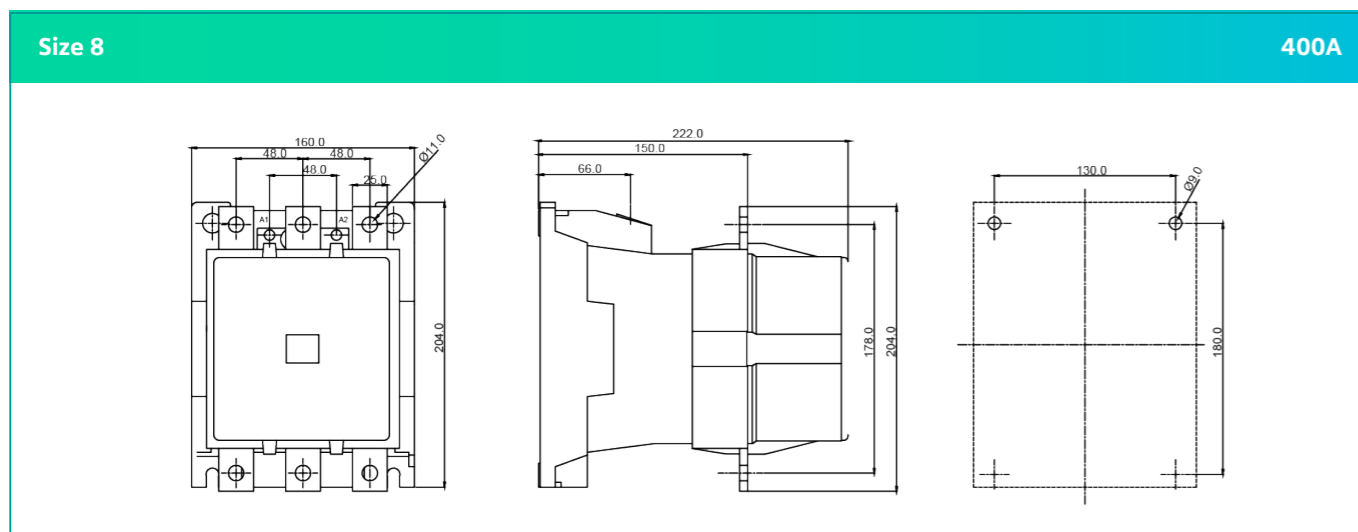
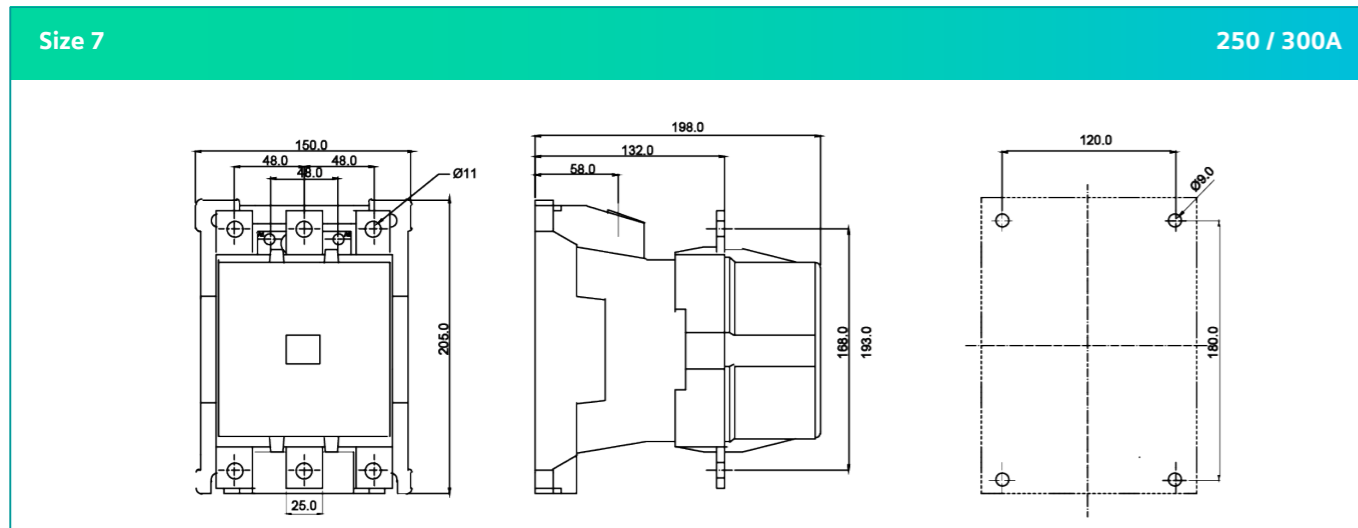
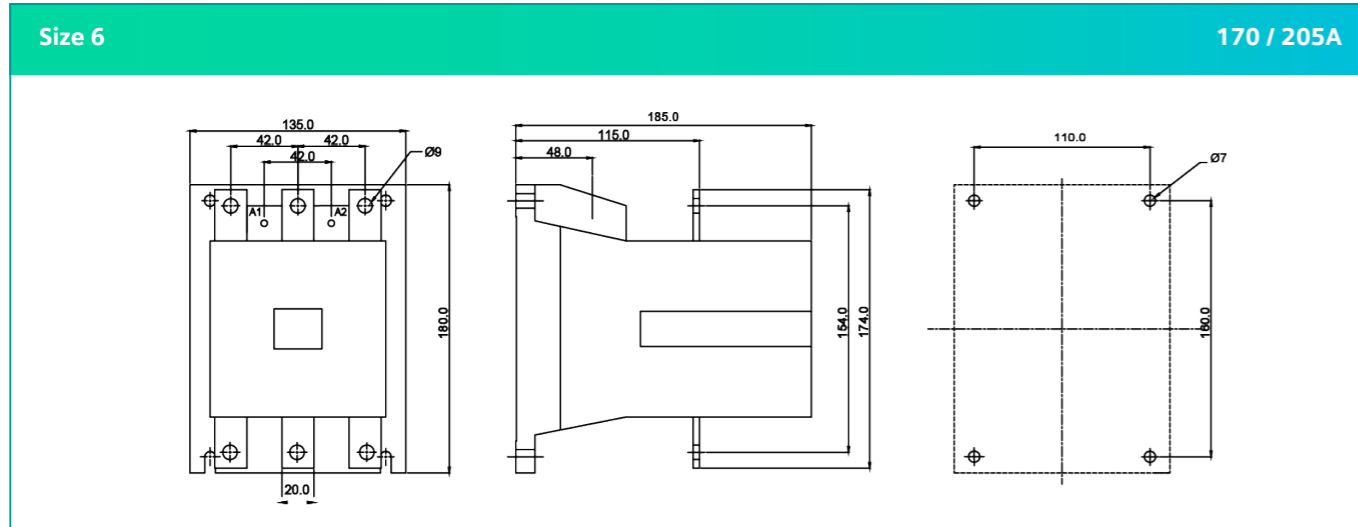

Note: All dimensions are in mm.

Dimension drawings

Accessories

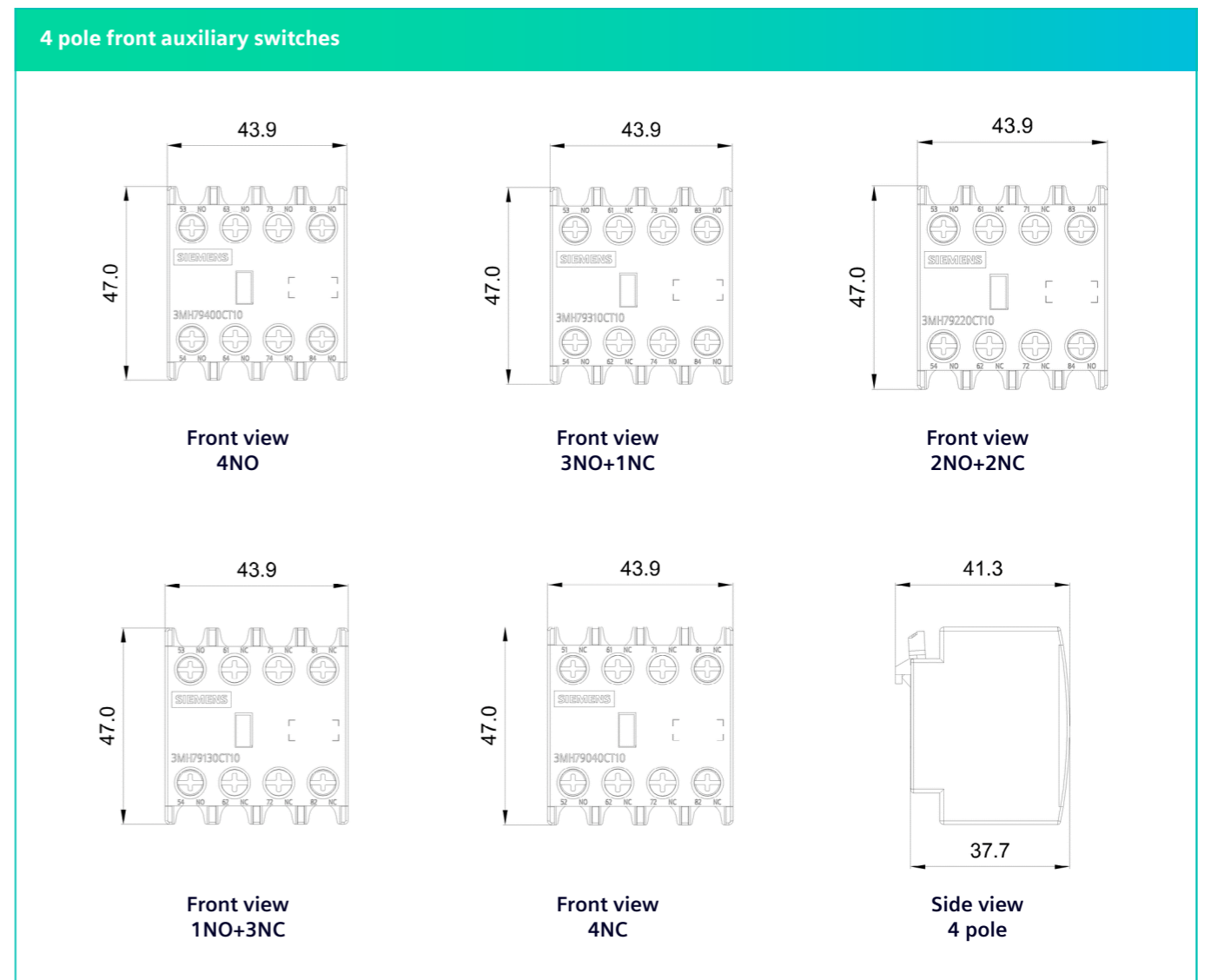
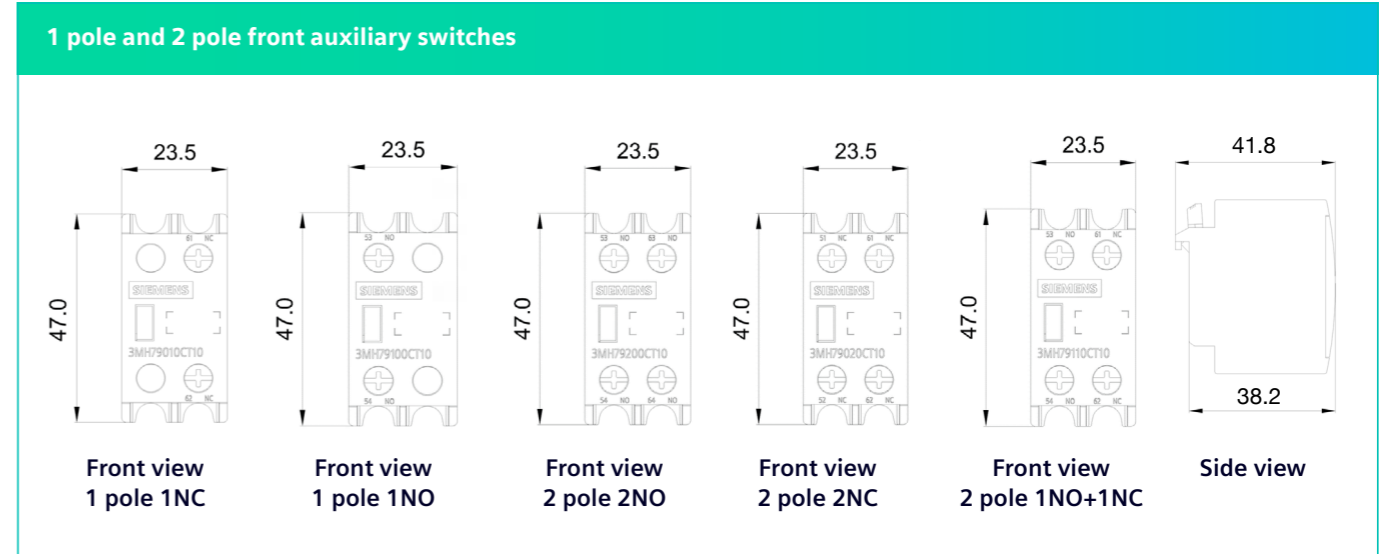

Note: All dimensions are in mm.

Dimension drawings

Accessories

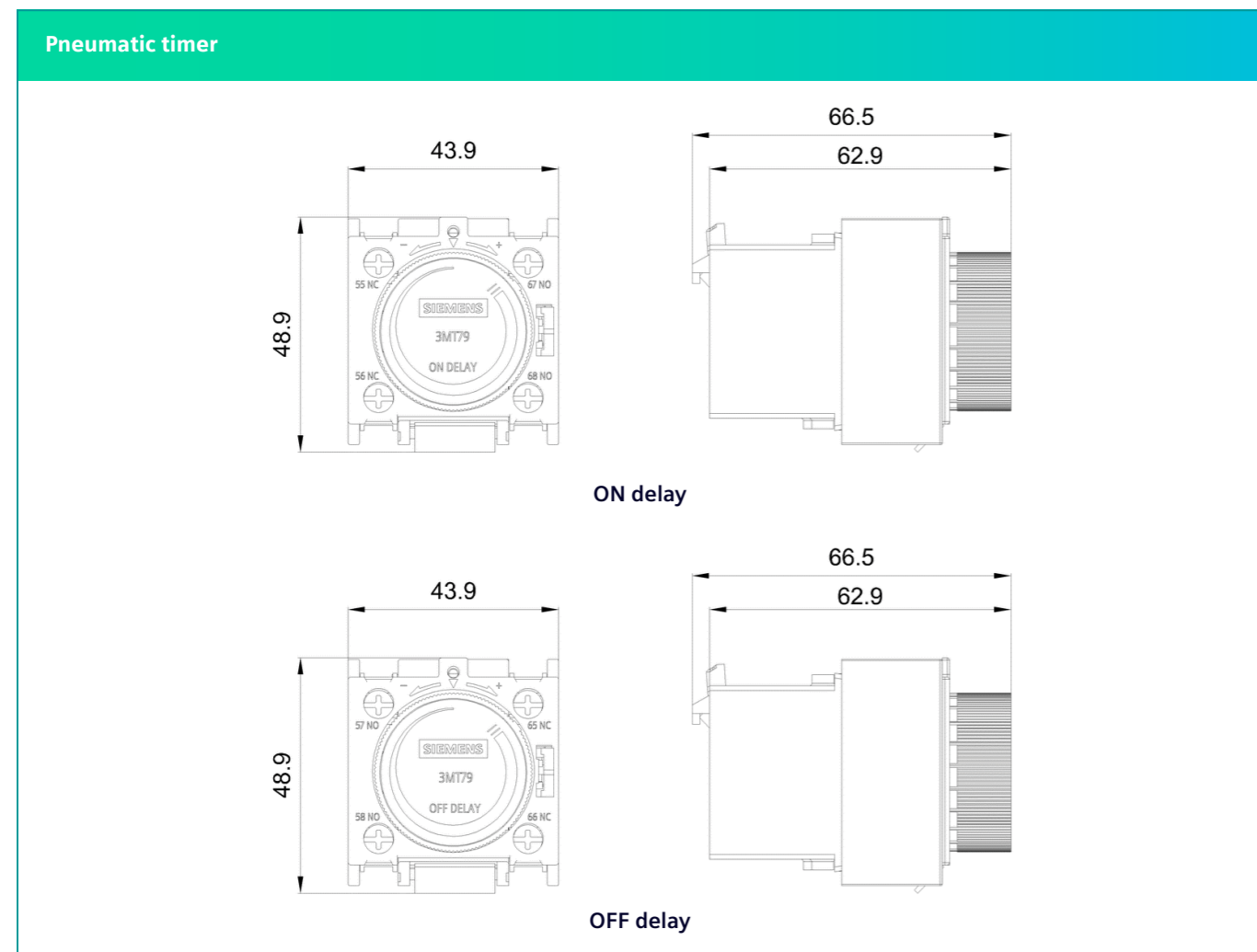
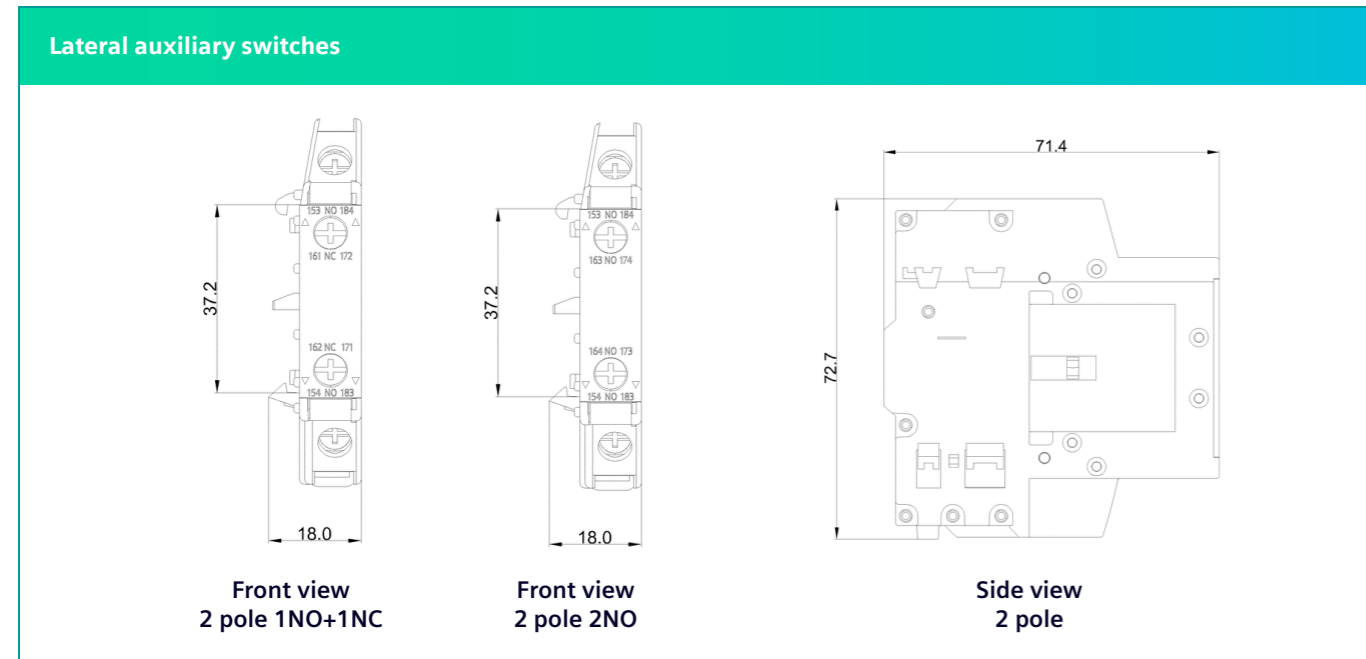

Note: All dimensions are in mm.

Dimension drawings

Accessories

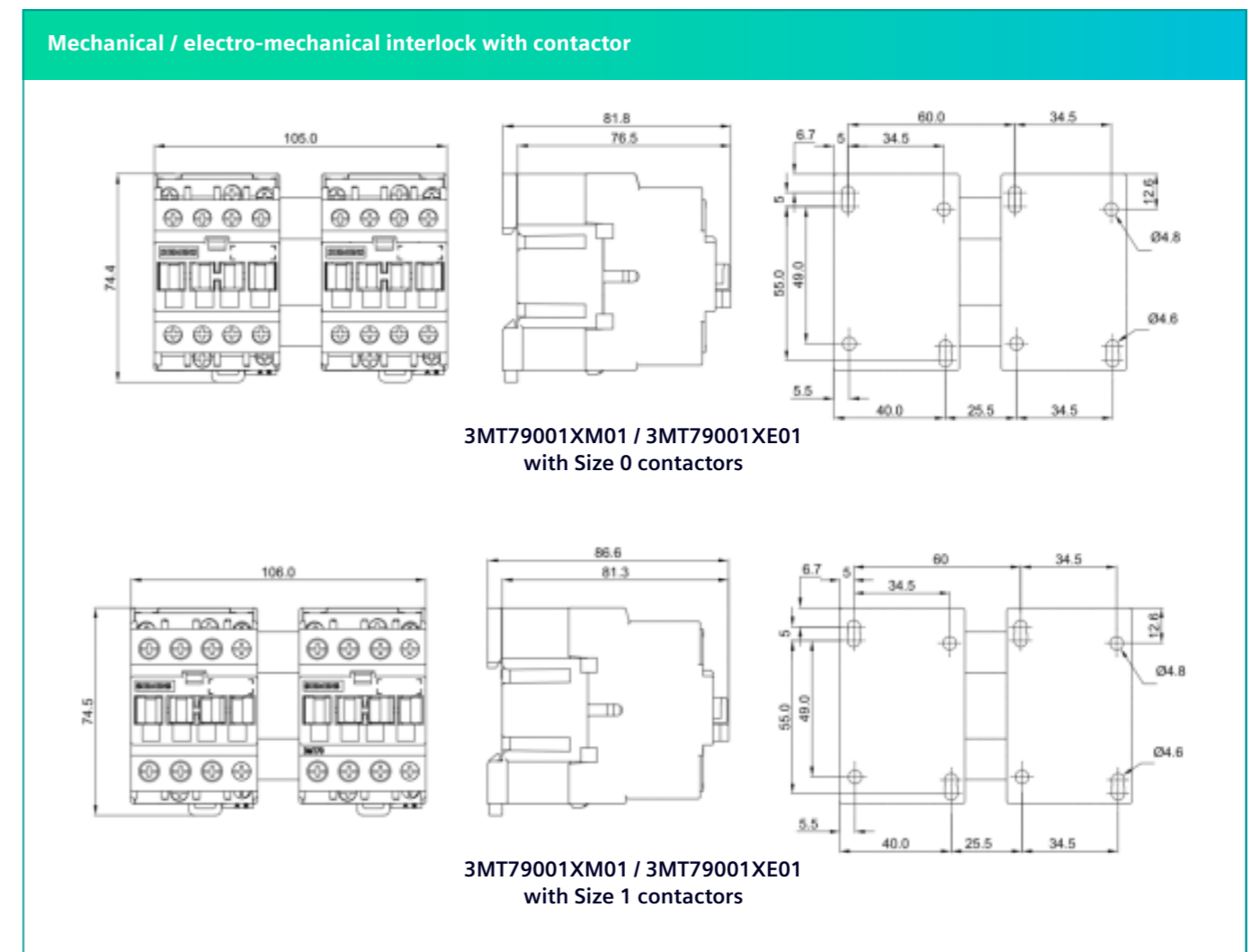

Note: All dimensions are in mm.

Dimension drawings

Accessories

Mechanical / electro-mechanical interlock with contactor

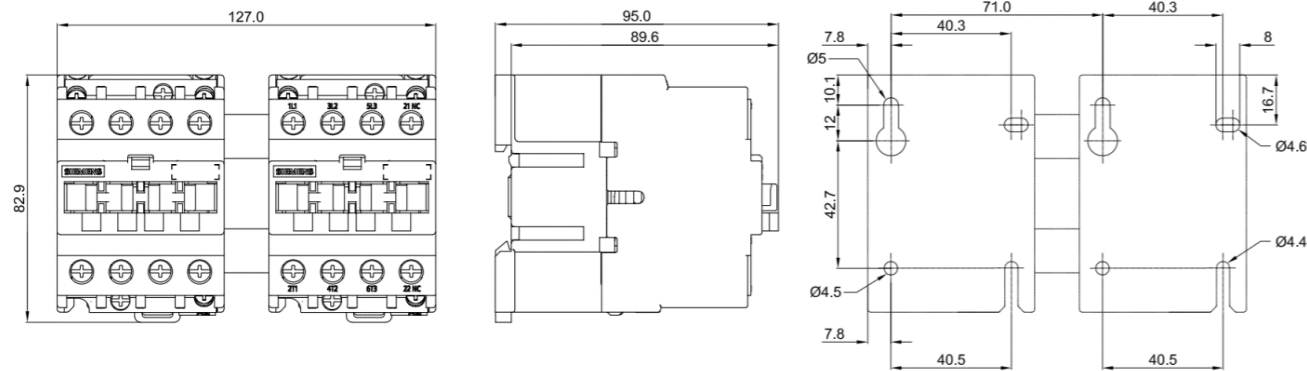

3MT79001XM01 / 3MT79001XE01
with Size 2 contactors

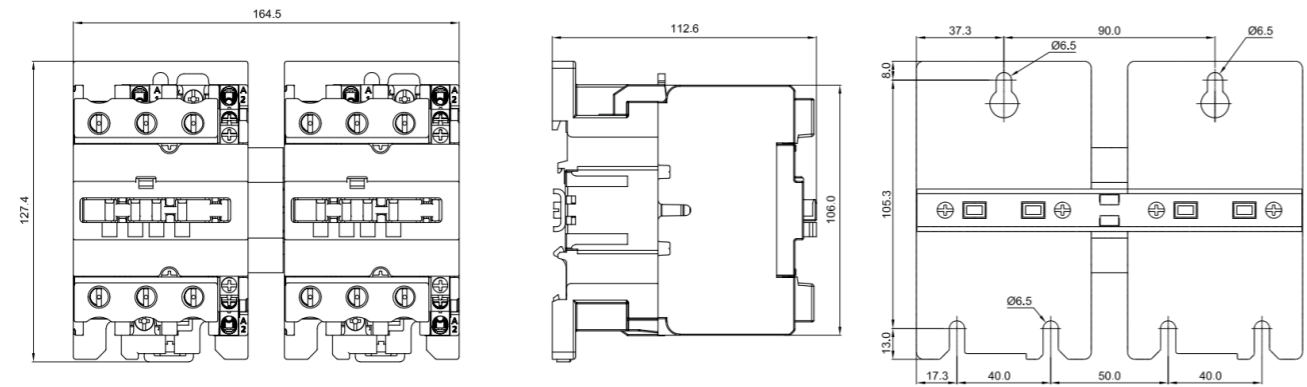

3MT79001XM02 / 3MT79001XE02
with Size 3 contactors

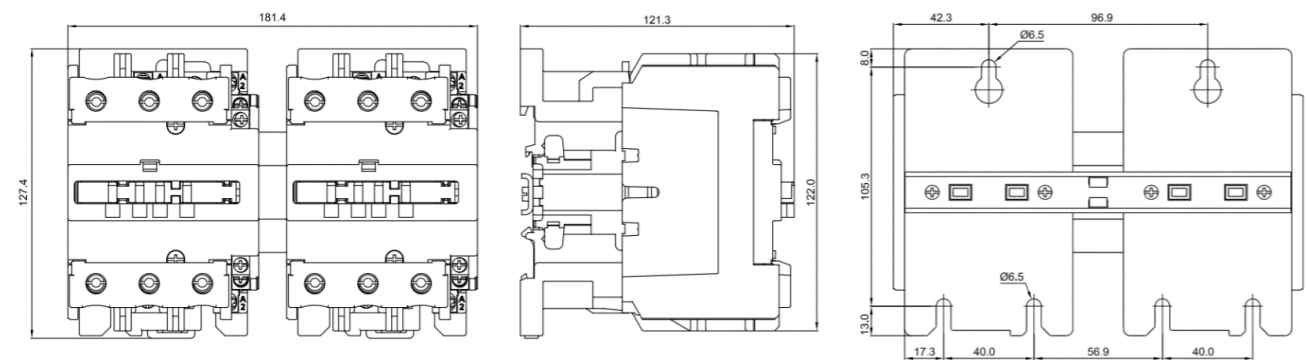

3MT79001XM03 / 3MT79001XE03
with Size 4 contactors

Note: All dimensions are in mm.

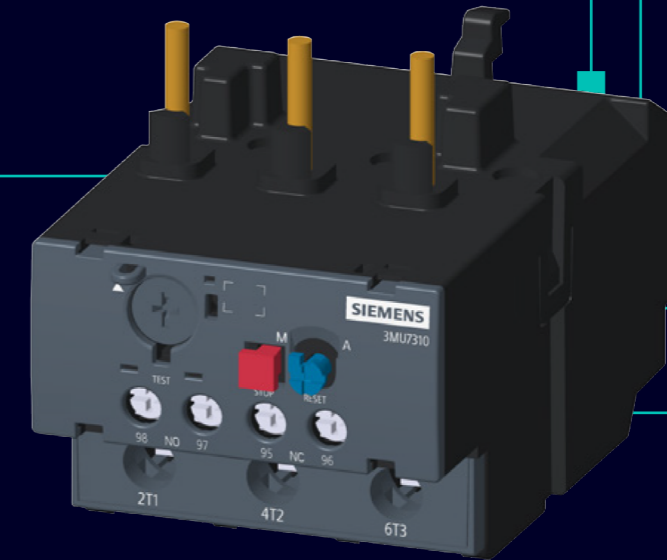

3MU7 overload relays

Overview	55
Technical specifications	58
Selection & ordering data	64
Wiring diagrams	66
Dimension drawings	67

SINOVA The Power of **Simplicity**

Overview

3MU7 thermal overload relays are designed for consistent motor protection in all standard applications. Coupled with the 3MT7 3 pole power contactors, they provide optimum control and protection for your motor feeders.

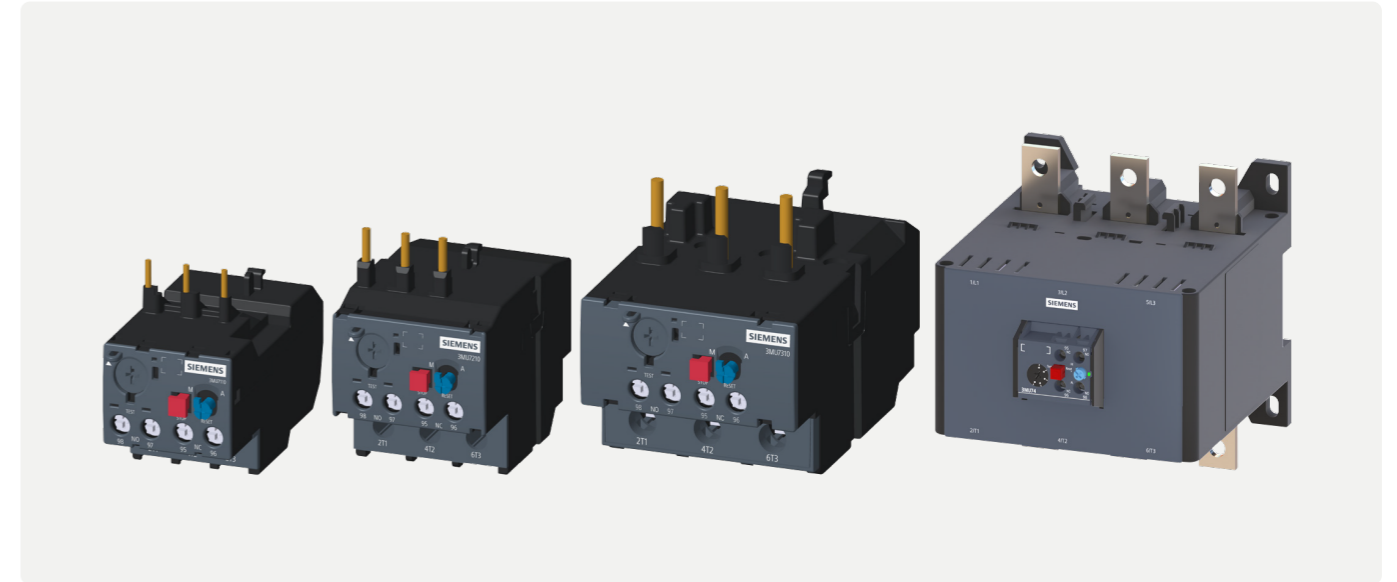

Article number scheme

Product version		Article no.								
Thermal overload relays		3MU7	<input type="checkbox"/>	<input type="checkbox"/>	<input type="checkbox"/>	-	<input type="checkbox"/>	<input type="checkbox"/>	A	<input type="checkbox"/>
Size	e.g. 0 = Size 1		1							
Class	10 = Class 10			1	0					
Setting range for overload release	e.g. 0A = 0.10-0.16A						0	A		
Installation type	e.g. 0 = Mounting on contactor 1 = Independent mounting									0
Example		3MU7	1	1	0	-	0	A	A	0

Note:

The above scheme shows an overview of the product versions to understand the logic behind the article number. For your orders, refer to the selection and ordering data.

Overview

Thermal overload relays & the matching 3 pole power contactors

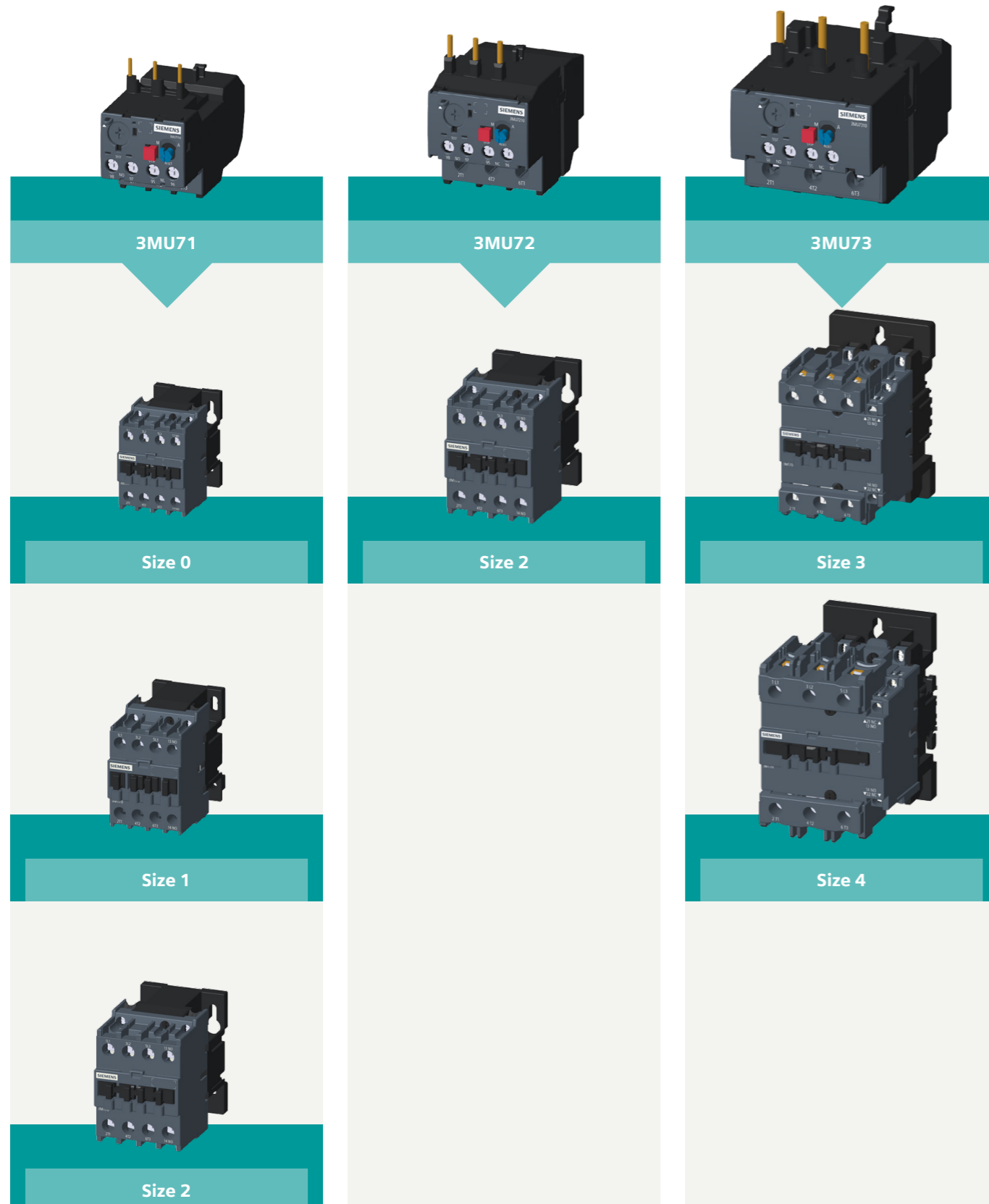

Overview

Functions

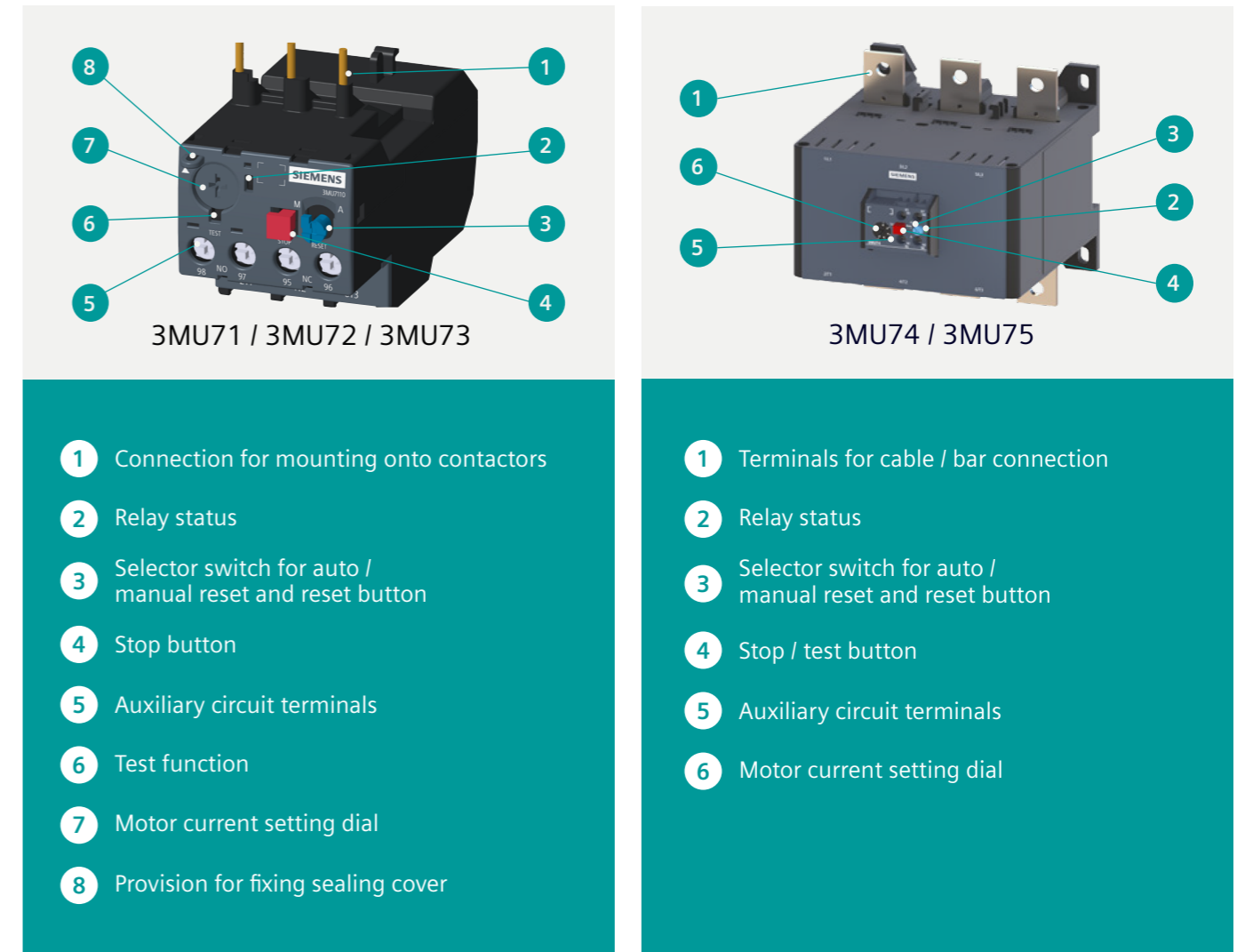

Protection

- Tripping due to overload
- Tripping due to single-phase failure

Application

Our 3MU7 thermal overload relays are suitable for applications that require optimum inverse-time delayed protection of three-phase or single-phase AC motors. In the case of a single-phase motor, all the conducting paths of the relay must be connected in series. 3MU71 / 3MU72 / 3MU73 relays comply with tripping class 10 and 3MU74 / 3MU75 relays comply to tripping class 10A as per IEC 60947-4-1. The 3MU7 thermal overload relays compensate ambient temperature from the range of -5 to +55°C according to IEC 60947-4-1.

Technical specifications

3MU7 thermal overload relays

Type	3MU71	3MU72	3MU73	
General data				
Dimension (W x H x D)				
• Basic unit	mm	44 x 63.6 x 91.8	54 x 76.1 x 92.4	70 x 79.2 x 115
Tripping in the event of	Overload, single-phase failure			
Trip class acc. to IEC 60947-4-1	Class 10			
Reset	Manual			
Recovery	Minimum recovery time depends on the strength of the tripping current and characteristic			
Rated insulation voltage U_i (pollution degree 3)	V	690		
Rated impulse withstand voltage U_{imp}	Main circuit kV Aux circuit kV	6 4		
Permissible ambient temperature				
During operation	°C	-5 ... +55		
During storage	°C	-25 ... +70		
Relative air humidity	%	10 ... 95		
Degree of protection IP on the front		IP20		
Installation altitude at height above sea level, maximum	m	2000		
Mounting position		22.5° inclination forward and backward, and ± 90° rotation, in relation to normal vertical mounting plane		
Type of mounting		Direct mounting on contactor Or stand-alone installation by screw fixing Or snap-on mounting on standard mounting rail		

Technical specifications

3MU7 thermal overload relays

Type	3MU71	3MU72	3MU73	
Main circuit				
Rated operational voltage U_e	V	400 / 690 (L-N / L-L)		
Operating frequency	Hz	50 / 60		
Current setting	A	0.10 ... 0.16 to 17 ... 25	23 ... 32 to 28 ... 36	23 ... 32 to 80 ... 93
Power loss for rated current in hot state (maximum)	W	16.2	16.5	25.5
• Per pole (maximum)	W	5.4	5.5	8.5
Short circuit protection		Refer "Selection & ordering data" Refer Type-2 coordination charts		
• With fuse without contactor				
• With fuse with contactor				
Auxiliary circuit				
Number of NO contacts		1		
Number of NC contacts		1		
Auxiliary contacts – Assignment		1 NO for the signal "tripped"; 1 NC for disconnecting the contactor		
Contact rating of the auxiliary contacts				
• AC-12 at 690V	A	5		
• AC-15 at rated operational voltage U_e				
- 24V	A	4.17		
- 48V	A	4.17		
- 110V	A	3.64		
- 220V	A	2.73		
- 380V	A	1.58		
- 600V	A	1		
- 690V	A	0.7		

Technical specifications

3MU7 thermal overload relays

Type	3MU71	3MU72	3MU73	
<ul style="list-style-type: none"> DC-13, at rated operational voltage U_e (1 conducting path) - 24V - 48V - 110V - 220V - 440V 	A	4.17	2.08	
<ul style="list-style-type: none"> - 24V - 48V - 110V - 220V - 440V 	A	0.45	0.2	
<ul style="list-style-type: none"> - 24V - 48V - 110V - 220V - 440V 	A	0.2	0.05	
<ul style="list-style-type: none"> - 24V - 48V - 110V - 220V - 440V 	A	0.05		
Short circuit protection of auxiliary circuit				
<ul style="list-style-type: none"> With fuse links of operational class gG: 	A	10		
Conductor cross-sections				
Main conductors				
Solid or stranded	mm ²	1 x (1 ... 6 mm ²)	1 x (1.5 ... 10mm ²)	1 x (4 ... 35 mm ²)
Finely stranded with end sleeve	mm ²	1x (1 ... 10 mm ²)	1x (1.5 ... 10 mm ²)	1x (2.5 ... 35 mm ²)
<ul style="list-style-type: none"> Terminal screw 		M4	M4	M10
<ul style="list-style-type: none"> Tightening torque 	Nm	1.85	2.5	9
Auxiliary conductors				
Solid or stranded	mm ²		1 x (1.0 ... 4.0 mm ²)	
Finely stranded with end sleeve	mm ²		1 x (1.0 ... 4.0 mm ²)	
<ul style="list-style-type: none"> Terminal screw 			M3.5	
<ul style="list-style-type: none"> Tightening torque 	Nm		1.2	

Technical specifications

3MU7 thermal overload relays

Type	3MU74	3MU75	
General data			
Dimension (W x H x D)			
<ul style="list-style-type: none"> Basic unit 	mm	147 x 157 x 173	
Tripping in the event of		Overload, single-phase failure	
Trip class acc. to IEC 60947-4-1		Class 10A	
Reset		Manual and remote reset	
Recovery		Minimum recovery time depends on the strength of the tripping current and characteristic	
Rated insulation voltage U_i (pollution degree 3)	V	1000	
Rated impulse withstand voltage U_{imp}	Main circuit Aux circuit	kV kV	8 6
Permissible ambient temperature			
During operation	°C	-5 ... +55	
During storage	°C	-25 ... +70	
Relative air humidity	%	10 ... 95	
Degree of protection IP on the front		IP00	
Installation altitude at height above sea level, maximum	m	2000	
Mounting position		22.5° inclination forward and backward, and ± 90° rotation, in relation to normal vertical mounting plane	
Type of mounting		Stand-alone installation by screw fixing	

Technical specifications

3MU7 thermal overload relays

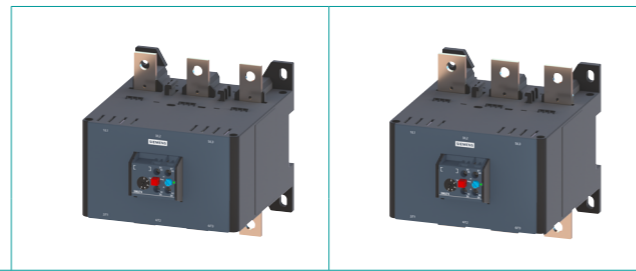

Type		3MU74	3MU75
Main circuit			
Rated operational voltage U_e	V	230 / 400 (L-N / L-L)	
Operating frequency	Hz	50 / 60	
Current setting	A	85-135 to 250-400	312-500
Power loss for rated current in hot state (maximum)	W	33.6	45
	• Per pole (maximum)	11.2	15
Short circuit protection of main circuit • With fuse links of operational class gG without contactor:	A	Refer "Selection & ordering data"	
Auxiliary circuit			
Number of NO contacts		1	
Number of NC contacts		1	
Auxiliary contacts – Assignment		1 NO for the signal "tripped"; 1 NC for disconnecting the contactor	
Contact rating of the auxiliary contacts			
• AC-12 at 690V	A	6	
• AC-15 at rated operational voltage U_e	- 24V	A	2
	- 48V	A	1.25
	- 110V	A	1.25
	- 220V	A	1.15
	- 380V	A	1
	- 600V	A	0.3
	- 690V	A	0.3

Technical specifications

3MU7 thermal overload relays

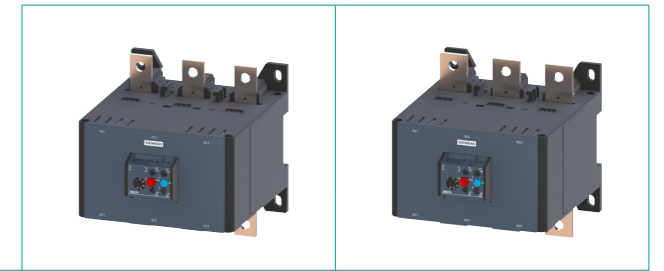

Type		3MU74	3MU75	
• DC-13, at rated operational voltage U_e (1 conducting path)	- 24V	A	1	
	- 48V	A	0.4	
	- 110V	A	0.22	
	- 220V	A	0.1	
	Short circuit protection of auxiliary circuit			
• With fuse links of operational class at 690V gG:	A	6		
Conductor cross-sections				
Main conductors		3MU7410-3BA1	3MU7410-3EA1	3MU7510-4AA1
Flexible cable with Lugs	mm ²	2 x (25 ... 95)	2 x (70 ... 240)	2 x (150 ... 240)
Terminal bar (max. width)	mm	2 x 20 x 3	2 x 25 x 3	2 x 30 x 5
• Terminal screw - Tightening torque		M8	M10	M10
	Nm	10-14	14-24	14-24
Auxiliary contacts				
Solid or stranded	mm ²	2 x (1.0 ... 2.5 mm ²)		
Finely stranded with end sleeve	mm ²	2 x (0.75 ... 1.5 mm ²)		
• Terminal screw - Tightening torque		M3.5		
	Nm	0.8-1.2		



Selection & ordering data

3MU7 thermal overload relays

Size	Trip class	Rated power three-phase motor at 400V	Current setting value	Short circuit protection with fuse, type of coordination "2" (operational class gG)	Suitable for contactor size	Article no.	List price per PU (Per Unit)
		kW	A	A			
	Class 10	0.04	0.10-0.16	2	0, 1, 2	3MU7110-0AA0	
	Class 10	0.06	0.16-0.25	2	0, 1, 2	3MU7110-0BA0	
	Class 10	0.09	0.25-0.40	2	0, 1, 2	3MU7110-0CA0	
	Class 10	0.18	0.40-0.63	2	0, 1, 2	3MU7110-0DA0	
	Class 10	0.25	0.63-1	4	0, 1, 2	3MU7110-0EA0	
	Class 10	0.55	1-1.6	4	0, 1, 2	3MU7110-0FA0	
	Class 10	0.75	1.25-2	6	0, 1, 2	3MU7110-0GA0	
	Class 10	0.75	1.6-2.5	6	0, 1, 2	3MU7110-0HA0	
	Class 10	1.5	2.5-4	10	0, 1, 2	3MU7110-0JA0	
	Class 10	2.2	4-6	16	0, 1, 2	3MU7110-0KA0	
	Class 10	3	5.5-8	20	0, 1, 2	3MU7110-0LA0	
	Class 10	4	7-10	20	0, 1, 2	3MU7110-0MA0	
	Class 10	5.5	9-13	25	0, 1, 2	3MU7110-0NA0	
	Class 10	7.5	12-18	32	1, 2	3MU7110-0PA0	
Class 10	11	17-25	50	1, 2	3MU7110-0QA0		
	Class 10	15	23-32	63	2	3MU7210-1AA0	
	Class 10	18.5	28-36	63	2	3MU7210-1BA0	
	Class 10	15	23-32	63	3, 4	3MU7310-2AA0	
	Class 10	18.5	30-40	80	3, 4	3MU7310-2BA0	
	Class 10	22	37-50	80	3, 4	3MU7310-2CA0	
	Class 10	30	48-65	80	3, 4	3MU7310-2DA0	
	Class 10	37	55-70	125	4	3MU7310-2EA0	
	Class 10	37	63-80	125	4	3MU7310-2FA0	
	Class 10	45	80-93	125	4	3MU7310-2GA0	

Selection & ordering data

3MU7 thermal overload relays

Size	Trip class	Current setting value	Short circuit protection with fuse, type of coordination "2" (operational class gG)	Suitable for contactor size	Article no.	List price per PU (Per Unit)
	Class 10A	85-135A	224	Screw mounting	3MU7410-3AA1	
	Class 10A	115-180A	250	Screw mounting	3MU7410-3BA1	
	Class 10A	160-250A	355	Screw mounting	3MU7410-3CA1	
	Class 10A	200-320A	400	Screw mounting	3MU7410-3DA1	
	Class 10A	250-400A	500	Screw mounting	3MU7410-3EA1	
	Class 10A	312-500A	500	Screw mounting	3MU7510-4AA1	

Accessories

Type	Overload relay size	Article no.	List price per PU (Per Unit)
	1	3MU7900-0MA10	
	2	3MU7900-0MA20	
	3	3MU7900-0MA30	
	1	3MU7900-0CA00	
	2		
	3		

Note: Accessories shown are only applicable to 3MU71, 3MU72 and 3MU73.

Wiring diagrams

3MU7 thermal overload relays

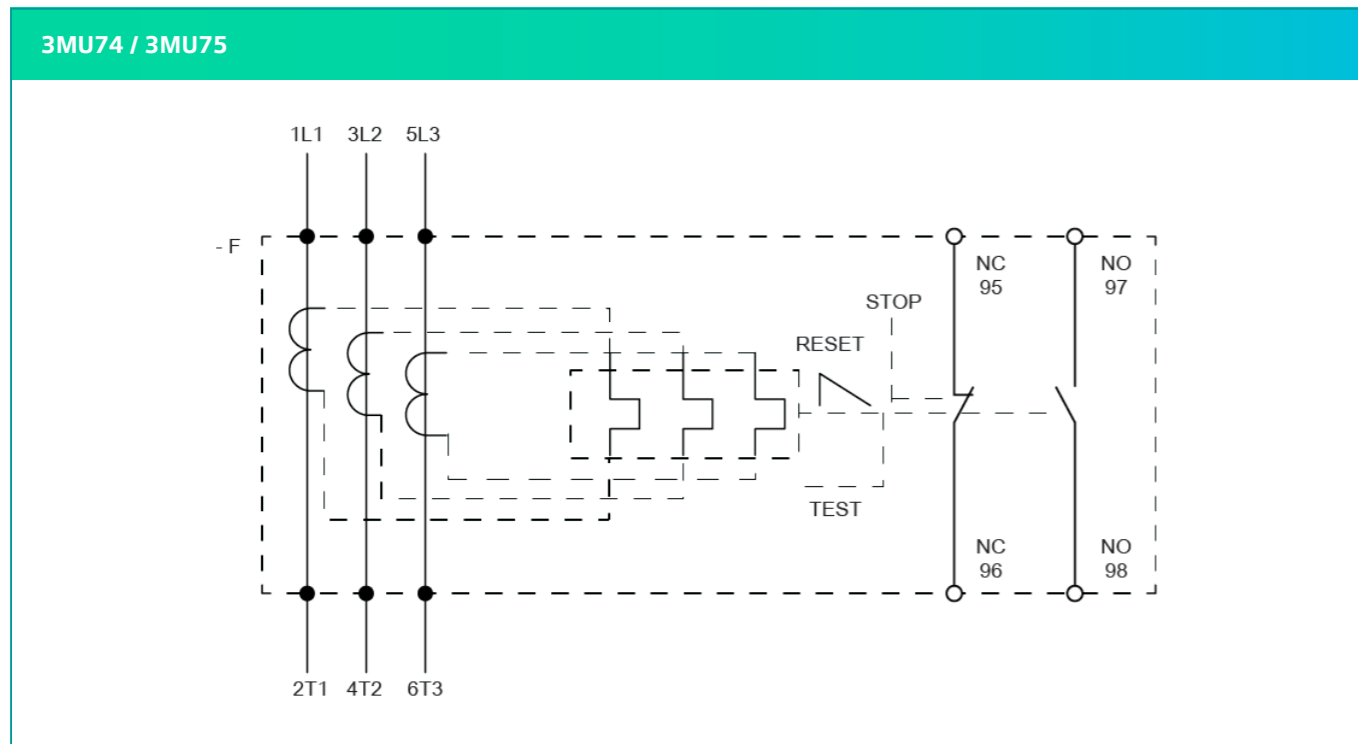
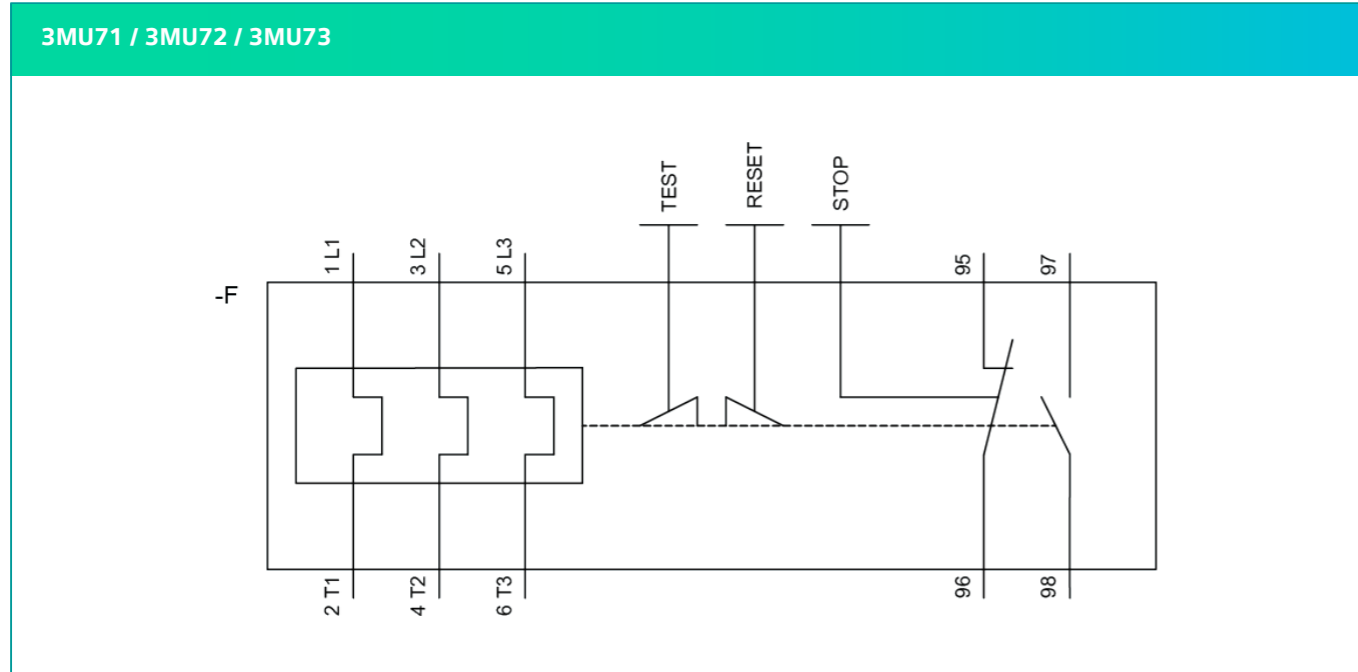

Dimension drawings

3MU7 thermal overload relays (with contactor)

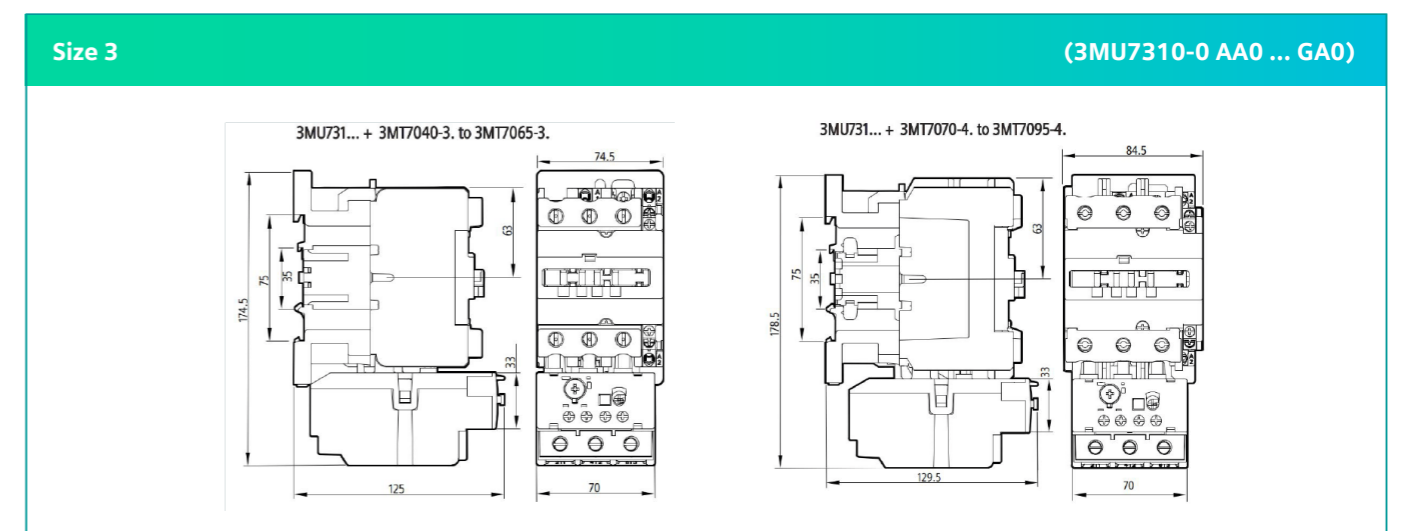
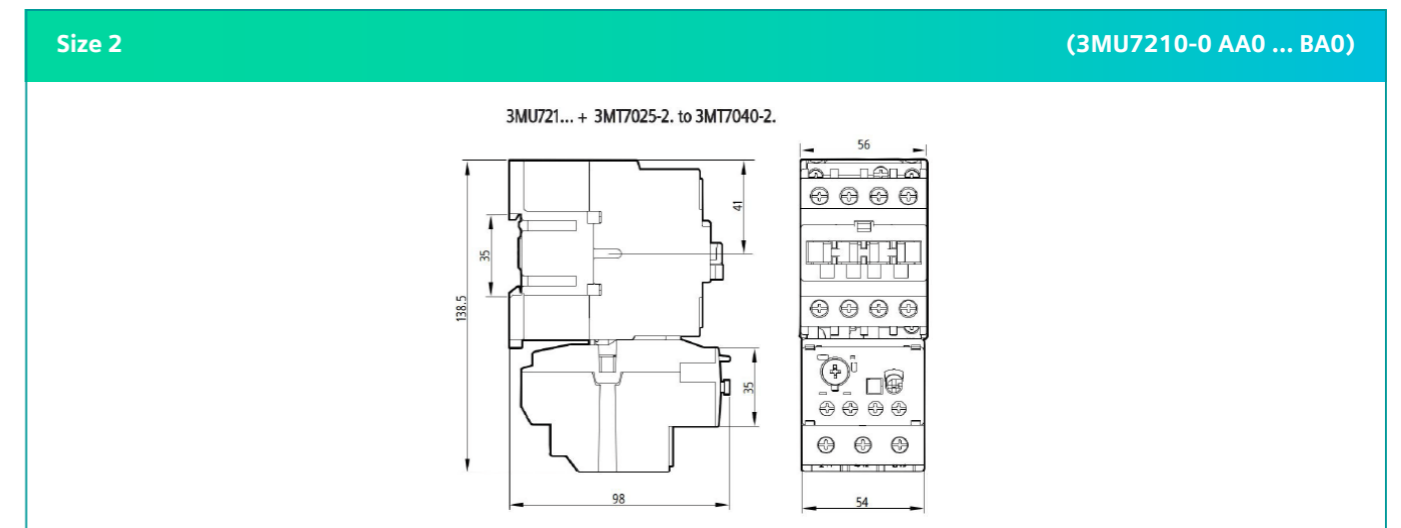
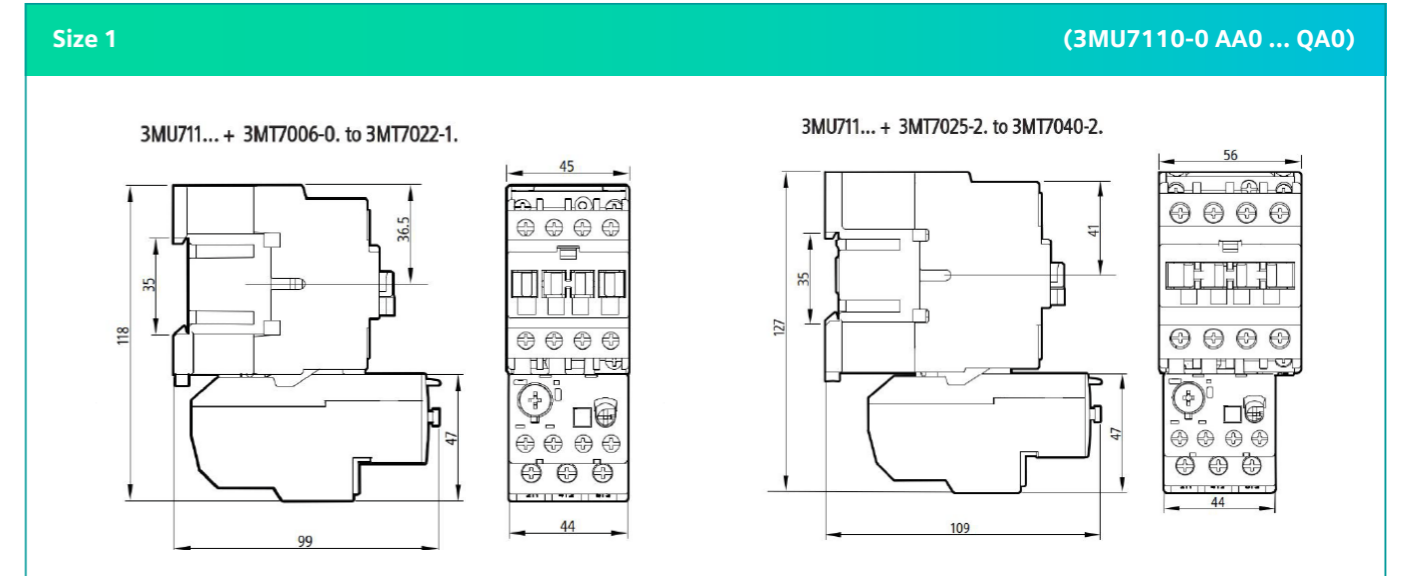

Note: All dimensions are in mm.

Dimension drawings

3MU7 thermal overload relays
(with stand-alone installation kit)

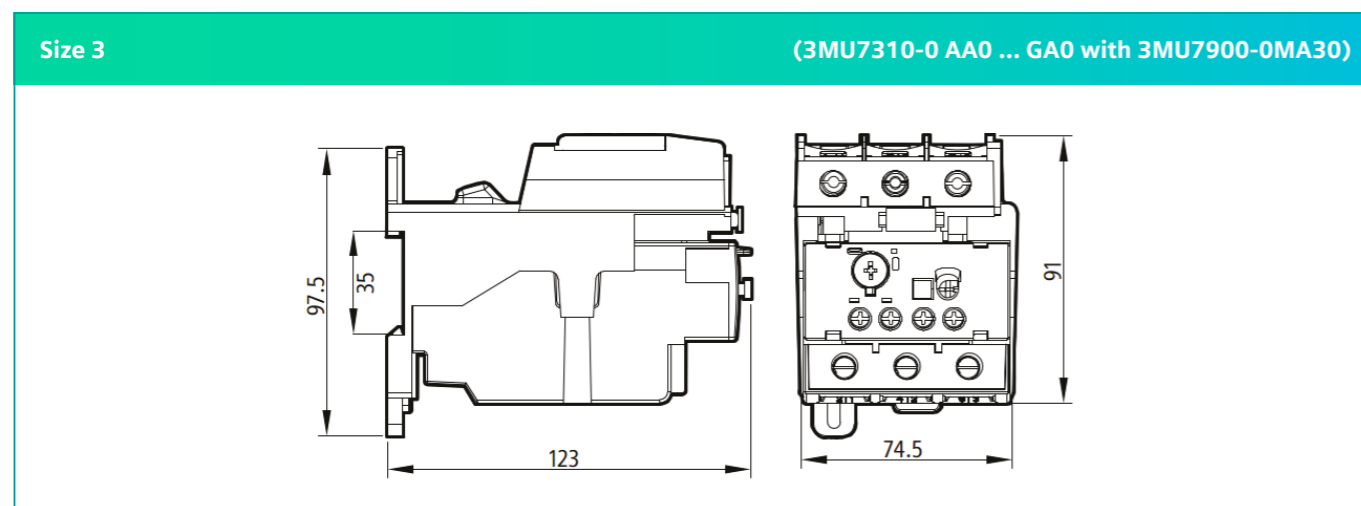
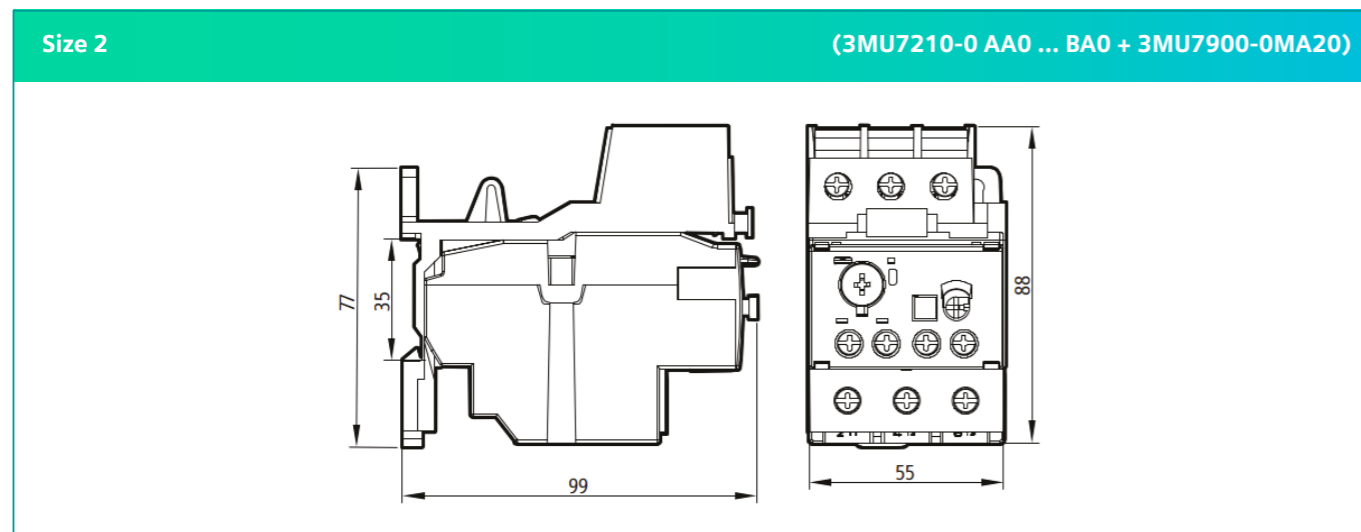
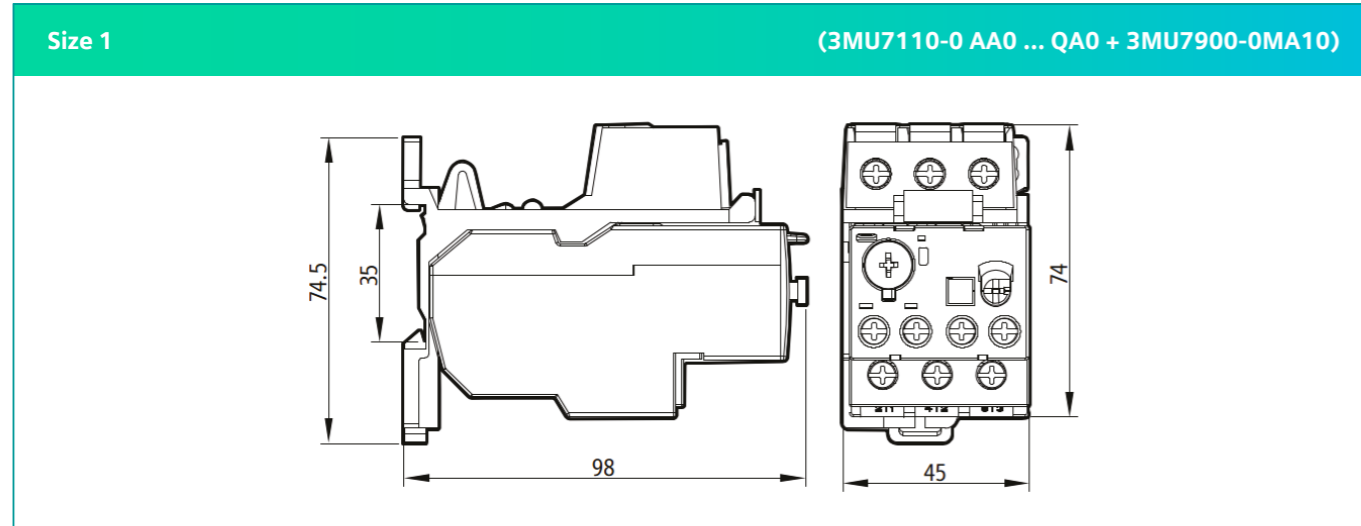

Note: All dimensions are in mm.

Dimension drawings

3MU7 thermal overload relays (stand-alone)

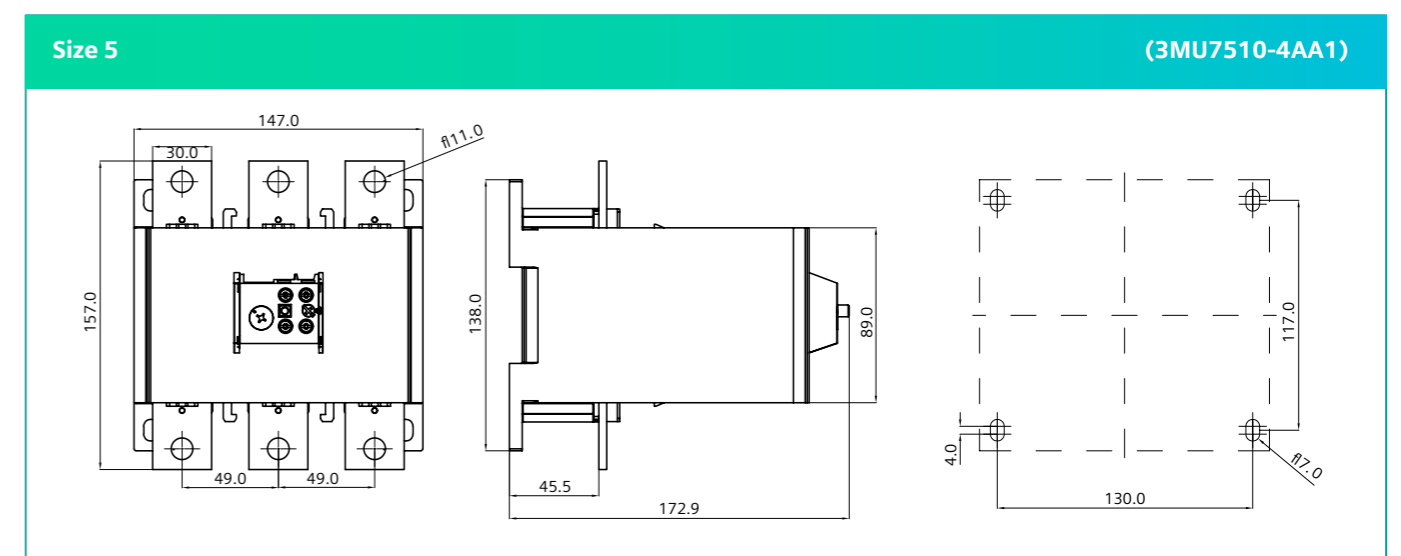
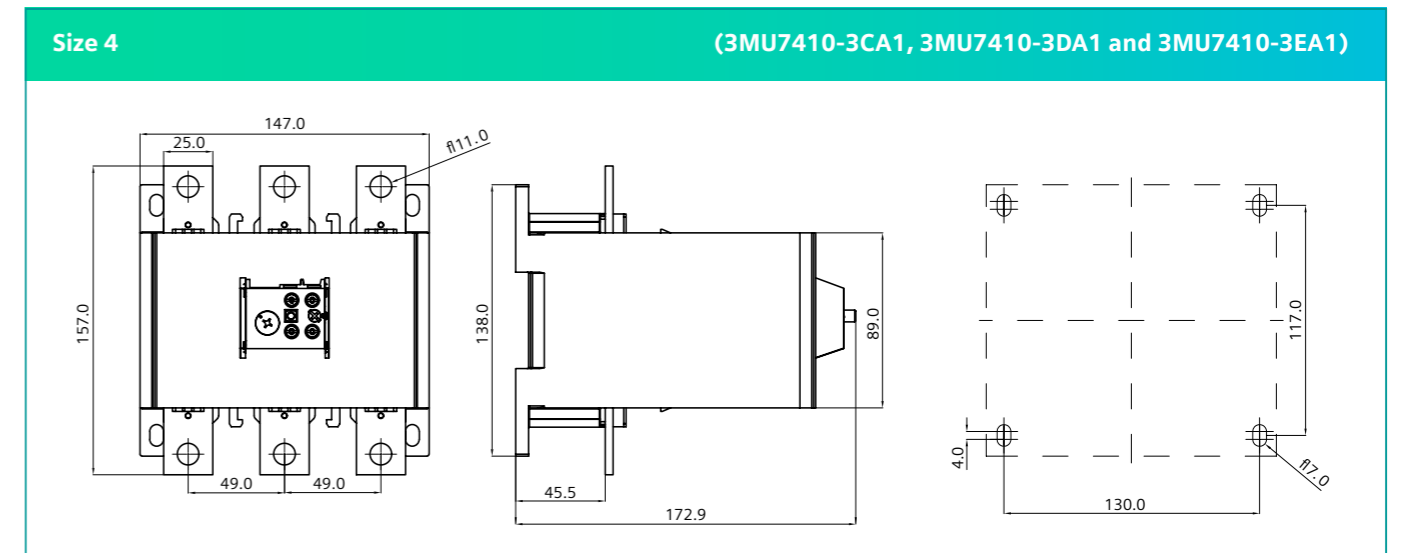
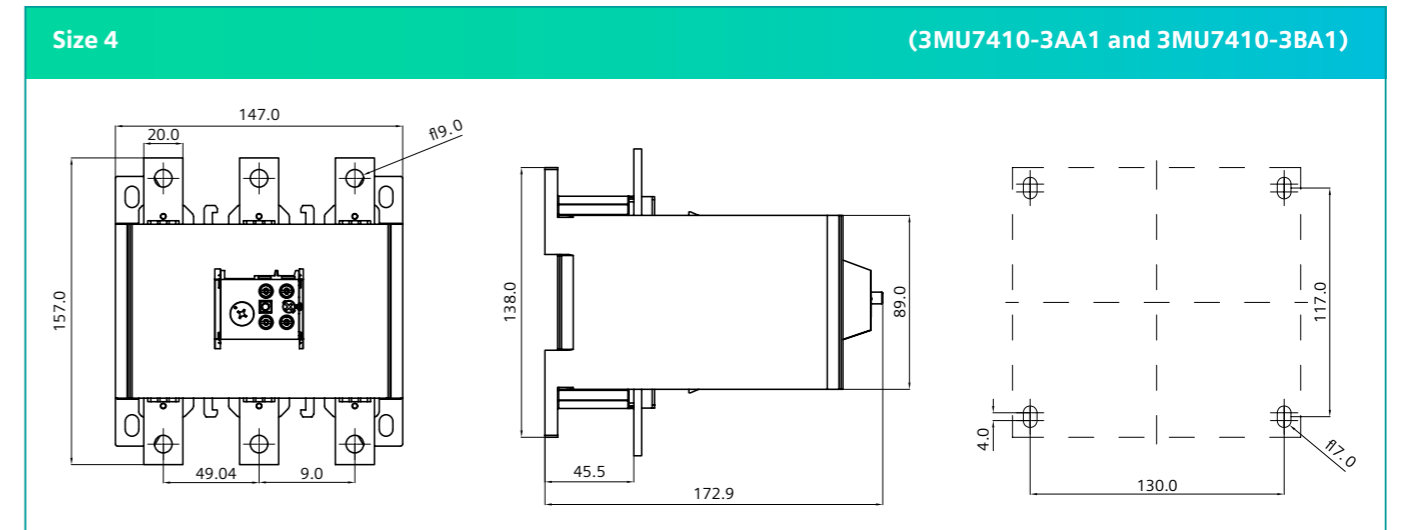

Note: All dimensions are in mm.

3MV8 motor starter protectors

Overview	71
Technical specifications	73
Selection & ordering data	76
Wiring diagrams	79
Dimension drawings	80

SINOVA The Power of **Simplicity**

Overview

Our 3MV8 motor starter protectors are a cost-efficient and reliable solution for a motor starting and protection. These are available in 2 frame sizes up to 52A. These come with optional built-in 1NO+1NC aux contacts.



Article number scheme

Product version	Article no.						
	3MV8	<input type="checkbox"/>	00	-	<input type="checkbox"/>	<input type="checkbox"/>	00
Motor starter protector							
Frame size		1					
Inbuilt aux contacts					1		
Current setting						MJ	
Example	3MV8	1	00	-	1	MJ	00

Note:
The article no. scheme shows an overview of product versions to understand the logic behind the article numbers. For your orders, please use the article numbers quoted in the selection and ordering data.

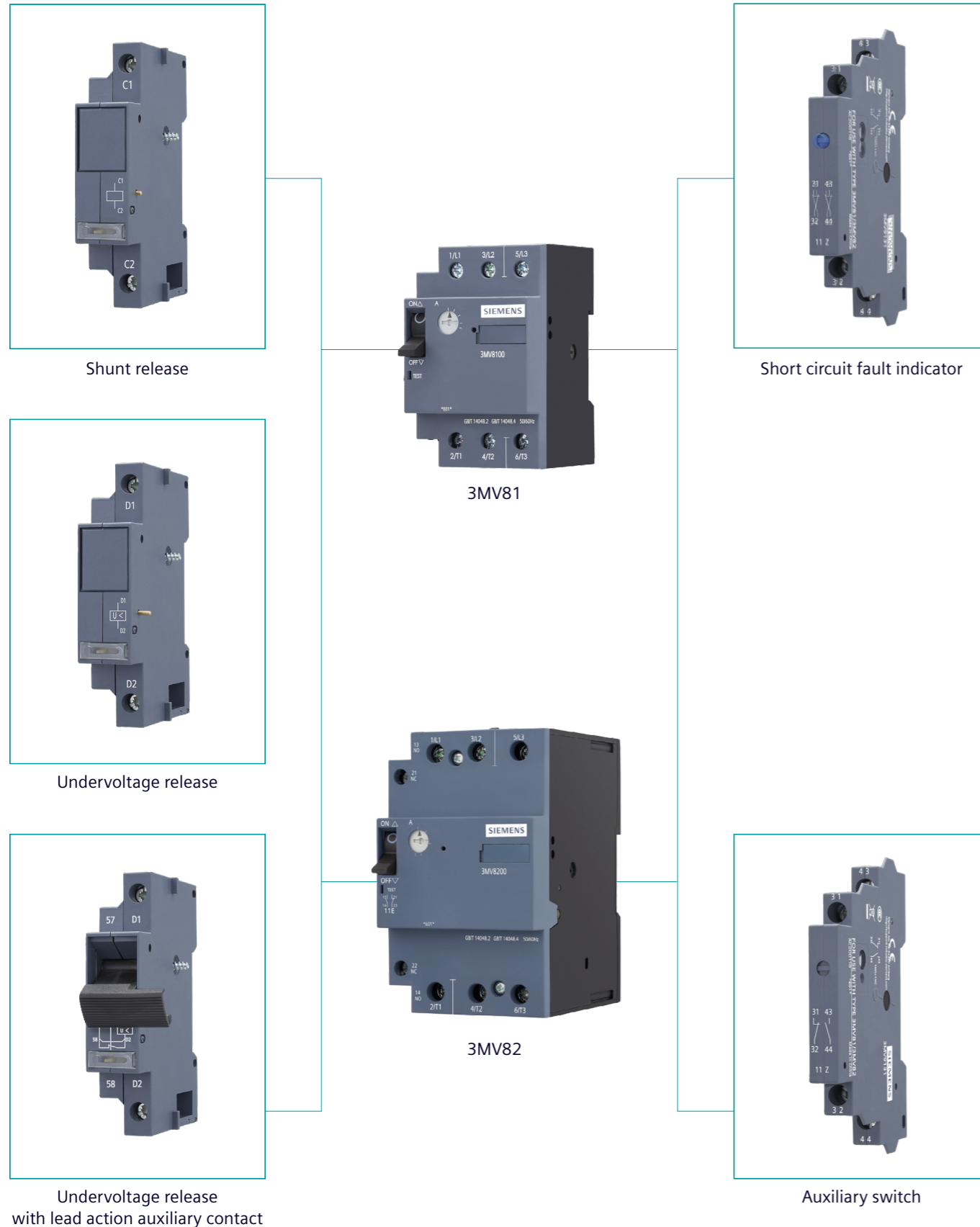

Overview

System overview





Technical specifications

3MV8 motor starter protectors

					
Type		3MV81	3MV82		
General data					
Dimension • Basic unit	W	54	70		
	H	86	115		
	D	70	108.5		
Mounting position		 90° inclination forward, backward, left and right			
Rated insulation voltage U_i (pollution degree 3) • Main circuit	V	750			
Rated impulse withstand voltage U_{imp} • Main circuit	kV	6			
Tripping class acc. to IEC 60947-4-1		Class 10A			
Permissible ambient temperature	During operation	°C -20 ... +55			
	During storage	°C -50 ... +80			
Relative air humidity	%	10 ... 90			
Degree of protection IP on the front		IP20 (with wiring)			
Installation altitude at height above sea level, maximum	m	2000			
Rated data for main contacts					
Load rating with AC • Utilization category for circuit breaker as per IEC 60947-2 / EN60947-2		A			
	• Utilization category for starter as per IEC 60947-4-1 / EN60947-4-1	AC-3			
Utilization categories AC-3 - Rated operational currents I_e up to 690V, 55°C	A	25	52		
Power loss per pole	W	I_e (A)	P (W)	I_e (A)	P (W)
		0.6	5	2.4	8
		4	6	6	7
		6	7	25	14
		25	9	52	23
Mechanical service life • Basic unit	Operating cycles	100,000 ≤25A		30,000 >25A	
	Electrical service life AC-3 @400V	Operating cycles	100,000 ≤25A		30,000 >25A
Switching frequency in operating cycles/hour • Switching frequency AC-3	1/h	25	25		

Technical specifications

3MV8 motor starter protectors

		
Type	3MV81	3MV82
Rated data for auxiliary contacts		
Load rating with AC		
• Rated operational currents I_e		
- AC-15 at rated operational voltage U_e		
230V	A	3
415V	A	1.5
500V	A	1
• Load rating with DC (1 conducting path)		
- DC-13, at rated operational voltage U_e		
24V	A	2.8
60V	A	0.7
220V	A	0.3
Switching frequency		
• Rated operation for utilization category	AC-15/DC-13	1/h
		25
Short circuit protection		
Auxiliary circuit		
• Back-up fuse (gL/gG)	A	10
• Miniature circuit breaker	A	6
Conductor cross-sections		
Main conductors		
Solid or stranded	mm ²	2 x (1 ... 6 mm ²)
		1 x (1.5 ... 25 mm ²); 2 x (1.5 ... 16 mm ²); 1.5 ... 25 + 1.5 ... 10 mm ²
Finely stranded with end sleeve	mm ²	2 x (1 ... 4 mm ²)
		1 x (1 ... 16 mm ²); 2 x (1 ... 10 mm ²); 1 ... 16 + 1 ... 6 mm ²
• Terminal screw		M4
- Tightening torque	Nm	1 ... 1.5
		M5
		2.5 ... 3
Auxiliary conductors		
Solid or stranded	mm ²	2 x (0.5 ... 2.5 mm ²);
Finely stranded with end sleeve	mm ²	2 x (0.5 ... 2.5 mm ²);
		2 x (0.5 ... 1.5 mm ²);
• Terminal screw		M3
- Tightening torque	Nm	0.8 ... 1.2
		M3
		0.8 ... 1.2

Technical specifications

Rated short-circuit breaking capacity

Type	Rating	<=240V AC			<=415V AC			<=440V AC			<=500V AC			<=690V AC		
		I_{cu} (kA)	I_{cs} (kA)	Fuse (gL/gG)	I_{cu} (kA)	I_{cs} (kA)	Fuse (gL/gG)	I_{cu} (kA)	I_{cs} (kA)	Fuse (gL/gG)	I_{cu} (kA)	I_{cs} (kA)	Fuse (gL/gG)	I_{cu} (kA)	I_{cs} (kA)	Fuse (gL/gG)
3MV81	<= 1A	100	100	•	100	100	•	100	100	•	100	100	•	100	100	•
	1.6A	100	100	•	100	100	•	100	100	•	100	100	•	2	2	20A
	2.4A	100	100	•	100	100	•	100	100	•	10	10	35A	2	2	35A
	3.2 & 4A	100	100	•	100	100	•	10	10	50A	3	3	50A	2	2	50A
	5 & 6A	100	100	•	100	100	•	5	5	63A	3	3	63A	2	2	63A
	8 & 10A	100	100	•	10	10	80A	5	5	80A	3	3	80A	2	2	80A
	13 & 16A	100	100	•	6	6	80A	5	5	80A	3	3	80A	2	2	80A
	20 & 25A	10	10	100A	6	6	80A	5	5	80A	3	3	80A	2	2	80A
3MV82	<= 2.4A	100	100	•	100	100	•	100	100	•	100	100	•	100	100	•
	4A	100	100	•	100	100	•	100	100	•	100	100	•	4	4	80A
	6A	100	100	•	100	100	•	100	100	•	100	50	•	4	4	100A
	10A	100	100	•	100	100	•	100	50	•	10	5	160A	4	4	125A
	16A	100	100	•	100	100	•	25	13	200A	10	5	160A	4	4	125A
	25A	100	100	•	100	50	•	25	13	200A	10	5	200A	4	4	160A
	32 & 52A	100	100	•	35	17	200A	25	13	200A	10	5	200A	4	4	160A

Note: "•" Indicates that no fuse is required because the breaking capacity of the circuit breakers is not less than 100kA. When the short circuit current at the installation point exceeds the circuit breaker's rated short circuit breaking capacity, the breakers must be protected by a backup fuse. The maximum rating of the backup fuse is given in the table for 100kA breaking capacity.

According to IEC 60947-2, the relationship between the short circuit breaking capacity and the minimum short circuit breaking capacity depends on the corresponding power factor.

Short circuit breaking capacity (A)	Power factor	Short circuit making capacity (A)
$I \leq 3000$	0.9	$1.42 \times I$
$3000 < I \leq 4500$	0.8	$1.47 \times I$
$4500 < I \leq 6000$	0.7	$1.5 \times I$
$6000 < I \leq 10000$	0.5	$1.7 \times I$
$10000 < I \leq 20000$	0.3	$2.0 \times I$
$20000 < I \leq 50000$	0.25	$2.1 \times I$
$50000 < I$	0.2	$2.2 \times I$

Selection & ordering data

3MV8 motor starter protectors

Product image	Rated current	Motor power	Current setting for thermal overload	Instantaneous trip	Auxiliary contacts	Article no.	List price per PU (Per Unit)
	(A)	(kW)	(A)	(A)			
	0.16	0.04	0.11 ~ 0.16	1.9	-	3MV8100-0MB00	
	0.24	0.06	0.16 ~ 0.24	2.9	-	3MV8100-0MC00	
	0.4	0.09/0.12	0.24 ~ 0.4	4.8	-	3MV8100-0MD00	
	0.6	0.12/0.18	0.4 ~ 0.6	7.2	-	3MV8100-0ME00	
	1	0.25	0.6 ~ 1	12	-	3MV8100-0MF00	
	1.6	0.37/0.55	1 ~ 1.6	19	-	3MV8100-0MG00	
	2.4	0.75	1.6 ~ 2.4	29	-	3MV8100-0MH00	
	3.2	1.1	2 ~ 3.2	38	-	3MV8100-0NH00	
	4	1.1/1.5	2.4 ~ 4	48	-	3MV8100-0MJ00	
	5	1.5/2.2	3.2 ~ 5	60	-	3MV8100-0NJ00	
	6	2.2	4 ~ 6	72	-	3MV8100-0MK00	
	8	3	5 ~ 8	96	-	3MV8100-0NK00	
	10	3/4	6 ~ 10	120	-	3MV8100-0ML00	
	13	4/5.5	8 ~ 13	156	-	3MV8100-0NL00	
	16	7.5	10 ~ 16	190	-	3MV8100-0MM00	
	20	7.5	14 ~ 20	240	-	3MV8100-0MN00	
	25	11	18 ~ 25	300	-	3MV8100-0MP00	
	0.16	0.04	0.11 ~ 0.16	1.9	1NO+1NC	3MV8100-1MB00	
	0.24	0.06	0.16 ~ 0.24	2.9	1NO+1NC	3MV8100-1MC00	
	0.4	0.09/0.12	0.24 ~ 0.4	4.8	1NO+1NC	3MV8100-1MD00	
	0.6	0.12/0.18	0.4 ~ 0.6	7.2	1NO+1NC	3MV8100-1ME00	
	1	0.25	0.6 ~ 1	12	1NO+1NC	3MV8100-1MF00	
	1.6	0.37/0.55	1 ~ 1.6	19	1NO+1NC	3MV8100-1MG00	
	2.4	0.75	1.6 ~ 2.4	29	1NO+1NC	3MV8100-1MH00	
	3.2	1.1	2 ~ 3.2	38	1NO+1NC	3MV8100-1NH00	
	4	1.1/1.5	2.4 ~ 4	48	1NO+1NC	3MV8100-1MJ00	
	5	1.5/2.2	3.2 ~ 5	60	1NO+1NC	3MV8100-1NJ00	
	6	2.2	4 ~ 6	72	1NO+1NC	3MV8100-1MK00	
8	3	5 ~ 8	96	1NO+1NC	3MV8100-1NK00		
10	3/4	6 ~ 10	120	1NO+1NC	3MV8100-1ML00		
13	4/5.5	8 ~ 13	156	1NO+1NC	3MV8100-1NL00		
16	7.5	10 ~ 16	190	1NO+1NC	3MV8100-1MM00		
20	7.5	14 ~ 20	240	1NO+1NC	3MV8100-1MN00		
25	11	18 ~ 25	300	1NO+1NC	3MV8100-1MP00		





Selection & ordering data

3MV8 motor starter protectors

Product image	Rated current	Motor power	Current setting for thermal overload	Instantaneous trip	Auxiliary contacts	Article no.	List price per PU (Per Unit)
	(A)	(kW)	(A)	(A)			
	1.6	0.37/0.55	1 ~ 1.6	19	-	3MV8200-0MG00	
	2.4	0.75	1.6 ~ 2.4	29	-	3MV8200-0MH00	
	4	1.1/1.5	2.4 ~ 4	48	-	3MV8200-0MJ00	
	6	2.2	4 ~ 6	72	-	3MV8200-0MK00	
	10	3/4	6 ~ 10	120	-	3MV8200-0ML00	
	16	5.5/7.5	10 ~ 16	190	-	3MV8200-0MM00	
	25	11	16 ~ 25	300	-	3MV8200-0MN00	
	32	15	22 ~ 32	380	-	3MV8200-0MP00	
	40	18.5	28 ~ 40	480	-	3MV8200-0MQ00	
	52	22	36 ~ 52	600	-	3MV8200-0MR00	
	1.6	0.37/0.55	1 ~ 1.6	19	1NO+1NC	3MV8200-1MG00	
	2.4	0.75	1.6 ~ 2.4	29	1NO+1NC	3MV8200-1MH00	
	4	1.1/1.5	2.4 ~ 4	48	1NO+1NC	3MV8200-1MJ00	
	6	2.2	4 ~ 6	72	1NO+1NC	3MV8200-1MK00	
	10	3/4	6 ~ 10	120	1NO+1NC	3MV8200-1ML00	
	16	5.5/7.5	10 ~ 16	190	1NO+1NC	3MV8200-1MM00	
	25	11	16 ~ 25	300	1NO+1NC	3MV8200-1MN00	
	32	15	22 ~ 32	380	1NO+1NC	3MV8200-1MP00	
	40	18.5	28 ~ 40	480	1NO+1NC	3MV8200-1MQ00	
	52	22	36 ~ 52	600	1NO+1NC	3MV8200-1MR00	

Selection & ordering data

Accessories

Type	Suitable for	Mounting	Auxiliary contacts	Article no.	List price per PU (Per Unit)
Auxiliary contact 	3MV81 / 3MV82	Right side	1NO+1NC	3MV9131-3AA00	
Short circuit fault indicator 	3MV81 / 3MV82	Right side	1NO+1NC	3MV9131-7AA00	
Undervoltage release 	3MV81 / 3MV82	Left side	AC230V 50Hz	3MV9132-0AB15	
			AC240V 50Hz	3MV9132-0AB25	
			AC400V 50Hz	3MV9132-0AB17	
			AC415V 50Hz	3MV9132-0AB18	
			AC120V 60Hz	3MV9132-0AB23	
			AC208V 60Hz	3MV9132-0AB24	
Undervoltage release with lead action auxiliary contacts 	3MV81 / 3MV82	Left side	AC230V 50Hz	3MV9132-0AB35	
			AC240V 50Hz	3MV9132-0AB45	
			AC400V 50Hz	3MV9132-0AB37	
			AC415V 50Hz	3MV9132-0AB38	
			AC120V 60Hz	3MV9132-0AB43	
			AC208V 60Hz	3MV9132-0AB44	
Shunt release 	3MV81 / 3MV82	Left side	AC24V 50Hz	3MV9132-0AB50	
			AC230V 50Hz	3MV9132-0AB55	
			AC240V 50Hz	3MV9132-0AB65	
			AC400V 50Hz	3MV9132-0AB57	
			AC415V 50Hz	3MV9132-0AB58	
			AC120V 60Hz	3MV9132-0AB63	
			AC208V 60Hz	3MV9132-0AB64	
			DC24-60V	3MV9132-0AB66	
DC110-240V	3MV9132-0AB73				

Note:
 (1) Auxiliary contacts and short circuit fault indicators can be installed on the right side of the circuit breakers at the same time (the short circuit fault indicators are installed on the inside first, and the auxiliary contacts are installed on the outside). It is also possible to install only one auxiliary contact or only one short circuit fault indicator.
 (2) Undervoltage release, undervoltage release with advance action auxiliary contact, and shunt release are all installed on the left side of the circuit breakers, but only one of the three can be installed at a time.

Wiring diagram

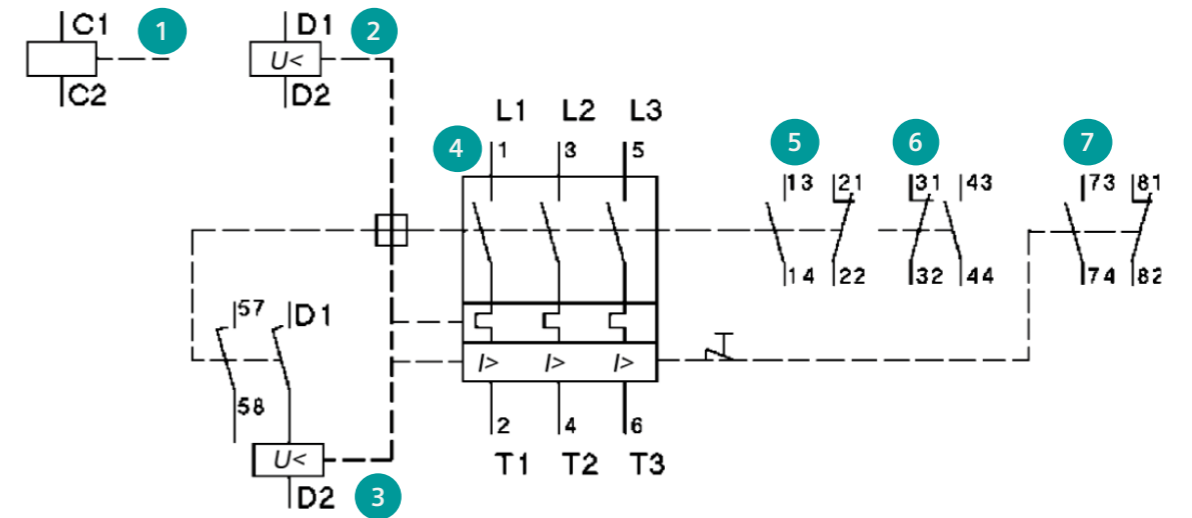

- 1 Shunt release
- 2 Undervoltage release
- 3 Undervoltage release with lead action contacts
- 4 3MV8 motor starter protector
- 5 Internal auxiliary contacts
- 6 Additional auxiliary contacts
- 7 Short circuit fault indicator

Dimension drawings

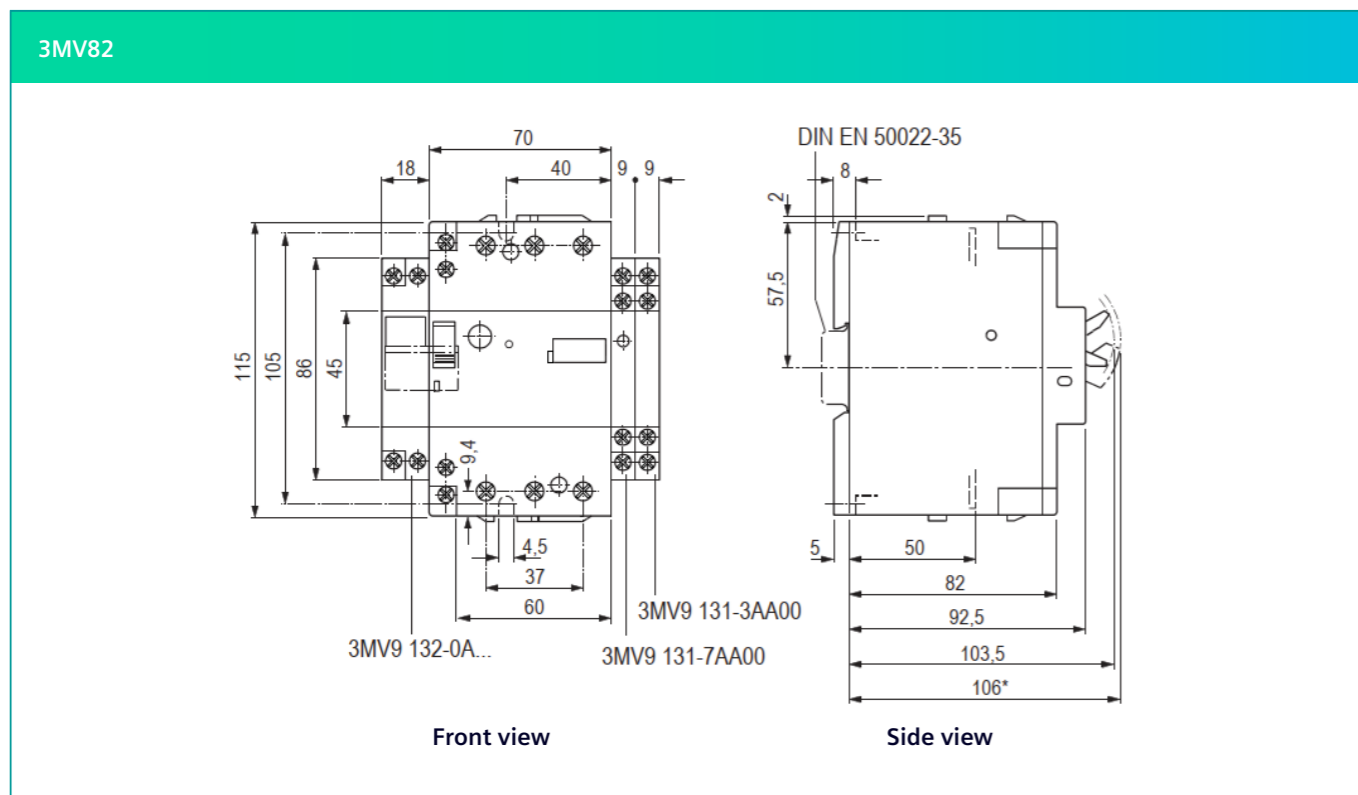
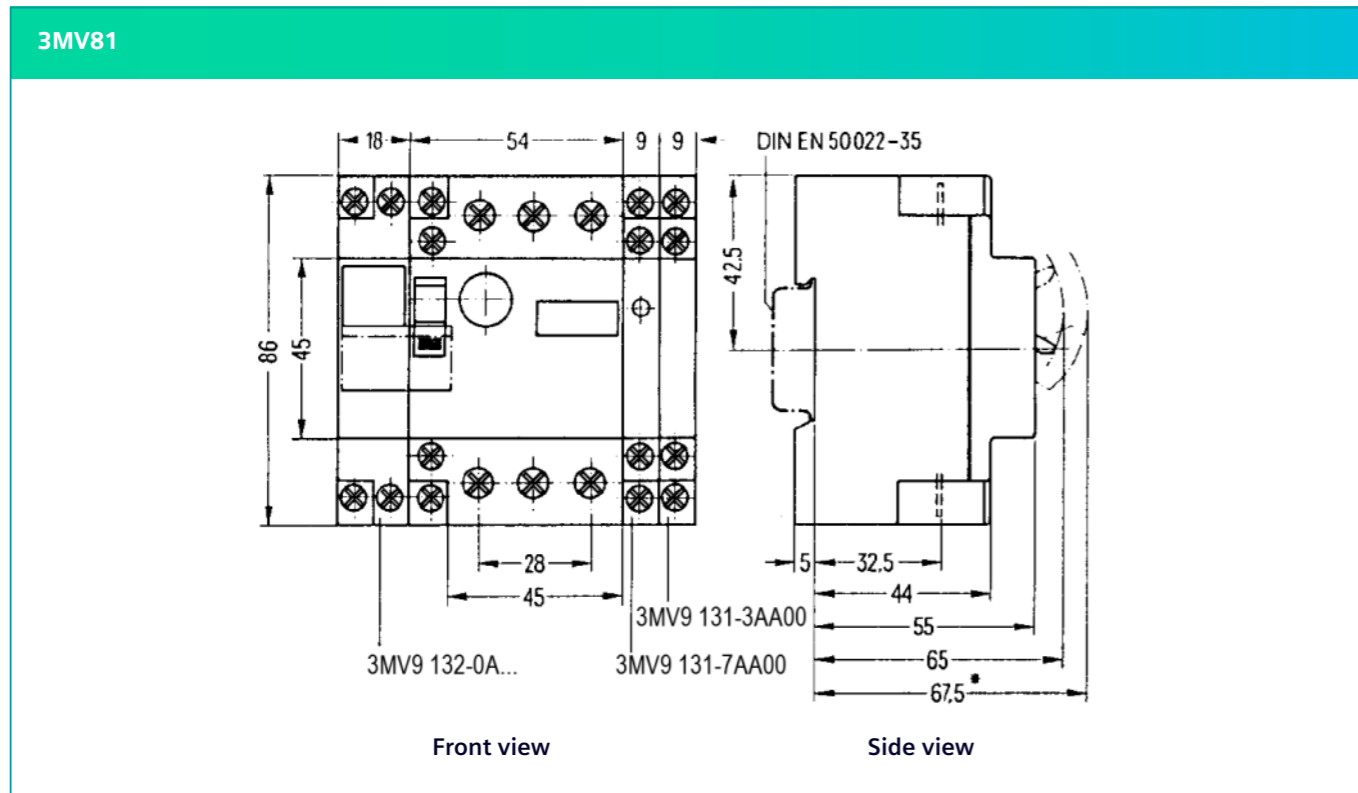

Note: All dimensions are in mm.

Type-2 coordination charts

Direct On-line (DOL) fuse IE2 / IE3	82
Star delta fuse IE2 / IE3	84

SINOVA The Power of **Simplicity**

Direct On-line (DOL) starter for IE2 / IE3: motors

Fuse protected selection Type-2, $I_q = 50\text{kA}$, IEC:60947-4-1 (3NA with 3MT7 & 3MU7)

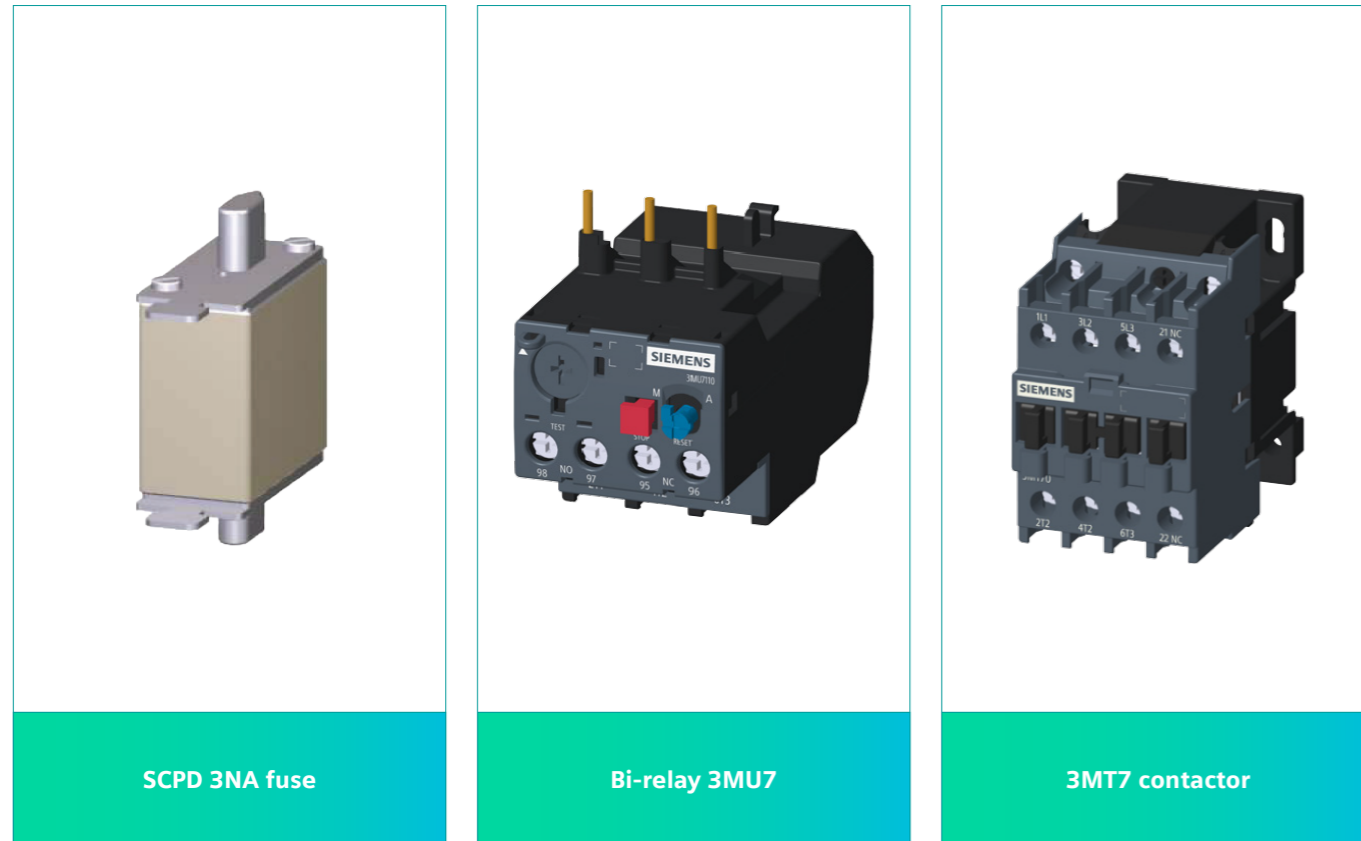

- The selection is valid only for complete Siemens combinations, i.e. DIN fuse + contactor + bi-relay (+ timer).
- In case this combination is changed to accommodate another brand/rating of DIN fuse/contactor/BMR, it shall be the responsibility of the person making such a change to assure Type-2 performance.
- Selection is for normal starting conditions. (For heavy starting applications, e.g. ID/FD fans, reciprocating compressors, ball mills, etc., please consult Siemens).
- All fuses are DIN HRC type.
- Tested Type-2 combinations.

Motor rating		Fuse		Contactor		Bi-relay	
kW @400 / 415V, 50Hz	I_L (A)	Type	Rating (A)	Type	Rating (A)	Type	Relay setting range (A)
0.37	1.1	3NA7804	4	3MT70060AA...	6	3MU71100FA0	1-1.6
0.55	1.5	3NA7801	6	3MT70060AA...	6	3MU71100GA0	1.25-2
0.75	1.9	3NA7801	6	3MT70060AA...	6	3MU71100HA0	1.6-2.5
1.1	2.7	3NA7801	6	3MT70060AA...	6	3MU71100HA0 3MU71100JA0	1.6-2.5 (IE2) 2.5-4 (IE3)
1.5	3.6	3NA7803	10	3MT70060AA...	6	3MU71100JA0	2.5-4
2.2	5	3NA7805	16	3MT70100AA...	9	3MU71100KA0	4-6
3.7	7.8	3NA7807	20	3MT70120AA...	12	3MU71100MA0	7-10
5.5	11.5	3NA7810	25	3MT70181AA...	18	3MU71100NA0	9-13
7.5	15.5	3NA7817	40	3MT70252AA...	25	3MU71100PA0	12-18
11	22	3NA7820	50	3MT70382AA...	38	3MU71100QA0	17-25
15	29	3NA7822	63	3MT70382AA...	38	3MU72101AA0	23-32
18.5	35	3NA7824	80	3MT70503AA110...	50	3MU73102BA0	30-40
22	41	3NA7824	80	3MT70653AA110...	65	3MU73102CA0	37-50
30	55	3NA7830	100	3MT70704AA110...	70	3MU73102DA0	48-65
37	66	3NA7832	125	3MT70954AA110...	95	3MU73102EA0	55-70
45	80	3NA7836	160	3MT70954AA110...	95	3MU73102FA0 3MU73102GA0	63-80 (IE2) 80-93 (IE3)

AC-3 motor rating @400/415V, 50Hz		SDF		HRC fuse		Contactor		Bi-relay	
kW	I_L (A)	Type	Rating	Type	Rating	Type	AC-3 rating	Type	Range (A)
55	96	3KL831	200	3NA7140	200	3MT7140	140	3MU7410-3AA1	85-135
75	131	3KL832	250	3NA7144	250	3MT7250	170	3MU7410-3BA1	115-180
90	156	3KL832	250	3NA7144	250	3MT7205	205	3MU7410-3BA1	115-180
110	189	3KL832	250	3NA7144	250	3MT7250	250	3MU7410-3CA1	160-250
132	189	3KL833	315	3NA7252	315	3MT7300	300	3MU7410-3CA1	160-250
160	271	3KL834	400	3NA7260	400	3MT7400	400	3MU7410-3DA1	200-320
200	339	3KL841	500	3NA7365	500	3MT7400	400	3MU7410-3EA1	250-400

Star delta starter for IE2 / IE3 motors

Fuse protected selection Type-2, IEC:60947-4-1 (3NA with 3MT7 & 3MU7)

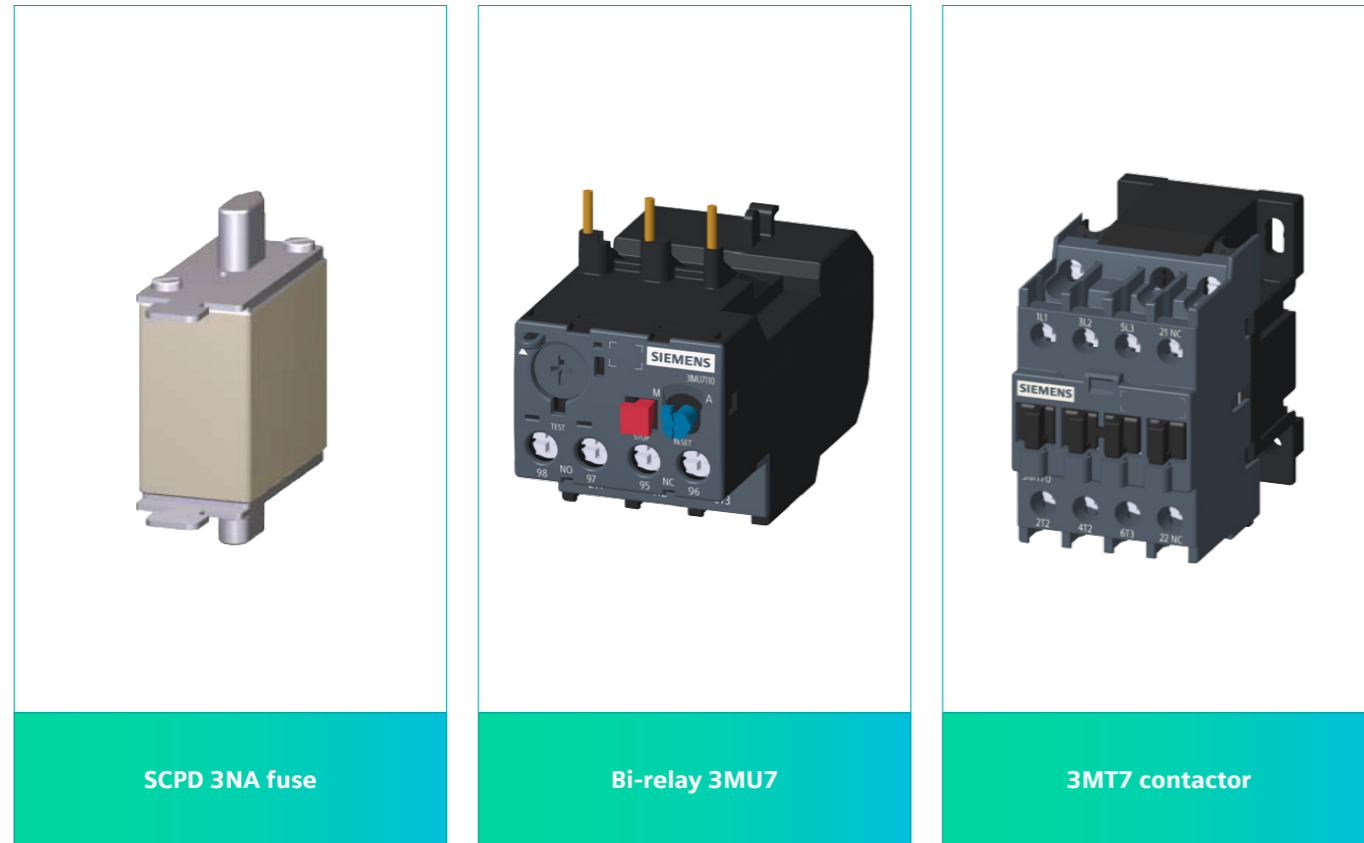

- The selection is valid only for complete Siemens combinations, i.e. DIN Fuse + Contactor + bi-relay (+ timer).
- In case this combination is changed to accommodate another brand/rating of DIN fuse/contactor/BMR, it shall be the responsibility of the person making such a change to assure Type-2 performance.
- Selection is for normal starting conditions. (For heavy starting applications, e.g. ID/FD fans, reciprocating compressors, ball mills, etc., please consult Siemens).
- The electronic star-delta timer type 3RP should be used in star-delta feeders.
- All fuses are DIN HRC type.
- Tested Type-2 combinations.

Motor rating		Fuse		Contactor line / delta		Contactor		Bi-relay	
kW @400 / 415V, 50Hz	I _L (A)	Type	Rating (A)	Type	Rating (A)	Type	Rating (A)	Type	Relay setting range (A)
3.7	8	3NA7803	10	3MT70100AA...	9	3MT70060AA...	6	3MU7110-0KA0	4-6
5.5	12	3NA7805	16	3MT70100AA...	9	3MT70100AA...	9	3MU7110-0LA0	5.5-8
7.5	16	3NA7807	20	3MT70120AA...	12	3MT70100AA...	9	3MU7110-0MA0	7-10
11	22	3NA7810	25	3MT70181AA...	18	3MT70120AA...	12	3MU7110-0PA0	12-18
15	29	3NA7812	32	3MT70221AA...	22	3MT70181AA...	18	3MU7110-0PA0	12-18
18.5	35	3NA7817	40	3MT70252AA...	25	3MT70181AA...	18	3MU7110-0QA0	17-25
22	41	3NA7820	50	3MT70382AA...	38	3MT70252AA...	25	3MU7210-1AA0	23-32
30	55	3NA7822	63	3MT70402AA...	40	3MT70382AA...	38	3MU7210-1BA0	28-36
37	66	3NA7824	80	3MT70503AA110...	50	3MT70382AA...	38	3MU7310-2CA0	37-50
45	80	3NA7830	100	3MT70704AA110...	70	3MT70503AA110...	50	3MU7310-2CA0	37-50
55	97	3NA7830	100	3MT70804AA110...	80	3MT70653AA110...	65	3MU7310-2DA0	48-65
75	132	3NA7836	160	3MT70954AA110...	95	3MT70804AA110...	80	3MU7310-2FA0	63-80

AC-3 motor rating @400/415V, 50Hz		SDF		HRC fuse		Line / delta contactor		Star contactor		Relay	
kW	I _L (A)	Type	Rating	Type	Rating	Type	AC-3 rating	Type	AC-3 rating	Type	Range (A)
110	189	3KL831	200	3NA7140	200	3MT7140	140	3MT7120	120	3MU7410-3AA1	85-135
132	227	3KL832	250	3NA7144	250	3MT7250	250	3MT7140	140	3MU7410-3BA1	115-180
160	271	3KL833	315	3NA7252	315	3MT7300	300	3MT7170	170	3MU7410-3BA1	115-180
200	339	3KL834	400	3NA7260	400	3MT7400	400	3MT7205	205	3MU7410-3CA1	160-250
250	398	3KL841	500	3NA7260	400	3MT7400	400	3MT7250	250	3MU7410-3DA1	200-320

SINOVA

The Power of **Simplicity**

Published by
Siemens Philippines

Smart Infrastructure
Electrical Products (EP)
15th Floor, NEX Tower
6786, Ayala Avenue
Makati City, 1229 Philippines
For more information, please contact
E-mail: smartinfrastructure.ph@siemens.com

Subject to changes and errors. The information given in this document only contains general descriptions and/or performance features which may not always specifically reflect those described, or which may undergo modification in the course of further development of the products. The requested performance features are binding only when they are expressly agreed upon in the concluded contract.