

Panel Mounted Multi-Functional Speaker

QMPS / QMPS-N

Both built-in sounds and option for external sound input via SD card (MP3) have 30 built-in sounds
Able to avoid signal confusion with a variety of tone options



QMPS I QMPS-N

- **QMPS(MP3)**
 - User defined 30 sounds
 - 30 built-in sounds
- **QMPS-N(standard unit)**
 - 30 built-in sounds

PRODUCT SPECIFICATION

QMPS I QMPS-N

Materials Housing-ABS, Cover-ABS
Ambient operating temperature -25°C to +50°C
Volume Max.95dB at 1m
Protection rating IP54
Compliant with RoHS directive

- Can prevent cross talk of different voice environments by selecting an audio signal fit for the specific environment and condition
- Offers both Binary and Bit input mode options with 30 pre-recorded sounds
- Binary input mode has built-in 30 messages that can be played with switch for sound selection
- Bit input mode is organized into 6 groups of 5 sound tones for a total of 30 sound tone options. Playback can be selected from one of the 5 tones in each group (MP3 file with bit input mode)
- Volume adjustment and sound selection switches located inside the unit
- SD card type can play MP3 voice message, user can select and change the sound message after record it
- Customer can choose any built-in sounds among 30 sound tons in case of a standard unit.

User-defined sound(MP3)

- User-defined sound(MP3) type

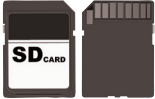

You can easily rearrange the sound playback and group arrangement with PC. Capacity is 32Gbyte.

Features

- Standard unit does not support either SD card or Play mode.

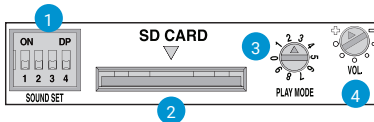

- 1 Switch for Sound selection
- 2 SD card slot for MP3
- 3 Switch for play Mode selection
- 4 Switch for Volume adjustment

Sound Selection Instruction for SDcard Type

- SD card type unit
- It can choose both built-in sounds and user defined sounds(MP3) by controlling sound setup switch no. 1.
- Standard unit
- It can choose both Bit input mode and Binary input mode by controlling sound setup switch no. 1.

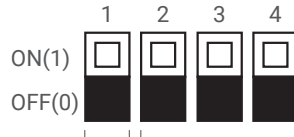

Sound Selection

- 0: Built-in sound
- 1: SD Card(MP3)

Standard unit(Built-in sound only)

- 0:Bit input(Can choose 5 channels per group)
- 1:Binary(Can choose 30 channels)

Bit input mode selection from 6 groups

- 001: WS(5 Warning sounds)
- 010: WP(5 Special warning sounds 1st group)
- 011: WM(5 Melodies)
- 100: WA(5 Alarms)
- 101: WO(5 Special warning sounds 2nd group)
- 110: WN(5 Special warning sounds 3rd group)

- 30 pre-recorded sounds offered(5 warning sounds, 5 special warning sounds 1st group, 5 melodies, 5 alarms, 5 special warning sounds 2nd group, 5 special warning sounds 3rd group)
- External MP3 sound support(SD card)
- Binary input: 30 channels
- Bit input: 5 channels(6 sound groups)
- A multi-functional product that can use an SD card for MP3 playback
- Please refer to [Sound pattern and combination for multifunctional product] on this catalogue for channel input setting.

Features per modelst

	QMPS(MP3)	QMPS-N(standard unit)	Column
Support SD card(MP3)	O	X	
Support 30 built-in sounds	O	O	
Play mode	O	X	
Bit/Binary input	O	O	Please refer to sound setup switch manual parts



QMPS Panel Mounted Speaker, Max.95dB

Model number	Voltage	Current	Volume	Input Method /No. of Ch	Certificates	Weight
QMPS SD card	DC12V -24V	Max. 0.570A	· SD card · Built-in sound: Max.98dB (Based on Ch17)	·Bit Input: 5Ch ·Binary Input: 30Ch	CE UL	0.35kg
	AC110V -220V	Max. 0.100A	· MP3: Max.90dB			0.53kg

- ※ When playing MP3 files, there may be difference of volume depending on user's audio file type.
- ※ DC type model has a free-voltage range of 10V-30V.
- ※ AC type model has a free-voltage range of 100V-240V.
- ※ CE compliant: DC12V-24V, UL Listed: DC12V-24V

QMPS-N Panel Mounted Speaker, Max.95dB

Model number	Voltage	Current	Volume	Input Method /No. of Ch	Certificates	Weight
QMPS-N Built-in standard sound	DC12V -24V	Max. 0.365A	· Built-in standard sound · Built-in sound: Max.95dB (Based on Ch17)	·Bit Input: 5Ch ·Binary Input: 30Ch	CE	0.35kg
	AC110V -220V	Max. 0.110A				0.53kg

- ※ DC type model has a free-voltage range of 10V-30V.
- ※ AC type model has a free-voltage range of 100V-240V.
- ※ CE compliant: DC12V-24V



QMPS



QMPS-N



Terminal block for power and sound(back side)

Technical Diagram

Units: mm

·QMPS / QMPS-N

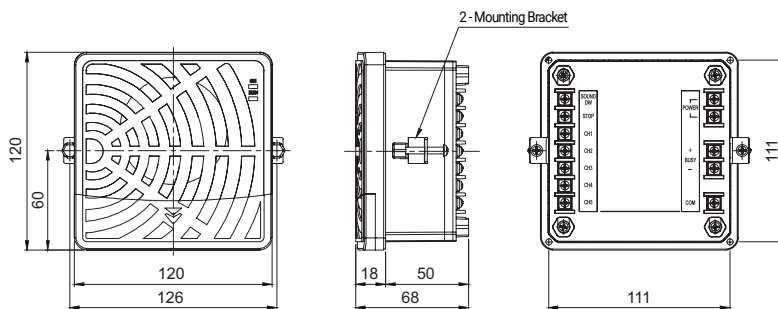

Ordering Specification

·QMPS

QMPS	-	12/24	-	INSD
[Model number]		[Voltage]		[Including SD card]
QMPS		12/24-DC12V-24V 110/220-AC110V-220V		None-Without SD card INSD-Including SD card

·QMPS-N

QMPS	-	12/24
[Model number]		[Voltage]
QMPS-N		12/24-DC12V-24V 110/220-AC110V-220V

Wiring Instructions

·QMPS-DC

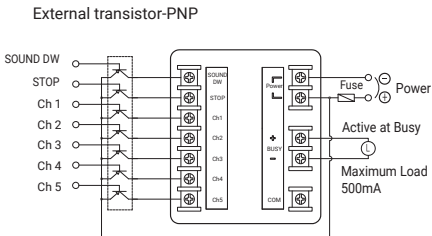
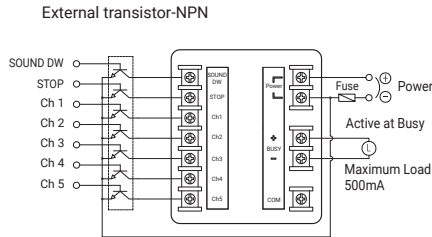
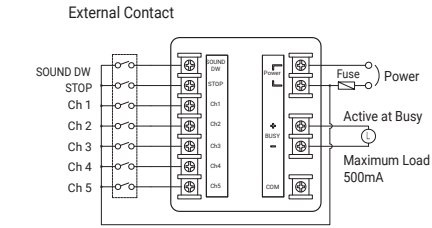

·QMPS-AC

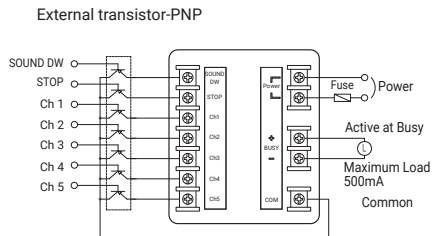
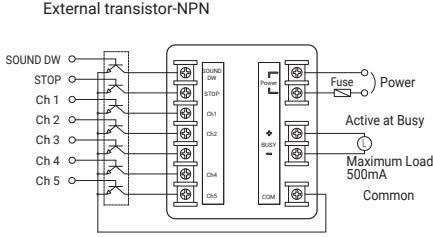
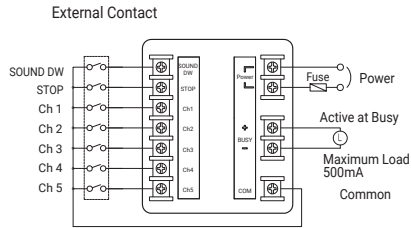

· In case of Bit input, 5 sound tones can be played. For Binary input, 30 sound tones can be played.
 ※ Please refer to [Sound pattern and combination for multifunctional product] on this catalogue for channel input setting(Wiring instruction is replaced to channel selection switch)

·QMPS-N-DC

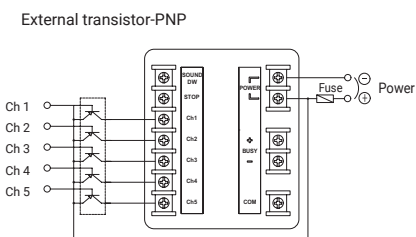
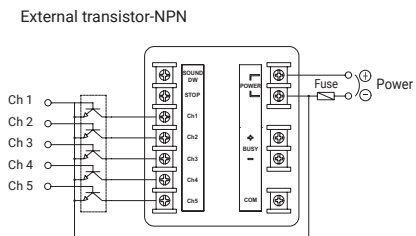
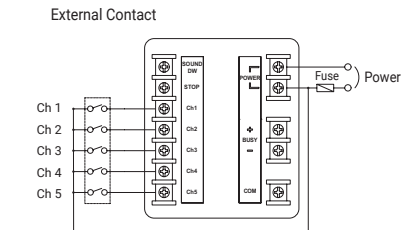

·QMPS-N-AC

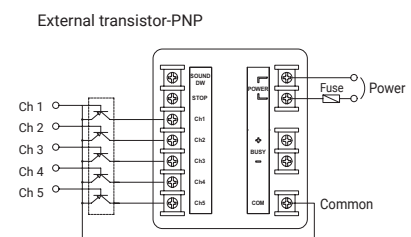
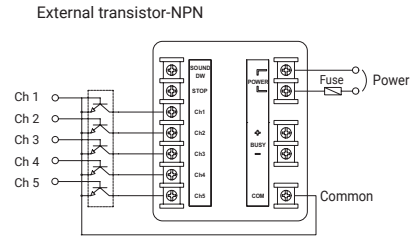
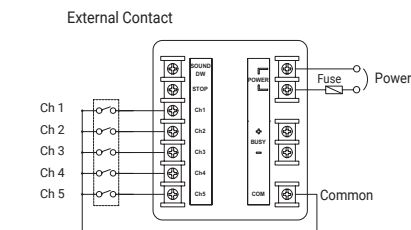

· In case of Bit input, 5 sound tones can be played. For Binary input, 30 sound tones can be played.