

## Mitsubishi Programmable Controller

MELSEC **Q** series

# Type QD75P/QD75D Positioning Module User's Manual

---

-QD75P1N  
-QD75P2N  
-QD75P4N  
-QD75D1N  
-QD75D2N  
-QD75D4N  
-QD75P1  
-QD75P2  
-QD75P4  
-QD75D1  
-QD75D2  
-QD75D4

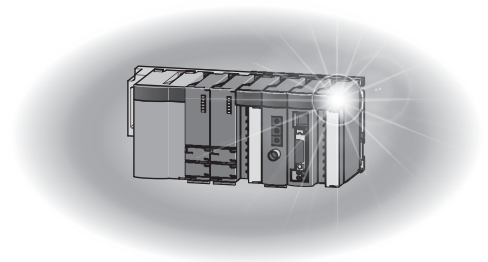





## ● SAFETY PRECAUTIONS ●

(Read these precautions before using this product.)

Before using this product, please read this manual and the relevant manuals carefully and pay full attention to safety to handle the product correctly.

The precautions given in this manual are concerned with this product only. For the safety precautions of the programmable controller system, refer to the user's manual for the CPU module used.

In this manual, the safety precautions are classified into two levels: "⚠WARNING" and "⚠CAUTION".

 <b>WARNING</b>	Indicates that incorrect handling may cause hazardous conditions, resulting in death or severe injury.
 <b>CAUTION</b>	Indicates that incorrect handling may cause hazardous conditions, resulting in minor or moderate injury or property damage.

Under some circumstances, failure to observe the precautions given under "⚠CAUTION" may lead to serious consequences.

Observe the precautions of both levels because they are important for personal and system safety.

Make sure that the end users read this manual and then keep the manual in a safe place for future reference.

### [Design Precautions]

#### **WARNING**

- Provide a safety circuit outside the programmable controller so that the entire system will operate safely even when an external power supply error or programmable controller fault occurs.

Failure to observe this could lead to accidents for incorrect outputs or malfunctioning.

- (1) Configure an emergency stop circuit and interlock circuit such as a positioning upper limit/lower limit to prevent mechanical damage outside the programmable controller.
- (2) The machine OPR operation is controlled by the OPR direction and OPR speed data. Deceleration starts when the near-point dog turns ON. Thus, if the OPR direction is incorrectly set, deceleration will not start and the machine will continue to travel. Configure an interlock circuit to prevent mechanical damage outside the programmable controller.
- (3) When the module detects an error, normally deceleration stop or sudden stop will take place according to the parameter stop group settings.  
Set the parameters to the positioning system specifications.  
Make sure that the OPR parameter and positioning data are within the parameter setting values.

## [Design Precautions]

### CAUTION

- Do not bundle or adjacently lay the connection cable connected to the module external I/O signals or drive unit with the main circuit line, power line, or the load line other than that for the programmable controller. Separate these by 100mm as a guide. Failure to observe this could lead to malfunctioning caused by noise, surge, or induction.

## [Mounting Precautions]

### CAUTION

- Use the programmable controller in an environment that meets the general specifications contained in QCPU User's Manual(Hardware Design, Maintenance and Inspection) to use. Using this programmable controller in an environment outside the range of the general specifications may cause electric shock, fire, malfunction, and damage to or deterioration of the product.
- While pressing the installation lever located at the bottom of module, insert the module fixing tab into the fixing hole in the base unit until it stops. Then, securely mount the module with the fixing hole as a supporting point.  
Incorrect loading of the module can cause a malfunction, failure or drop.  
When using the programmable controller in the environment of much vibration, tighten the module with a screw.  
Tighten the screw in the specified torque range.  
Undertightening can cause a drop, short circuit or malfunction.  
Overtightening can cause a drop, short circuit or malfunction due to damage to the screw or module.
- Completely turn off the externally supplied power used in the system before mounting or removing the module.  
Not doing so may damage the product.

## [Wiring Precautions]

### WARNING

- Always confirm the terminal layout before connecting the wires to the module.



## [Wiring Precautions]

### CAUTION

- Use applicable solderless terminals and tighten them within the specified torque range. If any spade solderless terminal is used, it may be disconnected when the terminal screw comes loose, resulting in failure.
- Tighten the connector screws within the specified torque range.  
Undertightening can cause short circuit, fire, or malfunction.  
Overtightening can damage the screw and/or module, resulting in drop, short circuit, fire, or malfunction.
- Connectors for external devices must be crimped with the tool specified by the manufacturer, or must be correctly soldered. Incomplete connections may cause short circuit, fire, or malfunction.
- When disconnecting the cable from the module, do not pull the cable by the cable part.  
For the cable with connector, hold the connector part of the cable.  
Pulling the cable connected to the module may result in malfunction or damage to the module or cable.
- Prevent foreign matter such as dust or wire chips from entering the module. Such foreign matter can cause a fire, failure, or malfunction.
- A protective film is attached to the top of the module to prevent foreign matter, such as wire chips, from entering the module during wiring. Do not remove the film during wiring. Remove it for heat dissipation before system operation.

## [Startup/Maintenance Precautions]

### WARNING

- Completely turn off the externally supplied power used in the system before cleaning or tightening the screws.  
Failure to turn all phases OFF could lead to electric shocks.

## [Startup/Maintenance Precautions]

### CAUTION

- Never disassemble or modify the module.  
Failure to observe this could lead to trouble, malfunctioning, injuries or fires.
- Completely turn off the externally supplied power used in the system before installing or removing the module.  
Failure to turn all phases OFF could lead to module trouble or malfunctioning.
- Do not install/remove the module to/from the base unit, or the terminal block to/from the module more than 50 times after the first use of the product. (IEC 61131-2 compliant)  
Failure to do so may cause malfunction.
- Before starting test operation, set the parameter speed limit value to the slowest value, and make sure that operation can be stopped immediately if a hazardous state occurs.
- Always make sure to touch the grounded metal to discharge the electricity charged in the body, etc., before touching the module.  
Failure to do so may cause a failure or malfunctions of the module.

## [Precautions for use]

### CAUTION

- Note that when the reference axis speed is designated for interpolation operation, the speed of the partner axis (2nd axis, 3rd axis and 4th axis) may be larger than the set speed (larger than the speed limit value).

## [Disposal Precautions]

### CAUTION

- When disposing of the product, handle it as industrial waste.

## • CONDITIONS OF USE FOR THE PRODUCT •

- (1) Mitsubishi programmable controller ("the PRODUCT") shall be used in conditions;
- i) where any problem, fault or failure occurring in the PRODUCT, if any, shall not lead to any major or serious accident; and
  - ii) where the backup and fail-safe function are systematically or automatically provided outside of the PRODUCT for the case of any problem, fault or failure occurring in the PRODUCT.

- (2) The PRODUCT has been designed and manufactured for the purpose of being used in general industries.

MITSUBISHI SHALL HAVE NO RESPONSIBILITY OR LIABILITY (INCLUDING, BUT NOT LIMITED TO ANY AND ALL RESPONSIBILITY OR LIABILITY BASED ON CONTRACT, WARRANTY, TORT, PRODUCT LIABILITY) FOR ANY INJURY OR DEATH TO PERSONS OR LOSS OR DAMAGE TO PROPERTY CAUSED BY the PRODUCT THAT ARE OPERATED OR USED IN APPLICATION NOT INTENDED OR EXCLUDED BY INSTRUCTIONS, PRECAUTIONS, OR WARNING CONTAINED IN MITSUBISHI'S USER, INSTRUCTION AND/OR SAFETY MANUALS, TECHNICAL BULLETINS AND GUIDELINES FOR the PRODUCT.

("Prohibited Application")

Prohibited Applications include, but not limited to, the use of the PRODUCT in;

- Nuclear Power Plants and any other power plants operated by Power companies, and/or any other cases in which the public could be affected if any problem or fault occurs in the PRODUCT.
- Railway companies or Public service purposes, and/or any other cases in which establishment of a special quality assurance system is required by the Purchaser or End User.
- Aircraft or Aerospace, Medical applications, Train equipment, transport equipment such as Elevator and Escalator, Incineration and Fuel devices, Vehicles, Manned transportation, Equipment for Recreation and Amusement, and Safety devices, handling of Nuclear or Hazardous Materials or Chemicals, Mining and Drilling, and/or other applications where there is a significant risk of injury to the public or property.

Notwithstanding the above, restrictions Mitsubishi may in its sole discretion, authorize use of the PRODUCT in one or more of the Prohibited Applications, provided that the usage of the PRODUCT is limited only for the specific applications agreed to by Mitsubishi and provided further that no special quality assurance or fail-safe, redundant or other safety features which exceed the general specifications of the PRODUCTS are required. For details, please contact the Mitsubishi representative in your region.

REVISIONS

\* The manual number is given on the bottom left of the back cover.

Print Date	* Manual Number	Revision
Dec., 1999	SH (NA)-080058-A	First edition
Oct., 2000	SH (NA)-080058-B	Addition of function version B (Overall revisions based on the Japanese Manual Version SH-080047-E)
Jun., 2001	SH (NA)-080058-C	<ul style="list-style-type: none"> <li>The software package names (GPP function software package, QD75 software package) have been replaced by the product names (GX Developer, GX Configurator-QP) for standardization.</li> </ul> <p>Partial corrections and additions</p> <p>CONTENTS, About Manuals, Generic Terms and Abbreviations, Section 1.4, Section 2.2, Section 2.3, Section 3.2.2 to Section 3.2.4, Section 3.3.2, Section 3.3.3, Section 3.4.1, Section 3.4.3, Section 3.4.4, Section 4.1.2, Section 4.3, Section 5.1.2, Section 5.1.3, Section 5.2.3, Section 5.2.5, Section 5.6.2, Section 5.7.1, Section 6.2 to Section 6.4, Section 6.5.3, Section 7.2, Section 8.2.2, Section 8.2.5, Section 8.2.6, Section 9.1.2, Section 9.2.1, Section 9.2.16, Section 9.2.17, Section 10.3.2, Section 10.6.2, Section 11.2.3, Section 11.3.3, Section 11.3.4, Section 11.4.3, Section 12.1.1, Section 12.5 to Section 12.7, Section 13.1, Section 13.3, Section 13.4, Section 14.2 to Section 14.7, Section 15.1, Section 15.2, Section 15.4, Appendix 1, Appendix 9.2, Appendix 11, INDEX</p>
Apr., 2003	SH (NA)-080058-D	<p>Partial corrections and additions</p> <p>SAFETY INSTRUCTIONS, CONTENTS, Component List, Section 1.2.3, Section 1.4, Section 2.3, Section 2.4, Section 3.1, Section 3.2.1, Section 3.2.3, Section 3.2.4, Section 3.4.1, Section 3.4.4, Section 4.1.2, Section 4.3.1, Section 4.3.2, Section 5.1.1, Section 5.1.7, Section 5.1.8, Section 5.2.1, Section 5.2.4, Section 5.6.2, Section 5.7.1, Section 6.4, Section 6.5.4, Section 6.5.6, Section 8.2.3 to Section 8.2.8, Section 9.2.17, Section 9.2.19, Section 11.2.1, Section 11.3.1, Section 11.4.1, Section 12.1.1, Section 12.5.1, Section 12.5.2, Section 12.7.3, Section 12.7.5, Section 12.7.9, Section 14.4, Section 15.2, Appendix 1.1, Appendix 4.1 to Appendix 4.3, Appendix 7.1, Appendix 9.2, Appendix 10 to Appendix 13, INDEX</p>
Oct., 2003	SH (NA)-080058-E	<p>Partial corrections and additions</p> <p>CONTENTS, Section 1.1.1, Section 1.4, Section 2.2, Section 2.4, Section 3.2.1, Section 3.2.3, Section 3.2.4, Section 3.3.2, Section 3.4.3, Section 3.4.4, Section 5.1.1, Section 5.1.8, Section 5.7.1, Section 6.5.3, Section 6.5.6, Section 7.1.2, Section 9.1.2, Section 9.2.3 to Section 9.2.9, Section 11.2.1, Section 11.3.1, Section 11.4.1, Section 12.2.1, Section 12.7.10, Appendix 9.2, Appendix 12, INDEX</p>
Feb., 2004	SH (NA)-080058-F	<p>Partial corrections and additions</p> <p>CONTENTS, Section 3.4.1, Section 3.4.3, Section 3.4.4, Section 5.2.1, Section 5.4, Section 5.5, Section 5.6.2, Section 8.2.6, Section 10.1.2, Section 10.3.3, Section 10.3.5, Section 10.3.7, Appendix 9.2, Appendix 12</p>

\* The manual number is given on the bottom left of the back cover.

Print Date	* Manual Number	Revision
Nov., 2004	SH (NA)-080058-G	<p>Partial corrections and additions</p> <p>SAFETY INSTRUCTIONS, Section 1.4, Section 2.3, Section 2.4, Section 4.2.1, Section 4.3.1, Section 4.5.1, Section 5.1.7, Section 5.2.1, Section 5.2.6, Section 5.6.2, Section 6.1, Section 9.2.19, Section 12.2.1, Section 12.4.4, Section 12.7.4, Appendix 1.1, Appendix 9.1</p>
Jun., 2005	SH (NA)-080058-H	<p>Partial corrections and additions</p> <p>Section 5.1.2, Section 9.1.2, Section 9.2.10, Section 9.2.21, Section 10.3.8, Section 11.4.1, Section 12.5.2, Section 12.7.1, Section 12.7.6, Section 15.1, Section 15.2</p>
Aug., 2006	SH (NA)-080058-I	<p>Partial corrections and additions</p> <p>Section 3.4.4, Section 5.2.1, Section 14.5 to 14.7, Appendix 6.1, INDEX</p>
Jul., 2008	SH (NA)-080058-J	<p>Partial corrections and additions</p> <p>SAFETY INSTRUCTIONS, ABOUT MANUALS, Compliance with the EMC and Low Voltage Directives, Section 1.3, Section 2.3, 2.4, Section 3.1, 3.4.1, Section 4.1.2, 4.2.1, 4.3.1, Section 5.1.2, 5.2.1, 5.2.4, 5.2.5, Section 6.2, Section 6.4, Section 9.2.16, 9.2.17, Section 12.6, Section 12.7.2, Section 14.3 to 14.7, Appendix 12, 13</p>
Oct., 2010	SH (NA)-080058-K	Full revision
Apr., 2011	SH (NA)-080058-L	<p>Partial corrections and additions</p> <p>Section 3.4.1, Section 4.3.1, 4.3.2, Section 5.6.1, 5.7.2, Section 6.2, 6.4, Section 7.2, Section 8.2.7, 8.2.8, Section 9.2.3, 9.2.16, 9.2.18, Section 10.5, Section 11.2.1, Section 12.4.2, 12.6, 12.7.4, Section 13.2, 13.3, 13.5, Section 14.3, Appendix 3, Appendix 9.2, Appendix 10, 10.2, 10.3</p> <p>Additions</p> <p>Appendix 10.4</p> <p>Changed item numbers</p> <p>Appendix 10.4 to 10.12 → Appendix 10.5 to 10.13</p>
Sep., 2011	SH (NA)-080058-M	<p>Partial corrections and additions</p> <p>Generic Terms and Abbreviations, Component List, Section 1.1.1, 1.2.1, Section 2.2, 2.3, 2.4, Section 3.1, 3.4.1 to 3.4.4, Section 4.1.2, 4.3.2, Section 5.1.1, 5.1.7, 5.2.1 to 5.2.4, 5.3, 5.4, 5.6.1, 5.6.2, 5.7.1, 5.7.2, Section 6.1, 6.4, 6.5.3, Section 7.1.1, 7.1.2, Section 8.2.2, 8.2.5, 8.3.1, Section 9.1.2, 9.1.4, 9.2.9, 9.2.16 to 9.2.18, Section 11.1.1, 11.2.1, 11.3.1, 11.3.4, 11.4.1, 11.4.4, Section 12.3.2, 12.7.5, 12.7.7, Section 13.5, Section 14.3, 14.6, Section 15.3, 15.4, Appendix 1.1, Appendix 2.2, Appendix 10.1 to 10.13, Appendix 12 to 14</p> <p>Additions</p> <p>Appendix 1.2</p> <p>Addition model</p> <p>QD75P1N, QD75P2N, QD75P4N, QD75D1N, QD75D2N, QD75D4N</p>

\* The manual number is given on the bottom left of the back cover.

Print Date	* Manual Number	Revision
Dec., 2011	SH (NA)-080058-N	Partial corrections and additions COMPLIANCE WITH EMC AND LOW VOLTAGE DIRECTIVES, Section 2.4, Section 3.4.2, Section 9.1.2, Appendix 2.2
Mar., 2012	SH (NA)-080058-O	Partial corrections and additions Section 3.2.1, Section 3.2.3, Section 3.2.4, Section 5.7.1, Section 9.1.2, Chapter 12, Section 12.1.1, Section 12.3, Appendix 1.1, Appendix 13 Additions Section 12.3.4
Jan., 2013	SH (NA)-080058-P	Partial corrections and additions Section 1.1.1, Section 1.2.3, Section 2.3, Section 3.4.1, Section 3.4.4, Section 5.2.1, Section 15.3, Appendix 3, Appendix 9.2, Appendix 10.14, Appendix 13
Jun., 2013	SH (NA)-080058-Q	Partial corrections and additions Section 2.3, Section 12.3.2
Jul., 2014	SH (NA)-080058-R	Partial corrections and additions Section 1.3, Section 5.6.2, Section 9.2.19, Section 9.2.21, Section 12.3.1
Feb., 2016	SH (NA)-080058-S	Partial corrections and additions Section 1.1.1, Section 1.3, Section 3.1, Section 3.2.1, Section 3.2.2, Section 3.2.4, Section 5.1.1, Section 5.1.2, Section 5.1.4, Section 5.2.3, Section 5.3, Section 5.6.2, Section 7.1.1, Section 7.2, Section 9.1, Section 9.1.1, Section 9.1.5, Section 9.1.6, Section 9.2.1, Section 12.4.1 to 12.4.3, Section 12.7.1, Section 13.2, Section 13.3, Section 15.3, Appendix 1.1, Appendix 2.2, Appendix 3, Appendix 10.9, Appendix 13 Additions Section 9.2.12, Section 9.2.13 Changed item numbers Section 9.2.12 to Section 9.2.23 → Section 9.2.14 to Section 9.2.25 Deletions Appendix 2.3

Japanese Manual Version SH-080047-Y

This manual confers no industrial property rights or any rights of any other kind, nor does it confer any patent licenses. Mitsubishi Electric Corporation cannot be held responsible for any problems involving industrial property rights which may occur as a result of using the contents noted in this manual.

© 1999 MITSUBISHI ELECTRIC CORPORATION

## INTRODUCTION

Thank you for purchasing the Mitsubishi general-purpose programmable controller MELSEC-Q Series. Always read through this manual, and fully comprehend the functions and performance of the Q Series programmable controller before starting use to ensure correct usage of this product.

## CONTENTS

SAFETY PRECAUTIONS.....	A- 1
CONDITIONS OF USE FOR THE PRODUCT .....	A- 5
REVISIONS .....	A- 6
INTRODUCTION .....	A- 9
CONTENTS.....	A- 9
ABOUT MANUALS .....	A- 17
USING THIS MANUAL .....	A- 17
COMPLIANCE WITH EMC AND LOW VOLTAGE DIRECTIVES .....	A- 18
GENERIC TERMS AND ABBREVIATIONS .....	A- 18
COMPONENT LIST .....	A- 19

### PART 1 PRODUCT SPECIFICATIONS AND HANDLING

#### 1. PRODUCT OUTLINE 1- 1 to 1- 24

1.1 Positioning control.....	1- 2
1.1.1 Features of QD75.....	1- 2
1.1.2 Purpose and applications of positioning control.....	1- 5
1.1.3 Mechanism of positioning control .....	1- 7
1.1.4 Outline design of positioning system .....	1- 9
1.1.5 Communicating signals between QD75 and each module.....	1- 12
1.2 Flow of system operation.....	1- 15
1.2.1 Flow of all processes.....	1- 15
1.2.2 Outline of starting .....	1- 18
1.2.3 Outline of stopping .....	1- 20
1.2.4 Outline of restarting .....	1- 22
1.3 Restrictions on using a stepping motor .....	1- 23
1.4 Function additions/modifications according to function version B.....	1- 23

#### 2. SYSTEM CONFIGURATION 2- 1 to 2- 10

2.1 General image of system.....	2- 2
2.2 Configuration list.....	2- 4
2.3 Applicable system .....	2- 6
2.4 How to check the function version and SERIAL No. ....	2- 8

<b>3. SPECIFICATIONS AND FUNCTIONS</b>	<b>3- 1 to 3- 30</b>
--	----------------------

3.1 Performance specifications.....	3- 2
3.2 List of functions .....	3- 6
3.2.1 QD75 control functions.....	3- 6
3.2.2 QD75 main functions.....	3- 8
3.2.3 QD75 sub functions and common functions .....	3- 10
3.2.4 Combination of QD75 main functions and sub functions.....	3- 14
3.3 Specifications of input/output signals with CPU module.....	3- 16
3.3.1 List of input/output signals with CPU module.....	3- 16
3.3.2 Details of input signals (QD75 → CPU module).....	3- 17
3.3.3 Details of output signals (CPU module → QD75).....	3- 18
3.4 Specifications of input/output interfaces with external devices .....	3- 19
3.4.1 Electrical specifications of input/output signals.....	3- 19
3.4.2 Signal layout for external device connection connector.....	3- 25
3.4.3 List of input/output signal details.....	3- 26
3.4.4 Input/output interface internal circuit.....	3- 28

<b>4. INSTALLATION, WIRING AND MAINTENANCE OF THE PRODUCT</b>	<b>4- 1 to 4- 16</b>
---	----------------------

4.1 Outline of installation, wiring and maintenance.....	4- 2
4.1.1 Installation, wiring and maintenance procedures.....	4- 2
4.1.2 Names of each part.....	4- 3
4.1.3 Handling precautions .....	4- 5
4.2 Installation .....	4- 7
4.2.1 Installation precautions .....	4- 7
4.3 Wiring.....	4- 8
4.3.1 Wiring precautions.....	4- 8
4.3.2 Wiring of the differential driver common terminal.....	4- 14
4.4 Checking installation and wiring .....	4- 15
4.4.1 Items to check when installation and wiring are completed.....	4- 15
4.5 Maintenance.....	4- 16
4.5.1 Maintenance precautions.....	4- 16
4.5.2 Disposal precautions.....	4- 16

<b>5. DATA USED FOR POSITIONING CONTROL</b>	<b>5- 1 to 5-134</b>
---	----------------------

5.1 Types of data.....	5- 2
5.1.1 Parameters and data required for control.....	5- 2
5.1.2 Setting items for positioning parameters .....	5- 5
5.1.3 Setting items for OPR parameters.....	5- 7
5.1.4 Setting items for positioning data.....	5- 8
5.1.5 Setting items for block start data .....	5- 10
5.1.6 Setting items for condition data .....	5- 11
5.1.7 Types and roles of monitor data .....	5- 12
5.1.8 Types and roles of control data .....	5- 15



5.2 List of parameters .....	5- 18
5.2.1 Basic parameters 1 .....	5- 18
5.2.2 Basic parameters 2 .....	5- 24
5.2.3 Detailed parameters 1 .....	5- 26
5.2.4 Detailed parameters 2 .....	5- 36
5.2.5 OPR basic parameters.....	5- 45
5.2.6 OPR detailed parameters .....	5- 52
5.3 List of positioning data .....	5- 56
5.4 List of block start data .....	5- 74
5.5 List of condition data .....	5- 80
5.6 List of monitor data.....	5- 86
5.6.1 System monitor data .....	5- 86
5.6.2 Axis monitor data.....	5- 96
5.7 List of control data .....	5-110
5.7.1 System control data .....	5-110
5.7.2 Axis control data .....	5-114

<b>6. SEQUENCE PROGRAM USED FOR POSITIONING CONTROL</b>	<b>6- 1 to 6- 46</b>
---	----------------------

6.1 Precautions for creating program .....	6- 2
6.2 List of devices used.....	6- 5
6.3 Creating a program .....	6- 11
6.3.1 General configuration of program .....	6- 11
6.3.2 Positioning control operation program.....	6- 12
6.4 Positioning program examples .....	6- 15
6.5 Program details .....	6- 25
6.5.1 Initialization program .....	6- 25
6.5.2 Start details setting program .....	6- 26
6.5.3 Start program.....	6- 28
6.5.4 Continuous operation interrupt program.....	6- 38
6.5.5 Restart program .....	6- 40
6.5.6 Stop program.....	6- 44

<b>7. MEMORY CONFIGURATION AND DATA PROCESS</b>	<b>7- 1 to 7- 12</b>
---	----------------------

7.1 Configuration and roles of QD75 memory .....	7- 2
7.1.1 Configuration and roles of QD75 memory.....	7- 2
7.1.2 Buffer memory area configuration .....	7- 5
7.2 Data transmission process .....	7- 6

**PART 2 CONTROL DETAILS AND SETTING**

**8. OPR CONTROL 8- 1 to 8- 24**

8.1 Outline of OPR control ..... 8- 2  
    8.1.1 Two types of OPR control ..... 8- 2  
8.2 Machine OPR ..... 8- 4  
    8.2.1 Outline of the machine OPR operation ..... 8- 4  
    8.2.2 Machine OPR method ..... 8- 5  
    8.2.3 OPR method (1): Near-point dog method ..... 8- 7  
    8.2.4 OPR method (2): Stopper method 1) ..... 8- 9  
    8.2.5 OPR method (3): Stopper method 2) ..... 8- 12  
    8.2.6 OPR method (4): Stopper method 3) ..... 8- 15  
    8.2.7 OPR method (5): Count method 1) ..... 8- 17  
    8.2.8 OPR method (6): Count method 2) ..... 8- 20  
8.3 Fast OPR ..... 8- 23  
    8.3.1 Outline of the fast OPR operation ..... 8- 23

**9. MAJOR POSITIONING CONTROL 9- 1 to 9-140**

9.1 Outline of major positioning controls ..... 9- 2  
    9.1.1 Data required for major positioning control ..... 9- 4  
    9.1.2 Operation patterns of major positioning controls ..... 9- 5  
    9.1.3 Designating the positioning address ..... 9- 16  
    9.1.4 Confirming the current value ..... 9- 17  
    9.1.5 Control unit "degree" handling ..... 9- 19  
    9.1.6 Interpolation control ..... 9- 23  
9.2 Setting the positioning data ..... 9- 29  
    9.2.1 Relation between each control and positioning data ..... 9- 29  
    9.2.2 1-axis linear control ..... 9- 31  
    9.2.3 2-axis linear interpolation control ..... 9- 33  
    9.2.4 3-axis linear interpolation control ..... 9- 37  
    9.2.5 4-axis linear interpolation control ..... 9- 43  
    9.2.6 1-axis fixed-feed control ..... 9- 47  
    9.2.7 2-axis fixed-feed control (interpolation) ..... 9- 49  
    9.2.8 3-axis fixed-feed control (interpolation) ..... 9- 52  
    9.2.9 4-axis fixed-feed control (interpolation) ..... 9- 57  
    9.2.10 2-axis circular interpolation control with sub point designation ..... 9- 60  
    9.2.11 2-axis circular interpolation control with center point designation ..... 9- 66  
    9.2.12 3-axis helical interpolation control with sub point designation ..... 9- 74  
    9.2.13 3-axis helical interpolation control with center point designation ..... 9- 82  
    9.2.14 1-axis speed control ..... 9- 91  
    9.2.15 2-axis speed control ..... 9- 94  
    9.2.16 3-axis speed control ..... 9- 97  
    9.2.17 4-axis speed control ..... 9-101  
    9.2.18 Speed-position switching control (INC mode) ..... 9-106  
    9.2.19 Speed-position switching control (ABS mode) ..... 9-115

9.2.20 Position-speed switching control .....	9-123
9.2.21 Current value changing .....	9-130
9.2.22 NOP instruction .....	9-135
9.2.23 JUMP instruction .....	9-136
9.2.24 LOOP .....	9-138
9.2.25 LEND .....	9-139

<b>10. HIGH-LEVEL POSITIONING CONTROL</b>	<b>10- 1 to 10- 28</b>
---	------------------------

10.1 Outline of high-level positioning control .....	10- 2
10.1.1 Data required for high-level positioning control .....	10- 3
10.1.2 "Block start data" and "condition data" configuration .....	10- 4
10.2 High-level positioning control execution procedure .....	10- 6
10.3 Setting the block start data .....	10- 7
10.3.1 Relation between various controls and block start data .....	10- 7
10.3.2 Block start (normal start) .....	10- 8
10.3.3 Condition start .....	10- 10
10.3.4 Wait start .....	10- 11
10.3.5 Simultaneous start .....	10- 12
10.3.6 Repeated start (FOR loop) .....	10- 14
10.3.7 Repeated start (FOR condition) .....	10- 15
10.3.8 Restrictions when using the NEXT start .....	10- 16
10.4 Setting the condition data .....	10- 17
10.4.1 Relation between various controls and the condition data .....	10- 17
10.4.2 Condition data setting examples .....	10- 20
10.5 Multiple axes simultaneous start control .....	10- 21
10.6 Start program for high-level positioning control .....	10- 24
10.6.1 Starting high-level positioning control .....	10- 24
10.6.2 Example of a start program for high-level positioning control .....	10- 25

<b>11. MANUAL CONTROL</b>	<b>11- 1 to 11- 34</b>
---------------------------	------------------------

11.1 Outline of manual control .....	11- 2
11.1.1 Three manual control methods .....	11- 2
11.2 JOG operation .....	11- 4
11.2.1 Outline of JOG operation .....	11- 4
11.2.2 JOG operation execution procedure .....	11- 7
11.2.3 Setting the required parameters for JOG operation .....	11- 8
11.2.4 Creating start programs for JOG operation .....	11- 10
11.2.5 JOG operation example .....	11- 13
11.3 Inching operation .....	11- 16
11.3.1 Outline of inching operation .....	11- 16
11.3.2 Inching operation execution procedure .....	11- 19
11.3.3 Setting the required parameters for inching operation .....	11- 20
11.3.4 Creating a program to enable/disable the inching operation .....	11- 21
11.3.5 Inching operation example .....	11- 24
11.4 Manual pulse generator operation .....	11- 26
11.4.1 Outline of manual pulse generator operation .....	11- 26

11.4.2 Manual pulse generator operation execution procedure .....	11- 30
11.4.3 Setting the required parameters for manual pulse generator operation .....	11- 31
11.4.4 Creating a program to enable/disable the manual pulse generator operation .....	11- 32

<b>12. CONTROL SUB FUNCTIONS</b>	<b>12- 1 to 12-110</b>
----------------------------------	------------------------

12.1 Outline of sub functions .....	12- 2
12.1.1 Outline of sub functions .....	12- 2
12.2 Sub functions specifically for machine OPR .....	12- 4
12.2.1 OPR retry function.....	12- 4
12.2.2 OP shift function .....	12- 8
12.3 Functions for compensating the control .....	12- 12
12.3.1 Backlash compensation function .....	12- 12
12.3.2 Electronic gear function .....	12- 14
12.3.3 Near pass function .....	12- 21
12.3.4 Output timing selection of near pass control .....	12- 23
12.4 Functions to limit the control .....	12- 27
12.4.1 Speed limit function .....	12- 27
12.4.2 Torque limit function .....	12- 29
12.4.3 Software stroke limit function .....	12- 33
12.4.4 Hardware stroke limit function .....	12- 39
12.5 Functions to change the control details.....	12- 41
12.5.1 Speed change function .....	12- 41
12.5.2 Override function .....	12- 48
12.5.3 Acceleration/deceleration time change function .....	12- 51
12.5.4 Torque change function .....	12- 56
12.5.5 Target position change function .....	12- 58
12.6 Absolute position restoration function .....	12- 62
12.7 Other functions .....	12- 73
12.7.1 Step function.....	12- 73
12.7.2 Skip function .....	12- 78
12.7.3 M code output function.....	12- 81
12.7.4 Teaching function .....	12- 86
12.7.5 Command in-position function .....	12- 93
12.7.6 Acceleration/deceleration processing function.....	12- 96
12.7.7 Pre-reading start function.....	12- 99
12.7.8 Deceleration start flag function .....	12-104
12.7.9 Stop command processing for deceleration stop function.....	12-108

<b>13. COMMON FUNCTIONS</b>	<b>13- 1 to 13- 8</b>
-----------------------------	-----------------------

13.1 Outline of common functions .....	13- 2
13.2 Parameter initialization function.....	13- 3
13.3 Execution data backup function .....	13- 5
13.4 External I/O signal logic switching function .....	13- 7
13.5 External I/O signal monitor function .....	13- 8

<b>14. DEDICATED INSTRUCTIONS</b>	<b>14- 1 to 14- 24</b>
14.1 List of dedicated instructions .....	14- 2
14.2 Interlock during dedicated instruction is executed .....	14- 2
14.3 Z.ABRST1, Z.ABRST2, Z.ABRST3, Z.ABRST4 .....	14- 3
14.4 ZP.PSTR1, ZP.PSTR2, ZP.PSTR3, ZP.PSTR4 .....	14- 8
14.5 ZP.TEACH1, ZP.TEACH2, ZP.TEACH3, ZP.TEACH4 .....	14- 12
14.6 ZP.PFWRT .....	14- 16
14.7 ZP.PINIT .....	14- 20
<b>15. TROUBLESHOOTING</b>	<b>15- 1 to 15- 50</b>
15.1 Troubleshooting .....	15- 2
15.2 Error and warning details .....	15- 6
15.3 List of errors .....	15- 10
15.4 List of warnings .....	15- 42
<b>APPENDICES</b>	<b>Appendix- 1 to Appendix-164</b>
Appendix 1 Version up of the functions .....	Appendix- 2
Appendix 1.1 Comparison of functions according to function versions .....	Appendix- 2
Appendix 1.2 Precautions for the replacement of QD75P□/QD75D□ with QD75P□N/QD75D□N .....	Appendix- 3
Appendix 2 Format sheets .....	Appendix- 7
Appendix 2.1 Positioning Module operation chart .....	Appendix- 7
Appendix 2.2 Parameter setting value entry table .....	Appendix- 10
Appendix 3 Positioning data (No. 1 to 600) List of buffer memory addresses .....	Appendix- 16
Appendix 4 Connection examples with servo amplifiers manufactured by MITSUBISHI Electric Corporation .....	Appendix- 48
Appendix 4.1 Connection example of QD75D□N and MR-J3- □ A (Differential driver) .....	Appendix- 48
Appendix 4.2 Connection example of QD75D□N and MR-H □ A (Differential driver) .....	Appendix- 49
Appendix 4.3 Connection example of QD75D□N and MR-J2/J2S- □ A (Differential driver) .....	Appendix- 50
Appendix 4.4 Connection example of QD75D□N and MR-C □ A (Differential driver) .....	Appendix- 51
Appendix 5 Connection examples with stepping motors manufactured by ORIENTALMOTOR Co., Ltd. .....	Appendix- 52
Appendix 5.1 Connection example of QD75P□N and VEXTA UPD (Open collector) .....	Appendix- 52
Appendix 6 Connection examples with servo amplifiers manufactured by Panasonic Corporation .....	Appendix- 53
Appendix 6.1 Connection example of QD75D□N and MINAS-A series (Differential driver) .....	Appendix- 53
Appendix 7 Connection examples with servo amplifiers manufactured by SANYO DENKI Co., Ltd. .....	Appendix- 54
Appendix 7.1 Connection example of QD75D□N and PYO series (Differential driver) .....	Appendix- 54
Appendix 8 Connection examples with servo amplifiers manufactured by YASKAWA Electric Corporation .....	Appendix- 55
Appendix 8.1 Connection example of QD75D□N and $\Sigma$ -II series (Differential driver) .....	Appendix- 55
Appendix 9 Comparisons with conventional positioning modules .....	Appendix- 56
Appendix 9.1 Comparisons with A1SD71S2 model .....	Appendix- 56

Appendix 9.2 Comparisons with A1SD75P1-S3/A1SD75P2-S3/ A1SD75P3-S3 models.....	Appendix- 57
Appendix 10 When using GX Works2.....	Appendix- 80
Appendix 10.1 Adding a module.....	Appendix- 81
Appendix 10.2 Setting parameters.....	Appendix- 82
Appendix 10.3 Setting auto refresh.....	Appendix- 87
Appendix 10.4 Positioning monitor.....	Appendix- 88
Appendix 10.5 Positioning test.....	Appendix- 98
Appendix 10.6 Wave trace.....	Appendix-106
Appendix 10.7 Location trace.....	Appendix-109
Appendix 10.8 Parameter initialization function.....	Appendix-112
Appendix 10.9 Execution data backup function.....	Appendix-114
Appendix 10.10 External I/O signal logic switching function.....	Appendix-116
Appendix 10.11 External I/O signal monitor function.....	Appendix-117
Appendix 10.12 History monitor function.....	Appendix-118
Appendix 10.13 Checking errors.....	Appendix-120
Appendix 11 MELSEC Explanation of positioning terms.....	Appendix-124
Appendix 12 Positioning control troubleshooting.....	Appendix-144
Appendix 13 List of buffer memory addresses.....	Appendix-150
Appendix 14 External dimension drawing.....	Appendix-159

INDEX	Index- 1 to Index- 12
-------	-----------------------

## ABOUT MANUALS

The following manuals are also related to this product.  
In necessary, order them by quoting the details in the tables below.

### Related Manuals

Manual Name	Manual Number (Model Code)
GX Configurator-QP Version 2 Operating Manual Data creation (such as parameters and positioning data) and operations of transferring data to modules, positioning monitor, and tests using GX Configurator-QP..... (sold separately) <sup>*1</sup>	SH-080172 (13JU19)
GX Developer Version 8 Operating Manual Operating methods of GX Developer, such as programming, printing, monitoring, and debugging (sold separately)	SH-080373E (13JU41)
GX Works2 Version1 Operating Manual (Common) System configuration, parameter settings, and online operations (common to Simple project and Structured project) of GX Works2..... (sold separately)	SH-080779ENG (13JU63)
GX Works2 Version1 Operating Manual (Intelligent Function Module) Parameter settings, monitoring, and operations of the pre-defined protocol support function of intelligent function modules, using GX Works2 ..... (sold separately)	SH-080921ENG (13JU69)

\*1: The manual is included in the CD-ROM of the software package in a PDF-format file.  
For users interested in buying the manual separately, a printed version is available. Please contact us with the manual number (model code) in the list above.

## USING THIS MANUAL

■ The symbols used in this manual are shown below.

Pr.\* ..... Symbol indicating positioning parameter and OPR parameter item.

Da.\* ..... Symbol indicating positioning data, block start data and condition data item.

Md.\* ..... Symbol indicating monitor data item.

Cd.\* ..... Symbol indicating control data item.

(A serial No. is inserted in the \* mark.)

■ Representation of numerical values used in this manual.

- Buffer memory addresses, error codes and warning codes are represented in decimal.
- X/Y devices are represented in hexadecimal.
- Setting data and monitor data are represented in decimal or hexadecimal.  
Data ended by "H" are represented in hexadecimal.

(Example) 10.....Decimal

10H .....Hexadecimal

## COMPLIANCE WITH EMC AND LOW VOLTAGE DIRECTIVES

### (1) Method of ensuring compliance

To ensure that Mitsubishi programmable controllers maintain EMC and Low Voltage Directives when incorporated into other machinery or equipment, certain measures may be necessary. Please refer to one of the following manuals.

- QCPU User's Manual (Hardware Design, Maintenance and Inspection)
- Safety Guidelines (this manual is included with the CPU module or base unit)

The CE mark on the side of the programmable controller indicates compliance with EMC and Low Voltage Directives.

### (2) Additional measures

To ensure that this product maintains EMC and Low Voltage Directives, please refer to Section 4.3.1.

## GENERIC TERMS AND ABBREVIATIONS

Unless specially noted, the following generic terms and abbreviations are used in this manual.

Generic term/abbreviation	Details of generic term/abbreviation
CPU module	Generic term for CPU module on which QD75 can be mounted.
QD75	Generic term for positioning module QD75P1N, QD75P2N, QD75P4N, QD75D1N, QD75D2N, QD75D4N, QD75P1, QD75P2, QD75P4, QD75D1, QD75D2, and QD75D4. The module type is described to indicate a specific module.
QD75P□N	Generic term for positioning module QD75P1N, QD75P2N, QD75P4N.
QD75D□N	Generic term for positioning module QD75D1N, QD75D2N, QD75D4N.
QD75P□	Generic term for positioning module QD75P1, QD75P2, QD75P4.
QD75D□	Generic term for positioning module QD75D1, QD75D2, QD75D4.
Peripheral device	Generic term for DOS/V personal computer that can run the following "GX Developer" and "GX Configurator-QP".
GX Configurator-QP	Abbreviation for GX Configurator-QP (SW2D5C-QD75P-E or later).
GX Developer	Abbreviation for GX Developer (SW4D5C-GPPW-E or later).
GX Works2	Product name of the software package for the MELSEC programmable controllers.
Drive unit (servo amplifier)	Abbreviation for pulse input compatible drive unit (servo amplifier).
Manual pulse generator	Abbreviation for manual pulse generator (prepared by user).
DOS/V personal computer	IBM PC/AT <sup>®</sup> and compatible DOS/V compliant personal computer.
Personal computer	Generic term for personal computer which supports Windows <sup>®</sup> .
Workpiece	Generic term for moving body such as workpiece and tool, and for various control targets.
Axis 1, axis 2, axis 3, axis 4	Indicates each axis connected to QD75.
1-axis, 2-axis, 3-axis, 4-axis	Indicates the number of axes. (Example: 2-axis = Indicates two axes such as axis 1 and axis 2, axis 2 and axis 3, and axis 3 and axis 1.)



COMPONENT LIST

The table below shows the component included in respective positioning modules:

Module name	Description	Quantity
QD75P1N	QD75P1N Positioning Module(1-axis open collector output system)	1
QD75P2N	QD75P2N Positioning Module(2-axes open collector output system)	1
QD75P4N	QD75P4N Positioning Module(4-axes open collector output system)	1
QD75D1N	QD75D1N Positioning Module(1-axis differential driver output system)	1
	Differential driver common terminal	1
QD75D2N	QD75D2N Positioning Module(2-axes differential driver output system)	1
	Differential driver common terminal	1
QD75D4N	QD75D4N Positioning Module(4-axes differential driver output system)	1
	Differential driver common terminal	1
QD75P1	QD75P1 Positioning Module(1-axis open collector output system)	1
QD75P2	QD75P2 Positioning Module(2-axes open collector output system)	1
QD75P4	QD75P4 Positioning Module(4-axes open collector output system)	1
QD75D1	QD75D1 Positioning Module(1-axis differential driver output system)	1
	Differential driver common terminal	1
QD75D2	QD75D2 Positioning Module(2-axes differential driver output system)	1
	Differential driver common terminal	1
QD75D4	QD75D4 Positioning Module(4-axes differential driver output system)	1
	Differential driver common terminal	1



## PART 1 PRODUCT SPECIFICATIONS AND HANDLING

PART 1 is configured for the following purposes (1) to (5).

- (1) To understand the outline of positioning control, and the QD75 specifications and functions
- (2) To carry out actual work such as installation and wiring
- (3) To set parameters and data required for positioning control
- (4) To create a sequence program required for positioning control
- (5) To understand the memory configuration and data transmission process

Read PART 2 for details on each control.

CHAPTER 1	PRODUCT OUTLINE .....	1- 1 to 1-	24
CHAPTER 2	SYSTEM CONFIGURATION .....	2- 1 to 2-	10
CHAPTER 3	SPECIFICATIONS AND FUNCTIONS .....	3- 1 to 3-	30
CHAPTER 4	INSTALLATION, WIRING AND MAINTENANCE OF THE PRODUCT ...	4- 1 to 4-	16
CHAPTER 5	DATA USED FOR POSITIONING CONTROL.....	5- 1 to 5-	134
CHAPTER 6	SEQUENCE PROGRAM USED FOR POSITIONING CONTROL .....	6- 1 to 6-	46
CHAPTER 7	MEMORY CONFIGURATION AND DATA PROCESS .....	7- 1 to 7-	12



# CHAPTER 1 PRODUCT OUTLINE

The purpose and outline of positioning control using QD75 are explained in this chapter. Reading this chapter will help you understand what can be done using the positioning system and which procedure to use for a specific purpose.

By understanding "What can be done", and "Which procedure to use" beforehand, the positioning system can be structured smoothly.

- 1.1 Positioning control ..... 1- 2
  - 1.1.1 Features of QD75 ..... 1- 2
  - 1.1.2 Purpose and applications of positioning control ..... 1- 5
  - 1.1.3 Mechanism of positioning control ..... 1- 7
  - 1.1.4 Outline design of positioning system ..... 1- 9
  - 1.1.5 Communicating signals between QD75 and each module ..... 1- 12
- 1.2 Flow of system operation ..... 1- 15
  - 1.2.1 Flow of all processes ..... 1- 15
  - 1.2.2 Outline of starting ..... 1- 18
  - 1.2.3 Outline of stopping ..... 1- 20
  - 1.2.4 Outline of restarting ..... 1- 22
- 1.3 Restrictions on using a stepping motor ..... 1- 23
- 1.4 Function additions/modifications according to function version B ..... 1- 23

## 1.1 Positioning control

### 1.1.1 Features of QD75

The features of the QD75 are shown below.

#### (1) Availability of one, two, and four axis modules

- (a) The pulse output types of the available modules are either the open collector output system or the differential driver output system. A module can be selected from the following depending on the drive unit type and the number of axes. (Refer to Section 2.2.)
  - Open collector output system:  
QD75P1N/QD75P2N/QD75P4N (QD75P1/QD75P2/QD75P4)
  - Differential driver output system:  
QD75D1N/QD75D2N/QD75D4N (QD75D1/QD75D2/QD75D4)
- (b) For connecting any of the QD75 modules to the base unit, a single slot and 32 dedicated I/O channels are required.  
Within the limit imposed by the maximum number of inputs and outputs supported by the CPU module, up to 64 modules can be used. (Refer to Section 3.1.)

#### (2) Wide variety of positioning control functions

- (a) A wide variety of positioning control functions essential to any positioning system are supported: positioning to an arbitrary position, fixed-feed control, equal-speed control, and so on. (Refer to Section 5.3 and 9.2.)
  - 1) Up to 600 positioning data items, including such information as positioning addresses, control systems, and operation patterns, can be prepared for each axis.  
Using the prepared positioning data, the positioning control is performed independently for each axis. (In addition, such controls as interpolation involving two to four axes and simultaneous startup of multiple axes are possible.)
  - 2) Independent control of each axis can be achieved in linear control mode (executable simultaneously over four axes).  
Such control can either be the independent positioning control using a single positioning data or the continuous positioning control enabled by the continuous processing of multiple positioning data.
  - 3) Coordinated control over multiple axes can take the form of either the linear interpolation through the speed or position control of two to four axes or the circular interpolation involving two axes.  
Such control can either be the independent positioning control using a single positioning data or the continuous positioning control enabled by the continuous processing of multiple positioning data.
- (b) For each positioning data, the user can specify any of the following control systems: position control, speed control, speed-position switching control, position-speed switching control, and so on. (Refer to Section 5.3 and 9.2.)

- (c) Continuous positioning control using multiple positioning data can be executed in accordance with the operation patterns the user assigned to the positioning data. (Refer to Section 5.3 and 9.1.2)  
Continuous positioning control can be executed over multiple blocks, where each block consists of multiple positioning data. (Refer to Section 10.3.2.)
- (d) OPR control is given additional features (Refer to Section 8.2.)
- 1) Six different machine OPR methods are provided: near point dog method (one method), stopper methods (three methods), and count methods (two methods).
  - 2) OPR retry function facilitates the machine OPR control from an arbitrary position.  
(The machine OP a premier reference position for positioning control. The machine is set to the machine OP through one of the machine OPR methods mentioned in 1) above.)
- (e) Two acceleration/deceleration control methods are provided: trapezoidal acceleration/deceleration and S-curve acceleration/deceleration. (Refer to Section 12.7.6.)  
(Note that there is a restriction on executing the S-curve acceleration/deceleration for the system using stepping motors. Refer to Section 1.3.)
- (3) **Quick startup (Refer to Section 3.1.)**  
The processing time to start the positioning operation is shortened.  
QD75P□N/QD75D□N: 1.5ms (QD75P□/QD75D□: 6ms)  
When operation using simultaneous start function or interpolation operation is executed, the axes start without delay.
- |           |  |   |                                     |
|-----------|--|---|-------------------------------------|
| (Example) | Axis 1 and Axis 3 are started by the simultaneous start function | : | No delay in Axis 1 and Axis 3 start |
|           | Axis 2 and Axis 4 are started by the interpolation operation     | : | No delay in Axis 2 and Axis 4 start |
- (4) **Faster pulse output and allowance of longer distance to drive unit (Refer to Section 3.1.)**  
The modules with a differential driver (QD75D□N (QD75D□)) incorporate the improvements in pulse output speed and maximum distance to the drive unit.
- QD75D□N: 4Mpulse/s, 10m max. (QD75D□: 1Mpulse/s, 10m max.)
  - QD75P□N: 200kpulse/s, 2m max. (QD75P□: 200kpulse/s, 2m max.)
- (5) **Easy maintenance**  
Each QD75 positioning module incorporates the following improvements in maintainability:
- (a) Data such as the positioning data and parameters can be stored on a flash ROM inside the QD75, eliminating the need of a battery for retaining data. (Refer to Section 7.1.1.)
  - (b) Error messages are classified in more detail to facilitate the initial troubleshooting procedure. (Refer to Section 15.1.)
  - (c) The module retains 16 error messages and 16 warning messages recently output, offering more complete error and warning histories. (Refer to Section 5.6.1.)

- (6) **Support of intelligent function module dedicated instructions**  
Dedicated instructions such as the absolute position restoration instruction, positioning start instruction, and teaching instruction are provided.  
The use of such dedicated instruction simplifies sequence programs. (Refer to CHAPTER 14.)
  
- (7) **Setups, monitoring, and testing through GX Configurator-QP**  
Using GX Configurator-QP, the user can control the QD75 parameters and positioning data without having to be conscious of the buffer memory addresses. Moreover, GX Configurator-QP has a test function which allows the user to check the wiring before creating a sequence program for positioning control, or test operation the QD75 using created parameters and positioning data for checking their integrity.  
The control monitor function of GX Configurator-QP allows the user to debug programs efficiently.



1.1.2 Purpose and applications of positioning control

"Positioning" refers to moving a moving body, such as a workpiece or tool (hereinafter, generically called "workpiece") at a designated speed, and accurately stopping it at the target position. The main application examples are shown below.

**■ Punch press (X, Y feed positioning)**

- To punch insulation material or leather, etc., as the same shape at a high yield, positioning is carried out with the X axis and Y axis servos.
- After positioning the table with the X axis servo, the press head is positioned with the Y axis servo, and is then punched with the press.
- When the material type or shape changes, the press head die is changed, and the positioning pattern is changed.

**■ Palletizer**

- Using the servo for one axis, the palletizer is positioned at a high accuracy.
- The amount to lower the palletizer according to the material thickness is saved.

**■ Compact machining center (ATC magazine positioning)**

Rotation direction for calling 11, 12, 1, 2 or 3

Rotation direction for calling 17 to 20, 1 to 5

Current value retrieval position

Current value retrieval position

Rotation direction for calling 5, 6, 7, 8, 9 or 10

Rotation direction for calling 7 to 16

<No. of tools: 12>

<No. of tools: 20>

- The ATC tool magazine for a compact machining center is positioned.
- The relation of the magazine's current value and target value is calculated, and positioning is carried out with forward run or reverse run to achieve the shortest access time.

■ Lifter (Storage of Braun tubes onto aging rack)

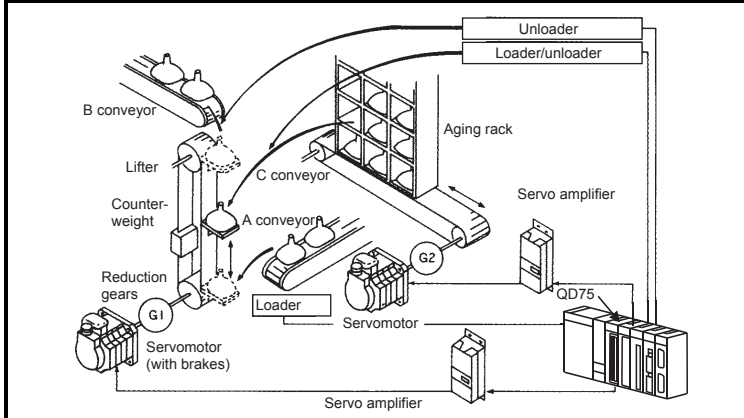

- During the aging process of braun tubes, storage onto the rack is carried out by positioning with the AC servo.
- The up/down positioning of the lifter is carried out with the 1-axis servo, and the horizontal position of the aging rack is positioned with the 2-axis servo.

■ Index table (High-accuracy indexing of angle)

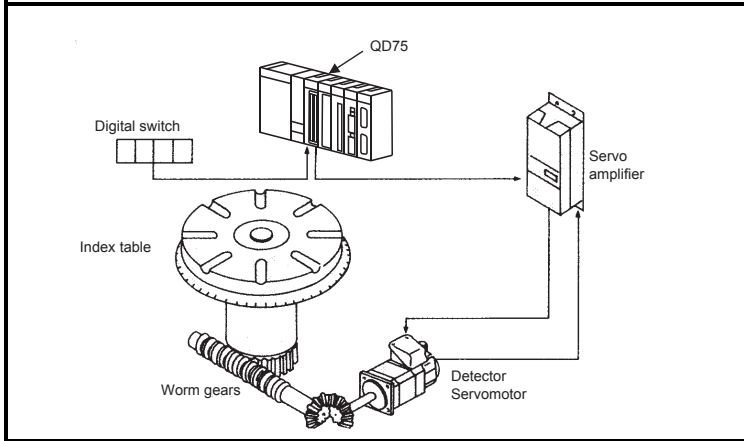

- The index table is positioned at a high accuracy using the 1-axis servo.

■ Inner surface grinder

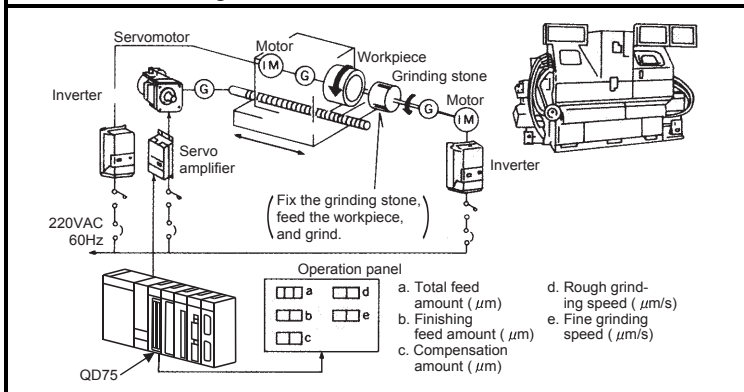

- The grinding of the workpiece's inner surface is controlled with the servo and inverter.
- The rotation of the workpiece is controlled with the 1-axis inverter, and the rotation of the grinding stone is controlled with the 2-axis inverter. The workpiece is fed and ground with the 3-axis servo.

1.1.3 Mechanism of positioning control

Positioning control using the QD75 is carried out with "pulse signals". (The QD75 is a module that generates pulses). In the positioning system using the QD75, various software and devices are used for the following roles. The QD75 realizes complicated positioning control when it reads in various signals, parameters and data and is controlled with the CPU module.

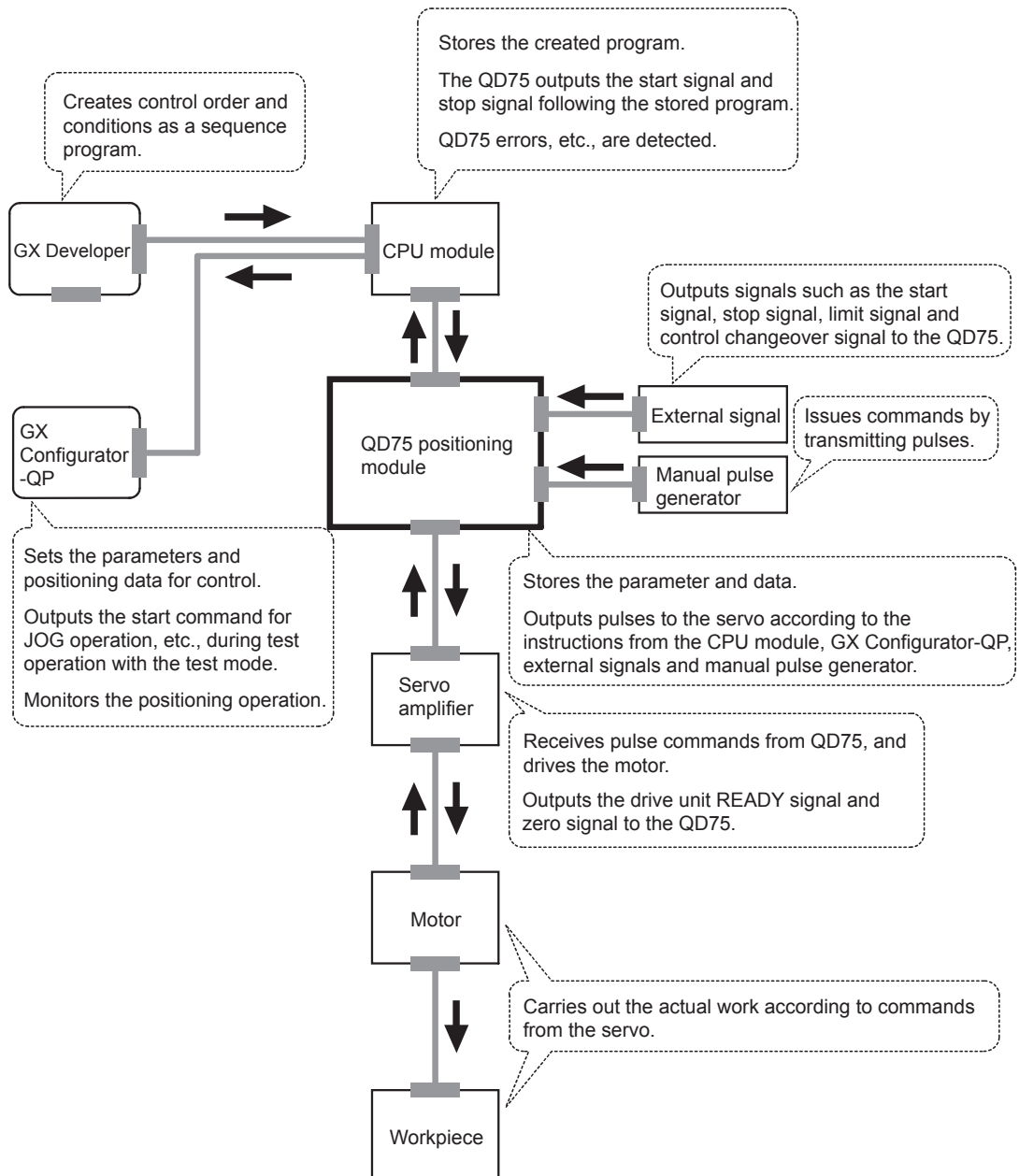

The principle of "position control" and "speed control" operation is shown below.

■ Position control

The total No. of pulses required to move the designated distance is obtained in the following manner.

$$\left[ \begin{array}{l} \text{Total No. of pulses} \\ \text{required to move} \\ \text{designated distance} \end{array} \right] = \left[ \frac{\text{Designated distance}}{\text{Movement amount of machine (load)}} \right] \times \left[ \begin{array}{l} \text{No. of pulses} \\ \text{required for motor to} \\ \text{rotate once} \end{array} \right]$$

\*The No. of pulses required for the motor to rotate once is the "encoder resolution" described in the motor catalog specification list.

When this total No. of pulses is issued from the QD75 to the servo amplifier, control to move the designated distance can be executed.

The machine side movement amount when one pulse is issued to the servo amplifier is called the "movement amount per pulse". This value is the min. value for the workpiece to move, and is also the electrical positioning precision.

■ Speed control

The "Total No. of pulses" mentioned above is invariably required for controlling the distance. For positioning or speed control, the speed must be controlled as well.

The speed is determined by the frequency of pulses sent from the QD75 to the drive unit.

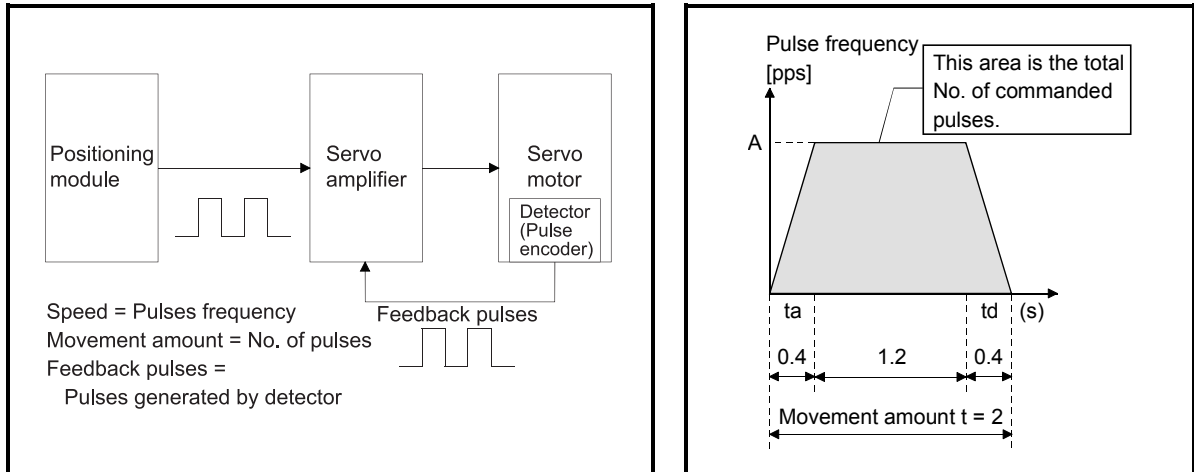

Fig. 1.1 Relationship between position control and speed control

**POINT**  
 The QD75 controls the position with the "total No. of pulses", and the speed with the "pulse frequency".

## 1.1.4 Outline design of positioning system

The outline of the positioning system operation and design, using the QD75, is shown below.

## (1) Positioning system using QD75

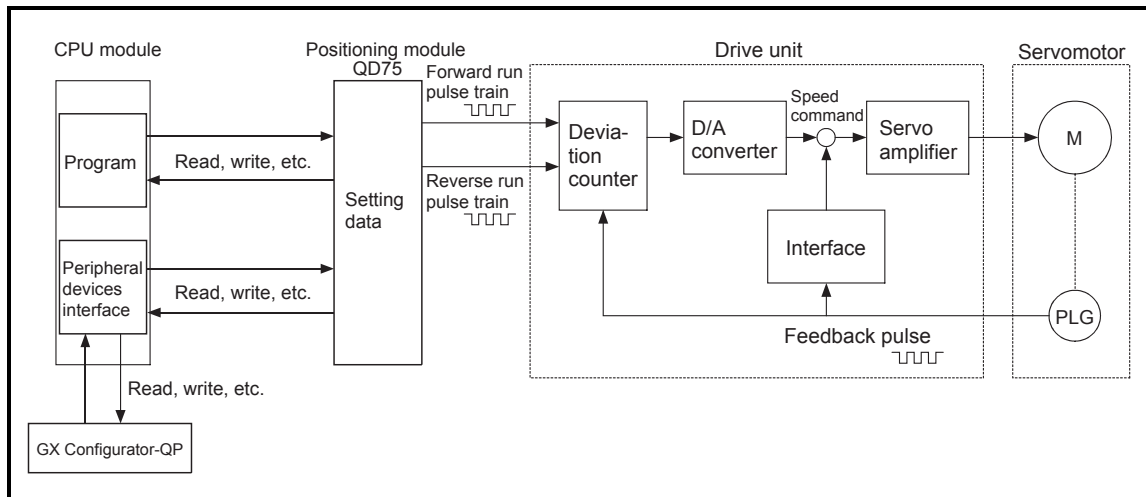

Fig. 1.2 Outline of the operation of positioning system using QD75

## (a) Positioning operation by the QD75

## 1) The QD75 output is a pulse train.

The pulse train output by the QD75 is counted by and stored in the deviation counter in the drive unit.

The D/A converter outputs an analog DC current proportionate to the count maintained by the deviation counter (called "pulse droop"). The analog DC current serves as the servomotor speed control signal.

## 2) The motor rotation is controlled by the speed control signal from the drive unit.

As the motor rotates, the pulse encoder (PLG) attached to the motor generates feedback pulses, the frequency of which is proportionate to the rotation speed.

The feedback pulses are fed back to the drive unit and decrements the pulse droop, the pulse count maintained by the deviation counter. The motor keeps on rotating as the pulse droop is maintained at a certain level.

## 3) When the QD75 terminates the output of a pulse train, the motor decelerates as the pulse droop decreases and stops when the count drops to zero.

Thus, the motor rotation speed is proportionate to the pulse frequency, while the overall motor rotation angle is proportionate to the total number of pulses output by the QD75.

Therefore, when a movement amount per pulse is given, the overall movement amount can be determined by the number of pulses in the pulse train.

The pulse frequency, on the other hand, determines the motor rotation speed (feed speed).

(b) Pulse train output from the QD75

- 1) As shown in Fig. 1.3, the pulse frequency increases as the motor accelerates. The pulses are sparse when the motor starts and more frequent when the motor speed comes close to the target speed.
- 2) The pulse frequency stabilizes when the motor speed equals the target speed.
- 3) The QD75 decreases the pulse frequency (sparser pulses) to decelerate the motor before it finally stops the output. There will be a little difference in timing between the decrease in the pulse frequency and the actual deceleration and stopping of the motor. This difference, called "the stop settling time", is required for gaining a stopping accuracy.

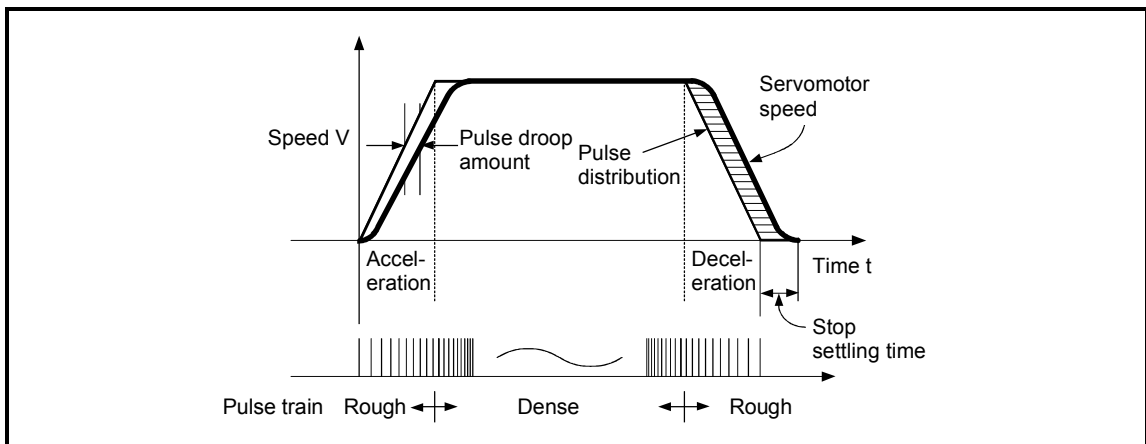

Fig. 1.3 QD75 output pulses

(2) Movement amount and speed in a system using worm gears

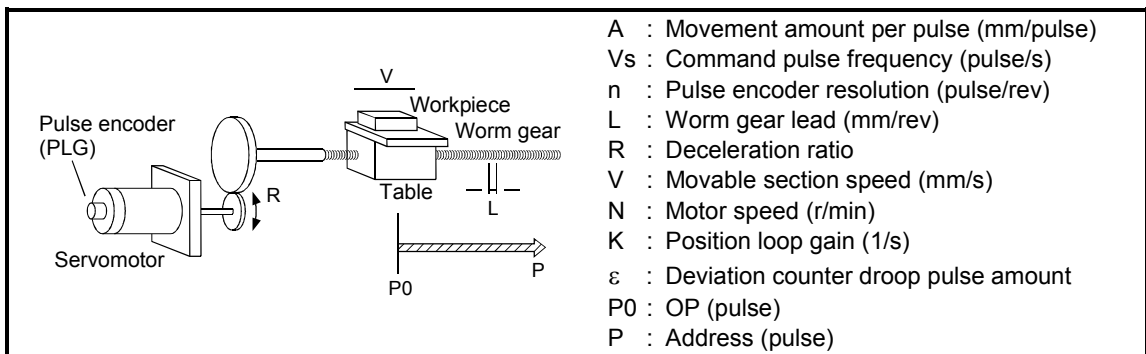

Fig. 1.4 System using worm gears

- (a) In the system shown in Fig. 1.4, the movement amount per pulse, command pulse frequency, and the deviation counter droop pulse amount are determined as follows:

- 1) Movement amount per pulse

The movement amount per pulse is determined by the worm gear lead, deceleration ratio, and the pulse encoder resolution.

The movement amount, therefore, is given as follows: (Number of pulses output) × (Movement amount per pulse).

$$A = \frac{L}{R \times n} \text{ [mm/pulse]}$$

- 2) Command pulse frequency

The command pulse frequency is determined by the speed of the moving part and movement amount per pulse:

$$Vs = \frac{V}{A} \text{ [pulse/s]}$$

- 3) Deviation counter droop pulse amount.

The deviation counter droop pulse amount is determined by the command pulse frequency and position loop gain.

$$\varepsilon = \frac{Vs}{K} \text{ [pulse]}$$

- (b) The QD75 allows the user to select from the following four units as the unit used by positioning commands to any of the axes (1 to 4, if the module supports four axes): mm, inch, degree, and pulse.

The unit selected for one axis may differ from the unit selected for another axis.

When such data as the acceleration/deceleration time, positioning speed, and positioning address are correctly set in consideration of the chosen unit, the QD75 can calculate the number of pulses required for a movement amount to the target positioning address and execute the positioning by outputting a pulse train that includes the calculated number of pulses.

1.1.5 Communicating signals between QD75 and each module

The outline of the signal communication between the QD75 and CPU module, peripheral device and drive unit, etc., is shown below.  
 (A peripheral device communicates with the QD75 via the CPU module to which it is connected)

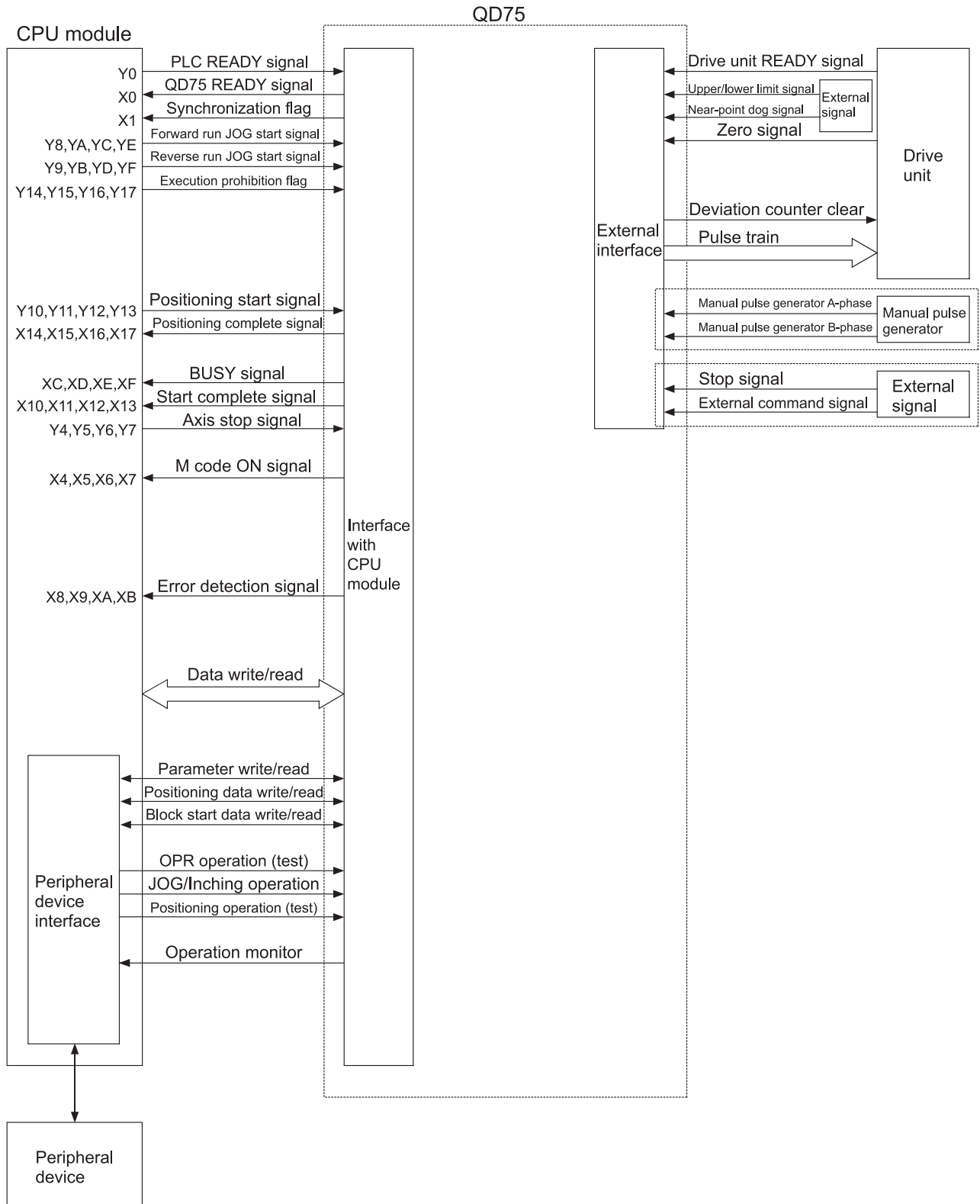



■ QD75 ↔ CPU module

The QD75 and CPU module communicate the following data via the base unit.

Direction Communication	QD75 → CPU module	CPU module → QD75
Control signal *	Signal indicating QD75 state, such as QD75 READY signal, BUSY signal.	Signal related to commands such as PLC READY signal, various start signals, stop signals
Data (read/write)	<ul style="list-style-type: none"> <li>• Parameter</li> <li>• Positioning data</li> <li>• Block start data</li> <li>• Control data</li> <li>• Monitor data</li> </ul>	<ul style="list-style-type: none"> <li>• Parameter</li> <li>• Positioning data</li> <li>• Block start data</li> <li>• Control data</li> </ul>

\* Refer to Section 3.3 "Specifications of input/output signals with CPU module " for details.

■ QD75 ↔ Peripheral device

The QD75 and peripheral device communicate the following data via the CPU module:

Direction Communication	QD75 → Peripheral device	Peripheral device → QD75
Data (read/write)	<ul style="list-style-type: none"> <li>• Parameter</li> <li>• Positioning data</li> <li>• Block start data</li> </ul>	<ul style="list-style-type: none"> <li>• Parameter</li> <li>• Positioning data</li> <li>• Block start data</li> </ul>
Test operation	-	<ul style="list-style-type: none"> <li>• OPR control start command</li> <li>• Positioning control start command</li> <li>• JOG/Inching operation start command</li> <li>• Teaching start command</li> <li>• Manual pulse generator operation enable/disable command</li> </ul>
Operation monitor	• Monitor data	-

■ QD75 ↔ Drive unit

The QD75 and drive unit communicate the following data via the external device connection connector.

Direction Communication	QD75 → Drive unit	Drive unit → QD75
Control signal	Signals related to commands such as deviation counter clear signal	Signals indicating drive unit state such as drive unit READY signal
Pulse train	• Pulse train output	-

■ QD75 ↔ Manual pulse generator

The QD75 and manual pulse generator communicate the following data via the external device connection connector.

(The manual pulse generator should be connected to an external device connection connector for axis 1 or for axes 1 and 2.)

Direction Communication	QD75 → Manual pulse generator	Manual pulse generator → QD75
Pulse signal	-	Manual pulse generator A-phase, manual pulse generator B-phase

## ■ QD75 ↔ External signal

The QD75 and external signal communicate the following data via the external device connection connector.

Direction Communication	QD75 → External signal	External signal → QD75
Control signal	–	<ul style="list-style-type: none"><li>• Signals from detector such as near-point dog signal, upper/lower limit signal, zero signal</li><li>• Control signals from external device such as stop signal, external command signal</li></ul>

1.2 Flow of system operation

1.2.1 Flow of all processes

The positioning control processes, using the QD75, are shown below.

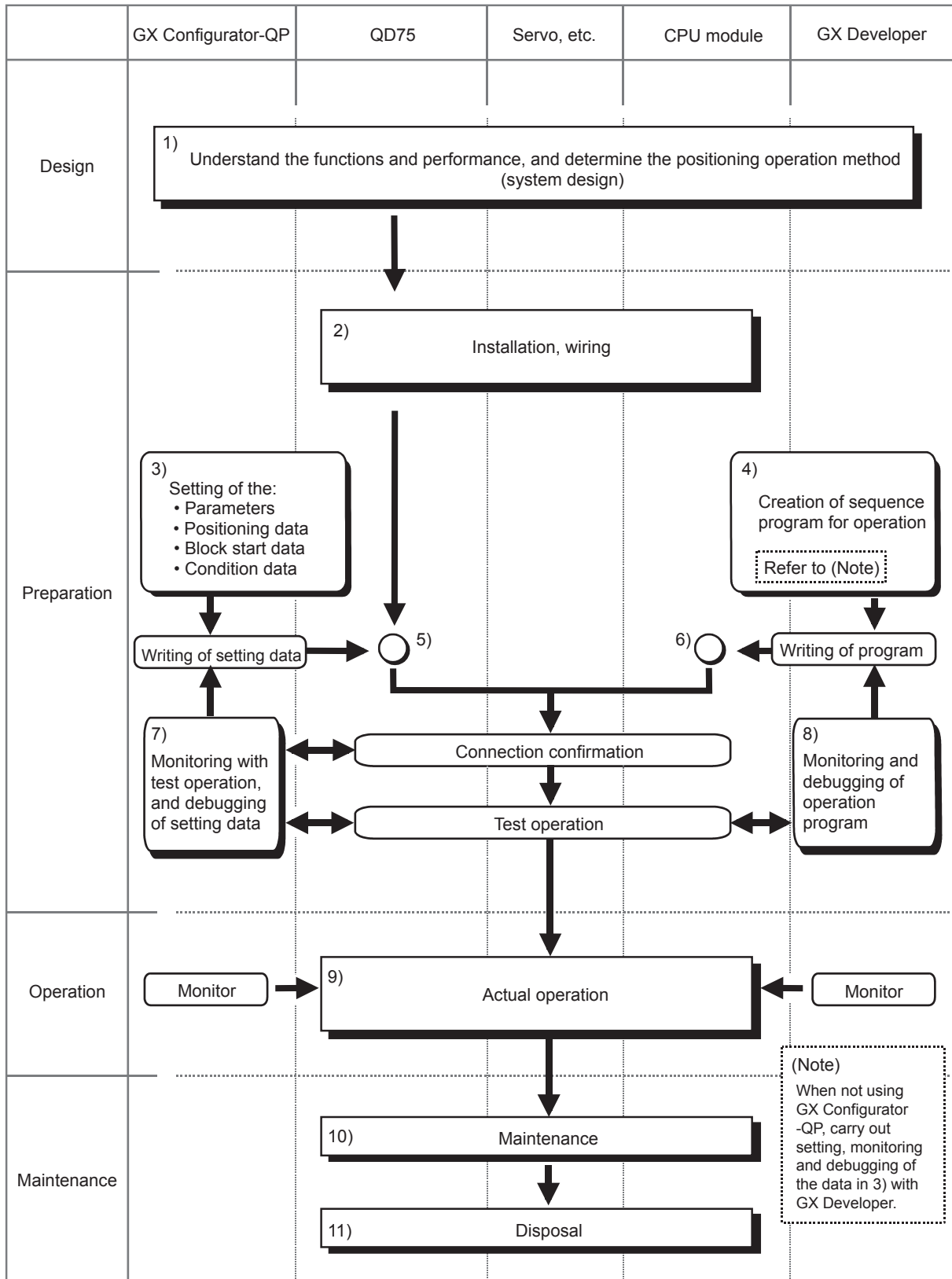

The following work is carried out with the processes shown on the previous page.

	Details	Reference
1)	Understand the product functions and usage methods, the configuration devices and specifications required for positioning control, and design the system.	<ul style="list-style-type: none"> <li>• CHAPTER 1</li> <li>• CHAPTER 2</li> <li>• CHAPTER 3</li> <li>• CHAPTER 8 to CHAPTER 13</li> </ul>
2)	Install the QD75 onto the base unit, wire the QD75 and external connection devices (drive unit, etc.).	<ul style="list-style-type: none"> <li>• CHAPTER 4</li> </ul>
3)	Using GX Configurator-QP, set the parameters, positioning data, block start data and condition data required for the positioning control to be executed. *1	<ul style="list-style-type: none"> <li>• CHAPTER 5</li> <li>• CHAPTER 8 to CHAPTER 13</li> <li>• GX Configurator-QP Operating Manual</li> </ul>
4)	Using GX Developer, create the sequence program required for positioning operation. (When not using GX Configurator-QP, also create the sequence program for setting data.)	<ul style="list-style-type: none"> <li>• CHAPTER 6</li> <li>• GX Developer Operating Manual</li> </ul>
5)	Write the parameters and positioning data, etc., created with GX Configurator-QP into the QD75.	<ul style="list-style-type: none"> <li>• CHAPTER 7</li> <li>• GX Configurator-QP Operating Manual</li> </ul>
6)	Using GX Developer, write the created sequence program into the CPU module. (When not using GX Configurator-QP, also write in the sequence program for setting data.)	<ul style="list-style-type: none"> <li>• CHAPTER 7</li> <li>• GX Developer Operating Manual</li> </ul>
7)	Carry out test operation and adjustments in the test mode to check the connection with the QD75 and external connection device, and to confirm that the designated positioning operation is executed correctly. (Debug the set "parameters" and "positioning data", etc.)	<ul style="list-style-type: none"> <li>• GX Configurator-QP Operating Manual</li> <li>• CHAPTER 13</li> <li>• GX Developer Operating Manual</li> </ul>
8)	Carry out test operation and adjustment to confirm that the designated positioning operation is executed correctly. (Debug the created sequence program. When not using GX Configurator-QP, also debug the set data.)	<ul style="list-style-type: none"> <li>• GX Developer Operating Manual</li> </ul>
9)	Actually operate the positioning operation. At this time, monitor the operation state as required. If an error or warning occurs, remedy.	<ul style="list-style-type: none"> <li>• CHAPTER 5</li> <li>• CHAPTER 15</li> <li>• GX Configurator-QP Operating Manual</li> <li>• GX Developer Operating Manual</li> </ul>
10)	Service the QD75 as required.	<ul style="list-style-type: none"> <li>• CHAPTER 4</li> </ul>
11)	Dispose of the QD75.	<ul style="list-style-type: none"> <li>• CHAPTER 4</li> </ul>

\*1: When setting the QD75P□N/QD75D□N using GX Configurator-QP, there are restrictions on the setting ranges of some items. (Refer to Appendix 1.2.)



1.2.2 Outline of starting

The outline for starting each control is shown with the following flowchart.

\*It is assumed that each module is installed, and the required system configuration, etc., has been prepared.

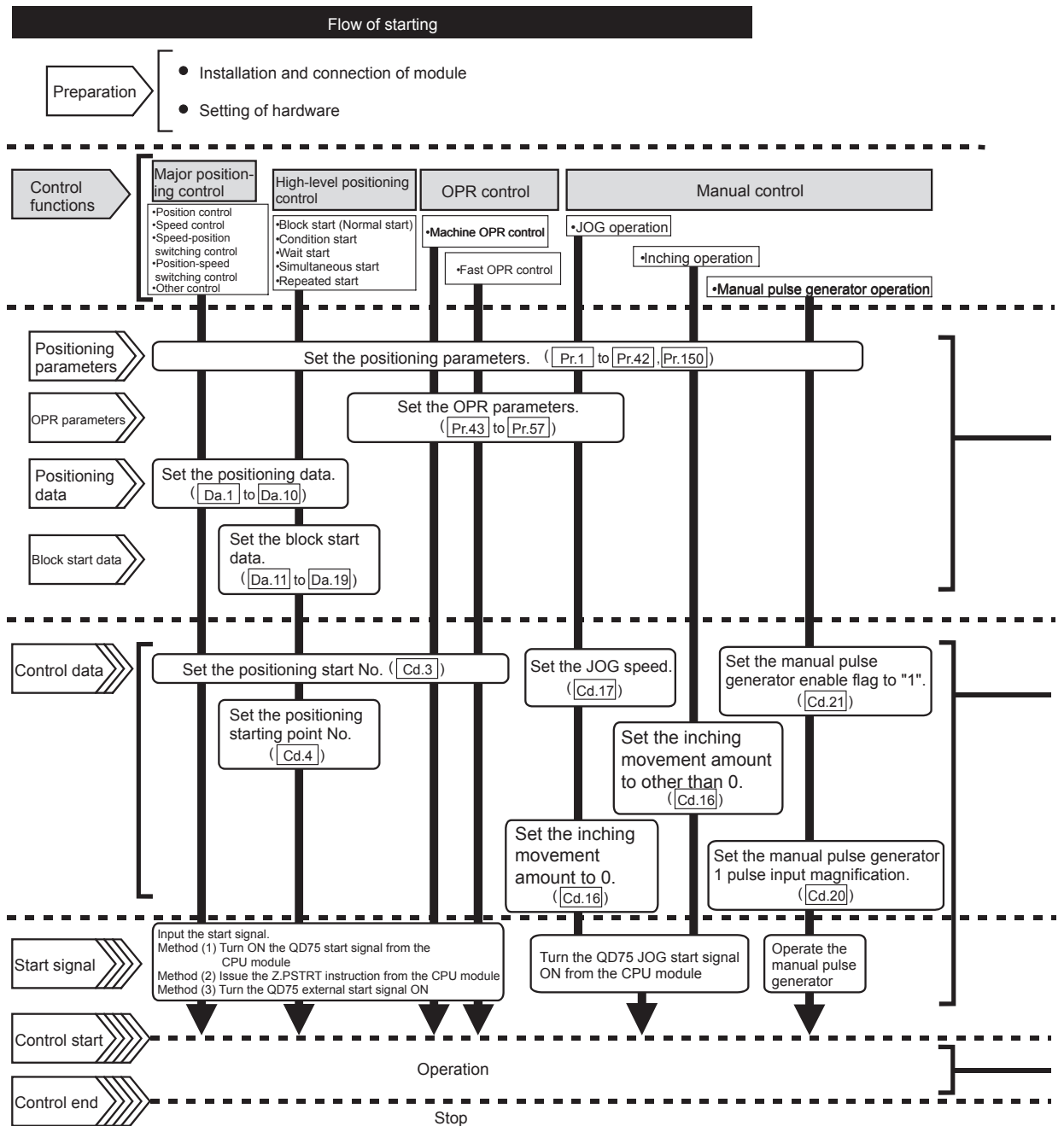

Setting method

 : Indicates the sequence program that must be created.

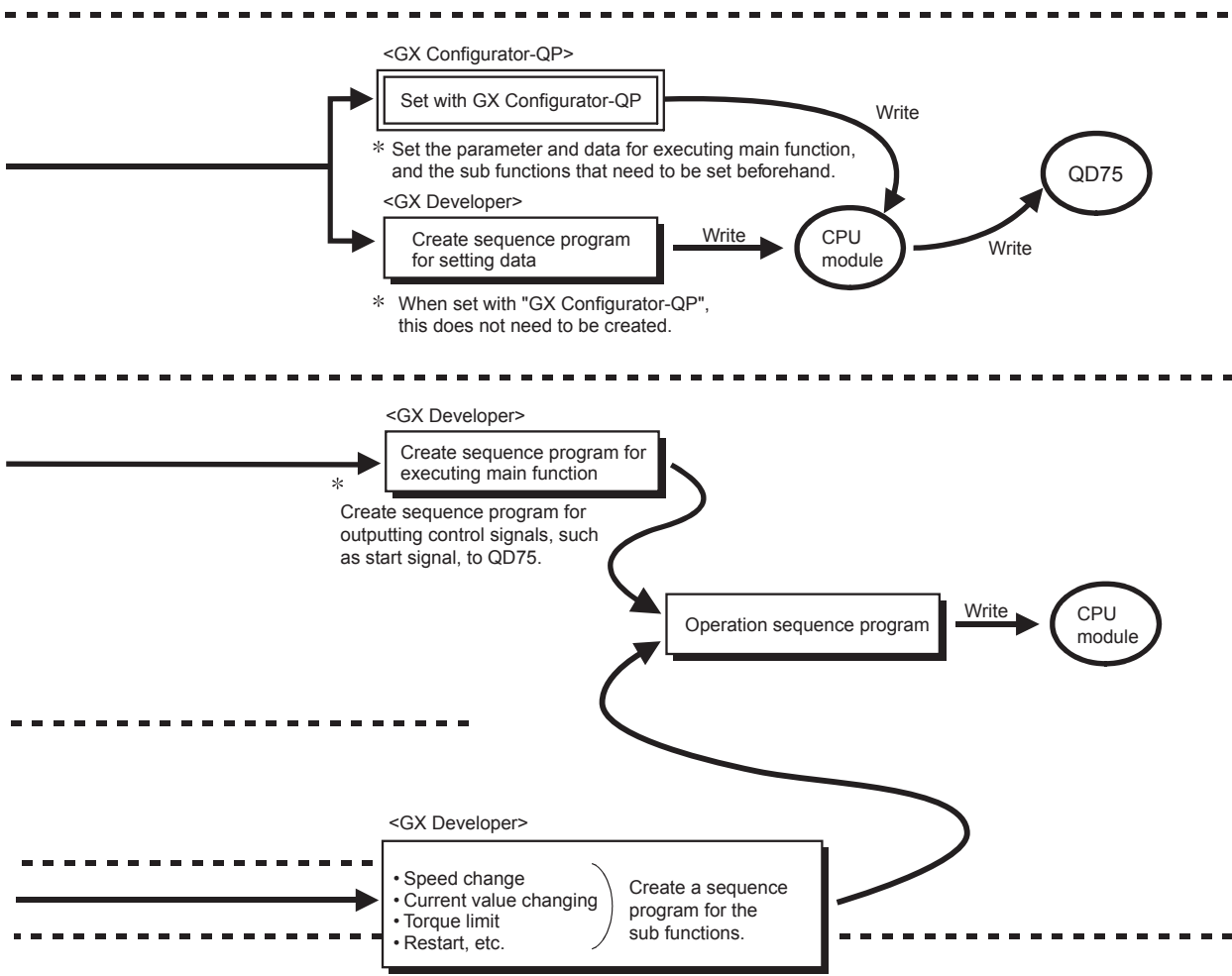

1.2.3 Outline of stopping

Each control is stopped in the following cases.

- (1) When each control is completed normally.
- (2) When the drive unit READY signal is turned OFF.
- (3) When a CPU module error occurs
- (4) When the PLC READY signal is turned OFF.
- (5) When an error occurs in the QD75.
- (6) When control is intentionally stopped (Stop signal from CPU module turned ON, stop signal from an external device, etc.)

The outline for the stopping process in these cases is shown below. (Excluding (1) for normal stopping.)

Stop cause		Stop axis	M code ON signal after stop	Axis operation status after stopping (Md.26)	Stop process					
					OPR control		Major positioning control	High-level positioning control	Manual control	
					Machine OPR control	Fast OPR control			JOG/Inching operation	Manual pulse generator operation
Forced stop	Drive unit READY signal OFF	Each axis	No change	Error	Immediate stop				Deceleration stop	
Fatal stop (Stop group 1)	Hardware stroke limit upper/lower limit error occurrence	Each axis	No change	Error	Deceleration stop/sudden stop (Select with " Pr.37 Stop group 1 sudden stop selection")				Deceleration stop	
Emergency stop (Stop group 2)	CPU module error occurrence	All axes	No change	Error	Deceleration stop/sudden stop (Select with " Pr.38 Stop group 2 sudden stop selection")				Deceleration stop	
	PLC READY signal OFF		Turns OFF							
	Error in test mode		No change							
Relatively safe stop (Stop group 3)	Axis error detection (Error other than stop group 1 or 2) *1	Each axis	No change	Error	Deceleration stop/sudden stop (Select with " Pr.39 Stop group 3 sudden stop selection")				Deceleration stop	
Intentional stop (Stop group 3)	"Stop signal" ON from external source	Each axis	No change	Stopped (Standby)						
	"Axis stop signal" ON from CPU module									
	"Stop signal" input from peripheral device *2									



\*1: When multiple positioning data is executed by the continuous positioning control and there is invalid setting value in a positioning data, an error occurs and deceleration is performed at the previous positioning data. In this case, sudden stop is not performed even when it is set for the stop group 3. If any of the following error occurs, the operation is immediately stopped after executing up to previous positioning data of the positioning data where an error occurred.

- No command speed (error code: 503)
- Outside linear movement amount range (error code: 504)
- Large arc error deviation (error code: 506)
- Software stroke limit + (error code: 507)
- Software stroke limit - (error code: 508)
- Sub point setting error (error code: 525)
- End point setting error (error code: 526)
- Center point setting error (error code: 527)
- Outside radius range (error code: 544)
- Illegal setting of ABS direction in unit of degree (error code: 546)

\*2: This means the stop using a stop button on the test dialog box when using the positioning test function of GX Works2 or test function of GX Configurator-QP.

1.2.4 Outline of restarting

When a stop cause has occurred during operation with position control causing the axis to stop, positioning to the end point of the positioning data can be restarted from the stopped position by using the " [Cd.6] Restart command".

If issued during a continuous positioning or continuous path control operation, the restart command will cause the positioning to be re-executed using the current position (pointed by the positioning data No. associated with the moment when the movement was interrupted) as the start point.

■ When " [Cd.6] Restart command" is ON

- (1) If the " [Md.26] Axis operation status" is "Stopped", positioning to the end point of the positioning data will be restarted from the stopped position regardless of the absolute system or incremental system.
- (2) When " [Md.26] Axis operation status" is not "Stopped", the warning "Restart not possible" (warning code: 104) will be applied, and the restart command will be ignored.

[Example for incremental system]

- (a) The restart operation when the axis 1 movement amount is 300, and the axis 2 movement amount is 600 is shown below.

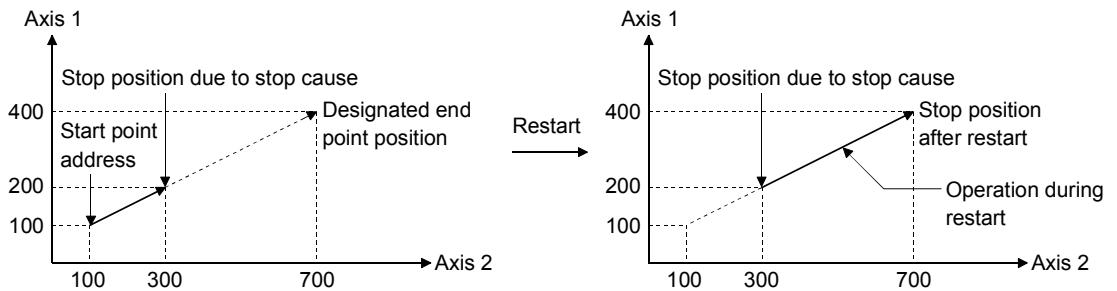

■ Reference

If the positioning start signal [Y10 to Y13]/external command signal\* is turned ON while the " [Md.26] Axis operation status" is "Standby" or "Stopped", positioning will be restarted from the start of the positioning start data regardless of the absolute system or incremental system. (\*: When the external command signal is set to "External positioning start")  
(Same as normal positioning.)

[Example for incremental system]

- (a) The positioning start operation when the axis 1 movement amount is 300 and the axis 2 movement amount is 600 is shown below.

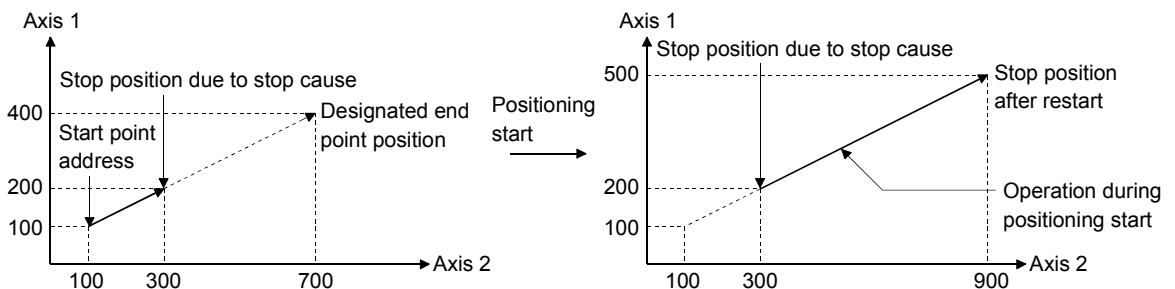

### 1.3 Restrictions on using a stepping motor

Note the following restrictions on using a stepping motor:

- (1) For an axis where a stepping motor is connected, executing the S-curve acceleration/deceleration may cause step-out.  
Before using the S-curve acceleration/deceleration, confirm that step-out does not occur.
- (2) The circular interpolation control and 3-axis helical interpolation control cannot be used for an axis where a stepping motor is connected.  
Although setting the bias speed at start is required by the characteristics of the stepping motor, the setting of the bias speed at start is disabled for circular interpolation control.  
Ensure to use a servomotor for all axes where interpolation controls are carried out when the circular interpolation control or 3-axis helical interpolation control is carried out.
- (3) The backlash compensation function cannot be used for an axis where a stepping motor is connected. If the function is used, the motor may lose steps.

### 1.4 Function additions/modifications according to function version B

POINT
When it is desired to check the following items, refer to the corresponding explanation sections. How to check the function version and SERIAL No. (Refer to Section 2.4)

The following function additions/modifications according to the function version B of the QD75:

Function	Outline	Reference
Multiple CPU compatible function	Refer to QCPU User's Manual (Multiple CPU System).	
Speed-position switching control (ABS mode)	Function which starts the axis under speed control, switches to position control at the external command signal input, then positions the axis to a stop at the designated address.	Section 9.2.19
Pre-reading start function	Function which shortens virtual start time.	Section 12.7.7
External I/O signal monitor function	Function which monitors the external I/O signal monitor information in the module's detailed information which can be displayed on the system monitor of GX Developer *1.	Section 13.5
Deceleration start flag function *2	Function that turns ON the flag when the constant speed status or acceleration status switches to the deceleration status during position control whose operation pattern is "Positioning complete".	Section 12.7.8
Stop command processing for deceleration stop function *3	Function that selects a deceleration curve when a stop cause occurs during deceleration stop processing to speed 0.	Section 12.7.9

\*1: For the QD75P□/QD75D□, this function is available in GX Developer (SW6D5C-GPPW-E or later). For details, refer to GX Developer Operating Manual.

For the QD75P□N/QD75D□N, external I/O signals cannot be monitored on GX Developer. Use the system monitor of GX Works2. For details on the system monitor of GX Works2, refer to GX Works2 Version 1 Operating Manual (Common).

\*2: For the QD75P□/QD75D□, this function is available for modules whose serial No. (first five digits) is "03042" or later.

\*3: For the QD75P□/QD75D□, this function is available for modules whose serial No. (first five digits) is "05072" or later.



# CHAPTER 2 SYSTEM CONFIGURATION

In this chapter, the general image of the system configuration of the positioning control using QD75, the configuration devices, applicable CPU and the precautions of configuring the system are explained.  
Prepare the required configuration devices to match the positioning control system.

2.1	General image of system .....	2-	2
2.2	Configuration list.....	2-	4
2.3	Applicable system.....	2-	6
2.4	How to check the function version and SERIAL No.....	2-	8

2.1 General image of system

The general image of the system, including the QD75, CPU module and peripheral devices is shown below.

(The Nos. in the illustration refer to the "No." in Section 2.2 "Component list".

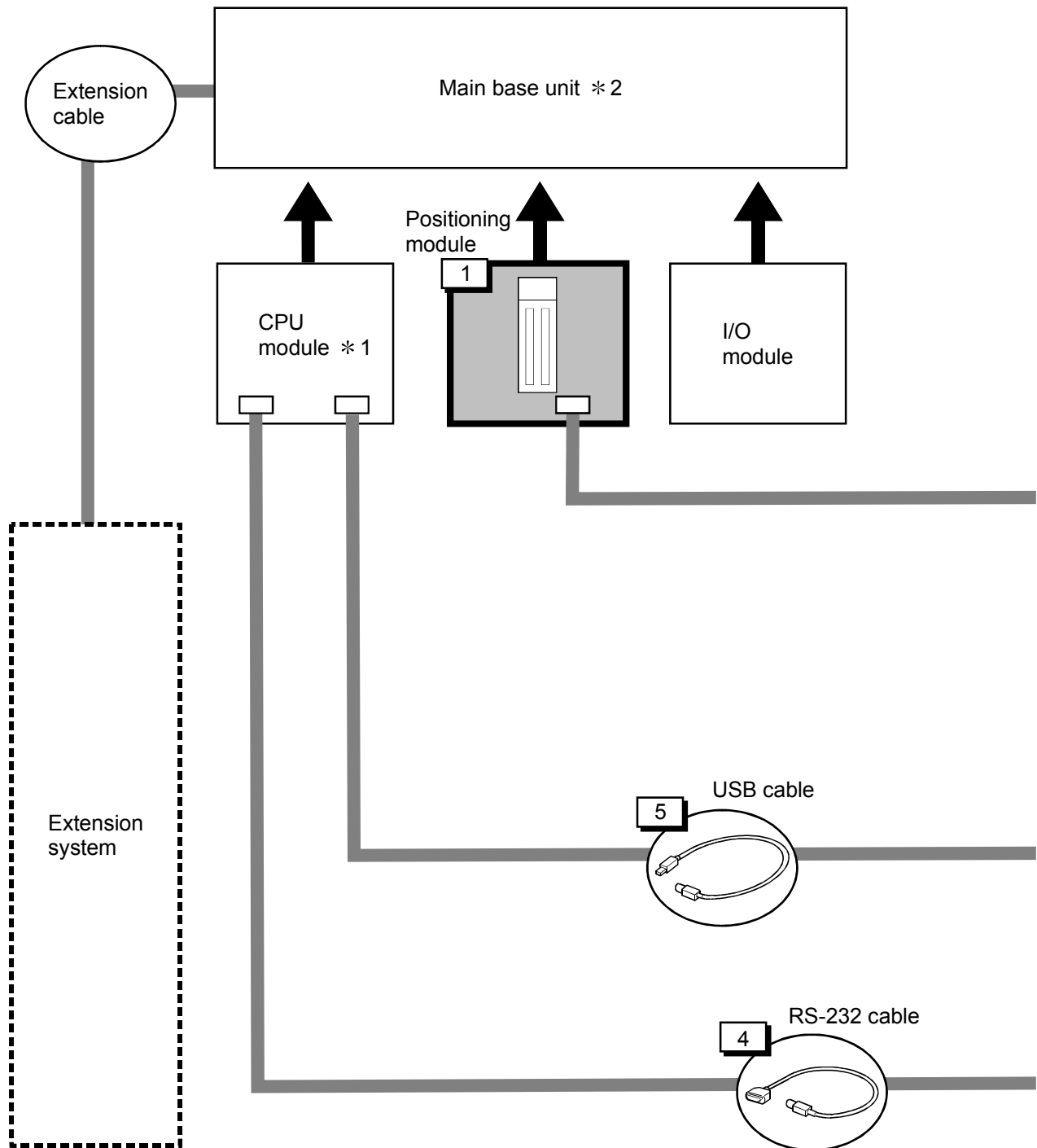

**REMARK**

\*1 Refer to Section 2.3 "Applicable system" for the CPU modules that can be used.

\*2 Refer to the CPU module User's Manual for the base units that can be used.

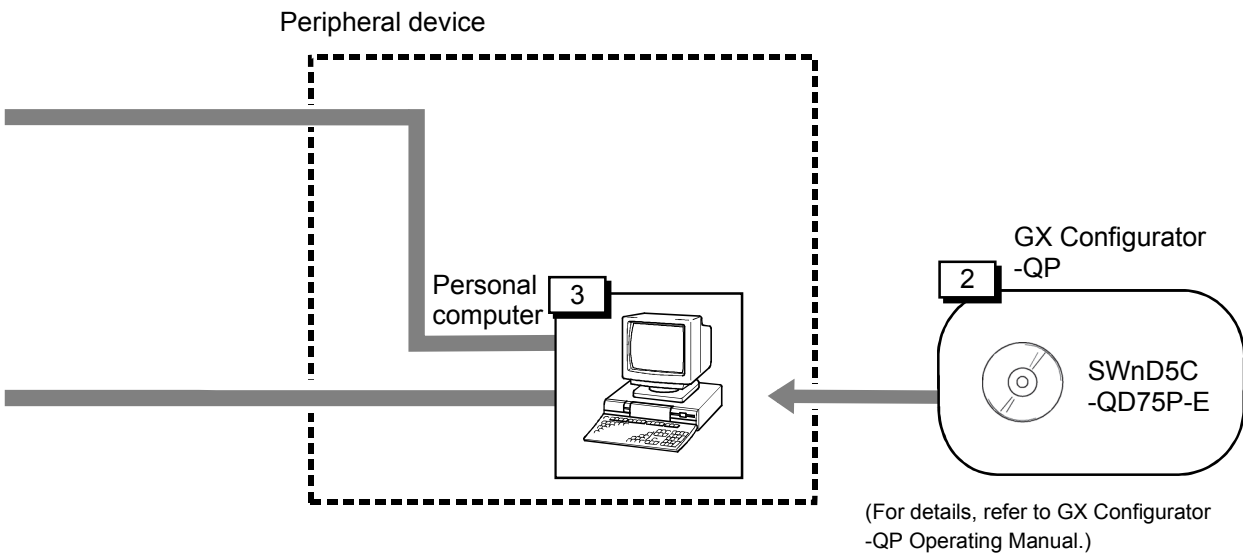
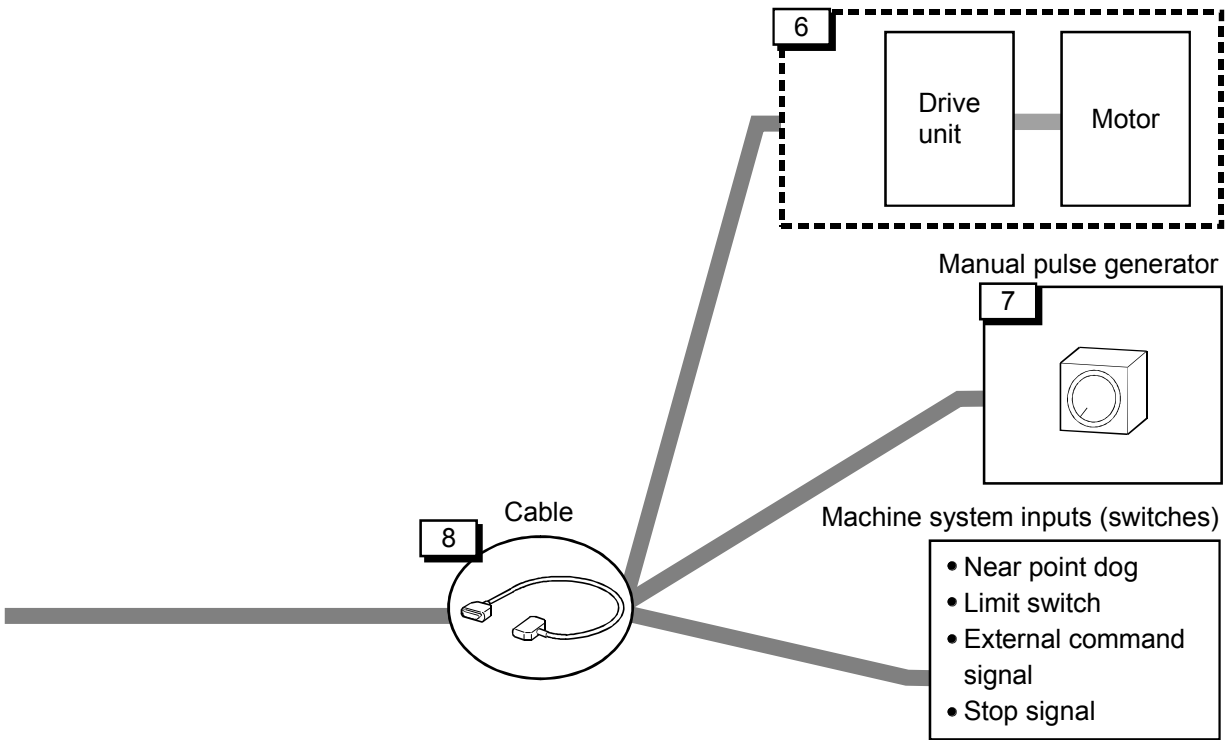

2.2 Configuration list

The positioning system using the QD75 is configured of the following devices.

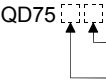
No.	Part name	Type	Remarks
1	Positioning module	QD75P1N QD75P2N QD75P4N QD75D1N QD75D2N QD75D4N QD75P1 QD75P2 QD75P4 QD75D1 QD75D2 QD75D4	 <p>No. of control axes</p> <ul style="list-style-type: none"> <li>• P: Open collector output system</li> <li>• D: Differential driver output system</li> </ul> <p>Refer to Appendix 1.2 for differences between QD75P□N/QD75D□N and QD75P□/QD75D□.</p>
2	GX Configurator-QP	SW□D5C-QD75P-E	Refer to GX Configurator-QP Operating Manual for details.
3	Personal computer	Personal computer which supports Windows®.	(Prepared by user) Refer to GX Configurator-QP Operating Manual for details.
4	RS-232 cable	QC30R2	(Prepared by user) An RS-232 cable is needed for connecting the CPU module with a personal computer. For details, refer to GX Configurator-QP Operating Manual.
5	USB cable	—	(Prepared by user) A USB cable is needed for connecting the CPU module with a personal computer. For details, refer to GX Configurator-QP Operating Manual.
6	Drive unit	—	(Prepared by user)
7	Manual pulse generator	—	(Prepared by user) Recommended: MR-HDP01 (Mitsubishi Electric)
8	Connection cable (For connecting between the QD75 and the drive unit)	—	(Prepared by user) Cables are needed to connect the QD75 with the drive unit, manual pulse generator, and input devices in the machine system. (Prepare them referring to the manuals for the connected devices and information given in 3.4.2 of this manual.)



■ Specifications of recommended manual pulse generator

Item	Specifications
Model name	MR-HDP01
Pulse resolution	25pulse/rev (100 pulse/rev after magnification by 4)
Output method	Voltage-output (power supply voltage -1V or more), Output current = Max. 20mA
Power supply voltage	4.5 to 13.2VDC <sup>*1</sup>
Current consumption	60mA
Output level	"H" level: power supply voltage <sup>*1</sup> -1V or more (in no-load) "L" level: 0.5V or less (with maximum leading-in)
Life time	100 revolutions (at 200r/min)
Permitted axial loads	Radial load: Max. 19.6N
	Thrust load: Max. 9.8N
Operation temperature	-10 to 60°C (14 to 140°F)
Weight	0.4 (0.88) [kg(lb)]
Number of max. revolution	Instantaneous Max. 600r/min. normal 200r/min
Pulse signal status	2 signals: A phase, B phase, 90° phase difference
Start friction torque	0.06N·m (at 20°C (68°F))

\*1: Use the stabilized power supply of 4.5 to 6.1 VDC for the power supply of the manual pulse generator.

## 2.3 Applicable system

The QD75 can be used in the following system.

### (1) Applicable modules and base units, and No. of modules

#### (a) When mounted with a CPU module

For the CPU modules, the number of modules, and base units applicable to the QD75, refer to the user's manual for the CPU modules used.

Check the following when the QD75 is mounted with the CPU module.

- Depending on the combination with other modules or the number of mounted modules, power supply capacity may be insufficient. Pay attention to the power supply capacity before mounting modules, and if the power supply capacity is insufficient, change the combination of the modules.
- Mount a module within the number of I/O points for the CPU module. If the number of slots is within the available range, the module can be mounted on any slot.

#### REMARK

To use a C Controller module with the QD75, refer to C Controller Module User's Manual.

#### (b) Mounting to a MELSECNET/H remote I/O station

For the MELSECNET/H remote I/O station, the number of modules, and base units applicable to the QD75, refer to the Q Corresponding MELSECNET/H Network System Reference Manual (Remote I/O network).

### (2) Compatibility with multiple CPU system

When using the QD75 in a multiple CPU system, refer to the QCPU User's Manual (Multiple CPU System).

(3) Supported software packages

The following table lists the compatibility between the systems using the QD75 and the software packages. GX Developer or GX Works2 is required for use of the QD75.

		Software version		
		GX Developer	GX Configurator-QP <sup>*1</sup>	GX Works2
Q00J/Q00/Q01CPU	Single CPU system	Version 7 or later	Version 2.10L or later	Refer to GX Works2 Version 1 Operating Manual (Common).
	Multiple CPU system	Version 8 or later		
Q02/Q02H/Q06H/ Q12H/Q25HCPU	Single CPU system	Version 4 or later	Version 2.00A or later	
	Multiple CPU system	Version 6 or later		
Q02PH/Q06PHCPU	Single CPU system	Version 8.68W or later	Version 2.29F or later	
	Multiple CPU system			
Q12PH/Q25PHCPU	Single CPU system	Version 7.10L or later	Version 2.13P or later	
	Multiple CPU system			
Q02U/Q03UD/ Q04UDH/ Q06UDHCPU	Single CPU system	Version 8.48A or later	Version 2.25B or later	
	Multiple CPU system			
Q13UDH/Q26UDH/ Q03UDE/Q04UDEH/ Q06UDEH/Q13UDEH/ Q26UDEHCPU	Single CPU system	Version 8.68W or later	Version 2.29F or later	
	Multiple CPU system			
Q00U/Q00UJ/Q01U/Q 10UDH/Q20UDH/ Q10UDEH/ Q20UDEHCPU	Single CPU system	Version 8.76E or later	Version 2.32J or later	
	Multiple CPU system			
CPU modules other than above		Not supported	Not supported	
For use on MELSECNET/H remote I/O station		Version 6 or later	Version 2.00A or later	

\*1: To use the QD75P□N/QD75D□N with GX Configurator-QP, select the QD75P□/QD75D□ as the model name. The QD75P□N/QD75D□N can be used in the same manner as the QD75P□/QD75D□; the setting ranges are the same. Therefore, a speed exceeding 1000000pulse/s cannot be set in some items. (Refer to Appendix 1.2)

<b>POINT</b>
<p>When using GX Works2, refer to the following:</p> <ul style="list-style-type: none"> <li>• GX Works2 Version 1 Operating Manual (Common)</li> <li>• GX Works2 Version 1 Operating Manual (Intelligent Function Module)</li> </ul>

2.4 How to check the function version and SERIAL No.

- (1) Confirming the serial number on the rating plate  
The rating plate is situated on the side face of the QD75.

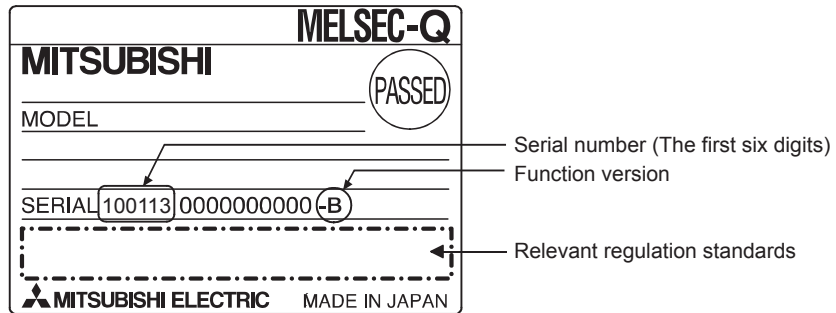

- (2) Checking on the front of the module  
The serial No. on the rating plate is also indicated on the front of the module (lower part).

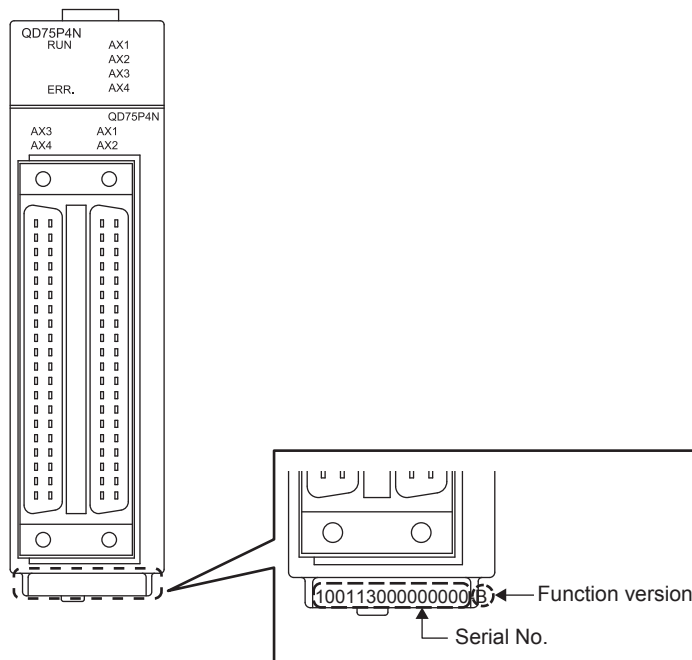

(3) Confirming the serial number with software

Check the function version and SERIAL No. in "Product information" displayed on System monitor "Module's Detailed Information" of GX Developer or on "OS information" of GX Configurator-QP \*1

(a) Checking on the System monitor (Product Information List) screen

To open the screen, select [Diagnostics] → [System monitor] and click the **Product Information List** button in GX Developer.

<GX Developer display screen>

Slot	Type	Series	Model name	Points	I/O No.	Master PLC	Serial No.	Ver.	Product No.
0-0	Intelli. Q	QD75P4		32pt	0010	PLC No.1	071120000000000	B	091012092915091-B
0-1	-	-	None	-	-	-	-	-	-
0-2	-	-	None	-	-	-	-	-	-
0-3	-	-	None	-	-	-	-	-	-
0-4	-	-	None	-	-	-	-	-	-

[Production No. display]

Since the QD75 does not support the production number display, "-" is displayed.

**POINT**

The serial No. on the rating plate may be different from the serial No. displayed on the product information screen of GX Developer.

- The serial No. on the rating plate indicates the management information of the product.
- The serial No. displayed on the product information screen of GX Developer indicates the function information of the product. The function information of the product is updated when a new function is added.

(b) Checking with GX Configurator-QP

<GX Configurator-QP display screen>

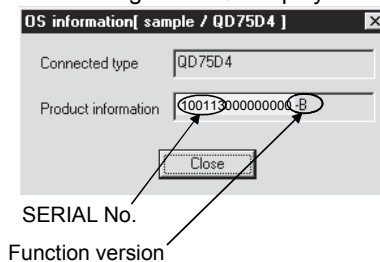

\*1: For details, refer to GX Configurator-QP Operating Manual.



# CHAPTER 3 SPECIFICATIONS AND FUNCTIONS

The various specifications of the QD75 are explained in this chapter.

The "Performance specifications", "List of functions", "Specifications of input/output signals with CPU module", and the "Specifications of input/output interfaces with external devices", etc., are described as information required when designing the positioning system.

Confirm each specification before designing the positioning system.

- 3.1 Performance specifications ..... 3- 2
- 3.2 List of functions ..... 3- 6
  - 3.2.1 QD75 control functions ..... 3- 6
  - 3.2.2 QD75 main functions ..... 3- 8
  - 3.2.3 QD75 sub functions and common functions ..... 3- 10
  - 3.2.4 Combination of QD75 main functions and sub functions ..... 3- 14
- 3.3 Specifications of input/output signals with CPU module ..... 3- 16
  - 3.3.1 List of input/output signals with CPU module ..... 3- 16
  - 3.3.2 Details of input signals (QD75 → CPU module) ..... 3- 17
  - 3.3.3 Details of output signals (CPU module → QD75) ..... 3- 18
- 3.4 Specifications of input/output interfaces with external devices ..... 3- 19
  - 3.4.1 Electrical specifications of input/output signals ..... 3- 19
  - 3.4.2 Signal layout for external device connection connector ..... 3- 25
  - 3.4.3 List of input/output signal details ..... 3- 26
  - 3.4.4 Input/output interface internal circuit ..... 3- 28

3.1 Performance specifications

■ QD75P□N/QD75D□N

Model		QD75P1N *1 QD75D1N	QD75P2N *1 QD75D2N	QD75P4N *1 QD75D4N
Item				
No. of control axes		1 axis	2 axes	4 axes
Interpolation function		None	2-axis linear interpolation 2-axis circular interpolation	2-, 3-, or 4-axis linear interpolation 2-axis circular interpolation 3-axis helical interpolation
Control system		PTP (Point To Point) control, path control (all of linear, circular, and helical can be set), speed control, speed-position switching control, position-speed switching control		
Control unit		mm, inch, degree, pulse		
Positioning data		600 data /axis (Can be set with peripheral device or sequence program.)		
Backup		Parameters, positioning data, and block start data can be saved on flash ROM (battery-less backup)		
Positioning	Positioning system	PTP control: Incremental system/absolute system Speed-position switching control: Incremental system/absolute system *2 Position-speed switching control: Incremental system Path control: Incremental system/absolute system		
	Positioning range	<div style="border: 1px solid black; padding: 2px;">In absolute system</div> <ul style="list-style-type: none"> <li>• -214748364.8 to 214748364.7 (μm)</li> <li>• -21474.83648 to 21474.83647 (inch)</li> <li>• 0 to 359.99999 (degree)</li> <li>• -2147483648 to 2147483647 (pulse)</li> </ul> <div style="border: 1px solid black; padding: 2px;">In incremental system</div> <ul style="list-style-type: none"> <li>• -214748364.8 to 214748364.7 (μm)</li> <li>• -21474.83648 to 21474.83647 (inch)</li> <li>• -21474.83648 to 21474.83647 (degree)</li> <li>• -2147483648 to 2147483647 (pulse)</li> </ul> <div style="border: 1px solid black; padding: 2px;">In speed-position switching control (INC mode) / position-speed switching control</div> <ul style="list-style-type: none"> <li>• 0 to 214748364.7 (μm)</li> <li>• 0 to 21474.83647 (inch)</li> <li>• 0 to 21474.83647 (degree)</li> <li>• 0 to 2147483647 (pulse)</li> </ul> <div style="border: 1px solid black; padding: 2px;">In speed-position switching control (ABS mode) *2</div> <ul style="list-style-type: none"> <li>• 0 to 359.99999 (degree)</li> </ul>		
	Speed command	0.01 to 2000000.00 (mm/min) 0.001 to 2000000.000 (inch/min) 0.001 to 2000000.000 (degree/min) 1 to 4000000 (pulse/s)		
	Acceleration/ deceleration process	Trapezoidal acceleration/deceleration, S-curve acceleration/deceleration		
	Acceleration/ deceleration time	1 to 8388608 (ms) Four patterns can be set for each of acceleration time and deceleration time		
	Sudden stop deceleration time	1 to 8388608 (ms)		

\*1: QD75P□N represents the open collector output system, and QD75D□N represents the differential driver output system.

\*2: In speed-position switching control (ABS mode), the control unit available is "degree" only. (For details, refer to Section 9.2.19 "Speed-position switching control (ABS mode)".)



Item	Model	QD75P1N *1 QD75D1N	QD75P2N *1 QD75D2N	QD75P4N *1 QD75D4N
Starting time *3	1-axis linear control		1.5ms	Factors in starting time extension The following times will be added to the starting time in the described conditions: • S-curve acceleration/ deceleration is selected: 0.1ms • Other axis is in operation: 0.5ms • During continuous positioning control: 0.3ms • During continuous path control: 0.3ms
	1-axis speed control		1.5ms	
	2-axis linear interpolation control (Composite speed)		1.5ms	
	2-axis linear interpolation control (Reference axis speed)		1.5ms	
	2-axis circular interpolation control		2.0ms	
	2-axis speed control		1.5ms	
	3-axis linear interpolation control (Composite speed)		1.7ms	
	3-axis linear interpolation control (Reference axis speed)		1.7ms	
	3-axis helical interpolation control		2.6ms	
	3-axis speed control		1.7ms	
	4-axis linear interpolation control		1.8ms	
4-axis speed control		1.8ms		
External wiring connection system	40-pin connector			
Applicable wire size	0.3mm <sup>2</sup> (22AWG) (for A6CON1 or A6CON4), 0.088 to 0.24mm <sup>2</sup> (28 to 24AWG) (for A6CON2)			
Applicable connector for external device	A6CON1, A6CON2, A6CON4 (sold separately)			
Max. output pulse	QD75P1N, QD75P2N, QD75P4N: 200kpps QD75D1N, QD75D2N, QD75D4N: 4Mpps			
Max. connection distance between servos	QD75P1N, QD75P2N, QD75P4N: 2m QD75D1N, QD75D2N, QD75D4N: 10m			
Internal current consumption (5VDC)	QD75P1N: 0.29A QD75D1N: 0.43A	QD75P2N: 0.30A QD75D2N: 0.45A	QD75P4N: 0.36A QD75D4N: 0.66A	
Flash ROM write count	Max. 100000 times			
No. of occupied I/O points	32 points (I/O assignment: intelligent 32 points)			
Outline dimensions	98 (H) × 27.4 (W) × 90 (D) mm			
Weight	QD75P1N: 0.14kg QD75D1N: 0.15kg	QD75P2N: 0.14kg QD75D2N: 0.15kg	QD75P4N: 0.16kg QD75D4N: 0.16kg	

\*1: QD75P□N represents the open collector output system, and QD75D□N represents the differential driver output system.

\*3: Using the "Pre-reading start function", the virtual start time can be shortened. (For details, refer to Section 12.7.7 "Pre-reading start function".

■ QD75P□/QD75D□

Model		QD75P1 *1 QD75D1	QD75P2 *1 QD75D2	QD75P4 *1 QD75D4
Item				
No. of control axes		1 axis	2 axes	4 axes
Interpolation function		None	2-axis linear interpolation 2-axis circular interpolation	2-, 3-, or 4-axis linear interpolation 2-axis circular interpolation
Control system		PTP (Point To Point) control, path control (both linear and arc can be set), speed control, speed-position switching control, position-speed switching control		
Control unit		mm, inch, degree, pulse		
Positioning data		600 data /axis (Can be set with peripheral device or sequence program.)		
Backup		Parameters, positioning data, and block start data can be saved on flash ROM (battery-less backup)		
Positioning	Positioning system	PTP control: Incremental system/absolute system Speed-position switching control: Incremental system/absolute system *2 Position-speed switching control: Incremental system Path control: Incremental system/absolute system		
	Positioning range	<div style="border: 1px solid black; padding: 2px;">In absolute system</div> <ul style="list-style-type: none"> <li>• -214748364.8 to 214748364.7 (μm)</li> <li>• -21474.83648 to 21474.83647 (inch)</li> <li>• 0 to 359.99999 (degree)</li> <li>• -2147483648 to 2147483647 (pulse)</li> </ul> <div style="border: 1px solid black; padding: 2px;">In incremental system</div> <ul style="list-style-type: none"> <li>• -214748364.8 to 214748364.7 (μm)</li> <li>• -21474.83648 to 21474.83647 (inch)</li> <li>• -21474.83648 to 21474.83647 (degree)</li> <li>• -2147483648 to 2147483647 (pulse)</li> </ul> <div style="border: 1px solid black; padding: 2px;">In speed-position switching control (INC mode) / position-speed switching control</div> <ul style="list-style-type: none"> <li>• 0 to 214748364.7 (μm)</li> <li>• 0 to 21474.83647 (inch)</li> <li>• 0 to 21474.83647 (degree)</li> <li>• 0 to 2147483647 (pulse)</li> </ul> <div style="border: 1px solid black; padding: 2px;">In speed-position switching control (ABS mode) *2</div> <ul style="list-style-type: none"> <li>• 0 to 359.99999 (degree)</li> </ul>		
	Speed command	0.01 to 20000000.00 (mm/min) 0.001 to 2000000.000 (inch/min) 0.001 to 2000000.000 (degree/min) 1 to 1000000 (pulse/s)		
	Acceleration/ deceleration process	Trapezoidal acceleration/deceleration, S-curve acceleration/deceleration		
	Acceleration/ deceleration time	1 to 8388608 (ms) Four patterns can be set for each of acceleration time and deceleration time		
	Sudden stop deceleration time	1 to 8388608 (ms)		

\*1: QD75P □ represents the open collector output system, and QD75D □ represents the differential driver output system.

\*2: In speed-position switching control (ABS mode), the control unit available is "degree" only. (For details, refer to Section 9.2.19 "Speed-position switching control (ABS mode)".)

Item	Model	QD75P1 *1 QD75D1	QD75P2 *1 QD75D2	QD75P4 *1 QD75D4
Starting time *3	1-axis linear control		6ms	Factors in starting time extension The following times will be added to the starting time in the described conditions: • S-curve acceleration/ deceleration is selected: 0.5ms • Other axis is in operation: 1.5ms • During continuous positioning control: 0.2ms • During continuous path control: 1.0ms
	1-axis speed control		6ms	
	2-axis linear interpolation control (Composite speed)		7ms	
	2-axis linear interpolation control (Reference axis speed)		7ms	
	2-axis circular interpolation control		7ms	
	2-axis speed control		6ms	
	3-axis linear interpolation control (Composite speed)		7ms	
	3-axis linear interpolation control (Reference axis speed)		7ms	
	3-axis speed control		6ms	
	4-axis linear interpolation control		7ms	
4-axis speed control		7ms		
External wiring connection system	40-pin connector			
Applicable wire size	0.3mm <sup>2</sup> (22AWG) (for A6CON1 or A6CON4), 0.088 to 0.24mm <sup>2</sup> (28 to 24AWG) (for A6CON2)			
Applicable connector for external device	A6CON1, A6CON2, A6CON4 (sold separately)			
Max. output pulse	QD75P1, QD75P2, QD75P4 : 200kpps QD75D1, QD75D2, QD75D4 : 1Mpps			
Max. connection distance between servos	QD75P1, QD75P2, QD75P4 : 2m QD75D1, QD75D2, QD75D4 : 10m			
Internal current consumption (5VDC)	QD75P1 : 0.40A QD75D1 : 0.52A	QD75P2 : 0.46A QD75D2 : 0.56A	QD75P4 : 0.58A QD75D4 : 0.82A	
Flash ROM write count	Max. 100000 times			
No. of occupied I/O points	32 points (I/O assignment: intelligent 32 points)			
Outline dimensions	98 (H) × 27.4 (W) × 90 (D) mm			
Weight	0.15 kg	0.15 kg	0.16 kg	

\*1: QD75P □ represents the open collector output system, and QD75D □ represents the differential driver output system.

\*3: Using the "Pre-reading start function", the virtual start time can be shortened. (For details, refer to Section 12.7.7 "Pre-reading start function".

■ Differential driver common terminal specifications(QD75D□N/QD75D□ only)

Applicable wire size	0.24 to 2.5mm <sup>2</sup> (24 to 12AWG)
Applicable sizes of two wires inserted into same spot of terminal	Solid wire: 0.2 to 0.8mm <sup>2</sup> × 2 pcs.
	Stranded wire: 0.2 to 0.8mm <sup>2</sup> × 2 pcs.
Screw tightening torque	0.5 to 0.6N · m

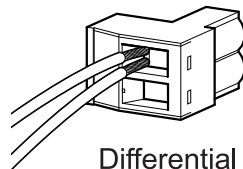

Differential driver common terminal (accessory)

Fig. 3.1 Two wires inserted into same spot of terminal

## 3.2 List of functions

### 3.2.1 QD75 control functions

The QD75 has several functions. In this manual, the QD75 functions are categorized and explained as follows.

#### ■ Main functions

##### (1) OPR control

"OPR control" is a function that established the start point for carrying out positioning control, and carries out positioning toward that start point. This is used to return a workpiece, located at a position other than the OP when the power is turned ON or after positioning stop, to the OP. The "OPR control" is preregistered in the QD75 as the "Positioning start data No. 9001 (Machine OPR)", and "Positioning start data No. 9002 (Fast OPR)". (Refer to CHAPTER 8 "OPR CONTROL".)

##### (2) Major positioning control

This control is carried out using the "Positioning data" stored in the QD75. Positioning control, such as position control and speed control, is executed by setting the required items in this "positioning data" and starting that positioning data. An "operation pattern" can be set in this "positioning data", and with this whether to carry out control with continuous positioning data (ex.: positioning data No. 1, No. 2, No. 3, ...) can be set. (Refer to CHAPTER 9 "MAJOR POSITIONING CONTROL".)

##### (3) High-level positioning control

This control executes the "positioning data" stored in the QD75 using the "block start data". The following types of applied positioning control can be carried out.

- Random blocks, handling several continuing positioning data items as "blocks", can be executed in the designated order.
- "Condition judgment" can be added to position control and speed control.
- The operation of the designated positioning data No. that is set for multiple axes can be started simultaneously. (Pulses are output simultaneously to multiple servos.)
- The designated positioning data can be executed repeatedly, etc., (Refer to CHAPTER 10 "HIGH-LEVEL POSITIONING CONTROL".)

##### (4) Manual control

By inputting a signal into the QD75 from an external source, the QD75 will output a random pulse train and carry out control. Use this manual control to move the workpiece to a random position (JOG operation), and to finely adjust the positioning (inching operation, manual pulse generator operation), etc. (Refer to CHAPTER 11 "MANUAL CONTROL".)

#### ■ Sub functions

When executing the main functions, control compensation, limits and functions can be added. (Refer to CHAPTER 12 "CONTROL SUB FUNCTIONS".)

#### ■ Common functions

Common control using the QD75 for "parameter initialization" or "backup of execution data" can be carried out. (Refer to CHAPTER 13 "COMMON FUNCTIONS".)

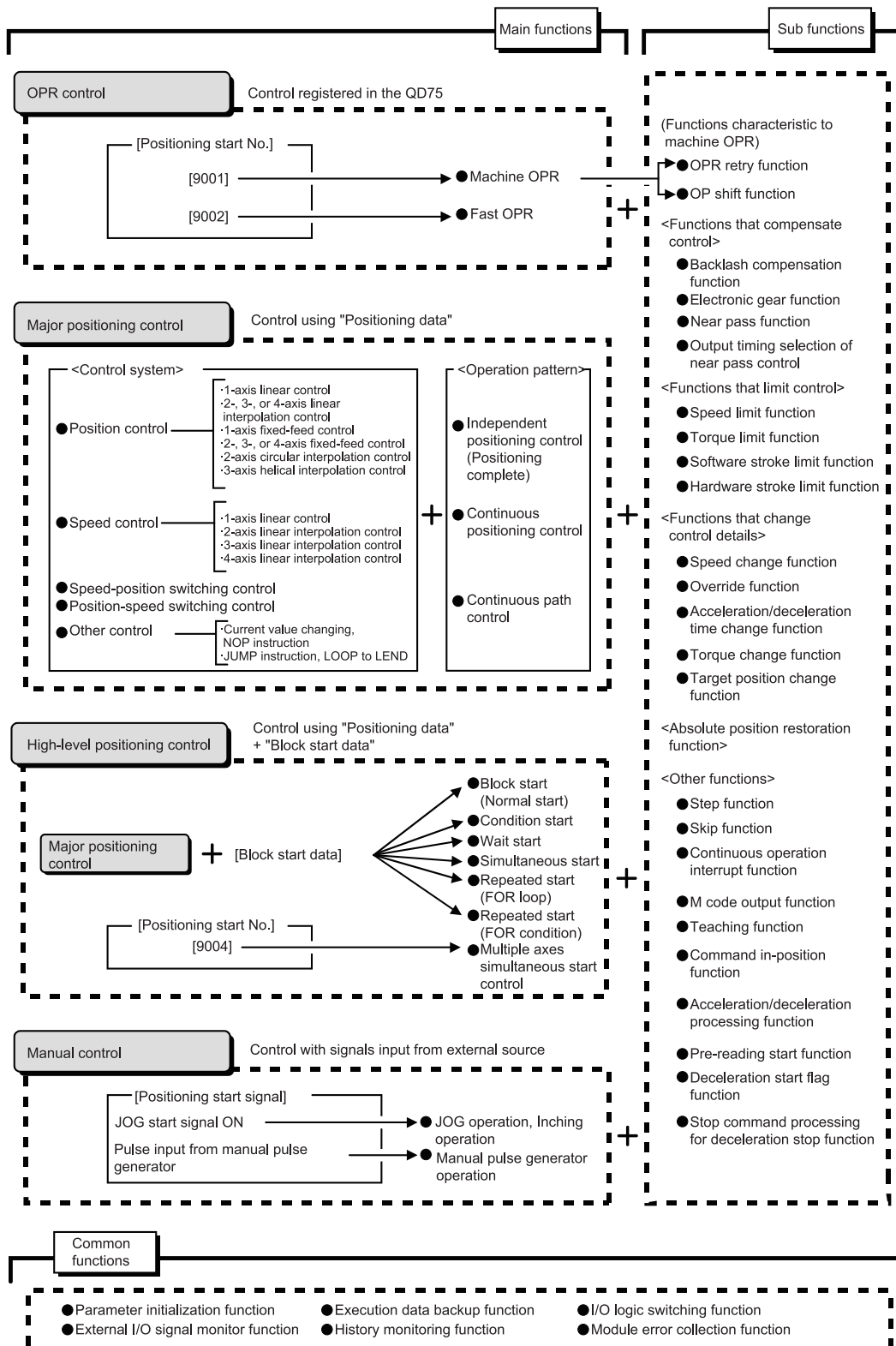

## 3.2.2 QD75 main functions

The outline of the main functions for positioning control with the QD75 is described below. (Refer to PART 2 for details on each function.)

Main functions		Details	Reference section
OPR control	Machine OPR control	Mechanically establishes the positioning start point using a near-point dog or stopper. (Positioning start No. 9001)	8.2
	Fast OPR control	Positions a target to the OP address ( $\overline{\text{Md.21}}$ Machine feed value) stored in the QD75 using machine OPR. (Positioning start No. 9002)	8.3
Major positioning control	Position control	Linear control (1-axis linear control) (2-axis linear interpolation control) (3-axis linear interpolation control) (4-axis linear interpolation control)	9.2.2 9.2.3 9.2.4 9.2.5
		Fixed-feed control (1-axis fixed-feed control) (2-axis fixed-feed control) (3-axis fixed-feed control) (4-axis fixed-feed control)	9.2.6 9.2.7 9.2.8 9.2.9
		2-axis circular interpolation control	9.2.10 9.2.11
		3-axis helical interpolation control	9.2.12 9.2.13
	Speed control	Linear control (1-axis speed control) (2-axis speed control) (3-axis speed control) (4-axis speed control)	9.2.14 9.2.15 9.2.16 9.2.17
		Speed-position switching control	9.2.18 9.2.19
	Position-speed switching control	9.2.20	
	Other control	Current value changing	9.2.21
		NOP instruction	9.2.22
		JUMP instruction	9.2.23
		LOOP	9.2.24
		LEND	9.2.25

Main functions		Details	Reference section
High-level positioning control	Block start (Normal start)	With one start, executes the positioning data in a random block with the set order.	10.3.2
	Condition start	Carries out condition judgment set in the "condition data" for the designated positioning data, and then executes the "block start data". When the condition is established, the "block start data" is executed. When not established, that "block start data" is ignored, and the next point's "block start data" is executed.	10.3.3
	Wait start	Carries out condition judgment set in the "condition data" for the designated positioning data, and then executes the "block start data". When the condition is established, the "block start data" is executed. When not established, stops the control until the condition is established. (Waits.)	10.3.4
	Simultaneous start	Simultaneously executes the positioning data having the No. for the axis designated with the "condition data". (Outputs pulses at the same timing.)	10.3.5
	Repeated start (FOR loop)	Repeats the program from the block start data set with the "FOR loop" to the block start data set in "NEXT" for the designated No. of times.	10.3.6
	Repeated start (FOR condition)	Repeats the program from the block start data set with the "FOR condition" to the block start data set in "NEXT" until the conditions set in the "condition data" are established.	10.3.7
	Multiple axes simultaneous start control	Starts the operation of multiple axes simultaneously according to the pulse output level. (Positioning start No. 9004, same as the "simultaneous start" above)	10.5
Manual control	JOG operation	Outputs a pulse to drive unit while the JOG start signal is ON.	11.2
	Inching operation	Outputs pulses corresponding to minute movement amount by manual operation to drive unit. (Performs fine adjustment with the JOG start signal.)	11.3
	Manual pulse generator operation	Outputs pulses commanded with the manual pulse generator to drive unit. (Carry out fine adjustment, etc., at the pulse level.)	11.4

With the "major positioning control" ("high-level positioning control"), whether or not to continuously execute the positioning data can be set with the "operation pattern".

Outlines of the "operation patterns" are given below.

Da.1 Operation pattern	Details	Reference section
Independent positioning control (Positioning complete)	When "independent positioning control" is set for the operation pattern of the started positioning data, only the designated positioning data will be executed, and then the positioning will end.	9.1.2
Continuous positioning control	When "continuous positioning control" is set for the operation pattern of the started positioning data, after the designated positioning data is executed, the program will stop once, and then the next following positioning data will be executed.	
Continuous path control	When "continuous path control" is set for the operation pattern of the started positioning data, the designated positioning data will be executed, and then without decelerating, the next following positioning data will be executed.	

## 3.2.3 QD75 sub functions and common functions

## ■ Sub functions

The functions that assist positioning control using the QD75 are described below.  
(Refer to PART 2 for details on each function.)

Sub function		Details	Reference section
Functions characteristic to machine OPR	OPR retry function	This function retries the machine OPR with the upper/lower limit switches during machine OPR. This allows machine OPR to be carried out even if the axis is not returned to before the near-point dog with JOG operation, etc.	12.2.1
	OP shift function	After returning to the machine OP, this function compensates the position by the designated distance from the machine OP position and sets that position as the OP address.	12.2.2
Functions that compensate control	Backlash compensation function	This function compensates the mechanical backlash. Feed pulses equivalent to the set backlash amount are output each time the movement direction changes.	12.3.1
	Electronic gear function	By setting the movement amount per pulse, this function can freely change the machine movement amount per commanded pulse. A flexible positioning system that matches the machine system can be structured with this function.	12.3.2
	Near pass function *1	This function suppresses the machine vibration when the positioning data is switched during continuous path control in the interpolation control.	12.3.3
	Output timing selection of near pass control	This function allows the user to select the timing to output the difference ( $\Delta \ell$ ) between the actual and the set positioning end addresses in continuous path control, in which the difference ( $\Delta \ell$ ) is output during the execution of the next positioning data.	12.3.4
Functions that limit control	Speed limit function	If the command speed exceeds " [Pr.8] Speed limit value" during control, this function limits the commanded speed to within the " [Pr.8] Speed limit value" setting range.	12.4.1
	Torque limit function *2	If the torque generated by the servomotor exceeds " [Pr.17] Torque limit setting value" during control, this function limits the generated torque to within the " [Pr.17] Torque limit setting value" setting range.	12.4.2
	Software stroke limit function	If a command outside of the upper/lower limit stroke limit setting range, set in the parameters, is issued, this function will not execute positioning for that command.	12.4.3
	Hardware stroke limit function	This function carries out deceleration stop with the limit switch connected to the QD75 external device connector.	12.4.4
Functions that change control details	Speed change function	This function changes the speed during positioning. Set the new speed in the speed change buffer memory ([Cd.14] New speed value), and change the speed with the Speed change request ([Cd.15]).	12.5.1
	Override function	This function changes the speed within a percentage of 1 to 300% during positioning. This is executed using " [Cd.13] Positioning operation speed override".	12.5.2
	Acceleration/deceleration time change function	This function changes the acceleration/deceleration time during speed change. (Functions added to the speed change function and override function)	12.5.3
	Torque change function	This function changes the "torque limit value" during control.	12.5.4
	Target position change function	This function changes the target position during positioning. Position and speed can be changed simultaneously.	12.5.5



\* 1: The near pass function is featured as standard and is valid only for position control. It cannot be set to be invalid with parameters.

\* 2: Using "Torque limit function" requires a "D/A conversion module" and a "drive unit capable of torque limit command with analog voltage".

Sub function	Details	Reference section
Absolute position restoration function *3	This function restores the absolute position of designated axis. By this function, the OPR after power ON from OFF is not required once the OPR is executed when the system operation is started.	12.6

\* 3: An I/O module (or general-purpose I/O function of QCPU) with arbitrary number of points and "the drive unit capable of configuring an absolute position detection system (, which is a Mitsubishi General-Purpose AC Servo and has an absolute position detection function (absolute position data transference protocol) equivalent to that of MR-J3-□A)" are required to execute the "absolute position restoration function".

Sub function		Details	Reference section
Other functions	Step function	This function temporarily stops the operation to confirm the positioning operation during debugging, etc. The operation can be stopped at each "automatic deceleration" or "positioning data".	12.7.1
	Skip function	This function stops (decelerates to a stop) the positioning being executed when the skip signal is input, and carries out the next positioning.	12.7.2
	M code output function	This function issues a command for a sub work (clamp or drill stop, tool change, etc.) corresponding to the M code No. (0 to 65535) that can be set for each positioning data.	12.7.3
	Teaching function	This function stores the address positioned with manual control into the positioning address having the designated positioning data No. ( <u>Cd.39</u> ).	12.7.4
	Command in-position function	At each automatic deceleration, this function calculates the remaining distance for the QD75 to reach the positioning stop position. When the value is less than the set value, the "command in-position flag" is set to "1". When using another auxiliary work before ending the control, use this function as a trigger for the sub work.	12.7.5
	Acceleration/deceleration process function	This function adjusts the control acceleration/deceleration. (acceleration/deceleration time and curve).	12.7.6
	Continuous operation interrupt function	This function interrupts continuous operation. When this request is accepted, the operation stops when the execution of the current positioning data is completed.	6.5.4
	Pre-reading start function	This function shortens the virtual start time.	12.7.7
	Deceleration start flag function	Function that turns ON the flag when the constant speed status or acceleration status switches to the deceleration status during position control, whose operation pattern is "Positioning complete", to make the stop timing known.	12.7.8
	Stop command processing for deceleration stop function	Function that selects a deceleration curve when a stop cause occurs during deceleration stop processing to speed 0.	12.7.9

### ■ Common functions

The outline of the functions executed as necessary are described below.  
(Refer to PART 2 for details on each function.)

Common functions	Details	Reference section
Parameter initialization function	This function returns the "parameters" stored in the QD75 buffer memory and flash ROM to the default values. The following two methods can be used. 1) Method using sequence program 2) Method using GX Configurator-QP	13.2
Execution data backup function	This functions stores the "setting data", currently being executed, into the flash ROM. 1) Method using sequence program 2) Method using GX Configurator-QP	13.3
External I/O signal logic switching function	This function switches I/O signal logic according to externally connected devices. This function enables the use of the system that does not use b (N.C.)-contact signals, such as Drive unit READY or Upper/lower limit signal, by setting parameters to positive logic.	13.4
External I/O signal monitor function	This function monitors the external I/O signal monitor information in the module's detailed information which can be displayed on the system monitor of GX Developer*4.	13.5

\*4: For the QD75P□/QD75D□, this function is available in GX Developer (SW6D5C-GPPW-E or later).

For the QD75P□N/QD75D□N, external I/O signals cannot be monitored on GX Developer. Use the system monitor of GX Works2.

3.2.4 Combination of QD75 main functions and sub functions

With positioning control using the QD75, the main functions and sub functions can be combined and used as necessary. A list of the main function and sub function combinations is given below.

Main functions		Sub functions	Functions characteristic to machine OPR			
			OPR retry function	OP shift function		
		Combination with operation pattern. ※1				
OPR control	Machine OPR control	×	○	○		
	Fast OPR control	×	×	×		
Major positioning control	Position control	1-axis linear control	○	×	×	
		2-, 3-, or 4-axis linear interpolation control	○	×	×	
		1-axis fixed-feed control	△ (Continuous path control cannot be set)	×	×	
		2-, 3-, or 4-axis fixed-feed control (interpolation)	△ (Continuous path control cannot be set)	×	×	
		2-axis circular interpolation control	○	×	×	
		3-axis helical interpolation control	○	×	×	
	Speed control (1- to 4-axis)		△ (Only independent positioning control can be set)	×	×	
	Speed-position switching control		△ (Continuous path control cannot be set)	×	×	
	Position-speed switching control		△ (Only independent positioning control can be set)			
	Other control		Current value changing	△ (Continuous path control cannot be set)	×	×
			NOP instruction	×		
JUMP instruction			×	×	×	
LOOP to LEND			×			
Manual control	JOG operation, inching operation		×	×		
	Manual pulse generator operation		×	×	×	

◎: Always combine, ○: Combination possible, △: Combination limited, ×: Combination not possible

- ※1 The operation pattern is one of the "positioning data" setting items.
- ※2 The near pass function is featured as standard and is valid only for setting continuous path control for position control.
- ※3 Invalid during creep speed.
- ※4 Invalid during continuous path control.
- ※5 Combination with the inching operation is not available. (Inching operation does not perform acceleration/deceleration processing.)
- ※6 Valid for the reference axis only.
- ※7 Valid for only the case where a deceleration start is made during position control.
- ※8 Valid when using the positioning data but invalid when using the positioning start No. 9003.

	Functions that compensate control			Functions that limit control				Functions that change control details					Other functions									
	Backlash compensation function	Electronic gear function	Near pass function	Output timing selection of near pass control	Speed limit function	Torque limit function	Software stroke limit function	Hardware stroke limit function	Speed change function	Override function	Acceleration/ deceleration time change function	Torque change function	Target position change function	Step function	Skip function	M code output function	Teaching function	Command in-position function	Acceleration/deceleration process function	Pre-reading start function	Deceleration start flag function	Stop command processing for deceleration stop function
	○	○	*2	×	○	○	×	⊙	△*3	△*3	△*3	○	×	×	×	×	×	○	×	×	○	
	○	○		×	○	○	×	⊙	○	○	○	○	×	×	×	×	×	×	○	×	×	○
	○	○		○	○	○	○	⊙	○	○	○	○	△*4	○	○	○	×	○	○	○	○	○
	○	○		○	○	○	○	⊙	○	○	○	○	×	○	○	○	×	○	○	○	△*6	○
	○	○		×	○	○	○	⊙	○	○	○	○	×	○	○	○	×	○	○	○	○	○
	○	○		×	○	○	○	⊙	○	○	○	○	×	○	○	○	×	○	○	○	△*6	○
	○	○		○	○	○	○	⊙	○	○	○	○	×	○	○	○	×	○	○	○	×	○
	○	○		○	○	○	○	⊙	○	○	○	○	×	○	○	○	×	○	○	○	×	○
	○	○		×	○	○	○	⊙	○	○	○	○	×	×	×	○	×	×	○	○	×	○
	○	○		×	○	○	○	⊙	○	○	○	○	×	○	○	○	×	○	○	○	△*7	○
	×	×		×	×	×	×	⊙	×	×	×	×	×	○	×	△*8	×	×	×	×	×	×
	×	×		×	×	×	×	⊙	×	×	×	×	×	×	×	×	×	×	×	×	×	×
	○	○		×	○	○	○	⊙	△*5	△*5	△*5	○	×	×	×	×	○	×	△*5	×	×	×
	○	○		×	×	○	○	⊙	×	×	×	○	×	×	×	×	○	×	×	×	×	×

3.3 Specifications of input/output signals with CPU module

3.3.1 List of input/output signals with CPU module

The QD75 uses 32 input points and 32 output points for exchanging data with the CPU module.

The input/output signals when the QD75 is mounted in slot No. 0 of the main base unit are shown below.

Device X refers to the signals input from the QD75 to the CPU module, and device Y refers to the signals output from the CPU module to the QD75.

Signal direction: QD75 → CPU module			Signal direction: CPU module → QD75		
Device No.	Signal name		Device No.	Signal name	
X0	QD75 READY		Y0	PLC READY	
X1	Synchronization flag		Y1	Use prohibited	
X2	Use prohibited		Y2		
X3			Y3		
X4	Axis 1	M code ON	Y4	Axis 1	Axis stop
X5	Axis 2		Y5	Axis 2	
X6	Axis 3		Y6	Axis 3	
X7	Axis 4		Y7	Axis 4	
X8	Axis 1	Error detection	Y8	Axis 1	Forward run JOG start
X9	Axis 2		Y9	Axis 1	Reverse run JOG start
XA	Axis 3		YA	Axis 2	Forward run JOG start
XB	Axis 4		YB	Axis 2	Reverse run JOG start
XC	Axis 1	BUSY	YC	Axis 3	Forward run JOG start
XD	Axis 2		YD	Axis 3	Reverse run JOG start
XE	Axis 3		YE	Axis 4	Forward run JOG start
XF	Axis 4		YF	Axis 4	Reverse run JOG start
X10	Axis 1	Start complete	Y10	Axis 1	Positioning start
X11	Axis 2		Y11	Axis 2	
X12	Axis 3		Y12	Axis 3	
X13	Axis 4		Y13	Axis 4	
X14	Axis 1	Positioning complete	Y14	Axis 1	Execution prohibition flag
X15	Axis 2		Y15	Axis 2	
X16	Axis 3		Y16	Axis 3	
X17	Axis 4		Y17	Axis 4	
X18	Use prohibited		Y18	Use prohibited	
X19					
X1A					
X1B					
X1C					
X1D					
X1E					
X1F					

**Important**  
 [Y1 to Y3], [Y18 to Y1F], [X2, X3], and [X18 to X1F] are used by the system, and cannot be used by the user.  
 If these devices are used, the operation of the QD75 will not be guaranteed.

3.3.2 Details of input signals (QD75 → CPU module)

The ON/OFF timing and conditions of the input signals are shown below.

Device No.	Signal name		Details
X0	QD75 READY		<p>ON: READY OFF: Not READY/ Watch dog timer error</p> <ul style="list-style-type: none"> <li>When the PLC READY signal [Y0] turns from OFF to ON, the parameter setting range is checked. If no error is found, this signal turns ON.</li> <li>When the PLC READY signal [Y0] turns OFF, this signal turns OFF.</li> <li>When watch dog timer error occurs, this signal turns OFF.</li> <li>This signal is used for interlock in a sequence program, etc.</li> </ul>
X1	Synchronization flag		<p>OFF: Module access disabled ON: Module access enabled</p> <ul style="list-style-type: none"> <li>After the programmable controller is turned ON or the CPU module is reset, this signal turns ON if the access from the CPU module to the QD75 is possible.</li> <li>When "Asynchronous" is selected in the module synchronization setting of the CPU module, this signal can be used as interlock for the access from a sequence program to the QD75.</li> </ul>
X4 X5 X6 X7	Axis 1 Axis 2 Axis 3 Axis 4	M code ON	<p>OFF: M code is not set ON: M code is set</p> <ul style="list-style-type: none"> <li>In the WITH mode, this signal turns ON when the positioning data operation is started. In the AFTER mode, this signal turns ON when the positioning data operation is completed.</li> <li>This signal turns OFF with the "Cd.7" M code OFF request".</li> <li>When M code is not designated (when "Da.10" M code is "0"), this signal will remain OFF.</li> <li>With using continuous path control for the positioning operation, the positioning will continue even when this signal does not turn OFF. However, the warning "M CODE ON SIGNAL START" (warning code: 503) will occur.</li> <li>When the PLC READY signal [Y0] turns OFF, the M code ON signal will also turn OFF.</li> <li>If the operation is started while the M code is ON, the error "M CODE ON SIGNAL START" (error code: 536) will occur.</li> </ul>
X8 X9 XA XB	Axis 1 Axis 2 Axis 3 Axis 4	Error detection	<p>OFF: No error ON: Error occurrence</p> <ul style="list-style-type: none"> <li>This signal turns ON when an error listed in Section 15.2 occurs, and turns OFF when the error is reset on "Cd.5" Axis error rest".</li> </ul>
XC XD XE XF	Axis 1 Axis 2 Axis 3 Axis 4	BUSY *1	<p>OFF: Not BUSY ON: BUSY</p> <ul style="list-style-type: none"> <li>This signal turns ON at the start of positioning, OPR or JOG operation. It turns OFF when the "Da.9" Dwell time" has passed after positioning stops. (This signal remains ON during positioning.) This signal turns OFF when the positioning is stopped with step operation.</li> <li>During manual pulse generator operation, this signal turns ON while the "Cd.21" Manual pulse generator enable flag" is ON.</li> <li>This signal turns OFF at error completion or positioning stop.</li> </ul>
X10 X11 X12 X13	Axis 1 Axis 2 Axis 3 Axis 4	Start complete	<p>OFF: Start incomplete ON: Start complete</p> <ul style="list-style-type: none"> <li>This signal turns ON when the positioning start signal turns ON and the QD75 starts the positioning process. (The start complete signal also turns ON during OPR control.)</li> </ul>
X14 X15 X16 X17	Axis 1 Axis 2 Axis 3 Axis 4	Positioning complete *2	<p>OFF: Positioning incomplete ON: Positioning complete</p> <ul style="list-style-type: none"> <li>This signal turns ON for the time set in "Pr.40" Positioning complete signal output time" from the instant when the positioning control for each positioning data No. is completed. For the interpolation control, the positioning completed signal of interpolation axis turns ON during the time set to the reference axis. (It does not turn ON when "Pr.40" Positioning complete signal output time" is "0".)</li> <li>If positioning (including OPR), JOG/Inching operation, or manual pulse generator operation is started while this signal is ON, the signal will turn OFF.</li> <li>This signal will not turn ON when speed control or positioning is canceled midway.</li> </ul>

**Important**

\*1: The BUSY signal turns ON even when position control of movement amount 0 is executed. However, since the ON time is short, the ON status may not be detected in the sequence program.

\*2: "Positioning complete" of the QD75 refers to the point when the pulse output from QD75 is completed. Thus, even if the QD75's positioning complete signal turns ON, the system may continue operation.

3.3.3 Detail of output signals (CPU module → QD75)

The ON/OFF timing and conditions of the output signals are shown below.

Device No.	Signal name		Details
Y0	PLC READY		<p>OFF: PLC READY OFF</p> <p>ON: PLC READY ON</p> <p>(a) This signal notifies the QD75 that the CPU module is normal.</p> <ul style="list-style-type: none"> <li>It is turned ON/OFF with the sequence program.</li> <li>The PLC READY signal is turned ON during positioning control, OPR control, JOG operation, inching operation, and manual pulse generator operation, unless the system is in the peripheral device test mode.</li> </ul> <p>(b) When parameters are changed, the PLC READY signal is turned OFF depending on the parameter (Refer to CHAPTER 7.).</p> <p>(c) The following processes are carried out when the PLC READY signal turns from OFF to ON.</p> <ul style="list-style-type: none"> <li>The parameter setting range is checked.</li> <li>The QD75 READY signal [X0] turns ON.</li> </ul> <p>(d) The following processes are carried out when the PLC READY signal turns from ON to OFF.</p> <p>In these cases, the OFF time should be set to 100ms or more.</p> <ul style="list-style-type: none"> <li>The QD75 READY signal [X0] turns OFF.</li> <li>The operating axis stops.</li> <li>The M code ON signal [X4 to X7] for each axis turns OFF, and "0" is stored in "[Md.25] Valid M code".</li> </ul> <p>(e) When parameters or positioning data (No. 1 to 600) are written from the peripheral device or CPU module to the flash ROM, the PLC READY signal will turn OFF.</p>
Y4 Y5 Y6 Y7	Axis 1 Axis 2 Axis 3 Axis 4	Axis stop	<p>OFF: Axis stop not requested</p> <p>ON: Axis stop requested</p> <ul style="list-style-type: none"> <li>When the axis stop signal turns ON, the OPR control, positioning control, JOG operation, inching operation and manual pulse generator operation will stop.</li> <li>By turning the axis stop signal ON during positioning operation, the positioning operation will be "stopped".</li> <li>Whether to decelerate or suddenly stop can be selected with "[Pr.39] Stop group 3 sudden stop selection".</li> <li>During interpolation control of the positioning operation, if the axis stop signal of any axis turns ON, all axes in the interpolation control will decelerate and stop.</li> </ul>
Y8 Y9 YA YB YC YD YE YF	Axis 1 Axis 1 Axis 2 Axis 2 Axis 3 Axis 3 Axis 4 Axis 4	Forward run JOG start Reverse run JOG start Forward run JOG start Reverse run JOG start Forward run JOG start Reverse run JOG start Forward run JOG start Reverse run JOG start	<p>OFF: JOG not started</p> <p>ON: JOG started</p> <ul style="list-style-type: none"> <li>When the JOG start signal is ON, JOG operation will be carried out at the "[Cd.17] JOG speed". When the JOG start signal turns OFF, the operation will decelerate and stop.</li> <li>When inching movement amount is set, the designated movement amount is output for one control cycle and then the operation stops.</li> </ul>
Y10 Y11 Y12 Y13	Axis 1 Axis 2 Axis 3 Axis 4	Positioning start	<p>OFF: Positioning start not requested</p> <p>ON: Positioning start requested</p> <ul style="list-style-type: none"> <li>OPR operation or positioning operation is started.</li> <li>The positioning start signal is valid at the rising edge, and the operation is started.</li> <li>When the positioning start signal turns ON during BUSY, the warning "Start during operation" (warning code: 100) will occur.</li> </ul>
Y14 Y15 Y16 Y17	Axis 1 Axis 2 Axis 3 Axis 4	Execution prohibition flag	<p>OFF: Not during execution prohibition</p> <p>ON: During execution prohibition</p> <ul style="list-style-type: none"> <li>If the execution prohibition flag is ON when the positioning start signal turns ON, positioning control does not start until the execution prohibition flag turns OFF. (Pulse output not provided) Used with the "Pre-reading start function". (Refer to Section 12.7.7)</li> </ul>



3.4 Specifications of input/output interfaces with external devices

3.4.1 Electrical specifications of input/output signals

■ QD75P□N/QD75D□N

(1) Input specifications

Signal name	Rated input voltage/current	Working voltage range	ON voltage/current	OFF voltage/current	Input resistance	Response time
Drive unit READY (READY) Stop signal (STOP) Upper limit signal (FLS) Lower limit signal (RLS)	24VDC/5mA	19.2 to 26.4VDC	17.5VDC or more/ 3.5mA or more	7VDC or less/ 1.7mA or less	Approx. 4.7kΩ	4ms or less
Zero signal (PG05/PG024)	5VDC/5mA	4.5 to 6.1VDC	2VDC or more/ 2mA or more	0.5VDC or less/ 0.5mA or less	Approx. 620Ω	1ms or less
	24VDC/5mA	12 to 26.4VDC	10VDC or more/ 3mA or more	3VDC or less/ 0.2mA or less	Approx. 4.7kΩ	1ms or less
	<p>ON: 3µs or less, OFF: 3µs or less, Pulse width: 1ms or more</p>					
Differential receiver equivalent to AM26LS32 (ON/OFF level ON: 1.8V or more, OFF: 0.6V or less)						
Manual pulse generator A phase (PULSE GENERATOR A) Manual pulse generator B phase (PULSE GENERATOR B)	5VDC/5mA	4.5 to 6.1VDC	2.5VDC or more/ 2mA or more	1VDC or less/ 0.1mA or less	Approx. 1.1kΩ	1ms or less
	<p>① Pulse width</p> <p>(Duty ratio: 50%)</p> <p>② Phase difference</p> <p>When the A phase leads the B phase, the positioning address (current value) increases.</p>					
Near-point dog signal (DOG)	24VDC/5mA	19.2 to 26.4VDC	17.5VDC or more/ 3.5mA or more	7VDC or less/ 1.7mA or less	Approx. 4.3kΩ	1ms or less
External command signal (CHG)	24VDC/5mA	19.2 to 26.4VDC	19VDC or more/ 2.7mA or more	7VDC or less/ 0.8mA or less	Approx. 7.7kΩ	1ms or less

(2) Output specifications

Signal name	Rated load voltage	Operating load voltage range	Max. load current/inrush current	Max. voltage drop at ON	Leakage current at OFF	Response time
Deviation counter clear (CLEAR)	5 to 24VDC	4.75 to 30VDC	0.1A/1 point/0.4A 10ms or less	1VDC (TYP) 2.5VDC (MAX)	0.1mA or less	2ms or less (resistance load)
QD75P□N Pulse output F (PULSE F) Pulse output R (PULSE R)	5 to 24VDC	4.75 to 30VDC	50mA/1 point/ 200mA 10ms or less	0.5VDC (TYP)	0.1mA or less	—
QD75D□N Pulse output F (+/-) (PULSE F+/-) Pulse output R (+/-) (PULSE R+/-)	Differential driver equivalent to AM26C31					

- Select the PULSE/SIGN type, CW/CCW type, and A phase/B phase type using the parameter (Pr.5 Pulse output mode) according to the drive unit specifications.
- The relation of the pulse output with the "Pr.5 Pulse output mode" and "Pr.23 Output signal logic selection" is shown below:

Pr.5 Pulse output mode <sup>*1</sup>	Terminal name	Pr.23 Output signal logic selection (bit0)			
		Positive logic		Negative logic	
		Forward run	Reverse run	Forward run	Reverse run
Open collector connection (QD75P□N)					
<ul style="list-style-type: none"> <li>• The voltage of a terminal having the PULSE COM terminal as a reference is shown. (Refer to Section 3.4.4, (2).)</li> <li>(The transistor output becomes OFF to High and ON to Low.)</li> </ul>					
PULSE	PULSE F	High Low		High Low	
SIGN	PULSE R	High Low		High Low	
CW	PULSE F	High Low		High Low	
CCW	PULSE R	High Low		High Low	
A phase	PULSE F	High Low		High Low	
B phase	PULSE R	High Low		High Low	
Differential driver connection (QD75D□N)					
<ul style="list-style-type: none"> <li>• The voltage of a terminal having the differential driver common terminal as a reference is shown. (Refer to Section 3.4.4, (3).)</li> <li>• For the differential driver common terminal, refer to "Section 4.3.2, Wiring of the differential driver common terminal".</li> </ul>					
PULSE	PULSE F+ PULSE F-	High Low High Low		High Low High Low	
SIGN	PULSE R+ PULSE R-	High Low High Low		High Low High Low	
CW	PULSE F+ PULSE F-	High Low High Low		High Low High Low	
CCW	PULSE R+ PULSE R-	High Low High Low		High Low High Low	
A phase	PULSE F+ PULSE F-	High Low High Low		High Low High Low	
B phase	PULSE R+ PULSE R-	High Low High Low		High Low High Low	

\*1: For details on "Pr.5 Pulse output mode", refer to "Section 5.2.1, Basic parameters 1".

POINT

Set the parameters, " [Pr.5] Pulse output mode" and " [Pr.23] Output signal logic selection", in accordance with the specifications of a connected servo amplifier. If not, the motor may rotate in the opposite direction or may not rotate at all.

Connection examples with a MELSERVO-J3 series servo amplifier are shown below.

Open collector connection (QD75P□N)

[Pr.5] Pulse output mode	QD75P□N ([Pr.23] Output signal logic selection (bit0))	Logic of MR-J3-□A servo amplifier
CW/CCW	Negative logic	Negative logic
	Positive logic	Positive logic
PULSE/SIGN	Negative logic	Negative logic
	Positive logic	Positive logic
A phase/ B phase	Negative logic	Negative logic
	Negative logic	Positive logic
	Positive logic	Negative logic
	Positive logic	Positive logic

Differential driver connection (QD75D□N)

[Pr.5] Pulse output mode	QD75D□N ([Pr.23] Output signal logic selection (bit0))	Logic of MR-J3-□A servo amplifier
CW/CCW	Negative logic	Positive logic
	Positive logic	Negative logic
PULSE/SIGN	Negative logic	Positive logic
	Positive logic	Negative logic
A phase/ B phase	Negative logic	Negative logic
	Negative logic	Positive logic
	Positive logic	Negative logic
	Positive logic	Positive logic

■ QD75P□/QD75D□

(1) Input specifications

Signal name	Rated input voltage/current	Working voltage range	ON voltage/current	OFF voltage/current	Input resistance	Response time
Drive unit READY (READY) Stop signal (STOP) Upper limit signal (FLS) Lower limit signal (RLS)	24VDC/5mA	19.2 to 26.4VDC	17.5VDC or more/ 3.5mA or more	7VDC or less/ 1.7mA or less	Approx. 4.7kΩ	4ms or less
Zero signal (PG05/PG024)	5VDC/5mA	4.5 to 6.1VDC	2VDC or more/ 2mA or more	0.5VDC or less/ 0.5mA or less	Approx. 0.3kΩ	1ms or less
	24VDC/5mA	12 to 26.4VDC	10VDC or more/ 3mA or more	3VDC or less/ 0.2mA or less	Approx. 4.7kΩ	1ms or less
	<p>ON: 3µs or less, OFF: 3µs or less, Pulse width: 1ms or more</p>					
Differential receiver equivalent to AM26LS32 (ON/OFF level ON: 1.8V or more, OFF: 0.6V or less)						
Manual pulse generator A phase (PULSE GENERATOR A) Manual pulse generator B phase (PULSE GENERATOR B)	5VDC/5mA	4.5 to 6.1VDC	2.5VDC or more/ 2mA or more	1VDC or less/ 0.1mA or less	Approx. 1.5kΩ	1ms or less
	<p>① Pulse width</p> <p>(Duty ratio: 50%)</p> <p>② Phase difference</p> <p>When the A phase leads the B phase, the positioning address (current value) increases.</p>					
Near-point dog signal (DOG) External command signal (CHG)	24VDC/5mA	19.2 to 26.4VDC	17.5VDC or more/ 3.5mA or more	7VDC or less/ 1.7mA or less	Approx. 4.3kΩ	1ms or less

(2) Output specifications

Signal name	Rated load voltage	Operating load voltage range	Max. load current/inrush current	Max. voltage drop at ON	Leakage current at OFF	Response time
Deviation counter clear (CLEAR)	5 to 24VDC	4.75 to 30VDC	0.1A/1 point/0.4A 10ms or less	1VDC (TYP) 2.5VDC (MAX)	0.1mA or less	2ms or less (resistance load)
QD75P□ Pulse output F (PULSE F) Pulse output R (PULSE R)	5 to 24VDC	4.75 to 30VDC	50mA/1 point/ 200mA 10ms or less	0.5VDC (TYP)	0.1mA or less	—
QD75D□ Pulse output F (+/-) (PULSE F+/-) Pulse output R (+/-) (PULSE R+/-)	Differential driver equivalent to AM26C31					

- Select the PULSE/SIGN type, CW/CCW type, and A phase/B phase type using the parameter ( [Pr.5] Pulse output mode) according to the drive unit specifications.
- The relation of the pulse output with the " [Pr.5] Pulse output mode" and " [Pr.23] Output signal logic selection" is shown below:

[Pr.5] Pulse output mode*1	Terminal name	[Pr.23] Output signal logic selection (bit0)			
		Positive logic		Negative logic	
		Forward run	Reverse run	Forward run	Reverse run
Open collector connection ( QD75P□ )					
<ul style="list-style-type: none"> <li>• The voltage of a terminal having the PULSE COM terminal as a reference is shown. (Refer to Section 3.4.4, (2).)</li> <li>(The transistor output becomes OFF to High and ON to Low.)</li> </ul>					
PULSE	PULSE F	High Low		High Low	
SIGN	PULSE R	High Low		High Low	
CW	PULSE F	High Low		High Low	
CCW	PULSE R	High Low		High Low	
A phase	PULSE F	High Low		High Low	
B phase	PULSE R	High Low		High Low	
Differential driver connection (QD75P□)					
<ul style="list-style-type: none"> <li>• The voltage of a terminal having the differential driver common terminal as a reference is shown. (Refer to Section 3.4.4, (3).)</li> <li>• For the differential driver common terminal, refer to "Section 4.3.2, Wiring of the differential driver common terminal".</li> </ul>					
PULSE	PULSE F+ PULSE F-	High Low High Low		High Low High Low	
SIGN	PULSE R+ PULSE R-	High Low High Low		High Low High Low	
CW	PULSE F+ PULSE F-	High Low High Low		High Low High Low	
CCW	PULSE R+ PULSE R-	High Low High Low		High Low High Low	
A phase	PULSE F+ PULSE F-	High Low High Low		High Low High Low	
B phase	PULSE R+ PULSE R-	High Low High Low		High Low High Low	

\* 1: For details on " [Pr.5] Pulse output mode", refer to "Section 5.2.1, Basic parameters 1".

POINT

Set the parameters, " Pr.5 Pulse output mode" and " Pr.23 Output signal logic selection", in accordance with the specifications of a connected servo amplifier. If not, the motor may rotate in the opposite direction or may not rotate at all.

Connection examples with a MELSERVO-J3 series servo amplifier are shown below.

Open collector connection (QD75P□)

Pr.5 Pulse output mode	QD75P□ Pr.23 Output signal logic selection (bit0)	Logic of MR-J3-□A servo amplifier
CW/CCW	Negative logic	Negative logic
	Positive logic	Positive logic
PULSE/SIGN	Negative logic	Negative logic
	Positive logic	Positive logic
A phase/ B phase	Negative logic	Negative logic
	Negative logic	Positive logic
	Positive logic	Negative logic
	Positive logic	Positive logic

Differential driver connection (QD75D□)

Pr.5 Pulse output mode	QD75D□ Pr.23 Output signal logic selection (bit0)	Logic of MR-J3-□A servo amplifier
CW/CCW	Negative logic	Positive logic
	Positive logic	Negative logic
PULSE/SIGN	Negative logic	Positive logic
	Positive logic	Negative logic
A phase/ B phase	Negative logic	Negative logic
	Negative logic	Positive logic
	Positive logic	Negative logic
	Positive logic	Positive logic

3.4.2 Signal layout for external device connection connector

The specifications of the connector section, which is the input/output interface for the QD75 and external device, are shown below.

The signal layout for the QD75 external device connection connector is shown.

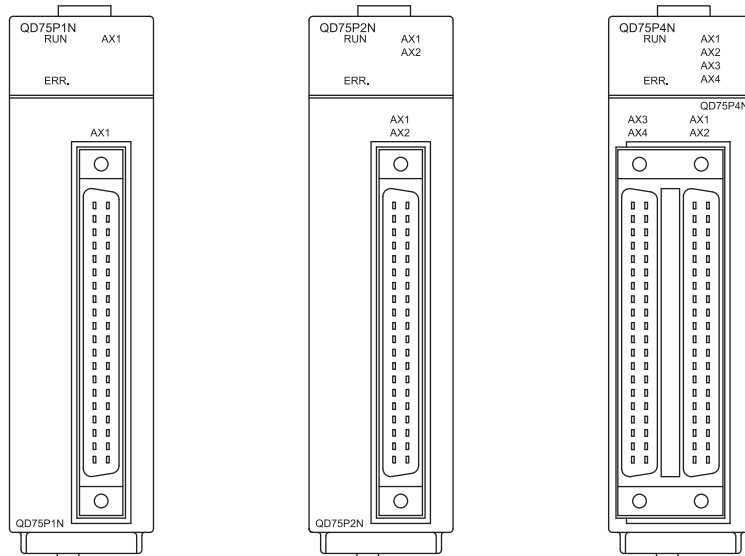

Pin layout	Axis 4 (AX4)		Axis 3 (AX3)		Axis 2 (AX2)		Axis 1 (AX1)	
	Pin No.	Signal name	Pin No.	Signal name	Pin No. *2	Signal name	Pin No.	Signal name
<div style="display: flex; align-items: center;"> <div style="margin-right: 10px;"> <p>B20</p><p>B19</p><p>B18</p><p>B17</p><p>B16</p><p>B15</p><p>B14</p><p>B13</p><p>B12</p><p>B11</p><p>B10</p><p>B9</p><p>B8</p><p>B7</p><p>B6</p><p>B5</p><p>B4</p><p>B3</p><p>B2</p><p>B1</p> </div> <div style="margin-right: 10px;"> <p>□ □</p><p>□ □</p><p>□ □</p><p>□ □</p><p>□ □</p><p>□ □</p><p>□ □</p><p>□ □</p><p>□ □</p><p>□ □</p><p>□ □</p><p>□ □</p><p>□ □</p><p>□ □</p><p>□ □</p><p>□ □</p><p>□ □</p><p>□ □</p><p>□ □</p><p>□ □</p> </div> <div> <p>A20</p><p>A19</p><p>A18</p><p>A17</p><p>A16</p><p>A15</p><p>A14</p><p>A13</p><p>A12</p><p>A11</p><p>A10</p><p>A9</p><p>A8</p><p>A7</p><p>A6</p><p>A5</p><p>A4</p><p>A3</p><p>A2</p><p>A1</p> </div> </div>	2B20	Vacant	2A20	Vacant	1B20	PULSER B-	1A20	PULSER B+
	2B19	Vacant	2A19	Vacant	1B19	PULSER A-	1A19	PULSER A+
	2B18	PULSE COM	2A18	PULSE COM	1B18	PULSE COM	1A18	PULSE COM
	*3	PULSE R-	*3	PULSE R-	*3	PULSE R-	*3	PULSE R-
	2B17	PULSE R	2A17	PULSE R	1B17	PULSE R	1A17	PULSE R
	*3	PULSE R+	*3	PULSE R+	*3	PULSE R+	*3	PULSE R+
	2B16	PULSE COM	2A16	PULSE COM	1B16	PULSE COM	1A16	PULSE COM
	*3	PULSE F-	*3	PULSE F-	*3	PULSE F-	*3	PULSE F-
	2B15	PULSE F	2A15	PULSE F	1B15	PULSE F	1A15	PULSE F
	*3	PULSE F+	*3	PULSE F+	*3	PULSE F+	*3	PULSE F+
	2B14	CLRCOM	2A14	CLRCOM	1B14	CLRCOM	1A14	CLRCOM
	2B13	CLEAR	2A13	CLEAR	1B13	CLEAR	1A13	CLEAR
	2B12	RDYCOM	2A12	RDYCOM	1B12	RDYCOM	1A12	RDYCOM
	2B11	READY	2A11	READY	1B11	READY	1A11	READY
	2B10	PG0COM	2A10	PG0COM	1B10	PG0COM	1A10	PG0COM
	2B9	PG05	2A9	PG05	1B9	PG05	1A9	PG05
	2B8	PG024	2A8	PG024	1B8	PG024	1A8	PG024
	2B7	COM	2A7	COM	1B7	COM	1A7	COM
	2B6	COM	2A6	COM	1B6	COM	1A6	COM
2B5	CHG	2A5	CHG	1B5	CHG	1A5	CHG	
2B4	STOP	2A4	STOP	1B4	STOP	1A4	STOP	
2B3	DOG	2A3	DOG	1B3	DOG	1A3	DOG	
2B2	RLS	2A2	RLS	1B2	RLS	1A2	RLS	
2B1	FLS	2A1	FLS	1B1	FLS	1A1	FLS	

\* 1: Pin No. "1□ □ □" indicates the pin No. for the right connector. Pin No. "2 □ □ □" indicates the pin No. for the left connector.

\* 2: When a 1-axis module is used, pin Nos. 1B1 to 1B18 are "vacant".

\* 3: The upper line indicates the signal name for the QD75P□N/QD75P□, and the lower line indicates the signal name for the QD75D□N/QD75D□.

3.4.3 List of input/output signal details

The details of each QD75 external device connection connector are shown below:

Signal name	Pin No.				Signal details (Negative logic is selected by external I/O signal logic selection)
	AX1	AX2	AX3	AX4	
Manual pulse generator A phase (PULSER A+) Manual pulse generator B phase (PULSER B+)	1A19 1A20			—	<ul style="list-style-type: none"> <li>Input the pulse signal from the manual pulse generator A phase and B phase.</li> <li>If the A phase leads the B phase, the positioning address will increase at the rising and falling edges of each phase.</li> <li>If the B phase leads the A phase, the positioning address will decrease at the rising and falling edges of each phase.</li> </ul>
Manual pulse generator A common (PULSER A-) Manual pulse generator B common (PULSER B-)	1B19 1B20			—	<p>[When increased]</p> <p>[When decreased]</p> <p>Positioning address +1+1+1+1+1+1+1+1</p> <p>Positioning address -1 -1 -1 -1 -1 -1 -1 -1</p>
Zero signal (+24V) (PG024)	1A8	1B8	2A8	2B8	<ul style="list-style-type: none"> <li>Input the zero signal for machine OPR. Use the pulse encoder's zero signal and so on.</li> <li>Also use this signal when the machine OPR method is the stopper method and the OPR complete is input from an external source.</li> <li>The zero signal is detected at turning from OFF to ON.</li> </ul>
Zero signal (+5V) (PG05)	1A9	1B9	2A9	2B9	
Zero signal common (PG0COM)	1A10	1B10	2A10	2B10	<ul style="list-style-type: none"> <li>Common for zero signal (+5V) and zero signal (+24V).</li> </ul>
Pulse output F (+) (PULSE F+) Pulse output F (-) (PULSE F-)	1A15 1A16	1B15 1B16	2A15 2A16	2B15 2B16	<ul style="list-style-type: none"> <li>Output the positioning pulses and pulse sign for the differential driver output system compatible drive unit. (QD75D□N/QD75D□ only)</li> </ul>
Pulse output R (+) (PULSE R+) Pulse output R (-) (PULSE R-)	1A17 1A18	1B17 1B18	2A17 2A18	2B17 2B18	
Pulse output F (PULSE F) Pulse output F common (PULSE COM)	1A15 1A16	1B15 1B16	2A15 2A16	2B15 2B16	
Pulse output R (PULSE R) Pulse output R common (PULSE COM)	1A17 1A18	1B17 1B18	2A17 2A18	2B17 2B18	<ul style="list-style-type: none"> <li>Output the positioning pulses and pulse sign for the open collector output system compatible drive unit. (QD75P□N/QD75P□ only)</li> </ul>
Upper limit signal (FLS)	1A1	1B1	2A1	2B1	<ul style="list-style-type: none"> <li>This signal is input from the limit switch installed at the upper limit position of the stroke.</li> <li>Positioning will stop when this signal turns OFF.</li> <li>When OPR retry function is valid, this will be the upper limit for finding the near-point dog signal.</li> </ul>
Lower limit signal (RLS)	1A2	1B2	2A2	2B2	<ul style="list-style-type: none"> <li>This signal is input from the limit switch installed at the lower limit position of the stroke.</li> <li>Positioning will stop when this signal turns OFF.</li> <li>When OPR retry function is valid, this will be the lower limit for finding the near-point dog signal.</li> </ul>



Signal name	Pin No.				Signal details (Negative logic is selected by external I/O signal logic selection)
	AX1	AX2	AX3	AX4	
Near-point dog signal (DOG)	1A3	1B3	2A3	2B3	<ul style="list-style-type: none"> <li>This signal is used for detecting the near-point dog during OPR.</li> <li>The near-point dog signal is detected at turning from OFF to ON.</li> </ul>
Stop signal (STOP)	1A4	1B4	2A4	2B4	<ul style="list-style-type: none"> <li>Input this signal to stop positioning.</li> <li>When this signal turns ON, the QD75 will stop the positioning being executed.</li> <li>After that, even if this signal is turned from ON to OFF, the system will not start.</li> </ul>
External command signal (CHG)	1A5	1B5	2A5	2B5	<ul style="list-style-type: none"> <li>Input a control switching signal during speed-position or position-speed switching control.</li> <li>Use this signal as the input signal of positioning start, speed change request, and skip request from an external source.</li> <li>Set the function to use this signal in " Pr.42 External command function selection".</li> </ul>
Common (COM)	1A6 1A7	1B6 1B7	2A6 2A7	2B6 2B7	<ul style="list-style-type: none"> <li>Common for upper/lower limit, near-point dog, stop, and external command signals.</li> </ul>
Drive unit READY (READY)	1A11	1B11	2A11	2B11	<ul style="list-style-type: none"> <li>This signal turns ON when the drive unit is normal and can accept the feed pulse.</li> <li>The QD75 checks the drive unit READY signal, and outputs the OPR request if the system is not in the READY state.</li> <li>When the drive unit is inoperable, such as if an error occurs in the drive unit's control power supply, this signal will turn OFF.</li> <li>If this signal is turned OFF during positioning, the system will stop. The system will not start even if this signal is turned ON again.</li> <li>When this signal turns OFF, the OPR complete signal will also turn OFF.</li> </ul>
Drive unit READY common (RDYCOM)	1A12	1B12	2A12	2B12	<ul style="list-style-type: none"> <li>Common for drive unit READY signal.</li> </ul>
Deviation counter clear (CLEAR)	1A13	1B13	2A13	2B13	<ul style="list-style-type: none"> <li>This signal is output during machine OPR. (Note that it is not output during the count method ②.)</li> <li>(Example) When machine OPR is carried out in the stopper ② method.</li> </ul> <p>The diagram illustrates the CLEAR signal output during machine OPR. The top graph shows Speed vs Time, with OPR speed (Pr.46) and Creep speed (Pr.47) phases, and a Stopper. The bottom graph shows CLEAR signal output time relative to Zero signal, Deviation counter (ON/OFF), and CLEAR signal (ON/OFF). The CLEAR signal output time is set in Pr.55.</p> <ul style="list-style-type: none"> <li>The output time of the deviation counter clear signal is set in " Pr.55 Deviation counter clear signal output time".</li> <li>Use the drive unit that can reset the droop pulse amount in the internal deviation counter when the QD75 turns this signal ON.</li> <li>(Note) The deviation counter clear is a signal output by the QD75 during machine OPR. It cannot be output randomly by the user.</li> </ul>
Deviation counter clear common (CLRCOM)	1A14	1B14	2A14	2B14	<ul style="list-style-type: none"> <li>Common for deviation counter clear signal</li> </ul>

3.4.4 Input/output interface internal circuit

The outline diagrams of the internal circuits for the QD75P1N/QD75D1N/QD75P1/QD75D1 external device connection interface are shown below.

(1) Input (Common to QD75P1N, QD75D1N, QD75P1, and QD75D1)

External wiring	Pin No.	Internal circuit	Signal name	Need for wiring *1
	1A3		Near-point dog signal DOG	△
	1A1		Upper limit signal FLS	○
	1A2		Lower limit signal RLS	○
	1A4		Stop signal STOP	△
	1A5		External command signal CHG	△
	1A6		Common COM	○
	1A7			
	(+) 1A19 (-) 1B19		Manual pulse generator A phase PULSER A+	△
			PULSER A-	
	(+) 1A20 (-) 1B20		Manual pulse generator B phase PULSER B+	△
			PULSER B-	
	1A11		Drive unit READY READY	○
	1A12		Drive unit READY common RDY COM	○
	1A8 1A9		Zero signal PG024	△
PG05				
1A10		Zero signal common PG0 COM		

\*1: The symbols in Need for wiring column indicate the following meanings:

- : Wiring is necessary for positioning.
- △ : Wiring is necessary depending on the situation.

\*2: Either polarity can be connected to the common (COM).

(a) Input signal ON/OFF status

The input signal ON/OFF status is defined by the external wiring and logic setting.

This is explained below with the example of near-point dog signal (DOG).

(The other input signals also perform the same operations as the near-point dog signal (DOG).)

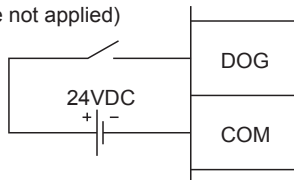
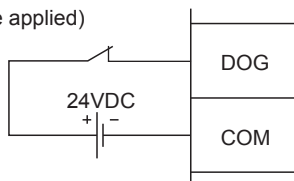
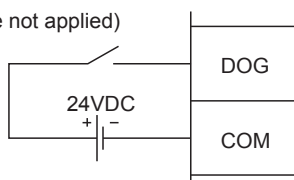
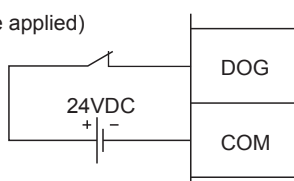
Logic setting *3, *4	External wiring *4	ON/OFF status of near-point dog signal (DOG) as seen from QD75
Negative logic (Initial value)	(Voltage not applied) 	OFF
	(Voltage applied) 	ON
Positive logic	(Voltage not applied) 	ON
	(Voltage applied) 	OFF

\*3: Set the logic setting using " [Pr.22] Input signal logic selection". For details of the settings, refer to "Section 5.2.3 Detailed parameters 1" and "Section 13.4 External I/O signal logic switching function".

\*4: When using the upper limit signal (FLS) or lower limit signal (RLS), always wire it as a "b" (normally closed) contact in the negative logic setting. The signal will turn OFF to stop positioning.

(b) About logic setting and internal circuit

In the QD75, the case where the internal circuit (photocoupler) is OFF in the negative logic setting is defined as "input signal OFF".

Reversely, the case where the internal circuit (photocoupler) is OFF in the positive logic setting is defined as "input signal ON".

<Photocoupler ON/OFF status>

When voltage is not applied : Photocoupler OFF

When voltage is applied : Photocoupler ON

(2) Output (For QD75P1N and QD75P1)

External wiring	Pin No.	Internal circuit	Signal name		Need for wiring*1
	1A13		Deviation counter clear	CLEAR	△
	1A14		Common	CLEAR COM	
	1A15		CW A phase PULSE	PULSE F	○
	1A16			PULSE COM	
	1A17		CCW B phase SIGN	PULSE R	
	1A18			PULSE COM	

(3) Output (For QD75D1N and QD75D1)

External wiring	Pin No.	Internal circuit	Signal name		Need for wiring*1	
	1A13		Deviation counter clear	CLEAR	△	
	1A14		Common	CLEAR COM		
	1A15		CW A phase PULSE	PULSE F+	○	
	1A16			PULSE F-		
	1A17		CCW B phase SIGN	PULSE R+		
	1A18			PULSE R-		
	*2		Differential driver common terminal	PULSE COM		△
	*2					

\*1: The symbols in Need for wiring column indicate the following meanings:

- ○: Wiring is necessary for positioning.
- △: Wiring is necessary depending on the situation.

\*2: A terminal block at the bottom of the module. (Refer to Section 4.1.2)

# CHAPTER 4 INSTALLATION, WIRING AND MAINTENANCE OF THE PRODUCT

The installation, wiring and maintenance of the QD75 are explained in this chapter.

Important information such as precautions to prevent malfunctioning of the QD75, accidents and injuries as well as the proper work methods are described. Read this chapter thoroughly before starting installation, wiring or maintenance, and always following the precautions.

4.1	Outline of installation, wiring and maintenance .....	4- 2
4.1.1	Installation, wiring and maintenance procedures .....	4- 2
4.1.2	Names of each part .....	4- 3
4.1.3	Handling precautions .....	4- 5
4.2	Installation .....	4- 7
4.2.1	Installation precautions .....	4- 7
4.3	Wiring .....	4- 8
4.3.1	Wiring precautions .....	4- 8
4.3.2	Wiring of the differential driver common terminal .....	4- 14
4.4	Checking the installation and wiring .....	4- 15
4.4.1	Items to check when installation and wiring are completed .....	4- 15
4.5	Maintenance .....	4- 16
4.5.1	Maintenance precautions .....	4- 16
4.5.2	Disposal precautions .....	4- 16

4.1 Outline of installation, wiring and maintenance

4.1.1 Installation, wiring and maintenance procedures

The outline and procedures for QD75 installation, wiring and maintenance are shown below.

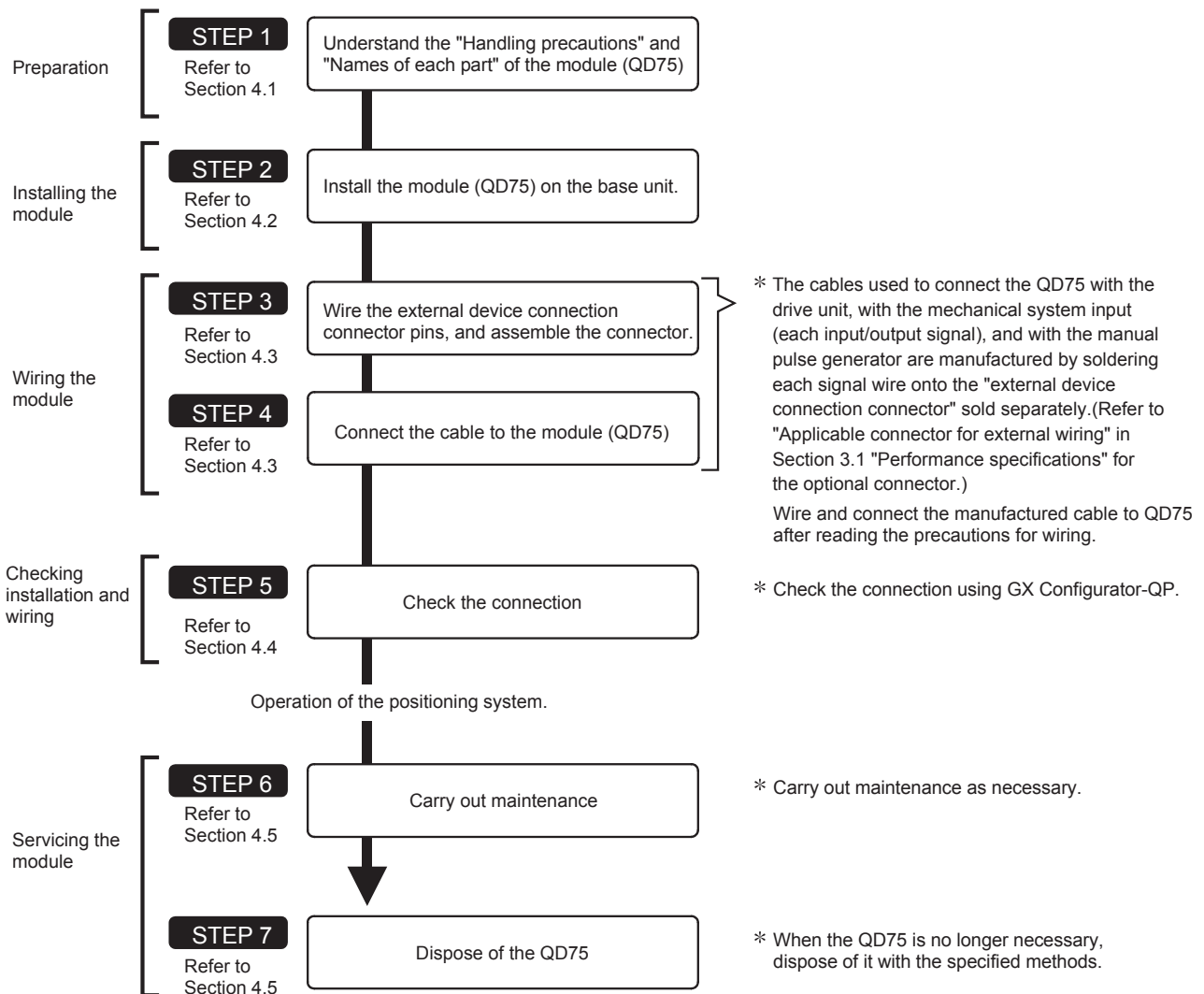

4.1.2 Names of each part

- (1) The part names of the QD75 are described with the QD75P□N/QD75D□N as an example. The QD75P□N/QD75D□N and QD75P□/QD75D□ are different in the indication of their model names and serial numbers

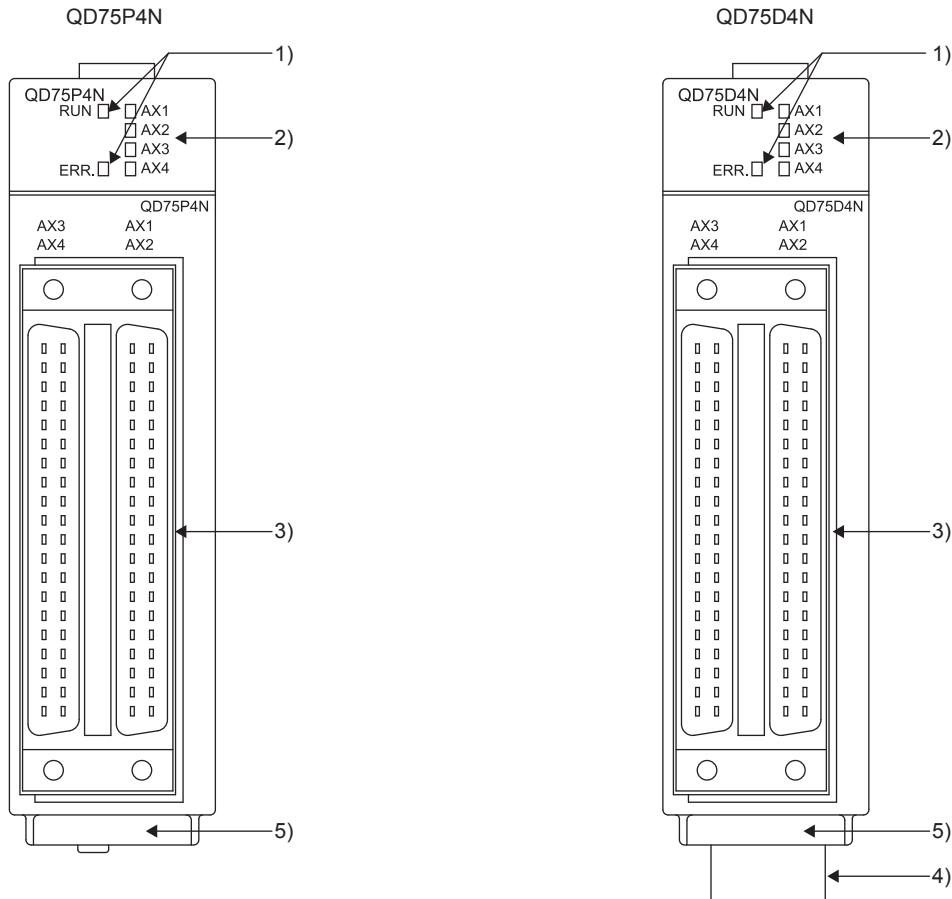

No.	Name	Details
1)	RUN indicator LED, ERR indicator LED	Refer to the next page.
2)	Axis display LED (AX1 to AX4)	
3)	External device connector	Connector for connection with the drive unit, mechanical system input or manual pulse generator. (40-pin connector) AX1: Axis 1, AX2: Axis 2, AX3: Axis 3, AX4: Axis 4 For details, refer to Section 3.4.2 "Signal layout for external device connection connector".
4)	Differential driver common terminal (Differential driver output system (the QD75D□N/QD75D□) only)	Terminal connected to the differential receiver common of the drive unit. For details, refer to Section 4.3.2 "Wiring of the differential driver common terminal".
5)	Serial number plate	Indicates the serial number of the QD75

(2) The LED display indicates the following operation statuses of the QD75 and axes.

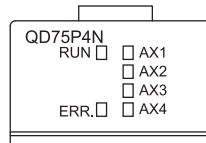

Display	Attention point	Description	Display	Attention point	Description
RUN <input type="checkbox"/> <input type="checkbox"/> AX1 <input type="checkbox"/> AX2 <input type="checkbox"/> AX3 ERR <input type="checkbox"/> <input type="checkbox"/> AX4	RUN is OFF.	Hardware failure, watch dog timer error	RUN <input checked="" type="checkbox"/> <input checked="" type="checkbox"/> AX1 <input type="checkbox"/> AX2 <input type="checkbox"/> AX3 ERR <input type="checkbox"/> <input type="checkbox"/> AX4	AX1 (or other axis) illuminates.	The corresponding axis is in operation.
RUN <input checked="" type="checkbox"/> <input type="checkbox"/> AX1 <input type="checkbox"/> AX2 <input type="checkbox"/> AX3 ERR <input type="checkbox"/> <input type="checkbox"/> AX4	RUN illuminates. ERR is OFF.	The module operates normally.	RUN <input checked="" type="checkbox"/> <input checked="" type="checkbox"/> AX1 <input type="checkbox"/> AX2 <input type="checkbox"/> AX3 ERR <input checked="" type="checkbox"/> <input type="checkbox"/> AX4	ERR flashes. AX1 (or other axis) flashes.	An error occurs on the corresponding axis.
RUN <input checked="" type="checkbox"/> <input type="checkbox"/> AX1 <input type="checkbox"/> AX2 <input type="checkbox"/> AX3 ERR <input checked="" type="checkbox"/> <input type="checkbox"/> AX4	ERR illuminates.	System error	RUN <input checked="" type="checkbox"/> <input checked="" type="checkbox"/> AX1 <input checked="" type="checkbox"/> AX2 <input checked="" type="checkbox"/> AX3 ERR <input checked="" type="checkbox"/> <input checked="" type="checkbox"/> AX4	All LEDs illuminate.	Hardware failure
RUN <input checked="" type="checkbox"/> <input type="checkbox"/> AX1 <input type="checkbox"/> AX2 <input type="checkbox"/> AX3 ERR <input type="checkbox"/> <input type="checkbox"/> AX4	AX1 to AX4 are OFF.	The axes are stopped or on standby.			

The symbols in the Display column indicate the following statuses:

: Turns OFF. : Illuminates. : Flashes.

(3) The interface of each QD75 is as shown below.

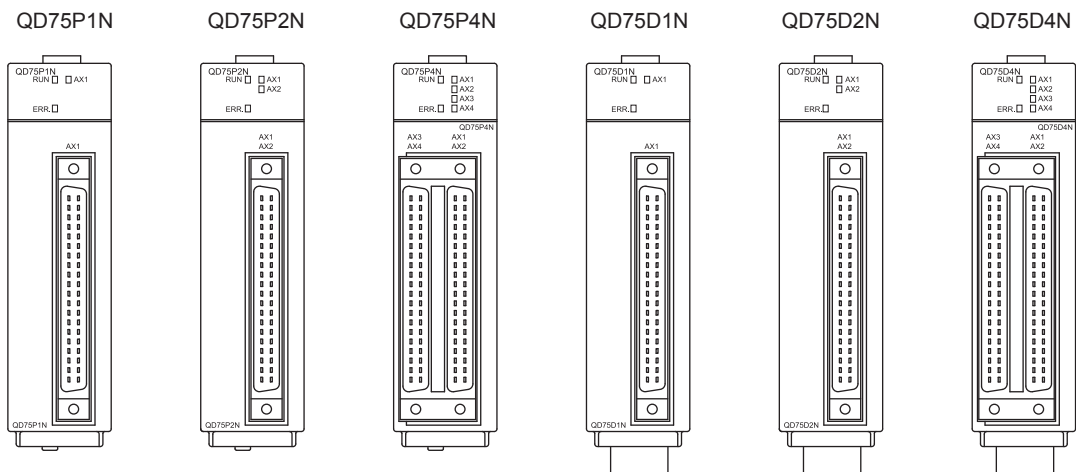



### 4.1.3 Handling precautions

Handle the QD75 and cable while observing the following precautions.

#### [1] Handling precautions

#### CAUTION

- Use the programmable controller in an environment that meets the general specifications contained in QCPU User's Manual(Hardware Design, Maintenance and Inspection) to use. Using this programmable controller in an environment outside the range of the general specifications may cause electric shock, fire, malfunction, and damage to or deterioration of the product.
- Do not directly touch the conductive section and electronic parts of the module. Failure to observe this could lead to module malfunctioning or trouble.
- Make sure that foreign matter, such as cutting chips or wire scraps, do not enter the module. Failure to observe this could lead to fires, trouble or malfunctioning.
- Never disassemble or modify the module. Failure to observe this could lead to trouble, malfunctioning, injuries or fires.

## [2] Other precautions

### (1) Main body

- The main body case is made of plastic. Take care not to drop or apply strong impacts onto the case.
- Do not remove the QD75 PCB from the case. Failure to observe this could lead to faults.

### (2) Cable

- Do not press on the cable with a sharp object.
- Do not twist the cable with force.
- Do not forcibly pull on the cable.
- Do not step on the cable.
- Do not place objects on the cable.
- Do not damage the cable sheath.

### (3) Installation environment

Do not install the module in the following type of environment.

- Where the ambient temperature exceeds the 0 to 55°C range.
- Where the ambient humidity exceeds the 5 to 95%RH range.
- Where there is sudden temperature changes, or where dew condenses.
- Where there is corrosive gas or flammable gas.
- Where there are high levels of dust, conductive powder, such as iron chips, oil mist, salt or organic solvents.
- Where the module will be subject to direct sunlight.
- Where there are strong electric fields or magnetic fields.
- Where vibration or impact could be directly applied onto the main body.

## 4.2 Installation

### 4.2.1 Installation precautions

The precautions for installing the QD75 are given below. Refer to this section as well as "4.1.3 Handling precautions" when carrying out the work.

#### Installation precautions

##### WARNING

- Completely turn off the externally supplied power used in the system before cleaning or tightening the screws.  
Failure to turn all phases OFF could lead to electric shocks.

##### CAUTION

- Never disassemble or modify the module.  
Failure to observe this could lead to trouble, malfunctioning, injuries or fires.
- Completely turn off the externally supplied power used in the system before installing or removing the module.  
Failure to turn all phases OFF could lead to module trouble or malfunctioning.
- Do not install/remove the module to/from the base unit, or the terminal block to/from the module more than 50 times after the first use of the product (IEC 61131-2 compliant). Failure to do so may cause the module to malfunction due to poor contact of connector.
- Use the programmable controller in an environment that meets the general specifications contained in QCPU User's Manual(Hardware Design, Maintenance and Inspection) to use.  
Using this programmable controller in an environment outside the range of the general specifications may cause electric shock, fire, malfunction, and damage to or deterioration of the product.
- Hold down the module mounting lever at the bottom of the module and securely insert the module fixing projection into the fixing holes of the base module. Improper mounting of the module may lead to malfunctioning, faults, or dropping.  
When using the module in the environment subject to much vibration, secure the module with a screw.  
Tighten the screw within the range of the specified tightening torque.  
Insufficient tightening may lead to dropping, short-circuit, or malfunctioning.  
Excessive tightening may damage the screw or module, leading to dropping, short-circuit, or malfunctioning.

### 4.3 Wiring

The precautions for wiring the QD75 are given below. Refer to this section as well as "4.1.3 Handling precautions" when carrying out the work.

#### 4.3.1 Wiring precautions

- (1) Always confirm the terminal layout before connecting the wires to the QD75. (For the terminal layout, refer to Section 3.4.2 "Signal layout for external device connection connector".)
- (2) Correctly solder the external wiring connector. An incomplete soldering could lead to malfunctioning.
- (3) Make sure that foreign matter such as cutting chips and wire scraps does not enter the QD75. Failure to observe this could lead to fires, faults or malfunctioning.
- (4) A protective label is attached on the top of the QD75 to avoid foreign matter such as wire scraps from entering inside during wiring process. Do not remove the label until the wiring is completed. Before starting the system, however, be sure to remove the label to ensure heat radiation.
- (5) Tighten the connector screws within the specified torque range. Undertightening can cause short circuit, fire, or malfunction. Overtightening can damage the screw and/or module, resulting in drop, short circuit, fire, or malfunction.
- (6) When disconnecting the cable from the QD75 or the drive unit, do not pull the cable by the cable part. Hold the connector part of the cable. Pulling the cable connected to the QD75 or the drive unit may result in malfunction or damage to the module, drive unit, or cable.
- (7) Do not bundle or adjacently lay the connection cable connected to the QD75 external I/O signals or drive unit with the main circuit line, power line, or the load line other than that for the programmable controller. Separate these by 100mm as a guide. Failure to observe this could lead to malfunctioning caused by noise, surge, or induction.
- (8) The shielded cable for connecting QD75 can be secured in place. If the shielded cable is not secured, unevenness or movement of the shielded cable or careless pulling on it could result in damage to the QD75 or drive unit or shielded cable or defective cable connections could cause mis-operation of the unit.
- (9) If the cable connected to the QD75 and the power line must be adjacently laid (less than 100mm), use a shielded cable. Ground the shield of the cable securely to the control panel on the QD75 side. (A wiring example is given on the next page.)

[Applicable connectors]

The table below shows applicable connectors for external devices. When wiring, use applicable wires and an appropriate tightening torque.

Mitsubishi 40-pin connector		Wire			
Model	Tightening torque	Diameter	Type	Material	Temperature rating
A6CON1	0.20 to 0.29N · m	0.3mm <sup>2</sup> (22AWG)	Stranded	Copper	75°C or more
A6CON2		0.088 to 0.24mm <sup>2</sup> (28 to 24AWG)			
A6CON4		0.3mm <sup>2</sup> (22AWG)			

[Wiring example of shielded cable]

The following shows a wiring example for noise reduction in the case where the connector A6CON1 is used.

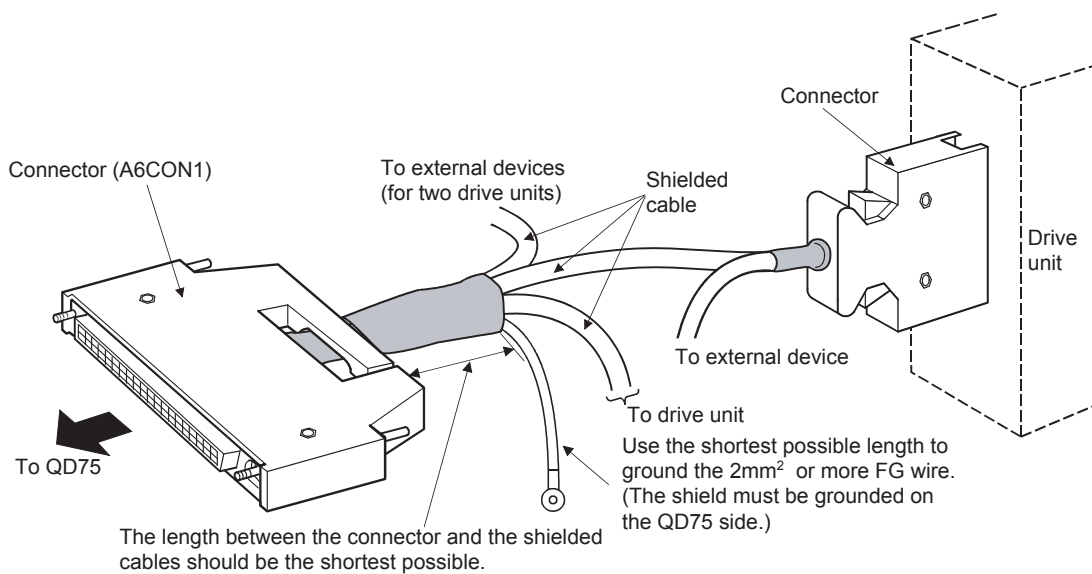

## [Processing example of shielded cables]

Connect a cable with the FG wire and bind all shielded cables as shown below.

Remove the covering from all shielded cables and bind the appeared shield with a conductive tape.

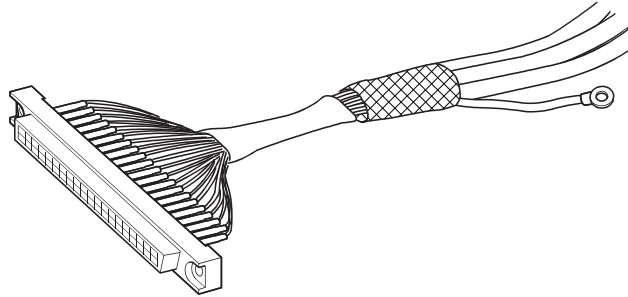
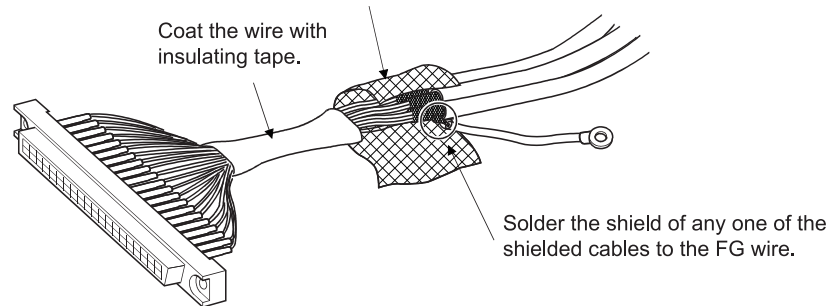

## Assembling of connector (A6CON1)

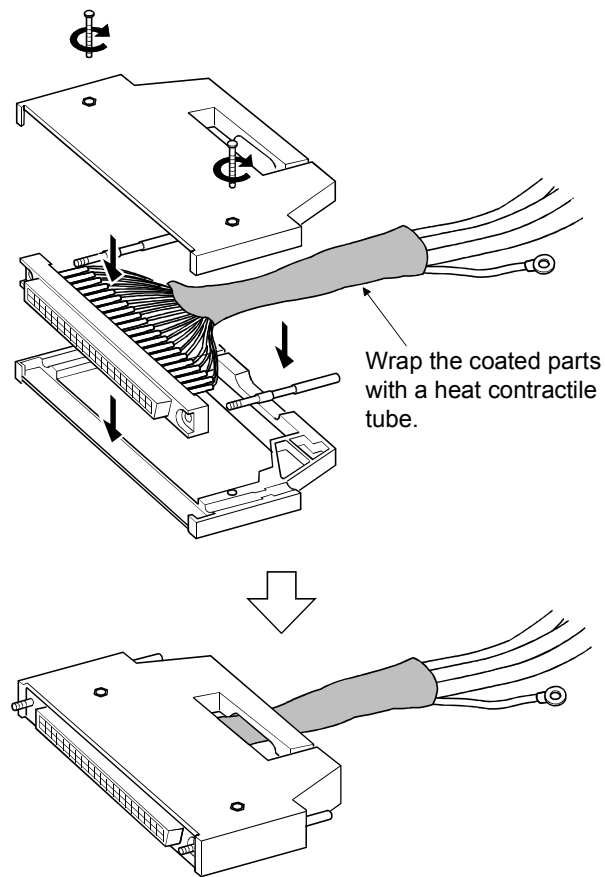

(10) For compliance with the EMC and Low Voltage Directives, satisfy the following requirements.

- The cable connecting the drive unit and the QD75 must be the length below.

QD75P□N/QD75P□: 2m or shorter

QD75D□N/QD75D□: 10m or shorter

- The cables connected to the external device for the QD75 must be 30m or shorter. (except the one for pulse output)

- Use shielded twisted pair cables and an AD75CK type cable clamp (manufactured by Mitsubishi Electric) to ground the cables to the control box.

Even when compliance with the EMC Directive is not required, attaching an AD75CK type cable clamp to the cable connected to the QD75 may reduce the influence of external noise.

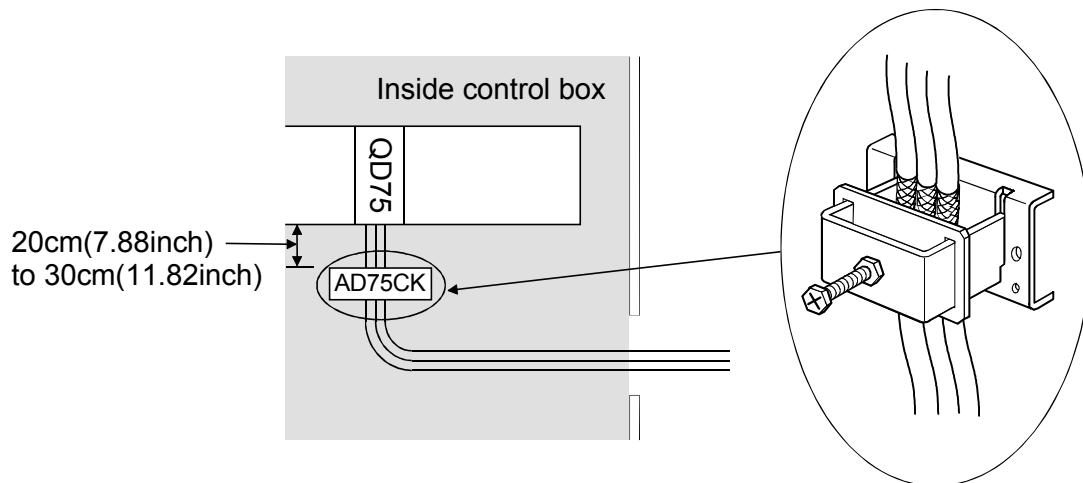

For details on AD75CK, refer to the following.

AD75CK-type Cable Clamping Instruction Manual



[Wiring examples using duct (incorrect example and corrected example)]

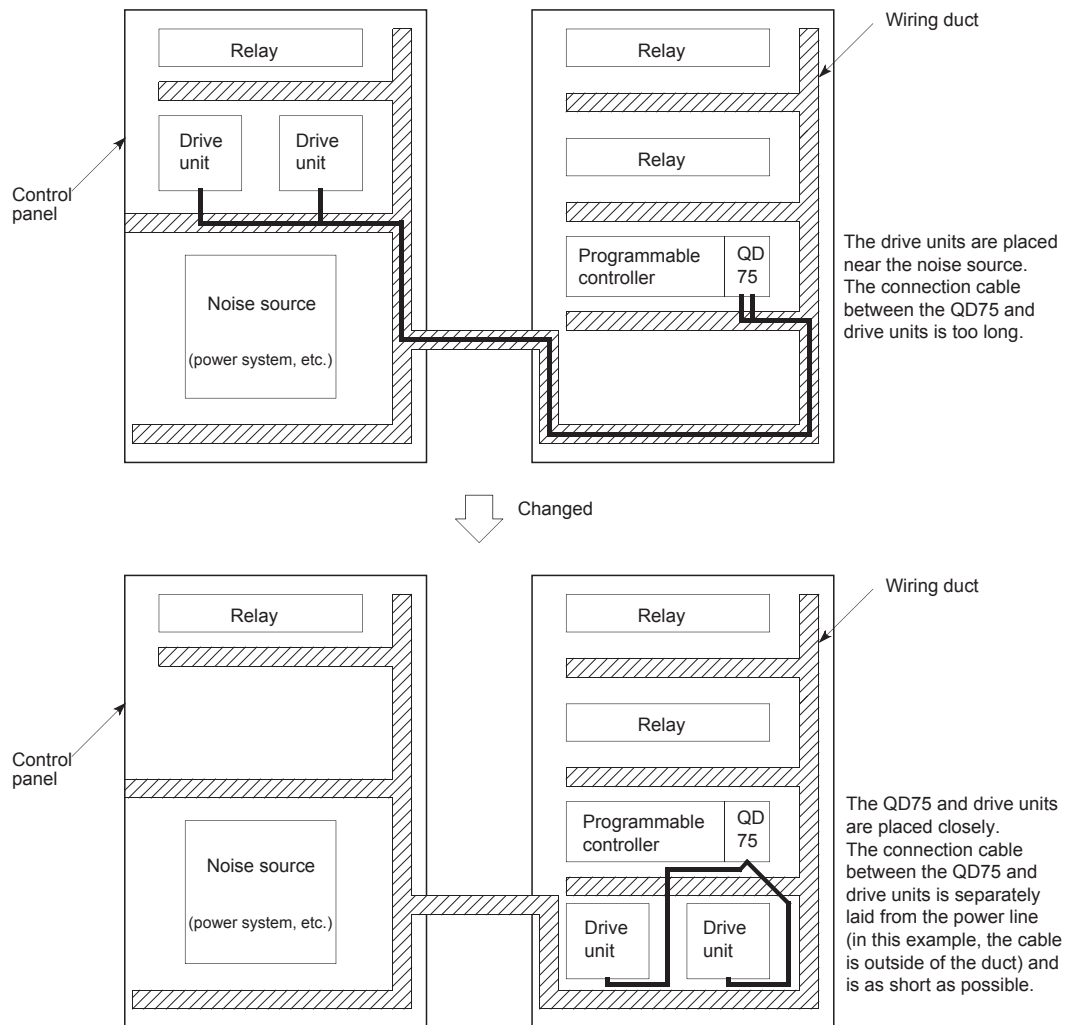

- (11) The influence of noise may be reduced by installing ferrite cores to the cable connected to the QD75 as a noise reduction technique.  
For the noise reduction techniques related to connection with the servo amplifier, also refer to the instruction manual of the servo amplifier.

4.3.2 Wiring of the differential driver common terminal

When the differential driver output system (QD75D□N/QD75D□) is used, a potential difference between commons may occur between the differential driver common terminal and the differential receiver common terminal of the drive unit. To remove the potential difference between commons, connect the differential driver common terminal of the QD75D□N/QD75D□ and the differential receiver common terminal of the drive unit.

When the common terminal of the drive unit is photocoupler-connected, the wiring to the differential driver common terminal of the QD75D□N/QD75D□ is not needed since a potential difference between commons does not exist.

(For the drive unit specifications, refer to the manual of the used drive unit.)

■ Applicable connectors

To wire the differential driver common terminal, use the wire applied to the following table.

Wire diameter	Type	Material	Temperature rating
0.24 to 2.5mm <sup>2</sup> (24 to 12AWG)	Stranded wire/single wire	Copper	75°C or more

■ Wiring example

The following shows an example of wiring to the differential driver common terminal of the QD75D□N/QD75D□.

Up to two cables can be connected to one differential driver common terminal. (For details, refer to Section 3.1 "Performance specifications".)

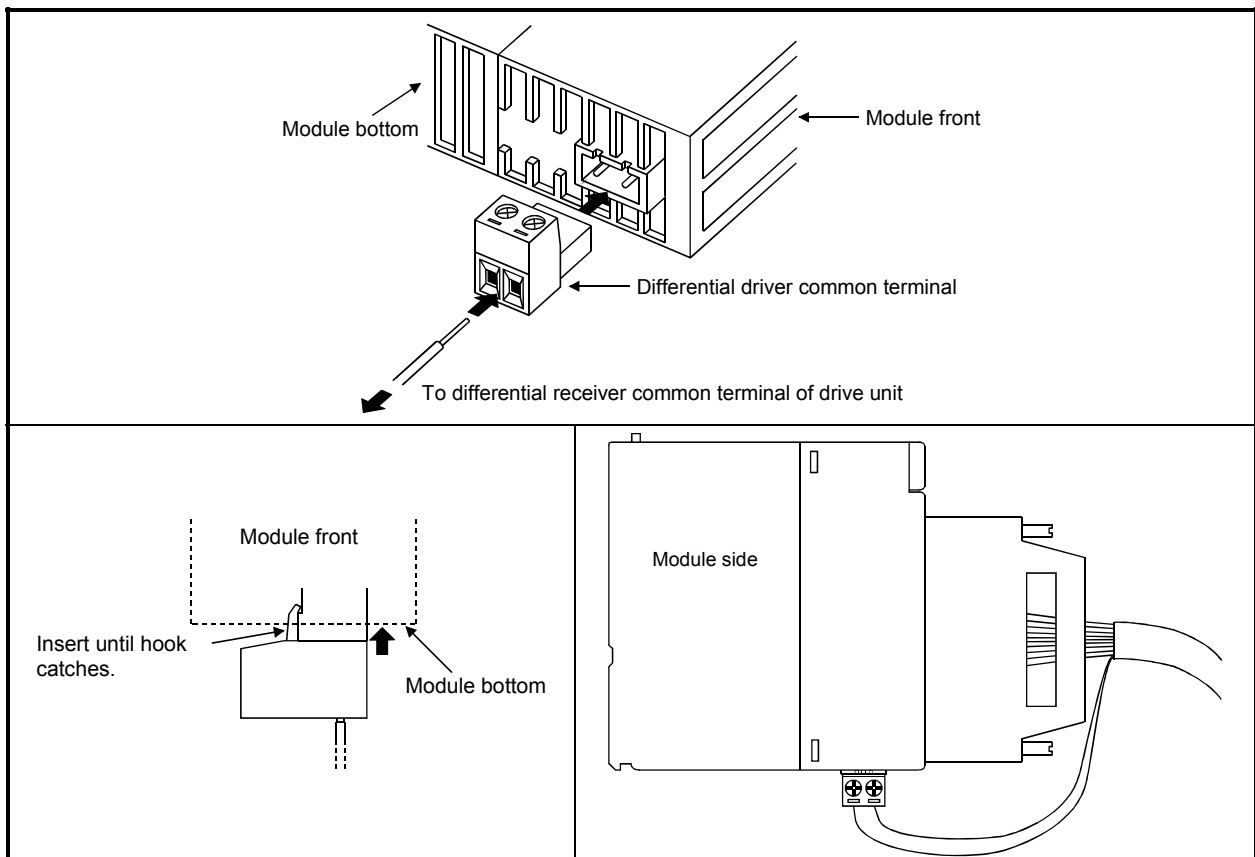

## 4.4 Checking installation and wiring

### 4.4.1 Items to check when installation and wiring are completed

Check the following points when completed with the QD75 installation and wiring.

- Is the module correctly wired? ... "Connection confirmation"

With "connection confirmation", the following three points are confirmed using GX Configurator-QP's connection confirmation function. (GX Configurator-QP is required for this "connection confirmation".)

- Are the QD75 and servo amplifier correctly connected?
- Are the servo amplifier and servomotor correctly connected?
- Are the QD75 and external device (input/output signal) correctly connected?

With this "connection confirmation", "whether the direction that the QD75 recognizes as forward run matches the address increment direction in the actual positioning work", and "whether the QD75 recognizes the external input/output signals such as the near-point dog signal and stop signal" can be checked.

Refer to GX Configurator-QP Operating Manual for details on "Connection confirmation".

Note that GX Developer (SW6D5C-GPPW-E or later)\*1 may also be used to "confirm the connection between the QD75 and external device (I/O signals)". For details, refer to Section 13.5 "External I/O signal monitor function" and GX Developer Operating Manual.

\*1: For the QD75P□N/QD75D□N, external I/O signals cannot be monitored on GX Developer. Use the system monitor of GX Works2. For details on the system monitor of GX Works2, refer to GX Works2 Version 1 Operating Manual (Common).

<b>Important</b>
------------------

<p>If the QD75 is faulty, or when the required signals such as the near-point dog signal and stop signal are not recognized, unexpected accidents such as "not decelerating at the near-point dog during machine OPR and colliding with the stopper", or "not being able to stop with the stop signal" may occur. The "connection confirmation" must be carried out not only when structuring the positioning system, but also when the system has been changed with module replacement or rewiring, etc.</p>
---

## 4.5 Maintenance

### 4.5.1 Maintenance precautions

The precautions for servicing the QD75 are given below. Refer to this section as well as "4.1.3 Handling precautions" when carrying out the work.

#### WARNING

- Always turn all phases of the power supply OFF externally before cleaning or tightening the screws.  
Failure to turn all phases OFF could lead to electric shocks.

#### CAUTION

- Never disassemble or modify the module.  
Failure to observe this could lead to trouble, malfunctioning, injuries or fires.
- Completely turn off the externally supplied power used in the system before installing or removing the module.  
Failure to turn all phases OFF could lead to module trouble or malfunctioning.

### 4.5.2 Disposal precautions

#### CAUTION

- When disposing of the product, handle it as industrial waste.

# CHAPTER 5 DATA USED FOR POSITIONING CONTROL

The parameters and data used to carry out positioning control with the QD75 are explained in this chapter.

With the positioning system using the QD75, the various parameters and data explained in this chapter are used for control. The parameters and data include parameters set according to the device configuration, such as the system configuration, and parameters and data set according to each control. Read this chapter thoroughly and make settings according to each control or application.

\* Read PART 2 for details on each control.

5.1	Types of data .....	5- 2
5.1.1	Parameters and data required for control .....	5- 2
5.1.2	Setting items for positioning parameters .....	5- 5
5.1.3	Setting items for OPR parameters .....	5- 7
5.1.4	Setting items for positioning data .....	5- 8
5.1.5	Setting items for block start data .....	5-10
5.1.6	Setting items for condition data .....	5-11
5.1.7	Types and roles of monitor data .....	5-12
5.1.8	Types and roles of control data .....	5-15
5.2	List of parameters .....	5-18
5.2.1	Basic parameters 1 .....	5-18
5.2.2	Basic parameters 2 .....	5-24
5.2.3	Detailed parameters 1 .....	5-26
5.2.4	Detailed parameters 2 .....	5-36
5.2.5	OPR basic parameters .....	5-45
5.2.6	OPR detailed parameters .....	5-52
5.3	List of positioning data .....	5-56
5.4	List of block start data .....	5-74
5.5	List of condition data .....	5-80
5.6	List of monitor data .....	5-86
5.6.1	System monitor data .....	5-86
5.6.2	Axis monitor data .....	5-96
5.7	List of control data .....	5-110
5.7.1	System control data .....	5-110
5.7.2	Axis control data .....	5-114

## 5.1 Types of data

## 5.1.1 Parameters and data required for control

The parameters and data required to carry out control with the QD75 include the "setting data", "monitor data" and "control data" shown below.

## Setting data

(Data set beforehand according to the machine and application, and stored in the flash ROM.)

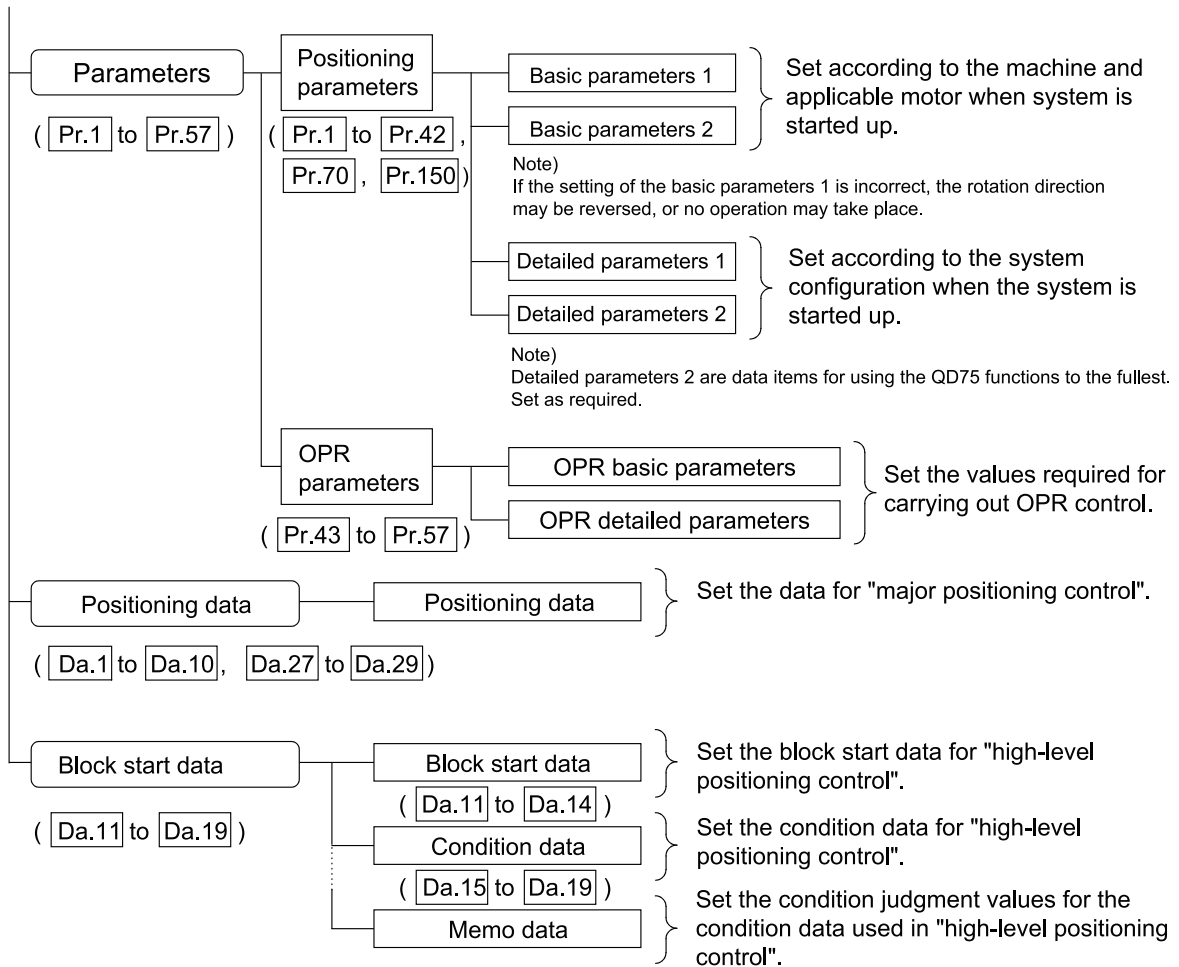

- ◇ The data is set with the sequence program or peripheral device.  
In this chapter, the method using the peripheral device will be explained.  
(Refer to "Point" on the next page.)
- ◇ The basic parameters 1, detailed parameters 1, and OPR parameters become valid when the PLC READY signal [Y0] turns from OFF to ON. Note, however, that the only valid value of the " Pr.5 Pulse output mode" is the value at the moment when the PLC READY signal [Y0] turns from OFF to ON for the first time after the power is switched ON or the CPU module is reset. Once the PLC READY signal [Y0] has been turned ON, the value will not be reset even if another value is set to the parameter and the PLC READY signal [Y0] is turned from OFF to ON.
- ◇ Even when the PLC READY signal [Y0] is ON, the values or contents of the following can be changed: basic parameters 2, detailed parameters 2, positioning data, and block start data.

- ◇ The only valid data assigned to basic parameters 2, detailed parameters 2, positioning data, or block start data are the data read at the moment when a positioning or JOG operation is started. Once the operation has started, any modification to the data is ignored.

Exceptionally, however, modifications to the following are valid even when they are made during a positioning operation: acceleration time 0 to 3, deceleration time 0 to 3, and external start command.

- Acceleration time 0 to 3 and deceleration time 0 to 3:  
Positioning data are pre-read and pre-analyzed. Modifications to the data four or more steps after the current step are valid.
- External command function selection: The value at the time of detection is valid.

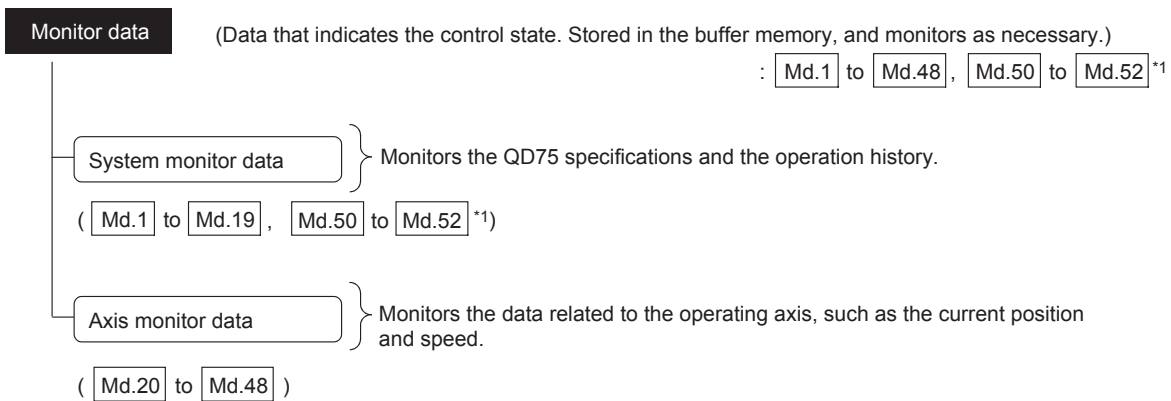

\*1: Md.50 to Md.52 are only for the QD75P□N/QD75D□N.

- ◇ The data is monitored with the sequence program or peripheral device. In this chapter, the method using the peripheral device will be explained.

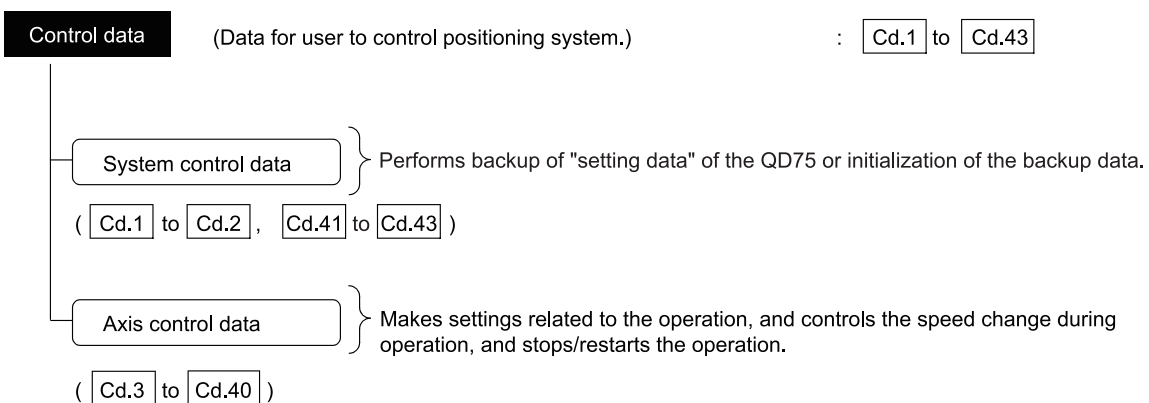

- ◇ Control using the control data is carried out with the sequence program.  
" Cd.41 Deceleration start flag valid" is valid for only the value at the time when the PLC READY signal [Y0] turns from OFF to ON.

POINT
<ul style="list-style-type: none"><li>(1) The "setting data" is created for each axis.</li><li>(2) The "setting data" parameters have determined default values, and are set to the default values before shipment from the factory. (Parameters related to axes that are not used are left at the default value.)</li><li>(3) The "setting data" can be initialized with GX Configurator-QP or the sequence program.</li><li>(4) It is recommended to set the "setting data" with GX Configurator-QP. When executed with the sequence program, many sequence programs and devices must be used. This will not only complicate the program, but will also increase the scan time.</li></ul>



5.1.2 Setting items for positioning parameters

The table below lists items set to the positioning parameters. Setting of positioning parameters is similarly done for individual axes for all controls achieved by the QD75. For details of controls, refer to PART 2. For details of setting items, refer to Section 5.2 "List of parameters".

Positioning parameter		Control	Major positioning control								Manual control		Related sub function
			OPR control	Position control			1 to 4 axis speed control	Speed-position or position-speed control	Other control		Manual pulse generator operation	JOG operation Inching operation	
				1-axis linear control 2/3/4-axis linear interpolation control	1-axis fixed-feed control 2/3/4-axis fixed-feed control	2-axis circular interpolation control 3-axis helical interpolation control			Current value changing	JUMP instruction, NOP instruction, LOOP to LEND			
Basic parameters 1	Pr.1	Unit setting	⊙	⊙	⊙	△	⊙	⊙	⊙	⊙	⊙	⊙	-
	Pr.2	No. of pulses per rotation (Ap) (Unit: pulse)	⊙	⊙	⊙	⊙	⊙	⊙	⊙	⊙	⊙	⊙	12.3.2
	Pr.3	Movement amount per rotation (Al)	⊙	⊙	⊙	⊙	⊙	⊙	⊙	⊙	⊙	⊙	
	Pr.4	Unit magnification (Am)	⊙	⊙	⊙	⊙	⊙	⊙	⊙	⊙	⊙	⊙	
	Pr.5	Pulse output mode	⊙	⊙	⊙	⊙	⊙	⊙	⊙	⊙	⊙	⊙	-
	Pr.6	Rotation direction setting	⊙	⊙	⊙	⊙	⊙	⊙	⊙	⊙	⊙	⊙	-
	Pr.7	Bias speed at start	○	○	○	○	○	○	-	-	-	○	-
Basic parameters 2	Pr.8	Speed limit value	⊙	⊙	⊙	⊙	⊙	⊙	-	-	-	⊙	12.4.1
	Pr.9	Acceleration time 0	⊙	⊙	⊙	⊙	⊙	⊙	-	-	-	⊙	12.7.6
	Pr.10	Deceleration time 0	⊙	⊙	⊙	⊙	⊙	⊙	-	-	-	⊙	
Detailed parameters 1	Pr.11	Backlash compensation amount	○	○	○	○	○	○	-	-	○	○	12.3.1
	Pr.12	Software stroke limit upper limit value	-	○	○	○	○	○	-	-	○	○	12.4.3
	Pr.13	Software stroke limit lower limit value	-	○	○	○	○	○	-	-	○	○	
	Pr.14	Software stroke limit selection	-	○	○	○	○	○	-	-	○	○	
	Pr.15	Software stroke limit valid/invalid setting	-	-	-	-	-	-	○	○	○	○	
	Pr.16	Command in-position width	-	○	○	○	-	○	-	-	-	-	12.7.5
	Pr.17	Torque limit setting value	△	○	○	○	○	○	-	-	△	△	12.4.2
	Pr.18	M code ON signal output timing	-	○	○	○	○	○	○	-	-	-	12.7.3
	Pr.19	Speed switching mode	-	○	○	○	-	-	-	-	-	-	-
	Pr.20	Interpolation speed designation method	-	△	△	△	△	-	-	-	-	-	-
	Pr.21	Current feed value during speed control	-	-	-	-	○	○	-	-	-	-	-
	Pr.22	Input signal logic selection	⊙	⊙	⊙	⊙	⊙	⊙	⊙	⊙	⊙	⊙	-
	Pr.23	Output signal logic selection	⊙	⊙	⊙	⊙	⊙	⊙	⊙	⊙	⊙	⊙	-
	Pr.24	Manual pulse generator input selection	-	-	-	-	-	-	-	-	⊙	-	-
Pr.150	Speed-position function selection	-	-	-	-	-	⊙	-	-	-	-	-	
Pr.70	Positioning option valid/invalid setting	-	○	○	○	○	○	○	-	-	-	-	

⊙: Always set, ○: Set as required, ×: Setting not possible, △: Setting restricted

-: Setting not required (This is an irrelevant item, so the set value will be ignored. If the value is the default value or within the setting range, there is no problem.)

Positioning parameter	Control	Major positioning control								Manual control		Related sub function	
		OPR control	Position control			1 to 4 axis speed control	Speed-position or position-speed control	Other control		Manual pulse generator operation	JOG operation Inching operation		
			1-axis linear control 2/3/4-axis linear interpolation control	1-axis fixed-feed control 2/3/4-axis fixed-feed control	2-axis circular interpolation control 3-axis helical interpolation control			Current value changing	JUMP instruction, NOP instruction, LOOP to LEND				
Detailed parameters 2	Pr.25	Acceleration time 1	○	○	○	○	○	○	-	-	-	○	12.7.6
	Pr.26	Acceleration time 2	○	○	○	○	○	○	-	-	-	○	
	Pr.27	Acceleration time 3	○	○	○	○	○	○	-	-	-	○	
	Pr.28	Deceleration time 1	○	○	○	○	○	○	-	-	-	○	
	Pr.29	Deceleration time 2	○	○	○	○	○	○	-	-	-	○	
	Pr.30	Deceleration time 3	○	○	○	○	○	○	-	-	-	○	
	Pr.31	JOG speed limit value	-	-	-	-	-	-	-	-	-	◎	12.4.1
	Pr.32	JOG operation acceleration time selection	-	-	-	-	-	-	-	-	-	◎	-
	Pr.33	JOG operation deceleration time selection	-	-	-	-	-	-	-	-	-	◎	-
	Pr.34	Acceleration/deceleration process selection	○	○	○	○	○	○	-	-	-	○	12.7.6
	Pr.35	S-curve ratio	○	○	○	○	○	○	-	-	-	○	
	Pr.36	Sudden stop deceleration time	○	○	○	○	○	○	-	-	-	○	
	Pr.37	Stop group 1 sudden stop selection	○	○	○	○	○	○	-	-	-	○	
	Pr.38	Stop group 2 sudden stop selection	○	○	○	○	○	○	-	-	-	○	-
	Pr.39	Stop group 3 sudden stop selection	○	○	○	○	○	○	-	-	-	○	-
	Pr.40	Positioning complete signal output time	-	○	○	○	○	○	○	-	-	-	-
	Pr.41	Allowable circular interpolation error width	-	-	-	○	-	-	-	-	-	-	-
	Pr.42	External command function selection	○	○	○	○	○	◎	○	-	-	○	12.5.1 12.7.2

- ◎: Always set
- : Set as required
- : Setting not required (This is an irrelevant item, so the setting value will be ignored. If the value is the default value or within the setting range, there is no problem.)

■ Checking the positioning parameters

Pr.1 to Pr.42 are checked with the following timing.

- (1) When the "PLC READY signal [Y0]" output from the CPU module to the QD75 changes from OFF to ON
- (2) When the test operation button is turned ON in the test mode using GX Configurator-QP
- (3) When an error check is carried out with GX Configurator-QP

**REMARK**

- "High-level positioning control" is carried out in combination with the "major positioning control". Refer to the "major positioning control" parameter settings for details on the parameters required for "high-level positioning control".

5.1.3 Setting items for OPR parameters

When carrying out "OPR control", the "OPR parameters" must be set. The setting items for the "OPR parameters" are shown below.

The "OPR parameters" are set commonly for each axis.

Refer to CHAPTER 8 "OPR CONTROL" for details on the "OPR control", and to Section 5.2 "List of parameters" for details on each setting item.

OPR parameters		Machine OPR control						Fast OPR control
		Near-point dog method	Stopper method 1)	Stopper method 2)	Stopper method 3)	Count method 1)	Count method 2)	
OPR basic parameters	Pr.43	OPR method						
	Pr.44	OPR direction	◎	◎	◎	◎	◎	◎
	Pr.45	OP address	◎	◎	◎	◎	◎	◎
	Pr.46	OPR speed	◎	◎	◎	◎	◎	◎
	Pr.47	Creep speed	◎	◎	◎	◎	◎	◎
	Pr.48	OPR retry	R	R	R	-	R	R
OPR detailed parameters	Pr.49	OPR dwell time	-	◎	-	-	-	-
	Pr.50	Setting for the movement amount after near-point dog ON	-	-	-	-	◎	◎
	Pr.51	OPR acceleration time selection	◎	◎	◎	◎	◎	◎
	Pr.52	OPR deceleration time selection	◎	◎	◎	◎	◎	◎
	Pr.53	OP shift amount	S	S	S	S	S	S
	Pr.54	OPR torque limit value	-	◎	◎	◎	-	-
	Pr.55	Deviation counter clear signal output time	C	C	C	C	C	-
	Pr.56	Speed designation during OP shift	S	S	S	S	S	S
	Pr.57	Dwell time during OPR retry	R	R	R	-	R	R

◎ : Always set

○ : Preset parameters are used for machine OPR control.

- : Setting not required (This is an irrelevant item, so the setting value will be ignored. If the value is the default value or within the setting range, there is no problem.)

R : Set when using the "12.2.1 OPR retry function".

S : Set when using the "12.2.2 OP shift function".

C : Set the deviation counter clear signal output time.

■ Checking the OPR parameters.

Pr.43 to Pr.57 are checked with the following timing.

- (1) When the "PLC READY signal [Y0]" output from the CPU module to the QD75 changes from OFF to ON
- (2) When the test operation button is turned ON in the test mode using GX Configurator-QP
- (3) When an error check is carried out with GX Configurator-QP

5.1.4 Setting items for positioning data

Positioning data must be set for carrying out any "major positioning control". The table below lists the items to be set for producing the positioning data.

One to 600 positioning data items can be set for each axis.

For details of the major positioning controls, refer to CHAPTER 9 "MAJOR POSITIONING CONTROL". For details of the individual setting items, refer to Section 5.3 "List of positioning data".

Major positioning control		Position control					1 to 4 axis speed control	Speed-position switching control	Position-speed switching control	Other control				
		1-axis linear control 2/3/4-axis linear interpolation control	1-axis fixed-feed control 2/3/4-axis fixed-feed control	2-axis circular interpolation control	3-axis helical interpolation control					NOP instruction	Current value changing	JUMP instruction	LOOP	LEND
Positioning data														
Da.1	Operation pattern	Independent positioning control	⊙	⊙	⊙	⊙	⊙	⊙	⊙	-	⊙	-	-	-
		Continuous positioning control	⊙	⊙	⊙	⊙	×	⊙	×	-	⊙	-	-	-
		Continuous path control	⊙	×	⊙	⊙	×	×	×	-	×	-	-	-
Da.2	Control system	Linear 1 Linear 2 Linear 3 Linear 4 * 1	Fixed-feed 1 Fixed-feed 2 Fixed-feed 3 Fixed-feed 4	Circular sub Circular right Circular left * 1	Helical sub Helical right Helical left * 1	Forward run speed 1 Reverse run speed 1 Forward run speed 2 Reverse run speed 2 Forward run speed 3 Reverse run speed 3 Forward run speed 4 Reverse run speed 4	Forward run speed/ position Reverse run speed/ position	Forward run position/speed Reverse run position/speed	NOP instruction	Current value changing	JUMP instruction	LOOP	LEND	
Da.3	Acceleration time No.	○	○	○	○	○	○	○	-	-	-	-	-	
Da.4	Deceleration time No.	○	○	○	○	○	○	○	-	-	-	-	-	
Da.5	Axis to be interpolated	⊙: 2-axis interpolation control, 3-axis helical interpolation control -: 1-axis control, 3-axis interpolation control, 4-axis interpolation control					-	-	-	-	-	-	-	
Da.6	Positioning address/movement amount	⊙	⊙	⊙	⊙	-	⊙	⊙	-	New address	-	-	-	
Da.7	Arc address	-	-	⊙	⊙	-	-	-	-	-	-	-	-	
Da.8	Command speed	⊙	⊙	⊙	⊙	⊙	⊙	⊙	-	-	-	-	-	
Da.9	Dwell time	○	○	○	○	○	○	○	-	-	JUMP destination positioning data No.	-	-	
Da.10	M code	○	○	○	○*2	○	○	○	-	○	JUMP condition data No.	No. of repetitions	-	
Da.27	M code ON signal output timing	○	○	○	○	○	○	○	-	○	-	-	-	
Da.28	ABS direction in degrees	○	○	○	○	○	○	○	-	-	-	-	-	
Da.29	Interpolation speed designation method	-: 1-axis control ○: 2-axis interpolation control, 3-axis interpolation control, 4-axis interpolation control					-	-	-	-	-	-	-	

◎: Always set, ○: Set as required, ✕: Setting not possible

–: Setting not required (This is an irrelevant item, so the set value will be ignored. If the value is the default value or within the setting range, there is no problem.)

\*1: Two control systems are available: the absolute (ABS) system and incremental (INC) system.

\*2: Set the M code for the reference axis and the number of pitch for the linear interpolation axis.

### ■ Checking the positioning data

The items  to  are checked at the following timings:

- (1) Startup of a positioning operation
- (2) Error check performed by GX Configurator-QP

## 5.1.5 Setting items for block start data

The "block start data" must be set when carrying out "high-level positioning control".  
The setting items for the "block start data" are shown below.

Up to 50 points of "block start data" can be set for each axis.

Refer to CHAPTER 10 "HIGH-LEVEL POSITIONING CONTROL" for details on the "high-level positioning control", and to Section 5.4 "List of block start data" for details on each setting item.

High-level positioning control		Block start (Normal start)	Condition start	Wait start	Simultaneous start	Repeated start (FOR loop)	Repeated start (FOR condition)
Block start data							
Da.11	Shape (end/continue)	○	○	○	○	○	○
Da.12	Start data No.	○	○	○	○	○	○
Da.13	Special start instruction	—	○	○	○	○	○
Da.14	Parameter	—	○	○	○	○	○

○ : Set as required

— : Setting not required (This is an irrelevant item, so the setting value will be ignored. If the value is the default value or within the setting range, there is no problem.)

#### ■ Checking the block start data

Da.11 to Da.14 are checked with the following timing.

- (1) When the "Block start data" starts
- (2) When an error check is carried out with GX Configurator-QP

5.1.6 Setting items for condition data

When carrying out "high-level positioning control" or using the JUMP instruction in the "major positioning control", the "condition data" must be set as required. The setting items for the "condition data" are shown below.

Up to 10 "condition data" items can be set for each axis.

For the "high-level positioning control", JUMP instruction, and setting items, refer to the following.

- "High-level positioning control" Refer to CHAPTER 10 "HIGH-LEVEL POSITIONING CONTROL"
- JUMP instruction .....Refer to Section 9.2.23 "JUMP instruction".
- Setting items .....Refer to Section 5.5 "List of condition data".

Control Condition data		Major positioning control		High-level positioning control					
		Other than JUMP instruction	JUMP instruction	Block start (Normal start )	Condition start	Wait start	Simul-taneous start	Repeated start (FOR loop)	Repeated start (FOR condition)
Da.15	Condition target	-	○	-	○	○	○	-	○
Da.16	Condition operator	-	○	-	○	○	○	-	○
Da.17	Address	-	△	-	△	△	-	-	△
Da.18	Parameter 1	-	○	-	○	○	△	-	○
Da.19	Parameter 2	-	△	-	△	△	△	-	△

- : Set as required
- △ : Setting limited
- : Setting not required (This is an irrelevant item, so the setting value will be ignored. If the value is the default value or within the setting range, there is no problem.)

■ Checking the condition data

Da.15 to Da.19 are checked with the following timing.

- (1) When the " Block start data" starts
- (2) When "JUMP instruction" starts
- (3) When an error check is carried out with GX Configurator-QP

## 5.1.7 Types and roles of monitor data

The monitor data area in the buffer memory stores data relating to the operating state of the positioning system, which are monitored as required while the positioning system is operating.

The following data are available for monitoring.

- System monitoring:

Monitoring of the QD75 configuration and operation history (through the system monitor data [Md.1] through [Md.19] [Md.50] through [Md.52] \*1)

\*1: [Md.50] through [Md.52] are for the QD75P□N/QD75D□N only.

- Axis operation monitoring:

Monitoring of the current position and speed, and other data related to the movements of axes (through the axis monitor data [Md.20] through [Md.48] \*2)

\*2: The axis monitor data are refreshed every 0.9ms (QD75P□N/QD75D□N) or 1.8ms (QD75P□/QD75D□). Note that " [Md.21] Machine feed value", " [Md.22] Feedrate", " [Md.28] Axis feedrate" and " [Md.30] External input/output signal" of QD75P□/QD75D□ are refreshed every 56.8ms. Also, " [Md.23] Valid M code", is updated when the "M code ON signal [X4, X5, X6, X7]" turns ON.

## [1] Monitoring the system

- Monitoring the positioning system operation history

Monitoring details		Corresponding item	
Whether the system is in the test mode or not		[Md.1] In test mode flag	
History of data that started an operation	Start information	[Md.3] Start information	
	Start No.	[Md.4] Start No.	
	Start	Year:month (QD75P□N/QD75D□N)	[Md.50] Start (Year:month)
		Day:hour (QD75P□N/QD75D□N)	[Md.5] Start (Day:hour)
		Hour (QD75P□/QD75D□)	
		Minute:second	[Md.6] Start (Minute:second)
	Error upon starting	[Md.7] Error judgment	
Pointer No. next to the pointer No. where the latest history is stored	[Md.8] Start history pointer		
History of all errors	Axis in which the error occurred	[Md.9] Axis in which the error occurred	
	Axis error No.	[Md.10] Axis error No.	
	Axis error occurrence	Year:month (QD75P□N/QD75D□N)	[Md.51] Axis error occurrence (Year:month)
		Day:hour (QD75P□N/QD75D□N)	[Md.11] Axis error occurrence (Day:hour)
		Hour (QD75P□/QD75D□)	
		Minute:second	[Md.12] Axis error occurrence (Minute:second)
Pointer No. next to the pointer No. where the latest history is stored	[Md.13] Error history pointer		



Monitoring details		Corresponding item	
History of all warnings	Axis in which the warning occurred	<a href="#">Md.14</a> Axis in which the warning occurred	
	Axis warning No.	<a href="#">Md.15</a> Axis warning No.	
	Axis warning occurrence	Year:month (QD75P□N/QD75D□N)	<a href="#">Md.52</a> Axis warning occurrence (Year:month)
		Day:hour (QD75P□N/QD75D□N)	<a href="#">Md.16</a> Axis warning occurrence (Day:hour)
		Hour (QD75P□/QD75D□)	
Minute:second	<a href="#">Md.17</a> Axis warning occurrence (Minute:second)		
Number of write accesses to the flash ROM after the power is switched ON	Pointer No. next to the pointer No. where the latest history is stored	<a href="#">Md.18</a> Warning history pointer	
	Number of write accesses to flash ROM	<a href="#">Md.19</a> No. of write accesses to flash ROM	

## [2] Monitoring the axis operation state

## ■ Monitoring the position

Monitor details	Corresponding item
Monitor the current machine feed value	<a href="#">Md.21</a> Machine feed value
Monitor the current "current feed value"	<a href="#">Md.20</a> Current feed value
Monitor the current target value	<a href="#">Md.32</a> Target value

## ■ Monitoring the speed

Monitor details		Corresponding item	
Monitor the current speed	During independent axis control	Indicates the speed of each axis	
	During interpolation control	When "0: Composite speed" is set for " <a href="#">Pr.20</a> Interpolation speed designation method"	Indicates the composite speed <a href="#">Md.22</a> Feedrate
		When "1: Reference axis speed" is set for " <a href="#">Pr.20</a> Interpolation speed designation method"	Indicates the reference axis speed
	Constantly indicates the speed of each axis		<a href="#">Md.28</a> Axis feedrate
Monitor the current target speed		<a href="#">Md.33</a> Target speed	

■ Monitoring the state

Monitor details	Corresponding item
Monitor the axis operation state	<a href="#">Md.26</a> Axis operation status
Monitor the latest error code that occurred with the axis	<a href="#">Md.23</a> Axis error No.
Monitor the latest warning code that occurred with the axis	<a href="#">Md.24</a> Axis warning No.
Monitor the external input/output signal and flag	<a href="#">Md.30</a> External input/output signal
	<a href="#">Md.31</a> Status
Monitor the valid M codes	<a href="#">Md.25</a> Valid M code
Monitor whether the speed is being limited	<a href="#">Md.39</a> In speed limit flag
Monitor whether the speed is being changed	<a href="#">Md.40</a> In speed change processing flag
Monitor the "start data" point currently being executed	<a href="#">Md.43</a> Start data pointer being executed
Monitor the "positioning data No." currently being executed	<a href="#">Md.44</a> Positioning data No. being executed
Monitor the remaining No. of repetitions (special start)	<a href="#">Md.41</a> Special start repetition counter
Monitor the remaining No. of repetitions (control system)	<a href="#">Md.42</a> Control system repetition counter
Monitor the block No.	<a href="#">Md.45</a> Block No. being executed
Monitor the current torque limit value	<a href="#">Md.35</a> Torque limit stored value
Monitor the "instruction code" of the special start data when using special start	<a href="#">Md.36</a> Special start data instruction code setting value
Monitor the "instruction parameter" of the special start data when using special start	<a href="#">Md.37</a> Special start data instruction parameter setting value
Monitor the "start data No." of the special start data when using special start	<a href="#">Md.38</a> Start positioning data No. setting value
Monitor the "positioning data No." executed last	<a href="#">Md.46</a> Last executed positioning data No.
Monitor the positioning data currently being executed	<a href="#">Md.47</a> Positioning data being executed
Monitor the movement amount after the current position control switching when using "speed-position switching control (INC mode)"	<a href="#">Md.29</a> Speed-position switching control positioning amount
Monitor switching from the constant speed status or acceleration status to the deceleration status during position control whose operation pattern is "Positioning complete"	<a href="#">Md.48</a> Deceleration start flag

### 5.1.8 Types and roles of control data

Operation of the positioning system is achieved through the execution of necessary controls. (Data required for controls are given through the default values when the power is switched ON, which can be modified as required by the sequence program.) Controls are performed over system data or machine operation.

- Controlling the system data :

Performs write/initialization, etc. of the QD75 "setting data". (the system control data Cd.1 and Cd.2)

- Controlling the operation :

Setting operation parameters, changing speed during operation, interrupting or restarting operation (the system control data Cd.41 and Cd.42, and the axis control data Cd.3 to Cd.40)

#### [1] Controlling the system data

##### ■ Setting and resetting the setting data

Control details	Controlled data item
Write setting data from buffer memory to flash ROM	<span style="border: 1px solid black; padding: 0 2px;">Cd.1</span> Flash ROM write request
Reset (initialize) parameters	<span style="border: 1px solid black; padding: 0 2px;">Cd.2</span> Parameter initialization request

## [2] Controlling the operation

## ■ Controlling the operation

Control details	Corresponding item
Set which positioning to execute (start No.)	<a href="#">Cd.3</a> Positioning start No.
Clear (reset) the axis error ( <a href="#">Md.23</a> ) and warning ( <a href="#">Md.24</a> )	<a href="#">Cd.5</a> Axis error reset
Issue instruction to restart (When axis operation is stopped)	<a href="#">Cd.6</a> Restart command
End current positioning (deceleration stop), and start next positioning	<a href="#">Cd.37</a> Skip command
Set start point No. for executing block start	<a href="#">Cd.4</a> Positioning starting point No.
Stop continuous control	<a href="#">Cd.18</a> Continuous operation interrupt request
Set start data Nos. for axes that start up simultaneously	<a href="#">Cd.30</a> Simultaneous starting axis start data No. (axis 1 start data No.)
	<a href="#">Cd.31</a> Simultaneous starting axis start data No. (axis 2 start data No.)
	<a href="#">Cd.32</a> Simultaneous starting axis start data No. (axis 3 start data No.)
	<a href="#">Cd.33</a> Simultaneous starting axis start data No. (axis 4 start data No.)
Specify write destination for teaching results	<a href="#">Cd.38</a> Teaching data selection
Specify data to be taught	<a href="#">Cd.39</a> Teaching positioning data No.

## ■ Controlling operation per step

Control details	Corresponding item
Stop positioning operation after each operation	<a href="#">Cd.35</a> Step valid flag
Set unit to carry out step	<a href="#">Cd.34</a> Step mode
Issue instruction to continue operation after a step is finished	<a href="#">Cd.36</a> Step start information

## ■ Controlling the speed

Control details	Corresponding item
Set new speed when changing speed during operation	<a href="#">Cd.14</a> New speed value
Issue instruction to change speed in operation to <a href="#">Cd.14</a> value (Only during positioning operation and JOG operation)	<a href="#">Cd.15</a> Speed change request
Change positioning operation speed between 1 and 300% range	<a href="#">Cd.13</a> Positioning operation speed override
Set inching movement amount	<a href="#">Cd.16</a> Inching movement amount
Set JOG speed	<a href="#">Cd.17</a> JOG speed
When changing acceleration time during speed change, set new acceleration time	<a href="#">Cd.10</a> New acceleration time value
When changing deceleration time during speed change, set new deceleration time	<a href="#">Cd.11</a> New deceleration time value
Set acceleration/deceleration time validity during speed change	<a href="#">Cd.12</a> Acceleration/deceleration time change during speed change, enable/disable selection

■ Making settings related to operation

Control details	Corresponding item
Turn M code ON signal OFF	<a href="#">Cd.7</a> M code OFF request
Set new value when changing current value	<a href="#">Cd.9</a> New current value
Validate speed-position switching signal from external source	<a href="#">Cd.24</a> Speed-position switching enable flag
Change movement amount for position control during speed-position switching control (INC mode)	<a href="#">Cd.23</a> Speed-position switching control movement amount change register
Validate external position-speed switching signal	<a href="#">Cd.26</a> Position-speed switching enable flag
Change speed for speed control during position-speed switching control	<a href="#">Cd.25</a> Position-speed switching control speed change register
Set up a flag when target position is changed during positioning	<a href="#">Cd.29</a> Target position change request flag
Set new positioning address when changing target position during positioning	<a href="#">Cd.27</a> Target position change value(new address)
Set new speed when changing target position during positioning	<a href="#">Cd.28</a> Target position change value(new speed)
Set absolute (ABS) moving direction in degrees	<a href="#">Cd.40</a> ABS direction in degrees
Set manual pulse generator operation validity	<a href="#">Cd.21</a> Manual pulse generator enable flag
Set scale per pulse of No. of input pulses from manual pulse generator	<a href="#">Cd.20</a> Manual pulse generator 1 pulse input magnification
Change OPR request flag from "ON to OFF"	<a href="#">Cd.19</a> OPR request flag OFF request
Validate external command signal	<a href="#">Cd.8</a> External command valid
Change " <a href="#">Md.35</a> Torque limit stored value"	<a href="#">Cd.22</a> New torque value
Set whether " <a href="#">Md.48</a> Deceleration start flag" is valid or invalid	<a href="#">Cd.41</a> Deceleration start flag valid
Set the stop command processing for deceleration stop function (deceleration curve re-processing/deceleration curve continuation)	<a href="#">Cd.42</a> Stop command processing for deceleration stop selection

5.2 List of parameters

5.2.1 Basic parameters 1

Item	Setting value, setting range		Default value	Setting value buffer memory address				
	Value set with peripheral device	Value set with sequence program		Axis 1	Axis 2	Axis 3	Axis 4	
<b>Pr.1</b> Unit setting	0 : mm 1 : inch 2 : degree 3 : pulse	0 1 2 3	3	0	150	300	450	
Movement amount per pulse	<b>Pr.2</b> No. of pulses per rotation (Ap) (Unit : pulse)	1 to 65535	20000	1	151	301	451	
	<b>Pr.3</b> Movement amount per rotation (Al)	The setting value range differs according to the " <b>Pr.1</b> Unit setting". Here, the value within the [Table 1] range is set.		20000	2	152	302	452
	<b>Pr.4</b> Unit magnification (Am)	1 : 1-fold 10 : 10-fold 100 : 100-fold 1000 : 1000-fold	1 10 100 1000	1	3	153	303	453

**Pr.1** Unit setting

Set the unit used for defining positioning operations. Choose from the following units depending on the type of the control target: mm, inch, degree, or pulse. Different units can be defined for different axes (axis 1 to 4).

(Example) Different units (mm, inch, degree, and pulse) are applicable to different systems:

mm or inch..... X-Y table, conveyor (Select mm or inch depending on the machine specifications.)

degree ..... Rotating body (360 degrees/rotation)

pulse..... X-Y table, conveyor

\* When you change the unit, note that the values of other parameters and data will not be changed automatically.

After changing the unit, check if the parameter and data values are within the allowable range.

Set "degree" to exercise speed-position switching control (ABS mode).

**Pr.2** to **Pr.4** Movement amount per pulse

These parameters define the amount of movement achieved by each single pulse within a pulse train output by the QD75.

The following paragraphs explain how to set the individual parameters **Pr.2**, **Pr.3**, and **Pr.4** assuming that the unit "mm" is selected with **Pr.1**.

The movement amount per pulse is given by the following expression:

$$\text{Movement amount per pulse} = \frac{\text{Movement amount per rotation (Al)}}{\text{No. of pulses per rotation (Ap)}}$$

- \* Due to the mechanical tolerance, the actual movement amount may differ slightly from the instructed movement amount. The error can be compensated by adjusting the movement amount per pulse defined here.  
(Refer to Section 12.3.2 "Electronic gear function".)

**POINT**

If the movement amount per pulse is less than 1, command frequency variations will occur. Smaller setting will increase variations and may cause machine vibration. If the movement amount per pulse becomes less than 1, also use the electronic gear function of the drive unit and make setting so that the movement amount per pulse is 1 or greater.

[Table 1]

<b>Pr.1</b> setting value	Value set with peripheral device (unit)	Value set with sequence program (unit) *
0 : mm	0.1 to 6553.5 (μm)	1 to 65535 (×10 <sup>-1</sup> μm)
1 : inch	0.00001 to 0.65535 (inch)	1 to 65535 (×10 <sup>-5</sup> inch)
2 : degree	0.00001 to 0.65535 (degree)	1 to 65535 (×10 <sup>-5</sup> degree)
3 : pulse	1 to 65535 (pulse)	1 to 65535 (pulse)

- \* 1 to 32767 : Set as a decimal  
32768 to 65535 : Convert into hexadecimal and set

**Pr.2** No. of pulses per rotation (Ap)

Set the number of pulses required for a complete rotation of the motor shaft.

If you are using the Mitsubishi servo amplifier, set the value given as the "resolution per servomotor rotation" in the speed/position detector specifications.

No. of pulses per rotation (Ap) = Resolution per servomotor rotation

- \* When the "Resolution per servomotor revolution" of Mitsubishi servo amplifier exceeds 65535 pulses, make setting after referring to the Servo Amplifier Instruction Manual.

**Pr.3** Movement amount per rotation (Al), **Pr.4** Unit magnification (Am)

The amount how the workpiece moves with one motor rotation is determined by the mechanical structure.

If the worm gear lead (mm/rev) is PB and the deceleration rate is 1/n, then

$$\text{Movement amount per rotation (AL)} = \text{PB} \times 1/n$$

However, the maximum value that can be set for this "movement amount per rotation (Al)" parameter is 6553.5µm (approx. 6.5mm). Set the "movement amount per rotation (Al)" as shown below so that the "movement amount per rotation (AL)" does not exceed this maximum value.

$$\begin{aligned} &\text{Movement amount per rotation (AL)} \\ &= \text{PB} \times 1/n \\ &= \text{Movement amount per rotation (Al)} \times \text{Unit magnification (Am)} \end{aligned}$$

Note) The unit magnification (Am) is a value of 1, 10, 100 or 1000. If the "PB × 1/n" value exceeds 6553.5µm, adjust with the unit magnification so that the "movement amount per rotation (Al)" does not exceed 6553.5µm.

Example 1)

When movement amount per rotation (AL) = PB × 1/n = 6000.0µm (= 6mm)

$$\begin{aligned} &\text{Movement amount per rotation (AL)} \\ &= \text{Movement amount per rotation (Al)} \times \text{Unit magnification (Am)} \\ &= 6000.0\mu\text{m} \times 1 \text{ time} \end{aligned}$$

Example 2)

When movement amount per rotation (AL) = PB × 1/n = 60000.0µm (= 60mm)

$$\begin{aligned} &\text{Movement amount per rotation (AL)} \\ &= \text{Movement amount per rotation (Al)} \times \text{Unit magnification (Am)} \\ &= 6000.0\mu\text{m} \times 10 \text{ times} \end{aligned}$$

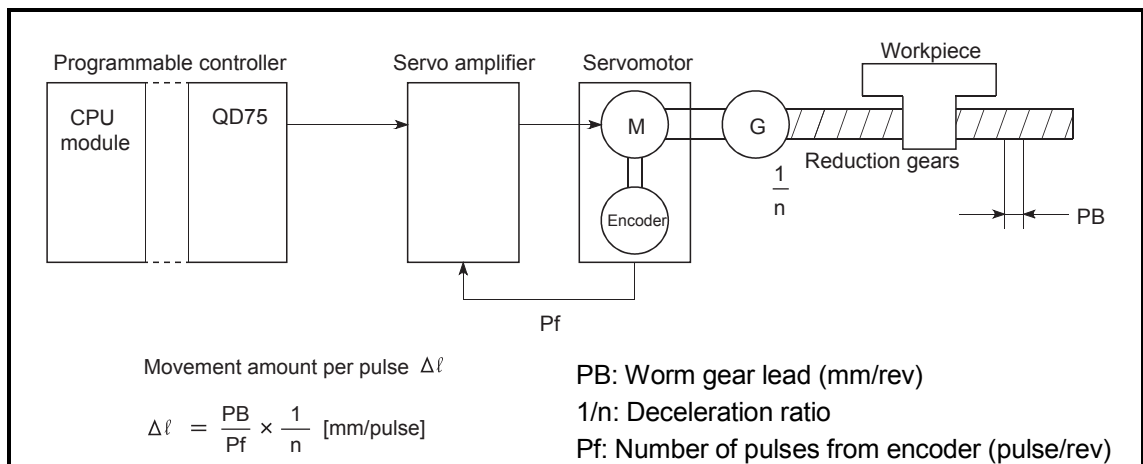

Item	Setting value, setting range		Default value	Setting value buffer memory address			
	Value set with peripheral device	Value set with sequence program		Axis 1	Axis 2	Axis 3	Axis 4
Pr.5 Pulse output mode	0 : PULSE/SIGN mode	0	1	4	154	304	454
	1 : CW/CCW mode	1					
	2 : A phase/B phase (multiple of 4)	2					
	3 : A phase/B phase (multiple of 1)	3					
Pr.6 Rotation direction setting	0 : Current value increment with forward run pulse output	0	0	5	155	305	455
	1 : Current value increment with reverse run pulse output	1					



**Pr.5** Pulse output mode

Set the pulse output mode to match the servo amplifier being used.

**IMPORTANT**

The only valid value of the " **Pr.5** Pulse output mode" is the value at the moment when the PLC READY signal [Y0] turns from OFF to ON for the first time after the power is switched ON or the CPU module is reset. Once the PLC READY signal [Y0] has been turned ON, the value will not be reset even if another value is set to the parameter and the PLC READY signal [Y0] is turned from OFF to ON.

Use " **Pr.23** Output signal logic selection" to choose between the positive logic (pulse rising edge detection) and negative logic (pulse falling edge detection). For the output specifications of each pulse output mode, refer to Section 3.4.1, (2) "Output specifications".

An example of the pulse output mode for positive and negative logic is shown below.

(1) PULSE/SIGN mode

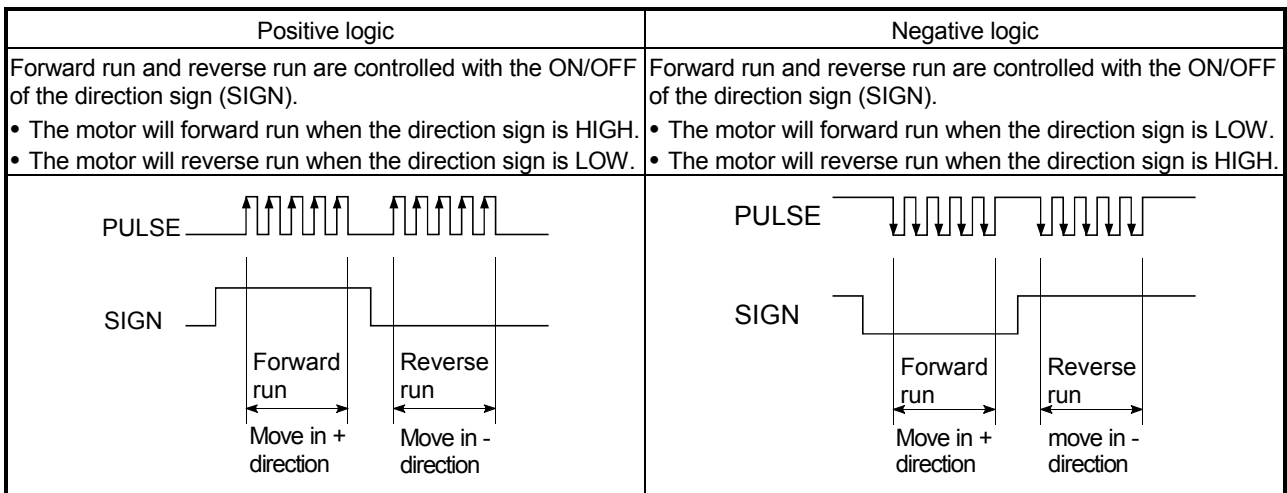

(2) CW/CCW mode

During forward run, the forward run feed pulse (PULSE F) will be output.

During reverse run, the reverse run feed pulse (PULSE R) will be output.

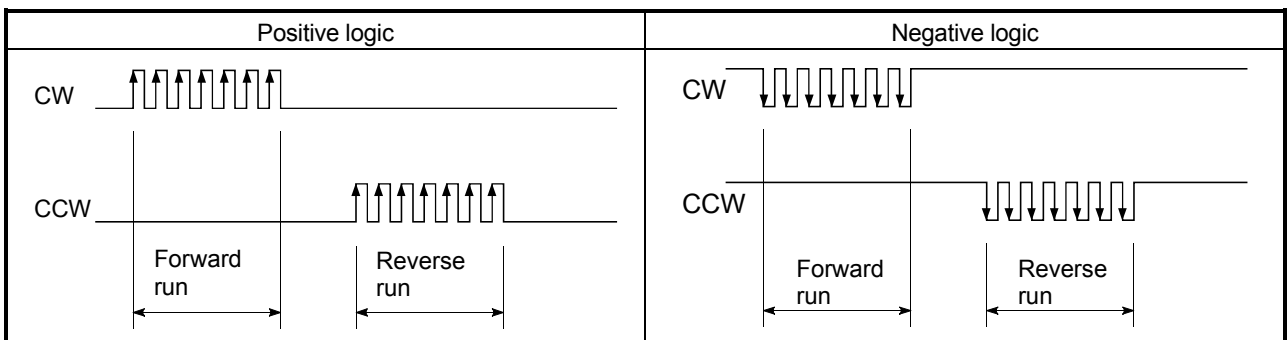

(3) A phase/B phase mode

Forward run and reverse run are controlled with the phase difference of the A phase (A $\phi$ ) and B phase (B $\phi$ ).

- When the B phase is 90° behind the A phase, the motor will forward run.
- When the B phase is 90° ahead of the A phase, the motor will reverse run.

1) For multiple of 1 setting

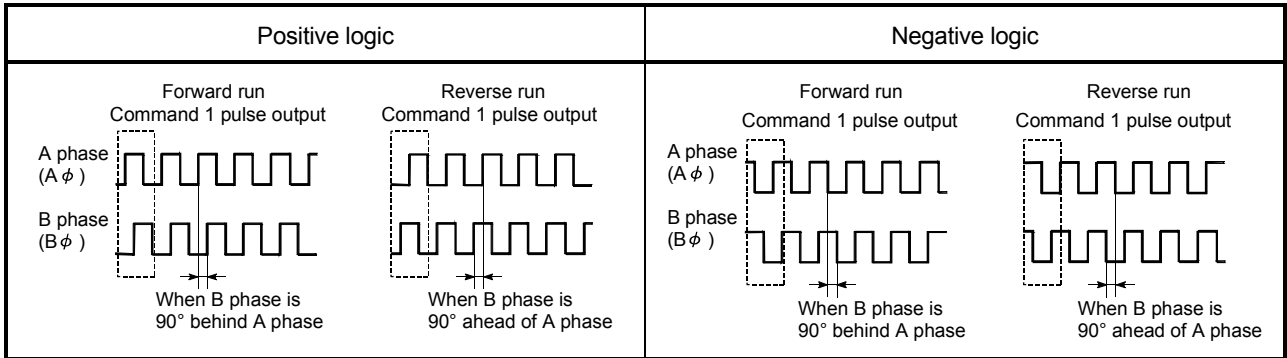

Example) When the command 1 pulse output is 1 pulse/s, the pulse rises and falls by four times per second.

2) For multiple of 4 setting

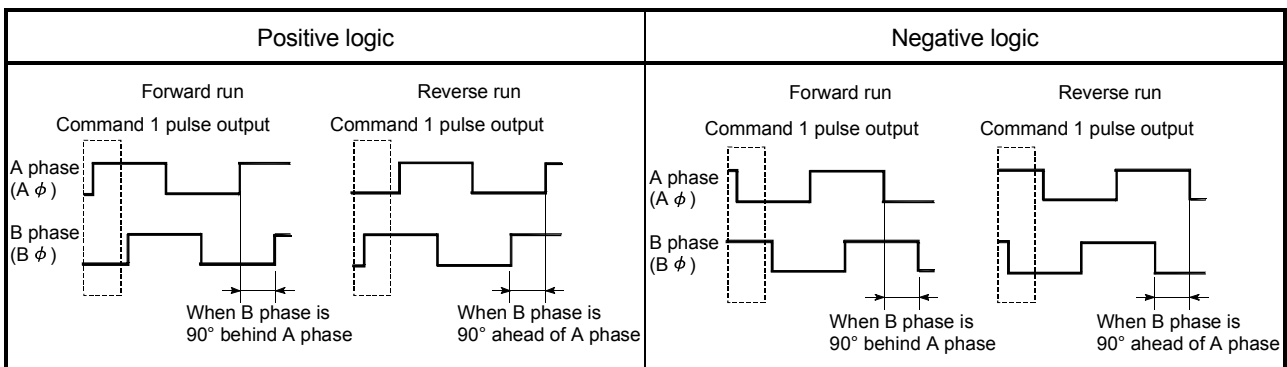

Example) When the command 1 pulse output is 1 pulse/s, the pulse rises and falls by one times per second.

**Pr.6** Rotation direction setting

Set the relation of the positioning direction (**Md.20** Current feed value increment direction/decrement direction) and the pulse output. For the relation of "Forward run pulse output, Reverse run pulse output" and "CW/A phase/PULSE signal, CCW/B phase/SIGN signal", refer to "**Pr.5** Pulse output mode".

**[Example]**

The following figure shows the pulse outputs of when "**Pr.5** Pulse output mode" is set to CW/CCW mode and the positioning with current feed value (increment direction)/(decrement direction) is executed.

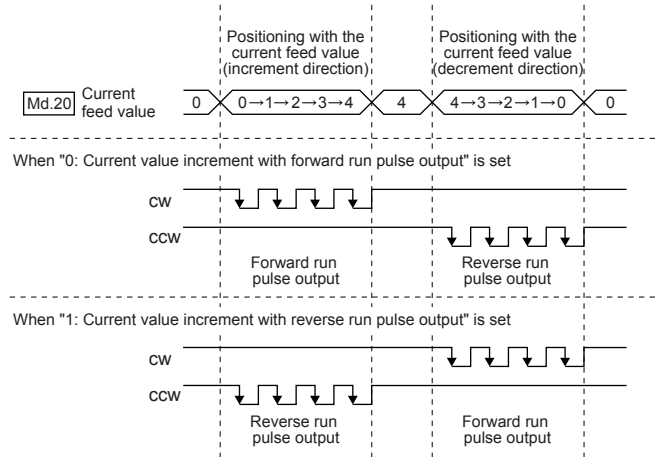

**POINT**

When **Pr.6** has been changed from "0" to "1", check that the upper and lower limit switches operate properly by JOG operation. If any malfunction is identified, check and correct the wiring.

Item	Setting value, setting range		Default value	Setting value buffer memory address			
	Value set with peripheral device	Value set with sequence program		Axis 1	Axis 2	Axis 3	Axis 4
<b>Pr.7</b> Bias speed at start	The setting range differs depending on the " <b>Pr.1</b> Unit setting". Here, the value within the [Table 1] range is set. 		0	6 7	156 157	306 307	456 457

**Pr.7** Bias speed at start

Set the bias speed (minimum speed) upon starting. The bias speed has to be defined to allow the motor to start smoothly especially when a stepping motor is used. (A stepping motor will not start smoothly if a low rotation speed is instructed at the beginning.)

The specified "bias speed at start" will be valid during the following operations:

- Positioning operation
- OPR operation
- JOG operation

Note that the bias speed should not exceed " **Pr.8** Speed limit value".

### ■ Precautions for using a stepping motor

- (1) For the system that uses a stepping motor, executing the S-curve acceleration/deceleration may cause step-out.  
Before using the S-curve acceleration/deceleration, confirm that step-out does not occur.
- (2) In the system that uses a stepping motor, the circular interpolation control cannot be carried out.  
Although setting the bias speed at start is required by the characteristics of the stepping motor, the setting of the bias speed at start is disabled for circular interpolation control.  
Ensure to use a servomotor for both 2 axes when the circular interpolation control is carried out.

## 5.2.2 Basic parameters 2

Item	Setting value, setting range		Default value	Setting value buffer memory address			
	Value set with peripheral device	Value set with sequence program		Axis 1	Axis 2	Axis 3	Axis 4
<b>Pr.8</b> Speed limit value	The setting range differs depending on the " <b>Pr.1</b> Unit setting". Here, the value within the [Table 2] range is set. 		200000	10 11	160 161	310 311	460 461
<b>Pr.9</b> Acceleration time 0	1 to 8388608 (ms)	1 to 8388608 (ms)	1000	12 13	162 163	312 313	462 463
<b>Pr.10</b> Deceleration time 0	1 to 8388608 (ms)	1 to 8388608 (ms)	1000	14 15	164 165	314 315	464 465

[Table 1]

Pr.1 setting value	Value set with peripheral device (unit)	Value set with sequence program (unit)
0 : mm	0 to 20000000.00 (mm/min)	0 to 2000000000 ( $\times 10^{-2}$ mm/min)
1 : inch	0 to 2000000.000 (inch/min)	0 to 2000000000 ( $\times 10^{-3}$ inch/min)
2 : degree	0 to 2000000.000 (degree/min)	0 to 2000000000 ( $\times 10^{-3}$ degree/min)
3 : pulse	0 to 1000000 (pulse/s) *1	[QD75P□N/QD75D□N] 0 to 4000000 (pulse/s) [QD75P□/QD75D□] 0 to 1000000 (pulse/s)

[Table 2]

Pr.1 setting value	Value set with peripheral device (unit)	Value set with sequence program (unit)
0 : mm	0.01 to 20000000.00 (mm/min)	1 to 2000000000 ( $\times 10^{-2}$ mm/min)
1 : inch	0.001 to 2000000.000 (inch/min)	1 to 2000000000 ( $\times 10^{-3}$ inch/min)
2 : degree	0.001 to 2000000.000 (degree/min)	1 to 2000000000 ( $\times 10^{-3}$ degree/min)
3 : pulse	[Select type *2 is QD75P□] 1 to 200000 (pulse/s) *1 [Select type *2 is QD75D□] 1 to 1000000 (pulse/s) *1	[QD75P□N/QD75D□N] 1 to 4000000 (pulse/s) [QD75P□/QD75D□] 1 to 1000000 (pulse/s)

\*1: In GX Configurator-QP, the QD75P□N/QD75D□N are recognized as the QD75P□/QD75D□. Therefore, the setting ranges are the same as those of the QD75P□/QD75D□. To set a value outside a setting range in GX Configurator-QP, set it through a sequence program or GX Works2. The setting ranges in GX Works2 are the same as those in sequence programs. (Refer to Appendix 1.2)

\*2: For Select type, refer to GX Configurator-QP Operating Manual.

**Pr.8** Speed limit value

Set the maximum speed during positioning and OPR operations. If the specified speed exceeds speed limit value, positioning will be limited at the speed limit value. Set the speed limit value within the range of the following formula. If the speed limit value exceeds the range, the error "Out of speed limit value range" (error code: 910) will occur.

The command pulse frequency converted from the speed limit value  $\leq$  Max. output pulse \*1

- \*1: QD75P□N/QD75P□: 200kpulse/s
- QD75D□N: 4Mpulse/s
- QD75D□: 1Mpulse/s

**Pr.9** Acceleration time 0, **Pr.10** Deceleration time 0

" **Pr.9** Acceleration time 0" specifies the time for the speed to increase from zero to " **Pr.8** Speed limit value" (or " **Pr.31** JOG speed limit value" during JOG operation).

" **Pr.10** Deceleration time 0" specifies the time for the speed to decrease from " **Pr.8** Speed limit value" (or " **Pr.31** JOG speed limit value" during JOG operation) to zero.

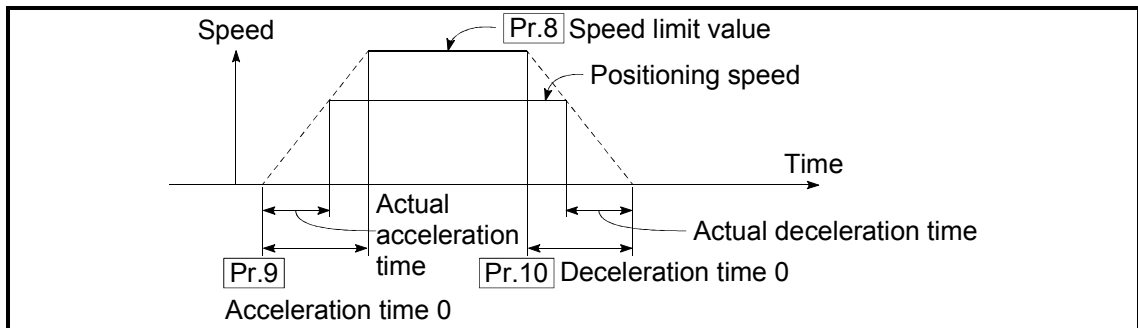

- 1) If the positioning speed is set lower than the parameter-defined speed limit value, the actual acceleration/deceleration time will be relatively short. Thus, set the maximum positioning speed equal to or only a little lower than the parameter-defined speed limit value.
- 2) These settings are valid for OPR, positioning and JOG operations.
- 3) When the positioning involves interpolation, the acceleration/deceleration time defined for the reference axis is valid.

5.2.3 Detailed parameters 1

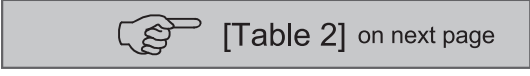
Item	Setting value, setting range		Default value	Setting value buffer memory address			
	Value set with peripheral device	Value set with sequence program		Axis 1	Axis 2	Axis 3	Axis 4
<b>Pr.11</b> Backlash compensation amount	The setting value range differs according to the " Pr.1 Unit setting". Here, the value within the [Table 1] range is set. 		0	17	167	317	467
<b>Pr.12</b> Software stroke limit upper limit value	The setting value range differs according to the " Pr.1 Unit setting". Here, the value within the [Table 2] range is set.		2147483647	18 19	168 169	318 319	468 469
<b>Pr.13</b> Software stroke limit lower limit value			-2147483648	20 21	170 171	320 321	470 471
<b>Pr.14</b> Software stroke limit selection	0 : Apply software stroke limit on current feed value	0	0	22	172	322	472
	1 : Apply software stroke limit on machine feed value	1					
<b>Pr.15</b> Software stroke limit valid/invalid setting	0 : Software stroke limit valid during JOG operation, inching operation and manual pulse generator operation	0	0	23	173	323	473
	1 : Software stroke limit invalid during JOG operation ,inching operation and manual pulse generator operation	1					

**Pr.11** Backlash compensation amount

The error that occurs due to backlash when moving the machine via gears can be compensated.

When the backlash compensation amount is set, pulses equivalent to the compensation amount will be output each time the direction changes during positioning.

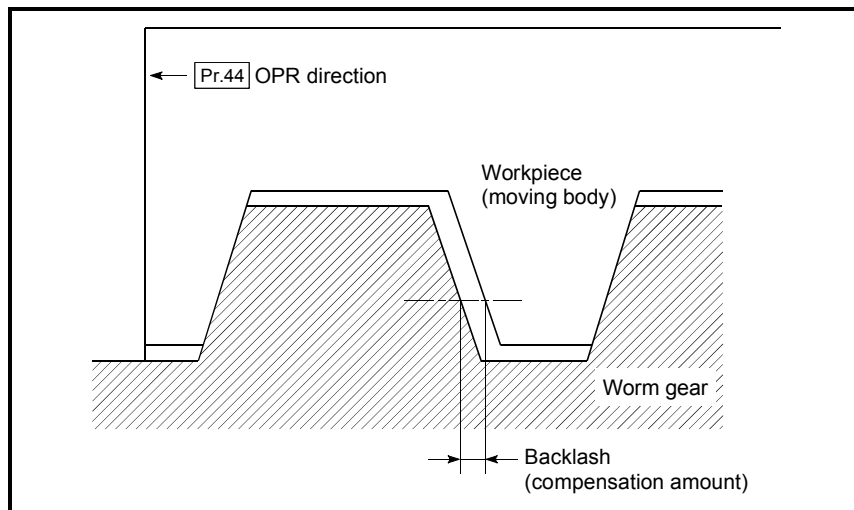

- 1) The backlash compensation is valid after machine OPR. Thus, if the backlash compensation amount is set or changed, always carry out machine OPR once.
- 2) The backlash compensation amount setting range is 0 to 65535, but it should be set to 255 or less by using the following expression.

$$0 \leq \frac{\text{Backlash compensation amount}}{\text{Movement amount per pulse}} \leq 255$$

[Table 1]

Pr.1 setting value	Value set with peripheral device (unit)	Value set with sequence program (unit) *
0 : mm	0 to 6553.5 (μm)	0 to 65535 (×10 <sup>-1</sup> μm)
1 : inch	0 to 0.65535 (inch)	0 to 65535 (×10 <sup>-5</sup> inch)
2 : degree	0 to 0.65535 (degree)	0 to 65535 (×10 <sup>-5</sup> degree)
3 : pulse	0 to 65535 (pulse)	0 to 65535 (pulse)

\* 1 to 32767 : Set as a decimal  
 32768 to 65535 : Convert into hexadecimal and set

[Table 2]

Pr.1 setting value	Value set with peripheral device (unit)	Value set with sequence program (unit)
0 : mm	-214748364.8 to 214748364.7 (μm)	-2147483648 to 2147483647 (×10 <sup>-1</sup> μm)
1 : inch	-21474.83648 to 21474.83647 (inch)	-2147483648 to 2147483647 (×10 <sup>-5</sup> inch)
2 : degree	0 to 359.99999 (degree)	0 to 35999999 (×10 <sup>-5</sup> degree)
3 : pulse	-2147483648 to 2147483647 (pulse)	-2147483648 to 2147483647 (pulse)

**Pr.12** Software stroke limit upper limit value

Set the upper limit for the machine's movement range during positioning control.

**Pr.13** Software stroke limit lower limit value

Set the lower limit for the machine's movement range during positioning control.

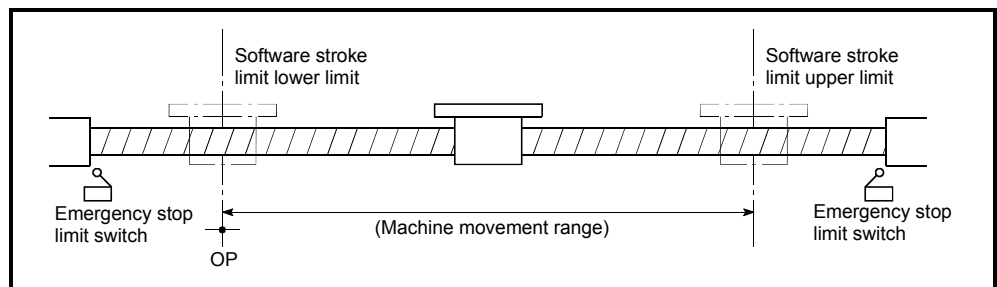

- 1) Generally, the OP is set at the lower limit or upper limit of the stroke limit.
- 2) By setting the upper limit value or lower limit value of the software stroke limit, overrun can be prevented in the software. However, an emergency stop limit switch must be installed nearby outside the range.
- 3) To invalidate the software stroke limit, set the setting value to "upper limit value = lower limit value". (The setting value can be anything in the setting range.)
- 4) When the unit is "degree", the software stroke limit check is invalid during speed control (including speed-position switching control, position-speed switching control) or during manual control.

**Pr.14** Software stroke limit selection

Set whether to apply the software stroke limit on the "current feed value" or the "machine feed value". The software stroke limit will be validated according to the set value.

**Pr.15** Software stroke limit valid/invalid setting

Set whether to validate the software stroke limit during JOG/Inching operation and manual pulse generator operation.

Item	Setting value, setting range		Default value	Setting value buffer memory address			
	Value set with peripheral device	Value set with sequence program		Axis 1	Axis 2	Axis 3	Axis 4
<b>Pr.16</b> Command in-position width	The setting value range differs depending on the " <b>Pr.1</b> Unit setting". Here, the value within the [Table 1] range is set.		100	24 25	174 175	324 325	474 475
<b>Pr.17</b> Torque limit setting value	1 to 500 (%)	1 to 500 (%)	300	26	176	326	476
<b>Pr.18</b> M code ON signal output timing	0 : WITH mode	0	0	27	177	327	477
	1 : AFTER mode	1					

**Pr.16** Command in-position width

Set the remaining distance that turns the command in-position ON. The command in-position signal is used as a front-loading signal of the positioning complete signal. When positioning control is started, the "command in-position flag" (3rd flag from right) in " **Md.31** Status" turns OFF, and the "command in-position flag" turns ON at the set position of the command in-position signal.

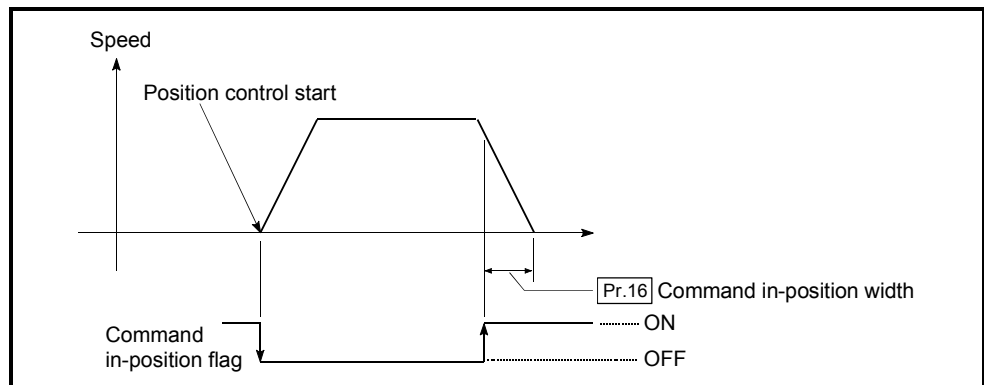



**Pr.17** Torque limit setting value

Set the maximum value of the torque generated by the servomotor as a percentage between 1 and 500%.

\* The torque limit function limits the torque generated by the servomotor within the set range.

If the torque required for control exceeds the torque limit value, it is controlled with the set torque limit value.

**Usage conditions**

Limits for pulse train output type

- (a) A drive unit that can issue a torque limit command with the analog voltage is required.
- (b) The D/A conversion module and the D/A conversion module and drive unit must be wired.
- (c) The set " **Pr.17** Torque limit setting value" is set in the buffer memory " **Md.35** Torque limit stored value", so transmit that " **Md.35** Torque limit stored value" to the D/A conversion module with the sequence program.

[Table 1]

<b>Pr.1</b> setting value	Value set with peripheral device (unit)	Value set with sequence program (unit)
0 : mm	0.1 to 214748364.7 ( $\mu\text{m}$ )	1 to 2147483647 ( $\times 10^{-1} \mu\text{m}$ )
1 : inch	0.00001 to 21474.83647 (inch)	1 to 2147483647 ( $\times 10^{-5} \text{inch}$ )
2 : degree	0.00001 to 21474.83647 (degree)	1 to 2147483647 ( $\times 10^{-5} \text{degree}$ )
3 : pulse	1 to 2147483647 (pulse)	1 to 2147483647 (pulse)

**Pr.18** M code ON signal output timing

This parameter sets the M code ON signal output timing.

Choose either WITH mode or AFTER mode as the M code ON signal output timing.

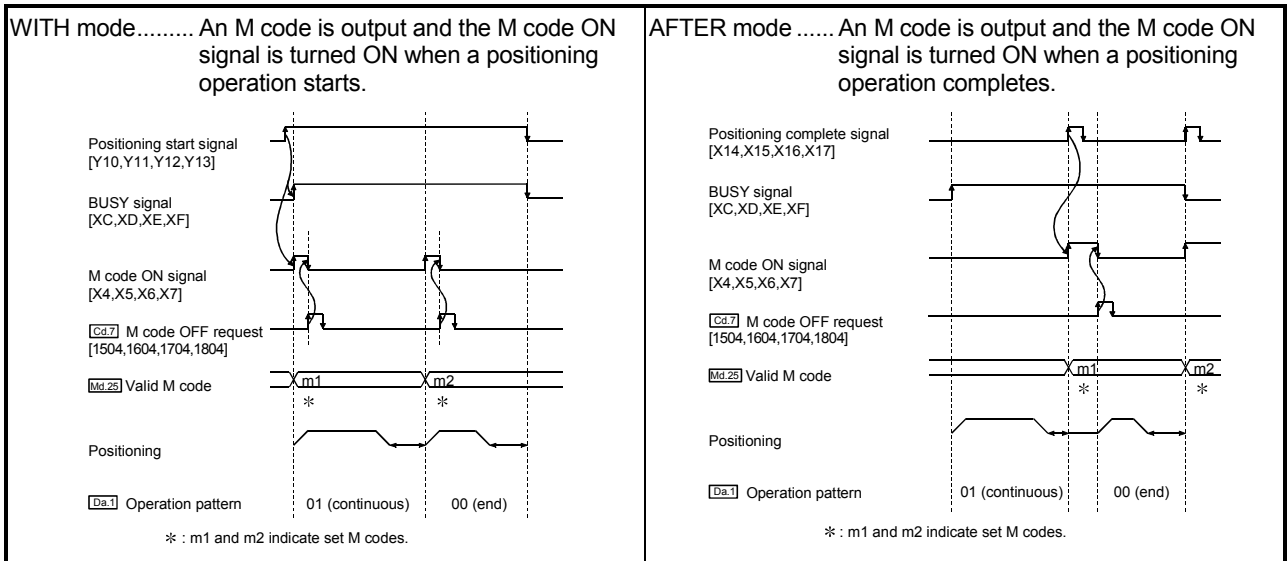

Note: If AFTER mode is used with speed control, an M code will not be output and the M code ON signal will not be turned ON.

An M code ([Da.10]) is a number between 0 and 65535 that can be assigned to each positioning data.

The sequence program can be coded to read an M code from the buffer memory address specified by "[Md.25] Valid M code" whenever the M code ON signal [X4, X5, X6, X7] turns ON so that a command for the sub work (e.g. clamping, drilling, tool change) associated with the M code can be issued.

The M code ON signal output timing can be set for each positioning data with the positioning option ("[Da.27] M code ON signal output timing") of the positioning data.

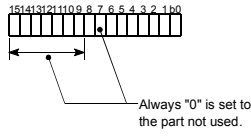
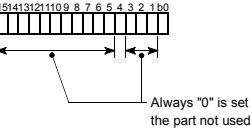
Item	Setting value, setting range		Default value	Setting value buffer memory address																								
	Value set with peripheral device	Value set with sequence program		Axis 1	Axis 2	Axis 3	Axis 4																					
<b>Pr.19</b> Speed switching mode	0 : Standard speed switching mode	0	0	28	178	328	478																					
	1 : Front-loading speed switching mode	1																										
<b>Pr.20</b> Interpolation speed designation method	0 : Composite speed	0	0	29	179	329	479																					
	1 : Reference axis speed	1																										
<b>Pr.21</b> Current feed value during speed control	0 : Do not update current feed value	0	0	30	180	330	480																					
	1 : Update current feed value	1																										
	2 : Clear current feed value to zero	2																										
<b>Pr.22</b> Input signal logic selection	<table border="0"> <tr><td>b0</td><td>Lower limit</td><td rowspan="10">0: Negative logic 1: Positive logic</td></tr> <tr><td>b1</td><td>Upper limit</td></tr> <tr><td>b2</td><td>Drive unit READY</td></tr> <tr><td>b3</td><td>Stop signal</td></tr> <tr><td>b4</td><td>External command</td></tr> <tr><td>b5</td><td>Zero signal</td></tr> <tr><td>b6</td><td>Near-point dog signal</td></tr> <tr><td>b7</td><td>Not used</td></tr> <tr><td>b8</td><td>Manual pulse generator input</td></tr> <tr><td>b9 to b15</td><td>Not used</td></tr> </table>	b0	Lower limit	0: Negative logic 1: Positive logic	b1	Upper limit	b2	Drive unit READY	b3	Stop signal	b4	External command	b5	Zero signal	b6	Near-point dog signal	b7	Not used	b8	Manual pulse generator input	b9 to b15	Not used		0	31	181	331	481
b0	Lower limit	0: Negative logic 1: Positive logic																										
b1	Upper limit																											
b2	Drive unit READY																											
b3	Stop signal																											
b4	External command																											
b5	Zero signal																											
b6	Near-point dog signal																											
b7	Not used																											
b8	Manual pulse generator input																											
b9 to b15	Not used																											
<b>Pr.23</b> Output signal logic selection	<table border="0"> <tr><td>b0</td><td>Command pulse signal</td><td rowspan="6">0: Negative logic 1: Positive logic</td></tr> <tr><td>b1</td><td>Not used</td></tr> <tr><td>b2</td><td>Not used</td></tr> <tr><td>b3</td><td>Not used</td></tr> <tr><td>b4</td><td>Deviation counter clear</td></tr> <tr><td>b5 to b15</td><td>Not used</td></tr> </table>	b0	Command pulse signal	0: Negative logic 1: Positive logic	b1	Not used	b2	Not used	b3	Not used	b4	Deviation counter clear	b5 to b15	Not used		0	32	182	332	482								
b0	Command pulse signal	0: Negative logic 1: Positive logic																										
b1	Not used																											
b2	Not used																											
b3	Not used																											
b4	Deviation counter clear																											
b5 to b15	Not used																											
<b>Pr.24</b> Manual pulse generator input selection	<table border="0"> <tr><td>0:</td><td>A-phase/B-phase multiplied by 4</td><td>0</td></tr> <tr><td>1:</td><td>A-phase/B-phase multiplied by 2</td><td>1</td></tr> <tr><td>2:</td><td>A-phase/B-phase multiplied by 1</td><td>2</td></tr> <tr><td>3:</td><td>PULSE/SIGN</td><td>3</td></tr> </table>	0:	A-phase/B-phase multiplied by 4	0	1:	A-phase/B-phase multiplied by 2	1	2:	A-phase/B-phase multiplied by 1	2	3:	PULSE/SIGN	3	0	33	-	-	-										
0:	A-phase/B-phase multiplied by 4	0																										
1:	A-phase/B-phase multiplied by 2	1																										
2:	A-phase/B-phase multiplied by 1	2																										
3:	PULSE/SIGN	3																										
<b>Pr.150</b> Speed-position function selection	<table border="0"> <tr><td>0:</td><td>Speed-position switching control (INC mode)</td><td>0</td></tr> <tr><td>2:</td><td>Speed-position switching control (ABS mode)</td><td>2</td></tr> </table>	0:	Speed-position switching control (INC mode)	0	2:	Speed-position switching control (ABS mode)	2	0	34	184	334	484																
0:	Speed-position switching control (INC mode)	0																										
2:	Speed-position switching control (ABS mode)	2																										
<b>Pr.70</b> Positioning option valid/invalid setting	<table border="0"> <tr><td>0:</td><td>Invalid</td><td>0</td></tr> <tr><td>1:</td><td>Valid</td><td>1</td></tr> </table>	0:	Invalid	0	1:	Valid	1	0	140	-	-	-																
0:	Invalid	0																										
1:	Valid	1																										

**Pr.19** Speed switching mode

Set whether to switch the speed switching mode with the standard switching or front-loading switching mode.

- 0 : Standard switching..... Switch the speed when executing the next positioning data.
- 1 : Front-loading switching..... The speed switches at the end of the positioning data currently being executed.

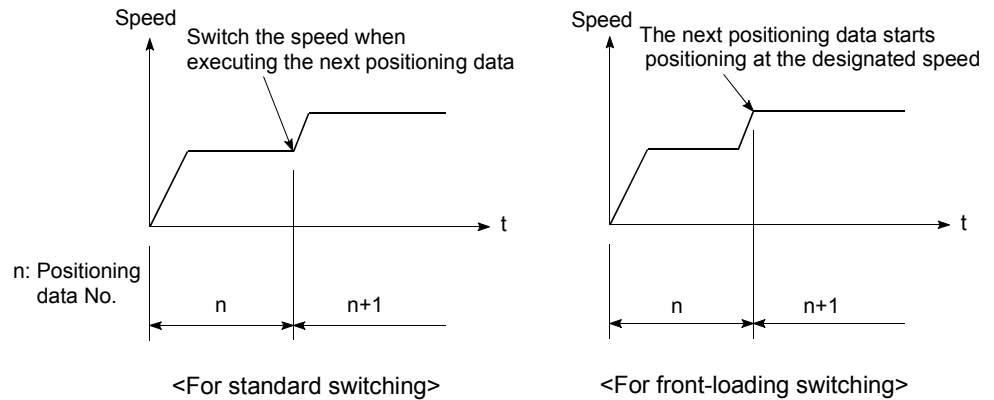

**Pr.20** Interpolation speed designation method

When carrying out linear interpolation/circular interpolation, set whether to designate the composite speed or reference axis speed.

- 0: Composite speed ..... The movement speed for the control target is designated, and the speed for each axis is calculated by the QD75.
- 1: Reference axis speed ..... The axis speed set for the reference axis is designated, and the speed for the other axis carrying out interpolation is calculated by the QD75.

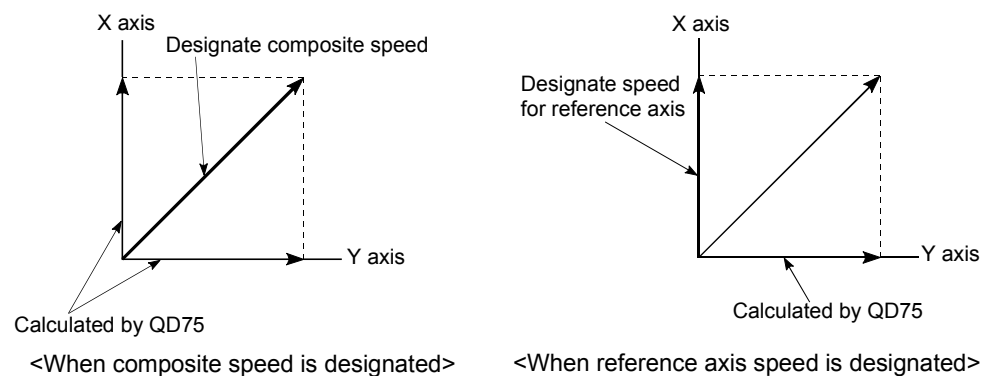

Note: Always specify the reference axis speed if the 4-axis linear interpolation or 2 to 4 axis speed control has to be performed.

If you specify the composite speed for a positioning operation that involves the 4-axis linear interpolation or 2 to 4 axis speed control, the error "Interpolation mode error" (error code 523) will be output when the positioning operation is attempted.

For a positioning operation that involves the circular interpolation or 3-axis helical interpolation control, specify the composite speed.

The interpolation speed designation method can be set for each positioning data with the positioning option ("Da.29 Interpolation speed designation method") of the positioning data.

**Pr.21** Current feed value during speed control

Specify whether you wish to enable or disable the update of " **Md.20** Current feed value" while operations are performed under the speed control (including the speed-position and position-speed switching control).

0: The update of the current feed value is disabled

The current feed value will not change.

(The value at the beginning of the speed control will be kept.)

1: The update of the current feed value is enabled

The current feed value will be updated.

(The current feed value will change from the initial.)

2: The current feed value is cleared to zero

The current feed will be set initially to zero and change from zero while the speed control is in effect.

Note1: When the speed control is performed over two to four axes, the choice between enabling and disabling the update of " **Md.20** Current feed value" depends on how the reference axis is set.

Note2: Set "1" to exercise speed-position switching control (ABS mode).

**Pr.22** Input signal logic selection, **Pr.23** Output signal logic selection

Set the I/O signal logic that matches the signaling specification of the connected external device.

Note1: A mismatch in the signal logic will disable normal operation. Be careful of this when you change from the default value.

Note2: Set the manual pulse generator input logic selection (b8) to axis 1. (Setting of any of axes 2 to 4 is invalid.)

**Pr.24** Manual pulse generator input selection

Set the manual pulse generator input pulse mode. (Only the value specified against the axis 1 is valid.)

0: A-phase/B-phase; multiplied by 4

1: A-phase/B-phase; multiplied by 2

2: A-phase/B-phase; multiplied by 1

3: PULSE/SIGN

**Pr.150** Speed-position function selection

Select the mode of speed-position switching control.

0: INC mode

2: ABS mode

Note1: If the setting is other than 0 and 2, operation is performed in the INC mode with the setting regarded as 0.

**Pr.70** Positioning option valid/invalid setting

Enable or disable the data set in the positioning option ("Da.27" M code ON signal output timing", "Da.28" ABS direction in degrees", and "Da.29" Interpolation speed designation method") of the positioning data. Setting this parameter to "1: Valid" carries out a positioning control according to the data set in the positioning option.

0: Invalid

1: Valid

Note 1: If a value other than 0 and 1 is set, the set value is regarded as 0 and the data is disabled.

Note 2: If "0: Invalid" is set, the setting is ignored even though the positioning option of the positioning data is set.

Note 3: Pr.70 Positioning option valid/invalid setting can be set only with GX Works2 (Version 1.540N or later) or sequence programs.



5.2.4 Detailed parameters 2

Item	Setting value, setting range		Default value	Setting value buffer memory address			
	Value set with peripheral device	Value set with sequence program		Axis 1	Axis 2	Axis 3	Axis 4
<b>Pr.25</b> Acceleration time 1	1 to 8388608 (ms)	1 to 8388608 (ms)	1000	36	186	336	486
<b>Pr.26</b> Acceleration time 2				37	187	337	487
<b>Pr.27</b> Acceleration time 3				38	188	338	488
<b>Pr.28</b> Deceleration time 1				39	189	339	489
<b>Pr.29</b> Deceleration time 2				40	190	340	490
<b>Pr.30</b> Deceleration time 3				41	191	341	491
				42	192	342	492
	43	193	343	493			
	44	194	344	494			
	45	195	345	495			
	46	196	346	496			
	47	197	347	497			
<b>Pr.31</b> JOG speed limit value	The setting range differs depending on the " <b>Pr.1</b> Unit setting". Here, the value within the [Table 1] range is set.  [Table 1] on next page		20000	48 49	198 199	348 349	498 499
<b>Pr.32</b> JOG operation acceleration time selection	0: <b>Pr.9</b> Acceleration time 0	0	0	50	200	350	500
	1: <b>Pr.25</b> Acceleration time 1	1					
	2: <b>Pr.26</b> Acceleration time 2	2					
	3: <b>Pr.27</b> Acceleration time 3	3					
<b>Pr.33</b> JOG operation deceleration time selection	0: <b>Pr.10</b> Deceleration time 0	0	0	51	201	351	501
	1: <b>Pr.28</b> Deceleration time 1	1					
	2: <b>Pr.29</b> Deceleration time 2	2					
	3: <b>Pr.30</b> Deceleration time 3	3					

**Pr.25** Acceleration time 1 to **Pr.27** Acceleration time 3

These parameters set the time for the speed to increase from zero to " **Pr.8** Speed limit value" (or " **Pr.31** JOG speed limit value" during JOG operation) during a positioning operation.

**Pr.28** Deceleration time 1 to **Pr.30** Deceleration time 3

These parameters set the time for the speed to decrease from " **Pr.8** Speed limit value" (or " **Pr.31** JOG speed limit value" during JOG operation) to zero during a positioning operation.



[Table 1]

Pr.1 setting value	Value set with peripheral device (unit)	Value set with sequence program (unit)
0 : mm	0.01 to 20000000.00 (mm/min)	1 to 2000000000 ( $\times 10^{-2}$ mm/min)
1 : inch	0.001 to 2000000.000 (inch/min)	1 to 2000000000 ( $\times 10^{-3}$ inch/min)
2 : degree	0.001 to 2000000.000 (degree/min)	1 to 2000000000 ( $\times 10^{-3}$ degree/min)
3 : pulse	[Select type *1 is QD75P□] 1 to 200000 (pulse/s) *2 [Select type *1 is QD75D□] 1 to 1000000 (pulse/s) *2	[QD75P□N/QD75D□N] 1 to 4000000 (pulse/s) [QD75P□/QD75D□] 1 to 1000000 (pulse/s)

\*1: For Select type, refer to GX Configurator-QP Operating Manual.

\*2: In GX Configurator-QP, the QD75P□N/QD75D□N are recognized as the QD75P□/QD75D□. Therefore, the setting ranges are the same as those of the QD75P□/QD75D□. To set a value outside a setting range in GX Configurator-QP, set it through a sequence program or GX Works2. The setting ranges in GX Works2 are the same as those in sequence programs. (Refer to Appendix 1.2)

#### Pr.31 JOG speed limit value

Set the maximum speed for JOG operation.

Note) • Set the "JOG speed limit value" to less than " Pr.8 Speed limit value".  
If the "speed limit value" is exceeded, the error "JOG speed limit value error" (error code: 956) will occur.

#### Pr.32 JOG operation acceleration time selection

Set which of "acceleration time 0 to 3" to use for the acceleration time during JOG operation.

0 : Use value set in " Pr.9 Acceleration time 0".

1 : Use value set in " Pr.25 Acceleration time 1".

2 : Use value set in " Pr.26 Acceleration time 2".

3 : Use value set in " Pr.27 Acceleration time 3".

#### Pr.33 JOG operation deceleration time selection

Set which of "deceleration time 0 to 3" to use for the deceleration time during JOG operation.

0 : Use value set in " Pr.10 Deceleration time 0".

1 : Use value set in " Pr.28 Deceleration time 1".

2 : Use value set in " Pr.29 Deceleration time 2".

3 : Use value set in " Pr.30 Deceleration time 3".

Item	Setting value, setting range		Default value	Setting value buffer memory address			
	Value set with peripheral device	Value set with sequence program		Axis 1	Axis 2	Axis 3	Axis 4
<b>Pr.34</b> Acceleration/deceleration process selection	0 : Trapezoid acceleration/deceleration process 1 : S-curve acceleration/deceleration process	0 1	0	52	202	352	502
<b>Pr.35</b> S-curve ratio	1 to 100 (%)	1 to 100 (%)	100	53	203	353	503
<b>Pr.36</b> Sudden stop deceleration time	1 to 8388608 (ms)	1 to 8388608 (ms)	1000	54 55	204 205	354 355	504 505
<b>Pr.37</b> Stop group 1 sudden stop selection	0 : Normal deceleration stop 1 : Sudden stop	0 1	0	56	206	356	506
<b>Pr.38</b> Stop group 2 sudden stop selection				57	207	357	507
<b>Pr.39</b> Stop group 3 sudden stop selection				58	208	358	508

**Pr.34** Acceleration/deceleration process selection

Set whether to use trapezoid acceleration/deceleration or S-curve acceleration/deceleration for the acceleration/deceleration process.

Note) Refer to Section 12.7.6 "Acceleration/deceleration process function" for details.

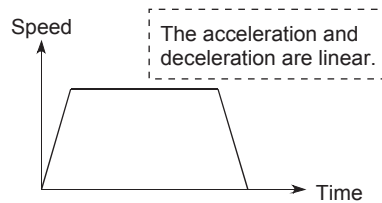

<Trapezoid acceleration/deceleration>

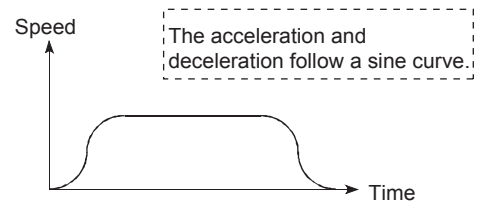

<S-curve acceleration/deceleration>

For the system that uses a stepping motor, executing the S-curve acceleration/deceleration may cause step-out.

Before using the S-curve acceleration/deceleration, confirm that step-out does not occur.

**Pr.35** S-curve ratio

Set the S-curve ratio (1 to 100%) for carrying out the S-curve acceleration/deceleration process.

The S-curve ratio indicates where to draw the acceleration/deceleration curve using the sine curve as shown below.

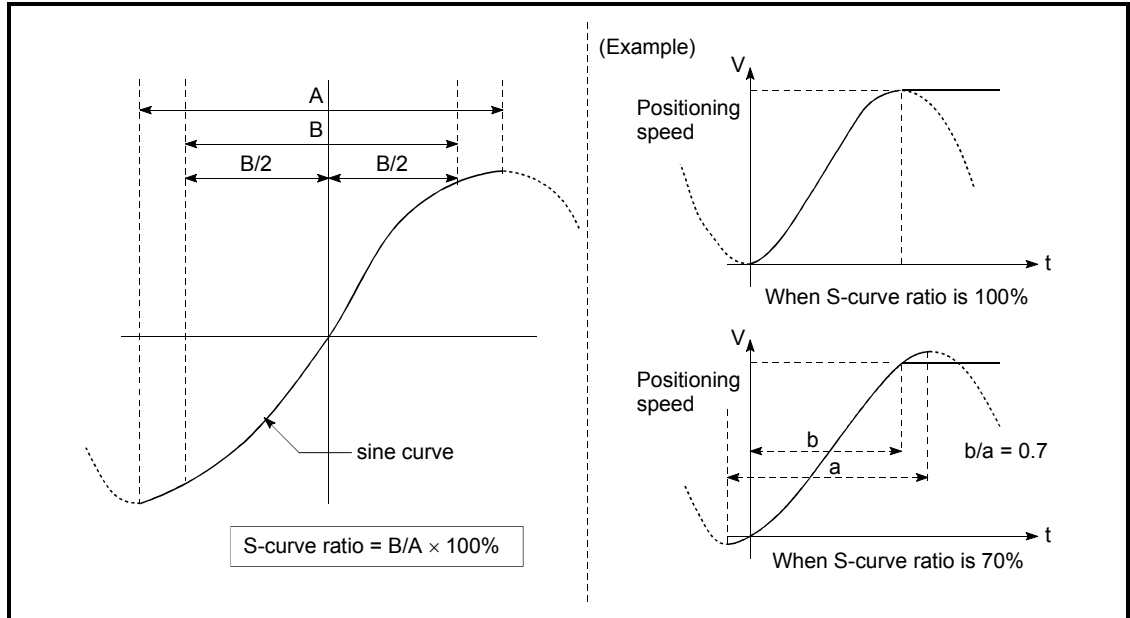

**Pr.36** Sudden stop deceleration time

Set the time to reach speed 0 from " **Pr.8** Speed limit value" (or " **Pr.31** JOG speed limit value" during JOG operation) during the sudden stop.  
 The illustration below shows the relationships with other parameters.

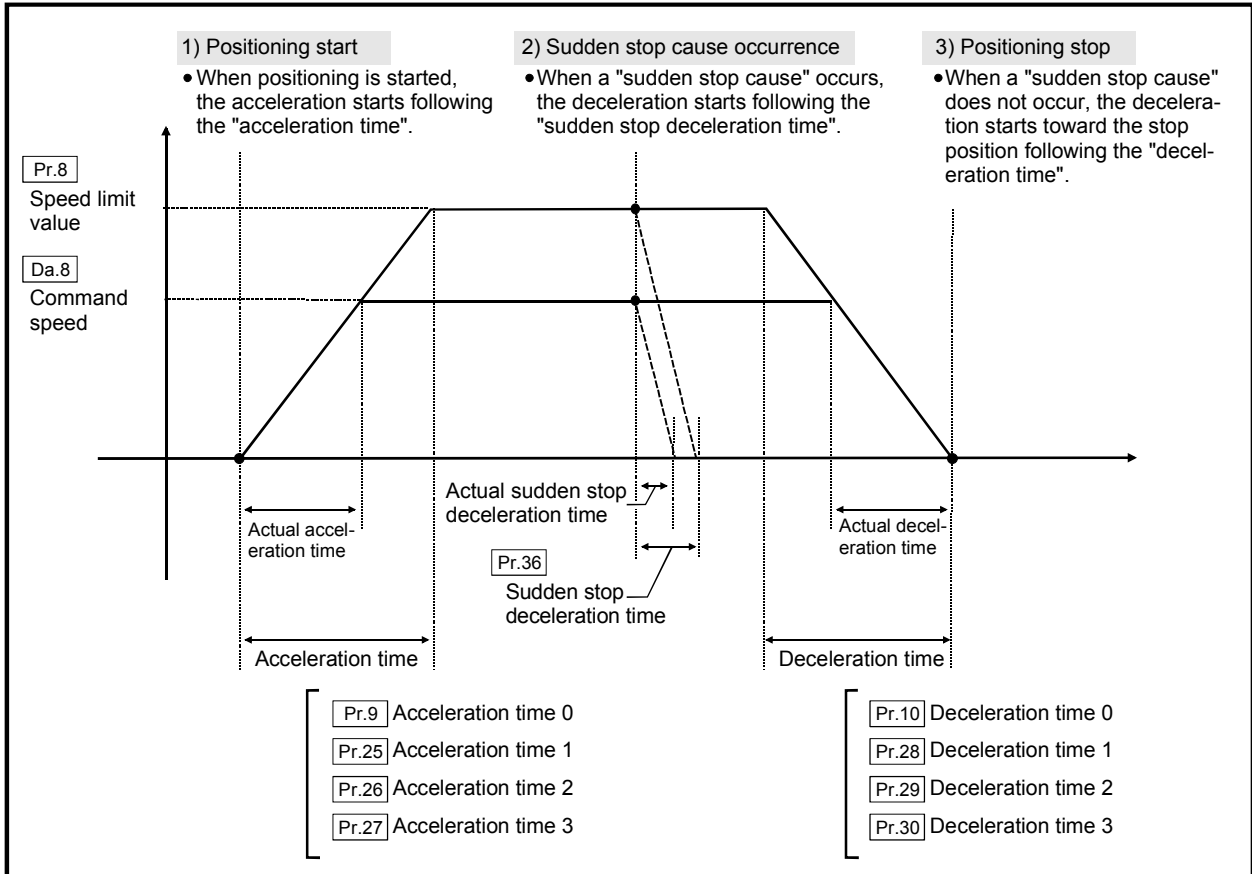

**Pr.37** Stop group 1 sudden stop selection to **Pr.39** Stop group 3 sudden stop selection

Set the method to stop when the stop causes in the following stop groups occur.

- Stop group 1 ..... Stop with hardware stroke limit
- Stop group 2 ..... CPU module error occurrence, PLC READY signal [Y0] OFF, Fault in test mode
- Stop group 3 ..... External stop signal  
Stop signal from CPU module  
Stop signal from peripheral device  
Error occurrence (excludes errors in stop groups 1 and 2: includes only the software stroke limit errors during JOG operation, speed control, speed-position switching control, and position-speed switching control)

The methods of stopping include "0: Normal deceleration stop" and "1: Sudden stop".

If "1: Sudden stop" is selected, the axis will suddenly decelerate to a stop when the stop cause occurs.

Item	Setting value, setting range		Default value	Setting value buffer memory address			
	Value set with peripheral device	Value set with sequence program		Axis 1	Axis 2	Axis 3	Axis 4
<b>Pr.40</b> Positioning complete signal output time	0 to 65535 (ms)	0 to 65535 (ms) 0 to 32767 : Set as a decimal 32768 to 65535: Convert into hexadecimal and set	300	59	209	359	509
<b>Pr.41</b> Allowable circular interpolation error width	The setting value range differs depending on the " <b>Pr.1</b> Unit setting". Here, the value within the [Table 1] range is set.		100	60 61	210 211	360 361	510 511
<b>Pr.42</b> External command function selection	0: External positioning start 1: External speed change request 2: Speed-position, position-speed switching request 3: Skip request	0 1 2 3	0	62	212	362	512

**Pr.40** Positioning complete signal output time

Set the output time of the positioning complete signal [X14, X15, X16, X17] output from the QD75.

A positioning completes when the specified dwell time has passed after the QD75 had terminated the output.

For the interpolation control, the positioning completed signal of interpolation axis is output only during the time set to the reference axis.

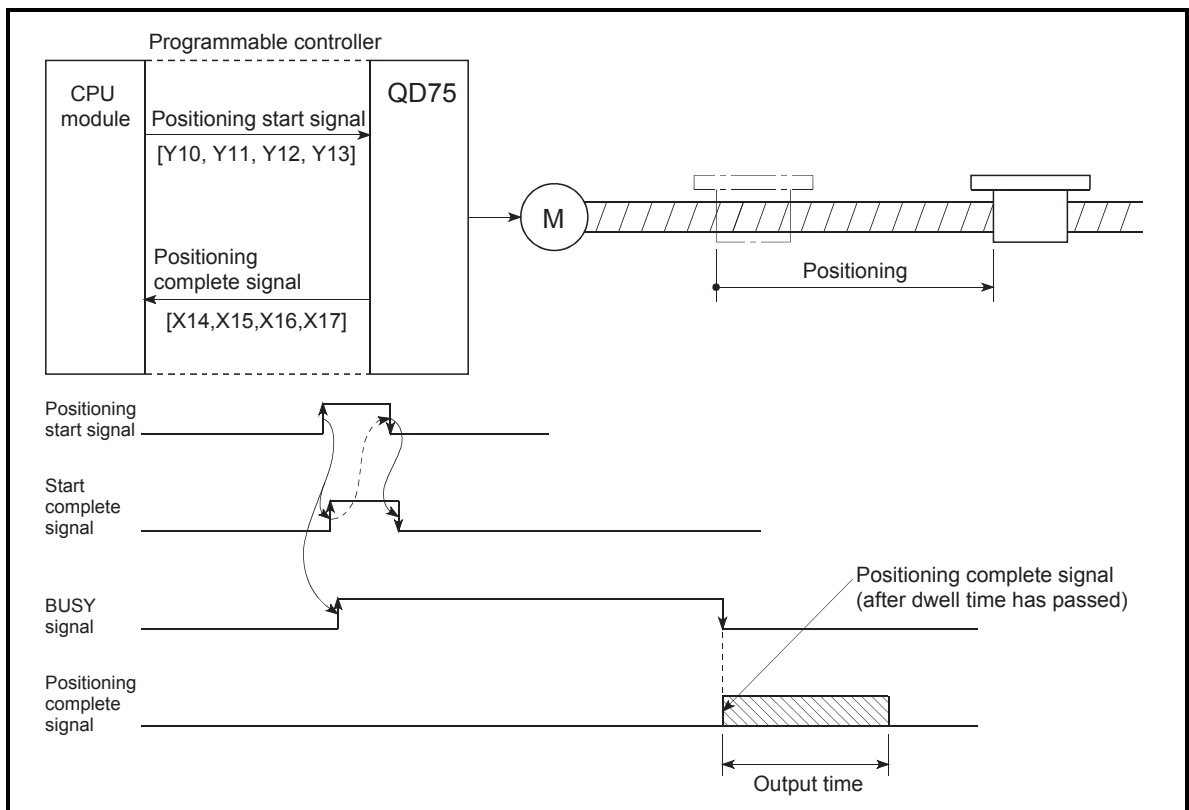

Positioning complete signal output time

[Table 1]

Pr.1 setting value	Value set with peripheral device (unit)	Value set with sequence program (unit)
0 : mm	0 to 10000.0 ( $\mu\text{m}$ )	0 to 100000 ( $\times 10^{-1}\mu\text{m}$ )
1 : inch	0 to 1.00000 (inch)	0 to 100000 ( $\times 10^{-5}\text{inch}$ )
2 : degree	0 to 1.00000 (degree)	0 to 100000 ( $\times 10^{-5}\text{degree}$ )
3 : pulse	0 to 100000 (pulse)	0 to 100000 (pulse)

**Pr.41** Allowable circular interpolation error width

With the "allowable circular interpolation error width", the allowable error range of the calculated arc path and end point address is set. \*1

If the error of the calculated arc path and end point address is within the set range, circular interpolation will be carried out to the set end point address while compensating the error with spiral interpolation.

The allowable circular interpolation error width is set in the following axis buffer memory addresses.

- If axis 1 is the reference axis, set in the axis 1 buffer memory address [60, 61].
- If axis 2 is the reference axis, set in the axis 2 buffer memory address [210, 211].
- If axis 3 is the reference axis, set in the axis 3 buffer memory address [360, 361].
- If axis 4 is the reference axis, set in the axis 4 buffer memory address [510, 511].

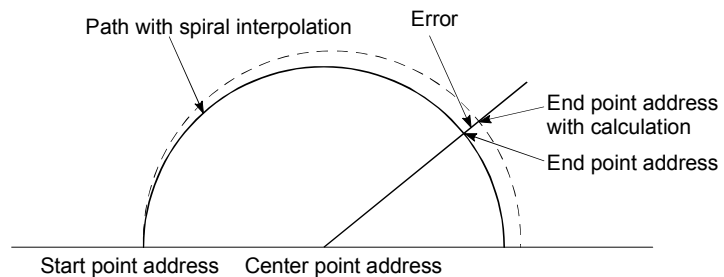

\*1: With circular interpolation control using the center point designation, the arc path calculated with the start point address and center point address and the end point address may deviate.

**Pr.42** External command function selection

Select a command with which the external command signal should be associated.

## 0: External positioning start

The external command signal input is used to start a positioning operation.

## 1: External speed change request

The external command signal input is used to change the speed in the current positioning operation. The new speed should be set in the " **Cd.14** New speed value"

## 2: Speed-position, position-speed switching request

The external command signal input is used to switch from the speed control to the position control while in the speed-position switching control mode, or from the position control to the speed control while in the position-speed switching control mode.

To enable the speed-position switching control, set the " **Cd.24** Speed-position switching enable flag" to "1".

To enable the position-speed switching control, set the " **Cd.26** Position-speed switching enable flag" to "1".

## 3: Skip request

The external command signal input is used skip the current positioning operation.

**POINT**

To enable the external command signal, set the " **Cd.8** External command enable" to "1".



5.2.5 OPR basic parameters

Item	Setting value, setting range		Default value	Setting value buffer memory address			
	Value set with peripheral device	Value set with sequence program		Axis 1	Axis 2	Axis 3	Axis 4
Pr.43 OPR method	0 : Near-point dog method	0	0	70	220	370	520
	1 : Stopper method 1)	1					
	2 : Stopper method 2)	2					
	3 : Stopper method 3)	3					
	4 : Count method 1)	4					
	5 : Count method 2)	5					

**Pr.43** OPR method

Set the "OPR method" for carrying out machine OPR.

- 0 : Near-point dog method ..... After decelerating at the near-point dog ON, stop at the zero signal and complete the machine OPR.
- 1 : Stopper method 1) ..... After decelerating at the near-point dog ON, stop with the stopper, and complete the machine OPR after the dwell time has passed.
- 2 : Stopper method 2) ..... After decelerating at the near-point dog ON, stop with the stopper, and complete the machine OPR with the zero signal.
- 3 : Stopper method 3) ..... After starting with the creep speed, stop with the stopper, and complete the machine OPR with the zero signal.
- 4 : Count method 1) ..... After decelerating at the near-point dog ON, move the designated distance, and complete the machine OPR with the zero signal.
- 5 : Count method 2) ..... After decelerating at the near-point dog ON, move the designated distance, and complete the machine OPR.

Note) Refer to Section 8.2.2 "Machine OPR method" for details on the OPR methods.

OPR method

0 : Near-point dog method

- (1) Start machine OPR.  
(Start movement at the " Pr.46 OPR speed" in the " Pr.44 OPR direction".)
- (2) Detect the near-point dog ON, and start deceleration.
- (3) Decelerate to " Pr.47 Creep speed", and move with the creep speed.  
(At this time, the near-point dog must be ON. If the near-point dog is OFF, the axis will decelerate to a stop.)
- (4) At the first zero signal (one pulse output at one motor revolution) after the near-point dog OFF, the pulse output from the QD75 stops, and the machine OPR is completed.

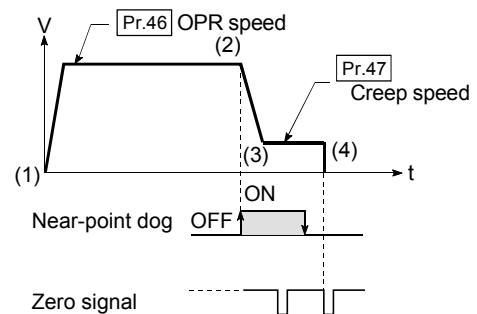

1 : Stopper method 1)

- (1) Start machine OPR.  
(Start movement at the " Pr.46 OPR speed" in the " Pr.44 OPR direction".)
- (2) Detect the near-point dog ON, and start deceleration.
- (3) Decelerate to " Pr.47 Creep speed", and move with the creep speed.  
(At this time " Pr.54 OPR torque limit value" is required. If the torque is not limited, the servomotor could be damaged in step (4).)
- (4) The axis contacts against the stopper at " Pr.47 Creep speed", and then stops.
- (5) When the near-point dog turns ON and the " Pr.49 OPR dwell time" is passed, the pulse output from the QD75 stops, and the machine OPR is completed.

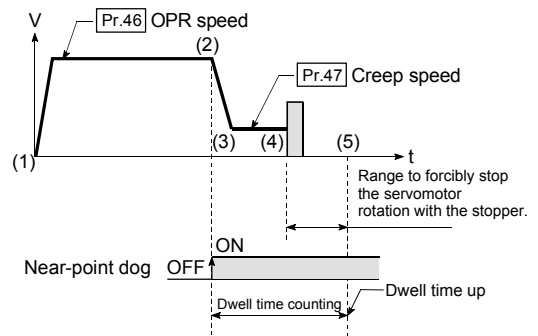

2 : Stopper method 2)

- (1) Start machine OPR.  
(Start movement at the " Pr.46 OPR speed" in the " Pr.44 OPR direction".)
- (2) Detect the near-point dog ON, and start deceleration.
- (3) Decelerate to " Pr.47 Creep speed", and move with the creep speed.  
(At this time " Pr.54 OPR torque limit value" is required. If the torque is not limited, the servomotor could be damaged in step (4).)
- (4) The axis contacts against the stopper at " Pr.47 Creep speed", and then stops.
- (5) After stopping, the pulse output from the QD75 stops with the zero signal (signal that is output on detection of contact with the stopper. Input externally), and the machine OPR is completed.

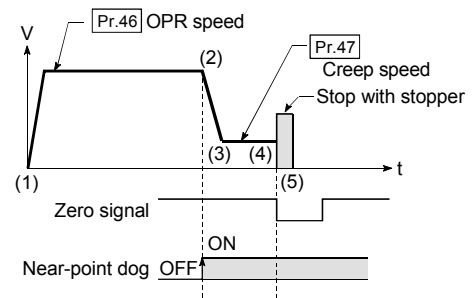

3 : Stopper method 3)

- (1) Start machine OPR.  
(Start movement at the " Pr.47 Creep speed" in the " Pr.44 OPR direction". At this time " Pr.54 OPR torque limit value" is required. If the torque is not limited, the servomotor could be damaged in step (2).)
- (2) The axis contacts against the stopper at " Pr.47 Creep speed", and then stops.
- (3) After stopping, the pulse output from the QD75 stops with the zero signal (signal that is output on detection of contact with the stopper. Input externally), and the machine OPR is completed.

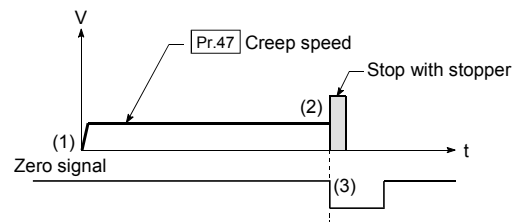

4 : Count method 1)

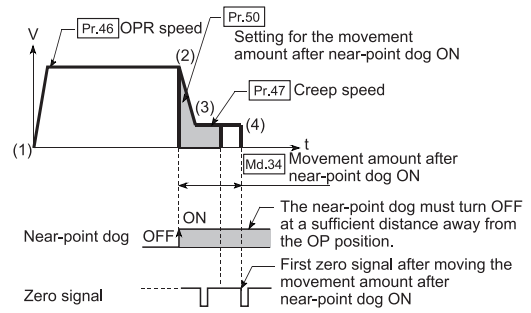

- (1) Start machine OPR.  
(Start movement at the " Pr.46 OPR speed" in the " Pr.44 OPR direction".)
- (2) Detect the near-point dog ON, and start deceleration.
- (3) Decelerate to " Pr.47 Creep speed", and move with the creep speed.
- (4) After the near-point dog turns ON and the movement amount set in " Pr.50 Setting for the movement amount after near-point dog ON" has passed, the pulse output from the QD75 stops with the first zero signal (one pulse output at one motor revolution), and the machine OPR is completed.

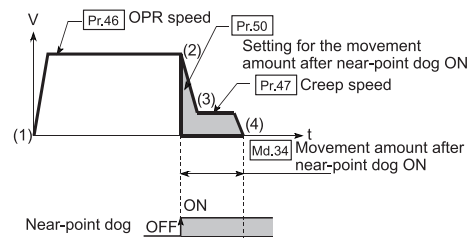

5 : Count method 2)

- (1) Start machine OPR.  
(Start movement at the " Pr.46 OPR speed" in the " Pr.44 OPR direction".)
- (2) Detect the near-point dog ON, and start deceleration.
- (3) Decelerate to " Pr.47 Creep speed", and move with the creep speed.
- (4) After the near-point dog turns ON and the movement amount set in " Pr.50 Setting for the movement amount after near-point dog ON" has passed, the pulse output from the QD75 stops with the first zero signal, and the machine OPR is completed.

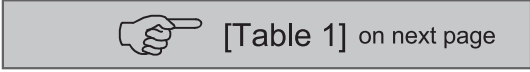

Item	Setting value, setting range		Default value	Setting value buffer memory address			
	Value set with peripheral device	Value set with sequence program		Axis 1	Axis 2	Axis 3	Axis 4
Pr.44 OPR direction	0 : Positive direction (address increment direction)	0	0	71	221	371	521
	1 : Negative direction (address decrement direction)	1					
Pr.45 OP address	The setting value range differs depending on the " Pr.1 Unit setting". Here, the value within the [Table 1] range is set.		0	72	222	372	522
				73	223	373	523
Pr.46 OPR speed	The setting value range differs depending on the " Pr.1 Unit setting". Here, the value within the [Table 2] range is set.		1	74	224	374	524
				75	225	375	525

**Pr.44** OPR direction

Set the direction to start movement when starting machine OPR.

0: Positive direction (address increment direction)

Moves in the direction that the address increments. (Arrow 2))

1: Negative direction (address decrement direction)

Moves in the direction that the address decrements. (Arrow 1))

Normally, the OP is set near the lower limit or the upper limit, so " **Pr.44** OPR direction" is set as shown below.

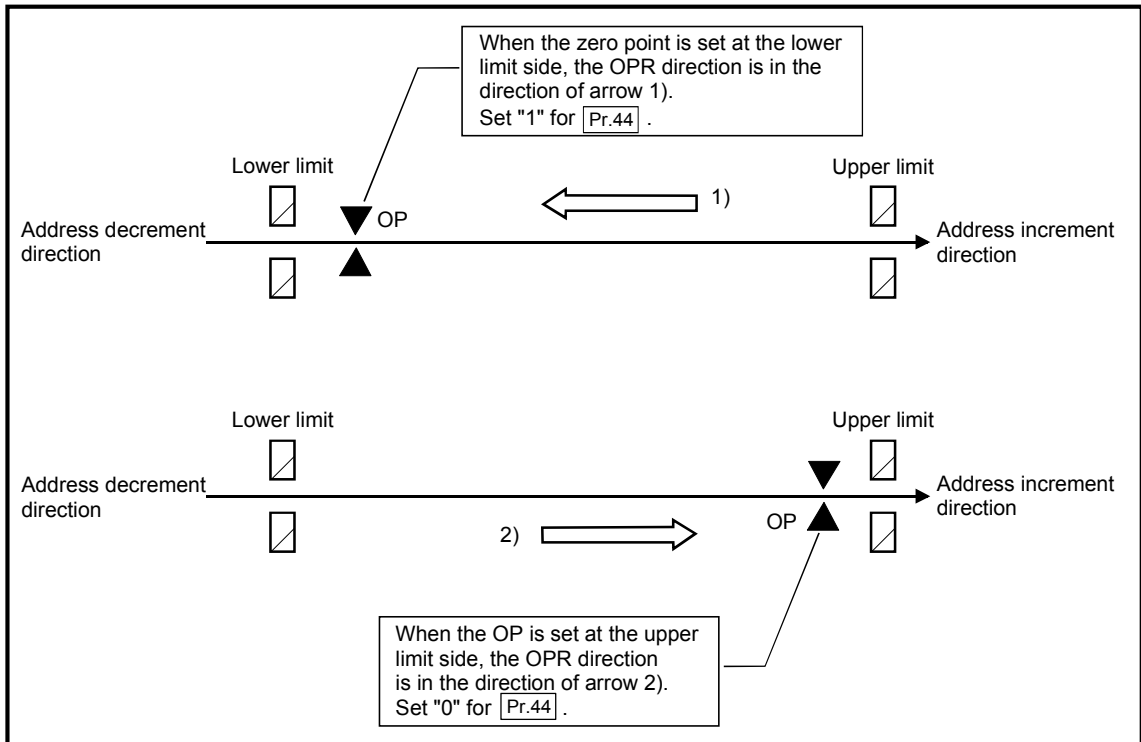

[Table 1]

<b>Pr.1</b> setting value	Value set with peripheral device (unit)	Value set with sequence program(unit)
0 : mm	-214748364.8 to 214748364.7 (μm)	-2147483648 to 2147483647 (×10 <sup>-1</sup> μm)
1 : inch	-21474.83648 to 21474.83647 (inch)	-2147483648 to 2147483647 (×10 <sup>-5</sup> inch)
2 : degree	0 to 359.99999 (degree)	0 to 35999999 (×10 <sup>-5</sup> degree)
3 : pulse	-2147483648 to 2147483647 (pulse)	-2147483648 to 2147483647 (pulse)

[Table 2]

<b>Pr.1</b> setting value	Value set with peripheral device (unit)	Value set with sequence program (unit)
0 : mm	0.01 to 20000000.00 (mm/min)	1 to 2000000000 (×10 <sup>-2</sup> mm/min)
1 : inch	0.001 to 2000000.000 (inch/min)	1 to 2000000000 (×10 <sup>-3</sup> inch/min)
2 : degree	0.001 to 2000000.000 (degree/min)	1 to 2000000000 (×10 <sup>-3</sup> degree/min)
3 : pulse	1 to 1000000 (pulse/s) * 1	[QD75P□/N/QD75D□/N] 1 to 4000000 (pulse/s) [QD75P□/QD75D□] 1 to 1000000 (pulse/s)

\*1: In GX Configurator-QP, the QD75P□/N/QD75D□/N are recognized as the QD75P□/QD75D□. Therefore, the setting ranges are the same as those of the QD75P□/QD75D□. To set a value outside a setting range in GX Configurator-QP, set it through a sequence program or GX Works2. The setting ranges in GX Works2 are the same as those in sequence programs. (Refer to Appendix 1.2)

**Pr.45** OP address

Set the address used as the reference point for positioning control (ABS system). (When the machine OPR is completed, the stop position address is changed to the address set in " **Pr.45** OP address". At the same time, the " **Pr.45** OP address" is stored in " **Md.20** Current feed value" and " **Md.21** Machine feed value".)

**Pr.46** OPR speed

Set the speed for OPR.

Note) Set the "OPR speed" to less than " **Pr.8** Speed limit value". If the "speed limit value" is exceeded, the error "Out of speed limit value range" (error code: 910) occurs and OPR is not performed.

The "OPR speed" should be equal to or faster than the " **Pr.7** Bias speed at start" and " **Pr.47** Creep speed".

Item	Setting value, setting range		Default value	Setting value buffer memory address			
	Value set with peripheral device	Value set with sequence program		Axis 1	Axis 2	Axis 3	Axis 4
<b>Pr.47</b> Creep speed	The setting value range differs depending on the " <b>Pr.1</b> Unit setting". Here, the value within the [Table 1] range is set. <div style="border: 1px solid black; padding: 5px; display: inline-block; margin-top: 10px;">  <b>[Table 1]</b> on next page                 </div>		1	76 77	226 227	376 377	526 527
<b>Pr.48</b> OPR retry	0 : Do not retry OPR with limit switch	0	0	78	228	378	528
	1 : Retry OPR with limit switch	1					

**Pr.47** Creep speed

Set the creep speed after near-point dog ON (the low speed just before stopping after decelerating from the OPR speed).

The creep speed is set within the following range.

$$(\text{Pr.46 OPR speed}) \geq (\text{Pr.47 Creep speed}) \geq (\text{Pr.7 Bias speed at start})$$

Note) The creep speed is related to the detection error when using the OPR method with zero signal, and the size of the collision if a collision occurs during OPR method using the stopper method.

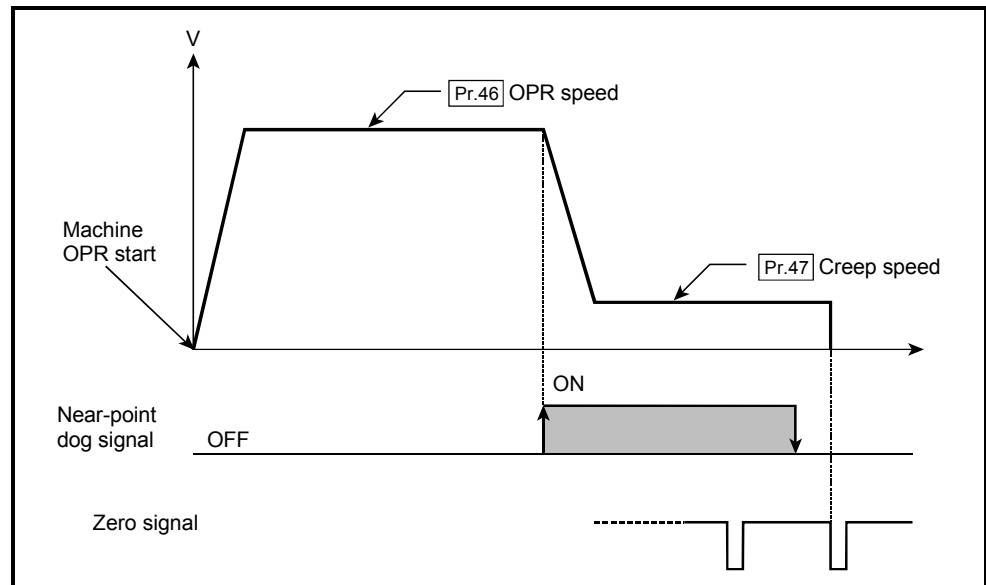

[Table 1]

Pr.1 setting value	Value set with peripheral device (unit)	Value set with sequence program (unit)
0 : mm	0.01 to 20000000.00 (mm/min)	1 to 2000000000 ( $\times 10^{-2}$ mm/min)
1 : inch	0.001 to 2000000.000 (inch/min)	1 to 2000000000 ( $\times 10^{-3}$ inch/min)
2 : degree	0.001 to 2000000.000 (degree/min)	1 to 2000000000 ( $\times 10^{-3}$ degree/min)
3 : pulse	1 to 1000000 (pulse/s) *1	[QD75P□N/QD75D□N] 1 to 4000000 (pulse/s) [QD75P□/QD75D□] 1 to 1000000 (pulse/s)

\*1: In GX Configurator-QP, the QD75P□N/QD75D□N are recognized as the QD75P□/QD75D□. Therefore, the setting ranges are the same as those of the QD75P□/QD75D□. To set a value outside a setting range in GX Configurator-QP, set it through a sequence program or GX Works2. The setting ranges in GX Works2 are the same as those in sequence programs. (Refer to Appendix 1.2)

**Pr.48** OPR retry

Set whether to carry out OPR retry.

When the OPR retry function is validated and the machine OPR is started, first the axis will move in the OPR direction (1)). If the upper/lower limit signal turns OFF before the near-point dog signal ON is detected (2)), the axis will decelerate to a stop, and then will move in the direction opposite to the specified OPR direction (3)). If the falling edge of the near-point dog signal is detected during movement in the opposite direction, the axis will decelerate to a stop (4)), and will carry out machine OPR again (5)), (6)).

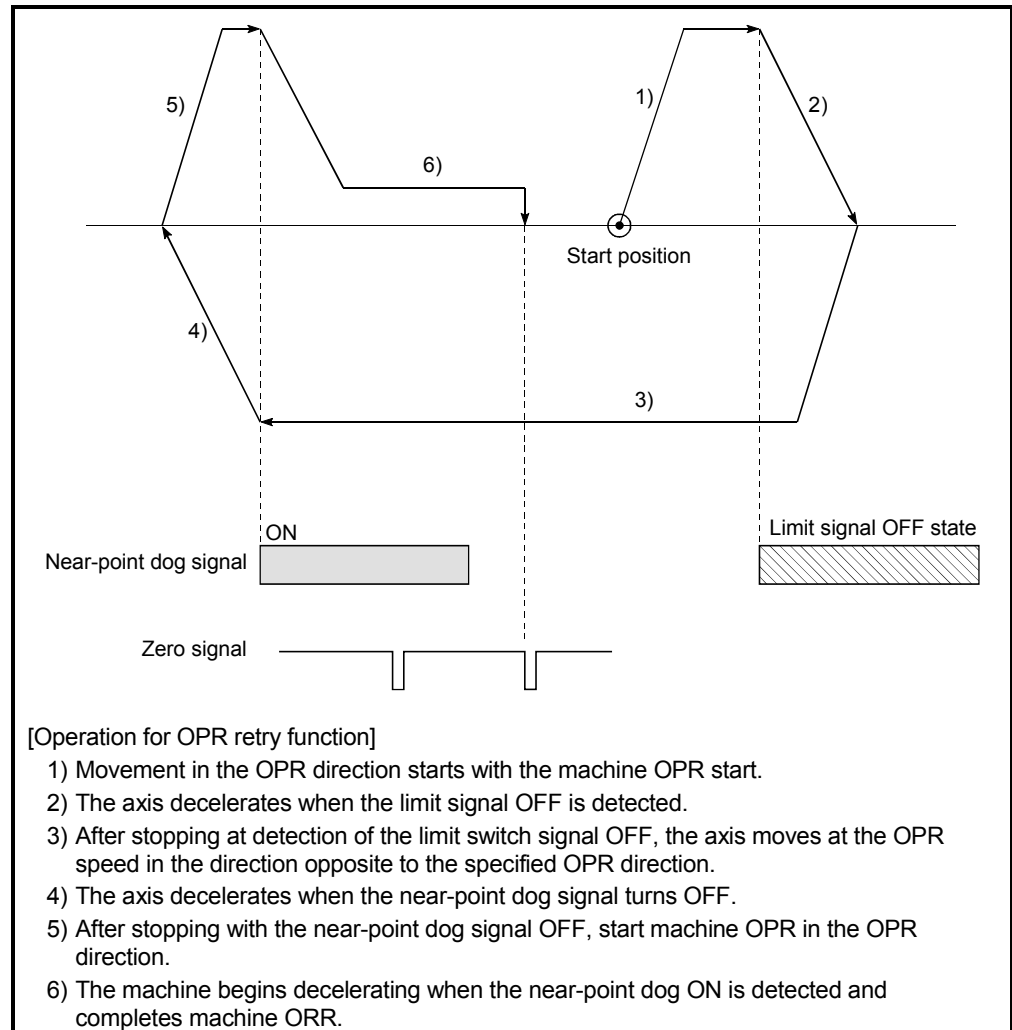

## 5.2.6 OPR detailed parameters

Item	Setting value, setting range		Default value	Setting value buffer memory address			
	Value set with peripheral device	Value set with sequence program		Axis 1	Axis 2	Axis 3	Axis 4
<b>Pr.49</b> OPR dwell time	0 to 65535 (ms)	0 to 65535 (ms) 0 to 32767 : Set as a decimal 32768 to 65535 : Convert into hexadecimal and set	0	79	229	379	529
<b>Pr.50</b> Setting for the movement amount after near-point dog ON	The setting value range differs depending on the " <b>Pr.1</b> Unit setting". Here, the value within the [Table 1] range is set.  <b>[Table 1]</b> on next page		0	80 81	230 231	380 381	530 531
<b>Pr.51</b> OPR acceleration time selection	0 : <b>Pr.9</b> Acceleration time 0	0	0	82	232	382	532
	1 : <b>Pr.25</b> Acceleration time 1	1					
	2 : <b>Pr.26</b> Acceleration time 2	2					
	3 : <b>Pr.27</b> Acceleration time 3	3					
<b>Pr.52</b> OPR deceleration time selection	0 : <b>Pr.10</b> Deceleration time 0	0	0	83	233	383	533
	1 : <b>Pr.28</b> Deceleration time 1	1					
	2 : <b>Pr.29</b> Deceleration time 2	2					
	3 : <b>Pr.30</b> Deceleration time 3	3					

**Pr.49** OPR dwell time

When stopper method 1) is set for " **Pr.43** OPR method", set the time for the machine OPR to complete after the near-point dog signal turns ON.

The setting value must be longer than the movement time from the near-point dog signal ON to stopping with the stopper.

(If the OPR method is not "stopper method 1)", the " **Pr.49** OPR dwell time" value is irrelevant.)

**Pr.50** Setting for the movement amount after near-point dog ON

When using the count method 1) or 2), set the movement amount to the OP after the near-point dog signal turns ON.

(The movement amount after near-point dog ON should be equal to or greater than the sum of the "distance covered by the deceleration from the OPR speed to the creep speed" and "distance of movement in 10ms at the OPR speed".)



[Table 1]

Pr.1 setting value	Value set with peripheral device (unit)	Value set with sequence program (unit)
0 : mm	0 to 214748364.7 (μm)	0 to 2147483647 (×10 <sup>-1</sup> μm)
1 : inch	0 to 21474.83647 (inch)	0 to 2147483647 (×10 <sup>-5</sup> inch)
2 : degree	0 to 21474.83647 (degree)	0 to 2147483647 (×10 <sup>-5</sup> degree)
3 : pulse	0 to 2147483647 (pulse)	0 to 2147483647 (pulse)

Example of setting for "Pr. 50 Setting for the movement amount after near-point dog ON"

Assuming that the "Pr. 8 Speed limit value" is set to 200 kpulse/s, "Pr. 46 OPR speed" to 10 kpulse/s, "Pr. 47 Creep speed" to 1 kpulse/s, and deceleration time to 300 ms, the minimum value of "Pr. 50 Setting for the movement amount after near-point dog ON" is calculated as follows:

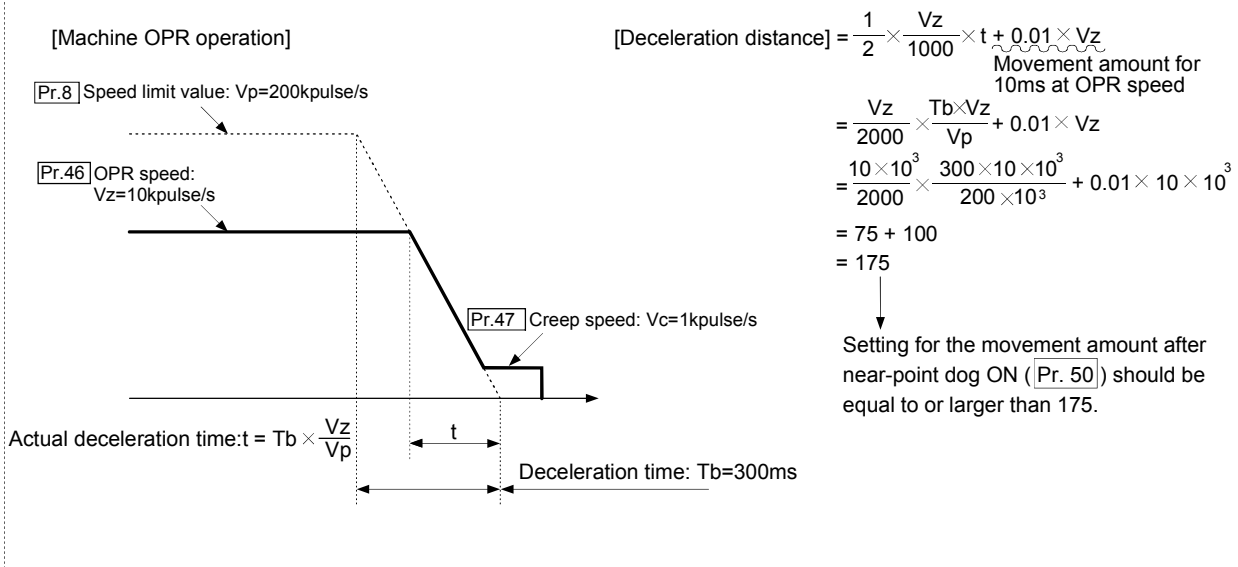

### Pr.51 OPR acceleration time selection

Set which of "acceleration time 0 to 3" to use for the acceleration time during OPR.

- 0 : Use the value set in "Pr.9 Acceleration time 0".
- 1 : Use the value set in "Pr.25 Acceleration time 1".
- 2 : Use the value set in "Pr.26 Acceleration time 2".
- 3 : Use the value set in "Pr.27 Acceleration time 3".

### Pr.52 OPR deceleration time selection

Set which of "deceleration time 0 to 3" to use for the deceleration time during OPR.

- 0 : Use the value set in "Pr.10 Deceleration time 0".
- 1 : Use the value set in "Pr.28 Deceleration time 1".
- 2 : Use the value set in "Pr.29 Deceleration time 2".
- 3 : Use the value set in "Pr.30 Deceleration time 3".

Item	Setting value, setting range		Default value	Setting value buffer memory address			
	Value set with peripheral device	Value set with sequence program		Axis 1	Axis 2	Axis 3	Axis 4
<b>Pr.53</b> OP shift amount	The setting value range differs depending on the " <b>Pr.1</b> Unit setting". Here, the value within the [Table 1] range is set. <div style="border: 1px solid gray; padding: 5px; display: inline-block; margin-top: 10px;">  [Table 1] on next page                     </div>		0	84 85	234 235	384 385	534 535
<b>Pr.54</b> OPR torque limit value	1 to 300 (%)	1 to 300 (%)	300	86	236	386	536
<b>Pr.55</b> Deviation counter clear signal output time	1 to 65535 (ms)	1 to 65535 (ms) 1 to 32767: Set the decimal value as it is. 32768 to 65535: Convert into hexadecimal and set.	11	87	237	387	537
<b>Pr.56</b> Speed designation during OP shift	0 : OPR speed 1 : Creep speed	0 1	0	88	238	388	538
<b>Pr.57</b> Dwell time during OPR retry	0 to 65535 (ms)	0 to 65535 (ms) 0 to 32767 : Set as a decimal 32768 to 65535 : Convert into hexadecimal and set	0	89	239	389	539

**Pr.53** OP shift amount

Set the amount to shift (move) from the position stopped at with machine OPR.

\* The OP shift function is used to compensate the OP position stopped at with machine OPR.

If there is a physical limit to the OP position, due to the relation of the near-point dog installation position, use this function to compensate the OP to an optimum position.

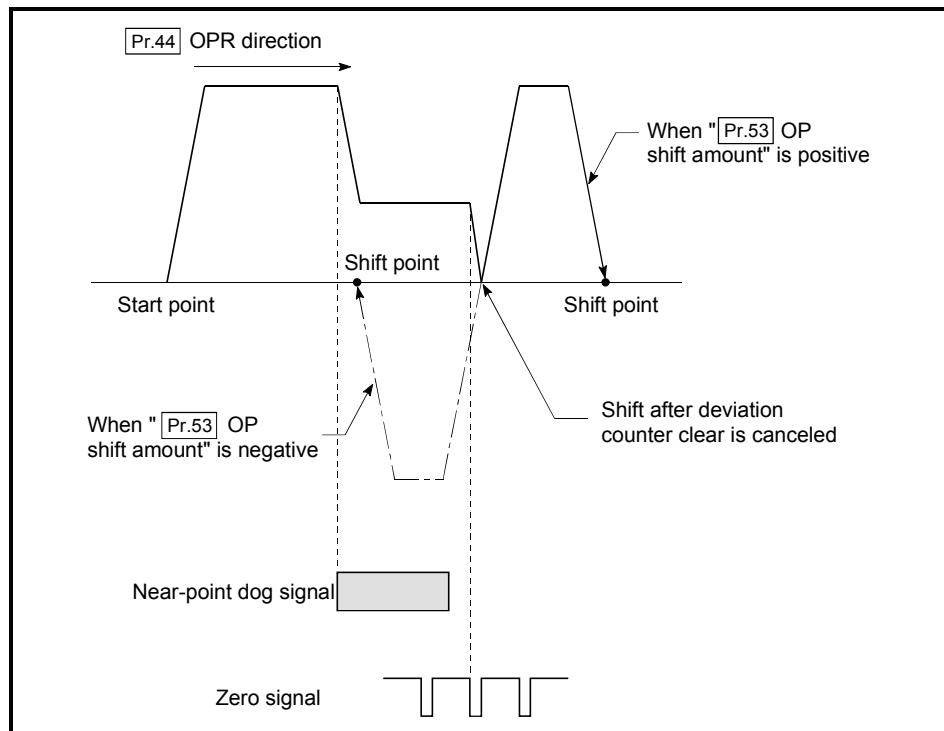

[Table 1]

Pr.1 setting value	Value set with peripheral device (unit)	Value set with sequence program (unit)
0 : mm	-214748364.8 to 214748364.7 ( $\mu\text{m}$ )	-2147483648 to 2147483647 ( $\times 10^{-1}\mu\text{m}$ )
1 : inch	-21474.83648 to 21474.83647 (inch)	-2147483648 to 2147483647 ( $\times 10^{-5}\text{inch}$ )
2 : degree	-21474.83648 to 21474.83647 (degree)	-2147483648 to 2147483647 ( $\times 10^{-5}\text{degree}$ )
3 : pulse	-2147483648 to 2147483647 (pulse)	-2147483648 to 2147483647 (pulse)

**Pr.54** OPR torque limit value

Set the value to limit the servomotor torque after reaching the creep speed during machine OPR.

Refer to Section 12.4.2 "Torque limit function" for details on the torque limits.

**Pr.55** Deviation counter clear signal output time

Set the duration of the deviation counter clear signal output during a machine OPR operation using any of the following methods: the near-point dog method, stopper methods 1) to 3), and count method 1). (For details, refer to your drive unit manual.)

**Pr.56** Speed designation during OP shift

Set the operation speed for when a value other than "0" is set for " **Pr.53** OP shift amount". Select the setting from " **Pr.46** OPR speed" or " **Pr.47** Creep speed".

0 : Designate " **Pr.46** OPR speed" as the setting value.

1 : Designate " **Pr.47** Creep speed" as the setting value.

**Pr.57** Dwell time during OPR retry

When OPR retry is validated (when "1" is set for **Pr.48**), set the stop time after decelerating in 2) and 4) in the following drawing.

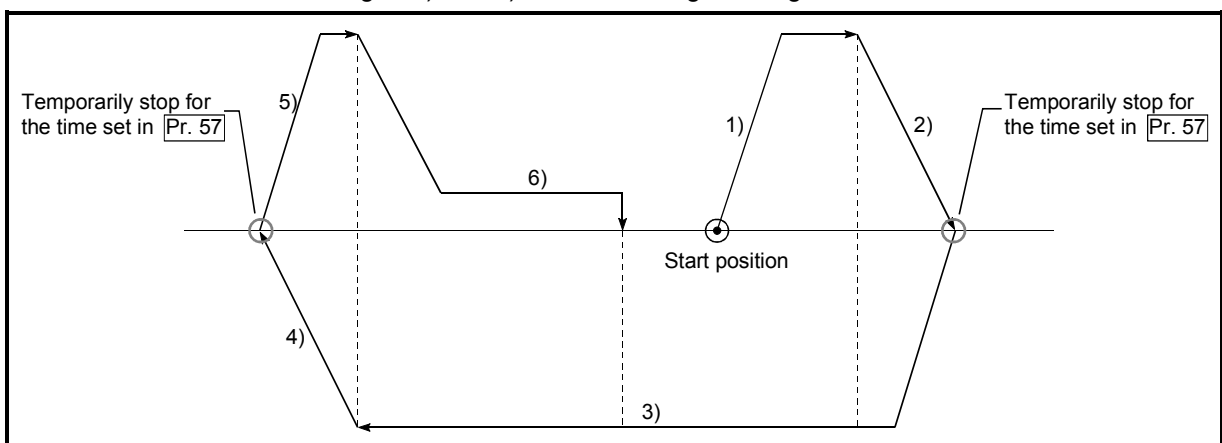

5.3 List of positioning data

Before explaining the positioning data setting items [Da.1] to [Da.10], the configuration of the positioning data will be shown below.

Before the explanation on the positioning data setting items [Da.1] to [Da.10] and [Da.27] to [Da.29], the configuration of the positioning data will be shown below.

The positioning data stored in the QD75 buffer memory has the following type of configuration.

Axis 1	Positioning data No.	1	2	3	...	599	600
	Positioning identifier [Da.1] to [Da.5]	2000	2010	2020	...	7980	7990
	[Da.10] M code	2001	2011	2021	...	7981	7991
	[Da.9] Dwell time	2002	2012	2022	...	7982	7992
	Positioning option [Da.27] to [Da.29]	2003	2013	2023	...	7983	7993
	[Da.8] Command speed	2004 2005	2014 2015	2024 2025	...	7984 7985	7994 7995
	[Da.6] Positioning address/ movement amount	2006 2007	2016 2017	2026 2027	...	7986 7987	7996 7997
	[Da.7] Arc address	2008 2009	2018 2019	2028 2029	...	7988 7989	7998 7999

• Up to 600 positioning data for each axis can be set (stored) in the buffer memory addresses shown on the left. These data are controlled as positioning data No.1 to No.600 for each axis.

• One positioning data is configured of the items shown in the bold box.

Axis 2	Positioning data No.	1	2	3	...	599	600
	Positioning identifier [Da.1] to [Da.5]	8000	8010	8020	...	13980	13990
	[Da.10] M code	8001	8011	8021	...	13981	13991
	[Da.9] Dwell time	8002	8012	8022	...	13982	13992
	Positioning option [Da.27] to [Da.29]	8003	8013	8023	...	13983	13993
	[Da.8] Command speed	8004 8005	8014 8015	8024 8025	...	13984 13985	13994 13995
	[Da.6] Positioning address/ movement amount	8006 8007	8016 8017	8026 8027	...	13986 13987	13996 13997
	[Da.7] Arc address	8008 8009	8018 8019	8028 8029	...	13988 13989	13998 13999

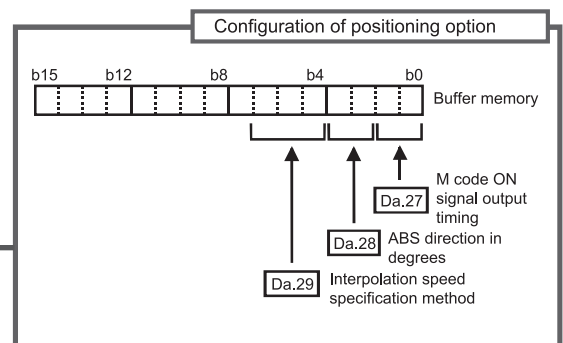
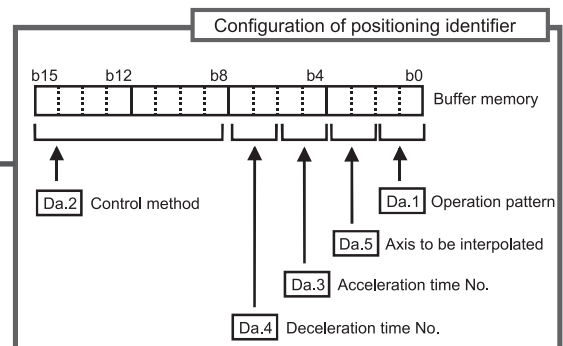

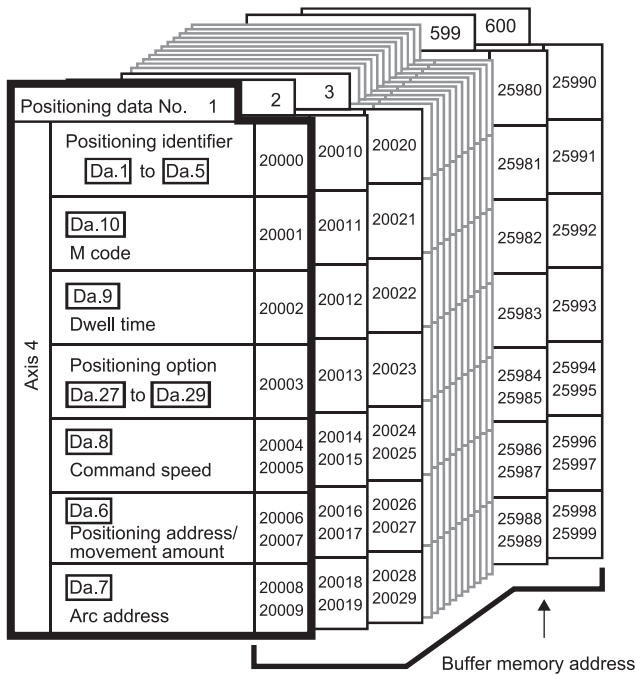
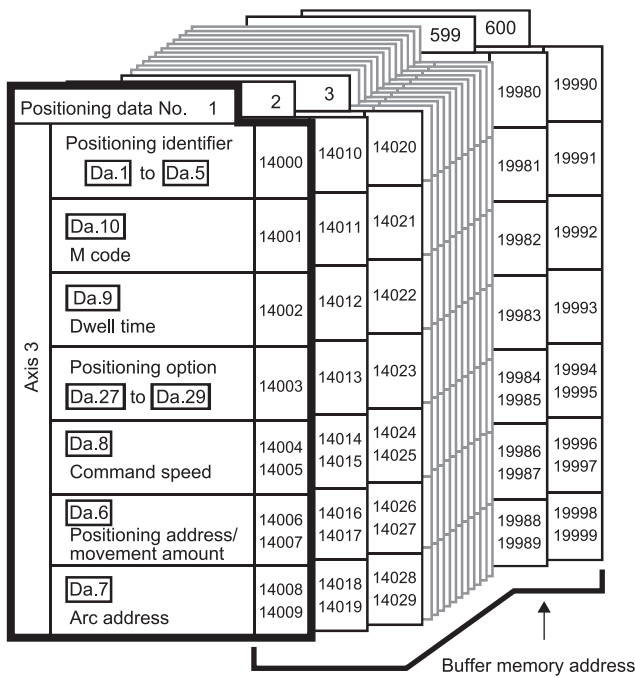

The descriptions that follow relate to the positioning data set items ([Da.1] to [Da.10], [Da.27] to [Da.29]).

(The buffer memory addresses shown are those of the "positioning data No. 1" for the axes 1 to 4.)

Positioning identifier configuration

The positioning identifier consists of "Da.1 Operation pattern" to "Da.5 Axis to be interpolated". The set values of those data are stored in one buffer memory address. Consider the positioning identifier configuration in the figure below when setting "Da.1 Operation pattern" to "Da.5 Axis to be interpolated".

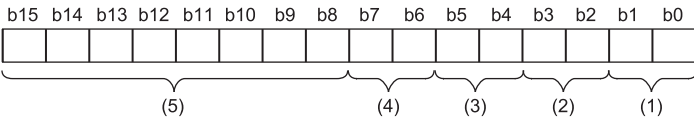
Positioning identifier configuration	Assignment	
	(1)	Da.1 Operation pattern
	(2)	Da.5 Axis to be interpolated
	(3)	Da.3 Acceleration time No.
	(4)	Da.4 Deceleration time No.
	(5)	Da.2 Control system

The following table lists the setting range and default value of each buffer memory area of the positioning identifier.

Item	Setting value		Default value	Setting value buffer memory address				
	Value set with peripheral device	Value set with sequence program		Axis 1	Axis 2	Axis 3	Axis 4	
Positioning identifier	Da.1 Operation pattern	00: Positioning complete	00	0000H	2000	8000	14000	20000
		01: Continuous positioning control	01					
		11: Continuous path control	11					
	ABS1 : 1-axis linear control (ABS)	01H						
	INC1 : 1-axis linear control (INC)	02H						
	FEED1: 1-axis fixed-feed control	03H						
	VF1 : 1-axis speed control (forward run)	04H						
	VR1 : 1-axis speed control (reverse run)	05H						
	VPF : Speed-position switching control (forward run)	06H						
	VPR : Speed-position switching control (reverse run)	07H						
	PVF : Position-speed switching control (forward run)	08H						
	PVR : Position-speed switching control (reverse run)	09H						
	ABS2 : 2-axis linear interpolation control (ABS)	0AH						
	INC2 : 2-axis linear interpolation control (INC)	0BH						
	FEED2: Fixed-feed control by 2-axis linear interpolation	0CH						
	ABS : Circular interpolation control with sub point specified (ABS)	0DH						
	INC : Circular interpolation control with sub point specified (INC)	0EH						
	ABS : Circular interpolation control with center point specified (ABS, CW)	0FH						
	ABS : Circular interpolation control with center point specified (ABS, CCW)	10H						
	INC : Circular interpolation control with center point specified (INC, CW)	11H						
	INC : Circular interpolation control with center point specified (INC, CCW)	12H						
	VF2 : 2-axis speed control (forward run)	13H						
	VR2 : 2-axis speed control (reverse run)	14H						
	Da.2 Control system	ABS3 : 3-axis linear interpolation control (ABS)	15H					
		INC3 : 3-axis linear interpolation control (INC)	16H					
		FEED3: Fixed-feed control by 3-axis linear interpolation control	17H					
	VF3 : 3-axis speed control (forward run)	18H						
	VR3 : 3-axis speed control (reverse run)	19H						
	ABSH : Helical interpolation control with sub point designation (ABS)	20H						
	INCH : Helical interpolation control with sub point designation (INC)	21H						
	ABSH : Helical interpolation control with center point designation (ABS, CW)	22H						
	ABSH : Helical interpolation control with center point designation (ABS, CCW)	23H						
	INCH : Helical interpolation control with center point designation (INC, CW)	24H						
	INCH : Helical interpolation control with center point designation (INC, CCW)	25H						
	ABS4 : 4-axis linear interpolation control (ABS)	1AH						
	INC4 : 4-axis linear interpolation control (INC)	1BH						
	FEED4: Fixed-feed control by 4-axis linear interpolation control	1CH						
	VF4 : 4-axis speed control (forward run)	1DH						
	VR4 : 4-axis speed control (reverse run)	1EH						
	NOP : NOP instruction	80H						
POS : Current value changing	81H							
JUMP : JUMP instruction	82H							
LOOP : Declares the beginning of LOOP to LEND section	83H							
LEND : Declares the end of LOOP to LEND section	84H							
Da.3 Acceleration time No.	0: Pr.9 Acceleration time 0	00						
	1: Pr.25 Acceleration time 1	01						
	2: Pr.26 Acceleration time 2	10						
	3: Pr.27 Acceleration time 3	11						
Da.4 Deceleration time No.	0: Pr.10 Deceleration time 0	00						
	1: Pr.28 Deceleration time 1	01						
	2: Pr.29 Deceleration time 2	10						
	3: Pr.30 Deceleration time 3	11						
Da.5 Axis to be interpolated	0: Axis 1	00						
	1: Axis 2	01						
	2: Axis 3	10						
	3: Axis 4	11						

**Da.1** Operation pattern

The operation pattern designates whether positioning of a certain data No. is to be ended with just that data, or whether the positioning for the next data No. is to be carried out in succession.

[Operation pattern]

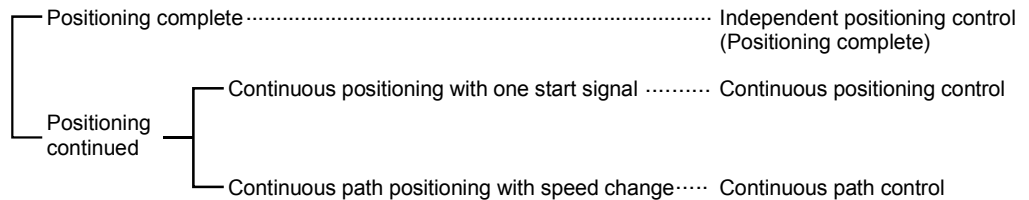

- 1) Positioning complete..... Set to execute positioning to the designated address, and then complete positioning.
- 2) Continuous positioning control ..... Positioning is carried out successively in order of data Nos. with one start signal. The operation halts at each position indicated by a positioning data.
- 3) Continuous path control..... Positioning is carried out successively in order of data Nos. with one start signal. The operation does not stop at each positioning data.

**Da.2** Control system

Set the "control system" for carrying out positioning control.

- Note)
- When "JUMP instruction" is set for the control system, the " **Da.9** Dwell time" and " **Da.10** M code" setting details will differ.
  - In case you selected "LOOP" as the control system, the " **Da.10** M code" should be set differently from other cases.
  - Refer to CHAPTER 9 "MAJOR POSITIONING CONTROL" for details on the control systems.
  - If "degree" is set for " **Pr.1** Unit setting", circular interpolation control or 3-axis helical interpolation control cannot be carried out. The error "Circular interpolation not possible" (error code: 535) will occur when executed.
  - The 3-axis helical interpolation control can be set only for the QD75N with a serial number (first five digits) of "17102" or later. If the 3-axis helical interpolation control is set for the QD75N with a serial number (first five digits) earlier than "17102", the error "Control system setting error" (error code: 524) will occur.

**Da.3** Acceleration time No.

Set which of "acceleration time 0 to 3" to use for the acceleration time during positioning.

- 0 : Use the value set in " **Pr.9** Acceleration time 0".
- 1 : Use the value set in " **Pr.25** Acceleration time 1".
- 2 : Use the value set in " **Pr.26** Acceleration time 2".
- 3 : Use the value set in " **Pr.27** Acceleration time 3".

**Da.4** Deceleration time No.

Set which of "deceleration time 0 to 3" to use for the deceleration time during positioning.

- 0 : Use the value set in " **Pr.10** Deceleration time 0".
- 1 : Use the value set in " **Pr.28** Deceleration time 1".
- 2 : Use the value set in " **Pr.29** Deceleration time 2".
- 3 : Use the value set in " **Pr.30** Deceleration time 3".



**Da.5** Axis to be interpolated

Set the target axis (partner axis) for operations under the 2-axis interpolation control, and the circular interpolation axis for operations under the 3-axis helical interpolation control.

0 : Selects the axis 1 as the target axis (partner axis).

1 : Selects the axis 2 as the target axis (partner axis).

2 : Selects the axis 3 as the target axis (partner axis).

3 : Selects the axis 4 as the target axis (partner axis).

Note) • Do not specify the own axis number or any number except the above. (If you do, the error "Illegal interpolation description command" (error code: 521) will occur during the program execution.)

- For 3-axis interpolation other than 3-axis helical interpolation control or 4-axis interpolation, this item does not need to be set.
- The following table lists the target axes for the 3-axis helical interpolation control.

Reference axis	Circular interpolation axis	Linear interpolation axis
Axis 1	Axis 2	Axis 3
	Axis 3	Axis 2
Axis 2	Axis 3	Axis 4
	Axis 4	Axis 3
Axis 3	Axis 4	Axis 1
	Axis 1	Axis 4
Axis 4	Axis 1	Axis 2
	Axis 2	Axis 1

Item	Setting value, setting range		Default value	Setting value buffer memory address			
	Value set with peripheral device	Value set with sequence program		Axis 1	Axis 2	Axis 3	Axis 4
<b>Da.6</b> Positioning address/ movement amount	The setting value range differs according to the " <b>Da.2</b> Control system". Here, the value within the following range of [Table 1] range is set.		0	2006 2007	8006 8007	14006 14007	20006 20007



**Da.6** Positioning address/movement amount

Set the address to be used as the target value for positioning control.  
 The setting value range differs according to the " **Da.2** Control system".  
 ((1) to (4))

(1) Absolute (ABS) system, current value changing

- The setting value (positioning address) for the ABS system and current value changing is set with an absolute address (address from OP).

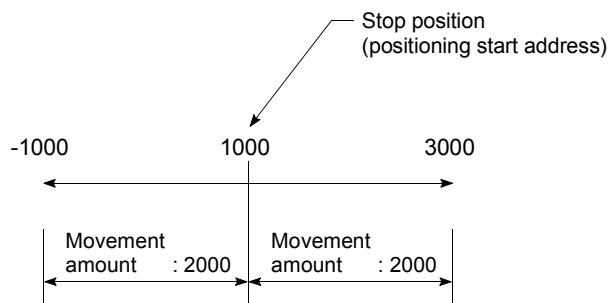

(2) Incremental (INC) system, fixed-feed 1, fixed-feed 2, fixed-feed 3, fixed-feed 4

- The setting value (movement amount) for the INC system is set as a movement amount with sign.

When movement amount is positive: Moves in the positive direction (address increment direction)

When movement amount is negative: Moves in the negative direction (address decrement direction)

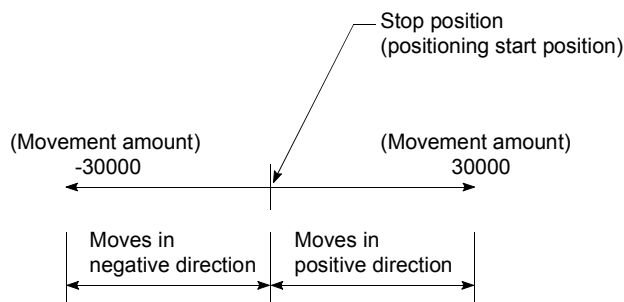

[Table 1]

■ When " Pr.1 Unit Setting" is "mm"

The table below lists the control systems that require the setting of the positioning address or movement amount and the associated setting ranges.

(With any control system excluded from the table below, neither the positioning address nor the movement amount needs to be set.)

Da.2 setting value	Value set with peripheral device ( $\mu\text{m}$ )	Value set with sequence program *1 ( $\times 10^{-1}\mu\text{m}$ )
ABS Linear 1 : 01H ABS Linear 2 : 0AH ABS Linear 3 : 15H ABS Linear 4 : 1AH Current value changing : 81H	◇ Set the address -214748364.8 to 214748364.7	◇ Set the address -2147483648 to 2147483647
INC Linear 1 : 02H INC Linear 2 : 0BH INC Linear 3 : 16H INC Linear 4 : 1BH Fixed-feed 1 : 03H Fixed-feed 2 : 0CH Fixed-feed 3 : 17H Fixed-feed 4 : 1CH	◇ Set the movement amount -214748364.8 to 214748364.7	◇ Set the movement amount -2147483648 to 2147483647
Forward run speed/position : 06H Reverse run speed/position : 07H Forward run position/speed : 08H Reverse run position/speed : 09H	◇ Set the movement amount 0 to 214748364.7	◇ Set the movement amount 0 to 2147483647
ABS circular sub : 0DH ABS circular right : 0FH ABS circular left : 10H	◇ Set the address -214748364.8 to 214748364.7	◇ Set the address -2147483648 to 2147483647
INC circular sub : 0EH INC circular right : 11H INC circular left : 12H	◇ Set the movement amount -214748364.8 to 214748364.7	◇ Set the movement amount -2147483648 to 2147483647
ABS helical sub : 20H ABS helical right : 22H ABS helical left : 23H	◇ Set the address -214748364.8 to 214748364.7	◇ Set the address -2147483648 to 2147483647
INC helical sub : 21H INC helical right : 24H INC helical left : 25H	◇ Set the movement amount -214748364.8 to 214748364.7	◇ Set the movement amount -2147483648 to 2147483647

\*1: Set an integer because the sequence program cannot handle fractions.  
(The value will be converted properly within the system.)

(3) Speed-position switching control

- INC mode:  
Set the amount of movement after the switching from speed control to position control.
- ABS mode:  
Set the absolute address which will be the target value after speed control is switched to position control. (The unit is "degree" only)

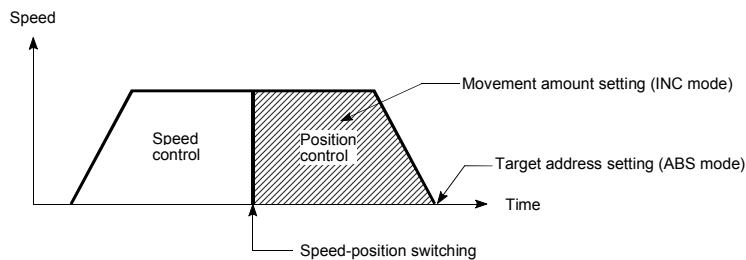

(4) Position-speed switching control

- Set the amount of movement before the switching from position control to speed control.

■ When " Pr.1 Unit Setting" is "degree"

The table below lists the control systems that require the setting of the positioning address or movement amount and the associated setting ranges.  
(With any control system excluded from the table below, neither the positioning address nor the movement amount needs to be set.)

Da.2 setting value	Value set with peripheral device (degree)	Value set with sequence program *1 ( $\times 10^{-5}$ degree)
ABS Linear 1 : 01H ABS Linear 2 : 0AH ABS Linear 3 : 15H ABS Linear 4 : 1AH Current value changing : 81H	◇ Set the address 0 to 359.99999	◇ Set the address 0 to 35999999
INC Linear 1 : 02H INC Linear 2 : 0BH INC Linear 3 : 16H INC Linear 4 : 1BH Fixed-feed 1 : 03H Fixed-feed 2 : 0CH Fixed-feed 3 : 17H Fixed-feed 4 : 1CH	◇ Set the movement amount -21474.83648 to 21474.83647	◇ Set the movement amount -2147483648 to 2147483647
ABS helical sub : 20H*2 ABS helical right : 22H*2 ABS helical left : 23H*2	◇ Set the address 0 to 359.99999	◇ Set the address 0 to 35999999
INC helical sub : 21H*2 INC helical right : 24H*2 INC helical left : 25H*2	◇ Set the movement amount -21474.83648 to 21474.83647	◇ Set the movement amount -2147483648 to 2147483647
Forward run speed/position : 06H Reverse run speed/position : 07H	In INC mode ◇ Set the movement amount 0 to 21474.83647 In ABS mode ◇ Set the address 0 to 359.99999	In INC mode ◇ Set the movement amount 0 to 2147483647 In ABS mode ◇ Set the address 0 to 35999999
Forward run position/speed : 08H Reverse run position/speed : 09H	◇ Set the movement amount 0 to 21474.83647	◇ Set the movement amount 0 to 2147483647

\*1: Set an integer because the sequence program cannot handle fractions.  
(The value will be converted properly within the system.)

\*2: In the 3-axis helical interpolation control, "degree" can be set only for the linear interpolation axis.

■ When " Pr.1 Unit Setting" is "pulse"

The table below lists the control systems that require the setting of the positioning address or movement amount and the associated setting ranges.

(With any control system excluded from the table below, neither the positioning address nor the movement amount needs to be set.)

Da.2 setting value	Value set with peripheral device (pulse)	Value set with sequence program *1 (pulse)
ABS Linear 1 : 01H ABS Linear 2 : 0AH ABS Linear 3 : 15H ABS Linear 4 : 1AH Current value changing : 81H	◇ Set the address -2147483648 to 2147483647	◇ Set the address -2147483648 to 2147483647
INC Linear 1 : 02H INC Linear 2 : 0BH INC Linear 3 : 16H INC Linear 4 : 1BH Fixed-feed 1 : 03H Fixed-feed 2 : 0CH Fixed-feed 3 : 17H Fixed-feed 4 : 1CH	◇ Set the movement amount -2147483648 to 2147483647	◇ Set the movement amount -2147483648 to 2147483647
Forward run speed/position : 06H Reverse run speed/position : 07H Forward run position/speed : 08H Reverse run position/speed : 09H	◇ Set the movement amount 0 to 2147483647	◇ Set the movement amount 0 to 2147483647
ABS circular sub : 0DH ABS circular right : 0FH ABS circular left : 10H	◇ Set the address -2147483648 to 2147483647	◇ Set the address -2147483648 to 2147483647
INC circular sub : 0EH INC circular right : 11H INC circular left : 12H	◇ Set the movement amount -2147483648 to 2147483647	◇ Set the movement amount -2147483648 to 2147483647
ABS helical sub : 20H ABS helical right : 22H ABS helical left : 23H	◇ Set the address -2147483648 to 2147483647	◇ Set the address -2147483648 to 2147483647
INC helical sub : 21H INC helical right : 24H INC helical left : 25H	◇ Set the movement amount -2147483648 to 2147483647	◇ Set the movement amount -2147483648 to 2147483647

■ When " Pr.1 Unit Setting" is "inch"

The table below lists the control systems that require the setting of the positioning address or movement amount and the associated setting ranges.

(With any control system excluded from the table below, neither the positioning address nor the movement amount needs to be set.)

Da.2 setting value	Value set with peripheral device (inch)	Value set with sequence program *1 ( $\times 10^{-5}$ inch)
ABS Linear 1 : 01H ABS Linear 2 : 0AH ABS Linear 3 : 15H ABS Linear 4 : 1AH Current value changing : 81H	◇ Set the address -21474.83648 to 21474.83647	◇ Set the address -2147483648 to 2147483647
INC Linear 1 : 02H INC Linear 2 : 0BH INC Linear 3 : 16H INC Linear 4 : 1BH Fixed-feed 1 : 03H Fixed-feed 2 : 0CH Fixed-feed 3 : 17H Fixed-feed 4 : 1CH	◇ Set the movement amount -21474.83648 to 21474.83647	◇ Set the movement amount -2147483648 to 2147483647
Forward run speed/position : 06H Reverse run speed/position : 07H Forward run position/speed : 08H Reverse run position/speed : 09H	◇ Set the movement amount 0 to 21474.83647	◇ Set the movement amount 0 to 2147483647
ABS circular sub : 0DH ABS circular right : 0FH ABS circular left : 10H	◇ Set the address -21474.83648 to 21474.83647	◇ Set the address -2147483648 to 2147483647
INC circular sub : 0EH INC circular right : 11H INC circular left : 12H	◇ Set the movement amount -21474.83648 to 21474.83647	◇ Set the movement amount -2147483648 to 2147483647
ABS helical sub : 20H ABS helical right : 22H ABS helical left : 23H	◇ Set the address -21474.83648 to 21474.83647	◇ Set the address -2147483648 to 2147483647
INC helical sub : 21H INC helical right : 24H INC helical left : 25H	◇ Set the movement amount -21474.83648 to 21474.83647	◇ Set the movement amount -2147483648 to 2147483647

\*1: Set an integer because the sequence program cannot handle fractions.  
(The value will be converted properly within the system.)

Item	Setting value, setting range		Default value	Setting value buffer memory address			
	Value set with peripheral device	Value set with sequence program		Axis 1	Axis 2	Axis 3	Axis 4
<b>Da.7</b> Arc address	The setting value range differs according to the " <b>Da.2</b> Control system". Here, the value within the [Table 1] range is set. <div style="border: 1px solid gray; padding: 5px; display: inline-block; margin-top: 10px;"> <b>[Table 1]</b> on next page                 </div>		0	2008 2009	8008 8009	14008 14009	20008 20009

**Da.7** Arc address

The arc address is data required only when the circular interpolation control or 3-axis helical interpolation control is carried out.

- (1) When carrying out circular interpolation with sub point designation, set the sub point (passing point) address as the arc address.
- (2) When carrying out circular interpolation with center point designation, set the center point address of the arc as the arc address.

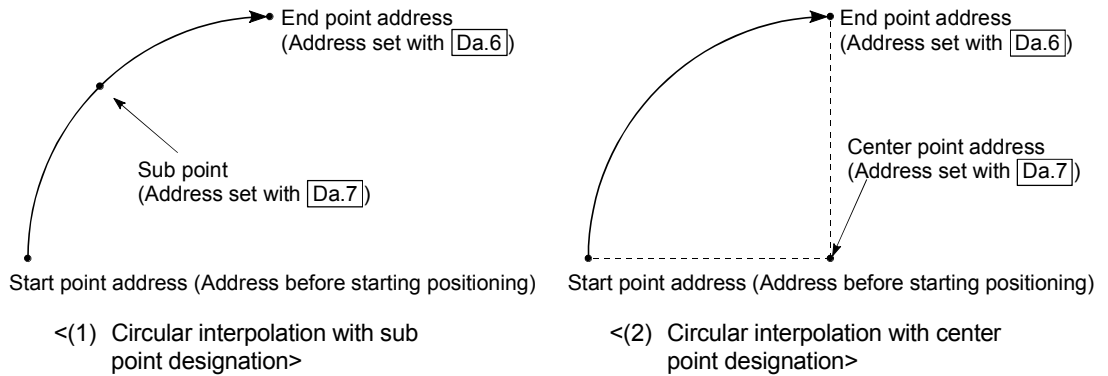

When the circular interpolation control or 3-axis helical interpolation control is not carried out, the value set in "**Da.7** Arc address" will be invalid.

[Table 1]

■ When " **Pr.1** Unit Setting" is "mm"

The table below lists the control systems that require the setting of the arc address and shows the setting range.

(With any control system excluded from the table below, the arc address does not need to be set.)

<b>Da.2</b> setting value	Value set with peripheral device ( $\mu\text{m}$ )	Value set with sequence program *1 ( $\times 10^{-1}\mu\text{m}$ )
ABS circular sub : 0D <sub>H</sub> ABS circular right : 0F <sub>H</sub> ABS circular left : 10 <sub>H</sub>	◇ Set the address -214748364.8 to 214748364.7	◇ Set the address -2147483648 to 2147483647
INC circular sub : 0E <sub>H</sub> INC circular right : 11 <sub>H</sub> INC circular left : 12 <sub>H</sub>	◇ Set the movement amount -214748364.8 to 214748364.7	◇ Set the movement amount -2147483648 to 2147483647
ABS helical sub : 20 <sub>H</sub> ABS helical right : 22 <sub>H</sub> ABS helical left : 23 <sub>H</sub>	◇ Set the address -214748364.8 to 214748364.7	◇ Set the address -2147483648 to 2147483647
INC helical sub : 21 <sub>H</sub> INC helical right : 24 <sub>H</sub> INC helical left : 25 <sub>H</sub>	◇ Set the movement amount -214748364.8 to 214748364.7 *2	◇ Set the movement amount -2147483648 to 2147483647 *2

\*1: Set an integer because the sequence program cannot handle fractions.  
(The value will be converted properly within the system.)

\*2: Note that the maximum radius that circular interpolation control is possible is 536870912, although the setting value can be input within the range shown in the above table, as an arc address.

■ When " **Pr.1** Unit Setting" is "degree"

No control system requires the setting of the arc address by "degree".

■ When " **Pr.1** Unit Setting" is "pulse"

The table below lists the control systems that require the setting of the arc address and shows the setting range.

(With any control system excluded from the table below, the arc address does not need to be set.)

<b>Da.2</b> setting value	Value set with peripheral device (pulse)	Value set with sequence program (pulse)
ABS circular sub : 0D <sub>H</sub> ABS circular right : 0F <sub>H</sub> ABS circular left : 10 <sub>H</sub>	◇ Set the address -2147483648 to 2147483647	◇ Set the address -2147483648 to 2147483647
INC circular sub : 0E <sub>H</sub> INC circular right : 11 <sub>H</sub> INC circular left : 12 <sub>H</sub>	◇ Set the movement amount -2147483648 to 2147483647 *1	◇ Set the movement amount -2147483648 to 2147483647 *1
ABS helical sub : 20 <sub>H</sub> ABS helical right : 22 <sub>H</sub> ABS helical left : 23 <sub>H</sub>	◇ Set the address -2147483648 to 2147483647	◇ Set the address -2147483648 to 2147483647
INC helical sub : 21 <sub>H</sub> INC helical right : 24 <sub>H</sub> INC helical left : 25 <sub>H</sub>	◇ Set the movement amount -2147483648 to 2147483647 *1	◇ Set the movement amount -2147483648 to 2147483647 *1

\*1: Note that the maximum radius that circular interpolation control is possible is 536870912, although the setting value can be input within the range shown in the above table, as an arc address.



■ When " Pr.1 Unit Setting" is "inch"

The table below lists the control systems that require the setting of the arc address and shows the setting range.

(With any control system excluded from the table below, the arc address does not need to be set.)

Da.2 setting value	Value set with peripheral device (inch)	Value set with sequence program *1 ( $\times 10^{-5}$ inch)
ABS circular sub : 0D <sub>H</sub> ABS circular right : 0F <sub>H</sub> ABS circular left : 10 <sub>H</sub>	◇ Set the address -21474.83648 to 21474.83647	◇ Set the address -2147483648 to 2147483647
INC circular sub : 0E <sub>H</sub> INC circular right : 11 <sub>H</sub> INC circular left : 12 <sub>H</sub>	◇ Set the movement amount -21474.83648 to 21474.83647	◇ Set the movement amount -2147483648 to 2147483647
ABS helical sub : 20 <sub>H</sub> ABS helical right : 22 <sub>H</sub> ABS helical left : 23 <sub>H</sub>	◇ Set the address -21474.83648 to 21474.83647	◇ Set the address -2147483648 to 2147483647
INC helical sub : 21 <sub>H</sub> INC helical right : 24 <sub>H</sub> INC helical left : 25 <sub>H</sub>	◇ Set the movement amount -21474.83648 to 21474.83647 *2	◇ Set the movement amount -2147483648 to 2147483647 *2

\*1: Set an integer because the sequence program cannot handle fractions.  
(The value will be converted properly within the system.)

\*2: Note that the maximum radius that circular interpolation control is possible is 536870912, although the setting value can be input within the range shown in the above table, as an arc address.

Item	Setting value, setting range		Default value	Setting value buffer memory address			
	Value set with peripheral device	Value set with sequence program		Axis 1	Axis 2	Axis 3	Axis 4
<b>Da.8</b> Command speed	The setting value range differs depending on the " <b>Pr.1</b> Unit setting". Here, the value within the [Table 1] range is set. <div style="text-align: center; border: 1px solid gray; padding: 5px; margin: 10px 0;"> <b>[Table 1]</b> on next page                 </div> <hr/> -1: Current speed (Speed set for previous positioning data No.)		0	2004 2005	8004 8005	14004 14005	20004 20005
<b>Da.9</b> Dwell time	Dwell time JUMP destination positioning data No.	The setting value range differs according to the " <b>Da.2</b> Control system". Here, the value within the [Table 2] range is set. <div style="text-align: center; border: 1px solid gray; padding: 5px; margin: 10px 0;"> <b>[Table 2]</b> on next page                 </div>	0	2002	8002	14002	20002
<b>Da.10</b> M code	M code Condition data No. No. of LOOP to LEND repetitions	The setting value range differs according to the " <b>Da.2</b> Control system". Here, the value within the [Table 3] range is set. <div style="text-align: center; border: 1px solid gray; padding: 5px; margin: 10px 0;"> <b>[Table 3]</b> on next page                 </div>	0	2001	8001	14001	20001

**Da.8** Command speed

Set the command speed for positioning.

- (1) If the set command speed exceeds " **Pr.8** Speed limit value", positioning will be carried out at the speed limit value.
- (2) If "-1" is set for the command speed, the current speed (speed set for previous positioning data No.) will be used for positioning control. Use the current speed for uniform speed control, etc. If "-1" is set for continuing positioning data, and the speed is changed, the following speed will also change.

(Note that when starting positioning, if the "-1" speed is set for the positioning data that carries out positioning control first, the error "No command speed" (error code: 503) will occur, and the positioning will not start. Refer to Section 15.3 "List of errors" for details on the errors.)

**Da.10** M code (or condition data No./No. of LOOP to LEND repetitions)

Set an "M code", a "condition data No.", or the "number of LOOP to LEND repetitions" depending on how the "**Da.2** Control system" is set.

- If a method other than "JUMP instruction" and "LOOP" is selected as the "**Da.2** Control system"
  - ..... Set an "M code".
    - If no "M code" needs to be output, set "0" (default value).
- If "3-axis helical interpolation control" is selected as the "**Da.2** Control system": Set the number of pitch for the linear interpolation axis. Set the rotation speed of the circular interpolation as the number of pitch.
- If "JUMP instruction" is selected as the "**Da.2** Control system"
  - ..... Set the "condition data No." for JUMP.
    - 0 : Unconditional JUMP to the positioning data specified by **Da.9**.
    - 1 to 10 : JUMP performed according to the condition data No. specified (a number between 1 and 10).
- If "LOOP" is selected as the "**Da.2** Control system"
  - ..... Set the number of LOOP to LEND repetitions by a number other than "0".
    - The error "Control system LOOP setting error" (error code: 545) will occur if you specify "0".

\* The condition data specifies the condition for the JUMP instruction to be executed. (A JUMP will take place when the condition is satisfied.)

[Table 1]

<b>Pr.1</b> setting value	Value set with peripheral device (unit)	Value set with sequence program (unit)
0 : mm	0.01 to 20000000.00 (mm/min)	1 to 2000000000 ( $\times 10^{-2}$ mm/min)
1 : inch	0.001 to 2000000.000 (inch/min)	1 to 2000000000 ( $\times 10^{-3}$ inch/min)
2 : degree	0.001 to 2000000.000 (degree/min)	1 to 2000000000 ( $\times 10^{-3}$ degree/min)
3 : pulse	1 to 1000000 (pulse/s) * 1	[QD75P□/QD75D□] 1 to 4000000 (pulse/s) [QD75P□/QD75D□] 1 to 1000000 (pulse/s)

\* 1: In GX Configurator-QP, the QD75P□/QD75D□ are recognized as the QD75P□/QD75D□. Therefore, the setting ranges are the same as those of the QD75P□/QD75D□. To set a value outside a setting range in GX Configurator-QP, set it through a sequence program or GX Works2. The setting ranges in GX Works2 are the same as those in sequence programs. (Refer to Appendix 1.2)

[Table 2]

<b>Da.2</b> setting value	Setting item	Value set with peripheral device	Value set with sequence program
JUMP instruction: 82 <sub>H</sub>	Positioning data No.	1 to 600	1 to 600
Other than JUMP instruction	Dwell time	0 to 65535 (ms)	0 to 65535 (ms)

[Table 3]

<b>Da.2</b> setting value	Setting item	Value set with peripheral device	Value set with sequence program
JUMP instruction: 82 <sub>H</sub>	Condition data No.	0 to 10	0 to 10
LOOP: 83 <sub>H</sub>	Repetition count	1 to 65535	1 to 65535
Helical interpolation: 20 <sub>H</sub> to 25 <sub>H</sub>	Number of pitch	0 to 999	0 to 999
Other than the above	M code	0 to 65535	0 to 65535

**Da.9** Dwell time (JUMP designation positioning data No.)

Set the "dwell time" or "positioning data No." corresponding to the " **Da.2** Control system".

- When a method other than "JUMP instruction " is set for " **Da.2** Control system"
  - ..... Set the "dwell time".
- When "JUMP instruction " is set for " **Da.2** Control system"
  - ..... Set the "positioning data No." for the JUMP destination.

When the "dwell time" is set, the setting details of the "dwell time" will be as follows according to " **Da.1** Operation pattern".

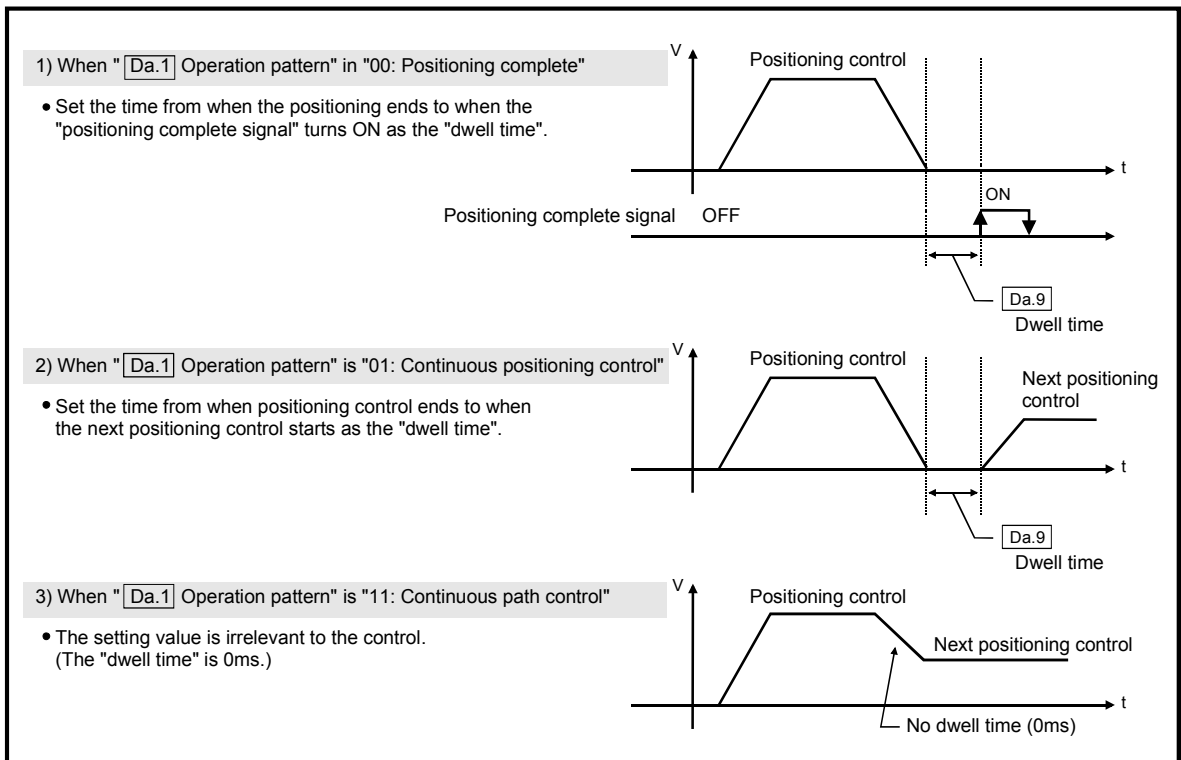

Item	Setting value, setting range		Default value	Setting value buffer memory address			
	Value set with peripheral	Value set with sequence program		Axis 1	Axis 2	Axis 3	Axis 4
Positioning option	Da.27 M code ON signal output timing	0: Use the set value in "Pr.18 M code ON signal output timing".	0	2003	8003	14003	20003
		1: WITH mode	1				
		2: AFTER mode	2				
	Da.28 ABS direction in degrees	0: Use the set value in "Cd.40 ABS direction in degrees".	0				
		1: ABS clockwise	1				
		2: ABS counterclockwise	2				
	Da.29 Interpolation speed designation method	0: Use the set value in "Pr.20 Interpolation speed designation method".	0				
		1: Composite speed	1				
		2: Reference axis speed	2				

Positioning option configuration

The positioning option consists of "Da.27 M code ON signal output timing" to "Da.29 Interpolation speed designation method". The set values of those data are stored in one buffer memory address. Consider the positioning option configuration in the figure below when setting "Da.27 M code ON signal output timing" to "Da.29 Interpolation speed designation method".

Positioning option configuration	Assignment
b15 b14 b13 b12 b11 b10 b9 b8 b7 b6 b5 b4 b3 b2 b1 b0	(1) Da.27 M code ON signal output timing
	(2) Da.28 ABS direction in degrees
	(3) Da.29 Interpolation speed designation method
	(4) Use prohibited (fixed to 0)

Da.27 M code ON signal output timing

Set the M code ON signal output timing for each positioning data.

Da.28 ABS direction in degrees

Set the ABS moving direction when "degree" is selected as the unit for each positioning data.

Da.29 Interpolation speed designation method

Set the interpolation speed designation method for each positioning data.

POINTS
(1) To use the positioning option, set "1: Valid" in Pr.70 Positioning option valid/invalid setting.
(2) The positioning option can be set only with GX Works2 (Version 1.540N or later) or sequence programs.
(3) The positioning option can be set only for the QD75N with a serial number (first five digits) of "17102" or later. If a value is set for the positioning option of the QD75N with a serial number (first five digits) earlier than "17102" and a positioning control is started, the value set in the positioning option is ignored.

5.4 List of block start data

The illustrations below show the organization of the block start data stored in the QD75 buffer memory. The block start data setting items **Da.11** to **Da.14** are explained in the pages that follow.

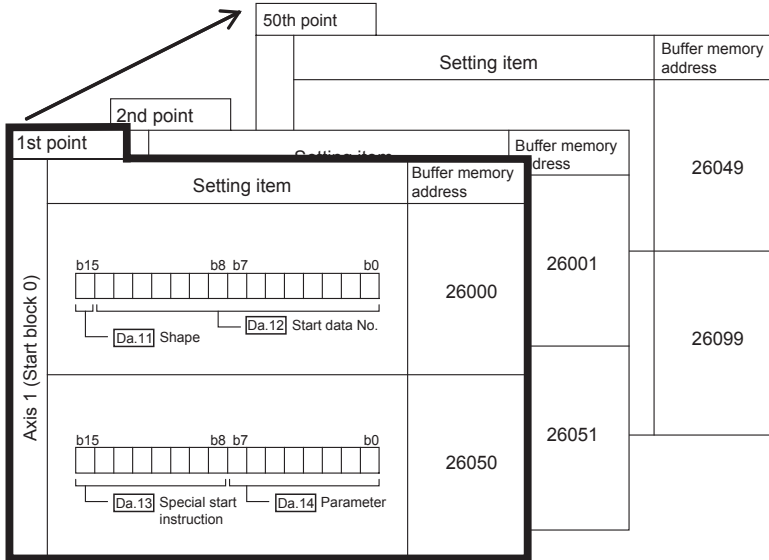

- Up to 50 block start data points can be set (stored) for each axis in the buffer memory addresses shown on the left.
- Items in a single unit of block start data are shown included in a bold frame. **□**
- Each axis has five start blocks (block Nos. 0 to 4).

\* For information on the organization of the buffer memory addresses assigned to the start blocks 1 to 4, refer to Appendix 13 "List of buffer memory addresses".

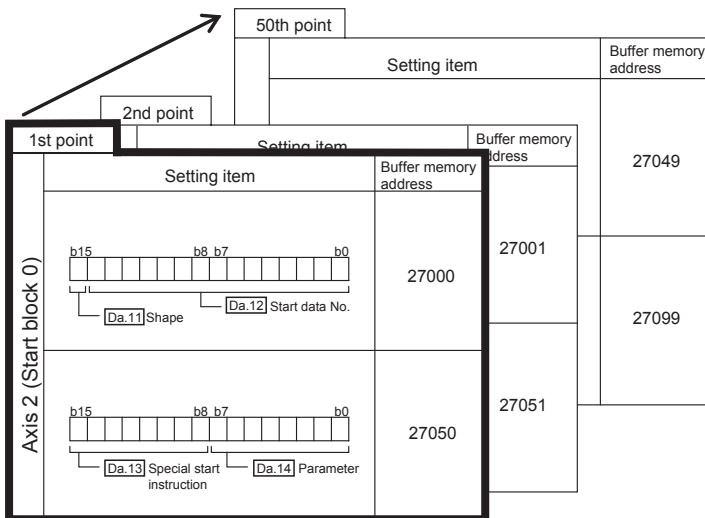

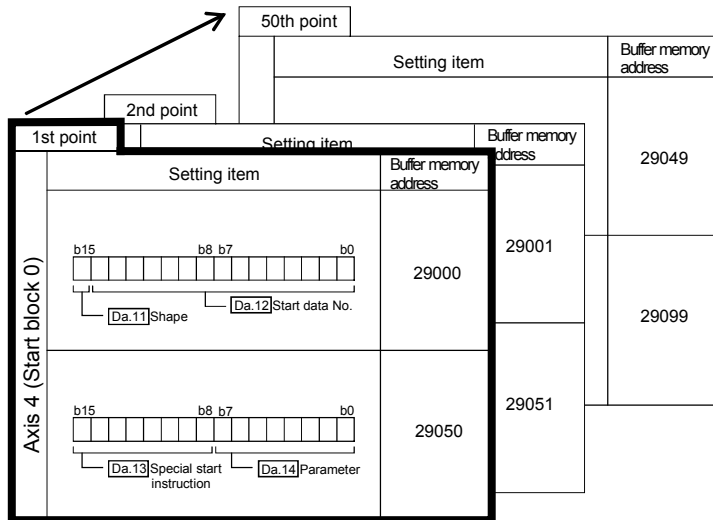
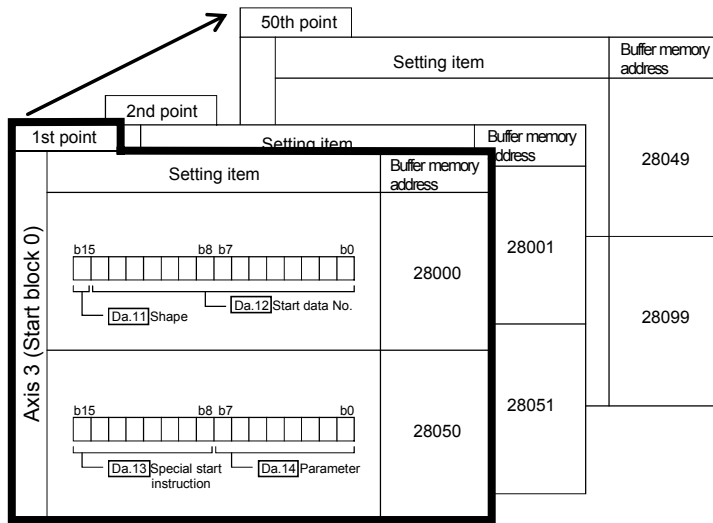

The pages that follow explain the block start data setting items (Da.11 to Da.14).  
 (The buffer memory addresses shown are those of the "1st point block start data (block No. 7000)" for the axes 1 to 4.)

**REMARK**

To perform an high-level positioning control using block start data, set a number between 7000 and 7004 to the " [Cd.3] Positioning start No." and use the " [Cd.4] Positioning starting point No." to specify a point number between 1 and 50, a position counted from the beginning of the block.

The number between 7000 and 7004 specified here is called the "block No.".

With the QD75, up to 50 "block start data" points and up to 10 "condition data" items can be assigned to each "block No.".

Block No. *	Axis	Block start data	Condition	Buffer memory	GX Configurator-QP
7000	Axis 1	Start block 0	Condition data (1 to 10)	Supports the settings	Supports the settings
	Axis 2		Condition data (1 to 10)		
	Axis 3		Condition data (1 to 10)		
	Axis 4		Condition data (1 to 10)		
7001	Axis 1	Start block 1	Condition data (1 to 10)		
	Axis 2		Condition data (1 to 10)		
	Axis 3		Condition data (1 to 10)		
	Axis 4		Condition data (1 to 10)		
7002	Axis 1	Start block 2	Condition data (1 to 10)		
	Axis 2		Condition data (1 to 10)		
	Axis 3		Condition data (1 to 10)		
	Axis 4		Condition data (1 to 10)		
7003	Axis 1	Start block 3	Condition data (1 to 10)		
	Axis 2		Condition data (1 to 10)		
	Axis 3		Condition data (1 to 10)		
	Axis 4		Condition data (1 to 10)		
7004	Axis 1	Start block 4	Condition data (1 to 10)		
	Axis 2		Condition data (1 to 10)		
	Axis 3		Condition data (1 to 10)		
	Axis 4		Condition data (1 to 10)		

\*: Setting cannot be made when the "Pre-reading start function" is used. If you set any of Nos. 7000 to 7004 and perform the Pre-reading start function, the error "Outside start No. range" (error code: 543) will occur.  
(For details, refer to Section 12.7.7 "Pre-reading start function".)



Item	Setting value		Default value	Setting value buffer memory address				
	Value set with peripheral device	Value set with sequence program		Axis 1	Axis 2	Axis 3	Axis 4	
<b>Da.11</b> Shape	0 : End <hr/> 1 : Continue	0 <hr/> 1		0000 <sub>H</sub>	26000	27000	28000	29000
<b>Da.12</b> Start data No.	Positioning data No.: 1 to 600 (01 <sub>H</sub> to 258 <sub>H</sub> )	01 <sub>H</sub> to 258 <sub>H</sub>						
<b>Da.13</b> Special start instruction	0 : Block start (normal start) <hr/> 1 : Condition start <hr/> 2 : Wait start <hr/> 3 : Simultaneous start <hr/> 4 : FOR loop <hr/> 5 : FOR condition <hr/> 6 : NEXT start	00 <sub>H</sub> <hr/> 01 <sub>H</sub> <hr/> 02 <sub>H</sub> <hr/> 03 <sub>H</sub> <hr/> 04 <sub>H</sub> <hr/> 05 <sub>H</sub> <hr/> 06 <sub>H</sub>		0000 <sub>H</sub>	26050	27050	28050	29050
<b>Da.14</b> Parameter	Condition data No.: 1 to 10 (01 <sub>H</sub> to 0A <sub>H</sub> ) No. of repetitions: 0 to 255 (00 <sub>H</sub> to FF <sub>H</sub> )	00 <sub>H</sub> to FF <sub>H</sub>						

**Da.11** Shape

Set whether to carry out only the local "block start data" and then end control, or to execute the "block start data" set in the next point.

Setting value	Setting details
0 : End	Execute the designated point's "block start data", and then complete the control.
1 : Continue	Execute the designated point's "block start data", and after completing control, execute the next point's "block start data".

**Da.12** Start data No.

Set the "positioning data No." designated with the "block start data".

**Da.13** Special start instruction

Set the "special start instruction " for using "high-level positioning control". (Set how to start the positioning data set in " **Da.12** Start data No.".)

Setting value	Setting details
00 <sub>H</sub> : Block start (Normal start)	Execute the random block positioning data in the set order with one start.
01 <sub>H</sub> : Condition start	Carry out the condition judgment set in "condition data" for the designated positioning data, and when the conditions are established, execute the "block start data". If not established, ignore that "block start data", and then execute the next point's "block start data".
02 <sub>H</sub> : Wait start	Carry out the condition judgment set in "condition data" for the designated positioning data, and when the conditions are established, execute the "block start data". If not established, stop the control (wait) until the conditions are established.
03 <sub>H</sub> : Simultaneous start	Simultaneous execute (output pulses at same timing) the positioning data with the No. designated for the axis designated in the "condition data". Up to four axes can start simultaneously.
04 <sub>H</sub> : Repeated start (FOR loop)	Repeat the program from the block start data with the "FOR loop" to the block start data with "NEXT" for the designated No. of times.
05 <sub>H</sub> : Repeated start (FOR condition)	Repeat the program from the block start data with the "FOR condition" to the block start data with "NEXT" until the conditions set in the "condition data" are established.
06 <sub>H</sub> : NEXT start	Set the end of the repetition when "05 <sub>H</sub> : Repetition start (FOR loop)" or "06 <sub>H</sub> : Repetition start (FOR condition)" is set.

Refer to CHAPTER 10 "HIGH-LEVEL POSITIONING CONTROL" for details on the control.

**Da.14** ParameterSet the value as required for " **Da.13** Special start instruction ".

<b>Da.13</b> Special start instruction	Setting value	Setting details
Block start (Normal start)	–	Not used. (There is no need to set.)
Condition start	1 to 10	Set the condition data No. (No. of "condition data" set to perform condition judgment) (For details of the condition data, refer to Section 5.5.)
Wait start		
Simultaneous start		
Repeated start (FOR loop)	0 to 255	Set the No. of repetitions.
Repeated start (FOR condition)	1 to 10	Set the condition data No. (No. of "condition data" set to perform condition judgment) (For details of the condition data, refer to Section 5.5.)

5.5 List of condition data

The illustrations below show the organization of the condition data stored in the QD75 buffer memory. The condition data setting items **Da.15** to **Da.19** are explained in the pages that follow.

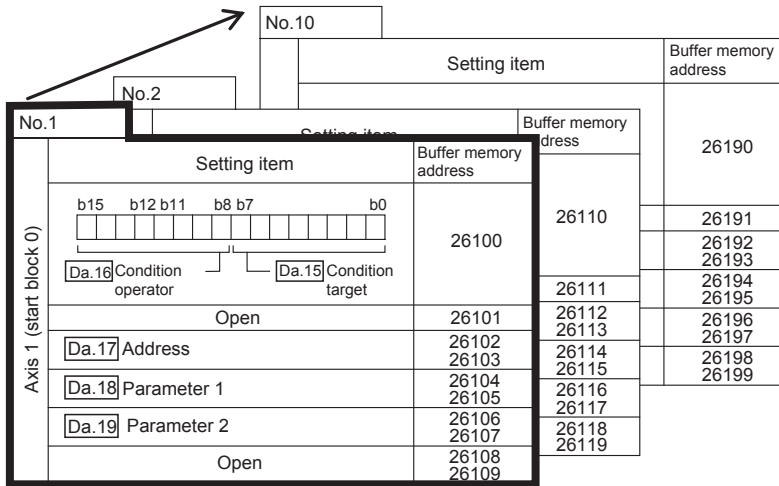

- Up to 10 block start data points can be set (stored) for each block No. in the buffer memory addresses shown on the left.
  - Items in a single unit of condition data are shown included in a bold frame.
  - Each axis has five start blocks (block Nos. 0 to 4).
- \* For information on the organization of the buffer memory addresses assigned to the start blocks 1 to 4, refer to Appendix 13 "List of buffer memory addresses".

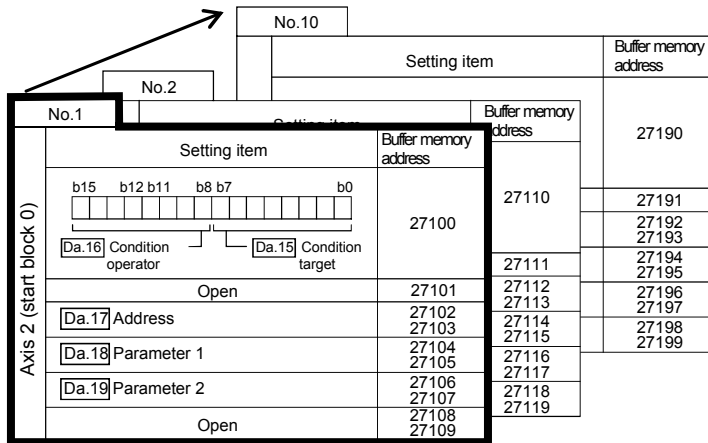

		No.10		
		No.2	Setting item	Buffer memory address
		No.1	Setting item	Buffer memory address
Axis 3 (start block 0)	Setting item		Buffer memory address	28190
	Setting item		Buffer memory address	28110
	<div style="display: flex; justify-content: space-between;"> <span>b15</span> <span>b12 b11</span> <span>b8 b7</span> <span>b0</span> </div>		28100	28191
	<div style="display: flex; justify-content: space-between;"> <span>Da.16 Condition operator</span> <span>Da.15 Condition target</span> </div>			28192
	Open		28101	28193
	Da.17 Address		28102	28111
	Da.18 Parameter 1		28103	28112
	Da.19 Parameter 2		28104	28113
	Open		28105	28114
	Open		28106	28115
	Open		28107	28116
	Open		28108	28117
	Open		28109	28118
Open			28119	

		No.10		
		No.2	Setting item	Buffer memory address
		No.1	Setting item	Buffer memory address
Axis 4 (start block 0)	Setting item		Buffer memory address	29190
	Setting item		Buffer memory address	29110
	<div style="display: flex; justify-content: space-between;"> <span>b15</span> <span>b12 b11</span> <span>b8 b7</span> <span>b0</span> </div>		29100	29191
	<div style="display: flex; justify-content: space-between;"> <span>Da.16 Condition operator</span> <span>Da.15 Condition target</span> </div>			29192
	Open		29101	29193
	Da.17 Address		29102	29111
	Da.18 Parameter 1		29103	29112
	Da.19 Parameter 2		29104	29113
	Open		29105	29114
	Open		29106	29115
	Open		29107	29116
	Open		29108	29117
	Open		29109	29118
Open			29119	

The pages that follow explain the condition data setting items (Da.15 to Da.19).  
 (The buffer memory addresses shown are those of the "condition data No. 1 (block No. 7000)" for the axes 1 to 4.)

**REMARK**

To perform an high-level positioning control using block start data, set a number between 7000 and 7004 to the " [Cd.3] Positioning start No." and use the " [Cd.4] Positioning starting point No." to specify a point number between 1 and 50, a position counted from the beginning of the block.

The number between 7000 and 7004 specified here is called the "block No.".

With the QD75, up to 50 "block start data" points and up to 10 "condition data" items can be assigned to each "block No.".

Block No. *	Axis	Block start data	Condition	Buffer memory	GX Configurator-QP
7000	Axis 1	Start block 0	Condition data (1 to 10)	Supports the settings	Supports the settings
	Axis 2		Condition data (1 to 10)		
	Axis 3		Condition data (1 to 10)		
	Axis 4		Condition data (1 to 10)		
7001	Axis 1	Start block 1	Condition data (1 to 10)		
	Axis 2		Condition data (1 to 10)		
	Axis 3		Condition data (1 to 10)		
	Axis 4		Condition data (1 to 10)		
7002	Axis 1	Start block 2	Condition data (1 to 10)		
	Axis 2		Condition data (1 to 10)		
	Axis 3		Condition data (1 to 10)		
	Axis 4		Condition data (1 to 10)		
7003	Axis 1	Start block 3	Condition data (1 to 10)		
	Axis 2		Condition data (1 to 10)		
	Axis 3		Condition data (1 to 10)		
	Axis 4		Condition data (1 to 10)		
7004	Axis 1	Start block 4	Condition data (1 to 10)		
	Axis 2		Condition data (1 to 10)		
	Axis 3		Condition data (1 to 10)		
	Axis 4		Condition data (1 to 10)		

\*: Setting cannot be made when the "Pre-reading start function" is used. If you set any of Nos. 7000 to 7004 and perform the Pre-reading start function, the error "Outside start No. range" (error code: 543) will occur.  
(For details, refer to Section 12.7.7 "Pre-reading start function".)

Item	Setting value		Default value	Setting value buffer memory address					
	Value set with peripheral device	Value set with sequence program		Axis 1	Axis 2	Axis 3	Axis 4		
Condition identifier	Da.15 Condition target	01 : Device X	01H		0000H	26100	27100	28100	29100
		02 : Device Y	02H						
		03 : Buffer memory (1-word)	03H						
		04 : Buffer memory (2-word)	04H						
		05 : Positioning data No.	05H						
	Da.16 Condition operator	01 : **=P1	01H						
		02 : **≠P1	02H						
		03 : **≤P1	03H						
		04 : **≥P1	04H						
		05 : P1≤**≤ P2	05H						
		06 : **≤P1, P2≤**	06H						
		07 : DEV=ON	07H						
		08 : DEV=OFF	08H						
		10 : Axis 1 selected	10H						
		20 : Axis 2 selected	20H						
		30 : Axes 1 and 2 selected	30H						
		40 : Axis 3 selected	40H						
		50 : Axes 1 and 3 selected	50H						
		60 : Axes 2 and 3 selected	60H						
		70 : Axes 1, 2, and 3 selected	70H						
80 : Axis 4 selected	80H								
90 : Axes 1 and 4 selected	90H								
A0 : Axes 2 and 4 selected	A0H								
B0 : Axes 1, 2, and 4 selected	B0H								
C0 : Axes 3 and 4 selected	C0H								
D0 : Axes 1, 3, and 4 selected	D0H								
E0 : Axes 2, 3, and 4 selected	E0H								
Da.17 Address	Buffer memory address	Example) 	0000H	26102 26103	27102 27103	28102 28103	29102 29103		
Da.18 Parameter 1	Value	Example) 	0000H	26104 26105	27104 27105	28104 28105	29104 29105		
Da.19 Parameter 2	Value	Example) 	0000H	26106 26107	27106 27107	28106 28107	29106 29107		

**Da.15** Condition target

Set the condition target as required for each control.

Setting value	Setting details
01H : Device X	Set the input/output signal ON/OFF of the QD75 as the conditions.
02H : Device Y	
03H : Buffer memory (1-word)	Set the value stored in the buffer memory as the condition. 03H: The target buffer memory is "1-word (16 bits)" 04H: The target buffer memory is "2-word (32 bits)"
04H : Buffer memory (2-word)	
05H : Positioning data No.	Select only for "simultaneous start".

**Da.16** Condition operatorSet the condition operator as required for the " **Da.15** Condition target".

<b>Da.15</b> Condition target	Setting value	Setting details
01H: Device X	07H : DEV=ON	The state (ON/OFF) of an I/O signal is defined as the condition. Select ON or OFF as the trigger.
02H: Device Y	08H : DEV=OFF	
03H: Buffer memory (1-word)	01H : **=P1	Select how to use the value (**) in the buffer memory as a part of the condition.
04H: Buffer memory (2-word)	02H : **≠P1	
	03H : **≤P1	
	04H : **≥P1	
	05H : P1≤**≤P2	
	06H : **≤P1, P2≤**	
05H: Positioning data No.	10H : Axis 1 selected	If "simultaneous start" is specified, select the axis (or axes) that should start simultaneously.
	20H : Axis 2 selected	
	30H : Axes 1 and 2 selected	
	40H : Axis 3 selected	
	50H : Axes 1 and 3 selected	
	60H : Axes 2 and 3 selected	
	70H : Axes 1, 2, and 3 selected	
	80H : Axis 4 selected	
	90H : Axes 1 and 4 selected	
	A0H : Axes 2 and 4 selected	
	B0H : Axes 1, 2, and 4 selected	
	C0H : Axes 3 and 4 selected	
D0H : Axes 1, 3, and 4 selected		
E0H : Axes 2, 3, and 4 selected		

**Da.17** AddressSet the address as required for the " **Da.15** Condition target".

<b>Da.15</b> Condition target	Setting value	Setting details
01H : Device X	-	Not used. (There is no need to set.)
02H : Device Y		
03H : Buffer memory (1-word)	Value (Buffer memory address)	Set the target "buffer memory address". (For 2 word, set the low-order buffer memory address.)
04H : Buffer memory (2-word)		
05H : Positioning data No.	-	Not used. (There is no need to set.)



## Da.18 Parameter 1

Set the parameters as required for the " Da.16 Condition operator".

Da.16 Condition operator	Setting value	Setting details
01H : **=P1	Value	The value of P1 should be equal to or smaller than the value of P2. ( $P1 \leq P2$ ) If P1 is greater than P2 ( $P1 > P2$ ), the error "Condition data error" (error code 533) will occur.
02H : **≠P1		
03H : **≤P1		
04H : **≥P1		
05H : $P1 \leq ** \leq P2$		
06H : **≤P1, $P2 \leq **$		
07H : DEV=ON	Value (bit No.)	Set the device bit No. X: 0H to 1H, 4H to 17H Y: 0, 4H to 17H
08H : DEV=OFF		
10H : Axis 1 selected	Value (positioning data No.)	Set the positioning data No. for starting axis 1 and/or axis 2. Low-order 16-bit : Axis 1 positioning data No. 1 to 600 (01H to 258H) High-order 16-bit : Axis 2 positioning data No. 1 to 600 (01H to 258H)
↓		
E0H : Axes 2, 3, and 4 selected		

## Da.19 Parameter 2

Set the parameters as required for the " Da.16 Condition operator".

Da.16 Condition operator	Setting value	Setting details
01H : **=P1	—	Not used. (No need to be set.)
02H : **≠P1		
03H : **≤P1		
04H : **≥P1		
05H : $P1 \leq ** \leq P2$	Value	The value of P2 should be equal to or greater than the value of P1. ( $P1 \leq P2$ ) If P1 is greater than P2 ( $P1 > P2$ ), the error "Condition data error" (error code 533) will occur.
06H : **≤P1, $P2 \leq **$		
07H : DEV=ON	—	Not used. (No need to be set.)
08H : DEV=OFF		
10H : Axis 1 selected		
20H : Axis 2 selected		
30H : Axes 1 and 2 selected		
40H : Axis 3 selected	Value (positioning data No.)	Set the positioning data No. for starting axis 3 and/or axis 4. Low-order 16-bit : Axis 3 positioning data No. 1 to 600 (01H to 258H) High-order 16-bit : Axis 4 positioning data No. 1 to 600 (01H to 258H)
50H : Axes 1 and 3 selected		
60H : Axes 2 and 3 selected		
70H : Axes 1, 2, and 3 selected		
80H : Axis 4 selected		
90H : Axes 1 and 4 selected		
A0H : Axes 2 and 4 selected		
B0H : Axes 1, 2, and 4 selected		
C0H : Axes 3 and 4 selected		
D0H : Axes 1, 3, and 4 selected		
E0H : Axes 2, 3, and 4 selected		

## 5.6 List of monitor data

## 5.6.1 System monitor data

Storage item	Storage details	
Md.1 In test mode flag	Whether the mode is the test mode from the peripheral device or not is stored. <ul style="list-style-type: none"><li>• When not in test mode : OFF</li><li>• When in test mode : ON</li></ul>	

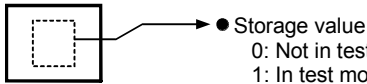
	Reading the monitor value	Default value	Storage buffer memory address (common for axis 1 to axis 4)
<p>■ Monitoring is carried out with a decimal.</p>	<p>Monitor value</p>  <p>Storage value 0: Not in test mode 1: In test mode</p>	0	1200

(Unless noted in particular, the monitor value is saved as binary data.)

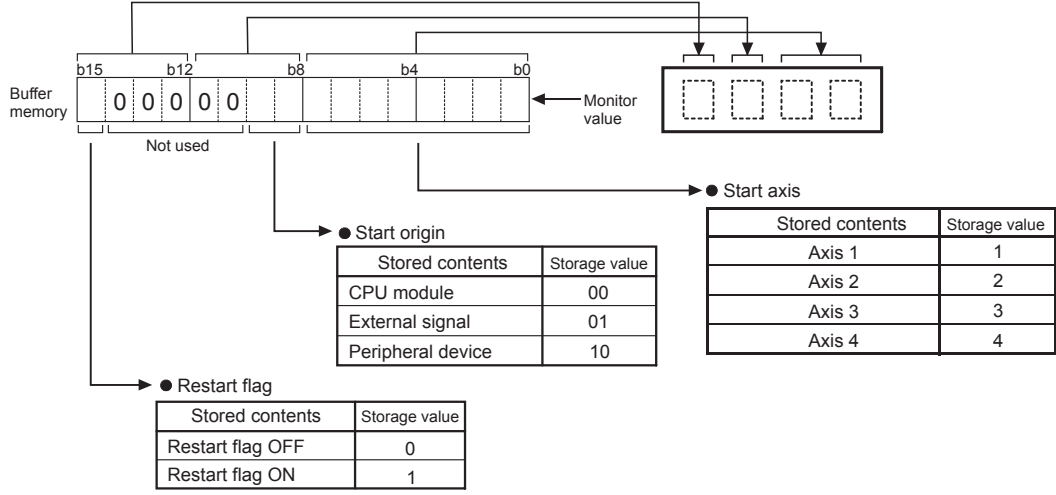
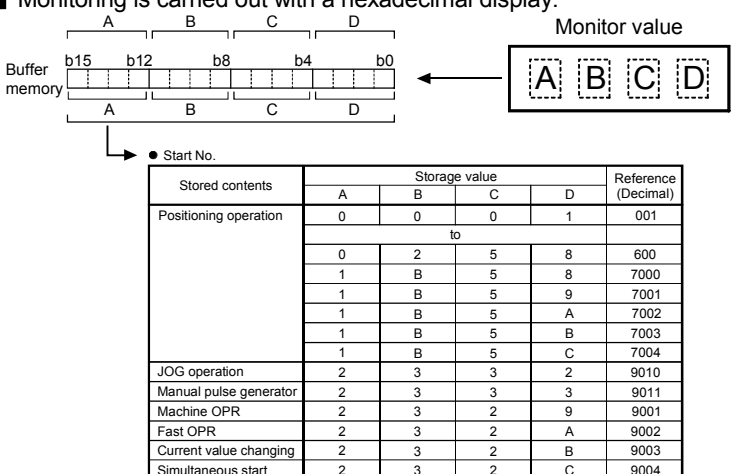
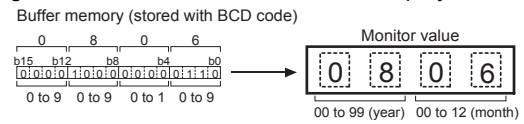
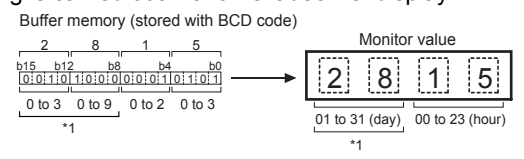
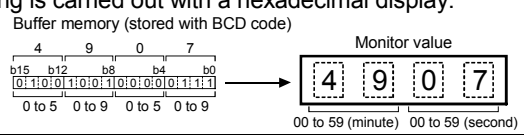
Storage item	Storage details	Reading the monitor value																																																																																								
Starting history (Up to 16 records can be stored)	<p><b>Md.3</b> Start information</p>	<p>[Storage details] This area stores the start information (restart flag, start origin, and start axis):</p> <ul style="list-style-type: none"> <li>Restart flag: Indicates whether the operation has or has not been halted and restarted.</li> <li>Start origin: Indicates the source of the start signal.</li> <li>Start axis : Indicates the started axis.</li> </ul> <p>[Reading the monitor value] ■ Monitoring is carried out with a hexadecimal display.</p> 																																																																																								
	<p><b>Md.4</b> Start No.</p>	<p>The starting No. is stored.</p>	<p>■ Monitoring is carried out with a hexadecimal display.</p>  <table border="1"> <thead> <tr> <th rowspan="2">Stored contents</th> <th colspan="4">Storage value</th> <th rowspan="2">Reference (Decimal)</th> </tr> <tr> <th>A</th> <th>B</th> <th>C</th> <th>D</th> </tr> </thead> <tbody> <tr> <td rowspan="7">Positioning operation</td> <td>0</td> <td>0</td> <td>0</td> <td>1</td> <td>001</td> </tr> <tr> <td colspan="5" style="text-align:center">to</td> </tr> <tr> <td>0</td> <td>2</td> <td>5</td> <td>8</td> <td>600</td> </tr> <tr> <td>1</td> <td>B</td> <td>5</td> <td>8</td> <td>7000</td> </tr> <tr> <td>1</td> <td>B</td> <td>5</td> <td>9</td> <td>7001</td> </tr> <tr> <td>1</td> <td>B</td> <td>5</td> <td>A</td> <td>7002</td> </tr> <tr> <td>1</td> <td>B</td> <td>5</td> <td>B</td> <td>7003</td> </tr> <tr> <td>1</td> <td>B</td> <td>5</td> <td>C</td> <td>7004</td> </tr> <tr> <td>JOG operation</td> <td>2</td> <td>3</td> <td>3</td> <td>2</td> <td>9010</td> </tr> <tr> <td>Manual pulse generator</td> <td>2</td> <td>3</td> <td>3</td> <td>3</td> <td>9011</td> </tr> <tr> <td>Machine OPR</td> <td>2</td> <td>3</td> <td>2</td> <td>9</td> <td>9001</td> </tr> <tr> <td>Fast OPR</td> <td>2</td> <td>3</td> <td>2</td> <td>A</td> <td>9002</td> </tr> <tr> <td>Current value changing</td> <td>2</td> <td>3</td> <td>2</td> <td>B</td> <td>9003</td> </tr> <tr> <td>Simultaneous start</td> <td>2</td> <td>3</td> <td>2</td> <td>C</td> <td>9004</td> </tr> </tbody> </table>	Stored contents	Storage value				Reference (Decimal)	A	B	C	D	Positioning operation	0	0	0	1	001	to					0	2	5	8	600	1	B	5	8	7000	1	B	5	9	7001	1	B	5	A	7002	1	B	5	B	7003	1	B	5	C	7004	JOG operation	2	3	3	2	9010	Manual pulse generator	2	3	3	3	9011	Machine OPR	2	3	2	9	9001	Fast OPR	2	3	2	A	9002	Current value changing	2	3	2	B	9003	Simultaneous start	2	3	2	C	9004
	Stored contents	Storage value				Reference (Decimal)																																																																																				
		A	B	C	D																																																																																					
	Positioning operation	0	0	0	1	001																																																																																				
to																																																																																										
0		2	5	8	600																																																																																					
1		B	5	8	7000																																																																																					
1		B	5	9	7001																																																																																					
1		B	5	A	7002																																																																																					
1		B	5	B	7003																																																																																					
1	B	5	C	7004																																																																																						
JOG operation	2	3	3	2	9010																																																																																					
Manual pulse generator	2	3	3	3	9011																																																																																					
Machine OPR	2	3	2	9	9001																																																																																					
Fast OPR	2	3	2	A	9002																																																																																					
Current value changing	2	3	2	B	9003																																																																																					
Simultaneous start	2	3	2	C	9004																																																																																					
<p><b>Md.50</b> Start (Year:month)</p>	<p>The starting time (year:month) is stored. (for the QD75P□N/QD75D□N only)</p>	<p>■ Monitoring is carried out with a hexadecimal display.</p> <p>Buffer memory (stored with BCD code)</p> 																																																																																								
<p><b>Md.5</b> Start (Day:hour)</p>	<p>The following are stored.</p> <ul style="list-style-type: none"> <li>QD75P□N/QD75D□N: the starting time (day:hour)</li> <li>QD75P□/QD75D□: the starting time (hour)</li> </ul>	<p>■ Monitoring is carried out with a hexadecimal display.</p> <p>Buffer memory (stored with BCD code)</p>  <p>*1: 00(not used) is stored for QD75P□/QD75D□.</p>																																																																																								
<p><b>Md.6</b> Start (Minute:second)</p>	<p>The starting time (minute:second) is stored.</p>	<p>■ Monitoring is carried out with a hexadecimal display.</p> <p>Buffer memory (stored with BCD code)</p> 																																																																																								







Note: If a start signal is issued against an operating axis, a record relating to this event may be output before a record relating to an earlier start signal is output.

Default value	Storage buffer memory address (common to axes 1 to 4)																																																																																																																														
0000H	<div style="text-align: center;"> <table border="1" style="margin: auto;"> <tr> <td style="padding: 5px;">Md.8</td> <td style="padding: 5px;">1292</td> </tr> <tr> <td colspan="2" style="text-align: center; padding: 5px;">Start history pointer</td> </tr> </table> <p style="text-align: center;">↑ Indicates a pointer No. that is next to the Pointer No. assigned to the latest of the existing starting history records.</p> </div>		Md.8	1292	Start history pointer																																																																																																																										
Md.8	1292																																																																																																																														
Start history pointer																																																																																																																															
0000H	<div style="display: flex; align-items: center;"> <div style="margin-right: 20px;"> <p>Pointer No.</p> <p>↓</p> </div> <table border="1" style="border-collapse: collapse; text-align: center;"> <tr> <td style="width: 100px; text-align: left;">Pointer No.</td> <td>0</td><td>1</td><td>2</td><td>3</td><td>4</td><td>5</td><td>6</td><td>7</td><td>8</td><td>9</td><td>10</td><td>11</td><td>12</td><td>13</td><td>14</td><td>15</td> </tr> <tr> <td style="text-align: right;">Starting history</td> <td style="border: 2px solid black;">Md.3 Start information</td> <td style="border: 2px solid black;">1212</td><td style="border: 2px solid black;">1217</td><td style="border: 2px solid black;">1222</td><td style="border: 2px solid black;">1227</td><td style="border: 2px solid black;">1232</td><td style="border: 2px solid black;">1237</td><td style="border: 2px solid black;">1242</td><td style="border: 2px solid black;">1247</td><td style="border: 2px solid black;">1252</td><td style="border: 2px solid black;">1257</td><td style="border: 2px solid black;">1262</td><td style="border: 2px solid black;">1267</td><td style="border: 2px solid black;">1272</td><td style="border: 2px solid black;">1277</td><td style="border: 2px solid black;">1282</td><td style="border: 2px solid black;">1287</td> </tr> <tr> <td></td> <td style="border: 2px solid black;">Md.4 Start No.</td> <td style="border: 2px solid black;">1213</td><td style="border: 2px solid black;">1218</td><td style="border: 2px solid black;">1223</td><td style="border: 2px solid black;">1228</td><td style="border: 2px solid black;">1233</td><td style="border: 2px solid black;">1238</td><td style="border: 2px solid black;">1243</td><td style="border: 2px solid black;">1248</td><td style="border: 2px solid black;">1253</td><td style="border: 2px solid black;">1258</td><td style="border: 2px solid black;">1263</td><td style="border: 2px solid black;">1268</td><td style="border: 2px solid black;">1273</td><td style="border: 2px solid black;">1278</td><td style="border: 2px solid black;">1283</td><td style="border: 2px solid black;">1288</td> </tr> <tr> <td></td> <td style="border: 2px solid black;">Md.50 Start year: month</td> <td style="border: 2px solid black;">1440</td><td style="border: 2px solid black;">1441</td><td style="border: 2px solid black;">1442</td><td style="border: 2px solid black;">1443</td><td style="border: 2px solid black;">1444</td><td style="border: 2px solid black;">1445</td><td style="border: 2px solid black;">1446</td><td style="border: 2px solid black;">1447</td><td style="border: 2px solid black;">1448</td><td style="border: 2px solid black;">1449</td><td style="border: 2px solid black;">1450</td><td style="border: 2px solid black;">1451</td><td style="border: 2px solid black;">1452</td><td style="border: 2px solid black;">1453</td><td style="border: 2px solid black;">1454</td><td style="border: 2px solid black;">1455</td> </tr> <tr> <td></td> <td style="border: 2px solid black;">Md.5 Start day: hour</td> <td style="border: 2px solid black;">1214</td><td style="border: 2px solid black;">1219</td><td style="border: 2px solid black;">1224</td><td style="border: 2px solid black;">1229</td><td style="border: 2px solid black;">1234</td><td style="border: 2px solid black;">1239</td><td style="border: 2px solid black;">1244</td><td style="border: 2px solid black;">1249</td><td style="border: 2px solid black;">1254</td><td style="border: 2px solid black;">1259</td><td style="border: 2px solid black;">1264</td><td style="border: 2px solid black;">1269</td><td style="border: 2px solid black;">1274</td><td style="border: 2px solid black;">1279</td><td style="border: 2px solid black;">1284</td><td style="border: 2px solid black;">1289</td> </tr> <tr> <td></td> <td style="border: 2px solid black;">Md.6 Start min: sec</td> <td style="border: 2px solid black;">1215</td><td style="border: 2px solid black;">1220</td><td style="border: 2px solid black;">1225</td><td style="border: 2px solid black;">1230</td><td style="border: 2px solid black;">1235</td><td style="border: 2px solid black;">1240</td><td style="border: 2px solid black;">1245</td><td style="border: 2px solid black;">1250</td><td style="border: 2px solid black;">1255</td><td style="border: 2px solid black;">1260</td><td style="border: 2px solid black;">1265</td><td style="border: 2px solid black;">1270</td><td style="border: 2px solid black;">1275</td><td style="border: 2px solid black;">1280</td><td style="border: 2px solid black;">1285</td><td style="border: 2px solid black;">1290</td> </tr> <tr> <td></td> <td style="border: 2px solid black;">Md.7 Error judgement</td> <td style="border: 2px solid black;">1216</td><td style="border: 2px solid black;">1221</td><td style="border: 2px solid black;">1226</td><td style="border: 2px solid black;">1231</td><td style="border: 2px solid black;">1236</td><td style="border: 2px solid black;">1241</td><td style="border: 2px solid black;">1246</td><td style="border: 2px solid black;">1251</td><td style="border: 2px solid black;">1256</td><td style="border: 2px solid black;">1261</td><td style="border: 2px solid black;">1266</td><td style="border: 2px solid black;">1271</td><td style="border: 2px solid black;">1276</td><td style="border: 2px solid black;">1281</td><td style="border: 2px solid black;">1286</td><td style="border: 2px solid black;">1291</td> </tr> </table> </div>		Pointer No.	0	1	2	3	4	5	6	7	8	9	10	11	12	13	14	15	Starting history	Md.3 Start information	1212	1217	1222	1227	1232	1237	1242	1247	1252	1257	1262	1267	1272	1277	1282	1287		Md.4 Start No.	1213	1218	1223	1228	1233	1238	1243	1248	1253	1258	1263	1268	1273	1278	1283	1288		Md.50 Start year: month	1440	1441	1442	1443	1444	1445	1446	1447	1448	1449	1450	1451	1452	1453	1454	1455		Md.5 Start day: hour	1214	1219	1224	1229	1234	1239	1244	1249	1254	1259	1264	1269	1274	1279	1284	1289		Md.6 Start min: sec	1215	1220	1225	1230	1235	1240	1245	1250	1255	1260	1265	1270	1275	1280	1285	1290		Md.7 Error judgement	1216	1221	1226	1231	1236	1241	1246	1251	1256	1261	1266	1271	1276	1281	1286	1291
Pointer No.	0	1	2	3	4	5	6	7	8	9	10	11	12	13	14	15																																																																																																															
Starting history	Md.3 Start information	1212	1217	1222	1227	1232	1237	1242	1247	1252	1257	1262	1267	1272	1277	1282	1287																																																																																																														
	Md.4 Start No.	1213	1218	1223	1228	1233	1238	1243	1248	1253	1258	1263	1268	1273	1278	1283	1288																																																																																																														
	Md.50 Start year: month	1440	1441	1442	1443	1444	1445	1446	1447	1448	1449	1450	1451	1452	1453	1454	1455																																																																																																														
	Md.5 Start day: hour	1214	1219	1224	1229	1234	1239	1244	1249	1254	1259	1264	1269	1274	1279	1284	1289																																																																																																														
	Md.6 Start min: sec	1215	1220	1225	1230	1235	1240	1245	1250	1255	1260	1265	1270	1275	1280	1285	1290																																																																																																														
	Md.7 Error judgement	1216	1221	1226	1231	1236	1241	1246	1251	1256	1261	1266	1271	1276	1281	1286	1291																																																																																																														
0000H	<p style="text-align: center;">↑ Item</p> <p style="text-align: center;">↑ Buffer memory address</p>	<ul style="list-style-type: none"> <li>• Each group of buffer memory addresses storing a complete starting history record is assigned a pointer No.</li> <li>Example: Pointer No. 0 = Buffer memory addresses 1212 to 1216, 1440</li> <li>Pointer No. 1 = Buffer memory addresses 1217 to 1221, 1441</li> <li>Pointer No. 2 = Buffer memory addresses 1222 to 1226, 1442</li> <li style="text-align: center;">⋮</li> <li>Pointer No. 15 = Buffer memory addresses 1287 to 1291, 1455</li> <li>• Each history record is assigned a pointer No. in the range between 0 and 15. If the pointer No. 15 has been assigned to a new record, the next record will be assigned the pointer number 0. (A new record replaces an older record when a pointer No. is reassigned.)</li> </ul>																																																																																																																													
0000H																																																																																																																															
0000H																																																																																																																															

Storage item	Storage details	Reading the monitor value
<p style="writing-mode: vertical-rl; transform: rotate(180deg);">Starting history (Up to 16 records can be stored)</p> <p><b>Md.7</b> Error judgment</p>	<p>[Storage details]</p> <p>This area stores the following results of the error judgment performed upon starting:</p> <ul style="list-style-type: none"> <li>• BUSY start warning flag</li> <li>• Error flag</li> <li>• Error No.</li> </ul>	<p>[Reading the monitor value] ■ Monitoring is carried out with a hexadecimal display.</p>
<p><b>Md.8</b> Start history pointer</p>	<p>Indicates a pointer No. that is next to the Pointer No. assigned to the latest of the existing starting history records.</p>	<p>■ Monitoring is carried out with a decimal display.</p> <p>Monitor value  ● Storage value (Pointer number) 0 to 15</p>

Default value	Storage buffer memory address (common to axes 1 to 4)																																																																																																																																	
0000H	<div style="text-align: center; margin-bottom: 10px;"> <table border="1" style="border-collapse: collapse;"> <tr> <td style="padding: 2px;">Md.8</td> <td style="padding: 2px;">1292</td> </tr> <tr> <td colspan="2" style="text-align: center; padding: 2px;">Start history pointer</td> </tr> </table> </div> <p style="text-align: center; margin-bottom: 10px;">↑ Indicates a pointer No. that is next to the Pointer No. assigned to the latest of the existing starting history records.</p> <div style="display: flex; align-items: center;"> <div style="margin-right: 10px;"> <p>Pointer No. ↓</p> </div> <table border="1" style="border-collapse: collapse; text-align: center;"> <tr> <td style="width: 100px;">Pointer No.</td> <td>0</td><td>1</td><td>2</td><td>3</td><td>4</td><td>5</td><td>6</td><td>7</td><td>8</td><td>9</td><td>10</td><td>11</td><td>12</td><td>13</td><td>14</td><td>15</td> </tr> <tr> <td style="writing-mode: vertical-rl; transform: rotate(180deg);">Starting history</td> <td style="border: 2px solid black;">Md.3 Start information</td> <td style="border: 2px solid black;">1212</td><td>1217</td><td>1222</td><td>1227</td><td>1232</td><td>1237</td><td>1242</td><td>1247</td><td>1252</td><td>1257</td><td>1262</td><td>1267</td><td>1272</td><td>1277</td><td>1282</td><td>1287</td> </tr> <tr> <td></td> <td style="border: 2px solid black;">Md.4 Start No.</td> <td style="border: 2px solid black;">1213</td><td>1218</td><td>1223</td><td>1228</td><td>1233</td><td>1238</td><td>1243</td><td>1248</td><td>1253</td><td>1258</td><td>1263</td><td>1268</td><td>1273</td><td>1278</td><td>1283</td><td>1288</td> </tr> <tr> <td></td> <td style="border: 2px solid black;">Md.5.0 Start year: month</td> <td style="border: 2px solid black;">1440</td><td>1441</td><td>1442</td><td>1443</td><td>1444</td><td>1445</td><td>1446</td><td>1447</td><td>1448</td><td>1449</td><td>1450</td><td>1451</td><td>1452</td><td>1453</td><td>1454</td><td>1455</td> </tr> <tr> <td></td> <td style="border: 2px solid black;">Md.5 Start day: hour</td> <td style="border: 2px solid black;">1214</td><td>1219</td><td>1224</td><td>1229</td><td>1234</td><td>1239</td><td>1244</td><td>1249</td><td>1254</td><td>1259</td><td>1264</td><td>1269</td><td>1274</td><td>1279</td><td>1284</td><td>1289</td> </tr> <tr> <td></td> <td style="border: 2px solid black;">Md.6 Start min: sec</td> <td style="border: 2px solid black;">1215</td><td>1220</td><td>1225</td><td>1230</td><td>1235</td><td>1240</td><td>1245</td><td>1250</td><td>1255</td><td>1260</td><td>1265</td><td>1270</td><td>1275</td><td>1280</td><td>1285</td><td>1290</td> </tr> <tr> <td></td> <td style="border: 2px solid black;">Md.7 Error judgement</td> <td style="border: 2px solid black;">1216</td><td>1221</td><td>1226</td><td>1231</td><td>1236</td><td>1241</td><td>1246</td><td>1251</td><td>1256</td><td>1261</td><td>1266</td><td>1271</td><td>1276</td><td>1281</td><td>1286</td><td>1291</td> </tr> </table> </div> <div style="margin-left: 10px; margin-top: 10px;"> <p>↑ Item</p> <p>↑ Buffer memory address</p> </div>	Md.8	1292	Start history pointer		Pointer No.	0	1	2	3	4	5	6	7	8	9	10	11	12	13	14	15	Starting history	Md.3 Start information	1212	1217	1222	1227	1232	1237	1242	1247	1252	1257	1262	1267	1272	1277	1282	1287		Md.4 Start No.	1213	1218	1223	1228	1233	1238	1243	1248	1253	1258	1263	1268	1273	1278	1283	1288		Md.5.0 Start year: month	1440	1441	1442	1443	1444	1445	1446	1447	1448	1449	1450	1451	1452	1453	1454	1455		Md.5 Start day: hour	1214	1219	1224	1229	1234	1239	1244	1249	1254	1259	1264	1269	1274	1279	1284	1289		Md.6 Start min: sec	1215	1220	1225	1230	1235	1240	1245	1250	1255	1260	1265	1270	1275	1280	1285	1290		Md.7 Error judgement	1216	1221	1226	1231	1236	1241	1246	1251	1256	1261	1266	1271	1276	1281	1286	1291
Md.8	1292																																																																																																																																	
Start history pointer																																																																																																																																		
Pointer No.	0	1	2	3	4	5	6	7	8	9	10	11	12	13	14	15																																																																																																																		
Starting history	Md.3 Start information	1212	1217	1222	1227	1232	1237	1242	1247	1252	1257	1262	1267	1272	1277	1282	1287																																																																																																																	
	Md.4 Start No.	1213	1218	1223	1228	1233	1238	1243	1248	1253	1258	1263	1268	1273	1278	1283	1288																																																																																																																	
	Md.5.0 Start year: month	1440	1441	1442	1443	1444	1445	1446	1447	1448	1449	1450	1451	1452	1453	1454	1455																																																																																																																	
	Md.5 Start day: hour	1214	1219	1224	1229	1234	1239	1244	1249	1254	1259	1264	1269	1274	1279	1284	1289																																																																																																																	
	Md.6 Start min: sec	1215	1220	1225	1230	1235	1240	1245	1250	1255	1260	1265	1270	1275	1280	1285	1290																																																																																																																	
	Md.7 Error judgement	1216	1221	1226	1231	1236	1241	1246	1251	1256	1261	1266	1271	1276	1281	1286	1291																																																																																																																	







- Each group of buffer memory addresses storing a complete starting history record is assigned a pointer No.  
Example: Pointer No. 0 = Buffer memory addresses 1212 to 1216, 1440  
Pointer No. 1 = Buffer memory addresses 1217 to 1221, 1441  
Pointer No. 2 = Buffer memory addresses 1222 to 1226, 1442  
⋮  
Pointer No. 15 = Buffer memory addresses 1287 to 1291, 1455
- Each history record is assigned a pointer No. in the range between 0 and 15. If the pointer No. 15 has been assigned to a new record, the next record will be assigned the pointer number 0. (A new record replaces an older record when a pointer No. is reassigned.)

Storage item	Storage details	Reading the monitor value																
<p><b>Md.9</b> Axis in which the error occurred</p>	<p>Stores a number (Axis No.) that indicates the axis that encountered an error.</p>	<p>■ Monitoring is carried out with a decimal display.</p> <p>Monitor value  → ● Storage value 1: Axis 1 2: Axis 2 3: Axis 3 4: Axis 4</p>																
<p><b>Md.10</b> Axis error No.</p>	<p>Stores an axis error No.</p>	<p>■ Monitoring is carried out with a decimal display.</p> <p>Monitor value  → ● Error No. For details on the error Nos. (error codes), refer to Section 15.3 "List of errors".</p>																
<p><b>Md.51</b> Axis error occurrence (Year:month)</p>	<p>Stores the time (year:month) at which an axis error was detected. (for the QD75P□N/QD75D□N only)</p>	<p>■ Monitoring is carried out with a hexadecimal display.</p> <p>Buffer memory (stored with BCD code)</p> <table border="1" data-bbox="766 907 1005 1019"> <tr> <td>0</td> <td>8</td> <td>0</td> <td>6</td> </tr> <tr> <td>b15</td> <td>b12</td> <td>b8</td> <td>b4</td> </tr> <tr> <td>01:0:0:0</td> <td>1:0:0:0</td> <td>0:0:0:0</td> <td>0:0:1:0</td> </tr> <tr> <td>0 to 9</td> <td>0 to 9</td> <td>0 to 1</td> <td>0 to 9</td> </tr> </table> <p>→ Monitor value  00 to 99 (year) 00 to 12 (month)</p>	0	8	0	6	b15	b12	b8	b4	01:0:0:0	1:0:0:0	0:0:0:0	0:0:1:0	0 to 9	0 to 9	0 to 1	0 to 9
0	8	0	6															
b15	b12	b8	b4															
01:0:0:0	1:0:0:0	0:0:0:0	0:0:1:0															
0 to 9	0 to 9	0 to 1	0 to 9															
<p><b>Md.11</b> Axis error occurrence (Day:hour)</p>	<p>The following are stored.</p> <ul style="list-style-type: none"> <li>QD75P□N/QD75D□N: the time (day:hour) at which an axis error was detected</li> <li>QD75P□/QD75D□: the time (hour) at which an axis error was detected</li> </ul>	<p>■ Monitoring is carried out with a hexadecimal display.</p> <p>Buffer memory (stored with BCD code)</p> <table border="1" data-bbox="766 1108 1005 1220"> <tr> <td>2</td> <td>8</td> <td>1</td> <td>5</td> </tr> <tr> <td>b15</td> <td>b12</td> <td>b8</td> <td>b4</td> </tr> <tr> <td>01:0:1:0</td> <td>1:0:0:0</td> <td>0:0:0:0</td> <td>0:1:1:0</td> </tr> <tr> <td>0 to 3</td> <td>0 to 9</td> <td>0 to 2</td> <td>0 to 3</td> </tr> </table> <p>*1 → Monitor value  01 to 31 (day) 00 to 23 (hour)</p> <p>*1: 00(not used) is stored for QD75P□/QD75D□.</p>	2	8	1	5	b15	b12	b8	b4	01:0:1:0	1:0:0:0	0:0:0:0	0:1:1:0	0 to 3	0 to 9	0 to 2	0 to 3
2	8	1	5															
b15	b12	b8	b4															
01:0:1:0	1:0:0:0	0:0:0:0	0:1:1:0															
0 to 3	0 to 9	0 to 2	0 to 3															
<p><b>Md.12</b> Axis error occurrence (Minute:second)</p>	<p>Stores the time (minute:second) at which an axis error was detected.</p>	<p>■ Monitoring is carried out with a hexadecimal display.</p> <p>Buffer memory (stored with BCD code)</p> <table border="1" data-bbox="766 1411 1005 1523"> <tr> <td>4</td> <td>9</td> <td>0</td> <td>7</td> </tr> <tr> <td>b15</td> <td>b12</td> <td>b8</td> <td>b4</td> </tr> <tr> <td>01:0:0:0</td> <td>1:0:0:0</td> <td>0:0:0:0</td> <td>0:0:1:1</td> </tr> <tr> <td>0 to 5</td> <td>0 to 9</td> <td>0 to 5</td> <td>0 to 9</td> </tr> </table> <p>→ Monitor value  00 to 59 (minute) 00 to 59 (second)</p>	4	9	0	7	b15	b12	b8	b4	01:0:0:0	1:0:0:0	0:0:0:0	0:0:1:1	0 to 5	0 to 9	0 to 5	0 to 9
4	9	0	7															
b15	b12	b8	b4															
01:0:0:0	1:0:0:0	0:0:0:0	0:0:1:1															
0 to 5	0 to 9	0 to 5	0 to 9															
<p><b>Md.13</b> Error history pointer</p>	<p>Indicates a pointer No. that is next to the Pointer No. assigned to the latest of the existing records.</p>	<p>■ Monitoring is carried out with a decimal display.</p> <p>Monitor value  → ● Storage value (Pointer number) 0 to 15</p>																

Error history (Up to 16 records can be stored)

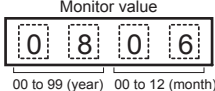

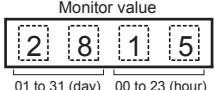
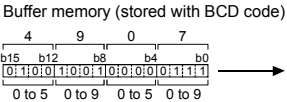
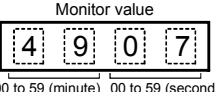
Default value	Storage buffer memory address (common to axes 1 to 4)					
0	<div style="text-align: center;"> <table border="1" style="margin: auto;"> <tr> <td style="padding: 5px;">Md.13</td> <td style="padding: 5px;">1357</td> </tr> <tr> <td colspan="2" style="text-align: center; padding: 5px;">Error history pointer</td> </tr> </table> </div>		Md.13	1357	Error history pointer	
Md.13	1357					
Error history pointer						
0	<p style="text-align: center;">Indicates a pointer No. that is next to the Pointer No. assigned to the latest of the existing error history records.</p>					
0000H						
0000H	<p style="text-align: center;">Item                      Buffer memory address</p>					
0000H	<ul style="list-style-type: none"> <li>• Each group of buffer memory addresses storing a complete error history record is assigned a pointer</li> <li>Example: Pointer No. 0 = Buffer memory addresses 1293 to 1296, 1456</li> <li>          Pointer No. 1 = Buffer memory addresses 1297 to 1300, 1457</li> <li>          Pointer No. 2 = Buffer memory addresses 1301 to 1304, 1458</li> <li>          ⋮</li> <li>          Pointer No. 15 = Buffer memory addresses 1353 to 1356, 1471</li> <li>• Each history record is assigned a pointer No. in the range between 0 and 15.</li> <li>If the pointer No. 15 has been assigned to a new record, the next record will be assigned the pointer number 0.</li> <li>(A new record replaces an older record when a pointer No. is reassigned.)</li> </ul>					
0	1357					

Storage item	Storage details	Reading the monitor value
<p><b>Md.14</b> Axis in which the warning occurred</p>	<p>Stores a number (Axis No.) that indicates the axis that encountered a warning.</p>	<p>■ Monitoring is carried out with a decimal display.</p> <p>Monitor value  ● Storage value 1: Axis 1 2: Axis 2 3: Axis 3 4: Axis 4</p>
<p><b>Md.15</b> Axis warning No.</p>	<p>Stores an axis warning No.</p>	<p>■ Monitoring is carried out with a decimal display.</p> <p>Monitor value  ● Warning No. For details of warning Nos. (warning codes), refer to Section 15.4 "List of warnings".</p>
<p><b>Md.52</b> Axis warning occurrence (Year:month)</p>	<p>Stores the time (year:month) at which an axis warning was detected. (for the QD75P□N/QD75D□N only)</p>	<p>■ Monitoring is carried out with a hexadecimal display.</p> <p>Buffer memory (stored with BCD code)   </p> <p>Monitor value </p>
<p><b>Md.16</b> Axis warning occurrence (Day:hour)</p>	<p>The following are stored.                  • QD75P□N/QD75D□N: the time (day:hour) at which an axis warning was detected                  • QD75P□/QD75D□: the time (hour) at which an axis warning was detected</p>	<p>■ Monitoring is carried out with a hexadecimal display.</p> <p>Buffer memory (stored with BCD code)   </p> <p>Monitor value </p> <p>*1: 00(not used) is stored for QD75P□/QD75D□.</p>
<p><b>Md.17</b> Axis warning occurrence (Minute:second)</p>	<p>Stores the time (minute:second) at which an axis warning was detected.</p>	<p>■ Monitoring is carried out with a hexadecimal display.</p> <p>Buffer memory (stored with BCD code)   </p> <p>Monitor value </p>
<p><b>Md.18</b> Warning history pointer</p>	<p>Indicates a pointer No. that is next to the Pointer No. assigned to the latest of the existing records.</p>	<p>■ Monitoring is carried out with a decimal display.</p> <p>Monitor value  ● Storage value (Pointer number) 0 to 15</p>
<p><b>Md.19</b> No. of write accesses to flash ROM</p>	<p>Stores the number of write accesses to the flash ROM after the power is switched ON. The count is cleared to "0" when the number of write accesses reach 26 and an error reset operation is performed.</p>	<p>■ Monitoring is carried out with a decimal display.</p> <p>Monitor value  ● Storage value 0 to 26</p>

Warning history (Up to 16 records can be stored)





## 5.6.2 Axis monitor data

Storage item	Storage details
<p><b>Md.20</b> Current feed value</p>	<p>The currently commanded address is stored. (Different from the actual motor position during operation) The current position address is stored. If "degree" is selected as the unit, the addresses will have a ring structure for values between 0 and 359.99999 degrees.</p> <ul style="list-style-type: none"> <li>• Update timing : 0.9ms (QD75P□N/QD75D□N), 1.8ms (QD75P□/QD75D□)</li> <li>• The OP address is stored when the machine OPR is completed.</li> <li>• When the current value is changed with the current value changing function, the changed value is stored.</li> </ul>
<p><b>Md.21</b> Machine feed value</p>	<p>The address of the current position according to the machine coordinates will be stored. (Different from the actual motor position during operation) Note that the current value changing function will not change the machine feed value. Under the speed control mode, the machine feed value is constantly updated always, irrespective of the parameter setting. The value will not be cleared to "0" at the beginning of fixed-feed control. Even if "degree" is selected as the unit, the addresses will not have a ring structure for values between 0 and 359.99999 degrees.</p> <ul style="list-style-type: none"> <li>• Machine coordinates: Characteristic coordinates determined with machine</li> <li>• Update timing: 0.9ms (QD75P□N/QD75D□N), 56.8ms (QD75P□/QD75D□)</li> </ul>
<p><b>Md.22</b> Feedrate</p>	<p>The command output speed of the operating workpiece is stored. (May be different from the actual motor speed during operation)</p> <ul style="list-style-type: none"> <li>• During interpolation operation, the speed is stored in the following manner. Reference axis : Composite speed or reference axis speed (Set with <b>Pr.20</b>) Interpolation axis : 0</li> <li>• Update timing: 0.9ms (QD75P□N/QD75D□N), 56.8ms (QD75P□/QD75D□)</li> </ul>
<p><b>Md.23</b> Axis error No.</p>	<p>When an axis error is detected, the error code corresponding to the error details is stored.</p> <ul style="list-style-type: none"> <li>• The latest error code is always stored. (When a new axis error occurs, the error code is overwritten.)</li> <li>• When " <b>Cd.5</b> Axis error reset" (axis control data) turns ON, the axis error No. is cleared (set to 0).</li> </ul>

Reading the monitor value	Default value	Storage buffer memory address																							
		Axis 1	Axis 2	Axis 3	Axis 4																				
<p>■ Monitoring is carried out with a hexadecimal.</p> <p>Low-order buffer memory Example) 800 b15 b12 b8 b4 b0 E F G H</p> <p>High-order buffer memory Example) 801 b31 b28 b24 b20 b16 A B C D</p> <p>◇ Sorting</p> <p>(High-order buffer memory) (Low-order buffer memory) A B C D E F G H</p> <p>◇ Converted from hexadecimal to decimal</p> <p>Decimal integer value R</p> <p>◇ Unit conversion <math>R \times 10^n</math></p> <p>Actual value</p> <ul style="list-style-type: none"> <li>● Unit conversion table (Md.20 Md.21)</li> <table border="1"> <thead> <tr> <th>n</th> <th>Unit</th> </tr> </thead> <tbody> <tr> <td>-1</td> <td>μm</td> </tr> <tr> <td>-5</td> <td>inch</td> </tr> <tr> <td>-5</td> <td>degree</td> </tr> <tr> <td>0</td> <td>pulse</td> </tr> </tbody> </table> <li>● Unit conversion table (Md.22)</li> <table border="1"> <thead> <tr> <th>n</th> <th>Unit</th> </tr> </thead> <tbody> <tr> <td>-2</td> <td>mm/min</td> </tr> <tr> <td>-3</td> <td>inch/min</td> </tr> <tr> <td>-3</td> <td>degree/min</td> </tr> <tr> <td>0</td> <td>pulse/s</td> </tr> </tbody> </table> </ul> <p>Md.20 Current feed value Md.21 Machine feed value Md.22 Feedrate</p>	n	Unit	-1	μm	-5	inch	-5	degree	0	pulse	n	Unit	-2	mm/min	-3	inch/min	-3	degree/min	0	pulse/s	0000H	800 801	900 901	1000 1001	1100 1101
n	Unit																								
-1	μm																								
-5	inch																								
-5	degree																								
0	pulse																								
n	Unit																								
-2	mm/min																								
-3	inch/min																								
-3	degree/min																								
0	pulse/s																								
	0000H	802 803	902 903	1002 1003	1102 1103																				
	0000H	804 805	904 905	1004 1005	1104 1105																				
<p>■ Monitoring is carried out with a decimal.</p> <p>Monitor value</p> <p>● Error No. For details on the error Nos. (error codes), refer to Section 15.3 "List of errors".</p>	0	806	906	1006	1106																				

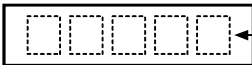
Storage item	Storage details
<p><b>[Md.24]</b> Axis warning No.</p>	<p>Whenever an axis warning is reported, a related warning code is stored.</p> <ul style="list-style-type: none"> <li>• This area stores the latest warning code always. (Whenever an axis warning is reported, a new warning code replaces the stored warning code.)</li> <li>• When the " <b>[Cd.5]</b> Axis error reset" (axis control data) is set to ON, the axis warning No. is cleared to "0".</li> </ul>
<p><b>[Md.25]</b> Valid M code</p>	<p>This area stores an M code that is currently active (i.e. set to the positioning data relating to the current operation).</p> <ul style="list-style-type: none"> <li>• Update timing : turning ON of the M code ON signal</li> </ul> <p>When the PLC READY signal (Y0) goes OFF, the value is set to "0".</p>
<p><b>[Md.26]</b> Axis operation status</p>	<p>This area stores the axis operation status.</p>
<p><b>[Md.27]</b> Current speed</p>	<p>" <b>[Da.8]</b> Command speed" of the positioning data currently in execution is stored.</p> <ul style="list-style-type: none"> <li>• If " <b>[Da.8]</b> Command speed" is set to "-1", this area stores the command speed set by the positioning data used one step earlier.</li> <li>• If " <b>[Da.8]</b> Command speed" is set to a value other than "-1", this area stores the command speed set by the current positioning data.</li> <li>• If the speed change function is executed, " <b>[Cd.14]</b> New speed value" is stored. (For details of the speed change function, refer to Section 12.5.1.)</li> </ul>

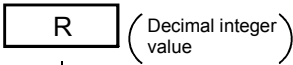
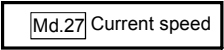
Reading the monitor value	Default value	Storage buffer memory address													
		Axis 1	Axis 2	Axis 3	Axis 4										
<p>■ Monitoring is carried out with a decimal display.</p> <p>Monitor value  ● Warning No. For details of warning Nos. (warning codes), refer to Section 15.4 "List of warnings".</p>	0	807	907	1007	1107										
<p>■ Monitoring is carried out with a decimal display.</p> <p>Monitor value  ● M code No. (0 to 65535)</p>	0	808	908	1008	1108										
<p>■ Monitoring is carried out with a decimal display.</p> <p>Monitor value  ● Axis operation status</p> <ul style="list-style-type: none"> <li>-2: Step standby</li> <li>-1: Error</li> <li>0: Standby</li> <li>1: Stopped</li> <li>2: Interpolation</li> <li>3: JOG operation</li> <li>4: Manual pulse generator operation</li> <li>5: Analyzing</li> <li>6: Special start standby</li> <li>7: OPR</li> <li>8: Position control</li> <li>9: Speed control</li> <li>10: Speed control in speed-position switching control</li> <li>11: Position control in speed-position switching control</li> <li>12: Position control in position-speed switching control</li> <li>13: Speed control in position-speed switching control</li> </ul>	0	809	909	1009	1109										
<p>■ Monitoring is carried out with a decimal display.</p> <p>Monitor value  (Decimal integer value)</p> <p>◇ Unit conversion <math>R \times 10^n</math></p> <p>Actual value </p> <p>● Unit conversion table (Md.27)</p> <table border="1" data-bbox="718 1489 933 1646"> <thead> <tr> <th>n</th> <th>Unit</th> </tr> </thead> <tbody> <tr> <td>-2</td> <td>mm/min</td> </tr> <tr> <td>-3</td> <td>inch/min</td> </tr> <tr> <td>-3</td> <td>degree/min</td> </tr> <tr> <td>0</td> <td>pulse/s</td> </tr> </tbody> </table>	n	Unit	-2	mm/min	-3	inch/min	-3	degree/min	0	pulse/s	0	810 811	910 911	1010 1011	1110 1111
n	Unit														
-2	mm/min														
-3	inch/min														
-3	degree/min														
0	pulse/s														

Storage item	Storage details	
<p><b>Md.28</b> Axis feedrate</p>	<ul style="list-style-type: none"> <li>The speed which is actually output as a command at that time in each axis is stored. (May be different from the actual motor speed)</li> <li>"0" is stored when the axis is at a stop.</li> </ul> <p>Update timing: 0.9ms (QD75P□N/QD75D□N), 56.8ms (QD75P□/QD75D□)</p>	
<p><b>Md.29</b> Speed-position switching control positioning amount</p>	<ul style="list-style-type: none"> <li>The movement amount for the position control to end after changing to position control with the speed-position switching control (INC mode) is stored. When the control method is "Reverse run: position/speed", the negative value is stored.</li> </ul>	
<p><b>Md.30</b> External input/output signal</p>	<p>The ON/OFF state of the external input/output signal is stored. The following items are stored.</p> <ul style="list-style-type: none"> <li>Upper limit signal</li> <li>Lower limit signal</li> <li>Drive unit READY signal</li> <li>Stop signal</li> <li>External command signal</li> <li>Zero signal</li> <li>Near-point dog signal</li> <li>Deviation counter clear signal</li> </ul> <p>Update timing: 0.9ms (QD75P□N/QD75D□N), 56.8ms (QD75P□/QD75D□)</p>	



Reading the monitor value	Default value	Storage buffer memory address																										
		Axis 1	Axis 2	Axis 3	Axis 4																							
<p>■ Monitoring is carried out with a hexadecimal.</p> <p>Low-order buffer memory Example) 812 b15 b12 b8 b4 b0 E F G H</p> <p>High-order buffer memory Example) 813 b31 b28 b24 b20 b16 A B C D</p> <p>Monitor value E F G H A B C D</p> <p>◇ Sorting</p> <p>(High-order buffer memory) (Low-order buffer memory) A B C D E F G H</p> <p>◇ Converted from hexadecimal to decimal</p> <p>Decimal integer value R</p> <p>◇ Unit conversion <math>R \times 10^n</math></p> <p>Actual value Md.28 Axis feedrate Md.29 Speed-position switching control positioning amount</p> <p>• Unit conversion table (Md.28)</p> <table border="1"> <thead> <tr> <th>n</th> <th>Unit</th> </tr> </thead> <tbody> <tr> <td>-2</td> <td>mm/min</td> </tr> <tr> <td>-3</td> <td>inch/min</td> </tr> <tr> <td>-3</td> <td>degree/min</td> </tr> <tr> <td>0</td> <td>pulse/s</td> </tr> </tbody> </table> <p>• Unit conversion table (Md.29)</p> <table border="1"> <thead> <tr> <th>n</th> <th>Unit</th> </tr> </thead> <tbody> <tr> <td>-1</td> <td><math>\mu</math>m</td> </tr> <tr> <td>-5</td> <td>inch</td> </tr> <tr> <td>-5</td> <td>degree</td> </tr> <tr> <td>0</td> <td>pulse</td> </tr> </tbody> </table>	n	Unit	-2	mm/min	-3	inch/min	-3	degree/min	0	pulse/s	n	Unit	-1	$\mu$ m	-5	inch	-5	degree	0	pulse	0000H	812 813	912 913	1012 1013	1112 1113			
n	Unit																											
-2	mm/min																											
-3	inch/min																											
-3	degree/min																											
0	pulse/s																											
n	Unit																											
-1	$\mu$ m																											
-5	inch																											
-5	degree																											
0	pulse																											
<p>■ Monitoring is carried out with a hexadecimal.</p> <p>Monitor value 0 0 0 0</p> <p>Buffer memory b15 b12 b8 b4 b0 0 0 0 0 0 0 0 0 0 0 0 0 0 0 0 0 Not used</p> <table border="1"> <thead> <tr> <th>Stored items</th> <th>Default value</th> <th>Meaning</th> </tr> </thead> <tbody> <tr> <td>b0</td> <td>0</td> <td rowspan="8">0: OFF 1: ON</td> </tr> <tr> <td>b1</td> <td>0</td> </tr> <tr> <td>b2</td> <td>0</td> </tr> <tr> <td>b3</td> <td>0</td> </tr> <tr> <td>b4</td> <td>0</td> </tr> <tr> <td>b5</td> <td>0</td> </tr> <tr> <td>b6</td> <td>0</td> </tr> <tr> <td>b7</td> <td>0</td> </tr> <tr> <td>b8</td> <td>0</td> <td></td> </tr> </tbody> </table>	Stored items	Default value	Meaning	b0	0	0: OFF 1: ON	b1	0	b2	0	b3	0	b4	0	b5	0	b6	0	b7	0	b8	0		0000H	816	916	1016	1116
Stored items	Default value	Meaning																										
b0	0	0: OFF 1: ON																										
b1	0																											
b2	0																											
b3	0																											
b4	0																											
b5	0																											
b6	0																											
b7	0																											
b8	0																											

Storage item	Storage details
<p><b>Md.31</b> Status</p>	<p>This area stores the states (ON/OFF) of various flags. Information on the following flags is stored.</p> <ul style="list-style-type: none"> <li>● In speed control flag: This signal that comes ON under the speed control can be used to judge whether the operation is performed under the speed control or position control. The signal goes OFF when the power is switched ON, under the position control, and during JOG operation or manual pulse generator operation. During the speed-position or position-speed switching control, this signal comes ON only when the speed control is in effect. During the speed-position switching control, this signal goes OFF when the speed-position switching signal executes a switching over from speed control to position control. During the position-speed switching control, this signal comes ON when the position-speed switching signal executes a switching over from position control to speed control.</li> <li>● Speed-position switching latch flag: This signal is used during the speed-position switching control for interlocking the movement amount change function. During the speed-position switching control, this signal comes ON when position control takes over. This signal goes OFF when the next positioning data is processed, and during JOG operation or manual pulse generator operation.</li> <li>● Command in-position flag: This signal is ON when the remaining distance is equal to or less than the command in-position range (set by a detailed parameter). This signal remains OFF with data that specify the continuous path control (P11) as the operation pattern. The state of this signal is monitored every 0.9ms (QD75P□N/QD75D□N) or 1.8ms (QD75P□/QD75D□) except when the monitoring is canceled under the speed control or while the speed control is in effect during the speed-position or position-speed switching control. While operations are performed with interpolation, this signal comes ON only in respect of the starting axis. (This signal goes OFF in respect of all axes upon starting.)</li> <li>● OPR request flag: This signal comes ON when the power is switched ON, when the drive unit READY signal goes OFF, when the PLC READY signal goes ON, when a machine OPR operation starts. This signal goes OFF when a machine OPR operation completes.</li> <li>● OPR complete flag: This signal comes ON when a machine OPR operation completes normally. This signal goes OFF when the operation starts and when the drive unit READY signal goes OFF or PLC READY signal goes ON.</li> <li>● Position-speed switching latch flag: This signal is used during the position-speed switching control for interlocking the command speed change function. During the position-speed switching control, this signal comes ON when speed control takes over. This signal goes OFF when the next positioning data is processed, and during JOG operation or manual pulse generator operation.</li> <li>● Axis warning detection flag: This signal comes ON when an axis warning is reported and goes OFF when the axis error reset signal comes ON.</li> <li>● Speed change 0 flag: This signal comes ON when a speed change request that specifies 0 as the new speed value is issued. This signal comes OFF when a speed change request that specifies a new speed value other than 0 is issued.</li> </ul>
<p><b>Md.32</b> Target value</p>	<p>This area stores the target value (<b>Da.6</b> Positioning address/movement amount) for a positioning operation.</p> <ul style="list-style-type: none"> <li>• At the beginning of positioning control and current value changing : Stores the value of "<b>Da.6</b> Positioning address/movement amount".</li> <li>• At the OP shift operation of OPR control : Stores the value of OP shift amount.</li> <li>• At other times : Stores "0".</li> </ul>

Reading the monitor value	Default value	Storage buffer memory address																							
		Axis 1	Axis 2	Axis 3	Axis 4																				
<p>■ Monitoring is carried out with a hexadecimal display.</p> <table border="1"> <thead> <tr> <th>Stored items</th> <th>Default value</th> <th>Meaning</th> </tr> </thead> <tbody> <tr> <td>b0</td> <td>0</td> <td rowspan="8">0: OFF 1: ON</td> </tr> <tr> <td>b1</td> <td>0</td> </tr> <tr> <td>b2</td> <td>0</td> </tr> <tr> <td>b3</td> <td>1</td> </tr> <tr> <td>b4</td> <td>0</td> </tr> <tr> <td>b5</td> <td>0</td> </tr> <tr> <td>b9</td> <td>0</td> </tr> <tr> <td>b10</td> <td>0</td> </tr> </tbody> </table>	Stored items	Default value	Meaning	b0	0	0: OFF 1: ON	b1	0	b2	0	b3	1	b4	0	b5	0	b9	0	b10	0	0008H	817	917	1017	1117
Stored items	Default value	Meaning																							
b0	0	0: OFF 1: ON																							
b1	0																								
b2	0																								
b3	1																								
b4	0																								
b5	0																								
b9	0																								
b10	0																								
<p>■ Monitoring is carried out with a decimal display.</p> <table border="1"> <thead> <tr> <th>n</th> <th>Unit</th> </tr> </thead> <tbody> <tr> <td>-1</td> <td>μm</td> </tr> <tr> <td>-5</td> <td>inch</td> </tr> <tr> <td>-5</td> <td>degree</td> </tr> <tr> <td>0</td> <td>pulse</td> </tr> </tbody> </table>	n	Unit	-1	μm	-5	inch	-5	degree	0	pulse	0	818 819	918 919	1018 1019	1118 1119										
n	Unit																								
-1	μm																								
-5	inch																								
-5	degree																								
0	pulse																								

Storage item	Storage details
<p><b>Md.33</b> Target speed</p>	<ul style="list-style-type: none"> <li>• During operation with positioning data : The actual target speed, considering the override and speed limit value, etc., is stored. "0" is stored when positioning is completed.</li> <li>• During interpolation of position control : The composite speed or reference axis speed is stored in the reference axis address, and "0" is stored in the interpolation axis address.</li> <li>• During interpolation of speed control : The target speeds of each axis are stored in the monitor of the reference axis and interpolation axis.</li> <li>• During JOG operation : The actual target speed, considering the JOG speed limit value for the JOG speed, is stored.</li> <li>• During manual pulse generator operation : "0" is stored.</li> </ul>
<p><b>Md.34</b> Movement amount after near-point dog ON</p>	<ul style="list-style-type: none"> <li>• "0" is stored when machine OPR starts.</li> <li>• After machine OPR starts, the movement amount from the near-point dog ON to the machine OPR completion is stored. (Movement amount: Movement amount to machine OPR completion using near-point dog ON as "0".)</li> <li>• "0" is always stored when using the stopper method 1), 2), or 3).</li> </ul>
<p><b>Md.35</b> Torque limit stored value</p>	<p>The " <b>Pr.17</b> Torque limit setting value" or " <b>Cd.22</b> New torque value" is stored.</p> <ul style="list-style-type: none"> <li>• During positioning start, JOG operation start, manual pulse generator operation ...The " <b>Pr.17</b> Torque limit setting value" is stored.</li> <li>• When value other than 0 is set to " <b>Cd.22</b> New torque value" ...The " <b>Cd.22</b> New torque value" is stored.</li> </ul>



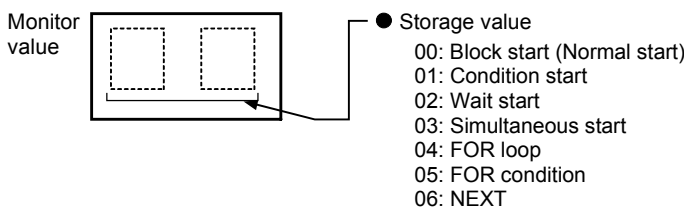
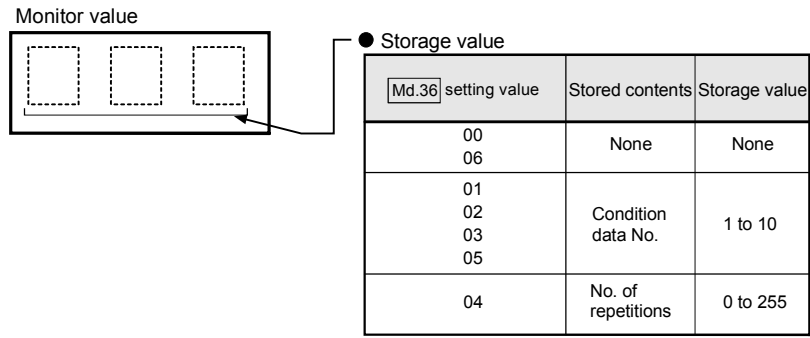
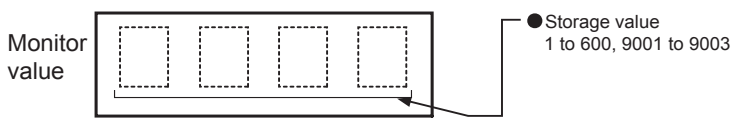
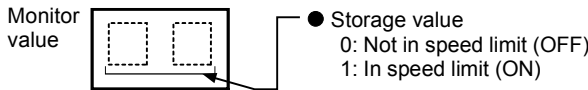
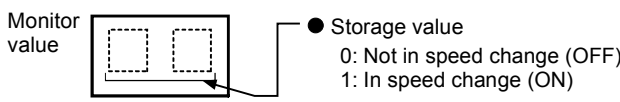

Reading the monitor value	Default value	Storage buffer memory address																							
		Axis 1	Axis 2	Axis 3	Axis 4																				
<p>■ Monitoring is carried out with a hexadecimal display.</p> <p>Low-order buffer memory Example) 820 b15 b12 b8 b4 b0 E F G H</p> <p>High-order buffer memory Example) 821 b31 b28 b24 b20 b16 A B C D</p> <p>Monitor value: E F G H (top row), A B C D (bottom row)</p> <p>◇ Sorting</p> <p>(High-order buffer memory) (Low-order buffer memory) A B C D E F G H</p> <p>◇ Converted from hexadecimal to decimal</p> <p>Decimal integer value: R</p> <p>◇ Unit conversion <math>R \times 10^n</math></p> <p>Actual value: Md.33 Target speed Md.34 Movement amount after near-point dog ON</p> <p>• Unit conversion table (Md.33)</p> <table border="1"> <thead> <tr> <th>n</th> <th>Unit</th> </tr> </thead> <tbody> <tr> <td>-2</td> <td>mm/min</td> </tr> <tr> <td>-3</td> <td>inch/min</td> </tr> <tr> <td>-3</td> <td>degree/min</td> </tr> <tr> <td>0</td> <td>pulse/s</td> </tr> </tbody> </table> <p>• Unit conversion table (Md.34)</p> <table border="1"> <thead> <tr> <th>n</th> <th>Unit</th> </tr> </thead> <tbody> <tr> <td>-1</td> <td><math>\mu\text{m}</math></td> </tr> <tr> <td>-5</td> <td>inch</td> </tr> <tr> <td>-5</td> <td>degree</td> </tr> <tr> <td>0</td> <td>pulse</td> </tr> </tbody> </table>	n	Unit	-2	mm/min	-3	inch/min	-3	degree/min	0	pulse/s	n	Unit	-1	$\mu\text{m}$	-5	inch	-5	degree	0	pulse	0000H	820 821	920 921	1020 1021	1120 1121
n	Unit																								
-2	mm/min																								
-3	inch/min																								
-3	degree/min																								
0	pulse/s																								
n	Unit																								
-1	$\mu\text{m}$																								
-5	inch																								
-5	degree																								
0	pulse																								
	0000H	824 825	924 925	1024 1025	1124 1125																				
<p>■ Monitoring is carried out with a decimal display.</p> <p>Monitor value: </p> <p>• Storage value 1 to 500 (%)</p>	0	826	926	1026	1126																				

Storage item	Storage details	
<p><b>Md.36</b> Special start data instruction code setting value</p>	<ul style="list-style-type: none"> <li>The "instruction code" used with special start and indicated by the start data pointer currently being executed is stored.</li> </ul>	
<p><b>Md.37</b> Special start data instruction parameter setting value</p>	<p>The "instruction parameter" used with special start and indicated by the start data pointer currently being executed is stored. The stored value differs according to the value set for <b>Md.36</b>.</p>	
<p><b>Md.38</b> Start positioning data No. setting value</p>	<ul style="list-style-type: none"> <li>The "positioning data No." indicated by the start data pointer currently being executed is stored.</li> </ul>	
<p><b>Md.39</b> In speed limit flag</p>	<ul style="list-style-type: none"> <li>If the speed exceeds the "<b>Pr.8</b> Speed limit value" due to a speed change or override, the speed limit functions, and the in speed limit flag turns ON.</li> <li>When the speed drops to less than "<b>Pr.8</b> Speed limit value", or when the axis stops, the in speed limit flag turns OFF.</li> </ul>	
<p><b>Md.40</b> In speed change processing flag</p>	<ul style="list-style-type: none"> <li>The speed change process flag turns ON when the speed is changed during positioning control.</li> <li>After the speed change process is completed or when deceleration starts with the stop signal during the speed change process, the in speed change process flag turns OFF.</li> </ul>	

Reading the monitor value	Default value	Storage buffer memory address															
		Axis 1	Axis 2	Axis 3	Axis 4												
<p>■ Monitoring is carried out with a decimal display.</p>  <p>● Storage value                      00: Block start (Normal start)                      01: Condition start                      02: Wait start                      03: Simultaneous start                      04: FOR loop                      05: FOR condition                      06: NEXT</p>	0	827	927	1027	1127												
<p>■ Monitoring is carried out with a decimal display.</p>  <table border="1" data-bbox="539 768 986 1048"> <thead> <tr> <th>Md.36 setting value</th> <th>Stored contents</th> <th>Storage value</th> </tr> </thead> <tbody> <tr> <td>00 06</td> <td>None</td> <td>None</td> </tr> <tr> <td>01 02 03 05</td> <td>Condition data No.</td> <td>1 to 10</td> </tr> <tr> <td>04</td> <td>No. of repetitions</td> <td>0 to 255</td> </tr> </tbody> </table>	Md.36 setting value	Stored contents	Storage value	00 06	None	None	01 02 03 05	Condition data No.	1 to 10	04	No. of repetitions	0 to 255	0	828	928	1028	1128
Md.36 setting value	Stored contents	Storage value															
00 06	None	None															
01 02 03 05	Condition data No.	1 to 10															
04	No. of repetitions	0 to 255															
<p>■ Monitoring is carried out with a decimal display.</p>  <p>● Storage value                      1 to 600, 9001 to 9003</p>	0	829	929	1029	1129												
<p>■ Monitoring is carried out with a decimal display.</p>  <p>● Storage value                      0: Not in speed limit (OFF)                      1: In speed limit (ON)</p>	0	830	930	1030	1130												
<p>■ Monitoring is carried out with a decimal display.</p>  <p>● Storage value                      0: Not in speed change (OFF)                      1: In speed change (ON)</p>	0	831	931	1031	1131												

Storage item	Storage details	
Md.41 Special start repetition counter	<ul style="list-style-type: none"> <li>• This area stores the remaining number of repetitions during "repetitions" specific to special starting.</li> <li>• The count is decremented by one (-1) at the loop end.</li> <li>• The control comes out of the loop when the count reaches "0".</li> <li>• This area stores "0" within an infinite loop.</li> </ul>	
Md.42 Control system repetition counter	<ul style="list-style-type: none"> <li>• This area stores the remaining number of repetitions during "repetitions" specific to control system.</li> <li>• The count is decremented by one (-1) at the loop start.</li> <li>• The loop is terminated with the positioning data of control method "LEND" after the counter becomes "0".</li> </ul>	
Md.43 Start data pointer being executed	<ul style="list-style-type: none"> <li>• This area stores a point No. (1 to 50) attached to the start data currently being executed.</li> <li>• This area stores "0" after completion of a positioning operation.</li> </ul>	
Md.44 Positioning data No. being executed	<ul style="list-style-type: none"> <li>• This area stores a positioning data No. attached to the positioning data currently being executed.</li> <li>• This area stores "0" after completion of a positioning operation.</li> <li>• This area stores "0" when the JOG/inching operation is executed.</li> </ul>	
Md.45 Block No. being executed	<ul style="list-style-type: none"> <li>• When the operation is controlled by "block start data", this area stores a block number (7000 to 7004) attached to the block currently being executed.</li> <li>• At other times, this area stores "0".</li> <li>• This area stores "0" after completion of a positioning operation.</li> </ul>	
Md.46 Last executed positioning data No.	<ul style="list-style-type: none"> <li>• This area stores the positioning data No. attached to the positioning data that was executed last time.</li> <li>• The value is retained until a new positioning operation is executed.</li> <li>• This area stores "0" when the JOG/inching operation is executed.</li> </ul>	
Md.47 Positioning data being executed	<ul style="list-style-type: none"> <li>• The addresses shown to the right store details of the positioning data currently being executed (positioning data No. given by Md.44).</li> </ul>	
Md.48 Deceleration start flag	<ul style="list-style-type: none"> <li>• "1" is stored when the constant speed status or acceleration status switches to the deceleration status during position control whose operation pattern is "Positioning complete".</li> <li>• "0" is stored at the next operation start or manual pulse generator operation enable.</li> </ul>	

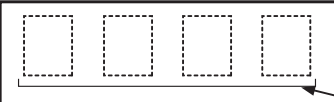
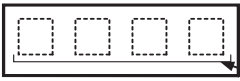
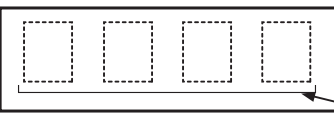

Reading the monitor value	Default value	Storage buffer memory address																																																																				
		Axis 1	Axis 2	Axis 3	Axis 4																																																																	
<p>■ Monitoring is carried out with a decimal display.</p> <p>Monitor value  ● Storage value 0 to 255</p>	0	832	932	1032	1132																																																																	
<p>■ Monitoring is carried out with a hexadecimal display.</p> <p>Monitor value  ● Storage value 0 to FFFF</p>	0000H	833	933	1033	1133																																																																	
<p>■ Monitoring is carried out with a decimal display.</p> <p>Monitor value  ● Storage value 1 to 50</p>	0	834	934	1034	1134																																																																	
<p>■ Monitoring is carried out with a decimal display.</p> <p>Monitor value  ● Storage value 1 to 600, 9001 to 9003</p>	0	835	935	1035	1135																																																																	
<p>■ Monitoring is carried out with a decimal display.</p> <p>Monitor value  ● Storage value 7000 to 7004</p>	0	836	936	1036	1136																																																																	
<p>■ Monitoring is carried out with a decimal display.</p> <p>Monitor value  ● Storage value 1 to 600, 9001 to 9003</p>	0	837	937	1037	1137																																																																	
<p>Information is stored in the following addresses:</p> <table border="1" data-bbox="183 1288 989 1780"> <thead> <tr> <th colspan="4">Stored address</th> <th rowspan="2">Stored item</th> <th rowspan="2">Reference</th> </tr> <tr> <th>Axis1</th> <th>Axis2</th> <th>Axis3</th> <th>Axis4</th> </tr> </thead> <tbody> <tr> <td>838</td> <td>938</td> <td>1038</td> <td>1138</td> <td>Positioning identifier</td> <td>Da.1 to Da.5</td> </tr> <tr> <td>839</td> <td>939</td> <td>1039</td> <td>1139</td> <td>M code</td> <td>Da.10</td> </tr> <tr> <td>840</td> <td>940</td> <td>1040</td> <td>1140</td> <td>Dwell time</td> <td>Da.9</td> </tr> <tr> <td>841</td> <td>941</td> <td>1041</td> <td>1141</td> <td>Positioning option*1</td> <td>Da.27 to Da.29</td> </tr> <tr> <td>842</td> <td>942</td> <td>1042</td> <td>1142</td> <td rowspan="2">Command speed</td> <td rowspan="2">Da.8</td> </tr> <tr> <td>843</td> <td>943</td> <td>1043</td> <td>1143</td> </tr> <tr> <td>844</td> <td>944</td> <td>1044</td> <td>1144</td> <td rowspan="3">Positioning address</td> <td rowspan="3">Da.6</td> </tr> <tr> <td>845</td> <td>945</td> <td>1045</td> <td>1145</td> </tr> <tr> <td>846</td> <td>946</td> <td>1046</td> <td>1146</td> </tr> <tr> <td>847</td> <td>947</td> <td>1047</td> <td>1147</td> <td>Arc address</td> <td>Da.7</td> </tr> </tbody> </table>		Stored address				Stored item	Reference	Axis1	Axis2	Axis3	Axis4	838	938	1038	1138	Positioning identifier	Da.1 to Da.5	839	939	1039	1139	M code	Da.10	840	940	1040	1140	Dwell time	Da.9	841	941	1041	1141	Positioning option*1	Da.27 to Da.29	842	942	1042	1142	Command speed	Da.8	843	943	1043	1143	844	944	1044	1144	Positioning address	Da.6	845	945	1045	1145	846	946	1046	1146	847	947	1047	1147	Arc address	Da.7	0	838 to 847	938 to 947	1038 to 1047	1138 to 1147
Stored address				Stored item	Reference																																																																	
Axis1	Axis2	Axis3	Axis4																																																																			
838	938	1038	1138	Positioning identifier	Da.1 to Da.5																																																																	
839	939	1039	1139	M code	Da.10																																																																	
840	940	1040	1140	Dwell time	Da.9																																																																	
841	941	1041	1141	Positioning option*1	Da.27 to Da.29																																																																	
842	942	1042	1142	Command speed	Da.8																																																																	
843	943	1043	1143																																																																			
844	944	1044	1144	Positioning address	Da.6																																																																	
845	945	1045	1145																																																																			
846	946	1046	1146																																																																			
847	947	1047	1147	Arc address	Da.7																																																																	
<p>*1: If "0: Invalid" is set in "Pr.70 Positioning option valid/invalid setting", 0 is always stored.</p>																																																																						
<p>■ Monitoring is carried out with a decimal display.</p> <p>Monitor value  ● Storage value 0: Status other than below 1: Status from deceleration start to next operation start or manual pulse generator operation enable</p>	0	899	999	1099	1199																																																																	

## 5.7 List of control data

## 5.7.1 System control data

Setting item	Setting details				
<p><b>Cd.1</b> Flash ROM write request</p>	<ul style="list-style-type: none"> <li>Requests writing of data (parameters, positioning data, and block start data) from the buffer memory to the flash ROM.</li> </ul>				
<p><b>Cd.2</b> Parameter initialization request</p>	<ul style="list-style-type: none"> <li>Requests initialization of setting data. Initialization: Resetting of setting data to default values</li> <li>Note: After completing the initialization of setting data, reset the CPU module or reboot the programmable controller power.</li> </ul> <p style="text-align: center;">Initialized setting data</p> <table border="1" style="margin-left: auto; margin-right: auto;"> <tr> <td>Parameters (<b>Pr.1</b> to <b>Pr.57</b>, <b>Pr.150</b>)</td> </tr> <tr> <td>Positioning data (No. 1 to No. 600)</td> </tr> <tr> <td>Block start data (No. 7000 to 7004)</td> </tr> </table>	Parameters ( <b>Pr.1</b> to <b>Pr.57</b> , <b>Pr.150</b> )	Positioning data (No. 1 to No. 600)	Block start data (No. 7000 to 7004)	
Parameters ( <b>Pr.1</b> to <b>Pr.57</b> , <b>Pr.150</b> )					
Positioning data (No. 1 to No. 600)					
Block start data (No. 7000 to 7004)					
<p><b>Cd.41</b> Deceleration start flag valid</p>	<p>Set whether "<b>Md.48</b> Deceleration start flag" is made valid or invalid.</p>				
<p><b>Cd.42</b> Stop command processing for deceleration stop selection</p>	<ul style="list-style-type: none"> <li>Set the stop command processing for deceleration stop function (deceleration curve re-processing/deceleration curve continuation).</li> </ul>				

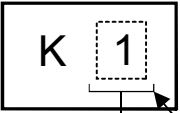
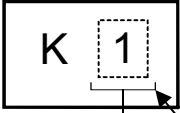
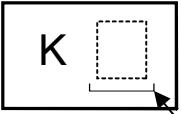
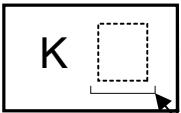



	Setting value	Default value	Storage buffer memory address (common to axes 1 to 4)
<p>■ Set with a decimal.</p>	<p>Setting value</p>  <p>● Flash ROM write request 1: Requests write access to flash ROM.</p> <p>The QD75 resets the value to "0" automatically when the write access completes. (This indicates the completion of write operation.)</p>	0	1900
<p>■ Set with a decimal.</p>	<p>Setting value</p>  <p>● Parameter initialization request 1: Requests parameter initialization.</p> <p>The QD75 resets the value to "0" automatically when the initialization completes. (This indicates the completion of parameter initialization.)</p>	0	1901
<p>■ Set with a decimal.</p>	<p>Setting value</p>  <p>● Deceleration start flag valid 0: Deceleration start flag invalid 1: Deceleration start flag valid</p>	0	1905
<p>■ Set with a decimal.</p>	<p>Setting value</p>  <p>● Stop command processing for deceleration stop selection 0: Deceleration curve re-processing 1: Deceleration curve continuation</p>	0	1907

Setting item	Setting details	
Cd.43 Output timing selection of near pass control	<ul style="list-style-type: none"><li>• Select the timing to output the difference (<math>\Delta \ell</math>) between the actual and the set positioning end addresses in continuous path control, in which the difference (<math>\Delta \ell</math>) is output during the execution of the next positioning data.</li></ul>	

	Setting value	Default value	Storage buffer memory address (common to axes 1 to 4)
	<p>■ Set with a decimal.</p> <p>Setting value</p>  <p>● Output timing selection of near pass control                      0: At constant speed                      1: At deceleration</p>	0	1934

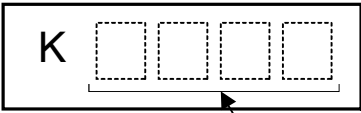
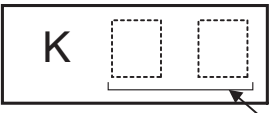
## 5.7.2 Axis control data

Setting item	Setting details	
<p>[Cd.3] Positioning start No.</p>	<ul style="list-style-type: none"> <li>• Set the positioning start No. (Only 1 to 600 for the Pre-reading start function. For details, refer to Section 12.7.7 "Pre-reading start function".)</li> </ul>	
<p>[Cd.4] Positioning starting point No.</p>	<ul style="list-style-type: none"> <li>• Set a "starting point No." (1 to 50) if block start data is used for positioning. (Handled as "1" if the value of other than 1 to 50 is set.)</li> </ul>	
<p>[Cd.5] Axis error reset</p>	<ul style="list-style-type: none"> <li>• Clears the axis error detection, axis error No., axis warning detection and axis warning No.</li> <li>• When the QD75 axis operation state is "Error", the error is cleared and the QD75 is returned to the "Standing" state.</li> </ul>	
<p>[Cd.6] Restart command</p>	<ul style="list-style-type: none"> <li>• When positioning is stopped for any reason (when axis operation state is "Stopped"), set "1" in [Cd.6]. Positioning will be carried out again from the stopped position to the end point of the stopped positioning data.</li> </ul>	
<p>[Cd.7] M code OFF request</p>	<ul style="list-style-type: none"> <li>• The M code ON signal turns OFF.</li> </ul>	

Setting value	Default value	Storage buffer memory address			
		Axis 1	Axis 2	Axis 3	Axis 4
<p>■ Set with a decimal.</p> <p>Setting value </p> <ul style="list-style-type: none"> <li>● Positioning data No.</li> <li>● 1 to 600 : Positioning data No.</li> <li>● 7000 to 7004 : Block start designation</li> <li>● 9001 : Machine OPR</li> <li>● 9002 : Fast-OPR</li> <li>● 9003 : Current value changing</li> <li>● 9004 : Simultaneous starting of multiple axes</li> </ul>	0	1500	1600	1700	1800
<p>■ Set with a decimal.</p> <p>Setting value </p> <ul style="list-style-type: none"> <li>● Positioning starting point No.</li> <li>1 to 50</li> </ul>	0	1501	1601	1701	1801
<p>■ Set with a decimal.</p> <p>Setting value </p> <ul style="list-style-type: none"> <li>● Error reset request</li> <li>1: Axis error is reset.</li> </ul> <p>After the axis error reset is completed, "0" is stored by the QD75 automatically. (Indicates that the axis error reset is completed.)</p>	0	1502	1602	1702	1802
<p>■ Set with a decimal.</p> <p>Setting value </p> <ul style="list-style-type: none"> <li>● Restart command</li> <li>1: Restarts</li> </ul> <p>After restart acceptance is completed, "0" is stored by the QD75 automatically. (Indicates that the restart acceptance is completed.)</p>	0	1503	1603	1703	1803
<p>■ Set with a decimal.</p> <p>Setting value </p> <ul style="list-style-type: none"> <li>● M code OFF request</li> <li>1: M code ON signal turns OFF</li> </ul> <p>After the M code ON signal turns OFF, "0" is stored by the QD75 automatically. (Indicates that the OFF request is completed.)</p>	0	1504	1604	1704	1804

Setting item	Setting details										
<p><b>Cd.8</b> External command valid</p>	<ul style="list-style-type: none"> <li>Validates or in validates external command signals.</li> </ul>										
<p><b>Cd.9</b> New current value</p>	<ul style="list-style-type: none"> <li>When changing the "current feed value" using the start No. "9003", use this data item to specify a new feed value.</li> <li>Set a value within the following range:</li> </ul> <table border="1" data-bbox="584 792 1407 967"> <thead> <tr> <th data-bbox="584 792 740 869"><b>Pr.1</b> Unit setting</th> <th data-bbox="740 792 906 869">mm (<math>\times 10^{-1} \mu\text{m}</math>)</th> <th data-bbox="906 792 1072 869">inch (<math>\times 10^{-5}</math> inch)</th> <th data-bbox="1072 792 1238 869">degree (<math>\times 10^{-5}</math> degree)</th> <th data-bbox="1238 792 1407 869">pulse (pulse)</th> </tr> </thead> <tbody> <tr> <td data-bbox="584 869 740 967">Setting range</td> <td data-bbox="740 869 906 967">-2147483648 to +2147483647</td> <td data-bbox="906 869 1072 967">-2147483648 to +2147483647</td> <td data-bbox="1072 869 1238 967">0 to 35999999</td> <td data-bbox="1238 869 1407 967">-2147483648 to +2147483647</td> </tr> </tbody> </table>	<b>Pr.1</b> Unit setting	mm ( $\times 10^{-1} \mu\text{m}$ )	inch ( $\times 10^{-5}$ inch)	degree ( $\times 10^{-5}$ degree)	pulse (pulse)	Setting range	-2147483648 to +2147483647	-2147483648 to +2147483647	0 to 35999999	-2147483648 to +2147483647
<b>Pr.1</b> Unit setting	mm ( $\times 10^{-1} \mu\text{m}$ )	inch ( $\times 10^{-5}$ inch)	degree ( $\times 10^{-5}$ degree)	pulse (pulse)							
Setting range	-2147483648 to +2147483647	-2147483648 to +2147483647	0 to 35999999	-2147483648 to +2147483647							



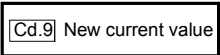
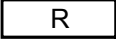

Setting value	Default value	Storage buffer memory address													
		Axis 1	Axis 2	Axis 3	Axis 4										
<p>■ Set with a decimal.</p> <p>Setting value </p> <p>• External command valid 0: Invalidates an external command. 1: Validates an external command.</p>	0	1505	1605	1705	1805										
<p>■ Set with a decimal.</p> <p>Actual value </p> <p>◇ Conversion into an integer value</p> <p>× 10<sup>n</sup> → • Unit conversion table ([Cd.9])</p> <table border="1" data-bbox="730 826 954 983"> <thead> <tr> <th>n</th> <th>Unit</th> </tr> </thead> <tbody> <tr> <td>-1</td> <td>μm</td> </tr> <tr> <td>-5</td> <td>inch</td> </tr> <tr> <td>-5</td> <td>degree</td> </tr> <tr> <td>0</td> <td>pulse</td> </tr> </tbody> </table> <p>Setting value (Decimal) </p>	n	Unit	-1	μm	-5	inch	-5	degree	0	pulse	0	1506 1507	1606 1607	1706 1707	1806 1807
n	Unit														
-1	μm														
-5	inch														
-5	degree														
0	pulse														

Setting item	Setting details		
<p><b>Cd.10</b> New acceleration time value</p>	<ul style="list-style-type: none"> <li>When changing the acceleration time during a speed change, use this data item to specify a new acceleration time.</li> </ul> <table border="1" data-bbox="584 479 1007 573"> <tr> <td><b>Cd.10</b> setting range (unit)</td> </tr> <tr> <td>0 to 8388608 (ms)</td> </tr> </table>	<b>Cd.10</b> setting range (unit)	0 to 8388608 (ms)
<b>Cd.10</b> setting range (unit)			
0 to 8388608 (ms)			
<p><b>Cd.11</b> New deceleration time value</p>	<ul style="list-style-type: none"> <li>When changing the deceleration time during a speed change, use this data item to specify a new deceleration time.</li> </ul> <table border="1" data-bbox="584 719 1007 813"> <tr> <td><b>Cd.11</b> setting range (unit)</td> </tr> <tr> <td>0 to 8388608 (ms)</td> </tr> </table>	<b>Cd.11</b> setting range (unit)	0 to 8388608 (ms)
<b>Cd.11</b> setting range (unit)			
0 to 8388608 (ms)			
<p><b>Cd.12</b> Acceleration/deceleration time change during speed change, enable/disable selection</p>	<ul style="list-style-type: none"> <li>Enables or disables modifications to the acceleration/deceleration time during a speed change.</li> </ul>		

Setting value	Default value	Storage buffer memory address			
		Axis 1	Axis 2	Axis 3	Axis 4
<p>■ Set with a decimal.</p> <p>Setting value <span style="border: 1px solid black; padding: 2px;">Cd.10</span> New acceleration time value  <span style="border: 1px solid black; padding: 2px;">Cd.11</span> New deceleration time value</p> <p style="border: 1px dashed black; padding: 5px; margin: 10px 0;">Example: When the "<span style="border: 1px solid black; padding: 2px;">Cd. 10</span> New acceleration time value" is set as "60000 ms", the buffer memory stores "60000".</p>	0	1508 1509	1608 1609	1708 1709	1808 1809
	0	1510 1511	1610 1611	1710 1711	1810 1811
<p>■ Set with a decimal.</p> <p>Setting value <span style="border: 1px solid black; padding: 2px;">K</span> <span style="border: 1px dashed black; padding: 2px; display: inline-block; width: 20px; height: 20px; vertical-align: middle;"></span></p> <ul style="list-style-type: none"> <li>● Acceleration/deceleration time change during speed change, enable/disable selection</li> <li>1 : Enables modifications to acceleration/deceleration time</li> <li>Other than 1: Disables modifications to acceleration/deceleration time</li> </ul>	0	1512	1612	1712	1812

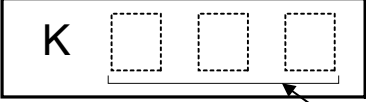
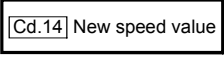
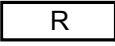
Setting item	Setting details										
<p><b>Cd.13</b> Positioning operation speed override</p>	<ul style="list-style-type: none"> <li>To use the positioning operation speed override function, use this data item to specify an "override" value.</li> <li>* For details of the override function, refer to Section 12.5.2" Override function".</li> </ul> <p>If the speed becomes lower than the minimum unit due to override 1% or others, it is raised to the minimum unit. At this time, the warning "Less than minimum speed" (warning code: 110) will occur.</p>										
<p><b>Cd.14</b> New speed value</p>	<ul style="list-style-type: none"> <li>When changing the speed, use this data item to specify a new speed.</li> <li>The operation halts if you specify "0".</li> </ul> <table border="1" data-bbox="576 797 1426 1003"> <thead> <tr> <th data-bbox="576 797 683 869"><b>Pr.1</b> Unit setting</th> <th data-bbox="683 797 836 869">mm (<math>\times 10^{-2}</math> mm/min)</th> <th data-bbox="836 797 991 869">inch (<math>\times 10^{-3}</math> inch/min)</th> <th data-bbox="991 797 1174 869">degree (<math>\times 10^{-3}</math> degree/min)</th> <th data-bbox="1174 797 1426 869">pulse (pulse/s)</th> </tr> </thead> <tbody> <tr> <td data-bbox="576 869 683 1003">Setting range</td> <td data-bbox="683 869 836 1003">0 to 2000000000</td> <td data-bbox="836 869 991 1003">0 to 2000000000</td> <td data-bbox="991 869 1174 1003">0 to 2000000000</td> <td data-bbox="1174 869 1426 1003">[QD75P□/QD75D□N] 0 to 4000000 [QD75P□/QD75D□] 0 to 1000000</td> </tr> </tbody> </table>	<b>Pr.1</b> Unit setting	mm ( $\times 10^{-2}$ mm/min)	inch ( $\times 10^{-3}$ inch/min)	degree ( $\times 10^{-3}$ degree/min)	pulse (pulse/s)	Setting range	0 to 2000000000	0 to 2000000000	0 to 2000000000	[QD75P□/QD75D□N] 0 to 4000000 [QD75P□/QD75D□] 0 to 1000000
<b>Pr.1</b> Unit setting	mm ( $\times 10^{-2}$ mm/min)	inch ( $\times 10^{-3}$ inch/min)	degree ( $\times 10^{-3}$ degree/min)	pulse (pulse/s)							
Setting range	0 to 2000000000	0 to 2000000000	0 to 2000000000	[QD75P□/QD75D□N] 0 to 4000000 [QD75P□/QD75D□] 0 to 1000000							
<p><b>Cd.15</b> Speed change request</p>	<ul style="list-style-type: none"> <li>After setting the " <b>Cd.14</b> New speed value", set this data item to "1" to execute the speed change (through validating the new speed value).</li> </ul>										



Setting value	Default value	Storage buffer memory address													
		Axis 1	Axis 2	Axis 3	Axis 4										
<p>■ Set with a decimal.</p> <p>Setting value </p> <p>● Override value (%) 1 to 300</p>	100	1513	1613	1713	1813										
<p>■ Set with a decimal.</p> <p>Actual value </p> <p>◇ Conversion into an integer value <math>\times 10^n</math></p> <p>● Unit conversion table (Cd.14)</p> <table border="1" data-bbox="730 813 954 969"> <thead> <tr> <th>n</th> <th>Unit</th> </tr> </thead> <tbody> <tr> <td>-2</td> <td>mm/min</td> </tr> <tr> <td>-3</td> <td>inch/min</td> </tr> <tr> <td>-3</td> <td>degree/min</td> </tr> <tr> <td>0</td> <td>pulse/s</td> </tr> </tbody> </table> <p>Setting value (Decimal) </p> <p>Example: When the "Cd. 14" New speed value" is set as "20000.00mm /min", the buffer memory stores "2000000".</p>	n	Unit	-2	mm/min	-3	inch/min	-3	degree/min	0	pulse/s	0	1514 1515	1614 1615	1714 1715	1814 1815
n	Unit														
-2	mm/min														
-3	inch/min														
-3	degree/min														
0	pulse/s														
<p>■ Set with a decimal.</p> <p>Setting value </p> <p>● Speed change request 1: Executes speed change.</p> <p>The QD75 resets the value to "0" automatically when the speed change request has been processed. (This indicates the completion of speed change request.)</p>	0	1516	1616	1716	1816										

Setting item	Setting details										
<p><b>Cd.16</b> Inching movement amount</p>	<ul style="list-style-type: none"> <li>• Use this data item to set the amount of movement by inching.</li> <li>• The machine performs a JOG operation if "0" is set.</li> <li>• Set a value within the following range:</li> </ul> <table border="1" data-bbox="587 640 1426 748"> <thead> <tr> <th data-bbox="587 640 740 712">Pr.1 Unit setting</th> <th data-bbox="740 640 911 712">mm (<math>\times 10^{-1} \mu\text{m}</math>)</th> <th data-bbox="911 640 1082 712">inch (<math>\times 10^{-5} \text{inch}</math>)</th> <th data-bbox="1082 640 1252 712">degree (<math>\times 10^{-5} \text{degree}</math>)</th> <th data-bbox="1252 640 1426 712">pulse (pulse)</th> </tr> </thead> <tbody> <tr> <td data-bbox="587 712 740 748">Setting range</td> <td data-bbox="740 712 911 748">0 to 65535</td> <td data-bbox="911 712 1082 748">0 to 65535</td> <td data-bbox="1082 712 1252 748">0 to 65535</td> <td data-bbox="1252 712 1426 748">0 to 65535</td> </tr> </tbody> </table>	Pr.1 Unit setting	mm ( $\times 10^{-1} \mu\text{m}$ )	inch ( $\times 10^{-5} \text{inch}$ )	degree ( $\times 10^{-5} \text{degree}$ )	pulse (pulse)	Setting range	0 to 65535	0 to 65535	0 to 65535	0 to 65535
Pr.1 Unit setting	mm ( $\times 10^{-1} \mu\text{m}$ )	inch ( $\times 10^{-5} \text{inch}$ )	degree ( $\times 10^{-5} \text{degree}$ )	pulse (pulse)							
Setting range	0 to 65535	0 to 65535	0 to 65535	0 to 65535							
<p><b>Cd.17</b> JOG speed</p>	<ul style="list-style-type: none"> <li>• Use this data item to set the JOG speed.</li> <li>• Set a value within the following range:</li> </ul> <table border="1" data-bbox="571 1196 1433 1402"> <thead> <tr> <th data-bbox="571 1196 692 1267">Pr.1 Unit setting</th> <th data-bbox="692 1196 847 1267">mm (<math>\times 10^{-2} \text{mm/min}</math>)</th> <th data-bbox="847 1196 1002 1267">inch (<math>\times 10^{-3} \text{inch/min}</math>)</th> <th data-bbox="1002 1196 1189 1267">degree (<math>\times 10^{-3} \text{degree/min}</math>)</th> <th data-bbox="1189 1196 1433 1267">pulse (pulse/s)</th> </tr> </thead> <tbody> <tr> <td data-bbox="571 1267 692 1402">Setting range</td> <td data-bbox="692 1267 847 1402">0 to 2000000000</td> <td data-bbox="847 1267 1002 1402">0 to 2000000000</td> <td data-bbox="1002 1267 1189 1402">0 to 2000000000</td> <td data-bbox="1189 1267 1433 1402">[QD75P□/QD75D□]N 0 to 4000000 [QD75P□/QD75D□] 0 to 1000000</td> </tr> </tbody> </table>	Pr.1 Unit setting	mm ( $\times 10^{-2} \text{mm/min}$ )	inch ( $\times 10^{-3} \text{inch/min}$ )	degree ( $\times 10^{-3} \text{degree/min}$ )	pulse (pulse/s)	Setting range	0 to 2000000000	0 to 2000000000	0 to 2000000000	[QD75P□/QD75D□]N 0 to 4000000 [QD75P□/QD75D□] 0 to 1000000
Pr.1 Unit setting	mm ( $\times 10^{-2} \text{mm/min}$ )	inch ( $\times 10^{-3} \text{inch/min}$ )	degree ( $\times 10^{-3} \text{degree/min}$ )	pulse (pulse/s)							
Setting range	0 to 2000000000	0 to 2000000000	0 to 2000000000	[QD75P□/QD75D□]N 0 to 4000000 [QD75P□/QD75D□] 0 to 1000000							
<p><b>Cd.18</b> Continuous operation interrupt request</p>	<ul style="list-style-type: none"> <li>• To interrupt a continuous operation, set "1" to this data item.</li> <li>• After processing the interruption request ("1"), the QD75 automatically resets the value to "0".</li> </ul>										

Setting value	Default value	Storage buffer memory address													
		Axis 1	Axis 2	Axis 3	Axis 4										
<p>■ Set with a decimal.</p> <p>Actual value <span style="border: 1px solid black; padding: 2px;">Cd.16 Inching movement amount</span></p> <p style="text-align: center;">↓ Conversion into an integer value</p> <p style="text-align: center;"><math>\times 10^n</math></p> <p>Setting value (Decimal) <span style="border: 1px solid black; padding: 2px;">R</span></p> <div style="border: 1px dashed black; padding: 5px; margin-top: 10px;"> <p>Example: When the "Cd. 16" Inching movement amount" is set as "1.0 μm", the buffer memory stores "10".</p> </div> <div style="margin-top: 10px;"> <p>● Unit conversion table (Cd.16)</p> <table border="1" style="display: inline-table;"> <thead> <tr> <th>n</th> <th>Unit</th> </tr> </thead> <tbody> <tr> <td>-1</td> <td>μm</td> </tr> <tr> <td>-5</td> <td>inch</td> </tr> <tr> <td>-5</td> <td>degree</td> </tr> <tr> <td>0</td> <td>pulse</td> </tr> </tbody> </table> </div>	n	Unit	-1	μm	-5	inch	-5	degree	0	pulse	0	1517	1617	1717	1817
n	Unit														
-1	μm														
-5	inch														
-5	degree														
0	pulse														
<p>■ Set with a decimal.</p> <p>Actual value <span style="border: 1px solid black; padding: 2px;">Cd.17 JOG speed</span></p> <p style="text-align: center;">↓ Conversion into an integer value</p> <p style="text-align: center;"><math>\times 10^n</math></p> <p>Setting value (Decimal) <span style="border: 1px solid black; padding: 2px;">R</span></p> <div style="border: 1px dashed black; padding: 5px; margin-top: 10px;"> <p>Example: When the "Cd. 17" JOG speed" is set as "20000.00mm/min", the buffer memory stores "2000000".</p> </div> <div style="margin-top: 10px;"> <p>● Unit conversion table (Cd.17)</p> <table border="1" style="display: inline-table;"> <thead> <tr> <th>n</th> <th>Unit</th> </tr> </thead> <tbody> <tr> <td>-2</td> <td>mm/min</td> </tr> <tr> <td>-3</td> <td>inch/min</td> </tr> <tr> <td>-3</td> <td>degree/min</td> </tr> <tr> <td>0</td> <td>pulse/s</td> </tr> </tbody> </table> </div>	n	Unit	-2	mm/min	-3	inch/min	-3	degree/min	0	pulse/s	0	1518 1519	1618 1619	1718 1719	1818 1819
n	Unit														
-2	mm/min														
-3	inch/min														
-3	degree/min														
0	pulse/s														
<p>■ Set with a decimal.</p> <p>Setting value <span style="border: 1px solid black; padding: 5px; display: inline-block;">K <span style="border: 1px dashed black; padding: 2px;">1</span></span></p> <p style="margin-left: 100px;">● Interruption request continuous operation 1: Interrupts continuous operation control or continuous path control.</p> <p style="margin-left: 100px; font-size: small;">The QD75 resets the value to "0" automatically when the continuous operation interrupt request is processed. (This indicates the completion of continuous operation interruption request.)</p>	0	1520	1620	1720	1820										

Setting item	Setting details	
<p><b>Cd.19</b> OPR request flag OFF request</p>	<ul style="list-style-type: none"> <li>• The sequence program can use this data item to forcibly turn the OPR request flag from ON to OFF.</li> </ul>	
<p><b>Cd.20</b> Manual pulse generator 1 pulse input magnification</p>	<ul style="list-style-type: none"> <li>• This data item determines the factor by which the number of pulses from the manual pulse generator is magnified.</li> <li>• Value "1001" or higher: read as "1000". (QD75P□N/QD75D□N)</li> <li>• Value "101" or higher: read as "100". (QD75P□/QD75D□)</li> </ul>	
<p><b>Cd.21</b> Manual pulse generator enable flag</p>	<ul style="list-style-type: none"> <li>• This data item enables or disables operations using a manual pulse generator.</li> </ul>	
<p><b>Cd.22</b> New torque value</p>	<ul style="list-style-type: none"> <li>• When changing the " <b>Md.35</b> Torque limit stored value", use this data item to specify a new torque limit stored value.</li> <li>• Set a value within the allowable range of the " <b>Pr.17</b> Torque limit setting value".</li> </ul>	



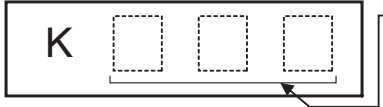

Setting value	Default value	Storage buffer memory address			
		Axis 1	Axis 2	Axis 3	Axis 4
<p>■ Set with a decimal.</p> <p>Setting value </p> <p>● OPR request flag OFF request 1: Turns the "OPR request flag" from ON to OFF.</p> <p>The QD75 resets the value to "0" automatically when the OPR request flag is turned OFF. (This indicates the completion of OPR request flag OFF request.)</p>	0	1521	1621	1721	1821
<p>■ Set with a decimal.</p> <p>Setting value </p> <p>● Manual pulse generator 1 pulse input magnification 1 to 1000 (QD75P□N/QD75D□N) 1 to 100 (QD75P□/QD75D)</p>	1	1522 1523	1622 1623	1722 1723	1822 1823
<p>■ Set with a decimal.</p> <p>Setting value </p> <p>● Manual pulse generator enable flag 0: Disable manual pulse generator operation. 1: Enable manual pulse generator operation.</p>	0	1524	1624	1724	1824
<p>■ Set with a decimal.</p> <p>Setting value </p> <p>● New torque value 1 to [Pr.17]: Torque limit setting value 0 : Torque value is not changed</p>	0	1525	1625	1725	1825

Setting item	Setting details										
<p><b>Cd.23</b> Speed-position switching control movement amount change register</p>	<ul style="list-style-type: none"> <li>• During the speed control stage of the speed-position switching control (INC mode), it is possible to change the specification of the movement amount during the position control stage. For that, use this data item to specify a new movement amount.</li> <li>• The new movement amount has to be set during the speed control stage of the speed-position switching control (INC mode).</li> <li>• The value is reset to "0" when the next operation starts.</li> <li>• Set a value within the following range:</li> </ul> <table border="1" data-bbox="587 707 1425 846"> <thead> <tr> <th data-bbox="587 707 740 779">Pr.1 Unit setting</th> <th data-bbox="740 707 911 779">mm (<math>\times 10^{-1} \mu\text{m}</math>)</th> <th data-bbox="911 707 1082 779">inch (<math>\times 10^{-5} \text{inch}</math>)</th> <th data-bbox="1082 707 1252 779">degree (<math>\times 10^{-5} \text{degree}</math>)</th> <th data-bbox="1252 707 1425 779">pulse (pulse)</th> </tr> </thead> <tbody> <tr> <td data-bbox="587 779 740 846">Setting range</td> <td data-bbox="740 779 911 846">0 to 2147483647</td> <td data-bbox="911 779 1082 846">0 to 2147483647</td> <td data-bbox="1082 779 1252 846">0 to 2147483647</td> <td data-bbox="1252 779 1425 846">0 to 2147483647</td> </tr> </tbody> </table>	Pr.1 Unit setting	mm ( $\times 10^{-1} \mu\text{m}$ )	inch ( $\times 10^{-5} \text{inch}$ )	degree ( $\times 10^{-5} \text{degree}$ )	pulse (pulse)	Setting range	0 to 2147483647	0 to 2147483647	0 to 2147483647	0 to 2147483647
Pr.1 Unit setting	mm ( $\times 10^{-1} \mu\text{m}$ )	inch ( $\times 10^{-5} \text{inch}$ )	degree ( $\times 10^{-5} \text{degree}$ )	pulse (pulse)							
Setting range	0 to 2147483647	0 to 2147483647	0 to 2147483647	0 to 2147483647							
<p><b>Cd.24</b> Speed-position switching enable flag</p>	<ul style="list-style-type: none"> <li>• Set whether the external control signal (external command signal [CHG]: "speed-position, position-speed switching request" is selected) is enabled or not.</li> </ul>										
<p><b>Cd.25</b> Position-speed switching control speed change register</p>	<ul style="list-style-type: none"> <li>• During the position control stage of the position-speed switching control, it is possible to change the specification of the speed during the speed control stage. For that, use this data item to specify a new speed.</li> <li>• The new speed has to be set during the position control stage of the position-speed switching control.</li> <li>• The value is reset to "0" when the next operation starts.</li> <li>• Set a value within the following range:</li> </ul> <table border="1" data-bbox="571 1659 1425 1865"> <thead> <tr> <th data-bbox="571 1659 692 1731">Pr.1 Unit setting</th> <th data-bbox="692 1659 847 1731">mm (<math>\times 10^{-2} \text{mm/min}</math>)</th> <th data-bbox="847 1659 1002 1731">inch (<math>\times 10^{-3} \text{inch/min}</math>)</th> <th data-bbox="1002 1659 1187 1731">degree (<math>\times 10^{-3} \text{degree/min}</math>)</th> <th data-bbox="1187 1659 1425 1731">pulse (pulse/s)</th> </tr> </thead> <tbody> <tr> <td data-bbox="571 1731 692 1865">Setting range</td> <td data-bbox="692 1731 847 1865">0 to 2000000000</td> <td data-bbox="847 1731 1002 1865">0 to 2000000000</td> <td data-bbox="1002 1731 1187 1865">0 to 2000000000</td> <td data-bbox="1187 1731 1425 1865">[QD75P□N/QD75D□N] 0 to 4000000 [QD75P□/QD75D□] 0 to 1000000</td> </tr> </tbody> </table>	Pr.1 Unit setting	mm ( $\times 10^{-2} \text{mm/min}$ )	inch ( $\times 10^{-3} \text{inch/min}$ )	degree ( $\times 10^{-3} \text{degree/min}$ )	pulse (pulse/s)	Setting range	0 to 2000000000	0 to 2000000000	0 to 2000000000	[QD75P□N/QD75D□N] 0 to 4000000 [QD75P□/QD75D□] 0 to 1000000
Pr.1 Unit setting	mm ( $\times 10^{-2} \text{mm/min}$ )	inch ( $\times 10^{-3} \text{inch/min}$ )	degree ( $\times 10^{-3} \text{degree/min}$ )	pulse (pulse/s)							
Setting range	0 to 2000000000	0 to 2000000000	0 to 2000000000	[QD75P□N/QD75D□N] 0 to 4000000 [QD75P□/QD75D□] 0 to 1000000							

Setting value	Default value	Storage buffer memory address													
		Axis 1	Axis 2	Axis 3	Axis 4										
<p>■ Set with a decimal.</p> <p>Actual value <span style="border: 1px solid black; padding: 2px;">Cd.23 Speed-position switching control movement amount change register</span></p> <p style="text-align: center;">↓ Conversion into an integer value</p> <p>Setting value (Decimal) <span style="border: 1px solid black; padding: 2px;">R</span></p> <p style="text-align: center;"><math>\times 10^n</math></p> <p>● Unit conversion table ((Cd.23))</p> <table border="1" style="margin-left: auto; margin-right: auto;"> <thead> <tr> <th>n</th> <th>Unit</th> </tr> </thead> <tbody> <tr> <td>-1</td> <td>μm</td> </tr> <tr> <td>-5</td> <td>inch</td> </tr> <tr> <td>-5</td> <td>degree</td> </tr> <tr> <td>0</td> <td>pulse</td> </tr> </tbody> </table> <p style="border: 1px dashed black; padding: 5px; margin-top: 10px;">Example: If "Cd. 23 Speed-position switching control movement amount change register" is set as "20000.0 μm", the buffer memory stores "200000".</p>	n	Unit	-1	μm	-5	inch	-5	degree	0	pulse	0	1526 1527	1626 1627	1726 1727	1826 1827
n	Unit														
-1	μm														
-5	inch														
-5	degree														
0	pulse														
<p>■ Set with a decimal.</p> <p>Setting value <span style="border: 1px solid black; padding: 2px;">K <span style="border: 1px dashed black; display: inline-block; width: 1em; height: 1em; vertical-align: middle;"></span></span></p> <p>● Speed-position switching enable flag</p> <p>0: Speed control will not be taken over by position control even when the external command signal comes ON.</p> <p>1: Speed control will be taken over by position control when the external command signal comes ON.</p>	0	1528	1628	1728	1828										
<p>■ Set with a decimal.</p> <p>Actual value <span style="border: 1px solid black; padding: 2px;">Cd.25 Position-speed switching control speed change register</span></p> <p style="text-align: center;">↓ Conversion into an integer value</p> <p>Setting value (Decimal) <span style="border: 1px solid black; padding: 2px;">R</span></p> <p style="text-align: center;"><math>\times 10^n</math></p> <p>● Unit conversion table ((Cd.25))</p> <table border="1" style="margin-left: auto; margin-right: auto;"> <thead> <tr> <th>n</th> <th>Unit</th> </tr> </thead> <tbody> <tr> <td>-2</td> <td>mm/min</td> </tr> <tr> <td>-3</td> <td>inch/min</td> </tr> <tr> <td>-3</td> <td>degree/min</td> </tr> <tr> <td>0</td> <td>pulse/s</td> </tr> </tbody> </table> <p style="border: 1px dashed black; padding: 5px; margin-top: 10px;">Example: If "Cd. 25 Position-speed switching control speed change register" is set as "2000.00 mm/min", the buffer memory stores "200000".</p>	n	Unit	-2	mm/min	-3	inch/min	-3	degree/min	0	pulse/s	0	1530 1531	1630 1631	1730 1731	1830 1831
n	Unit														
-2	mm/min														
-3	inch/min														
-3	degree/min														
0	pulse/s														

Setting item	Setting details															
<p><b>Cd.26</b> Position-speed switching enable flag</p>	<ul style="list-style-type: none"> <li>Set whether the external control signal (external command signal [CHG]: "speed-position, position-speed switching request" is selected) is enabled or not.</li> </ul>															
<p><b>Cd.27</b> Target position change value (New address)</p>	<ul style="list-style-type: none"> <li>When changing the target position during a positioning operation, use this data item to specify a new positioning address.</li> <li>Set a value within the following range:</li> </ul> <table border="1" data-bbox="587 824 1426 1086"> <thead> <tr> <th data-bbox="587 824 742 891">Pr.1</th> <th data-bbox="742 824 911 891">mm (<math>\times 10^{-1} \mu\text{m}</math>)</th> <th data-bbox="911 824 1080 891">inch (<math>\times 10^{-5} \text{inch}</math>)</th> <th data-bbox="1080 824 1249 891">degree (<math>\times 10^{-5} \text{degree}</math>)</th> <th data-bbox="1249 824 1426 891">pulse (pulse)</th> </tr> </thead> <tbody> <tr> <td data-bbox="587 891 742 987">ABS</td> <td data-bbox="742 891 911 987">-2147483648 to +2147483647</td> <td data-bbox="911 891 1080 987">-2147483648 to +2147483647</td> <td data-bbox="1080 891 1249 987">0 to 359999999</td> <td data-bbox="1249 891 1426 987">-2147483648 to +2147483647</td> </tr> <tr> <td data-bbox="587 987 742 1086">INC</td> <td data-bbox="742 987 911 1086">-2147483648 to +2147483647</td> <td data-bbox="911 987 1080 1086">-2147483648 to +2147483647</td> <td data-bbox="1080 987 1249 1086">-2147483648 to +2147483647</td> <td data-bbox="1249 987 1426 1086">-2147483648 to +2147483647</td> </tr> </tbody> </table>	Pr.1	mm ( $\times 10^{-1} \mu\text{m}$ )	inch ( $\times 10^{-5} \text{inch}$ )	degree ( $\times 10^{-5} \text{degree}$ )	pulse (pulse)	ABS	-2147483648 to +2147483647	-2147483648 to +2147483647	0 to 359999999	-2147483648 to +2147483647	INC	-2147483648 to +2147483647	-2147483648 to +2147483647	-2147483648 to +2147483647	-2147483648 to +2147483647
Pr.1	mm ( $\times 10^{-1} \mu\text{m}$ )	inch ( $\times 10^{-5} \text{inch}$ )	degree ( $\times 10^{-5} \text{degree}$ )	pulse (pulse)												
ABS	-2147483648 to +2147483647	-2147483648 to +2147483647	0 to 359999999	-2147483648 to +2147483647												
INC	-2147483648 to +2147483647	-2147483648 to +2147483647	-2147483648 to +2147483647	-2147483648 to +2147483647												
<p><b>Cd.28</b> Target position change value (New speed)</p>	<ul style="list-style-type: none"> <li>When changing the target position during a positioning operation, use this data item to specify a new speed.</li> <li>The speed will not change if "0" is set.</li> <li>Set a value within the following range:</li> </ul> <table border="1" data-bbox="574 1249 1426 1458"> <thead> <tr> <th data-bbox="574 1249 683 1317">Pr.1 Unit setting</th> <th data-bbox="683 1249 837 1317">mm (<math>\times 10^{-2} \text{mm/min}</math>)</th> <th data-bbox="837 1249 992 1317">inch (<math>\times 10^{-3} \text{inch/min}</math>)</th> <th data-bbox="992 1249 1177 1317">degree (<math>\times 10^{-3} \text{degree/min}</math>)</th> <th data-bbox="1177 1249 1426 1317">pulse (pulse/s)</th> </tr> </thead> <tbody> <tr> <td data-bbox="574 1317 683 1458">Setting range</td> <td data-bbox="683 1317 837 1458">0 to 2000000000</td> <td data-bbox="837 1317 992 1458">0 to 2000000000</td> <td data-bbox="992 1317 1177 1458">0 to 2000000000</td> <td data-bbox="1177 1317 1426 1458">[QD75P□N/QD75D□N] 0 to 4000000 [QD75P□/QD75D□] 0 to 1000000</td> </tr> </tbody> </table>	Pr.1 Unit setting	mm ( $\times 10^{-2} \text{mm/min}$ )	inch ( $\times 10^{-3} \text{inch/min}$ )	degree ( $\times 10^{-3} \text{degree/min}$ )	pulse (pulse/s)	Setting range	0 to 2000000000	0 to 2000000000	0 to 2000000000	[QD75P□N/QD75D□N] 0 to 4000000 [QD75P□/QD75D□] 0 to 1000000					
Pr.1 Unit setting	mm ( $\times 10^{-2} \text{mm/min}$ )	inch ( $\times 10^{-3} \text{inch/min}$ )	degree ( $\times 10^{-3} \text{degree/min}$ )	pulse (pulse/s)												
Setting range	0 to 2000000000	0 to 2000000000	0 to 2000000000	[QD75P□N/QD75D□N] 0 to 4000000 [QD75P□/QD75D□] 0 to 1000000												
<p><b>Cd.29</b> Target position change request flag</p>	<ul style="list-style-type: none"> <li>Requests the target position change during a positioning operation.</li> </ul>															

Setting value	Default value	Storage buffer memory address																											
		Axis 1	Axis 2	Axis 3	Axis 4																								
<p>■ Set with a decimal.</p> <p>Setting value </p> <p>● Position-speed switching enable flag                      0: Position control will not be taken over by speed control even when the external command signal [CHG] comes ON.                      1: Position control will be taken over by speed control when the external command signal [CHG] comes ON.</p>	0	1532	1632	1732	1832																								
<p>■ Set with a decimal.</p> <p>Actual value <table border="1" data-bbox="338 837 813 913"> <tr><td>Cd. 27</td><td>Target position change value (address)</td></tr> <tr><td>Cd. 28</td><td>Target position change value (speed)</td></tr> </table></p> <p>◇ Conversion into an integer value  <math>\times 10^n</math></p> <p>Setting value (Decimal) </p> <p>● Unit conversion table (Cd.27)</p> <table border="1" data-bbox="735 1003 956 1160"> <thead> <tr><th>n</th><th>Unit</th></tr> </thead> <tbody> <tr><td>-1</td><td>μm</td></tr> <tr><td>-5</td><td>inch</td></tr> <tr><td>-5</td><td>degree</td></tr> <tr><td>0</td><td>pulse</td></tr> </tbody> </table> <p>● Unit conversion table (Cd.28)</p> <table border="1" data-bbox="735 1218 956 1375"> <thead> <tr><th>n</th><th>Unit</th></tr> </thead> <tbody> <tr><td>-2</td><td>mm/min</td></tr> <tr><td>-3</td><td>inch/min</td></tr> <tr><td>-3</td><td>degree/min</td></tr> <tr><td>0</td><td>pulse/s</td></tr> </tbody> </table> <p>Example: If "Cd. 28 Target position change value (speed) is set as "10000.00 mm/min", the buffer memory stores "1000000".</p>	Cd. 27	Target position change value (address)	Cd. 28	Target position change value (speed)	n	Unit	-1	μm	-5	inch	-5	degree	0	pulse	n	Unit	-2	mm/min	-3	inch/min	-3	degree/min	0	pulse/s	0	1534 1535	1634 1635	1734 1735	1834 1835
Cd. 27	Target position change value (address)																												
Cd. 28	Target position change value (speed)																												
n	Unit																												
-1	μm																												
-5	inch																												
-5	degree																												
0	pulse																												
n	Unit																												
-2	mm/min																												
-3	inch/min																												
-3	degree/min																												
0	pulse/s																												
<p>■ Set with a decimal.</p> <p>Setting value </p> <p>● Target position change request flag                      1: Requests a target position change</p> <p>The QD75 resets the value to "0" automatically when the new target position value has been written.                      (This indicates the completion of target position change request.)</p>	0	1538	1638	1738	1838																								

Setting item	Setting details
Cd.30 Simultaneous starting axis start data No. (axis 1 start data No.)	<ul style="list-style-type: none"> <li>• Use these data items to specify a start data No. for each axis that has to start simultaneously.</li> <li>• Set "0" to any axis that should not start simultaneously.</li> </ul>
Cd.31 Simultaneous starting axis start data No. (axis 2 start data No.)	
Cd.32 Simultaneous starting axis start data No. (axis 3 start data No.)	
Cd.33 Simultaneous starting axis start data No. (axis 4 start data No.)	
Cd.34 Step mode	<ul style="list-style-type: none"> <li>• To perform a step operation, use this data item to specify the units by which the stepping should be performed.</li> </ul>
Cd.35 Step valid flag	<ul style="list-style-type: none"> <li>• This data item validates or invalidates step operations.</li> </ul>

Setting value	Default value	Storage buffer memory address			
		Axis 1	Axis 2	Axis 3	Axis 4
<p>■ Set with a decimal.</p> <p>Setting value</p> <div style="display: flex; align-items: center;"> <div style="border: 1px solid black; padding: 5px; margin-right: 10px;"> <span style="font-size: 24px; font-weight: bold;">K</span> <div style="display: flex; gap: 10px; margin-left: 10px;"> <div style="border: 1px dashed black; width: 30px; height: 30px;"></div> <div style="border: 1px dashed black; width: 30px; height: 30px;"></div> <div style="border: 1px dashed black; width: 30px; height: 30px;"></div> </div> </div> <div style="margin-left: 20px;"> <p><span style="border: 1px solid black; padding: 2px;">Cd.30</span> to <span style="border: 1px solid black; padding: 2px;">Cd.33</span>                      Simultaneous starting axis start data No.: 1 to 600</p> </div> </div>	0	1540	1640	1740	1840
	0	1541	1641	1741	1841
	0	1542	1642	1742	1842
	0	1543	1643	1743	1843
<p>■ Set with a decimal.</p> <p>Setting value</p> <div style="display: flex; align-items: center;"> <div style="border: 1px solid black; padding: 5px; margin-right: 10px;"> <span style="font-size: 24px; font-weight: bold;">K</span> <div style="border: 1px dashed black; width: 30px; height: 30px; margin-left: 10px;"></div> </div> <div style="margin-left: 20px;"> <p>● Step mode                      0: Stepping by deceleration units                      1: Stepping by data No. units</p> </div> </div>	0	1544	1644	1744	1844
<p>■ Set with a decimal.</p> <p>Setting value</p> <div style="display: flex; align-items: center;"> <div style="border: 1px solid black; padding: 5px; margin-right: 10px;"> <span style="font-size: 24px; font-weight: bold;">K</span> <div style="border: 1px dashed black; width: 30px; height: 30px; margin-left: 10px;"></div> </div> <div style="margin-left: 20px;"> <p>● Step valid flag                      0: Invalidates step operations                      1: Validates step operations</p> </div> </div>	0	1545	1645	1745	1845

Setting item	Setting details	
Cd.36 Step start information	<ul style="list-style-type: none"> <li>To continue the step operation when the step function is used, set "1" in this data item.</li> </ul>	
Cd.37 Skip command	<ul style="list-style-type: none"> <li>To skip the current positioning operation, set "1" in this data item.</li> </ul>	
Cd.38 Teaching data selection	<ul style="list-style-type: none"> <li>This data item specifies the teaching result write destination.</li> <li>Data are cleared to "0" when the teaching ends.</li> </ul>	
Cd.39 Teaching positioning data No.	<ul style="list-style-type: none"> <li>This data item specifies data to be produced by teaching.</li> <li>If a value between 1 and 600 is set, a teaching operation is done.</li> <li>The value is cleared to "0" when the QD75 is initialized, when a teaching operation completes, and when an illegal value (601 or higher) is entered.</li> </ul>	
Cd.40 ABS direction in degrees	<ul style="list-style-type: none"> <li>This data item specifies the ABS moving direction carrying out the position control when "degree" is selected as the unit.</li> </ul>	

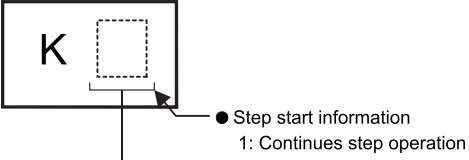
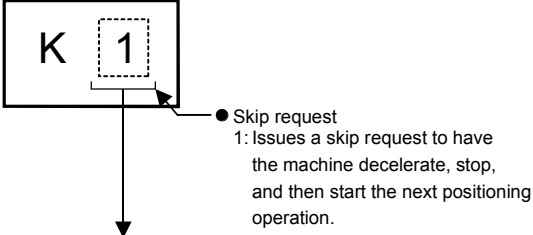
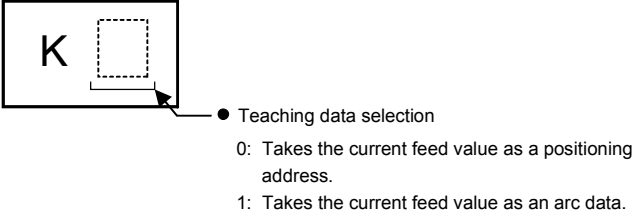
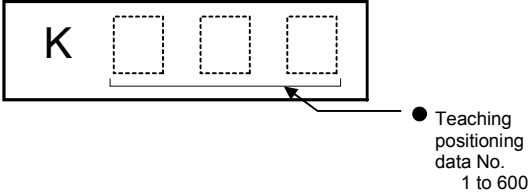
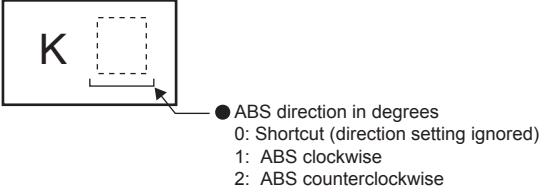

Setting value	Default value	Storage buffer memory address			
		Axis 1	Axis 2	Axis 3	Axis 4
<p>■ Set with a decimal.</p> <p>Setting value</p>  <p>● Step start information 1: Continues step operation</p> <p>The QD75 resets the value to "0" automatically when processing of the step start request completes.</p>	0	1546	1646	1746	1846
<p>■ Set with a decimal.</p> <p>Setting value</p>  <p>● Skip request 1: Issues a skip request to have the machine decelerate, stop, and then start the next positioning operation.</p> <p>The QD75 resets the value to "0" automatically when processing of the skip request completes.</p>	0	1547	1647	1747	1847
<p>■ Set with a decimal.</p> <p>Setting value</p>  <p>● Teaching data selection 0: Takes the current feed value as a positioning address. 1: Takes the current feed value as an arc data.</p>	0	1548	1648	1748	1848
<p>■ Set with a decimal.</p> <p>Setting value</p>  <p>● Teaching positioning data No. 1 to 600</p>	0	1549	1649	1749	1849
<p>■ Set with a decimal.</p> <p>Setting value</p>  <p>● ABS direction in degrees 0: Shortcut (direction setting ignored) 1: ABS clockwise 2: ABS counterclockwise</p>	0	1550	1650	1750	1850



# CHAPTER 6 SEQUENCE PROGRAM USED FOR POSITIONING CONTROL

The programs required to carry out positioning control with the QD75 are explained in this chapter.

The program required for control is created allowing for the "start conditions", "start time chart", "device settings" and general control configuration.  
(The parameters, positioning data, block start data and condition data, etc., must be set in the QD75 according to the control to be executed, and program for setting the control data or a program for starting the various control must be created.)

The first half of this chapter explains the program configuration of general control, and the latter half explains the program details. Create the required program while referring to the various control details explained in PART 2, and to CHAPTER 5 "DATA USED FOR POSITIONING CONTROL".

- 6.1 Precautions for creating program .....6- 2
- 6.2 List of devices used .....6- 5
- 6.3 Creating a program .....6- 11
  - 6.3.1 General configuration of program .....6- 11
  - 6.3.2 Positioning control operation program .....6- 12
- 6.4 Positioning program examples..... 6- 15
- 6.5 Program details ..... 6- 25
  - 6.5.1 Initialization program..... 6- 25
  - 6.5.2 Start details setting program..... 6- 26
  - 6.5.3 Start program ..... 6- 28
  - 6.5.4 Continuous operation interrupt program ..... 6- 38
  - 6.5.5 Restart program ..... 6- 40
  - 6.5.6 Stop program ..... 6- 44

## 6.1 Precautions for creating program

The common precautions to be taken when writing data from the CPU module to the QD75 buffer memory are described below.

When diverting any of the program examples introduced in this manual to the actual system, fully verify that there are no problems in the controllability of the target system.

### (1) Reading/writing the data

Setting the data explained in this chapter (various parameters, positioning data, block start data) should be set using GX Configurator-QP.

When set with the sequence program, many sequence programs and devices must be used. This will not only complicate the program, but will also increase the scan time.

When rewriting the positioning data during continuous path control or continuous positioning control, rewrite the data four positioning data items before the actual execution. If the positioning data is not rewritten before the positioning data four items earlier is executed, the process will be carried out as if the data was not rewritten.

### (2) Restrictions to speed change execution interval

Provide an interval of 100ms or more when changing the speed or performing override function with the QD75.

### (3) Process during overrun

Overrun is prevented by the setting of the upper and lower stroke limits with the detail parameter 1.

However, this applies only when the QD75 is operating correctly.

It is recommended to create an external circuit including a boundary limit switch to ensure the whole system safety as follows: the external circuit powers OFF the motor when the boundary limit switch operates.

(4) System configuration

Unless particularly designated, the sequence program for the following system is shown in this chapter and subsequent. In the program, the unit of "0 (mm)" is set for the basic parameter 1.

Refer to Section 6.2 for the application of the devices to be used.

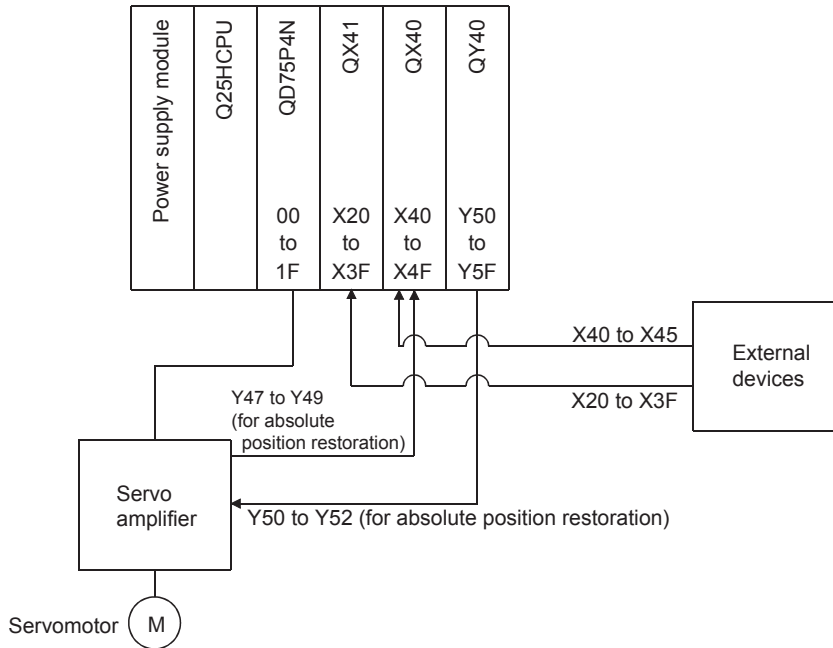

(5) Communication with QD75

There are two methods for communication with QD75 using the sequence program: a method using an "intelligent function device" and a method using a FROM/TO instruction.

In the sequence program in this chapter and subsequent, the program example using the "intelligent function device" is shown without using a FROM/TO instruction for communication with QD75.

When using the FROM/TO instruction for communication with QD75, change the circuit incorporating the "intelligent function device" as follows.

- (a) When the circuit uses the "intelligent function device" on the destination (D) side of a MOV instruction, change the instruction to a TO instruction.

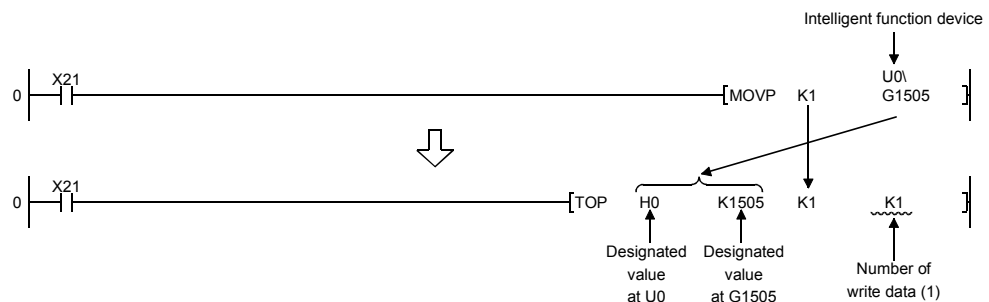

(b) When the circuit uses the "intelligent function device" on the source(s) side and the destination (D) side of a MOV instruction, change the instruction to a FROM instruction and a TO instruction.

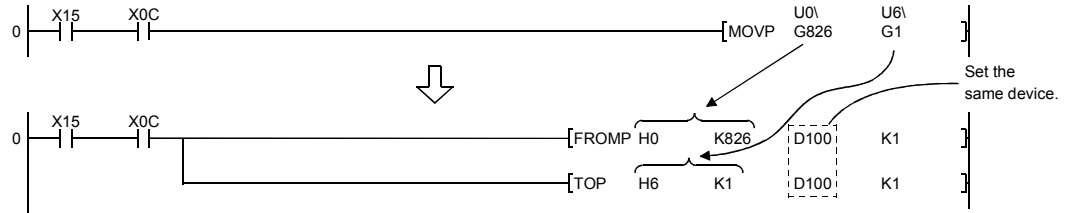

(c) When the circuit uses the "intelligent function device" for a COMPARISON instruction, change the instruction to a FROM instruction and a COMPARISON instruction.

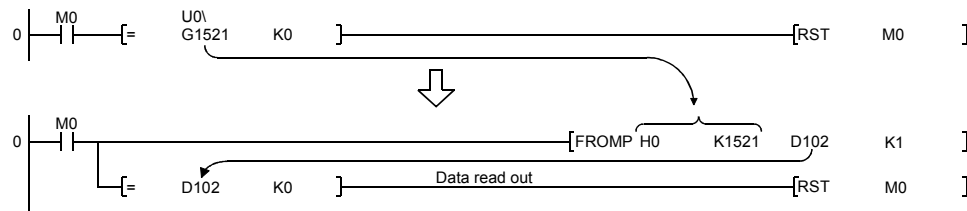

(d) When the circuit uses the "intelligent function device" for a WAND instruction, change the instruction to a FROM instruction and a WAND instruction.

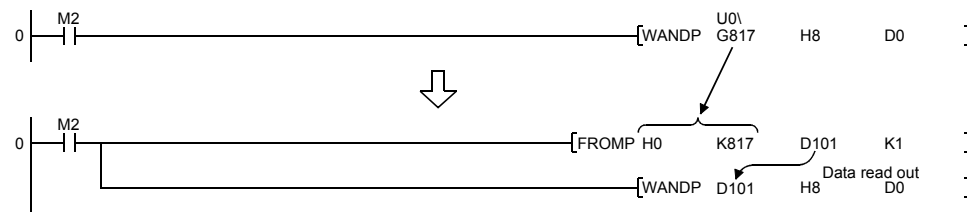

**REMARK**

Refer to QCPU (Q mode) User's Manual (Functions and Programs Basic Part) for the intelligent function devices.  
 Refer to QCPU (Q mode) Programming Manual (Common Commands Part) for detail commands used in those programs shown in this chapter and subsequent.

## 6.2 List of devices used

In the sequence programs shown in this chapter and subsequent, the application of the devices used are as follows.

The I/O numbers for QD75 indicate those when QD75 is mounted in the 0-slot of the main base.

If it is mounted in the slot other than the 0-slot of the main base, change the I/O number to that for the position where QD75 was installed.

In addition, change the external inputs, external outputs, internal relays, data registers, and timers according to the system used.

## (1) Inputs/outputs, external inputs/external outputs, and internal relays of QD75

Device name	Device				Application	Details when ON	
	Axis 1	Axis 2	Axis 3	Axis 4			
Inputs/ outputs of QD75	Input	X0				QD75 READY signal	Preparation completed
		X1				Synchronization flag	QD75 buffer memory accessible
		X4	X5	X6	X7	M code ON signal	M code outputting
		X8	X9	XA	XB	Error detection signal	Error detected
		XC	XD	XE	XF	BUSY signal	BUSY (operating)
		X10	X11	X12	X13	Start complete signal	Start completed
		X14	X15	X16	X17	Positioning complete signal	Positioning completed
	Out- put	Y0				PLC READY signal	CPU module preparation completed
		Y4	Y5	Y6	Y7	Axis stop signal	Requesting stop
		Y8	YA	YC	YE	Forward run JOG start signal	Starting forward run JOG
		Y9	YB	YD	YF	Reverse run JOG start signal	Starting reverse run JOG
		Y10	Y11	Y12	Y13	Positioning start signal	Requesting start
	External input (command)	X20				OPR request OFF command	Commanding OPR request OFF
		X21				External command valid command	Commanding external command valid setting
X22					External command invalid command	Commanding external command invalid	
X23					Machine OPR command	Commanding machine OPR	
X24					Fast OPR command	Commanding fast OPR	
X25					Positioning start command	Commanding positioning start	
X26					Speed-position switching operation command	Commanding speed-position switching operation	
X27					Speed-position switching enable command	Commanding speed-position switching enable command	
X28					Speed-position switching prohibit command	Commanding speed-position switching prohibit	
X29					Movement amount change command	Commanding movement amount change	
X2A					High-level positioning control start command	Commanding high-level positioning control start	
X2B					Positioning start command (dedicated instruction)	Commanding positioning start	

Device name	Device				Application	Details when ON	
	Axis 1	Axis 2	Axis 3	Axis 4			
External input (command)	X2C	—	—	—	M code OFF command	Commanding M code OFF	
	X2D				JOG operation speed setting command	Commanding JOG operation speed setting	
	X2E				Forward run JOG/inching command	Commanding forward run JOG/inching operation	
	X2F				Reverse run JOG/inching command	Commanding reverse run JOG/inching operation	
	X30				Manual pulse generator operation enable command	Commanding manual pulse generator operation enable	
	X31				Manual pulse generator operation disable command	Commanding manual pulse generator operation disable	
	X32				Speed change command	Commanding speed change	
	X33				Override command	Commanding override	
	X34				Acceleration/deceleration time change command	Commanding acceleration/deceleration time change	
	X35				Acceleration/deceleration time change disable command	Commanding acceleration/deceleration time change disable	
	X37				Step operation command	Commanding step operation	
	X38				Skip operation command	Commanding skip operation	
	X39				Teaching command	Commanding teaching	
	X3A				Continuous operation interrupt command	Commanding continuous operation interrupt command	
	X3B				Restart command	Commanding restart	
	X3C				Parameter initialization command	Commanding parameter initialization	
	X3D				Flash ROM write command	Commanding flash ROM write	
	X3E				Error reset command	Commanding error reset	
	X3F				Stop command	Commanding stop	
	X40				Position-speed switching operation command	Commanding position-speed switching operation	
	X41				Position-speed switching enable command	Commanding position-speed switching enable	
	X42				Position-speed switching prohibit command	Commanding position-speed switching prohibit	
	X43				Speed change command	Commanding speed change	
	X44				Inching movement amount setting command	Commanding inching movement amount setting	
	X45				Target position change command	Commanding target position change	
X4D	Speed-position switching control (ABS mode) setting command	Commanding speed-position switching control (ABS mode) setting					
X4E	Positioning start command (Y start)	Positioning start command being given					
External input (absolute position restoration)	X47	—	—	—	ABS data bit 0	—	
	X48				ABS data bit 1	—	
	X49				Transmission data READY flag	—	
External output (absolute position restoration)	Y50	—	—	—	Servo ON signal	—	
	Y51				ABS transmission mode	—	
	Y52				ABS request mode	—	



Device name	Device				Application	Details when ON	
	Axis 1	Axis 2	Axis 3	Axis 4			
Internal relay	M0				OPR request OFF command	Commanding OPR request OFF	
	M1				OPR request OFF command pulse	OPR request OFF commanded	
	M2				OPR request OFF command storage	OPR request OFF command held	
	M3				Fast OPR command	Commanding fast OPR	
	M4				Fast OPR command storage	Fast OPR command held	
	M5				Positioning start command pulse	Positioning start commanded	
	M6				Positioning start command storage	Positioning start command held	
	M7				In-JOG/Inching operation flag	Operating JOG/Inching	
	M8				Manual pulse generator operation enable command	Commanding manual pulse generator operation enable	
	M9				Manual pulse generator operating flag	Operating manual pulse generator	
	M10				Manual pulse generator operation disable command	Commanding manual pulse generator operation disable	
	M11		—		Speed change command pulse	Speed change commanded	
	M12				Speed change command storage	Speed change command held	
	M13				Override command	Requesting override	
	M14				Acceleration/deceleration time change command	Requesting acceleration/deceleration time change	
	M16				Step operation command pulse	Step operation commanded	
	M17				Skip command pulse	Skip commanded	
	M18				Skip command storage	Skip command held	
	M19				Teaching command pulse	Teaching commanded	
	M20				Teaching command storage	Teaching command held	
	M21				Continuous operation interrupt command	Requesting continuous operation interrupt	
	M22				Restart command	Requesting restart	
	M23				Restart command storage	Restart command held	
			M24			Parameter initialization command pulse	Parameter initialization commanded
			M25			Parameter initialization command storage	Parameter initialization command held
			M26			Flash ROM write command pulse	Flash ROM write commanded
			M27			Flash ROM write command storage	Flash ROM write command held
		M28				Error reset	Error reset completed
		M29				Stop command pulse	Stop commanded
		M30				Target position change command pulse	Target position change commanded
		M31				Target position change command storage	Target position change command held
		M32				ZP.PSTR1 instruction complete device	ZP.PSTR1 instruction completed
		M33				ZP.PSTR1 instruction error failure device	ZP.PSTR1 instruction failed

Device name	Device				Application	Details when ON
	Axis 1	Axis 2	Axis 3	Axis 4		
Internal relay	M34	—			ZP.TEACH1 instruction complete device	ZP.TEACH1 instruction completed
	M35				ZP.TEACH1 instruction failure device	ZP.TEACH1 instruction failed
	M36				ZP.PINIT instruction complete device	ZP.PINIT instruction completed
	M37				ZP.PINIT instruction failure device	ZP.PINIT instruction failed
	M38				ZP.PFWRT instruction complete device	ZP.PFWRT instruction completed
	M39				ZP.PFWRT instruction failure device	ZP.PFWRT instruction failed
	M40				Absolute position restoration instruction pulse	Absolute position restoration commanded
	M41				Absolute position restoration instruction storage	Absolute position restoration instruction held
	M42				Z.ABRST instruction complete device	Z.ABRST instruction completed
	M43				Z.ABRST instruction failure device	Z.ABRST instruction failed
	M50				Basic parameter 1 setting complete device	Basic parameter 1 setting completed
	M51				OPR basic parameter setting complete device	OPR basic parameter setting completed

## (2) Data registers and timers

Device name	Device				Application	Details of storage
	Axis 1	Axis 2	Axis 3	Axis 4		
Data register	D0	—			OPR request flag	(Md.31) Status (bit 3))
	D1				Speed (low-order 16 bits)	(Cd.25) Position-speed switching control speed change resistor)
	D2				Speed (high-order 16 bits)	
	D3				Movement amount (low-order 16 bits)	(Cd.23) Speed-position switching control movement amount change resistor)
	D4				Movement amount (high-order 16 bits)	
	D5				Inching movement amount	(Cd.16) Inching movement amount)
	D6				JOG operation speed (low-order 16 bits)	(Cd.17) JOG operation speed)
	D7				JOG operation speed (high-order 16 bits)	
	D8				Manual pulse generator 1 pulse input magnification (low-order)	(Cd.20) Manual pulse generator 1 pulse input magnification)
	D9				Manual pulse generator 1 pulse input magnification (high-order)	
	D10				Manual pulse generator operation enable	(Cd.21) Manual pulse generator enable flag)
	D11				Speed change value (low-order 16 bits)	(Cd.14) New speed value)
	D12				Speed change value (high-order 16 bits)	
	D13				Speed change request	(Cd.15) Speed change request)
	D14				Override value	(Cd.13) Positioning operation speed override)

Device name	Device				Application	Details of storage
	Axis 1	Axis 2	Axis 3	Axis 4		
Data register	D15	—	—	—	Acceleration time setting (low-order 16 bits)	(Cd.10) New acceleration time value)
	D16				Acceleration time setting (high-order 16 bits)	
	D17				Deceleration time setting (low-order 16 bits)	(Cd.11) New deceleration time value)
	D18				Deceleration time setting (high-order 16 bits)	
	D19				Acceleration/deceleration time change enable	(Cd.12) Acceleration/deceleration time change during speed change, enable/disable selection)
	D20				Step mode	(Cd.34) Step mode)
	D21				Step valid flag	(Cd.35) Step valid flag)
	D22				Unused	—
	D23				Target position (low-order 16 bits)	(Cd.27) Target position change value (new address))
	D24				Target position (high-order 16 bits)	
	D25				Target speed (low-order 16 bits)	(Cd.28) Target position change value (new speed))
	D26				Target speed (high-order 16 bits)	
	D27				Target position change request	(Cd.29) Target position change request flag)
	D28				Unused	—
	D29				Unused	—
	D30				ZP.PSTRT1 instruction control data	—
	D31				Completion status	—
	D32				Start number	—
	D33				ZP.TEACH1 instruction control data	—
	D34				Completion status	—
	D35				Teaching data	—
	D36				Positioning data No.	—
	D37				ZP.PINIT instruction control data	—
	D38				Completion status	—
	D39				ZP.PFWRT instruction control data	—
	D40				Completion status	—
	D41				Z.ABRST1 control data	—
	D42				Completion status	—
	D43				Signals received from servo	—
	D44				Signals transmitted to servo	—
	D45				Status	—
D46	System area	—				
D47	System area	—				
D48	System area	—				
D49	Error code	Error code at absolute position restoration				
D79	Error code	(Md.23) Axis error No.)				
D50	Unit setting	(Pr.1) Unit setting)				
D51	No. of pulses per rotation	(Pr.2) No. of pulses per rotation)				

Device name	Device				Application	Details of storage		
	Axis 1	Axis 2	Axis 3	Axis 4				
Data register	D52	—	—	—	Movement amount per rotation	(Pr.3) Movement amount per rotation)		
	D53				Unit magnification	(Pr.4) Unit magnification)		
	D54				Pulse output mode	(Pr.5) Pulse output mode)		
	D55				Rotation direction setting	(Pr.6) Rotation direction setting)		
	D56				Bias speed at start (low-order 16 bits)	(Pr.7) Bias speed at start)		
	D57				Bias speed at start (high-order 16 bits)			
	D200				OPR method	(Pr.43) OPR method)		
	D201				OPR direction	(Pr.44) OPR direction)		
	D202				OP address (low-order 16 bits)	(Pr.45) OP address)		
	D203				OP address (high-order 16 bits)			
	D204				OPR speed (low-order 16 bits)	(Pr.46) OPR speed)		
	D205				OPR speed (high-order 16 bits)			
	D206				Creep speed (low-order 16 bits)	(Pr.47) Creep speed)		
	D207				Creep speed (high-order 16 bits)			
	D208				OPR retry	(Pr.48) OPR retry)		
	D58				Positioning data No.1	Positioning identifier	(Da.1) Operation pattern)	
							(Da.2) Control system)	
							(Da.3) Acceleration time No.)	
							(Da.4) Deceleration time No.)	
							(Da.5) Axis to be interpolated)	
	D59					M code	(Da.10) M code)	
	D60					Dwell time	(Da.9) Dwell time)	
	D61					Positioning option	(Da.27) M code ON signal output timing)	
							(Da.28) ABS direction in degrees)	
							(Da.29) Interpolation speed designation method)	
	D62					Command speed (low-order 16 bits)	(Da.8) Command speed)	
	D63					Command speed (high-order 16 bits)		
	D64					Positioning address/movement amount	(low-order 16 bits)	(Da.6) Positioning address/movement amount)
							(high-order 16 bits)	
	D65					Arc address	(low-order 16 bits)	(Da.7) Arc address)
(high-order 16 bits)								
D66	Block start data (Block 0)	Point 1 (shape, start No.)						
D69		Point 2 (shape, start No.)						
D70		Point 3 (shape, start No.)						
D71		Point 4 (shape, start No.)	(Da.11) Shape)					
D72		Point 5 (shape, start No.)	(Da.12) Start data No.)					
D73		Point 1 (special start instruction)	(Da.13) Special start instruction)					
D74		Point 2 (special start instruction)	(Da.14) Parameter)					
D75		Point 3 (special start instruction)						
D76		Point 4 (special start instruction)						
D77		Point 5 (special start instruction)						
Timer		T0	—	PLC READY signal OFF confirmation	PLC READY signal OFF			
		T1		PLC READY signal OFF confirmation				

### 6.3 Creating a program

The "positioning control operation program" actually used is explained in this chapter. The functions and programs explained in PART 2 are assembled into the "positioning control operation program" explained here. (To monitor the control, add the required monitor program that matches the system. Refer to Section 5.6 "List of monitor data" for details on the monitor items.)

#### 6.3.1 General configuration of program

The general configuration of the "positioning control operation program" is shown below.

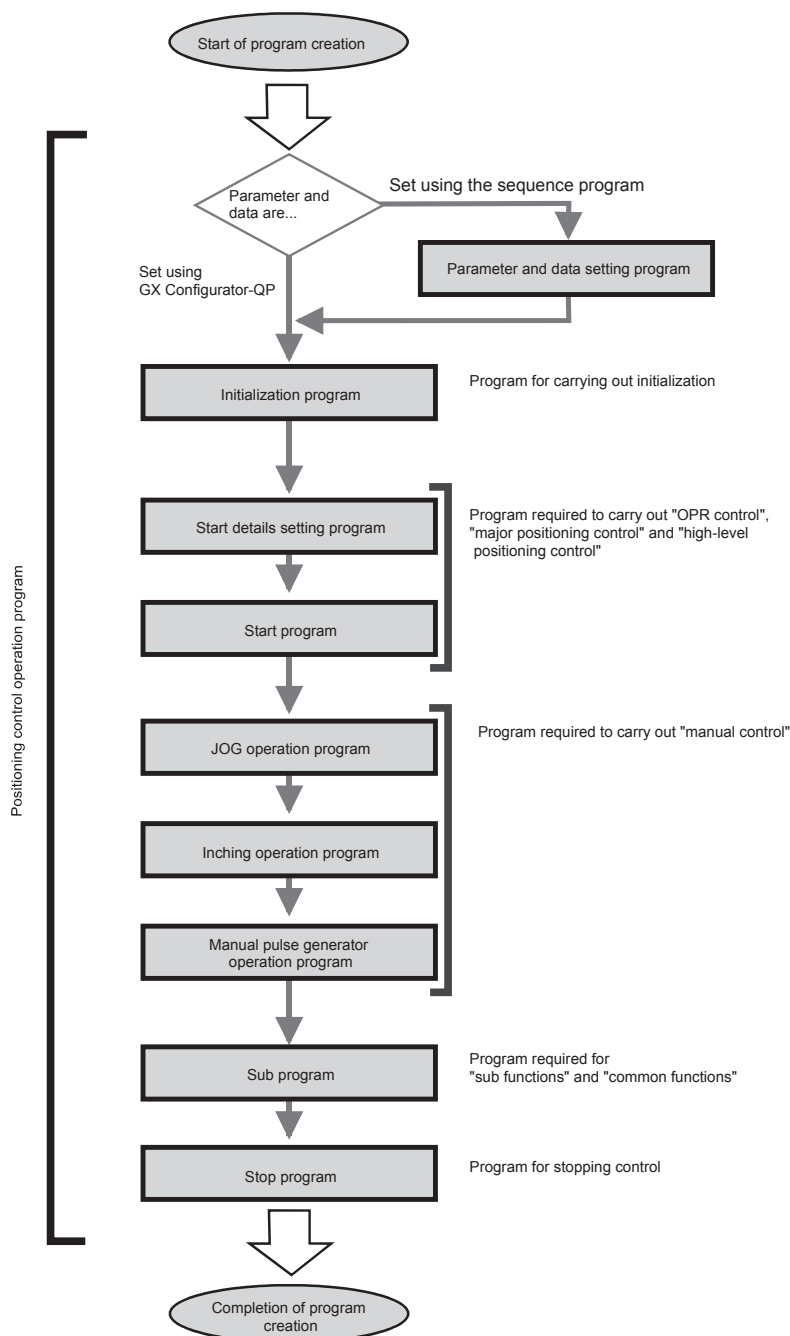

6.3.2 Positioning control operation program

The various programs that configure the "positioning control operation program" are shown below. When creating the program, refer to the explanation of each program and Section 6.4 "Positioning program examples", and create an operation program that matches the positioning system. (Numbers are assigned to the following programs. Configuring the program in the order of these numbers is recommended.)

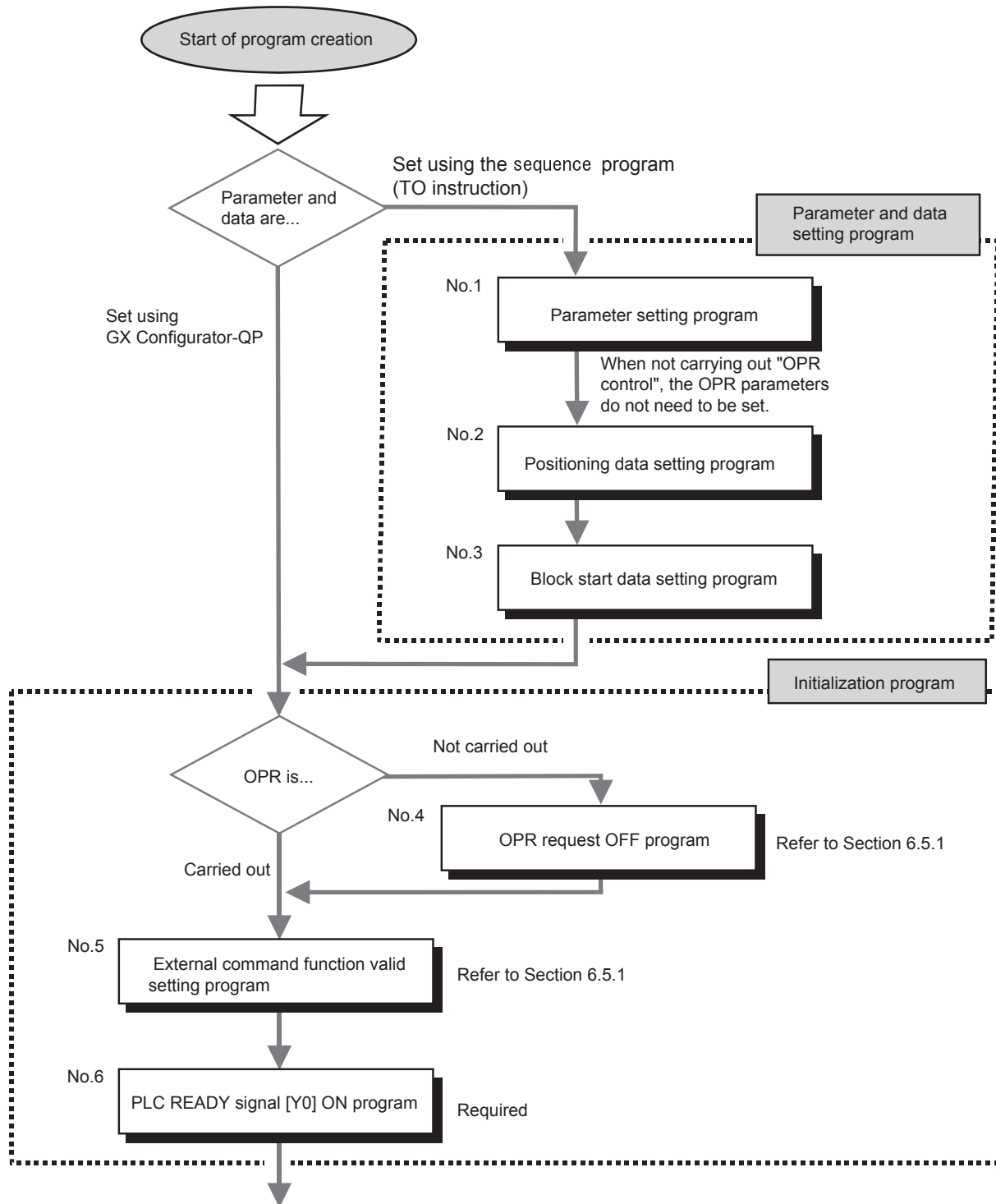

Continued on next page

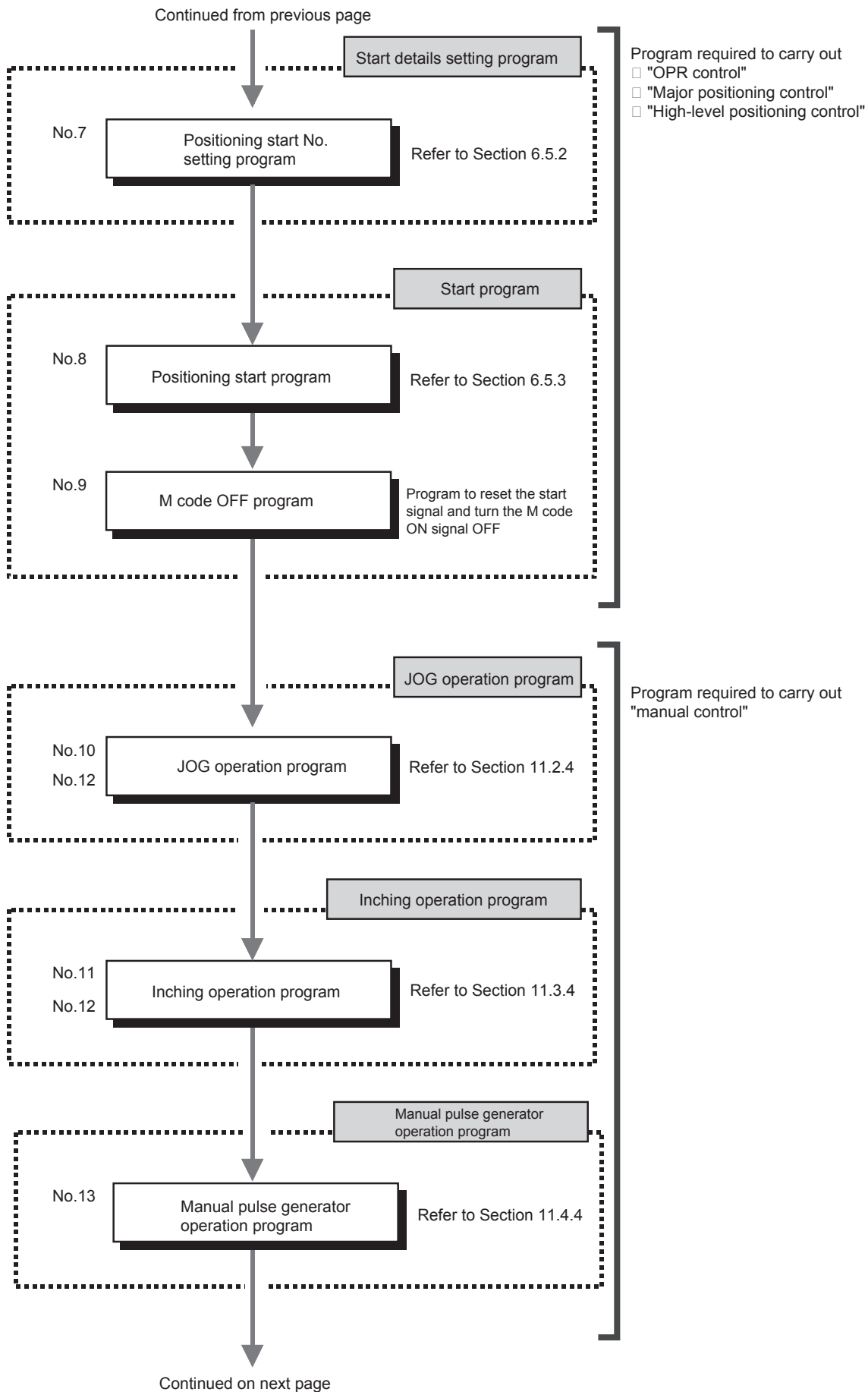

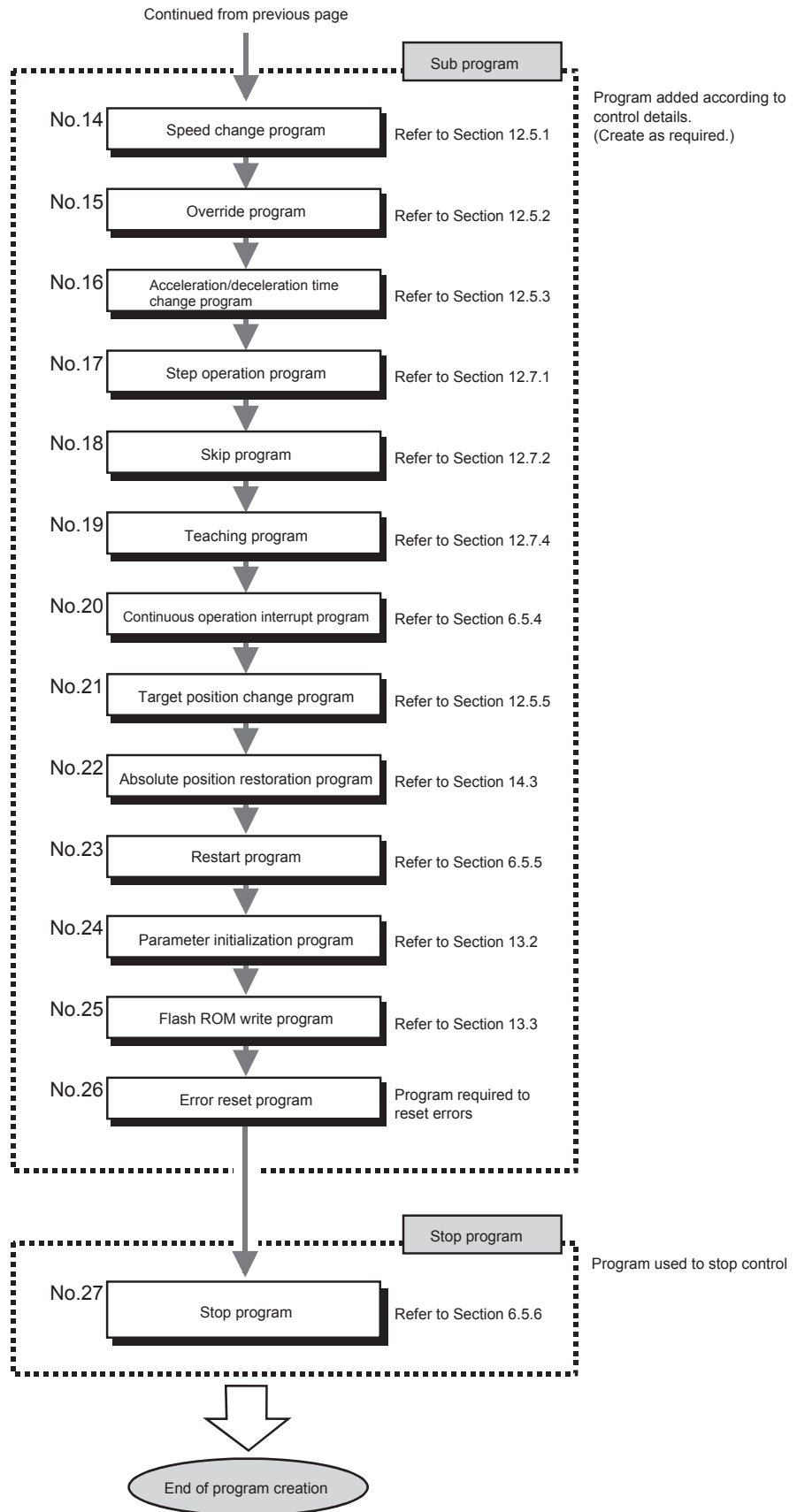





\*  
 \* No. 2 Positioning data setting program  
 \* (For positioning data No. 1 <axis 1>)  
 \* <Positioning identifier>  
 \* Operation pattern: Positioning complete  
 \* Control system: 1-axis linear control (ABS)  
 \* Acceleration time No.: 1, deceleration time No.: 2  
 \*

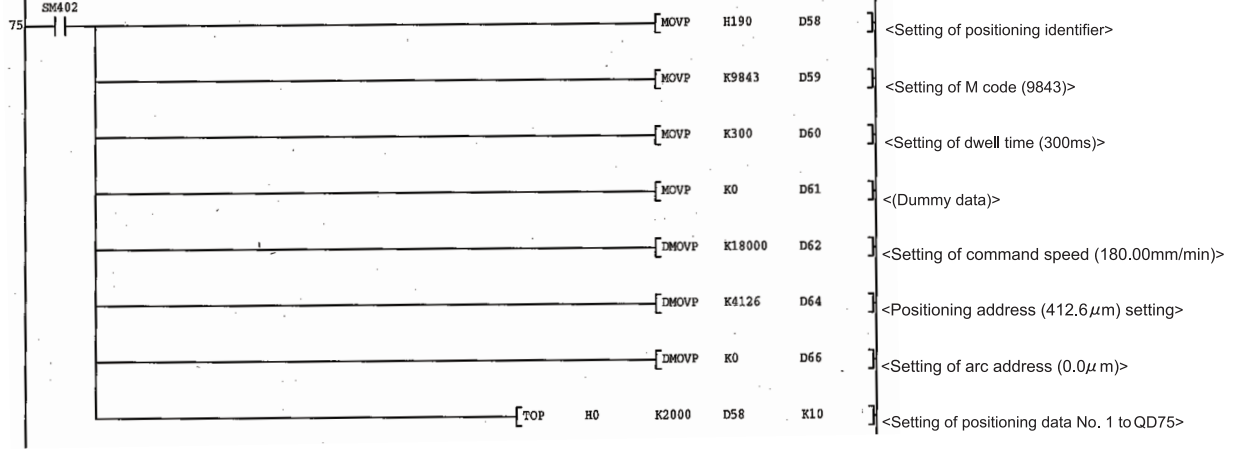

\* Positioning option enable/disable parameter setting program  
 \* (The program is not required when positioning option is not used.)

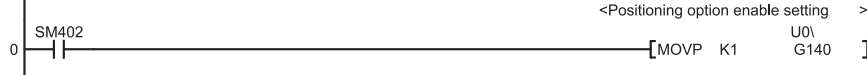

\*  
 \* No. 2 Positioning data setting program  
 \* (For using positioning option)  
 \* (For positioning data No. 1 <axis 1>)  
 \* <Positioning identifier>  
 \* Operation pattern: Positioning complete  
 \* Control system: 1-axis linear control (ABS)  
 \* Acceleration time No.: 1, deceleration time No.: 2  
 \* <Positioning option>  
 \* M code ON signal output timing: WITH mode (1)  
 \* ABS direction in degrees: 0  
 \* Interpolation speed designation method: 0  
 \*

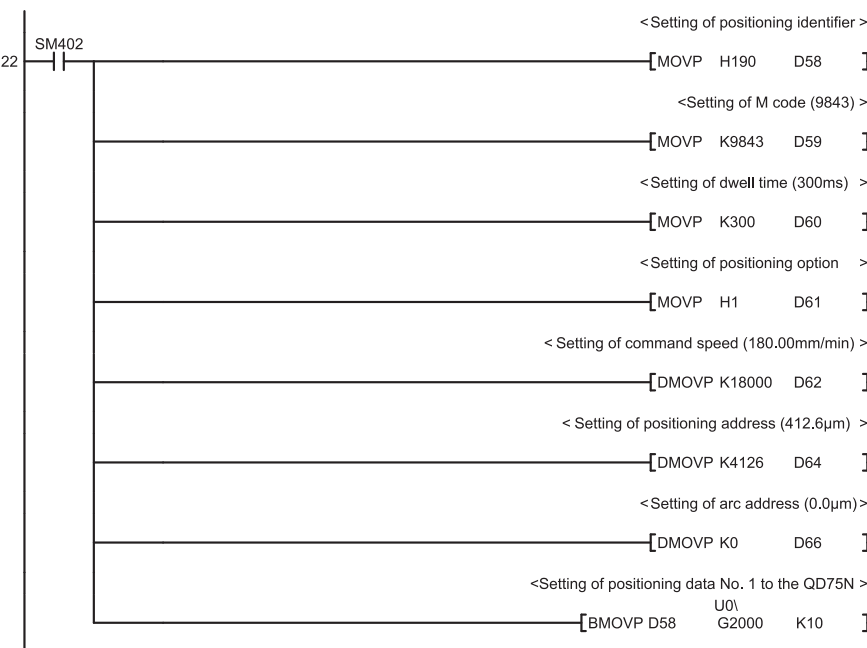

\*  
 \* No. 3 Block start data setting program  
 \* Block start data of start block 0 (axis 1)  
 \* For setting of points 1 to 5  
 \* (Conditions)  
 \* Shape: Continued at points 1 to 4, ended at point 5  
 \* Special start instruction: Normal start at all of points 1 to 5  
 \* <Positioning data are already preset>  
 \*  
 \*  
 \* [Setting of shape and start data No.]  
 \*  
 \*

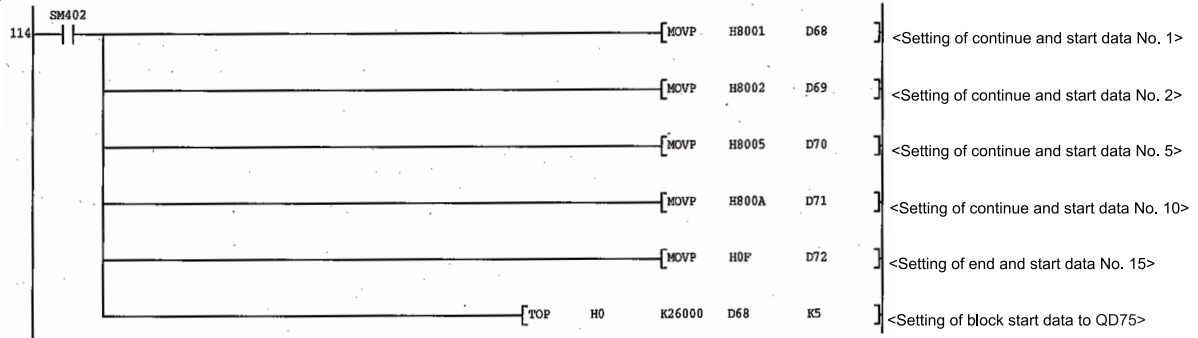

\*  
\* [Setting of special start instruction to normal start]  
\*

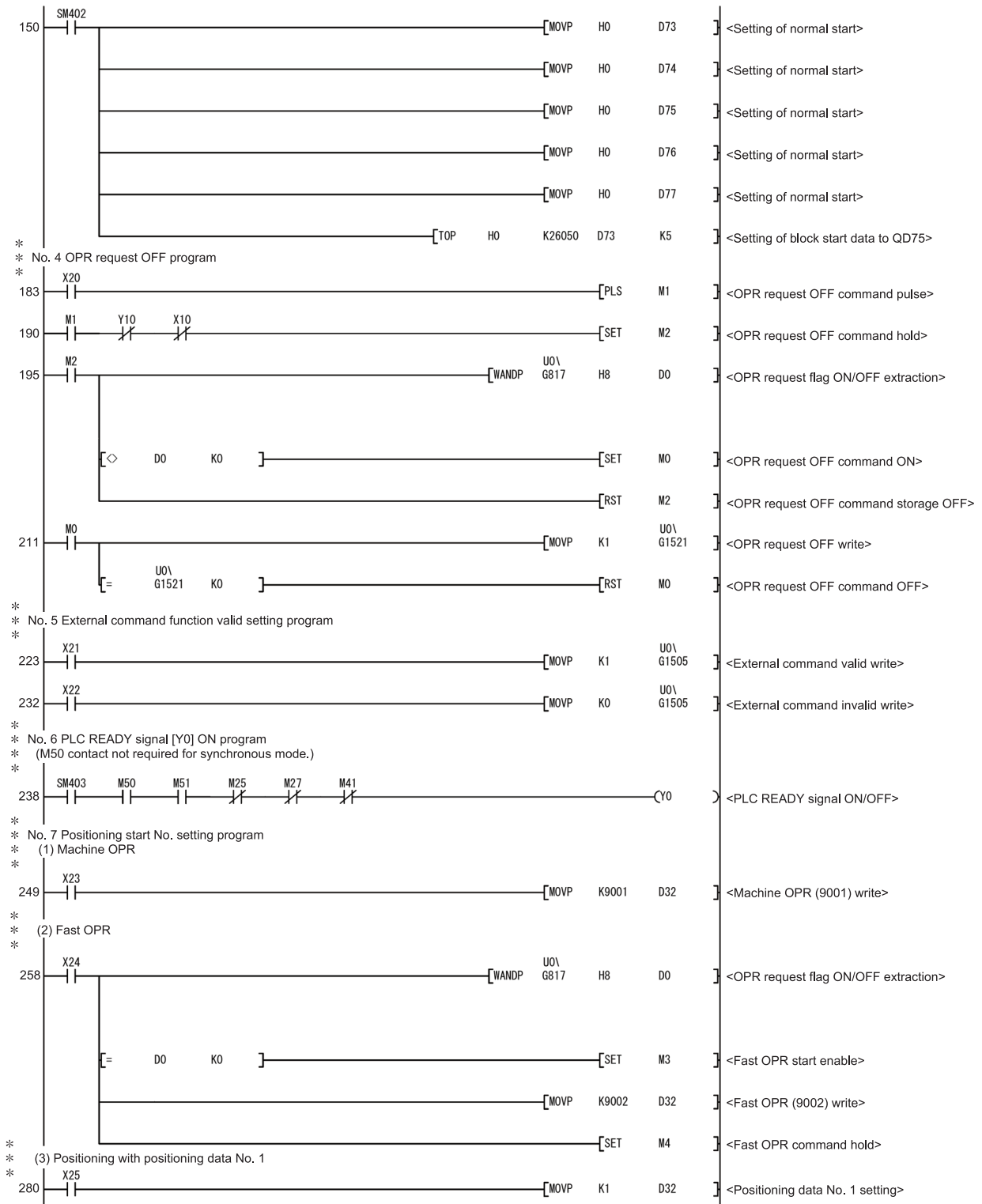

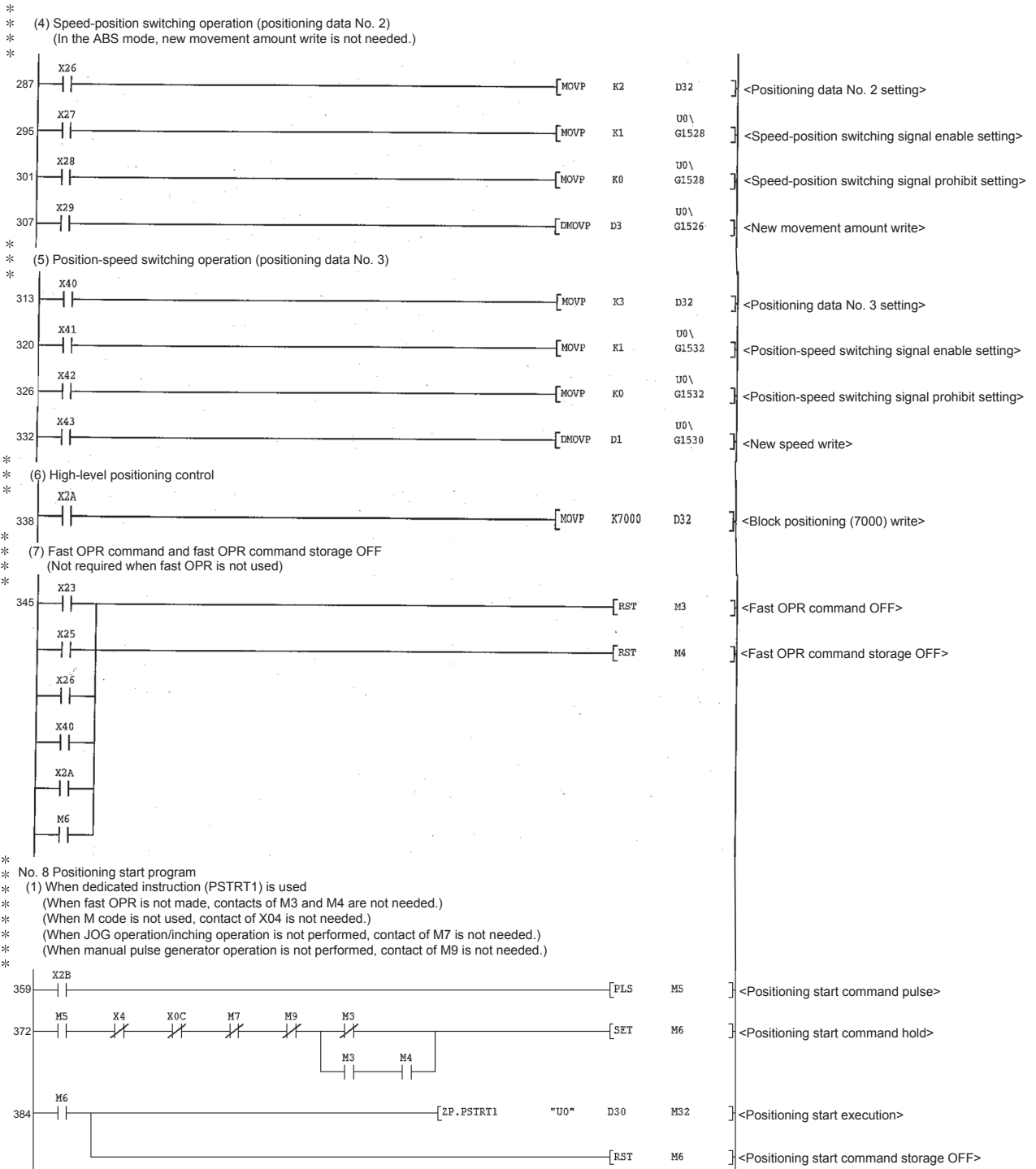

\*  
 \* (2) When positioning start signal (Y10) is used  
 \* (When fast OPR is not made, contacts of M3 and M4 are not needed.)  
 \* (When M code is not used, contact of X04 is not needed.)  
 \* (When JOG operation/inching operation is not performed, contact of M7 is not needed.)  
 \* (When manual pulse generator operation is not performed, contact of M9 is not needed.)  
 \*

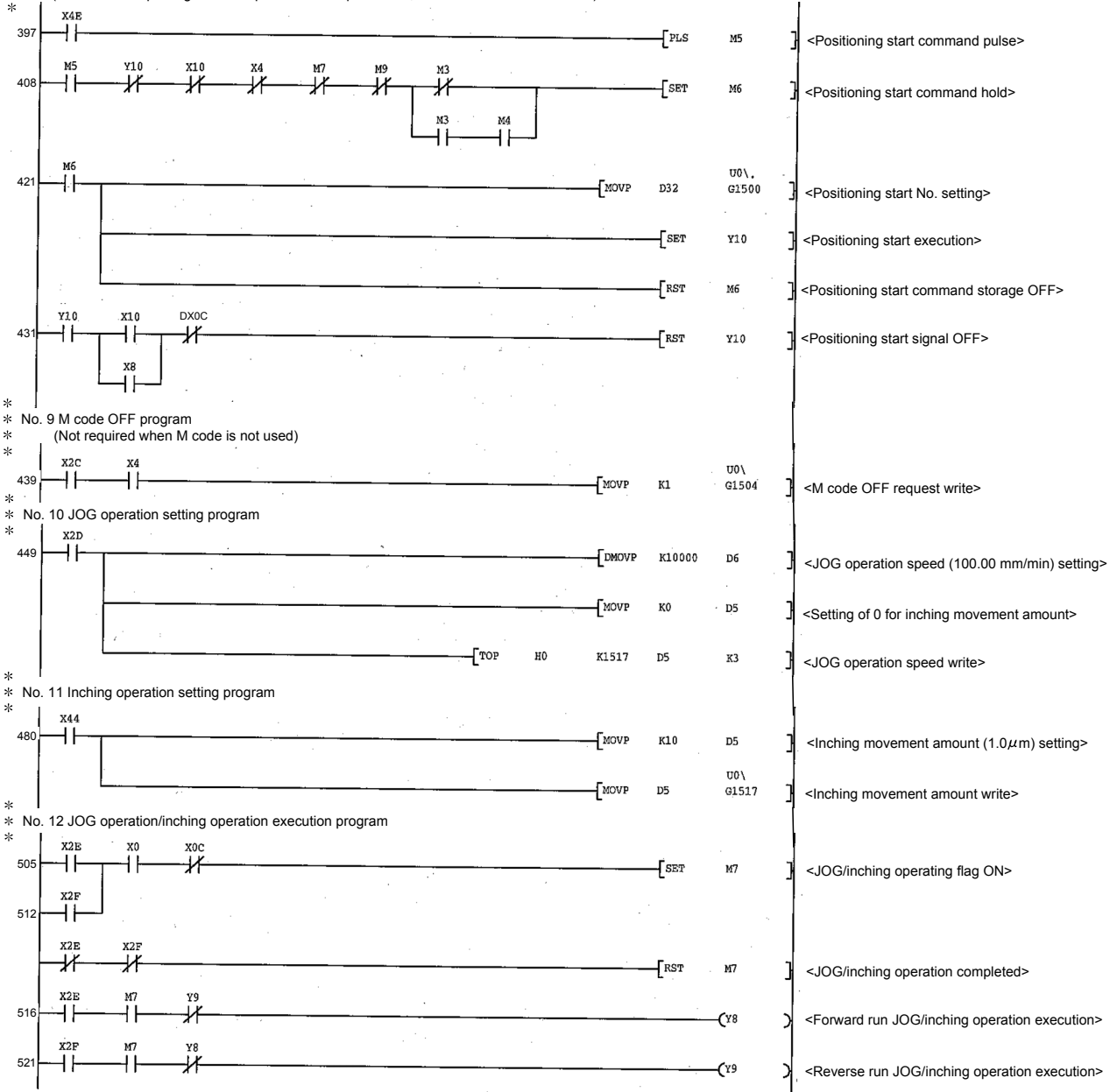

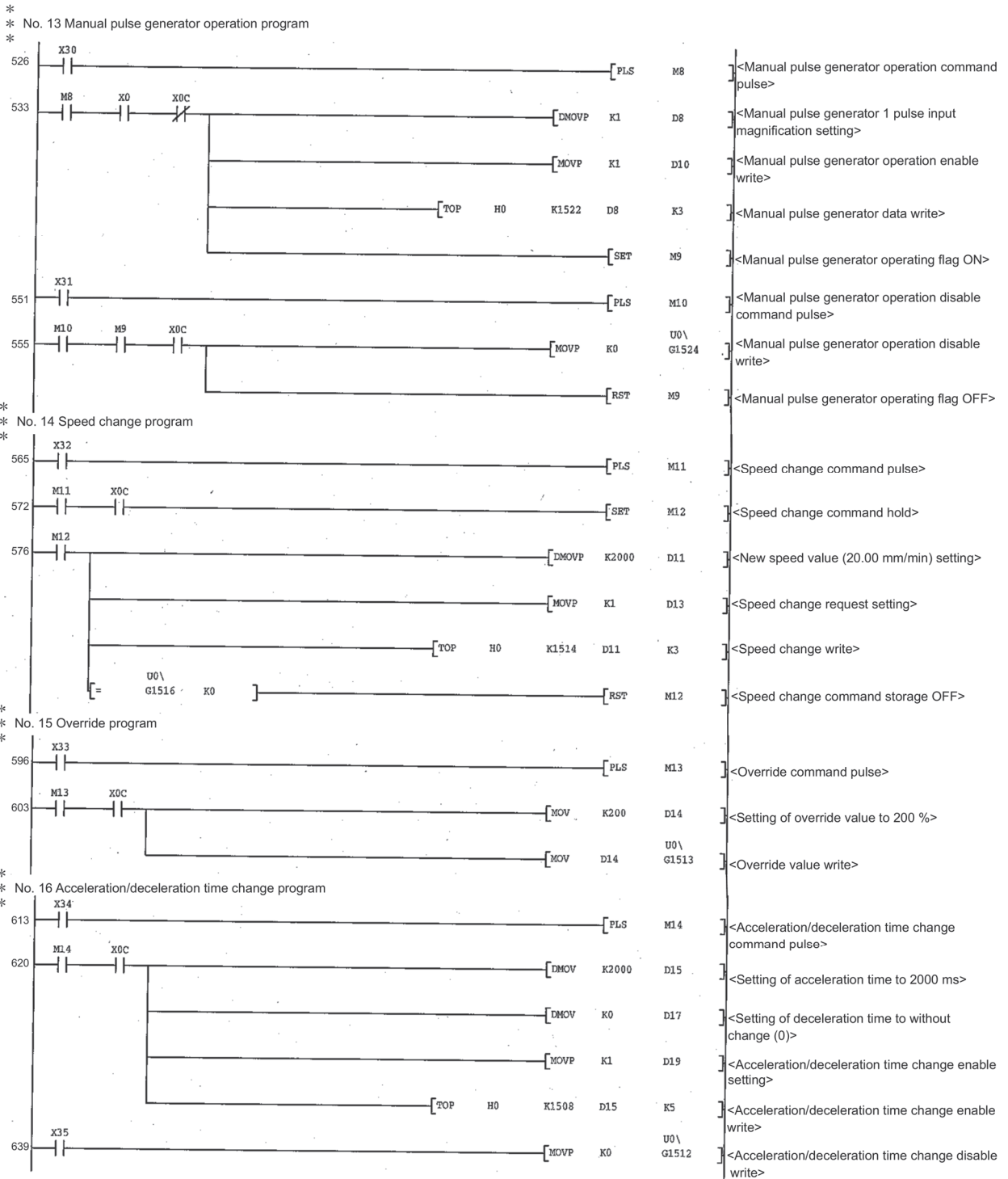

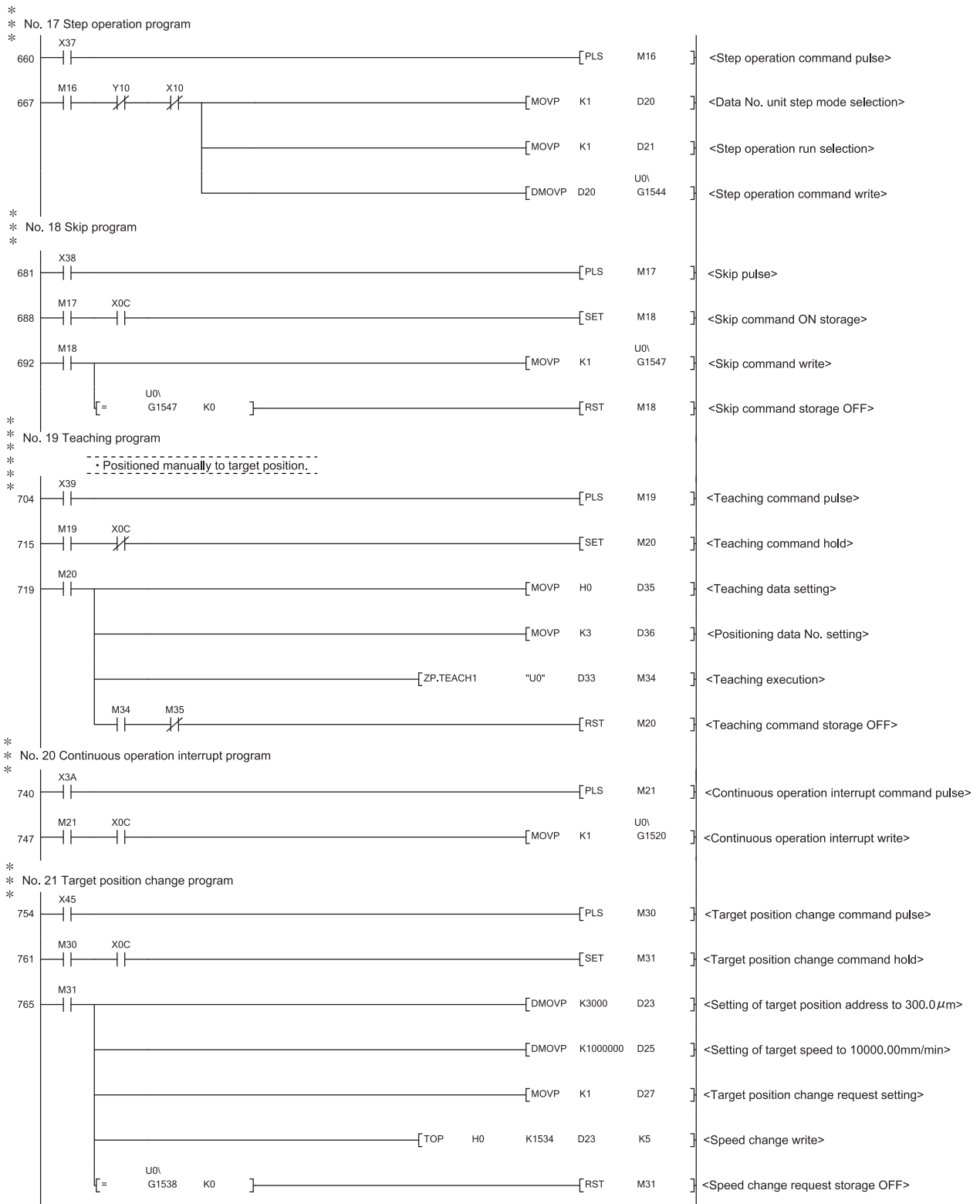



\*  
\* No. 22 Absolute position restoration program  
\* (1) Absolute position restoration command acceptance  
\*

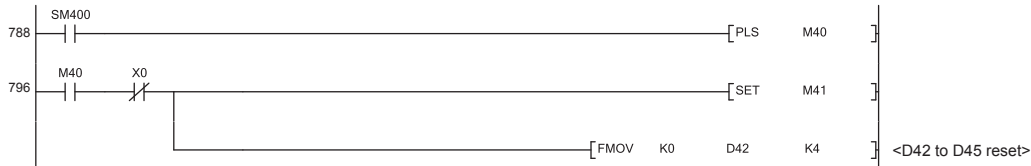

\*  
\* (2) Setting of transmit data to servo-amplifier and confirmation of absolute position restoration completion  
\* ABRST1 instruction completed when M42 is ON and M43 is OFF.  
\* Absolute position data restoration completed when status = 0.  
\*

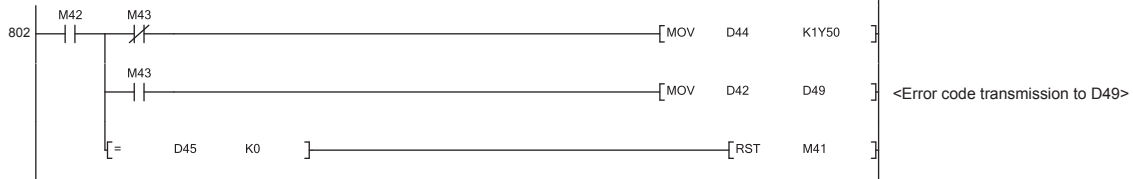

\*  
\* (3) ABS data setting and ABRST1 instruction execution  
\*

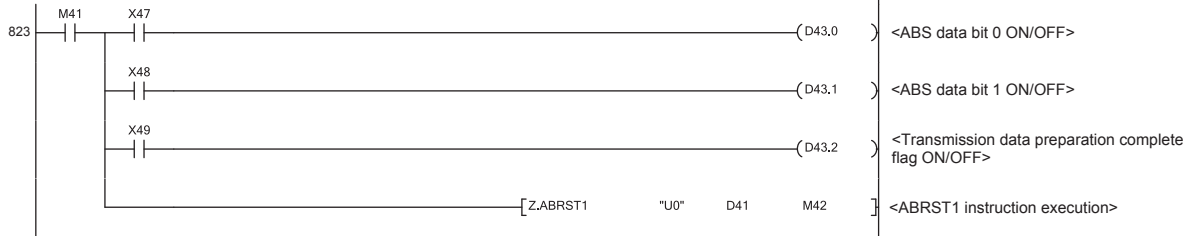

\*  
\* No. 23 Restart program  
\*

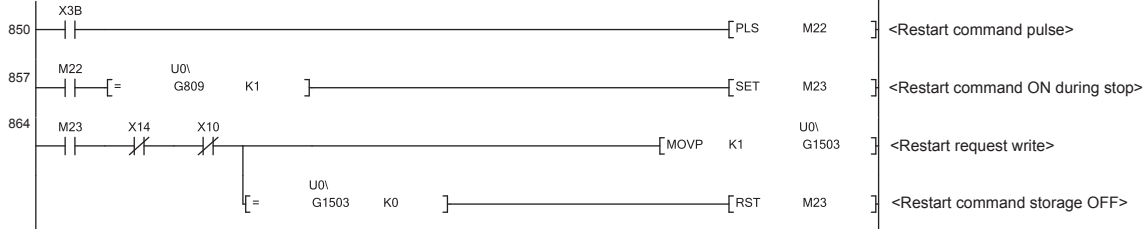

\*  
\* No. 24 Parameter initialization program  
\*

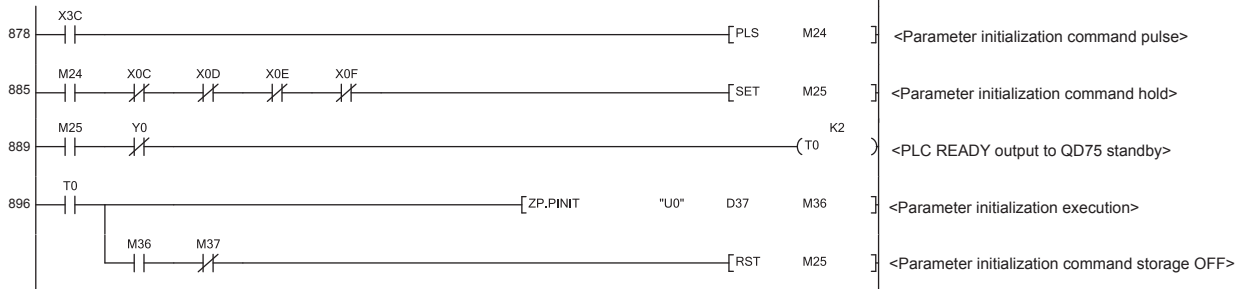



6.5 Program details

6.5.1 Initialization program

[1] OPR request OFF program

This program forcibly turns OFF the "OPR request flag" ([Md.31] Status : b3) which is ON.

When using a system that does not require OPR, assemble the program to cancel the "OPR request" made by the QD75 when the power is turned ON, etc.

■ Data requiring setting

Set the following data to use the OPR request flag OFF request.

Setting item	Setting value	Setting details	Buffer memory address			
			Axis 1	Axis 2	Axis 3	Axis 4
[Cd.19] OPR request flag OFF request	1	Set to "1: Turn OPR request flag OFF".	1521	1621	1721	1821

\* Refer to Section 5.7 "List of control data" for details on the setting details.

■ Time chart for OPR request OFF

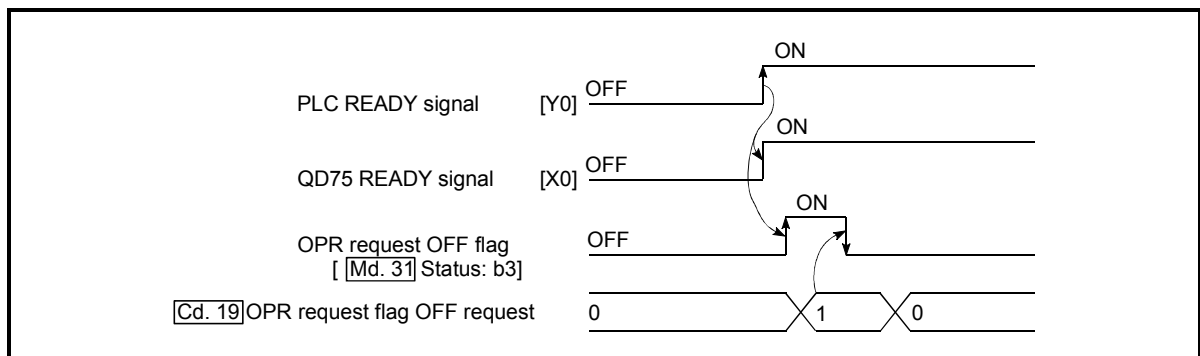

Fig. 6.1 Time chart for OPR request OFF

[2] External command function valid setting program

This program is used to validate the "external command signal" beforehand when using the external command functions (external start, speed change, speed-position switching, position-speed switching, skip). (Set which function to use beforehand in " [Pr.42] External command function selection".)

Set the following data to validate the "external command signal".

Setting item	Setting value	Setting details	Buffer memory address			
			Axis 1	Axis 2	Axis 3	Axis 4
[Cd.8] External command valid	1	Set to "1: Validate external command".	1505	1605	1705	1805

\* Refer to Section 5.7 "List of control data" for details on the setting details.

## 6.5.2 Start details setting program

This program sets which control, out of "OPR", "major positioning control" or "high-level positioning control" to execute. For "high-level positioning control", "fast OPR", "speed-position switching control" and "position-speed switching control", add the respectively required sequence program.

(Refer to CHAPTER 10 for details on starting the "high-level positioning control".)

■ Procedures for setting the starting details

- (1) Set the "positioning start No." corresponding to the control to be started in " **Cd.3** Positioning start No."

Setting item	Setting value	Setting details	Buffer memory address			
			Axis 1	Axis 2	Axis 3	Axis 4
<b>Cd.3</b> Positioning start No.	→	1 to 600 : Positioning data No. 9001 : Machine OPR 9002 : Fast OPR 9003 : Current value changing 9004 : Simultaneous start 7000 to 7004 : Block No. (For "high-level positioning control")	1500	1600	1700	1800

\* Refer to Section 5.7 "List of control data" for details on the setting details.

- (2) For "high-level positioning control", set the "positioning start point No." of the block to be started in " **Cd.4** Positioning starting point No."

Setting item	Setting value	Setting details	Buffer memory address			
			Axis 1	Axis 2	Axis 3	Axis 4
<b>Cd.4</b> Positioning starting point No.	→	1 to 50 : Point No. of block start data	1501	1601	1701	1801

\* Refer to Section 5.7 "List of control data" for details on the setting details.

- (3) Set the following control data for "speed-position switching control (INC mode)".  
(Set " **Cd.23** Speed-position switching control movement amount change register as required". Setting is not required in the ABS mode.)

Setting item	Setting value	Setting details	Buffer memory address			
			Axis 1	Axis 2	Axis 3	Axis 4
<b>Cd.23</b> Speed-position switching control movement amount change register	→	Set the new value when the position control's movement amount is to be changed during speed control.	1526 1527	1626 1627	1726 1727	1826 1827
<b>Cd.24</b> Speed-position switching enable flag	1	When "1" is set, the speed-position switching signal will be validated.	1528	1628	1728	1828

\* Refer to Section 5.7 "List of control data" for details on the setting details.

- (4) For "position-speed switching control", set the control data shown below.  
 (As required, set the " Cd.25 Position-speed switching control speed change resistor".)

Setting item		Setting value	Setting details	Buffer memory address			
				Axis 1	Axis 2	Axis 3	Axis 4
<span style="border: 1px solid black; padding: 0 2px;">Cd.25</span>	Position-speed switching control speed change resistor	→	Used to set a new value when speed is changed during positioning control.	1530	1630	1730	1830
				1531	1631	1731	1831
<span style="border: 1px solid black; padding: 0 2px;">Cd.26</span>	Position-speed switching enable flag	1	To validate position-speed switching signal, this is set to 1.	1532	1632	1732	1832

\* Refer to Section 5.7 "List of control data" for details on the setting details.

## 6.5.3 Start program

This program is used to start the control with start commands.

The control can be started with the following two methods.

- [1] Starting by inputting positioning start signal [Y10, Y11, Y12, Y13]
- [2] Starting by inputting external command signal

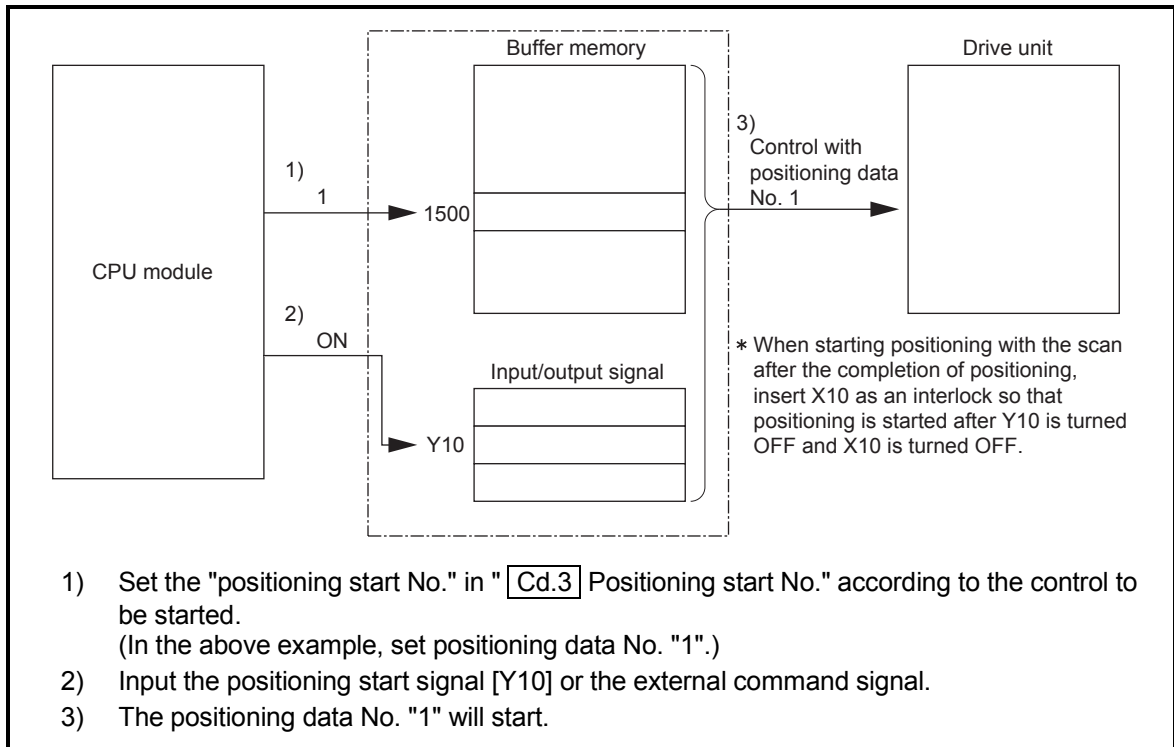

Fig. 6.2 Procedures for starting control (for axis 1)

### ■ Starting conditions

To start the control, the following conditions must be satisfied.

The necessary start conditions must be incorporated in the sequence program so that the control is not started when the conditions are not satisfied.

Signal name		Signal state		Device			
				Axis 1	Axis 2	Axis 3	Axis 4
Interface signal	PLC READY signal	ON	CPU module preparation completed	Y0			
	QD75 READY signal	ON	QD75 preparation completed	X0			
	Synchronization flag *	ON	QD75 buffer memory Accessible	X1			
	Axis stop signal	OFF	Axis stop signal is OFF.	Y4	Y5	Y6	Y7
	M code ON signal	OFF	M code ON signal is OFF.	X4	X5	X6	X7
	Error detection signal	OFF	No error is present.	X8	X9	XA	XB
	BUSY signal	OFF	BUSY signal is OFF.	XC	XD	XE	XF
	Start complete signal	OFF	Start complete signal is OFF.	X10	X11	X12	X13
External signal	Drive unit READY signal	ON	Drive unit preparation completed	-			
	Stop signal	OFF	Stop signal is OFF.	-			
	Upper limit (FLS)	ON	Within limit range	-			
	Lower limit (RLS)	ON	Within limit range	-			

※: When the synchronous setting of the CPU module is made in the nonsynchronous mode, this must be provided as an interlock.

When it is made in the synchronous mode, no interlock must be provided in the program because the flag is turned ON when calculation is run on the CPU module.

## [1] Starting by inputting positioning start signal

## ■ Operation when starting

- (1) When the positioning start signal turns ON, the start complete signal and BUSY signal turn ON, and the positioning operation starts.  
It can be seen that the axis is operating when the BUSY signal is ON.
- (2) When the positioning start signal turns OFF, the start complete signal also turns OFF.  
If the positioning start signal is ON even after positioning is completed, the start complete signal will remain ON.
- (3) If the positioning start signal turns ON again while the BUSY signal is ON, the warning "Start during operation" (warning code: 100) will occur.
- (4) The process taken when positioning is completed will differ according to case (a) and (b) below.
  - (a) When next positioning is not to be carried out
    - If a dwell time is set, the system will wait for the set time to pass, and then positioning will be completed.
    - When positioning is completed, the BUSY signal will turn OFF and the positioning complete signal will turn ON. However, when using speed control or when the positioning complete signal ON time is "0", the signal will not turn ON.
    - When the positioning complete signal ON time is passed, the positioning complete signal will turn OFF.
  - (b) When next positioning is to be carried out
    - If a dwell time is set, the system will wait for the set time to pass.
    - When the set dwell time is passed, the next positioning will start.

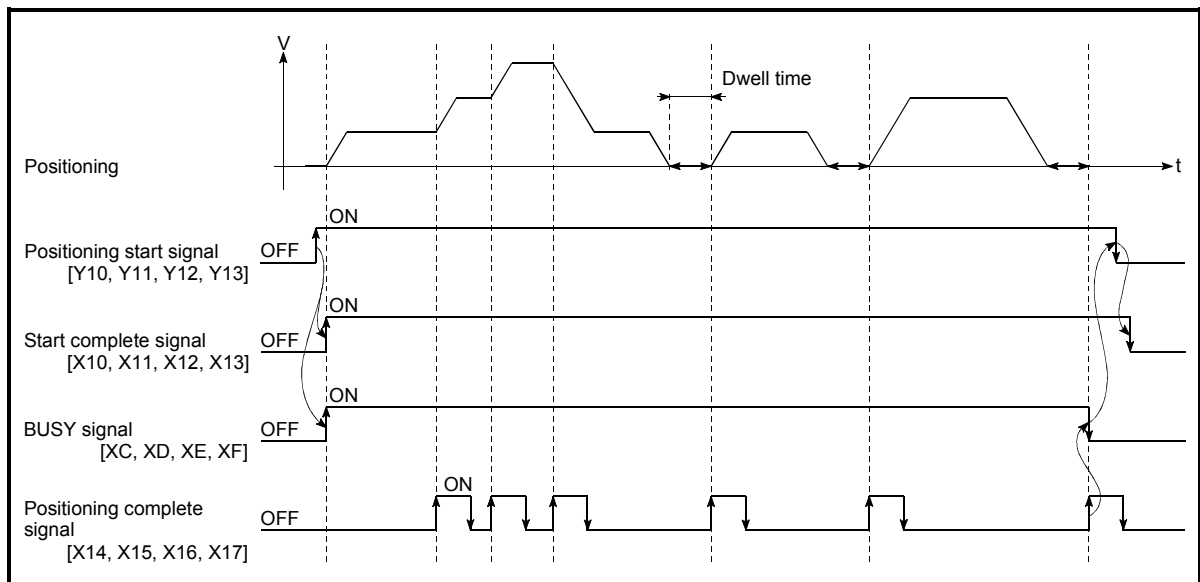

Fig. 6.3 ON/OFF timing of each signal at start of positioning

**POINTS**

The BUSY signal [XC, XD, XE, XF] turns ON even when position control of movement amount 0 is executed. However, since the ON time is short, the ON status may not be detected in the sequence program.

(The ON status of the start complete signal [X10, X11, X12, X13], positioning complete signal [X14, X15, X16, X17] and M code ON signal [X4, X5, X6, X7] can be detected in the sequence program.)



■ Starting time chart

The time chart for starting each control is shown below.

(1) Time chart for starting "machine OPR"

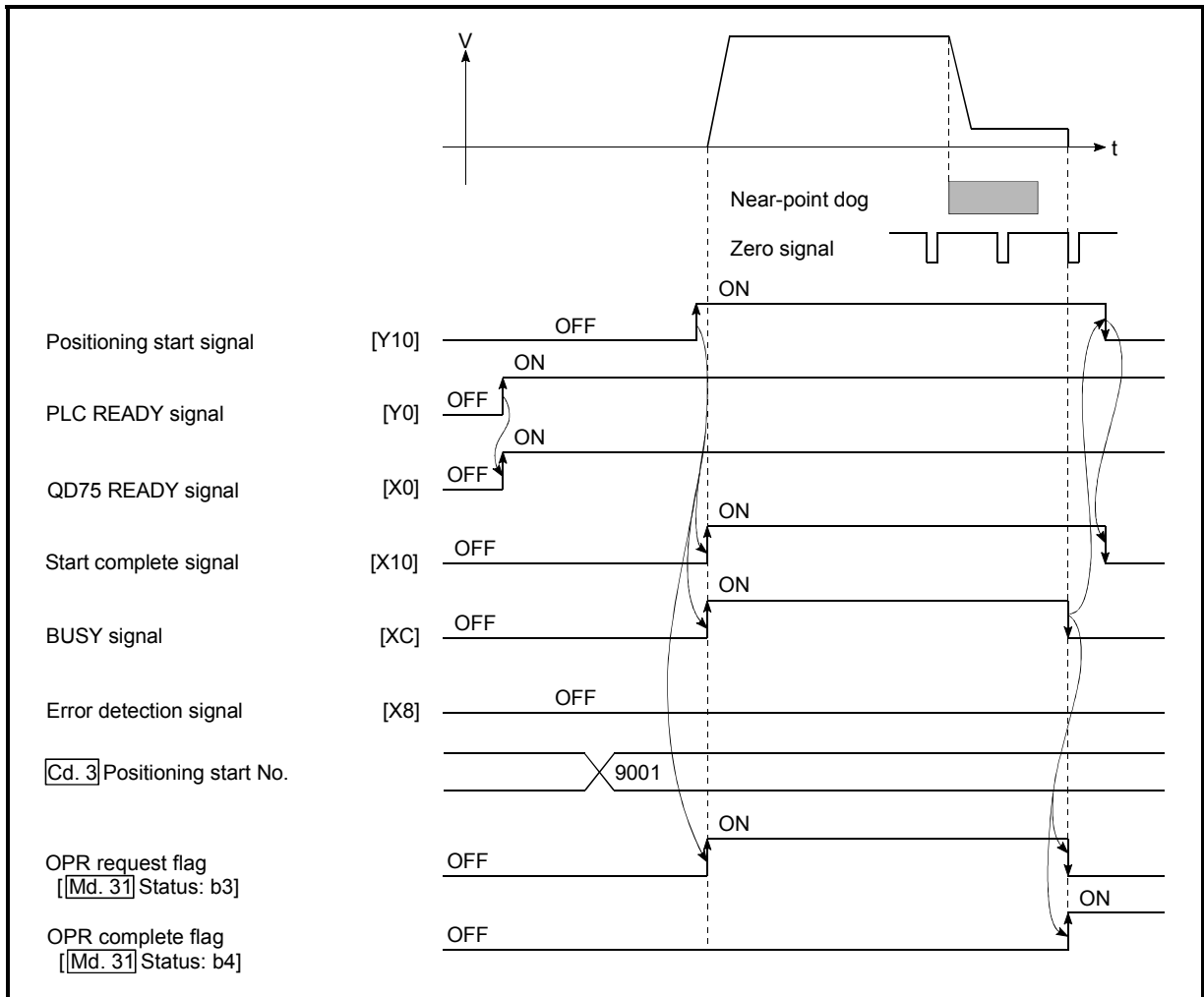

Fig. 6.4 Time chart for starting "machine OPR"

(2) Time chart for starting "fast OPR"

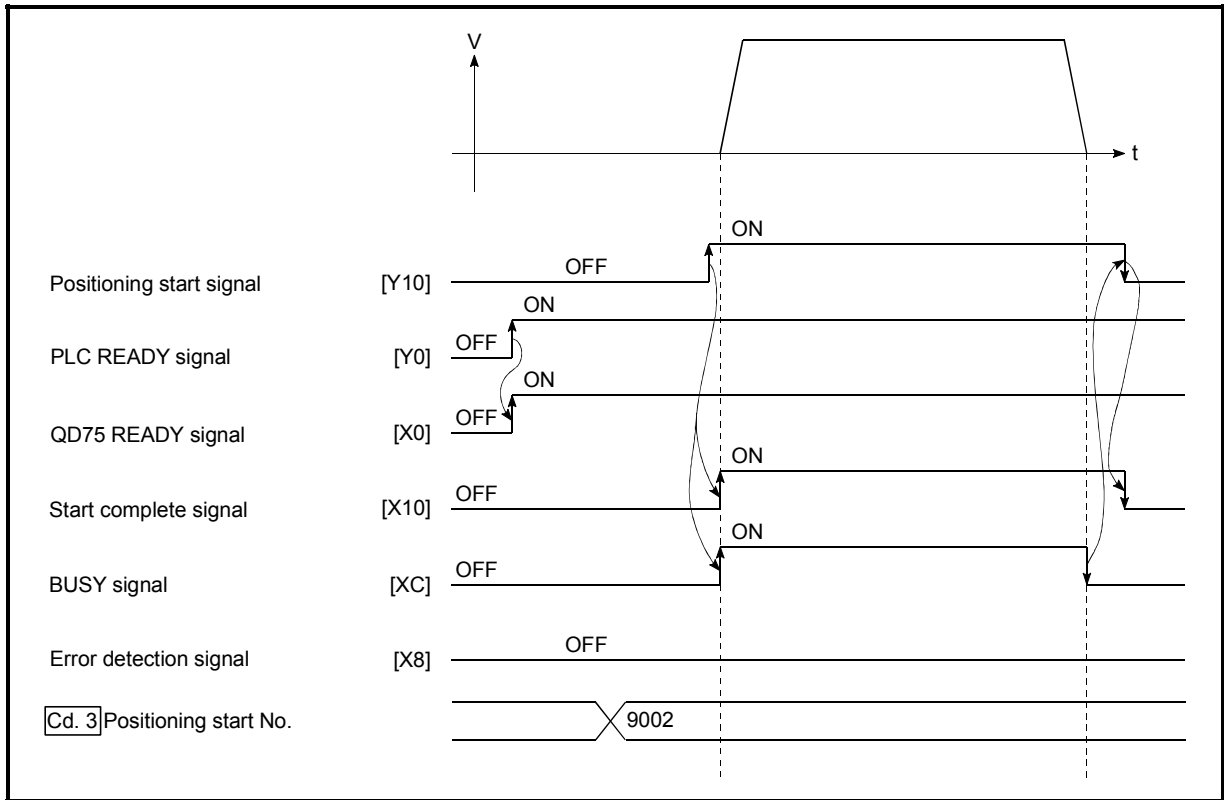

Fig. 6.5 Time chart for starting "fast OPR"

(3) Time chart for starting "major positioning control"

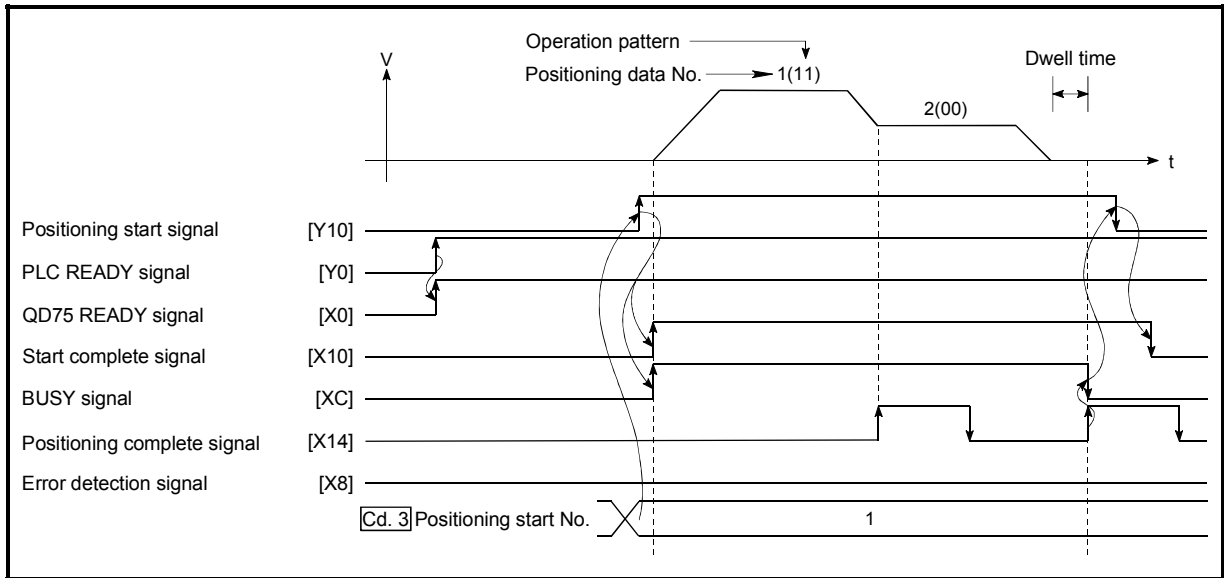

Fig. 6.6 Time chart for starting "major positioning control"

(4) Time chart for starting "speed-position switching control"

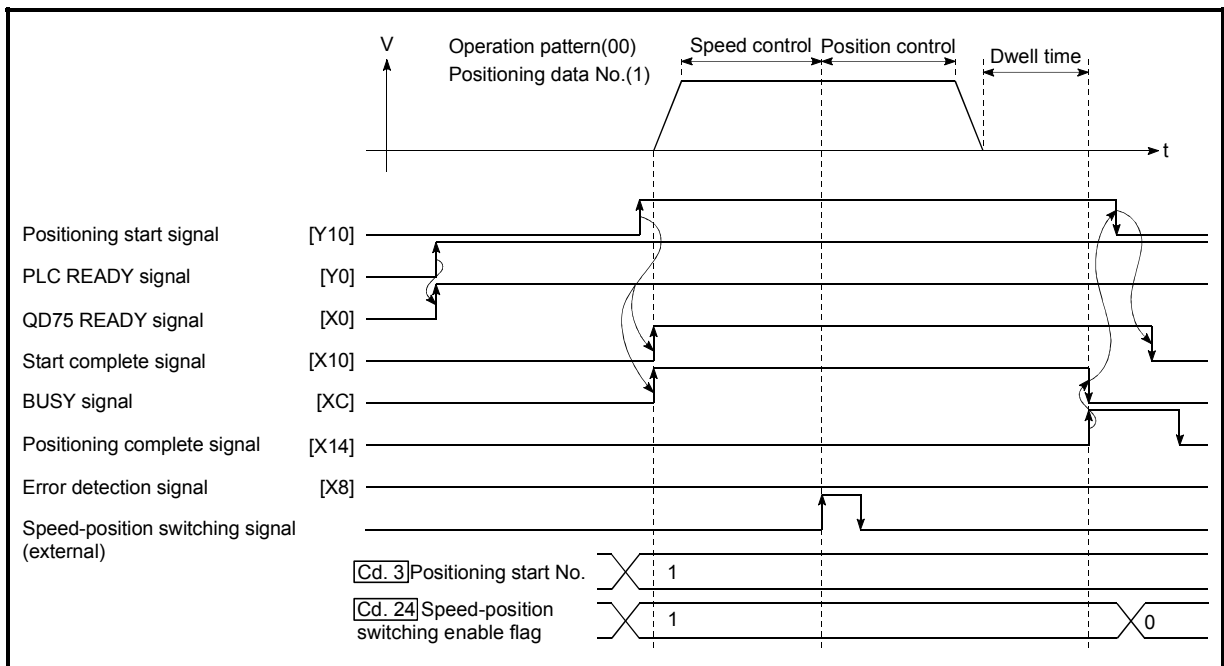

Fig. 6.7 Time chart for starting "speed-position switching control"

(5) Time chart for starting "position-speed switching control"

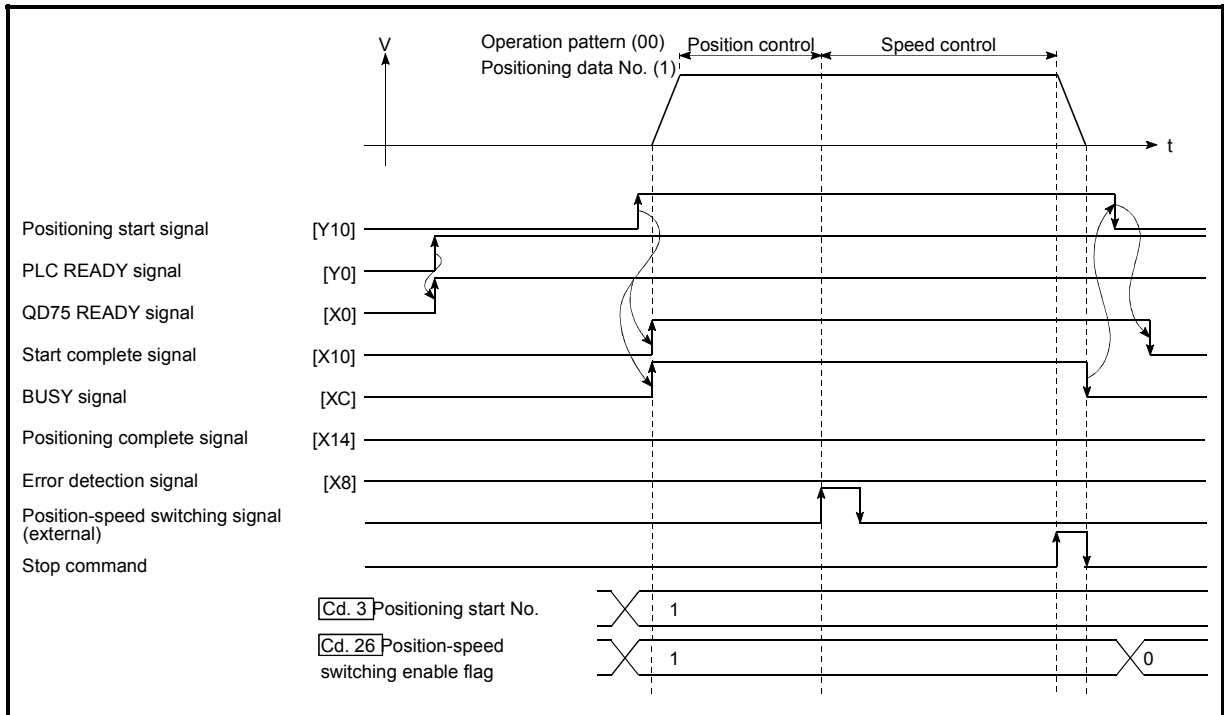

Fig. 6.8 Time chart for starting "position-speed switching control"

Machine OPR operation timing and process time

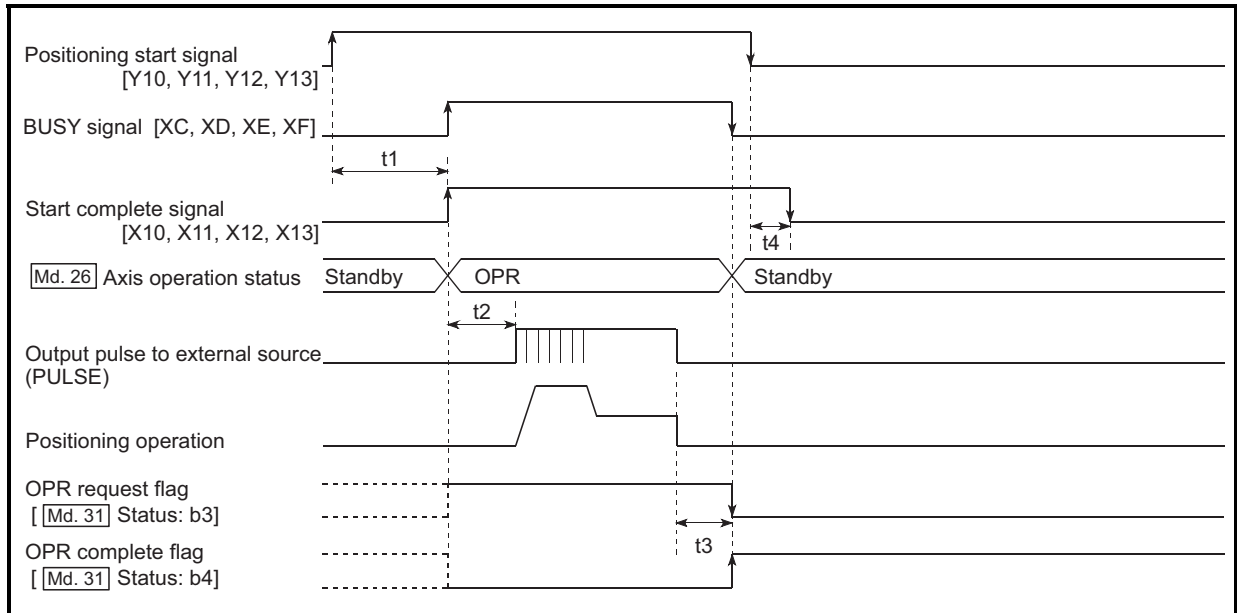

Fig. 6.9 Machine OPR operation timing and process time

Normal timing time

Model	t1	t2	t3	t4
QD75P□N/QD75D□N	0.2 to 1.1ms	0.4 to 1.3ms	0 to 0.9ms	0 to 0.9ms
QD75P□/QD75D□	1.0 to 1.4ms	2.7 to 4.4ms	0 to 1.8ms	0 to 1.8ms

- The t1 timing time could be delayed depending on the operating conditions of the other axis.

■ Position control operation timing and process time

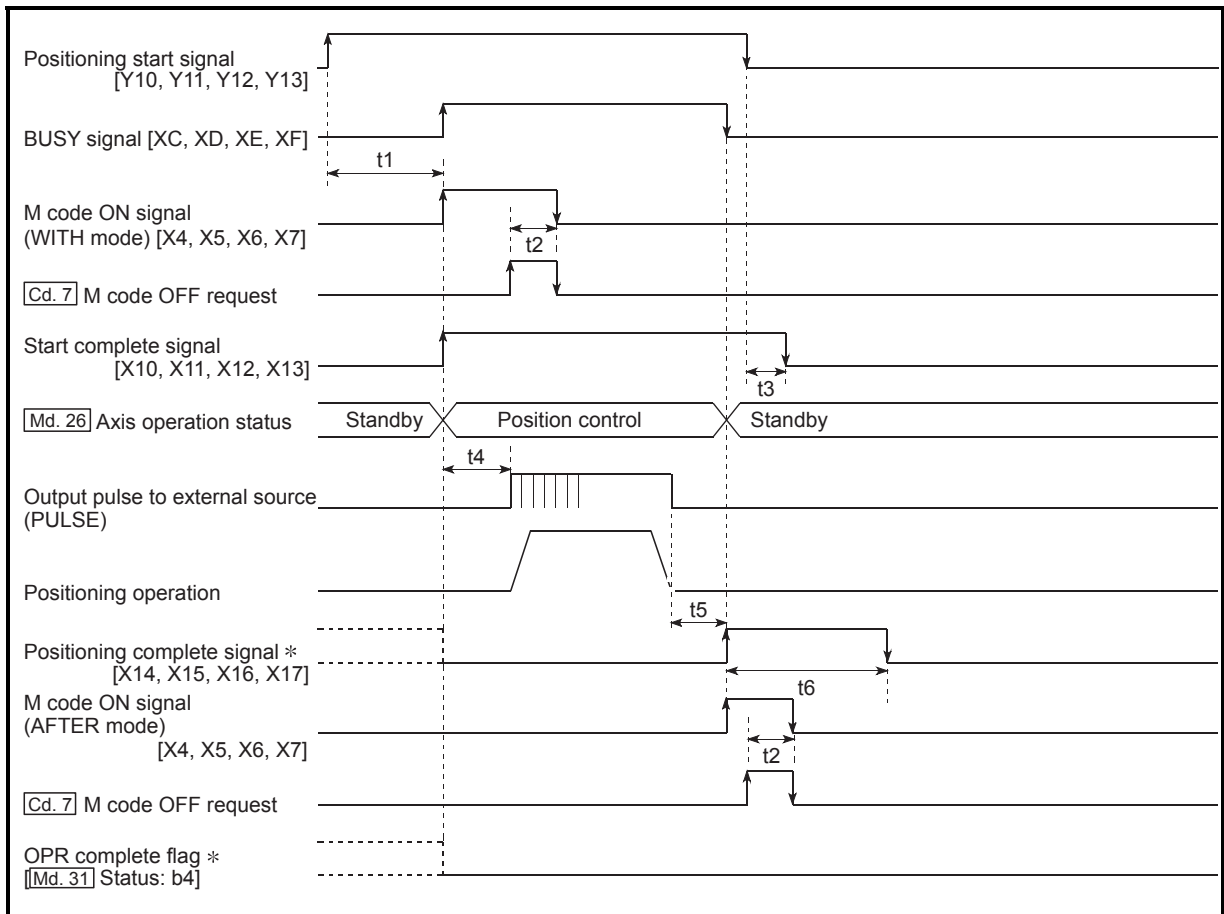

Fig. 6.10 Position control operation timing and process time

- When the positioning start signal turns ON, if all signals marked with an asterisk (\*) are already ON, the signals marked with an asterisk (\*) will turn OFF when the positioning start signal turns ON.

Normal timing time

Model	t1	t2	t3	t4	t5	t6
QD75P□N/QD75D□N	0.2 to 1.1ms	0 to 0.9ms	0 to 0.9ms	0.4 to 1.3ms	0 to 0.9ms	Follows parameters
QD75P□/QD75D□	1.2 to 2.3ms	0 to 1.8ms	0 to 1.8ms	2.7 to 4.4ms	0 to 1.8ms	

- The t1 timing time could be delayed depending on the operating conditions of the other axis.

[2] Starting by inputting external command signal

When starting positioning control by inputting the external command signal, the start command can be directly input into the QD75. This allows the variation time equivalent to one scan time of the CPU module to be eliminated. This is an effective procedure when operation is to be started as quickly as possible with the start command or when the starting variation time is to be suppressed. To start positioning control by inputting the external command signal, set the "data required to be set" and then turn ON the external command signal.

■ Restrictions

When starting by inputting the external command signal, the start complete signal [X10, X11, X12, X13] will not turn ON.

■ Data required to be set

To execute positioning start with the external command signal, set parameter (Pr.42) beforehand, and validate the "external command signal" with the "External command function valid setting program (program No. 5)".

Setting item	Setting value	Setting details	Buffer memory address			
			Axis 1	Axis 2	Axis 3	Axis 4
Pr.42 External command function selection	0	Set to "0: External positioning start".	62	212	362	512
Cd.8 External command valid	1	Set to "1: Validate external command".	1505	1605	1705	1805

\* Refer to CHAPTER 5 "DATA USED FOR POSITIONING CONTROL" for details on the setting details.

■ Starting time chart

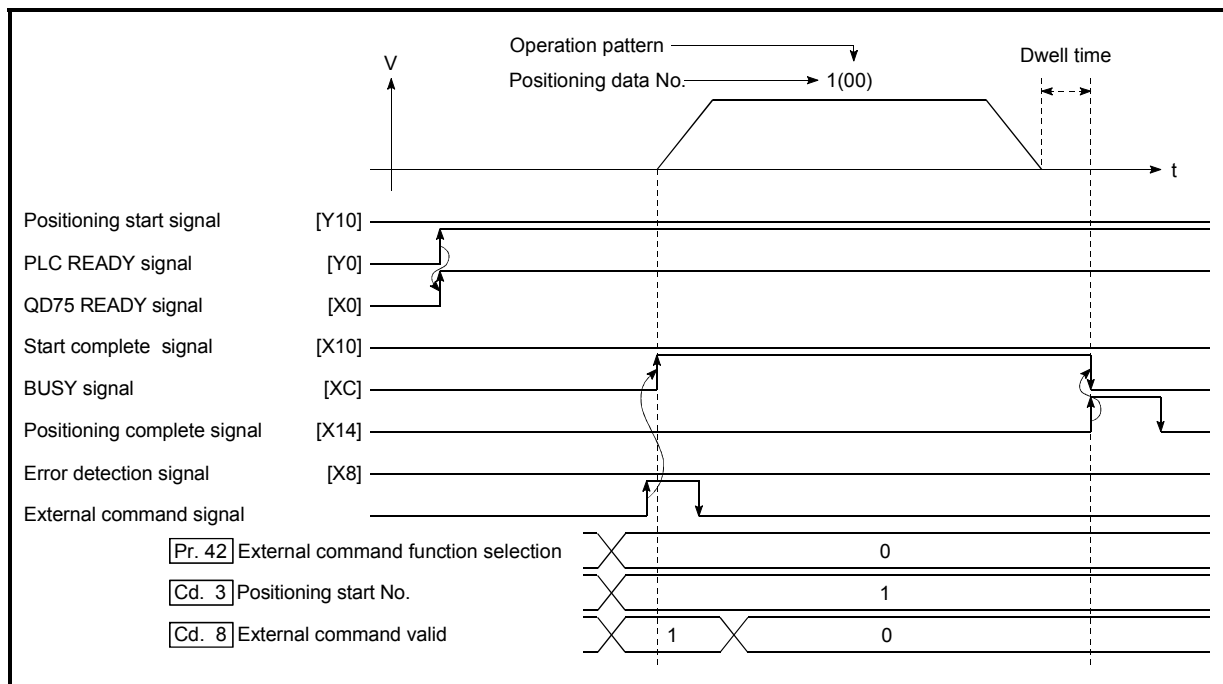

Fig. 6.11 Time chart for starting with external start signal

## 6.5.4 Continuous operation interrupt program

During positioning control, the control can be interrupted during continuous positioning control and continuous path control (continuous operation interrupt function). When "continuous operation interruption" is execution, the control will stop when the operation of the positioning data being executed ends. To execute continuous operation interruption, set "1: Continuous operation interrupt request" for " [Cd.18] Continuous operation interrupt request".

## [1] Operation during continuous operation interruption

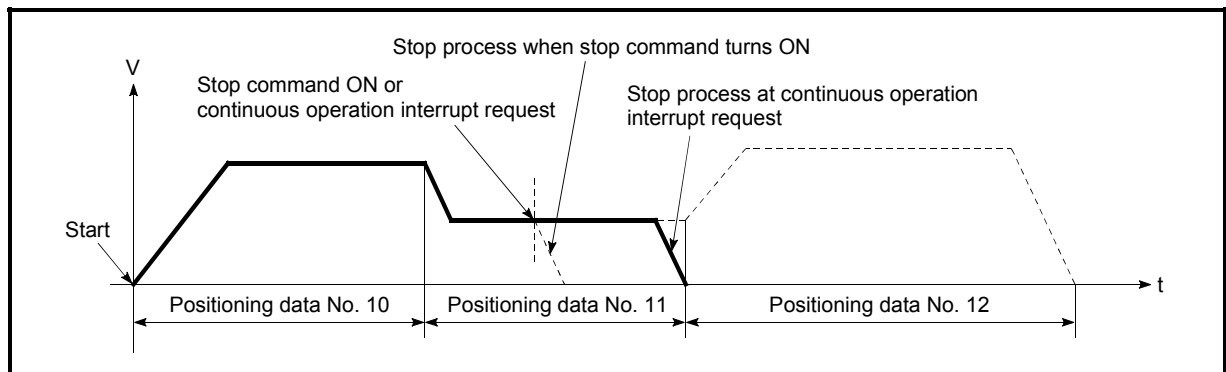

Fig. 6.12 Operation during continuous operation interruption

## [2] Restrictions

- (1) When the "continuous operation interrupt request" is executed, the positioning will end.

Thus, after stopping, the operation cannot be "restarted".

When " [Cd.6] Restart command" is issued, a warning "Restart not possible" (warning code: 104) will occur.

- (2) Even if the stop command is turned ON after executing the "continuous operation interrupt request", the "continuous operation interrupt request" cannot be canceled.

Thus, if "restart" is executed after stopping by turning the stop command ON, the operation will stop when the positioning data No. where "continuous operation interrupt request" was executed is completed.

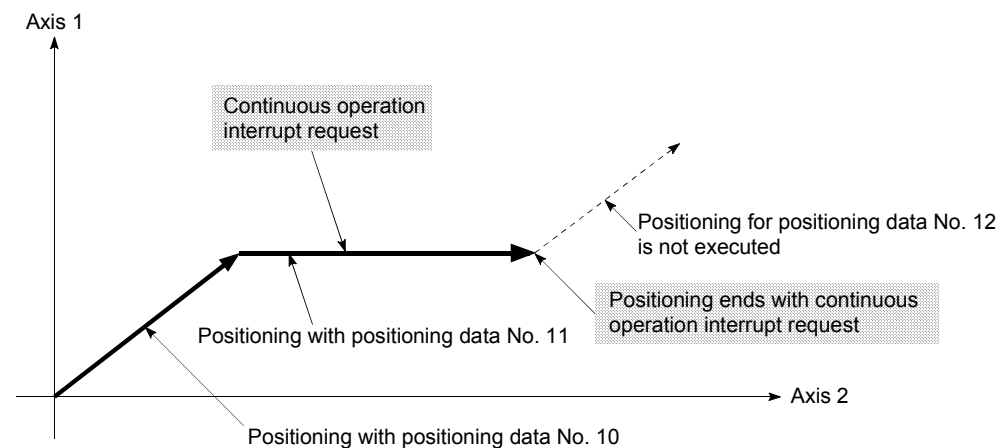



(3) If the operation cannot be decelerated to a stop because the remaining distance is insufficient when "continuous operation interrupt request" is executed with continuous path control, the interruption of the continuous operation will be postponed until the positioning data shown below.

- Positioning data No. have sufficient remaining distance
- Positioning data No. for positioning complete (pattern: 00)
- Positioning data No. for continuous positioning control (pattern: 01)

Even when the continuous operation interrupt is requested, the remaining distance is insufficient, and thus, the operation cannot stop at the positioning No. being executed.

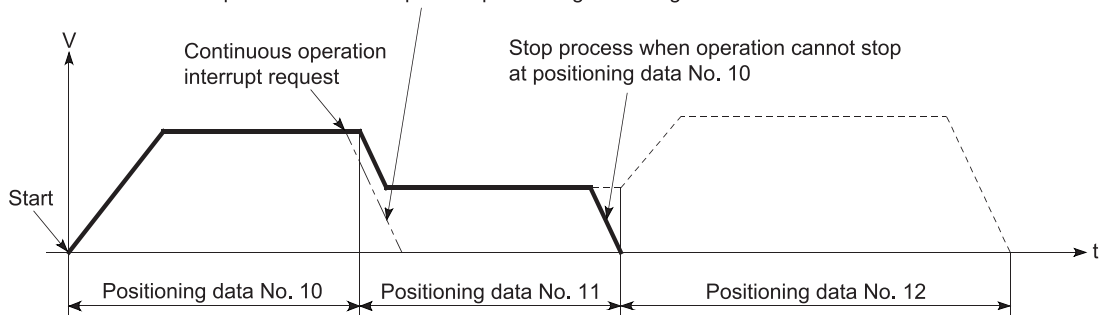

(4) When operation is not performed (BUSY signal [XC, XD, XE, XF] is OFF), the interrupt request during continuous operation is not accepted. It is cleared to 0 at a start or restart.

[3] Control data requiring settings

Set the following data to interrupt continuous operation.

Setting item	Setting value	Setting details	Buffer memory address			
			Axis 1	Axis 2	Axis 3	Axis 4
Cd.18 Continuous operation interrupt request	1	Set "1: Continuous operation interrupt request".	1520	1620	1720	1820

\* Refer to Section 5.7 "List of control data" for details on the setting details.

### 6.5.5 Restart program

When a stop factor occurs during position control and the operation stops, the positioning can be restarted from the stopped position to the position control end point by using the "restart command" (Cd.6 Restart command).

("Restarting" is not possible when "continuous operation is interrupted.")

This instruction is efficient when performing the remaining positioning from the stopped position during position control of incremental system such as the INC Linear 1.

(Calculation of remaining distance is not required.)

#### [1] Restart operation

After a deceleration stop by the stop command is completed, write "1" to the "Cd.6 Restart command" with "Md.26 Axis operation status" is "Stopped" and the positioning restarts.

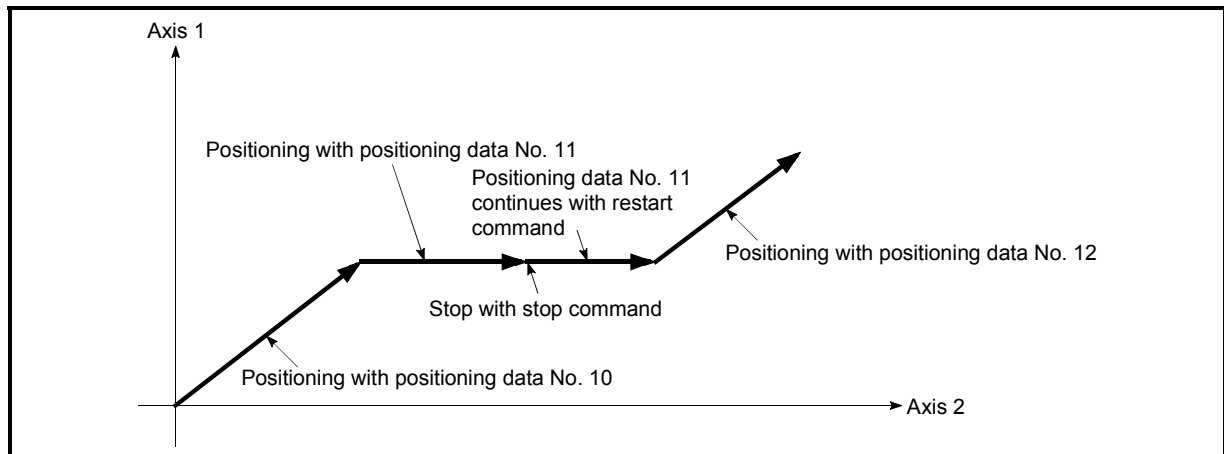

Fig. 6.13 Restart operation

#### [2] Restrictions

- (1) Restarting can be executed only when the "Md.26 Axis operation status" is "Stopped (the deceleration stop by stop command is completed)".  
If the axis operation is not "stopped", restarting is not possible.  
In this case, a warning "Restart not possible" (warning code: 104) will occur, and the process at that time will be continued.
- (2) Restarting can be executed even while the positioning start signal is ON.  
However, make sure that the positioning start signal does not change from OFF to ON while "Md.26 Axis operation status" is "Stopped".  
If the signal is changed from OFF to ON while "Md.26 Axis operation status" is "Stopped", the normal positioning (the positioning data set in "Cd.3 Positioning start signal") is started.
- (3) If the PLC READY signal is turned ON from OFF while "Md.26 Axis operation status" is "Stopped", the positioning cannot be restarted. If restart is requested, a warning "Restart not possible" (warning code: 104) will occur.

- (4) Do not execute restart while the stop command is ON.  
If restart is executed while stopped, an error "Stop signal ON at start" (error code: 106) will occur, and the " Md.26 Axis operation status" will change to "Error".  
Thus, even if the error is reset, the operation cannot be restarted.
- (5) If positioning is ended with the continuous operation interrupt request, the operation cannot be restarted.  
If restart is requested, a warning "Restart not possible" (warning code: 104) will occur.
- (6) When stopped with interpolation operation, write "1: Restarts" into " Cd.6 Restart command" for the reference axis, and then restart.
- (7) If any of reference partner axes executes the positioning operation once, a warning "Restart not possible" (warning code: 104) will occur, and the positioning cannot restarts.
- (8) When the machine OPR and fast OPR is stopped, an error "OPR restart not possible" (error code: 209) will occur and the positioning cannot restarts.

## [3] Control data requiring setting

Set the following data to execute restart.

Setting item	Setting value	Setting details	Buffer memory address			
			Axis 1	Axis 2	Axis 3	Axis 4
Cd.6 Restart command	1	Set "1: Restarts".	1503	1603	1703	1803

\* Refer to Section 5.7 "List of control data" for details on the setting details.

## [4] Starting conditions

The following conditions must be satisfied when restarting. (Assemble the required conditions into the sequence program as an interlock.)

## (1) Operation state

" Md.26 Axis operation status" is "1: Stopped"

## (2) Signal state

Signal name		Signal state		Device			
				Axis 1	Axis 2	Axis 3	Axis 4
Interface signal	PLC READY signal	ON	CPU module preparation completed	Y0			
	QD75 READY signal	ON	QD75 preparation completed	X0			
	Synchronization flag *	ON	QD75 buffer memory Accessible	X1			
	Axis stop signal	OFF	Axis stop signal is OFF	Y4	Y5	Y6	Y7
	M code ON signal	OFF	M code ON signal is OFF	X4	X5	X6	X7
	Error detection signal	OFF	No error is present	X8	X9	XA	XB
	BUSY signal	OFF	BUSY signal is OFF	XC	XD	XE	XF
Start complete signal	OFF	Start complete signal is OFF	X10	X11	X12	X13	
External signal	Drive unit READY signal	ON	Drive unit preparation completed	-			
	Stop signal	OFF	Stop signal is OFF	-			
	Upper limit (FLS)	ON	Within limit range	-			
	Lower limit (RLS)	ON	Within limit range	-			

※: When the synchronous setting of the CPU module is made in the nonsynchronous mode, this must be provided as an interlock.  
When it is made in the synchronous mode, no interlock must be provided in the program because the flag is turned ON when calculation is run on the CPU module.

(5) Time chart for restarting

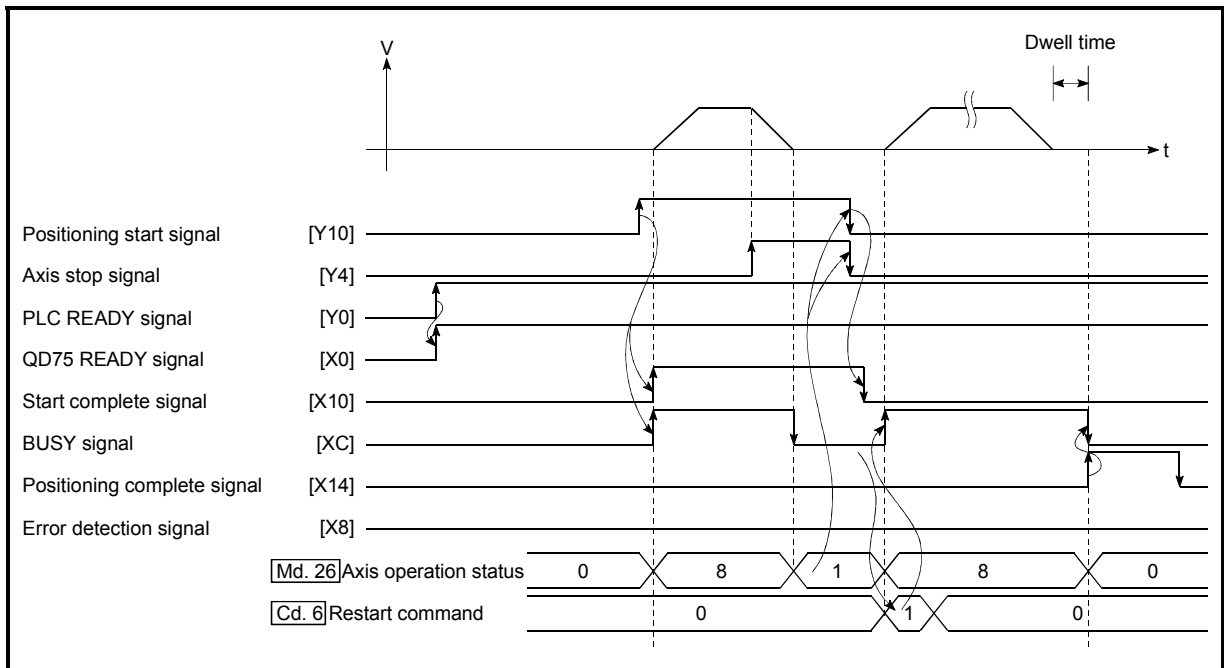

Fig. 6.14 Time chart for restarting

6.5.6 Stop program

The axis stop signal [Y4, Y5, Y6, Y7] or a stop signal from an external source is used to stop the control.

Create a program to turn ON the axis stop signal [Y4, Y5, Y6, Y7] as the stop program.

The process for stopping control is explained below.

Each control is stopped in the following cases.

- (1) When each control is completed normally.
- (2) When the drive unit READY signal is turned OFF.
- (3) When a CPU module error occurs
- (4) When the PLC READY signal is turned OFF.
- (5) When an error occurs in QD75.
- (6) When control is intentionally stopped  
(Stop signal from CPU module turned ON, stop signal from peripheral devices)

The stop process for the above cases is shown below.

(Excluding item (1) above "When each control is completed normally".)

[1] Stop process

Stop cause	Stop axis	M code ON signal after stop	Axis operation status (Md.26) after stopping	Stop process					
				OPR control		Major positioning control	High-level positioning control	Manual control	
				Machine OPR control	Fast OPR control			JOG/Inching operation	Manual pulse generator operation
Forced stop	Drive unit READY signal OFF	Each axis	No change	Error	Immediate stop				Deceleration stop
Fatal stop (Stop group 1)	Hardware stroke limit upper/lower limit error occurrence	Each axis	No change	Error	Deceleration stop/sudden stop (Select with " Pr.37 Stop group 1 sudden stop selection".				Deceleration stop
Emergency stop (Stop group 2)	CPU module error occurrence	All axes	No change	Error	Delegation stop/sudden stop (Select with " Pr.38 Stop group 2 sudden stop selection".				Deceleration stop
	PLC READY signal OFF		Turns OFF						
	Error in test mode		No change						
Relatively safe stop (Stop group 3)	Axis error detection (Error other than stop group 1 or 2)	Each axis	No change	Error	Deceleration stop/sudden stop (Select with " Pr.39 Stop group 3 sudden stop selection".				Deceleration stop
	"Stop" input from peripheral device								
Intentional stop (Stop group 3)	"Stop signal" ON from external source	Each axis	No change	Stopped (Standby)					
	"Axis stop signal" ON from CPU module								

## [2] Types of stop processes

The operation can be stopped with deceleration stop, sudden stop or immediate stop.

### (1) Deceleration stop \*1

The operation stops with "deceleration time 0 to 3"  
([Pr.10](#), [Pr.28](#), [Pr.29](#), [Pr.30](#)).

Which time from "deceleration time 0 to 3" to use for control is set in positioning data ([Da.4](#)).

### (2) Sudden stop

The operation stops with "[Pr.36](#) Sudden stop deceleration time".

### (3) Immediate stop

The operation does not decelerate.

The QD75 immediately stops the pulse output, but the operation will coast for the droop pulses accumulated in the drive unit's deviation counter.

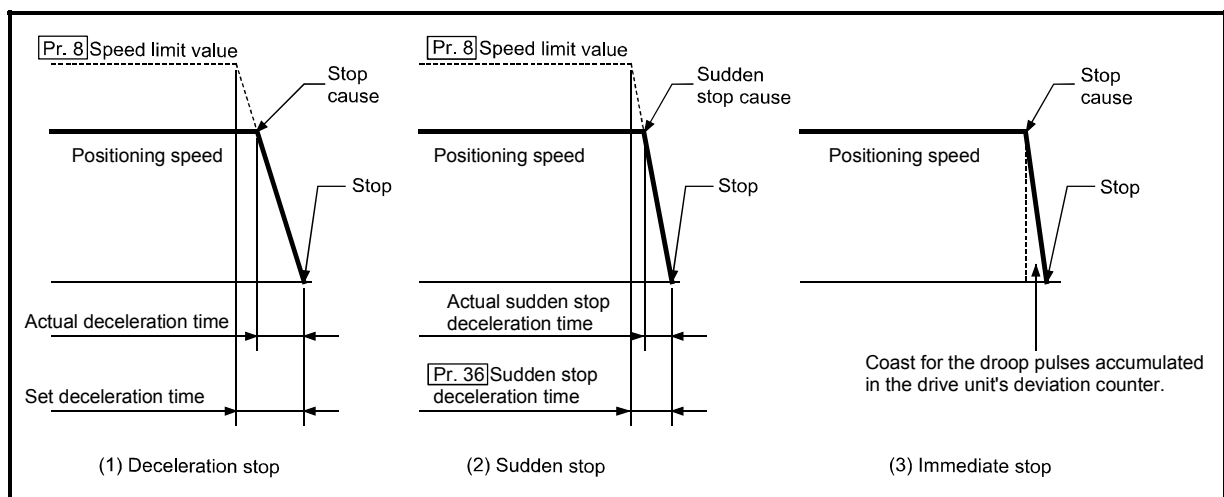

Fig. 6.15 Types of stop processes

## REMARK

\*1 "Deceleration stop" and "sudden stop" are selected with the details parameter 2 "stop group 1 to 3 sudden stop selection". (The default setting is "deceleration stop".)

### [3] Order of priority for stop process

The order of priority for the QD75 stop process is as follows.

Deceleration stop < Sudden stop < Immediate stop

- (1) If the deceleration stop command ON (stop signal ON) or deceleration stop cause occurs during deceleration to speed 0 (including automatic deceleration), operation changes depending on the setting of " Cd.42 Stop command processing for deceleration stop selection".
  - (a) Manual control  
Independently of the Cd.42 setting, a deceleration curve is re-processed from the speed at stop cause occurrence.
  - (b) OPR control, positioning control
    - When Cd.42 = 0 (deceleration curve re-processing):  
A deceleration curve is re-processed from the speed at stop cause occurrence.
    - When Cd.42 = 1 (deceleration curve continuation):  
The current deceleration curve is continued after stop cause occurrence.  
(For details, refer to "Section 12.7.9 Stop command processing for deceleration stop function".)
  
- (2) If the stop signal ON or stop cause specified for a sudden stop occurs during deceleration, sudden stop process will start at that point. However, if the sudden stop deceleration time is longer than the deceleration time, the deceleration stop process will be continued even if a sudden stop cause occurs during the deceleration stop process.

#### Example

The process when a sudden stop cause occurs during deceleration stop is shown below.

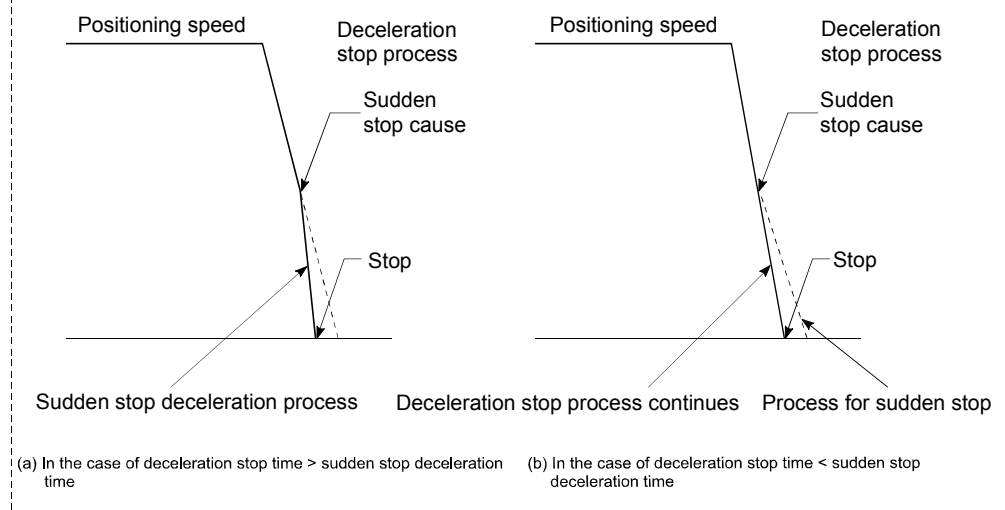

- (3) Operation will stop immediately if the target reaches the positioning address specified in the currently executed positioning data during deceleration of position control.



# CHAPTER 7 MEMORY CONFIGURATION AND DATA PROCESS

The QD75 memory configuration and data transmission are explained in this chapter.

The QD75 is configured of two memories. By understanding the configuration and roles of two memories, the QD75 internal data transmission process, such as "when the power is turned ON" or "when the PLC READY signal changes from OFF to ON" can be easily understood. This also allows the transmission process to be carried out correctly when saving or changing the data.

7.1	Configuration and roles of QD75 memory.....	7-	2
7.1.1	Configuration and roles of QD75 memory .....	7-	2
7.1.2	Buffer memory area configuration.....	7-	5
7.2	Data transmission process.....	7-	6

## 7.1 Configuration and roles of QD75 memory

## 7.1.1 Configuration and roles of QD75 memory

The QD75 is configured of the following two memories.

Memory configuration	Role	Area configuration						Backup
		Parameter area	Monitor data area	Control data area	Positioning data area (No. 1 to 600)	Block start data area (No.7000 to 7004)	PLC CPU memo area	
• Buffer memory	Area that can be directly accessed with sequence program from CPU module.	○	○	○	○	○	○	Not possible
• Flash ROM	Area for backing up data required for positioning.	○	—	—	○	○	—	Possible

○ : Setting and storage area provided, Not possible: Data is lost when power is turned OFF

— : Setting and storage area not provided, Possible: Data is held even when power is turned OFF

**■ Details of areas**

- Parameter area  
Area where parameters, such as positioning parameters and OPR parameters, required for positioning control are set and stored.  
(Set the items indicated with **Pr.1** to **Pr.57**, **Pr.70**, and **Pr.150** for each axis.)
  
- Monitor data area  
Area where positioning system or QD75 operation state is stored.  
(Set the items indicated with **Md.1** to **Md.48**, **Md.50** to **Md.52** \*1.)  
\*1: **Md.50** to **Md.52** are for the QD75P□N/QD75D□N only.
  
- Control data area  
Area where data for operating and controlling positioning system is set and stored. (Set the items indicated with **Cd.1** to **Cd.42**.)
  
- Positioning data area (No.1 to 600)  
Area where positioning data No.1 to 600 is set and stored.  
(Set the items indicated with **Da.1** to **Da.10** and **Da.27** to **Da.29** for each positioning data.)
  
- Block start data area (No.7000 to 7004)  
Area where information required only when carrying out block No. 7000 to 7004 high-level positioning is set and stored. (Set the items indicated with **Da.11** to **Da.19**.)
  
- PLC CPU memo area  
Area where condition judgment values required for special positioning, etc., are set and stored.

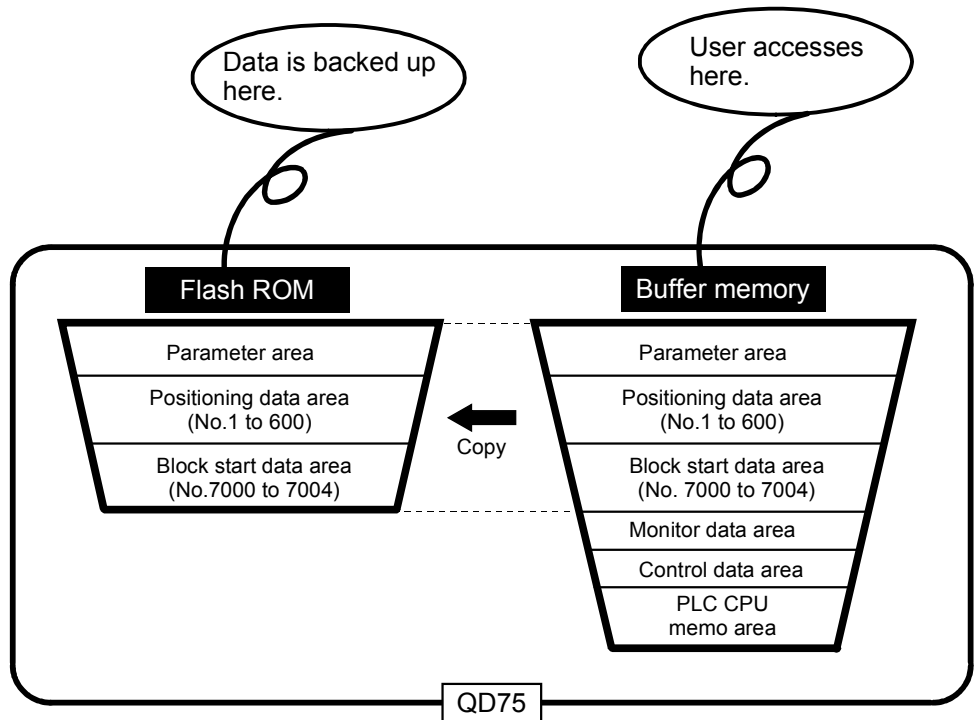

## 7.1.2 Buffer memory area configuration

The QD75 buffer memory is configured of the following types of areas.

Buffer memory area configuration		Buffer memory address*1				Writing possibility
		Axis 1	Axis 2	Axis 3	Axis 4	
Parameter area	Basic parameter area	0 to 15	150 to 165	300 to 315	450 to 465	Possible
	Detailed parameter area	17 to 62	167 to 212	317 to 362	467 to 512	
	140*2					
	OPR basic parameter area	70 to 78	220 to 228	370 to 378	520 to 528	
	OPR detailed parameter area	79 to 89	229 to 239	379 to 389	529 to 539	
Monitor data area	System monitor area	1200 to 1425, 1440 to 1487*2				Not possible
	Axis monitor area	800 to 847, 899	900 to 947, 999	1000 to 1047, 1099	1100 to 1147, 1199	
Control data area	System control data area	1900, 1901, 1905, 1907				Possible
	Axis control data area	1500 to 1550	1600 to 1650	1700 to 1750	1800 to 1850	
Positioning data area (No.1 to 600)	Positioning data area	2000 to 7999	8000 to 13999	14000 to 19999	20000 to 25999	Possible
Block start data area (No.7000)	Block start data area	26000 to 26049	27000 to 27049	28000 to 28049	29000 to 29049	
		26050 to 26099	27050 to 27099	28050 to 28099	29050 to 29099	
	Condition data area	26100 to 26199	27100 to 27199	28100 to 28199	29100 to 29199	
Block start data area (No.7001)	Block start data area	26200 to 26249	27200 to 27249	28200 to 28249	29200 to 29249	
		26250 to 26299	27250 to 27299	28250 to 28299	29250 to 29299	
	Condition data area	26300 to 26399	27300 to 27399	28300 to 28399	29300 to 29399	
Block start data area (No.7002)	Block start data area	26400 to 26449	27400 to 27449	28400 to 28449	29400 to 29449	
		26450 to 26499	27450 to 27499	28450 to 28499	29450 to 29499	
	Condition data area	26500 to 26599	27500 to 27599	28500 to 28599	29500 to 29599	
Block start data area (No.7003)	Block start data area	26600 to 26649	27600 to 27649	28600 to 28649	29600 to 29649	
		26650 to 26699	27650 to 27699	28650 to 28699	29650 to 29699	
	Condition data area	26700 to 26799	27700 to 27799	28700 to 28799	29700 to 29799	
Block start data area (No.7004)	Block start data area	26800 to 26849	27800 to 27849	28800 to 28849	29800 to 29849	
		26850 to 26899	27850 to 27899	28850 to 28899	29850 to 29899	
	Condition data area	26900 to 26999	27900 to 27999	28900 to 28999	29900 to 29999	
PLC CPU memo area	PLC CPU memo area	30000 to 30099				Possible

\*1: Use of address Nos. skipped above is prohibited. If used, the system may not operate correctly.

\*2: These addresses are not used for the QD75P□/QD75D□.

7.2 Data transmission process

The data is transmitted between the QD75 memories with steps (1) to (8) shown below.

\*The data transmission patterns numbered (1) to (8) on the right page correspond to the numbers (1) to (8) on the left page.

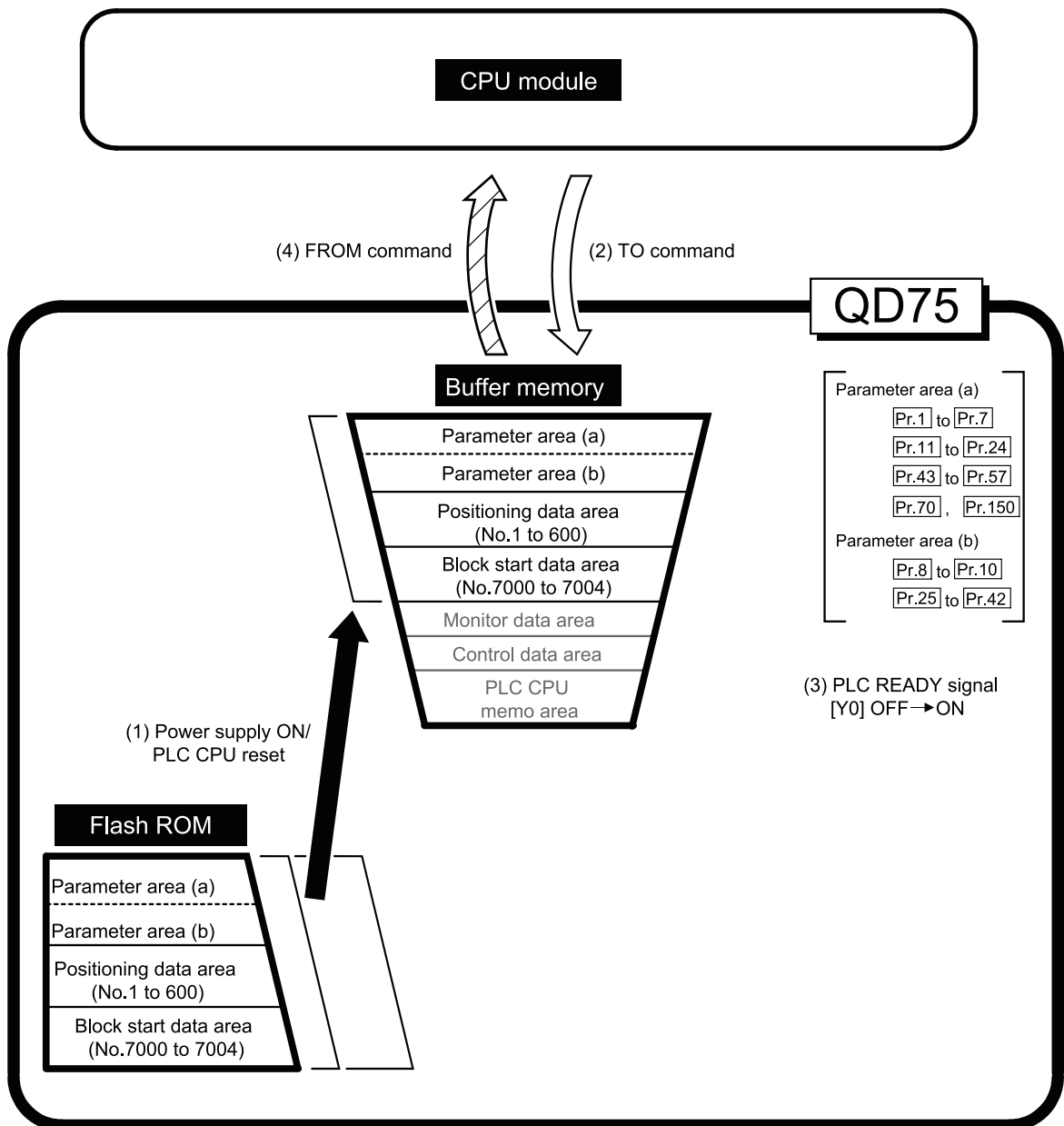

- (1) Transmitting data when power is turned ON or CPU module is reset (  )

When the power is turned ON or the CPU module is reset, the "parameters", "positioning data" and "block start data" stored (backed up) in the flash ROM is transmitted to the buffer memory.

- (2) Transmitting data with TO instruction from CPU module (  )

The parameters or data is written from the CPU module to the buffer memory using the TO instruction. At this time, when the "parameter area (b) \*1", "positioning data (No. 1 to 600)", "block start data (No. 7000 to 7004)", "control data" and "PLC CPU memo area" are written into the buffer memory with the TO instruction, it is simultaneously valid.

\*1 Parameter area (b) ..... Parameters validated with the next each positioning control is started.

( Pr.8 to Pr.10, Pr.25 to Pr.42 )

- (3) Validate parameters when PLC READY signal [Y0] changes from OFF to ON

When the PLC READY signal [Y0] changes from OFF to ON, the data stored in the buffer memory's "parameter area (a) \*2" is validated.

For Pr.5, however, only the data obtained first after the PLC READY signal [Y0] changes from OFF to ON when the power is turned ON or CPU module is reset becomes validate.

(Refer to Section 5.2 "List of parameters" for details.)

\*2: Parameter area (a) .... Parameters validated when PLC READY signal [Y0] changes from OFF to ON.

( Pr.1 to Pr.7, Pr.11 to Pr.24, Pr.43 to Pr.57, Pr.70, Pr.150 )

POINT
<p>The setting values of the parameters that correspond to parameter area (b) are valid when written into the buffer memory with the TO instruction.</p> <p>However, the setting values of the parameters that correspond to parameter area (a) are not validated until the PLC READY signal [Y0] changes from OFF to ON.</p>

- (4) Accessing with FROM instruction from CPU module (  )

The data is read from the buffer memory to the CPU module using the FROM instruction.

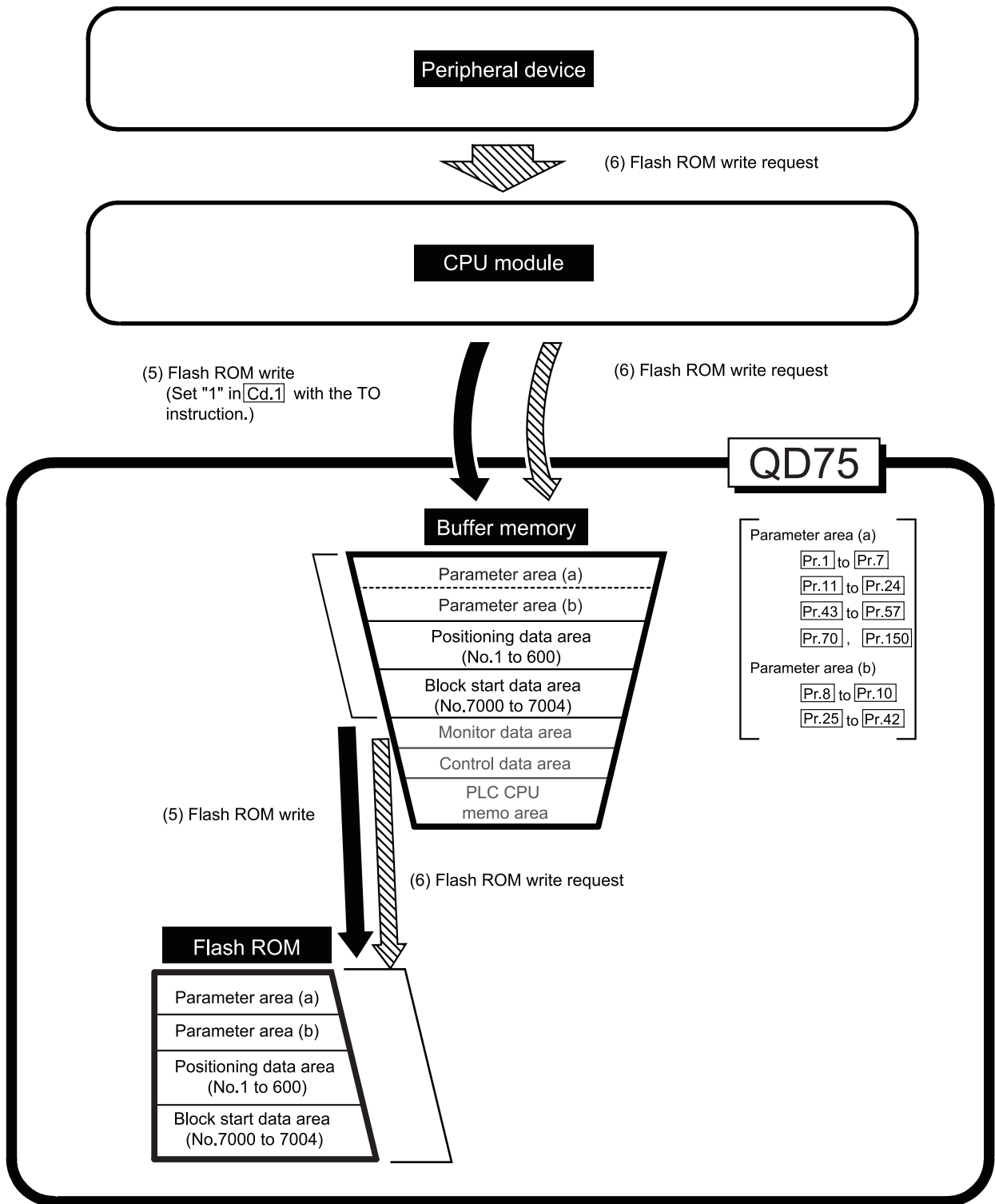



(5) Flash ROM write (  )

The following transmission process is carried out by setting "1" in " Cd.1 Flash ROM write request" (buffer memory [1900]).

- 1) The "parameters", "positioning data (No. 1 to 600)" and "block start data (No. 7000 to 7004)" in the buffer memory area are transmitted to the flash ROM. The writing to the flash ROM may also be carried out using a dedicated instruction "ZP.PFWRT". (Refer to CHAPTER 14 "DEDICATED INSTRUCTIONS" for details.)

(6) Flash ROM request (writing) (  )

The following transmission processes are carried out with the [flash ROM request] (write) from the peripheral device.

- 1) The "parameters", "positioning data (No. 1 to 600)" and "block start data (No. 7000 to 7004)" in the buffer memory area are transmitted to the flash ROM.

Note) This transmission process is the same as (5) above.

**IMPORTANT**

- (1) Do not turn the power OFF or reset the CPU module while writing to the flash ROM. If the power is turned OFF or the CPU module is reset to forcibly end the process, the data backed up in the flash ROM will be lost.
- (2) Do not write the data to the buffer memory before writing to the flash ROM is completed.
- (3) The number of writes to the flash ROM with the programmable controller program is 25 max. while the power is turned ON. Writing to the flash ROM beyond 25 times will cause the error "Flash ROM write number error" (error code: 805). Refer to Section 15.3 "List of errors" for details.

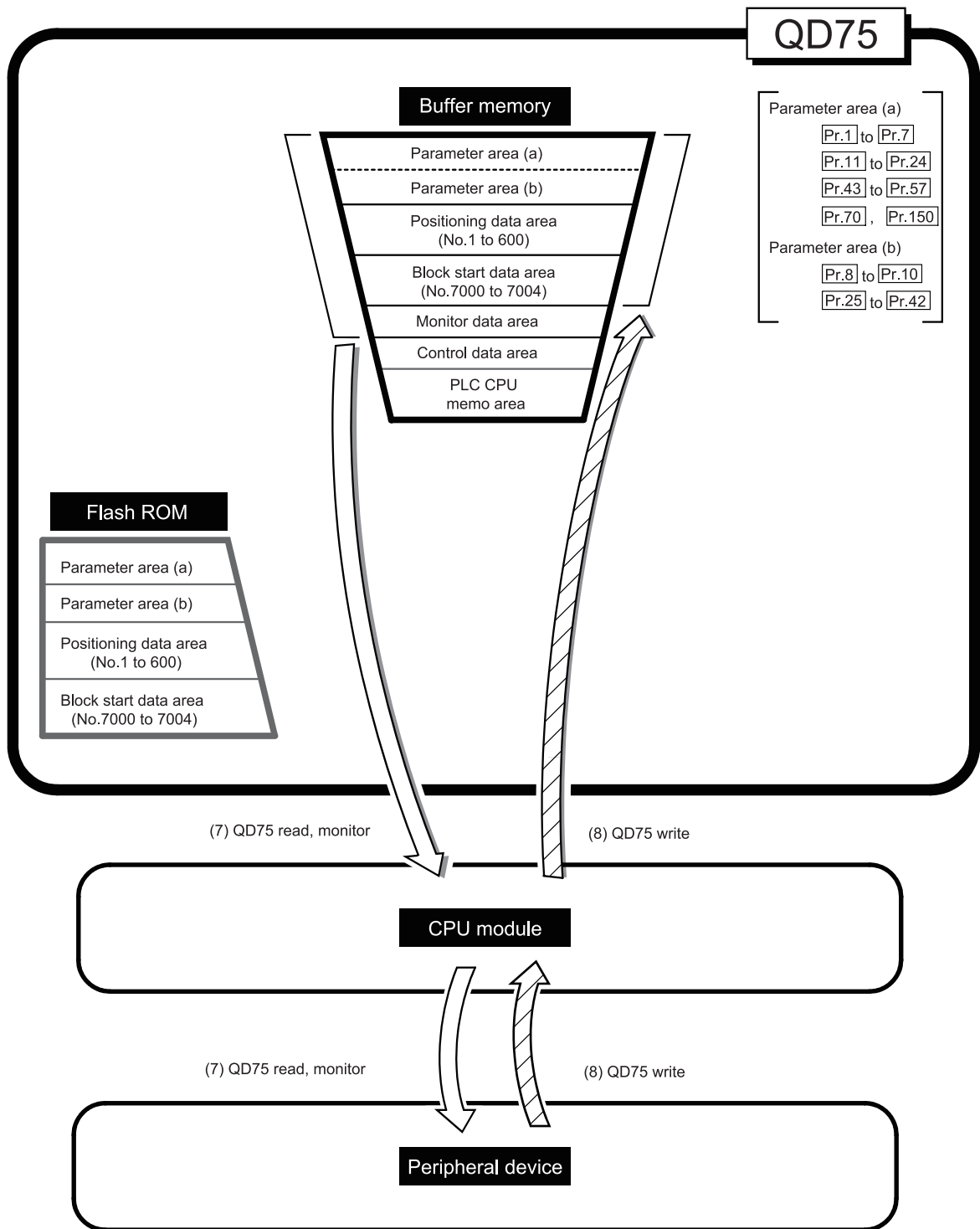

## (7) Reading data from buffer memory to peripheral device (⇨)

The following transmission processes are carried out with the [Read from module] from the peripheral device.

- 1) The "parameters", "positioning data (No. 1 to 600)" and "block start data (No. 7000 to 7004)" in the buffer memory area are transmitted to the peripheral device via the CPU module.

The following transmission processes are carried out with the [monitor] from the peripheral device.

- 2) The "monitor data" in the buffer memory area is transmitted to the peripheral device via the CPU module.

## (8) Writing data from peripheral device to buffer memory (⇨)

The following transmission processes are carried out with the [Write to module] from the peripheral device.

- 1) The "parameters", "positioning data (No. 1 to 600)" and "block start data (No. 7000 to 7004)" in the peripheral device area transmitted to the buffer memory via the CPU module.

At this time, when [Flash ROM write] is set with the peripheral device, the transmission processes indicated with the following are carried out.

- (5) Flash ROM write

The data transmission is carried out as shown in the previous pages, but the main method of using this data process is shown below.

(Ex.) Setting the positioning data

The following methods can be used to set the positioning data.

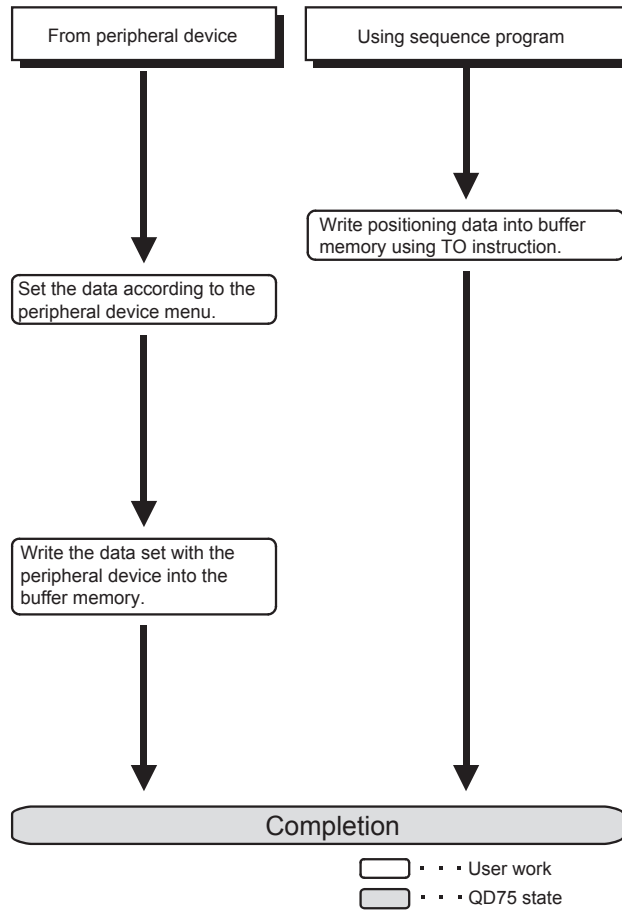

# PART 2 CONTROL DETAILS AND SETTING

PART 2 is configured for the following purposes (1) to (3).

- (1) To understand the operation and restrictions of each control.
- (2) To carry out the required settings in each control.
- (3) To deal with errors.

The required settings in each control include parameter setting, positioning data setting, control data setting by a sequence program, etc.

Carry out these settings while referring to CHAPTER 5 "DATA USED FOR POSITIONING CONTROL".

Also refer to CHAPTER 6 "SEQUENCE PROGRAMS USED FOR POSITIONING CONTROL" when creating the programs required in each control, and consider the entire control program configuration when creating each program.

CHAPTER 8	OPR CONTROL .....	8-	1 to 8- 24
CHAPTER 9	MAJOR POSITIONING CONTROL.....	9-	1 to 9-140
CHAPTER 10	HIGH-LEVEL POSITIONING CONTROL.....	10-	1 to 10- 28
CHAPTER 11	MANUAL CONTROL.....	11-	1 to 11- 34
CHAPTER 12	CONTROL SUB FUNCTIONS.....	12-	1 to 12-110
CHAPTER 13	COMMON FUNCTIONS .....	13-	1 to 13- 8
CHAPTER 14	DEDICATED INSTRUCTIONS .....	14-	1 to 14- 24
CHAPTER 15	TROUBLESHOOTING .....	15-	1 to 15- 50



# CHAPTER 8 OPR CONTROL

The details and usage of "OPR control" are explained in this chapter.

OPR control includes "machine OPR" that establish a machine OP without using address data, and "fast OPR" that store the coordinates established by the machine OPR, and carry out positioning to that position.

OPR carried out by sequence programs from the CPU module are explained in this chapter.

Refer to GX Configurator-QP Operating Manual for details on OPR using the peripheral device.

8.1	Outline of OPR control .....	8- 2
8.1.1	Two types of OPR control.....	8- 2
8.2	Machine OPR .....	8- 4
8.2.1	Outline of the machine OPR operation .....	8- 4
8.2.2	Machine OPR method .....	8- 5
8.2.3	OPR method (1): Near-point dog method .....	8- 7
8.2.4	OPR method (2): Stopper method 1).....	8- 9
8.2.5	OPR method (3): Stopper method 2).....	8- 12
8.2.6	OPR method (4): Stopper method 3).....	8- 15
8.2.7	OPR method (5): Count method 1).....	8- 17
8.2.8	OPR method (6): Count method 2).....	8- 20
8.3	Fast OPR .....	8- 23
8.3.1	Outline of the fast OPR operation .....	8- 23

## 8.1 Outline of OPR control

### 8.1.1 Two types of OPR control

In "OPR control" a position is established as the starting point (or "OP") when carrying out positioning control, and positioning is carried out toward that starting point.

It is used to return a machine system at any position other than the OP to the OP when the QD75 issues a "OPR request"\* with the power turned ON or others, or after a positioning stop.

In the QD75, the two types of controls shown below are defined as "OPR control", following the flow of the OPR work.

These two types of OPR control can be executed by setting the "OPR parameters", setting "Positioning start No. 9001" and "Positioning start No. 9002" prepared beforehand in the QD75 to "[Cd.3] Positioning start No.", and turning ON the positioning start signal.

The ZP.PSTRT  start numbers of the dedicated instruction can also be set to 9001 or 9002 to execute the OPR control. (For details, refer to CHAPTER 14 "DEDICATED INSTRUCTIONS".)

- (1) Establish a positioning control OP
  - "Machine OPR" (positioning start No. 9001)
- (2) Carry out positioning toward the OP
  - "Fast OPR" (positioning start No. 9002).

\* The "machine OPR" in (1) above must always be carried out before executing the "fast OPR" in (2).

REMARK
--------

#### OPR request \*

The "OPR request flag" ([Md.31] Status: b3) must be turned ON in the QD75, and a machine OPR must be executed in the following cases.

- When the power is turned ON
- At the ON → OFF of the drive unit READY signal ([Md.30] External input/output signal: b2).
- At the OFF → ON of the PLC READY signal [Y0]

The address information stored in the QD75 cannot be guaranteed while the "OPR request flag" is ON.

The "OPR request flag" turns OFF and the "OPR complete flag" ([Md.31] Status: b4) turns ON if the machine OPR is executed and is completed normally.



### ■ OPR sub functions

Refer to Section 3.2.4 "Combination of QD75 main functions and sub functions" for details on "sub functions" that can be combined with OPR control. Also refer to CHAPTER 12 "CONTROL SUB FUNCTIONS" for details on each sub function.

#### [Remarks]

The following two sub functions are only related to machine OPR.

Sub function name	Machine OPR	Fast OPR	Reference
OPR retry function	△	×	Section 12.2.1
OP shift function	○	×	Section 12.2.2

○ : Combination possible, △: Restricted, ×: Combination not possible

### ■ When an OPR is not required

Control can be carried out ignoring the "OPR request flag" (**[Md.31]** Status: b3) in systems that do not require an OPR.

In this case, the "OPR parameters (**[Pr.43]** to **[Pr.57]**)" must all be set to their initial values or a value at which an error does not occur.

### ■ OPR from peripheral devices

"Machine OPR" and "fast OPR" can be executed from the test mode of the peripheral device.

Refer to GX Configurator-QP Operating Manual for details on OPR from the peripheral device.

## 8.2 Machine OPR

## 8.2.1 Outline of the machine OPR operation

**Important**

Use the OPR retry function when the OP position is not always in the same direction from the workpiece operation area (when the OP is not set near the upper or lower limit of the machine).

\*The machine OPR may not complete unless the OPR retry function is used.

**Machine OPR operation**

In a machine OPR, a machine OP is established.

None of the address information stored in the QD75, CPU module, or servo is used at this time. The position mechanically established after the machine OPR is regarded as the "OP" to be the starting point for positioning control.

The method for establishing an "OP" by a machine OPR differs according to the method set in "Pr.43 OPR method".

The following shows the operation when starting a machine OPR.

1)	The machine OPR is started.
2)	The operation starts according to the speed and direction set in the OPR parameters (Pr.43 to Pr.57).
3)	The "OP" is established by the method set in "Pr.43 OPR method", and the machine stops. (Refer to Sections 8.2.2 to 8.2.8)
4)	If "a" is set as "Pr.45 OP address", "a" will be stored as the current position in the "Md.20 Current feed value" and "Md.21 Machine feed value" which are monitoring the position.
5)	The machine OPR is completed.

\* The "Pr.45 OP address" is a fixed value set by the user.

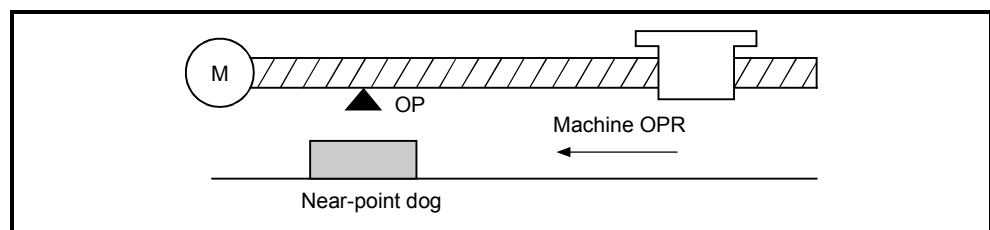

Fig. 8.1 Example of a machine OPR

## 8.2.2 Machine OPR method

The method by which the machine OP is established (method for judging the OP position and machine OPR completion) is designated in the machine OPR according to the configuration and application of the positioning method.

The following table shows the six methods that can be used for this OPR method.

(The OPR method is one of the items set in the OPR parameters. It is set in "Pr.43 OPR method" of the basic parameters for OPR.)

Pr.43 OPR method	Operation details
Near-point dog method	Deceleration starts by the OFF → ON of the near-point dog. (Speed is reduced to "Pr.47 Creep speed".) The operation stops at the first zero signal* after the near-point dog turns from ON → OFF. When a "deviation counter clear output" is completed, the machine OPR is completed.
Stopper method 1)	The stopper position is regarded as the OP. After the deceleration starts by the OFF → ON of the near-point dog, the machine presses against the stopper at the "Pr.47 Creep speed" and stops. The machine OPR is regarded as completed on completion of the deviation counter clear output provided after "Pr.49 OPR dwell time" passed after stoppage.
Stopper method 2)	The stopper position is regarded as the OP. After the deceleration starts by the OFF → ON of the near-point dog, the machine presses against the stopper at the "Pr.47 Creep speed" and stops. The machine OPR is regarded as completed on completion of the deviation counter clear output provided after the zero signal* is detected after stoppage.
Stopper method 3)	The stopper position is regarded as the OP. The machine starts at the "Pr.47 Creep speed" from the beginning, then presses against the stopper at the "Pr.47 Creep speed" and stops. The machine OPR is regarded as completed on completion of the deviation counter clear output provided after the zero signal* is detected after stoppage.
Count method 1)	The deceleration starts by the OFF → ON of the near-point dog, and the machine moves at the "Pr.47 Creep speed". The machine stops at the zero signal* after moving the distance set in the "Pr.50 Setting for the movement amount after near-point dog ON" from the near point dog OFF → ON position. When a "deviation counter clear signal output" is completed, the machine OPR is regarded as completed.
Count method 2)	The deceleration starts by the OFF → ON of the near-point dog, and the machine moves at the "Pr.47 Creep speed". The machine moves the distance set in the "Pr.50 Setting for the movement amount after near-point dog ON" from the near point dog OFF → ON position, and stops at that position. The machine OPR is then regarded as completed.

\*: The following are the signals input as the zero signals of the QD75 in the corresponding OPR methods.

Near-point dog method, count method 1): Signal that is output as a single pulse at one motor revolution (e.g. Z-phase signal output from the drive unit)

Stopper method 2), 3) : Signal that is output on detection of contact with the stopper. (Input externally)

The following shows the external I/O signals used for machine OPR.

Pr.43 OPR method	Signal required for control				Torque limit
	Near-point dog	Zero signal	Upper/lower limit switches	Deviation counter clear output	
Near-point dog method	◎	◎	○	◎	-
Stopper method 1)	◎	-	○	◎	◎
Stopper method 2)	◎	◎	○	◎	◎
Stopper method 3)	-	◎	○	◎	◎
Count method 1)	◎	◎	○	◎	-
Count method 2)	◎	-	○	-	-

◎: Necessary ○: Necessary as required -: Unnecessary

### REMARK

#### Creep speed

The stopping accuracy is poor when the machine suddenly stops from fast speeds. To improve the machine's stopping accuracy, its must change over to a slow speed before stopping. This speed is set in the " Pr.47 Creep speed".

8.2.3 OPR method (1): Near-point dog method

The following shows an operation outline of the "near-point dog method" OPR method.

■ Operation chart

1)	The machine OPR is started. (The machine begins the acceleration designated in " [Pr.51] OPR acceleration time selection", in the direction designated in " [Pr.44] OPR direction". It then moves at the " [Pr.46] OPR speed" when the acceleration is completed.)
2)	The machine begins decelerating when the near-point dog ON is detected.
3)	The machine decelerates to the " [Pr.47] Creep speed", and subsequently moves at that speed. (At this time, the near-point dog must be ON. The workpiece will continue decelerating and stop if the near-point dog is OFF.)
4)	After the near-point dog turns OFF, the pulse output from the QD75 will stop at the first zero signal, outputting a "deviation counter clear signal" to the drive unit. (The "deviation counter clear signal output time" is set in [Pr.55].)
5)	After a "deviation counter clear signal" is output to the drive unit, the OPR complete flag ( [Md.31] Status: b4) turns from OFF to ON and the OPR request flag ( [Md.31] Status: b3) turns from ON to OFF.

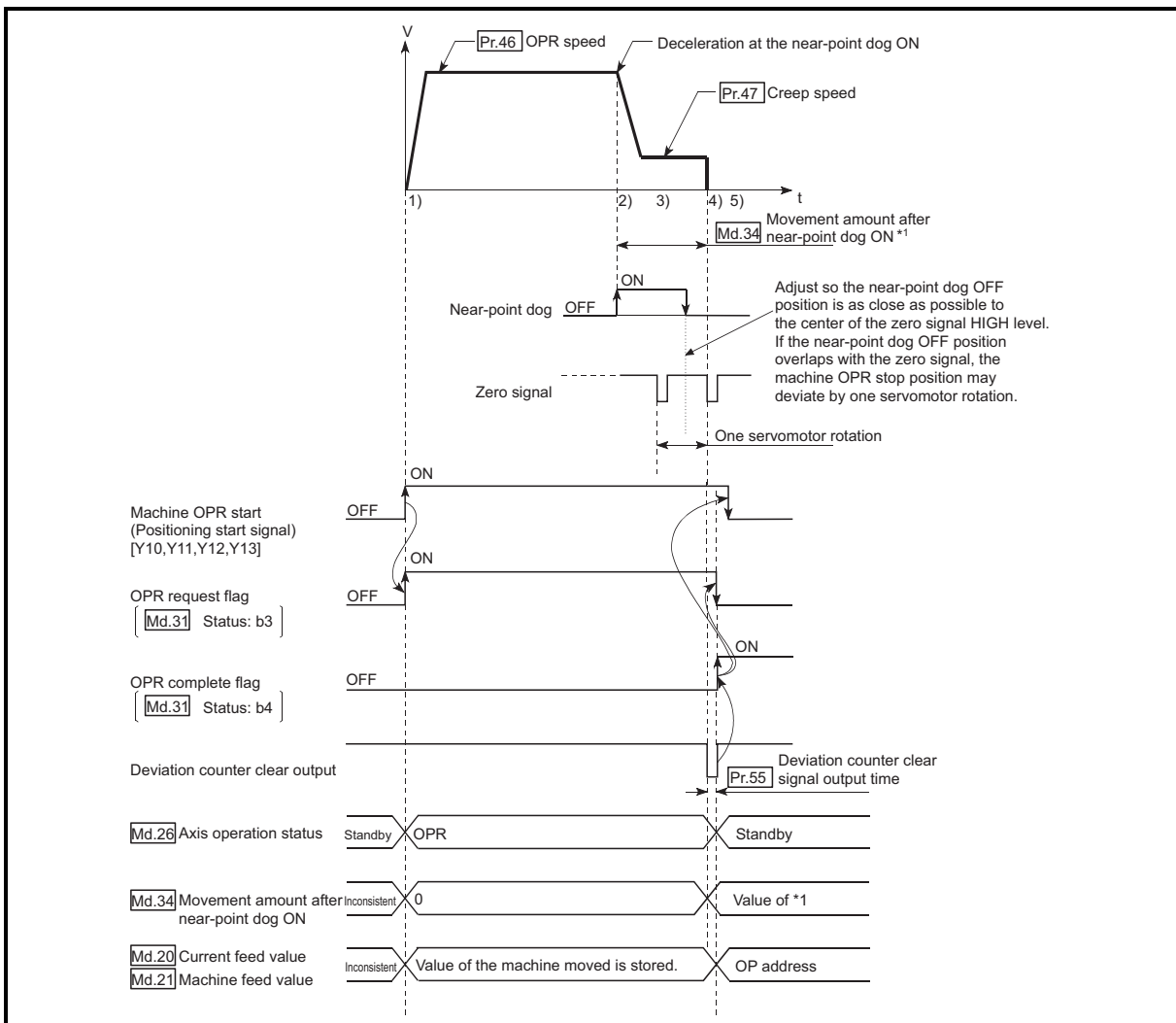

Fig. 8.2 Near-point dog method machine OPR

■ Restrictions

A pulse generator with a zero signal is required.

When using a pulse generator without a zero signal, generate a zero signal using an external signal.

■ Precautions during operation

- (1) An error "Start at OP (error code: 201)" will occur if another machine OPR is attempted after a machine OPR completion when the OPR retry function is not set ("0" is set in "Pr.48 OPR retry").
- (2) Machine OPR carried out from the near-point dog ON position will start at the "Pr.47 Creep speed".
- (3) The near-point dog must be ON during deceleration from the OPR speed "Pr.47 Creep speed".
- \* The workpiece will continue decelerating and stop if the near-point dog is turned OFF before it has decelerated to the creep speed, thus causing an error "Dog detection timing fault" (error code: 203).

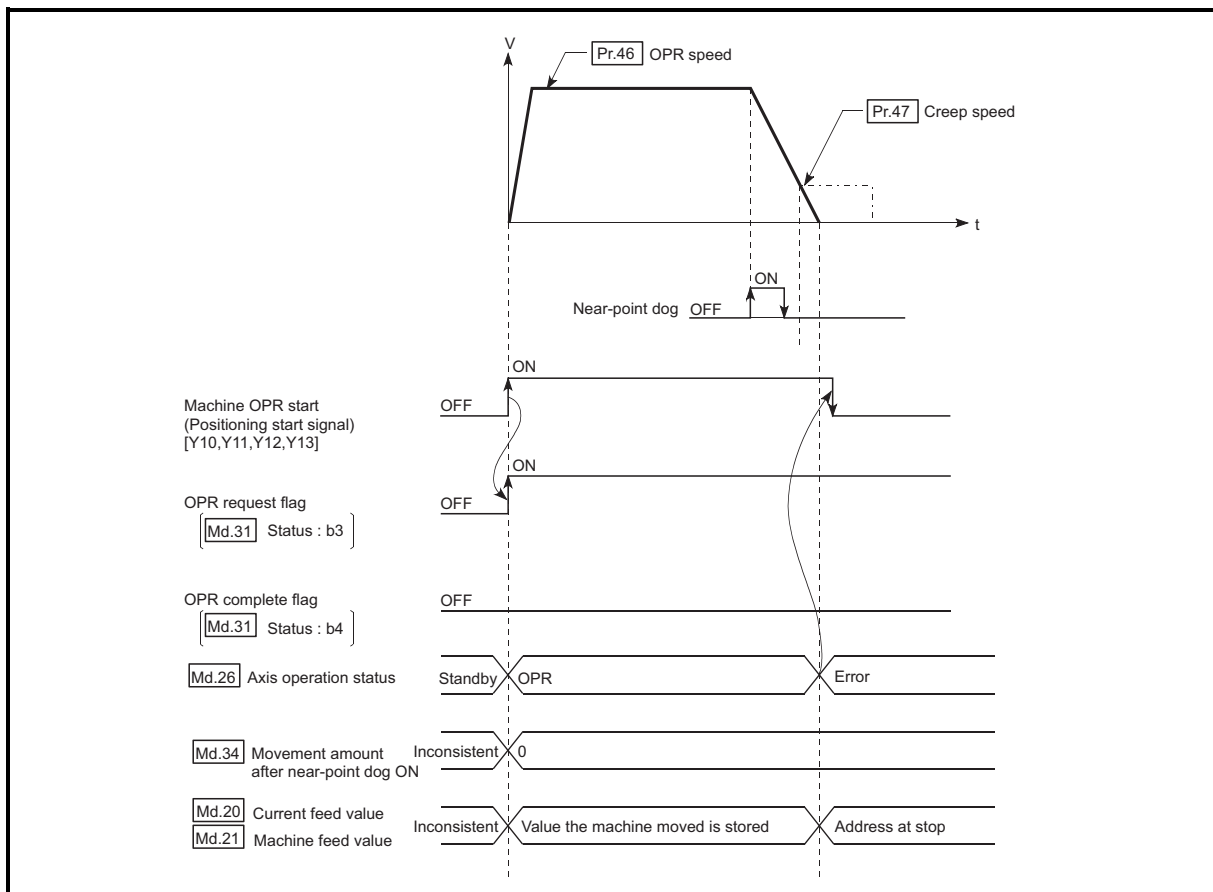

Fig. 8.3 Operation when the near-point dog is turned OFF before the creep speed is reached

- (4) When a machine OPR is stopped with the stop signal, perform a machine OPR again. If the restart command is turned ON after a stop with the stop signal, an error "OPR restart not possible" (error code: 209) occurs.

8.2.4 OPR method (2): Stopper method 1)

The following shows an operation outline of the "stopper method 1)" OPR method.

■ Operation chart

1)	The machine OPR is started. (The machine begins the acceleration designated in "[Pr.51] OPR acceleration time selection", in the direction designated in "[Pr.44] OPR direction". It then moves at the "[Pr.46] OPR speed" when the acceleration is completed.)
2)	The machine begins decelerating when the near-point dog ON is detected.
3)	The machine decelerates to the "[Pr.47] Creep speed", and subsequently moves at that speed. (Torque limiting is required at this time. If the torque is not limited, the servomotor may fail in step 4.)
4)	The machine presses against the stopper at the creep speed and stops.
5)	The pulse output from the QD75 will stop when the "[Pr.49] OPR dwell time" has elapsed after the near-point dog turns ON, outputting the "deviation counter clear output" to the drive unit. (A "deviation counter clear signal output time" is set in the [Pr.55].)
6)	After a "deviation counter clear output" is output to the drive unit, the OPR complete flag ([Md.31] Status: b4) turns from OFF to ON, and the OPR request flag ([Md.31] Status: b3) turns from ON to OFF.

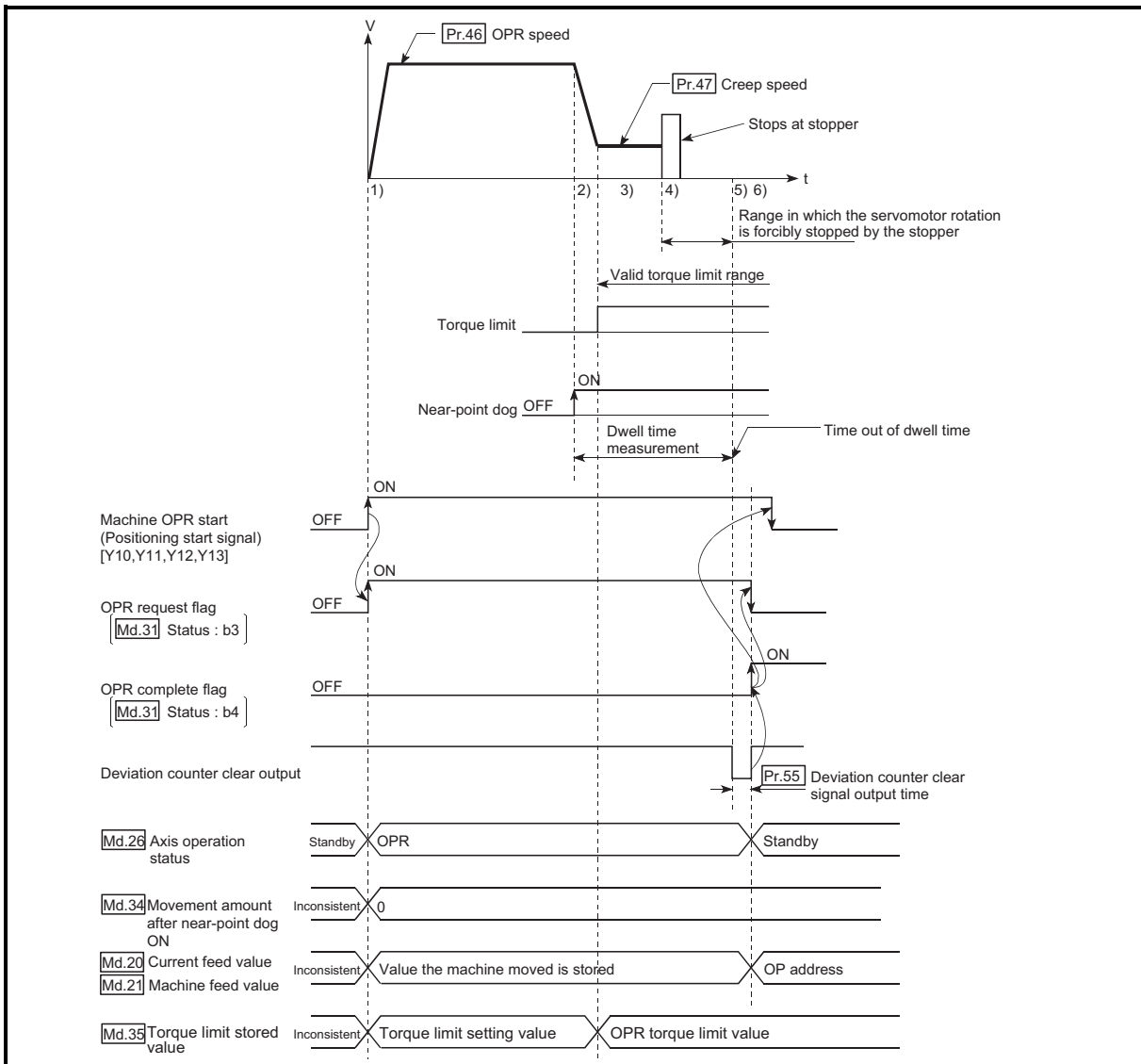

Fig. 8.4 Stopper method 1) machine OPR

■ Restrictions

Always limit the servomotor torque after the " [Pr.47] Creep speed" is reached. If the torque is not limited, the servomotor may fail when the machine presses against the stopper. (Refer to Section 12.4.2 "Torque limit function".)

■ Precautions during operation

- (1) Set a value in the " [Pr.49] OPR dwell time" that is equal to or higher than the movement time from the near-point dog ON to the time the machine presses against the stopper.
- (2) The workpiece will continue decelerating and stop if the " [Pr.49] OPR dwell time" elapses during deceleration from the " [Pr.46] OPR speed", thus causing an error "Dwell time fault" (error code: 205).

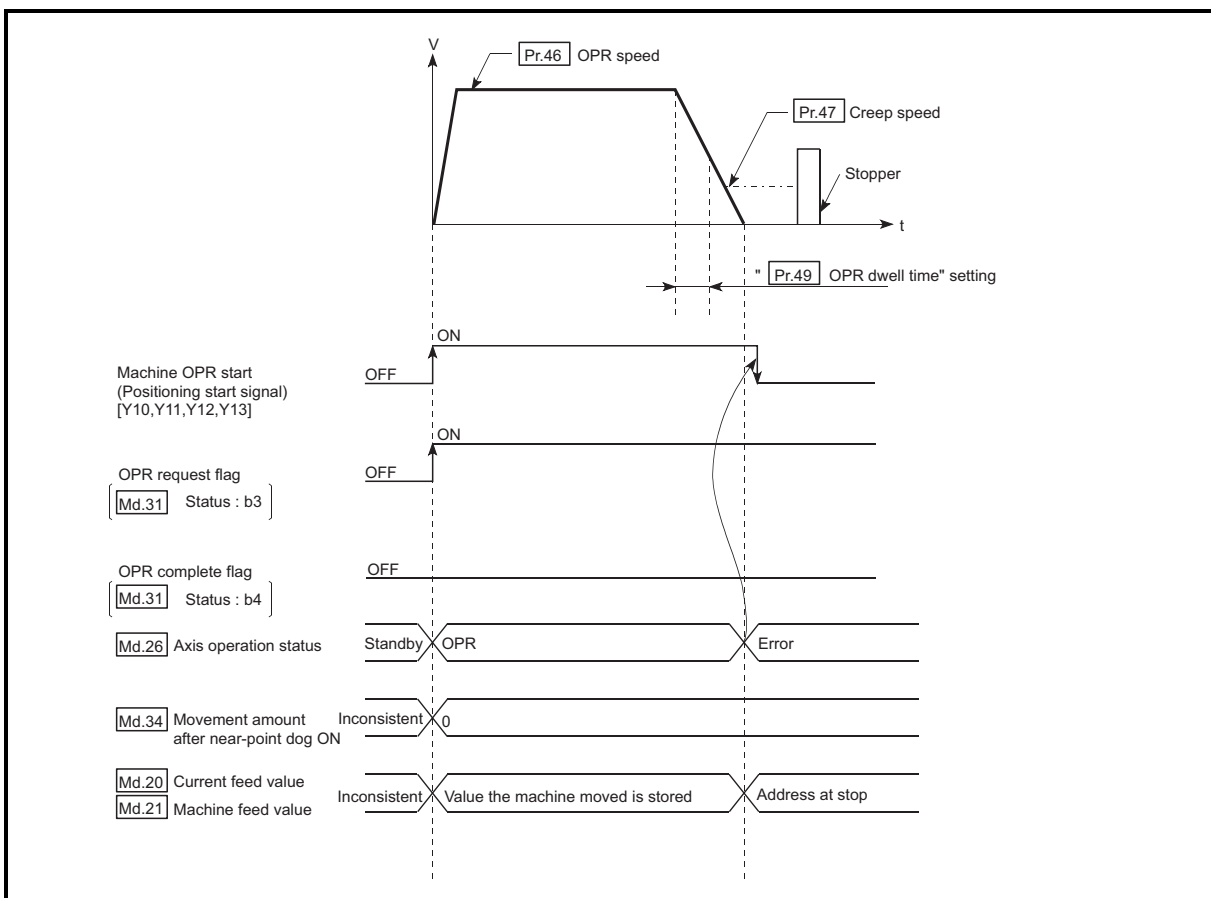

Fig. 8.5 Operation when the dwell time elapses during deceleration from the OPR speed



- (3) If the " Pr.49 OPR dwell time" elapses before the stop at the stopper, the workpiece will stop at that position, and that position will be regarded as the OP. At this time, an error will not occur.

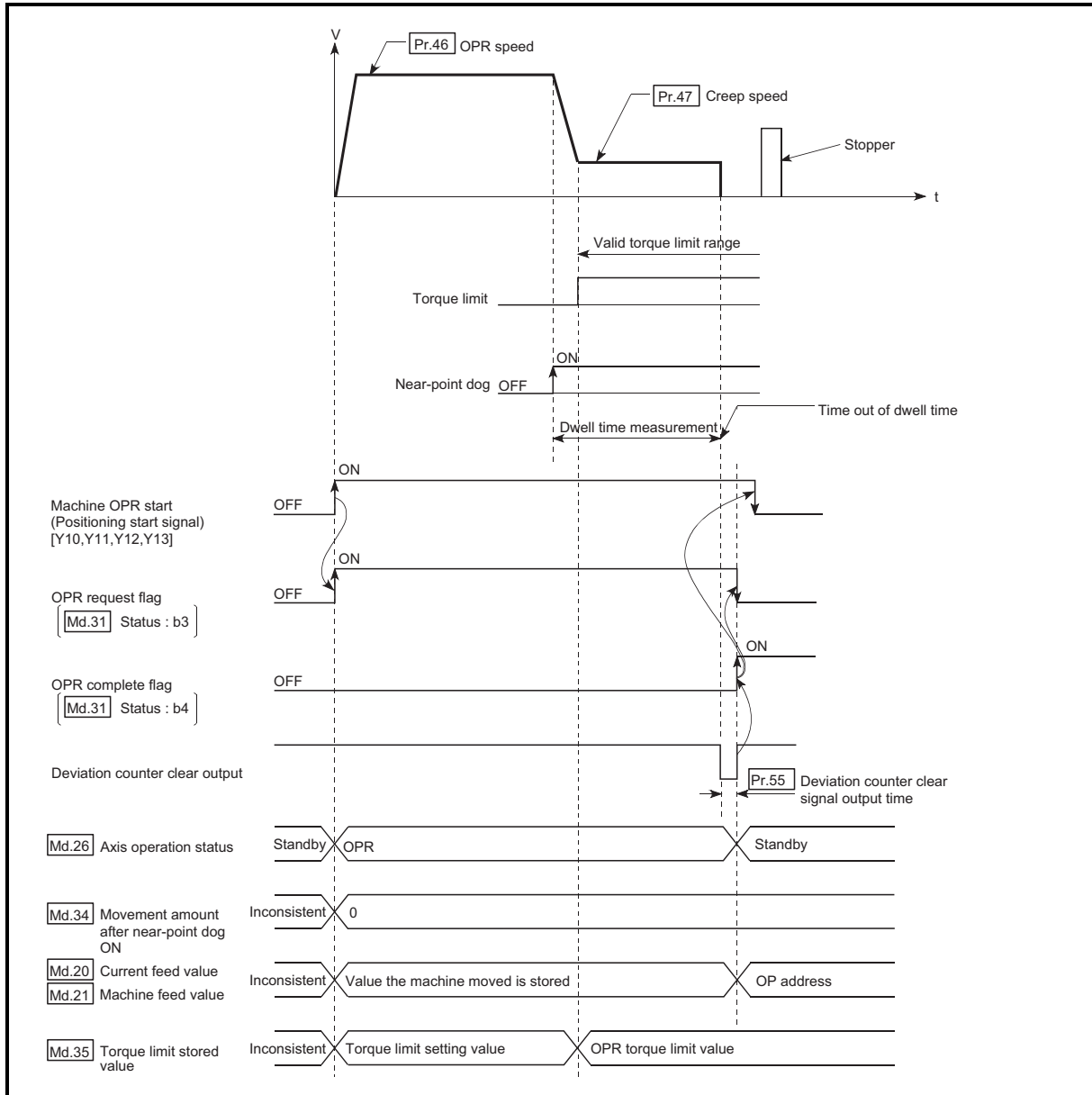

Fig. 8.6 Operation when the dwell time elapses before the stop at the stopper

- (4) The near-point dog must be turned ON until it presses against the stopper. If any range that the near-point is turned OFF exists until it presses against the stopper, executing the machine OPR from the area leads it to be pressed against the stopper at OPR speed.
- (5) Machine OPR started while the near-point dog is ON will start at the " Pr.47 Creep speed".
- (6) When a machine OPR is stopped with the stop signal, perform a machine OPR again. If the restart command is turned ON after a stop with the stop signal, an error "OPR restart not possible" (error code: 209) occurs.

8.2.5 OPR method (3): Stopper method 2)

The following shows an operation outline of the "stopper method 2)" OPR method.

■ Operation chart

1)	The machine OPR is started. (The machine begins the acceleration designated in "[Pr.51] OPR acceleration time selection", in the direction designated in "[Pr.44] OPR direction". It then moves at the "[Pr.46] OPR speed" when the acceleration is completed.)
2)	The machine begins decelerating when the near-point dog ON is detected.
3)	The machine decelerates to the "[Pr.47] Creep speed", and subsequently moves at that speed. (Torque limiting is required at this time. If the torque is not limited, the servomotor may fail in step 4).)
4)	The machine presses against the stopper at the creep speed and stops.
5)	The pulse output from the QD75 will stop at the zero signal after the machine stops, outputting the "deviation counter clear output" to the drive unit. (A "deviation counter clear signal output time" is set in the [Pr.55].)
6)	After a "deviation counter clear output" is output to the drive unit, the OPR complete flag ([Md.31] Status: b4) turns from OFF to ON, and the OPR request flag ([Md.31] Status: b3) turns from ON to OFF.

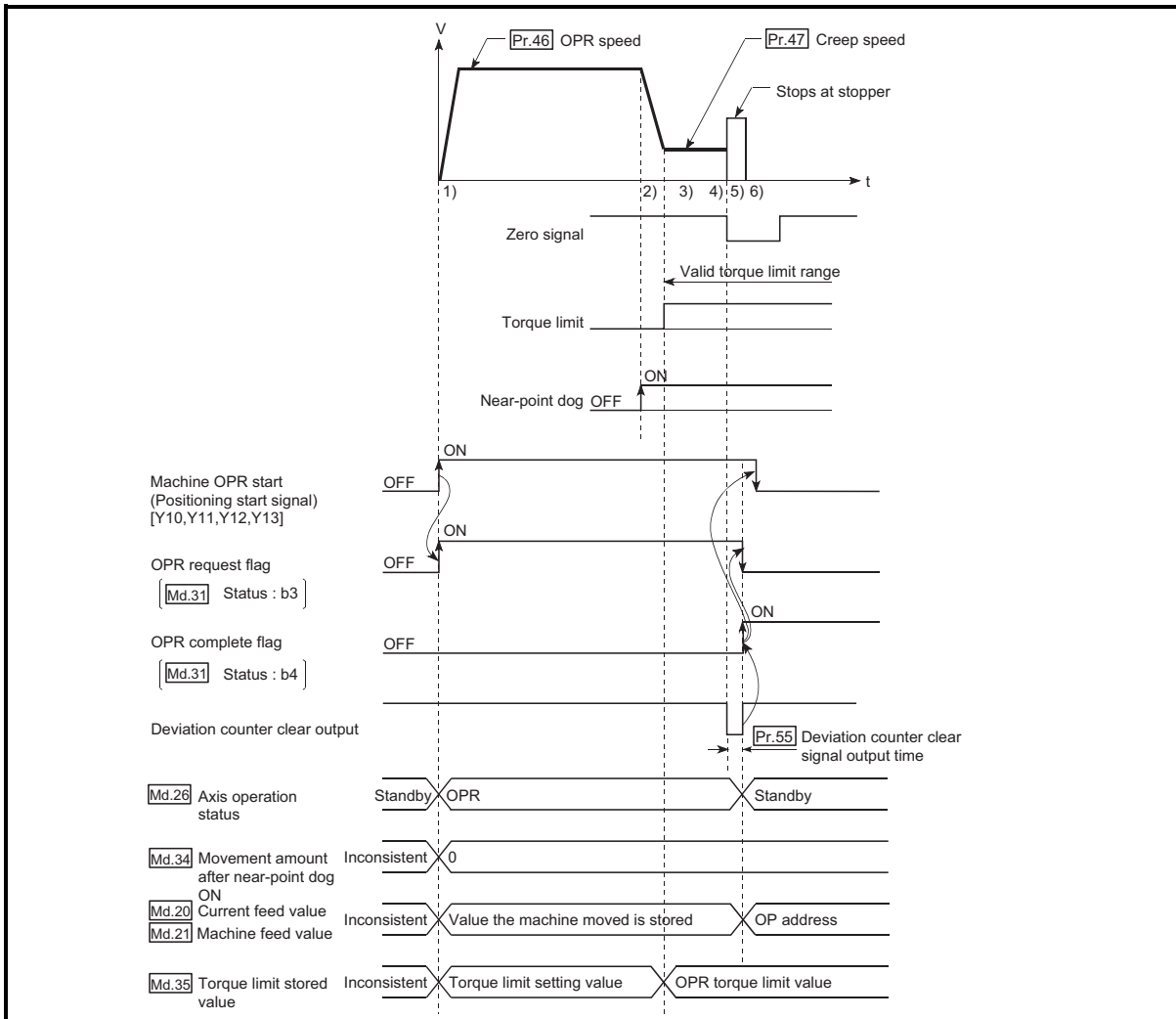

Fig. 8.7 Stopper method 2) machine OPR

■ Restrictions

- (1) Always limit the servomotor torque after the " [Pr.47] Creep speed" is reached. If the torque is not limited, the servomotor may fail when the machine presses against the stopper. (Refer to Section 12.4.2 "Torque limit function".)
- (2) Use an external input signal as the zero signal.

■ Precautions during operation

- (1) Input a zero signal from an external source after the machine presses against the stopper.  
The workpiece will continue decelerating and stop if a zero signal is input before deceleration to the " [Pr.47] Creep speed". An error "OP detection timing fault" (error code: 204) will occur after the machine stops.

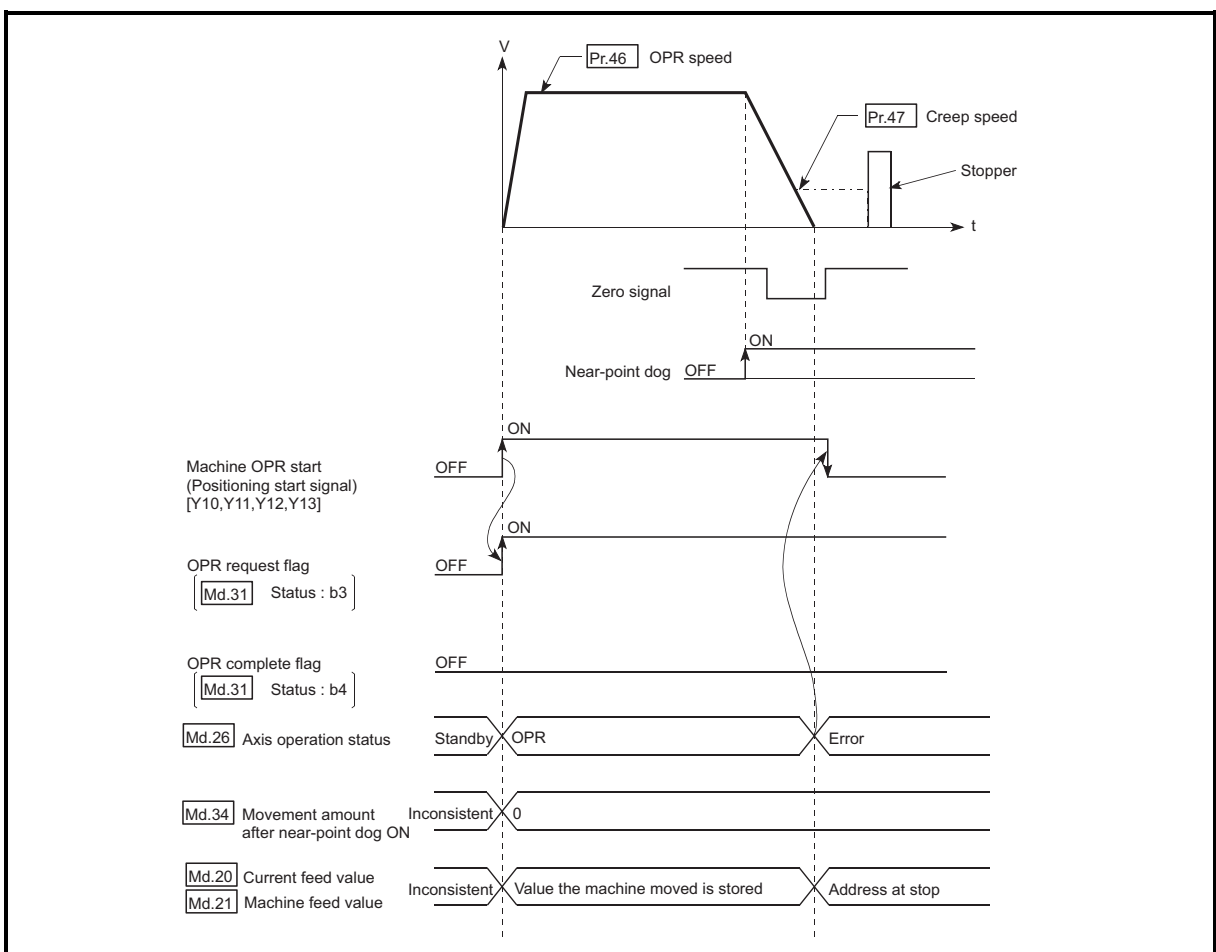

Fig. 8.8 Operation when a zero signal is input before the creep speed is reached

- (2) If the zero signal is input before the workpiece stops at the stopper, the workpiece will stop at that position, and that position will be regarded as the OP.

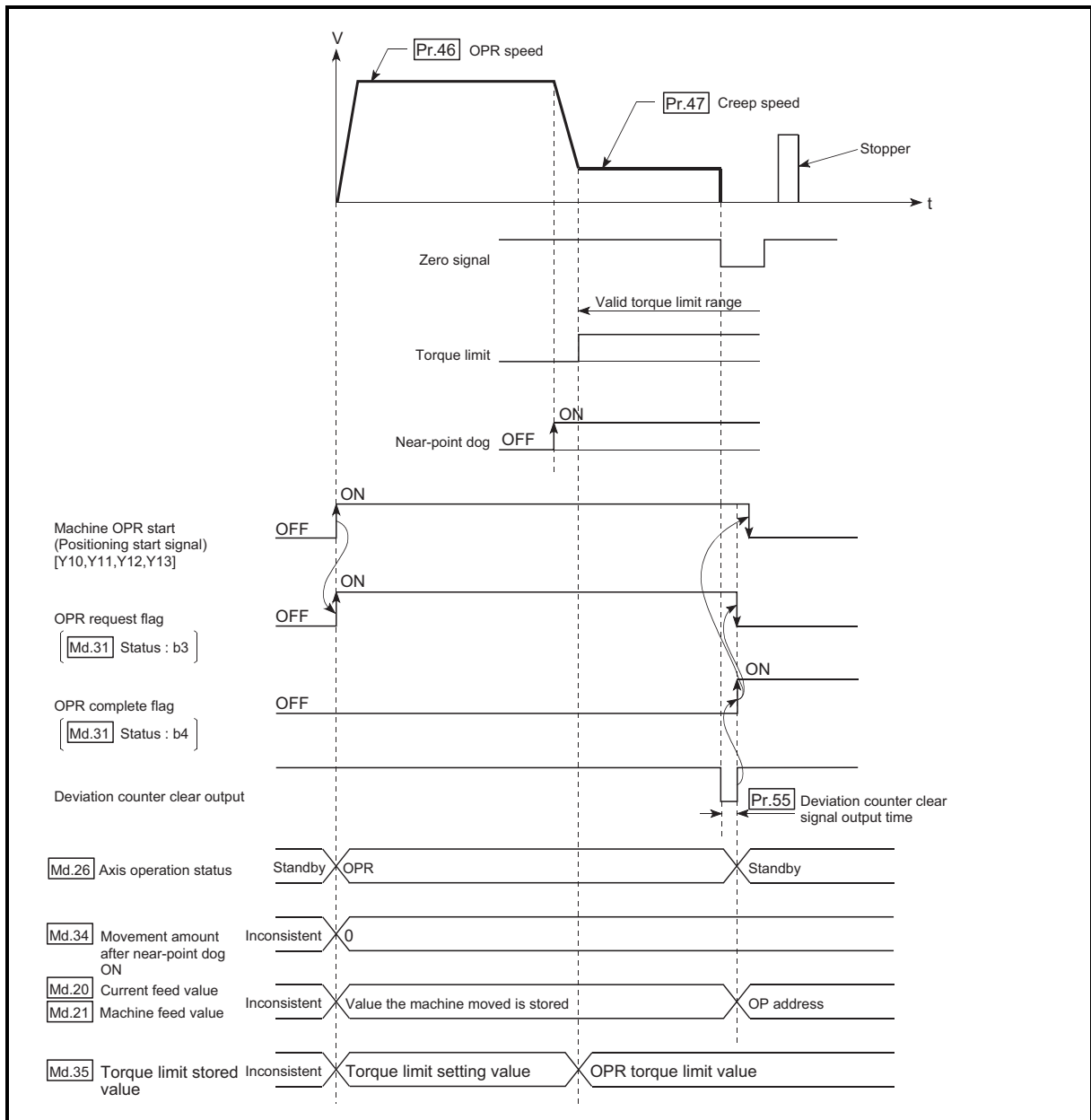

Fig. 8.9 Operation when the zero signal is input before the stop at the stopper

- (3) The near-point dog must be turned ON until it presses against the stopper. If any range that the near-point is turned OFF exists until it presses against the stopper, executing the machine OPR from the area leads it to be pressed against the stopper at ORR speed.
- (4) Machine OPR started while the near-point dog is ON will start at the "**Pr.47** Creep speed".
- (5) When a machine OPR is stopped with the stop signal, perform a machine OPR again. If the restart command is turned ON after a stop with the stop signal, an error "OPR restart not possible" (error code: 209) occurs.

8.2.6 OPR method (4): Stopper method 3)

The following shows an operation outline of the "stopper method 3)" OPR method.  
 The "stopper method 3)" method is effective when a near-point dog has not been installed.  
 (Note that the operation is carried out from the start at the " [Pr.47] Creep speed", so it will take some time until the machine OPR completion.)

■ Operation chart

1)	The machine OPR is started. (The machine moves at the " [Pr.47] Creep speed", in the direction designated in " [Pr.44] OPR direction". Torque limiting is required at this time. If the torque is not limited, the servomotor may fail when the machine presses against the stopper in step 2.)
2)	The machine presses against the stopper at the " [Pr.47] Creep speed" and stops.
3)	The pulse output from the QD75 will stop at the zero signal after the machine stops, outputting the "deviation counter clear output" to the drive unit. (A "deviation counter clear signal output time" is set in the [Pr.55].)
4)	After a "deviation counter clear output" is output to the drive unit, the OPR complete flag ([Md.31] Status: b4) turns from OFF to ON, and the OPR request flag ([Md.31] Status: b3) turns from ON to OFF.

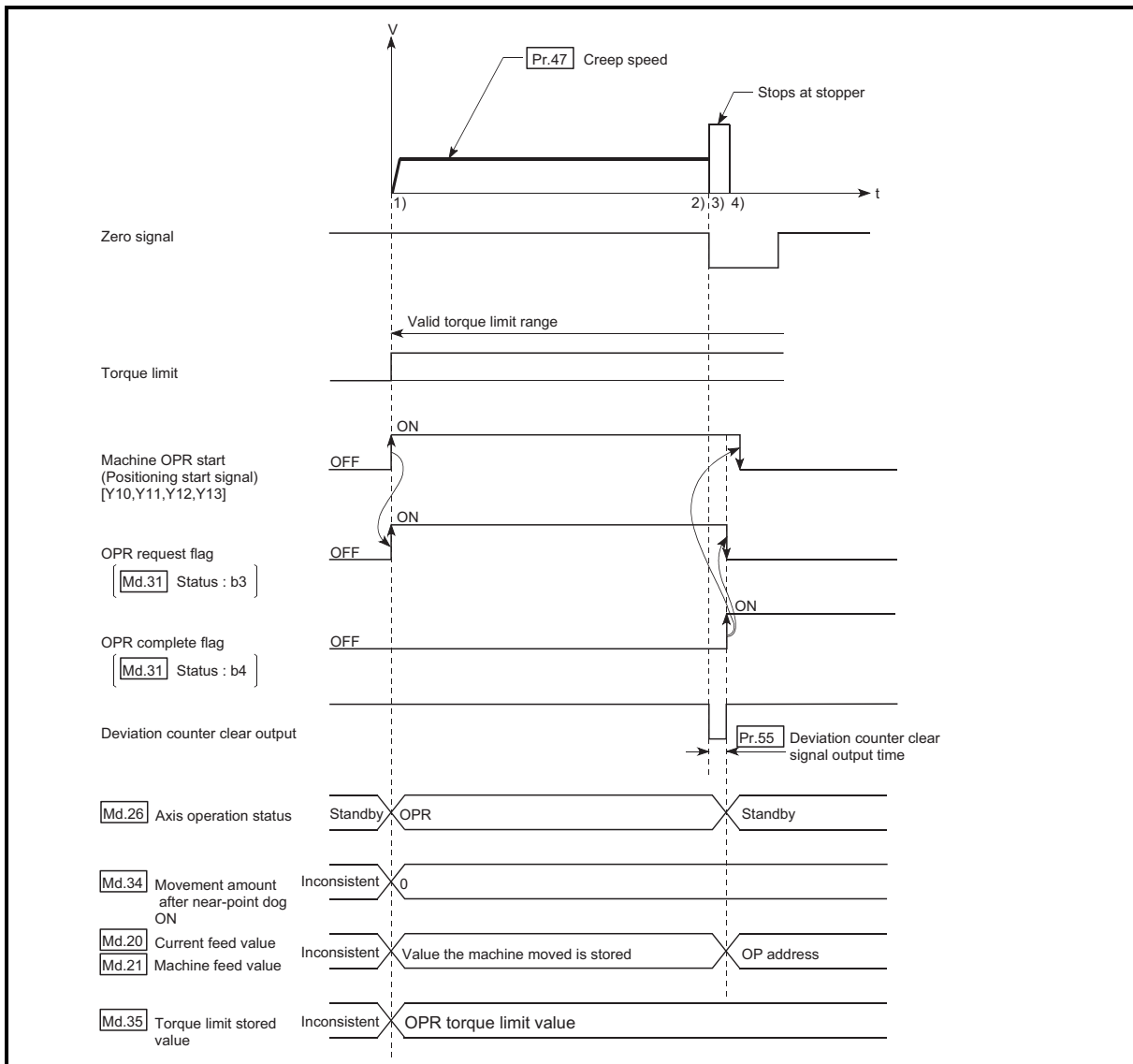

Fig. 8.10 Stopper method 3) machine OPR

■ Restrictions

- (1) Always limit the servomotor torque after the "[Pr.47] Creep speed" is reached. If the torque is not limited, the servomotor may fail when the machine presses against the stopper. (Refer to Section 12.4.2 "Torque limit function".)
- (2) Use an external input signal as the zero signal.
- (3) The OPR retry function cannot be used in "stopper stop method 3)".

■ Precautions during operation

- (1) If the zero signal is input before the workpiece stops at the stopper, the workpiece will stop at that position, and that position will become the OP. At this time an error will not occur.

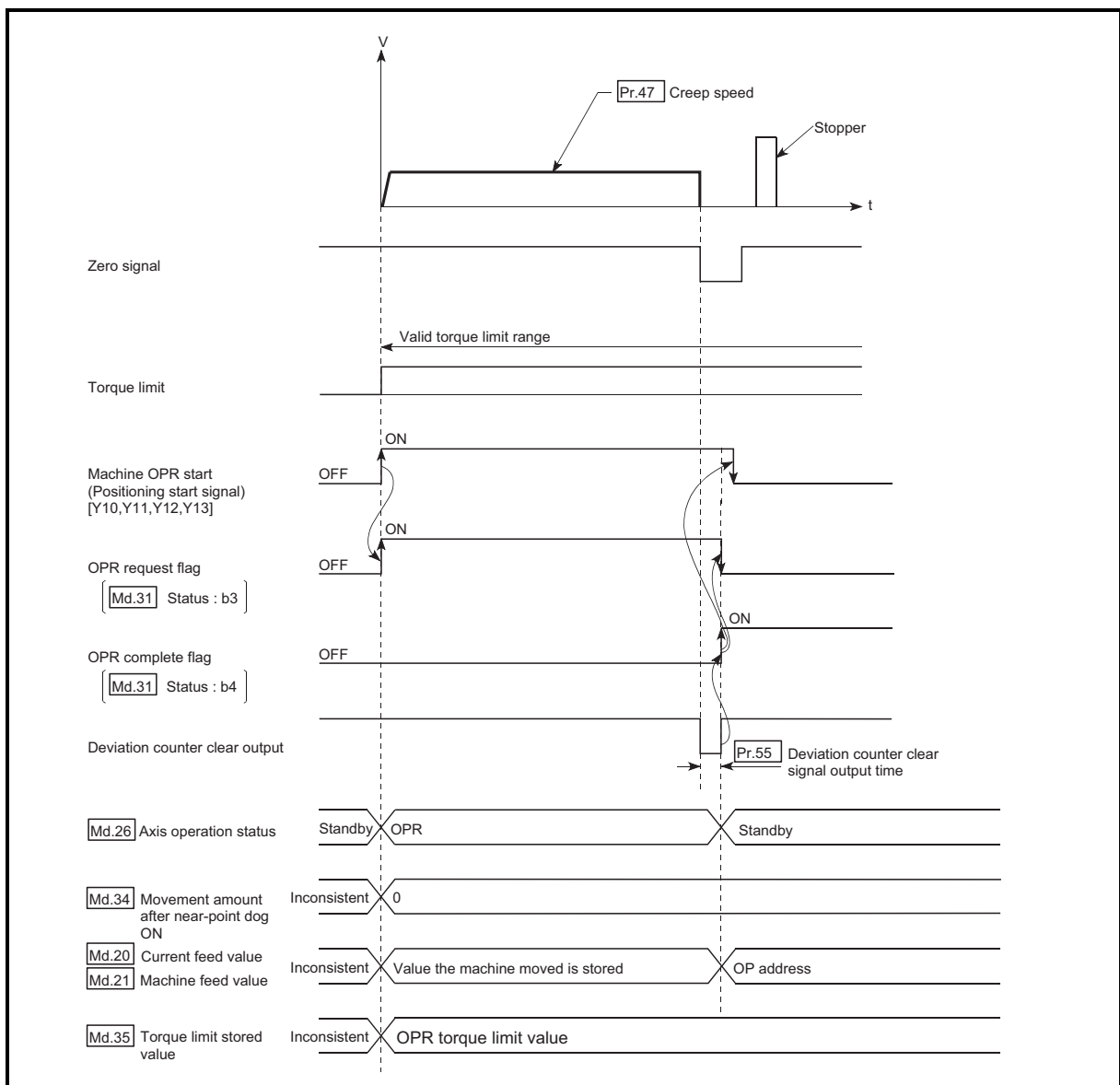

Fig. 8.11 When the zero signal is input before the stop at the stopper

- (2) When a machine OPR is stopped with the stop signal, perform a machine OPR again. If the restart command is turned ON after a stop with the stop signal, an error "OPR restart not possible" (error code: 209) occurs.

8.2.7 OPR method (5): Count method1)

The following shows an operation outline of the "count method 1)" OPR method. In the "count method 1)", machine OPR can be performed even in the following situations:

- when near-point dog is ON
- after completion of a machine OPR

■ Operation chart

1)	The machine OPR is started. (The machine begins the acceleration designated in " Pr.51 OPR acceleration time selection", in the direction designated in " Pr.44 OPR direction". It then moves at the " Pr.46 OPR speed" when the acceleration is completed.)
2)	The machine begins decelerating when the near-point dog ON is detected.
3)	The machine decelerates to the " Pr.47 Creep speed", and subsequently moves at that speed.
4)	On detection of the first zero signal after the axis has traveled the movement amount set in " Pr.50 Setting for the movement amount after near-point dog ON" after near-point dog ON, the pulse output from the QD75 stops and the "deviation counter clear output" is output to the drive unit. (A "deviation counter clear signal output time" is set in Pr.55.)
5)	After a "deviation counter clear output" is output to the drive unit, the OPR complete flag Md.31 Status: b4) turns from OFF to ON, and the OPR request flag (Md.31 Status: b3) turns from ON to OFF.

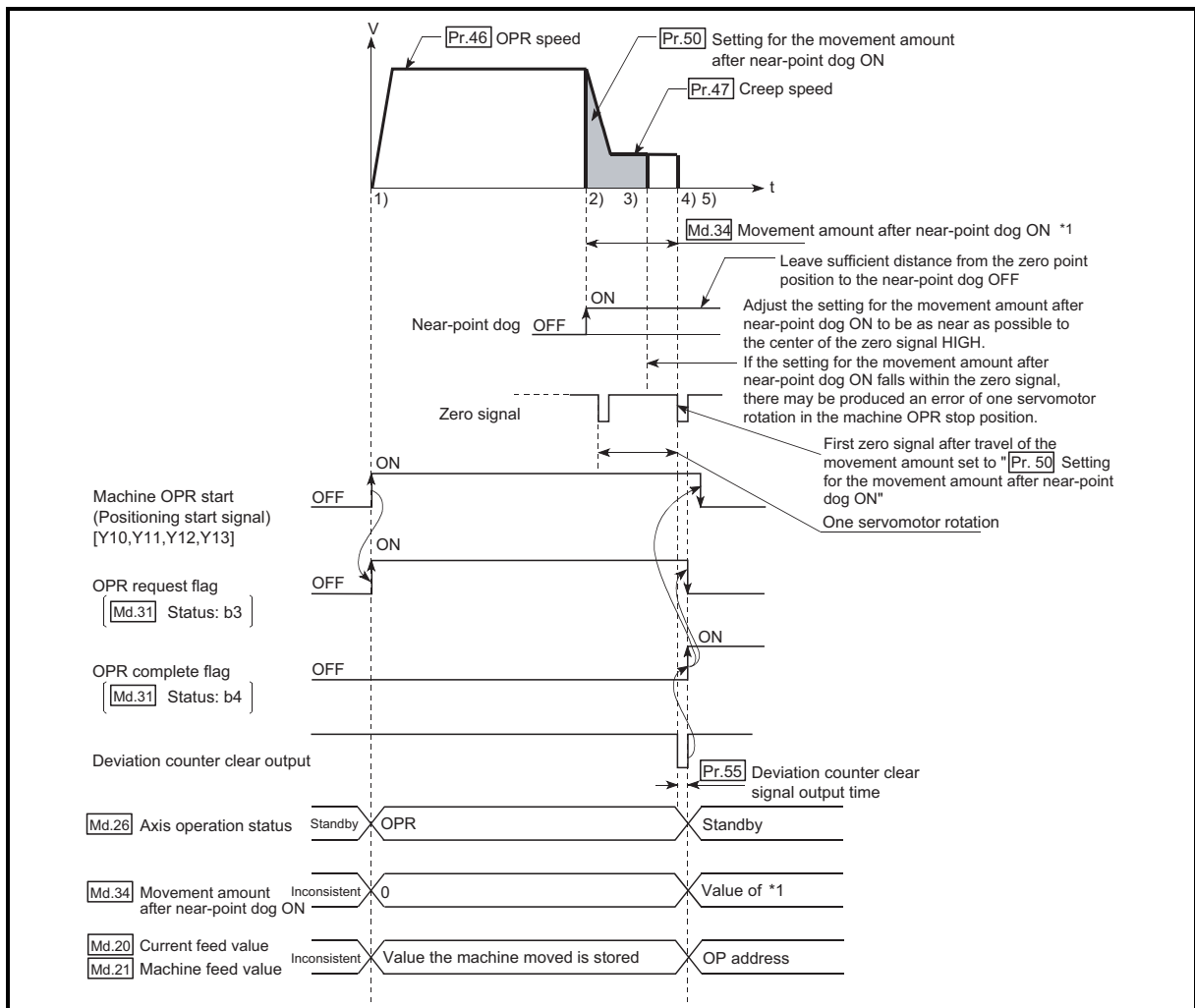

Fig. 8.12 Count method1) machine OPR

### ■ Restrictions

A pulse generator with a zero signal is required.

When using a pulse generator without a zero signal, generate a zero signal using an external signal.

### ■ Precautions during operation

- (1) An error "Count method movement amount fault" (error code: 206) will occur and the operation will not start if the " **Pr.50** Setting for the movement amount after near-point dog ON" is smaller than the deceleration distance from the " **Pr.46** OPR speed" to " **Pr.47** Creep speed".
- (2) If the speed is changed to a speed faster than " **Pr.46** OPR speed" by the speed change function (refer to "12.5.1 Speed change function".) during a machine OPR, the distance to decelerate to " **Pr.47** Creep speed" may not be ensured, depending on the setting value of " **Pr.50** Setting for the movement amount after near-point dog ON". In this case, the error "Count method movement amount fault" (error code: 206) occurs and the Machine OPR is stopped.
- (3) The following shows the operation when a machine OPR is started while the near-point dog is ON.

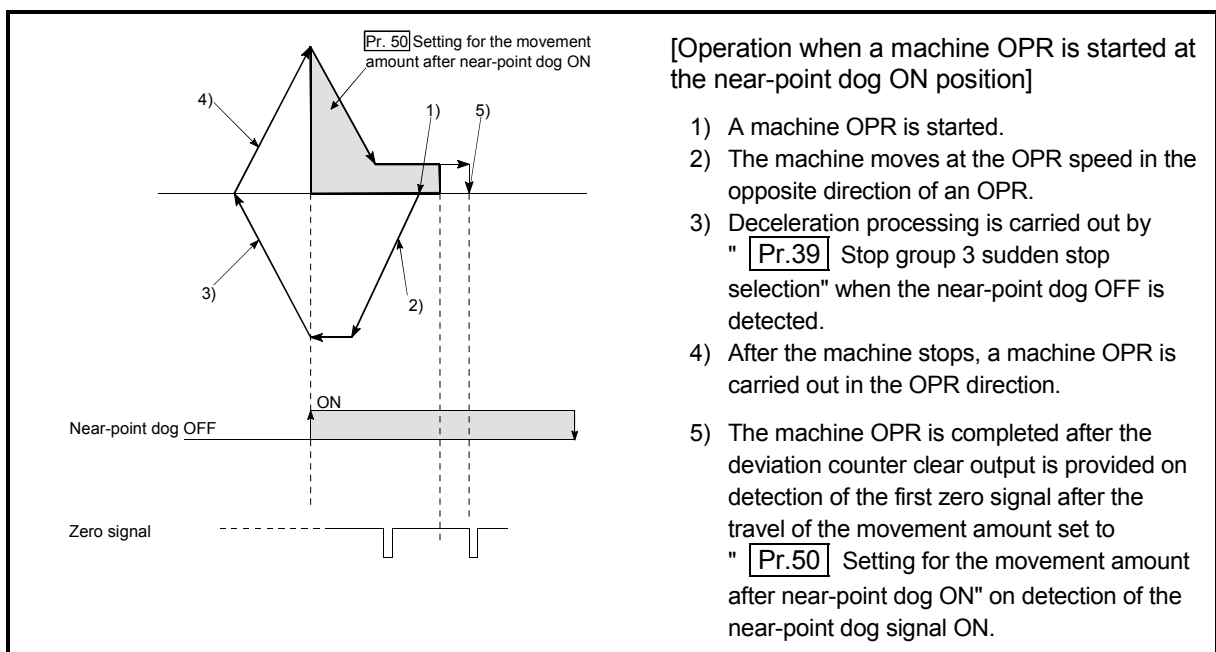

Fig. 8.13 Count method 1) machine OPR on the near-point dog ON position



- (4) Turn OFF the near-point dog at a sufficient distance from the OP.  
Although there is no harm in operation if the near-point dog is turned OFF during a machine OPR, it is recommended to leave a sufficient distance from the OP when the near-point dog is turned OFF for the following reason.  
If machine OPRs are performed consecutively after the near-point dog is turned OFF at the time of machine OPR completion, operation will be performed at the OPR speed until the hardware stroke limit (upper/lower limit) is reached.  
If a sufficient distance cannot be kept, consider the use of the OPR retry function.
- (5) When a machine OPR is stopped with the stop signal, perform a machine OPR again.  
If the restart command is turned ON after a stop with the stop signal, an error "OPR restart not possible" (error code: 209) occurs.

8.2.8 OPR method (6): Count method 2)

The following shows an operation outline of the "method 2)" OPR method.

The "count method 2)" method is effective when a "zero signal" cannot be received.

(Note that compared to the "count method 1)" method, using this method will result in more deviation in the stop position during machine OPR.)

In the "count method 2)", as well as in the "count method 1)", machine OPR can be performed even in the following situations:

- when near-point dog is ON
- after completion of a machine OPR

■ Operation chart

1)	The machine OPR is started. (The machine begins the acceleration designated in " [Pr.51] OPR acceleration time selection", in the direction designated in " [Pr.44] OPR direction". It then moves at the " [Pr.46] OPR speed" when the acceleration is completed.)
2)	The machine begins decelerating when the near-point dog ON is detected.
3)	The machine decelerates to the " [Pr.47] Creep speed", and subsequently moves at that speed.
4)	The pulse output from the QD75 will stop and the machine OPR will be completed when the machine moves the movement amount set in " [Pr.50] Setting for the movement amount after near-point dog ON" from the near-point dog ON position.

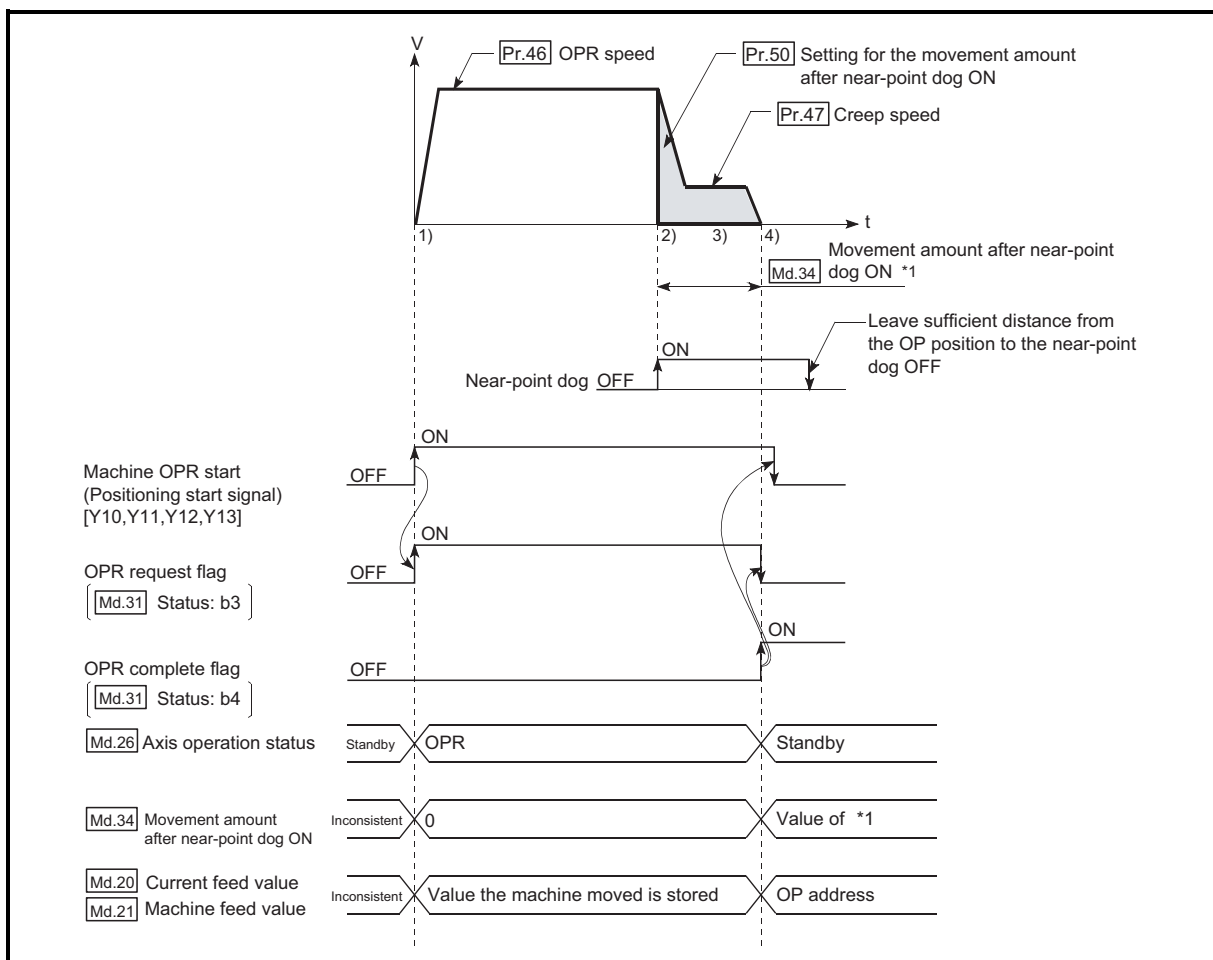

Fig. 8.14 Count method 2) machine OPR

### ■ Restrictions

When this method is used, a deviation will occur in the stop position (OP) compared to other OPR methods because an error of about 1ms occurs in taking in the near-point dog ON.

### ■ Precautions during operation

- (1) An error "Count method movement amount fault" (error code: 206) will occur and the operation will not start if the " [Pr.50] Setting for the movement amount after near-point dog ON" is smaller than the deceleration distance from the " [Pr.46] OPR speed" to " [Pr.47] Creep speed".
- (2) If the speed is changed to a speed faster than " [Pr.46] OPR speed" by the speed change function (refer to Section 12.5.1 "Speed change function".) during a machine OPR, the distance to decelerate to " [Pr.47] Creep speed" may not be ensured, depending on the setting value of " [Pr.50] Setting for the movement amount after near-point dog ON". In this case, the error "Count method movement amount fault" (error code: 206) occurs and the Machine OPR is stopped.
- (3) The following shows the operation when a machine OPR is started while the near-point dog is ON.

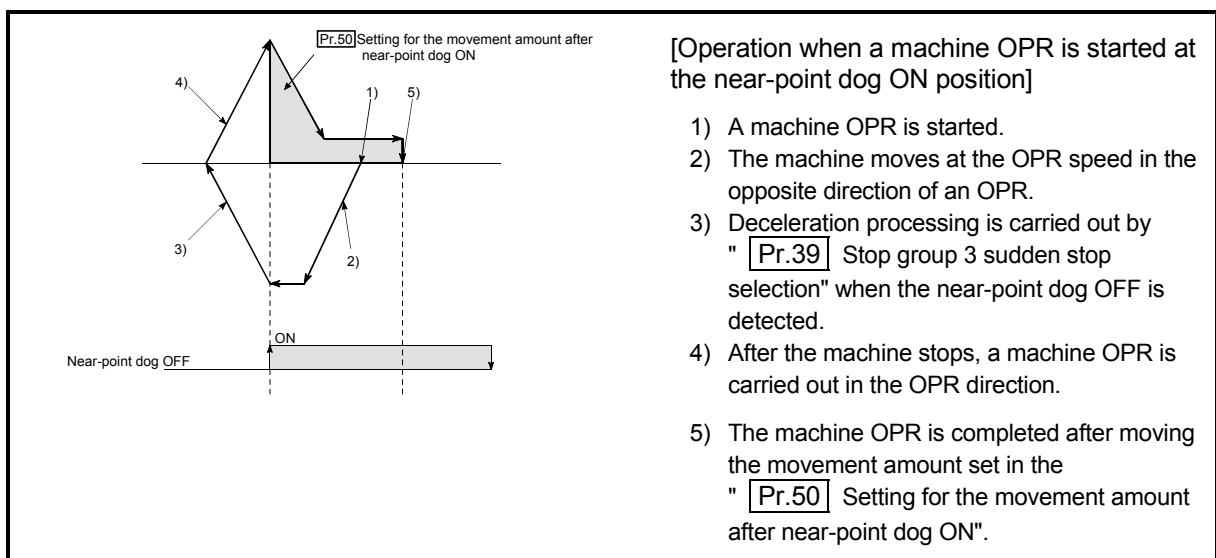

Fig. 8.15 Count method 2) machine OPR on the near-point dog ON position

- (4) Turn OFF the near-point dog at a sufficient distance from the OP. Although there is no harm in operation if the near-point dog is turned OFF during a machine OPR, it is recommended to leave a sufficient distance from the OP when the near-point dog is turned OFF for the following reason. If machine OPRs are performed consecutively after the near-point dog is turned OFF at the time of machine OPR completion, operation will be performed at the OPR speed until the hardware stroke limit (upper/lower limit) is reached. If a sufficient distance cannot be kept, consider the use of the OPR retry function.

- (5) When a machine OPR is stopped with the stop signal, perform a machine OPR again.

If the restart command is turned ON after a stop with the stop signal, an error "OPR restart not possible" (error code: 209) occurs.

## 8.3 Fast OPR

## 8.3.1 Outline of the fast OPR operation

### ■ Fast OPR operation

After establishing OP position by a machine OPR, positioning control to the OP position is executed without using a near-point dog or a zero signal. The following shows the operation during a fast OPR start.

- 1) The fast OPR is started.
- 2) Positioning control to the OP position established by a machine OPR begins at the speed set in the OPR parameters (Pr.43 to Pr.57).
- 3) The fast OPR is completed.

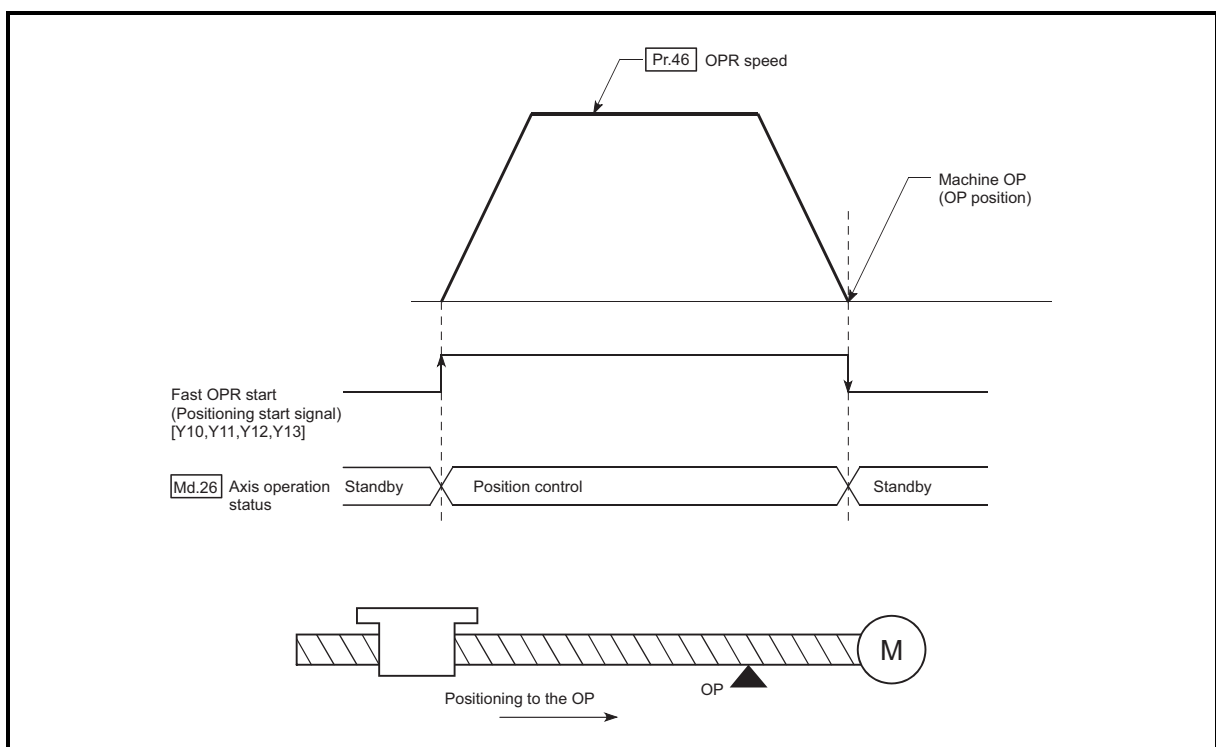

Fig. 8.16 Fast OPR

■ Operation timing and processing time of fast OPR

The following shows details about the operation timing and time during fast OPR.

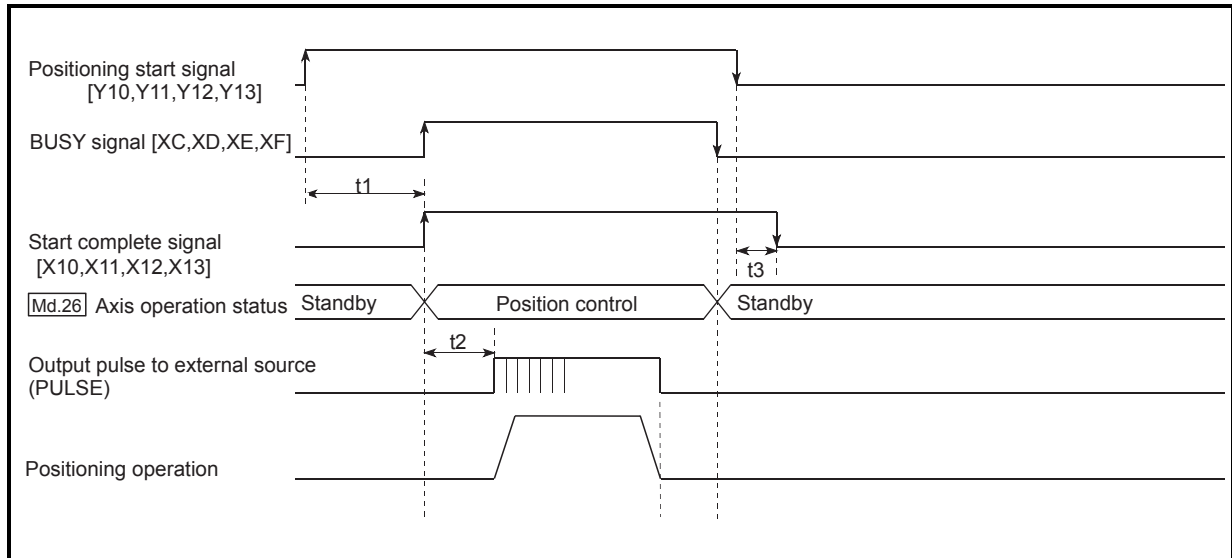

Fig. 8.17 Operation timing and processing time of fast OPR

Normal timing time

Model	t1	t2	t3
QD75P□N/QD75D□N	0.2 to 1.1ms	0.4 to 1.3ms	0 to 0.9ms
QD75P□/QD75D□	1.0 to 1.3ms	2.7 to 4.4ms	0 to 1.8ms

•The t1 timing time could be delayed by the operation state of other axes.

■ Operating restrictions

- (1) The fast OPR can only be executed after the OP position is established by executing the Machine OPR.  
If not, the error "OPR request ON" (error code: 207) will occur.  
(OPR request flag (Md.31) Status: b3) must be turned OFF.)
- (2) If the fraction pulse is cleared to zero using current value changing or fixed-feed control, execute the fast OPR and an error will occur by a cleared amount.
- (3) When unlimited length feed is executed by speed control and the current machine feed value overflows or underflows once, the fast OPR cannot be executed normally.
- (4) The OPR complete flag (Md.31) Status: b4) is not turned ON.
- (5) The axis operation status during fast OPR is "Position control".

# CHAPTER 9 MAJOR POSITIONING CONTROL

The details and usage of the major positioning controls (control functions using the "positioning data") are explained in this chapter.

The major positioning controls include such controls as "positioning control" in which positioning is carried out to a designated position using the address information, "speed control" in which a rotating object is controlled at a constant speed, "speed-position switching control" in which the operation is shifted from "speed control" to "position control" and "position-speed switching control" in which the operation is shifted from "position control" to "speed control".

Carry out the required settings to match each control.

9.1	Outline of major positioning controls.....	9- 2
9.1.1	Data required for major positioning control.....	9- 4
9.1.2	Operation patterns of major positioning controls.....	9- 5
9.1.3	Designating the positioning address.....	9- 16
9.1.4	Confirming the current value.....	9- 17
9.1.5	Control unit "degree" handling.....	9- 19
9.1.6	Interpolation control.....	9- 23
9.2	Setting the positioning data.....	9- 29
9.2.1	Relation between each control and positioning data.....	9- 29
9.2.2	1-axis linear control.....	9- 31
9.2.3	2-axis linear interpolation control.....	9- 33
9.2.4	3-axis linear interpolation control.....	9- 37
9.2.5	4-axis linear interpolation control.....	9- 43
9.2.6	1-axis fixed-feed control.....	9- 47
9.2.7	2-axis fixed-feed control (interpolation).....	9- 49
9.2.8	3-axis fixed-feed control (interpolation).....	9- 52
9.2.9	4-axis fixed-feed control (interpolation).....	9- 57
9.2.10	2-axis circular interpolation control with sub point designation.....	9- 60
9.2.11	2-axis circular interpolation control with center point designation.....	9- 66
9.2.12	3-axis helical interpolation control with sub point designation.....	9- 74
9.2.13	3-axis helical interpolation control with center point designation.....	9- 82
9.2.14	1-axis speed control.....	9- 91
9.2.15	2-axis speed control.....	9- 94
9.2.16	3-axis speed control.....	9- 97
9.2.17	4-axis speed control.....	9-101
9.2.18	Speed-position switching control (INC mode).....	9-106
9.2.19	Speed-position switching control (ABS mode).....	9-115
9.2.20	Position-speed switching control.....	9-123
9.2.21	Current value changing.....	9-130
9.2.22	NOP instruction.....	9-135
9.2.23	JUMP instruction.....	9-136
9.2.24	LOOP.....	9-138
9.2.25	LEND.....	9-139

9.1 Outline of major positioning controls

"Major positioning controls" are carried out using the "positioning data" stored in the QD75.

The basic controls such as position control and speed control are executed by setting the required items in this "positioning data", and then starting that positioning data.

The control system for the "major positioning controls" is set in setting item

" [Da.2] Control system" of the positioning data.

Control defined as a "major positioning control" carries out the following types of control according to the " [Da.2] Control system" setting.

Major positioning control		[Da.2] Control system	Details	
Position control *	Linear control	1-axis linear control	ABS Linear 1 INC Linear 1	Positioning of a designated 1 axis is carried out from the start address (current stop position) to the designated position.
		2-axis linear interpolation control *	ABS Linear 2 INC Linear 2	Using a designated 2 axes, linear interpolation control is carried out from the start address (current stop position) to the designated position.
		3-axis linear interpolation control *	ABS Linear 3 INC Linear 3	Using a designated 3 axes, linear interpolation control is carried out from the start address (current stop position) to the designated position.
		4-axis linear interpolation control *	ABS Linear 4 INC Linear 4	Using a designated 4 axes, linear interpolation control is carried out from the start address (current stop position) to the designated position.
	Fixed-feed control	1-axis fixed-feed control	Fixed-feed 1	Positioning of a designated 1 axis is carried out from the start address (current stop position). (The " [Md.20] Current feed value" is set to "0" at the start.)
		2-axis fixed-feed control *	Fixed-feed 2	Using a designated 2 axes, linear interpolation control is carried out from the start address (current stop position). (The " [Md.20] Current feed value" is set to "0" at the start.)
		3-axis fixed-feed control *	Fixed-feed 3	Using a designated 3 axes, linear interpolation control is carried out from the start address (current stop position). (The " [Md.20] Current feed value" is set to "0" at the start.)
		4-axis fixed-feed control *	Fixed-feed 4	Using a designated 4 axes, linear interpolation control is carried out from the start address (current stop position). (The " [Md.20] Current feed value" is set to "0" at the start.)
	2-axis circular interpolation control *	Sub point designation	ABS Circular sub INC Circular sub	Positioning is carried out in an arc path to a position designated from the start point address (current stop position), using the designated 2 axes.
		Center point designation	ABS Circular right ABS Circular left INC Circular right INC Circular left	
	3-axis helical interpolation control *	Sub point designation	ABS helical sub INC helical sub	Circular interpolation control is carried out with two of the three axes. The other axis tracks the movement of the circular interpolation control to carry out the positioning in helical or tangential/normal control.
		Center point designation	ABS helical right ABS helical left INC helical right INC helical left	



Major positioning control		Da.2 Control system	Details
Speed control *	1-axis speed control	Forward run speed 1 Reverse run speed 1	The speed control of the designated 1 axis is carried out.
	2-axis speed control *	Forward run speed 2 Reverse run speed 2	The speed control of the designated 2 axes is carried out.
	3-axis speed control *	Forward run speed 3 Reverse run speed 3	The speed control of the designated 3 axes is carried out.
	4-axis speed control *	Forward run speed 4 Reverse run speed 4	The speed control of the 4 axes is carried out.
Speed-position switching control		Forward run speed/position Reverse run speed/position	The control is continued as position control (positioning for the designated address or movement amount) by turning ON the "speed-position switching signal" after first carrying out speed control.
Position-speed switching control		Forward run position/speed Reverse run position/speed	The control is continued as speed control by turning ON the "position-speed switching signal" after first carrying out position control.
Other control	NOP instruction	NOP instruction	A nonexecutable control system. When this instruction is set, the operation is transferred to the next data operation, and the instruction is not executed.
	Current value changing	Current value changing	The current feed value ( <u>Md.20</u> ) is changed to an address set in the positioning data. This can be carried out by either of the following 2 methods. (The machine feed value cannot be changed.) <ul style="list-style-type: none"> <li>• Current value changing using the control system</li> <li>• Current value changing using the current value changing start No. (No. 9003).</li> </ul>
	JUMP instruction	JUMP instruction	An unconditional or conditional JUMP is carried out to a designated positioning data No.
	LOOP	LOOP	A repeat control is carried out by repeat LOOP to LEND.
	LEND	LEND	Control is returned to the top of the repeat control by repeat LOOP to LEND. After the repeat operation is completed specified times, the next positioning data is run.

\* In "2-axis linear interpolation control", "3-axis linear interpolation control", "4-axis linear interpolation control", "2-axis fixed-feed control", "3-axis fixed-feed control", "4-axis fixed-feed control", "2-axis circular interpolation control", "3-axis helical interpolation control", "2-axis speed control", "3-axis speed control", and "4-axis speed control", control is carried out so that linear and arc paths are drawn using a motor set in two or more axis directions. This kind of control is called "interpolation control". (Refer to Section 9.1.6 "Interpolation control" for details.)

## 9.1.1 Data required for major positioning control

The following table shows an outline of the "positioning data" configuration and setting details required to carry out the "major positioning controls".

Setting item		Setting details	
Positioning data No. 1	Da.1	Operation pattern	Set the method by which the continuous positioning data (Ex: positioning data No. 1, No. 2, No. 3) will be controlled. (Refer to Section 9.1.2.)
	Da.2	Control system	Set the control system defined as a "major positioning control". (Refer to Section 9.1.)
	Da.3	Acceleration time No.	Select and set the acceleration time at control start. (Select one of the four values set in Pr.9, Pr.25, Pr.26, and Pr.27 for the acceleration time.)
	Da.4	Deceleration time No.	Select and set the deceleration time at control stop. (Select one of the four values set in Pr.10, Pr.28, Pr.29, and Pr.30 for the deceleration time.)
	Da.5	Axis to be interpolated	Set an axis to be interpolated (partner axis) during the 2-axis interpolation operation and a circular interpolation axis during the 3-axis helical interpolation control. (Refer to Section 9.1.6.)
	Da.6	Positioning address/movement amount	Set the target value during position control. (Refer to Section 9.1.3.)
	Da.7	Arc address	Set the sub point or center point address during circular interpolation control.
	Da.8	Command speed	Set the speed during the control execution.
	Da.9	Dwell time	The time between the command pulse output is completed to the positioning completed signal is turned ON. Set it for absorbing the delay of the mechanical system to the instruction, such as the delay of the servo system (deviation).
	Da.10	M code	Set this item when carrying out sub work (clamp and drill stops, tool replacement, etc.) corresponding to the code No. related to the positioning data execution.
	Da.27	M code ON signal output timing	Set the M code ON signal output timing for each positioning data.
	Da.28	ABS direction in degrees	Set the ABS direction, in degrees for each positioning data.
	Da.29	Interpolation speed designation method	Set the interpolation speed designation method for each positioning data.

\* The settings and setting requirement for the setting details of Da.1 to Da.10 and Da.27 to Da.29 differ according to the Da.2 Control system". (Refer to Section 9.2 "Setting the positioning data".)

#### ■ Major positioning control sub functions

Refer to Section 3.2.4 "Combination of QD75 major functions and sub functions" for details on "sub functions" that can be combined with the major positioning control.

Also refer to CHAPTER 12 "CONTROL SUB FUNCTIONS" for details on each sub function.

#### ■ Major positioning control from peripheral devices

"Major positioning control" can be executed from the peripheral device test mode. Refer to GX Configurator-QP Operating Manual for details on carrying out major positioning control from the peripheral device.

#### REMARK

- 600 positioning data (positioning data No. 1 to 600) items can be set per axis.

9.1.2 Operation patterns of major positioning controls

In "major positioning control" (high-level positioning control), " **Da.1** Operation pattern" can be set to designate whether to continue executing positioning data after the started positioning data. The "operation pattern" includes the following 3 types.

- Positioning complete — (1) Independent positioning control (operation pattern: 00)
- Positioning continue — (2) Continuous positioning control (operation pattern: 01)
- (3) Continuous path control (operation pattern: 11)

The following shows examples of operation patterns when "1-axis linear control (ABS linear 1)" is set in positioning data No. 1 to No. 6 of axis 1. Details of each operation pattern are shown on the following pages.

< Operation example when "1-axis linear positioning" is set in the positioning data of axis 1 >

(Setting details)

Positioning data No.1	Positioning to address [A] at command speed [a]	Operation pattern = 11: Continuous path control	No.1 Start
No.2	Positioning to address [B] at command speed [b]	Operation pattern = 11: Continuous path control	↓
No.3	Positioning to address [C] at command speed [a]	Operation pattern = 01: Continuous positioning control	
No.4	Positioning to address [D] at command speed [b]	Operation pattern = 01: Continuous positioning control	
No.5	Positioning to address [E] at command speed [a]	Operation pattern = 00: Independent positioning control (Positioning complete)	
No.6	Positioning to address [F] at command speed [a]	Operation pattern = 11: Continuous path control	

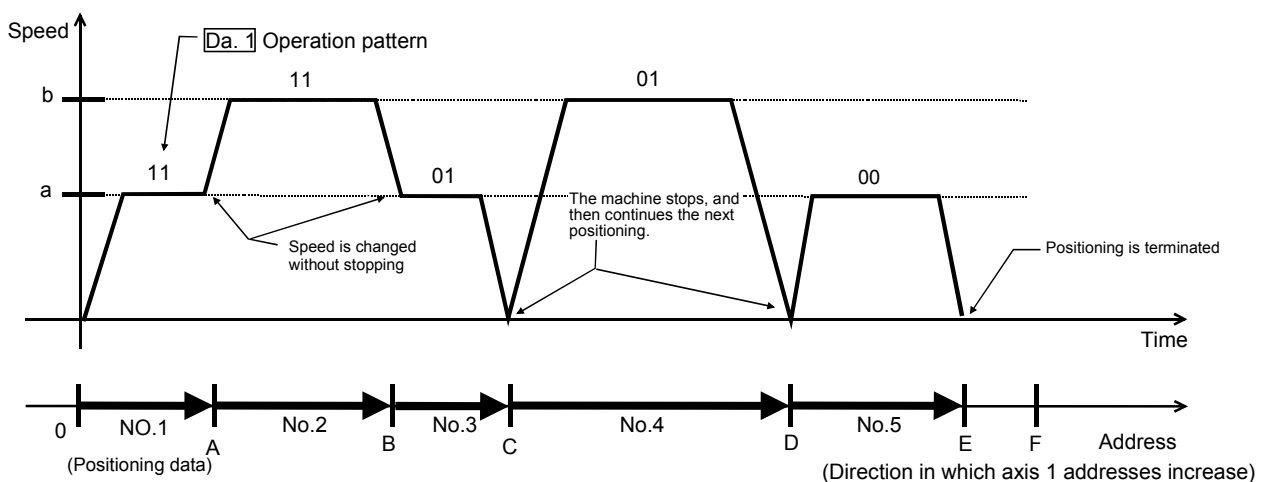

For **1-axis linear control**

(One motor is driven, and positioning is carried out to an addresses designated in one direction.)

**POINT**  
 The BUSY signal [XC, XD, XE, XF] turns ON even when position control of movement amount 0 is executed. However, since the ON time is short, the ON status may not be detected in the sequence program.

[1] Independent positioning control (Positioning complete)

This control is set when executing only one designated data item of positioning. If a dwell time is designated, the positioning will complete after the designated time elapses.

This data (operation pattern [00] data) becomes the end of block data when carrying out block positioning. (The positioning stops after this data is executed.)

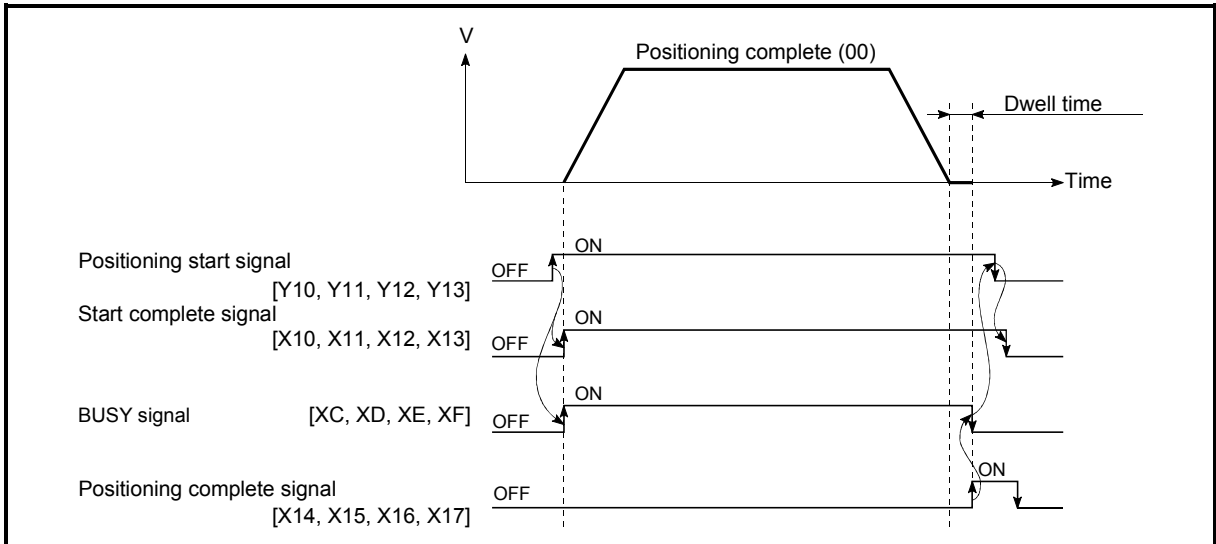

Fig. 9.1 Operation during independent positioning control

[2] Continuous positioning control

- (1) The machine always automatically decelerates each time the positioning is completed. Acceleration is then carried out after the QD75 command speed reaches 0 to carry out the next positioning data operation. If a dwell time is designated, the acceleration is carried out after the designated time elapses.
- (2) In operation by continuous positioning control (operation pattern "01"), the next positioning No. is automatically executed. Always set operation pattern "00" in the last positioning data to complete the positioning. If the operation pattern is set to positioning continue ("01" or "11"), the operation will continue until operation pattern "00" is found. If the operation pattern "00" cannot be found, the operation may be carried out until the positioning data No. 600. If the operation pattern of the positioning data No. 600 is not completed, the operation will be started again from the positioning data No. 1.

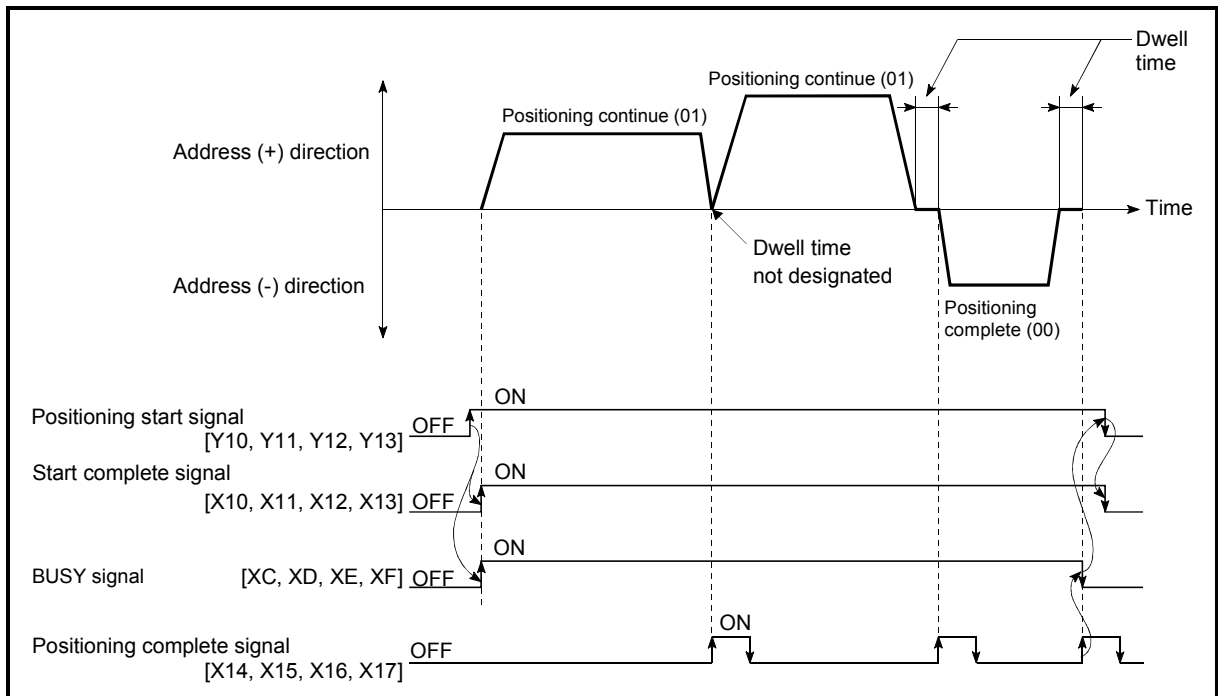

Fig. 9.2 Operation during continuous positioning control

[3] Continuous path control  
 (1) Continuous path control

- (a) The speed is changed without deceleration stop between the command speed of the running positioning data and the command speed of the positioning data that will run next. The speed is not changed if the current speed and the next speed are equal.

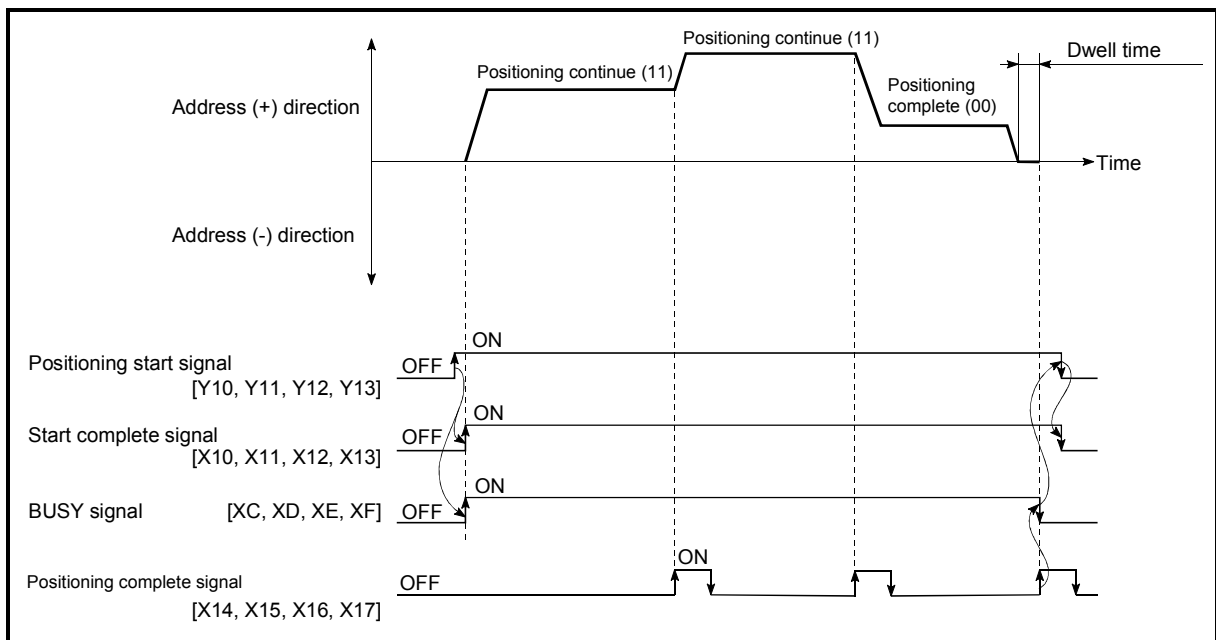

Fig. 9.3 Operation during continuous path control (Standard speed switching mode)

- (b) The speed will become the speed used in the previous positioning operation if the command speed is set to "-1".
- (c) Dwell time will be ignored, even if set.
- (d) The next positioning No. is executed automatically in operations by continuous path control (operation pattern "11"). Always complete the positioning by setting operation pattern "00" in the last positioning data. If the operation pattern is set to positioning continue ("01" or "11"), the operation will continue until operation pattern "00" is found. If the operation pattern "00" cannot be found, the operation may be carried out until the positioning data No. 600. If the operation pattern of the positioning data No. 600 is not completed, the operation will be started again from the positioning data No. 1.
- (e) The speed switching patterns include the "front-loading speed switching pattern" in which the speed is changed at the end of the current positioning side, and the "standard speed switching pattern" in which the speed is at the start of the next positioning side. (Refer to " [Pr.19] Speed switching mode".)

Continuous path control — Standard speed switching mode  
 — Front-loading speed switching mode

(f) In continuous path control, the positioning may be completed before the set address/movement amount by the distance  $\Delta \ell$ , and the data may switch to the "positioning data that will run next".

The value of the distance  $\Delta \ell$  is as follows:

- QD75P□N/QD75D□N:  
 $0 \leq \Delta \ell < (\text{Moving distance in } 0.9\text{ms at the command speed})$
- QD75P□/QD75D□:  
 $0 \leq \Delta \ell < (\text{Moving distance in } 1.8\text{ms at the command speed})$

【Acceleration/deceleration (setting)】

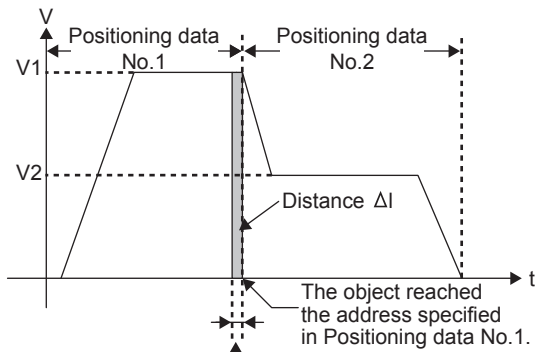

- QD75P□N/QD75D□N: Less than 0.9ms
- QD75P□/QD75D□: Less than 1.8ms

【Acceleration/deceleration (actual one)】

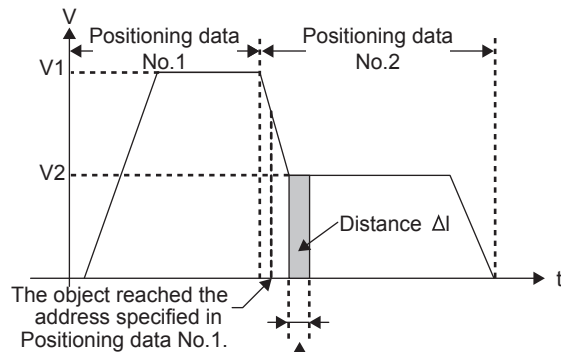

- QD75P□N/QD75D□N: 0.9ms or more
- QD75P□/QD75D□: 1.8ms or more

The distance  $\Delta \ell$  is output when the next positioning data is running at the specified speed.

Therefore, the execution time of the next positioning data may be longer than the set execution time.\*1

If this causes a control problem, take one of the following measures.

- 1) Use the function "output timing selection of near pass control".  
 By selecting "At deceleration" as an output timing, the positioning execution time of the next positioning data remains the same as it was set. (Refer to Section 12.3.4 "Output timing selection of near pass control".)
- 2) Use the "speed change function".  
 Change speed using the speed change function instead of continuous path control. (Refer to Section 12.5.1 "Speed change function".)

\*1: When the command speed V1 of a positioning data and the command speed V2 of the next positioning data is different significantly, and  $V1 > V2$

For positioning data in which automatic deceleration is set, the positioning is completed at the set address. Therefore, in continuous path control, the address where a positioning is completed may be different from the set address. However, the address will be the specified one on completion of automatic deceleration for continuous positioning control (01) or positioning complete (00).

**POINT**

In the continuous path control, a speed variation will not occur using the near-pass function when the positioning data No. is switched (Refer to Section 12.3.3 "Near-pass function").

## (2) Deceleration stop conditions during continuous path control

Deceleration stops are basically not carried out in continuous path control, but the machine will carry out a deceleration stop to speed "0" in the following cases (a) to (c).

- (a) When the operation pattern of the positioning data currently being executed is "continuous path control: 11", and the movement direction of the positioning data currently being executed differs from that of the next positioning data. (Only for 1-axis positioning control (Refer to the "Point" in the next page.))

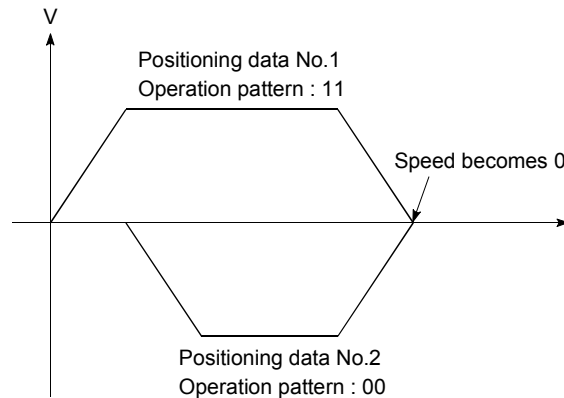



- (b) During operation by step operation.  
(Refer to Section 12.7.1 "Step function".)
- (c) When there is an error in the positioning data to carry out the next operation.

**POINTS**

(1) The movement direction is not checked during interpolation operations. Thus, automatic deceleration to a stop will not be carried out even if the movement direction is changed (See the figures below). Because of this, the interpolation axis may suddenly reverse direction. To avoid this sudden direction reversal in the interpolation axis, set the pass point to continuous positioning control "01" instead of setting it to continuous path control "11".

[Positioning by interpolation]

[Reference axis operation]

[Interpolation axis operation]

(2) When the interpolation axis reverses direction suddenly, the command pulses from QD75 are output as shown in the figure below.

The  $t_1$  and  $t_2$  are calculated using the following expressions, where a command frequency is  $f$  (pps).  
 $t_1 = 1/2 f$  (s)    $t_2 = 1/f$  (s)  
 A time of  $t_1$  must be maintained by the drive unit for a specified period  $T$  (s).  
 ( $T$  depends on the drive unit specifications.)  
 If  $t_1$  cannot be maintained for  $T$  or longer, lower the " [Da.8] Command speed" of the positioning data.

(3) When a "0" is set in the " [Da.6] Positioning address/movement amount" of the continuous path control positioning data, the command speed of about 0.9ms (QD75P□N/QD75D□N) or 2ms (QD75P□/QD75D□) is reduced to 0. When a "0" is set in the " [Da.6] Positioning address/movement amount" to increase the number of speed change points in the future, change the " [Da.2] Control system" to the "NOP instruction" to make the control nonexecutable.  
 (Refer to Section 9.2.20 "NOP instruction".)

(4) In the continuous path control positioning data, assure a movement distance so that the execution time with that data is 100ms or longer, or lower the command speed.

(3) Speed handling

- (a) Continuous path control command speeds are set with each positioning data.  
The QD75 then carries out the positioning at the speed designated with each positioning data.
- (b) The command speed can be set to "-1" in continuous path control.  
The control will be carried out at the speed used in the previous positioning data No. if the command speed is set to "-1".  
(The "current speed" will be displayed in the command speed when the positioning data is set with a peripheral device. The current speed is the speed of the positioning control being executed currently.)
  - 1) The speed does not need to be set in each positioning data when carrying out uniform speed control if "-1" is set beforehand in the command speed.
  - 2) If the speed is changed or the override function is executed in the previous positioning data when "-1" is set in the command speed, the operation can be continued at the new speed.
  - 3) An error "No command speed" (error code: 503) occurs and positioning cannot be started if "-1" is set in the command speed of the first positioning data at start.

[Relation between the command speed and current speed]

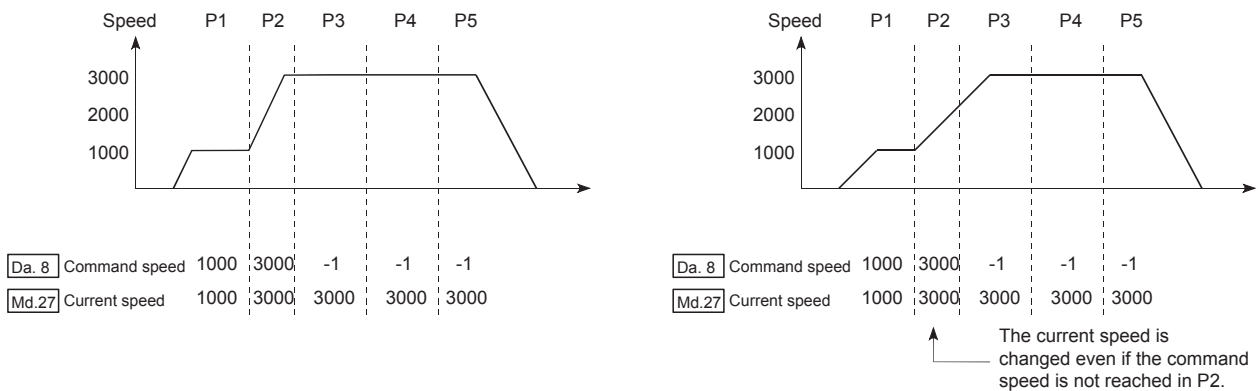

**POINTS**

- (1) In the continuous path control, a speed variation will not occur using the near-pass function when the positioning data is switched (Refer to Section 12.3.3 "Near-pass function").
- (2) The QD75 holds the command speed set with the positioning data, and the latest value of the speed set with the speed change request as the "Md.27 Current speed". It controls the operation at the "current speed" when "-1" is set in the command speed.  
(Depending on the relation between the movement amount and the speed, the feedrate may not reach the command speed value, but even then the current speed will be updated.)
- (3) When the address for speed change is identified beforehand, generate and execute the positioning data for speed change by the continuous path control to carry out the speed change without requesting the speed change with a sequence program.

(4) Speed switching  
 (Refer to " Pr.19 Speed switching mode".)

The two modes for changing the speed are shown below.

- Standard switching.....Switch the speed when executing the next positioning data.
- Front-loading switching.....The speed switches at the end of the positioning data currently being executed.

(a) Standard speed switching mode

- 1) If the respective command speeds differ in the "positioning data currently being executed" and the "positioning data to carry out the next operation", the machine will accelerate or decelerate after reaching the positioning point set in the "positioning data currently being executed" and the speed will change over to the speed set in the "positioning data to carry out the next operation".
- 2) The parameters used in acceleration/deceleration to the command speed set in the "positioning data to carry out the next operation" are those of the positioning data to carry out acceleration/deceleration.  
 Speed switching will not be carried out if the command speeds are the same.

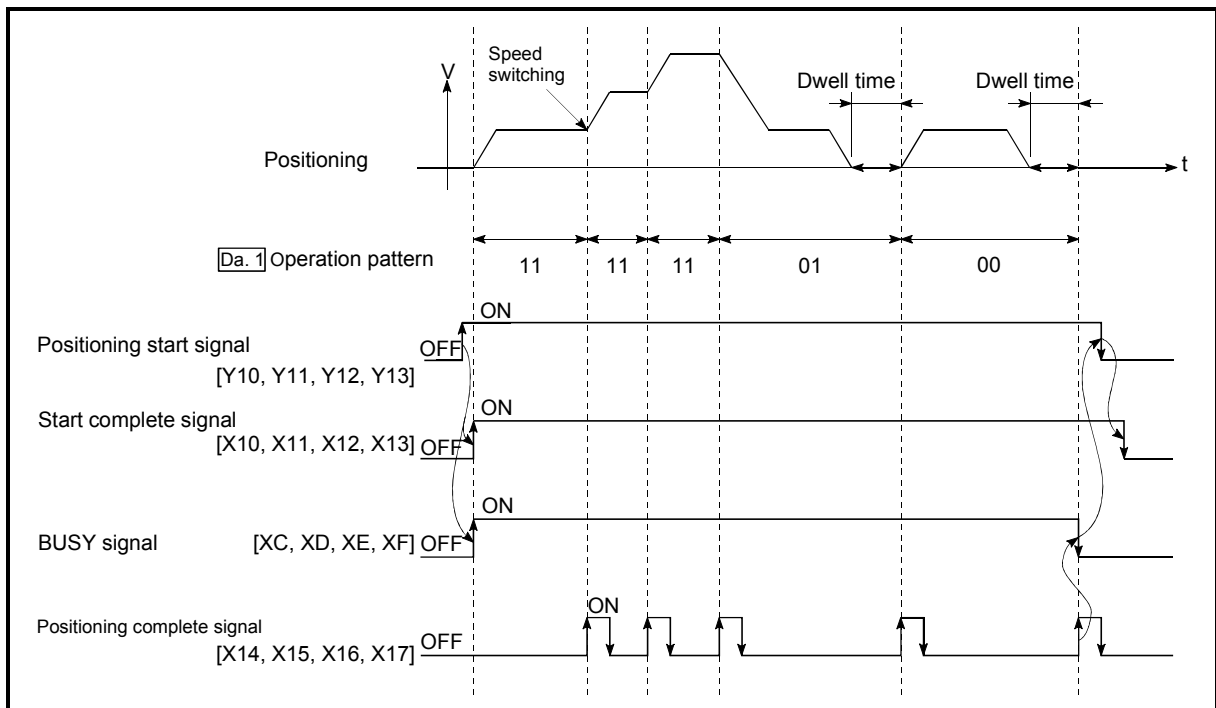
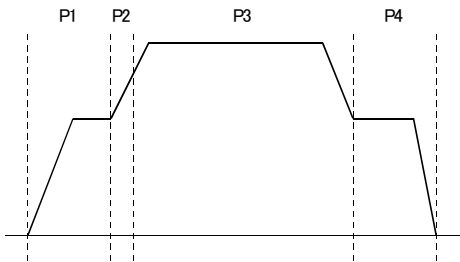

Fig. 9.4 Operation for the standard speed switching mode

- 3) Speed switching condition  
 If the movement amount is small in regard to the target speed, the current speed may not reach the target speed even if acceleration/deceleration is carried out. In this case, the machine is accelerated/decelerated so that it nears the target speed. If the movement amount will be exceeded when automatic deceleration is required (Ex. Operation patterns "00", "01"), the machine will immediately stop at the designated positioning address, and a warning "Insufficient movement distance" (warning code: 513) will occur.

[When the speed cannot change over in P2]  
 When the relation of the speeds is  $P1 = P4, P2 = P3, P1 < P2$ .



[When the movement amount is small during automatic deceleration]

The movement amount required to carry out the automatic deceleration cannot be secured, so the machine immediately stops in a speed  $\neq 0$  status.

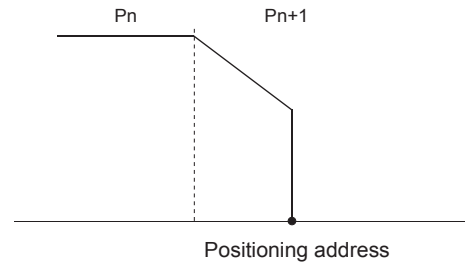

(b) Front-loading speed switching mode

- 1) If the respective command speeds differ in the "positioning data currently being executed" and the "positioning data to carry out the next operation", the speed will change over to the speed set in the "positioning data to carry out the next operation" at the end of the "positioning data currently being executed".
- 2) The parameters used in acceleration/deceleration to the command speed set in the "positioning data to carry out the next operation" are those of the positioning data to carry out acceleration/deceleration. Speed switching will not be carried out if the command speeds are the same.

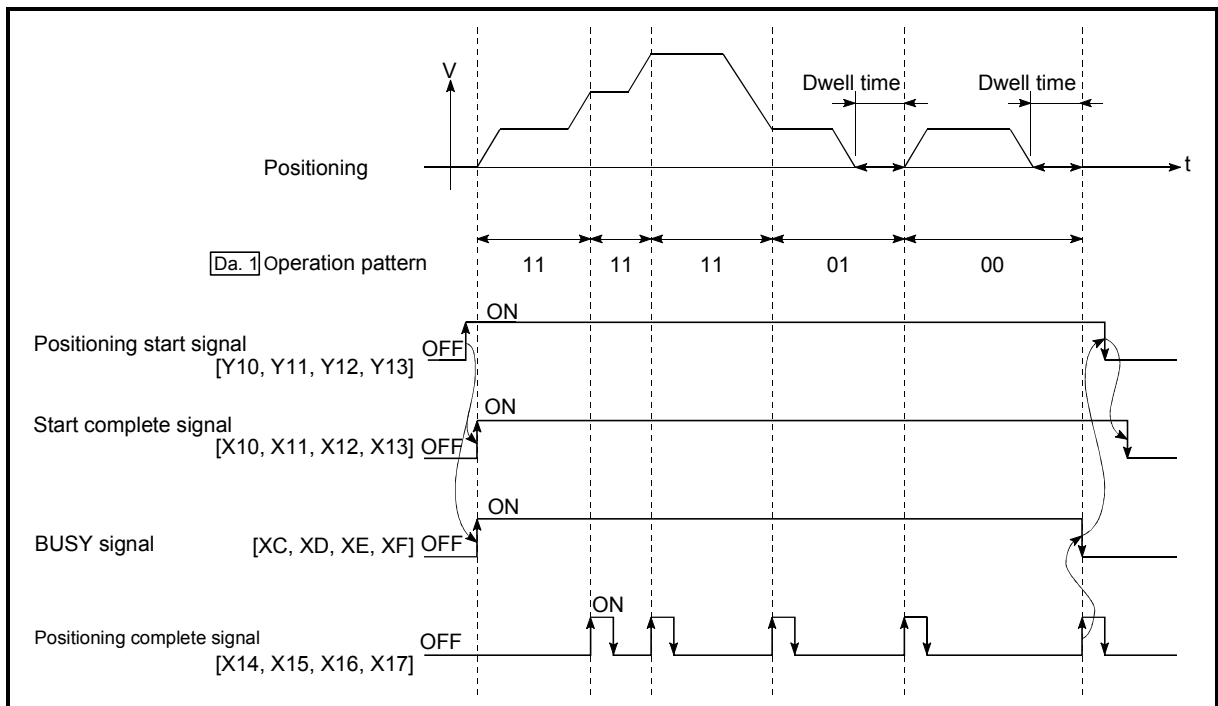

Fig. 9.5 Operation for the front-loading speed switching mode

3) Speed switching condition

If the movement amount is small in regard to the target speed, the current speed may not reach the target speed even if acceleration/deceleration is carried out. In this case, the machine is accelerated/decelerated so that it nears the target speed. If the movement amount will be exceeded when automatic deceleration is required (Ex. Operation patterns "00", "01"), the machine will immediately stop at the designated positioning address, and a warning "Insufficient movement distance" (warning code: 513) will occur.

[When the speed cannot change over to the P2 speed in P1]

When the relation of the speeds is  $P1 = P4$ ,  $P2 = P3$ ,  $P1 < P2$ .

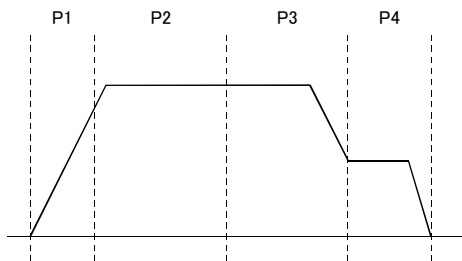

[When the movement amount is small during automatic deceleration]

The movement amount required to carry out the automatic deceleration cannot be secured, so the machine immediately stops in a speed  $\neq 0$  status.

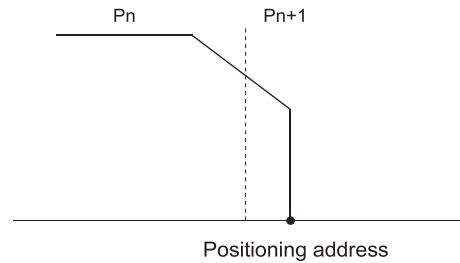

9.1.3 Designating the positioning address

The following shows the two methods for commanding the position in control using positioning data.

■ Absolute system

Positioning is carried out to a designated position (absolute address) having the OP as a reference. This address is regarded as the positioning address. (The start point can be anywhere.)

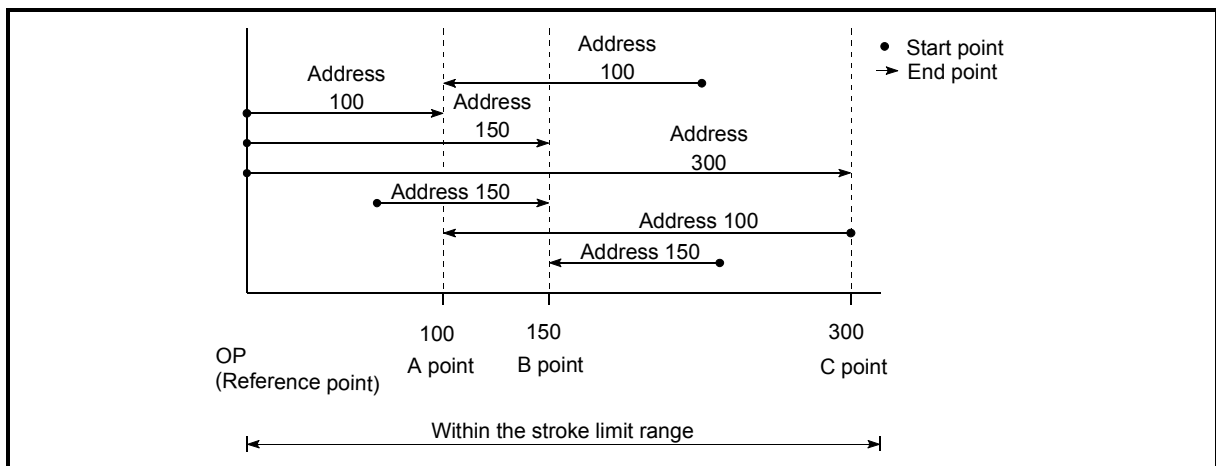

Fig. 9.6 Absolute system positioning

■ Incremental system

The position where the machine is currently stopped is regarded as the start point, and positioning is carried out for a designated movement amount in a designated movement direction.

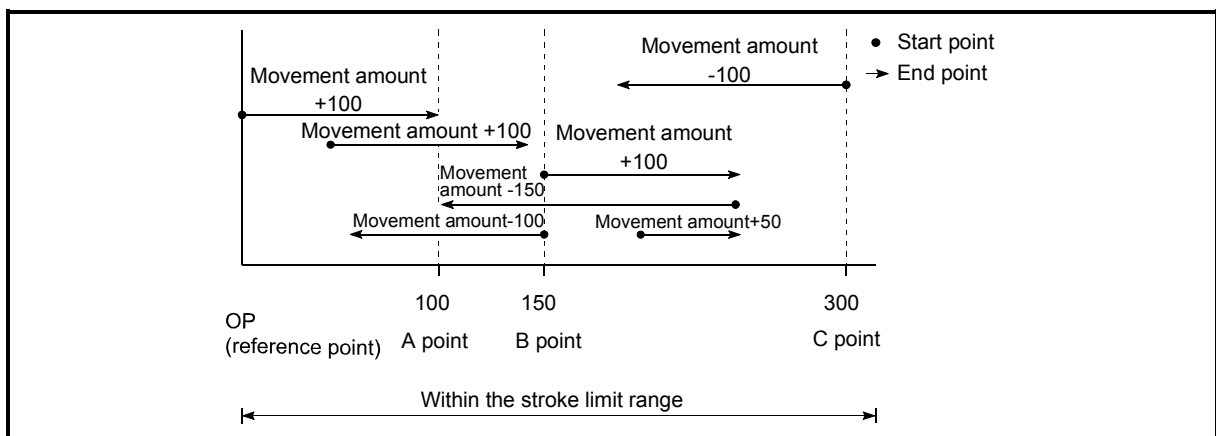

Fig. 9.7 Incremental system positioning

9.1.4 Confirming the current value

■ Values showing the current value

The following two types of addresses are used as values to show the position in the QD75.

These addresses ("current feed value" and "machine feed value") are stored in the monitor data area, and used in monitoring the current value display, etc.

Current feed value	<ul style="list-style-type: none"> <li>• This is the value stored in "Md.20 Current feed value".</li> <li>• This value has an address established with a "machine OPR" as a reference, but the address can be changed by changing the current value to a new value.</li> <li>• This value is updated every 0.9ms (QD75P□N/QD75D□N) or 1.8ms (QD75P□/QD75D□).</li> </ul>
Machine feed value	<ul style="list-style-type: none"> <li>• This is the value stored in "Md.21 Machine feed value".</li> <li>• This value always has an address established with a "machine OPR" as a reference. The address cannot be changed, even if the current value is changed to a new value.</li> <li>• This value is updated every 0.9ms (QD75P□N/QD75D□N) or 56.8ms (QD75P□/QD75D□).</li> </ul>

The "current feed value" and "machine feed value" are used in monitoring the current value display, etc.

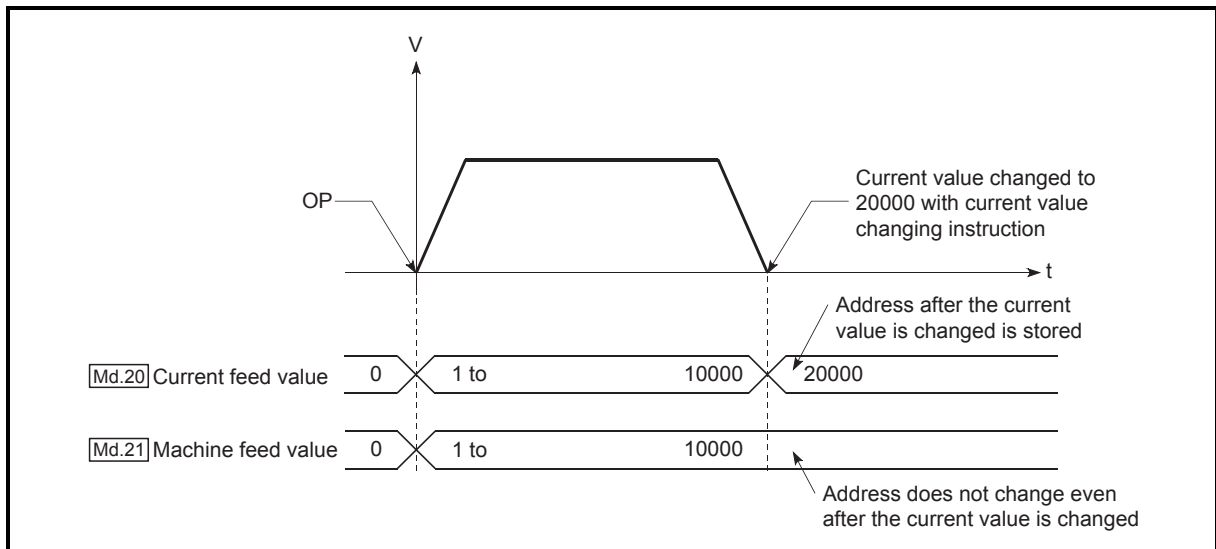

Fig. 9.8 Current feed value and machine feed value

■ Restrictions

A 0.9ms (QD75P□N /QD75D□N) or 1.8ms (QD75P□/QD75D□) error will occur in the current value update timing when the stored "current feed value" is used in the control.

A 0.9ms (QD75P□N /QD75D□N) or 56.8ms (QD75P□/QD75D□) error will occur in the current value update timing when the stored "machine feed value" is used in the control.

■ Monitoring the current value

The "current feed value" and "machine feed value" are stored in the following buffer memory addresses, and can be read using a "DFRO (P) instruction" or "DMOV (P) instruction" from the CPU module.

	Buffer memory addresses			
	Axis 1	Axis 2	Axis 3	Axis 4
<u>Md.20</u> Current feed value	800, 801	900, 901	1000, 1001	1100, 1101
<u>Md.21</u> Machine feed value	802, 803	902, 903	1002, 1003	1102, 1103

(1) The following shows the examples of programs to read out the current feed value of the axis 1 to D104 and D105 when X40 is turned ON.

(a) For the DFRO(P) instruction

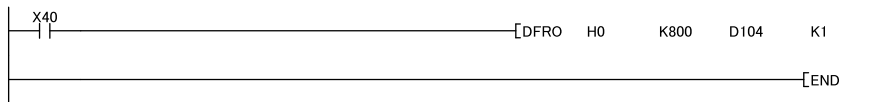

(b) For the DMOV(P) instruction

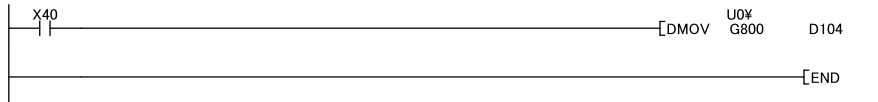



9.1.5 Control unit "degree" handling

When the control unit is set to "degree", the following items differ from when other control units are set.

[1] Current feed value and machine feed value addresses

The address of "Md.20 Current feed value" becomes a ring address from 0 to 359.99999°.

But the address of "Md.21 Machine feed value" doesn't become a ring address.

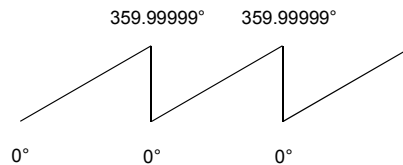

[2] Software stroke limit valid/invalid setting

With the control unit set to "degree", the software stroke limit upper and lower limit values are 0 to 359.99999.

(a) Setting to validate software stroke limit

To validate the software stroke limit, set the software stroke limit lower limit value and the upper limit value in a clockwise direction.

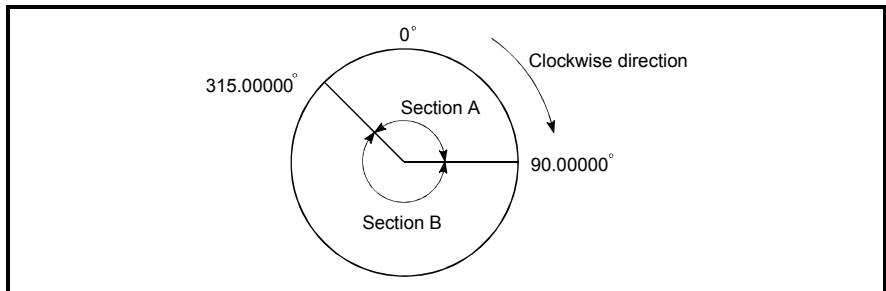

1) To set the movement range A, set as follows.

- Software stroke limit lower limit value .....315.00000°
- Software stroke limit upper limit value .....90.00000°

2) To set the movement range B, set as follows.

- Software stroke limit lower limit value .....90.00000°
- Software stroke limit upper limit value .....315.00000°

(b) Setting to invalidate software stroke limit

To invalidate the software stroke limit, set the software stroke limit lower limit value equal to the software stroke limit upper limit value.

The control can be carried out irrespective of the setting of the software stroke limit.

[3] Positioning control method when the control unit is set to "degree"

1) Absolute system

(a) When the software stroke limit is invalid

Positioning is carried out in the nearest direction to the designated address, using the current value as a reference.

(This is called "shortcut control".)

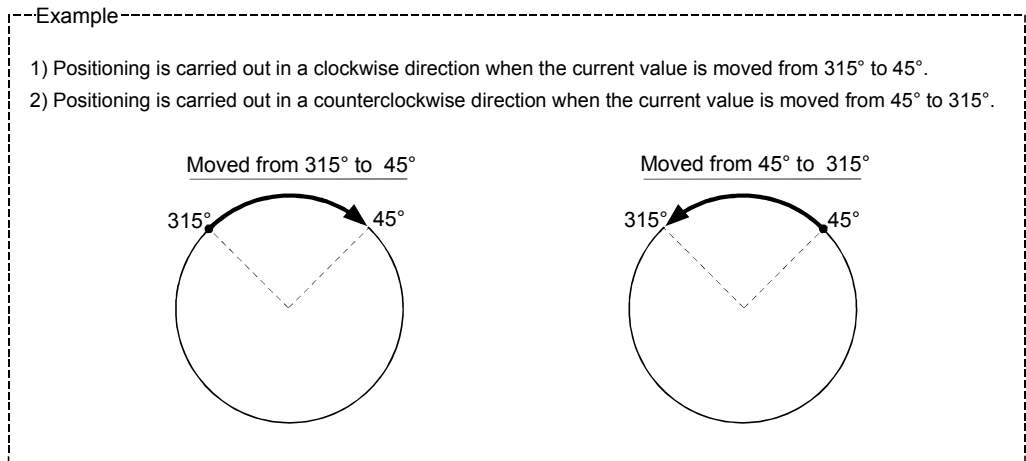

[To specify the positioning direction (not carrying out the shortcut control)]

Use "[Cd.40] ABS direction in degrees" or "[Da.28] ABS direction in degrees" to specify the positioning direction.

This function can be performed when the software stroke limit is invalid. When the software stroke limit is valid, an error "Illegal setting of ABS direction in unit of degree" (error code: 546) occurs and positioning is not started.

In "[Cd.40] ABS direction in degrees" or "[Da.28] ABS direction in degrees", the set value for the reference axis is applied to both the reference axis and interpolation axis. Even if a unit other than degree is set for the reference axis, the setting of the reference axis is applied to the interpolation axis as shown below (for 3-axis linear interpolation control (ABS3)).

Axis	Unit setting	"[Cd.40] ABS direction in degrees"	Rotation direction of the axis with degree setting
Reference axis	pulse	1: ABS clockwise	0
Sub axis 1	degree	-	1: ABS clockwise
Sub axis 2	degree	-	1: ABS clockwise

[To specify the rotation direction in degrees for each positioning data]

To specify the rotation direction for each positioning data in a control executing multiple positioning data sets within one positioning operation continuously, such as continuous positioning control and continuous path control, use "[Da.28] ABS direction in degrees".

[To set the same rotation direction for all positioning data]

Setting "[Cd.40] ABS direction in degrees" enables batch specification of the rotation direction for each positioning data. To use "[Cd.40] ABS direction in degrees", set "0" in "[Da.28] ABS direction in degrees". When a value other than "0" is set, the setting of "[Da.28] ABS direction in degrees" becomes valid. The set value in "[Cd.40] ABS direction in degrees" becomes valid only when the positioning control is started. In the continuous positioning control or continuous path control, the operation is continued with the setting made at a start if the setting is changed during the operation.

Name	Function	Buffer memory address				Initial value
		Axis 1	Axis 2	Axis 3	Axis 4	
[Cd.40] ABS direction in degrees	This data item specifies the ABS moving direction in which the position control carries out when "degree" is selected as the unit. 0: Takes a shortcut. (direction setting ignored) 1: ABS clockwise 2: ABS counterclockwise	1550	1650	1750	1850	0
[Da.28] ABS direction in degrees	"[Cd.40] ABS direction in degrees" is set for each positioning data. 0: Use the set value in "[Cd.40] ABS direction in degrees". 1: ABS clockwise 2: ABS counterclockwise 3: Takes a shortcut. (direction setting ignored)	2003 +N* (b2 to b3)	8003 +N* (b2 to b3)	14003 +N* (b2 to b3)	20003 +N* (b2 to b3)	0

\*: N indicates the offset address of each positioning data.  
N = ((Positioning data No.) - 1) × 10

## (b) When the software stroke limit is valid

The positioning is carried out in a clockwise/counterclockwise direction depending on the software stroke limit range setting method.

Because of this, positioning with "shortcut control" may not be possible.

## Example

When the current value is moved from  $0^\circ$  to  $315^\circ$ , positioning is carried out in the clockwise direction if the software stroke limit lower limit value is  $0^\circ$  and the upper limit value is  $345^\circ$ .

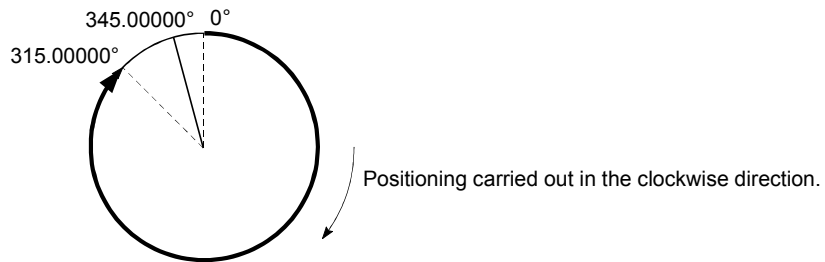
**POINT**

Positioning addresses are within a range of  $0^\circ$  to  $359.99999^\circ$ .

Use the incremental system to carry out positioning of one rotation or more.

## 2) Incremental system

Positioning is carried out for a designated movement amount in a designated movement direction when in the incremental system of positioning.

The movement direction is determined by the sign (+, -) of the movement amount.

- For a positive (+) movement direction ....Clockwise
- For a negative (-) movement direction ...Counterclockwise

**POINT**

Positioning of  $360^\circ$  or more can be carried out with the incremental system.

At this time, set as shown below to invalidate the software stroke limit.

(Set the value with in the setting range ( $0^\circ$  to  $359.99999^\circ$ .)

[Software stroke limit upper limit value = Software stroke limit lower limit value]

9.1.6 Interpolation control

■ Meaning of interpolation control

In "2-axis linear interpolation control", "3-axis linear interpolation control", "4-axis linear interpolation control", "2-axis fixed-feed control", "3-axis fixed-feed control", "4-axis fixed-feed control", "2-axis speed control", "3-axis speed control", "4-axis speed control", "2-axis circular interpolation control", and "3-axis helical interpolation control", control is carried out so that a specified path is drawn using a motor set in two to four axis directions.

This kind of control is called "interpolation control".

In interpolation control, the axis in which the control system is set is defined as the "reference axis", and the other axis is defined as the "interpolation axis".

The QD75 controls the "reference axis" following the positioning data set in the "reference axis", and controls the "interpolation axis" corresponding to the reference axis control so that a linear or arc path is drawn.

The following table shows the reference axis and interpolation axis combinations.

Axis set to interpolation control in " [Da.2] Control system"	Axis definition	Reference axis	Interpolation axis
2-axis linear interpolation control, "2-axis fixed-feed control, 2-axis circular interpolation control, 2-axis speed control		Any of axes 1, 2, 3, and 4	"Axes to be interpolated" set in reference axis
	3-axis linear interpolation control, "3-axis fixed-feed control, 3-axis speed control	Axis 1	Axis 2, Axis 3
		Axis 2	Axis 3, Axis 4
		Axis 3	Axis 4, Axis 1
Axis 4		Axis 1, Axis 2	
4-axis linear interpolation control, "4-axis fixed-feed control, 4-axis speed control	Axis 1	Axis 2, Axis 3, Axis 4	
	Axis 2	Axis 3, Axis 4, Axis 1	
	Axis 3	Axis 4, Axis 1, Axis 2	
	Axis 4	Axis 1, Axis 2, Axis 3	

The available axis combinations in the 3-axis helical interpolation control are the same as the ones in the "3-axis linear interpolation control", "3-axis fixed-feed control", and "3-axis speed control". However, the circular interpolation axis can be specified with " [Da.5] Axis to be interpolated" of the reference axis.

The following table lists the combinations of the reference axis, circular interpolation axis, and linear interpolation axis for the 3-axis helical interpolation control.

Axis set to interpolation control in " [Da.2] Control system"	Axis definition	Reference axis	Circular interpolation axis *1	Linear interpolation axis *2
3-axis helical interpolation control	Axis 1		Axis 2	Axis 3
			Axis 3	Axis 2
	Axis 2		Axis 3	Axis 4
			Axis 4	Axis 3
	Axis 3		Axis 4	Axis 1
			Axis 1	Axis 4
	Axis 4		Axis 1	Axis 2
			Axis 2	Axis 1

\*1: Specify with " [Da.5] Axis to be interpolated" of the reference axis.

\*2: An axis which is not specified with " [Da.5] Axis to be interpolated" of the reference axis is automatically assigned.

■ Setting the positioning data during interpolation control

When carrying out interpolation control, the same positioning data Nos. are set for the "reference axis" and the "interpolation axis".

The following table shows the "positioning data" setting items for the reference axis and interpolation axis.

Setting item		Axis	Reference axis setting item	Interpolation axis setting item
Same positioning data Nos	Da.1	Operation pattern	◎	—
	Da.2	Control system	Linear 2, 3, 4, Fixed-feed 2, 3, 4, Circular sub, Circular right, Circular left Helical sub, Helical right, Helical left Forward run speed 2, 3, 4 Reverse run speed 2, 3, 4	—
	Da.3	Acceleration time No.	◎	—
	Da.4	Deceleration time No.	◎	—
	Da.5	Axis to be interpolated.	○ *	—
	Da.6	Positioning address/movement amount	△ Forward run speed 2, 3, and 4. Reverse run speed 2, 3, and 4 not required.	△ Forward run speed 2, 3, and 4. Reverse run speed 2, 3, and 4 not required.
	Da.7	Arc address	△ (Only for circular sub, circular right, circular left, helical sub, helical right, and helical left)	△ (Only for circular sub, circular right, circular left, helical sub, helical right, and helical left)
	Da.8	Command speed	◎	△ Only during forward run speed 2, 3, 4 and reverse run speed 2, 3, 4.
	Da.9	Dwell time	○	—
	Da.10	M code	○	△ Only for helical sub, helical right, and helical left, set the number of pitch for the linear interpolation axis.
	Da.27	M code ON signal output timing	○	—
	Da.28	ABS direction in degrees	○	—
	Da.29	Interpolation speed designation method	○	—

◎ : Setting always required

○ : Set according to requirements

△ : Setting restrictions exist

— : Setting not required (Unrelated setting item, so any setting value will be ignored. Use the initial value or a value within the setting range.)

\* : For 2-axis interpolation, set the partner axis. If the self-axis is set, the error "Illegal interpolation description command" (error code: 521) will occur. For 3-axis interpolation other than 3-axis helical interpolation or 4-axis interpolation, this item does not need to be set. For 3-axis helical interpolation, refer to the previous page for the reference axis and interpolation axis combinations. If axes are set in a combination other than the ones in the previous page, the error "Illegal interpolation description command" (error code: 521) will occur.

Refer to Section 5.3 "List of positioning data" for information on the setting details.

### ■ Starting the interpolation control

The positioning data Nos. of the reference axis (axis in which interpolation control was set in " **Da.2** Control system") are started when starting the interpolation control. (Starting of the interpolation axis is not required.)

The following errors or warnings will occur and the positioning will not start if both reference axis and the interpolation axis are started.

- Reference axis : The error "Interpolation while interpolation axis BUSY" (error code: 519)
- Interpolation axis : The error "Control system setting error" (error code: 524),  
The warning "Start during operation" (warning code: 100)

### ■ Interpolation control continuous positioning

When carrying out interpolation control in which "continuous positioning control" and "continuous path control" are designated in the operation pattern, the positioning method for all positioning data from the started positioning data to the positioning data in which "positioning complete" is set must be set to interpolation control.

The number of the interpolation axes and axes to be interpolated cannot be changed from the intermediate positioning data. An error "Control system setting error" (error code: 524) will occur and the positioning will stop if setting, which changes the number of the interpolation axes and axes to be interpolated, is carried out.

### ■ Speed during interpolation control

Either the "composite speed" or "reference axis speed" can be designated as the speed during interpolation control.

(**Pr.20** Interpolation speed designation method)

Only the "Reference axis speed" can be designated in the following interpolation control.

When a "composite speed" is set and positioning is started, the error "Interpolation mode error" (error code: 523) occurs, and the system will not start.

- 4-axis linear interpolation
- 2-axis speed control
- 3-axis speed control
- 4-axis speed control

### ■ Cautions in interpolation control

- (1) If a stepping motor is used, the circular interpolation control or 3-axis helical interpolation control cannot be carried out.  
Make sure to use a servomotor when the circular interpolation control or 3-axis helical interpolation control is carried out.
  - (2) If either of the axes exceeds the " **Pr.8** Speed limit value" in the 2 to 4 axes speed control, the axis which exceeded the speed limit value is controlled by the speed limit value.  
For the other axes which perform interpolation, the speed can be suppressed by the ratio of a command speed.
  - (3) If any axis exceeds " **Pr.8** Speed limit value" in any of the following control, the axis in excess of the speed limit value is controlled at the speed limit value.  
For the other axes performing interpolation, the speed can be suppressed by the ratio of a movement distance.
    - 2- to 4-axis linear interpolation control<sup>\*1</sup>
    - 2- to 4-axis fixed-feed control<sup>\*1</sup>
    - 2-axis circular interpolation control
    - 3-axis helical interpolation control<sup>\*2</sup>
- \*1: The speed limit value for the interpolation axis may not function under the following condition: "Reference axis speed" is set in in " **Pr.20** Interpolation speed designation method" or " **Da.29** Interpolation speed designation method", the reference axis is the minor axis, and the interpolation axis is the major axis.
- \*2: In 3-axis helical interpolation control, control the composite speed of the circular interpolation or the speed of the linear interpolation axis so that the speeds do not exceed " **Pr.8** Speed limit value".
- (4) In 2-axis interpolation, you cannot change the combination of interpolated axes midway through operation.

#### POINT

- When the "reference axis speed" is set during interpolation control, set so the major axis side becomes the reference axis. If the minor axis side is set as the reference axis, the major axis side speed may exceed the " **Pr.8** Speed limit value".



■ Interpolation speed designation method

To perform interpolation control, set the composite speed or reference axis speed in "[Pr.20] Interpolation speed designation method" or "[Da.29] Interpolation speed designation method" of the reference axis.

0: Composite speed ..... The movement speed for the control target is specified, and the speed for each axis is calculated by the QD75.

1: Reference axis speed ..... The axis speed set for the reference axis is specified, and the speed for the other axis carrying out interpolation is calculated by the QD75.

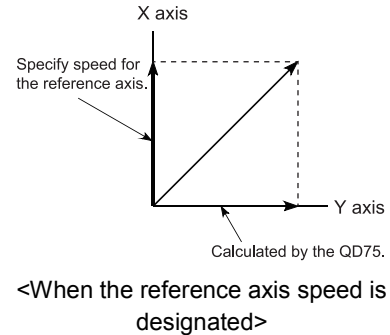
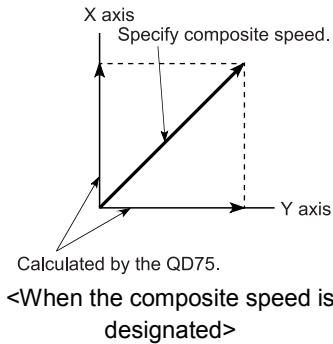

[To specify the interpolation speed for each positioning data]

To specify interpolation speed for each positioning data, use "[Da.29] Interpolation speed designation method".

[To set the same interpolation speed for all positioning data]

Setting "[Pr.20] Interpolation speed designation method" enables batch specification of the interpolation speed designation method for each positioning data.

To use "[Pr.20] Interpolation speed designation method", set "0" in "[Da.29] Interpolation speed designation method". When a value other than 0 is set, "[Da.29] Interpolation speed designation method" will be valid.

Name	Function	Buffer memory address				Initial value
		Axis 1	Axis 2	Axis 3	Axis 4	
[Pr.20] Interpolation speed designation method	When carrying out linear interpolation/circular interpolation, set whether to specify the composite speed or reference axis speed. 0: Composite speed 1: Reference axis speed	29	179	329	479	0
[Da.29] Interpolation speed designation method	Set the interpolation speed designation method for each positioning data. 0: Use the set value in "[Pr.20] Interpolation speed designation method". 1: Composite speed 2: Reference axis speed	2003 +N* (b4 to b6)	8003 +N* (b4 to b6)	14003 +N* (b4 to b6)	20003 +N* (b4 to b6)	0

\*: N indicates the offset address of each positioning data.  
N = ((Positioning data No.) - 1) × 10

■ Limits to interpolation control

There are limits to the interpolation control that can be executed and speed ([Pr.20] Interpolation speed designation method) that can be set, depending on the "[Pr.1] Unit setting" of the reference axis and interpolation axis. (For example, circular interpolation control cannot be executed if the reference axis and interpolation axis units differ.)

The following table shows the interpolation control and speed designation limits.

" [Da.2] Control system" interpolation control	[Pr.20] Interpolation speed designation method or [Da.29] Interpolation speed designation method *5	[Pr.1] Unit setting *1	
		Reference axis and interpolation axis units are the same, or a combination of "mm" and "inch". *3	Reference axis and interpolation axis units differ *3
Linear 2 (ABS, INC) Fixed-feed 2	Composite speed	○	×
	Reference axis speed	○	○
Circular sub (ABS, INC) Circular right (ABS, INC) Circular left (ABS, INC)	Composite speed	○ *2	×
	Reference axis speed	×	×
Helical sub (ABS, INC) Helical right (ABS, INC) Helical left (ABS, INC)	Composite speed	○ *2	○ *4
	Reference axis speed	×	×
Linear 3 (ABS, INC) Fixed-feed 3	Composite speed	○	×
	Reference axis speed	○	○
Linear 4 (ABS, INC) Fixed-feed 4	Composite speed	×	×
	Reference axis speed	○	○

○ : Setting possible, × : Setting not possible.

\*1 "mm" and "inch" unit mix possible.

\*2 The error "Circular interpolation not possible" (error code: 535) will occur and the positioning cannot be started if circular interpolation control or 3-axis helical interpolation control is set when the unit is "degree". The machine will immediately stop if "degree" is set during positioning control.

\*3 The unit set in the reference axis will be used for the speed unit during control if the units differ or if "mm" and "inch" are combined.

\*4 Only for the linear interpolation axis, a unit different from the one set for the reference axis can be used.

\*5 When positioning is started with the following setting, the error "Interpolation mode error" (error code: 523) will occur.

- A "composite speed" is set for the 2-axis speed control, 3-axis speed control, or 4-axis linear interpolation control.
- A "reference axis speed" is set for the circular interpolation control or 3-axis helical interpolation control.

■ Axis operation status during interpolation control

"Interpolation" will be stored in the "[Md.26] Axis operation status" during interpolation control. "Standby" will be stored when the interpolation operation is terminated. Both the reference axis and interpolation axis will carry out a deceleration stop if an error occurs during control, and "error occurring" will be stored in the operation status.

9.2 Setting the positioning data

9.2.1 Relation between each control and positioning data

The setting requirements and details for the setting items of the positioning data to be set differ according to the " Da.2 Control system".

The following table shows the positioning data setting items corresponding to the different types of control. Details and settings for the operation of each control are shown in Section 9.2.2 and subsequent sections.

(In this section, GX Configurator-QP or GX Works2 is used for setting positioning data.)

Major positioning control			Position control				Speed control	Speed-position switching control
			1-axis linear control 2-axis linear interpolation control 3-axis linear interpolation control 4-axis linear interpolation control	1-axis fixed-feed control 2-axis fixed-feed control 3-axis fixed-feed control 4-axis fixed-feed control	2-axis circular interpolation control	3-axis helical interpolation control	1-axis, 2-axis, 3-axis, 4-axis Speed control	
Positioning data setting items								
Da.1	Operation pattern	Independent positioning control (Positioning complete)	◎	◎	◎	◎	◎	◎
		Continuous positioning control	◎	◎	◎	◎	×	◎
		Continuous path control	◎	×	◎	◎	×	×
Da.2	Control system	Linear 1 Linear 2 Linear 3 Linear 4 *1	Fixed-feed 1 Fixed-feed 2 Fixed-feed 3 Fixed-feed 4	Circular sub Circular right Circular left *1	Helical sub Helical right Helical left *1	Forward run speed 1 Reverse run speed 1 Forward run speed 2 Reverse run speed 2 Forward run speed 3 Reverse run speed 3 Forward run speed 4 Reverse run speed 4	Forward run speed/position Reverse run speed/position *1	
Da.3	Acceleration time No.	◎	◎	◎	◎	◎	◎	
Da.4	Deceleration time No.	◎	◎	◎	◎	◎	◎	
Da.5	Axis to be interpolated	◎: 2-axis -: 1, 3, 4-axis						-
Da.6	Positioning address/movement amount	◎	◎	◎	◎	-	◎	
Da.7	Arc address	-	-	◎	◎	-	-	
Da.8	Command speed	◎	◎	◎	◎	◎	◎	
Da.9	Dwell time	○	○	○	○	-	○	
Da.10	M code	○	○	○	○*2	○	○	
Da.27	M code ON signal output timing	○	○	○	○	○	○	
Da.28	ABS direction in degrees	○	○	○	○	○	○	
Da.29	Interpolation speed designation method	-: 1-axis control, ○: 2-axis interpolation control, 3-axis interpolation control, 4-axis interpolation control						

Major positioning control  Positioning data setting items			Position-speed switching control	Other control				
				NOP instruction	Current value changing	JUMP instruction	LOOP instruction	LEND instruction
Da.1	Operation pattern	Independent positioning control (Positioning complete)	◎	-	◎	-	-	-
		Continuous positioning control	×	-	◎	-	-	-
		Continuous path control	×	-	×	-	-	-
Da.2	Control system	Forward run position/speed Reverse run position/speed	NOP instruction	Current value changing	JUMP instruction	LOOP instruction	LEND instruction	
Da.3	Acceleration time No.	◎	-	-	-	-	-	
Da.4	Deceleration time No.	◎	-	-	-	-	-	
Da.5	Axis to be interpolated	-	-	-	-	-	-	
Da.6	Positioning address/movement amount	◎	-	Change destination address	-	-	-	
Da.7	Arc address	-	-	-	-	-	-	
Da.8	Command speed	◎	-	-	-	-	-	
Da.9	Dwell time	○	-	-	JUMP destination-positioning data No.	-	-	
Da.10	M code	○	-	○	Condition data No. at JUMP	No. of repetition	-	
Da.27	M code ON signal output timing	○	-	○	-	-	-	
Da.28	ABS direction in degrees	○	-	-	-	-	-	
Da.29	Interpolation speed designation method	-	-	-	-	-	-	

◎ : Always set      ○ : Set as required

× : Setting not possible (If the setting is made, the error "Continuous path control not possible" (error code: 516) or "New current value not possible" (error code: 515) will occur at a start.)

- : Setting not required (Setting value is invalid. Use the initial values or setting values within a range where no error occurs.)

\*1: The "ABS (absolute) system" or "INC (incremental) system" can be used for the control system.

\*2: Set the M code for the reference axis and the number of pitch for the linear interpolation axis.

**REMARK**

It is recommended that the "positioning data" be set whenever possible with GX Configurator-QP or GX Works2. Execution by sequence program uses many sequence programs and devices. The execution becomes complicated, and the scan times will increase.

9.2.2 1-axis linear control

In "1-axis linear control" (" **Da.2** Control system" = ABS linear 1, INC linear 1), one motor is used to carry out position control in a set axis direction.

[1] 1-axis linear control (ABS linear 1)

■ Operation chart

In absolute system 1-axis linear control, positioning is carried out from the current stop position (start point address) to the address (end point address) set in " **Da.6** Positioning address/movement amount".

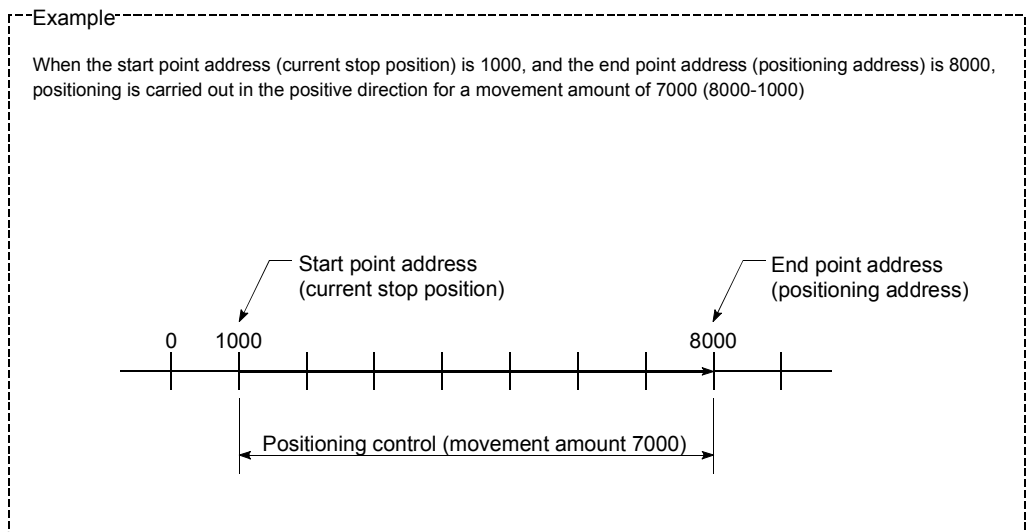

■ Positioning data setting example

The following table shows setting examples when "1-axis linear control (ABS linear 1)" is set in positioning data No. 1 of axis 1.

Setting item		Setting example	Setting details
Axis 1 Positioning data No. 1	<b>Da.1</b> Operation pattern	Positioning complete	Set "Positioning complete" assuming the next positioning data will not be executed.
	<b>Da.2</b> Control system	ABS linear 1	Set absolute system 1-axis linear control.
	<b>Da.3</b> Acceleration time No.	1	Designate the value set in " <b>Pr.25</b> Acceleration time 1" as the acceleration time at start.
	<b>Da.4</b> Deceleration time No.	0	Designate the value set in " <b>Pr.10</b> Deceleration time 0" as the deceleration time at deceleration.
	<b>Da.5</b> Axis to be interpolated	–	Setting not required (setting value will be ignored).
	<b>Da.6</b> Positioning address/movement amount	8000.0μm	Set the positioning address. (Assuming "mm" is set in " <b>Pr.1</b> Unit setting".)
	<b>Da.7</b> Arc address	–	Setting not required (setting value will be ignored).
	<b>Da.8</b> Command speed	6000.00mm/min	Set the speed during movement to the positioning address.
	<b>Da.9</b> Dwell time	500ms	Set the time the machine dwells after the positioning stop (pulse output stop) to the output of the positioning complete signal.
	<b>Da.10</b> M code	10	Set this when other sub operation commands are issued in combination with the No. 1 positioning data.

\* Refer to Section 5.3 "List of positioning data" for information on the setting details.

[2] 1-axis linear control (INC linear 1)

■ Operation chart

In incremental system 1-axis linear control, positioning of movement amount set in " [Da.6] Positioning address/movement amount" is carried out from the current stop position (start point address). The movement direction is determined by the sign of the movement amount.

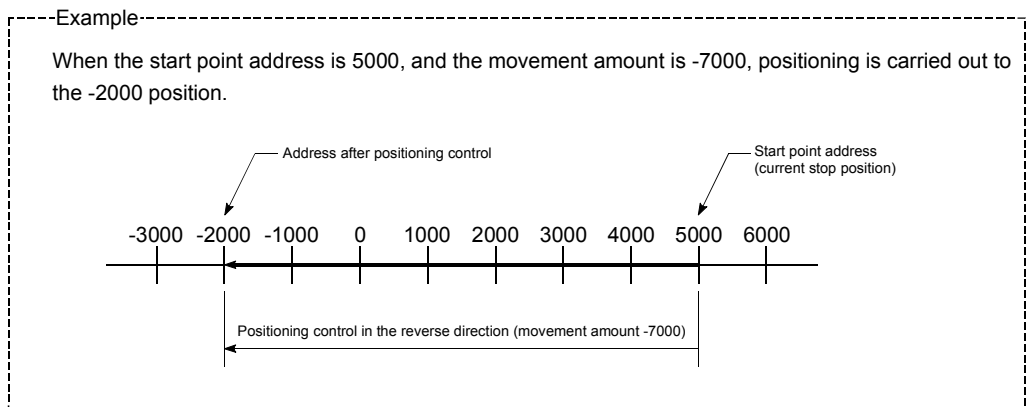
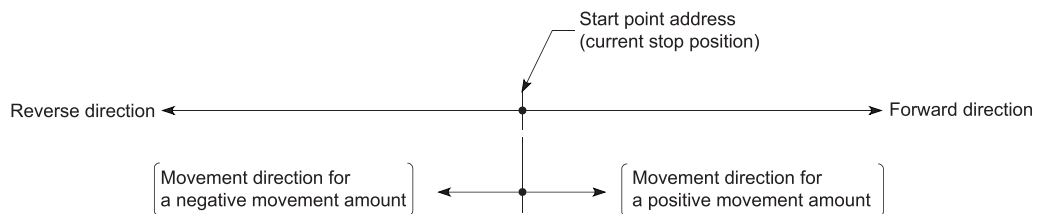

■ Positioning data setting example

The following table shows setting examples when "1-axis linear control (INC linear 1)" is set in positioning data No. 1 of axis 1.

Setting item		Setting example	Setting details
Axis 1 Positioning data No. 1	[Da.1] Operation pattern	Positioning complete	Set "Positioning complete" assuming the next positioning data will not be executed.
	[Da.2] Control system	INC linear 1	Set incremental system 1-axis linear control.
	[Da.3] Acceleration time No.	1	Designate the value set in " [Pr.25] Acceleration time 1" as the acceleration time at start.
	[Da.4] Deceleration time No.	0	Designate the value set in " [Pr.10] Deceleration time 0" as the deceleration time at deceleration.
	[Da.5] Axis to be interpolated	-	Setting not required (setting value will be ignored).
	[Da.6] Positioning address/movement amount	-7000.0 μm	Set the movement amount. (Assuming "mm" is set in " [Pr.1] Unit setting".)
	[Da.7] Arc address	-	Setting not required (setting value will be ignored).
	[Da.8] Command speed	6000.00mm/min	Set the speed during movement.
	[Da.9] Dwell time	500ms	Set the time the machine dwells after the positioning stop (pulse output stop) to the output of the positioning complete signal.
	[Da.10] M code	10	Set this when other sub operation commands are issued in combination with the No. 1 positioning data.

\* Refer to Section 5.3 "List of positioning data" for information on the setting details.

9.2.3 2-axis linear interpolation control

In "2-axis linear interpolation control" (" Da.2 Control system" = ABS linear 2, INC linear 2), two motors are used to carry out position control in a linear path while carrying out interpolation for the axis directions set in each axis.  
 (Refer to Section 9.1.6 "Interpolation control" for details on interpolation control.)

[1] 2-axis linear interpolation control (ABS linear 2)

■ Operation chart

In absolute system 2-axis linear interpolation control, specified two axes are used to perform linear interpolation positioning from the current stop position (start point address) to the address set in the " Da.6 Positioning address/movement amount" (end point address).

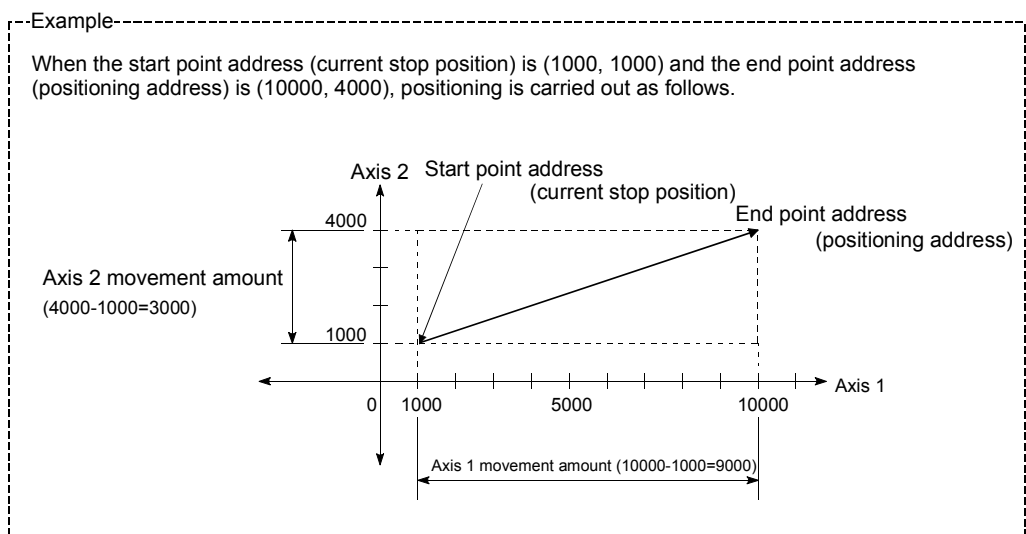
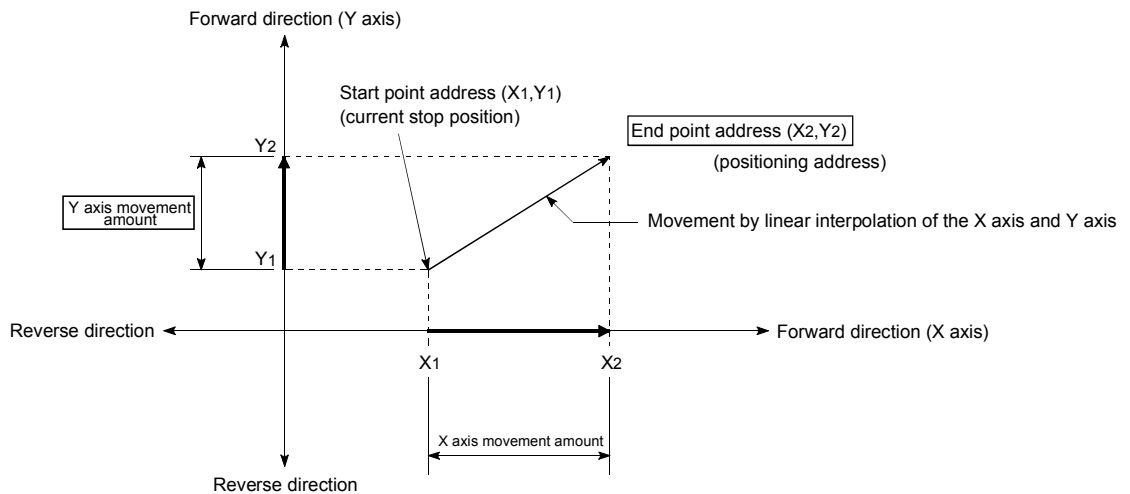

■ Restrictions

An error will occur and the positioning will not start in the following cases. The machine will immediately stop if the error is detected during a positioning control.

- If the movement amount of each axis exceeds "1073741824 (=2<sup>30</sup>)" when "0: Composite speed" is set in " [Pr.20] Interpolation speed designation method" ... The error "Outside linear movement amount range" (error code: 504) occurs at a positioning start.

(The maximum movement amount that can be set in " [Da.6] Positioning address/movement amount" is "1073741824 (=2<sup>30</sup>).")

■ Positioning data setting example

[Reference axis and interpolation axis are designated as axis 1 and axis 2, respectively.]

The following table shows setting examples when "2-axis linear interpolation control (ABS linear 2)" is set in positioning data No. 1 of axis 1. (The required values are also set in positioning data No. 1 of axis 2.)

Setting item		Axis	Axis 1 (reference axis) setting example	Axis 2 (interpolation axis) setting example	Setting details
Axis 1 Positioning data No. 1	[Da.1]	Operation pattern	Positioning complete	–	Set "Positioning complete" assuming the next positioning data will not be executed.
	[Da.2]	Control system	ABS linear 2	–	Set absolute system 2-axis linear interpolation control.
	[Da.3]	Acceleration time No.	1	–	Designate the value set in " [Pr.25] Acceleration time 1" as the acceleration time at start.
	[Da.4]	Deceleration time No.	0	–	Designate the value set in " [Pr.10] Deceleration time 0" as the deceleration time at deceleration.
	[Da.5]	Axis to be interpolated	Axis 2	–	Set the axis to be interpolated (partner axis). If the self-axis is set, an error will occur.
	[Da.6]	Positioning address/movement amount	10000.0μm	4000.0μm	Set the end point address. (Assuming "mm" is set in " [Pr.1] Unit setting".)
	[Da.7]	Arc address	–	–	Setting not required (setting value will be ignored).
	[Da.8]	Command speed	6000.00 mm/min	–	Set the speed during movement to the end point address.
	[Da.9]	Dwell time	500ms	–	Set the time the machine dwells after the positioning stop (pulse output stop) to the output of the positioning complete signal.
	[Da.10]	M code	10	–	Set this when other sub operation commands are issued in combination with the No. 1 positioning data.

\* Refer to Section 5.3 "List of positioning data" for information on the setting details.

<b>POINT</b>
<ul style="list-style-type: none"> <li>• When the "reference axis speed" is set during 2-axis linear interpolation control, set so the major axis side becomes the reference axis. If the minor axis side is set as the reference axis, the major axis side speed may exceed the " [Pr.8] Speed limit value".</li> </ul>



[2] 2-axis linear interpolation control (INC linear 2)

■ Operation chart

In incremental system 2-axis linear interpolation control, designated 2 axes are used. Linear interpolation positioning of movement amount set in "Da.6 Positioning address/movement amount" is carried out from the current stop position (start point address). The movement direction is determined by the sign of the movement amount.

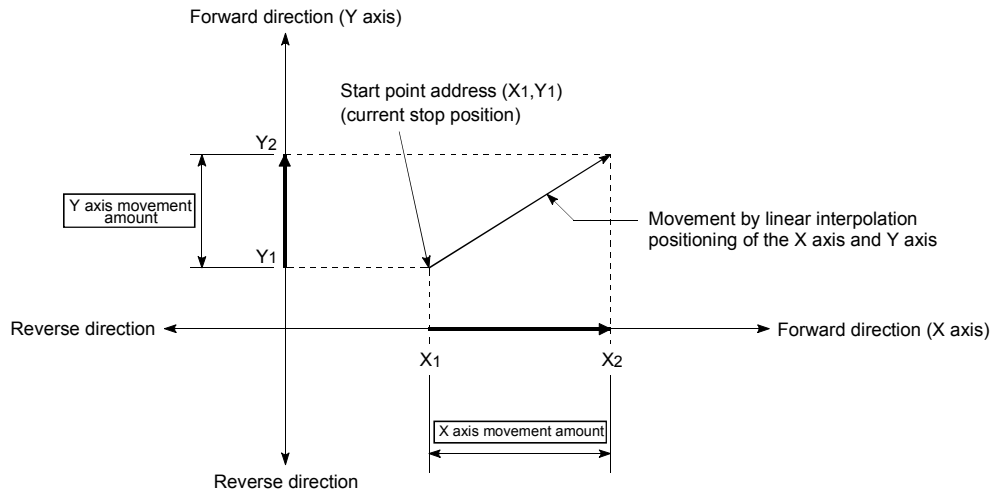

Example

When the axis 1 movement amount is 9000 and the axis 2 movement amount is -3000, positioning is carried out as follows.

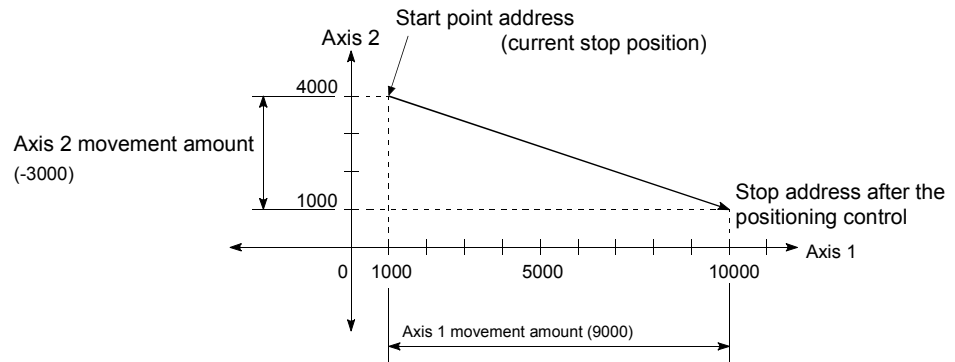

■ Restrictions

An error will occur and the positioning will not start in the following cases. The machine will immediately stop if the error is detected during a positioning operation.

- If the movement amount of each axis exceeds "1073741824 (=2<sup>30</sup>)" when "0: Composite speed" is set in " [Pr.20] Interpolation speed designation method" ... The error "Outside linear movement amount range" (error code: 504) occurs at a positioning start.  
(The maximum movement amount that can be set in " [Da.6] Positioning address/movement amount" is "1073741824 (=2<sup>30</sup>)".)

■ Positioning data setting example

[Reference axis and interpolation axis are designated as axis 1 and axis 2, respectively.]

The following table shows setting examples when "2-axis linear interpolation control (INC linear 2)" is set in positioning data No. 1 of axis 1. (The required values are also set in positioning data No. 1 of axis 2.)

Setting item		Axis	Axis 1 (reference axis) setting example	Axis 2 (interpolation axis) setting example	Setting details
Axis 1 Positioning data No. 1	[Da.1]	Operation pattern	Positioning complete	–	Set "Positioning complete" assuming the next positioning data will not be executed.
	[Da.2]	Control system	INC linear 2	–	Set incremental system 2-axis linear interpolation control.
	[Da.3]	Acceleration time No.	1	–	Designate the value set in " [Pr.25] Acceleration time 1" as the acceleration time at start.
	[Da.4]	Deceleration time No.	0	–	Designate the value set in " [Pr.10] Deceleration time 0" as the deceleration time at deceleration.
	[Da.5]	Axis to be interpolated	Axis 2	–	Set the axis to be interpolated (partner axis). If the self-axis is set, an error will occur.
	[Da.6]	Positioning address/movement amount	9000.0μm	-3000.0μm	Set the movement amount. (Assuming "mm" is set in " [Pr.1] Unit setting".)
	[Da.7]	Arc address	–	–	Setting not required (setting value will be ignored).
	[Da.8]	Command speed	6000.00 mm/min	–	Set the speed during movement.
	[Da.9]	Dwell time	500ms	–	Set the time the machine dwells after the positioning stop (pulse output stop) to the output of the positioning complete signal.
	[Da.10]	M code	10	–	Set this when other sub operation commands are issued in combination with the No. 1 positioning data.

\* Refer to Section 5.3 "List of positioning data" for information on the setting details.

<b>POINT</b>
<ul style="list-style-type: none"> <li>• When the "reference axis speed" is set during 2-axis linear interpolation control, set so the major axis side becomes the reference axis. If the minor axis side is set as the reference axis, the major axis side speed may exceed the " [Pr.8] Speed limit value".</li> </ul>

9.2.4 3-axis linear interpolation control

In "3-axis linear interpolation control" (" **Da.2** Control system" = ABS linear 3, INC linear 3), three motors are used to carry out position control in a linear path while carrying out interpolation for the axis directions set in each axis.  
 (Refer to Section 9.1.6 "Interpolation control" for details on interpolation control.)

[1] 3-axis linear interpolation control (ABS linear 3)

■ Operation chart

In absolute system 3-axis linear interpolation control, 3 axes are used. Linear interpolation positioning is carried out from the current stop position (start point address) to the address (end point address) set in " **Da.6** Positioning address/movement amount".

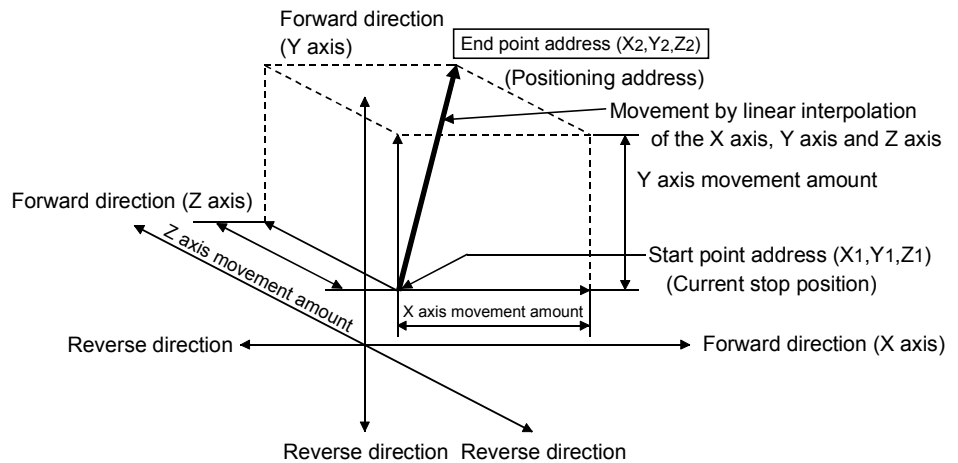

Example

When the start point address (current stop position) is (1000, 2000, 1000) and the end point address (positioning address) is (4000, 8000, 4000), positioning is carried out as follows.

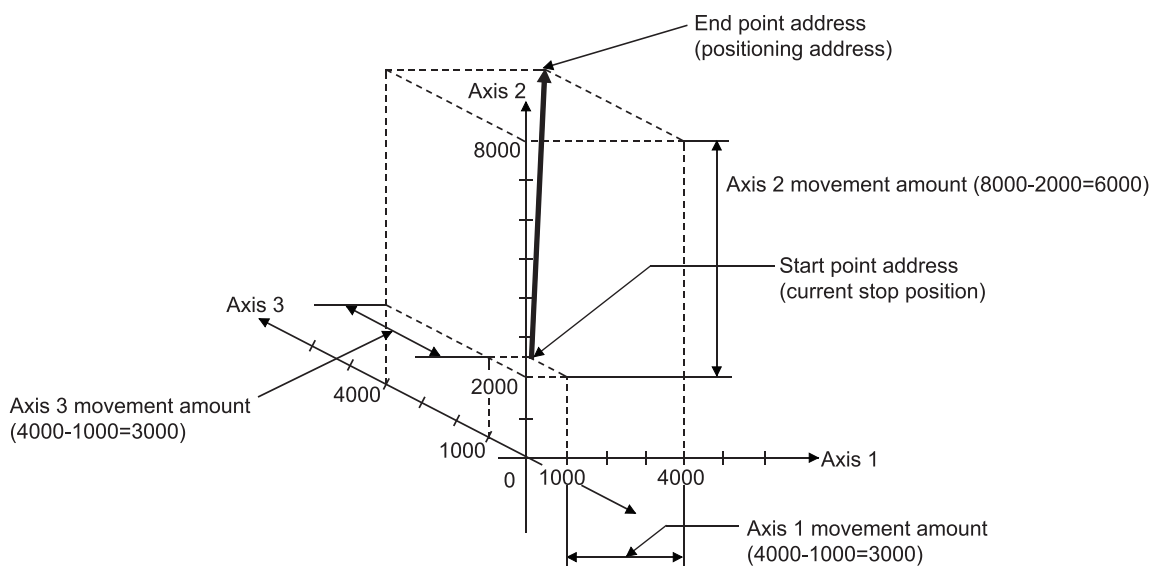

■ Restrictions

An error will occur and the positioning will not start in the following cases. The machine will immediately stop if the error is detected during a positioning control.

- If the movement amount of each axis exceeds "1073741824 (=2<sup>30</sup>)" when "0: Composite speed" is set in " [Pr.20] Interpolation speed designation method" ... The error "Outside linear movement amount range" (error code: 504) occurs at a positioning start.

(The maximum movement amount that can be set in " [Da.6] Positioning address/movement amount" is "1073741824 (=2<sup>30</sup>).")

■ Positioning data setting example

[Reference axis is designated as axis 1.]

The following table shows setting examples when "3-axis linear interpolation control (ABS linear 3)" is set in positioning data No. 1 of axis 1. (The required values are also set in positioning data No. 1 of axis 2 and axis 3.)

Setting item		Axis	Axis 1 (reference axis) setting example	Axis 2 (interpolation axis) setting example	Axis 3 (interpolation axis) setting example	Setting details
Axis 1 Positioning data No. 1	[Da.1] Operation pattern		Positioning complete	-	-	Set "Positioning complete" assuming the next positioning data will not be executed.
	[Da.2] Control system		ABS linear 3	-	-	Set absolute system 3-axis linear interpolation control.
	[Da.3] Acceleration time No.		1	-	-	Designate the value set in " [Pr.25] Acceleration time 1" as the acceleration time at start.
	[Da.4] Deceleration time No.		0	-	-	Designate the value set in " [Pr.10] Deceleration time 0" as the deceleration time at deceleration.
	[Da.5] Axis to be interpolated		-	-	-	Setting not required (setting value will be ignored). When axis 1 is used as a reference axis, the interpolation axes are axes 2 and 3.
	[Da.6] Positioning address/movement amount		4000.0μm	8000.0μm	4000.0μm	Set the end point address. (Assuming "mm" is set in " [Pr.1] Unit setting".)
	[Da.7] Arc address		-	-	-	Setting not required (setting value will be ignored).
	[Da.8] Command speed		6000.00 mm/min	-	-	Set the speed during movement to the end point address.
	[Da.9] Dwell time		500ms	-	-	Set the time the machine dwells after the positioning stop (pulse output stop) to the output of the positioning complete signal.
	[Da.10] M code		10	-	-	Set this when other sub operation commands are issued in combination with the No. 1 positioning data.

\* Refer to Section 5.3 "List of positioning data" for information on the setting details.

**POINTS**

- When the "reference axis speed" is set during 3-axis linear interpolation control, set so the major axis side becomes the reference axis. If the minor axis side is set as the reference axis, the major axis side speed may exceed the " **Pr.8** Speed limit value".
- Refer to Section 9.1.6 "Interpolation control" for the reference axis and interpolation axis combinations.

[2] 3-axis linear interpolation control (INC linear 3)

■ Operation chart

In incremental system 3-axis linear interpolation control, designated 3 axes are used. Linear interpolation positioning of movement amount set in " [Da.6] Positioning address/movement amount" is carried out from the current stop position (start point address). The movement direction is determined by the sign of the movement amount.

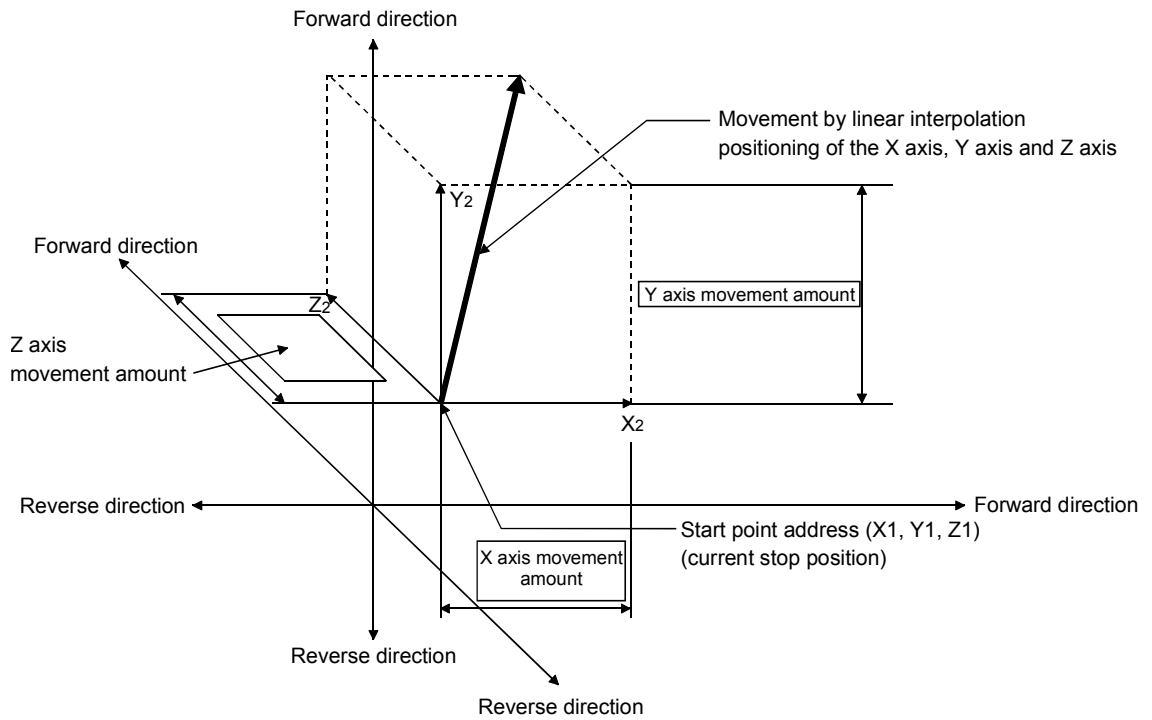

-Example-

When the axis 1 movement amount is 10000, the axis 2 movement amount is 5000 and the axis 3 movement amount is 6000, positioning is carried out as follows.

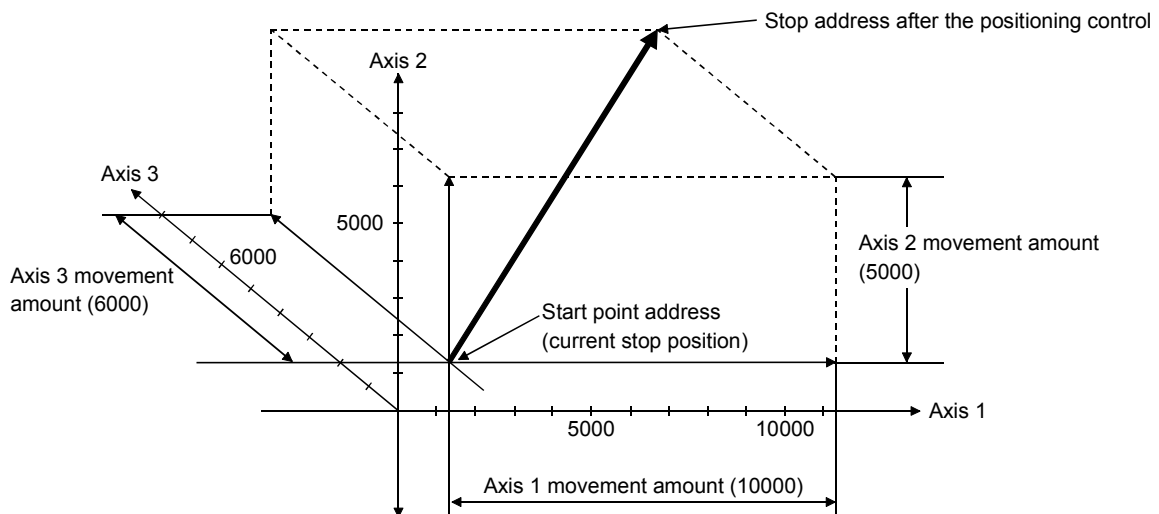

■ Restrictions

An error will occur and the positioning will not start in the following cases. The machine will immediately stop if the error is detected during a positioning operation.

- If the movement amount of each axis exceeds "1073741824 (=2<sup>30</sup>)" when "0: Composite speed" is set in " [Pr.20] Interpolation speed designation method" ... The error "Outside linear movement amount range" (error code: 504) occurs at a positioning start.  
(The maximum movement amount that can be set in " [Da.6] Positioning address/movement amount" is "1073741824 (=2<sup>30</sup>).")

■ Positioning data setting example

[Reference axis is designated as axis 1.]

The following table shows setting examples when "3-axis linear interpolation control (INC linear 3)" is set in positioning data No. 1 of axis 1. (The required values are also set in positioning data No. 1 of axis 2 and axis 3.)

Setting item		Axis			Setting details
		Axis 1 (reference axis) setting example	Axis 2 (interpolation axis) setting example	Axis 3 (interpolation axis) setting example	
Axis 1 Positioning data No. 1	[Da.1] Operation pattern	Positioning complete	-	-	Set "Positioning complete" assuming the next positioning data will not be executed.
	[Da.2] Control system	INC linear 3	-	-	Set incremental system 3-axis linear interpolation control.
	[Da.3] Acceleration time No.	1	-	-	Designate the value set in " [Pr.25] Acceleration time 1" as the acceleration time at start.
	[Da.4] Deceleration time No.	0	-	-	Designate the value set in " [Pr.10] Deceleration time 0" as the deceleration time at deceleration.
	[Da.5] Axis to be interpolated	-	-	-	Setting not required (setting value will be ignored). When axis 1 is used as a reference axis, the interpolation axes are axes 2 and 3.
	[Da.6] Positioning address/movement amount	10000.0μm	5000.0μm	6000.0μm	Set the movement amount. (Assuming "mm" is set in " [Pr.1] Unit setting".)
	[Da.7] Arc address	-	-	-	Setting not required (setting value will be ignored).
	[Da.8] Command speed	6000.00 mm/min	-	-	Set the speed during movement.
	[Da.9] Dwell time	500ms	-	-	Set the time the machine dwells after the positioning stop (pulse output stop) to the output of the positioning complete signal.
	[Da.10] M code	10	-	-	Set this when other sub operation commands are issued in combination with the No. 1 positioning data.

\* Refer to Section 5.3 "List of positioning data" for information on the setting details.

**POINTS**

- (1) When the "reference axis speed" is set during 3-axis linear interpolation control, set so the major axis side becomes the reference axis. If the minor axis side is set as the reference axis, the major axis side speed may exceed the " **Pr.8** Speed limit value".
- (2) Refer to Section 9.1.6 "Interpolation control" for the reference axis and interpolation axis combinations.



### 9.2.5 4-axis linear interpolation control

In "4-axis linear interpolation control" (" [Da.2](#) Control system" = ABS linear 4, INC linear 4), four motors are used to carry out position control in a linear path while carrying out interpolation for the axis directions set in each axis.  
(Refer to Section 9.1.6 "Interpolation control" for details on interpolation control.)

#### [1] 4-axis linear interpolation control (ABS linear 4)

In absolute system 4-axis linear interpolation control, 4 axes are used. Linear interpolation positioning is carried out from the current stop position (start point address) to the address (end point address) set in " [Da.6](#) Positioning address/movement amount".

■ Positioning data setting example

[Reference axis is designated as axis 1.]

The following table shows setting examples when "4-axis linear interpolation control (ABS linear 4)" is set in positioning data No. 1 of axis 1. (The required values are also set in positioning data No. 1 of axis 2, axis 3 and axis 4.)

Setting item		Axis	Axis 1 (reference axis) setting example	Axis 2 (interpolation axis) setting example	Axis 3 (interpolation axis) setting example	Axis 4 (interpolation axis) setting example	Setting details
Axis 1 Positioning data No. 1	Da.1	Operation pattern	Positioning complete	-	-	-	Set "Positioning complete" assuming the next positioning data will not be executed.
	Da.2	Control system	ABS linear 4	-	-	-	Set absolute system 4-axis linear interpolation control.
	Da.3	Acceleration time No.	1	-	-	-	Designate the value set in " Pr.25 Acceleration time 1" as the acceleration time at start.
	Da.4	Deceleration time No.	0	-	-	-	Designate the value set in " Pr.10 Deceleration time 0" as the deceleration time at deceleration.
	Da.5	Axis to be interpolated	-	-	-	-	Setting not required (setting value will be ignored). When axis 1 is used as a reference axis, the interpolation axes are axes 2, 3 and 4.
	Da.6	Positioning address/movement amount	4000.0μm	8000.0μm	4000.0μm	3000.0μm	Set the end point address. (Assuming "mm" is set in " Pr.1 Unit setting".)
	Da.7	Arc address	-	-	-	-	Setting not required (setting value will be ignored).
	Da.8	Command speed	6000.00 mm/min	-	-	-	Set the speed during movement to the end point address.
	Da.9	Dwell time	500ms	-	-	-	Set the time the machine dwells after the positioning stop (pulse output stop) to the output of the positioning complete signal.
	Da.10	M code	10	-	-	-	Set this when other sub operation commands are issued in combination with the No. 1 positioning data.

\* Refer to Section 5.3 "List of positioning data" for information on the setting details.

<b>POINTS</b>
<p>(1) When the "reference axis speed" is set during 4-axis linear interpolation control, set so the major axis side becomes the reference axis. If the minor axis side is set as the reference axis, the major axis side speed may exceed the " Pr.8 Speed limit value".</p> <p>(2) Refer to Section 9.1.6 "Interpolation control" for the reference axis and interpolation axis combinations.</p>

**[2] 4-axis linear interpolation control (INC linear 4)****■ Operation chart**

In incremental system 4-axis linear interpolation control, designated 4 axes are used. Linear interpolation positioning of movement amount set in " Da.6 Positioning address/movement amount" is carried out from the current stop position (start point address). The movement direction is determined by the sign of the movement amount.

■ Positioning data setting example

[Reference axis is designated as axis 1.]

The following table shows setting examples when "4-axis linear interpolation control (INC linear 4)" is set in positioning data No. 1 of axis 1. (The required values are also set in positioning data No. 1 of axis 2, axis 3 and axis 4.)

Setting item		Axis	Axis 1 (reference axis) setting example	Axis 2 (interpolation axis) setting example	Axis 3 (interpolation axis) setting example	Axis 4 (interpolation axis) setting example	Setting details
Axis 1 Positioning data No. 1	Da.1	Operation pattern	Positioning complete	-	-	-	Set "Positioning complete" assuming the next positioning data will not be executed.
	Da.2	Control system	INC linear 4	-	-	-	Set incremental system 4-axis linear interpolation control.
	Da.3	Acceleration time No.	1	-	-	-	Designate the value set in " Pr.25 Acceleration time 1" as the acceleration time at start.
	Da.4	Deceleration time No.	0	-	-	-	Designate the value set in " Pr.10 Deceleration time 0" as the deceleration time at deceleration.
	Da.5	Axis to be interpolated	-	-	-	-	Setting not required (setting value will be ignored). When axis 1 is used as a reference axis, the interpolation axes are axes 2, 3 and 4.
	Da.6	Positioning address/movement amount	4000.0μm	8000.0μm	4000.0μm	3000.0μm	Set the movement amount. (Assuming "mm" is set in " Pr.1 Unit setting".)
	Da.7	Arc address	-	-	-	-	Setting not required (setting value will be ignored).
	Da.8	Command speed	6000.00 mm/min	-	-	-	Set the speed during movement.
	Da.9	Dwell time	500ms	-	-	-	Set the time the machine dwells after the positioning stop (pulse output stop) to the output of the positioning complete signal.
	Da.10	M code	10	-	-	-	Set this when other sub operation commands are issued in combination with the No. 1 positioning data.

\* Refer to Section 5.3 "List of positioning data" for information on the setting details.

POINTS
(1) When the "reference axis speed" is set during 4-axis linear interpolation control, set so the major axis side becomes the reference axis. If the minor axis side is set as the reference axis, the major axis side speed may exceed the " Pr.8 Speed limit value".
(2) Refer to Section 9.1.6 "Interpolation control" for the reference axis and interpolation axis combinations.

## 9.2.6 1-axis fixed-feed control

In "1-axis fixed-feed control" (" [Da.2] Control system" = fixed-feed 1), one motor is used to carry out fixed-feed control in a set axis direction.

In fixed-feed control, any remainder of the movement amount designated in the positioning data is rounded down if less than that required for control accuracy to output the same amount of pulses.

#### ■ Operation chart

In 1-axis fixed-feed control, the address ([Md.20] Current feed value) of the current stop position (start point address) is set to "0". Positioning is then carried out to a position at the end of the movement amount set in " [Da.6] Positioning address/movement amount".

The movement direction is determined by the movement amount sign.

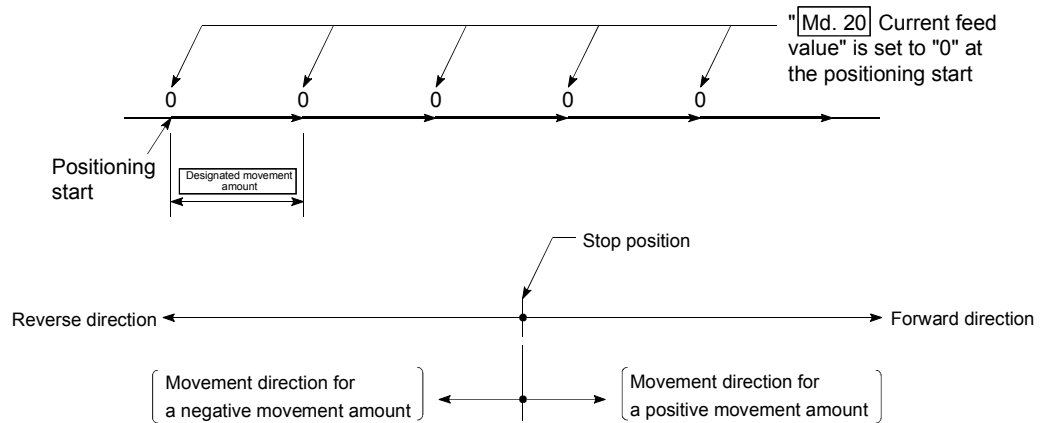

#### ■ Restrictions

- (1) An axis error "Continuous path control not possible" (error code: 516) will occur and the operation cannot start if "continuous path control" is set in " [Da.1] Operation pattern". ("Continuous path control" cannot be set in fixed-feed control.)
- (2) "Fixed-feed" cannot be set in " [Da.2] Control system" in the positioning data when "continuous path control" has been set in " [Da.1] Operation pattern" of the immediately prior positioning data. (For example, if the operation pattern of positioning data No. 1 is "continuous path control", fixed-feed control cannot be set in positioning data No. 2.) An axis error "Continuous path control not possible" (error code: 516) will occur and the machine will carry out a deceleration stop if this type of setting is carried out.

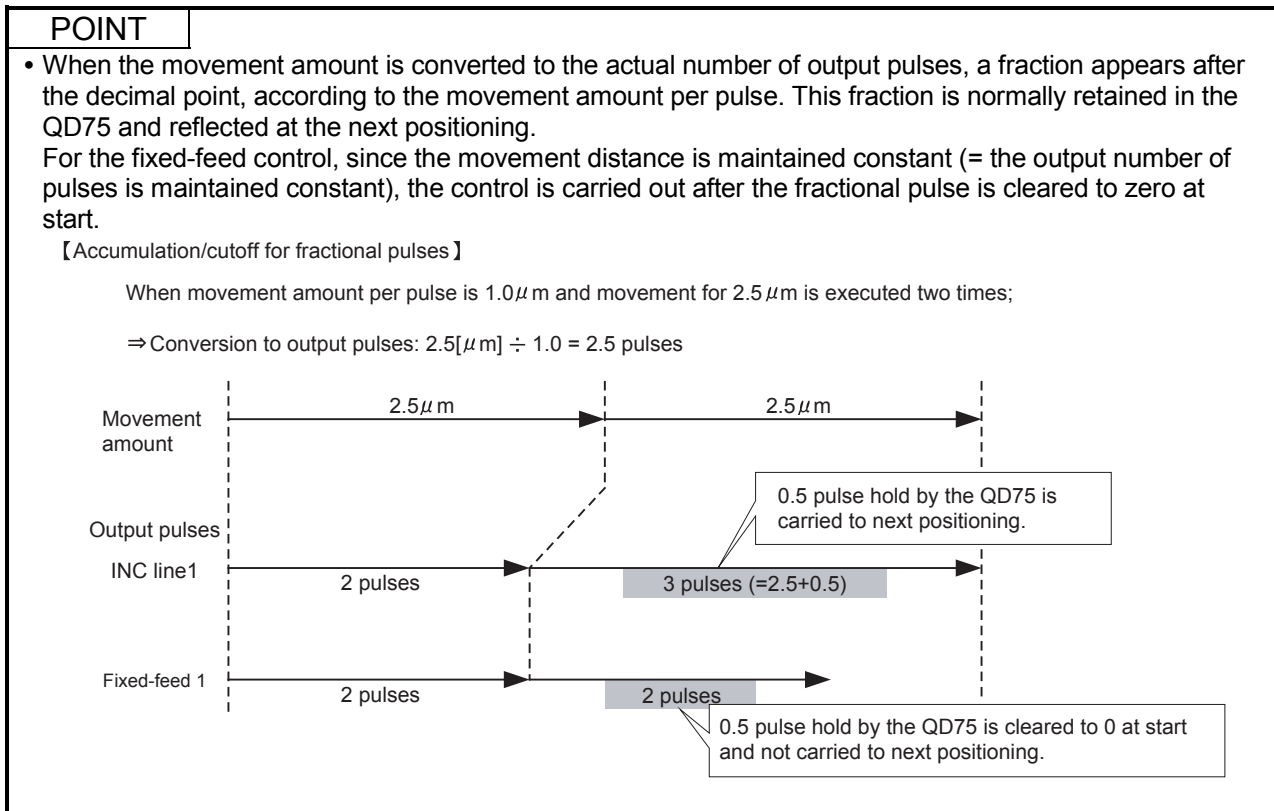

■ Positioning data setting example

The following table shows setting examples when "1-axis fixed-feed control (fixed-feed 1)" is set in positioning data No. 1 of axis 1.

Setting item		Setting example	Setting details
Axis 1 Positioning data No. 1	Da.1	Operation pattern	Positioning complete Set "Positioning complete" assuming the next positioning data will not be executed.
	Da.2	Control system	Fixed-feed 1 Set 1-axis fixed-feed control.
	Da.3	Acceleration time No.	1 Designate the value set in " Pr.25 Acceleration time 1" as the acceleration time at start.
	Da.4	Deceleration time No.	0 Designate the value set in " Pr.10 Deceleration time 0" as the deceleration time at deceleration.
	Da.5	Axis to be interpolated	- Setting not required (setting value will be ignored).
	Da.6	Positioning address/movement amount	8000.0 $\mu\text{m}$ Set the positioning address. (Assuming "mm" is set in " Pr.1 Unit setting".)
	Da.7	Arc address	- Setting not required (setting value will be ignored).
	Da.8	Command speed	6000.00mm/min Set the speed during movement to the positioning address.
	Da.9	Dwell time	500ms Set the time the machine dwells after the positioning stop (pulse output stop) to the output of the positioning complete signal.
	Da.10	M code	10 Set this when other sub operation commands are issued in combination with the No. 1 positioning data.

\* Refer to Section 5.3 "List of positioning data" for information on the setting details.

## 9.2.7 2-axis fixed-feed control (interpolation)

In "2-axis fixed-feed control" ("Da.2" Control system" = fixed-feed 2), two motors are used to carry out fixed-feed control in a linear path while carrying out interpolation for the axis directions set in each axis.

In fixed-feed control, any remainder of the movement amount designated in the positioning data is rounded down if less than that required for control accuracy to output the same amount of pulses.

(Refer to Section 9.1.6 "Interpolation control" for details on interpolation control.)

### ■ Operation chart

In incremental system 2-axis fixed-feed control, the addresses (Md.20" Current feed value) of the current stop position (start addresses) of both axes are set to "0". Linear interpolation positioning is then carried out from that position to a position at the end of the movement amount set in "Da.6" Positioning address/movement amount". The movement direction is determined by the sign of the movement amount.

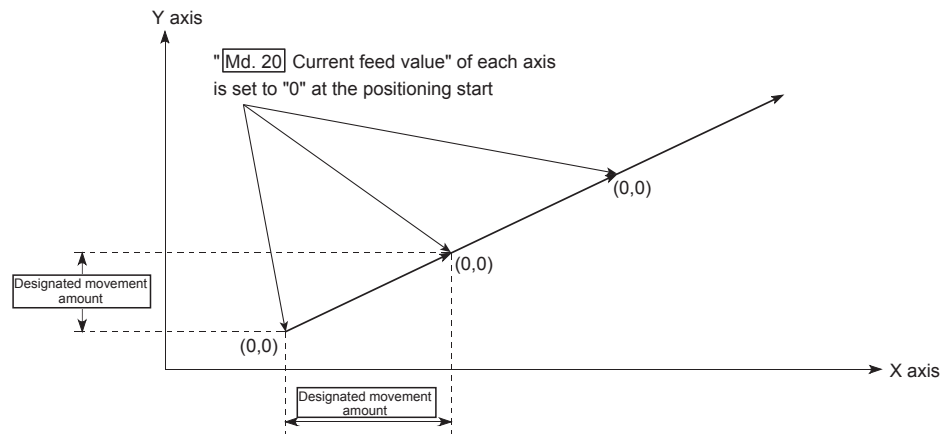

### ■ Restrictions

- (1) An axis error "Continuous path control not possible" (error code: 516) will occur and the operation cannot start if "continuous path control" is set in "Da.1" Operation pattern". ("Continuous path control" cannot be set in fixed-feed control.)
- (2) If the movement amount of each axis exceeds "1073741824 (=2<sup>30</sup>)" when "0: Composite speed" is set in "Pr.20" Interpolation speed designation method", the error "Outside linear movement amount range" (error code: 504) occurs at a positioning start and positioning cannot be started. (The maximum movement amount that can be set in "Da.6" Positioning address/movement amount" is "1073741824 (= 2<sup>30</sup>)".)
- (3) "Fixed-feed" cannot be set in "Da.2" Control system" in the positioning data when "continuous path control" has been set in "Da.1" Operation pattern" of the immediately prior positioning data. (For example, if the operation pattern of positioning data No. 1 is "continuous path control", fixed-feed control cannot be set in positioning data No. 2.) An axis error "Continuous path control not possible" (error code: 516) will occur and the machine will carry out a deceleration stop if this type of setting is carried out.

### ■ Positioning data setting example

[Reference axis and interpolation axis are designated as axis 1 and axis 2, respectively.]

The following table shows setting examples when "2-axis fixed-dimension feed control (fixed-feed 2)" is set in positioning data No. 1 of axis 1. (The required values are also set in positioning data No. 1 of axis 2.)

Setting item		Axis		Setting details	
		Axis 1 (reference axis) setting example	Axis 2 (interpolation axis) setting example		
Axis 1 Positioning data No. 1	Da.1	Operation pattern	Positioning complete	–	Set "Positioning complete" assuming the next positioning data will not be executed.
	Da.2	Control system	Fixed-feed 2	–	Set 2-axis fixed-feed control.
	Da.3	Acceleration time No.	1	–	Designate the value set in " Pr.25 Acceleration time 1" as the acceleration time at start.
	Da.4	Deceleration time No.	0	–	Designate the value set in " Pr.10 Deceleration time 0" as the deceleration time at deceleration.
	Da.5	Axis to be interpolated	Axis 2	–	Set the axis to be interpolated (partner axis). If the self-axis is set, an error will occur.
	Da.6	Positioning address/ movement amount	8000.0μm	6000.0μm	Set the positioning address. (Assuming "mm" is set in " Pr.1 Unit setting".)
	Da.7	Arc address	–	–	Setting not required (setting value will be ignored).
	Da.8	Command speed	6000.00 mm/min	–	Set the speed during movement. (Designate the composite speed of reference axis speed in " Pr.20 Interpolation speed designation method".)
	Da.9	Dwell time	500ms	–	Set the time the machine dwells after the positioning stop (pulse output stop) to the output of the positioning complete signal.
	Da.10	M code	10	–	Set this when other sub operation commands are issued in combination with the No. 1 positioning data.

\* Refer to Section 5.3 "List of positioning data" for information on the setting details.



**POINTS**

- (1) When the movement amount is converted to the actual number of output pulses, a fraction appears after the decimal point, according to the movement amount per pulse. This fraction is normally retained in the QD75 and reflected at the next positioning.  
 For the fixed-feed control, since the movement distance is maintained constant (= the output number of pulses is maintained constant), the control is carried out after the fractional pulse is cleared to zero at start.

**【Accumulation/cutoff for fractional pulses】**

When movement amount per pulse is  $1.0\mu\text{m}$  and movement for  $2.5\mu\text{m}$  is executed two times;

⇒ Conversion to output pulses:  $2.5[\mu\text{m}] \div 1.0 = 2.5$  pulses

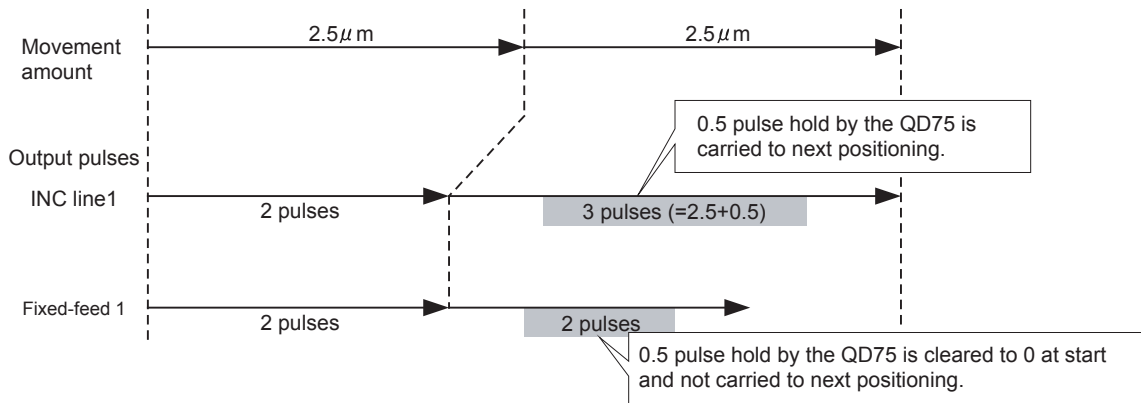

- (2) When the "reference axis speed" is set during 2-axis fixed-feed control, set so the major axis side becomes the reference axis. If the minor axis side is set as the reference axis, the major axis side speed may exceed the " **Pr.8** Speed limit value".

### 9.2.8 3-axis fixed-feed control (interpolation)

In "3-axis fixed-feed control" (" Da.2 Control system" = fixed-feed 3), three motors are used to carry out fixed-feed control in a linear path while carrying out interpolation for the axis directions set in each axis.

In fixed-feed control, any remainder of the movement amount designated in the positioning data is rounded down if less than that required for control accuracy to output the same amount of pulses.

(Refer to Section 9.1.6 "Interpolation control" for details on interpolation control.)

■ Operation chart

In incremental system 3-axis fixed-feed control, the addresses ( $[Md.20]$  Current feed value) of the current stop position (start addresses) of every axes are set to "0". Linear interpolation positioning is then carried out from that position to a position at the end of the movement amount set in " $[Da.6]$  Positioning address/movement amount". The movement direction is determined by the sign of the movement amount.

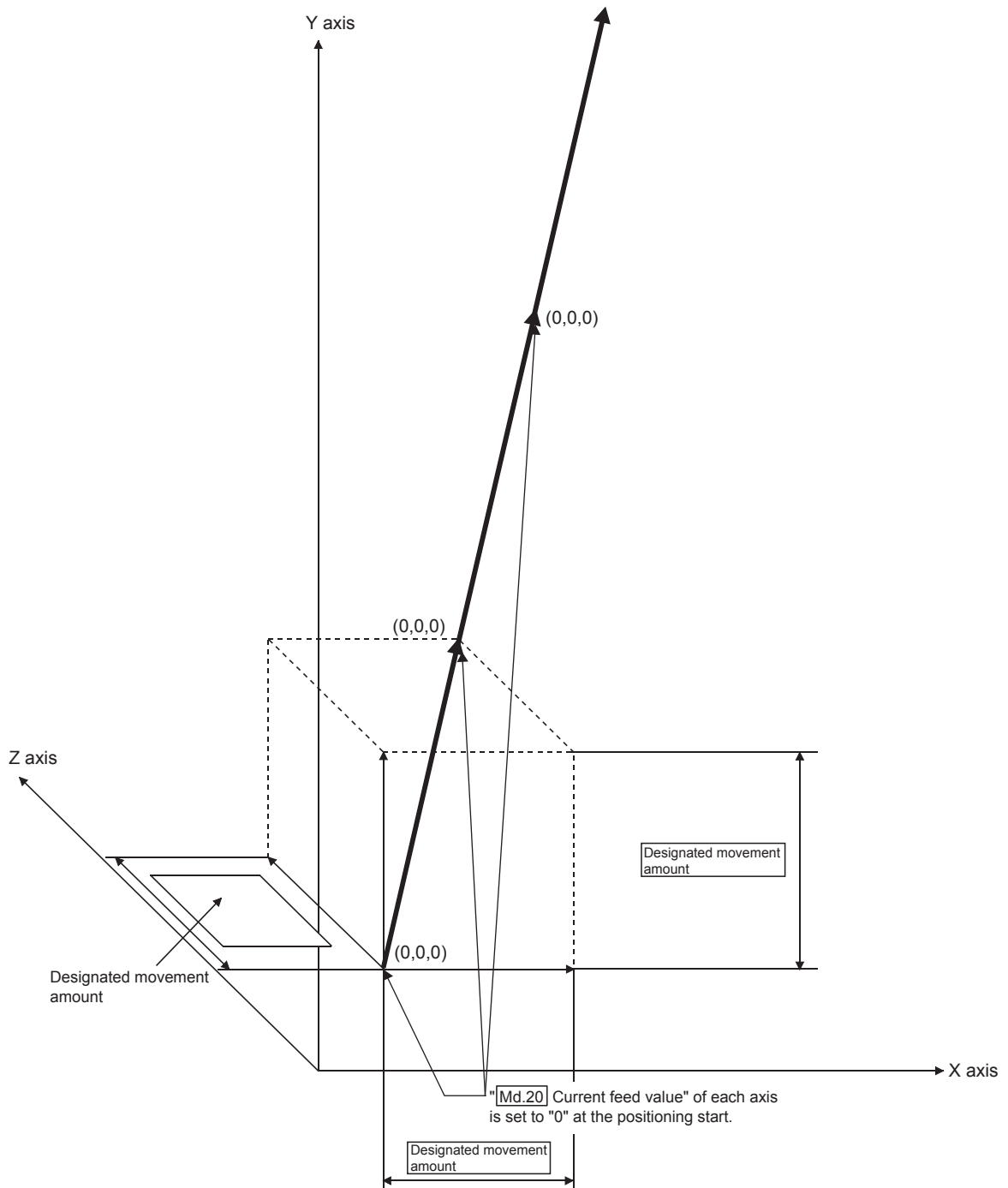

**■ Restrictions**

- (1) An axis error "Continuous path control not possible" (error code: 516) will occur and the operation cannot start if "continuous path control" is set in "Da.1 Operation pattern". ("Continuous path control" cannot be set in fixed-feed control.)
- (2) If the movement amount of each axis exceeds "1073741824 (=2<sup>30</sup>)" when "0: Composite speed" is set in "Pr.20 Interpolation speed designation method", the error "Outside linear movement amount range" (error code: 504) occurs at a positioning start and positioning cannot be started. (The maximum movement amount that can be set in "Da.6 Positioning address/movement amount" is "1073741824 (= 2<sup>30</sup>)".)
- (3) "Fixed-feed" cannot be set in "Da.2 Control system" in the positioning data when "continuous path control" has been set in "Da.1 Operation pattern" of the immediately prior positioning data. (For example, if the operation pattern of positioning data No. 1 is "continuous path control", fixed-feed control cannot be set in positioning data No. 2.) An axis error "Continuous path control not possible" (error code: 516) will occur and the machine will carry out a deceleration stop if this type of setting is carried out.

**■ Positioning data setting example**

[Reference axis is designated as axis 1.]

The following table shows setting examples when "3-axis fixed-feed control (fixed-feed 3)" is set in positioning data No. 1 of axis 1. (The required values are also set in positioning data No. 1 of axis 2 and axis 3.)

Setting item		Axis			Setting details	
		Axis 1 (reference axis) setting example	Axis 2 (interpolation axis) setting example	Axis 3 (interpolation axis) setting example		
Axis 1 Positioning data No. 1	Da.1	Operation pattern	Positioning complete	–	–	Set "Positioning complete" assuming the next positioning data will not be executed.
	Da.2	Control system	Fixed-feed 3	–	–	Set 3-axis fixed-feed control.
	Da.3	Acceleration time No.	1	–	–	Designate the value set in " Pr.25 Acceleration time 1" as the acceleration time at start.
	Da.4	Deceleration time No.	0	–	–	Designate the value set in " Pr.10 Deceleration time 0" as the deceleration time at deceleration.
	Da.5	Axis to be interpolated	–	–	–	Setting not required (setting value will be ignored). When axis 1 is used as a reference axis, the interpolation axes are axes 2 and 3.
	Da.6	Positioning address/movement amount	10000.0μm	5000.0μm	6000.0μm	Set the positioning address. (Assuming "mm" is set in " Pr.1 Unit setting".)
	Da.7	Arc address	–	–	–	Setting not required (setting value will be ignored).
	Da.8	Command speed	6000.00 mm/min	–	–	Set the speed during movement.
	Da.9	Dwell time	500ms	–	–	Set the time the machine dwells after the positioning stop (pulse output stop) to the output of the positioning complete signal.
	Da.10	M code	10	–	–	Set this when other sub operation commands are issued in combination with the No. 1 positioning data.

\* Refer to Section 5.3 "List of positioning data" for information on the setting details.

**POINTS**

- (1) When the movement amount is converted to the actual number of output pulses, a fraction appears after the decimal point, according to the movement amount per pulse. This fraction is normally retained in the QD75 and reflected at the next positioning.  
 For the fixed-feed control, since the movement distance is maintained constant (= the output number of pulses is maintained constant), the control is carried out after the fractional pulse is cleared to zero at start.

**【Accumulation/cutoff for fractional pulses】**

When movement amount per pulse is  $1.0\mu\text{m}$  and movement for  $2.5\mu\text{m}$  is executed two times;

⇒ Conversion to output pulses:  $2.5[\mu\text{m}] \div 1.0 = 2.5$  pulses

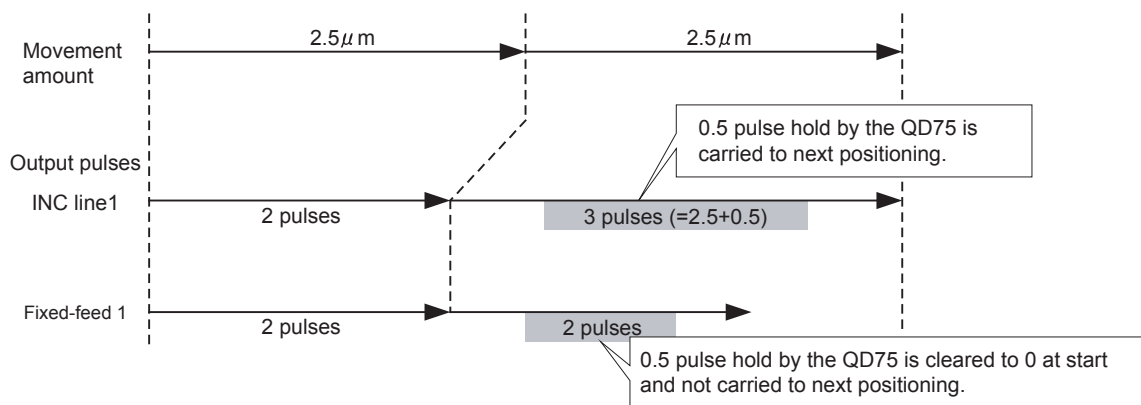

- (2) When the "reference axis speed" is set during 3-axis fixed-feed control, set so the major axis side becomes the reference axis. If the minor axis side is set as the reference axis, the major axis side speed may exceed the " Pr.8 Speed limit value".
- (3) Refer to Section 9.1.6 "Interpolation control" for the reference axis and interpolation axis combinations.

### 9.2.9 4-axis fixed-feed control (interpolation)

In "4-axis fixed-feed control" (" [Da.2](#) Control system" = fixed-feed 4), four motors are used to carry out fixed-feed control in a linear path while carrying out interpolation for the axis directions set in each axis.

In fixed-feed control, any remainder of the movement amount designated in the positioning data is rounded down if less than that required for control accuracy to output the same amount of pulses.

(Refer to Section 9.1.6 "Interpolation control" for details on interpolation control.)

#### ■ Operation chart

In incremental system 4-axis fixed-feed control, the addresses ([Md.20](#) Current feed value) of the current stop position (start addresses) of every axes are set to "0". Linear interpolation positioning is then carried out from that position to a position at the end of the movement amount set in " [Da.6](#) Positioning address/movement amount". The movement direction is determined by the sign of the movement amount.

#### ■ Restrictions

- (1) An axis error "Continuous path control not possible" (error code: 516) will occur and the operation cannot start if "continuous path control" is set in " [Da.1](#) Operation pattern". ("Continuous path control" cannot be set in fixed-feed control.)
- (2) For 4-axis fixed-feed control, set "1: Reference axis speed" in " [Pr.20](#) Interpolation speed designation method". An error "Interpolation mode error" (error code: 523) will occur and the operation cannot start if "0: Composite speed" is set.
- (3) "Fixed-feed" cannot be set in " [Da.2](#) Control system" in the positioning data when "continuous path control" has been set in " [Da.1](#) Operation pattern" of the immediately prior positioning data. (For example, if the operation pattern of positioning data No. 1 is "continuous path control", fixed-feed control cannot be set in positioning data No. 2.) An axis error "Continuous path control not possible" (error code: 516) will occur and the machine will carry out a deceleration stop if this type of setting is carried out.

■ Positioning data setting example

[Reference axis is designated as axis 1.]

The following table shows setting examples when "4-axis fixed-feed control (fixed-feed 4)" is set in positioning data No. 1 of axis 1. (The required values are also set in positioning data No. 1 of axis 2, axis 3 and axis 4.)

Setting item		Axis	Axis 1 (reference axis) setting example	Axis 2 (interpolation axis) setting example	Axis 3 (interpolation axis) setting example	Axis 4 (interpolation axis) setting example	Setting details
Axis 1 Positioning data No. 1	Da.1	Operation pattern	Positioning complete	–	–	–	Set "Positioning complete" assuming the next positioning data will not be executed.
	Da.2	Control system	Fixed-feed 4	–	–	–	Set 4-axis fixed-feed control.
	Da.3	Acceleration time No.	1	–	–	–	Designate the value set in " Pr.25 Acceleration time 1" as the acceleration time at start.
	Da.4	Deceleration time No.	0	–	–	–	Designate the value set in " Pr.10 Deceleration time 0" as the deceleration time at deceleration.
	Da.5	Axis to be interpolated	–	–	–	–	Setting not required (setting value will be ignored). When axis 1 is used as a reference axis, the interpolation axes are axes 2, 3 and 4.
	Da.6	Positioning address/movement amount	4000.0μm	8000.0μm	4000.0μm	3000.0μm	Set the positioning address. (Assuming "mm" is set in " Pr.1 Unit setting".)
	Da.7	Arc address	–	–	–	–	Setting not required (setting value will be ignored).
	Da.8	Command speed	6000.00 mm/min	–	–	–	Set the speed during movement.
	Da.9	Dwell time	500ms	–	–	–	Set the time the machine dwells after the positioning stop (pulse output stop) to the output of the positioning complete signal.
	Da.10	M code	10	–	–	–	Set this when other sub operation commands are issued in combination with the No. 1 positioning data.

\* Refer to Section 5.3 "List of positioning data" for information on the setting details.



**POINTS**

- (1) When the movement amount is converted to the actual number of output pulses, a fraction appears after the decimal point, according to the movement amount per pulse. This fraction is normally retained in the QD75 and reflected at the next positioning. For the fixed-feed control, since the movement distance is maintained constant (= the output number of pulses is maintained constant), the control is carried out after the fractional pulse is cleared to zero at start.

**【Accumulation/cutoff for fractional pulses】**

When movement amount per pulse is  $1.0\mu\text{m}$  and movement for  $2.5\mu\text{m}$  is executed two times;

⇒ Conversion to output pulses:  $2.5[\mu\text{m}] \div 1.0 = 2.5$  pulses

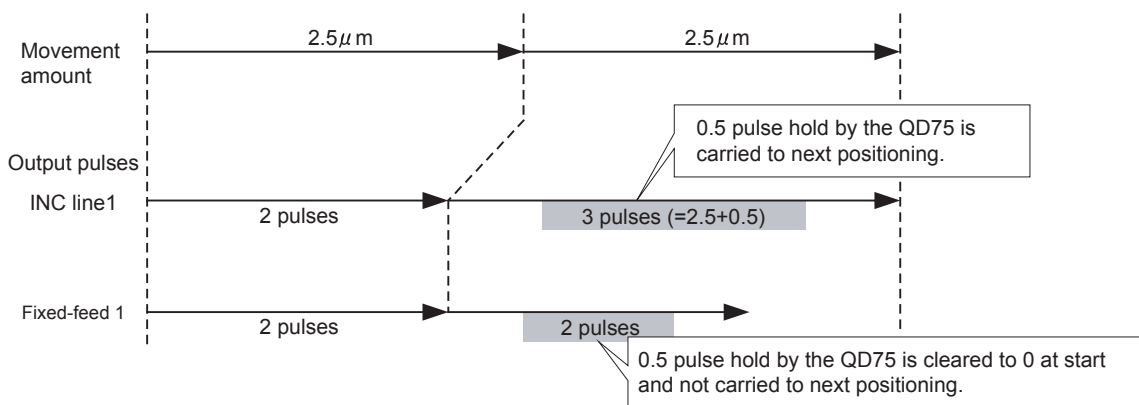

- (2) For 4-axis fixed-feed control, set the "reference axis speed" and make setting so that the major axis side becomes the reference axis. If the minor axis side is set as the reference axis, the major axis side speed may exceed the " Pr.8 Speed limit value".
- (3) Refer to Section 9.1.6 "Interpolation control" for the reference axis and interpolation axis combinations.

9.2.10 2-axis circular interpolation control with sub point designation

In "2-axis circular interpolation control" (" [Da.2] Control system" = ABS circular sub, INC circular sub), two motors are used to carry out position control in an arc path passing through designated sub points, while carrying out interpolation for the axis directions set in each axis.

(Refer to Section 9.1.6 "Interpolation control" for details on interpolation control.)

[1] 2-axis circular interpolation control with sub point designation (ABS circular sub)

■ Operation chart

In the absolute system, 2-axis circular interpolation control with sub point designation, positioning is carried out from the current stop position (start point address) to the address (end point address) set in " [Da.6] Positioning address/movement amount", in an arc path that passes through the sub point address set in " [Da.7] Arc address".

The resulting control path is an arc having as its center the intersection point of perpendicular bisectors of a straight line between the start point address (current stop position) and sub point address (arc address), and a straight line between the sub point address (arc address) and end point address (positioning address).

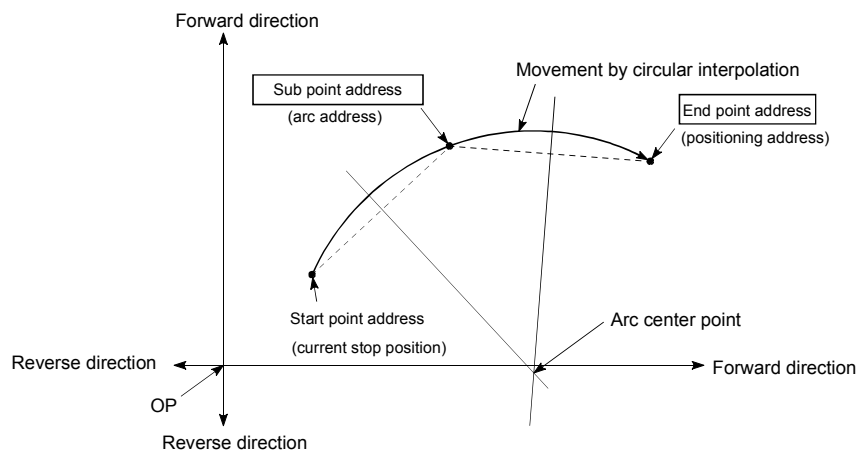

**■ Restrictions**

- (1) 2-axis circular interpolation control cannot be set in the following cases.
  - When "degree" is set in " **Pr.1** Unit setting"
  - When the units set in " **Pr.1** Unit setting" are different for the reference axis and interpolation axis. ("mm" and "inch" combinations are possible.)
  - When "reference axis speed" is set in " **Pr.20** Interpolation speed designation method"
- (2) An error will occur and the positioning start will not be possible in the following cases. The machine will immediately stop if the error is detected during positioning control.
  - When the radius exceeds "536870912 ( $=2^{29}$ )". (The maximum radius for which circular interpolation control is possible is "536870912 ( $=2^{29}$ )"
    - ... An error "Outside radius range" (error code: 544) will occur at positioning start.
  - When the center point address is outside the range of " $-2^{31}$  to  $2^{31}-1$ "
    - ... An error "Sub point setting error" (error code: 525) will occur at positioning start.
  - When the start point address is the same as the end point address
    - ... An error "End point setting error" (error code: 526) will occur.
  - When the start point address is the same as the sub point address
    - ... An error "Sub point setting error" (error code: 525) will occur.
  - When the end point address is the same as the sub point address
    - ... An error "Sub point setting error" (error code: 525) will occur.
  - When the start point address, sub point address, and end point address are in a straight line
    - ... An error "Sub point setting error" (error code: 525) will occur.

■ Positioning data setting example

[Reference axis and interpolation axis are designated as axis 1 and axis 2, respectively.]

The following table shows setting examples when "2-axis circular interpolation control with sub point designation (ABS circular sub)" is set in positioning data No. 1 of axis 1. (The required values are also set in positioning data No. 1 of axis 2.)

Setting item		Axis		Setting details	
		Axis 1 (reference axis) setting example	Axis 2 (interpolation axis) setting example		
Axis 1 Positioning data No. 1	Da.1	Operation pattern	Positioning complete	–	Set "Positioning complete" assuming the next positioning data will not be executed.
	Da.2	Control system	ABS circular sub	–	Set absolute system, 2-axis circular interpolation control with sub point designation.
	Da.3	Acceleration time No.	1	–	Designate the value set in " Pr.25 Acceleration time 1" as the acceleration time at start.
	Da.4	Deceleration time No.	0	–	Designate the value set in " Pr.10 Deceleration time 0" as the deceleration time at deceleration.
	Da.5	Axis to be interpolated	Axis 2	–	Set the axis to be interpolated (partner axis). If the self-axis is set, an error will occur.
	Da.6	Positioning address/movement amount	8000.0μm	6000.0μm	Set the positioning address. (Assuming "mm" is set in " Pr.1 Unit setting".)
	Da.7	Arc address	4000.0μm	3000.0μm	Set the sub point address. (Assuming that the " Pr.1 Unit setting" is set to "mm".)
	Da.8	Command speed	6000.00 mm/min	–	Set the speed when moving to the end point address. (Designate the composite speed in " Pr.20 Interpolation speed designation method".)
	Da.9	Dwell time	500ms	–	Set the time the machine dwells after the positioning stop (pulse output stop) to the output of the positioning complete signal.
	Da.10	M code	10	–	Set this when other sub operation commands are issued in combination with the No. 1 positioning data.

\* Refer to Section 5.3 "List of positioning data" for information on the setting details.

<b>POINT</b>
Set a value in " Da.8 Command speed" so that the speed of each axis does not exceed the " Pr.8 Speed limit value". (The speed limit does not function for the speed calculated by the QD75 during interpolation control.)

[2] 2-axis circular interpolation control with sub point designation (INC circular sub)

■ Operation chart

In the incremental system, 2-axis circular interpolation control with sub point designation, positioning is carried out from the current stop position (start point address) to a position at the end of the movement amount set in " Da.6 Positioning address/movement amount" in an arc path that passes through the sub point address set in " Da.7 Arc address". The movement direction depends on the sign (+ or -) of the movement amount.

The resulting control path is an arc having as its center the intersection point of perpendicular bisectors of the straight line between the start point address (current stop position) and sub point address (arc address) calculated from the movement amount to the sub point, and a straight line between the sub point address (arc address) and end point address (positioning address) calculated from the movement amount to the end point.

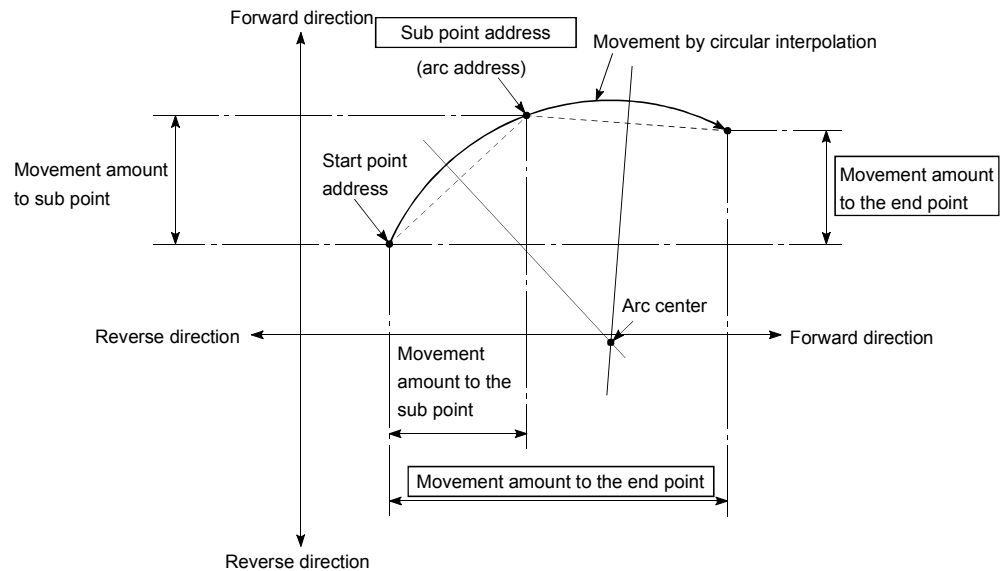

**■ Restrictions**

- (1) 2-axis circular interpolation control cannot be set in the following cases.
  - When "degree" is set in " **Pr.1** Unit setting"
  - When the units set in " **Pr.1** Unit setting" are different for the reference axis and interpolation axis. ("mm" and "inch" combinations are possible.)
  - When "reference axis speed" is set in " **Pr.20** Interpolation speed designation method"
- (2) An error will occur and the positioning start will not be possible in the following cases. The machine will immediately stop if the error is detected during positioning control.
  - When the radius exceeds "536870912 ( $=2^{29}$ )". (The maximum radius for which circular interpolation control is possible is "536870912 ( $=2^{29}$ )"
    - ... An error "Outside radius range" (error code: 544) will occur at positioning start.
  - When the auxiliary point address is outside the range of -2147483648 ( $-2^{31}$ ) to 2147483647 ( $2^{31}-1$ ).
    - ... An error "Sub point setting error" (error code: 525) will occur.
  - When the end point address is outside the range of -2147483648 ( $-2^{31}$ ) to 2147483647 ( $2^{31}-1$ ).
    - ... An error "End point setting error" (error code: 526) will occur.
  - When the auxiliary point address, center point address is outside the range of "-2147483648 ( $-2^{31}$ ) to 2147483647 ( $2^{31}-1$ )"
    - ... An error "Sub point setting error" (error code: 525) will occur at positioning start.
  - When the start point address is the same as the end point address
    - ... An error "End point setting error" (error code: 526) will occur.
  - When the start point address is the same as the sub point address
    - ... An error "Sub point setting error" (error code: 525) will occur.
  - When the end point address is the same as the sub point address
    - ... An error "Sub point setting error" (error code: 525) will occur.
  - When the start point address, sub point address, and end point address are in a straight line
    - ... An error "Sub point setting error" (error code: 525) will occur.

■ Positioning data setting example

[Reference axis and interpolation axis are designated as axis 1 and axis 2, respectively.]

The following table shows setting examples when "2-axis circular interpolation control with sub point designation (INC circular sub)" is set in positioning data No. 1 of axis 1. (The required values are also set in positioning data No. 1 of axis 2.)

Setting item		Axis	Axis 1 (reference axis) setting example	Axis 2 (interpolation axis) setting example	Setting details
Axis 1 Positioning data No. 1	Da.1	Operation pattern	Positioning complete	–	Set "Positioning complete" assuming the next positioning data will not be executed.
	Da.2	Control system	INC circular sub	–	Set incremental system, 2-axis circular interpolation control with sub point designation.
	Da.3	Acceleration time No.	1	–	Designate the value set in " Pr.25 Acceleration time 1" as the acceleration time at start.
	Da.4	Deceleration time No.	0	–	Designate the value set in " Pr.10 Deceleration time 0" as the deceleration time at deceleration.
	Da.5	Axis to be interpolated	Axis 2	–	Set the axis to be interpolated (partner axis). If the self-axis is set, an error will occur.
	Da.6	Positioning address/movement amount	8000.0μm	6000.0μm	Set the movement amount. (Assuming that the " Pr.1 Unit setting" is set to "mm".)
	Da.7	Arc address	4000.0μm	-3000.0μm	Set the sub point address. (Assuming that the " Pr.1 Unit setting" is set to "mm".)
	Da.8	Command speed	6000.00 mm/min	–	Set the speed during movement. (Designate the composite speed in " Pr.20 Interpolation speed designation method".)
	Da.9	Dwell time	500ms	–	Set the time the machine dwells after the positioning stop (pulse output stop) to the output of the positioning complete signal.
	Da.10	M code	10	–	Set this when other sub operation commands are issued in combination with the No. 1 positioning data.

\* Refer to Section 5.3 "List of positioning data" for information on the setting details.

<b>POINT</b>
Set a value in " Da.8 Command speed" so that the speed of each axis does not exceed the " Pr.8 Speed limit value". (The speed limit does not function for the speed calculated by the QD75 during interpolation control.)

9.2.11 2-axis circular interpolation control with center point designation

In "2-axis circular interpolation control" (" Da.2 Control system" = ABS circular right, INC circular right, ABS circular left, INC circular left), two motors are used to carry out position control in an arc path having an arc address as a center point, while carrying out interpolation for the axis directions set in each axis.  
 (Refer to Section 9.1.6 "Interpolation control" for details on interpolation control.)

The following table shows the rotation directions, arc center angles that can be controlled, and positioning paths for the different control systems.

Control system	Rotation direction	Arc center angle that can be controlled	Positioning path
ABS circular right	Clockwise	$0^\circ < \theta \leq 360^\circ$	
INC circular right			
ABS circular left	Counterclockwise		
INC circular left			



### ■ Circular interpolation error compensation

In circular interpolation control with center point designation, the arc path calculated from the start point address and center point address may deviate from the position of the end point address set in " [Da.6] Positioning address/movement amount".

(Refer to " [Pr.41] Allowable circular interpolation error width".)

- (1) Calculated error  $\leq$  " [Pr.41] Allowable circular interpolation error width"  
Circular interpolation control to the set end point address is carried out while the error compensation is carried out. (This is called "spiral interpolation".)

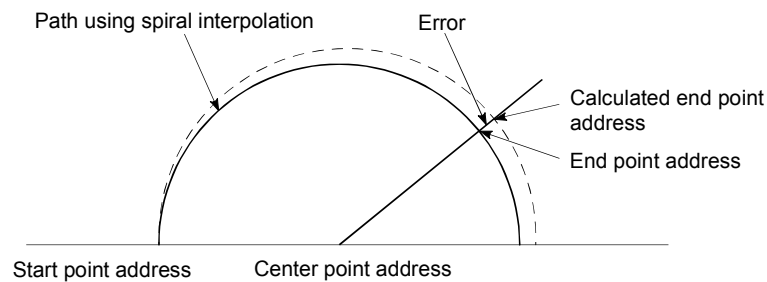

In circular interpolation control with center point designation, an angular velocity is calculated on the assumption that operation is carried out at a command speed on the arc using the radius calculated from the start point address and center point address, and the radius is compensated in proportion to the angular velocity deviated from that at the start point.

Thus, when there is a difference (error) between a radius calculated from the start point address and center point address (start point radius) and a radius calculated from the end point address and center point address (end point radius), the composite speed differs from the command speed as follows.

- \* Start point radius > End point radius: As compared with the speed without error, the speed becomes slower as end point address is reached.
- \* Start point radius < End point radius: As compared with the speed without error, the speed becomes faster as end point address is reached.

- (2) Calculated error > " [Pr.41] Allowable circular interpolation error width"  
At the positioning start, an error "Large arc error deviation" (error code: 506) will occur and the control will not start. The machine will immediately stop if the error is detected during positioning control.

[1] 2-axis circular interpolation control with center point designation  
(ABS circular right, ABS circular left)

■ Operation chart

In the absolute system, 2-axis circular interpolation control with center point designation, positioning is carried out from the current stop position (start point address) to the address (end point address) set in " [Da.6] Positioning address/movement amount" in an arc path having as its center the address (arc address) of the center point set in " [Da.7] Arc address".

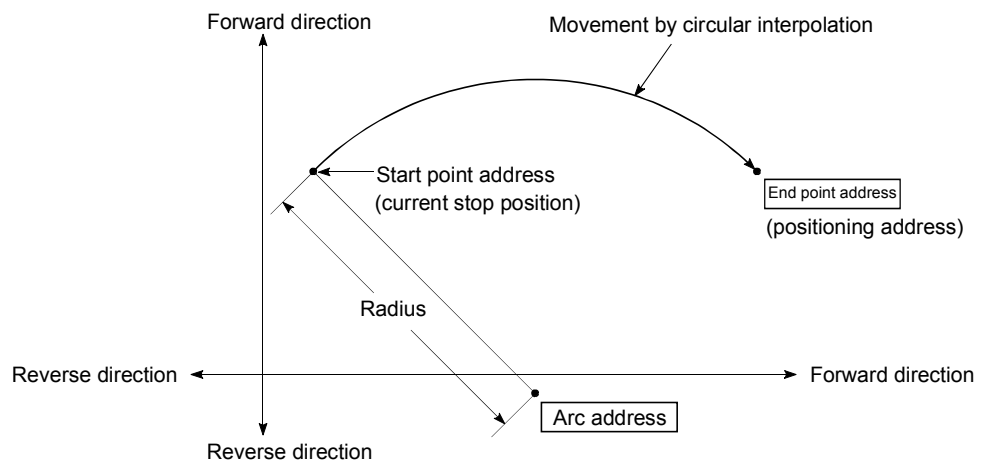

Positioning of a complete round with a radius from the start point address to the arc center point can be carried out by setting the end point address (positioning address) to the same address as the start point address.

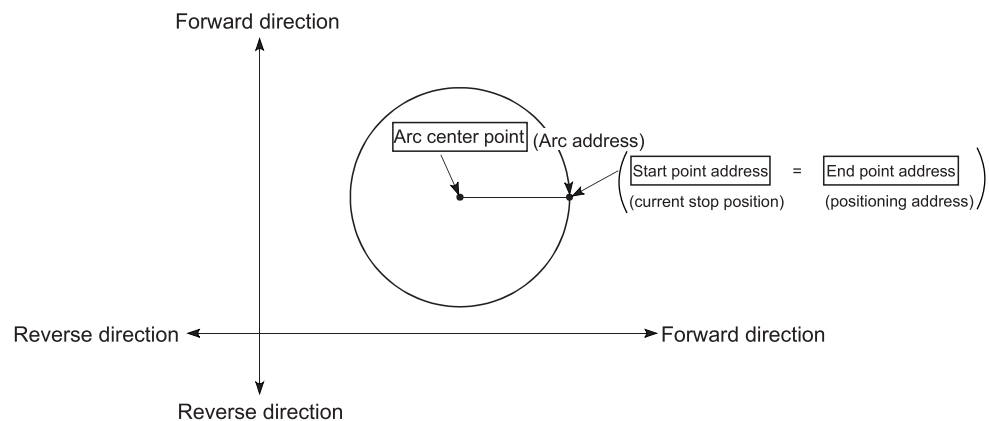

In circular interpolation control with center point designation, an angular velocity is calculated on the assumption that operation is carried out at a command speed on the arc using the radius calculated from the start point address and center point address, and the radius is compensated in proportion to the angular velocity deviated from that at the start point.

Thus, when there is a difference (error) between a radius calculated from the start point address and center point address (start point radius) and a radius calculated from the end point address and center point address (end point radius), the composite speed differs from the command speed as follows.

- \* Start point radius > End point radius: As compared with the speed without error, the speed becomes slower as end point address is reached.
- \* Start point radius < End point radius: As compared with the speed without error, the speed becomes faster as end point address is reached.

#### ■ Restrictions

- (1) 2-axis circular interpolation control cannot be set in the following cases.
  - When "degree" is set in " Pr.1 Unit setting"
  - When the units set in " Pr.1 Unit setting" are different for the reference axis and interpolation axis. ("mm" and "inch" combinations are possible.)
  - When "reference axis speed" is set in " Pr.20 Interpolation speed designation method"
- (2) An error will occur and the positioning start will not be possible in the following cases. The machine will immediately stop if the error is detected during positioning control.
  - When the radius exceeds "536870912 ( $=2^{29}$ )". (The maximum radius for which circular interpolation control is possible is "536870912 ( $=2^{29}$ )"  
... An error "Outside radius range " (error code: 544) will occur at positioning start.
  - When the start point address is the same as the center point address  
... An error "Center point setting error" (error code: 527) will occur.
  - When the end point address is the same as the center point address  
... An error "Center point setting error" (error code: 527) will occur.
  - When the center point address is outside the range of  $-2147483648(-2^{31})$  to  $2147483647(2^{31}-1)$   
... An error "Center point setting error" (error code: 527) will occur.

■ Positioning data setting examples

[Reference axis and interpolation axis are designated as axis 1 and axis 2, respectively.]

The following table shows setting examples when "2-axis circular interpolation control with center point designation (ABS right arc, ABS left arc)" is set in positioning data No. 1 of axis 1. (The required values are also set in positioning data No. 1 of axis 2.)

Setting item		Axis	Axis 1 (reference axis) setting example	Axis 2 (interpolation axis) setting example	Setting details
Axis 1 Positioning data No. 1	Da.1	Operation pattern	Positioning complete	–	Set "Positioning complete" assuming the next positioning data will not be executed.
	Da.2	Control system	ABS circular right ABS circular left	–	Set absolute system, 2-axis circular interpolation control with center point designation. (Select clockwise or counterclockwise according to the control.)
	Da.3	Acceleration time No.	1	–	Designate the value set in " Pr.25 Acceleration time 1" as the acceleration time at start.
	Da.4	Deceleration time No.	0	–	Designate the value set in " Pr.10 Deceleration time 0" as the deceleration time at deceleration.
	Da.5	Axis to be interpolated	Axis 2	–	Set the axis to be interpolated (partner axis). If the self-axis is set, an error will occur.
	Da.6	Positioning address/movement amount	8000.0μm	6000.0μm	Set the positioning address. (Assuming "mm" is set in " Pr.1 Unit setting".)
	Da.7	Arc address	4000.0μm	3000.0μm	Set the arc address. (Assuming that the " Pr.1 Unit setting" is set to "mm".)
	Da.8	Command speed	6000.00 mm/min	–	Set the speed when moving to the end point address. (Designate the composite speed in " Pr.20 Interpolation speed designation method".)
	Da.9	Dwell time	500ms	–	Set the time the machine dwells after the positioning stop (pulse output stop) to the output of the positioning complete signal.
	Da.10	M code	10	–	Set this when other sub operation commands are issued in combination with the No. 1 positioning data.

\* Refer to Section 5.3 "List of positioning data" for information on the setting details.

<b>POINT</b>
Set a value in " Da.8 Command speed" so that the speed of each axis does not exceed the " Pr.8 Speed limit value". (The speed limit does not function for the speed calculated by the QD75 during interpolation control.)

[2] 2-axis circular interpolation control with center point designation (INC circular right, INC circular left)

■ Operation chart

In the incremental system, 2-axis circular interpolation control with center point designation, positioning is carried out from the current stop position (start point address) to a position at the end of the movement amount set in " [Da.6] Positioning address/movement amount" in an arc path having as its center the address (arc address) of the center point set in " [Da.7] Arc address".

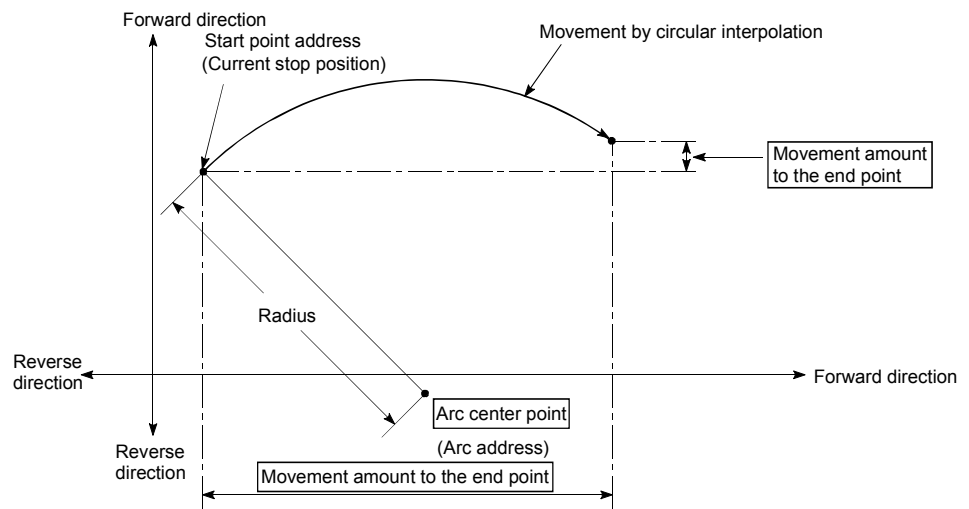

Positioning of a complete round with a radius of the distance from the start point address to the arc center point can be carried out by setting the movement amount to "0".

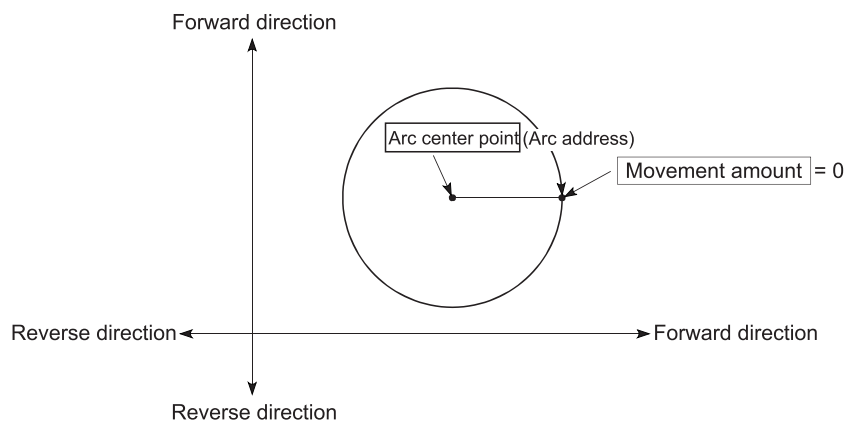

In circular interpolation control with center point designation, an angular velocity is calculated on the assumption that operation is carried out at a command speed on the arc using the radius calculated from the start point address and center point address, and the radius is compensated in proportion to the angular velocity deviated from that at the start point.

Thus, when there is a difference (error) between a radius calculated from the start point address and center point address (start point radius) and a radius calculated from the end point address and center point address (end point radius), the composite speed differs from the command speed as follows.

- \* Start point radius > End point radius: As compared with the speed without error, the speed becomes slower as end point address is reached.
- \* Start point radius < End point radius: As compared with the speed without error, the speed becomes faster as end point address is reached.

### ■ Restrictions

(1) 2-axis circular interpolation control cannot be set in the following cases.

- When "degree" is set in " Pr.1 Unit setting"
- When the units set in " Pr.1 Unit setting" are different for the reference axis and interpolation axis. ("mm" and "inch" combinations are possible.)
- When "reference axis speed" is set in " Pr.20 Interpolation speed designation method"

(2) An error will occur and the positioning start will not be possible in the following cases. The machine will immediately stop if the error is detected during positioning control.

- When the radius exceeds "536870912 (=2<sup>29</sup>)". (The maximum radius for which circular interpolation control is possible is "536870912 (=2<sup>29</sup>)"  
... An error "Outside radius range" (error code: 544) will occur at positioning start.
- When the end point address is outside the range of -2147483648(-2<sup>31</sup>) to 2147483647(2<sup>31</sup>-1)  
... An error "End point setting error" (error code: 526) will occur.
- When the start point address is the same as the center point address  
... An error "Center point setting error" (error code: 527) will occur.
- When the end point address is the same as the center point address  
... An error "Center point setting error" (error code: 527) will occur.
- When the center point address is outside the range of -2147483648(-2<sup>31</sup>) to 2147483647(2<sup>31</sup>-1)  
... An error "Center point setting error" (error code: 527) will occur.

■ Positioning data setting examples

[Reference axis and interpolation axis are designated as axis 1 and axis 2, respectively.]

The following table shows setting examples when "2-axis circular interpolation control with center point designation (INC circular right, INC circular left)" is set in positioning data No. 1 of axis 1. (The required values are also set in positioning data No. 1 of axis 2.)

Setting item		Axis		Setting details	
		Axis 1 (reference axis) setting example	Axis 2 (interpolation axis) setting example		
Axis 1 Positioning data No. 1	Da.1	Operation pattern	Positioning complete	–	Set "Positioning complete" assuming the next positioning data will not be executed.
	Da.2	Control system	INC circular right INC circular left	–	Set incremental system, 2-axis circular interpolation control with center point designation. (Select clockwise or counterclockwise according to the control.)
	Da.3	Acceleration time No.	1	–	Designate the value set in " Pr.25 Acceleration time 1" as the acceleration time at start.
	Da.4	Deceleration time No.	0	–	Designate the value set in " Pr.10 Deceleration time 0" as the deceleration time at deceleration.
	Da.5	Axis to be interpolated	Axis 2	–	Set the axis to be interpolated (partner axis). If the self-axis is set, an error will occur.
	Da.6	Positioning address/movement amount	8000.0μm	6000.0μm	Set the movement amount. (Assuming that the " Pr.1 Unit setting" is set to "mm".)
	Da.7	Arc address	4000.0μm	3000.0μm	Set the center point address. (Assuming that the " Pr.1 Unit setting" is set to "mm".)
	Da.8	Command speed	6000.00 mm/min	–	Set the speed when moving to the end point address. (Designate the composite speed in " Pr.20 Interpolation speed designation method".)
	Da.9	Dwell time	500ms	–	Set the time the machine dwells after the positioning stop (pulse output stop) to the output of the positioning complete signal.
	Da.10	M code	10	–	Set this when other sub operation commands are issued in combination with the No. 1 positioning data.

\* Refer to Section 5.3 "List of positioning data" for information on the setting details.

<b>POINT</b>
Set a value in " Da.8 Command speed" so that the speed of each axis does not exceed the " Pr.8 Speed limit value". (The speed limit does not function for the speed calculated by the QD75 during interpolation control.)

9.2.12 3-axis helical interpolation control with sub point designation

In the 3-axis helical interpolation control, circular interpolation control is carried out with two of the three axes. The other axis tracks the movement of the circular interpolation control to carry out "helical control" or "tangential control". (\* Refer to Section 9.1.6 "Interpolation control" for interpolation control.)

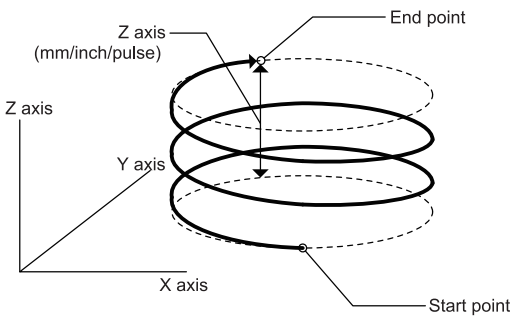
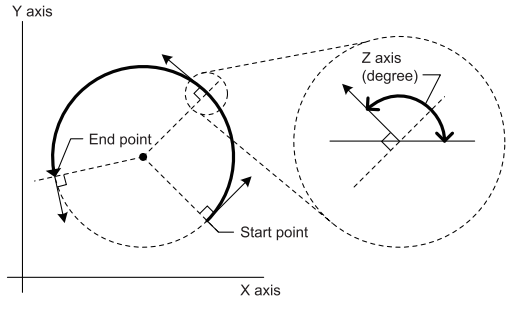
Control details	Outline of control	Positioning path
<p>Helical control</p>		<p>In this control, the linear interpolation axis (linear control) tracks the movement of circular interpolation control, and a helical path is drawn.</p> <p>■ Unit setting</p> <ul style="list-style-type: none"> <li>• Reference axis: mm/inch, pulse</li> <li>• Circular interpolation axis: Same setting as the one for the reference axis</li> <li>• Linear interpolation axis: mm/inch, pulse</li> </ul>
<p>Tangential control</p>		<p>In this control, the value of the linear interpolation axis (degree) changes according to the movement of circular interpolation control to keep the direction of a workpiece to the center point of the circular interpolation control. The figure on the left shows an example of the control that keeps the direction of the workpiece in the tangential direction.</p> <p>■ Unit setting</p> <ul style="list-style-type: none"> <li>• Reference axis: mm/inch, pulse</li> <li>• Circular interpolation axis: Same setting as the one for the reference axis</li> <li>• Linear interpolation axis: degree</li> </ul>

X-axis: Reference axis, Y-axis: Circular interpolation axis, Z-axis: Linear interpolation axis

■ Helical interpolation control speed

The command speed of the 3-axis helical interpolation control is the same as the speed of circular interpolation control (composite speed of reference axis and circular interpolation axis).

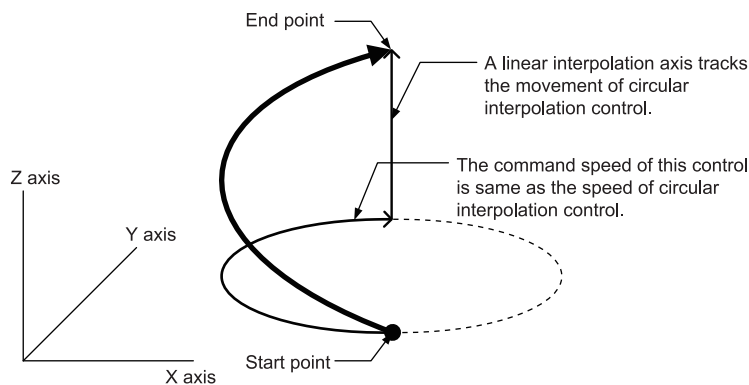



<b>POINT</b>
<p>When "0: Composite speed" is set in "[Pr.20] Interpolation speed designation method", the command speed of ABS3/INC3 is the same as the composite speed of the 3 axes (x axis - y axis - z axis). The command speed of 3-axis helical interpolation control is the same as the composite speed of the circular interpolation axis (x axis - y axis). When continuous path control is carried out in ABS3/INC3 and 3-axis helical interpolation control, adjust the command speed to prevent the workpiece from moving unsteadily because the workpiece movement speed may change when positioning data is switched.</p>

■ Rotation angle of the circular interpolation axis (X axis - Y axis)

The following shows the rotation angle of the circular interpolation axis in 3-axis helical interpolation control.

Number of pitch	Circular interpolation axis control	
	Y axis	
0	$\theta^\circ$	
1	$360^\circ + \theta^\circ$	
2	$720^\circ + \theta^\circ$	
to	to	
n	$360^\circ \times n + \theta^\circ$	
to	to	
999	$360^\circ \times 999 + \theta^\circ$	

<b>POINT</b>
<p>When "degree" is set for the unit setting in the absolute system, the positioning range is 0 to 359.99999°. When the axis rotates 360° or more in circular interpolation control (x axis - y axis), the tangential/normal control cannot be carried out because a degree of 360° or more cannot be set in linear control (z axis: degree). To carry out tangential/normal control in which the axis rotates 360° or more, use 3-axis helical interpolation control (INC).</p>

■ Rotation direction when the unit for the linear axis (z axis) is degree

When "[Pr.1] Unit setting" for the linear axis is "degree", the rotation direction is determined according to the axis control data "[Cd.40] ABS direction in degrees" of the reference axis. To set the rotation direction for each positioning data, set the position data "[Da.28] ABS direction in degrees".

### [1] 3-axis helical interpolation control with sub point designation (ABS helical sub)

#### ■ Operation chart

In this control, positioning is carried out from the current stop position (X0, Y0, Z0) to the circular end address (X1, Y1) and linear axis end address (Z1) set in "[Da.6] Positioning address/movement amount". Circular interpolation where the arc path passes through the address of the sub point (sub point address) set in "[Da.7] Arc address" is carried out. Simultaneously, linear interpolation is carried out with the other linear axis. The control path is helically rotated for the number of pitch set in "[Da.10] M code" of the linear axis to complete the positioning to the specified position.

The resulting control path is an arc having its center as the intersection point of perpendicular bisectors of a straight line between the start point address (current stop position) and sub point address (arc address), and a straight line between the sub point address (arc address) and end point address (positioning address).

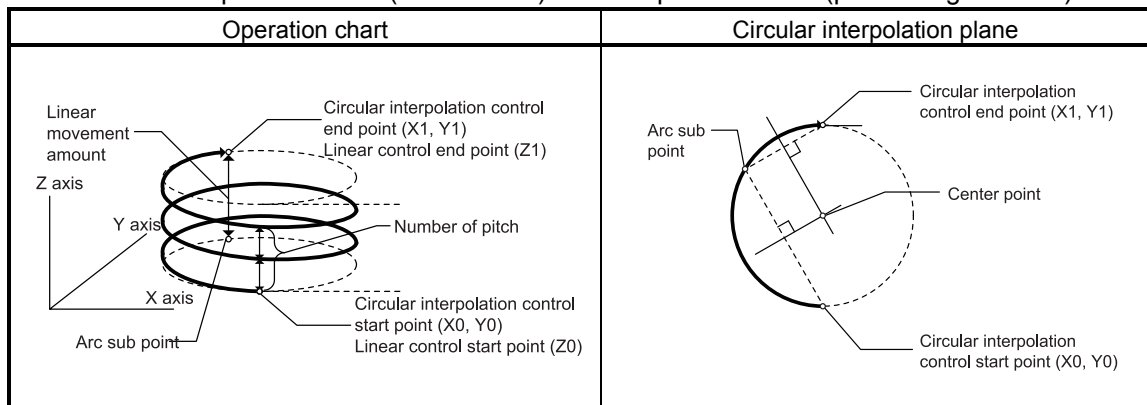

#### ■ Restrictions

(1) In the following cases, 3-axis helical interpolation control cannot be set.

- When "degree" is set in "[Pr.1] Unit setting" for the reference axis and circular interpolation axis
- When the units set in "[Pr.1] Unit setting" are different between the reference axis and circular interpolation axis. ("mm" and "inch" combinations are possible.)
- When a method other than "composite speed" is set in "[Pr.20] Interpolation speed designation method" or "[Da.29] Interpolation speed designation method"

- (2) An error will occur and the positioning start will not be possible in the following cases. The machine will immediately stop if the error is detected during positioning control.
- When the radius exceeds "536870912 ( $=2^{29}$ )"  
(The maximum radius for which circular interpolation control is possible is "536870912 ( $=2^{29}$ )".)  
... An error "Outside radius range" (error code: 544) will occur at positioning start.
  - When the center point address is outside the range of "-2147483648 ( $-2^{31}$ ) to 2147483647 ( $2^{31}-1$ )"  
... An error "Sub point setting error" (error code: 525) will occur at positioning start.
  - Start point address = End point address  
... Error "End point setting error" (error code: 526)
  - Start point address = Sub point address  
... Error "Sub point setting error" (error code: 525)
  - End point address = Sub point address  
... Error "Sub point setting error" (error code: 525)
  - When the start point address, end point address, and sub point address are in a straight line  
... Error "Sub point setting error" (error code: 525)

■ Positioning data setting example

[Reference axis, circular interpolation axis, and linear interpolation axis are specified as axis 1, axis 2, and axis 3, respectively.]

The following table shows setting examples when "helical interpolation control with sub point designation (ABS)" is set in positioning data No. 1 of axis 1.

(The required values are also set in positioning data No. 1 of axis 2 and axis 3.)

Item	Axis		Axis 1 (reference axis) setting example	Axis 2 (circular interpolation axis) setting example	Axis 3 (linear interpolation axis) setting example	Setting details
Positioning data No. 1	Da.1	Operation pattern	Positioning complete	-	-	Set "Positioning complete" assuming that the next positioning data will not be executed.
	Da.2	Control system	ABS helical sub	-	-	Set absolute system, 3-axis helical interpolation control with sub point designation.
	Da.3	Acceleration time No.	1	-	-	Specify the value set in "Pr.25" Acceleration time 1" as the acceleration time at start.
	Da.4	Deceleration time No.	0	-	-	Specify the value set in "Pr.10" Deceleration time 0" as the deceleration time at deceleration.
	Da.5	Axis to be interpolated	Axis 2	-	-	Set the axis to be interpolated (partner axis). If the self-axis is set, an error will occur.
	Da.6	Positioning address/movement amount	8000.0μm	6000.0μm	3000.0μm	Set the end point address. (Assuming "mm" is set in "Pr.1" Unit setting".)
	Da.7	Arc address	4000.0μm	3000.0μm	-	Set the sub point address. (Assuming "mm" is set in "Pr.1" Unit setting".)
	Da.8	Command speed	6000.00mm/min	-	-	Set the speed during movement to the end point address. (Set the composite speed in "Pr.20" Interpolation speed designation method".)
	Da.9	Dwell time	500ms	-	-	Set the time the machine dwells from the positioning stop (pulse output stop) to the output of the positioning complete signal.
	Da.10	M code	10	-	50	Set this item when other sub operation commands are issued in combination with the No. 1 positioning data. Set the number of pitch for the linear interpolation axis.

\* Refer to Section 5.3 "List of positioning data" for information on the setting details.

<b>POINT</b>
Set a value in "Da.8" Command speed" so that the speed of each axis does not exceed the "Pr.8" Speed limit value". (The speed limit does not function for the speed calculated by the QD75N during interpolation control.)

## [2] 3-axis helical interpolation control with sub point designation (INC helical sub)

### ■ Operation chart

In this control, positioning is carried out from the current stop position (X0, Y0, Z0) to the movement amount position (X1, Y1, Z1) set in "[Da.6] Positioning address/movement amount". Circular interpolation where the arc path passes through the address of the sub point (sub point address) set in "[Da.7] Arc address" is carried out. Simultaneously, linear interpolation is carried out with the other linear axis. The control path is helically rotated for the number of pitch set in "[Da.10] M code" of the linear axis to complete the positioning to the specified position. The movement direction is determined by the sign of the movement amount.

The resulting control path is an arc having its center as the intersection point of perpendicular bisectors of the straight line between the start point address (current stop position) and sub point address (arc address) calculated from the movement amount to the sub point, and a straight line between the sub point address (arc address) and end point address (positioning address) calculated from the movement amount to the end point.

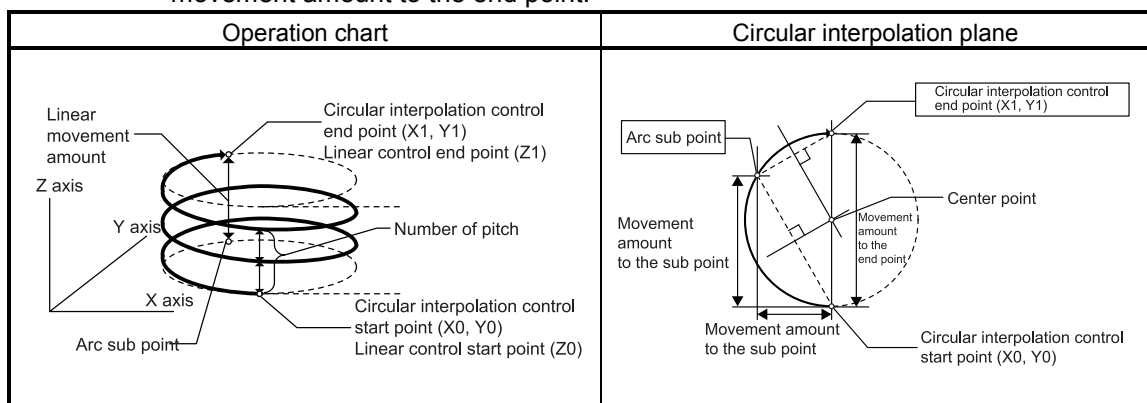

### ■ Restrictions

(1) In the following cases, 3-axis helical interpolation control cannot be set.

- When "degree" is set in "[Pr.1] Unit setting" for the reference axis and circular interpolation axis
- When the units set in "[Pr.1] Unit setting" are different between the reference axis and circular interpolation axis. ("mm" and "inch" combinations are possible.)
- When a method other than "composite speed" is set in "[Pr.20] Interpolation speed designation method" or "[Da.29] Interpolation speed designation method"

- (2) An error will occur and the positioning start will not be possible in the following cases. The machine will immediately stop if the error is detected during positioning control.
- When the radius exceeds "536870912 ( $=2^{29}$ )"  
(The maximum radius for which circular interpolation control is possible is "536870912 ( $=2^{29}$ )".)  
... An error "Outside radius range" (error code: 544) will occur at positioning start.
  - When the sub point address is outside the range of  $-2^{31}$  to  $2^{31}-1$   
... An error "Sub point setting error" (error code: 525) will occur at positioning start.
  - When the end point address is outside the range of  $-2^{31}$  to  $2^{31}-1$   
... An error "End point setting error" (error code: 526) will occur at positioning start.
  - When the center point address is outside the range of  $-2^{31}$  to  $2^{31}-1$   
... An error "Sub point setting error" (error code: 525) will occur at positioning start.
  - Start point address = End point address  
... Error "End point setting error" (error code: 526)
  - Start point address = Sub point address  
... Error "Sub point setting error" (error code: 525)
  - End point address = Sub point address  
... Error "Sub point setting error" (error code: 525)
  - When the start point address, end point address, and sub point address are in a straight line  
... Error "Sub point setting error" (error code: 525)

■ Positioning data setting example

[Reference axis, circular interpolation axis, and linear interpolation axis are specified as axis 1, axis 2, and axis 3, respectively.]

The following table shows setting examples when "helical interpolation control with sub point designation (INC)" is set in positioning data No. 1 of axis 1.

(The required values are also set in positioning data No. 1 of axis 2 and axis 3.)

Item		Axis	Axis 1 (reference axis) setting example	Axis 2 (circular interpolation axis) setting example	Axis 3 (linear interpolation axis) setting example	Setting details
Positioning data No. 1	Da.1	Operation pattern	Positioning complete	-	-	Set "Positioning complete" assuming that the next positioning data will not be executed.
	Da.2	Control system	INC helical sub	-	-	Set incremental system, 3-axis helical interpolation control with sub point designation.
	Da.3	Acceleration time No.	1	-	-	Specify the value set in "[Pr.25] Acceleration time 1" as the acceleration time at start.
	Da.4	Deceleration time No.	0	-	-	Specify the value set in "[Pr.10] Deceleration time 0" as the deceleration time at deceleration.
	Da.5	Axis to be interpolated	Axis 2	-	-	Set the axis to be interpolated (partner axis). If the self-axis is set, an error will occur.
	Da.6	Positioning address/movement amount	8000.0μm	6000.0μm	3000.0μm	Set the movement amount. (Assuming "mm" is set in "[Pr.1] Unit setting".)
	Da.7	Arc address	4000.0μm	-3000.0μm	-	Set the sub point address. (Assuming "mm" is set in "[Pr.1] Unit setting".)
	Da.8	Command speed	6000.00mm/min	-	-	Set the speed during movement. (Set the composite speed in "[Pr.20] Interpolation speed designation method".)
	Da.9	Dwell time	500ms	-	-	Set the time the machine dwells from the positioning stop (pulse output stop) to the output of the positioning complete signal.
	Da.10	M code	10	-	50	Set this item when other sub operation commands are issued in combination with the No. 1 positioning data. Set the number of pitch for the linear interpolation axis.

\* Refer to Section 5.3 "List of positioning data" for information on the setting details.

<b>POINT</b>
Set a value in "[Da.8] Command speed" so that the speed of each axis does not exceed the "[Pr.8] Speed limit value". (The speed limit does not function for the speed calculated by the QD75N during interpolation control.)

9.2.13 3-axis helical interpolation control with center point designation

In the 3-axis helical interpolation control, circular interpolation control is carried out with two of the three axes. The other axis tracks the movement of the circular interpolation control to carry out "helical control" or "tangential control". (Refer to Section 9.1.6 "Interpolation control" for interpolation control.)

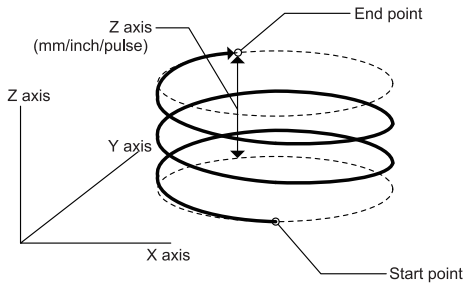
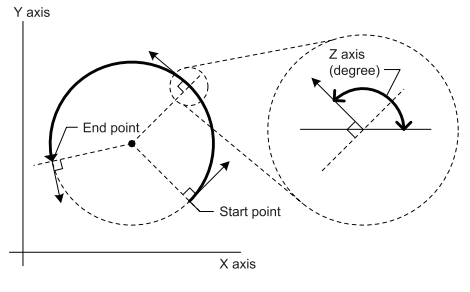
Control details	Outline of control	Positioning path
<p>Helical control</p>		<p>In this control, the linear interpolation axis (linear control) tracks the movement of circular interpolation control, and a helical path is drawn.</p> <p>■ Unit setting</p> <ul style="list-style-type: none"> <li>• Reference axis: mm/inch, pulse</li> <li>• Circular interpolation axis: Same setting as the one for the reference axis</li> <li>• Linear interpolation axis: mm/inch, pulse</li> </ul>
<p>Tangential control</p>		<p>In this control, the value of the linear interpolation axis (degree) changes according to the movement of circular interpolation control to keep the direction of a workpiece to the center point of the circular interpolation control. The figure on the left shows an example of the control that keeps the direction of the workpiece in the tangential direction.</p> <p>■ Unit setting</p> <ul style="list-style-type: none"> <li>• Reference axis: mm/inch, pulse</li> <li>• Circular interpolation axis: Same setting as the one for the reference axis</li> <li>• Linear interpolation axis: degree</li> </ul>

X-axis: Reference axis, Y-axis: Circular interpolation axis, Z-axis: Linear interpolation axis

■ Helical interpolation control speed

The command speed of the 3-axis helical interpolation control is the same as the speed of circular interpolation control (composite speed of reference axis and circular interpolation axis).

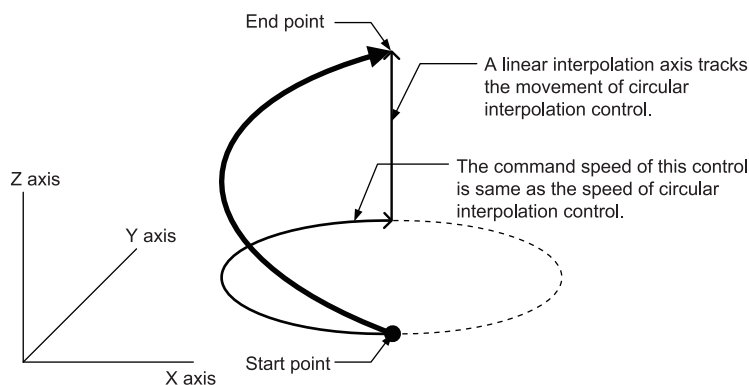



**POINT**

When "0: Composite speed" is set in "[Pr.20] Interpolation speed designation method", the command speed of ABS3/INC3 is the same as the composite speed of the 3 axes (x axis - y axis - z axis). The command speed of 3-axis helical interpolation control is the same as the composite speed of the circular interpolation axis (x axis - y axis). When continuous path control is carried out in ABS3/INC3 and 3-axis helical interpolation control, adjust the command speed to prevent the workpiece from moving unsteadily because the workpiece movement speed may change when positioning data is switched.

■ Rotation angle of the circular interpolation axis (X axis - Y axis)

The following shows the rotation angle of the circular interpolation axis in 3-axis helical interpolation control.

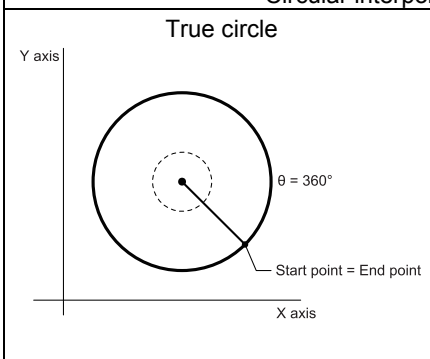
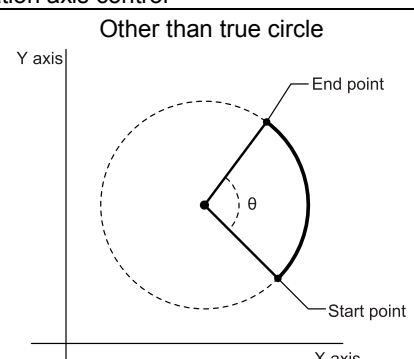
	Circular interpolation axis control	
	True circle	Other than true circle
Number of pitch		
0	360°	θ°
1	360°	360° + θ°
2	720°	720° + θ°
to	to	to
n	360° × n	360° × n + θ°
to	to	to
999	360° × 999	360° × 999 + θ°

A true circle can be set only when the start point equals to the end point in 3-axis helical interpolation (ABS/INC, center point).

**POINT**

When "degree" is set for the unit setting in the absolute system, the positioning range is 0 to 359.99999°. When the axis rotates 360° or more in circular interpolation control (x axis - y axis), the tangential/normal control cannot be carried out because a degree of 360° or more cannot be set in linear control (z axis: degree). To carry out tangential/normal control in which the axis rotates 360° or more, use 3-axis helical interpolation control (INC).

### ■ Rotation angle of the circular interpolation axis (X axis - Y axis)

In 3-axis helical interpolation control, "[Pr.41] Allowable circular interpolation error width" is made valid as well as in circular interpolation control (2 axes). When a circular interpolation error occurs, the path of the circular interpolation control (x axis - y axis) forms a spiral as shown below.

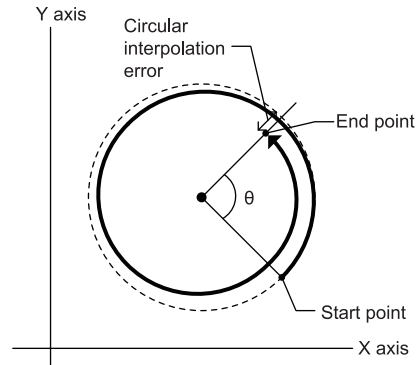

### ■ Rotation direction when the unit for the linear axis (z axis) is degree

When "[Pr.1] Unit setting" for the linear axis is "degree", the rotation direction is determined according to the axis control data "[Cd.40] ABS direction in degrees" of the reference axis. To set the rotation direction for each positioning data, set the position data "[Da.28] ABS direction in degrees".

[1] 3-axis helical interpolation control with center point designation  
(ABS helical right, ABS helical left)

■ Operation chart

In this control, positioning is carried out from the current stop position (X0, Y0, Z0) to the circular end address (X1, Y1) and linear axis end address (Z1) set in "Da.6 Positioning address/movement amount". Circular interpolation with an arc path having its center as the address of the center point (arc address) set in "Da.7 Arc address" is carried out. Simultaneously, linear interpolation is carried out with the other linear axis. The control path is helically rotated for the number of pitch set in "Da.10 M code" of the linear axis to complete the positioning to the specified position.

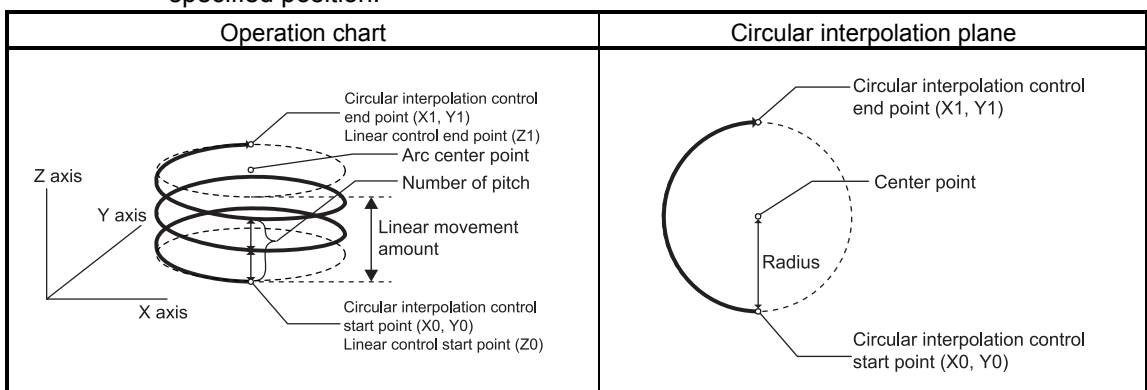

Positioning of a true circle with a radius of the distance from the start point address to the arc center point can be carried out by setting the end point address (positioning address) of the circular interpolation axis to the same address as the start point address.

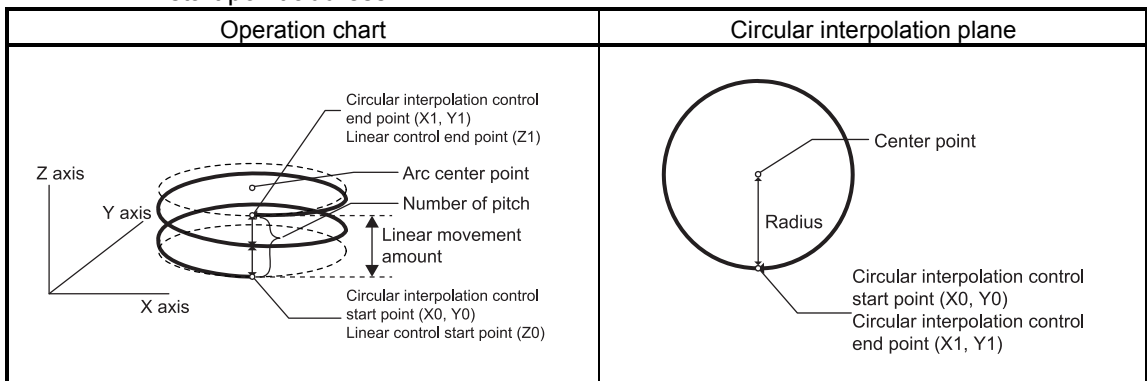

**■ Restrictions**

- (1) In the following cases, 3-axis helical interpolation control cannot be set.
- When "degree" is set in "[Pr.1] Unit setting" for the reference axis and circular interpolation axis
  - When the units set in "[Pr.1] Unit setting" are different between the reference axis and circular interpolation axis. ("mm" and "inch" combinations are possible.)
  - When the "reference axis speed" is set in "[Pr.20] Interpolation speed designation method" or "[Da.29] Interpolation speed designation method"
- (2) An error will occur and the positioning start will not be possible in the following cases. The machine will immediately stop if the error is detected during positioning control.
- When the radius exceeds "536870912 ( $=2^{29}$ )"  
(The maximum radius for which circular interpolation control is possible is "536870912 ( $=2^{29}$ )".)  
... An error "Outside radius range" (error code: 544) will occur at positioning start.
  - Start point address = Center point address  
... Error "Center point setting error" (error code: 527)
  - End point address = Center point address  
... Error "Center point setting error" (error code: 527)
  - When the center point address is outside the range of "-2147483648 ( $-2^{31}$ ) to 2147483647 ( $2^{31}-1$ )"  
... Error "Center point setting error" (error code: 527)

■ Positioning data setting example

[Reference axis, circular interpolation axis, and linear interpolation axis are specified as axis 1, axis 2, and axis 3, respectively.]

The following table shows setting examples when "helical interpolation control with center point designation (ABS helical right, ABS helical left)" is set in positioning data No. 1 of axis 1.

(The required values are also set in positioning data No. 1 of axis 2 and axis 3.)

Item		Axis	Axis 1 (reference axis) setting example	Axis 2 (circular interpolation axis) setting example	Axis 3 (linear interpolation axis) setting example	Setting details
Positioning data No. 1	Da.1	Operation pattern	Positioning complete	-	-	Set "Positioning complete" assuming that the next positioning data will not be executed.
	Da.2	Control system	ABS helical right ABS helical left	-	-	Set absolute system, 3-axis helical interpolation control with center point designation. (Select clockwise or counterclockwise according to the control.)
	Da.3	Acceleration time No.	1	-	-	Specify the value set in "[Pr.25] Acceleration time 1" as the acceleration time at start.
	Da.4	Deceleration time No.	0	-	-	Specify the value set in "[Pr.10] Deceleration time 0" as the deceleration time at deceleration.
	Da.5	Axis to be interpolated	Axis 2	-	-	Set the axis to be interpolated (partner axis). If the self-axis is set, an error will occur.
	Da.6	Positioning address/movement amount	8000.0μm	6000.0μm	3000.0μm	Set the end point address. (Assuming "mm" is set in "[Pr.1] Unit setting".)
	Da.7	Arc address	4000.0μm	3000.0μm	-	Set the arc address. (Assuming "mm" is set in "[Pr.1] Unit setting".)
	Da.8	Command speed	6000.00mm/min	-	-	Set the speed during movement to the end point address. (Set the composite speed in "[Pr.20] Interpolation speed designation method".)
	Da.9	Dwell time	500ms	-	-	Set the time the machine dwells from the positioning stop (pulse output stop) to the output of the positioning complete signal.
	Da.10	M code	10	-	50	Set this item when other sub operation commands are issued in combination with the No. 1 positioning data. Set the number of pitch for the linear interpolation axis.

\* Refer to Section 5.3 "List of positioning data" for information on the setting details.

<b>POINT</b>
Set a value in "[Da.8] Command speed" so that the speed of each axis does not exceed the "[Pr.8] Speed limit value". (The speed limit does not function for the speed calculated by the QD75N during interpolation control.)

[1] 3-axis helical interpolation control with center point designation (INC helical right, INC helical left)

■ Operation chart

In this control, positioning is carried out from the current stop position (X0, Y0, Z0) to the movement amount position (X1, Y1, Z1) set in "Da.6" Positioning address/movement amount". Circular interpolation with an arc path having its center as the address of the center point (arc address) set in "Da.7" Arc address" is carried out. Simultaneously, linear interpolation is carried out with the other linear axis. The control path is helically rotated for the number of pitch set in "Da.10" M code" of the linear axis to complete the positioning to the specified position.

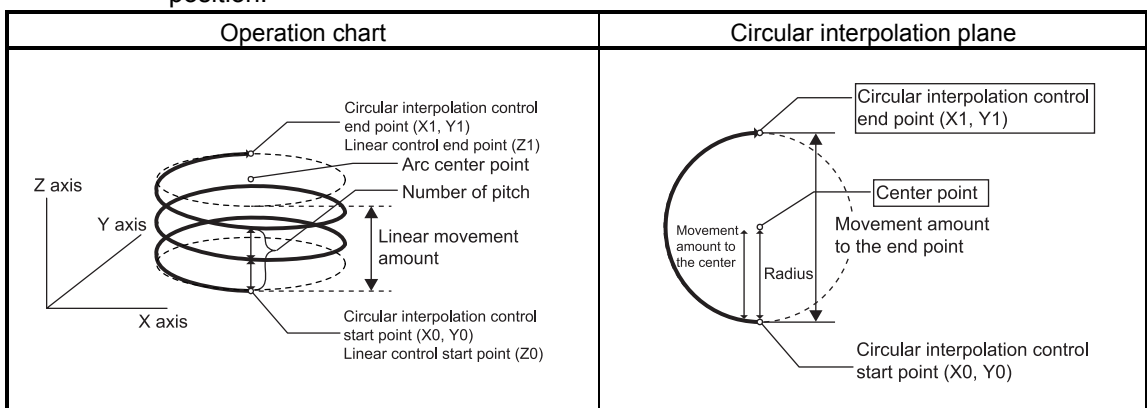

Positioning of a true circle with a radius of the distance from the start point address to the arc center point can be carried out by setting the movement amount of the circular interpolation axis to "0".

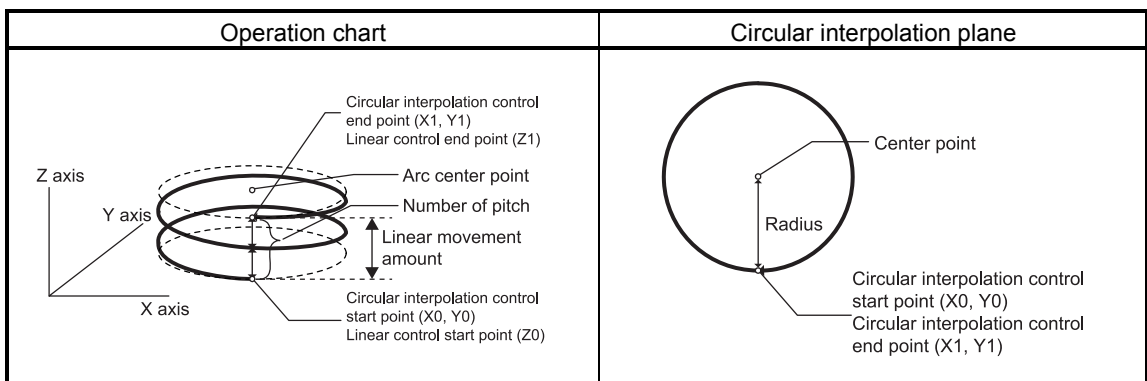

**■ Restrictions**

- (1) In the following cases, 3-axis helical interpolation control cannot be set.
  - When "degree" is set in "[Pr.1] Unit setting" for the reference axis and circular interpolation axis
  - When the units set in "[Pr.1] Unit setting" are different between the reference axis and circular interpolation axis. ("mm" and "inch" combinations are possible.)
  - When the "reference axis speed" is set in "[Pr.20] Interpolation speed designation method" or "[Da.29] Interpolation speed designation method"
- (2) An error will occur and the positioning start will not be possible in the following cases. The machine will immediately stop if the error is detected during positioning control.
  - When the radius exceeds "536870912 ( $=2^{29}$ )"  
(The maximum radius for which circular interpolation control is possible is "536870912 ( $=2^{29}$ )".)
    - ... An error "Outside radius range" (error code: 544) will occur at positioning start.
  - When the end point address is outside the range of  $-2147483648 (-2^{31})$  to  $2147483647 (2^{31}-1)$ 
    - ... An error "End point setting error" (error code: 526) will occur at positioning start.
  - Start point address = Center point address
    - ... Error "Center point setting error" (error code: 527)
  - End point address = Center point address
    - ... Error "Center point setting error" (error code: 527)
  - When the center point address is outside the range of  $-2147483648 (-2^{31})$  to  $2147483647 (2^{31}-1)$ 
    - ... Error "Center point setting error" (error code: 527)

■ Positioning data setting example

[Reference axis, circular interpolation axis, and linear interpolation axis are specified as axis 1, axis 2, and axis 3, respectively.]

The following table shows setting examples when "helical interpolation control with center point designation (INC helical right, INC helical left)" is set in positioning data No. 1 of axis 1.

(The required values are also set in positioning data No. 1 of axis 2 and axis 3.)

Item		Axis	Axis 1 (reference axis) setting example	Axis 2 (circular interpolation axis) setting example	Axis 3 (linear interpolation axis) setting example	Setting details
Positioning data No. 1	Da.1	Operation pattern	Positioning complete	-	-	Set "Positioning complete" assuming that the next positioning data will not be executed.
	Da.2	Control system	ABS helical right ABS helical left	-	-	Set absolute system, 3-axis helical interpolation control with center point designation. (Select clockwise or counterclockwise according to the control.)
	Da.3	Acceleration time No.	1	-	-	Specify the value set in "Pr.25 Acceleration time 1" as the acceleration time at start.
	Da.4	Deceleration time No.	0	-	-	Specify the value set in "Pr.10 Deceleration time 0" as the deceleration time at deceleration.
	Da.5	Axis to be interpolated	Axis 2	-	-	Set the axis to be interpolated (partner axis). If the self-axis is set, an error will occur.
	Da.6	Positioning address/movement amount	8000.0μm	6000.0μm	3000.0μm	Set the end point address. (Assuming "mm" is set in "Pr.1 Unit setting".)
	Da.7	Arc address	4000.0μm	3000.0μm	-	Set the arc address. (Assuming "mm" is set in "Pr.1 Unit setting".)
	Da.8	Command speed	6000.00mm/min	-	-	Set the speed during movement to the end point address. (Set the composite speed in "Pr.20 Interpolation speed designation method".)
	Da.9	Dwell time	500ms	-	-	Set the time the machine dwells from the positioning stop (pulse output stop) to the output of the positioning complete signal.
	Da.10	M code	10	-	50	Set this item when other sub operation commands are issued in combination with the No. 1 positioning data. Set the number of pitch for the linear interpolation axis.

\* Refer to Section 5.3 "List of positioning data" for information on the setting details.

<b>POINT</b>
Set a value in "Da.8 Command speed" so that the speed of each axis does not exceed the "Pr.8 Speed limit value". (The speed limit does not function for the speed calculated by the QD75N during interpolation control.)



9.2.14 1-axis speed control

In "1-axis speed control" (" [Da.2] Control system" = Forward run: speed 1, Reverse run: speed 1), control is carried out in the axis direction in which the positioning data has been set by continuously outputting pulses for the speed set in " [Da.8] Command speed" until the input of a stop command.

The two types of 1-axis speed control are "Forward run: speed 1" in which the control starts in the forward run direction, and "Reverse run: speed 1" in which control starts in the reverse run direction.

■ Operation chart

The following chart shows the operation timing for 1-axis speed control with axis 1 as the reference axis.

The "in speed control" flag ([Md.31] Status: b0) is turned ON during speed control. The "Positioning complete signal" is not turned ON.

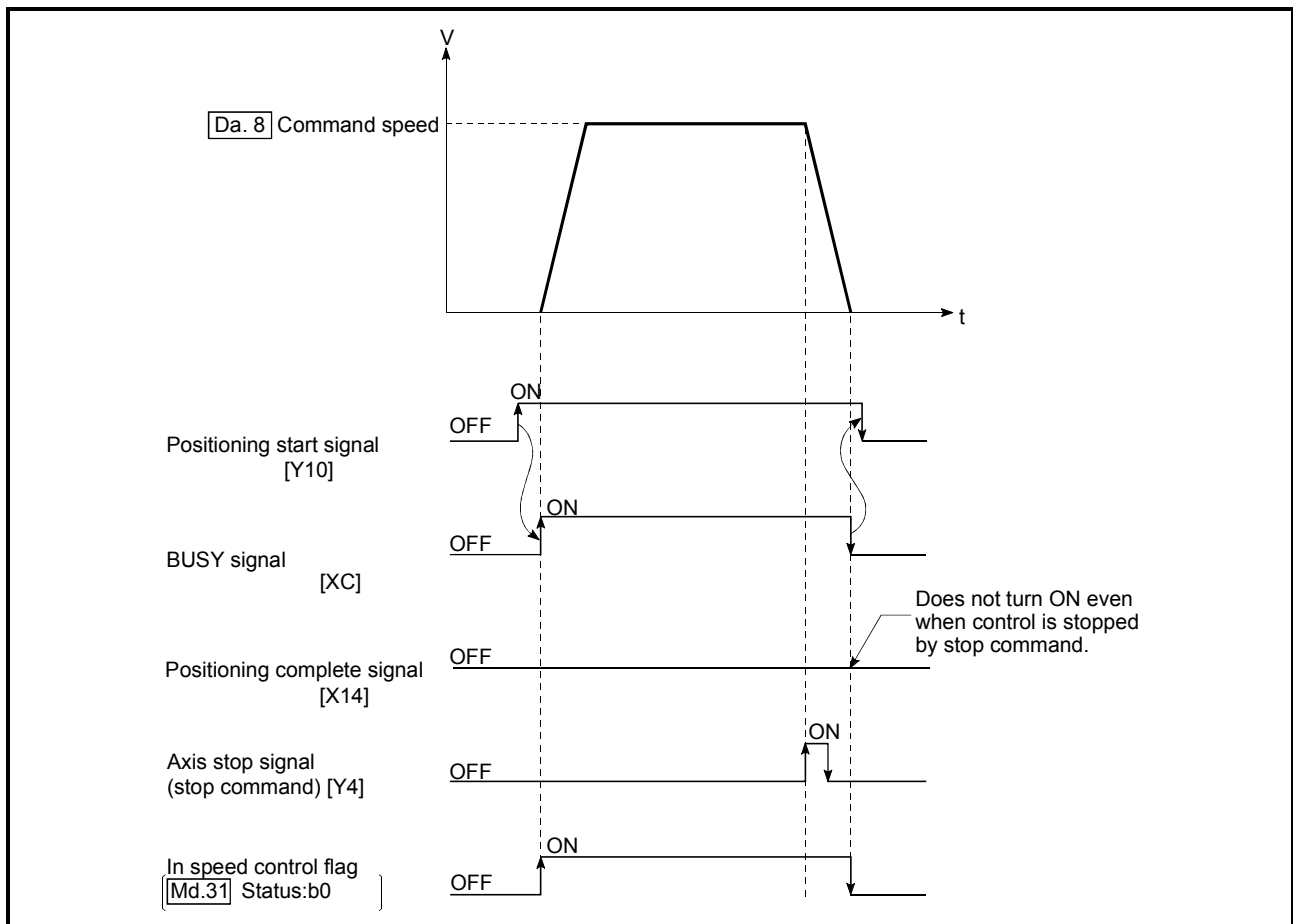
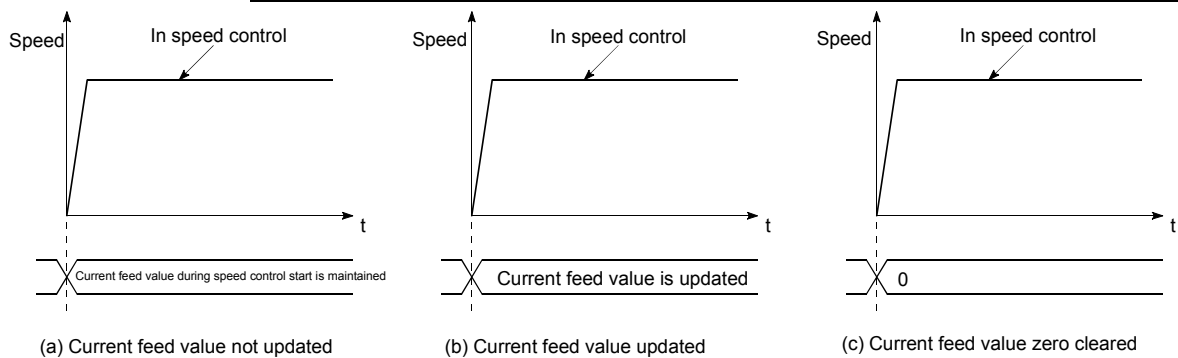

Fig.9.9 1-axis speed control operation timing

### ■ Current feed value during 1-axis speed control

The following table shows the " [Md.20](#) Current feed value" during 1-axis speed control corresponding to the " [Pr.21](#) Current feed value during speed control" settings.

" <a href="#">Pr.21</a> Current feed value during speed control" setting	<a href="#">Md.20</a> Current feed value
0: Do not update current feed value	The current feed value at speed control start is maintained.
1: Update current feed value	The current feed value is updated.
2: Zero clear current feed value	The current feed value is fixed at 0.



### ■ Restrictions

- (1) Set "Positioning complete" in " [Da.1](#) Operation pattern". An axis error "Continuous path control not possible" (error code: 516) will occur and the operation cannot start if "continuous positioning control" or "continuous path control" is set in " [Da.1](#) Operation pattern". ("Continuous positioning control" and "continuous path control" cannot be set in speed control.)
- (2) Set the WITH mode in " [Pr.18](#) M code ON signal output timing" when using an M code. The M code will not be output, and the M code ON signal will not turn ON if the AFTER mode is set.
- (3) An error "No command speed" (error code: 503) will occur if the current speed (-1) is set in " [Da.8](#) Command speed".
- (4) The software stroke limit check will not be carried out if the control unit is set to "degree".

■ Positioning data setting examples

The following table shows the setting examples when "1-axis speed control (forward run: speed 1)" is set in the positioning data No. 1 of axis 1.

Setting item		Setting example	Setting details	
Axis 1 Positioning data No. 1	Da.1	Operation pattern	Positioning complete	Setting other than "Positioning complete" is not possible in speed control.
	Da.2	Control system	Forward run speed 1	Set 1-axis speed control.
	Da.3	Acceleration time No.	1	Designate the value set in " Pr.25 Acceleration time 1" as the acceleration time at start.
	Da.4	Deceleration time No.	0	Designate the value set in " Pr.10 Deceleration time 0" as the deceleration time at deceleration.
	Da.5	Axis to be interpolated	–	Setting not required (setting value will be ignored).
	Da.6	Positioning address/movement amount	–	Setting not required (setting value will be ignored).
	Da.7	Arc address	–	Setting not required (setting value will be ignored).
	Da.8	Command speed	6000.00mm/min	Set the speed to be commanded.
	Da.9	Dwell time	–	Setting not required (setting value will be ignored).
	Da.10	M code	10	Set this when other sub operation commands are issued in combination with the No. 1 positioning data. (" Pr.18 M code ON signal output timing" setting only possible in the WITH mode.)

\* Refer to Section 5.3 "List of positioning data" for information on the setting details.

9.2.15 2-axis speed control

In "2-axis speed control" (" **Da.2** Control system" = Forward run: speed 2, Reverse run: speed 2), control is carried out in the 2-axis direction in which the positioning data has been set by continuously outputting pulses for the speed set in " **Da.8** Command speed" until the input of a stop command.

The two types of 2-axis speed control are "Forward run: speed 2" in which the control starts in the forward run direction, and "Reverse run: speed 2" in which control starts in the reverse run direction.

(Refer to Section 9.1.6 "Interpolation control" for the combination of the reference axis with the interpolation axis.)

■ Operation chart

The following chart shows the operation timing for 2-axis (axes 1 and 2) speed control with axis 1 as the reference axis. The "in speed control" flag (**Md.31** Status: b0) is turned ON during speed control. The "positioning complete signal" is not turned ON.

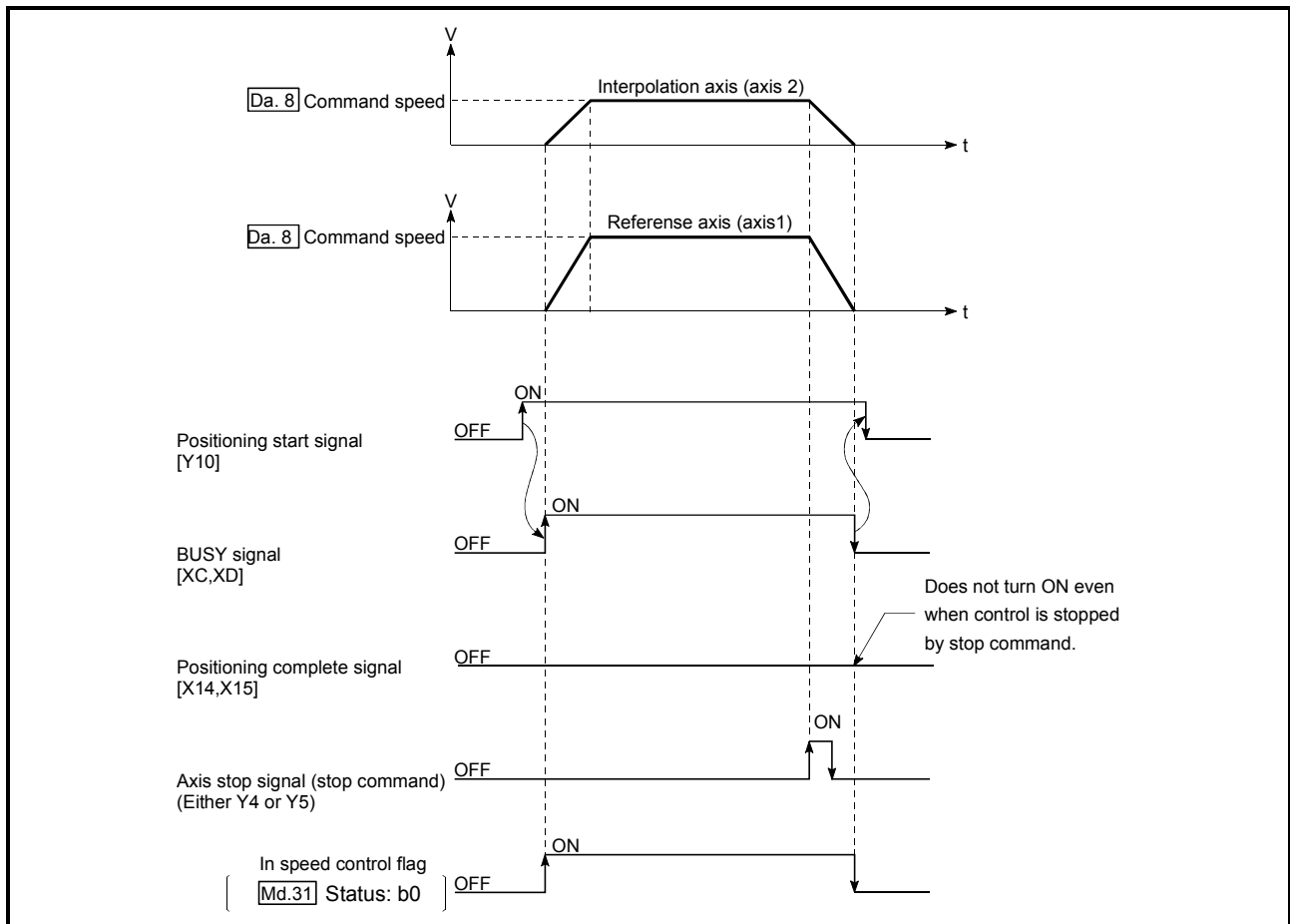
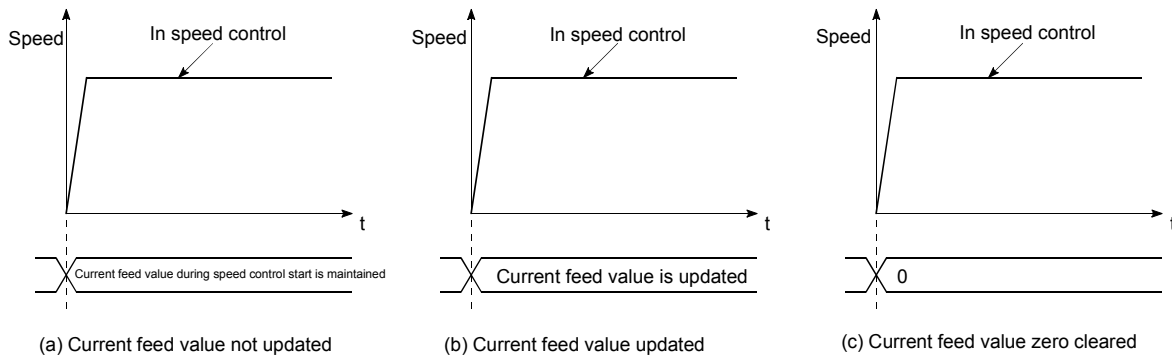

Fig. 9.10 2-axis speed control operation timing

■ Current feed value during 2-axis speed control

The following table shows the "Md.20 Current feed value" during 2-axis speed control corresponding to the "Pr.21 Current feed value during speed control" settings. (Note that the reference axis setting values are used for parameters.)

"Pr.21 Current feed value during speed control" setting	Md.20 Current feed value
0: Do not update current feed value	The current feed value at speed control start is maintained.
1: Update current feed value	The current feed value is updated.
2: Zero clear current feed value	The current feed value is fixed at 0.



■ Restrictions

- Set "Positioning complete" in "Da.1 Operation pattern". An axis error "Continuous path control not possible" (error code: 516) will occur and the operation cannot start if "continuous positioning control" or "continuous path control" is set. ("Continuous positioning control" and "continuous path control" cannot be set in speed control.)
- Set the WITH mode in "Pr.18 M code ON signal output timing" when using an M code. The M code will not be output, and the M code ON signal will not turn ON if the AFTER mode is set.
- Set the "reference axis speed" in "Pr.20 Interpolation speed designation method". An error "Interpolation mode error" (error code: 523) will occur and the operation cannot start if a composite speed is set.
- When either of two axes exceeds the speed limit, that axis is controlled with the speed limit value. The speeds of the other axes are limited at the ratios of "Da.8 Command speed".  
(Examples)

Setting item		Axis	Axis 1 setting	Axis 2 setting
Pr.8	Speed limit value		4000.00mm/min	5000.00mm/min
Da.8	Command speed		8000.00mm/min	6000.00mm/min

With the settings shown above, the operation speed in speed control is as follows.

Axis 1: 4000.00 mm/min (Speed is limited by Pr.8).

Axis 2: 3000.00 mm/min (Speed is limited at an ratio of an axis 1 command speed to an axis 2 command speed).

Note: Operation runs at speed 1 when a reference axis speed is less than 1 as a result of speed limit.

In addition, when a bias speed is set, it will be the minimum speed.

- (5) An error "No command speed" (error code: 503) occurs if a current speed (-1) is set in " [Da.8] Command speed".
- (6) The software stroke limit check is not carried out when the control unit is set to "degree".

■ Positioning data setting examples

[Setting examples when the reference axis and interpolation axis are designated as axes 1 and 2, respectively.]

The following table shows the setting examples when "2-axis speed control (forward run: speed 2)" is set in the positioning data No. 1 of axis 1 (reference axis).

Setting item		Axis		Setting details
		Axis 1 (reference axis) setting example	Axis 2 (interpolation axis) setting example	
Axis 1 Positioning data No. 1	[Da.1] Operation pattern	Positioning complete	–	Setting other than "Positioning complete" is not possible in speed control.
	[Da.2] Control system	Forward run speed 2	–	Set 2-axis speed control.
	[Da.3] Acceleration time No.	1	–	Designate the value set in " [Pr.25] Acceleration time 1" as the acceleration time at start.
	[Da.4] Deceleration time No.	0	–	Designate the value set in " [Pr.10] Deceleration time 0" as the deceleration time at deceleration.
	[Da.5] Axis to be interpolated	Axis 2	–	Set the axis to be interpolated (partner axis). If the self-axis is set, an error will occur.
	[Da.6] Positioning address/movement amount	–	–	Setting not required (setting value will be ignored).
	[Da.7] Arc address	–	–	Setting not required (setting value will be ignored).
	[Da.8] Command speed	6000.00 mm/min	3000.00 mm/min	Set the speed to be commanded.
	[Da.9] Dwell time	–	–	Setting not required (setting value will be ignored).
	[Da.10] M code	10	–	Set this when other sub operation commands are issued in combination with the No. 1 positioning data. (" [Pr.18] M code ON signal output timing" setting only possible in the WITH mode.)

\* Refer to Section 5.3 "List of positioning data" for information on the setting details.

9.2.16 3-axis speed control

In "3-axis speed control" (" **Da.2** Control system" = Forward run: speed 3, Reverse run: speed 3), control is carried out in the 3-axis direction in which the positioning data has been set by continuously outputting pulses for the speed set in " **Da.8** Command speed" until the input of a stop command.

The two types of 3-axis speed control are "Forward run: speed 3" in which the control starts in the forward run direction, and "Reverse run: speed 3" in which control starts in the reverse run direction.

(Refer to Section 9.1.6 "Interpolation control" for the combination of the reference axis with the interpolation axes.)

■ Operation chart

The following chart shows the operation timing for 3-axis (axes 1, 2, and 3) speed control with axis 1 as the reference axis.

The "in speed control" flag (**Md.31** Status: b0) is turned ON during speed control. The "positioning complete signal" is not turned ON.

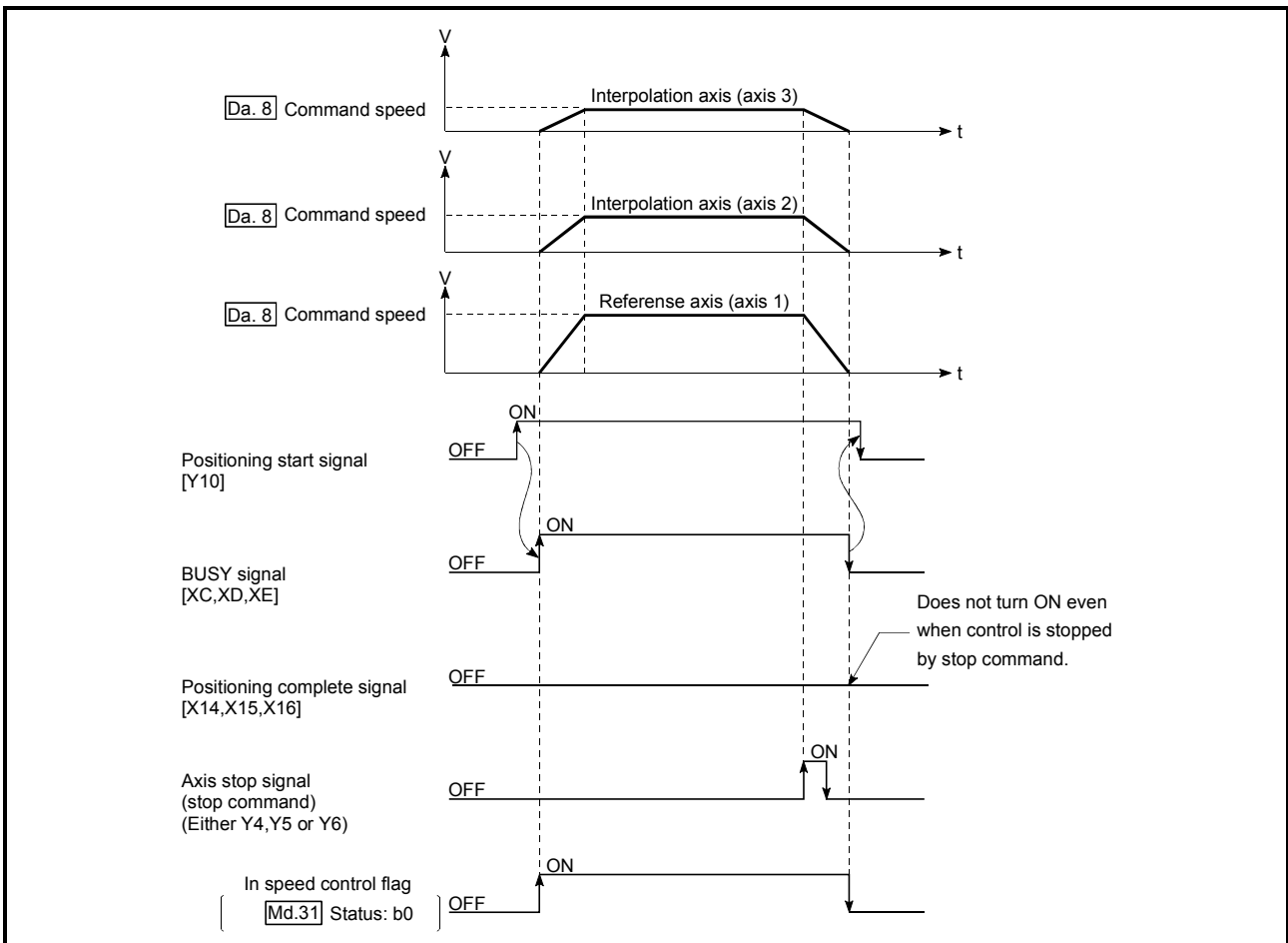
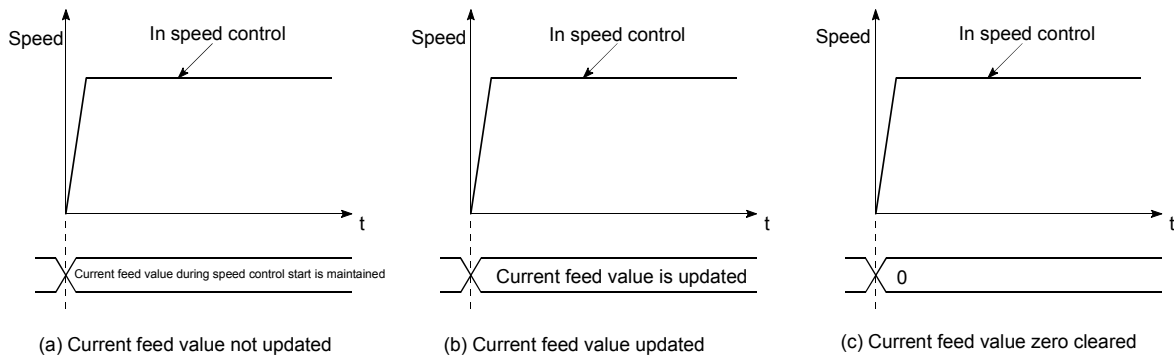

Fig. 9.11 3-axis speed control operation timing

■ Current feed value during 3-axis speed control

The following table shows the "Md.20 Current feed value" during 3-axis speed control corresponding to the "Pr.21 Current feed value during speed control" settings. (Note that the reference axis setting values are used for parameters.)

"Pr.21 Current feed value during speed control" setting	Md.20 Current feed value
0: Do not update current feed value	The current feed value at speed control start is maintained.
1: Update current feed value	The current feed value is updated.
2: Zero clear current feed value	The current feed value is fixed at 0.



■ Restrictions

- (1) Set "Positioning complete" in "Da.1 Operation pattern". An axis error "Continuous path control not possible" (error code: 516) will occur and the operation cannot start if "continuous positioning control" or "continuous path control" is set. ("Continuous positioning control" and "continuous path control" cannot be set in speed control.)
- (2) Set the WITH mode in "Pr.18 M code ON signal output timing" when using an M code. The M code will not be output, and the M code ON signal will not turn ON if the AFTER mode is set.
- (3) Set the "reference axis speed" in "Pr.20 Interpolation speed designation method". An error "Interpolation mode error" (error code: 523) will occur and the operation cannot start if a composite speed is set.



- (4) When either of three axes exceeds the speed limit, that axis is controlled with the speed limit value. The speeds of the other axes are limited at the ratios of " [Da.8] Command speed".

(Examples)

Setting item		Axis		
		Axis 1 setting	Axis 2 setting	Axis 3 setting
[Pr.8]	Speed limit value	4000.00mm/min	5000.00mm/min	6000.00mm/min
[Da.8]	Command speed	8000.00mm/min	6000.00mm/min	4000.00mm/min

With the settings shown above, the operation speed in speed control is as follows.

Axis 1: 4000.00 mm/min (Speed is limited by [Pr.8]).

Axis 2: 3000.00 mm/min (Speed is limited at ratios in axes 1, 2, and 3 command speeds).

Axis 3: 2000.00 mm/min (Speed is limited at ratios in axes 1, 2, and 3 command speeds).

Note: Operation runs at speed 1 when a reference axis speed is less than 1 as a result of speed limit.

In addition, when a bias speed is set, it will be the minimum speed.

- (5) An error "No command speed" (error code: 503) will occur if a current speed (-1) is set in " [Da.8] Command speed".
- (6) The software stroke limit check is not carried out when the control unit is set to "degree".

■ Positioning data setting examples

The following table shows the setting examples when "3-axis speed control (forward run: speed 3)" is set in the positioning data No. 1 of axis 1 (reference axis).

Setting item		Axis	Axis 1 (reference axis) setting example	Axis 2 (interpolation axis) setting example	Axis 3 (interpolation axis) setting example	Setting details	
Axis 1	Positioning data No. 1	Da.1	Operation pattern	Positioning complete	–	–	Setting other than "Positioning complete" is not possible in speed control.
		Da.2	Control system	Forward run speed 3	–	–	Set 3-axis speed control.
		Da.3	Acceleration time No.	1	–	–	Designate the value set in " [Pr.25] Acceleration time 1" as the acceleration time at start.
		Da.4	Deceleration time No.	0	–	–	Designate the value set in " [Pr.10] Deceleration time 0" as the deceleration time at deceleration.
		Da.5	Axis to be interpolated	–	–	–	Setting not required (setting value will be ignored). When axis 1 is used as a reference axis, the interpolation axes are axes 2 and 3.
		Da.6	Positioning address/movement amount	–	–	–	Setting not required (setting value will be ignored).
		Da.7	Arc address	–	–	–	Setting not required (setting value will be ignored).
		Da.8	Command speed	6000.00 mm/min	3000.00 mm/min	2000.00 mm/min	Set the speed to be commanded.
		Da.9	Dwell time	–	–	–	Setting not required (setting value will be ignored).
		Da.10	M code	10	–	–	Set this when other sub operation commands are issued in combination with the No. 1 positioning data. (" [Pr.18] M code ON signal output timing" setting only possible in the WITH mode.)

\* Refer to Section 5.3 "List of positioning data" for information on the setting details.

### 9.2.17 4-axis speed control

In "4-axis speed control" (" Da.2 Control system" = Forward run: speed 4, Reverse run: speed 4), control is carried out in the 4-axis direction in which the positioning data has been set by continuously outputting pulses for the speed set in " Da.8 Command speed" until the input of a stop command.

The two types of 4-axis speed control are "Forward run: speed 4" in which the control starts in the forward run direction, and "Reverse run: speed 4" in which control starts in the reverse run direction.

(Refer to Section 9.1.6 "Interpolation control" for the combination of the reference axis with the interpolation axes.)

■ Operation chart

The following chart shows the operation timing for 4-axis speed control with axis 1 as the reference axis.

The "in speed control" flag ( $\overline{\text{Md.31}}$  Status: b0) is turned ON during speed control.  
 The "positioning complete signal" is not turned ON.

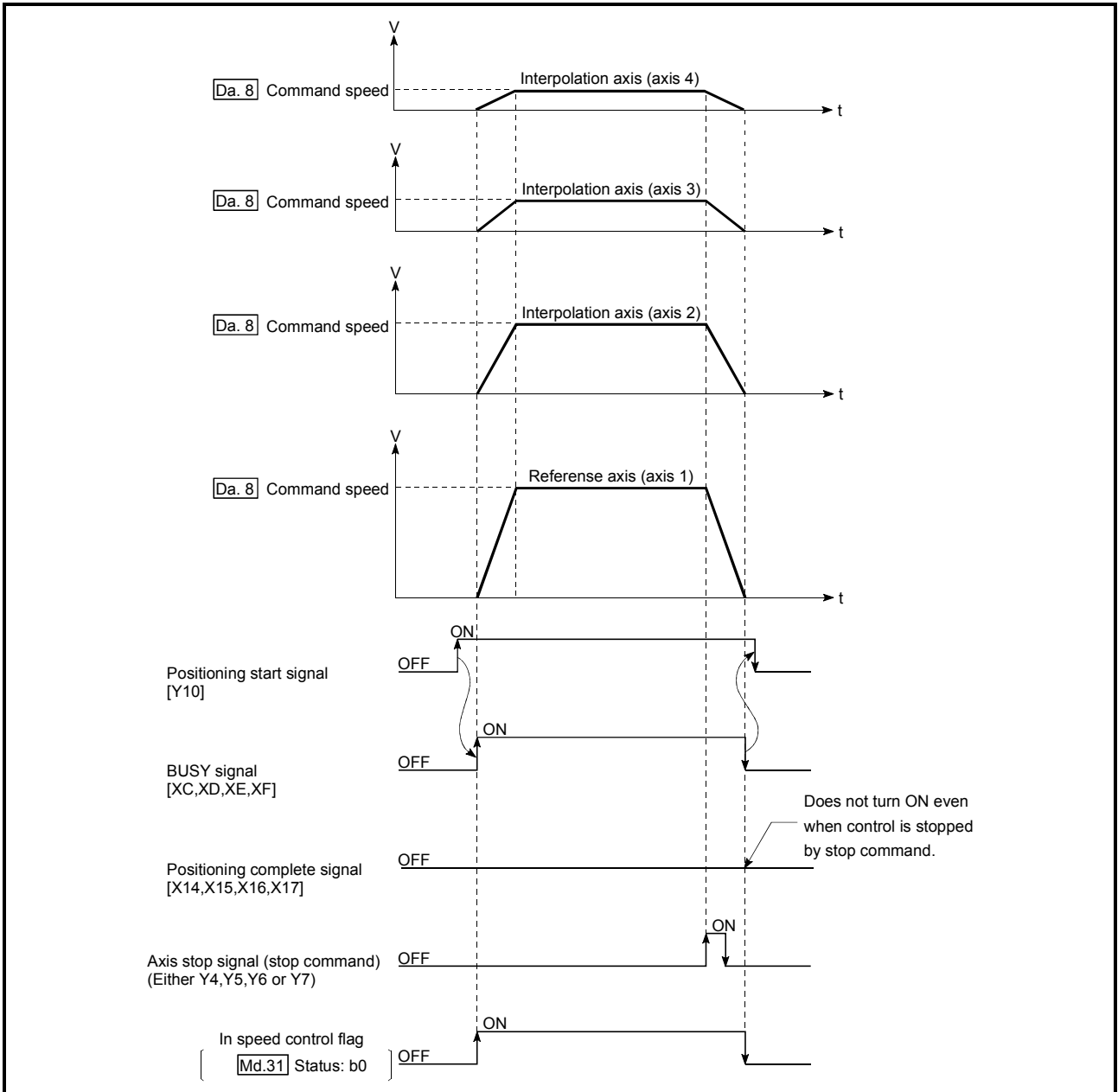
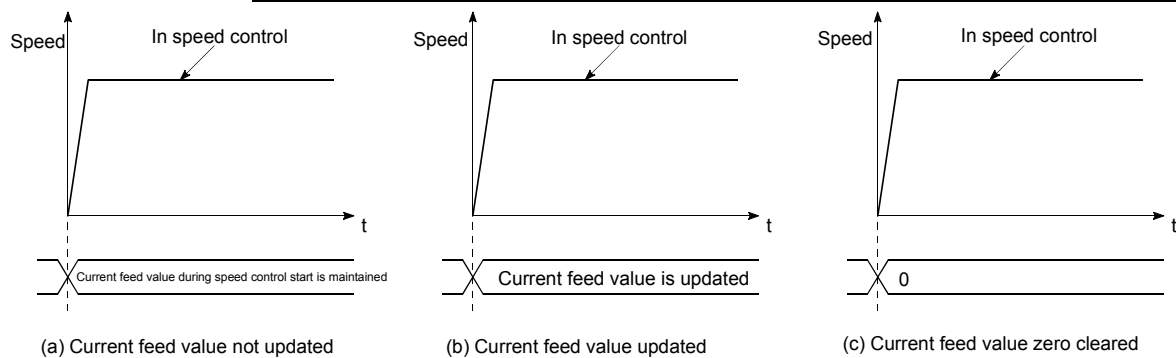

Fig. 9.12 4-axis speed control operation timing

### ■ Current feed value during 4-axis speed control

The following table shows the "Md.20 Current feed value" during 4-axis speed control corresponding to the "Pr.21 Current feed value during speed control" settings. (Note that the reference axis setting values are used for parameters.)

"Pr.21 Current feed value during speed control" setting	Md.20 Current feed value
0: Do not update current feed value	The current feed value at speed control start is maintained.
1: Update current feed value	The current feed value is updated.
2: Zero clear current feed value	The current feed value is fixed at 0.



### ■ Restrictions

- (1) Set "Positioning complete" in "Da.1 Operation pattern". An axis error "Continuous path control not possible" (error code: 516) will occur and the operation cannot start if "continuous positioning control" or "continuous path control" is set. ("Continuous positioning control" and "continuous path control" cannot be set in speed control.)
- (2) Set the WITH mode in "Pr.18 M code ON signal output timing" when using an M code. The M code will not be output, and the M code ON signal will not turn ON if the AFTER mode is set.
- (3) Set the "reference axis speed" in "Pr.20 Interpolation speed designation method". An error "Interpolation mode error" (error code: 523) will occur and the operation cannot start if a composite speed is set.

- (4) When either of four axes exceeds the speed limit, that axis is controlled with the speed limit value. The speeds of the other axes are limited at the ratios of "  Command speed".

(Examples)

Setting item		Axis			
		Axis 1 setting	Axis 2 setting	Axis 3 setting	Axis 4 setting
<input type="text" value="Pr.8"/>	Speed limit value	4000.00mm/min	5000.00mm/min	6000.00mm/min	8000.00mm/min
<input type="text" value="Da.8"/>	Command speed	8000.00mm/min	6000.00mm/min	4000.00mm/min	1500.00mm/min

With the settings shown above, the operation speed in speed control is as follows.

Axis 1: 4000.00 mm/min (Speed is limited by ).

Axis 2: 3000.00 mm/min (Speed is limited at ratios in axes 1, 2, 3 and 4 command speeds).

Axis 3: 2000.00 mm/min (Speed is limited at ratios in axes 1, 2, 3 and 4 command speeds).

Axis 4: 750.00 mm/min (Speed is limited at ratios in axes 1, 2, 3 and 4 command speeds).

Note: Operation runs at speed 1 when a reference axis speed is less than 1 as a result of speed limit.

In addition, when a bias speed is set, it will be the minimum speed.

- (5) An error "No command speed" (error code: 503) will occur if a current speed (-1) is set in "  Command speed".
- (6) The software stroke limit check is not carried out when the control unit is set to "degree".

■ Positioning data setting examples

The following table shows the setting examples when "4-axis speed control (forward run: speed 4)" is set in the positioning data No. 1 of axis 1 (reference axis).

Setting item		Axis	Axis 1 (reference axis) setting example	Axis 2 (interpolation axis) setting example	Axis 3 (interpolation axis) setting example	Axis 4 (interpolation axis) setting example	Setting details
Axis 1 Positioning data No. 1	Da.1	Operation pattern	Positioning complete	–	–	–	Setting other than "Positioning complete" is not possible in speed control.
	Da.2	Control system	Forward run speed 4	–	–	–	Set 4-axis speed control.
	Da.3	Acceleration time No.	1	–	–	–	Designate the value set in " Pr.25 Acceleration time 1" as the acceleration time at start.
	Da.4	Deceleration time No.	0	–	–	–	Designate the value set in " Pr.10 Deceleration time 0" as the deceleration time at deceleration.
	Da.5	Axis to be interpolated	–	–	–	–	Setting not required (setting value will be ignored). When axis 1 is used as a reference axis, the interpolation axes are axes 2, 3 and 4.
	Da.6	Positioning address/movement amount	–	–	–	–	Setting not required (setting value will be ignored).
	Da.7	Arc address	–	–	–	–	Setting not required (setting value will be ignored).
	Da.8	Command speed	6000.00 mm/min	3000.00 mm/min	2000.00 mm/min	1000.00 mm/min	Set the speed to be commanded.
	Da.9	Dwell time	–	–	–	–	Setting not required (setting value will be ignored).
	Da.10	M code	10	–	–	–	Set this when other sub operation commands are issued in combination with the No. 1 positioning data. ( " Pr.18 M code ON signal output timing" setting only possible in the WITH mode.)

\* Refer to Section 5.3 "List of positioning data" for information on the setting details.

## 9.2.18 Speed-position switching control (INC mode)

In "speed-position switching control (INC mode)" (" [Da.2] Control system" = Forward run: speed/position, Reverse run: speed/position), the pulses of the speed set in " [Da.8] Command speed" are kept output on the axial direction set to the positioning data. When the "speed-position switching signal" is input, position control of the movement amount set in " [Da.6] Positioning address/movement amount" is exercised.

"Speed-position switching control (INC mode)" is available in two different types: "forward run: speed/position" which starts the axis in the forward run direction and "reverse run: speed/position" which starts the axis in the reverse run direction.

Use the detailed parameter 1 " [Pr.150] Speed-position function selection" with regard to the choice for "speed-position switching control (INC mode)".

Setting item		Setting value	Setting details	Buffer memory address			
				Axis 1	Axis 2	Axis 3	Axis 4
[Pr.150]	Speed-position function selection	0	Speed-position switching control (INC mode)	34	184	334	484

\* If the set value is other than 0 and 2, it is regarded as 0 and operation is performed in the INC mode.

For details of the setting, refer to Section 5.2 "List of parameters".

#### ■ Switching over from speed control to position control

- (1) The control is switched over from speed control to position control by executing the external command signal set in "speed-position switching signal".
- (2) Besides setting the positioning data, the " [Cd.24] Speed-position switching enable flag" must also be turned ON to switch over from speed control to position control. (If the " [Cd.24] Speed-position switching enable flag" turns ON after the speed-position switching signal turns ON, the control will continue as speed control without switching over to position control. The control will be switched over from speed control to position control when the speed-position switching signal turns from OFF to ON again. Only position control will be carried out when the " [Cd.24] Speed-position switching enable flag" and speed-position switching signal are ON at the operation start.)

Setting item		Setting value	Setting details	Buffer memory address			
				Axis 1	Axis 2	Axis 3	Axis 4
[Cd.24]	Speed-position switching enable flag	1	Set "1: Switch from speed control to position control when the external command signal [CHG] turns ON."	1528	1628	1728	1828



### ■ Speed-position switching signal setting

The following table shows the items that must be set to use the external command signals (CHG) as speed-position switching signals.

Setting item		Setting value	Setting details	Buffer memory address			
				Axis 1	Axis 2	Axis 3	Axis 4
Pr.42	External command function selection	2	Set the "2: speed-position and position-speed switching requests".	62	212	362	512
Cd.8	External command valid	1	Set "1: Validate external command".	1505	1605	1705	1805

\* Refer to Section 5.2 "List of parameters" and Section 5.7 "List of control data" for information on the setting details.

■ Operation chart

The following chart (Fig.9.13) shows the operation timing for speed-position switching control (INC mode). The "in speed control flag" ([Md.31] Status: b0) is turned ON during speed control of speed-position switching control (INC mode).

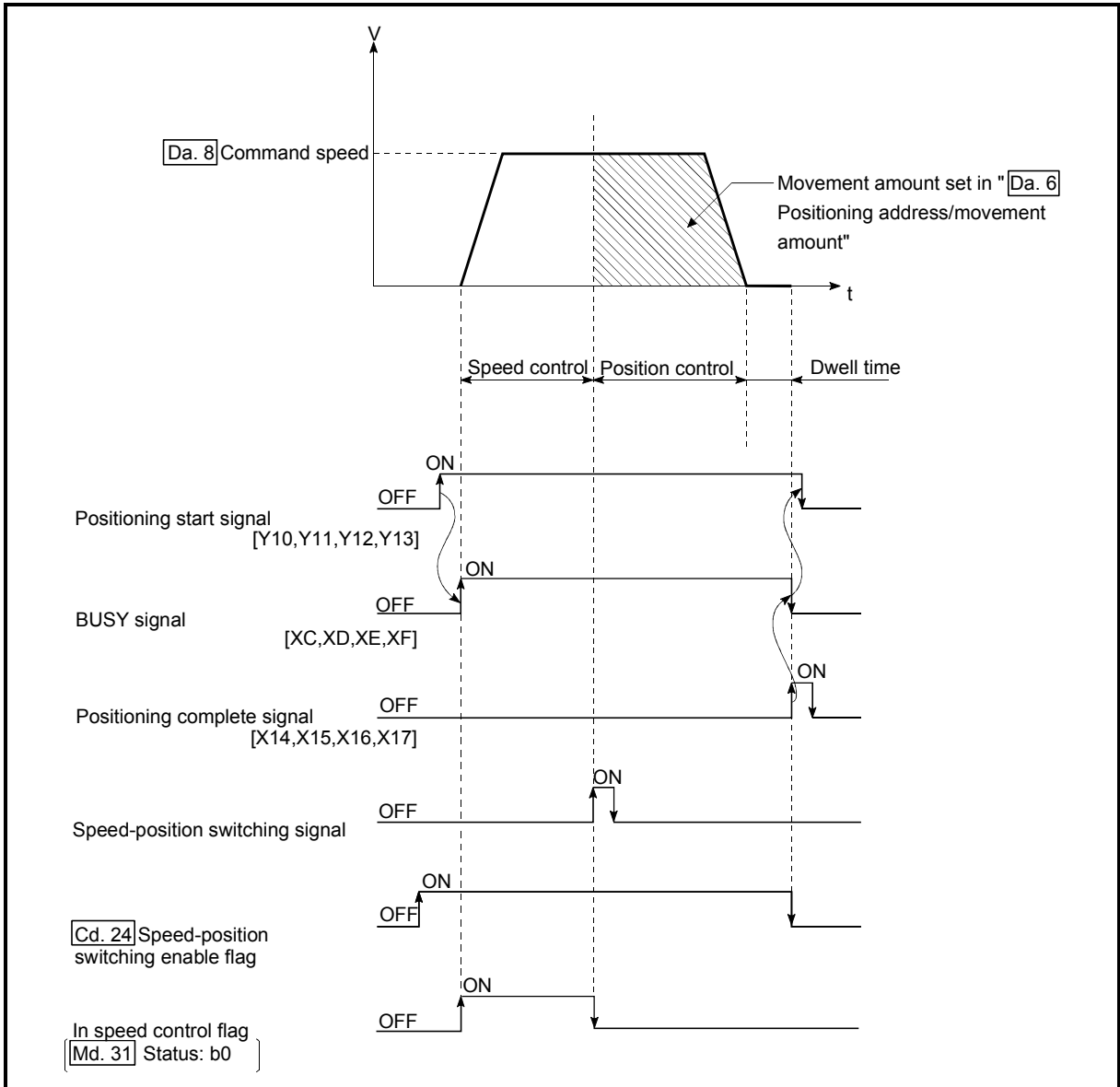
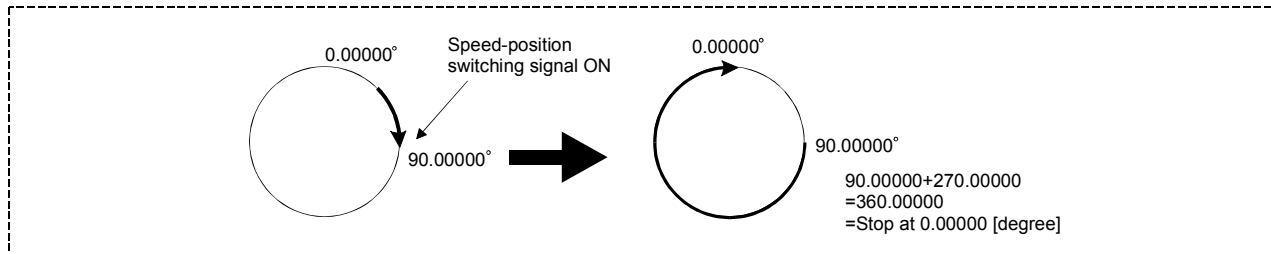

Fig. 9.13 Speed-position switching control (INC mode) operation timing

## [Operation example]

The following operation assumes that the speed-position switching signal is input at the position of the current feed value of 90.00000 [degree] during execution of " [Da.2] Control system" "Forward run: speed/position" at " [Pr.1] Unit setting" of "2: degree" and " [Pr.21] Current feed value during speed control" setting of "1: Update current feed value".

(The value set in " [Da.6] Positioning address/movement amount" is 270.00000 [degree])



■ Operation timing and processing time during speed-position switching control (INC mode)

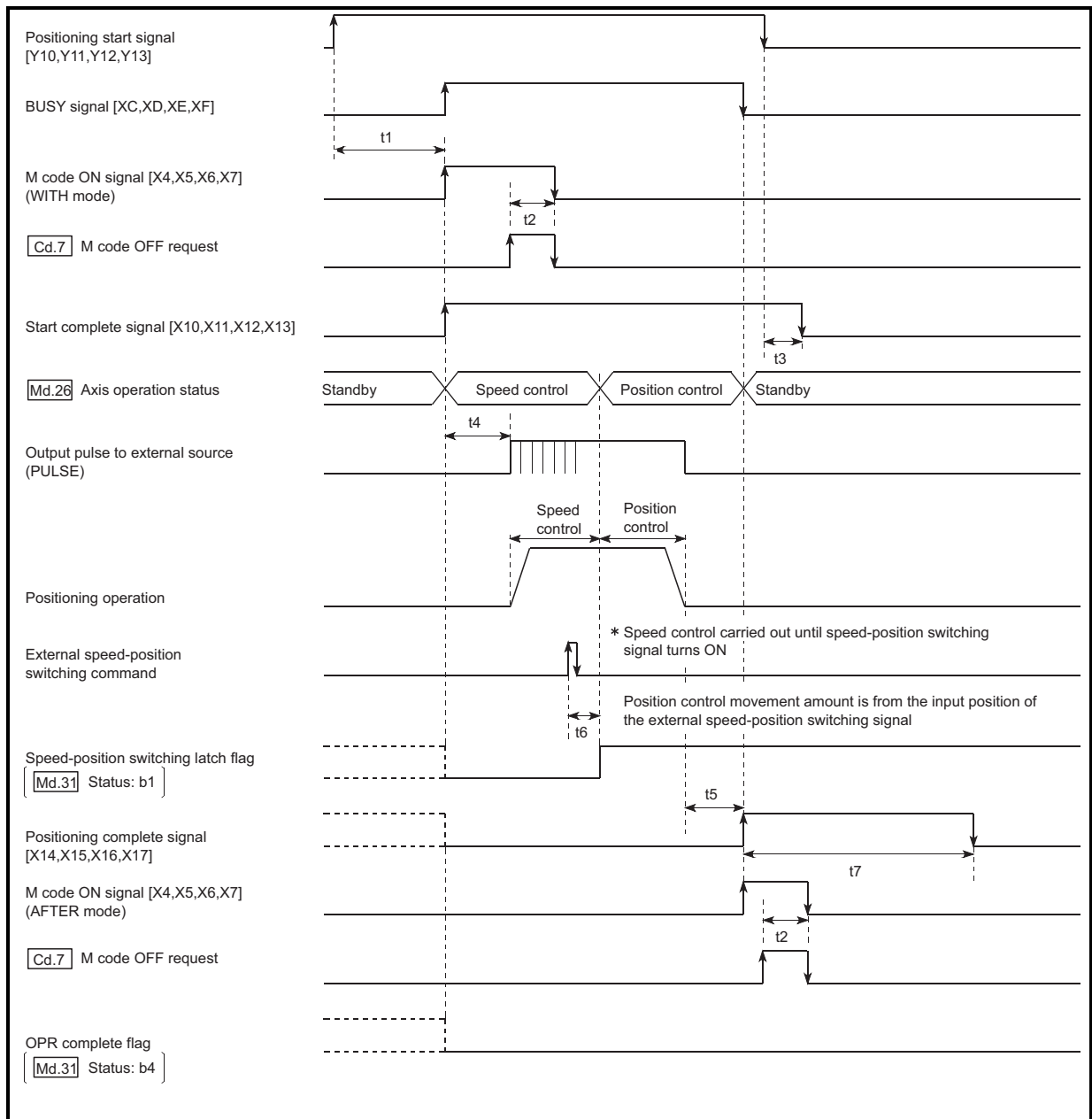

Fig. 9.14 Operation timing and processing time during speed-position switching control (INC mode)

Normal timing time

Model	t1	t2	t3	t4	t5	t6	t7
QD75P□/QD75D□N	0.2 to 1.1ms	0 to 0.9ms	0 to 0.9ms	0.4 to 1.3ms	0 to 0.9ms	1.0ms	Follows parameters
QD75P□/QD75D□	1.1ms	0 to 1.8ms	0 to 1.8ms	2.7 to 4.4ms	0 to 1.8ms	1.0ms	

- The t1 timing time could be delayed by the operation state of other axes.

■ Current feed value during speed-position switching control (INC mode)

The following table shows the "Md.20 Current feed value" during speed-position switching control (INC mode) corresponding to the "Pr.21 Current feed value during speed control" settings.

"Pr.21 Current feed value during speed control" setting	Md.20 Current feed value
0: Do not update current feed value	The current feed value at control start is maintained during speed control, and updated from the switching to position control.
1: Update current feed value	The current feed value is updated during speed control and position control.
2: Zero clear current feed value	The current feed value is cleared (set to "0") at control start, and updated from the switching to position control.

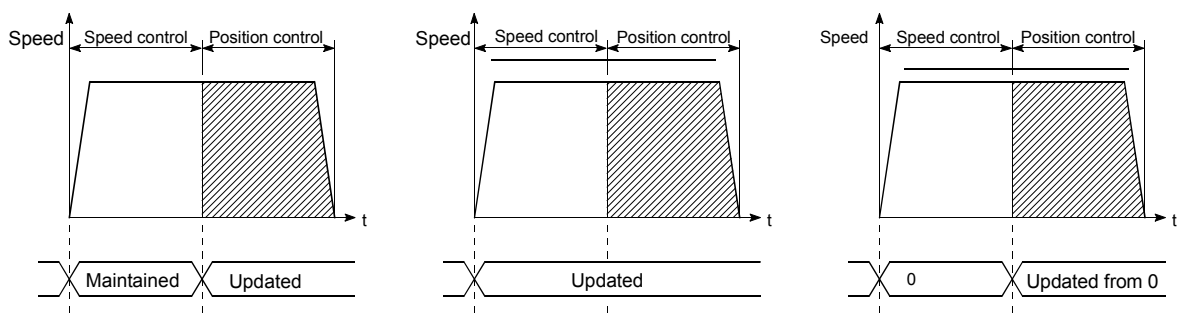

(a) Current feed value not updated

(b) Current feed value updated

(c) Current feed value zero cleared

■ Switching time from speed control to position control

There is 1ms from the time the speed-position switching signal is turned ON to the time the speed-position switching latch flag (Md.31 Status: b1) turns ON.

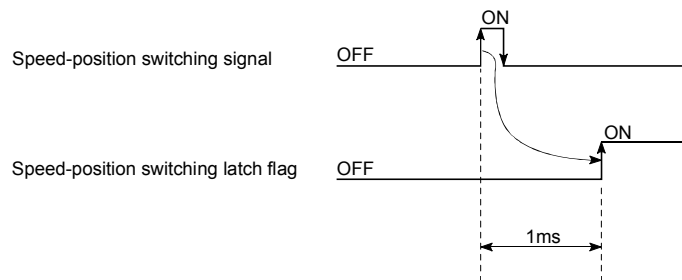

■ Changing the position control movement amount

In "speed-position switching control (INC mode)", the position control movement amount can be changed during the speed control section.

- (1) The "new movement amount" is stored in " [Cd.23] Speed-position switching control movement amount change register" by the sequence program during speed control.

When the speed-position switching signal is turned ON, the movement amount for position control is stored in " [Cd.23] Speed-position switching control movement amount change register".

- (2) The movement amount is stored in the " [Md.29] Speed-position switching control positioning amount" of the axis monitor area from the point where the control changes to position control by the input of a speed-position switching signal from an external source.

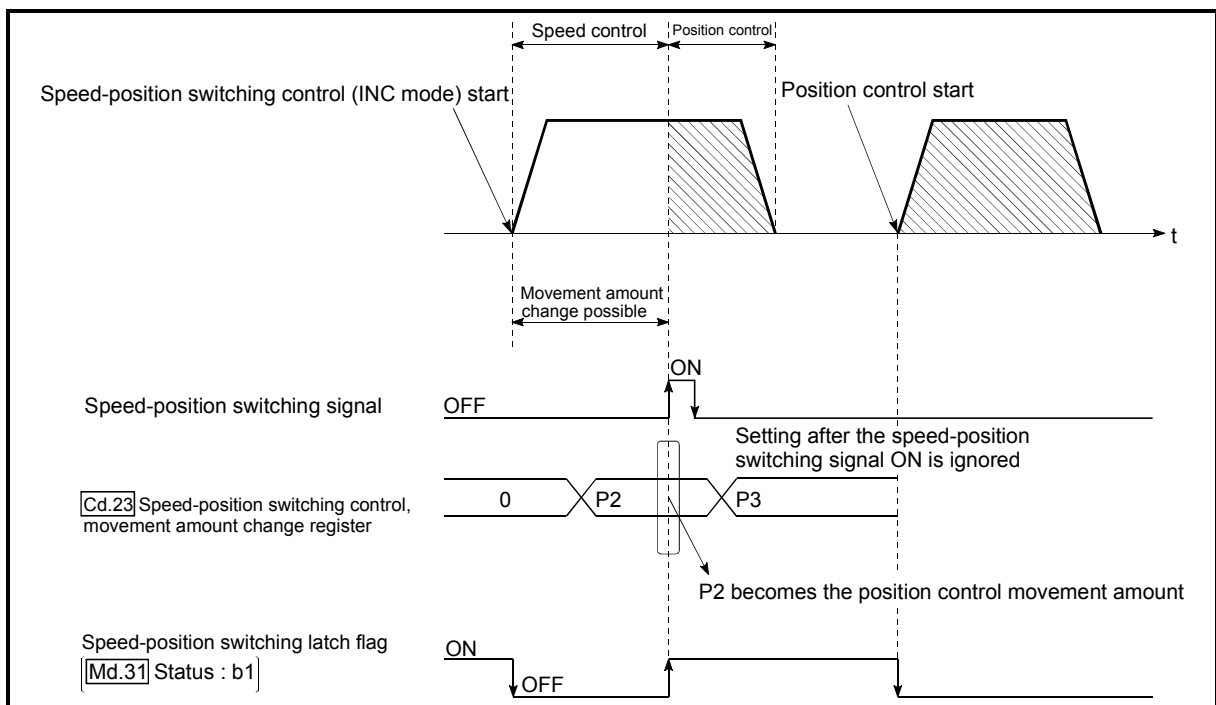

Fig. 9.15 Position control movement amount change timing

## POINT

- The machine recognizes the presence of a movement amount change request when the data is written to " [Cd.23] Speed-position switching control movement amount change register" with the sequence program.
- The new movement amount is validated after execution of the speed-position switching control (INC mode), before the input of the speed-position switching signal.
- The movement amount change can be enable/disable with the interlock function in position control using the "speed-position switching latch flag" ( [Md.31] Status : b1) of the axis monitor area.

■ Restrictions

- (1) The axis error "Continuous path control not possible" (error code: 516) will occur, and the operation cannot start if "continuous path control" is set in " [Da.1] Operation pattern".
- (2) "Speed-position switching control" cannot be set in " [Da.2] Control system" of the positioning data when "continuous path control" has been set in " [Da.1] Operation pattern" of the immediately prior positioning data. (For example, if the operation pattern of positioning data No. 1 is "continuous path control", "speed-position switching control" cannot be set in positioning data No. 2.) The axis error "Continuous path control not possible" (error code: 516) will occur and the machine will carry out a deceleration stop if this type of setting is carried out.
- (3) The error "No command speed" (error code: 503) will occur if "current speed (-1)" is set in " [Da.8] Command speed".
- (4) The software stroke limit range check during speed control is made only when the following (a) and (b) are satisfied:
  - (a) When " [Pr.21] Current feed value during speed control" is "1: Update current feed value"
 

If the movement amount exceeds the software stroke limit range during speed control in cases of settings other than the one above, the error "Software stroke limit+" (error code: 507) or "Software stroke limit-" (error code: 508) will occur as soon as speed control is changed to position control, and the axis will decelerate to a stop.
  - (b) When " [Pr.1] Unit setting" is other than "2: degree"
 

If the unit is "degree", the software stroke limit range check is not performed.
- (5) If the value set in " [Da.6] Positioning address/movement amount" is negative, the error "Outside address range" (error code: 530) will occur.
- (6) Deceleration processing is carried out from the point where the speed-position switching signal is input if the position control movement amount set in " [Da.6] Positioning address/movement amount" is smaller than the deceleration distance from the " [Da.8] Command speed".
- (7) Turn ON the speed-position switching signal in the speed stabilization region (constant speed status). The warning "Speed-position switching (during acceleration) signal ON" (warning code: 508) will occur because of large deviation in the droop pulse amount if the signal is turned ON during acceleration.
 

During use of the servomotor, the actual movement amount after switching of speed control to position control is the "preset movement amount + droop pulse amount". If the signal is turned ON during acceleration/deceleration, the stop position will vary due to large variation of the droop pulse amount. Even though " [Md.29] Speed-position switching control positioning amount" is the same, the stop position will change due to a change in droop pulse amount when " [Da.8] Command speed" is different.

### ■ Positioning data setting examples

The following table shows setting examples when "speed-position switching control (INC mode) by forward run" is set in positioning data No. 1 of axis 1.

Setting item		Setting example	Setting details	
Axis 1 Positioning data No. 1	Da.1	Operation pattern	Positioning complete	Set "Positioning complete" assuming the next positioning data will not be executed. ("Continuous path control" cannot be set in "speed-position switching control (INC mode)".)
	Da.2	Control system	Forward run: speed/position	Set speed-position switching control by forward run.
	Da.3	Acceleration time No.	1	Designate the value set in " Pr.25 Acceleration time 1" as the acceleration time at start.
	Da.4	Deceleration time No.	0	Designate the value set in " Pr.10 Deceleration time 0" as the deceleration time at deceleration.
	Da.5	Axis to be interpolated	–	Setting not required. (Setting value is ignored.)
	Da.6	Positioning address/ movement amount	10000.0μm	INC mode ( Pr.150 = 0) Set the movement amount after the switching to position control. (Assuming that the " Pr.1 Unit setting" is set to "mm".)
	Da.7	Arc address	–	Setting not required. (Setting value is ignored.)
	Da.8	Command speed	6000.00mm/min	Set the speed to be controlled.
	Da.9	Dwell time	500ms	Set a time from the positioning stop (pulse output stop) by position control until the positioning complete signal is output. When the system is stopped by speed control, ignore the setting value.
	Da.10	M code	10	Set this when other sub operation commands are issued in combination with the No. 1 positioning data.

\* Refer to Section 5.3 "List of positioning data" for information on the setting details.



9.2.19 Speed-position switching control (ABS mode)

In case of "speed-position switching control (ABS mode)" (" **Da.2** Control system" = Forward run: speed/position, Reverse run: speed/position), the pulses of the speed set in " **Da.8** Command speed" are kept output in the axial direction set to the positioning data. When the "speed-position switching signal" is input, position control to the address set in " **Da.6** Positioning address/movement amount" is exercised.

"Speed-position switching control (ABS mode)" is available in two different types: "forward run: speed/position" which starts the axis in the forward run direction and "reverse run: speed/position" which starts the axis in the reverse run direction.

"Speed-position switching control (ABS mode)" is valid only when " **Pr.1** Unit setting" is "2: degree".

<b>Pr.1</b> Unit setting	mm	inch	degree	pulse
Speed-position function selection				
INC mode	○	○	○	○
ABS mode	×	×	○	×

- : Setting allowed,
- ×: Setting disallowed (If setting is made, the error "Speed-position function selection error" (error code: 935) will occur when the PLC READY (Y0) turns ON.)

Use the detailed parameter 1 " **Pr.150** Speed-position function selection" to choose "speed-position switching control (ABS mode)".

Setting item		Setting value	Setting details	Buffer memory address			
				Axis 1	Axis 2	Axis 3	Axis 4
<b>Pr.150</b>	Speed-position function selection	2	Speed-position switching control (ABS mode)	34	184	334	484

\* If the set value is other than 0 and 2, it is regarded as 0 and operation is performed in the INC mode.  
For details of the setting, refer to Section 5.2 "List of parameters".

■ Switching over from speed control to position control

- (1) The control is switched over from speed control to position control by executing the external command signal set in "speed-position switching signal".
- (2) Besides setting the positioning data, the " Cd.24 Speed-position switching enable flag" must also be turned ON to switch over from speed control to position control. (If the " Cd.24 Speed-position switching enable flag" turns ON after the speed-position switching signal turns ON, the control will continue as speed control without switching over to position control. The control will be switched over from speed control to position control when the speed-position switching signal turns from OFF to ON again. Only position control will be carried out when the " Cd.24 Speed-position switching enable flag" and speed-position switching signal are ON at the operation start.)

Setting item		Setting value	Setting details	Buffer memory address			
				Axis 1	Axis 2	Axis 3	Axis 4
<span style="border: 1px solid black; padding: 0 2px;">Cd.24</span>	Speed-position switching enable flag	1	Set "1: Switch from speed control to position control when the external command signal [CHG] turns ON.".	1528	1628	1728	1828

■ Speed-position switching signal setting

The following table shows the items that must be set to use the external command signals (CHG) as speed-position switching signals.

Setting item		Setting value	Setting details	Buffer memory address			
				Axis 1	Axis 2	Axis 3	Axis 4
<span style="border: 1px solid black; padding: 0 2px;">Pr.42</span>	External command function selection	2	Set the "2: speed-position and position-speed switching requests".	62	212	362	512
<span style="border: 1px solid black; padding: 0 2px;">Cd.8</span>	External command valid	1	Set "1: Validate external command".	1505	1605	1705	1805

\* Refer to Section 5.2 "List of parameters" and Section 5.7 "List of control data" for information on the setting details.

■ Operation chart

The following chart (Fig.9.16) shows the operation timing for speed-position switching control (ABS mode). The "in speed control flag" (Md.31 Status: b0) is turned ON during speed control of speed-position switching control (ABS mode).

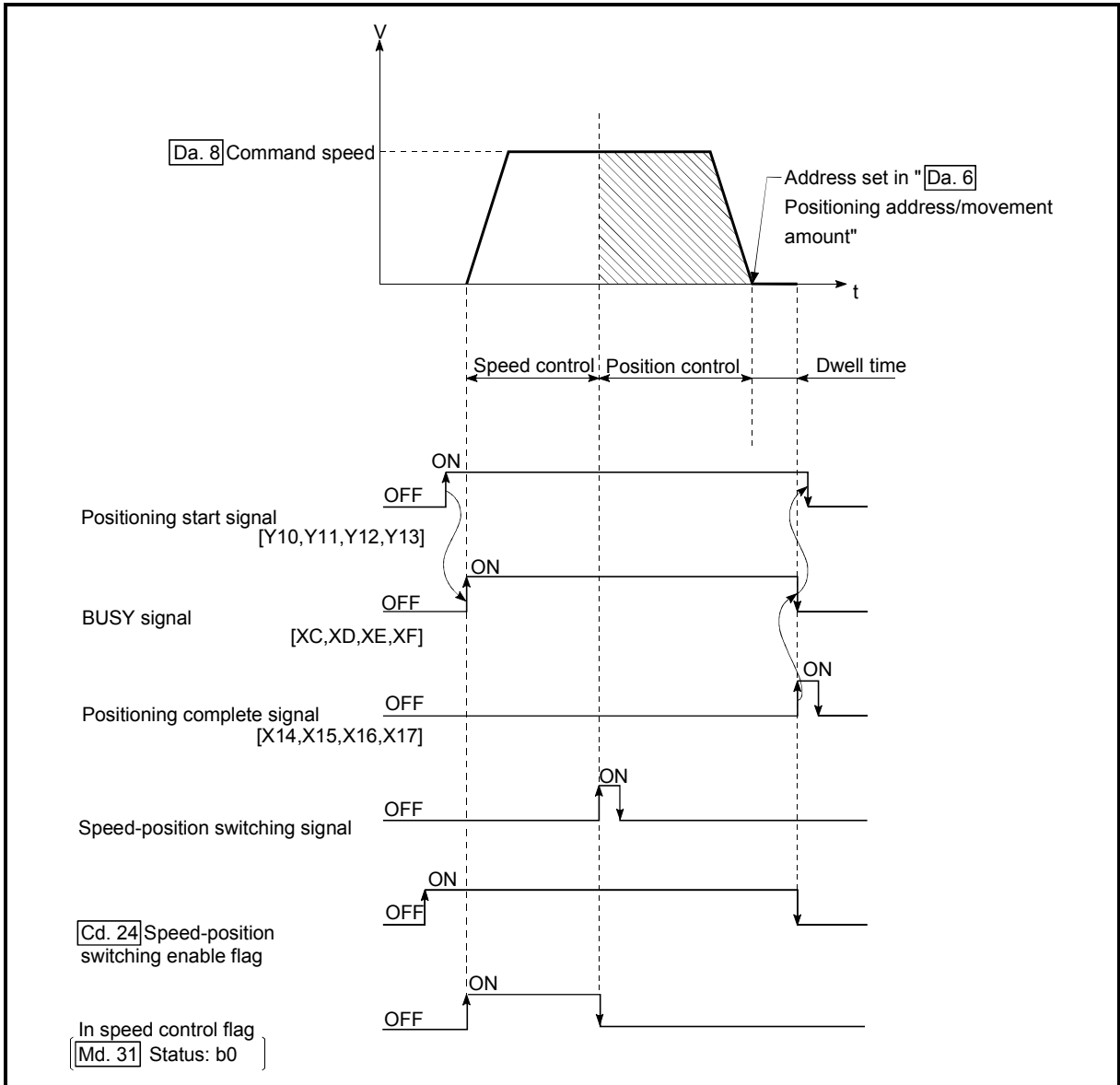
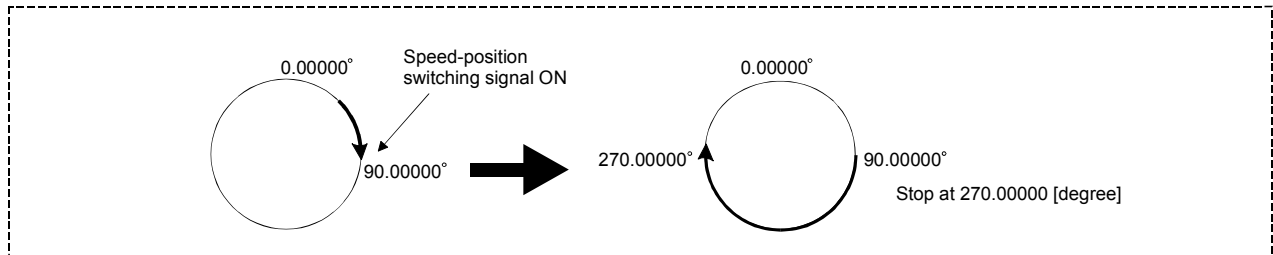

Fig. 9.16 Speed-position switching control (ABS mode) operation timing

## [Operation example]

The following operation assumes that the speed-position switching signal is input at the position of the current feed value of 90.00000 [degree] during execution of " [Da.2] Control system "Forward run: speed/position" at " [Pr.1] Unit setting " of "2: degree" and " [Pr.21] Current feed value during speed control" setting of "1: Update current feed value".

(The value set in " [Da.6] Positioning address/movement amount" is 270.00000 [degree])



■ Operation timing and processing time during speed-position switching control (ABS mode)

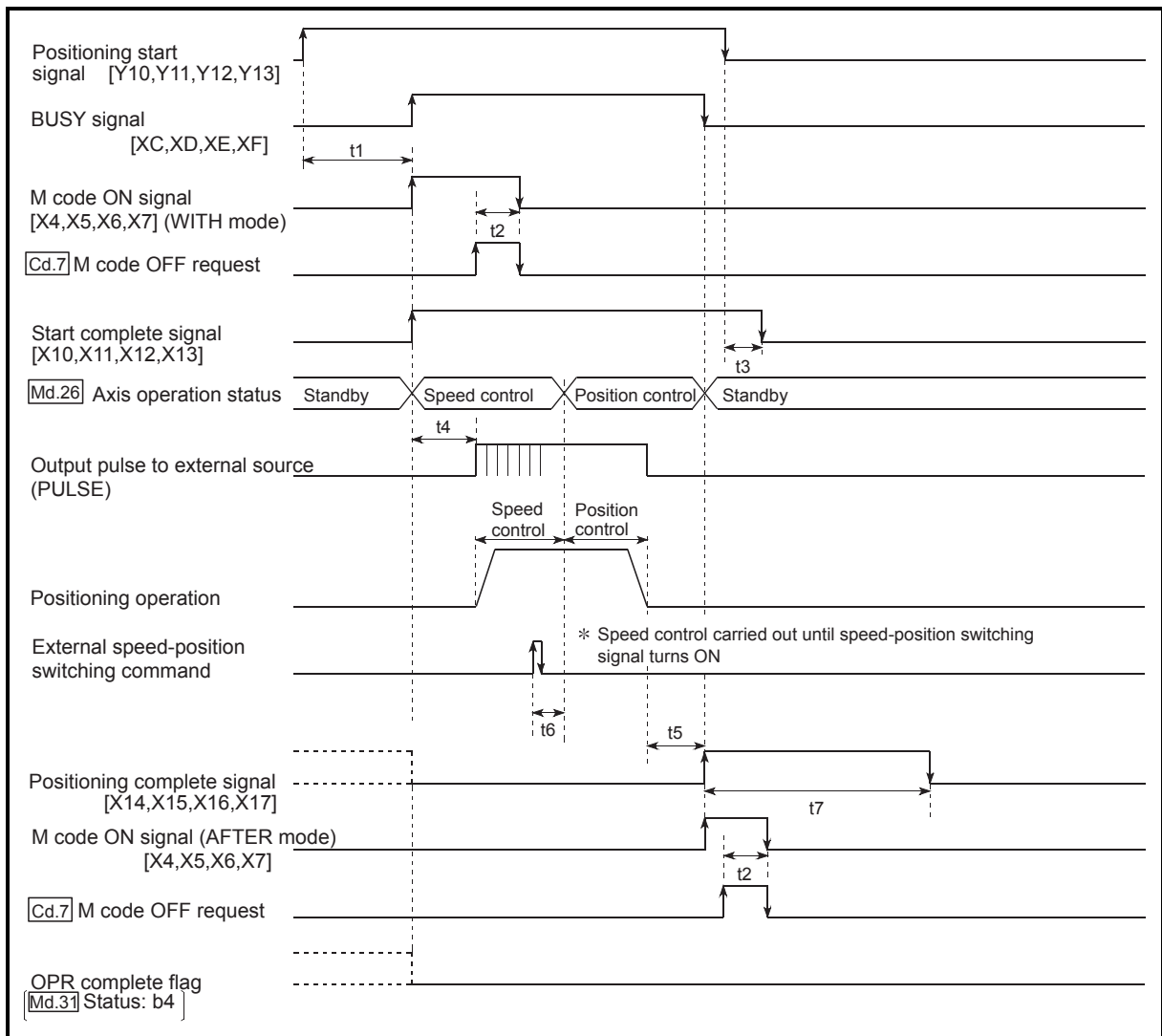

Fig. 9.17 Operation timing and processing time during speed-position switching control (ABS mode)

Normal timing time

Model	t1	t2	t3	t4	t5	t6	t7
QD75P□N/QD75D□N	0.2 to 1.1ms	0 to 0.9ms	0 to 0.9ms	0.4 to 1.3ms	0 to 0.9ms	1.0ms	Follows parameters
QD75P□/QD75D□	1.1ms	0 to 1.8ms	0 to 1.8ms	2.7 to 4.4ms	0 to 1.8ms	1.0ms	

- The t1 timing time could be delayed by the operation state of other axes.

■ Current feed value during speed-position switching control (ABS mode)

The following table shows the "Md.20 Current feed value" during speed-position switching control (ABS mode) corresponding to the "Pr.21 Current feed value during speed control" settings.

"Pr.21 Current feed value during speed control" setting	Md.20 Current feed value
1: Update current feed value	The current feed value is updated during speed control and position control.

Only "1: Update current value" is valid for the setting of "Pr.21 Current feed value during speed control" in speed-position switching control (ABS mode). The error "Speed-position function selection error" (error code: 935) will occur if the "Pr.21 Current feed value during speed control" setting is other than 1.

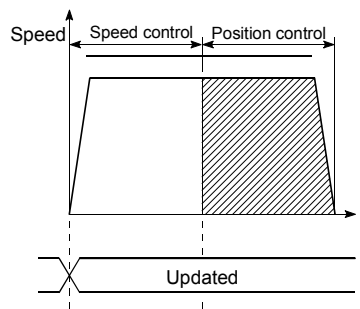

Current feed value updated

■ Switching time from speed control to position control

There is 1ms from the time the speed-position switching signal is turned ON to the time the speed-position switching latch flag (Md.31 Status: b1) turns ON.

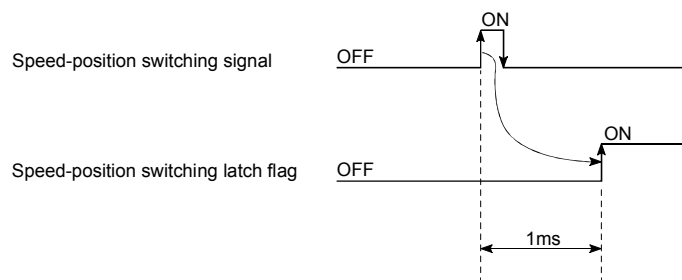

### ■ Restrictions

- (1) The axis error "Continuous path control not possible" (error code: 516) will occur, and the operation cannot start if "continuous path control" is set in " [Da.1] Operation pattern".
- (2) "Speed-position switching control" cannot be set in " [Da.2] Control system" of the positioning data when "continuous path control" has been set in " [Da.1] Operation pattern" of the immediately prior positioning data. (For example, if the operation pattern of positioning data No. 1 is "continuous path control", "speed-position switching control" cannot be set in positioning data No. 2.) The axis error "Continuous path control not possible" (error code: 516) will occur and the machine will carry out a deceleration stop if this type of setting is carried out.
- (3) The error "No command speed" (error code: 503) will occur if "current speed (-1)" is set in " [Da.8] Command speed".
- (4) If the value set in " [Da.6] Positioning address/movement amount" is negative, the error "Outside address range" (error code: 530) will occur.
- (5) Even though the axis control data " [Cd.23] Speed-position switching control movement amount change register" was set in speed-position switching control (ABS mode), it would not function. The set value is ignored.
- (6) To exercise speed-position switching control (ABS mode), the following conditions must be satisfied:
  - (a) " [Pr.1] Unit setting" is "2: degree"
  - (b) The software stroke limit function is invalid (upper limit value = lower limit value)
  - (c) " [Pr.21] Current feed value during speed control" is "1: Update current feed value"
  - (d) The setting range of " [Da.6] Positioning address/movement amount" is within 0 to 359.99999 (degree)  
(If the value is outside of the range, the error "Outside address range" (error code: 530) will occur at the start.)
  - (e) The " [Pr.150] Speed-position function selection" setting is "2: Speed-position switching control (ABS mode)".
- (7) If any of the conditions in (6)(a) to (6)(c) is not satisfied in the case of (6)(e), the error "Speed-position function selection error" (error code: 935) will occur when the PLC READY [Y0] turns from OFF to ON.
- (8) If the axis reaches the positioning address midway through deceleration after automatic deceleration started at the input of the speed-position switching signal, the axis will not stop immediately at the positioning address. The axis will stop at the positioning address after N revolutions so that automatic deceleration can always be made. (N: Natural number)  
In the following example, since making deceleration in the path of dotted line will cause the axis to exceed the positioning addresses twice, the axis will decelerate to a stop at the third positioning address.

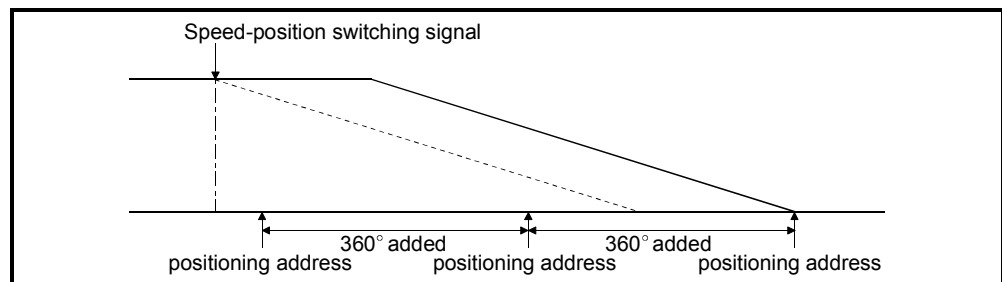

### ■ Positioning data setting examples

The following table shows setting examples when "speed-position switching control (ABS mode) by forward run" is set in positioning data No. 1 of axis 1.

Setting item		Setting example	Setting details
Axis 1 Positioning data No. 1	Da.1	Operation pattern	Positioning complete Set "Positioning complete" assuming the next positioning data will not be executed. ("Continuous path control" cannot be set in "speed-position switching control (ABS mode)".)
	Da.2	Control system	Forward run: speed/position Set speed-position switching control by forward run.
	Da.3	Acceleration time No.	1 Designate the value set in " Pr.25 Acceleration time 1" as the acceleration time at start.
	Da.4	Deceleration time No.	0 Designate the value set in " Pr.10 Deceleration time 0" as the deceleration time at deceleration.
	Da.5	Axis to be interpolated	- Setting not required. (Setting value is ignored.)
	Da.6	Positioning address/movement amount	270.00000 degree ABS mode ( Pr.150 = 2) Set the address after the switching to position control. (Assuming that the " Pr.1 Unit setting" is set to "degree".)
	Da.7	Arc address	- Setting not required. (Setting value is ignored.)
	Da.8	Command speed	6000.00mm/min Set the speed to be controlled.
	Da.9	Dwell time	500ms Set a time from the positioning stop (pulse output stop) by position control until the positioning complete signal is output. When the system is stopped by speed control, ignore the setting value.
	Da.10	M code	10 Set this when other sub operation commands are issued in combination with the No. 1 positioning data.

\* Refer to Section 5.3 "List of positioning data" for information on the setting details.



9.2.20 Position-speed switching control

In "position-speed switching control" (" [Da.2] Control system" = Forward run: position/speed, Reverse run: position/speed), before the position-speed switching signal is input, position control is carried out for the movement amount set in " [Da.6] Positioning address/movement amount" in the axis direction in which the positioning data has been set. When the position-speed switching signal is input, the position control is carried out by continuously outputting the pulses for the speed set in " [Da.8] Command speed" until the input of a stop command.

The two types of position-speed switching control are "Forward run: position/speed" in which the control starts in the forward run direction, and "Reverse run: position/speed" in which control starts in the reverse run direction.

■ Switching over from position control to speed control

- (1) The control is switched over from position control to speed control by executing the external command signal set in "position-speed switching signal".
- (2) Besides setting the positioning data, the " [Cd.26] Position-speed switching enable flag" must also be turned ON to switch over from position control to speed control. (If the " [Cd.26] Position-speed switching enable flag" turns ON after the position-speed switching signal turns ON, the control will continue as position control without switching over to speed control. The control will be switched over from position control to speed control when the position-speed switching signal turns from OFF to ON again. Only speed control will be carried out when the " [Cd.26] Position-speed switching enable flag" and position-speed switching signal are ON at the operation start.)

Setting item		Setting value	Setting details	Buffer memory address			
				Axis 1	Axis 2	Axis 3	Axis 4
[Cd.26]	Position-speed switching enable flag	1	Set "1: Switch from position control to speed control when the external command signal [CHG] turns ON".	1532	1632	1732	1832

■ Position-speed switching signal setting

The following table shows the items that must be set to use the external command signals (CHG) as position-speed switching signals.

Setting item		Setting value	Setting details	Buffer memory address			
				Axis 1	Axis 2	Axis 3	Axis 4
[Pr.42]	External command function selection	2	Set the "2: speed-position and position-speed switching requests".	62	212	362	512
[Cd.8]	External command valid	1	Set "1: Validate external command".	1505	1605	1705	1805

\* Refer to Section 5.2 "List of parameters" and Section 5.7 "List of control data" for information on the setting details.

■ Operation chart

The following chart shows the operation timing for position-speed switching control.

The "in speed control" flag (**[Md.31]** Status: b0) is turned ON during speed control of position-speed switching control.

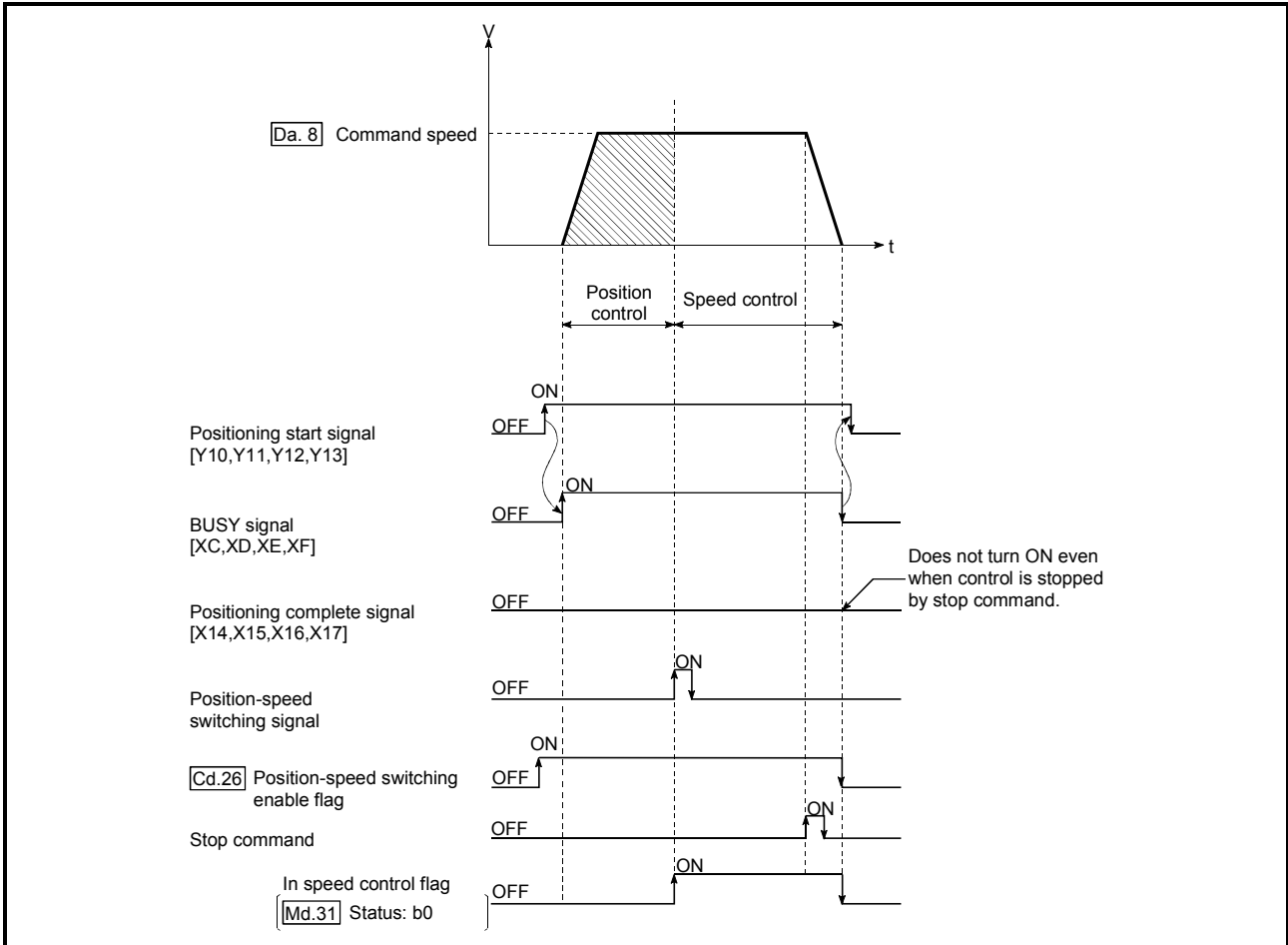

Fig. 9.18 Position-speed switching control operation timing

■ Operation timing and processing time during position-speed switching control

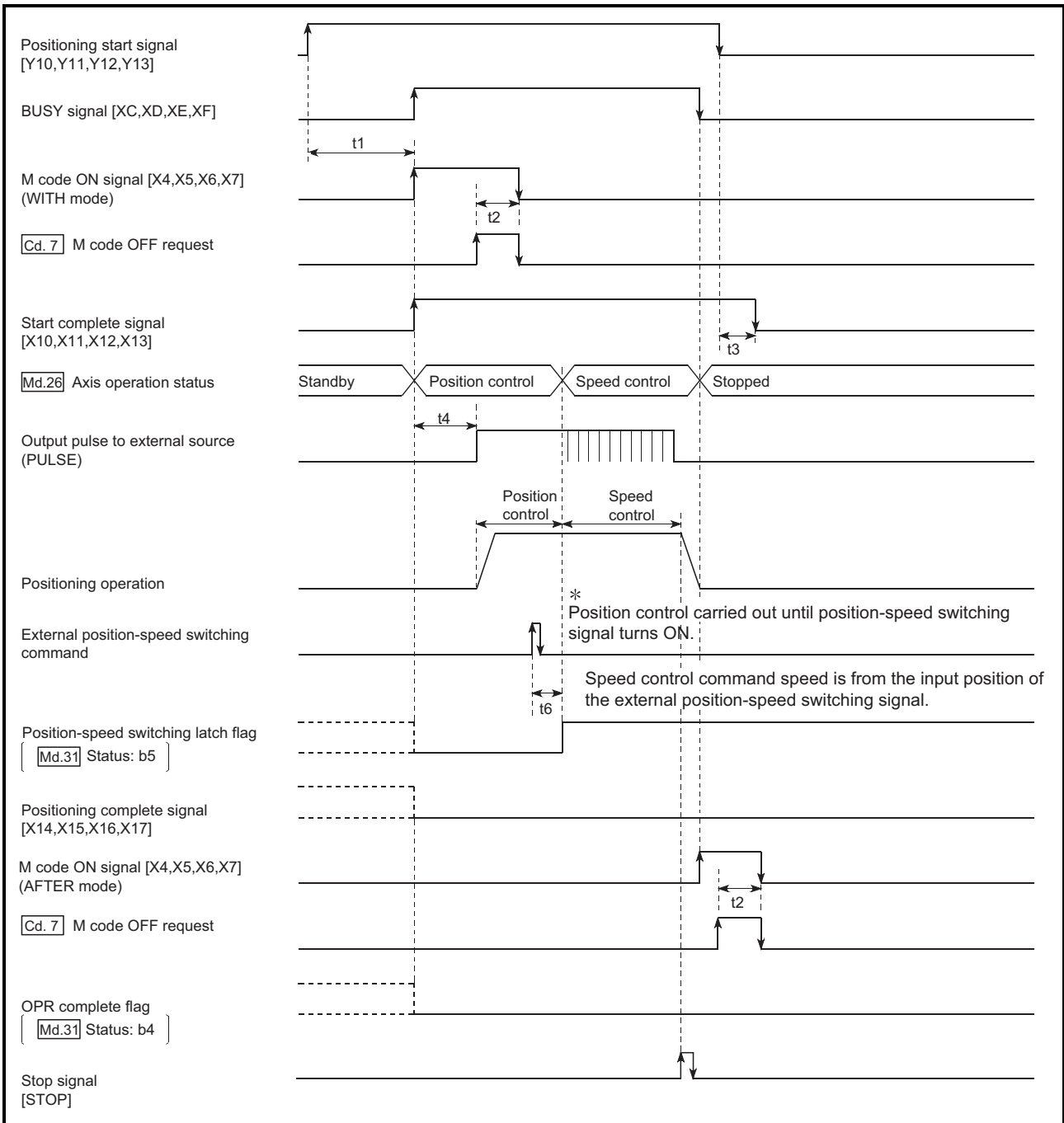

Fig. 9.19 Operation timing and processing time during position-speed switching control

Normal timing time

Model	t1	t2	t3	t4	t5	t6
QD75P□N/QD75D□N	0.2 to 1.1ms	0 to 0.9ms	0 to 0.9ms	0.4 to 1.3ms	-	1.0ms
QD75P□/QD75D□	1.0 to 1.4ms	0 to 1.8ms	0 to 1.8ms	2.7 to 4.4ms	-	1.0ms

- The t1 timing time could be delayed by the operation state of other axes.

■ Current feed value during position-speed switching control

The following table shows the " [Md.20] Current feed value" during position-speed switching control corresponding to the " [Pr.21] Current feed value during speed control" settings.

" [Pr.21] Current feed value during speed control" setting	[Md.20] Current feed value
0: Do not update current feed value	The current feed value is updated during position control, and the current feed value at the time of switching is maintained as soon as position control is switched to speed control.
1: Update current feed value	The current feed value is updated during position control and speed control.
2: Zero clear current feed value	The current feed value is updated during positioning control, and the current feed value is cleared (to "0") as soon as position control is switched to speed control.

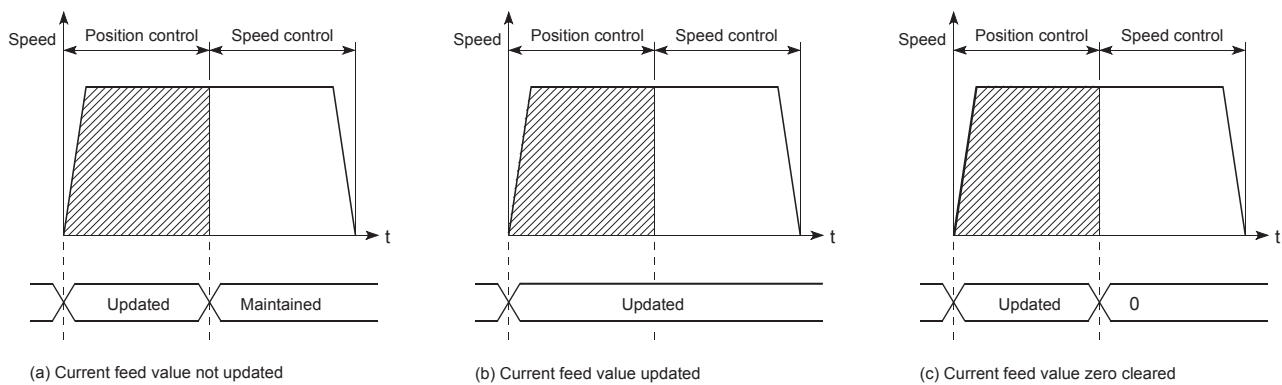

■ Switching time from position control to speed control

There is 1ms from the time the position-speed switching signal is turned ON to the time the position-speed switching latch flag ([Md.31] Status: b5) turns ON.



■ Changing the speed control command speed

In "position-speed switching control", the speed control command speed can be changed during the position control.

- (1) The speed control command speed can be changed during the position control of position-speed switching control.

A command speed change request will be ignored unless issued during the position control of the position-speed switching control.

- (2) The "new command speed" is stored in " [Cd.25] Position-speed switching control speed change register" by the sequence program during position control.

This value then becomes the speed control command speed when the position-speed switching signal turns ON.

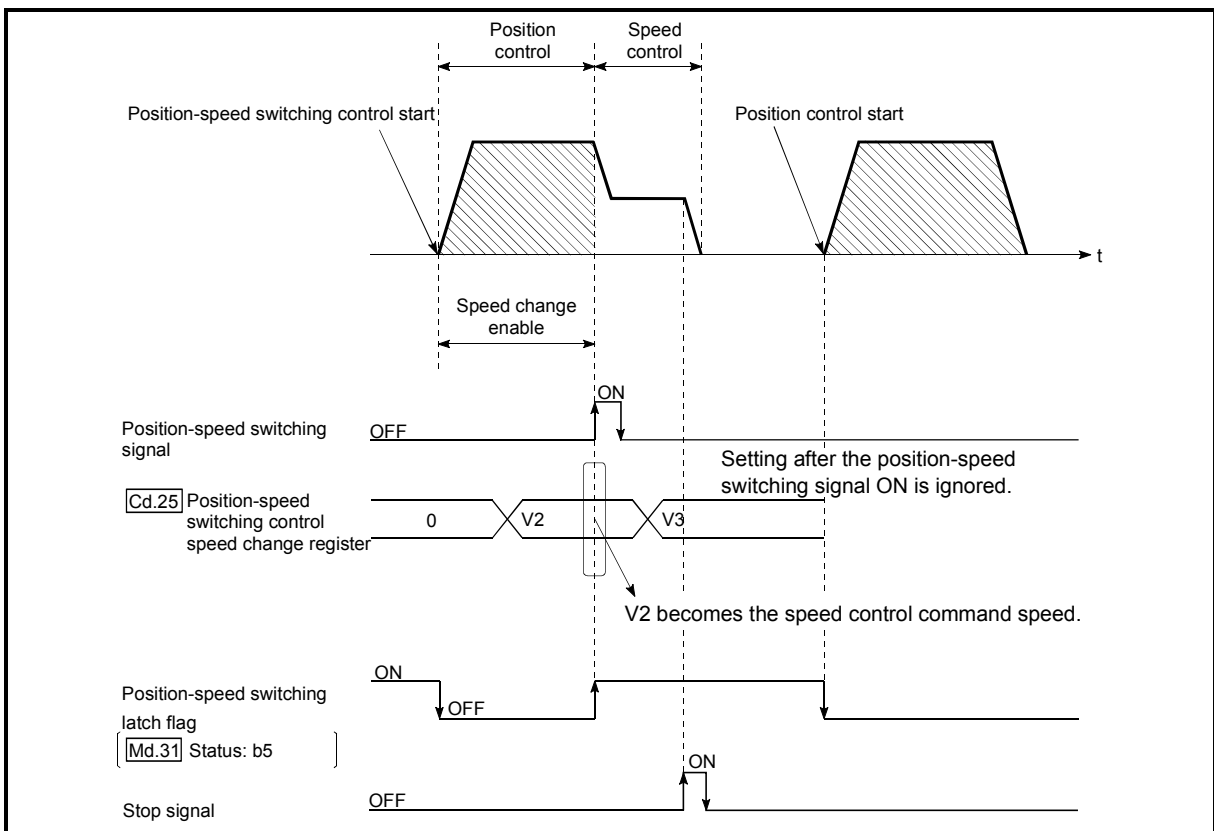

Fig. 9.20 Speed control speed change timing

## POINTS

- The machine recognizes the presence of a command speed change request when the data is written to " [Cd.25] Position-speed switching control speed change register" with the sequence program.
- The new command speed is validated after execution of the position-speed switching control before the input of the position-speed switching signal.
- The command speed change can be enabled/disabled with the interlock function in speed control using the "position-speed switching latch flag" ([Md.31] Status: b5) of the axis monitor area.

### ■ Restrictions

- (1) The axis error "Continuous path control not possible" (error code: 516) will occur and the operation cannot start if "continuous positioning control" or "continuous path control" is set in " [Da.1] Operation pattern".
- (2) "Position-speed switching control" cannot be set in " [Da.2] Control system" of the positioning data when "continuous path control" has been set in " [Da.1] Operation pattern" of the immediately prior positioning data. (For example, if the operation pattern of positioning data No. 1 is "continuous path control", "position-speed switching control" cannot be set in positioning data No. 2.) The axis error "Continuous path control not possible" (error code: 516) will occur and the machine will carry out a deceleration stop if this type of setting is carried out.
- (3) The software stroke limit range is only checked during speed control if the "1: Update current feed value" is set in " [Pr.21] Current feed value during speed control".  
The software stroke limit range is not checked when the control unit is set to "degree".
- (4) The error "Software stroke limit+" or "Software stroke limit-" (error code: 507 or 508) will occur and the operation cannot start if the start point address or end point address for position control exceeds the software stroke limit range.
- (5) Deceleration stop will be carried out if the position-speed switching signal is not input before the machine is moved by a specified movement amount.  
When the position-speed switching signal is input during automatic deceleration by positioning control, acceleration is carried out again to the command speed to continue speed control.  
When the position-speed switching signal is input during deceleration to a stop with the stop signal, the control is switched to the speed control to stop the machine.  
Restart is carried out by speed control using the restart command.
- (6) The warning "Speed limit value over" (warning code: 501) will occur and control is continued by " [Pr.8] Speed limit value" if a new speed exceeds " [Pr.8] Speed limit value" at the time of change of the command speed.
- (7) If the value set in " [Da.6] Positioning address/movement amount" is negative, the error "Outside address range" (error code: 530) will occur.

### ■ Positioning data setting examples

The following table shows setting examples when "position-speed switching control (forward run: position/speed)" is set in positioning data No. 1 of axis 1.

Setting item		Setting example	Setting details
Axis 1 Positioning data No. 1	Da.1	Operation pattern	Positioning complete Set "Positioning complete" assuming the next positioning data will not be executed. ("Continuous positioning control" and "Continuous path control" cannot be set in "position/speed changeover control".)
	Da.2	Control system	Forward run: position/speed Set position-speed switching control.
	Da.3	Acceleration time No.	1 Designate the value set in " Pr.25 Acceleration time 1" as the acceleration time at start.
	Da.4	Deceleration time No.	0 Designate the value set in " Pr.10 Deceleration time 0" as the deceleration time at deceleration.
	Da.5	Axis to be interpolated	– Setting not required. (Setting value is ignored.)
	Da.6	Positioning address/movement amount	10000.0μm Set the movement amount at the time of position control before the switching to speed control. (Assuming that the " Pr.1 Unit setting" is set to "mm".)
	Da.7	Arc address	– Setting not required. (Setting value is ignored.)
	Da.8	Command speed	6000.00mm/min Set the speed to be controlled.
	Da.9	Dwell time	500ms Set the time the machine dwells after the positioning stop (pulse output stop) by position control to the output of the positioning complete signal. If the machine is stopped by speed control, the setting value will be ignored.
	Da.10	M code	10 Set this when other sub operation commands are issued in combination with the No. 1 positioning data.

\* Refer to Section 5.3 "List of positioning data" for information on the setting details.

## 9.2.21 Current value changing

When the current value is changed to a new value, control is carried out in which the " [Md.20] Current feed value" of the stopped axis is changed to a random address set by the user. (The " [Md.21] Machine feed value" is not changed when the current value is changed.)

The two methods for changing the current value are shown below.

- [1] Changing to a new current value using the positioning data
- [2] Changing to a new current value using the start No. (No. 9003) for a current value changing

The current value changing using method [1] is used during continuous positioning of multiple blocks, etc.

## [1] Changing to a new current value using the positioning data

## ■ Operation chart

The following chart shows the operation timing for a current value changing. The " [Md.20] Current feed value" is changed to the value set in " [Da.6] Positioning address/movement amount" when the positioning start signal turns ON.

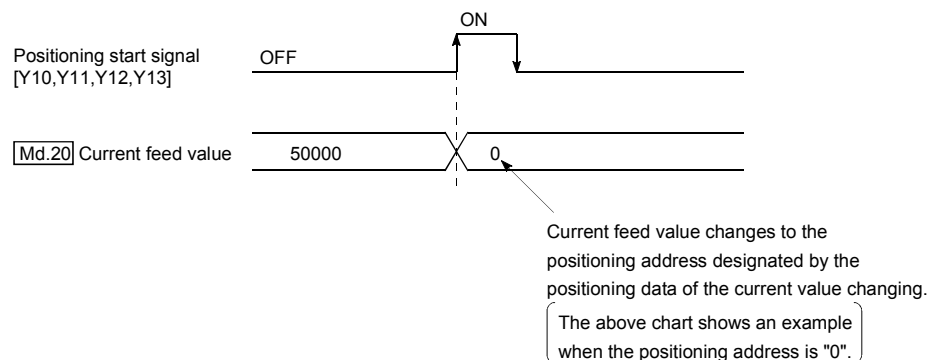

## ■ Restrictions

- (1) An axis error "New current value not possible" (error code: 515) will occur and the operation cannot start if "continuous path control" is set in " [Da.1] Operation pattern". ("Continuous path control" cannot be set in current value changing.)
- (2) "Current value changing" cannot be set in " [Da.2] Control system" of the positioning data when "continuous path control" has been set in " [Da.1] Operation pattern" of the immediately prior positioning data. (For example, if the operation pattern of positioning data No. 1 is "continuous path control", "current value changing" cannot be set in positioning data No. 2.) An axis error "New current value not possible" (error code: 515) will occur and the machine will carry out a deceleration stop if this type of setting is carried out.
- (3) An axis error "Outside new current value range" (error code: 514) will occur and the operation cannot start if "degree" is set in " [Pr.1] Unit setting" and the value set in " [Da.6] Positioning address/movement amount" is outside the setting range (0 to 359.99999 [degree]).



- (4) If the value set in " Da.6 Positioning address/movement amount" is outside the software stroke limit ( Pr.12, Pr.13 ) setting range, an error "Software stroke limit +" or "Software stroke limit -" (error code: 507 or 508) will occur at the positioning start, and the operation will not start.

■ Positioning data setting examples

The following table shows the setting examples when " current value changing" is set in the positioning data No. 1 of axis 1.

Setting item		Setting example	Setting details	
Axis 1 positioning data No. 1	<span style="border: 1px solid black; padding: 0 2px;">Da.1</span>	Operation pattern	Positioning complete	Set "Positioning complete" assuming that the next positioning data will be executed. ("Continuous path control" cannot be set by current value change.)
	<span style="border: 1px solid black; padding: 0 2px;">Da.2</span>	Control system	Current value changing	Set the current value changing.
	<span style="border: 1px solid black; padding: 0 2px;">Da.3</span>	Acceleration time No.	–	Setting not required (Setting value is ignored.)
	<span style="border: 1px solid black; padding: 0 2px;">Da.4</span>	Deceleration time No.	–	Setting not required (Setting value is ignored.)
	<span style="border: 1px solid black; padding: 0 2px;">Da.5</span>	Axis to be interpolated	–	Setting not required (Setting value is ignored.)
	<span style="border: 1px solid black; padding: 0 2px;">Da.6</span>	Positioning address/movement amount	10000.0 $\mu$ m	Set the address to which address change is desired. (Assuming that the " <span style="border: 1px solid black; padding: 0 2px;">Pr.1</span> Unit setting" is set to "mm".)
	<span style="border: 1px solid black; padding: 0 2px;">Da.7</span>	Arc address	–	Setting not required (Setting value is ignored.)
	<span style="border: 1px solid black; padding: 0 2px;">Da.8</span>	Command speed	–	Setting not required (Setting value is ignored.)
	<span style="border: 1px solid black; padding: 0 2px;">Da.9</span>	Dwell time	–	Setting not required (Setting value is ignored.)
	<span style="border: 1px solid black; padding: 0 2px;">Da.10</span>	M code	10	Set this when other sub operation commands are issued in combination with the No. 1 positioning data.

\* Refer to Section 5.3 "List of positioning data" for information on the setting details.

## [2] Changing to a new current value using the start No. (No. 9003) for a current value changing

### ■ Operation chart

The current value is changed by setting the new current value in the current value changing buffer memory " [Cd.9] Current value changing", setting "9003" in the " [Cd.3] Positioning start No.", and turning ON the positioning start signal.

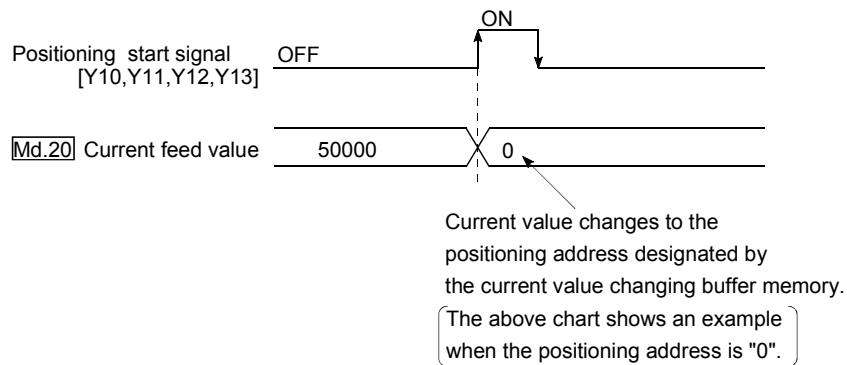

### ■ Restrictions

- (1) An axis error "Outside new current value range" (error code: 514) will occur if the designated value is outside the setting range when "degree" is set in "Unit setting".
- (2) An error "Software stroke limit +" or "Software stroke limit -" (error code: 507 or 508) will occur if the designated value is outside the software stroke limit range.
- (3) The current value cannot be changed during stop commands and while the M code ON signal is ON.
- (4) The M code output function is made invalid.

### ■ Current value changing procedure

The following shows the procedure for changing the current value to a new value.

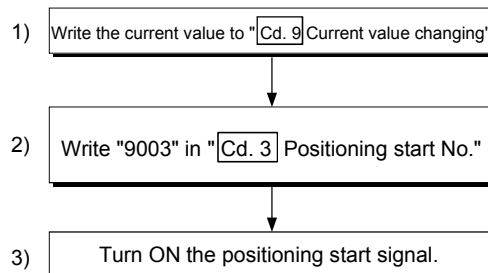

■ Setting method for the current value changing function

The following shows an example of a sequence program and data setting to change the current value to a new value with the positioning start signal. (The "Md.20" Current feed value is changed to "5000.0μm" in the example shown.)

- (1) Set the following data.  
(Set with the sequence program shown in (3), while referring to the start time chart shown in (2).)

Setting item	Setting value	Setting details	Buffer memory address			
			Axis 1	Axis 2	Axis 3	Axis 4
Cd.3	Positioning start No.	9003	Set the start No. "9003" for the new current value.			
Cd.9	Current value changing	50000	Set the new "Md.20" Current feed value".			
			1506	1606	1706	1806
			1507	1607	1707	1807

\* Refer to Section 5.7 "List of control data" for details on the setting details.

- (2) The following shows a start time chart.

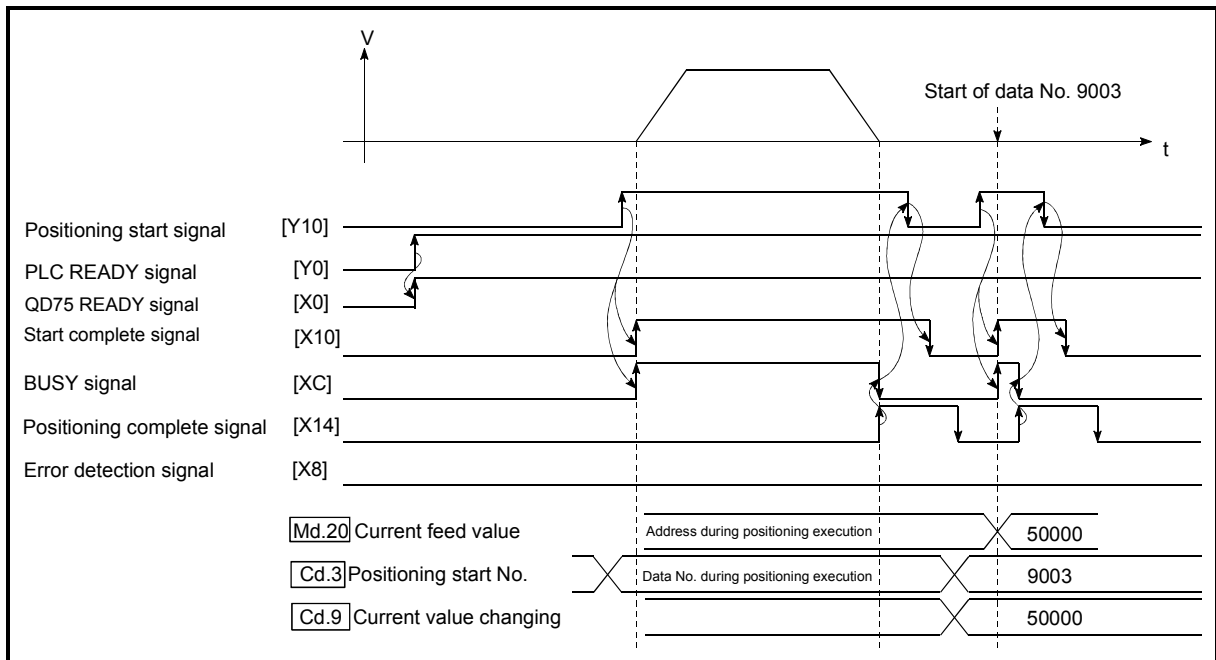
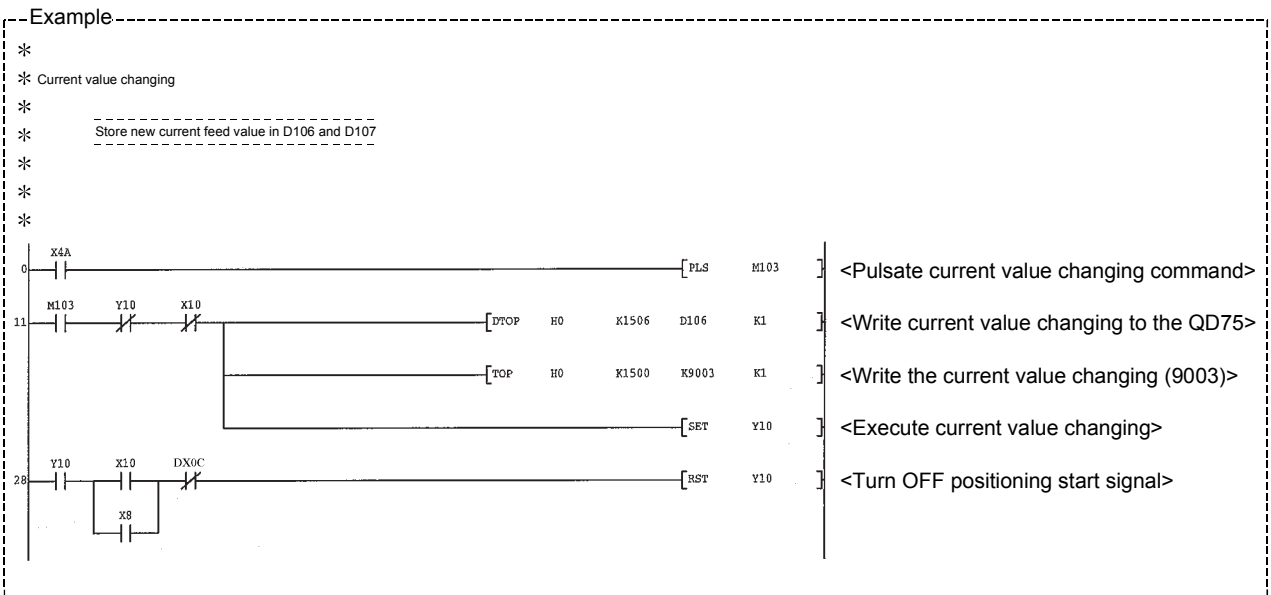

Fig. 9.21 Changing to a new current value using the start No. (No. 9003) for a current value changing

(3) Add the following sequence program to the control program, and write it to the CPU module.



## 9.2.22 NOP instruction

The NOP instruction is used for the nonexecutable control system.

### ■ Operation

The positioning data No. to which the NOP instruction is set transfers, without any processing, to the operation for the next positioning data No.

### ■ Positioning data setting examples

The following table shows the setting examples when "NOP instruction" is set in positioning data No. 1 of axis 1.

Setting item		Setting example	Setting details	
Axis 1 positioning data No. 1	Da.1	Operation pattern	–	Setting not required (Setting value is ignored.)
	Da.2	Control system	NOP instruction	Set the NOP instruction
	Da.3	Acceleration time No.	–	Setting not required (Setting value is ignored.)
	Da.4	Deceleration time No.	–	Setting not required (Setting value is ignored.)
	Da.5	Axis to be interpolated	–	Setting not required (Setting value is ignored.)
	Da.6	Positioning address/movement amount	–	Setting not required (Setting value is ignored.)
	Da.7	Arc address	–	Setting not required (Setting value is ignored.)
	Da.8	Command speed	–	Setting not required (Setting value is ignored.)
	Da.9	Dwell time	–	Setting not required (Setting value is ignored.)
	Da.10	M code	–	Setting not required (Setting value is ignored.)

\* Refer to Section 5.3 "List of positioning data" for information on the setting details.

### ■ Restrictions

An error "Control system setting error" (error code: 524) will occur if the "NOP instruction" is set for the control system of the positioning data No. 600.

POINT
<p>&lt;Use example of NOP instruction&gt;</p> <p>If there is a possibility of speed switching or temporary stop (automatic deceleration) at a point between two points during positioning, that data can be reserved with the NOP instruction to change the data merely by the replacement of the identifier.</p>

### 9.2.23 JUMP instruction

The JUMP instruction is used to control the operation so it jumps to a positioning data No. set in the positioning data during "continuous positioning control" or "continuous path control".

JUMP instruction include the following two types of JUMP.

- (1) Unconditional JUMP  
When no execution conditions are set for the JUMP instruction  
(When "0" is set as the condition data No.)
- (2) Conditional JUMP  
When execution conditions are set for the JUMP instruction  
(The conditions are set in the "condition data" used with "high-level positioning control".)

Using the JUMP instruction enables repeating of the same positioning control, or selection of positioning data by the execution conditions during "continuous positioning control" or "continuous path control".

#### ■ Operation

- (1) Unconditional JUMP  
The JUMP instruction is unconditionally executed. The operation jumps to the positioning data No. set in " [Da.9] Dwell time".
- (2) Conditional JUMP  
The block start condition data is used as the JUMP instruction execution conditions.
  - When block positioning data No. 7000 to 7004 is started:  
Each block condition data is used.
  - When positioning data No. 1 to 600 is started:  
Start block 0 condition data is used.
  - When the execution conditions set in " [Da.10] M code" of the JUMP instruction have been established:  
the JUMP instruction is executed to jump the operation to the positioning data No. set in " [Da.9] Dwell time".
  - When the execution conditions set in " [Da.10] M code" of the JUMP instruction have not been established:  
the JUMP instruction is ignored, and the next positioning data No. is executed.

#### ■ Restrictions

- (1) When using a conditional JUMP instruction, establish the JUMP instruction execution conditions by the 4th positioning data No. before the JUMP instruction positioning data No.  
If the JUMP instruction execution conditions are not established by the time the 4th positioning control is carried out before the JUMP instruction positioning data No., the operation will be processed as an operation without established JUMP instruction execution conditions.  
(During execution of continuous path control/continuous positioning control, the QD75 calculates the positioning data of the positioning data No. four items ahead of the current positioning data.)

- (2) Positioning control such as loops cannot be executed by conditional JUMP instructions alone until the conditions have been established.  
As the target of the JUMP instruction, specify a positioning data that is controlled by other than JUMP and NOP instructions.

■ Positioning data setting example

The following table shows setting examples when "JUMP instruction" is set in positioning data No. 1 of axis 1.

Setting item		Setting example	Setting details	
Axis 1 Positioning data No. 1	Da.1	Operation pattern	–	Setting not required. (Setting value is ignored.)
	Da.2	Control system	JUMP instruction	Set the JUMP instruction.
	Da.3	Acceleration time No.	–	Setting not required. (Setting value is ignored.)
	Da.4	Deceleration time No.	–	Setting not required. (Setting value is ignored.)
	Da.5	Axis to be interpolated	–	Setting not required. (Setting value is ignored.)
	Da.6	Positioning address/movement amount	–	Setting not required. (Setting value is ignored.)
	Da.7	Arc address	–	Setting not required. (Setting value is ignored.)
	Da.8	Command speed	–	Setting not required. (Setting value is ignored.)
	Da.9	Dwell time	500	Set the positioning data No. 1 to 600 for the JUMP destination. (The positioning data No. of the JUMP instruction cannot be set. Setting its own positioning data No. will result in an error "Illegal data No." (error code: 502).)
	Da.10	M code	1	Set the JUMP instruction execution conditions with the condition data No. 0 : Unconditional JUMP 1 to 10 : Condition data No. (“Simultaneous start” condition data cannot be set.)

\* Refer to Section 5.3 "List of positioning data" for information on the setting details.

9.2.24 LOOP

The LOOP is used for loop control by the repetition of LOOP to LEND.

■ Operation

The LOOP to LEND loop is repeated by set repeat cycles.

■ Positioning data setting examples

The following table shows the setting examples when "LOOP" is set in positioning data No. 1 of axis 1.

Setting item		Setting example	Setting details	
Axis 1 Positioning data No. 1	Da.1	Operation pattern	–	Setting not required. (Setting value is ignored.)
	Da.2	Control system	LOOP	Set the LOOP.
	Da.3	Acceleration time No.	–	Setting not required. (Setting value is ignored.)
	Da.4	Deceleration time No.	–	Setting not required. (Setting value is ignored.)
	Da.5	Axis to be interpolated	–	Setting not required. (Setting value is ignored.)
	Da.6	Positioning address/movement amount	–	Setting not required. (Setting value is ignored.)
	Da.7	Arc address	–	Setting not required. (Setting value is ignored.)
	Da.8	Command speed	–	Setting not required. (Setting value is ignored.)
	Da.9	Dwell time	–	Setting not required. (Setting value is ignored.)
	Da.10	M code	5	Set the LOOP to LEND repeat cycles.

\* Refer to Section 5.3 "List of positioning data" for information on the setting details.

■ Restrictions

- (1) An error "Control system LOOP setting error" (error code: 545) will occur if a "0" is set for the repeat cycles.
- (2) Even if LEND is absent after LOOP, no error will occur, but repeat processing will not be carried out.
- (3) Nesting is not allowed between LOOP-LEND's. If such setting is made, only the inner LOOP-LEND is processed repeatedly.

<b>POINT</b>
<p>The setting by this control system is easier than that by the special start "FOR loop" of "High-level Positioning Control" (refer to CHAPTER 10).</p> <p>&lt;Setting data&gt;</p> <ul style="list-style-type: none"> <li>• For special start: Positioning start data, special start data, condition data, and positioning data</li> <li>• For control system: Positioning data</li> </ul> <p>For the special start FOR to NEXT, the positioning data is required for each of FOR and NEXT points. For the control system, loop can be executed even only by one data.</p> <p>Also, nesting is enabled by using the control system LOOP to LEND in combination with the special start FOR to NEXT.</p> <p>However LOOP to LEND cannot be set across block. Always set LOOP to LEND so that the processing ends within one block.</p> <p>(For details of the "block", refer to Section 10.1 "Outline of high-level positioning control".)</p>



9.2.25 LEND

The LEND is used to return the operation to the top of the repeat (LOOP to LEND) loop.

■ Operation

When the repeat cycle designated by the LOOP becomes 0, the loop is terminated, and the next positioning data No. processing is started. (The operation pattern, if set to "Positioning complete", will be ignored.)

When the operation is stopped after the repeat operation is executed by designated cycles, the dummy positioning data (for example, incremental positioning without movement amount) is set next to LEND.

Positioning data No.	Operation pattern	Control system	Conditions	Operation
1	Continuous control	ABS2		Executed in the order of the positioning data No. 1 → 2 → 3 → 4 → 5 → 2 → 3 → 4 → 5 → 6. (The operation patterns of the positioning data Nos. 2 and 5 are ignored.)
2	Positioning complete	LOOP	Number of loop cycles: 2	
3	Continuous path control	ABS2		
4	Continuous control	ABS2		
5	Positioning complete	LEND		
6	Positioning complete	ABS2		

■ Positioning data setting examples

The following table shows the setting examples when "LEND" is set in positioning data No. 8 of axis 1.

	Setting item	Setting example	Setting details
Axis 1 Positioning data No. 8	Da.1	Operation pattern	– Setting not required. (Setting value is ignored.)
	Da.2	Control system	LEND Set the LEND.
	Da.3	Acceleration time No.	– Setting not required. (Setting value is ignored.)
	Da.4	Deceleration time No.	– Setting not required. (Setting value is ignored.)
	Da.5	Axis to be interpolated	– Setting not required. (Setting value is ignored.)
	Da.6	Positioning address/movement amount	– Setting not required. (Setting value is ignored.)
	Da.7	Arc address	– Setting not required. (Setting value is ignored.)
	Da.8	Command speed	– Setting not required. (Setting value is ignored.)
	Da.9	Dwell time	– Setting not required. (Setting value is ignored.)
	Da.10	M code	– Setting not required. (Setting value is ignored.)

\* Refer to Section 5.3 "List of positioning data" for information on the setting details.

■ Restrictions

(1) Ignore the "LEND" before the "LOOP" is executed.



# CHAPTER 10 HIGH-LEVEL POSITIONING CONTROL

The details and usage of high-level positioning control (control functions using the "block start data") are explained in this chapter.

High-level positioning control is used to carry out applied control using the "positioning data". Examples of applied control are using conditional judgment to control "positioning data" set with the major positioning control, or simultaneously starting "positioning data" for several different axes.

Read the execution procedures and settings for each control, and set as required.

10.1	Outline of high-level positioning control .....	10- 2
10.1.1	Data required for high-level positioning control.....	10- 3
10.1.2	"Block start data" and "condition data" configuration .....	10- 4
10.2	High-level positioning control execution procedure .....	10- 6
10.3	Setting the block start data .....	10- 7
10.3.1	Relation between various controls and block start data .....	10- 7
10.3.2	Block start (normal start) .....	10- 8
10.3.3	Condition start .....	10-10
10.3.4	Wait start .....	10-11
10.3.5	Simultaneous start .....	10-12
10.3.6	Repeated start (FOR loop) .....	10-14
10.3.7	Repeated start (FOR condition) .....	10-15
10.3.8	Restrictions when using the NEXT start.....	10-16
10.4	Setting the condition data .....	10-17
10.4.1	Relation between various controls and the condition data .....	10-17
10.4.2	Condition data setting examples .....	10-20
10.5	Multiple axes simultaneous start control.....	10-21
10.6	Start program for high-level positioning control .....	10-24
10.6.1	Starting high-level positioning control.....	10-24
10.6.2	Example of a start program for high-level positioning control .....	10-25

### 10.1 Outline of high-level positioning control

In "high-level positioning control" the execution order and execution conditions of the "positioning data" are set to carry out more applied positioning. (The execution order and execution conditions are set in the "block start data" and "condition data".) The following applied positioning controls can be carried out with "high-level positioning control".

High-level positioning control	Details
Block *1 start (Normal start)	With one start, executes the positioning data in a random block with the set order.
Condition start	Carries out condition judgment set in the "condition data" for the designated positioning data, and then executes the "block start data". <ul style="list-style-type: none"> <li>• When the condition is established, the " block start data" is executed.</li> <li>• When not established, that " block start data" is ignored, and the next point's " block start data" is executed.</li> </ul>
Wait start	Carries out condition judgment set in the "condition data" for the designated positioning data, and then executes the " block start data". <ul style="list-style-type: none"> <li>• When the condition is established, the " block start data" is executed.</li> <li>• When not established, stops the control until the condition is established. (Waits.)</li> </ul>
Simultaneous start *2	Simultaneously executes the positioning data having the No. for the axis designated with the "condition data". (Outputs pulses at the same timing.)
Repeated start (FOR loop)	Repeats the program from the " block start data" set with the "FOR loop" to the " block start data" set in "NEXT" for the designated No. of times.
Repeated start (FOR condition)	Repeats the program from the " block start data" set with the "FOR condition" to the " block start data" set in "NEXT" until the conditions set in the "condition data" are established.

#### ■ High-level positioning control sub functions

"High-level positioning control" uses the "positioning data" set with the "major positioning control". Refer to Section 3.2.4 "Combination of QD75 main functions and sub functions" for details on sub functions that can be combined with the major positioning control.

Note that the sub function Section 12.7.7 "Pre-reading start function" cannot be used together with "high-level positioning control".

#### ■ High-level positioning control from peripheral devices

"High-level positioning control" (start of the "block start data") can be executed from GX Configurator-QP test mode.

Refer to GX Configurator-QP Operating Manual for details on starting of the "block start data" from GX Configurator-QP.

#### REMARK

Block \*1:

"1 block" is defined as all the data continuing from the positioning data in which "continuous positioning control" or "continuous path control" is set in the operation pattern (Da.1) to the positioning data in which "independent positioning control (Positioning complete)" is set.

Simultaneous start \*2:

Besides the simultaneous start of "block start data" system, the "simultaneous starts" include the "multiple axes simultaneous start control" of control system. Refer to Section 10.5 "Multiple axes simultaneous start control" for details.

## 10.1.1 Data required for high-level positioning control

"High-level positioning control" is executed by setting the required items in the "block start data" and "condition data", then starting that "block start data". Judgment about whether execution is possible, etc., is carried out at execution using the "condition data" designated in the "block start data".

"Block start data" can be set for each No. from 7000 to 7004 (called "block Nos."), and up to 50 points can be set for each axis. (This data is controlled with Nos. called "points" to distinguish it from the positioning data. For example, the 1st block start data item is called the "1st point block start data" or "point No. 1 block start data".)

"Condition data" can be set for each No. from 7000 to 7004 (called "block Nos."), and up to 10 data items can be set for each block No.

The "block start data" and "condition data" are set as 1 set for each block No.

The following table shows an outline of the "block start data" and "condition data" stored in the QD75.

Setting item		Setting details	
Block start data	Da.11	Shape	Set whether to end the control after executing only the "block start data" of the shape itself, or continue executing the "block start data" set in the next point.
	Da.12	Start data No.	Set the "positioning data No." to be executed.
	Da.13	Special start instruction	Set the method by which the positioning data set in Da.12 will be started.
	Da.14	Parameter	Set the conditions by which the start will be executed according to the commands set in Da.13. (Designate the "condition data No." and "No. of repetitions".)

Setting item		Setting details	
Condition data	Da.15	Condition target	Designate the "device", "buffer memory storage details", and "positioning data No." elements for which the conditions are set.
	Da.16	Condition operator	Set the judgment method carried out for the target set in Da.15.
	Da.17	Address	Set the buffer memory address in which condition judgment is carried out (only when the details set in Da.15 are "buffer memory storage details").
	Da.18	Parameter 1	Set the required conditions according to the details set in Da.15 and Da.16.
	Da.19	Parameter 2	Set the required conditions according to the details set in Da.15 and Da.16.



Set in QD75 the "block start data" and "condition data" corresponding to the following "block Nos. 7001 to 7004" using GX Configurator-QP or the sequence program. (The following drawing shows an example for axis 1.)

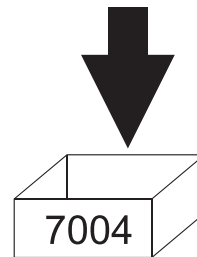
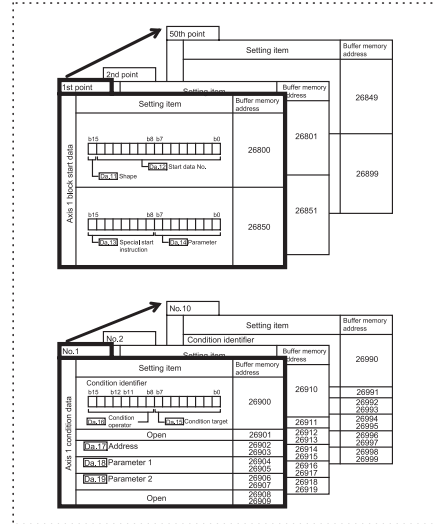
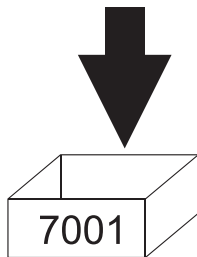
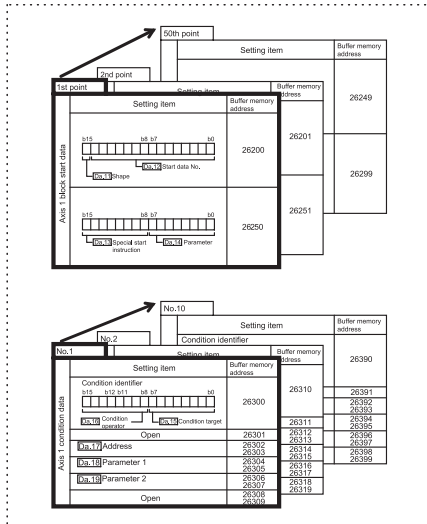

10.2 High-level positioning control execution procedure

High-level positioning control is carried out using the following procedure.

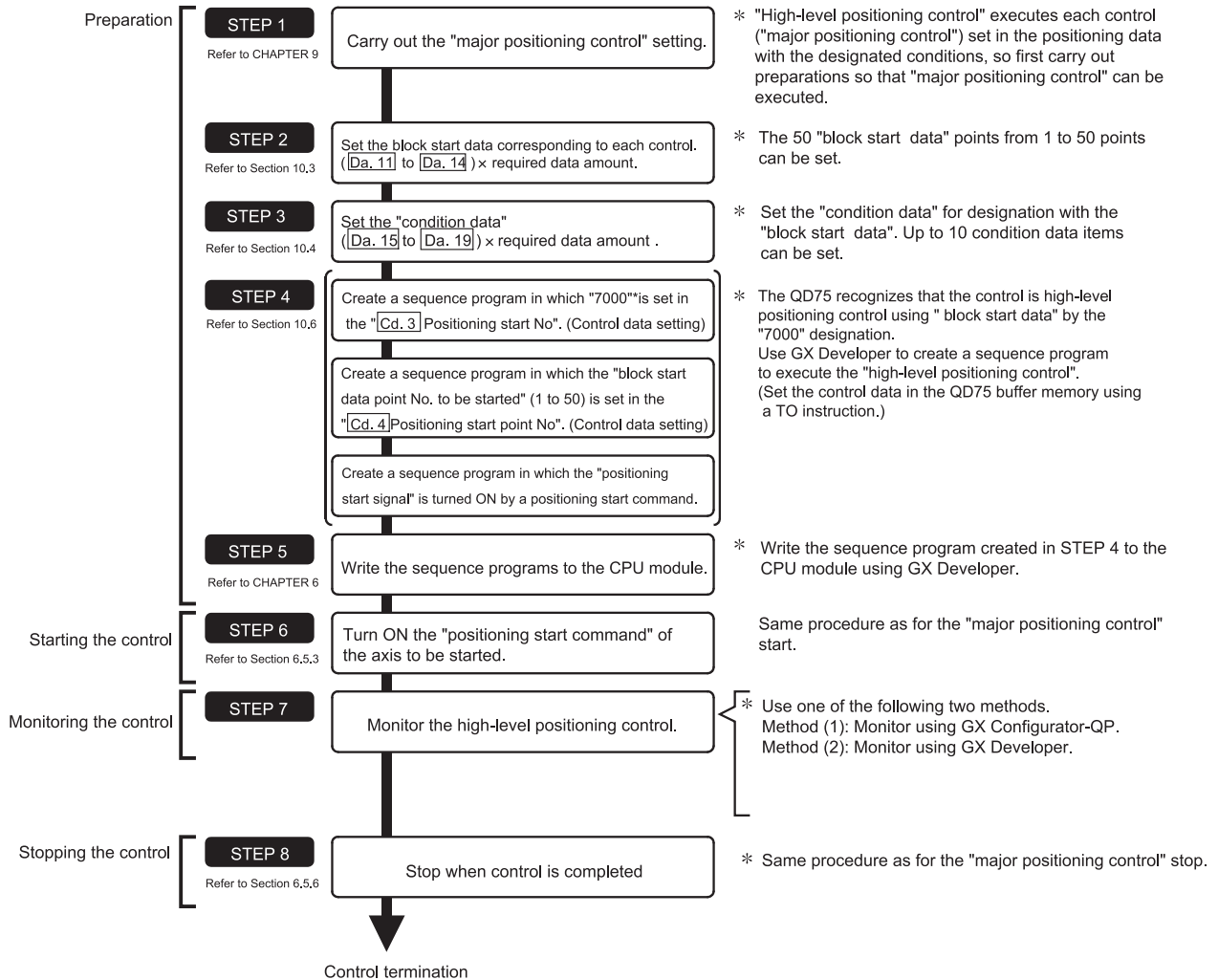

**REMARK**

- \* (1) Five sets of "block start data (50 points)" and "condition data (10 items) corresponding to "7000" to "7004" are set with a sequence program.
- (2) Five sets of data from "7000" to "7004" can be set when GX Configurator-QP is used. If GX Configurator-QP is used to set the "block start data" and "condition data" corresponding to "7000" to "7004" and write the data to the QD75, "7000" to "7004" can be set in " [Cd.3] Positioning start No." in STEP 4.



## 10.3 Setting the block start data

### 10.3.1 Relation between various controls and block start data

The "block start data" must be set to carry out "high-level positioning control". The setting requirements and details of each "block start data" item to be set differ according to the "Da.13" Special start instruction" setting.

The following shows the "block start data" setting items corresponding to various control systems. The operation details of each control type are explained starting in Section 10.3.2. Also refer to Section 10.4 "Setting the condition data for details on "condition data" with which control execution is judged.

(The "block start data" settings in this chapter are assumed to be carried out using GX Configurator-QP.)

High-level positioning control		Block start (Normal start)	Condition start	Wait start	Simultaneous start	Repeated start (FOR loop)	Repeated start (FOR condition)	NEXT start *	
Da.11	Shape	0 : End	◎	◎	◎	◎	×	×	◎
		1 : Continue	◎	◎	◎	◎	◎	◎	◎
Da.12	Start data No.	1 to 600							
Da.13	Special start instruction	0	1	2	3	4	5	6	
Da.14	Parameter	—	Condition data No.			No. of repetitions	Condition data No.	—	

◎ : One of the two setting items must be set.

○ : Set when required

× : Setting not possible

— : Setting not required (Setting value will be ignored. Use the initial value or a value within the setting range.)

\* The "NEXT start" instruction is used in combination with "repeated start (FOR loop)" and "repeated start (FOR condition)". Control using only the "NEXT start" will not be carried out.

#### REMARK

It is recommended that the "block start data" be set whenever possible with GX Configurator-QP. Execution by sequence program uses many sequence programs and devices. The execution becomes complicated, and the scan times will increase.

10.3.2 Block start (normal start)

In a "block start (normal start)", the positioning data groups of a block are continuously executed in a set sequence starting from the positioning data set in " [Da.12] Start data No." by one start.

Section [2] shows a control example where the " block start data" and "positioning data" are set as shown in section [1].

[1] Setting examples

(1) Block start data setting example

Axis 1 block start data	[Da.11] Shape	[Da.12] Start data No.	[Da.13] Special start instruction	[Da.14] Parameter
1st point	1: Continue	1	0: Block start	—
2nd point	1: Continue	2	0: Block start	—
3rd point	1: Continue	5	0: Block start	—
4th point	1: Continue	10	0: Block start	—
5th point	0: End	15	0: Block start	—
•				
•				

(2) Positioning data setting example

Axis 1 positioning data No.	[Da.1] Operation pattern	
1	00: Positioning complete	} 1 block *
2	11: Continuous path control	
3	01: Continuous positioning control	
4	00: Positioning complete	
5	11: Continuous path control	
6	00: Positioning complete	
•		} 1 block
10	00: Positioning complete	
•		
15	00: Positioning complete	
•		

**REMARK**

Block \* :

"1 block" is defined as all the data continuing from the positioning data in which "continuous positioning control" or "continuous path control" is set in the operation pattern ([Da.1]) to the positioning data in which "independent positioning control (Positioning complete)" is set.

[2] Control examples

The following shows the control executed when the "block start data" of the 1st point of axis 1 is set as shown in section [1] and started.

<1> The positioning data is executed in the following order before stopping.  
 Axis 1 positioning data No. 1 → 2 → 3 → 4 → 5 → 6 → 10 → 15.

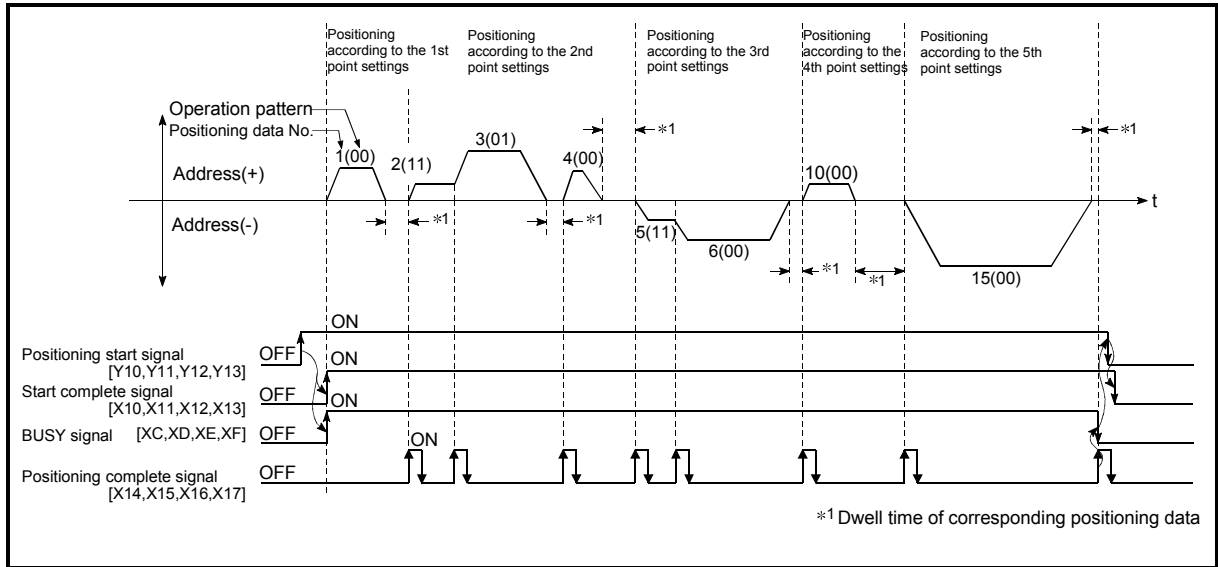

Fig. 10.1 Block start control example

## 10.3.3 Condition start

In a "condition start", the "condition data" conditional judgment designated in " [Da.14] Parameter" is carried out for the positioning data set in " [Da.12] Start data No.". If the conditions have been established, the " block start data" set in "1: condition start" is executed. If the conditions have not been established, that " block start data" will be ignored, and the "block start data" of the next point will be executed.

Section [2] shows a control example where the " block start data" and "positioning data" are set as shown in section [1].

## [1] Setting examples

## (1) Block start data setting example

Axis 1 block start data	[Da.11] Shape	[Da.12] Start data No.	[Da.13] Special start instruction	[Da.14] Parameter
1st point	1: Continue	1	1: Condition start	1
2nd point	1: Continue	10	1: Condition start	2
3rd point	0: End	50	0: Block start	–
•				
•				

\* The "condition data Nos." have been set in " [Da.14] Parameter".

## (2) Positioning data setting example

Axis 1 positioning data No.	[Da.1] Operation pattern
1	01: Continuous positioning control
2	01: Continuous positioning control
3	00: Positioning complete
•	
10	11: Continuous path control
11	11: Continuous path control
12	00: Positioning complete
•	
50	00: Positioning complete
•	

## [2] Control examples

The following shows the control executed when the " block start data" of the 1st point of axis 1 is set as shown in section [1] and started.

- <1> The conditional judgment set in "condition data No. 1" is carried out before execution of the axis 1 "positioning data No. 1".  
 → Conditions established → Execute positioning data No. 1, 2, and 3 → Go to <2>.  
 → Conditions not established → Go to <2>.
- <2> The conditional judgment set in "condition data No. 2" is carried out before execution of the axis 1 "positioning data No. 10".  
 → Conditions established → Execute positioning data No. 10, 11, and 12 → Go to <3>.  
 → Conditions not established → Go to <3>.
- <3> Execute axis 1 "positioning data No. 50" and stop the control.

10.3.4 Wait start

In a "wait start", the "condition data" conditional judgment designated in " [Da.14] Parameter" is carried out for the positioning data set in " [Da.12] Start data No.". If the conditions have been established, the " block start data" is executed. If the conditions have not been established, the control stops (waits) until the conditions are established.

Section [2] shows a control example where the " block start data" and "positioning data" are set as shown in section [1].

[1] Setting examples

(1) Block start data setting example

Axis 1 block start data	[Da.11] Shape	[Da.12] Start data No.	[Da.13] Special start instruction	[Da.14] Parameter
1st point	1: Continue	1	2: Wait start	3
2nd point	1: Continue	10	0: Block start	—
3rd point	0: End	50	0: Block start	—
•				
•				

\* The "condition data Nos." have been set in " [Da.14] Parameter".

(2) Positioning data setting example

Axis 1 positioning data No.	[Da.1] Operation pattern
1	01: Continuous positioning control
2	01: Continuous positioning control
3	00: Positioning complete
•	
10	11: Continuous path control
11	11: Continuous path control
12	00: Positioning complete
•	
50	00: Positioning complete
•	

[2] Control examples

The following shows the control executed when the " block start data" of the 1st point of axis 1 is set as shown in section [1] and started.

- <1> The conditional judgment set in "condition data No. 3" is carried out before execution of the axis 1 "positioning data No. 1".
  - Conditions established → Execute positioning data No. 1, 2, and 3 → Go to <2>.
  - Conditions not established → Control stops (waits) until conditions are established → Go to <1>.
- <2> Execute the axis 1 "positioning data No. 10, 11, 12, and 50" and stop the control.

10.3.5 Simultaneous start

In a "simultaneous start", the positioning data set in the " [Da.12] Start data No." and positioning data of other axes set in the "condition data" are simultaneously executed (pulses are output with the same timing).

(The "condition data" is designated with " [Da.14] Parameter".)

Section [2] shows a control example where the " block start data" and "positioning data" are set as shown in section [1].

[1] Setting examples

(1) Block start data setting example

Axis 1 block start data	[Da.11] Shape	[Da.12] Start data No.	[Da.13] Special start instruction	[Da.14] Parameter
1st point	0: End	1	3: Simultaneous start	4
•				
•				
•				
•				

\* It is assumed that the "axis 2 positioning data" for simultaneous starting is set in the "condition data" designated with " [Da.14] Parameter".

(2) Positioning data setting example

Axis 1 positioning data No.	[Da.1] Operation pattern
1	01: Continuous positioning control
2	01: Continuous positioning control
3	00: Positioning complete
•	
•	
•	
•	
•	
•	

[2] Control examples

The following shows the control executed when the " block start data" of the 1st point of axis 1 is set as shown in section [1] and started.

<1> Check the axis operation status of axis 2 which is regarded as the simultaneously started axis.

→ Axis 2 is standing by → Go to <2>.

→ Axis 2 is carrying out positioning. → An error occurs and simultaneous start will not be carried out.

<2> Simultaneously start the axis 1 "positioning data No. 1" and axis 2 positioning data set in "condition data No. 4".

**[3] Precautions**

Positioning data No. executed by simultaneously started axes is set to condition data (" **Da.18** Parameter 1", " **Da.19** Parameter 2", but the setting value of start axis (the axis which carries out positioning start) should be "0". If the setting value is set to other than "0", the positioning data set in " **Da.18** Parameter 1", " **Da.19** Parameter 2" is given priority to be executed rather than " **Da.12** Start data No."

(For details, refer to section 5.5 "List of condition data".)

10.3.6 Repeated start (FOR loop)

In a "repeated start (FOR loop)", the data between the " block start data" in which "4: FOR loop" is set in " Da.13 Special start instruction" and the "block start data" in which "6: NEXT start" is set in " Da.13 Special start instruction " is repeatedly executed for the No. of times set in " Da.14 Parameter". An endless loop will result if the No. of repetitions is set to "0".

(The No. of repetitions is set in " Da.14 Parameter" of the " block start data" in which "4: FOR loop" is set in " Da.13 Special start instruction".)

Section [2] shows a control example where the " block start data" and "positioning data" are set as shown in section [1].

[1] Setting examples

(1) Block start data setting example

Axis 1 block start data	Da.11 Shape	Da.12 Start data No.	Da.13 Special start instruction	Da.14 Parameter
1st point	1: Continue	1	4: FOR loop	2
2nd point	1: Continue	10	0: Block start	-
3rd point	0: End	50	6: NEXT start	-
•				
•				

\* The "condition data Nos." have been set in " Da.14 Parameter".

(2) Positioning data setting example

Axis 1 positioning data No.	Da.1 Operation pattern
1	01: Continuous positioning control
2	01: Continuous positioning control
3	00: Positioning complete
•	
10	11: Continuous path control
11	00: Positioning complete
•	
50	01: Continuous positioning control
51	00: Positioning complete
•	

[2] Control examples

The following shows the control executed when the " block start data" of the 1st point of axis 1 is set as shown in section [1] and started.

<1> Execute the axis 1 "positioning data No. 1, 2, 3, 10, 11, 50, and 51".

<2> Return to the axis 1 "1st point block start data". Again execute the axis 1 "positioning data No. 1, 2, 3, 10, 11, 50 and 51", and then stop the control. (Repeat for the No. of times (2 times) set in Da.14.)



10.3.7 Repeated start (FOR condition)

In a "repeated start (FOR condition)", the data between the " block start data" in which "5: FOR condition" is set in " Da.13 Special start instruction" and the " block start data" in which "6: NEXT start" is set in " Da.13 Special start instruction" is repeatedly executed until the establishment of the conditions set in the "condition data". Conditional judgment is carried out as soon as switching to the point of "6: NEXT start" (before positioning of NEXT start point). (The "condition data" designation is set in " Da.14 Parameter" of the " block start data" in which "5: FOR condition" is set in " Da.13 Special start instruction".)

Section [2] shows a control example where the " block start data" and "positioning data" are set as shown in section [1].

[1] Setting examples

(1) Block start data setting example

Axis 1 block start data	Da.11 Shape	Da.12 Start data No.	Da.13 Special start instruction	Da.14 Parameter
1st point	1: Continue	1	5: FOR condition	5
2nd point	1: Continue	10	0: Block start	–
3rd point	0: End	50	6: NEXT start	–
•				
•				

\* The "condition data Nos." have been set in " Da.14 Parameter".

(2) Positioning data setting example

Axis 1 positioning data No.	Da.1 Operation pattern
1	01: Continuous positioning control
2	01: Continuous positioning control
3	00: Positioning complete
•	
10	11: Continuous path control
11	00: Positioning complete
•	
50	01: Continuous positioning control
51	00: Positioning complete
•	

[2] Control examples

The following shows the control executed when the " block start data" of the 1st point of axis 1 is set as shown in section [1] and started.

<1> Execute axis 1 "Positioning data No. 1, 2, 3, 10, 11".

<2> Execute the conditional judgment set in axis 1 "Condition data No.5". \*1  
 → Conditions not established → Execute "Positioning data No. 50, 51".  
 Go to <1>  
 → Conditions established → Execute "Positioning data No.50, 51" and complete the positioning.

\*1: Conditional judgment is carried out as soon as switching to NEXT start point (before positioning of NEXT start point).

10.3.8 Restrictions when using the NEXT start

The "NEXT start" is a instruction indicating the end of the repetitions when executing Section 10.3.6 "Repeated start (FOR loop)" and Section 10.3.7 "Repeated start (FOR condition)".

The following shows the restrictions when setting "6: NEXT start" in the " block start data".

- (1) The processing when "6: NEXT start" is set before execution of "4: FOR loop" or "5: FOR condition" is the same as that for a "0: block start".
- (2) Repeated processing will not be carried out if there is no "6: NEXT start" instruction after the "4: FOR loop" or "5: FOR condition" instruction. (Note that an "error" will not occur.)
- (3) Nesting is not possible between "4: FOR loop" and "6: NEXT start", or between "5: FOR condition" and "6: NEXT start". A warning "FOR to NEXT nest construction" (warning code: 506) will occur if nesting is attempted.

[Operating examples without nesting structure]

Start block data	Da.13 Special start instruction
1st point	Normal start
2nd point	FOR ←
3rd point	Normal start
4th point	NEXT —
5th point	Normal start
6th point	Normal start
7th point	FOR ←
8th point	Normal start
9th point	NEXT —
.	
.	

[Operating examples with nesting structure]

Start block data	Da.13 Special start instruction
1st point	Normal start
2nd point	FOR
3rd point	Normal start
4th point	FOR ←
5th point	Normal start
6th point	Normal start
7th point	NEXT —
8th point	Normal start
9th point	NEXT
.	
.	

A warning will occur when starting the 4th point "FOR".  
 The JUMP destination of the 7th point "NEXT" is the 4th point. The 9th point "NEXT" is processed as normal start.

10.4 Setting the condition data

10.4.1 Relation between various controls and the condition data

"Condition data" is set in the following cases.

- (1) When setting conditions during execution of Section 9.2.23 "JUMP instruction" (major positioning control)
- (2) When setting conditions during execution of "high-level positioning control"

The "condition data" to be set includes the 5 setting items from [Da.15] to [Da.19], but the setting requirements and details differ according to the control system and setting conditions.

The following shows the "condition data" "[Da.15] Condition target" corresponding to the different types of control.

(The "condition data" settings in this chapter are assumed to be carried out using GX Configurator-QP.)

Control type [Da.15] Setting item	High-level positioning control				Major positioning control
	Block start	Wait start	Simultaneous start	Repeated start (For condition)	JUMP instruction
01: Device X*1	◎	◎	×	◎	◎
02: Device Y*1	◎	◎	×	◎	◎
03: Buffer memory (1 word)	◎	◎	×	◎	◎
04: Buffer memory (2 words)	◎	◎	×	◎	◎
05: Positioning data No.	×	×	◎	×	×

◎ : One of the setting items must be set.

× : Setting not possible

\*1: Refers to buffer memories and devices X/Y which belongs to QD75.

**REMARK**

It is recommended that the "condition data" be set whenever possible with GX Configurator-QP. Execution by sequence program uses many sequence programs and devices. The execution becomes complicated, and the scan times will increase.

The setting requirements and details of the following "condition data" [Da.16] to [Da.19] setting items differ according to the "[Da.15] Condition target" setting. The following shows the [Da.16] to [Da.19] setting items corresponding to the "[Da.15] Condition target".

Other setting item [Da.15] Setting item	[Da.16] Condition operator	[Da.17] Address	[Da.18] Parameter 1		[Da.19] Parameter 2	
01H: Device X	07H : DEV=ON	-	0 to 1FH (bit No.)		-	
02H: Device Y	08H : DEV=OFF		0 to 1FH (bit No.)			
03H: Buffer memory (1 word) *1	01H : **=P1 02H : **≠P1	Buffer memory address	P1 (numeric value)		P2 (numeric value) (Set only when [Da.16] is [05H] or [06H].)	
04H: Buffer memory (2 words) *1	03H : **≤P1 04H : **≥P1					
	05H : P1≤**≤P2 06H : **≤P1, P2≤**					
05H: Positioning data No.	10H : Axis 1 designation	-	Low-order 16 bits	Axis 1 positioning data No. *2	Low-order 16 bits	Axis 3 positioning data No. *2
	20H : Axis 2 designation					
	30H : Axis 1 and axis 2 designation					
	40H : Axis 3 designation					
	50H : Axis 1 and axis 3 designation					
	60H : Axis 2 and axis 3 designation					
	70H : Axis 1, axis 2 and axis 3 designation					
	80H : Axis 4 designation		High-order 16 bits	Axis 2 positioning data No. *2	High-order 16 bits	Axis 4 positioning data No. *2
	90H : Axis 1 and axis 4 designation					
	A0H : Axis 2 and axis 4 designation					
B0H : Axis 1, axis 2 and axis 4 designation						
C0H : Axis 3 and axis 4 designation						
D0H : Axis 1, axis 3 and axis 4 designation						
E0H : Axis 2, axis 3 and axis 4 designation						

- : Setting not required (Setting value will be ignored. Use the initial value or a value within the setting range.)

\*\* : Value stored in buffer memory designated in [Da.17].

\*1 : Comparison of ≤ and ≥ is judged as signed values. Refer to Section 5.5 "List of condition data" for the setting contents.

\*2 : The setting value of start axis (the axis which executes positioning start) should be "0". If the setting value is set to other than "0", the positioning data set in [Da.18] Parameter 1 and [Da.19] Parameter 2 is given priority to be executed rather than "[Da.12] Start data No.".

Judgment whether the condition operator is "=" or "≠" at the wait start. Judgment on data is carried out for each control cycle of the QD75. Thus, in the judgment on the data such as current feed value which varies continuously, the operator "=" may not be detected. If this occurs, use a range operator.

**REMARK**

The "PLC CPU memory area" can be designated as the buffer memory address to be designated in [Da.17](#). (Refer to Section 7.1.1 "Configuration and roles of QD75 memory".)

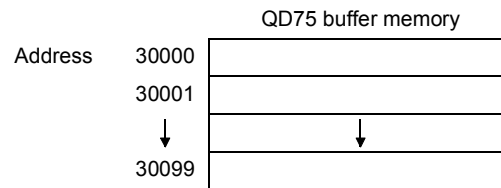

10.4.2 Condition data setting examples

The following shows setting examples for "condition data".

(1) Setting the device ON/OFF as a condition

[Condition] Device "XC" (= Axis 1 Busy signal) is OFF

Da.15 Condition target	Da.16 Condition operator	Da.17 Address	Da.18 Parameter 1	Da.19 Parameter 2
01H: Device X	08H: DEV=OFF	-	0CH	-

(2) Setting the numeric value stored in the "buffer memory" as a condition

[Condition]

The value stored in buffer memory addresses "800, 801" (= "Md.20 Current feed value") is "1000" or larger.

Da.15 Condition target	Da.16 Condition operator	Da.17 Address	Da.18 Parameter 1	Da.19 Parameter 2
04H: Buffer memory (2 words)	04H: * * ≥ P1	800	1000	-

(3) Designating the axis and positioning data No. to be simultaneously started in "simultaneous start"

[Condition]

Simultaneously starting "axis 2 positioning data No.3".

Da.15 Condition target	Da.16 Condition operator	Da.17 Address	Da.18 Parameter 1	Da.19 Parameter 2
05H: Positioning data No.	20H: Axis 2 designation	-	High-order 16 bits "0003H" *1	- *1

\*1: The setting value of start axis (the axis which executes positioning start) should be "0000H".

### 10.5 Multiple axes simultaneous start control

The "multiple axes simultaneous start control" starts and controls the multiple axes simultaneously by outputting pulses to the axis to be started at the same timing as the start axis.

The maximum of four axes can be started simultaneously.

#### [1] Control details

Multiple axes simultaneous start control is executed as follows.

Set the start data No. to the buffer memory areas " [Cd.30] to [Cd.33]

Simultaneous starting axis start data No. (axis 1 to 4 start data No.)."

Set "9004" to " [Cd.3] Positioning start No." of the start axis.

Turn ON the positioning start signal.

#### [2] Restrictions

- (1) The error "Error before simultaneous start" (error code: 501) will occur and all simultaneously started axes will not start if the simultaneously started axis start data No. is not set to the axis control data on the start axis or set outside the setting range.
- (2) The error "Error before simultaneous start" (error code: 501) will occur and all simultaneously started axes will not start if either of the simultaneously started axes is BUSY.
- (3) The error "Error before simultaneous start" (error code: 501) will occur and all simultaneously started axes will not start if an error occurs during the analysis of the positioning data on the simultaneously started axes.
- (4) No error or warning will occur if only the start axis is the simultaneously started axis.
- (5) This function cannot be used with the sub function Section 12.7.7 "Pre-reading start function".

#### [3] Multiple axes simultaneous start control procedure

The procedure for multiple axes simultaneous start control is as follows.

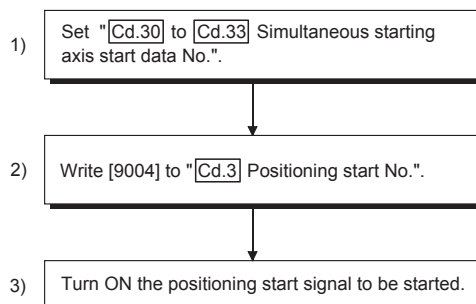

## [4] Multiple axes simultaneous start control function setting method

The following shows the setting of the data used to execute the multiple axes simultaneous start control with positioning start signals (The axis control data on the start axis is set).

Setting item	Setting value	Setting details	Buffer memory address			
			Axis 1	Axis 2	Axis 3	Axis 4
<input type="checkbox"/> Cd.3	Positioning start No.	9004	Set the multiple axes simultaneous start control start No. "9004".			
<input type="checkbox"/> Cd.30	Simultaneous starting axis start data No. (Axis 1 start data No.)	Set the simultaneously started axis start data No. Set a "0" for the axis other than the simultaneously started axes.	1500	1600	1700	1800
<input type="checkbox"/> Cd.31	Simultaneous starting axis start data No. (Axis 2 start data No.)		1540	1640	1740	1840
<input type="checkbox"/> Cd.32	Simultaneous starting axis start data No. (Axis 3 start data No.)		1541	1641	1741	1841
<input type="checkbox"/> Cd.33	Simultaneous starting axis start data No. (Axis 4 start data No.)		1542	1642	1742	1842
<input type="checkbox"/> Cd.33	Simultaneous starting axis start data No. (Axis 4 start data No.)		1543	1643	1743	1843

\* Refer to Section 5.7 "List of control data" for information on setting details.

## [5] Setting examples

The following shows the setting examples in which the axis 1 is used as the start axis and the simultaneously started axes are used as the axes 2 and 4.

Setting item	Setting value	Setting details	Buffer memory address (Axis 1)
<input type="checkbox"/> Cd.3	Positioning start No.	9004	1500
<input type="checkbox"/> Cd.30	Simultaneous starting axis start data No. (Axis 1 start data No.)	100	1540
<input type="checkbox"/> Cd.31	Simultaneous starting axis start data No. (Axis 2 start data No.)	200	1541
<input type="checkbox"/> Cd.32	Simultaneous starting axis start data No. (Axis 3 start data No.)	0	1542
<input type="checkbox"/> Cd.33	Simultaneous starting axis start data No. (Axis 4 start data No.)	300	1543



POINTS
--------

- |   |
|---|
| <p>(1) The "multiple axes simultaneous start control" carries out an operation equivalent to the "simultaneous start" using the "block start data".</p> <p>(2) The setting of the "multiple axes simultaneous start control" is easier than that of the "simultaneous start" using the "block start data".</p> <ul style="list-style-type: none"><li>• Setting items for "simultaneous start" using "block start data"<br/>Positioning start data, block start data, condition data, and positioning data</li><li>• Setting items for "multiple axes simultaneous start control"<br/>Positioning data and axis control data</li></ul> |
|---|

## 10.6 Start program for high-level positioning control

## 10.6.1 Starting high-level positioning control

To execute high-level positioning control, a sequence program must be created to start the control in the same method as for major positioning control.

The following shows the procedure for starting the "1st point block start data" (regarded as block No. 7000) set in axis 1.

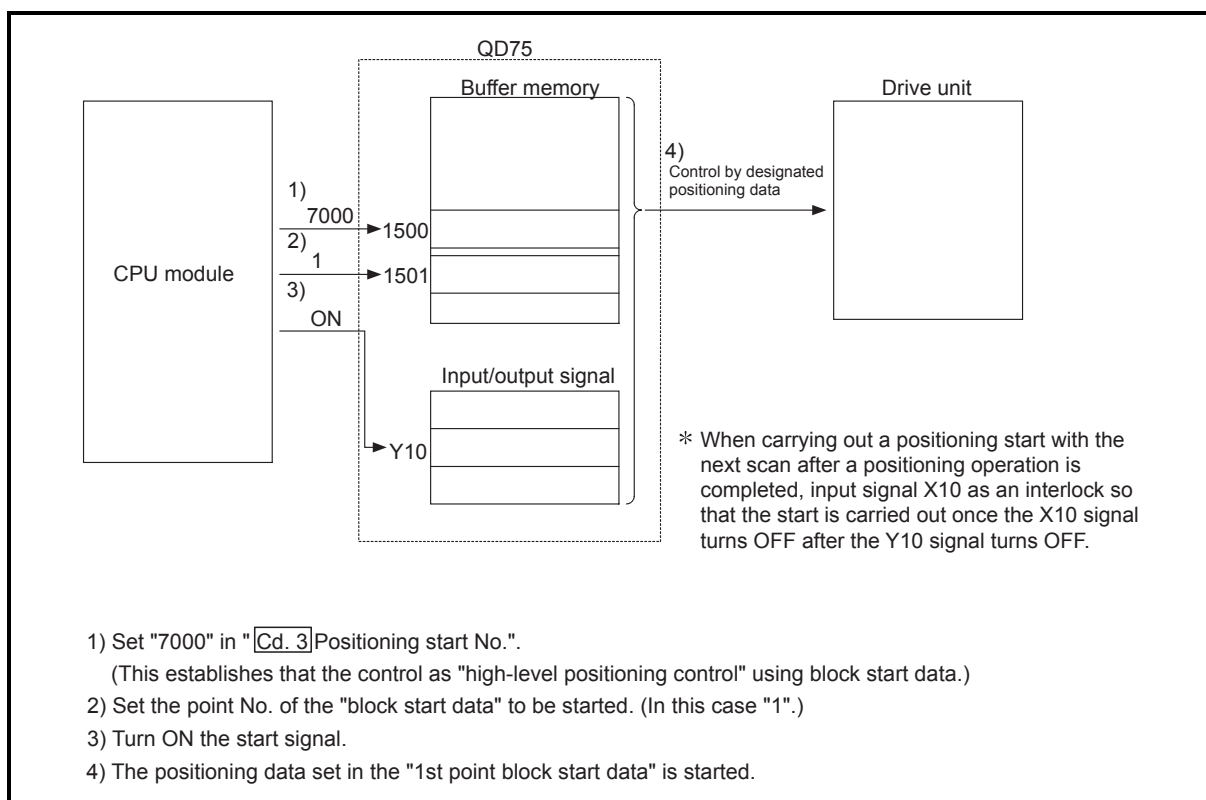

Fig. 10.2 High-level positioning control start procedure

## 10.6.2 Example of a start program for high-level positioning control

The following shows an example of a start program for high-level positioning control in which the 1st point "block start data" of axis 1 is started. (The block No. is regarded as "7000".)

### ■ Control data that require setting

The following control data must be set to execute high-level positioning control. The setting is carried out using a sequence program.

Setting item	Setting value	Setting details	Buffer memory address				
			Axis 1	Axis 2	Axis 3	Axis 4	
Cd.3	Positioning start No.	7000	Set "7000" to indicate control using "block start data".	1500	1600	1700	1800
Cd.4	Positioning starting point No.	1	Set the point No. of the "block start data" to be started.	1501	1601	1701	1801

\* Refer to Section 5.7 "List of control data" for details on the setting details.

### ■ Start conditions

The following conditions must be fulfilled when starting the control. The required conditions must also be integrated into the sequence program, and configured so the control does not start unless the conditions are fulfilled.

Signal name	Signal state	Device						
		Axis 1	Axis 2	Axis 3	Axis 4			
Interface signal	PLC READY signal	ON	CPU module preparation completed		Y0			
	QD75 READY signal	ON	QD75 preparation completed		X0			
	Synchronization flag	ON	QD75 buffer memory The access is possible.		X1			
	Axis stop signal	OFF	Axis stop signal is OFF		Y4	Y5	Y6	Y7
	Start complete signal	OFF	Start complete signal is OFF		X10	X11	X12	X13
	BUSY signal	OFF	BUSY signal is OFF		XC	XD	XE	XF
	Error detection signal	OFF	There is no error		X8	X9	XA	XB
M code ON signal	OFF	M code ON signal is OFF		X4	X5	X6	X7	
External signal	Drive unit READY signal	ON	Drive unit preparation completed		-			
	Stop signal	OFF	Stop signal is OFF		-			
	Upper limit (FLS)	ON	Within limit range		-			
	Lower limit (RLS)	ON	Within limit range		-			

■ Start time chart

The following chart shows a time chart in which the positioning data No. 1, 2, 10, 11, and 12 of axis 1 are continuously executed as an example.

(1) Block start data setting example

Axis 1 block start data	Da.11 Shape	Da.12 Start data No.	Da.13 Special start instruction	Da.14 Parameter
1st point	1: Continue	1	0: Block start	-
2nd point	0: End	10	0: Block start	-
•				
•				

(2) Positioning data setting example

Axis 1 positioning data No.	Da.1 Operation pattern
1	11: Continuous path control
2	00: Positioning complete
•	
10	11: Continuous path control
11	11: Continuous path control
12	00: Positioning complete
•	

(3) Start time chart

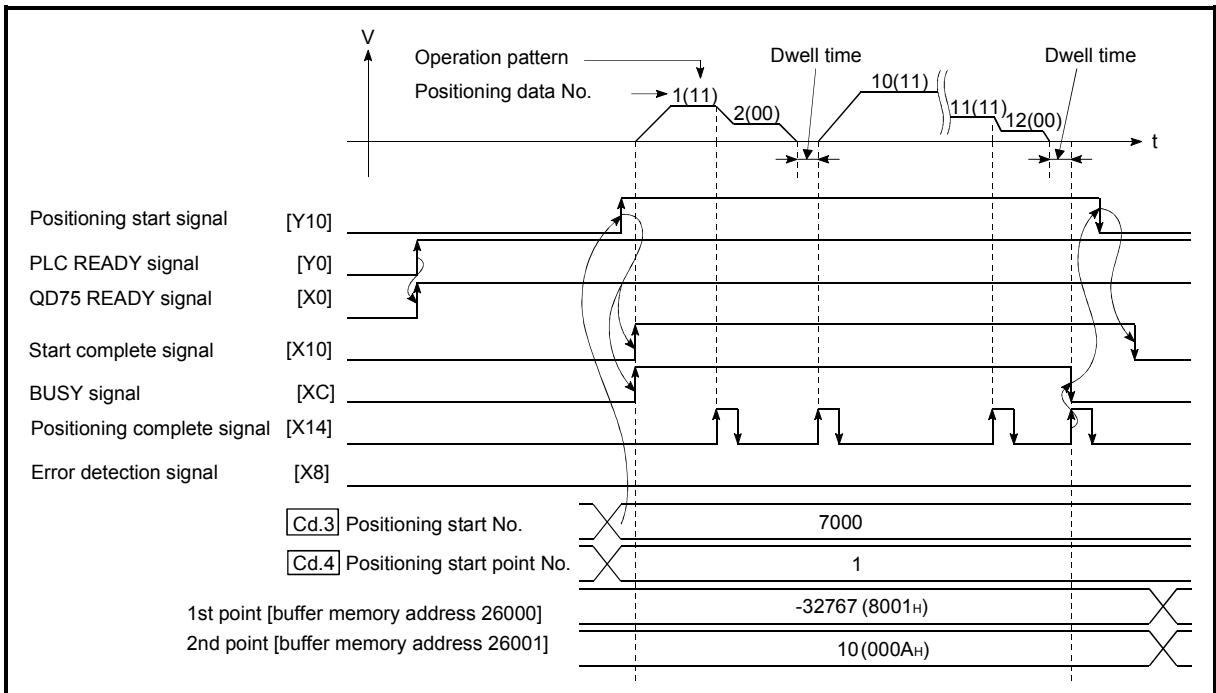
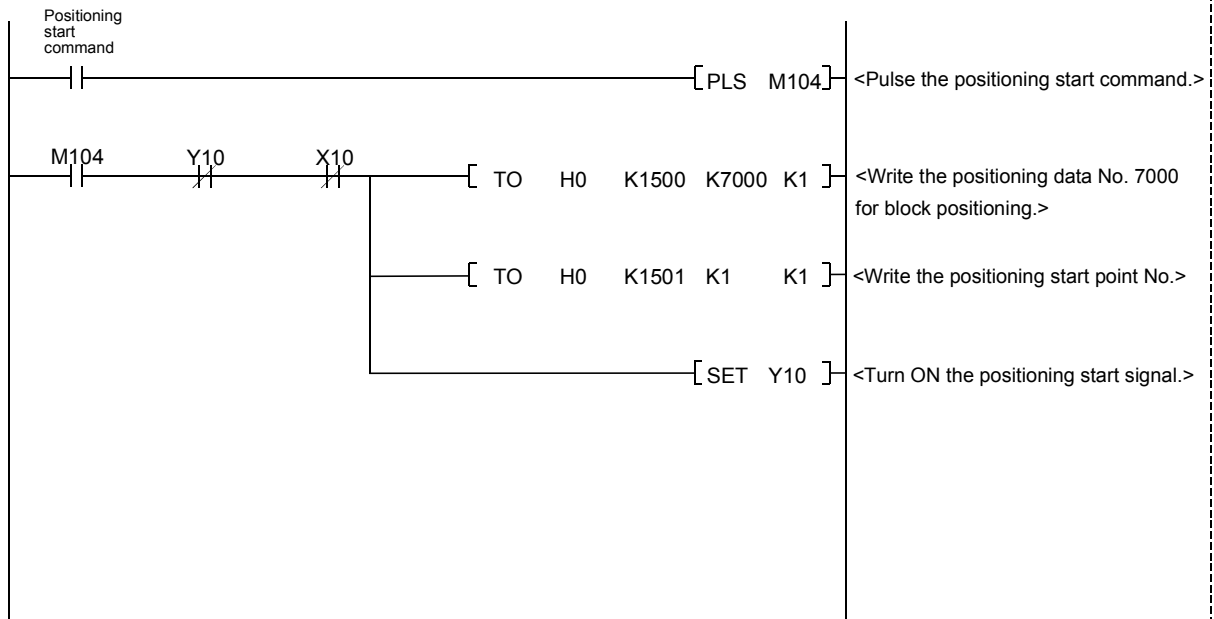

Fig. 10.3 Start time chart for high-level positioning control (block start)

■ Creating the program

Example

Set the block start data beforehand.



Y10: Positioning start signal  
 X10: Start complete signal  
 M104: Positioning start command pulse



# CHAPTER 11 MANUAL CONTROL

The details and usage of manual control are explained in this chapter. In manual control, pulse output commands are issued during a JOG operation and an inching operation executed by the turning ON of the JOG START signal, or from a manual pulse generator connected to the QD75. Manual control using a sequence program from the CPU module is explained in this chapter. Refer to GX Configurator-QP Operating Manual for an explanation of manual control (JOG operation, inching operation and manual pulse generator operation) using the peripheral devices.

11.1	Outline of manual control .....	11- 2
11.1.1	Three manual control methods.....	11- 2
11.2	JOG operation.....	11- 4
11.2.1	Outline of JOG operation .....	11- 4
11.2.2	JOG operation execution procedure .....	11- 7
11.2.3	Setting the required parameters for JOG operation .....	11- 8
11.2.4	Creating start programs for JOG operation.....	11- 10
11.2.5	JOG operation example.....	11- 13
11.3	Inching operation .....	11- 16
11.3.1	Outline of inching operation .....	11- 16
11.3.2	Inching operation execution procedure .....	11- 19
11.3.3	Setting the required parameters for inching operation .....	11- 20
11.3.4	Creating a program to enable/disable the inching operation.....	11- 21
11.3.5	Inching operation example.....	11- 24
11.4	Manual pulse generator operation .....	11- 26
11.4.1	Outline of manual pulse generator operation.....	11- 26
11.4.2	Manual pulse generator operation execution procedure .....	11- 30
11.4.3	Setting the required parameters for manual pulse generator operation .....	11- 31
11.4.4	Creating a program to enable/disable the manual pulse generator operation .....	11- 32

11.1 Outline of manual control

11.1.1 Three manual control methods

"Manual control" refers to control in which positioning data is not used, and a positioning operation is carried out in response to signal input from an external source. The three types of this "manual control" are explained below.

[1] JOG operation

"JOG operation" is a control method in which the machine is moved by only a movement amount (pulses are continuously outputted while the JOG START signal is ON). This operation is used to move the workpiece in the direction in which the limit signal is ON, when the operation is stopped by turning the limit signal OFF to confirm the positioning system connection and obtain the positioning data address (Refer to Section 12.7.4 "Teaching function").

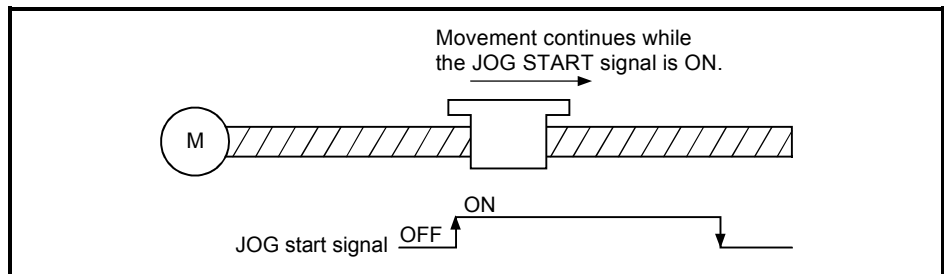

Fig. 11.1 JOG operation

[2] Inching operation

"Inching operation" is a control method in which a minute movement amount of pulses is output manually at 1.8ms. When the "inching movement amount" of the axis control data is set by JOG operation, the workpiece is moved by a set movement amount. (When the "inching movement amount" is set to "0", the operation is performed as the JOG operation.)

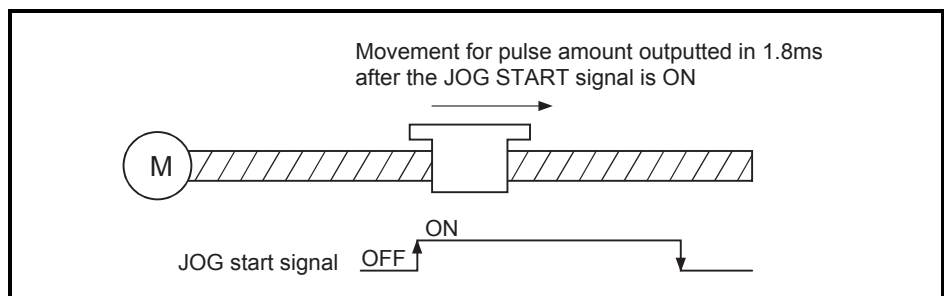

Fig. 11.2 Inching operation



### [3] Manual pulse generator operation

"Manual pulse generator operation" is a control method in which positioning is carried out in response to the No. of pulses input from a manual pulse generator (the No. of input pulses is output). This operation is used for manual fine adjustment, etc., when carrying out accurate positioning to obtain the positioning address.

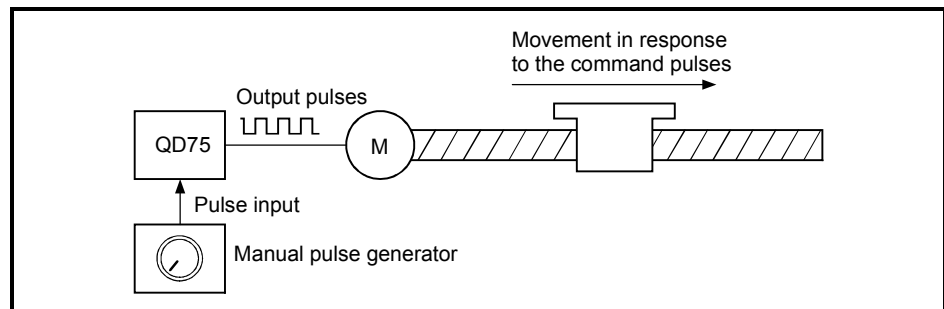

Fig. 11.3 Manual pulse generator control

#### ■ Manual control sub functions

Refer to Section 3.2.4 "Combination of QD75 major functions and sub functions" for details on "sub functions" that can be combined with manual control. Also refer to CHAPTER 12 "CONTROL SUB FUNCTIONS" for details on each sub function.

#### ■ Carrying out manual control from peripheral devices

"JOG operation", "Inching operation" and enabling/disabling of the "manual pulse generator operation" can be executed from GX Configurator-QP test mode. Refer to GX Configurator-QP Operating Manual for details on manual control from GX Configurator-QP.

#### ■ Monitoring manual control

Refer to Section 5.6 "List of monitor data" when directly monitoring the buffer memory using GX Developer. Also refer to GX Configurator-QP Operating Manual when monitoring with the monitor functions of GX Configurator-QP.

11.2 JOG operation

11.2.1 Outline of JOG operation

**Important**

Use the hardware stroke limit function when carrying out JOG operation near the upper or lower limits. (Refer to Section 12.4.4).

\* If the hardware stroke limit function is not used, the workpiece may exceed the moving range, causing an accident.

■ JOG operation

In JOG operation, the FORWARD run JOG start signal (Y8, YA, YC, YE) or REVERSE run JOG start signal (Y9, YB, YD, YF) turns ON, causing pulses to be output to the drive unit from the QD75 while the signal is ON. The workpiece is then moved in the designated direction.

The following shows examples of JOG operation.

1)	When the START signal turns ON, acceleration begins in the direction designated by the START signal, and continues for the acceleration time designated in " [Pr.32] JOG operation acceleration time selection". At this time, the BUSY signal changes from OFF to ON.
2)	When the workpiece being accelerated reaches the speed set in " [Cd.17] JOG speed", the movement continues at this speed. The constant speed movement takes place at 2) and 3).
3)	When the START signal is turned OFF, deceleration begins from the speed set in " [Cd.17] JOG speed", and continues for the deceleration time designated in " [Pr.33] JOG operation deceleration time selection".
4)	The operation stops when the speed becomes "0". At this time, the BUSY signal changes from ON to OFF.

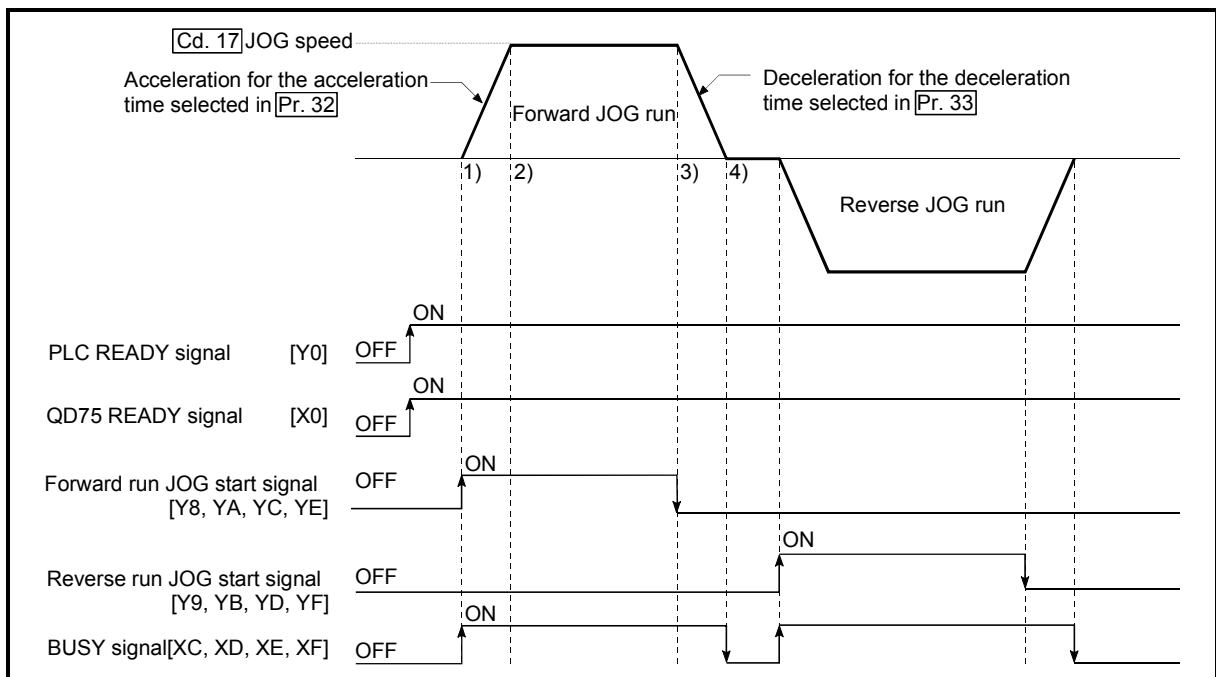

Fig. 11.4 JOG operation

### ■ Precautions during operation

- (1) For safety, first set " [Cd.17] JOG speed" to a smaller value and check the movement. Then gradually increase the value.
- (2) The axis error "Outside JOG speed range" (error code: 300) will occur and the operation will not start if the "JOG speed" is outside the setting range at the JOG start.
- (3) The axis error "JOG speed limit value error" (error code: 956) will occur and the operation will not start if " [Pr.31] JOG speed limit value" is set to a value larger than " [Pr.8] Speed limit value".
- (4) If " [Cd.17] JOG speed" exceeds the speed set in " [Pr.31] JOG speed limit value", the workpiece will move at the " [Pr.31] JOG speed limit value" and the warning "JOG speed limit value" (warning code: 301) will occur in the QD75.
- (5) The JOG operation can be continued even if an "Axis warning" has occurred.
- (6) Set a "0" in " [Cd.16] Inching movement amount". If a value other than "0" is set, the operation will become an inching operation (Refer to Section 11.3 "Inching operation").

### ■ Operations when stroke limit error occurs

When the operation is stopped by hardware stroke limit error or software stroke limit error, the JOG operation can execute in an opposite way (direction within normal limits) after an error reset. (An error will occur again if JOG start signal is turned ON in a direction to outside the stroke limit.)

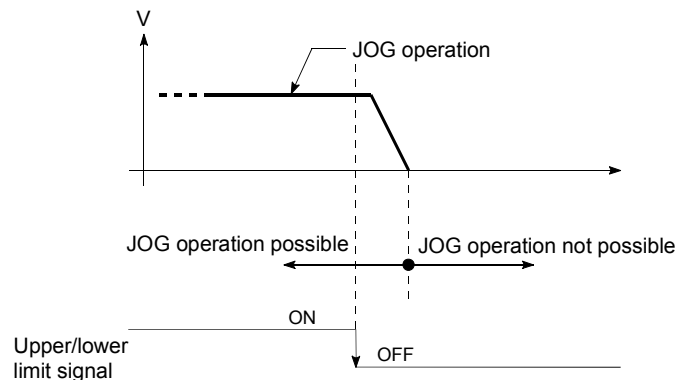

■ JOG operation timing and processing time

The following drawing shows details of the JOG operation timing and processing time.

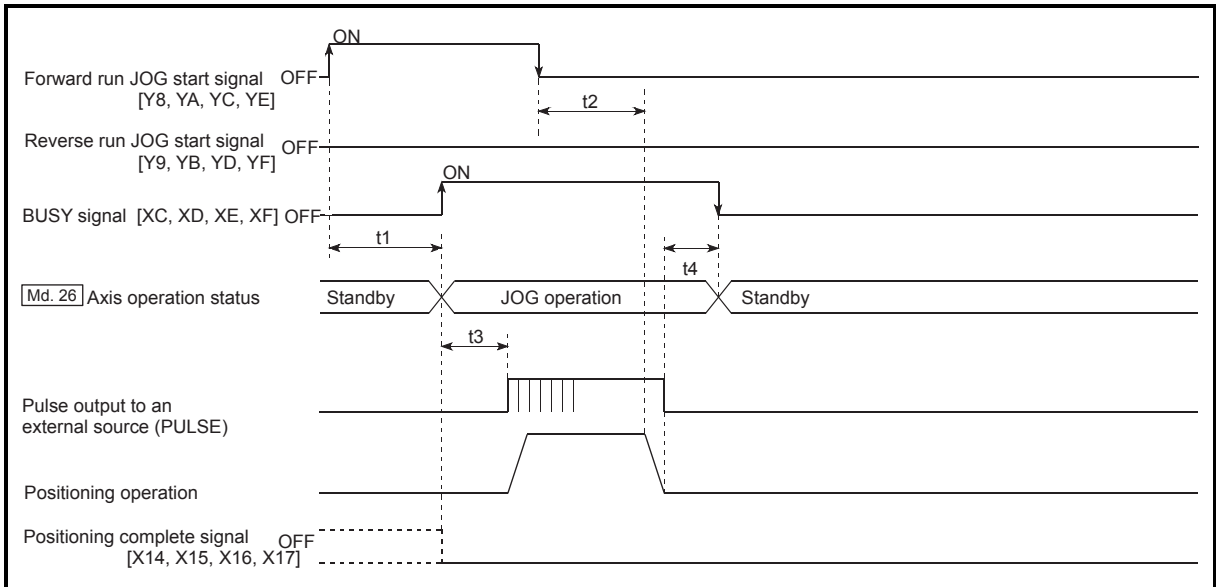

Fig. 11.5 JOG operation timing and processing times

Normal timing times

Model	t1	t2	t3	t4
QD75P□N/QD75D□N	1.0 to 3.0ms	0 to 0.9ms	1.3 to 2.2ms	0 to 0.9ms
QD75P□/QD75D□	1.0 to 3.0ms	0 to 1.8ms	2.7 to 4.4ms	0 to 1.8ms

- Delays may occur in the t1 timing time due to the operation status of other axes.

11.2.2 JOG operation execution procedure

The JOG operation is carried out by the following procedure.

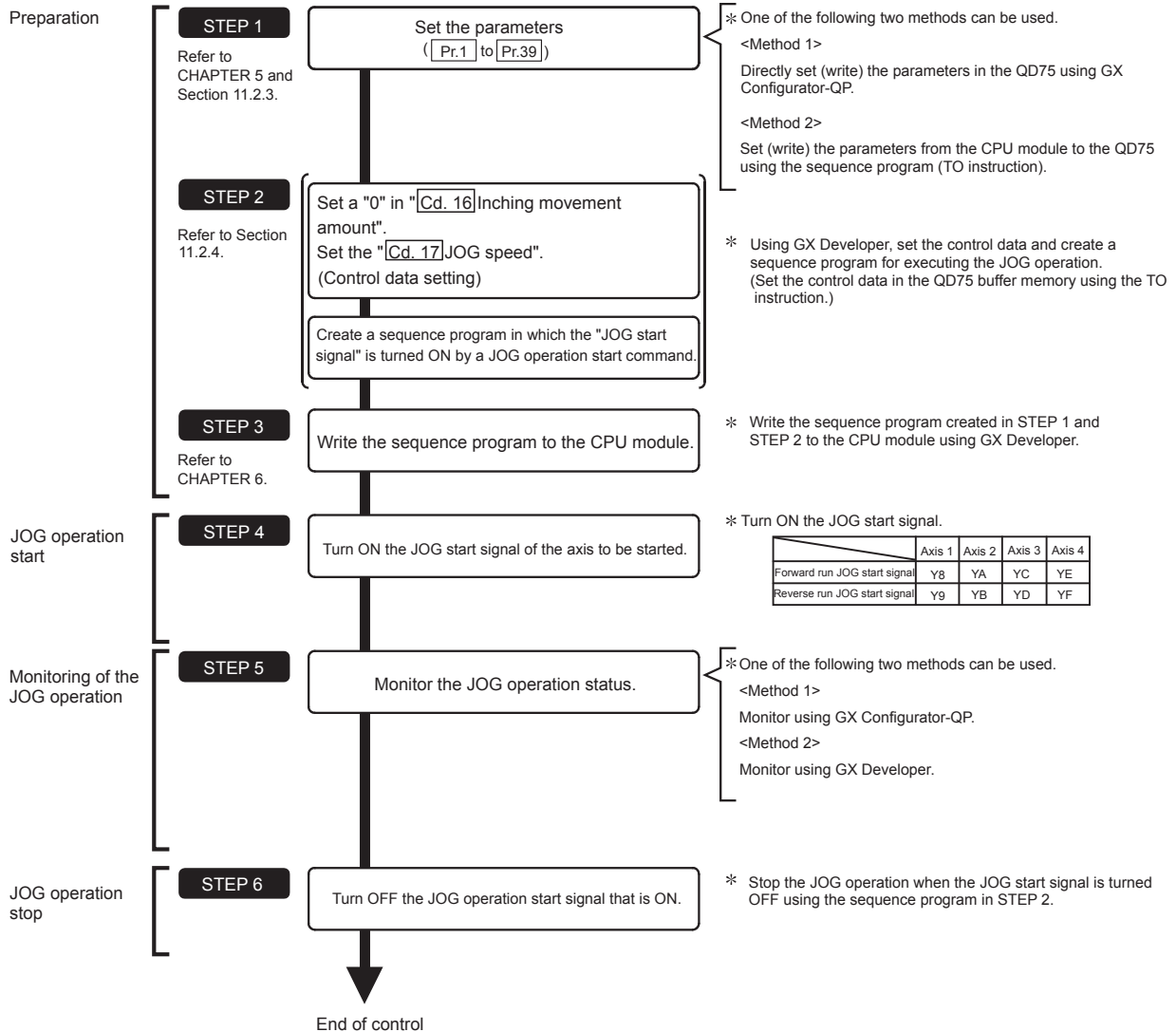

**REMARK**

- Mechanical elements such as limit switches are considered as already installed.
- Parameter settings work in common for all control using the QD75.

## 11.2.3 Setting the required parameters for JOG operation

The "Parameters" must be set to carry out JOG operation.

The following table shows the setting items of the required parameters for carrying out JOG operation. When only JOG operation will be carried out, no parameters other than those shown below need to be set. (Use the initial values or setting values within a range where no error occurs for trouble-free operation.)

Setting item		Setting requirement	Factory-set initial value (setting details)	
Parameters	Pr.1	Unit setting	◎	3 (pulse)
	Pr.2	No. of pulses per rotation (Ap) (Unit: pulse)	◎	20000
	Pr.3	Movement amount per rotation (Al) (Unit: pulse)	◎	20000
	Pr.4	Unit magnification (Am)	◎	1 (1-fold)
	Pr.5	Pulse output mode	◎	1 (CW/CCW mode)
	Pr.6	Rotation direction setting	◎	0 (current value increases by forward run pulse output)
	Pr.7	Bias speed at start (Unit: pulse/s)	○	0
	Pr.8	Speed limit value (Unit: pulse/s)	◎	200000
	Pr.9	Acceleration time 0 (Unit: ms)	◎	1000
	Pr.10	Deceleration time 0 (Unit: ms)	◎	1000
	Pr.11	Backlash compensation amount (Unit: pulse)	○	0
	Pr.12	Software stroke limit upper limit value (Unit: pulse)	○	2147483647
	Pr.13	Software stroke limit lower limit value (Unit: pulse)	○	-2147483648
	Pr.14	Software stroke limit selection	○	0 (current feed value)
	Pr.15	Software stroke limit valid/invalid setting	○	0 (valid)
	Pr.17	Torque limit setting value (Unit: %)	○	300
Pr.23	Output signal logic selection	○	0 (Pulse output to drive unit is negative logic.)	

◎ : Setting always required.

○ : Set according to requirements (Leave set to the initial value when not used.)

**REMARK**

- Parameter settings work in common for all control using the QD75. When carrying out other control ("major positioning control", "high-level positioning control", "OPR positioning control"), the respective setting items must also be matched and set.
- Parameters are set for each axis.
- Refer to CHAPTER 5 "DATA USED FOR POSITIONING CONTROL" for setting details.

Setting item		Setting requirement	Factory-set initial value (setting details)	
Parameters	Pr.25	Acceleration time 1 (Unit: ms)	○	1000
	Pr.26	Acceleration time 2 (Unit: ms)	○	1000
	Pr.27	Acceleration time 3 (Unit: ms)	○	1000
	Pr.28	Deceleration time 1 (Unit: ms)	○	1000
	Pr.29	Deceleration time 2 (Unit: ms)	○	1000
	Pr.30	Deceleration time 3 (Unit: ms)	○	1000
	Pr.31	JOG speed limit value (Unit: pulse/s)	◎	20000
	Pr.32	JOG operation acceleration time selection	◎	0 (acceleration time 0)
	Pr.33	JOG operation deceleration time selection	◎	0 (deceleration time 0)
	Pr.34	Acceleration/deceleration process selection	○	0 (trapezoidal acceleration/ deceleration processing)
	Pr.35	S-curve ratio (Unit: %)	○	100
	Pr.36	Sudden stop deceleration time (Unit: ms)	○	1000
	Pr.37	Stop group 1 sudden stop selection	○	0 (deceleration stop)
	Pr.38	Stop group 2 sudden stop selection	○	0 (deceleration stop)
	Pr.39	Stop group 3 sudden stop selection	○	0 (deceleration stop)

◎ : Setting always required.

○ : Set according to requirements (Leave set to the initial value when not used.)

### 11.2.4 Creating start programs for JOG operation

A sequence program must be created to execute a JOG operation. Consider the "required control data setting", "start conditions" and "start time chart" when creating the program.

The following shows an example when a JOG operation is started for axis 1. ("Cd.17" JOG speed" is set to "100.00mm/min" in the example shown.)

#### ■ Required control data setting

The control data shown below must be set to execute a JOG operation. The setting is carried out with the sequence program.

Setting item	Setting value	Setting details	Buffer memory address							
			Axis 1	Axis 2	Axis 3	Axis 4				
Cd.16	Inching movement amount	0	Set "0".				1517	1617	1717	1817
Cd.17	JOG speed	10000	Set a value equal to or above the "Pr.7" Bias speed at start" and equal to or below the "Pr.31" JOG speed limit value".				1518 1519	1618 1619	1718 1719	1818 1819

\* Refer to Section 5.7 "List of control data" for details on the setting details.

#### ■ Start conditions

The following conditions must be fulfilled when starting. The required conditions must also be assembled in the sequence program, and the sequence program must be configured so the operation will not start if the conditions are not fulfilled.

Signal name	Signal state	Device						
		Axis 1	Axis 2	Axis 3	Axis 4			
Interface signal	PLC READY signal	ON	CPU module preparation completed		Y0			
	QD75 READY signal	ON	QD75 preparation completed		X0			
	Synchronization flag *	ON	QD75 buffer memory The access is possible.		X1			
	Axis stop signal	OFF	Axis stop signal is OFF		Y4	Y5	Y6	Y7
	Start complete signal	OFF	Start complete signal is OFF		X10	X11	X12	X13
	BUSY signal	OFF	QD75 is not operating		XC	XD	XE	XF
	Error detection signal	OFF	There is no error		X8	X9	XA	XB
M code ON signal	OFF	M code ON signal is OFF		X4	X5	X6	X7	
External signal	Drive unit READY signal	ON	Drive unit preparation completed		-			
	Stop signal	OFF	Stop signal is OFF		-			
	Upper limit (FLS)	ON	Within limit range		-			
	Lower limit (RLS)	ON	Within limit range		-			

\* If the CPU module is set to the asynchronous mode in the synchronization setting, this must be inserted in the program for interlocking. If it is set to the synchronous mode, it must not be inserted in the program for interlocking because it is turned ON when the CPU module executes calculation.



■ Start time chart

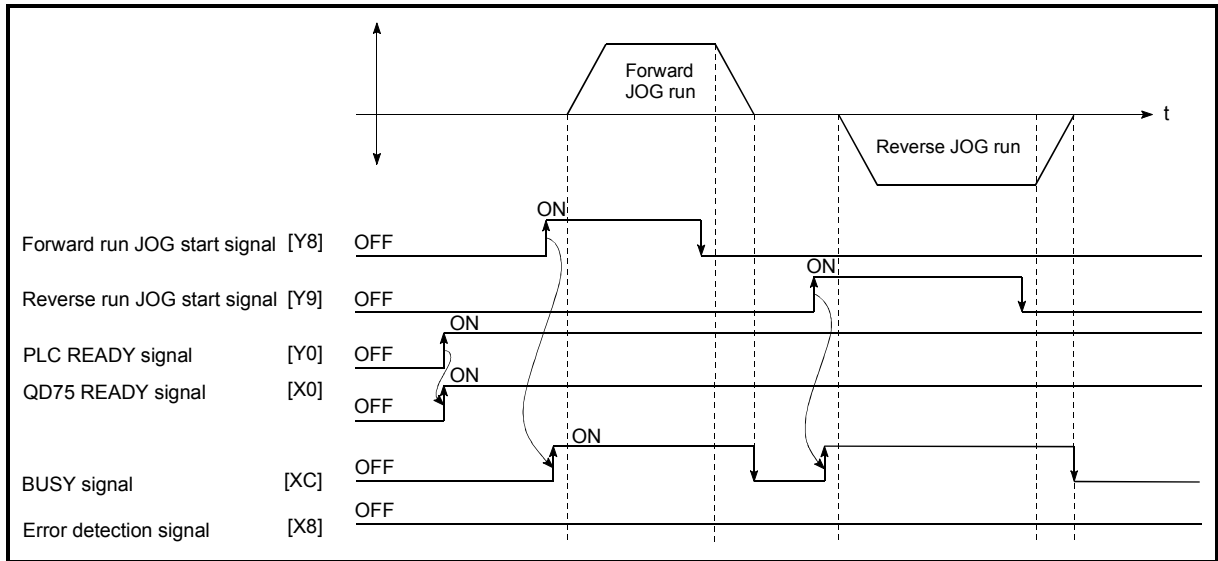
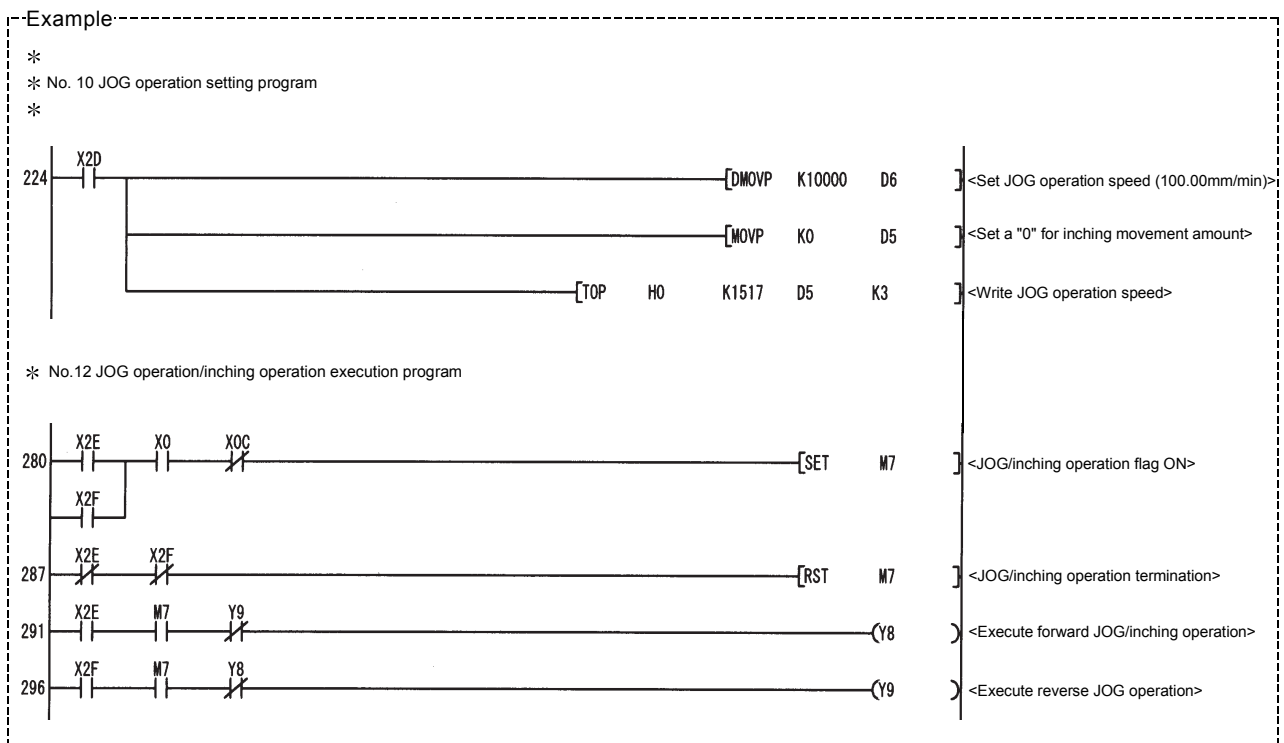

Fig. 11.6 JOG operation start time chart

■ Creating the program



11.2.5 JOG operation example

■ When the "stop signal" is turned ON during JOG operation

When the "stop signal" is turned ON during JOG operation, the JOG operation will stop by the "deceleration stop" method.  
 An error "Stop signal ON at start" (error code 106) will occur if JOG start signal is turned ON while the stop signal is ON.  
 The operation can be started by turning the stop signal OFF, and turning the JOG start signal from OFF to ON again.

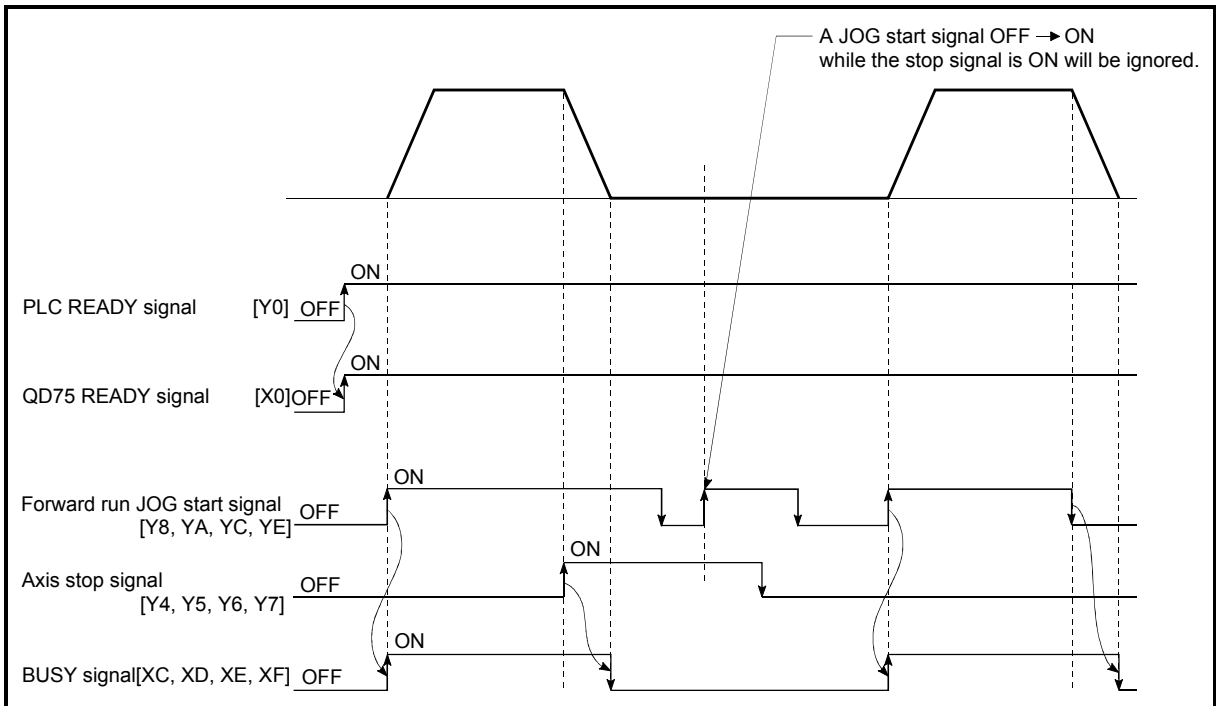

Fig. 11.7 Operation when the stop signal is turned ON during JOG operation

- When both the "forward run JOG start signal" and "reverse run JOG start signal" are turned ON simultaneously for one axis

When both the "forward run JOG start signal" and "reverse run JOG start signal" are turned ON simultaneously for one axis, the "forward run JOG start signal" is given priority. In this case, the "reverse run JOG start signal" is validated when the QD75 BUSY signal is turned OFF.

If the forward run JOG operation is stopped due to stop or axis error by a stop signal, the reverse run JOG operation will not be executed even if the "reverse run JOG start signal" turns ON.

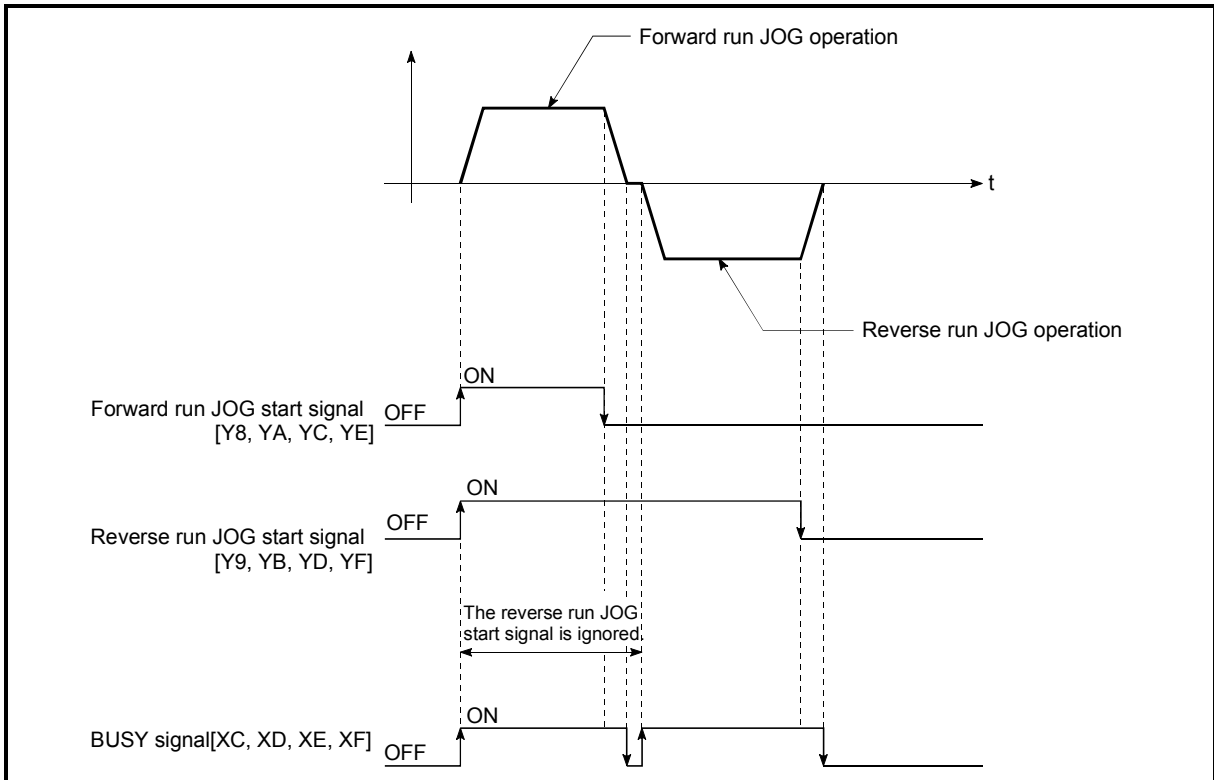

Fig. 11.8 Operation when both the forward run JOG start signal and reverse run JOG start signal are turned ON simultaneously

- When the "JOG start signal" is turned ON again during deceleration caused by the ON → OFF of the "JOG start signal"

When the "JOG start signal" is turned ON again during deceleration caused by the ON → OFF of the "JOG start signal", the JOG operation will be carried out from the time the "JOG start signal" is turned ON.

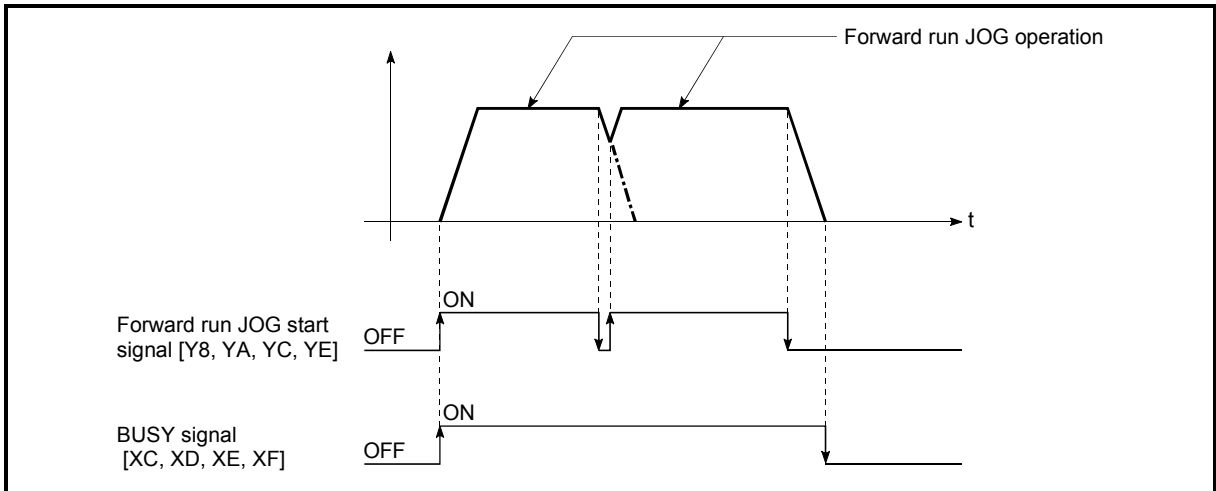

Fig. 11.9 Operation when the JOG start signal is turned ON during deceleration

- When the "JOG start signal" is turned ON during a peripheral device test mode

When the "JOG start signal" is turned ON during a peripheral device test mode, it will be ignored and the JOG operation will not be carried out.

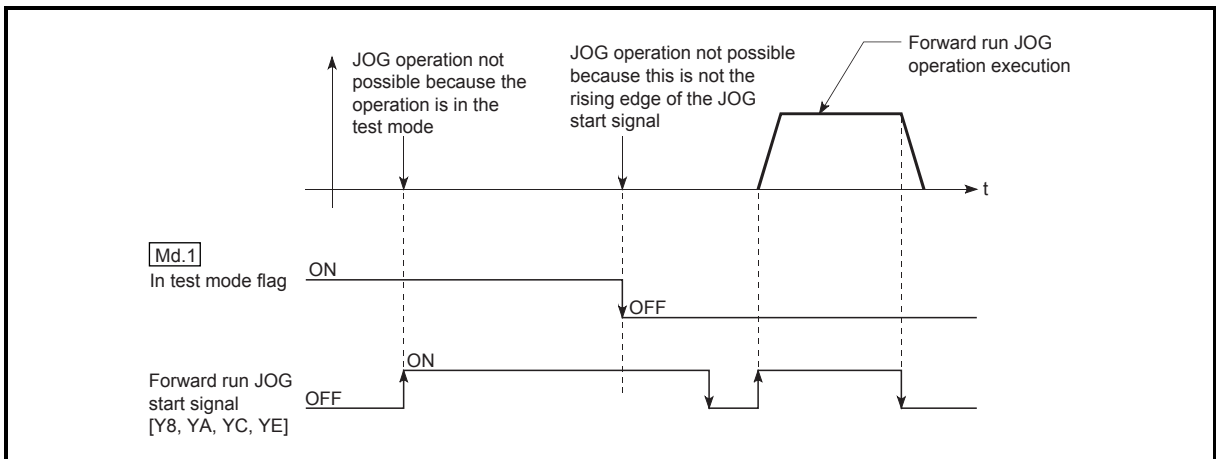

Fig. 11.10 Operation when the JOG start signal is turned ON during a test mode

### 11.3 Inching operation

#### 11.3.1 Outline of inching operation

**Important**

When the inching operation is carried out near the upper or lower limit, use the hardware stroke limit function (Refer to Section 12.4.4).

\* If the hardware stroke limit function is not used, the workpiece may exceed the movement range, and an accident may result.

**■ Inching operation**

In inching operation, pulses are input to the drive unit at 1.8ms to move the workpiece by a designated movement amount after the forward run JOG start signal [Y8, YA, YC, YE] or reverse JOG start signal [Y9, YB, YD, YF] is turned ON. The following shows the example of inching operation.

- |    |   |
|----|---|
| 1) | When the start signal is turned ON, inching operation is carried out in the direction designated by the start signal. In this case, BUSY signal is turned from OFF to ON.                                     |
| 2) | The workpiece is moved by a movement amount set in " <span style="border: 1px solid black; padding: 0 2px;">Cd.16</span> Inching movement amount".  |
| 3) | The workpiece movement stops when the speed becomes "0". In this case, BUSY signal is turned from ON to OFF. The positioning complete signal is turned from OFF to ON.  |
| 4) | The positioning complete signal is turned from ON to OFF after a time set in " <span style="border: 1px solid black; padding: 0 2px;">Pr.40</span> Positioning complete signal output time" has been elapsed. |

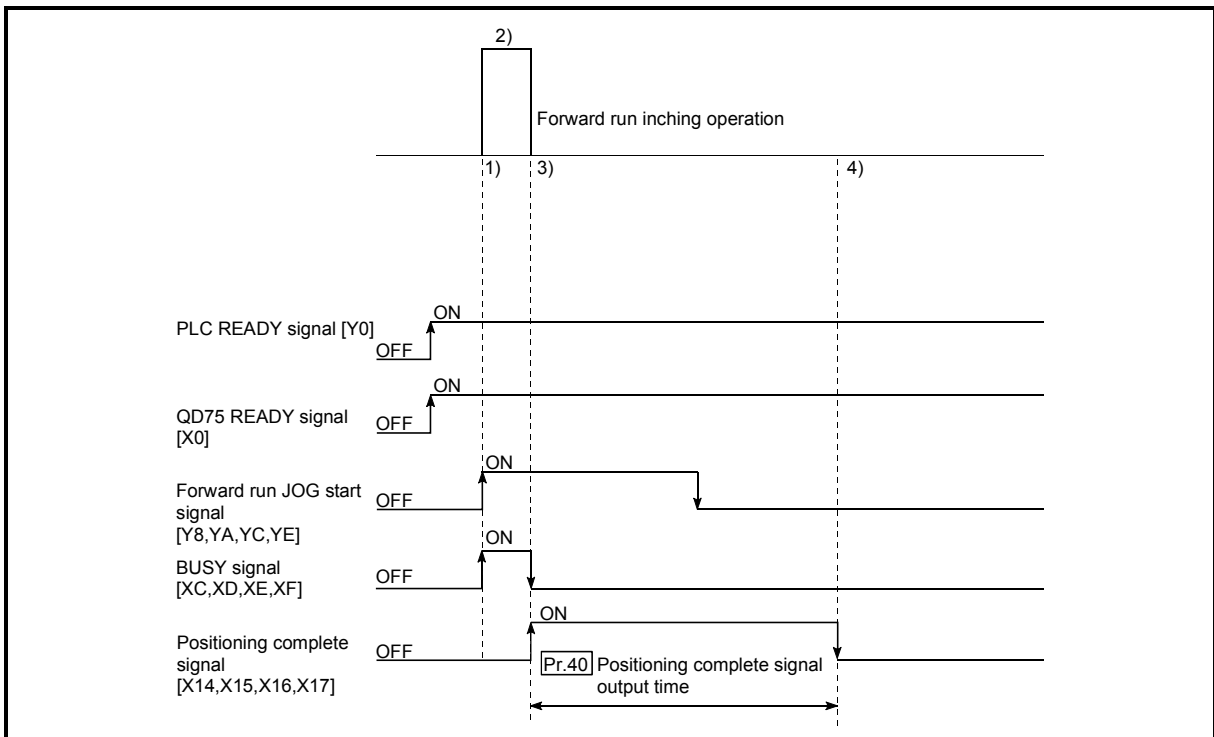

Fig. 11.11 Inching operation

■ Precautions during operation

- (1) Acceleration/deceleration processing is not carried out during inching operation. (Pulses corresponding to the designated inching movement amount are output at 1.8ms. The movement direction of inching operation is reversed and, when backlash compensation is carried out, first pulses corresponding to the backlash amount are output at 1.8ms and then pulses corresponding to the designated inching movement amount are output in the next 1.8ms.)  
The " [Cd.17] JOG speed" is ignored even if it is set. However, the error "Inching movement amount error" (error code: 301) will occur in the following cases:

$$([Cd.16] \text{ Inching movement amount}) \times (A) > ([Pr.31] \text{ JOG speed limit value})$$

Where (A) is as follows.

- When the unit is pulse: 562.5
- When the unit is other than pulse: 337.5

- (2) Set a value other than a "0" in " [Cd.16] Inching movement amount".  
If a "0" is set, the operation will become JOG operation (Refer to Section 11.2 "JOG operation").

■ Operations when stroke limit error occurs

When the operation is stopped by hardware stroke limit error or software stroke limit error, the inching operation can be performed in an opposite way (direction within normal limits) after an error reset. (An error will occur again if JOG start signal is turned ON in a direction to outside the stroke limit.)

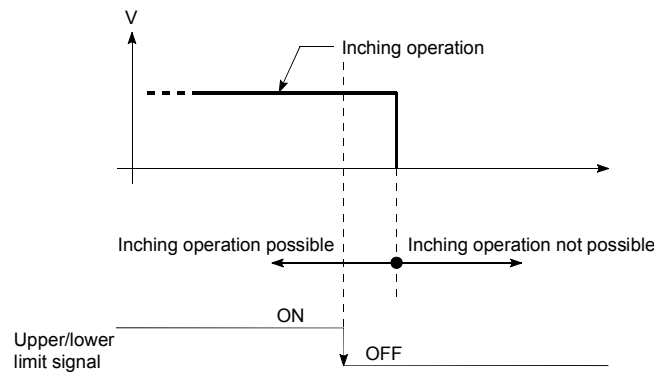

■ Inching operation timing and processing times

The following drawing shows the details of the inching operation timing and processing time.

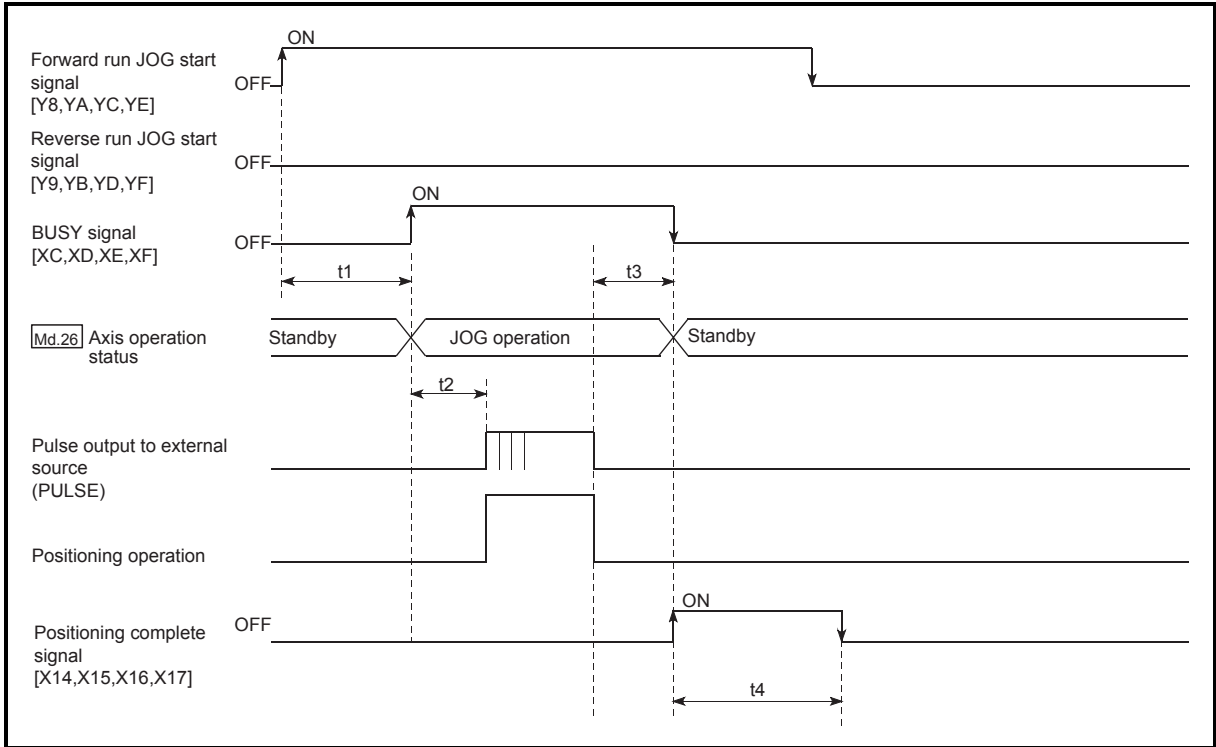

Fig. 11.12 Inching operation timing and processing times

Normal timing times

Model	t1	t2	t3	t4
QD75P□N/QD75D□N	1.0 to 3.0ms	1.3 to 2.2ms	0 to 0.9ms	Depending on parameters
QD75P□/QD75D□	1.0 to 3.0ms	2.7 to 4.4ms	0 to 1.8ms	

- Depending on the operating statuses of the other axes, delay may occur in the t1 timing time.



### 11.3.2 Inching operation execution procedure

The inching operation is carried out by the following procedure.

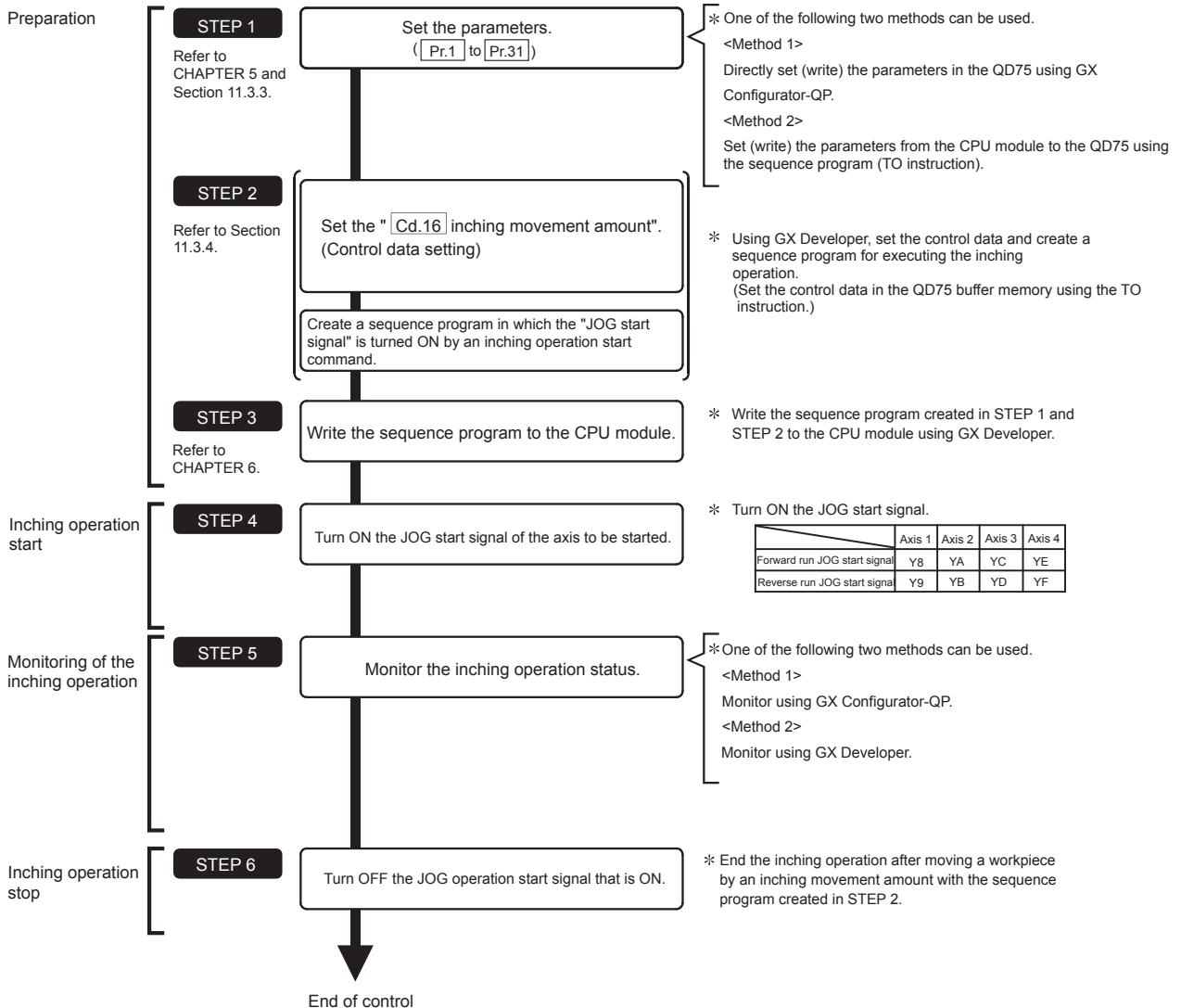

	Axis 1	Axis 2	Axis 3	Axis 4
Forward run JOG start signal	Y8	YA	YC	YE
Reverse run JOG start signal	Y9	YB	YD	YF

**REMARK**

- Mechanical elements such as limit switches are considered as already installed.
- Parameter settings work in common for all control using the QD75.

## 11.3.3 Setting the required parameters for inching operation

The "Parameters" must be set to carry out inching operation.

The following table shows the setting items of the required parameters for carrying out inching operation. When only inching operation will be carried out, no parameters other than those shown below need to be set. (Use the initial values or setting values within a range where no error occurs for trouble-free operation.)

Setting item		Setting requirement	Factory-set initial value (setting details)	
Parameters	Pr.1	Unit setting	◎	3 (pulse)
	Pr.2	No. of pulses per rotation (Ap) (Unit: pulse)	◎	20000
	Pr.3	Movement amount per rotation (Al) (Unit: pulse)	◎	20000
	Pr.4	Unit magnification (Am)	◎	1 (1-fold)
	Pr.5	Pulse output mode	◎	1 (CW/CCW mode)
	Pr.6	Rotation direction setting	◎	0 (current value increases by forward run pulse output)
	Pr.11	Backlash compensation amount (Unit: pulse)	○	0
	Pr.12	Software stroke limit upper limit value (Unit: pulse)	○	2147483647
	Pr.13	Software stroke limit lower limit value (Unit: pulse)	○	-2147483648
	Pr.14	Software stroke limit selection	○	0 (current feed value)
	Pr.15	Software stroke limit valid/invalid setting	○	0 (valid)
	Pr.17	Torque limit setting value (Unit: %)	○	300
	Pr.23	Output signal logic selection	○	0 (Pulse output to the drive unit is negative logic)
	Pr.31	JOG speed limit value (Unit: pulse/s)	◎	20000

◎ : Setting always required.

○ : Set according to requirements (Leave set to the initial value when not used.)

**REMARK**

- Parameter settings work in common for all control using the QD75. When carrying out other controls ("major positioning control", "high-level positioning control", and "OPR positioning control"), the respective setting items must also be set.
- Parameters are set for each axis.
- Refer to CHAPTER 5 "DATA USED FOR POSITIONING CONTROL" for setting details.

11.3.4 Creating a program to enable/disable the inching operation

A sequence program must be created to execute an inching operation. Consider the "required control data setting", "start conditions", and "start time chart" when creating the program.

The following shows an example when an inching operation is started for axis 1. (The example shows the inching operation when a "10.0 μm" is set in " Cd.16 Inching movement amount".)

■ Required control data setting

The control data shown below must be set to execute an inching operation. The setting is carried out with the sequence program.

Setting item	Setting value	Setting details	Buffer memory address			
			Axis 1	Axis 2	Axis 3	Axis 4
Cd.16 Inching movement amount	100	Set the setting value so that the command pulse is not increased larger than the maximum output pulse. (The max. output pulse QD75D□N: 4Mpps QD75D□: 1Mpps QD75P□N/QD75P□: 200kpps)	1517	1617	1717	1817

\* Refer to Section 5.7 "List of control data" for information on setting details.

■ Start conditions

The following conditions must be fulfilled when starting. The required conditions must also be assembled in the sequence program, and the sequence program must be configured so the operation will not start if the conditions are not fulfilled.

Signal name	Signal state	Device								
		Axis 1	Axis 2	Axis 3	Axis 4					
Interface signal	PLC READY signal	ON	CPU module preparation completed				Y0			
	QD75 READY signal	ON	QD75 preparation completed				X0			
	Synchronization flag *	ON	Accessible to QD75 buffer memory				X1			
	Axis stop signal	OFF	Axis stop signal is OFF				Y4	Y5	Y6	Y7
	Start complete signal	OFF	Start complete signal is OFF				X10	X11	X12	X13
	BUSY signal	OFF	QD75 is not operating				XC	XD	XE	XF
	Positioning complete signal	OFF	Positioning complete signal is OFF				X14	X15	X16	X17
	Error detection signal	OFF	There is no error				X8	X9	XA	XB
M code ON signal	OFF	M code ON signal is OFF				X4	X5	X6	X7	
External signal	Drive unit READY signal	ON	Drive unit preparation completed				-			
	Stop signal	OFF	Stop signal is OFF				-			
	Upper limit (FLS)	ON	Within limit range				-			
	Lower limit (RLS)	ON	Within limit range				-			

\* If the CPU module is set to the asynchronous mode in the synchronization setting, this must be inserted in the program for interlocking. If it is set to the synchronous mode, it must not be inserted in the program for interlocking because it is turned ON when the CPU module executes calculation.

■ Start time chart

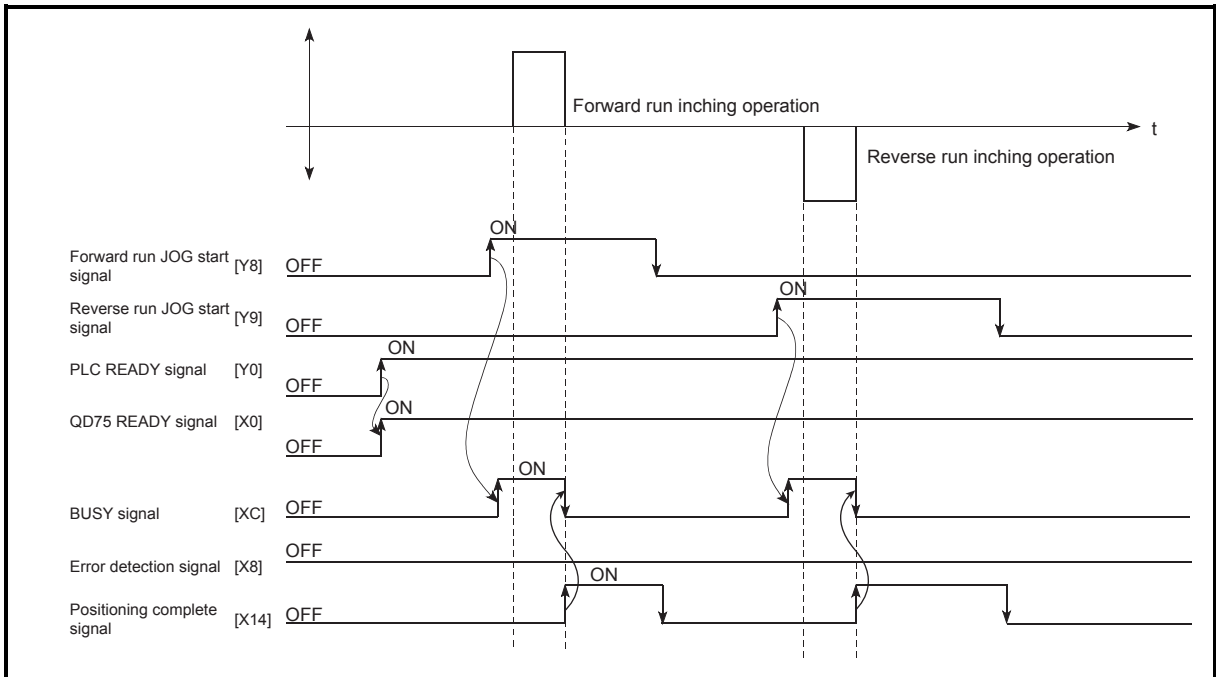
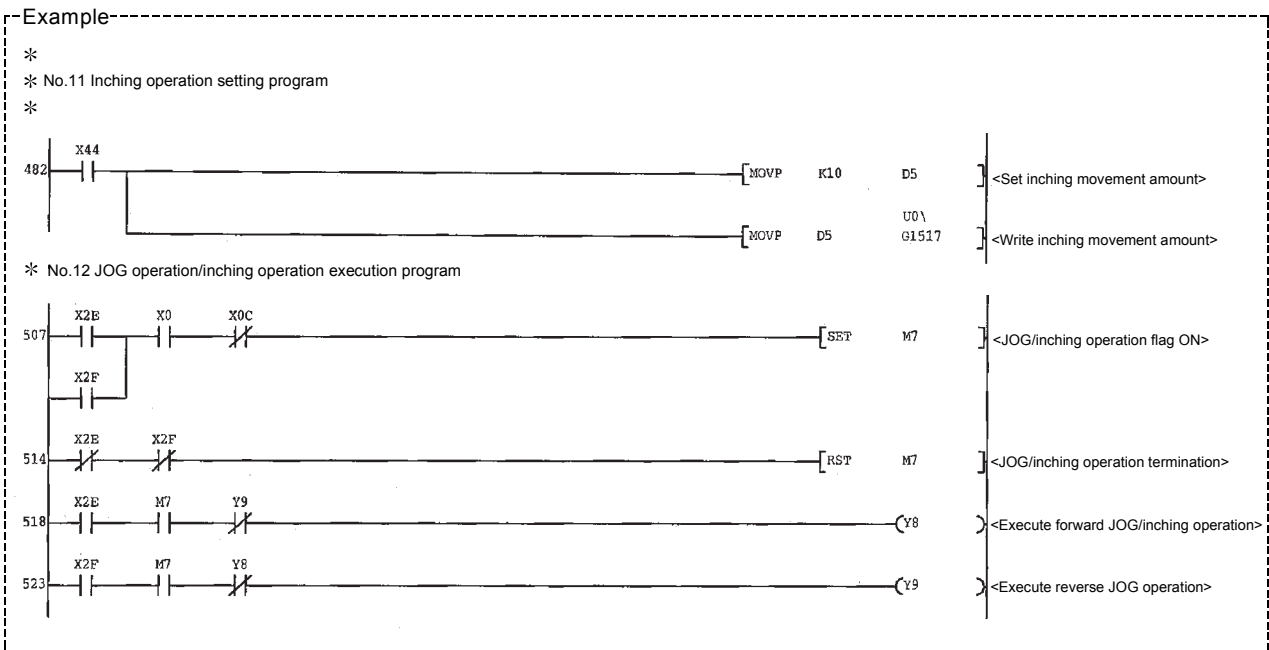

Fig. 11.13 Inching operation start time chart

■ Creating the program



11.3.5 Inching operation example

■ When executing inching operation while stop signal is turned ON:

If the JOG start signal is turned ON while the stop signal is ON, an error "Stop signal ON at start" (error code: 106) will occur.

The inching operation can be re-started when the stop signal is turned OFF and the JOG start signal is turned OFF and then turned ON.

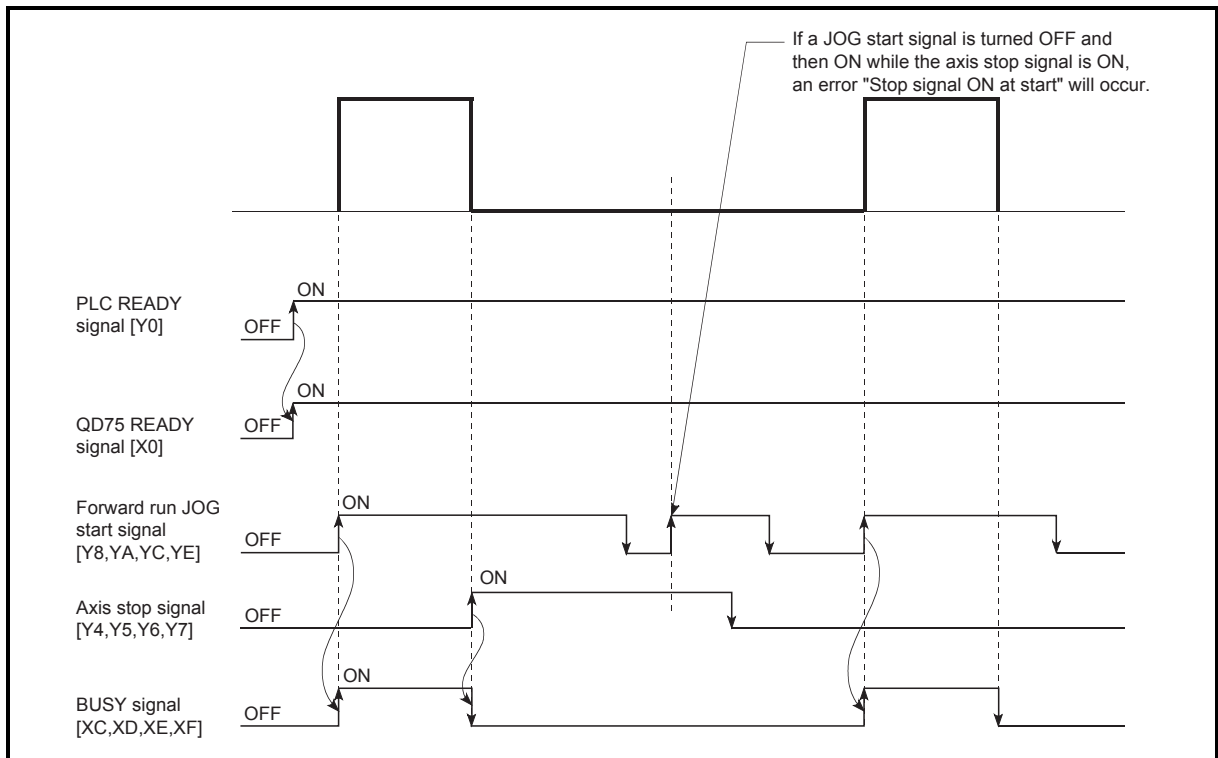

Fig. 11.14 Operation when executing inching operation while stop signal is ON

■ When "JOG start signal" is turned ON when peripheral devices are in the test mode:

If "JOG start signal" is turned ON when peripheral devices are in the test mode, the "JOG start signal" will be ignored and inching operation will not be carried out.

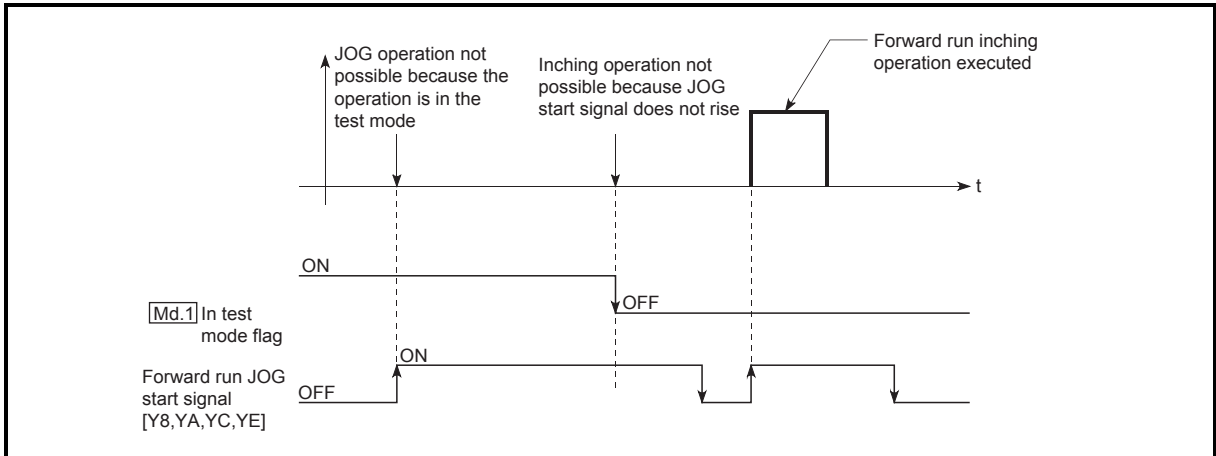

Fig. 11.15 Operation when JOG start signal is turned ON in test mode

11.4 Manual pulse generator operation

11.4.1 Outline of manual pulse generator operation

**Important**

Create the sequence program so that " Cd.21 Manual pulse generator enable flag" is always set to "0" (disabled) when a manual pulse generator operation is not carried out.

\* Mistakenly touching the manual pulse generator when the manual pulse generator enable flag is set to "1" (enable) can cause accidents or incorrect positioning.

■ Manual pulse generator operation

In manual pulse generator operations, pulses are input to the QD75 from the manual pulse generator. This causes the same No. of input pulses to be output from the QD75 to the servo amplifier, and the workpiece is moved in the designated direction.

The following shows an example of manual pulse generator operation.

- |    |   |
|----|---|
| 1) | When the " Cd.21 Manual pulse generator enable flag" is set to "1", the BUSY signal turns ON and the manual pulse generator operation is enabled.   |
| 2) | The workpiece is moved corresponding to the No. of pulses input from the manual pulse generator.  |
| 3) | The workpiece movement stops when no more pulses are input from the manual pulse generator.   |
| 4) | When the " Cd.21 Manual pulse generator enable flag" is set to "0", the BUSY signal turns OFF and the manual pulse generator operation is disabled. |

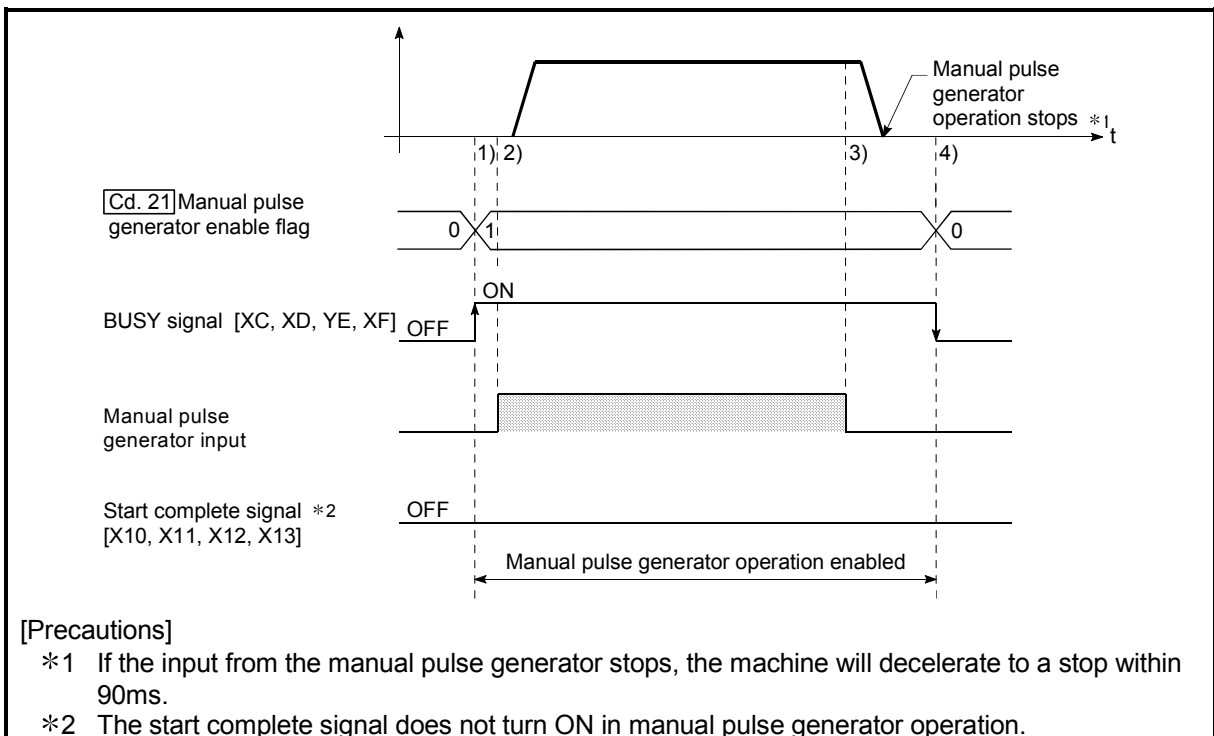

Fig. 11.16 Manual pulse generator operation



**■ Restricted items**

A manual pulse generator is required to carry out manual pulse generator operation.

**■ Precautions during operation**

- (1) The speed during manual pulse generator operation is not limited by the " **Pr.8** Speed limit value".
- (2) If the " **Cd.21** Manual pulse generator enable flag" is turned ON while the QD75 is BUSY (BUSY signal ON), a warning "Start during operation" (warning code: 100) will occur.
- (3) If a stop factor occurs during manual pulse generator operation, the operation will stop, and the BUSY signal will turn OFF.  
At this time, the " **Cd.21** Manual pulse generator enable flag" will be left ON, but manual pulse generator operation will not be possible. To carry out manual pulse generator operation again, measures must be carried out to eliminate the stop factor. Once eliminated, the operation can be carried out again by turning the " **Cd.21** Manual pulse generator enable flag" ON → OFF → ON.  
(Note that this excludes when hardware/software stroke limit errors occurs.)
- (4) Pulses will not be output if an error occurs when the manual pulse generator operation starts.

**REMARK**

- One QD75 module can be connected to one manual pulse generator.
- The QD75 module can simultaneously output pulses to the axis 1 to axis 4 drive units by one manual pulse generator.  
(1- to 4-axis simultaneous operation is possible.)

■ Operations when stroke limit error occurs

When the hardware stroke limit error or the software stroke limit error is detected during operation, the operation will decelerate to a stop. However, "Md.26 Axis operation status" will keep the status "Manual pulse generator operation" in that case. \*1

After stopping, manual pulse generator input pulses to the outside direction of the limit range are not accepted, but operation can be executed within the range.

\*1: Only when the current feed value or the current machine feed value overflows or underflows during deceleration, the manual pulse generator operation will terminate as "Md.26 Axis operation status" is changed to "Error". To carry out manual pulse generator operation again, "Cd.21 Manual pulse generator enable flag" must be turned OFF once and turn ON.

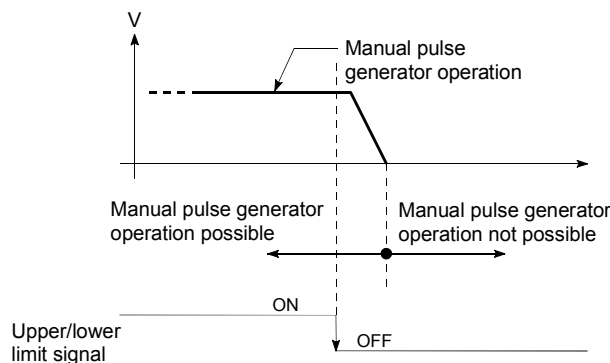

■ Manual pulse generator operation timing and processing time

The following drawing shows details of the manual pulse generator operation timing and processing time.

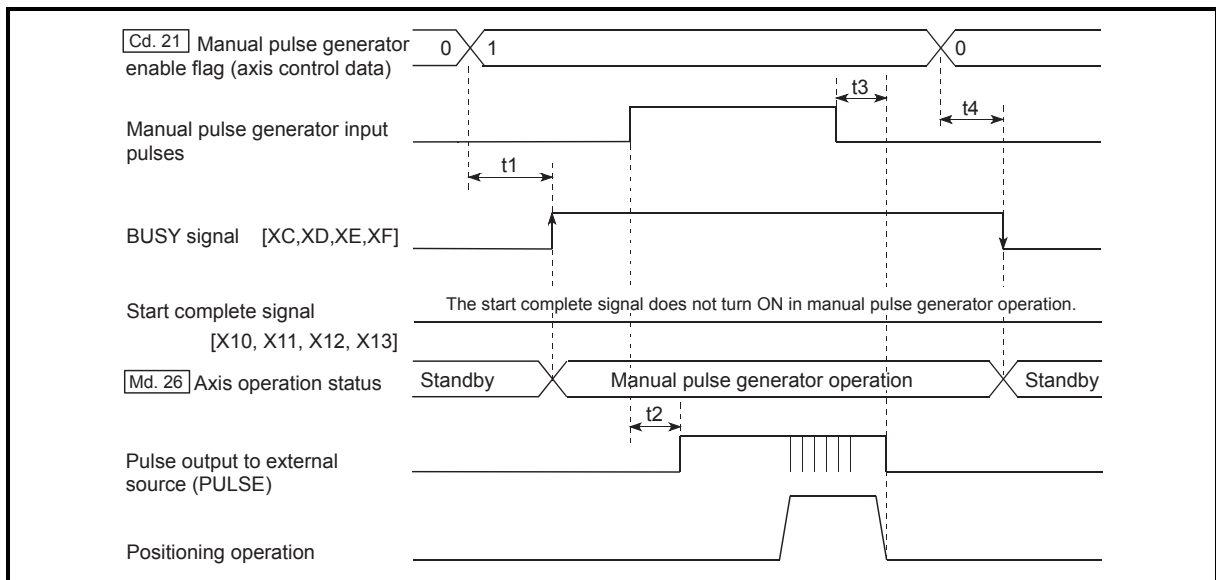

Fig. 11.17 Manual pulse generator operation timing and processing times

Normal timing times

Model	t1	t2	t3	t4
QD75P□N/QD75D□N	0 to 0.9ms	1.7 to 30.2ms	58.6 to 87.6ms	28.4 to 57.2ms
QD75P□/QD75D□	0 to 2.6ms	6.2 to 32ms	60.4 to 90ms	28.4 to 57.6ms

• Delays may occur in the t1 timing time due to the operation status of other axes.

■ Position control by manual pulse generator operation

In manual pulse generator operation, the position is moved by a "manual pulse generator 1 pulse movement amount" per pulse.

The current feed value in the positioning control by manual pulse generator operation can be calculated using the expression shown below.

$$\text{Current feed value} = \text{Number of input pulses} \times \text{Cd.20 Manual pulse generator 1 pulse input magnification} \times \text{Manual pulse generator 1 pulse movement amount}$$

Pr.1 Unit setting	mm	inch	degree	pulse
Manual pulse generator 1 pulse movement amount	0.1μm	0.00001inch	0.00001degree	1pulse

For example, when " Pr.1 Unit setting" is mm and " Cd.20 Manual pulse generator 1 pulse input magnification" is 2, and 100 pulses are input from the manual pulse generator, the current feed value is as follows.

$$100 \times 2 \times 0.1 = 20 [\mu\text{m}] \\ = 200 [\text{Current feed value}]$$

The number of pulses output actually to the drive unit is "Manual pulse generator 1 pulse movement amount/movement amount per pulse \*". For example, when " Pr.1 Unit setting" is mm and the movement amount per pulse is 1 μm, 0.1/1 = 1/10, i.e., the output to the drive unit per pulse from the manual pulse generator is 1/10 pulse. Thus, the QD75 outputs 1 pulse to the drive unit after receiving 10 pulses from the manual pulse generator.

$$* \text{ Movement amount per pulse} = \frac{\text{Pr.3 Movement amount per rotation}}{\text{Pr.2 No. of pulses per rotation}} \times \text{Pr.4 Unit magnification}$$

■ Speed control by manual pulse generation operation

The speed during positioning control by manual pulse generator operation is a speed corresponding to the No. of input pulses per unit time, and can be obtained using the following equation.

$$\text{Output command frequency} = \text{Input frequency} \times \text{Cd.20 Manual pulse generator 1 pulse input magnification}$$

11.4.2 Manual pulse generator operation execution procedure

The manual pulse generator operation is carried out by the following procedure.

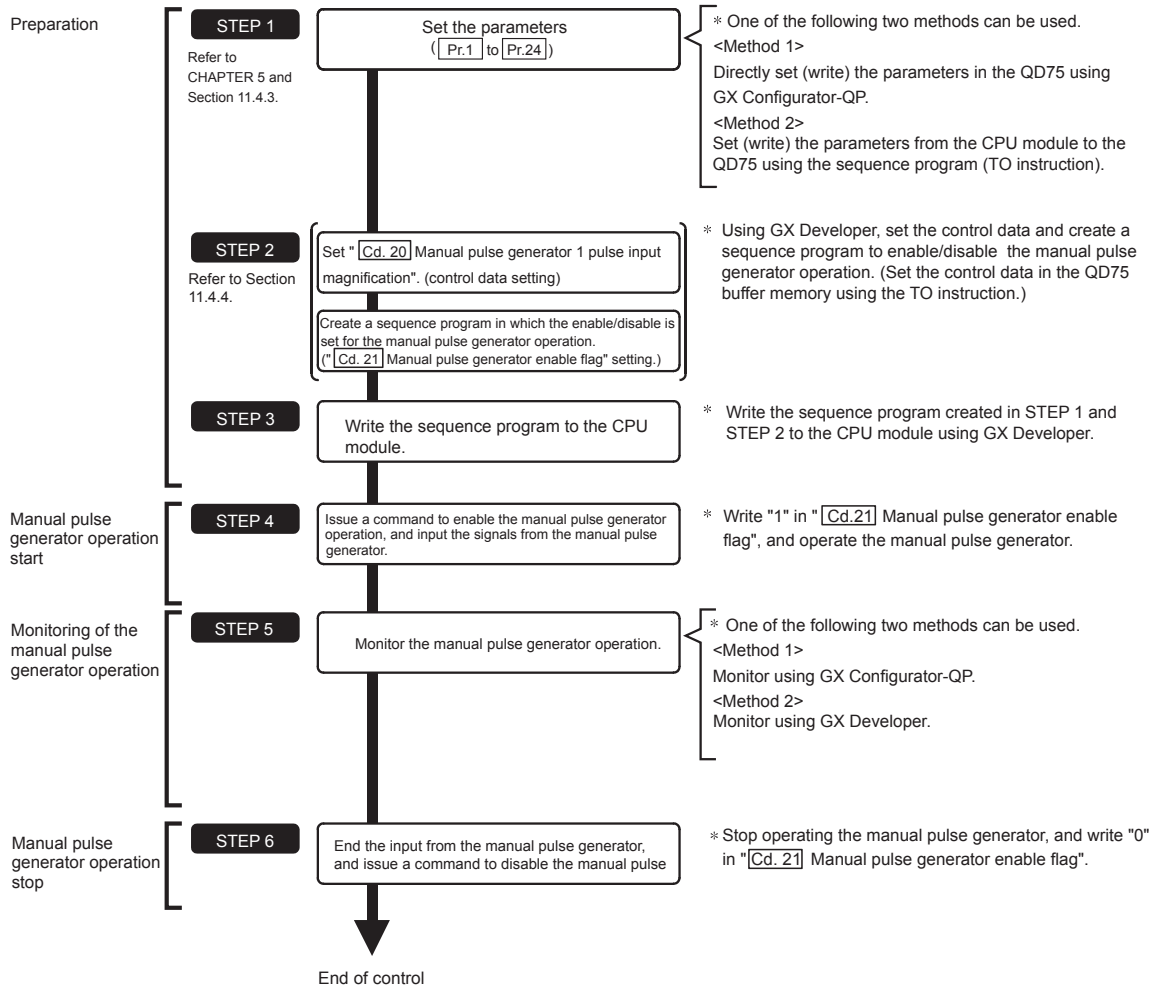

**REMARK**

- Mechanical elements such as limit switches are considered as already installed.
- Parameter settings work in common for all control using the QD75.

## 11.4.3 Setting the required parameters for manual pulse generator operation

The "Parameters" must be set to carry out manual pulse generator operation.

The following table shows the setting items of the required parameters for carrying out manual pulse generator operation. When only manual pulse generator operation will be carried out, no parameters other than those shown below need to be set. (Use the initial values or setting values within a range where no error occurs for trouble-free operation.)

Setting item		Setting requirement	Factory-set initial value (setting details)	
Parameters	Pr.1	Unit setting	◎	3 (pulse)
	Pr.2	No. of pulses per rotation (Ap) (Unit: pulse)	◎	20000
	Pr.3	Movement amount per rotation (Al) (Unit: pulse)	◎	20000
	Pr.4	Unit magnification (Am)	◎	1 (1-fold)
	Pr.5	Pulse output mode	◎	1 (CW/CCW mode)
	Pr.6	Rotation direction setting	◎	0 (current value increases by forward run pulse output)
	Pr.11	Backlash compensation amount (Unit: pulse)	○	0
	Pr.12	Software stroke limit upper limit value (Unit: pulse)	○	2147483647
	Pr.13	Software stroke limit lower limit value (Unit: pulse)	○	-2147483648
	Pr.14	Software stroke limit selection	○	0 (current feed value)
	Pr.15	Software stroke limit valid/invalid setting	○	0 (valid)
	Pr.17	Torque limit setting value (Unit: %)	○	300
	Pr.22	Input signal logic selection	○	0 (Manual pulse generator input is negative logic.)
	Pr.23	Output signal logic selection	○	0 (Pulse output to drive unit is negative logic.)
	Pr.24	Manual pulse generator input selection	○	0 (4 times multiplication of A phase/B phase)

◎ : Setting always required.

○ : Set according to requirements (Leave set to the initial value when not used.)

**REMARK**

- Parameter settings work in common for all control using the QD75. When carrying out other control ("major positioning control", "high-level positioning control", "OPR positioning control"), the respective setting items must also be matched and set.
- Parameters are set for each axis. But Pr.22 Manual pulse generator input logic (b8), Pr.24 is set only for axis 1. (The setting for axes 2,3, and 4 is ignored.)
- Refer to CHAPTER 5 "DATA USED FOR POSITIONING CONTROL" for setting details.

## 11.4.4 Creating a program to enable/disable the manual pulse generator operation

A sequence program must be created to execute a manual pulse generator operation. Consider the "required control data setting", "start conditions" and "start time chart" when creating the program.

The following shows an example when a manual pulse generator operation is started for axis 1.

#### ■ Required control data setting

The control data shown below must be set to execute a manual pulse generator operation. The setting is carried out with the sequence program.

Setting item	Setting value	Setting details	Buffer memory address				
			Axis 1	Axis 2	Axis 3	Axis 4	
Cd.20	Manual pulse generator 1 pulse input magnification	1	Set the manual pulse generator 1 pulse input magnification. (QD75P□N/QD75D□N: 1 to 1000 times QD75P□/QD75D□: 1 to 100 times)	1522 1523	1622 1623	1722 1723	1822 1823
Cd.21	Manual pulse generator enable flag	1 (0)	Set "1: Enable manual pulse generator operation". (Set "0: Disable manual pulse generator operation" when finished with the manual pulse generator operation.)	1524	1624	1724	1824

\* Refer to Section 5.7 "List of control data" for details on the setting details.

#### ■ Start conditions

The following conditions must be fulfilled when starting. The required conditions must also be assembled in the sequence program, and the sequence program must be configured so the operation will not start if the conditions are not fulfilled.

Signal name	Signal state	Device						
		Axis 1	Axis 2	Axis 3	Axis 4			
Interface signal	PLC READY signal	ON	CPU module preparation completed		Y0			
	QD75 READY signal	ON	QD75 preparation completed		X0			
	Synchronization flag *	ON	QD75 buffer memory The access is possible.		X1			
	Axis stop signal	OFF	Axis stop signal is OFF		Y4	Y5	Y6	Y7
	Start complete signal	OFF	Start complete signal is OFF		X10	X11	X12	X13
	BUSY signal	OFF	QD75 is not operating		XC	XD	XE	XF
	Error detection signal	OFF	There is no error		X8	X9	XA	XB
M code ON signal	OFF	M code ON signal is OFF		X4	X5	X6	X7	
External signal	Drive unit READY signal	ON	Drive unit preparation completed		-			
	Stop signal	OFF	Stop signal is OFF		-			
	Upper limit (FLS)	ON	Within limit range		-			
	Lower limit (RLS)	ON	Within limit range		-			

\* If the CPU module is set to the asynchronous mode in the synchronization setting, this must be inserted in the program for interlocking. If it is set to the synchronous mode, it must not be inserted in the program for interlocking because it is turned ON when the CPU module executes calculation.

■ Start time chart

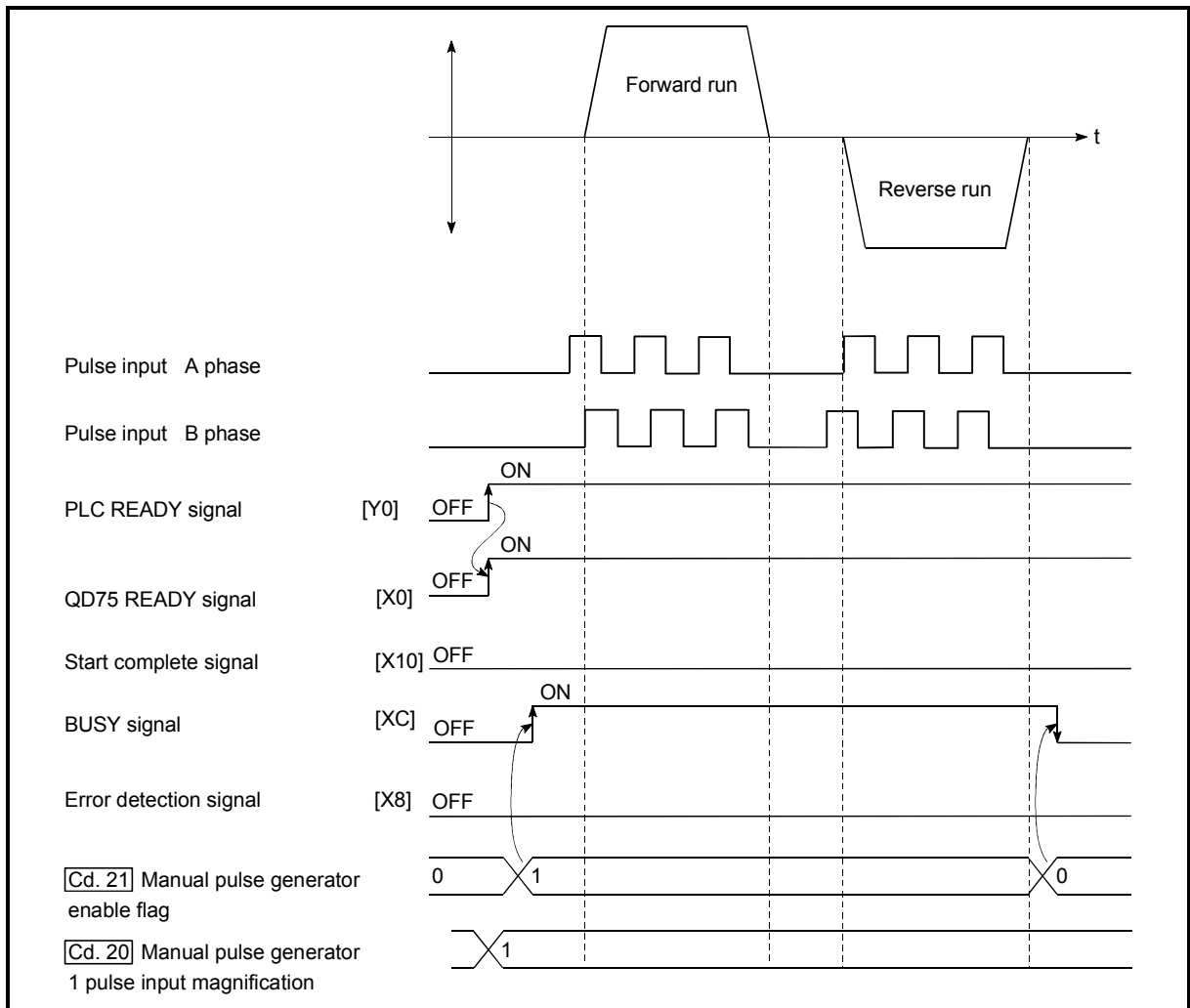
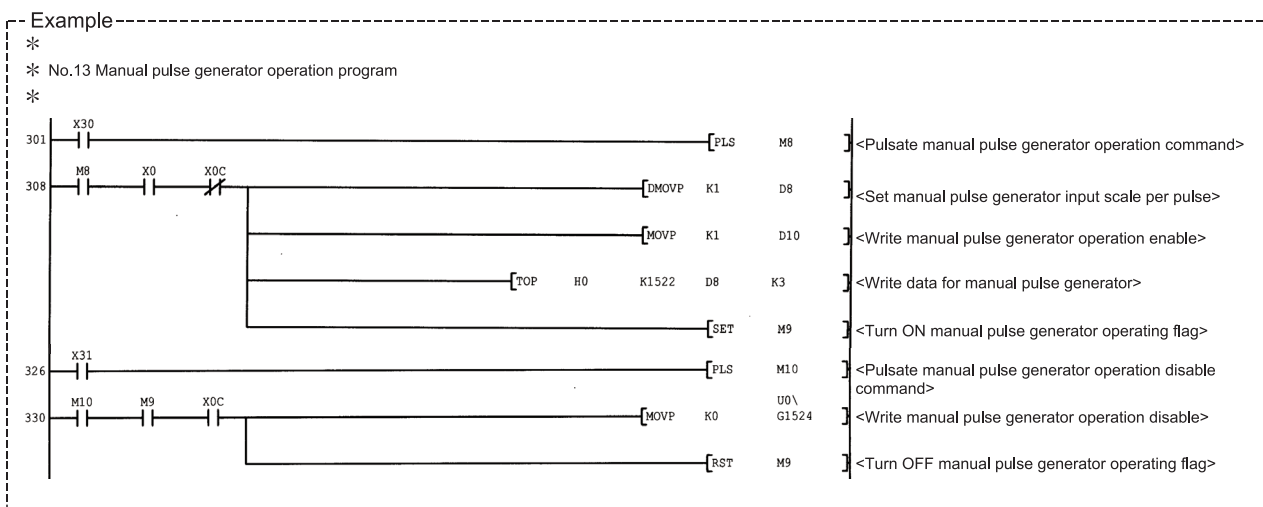

Fig. 11.18 Manual pulse generator operation start time chart

■ Creating the program





# CHAPTER 12 CONTROL SUB FUNCTIONS

The details and usage of the "sub functions" added and used in combination with the main functions are explained in this chapter.

A variety of sub functions are available, including functions specifically for machine OPR and generally related functions such as control compensation, etc. More appropriate, finer control can be carried out by using these sub functions. Each sub function is used together with a main function by creating matching parameter settings and sequence programs. Read the execution procedures and settings for each sub function, and set as required.

12.1	Outline of sub functions .....	12- 2
12.1.1	Outline of sub functions .....	12- 2
12.2	Sub functions specifically for machine OPR.....	12- 4
12.2.1	OPR retry function.....	12- 4
12.2.2	OP shift function .....	12- 8
12.3	Functions for compensating the control.....	12- 12
12.3.1	Backlash compensation function.....	12- 12
12.3.2	Electronic gear function .....	12- 14
12.3.3	Near pass function .....	12- 21
12.3.4	Output timing selection of near pass control.....	12- 23
12.4	Functions to limit the control.....	12- 27
12.4.1	Speed limit function.....	12- 27
12.4.2	Torque limit function.....	12- 29
12.4.3	Software stroke limit function.....	12- 33
12.4.4	Hardware stroke limit function .....	12- 39
12.5	Functions to change the control details .....	12- 41
12.5.1	Speed change function .....	12- 41
12.5.2	Override function .....	12- 48
12.5.3	Acceleration/deceleration time change function .....	12- 51
12.5.4	Torque change function .....	12- 56
12.5.5	Target position change function .....	12- 58
12.6	Absolute position restoration function .....	12- 62
12.7	Other functions.....	12- 73
12.7.1	Step function .....	12- 73
12.7.2	Skip function .....	12- 78
12.7.3	M code output function.....	12- 81
12.7.4	Teaching function.....	12- 86
12.7.5	Command in-position function .....	12- 93
12.7.6	Acceleration/deceleration processing function.....	12- 96
12.7.7	Pre-reading start function.....	12- 99
12.7.8	Deceleration start flag function .....	12-104
12.7.9	Stop command processing for deceleration stop function.....	12-108

## 12.1 Outline of sub functions

"Sub functions" are functions that compensate, limit, add functions, etc., to the control when the main functions are executed. These sub functions are executed by parameter settings, commands from GX Configurator-QP, sub function sequence programs, etc.

## 12.1.1 Outline of sub functions

The following table shows the types of sub functions available.

Sub function		Details
Sub functions specifically for machine OPR	OPR retry function	This function retries the machine OPR with the upper/lower limit switches during machine OPR. This allows machine OPR to be carried out even if the axis is not returned to before the near-point dog with JOG operation, etc.
	OP shift function	After returning to the machine OP, this function offsets the position by the designated distance from the machine OP position and sets that position as the OP address.
Functions for compensating the control	Backlash compensation function	This function compensates the mechanical backlash. Feed pulses equivalent to the set backlash amount are output each time the movement direction changes.
	Electronic gear function	By setting the movement amount per pulse, this function can freely change the machine movement amount per commanded pulse. A flexible positioning system that matches the machine system can be structured with this function.
	Near pass function *1	This function suppresses the machine vibration when the positioning data is switched during continuous path control in the interpolation control.
	Output timing selection of near pass control	This function allows the user to select the timing to output the difference ( $\Delta \ell$ ) between the actual and the set positioning end addresses in continuous path control, in which the difference ( $\Delta \ell$ ) is output during the execution of the next positioning data.
Functions to limit the control	Speed limit function	If the command speed exceeds " [Pr.8] Speed limit value" during control, this function limits the commanded speed to within the " [Pr.8] Speed limit value" setting range.
	Torque limit function *2	If the torque generated by the servomotor exceeds " [Pr.17] Torque limit setting value" during control, this function limits the generated torque to within the " [Pr.17] Torque limit setting value" setting range.
	Software stroke limit function	If a command outside of the upper/lower limit stroke limit setting range, set in the parameters, is issued, this function will not execute positioning for that command.
	Hardware stroke limit function	This function carries out deceleration stop with the limit switch connected to the QD75 external device connector.
Functions to change the control details	Speed change function	This function changes the speed during positioning. Set the changed speed in the speed change buffer memory ( [Cd.14] New speed value), and change the speed with the speed change request ( [Cd.15] Speed change request).
	Override function	This function changes the speed within a percentage of 1 to 300% during positioning. This is executed using " [Cd.13] Positioning operation speed override".
	Acceleration/deceleration time change function	This function changes the acceleration/deceleration time during speed change. (function added to the speed change function and override function)
	Torque change function	This function changes the "torque limit value" during control.
	Target position change function	This function changes the target position during the execution of positioning. At the same time, this also can change the speed.

\*1 The near pass function is validated only when the machine of the standard specification carries out the position control with the continuous path control mode.

It cannot be invalidated with parameters.

\*2 To carry out "torque limit", the "D/A conversion module" and a "drive unit capable of the torque limit command with an analog voltage" must be prepared.

Sub function		Details
Absolute position restoration function *3		This function restores the absolute position of designated axis. By this function, the OPR after power ON from OFF is not required once the OPR is executed when the system operation is started.
Other functions	Step function	This function temporarily stops the operation to confirm the positioning operation during debugging, etc. The operation can be stopped at each "automatic deceleration" or "positioning data".
	Skip function	This function stops the positioning being executed (decelerates to a stop) when the skip signal is input, and carries out the next positioning.
	M code output function	This function issues a sub work (clamp or drill stop, tool change, etc.) according to the code No. (0 to 65535) set for each positioning data.
	Teaching function	This function stores the address positioned with manual control into the positioning address (Da.6 Positioning address/movement amount) having the designated positioning data No.
	Command in-position function	At each automatic deceleration, this function calculates the remaining distance for the QD75 to reach the positioning stop position, and when the value is less than the set value, sets the "command in-position flag" to 1. When using another sub work before ending the control, use this function as a trigger for the sub work.
	Acceleration/deceleration processing function	This function adjusts the control acceleration/deceleration. (acceleration/deceleration time and curve).
	Pre-reading start function	This function shortens the virtual start time.
	Deceleration start flag function	Function that turns ON the flag when the constant speed status or acceleration status switches to the deceleration status during position control, whose operation pattern is "Positioning complete", to make the stop timing known.
Stop command processing for deceleration stop function	Function that selects a deceleration curve when a stop cause occurs during deceleration stop processing to speed 0.	

\*3 "The 16-point input module", "16-point output module", and "the drive unit capable of configuring an absolute position detection system (, which is a Mitsubishi General-Purpose AC Servo and has an absolute position detection function (absolute position data transference protocol) equivalent to that of MR-J3-□A)" are required to execute the "absolute position restoration function".

## 12.2 Sub functions specifically for machine OPR

The sub functions specifically for machine OPR include the "OPR retry function" and "OP shift function". Each function is executed by parameter setting.

### 12.2.1 OPR retry function

When the workpiece goes past the OP without stopping during positioning control, it may not move back in the direction of the OP although a machine OPR is commanded, depending on the workpiece position. This normally means the workpiece has to be moved to a position before the near-point dog by a JOG operation, etc., to start the machine OPR again. However, by using the OPR retry function, a machine OPR can be carried out regardless of the workpiece position.

The details shown below explain about the "OPR retry function".

- [1] Control details
- [2] Control Precautions
- [3] Setting method

#### [1] Control details

The following drawing shows the operation of the OPR retry function.

- (1) OPR retry point return retry operation when the workpiece is within the range between the upper/lower limits.

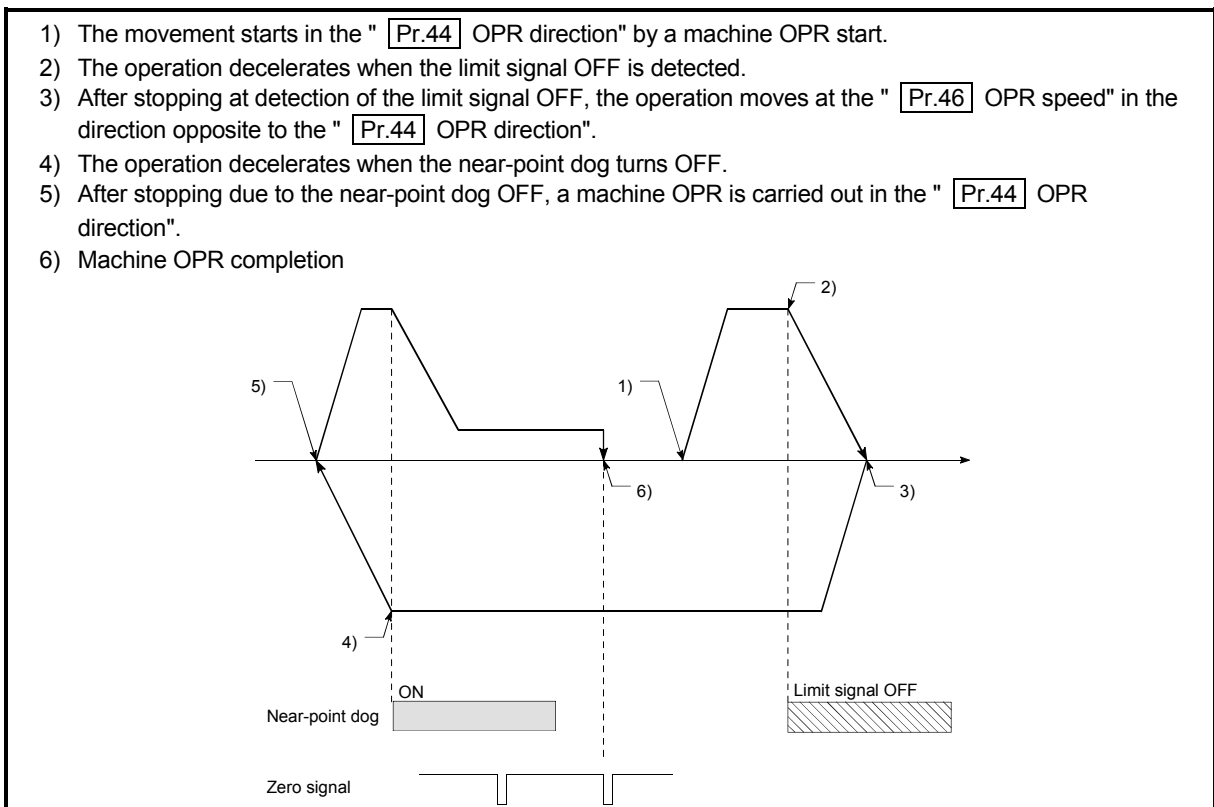

Fig. 12.1 OPR retry operation by limit signal detection

(2) OPR retry operation when the workpiece is outside the range between the upper/lower limits.

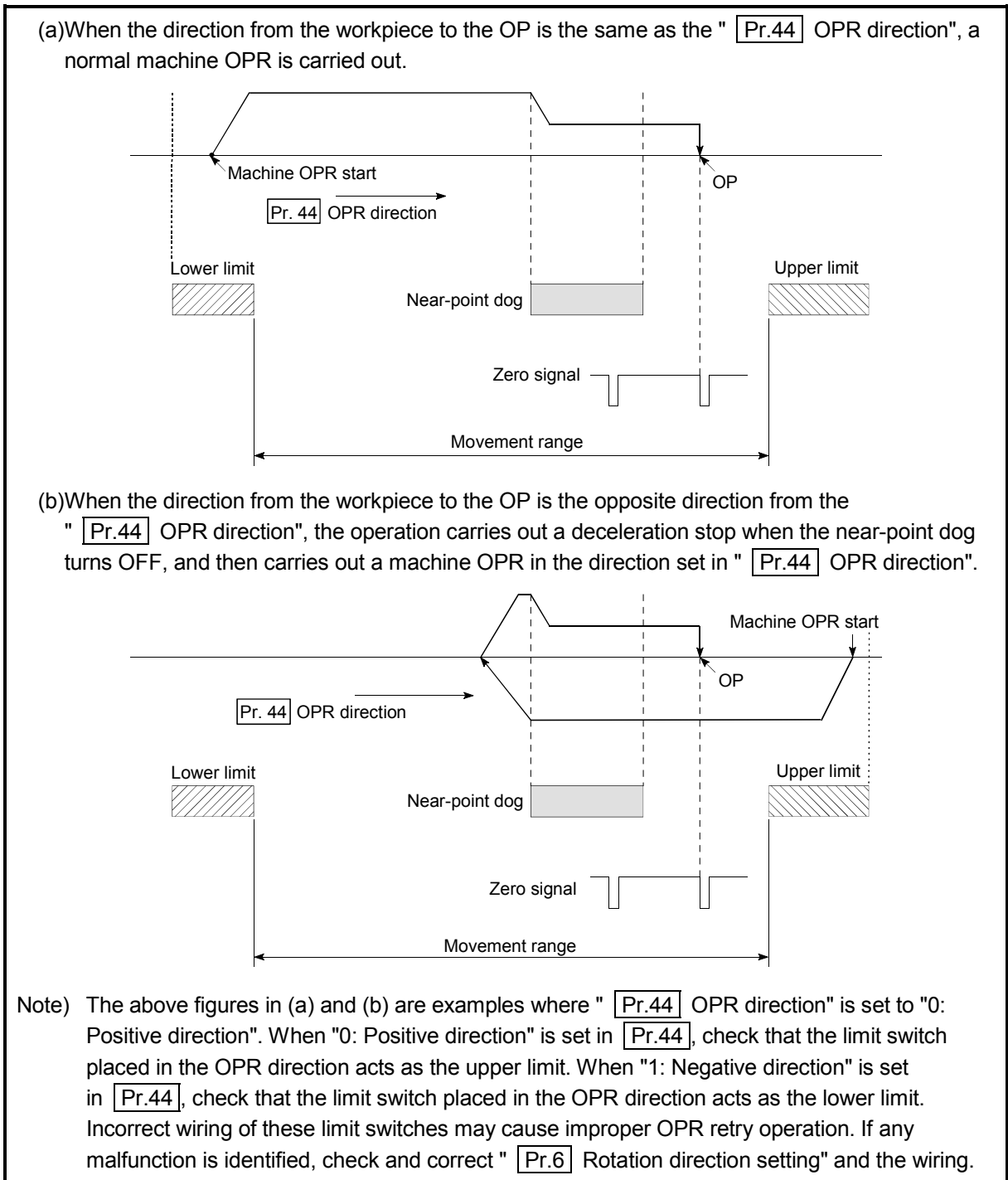

Fig. 12.2 OPR retry operation from on limit (limit switch OFF)

(3) Setting the dwell time during an OPR retry

The OPR retry function can perform such function as the dwell time using " Pr.57 Dwell time at OPR retry" when the reverse run operation is carried out due to detection by the limit signal for upper/lower limits and when the machine OPR is executed after the near point dog is turned OFF to stop the operation.

" Pr.57 Dwell time during OPR" is validated when the operation stops at the "A" and "B" positions in the following drawing. (The dwell time is the same value at both positions "A" and "B".)

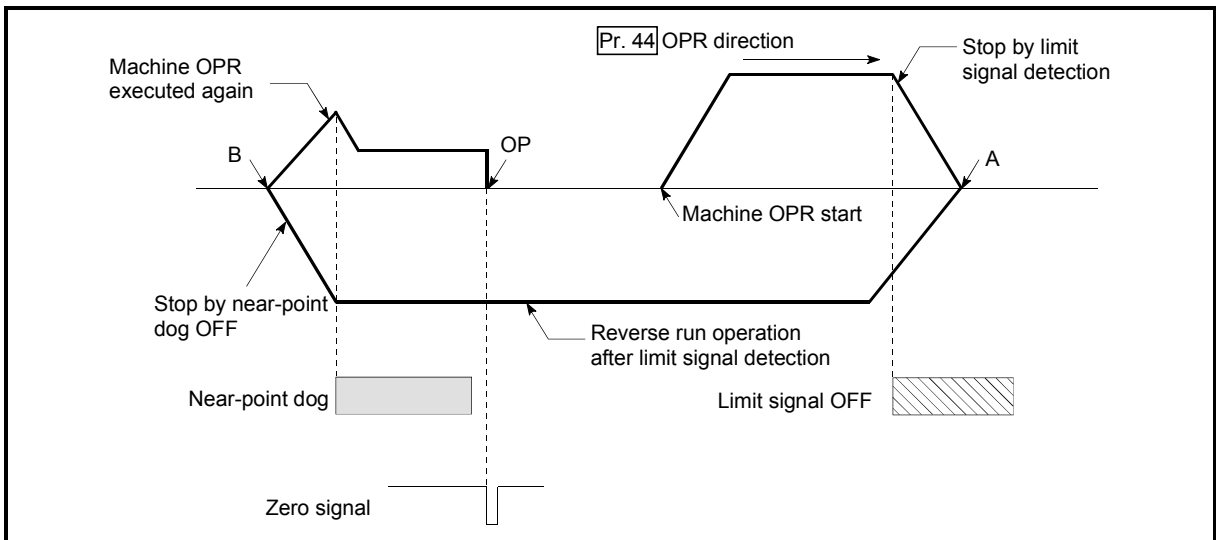

Fig. 12.3 Setting the dwell time during an OPR retry

[2] Control Precautions

(1) The following table shows whether the OPR retry function may be executed by the " [Pr.43] OPR method".

[Pr.43] OPR method	Execution status of OPR retry function
Near-point dog method	○ : Execution possible
Stopper method 1)	○ : Execution possible*1
Stopper method 2)	○ : Execution possible*1
Stopper method 3)	× : Execution not possible
Count method 1)	○ : Execution possible
Count method 2)	○ : Execution possible

\*1 Starting can be executed from the position of the limit switch installed in the opposition direction of " [Pr.44] OPR direction". (The limit signal is OFF.) However, the retry operation by the limit switch in the OPR direction cannot be executed since a stopper is installed in the OPR direction.

- (2) Always establish upper/lower limit switches at the upper/lower limit positions of the machine, and connect them to the QD75. If the OPR retry function is used without hardware stroke limit switches, the motor will continue rotation until a hardware stroke limit signal is detected.
- (3) Do not configure a system so that the drive unit power turns OFF by the upper/lower limit switches connected to the QD75. If the drive unit power is turned OFF, the OPR retry cannot be carried out.

[3] Setting method

To use the "OPR retry function", set the required details in the parameters shown in the following table, and write them to the QD75.

When the parameters are set, the OPR retry function will be added to the machine OPR control. The set details are validated at the rising edge (OFF → ON) of the PLC READY signal (Y0). (Set " [Pr.57] Dwell time during OPR retry" according to the user's requirements.)

Setting item	Setting value	Setting details	Factory-set initial value
[Pr.48] OPR retry	1	Set "1: Carry out OPR retry by limit switch".	0
[Pr.57] Dwell time during OPR retry	→	Set the deceleration stop time during OPR retry. (Random value between 0 and 65535 (ms))	0

\* Refer to Section 5.2 "List of parameters" for setting details.

**REMARK**

- Parameters are set for each axis.
- It is recommended that the parameters be set whenever possible with GX Configurator-QP. Execution by sequence program uses many sequence programs and devices. The execution becomes complicated, and the scan times will increase.

## 12.2.2 OP shift function

When a machine OPR is carried out, the OP is normally established using the near-point dog, stopper, and zero signal. However, by using the OP shift function, the machine can be moved a designated movement amount from the position where the zero signal was detected. A mechanically established OP can then be interpreted at that point.

The OP shift function can be used without relation to " [Pr.43](#) OPR method".

The details shown below explain about the "OP shift function".

- [1] Control details
- [2] Setting range for the OP shift amount
- [3] Movement speed during OP shift
- [4] Control Precautions
- [5] Setting method

## [1] Control details

The following drawing shows the operation of the OP shift function.

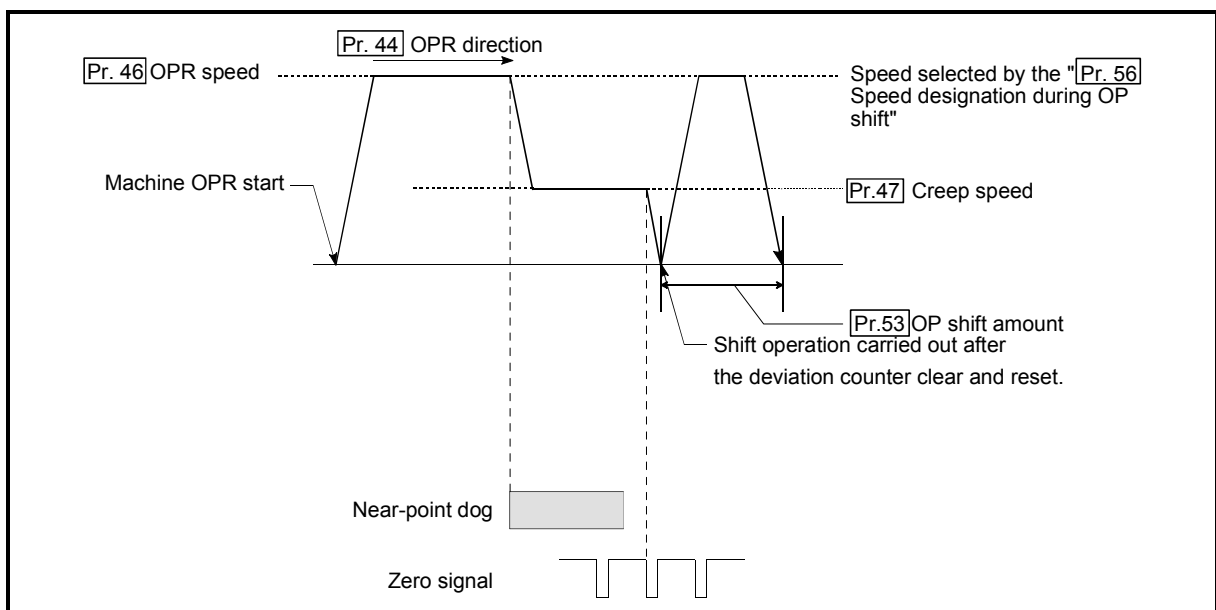

Fig. 12.4 OP shift operation



[2] Setting range for the OP shift amount

Set the OP shift amount within the range from the detected zero signal to the upper/lower limit switches.

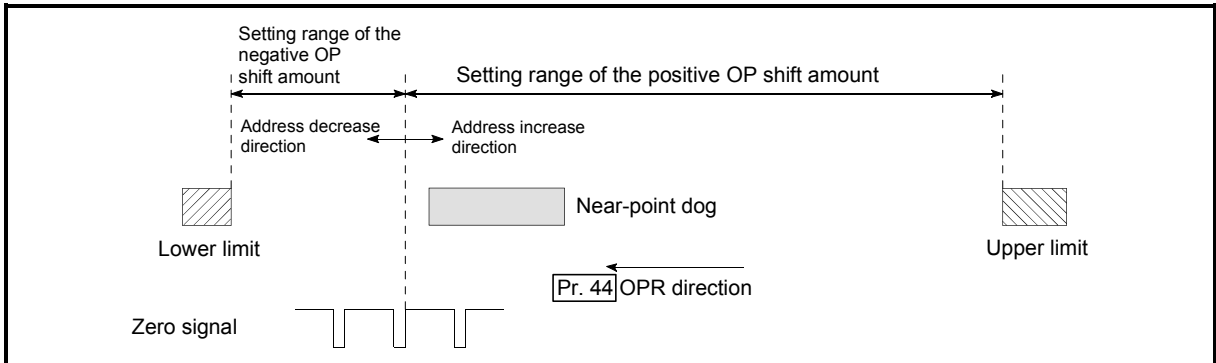

Fig. 12.5 Setting range for the OP shift amount

[3] Movement speed during OP shift

When using the OP shift function, the movement speed during the OP shift is set in " Pr.56 Speed designation during OP shift". The movement speed during the OP shift is selected from either the " Pr.46 OPR speed" or the " Pr.47 Creep speed".

The following drawings show the movement speed during the OP shift when a mechanical OPR is carried out by the near-point dog method.

(1) OP shift operation at the " Pr.46 OPR speed"

(When " Pr.56 Speed designation during OP shift" is 0)

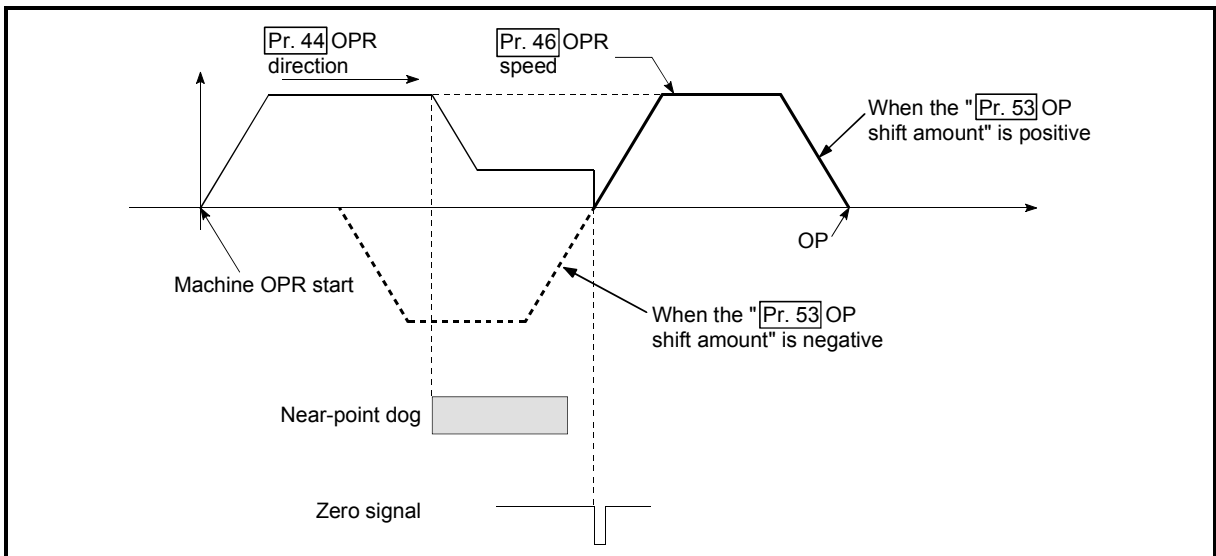

Fig. 12.6 OP shift operation at the OPR speed

(2) OP shift operation at the " Pr.47 Creep speed"  
 (When " Pr.56 Speed designation during OP shift" is 1)

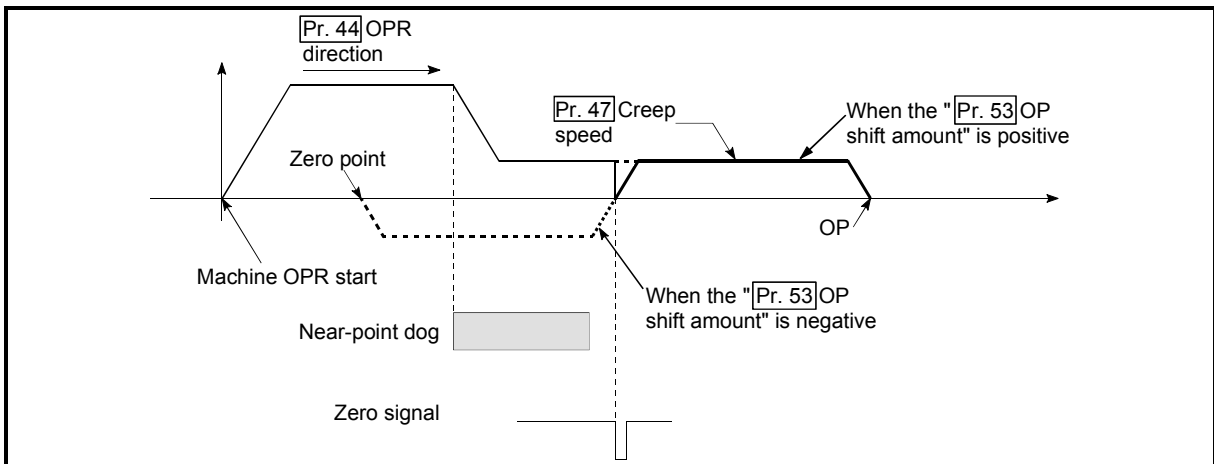

Fig. 12.7 OP shift operation at the creep speed

[4] Control Precautions

- (1) The following data are set after the OP shift amount is complete.
  - OPR complete flag (" Md.31 Status: b4)
  - Md.20 Current feed value
  - Md.21 Machine feed value
  - Md.26 Axis operation status
 OPR request flag (Md.31 Status: b3) is reset after completion of the OP shift.
- (2) " Pr.53 OP shift amount" is not added to " Md.34 Movement amount after near-point dog ON". The movement amount immediately before the OP shift operation, considering near-point dog ON as "0", is stored. For the stopper method (1) 2) 3)), the movement amount is not changed from "0".
- (3) When using the OP shift function with the stopper method (1) 2) 3)) selected for the OPR method, configure the OP shift operation in the opposite direction of the OPR direction.  
 It cannot shift to the OPR direction due to a mechanical stopper in the OPR direction.

[5] Setting method

To use the "OP shift function", set the required details in the parameters shown in the following table, and write them to the QD75.  
 When the parameters are set, the OP shift function will be added to the machine OPR control. The set details are validated at the rising edge (OFF → ON) of the PLC READY signal (Y0).

Setting item	Setting value	Setting details	Factory-set initial value
Pr.53 OP shift amount	→	Set the shift amount during the OP shift.	0
Pr.56 Speed designation during OP shift	→	Select the speed during the OP shift 0: Pr.46 OPR speed 1: Pr.47 Creep speed	0

\* Refer to Section 5.2 "List of parameters" for setting details.

**REMARK**

- Parameters are set for each axis.
- It is recommended that the parameters be set whenever possible with GX Configurator-QP. Execution by sequence program uses many sequence programs and devices. The execution becomes complicated, and the scan times will increase.

### 12.3 Functions for compensating the control

The sub functions for compensating the control include the "backlash compensation function", "electronic gear function", "near pass function", and "output timing selection of near pass control". Each function is executed by parameter setting or sequence program creation and writing.

#### 12.3.1 Backlash compensation function

The "backlash compensation function" compensates the backlash amount in the mechanical system. When the backlash compensation amount is set, an extra amount of pulses equivalent to the set backlash amount is output every time the movement direction changes.

The details shown below explain about the "backlash compensation function".

- [1] Control details
- [2] Control Precautions
- [3] Setting method

#### [1] Control details

The following drawing shows the operation of the backlash compensation function.

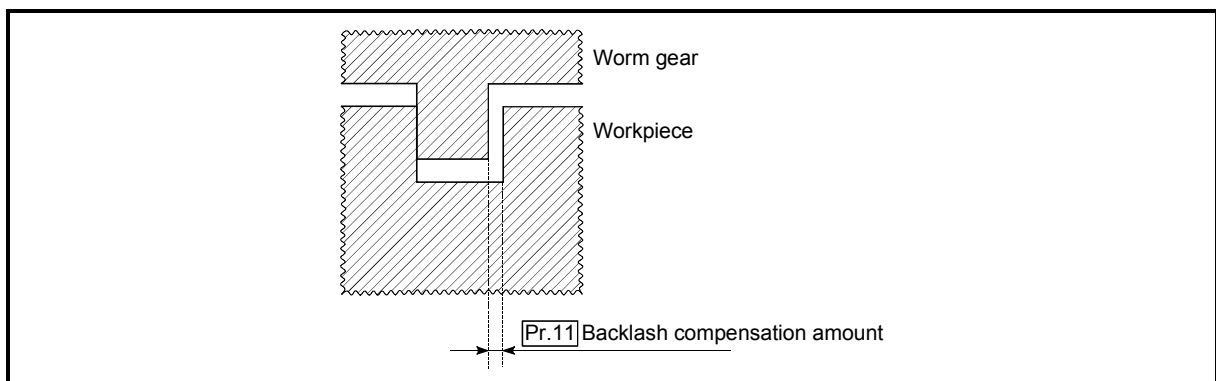

Fig. 12.8 Backlash compensation amount

[2] Control Precautions

- (1) The feed pulses of the backlash compensation amount are not added to the " [Md.20] Current feed value" or " [Md.21] Machine feed value".
- (2) Always carry out a machine OPR before starting the control when using the backlash compensation function (when " [Pr.11] Backlash compensation amount" is set). The backlash in the mechanical system cannot be correctly compensated if a machine OPR is not carried out.
- (3) Set the No. of pulses output in one backlash compensation (value in which the " [Pr.11] Backlash compensation amount" is divided by the "movement amount per pulse") to a value of 255 or lower. An error "Backlash compensation amount error" (error code: 920) will occur if a value over 255 is set. (Depending on the connected servo, tracking may not be possible if a large amount of pulses is output at once.)

$$0 \leq \frac{\text{Backlash compensation amount}}{\text{Movement amount per pulse}} \leq 255$$

(Omit values after the decimal point.)

- (4) Backlash compensation, which includes the movement amount and " [Pr.11] Backlash compensation amount", is output the moment at the moving direction changes.
- (5) Backlash compensation cannot be made when the stepping motor is used. The backlash compensation function cannot be used for an axis where a stepping motor is connected. Set 0 (initial value) in " [Pr.11] Backlash compensation amount".

[3] Setting method

To use the "backlash compensation function", set the "backlash compensation amount" in the parameter shown in the following table, and write it to the QD75. The set details are validated at the rising edge (OFF → ON) of the PLC READY signal (Y0).

Setting item		Setting value	Setting details	Factory-set initial value
[Pr.11]	Backlash compensation amount	→	Set the backlash compensation amount.	0

\* Refer to Section 5.2 "List of parameters" for setting details.

**REMARK**

- Parameters are set for each axis.
- It is recommended that the parameters be set whenever possible with GX Configurator-QP. Execution by sequence program uses many sequence programs and devices. The execution becomes complicated, and the scan times will increase.

### 12.3.2 Electronic gear function

The "electronic gear function" adjusts the pulses calculated and output according to the parameters set in the QD75 with the actual machine movement amount.

The "electronic gear function" has the following four functions.

- [A] The function converts the command value (speed, movement amount from the start point to the end point), which is set in mm units, to pulse units, and determines the pulse frequency and pulse number of the command pulse.

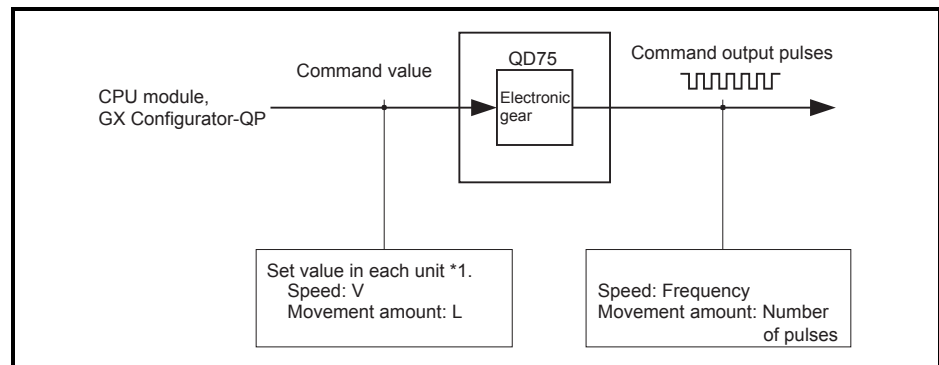

Fig. 12.9 Conversion to pulse units

\*1: Unit specified with " Pr.1 Unit setting" (mm, inch, degree, pulse)

- [B] If values less than one pulse are generated by converting the movement amount from the start point to the end point to pulse units, the values are not output and the machine stops at the front side of the positioning direction. The function accumulates values less than one pulse that could not be pulse output in the QD75 and outputs one pulse when the total cumulative value reached one pulse or more.
- [C] When machine OPR is completed, current value changing is completed, speed control is started (except when current feed value change is present), or fixed-feed control is started, the function clears to "0" the cumulative values of less than one pulse which could not be output. (If the cumulative value is cleared, an error will occur by a cleared amount in the feed machine value. Control can be constantly carried out at the same machine movement amount, even when the fixed-feed control is continued.)
- [D] The function compensates the mechanical system error of the command movement amount and actual movement amount by adjusting the "movement amount per pulse".  
(The "movement amount per pulse" value is defined by " Pr.2 No. of pulses per rotation (Ap)", " Pr.3 Movement amount per rotation (Al)", and " Pr.4 Unit magnification (Am)".)

The QD75 automatically carries out the processing for [A] and [C].

The details shown below explain about the "electronic gear function", including the method for compensating the error in [D] above, etc.

- [1] Movement amount per pulse
- [2] Error compensation method
- [3] Control Precautions

[1] Movement amount per pulse

" [Pr.2] No. of pulses per rotation (Ap)", " [Pr.3] Movement amount per rotation (Al)", and " [Pr.4] Unit magnification (Am)" are the items for determining how many rotations (equivalent to how many pulses) a motor should operate to move a machine for movement amount set in a program.  
 The drive unit controls the motor with the pulse number.  
 The following shows the details of control of the QD75.

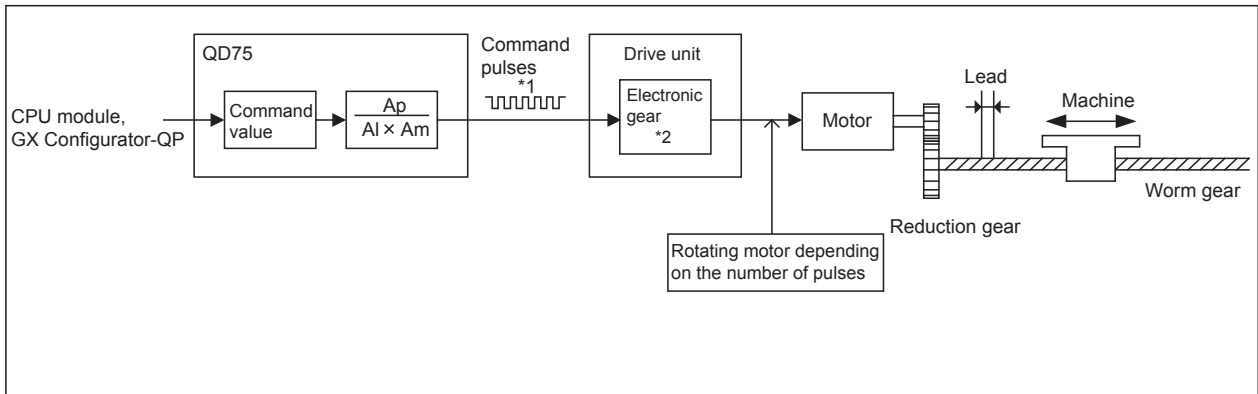

Fig. 12.10 System using a ball screw

\*1: The upper limits of the command pulse frequency are as follows

- QD75D□N : 4Mpulse/s
- QD75D□ : 1Mpulse/s
- QD75P□N/QD75P□ : 200kpulse/s

\*2: For a drive unit without electronic gear function, or when not using electronic gear function, this value is 1 (single).

Consider a system with the motor connected to a ball screw, such as the figure above.

1 is set to the electronic gear of the drive unit.

The movement amount of the machine is in mm or inch unit. Set the command value in mm or inch units to the QD75 for the CPU module program.

The motor is controlled by the drive unit in pulse number units.

Consequently, since the command value in mm or inch units is converted to pulse units, set Ap, Al, and Am so that the following relational expressions are satisfied.

$$\begin{aligned} \text{Number of pulses per rotation of motor} &= A_p \\ \text{Movement amount per rotation of motor} &= A_l \times A_m \end{aligned}$$

In this case, the machine movement amount for the command 1 pulse output from the QD75 is calculated by the following expression.

$$\text{Movement amount per pulse (A)} = \frac{A_l \times A_m}{A_p}$$

<b>POINT</b>
<p>The command frequency from the QD75 is limited by a ceiling. If the command frequency exceeds the upper limit, increase the "Movement amount per pulse (A)" greater (N times) to decrease the command frequency.</p> <p>In this case, the electronic gear on the drive unit must be increased by N times as well.</p> <p>The command pulse from the QD75 is changes to 1/N times. Therefore, multiply it by N on the drive unit side to keep the number of motor rotations.</p> <p>Since the "movement amount per pulse (A)" is increased, the position accuracy (command resolution) for the command 1 pulse from the QD75 decreases.</p> <p>Consider to decrease the command speed when the position accuracy is required.</p>

(1) Setting range of Ap, Al, Am

Determined setting ranges are available for Ap, Al, and Am. The following shows the setting ranges.

Setting item		Setting range	
Pr.2	No. of pulses per rotation (Ap)	1 to 65535	
Pr.3	Movement amount per rotation (Al)	1 to 65535	$\times 10^{-1} \mu\text{m}$
			$\times 10^{-5} \text{inch}$
			$\times 10^{-5} \text{degree}$
			pulse
Pr.4	Unit magnification (Am)	1/10/100/1000	

For details of the setting, refer to Section 5.2 "List of parameters". In addition, use the value set in " Pr.3 Movement amount per rotation (Al)" as movement amount per rotation (Al) to calculate movement amount per pulse (A).

Example: Movement amount per pulse (A) when " Pr.1 Unit setting" is "0: mm"

- " Pr.2 No. of pulses per rotation": 20000
- " Pr.3 Movement amount per rotation": 40000
- " Pr.4 Unit magnification": 1

$$\text{Movement amount per pulse (A)} = \frac{40000 \times 10^{-1}}{20000} \times 1 = 0.2\mu\text{m}$$

If the value is beyond the setting range, setting values of each parameter can be decreased by canceling the numerator and denominator with the movement amount per pulse (A) kept.



## [2] Error compensation method

When position control is carried out by the "movement amount per pulse" set in the QD75 parameters, an error sometimes occurs between the command movement amount (L) and the actual movement amount (L').

That error is compensated in the QD75 by adjusting the values in " [Pr.2] No. of pulses per rotation (Ap)", " [Pr.3] Movement amount per rotation (Al)", and " [Pr.4] Unit magnification (Am)". (When " [Pr.1] Unit setting" is "0: mm")

### (1) Definition

The "error compensation amount" used to carry out the error compensation is defined as follows.

$$\text{Error compensation amount} = \frac{\text{Actual movement amount (L')}}{\text{Designated movement amount (L)}}$$

The QD75 "movement amount per pulse" is calculated with the following equation.

Movement amount per pulse is "A", " [Pr.2] No. of pulses per rotation" is (Ap), " [Pr.3] Movement amount per rotation" is (Al), and " [Pr.4] Unit magnification" is (Am).

$$A = \frac{Al}{Ap} \times Am$$

### (2) Procedure

- (a) Set the "command movement amount (L)", and carry out positioning. (Set the "movement amount per pulse (A)" according to Section 5.2 "List of parameters".)
- (b) After positioning, measure the "actual movement amount (L)'".
- (c) Calculate the "error compensation amount".

$$\text{Error compensation amount} = \frac{L'}{L}$$

- (d) Calculate the post-compensation " [Pr.2] No. of pulses per rotation (Ap')", " [Pr.3] Movement amount per rotation (Al')", and " [Pr.4] Unit magnification (Am')" from the "post-compensation movement amount per pulse (A)'".

$$\begin{aligned} A &= A \times \text{Error compensation amount} \\ &= \frac{Al}{Ap} \times Am \times \frac{L'}{L} \\ &= \frac{Al'}{Ap'} \times Am' \end{aligned}$$

(Adjust with Am' so that Al' and Ap' do not exceed the setting range.)

-- Calculation example --

(Conditions)

Movement amount per pulse : 500 (μm/rev)  
 No. of pulses per rotation : 12000 (pulse/rev)  
 Unit magnification : 1

(Positioning results)

Command movement amount : 100mm  
 Actual movement amount : 101mm

(Compensation amount)

$$\frac{AL'}{AP'} = \frac{5 \times 10^3}{12000} \times \frac{101 \times 10^3}{101 \times 10^3} = \frac{5050}{12000} = \frac{101}{240}$$

Movement amount per pulse : 101 (μm/rev) [Set in Pr.3]  
 No. of pulses per rotation : 240 (pulse/rev) [Set in Pr.2]  
 Unit magnification : 1 [Set in Pr.4]

- (e) Set the post-compensation " Pr.2 No. of pulses per rotation (Ap')", " Pr.3 Movement amount per rotation (Al')", and " Pr.4 Unit magnification (Am')" in the parameters, and write them to the QD75. The set details are validated at the rising edge (OFF → ON) of the PLC READY signal (Y0).

Setting item	Setting value	Setting details	Pre-compensation value
<span style="border: 1px solid black; padding: 0 2px;">Pr.2</span> No. of pulses per rotation	Ap'	Set the post-compensation value.	Ap
<span style="border: 1px solid black; padding: 0 2px;">Pr.3</span> Movement amount per rotation	Al'	Set the post-compensation value.	Al
<span style="border: 1px solid black; padding: 0 2px;">Pr.4</span> Unit magnification	Am'	Set the post-compensation value.	Am

\* Refer to Section 5.2 "List of parameters" for setting details.

[3] Control Precautions

If values less than one pulse are generated by converting the movement amount from the start point to the end point to pulse units with the electronic gear function, the values are not output and the machine stops at the front side of the positioning direction. The function accumulates values less than one pulse that could not be pulse output in the QD75 and outputs one pulse when the total cumulative value reached one pulse or more.

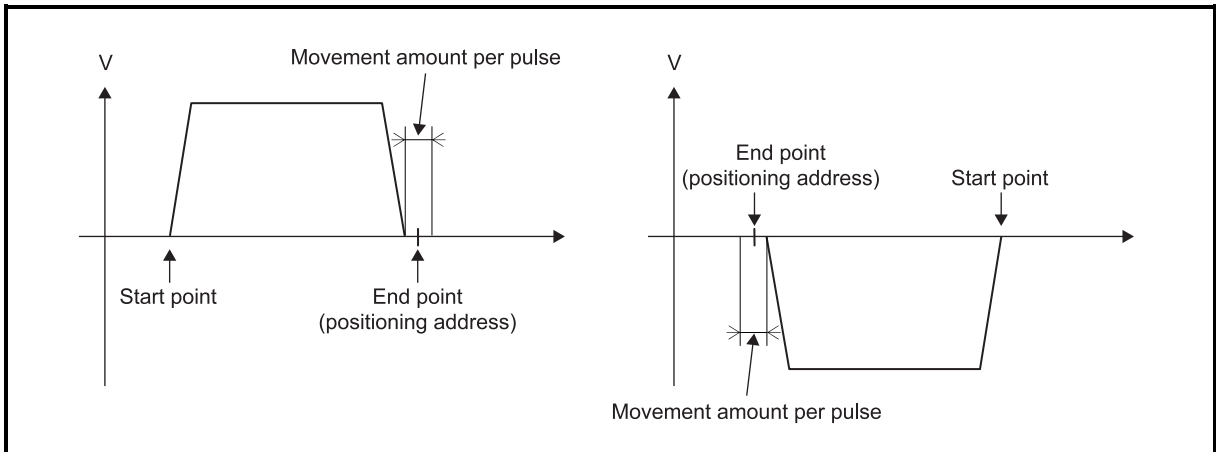

Fig. 12.11 Operation when values less than one pulse are generated

To prevent values less than one pulse from being generated, set the positioning address so that the value, calculated by multiplying the inverse number of movement amount per pulse (A) to the movement amount to the end point, becomes an integer.

It is recommended that the "movement amount per pulse (A)" be set to a value close to "1" for the following reasons. The "movement amount per pulse" of "1" means the minimum value in each " Pr.1 Unit setting". (0.1 [μm] for the unit [mm])

- (1) When the setting of the movement amount per pulse is decreased, the command frequency may increase. Be careful when changing the setting.
- (2) If the setting of the movement amount per pulse is less than 1, the mechanical system may oscillate. Be sure to use the movement amount per pulse among the range indicated below.

$$\text{Movement amount per pulse (A)} \geq \frac{1}{500}$$

If the mechanical system oscillates, also use the electronic gear function of the drive unit and the movement amount per pulse greater.

- (3) Set the movement amount per pulse so that the pulse output frequency for the drive unit becomes a value in the following table.

	QD75P□N/QD75P□	QD75D□N	QD75D□
Pulse output frequency for drive unit	200kpulse/s or less	4Mpulse/s or less	1Mpulse/s or less

If the setting of pulse output frequency for the drive unit exceeds a value in the table, the QD75 may not operate correctly.

**REMARK**

In the QD75, the general term for the functions in this section is defined as the "electronic gear function". Refer to the User's Manual for the servomotor for the definition of the "electronic gear" on the servomotor side.

### 12.3.3 Near pass function

When continuous pass control is carried out using interpolation control, the near pass function is carried out.

The "near pass function" is a function to suppress the mechanical vibration occurring at the time of switching the positioning data when continuous pass control is carried out using interpolation control.

#### [Near pass function]

The extra movement amount occurring at the end of each positioning data unit being continuously executed is carried over to the next positioning data unit. Alignment is not carried out, and thus the output speed drops are eliminated, and the mechanical vibration occurring during speed changes can be suppressed. Because alignment is not carried out, the operation is controlled on a path that passes near the position set in " [Da.6] Positioning address/movement amount".

The details shown below explain about the "near pass function".

[1] Control details

[2] Control Precautions

#### [1] Control details

The following drawing shows the path of the continuous path control by the 2-axis linear interpolation control.

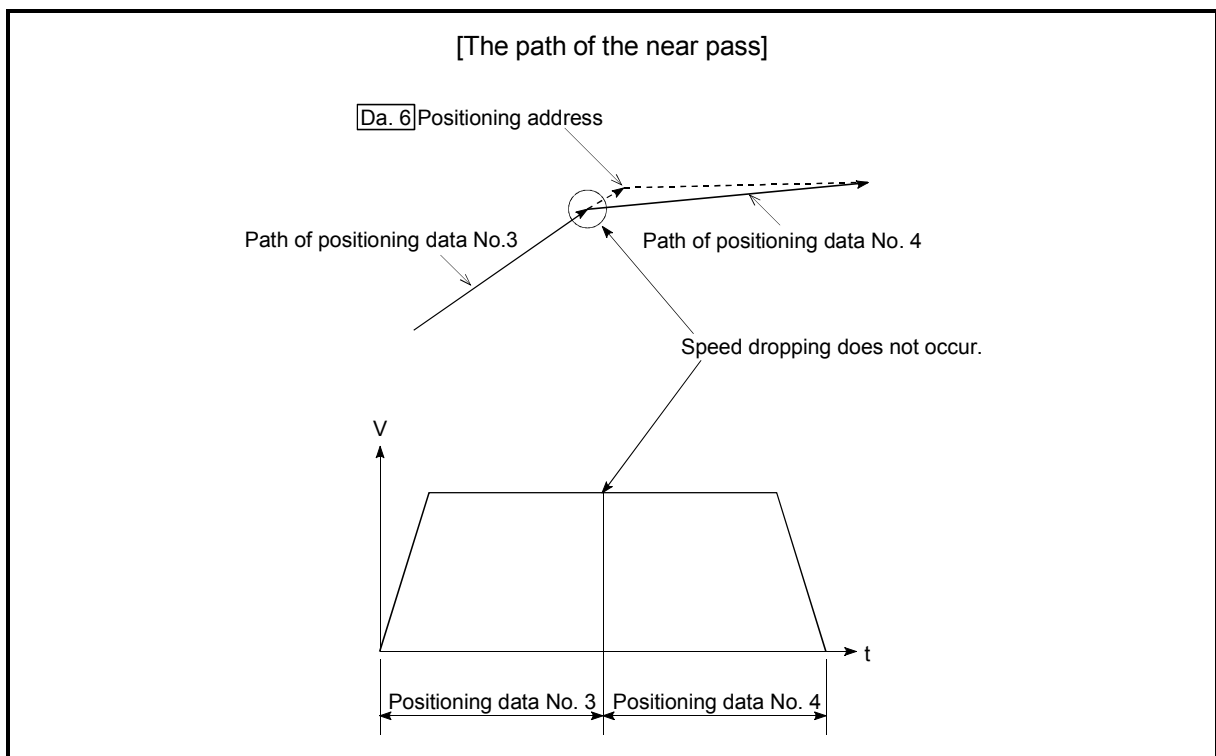

Fig. 12.12 The path of the continuous path control

[2] Control Precautions

- (1) If the movement amount designated by the positioning data is small when the continuous path control is executed, the output speed may not reach the designated speed.
- (2) The movement direction is not checked during interpolation operation. Therefore, a deceleration stops are not carried out even the movement direction changes. (See below) For this reason, the output will suddenly reverse when the reference axis movement direction changes. To prevent the sudden output reversal, assign not the continuous path control "11", but the continuous positioning control "01" to the positioning data of the passing point.

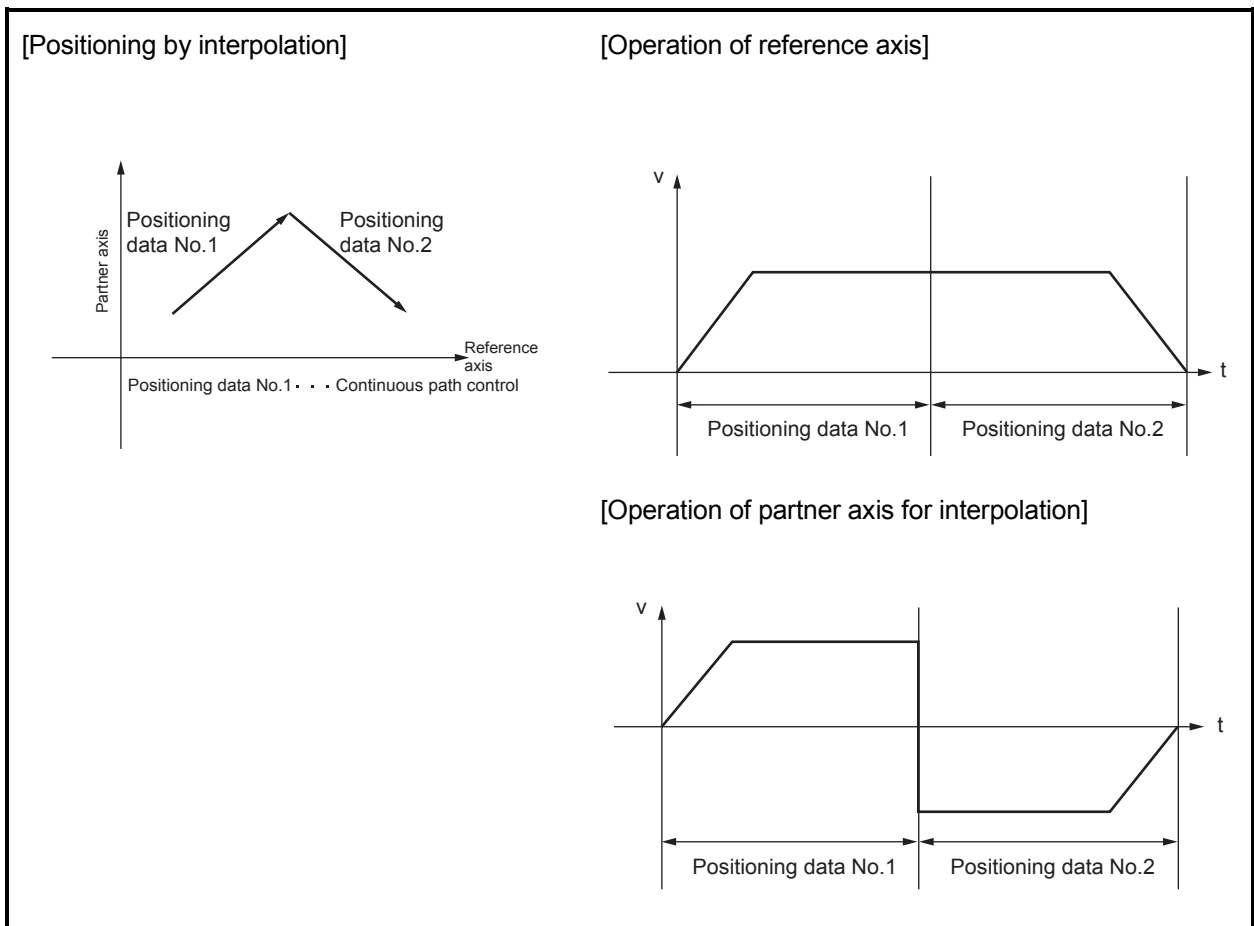

Fig. 12.13 Path and output speed of various axes when movement direction varies during continuous path control

### 12.3.4 Output timing selection of near pass control

The function "output timing selection of near pass control" allows the user to select the timing to output the difference ( $\Delta \ell$ ) between the actual and the set positioning end addresses in continuous path control, in which the difference ( $\Delta \ell$ ) is output during the execution of the next positioning data.

The details shown below explain about the function "output timing selection of near pass control".

- [1] Control details
- [2] Control precautions
- [3] Setting method

#### [1] Control details

There are two options for an output timing of near pass control: "At constant speed" and "At deceleration".

- At constant speed: The distance  $\Delta \ell$  is output when the next positioning data is executed in constant speed.
- At deceleration: The distance  $\Delta \ell$  is output when the next positioning speed decelerates from V1 to V2.

When "At constant speed" is selected in a condition where the specified speed of positioning data No.1 and No.2 in the figure 12.14 are "V1 > V2", the distance  $\Delta \ell$  is output when the next positioning data is executed in constant speed; therefore, the positioning execution time is extended.

When "At deceleration" is selected, the positioning execution time is not extended and remains the same as it was set.

The following drawing shows the operation of the function "output timing selection of near pass control".

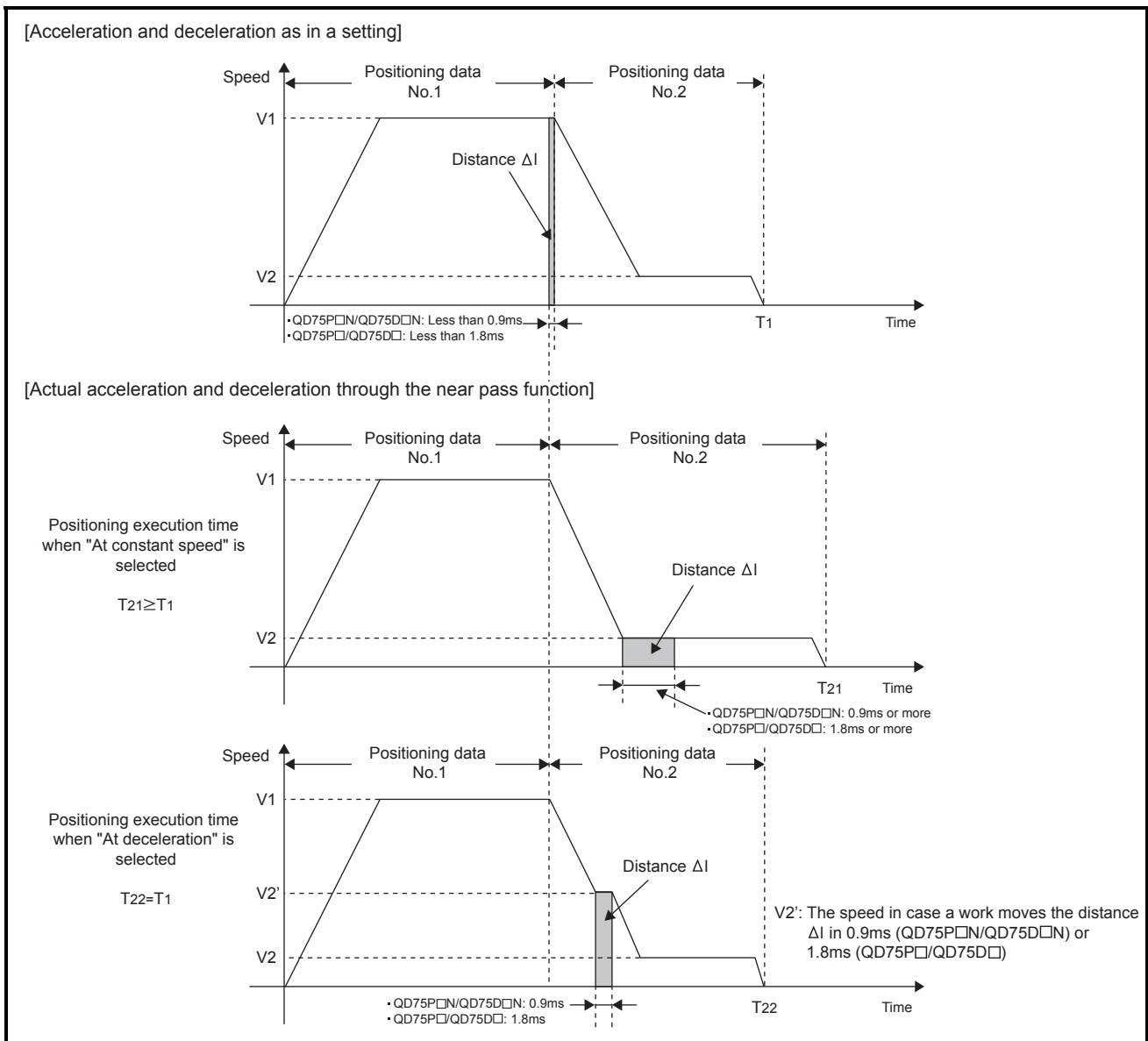

Fig. 12.14 Acceleration and deceleration depending on the output timing selection of near pass control



[2] Control precautions

When command speed V1 and V2 are in the condition 1) or 2) below, the command output is that of "At constant speed" even though "At deceleration" was selected.

1) When "V1 ≤ V2"

2) When "(Speed value converted from distance  $\Delta \ell$ )<sup>\*1</sup> ≤ V2 < V1"

\*1: The height of the grey area in the graph on the bottom right

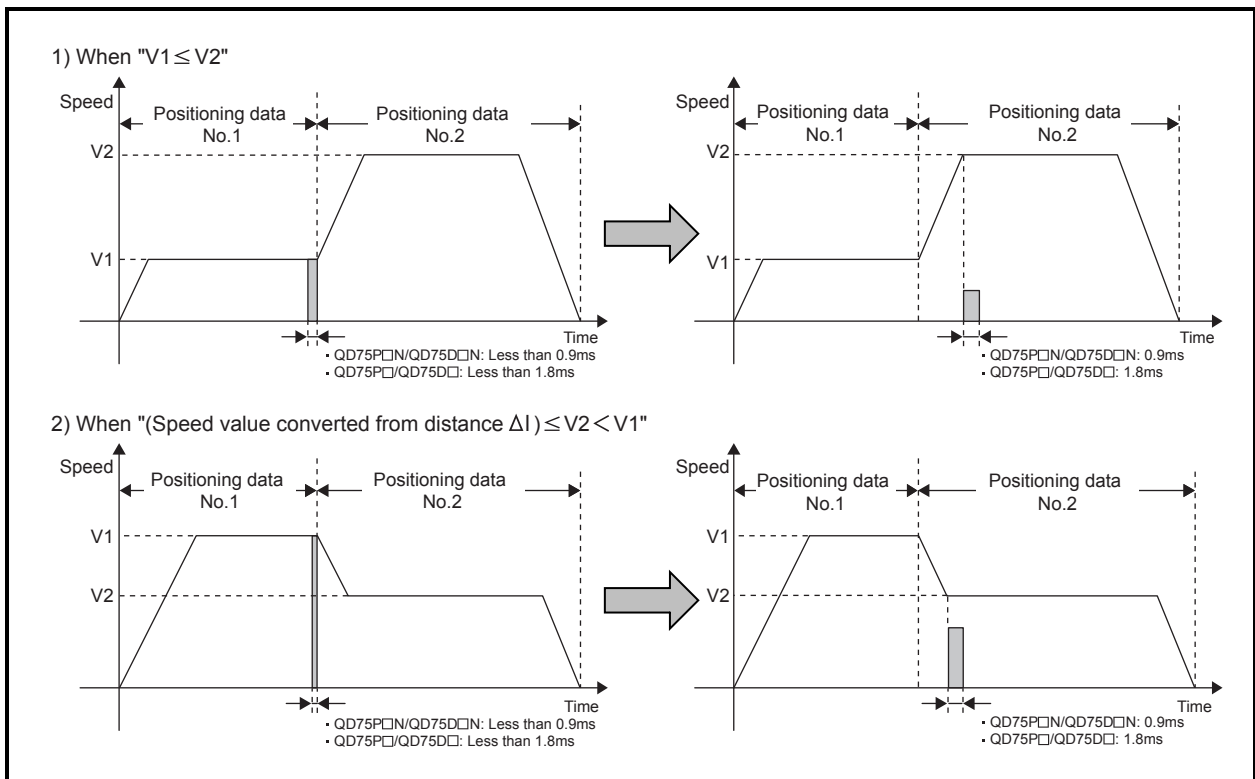

Fig. 12.15 Examples of when the command output is that of "At constant speed" even though "At deceleration" was selected

## [3] Setting method

To use the function "output timing selection of near pass control", set the following control data in a sequence program.

The set detail is validated at the rising edge (OFF → ON) of the PLC READY signal (Y0).

Setting item		Setting value	Setting details	Buffer memory address
Cd.43	Output timing selection of near pass control	→	Select the timing to output the difference ( $\Delta \ell$ ) between the actual and the set positioning end addresses in continuous path control, in which the difference ( $\Delta \ell$ ) is output during the execution of the next positioning data. 0: At constant speed 1: At deceleration	1934

\* Refer to Section 5.7 "List of control data" for setting details.

12.4 Functions to limit the control

Functions to limit the control include the "speed limit function", "torque limit function", "software stroke limit", and "hardware stroke limit". Each function is executed by parameter setting or sequence program creation and writing.

12.4.1 Speed limit function

The "speed limit function" limits the command speed to a value within the "speed limit value" setting range when the command speed during control exceeds the "speed limit value".

The details shown below explain about the "speed limit function".

[1] Relation between the speed limit function and various controls

[2] Control precautions

[3] Setting method

[1] Relation between the speed limit function and various controls

The following table shows the relation of the "speed limit function" and various controls.

Control type		Speed limit function	Speed limit value	
OPR control	Machine OPR control	◎	[Pr.8] Speed limit value	
	Fast OPR control	◎		
Major positioning control	Position control	1-axis linear control		◎
		2- to 4-axis linear interpolation control		◎
		1-axis fixed-feed control		◎
		2- to 4-axis fixed-feed control (interpolation)		◎
		2-axis circular interpolation control		◎
		3-axis helical interpolation control		◎
	1- to 4-axis Speed control	◎		
	Speed-position switching control, Position-speed switching control	◎		
Other control	Current value changing	—	Setting value invalid	
	JUMP instruction, NOP instruction, LOOP to LEND	—		
Manual control	JOG operation, Inching operation	◎	[Pr.31] JOG speed limit value	
	Manual pulse generator operation	—	Setting is invalid	

◎ : Always set

— : Setting not required (Setting value is invalid. Use the initial values or setting values within a range where no error occurs.)

[2] Control precautions

- If any axis exceeds "[Pr.8] Speed limit value" during 2- to 4-axis speed control, the axis in excess of the speed limit value is controlled at the speed limit value. For the other axes which perform interpolation, the speed can be suppressed by the ratio of a command speed.
- If any axis exceeds "[Pr.8] Speed limit value" during 2- to 4-axis linear interpolation control, 2- to 4-axis fixed-feed control, 2-axis circular interpolation control, or 3-axis helical interpolation control, the axis exceeding the speed limit value is controlled at the speed limit value. For the other axes performing interpolation, the speed can be suppressed by the ratio of a movement distance.
- In 2- to 4-axis linear interpolation control or 2- to 4-axis fixed-feed control, the speed limit value for the interpolation axis may not function under the following condition: "1: Reference axis speed" is set in "[Pr.20] Interpolation speed designation method" or "[Da.29] Interpolation speed designation method", and the reference axis is the minor axis and the interpolation axis is the major axis.
- In 3-axis helical interpolation control, control the composite speed of the circular interpolation axis or the speed of the linear interpolation axis so that the speeds do not exceed "[Pr.8] Speed limit value".

[3] Setting method

To use the "speed limit function", set the "speed limit value" in the parameters shown in the following table, and write them to the QD75.

The set details are validated after they are written to the QD75.

Setting item		Setting value	Setting details	Factory-set initial value
[Pr.8]	Speed limit value	→	Set the speed limit value (max. speed during control).	200000
[Pr.31]	JOG speed limit value	→	Set the speed limit value during JOG operation (max. speed during control). (Note that "[Pr.31] JOG speed limit value" shall be less than or equal to "[Pr.8] Speed limit value".)	20000

\* Refer to Section 5.2 "List of parameters" for setting details.

**REMARK**

- Parameters are set for each axis.
- It is recommended that the parameters be set whenever possible with GX Configurator-QP. Execution by sequence program uses many sequence programs and devices. The execution becomes complicated, and the scan times will increase.

12.4.2 Torque limit function

The "torque limit function" limits the generated torque to a value within the "torque limit value" setting range when the torque generated in the servomotor exceeds the "torque limit value".

The "torque limit function" protects the deceleration function, limits the power of the operation pressing against the stopper, etc. It controls the operation so that unnecessary force is not applied to the load and machine.

The QD75 does not carry out the torque limit of servo motor directly with this function. The torque limit command to servo amplifier is carried out by the D/A converter module.

The details shown below explain about the "torque limit function".

- [1] System configuration for carrying out the torque limit
- [2] Relation between the torque limit function and various controls
- [3] Control details
- [4] Control precautions
- [5] Setting method

[1] System configuration for carrying out the torque limit

Carry out the torque limit in the configuration in the figure below. (The following modules are required.)

- D/A converter module
- Drive unit capable of torque limit control by analog voltage input

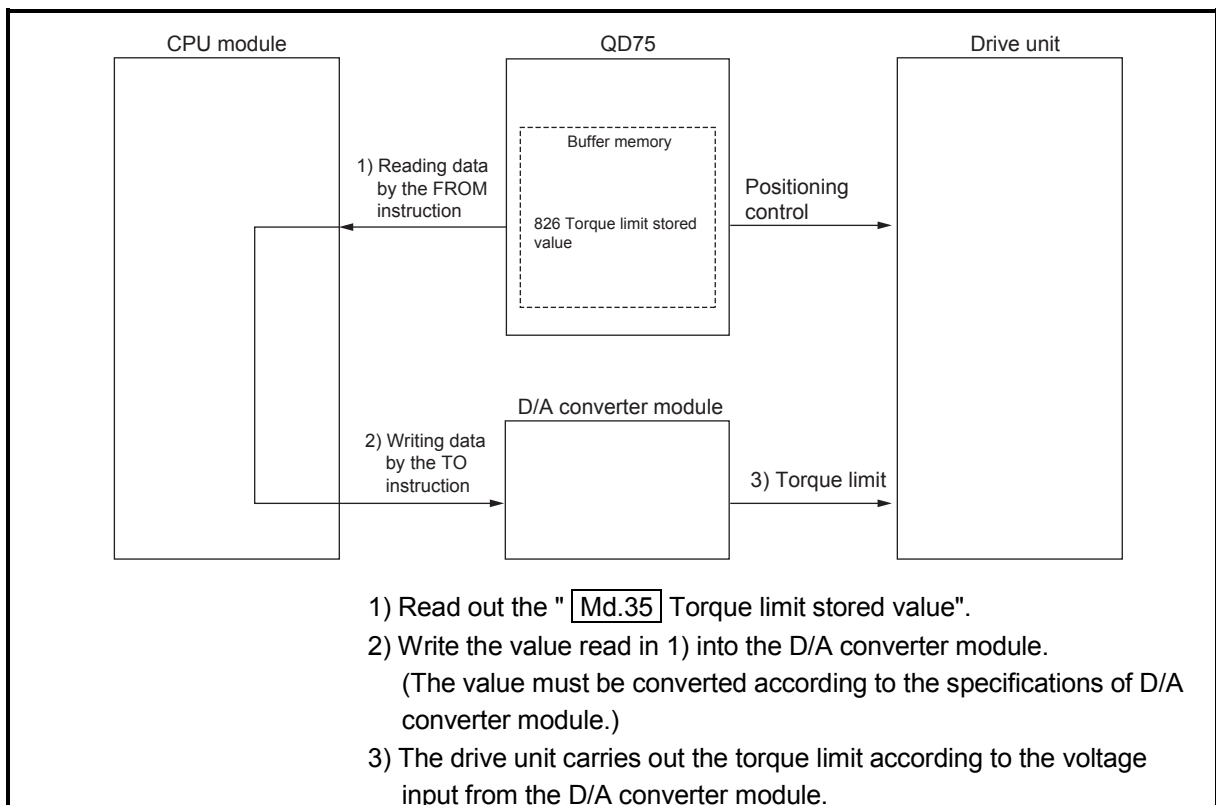

Fig. 12.16 Torque limit to the drive unit (axis 1)

POINT
<p>The QD75 monitors the creep speed reach during the OPR control and updates the " [Md.35] Torque limit stored value" to the " [Pr.54] OPR torque limit value".</p> <p>Monitoring this value prevents the need to monitor the creep speed reach by the program. If all controls of torque limit value are carried out by the program (1) Reading data by the FROM instruction, this function must not be used.</p>

[2] Relation between the torque limit function and various controls

The following table shows the relation of the "torque limit function" and various controls.

Control type		Torque limit function	Torque limit value *
OPR control	Machine OPR control	○	[Pr.17] Torque limit setting value * After the " [Pr.47] Creep speed" is reached, this value becomes the " [Pr.54] OPR torque limit value".
	Fast OPR control	○	
Major positioning control	Position control	1-axis linear control	○
		2- to 4-axis linear interpolation control	○
		1-axis fixed-feed control	○
		2- to 4-axis fixed-feed control (interpolation)	○
		2-axis circular interpolation control	○
		3-axis helical interpolation control	○
	1- to 4-axis Speed control	○	[Pr.17] Torque limit setting value
	Speed-position switching control	○	
	Position-speed switching control	○	
	Other control	Current value changing	-
JUMP instruction, NOP instruction, LOOP to LEND		-	
Manual control	JOG operation, Inching operation	○	[Pr.17] Torque limit setting value
	Manual pulse generator operation	○	[Pr.17] Torque limit setting value

○ : Set when required

- : Setting not required (Setting value is invalid. Use the initial values or setting values within a range where no error occurs.)

\* : Shows the torque limit value when " [Cd.22] New torque value" is set to "0".

## [3] Control details

The following drawing shows the operation of the torque limit function.

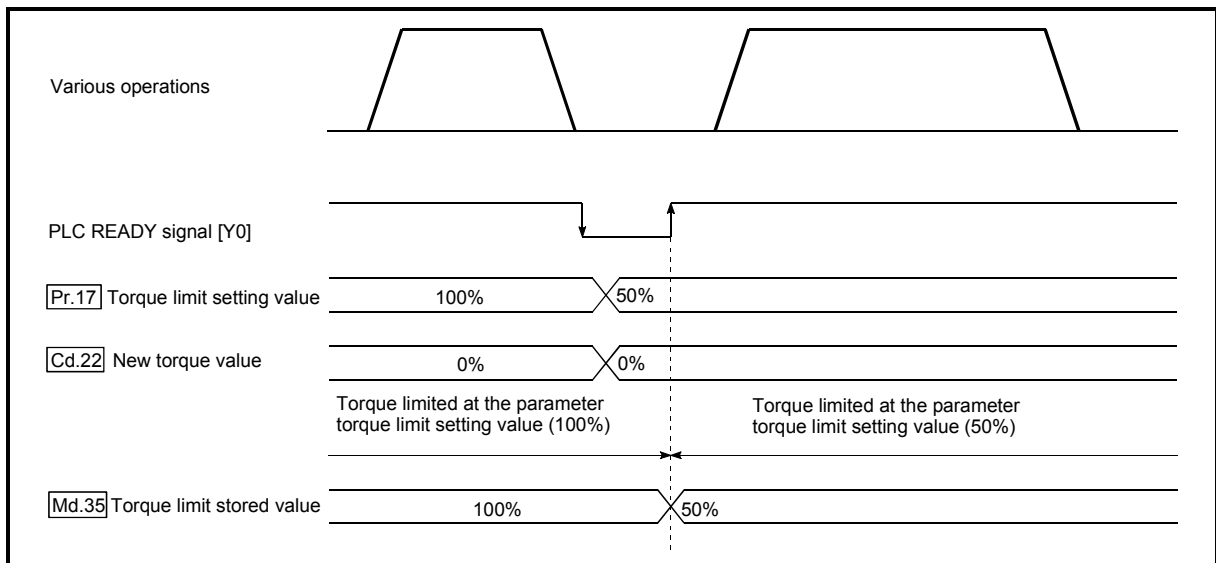

Fig. 12.17 Torque limit function operation

## [4] Control precautions

- (1) When limiting the torque at the "Pr.17 Torque limit setting value", confirm that "Cd.22 New torque value" is set to "0". If this parameter is set to a value besides "0", the "Cd.22 New torque value" will be validated, and the torque will be limited at that value. (Refer to Section 12.5.4 "Torque change function" for details about the "new torque value".)
- (2) When "Pr.54 OPR shift amount" exceeds "Pr.17 Torque limit setting value", the error "OPR torque limit value error" (error code: 995) will occur.
- (3) When the operation is stopped by torque limiting, the droop pulse will remain in the deviation counter. If a "deviation counter clear" is carried out by issuing an external signal at this time, positional deviation will occur when the operation is continued. If the load torque is eliminated, operation for the amount of droop pulses will be carried out.

## [5] Setting method

- (1) To use the "torque limit function", set the "torque limit value" in the parameters shown in the following table, and write them to the QD75. The set details are validated at the rising edge (OFF → ON) of the PLC READY signal (Y0).

Setting item	Setting value	Setting details	Factory-set initial value
[Pr.17] Torque limit setting value	→	Set the torque limit value as a percentage.	300
[Pr.54] OPR torque limit value	→	Set the torque limit value after the "[Pr.47] Creep speed" is reached. Set as a percentage.	300

\* Refer to Section 5.2 "List of parameters" for setting details.

The following table shows the "[Md.35] Torque limit stored value" of the buffer memory address.

Monitor item	Monitor value	Storage details	Buffer memory address			
			Axis 1	Axis 2	Axis 3	Axis 4
[Md.35] Torque limit stored value	→	The "torque limit value" valid at that time is stored. ([Pr.17], [Pr.54], or [Cd.22])	826	926	1026	1126

\* Refer to Section 5.6 "List of monitor data" for information on the setting details.

**REMARK**

- Parameters are set for each axis.
- It is recommended that the parameters be set whenever possible with GX Configurator-QP. Execution by sequence program uses many sequence programs and devices. The execution becomes complicated, and the scan times will increase.



## 12.4.3 Software stroke limit function

In the "software stroke limit function" the address established by a machine OPR is used to set the upper/lower limits of the moveable range of the workpiece. Movement commands issued to addresses outside that setting range will not be executed. In the QD75, the "current feed value" and "machine feed value" are used as the addresses indicating the current position. However, in the "software stroke limit function", the address used to carry out the limit check is designated in the " [Pr.14] Software stroke limit selection". (Refer to Section 9.1.4 "Confirming the current value" or details on the "current feed value" and "machine feed value".)

The upper/lower limits of the moveable range of the workpiece are set in " [Pr.12] Software stroke limit upper limit value"/ " [Pr.13] Software stroke limit lower limit value".

The details shown below explain about the "software stroke limit function".

- [1] Differences in the moveable range when "current feed value" and "machine feed value" are selected.
- [2] Software stroke limit check details
- [3] Relation between the software stroke limit function and various controls
- [4] Precautions during software stroke limit check
- [5] Setting method
- [6] Invalidating the software stroke limit
- [7] Setting when the control unit is "degree"

[1] Differences in the moveable range when "current feed value" and "machine feed value" are selected.

The following drawing shows the moveable range of the workpiece when the software stroke limit function is used.

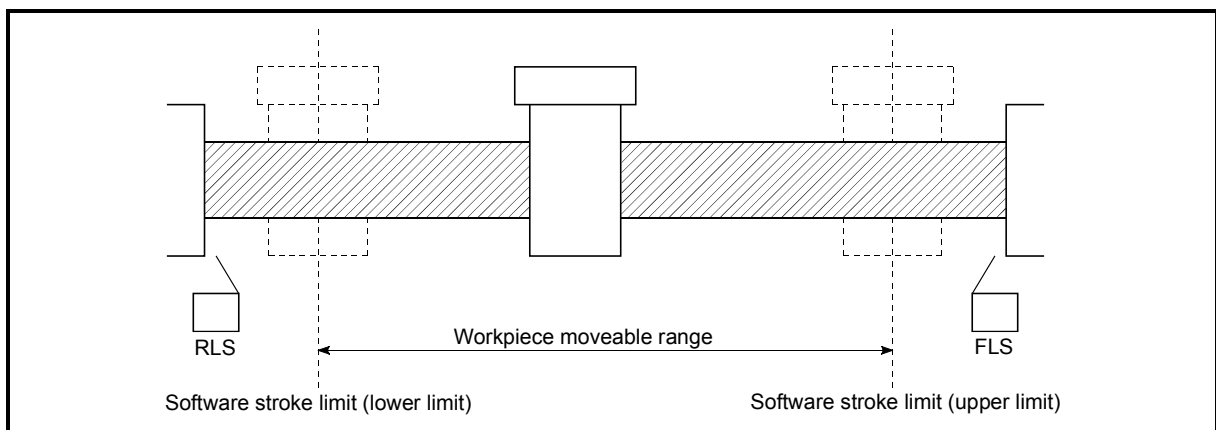

Fig. 12.18 Workpiece moveable range

The following drawing shows the differences in the operation when "Md.20 Current feed value" and "Md.21 Machine feed value" are used in the moveable range limit check.

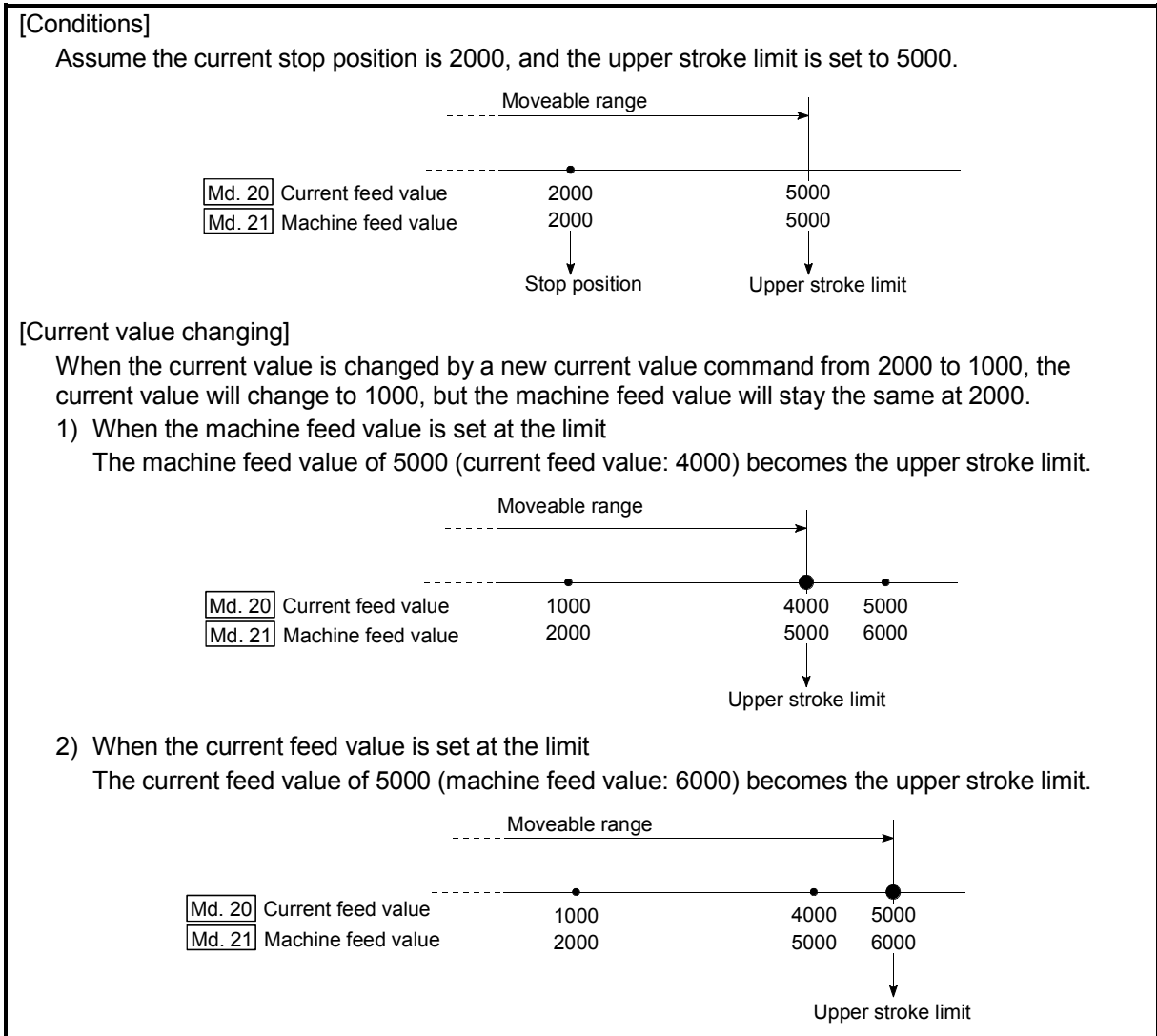

Fig. 12.19 Software stroke limits of the current feed value and machine feed value

**POINT**  
When "machine feed value" is set in "Pr.14 Software stroke limit selection", the moveable range becomes an absolute range referenced on the OP. When "current feed value" is set, the moveable range is the relative range from the "current feed value".

[2] Software stroke limit check details

Check details		Processing when an error occurs
1)	An error shall occur if the current value *1 is outside the software stroke limit range *2. (Check " [Md.20] Current feed value" or " [Md.21] Machine feed value".)	An error "Software stroke limit +" or "Software stroke limit -" (error code: 507 or 508) will occur.
2)	An error shall occur if the command address is outside the software stroke limit range. (Check " [Da.6] Positioning address/movement amount".)	

\*1: Check whether the " [Md.20] Current feed value" or " [Md.21] Machine feed value" is set in " [Pr.14] Software stroke limit selection".

\*2: Moveable range from the " [Pr.12] Software stroke limit upper limit value" to the " [Pr.13] Software stroke limit lower limit value".

[3] Relation between the software stroke limit function and various controls

Control type		Limit check	Processing at check
OPR control	Machine OPR control	—	Check not carried out.
	Fast OPR control	—	
Major positioning control	Position control	1-axis linear control	Checks 1) and 2) in the previous section [2] are carried out. For speed control: The axis decelerates to a stop when it exceeds the software stroke limit range. For position control: The axis comes to an immediate stop when it exceeds the software stroke limit range.
		2- to 4-axis axis linear interpolation control	
		1-axis fixed-feed control	
		2- to 4-axis fixed-feed control (interpolation)	
		2-axis circular interpolation control	
		3-axis helical interpolation control	
	1- to 4-axis speed control	○ *3, 4	
	Speed-position switching control	○	
	Position-speed switching control	*3, 4	
Other control	Current value changing	◎	The current value will not be changed if the new current value is outside the software stroke limit range.
	JUMP instruction, NOP instruction, LOOP to LEND	—	Check not carried out.
Manual control	JOG operation, Inching operation	△ *5	Check 1) in the previous section [2] is carried out. The machine will carry out a deceleration stop when the software stroke limit range is exceeded. If the address falls out of the software stroke limit range, the operation can be started only toward the movable range.
	Manual pulse generator operation	△ *5	

◎ : Check valid

○ : Check is not made when the current feed value is not updated (Refer to [Pr.21]) at the setting of " current feed value" in " [Pr.14] Software stroke limit selection" during speed control.

— : Check not carried out (check invalid).

△ : Valid only when "1:valid" is set in the " [Pr.15] Software stroke limit valid/invalid setting".

\*3: The value in " [Md.20] Current feed value" will differ according to the " [Pr.21] Current feed value during speed control" setting.

\*4: When the unit is "degree", check is not made during speed control.

\*5: When the unit is "degree", check is not carried out.

[4] Precautions during software stroke limit check

- (1) A machine OPR must be executed beforehand for the "software stroke limit function" to function properly.
- (2) During interpolation control, a stroke limit check is carried out for the every current value of both the reference axis and the interpolation axis. Every axis will not start if an error occurs, even if it only occurs in one axis.
- (3) During circular interpolation control, the "[Pr.12] Software stroke limit upper limit value"/"[Pr.13] Software stroke limit lower limit value" may be exceeded.

In this case, a deceleration stop will not be carried out even if the stroke limit is exceeded. Always install an external limit switch if there is a possibility the stroke limit will be exceeded.

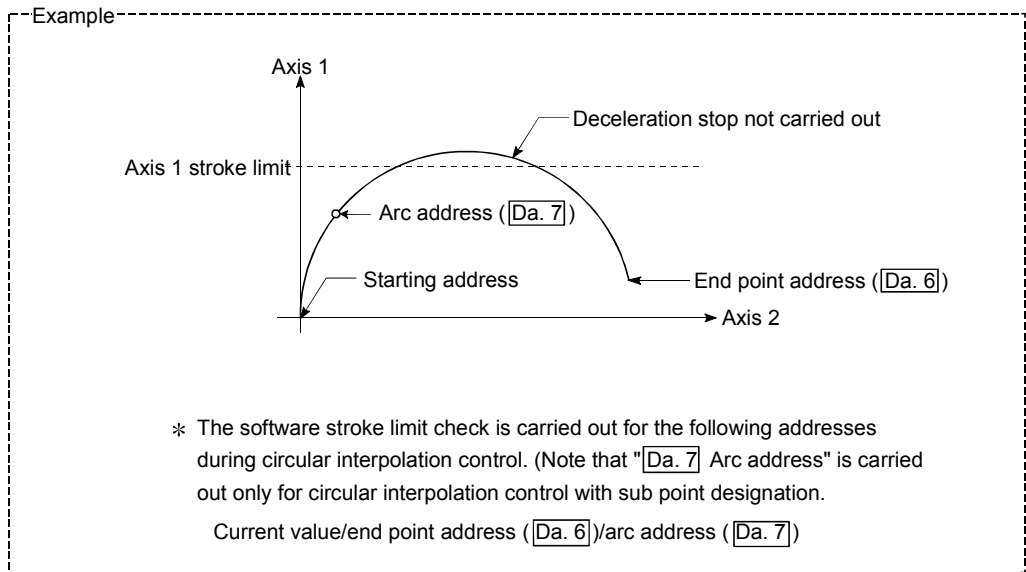

- (4) If an error is detected during continuous path control, the axis stops immediately on completion of execution of the positioning data located right before the positioning data in error.

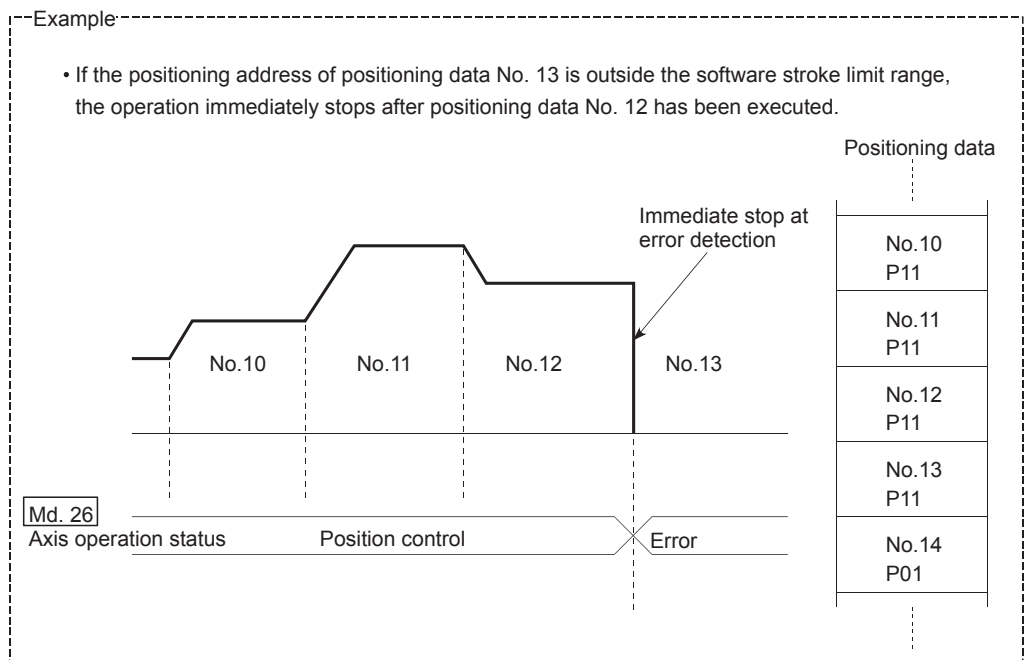

- (5) During simultaneous start, a stroke limit check is carried out for the current values of every axis to be started. Every axis will not start if an error occurs, even if it only occurs in one axis.

[5] Setting method

To use the "software stroke limit function", set the required values in the parameters shown in the following table, and write them to the QD75.

The set details are validated at the rising edge (OFF → ON) of the PLC READY signal (Y0).

Setting item	Setting value	Setting details	Factory-set initial value
Pr.12 Software stroke limit upper limit value	→	Set the upper limit value of the moveable range.	2147483647
Pr.13 Software stroke limit lower limit value	→	Set the lower limit value of the moveable range.	-2147483648
Pr.14 Software stroke limit selection	→	Set whether to use the "Md.20 Current feed value" or "Md.21 Machine feed value" as the "current value".	0: Current feed value
Pr.15 Software stroke limit valid/invalid setting	0: Valid	Set whether the software stroke limit is validated or invalidated during manual control (JOG operation, Inching operation, manual pulse generator operation).	0: valid

\* Refer to Section 5.2 "List of parameters" for setting details.

[6] Invalidating the software stroke limit

To invalidate the software stroke limit, set the following parameters as shown, and write them to the QD75. (Set the value within the setting range.)

$$\boxed{\text{Pr.12}} \text{ Software stroke limit upper limit value} = \boxed{\text{Pr.13}} \text{ Software stroke limit lower limit value}$$

To invalidate only the manual operation, set "0: software stroke limit invalid" in the "Pr.15 Software stroke limit valid/invalid setting".

The set details are validated at the rising edge (OFF → ON) of the PLC READY signal (Y0).

When the unit is "degree", the software stroke limit check is not performed during speed control (including speed control in speed-position switching control or position-speed switching control) or during manual control, independently of the values set in Pr.12, Pr.13 and Pr.15.

**REMARK**

- Parameters are set for each axis.
- It is recommended that the parameters be set whenever possible with GX Configurator-QP. Execution by sequence program uses many sequence programs and devices. The execution becomes complicated, and the scan times will increase.

[7] Setting when the control unit is "degree"

■ Current value address

The "Md.20" Current feed value" address is a ring address between 0 and 359.99999° .

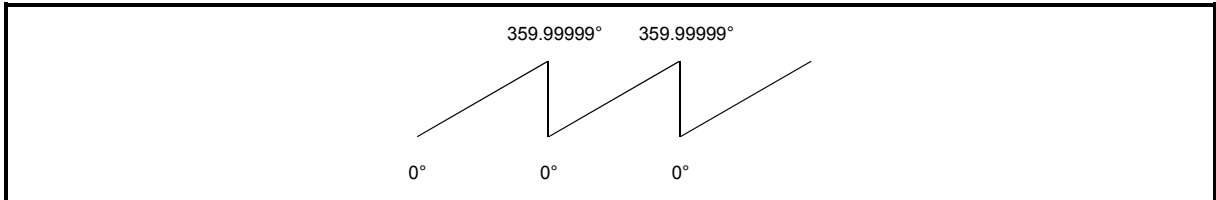

Fig. 12.20 Current value address when the control unit is "degree"

■ Setting the software stroke limit

The upper limit value/lower limit value of the software stroke limit is a value between 0 and 359.99999° .

(1) Setting when the software stroke limit is to be validated.

When the software stroke limit is to be validated, set the upper limit value in a clockwise direction from the lower limit value.

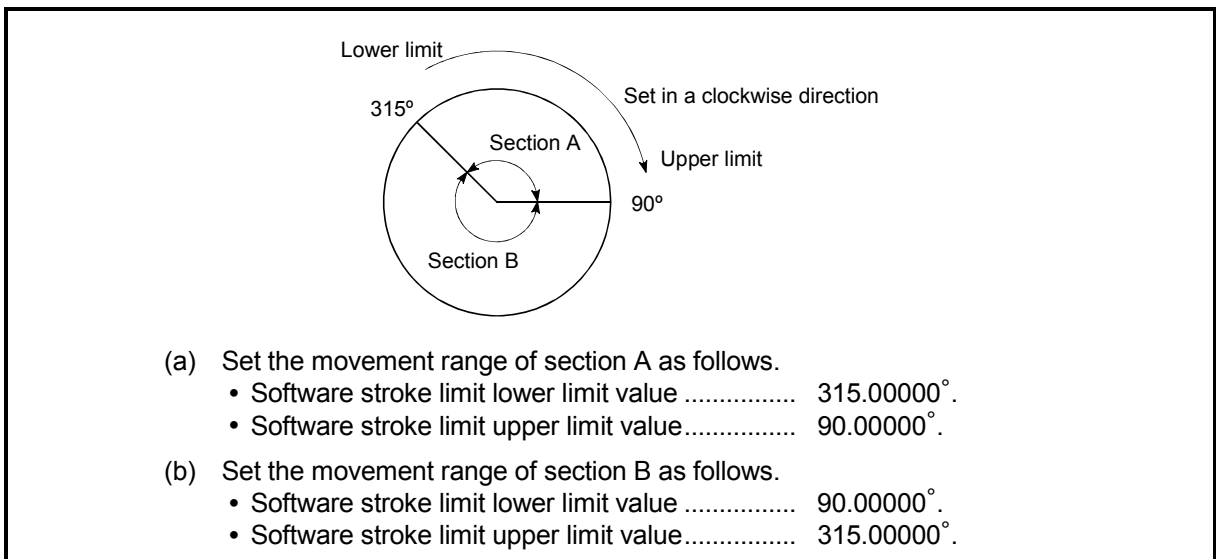

Fig. 12.21 Software stroke limit when the control unit is "degree"

12.4.4 Hardware stroke limit function

**⚠ WARNING**

When the hardware stroke limit is required to be wired, ensure to wire it in the negative logic using b-contact. If it is set in positive logic using a-contact, a serious accident may occur.

In the "hardware stroke limit function", limit switches are set at the upper/lower limit of the physical moveable range, and the control is stopped (by deceleration stop) by the input of a signal from the limit switch. Damage to the machine can be prevented by stopping the control before the upper/lower limit of the physical moveable range is reached.

Hardware stroke limit switches are normally "installed inside the stroke limit/stroke end on the drive unit side", and the control is stopped before the stroke limit/stroke end on the drive unit side is reached.

The details shown below explain about the "hardware stroke limit function".

- [1] Control details
- [2] Wiring the hardware stroke limit
- [3] Control Precautions
- [4] When the hardware stroke limit is not used

**[1] Control details**

The following drawing shows the operation of the hardware stroke limit function.

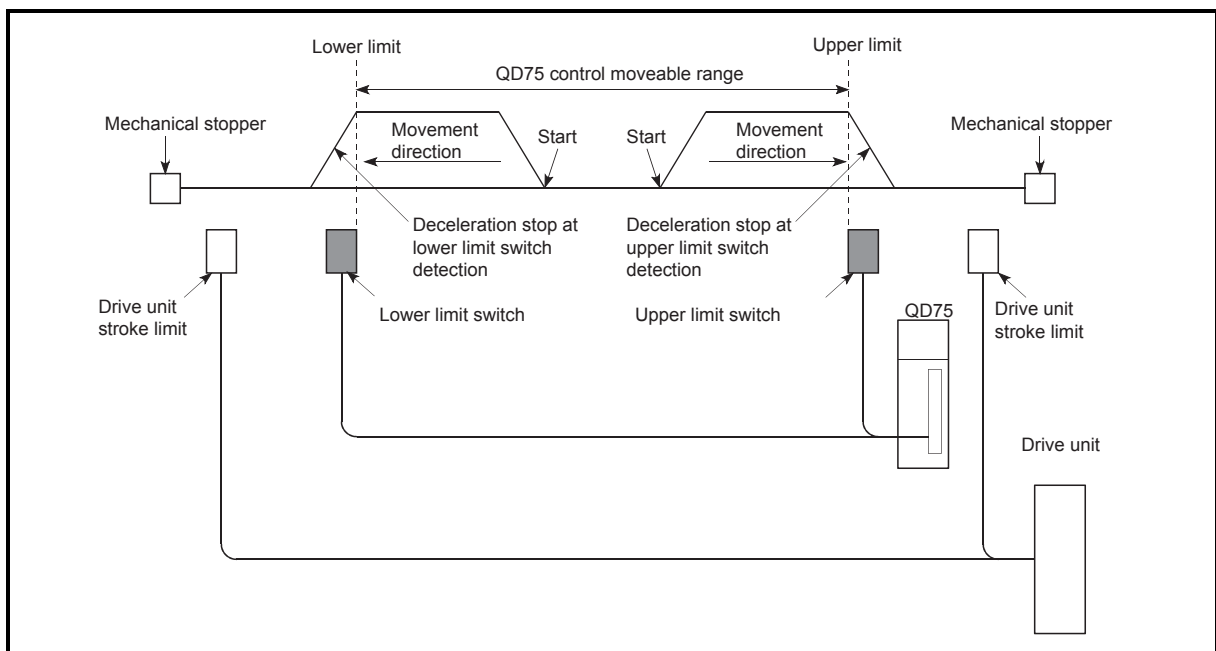

Fig. 12.22 Hardware stroke limit function operation

[2] Wiring the hardware stroke limit

When using the hardware stroke limit function, wire the terminals of the QD75 upper/lower limit stroke limit as shown in the following drawing.  
 (When " [Pr.22] Input signal logic selection" is set to the initial value)

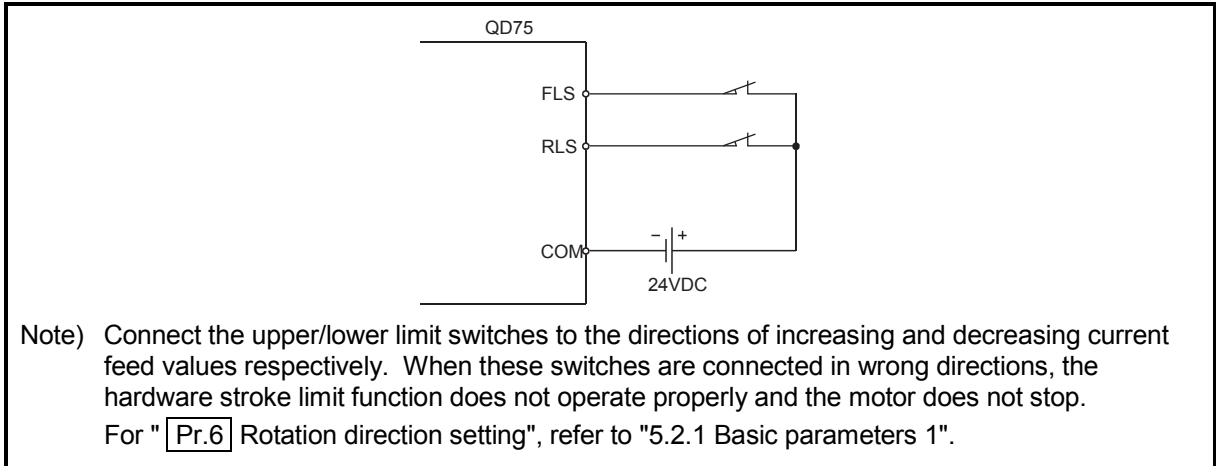

Fig. 12.23 Wiring when using the hardware stroke limit

[3] Control Precautions

- (1) If the machine is stopped outside the QD75 control range (outside the upper/lower limit switches), or if stopped by hardware stroke limit detection, the "OPR control", "major positioning control", and "high-level positioning control" cannot start. To carry out these types of control again, return the workpiece to the QD75 control range by a "JOG operation", "inching operation" or "manual pulse generator operation".
- (2) When " [Pr.22] Input signal logic selection" is set to the initial value, the QD75 cannot carry out the positioning control if FLS (upper limit signal) is separated from COM or RLS (lower limit signal) is separated from COM (including when wiring is not carried out).

[4] When the hardware stroke limit function is not used

When not using the hardware stroke limit function, wire the terminals of the QD75 upper/lower limit stroke limit as shown in the following drawing.  
 When the logic of FLS and RLS is set to "positive logic" using " [Pr.22] Input signal logic selection", positioning control can be carried out even if FLS and RLS are not wired.  
 (For details, refer to Section 13.4 "External I/O signal logic switching function".)

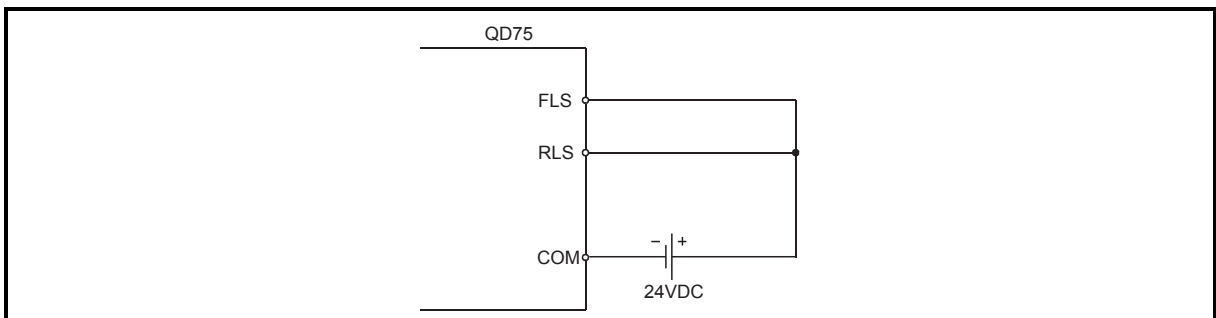

Fig. 12.24 Wiring when not using the hardware stroke limit function  
 (When " [Pr.22] Input signal logic selection" is the initial value)



## 12.5 Functions to change the control details

Functions to change the control details include the "speed change function", "override function", "acceleration/deceleration time change function" and "torque change function". Each function is executed by parameter setting or sequence program creation and writing.

Both the "speed change function" or "override function" change the speed, but the differences between the functions are shown below. Use the function that corresponds to the application.

### "Speed change function"

- The speed is changed at any time, only in the control being executed.
- The new speed is directly set.

### "Override function"

- The speed is changed for all control to be executed. (Note that this excludes manual pulse generator operation.)
- The new speed is set as a percent (%) of the command speed.

### 12.5.1 Speed change function

The "Speed change function" is used to change the speed during control to a newly designated speed at any time.

The new speed is directly set in the buffer memory, and the speed is changed by a speed change command (`Cd.15` Speed change request) or external command signal.

During the machine OPR, a speed change to the creep speed cannot be carried out after deceleration start because the near point dog ON is detected.

The details shown below explain about the "speed change function".

- [1] Control details
- [2] Control precautions
- [3] Setting the speed change function from the CPU module
- [4] Setting the speed change function using an external command signal

#### [1] Control details

The following drawing shows the operation during a speed change.

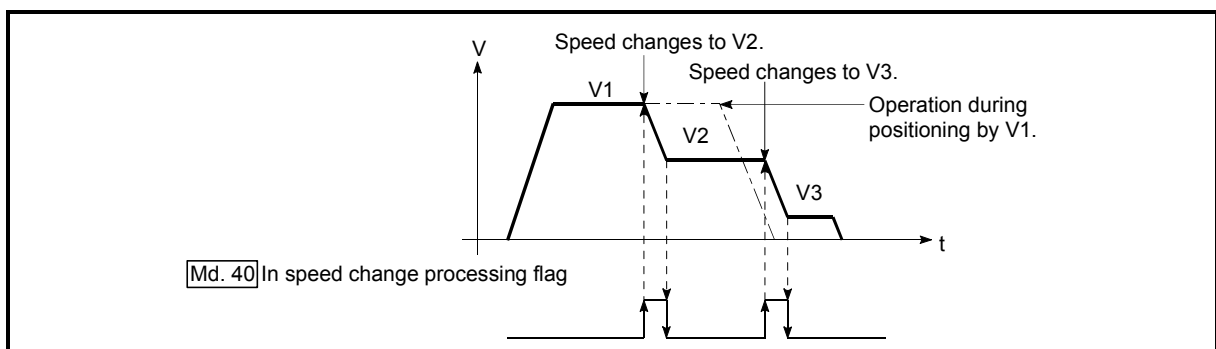

Fig. 12.25 Speed change operation

[2] Control precautions

- (1) Control is carried out as follows at the speed change during continuous path control.
  - a) When no speed designation (current speed) is provided in the next positioning data:
    - The next positioning data is controlled at the " [Cd.14] New speed value".
  - b) When a speed designation is provided in the next positioning data:
    - The next positioning data is controlled at its command speed ([Da.8]).

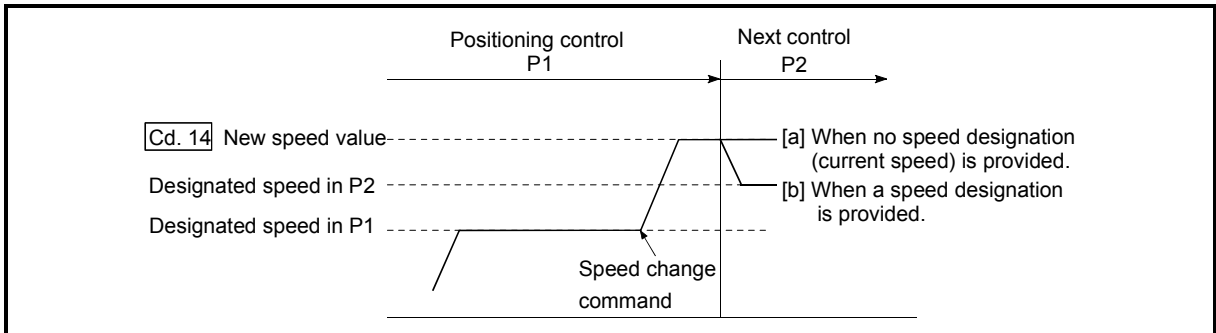

Fig. 12.26 Speed change during continuous path control

- (2) When changing the speed during continuous path control, the speed change will be ignored if there is not enough distance remaining to carry out the change.
- (3) When the stop command was given to make a stop after a speed change that had been made during position control, the restarting speed depends on the function version.

Function version	Restarting speed
A	[Da.8] Command speed
B or later	[Cd.14] New speed value

Refer to Section 2.4 for the way to check the function version.

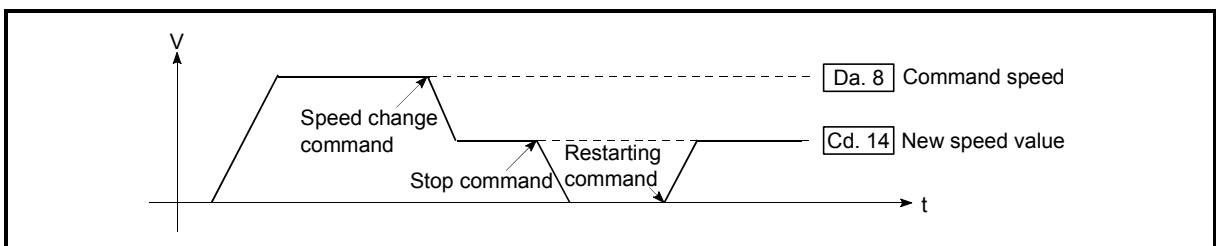

Fig. 12.27 Restarting speed after speed change made during position control (Function version B)

- (4) When the speed is changed by setting " **Cd.14** New speed value" to "0", the operation is carried out as follows.
- When " **Cd.15** Speed change request" is turned ON, the speed change 0 flag ( **Md.31** Status: b10) turns ON.  
(During interpolation control, the speed change 0 flag on the reference axis side turns ON.)
  - The axis stops, but " **Md.26** Axis operation status" does not change, and the BUSY signal remains ON. (If a stop signal is input, the BUSY signal will turn OFF, and " **Md.26** Axis operation status" will change to "Stopped".)
- \*In this case, setting the " **Cd.14** New speed value" to a value besides "0" will turn OFF the speed change 0 flag ( **Md.31** Status: b10), and enable continued operation.

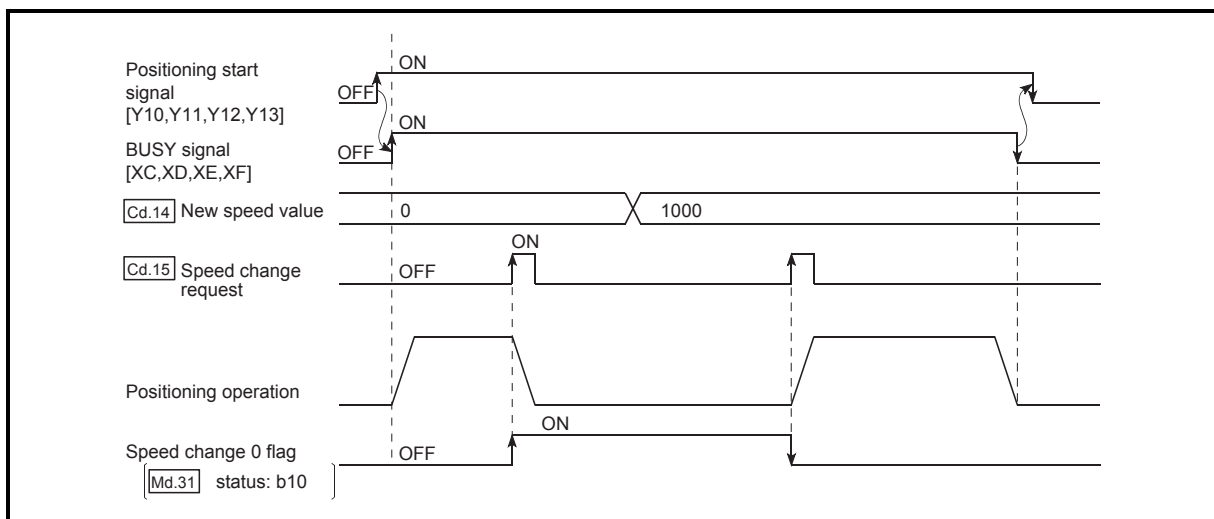

Fig. 12.28 Speed change at new speed value "0"

- (5) A warning "Deceleration/stop speed change" (warning code: 500) occurs and the speed cannot be changed in the following cases.
- During deceleration by a stop command
  - During automatic deceleration during positioning control
- (6) A warning "Speed limit value over" (warning code: 501) occurs and the speed is controlled at the " **Pr.8** Speed limit value" when the value set in " **Cd.14** New speed value" exceeds the " **Pr.8** Speed limit value".
- (7) When the speed is changed during interpolation control, the required speed is set in the reference axis.
- (8) When carrying out consecutive speed changes, be sure there is an interval between the speed changes of 100ms or more.  
(If the interval between speed changes is short, the QD75 will not be able to track, and it may become impossible to carry out commands correctly.)
- (9) When a speed change is requested simultaneously for multiple axes, change the speed one by one. Therefore, the start timing of speed change is different for each axis.
- (10) The speed cannot be changed to 0 during the machine OPR. The speed change request is ignored.
- (11) When deceleration is started by the speed change function, the deceleration start flag does not turn ON.

[3] Setting the speed change function from the CPU module

The following shows the data settings and sequence program example for changing the control speed of axis 1 from the CPU module. (In this example, the control speed is changed to "20.00mm/min".)

(1) Set the following data.

(Use the start time chart shown in section (2) below as a reference, and set using the sequence program shown in section (3).)

Setting item	Setting value	Setting details	Buffer memory address			
			Axis 1	Axis 2	Axis 3	Axis 4
<b>Cd.14</b> New speed value	2000	Set the new speed.	1514 1515	1614 1615	1714 1715	1814 1815
<b>Cd.15</b> Speed change request	1	Set "1: Change the speed".	1516	1616	1716	1816

\* Refer to Section 5.7 "List of control data" for details on the setting details.

(2) The following shows the speed change time chart.

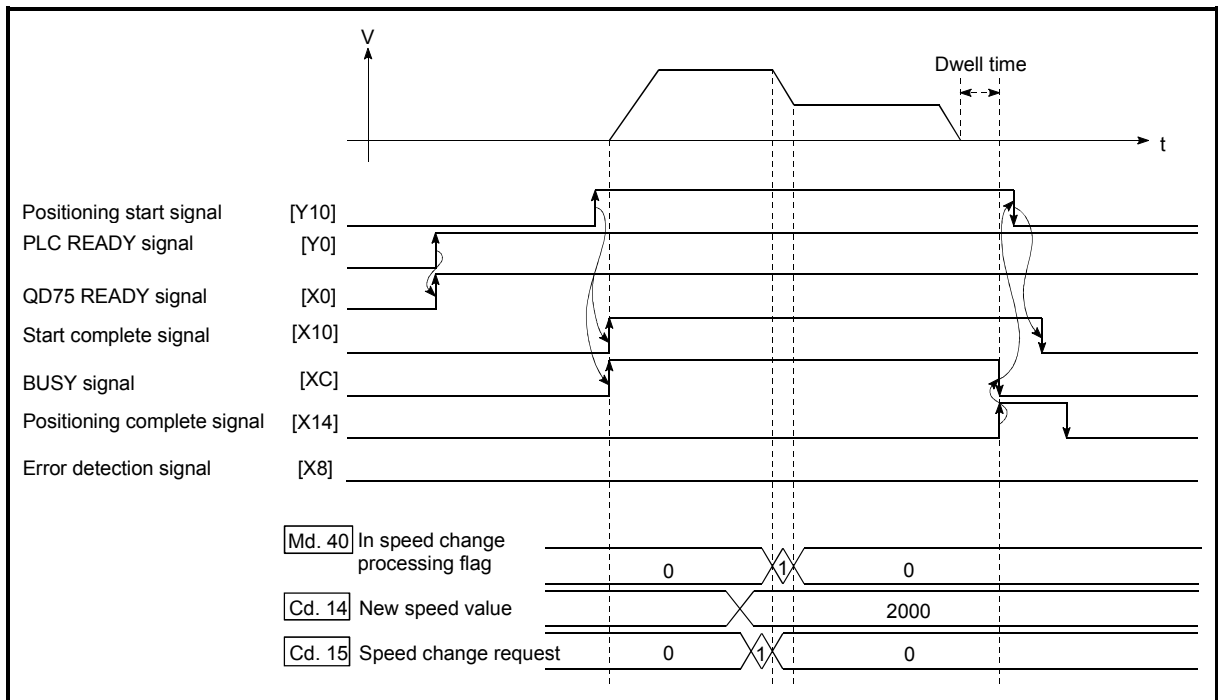
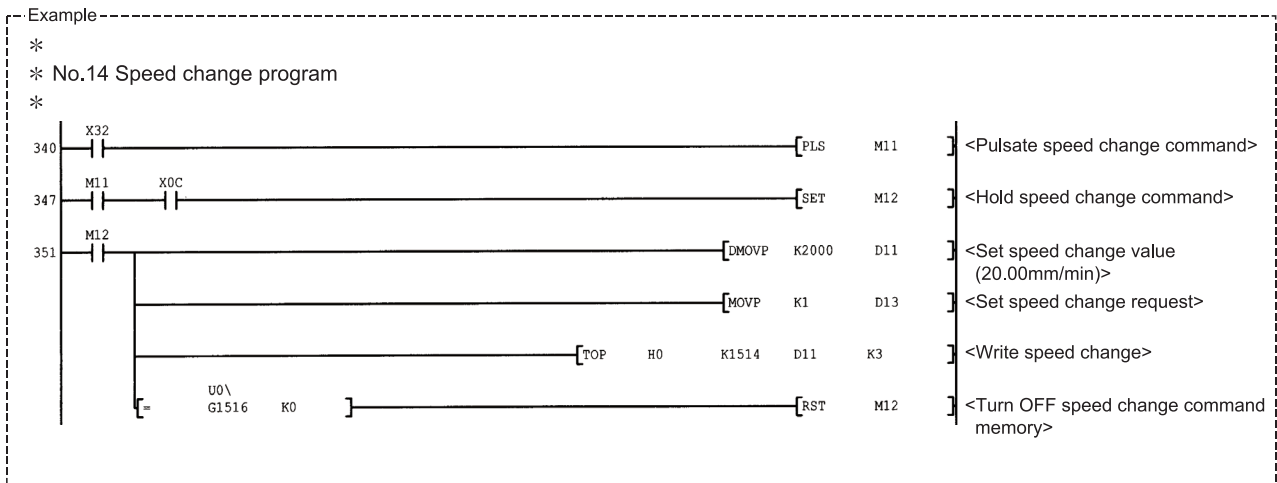

Fig. 12.29 Time chart for changing the speed from the CPU module

(3) Add the following sequence program to the control program, and write it to the CPU module.



[4] Setting the speed change function using an external command signal

The speed can also be changed using an "external command signal".

The following shows the data settings and sequence program example for changing the control speed of axis 1 using an "external command signal". (In this example, the control speed is changed to "10000.00mm/min".)

- (1) Set the following data to change the speed using an external command signal.

(Use the start time chart shown in section (2) below as a reference, and set using the sequence program shown in section (3).)

Setting item	Setting value	Setting details	Buffer memory address			
			Axis 1	Axis 2	Axis 3	Axis 4
Pr.42 External command function selection	1	Set "1: External speed change request".	62	212	362	512
Cd.8 External command valid	1	Set "1: Validate the external command".	1505	1605	1705	1805
Cd.14 New speed value	1000000	Set the new speed.	1514 1515	1614 1615	1714 1715	1814 1815

\* Refer to Section 5.7 "List of control data" for details on the setting details.

- (2) The following shows the speed change time chart.

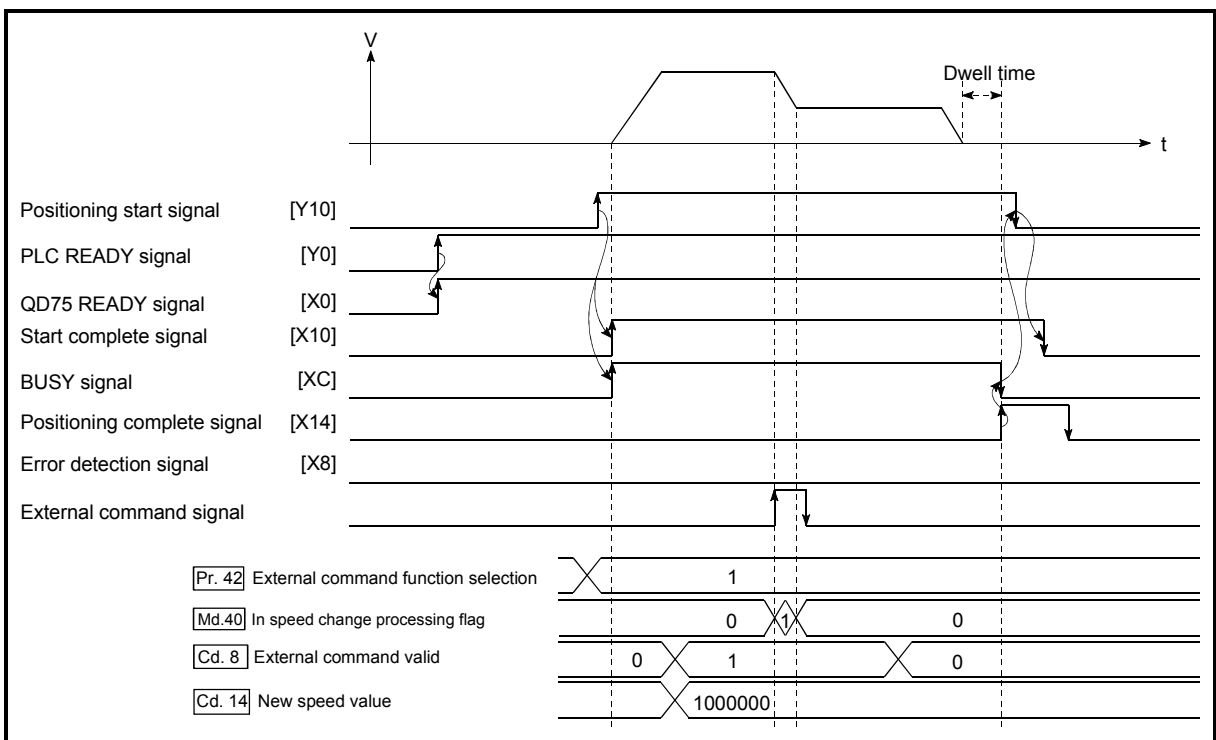
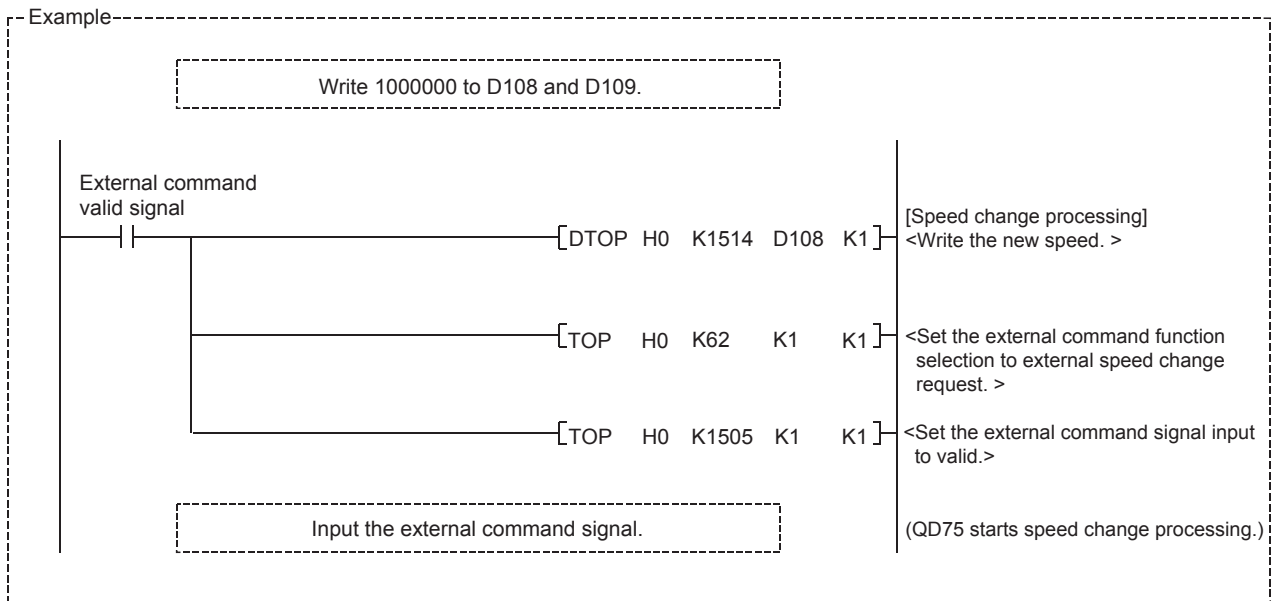

Fig. 12.30 Time chart for changing the speed using an external command signal

- (3) Add the following sequence program to the control program, and write it to the CPU module.



12.5.2 Override function

The "override function" changes the command speed by a designated percentage (1 to 300%) for all control to be executed.

The speed can be changed by setting the percentage (%) by which the speed is changed in " [Cd.13] Positioning operation speed override".

- [1] Control details
- [2] Control precautions
- [3] Setting method

[1] Control details

The following shows that operation of the override function.

- 1) A value changed by the override function is monitored by " [Md.22] Feedrate". (When [Md.22] " becomes "0", the warning "Less than minimum speed" (warning code: 110) is generated and the axis is controlled in the then speed unit of "1".)
- 2) If " [Cd.13] Positioning operation speed override" is set to 100%, the speed will not change.
- 3) If " [Cd.13] Positioning operation speed override" is set a value 100% or less, the warning "Less than minimum speed" (warning code: 110) is generated, and control will be carried out at speed unit "1" at the time "Feedrate" becomes a value of "1" or less.
- 4) If there is not enough remaining distance to change the speed by the "override function" during the "position control" or position control by the "speed-position switching control" or "position-speed switching control", the operation will be carried out at the possible speed for the distance.
- 5) If the speed changed by the "override function" is greater than the " [Pr.8] Speed limit value", a warning "Speed limit value over" (warning code: 501) will occur and the speed will be controlled at the " [Pr.8] Speed limit value". The " [Md.39] In speed limit flag" will turn ON.

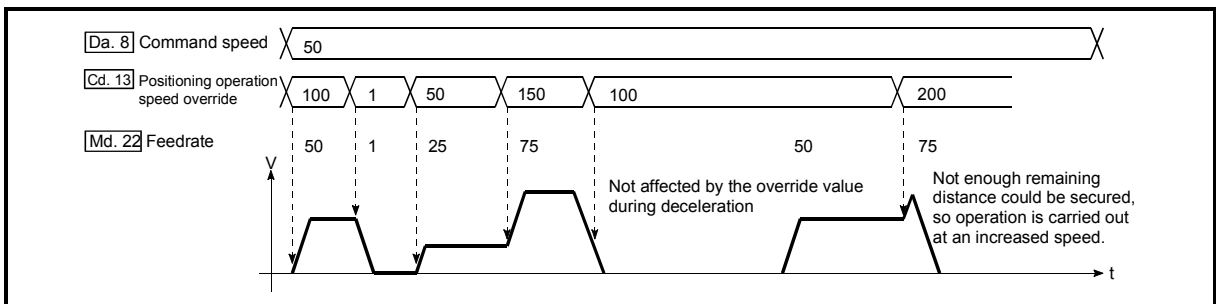

Fig. 12.31 Override function operation



[2] Control precautions

- (1) When changing the speed by the "override function" during continuous path control, the speed change will be ignored if there is not enough distance remaining to carry out the change.
- (2) A warning "Deceleration/stop speed change" (warning code: 500) occurs and the speed cannot be changed by the "override function" in the following cases.  
(The value set in " Cd.13 Positioning operation speed override" is validated after a deceleration stop.)
  - During deceleration by a stop command
  - During automatic deceleration during positioning control
- (3) When the speed is changed by the "override function" during interpolation control, the required speed is set in the reference axis.
- (4) When carrying out consecutive speed changes by the "override function", be sure there is an interval between the speed changes of 100ms or more. (If the interval between speed changes is short, the QD75 will not be able to track, and it may become impossible to carry out commands correctly.)
- (5) When a machine OPR is performed, the speed change by the "override function" cannot be carried out after a deceleration start to the creep speed following the detection of near-point dog ON. In this case, a request for speed change is ignored.
- (6) When deceleration is started by the override function, the deceleration start flag does not turn ON.

[3] Setting method

The following shows the data settings and sequence program example for setting the override value of axis 1 to "200%".

- (1) Set the following data. (Use the start time chart shown in section (2) below as a reference, and set using the sequence program shown in section (3).)

Setting item		Setting value	Setting details	Buffer memory address			
				Axis 1	Axis 2	Axis 3	Axis 4
Cd.13	Positioning operation speed override	200	Set the new speed as a percentage (%).	1513	1613	1713	1813

\* Refer to Section 5.7 "List of control data" for details on the setting details.

(2) The following shows a time chart for changing the speed using the override function.

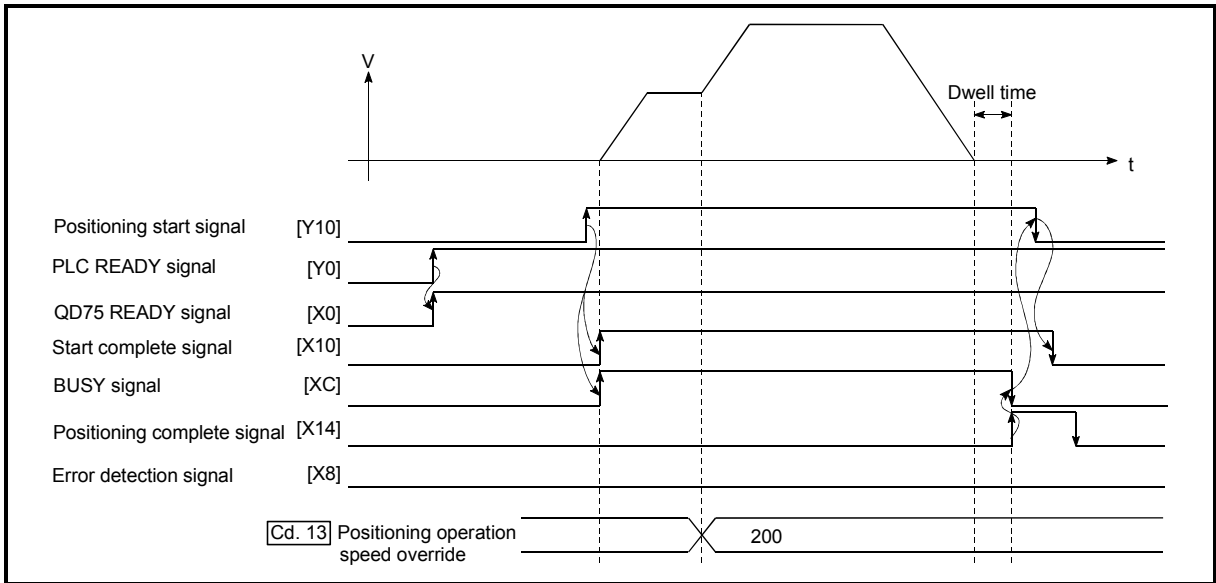
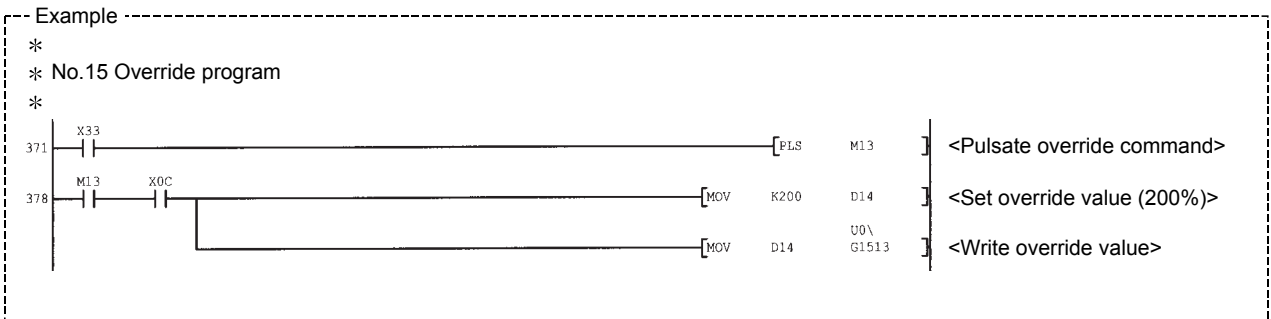

Fig. 12.32 Time chart for changing the speed using the override function

(3) Add the following sequence program to the control program, and write it to the CPU module.



### 12.5.3 Acceleration/deceleration time change function

The "acceleration/deceleration time change function" is used to change the acceleration/deceleration time during a speed change to a random value when carrying out the speed change by the "speed change function" and "override function". In a normal speed change (when the acceleration/deceleration time is not changed), the acceleration/deceleration time previously set in the parameters ( $\overline{\text{Pr.9}}$ ,  $\overline{\text{Pr.10}}$ , and  $\overline{\text{Pr.25}}$  to  $\overline{\text{Pr.30}}$  values) is set in the positioning parameter data items  $\overline{\text{Da.3}}$  and  $\overline{\text{Da.4}}$ , and control is carried out with that acceleration/deceleration time. However, by setting the new acceleration/deceleration time ( $\overline{\text{Cd.10}}$ ,  $\overline{\text{Cd.11}}$ ) in the control data, and issuing an acceleration/deceleration time change enable command ( $\overline{\text{Cd.12}}$  Acceleration/deceleration time change during speed change, enable/disable selection) to change the speed when the acceleration/deceleration time change is enabled, the speed will be changed with the new acceleration/deceleration time ( $\overline{\text{Cd.10}}$ ,  $\overline{\text{Cd.11}}$ ).

The details shown below explain about the "acceleration/deceleration time change function".

- [1] Control details
- [2] Control precautions
- [3] Setting method

[1] Control details

After setting the following two items, carry out the speed change to change the acceleration/deceleration time during the speed change.

- Set change value of the acceleration/deceleration time (" [Cd.10] New acceleration time value", " [Cd.11] New deceleration time value")
- Setting acceleration/deceleration time change to enable (" [Cd.12] Acceleration/deceleration time change during speed change, enable/disable selection")

The following drawing shows the operation during an acceleration/deceleration time change.

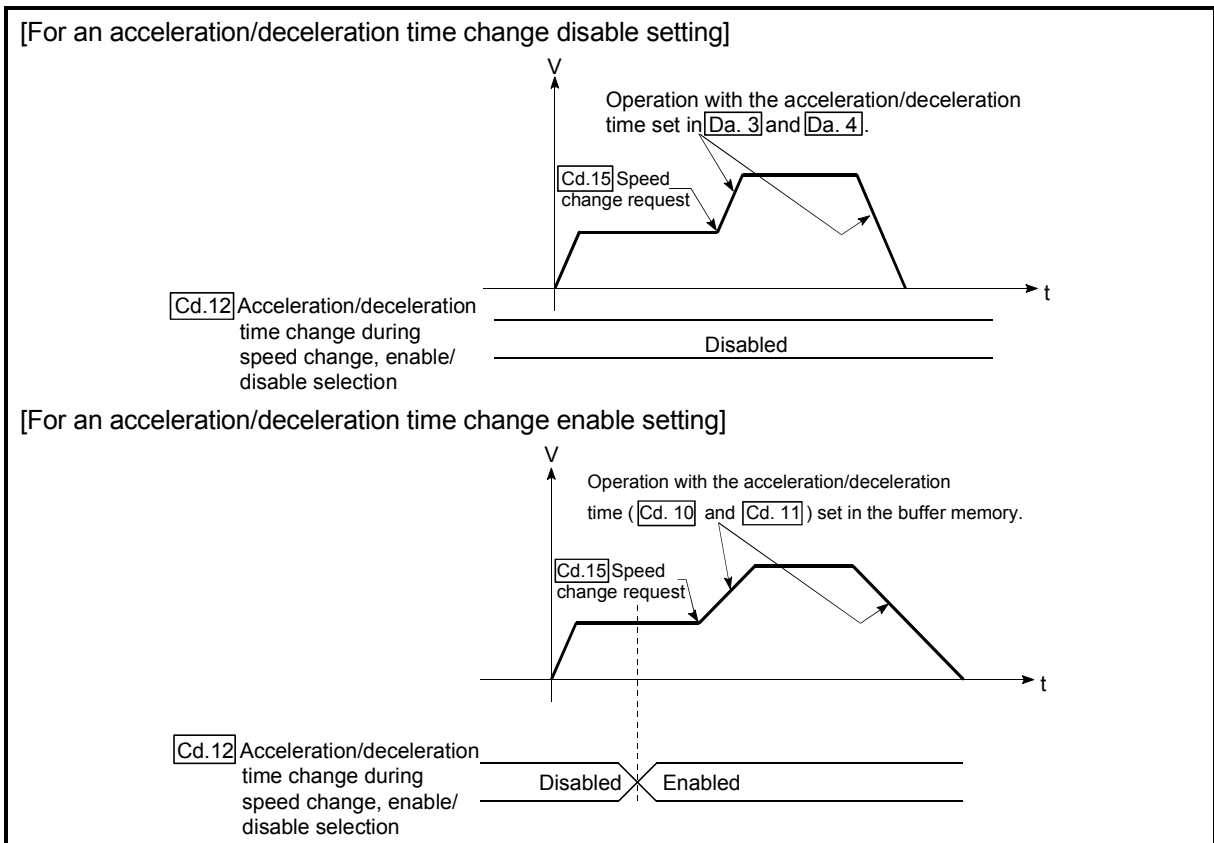
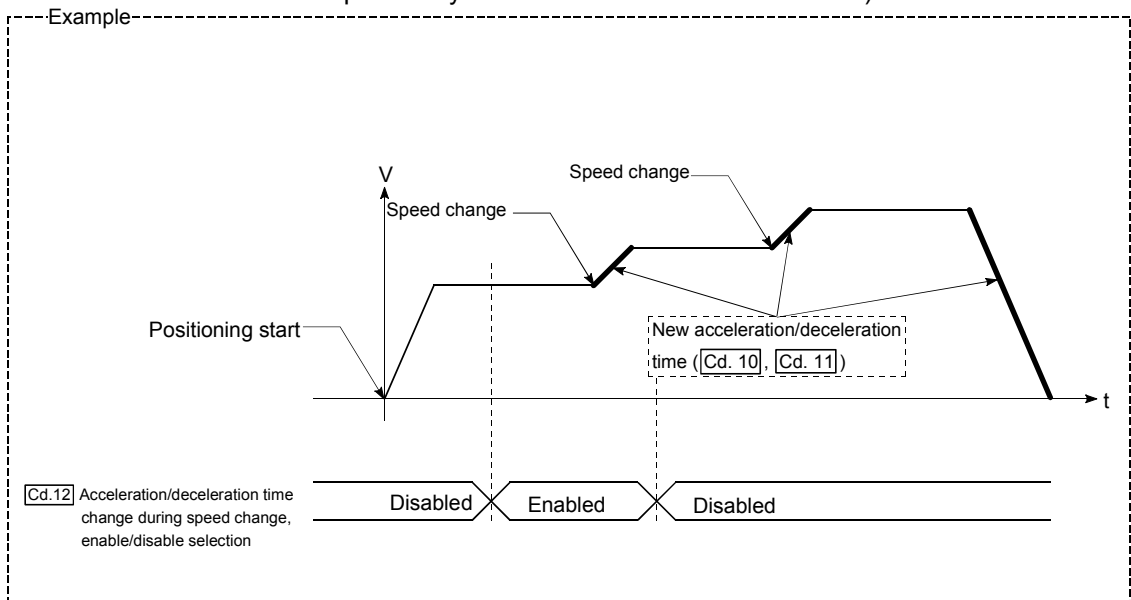

Fig. 12.33 Operation during an acceleration/deceleration time change

[2] Control precautions

- (1) When "0" is set in " [Cd.10] New acceleration time value" and " [Cd.11] New deceleration time value", the acceleration/deceleration time will not be changed even if the speed is changed. In this case, the operation will be controlled at the acceleration/deceleration time previously set in the parameters.
- (2) The "new acceleration/deceleration time" is valid during execution of the positioning data for which the speed was changed. In continuous positioning control and continuous path control, the speed is changed and control is carried out with the previously set acceleration/deceleration time at the changeover to the next positioning data, even if the acceleration/deceleration time is changed to the "new acceleration/deceleration time ([Cd.10], [Cd.11])".
- (3) Even if the acceleration/deceleration time change is set to disable after the "new acceleration/deceleration time" is validated, the positioning data for which the "new acceleration/deceleration time" was validated will continue to be controlled with that value. (The next positioning data will be controlled with the previously set acceleration/deceleration time.)



- (4) If the "new acceleration/deceleration time" is set to "0" and the speed is changed after the "new acceleration/deceleration time" is validated, the operation will be controlled with the previous "new acceleration/deceleration time".

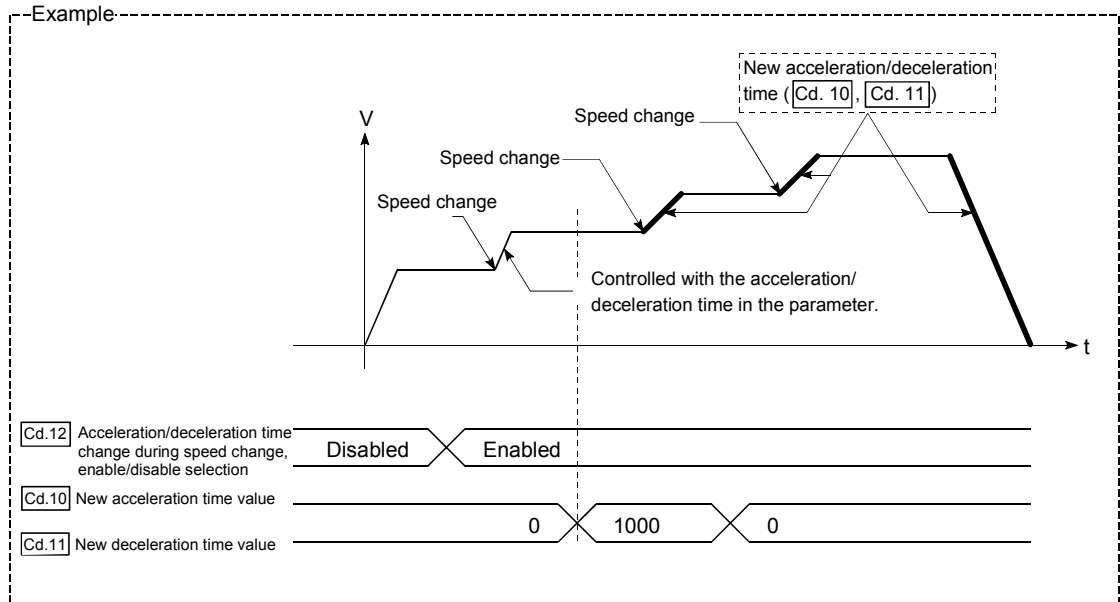

**POINT**

If the speed is changed when an acceleration/deceleration change is enabled, the "new acceleration/deceleration time" will become the acceleration/deceleration time of the positioning data being executed. The "new acceleration/deceleration time" remains valid until the changeover to the next positioning data. (The automatic deceleration processing at the completion of the positioning will also be controlled by the "new acceleration/deceleration time".)

[3] Setting method

To use the "acceleration/deceleration time change function", write the data shown in the following table to the QD75 using the sequence program. The set details are validated when a speed change is executed after the details are written to the QD75.

Setting item	Setting value	Setting details	Buffer memory address			
			Axis 1	Axis 2	Axis 3	Axis 4
Cd.10 New acceleration time value	→	Set the new acceleration time.	1508 1509	1608 1609	1708 1709	1808 1809
Cd.11 New deceleration time value	→	Set the new deceleration time.	1510 1511	1610 1611	1710 1711	1810 1811
Cd.12 Acceleration/deceleration time change during speed change, enable/disable selection	1	Set "1: Acceleration/deceleration time change enable".	1512	1612	1712	1812

\* Refer to Section 5.7 "List of control data" for details on the setting details.

Example

\*  
 \* No.16 Acceleration/deceleration time change program  
 \*

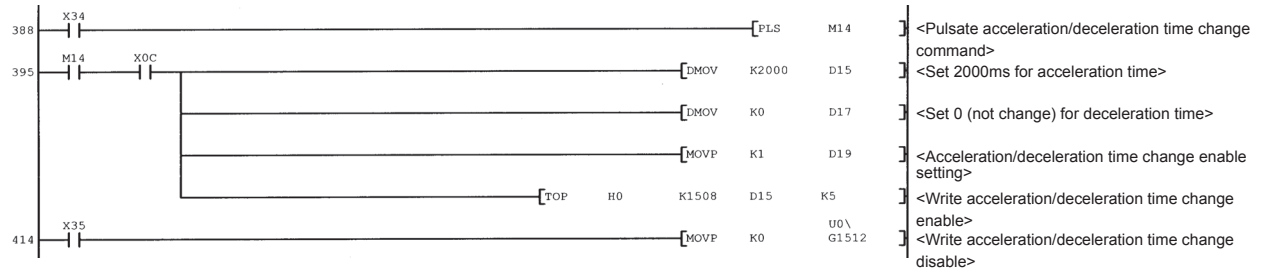

12.5.4 Torque change function

The "torque change function" is used to change the torque limit value during torque limiting.

The torque limit value during torque limiting is normally the value set in the " [Pr.17] Torque limit setting value" that was previously set in the parameters. However, by setting the new torque limit value in the axis control data " [Cd.22] New torque value", and writing it to the QD75, the torque generated by the servomotor during control can be limited with the new torque value. (The " [Cd.22] New torque value" is validated when written to the QD75.)

The details shown below explain about the "torque change function".

- [1] Control details
- [2] Control precautions
- [3] Setting method

[1] Control details

The torque value of the axis control data can be changed at all times. The torque can be limited with a new torque value from the time the new torque value has been written to the QD75. (a torque change is made only during operation.) The torque limiting is not carried out from the time the power supply is turned ON to the time the PLC READY signal (Y0) is turned ON.

The torque setting range is from 0 to " [Pr.17] Torque limit setting value".

When the new torque value is 0, a torque change is considered not to be carried out.

The torque change range is 1 to " [Pr.17] Torque limit setting value".

The following drawing shows the torque change operation.

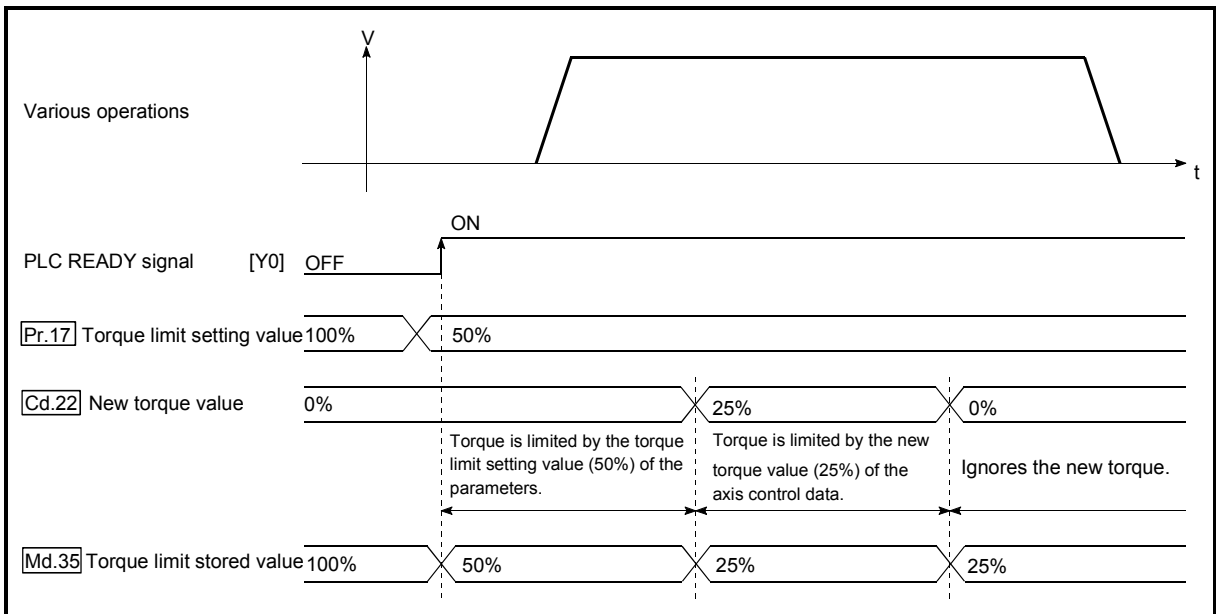

Fig. 12.34 Torque change operation



## [2] Control precautions

- (1) If a value besides "0" is set in the " Cd.22 New torque value", the torque generated by the servomotor will be limited by that value. To limit the torque with the value set in " Pr.17 Torque limit setting value", set the " Cd.22 New torque value" to "0".
- (2) The " Cd.22 New torque value" is validated when written to the QD75. (Note that it is not validated from the time the power supply is turned ON to the time the PLC READY signal (Y0) is turned ON.)
- (3) If the setting value is outside the setting range, an axis warning "Outside new torque value range" (warning code: 113) will occur and the torque will not be changed.
- (4) If the time to hold the new torque value is not more than 100ms, a torque change may not be executed.

## [3] Setting method

To use the "torque change function", write the data shown in the following table to the QD75 using the sequence program.

The set details are validated when written to the QD75.

Setting item	Setting value	Setting details	Buffer memory address			
			Axis 1	Axis 2	Axis 3	Axis 4
<span style="border: 1px solid black; padding: 0 2px;">Cd.22</span> New torque value	→	Set the new torque limit value.	1525	1625	1725	1825

\* Refer to Section 5.7 "List of control data" for details on the setting details.

12.5.5 Target position change function

The "target position change function" is a function to change a target position to a newly designated target position at any timing during the position control (1-axis linear control). A command speed can also be changed simultaneously.

The target position and command speed changed are set directly in the buffer memory, and the target position change is executed by turning ON " Cd.29 Target position change request flag".

The following shows the details of the "target position change function".

- [1] Control details
- [2] Control precautions
- [3] Setting method

[1] Control details

The following charts show the details of control of the target position change function.

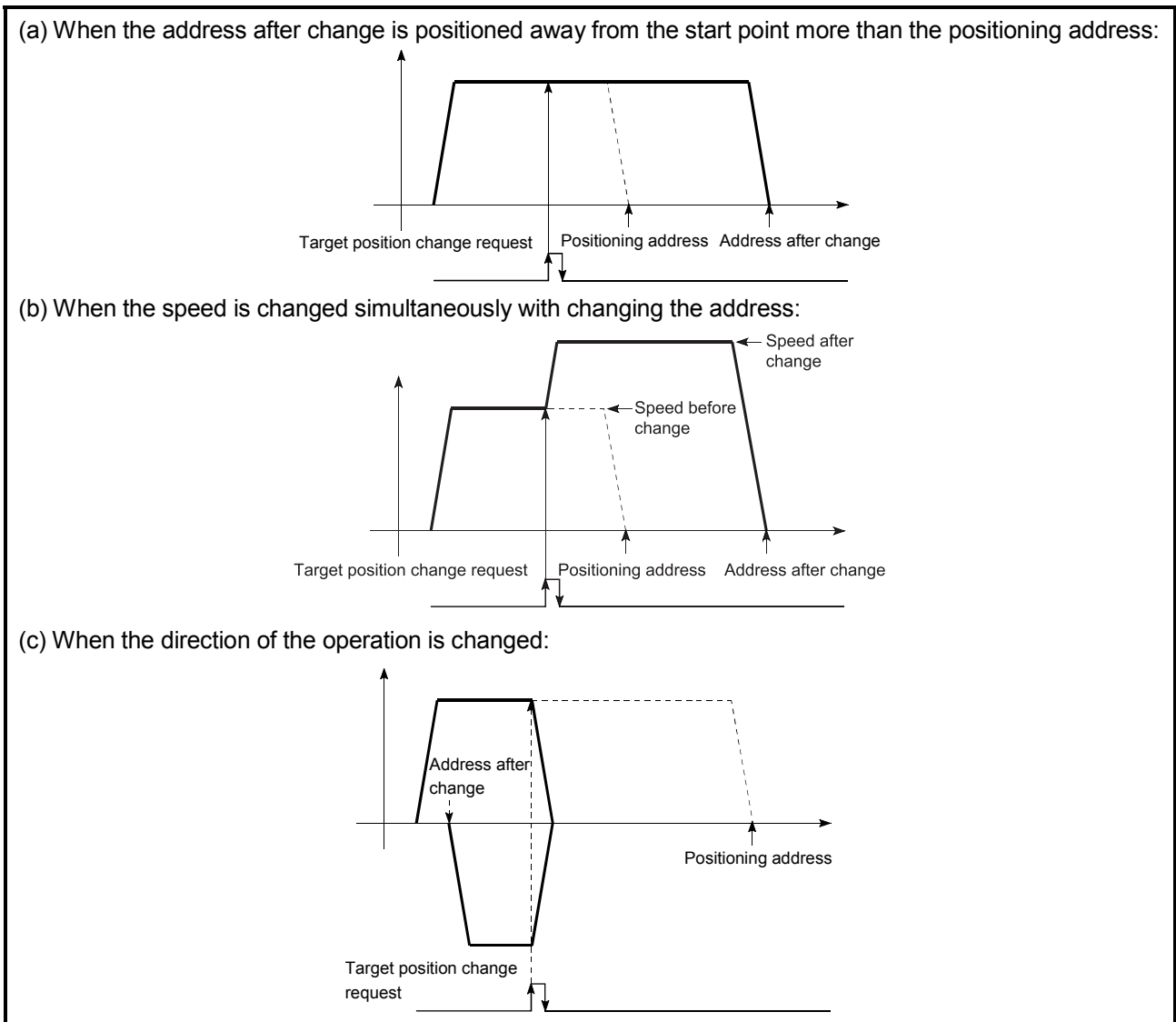

Fig. 12.35 Target position change operation

**[2] Control precautions**

- (1) If the positioning movement direction from the stop position to a new target position is reversed, stop the operation once and then position to the new target position. (Refer to Fig. 12.35 (c).)
- (2) If a command speed exceeding the speed limit value is set to change the command speed, the warning "Speed limit value over" (warning code: 501) will occur, and the new command speed will be the speed limit value. Also, if the command speed change disables the remaining distance to the target value from being assured, the warning "Insufficient remaining distance" (warning code: 509) will occur.
- (3) In the following cases, the target position change request is ignored, and the warning "Target position change not possible" (warning code: 518) will occur.
  - During interpolation control
  - A new target position value (address) is outside the software stroke limit range.
  - The axis is decelerating to a stop by a stop cause.
  - While the positioning data whose operation pattern is continuous path control is executed.
  - When the speed change 0 flag (Md.31 Status: b10) is ON.
- (4) When a command speed is changed, the current speed is also changed. When the next positioning speed uses the current speed in the continuous positioning, the next positioning operation is carried out at the new speed value. When the speed is set with the next positioning data, that speed becomes the current speed and the operation is carried out at the current speed.
- (5) When a target position change request is given during automatic deceleration in position control, positioning control to a new position is exercised after the axis has stopped once if the moving direction is reversed. If the moving direction is not reversed, the axis is accelerated to the command speed again and positioned to the new position.
- (6) If the constant speed status is regained or the output is reversed by a target position change made while " Md.48 Deceleration start flag" is ON, the deceleration start flag remains ON. (For details, refer to Section 12.7.8.)
- (7) Carrying out the target position change to the ABS linear 1 in degrees may carry out the positioning to the new target position after the operation decelerates to stop once, even the movement direction is not is reversed.

**POINT**

When carrying out the target position change continuously, take an interval of 100ms or longer between the times of the target position changes. Also, take an interval of 100ms or longer when the speed change and override is carried out after changing the target position or the target position change is carried out after the speed change and override.

[3] Setting method

The following table and chart show the example of a data setting and program used to change the target position of the axis 1 by the command from CPU module, respectively."

(In this example, the target position and command speed is changed to "300.0 μm" and "10000.00 mm/min".)

- (1) The following data is set.  
(Referring to the starting time chart shown in item (2) below, carry out the setting with the program shown in item (3).)

Setting item	Setting value	Setting details	Buffer memory address			
			Axis 1	Axis 2	Axis 3	Axis 4
Cd.27 Target position change value (new address)	3000	Set the new address.	1534 1535	1634 1635	1734 1735	1834 1835
Cd.28 Target position change value (new speed)	1000000	Set the new speed.	1536 1537	1636 1637	1736 1737	1836 1837
Cd.29 Target position change request flag	1	Set "1: Carry out speed change".	1538	1638	1738	1838

Refer to Section 5.7 "List of control data" for details on the setting details.

- (2) The following shows the time chart for target position change.

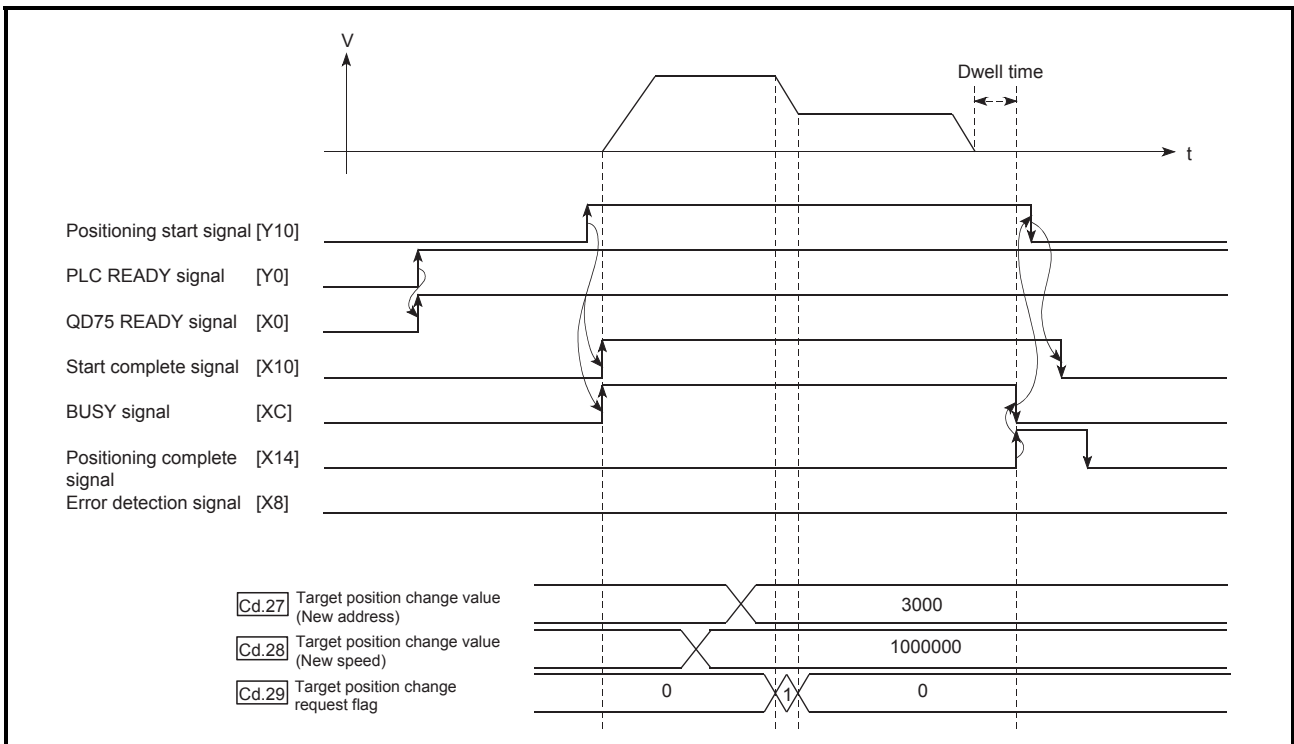
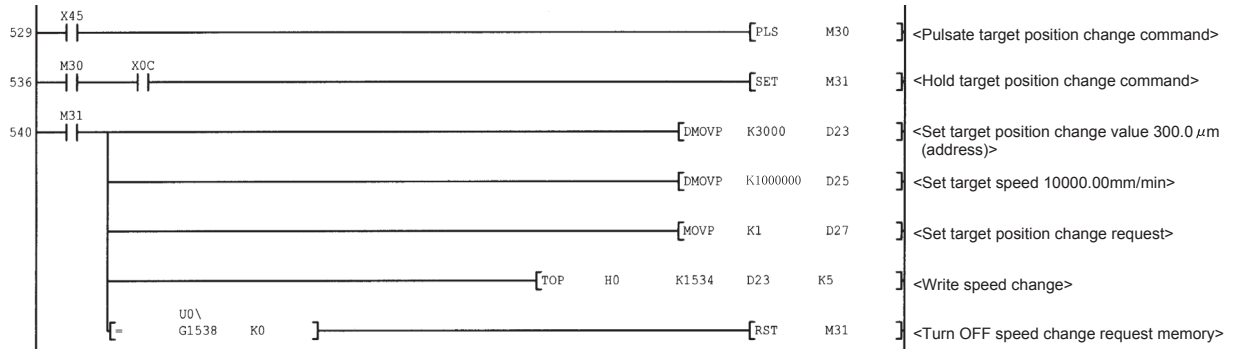

Fig. 12.36 Time chart for target position change from CPU module

(3) The following program is added to the control program, and written to the CPU module.

Example

\*  
 \* No.21 Target position change program  
 \*



12.6 Absolute position restoration function

**⚠ CAUTION**

An absolute position restoration by the positioning function may turn off the servo-on signal (servo off) for approximately 60ms + scan time, and the motor may run unexpectedly. If this causes a problem, provide an electromagnetic brake to lock the motor during absolute position restoration.

The "absolute position restoration function" is a function to restore the absolute position of the designated axis by the absolute position detection system. By this function, the OPR after power OFF such as instantaneous power interruption and emergency stop is not required, and the restoration operation at site can be carried out easily.

The details of the "absolute position restoration function" are described below.

- [1] Configuration and preparation of absolute position detection system
- [2] Outline of absolute position detection data communication
- [3] Absolute position signal transmission procedure
- [4] Control precautions

[1] Configuration and preparation of absolute position detection system

(1) Configuration

The following drawing shows the configuration of the absolute position detection system.

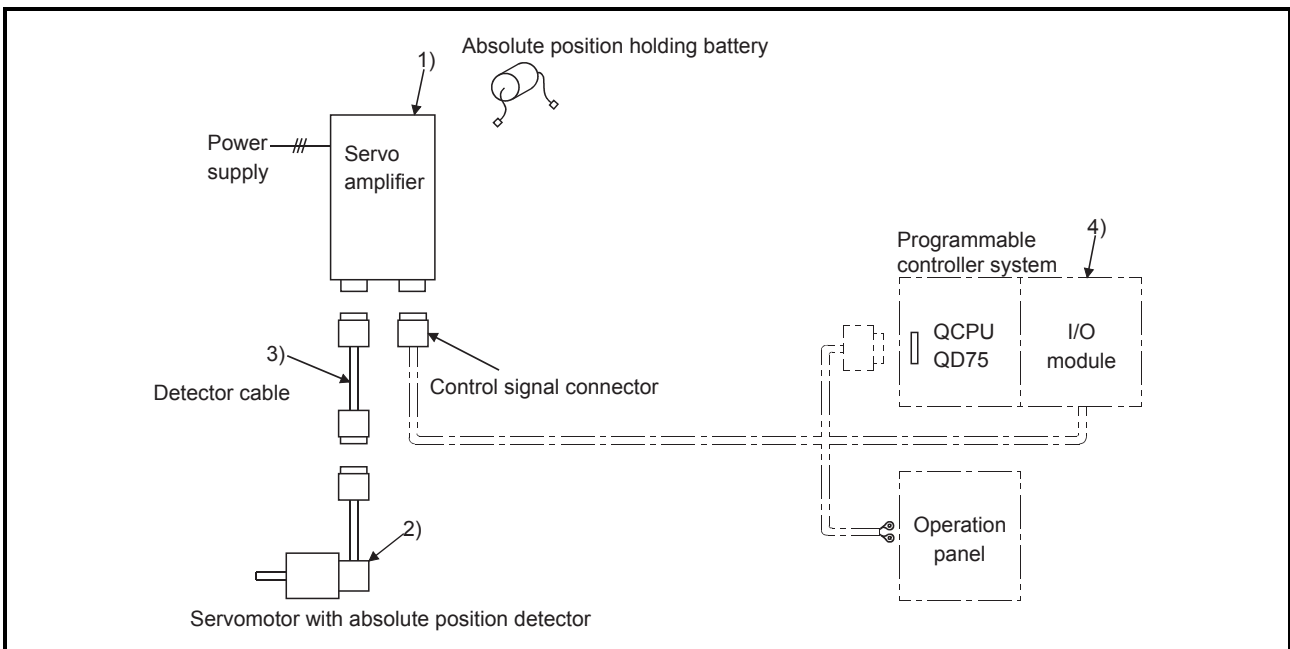

Fig. 12.37 Configuration of absolute position detection system

## (2) Preparation

Prepare the absolute position detection system taking care of the following.

Component	Details
1) Servo amplifier	<ul style="list-style-type: none"> <li>• Use a Mitsubishi General-Purpose AC Servo which has an absolute position detection function (absolute position data transference protocol) equivalent to that of MR-J3-□A).</li> <li>• Install the battery to the servo amplifier.</li> <li>• Validate the absolute position detection function of the servo amplifier.</li> </ul> Refer to the servo amplifier manual for details.
2) Servomotor	<ul style="list-style-type: none"> <li>• Use a servomotor with absolute position detector.</li> </ul> Refer to the servomotor manual for details.
3) Detector cable	<ul style="list-style-type: none"> <li>• Add a battery power connection cable (BAT/LG signal) for wiring the incremental detector cable.</li> </ul> Refer to the cable operation manual for details.
4) Programmable controller system	<ul style="list-style-type: none"> <li>• Carry out the transmission and receiving of the absolute position detection data by the I/O modules (input 3 points/output 3 points).</li> <li>• As input/output modules, use the "16 point input module" and "16 point output module".</li> <li>• Place the 3 points of input signals so that the □ □ is the same among the input number □ □0 to □ □F. The same for the 3 points of output signals.</li> </ul>

[2] Outline of absolute position detection data communication

As shown in Fig. 12.38 System block diagram, the detector comprises an encoder for detecting its position in one rotation in addition to the A, B, Z phase signal for position control in normal operation and a cumulative rotation counter for detecting the number of rotations.

The absolute position detection system detects the absolute position of the machine constantly and stores it with the backup of the battery irrespective of whether the programmable controller system power is turned ON/OFF. Thus, once the OP initial setting is carried out at the time of installation of the machine, the OPR is not required even when the power is later turned ON. The restoration can be carried out easily when an instantaneous power interruption or emergency stop occurs.

In addition, because the absolute position data is backed up by a super condenser built in the detector, the absolute position data will be stored for a specified time even if the cable is disconnected or broken.

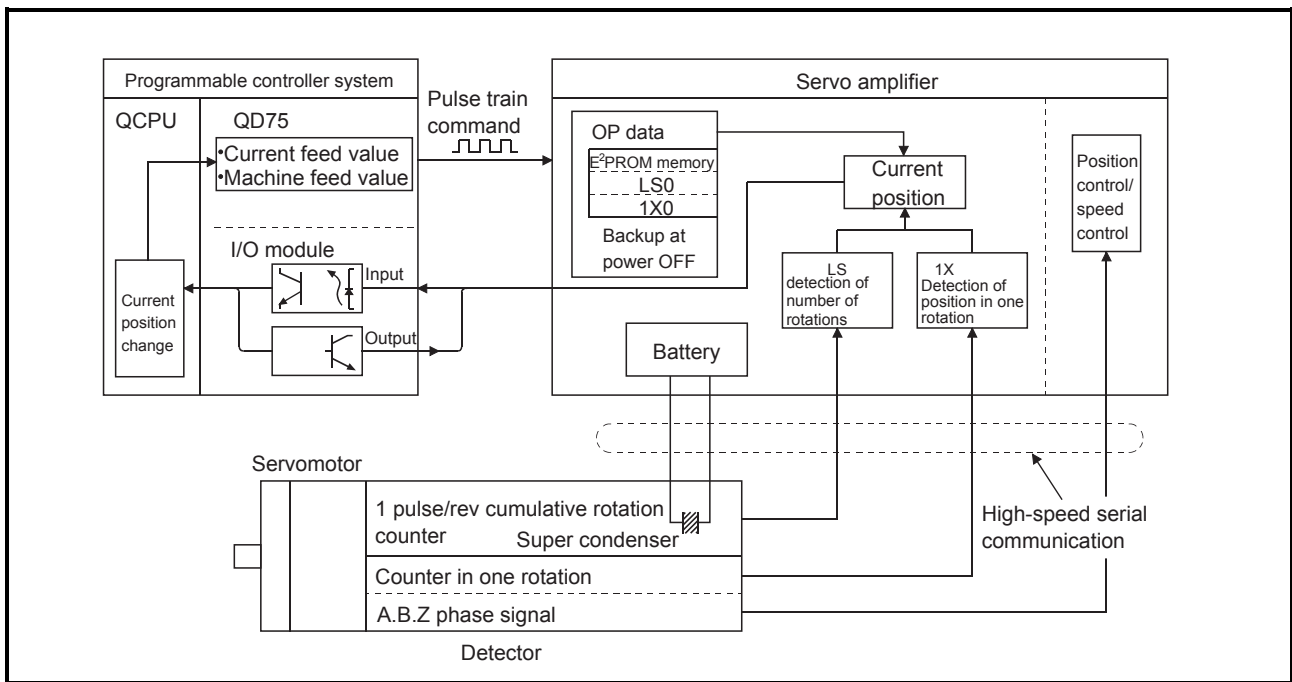

Fig. 12.38 System block diagram



[3] Absolute position signal transmission procedure

(1) Figure 12.39 shows the outline of the absolute position signal transmission procedure between the servo amplifier and the programmable controller system (CPU module, QD75, I/O module).

Refer to the operation manual of the servo amplifier for details on the communication between the servo amplifier and the programmable controller system.

(2) Errors during communication

(a) If the system expires during communication, an error "ABS transmission time" (error code: 213) will occur.

(b) If the transmission data causes a sum error, an error "ABS transmission SUM" (error code: 214) will occur.

\*Refer to Section 15.3 "List of errors" for the remedial method to be taken when an error occurs.

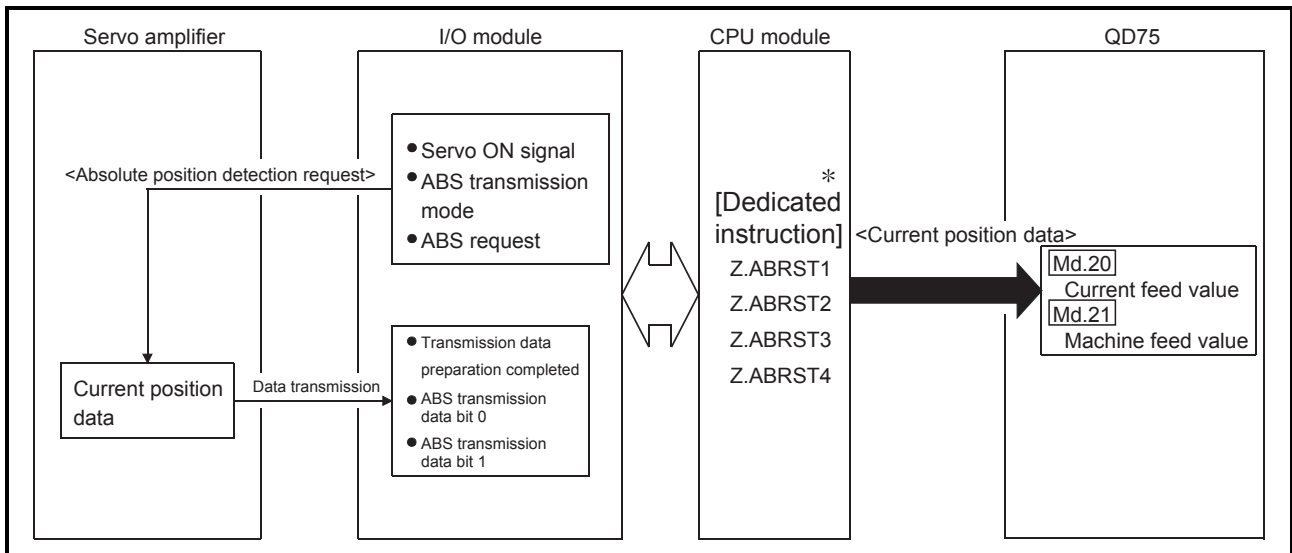
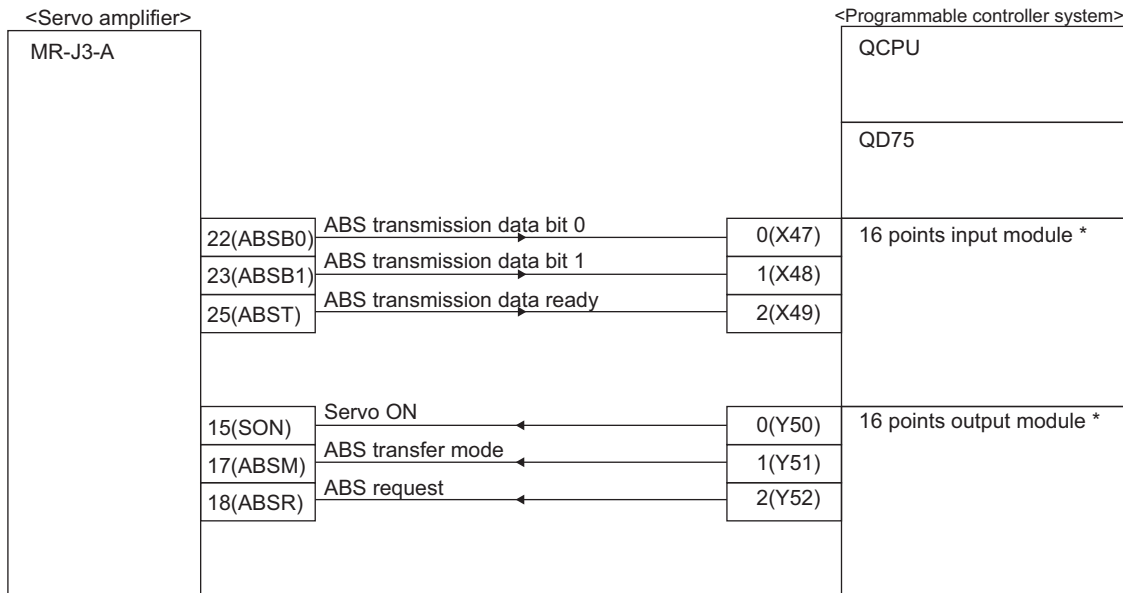

Fig. 12.39 Absolute position signal transmission procedure

\* Refer to CHAPTER 14 "DEDICATED INSTRUCTIONS" for details of the dedicated instructions.

(3) Connection example

The following diagram shows the example of connection between the programmable controller system and the Mitsubishi Electric servo amplifier (MR-J3-A).



\*: The X and Y devices can be set arbitrarily with the program.

Details of servo amplifier connector pins

The following table shows the pins for setting the "absolute position detection system".

Signal name	Abbreviation	Pin No.	Function and application
ABS transfer mode	ABSM	17*	While the ABSM is turned ON, the servo amplifier is in the ABS transfer mode, and the CN1-22 • 23 • 25 functions are as shown in this table.
ABS request	ABSR	18*	The ABSR is turned ON when ABS data is requested in the ABS transfer mode.
ABS transmission data bit 0	ABSB0	22	This indicates the lower order bit among 2 bits of ABS data to be transferred from the servo amplifier to the programmable controller system in the ABS transfer mode. The ABSB0 turns ON when this signal occurs.
ABS transmission data bit 1	ABSB1	23	This indicates the upper order bit among 2 bits of ABS data to be transferred from the servo amplifier to the programmable controller system in the ABS transfer mode. The ABSB1 turns ON when this signal occurs.
ABS Transmission data ready	ABST	25	This indicates the ABS transmission data preparation completed in the ABS transfer mode. When the preparation is completed, the ABST is turned ON.

\* When "use in the absolute position detection system" is selected in the parameter No. PA03, the pin 17 is the ABS transfer mode (ABSM), and the pin 18 is the ABS request (ABSR). The signals do not return to the original signal even after the data transfer is completed.

For details on signals of the pin 17 and 18 when the ABS transfer mode is off and I/O interface, refer to the manual of the servo amplifier (MR-J3-A).

The following drawing shows an operation when data is transferred to the servo amplifier.

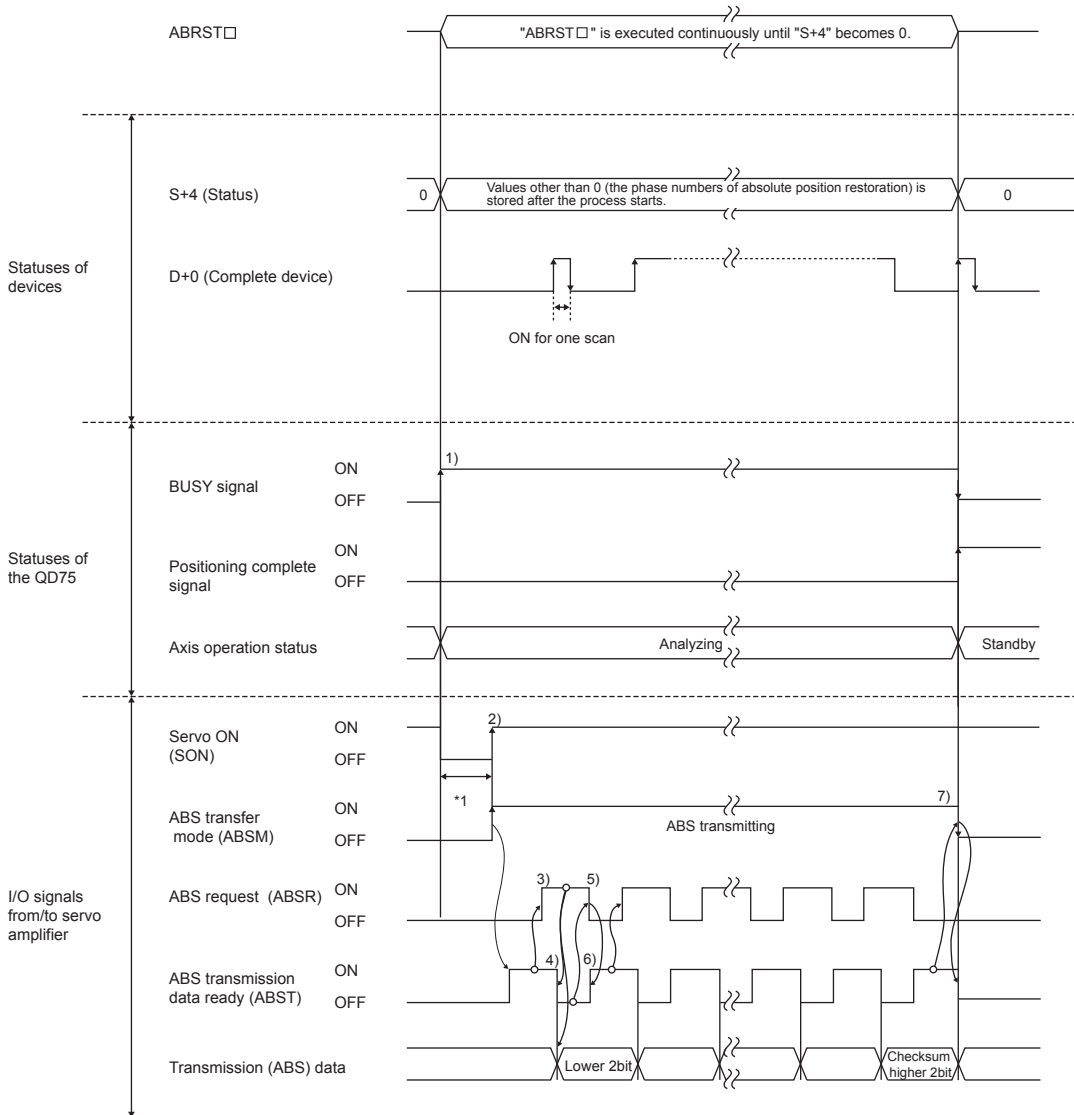

\*1: Approx. 60ms + scan time

Fig. 12.40 Signal state during the absolute position detection

- 1) The BUSY signal is turned ON and the axis operation status is set to "Analyzing" by the dedicated instruction "ABRST□". At this time, the signal is controlled to turn OFF the servo amplifier. The servo is powered OFF in 60ms + scan time.
- 2) When the servo is turned ON, the ABS transfer mode is simultaneously turned ON. After receiving the ABS transfer mode, detecting the absolute position and calculating the absolute position, the servo amplifier will turn ON the ABS transmission data ready (ABST) and answer back to QD75 notifying that the send data is ready.
- 3) After recognizing that the ABS transmission data ready (ABST) turned ON, QD75 turns ON the ABS request (ABSR).

- 4) The servo amplifier outputs the ABS lower 2 bits and ABS transmission data ready (ABST) OFF by the ABS request (ABSR).
- 5) After recognizing that the ABS transmission data ready (ABST) turned OFF (the ABS2bit data is output), QD75 reads the lower 2bits of ABS and turns OFF the ABS request (ABSR).
- 6) The servo amplifier turns ON the ABS transmission data ready (ABST) and prepares for the next transmission. After that, procedures 3) to 6) are repeated until the data corresponding to 32bits and the checksum corresponding to 6bits are sent.
- 7) After the sum check, the QD75 turns OFF the ABS transfer mode (ABSM). If the ABS transfer mode (ABSM) is turned OFF during the data transmission, the ABS transfer mode will be interrupted.

[4] Control precautions

- (1) When an absolute position detection system is constructed, absolute position restoration must be made at least once after power supply on or resetting. Also, the servo amplifier does not switch on unless the absolute position restoration is completed.
- (2) For use of positioning in an absolute position detection system, the following controls cannot be carried out:
  - Limitless-feed control which exercises control only in the fixed direction, e.g. turntable
  - Control where the movement amount from the OP address exceeds the range of the following conditions 1 and 2

When performing positioning in an absolute position detection system, use it in the range which satisfies Conditions 1 and 2 given below.

In the range which does not satisfy Conditions 1 and 2, positioning cannot be used in the absolute position detection system since the normal current value cannot be provided during absolute position restoration.

Condition 1. Number of output pulses

- a) Indicates the number of pulses that may be output to a servo amplifier when an axis is to be positioned from the OP in an absolute position detection system. In the absolute position detection system, pulses within the range of the following expression can be output to the servo amplifier.

$$[-32768 \times (\text{number of feedback pulses})] \leq [\text{number of output pulses}] \leq [32768 \times (\text{number of feedback pulses}) - 1]$$

- b) Pulses are positive in the address increasing direction from the OP, and negative in the address decreasing direction from the OP.

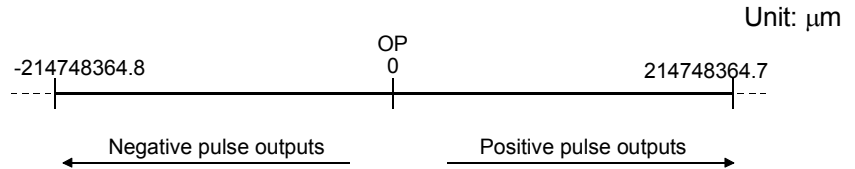

- c) The number of output pulses varies with the number of feedback pulses as indicated below:
  - When the number of feedback pulses is 8192 (pulse):  
-268435456 (pulse) to 268435455 (pulse)
  - When the number of feedback pulses is 16384 (pulse):  
-536870912 (pulse) to 536870911 (pulse)

When the electronic gear of the servo amplifier is used, the electronic gear ratio must be considered. The actual range of the number of output pulses is the value of the range of output pulses above multiplied by the inverse number of the electronic gear ratio.

Condition 2. Positioning address

- a) The following positioning addresses can be specified on the QD75:

- When the unit is mm: -214748364.8 (μm) to 214748364.7 (μm)
- When the unit is inch: -21474.83648 (inch) to 21474.83647 (inch)
- When the unit is pulse: -2147483648 (pulse) to 2147483647 (pulse)
- When the unit is degree: 0° to 359.99999°

[Calculation of positioning address and concept of absolute position detection system]

Use the following expression to calculate the positioning address.

$$\text{(Positioning address)} = \text{(movement amount per pulse)} \times \text{(number of output pulses)} + \text{(OP address)} \dots\dots\dots \text{Expression 1}$$

1. Concept for the unit of mm, inch or pulse

The range which satisfies Conditions 1 and 2 can be used as the positioning address of the absolute position detection system.

The range which does not satisfy Conditions 1 and 2 cannot be used as the positioning address of the absolute position detection system.

The concepts of the positioning addresses in mm, inch and pulse are identical, the following examples provide those of the mm unit.

Example 1.

(1) There are the following conditions to calculate the positioning address:

- Movement amount per pulse: 0.1 (μm)
- OP address: 0.0 (μm)
- Feedback pulses = 8192 (pulse)

(2) Calculate the upper/lower limit values of the positioning address which can be specified from the output pulse count using range in Condition 1 and the positioning address calculation expression (Expression 1).

- Lower limit value of positioning address (the number of negative pulses in Condition 1 is used for calculation)

$$\begin{aligned} \text{(Positioning address)} &= \text{(Movement amount per pulse)} \\ &\quad \times \text{(number of output pulses)} + \text{(OP address)} \\ &= 0.1 \times (-268435456) + 0.0 \\ &= -26843545.6(\mu\text{m}) \end{aligned}$$

- Upper limit value of positioning address (the number of positive pulses in Condition 1 is used for calculation)

$$\begin{aligned} \text{(Positioning address)} &= \text{(Movement amount per pulse)} \\ &\quad \times \text{(number of output pulses)} + \text{(OP address)} \\ &= 0.1 \times (268435456) + 0.0 \\ &= 26843545.5(\mu\text{m}) \end{aligned}$$

(3) The upper/lower limit values of the positioning address calculated are within the range of Condition 2.

Hence, the positioning range [-26843545.6 (μm) to 26843545.5 (μm)] calculated in Condition 1 can be used in the absolute position detection system. Positioning outside of the range -26843545.6 (μm) to 26843545.5 (μm) cannot be used in the absolute position detection system.

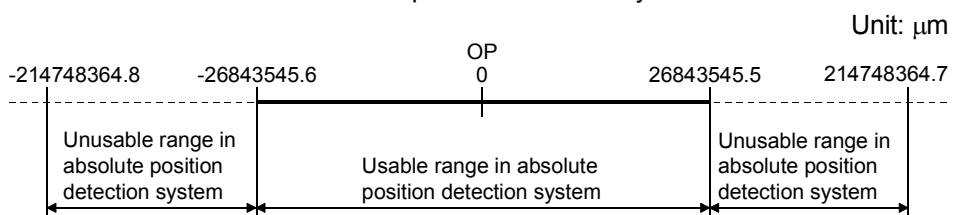

## Example 2.

(1) Using Expression 1, calculate the positioning address which can be specified in the system where the OP address in Example 1 is 214740000.0 (μm).

- Lower limit value of positioning address

$$\begin{aligned} \text{(Positioning address)} &= 0.1 \times (-268435456) + 214740000.0 \\ &= 187896454.4 \text{ (}\mu\text{m)} \end{aligned}$$

- Upper limit value of positioning address

$$\begin{aligned} \text{(Positioning address)} &= 0.1 \times 268435455 + 214740000.0 \\ &= 241583545.5 \text{ (}\mu\text{m)} \end{aligned}$$

(2) Since the lower limit value of the positioning address calculated is within the range of Condition 2, the calculated address 187896454.4 (μm) is the lower limit for positioning in the absolute position detection system.

Since the upper limit of the positioning address calculated is outside of the range of Condition 2, the upper limit value 214748364.7 (μm) is the upper limit for positioning in the absolute position detection system.

In the absolute position detection system, use the positioning address within the range 187896454.4 (μm) to 214748364.7 (μm).

Positioning in excess of 187896454.4 (μm) cannot be used in the absolute position detection system.

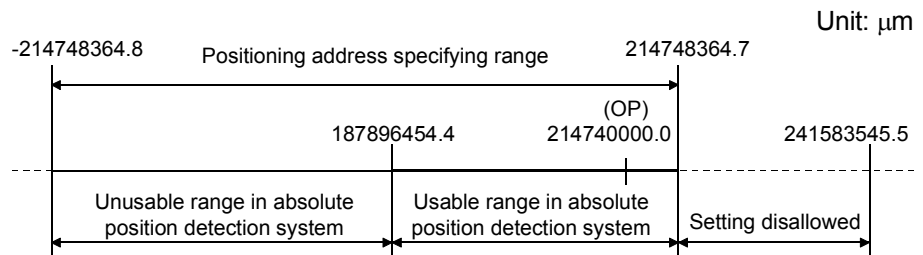

## Example 3.

(1) There are the following conditions to calculate the positioning address:

- Movement amount per pulse: 0.9 (μm)
- OP address: 0.0 (μm)
- Feedback pulses = 8192 (pulse)

(2) Calculate the positioning address from the output pulse count using range in Condition 1 and the positioning address calculation expression (Expression 1).

- Lower limit value of positioning address (the number of negative pulses in Condition 1 is used for calculation)

$$\begin{aligned} \text{(Positioning address)} &= (\text{Movement amount per pulse}) \\ &\quad \times (\text{number of output pulses}) + (\text{OP address}) \\ &= 0.9 \times (-268435456) + 0.0 \\ &= -241591910.4 \text{ (}\mu\text{m)} \end{aligned}$$

- Upper limit value of positioning address (the number of positive pulses in Condition 1 is used for calculation)

$$\begin{aligned} \text{(Positioning address)} &= (\text{Movement amount per pulse}) \\ &\quad \times (\text{number of output pulses}) + (\text{OP address}) \\ &= 0.9 \times 268435455 + 0.0 \\ &= 241591909.5 \text{ (}\mu\text{m)} \end{aligned}$$

(3) Since the upper/lower limit values of the positioning address calculated are outside of the range of Condition 2, use the positioning address within the positioning range of Condition 2 (-214748364.8(μm) to 214748364.7(μm)).

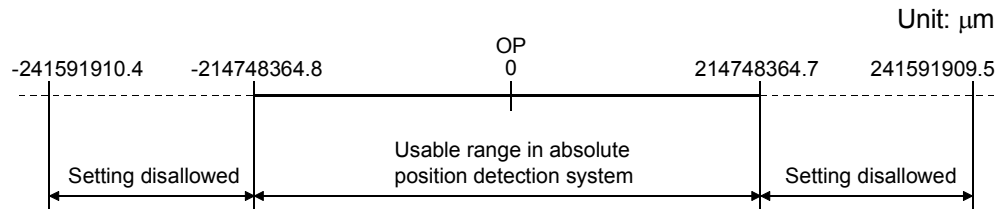

2. Concept for the unit of degree

- The positioning address is within the range 0° to 359.99999° at the position to which a machine OPR was made. When the OP position is not 0°, the range is also 0° to 359.99999°.
- For positioning in the same direction, control from maximum to minimum (for address increase: 359.99999° to 0°/for address decrease: 0° to 359.99999°) cannot be exercised. (See below)

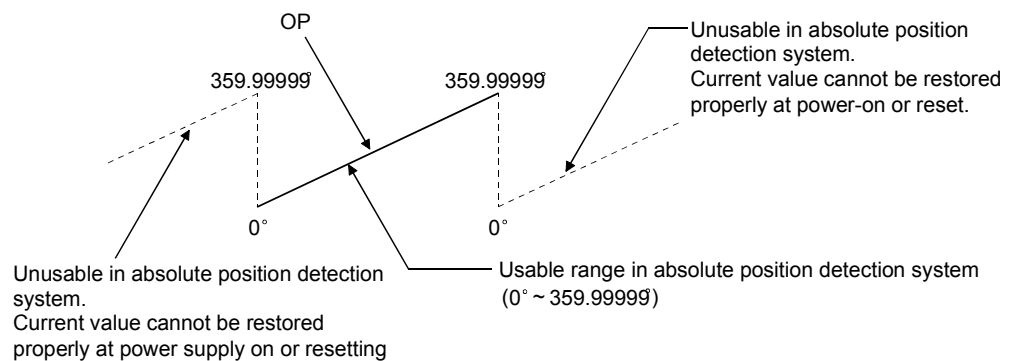

- When positioning is to be used in the absolute position detection system, set the upper/lower limit values of the software stroke limit within the range 0° to 359.99999°.



## 12.7 Other functions

Other functions include the "step function", "skip function", "M code output function", "teaching function", "command in-position function", "acceleration/deceleration processing function", "pre-reading start function", "deceleration start flag function" and "stop command processing for deceleration stop function". Each function is executed by parameter setting or sequence program creation and writing.

### 12.7.1 Step function

The "step function" is used to confirm each operation of the positioning control one by one.

It is used in debugging work for major positioning control, etc.

A positioning operation in which a "step function" is used is called a "step operation". In step operations, the timing for stopping the control can be set. (This is called the "step mode".) Control stopped by a step operation can be continued by setting "step continue" (to continue the control)" in the "step start information".

The details shown below explain about the "step function".

- [1] Relation between the step function and various controls
- [2] Step mode
- [3] Step start information
- [4] Using the step operation
- [5] Control details
- [6] Control precautions
- [7] Setting method

#### [1] Relation between the step function and various controls

The following table shows the relation between the "step function" and various controls.

Control type		Step function	Step applicability
OPR control	Machine OPR control	×	Step operation not possible
	Fast OPR control	×	
Major positioning control	Position control	1-axis linear control	○
		2- to 4-axis linear interpolation control	○
		1-axis fixed-feed control	○
		2- to 4-axis fixed-feed control (interpolation)	○
		2-axis circular interpolation control	○
		3-axis helical interpolation control	○
	1- to 4-axis Speed control	×	Step operation not possible
	Speed-position switching control Position-speed switching control	○	Step operation possible
Other control	Current value changing	○	Step operation not possible
	JUMP instruction, NOP instruction, LOOP to LEND	×	
Manual control	JOG operation, Inching operation	×	Step operation not possible
	Manual pulse generator operation	×	

○ : Set when required. × : Setting not possible

[2] Step mode

In step operations, the timing for stopping the control can be set. This is called the "step mode". (The "step mode" is set in the control data " [Cd.34](#) Step mode".)

The following shows the two types of "step mode" functions.

(1) Deceleration unit step

The operation stops at positioning data requiring automatic deceleration. (A normal operation will be carried out until the positioning data requiring automatic deceleration is found. Once found, that positioning data will be executed, and the operation will then automatically decelerate and stop.)

(2) Data No. unit step

The operation automatically decelerates and stops for each positioning data. (Even in continuous path control, an automatic deceleration and stop will be forcibly carried out.)

[3] Step start information

Control stopped by a step operation can be continued by setting "step continue" (to continue the control) in the "step start information". (The "step start information" is set in the control data " [Cd.36](#) Step start information".)

The following table shows the results of starts using the "step start information" during step operation.

Stop status in the step operation	<a href="#">Md.26</a> Axis operation status	<a href="#">Cd.36</a> Step start information	Step start results
1 step of positioning stopped normally	Step standby	1: Step continue	The next positioning data is executed.

The warnings "Step not possible" (warning code: 511) will occur and the step operation will not be continued if the " [Md.26](#) Axis operation status" is other than "Step standby" or the step valid flag is OFF when step start information is set.

[4] Using the step operation

The following shows the procedure for checking positioning data using the step operation.

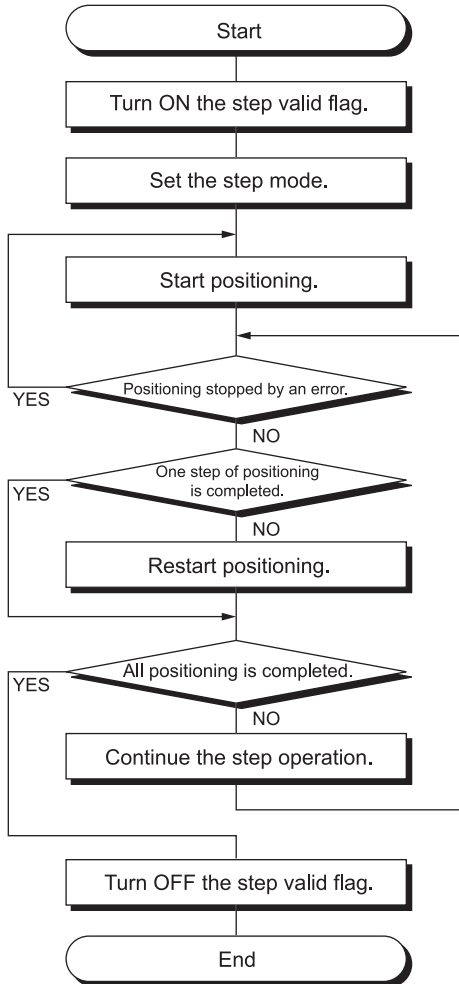

Write "1" (carry out step operation) in "[Cd.35]Step valid flag".

Set in "[Cd.34]Step mode".

Write "1" (restart) to "[Cd.6]Restart command" and check whether the positioning data operates normally.

Write "1" (step continue) to "[Cd36]Step start information", and check whether the next positioning data operates normally.

Write "0" (carry out no step operation) in "[Cd.35]Step valid flag".

[5] Control details

(1) The following drawing shows a step operation during a "deceleration unit step".

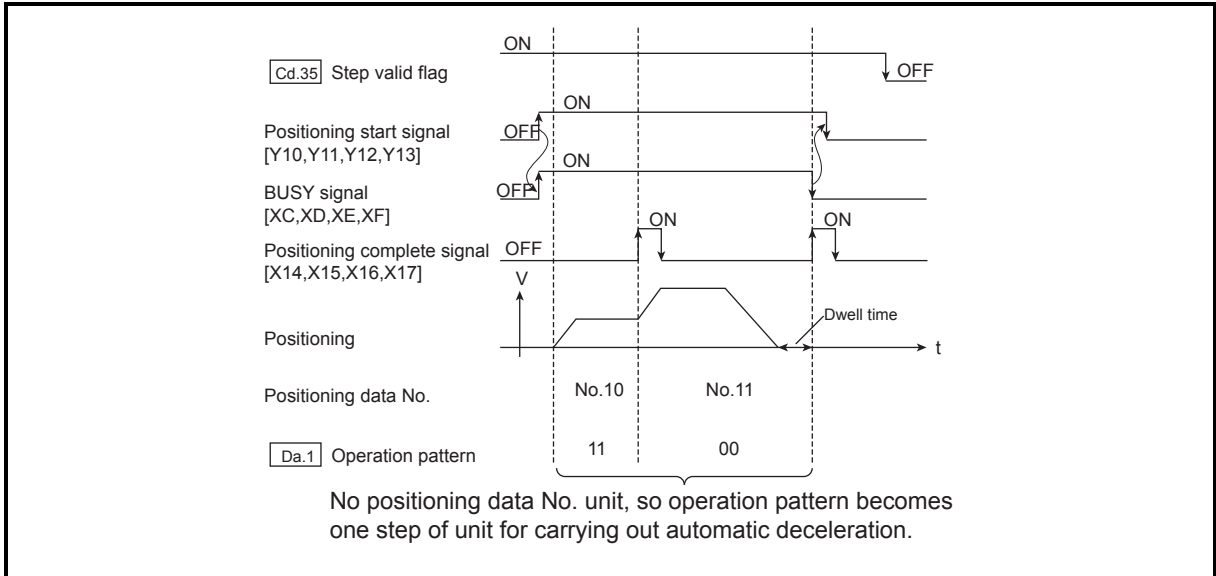

Fig. 12.41 Operation during step execution by deceleration unit step

(2) The following drawing shows a step operation during a "data No. unit step".

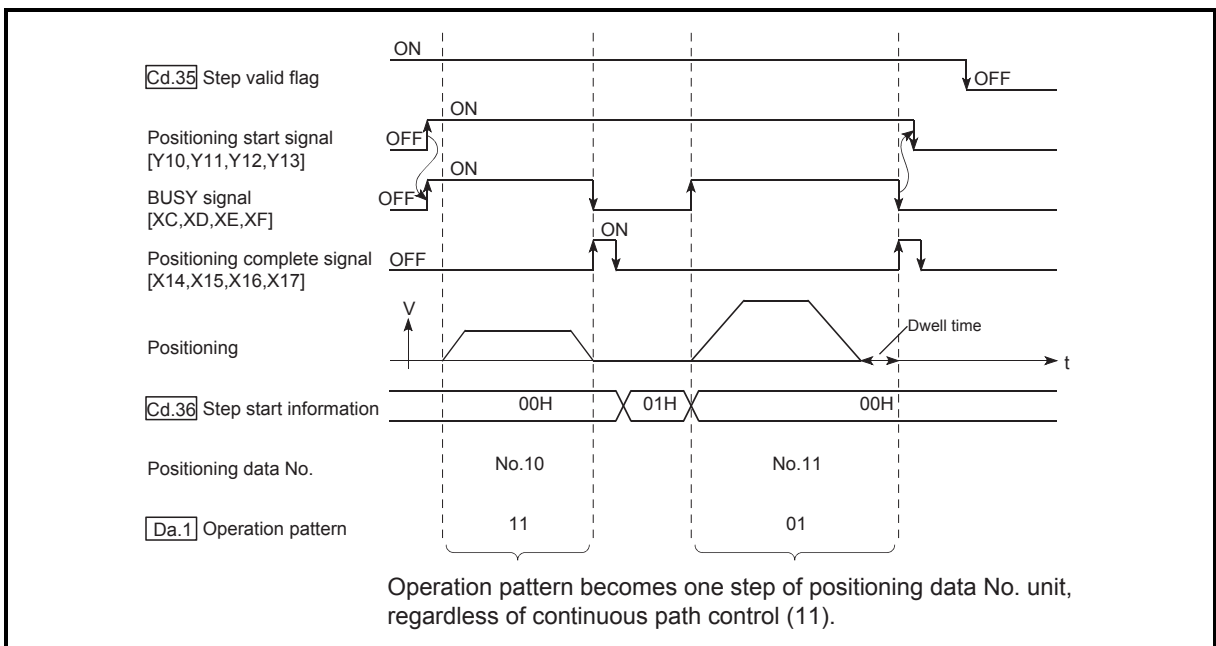

Fig. 12.42 Operation during step execution positioning data No. unit step

**[6] Control precautions**

- (1) When step operation is carried out using interpolation control positioning data, the step function settings are carried out for the reference axis.
- (2) When the step valid flag is ON, the step operation will start from the beginning if the positioning start signal is turned ON while " Md.26 Axis operation status" is "Step standby". (The step operation will be carried out from the positioning data set in " Cd.3 Positioning start No.".)

**[7] Setting method**

To use the "step function", write the data shown in the following table to the QD75 using the sequence program. Refer to section [4] "Using the step operation" for the timing of the settings.

The set details are validated when written to the QD75.

Setting item		Setting value	Setting details	Buffer memory address			
				Axis 1	Axis 2	Axis 3	Axis 4
<span style="border: 1px solid black; padding: 0 2px;">Cd.34</span>	Step mode	→	Set "0: Deceleration unit step" or "1: Data No. unit step".	1544	1644	1744	1844
<span style="border: 1px solid black; padding: 0 2px;">Cd.35</span>	Step valid flag	1	Set "1: Carry out step operation".	1545	1645	1745	1845
<span style="border: 1px solid black; padding: 0 2px;">Cd.36</span>	Step start information	→	Set "1: Step continue", depending on the stop status.	1546	1646	1746	1846

\* Refer to Section 5.7 "List of control data" for details on the setting details.

## 12.7.2 Skip function

The "skip function" is used to stop (deceleration stop) the control of the positioning data being executed at the time of the skip signal input, and execute the next positioning data.

A skip is executed by a skip command ([Cd.37](#) Skip command) or external command signal.

The "skip function" can be used during control in which positioning data is used.

The details shown below explain about the "skip function".

[1] Control details

[2] Control precautions

[3] Setting the skip function from the CPU module

[4] Setting the skip function using an external command signal

### [1] Control details

The following drawing shows the skip function operation.

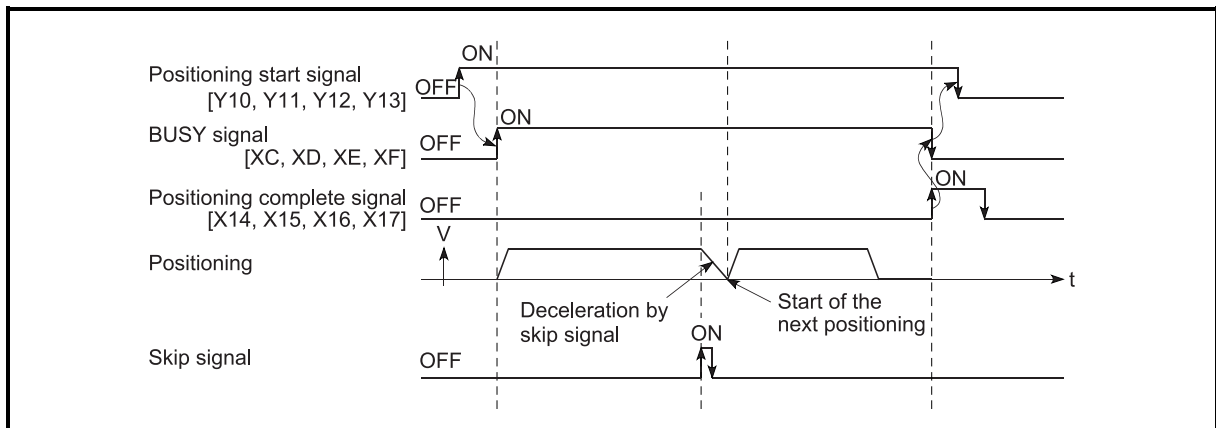

Fig. 12.43 Operation when a skip signal is input during positioning control

### [2] Control precautions

- (1) If the skip signal is turned ON at the last of an operation, a deceleration stop will occur and the operation will be terminated.
- (2) When a control is skipped (when the skip signal is turned ON during a control), the positioning complete signals (X14, X15, X16, X17) will not turn ON.
- (3) When the skip signal is turned ON during the dwell time, the remaining dwell time will be ignored, and the next positioning data will be executed.
- (4) When a control is skipped during interpolation control, the reference axis skip signal is turned ON. When the reference axis skip signal is turned ON, a deceleration stop will be carried out for every axis, and the next reference axis positioning data will be executed.
- (5) The M code ON signals (X4, X5, X6, X7) will not turn ON when the M code output is set to the AFTER mode (when "1: AFTER mode" is set in "[Pr.18](#) M code ON signal output timing").  
(In this case, the M code will not be stored in "[Md.25](#) Valid M code".)
- (6) The skip cannot be carried out by the speed control and position-speed switching control.
- (7) If the skip signal is turned ON with the M code signal turned ON, the transition to the next data is not carried out until the M code signal is turned OFF.







12.7.3 M code output function

The "M code output function" is used to command sub work (clamping, drill rotation, tool replacement, etc.) related to the positioning data being executed. When the M code ON signal (X4, X5, X6, X7) is turned ON during positioning execution, a No. called the M code is stored in " [Md.25] Valid M code". These " [Md.25] Valid M code" are read from the CPU module, and used to command auxiliary work. M codes can be set for each positioning data. (Set in setting item " [Da.10] M code" of the positioning data.) The timing for outputting (storing) the M codes can also be set in the "M code output function".

The details shown below explain about the "M code output function".

- [1] M code ON signal output timing
- [2] M code OFF request
- [3] Control precautions
- [4] Setting method
- [5] Reading M codes

[1] M code ON signal output timing

The timing for outputting (storing) the M codes can be set in the "M code output function". (The M code is stored in " [Md.25] Valid M code" when the M code ON signal is turned ON.)

The following shows the two types of timing for outputting M codes: the "WITH" mode and the "AFTER" mode.

(1) WITH mode

The M code ON signal (X4, X5, X6, X7) is turned ON at the positioning start, and the M code is stored in " [Md.25] Valid M code".

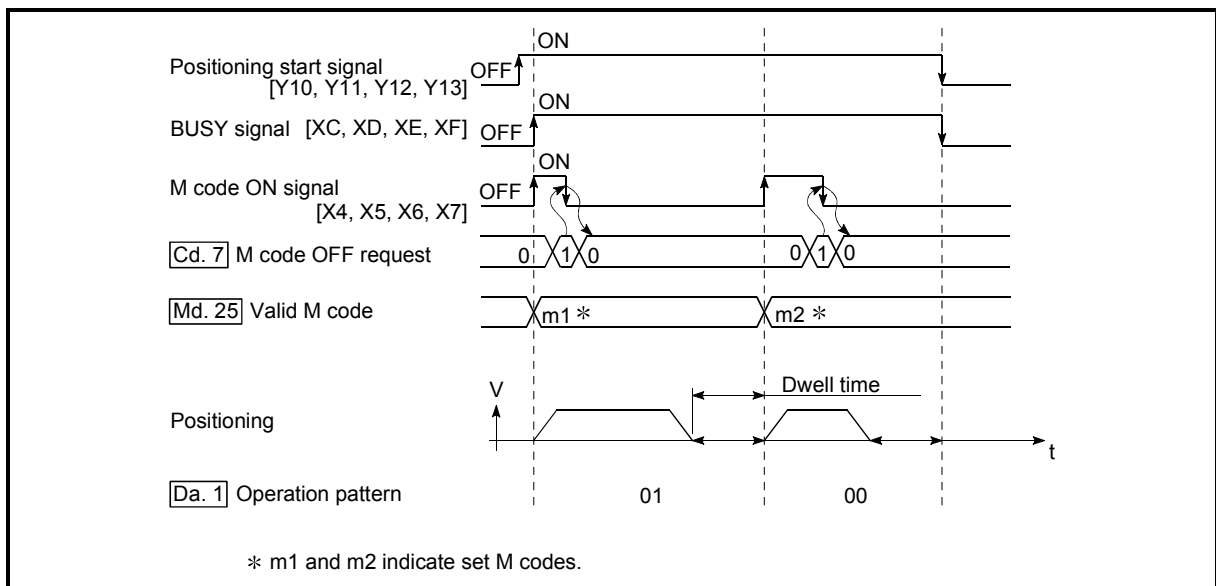

Fig. 12.44 M code ON/OFF timing (WITH mode)

(2) AFTER mode

The M code ON signal (X4, X5, X6, X7) is turned ON at the positioning completion, and the M code is stored in " **[Md.25]** Valid M code".

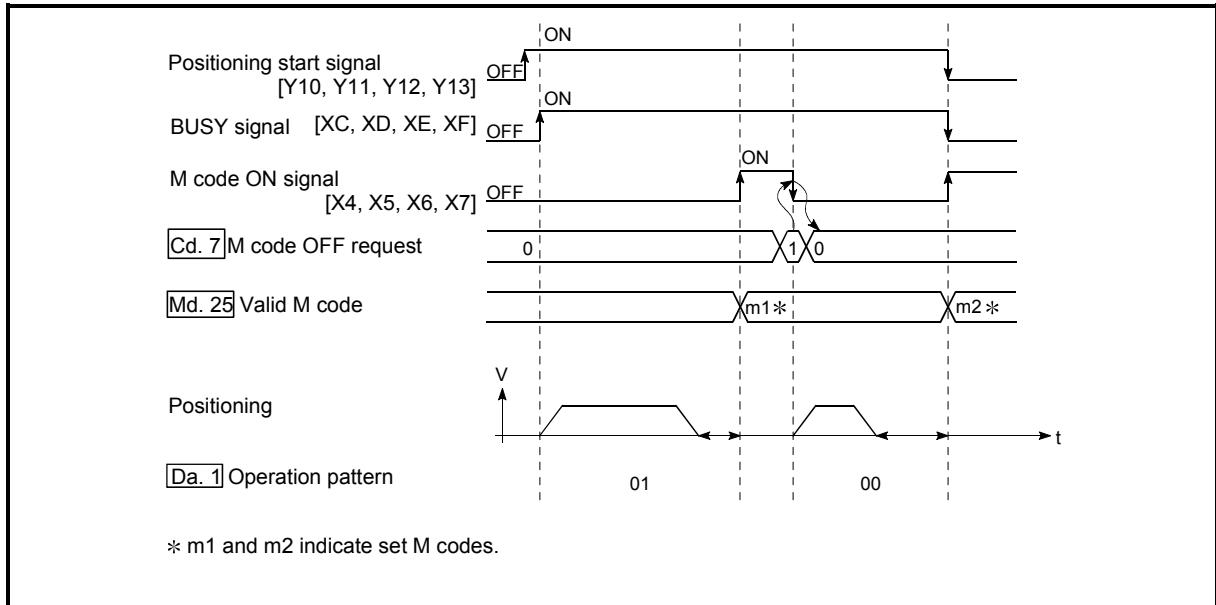

Fig. 12.45 M code ON/OFF timing (AFTER mode)

[2] M code OFF request

When the M code ON signal (X4, X5, X6, X7) is ON, it must be turned OFF by the sequence program.

To turn OFF the M code ON signal, set "1" (turn OFF the M code signal) in " **[Cd.7]** M code OFF request".

Setting item	Setting value	Setting details	Buffer memory address			
			Axis 1	Axis 2	Axis 3	Axis 4
<b>[Cd.7]</b> M code OFF request	1	Set "1": Turn OFF the M code ON signal".	1504	1604	1704	1804

\* Refer to Section 5.7 "List of control data" for details on the setting details.

The next positioning data will be processed as follows if the M code ON signal is not turned OFF. (The processing differs according to the " **[Da.1]** Operation pattern".)

<b>[Da.1]</b> Operation pattern	Processing
00 Independent positioning control (Positioning complete)	The next positioning data will not be executed until the M code ON signal is turned OFF.
01 Continuous positioning control	
11 Continuous path control	The next positioning data will be executed. If the M code is set to the next positioning data, a warning "M code ON signal ON start" (warning code: 503) will occur. (Refer to Fig. 12.46.)

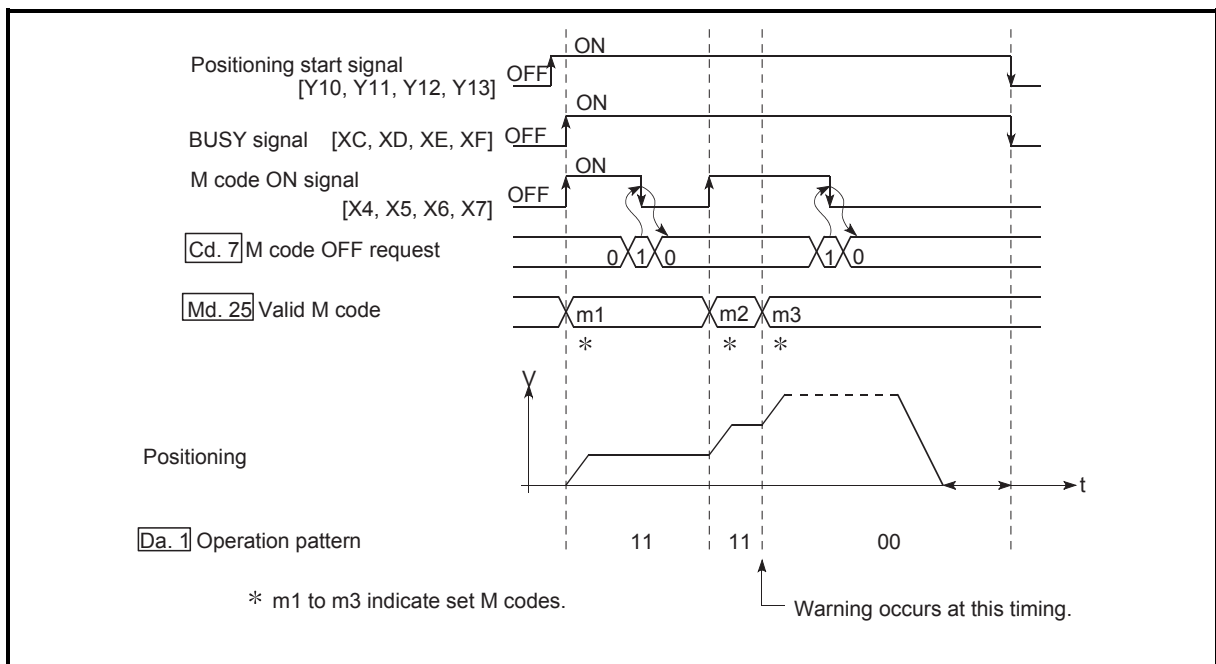

Fig. 12.46 Warning due to an M code ON signal during continuous path control

**POINT**

If the M code output function is not required, set a "0" in setting item " Da.10 M code" of the positioning data.

**[3] Control precautions**

- (1) During interpolation control, the reference axis M code ON signal is turned ON.
- (2) The M code ON signal will not turn ON if "0" is set in " Da.10 M code". (The M code will not be output, and the previously output value will be held in " Md.25 Valid M code".)
- (3) If the M code ON signal is ON at the positioning start, an error "M code ON signal start" (error code: 536) will occur, and the positioning will not start.
- (4) If the PLC READY signal (Y0) is turned OFF, the M code ON signal will turn OFF and "0" will be stored in " Md.25 Valid M code".
- (5) If the positioning operation time is short during continuous path control, there will not be enough time to turn OFF the M code ON signal, and a warning "M code ON signal ON" (warning code: 503) may occur. In this case, set a "0" in the " Da.10 M code" of that section's positioning data.
- (6) In the AFTER mode during speed control, the M code is not output and the M code ON signal does not turn ON.
- (7) If current value changing where "9003" has been set to " Cd.3 Positioning start No." is performed, the M code output function is made invalid.

[4] Setting method

The following shows the settings to use the "M code output function".

- (1) To specify the M code ON signal output timing for each positioning data  
Use "[Da.27] M code ON signal output timing".

The following shows the settings to use "[Da.27] M code ON signal output timing".

- Set the M code No. in the positioning data "[Da.10] M code".
- Set the timing to output the M code ON signal [X4, X5, X6, X7] in the positioning data "[Da.27] M code ON signal output timing".

- (2) To set the same M code ON signal output timing for all positioning data  
Setting "[Pr.18] M code ON signal output timing" enables batch specification of M code ON signal output timing for each positioning data. Set 0 in "[Da.27] M code ON signal output timing" when using "[Pr.18] M code ON signal output timing". When a value other than 0 is set, "[Da.27] M code ON signal output timing" will be valid. (The setting in "[Pr.18] M code ON signal output timing" becomes valid on the rising edge (OFF to ON) of the PLC READY signal [Y0].)

The following shows the settings to use "[Pr.18] M code ON signal output timing".

- Set the M code No. in the positioning data "[Da.10] M code".
- Set "0: Use the set value in "[Pr.18] M code ON signal output timing"." (initial value) in the positioning data "[Da.27] M code ON signal output timing".
- Set the timing to output the M code ON signal [X4, X5, X6, X7] in the detailed parameter "[Pr.18] M code ON signal output timing".

Setting item		Setting value	Setting details	Buffer memory address			
				Axis 1	Axis 2	Axis 3	Axis 4
[Pr.18]	M code ON signal output timing	→	Set the timing to output the M code ON signal. 0: WITH mode 1: AFTER mode	27	177	327	477
[Da.27]	M code ON signal output timing	→	Set the M code ON signal output timing for each positioning data. 0: Use the set value in "[Pr.18] M code ON signal output timing". 1: WITH mode 2: AFTER mode	2003 + N*1 (b0 to b1)	8003 + N*1 (b0 to b1)	14003 + N*1 (b0 to b1)	20003 + N*1 (b0 to b1)

\* 1 N indicates the offset address of each positioning data.

$$N = ((\text{Positioning data No.}) - 1) \times 10$$

\* Refer to Section 5.2 "List of parameters" for the information on detail settings.

[5] Reading M codes

"M codes" are stored in the following buffer memory when the M code ON signal turns ON.

Monitor item	Monitor value	Storage details	Buffer memory address			
			Axis 1	Axis 2	Axis 3	Axis 4
Md.25	Valid M code	→	The M code No. (Da.10 M code) set in the positioning data is stored.			
			808	908	1008	1108

\* Refer to Section 5.6 "List of monitor data" for information on the storage details.

The following shows a sequence program example for reading the "Md.25 Valid M code" to the CPU module data register (D110). (The read value is used to command the sub work.)

Read M codes not as "rising edge commands", but as "ON execution commands".

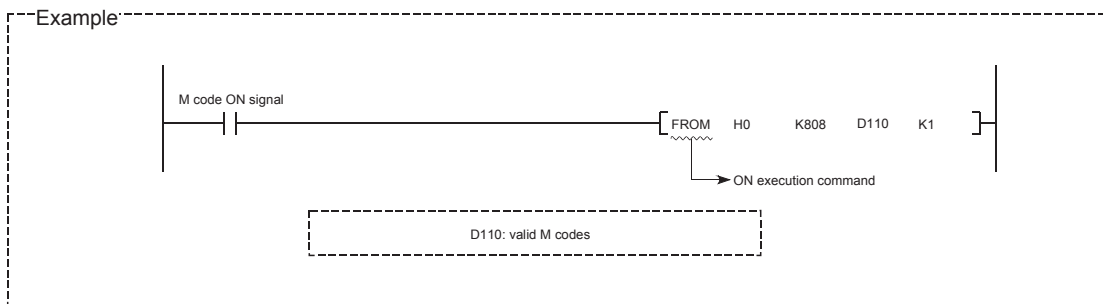

### 12.7.4 Teaching function

The "teaching function" is used to set addresses aligned using the manual control (JOG operation, inching operation, and manual pulse generator operation) in the positioning data addresses (" [Da.6] Positioning address/movement amount", " [Da.7] Arc address").

The details shown below explain about the "teaching function".

- [1] Control details
- [2] Control precautions
- [3] Data used in teaching
- [4] Teaching procedure
- [5] Teaching program example

#### [1] Control details

##### (1) Teaching timing

Teaching is executed using the sequence program when the BUSY signal (XC, XD, XE, XF) is OFF. (During manual control, teaching can be carried out as long as the axis is not BUSY, even when an error or warning has occurred.)

##### (2) Addresses for which teaching is possible

The addresses for which teaching is possible are "current feed values" ([Md.20] Current feed value) having the OP as a reference. The settings of the "movement amount" used in incremental system positioning cannot be used. In the teaching function, these "current feed values" are set in the " [Da.6] Positioning address/movement amount" or " [Da.7] Arc address".

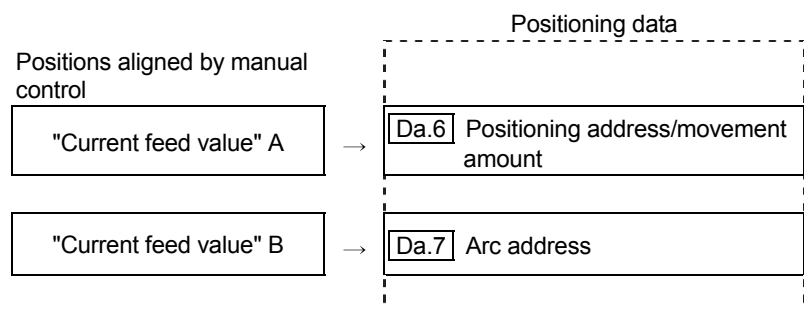

##### (3) Dedicated instructions "ZP.TEACH 1, ZP.TEACH 2, ZP.TEACH 3, ZP.TEACH 4, ZP.PFWRT"

When the dedicated instructions "ZP.TEACH 1, ZP.TEACH 2, ZP.TEACH 3, ZP.TEACH 4, ZP.PFWRT" are used to execute the teaching function, the programming becomes easier. Refer to CHAPTER 14 "DEDICATED INSTRUCTIONS" for details.

[2] Control precautions

- (1) Before teaching, a "machine OPR" must be carried out to establish the OP. (When a current value changing, etc., is carried out, " [Md.20] Current feed value" may not show absolute addresses having the OP as a reference.)
- (2) Teaching cannot be carried out for positions to which movement cannot be executed by manual control (positions to which the workpiece cannot physically move). (During center point designation circular interpolation control, etc., teaching of " [Da.7] Arc address" cannot be carried out if the center point of the arc is not within the moveable range of the workpiece.)
- (3) Writing to the flash ROM can be executed up to 100,000 times. If writing to the flash ROM exceeds 100,000 times, the writing may become impossible (assured value is up to 100,000 times). If the error "Flash ROM write number error" (error code: 805) occurs when writing to the flash ROM has been completed, check whether or not the program is created so as to write continuously to the flash ROM.

[3] Data used in teaching

The following control data is used in teaching.

Setting item	Setting value	Setting details	Buffer memory address			
			Axis 1	Axis 2	Axis 3	Axis 4
[Cd.1] Flash ROM write request	1	Write the set details to the flash ROM (backup the changed data).	1900			
[Cd.38] Teaching data selection	→	Sets to which "current feed value" is written. 0: Written to " [Da.6] Positioning address/movement amount". 1: Written to " [Da.7] Arc address".	1548	1648	1748	1848
[Cd.39] Teaching positioning data No.	→	Designates the data to be taught. (Teaching is carried out when the setting value is 1 to 600.) When teaching has been completed, this data is cleared to zero.	1549	1649	1749	1849

\* Refer to Section 5.7 "List of control data" for details on the setting details.

[4] Teaching procedure

The following shows the procedure for a teaching operation.

- (1) When teaching to the " [Da.6] Positioning address/movement amount"  
(Teaching example on axis 1)

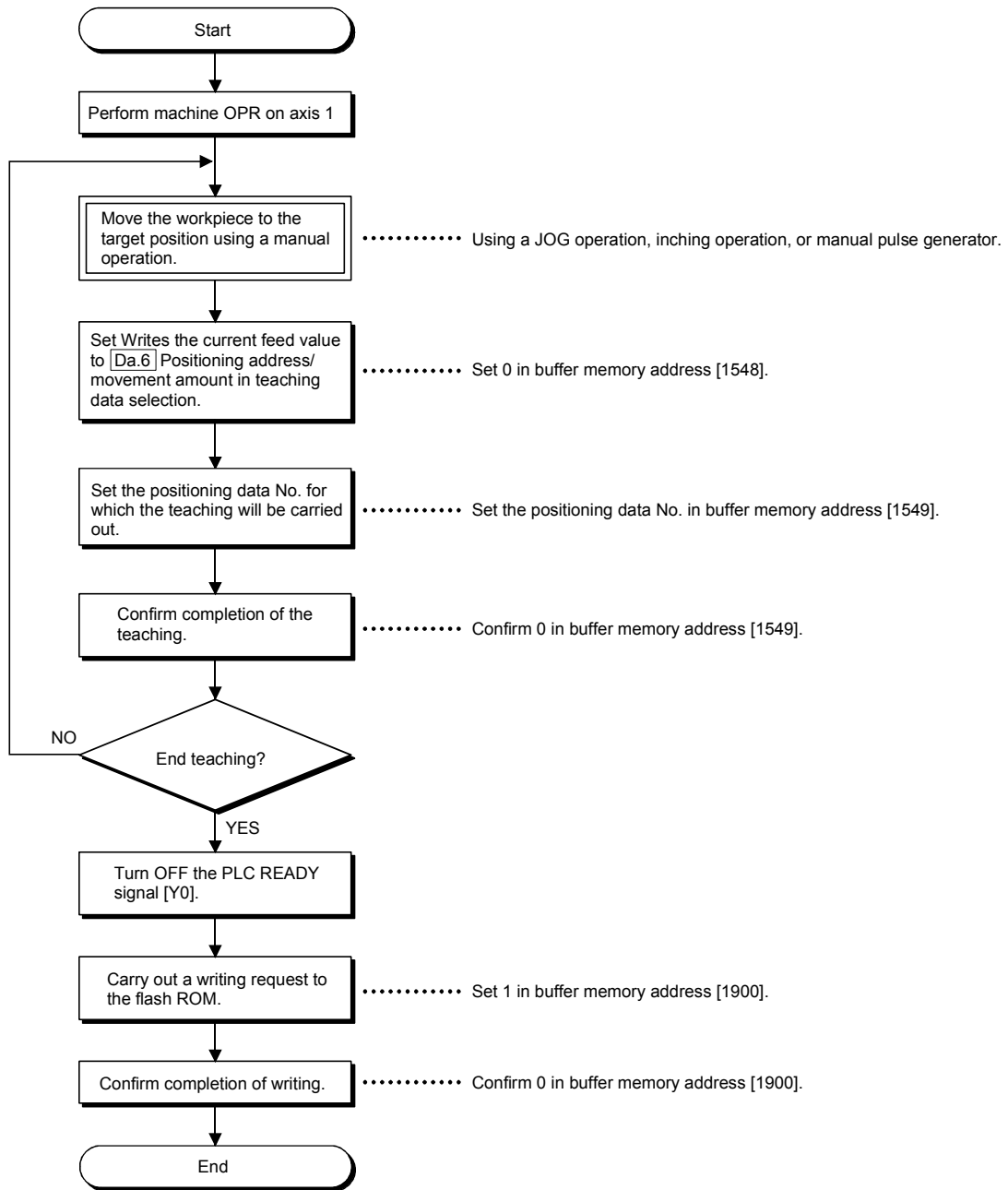



(2) When entering teaching data into " [Da.7] Arc address" and then into " [Da.6] Positioning address/movement amount" (Teaching example for 2-axis circular interpolation control with sub point designation on axes 1 and 2)

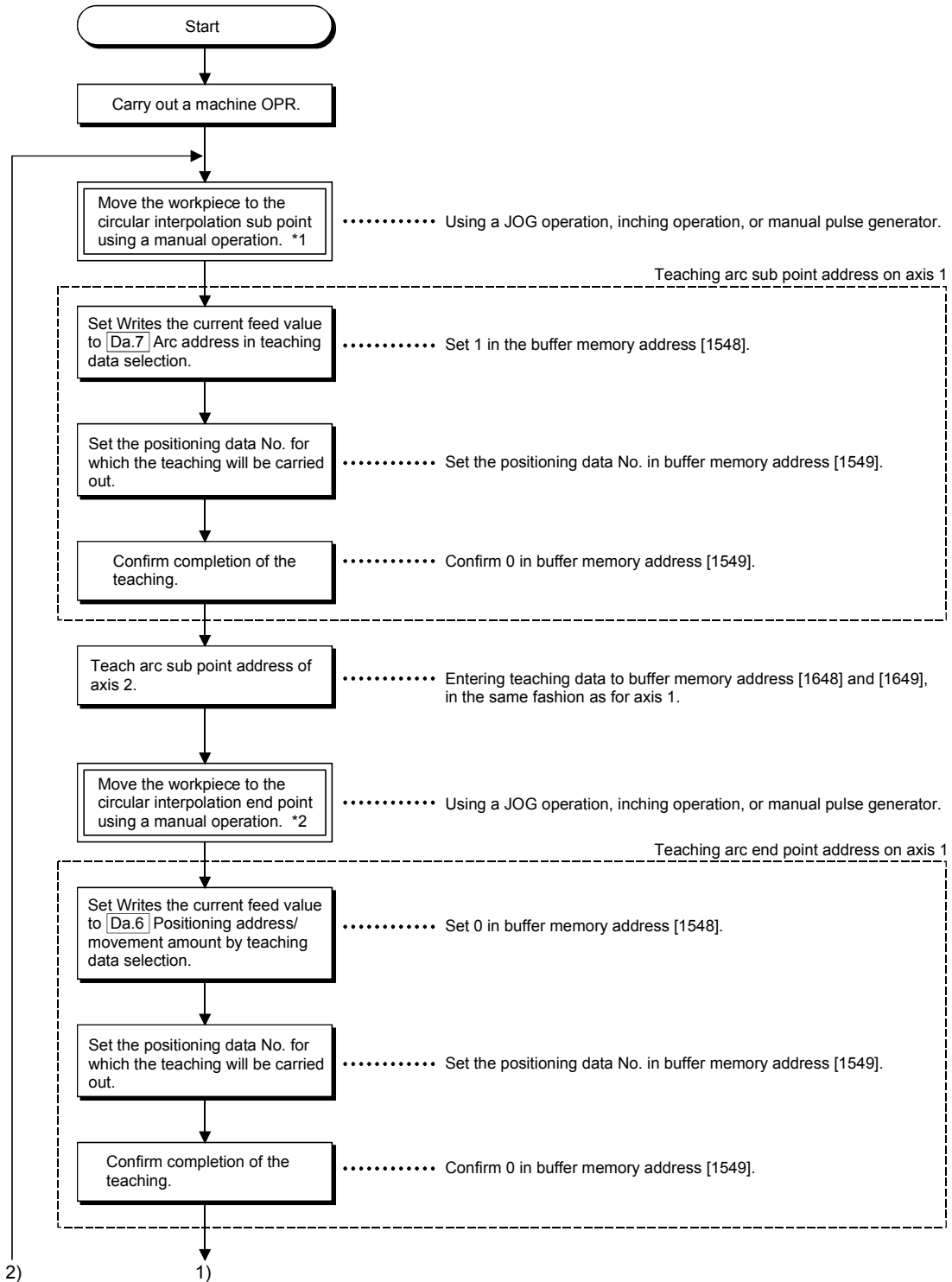

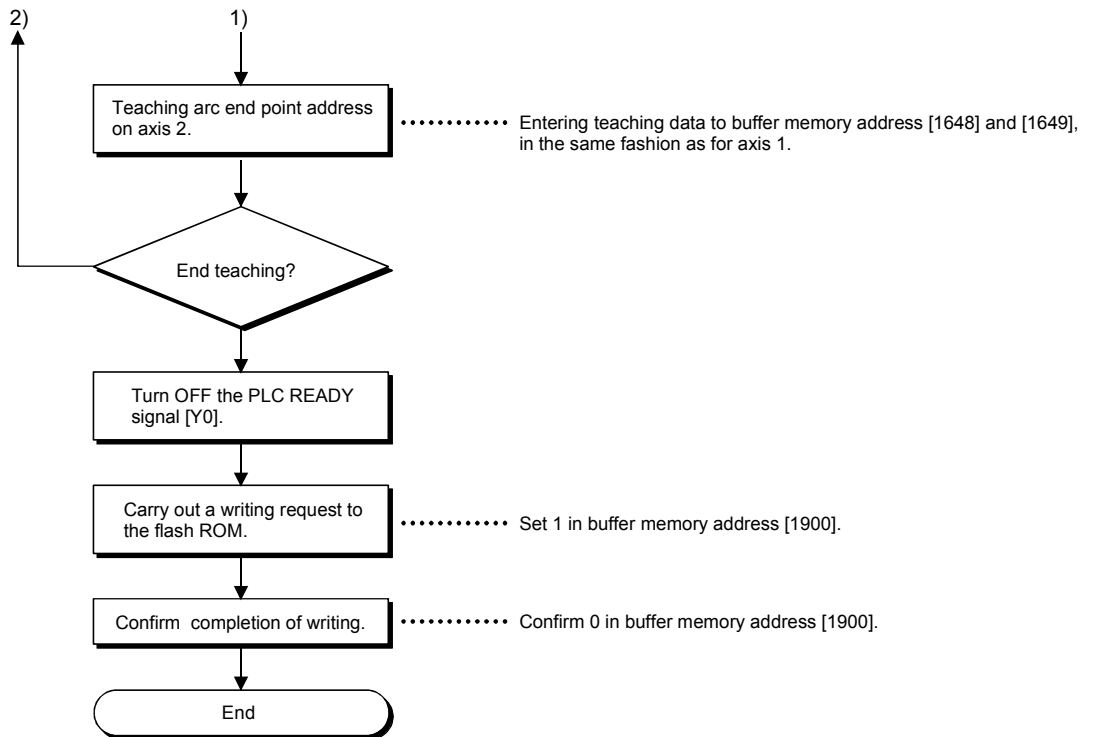

[Motion path]

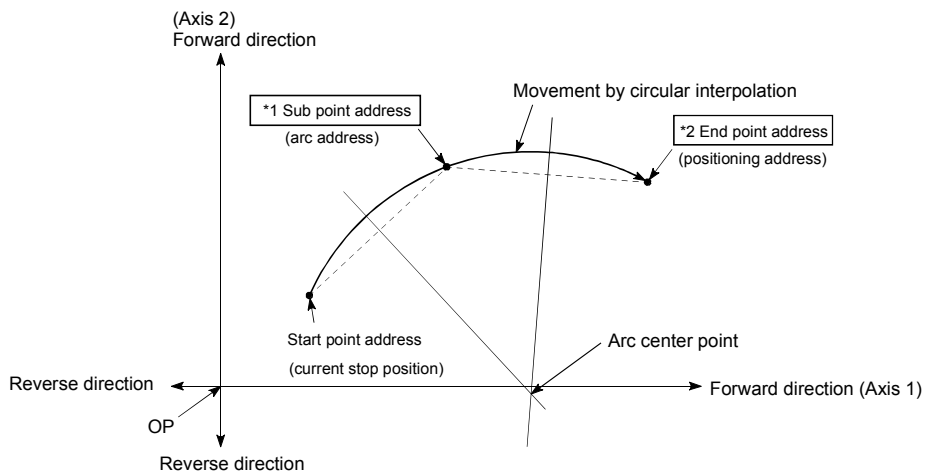

[5] Teaching program example

The following shows a sequence program example for setting (writing) the positioning data obtained with the teaching function to the QD75.

(1) Setting conditions

- When setting the current feed value as the positioning address, write it when the BUSY signal is OFF.

(2) Program example

- The following example shows a program to carry out the teaching of axis 1 by the dedicated instruction "ZP.TEACH 1".
  - 1) Move the workpiece to the target position using a JOG operation (or an inching operation, a manual pulse generator operation).

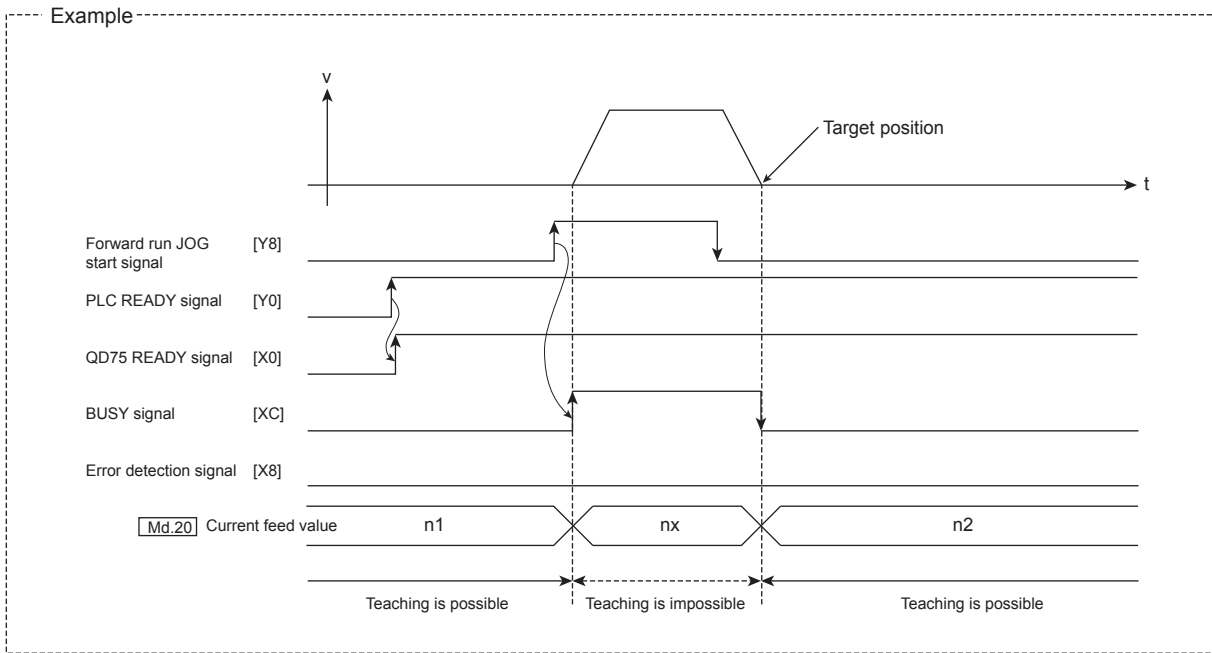

2) Carry out the teaching operation with the following program.

Example

```

*
* No.19 Teaching program
*
* -----
* *Position to the target position with manual operation.
* -----
*
*
*

```

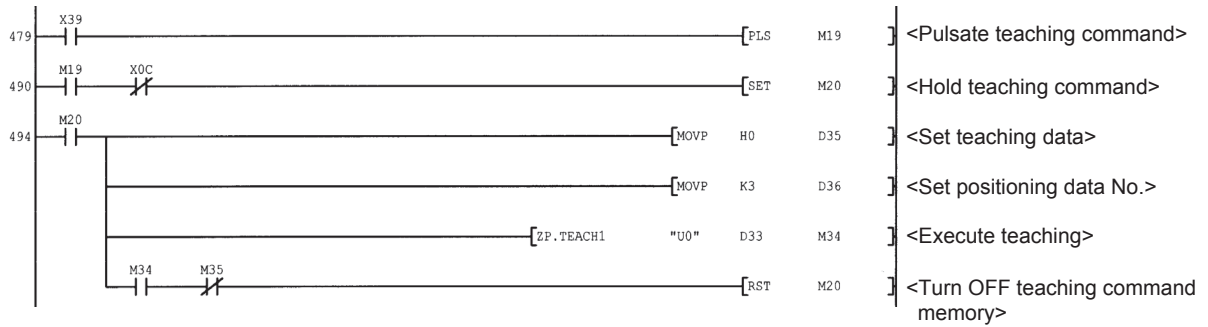

**POINT**

- (1) Confirm the teaching function and teaching procedure before setting the positioning data.
- (2) The positioning addresses that are written are absolute address (ABS) values.
- (3) If the positioning operation is correctly completed with the written positioning data, it is recommended that the positioning data be registered in the QD75 flash ROM.

### 12.7.5 Command in-position function

The "command in-position function" checks the remaining distance to the stop position during the automatic deceleration of positioning control, and set a flag to 1. This flag is called the "command in-position flag". The command in-position flag is used as a front-loading signal indicating beforehand the completion of the position control.

The details shown below explain about the "command in-position function".

- [1] Control details
- [2] Control precautions
- [3] Setting method
- [4] Confirming the command in-position flag

#### [1] Control details

The following shows control details of the command in-position function.

- (1) When the remaining distance to the stop position during the automatic deceleration of positioning control becomes equal to or less than the value set in " [Pr.16] Command in-position width", "1" is stored in the command in-position flag ( [Md.31] Status: b2).

(Command in-position width check)

Remaining distance  $\leq$  " [Pr.16] Command in-position width" setting value

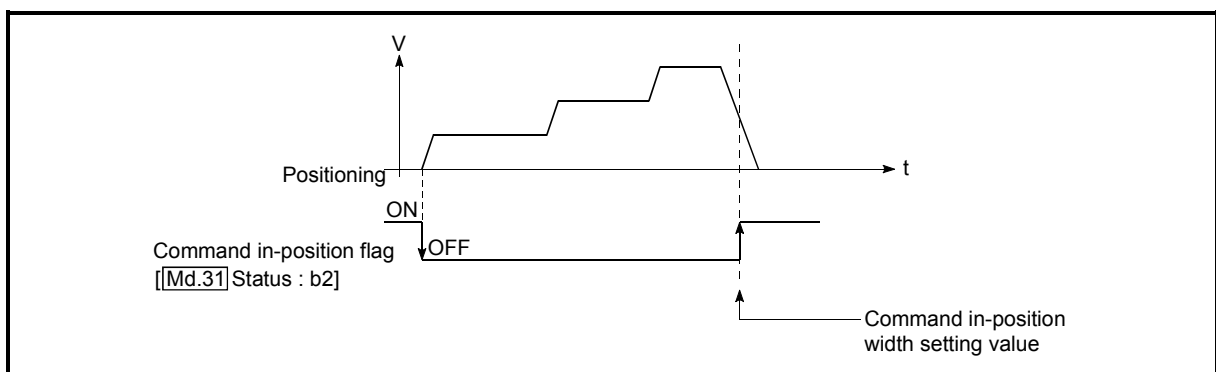

Fig. 12.47 Command in-position operation

- (2) A command in-position width check is carried out every 0.9ms (QD75P□N/QD75D□N) or 1.8ms (QD75P□/QD75D□).

## [2] Control precautions

(1) A command in-position width check will not be carried out in the following cases.

- During speed control
- During speed control in speed-position switching control
- During speed control in position-speed switching control

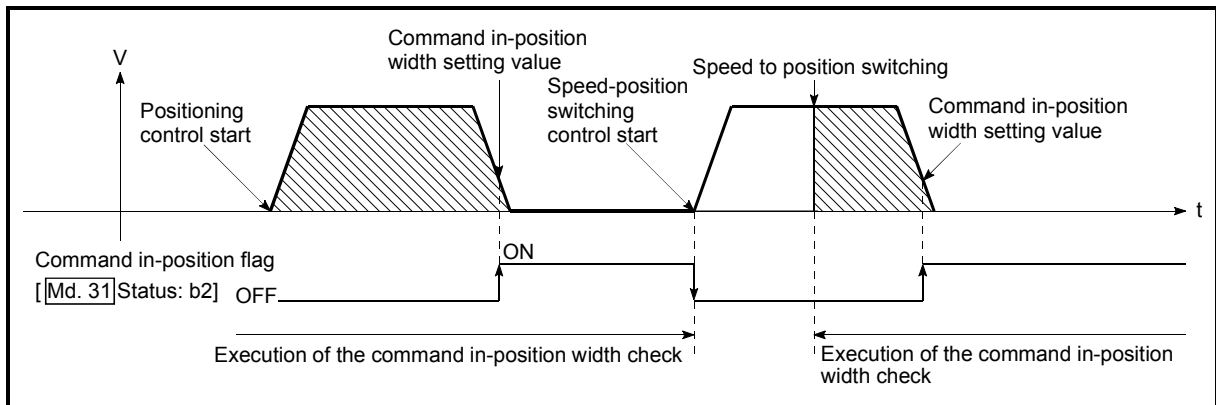

Fig. 12.48 Command in-position width check

(2) The command in-position flag will be turned OFF in the following cases.

("0" will be stored in " [Md.31] Status: b2".)

- At the positioning control start
- At the speed control start
- At the speed-position switching control, position-speed switching control start
- At the OPR control start
- At the JOG operation start
- At the inching operation start
- When the manual pulse generator operation is enabled.

(3) The " [Pr.16] Command in-position width" and command in-position flag ([Md.31] Status: b2) of the reference axis are used during interpolation control. When the " [Pr.20] Interpolation speed designation method" is "Composite speed", the command in-position width check is carried out in the remaining distance on the composite axis (line/arc connecting the start point address and end point address).

**[3] Setting method**

To use the "command in-position function", set the required value in the parameter shown in the following table, and write it to the QD75.

The set details are validated at the rising edge (OFF → ON) of the PLC READY signal (Y0).

Setting item	Setting value	Setting details	Factory-set initial value
<b>Pr.16</b> Command in-position width	→	Turn ON the command in-position flag, and set the remaining distance to the stop position of the position control.	100

\* Refer to Section 5.2 "List of parameters" for setting details.

**[4] Confirming the command in-position flag**

The "command in-position flag" is stored in the following buffer memory.

Monitor item	Monitor value	Storage details	Buffer memory address			
			Axis 1	Axis 2	Axis 3	Axis 4
<b>Md.31</b> Status	→	The command in-position flag is stored in the "b2" position.	817	917	1017	1117

\* Refer to Section 5.6 "List of monitor data" for information on the storage details.

**REMARK**

- Parameters are set for each axis.
- It is recommended that the parameters be set whenever possible with GX Configurator-QP. Execution by sequence program uses many sequence programs and devices. The execution becomes complicated, and the scan times will increase.

12.7.6 Acceleration/deceleration processing function

The "acceleration/deceleration processing function" adjusts the acceleration/deceleration of each control to the acceleration/deceleration curve suitable for devices.

Setting the acceleration/deceleration time changes the slope of the acceleration/deceleration curve.

The following two methods can be selected for the acceleration/deceleration curve:

- Trapezoidal acceleration/deceleration
- S-curve acceleration/deceleration

The details shown below explain about the "acceleration/deceleration processing function".

[1] "Acceleration/deceleration time 0 to 3" control details and setting

[2] "Acceleration/deceleration method setting" control details and setting

[1] "Acceleration/deceleration time 0 to 3" control details and setting

In the QD75, four types each of acceleration time and deceleration time can be set. By using separate acceleration/deceleration times, control can be carried out with different acceleration/deceleration times for positioning control, JOG operation, OPR, etc.

Set the required values for the acceleration/deceleration time in the parameters shown in the following table, and write them to the QD75.

The set details are validated when written to the QD75.

Setting item		Setting value	Setting details	Factory-set initial value
Pr.9	Acceleration time 0	→	Set the acceleration time at a value within the range of 1 to 8388608ms.	1000
Pr.25	Acceleration time 1	→		1000
Pr.26	Acceleration time 2	→		1000
Pr.27	Acceleration time 3	→		1000
Pr.10	Deceleration time 0	→	Set the deceleration time at a value within the range of 1 to 8388608ms.	1000
Pr.28	Deceleration time 1	→		1000
Pr.29	Deceleration time 2	→		1000
Pr.30	Deceleration time 3	→		1000

\* Refer to Section 5.2 "List of parameters" for setting details.



## [2] "Acceleration/deceleration method setting" control details and setting

In the "acceleration/deceleration method setting", the acceleration/deceleration processing method is selected and set. The set acceleration/deceleration processing is applied to all acceleration/deceleration (except for inching operation and manual pulse generator operation).

The two types of "acceleration/deceleration method setting" are shown below.

### (1) Trapezoidal acceleration/deceleration processing method

This is a method in which linear acceleration/deceleration is carried out based on the acceleration time, deceleration time, and speed limit value set by the user.

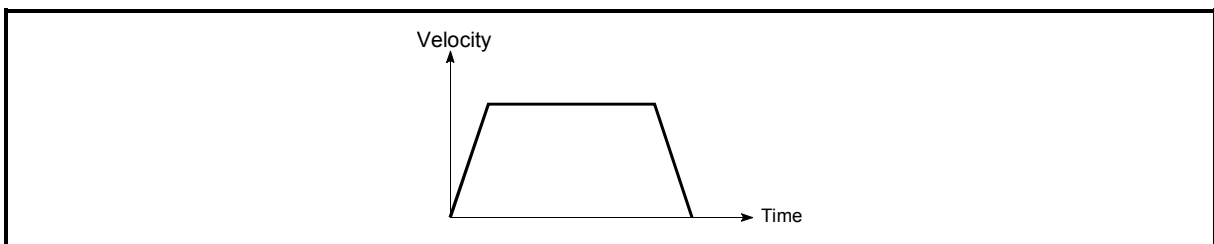

Fig. 12.49 Trapezoidal acceleration/deceleration processing method

### (2) S-curve acceleration/deceleration processing method

In this method, the motor burden is reduced during starting and stopping. This is a method in which acceleration/deceleration is carried out gradually, based on the acceleration time, deceleration time, speed limit value, and " Pr.35 S-curve ratio" (1 to 100%) set by the user.

When the stepping motor is used, the acceleration around the inflection point on the s shape is faster compared with the trapezoidal acceleration/deceleration. This may cause step-out. \*1

In this case, adjust the acceleration/deceleration time to decrease the acceleration around the inflection point, or use a servo motor.

\*1: When comparing the trapezoidal acceleration/deceleration and S-curve acceleration/deceleration processing method in the same acceleration/deceleration time.

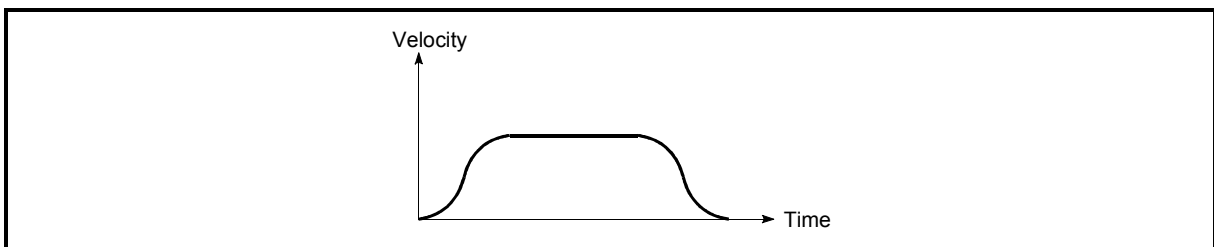

Fig. 12.50 S-curve acceleration/deceleration processing method

When a speed change request or override request is given during S-curve acceleration/deceleration processing, S-curve acceleration/deceleration processing begins at the start of a speed change request or an override request.

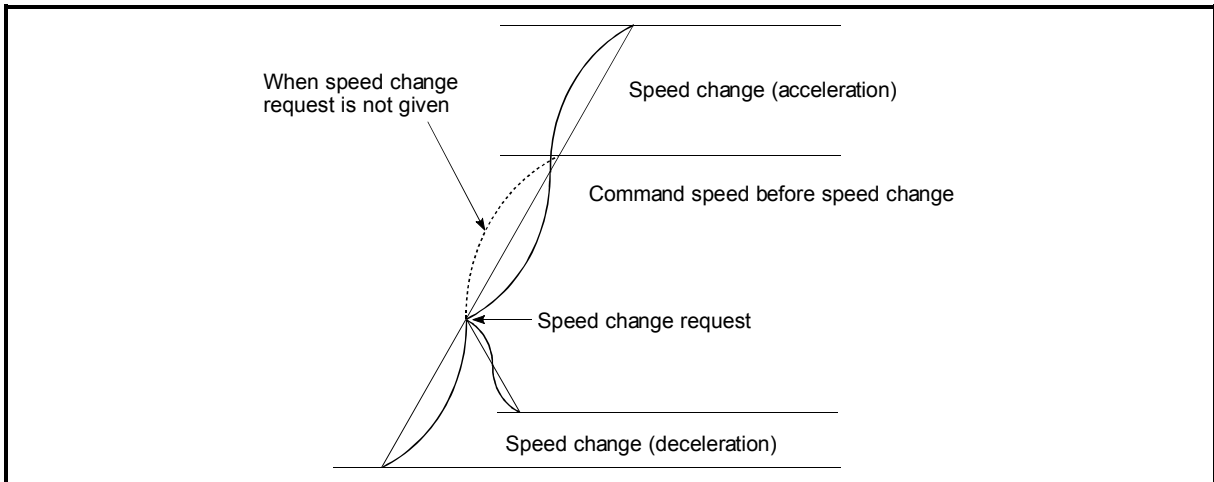

Fig. 12.51 Speed change during S-curve acceleration/deceleration processing

Set the required values for the "acceleration/deceleration method setting" in the parameters shown in the following table, and write them to the QD75. The set details are validated when written to the QD75.

Setting item	Setting value	Setting details	Factory-set initial value
Pr.34 Acceleration/deceleration process selection	→	Set the acceleration/deceleration method. 0: Trapezoidal acceleration/deceleration processing 1: S-curve acceleration/deceleration processing	0
Pr.35 S-curve ratio	→	Set the acceleration/deceleration curve when "1" is set in " Pr.34 Acceleration/deceleration processing selection".	100

\* Refer to Section 5.2 "List of parameters" for setting details.

**REMARK**

- Parameters are set for each axis.
- It is recommended that the parameters be set whenever possible with GX Configurator-QP. Execution by sequence program uses many sequence programs and devices. The execution becomes complicated, and the scan times will increase.

12.7.7 Pre-reading start function

The "pre-reading start function" does not output pulses while the execution prohibition flag is ON if a positioning start request is given with the execution prohibition flag ON, and starts outputting pulses within 1.3ms (QD75P□N/QD75D□N) or 3ms (QD75P□/QD75D□) after OFF of the execution prohibition flag is detected. The positioning start request is given when the axis is in a standby status, and the execution prohibition flag is turned OFF at the axis operating timing. This shortens the virtual start time. The QD75 normally takes 1.5 to 2.0ms (QD75P□N/QD75D□N) or 6 to 7ms (QD75P□/QD75D□) from when it receives a positioning start request until it starts pulse output (start time). Some systems often need the start time to be shortened. This "pre-reading start function" can improve the tact time of the system.

The "pre-reading start function" will be explained below.

- [1] Control details
- [2] Control precautions
- [3] Program examples

[1] Control details

The pre-reading start function is performed by turning ON the positioning start signal [Y10, Y11, Y12, Y13] with the execution prohibition flag [Y14, Y15, Y16, Y17] ON, or by executing the dedicated instruction (ZP.PSTRT1, ZP.PSTRT2, ZP.PSTRT3, ZP.PSTRT4). However, if positioning is started with the execution prohibition flag ON, the positioning data is analyzed but pulse output is not provided. While the execution prohibition flag is ON, " [Md.26] Axis operation status" remains unchanged from "5: Analyzing". Pulse output starts within 1.3ms (QD75P□N/QD75D□N) or 3ms (QD75P□/QD75D□) after the execution prohibition flag [Y14, Y15, Y16, Y17] has turned OFF, and " [Md.26] Axis operation status" changes to the status (e.g. "Position control", "Speed control") that matches the control system. (Refer to Fig. 12.52)

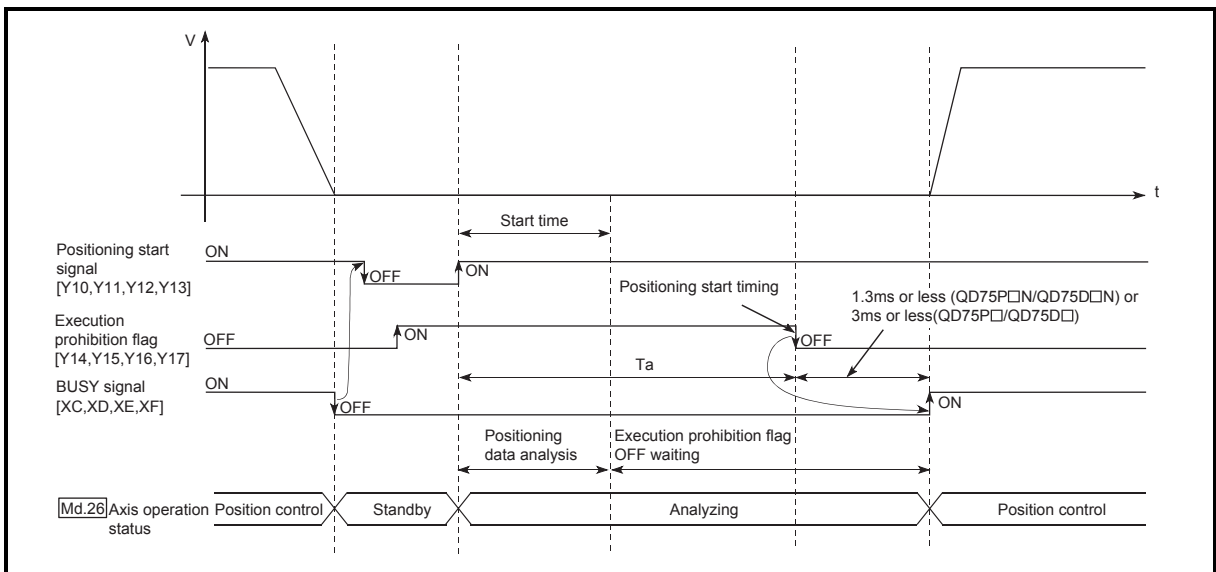

Fig. 12.52 Operations of pre-reading start function

The pre-reading start function is effective for the system as shown below.

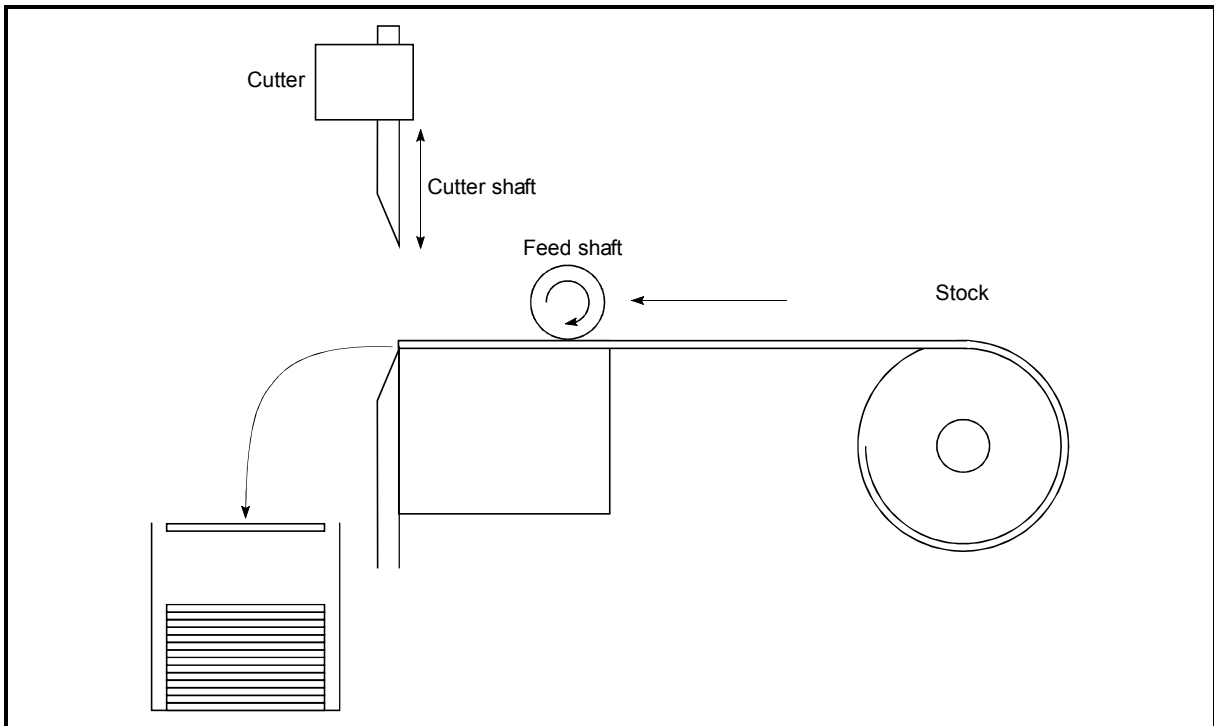

Fig. 12.53 System example using pre-reading start function

Fig. 12.53 shows a system example which repeats:

- 1) Feeding a stock with a feed shaft; and
- 2) Cutting it with a cutter

to cut the stock to fixed size. The operations of the feed shaft and cutter shaft are represented as shown in Fig. 12.54.

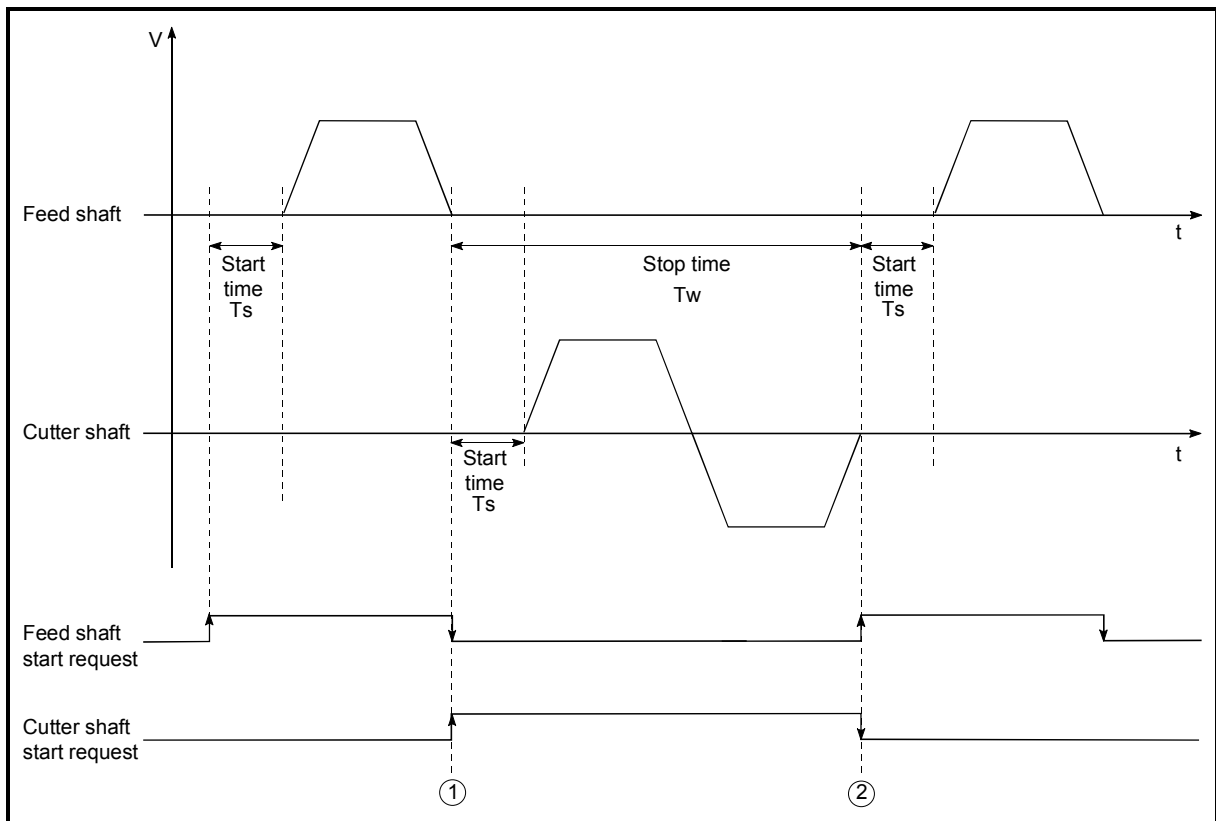

Fig. 12.54 Operation timings of system example

The cutter shaft starts from the moment the feed shaft has completed feeding the stock "①", and the feed shaft starts from the moment the cutter shaft has returned to the standby position "②". Actually, however, there is a delay of start time  $T_s$  (1.5 to 2.0ms (QD75P□N/QD75D□N) or 6 to 7ms (QD75P□/QD75D□)) from when the QD75 receives a start request until it outputs pulses. The system's tact time can be reduced by the shortening of this delay with the Pre-reading start function.

In Fig. 12.54, the feed shaft stands by during the stop time  $T_w$ .

Hence, pre-reading of the next data starts during the stop time  $T_w$ . If  $T_w$  is a certain period of time, the analysis of the next data is completed during that period, and the system is placed in an execution prohibition flag OFF waiting status. Therefore, replacing the positioning start timing at ② with the execution prohibition flag OFF allows the time from when the axis operation request turns ON until pulse output starts to be reduced to within 1.3ms (QD75P□N/QD75D□N) or 3ms (QD75P□/QD75D□) in the sequence program. (Refer to Fig. 12.52.)

[2] Control precautions

- (1) The time required to analyze the positioning data is up to 7ms.
- (2) After positioning data analysis, the system is put in an execution prohibition flag OFF waiting status. Any change made to the positioning data in the execution prohibition flag OFF waiting status is not reflected on the positioning data. Change the positioning data before turning ON the positioning start signal.
- (3) The pre-reading start function is invalid if the execution prohibition flag is turned OFF between when the positioning start signal has turned ON and when positioning data analysis is completed (Ta < start time, Ta: Refer to Fig. 12.52).
- (4) The data No. which can be executed positioning start using "Cd.3 Positioning start No." with the pre-reading start function are No. 1 to 600 only. Performing the pre-reading start function at the setting of No. 7000 to 7004 or 9001 to 9004 will result in an error "Outside start No. range" (error code: 543).
- (5) Always turn ON the execution prohibition flag at the same time or before turning ON the positioning start signal. Pre-reading may not be started if the execution prohibition flag is turned ON during Ta after the positioning start signal is turned ON. The pre-reading start function is invalid if the execution prohibition flag is turned ON after positioning start (pulse output) with the execution prohibition flag OFF. (It is made valid at the next positioning start.)

[3] Program examples

\*  
 \* Pre-reading start function (when positioning start signal Y10 is used)  
 \*

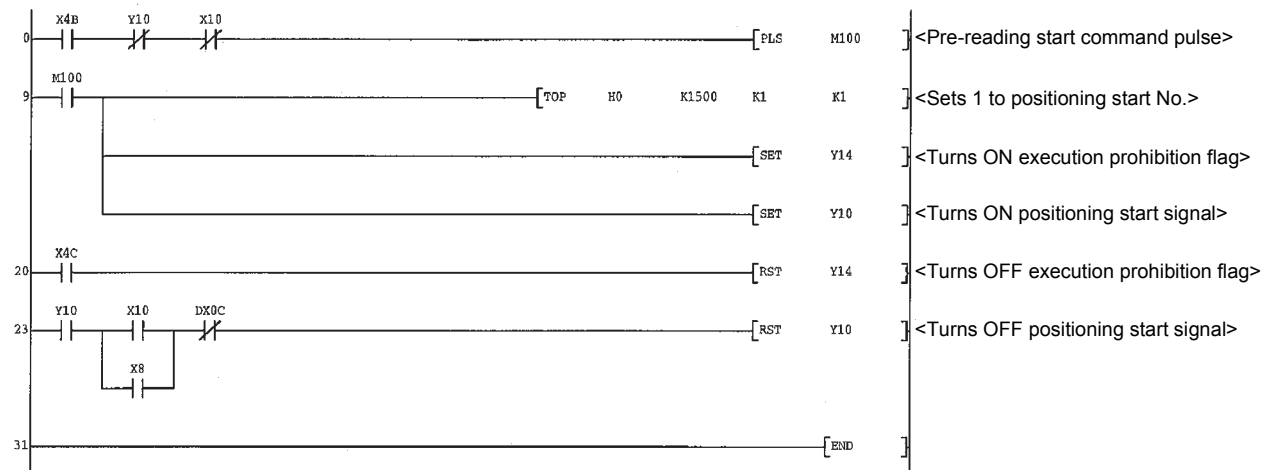

\*  
 \* Pre-reading start function (when dedicated instruction PSTRT1 is used)  
 \*

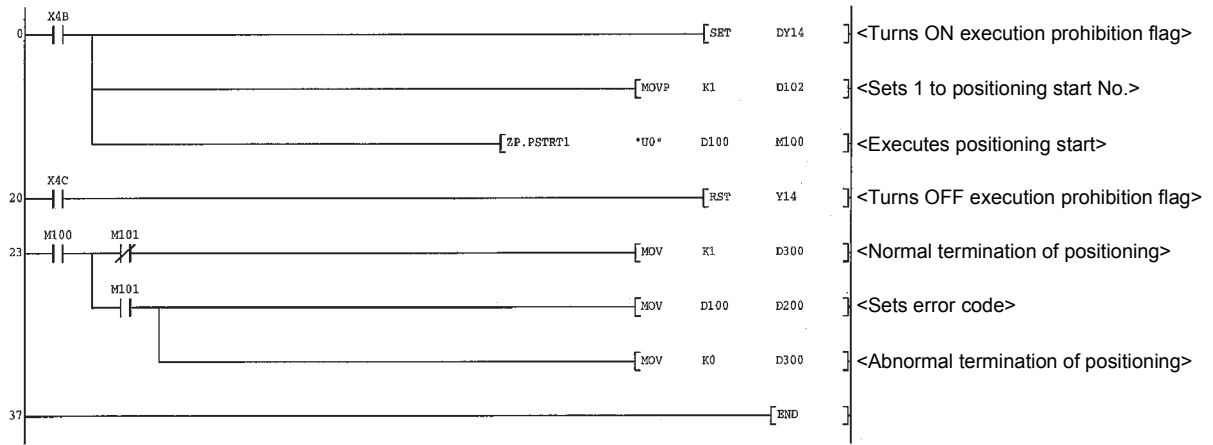

## 12.7.8 Deceleration start flag function

The "deceleration start flag function" turns ON the flag when the constant speed status or acceleration status switches to the deceleration status during position control whose operation pattern is "Positioning complete". This function can be used as a signal to start the operation to be performed by other equipment at each end of position control or to perform preparatory operation, etc. for the next position control.

For the "deceleration start flag function", the following will be explained.

- [1] Control details
- [2] Control precautions
- [3] Setting method
- [4] Checking of deceleration start flag

## [1] Control details

When deceleration for a stop is started in the position control whose operation pattern is "Positioning complete", "1" is stored into "Md.48 Deceleration start flag". When the next operation start is made or the manual pulse generator operation enable status is gained, "0" is stored. (Refer to Fig. 12.55.)

(1) Start made with positioning data No. specified

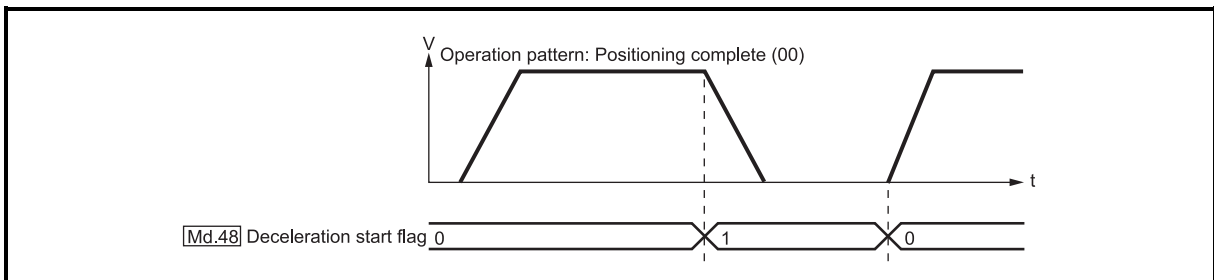

Fig. 12.55 Operation of deceleration start flag



(2) Block start

At a block start, this function is valid for only the position control whose operation pattern is "Positioning complete" at the point whose shape has been set to "End". (Refer to Fig. 12.56.)

The following table indicates the operation of the deceleration start flag in the case of the following block start data and positioning data.

Block start data	Da.11 Shape	Da.12 Start data No.	Da.13 Special start instruction
1st point	1: Continue	1	0: Block start
2nd point	1: Continue	3	0: Block start
3rd point	0: End	4	0: Block start
•			
•			

Positioning Data No.	Da.1 Operation pattern
1	01: Continuous positioning control
2	00: Positioning complete
3	00: Positioning complete
4	11: Continuous path control
5	00: Positioning complete
•	
•	

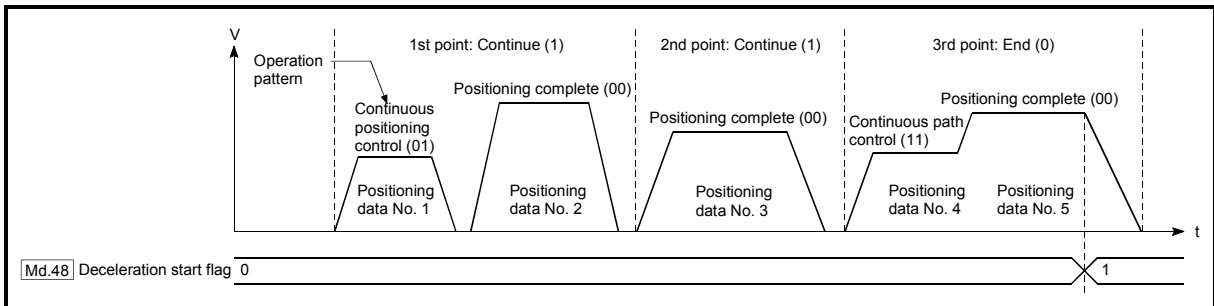
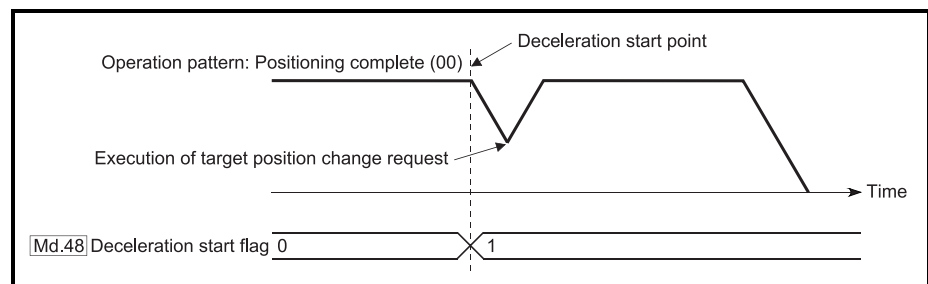

Fig. 12.56 Operation of deceleration start flag at block start

## [2] Control precautions

- (1) The deceleration start flag function is valid for the control system of "1-axis linear control", "2-axis linear interpolation control", "3-axis linear interpolation control", "4-axis linear interpolation control", "speed-position switching control" or "position-speed switching control". (In the case of linear interpolation control, the function is valid for only the reference axis.) Refer to Section 3.2.4 "Combination of QD75 main functions and sub functions".
- (2) The deceleration start flag does not turn ON when the operation pattern is "continuous positioning control" or "continuous path control".
- (3) The deceleration start flag function is invalid for an OPR, JOG operation, inching operation, manual pulse generator operation, and deceleration made with a stop signal.
- (4) The deceleration start flag does not turn ON when a speed change or override is used to make deceleration.
- (5) If a target position change is made while the deceleration start flag is ON, the deceleration start flag remains ON.



- (6) When the movement direction is reversed by a target position change, the deceleration start flag turns ON.

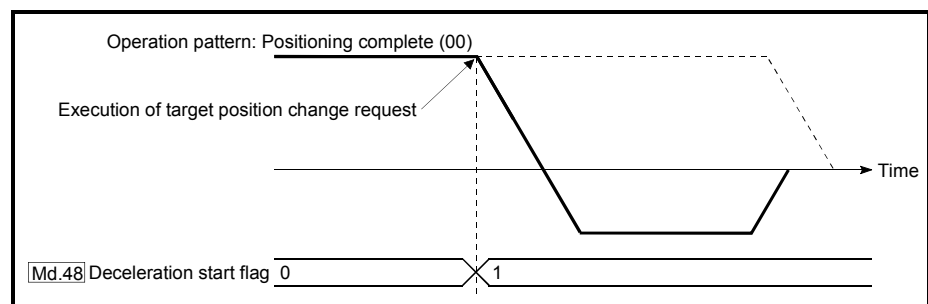

- (7) During position control of position-speed switching control, the deceleration start flag is turned ON by automatic deceleration. The deceleration start flag remains ON if position control is switched to speed control by the position-speed switching signal after the deceleration start flag has turned ON.
- (8) If the condition start of a block start is not made since the condition is not satisfied, the deceleration start flag turns ON when the shape is "End".
- (9) When a continuous operation interrupt request is issued, the deceleration start flag turns ON at a start of deceleration in the positioning data being executed.

### [3] Setting method

To use the "deceleration start flag function", set "1" to the following control data using a sequence program.

The set data is made valid on the rising edge (OFF to ON) of the PLC READY signal [Y0].

Setting item		Setting value	Setting details	Buffer memory address
Cd.41	Deceleration start flag valid	→	Set whether the deceleration start flag function is made valid or invalid. 0: Deceleration start flag invalid 1: Deceleration start flag valid	1905

\* Refer to Section 5.7 "List of control data" for details on the setting details.

### [4] Checking of deceleration start flag

The "deceleration start flag" is stored into the following buffer memory addresses.

Monitor item	Monitor value	Storage details	Buffer memory address			
			Axis 1	Axis 2	Axis 3	Axis 4
Md.48	Deceleration start flag	→	0: Status other than below 1: Status from deceleration start to next operation start			
			899	999	1099	1199

\* Refer to Section 5.6 "List of monitor data" for information on the storage details.

### 12.7.9 Stop command processing for deceleration stop function

The "stop command processing for deceleration stop function" is provided to set the deceleration curve if a stop cause occurs during deceleration stop processing (including automatic deceleration).

This function is valid for both trapezoidal and S-curve acceleration/deceleration processing methods.

(For the stop cause, refer to Section 1.2.3 Outline of stopping.)

The "stop command processing for deceleration stop function" performs the following two operations:

- (1) **Deceleration curve re-processing**  
Re-processes a deceleration curve starting from the speed at stop cause occurrence to stop, according to the preset deceleration time.
- (2) **Deceleration curve continuation**  
Continues the current deceleration curve after a stop cause has occurred.

This section explains the "stop command processing for deceleration stop function" as follows:

- [1] Control details
- [2] Control precautions
- [3] Setting method

#### [1] Control details

The operation of "stop command processing for deceleration stop function" is explained below.

##### (1) Deceleration curve re-processing

A deceleration curve is re-processed starting from the speed at stop cause occurrence to stop, according to the preset deceleration time.

If a stop cause occurs during automatic deceleration of position control, the deceleration stop processing stops as soon as the target has reached the positioning address specified in the positioning data that is currently executed.

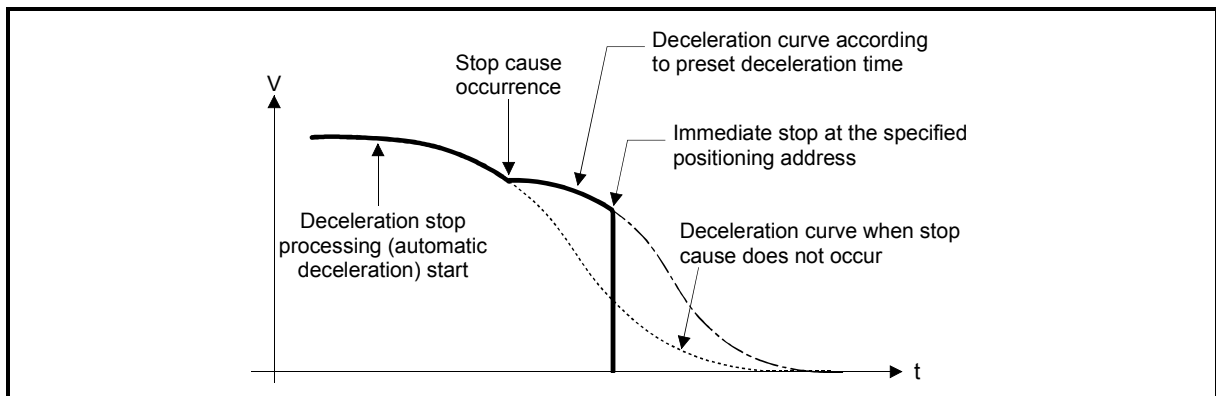

Fig. 12.57 Deceleration curve re-processing operation (for position control or S-curve acceleration/deceleration processing)

(2) Deceleration curve continuation

The current deceleration curve is continued after a stop cause has occurred.

If a stop cause occurs during automatic deceleration of position control, the deceleration stop processing may be complete before the target has reached the positioning address specified in the positioning data that is currently executed.

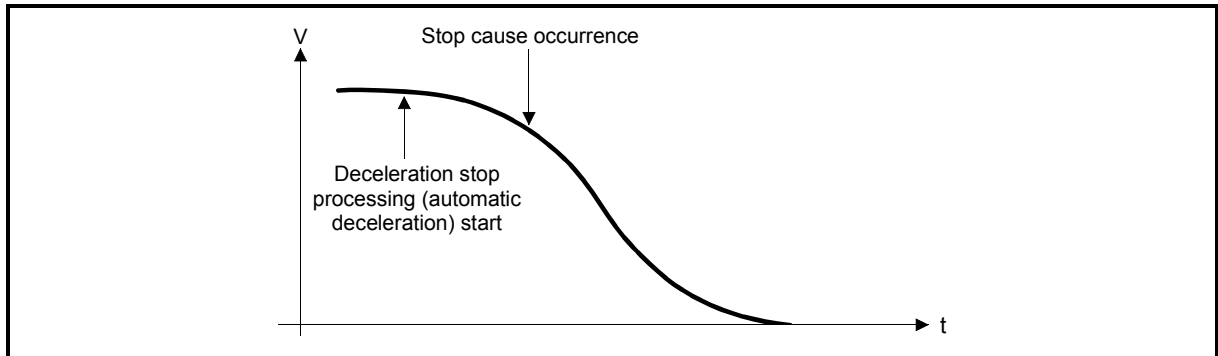

Fig. 12.58 Deceleration curve continuation operation (for position control or S-curve acceleration/deceleration processing)

[2] Control precautions

- (1) In manual control (JOG operation, inching operation, manual pulse generator operation), the stop command processing for deceleration stop function is invalid.
- (2) The stop command processing for deceleration stop function is valid when "0: Normal deceleration stop" is set in " [Pr.37] Stop group 1 sudden stop selection" to " [Pr.39] Stop group 3 sudden stop selection" as the stopping method for stop cause occurrence.
- (3) The stop command processing for deceleration stop function is invalid when "1: Sudden stop" is set in " [Pr.37] Stop group 1 sudden stop selection" to " [Pr.39] Stop group 3 sudden stop selection". (A deceleration curve is re-processed, according to the " [Pr.36] Sudden stop deceleration time" (starting from the speed at stop cause occurrence to a stop))  
 In the position control (including position control of speed/position changeover control or position/speed changeover control) mode, positioning may stop immediately depending on the stop cause occurrence timing and " [Pr.36] Sudden stop deceleration time" setting.

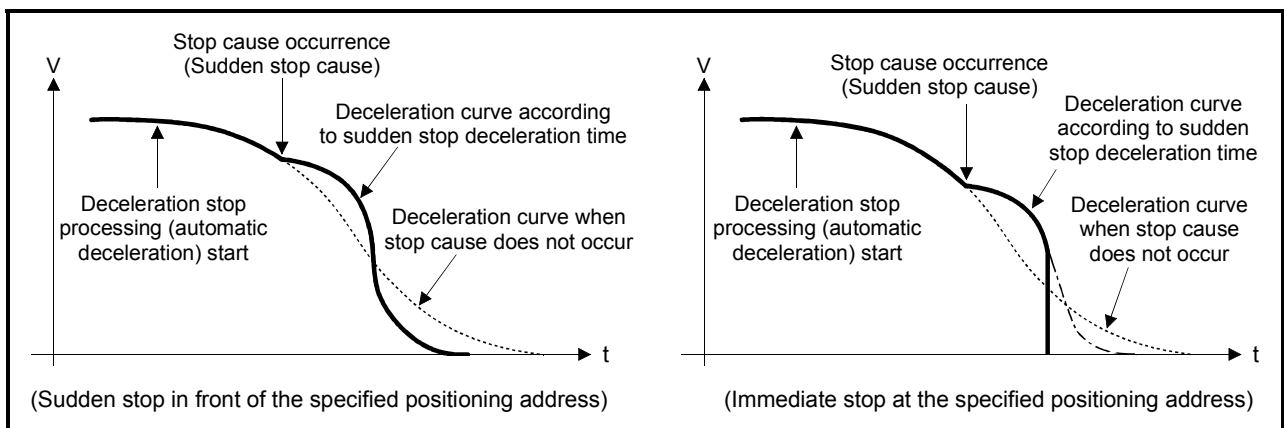

Fig. 12.59 Sudden stop operation (for position control or S-curve acceleration/deceleration processing)

## [3] Setting method

To use the "stop command processing for deceleration stop function", set the following control data in a sequence program.

The set data are made valid as soon as they are written to the buffer memory.

The PLC READY signal [Y0] is irrelevant.

Setting item	Setting value	Setting details	Buffer memory address
Cd.42	→	Set the stop command processing for deceleration stop function. 0: Deceleration curve re-processing 1: Deceleration curve continuation	1907

\* For details of the setting details, refer to "Section 5.7 Control data list".

# CHAPTER 13 COMMON FUNCTIONS

The details and usage of the "common functions" executed according to the user's requirements are explained in this chapter.

Common functions include functions required when using the QD75, such as parameter initialization and execution data backup.

Read the setting and execution procedures for each common function indicated in this chapter thoroughly, and execute the appropriate function where required.

13.1	Outline of common functions.....	13-	2
13.2	Parameter initialization function .....	13-	3
13.3	Execution data backup function .....	13-	5
13.4	External I/O signal logic switching function.....	13-	7
13.5	External I/O signal monitor function .....	13-	8

## 13.1 Outline of common functions

"Common functions" are executed according to the user's requirements, regardless of the control system, etc. These common functions are executed by peripheral devices or using sequence programs.

The following table shows the functions included in the "common functions".

Common function	Details	Means	
		Sequence program	Peripheral devices
Parameter initialization function	This function returns the parameter stored in the QD75 buffer memory and flash ROM to the factory-set initial value.	○	○
Execution data backup function	This function writes the "execution data", currently being used for control, to the flash ROM.	○	○
External I/O signal logic switching function	This function switches I/O signal logic according to the equipment connected to the QD75. For the system in which drive unit READY with b-contact, upper limit switch, and lower limit switch are not used, the parameter logic setting can be controlled without wiring if it is changed to a "positive logic".	○	○
External I/O signal monitor function	This function monitors the external I/O signal monitor information in the module's detailed information which can be displayed on the system monitor of GX Developer*.	—	—

\* For the QD75P□/QD75D□, this function is available in GX Developer (SW6D5C-GPPW-E or later).

For the QD75P□N/QD75D□N, external I/O signals cannot be monitored on GX Developer. Use the system monitor of GX Works2.



## 13.2 Parameter initialization function

The "parameter initialization function" is used to return the setting data set in the QD75 buffer memory and flash ROM to their factory-set initial values.

The details shown below explain about the "parameter initialization function".

[1] Parameter initialization means

[2] Control details

[3] Control Precautions

[4] Parameter initialization method

### [1] Parameter initialization means

- Initialization is executed with a sequence program.
- Initialization is executed by peripheral device.

Refer to GX Configurator-QP Operating Manual for the execution method by peripheral device.

### [2] Control details

The following table shows the setting data initialized by the "parameter initialization function".

(The data initialized are "buffer memory" and " flash ROM " setting data.)

Setting data
Basic parameters (Pr.1 to Pr.10)
Detailed parameters (Pr.11 to Pr.42, Pr.70 , Pr.150)
OPR basic parameters (Pr.43 to Pr.48)
OPR detailed parameters (Pr.49 to Pr.57)
Positioning data (No.1 to No.600)
Block start data (No.7000 to No.7004)

### [3] Control Precautions

- (1) Parameter initialization is only executed when the positioning control is not carried out (when the PLC READY signal (Y0) is OFF).  
The warning "In PLC READY" (warning code: 111) will occur if executed when the PLC READY [Y0] is ON.
- (2) Writing to the flash ROM can be executed up to 100,000 times.  
If writing to the flash ROM exceeds 100,000 times, the writing may become impossible, and the error "Flash ROM write error" (error code: 801) will occur.
- (3) A "CPU module reset" or "CPU module power restart" must be carried out after the parameters are initialized.
- (4) If an error occurs on the parameter set in the QD75 when the PLC READY signal [Y0] is turned ON, the QD75 READY signal [X0] will not be turned ON and the control cannot be carried out.

**Important**

Parameter initialization takes about 10 seconds. (Up to 30 seconds are sometimes required.)

Do not turn the power ON/OFF; reset the CPU module, etc., during parameter initialization. If the power is turned OFF or the CPU module is reset to forcibly end the process, the data backed up in the flash ROM will be lost.

**[4] Parameter initialization method**

(1) Parameter initialization is carried out using the dedicated instruction "ZP.PINIT".

(Refer to CHAPTER 14 "DEDICATED INSTRUCTIONS" for details.)

(2) Parameter initialization can also be carried out by the writing of the data shown in the table below to the buffer memory using the TO instruction /intelligent function device.

The initialization of the parameter is executed at the time point the data is written to the QD75 buffer memory.

Setting item	Setting value	Setting details	Buffer memory address			
			Axis 1	Axis 2	Axis 3	Axis 4
<b>Cd.2</b> Parameter initialization request	1	Set "1" (parameter initialization request).	1901			

\* Refer to Section 5.7 "List of control data" for details on the setting details.

When the initialization is complete, "0" will be set in " **Cd.2** Parameter initialization request" by the QD75 automatically.

### 13.3 Execution data backup function

When the QD75 buffer memory data is rewritten from the CPU module, "the data backed up in the QD75 flash ROM" may differ from "the data (buffer memory data) for which control is being executed".

In cases like these, the data being executed will be lost when the programmable controller power is turned OFF. (Refer to CHAPTER 7 "MEMORY CONFIGURATION AND DATA PROCESS")

In cases like these, the "execution data backup function" backs up the data being executed by writing it to the flash ROM. The data that was backed up is then written to the buffer memory when the power is turned ON next.

The details shown below explain about the "execution data backup function".

[1] Execution data backup means

[2] Control details

[3] Control Precautions

[4] Execution data backup method

[1] Execution data backup (written to flash ROM) means

- The backup is executed with a sequence program.
- The backup is executed by peripheral device.

Refer to GX Configurator-QP Operating Manual for execution data backup method by peripheral device.

[2] Control details

The following shows the data that can be written to the flash ROM using the "execution data backup function".

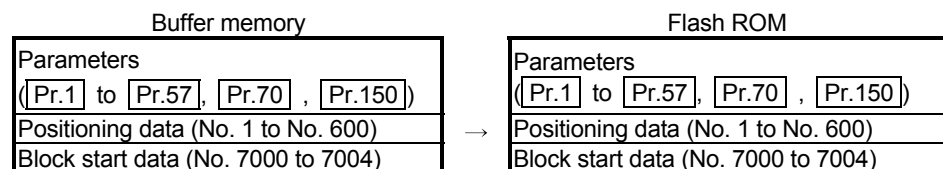

[3] Control Precautions

- (1) Parameter initialization is only executed when the positioning control is not carried out (when the PLC READY signal (Y0) is OFF). The warning "In PLC READY" (warning code: 111) will occur if executed when the PLC READY [Y0] is ON.
- (2) Writing to the flash ROM can be executed up to 100,000 times. If writing to the flash ROM exceeds 100,000 times, the writing may become impossible, and the error "Flash ROM write error" (error code: 801) will occur.
- (3) After one power ON/CPU module reset operation, writing to the flash ROM using a sequence program is limited to up to 25 times. If the 26th writing is executed, the error "Flash ROM write number error" (error code: 805) will occur. If this error occurs, carry out the power OFF→ON/CPU module reset operation again. Refer to [Md.19] of Section 5.1.7 "Types and roles of monitor data" for details.

#### Important

If the power is turned OFF or the CPU module is reset to forcibly end the process, the data backed up in the flash ROM will be lost.

## [4] Execution data backup method

- (1) Execution data backup (writing to the flash ROM) is carried out using the dedicated instruction "PFWRT". (Refer to CHAPTER 14 "DEDICATED INSTRUCTIONS" for details.)
- (2) Refer to Section 7.2 "Data transmission process" for the data transmission processing at the backup of the execution data.
- (3) Execution data backup can also be carried out by the writing of the data shown in the table below to the QD75 buffer memory using the TO instruction /intelligent function device.  
The writing to the flash ROM is executed at the time point the data is written to the QD75 buffer memory.

Setting item	Setting value	Setting details	Buffer memory address			
			Axis 1	Axis 2	Axis 3	Axis 4
<span style="border: 1px solid black; padding: 2px;">Cd.1</span> Flash ROM write request	1	Set "1" (flash ROM write request).	1900			

\* Refer to Section 5.7 "List of control data" for details on the setting details.

When the writing to the flash ROM is complete, "0" will be set in " Cd.1 Flash ROM write request" by the QD75 automatically.

### 13.4 External I/O signal logic switching function

This function switches the signal logic according to the external equipment connected to the QD75.

For the system in which drive unit READY with b-contact, upper limit switch, and lower limit switch are not used, the parameter logic setting can be controlled without wiring if it is changed to a "positive logic".

When the drive unit READY, upper limit switch, and lower limit switch are used, ensure to use them with b-contact.

The details shown below explain about the "external I/O signal logic switching function".

[1] Parameter setting details

[2] Precautions on parameter setting

#### [1] Parameter setting details

To use the "external I/O signal logic switching function", set the parameters shown in the following table.

Setting item		Setting details		Factory-set initial value	Buffer memory address					
					Axis 1	Axis 2	Axis 3	Axis 4		
Pr.22	Input signal logic selection	• Selection of logic of signals input from external source to QD75			0	31	181	331	481	
		b0	Lower limit	0: Negative logic, 1: Positive logic						
		b1	Upper limit							
		b2	Drive unit READY							
		b3	Stop signal							
		b4	External command signal							
		b5	Zero signal							
		b6	Near-point dog signal							
		b7	Unused							Set "0".
		b8	Manual pulse generator input							0: Negative logic, 1: Positive logic
b9 to b15	Unused	Set "0".								
Pr.23	Output signal logic selection	• Selection of logic of signals output from QD75 to external source			0	32	182	332	482	
		b0	Command pulse signal	0: Negative logic, 1: Positive logic						
		b1 to b3	Unused	Set "0".						
		b4	Deviation counter clear signal	0: Negative logic, 1: Positive logic						
		b5 to b15	Unused	Set "0".						

\* Refer to Section 5.2 "List of parameters" for the information on detail settings.

#### [2] Precautions on parameter setting

(1) The external I/O signal logic switching parameters are validated when the PLC READY signal [Y0] is turned OFF to ON. (The logic is negative right after power-on.)

(2) If each signal logic is set erroneously, the operation may not be carried out correctly.

Before setting, check the specifications of the equipment to be used.

## 13.5 External I/O signal monitor function

The "external I/O signal monitor function" monitors the module's information and external I/O signal monitor information in the module's detailed information which can be displayed on the system monitor of GX Developer\*1.

The information that can be monitored are the module's information (same as the QD75 front "RUN", "ERR" LED indicators) and the following external I/O signals. (Set the logic of the external I/O signals in " Pr.22 Input signal logic selection" and " Pr.23 Output signal logic selection".)

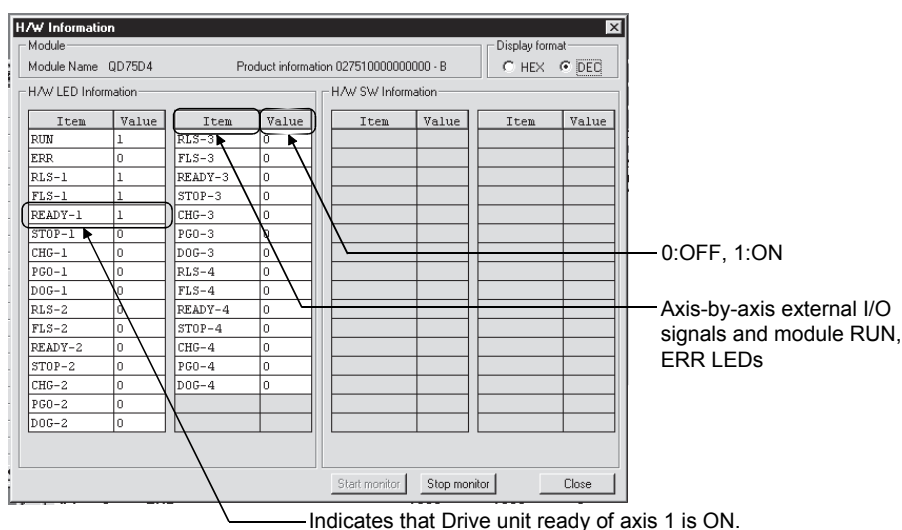

\*1: For the QD75P□/QD75D□, this function is available in GX Developer (SW6D5C-GPPW-E or later). For details, refer to GX Developer Operating Manual.

For the QD75P□N/QD75D□N, external I/O signals cannot be monitored on GX Developer. Use the system monitor of GX Works2. For details on the system monitor of GX Works2, refer to GX Works2 Version 1 Operating Manual (Common).

# CHAPTER 14 DEDICATED INSTRUCTIONS

The QD75 dedicated instructions are explained in this chapter.

These instructions are used to facilitate the programming for the use of the functions of the intelligent function module.

Using the dedicated instructions, the programming can be carried out without being aware of the QD75 buffer memory address and interlock signal.

14.1	List of dedicated instructions .....	14- 2
14.2	Interlock during dedicated instruction is executed .....	14- 2
14.3	Z.ABRST1, Z.ABRST2, Z.ABRST3, Z.ABRST4 .....	14- 3
14.4	ZP.PSTR1, ZP.PSTR2, ZP.PSTR3, ZP.PSTR4 .....	14- 8
14.5	ZP.TEACH1, ZP.TEACH2, ZP.TEACH3, ZP.TEACH4 .....	14- 12
14.6	ZP.PFWRT .....	14- 16
14.7	ZP.PINIT .....	14- 20

14.1 List of dedicated instructions

The dedicated instructions explained in this Chapter are listed in Table 14.1.

Table 14.1 List of dedicated instructions

Application	Dedicated instruction	Outline of functions	Reference
Absolute position restoration	Z.ABRST1	This function restores the absolute position of the designated axis of the QD75.	Section 14.3
	Z.ABRST2		
	Z.ABRST3		
	Z.ABRST4		
Positioning start	ZP.PSTRT1	This function starts the positioning control of the designated axis of the QD75.	Section 14.4
	ZP.PSTRT2		
	ZP.PSTRT3		
	ZP.PSTRT4		
Teaching	ZP.TEACH1	This function carries out teaching the designated axis of the QD75.	Section 14.5
	ZP.TEACH2		
	ZP.TEACH3		
	ZP.TEACH4		
Writing to flash ROM	ZP.PFWRT	This function writes the buffer memory parameters, positioning data and block start data to the flash ROM.	Section 14.6
Parameter initialization	ZP.PINIT	This function initializes the buffer memory and flash ROM setting data to the factory-set data (initial values).	Section 14.7

14.2 Interlock during dedicated instruction is executed

The absolute position restoration instruction (Z.ABRST□), positioning start instruction (ZP.PSTRT□) and teaching instruction (ZP.TEACH□) cannot be executed simultaneously in each axis. If they are executed at the same time, the second and later instructions are ignored by an internal interlock (no error will occur).

The timing of the positioning start dedicated instruction (ZP.PSTRT□) is as shown below.

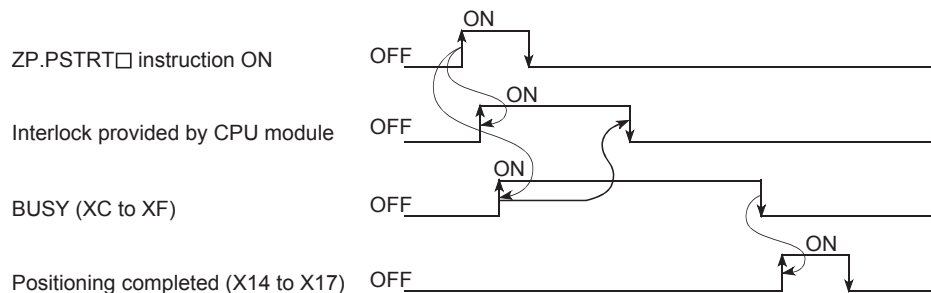



14.3 Z.ABRST1, Z.ABRST2, Z.ABRST3, Z.ABRST4

These dedicated instructions restore the absolute position of the designated axis.

Setting data	Usable device								
	Internal device		File register	Link direct device J□□		Intelligent function module U□G□	Index register Zn	Constant K, H	Others
	Bit	Word		Bit	Word				
(S)	—	○	—	—	—	—	—	—	
(D)	○	○	—	—	—	—	—	—	

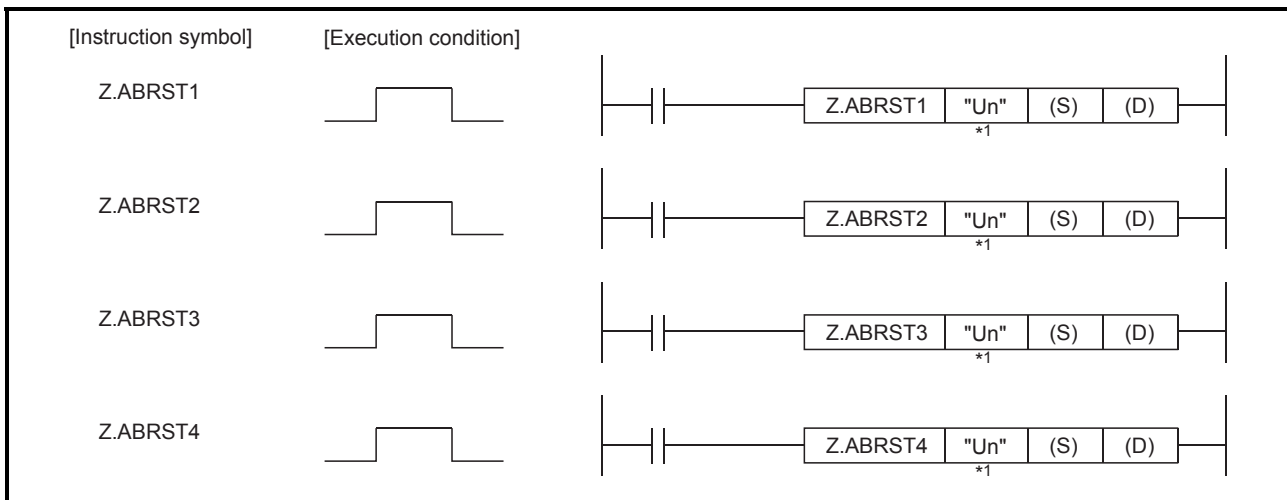

\*1 If the originating station is a Basic model QCPU (function version B or later), universal model QCPU, or safety CPU, "" (double quotation) of the first argument can be omitted.

When Z.ABRST1, Z.ABRST2, Z.ABRST3, and Z.ABRST4 are common to each other, they are designated as "Z.ABRST□".

[Setting data]

Setting data	Setting details	Setting side (*1)	Data type
"Un"	QD75 head I/O number (00 to FE: High-order two digits of I/O number expressed in three digits)	User	BIN 16 bits
(S)	Head number of a device in which control data is stored	—	Device name
(D)	Head number of a bit device which turns ON the operation by one scan at the time of completion of the instruction. If the instruction is completed abnormally, ((D) + 1) will also be turned ON.	System	Bit

Note) The file register of each of the local device and the program cannot be used as a device for setting data.

\*1: The data on the setting side is as follows.

- User : Data before the execution of dedicated instructions is stored by user.
- System : Data after the execution of dedicated instruction is stored by CPU module.

[Control data]

Device	Item	Setting data	Setting range	Setting side (*1)
(S)+0	System area	—	—	—
(S)+1	Complete status	The state at the time of completion is stored. • 0 : Normal completion • Other than 0 : Abnormal completion (error code)(*2)	—	System
(S)+2	Signal received from servo amplifier	The following signal states taken in from the servo amplifier to the input module are written. • b0: ABS data bit 0 • b1: ABS data bit 1 • b2: Transmission data READY flag	b0: 0/1 b1: 0/1 b2: 0/1	User
(S)+3	Signal transmitted to servo amplifier	The ON/OFF states of the following data which are calculated using the dedicated instructions by the "signals received from the servo amplifier" and output to the servo amplifier are stored. • b0: Servo amplifier ON • b1: ABS transfer mode • b2: ABS request flag	—	System
(S)+4	Status	Status of communication with servo amplifier • 0 : Communication completed (Set by user at communication start) • Other than 0 : During communication (System stores)	0	User/system
(S)+5 to (S)+7	System area	—	—	—

\*1: The data on the setting side is as follows.

- User : Data before the execution of dedicated instructions is stored by user.
- System : Data after the execution of dedicated instruction is stored by CPU module.

\*2: Refer to Section 15.3 for error codes at abnormal completion.

[Functions]

- (1) The positioning data is read from the servo amplifier capable of processing the absolute positions of the axes to be set (See below), and the values converted with respect to a unit are stored in "Md.20 Current feed value" and "Md.21 Machine feed value" area of the QD75.
  - Z.ABRST1: Axis 1
  - Z.ABRST2: Axis 2
  - Z.ABRST3: Axis 3
  - Z.ABRST4: Axis 4

For absolute position detection system, carry out the absolute position restoration operation each time the power is turned ON or CPU module is reset.

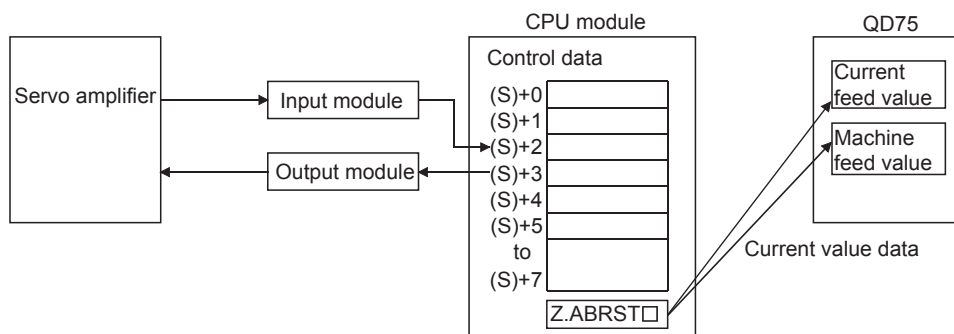

(2) An I/O module is used for communication (data read/write) with the servo amplifier capable of processing the absolute positions.

When using the Z.ABRST□, prepare the input/output with the following number of points, for each axis, for communication with the servo amplifier.

- Input : 3 points
- Output : 3 points

Refer to Section 12.6 for wiring of I/O signals.

(3) The Z.ABRST□ instruction completion can be confirmed using the complete devices ((D)+0) and ((D)+1).

(a) Complete device ((D)+0)

This device is turned ON by the END processing of the scan for which Z.ABRST□ instruction is completed, and turned OFF by the next END processing.

(b) Complete state display device ((D)+1)

This device is turned ON and OFF according to the state in which Z.ABRST□ instruction is completed.

- When completed normally : Kept unchanged at OFF.
- When completed abnormally : This device is turned ON by the END processing of the scan for which Z.ABRST□ instruction is completed, and turned OFF by the next END processing (same ON/OFF operation as complete device).

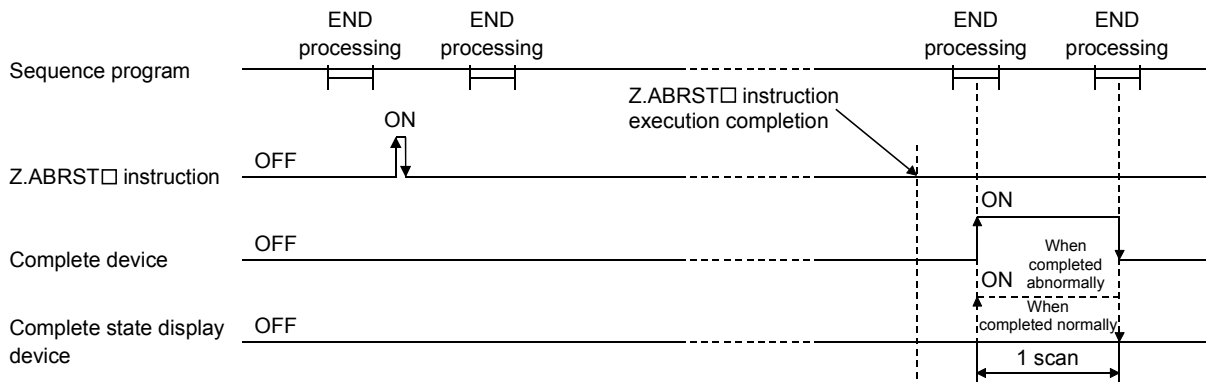

The completion of absolute position restoration can be confirmed using the ((S)+4) "status".

- (4) Using the Z.ABRST□ instruction, the absolute position restoration is carried out in the following procedure.

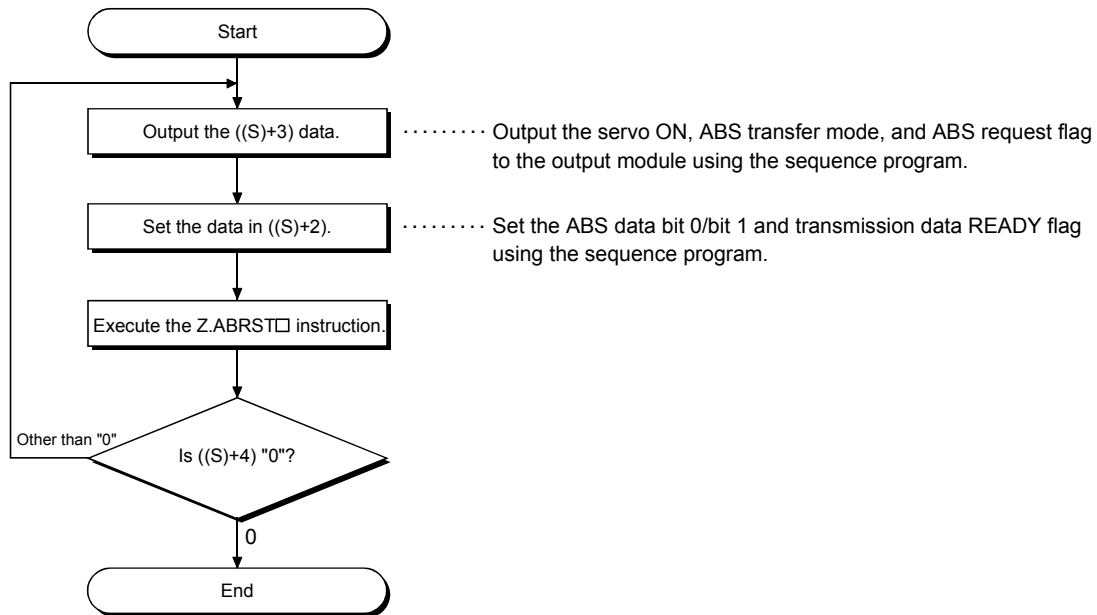

#### [Errors]

- (1) When a dedicated instruction is completed abnormally, the error complete signal ((D)+1) is turned ON, and the error code is stored in the complete status ((S)+1). Check and take a measure against the error referring to Section 15.3 "List of error codes".

#### [Precautions]

- (1) After the absolute position detection system is configured, the absolute position restoration must be carried out at least once after the power is turned ON or reset. Unless the absolute position restoration of the QD75 is completed, the servo amplifier will not be turned ON.
- (2) Execute absolute position restoration when the PLC READY signal [Y0] is OFF.
- (3) The restoration of the absolute position (Z.ABRST□ instruction execution) can also be carried out when the servo amplifier is turned ON. If this is carried out, however, the servo ON signal is turned OFF for approx. 60ms + scan time (servo OFF) and the motor may move.  
When carrying out the absolute position restoration during servo OFF, install an electromagnetic brake and output the Z.ABRST□ instruction to that brake during the Z.ABRST□ instruction execution.
- (4) The following dedicated instructions cannot be executed simultaneously for the same axis.  
(Can be executed simultaneously for different axes.)
  - Positioning start instructions (ZP.PSTR1 to ZP.PSTR4)
  - Absolute position restoration instructions (Z.ABRST1 to Z.ABRST4)
  - Teaching instructions (ZP.TEACH1 to ZP.TEACH4)
- (5) When the remote I/O station\* (Q Corresponding MELSECNET/H network remote I/O module) is used, the dedicated instruction (Z.ABRST□) is unusable.  
(For the sequence program example for use when the dedicated instruction is not used, refer to the Mitsubishi General-Purpose AC Servo "Absolute Position Detection System" Installation Guide.)  
\*: For details of the remote I/O station, refer to Q Corresponding MELSECNET/H Network System Reference Manual (Remote I/O Network).

- (6) If the Z.ABRST□ instruction is executed in either of the following cases, an error "Dedicated instruction error" (error code: 804) will occur and absolute position restoration cannot be carried out.
- Any value other than 0 is set to "Status" (device: (S)+4) of the control data (at communication start with servo amplifier).
  - The instruction for a non-existent axis is specified.  
(Example: The Z.ABRST2 instruction is specified when the QD75P1 is used.)
  - "Status" (device: (S)+4) of the control data is changed during absolute position restoration (during communication with servo amplifier).

[Program examples]

Program to restore the absolute position of axis 1.

The X47 to X49 and Y50 to Y52 are used for communication with the servo amplifier.

- X47: ABS data bit 0
- X48: ABS data bit 1
- X49: Transmission data READY flag
- Y50: Servo ON signal
- Y51: ABS transfer mode
- Y52: ABS request flag

\* (1) Absolute position restoration command acceptance

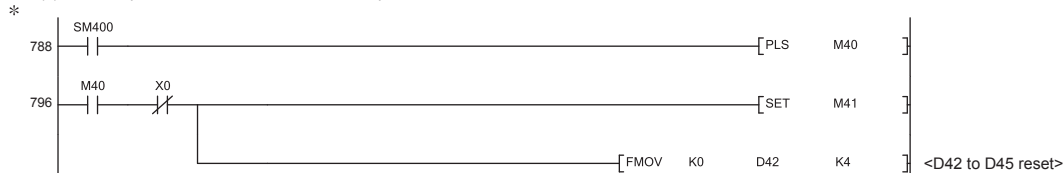

\* (2) Setting of transmit data to servo-amplifier and confirmation of absolute position restoration completion  
 ABRST1 instruction completed when M42 is ON and M43 is OFF.  
 Absolute position data restoration completed when status = 0.

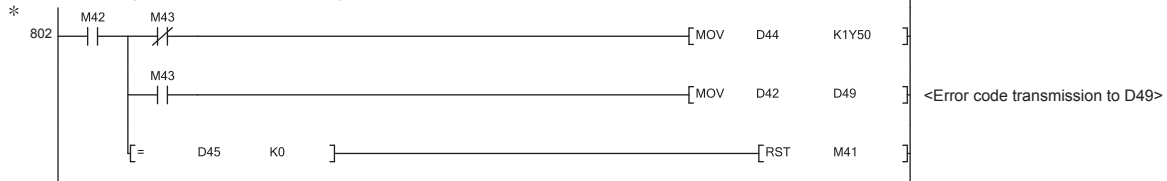

\* (3) ABS data setting and ABRST1 instruction execution

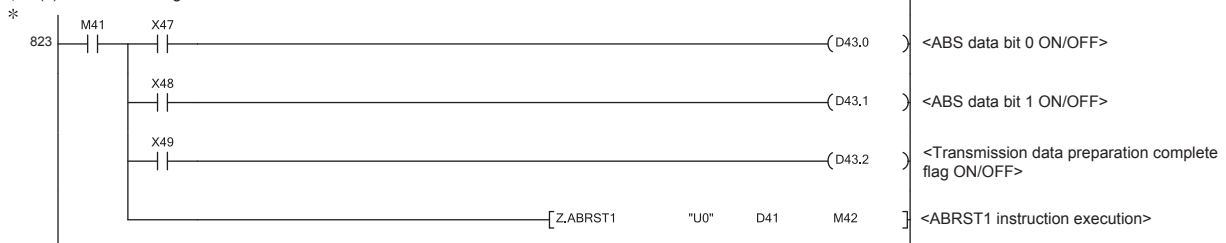

14.4 ZP.PSTR1, ZP.PSTR2, ZP.PSTR3, ZP.PSTR4

These dedicated instructions are used to start the positioning of the designated axis.

Setting data	Usable device								
	Internal device		File register	Link direct device J□□		Intelligent function module U□G□	Index register Zn	Constant K, H	Others
	Bit	Word		Bit	Word				
(S)	-	○	-	-	-	-	-	-	
(D)	○	○	-	-	-	-	-	-	

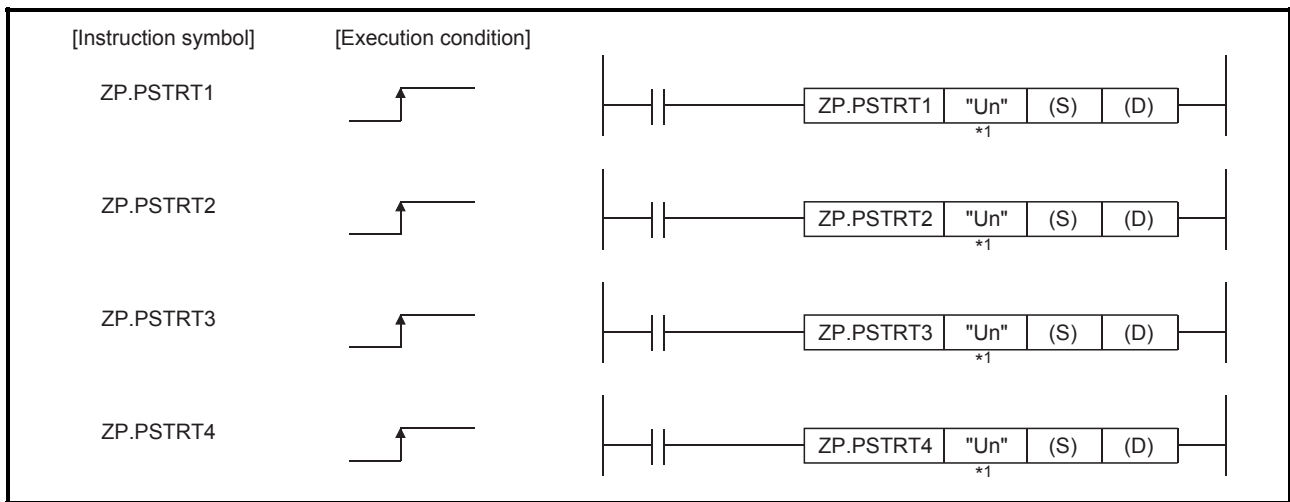

\*1 If the originating station is a Basic model QCPU (function version B or later), universal model QCPU, or safety CPU, "" (double quotation) of the first argument can be omitted.

When ZP.PSTR1, ZP.PSTR2, ZP.PSTR3, and ZP.PSTR4 are common to each other, they are designated as "ZP.PSTR□".

[Setting data]

Setting data	Setting details	Setting side (*1)	Data type
"Un"	QD75 head I/O number (00 to FE: High-order two digits of I/O number expressed in three digits)	User	BIN 16 bits
(S)	Head number of a device in which control data is stored	-	Device name
(D)	Head number of a bit device which turns ON the operation by one scan at the time of completion of the instruction. If the instruction is completed abnormally, ((D) + 1) will also be turned ON.	System	Bit

Note) The file register of each of the local device and the program cannot be used as a device for setting data.

\*1: The data on the setting side is as follows.

- User : Data before the execution of dedicated instructions is stored by user.
- System : Data after the execution of dedicated instruction is stored by CPU module.

## [Control data]

Device	Item	Setting data	Setting range	Setting side (*1)
(S)+0	System area	–	–	–
(S)+1	Complete status	The state at the time of completion is stored. <ul style="list-style-type: none"> <li>• 0 : Normal completion</li> <li>• Other than 0: Abnormal completion (error code)(*2)</li> </ul>	–	System
(S)+2	Start No.	The following data Nos. to be started by the ZP.PSTRT□ instruction are designated. <ul style="list-style-type: none"> <li>• Positioning data No. : 1 to 600</li> <li>• Block start : 7000 to 7004</li> <li>• Machine OPR : 9001</li> <li>• Fast OPR : 9002</li> <li>• Current value changing : 9003</li> <li>• Multiple axes simultaneous start: 9004</li> </ul>	1 to 600 7000 to 7004 9001 to 9004	User

\*1: The data on the setting side is as follows.

- User : Data before the execution of dedicated instructions is stored by user.
- System : Data after the execution of dedicated instruction is stored by CPU module.

\*2: Refer to Section 15.3 for error codes at abnormal completion.

## [Functions]

- (1) The positioning start of the axes to be processed (See below) is carried out.
  - ZP.PSTRT1: Axis 1
  - ZP.PSTRT2: Axis 2
  - ZP.PSTRT3: Axis 3
  - ZP.PSTRT4: Axis 4
  
- (2) The block start, OPR start, current value changing, and multiple axes simultaneous start can be carried out by the setting of "start number" 7000 to 7004/9001 to 9004 in ((S)+2).
  
- (3) The ZP.PSTRT□ instruction completion can be confirmed using the complete devices ((D)+0) and ((D)+1).
  - (a) Complete device ((D)+0)  
This device is turned ON by the END processing of the scan for which ZP.PSTRT□ instruction is completed, and turned OFF by the next END processing.
  - (b) Complete state display device ((D)+1)  
This device is turned ON and OFF according to the state in which ZP.PSTRT□ instruction is completed.
    - When completed normally : Kept unchanged at OFF.
    - When completed abnormally : This device is turned ON by the END processing of the scan for which ZP.PSTRT□ instruction is completed, and turned OFF by the next END processing (same ON/OFF operation as complete device).

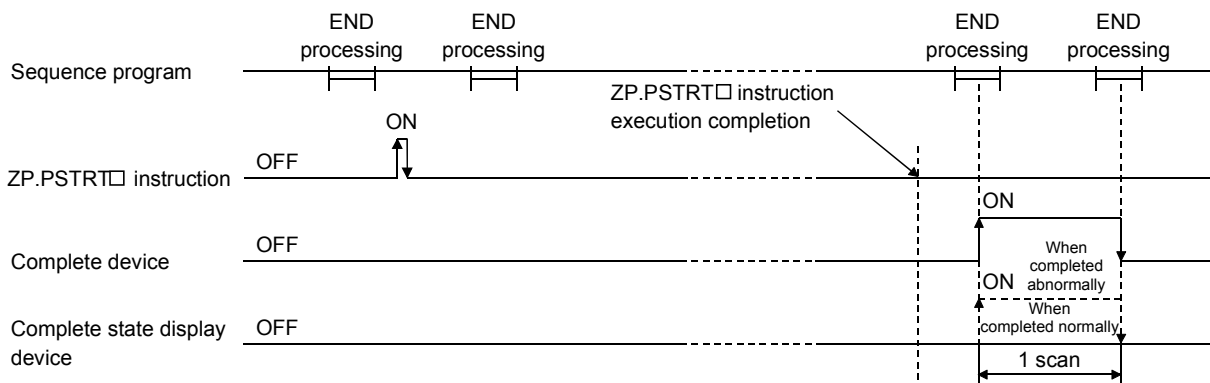

### [Errors]

- (1) When an ZP.PSTRT□ instruction is completed abnormally, the error complete signal ((D)+1) is turned ON, and the error code is stored in the complete status ((S)+1).  
Check and take a measure against the error referring to Section 15.3 "List of error codes".

### [Precautions]

- (1) When positioning is started by the ZP.PSTRT□ instruction, the positioning start signals (Y10 to Y13) will not turn ON.  
Therefore, the start complete signal (X10 to X13) cannot be used for confirming completion of start of positioning.  
To confirm that positioning control is being executed, use the ZP.PSTRT□ start command or BUSY signals (XC to XF).
- (2) If, after positioning has been started by the ZP.PSTRT□ instruction, a stop command is input before positioning is complete, the complete device (D) turns ON one scan and the execution of the ZP.PSTRT□ instruction is completed.
- (3) The following dedicated instructions cannot be executed simultaneously for the same axis.  
(Can be executed simultaneously for different axes.)
  - Positioning start instructions (ZP.PSTRT1 to ZP.PSTRT4)
  - Absolute position restoration instructions (Z.ABRST1 to Z.ABRST4)
  - Teaching instructions (ZP.TEACH1 to ZP.TEACH4)
- (4) The ZP.PSTRT□ instruction can only be executed when the QD75 READY signal (X0) is turned ON.  
Even if the ZP.PSTRT□ instruction execution request is given when the QD75 READY signal is turned OFF, the ZP.PSTRT□ instruction will not be executed. (not processed.)  
Before executing the ZP.PSTRT□ instruction, turn ON the PLC READY signal (Y0), and turn ON the QD75 READY signal (X0).



- (5) When the remote I/O station\* (Q Corresponding MELSECNET/H network remote I/O module) is used, the dedicated instruction (ZP.PSTRT□) is unusable.  
 \*: For details of the remote I/O station, refer to Q Corresponding MELSECNET/H Network System Reference Manual (Remote I/O Network).
- (6) If the ZP.PSTRT□ instruction is executed in either of the following cases, an error "Dedicated instruction error" (error code: 804) will occur and positioning cannot be started.
  - Any value other than 1 to 600, 7000 to 7004, and 9001 to 9004 is set to "Starting number" (device: (S)+2) of the control data.
  - The instruction for a non-existent axis is specified.  
 (Example: The ZP.PSTRT2 instruction is specified when the QD75P1 is used.)
- (7) When the multiple axes simultaneous start is executed by ZP.PSTRT□ instruction, the completion device (D) will turn ON when the positioning of the axes executed by ZP.PSTRT□ instructions is completed. (When the instructions is ZP.PSTRT1, the axis will be axis 1.)

[Program examples]

- The following program executes the positioning start of positioning data No. 1 when X100 turns ON.  
 Use D30 to D32 as the control data devices of positioning data No. 1, and M32 and M33 as the completion devices.

(1) Positioning start program

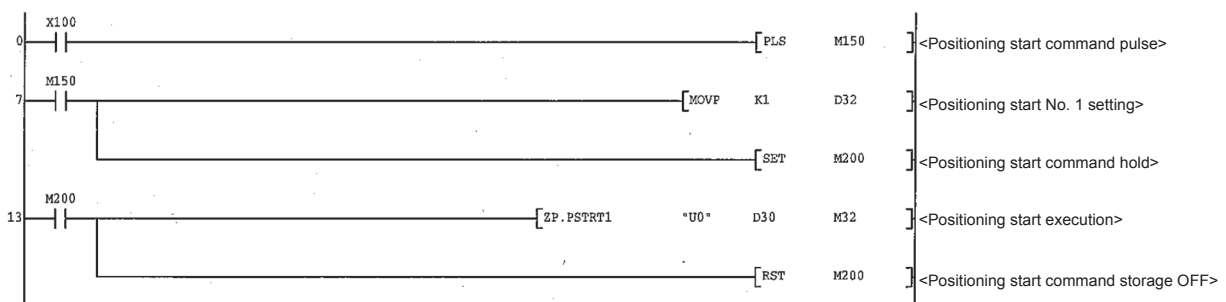

(2) Positioning start program (when the dedicated instruction is not used)

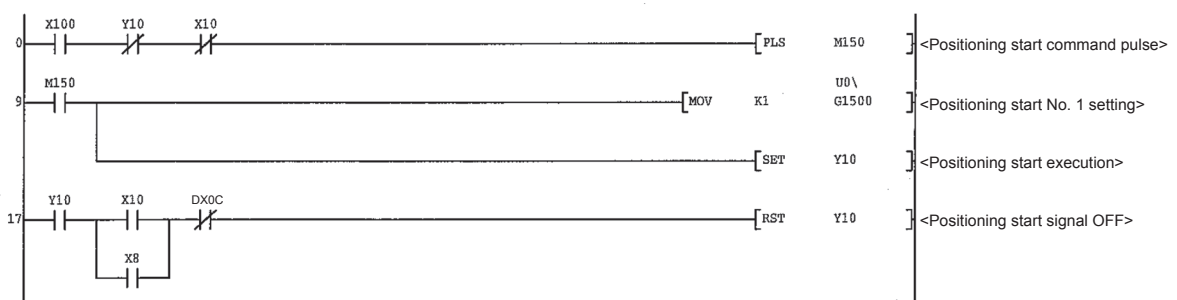

14.5 ZP.TEACH1, ZP.TEACH2, ZP.TEACH3, ZP.TEACH4

This dedicated instruction is used to teach the designated axis.

Setting data	Usable device								
	Internal device		File register	Link direct device J□□		Intelligent function module U□G□	Zn	Constant K, H	Others
	Bit	Word		Bit	Word				
(S)	—	○	—	—	—	—	—	—	
(D)	○	○	—	—	—	—	—	—	

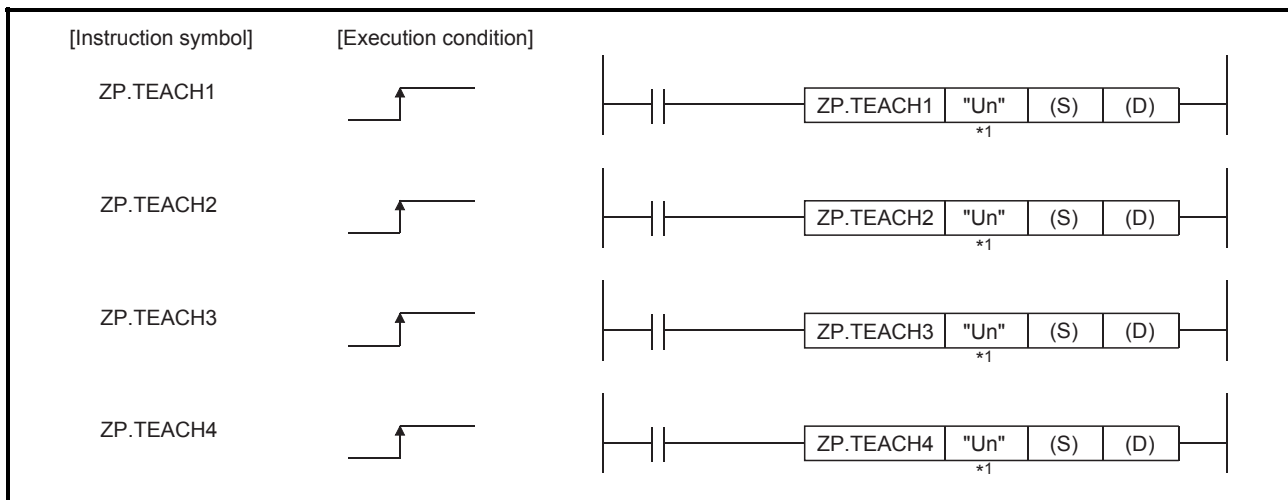

\*1 If the originating station is a Basic model QCPU (function version B or later), universal model QCPU, or safety CPU, "" (double quotation) of the first argument can be omitted.

When ZP.TEACH1, ZP.TEACH2, ZP.TEACH3, and ZP.TEACH4 are common to each other, they are designated as "ZP.TEACH□".

[Setting data]

Setting data	Setting details	Setting side (*1)	Data type
"Un"	QD75 head I/O number (00 to FE: High-order two digits of I/O number expressed in three digits)	User	BIN 16 bits
(S)	Head number of a device in which control data is stored	—	Device name
(D)	Head number of a bit device which turns ON the operation by one scan at the time of completion of the instruction. If the instruction is completed abnormally, ((D) + 1) will also be turned ON.	System	Bit

Note) The file register of each of the local device and the program cannot be used as a device for setting data.

\*1: The data on the setting side is as follows.

- User : Data before the execution of dedicated instructions is stored by user.
- System : Data after the execution of dedicated instruction is stored by CPU module.

## [Control data]

Device	Item	Setting data	Setting range	Setting side (*1)
(S)+0	System area	–	–	–
(S)+1	Complete status	The state at the time of completion is stored. 0 : Normal completion Other than 0 : Abnormal completion (error code)(*2)	–	System
(S)+2	Teaching data selection	The address (positioning address/arc address) to which the current feed value is written is set. 0: Current feed value is written to positioning address. 1: Current feed value is written to arc address.	0, 1	User
(S)+3	Positioning data No.	The positioning data No. for which teaching is carried out is set.	1 to 600	User

\*1: The data on the setting side is as follows.

- User : Data before the execution of dedicated instructions is stored by user.
- System : Data after the execution of dedicated instruction is stored by CPU module.

\*2: Refer to Section 15.3 for error codes at abnormal completion.

## [Functions]

- (1) The "current feed value" of the axes to be set (See below) is set in the positioning address or arc address.

The positioning data other than the positioning addresses and arc addresses are set by peripheral device or using a sequence program.

- ZP.TEACH1: Axis 1
- ZP.TEACH2: Axis 2
- ZP.TEACH3: Axis 3
- ZP.TEACH4: Axis 4

- (2) Teaching can be carried out for the positioning data No. 1 to 600.

- (3) The movement of the machine to the address (position) set in the positioning address/arc address of the positioning data is carried out by the JOG operation, inching operation, or manual pulse generator operation.

- (4) The ZP.TEACH□ instruction completion can be confirmed using the complete devices ((D)+0) and ((D)+1).

- (a) Complete device ((D)+0)

This device is turned ON by the END processing of the scan for which ZP.TEACH□ instruction is completed, and turned OFF by the next END processing.

- (b) Complete state display device ((D)+1)

This device is turned ON and OFF according to the state in which ZP.TEACH□ instruction is completed.

- When completed normally : Kept unchanged at OFF.
- When completed abnormally : This device is turned ON by the END processing of the scan for which ZP.TEACH□ instruction is completed, and turned OFF by the next END processing (same ON/OFF operation as complete device).

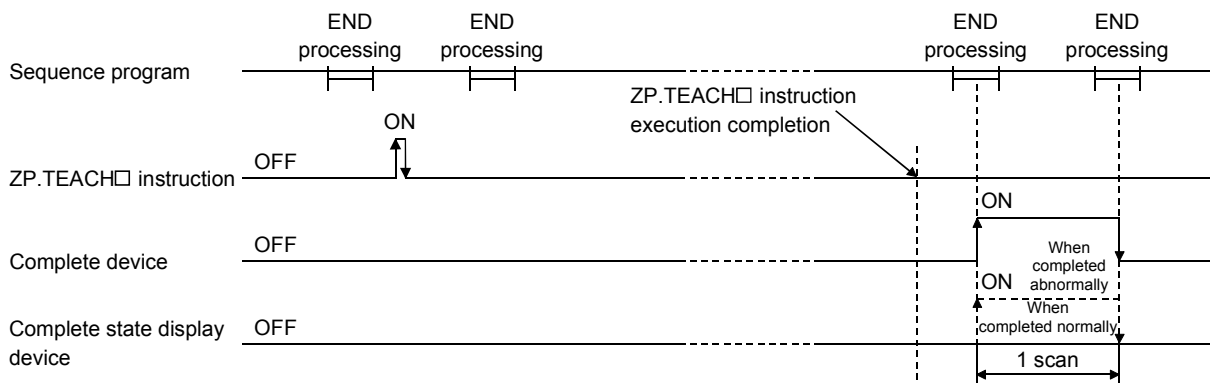

### [Errors]

- (1) When a ZP.TEACH instruction is completed abnormally, the error complete signal ((D)+1) is turned ON, and the error code is stored in the complete status (S)+1. Check and take a measure against the error referring to Section 15.3 "List of error codes".

### [Precautions]

- (1) The following dedicated instructions cannot be executed simultaneously for the same axis.  
(Can be executed simultaneously for different axes.)
  - Positioning start instructions (ZP.PSTR1 to ZP.PSTR4)
  - Absolute position restoration instructions (Z.ABRST1 to Z.ABRST4)
  - Teaching instructions (ZP.TEACH1 to ZP.TEACH4)
- (2) The ZP.TEACH instruction can only be executed when the BUSY signal (XC, XD, XE, XF) is turned OFF.  
When the BUSY signal is turned ON, the ZP.TEACH instruction will not be executed. (not processed.)  
Before executing the ZP.TEACH instruction, make sure that the BUSY signal for the axis to be processed is turned OFF.
- (3) When the remote I/O station\* (Q Corresponding MELSECNET/H network remote I/O module) is used, the dedicated instruction (ZP.TEACH) is unusable.  
\*: For details of the remote I/O station, refer to Q Corresponding MELSECNET/H Network System Reference Manual (Remote I/O Network).
- (4) If the ZP.TEACH instruction is executed in any of the following cases, an error "Dedicated instruction error" (error code: 804) will occur and teaching cannot be performed.
  - Any value other than 0 and 1 is set to "Teaching selection" (device: (S)+2) of the control data.
  - Any value other than 1 to 600 is set to "Positioning No." (device: (S)+3) of the control data.
  - The instruction for a non-existent axis is specified.  
(Example: The ZP.TEACH2 instruction is specified when the QD75P1 is used.)

[Program example]

Program to execute the teaching of the positioning data No. 3 of the axis 1 when X39 is turned ON.

(1) Teaching program

Positioning is carried out for a target position by manual operation.

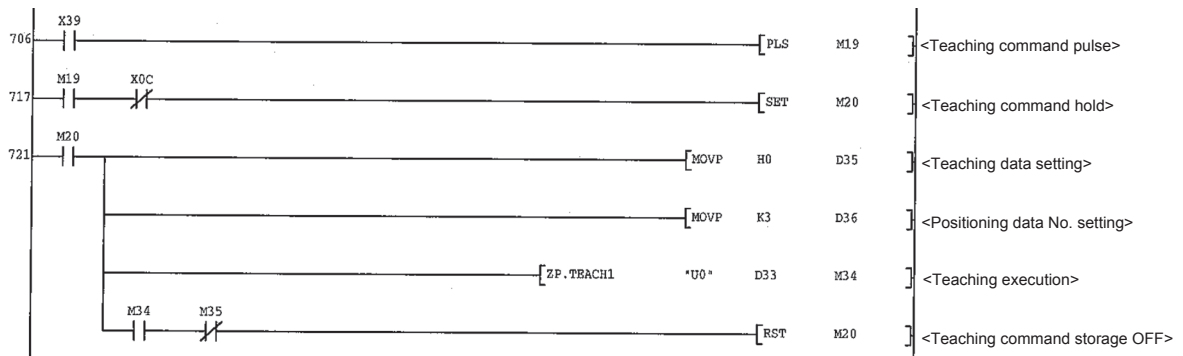

(2) Teaching program (when the dedicated instruction is not used)

Positioning is carried out for a target position by manual operation.

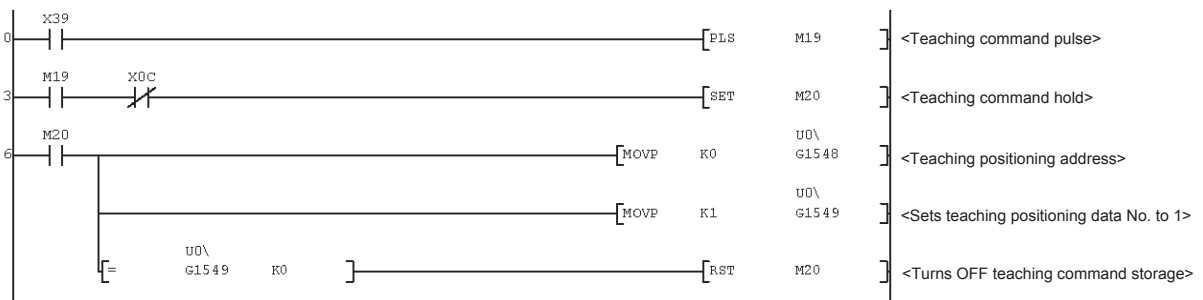

14.6 ZP.PFWRT

These dedicated instructions are used to write the QD75 parameters, positioning data and block start data to the flash ROM.

Setting data	Usable device								
	Internal device		File register	Link direct device J□□		Intelligent function module U□G□	Index register Zn	Constant K, H	Others
	Bit	Word		Bit	Word				
(S)	—	○	—	—	—	—	—	—	
(D)	○	○	—	—	—	—	—	—	

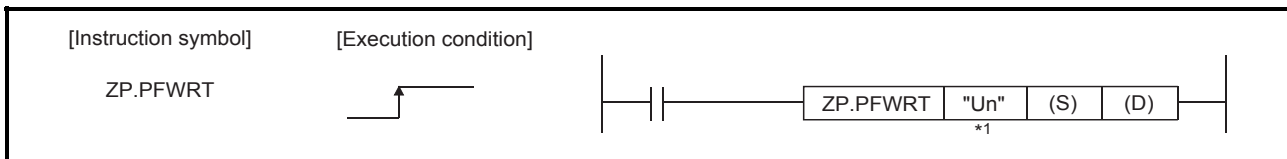

\*1 If the originating station is a Basic model QCPU (function version B or later), universal model QCPU, or safety CPU, "" (double quotation) of the first argument can be omitted.

[Setting data]

Setting data	Setting details	Setting side (*1)	Data type
"Un"	QD75 head I/O number (00 to FE: High-order two digits of I/O number expressed in three digits)	User	BIN 16 bits
(S)	Head number of a device in which control data is stored	—	Device name
(D)	Head number of a bit device which turns ON the operation by one scan at the time of completion of the instruction. If the instruction is completed abnormally, ((D) + 1) will also be turned ON.	System	Bit

Note) The file register of each of the local device and the program cannot be used as a device for setting data.

\*1: The data on the setting side is as follows.

- User : Data before the execution of dedicated instructions is stored by user.
- System : Data after the execution of dedicated instruction is stored by CPU module.

[Control data]

Device	Item	Setting data	Setting Range	Setting side (*1)
(S)+0	System area	—	—	—
(S)+1	Complete status	The state at the time of completion is stored. 0 :Normal completion Other than 0 :Abnormal completion (error code)(*2)	—	System

\*1: The data on the setting side is as follows.

- User : Data before the execution of dedicated instructions is stored by user.
- System : Data after the execution of dedicated instruction is stored by CPU module.

\*2: Refer to Section 15.3 for error codes at abnormal completion.

[Functions]

(1) The ZP.PFWRT instruction completion can be confirmed using the complete devices ((D)+0) and ((D)+1).

(a) Complete device ((D)+0)

This device is turned ON by the END processing of the scan for which ZP.PFWRT instruction is completed, and turned OFF by the next END processing.

(b) Complete state display device ((D)+1)

This device is turned ON and OFF according to the state in which ZP.PFWRT instruction is completed.

- When completed normally : Kept unchanged at OFF.
- When completed abnormally : This device is turned ON by the END processing of the scan for which ZP.PFWRT instruction is completed, and turned OFF by the next END processing (same ON/OFF operation as complete device).

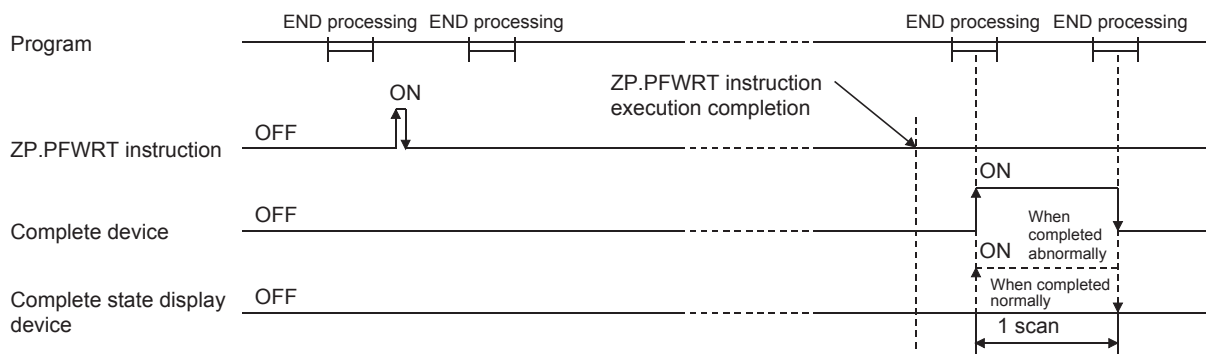

[Errors]

(1) When a dedicated instruction is completed abnormally, the error complete signal ((D)+1) is turned ON, and the error code is stored in the complete status ((S)+1). Check and take measures against the error referring to Section 15.3 "List of error codes".

**[Precautions]**

- (1) Do not turn ON the power and reset the CPU module while parameters, positioning data and block start data are written to the flash ROM using the ZP.PFWRT instruction.  
A parameter error will occur or normal positioning start will become impossible because the parameters, positioning data and block start data are not written normally to the flash ROM.  
If this occurs, restart the operation by the method shown below.
  - For GX Configurator-QP or GX Works2, write the parameters, positioning data and block start data again to the flash ROM.
  - For a sequence program, write the parameters, positioning data and block start data to the QD75 after initializing the parameters (ZP.PINIT instruction execution and others).  
Then execute the ZP.PFWRT instruction again.
  
- (2) Writing to the flash ROM can be executed up to 100,000 times.  
If writing to the flash ROM exceeds 100,000 times, the writing may become impossible.
  
- (3) After the power ON and CPU module reset operation, writing to the flash ROM using a sequence program is limited to up to 25 times. (Not limited to up to 25 times when writing to the flash ROM is carried out by peripheral device.)  
If the 26th or more writing is requested after the power ON/CPU module reset operation, an error "flash ROM write number error" (error code: 805) will occur, and the writing will be disabled. If a flash ROM write error occurs by one writing to the flash ROM, check and correct the flash ROM writing program. Then reset the error or turn ON the power and reset the CPU module again.
  
- (4) The ZP.PFWRT instruction can only be executed when the QD75 READY signal (X0) is turned OFF.  
When the QD75 READY signal is turned ON, the ZP.PFWRT instruction cannot be executed.  
Before executing the ZP.PFWRT instruction, turn OFF the PLC READY signal (Y0) and then turn OFF the QD75 READY signal.
  
- (5) When the remote I/O station\* (Q Corresponding MELSECNET/H network remote I/O module) is used, the dedicated instruction (ZP.PFWRT) is unusable.  
\*: For details of the remote I/O station, refer to Q Corresponding MELSECNET/H Network System Reference Manual (Remote I/O Network).



[Program example]

Program used to write the parameters and positioning data stored in the buffer memory to the flash ROM when X3D is turned ON.

(1) Flash ROM write program

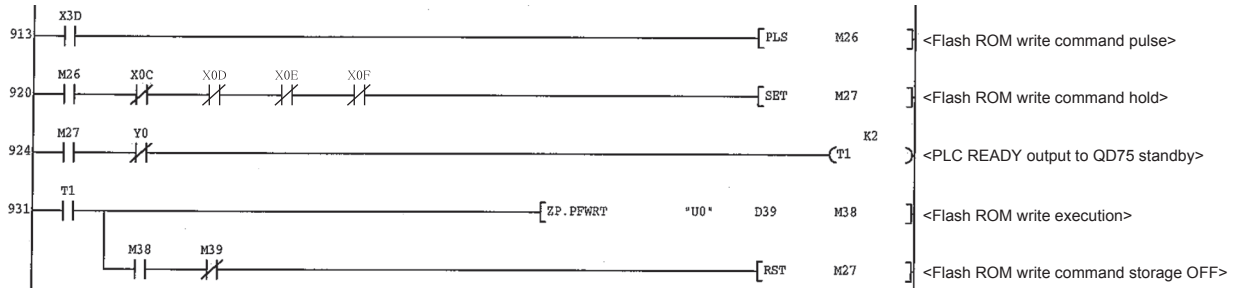

[Program example for use when dedicated instruction is not used]

(2) Flash ROM write program (when the dedicated instruction is not used)

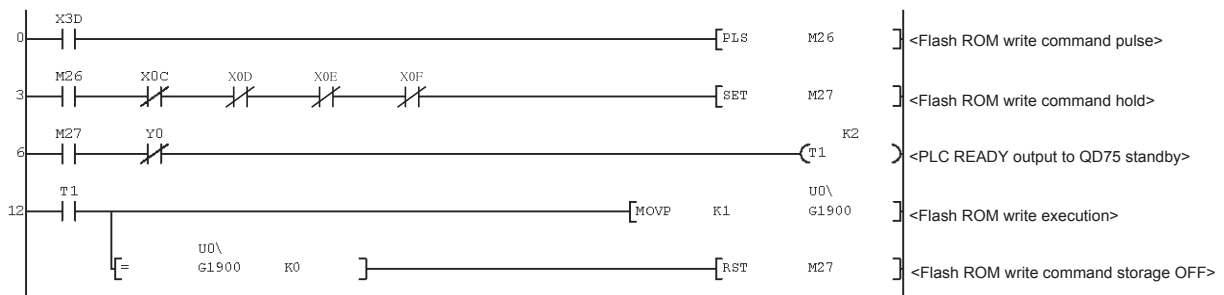

14.7 ZP.PINIT

This dedicated instruction is used to initialize the setting data of the QD75.

Setting data	Usable device								
	Internal device		File register	Link direct device J□□		U□G□	Index register Zn	Constant K, H	Others
	Bit	Word		Bit	Word				
(S)	–	○	–	–	–	–	–	–	
(D)	○	○	–	–	–	–	–	–	

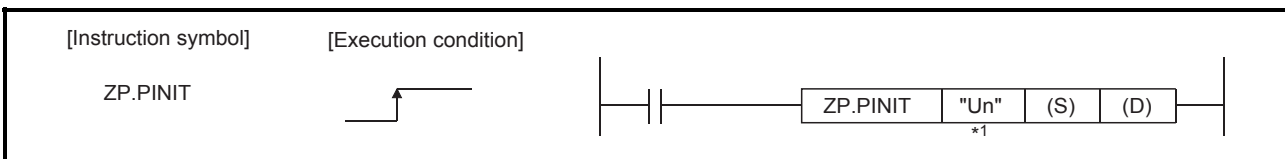

\*1 If the originating station is a Basic model QCPU (function version B or later), Universal model QCPU, or safety CPU, "" (double quotation) of the first argument can be omitted.

[Setting data]

Setting data	Setting details	Setting side (*1)	Data type
"Un"	QD75 head I/O number (00 to FE: High-order two digits of I/O number expressed in three digits)	User	BIN 16 bits
(S)	Head number of a device in which control data is stored	–	Device name
(D)	Head number of a bit device which turns ON the operation by one scan at the time of completion of the instruction. If the instruction is completed abnormally, ((D) + 1) will also be turned ON.	System	Bit

Note) The file register of each of the local device and the program cannot be used as a device for setting data.

\*1: The data on the setting side is as follows.

- User : Data before the execution of dedicated instructions is stored by user.
- System : Data after the execution of dedicated instruction is stored by CPU module.

[Control data]

Device	Item	Setting data	Setting range	Setting side (*1)
(S)+0	System area	–	–	–
(S)+1	Complete status	The state at the time of completion is stored. 0 : Normal completion Other than 0: Abnormal completion (error code)(*2)	–	System

\*1: The data on the setting side is as follows.

- User : Data before the execution of dedicated instructions is stored by user.
- System : Data after the execution of dedicated instruction is stored by CPU module.

\*2: Refer to Section 15.3 for error codes at abnormal completion.

[Functions]

- (1) This dedicated instruction is used to return the setting data set in the QD75 buffer memory and flash ROM to their factory-set data (initial values).

Initialized setting data
Parameters (Pr.1 to Pr.57, Pr.70, Pr.150)
Positioning data (No. 1 to No. 600)
Block start data (No. 7000 to 7004)

- (2) The ZP.PINIT instruction completion can be confirmed using the complete devices ((D)+0) and ((D)+1).
  - (a) Complete device ((D)+0)  
This device is turned ON by the END processing of the scan for which ZP.PINIT instruction is completed, and turned OFF by the next END processing.
  - (b) Complete state display device ((D)+1)  
This device is turned ON and OFF according to the state in which ZP.PINIT instruction is completed.
    - When completed normally : Kept unchanged at OFF.
    - When completed abnormally : This device is turned ON by the END processing of the scan for which ZP.PINIT instruction is completed, and turned OFF by the next END processing (same ON/OFF operation as complete device).

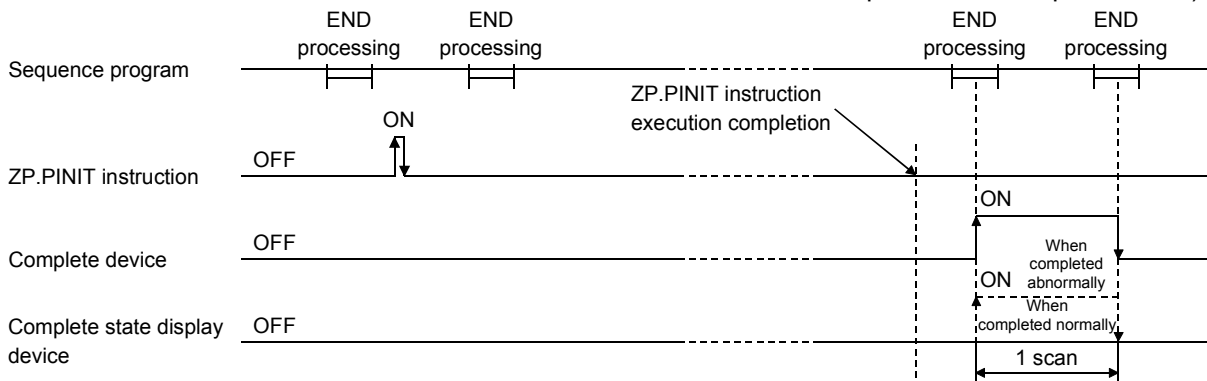

[Errors]

- (1) When a dedicated instruction is completed abnormally, the error complete signal ((D)+1) is turned ON, and the error code is stored in the complete status ((S)+1). Check and take measures against the error referring to Section 15.3 "List of error codes".

[Precautions]

- (1) The ZP.PINIT instruction can only be executed when the QD75 READY signal (X0) is turned OFF.  
When the QD75 READY signal is turned ON, the ZP.PINIT instruction cannot be executed.  
Before executing the ZP.PINIT instruction, turn OFF the PLC READY signal (Y0) and then turn OFF the QD75 READY signal.
- (2) When the remote I/O station\* (Q Corresponding MELSECNET/H network remote I/O module) is used, the dedicated instruction (ZP.PINIT) is unusable.  
\*: For details of the remote I/O station, refer to Q Corresponding MELSECNET/H Network System Reference Manual (Remote I/O Network).

- (3) Writing to the flash ROM can be executed up to 100,000 times.  
If writing to the flash ROM exceeds 100,000 times, the writing may become impossible.
- (4) After the power ON and CPU module reset operation, writing to the flash ROM using a sequence program is limited to up to 25 times. (Not limited to up to 25 times when writing to the flash ROM is carried out by peripheral device.)  
If the 26th or more writing is requested after the power ON/CPU module reset operation, an error "flash ROM write number error" (error code: 805) will occur, and the writing will be disabled. If a flash ROM write error occurs by one writing to the flash ROM, check and correct the flash ROM writing program. Then reset the error or turn ON the power and reset the CPU module again.

[Program example]

The following program initializes the parameters in buffer memory and flash ROM when X3C turns ON.

(1) Parameter initialization program

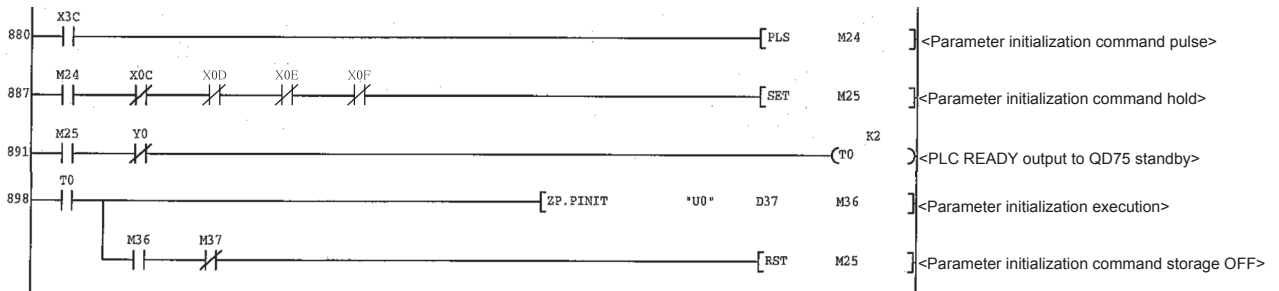

(2) Parameter initialization program (when the dedicated instruction is not used)

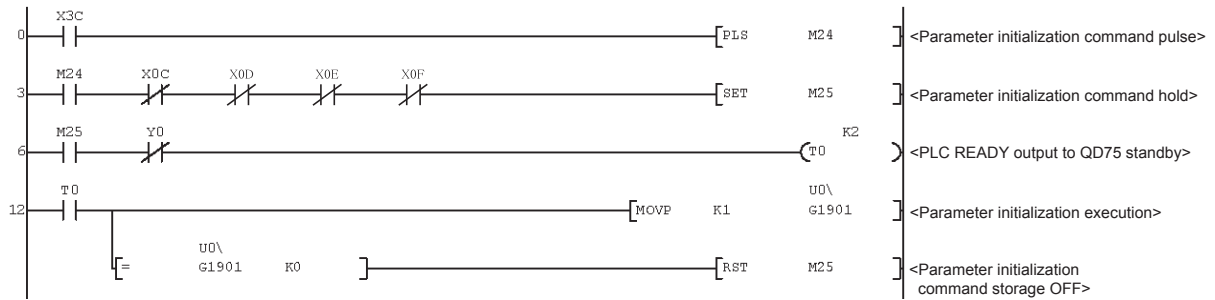



# CHAPTER 15 TROUBLESHOOTING

The "errors" and "warnings" detected by the QD75 are explained in this chapter.

Errors can be confirmed with the QD75 LED display and peripheral devices.  
When an error or warning is detected, confirm the detection details and carry out the required measures.

15.1	Troubleshooting .....	15- 2
15.2	Error and warning details.....	15- 6
15.3	List of errors .....	15- 10
15.4	List of warnings .....	15- 42

## 15.1 Troubleshooting

## (1) Troubleshooting using the LEDs

Check items and corrective actions for troubleshooting using the indicator LEDs of the QD75 are described below.

## (a) When the RUN LED turns off

Check item	Action
Is the power supplied?	Check that the voltage supplied to the power supply module is within the rated range.
Is the power supply capacity sufficient?	Calculate the total current consumption of the connected modules (CPU module, I/O modules, and intelligent function modules) and check that the power supply capacity is not insufficient.
Is the module connected correctly?	Check that the module is correctly connected to the base unit.

If there is no problem on the above check items, a watchdog timer error may have occurred. Reset the CPU module and check that the RUN LED turns on.

If not, the possible cause is a hardware failure. Please consult your local Mitsubishi representative.

## (b) When the ERR. LED turns on

Check item	Action
Is there a system error?	An error may have occurred in the CPU module. Check the error and take a corrective action.

## (c) When the ERR. LED and axis LED flash

Check item	Action
Is there an axis error?	Check the error code and take the action described in Section 15.3.

## (d) When all LEDs turn on

Reset the CPU module and check that the module is in the normal status. If all LEDs still turn on, the possible cause is a hardware failure. Please consult your local Mitsubishi representative.



(2) Troubleshooting when a motor does not rotate

Check items and corrective actions for troubleshooting when a motor does not rotate are described below.

POINT
<p>The following signals must be ON for the QD75 to operate (excluding when the positioning test function of GX Works2 is used).</p> <ul style="list-style-type: none"> <li>• QD75 READY signal (X0)</li> <li>• Drive unit READY signal</li> <li>• Upper limit signal and Lower limit signal</li> </ul> <p>The status of the drive unit READY signal and upper/lower limit signals can be checked in b0 to b2 of " <span style="border: 1px solid black; padding: 0 2px;">Md.30</span> External I/O signal".</p>

Check item	Action
Are the QD75 READY signal (X0), drive unit READY signal, and upper/lower limit signals ON?	Review and correct the program and wiring so that all the QD75 READY signal (X0), drive unit READY signal, and upper/lower limit signals turn ON.
Is there an error in the QD75? (ERR. LED is on or flashing)	Check the error code and take a corrective action.
Is the drive unit powered ON?	Power on the drive unit.
Is there an error in the drive unit?	Check the error code of the drive unit and take a corrective action.
Is the wiring between the QD75 and drive unit correct?	Check the wiring between the QD75 and drive unit, and correct it.
Is the wiring between the drive unit and motor correct?	Check the wiring between the drive unit and motor, and correct it.
Is the value in " <span style="border: 1px solid black; padding: 0 2px;">Md.20</span> Current feed value" changed after positioning control is performed?	Review the start program.
Is the number of the input pulses for monitoring changed after positioning control is performed? *1	Refer to the drive unit operating manual and check that the function to suppress the motor rotation is not working.
Isn't the value in " <span style="border: 1px solid black; padding: 0 2px;">Md.26</span> Axis operation status" "1: Stopped"?	<ul style="list-style-type: none"> <li>• Review the stop program.</li> <li>• Check that the stop signal (STOP) is not input.</li> </ul>
Does the pulse output mode setting meet the specifications of the drive unit?	Set the value in " <span style="border: 1px solid black; padding: 0 2px;">Pr.5</span> Pulse output mode" so that it satisfies the specifications of the drive unit.
Does the output logic setting of the command pulse signal meet the specifications of the drive unit?	Set the value of the logic selection of the command pulse signal ( <span style="border: 1px solid black; padding: 0 2px;">Pr.23</span> Output signal logic selection: b0) so that it satisfies the specifications of the drive unit.

\*1: This check item applies only for the drive unit having a monitor function for the number of input pulses.

If a motor does not rotate even after the above items are checked, the possible cause is a hardware failure.

Please consult your local Mitsubishi representative.

(3) Troubleshooting when a motor does not rotate as intended.

Check items and corrective actions for troubleshooting when a motor does not rotate as intended are described below.

(a) When a motor rotates only in one direction

Check item	Action
Is the wiring correct?	Check that the signal line of the pulse output (for axis 1, connector pin No. "1A15 to 18") is correctly wired or not disconnected.
Does the pulse output mode setting meet the specifications of the drive unit?	Set the value in " [Pr.5] Pulse output mode" so that it satisfies the specifications of the drive unit.

(b) When a motor rotates in the opposite direction

Check item	Action
Is the wiring correct?	Check that the signal line of the pulse output (for axis 1, connector pin No. "1A15 to 18") is wired correctly. (CW and CCW or phase A and phase B should be correctly wired.)
Do the values in " [Pr.6] Rotation direction setting" and " [Pr.23] Output signal logic selection (b0: Command pulse signal)" match the settings of the drive unit?	Check that the values in " [Pr.6] Rotation direction setting" and " [Pr.23] Output signal logic selection (b0: Command pulse signal)" match the settings of the drive unit.

(c) When a motor does not rotate at the set speed

Check item	Action
	[When " <b>Md.28</b> Axis feedrate" indicates the set speed] <ul style="list-style-type: none"> <li>• Check that the values in " <b>Pr.2</b> No. of pulses per rotation", " <b>Pr.3</b> Movement amount per rotation", and " <b>Pr.4</b> Unit magnification" meet the system.</li> <li>• When the drive unit has the electronic gear function, check that the settings meet the system.</li> </ul>
Does the value in " <b>Md.28</b> Axis feedrate" indicate the set speed?	[When " <b>Md.28</b> Axis feedrate" does not indicate the set speed] <ul style="list-style-type: none"> <li>• Check that the speed is not limited by the value in " <b>Pr.8</b> Speed limit value".</li> <li>• In the JOG operation, Check that the speed is not limited by the value in " <b>Pr.31</b> JOG speed limit value".</li> <li>• In the JOG operation, check that Forward/Reverse run JOG start signals (Y8 to YF) do not repeatedly turn ON and OFF.</li> </ul>

(d) When the set position is not reached

Check item	Action
	[When " <b>Md.20</b> Current feed value" reaches the set position] <ul style="list-style-type: none"> <li>• Check that the values in " <b>Pr.2</b> No. of pulses per rotation", " <b>Pr.3</b> Movement amount per rotation", and " <b>Pr.4</b> Unit magnification" meet the system.</li> <li>• When the drive unit has the electronic gear function, check that the settings meet the system.</li> </ul>
Does the value in " <b>Md.20</b> Current feed value" indicate the intended position when the motor stops?	[When " <b>Md.20</b> Current feed value" does not reaches the set position] <ul style="list-style-type: none"> <li>• Check that the motor is not stopped by Axis stop signals (Y4 to Y7) or a stop signal (STOP). If a motor is stopped by them, the value "1: Stopped" is stored in " <b>Md.26</b> Axis operation status".</li> </ul>

## 15.2 Error and warning details

## [1] Errors

## ■ Types of errors

Errors detected by the QD75 include parameter setting range errors and errors at the operation start or during operation.

## (1) Parameter setting range errors

The parameters are checked when the power is turned ON and at the rising edge (OFF → ON) of the PLC READY signal [Y0]. An error will occur if there is a mistake in the parameter setting details at that time.

When this kind of error occurs, the QD75 READY signal does not turn ON. To cancel this kind of error, set the correct value in the parameter for which the error occurred, and then turn ON the PLC READY signal [Y0].

## (2) Errors at the operation start or during operation

These are errors that occur at the operation start or during operation when the positioning control, JOG operation, or inching operation is used. If an axis error occurs during interpolation operation, the error No. will be stored in both the reference axis and the interpolation axis.

Note that, in the following cases (a) and (b), the axis error No. will be stored only in the reference axis during analysis of the positioning data set in each point of the positioning start data table.

(a) When the interpolation axis is BUSY.

(b) When the error occurred in positioning data or parameters unrelated to interpolation control.

If the error occurred at the simultaneous start of a positioning operation, the axis error storage details will differ depending on whether the error occurred before or after the simultaneous start.

- If the error occurred before the simultaneous start (illegal axis No., other axis BUSY, etc.), an error "Error before simultaneous start" (error code: 501) will occur.
- If the error occurred after the simultaneous start (positioning data error, software stroke limit error, etc.), an error code corresponding to the axis in which the error occurred will be stored. Because a simultaneous start cannot be carried out due to this, an error "Simultaneous start not possible" (error code: 532) error code will be stored in all axes in which an error has not occurred.

The axis operation status will be displayed as "error occurring" for axes in which an error occurred.

If an error occurs during operation, any moving axes will deceleration stop, and their operation status will be displayed as "error occurring".

All axes will decelerate to a stop during interpolation operations, even if the error occurs in only one axis.

## (3) Types of error codes

Error code	Error type
001 to 009	Fatal error
100 to 199	Common error
200 to 299	Error at OPR or absolute position restoration
300 to 399	Error during JOG operation or during inching operation
500 to 599	Error during positioning operation
800 to 899	I/F (Interface) error
900 to 999	Error during parameter setting range check

### ■ Error storage

When an error occurs, the error detection signal turns ON, and the error code corresponding to the error details is stored in the following buffer memory address (**[Md.23]** Axis error No.) for axis error No. storage.

Axis No.	Error detection signal	Buffer memory address
1	X8	806
2	X9	906
3	XA	1006
4	XB	1106

A new error code is stored in the buffer memory address (**[Md.23]** Axis error No.) for axis error storage every time an error occurs.

### POINT

When any of the following errors is detected, it is stored in the axis error No. of axis 1.  
Error code: 001, 002, 107, 800, 801, 802, 805

## [2] Warnings

### ■ Types of warnings

- (1) Warnings include system warnings and axis warnings.  
The types of system warnings are shown below.
  - System control data setting warnings  
An axis warning for axis 1 will occur.
  - Positioning data setting warnings  
An axis warning for each axis will occur.  
Note that a warning will occur for the reference axis when an interpolation designation or axis setting warning occurs.
- (2) Axis warnings occur due to setting warnings from operations such as positioning operations, JOG operations, manual pulse generator operations, or system errors. They can be canceled by turning ON the "**[Cd.5]** Axis error reset".  
Note that some warnings cannot be canceled unless the cause of the warning is eliminated.  
The axis operation status does not change even if an axis warning occurs.

### (3) Types of warning codes

Warning code	Warning type
100 to 199	Common warning
300 to 399	Warning during JOG operation
400 to 499	Warning during manual pulse generator operation
500 to 599	Warning during positioning operation

### ■ Warning storage

- (1) When an axis warning occurs, the warning code corresponding to the warning details is stored in the following buffer memory ([Md.24](#) Axis warning No.) for axis warning No. storage.

Axis No.	Buffer memory address
1	807
2	907
3	1007
4	1107

- (2) When an axis warning occurs in a positioning operation, etc., "1" is set in bit 9 (b9) of the following buffer memory ([Md.31](#) Status) for axis status storage.

Axis No.	Buffer memory address
1	817
2	917
3	1017
4	1117

### [3] Resetting errors and warnings

Remove the cause of error or warning following the actions described in Section 15.3 and 15.4, before cancel an error or warning state by resetting the error.

### ■ How to clear errors or warnings

An error or warning state is canceled after the following processing has been carried out by setting a "1" in the address [1502 (for axis 1)], [1602 (for axis 2)], [1702 (for axis 3)], and [1802 (for axis 4)] of the buffer memory for axis error resetting ([Cd.5](#) Axis error reset).

- Axis error detection signal turned OFF
- "[Md.23](#) Axis error No." cleared
- "[Md.24](#) Axis warning No." cleared
- Changing of "[Md.26](#) Axis operation status" from "Error" to "Standby".
- Axis warning detection ("[Md.31](#) Status : b9)" turned OFF

### [4] Confirming the error and warning definitions

The error and warning definitions can be confirmed with the error and warning codes. Confirming them requires GX Developer or GX Configurator-QP. For details, refer to GX Developer Operating Manual or GX Configurator-QP Operating Manual. (Refer to Section 15.3 and Section 15.4 for details of the error and warning codes.)



## 15.3 List of errors

The following table shows the error details and remedies to be taken when an error occurs.

Classification of errors	Error code	Error name	Error	Operation status at error occurrence
—	000	(Normal status)	—	—
Fatal errors	001	Faults	Hardware is faulty.	The system stops.
	002	Internal circuit fault		
Common	101	PLC READY OFF during operation	A PLC READY signal (Y0) is turned OFF during operation.	The system stops with the setting (deceleration stop/sudden stop) of the detailed parameter 2 Sudden stop selection (stop group 2). (Note that the deceleration stop only occurs during the manual pulse generator operation.)
			The drive unit READY signal is turned OFF during operation.	The system stops immediately.
	102	Drive unit READY OFF	The start of an operation is requested when the drive unit READY signal is OFF.	The system does not start.
	103	Test mode faults during operation	The personal computer cannot communicate with the CPU unit.	The system stops with the setting (deceleration stop/sudden stop) of the detailed parameter 2 Sudden stop selection (stop group 2). (Note that the deceleration stop only occurs during the manual pulse generator operation.)
	104	Hardware stroke limit (+)	The hardware stroke limit (upper limit signal FLS) is turned OFF during operation.	The system stops with the setting (deceleration stop/sudden stop) of the detailed parameter 2 Sudden stop selection (stop group 1). (Note that the deceleration stop only occurs during the manual pulse generator operation.)
			The start of an operation is requested when the hardware stroke limit (upper limit signal FLS) is OFF.	The system does not start.



	Related buffer memory address				Set range (Setting with sequence program)	Remedy
	Axis 1	Axis 2	Axis 3	Axis 4		
	—	—	—	—	—	—
	—	—	—	—	—	Check that there is no influence from noise.
	—	—	—	—	—	Review the sequence program which turns ON/OFF PLC READY signal (Y0).
	—	—	—	—	—	Check the power, wiring, and connector connection status of the drive unit.
	—	—	—	—	—	<ul style="list-style-type: none"> <li>• Check the power, wiring, and connector connection status of the drive unit.</li> <li>• Check the values in <span style="border: 1px solid black; padding: 2px;">Pr.22</span> Input signal logic selection.</li> <li>• When a drive unit without READY signal output is used, wire the system so that the drive unit READY signal input of the QD75 is always ON.</li> </ul>
	—	—	—	—	—	<ul style="list-style-type: none"> <li>• Check that there is no error on the personal computer side I/F to which a cable is connected.</li> <li>• Because communication takes a long time between the personal computer and a CPU module, ensure high-speed communication by setting the transmission speed to high at the transfer setup of GX Configurator-QP or GX Works2, or connecting the personal computer directly to the communication I/F of the CPU module.</li> <li>• Reduce the load of communication by stopping the access to a CPU module from GX Developer or GX Works2 (such as monitor function).</li> </ul>
	—	—	—	—	—	After making an axis error reset (refer to [3] in Section 15.2), perform manual control operation (refer to CHAPTER 11) to move the axis to the other position in order that the upper limit signal (FLS) will not turn OFF.
	—	—	—	—	—	<ul style="list-style-type: none"> <li>• Check the wiring of the upper limit signal (FLS).</li> <li>• Check if the values in <span style="border: 1px solid black; padding: 2px;">Pr.22</span> Input signal logic selection meet the specifications of the limit switch.</li> <li>• In a system which does not require a hardware stroke limit (limit switch), wire the system so that the upper limit signal (FLS) input of the QD75 is always ON.</li> </ul>

Classification of errors	Error code	Error name	Error	Operation status at error occurrence	
Common	105	Hardware stroke limit (-)	The hardware stroke limit (lower limit signal RLS) is turned OFF during operation.	The system stops with the setting (deceleration stop/sudden stop) of the detailed parameter 2 Sudden stop selection (stop group 1). (Note that the deceleration stop only occurs during the manual pulse generator operation.)	
			The start of an operation is requested when the hardware stroke limit (lower limit signal RLS) is OFF.	The system does not start.	
	106	Stop signal ON at start	Start is requested when a stop signal is turned ON.	The system does not start.	
	107	READY OFF → ON during BUSY	The PLC READY signal is turned from OFF to ON when BUSY signal is turned ON.	The QD75 READY signal (X0) is not turned ON.	
OPR	201	Start at OP	When the OPR retry invalid is set, the near-point dog machine OPR is started with the OPR complete flag turned ON.	The machine OPR is not started.	
	203	Dog detection timing fault	The near-point dog signal is turned OFF during the deceleration from an OPR speed to a creep speed by the near-point dog machine OPR.	The system stops with the setting (deceleration stop/sudden stop) of the detailed parameter 2 Sudden stop selection (stop group 3). (Note that the deceleration stop only occurs during the manual pulse generator operation.)	
	204	OP detection timing fault	The zero signal is turned OFF during the deceleration from an OPR speed to a creep speed by the stopper method 2)-OPR.		
	205	Dwell time fault	A dwell time is passed during the deceleration from a creep speed to a OPR speed by the stopper method 1)-OPR.		
	206	Count method movement amount fault	In the count method 1 and 2 machine OPR, a parameter "Setting of movement amount after near-point dog ON" is smaller than a distance necessary for deceleration stop from an OPR speed.	The machine OPR is not started.	

Related buffer memory address					Set range (Setting with sequence program)	Remedy
Axis 1	Axis 2	Axis 3	Axis 4			
—	—	—	—	—	—	After making an axis error reset (refer to [3] in Section 15.2), perform manual control operation (refer to CHAPTER 11) to move the axis to the other position in order that the lower limit signal (RLS) will not turn OFF.
—	—	—	—	—	—	<ul style="list-style-type: none"> <li>• Check the wiring of the lower limit signal (RLS).</li> <li>• Check if the values in <span style="border: 1px solid black; padding: 2px;">Pr.22</span> Input signal logic selection meet the specifications of the limit switch.</li> <li>• In a system which does not require a hardware stroke limit (limit switch), wire the system so that the lower limit signal (RLS) input of the QD75 is always ON.</li> </ul>
—	—	—	—	—	—	<p>The start timing is reviewed so that the operation starts after the stop command is reset.</p> <ul style="list-style-type: none"> <li>• Output signals to QD75 Axis 1: Y4, Axis 2: Y5, Axis 3: Y6, Axis 4: Y7</li> <li>• External input Connectors for external device connection: Stop signals (STOP)</li> </ul>
—	—	—	—	—	—	Turn ON the PLC READY signal (Y0) with the BUSY signals of all axes OFF.
78	228	378	528		<OPR retry> 0, 1	<ul style="list-style-type: none"> <li>• Validate the OPR retry function (set value: 1). (Refer to Section 12.1.1)</li> <li>• Move the workpiece from the current position (on OP) using the manual control operation (refer to CHAPTER 11), then carry out a machine OPR again.</li> </ul>
74 75	224 225	374 375	524 525		<OPR speed> QD75P□/QD75D□N: 1 to 4000000 [pulse/s] 1 to 2000000000 [×10 <sup>-2</sup> mm/min or others]	<ul style="list-style-type: none"> <li>• Lower the OPR speed.</li> <li>• Increase the dog signal input time. (Refer to Section 8.2.3)</li> </ul>
74 75	224 225	374 375	524 525		QD75P□/QD75D□: 1 to 1000000 [pulse/s] 1 to 2000000000 [×10 <sup>-2</sup> mm/min or others]	<ul style="list-style-type: none"> <li>• Lower the OPR speed.</li> <li>• Input external zero signals during the movement at a creep speed. (Refer to Section 8.2.5)</li> </ul>
74 75	224 225	374 375	524 525			<ul style="list-style-type: none"> <li>• Lower the OPR speed.</li> </ul>
79	229	379	529		<OPR dwell time> 0 to 65535	<ul style="list-style-type: none"> <li>• Increase the OPR dwell time. (Refer to Section 8.2.4)</li> </ul>
80 81	230 231	380 381	530 531		<Movement amount setting after near-point dog ON> 0 to 2147483647	<ul style="list-style-type: none"> <li>• Calculate the movement distance using a speed limit, OPR speed, and deceleration time, and set the movement amount after near-point dog ON so that the distance becomes a deceleration distance or longer.</li> <li>• Lower the OPR speed.</li> <li>• Adjust the near-point dog position so that the movement amount after near-point dog ON becomes longer. (Refer to Section 8.2.7, 8.2.8)</li> </ul>
74 75	224 225	374 375	524 525		<OPR speed> QD75P□/QD75D□N: 1 to 4000000 [pulse/s] 1 to 2000000000 [×10 <sup>-2</sup> mm/min or others] QD75P□/QD75D□: 1 to 1000000 [pulse/s] 1 to 2000000000 [×10 <sup>-2</sup> mm/min or others]	

Classification of errors	Error code	Error name	Error	Operation status at error occurrence	
OPR	207	OPR request ON	The OPR request flag is turned ON when a fast-OPR is started (positioning start No. 9002).	The fast OPR is not started.	
	209	OPR restart not possible	The restart command is turned ON after the machine OPR is stopped using a stop signal.	The restart is not carried out.	
	213	ABS transmission time	Communication cannot be carried out with the servo-amplifier using an absolute position restoration instruction.	The absolute position restoration is not carried out.	
	214	ABS transmission SUM			
JOG inching	300	Outside JOG speed range	At the time of JOG starting, the JOG speed comes out of a specified range.	The JOG operation is not carried out when the JOG speed is outside the setting range at the time of JOG start.	
	301	Inching movement amount error	The inching movement amount does not meet the setting condition. (The setting value is larger.) Setting condition: "Inching movement amount $\times$ (A) $\leq$ JOG speed limit value" (A)... When the setting unit is pulse: 562.5 When the setting unit is other than pulse: 337.5	The inching operation is not carried out.	

Related buffer memory address				Set range (Setting with sequence program)	Remedy
Axis 1	Axis 2	Axis 3	Axis 4		
1500	1600	1700	1800	<Positioning start No.> 1 to 600 7000 to 7004 9001 to 9004	Execute the machine OPR (positioning No. 9001). (Refer to Section 8.2)
1500	1600	1700	1800	<Positioning start No.> 1 to 600 7000 to 7004 9001 to 9004	Start the machine OPR (positioning start No. 9001) again. (Refer to Section 8.2)
—	—	—	—	—	<ul style="list-style-type: none"> <li>Review the wiring. (Refer to Section 12.6)</li> <li>Review the sequence program.</li> </ul>
—	—	—	—	—	<ul style="list-style-type: none"> <li>Review the wiring. (Refer to Section 12.6)</li> <li>Review the sequence program.</li> <li>Review the dedicated instruction parameters. (Refer to Section 14.3)</li> </ul>
1518 1519	1618 1619	1718 1719	1818 1819	<JOG speed> QD75P□N/QD75D□N: 1 to 4000000 [pulse/s] 1 to 2000000000 [ $\times 10^{-2}$ mm/min or others] QD75P□/QD75D□: 1 to 1000000 [pulse/s] 1 to 2000000000 [ $\times 10^{-2}$ mm/min or others]	Bring the JOG speed into the setting range. (Refer to Section 11.2)
1517	1617	1717	1817	<Inching movement amount> 0 to 65535	Reduce the inching movement amount to satisfy setting conditions. (Refer to Section 11.3)

Classification of errors	Error code	Error name	Error	Operation status at error occurrence	
Positioning operation	500	Illegal condition data No.	The condition data No. is outside the setting range when a block using the condition data is started by a special starting (conditional start, wait start, simultaneous start, FOR (condition)). (1 ≤ Condition data No. ≤ 10)	The operation is terminated.	
	501	Error before simultaneous start	<p>&lt;When blocks are started simultaneously&gt;</p> <ul style="list-style-type: none"> <li>• The partner axis for simultaneous start is BUSY.</li> </ul> <p>&lt;When multiple axes are started and controlled simultaneously&gt;</p> <ul style="list-style-type: none"> <li>• The partner axis for simultaneous start is BUSY.</li> <li>• The "Simultaneous start axis start data No." of the start axis is 0 or is outside the setting range.</li> <li>• The "Simultaneous start axis start data No." of those axes other than the start axis is outside the setting range.</li> </ul>	At start: The system will not operate. During operation: The system stops immediately.	
Positioning operation	502	Illegal data No.	<ul style="list-style-type: none"> <li>• The positioning data No. tried to be executed is outside the ranges of 1 to 600, 7000 to 7004, and 9001 to 9004.</li> <li>• The designation of a JUMP destination is executed currently.</li> <li>• The designation of a JUMP destination is outside the ranges of 1 to 600.</li> </ul>	The positioning data is not executed.	
	503	No command speed	<ul style="list-style-type: none"> <li>• At the start of positioning, a current speed (-1) is set for the command speed of the positioning data to be initially executed.</li> <li>• The current speed is set by speed control.</li> <li>• The current speed is set for speed-position switching control or position-speed switching control.</li> </ul>	At the start of positioning, operation does not start.	

Related buffer memory address				Set range (Setting with sequence program)	Remedy	
Axis 1	Axis 2	Axis 3	Axis 4			
Refer to Section 5.4 "List of block start data"				<Condition data No.> 1 to 10	Review the condition data No. (Refer to Section 5.4 <a href="#">Da.14</a> )	
Refer to Section 5.5 "List of condition data"				<Condition operators> Axis designation: 10H, 20H, 30H, 40H, 50H, 60H, 70H, 80H, 90H, A0H, B0H, C0H, D0H, E0H	Normalize the condition operators. (Refer to Section 5.5 <a href="#">Da.16</a> )	
1540	1640	1740	1840	Axis 1 start data No.	Simultaneous start axis start data No.  0 to 600	Normalize the simultaneous start axis start data No. (Refer to Section 10.5)
1541	1641	1741	1841	Axis 2 start data No.		
1542	1642	1742	1842	Axis 3 start data No.		
1543	1643	1743	1843	Axis 4 start data No.		
1500	1600	1700	1800	<Positioning start No.> 1 to 600, 7000 to 7004, 9001 to 9004	Normalize the positioning start No., positioning start data (in block start), and positioning data (in JUMP instruction).	
				<JUMP destination> 1 to 600		
Refer to Section 5.3 "List of positioning data"				<Command speed> QD75P□N/QD75D□N: 1 to 4000000 [pulse/s] 1 to 2000000000 [×10 <sup>-2</sup> mm/min or others] QD75P□/QD75D□: 1 to 1000000 [pulse/s] 1 to 2000000000 [×10 <sup>-2</sup> mm/min or others]	Normalize the positioning data.	

Classification of errors	Error code	Error name	Error	Operation status at error occurrence	
Positioning operation	504	Outside linear movement amount range	<ul style="list-style-type: none"> <li>• When the parameter or positioning data "Interpolation speed designation method" performs a linear interpolation in setting a "composite speed", the axis movement amount for each positioning data exceeds 1073741824(2<sup>30</sup>).</li> <li>• The positioning address is -360.00000 or less or 360.00000 or more using INC instruction, where the control unit is set to "degree" and software stroke limit upper limit is not equal to the software stroke limit lower limit.</li> </ul>	At start: The system will not operate. During operation: The system stops immediately.	
	506	Large arc error deviation	When an arc or helical is interpolated with center point designation, a difference between a radius of start point-center point and a radius of end point-center point exceeds the parameter "Allowable circular interpolation error width".	At start: The system will not operate. During operation: The system will stop immediately.	



Related buffer memory address				Set range (Setting with sequence program)	Remedy
Axis 1	Axis 2	Axis 3	Axis 4		
Refer to Section 5.3 "List of positioning data"				<Positioning address/movement amount> • ABS unit [mm] [pulse] [inch] -2147483648 to 2147483647 Unit [degree] 0 to 35999999 • INC (When software stroke limits are valid) Unit [degree]: -35999999 to 35999999 Unit [mm], [pulse], [inch]: -2147483648 to 2147483647 (When software stroke limits are invalid) -2147483648 to 2147483647 • Speed-position switching INC mode: 0 to 2147483647 ABS mode: 0 to 35999999 • Position-speed switching 0 to 2147483647 <Arc address> -2147483648 to 2147483647	Review the positioning address.
					• Center point address (arc address) • End address (positioning address)

Classification of errors	Error code	Error name	Error	Operation status at error occurrence
Positioning operation	507	Software stroke limit+	<ul style="list-style-type: none"> <li>• Positioning is carried out at a position beyond the software stroke limit upper limit.</li> <li>• The positioning address and new current value exceed the software stroke limit upper limit.</li> <li>• The sub point exceeds the software stroke limit upper limit in the circular interpolation or helical interpolation with sub point designation.</li> </ul>	<p>At start: The system will not operate. In the analysis of new current value: Current value is not changed.</p> <p>During operation:</p> <ul style="list-style-type: none"> <li>• The system stops immediately when the positioning address during position control (including position control in speed-position switching control or position-speed switching control) is switched to the data outside the software stroke limit range.</li> <li>• The system makes a stop at the setting (normal deceleration stop only) of sudden stop selection (stop group 3) in the detailed parameter 2 when the current feed value or machine feed value during speed control (including speed control in speed-position switching control or position-speed switching control) or during manual control falls outside the software stroke limit range.</li> </ul>
	508	Software stroke limit-	<ul style="list-style-type: none"> <li>• Positioning is carried out at a position beyond the software stroke limit lower limit.</li> <li>• The positioning address and new current value exceed the software stroke limit lower limit.</li> <li>• The sub point exceeds the software stroke limit lower limit in the circular interpolation or helical interpolation with sub point designation.</li> </ul>	

Related buffer memory address				Set range (Setting with sequence program)	Remedy
Axis 1	Axis 2	Axis 3	Axis 4		
New current value				<New current value> <Software stroke upper and lower limits> • [mm] [inch] [pulse] -2147483648 to 2147483647 • [degree] 0 to 35999999	At start: Bring the current feed value into the software stroke limit using the manual control operation. (Refer to CHAPTER 11) Correct the positioning address (Also check the arc address in the circular interpolation or helical interpolation with sub point designation.). New current value: Bring the new current value into the software stroke limit. (Refer to Section 9.2.21) During operation: Correct the positioning address. (For the positioning and arc addresses, refer to <b>Da.6</b> and <b>Da.7</b> in Section 5.3.)
1506 1507	1606 1607	1706 1707	1806 1807		
Software stroke limit upper limit					
18 19	168 169	318 319	468 469		
Software stroke limit lower limit					
20 21	170 171	320 321	470 471		

Classification of errors	Error code	Error name	Error	Operation status at error occurrence	
Positioning operation	514	Outside new current value range	The new current address is outside the ranges of 0 to 359.99999, where the control unit is set to "degree".	The current value is not changed.	
	515	New current value not possible	<ul style="list-style-type: none"> <li>The operation pattern "continuous path control" is set in the positioning data in which the control system "current value changing" is set.</li> <li>The control system "current value changing" is set in the positioning data following the positioning data in which the operation pattern "continuous path control" is set.</li> </ul>		
	516	Continuous path control not possible	<ul style="list-style-type: none"> <li>The continuous path control is designated using a control system which is not allowed to use for continuous path control such as speed control, speed-position switching control, position-speed switching control, fixed-feed, and current value change.</li> <li>The previous data such as those on speed control, speed-position switching control, position-speed switching control, fixed-feed, and current value change shows a continuous path control.</li> <li>The continuous positioning control is designated for speed control or position-speed switching control.</li> </ul>	At start, the system will not operate.	
	518	Outside operation pattern range	<ul style="list-style-type: none"> <li>The operation pattern set value is 2.</li> </ul>	At start: The system will not operate. During operation: The system stops with the setting (deceleration stop/sudden stop) of the detailed parameter 2 Sudden stop selection (stop group 3). (Note that the deceleration stop only occurs during the manual pulse generator operation.)	
	519	Interpolation while interpolation axis BUSY	Interpolation is started during the operation of the interpolation axis.		
	520	Unit group unmatched	When the "composite speed" has been set in "Interpolation speed designation method" of the parameter or positioning data, the units of the reference axis and interpolation axis differ.		
	521	Illegal interpolation description command	<ul style="list-style-type: none"> <li>The self-axis or a non-existent axis is set as the axis to be interpolated in the 2-axis interpolation or helical interpolation.</li> </ul>		

Related buffer memory address				Set range (Setting with sequence program)	Remedy
Axis 1	Axis 2	Axis 3	Axis 4		
1506 1507	1606 1607	1706 1707	1806 1807	<New current value> [degree] 0 to 35999999	Bring the new current value into the setting range. (Refer to Section 9.2.21)
Refer to Section 5.3 "List of positioning data"				<Control system> 01H to 1EH, 80H to 84H • 03H, 0CH, 17H, 1CH: 1 to 4 axis fixed-feed control • 04H, 05H, 13H, 14H, 18H, 19H, 1DH, 1EH: 1 to 4 axis speed control • 81H: current value changing • Speed-position switching control: 06H, 07H • Position-speed switching control: 08H, 09H <Operation pattern> 00, 01, 11 • 01: Continuous positioning control • 11: Continuous path control	<ul style="list-style-type: none"> <li>Do not designate the "continuous path control" using the "current value changing".</li> <li>Do not designate the "current value changing" using the positioning data following the positioning data that the "continuous path control" is designated. (Refer to Section 9.2.21)</li> </ul>
					<ul style="list-style-type: none"> <li>Do not designate a speed control, fixed-feed, speed-position switching control, position-speed switching control, and current value change using the positioning data following the continuous path control data.</li> <li>Do not carry out the fixed-feed, speed control, speed-position switching control, position-speed switching control, and current value change using the continuous path control operation pattern.</li> <li>Do not carry out the speed control and position-speed switching control using the continuous path control operation pattern. (Refer to CHAPTER 9)</li> </ul>
Same as error codes 515 to 516					Correct the operation pattern. (Refer to Section 5.3 <a href="#">Da.1</a> )
					Correct the control system. (Refer to Section 5.3 <a href="#">Da.2</a> )
0	150	300	450	<Unit setting> 0, 1, 2, 3	Correct the positioning data or change the parameter "Unit setting" of the axis to be interpolated. (Refer to Section 9.1.6)
Same as error codes 515 to 516					<ul style="list-style-type: none"> <li>Correct the control system. (Refer to Section 5.3 <a href="#">Da.2</a>)</li> <li>Correct the axis to be interpolated. (Refer to Section 5.3 <a href="#">Da.5</a>)</li> </ul>

Classification of errors	Error code	Error name	Error	Operation status at error occurrence
Positioning operation	522	Command speed setting error	The command speed is outside the setting range. Linear interpolation, circular interpolation, helical interpolation: Reference axis is outside the setting range. Speed control interpolation: Either of reference axis and interpolation axis is outside the speed range.	
	523	Interpolation mode error	<ul style="list-style-type: none"> <li>In the interpolation control of the speed control, 4-axis linear interpolation control, or 4-axis fixed-feed control, the system is started while a composite speed is set in "Interpolation speed designation method" of the parameter or positioning data of the reference axis.</li> <li>In the circular interpolation control or helical interpolation control, the system is started while a reference axis speed is set in "Interpolation speed designation method" of the parameter or positioning data of the reference axis.</li> </ul>	At start: The system will not operate. During operation: The system stops with the setting (deceleration stop/sudden stop) of the detail parameter 2 Sudden stop selection (stop group 3). (Note that the deceleration stop only occurs during the manual pulse generator operation.)
	524	Control system setting error	<ul style="list-style-type: none"> <li>The control system setting value is outside the specified limit.</li> <li>The number of control axes or the axis to be interpolated differs from the previous data when the operation is continuously performed by setting the continuous positioning control or continuous path control.</li> <li>Machine OPR, fast OPR, or speed-position or position-speed switching control was performed in the wiring-less mode.</li> <li>The NOP instruction was set to the control system of positioning data No. 600.</li> <li>Any value other than 0 was set at buffer memory address 1906 (use prohibited area).</li> </ul>	
	525	Sub point setting error	One of the following settings is configured in circular interpolation or helical interpolation with sub point designation. <ul style="list-style-type: none"> <li>Start point = sub point</li> <li>End point = sub point</li> <li>Start point, end point, and sub point are in line with each other.</li> <li>Sub point address and center point address are outside the range of -2147483648 to 2147483647.</li> </ul>	At start: The system will not operate. During operation: The system stops immediately.

Related buffer memory address				Set range (Setting with sequence program)	Remedy
Axis 1	Axis 2	Axis 3	Axis 4		
Command speed storage addresses of positioning data No. 1 to 600				<Command speed> QD75P□N/QD75D□N: 1 to 4000000 [pulse/s] 1 to 2000000000 [ $\times 10^{-2}$ mm/min or others] QD75P□/QD75D□: 1 to 1000000 [pulse/s] 1 to 2000000000 [ $\times 10^{-2}$ mm/min or others]	Correct the command speed. (Refer to Section 5.3 [Da.8])
29	179	329	479	<Interpolation speed designation method> 0: Composite speed 1: Reference axis speed	Set the "Interpolation speed designation method" correctly. (Refer to Section 9.1.6)
Same as error codes 515 to 516					<ul style="list-style-type: none"> <li>• Correct the control system axis to be interpolated, or parameter. (Refer to Section 9.1.6, 9.2.22)</li> <li>• Do not make setting at buffer memory address 1906 (use prohibited area).</li> </ul>
Refer to Section 5.3 "List of positioning data"				<Positioning address/movement amount> • unit [mm] [pulse] [inch] -2147483648 to 2147483647 (Unit [degree] cannot be set.) <Arc address> -2147483648 to 2147483647	Correct the sub address (arc address). (Refer to Section 9.2.10, 9.2.12)

Classification of errors	Error code	Error name	Error	Operation status at error occurrence	
Positioning operation	526	End point setting error	<ul style="list-style-type: none"> <li>The start point is equal to the end point in circular interpolation or helical interpolation with sub point designation.</li> <li>The end point address is outside the range of -2147483648 to 2147483647 in circular interpolation or helical interpolation with sub point designation or center point designation.</li> </ul>	At start: The system will not operate. During operation: The system stops immediately.	
	527	Center point setting error	One of the following settings is configured in circular interpolation or helical interpolation with center point designation. <ul style="list-style-type: none"> <li>Start point = Center point</li> <li>End point = Center point</li> <li>Center point address is outside the range of -2147483648 to 2147483647.</li> </ul>	At start: The system will not operate. During operation: The system stops immediately.	
	530	Outside address range	<ul style="list-style-type: none"> <li>In the speed-position switching control and the position-speed switching control, the setting value of a positioning address is negative.</li> <li>In the 1-axis linear control (ABS), 2- to 4-axis linear interpolation control (ABS), or helical interpolation control (ABS), the setting value of a positioning address is outside the range of 0 to 359.99999 [degree].</li> </ul>	At start: The system will not operate. During operation: The system stops immediately with the setting (deceleration stop/sudden stop) of the detailed parameter 2 sudden stop selection (stop group 3).	
	532	Simultaneous start not possible	Among the axes to be started simultaneously, there is an axis on which an error other than this error occurs.	(Note that the deceleration stop only occurs during the manual pulse generator operation.)	
	533	Condition data error	<ul style="list-style-type: none"> <li>The condition setting values are not set or outside the setting range.</li> <li>The condition operator setting values are not set or outside the setting range.</li> <li>The condition operator is a bit operator, and the parameter 1 is 32 or more.</li> <li>An unusable condition operator is set for the set condition.</li> <li>The conditional operator has been [parameter 1 &gt; parameter 2] with 05H (P1 ≤ ** ≤ P2).</li> <li>The value in 'address' is out of the setting range when the condition target is set to 'Buffer memory (1-word/2-word)'. (1-word: 0 to 32767, 2-word: 0 to 32766)</li> </ul>	The operation is terminated.	
	534	Special start instruction error	No applicable special start instruction is present.		
	535	Circular interpolation not possible	The circular interpolation or helical interpolation is carried out for the axis with the "degree" unit setting.		



Related buffer memory address				Set range (Setting with sequence program)	Remedy
Axis 1	Axis 2	Axis 3	Axis 4		
Refer to Section 5.3 "List of positioning data"				Same as in error codes 525.	Correct the end address (positioning address). (Refer to Section 9.2.10, 9.2.12)
					Correct the center point address (arc address). (Refer to Section 9.2.11, 9.2.13)
				Same as in error codes 504, 506.	Correct the positioning address. (Refer to Section 9.2.18, 9.2.19, 9.2.20)
Refer to Section 5.3 "List of positioning data" and Section 5.4 "Block start data"				—	In the error history, check the axis where the error other than this error occurred, and remove the error factor. Correct the block start data and positioning data.
Refer to Section 5.4 "Block start data"				—	Normalize the block start data.
				<Special start instruction> 00H to 06H	Correct the special start instruction code. (Refer to Section 5.4 <a href="#">Da.13</a> )
Refer to Section 5.3 "List of positioning data"				—	Correct the control system. (Refer to Section 5.3 <a href="#">Da.2</a> )

Classification of errors	Error code	Error name	Error	Operation status at error occurrence	
Positioning operation	536	M code ON signal start	The positioning start is carried out when an M code ON signal (X4 to X7) is turned ON.	At start, the system will not operate.	
	537	PLC READY OFF start	The positioning start is carried out when the PLC READY signal (Y0) is turned OFF.		
	538	READY OFF start	The positioning start is carried out when the QD75 READY signal (X0) is turned OFF.		
	543	Outside start No. range	<ul style="list-style-type: none"> <li>At the start of positioning, the setting value of the "positioning start No." of the axis control data is outside the ranges of 1 to 600, 7000 to 7004, and 9001 to 9004.</li> <li>At a Pre-reading start, the "positioning start No." setting of the axis control data is other than 1 to 600.</li> </ul>		
	544	Outside radius range	The arc radius exceeds 536870912.	At start: The system will not operate. During operation: The system stops immediately.	
	545	Control system LOOP setting error	A "0" is set for number of repetitions of the control system "LOOP".	The operation is terminated.	
	546	Illegal setting of ABS direction in unit of degree	<p>The setting value of ABS direction in the unit of degree is as follows.</p> <ul style="list-style-type: none"> <li>Set outside the setting range.</li> <li>A figure other than "0" is set when the software stroke limit is valid.</li> </ul>	At start: The system will not operate. During operation: The system decelerates to a stop. (Note that, in the continuous positioning control and continuous path control, the system continues operating with the setting set at the time of start even if the setting is changed during the operation.)	
	553	M code ON timing error	The setting value of the positioning data "M code ON signal output timing" is outside the range.	At start: The system will not operate. During operation: The system stops with the setting (deceleration stop/sudden stop) of the detailed parameter 2 sudden stop selection (stop group 3).	
	554	Interpolation speed designation method error	The setting value of the positioning data "Interpolation speed designation method" is outside the range.		
	555	Outside range of the number of pitches	In the helical interpolation, the number of pitches set in the positioning data "M code" of the linear interpolation axis is outside the range.		

Related buffer memory address				Set range (Setting with sequence program)	Remedy
Axis 1	Axis 2	Axis 3	Axis 4		
1504	1604	1704	1804	<M code OFF request> 1: M code ON signal is turned OFF	After turning OFF the M code ON signal, start the system. (Refer to Section 12.7.3)
—	—	—	—	—	Check the sequence program which turns ON/OFF the PLC READY signal (Y0), and turn ON the PLC READY signal. Then start the system.
—	—	—	—	—	Check the QD75 READY ON signal, and then start the system. (Refer to Section 3.3.2)
1500	1600	1700	1800	<Positioning start No.> 1 to 600, 7000 to 7004, 9001 to 9004	Normalize the positioning start No. (Refer to Section 12.7.7)
Refer to Section 5.3 "List of positioning data"				<Maximum radius> 536870912	Correct the positioning data. (Refer to Section 9.2.10, 9.2.11)
				<LOOP to LEND> 1 to 65535	Set 1 to 65535 for number of repetitions of the "LOOP". (Refer to Section 9.2.22)
ABS setting direction in the unit of degree				0: Shortcut 1: ABS clockwise 2: ABS counterclockwise	<ul style="list-style-type: none"> <li>Set the ABS setting direction in the unit of degree within the setting range.</li> <li>Set "0" when the software stroke limits are valid. (Refer to Section 9.1.5)</li> </ul>
1550	1650	1750	1850		
Software stroke limit upper limit				<ul style="list-style-type: none"> <li>[mm] [inch] [pulse] -2147483648 to 2147483647</li> <li>[degree] 0 to 35999999</li> </ul>	Invalidate the software stroke limit. (To invalidate, set the software stroke limit upper limit value to the software stroke limit lower limit value.) (Refer to Section 9.1.5)
18	168	318	468		
19	169	319	469		
Software stroke limit lower limit					
20	170	320	470		
21	171	321	471		
Refer to Section 5.3 "List of positioning data"				0: Use the set value in "Pr.18" M code ON signal output timing". 1: WITH mode 2: AFTER mode	Correct the positioning data "M code ON signal output timing" to 0 to 2.
				0: Use the set value in "Pr.20" Interpolation speed designation method". 1: Composite speed 2: Reference axis speed	Correct the positioning data "Interpolation speed designation method" to 0 to 2.
				<Number of pitch> 0 to 999	Correct the number of pitch set in the positioning data "M code" of the linear interpolation axis to 0 to 999.

Classification of errors	Error code	Error name	Error	Operation status at error occurrence
I/F	800	Hold error	In the CPU module parameter "Output at error stop", the setting for QD75 is "Hold".	At start: The system will not operate. During operation: The system stops with the setting (deceleration stop/sudden stop) of the detailed parameter 2 sudden stop selection (stop group 3). (Note that the deceleration stop only occurs during the manual pulse generator operation.)
	801	Flash ROM write error	Data is not written to the flash ROM.	At start: The system will not operate.
	802	Flash ROM sum check error	While data is written to the flash ROM, the power is turned OFF.	

	Related buffer memory address				Set range (Setting with sequence program)	Remedy
	Axis 1	Axis 2	Axis 3	Axis 4		
	—	—	—	—	—	Clear the setting of the CPU module parameter "Output at error stop".
	—	—	—	—	—	The flash ROM is expected to be at the end of its writable life. Replace the flash ROM with a new one.
	1901				<Parameter initialization request> 1: Parameter initialization is requested	Return the parameter to that set at the time of delivery from the plant. (Refer to Section 13.2)

Classification of errors	Error code	Error name	Error	Operation status at error occurrence
I/F	803	PLC CPU error	The CPU module resulted in an error.	At start: The system will not operate. During operation: The system stops with the setting (deceleration stop/sudden stop) of the detailed parameter 2 sudden stop selection (stop group 2). (Note that the deceleration stop only occurs during the manual pulse generator operation.)
	804	Dedicated instruction error	<ul style="list-style-type: none"> <li>• The Z.ABRST□ instruction is executed with the status set to other than 0 (at the start of communication with the servo-amplifier).</li> <li>• The status of the Z.ABRST□ instruction is changed during absolute position restoration (during communication with the servo-amplifier).</li> <li>• The ZP.PSTRT□ instruction is executed with the start No. set to other than 1 to 600, 7000 to 7004 and 9001 to 9004.</li> <li>• The ZP.TEACH□ instruction is executed with the teaching data selection set to other than 0 and 1.</li> <li>• The ZP.TEACH□ instruction is executed with the positioning data No. set to other than 1 to 600.</li> <li>• The instruction of a non-existent axis is specified by the Z.ABRST□, ZP.PSTRT□ or ZP.TEACH□ instruction.</li> </ul>	The function corresponding to the instruction is not executed.
	805	Flash ROM write number error	Data is written to the flash ROM continuously 25 times or more from the sequence program.	At start: The system will not operate.
	806	Dedicated instruction I/F error	Mismatching occurs between the CPU module and QD75.	

	Related buffer memory address				Set range (Setting with sequence program)	Remedy
	Axis 1	Axis 2	Axis 3	Axis 4		
	—	—	—	—	—	Check the error code of CPU module and refer to the QCPU User's Manual.
	—	—	—	—	<p>&lt; Z.ABRST□ status &gt;            0: Communication complete            (received from the servo amplifier)            &lt; ZP.PSTRT□ start No. &gt;            1 to 600            7000 to 7004            9001 to 9004            &lt; ZP.TEACH□ teaching data selection &gt;            0: The current feed value is written to the positioning address.            1: The current feed value is written to the arc address.            &lt; ZP.TEACH□ positioning data No. &gt;            1 to 600</p>	<ul style="list-style-type: none"> <li>• When executing the Z.ABRST□ instruction, set the status to 0 (refer to Section 14.3).</li> <li>• Do not change the status during absolute position restoration by the Z.ABRST□ instruction.</li> <li>• When executing the ZP.PSTRT□ instruction, set the start No. to within the setting range (refer to Section 14.4).</li> <li>• When executing the ZP.TEACH□ instruction, set the teaching data selection and positioning data No. to within the setting range (refer to Section 14.5).</li> <li>• Do not specify the instruction of a non-existent axis by the Z.ABRST□, ZP.PSTRT□ and ZP.TEACH□ instructions (refer to Section 14.3 to Section 14.5).</li> </ul>
	—	—	—	—	—	Review the sequence program so that data is not written continuously to the flash ROM. (Using <a href="#">Md.19</a> in Section 5.6.1, the number of flash ROM write times can be monitored.) (If this error has occurred in a proper using method, writing is enabled by resetting the error, switching power OFF, then ON, or resetting the CPU module.)
	—	—	—	—	—	A trouble occurs. Repair.

Classification of errors	Error code	Error name	Error	Operation status at error occurrence
Parameter	900	Outside unit setting range	The set value of the basic parameter 1 "Unit setting" is outside the setting range.	The QD75 READY signal (X0) is not turned ON.
	901	Outside pulse number per rotation range	The set value of the basic parameter 1 "No. of pulses per rotation" is outside the setting range.	
	902	Outside movement amount per rotation range	The set value of the basic parameter 1 "Movement amount per rotation" is outside the setting range.	
	903	Outside unit magnification range	The set value of the basic parameter 1 "Unit magnification" is outside the setting range.	
	904	Pulse output mode error	The set value of the basic parameter 1 "Pulse output mode" is outside the setting range.	
	905	Rotation direction setting error	The set value of the basic parameter 1 "Rotation direction setting" is outside the setting range.	
	906	Outside bias speed range	<ul style="list-style-type: none"> <li>The set value of the basic parameter 1 "Bias speed at start" is outside the setting range.</li> <li>The bias speed exceeds the speed limit.</li> </ul>	When the power is turned ON or PLC READY signal (Y0) is turned from OFF to ON: QD75 READY signal (X0) is not turned ON. At start: The system will not operate.
	910	Outside speed limit value range	<ul style="list-style-type: none"> <li>The set value of the basic parameter 2 "Speed limit value" is outside the setting range.</li> <li>The value obtained by the conversion of the speed limit value with respect to the frequency exceeds the maximum output frequency of the unit.</li> <li>The speed limit value is smaller than the OPR speed.</li> </ul>	
	911	Outside acceleration time 0 range	The set value of the basic parameter 2 "Acceleration time 0" is outside the setting range.	
	912	Outside deceleration time 0 range	The set value of the basic parameter 2 "Deceleration time 0" is outside the setting range.	
	920	Backlash compensation amount error	The value converted into pulse number using the movement amount per pulse is 256 pulses or more.	The QD75 READY signal (X0) is not turned ON.
	921	Software stroke limit upper limit	<ul style="list-style-type: none"> <li>In the unit of degree, the set value of the detailed parameter 1 "Software stroke limit upper limit value" is outside the setting range.</li> <li>In a unit other than degree, the software stroke limit upper limit value is smaller than the software stroke limit lower limit value.</li> </ul>	



Related buffer memory address				Set range (Setting with sequence program)	Remedy
Axis 1	Axis 2	Axis 3	Axis 4		
0	150	300	450	0, 1, 2, 3	With the setting brought into the setting range, turn the PLC READY signal [Y0] from OFF to ON.
1	151	301	451	1 to 65535	
2	152	302	452	1 to 65535	
3	153	303	453	1, 10, 100, 1000	
4	154	304	454	0, 1, 2, 3	
5	155	305	455	0, 1	
6 7	156 157	306 307	456 457	QD75P□N/QD75D□N: 0 to 4000000 [pulse/s] 0 to 2000000000 [ $\times 10^{-2}$ mm/min or others] QD75P□/QD75D□: 0 to 1000000 [pulse/s] 0 to 2000000000 [ $\times 10^{-2}$ mm/min or others]	Set the bias speed to not more than the speed limit value. With the setting brought into the setting range, turn the PLC READY signal [Y0] from OFF to ON.
10 11	160 161	310 311	460 461	QD75P□N/QD75D□N: 1 to 4000000 [pulse/s] 1 to 2000000000 [ $\times 10^{-2}$ mm/min or others] QD75P□/QD75D□: 1 to 1000000 [pulse/s] 1 to 2000000000 [ $\times 10^{-2}$ mm/min or others]	<ul style="list-style-type: none"> <li>The value converted into the frequency should not exceed the maximum output frequency of the module.</li> <li>Set a value which is not less than the OPR speed.</li> <li>With the setting brought into the setting range, turn the PLC READY signal [Y0] from OFF to ON.</li> </ul>
12 13	162 163	312 313	462 463	1 to 8388608	With the setting brought into the setting range, turn the PLC READY signal [Y0] from OFF to ON.
14 15	164 165	314 315	464 465	1 to 8388608	
17	167	317	467	0 to 255	Set the value converted into the pulse number using "the movement amount per pulse" to less than 256 pulses. (Refer to Section 12.3.1)
18 19	168 169	318 319	468 469	<ul style="list-style-type: none"> <li>[mm] [inch] [pulse] -2147483648 to 2147483647</li> <li>[degree] 0 to 35999999</li> </ul>	<ul style="list-style-type: none"> <li>Bring the setting into the setting range.</li> <li>In a unit other than degree, set the setting so that the lower limit value is smaller than the upper limit value.</li> </ul>

Classification of errors	Error code	Error name	Error	Operation status at error occurrence	
Parameter	922	Software stroke limit lower limit	<ul style="list-style-type: none"> <li>In the unit of degree, the set value of the detailed parameter 1 "Software stroke limit lower limit value" is outside the setting range.</li> <li>In a unit other than degree, the software stroke limit upper limit value is smaller than the software stroke limit lower limit value.</li> </ul>	The QD75 READY signal (X0) is not turned ON.	
	923	Software stroke limit selection	The set value of the detailed parameter 1 "Software stroke limit selection" is outside the setting range.		
	924	Software stroke limit valid/invalid setting	The set value of the detailed parameter 1 "Software stroke limit valid/invalid setting" is outside the setting range.		
	925	Command in-position width	The set value of the detailed parameter 1 "Command in-position width" is outside the setting range.		
	926	Illegal torque limit setting value	The set value of the detailed parameter 1 "Torque limit setting value" is outside the setting range.		
	927	M code ON timing error	The set value of the detailed parameter 1 "M code ON signal output timing" is outside the setting range.		
	928	Speed changeover mode error	The set value of the detailed parameter 1 "Speed changeover mode" is outside the setting range.		
	929	Interpolation speed designation method error	The set value of the detailed parameter 1 "Interpolation speed designation method" is outside the setting range.		
	930	Current value update request error	The set value of the detailed parameter 1 "Current feed value during speed control" is outside the setting range.		
	932	Manual pulse generator input mode error	The set value of the detailed parameter 1 "Manual pulse generator input selection" is outside the setting range.		
	935	Speed-position function selection error	The detailed parameter 1 "speed-position function selection" is preset to 2 and the following three conditions are not satisfied: 1) Unit is "degree". 2) Software stroke limits are invalid. 3) Update current feed value.		
	950	Acceleration time 1 setting error	The set value of the detailed parameter 2 "Acceleration time 1" is outside the setting range.		At start: The system will not operate. During operation: The system stops with the setting (deceleration stop/sudden stop) of the detailed parameter 2 sudden stop selection (stop group 3). (Note that the deceleration stop only occurs during the manual pulse generator operation.)
	951	Acceleration time 2 setting error	The set value of the detailed parameter 2 "Acceleration time 2" is outside the setting range.		
	952	Acceleration time 3 setting error	The set value of the detailed parameter 2 "Acceleration time 3" is outside the setting range.		
953	Deceleration time 1 setting error	The set value of the detailed parameter 2 "Deceleration time 1" is outside the setting range.			

Related buffer memory address				Set range (Setting with sequence program)	Remedy
Axis 1	Axis 2	Axis 3	Axis 4		
20 21	170 171	320 321	470 471	<ul style="list-style-type: none"> <li>• [mm] [inch] [pulse] -2147483648 to 2147483647</li> <li>• [degree] 0 to 35999999</li> </ul>	<ul style="list-style-type: none"> <li>• Bring the setting into the setting range.</li> <li>• In a unit other than degree, set so that the lower limit value is smaller than the upper limit value.</li> </ul>
22	172	322	472	0, 1	With the setting brought into the setting range, turn the PLC READY signal [Y0] from OFF to ON.
23	173	323	473	0, 1	
24 25	174 175	324 325	474 475	1 to 2147483647	
26	176	326	476	1 to 500	
27	177	327	477	0, 1	
28	178	328	478	0, 1	
29	179	329	479	0, 1	
30	180	330	480	0, 1, 2	
33	—	—	—	0, 1, 2, 3	
34	184	334	484	0, 2	
36 37	186 187	336 337	486 487	1 to 8388608	With the setting brought into the setting range, turn the PLC READY signal [Y0] from OFF to ON.
38 39	188 189	338 339	488 489	1 to 8388608	
40 41	190 191	340 341	490 491	1 to 8388608	
42 43	192 193	342 343	492 493	1 to 8388608	

Classification of errors	Error code	Error name	Error	Operation status at error occurrence
Parameter	954	Deceleration time 2 setting error	The set value of the detailed parameter 2 "Deceleration time 2" is outside the setting range.	At start: The system will not operate. During operation: The system stops with the setting (deceleration stop/sudden stop) of the detailed parameter 2 Sudden stop selection (stop group 3). (Note that the deceleration stop only occurs during the manual pulse generator operation.)
	955	Deceleration time 3 setting error	The set value of the detailed parameter 2 "Deceleration time 3" is outside the setting range.	
	956	JOG speed limit value error	<ul style="list-style-type: none"> <li>The set value of the detailed parameter 2 "JOG speed limit value" is outside the setting range.</li> <li>The set range of the detailed parameter 2 "JOG speed limit value" exceeds the speed limit.</li> </ul>	
	957	JOG acceleration time selection setting error	The set value of the detailed parameter 2 "JOG acceleration time selection setting" is outside the setting range.	
	958	JOG deceleration time selection setting error	The set value of the detailed parameter 2 "JOG deceleration time selection setting" is outside the setting range.	
	959	Acceleration/ deceleration process selection setting error	The set value of the detailed parameter 2 "Acceleration/deceleration process selection setting" is outside the setting range.	
	960	S-curve ratio setting error	The set value of the detailed parameter 2 "S-curve ratio" is outside the setting range.	
	961	Illegal sudden stop deceleration time	The set value of the detailed parameter 2 "Sudden stop deceleration time" is outside the setting range.	
	962	Stop group 1 sudden stop selection error	The set value of the detailed parameter 2 "Stop group 1 sudden stop selection" is outside the setting range.	
	963	Stop group 2 sudden stop selection error	The set value of the detailed parameter 2 "Stop group 2 sudden stop selection" is outside the setting range.	
	964	Stop group 3 sudden stop selection error	The set value of the detailed parameter 2 "Stop group 3 sudden stop selection" is outside the setting range.	
	966	Outside allowance circular interpolation error width	The set value of the detailed parameter 2 "Allowance circular interpolation error width" is outside the setting range.	
	967	External command function selection error	The set value of the detailed parameter 2 "External command function selection" is outside the setting range.	
	980	OPR method error	The set value of the OPR basic parameter "OPR method" is outside the setting range.	

Related buffer memory address				Set range (Setting with sequence program)	Remedy
Axis 1	Axis 2	Axis 3	Axis 4		
44 45	194 195	344 345	494 495	1 to 8388608	With the setting brought into the setting range, turn the PLC READY signal [Y0] from OFF to ON.
46 47	196 197	346 347	496 497	1 to 8388608	
48 49	198 199	348 349	498 499	QD75P□N/QD75D□N: 1 to 4000000 [pulse/s] 1 to 2000000000 [×10 <sup>-2</sup> mm/min or others] QD75P□/QD75D□: 1 to 1000000 [pulse/s] 1 to 2000000000 [×10 <sup>-2</sup> mm/min or others]	<ul style="list-style-type: none"> <li>• With the setting brought into the setting range, turn the PLC READY signal [Y0] from OFF to ON.</li> <li>• Bring the setting into the speed limit value or below.</li> </ul>
50	200	350	500	0, 1, 2, 3	With the setting brought into the setting range, turn the PLC READY signal [Y0] from OFF to ON.
51	201	351	501	0, 1, 2, 3	
52	202	352	502	0, 1	
53	203	353	503	1 to 100	
54 55	204 205	354 355	504 505	1 to 8388608	
56	206	356	506	0, 1	
57	207	357	507	0, 1	
58	208	358	508	0, 1	
60 61	210 211	360 361	510 511	0 to 10000	
62	212	362	512	0, 1, 2, 3	
70	220	370	520	0, 1, 2, 3, 4, 5	

Classification of errors	Error code	Error name	Error	Operation status at error occurrence
Parameter	981	OPR direction error	The set value of the OPR basic parameter "OPR direction" is outside the setting range.	The QD75 READY signal (X0) is not turned ON.
	982	OP address setting error	The set value of the OPR basic parameter "OP address" is outside the setting range.	
	983	OPR speed error	<ul style="list-style-type: none"> <li>The set value of the OPR basic parameter "OPR speed" is outside the setting range.</li> <li>The set value of the OPR basic parameter "OPR speed" is smaller than the bias speed at start.</li> </ul>	
	984	Creep speed error	<ul style="list-style-type: none"> <li>The set value of the OPR basic parameter "Creep speed" is outside the setting range.</li> <li>The set value of the OPR basic parameter "Creep speed" is larger than the OPR speed.</li> <li>The set value of the OPR basic parameter "Creep speed" is smaller than the bias speed at start.</li> </ul>	
	985	OPR retry error	The set value of the OPR basic parameter "OPR retry" is outside the setting range.	
	991	Setting for the movement amount after near-point dog ON error	The set value of the OPR detailed parameter "Setting for the movement amount after near-point dog ON" is outside the setting range.	
	992	OPR acceleration time selection error	The set value of the OPR detailed parameter "OPR acceleration time selection" is outside the setting range.	
	993	OPR deceleration time selection error	The set value of the OPR detailed parameter "OPR deceleration time selection" is outside the setting range.	
	995	OPR torque limit value error	<ul style="list-style-type: none"> <li>The set value of the OPR detailed parameter "OPR torque limit value" is outside the setting range.</li> <li>The OPR detailed parameter "OPR torque limit value" has exceeded the detailed parameter 1 "Torque limit setting value".</li> </ul>	
	996	Deviation counter clear signal output time setting error	The set value of the OPR detailed parameter "Deviation counter clear signal output time" is outside the setting range.	
997	Speed designation during OP shift error	The set value of the OPR detailed parameter "Speed designation during OP shift" is outside the setting range.		

Related buffer memory address				Set range (Setting with sequence program)	Remedy
Axis 1	Axis 2	Axis 3	Axis 4		
71	221	371	521	0, 1	With the setting brought into the setting range, turn the PLC READY signal [Y0] from OFF to ON.
72 73	222 223	372 373	522 523	• [mm] [inch] [pulse] -2147483648 to 2147483647 • [degree] 0 to 35999999	
74 75	224 225	374 375	524 525	QD75P□N/QD75D□N: 1 to 4000000 [pulse/s] 1 to 2000000000 [ $\times 10^{-2}$ mm/min or others] QD75P□/QD75D□: 1 to 1000000 [pulse/s] 1 to 2000000000 [ $\times 10^{-2}$ mm/min or others]	<ul style="list-style-type: none"> <li>Bring the setting into the setting range.</li> <li>Set the speed to the bias speed at start or higher. (Refer to Section 5.2.5)</li> </ul>
76 77	226 227	376 377	526 527		<ul style="list-style-type: none"> <li>Bring the setting into the setting range.</li> <li>Set the speed to that below the OPR speed.</li> <li>Set the value to the bias speed at start or higher. (Refer to Section 5.2.5)</li> </ul>
78	228	378	528	0, 1	With the setting brought into the setting range, turn the PLC READY signal [Y0] from OFF to ON.
80 81	230 231	380 381	530 531	0 to 2147483647	
82	232	382	532	0, 1, 2, 3	
83	233	383	533	0, 1, 2, 3	
86	236	386	536	1 to 300	
87	237	387	537	1 to 65535	
88	238	388	538	0, 1	

## 15.4 List of warnings

The following table shows the warning details and remedies to be taken when a warning occurs.

Classification of warnings	Warning code	Warning name	Warning	Operation status at warning occurrence	
—	000	(Normal status)	—	—	
Common	100	Start during operation	The start request is issued while the axis is BUSY.	Continue the operation.	
	102	Deviation counter clear request	The deviation counter clear request is issued while the axis is BUSY.	The deviation counter clear request is ignored.	
	104	Restart not possible	The restart command is issued when the axis operation status is not "Stopped".	Continue the operation.	
	109	Teaching in BUSY	The teaching request is issued while the axis is BUSY.	The warning is issued for the axis designated at the time of the teaching request.	
	110	Less than minimum speed	The overridden speed becomes "0".	The system is controlled with the currently executing unit of 1.	
	111	In PLC READY	The request for writing to the flash ROM is issued when the PLC READY is turned ON.	The warning for axis 1 is issued.	
	112	Illegal override value	A value other than 1 to 300 is set for the override value.	<ul style="list-style-type: none"> <li>• Controlled at a setting value of 0 : 100.</li> <li>• Controlled at a setting value of 301 or over : 300.</li> </ul>	
	113	Outside new torque value range	The new torque value exceeds the torque limit setting value.	Set a value smaller than the torque limit setting value to the new torque value.	
	114	Below bias speed	The command speed is below the bias speed at start.	Operate by the bias speed at start.	



Related buffer memory address					Set range (Setting with sequence program)	Remedy
Axis 1	Axis 2	Axis 3	Axis 4			
—	—	—	—	—	—	—
—	—	—	—	—	—	Normalize the start request ON timing.
—	—	—	—	—	—	Do not carry out the deviation counter clear while the axis is running. (Refer to CHAPTER 8)
1503	1603	1703	1803	<Restart command> 1: Restart	Normalize the start request ON timing. (Refer to Section 6.5.5) (Do not issue the restart command when the axis operation is not stopped.)	
1548 1549	1648 1649	1748 1749	1848 1849	<Teaching data selection> 0, 1 <Teaching positioning data No.> 1 to 600	Carry out the teaching request when the axis is not BUSY. (Refer to Section 12.7.4)	
1513	1613	1713	1813	<Positioning operation speed override> 1 to 300	Prevent the overridden speed from being reduced to 0. (Refer to Section 12.5.2)	
1900 1901					<Flash ROM write request> 1: Flash ROM write request <Parameter initialization request> 1: Parameter initialization request	Issue a write request when PLC READY signal (Y0) is OFF.
1513	1613	1713	1813	<Positioning operation speed override> 1 to 300	Set a value within the setting range.	
1525	1625	1725	1825	<New torque value> 1 to [Torque limit set value]	Set a value smaller than the torque limit setting value to the new torque value.	
26	176	326	476	<Torque limit set value> 1 to 500		
Refer to Section 5.3 "List of positioning data" for command speed					<Command speed> QD75P□N/QD75D□N: 1 to 4000000 [pulse/s] 1 to 2000000000 [×10 <sup>-2</sup> mm/min or others] QD75P□/QD75D□: 1 to 1000000 [pulse/s] 1 to 2000000000 [×10 <sup>-2</sup> mm/min or others]	Re-set the command speed/bias speed at start so that the command speed is equal to or larger than the bias speed at start.
					Bias speed at start	
6 7	156 157	306 307	456 457	<Bias speed at start> QD75P□N/QD75D□N: 0 to 4000000 [pulse/s] 0 to 2000000000 [×10 <sup>-2</sup> mm/min or others] QD75P□/QD75D□: 0 to 1000000 [pulse/s] 0 to 2000000000 [×10 <sup>-2</sup> mm/min or others]		

Classification of warnings	Warning code	Warning name	Warning	Operation status at warning occurrence	
JOG	300	Speed change during deceleration	The speed change request is issued during deceleration stop with JOG start signal OFF.	The speed change is not carried out.	
	301	JOG speed limit value	<ul style="list-style-type: none"> <li>• The JOG speed exceeds the JOG speed limit value at the JOG start.</li> <li>• The new speed value exceeds the JOG speed limit value when the speed is changed during operation.</li> </ul>	<ul style="list-style-type: none"> <li>• When the speed exceeds the JOG speed limit, the JOG operation is carried out with the JOG speed limit value.</li> <li>• While the speed is limited by the JOG speed limit value, the "Speed limiting flag" is turned ON.</li> </ul>	
Manual pulse generator	401	Outside manual pulse generator input magnification range	<p>The manual pulse generator 1 pulse input magnification is set as follows.</p> <ul style="list-style-type: none"> <li>• 0 or 1001 or higher (QD75P□N/QD75D□N)</li> <li>• 0 or 101 or higher (QD75P□/QD75D□)</li> </ul>	<ul style="list-style-type: none"> <li>• When input magnification is set at 1001 or higher: Re-set to 1000. (QD75P□N/QD75D□N)</li> <li>• When input magnification is set at 101 or higher: Re-set to 100. (QD75P□/QD75D□)</li> <li>• When input magnification is set at 0: Re-set to 1.</li> </ul>	

Related buffer memory address				Set range (Setting with sequence program)	Remedy
Axis 1	Axis 2	Axis 3	Axis 4		
1516	1616	1716	1816	<Speed change request> 1: Speed change is requested	Do not carry out the JOG speed change during deceleration with the JOG start signal OFF.
New speed value				QD75P□N/QD75D□N: 0 to 4000000 [pulse/s] 0 to 2000000000 [ $\times 10^{-2}$ mm/min or others] QD75P□/QD75D□: 0 to 1000000 [pulse/s] 0 to 2000000000 [ $\times 10^{-2}$ mm/min or others]	Bring the set value into the setting range.
1514 1515	1614 1615	1714 1715	1814 1815		
JOG speed limit value				QD75P□N/QD75D□N: 1 to 4000000 [pulse/s] 1 to 2000000000 [ $\times 10^{-2}$ mm/min or others] QD75P□/QD75D□: 1 to 1000000 [pulse/s] 1 to 2000000000 [ $\times 10^{-2}$ mm/min or others]	
48 49	198 199	348 349	498 499		
1522 1523	1622 1623	1722 1723	1822 1823	<Manual pulse generator 1 pulse input magnification> 1 to 1000 (QD75P□N/QD75D□N) 1 to 100 (QD75P□/QD75D□)	Set the manual pulse generator 1 pulse input magnification to within the setting range.

Classification of warnings	Warning code	Warning name	Warning	Operation status at warning occurrence	
Positioning operation	500	Deceleration/stop speed change	The speed change request is issued during deceleration stop.	The speed change is not carried out.	
	501	Speed limit value over	The new value exceeds the speed limit value when the speed is changed during operation.	<ul style="list-style-type: none"> <li>The speed is controlled with the speed limit value.</li> <li>The "speed limiting flag" is turned ON.</li> </ul>	
	503	M code ON signal ON start	The M code ON signal is turned ON when the positioning data is executed.	Continue executing the positioning data.	
	505	No operation termination setting	In the positioning by block starting, the 50th point of the positioning start data is set to CONTINUE.	The operation is terminated.	
	506	FOR to NEXT nest construction	FOR to NEXT is nested.	The operation is continued.	
	508	Speed-position switching (during acceleration) signal ON	The switching signal for speed-position switching control (INC mode) is turned ON during acceleration.		
	509	Insufficient remaining distance	<ul style="list-style-type: none"> <li>At a continuous operation interrupt request, the distance required deceleration stop is not long enough.</li> <li>At a speed change request, the remaining distance is shorter than the distance required for speed change.</li> </ul>	<ul style="list-style-type: none"> <li>When a command speed is changed: Change to a value as near a new speed value as possible.</li> <li>When a target position is changed: Adjust the speed to a value as near the command speed as possible, and then change to a target position.</li> </ul> (When the operation pattern is a continuous path control, ignore the operations stated above.)	

Related buffer memory address					Set range (Setting with sequence program)	Remedy
Axis 1	Axis 2	Axis 3	Axis 4			
1516	1616	1716	1816		<Speed change request> 1: Speed change is requested	Do not carry out the speed change during deceleration with a stop command, during stoppage, or during automatic deceleration with position control.
New speed value					QD75P□N/QD75D□N: 0 to 4000000 [pulse/s] 0 to 2000000000 [×10 <sup>-2</sup> mm/min or others] QD75P□/QD75D□: 0 to 1000000 [pulse/s] 0 to 2000000000 [×10 <sup>-2</sup> mm/min or others]	Set the new speed value to a range of 0 to "speed limit value".
1514 1515	1614 1615	1714 1715	1814 1815			
Speed limit value					QD75P□N/QD75D□N: 1 to 4000000 [pulse/s] 1 to 2000000000 [×10 <sup>-2</sup> mm/min or others] QD75P□/QD75D□: 1 to 1000000 [pulse/s] 1 to 2000000000 [×10 <sup>-2</sup> mm/min or others]	
10 11	160 161	310 311	460 461			
1504	1604	1704	1804		<M code OFF request> 1: M code ON signal is turned OFF	Normalize the ON and OFF timings of the "M code OFF request". (Refer to Section 12.7.3)
Refer to Section 5.3 "List of positioning data"					<Operation pattern> 00: Positioning complete 01: Continuous positioning control 11: Continuous path control	Set the operation termination to the 50th point. (Refer to CHAPTER 10)
—	—	—	—		—	Make 1 nest construction for FOR to NEXT. (Refer to Section 10.3.8)
—	—	—	—		—	Do not turn ON the speed-position switching signal during acceleration. (Refer to Section 9.2.16)
—	—	—	—		—	Give a request at the position where there is an enough remaining distance.

Classification of warnings	Warning code	Warning name	Warning	Operation status at warning occurrence	
Positioning operation	511	Step not possible	Code 1 is set for the step start information when the step is outside standby.	The step will not start.	
	512	Illegal external command function	The detailed parameter 2 "External command function selection" setting range is exceeded.	Even if the external command signal is turned ON, the system will not perform anything.	
	513	Insufficient movement amount	The movement amount is not large enough for automatic deceleration.	The system stops immediately after it reaches the positioning address.	
	514	Outside command speed range	The command speed exceeds the speed limit.	<ul style="list-style-type: none"> <li>• The command speed is controlled at the "speed limit value".</li> <li>• The "speed limiting flag" turns ON.</li> </ul>	
	516	Illegal teaching data No.	The positioning data No. is set outside the setting range.	Teaching is not carried out when the set value is 0 or 601 or more. (A "0" is canceled by the QD75 automatically even when a "0" or "601" or more is set.)	
	517	Illegal teaching data selection	The teaching data selection set value is outside the setting range.	Teaching is not carried out.	
	518	Target position change not possible	<ul style="list-style-type: none"> <li>• A target position change request was given for the control system other than ABS1 and INC1.</li> <li>• The target position change request is turned ON during continuous path control.</li> <li>• A new target position address is outside the software stroke limit range.</li> <li>• A target position change request was given during deceleration to a stop.</li> <li>• A target position change request is given while the speed change 0 flag (Md.31 Status: b10) is ON.</li> </ul>	The target position change is not carried out.	

Related buffer memory address					Set range (Setting with sequence program)	Remedy
Axis 1	Axis 2	Axis 3	Axis 4			
1546	1646	1746	1846	<Step start information> 1: Step is continued 2: Re-start is carried out	Do not set a "1" to the step start information when the step is not in standby state. (Refer to Section 12.7.1)	
62	212	362	512	<External command function selection> 0, 1, 2, 3	Set the detailed parameter 2 "External command function selection" to within the setting range.	
Refer to Section 5.3 "List of positioning data"					—	Set a decelerating address or a movement amount to the positioning data.
For command speed, refer to Section 5.3 "List of positioning data"					QD75P□N/QD75D□N: 1 to 4000000 [pulse/s] 1 to 2000000000 [×10 <sup>-2</sup> mm/min or others] QD75P□/QD75D□: 1 to 1000000 [pulse/s] 1 to 2000000000 [×10 <sup>-2</sup> mm/min or others]	Set the command speed to within the setting range.
Speed limit value						
10 11	160 161	310 311	460 461			
1549	1649	1749	1849	<Teaching positioning data No.> 1 to 600	Set the positioning data No. to within the setting range.	
1548	1648	1748	1848	<Teaching data selection> 0, 1	Set the teaching data selection set value to within the setting range.	
1538	1638	1738	1838	<Target position change request flag> 1: Target position change request	<ul style="list-style-type: none"> <li>Do not turn ON the target position change request in the following cases.                             <ul style="list-style-type: none"> <li>An operating pattern "continuous path control" is used.</li> <li>A control system other than ABS1, and INC1 is used.</li> <li>During deceleration stop.</li> <li>When the speed change 0 flag (Md.31) Status: b10) is ON.</li> </ul> </li> <li>When the target position change address is outside the stroke limit, correct the target position change address. (Refer to Section 12.5.5)</li> </ul>	





# APPENDICES

Appendix 1 Version up of the functions .....	Appendix- 2
Appendix 1.1 Comparison of functions according to function versions.....	Appendix- 2
Appendix 1.2 Precautions for the replacement of QD75P□/QD75D□ with QD75P□N/QD75D□N .....	Appendix- 3
Appendix 2 Format sheets .....	Appendix- 7
Appendix 2.1 Positioning Module operation chart .....	Appendix- 7
Appendix 2.2 Parameter setting value entry table .....	Appendix- 10
Appendix 3 Positioning data (No. 1 to 600) List of buffer memory addresses .....	Appendix- 16
Appendix 4 Connection examples with servo amplifiers manufactured by MITSUBISHI Electric Corporation.....	Appendix- 48
Appendix 4.1 Connection example of QD75D□N and MR-J3-□ A (Differential driver).....	Appendix- 48
Appendix 4.2 Connection example of QD75D□N and MR-H □ A (Differential driver).....	Appendix- 49
Appendix 4.3 Connection example of QD75D□N and MR-J2/J2S- □ A (Differential driver).....	Appendix- 50
Appendix 4.4 Connection example of QD75D□N and MR-C □ A (Differential driver).....	Appendix- 51
Appendix 5 Connection examples with stepping motors manufactured by ORIENTALMOTOR Co., Ltd.....	Appendix- 52
Appendix 5.1 Connection example of QD75P□N and VEXTA UPD (Open collector).....	Appendix- 52
Appendix 6 Connection examples with servo amplifiers manufactured by Panasonic Corporation .....	Appendix- 53
Appendix 6.1 Connection example of QD75D□N and MINAS-A series (Differential driver).....	Appendix- 53
Appendix 7 Connection examples with servo amplifiers manufactured by SANYO DENKI Co., Ltd.....	Appendix- 54
Appendix 7.1 Connection example of QD75D□N and PYO series (Differential driver).....	Appendix- 54
Appendix 8 Connection examples with servo amplifiers manufactured by YASKAWA Electric Corporation.....	Appendix- 55
Appendix 8.1 Connection example of QD75D□N and $\Sigma$ -II series (Differential driver).....	Appendix- 55
Appendix 9 Comparisons with conventional positioning modules .....	Appendix- 56
Appendix 9.1 Comparisons with A1SD71S2 model.....	Appendix- 56
Appendix 9.2 Comparisons with A1SD75P1-S3/A1SD75P2-S3/ A1SD75P3-S3 models .....	Appendix- 57
Appendix 10 When using GX Works2 .....	Appendix- 80
Appendix 10.1 Adding a module .....	Appendix- 81
Appendix 10.2 Setting parameters .....	Appendix- 82
Appendix 10.3 Setting auto refresh .....	Appendix- 87
Appendix 10.4 Positioning monitor .....	Appendix- 88
Appendix 10.5 Positioning test.....	Appendix- 98
Appendix 10.6 Wave trace .....	Appendix-106
Appendix 10.7 Location trace .....	Appendix-109
Appendix 10.8 Parameter initialization function .....	Appendix-112
Appendix 10.9 Execution data backup function .....	Appendix-114
Appendix 10.10 External I/O signal logic switching function.....	Appendix-116
Appendix 10.11 External I/O signal monitor function .....	Appendix-117
Appendix 10.12 History monitor function.....	Appendix-118
Appendix 10.13 Checking errors .....	Appendix- 120
Appendix 11 MELSEC Explanation of positioning terms .....	Appendix-124
Appendix 12 Positioning control troubleshooting .....	Appendix-144
Appendix 13 List of buffer memory addresses .....	Appendix-150
Appendix 14 External dimension drawing .....	Appendix-159

## Appendix 1 Version up of the functions

## Appendix 1.1 Comparison of functions according to function versions

The following tables list the QD75 functions compared according to function versions and the buffer memory for their additional functions.

## (1) Function comparison

Item	Function versions			Reference
	QD75P□N/ QD75D□N	QD75P□/QD75D□		
	A	A	B	
Speed-position switching control (ABS mode)	○	×	○	Section 9.2.19
Pre-reading start function	○	×	○	Section 12.7.7
External I/O signal monitor function	○*1	×	○*2	Section 13.5
Multiple programmable controller compatible function*3	○	×	○	—
Deceleration start flag function	○	×	○*4	Section 12.7.8
Stop command processing for deceleration stop function	○	×	○*5	Section 12.7.9
Output timing selection of near pass control	○*6	×	○*7	Section 12.3.4
3-axis helical interpolation control	○*8	×	×	Section 9.2.12 Section 9.2.13
Positioning option	○*8	×	×	Section 5.3

○:Available × :Not available

- \*1: For the QD75P□N/QD75D□N, external I/O signals can not be monitored on GX Developer. Use the system monitor of GX Works2.
- \*2: Usable on GX Developer of SW6D5C-GPPW-E or later.
- \*3: Compatible with QCPU of function version B.
- \*4: Supported by the module whose first five digits of SERIAL No. are "03042" or later.
- \*5: Supported by the module whose first five digits of SERIAL No. are "05072" or later.
- \*6: Supported by the module whose first five digits of SERIAL No. are "14032" or later.
- \*7: Supported by the module whose first five digits of SERIAL No. are "14012" or later.
- \*8: Supported by the module whose first five digits of the serial number are "17102" or later. GX Configurator-QP does not support these functions. Only GX Works2 (Version 1.540N or later) supports the functions.

## (2) Additional buffer memory

Buffer memory addresses				Name	Used function
Axis 1	Axis 2	Axis 3	Axis 4		
34	184	334	484	Speed-position function selection	Speed-position switching control
140				Positioning option valid/invalid setting	Positioning option
899	999	1099	1199	Deceleration start flag	Deceleration start flag function
1905				Deceleration start flag valid	
1907				Stop command processing for deceleration stop selection	Stop command processing for deceleration stop function
2003 *1	8003 *1	14003 *1	20003 *1	M code ON signal output timing	Positioning option
				ABS direction in degrees	
				Interpolation speed designation method	

\*1: The listed buffer memory addresses are those of the positioning data No. 1 of each axis. For the buffer memory address of other positioning data No., refer to Appendix 3.

## (3) Additional devices

Device No.	Name		Used function
Y14	Axis 1	Execution prohibition flag	Pre-reading start function
Y15	Axis 2		
Y16	Axis 3		
Y17	Axis 4		

## Appendix 1.2 Precautions for the replacement of the QD75P□/QD75D□ with the QD75P□N/QD75D□N

### (1) Specification differences between the QD75P□N/QD75D□N and the QD75P□/QD75D□

The following table shows the differences. The specifications not listed below are the same for the both models.

Item		QD75P□N/QD75D□N	QD75P□/QD75D□
Max. output pulse		4Mpulse/s (QD75D□N)	1Mpulse/s (Q75D□)
Speed command (pulse unit)		1 to 4000000pulse/s	1 to 1000000pulse/s
Starting time (1-axis linear control)		Trapezoidal acceleration/ deceleration: 1.5ms S-curve acceleration/ deceleration: 1.6ms	Trapezoidal acceleration/ deceleration: 6ms S-curve acceleration/ deceleration: 6.5ms
Monitor data refreshing cycle	Current feed value	0.9ms	1.8ms
	Other axis monitors (except external I/O signals)	0.9ms	56.8ms
Manual pulse generator 1 pulse input magnification		1 to 1000	1 to 100
ON voltage/current of external input	External command signal	19VDC or more/2.7mA or more	17.5VDC or more/ 3.5mA or more
OFF voltage/current of external input	External command signal	7VDC or less/ 0.8mA or less	7VDC or less/ 1.7mA or less
Input resistance of external input	Zero signal (5VDC)	Approx. 620Ω	Approx. 300Ω
	Manual pulse generator A/B phase	Approx. 1.1kΩ	Approx. 1.5kΩ
	External command signal	Approx. 7.7kΩ	Approx. 4.3kΩ
Internal current consumption (5VDC)		QD75P1N: 0.29A QD75P2N: 0.30A QD75P4N: 0.36A QD75D1N: 0.43A QD75D2N: 0.45A QD75D4N: 0.66A	QD75P1: 0.40A QD75P2: 0.46A QD75P4: 0.58A QD75D1: 0.52A QD75D2: 0.56A QD75D4: 0.82A
Weight		QD75P1N: 0.14kg QD75P2N: 0.14kg QD75P4N: 0.16kg QD75D1N: 0.15kg QD75D2N: 0.15kg QD75D4N: 0.16kg	QD75P1: 0.15kg QD75P2: 0.15kg QD75P4: 0.16kg QD75D1: 0.15kg QD75D2: 0.15kg QD75D4: 0.16kg

## (2) Precaution on the use of sequence programs

The QD75P□N/QD75D□N is upgraded from the QD75P□/QD75D□. Therefore, the recognized sequence programs for the QD75P□/QD75D□ can be applied to the QD75P□N/QD75D□N. Note that specifications such as time takes for start-up and data update cycle are improved. When applying a sequence program to the QD75P□N/QD75D□N, modify the sequence program if necessary, checking the processing timing.

## (3) Transferring the set data of the QD75P□/QD75D□ using GX Works2

When GX Works2 is used, the set data of the QD75P□/QD75D□ can be transferred to the QD75P□N/QD75D□N in the following procedure.

- (a) Saving the set data of the QD75P□/QD75D□ from "Save the Positioning Module Data..."
  - 1) In the project view, select the QD75P□/QD75D□ from where the set data is transferred.
  - 2) Go to [Project] → [Intelligent Function Module] → [Save the Positioning Module Data...].
  - 3) Input the file name, and save the set data.
- (b) Reading the set data to the QD75P□N/QD75D□N from "Read from the Positioning Module Data..."
  - 1) In the project view, select the QD75P□N/QD75D□N to where the saved data is transferred.
  - 2) Go to [Project] → [Intelligent Function Module] → [Read from the Positioning Module Data...].
  - 3) Select the name of the file saved in step (a), and open it. The following window opens.

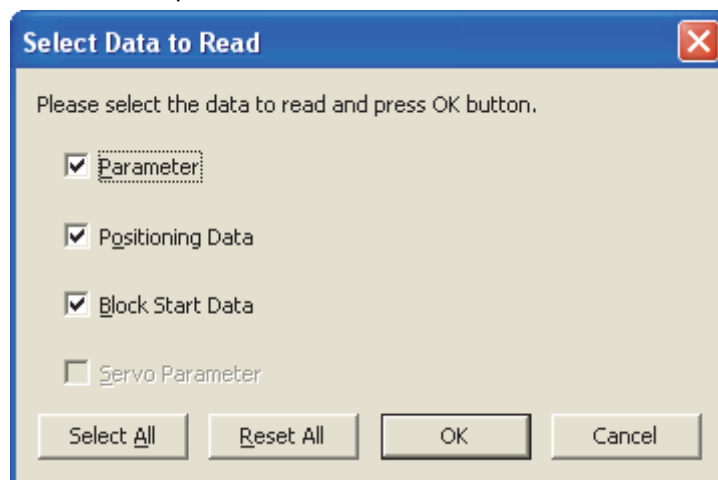

- 4) Check the data to read and click . The set data is read to the QD75P□N/QD75D□N.

(4) Precaution on the use of GX Configurator-QP

To use the QD75P□N/QD75D□N with GX Configurator-QP, select the QD75P□/QD75D□ in "Select module type". The QD75P□N/QD75D□N can be used in the same manner as the QD75P□/QD75D□. Note that a speed exceeding 1000000pulse/s cannot be set in the following items when "Pulse" is set in "[Pr.1] Unit setting"). To set a value outside a setting range in GX Configurator-QP, set it through a sequence program or GX Works2 of the version 1.64S or later.

Setting item	Setting range in GX Configurator-QP	Setting range in GX Works2 and sequence programs
[Pr.7] Bias speed at start	0 to 1000000(pulse/s)	0 to 4000000(pulse/s)
[Pr.8] Speed limit value	[QD75P□N] 1 to 200000(pulse/s)	1 to 4000000(pulse/s)
[Pr.31] JOG speed limit value	[QD75D□N] 1 to 1000000(pulse/s)	
[Pr.46] OPR speed	1 to 1000000(pulse/s)	
[Pr.47] Creep speed		
[Da.8] Command speed		









Appendix 2.2 Parameter setting value entry table

Item		Setting range			
		mm	inch	degree	pulse
Basic parameters 1	Pr.1 Unit setting	0	1	2	3
	Pr.2 No. of pulses per rotation (Ap)	1 to 65535 pulse			
	Pr.3 Movement amount per rotation (Al)	1 to 65535 $\times 10^{-1}\mu\text{m}$	1 to 65535 $\times 10^{-5}\text{inch}$	1 to 65535 $\times 10^{-5}\text{degree}$	1 to 65535 pulse
	Pr.4 Unit magnification (Am)	1: 1-fold, 10: 10-fold, 100: 100-fold, 1000: 1000-fold			
	Pr.5 Pulse output mode	0: PULSE/SIGN mode, 1: CW/CCW mode, 2: A phase/B phase (multiple of 4), 3: A phase/B phase (multiple of 1)			
	Pr.6 Rotation direction setting	0: Current value increment with forward run pulse output 1: Current value increment with reverse run pulse output			
	Pr.7 Bias speed at start	0 to 2000000000 $\times 10^{-2}\text{mm/min}$	0 to 2000000000 $\times 10^{-3}\text{inch/min}$	0 to 2000000000 $\times 10^{-3}\text{degree/min}$	QD75P□/QD75D□N: 0 to 4000000 pulse/s QD75P□/QD75D□: 0 to 1000000 pulse/s
Basic parameters 2	Pr.8 Speed limit value	1 to 2000000000 $\times 10^{-2}\text{mm/min}$	1 to 2000000000 $\times 10^{-3}\text{mm/min}$	1 to 2000000000 $\times 10^{-3}\text{degree/min}$	QD75P□/QD75D□N: 1 to 4000000 pulse/s QD75P□/QD75D□: 1 to 1000000 pulse/s
	Pr.9 Acceleration time 0	1 to 8388608ms			
	Pr.10 Deceleration time 0				
Detailed parameters 1	Pr.11 Backlash compensation amount	0 to 65535 $\times 10^{-1}\mu\text{m}$	0 to 65535 $\times 10^{-5}\text{inch}$	0 to 65535 $\times 10^{-5}\text{degree}$	0 to 65535 pulse
	Pr.12 Software stroke limit upper limit value	-2147483648 to 2147483647	-2147483648 to 2147483647	0 to 35999999 $\times 10^{-5}\text{degree}$	-2147483648 to 2147483647 pulse
	Pr.13 Software stroke limit lower limit value	$\times 10^{-1}\mu\text{m}$	$\times 10^{-5}\text{inch}$		
	Pr.14 Software stroke limit selection	0: Apply software stroke limit on current feed value 1: Apply software stroke limit on machine feed value			
	Pr.15 Software stroke limit valid/invalid setting	0: Software stroke limit valid during JOG operation, inching operation, and manual pulse generator operation 1: Software stroke limit invalid during JOG operation, inching operation, and manual pulse generator operation			
	Pr.16 Command in-position width	1 to 2147483647 $\times 10^{-1}\mu\text{m}$	1 to 2147483647 $\times 10^{-5}\text{inch}$	1 to 2147483647 $\times 10^{-5}\text{degree}$	1 to 2147483647 pulse
	Pr.17 Torque limit setting value	1 to 500%			
	Pr.18 M code ON signal output timing	0: WITH mode, 1: AFTER mode			
	Pr.19 Speed switching mode	0: Standard speed switching mode 1: Front-loading speed switching mode			
	Pr.20 Interpolation speed designation method	0: Composite speed, 1: Reference axis speed			
	Pr.21 Current feed value during speed control	0: Do not update current feed value, 1: Update current feed value 2: Clear current feed value			

	Initial value	Axis 1	Axis 2	Axis 3	Axis 4	Remarks
	3					
	20000					
	20000					
	1					
	1					
	0					
	0					
	20000					
	1000					
	1000					
	0					
	2147483647					
	-2147483648					
	0					
	0					
	100					
	300					
	0					
	0					
	0					
	0					

Item		Setting range						
		mm		inch		degree		pulse
Detailed parameters 1	Pr.22 Input signal logic selection	b0	Lower limit	b3	Stop signal	b6	Near-point dog signal	Setting of each bit value 0: Negative logic 1: Positive logic ("0" is set for unused bit.)
		b1	Upper limit	b4	External command	b7, b9 to b15	Unused	
		b2	Drive unit READY	b5	Zero signal	b8	Manual pulse generator input	
	Pr.23 Output signal logic selection	b0	Command pulse signal	b2	Unused	b4	Deviation counter clear	
		b1	Unused	b3	Unused	b5 to b15	Unused	
	Pr.24 Manual pulse generator input selection	0: A phase/B phase multiple of 4 1: A phase/B phase multiple of 2 2: A phase/B phase multiple of 1 3: PULSE/SIGN mode						
Pr.70 Positioning option valid/invalid setting	0: Invalid 1: Valid							
Pr.150 Speed -position function selection	0: Speed-position switching control (INC mode) 2: Speed-position switching control (ABS mode)							
Detailed parameters 2	Pr.25 Acceleration time 1	1 to 8388608ms						
	Pr.26 Acceleration time 2							
	Pr.27 Acceleration time 3							
	Pr.28 Deceleration time 1							
	Pr.29 Deceleration time 2							
	Pr.30 Deceleration time 3							
	Pr.31 JOG speed limit value	1 to 2000000000 × 10 <sup>-2</sup> mm/min	1 to 2000000000 × 10 <sup>-3</sup> inch/min	1 to 2000000000 × 10 <sup>-3</sup> degree/min	QD75P□N/QD75D□N: 1 to 4000000 pulse/s QD75P□/QD75D□: 1 to 1000000 pulse/s			
	Pr.32 JOG operation acceleration time selection	0 to 3						
	Pr.33 JOG operation deceleration time selection							
	Pr.34 Acceleration/deceleration process selection	0: Trapezoidal acceleration/deceleration process 1: S-curve acceleration/deceleration process						
	Pr.35 S-curve ratio	1 to 100%						
	Pr.36 Sudden stop deceleration time	1 to 8388608ms						
	Pr.37 Stop group 1 sudden stop selection	0: Normal deceleration stop 1: Sudden stop						
Pr.38 Stop group 2 sudden stop selection								
Pr.39 Stop group 3 sudden stop selection								
Pr.40 Positioning complete signal output time	0 to 65535ms							
Pr.41 Allowable circular interpolation error width	1 to 100000 × 10 <sup>-1</sup> μm	1 to 100000 × 10 <sup>-5</sup> inch	1 to 100000 × 10 <sup>-5</sup> degree	1 to 100000 pulse				

	Initial value	Axis 1	Axis 2	Axis 3	Axis 4	Remarks
	0					
	0					
	0					
	0					
	0					
	1000					
	1000					
	1000					
	1000					
	1000					
	1000					
	20000					
	0					
	0					
	0					
	100					
	1000					
	0					
	0					
	0					
	300					
	100					

Item		Setting range			
		mm	inch	degree	pulse
Detailed parameters 2	Pr.42 External command function selection	0: External positioning start 1: External speed change request 2: Speed-position or position-speed switching request 3: Skip request			
OPR basic parameters	Pr.43 OPR method	0: Near-point dog method 1: Stopper method 1) (By dwell time elapse) 2: Stopper method 2) (By OP signal when stopper is hit) 3: Stopper method 3) (Without near-point dog method) 4: Count method 1) (Use zero signal) 5: Count method 2) (Do not use zero signal)			
	Pr.44 OPR direction	0: Positive direction (address increment direction) 1: Negative direction (address decrement direction)			
	Pr.45 OP address	-2147483648 to 2147483647 × 10 <sup>-1</sup> μm	-2147483648 to 2147483647 × 10 <sup>-5</sup> inch	0 to 35999999 × 10 <sup>-5</sup> degree	-2147483648 to 2147483647 pulse
	Pr.46 OPR speed	1 to 2000000000 × 10 <sup>-2</sup> mm/min	1 to 2000000000 × 10 <sup>-3</sup> inch/min	1 to 2000000000 × 10 <sup>-3</sup> degree/min	QD75P□N/QD75D□N: 1 to 4000000 pulse/s
	Pr.47 Creep speed				QD75P□/QD75D□: 1 to 1000000 pulse/s
	Pr.48 OPR retry	0: Do not retry OPR with upper/lower limit switch 1: Retry OPR with upper/lower limit switch			
OPR detailed parameters	Pr.49 OPR dwell time	0 to 65535ms			
	Pr.50 Setting for the movement amount after near-point dog ON	0 to 2147483647 × 10 <sup>-1</sup> μm	0 to 2147483647 × 10 <sup>-5</sup> inch	0 to 2147483647 × 10 <sup>-5</sup> degree	0 to 2147483647 pulse
	Pr.51 OPR acceleration time selection	0 to 3			
	Pr.52 OPR deceleration time selection				
	Pr.53 OP shift amount	-2147483648 to 2147483647 × 10 <sup>-1</sup> μm	-2147483648 to 2147483647 × 10 <sup>-5</sup> inch	-2147483648 to 2147483647 × 10 <sup>-5</sup> degree	-2147483648 to 2147483647 pulse
	Pr.54 OPR torque limit value	1 to 300%			
	Pr.55 Deviation counter clear signal output time	1 to 65535ms			
	Pr.56 Speed designation during OP shift	0: OPR speed 1: Creep speed			
	Pr.57 Dwell time during OPR retry	0 to 65535ms			

	Initial value	Axis 1	Axis 2	Axis 3	Axis 4	Remarks
	0					
	0					
	0					
	0					
	1					
	1					
	0					
	0					
	0					
	0					
	0					
	0					
	0					
	300					
	11					
	0					
	0					

Appendix 3 Positioning data (No. 1 to 600)  
List of buffer memory addresses

(1) For axis 1

Data No.	Positioning identifier	M code	Dwell time	Command speed		Positioning address		Arc data	
				Low-order	High-order	Low-order	High-order	Low-order	High-order
1	2000	2001	2002	2004	2005	2006	2007	2008	2009
2	2010	2011	2012	8014	2015	2016	2017	2018	2019
3	2020	2021	2022	2024	2025	2026	2027	2028	2029
4	2030	2031	2032	2034	2035	2036	2037	2038	2039
5	2040	2041	2042	2044	2045	2046	2047	2048	2049
6	2050	2051	2052	2054	2055	2056	2057	2058	2059
7	2060	2061	2062	2064	2065	2066	2067	2068	2069
8	2070	2071	2072	2074	2075	2076	2077	2078	2079
9	2080	2081	2082	2084	2085	2086	2087	2088	2089
10	2090	2091	2092	2094	2095	2096	2097	2098	2099
11	2100	2101	2102	2104	2105	2106	2107	2108	2109
12	2110	2111	2112	2114	2115	2116	2117	2118	2119
13	2120	2121	2122	2124	2125	2126	2127	2128	2129
14	2130	2131	2132	2134	2135	2136	2137	2138	2139
15	2140	2141	2142	2144	2145	2146	2147	2148	2149
16	2150	2151	2152	2154	2155	2156	2157	2158	2159
17	2160	2161	2162	2164	2165	2166	2167	2168	2169
18	2170	2171	2172	2174	2175	2176	2177	2178	2179
19	2180	2181	2182	2184	2185	2186	2187	2188	2189
20	2190	2191	2192	2194	2195	2196	2197	2198	2199
21	2200	2201	2202	2204	2205	2206	2207	2208	2209
22	2210	2211	2212	2214	2215	2216	2217	2218	2219
23	2220	2221	2222	2224	2225	2226	2227	2228	2229
24	2230	2231	2232	2234	2235	2236	2237	2238	2239
25	2240	2241	2242	2244	2245	2246	2247	2248	2249
26	2250	2251	2252	2254	2255	2256	2257	2258	2259
27	2260	2261	2262	2264	2265	2266	2267	2268	2269
28	2270	2271	2272	2274	2275	2276	2277	2278	2279
29	2280	2281	2282	2284	2285	2286	2287	2288	2289
30	2290	2291	2292	2294	2295	2296	2297	2298	2299
31	2300	2301	2302	2304	2305	2306	2307	2308	2309
32	2310	2311	2312	2314	2315	2316	2317	2318	2319
33	2320	2321	2322	2324	2325	2326	2327	2328	2329
34	2330	2331	2332	2334	2335	2336	2337	2338	2339
35	2340	2341	2342	2344	2345	2346	2347	2348	2349
36	2350	2351	2352	2354	2355	2356	2357	2358	2359
37	2360	2361	2362	2364	2365	2366	2367	2368	2369
38	2370	2371	2372	2374	2375	2376	2377	2378	2379
39	2380	2381	2382	2384	2385	2386	2387	2388	2389
40	2390	2391	2392	2394	2395	2396	2397	2398	2399
41	2400	2401	2402	2404	2405	2406	2407	2408	2409
42	2410	2411	2412	2414	2415	2416	2417	2418	2419
43	2420	2421	2422	2424	2425	2426	2427	2428	2429
44	2430	2431	2432	2434	2435	2436	2437	2438	2439
45	2440	2441	2442	2444	2445	2446	2447	2448	2449
46	2450	2451	2452	2454	2455	2456	2457	2458	2459
47	2460	2461	2462	2464	2465	2466	2467	2468	2469
48	2470	2471	2472	2474	2475	2476	2477	2478	2479
49	2480	2481	2482	2484	2485	2486	2487	2488	2489
50	2490	2491	2492	2494	2495	2496	2497	2498	2499

Data No.	Positioning identifier	M code	Dwell time	Command speed		Positioning address		Arc data	
				Low-order	High-order	Low-order	High-order	Low-order	High-order
51	2500	2501	2502	2504	2505	2506	2507	2508	2509
52	2510	2511	2512	2514	2515	2516	2517	2518	2519
53	2520	2521	2522	2524	2525	2526	2527	2528	2529
54	2530	2531	2532	2534	2535	2536	2537	2538	2539
55	2540	2541	2542	2544	2545	2546	2547	2548	2549
56	2550	2551	2552	2554	2555	2556	2557	2558	2559
57	2560	2561	2562	2564	2565	2566	2567	2568	2569
58	2570	2571	2572	2574	2575	2576	2577	2578	2579
59	2580	2581	2582	2584	2585	2586	2587	2588	2589
60	2590	2591	2592	2594	2595	2596	2597	2598	2599
61	2600	2601	2602	2604	2605	2606	2607	2608	2609
62	2610	2611	2612	2614	2615	2616	2617	2618	2619
63	2620	2621	2622	2624	2625	2626	2627	2628	2629
64	2630	2631	2632	2634	2635	2636	2637	2638	2639
65	2640	2641	2642	2644	2645	2646	2647	2648	2649
66	2650	2651	2652	2654	2655	2656	2657	2658	2659
67	2660	2661	2662	2664	2665	2666	2667	2668	2669
68	2670	2671	2672	2674	2675	2676	2677	2678	2679
69	2680	2681	2682	2684	2685	2686	2687	2688	2689
70	2690	2691	2692	2694	2695	2696	2697	2698	2699
71	2700	2701	2702	2704	2705	2706	2707	2708	2709
72	2710	2711	2712	2714	2715	2716	2717	2718	2719
73	2720	2721	2722	2724	2725	2726	2727	2728	2729
74	2730	2731	2732	2734	2735	2736	2737	2738	2739
75	2740	2741	2742	2744	2745	2746	2747	2748	2749
76	2750	2751	2752	2754	2755	2756	2757	2758	2759
77	2760	2761	2762	2764	2765	2766	2767	2768	2769
78	2770	2771	2772	2774	2775	2776	2777	2778	2779
79	2780	2781	2782	2784	2785	2786	2787	2788	2789
80	2790	2791	2792	2794	2795	2796	2797	2798	2799
81	2800	2801	2802	2804	2805	2806	2807	2808	2809
82	2810	2811	2812	2814	2815	2816	2817	2818	2819
83	2820	2821	2822	2824	2825	2826	2827	2828	2829
84	2830	2831	2832	2834	2835	2836	2837	2838	2839
85	2840	2841	2842	2844	2845	2846	2847	2848	2849
86	2850	2851	2852	2854	2855	2856	2857	2858	2859
87	2860	2861	2862	2864	2865	2866	2867	2868	2869
88	2870	2871	2872	2874	2875	2876	2877	2878	2879
89	2880	2881	2882	2884	2885	2886	2887	2888	2889
90	2890	2891	2892	2894	2895	2896	2897	2898	2899
91	2900	2901	2902	2904	2905	2906	2907	2908	2909
92	2910	2911	2912	2914	2915	2916	2917	2918	2919
93	2920	2921	2922	2924	2925	2926	2927	2928	2929
94	2930	2931	2932	2934	2935	2936	2937	2938	2939
95	2940	2941	2942	2944	2945	2946	2947	2948	2949
96	2950	2951	2952	2954	2955	2956	2957	2958	2959
97	2960	2961	2962	2964	2965	2966	2967	2968	2969
98	2970	2971	2972	2974	2975	2976	2977	2978	2979
99	2980	2981	2982	2984	2985	2986	2987	2988	2989
100	2990	2991	2992	2994	2995	2996	2997	2998	2999



(1) For axis 1

Data No.	Positioning identifier	M code	Dwell time	Command speed		Positioning address		Arc data	
				Low-order	High-order	Low-order	High-order	Low-order	High-order
101	3000	3001	3002	3004	3005	3006	3007	3008	3009
102	3010	3011	3012	3014	3015	3016	3017	3018	3019
103	3020	3021	3022	3024	3025	3026	3027	3028	3029
104	3030	3031	3032	3034	3035	3036	3037	3038	3039
105	3040	3041	3042	3044	3045	3046	3047	3048	3049
106	3050	3051	3052	3054	3055	3056	3057	3058	3059
107	3060	3061	3062	3064	3065	3066	3067	3068	3069
108	3070	3071	3072	3074	3075	3076	3077	3078	3079
109	3080	3081	3082	3084	3085	3086	3087	3088	3089
110	3090	3091	3092	3094	3095	3096	3097	3098	3099
111	3100	3101	3102	3104	3105	3106	3107	3108	3109
112	3110	3111	3112	3114	3115	3116	3117	3118	3119
113	3120	3121	3122	3124	3125	3126	3127	3128	3129
114	3130	3131	3132	3134	3135	3136	3137	3138	3139
115	3140	3141	3142	3144	3145	3146	3147	3148	3149
116	3150	3151	3152	3154	3155	3156	3157	3158	3159
117	3160	3161	3162	3164	3165	3166	3167	3168	3169
118	3170	3171	3172	3174	3175	3176	3177	3178	3179
119	3180	3181	3182	3184	3185	3186	3187	3188	3189
120	3190	3191	3192	3194	3195	3196	3197	3198	3199
121	3200	3201	3202	3204	3205	3206	3207	3208	3209
122	3210	3211	3212	3214	3215	3216	3217	3218	3219
123	3220	3221	3222	3224	3225	3226	3227	3228	3229
124	3230	3231	3232	3234	3235	3236	3237	3238	3239
125	3240	3241	3242	3244	3245	3246	3247	3248	3249
126	3250	3251	3252	3254	3255	3256	3257	3258	3259
127	3260	3261	3262	3264	3265	3266	3267	3268	3269
128	3270	3271	3272	3274	3275	3276	3277	3278	3279
129	3280	3281	3282	3284	3285	3286	3287	3288	3289
130	3290	3291	3292	3294	3295	3296	3297	3298	3299
131	3300	3301	3302	3304	3305	3306	3307	3308	3309
132	3310	3311	3312	3314	3315	3316	3317	3318	3319
133	3320	3321	3322	3324	3325	3326	3327	3328	3329
134	3330	3331	3332	3334	3335	3336	3337	3338	3339
135	3340	3341	3342	3344	3345	3346	3347	3348	3349
136	3350	3351	3352	3354	3355	3356	3357	3358	3359
137	3360	3361	3362	3364	3365	3366	3367	3368	3369
138	3370	3371	3372	3374	3375	3376	3377	3378	3379
139	3380	3381	3382	3384	3385	3386	3387	3388	3389
140	3390	3391	3392	3394	3395	3396	3397	3398	3399
141	3400	3401	3402	3404	3405	3406	3407	3408	3409
142	3410	3411	3412	3414	3415	3416	3417	3418	3419
143	3420	3421	3422	3424	3425	3426	3427	3428	3429
144	3430	3431	3432	3434	3435	3436	3437	3438	3439
145	3440	3441	3442	3444	3445	3446	3447	3448	3449
146	3450	3451	3452	3454	3455	3456	3457	3458	3459
147	3460	3461	3462	3464	3465	3466	3467	3468	3469
148	3470	3471	3472	3474	3475	3476	3477	3478	3479
149	3480	3481	3482	3484	3485	3486	3487	3488	3489
150	3490	3491	3492	3494	3495	3496	3497	3498	3499

Data No.	Positioning identifier	M code	Dwell time	Command speed		Positioning address		Arc data	
				Low-order	High-order	Low-order	High-order	Low-order	High-order
151	3500	3501	3502	3504	3505	3506	3507	3508	3509
152	3510	3511	3512	3514	3515	3516	3517	3518	3519
153	3520	3521	3522	3524	3525	3526	3527	3528	3529
154	3530	3531	3532	3534	3535	3536	3537	3538	3539
155	3540	3541	3542	3544	3545	3546	3547	3548	3549
156	3550	3551	3552	3554	3555	3556	3557	3558	3559
157	3560	3561	3562	3564	3565	3566	3567	3568	3569
158	3570	3571	3572	3574	3575	3576	3577	3578	3579
159	3580	3581	3582	3584	3585	3586	3587	3588	3589
160	3590	3591	3592	3594	3595	3596	3597	3598	3599
161	3600	3601	3602	3604	3605	3606	3607	3608	3609
162	3610	3611	3612	3614	3615	3616	3617	3618	3619
163	3620	3621	3622	3624	3625	3626	3627	3628	3629
164	3630	3631	3632	3634	3635	3636	3637	3638	3639
165	3640	3641	3642	3644	3645	3646	3647	3648	3649
166	3650	3651	3652	3654	3655	3656	3657	3658	3659
167	3660	3661	3662	3664	3665	3666	3667	3668	3669
168	3670	3671	3672	3674	3675	3676	3677	3678	3679
169	3680	3681	3682	3684	3685	3686	3687	3688	3689
170	3690	3691	3692	3694	3695	3696	3697	3698	3699
171	3700	3701	3702	3704	3705	3706	3707	3708	3709
172	3710	3711	3712	3714	3715	3716	3717	3718	3719
173	3720	3721	3722	3724	3725	3726	3727	3728	3729
174	3730	3731	3732	3734	3735	3736	3737	3738	3739
175	3740	3741	3742	3744	3745	3746	3747	3748	3749
176	3750	3751	3752	3754	3755	3756	3757	3758	3759
177	3760	3761	3762	3764	3765	3766	3767	3768	3769
178	3770	3771	3772	3774	3775	3776	3777	3778	3779
179	3780	3781	3782	3784	3785	3786	3787	3788	3789
180	3790	3791	3792	3794	3795	3796	3797	3798	3799
181	3800	3801	3802	3804	3805	3806	3807	3808	3809
182	3810	3811	3812	3814	3815	3816	3817	3818	3819
183	3820	3821	3822	3824	3825	3826	3827	3828	3829
184	3830	3831	3832	3834	3835	3836	3837	3838	3839
185	3840	3841	3842	3844	3845	3846	3847	3848	3849
186	3850	3851	3852	3854	3855	3856	3857	3858	3859
187	3860	3861	3862	3864	3865	3866	3867	3868	3869
188	3870	3871	3872	3874	3875	3876	3877	3878	3879
189	3880	3881	3882	3884	3885	3886	3887	3888	3889
190	3890	3891	3892	3894	3895	3896	3897	3898	3899
191	3900	3901	3902	3904	3905	3906	3907	3908	3909
192	3910	3911	3912	3914	3915	3916	3917	3918	3919
193	3920	3921	3922	3924	3925	3926	3927	3928	3929
194	3930	3931	3932	3934	3935	3936	3937	3938	3939
195	3940	3941	3942	3944	3945	3946	3947	3948	3949
196	3950	3951	3952	3954	3955	3956	3957	3958	3959
197	3960	3961	3962	3964	3965	3966	3967	3968	3969
198	3970	3971	3972	3974	3975	3976	3977	3978	3979
199	3980	3981	3982	3984	3985	3986	3987	3988	3989
200	3990	3991	3992	3994	3995	3996	3997	3998	3999

(1) For axis 1

Data No.	Positioning identifier	M code	Dwell time	Command speed		Positioning address		Arc data	
				Low-order	High-order	Low-order	High-order	Low-order	High-order
201	4000	4001	4002	4004	4005	4006	4007	4008	4009
202	4010	4011	4012	4014	4015	4016	4017	4018	4019
203	4020	4021	4022	4024	4025	4026	4027	4028	4029
204	4030	4031	4032	4034	4035	4036	4037	4038	4039
205	4040	4041	4042	4044	4045	4046	4047	4048	4049
206	4050	4051	4052	4054	4055	4056	4057	4058	4059
207	4060	4061	4062	4064	4065	4066	4067	4068	4069
208	4070	4071	4072	4074	4075	4076	4077	4078	4079
209	4080	4081	4082	4084	4085	4086	4087	4088	4089
210	4090	4091	4092	4094	4095	4096	4097	4098	4099
211	4100	4101	4102	4104	4105	4106	4107	4108	4109
212	4110	4111	4112	4114	4115	4116	4117	4118	4119
213	4120	4121	4122	4124	4125	4126	4127	4128	4129
214	4130	4131	4132	4134	4135	4136	4137	4138	4139
215	4140	4141	4142	4144	4145	4146	4147	4148	4149
216	4150	4151	4152	4154	4155	4156	4157	4158	4159
217	4160	4161	4162	4164	4165	4166	4167	4168	4169
218	4170	4171	4172	4174	4175	4176	4177	4178	4179
219	4180	4181	4182	4184	4185	4186	4187	4188	4189
220	4190	4191	4192	4194	4195	4196	4197	4198	4199
221	4200	4201	4202	4204	4205	4206	4207	4208	4209
222	4210	4211	4212	4214	4215	4216	4217	4218	4219
223	4220	4221	4222	4224	4225	4226	4227	4228	4229
224	4230	4231	4232	4234	4235	4236	4237	4238	4239
225	4240	4241	4242	4244	4245	4246	4247	4248	4249
226	4250	4251	4252	4254	4255	4256	4257	4258	4259
227	4260	4261	4262	4264	4265	4266	4267	4268	4269
228	4270	4271	4272	4274	4275	4276	4277	4278	4279
229	4280	4281	4282	4284	4285	4286	4287	4288	4289
230	4290	4291	4292	4294	4295	4296	4297	4298	4299
231	4300	4301	4302	4304	4305	4306	4307	4308	4309
232	4310	4311	4312	4314	4315	4316	4317	4318	4319
233	4320	4321	4322	4324	4325	4326	4327	4328	4329
234	4330	4331	4332	4334	4335	4336	4337	4338	4339
235	4340	4341	4342	4344	4345	4346	4347	4348	4349
236	4350	4351	4352	4354	4355	4356	4357	4358	4359
237	4360	4361	4362	4364	4365	4366	4367	4368	4369
238	4370	4371	4372	4374	4375	4376	4377	4378	4379
239	4380	4381	4382	4384	4385	4386	4387	4388	4389
240	4390	4391	4392	4394	4395	4396	4397	4398	4399
241	4400	4401	4402	4404	4405	4406	4407	4408	4409
242	4410	4411	4412	4414	4415	4416	4417	4418	4419
243	4420	4421	4422	4424	4425	4426	4427	4428	4429
244	4430	4431	4432	4434	4435	4436	4437	4438	4439
245	4440	4441	4442	4444	4445	4446	4447	4448	4449
246	4450	4451	4452	4454	4455	4456	4457	4458	4459
247	4460	4461	4462	4464	4465	4466	4467	4468	4469
248	4470	4471	4472	4474	4475	4476	4477	4478	4479
249	4480	4481	4482	4484	4485	4486	4487	4488	4489
250	4490	4491	4492	4494	4495	4496	4497	4498	4499

Data No.	Positioning identifier	M code	Dwell time	Command speed		Positioning address		Arc data	
				Low-order	High-order	Low-order	High-order	Low-order	High-order
251	4500	4501	4502	4504	4505	4506	4507	4508	4509
252	4510	4511	4512	4514	4515	4516	4517	4518	4519
253	4520	4521	4522	4524	4525	4526	4527	4528	4529
254	4530	4531	4532	4534	4535	4536	4537	4538	4539
255	4540	4541	4542	4544	4545	4546	4547	4548	4549
256	4550	4551	4552	4554	4555	4556	4557	4558	4559
257	4560	4561	4562	4564	4565	4566	4567	4568	4569
258	4570	4571	4572	4574	4575	4576	4577	4578	4579
259	4580	4581	4582	4584	4585	4586	4587	4588	4589
260	4590	4591	4592	4594	4595	4596	4597	4598	4599
261	4600	4601	4602	4604	4605	4606	4607	4608	4609
262	4610	4611	4612	4614	4615	4616	4617	4618	4619
263	4620	4621	4622	4624	4625	4626	4627	4628	4629
264	4630	4631	4632	4634	4635	4636	4637	4638	4639
265	4640	4641	4642	4644	4645	4646	4647	4648	4649
266	4650	4651	4652	4654	4655	4656	4657	4658	4659
267	4660	4661	4662	4664	4665	4666	4667	4668	4669
268	4670	4671	4672	4674	4675	4676	4677	4678	4679
269	4680	4681	4682	4684	4685	4686	4687	4688	4689
270	4690	4691	4692	4694	4695	4696	4697	4698	4699
271	4700	4701	4702	4704	4705	4706	4707	4708	4709
272	4710	4711	4712	4714	4715	4716	4717	4718	4719
273	4720	4721	4722	4724	4725	4726	4727	4728	4729
274	4730	4731	4732	4734	4735	4736	4737	4738	4739
275	4740	4741	4742	4744	4745	4746	4747	4748	4749
276	4750	4751	4752	4754	4755	4756	4757	4758	4759
277	4760	4761	4762	4764	4765	4766	4767	4768	4769
278	4770	4771	4772	4774	4775	4776	4777	4778	4779
279	4780	4781	4782	4784	4785	4786	4787	4788	4789
280	4790	4791	4792	4794	4795	4796	4797	4798	4799
281	4800	4801	4802	4804	4805	4806	4807	4808	4809
282	4810	4811	4812	4814	4815	4816	4817	4818	4819
283	4820	4821	4822	4824	4825	4826	4827	4828	4829
284	4830	4831	4832	4834	4835	4836	4837	4838	4839
285	4840	4841	4842	4844	4845	4846	4847	4848	4849
286	4850	4851	4852	4854	4855	4856	4857	4858	4859
287	4860	4861	4862	4864	4865	4866	4867	4868	4869
288	4870	4871	4872	4874	4875	4876	4877	4878	4879
289	4880	4881	4882	4884	4885	4886	4887	4888	4889
290	4890	4891	4892	4894	4895	4896	4897	4898	4899
291	4900	4901	4902	4904	4905	4906	4907	4908	4909
292	4910	4911	4912	4914	4915	4916	4917	4918	4919
293	4920	4921	4922	4924	4925	4926	4927	4928	4929
294	4930	4931	4932	4934	4935	4936	4937	4938	4939
295	4940	4941	4942	4944	4945	4946	4947	4948	4949
296	4950	4951	4952	4954	4955	4956	4957	4958	4959
297	4960	4961	4962	4964	4965	4966	4967	4968	4969
298	4970	4971	4972	4974	4975	4976	4977	4978	4979
299	4980	4981	4982	4984	4985	4986	4987	4988	4989
300	4990	4991	4992	4994	4995	4996	4997	4998	4999

(1) For axis 1

Data No.	Positioning identifier	M code	Dwell time	Command speed		Positioning address		Arc data	
				Low-order	High-order	Low-order	High-order	Low-order	High-order
301	5000	5001	5002	5004	5005	5006	5007	5008	5009
302	5010	5011	5012	5014	5015	5016	5017	5018	5019
303	5020	5021	5022	5024	5025	5026	5027	5028	5029
304	5030	5031	5032	5034	5035	5036	5037	5038	5039
305	5040	5041	5042	5044	5045	5046	5047	5048	5049
306	5050	5051	5052	5054	5055	5056	5057	5058	5059
307	5060	5061	5062	5064	5065	5066	5067	5068	5069
308	5070	5071	5072	5074	5075	5076	5077	5078	5079
309	5080	5081	5082	5084	5085	5086	5087	5088	5089
310	5090	5091	5092	5094	5095	5096	5097	5098	5099
311	5100	5101	5102	5104	5105	5106	5107	5108	5109
312	5110	5111	5112	5114	5115	5116	5117	5118	5119
313	5120	5121	5122	5124	5125	5126	5127	5128	5129
314	5130	5131	5132	5134	5135	5136	5137	5138	5139
315	5140	5141	5142	5144	5145	5146	5147	5148	5149
316	5150	5151	5152	5154	5155	5156	5157	5158	5159
317	5160	5161	5162	5164	5165	5166	5167	5168	5169
318	5170	5171	5172	5174	5175	5176	5177	5178	5179
319	5180	5181	5182	5184	5185	5186	5187	5188	5189
320	5190	5191	5192	5194	5195	5196	5197	5198	5199
321	5200	5201	5202	5204	5205	5206	5207	5208	5209
322	5210	5211	5212	5214	5215	5216	5217	5218	5219
323	5220	5221	5222	5224	5225	5226	5227	5228	5229
324	5230	5231	5232	5234	5235	5236	5237	5238	5239
325	5240	5241	5242	5244	5245	5246	5247	5248	5249
326	5250	5251	5252	5254	5255	5256	5257	5258	5259
327	5260	5261	5262	5264	5265	5266	5267	5268	5269
328	5270	5271	5272	5274	5275	5276	5277	5278	5279
329	5280	5281	5282	5284	5285	5286	5287	5288	5289
330	5290	5291	5292	5294	5295	5296	5297	5298	5299
331	5300	5301	5302	5304	5305	5306	5307	5308	5309
332	5310	5311	5312	5314	5315	5316	5317	5318	5319
333	5320	5321	5322	5324	5325	5326	5327	5328	5329
334	5330	5331	5332	5334	5335	5336	5337	5338	5339
335	5340	5341	5342	5344	5345	5346	5347	5348	5349
336	5350	5351	5352	5354	5355	5356	5357	5358	5359
337	5360	5361	5362	5364	5365	5366	5367	5368	5369
338	5370	5371	5372	5374	5375	5376	5377	5378	5379
339	5380	5381	5382	5384	5385	5386	5387	5388	5389
340	5390	5391	5392	5394	5395	5396	5397	5398	5399
341	5400	5401	5402	5404	5405	5406	5407	5408	5409
342	5410	5411	5412	5414	5415	5416	5417	5418	5419
343	5420	5421	5422	5424	5425	5426	5427	5428	5429
344	5430	5431	5432	5434	5435	5436	5437	5438	5439
345	5440	5441	5442	5444	5445	5446	5447	5448	5449
346	5450	5451	5452	5454	5455	5456	5457	5458	5459
347	5460	5461	5462	5464	5465	5466	5467	5468	5469
348	5470	5471	5472	5474	5475	5476	5477	5478	5479
349	5480	5481	5482	5484	5485	5486	5487	5488	5489
350	5490	5491	5492	5494	5495	5496	5497	5498	5499

Data No.	Positioning identifier	M code	Dwell time	Command speed		Positioning address		Arc data	
				Low-order	High-order	Low-order	High-order	Low-order	High-order
351	5500	5501	5502	5504	5505	5506	5507	5508	5509
352	5510	5511	5512	5514	5515	5516	5517	5518	5519
353	5520	5521	5522	5524	5525	5526	5527	5528	5529
354	5530	5531	5532	5534	5535	5536	5537	5538	5539
355	5540	5541	5542	5544	5545	5546	5547	5548	5549
356	5550	5551	5552	5554	5555	5556	5557	5558	5559
357	5560	5561	5562	5564	5565	5566	5567	5568	5569
358	5570	5571	5572	5574	5575	5576	5577	5578	5579
359	5580	5581	5582	5584	5585	5586	5587	5588	5589
360	5590	5591	5592	5594	5595	5596	5597	5598	5599
361	5600	5601	5602	5604	5605	5606	5607	5608	5609
362	5610	5611	5612	5614	5615	5616	5617	5618	5619
363	5620	5621	5622	5624	5625	5626	5627	5628	5629
364	5630	5631	5632	5634	5635	5636	5637	5638	5639
365	5640	5641	5642	5644	5645	5646	5647	5648	5649
366	5650	5651	5652	5654	5655	5656	5657	5658	5659
367	5660	5661	5662	5664	5665	5666	5667	5668	5669
368	5670	5671	5672	5674	5675	5676	5677	5678	5679
369	5680	5681	5682	5684	5685	5686	5687	5688	5689
370	5690	5691	5692	5694	5695	5696	5697	5698	5699
371	5700	5701	5702	5704	5705	5706	5707	5708	5709
372	5710	5711	5712	5714	5715	5716	5717	5718	5719
373	5720	5721	5722	5724	5725	5726	5727	5728	5729
374	5730	5731	5732	5734	5735	5736	5737	5738	5739
375	5740	5741	5742	5744	5745	5746	5747	5748	5749
376	5750	5751	5752	5754	5755	5756	5757	5758	5759
377	5760	5761	5762	5764	5765	5766	5767	5768	5769
378	5770	5771	5772	5774	5775	5776	5777	5778	5779
379	5780	5781	5782	5784	5785	5786	5787	5788	5789
380	5790	5791	5792	5794	5795	5796	5797	5798	5799
381	5800	5801	5802	5804	5805	5806	5807	5808	5809
382	5810	5811	5812	5814	5815	5816	5817	5818	5819
383	5820	5821	5822	5824	5825	5826	5827	5828	5829
384	5830	5831	5832	5834	5835	5836	5837	5838	5839
385	5840	5841	5842	5844	5845	5846	5847	5848	5849
386	5850	5851	5852	5854	5855	5856	5857	5858	5859
387	5860	5861	5862	5864	5865	5866	5867	5868	5869
388	5870	5871	5872	5874	5875	5876	5877	5878	5879
389	5880	5881	5882	5884	5885	5886	5887	5888	5889
390	5890	5891	5892	5894	5895	5896	5897	5898	5899
391	5900	5901	5902	5904	5905	5906	5907	5908	5909
392	5910	5911	5912	5914	5915	5916	5917	5918	5919
393	5920	5921	5922	5924	5925	5926	5927	5928	5929
394	5930	5931	5932	5934	5935	5936	5937	5938	5939
395	5940	5941	5942	5944	5945	5946	5947	5948	5949
396	5950	5951	5952	5954	5955	5956	5957	5958	5959
397	5960	5961	5962	5964	5965	5966	5967	5968	5969
398	5970	5971	5972	5974	5975	5976	5977	5978	5979
399	5980	5981	5982	5984	5985	5986	5987	5988	5989
400	5990	5991	5992	5994	5995	5996	5997	5998	5999

(1) For axis 1

Data No.	Positioning identifier	M code	Dwell time	Command speed		Positioning address		Arc data	
				Low-order	High-order	Low-order	High-order	Low-order	High-order
401	6000	6001	6002	6004	6005	6006	6007	6008	6009
402	6010	6011	6012	6014	6015	6016	6017	6018	6019
403	6020	6021	6022	6024	6025	6026	6027	6028	6029
404	6030	6031	6032	6034	6035	6036	6037	6038	6039
405	6040	6041	6042	6044	6045	6046	6047	6048	6049
406	6050	6051	6052	6054	6055	6056	6057	6058	6059
407	6060	6061	6062	6064	6065	6066	6067	6068	6069
408	6070	6071	6072	6074	6075	6076	6077	6078	6079
409	6080	6081	6082	6084	6085	6086	6087	6088	6089
410	6090	6091	6092	6094	6095	6096	6097	6098	6099
411	6100	6101	6102	6104	6105	6106	6107	6108	6109
412	6110	6111	6112	6114	6115	6116	6117	6118	6119
413	6120	6121	6122	6124	6125	6126	6127	6128	6129
414	6130	6131	6132	6134	6135	6136	6137	6138	6139
415	6140	6141	6142	6144	6145	6146	6147	6148	6149
416	6150	6151	6152	6154	6155	6156	6157	6158	6159
417	6160	6161	6162	6164	6165	6166	6167	6168	6169
418	6170	6171	6172	6174	6175	6176	6177	6178	6179
419	6180	6181	6182	6184	6185	6186	6187	6188	6189
420	6190	6191	6192	6194	6195	6196	6197	6198	6199
421	6200	6201	6202	6204	6205	6206	6207	6208	6209
422	6210	6211	6212	6214	6215	6216	6217	6218	6219
423	6220	6221	6222	6224	6225	6226	6227	6228	6229
424	6230	6231	6232	6234	6235	6236	6237	6238	6239
425	6240	6241	6242	6244	6245	6246	6247	6248	6249
426	6250	6251	6252	6254	6255	6256	6257	6258	6259
427	6260	6261	6262	6264	6265	6266	6267	6268	6269
428	6270	6271	6272	6274	6275	6276	6277	6278	6279
429	6280	6281	6282	6284	6285	6286	6287	6288	6289
430	6290	6291	6292	6294	6295	6296	6297	6298	6299
431	6300	6301	6302	6304	6305	6306	6307	6308	6309
432	6310	6311	6312	6314	6315	6316	6317	6318	6319
433	6320	6321	6322	6324	6325	6326	6327	6328	6329
434	6330	6331	6332	6334	6335	6336	6337	6338	6339
435	6340	6341	6342	6344	6345	6346	6347	6348	6349
436	6350	6351	6352	6354	6355	6356	6357	6358	6359
437	6360	6361	6362	6364	6365	6366	6367	6368	6369
438	6370	6371	6372	6374	6375	6376	6377	6378	6379
439	6380	6381	6382	6384	6385	6386	6387	6388	6389
440	6390	6391	6392	6394	6395	6396	6397	6398	6399
441	6400	6401	6402	6404	6405	6406	6407	6408	6409
442	6410	6411	6412	6414	6415	6416	6417	6418	6419
443	6420	6421	6422	6424	6425	6426	6427	6428	6429
444	6430	6431	6432	6434	6435	6436	6437	6438	6439
445	6440	6441	6442	6444	6445	6446	6447	6448	6449
446	6450	6451	6452	6454	6455	6456	6457	6458	6459
447	6460	6461	6462	6464	6465	6466	6467	6468	6469
448	6470	6471	6472	6474	6475	6476	6477	6478	6479
449	6480	6481	6482	6484	6485	6486	6487	6488	6489
450	6490	6491	6492	6494	6495	6496	6497	6498	6499

Data No.	Positioning identifier	M code	Dwell time	Command speed		Positioning address		Arc data	
				Low-order	High-order	Low-order	High-order	Low-order	High-order
451	6500	6501	6502	6504	6505	6506	6507	6508	6509
452	6510	6511	6512	6514	6515	6516	6517	6518	6519
453	6520	6521	6522	6524	6525	6526	6527	6528	6529
454	6530	6531	6532	6534	6535	6536	6537	6538	6539
455	6540	6541	6542	6544	6545	6546	6547	6548	6549
456	6550	6551	6552	6554	6555	6556	6557	6558	6559
457	6560	6561	6562	6564	6565	6566	6567	6568	6569
458	6570	6571	6572	6574	6575	6576	6577	6578	6579
459	6580	6581	6582	6584	6585	6586	6587	6588	6589
460	6590	6591	6592	6594	6595	6596	6597	6598	6599
461	6600	6601	6602	6604	6605	6606	6607	6608	6609
462	6610	6611	6612	6614	6615	6616	6617	6618	6619
463	6620	6621	6622	6624	6625	6626	6627	6628	6629
464	6630	6631	6632	6634	6635	6636	6637	6638	6639
465	6640	6641	6642	6644	6645	6646	6647	6648	6649
466	6650	6651	6652	6654	6655	6656	6657	6658	6659
467	6660	6661	6662	6664	6665	6666	6667	6668	6669
468	6670	6671	6672	6674	6675	6676	6677	6678	6679
469	6680	6681	6682	6684	6685	6686	6687	6688	6689
470	6690	6691	6692	6694	6695	6696	6697	6698	6699
471	6700	6701	6702	6704	6705	6706	6707	6708	6709
472	6710	6711	6712	6714	6715	6716	6717	6718	6719
473	6720	6721	6722	6724	6725	6726	6727	6728	6729
474	6730	6731	6732	6734	6735	6736	6737	6738	6739
475	6740	6741	6742	6744	6745	6746	6747	6748	6749
476	6750	6751	6752	6754	6755	6756	6757	6758	6759
477	6760	6761	6762	6764	6765	6766	6767	6768	6769
478	6770	6771	6772	6774	6775	6776	6777	6778	6779
479	6780	6781	6782	6784	6785	6786	6787	6788	6789
480	6790	6791	6792	6794	6795	6796	6797	6798	6799
481	6800	6801	6802	6804	6805	6806	6807	6808	6809
482	6810	6811	6812	6814	6815	6816	6817	6818	6819
483	6820	6821	6822	6824	6825	6826	6827	6828	6829
484	6830	6831	6832	6834	6835	6836	6837	6838	6839
485	6840	6841	6842	6844	6845	6846	6847	6848	6849
486	6850	6851	6852	6854	6855	6856	6857	6858	6859
487	6860	6861	6862	6864	6865	6866	6867	6868	6869
488	6870	6871	6872	6874	6875	6876	6877	6878	6879
489	6880	6881	6882	6884	6885	6886	6887	6888	6889
490	6890	6891	6892	6894	6895	6896	6897	6898	6899
491	6900	6901	6902	6904	6905	6906	6907	6908	6909
492	6910	6911	6912	6914	6915	6916	6917	6918	6919
493	6920	6921	6922	6924	6925	6926	6927	6928	6929
494	6930	6931	6932	6934	6935	6936	6937	6938	6939
495	6940	6941	6942	6944	6945	6946	6947	6948	6949
496	6950	6951	6952	6954	6955	6956	6957	6958	6959
497	6960	6961	6962	6964	6965	6966	6967	6968	6969
498	6970	6971	6972	6974	6975	6976	6977	6978	6979
499	6980	6981	6982	6984	6985	6986	6987	6988	6989
500	6990	6991	6992	6994	6995	6996	6997	6998	6999

(1) For axis 1

Data No.	Positioning identifier	M code	Dwell time	Command speed		Positioning address		Arc data	
				Low-order	High-order	Low-order	High-order	Low-order	High-order
501	7000	7001	7002	7004	7005	7006	7007	7008	7009
502	7010	7011	7012	7014	7015	7016	7017	7018	7019
503	7020	7021	7022	7024	7025	7026	7027	7028	7029
504	7030	7031	7032	7034	7035	7036	7037	7038	7039
505	7040	7041	7042	7044	7045	7046	7047	7048	7049
506	7050	7051	7052	7054	7055	7056	7057	7058	7059
507	7060	7061	7062	7064	7065	7066	7067	7068	7069
508	7070	7071	7072	7074	7075	7076	7077	7078	7079
509	7080	7081	7082	7084	7085	7086	7087	7088	7089
510	7090	7091	7092	7094	7095	7096	7097	7098	7099
511	7100	7101	7102	7104	7105	7106	7107	7108	7109
512	7110	7111	7112	7114	7115	7116	7117	7118	7119
513	7120	7121	7122	7124	7125	7126	7127	7128	7129
514	7130	7131	7132	7134	7135	7136	7137	7138	7139
515	7140	7141	7142	7144	7145	7146	7147	7148	7149
516	7150	7151	7152	7154	7155	7156	7157	7158	7159
517	7160	7161	7162	7164	7165	7166	7167	7168	7169
518	7170	7171	7172	7174	7175	7176	7177	7178	7179
519	7180	7181	7182	7184	7185	7186	7187	7188	7189
520	7190	7191	7192	7194	7195	7196	7197	7198	7199
521	7200	7201	7202	7204	7205	7206	7207	7208	7209
522	7210	7211	7212	7214	7215	7216	7217	7218	7219
523	7220	7221	7222	7224	7225	7226	7227	7228	7229
524	7230	7231	7232	7234	7235	7236	7237	7238	7239
525	7240	7241	7242	7244	7245	7246	7247	7248	7249
526	7250	7251	7252	7254	7255	7256	7257	7258	7259
527	7260	7261	7262	7264	7265	7266	7267	7268	7269
528	7270	7271	7272	7274	7275	7276	7277	7278	7279
529	7280	7281	7282	7284	7285	7286	7287	7288	7289
530	7290	7291	7292	7294	7295	7296	7297	7298	7299
531	7300	7301	7302	7304	7305	7306	7307	7308	7309
532	7310	7311	7312	7314	7315	7316	7317	7318	7319
533	7320	7321	7322	7324	7325	7326	7327	7328	7329
534	7330	7331	7332	7334	7335	7336	7337	7338	7339
535	7340	7341	7342	7344	7345	7346	7347	7348	7349
536	7350	7351	7352	7354	7355	7356	7357	7358	7359
537	7360	7361	7362	7364	7365	7366	7367	7368	7369
538	7370	7371	7372	7374	7375	7376	7377	7378	7379
539	7380	7381	7382	7384	7385	7386	7387	7388	7389
540	7390	7391	7392	7394	7395	7396	7397	7398	7399
541	7400	7401	7402	7404	7405	7406	7407	7408	7409
542	7410	7411	7412	7414	7415	7416	7417	7418	7419
543	7420	7421	7422	7424	7425	7426	7427	7428	7429
544	7430	7431	7432	7434	7435	7436	7437	7438	7439
545	7440	7441	7442	7444	7445	7446	7447	7448	7449
546	7450	7451	7452	7454	7455	7456	7457	7458	7459
547	7460	7461	7462	7464	7465	7466	7467	7468	7469
548	7470	7471	7472	7474	7475	7476	7477	7478	7479
549	7480	7481	7482	7484	7485	7486	7487	7488	7489
550	7490	7491	7492	7494	7495	7496	7497	7498	7499

Data No.	Positioning identifier	M code	Dwell time	Command speed		Positioning address		Arc data	
				Low-order	High-order	Low-order	High-order	Low-order	High-order
551	7500	7501	7502	7504	7505	7506	7507	7508	7509
552	7510	7511	7512	7514	7515	7516	7517	7518	7519
553	7520	7521	7522	7524	7525	7526	7527	7528	7529
554	7530	7531	7532	7534	7535	7536	7537	7538	7539
555	7540	7541	7542	7544	7545	7546	7547	7548	7549
556	7550	7551	7552	7554	7555	7556	7557	7558	7559
557	7560	7561	7562	7564	7565	7566	7567	7568	7569
558	7570	7571	7572	7574	7575	7576	7577	7578	7579
559	7580	7581	7582	7584	7585	7586	7587	7588	7589
560	7590	7591	7592	7594	7595	7596	7597	7598	7599
561	7600	7601	7602	7604	7605	7606	7607	7608	7609
562	7610	7611	7612	7614	7615	7616	7617	7618	7619
563	7620	7621	7622	7624	7625	7626	7627	7628	7629
564	7630	7631	7632	7634	7635	7636	7637	7638	7639
565	7640	7641	7642	7644	7645	7646	7647	7648	7649
566	7650	7651	7652	7654	7655	7656	7657	7658	7659
567	7660	7661	7662	7664	7665	7666	7667	7668	7669
568	7670	7671	7672	7674	7675	7676	7677	7678	7679
569	7680	7681	7682	7684	7685	7686	7687	7688	7689
570	7690	7691	7692	7694	7695	7696	7697	7698	7699
571	7700	7701	7702	7704	7705	7706	7707	7708	7709
572	7710	7711	7712	7714	7715	7716	7717	7718	7719
573	7720	7721	7722	7724	7725	7726	7727	7728	7729
574	7730	7731	7732	7734	7735	7736	7737	7738	7739
575	7740	7741	7742	7744	7745	7746	7747	7748	7749
576	7750	7751	7752	7754	7755	7756	7757	7758	7759
577	7760	7761	7762	7764	7765	7766	7767	7768	7769
578	7770	7771	7772	7774	7775	7776	7777	7778	7779
579	7780	7781	7782	7784	7785	7786	7787	7788	7789
580	7790	7791	7792	7794	7795	7796	7797	7798	7799
581	7800	7801	7802	7804	7805	7806	7807	7808	7809
582	7810	7811	7812	7814	7815	7816	7817	7818	7819
583	7820	7821	7822	7824	7825	7826	7827	7828	7829
584	7830	7831	7832	7834	7835	7836	7837	7838	7839
585	7840	7841	7842	7844	7845	7846	7847	7848	7849
586	7850	7851	7852	7854	7855	7856	7857	7858	7859
587	7860	7861	7862	7864	7865	7866	7867	7868	7869
588	7870	7871	7872	7874	7875	7876	7877	7878	7879
589	7880	7881	7882	7884	7885	7886	7887	7888	7889
590	7890	7891	7892	7894	7895	7896	7897	7898	7899
591	7900	7901	7902	7904	7905	7906	7907	7908	7909
592	7910	7911	7912	7914	7915	7916	7917	7918	7919
593	7920	7921	7922	7924	7925	7926	7927	7928	7929
594	7930	7931	7932	7934	7935	7936	7937	7938	7939
595	7940	7941	7942	7944	7945	7946	7947	7948	7949
596	7950	7951	7952	7954	7955	7956	7957	7958	7959
597	7960	7961	7962	7964	7965	7966	7967	7968	7969
598	7970	7971	7972	7974	7975	7976	7977	7978	7979
599	7980	7981	7982	7984	7985	7986	7987	7988	7989
600	7990	7991	7992	7994	7995	7996	7997	7998	7999

## (1) For axis 1 (positioning option)

Data No.	Positioning option	Data No.	Positioning option	Data No.	Positioning option	Data No.	Positioning option	Data No.	Positioning option	Data No.	Positioning option
1	2003	51	2503	101	3003	151	3503	201	4003	251	4503
2	2013	52	2513	102	3013	152	3513	202	4013	252	4513
3	2023	53	2523	103	3023	153	3523	203	4023	253	4523
4	2033	54	2533	104	3033	154	3533	204	4033	254	4533
5	2043	55	2543	105	3043	155	3543	205	4043	255	4543
6	2053	56	2553	106	3053	156	3553	206	4053	256	4553
7	2063	57	2563	107	3063	157	3563	207	4063	257	4563
8	2073	58	2573	108	3073	158	3573	208	4073	258	4573
9	2083	59	2583	109	3083	159	3583	209	4083	259	4583
10	2093	60	2593	110	3093	160	3593	210	4093	260	4593
11	2103	61	2603	111	3103	161	3603	211	4103	261	4603
12	2113	62	2613	112	3113	162	3613	212	4113	262	4613
13	2123	63	2623	113	3123	163	3623	213	4123	263	4623
14	2133	64	2633	114	3133	164	3633	214	4133	264	4633
15	2143	65	2643	115	3143	165	3643	215	4143	265	4643
16	2153	66	2653	116	3153	166	3653	216	4153	266	4653
17	2163	67	2663	117	3163	167	3663	217	4163	267	4663
18	2173	68	2673	118	3173	168	3673	218	4173	268	4673
19	2183	69	2683	119	3183	169	3683	219	4183	269	4683
20	2193	70	2693	120	3193	170	3693	220	4193	270	4693
21	2203	71	2703	121	3203	171	3703	221	4203	271	4703
22	2213	72	2713	122	3213	172	3713	222	4213	272	4713
23	2223	73	2723	123	3223	173	3723	223	4223	273	4723
24	2233	74	2733	124	3233	174	3733	224	4233	274	4733
25	2243	75	2743	125	3243	175	3743	225	4243	275	4743
26	2253	76	2753	126	3253	176	3753	226	4253	276	4753
27	2263	77	2763	127	3263	177	3763	227	4263	277	4763
28	2273	78	2773	128	3273	178	3773	228	4273	278	4773
29	2283	79	2783	129	3283	179	3783	229	4283	279	4783
30	2293	80	2793	130	3293	180	3793	230	4293	280	4793
31	2303	81	2803	131	3303	181	3803	231	4303	281	4803
32	2313	82	2813	132	3313	182	3813	232	4313	282	4813
33	2323	83	2823	133	3323	183	3823	233	4323	283	4823
34	2333	84	2833	134	3333	184	3833	234	4333	284	4833
35	2343	85	2843	135	3343	185	3843	235	4343	285	4843
36	2353	86	2853	136	3353	186	3853	236	4353	286	4853
37	2363	87	2863	137	3363	187	3863	237	4363	287	4863
38	2373	88	2873	138	3373	188	3873	238	4373	288	4873
39	2383	89	2883	139	3383	189	3883	239	4383	289	4883
40	2393	90	2893	140	3393	190	3893	240	4393	290	4893
41	2403	91	2903	141	3403	191	3903	241	4403	291	4903
42	2413	92	2913	142	3413	192	3913	242	4413	292	4913
43	2423	93	2923	143	3423	193	3923	243	4423	293	4923
44	2433	94	2933	144	3433	194	3933	244	4433	294	4933
45	2443	95	2943	145	3443	195	3943	245	4443	295	4943
46	2453	96	2953	146	3453	196	3953	246	4453	296	4953
47	2463	97	2963	147	3463	197	3963	247	4463	297	4963
48	2473	98	2973	148	3473	198	3973	248	4473	298	4973
49	2483	99	2983	149	3483	199	3983	249	4483	299	4983
50	2493	100	2993	150	3493	200	3993	250	4493	300	4993

## (1) For axis 1 (positioning option)

Data No.	Positioning option	Data No.	Positioning option	Data No.	Positioning option	Data No.	Positioning option	Data No.	Positioning option	Data No.	Positioning option
301	5003	351	5503	401	6003	451	6503	501	7003	551	7503
302	5013	352	5513	402	6013	452	6513	502	7013	552	7513
303	5023	353	5523	403	6023	453	6523	503	7023	553	7523
304	5033	354	5533	404	6033	454	6533	504	7033	554	7533
305	5043	355	5543	405	6043	455	6543	505	7043	555	7543
306	5053	356	5553	406	6053	456	6553	506	7053	556	7553
307	5063	357	5563	407	6063	457	6563	507	7063	557	7563
308	5073	358	5573	408	6073	458	6573	508	7073	558	7573
309	5083	359	5583	409	6083	459	6583	509	7083	559	7583
310	5093	360	5593	410	6093	460	6593	510	7093	560	7593
311	5103	361	5603	411	6103	461	6603	511	7103	561	7603
312	5113	362	5613	412	6113	462	6613	512	7113	562	7613
313	5123	363	5623	413	6123	463	6623	513	7123	563	7623
314	5133	364	5633	414	6133	464	6633	514	7133	564	7633
315	5143	365	5643	415	6143	465	6643	515	7143	565	7643
316	5153	366	5653	416	6153	466	6653	516	7153	566	7653
317	5163	367	5663	417	6163	467	6663	517	7163	567	7663
318	5173	368	5673	418	6173	468	6673	518	7173	568	7673
319	5183	369	5683	419	6183	469	6683	519	7183	569	7683
320	5193	370	5693	420	6193	470	6693	520	7193	570	7693
321	5203	371	5703	421	6203	471	6703	521	7203	571	7703
322	5213	372	5713	422	6213	472	6713	522	7213	572	7713
323	5223	373	5723	423	6223	473	6723	523	7223	573	7723
324	5233	374	5733	424	6233	474	6733	524	7233	574	7733
325	5243	375	5743	425	6243	475	6743	525	7243	575	7743
326	5253	376	5753	426	6253	476	6753	526	7253	576	7753
327	5263	377	5763	427	6263	477	6763	527	7263	577	7763
328	5273	378	5773	428	6273	478	6773	528	7273	578	7773
329	5283	379	5783	429	6283	479	6783	529	7283	579	7783
330	5293	380	5793	430	6293	480	6793	530	7293	580	7793
331	5303	381	5803	431	6303	481	6803	531	7303	581	7803
332	5313	382	5813	432	6313	482	6813	532	7313	582	7813
333	5323	383	5823	433	6323	483	6823	533	7323	583	7823
334	5333	384	5833	434	6333	484	6833	534	7333	584	7833
335	5343	385	5843	435	6343	485	6843	535	7343	585	7843
336	5353	386	5853	436	6353	486	6853	536	7353	586	7853
337	5363	387	5863	437	6363	487	6863	537	7363	587	7863
338	5373	388	5873	438	6373	488	6873	538	7373	588	7873
339	5383	389	5883	439	6383	489	6883	539	7383	589	7883
340	5393	390	5893	440	6393	490	6893	540	7393	590	7893
341	5403	391	5903	441	6403	491	6903	541	7403	591	7903
342	5413	392	5913	442	6413	492	6913	542	7413	592	7913
343	5423	393	5923	443	6423	493	6923	543	7423	593	7923
344	5433	394	5933	444	6433	494	6933	544	7433	594	7933
345	5443	395	5943	445	6443	495	6943	545	7443	595	7943
346	5453	396	5953	446	6453	496	6953	546	7453	596	7953
347	5463	397	5963	447	6463	497	6963	547	7463	597	7963
348	5473	398	5973	448	6473	498	6973	548	7473	598	7973
349	5483	399	5983	449	6483	499	6983	549	7483	599	7983
350	5493	400	5993	450	6493	500	6993	550	7493	600	7993

(2) For axis 2

Data No.	Positioning identifier	M code	Dwell time	Command speed		Positioning address		Arc data	
				Low-order	High-order	Low-order	High-order	Low-order	High-order
1	8000	8001	8002	8004	8005	8006	8007	8008	8009
2	8010	8011	8012	8014	8015	8016	8017	8018	8019
3	8020	8021	8022	8024	8025	8026	8027	8028	8029
4	8030	8031	8032	8034	8035	8036	8037	8038	8039
5	8040	8041	8042	8044	8045	8046	8047	8048	8049
6	8050	8051	8052	8054	8055	8056	8057	8058	8059
7	8060	8061	8062	8064	8065	8066	8067	8068	8069
8	8070	8071	8072	8074	8075	8076	8077	8078	8079
9	8080	8081	8082	8084	8085	8086	8087	8088	8089
10	8090	8091	8092	8094	8095	8096	8097	8098	8099
11	8100	8101	8102	8104	8105	8106	8107	8108	8109
12	8110	8111	8112	8114	8115	8116	8117	8118	8119
13	8120	8121	8122	8124	8125	8126	8127	8128	8129
14	8130	8131	8132	8134	8135	8136	8137	8138	8139
15	8140	8141	8142	8144	8145	8146	8147	8148	8149
16	8150	8151	8152	8154	8155	8156	8157	8158	8159
17	8160	8161	8162	8164	8165	8166	8167	8168	8169
18	8170	8171	8172	8174	8175	8176	8177	8178	8179
19	8180	8181	8182	8184	8185	8186	8187	8188	8189
20	8190	8191	8192	8194	8195	8196	8197	8198	8199
21	8200	8201	8202	8204	8205	8206	8207	8208	8209
22	8210	8211	8212	8214	8215	8216	8217	8218	8219
23	8220	8221	8222	8224	8225	8226	8227	8228	8229
24	8230	8231	8232	8234	8235	8236	8237	8238	8239
25	8240	8241	8242	8244	8245	8246	8247	8248	8249
26	8250	8251	8252	8254	8255	8256	8257	8258	8259
27	8260	8261	8262	8264	8265	8266	8267	8268	8269
28	8270	8271	8272	8274	8275	8276	8277	8278	8279
29	8280	8281	8282	8284	8285	8286	8287	8288	8289
30	8290	8291	8292	8294	8295	8296	8297	8298	8299
31	8300	8301	8302	8304	8305	8306	8307	8308	8309
32	8310	8311	8312	8314	8315	8316	8317	8318	8319
33	8320	8321	8322	8324	8325	8326	8327	8328	8329
34	8330	8331	8332	8334	8335	8336	8337	8338	8339
35	8340	8341	8342	8344	8345	8346	8347	8348	8349
36	8350	8351	8352	8354	8355	8356	8357	8358	8359
37	8360	8361	8362	8364	8365	8366	8367	8368	8369
38	8370	8371	8372	8374	8375	8376	8377	8378	8379
39	8380	8381	8382	8384	8385	8386	8387	8388	8389
40	8390	8391	8392	8394	8395	8396	8397	8398	8399
41	8400	8401	8402	8404	8405	8406	8407	8408	8409
42	8410	8411	8412	8414	8415	8416	8417	8418	8419
43	8420	8421	8422	8424	8425	8426	8427	8428	8429
44	8430	8431	8432	8434	8435	8436	8437	8438	8439
45	8440	8441	8442	8444	8445	8446	8447	8448	8449
46	8450	8451	8452	8454	8455	8456	8457	8458	8459
47	8460	8461	8462	8464	8465	8466	8467	8468	8469
48	8470	8471	8472	8474	8475	8476	8477	8478	8479
49	8480	8481	8482	8484	8485	8486	8487	8488	8489
50	8490	8491	8492	8494	8495	8496	8497	8498	8499

Data No.	Positioning identifier	M code	Dwell time	Command speed		Positioning address		Arc data	
				Low-order	High-order	Low-order	High-order	Low-order	High-order
51	8500	8501	8502	8504	8505	8506	8507	8508	8509
52	8510	8511	8512	8514	8515	8516	8517	8518	8519
53	8520	8521	8522	8524	8525	8526	8527	8528	8529
54	8530	8531	8532	8534	8535	8536	8537	8538	8539
55	8540	8541	8542	8544	8545	8546	8547	8548	8549
56	8550	8551	8552	8554	8555	8556	8557	8558	8559
57	8560	8561	8562	8564	8565	8566	8567	8568	8569
58	8570	8571	8572	8574	8575	8576	8577	8578	8579
59	8580	8581	8582	8584	8585	8586	8587	8588	8589
60	8590	8591	8592	8594	8595	8596	8597	8598	8599
61	8600	8601	8602	8604	8605	8606	8607	8608	8609
62	8610	8611	8612	8614	8615	8616	8617	8618	8619
63	8620	8621	8622	8624	8625	8626	8627	8628	8629
64	8630	8631	8632	8634	8635	8636	8637	8638	8639
65	8640	8641	8642	8644	8645	8646	8647	8648	8649
66	8650	8651	8652	8654	8655	8656	8657	8658	8659
67	8660	8661	8662	8664	8665	8666	8667	8668	8669
68	8670	8671	8672	8674	8675	8676	8677	8678	8679
69	8680	8681	8682	8684	8685	8686	8687	8688	8689
70	8690	8691	8692	8694	8695	8696	8697	8698	8699
71	8700	8701	8702	8704	8705	8706	8707	8708	8709
72	8710	8711	8712	8714	8715	8716	8717	8718	8719
73	8720	8721	8722	8724	8725	8726	8727	8728	8729
74	8730	8731	8732	8734	8735	8736	8737	8738	8739
75	8740	8741	8742	8744	8745	8746	8747	8748	8749
76	8750	8751	8752	8754	8755	8756	8757	8758	8759
77	8760	8761	8762	8764	8765	8766	8767	8768	8769
78	8770	8771	8772	8774	8775	8776	8777	8778	8779
79	8780	8781	8782	8784	8785	8786	8787	8788	8789
80	8790	8791	8792	8794	8795	8796	8797	8798	8799
81	8800	8801	8802	8804	8805	8806	8807	8808	8809
82	8810	8811	8812	8814	8815	8816	8817	8818	8819
83	8820	8821	8822	8824	8825	8826	8827	8828	8829
84	8830	8831	8832	8834	8835	8836	8837	8838	8839
85	8840	8841	8842	8844	8845	8846	8847	8848	8849
86	8850	8851	8852	8854	8855	8856	8857	8858	8859
87	8860	8861	8862	8864	8865	8866	8867	8868	8869
88	8870	8871	8872	8874	8875	8876	8877	8878	8879
89	8880	8881	8882	8884	8885	8886	8887	8888	8889
90	8890	8891	8892	8894	8895	8896	8897	8898	8899
91	8900	8901	8902	8904	8905	8906	8907	8908	8909
92	8910	8911	8912	8914	8915	8916	8917	8918	8919
93	8920	8921	8922	8924	8925	8926	8927	8928	8929
94	8930	8931	8932	8934	8935	8936	8937	8938	8939
95	8940	8941	8942	8944	8945	8946	8947	8948	8949
96	8950	8951	8952	8954	8955	8956	8957	8958	8959
97	8960	8961	8962	8964	8965	8966	8967	8968	8969
98	8970	8971	8972	8974	8975	8976	8977	8978	8979
99	8980	8981	8982	8984	8985	8986	8987	8988	8989
100	8990	8991	8992	8994	8995	8996	8997	8998	8999



(2) For axis 2

Data No.	Positioning identifier	M code	Dwell time	Command speed		Positioning address		Arc data	
				Low-order	High-order	Low-order	High-order	Low-order	High-order
101	9000	9001	9002	9004	9005	9006	9007	9008	9009
102	9010	9011	9012	9014	9015	9016	9017	9018	9019
103	9020	9021	9022	9024	9025	9026	9027	9028	9029
104	9030	9031	9032	9034	9035	9036	9037	9038	9039
105	9040	9041	9042	9044	9045	9046	9047	9048	9049
106	9050	9051	9052	9054	9055	9056	9057	9058	9059
107	9060	9061	9062	9064	9065	9066	9067	9068	9069
108	9070	9071	9072	9074	9075	9076	9077	9078	9079
109	9080	9081	9082	9084	9085	9086	9087	9088	9089
110	9090	9091	9092	9094	9095	9096	9097	9098	9099
111	9100	9101	9102	9104	9105	9106	9107	9108	9109
112	9110	9111	9112	9114	9115	9116	9117	9118	9119
113	9120	9121	9122	9124	9125	9126	9127	9128	9129
114	9130	9131	9132	9134	9135	9136	9137	9138	9139
115	9140	9141	9142	9144	9145	9146	9147	9148	9149
116	9150	9151	9152	9154	9155	9156	9157	9158	9159
117	9160	9161	9162	9164	9165	9166	9167	9168	9169
118	9170	9171	9172	9174	9175	9176	9177	9178	9179
119	9180	9181	9182	9184	9185	9186	9187	9188	9189
120	9190	9191	9192	9194	9195	9196	9197	9198	9199
121	9200	9201	9202	9204	9205	9206	9207	9208	9209
122	9210	9211	9212	9214	9215	9216	9217	9218	9219
123	9220	9221	9222	9224	9225	9226	9227	9228	9229
124	9230	9231	9232	9234	9235	9236	9237	9238	9239
125	9240	9241	9242	9244	9245	9246	9247	9248	9249
126	9250	9251	9252	9254	9255	9256	9257	9258	9259
127	9260	9261	9262	9264	9265	9266	9267	9268	9269
128	9270	9271	9272	9274	9275	9276	9277	9278	9279
129	9280	9281	9282	9284	9285	9286	9287	9288	9289
130	9290	9291	9292	9294	9295	9296	9297	9298	9299
131	9300	9301	9302	9304	9305	9306	9307	9308	9309
132	9310	9311	9312	9314	9315	9316	9317	9318	9319
133	9320	9321	9322	9324	9325	9326	9327	9328	9329
134	9330	9331	9332	9334	9335	9336	9337	9338	9339
135	9340	9341	9342	9344	9345	9346	9347	9348	9349
136	9350	9351	9352	9354	9355	9356	9357	9358	9359
137	9360	9361	9362	9364	9365	9366	9367	9368	9369
138	9370	9371	9372	9374	9375	9376	9377	9378	9379
139	9380	9381	9382	9384	9385	9386	9387	9388	9389
140	9390	9391	9392	9394	9395	9396	9397	9398	9399
141	9400	9401	9402	9404	9405	9406	9407	9408	9409
142	9410	9411	9412	9414	9415	9416	9417	9418	9419
143	9420	9421	9422	9424	9425	9426	9427	9428	9429
144	9430	9431	9432	9434	9435	9436	9437	9438	9439
145	9440	9441	9442	9444	9445	9446	9447	9448	9449
146	9450	9451	9452	9454	9455	9456	9457	9458	9459
147	9460	9461	9462	9464	9465	9466	9467	9468	9469
148	9470	9471	9472	9474	9475	9476	9477	9478	9479
149	9480	9481	9482	9484	9485	9486	9487	9488	9489
150	9490	9491	9492	9494	9495	9496	9497	9498	9499

Data No.	Positioning identifier	M code	Dwell time	Command speed		Positioning address		Arc data	
				Low-order	High-order	Low-order	High-order	Low-order	High-order
151	9500	9501	9502	9504	9505	9506	9507	9508	9509
152	9510	9511	9512	9514	9515	9516	9517	9518	9519
153	9520	9521	9522	9524	9525	9526	9527	9528	9529
154	9530	9531	9532	9534	9535	9536	9537	9538	9539
155	9540	9541	9542	9544	9545	9546	9547	9548	9549
156	9550	9551	9552	9554	9555	9556	9557	9558	9559
157	9560	9561	9562	9564	9565	9566	9567	9568	9569
158	9570	9571	9572	9574	9575	9576	9577	9578	9579
159	9580	9581	9582	9584	9585	9586	9587	9588	9589
160	9590	9591	9592	9594	9595	9596	9597	9598	9599
161	9600	9601	9602	9604	9605	9606	9607	9608	9609
162	9610	9611	9612	9614	9615	9616	9617	9618	9619
163	9620	9621	9622	9624	9625	9626	9627	9628	9629
164	9630	9631	9632	9634	9635	9636	9637	9638	9639
165	9640	9641	9642	9644	9645	9646	9647	9648	9649
166	9650	9651	9652	9654	9655	9656	9657	9658	9659
167	9660	9661	9662	9664	9665	9666	9667	9668	9669
168	9670	9671	9672	9674	9675	9676	9677	9678	9679
169	9680	9681	9682	9684	9685	9686	9687	9688	9689
170	9690	9691	9692	9694	9695	9696	9697	9698	9699
171	9700	9701	9702	9704	9705	9706	9707	9708	9709
172	9710	9711	9712	9714	9715	9716	9717	9718	9719
173	9720	9721	9722	9724	9725	9726	9727	9728	9729
174	9730	9731	9732	9734	9735	9736	9737	9738	9739
175	9740	9741	9742	9744	9745	9746	9747	9748	9749
176	9750	9751	9752	9754	9755	9756	9757	9758	9759
177	9760	9761	9762	9764	9765	9766	9767	9768	9769
178	9770	9771	9772	9774	9775	9776	9777	9778	9779
179	9780	9781	9782	9784	9785	9786	9787	9788	9789
180	9790	9791	9792	9794	9795	9796	9797	9798	9799
181	9800	9801	9802	9804	9805	9806	9807	9808	9809
182	9810	9811	9812	9814	9815	9816	9817	9818	9819
183	9820	9821	9822	9824	9825	9826	9827	9828	9829
184	9830	9831	9832	9834	9835	9836	9837	9838	9839
185	9840	9841	9842	9844	9845	9846	9847	9848	9849
186	9850	9851	9852	9854	9855	9856	9857	9858	9859
187	9860	9861	9862	9864	9865	9866	9867	9868	9869
188	9870	9871	9872	9874	9875	9876	9877	9878	9879
189	9880	9881	9882	9884	9885	9886	9887	9888	9889
190	9890	9891	9892	9894	9895	9896	9897	9898	9899
191	9900	9901	9902	9904	9905	9906	9907	9908	9909
192	9910	9911	9912	9914	9915	9916	9917	9918	9919
193	9920	9921	9922	9924	9925	9926	9927	9928	9929
194	9930	9931	9932	9934	9935	9936	9937	9938	9939
195	9940	9941	9942	9944	9945	9946	9947	9948	9949
196	9950	9951	9952	9954	9955	9956	9957	9958	9959
197	9960	9961	9962	9964	9965	9966	9967	9968	9969
198	9970	9971	9972	9974	9975	9976	9977	9978	9979
199	9980	9981	9982	9984	9985	9986	9987	9988	9989
200	9990	9991	9992	9994	9995	9996	9997	9998	9999

(2) For axis 2

Data No.	Positioning identifier	M code	Dwell time	Command speed		Positioning address		Arc data	
				Low-order	High-order	Low-order	High-order	Low-order	High-order
201	10000	10001	10002	10004	10005	10006	10007	10008	10009
202	10010	10011	10012	10014	10015	10016	10017	10018	10019
203	10020	10021	10022	10024	10025	10026	10027	10028	10029
204	10030	10031	10032	10034	10035	10036	10037	10038	10039
205	10040	10041	10042	10044	10045	10046	10047	10048	10049
206	10050	10051	10052	10054	10055	10056	10057	10058	10059
207	10060	10061	10062	10064	10065	10066	10067	10068	10069
208	10070	10071	10072	10074	10075	10076	10077	10078	10079
209	10080	10081	10082	10084	10085	10086	10087	10088	10089
210	10090	10091	10092	10094	10095	10096	10097	10098	10099
211	10100	10101	10102	10104	10105	10106	10107	10108	10109
212	10110	10111	10112	10114	10115	10116	10117	10118	10119
213	10120	10121	10122	10124	10125	10126	10127	10128	10129
214	10130	10131	10132	10134	10135	10136	10137	10138	10139
215	10140	10141	10142	10144	10145	10146	10147	10148	10149
216	10150	10151	10152	10154	10155	10156	10157	10158	10159
217	10160	10161	10162	10164	10165	10166	10167	10168	10169
218	10170	10171	10172	10174	10175	10176	10177	10178	10179
219	10180	10181	10182	10184	10185	10186	10187	10188	10189
220	10190	10191	10192	10194	10195	10196	10197	10198	10199
221	10200	10201	10202	10204	10205	10206	10207	10208	10209
222	10210	10211	10212	10214	10215	10216	10217	10218	10219
223	10220	10221	10222	10224	10225	10226	10227	10228	10229
224	10230	10231	10232	10234	10235	10236	10237	10238	10239
225	10240	10241	10242	10244	10245	10246	10247	10248	10249
226	10250	10251	10252	10254	10255	10256	10257	10258	10259
227	10260	10261	10262	10264	10265	10266	10267	10268	10269
228	10270	10271	10272	10274	10275	10276	10277	10278	10279
229	10280	10281	10282	10284	10285	10286	10287	10288	10289
230	10290	10291	10292	10294	10295	10296	10297	10298	10299
231	10300	10301	10302	10304	10305	10306	10307	10308	10309
232	10310	10311	10312	10314	10315	10316	10317	10318	10319
233	10320	10321	10322	10324	10325	10326	10327	10328	10329
234	10330	10331	10332	10334	10335	10336	10337	10338	10339
235	10340	10341	10342	10344	10345	10346	10347	10348	10349
236	10350	10351	10352	10354	10355	10356	10357	10358	10359
237	10360	10361	10362	10364	10365	10366	10367	10368	10369
238	10370	10371	10372	10374	10375	10376	10377	10378	10379
239	10380	10381	10382	10384	10385	10386	10387	10388	10389
240	10390	10391	10392	10394	10395	10396	10397	10398	10399
241	10400	10401	10402	10404	10405	10406	10407	10408	10409
242	10410	10411	10412	10414	10415	10416	10417	10418	10419
243	10420	10421	10422	10424	10425	10426	10427	10428	10429
244	10430	10431	10432	10434	10435	10436	10437	10438	10439
245	10440	10441	10442	10444	10445	10446	10447	10448	10449
246	10450	10451	10452	10454	10455	10456	10457	10458	10459
247	10460	10461	10462	10464	10465	10466	10467	10468	10469
248	10470	10471	10472	10474	10475	10476	10477	10478	10479
249	10480	10481	10482	10484	10485	10486	10487	10488	10489
250	10490	10491	10492	10494	10495	10496	10497	10498	10499

Data No.	Positioning identifier	M code	Dwell time	Command speed		Positioning address		Arc data	
				Low-order	High-order	Low-order	High-order	Low-order	High-order
251	10500	10501	10502	10504	10505	10506	10507	10508	10509
252	10510	10511	10512	10514	10515	10516	10517	10518	10519
253	10520	10521	10522	10524	10525	10526	10527	10528	10529
254	10530	10531	10532	10534	10535	10536	10537	10538	10539
255	10540	10541	10542	10544	10545	10546	10547	10548	10549
256	10550	10551	10552	10554	10555	10556	10557	10558	10559
257	10560	10561	10562	10564	10565	10566	10567	10568	10569
258	10570	10571	10572	10574	10575	10576	10577	10578	10579
259	10580	10581	10582	10584	10585	10586	10587	10588	10589
260	10590	10591	10592	10594	10595	10596	10597	10598	10599
261	10600	10601	10602	10604	10605	10606	10607	10608	10609
262	10610	10611	10612	10614	10615	10616	10617	10618	10619
263	10620	10621	10622	10624	10625	10626	10627	10628	10629
264	10630	10631	10632	10634	10635	10636	10637	10638	10639
265	10640	10641	10642	10644	10645	10646	10647	10648	10649
266	10650	10651	10652	10654	10655	10656	10657	10658	10659
267	10660	10661	10662	10664	10665	10666	10667	10668	10669
268	10670	10671	10672	10674	10675	10676	10677	10678	10679
269	10680	10681	10682	10684	10685	10686	10687	10688	10689
270	10690	10691	10692	10694	10695	10696	10697	10698	10699
271	10700	10701	10702	10704	10705	10706	10707	10708	10709
272	10710	10711	10712	10714	10715	10716	10717	10718	10719
273	10720	10721	10722	10724	10725	10726	10727	10728	10729
274	10730	10731	10732	10734	10735	10736	10737	10738	10739
275	10740	10741	10742	10744	10745	10746	10747	10748	10749
276	10750	10751	10752	10754	10755	10756	10757	10758	10759
277	10760	10761	10762	10764	10765	10766	10767	10768	10769
278	10770	10771	10772	10774	10775	10776	10777	10778	10779
279	10780	10781	10782	10784	10785	10786	10787	10788	10789
280	10790	10791	10792	10794	10795	10796	10797	10798	10799
281	10800	10801	10802	10804	10805	10806	10807	10808	10809
282	10810	10811	10812	10814	10815	10816	10817	10818	10819
283	10820	10821	10822	10824	10825	10826	10827	10828	10829
284	10830	10831	10832	10834	10835	10836	10837	10838	10839
285	10840	10841	10842	10844	10845	10846	10847	10848	10849
286	10850	10851	10852	10854	10855	10856	10857	10858	10859
287	10860	10861	10862	10864	10865	10866	10867	10868	10869
288	10870	10871	10872	10874	10875	10876	10877	10878	10879
289	10880	10881	10882	10884	10885	10886	10887	10888	10889
290	10890	10891	10892	10894	10895	10896	10897	10898	10899
291	10900	10901	10902	10904	10905	10906	10907	10908	10909
292	10910	10911	10912	10914	10915	10916	10917	10918	10919
293	10920	10921	10922	10924	10925	10926	10927	10928	10929
294	10930	10931	10932	10934	10935	10936	10937	10938	10939
295	10940	10941	10942	10944	10945	10946	10947	10948	10949
296	10950	10951	10952	10954	10955	10956	10957	10958	10959
297	10960	10961	10962	10964	10965	10966	10967	10968	10969
298	10970	10971	10972	10974	10975	10976	10977	10978	10979
299	10980	10981	10982	10984	10985	10986	10987	10988	10989
300	10990	10991	10992	10994	10995	10996	10997	10998	10999

(2) For axis 2

Data No.	Positioning identifier	M code	Dwell time	Command speed		Positioning address		Arc data	
				Low-order	High-order	Low-order	High-order	Low-order	High-order
301	11000	11001	11002	11004	11005	11006	11007	11008	11009
302	11010	11011	11012	11014	11015	11016	11017	11018	11019
303	11020	11021	11022	11024	11025	11026	11027	11028	11029
304	11030	11031	11032	11034	11035	11036	11037	11038	11039
305	11040	11041	11042	11044	11045	11046	11047	11048	11049
306	11050	11051	11052	11054	11055	11056	11057	11058	11059
307	11060	11061	11062	11064	11065	11066	11067	11068	11069
308	11070	11071	11072	11074	11075	11076	11077	11078	11079
309	11080	11081	11082	11084	11085	11086	11087	11088	11089
310	11090	11091	11092	11094	11095	11096	11097	11098	11099
311	11100	11101	11102	11104	11105	11106	11107	11108	11109
312	11110	11111	11112	11114	11115	11116	11117	11118	11119
313	11120	11121	11122	11124	11125	11126	11127	11128	11129
314	11130	11131	11132	11134	11135	11136	11137	11138	11139
315	11140	11141	11142	11144	11145	11146	11147	11148	11149
316	11150	11151	11152	11154	11155	11156	11157	11158	11159
317	11160	11161	11162	11164	11165	11166	11167	11168	11169
318	11170	11171	11172	11174	11175	11176	11177	11178	11179
319	11180	11181	11182	11184	11185	11186	11187	11188	11189
320	11190	11191	11192	11194	11195	11196	11197	11198	11199
321	11200	11201	11202	11204	11205	11206	11207	11208	11209
322	11210	11211	11212	11214	11215	11216	11217	11218	11219
323	11220	11221	11222	11224	11225	11226	11227	11228	11229
324	11230	11231	11232	11234	11235	11236	11237	11238	11239
325	11240	11241	11242	11244	11245	11246	11247	11248	11249
326	11250	11251	11252	11254	11255	11256	11257	11258	11259
327	11260	11261	11262	11264	11265	11266	11267	11268	11269
328	11270	11271	11272	11274	11275	11276	11277	11278	11279
329	11280	11281	11282	11284	11285	11286	11287	11288	11289
330	11290	11291	11292	11294	11295	11296	11297	11298	11299
331	11300	11301	11302	11304	11305	11306	11307	11308	11309
332	11310	11311	11312	11314	11315	11316	11317	11318	11319
333	11320	11321	11322	11324	11325	11326	11327	11328	11329
334	11330	11331	11332	11334	11335	11336	11337	11338	11339
335	11340	11341	11342	11344	11345	11346	11347	11348	11349
336	11350	11351	11352	11354	11355	11356	11357	11358	11359
337	11360	11361	11362	11364	11365	11366	11367	11368	11369
338	11370	11371	11372	11374	11375	11376	11377	11378	11379
339	11380	11381	11382	11384	11385	11386	11387	11388	11389
340	11390	11391	11392	11394	11395	11396	11397	11398	11399
341	11400	11401	11402	11404	11405	11406	11407	11408	11409
342	11410	11411	11412	11414	11415	11416	11417	11418	11419
343	11420	11421	11422	11424	11425	11426	11427	11428	11429
344	11430	11431	11432	11434	11435	11436	11437	11438	11439
345	11440	11441	11442	11444	11445	11446	11447	11448	11449
346	11450	11451	11452	11454	11455	11456	11457	11458	11459
347	11460	11461	11462	11464	11465	11466	11467	11468	11469
348	11470	11471	11472	11474	11475	11476	11477	11478	11479
349	11480	11481	11482	11484	11485	11486	11487	11488	11489
350	11490	11491	11492	11494	11495	11496	11497	11498	11499

Data No.	Positioning identifier	M code	Dwell time	Command speed		Positioning address		Arc data	
				Low-order	High-order	Low-order	High-order	Low-order	High-order
351	11500	11501	11502	11504	11505	11506	11507	11508	11509
352	11510	11511	11512	11514	11515	11516	11517	11518	11519
353	11520	11521	11522	11524	11525	11526	11527	11528	11529
354	11530	11531	11532	11534	11535	11536	11537	11538	11539
355	11540	11541	11542	11544	11545	11546	11547	11548	11549
356	11550	11551	11552	11554	11555	11556	11557	11558	11559
357	11560	11561	11562	11564	11565	11566	11567	11568	11569
358	11570	11571	11572	11574	11575	11576	11577	11578	11579
359	11580	11581	11582	11584	11585	11586	11587	11588	11589
360	11590	11591	11592	11594	11595	11596	11597	11598	11599
361	11600	11601	11602	11604	11605	11606	11607	11608	11609
362	11610	11611	11612	11614	11615	11616	11617	11618	11619
363	11620	11621	11622	11624	11625	11626	11627	11628	11629
364	11630	11631	11632	11634	11635	11636	11637	11638	11639
365	11640	11641	11642	11644	11645	11646	11647	11648	11649
366	11650	11651	11652	11654	11655	11656	11657	11658	11659
367	11660	11661	11662	11664	11665	11666	11667	11668	11669
368	11670	11671	11672	11674	11675	11676	11677	11678	11679
369	11680	11681	11682	11684	11685	11686	11687	11688	11689
370	11690	11691	11692	11694	11695	11696	11697	11698	11699
371	11700	11701	11702	11704	11705	11706	11707	11708	11709
372	11710	11711	11712	11714	11715	11716	11717	11718	11719
373	11720	11721	11722	11724	11725	11726	11727	11728	11729
374	11730	11731	11732	11734	11735	11736	11737	11738	11739
375	11740	11741	11742	11744	11745	11746	11747	11748	11749
376	11750	11751	11752	11754	11755	11756	11757	11758	11759
377	11760	11761	11762	11764	11765	11766	11767	11768	11769
378	11770	11771	11772	11774	11775	11776	11777	11778	11779
379	11780	11781	11782	11784	11785	11786	11787	11788	11789
380	11790	11791	11792	11794	11795	11796	11797	11798	11799
381	11800	11801	11802	11804	11805	11806	11807	11808	11809
382	11810	11811	11812	11814	11815	11816	11817	11818	11819
383	11820	11821	11822	11824	11825	11826	11827	11828	11829
384	11830	11831	11832	11834	11835	11836	11837	11838	11839
385	11840	11841	11842	11844	11845	11846	11847	11848	11849
386	11850	11851	11852	11854	11855	11856	11857	11858	11859
387	11860	11861	11862	11864	11865	11866	11867	11868	11869
388	11870	11871	11872	11874	11875	11876	11877	11878	11879
389	11880	11881	11882	11884	11885	11886	11887	11888	11889
390	11890	11891	11892	11894	11895	11896	11897	11898	11899
391	11900	11901	11902	11904	11905	11906	11907	11908	11909
392	11910	11911	11912	11914	11915	11916	11917	11918	11919
393	11920	11921	11922	11924	11925	11926	11927	11928	11929
394	11930	11931	11932	11934	11935	11936	11937	11938	11939
395	11940	11941	11942	11944	11945	11946	11947	11948	11949
396	11950	11951	11952	11954	11955	11956	11957	11958	11959
397	11960	11961	11962	11964	11965	11966	11967	11968	11969
398	11970	11971	11972	11974	11975	11976	11977	11978	11979
399	11980	11981	11982	11984	11985	11986	11987	11988	11989
400	11990	11991	11992	11994	11995	11996	11997	11998	11999

(2) For axis 2

Data No.	Positioning identifier	M code	Dwell time	Command speed		Positioning address		Arc data	
				Low-order	High-order	Low-order	High-order	Low-order	High-order
401	12000	12001	12002	12004	12005	12006	12007	12008	12009
402	12010	12011	12012	12014	12015	12016	12017	12018	12019
403	12020	12021	12022	12024	12025	12026	12027	12028	12029
404	12030	12031	12032	12034	12035	12036	12037	12038	12039
405	12040	12041	12042	12044	12045	12046	12047	12048	12049
406	12050	12051	12052	12054	12055	12056	12057	12058	12059
407	12060	12061	12062	12064	12065	12066	12067	12068	12069
408	12070	12071	12072	12074	12075	12076	12077	12078	12079
409	12080	12081	12082	12084	12085	12086	12087	12088	12089
410	12090	12091	12092	12094	12095	12096	12097	12098	12099
411	12100	12101	12102	12104	12105	12106	12107	12108	12109
412	12110	12111	12112	12114	12115	12116	12117	12118	12119
413	12120	12121	12122	12124	12125	12126	12127	12128	12129
414	12130	12131	12132	12134	12135	12136	12137	12138	12139
415	12140	12141	12142	12144	12145	12146	12147	12148	12149
416	12150	12151	12152	12154	12155	12156	12157	12158	12159
417	12160	12161	12162	12164	12165	12166	12167	12168	12169
418	12170	12171	12172	12174	12175	12176	12177	12178	12179
419	12180	12181	12182	12184	12185	12186	12187	12188	12189
420	12190	12191	12192	12194	12195	12196	12197	12198	12199
421	12200	12201	12202	12204	12205	12206	12207	12208	12209
422	12210	12211	12212	12214	12215	12216	12217	12218	12219
423	12220	12221	12222	12224	12225	12226	12227	12228	12229
424	12230	12231	12232	12234	12235	12236	12237	12238	12239
425	12240	12241	12242	12244	12245	12246	12247	12248	12249
426	12250	12251	12252	12254	12255	12256	12257	12258	12259
427	12260	12261	12262	12264	12265	12266	12267	12268	12269
428	12270	12271	12272	12274	12275	12276	12277	12278	12279
429	12280	12281	12282	12284	12285	12286	12287	12288	12289
430	12290	12291	12292	12294	12295	12296	12297	12298	12299
431	12300	12301	12302	12304	12305	12306	12307	12308	12309
432	12310	12311	12312	12314	12315	12316	12317	12318	12319
433	12320	12321	12322	12324	12325	12326	12327	12328	12329
434	12330	12331	12332	12334	12335	12336	12337	12338	12339
435	12340	12341	12342	12344	12345	12346	12347	12348	12349
436	12350	12351	12352	12354	12355	12356	12357	12358	12359
437	12360	12361	12362	12364	12365	12366	12367	12368	12369
438	12370	12371	12372	12374	12375	12376	12377	12378	12379
439	12380	12381	12382	12384	12385	12386	12387	12388	12389
440	12390	12391	12392	12394	12395	12396	12397	12398	12399
441	12400	12401	12402	12404	12405	12406	12407	12408	12409
442	12410	12411	12412	12414	12415	12416	12417	12418	12419
443	12420	12421	12422	12424	12425	12426	12427	12428	12429
444	12430	12431	12432	12434	12435	12436	12437	12438	12439
445	12440	12441	12442	12444	12445	12446	12447	12448	12449
446	12450	12451	12452	12454	12455	12456	12457	12458	12459
447	12460	12461	12462	12464	12465	12466	12467	12468	12469
448	12470	12471	12472	12474	12475	12476	12477	12478	12479
449	12480	12481	12482	12484	12485	12486	12487	12488	12489
450	12490	12491	12492	12494	12495	12496	12497	12498	12499

Data No.	Positioning identifier	M code	Dwell time	Command speed		Positioning address		Arc data	
				Low-order	High-order	Low-order	High-order	Low-order	High-order
451	12500	12501	12502	12504	12505	12506	12507	12508	12509
452	12510	12511	12512	12514	12515	12516	12517	12518	12519
453	12520	12521	12522	12524	12525	12526	12527	12528	12529
454	12530	12531	12532	12534	12535	12536	12537	12538	12539
455	12540	12541	12542	12544	12545	12546	12547	12548	12549
456	12550	12551	12552	12554	12555	12556	12557	12558	12559
457	12560	12561	12562	12564	12565	12566	12567	12568	12569
458	12570	12571	12572	12574	12575	12576	12577	12578	12579
459	12580	12581	12582	12584	12585	12586	12587	12588	12589
460	12590	12591	12592	12594	12595	12596	12597	12598	12599
461	12600	12601	12602	12604	12605	12606	12607	12608	12609
462	12610	12611	12612	12614	12615	12616	12617	12618	12619
463	12620	12621	12622	12624	12625	12626	12627	12628	12629
464	12630	12631	12632	12634	12635	12636	12637	12638	12639
465	12640	12641	12642	12644	12645	12646	12647	12648	12649
466	12650	12651	12652	12654	12655	12656	12657	12658	12659
467	12660	12661	12662	12664	12665	12666	12667	12668	12669
468	12670	12671	12672	12674	12675	12676	12677	12678	12679
469	12680	12681	12682	12684	12685	12686	12687	12688	12689
470	12690	12691	12692	12694	12695	12696	12697	12698	12699
471	12700	12701	12702	12704	12705	12706	12707	12708	12709
472	12710	12711	12712	12714	12715	12716	12717	12718	12719
473	12720	12721	12722	12724	12725	12726	12727	12728	12729
474	12730	12731	12732	12734	12735	12736	12737	12738	12739
475	12740	12741	12742	12744	12745	12746	12747	12748	12749
476	12750	12751	12752	12754	12755	12756	12757	12758	12759
477	12760	12761	12762	12764	12765	12766	12767	12768	12769
478	12770	12771	12772	12774	12775	12776	12777	12778	12779
479	12780	12781	12782	12784	12785	12786	12787	12788	12789
480	12790	12791	12792	12794	12795	12796	12797	12798	12799
481	12800	12801	12802	12804	12805	12806	12807	12808	12809
482	12810	12811	12812	12814	12815	12816	12817	12818	12819
483	12820	12821	12822	12824	12825	12826	12827	12828	12829
484	12830	12831	12832	12834	12835	12836	12837	12838	12839
485	12840	12841	12842	12844	12845	12846	12847	12848	12849
486	12850	12851	12852	12854	12855	12856	12857	12858	12859
487	12860	12861	12862	12864	12865	12866	12867	12868	12869
488	12870	12871	12872	12874	12875	12876	12877	12878	12879
489	12880	12881	12882	12884	12885	12886	12887	12888	12889
490	12890	12891	12892	12894	12895	12896	12897	12898	12899
491	12900	12901	12902	12904	12905	12906	12907	12908	12909
492	12910	12911	12912	12914	12915	12916	12917	12918	12919
493	12920	12921	12922	12924	12925	12926	12927	12928	12929
494	12930	12931	12932	12934	12935	12936	12937	12938	12939
495	12940	12941	12942	12944	12945	12946	12947	12948	12949
496	12950	12951	12952	12954	12955	12956	12957	12958	12959
497	12960	12961	12962	12964	12965	12966	12967	12968	12969
498	12970	12971	12972	12974	12975	12976	12977	12978	12979
499	12980	12981	12982	12984	12985	12986	12987	12988	12989
500	12990	12991	12992	12994	12995	12996	12997	12998	12999

(2) For axis 2

Data No.	Positioning identifier	M code	Dwell time	Command speed		Positioning address		Arc data	
				Low-order	High-order	Low-order	High-order	Low-order	High-order
501	13000	13001	13002	13004	13005	13006	13007	13008	13009
502	13010	13011	13012	13014	13015	13016	13017	13018	13019
503	13020	13021	13022	13024	13025	13026	13027	13028	13029
504	13030	13031	13032	13034	13035	13036	13037	13038	13039
505	13040	13041	13042	13044	13045	13046	13047	13048	13049
506	13050	13051	13052	13054	13055	13056	13057	13058	13059
507	13060	13061	13062	13064	13065	13066	13067	13068	13069
508	13070	13071	13072	13074	13075	13076	13077	13078	13079
509	13080	13081	13082	13084	13085	13086	13087	13088	13089
510	13090	13091	13092	13094	13095	13096	13097	13098	13099
511	13100	13101	13102	13104	13105	13106	13107	13108	13109
512	13110	13111	13112	13114	13115	13116	13117	13118	13119
513	13120	13121	13122	13124	13125	13126	13127	13128	13129
514	13130	13131	13132	13134	13135	13136	13137	13138	13139
515	13140	13141	13142	13144	13145	13146	13147	13148	13149
516	13150	13151	13152	13154	13155	13156	13157	13158	13159
517	13160	13161	13162	13164	13165	13166	13167	13168	13169
518	13170	13171	13172	13174	13175	13176	13177	13178	13179
519	13180	13181	13182	13184	13185	13186	13187	13188	13189
520	13190	13191	13192	13194	13195	13196	13197	13198	13199
521	13200	13201	13202	13204	13205	13206	13207	13208	13209
522	13210	13211	13212	13214	13215	13216	13217	13218	13219
523	13220	13221	13222	13224	13225	13226	13227	13228	13229
524	13230	13231	13232	13234	13235	13236	13237	13238	13239
525	13240	13241	13242	13244	13245	13246	13247	13248	13249
526	13250	13251	13252	13254	13255	13256	13257	13258	13259
527	13260	13261	13262	13264	13265	13266	13267	13268	13269
528	13270	13271	13272	13274	13275	13276	13277	13278	13279
529	13280	13281	13282	13284	13285	13286	13287	13288	13289
530	13290	13291	13292	13294	13295	13296	13297	13298	13299
531	13300	13301	13302	13304	13305	13306	13307	13308	13309
532	13310	13311	13312	13314	13315	13316	13317	13318	13319
533	13320	13321	13322	13324	13325	13326	13327	13328	13329
534	13330	13331	13332	13334	13335	13336	13337	13338	13339
535	13340	13341	13342	13344	13345	13346	13347	13348	13349
536	13350	13351	13352	13354	13355	13356	13357	13358	13359
537	13360	13361	13362	13364	13365	13366	13367	13368	13369
538	13370	13371	13372	13374	13375	13376	13377	13378	13379
539	13380	13381	13382	13384	13385	13386	13387	13388	13389
540	13390	13391	13392	13394	13395	13396	13397	13398	13399
541	13400	13401	13402	13404	13405	13406	13407	13408	13409
542	13410	13411	13412	13414	13415	13416	13417	13418	13419
543	13420	13421	13422	13424	13425	13426	13427	13428	13429
544	13430	13431	13432	13434	13435	13436	13437	13438	13439
545	13440	13441	13442	13444	13445	13446	13447	13448	13449
546	13450	13451	13452	13454	13455	13456	13457	13458	13459
547	13460	13461	13462	13464	13465	13466	13467	13468	13469
548	13470	13471	13472	13474	13475	13476	13477	13478	13479
549	13480	13481	13482	13484	13485	13486	13487	13488	13489
550	13490	13491	13492	13494	13495	13496	13497	13498	13499

Data No.	Positioning identifier	M code	Dwell time	Command speed		Positioning address		Arc data	
				Low-order	High-order	Low-order	High-order	Low-order	High-order
551	13500	13501	13502	13504	13505	13506	13507	13508	13509
552	13510	13511	13512	13514	13515	13516	13517	13518	13519
553	13520	13521	13522	13524	13525	13526	13527	13528	13529
554	13530	13531	13532	13534	13535	13536	13537	13538	13539
555	13540	13541	13542	13544	13545	13546	13547	13548	13549
556	13550	13551	13552	13554	13555	13556	13557	13558	13559
557	13560	13561	13562	13564	13565	13566	13567	13568	13569
558	13570	13571	13572	13574	13575	13576	13577	13578	13579
559	13580	13581	13582	13584	13585	13586	13587	13588	13589
560	13590	13591	13592	13594	13595	13596	13597	13598	13599
561	13600	13601	13602	13604	13605	13606	13607	13608	13609
562	13610	13611	13612	13614	13615	13616	13617	13618	13619
563	13620	13621	13622	13624	13625	13626	13627	13628	13629
564	13630	13631	13632	13634	13635	13636	13637	13638	13639
565	13640	13641	13642	13644	13645	13646	13647	13648	13649
566	13650	13651	13652	13654	13655	13656	13657	13658	13659
567	13660	13661	13662	13664	13665	13666	13667	13668	13669
568	13670	13671	13672	13674	13675	13676	13677	13678	13679
569	13680	13681	13682	13684	13685	13686	13687	13688	13689
570	13690	13691	13692	13694	13695	13696	13697	13698	13699
571	13700	13701	13702	13704	13705	13706	13707	13708	13709
572	13710	13711	13712	13714	13715	13716	13717	13718	13719
573	13720	13721	13722	13724	13725	13726	13727	13728	13729
574	13730	13731	13732	13734	13735	13736	13737	13738	13739
575	13740	13741	13742	13744	13745	13746	13747	13748	13749
576	13750	13751	13752	13754	13755	13756	13757	13758	13759
577	13760	13761	13762	13764	13765	13766	13767	13768	13769
578	13770	13771	13772	13774	13775	13776	13777	13778	13779
579	13780	13781	13782	13784	13785	13786	13787	13788	13789
580	13790	13791	13792	13794	13795	13796	13797	13798	13799
581	13800	13801	13802	13804	13805	13806	13807	13808	13809
582	13810	13811	13812	13814	13815	13816	13817	13818	13819
583	13820	13821	13822	13824	13825	13826	13827	13828	13829
584	13830	13831	13832	13834	13835	13836	13837	13838	13839
585	13840	13841	13842	13844	13845	13846	13847	13848	13849
586	13850	13851	13852	13854	13855	13856	13857	13858	13859
587	13860	13861	13862	13864	13865	13866	13867	13868	13869
588	13870	13871	13872	13874	13875	13876	13877	13878	13879
589	13880	13881	13882	13884	13885	13886	13887	13888	13889
590	13890	13891	13892	13894	13895	13896	13897	13898	13899
591	13900	13901	13902	13904	13905	13906	13907	13908	13909
592	13910	13911	13912	13914	13915	13916	13917	13918	13919
593	13920	13921	13922	13924	13925	13926	13927	13928	13929
594	13930	13931	13932	13934	13935	13936	13937	13938	13939
595	13940	13941	13942	13944	13945	13946	13947	13948	13949
596	13950	13951	13952	13954	13955	13956	13957	13958	13959
597	13960	13961	13962	13964	13965	13966	13967	13968	13969
598	13970	13971	13972	13974	13975	13976	13977	13978	13979
599	13980	13981	13982	13984	13985	13986	13987	13988	13989
600	13990	13991	13992	13994	13995	13996	13997	13998	13999

## (2) For axis 2 (positioning option)

Data No.	Positioning option	Data No.	Positioning option	Data No.	Positioning option	Data No.	Positioning option	Data No.	Positioning option	Data No.	Positioning option
1	8003	51	8503	101	9003	151	9503	201	10003	251	10503
2	8013	52	8513	102	9013	152	9513	202	10013	252	10513
3	8023	53	8523	103	9023	153	9523	203	10023	253	10523
4	8033	54	8533	104	9033	154	9533	204	10033	254	10533
5	8043	55	8543	105	9043	155	9543	205	10043	255	10543
6	8053	56	8553	106	9053	156	9553	206	10053	256	10553
7	8063	57	8563	107	9063	157	9563	207	10063	257	10563
8	8073	58	8573	108	9073	158	9573	208	10073	258	10573
9	8083	59	8583	109	9083	159	9583	209	10083	259	10583
10	8093	60	8593	110	9093	160	9593	210	10093	260	10593
11	8103	61	8603	111	9103	161	9603	211	10103	261	10603
12	8113	62	8613	112	9113	162	9613	212	10113	262	10613
13	8123	63	8623	113	9123	163	9623	213	10123	263	10623
14	8133	64	8633	114	9133	164	9633	214	10133	264	10633
15	8143	65	8643	115	9143	165	9643	215	10143	265	10643
16	8153	66	8653	116	9153	166	9653	216	10153	266	10653
17	8163	67	8663	117	9163	167	9663	217	10163	267	10663
18	8173	68	8673	118	9173	168	9673	218	10173	268	10673
19	8183	69	8683	119	9183	169	9683	219	10183	269	10683
20	8193	70	8693	120	9193	170	9693	220	10193	270	10693
21	8203	71	8703	121	9203	171	9703	221	10203	271	10703
22	8213	72	8713	122	9213	172	9713	222	10213	272	10713
23	8223	73	8723	123	9223	173	9723	223	10223	273	10723
24	8233	74	8733	124	9233	174	9733	224	10233	274	10733
25	8243	75	8743	125	9243	175	9743	225	10243	275	10743
26	8253	76	8753	126	9253	176	9753	226	10253	276	10753
27	8263	77	8763	127	9263	177	9763	227	10263	277	10763
28	8273	78	8773	128	9273	178	9773	228	10273	278	10773
29	8283	79	8783	129	9283	179	9783	229	10283	279	10783
30	8293	80	8793	130	9293	180	9793	230	10293	280	10793
31	8303	81	8803	131	9303	181	9803	231	10303	281	10803
32	8313	82	8813	132	9313	182	9813	232	10313	282	10813
33	8323	83	8823	133	9323	183	9823	233	10323	283	10823
34	8333	84	8833	134	9333	184	9833	234	10333	284	10833
35	8343	85	8843	135	9343	185	9843	235	10343	285	10843
36	8353	86	8853	136	9353	186	9853	236	10353	286	10853
37	8363	87	8863	137	9363	187	9863	237	10363	287	10863
38	8373	88	8873	138	9373	188	9873	238	10373	288	10873
39	8383	89	8883	139	9383	189	9883	239	10383	289	10883
40	8393	90	8893	140	9393	190	9893	240	10393	290	10893
41	8403	91	8903	141	9403	191	9903	241	10403	291	10903
42	8413	92	8913	142	9413	192	9913	242	10413	292	10913
43	8423	93	8923	143	9423	193	9923	243	10423	293	10923
44	8433	94	8933	144	9433	194	9933	244	10433	294	10933
45	8443	95	8943	145	9443	195	9943	245	10443	295	10943
46	8453	96	8953	146	9453	196	9953	246	10453	296	10953
47	8463	97	8963	147	9463	197	9963	247	10463	297	10963
48	8473	98	8973	148	9473	198	9973	248	10473	298	10973
49	8483	99	8983	149	9483	199	9983	249	10483	299	10983
50	8493	100	8993	150	9493	200	9993	250	10493	300	10993

## (2) For axis 2 (positioning option)

Data No.	Positioning option	Data No.	Positioning option	Data No.	Positioning option	Data No.	Positioning option	Data No.	Positioning option	Data No.	Positioning option
301	11003	351	11503	401	12003	451	12503	501	13003	551	13503
302	11013	352	11513	402	12013	452	12513	502	13013	552	13513
303	11023	353	11523	403	12023	453	12523	503	13023	553	13523
304	11033	354	11533	404	12033	454	12533	504	13033	554	13533
305	11043	355	11543	405	12043	455	12543	505	13043	555	13543
306	11053	356	11553	406	12053	456	12553	506	13053	556	13553
307	11063	357	11563	407	12063	457	12563	507	13063	557	13563
308	11073	358	11573	408	12073	458	12573	508	13073	558	13573
309	11083	359	11583	409	12083	459	12583	509	13083	559	13583
310	11093	360	11593	410	12093	460	12593	510	13093	560	13593
311	11103	361	11603	411	12103	461	12603	511	13103	561	13603
312	11113	362	11613	412	12113	462	12613	512	13113	562	13613
313	11123	363	11623	413	12123	463	12623	513	13123	563	13623
314	11133	364	11633	414	12133	464	12633	514	13133	564	13633
315	11143	365	11643	415	12143	465	12643	515	13143	565	13643
316	11153	366	11653	416	12153	466	12653	516	13153	566	13653
317	11163	367	11663	417	12163	467	12663	517	13163	567	13663
318	11173	368	11673	418	12173	468	12673	518	13173	568	13673
319	11183	369	11683	419	12183	469	12683	519	13183	569	13683
320	11193	370	11693	420	12193	470	12693	520	13193	570	13693
321	11203	371	11703	421	12203	471	12703	521	13203	571	13703
322	11213	372	11713	422	12213	472	12713	522	13213	572	13713
323	11223	373	11723	423	12223	473	12723	523	13223	573	13723
324	11233	374	11733	424	12233	474	12733	524	13233	574	13733
325	11243	375	11743	425	12243	475	12743	525	13243	575	13743
326	11253	376	11753	426	12253	476	12753	526	13253	576	13753
327	11263	377	11763	427	12263	477	12763	527	13263	577	13763
328	11273	378	11773	428	12273	478	12773	528	13273	578	13773
329	11283	379	11783	429	12283	479	12783	529	13283	579	13783
330	11293	380	11793	430	12293	480	12793	530	13293	580	13793
331	11303	381	11803	431	12303	481	12803	531	13303	581	13803
332	11313	382	11813	432	12313	482	12813	532	13313	582	13813
333	11323	383	11823	433	12323	483	12823	533	13323	583	13823
334	11333	384	11833	434	12333	484	12833	534	13333	584	13833
335	11343	385	11843	435	12343	485	12843	535	13343	585	13843
336	11353	386	11853	436	12353	486	12853	536	13353	586	13853
337	11363	387	11863	437	12363	487	12863	537	13363	587	13863
338	11373	388	11873	438	12373	488	12873	538	13373	588	13873
339	11383	389	11883	439	12383	489	12883	539	13383	589	13883
340	11393	390	11893	440	12393	490	12893	540	13393	590	13893
341	11403	391	11903	441	12403	491	12903	541	13403	591	13903
342	11413	392	11913	442	12413	492	12913	542	13413	592	13913
343	11423	393	11923	443	12423	493	12923	543	13423	593	13923
344	11433	394	11933	444	12433	494	12933	544	13433	594	13933
345	11443	395	11943	445	12443	495	12943	545	13443	595	13943
346	11453	396	11953	446	12453	496	12953	546	13453	596	13953
347	11463	397	11963	447	12463	497	12963	547	13463	597	13963
348	11473	398	11973	448	12473	498	12973	548	13473	598	13973
349	11483	399	11983	449	12483	499	12983	549	13483	599	13983
350	11493	400	11993	450	12493	500	12993	550	13493	600	13993

(3) For axis 3

Data No.	Positioning identifier	M code	Dwell time	Command speed		Positioning address		Arc data	
				Low-order	High-order	Low-order	High-order	Low-order	High-order
1	14000	14001	14002	14004	14005	14006	14007	14008	14009
2	14010	14011	14012	14014	14015	14016	14017	14018	14019
3	14020	14021	14022	14024	14025	14026	14027	14028	14029
4	14030	14031	14032	14034	14035	14036	14037	14038	14039
5	14040	14041	14042	14044	14045	14046	14047	14048	14049
6	14050	14051	14052	14054	14055	14056	14057	14058	14059
7	14060	14061	14062	14064	14065	14066	14067	14068	14069
8	14070	14071	14072	14074	14075	14076	14077	14078	14079
9	14080	14081	14082	14084	14085	14086	14087	14088	14089
10	14090	14091	14092	14094	14095	14096	14097	14098	14099
11	14100	14101	14102	14104	14105	14106	14107	14108	14109
12	14110	14111	14112	14114	14115	14116	14117	14118	14119
13	14120	14121	14122	14124	14125	14126	14127	14128	14129
14	14130	14131	14132	14134	14135	14136	14137	14138	14139
15	14140	14141	14142	14144	14145	14146	14147	14148	14149
16	14150	14151	14152	14154	14155	14156	14157	14158	14159
17	14160	14161	14162	14164	14165	14166	14167	14168	14169
18	14170	14171	14172	14174	14175	14176	14177	14178	14179
19	14180	14181	14182	14184	14185	14186	14187	14188	14189
20	14190	14191	14192	14194	14195	14196	14197	14198	14199
21	14200	14201	14202	14204	14205	14206	14207	14208	14209
22	14210	14211	14212	14214	14215	14216	14217	14218	14219
23	14220	14221	14222	14224	14225	14226	14227	14228	14229
24	14230	14231	14232	14234	14235	14236	14237	14238	14239
25	14240	14241	14242	14244	14245	14246	14247	14248	14249
26	14250	14251	14252	14254	14255	14256	14257	14258	14259
27	14260	14261	14262	14264	14265	14266	14267	14268	14269
28	14270	14271	14272	14274	14275	14276	14277	14278	14279
29	14280	14281	14282	14284	14285	14286	14287	14288	14289
30	14290	14291	14292	14294	14295	14296	14297	14298	14299
31	14300	14301	14302	14304	14305	14306	14307	14308	14309
32	14310	14311	14312	14314	14315	14316	14317	14318	14319
33	14320	14321	14322	14324	14325	14326	14327	14328	14329
34	14330	14331	14332	14334	14335	14336	14337	14338	14339
35	14340	14341	14342	14344	14345	14346	14347	14348	14349
36	14350	14351	14352	14354	14355	14356	14357	14358	14359
37	14360	14361	14362	14364	14365	14366	14367	14368	14369
38	14370	14371	14372	14374	14375	14376	14377	14378	14379
39	14380	14381	14382	14384	14385	14386	14387	14388	14389
40	14390	14391	14392	14394	14395	14396	14397	14398	14399
41	14400	14401	14402	14404	14405	14406	14407	14408	14409
42	14410	14411	14412	14414	14415	14416	14417	14418	14419
43	14420	14421	14422	14424	14425	14426	14427	14428	14429
44	14430	14431	14432	14434	14435	14436	14437	14438	14439
45	14440	14441	14442	14444	14445	14446	14447	14448	14449
46	14450	14451	14452	14454	14455	14456	14457	14458	14459
47	14460	14461	14462	14464	14465	14466	14467	14468	14469
48	14470	14471	14472	14474	14475	14476	14477	14478	14479
49	14480	14481	14482	14484	14485	14486	14487	14488	14489
50	14490	14491	14492	14494	14495	14496	14497	14498	14499

Data No.	Positioning identifier	M code	Dwell time	Command speed		Positioning address		Arc data	
				Low-order	High-order	Low-order	High-order	Low-order	High-order
51	14500	14501	14502	14504	14505	14506	14507	14508	14509
52	14510	14511	14512	14514	14515	14516	14517	14518	14519
53	14520	14521	14522	14524	14525	14526	14527	14528	14529
54	14530	14531	14532	14534	14535	14536	14537	14538	14539
55	14540	14541	14542	14544	14545	14546	14547	14548	14549
56	14550	14551	14552	14554	14555	14556	14557	14558	14559
57	14560	14561	14562	14564	14565	14566	14567	14568	14569
58	14570	14571	14572	14574	14575	14576	14577	14578	14579
59	14580	14581	14582	14584	14585	14586	14587	14588	14589
60	14590	14591	14592	14594	14595	14596	14597	14598	14599
61	14600	14601	14602	14604	14605	14606	14607	14608	14609
62	14610	14611	14612	14614	14615	14616	14617	14618	14619
63	14620	14621	14622	14624	14625	14626	14627	14628	14629
64	14630	14631	14632	14634	14635	14636	14637	14638	14639
65	14640	14641	14642	14644	14645	14646	14647	14648	14649
66	14650	14651	14652	14654	14655	14656	14657	14658	14659
67	14660	14661	14662	14664	14665	14666	14667	14668	14669
68	14670	14671	14672	14674	14675	14676	14677	14678	14679
69	14680	14681	14682	14684	14685	14686	14687	14688	14689
70	14690	14691	14692	14694	14695	14696	14697	14698	14699
71	14700	14701	14702	14704	14705	14706	14707	14708	14709
72	14710	14711	14712	14714	14715	14716	14717	14718	14719
73	14720	14721	14722	14724	14725	14726	14727	14728	14729
74	14730	14731	14732	14734	14735	14736	14737	14738	14739
75	14740	14741	14742	14744	14745	14746	14747	14748	14749
76	14750	14751	14752	14754	14755	14756	14757	14758	14759
77	14760	14761	14762	14764	14765	14766	14767	14768	14769
78	14770	14771	14772	14774	14775	14776	14777	14778	14779
79	14780	14781	14782	14784	14785	14786	14787	14788	14789
80	14790	14791	14792	14794	14795	14796	14797	14798	14799
81	14800	14801	14802	14804	14805	14806	14807	14808	14809
82	14810	14811	14812	14814	14815	14816	14817	14818	14819
83	14820	14821	14822	14824	14825	14826	14827	14828	14829
84	14830	14831	14832	14834	14835	14836	14837	14838	14839
85	14840	14841	14842	14844	14845	14846	14847	14848	14849
86	14850	14851	14852	14854	14855	14856	14857	14858	14859
87	14860	14861	14862	14864	14865	14866	14867	14868	14869
88	14870	14871	14872	14874	14875	14876	14877	14878	14879
89	14880	14881	14882	14884	14885	14886	14887	14888	14889
90	14890	14891	14892	14894	14895	14896	14897	14898	14899
91	14900	14901	14902	14904	14905	14906	14907	14908	14909
92	14910	14911	14912	14914	14915	14916	14917	14918	14919
93	14920	14921	14922	14924	14925	14926	14927	14928	14929
94	14930	14931	14932	14934	14935	14936	14937	14938	14939
95	14940	14941	14942	14944	14945	14946	14947	14948	14949
96	14950	14951	14952	14954	14955	14956	14957	14958	14959
97	14960	14961	14962	14964	14965	14966	14967	14968	14969
98	14970	14971	14972	14974	14975	14976	14977	14978	14979
99	14980	14981	14982	14984	14985	14986	14987	14988	14989
100	14990	14991	14992	14994	14995	14996	14997	14998	14999



(3) For axis 3

Data No.	Positioning identifier	M code	Dwell time	Command speed		Positioning address		Arc data	
				Low-order	High-order	Low-order	High-order	Low-order	High-order
101	15000	15001	15002	15004	15005	15006	15007	15008	15009
102	15010	15011	15012	15014	15015	15016	15017	15018	15019
103	15020	15021	15022	15024	15025	15026	15027	15028	15029
104	15030	15031	15032	15034	15035	15036	15037	15038	15039
105	15040	15041	15042	15044	15045	15046	15047	15048	15049
106	15050	15051	15052	15054	15055	15056	15057	15058	15059
107	15060	15061	15062	15064	15065	15066	15067	15068	15069
108	15070	15071	15072	15074	15075	15076	15077	15078	15079
109	15080	15081	15082	15084	15085	15086	15087	15088	15089
110	15090	15091	15092	15094	15095	15096	15097	15098	15099
111	15100	15101	15102	15104	15105	15106	15107	15108	15109
112	15110	15111	15112	15114	15115	15116	15117	15118	15119
113	15120	15121	15122	15124	15125	15126	15127	15128	15129
114	15130	15131	15132	15134	15135	15136	15137	15138	15139
115	15140	15141	15142	15144	15145	15146	15147	15148	15149
116	15150	15151	15152	15154	15155	15156	15157	15158	15159
117	15160	15161	15162	15164	15165	15166	15167	15168	15169
118	15170	15171	15172	15174	15175	15176	15177	15178	15179
119	15180	15181	15182	15184	15185	15186	15187	15188	15189
120	15190	15191	15192	15194	15195	15196	15197	15198	15199
121	15200	15201	15202	15204	15205	15206	15207	15208	15209
122	15210	15211	15212	15214	15215	15216	15217	15218	15219
123	15220	15221	15222	15224	15225	15226	15227	15228	15229
124	15230	15231	15232	15234	15235	15236	15237	15238	15239
125	15240	15241	15242	15244	15245	15246	15247	15248	15249
126	15250	15251	15252	15254	15255	15256	15257	15258	15259
127	15260	15261	15262	15264	15265	15266	15267	15268	15269
128	15270	15271	15272	15274	15275	15276	15277	15278	15279
129	15280	15281	15282	15284	15285	15286	15287	15288	15289
130	15290	15291	15292	15294	15295	15296	15297	15298	15299
131	15300	15301	15302	15304	15305	15306	15307	15308	15309
132	15310	15311	15312	15314	15315	15316	15317	15318	15319
133	15320	15321	15322	15324	15325	15326	15327	15328	15329
134	15330	15331	15332	15334	15335	15336	15337	15338	15339
135	15340	15341	15342	15344	15345	15346	15347	15348	15349
136	15350	15351	15352	15354	15355	15356	15357	15358	15359
137	15360	15361	15362	15364	15365	15366	15367	15368	15369
138	15370	15371	15372	15374	15375	15376	15377	15378	15379
139	15380	15381	15382	15384	15385	15386	15387	15388	15389
140	15390	15391	15392	15394	15395	15396	15397	15398	15399
141	15400	15401	15402	15404	15405	15406	15407	15408	15409
142	15410	15411	15412	15414	15415	15416	15417	15418	15419
143	15420	15421	15422	15424	15425	15426	15427	15428	15429
144	15430	15431	15432	15434	15435	15436	15437	15438	15439
145	15440	15441	15442	15444	15445	15446	15447	15448	15449
146	15450	15451	15452	15454	15455	15456	15457	15458	15459
147	15460	15461	15462	15464	15465	15466	15467	15468	15469
148	15470	15471	15472	15474	15475	15476	15477	15478	15479
149	15480	15481	15482	15484	15485	15486	15487	15488	15489
150	15490	15491	15492	15494	15495	15496	15497	15498	15499

Data No.	Positioning identifier	M code	Dwell time	Command speed		Positioning address		Arc data	
				Low-order	High-order	Low-order	High-order	Low-order	High-order
151	15500	15501	15502	15504	15505	15506	15507	15508	15509
152	15510	15511	15512	15514	15515	15516	15517	15518	15519
153	15520	15521	15522	15524	15525	15526	15527	15528	15529
154	15530	15531	15532	15534	15535	15536	15537	15538	15539
155	15540	15541	15542	15544	15545	15546	15547	15548	15549
156	15550	15551	15552	15554	15555	15556	15557	15558	15559
157	15560	15561	15562	15564	15565	15566	15567	15568	15569
158	15570	15571	15572	15574	15575	15576	15577	15578	15579
159	15580	15581	15582	15584	15585	15586	15587	15588	15589
160	15590	15591	15592	15594	15595	15596	15597	15598	15599
161	15600	15601	15602	15604	15605	15606	15607	15608	15609
162	15610	15611	15612	15614	15615	15616	15617	15618	15619
163	15620	15621	15622	15624	15625	15626	15627	15628	15629
164	15630	15631	15632	15634	15635	15636	15637	15638	15639
165	15640	15641	15642	15644	15645	15646	15647	15648	15649
166	15650	15651	15652	15654	15655	15656	15657	15658	15659
167	15660	15661	15662	15664	15665	15666	15667	15668	15669
168	15670	15671	15672	15674	15675	15676	15677	15678	15679
169	15680	15681	15682	15684	15685	15686	15687	15688	15689
170	15690	15691	15692	15694	15695	15696	15697	15698	15699
171	15700	15701	15702	15704	15705	15706	15707	15708	15709
172	15710	15711	15712	15714	15715	15716	15717	15718	15719
173	15720	15721	15722	15724	15725	15726	15727	15728	15729
174	15730	15731	15732	15734	15735	15736	15737	15738	15739
175	15740	15741	15742	15744	15745	15746	15747	15748	15749
176	15750	15751	15752	15754	15755	15756	15757	15758	15759
177	15760	15761	15762	15764	15765	15766	15767	15768	15769
178	15770	15771	15772	15774	15775	15776	15777	15778	15779
179	15780	15781	15782	15784	15785	15786	15787	15788	15789
180	15790	15791	15792	15794	15795	15796	15797	15798	15799
181	15800	15801	15802	15804	15805	15806	15807	15808	15809
182	15810	15811	15812	15814	15815	15816	15817	15818	15819
183	15820	15821	15822	15824	15825	15826	15827	15828	15829
184	15830	15831	15832	15834	15835	15836	15837	15838	15839
185	15840	15841	15842	15844	15845	15846	15847	15848	15849
186	15850	15851	15852	15854	15855	15856	15857	15858	15859
187	15860	15861	15862	15864	15865	15866	15867	15868	15869
188	15870	15871	15872	15874	15875	15876	15877	15878	15879
189	15880	15881	15882	15884	15885	15886	15887	15888	15889
190	15890	15891	15892	15894	15895	15896	15897	15898	15899
191	15900	15901	15902	15904	15905	15906	15907	15908	15909
192	15910	15911	15912	15914	15915	15916	15917	15918	15919
193	15920	15921	15922	15924	15925	15926	15927	15928	15929
194	15930	15931	15932	15934	15935	15936	15937	15938	15939
195	15940	15941	15942	15944	15945	15946	15947	15948	15949
196	15950	15951	15952	15954	15955	15956	15957	15958	15959
197	15960	15961	15962	15964	15965	15966	15967	15968	15969
198	15970	15971	15972	15974	15975	15976	15977	15978	15979
199	15980	15981	15982	15984	15985	15986	15987	15988	15989
200	15990	15991	15992	15994	15995	15996	15997	15998	15999

(3) For axis 3

Data No.	Positioning identifier	M code	Dwell time	Command speed		Positioning address		Arc data	
				Low-order	High-order	Low-order	High-order	Low-order	High-order
201	16000	16001	16002	16004	16005	16006	16007	16008	16009
202	16010	16011	16012	16014	16015	16016	16017	16018	16019
203	16020	16021	16022	16024	16025	16026	16027	16028	16029
204	16030	16031	16032	16034	16035	16036	16037	16038	16039
205	16040	16041	16042	16044	16045	16046	16047	16048	16049
206	16050	16051	16052	16054	16055	16056	16057	16058	16059
207	16060	16061	16062	16064	16065	16066	16067	16068	16069
208	16070	16071	16072	16074	16075	16076	16077	16078	16079
209	16080	16081	16082	16084	16085	16086	16087	16088	16089
210	16090	16091	16092	16094	16095	16096	16097	16098	16099
211	16100	16101	16102	16104	16105	16106	16107	16108	16109
212	16110	16111	16112	16114	16115	16116	16117	16118	16119
213	16120	16121	16122	16124	16125	16126	16127	16128	16129
214	16130	16131	16132	16134	16135	16136	16137	16138	16139
215	16140	16141	16142	16144	16145	16146	16147	16148	16149
216	16150	16151	16152	16154	16155	16156	16157	16158	16159
217	16160	16161	16162	16164	16165	16166	16167	16168	16169
218	16170	16171	16172	16174	16175	16176	16177	16178	16179
219	16180	16181	16182	16184	16185	16186	16187	16188	16189
220	16190	16191	16192	16194	16195	16196	16197	16198	16199
221	16200	16201	16202	16204	16205	16206	16207	16208	16209
222	16210	16211	16212	16214	16215	16216	16217	16218	16219
223	16220	16221	16222	16224	16225	16226	16227	16228	16229
224	16230	16231	16232	16234	16235	16236	16237	16238	16239
225	16240	16241	16242	16244	16245	16246	16247	16248	16249
226	16250	16251	16252	16254	16255	16256	16257	16258	16259
227	16260	16261	16262	16264	16265	16266	16267	16268	16269
228	16270	16271	16272	16274	16275	16276	16277	16278	16279
229	16280	16281	16282	16284	16285	16286	16287	16288	16289
230	16290	16291	16292	16294	16295	16296	16297	16298	16299
231	16300	16301	16302	16304	16305	16306	16307	16308	16309
232	16310	16311	16312	16314	16315	16316	16317	16318	16319
233	16320	16321	16322	16324	16325	16326	16327	16328	16329
234	16330	16331	16332	16334	16335	16336	16337	16338	16339
235	16340	16341	16342	16344	16345	16346	16347	16348	16349
236	16350	16351	16352	16354	16355	16356	16357	16358	16359
237	16360	16361	16362	16364	16365	16366	16367	16368	16369
238	16370	16371	16372	16374	16375	16376	16377	16378	16379
239	16380	16381	16382	16384	16385	16386	16387	16388	16389
240	16390	16391	16392	16394	16395	16396	16397	16398	16399
241	16400	16401	16402	16404	16405	16406	16407	16408	16409
242	16410	16411	16412	16414	16415	16416	16417	16418	16419
243	16420	16421	16422	16424	16425	16426	16427	16428	16429
244	16430	16431	16432	16434	16435	16436	16437	16438	16439
245	16440	16441	16442	16444	16445	16446	16447	16448	16449
246	16450	16451	16452	16454	16455	16456	16457	16458	16459
247	16460	16461	16462	16464	16465	16466	16467	16468	16469
248	16470	16471	16472	16474	16475	16476	16477	16478	16479
249	16480	16481	16482	16484	16485	16486	16487	16488	16489
250	16490	16491	16492	16494	16495	16496	16497	16498	16499

Data No.	Positioning identifier	M code	Dwell time	Command speed		Positioning address		Arc data	
				Low-order	High-order	Low-order	High-order	Low-order	High-order
251	16500	16501	16502	16504	16505	16506	16507	16508	16509
252	16510	16511	16512	16514	16515	16516	16517	16518	16519
253	16520	16521	16522	16524	16525	16526	16527	16528	16529
254	16530	16531	16532	16534	16535	16536	16537	16538	16539
255	16540	16541	16542	16544	16545	16546	16547	16548	16549
256	16550	16551	16552	16554	16555	16556	16557	16558	16559
257	16560	16561	16562	16564	16565	16566	16567	16568	16569
258	16570	16571	16572	16574	16575	16576	16577	16578	16579
259	16580	16581	16582	16584	16585	16586	16587	16588	16589
260	16590	16591	16592	16594	16595	16596	16597	16598	16599
261	16600	16601	16602	16604	16605	16606	16607	16608	16609
262	16610	16611	16612	16614	16615	16616	16617	16618	16619
263	16620	16621	16622	16624	16625	16626	16627	16628	16629
264	16630	16631	16632	16634	16635	16636	16637	16638	16639
265	16640	16641	16642	16644	16645	16646	16647	16648	16649
266	16650	16651	16652	16654	16655	16656	16657	16658	16659
267	16660	16661	16662	16664	16665	16666	16667	16668	16669
268	16670	16671	16672	16674	16675	16676	16677	16678	16679
269	16680	16681	16682	16684	16685	16686	16687	16688	16689
270	16690	16691	16692	16694	16695	16696	16697	16698	16699
271	16700	16701	16702	16704	16705	16706	16707	16708	16709
272	16710	16711	16712	16714	16715	16716	16717	16718	16719
273	16720	16721	16722	16724	16725	16726	16727	16728	16729
274	16730	16731	16732	16734	16735	16736	16737	16738	16739
275	16740	16741	16742	16744	16745	16746	16747	16748	16749
276	16750	16751	16752	16754	16755	16756	16757	16758	16759
277	16760	16761	16762	16764	16765	16766	16767	16768	16769
278	16770	16771	16772	16774	16775	16776	16777	16778	16779
279	16780	16781	16782	16784	16785	16786	16787	16788	16789
280	16790	16791	16792	16794	16795	16796	16797	16798	16799
281	16800	16801	16802	16804	16805	16806	16807	16808	16809
282	16810	16811	16812	16814	16815	16816	16817	16818	16819
283	16820	16821	16822	16824	16825	16826	16827	16828	16829
284	16830	16831	16832	16834	16835	16836	16837	16838	16839
285	16840	16841	16842	16844	16845	16846	16847	16848	16849
286	16850	16851	16852	16854	16855	16856	16857	16858	16859
287	16860	16861	16862	16864	16865	16866	16867	16868	16869
288	16870	16871	16872	16874	16875	16876	16877	16878	16879
289	16880	16881	16882	16884	16885	16886	16887	16888	16889
290	16890	16891	16892	16894	16895	16896	16897	16898	16899
291	16900	16901	16902	16904	16905	16906	16907	16908	16909
292	16910	16911	16912	16914	16915	16916	16917	16918	16919
293	16920	16921	16922	16924	16925	16926	16927	16928	16929
294	16930	16931	16932	16934	16935	16936	16937	16938	16939
295	16940	16941	16942	16944	16945	16946	16947	16948	16949
296	16950	16951	16952	16954	16955	16956	16957	16958	16959
297	16960	16961	16962	16964	16965	16966	16967	16968	16969
298	16970	16971	16972	16974	16975	16976	16977	16978	16979
299	16980	16981	16982	16984	16985	16986	16987	16988	16989
300	16990	16991	16992	16994	16995	16996	16997	16998	16999

(3) For axis 3

Data No.	Positioning identifier	M code	Dwell time	Command speed		Positioning address		Arc data	
				Low-order	High-order	Low-order	High-order	Low-order	High-order
301	17000	17001	17002	17004	17005	17006	17007	17008	17009
302	17010	17011	17012	17014	17015	17016	17017	17018	17019
303	17020	17021	17022	17024	17025	17026	17027	17028	17029
304	17030	17031	17032	17034	17035	17036	17037	17038	17039
305	17040	17041	17042	17044	17045	17046	17047	17048	17049
306	17050	17051	17052	17054	17055	17056	17057	17058	17059
307	17060	17061	17062	17064	17065	17066	17067	17068	17069
308	17070	17071	17072	17074	17075	17076	17077	17078	17079
309	17080	17081	17082	17084	17085	17086	17087	17088	17089
310	17090	17091	17092	17094	17095	17096	17097	17098	17099
311	17100	17101	17102	17104	17105	17106	17107	17108	17109
312	17110	17111	17112	17114	17115	17116	17117	17118	17119
313	17120	17121	17122	17124	17125	17126	17127	17128	17129
314	17130	17131	17132	17134	17135	17136	17137	17138	17139
315	17140	17141	17142	17144	17145	17146	17147	17148	17149
316	17150	17151	17152	17154	17155	17156	17157	17158	17159
317	17160	17161	17162	17164	17165	17166	17167	17168	17169
318	17170	17171	17172	17174	17175	17176	17177	17178	17179
319	17180	17181	17182	17184	17185	17186	17187	17188	17189
320	17190	17191	17192	17194	17195	17196	17197	17198	17199
321	17200	17201	17202	17204	17205	17206	17207	17208	17209
322	17210	17211	17212	17214	17215	17216	17217	17218	17219
323	17220	17221	17222	17224	17225	17226	17227	17228	17229
324	17230	17231	17232	17234	17235	17236	17237	17238	17239
325	17240	17241	17242	17244	17245	17246	17247	17248	17249
326	17250	17251	17252	17254	17255	17256	17257	17258	17259
327	17260	17261	17262	17264	17265	17266	17267	17268	17269
328	17270	17271	17272	17274	17275	17276	17277	17278	17279
329	17280	17281	17282	17284	17285	17286	17287	17288	17289
330	17290	17291	17292	17294	17295	17296	17297	17298	17299
331	17300	17301	17302	17304	17305	17306	17307	17308	17309
332	17310	17311	17312	17314	17315	17316	17317	17318	17319
333	17320	17321	17322	17324	17325	17326	17327	17328	17329
334	17330	17331	17332	17334	17335	17336	17337	17338	17339
335	17340	17341	17342	17344	17345	17346	17347	17348	17349
336	17350	17351	17352	17354	17355	17356	17357	17358	17359
337	17360	17361	17362	17364	17365	17366	17367	17368	17369
338	17370	17371	17372	17374	17375	17376	17377	17378	17379
339	17380	17381	17382	17384	17385	17386	17387	17388	17389
340	17390	17391	17392	17394	17395	17396	17397	17398	17399
341	17400	17401	17402	17404	17405	17406	17407	17408	17409
342	17410	17411	17412	17414	17415	17416	17417	17418	17419
343	17420	17421	17422	17424	17425	17426	17427	17428	17429
344	17430	17431	17432	17434	17435	17436	17437	17438	17439
345	17440	17441	17442	17444	17445	17446	17447	17448	17449
346	17450	17451	17452	17454	17455	17456	17457	17458	17459
347	17460	17461	17462	17464	17465	17466	17467	17468	17469
348	17470	17471	17472	17474	17475	17476	17477	17478	17479
349	17480	17481	17482	17484	17485	17486	17487	17488	17489
350	17490	17491	17492	17494	17495	17496	17497	17498	17499

Data No.	Positioning identifier	M code	Dwell time	Command speed		Positioning address		Arc data	
				Low-order	High-order	Low-order	High-order	Low-order	High-order
351	17500	17501	17502	17504	17505	17506	17507	17508	17509
352	17510	17511	17512	17514	17515	17516	17517	17518	17519
353	17520	17521	17522	17524	17525	17526	17527	17528	17529
354	17530	17531	17532	17534	17535	17536	17537	17538	17539
355	17540	17541	17542	17544	17545	17546	17547	17548	17549
356	17550	17551	17552	17554	17555	17556	17557	17558	17559
357	17560	17561	17562	17564	17565	17566	17567	17568	17569
358	17570	17571	17572	17574	17575	17576	17577	17578	17579
359	17580	17581	17582	17584	17585	17586	17587	17588	17589
360	17590	17591	17592	17594	17595	17596	17597	17598	17599
361	17600	17601	17602	17604	17605	17606	17607	17608	17609
362	17610	17611	17612	17614	17615	17616	17617	17618	17619
363	17620	17621	17622	17624	17625	17626	17627	17628	17629
364	17630	17631	17632	17634	17635	17636	17637	17638	17639
365	17640	17641	17642	17644	17645	17646	17647	17648	17649
366	17650	17651	17652	17654	17655	17656	17657	17658	17659
367	17660	17661	17662	17664	17665	17666	17667	17668	17669
368	17670	17671	17672	17674	17675	17676	17677	17678	17679
369	17680	17681	17682	17684	17685	17686	17687	17688	17689
370	17690	17691	17692	17694	17695	17696	17697	17698	17699
371	17700	17701	17702	17704	17705	17706	17707	17708	17709
372	17710	17711	17712	17714	17715	17716	17717	17718	17719
373	17720	17721	17722	17724	17725	17726	17727	17728	17729
374	17730	17731	17732	17734	17735	17736	17737	17738	17739
375	17740	17741	17742	17744	17745	17746	17747	17748	17749
376	17750	17751	17752	17754	17755	17756	17757	17758	17759
377	17760	17761	17762	17764	17765	17766	17767	17768	17769
378	17770	17771	17772	17774	17775	17776	17777	17778	17779
379	17780	17781	17782	17784	17785	17786	17787	17788	17789
380	17790	17791	17792	17794	17795	17796	17797	17798	17799
381	17800	17801	17802	17804	17805	17806	17807	17808	17809
382	17810	17811	17812	17814	17815	17816	17817	17818	17819
383	17820	17821	17822	17824	17825	17826	17827	17828	17829
384	17830	17831	17832	17834	17835	17836	17837	17838	17839
385	17840	17841	17842	17844	17845	17846	17847	17848	17849
386	17850	17851	17852	17854	17855	17856	17857	17858	17859
387	17860	17861	17862	17864	17865	17866	17867	17868	17869
388	17870	17871	17872	17874	17875	17876	17877	17878	17879
389	17880	17881	17882	17884	17885	17886	17887	17888	17889
390	17890	17891	17892	17894	17895	17896	17897	17898	17899
391	17900	17901	17902	17904	17905	17906	17907	17908	17909
392	17910	17911	17912	17914	17915	17916	17917	17918	17919
393	17920	17921	17922	17924	17925	17926	17927	17928	17929
394	17930	17931	17932	17934	17935	17936	17937	17938	17939
395	17940	17941	17942	17944	17945	17946	17947	17948	17949
396	17950	17951	17952	17954	17955	17956	17957	17958	17959
397	17960	17961	17962	17964	17965	17966	17967	17968	17969
398	17970	17971	17972	17974	17975	17976	17977	17978	17979
399	17980	17981	17982	17984	17985	17986	17987	17988	17989
400	17990	17991	17992	17994	17995	17996	17997	17998	17999

(3) For axis 3

Data No.	Positioning identifier	M code	Dwell time	Command speed		Positioning address		Arc data	
				Low-order	High-order	Low-order	High-order	Low-order	High-order
401	18000	18001	18002	18004	18005	18006	18007	18008	18009
402	18010	18011	18012	18014	18015	18016	18017	18018	18019
403	18020	18021	18022	18024	18025	18026	18027	18028	18029
404	18030	18031	18032	18034	18035	18036	18037	18038	18039
405	18040	18041	18042	18044	18045	18046	18047	18048	18049
406	18050	18051	18052	18054	18055	18056	18057	18058	18059
407	18060	18061	18062	18064	18065	18066	18067	18068	18069
408	18070	18071	18072	18074	18075	18076	18077	18078	18079
409	18080	18081	18082	18084	18085	18086	18087	18088	18089
410	18090	18091	18092	18094	18095	18096	18097	18098	18099
411	18100	18101	18102	18104	18105	18106	18107	18108	18109
412	18110	18111	18112	18114	18115	18116	18117	18118	18119
413	18120	18121	18122	18124	18125	18126	18127	18128	18129
414	18130	18131	18132	18134	18135	18136	18137	18138	18139
415	18140	18141	18142	18144	18145	18146	18147	18148	18149
416	18150	18151	18152	18154	18155	18156	18157	18158	18159
417	18160	18161	18162	18164	18165	18166	18167	18168	18169
418	18170	18171	18172	18174	18175	18176	18177	18178	18179
419	18180	18181	18182	18184	18185	18186	18187	18188	18189
420	18190	18191	18192	18194	18195	18196	18197	18198	18199
421	18200	18201	18202	18204	18205	18206	18207	18208	18209
422	18210	18211	18212	18214	18215	18216	18217	18218	18219
423	18220	18221	18222	18224	18225	18226	18227	18228	18229
424	18230	18231	18232	18234	18235	18236	18237	18238	18239
425	18240	18241	18242	18244	18245	18246	18247	18248	18249
426	18250	18251	18252	18254	18255	18256	18257	18258	18259
427	18260	18261	18262	18264	18265	18266	18267	18268	18269
428	18270	18271	18272	18274	18275	18276	18277	18278	18279
429	18280	18281	18282	18284	18285	18286	18287	18288	18289
430	18290	18291	18292	18294	18295	18296	18297	18298	18299
431	18300	18301	18302	18304	18305	18306	18307	18308	18309
432	18310	18311	18312	18314	18315	18316	18317	18318	18319
433	18320	18321	18322	18324	18325	18326	18327	18328	18329
434	18330	18331	18332	18334	18335	18336	18337	18338	18339
435	18340	18341	18342	18344	18345	18346	18347	18348	18349
436	18350	18351	18352	18354	18355	18356	18357	18358	18359
437	18360	18361	18362	18364	18365	18366	18367	18368	18369
438	18370	18371	18372	18374	18375	18376	18377	18378	18379
439	18380	18381	18382	18384	18385	18386	18387	18388	18389
440	18390	18391	18392	18394	18395	18396	18397	18398	18399
441	18400	18401	18402	18404	18405	18406	18407	18408	18409
442	18410	18411	18412	18414	18415	18416	18417	18418	18419
443	18420	18421	18422	18424	18425	18426	18427	18428	18429
444	18430	18431	18432	18434	18435	18436	18437	18438	18439
445	18440	18441	18442	18444	18445	18446	18447	18448	18449
446	18450	18451	18452	18454	18455	18456	18457	18458	18459
447	18460	18461	18462	18464	18465	18466	18467	18468	18469
448	18470	18471	18472	18474	18475	18476	18477	18478	18479
449	18480	18481	18482	18484	18485	18486	18487	18488	18489
450	18490	18491	18492	18494	18495	18496	18497	18498	18499

Data No.	Positioning identifier	M code	Dwell time	Command speed		Positioning address		Arc data	
				Low-order	High-order	Low-order	High-order	Low-order	High-order
451	18500	18501	18502	18504	18505	18506	18507	18508	18509
452	18510	18511	18512	18514	18515	18516	18517	18518	18519
453	18520	18521	18522	18524	18525	18526	18527	18528	18529
454	18530	18531	18532	18534	18535	18536	18537	18538	18539
455	18540	18541	18542	18544	18545	18546	18547	18548	18549
456	18550	18551	18552	18554	18555	18556	18557	18558	18559
457	18560	18561	18562	18564	18565	18566	18567	18568	18569
458	18570	18571	18572	18574	18575	18576	18577	18578	18579
459	18580	18581	18582	18584	18585	18586	18587	18588	18589
460	18590	18591	18592	18594	18595	18596	18597	18598	18599
461	18600	18601	18602	18604	18605	18606	18607	18608	18609
462	18610	18611	18612	18614	18615	18616	18617	18618	18619
463	18620	18621	18622	18624	18625	18626	18627	18628	18629
464	18630	18631	18632	18634	18635	18636	18637	18638	18639
465	18640	18641	18642	18644	18645	18646	18647	18648	18649
466	18650	18651	18652	18654	18655	18656	18657	18658	18659
467	18660	18661	18662	18664	18665	18666	18667	18668	18669
468	18670	18671	18672	18674	18675	18676	18677	18678	18679
469	18680	18681	18682	18684	18685	18686	18687	18688	18689
470	18690	18691	18692	18694	18695	18696	18697	18698	18699
471	18700	18701	18702	18704	18705	18706	18707	18708	18709
472	18710	18711	18712	18714	18715	18716	18717	18718	18719
473	18720	18721	18722	18724	18725	18726	18727	18728	18729
474	18730	18731	18732	18734	18735	18736	18737	18738	18739
475	18740	18741	18742	18744	18745	18746	18747	18748	18749
476	18750	18751	18752	18754	18755	18756	18757	18758	18759
477	18760	18761	18762	18764	18765	18766	18767	18768	18769
478	18770	18771	18772	18774	18775	18776	18777	18778	18779
479	18780	18781	18782	18784	18785	18786	18787	18788	18789
480	18790	18791	18792	18794	18795	18796	18797	18798	18799
481	18800	18801	18802	18804	18805	18806	18807	18808	18809
482	18810	18811	18812	18814	18815	18816	18817	18818	18819
483	18820	18821	18822	18824	18825	18826	18827	18828	18829
484	18830	18831	18832	18834	18835	18836	18837	18838	18839
485	18840	18841	18842	18844	18845	18846	18847	18848	18849
486	18850	18851	18852	18854	18855	18856	18857	18858	18859
487	18860	18861	18862	18864	18865	18866	18867	18868	18869
488	18870	18871	18872	18874	18875	18876	18877	18878	18879
489	18880	18881	18882	18884	18885	18886	18887	18888	18889
490	18890	18891	18892	18894	18895	18896	18897	18898	18899
491	18900	18901	18902	18904	18905	18906	18907	18908	18909
492	18910	18911	18912	18914	18915	18916	18917	18918	18919
493	18920	18921	18922	18924	18925	18926	18927	18928	18929
494	18930	18931	18932	18934	18935	18936	18937	18938	18939
495	18940	18941	18942	18944	18945	18946	18947	18948	18949
496	18950	18951	18952	18954	18955	18956	18957	18958	18959
497	18960	18961	18962	18964	18965	18966	18967	18968	18969
498	18970	18971	18972	18974	18975	18976	18977	18978	18979
499	18980	18981	18982	18984	18985	18986	18987	18988	18989
500	18990	18991	18992	18994	18995	18996	18997	18998	18999

(3) For axis 3

Data No.	Positioning identifier	M code	Dwell time	Command speed		Positioning address		Arc data	
				Low-order	High-order	Low-order	High-order	Low-order	High-order
501	19000	19001	19002	19004	19005	19006	19007	19008	19009
502	19010	19011	19012	19014	19015	19016	19017	19018	19019
503	19020	19021	19022	19024	19025	19026	19027	19028	19029
504	19030	19031	19032	19034	19035	19036	19037	19038	19039
505	19040	19041	19042	19044	19045	19046	19047	19048	19049
506	19050	19051	19052	19054	19055	19056	19057	19058	19059
507	19060	19061	19062	19064	19065	19066	19067	19068	19069
508	19070	19071	19072	19074	19075	19076	19077	19078	19079
509	19080	19081	19082	19084	19085	19086	19087	19088	19089
510	19090	19091	19092	19094	19095	19096	19097	19098	19099
511	19100	19101	19102	19104	19105	19106	19107	19108	19109
512	19110	19111	19112	19114	19115	19116	19117	19118	19119
513	19120	19121	19122	19124	19125	19126	19127	19128	19129
514	19130	19131	19132	19134	19135	19136	19137	19138	19139
515	19140	19141	19142	19144	19145	19146	19147	19148	19149
516	19150	19151	19152	19154	19155	19156	19157	19158	19159
517	19160	19161	19162	19164	19165	19166	19167	19168	19169
518	19170	19171	19172	19174	19175	19176	19177	19178	19179
519	19180	19181	19182	19184	19185	19186	19187	19188	19189
520	19190	19191	19192	19194	19195	19196	19197	19198	19199
521	19200	19201	19202	19204	19205	19206	19207	19208	19209
522	19210	19211	19212	19214	19215	19216	19217	19218	19219
523	19220	19221	19222	19224	19225	19226	19227	19228	19229
524	19230	19231	19232	19234	19235	19236	19237	19238	19239
525	19240	19241	19242	19244	19245	19246	19247	19248	19249
526	19250	19251	19252	19254	19255	19256	19257	19258	19259
527	19260	19261	19262	19264	19265	19266	19267	19268	19269
528	19270	19271	19272	19274	19275	19276	19277	19278	19279
529	19280	19281	19282	19284	19285	19286	19287	19288	19289
530	19290	19291	19292	19294	19295	19296	19297	19298	19299
531	19300	19301	19302	19304	19305	19306	19307	19308	19309
532	19310	19311	19312	19314	19315	19316	19317	19318	19319
533	19320	19321	19322	19324	19325	19326	19327	19328	19329
534	19330	19331	19332	19334	19335	19336	19337	19338	19339
535	19340	19341	19342	19344	19345	19346	19347	19348	19349
536	19350	19351	19352	19354	19355	19356	19357	19358	19359
537	19360	19361	19362	19364	19365	19366	19367	19368	19369
538	19370	19371	19372	19374	19375	19376	19377	19378	19379
539	19380	19381	19382	19384	19385	19386	19387	19388	19389
540	19390	19391	19392	19394	19395	19396	19397	19398	19399
541	19400	19401	19402	19404	19405	19406	19407	19408	19409
542	19410	19411	19412	19414	19415	19416	19417	19418	19419
543	19420	19421	19422	19424	19425	19426	19427	19428	19429
544	19430	19431	19432	19434	19435	19436	19437	19438	19439
545	19440	19441	19442	19444	19445	19446	19447	19448	19449
546	19450	19451	19452	19454	19455	19456	19457	19458	19459
547	19460	19461	19462	19464	19465	19466	19467	19468	19469
548	19470	19471	19472	19474	19475	19476	19477	19478	19479
549	19480	19481	19482	19484	19485	19486	19487	19488	19489
550	19490	19491	19492	19494	19495	19496	19497	19498	19499

Data No.	Positioning identifier	M code	Dwell time	Command speed		Positioning address		Arc data	
				Low-order	High-order	Low-order	High-order	Low-order	High-order
551	19500	19501	19502	19504	19505	19506	19507	19508	19509
552	19510	19511	19512	19514	19515	19516	19517	19518	19519
553	19520	19521	19522	19524	19525	19526	19527	19528	19529
554	19530	19531	19532	19534	19535	19536	19537	19538	19539
555	19540	19541	19542	19544	19545	19546	19547	19548	19549
556	19550	19551	19552	19554	19555	19556	19557	19558	19559
557	19560	19561	19562	19564	19565	19566	19567	19568	19569
558	19570	19571	19572	19574	19575	19576	19577	19578	19579
559	19580	19581	19582	19584	19585	19586	19587	19588	19589
560	19590	19591	19592	19594	19595	19596	19597	19598	19599
561	19600	19601	19602	19604	19605	19606	19607	19608	19609
562	19610	19611	19612	19614	19615	19616	19617	19618	19619
563	19620	19621	19622	19624	19625	19626	19627	19628	19629
564	19630	19631	19632	19634	19635	19636	19637	19638	19639
565	19640	19641	19642	19644	19645	19646	19647	19648	19649
566	19650	19651	19652	19654	19655	19656	19657	19658	19659
567	19660	19661	19662	19664	19665	19666	19667	19668	19669
568	19670	19671	19672	19674	19675	19676	19677	19678	19679
569	19680	19681	19682	19684	19685	19686	19687	19688	19689
570	19690	19691	19692	19694	19695	19696	19697	19698	19699
571	19700	19701	19702	19704	19705	19706	19707	19708	19709
572	19710	19711	19712	19714	19715	19716	19717	19718	19719
573	19720	19721	19722	19724	19725	19726	19727	19728	19729
574	19730	19731	19732	19734	19735	19736	19737	19738	19739
575	19740	19741	19742	19744	19745	19746	19747	19748	19749
576	19750	19751	19752	19754	19755	19756	19757	19758	19759
577	19760	19761	19762	19764	19765	19766	19767	19768	19769
578	19770	19771	19772	19774	19775	19776	19777	19778	19779
579	19780	19781	19782	19784	19785	19786	19787	19788	19789
580	19790	19791	19792	19794	19795	19796	19797	19798	19799
581	19800	19801	19802	19804	19805	19806	19807	19808	19809
582	19810	19811	19812	19814	19815	19816	19817	19818	19819
583	19820	19821	19822	19824	19825	19826	19827	19828	19829
584	19830	19831	19832	19834	19835	19836	19837	19838	19839
585	19840	19841	19842	19844	19845	19846	19847	19848	19849
586	19850	19851	19852	19854	19855	19856	19857	19858	19859
587	19860	19861	19862	19864	19865	19866	19867	19868	19869
588	19870	19871	19872	19874	19875	19876	19877	19878	19879
589	19880	19881	19882	19884	19885	19886	19887	19888	19889
590	19890	19891	19892	19894	19895	19896	19897	19898	19899
591	19900	19901	19902	19904	19905	19906	19907	19908	19909
592	19910	19911	19912	19914	19915	19916	19917	19918	19919
593	19920	19921	19922	19924	19925	19926	19927	19928	19929
594	19930	19931	19932	19934	19935	19936	19937	19938	19939
595	19940	19941	19942	19944	19945	19946	19947	19948	19949
596	19950	19951	19952	19954	19955	19956	19957	19958	19959
597	19960	19961	19962	19964	19965	19966	19967	19968	19969
598	19970	19971	19972	19974	19975	19976	19977	19978	19979
599	19980	19981	19982	19984	19985	19986	19987	19988	19989
600	19990	19991	19992	19994	19995	19996	19997	19998	19999

## (3) For axis 3 (positioning option)

Data No.	Positioning option	Data No.	Positioning option	Data No.	Positioning option	Data No.	Positioning option	Data No.	Positioning option	Data No.	Positioning option
1	14003	51	14503	101	15003	151	15503	201	16003	251	16503
2	14013	52	14513	102	15013	152	15513	202	16013	252	16513
3	14023	53	14523	103	15023	153	15523	203	16023	253	16523
4	14033	54	14533	104	15033	154	15533	204	16033	254	16533
5	14043	55	14543	105	15043	155	15543	205	16043	255	16543
6	14053	56	14553	106	15053	156	15553	206	16053	256	16553
7	14063	57	14563	107	15063	157	15563	207	16063	257	16563
8	14073	58	14573	108	15073	158	15573	208	16073	258	16573
9	14083	59	14583	109	15083	159	15583	209	16083	259	16583
10	14093	60	14593	110	15093	160	15593	210	16093	260	16593
11	14103	61	14603	111	15103	161	15603	211	16103	261	16603
12	14113	62	14613	112	15113	162	15613	212	16113	262	16613
13	14123	63	14623	113	15123	163	15623	213	16123	263	16623
14	14133	64	14633	114	15133	164	15633	214	16133	264	16633
15	14143	65	14643	115	15143	165	15643	215	16143	265	16643
16	14153	66	14653	116	15153	166	15653	216	16153	266	16653
17	14163	67	14663	117	15163	167	15663	217	16163	267	16663
18	14173	68	14673	118	15173	168	15673	218	16173	268	16673
19	14183	69	14683	119	15183	169	15683	219	16183	269	16683
20	14193	70	14693	120	15193	170	15693	220	16193	270	16693
21	14203	71	14703	121	15203	171	15703	221	16203	271	16703
22	14213	72	14713	122	15213	172	15713	222	16213	272	16713
23	14223	73	14723	123	15223	173	15723	223	16223	273	16723
24	14233	74	14733	124	15233	174	15733	224	16233	274	16733
25	14243	75	14743	125	15243	175	15743	225	16243	275	16743
26	14253	76	14753	126	15253	176	15753	226	16253	276	16753
27	14263	77	14763	127	15263	177	15763	227	16263	277	16763
28	14273	78	14773	128	15273	178	15773	228	16273	278	16773
29	14283	79	14783	129	15283	179	15783	229	16283	279	16783
30	14293	80	14793	130	15293	180	15793	230	16293	280	16793
31	14303	81	14803	131	15303	181	15803	231	16303	281	16803
32	14313	82	14813	132	15313	182	15813	232	16313	282	16813
33	14323	83	14823	133	15323	183	15823	233	16323	283	16823
34	14333	84	14833	134	15333	184	15833	234	16333	284	16833
35	14343	85	14843	135	15343	185	15843	235	16343	285	16843
36	14353	86	14853	136	15353	186	15853	236	16353	286	16853
37	14363	87	14863	137	15363	187	15863	237	16363	287	16863
38	14373	88	14873	138	15373	188	15873	238	16373	288	16873
39	14383	89	14883	139	15383	189	15883	239	16383	289	16883
40	14393	90	14893	140	15393	190	15893	240	16393	290	16893
41	14403	91	14903	141	15403	191	15903	241	16403	291	16903
42	14413	92	14913	142	15413	192	15913	242	16413	292	16913
43	14423	93	14923	143	15423	193	15923	243	16423	293	16923
44	14433	94	14933	144	15433	194	15933	244	16433	294	16933
45	14443	95	14943	145	15443	195	15943	245	16443	295	16943
46	14453	96	14953	146	15453	196	15953	246	16453	296	16953
47	14463	97	14963	147	15463	197	15963	247	16463	297	16963
48	14473	98	14973	148	15473	198	15973	248	16473	298	16973
49	14483	99	14983	149	15483	199	15983	249	16483	299	16983
50	14493	100	14993	150	15493	200	15993	250	16493	300	16993

## (3) For axis 3 (positioning option)

Data No.	Positioning option	Data No.	Positioning option	Data No.	Positioning option	Data No.	Positioning option	Data No.	Positioning option	Data No.	Positioning option
301	17003	351	17503	401	18003	451	18503	501	19003	551	19503
302	17013	352	17513	402	18013	452	18513	502	19013	552	19513
303	17023	353	17523	403	18023	453	18523	503	19023	553	19523
304	17033	354	17533	404	18033	454	18533	504	19033	554	19533
305	17043	355	17543	405	18043	455	18543	505	19043	555	19543
306	17053	356	17553	406	18053	456	18553	506	19053	556	19553
307	17063	357	17563	407	18063	457	18563	507	19063	557	19563
308	17073	358	17573	408	18073	458	18573	508	19073	558	19573
309	17083	359	17583	409	18083	459	18583	509	19083	559	19583
310	17093	360	17593	410	18093	460	18593	510	19093	560	19593
311	17103	361	17603	411	18103	461	18603	511	19103	561	19603
312	17113	362	17613	412	18113	462	18613	512	19113	562	19613
313	17123	363	17623	413	18123	463	18623	513	19123	563	19623
314	17133	364	17633	414	18133	464	18633	514	19133	564	19633
315	17143	365	17643	415	18143	465	18643	515	19143	565	19643
316	17153	366	17653	416	18153	466	18653	516	19153	566	19653
317	17163	367	17663	417	18163	467	18663	517	19163	567	19663
318	17173	368	17673	418	18173	468	18673	518	19173	568	19673
319	17183	369	17683	419	18183	469	18683	519	19183	569	19683
320	17193	370	17693	420	18193	470	18693	520	19193	570	19693
321	17203	371	17703	421	18203	471	18703	521	19203	571	19703
322	17213	372	17713	422	18213	472	18713	522	19213	572	19713
323	17223	373	17723	423	18223	473	18723	523	19223	573	19723
324	17233	374	17733	424	18233	474	18733	524	19233	574	19733
325	17243	375	17743	425	18243	475	18743	525	19243	575	19743
326	17253	376	17753	426	18253	476	18753	526	19253	576	19753
327	17263	377	17763	427	18263	477	18763	527	19263	577	19763
328	17273	378	17773	428	18273	478	18773	528	19273	578	19773
329	17283	379	17783	429	18283	479	18783	529	19283	579	19783
330	17293	380	17793	430	18293	480	18793	530	19293	580	19793
331	17303	381	17803	431	18303	481	18803	531	19303	581	19803
332	17313	382	17813	432	18313	482	18813	532	19313	582	19813
333	17323	383	17823	433	18323	483	18823	533	19323	583	19823
334	17333	384	17833	434	18333	484	18833	534	19333	584	19833
335	17343	385	17843	435	18343	485	18843	535	19343	585	19843
336	17353	386	17853	436	18353	486	18853	536	19353	586	19853
337	17363	387	17863	437	18363	487	18863	537	19363	587	19863
338	17373	388	17873	438	18373	488	18873	538	19373	588	19873
339	17383	389	17883	439	18383	489	18883	539	19383	589	19883
340	17393	390	17893	440	18393	490	18893	540	19393	590	19893
341	17403	391	17903	441	18403	491	18903	541	19403	591	19903
342	17413	392	17913	442	18413	492	18913	542	19413	592	19913
343	17423	393	17923	443	18423	493	18923	543	19423	593	19923
344	17433	394	17933	444	18433	494	18933	544	19433	594	19933
345	17443	395	17943	445	18443	495	18943	545	19443	595	19943
346	17453	396	17953	446	18453	496	18953	546	19453	596	19953
347	17463	397	17963	447	18463	497	18963	547	19463	597	19963
348	17473	398	17973	448	18473	498	18973	548	19473	598	19973
349	17483	399	17983	449	18483	499	18983	549	19483	599	19983
350	17493	400	17993	450	18493	500	18993	550	19493	600	19993

(4) For axis 4

Data No.	Positioning identifier	M code	Dwell time	Command speed		Positioning address		Arc data	
				Low-order	High-order	Low-order	High-order	Low-order	High-order
1	20000	20001	20002	20004	20005	20006	20007	20008	20009
2	20010	20011	20012	20014	20015	20016	20017	20018	20019
3	20020	20021	20022	20024	20025	20026	20027	20028	20029
4	20030	20031	20032	20034	20035	20036	20037	20038	20039
5	20040	20041	20042	20044	20045	20046	20047	20048	20049
6	20050	20051	20052	20054	20055	20056	20057	20058	20059
7	20060	20061	20062	20064	20065	20066	20067	20068	20069
8	20070	20071	20072	20074	20075	20076	20077	20078	20079
9	20080	20081	20082	20084	20085	20086	20087	20088	20089
10	20090	20091	20092	20094	20095	20096	20097	20098	20099
11	20100	20101	20102	20104	20105	20106	20107	20108	20109
12	20110	20111	20112	20114	20115	20116	20117	20118	20119
13	20120	20121	20122	20124	20125	20126	20127	20128	20129
14	20130	20131	20132	20134	20135	20136	20137	20138	20139
15	20140	20141	20142	20144	20145	20146	20147	20148	20149
16	20150	20151	20152	20154	20155	20156	20157	20158	20159
17	20160	20161	20162	20164	20165	20166	20167	20168	20169
18	20170	20171	20172	20174	20175	20176	20177	20178	20179
19	20180	20181	20182	20184	20185	20186	20187	20188	20189
20	20190	20191	20192	20194	20195	20196	20197	20198	20199
21	20200	20201	20202	20204	20205	20206	20207	20208	20209
22	20210	20211	20212	20214	20215	20216	20217	20218	20219
23	20220	20221	20222	20224	20225	20226	20227	20228	20229
24	20230	20231	20232	20234	20235	20236	20237	20238	20239
25	20240	20241	20242	20244	20245	20246	20247	20248	20249
26	20250	20251	20252	20254	20255	20256	20257	20258	20259
27	20260	20261	20262	20264	20265	20266	20267	20268	20269
28	20270	20271	20272	20274	20275	20276	20277	20278	20279
29	20280	20281	20282	20284	20285	20286	20287	20288	20289
30	20290	20291	20292	20294	20295	20296	20297	20298	20299
31	20300	20301	20302	20304	20305	20306	20307	20308	20309
32	20310	20311	20312	20314	20315	20316	20317	20318	20319
33	20320	20321	20322	20324	20325	20326	20327	20328	20329
34	20330	20331	20332	20334	20335	20336	20337	20338	20339
35	20340	20341	20342	20344	20345	20346	20347	20348	20349
36	20350	20351	20352	20354	20355	20356	20357	20358	20359
37	20360	20361	20362	20364	20365	20366	20367	20368	20369
38	20370	20371	20372	20374	20375	20376	20377	20378	20379
39	20380	20381	20382	20384	20385	20386	20387	20388	20389
40	20390	20391	20392	20394	20395	20396	20397	20398	20399
41	20400	20401	20402	20404	20405	20406	20407	20408	20409
42	20410	20411	20412	20414	20415	20416	20417	20418	20419
43	20420	20421	20422	20424	20425	20426	20427	20428	20429
44	20430	20431	20432	20434	20435	20436	20437	20438	20439
45	20440	20441	20442	20444	20445	20446	20447	20448	20449
46	20450	20451	20452	20454	20455	20456	20457	20458	20459
47	20460	20461	20462	20464	20465	20466	20467	20468	20469
48	20470	20471	20472	20474	20475	20476	20477	20478	20479
49	20480	20481	20482	20484	20485	20486	20487	20488	20489
50	20490	20491	20492	20494	20495	20496	20497	20498	20499

Data No.	Positioning identifier	M code	Dwell time	Command speed		Positioning address		Arc data	
				Low-order	High-order	Low-order	High-order	Low-order	High-order
51	20500	20501	20502	20504	20505	20506	20507	20508	20509
52	20510	20511	20512	20514	20515	20516	20517	20518	20519
53	20520	20521	20522	20524	20525	20526	20527	20528	20529
54	20530	20531	20532	20534	20535	20536	20537	20538	20539
55	20540	20541	20542	20544	20545	20546	20547	20548	20549
56	20550	20551	20552	20554	20555	20556	20557	20558	20559
57	20560	20561	20562	20564	20565	20566	20567	20568	20569
58	20570	20571	20572	20574	20575	20576	20577	20578	20579
59	20580	20581	20582	20584	20585	20586	20587	20588	20589
60	20590	20591	20592	20594	20595	20596	20597	20598	20599
61	20600	20601	20602	20604	20605	20606	20607	20608	20609
62	20610	20611	20612	20614	20615	20616	20617	20618	20619
63	20620	20621	20622	20624	20625	20626	20627	20628	20629
64	20630	20631	20632	20634	20635	20636	20637	20638	20639
65	20640	20641	20642	20644	20645	20646	20647	20648	20649
66	20650	20651	20652	20654	20655	20656	20657	20658	20659
67	20660	20661	20662	20664	20665	20666	20667	20668	20669
68	20670	20671	20672	20674	20675	20676	20677	20678	20679
69	20680	20681	20682	20684	20685	20686	20687	20688	20689
70	20690	20691	20692	20694	20695	20696	20697	20698	20699
71	20700	20701	20702	20704	20705	20706	20707	20708	20709
72	20710	20711	20712	20714	20715	20716	20717	20718	20719
73	20720	20721	20722	20724	20725	20726	20727	20728	20729
74	20730	20731	20732	20734	20735	20736	20737	20738	20739
75	20740	20741	20742	20744	20745	20746	20747	20748	20749
76	20750	20751	20752	20754	20755	20756	20757	20758	20759
77	20760	20761	20762	20764	20765	20766	20767	20768	20769
78	20770	20771	20772	20774	20775	20776	20777	20778	20779
79	20780	20781	20782	20784	20785	20786	20787	20788	20789
80	20790	20791	20792	20794	20795	20796	20797	20798	20799
81	20800	20801	20802	20804	20805	20806	20807	20808	20809
82	20810	20811	20812	20814	20815	20816	20817	20818	20819
83	20820	20821	20822	20824	20825	20826	20827	20828	20829
84	20830	20831	20832	20834	20835	20836	20837	20838	20839
85	20840	20841	20842	20844	20845	20846	20847	20848	20849
86	20850	20851	20852	20854	20855	20856	20857	20858	20859
87	20860	20861	20862	20864	20865	20866	20867	20868	20869
88	20870	20871	20872	20874	20875	20876	20877	20878	20879
89	20880	20881	20882	20884	20885	20886	20887	20888	20889
90	20890	20891	20892	20894	20895	20896	20897	20898	20899
91	20900	20901	20902	20904	20905	20906	20907	20908	20909
92	20910	20911	20912	20914	20915	20916	20917	20918	20919
93	20920	20921	20922	20924	20925	20926	20927	20928	20929
94	20930	20931	20932	20934	20935	20936	20937	20938	20939
95	20940	20941	20942	20944	20945	20946	20947	20948	20949
96	20950	20951	20952	20954	20955	20956	20957	20958	20959
97	20960	20961	20962	20964	20965	20966	20967	20968	20969
98	20970	20971	20972	20974	20975	20976	20977	20978	20979
99	20980	20981	20982	20984	20985	20986	20987	20988	20989
100	20990	20991	20992	20994	20995	20996	20997	20998	20999



(4) For axis 4

Data No.	Positioning identifier	M code	Dwell time	Command speed		Positioning address		Arc data	
				Low-order	High-order	Low-order	High-order	Low-order	High-order
101	21000	21001	21002	21004	21005	21006	21007	21008	21009
102	21010	21011	21012	21014	21015	21016	21017	21018	21019
103	21020	21021	21022	21024	21025	21026	21027	21028	21029
104	21030	21031	21032	21034	21035	21036	21037	21038	21039
105	21040	21041	21042	21044	21045	21046	21047	21048	21049
106	21050	21051	21052	21054	21055	21056	21057	21058	21059
107	21060	21061	21062	21064	21065	21066	21067	21068	21069
108	21070	21071	21072	21074	21075	21076	21077	21078	21079
109	21080	21081	21082	21084	21085	21086	21087	21088	21089
110	21090	21091	21092	21094	21095	21096	21097	21098	21099
111	21100	21101	21102	21104	21105	21106	21107	21108	21109
112	21110	21111	21112	21114	21115	21116	21117	21118	21119
113	21120	21121	21122	21124	21125	21126	21127	21128	21129
114	21130	21131	21132	21134	21135	21136	21137	21138	21139
115	21140	21141	21142	21144	21145	21146	21147	21148	21149
116	21150	21151	21152	21154	21155	21156	21157	21158	21159
117	21160	21161	21162	21164	21165	21166	21167	21168	21169
118	21170	21171	21172	21174	21175	21176	21177	21178	21179
119	21180	21181	21182	21184	21185	21186	21187	21188	21189
120	21190	21191	21192	21194	21195	21196	21197	21198	21199
121	21200	21201	21202	21204	21205	21206	21207	21208	21209
122	21210	21211	21212	21214	21215	21216	21217	21218	21219
123	21220	21221	21222	21224	21225	21226	21227	21228	21229
124	21230	21231	21232	21234	21235	21236	21237	21238	21239
125	21240	21241	21242	21244	21245	21246	21247	21248	21249
126	21250	21251	21252	21254	21255	21256	21257	21258	21259
127	21260	21261	21262	21264	21265	21266	21267	21268	21269
128	21270	21271	21272	21274	21275	21276	21277	21278	21279
129	21280	21281	21282	21284	21285	21286	21287	21288	21289
130	21290	21291	21292	21294	21295	21296	21297	21298	21299
131	21300	21301	21302	21304	21305	21306	21307	21308	21309
132	21310	21311	21312	21314	21315	21316	21317	21318	21319
133	21320	21321	21322	21324	21325	21326	21327	21328	21329
134	21330	21331	21332	21334	21335	21336	21337	21338	21339
135	21340	21341	21342	21344	21345	21346	21347	21348	21349
136	21350	21351	21352	21354	21355	21356	21357	21358	21359
137	21360	21361	21362	21364	21365	21366	21367	21368	21369
138	21370	21371	21372	21374	21375	21376	21377	21378	21379
139	21380	21381	21382	21384	21385	21386	21387	21388	21389
140	21390	21391	21392	21394	21395	21396	21397	21398	21399
141	21400	21401	21402	21404	21405	21406	21407	21408	21409
142	21410	21411	21412	21414	21415	21416	21417	21418	21419
143	21420	21421	21422	21424	21425	21426	21427	21428	21429
144	21430	21431	21432	21434	21435	21436	21437	21438	21439
145	21440	21441	21442	21444	21445	21446	21447	21448	21449
146	21450	21451	21452	21454	21455	21456	21457	21458	21459
147	21460	21461	21462	21464	21465	21466	21467	21468	21469
148	21470	21471	21472	21474	21475	21476	21477	21478	21479
149	21480	21481	21482	21484	21485	21486	21487	21488	21489
150	21490	21491	21492	21494	21495	21496	21497	21498	21499

Data No.	Positioning identifier	M code	Dwell time	Command speed		Positioning address		Arc data	
				Low-order	High-order	Low-order	High-order	Low-order	High-order
151	21500	21501	21502	21504	21505	21506	21507	21508	21509
152	21510	21511	21512	21514	21515	21516	21517	21518	21519
153	21520	21521	21522	21524	21525	21526	21527	21528	21529
154	21530	21531	21532	21534	21535	21536	21537	21538	21539
155	21540	21541	21542	21544	21545	21546	21547	21548	21549
156	21550	21551	21552	21554	21555	21556	21557	21558	21559
157	21560	21561	21562	21564	21565	21566	21567	21568	21569
158	21570	21571	21572	21574	21575	21576	21577	21578	21579
159	21580	21581	21582	21584	21585	21586	21587	21588	21589
160	21590	21591	21592	21594	21595	21596	21597	21598	21599
161	21600	21601	21602	21604	21605	21606	21607	21608	21609
162	21610	21611	21612	21614	21615	21616	21617	21618	21619
163	21620	21621	21622	21624	21625	21626	21627	21628	21629
164	21630	21631	21632	21634	21635	21636	21637	21638	21639
165	21640	21641	21642	21644	21645	21646	21647	21648	21649
166	21650	21651	21652	21654	21655	21656	21657	21658	21659
167	21660	21661	21662	21664	21665	21666	21667	21668	21669
168	21670	21671	21672	21674	21675	21676	21677	21678	21679
169	21680	21681	21682	21684	21685	21686	21687	21688	21689
170	21690	21691	21692	21694	21695	21696	21697	21698	21699
171	21700	21701	21702	21704	21705	21706	21707	21708	21709
172	21710	21711	21712	21714	21715	21716	21717	21718	21719
173	21720	21721	21722	21724	21725	21726	21727	21728	21729
174	21730	21731	21732	21734	21735	21736	21737	21738	21739
175	21740	21741	21742	21744	21745	21746	21747	21748	21749
176	21750	21751	21752	21754	21755	21756	21757	21758	21759
177	21760	21761	21762	21764	21765	21766	21767	21768	21769
178	21770	21771	21772	21774	21775	21776	21777	21778	21779
179	21780	21781	21782	21784	21785	21786	21787	21788	21789
180	21790	21791	21792	21794	21795	21796	21797	21798	21799
181	21800	21801	21802	21804	21805	21806	21807	21808	21809
182	21810	21811	21812	21814	21815	21816	21817	21818	21819
183	21820	21821	21822	21824	21825	21826	21827	21828	21829
184	21830	21831	21832	21834	21835	21836	21837	21838	21839
185	21840	21841	21842	21844	21845	21846	21847	21848	21849
186	21850	21851	21852	21854	21855	21856	21857	21858	21859
187	21860	21861	21862	21864	21865	21866	21867	21868	21869
188	21870	21871	21872	21874	21875	21876	21877	21878	21879
189	21880	21881	21882	21884	21885	21886	21887	21888	21889
190	21890	21891	21892	21894	21895	21896	21897	21898	21899
191	21900	21901	21902	21904	21905	21906	21907	21908	21909
192	21910	21911	21912	21914	21915	21916	21917	21918	21919
193	21920	21921	21922	21924	21925	21926	21927	21928	21929
194	21930	21931	21932	21934	21935	21936	21937	21938	21939
195	21940	21941	21942	21944	21945	21946	21947	21948	21949
196	21950	21951	21952	21954	21955	21956	21957	21958	21959
197	21960	21961	21962	21964	21965	21966	21967	21968	21969
198	21970	21971	21972	21974	21975	21976	21977	21978	21979
199	21980	21981	21982	21984	21985	21986	21987	21988	21989
200	21990	21991	21992	21994	21995	21996	21997	21998	21999

(4) For axis 4

Data No.	Positioning identifier	M code	Dwell time	Command speed		Positioning address		Arc data	
				Low-order	High-order	Low-order	High-order	Low-order	High-order
201	22000	22001	22002	22004	22005	22006	22007	22008	22009
202	22010	22011	22012	22014	22015	22016	22017	22018	22019
203	22020	22021	22022	22024	22025	22026	22027	22028	22029
204	22030	22031	22032	22034	22035	22036	22037	22038	22039
205	22040	22041	22042	22044	22045	22046	22047	22048	22049
206	22050	22051	22052	22054	22055	22056	22057	22058	22059
207	22060	22061	22062	22064	22065	22066	22067	22068	22069
208	22070	22071	22072	22074	22075	22076	22077	22078	22079
209	22080	22081	22082	22084	22085	22086	22087	22088	22089
210	22090	22091	22092	22094	22095	22096	22097	22098	22099
211	22100	22101	22102	22104	22105	22106	22107	22108	22109
212	22110	22111	22112	22114	22115	22116	22117	22118	22119
213	22120	22121	22122	22124	22125	22126	22127	22128	22129
214	22130	22131	22132	22134	22135	22136	22137	22138	22139
215	22140	22141	22142	22144	22145	22146	22147	22148	22149
216	22150	22151	22152	22154	22155	22156	22157	22158	22159
217	22160	22161	22162	22164	22165	22166	22167	22168	22169
218	22170	22171	22172	22174	22175	22176	22177	22178	22179
219	22180	22181	22182	22184	22185	22186	22187	22188	22189
220	22190	22191	22192	22194	22195	22196	22197	22198	22199
221	22200	22201	22202	22204	22205	22206	22207	22208	22209
222	22210	22211	22212	22214	22215	22216	22217	22218	22219
223	22220	22221	22222	22224	22225	22226	22227	22228	22229
224	22230	22231	22232	22234	22235	22236	22237	22238	22239
225	22240	22241	22242	22244	22245	22246	22247	22248	22249
226	22250	22251	22252	22254	22255	22256	22257	22258	22259
227	22260	22261	22262	22264	22265	22266	22267	22268	22269
228	22270	22271	22272	22274	22275	22276	22277	22278	22279
229	22280	22281	22282	22284	22285	22286	22287	22288	22289
230	22290	22291	22292	22294	22295	22296	22297	22298	22299
231	22300	22301	22302	22304	22305	22306	22307	22308	22309
232	22310	22311	22312	22314	22315	22316	22317	22318	22319
233	22320	22321	22322	22324	22325	22326	22327	22328	22329
234	22330	22331	22332	22334	22335	22336	22337	22338	22339
235	22340	22341	22342	22344	22345	22346	22347	22348	22349
236	22350	22351	22352	22354	22355	22356	22357	22358	22359
237	22360	22361	22362	22364	22365	22366	22367	22368	22369
238	22370	22371	22372	22374	22375	22376	22377	22378	22379
239	22380	22381	22382	22384	22385	22386	22387	22388	22389
240	22390	22391	22392	22394	22395	22396	22397	22398	22399
241	22400	22401	22402	22404	22405	22406	22407	22408	22409
242	22410	22411	22412	22414	22415	22416	22417	22418	22419
243	22420	22421	22422	22424	22425	22426	22427	22428	22429
244	22430	22431	22432	22434	22435	22436	22437	22438	22439
245	22440	22441	22442	22444	22445	22446	22447	22448	22449
246	22450	22451	22452	22454	22455	22456	22457	22458	22459
247	22460	22461	22462	22464	22465	22466	22467	22468	22469
248	22470	22471	22472	22474	22475	22476	22477	22478	22479
249	22480	22481	22482	22484	22485	22486	22487	22488	22489
250	22490	22491	22492	22494	22495	22496	22497	22498	22499

Data No.	Positioning identifier	M code	Dwell time	Command speed		Positioning address		Arc data	
				Low-order	High-order	Low-order	High-order	Low-order	High-order
251	22500	22501	22502	22504	22505	22506	22507	22508	22509
252	22510	22511	22512	22514	22515	22516	22517	22518	22519
253	22520	22521	22522	22524	22525	22526	22527	22528	22529
254	22530	22531	22532	22534	22535	22536	22537	22538	22539
255	22540	22541	22542	22544	22545	22546	22547	22548	22549
256	22550	22551	22552	22554	22555	22556	22557	22558	22559
257	22560	22561	22562	22564	22565	22566	22567	22568	22569
258	22570	22571	22572	22574	22575	22576	22577	22578	22579
259	22580	22581	22582	22584	22585	22586	22587	22588	22589
260	22590	22591	22592	22594	22595	22596	22597	22598	22599
261	22600	22601	22602	22604	22605	22606	22607	22608	22609
262	22610	22611	22612	22614	22615	22616	22617	22618	22619
263	22620	22621	22622	22624	22625	22626	22627	22628	22629
264	22630	22631	22632	22634	22635	22636	22637	22638	22639
265	22640	22641	22642	22644	22645	22646	22647	22648	22649
266	22650	22651	22652	22654	22655	22656	22657	22658	22659
267	22660	22661	22662	22664	22665	22666	22667	22668	22669
268	22670	22671	22672	22674	22675	22676	22677	22678	22679
269	22680	22681	22682	22684	22685	22686	22687	22688	22689
270	22690	22691	22692	22694	22695	22696	22697	22698	22699
271	22700	22701	22702	22704	22705	22706	22707	22708	22709
272	22710	22711	22712	22714	22715	22716	22717	22718	22719
273	22720	22721	22722	22724	22725	22726	22727	22728	22729
274	22730	22731	22732	22734	22735	22736	22737	22738	22739
275	22740	22741	22742	22744	22745	22746	22747	22748	22749
276	22750	22751	22752	22754	22755	22756	22757	22758	22759
277	22760	22761	22762	22764	22765	22766	22767	22768	22769
278	22770	22771	22772	22774	22775	22776	22777	22778	22779
279	22780	22781	22782	22784	22785	22786	22787	22788	22789
280	22790	22791	22792	22794	22795	22796	22797	22798	22799
281	22800	22801	22802	22804	22805	22806	22807	22808	22809
282	22810	22811	22812	22814	22815	22816	22817	22818	22819
283	22820	22821	22822	22824	22825	22826	22827	22828	22829
284	22830	22831	22832	22834	22835	22836	22837	22838	22839
285	22840	22841	22842	22844	22845	22846	22847	22848	22849
286	22850	22851	22852	22854	22855	22856	22857	22858	22859
287	22860	22861	22862	22864	22865	22866	22867	22868	22869
288	22870	22871	22872	22874	22875	22876	22877	22878	22879
289	22880	22881	22882	22884	22885	22886	22887	22888	22889
290	22890	22891	22892	22894	22895	22896	22897	22898	22899
291	22900	22901	22902	22904	22905	22906	22907	22908	22909
292	22910	22911	22912	22914	22915	22916	22917	22918	22919
293	22920	22921	22922	22924	22925	22926	22927	22928	22929
294	22930	22931	22932	22934	22935	22936	22937	22938	22939
295	22940	22941	22942	22944	22945	22946	22947	22948	22949
296	22950	22951	22952	22954	22955	22956	22957	22958	22959
297	22960	22961	22962	22964	22965	22966	22967	22968	22969
298	22970	22971	22972	22974	22975	22976	22977	22978	22979
299	22980	22981	22982	22984	22985	22986	22987	22988	22989
300	22990	22991	22992	22994	22995	22996	22997	22998	22999

(4) For axis 4

Data No.	Positioning identifier	M code	Dwell time	Command speed		Positioning address		Arc data	
				Low-order	High-order	Low-order	High-order	Low-order	High-order
301	23000	23001	23002	23004	23005	23006	23007	23008	23009
302	23010	23011	23012	23014	23015	23016	23017	23018	23019
303	23020	23021	23022	23024	23025	23026	23027	23028	23029
304	23030	23031	23032	23034	23035	23036	23037	23038	23039
305	23040	23041	23042	23044	23045	23046	23047	23048	23049
306	23050	23051	23052	23054	23055	23056	23057	23058	23059
307	23060	23061	23062	23064	23065	23066	23067	23068	23069
308	23070	23071	23072	23074	23075	23076	23077	23078	23079
309	23080	23081	23082	23084	23085	23086	23087	23088	23089
310	23090	23091	23092	23094	23095	23096	23097	23098	23099
311	23100	23101	23102	23104	23105	23106	23107	23108	23109
312	23110	23111	23112	23114	23115	23116	23117	23118	23119
313	23120	23121	23122	23124	23125	23126	23127	23128	23129
314	23130	23131	23132	23134	23135	23136	23137	23138	23139
315	23140	23141	23142	23144	23145	23146	23147	23148	23149
316	23150	23151	23152	23154	23155	23156	23157	23158	23159
317	23160	23161	23162	23164	23165	23166	23167	23168	23169
318	23170	23171	23172	23174	23175	23176	23177	23178	23179
319	23180	23181	23182	23184	23185	23186	23187	23188	23189
320	23190	23191	23192	23194	23195	23196	23197	23198	23199
321	23200	23201	23202	23204	23205	23206	23207	23208	23209
322	23210	23211	23212	23214	23215	23216	23217	23218	23219
323	23220	23221	23222	23224	23225	23226	23227	23228	23229
324	23230	23231	23232	23234	23235	23236	23237	23238	23239
325	23240	23241	23242	23244	23245	23246	23247	23248	23249
326	23250	23251	23252	23254	23255	23256	23257	23258	23259
327	23260	23261	23262	23264	23265	23266	23267	23268	23269
328	23270	23271	23272	23274	23275	23276	23277	23278	23279
329	23280	23281	23282	23284	23285	23286	23287	23288	23289
330	23290	23291	23292	23294	23295	23296	23297	23298	23299
331	23300	23301	23302	23304	23305	23306	23307	23308	23309
332	23310	23311	23312	23314	23315	23316	23317	23318	23319
333	23320	23321	23322	23324	23325	23326	23327	23328	23329
334	23330	23331	23332	23334	23335	23336	23337	23338	23339
335	23340	23341	23342	23344	23345	23346	23347	23348	23349
336	23350	23351	23352	23354	23355	23356	23357	23358	23359
337	23360	23361	23362	23364	23365	23366	23367	23368	23369
338	23370	23371	23372	23374	23375	23376	23377	23378	23379
339	23380	23381	23382	23384	23385	23386	23387	23388	23389
340	23390	23391	23392	23394	23395	23396	23397	23398	23399
341	23400	23401	23402	23404	23405	23406	23407	23408	23409
342	23410	23411	23412	23414	23415	23416	23417	23418	23419
343	23420	23421	23422	23424	23425	23426	23427	23428	23429
344	23430	23431	23432	23434	23435	23436	23437	23438	23439
345	23440	23441	23442	23444	23445	23446	23447	23448	23449
346	23450	23451	23452	23454	23455	23456	23457	23458	23459
347	23460	23461	23462	23464	23465	23466	23467	23468	23469
348	23470	23471	23472	23474	23475	23476	23477	23478	23479
349	23480	23481	23482	23484	23485	23486	23487	23488	23489
350	23490	23491	23492	23494	23495	23496	23497	23498	23499

Data No.	Positioning identifier	M code	Dwell time	Command speed		Positioning address		Arc data	
				Low-order	High-order	Low-order	High-order	Low-order	High-order
351	23500	23501	23502	23504	23505	23506	23507	23508	23509
352	23510	23511	23512	23514	23515	23516	23517	23518	23519
353	23520	23521	23522	23524	23525	23526	23527	23528	23529
354	23530	23531	23532	23534	23535	23536	23537	23538	23539
355	23540	23541	23542	23544	23545	23546	23547	23548	23549
356	23550	23551	23552	23554	23555	23556	23557	23558	23559
357	23560	23561	23562	23564	23565	23566	23567	23568	23569
358	23570	23571	23572	23574	23575	23576	23577	23578	23579
359	23580	23581	23582	23584	23585	23586	23587	23588	23589
360	23590	23591	23592	23594	23595	23596	23597	23598	23599
361	23600	23601	23602	23604	23605	23606	23607	23608	23609
362	23610	23611	23612	23614	23615	23616	23617	23618	23619
363	23620	23621	23622	23624	23625	23626	23627	23628	23629
364	23630	23631	23632	23634	23635	23636	23637	23638	23639
365	23640	23641	23642	23644	23645	23646	23647	23648	23649
366	23650	23651	23652	23654	23655	23656	23657	23658	23659
367	23660	23661	23662	23664	23665	23666	23667	23668	23669
368	23670	23671	23672	23674	23675	23676	23677	23678	23679
369	23680	23681	23682	23684	23685	23686	23687	23688	23689
370	23690	23691	23692	23694	23695	23696	23697	23698	23699
371	23700	23701	23702	23704	23705	23706	23707	23708	23709
372	23710	23711	23712	23714	23715	23716	23717	23718	23719
373	23720	23721	23722	23724	23725	23726	23727	23728	23729
374	23730	23731	23732	23734	23735	23736	23737	23738	23739
375	23740	23741	23742	23744	23745	23746	23747	23748	23749
376	23750	23751	23752	23754	23755	23756	23757	23758	23759
377	23760	23761	23762	23764	23765	23766	23767	23768	23769
378	23770	23771	23772	23774	23775	23776	23777	23778	23779
379	23780	23781	23782	23784	23785	23786	23787	23788	23789
380	23790	23791	23792	23794	23795	23796	23797	23798	23799
381	23800	23801	23802	23804	23805	23806	23807	23808	23809
382	23810	23811	23812	23814	23815	23816	23817	23818	23819
383	23820	23821	23822	23824	23825	23826	23827	23828	23829
384	23830	23831	23832	23834	23835	23836	23837	23838	23839
385	23840	23841	23842	23844	23845	23846	23847	23848	23849
386	23850	23851	23852	23854	23855	23856	23857	23858	23859
387	23860	23861	23862	23864	23865	23866	23867	23868	23869
388	23870	23871	23872	23874	23875	23876	23877	23878	23879
389	23880	23881	23882	23884	23885	23886	23887	23888	23889
390	23890	23891	23892	23894	23895	23896	23897	23898	23899
391	23900	23901	23902	23904	23905	23906	23907	23908	23909
392	23910	23911	23912	23914	23915	23916	23917	23918	23919
393	23920	23921	23922	23924	23925	23926	23927	23928	23929
394	23930	23931	23932	23934	23935	23936	23937	23938	23939
395	23940	23941	23942	23944	23945	23946	23947	23948	23949
396	23950	23951	23952	23954	23955	23956	23957	23958	23959
397	23960	23961	23962	23964	23965	23966	23967	23968	23969
398	23970	23971	23972	23974	23975	23976	23977	23978	23979
399	23980	23981	23982	23984	23985	23986	23987	23988	23989
400	23990	23991	23992	23994	23995	23996	23997	23998	23999

(4) For axis 4

Data No.	Positioning identifier	M code	Dwell time	Command speed		Positioning address		Arc data	
				Low-order	High-order	Low-order	High-order	Low-order	High-order
401	24000	24001	24002	24004	24005	24006	24007	24008	24009
402	24010	24011	24012	24014	24015	24016	24017	24018	24019
403	24020	24021	24022	24024	24025	24026	24027	24028	24029
404	24030	24031	24032	24034	24035	24036	24037	24038	24039
405	24040	24041	24042	24044	24045	24046	24047	24048	24049
406	24050	24051	24052	24054	24055	24056	24057	24058	24059
407	24060	24061	24062	24064	24065	24066	24067	24068	24069
408	24070	24071	24072	24074	24075	24076	24077	24078	24079
409	24080	24081	24082	24084	24085	24086	24087	24088	24089
410	24090	24091	24092	24094	24095	24096	24097	24098	24099
411	24100	24101	24102	24104	24105	24106	24107	24108	24109
412	24110	24111	24112	24114	24115	24116	24117	24118	24119
413	24120	24121	24122	24124	24125	24126	24127	24128	24129
414	24130	24131	24132	24134	24135	24136	24137	24138	24139
415	24140	24141	24142	24144	24145	24146	24147	24148	24149
416	24150	24151	24152	24154	24155	24156	24157	24158	24159
417	24160	24161	24162	24164	24165	24166	24167	24168	24169
418	24170	24171	24172	24174	24175	24176	24177	24178	24179
419	24180	24181	24182	24184	24185	24186	24187	24188	24189
420	24190	24191	24192	24194	24195	24196	24197	24198	24199
421	24200	24201	24202	24204	24205	24206	24207	24208	24209
422	24210	24211	24212	24214	24215	24216	24217	24218	24219
423	24220	24221	24222	24224	24225	24226	24227	24228	24229
424	24230	24231	24232	24234	24235	24236	24237	24238	24239
425	24240	24241	24242	24244	24245	24246	24247	24248	24249
426	24250	24251	24252	24254	24255	24256	24257	24258	24259
427	24260	24261	24262	24264	24265	24266	24267	24268	24269
428	24270	24271	24272	24274	24275	24276	24277	24278	24279
429	24280	24281	24282	24284	24285	24286	24287	24288	24289
430	24290	24291	24292	24294	24295	24296	24297	24298	24299
431	24300	24301	24302	24304	24305	24306	24307	24308	24309
432	24310	24311	24312	24314	24315	24316	24317	24318	24319
433	24320	24321	24322	24324	24325	24326	24327	24328	24329
434	24330	24331	24332	24334	24335	24336	24337	24338	24339
435	24340	24341	24342	24344	24345	24346	24347	24348	24349
436	24350	24351	24352	24354	24355	24356	24357	24358	24359
437	24360	24361	24362	24364	24365	24366	24367	24368	24369
438	24370	24371	24372	24374	24375	24376	24377	24378	24379
439	24380	24381	24382	24384	24385	24386	24387	24388	24389
440	24390	24391	24392	24394	24395	24396	24397	24398	24399
441	24400	24401	24402	24404	24405	24406	24407	24408	24409
442	24410	24411	24412	24414	24415	24416	24417	24418	24419
443	24420	24421	24422	24424	24425	24426	24427	24428	24429
444	24430	24431	24432	24434	24435	24436	24437	24438	24439
445	24440	24441	24442	24444	24445	24446	24447	24448	24449
446	24450	24451	24452	24454	24455	24456	24457	24458	24459
447	24460	24461	24462	24464	24465	24466	24467	24468	24469
448	24470	24471	24472	24474	24475	24476	24477	24478	24479
449	24480	24481	24482	24484	24485	24486	24487	24488	24489
450	24490	24491	24492	24494	24495	24496	24497	24498	24499

Data No.	Positioning identifier	M code	Dwell time	Command speed		Positioning address		Arc data	
				Low-order	High-order	Low-order	High-order	Low-order	High-order
451	24500	24501	24502	24504	24505	24506	24507	24508	24509
452	24510	24511	24512	24514	24515	24516	24517	24518	24519
453	24520	24521	24522	24524	24525	24526	24527	24528	24529
454	24530	24531	24532	24534	24535	24536	24537	24538	24539
455	24540	24541	24542	24544	24545	24546	24547	24548	24549
456	24550	24551	24552	24554	24555	24556	24557	24558	24559
457	24560	24561	24562	24564	24565	24566	24567	24568	24569
458	24570	24571	24572	24574	24575	24576	24577	24578	24579
459	24580	24581	24582	24584	24585	24586	24587	24588	24589
460	24590	24591	24592	24594	24595	24596	24597	24598	24599
461	24600	24601	24602	24604	24605	24606	24607	24608	24609
462	24610	24611	24612	24614	24615	24616	24617	24618	24619
463	24620	24621	24622	24624	24625	24626	24627	24628	24629
464	24630	24631	24632	24634	24635	24636	24637	24638	24639
465	24640	24641	24642	24644	24645	24646	24647	24648	24649
466	24650	24651	24652	24654	24655	24656	24657	24658	24659
467	24660	24661	24662	24664	24665	24666	24667	24668	24669
468	24670	24671	24672	24674	24675	24676	24677	24678	24679
469	24680	24681	24682	24684	24685	24686	24687	24688	24689
470	24690	24691	24692	24694	24695	24696	24697	24698	24699
471	24700	24701	24702	24704	24705	24706	24707	24708	24709
472	24710	24711	24712	24714	24715	24716	24717	24718	24719
473	24720	24721	24722	24724	24725	24726	24727	24728	24729
474	24730	24731	24732	24734	24735	24736	24737	24738	24739
475	24740	24741	24742	24744	24745	24746	24747	24748	24749
476	24750	24751	24752	24754	24755	24756	24757	24758	24759
477	24760	24761	24762	24764	24765	24766	24767	24768	24769
478	24770	24771	24772	24774	24775	24776	24777	24778	24779
479	24780	24781	24782	24784	24785	24786	24787	24788	24789
480	24790	24791	24792	24794	24795	24796	24797	24798	24799
481	24800	24801	24802	24804	24805	24806	24807	24808	24809
482	24810	24811	24812	24814	24815	24816	24817	24818	24819
483	24820	24821	24822	24824	24825	24826	24827	24828	24829
484	24830	24831	24832	24834	24835	24836	24837	24838	24839
485	24840	24841	24842	24844	24845	24846	24847	24848	24849
486	24850	24851	24852	24854	24855	24856	24857	24858	24859
487	24860	24861	24862	24864	24865	24866	24867	24868	24869
488	24870	24871	24872	24874	24875	24876	24877	24878	24879
489	24880	24881	24882	24884	24885	24886	24887	24888	24889
490	24890	24891	24892	24894	24895	24896	24897	24898	24899
491	24900	24901	24902	24904	24905	24906	24907	24908	24909
492	24910	24911	24912	24914	24915	24916	24917	24918	24919
493	24920	24921	24922	24924	24925	24926	24927	24928	24929
494	24930	24931	24932	24934	24935	24936	24937	24938	24939
495	24940	24941	24942	24944	24945	24946	24947	24948	24949
496	24950	24951	24952	24954	24955	24956	24957	24958	24959
497	24960	24961	24962	24964	24965	24966	24967	24968	24969
498	24970	24971	24972	24974	24975	24976	24977	24978	24979
499	24980	24981	24982	24984	24985	24986	24987	24988	24989
500	24990	24991	24992	24994	24995	24996	24997	24998	24999

(4) For axis 4

Data No.	Positioning identifier	M code	Dwell time	Command speed		Positioning address		Arc data	
				Low-order	High-order	Low-order	High-order	Low-order	High-order
501	25000	25001	25002	25004	25005	25006	25007	25008	25009
502	25010	25011	25012	25014	25015	25016	25017	25018	25019
503	25020	25021	25022	25024	25025	25026	25027	25028	25029
504	25030	25031	25032	25034	25035	25036	25037	25038	25039
505	25040	25041	25042	25044	25045	25046	25047	25048	25049
506	25050	25051	25052	25054	25055	25056	25057	25058	25059
507	25060	25061	25062	25064	25065	25066	25067	25068	25069
508	25070	25071	25072	25074	25075	25076	25077	25078	25079
509	25080	25081	25082	25084	25085	25086	25087	25088	25089
510	25090	25091	25092	25094	25095	25096	25097	25098	25099
511	25100	25101	25102	25104	25105	25106	25107	25108	25109
512	25110	25111	25112	25114	25115	25116	25117	25118	25119
513	25120	25121	25122	25124	25125	25126	25127	25128	25129
514	25130	25131	25132	25134	25135	25136	25137	25138	25139
515	25140	25141	25142	25144	25145	25146	25147	25148	25149
516	25150	25151	25152	25154	25155	25156	25157	25158	25159
517	25160	25161	25162	25164	25165	25166	25167	25168	25169
518	25170	25171	25172	25174	25175	25176	25177	25178	25179
519	25180	25181	25182	25184	25185	25186	25187	25188	25189
520	25190	25191	25192	25194	25195	25196	25197	25198	25199
521	25200	25201	25202	25204	25205	25206	25207	25208	25209
522	25210	25211	25212	25214	25215	25216	25217	25218	25219
523	25220	25221	25222	25224	25225	25226	25227	25228	25229
524	25230	25231	25232	25234	25235	25236	25237	25238	25239
525	25240	25241	25242	25244	25245	25246	25247	25248	25249
526	25250	25251	25252	25254	25255	25256	25257	25258	25259
527	25260	25261	25262	25264	25265	25266	25267	25268	25269
528	25270	25271	25272	25274	25275	25276	25277	25278	25279
529	25280	25281	25282	25284	25285	25286	25287	25288	25289
530	25290	25291	25292	25294	25295	25296	25297	25298	25299
531	25300	25301	25302	25304	25305	25306	25307	25308	25309
532	25310	25311	25312	25314	25315	25316	25317	25318	25319
533	25320	25321	25322	25324	25325	25326	25327	25328	25329
534	25330	25331	25332	25334	25335	25336	25337	25338	25339
535	25340	25341	25342	25344	25345	25346	25347	25348	25349
536	25350	25351	25352	25354	25355	25356	25357	25358	25359
537	25360	25361	25362	25364	25365	25366	25367	25368	25369
538	25370	25371	25372	25374	25375	25376	25377	25378	25379
539	25380	25381	25382	25384	25385	25386	25387	25388	25389
540	25390	25391	25392	25394	25395	25396	25397	25398	25399
541	25400	25401	25402	25404	25405	25406	25407	25408	25409
542	25410	25411	25412	25414	25415	25416	25417	25418	25419
543	25420	25421	25422	25424	25425	25426	25427	25428	25429
544	25430	25431	25432	25434	25435	25436	25437	25438	25439
545	25440	25441	25442	25444	25445	25446	25447	25448	25449
546	25450	25451	25452	25454	25455	25456	25457	25458	25459
547	25460	25461	25462	25464	25465	25466	25467	25468	25469
548	25470	25471	25472	25474	25475	25476	25477	25478	25479
549	25480	25481	25482	25484	25485	25486	25487	25488	25489
550	25490	25491	25492	25494	25495	25496	25497	25498	25499

Data No.	Positioning identifier	M code	Dwell time	Command speed		Positioning address		Arc data	
				Low-order	High-order	Low-order	High-order	Low-order	High-order
551	25500	25501	25502	25504	25505	25506	25507	25508	25509
552	25510	25511	25512	25514	25515	25516	25517	25518	25519
553	25520	25521	25522	25524	25525	25526	25527	25528	25529
554	25530	25531	25532	25534	25535	25536	25537	25538	25539
555	25540	25541	25542	25544	25545	25546	25547	25548	25549
556	25550	25551	25552	25554	25555	25556	25557	25558	25559
557	25560	25561	25562	25564	25565	25566	25567	25568	25569
558	25570	25571	25572	25574	25575	25576	25577	25578	25579
559	25580	25581	25582	25584	25585	25586	25587	25588	25589
560	25590	25591	25592	25594	25595	25596	25597	25598	25599
561	25600	25601	25602	25604	25605	25606	25607	25608	25609
562	25610	25611	25612	25614	25615	25616	25617	25618	25619
563	25620	25621	25622	25624	25625	25626	25627	25628	25629
564	25630	25631	25632	25634	25635	25636	25637	25638	25639
565	25640	25641	25642	25644	25645	25646	25647	25648	25649
566	25650	25651	25652	25654	25655	25656	25657	25658	25659
567	25660	25661	25662	25664	25665	25666	25667	25668	25669
568	25670	25671	25672	25674	25675	25676	25677	25678	25679
569	25680	25681	25682	25684	25685	25686	25687	25688	25689
570	25690	25691	25692	25694	25695	25696	25697	25698	25699
571	25700	25701	25702	25704	25705	25706	25707	25708	25709
572	25710	25711	25712	25714	25715	25716	25717	25718	25719
573	25720	25721	25722	25724	25725	25726	25727	25728	25729
574	25730	25731	25732	25734	25735	25736	25737	25738	25739
575	25740	25741	25742	25744	25745	25746	25747	25748	25749
576	25750	25751	25752	25754	25755	25756	25757	25758	25759
577	25760	25761	25762	25764	25765	25766	25767	25768	25769
578	25770	25771	25772	25774	25775	25776	25777	25778	25779
579	25780	25781	25782	25784	25785	25786	25787	25788	25789
580	25790	25791	25792	25794	25795	25796	25797	25798	25799
581	25800	25801	25802	25804	25805	25806	25807	25808	25809
582	25810	25811	25812	25814	25815	25816	25817	25818	25819
583	25820	25821	25822	25824	25825	25826	25827	25828	25829
584	25830	25831	25832	25834	25835	25836	25837	25838	25839
585	25840	25841	25842	25844	25845	25846	25847	25848	25849
586	25850	25851	25852	25854	25855	25856	25857	25858	25859
587	25860	25861	25862	25864	25865	25866	25867	25868	25869
588	25870	25871	25872	25874	25875	25876	25877	25878	25879
589	25880	25881	25882	25884	25885	25886	25887	25888	25889
590	25890	25891	25892	25894	25895	25896	25897	25898	25899
591	25900	25901	25902	25904	25905	25906	25907	25908	25909
592	25910	25911	25912	25914	25915	25916	25917	25918	25919
593	25920	25921	25922	25924	25925	25926	25927	25928	25929
594	25930	25931	25932	25934	25935	25936	25937	25938	25939
595	25940	25941	25942	25944	25945	25946	25947	25948	25949
596	25950	25951	25952	25954	25955	25956	25957	25958	25959
597	25960	25961	25962	25964	25965	25966	25967	25968	25969
598	25970	25971	25972	25974	25975	25976	25977	25978	25979
599	25980	25981	25982	25984	25985	25986	25987	25988	25989
600	25990	25991	25992	25994	25995	25996	25997	25998	25999

## (4) For axis 4 (positioning option)

Data No.	Positioning option	Data No.	Positioning option	Data No.	Positioning option	Data No.	Positioning option	Data No.	Positioning option	Data No.	Positioning option
1	20003	51	20503	101	21003	151	21503	201	22003	251	22503
2	20013	52	20513	102	21013	152	21513	202	22013	252	22513
3	20023	53	20523	103	21023	153	21523	203	22023	253	22523
4	20033	54	20533	104	21033	154	21533	204	22033	254	22533
5	20043	55	20543	105	21043	155	21543	205	22043	255	22543
6	20053	56	20553	106	21053	156	21553	206	22053	256	22553
7	20063	57	20563	107	21063	157	21563	207	22063	257	22563
8	20073	58	20573	108	21073	158	21573	208	22073	258	22573
9	20083	59	20583	109	21083	159	21583	209	22083	259	22583
10	20093	60	20593	110	21093	160	21593	210	22093	260	22593
11	20103	61	20603	111	21103	161	21603	211	22103	261	22603
12	20113	62	20613	112	21113	162	21613	212	22113	262	22613
13	20123	63	20623	113	21123	163	21623	213	22123	263	22623
14	20133	64	20633	114	21133	164	21633	214	22133	264	22633
15	20143	65	20643	115	21143	165	21643	215	22143	265	22643
16	20153	66	20653	116	21153	166	21653	216	22153	266	22653
17	20163	67	20663	117	21163	167	21663	217	22163	267	22663
18	20173	68	20673	118	21173	168	21673	218	22173	268	22673
19	20183	69	20683	119	21183	169	21683	219	22183	269	22683
20	20193	70	20693	120	21193	170	21693	220	22193	270	22693
21	20203	71	20703	121	21203	171	21703	221	22203	271	22703
22	20213	72	20713	122	21213	172	21713	222	22213	272	22713
23	20223	73	20723	123	21223	173	21723	223	22223	273	22723
24	20233	74	20733	124	21233	174	21733	224	22233	274	22733
25	20243	75	20743	125	21243	175	21743	225	22243	275	22743
26	20253	76	20753	126	21253	176	21753	226	22253	276	22753
27	20263	77	20763	127	21263	177	21763	227	22263	277	22763
28	20273	78	20773	128	21273	178	21773	228	22273	278	22773
29	20283	79	20783	129	21283	179	21783	229	22283	279	22783
30	20293	80	20793	130	21293	180	21793	230	22293	280	22793
31	20303	81	20803	131	21303	181	21803	231	22303	281	22803
32	20313	82	20813	132	21313	182	21813	232	22313	282	22813
33	20323	83	20823	133	21323	183	21823	233	22323	283	22823
34	20333	84	20833	134	21333	184	21833	234	22333	284	22833
35	20343	85	20843	135	21343	185	21843	235	22343	285	22843
36	20353	86	20853	136	21353	186	21853	236	22353	286	22853
37	20363	87	20863	137	21363	187	21863	237	22363	287	22863
38	20373	88	20873	138	21373	188	21873	238	22373	288	22873
39	20383	89	20883	139	21383	189	21883	239	22383	289	22883
40	20393	90	20893	140	21393	190	21893	240	22393	290	22893
41	20403	91	20903	141	21403	191	21903	241	22403	291	22903
42	20413	92	20913	142	21413	192	21913	242	22413	292	22913
43	20423	93	20923	143	21423	193	21923	243	22423	293	22923
44	20433	94	20933	144	21433	194	21933	244	22433	294	22933
45	20443	95	20943	145	21443	195	21943	245	22443	295	22943
46	20453	96	20953	146	21453	196	21953	246	22453	296	22953
47	20463	97	20963	147	21463	197	21963	247	22463	297	22963
48	20473	98	20973	148	21473	198	21973	248	22473	298	22973
49	20483	99	20983	149	21483	199	21983	249	22483	299	22983
50	20493	100	20993	150	21493	200	21993	250	22493	300	22993

## (4) For axis 4 (positioning option)

Data No.	Positioning option	Data No.	Positioning option	Data No.	Positioning option	Data No.	Positioning option	Data No.	Positioning option	Data No.	Positioning option
301	23003	351	23503	401	24003	451	24503	501	25003	551	25503
302	23013	352	23513	402	24013	452	24513	502	25013	552	25513
303	23023	353	23523	403	24023	453	24523	503	25023	553	25523
304	23033	354	23533	404	24033	454	24533	504	25033	554	25533
305	23043	355	23543	405	24043	455	24543	505	25043	555	25543
306	23053	356	23553	406	24053	456	24553	506	25053	556	25553
307	23063	357	23563	407	24063	457	24563	507	25063	557	25563
308	23073	358	23573	408	24073	458	24573	508	25073	558	25573
309	23083	359	23583	409	24083	459	24583	509	25083	559	25583
310	23093	360	23593	410	24093	460	24593	510	25093	560	25593
311	23103	361	23603	411	24103	461	24603	511	25103	561	25603
312	23113	362	23613	412	24113	462	24613	512	25113	562	25613
313	23123	363	23623	413	24123	463	24623	513	25123	563	25623
314	23133	364	23633	414	24133	464	24633	514	25133	564	25633
315	23143	365	23643	415	24143	465	24643	515	25143	565	25643
316	23153	366	23653	416	24153	466	24653	516	25153	566	25653
317	23163	367	23663	417	24163	467	24663	517	25163	567	25663
318	23173	368	23673	418	24173	468	24673	518	25173	568	25673
319	23183	369	23683	419	24183	469	24683	519	25183	569	25683
320	23193	370	23693	420	24193	470	24693	520	25193	570	25693
321	23203	371	23703	421	24203	471	24703	521	25203	571	25703
322	23213	372	23713	422	24213	472	24713	522	25213	572	25713
323	23223	373	23723	423	24223	473	24723	523	25223	573	25723
324	23233	374	23733	424	24233	474	24733	524	25233	574	25733
325	23243	375	23743	425	24243	475	24743	525	25243	575	25743
326	23253	376	23753	426	24253	476	24753	526	25253	576	25753
327	23263	377	23763	427	24263	477	24763	527	25263	577	25763
328	23273	378	23773	428	24273	478	24773	528	25273	578	25773
329	23283	379	23783	429	24283	479	24783	529	25283	579	25783
330	23293	380	23793	430	24293	480	24793	530	25293	580	25793
331	23303	381	23803	431	24303	481	24803	531	25303	581	25803
332	23313	382	23813	432	24313	482	24813	532	25313	582	25813
333	23323	383	23823	433	24323	483	24823	533	25323	583	25823
334	23333	384	23833	434	24333	484	24833	534	25333	584	25833
335	23343	385	23843	435	24343	485	24843	535	25343	585	25843
336	23353	386	23853	436	24353	486	24853	536	25353	586	25853
337	23363	387	23863	437	24363	487	24863	537	25363	587	25863
338	23373	388	23873	438	24373	488	24873	538	25373	588	25873
339	23383	389	23883	439	24383	489	24883	539	25383	589	25883
340	23393	390	23893	440	24393	490	24893	540	25393	590	25893
341	23403	391	23903	441	24403	491	24903	541	25403	591	25903
342	23413	392	23913	442	24413	492	24913	542	25413	592	25913
343	23423	393	23923	443	24423	493	24923	543	25423	593	25923
344	23433	394	23933	444	24433	494	24933	544	25433	594	25933
345	23443	395	23943	445	24443	495	24943	545	25443	595	25943
346	23453	396	23953	446	24453	496	24953	546	25453	596	25953
347	23463	397	23963	447	24463	497	24963	547	25463	597	25963
348	23473	398	23973	448	24473	498	24973	548	25473	598	25973
349	23483	399	23983	449	24483	499	24983	549	25483	599	25983
350	23493	400	23993	450	24493	500	24993	550	25493	600	25993

Appendix 4 Connection examples with servo amplifiers manufactured by MITSUBISHI Electric Corporation

Appendix 4.1 Connection example of QD75D□N and MR-J3-□ A (Differential driver) \*5

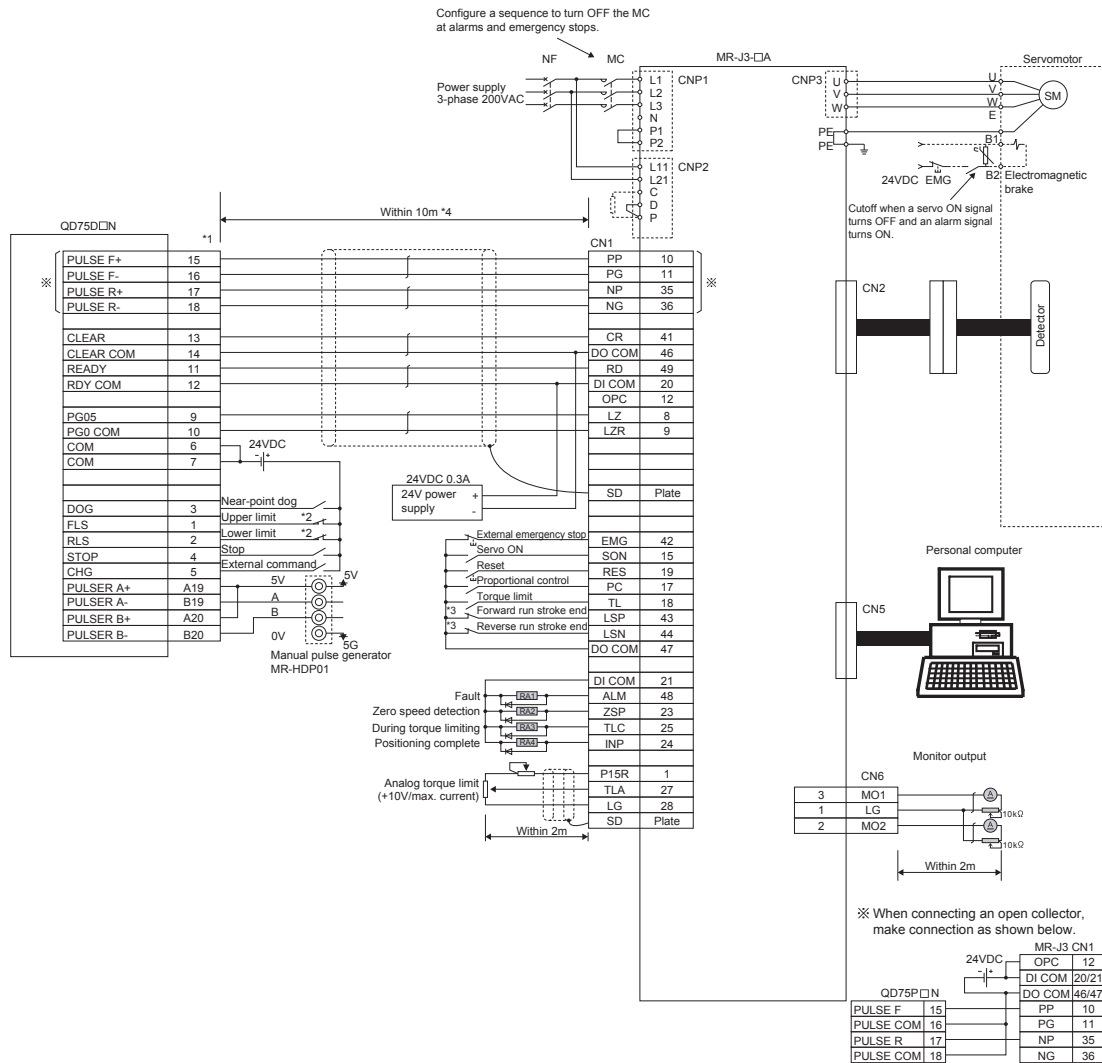

**REMARK**

- (1) It is recommended to make differential driver connection since differential driver connection is more excellent than open collector connection in max. output pulse and max. connection distance between servos. (Refer to Section 3.1 "Performance specifications".)
- (2) \*1: The logic for each I/O terminal can be changed with " Pr.22 Input signal logic selection" and " Pr.23 Output signal logic selection" in detailed parameters 1. (Negative logic is used for all terminals in the example above.)
- (3) \*2: The QD75D□N upper limit (FLS) and lower limit (RLS) are used in the OPR retry function. Set these signals inside the servo amplifier limit switches.
- (4) \*3: These are limit switches for the servo (for stop).
- (5) \*4: This indicates the distance between the QD75D□N and servo amplifier.
- (6) \*5: When used, check the logic for the QD75D□N and servo amplifier in Section 3.4.1, (2) "Output specifications". The QD75D□N is initially set to negative logic.
- (7) "FA-CBLQ75M2J3(-P) cable" can be used for connecting the QD75D□N and MR-J3-□A.



Appendix 4.2 Connection example of QD75D□N and MR-H □ A (Differential driver) \*6

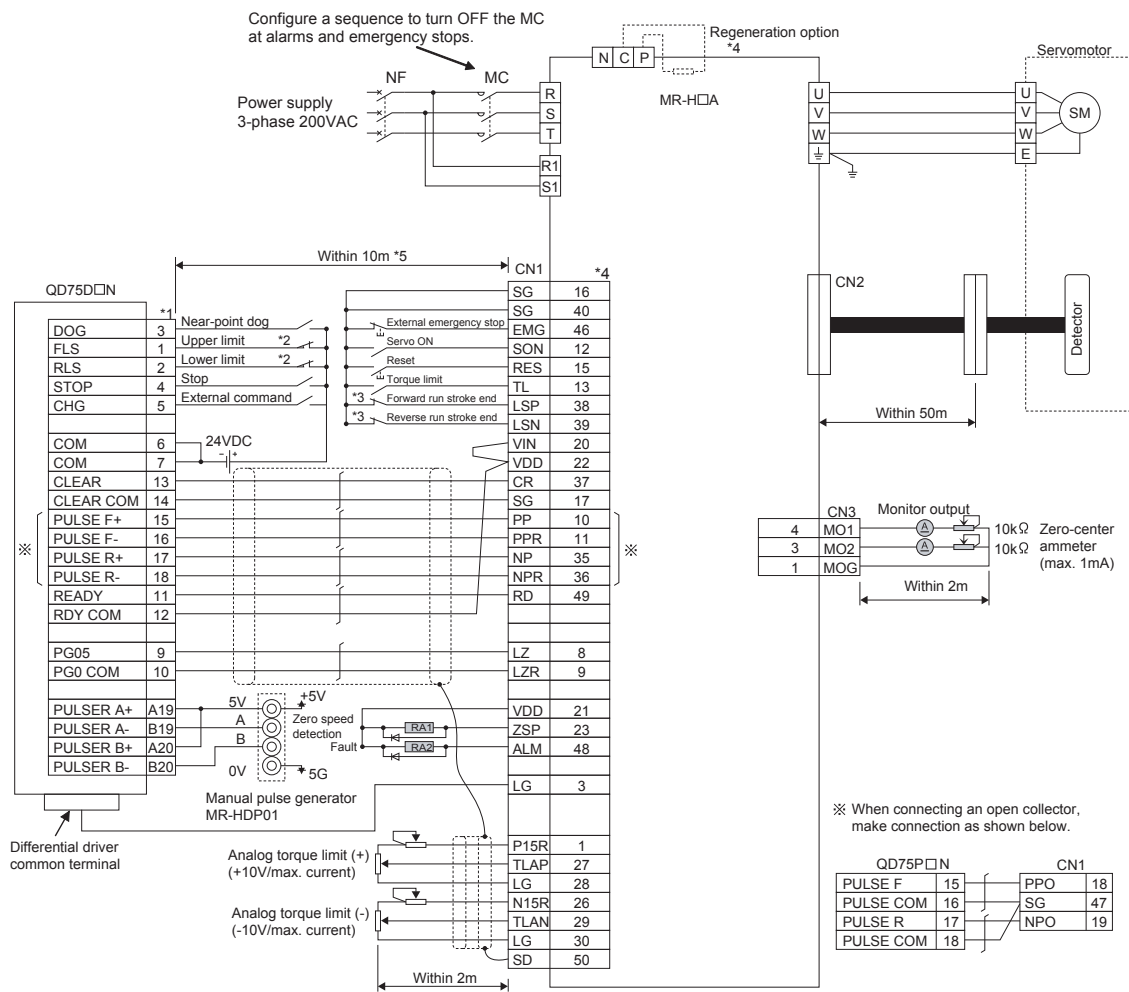

**REMARK**

- (1) It is recommended to make differential driver connection since differential driver connection is more excellent than open collector connection in max. output pulse and max. connection distance between servos. (Refer to Section 3.1 "Performance specifications".)
- (2) \*1: The logic for each I/O terminal can be changed with " Pr.22 Input signal logic selection" and " Pr.23 Output signal logic selection" in detailed parameters 1. (Negative logic is used for all terminals in the example above.)
- (3) \*2: The QD75D□N upper limit (FLS) and lower limit (RLS) are used in the OPR retry function. Set these signals inside the servo amplifier limit switches.
- (4) \*3: These are limit switches for the servo (for stop).
- (5) \*4: Refer to the specification and handling instruction manual of the servo amplifier MR-H for details on connection.
- (6) \*5: This indicates the distance between the QD75D□N and servo amplifier.
- (7) \*6: Use the same logic (positive logic/negative logic) for the QD75D□N and servo amplifier. The QD75D□N is initially set to negative logic.

Appendix 4.3 Connection example of QD75D□N and MR-J2/J2S- □ A (Differential driver)

\*5

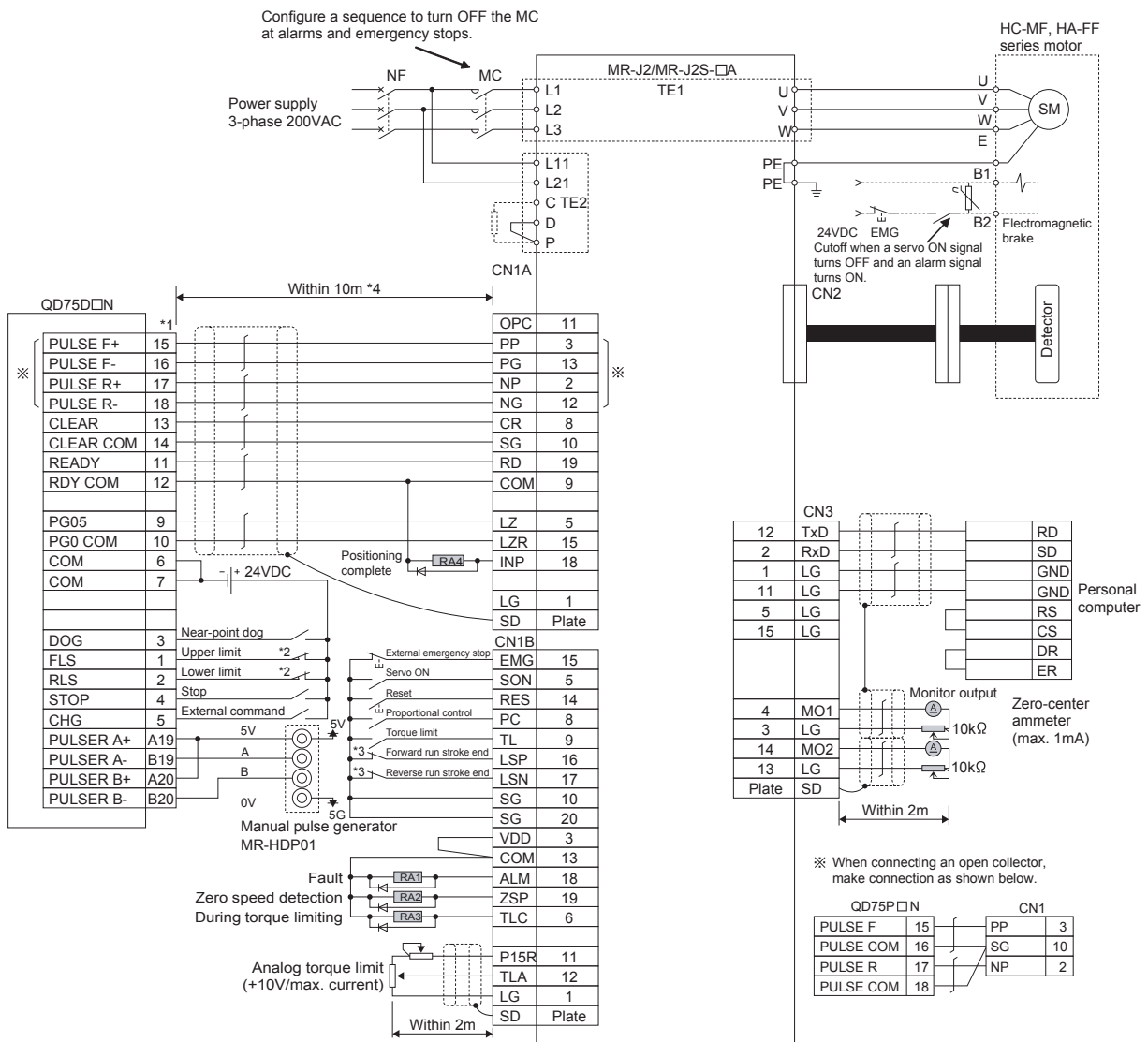

**REMARK**

- (1) It is recommended to make differential driver connection since differential driver connection is more excellent than open collector connection in max. output pulse and max. connection distance between servos. (Refer to Section 3.1 "Performance specifications".)
- (2) \*1: The logic for each I/O terminal can be changed with " Pr.22 Input signal logic selection" and " Pr.23 Output signal logic selection" in detailed parameters 1. (Negative logic is used for all terminals in the example above.)
- (3) \*2: The QD75D□N upper limit (FLS) and lower limit (RLS) are used in the OPR retry function. Set these signals inside the servo amplifier limit switches.
- (4) \*3: These are limit switches for the servo amplifier (for stop).
- (5) \*4: This indicates the distance between the QD75D□N and servo amplifier.
- (6) \*5: Use the same logic (positive logic/negative logic) for the QD75D□N and servo amplifier. The QD75D□N is initially set to negative logic.



Appendix 5 Connection examples with stepping motors manufactured by ORIENTALMOTOR Co., Ltd.

Appendix 5.1 Connection example of QD75P□N and VEXTA UPD (Open collector) \*4

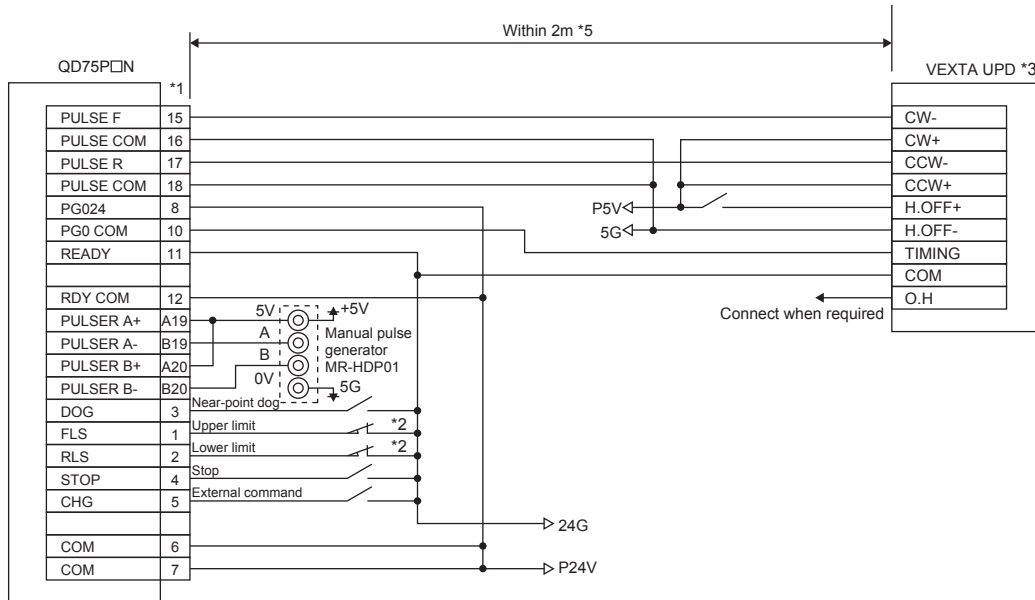

**REMARK**

- (1) \*1: The logic for each I/O terminal can be changed with " Pr.22 Input signal logic selection" and " Pr.23 Output signal logic selection" in detailed parameters 1. (Negative logic is used for all terminals in the example above.)
- (2) \*2: The QD75P□N upper limit (FLS) and lower limit (RLS) are used in the OPR retry function.
- (3) \*3: Refer to the manual of the stepping motor drive for information on the stepping motor drive side wiring and various signal wire shields not shown above.
- (4) \*4: Use the same logic (positive logic/negative logic) for the QD75P□N and stepping motor. The QD75P□N is initially set to negative logic.
- (5) \*5: This indicates the distance between the QD75P□N and VEXTA UPD.

Appendix 6 Connection examples with servo amplifiers manufactured by Panasonic Corporation

Appendix 6.1 Connection example of QD75D□N and MINAS-A series (Differential driver) \*4

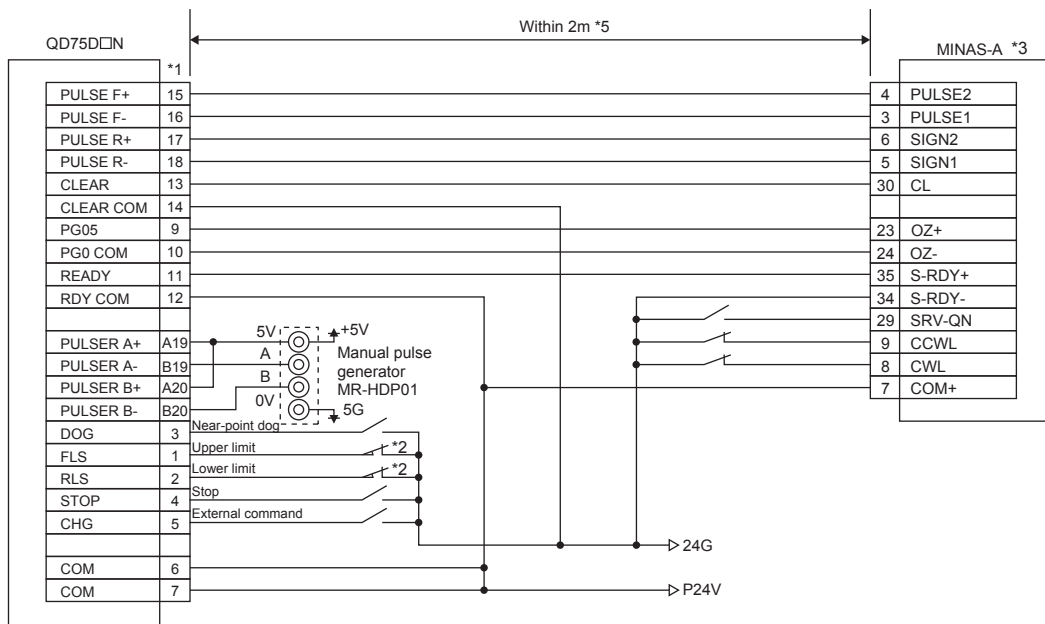

**REMARK**

- (1) \*1: The logic for each I/O terminal can be changed with " Pr.22 Input signal logic selection" and " Pr.23 Output signal logic selection" in detailed parameters 1. (Negative logic is used for all terminals in the example above.)
- (2) \*2: The QD75D□N upper limit (FLS) and lower limit (RLS) are used in the OPR retry function. Set these signals inside the servo amplifier limit switches.
- (3) \*3: Refer to the manual of the servo amplifier for information on the servo amplifier side wiring and various signal wire shields not shown above.
- (4) \*4: Use the same logic (positive logic/negative logic) for the QD75D□N and servo amplifier. The QD75D□N is initially set to negative logic.
- (5) \*5: This indicates the distance between the QD75D□N and MINAS-A.

Appendix 7 Connection examples with servo amplifiers manufactured by SANYO DENKI Co., Ltd.

Appendix 7.1 Connection example of QD75D□N and PYO series (Differential driver) \*4

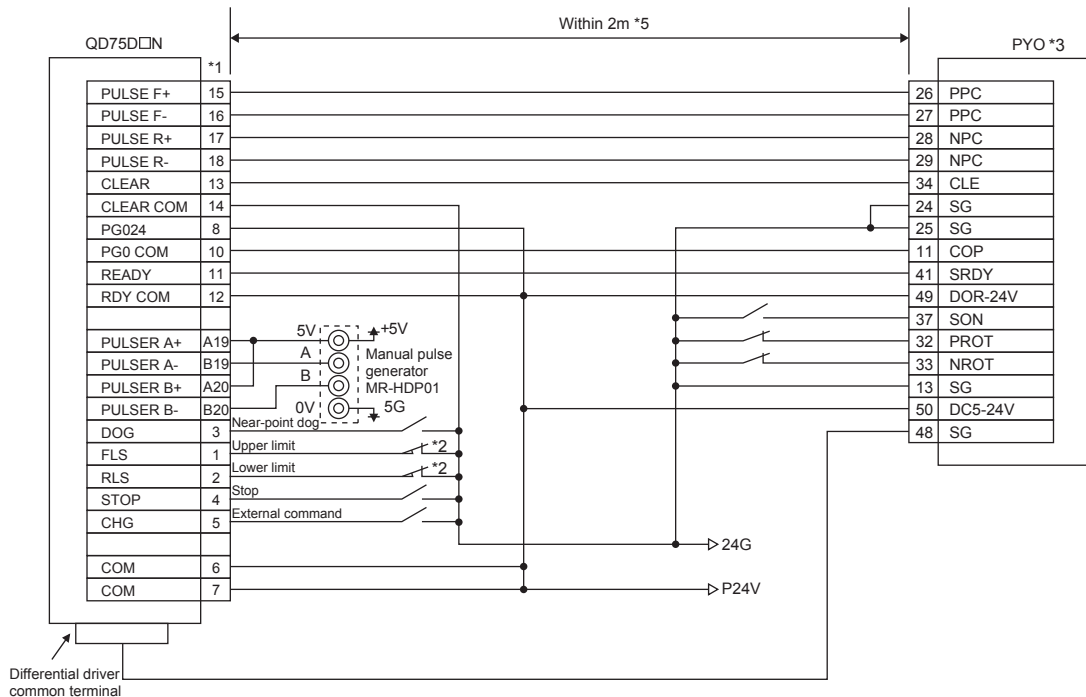

**REMARK**

- (1) \*1: The logic for each I/O terminal can be changed with " Pr.22 Input signal logic selection" and " Pr.23 Output signal logic selection" in detailed parameters 1. (Negative logic is used for all terminals in the example above.)
- (2) \*2: The QD75D□N upper limit (FLS) and lower limit (RLS) are used in the OPR retry function. Set these signals inside the servo amplifier limit switches.
- (3) \*3: Refer to the manual of the servo amplifier for information on the servo amplifier side wiring and various signal wire shields not shown above.
- (4) \*4: Use the same logic (positive logic/negative logic) for the QD75D□N and servo amplifier. The QD75D□N is initially set to negative logic.
- (5) \*5: This indicates the distance between the QD75D□N and PYO.

Appendix 8 Connection examples with servo amplifiers manufactured by YASKAWA Electric Corporation

Appendix 8.1 Connection example of QD75D□N and  $\Sigma$ -II series (Differential driver)\*4

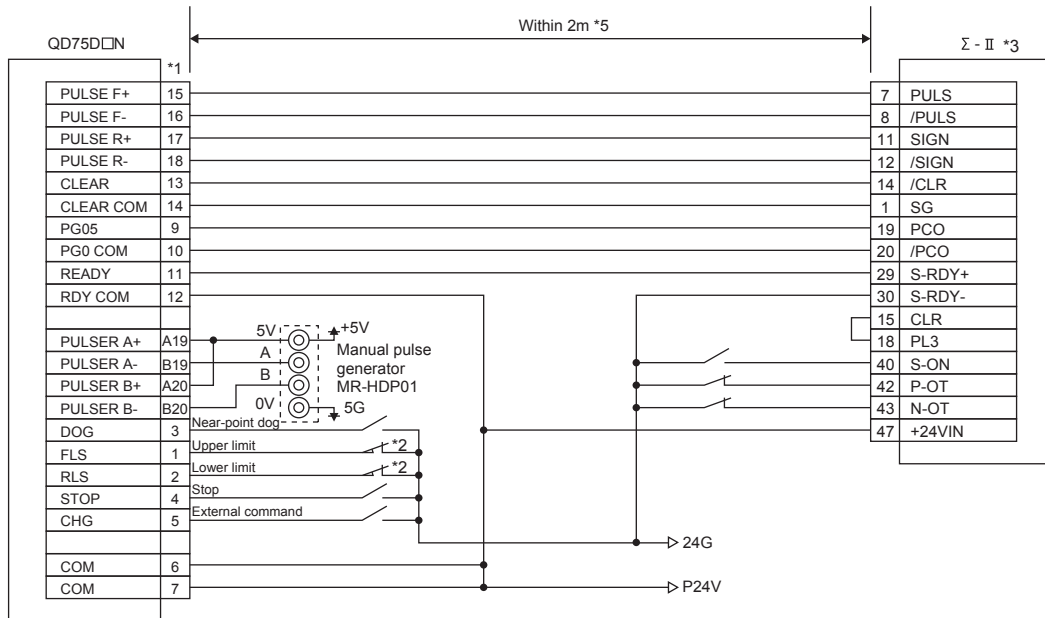

**REMARK**

- (1) \*1: The logic of each I/O terminal can be changed with " Pr.22 Input signal logic selection" and " Pr.23 Output signal logic selection" in detailed parameters 1. (Negative logic is used for all terminals in the example above.)
- (2) \*2: The QD75D□N upper limit (FLS) and lower limit (RLS) are used in the OPR retry function. Set these signals inside the servo amplifier limit switches.
- (3) \*3: Refer to the manual of the servo amplifier for information on the servo amplifier side wiring and various signal wire shields not shown above.
- (4) \*4: Use the same logic (positive logic/negative logic) for the QD75D□N and servo amplifier. The QD75D□N is initially set to negative logic.
- (5) \*5: This indicates the distance between the QD75D□N and  $\Sigma$ -II.

Appendix 9 Comparisons with conventional positioning modules

Appendix 9.1 Comparisons with A1SD71S2 model

The following shows comparisons with the conventional positioning module A1SD71S2, centered on the QD75 specifications.

Item		Model	QD75P1N/QD75P1	QD75P2N/QD75P2	QD75P4N/QD75P4	A1SD71S2
		QD75D1N/QD75D1	QD75D2N/QD75D2	QD75D4N/QD75D4		
No. of control axes			1	2	4	2
No. of positioning data items			600/axis			400/axis
Interpolation functions	2-axis linear interpolation		×	○	○	○
	3-axis linear interpolation		×	×	○	×
	4-axis linear interpolation		×	×	○	×
	2-axis circular interpolation		×	○	○	×
Positioning systems	Position control		○			○
	Speed control		○			○
	Speed-position switching control		○ (INC/ABS mode)			○ (Only INC mode)
	Position-speed switching control		○			×
Machine OPR function (OPR method)			○ (6 types)			○ (3 types)
JOG operation			○			○
Inching operation			○			×
Manual pulse generator function			○			×
Acceleration/deceleration processing	Trapezoidal acceleration/deceleration		○			○
	S-curve acceleration/deceleration		○			×
Acceleration/deceleration time			Acceleration time and deceleration time setting possible (4 patterns each)			Acceleration/deceleration time same
Compensation			Electronic gears, backlash compensation			Backlash compensation
Error display			Error LED			Error LED
History data storage (Start, error, warning)			Provided (3 types, 16 items/axis)			None
Data storage destination			Flash ROM (battery-less backup)			Buffer memory (battery backup)
No. of occupied I/O points			32			48
No. of module occupied slots			1			2
Peripheral devices (data setting, etc.)	AD71TU		×			○
	AD75TU		×			×
	A6GPP, A6PHP		×			○
	DOS/V personal computer		○			○

○ : Possible, × : Not possible



Appendix 9.2 Comparisons with A1SD75P1-S3/ A1SD75P2-S3/ A1SD75P3-S3 models

The following shows the comparisons between the QD75 and the conventional positioning modules A1SD75P1-S3/A1SD75P2-S3/A1SD75P3-S3.

(1) Comparisons of performance specifications

Item		Model	QD75P1N/QD75P1 QD75D1N/QD75D1	QD75P2N/QD75P2 QD75D2N/QD75D2	QD75P4N/QD75P4 QD75D4N/QD75D4	A1SD75P1 -S3	A1SD75P2 -S3	A1SD75P3 -S3	
No. of control axes			1	2	4	1	2	3	
No. of positioning data items			600/axis			600/axis *1			
Position control interpolation functions	2-axis linear interpolation		×	○	○	×	○	○	
	3-axis linear interpolation		×	×	○	×	×	×	
	4-axis linear interpolation		×	×	○	×	×	×	
	2-axis circular interpolation		×	○	○	×	○	○	
Positioning systems	Position control		○			○			
	Speed control	1-axis		○	○	○	○	○	
		2-axis linear interpolation		×	○	○	×	×	×
		3-axis linear interpolation		×	×	○	×	×	×
		4-axis linear interpolation		×	×	○	×	×	×
	Speed-position switching control		○			○			
Position-speed switching control		○			×				
Positioning range *2			<Absolute system> -214748364.8 to 214748364.7 (μm) -21474.83648 to 21474.83647 (inch) 0 to 359.99999 (degree) -2147483648 to 2147483647 (pulse)  <Incremental system > -214748364.8 to 214748364.7 (μm) -21474.83648 to 21474.83647 (inch) -21474.83648 to 21474.83647 (degree) -2147483648 to 2147483647 (pulse)			<Absolute system > -214748364.8 to 214748364.7 (μm) /-13421772.8 to 13421772.7 (μm) -21474.83648 to 21474.83647 (inch) /-1342.17728 to 1342.17727 (inch) 0 to 359.99999 (degree) /0 to 359.99999 (degree) -2147483648 to 2147483647 (pulse) /-134217728 to 134217727 (pulse)			
			<Speed-position or position-speed switching controls> 0 to 214748364.7 (μm) 0 to 21474.83647 (inch) 0 to 21474.83647 (degree)/ 0 to 359.99999 (degree) *3 0 to 2147483647 (pulse)			<Incremental system > -214748364.8 to 214748364.7 (μm) /-13421772.8 to 13421772.7 (μm) -21474.83648 to 21474.83647 (inch) /-1342.17728 to 1342.17727 (inch) -21474.83648 to 21474.83647 (degree) /-1342.17728 to 1342.17727 (degree) -2147483648 to 2147483647 (pulse) /-134217728 to 134217727 (pulse)			
						<Speed-position switching control> 0 to 214748364.7 (μm) /0 to 13421772.7 (μm) 0 to 21474.83647 (inch) /0 to 1342.17727 (inch) 0 to 21474.83647 (degree) /0 to 1342.17727 (degree) 0 to 2147483647 (pulse) /0 to 134217727 (pulse)			

Item	Model	QD75P1N/QD75P1 QD75D1N/QD75D1	QD75P2N/QD75P2 QD75D2N/QD75D2	QD75P4N/QD75P4 QD75D4N/QD75D4	A1SD75P1 -S3	A1SD75P2 -S3	A1SD75P3 -S3
Speed command range *2		QD75P□N/QD75D□N: 0.01 to 2000000.00 (mm/min) 0.001 to 2000000.000 (inch/min) 0.001 to 2000000.000 (degree/min) 1 to 4000000 (pulse/s) QD75P□/QD75D□ : 0.01 to 2000000.00 (mm/min) 0.001 to 2000000.000 (inch/min) 0.001 to 2000000.000 (degree/min) 1 to 1000000 (pulse/s)			0.01 to 6000000.00 (mm/min) /0.01 to 375000.00 (mm/min) 0.001 to 600000.000 (inch/min) /0.001 to 37500.000 (inch/min) 0.001 to 600000.000 (degree/min) /0.001 to 37500.000 (degree/min) 1 to 1000000 (pulse/s) /1 to 62500 (pulse/s)		
Machine OPR function (OPR method)		○ (6 types) *4			○ (6 types)		
JOG operation		○			○		
Inching operation		○			×		
Manual pulse generator function		1 generator/module *5			1 generator/axis *6		
Acceleration /deceleration processing	Trapezoidal acceleration /deceleration	○			○		
	S-curve acceleration /deceleration	○			○		
Acceleration/ deceleration time	No. of patterns	Acceleration time and deceleration time can be set independently. (4 patterns each)			Acceleration time and deceleration time can be set independently. (4 patterns each)		
	Setting range	1 to 8388608ms			1 to 65535ms/1 to 8388608ms selectable		
Compensation		Electronic gears, backlash compensation, near pass *6			Electronic gears, backlash compensation, near pass *6		
Error display		Error LED			17-segment LED		
History data storage (Start, error, warning)		Provided (3 types, 16 items/axis)			Provided (4 types, 16 items/axis)		
Data storage destination		Flash ROM (battery-less backup)			Flash ROM (battery-less backup)		
Connection connector		A6CON1 (Soldering type, sold separately)			10136-3000VE (Soldering type, supplied)		
		A6CON2 (Crimp type, sold separately)			10136-6000EL (Crimp type, sold separately)		
		A6CON4 (Soldering type, usable for straight out and diagonal out, sold separately)					
Applicable wire size		A6CON1, A6CON4: 0.3mm <sup>2</sup> (22AWG)			10136-3000VE: Approx. 0.05 to 0.24mm <sup>2</sup> (30 to 24AWG)		
		A6CON2: 0.088 to 0.24mm <sup>2</sup> (28 to 24AWG)			10136-6000EL: Approx. 0.088mm <sup>2</sup> (28AWG)		
Command pulse output system		QD75P□N/QD75P□: Open collector QD75D□N/QD75D□: Differential driver			Both differential driver and open collector available		
Max. output pulse		When connected with open collector: 200kpps When connected with differential driver: 4Mpps (QD75D□N), 1Mpps (QD75D□)			When connected with open collector: 200kpps When connected with differential driver: 400kpps		
Max. connection distance between servos		When connected with open collector: 2m (6.56ft) When connected with differential driver: 10m (32.79ft)			When connected with open collector: 2m (6.56ft) When connected with differential driver: 10m (32.79ft)		
Internal current consumption [5VDC]		QD75P1N: 0.29A	QD75P2N: 0.30A	QD75P4N: 0.36A	0.7A or less		
		QD75D1N: 0.43A	QD75D2N: 0.45A	QD75D4N: 0.66A			
		QD75P1: 0.40A	QD75P2: 0.46A	QD75P4: 0.58A			
		QD75D1: 0.52A	QD75D2: 0.56A	QD75D4: 0.82A			
Flash ROM write count		Max. 100000 times			Max. 100000 times		
No. of occupied I/O points		32			32		
No. of module occupied slots		1			1		
Outline dimensions		98(3.86)(H)×27.4(1.08)(W)×90(3.55)(D)mm (inch)			130(5.12)(H)×34.5(1.36)(W)×93.6(3.69)(D)mm (inch)		
Weight		QD75P1N: 0.14kg (0.31lb)	QD75P2N: 0.14kg (0.31lb)	QD75P4N: 0.16kg (0.35lb)	0.35kg (0.77lb)		
		QD75D1N: 0.15kg (0.33lb)	QD75D2N: 0.15kg (0.33lb)	QD75D4N: 0.16kg (0.35lb)			
		QD75P1: 0.15kg (0.33lb)	QD75P2: 0.15kg (0.33lb)	QD75P4: 0.16kg (0.35lb)			
		QD75D1: 0.15kg (0.33lb)	QD75D2: 0.15kg (0.33lb)	QD75D4: 0.16kg (0.35lb)			

Item		Model	QD75P1N/QD75P1	QD75P2N/QD75P2	QD75P4N/QD75P4	A1SD75P1	A1SD75P2	A1SD75P3
			QD75D1N/QD75D1	QD75D2N/QD75D2	QD75D4N/QD75D4	-S3	-S3	-S3
I/O signal for external devices	STRT signal	× (integrated into "CHG")				○ (External start signal)		
	CHG signal	External command signal (External start or speed-position switching selectable with parameters)				Speed-position switching signal		
	In-position (INP)	×				○ (for monitor)		
	Signal logic switching	○				Command pulse output signal only		
Peripheral devices (data setting, etc.)	Connection with peripheral devices	Connection via CPU module, Q Corresponding Serial Communication Module, Q Corresponding MELSEC/H Remote I/O Module				Direct connection		
	AD71TU	×				×		
	AD75TU	×				○		
	A6GPP, A6PHP	×				○		
	DOS/V personal computer	○				○		

○ : Possible, × : Not possible

- \*1: Up to 100 data items/axis of positioning data (No. 1 to 100) can be set using the buffer memory. The positioning data in the buffer memory is not backed up.
- \*2: Indicates the standard mode/stepping motor mode about A1SD75P□-S3.
- \*3: Indicates the INC mode/ABS mode in speed-position switching control.
- \*4: The deviation counter clear signal output time can be set with parameters.
- \*5: The movement amount against the number of pulses input from manual pulsar is as follows:
  - QD75: Movement amount = "Number of pulses" × "Unit setting" × "Manual pulse generator 1 pulse input magnification" (refer to Section 11.4.1.)
  - A1SD75: Movement amount = "Number of pulses" × "Manual pulse generator 1 pulse input magnification"
- \*6: The near pass function is valid only during the continuous path control. (A1SD75: Selected with parameters, QD75: Standard function)

## (2) Function comparisons

Functions added to those of A1SD75P1-S3/A1SD75P2-S3/A1SD75P3-S3

Added functions		Remarks
External I/O signal logic switching function		Refer to Section 13.4.
Inching operation		Refer to Section 11.3.
Target position change function		Refer to Section 12.5.5.
Multiple axes simultaneous start control		Refer to Section 10.5.
Control systems	3-axis linear interpolation control 4-axis linear interpolation control 3-axis fixed-feed control 4-axis fixed-feed control 2-axis speed control 3-axis speed control 4-axis speed control Position-speed switching control NOP instruction LOOP instruction, LEND instruction	Refer to CHAPTER 9.
Dedicated instructions	Absolute position restoration Positioning start Teaching Flash ROM writing Parameter initialization	Refer to CHAPTER 14.
Automatic refresh of intelligent function modules		Refer to GX Configurator-QP Operating Manual.
Output hold/clear parameter setting during CPU module error stop		Refer to QCPU User's Manual (Function Explanation, Program Fundamentals).
Flash ROM write limit		Refer to Section 13.3.
Speed-position switching control (ABS mode)		Refer to Section 9.2.19.
Pre-reading start function		Refer to Section 12.7.7.
External I/O signal monitor function		Refer to Section 13.5.
Multiple PLC compatible function		Refer to QCPU User's Manual (Multiple CPU System).
Deceleration start flag function		Refer to Section 12.7.8
Stop command processing for deceleration stop function		Refer to Section 12.7.9

## Functions deleted from those of A1SD75P1-S3/A1SD75P2-S3/A1SD75P3-S3

Deleted functions	Remarks
Stepping motor mode	–
OPR operation error (Error code: 208)	–
Fast machine OPR	–
Special start (stop)	–
Indirect designation	In the QD75, the start block area on the buffer memory is expanded to five blocks (0 to 4). Each start block can be directly designated with positioning start No. (7000 to 7004).
Block transfer	With the A1SD75, this interface is used to set positioning data Nos. 101 to 600 that do not exist on the buffer memory.
Positioning data I/F	Since all positioning data can be set in the buffer memory with the QD75, this function is deleted.
Start history storage during error	The contents are the same as those of the start history. Therefore, the QD75 stores only the start history.
System monitor data (module type, OS information)	These data were deleted because they can be displayed in system monitor "Module's detailed information" of GX Developer. (Refer to GX Developer Operating Manual.)

## Functions changed from those of A1SD75P1-S3/A1SD75P2-S3/A1SD75P3-S3

Changed functions	Descriptions
Software stroke limit function	<ol style="list-style-type: none"> <li>The limit check of arc address is carried out only when a sub point is designated. It is not carried out when a center point is designated.</li> <li>The software stroke limit check during speed control is carried out in the following cases: <ul style="list-style-type: none"> <li>When the software stroke limit is applied to the current feed value with [Pr.14] and the current feed value is updated with [Pr.21].</li> <li>When the software stroke limit is applied to the machine feed value.</li> </ul> </li> <li>If an attempt is made to change the current value but the designated address is out of the software stroke limit range, the attempt is considered as an error and the current value is not changed.</li> <li>The conventional models feature three types of software stroke limit error codes for upper limit and lower limit respectively. With the QD75, errors for the software stroke upper limit are integrated into error code 507, and errors for the lower limit are integrated into error code 508. Error codes 509 to 512 are deleted.</li> </ol>
Current value changing M code function	<ol style="list-style-type: none"> <li>An error occurs when the designated new current value is out of the software stroke limit range.</li> <li>The M code setting value is valid during the positioning data current value changing instruction.</li> </ol>
Acceleration/deceleration control	<ol style="list-style-type: none"> <li>An error occurs when the command frequency value calculated from the speed limit value is out of the maximum command frequency of the positioning module being used.</li> <li>Only two-word type (1 to 8388608ms) can be used as the setting value for the acceleration/deceleration time. (The switch between 1-word type and 2-word type is eliminated.)</li> </ol>

Changed functions	Descriptions		
Stop process and restart after stop Positioning operation stop	1. "Peripheral side (emergency) stop" is deleted from the stop causes of Stop group 2 sudden stop selection. "Test mode fault" in the stop causes of Stop group 3 sudden stop selection is changed to be in the stop causes of Stop group 2 sudden stop selection. 2. "Stop (QD75 peripheral)" is added to the stop causes of Stop group 3 sudden stop selection. 3. Error code 100 (Peripheral device stop during operation) is deleted. 4. "CPU module error occurrence" is added to the stop causes of Stop group 2 sudden stop selection.		
READY signal (X0)		A1SD75	QD75
	OFF	Normal (READY)	Not READY /WDT error
	ON	Not READY /WDT error	Normal (READY)
Manual pulse generator operation	The No. of connectable manual pulse generator is changed from 1 generator/1 axis to 1 generator/1 module.		
Axis operation status	"Step stopped" is changed to "Stopped" and "Step error occurring" is changed to "Error occurring". "In position control for position-speed switching control", "In speed control for position-speed switching control", and "In absolute position restoration" are added.		
Continuous path control	A1SD75: If the reference axis operates in reverse direction, the control is internally changed into the continuous positioning control (restart after deceleration stop). QD75: Even if the reference axis operates in reverse direction with interpolation, the control remains as the continuous path control. (In single-axis operation, the operation is the same as that of the A1SD75.)		
Near pass	For the continuous path control, only the near pass function is available.		
2-axis interpolation <ul style="list-style-type: none"> <li>• 2-axis linear interpolation</li> <li>• 2-axis fixed-feed</li> <li>• Circular interpolation</li> <li>• 2-axis speed control</li> </ul>	The interpolation target axis can be randomly set with a positioning identifier.		
Step function	1. "Step stopped" is changed to "Stopped" and "Step error occurring" is changed to "Error occurring" in the axis operation status parameters. 2. The restart command for step start information (02H) is deleted. 3. The step operation is restarted with the restart command.		
Command in-position function	The command in-position width is expanded. • A1SD75 : 1 to 32767000 • QD75 : 1 to 2147483647		
Control unit "degree" handling	The operating direction can be designated even for the ABS control in the unit of "degree".		

Changed functions	Descriptions		
Positioning start No.	No. 9004 (Multiple axes simultaneous start control) is added. Nos. 7004 to 7010 (block start designation) and 8000 to 8049 (indirect designation) are deleted.		
Block start data	With the QD75, the number of blocks is changed to 5 (7000 to 7004). (With the A1SD75, this data is called "positioning start information".)		
Special start data "Simultaneous start"	The simultaneous start is possible up to 4 axes.		
List of errors/warnings	Refer to the following "Error code comparisons" and "Warning code comparisons".		
Start history	The configuration of "start information" and "start No." is changed so that the start No. can be directly checked.		
Synchronization flag (X1)	When the CPU module starting method is set to asynchronous, interlock is established with the synchronization flag (X1) signal.		
Basic parameter 1 " Pr.5 Pulse output mode"	When the programmable controller is turned ON or the CPU module is reset, the valid value is only the first value after the PLC READY signal (Y0) turns from OFF to ON.		
Detailed parameters " Pr.15 Software stroke limit valid/invalid setting"		A1SD75	QD75
	0 (Factory setting)	Software stroke limits invalid for manual operation	Software stroke limits valid for manual operation
	1	Software stroke limits valid for manual operation	Software stroke limits invalid for manual operation

Error code comparisons

Error name	Error code	
	A1SD75	QD75
Outside bias speed range	913	906
Illegal sudden stop deceleration time	962	961
Stop group 1 sudden stop selection error	963	962
Stop group 2 sudden stop selection error	964	963
Stop group 3 sudden stop selection error	965	964
OPR torque limit value error	991	995
Setting for the movement amount after near-point dog ON error	992	991
OPR acceleration time selection error	993	992
OPR deceleration time selection error	994	993

Error type	Added	Deleted
Fatal error	002	51, 52
Common	–	100, 108
OPR, Absolute position restoration	213, 214	208
JOG/Inching operation	301	–
Manual pulse generator operation	–	–
Positioning operation	523, 535, 545, 546	509 to 512
I/F	800 to 806	–
Parameter	920, 935, 990, 996	931, 933, 938, 971, 999
Error whose name is changed: Error code 967 A1SD75: External start selection error QD75: External command function selection error		

Warning code comparisons

Warning type	Added	Deleted
Fatal warning	–	51, 52
Common	110	101, 105 to 108, 115
OPR, Absolute position restoration	–	–
JOG operation/Inching operation	–	–
Manual pulse generator operation	–	402
Positioning operation	516, 517, 518	–
I/F	–	–
Parameter	–	900
Warning whose name is changed: Warning code 512 A1SD75 : Illegal external start function QD75 : Illegal external command function		

\*: Refer to "Section 15.3 List of errors" and "Section 15.4 List of warnings" for details on error codes and warning codes.

(3) Input/output (X/Y) comparisons

Name		Input (X)	
		A1SD75	QD75
(QD75/A1SD75) READY		X00 *	X00 *
Axis 1	Start complete	X01	X10
Axis 2		X02	X11
Axis 3		X03	X12
Axis 4		–	X13
Axis 1	BUSY	X04	X0C
Axis 2		X05	X0D
Axis 3		X06	X0E
Axis 4		–	X0F
Axis 1	Positioning complete	X07	X14
Axis 2		X08	X15
Axis 3		X09	X16
Axis 4		–	X17
Axis 1	Error detection	X0A	X08
Axis 2		X0B	X09
Axis 3		X0C	X0A
Axis 4		–	X0B
Axis 1	M code ON	X0D	X04
Axis 2		X0E	X05
Axis 3		X0F	X06
Axis 4		–	X07
Synchronization flag		–	X01
Use prohibited		X10 to X1F	X02, X03 X18 to X1F

Name		Output (Y)	
		A1SD75	QD75
Axis 1	Positioning start	Y10	Y10
Axis 2		Y11	Y11
Axis 3		Y12	Y12
Axis 4		–	Y13
Axis 1	Axis stop	Y13	Y04
Axis 2		Y14	Y05
Axis 3		Y1C	Y06
Axis 4		–	Y07
Axis 1	Forward run JOG start	Y16	Y08
Axis 1	Reverse run JOG start	Y17	Y09
Axis 2	Forward run JOG start	Y18	Y0A
Axis 2	Reverse run JOG start	Y19	Y0B
Axis 3	Forward run JOG start	Y1A	Y0C
Axis 3	Reverse run JOG start	Y1B	Y0D
Axis 4	Forward run JOG start	–	Y0E
Axis 4	Reverse run JOG start	–	Y0F
PLC READY		Y1D	Y00
Axis 1	Execution prohibition flag	–	Y14
Axis 2		–	Y15
Axis 3		–	Y16
Axis 4		–	Y17
Use prohibited		Y00 to Y0F Y1E to Y1F	Y01 to Y03 Y18 to Y1F

\*: The ON/OFF statuses for READY are different between the QD75 and A1SD75.

	Not READY/WDT error	READY
QD75	OFF	ON
A1SD75	ON	OFF

## (4) Buffer memory address comparisons

The following table shows the buffer memory addresses of the QD75 (Axis 1 to Axis 3) corresponding to the items of the A1SD75.

The shaded area shows the differences between the A1SD75 and QD75.

Items of A1SD75	Buffer memory address					
	A1SD75			QD75		
	Axis 1	Axis 2	Axis 3	Axis 1	Axis 2	Axis 3
Pr.1 Unit setting	0	150	300	0	150	300
Pr.2 No. of pulses per rotation (Ap)	1	151	301	1	151	301
Pr.3 Movement amount per rotation (Al)	2	152	302	2	152	302
Pr.4 Unit magnification (Am)	3	153	303	3	153	303
Pr.5 Pulse output mode	4	154	304	4	154	304
Pr.6 Rotation direction setting	5	155	305	5	155	305
Pr.7 Speed limit value	6	156	306	10	160	310
	7	157	307	11	161	311
Pr.8 Acceleration time 0	8	158	308	12	162	312
	9	159	309	13	163	313
Pr.9 Deceleration time 0	10	160	310	14	164	314
	11	161	311	15	165	315
Pr.10 Bias speed at start	12	162	312	6	156	306
	13	163	313	7	157	307
Pr.11 Stepping motor mode selection amount	14	164	314	–	–	–
Pr.12 Backlash compensation amount	15	165	315	17	167	317
Pr.13 Software stroke limit upper limit value	16	166	316	18	168	318
	17	167	317	19	169	319
Pr.14 Software stroke limit lower limit value	18	168	318	20	170	320
	19	169	319	21	171	321
Pr.15 Software stroke limit selection	20	170	320	22	172	322
Pr.16 Software stroke limit valid/invalid setting	21	171	321	23	173	323
Pr.17 Command in-position width	22	172	322	24	174	324
	23	173	323	25	175	325
Pr.18 Torque limit setting value	24	174	324	26	176	326
Pr.19 M code ON signal output timing	25	175	325	27	177	327
Pr.20 Speed switching mode	26	176	326	28	178	328
Pr.21 Interpolation speed designation method	27	177	327	29	179	329
Pr.22 Current feed value during speed control	28	178	328	30	180	330
Pr.23 Manual pulse generator selection	29	179	329	–	–	–
Pr.24 Logic selection for pulse output to the drive unit	30	180	330	–	–	–
Pr.25 Size selection for acceleration/deceleration time	31	181	331	–	–	–
Pr.26 Acceleration time 1	36	186	336	36	186	336
	37	187	337	37	187	337
Pr.27 Acceleration time 2	38	188	338	38	188	338
	39	189	339	39	189	339



Items of A1SD75	Buffer memory address					
	A1SD75			QD75		
	Axis 1	Axis 2	Axis 3	Axis 1	Axis 2	Axis 3
Pr.28 Acceleration time 3	40	190	340	40	190	340
	41	191	341	41	191	341
Pr.29 Deceleration time 1	42	192	342	42	192	342
	43	193	343	43	193	343
Pr.30 Deceleration time 2	44	194	344	44	194	344
	45	195	345	45	195	345
Pr.31 Deceleration time 3	46	196	346	46	196	346
	47	197	347	47	197	347
Pr.32 JOG speed limit value	48	198	348	48	198	348
	49	199	349	49	199	349
Pr.33 JOG operation acceleration time selection	50	200	350	50	200	350
Pr.34 JOG operation deceleration time selection	51	201	351	51	201	351
Pr.35 Acceleration/deceleration process selection	52	202	352	52	202	352
Pr.36 S-curve ratio	53	203	353	53	203	353
Pr.37 Sudden stop deceleration time	54	204	354	54	204	354
	55	205	355	55	205	355
Pr.38 Stop group 1 sudden stop selection	56	206	356	56	206	356
Pr.39 Stop group 2 sudden stop selection	57	207	357	57	207	357
Pr.40 Stop group 3 sudden stop selection	58	208	358	58	208	358
Pr.41 Positioning complete signal output time	59	209	359	59	209	359
Pr.42 Allowable circular interpolation error width	60	210	360	60	210	360
	61	211	361	61	211	361
Pr.43 External start function selection	62	212	362	62	212	362
(QD75: Pr.42 External command function selection)						
Pr.44 Near pass mode selection for path control	66	216	366	–	–	–
Pr.45 OPR method	70	220	370	70	220	370
Pr.46 OPR direction	71	221	371	71	221	371
Pr.47 OP address	72	222	372	72	222	372
	73	223	373	73	223	373
Pr.48 OPR speed	74	224	374	74	224	374
	75	225	375	75	225	375
Pr.49 Creep speed	76	226	376	76	226	376
	77	227	377	77	227	377
Pr.50 OPR retry	78	228	378	78	228	378
Pr.51 OPR dwell time	79	229	379	79	229	379
Pr.52 Setting for the movement amount after near-point dog ON	80	230	380	80	230	380
	81	231	381	81	231	381
Pr.53 OPR acceleration time selection	82	232	382	82	232	382
Pr.54 OPR deceleration time selection	83	233	383	83	233	383
Pr.55 OP shift amount	84	234	384	84	234	384
	85	235	385	85	235	385
Pr.56 OPR torque limit value	86	236	386	86	236	386
Pr.57 Speed designation during OP shift	88	238	388	88	238	388
Pr.58 Dwell time during OPR retry	89	239	389	89	239	389

Items of A1SD75		Buffer memory address	
		A1SD75	QD75
		Common for axis 1, 2, 3	Common for axis 1, 2, 3, 4
Md.1	In test mode flag	450	1200
Md.2	Module name	451	–
Md.3	OS type	452 453 454 455	–
Md.4	OS version	456 457	–
Md.5	Clock data (hour: minute)	460	–
Md.6	Clock data (second: 100ms)	461	–
(Pointer number)		(0) to (15)	
Md.7	Start axis (QD75: Md.3 Start information)	462 to 537	1212 to 1287
Md.8	Operation type (QD75: Md.4 Start No.)	463 to 538	1213 to 1288
Md.9	Start Hour: minute (QD75: Md.5 Start Day: Hour)	464 to 539	1214 to 1289
Md.10	Start Second: 100ms (QD75: Md.3 Start Minute: second)	465 to 540	1215 to 1290
Md.11	Error judgment	466 to 541	1216 to 1291
Md.12	Start history pointer	542	1292
(Pointer number)		(0) to (15)	
Md.13	Start axis	543 to 618	–
Md.14	Operation type	544 to 619	–
Md.15	Start Hour: minute	545 to 620	–
Md.16	Start Second: 100ms	546 to 621	–
Md.17	Error judgment	547 to 622	–
Md.18	Start history storage during error	623	–
(Pointer number)		(0) to (15)	
Md.19	Axis in which the error occurred	624 to 684	1293 to 1353
Md.20	Axis error No.	625 to 685	1294 to 1354
Md.21	Axis error occurrence Hour: minute (QD75: Md.11 Axis error occurrence (Day: Hour))	626 to 686	1295 to 1355
Md.22	Axis error occurrence Second: 100ms (QD75: Md.12 Axis error occurrence (Minute: second))	627 to 687	1296 to 1356
Md.23	Error history pointer	688	1357

Items of A1SD75		Buffer memory address	
		A1SD75	QD75
		Common for axis 1, 2, 3	Common for axis 1, 2, 3, 4
(Pointer number)	Warning history	(0) to (15)	
Md.24 Axis in which the warning occurred		689 to 749	1358 to 1418
Md.25 Axis warning No.		690 to 750	1359 to 1419
Md.26 Axis warning occurrence Hour: minute		691 to 751	1360 to 1420
(QD75: Md.16 Axis warning occurrence (Day: Hour))			
Md.27 Axis warning occurrence Second: 100ms		692 to 752	1361 to 1421
(QD75: Md.17 Axis warning occurrence (Minute: second))			
Md.28 Warning history pointer		753	1422

Items of A1SD75	Buffer memory address					
	A1SD75			QD75		
	Axis 1	Axis 2	Axis 3	Axis 1	Axis 2	Axis 3
Md.29 Current feed value	800	900	1000	800	900	1000
	801	901	1001	801	901	1001
Md.30 Machine feed value	802	902	1002	802	902	1002
	803	903	1003	803	903	1003
Md.31 Feedrate	804	904	1004	804	904	1004
	805	905	1005	805	905	1005
Md.32 Valid M code	806	906	1006	808	908	1008
Md.33 Axis error No.	807	907	1007	806	906	1006
Md.34 Axis warning No.	808	908	1008	807	907	1007
Md.35 Axis operation status	809	909	1009	809	909	1009
Md.36 Current speed	810	910	1010	810	910	1010
	811	911	1011	811	911	1011
Md.37 Axis feedrate	812	912	1012	812	912	1012
	813	913	1013	813	913	1013
Md.38 Speed-position switching control positioning amount	814	914	1014	814	914	1014
	815	915	1015	815	915	1015
Md.39 External input/output signal	816	916	1016	816	916	1016
Md.40 Status	817	917	1017	817	917	1017
Md.41 Target value	818	918	1018	818	918	1018
	819	919	1019	819	919	1019
Md.42 Target speed	820	920	1020	820	920	1020
	821	921	1021	821	921	1021
Md.43 OP absolute position	822	922	1022	—	—	—
	823	923	1023	—	—	—
Md.44 Movement amount after near-point dog ON	824	924	1024	824	924	1024
	825	925	1025	825	925	1025
Md.45 Torque limit stored value	826	926	1026	826	926	1026
Md.46 Special start data instruction code setting value	827	927	1027	827	927	1027
Md.47 Special start data instruction parameter setting value	828	928	1028	828	928	1028
Md.48 Start positioning data No. setting value	829	929	1029	829	929	1029
Md.49 In speed limit flag	830	930	1030	830	930	1030
Md.50 In speed change processing flag	831	931	1031	831	931	1031
Md.51 Start data pointer being executed	832	932	1032	834	934	1034
Md.52 Last executed positioning data No.	833	933	1033	837	937	1037
Md.53 Repetition counter	834	934	1034	832	932	1032
(QD75: Md.41 Special start repetition counter)				832	932	1032
Md.54 Positioning data No. being executed	835	935	1035	835	935	1035
Md.55 Block No. being executed	836	936	1036	836	936	1036
Md.56 Positioning data being executed	838 to 847	938 to 947	1038 to 1047	838 to 847	938 to 947	1038 to 1047

Items of A1SD75	Buffer memory address					
	A1SD75			QD75		
	Axis 1	Axis 2	Axis 3	Axis 1	Axis 2	Axis 3
Cd.1 Clock data setting (hour)	1100			-		
Cd.2 Clock data setting (minute, second)	1101			-		
Cd.3 Clock data writing	1102			-		
Cd.4 Target axis	1103			-		
Cd.5 Positioning data No.	1104			-		
Cd.6 Write pattern	1105			-		
Cd.7 Read/write request	1106			-		
Cd.8 Read/write positioning data I/F	1108 to 1137			-		
Cd.9 Flash ROM write request	1138			-		
Cd.10 Parameter initialization request	1139			1901		
Cd.11 Positioning start No.	1150	1200	1250	1500	1600	1700
Cd.12 Axis error reset	1151	1201	1251	1502	1602	1702
Cd.13 Restart command	1152	1202	1252	1503	1603	1703
Cd.14 M code OFF request	1153	1203	1253	1504	1604	1704
Cd.15 New current value	1154	1204	1254	1506	1606	1706
	1155	1205	1255	1507	1607	1707
Cd.16 New speed value	1156	1206	1256	1514	1614	1714
	1157	1207	1257	1515	1615	1715
Cd.17 Speed change request	1158	1208	1258	1516	1616	1716
Cd.18 Positioning operation speed override	1159	1209	1259	1513	1613	1713
Cd.19 JOG speed	1160	1210	1260	1518	1618	1718
	1161	1211	1261	1519	1619	1719
Cd.20 Speed-position switching enable flag	1163	1213	1263	1528	1628	1728
Cd.21 Speed-position switching control movement amount change register	1164	1214	1264	1526	1626	1726
	1165	1215	1265	1527	1627	1727
Cd.22 Manual pulse generator enable flag	1167	1217	1267	1524	1624	1724
Cd.23 Manual pulse generator 1 pulse input magnification	1168	1218	1268	1522	1622	1722
	1169	1219	1269	1523	1623	1723
Cd.24 OPR return request flag OFF request	1170	1220	1270	1521	1621	1721
Cd.25 External start valid	1171	1221	1271	1505	1605	1705
(QD75: Cd.8 External command valid)						
Cd.26 Step valid flag	1172	1222	1272	1545	1645	1745
Cd.27 Step mode	1173	1223	1273	1544	1644	1744
Cd.28 Step start information	1174	1224	1274	1546	1646	1746
Cd.29 Skip command	1175	1225	1275	1547	1647	1747
Cd.30 New torque value	1176	1226	1276	1525	1625	1725
Cd.31 Positioning starting point No.	1178	1228	1278	1501	1601	1701
Cd.32 Interrupt request during continuous operation	1181	1231	1281	1520	1620	1720
Cd.33 New acceleration time value	1184	1234	1284	1508	1608	1708
	1185	1235	1285	1509	1609	1709

Items of A1SD75		Buffer memory address							
		A1SD75			QD75				
		Axis 1	Axis 2	Axis 3	Axis 1	Axis 2	Axis 3		
Cd.34	New deceleration time value	1186	1236	1286	1510	1610	1710		
		1187	1237	1287	1511	1611	1711		
Cd.35	Acceleration/deceleration time change during speed change, enable/disable selection	1188	1238	1288	1512	1612	1712		
Positioning data * 1	Da.1	No.1	1300	2300	3300	2000	8000	14000	
	Da.2								Control system
	Da.3		Acceleration time No.						
	Da.4		Deceleration time No.						
	Da.9		M code/condition data	1301	2301	3301	2001	8001	14001
	Da.8		Dwell time/JUMP destination positioning data No.	1302	2302	3302	2002	8002	14002
	Da.7		Command speed	1304	2304	3304	2004	8004	14004
				1305	2305	3305	2005	8005	14005
	Da.5		Positioning address/movement amount	1306	2306	3306	2006	8006	14006
				1307	2307	3307	2007	8007	14007
	Da.6		Arc address	1308	2308	3308	2008	8008	14008
				1309	2309	3309	2009	8009	14009
	No.2		1310 to 1319	2310 to 2319	3310 to 3319	2010 to 2019	8010 to 8019	14010 to 14019	
	No.3		1320 to 1329	2320 to 2329	3320 to 3329	2020 to 2029	8020 to 8029	14020 to 14029	
to		to	to	to	to	to	to		
No.100		2290 to 2299	3290 to 3299	4290 to 4299	2990 to 2999	8990 to 8999	14990 to 14999		

\* 1: With the QD75, the positioning data buffer memory addresses are Nos. 1 to 600.

Refer to Appendix 13 "List of buffer memory addresses" for details.

Items of A1SD75				Buffer memory address											
				A1SD75						QD75					
				Axis 1		Axis 2		Axis 3		Axis 1		Axis 2		Axis 3	
Positioning start information * 2	Start block data * 2	Da.10 Shape	1st point												
		Da.11 Start data No.		4300	4350	4550	4600	4800	4850	26000	26050	27000	27050	28000	28050
		Da.12 Special start instruction													
		Da.13 Parameter													
		2nd point		4301	4351	4551	4601	4801	4851	26001	26051	27001	27051	28001	28051
	3rd point	4302	4352	4552	4602	4802	4852	26002	26052	27002	27052	28002	28052		
	to	to	to	to	to	to	to	to	to	to	to	to	to		
	50th point	4349	4399	4599	4649	4849	4899	26049	26099	27049	27099	28049	28099		
	Condition data	Da.14 Condition target	No. 1	4400	4650	4900	26100	27100	28100						
		Da.15 Condition operator													
		Da.16 Address		4402	4652	4902	26102	27102	28102						
				4403	4653	4903	26103	27103	28103						
		Da.17 Parameter 1		4404	4654	4904	26104	27104	28104						
				4405	4655	4905	26105	27105	28105						
		Da.18 Parameter 2		4406	4656	4906	26106	27106	28106						
				4407	4657	4907	26107	27107	28107						
		No. 2		4410 to 4419	4660 to 4669	4910 to 4919	26110 to 26119	27110 to 27119	28110 to 28119						
		No. 3		4420 to 4429	4670 to 4679	4920 to 4929	26120 to 26129	27120 to 27129	28120 to 28129						
	to	to	to	to	to	to	to								
	No. 10	4490 to 4499	4740 to 4749	4990 to 4999	26190 to 26199	27190 to 27199	28190 to 28199								
Positioning start information	Indirect specification	Start No. 8001	4500	4750	5000	-	-	-							
		Start No. 8002	4501	4751	5001	-	-	-							
		to	to	to	to	to	to	to							
		Start No. 8050	4549	4799	5049	-	-	-							
PLC CPU memo area	Condition judgment target data of the condition data	5050	30000												
		to	to												
		5099	30099												
Target axis	5100						-								
Head positioning block No.	5101						-								
No. of read/write data items	5102						-								
Read/write request	5103						-								
Read/write block	5110 to 6109						-								

\*2: With the QD75, it is called "block start data".

\*3: With the QD75, the "block start data" and "condition data" in the shaded area are called "start block 0". There are five start blocks: 0 to 4.

Refer to Appendix 13 "List of buffer memory addresses" for details.

## (5) Data indication No. comparisons

The following table shows the comparisons of numbers for each symbols (Pr., Md., Cd., and Da.) indicating parameters or positioning data items.

The shaded sections indicate the added or changed items with the QD75.

## Parameters

Item	A1SD75	QD75
Unit setting		Pr.1
No. of pulses per rotation (Ap)		Pr.2
Movement amount per rotation (Al)		Pr.3
Unit magnification (Am)		Pr.4
Pulse output mode		Pr.5
Rotation direction setting		Pr.6
Speed limit value	Pr.7	Pr.8
Acceleration time 0	Pr.8	Pr.9
Deceleration time 0	Pr.9	Pr.10
Bias speed at start	Pr.10	Pr.7
Stepping motor mode selection	Pr.11	-
Backlash compensation amount	Pr.12	Pr.11
Software stroke limit upper limit value	Pr.13	Pr.12
Software stroke limit lower limit value	Pr.14	Pr.13
Software stroke limit selection	Pr.15	Pr.14
Software stroke limit valid/invalid setting	Pr.16	Pr.15
Command in-position width	Pr.17	Pr.16
Torque limit setting value	Pr.18	Pr.17
M code ON signal output timing	Pr.19	Pr.18
Speed switching mode	Pr.20	Pr.19
Interpolation speed designation method	Pr.21	Pr.20
Current feed value during speed control	Pr.22	Pr.21
Manual pulse generator selection	Pr.23	-
Logic selection for pulse output to the drive unit	Pr.24	-
Input signal logic selection	-	Pr.22
Output signal logic selection	-	Pr.23
Manual pulse generator input selection	-	Pr.24
Size selection for acceleration/deceleration time	Pr.25	-
Acceleration time 1	Pr.26	Pr.25
Acceleration time 2	Pr.27	Pr.26



Item	A1SD75	QD75
Acceleration time 3	Pr.28	Pr.27
Deceleration time 1	Pr.29	Pr.28
Deceleration time 2	Pr.30	Pr.29
Deceleration time 3	Pr.31	Pr.30
JOG speed limit value	Pr.32	Pr.31
JOG operation acceleration time selection	Pr.33	Pr.32
JOG operation deceleration time selection	Pr.34	Pr.33
Acceleration/deceleration process selection	Pr.35	Pr.34
S-curve ratio	Pr.36	Pr.35
Sudden stop deceleration time	Pr.37	Pr.36
Stop group 1 sudden stop selection	Pr.38	Pr.37
Stop group 2 sudden stop selection	Pr.39	Pr.38
Stop group 3 sudden stop selection	Pr.40	Pr.39
Positioning complete signal output time	Pr.41	Pr.40
Allowable circular interpolation error width	Pr.42	Pr.41
External start function selection (QD75: Pr.42 External command function selection)	Pr.43	Pr.42
Near pass mode selection for path control	Pr.44	–
OPR method	Pr.45	Pr.43
OPR direction	Pr.46	Pr.44
OP address	Pr.47	Pr.45
OPR speed	Pr.48	Pr.46
Creep speed	Pr.49	Pr.47
OPR retry	Pr.50	Pr.48
OPR dwell time	Pr.51	Pr.49
Setting for the movement amount after near-point dog ON	Pr.52	Pr.50
OPR acceleration time selection	Pr.53	Pr.51
OPR deceleration time selection	Pr.54	Pr.52
OP shift amount	Pr.55	Pr.53
OPR torque limit value	Pr.56	Pr.54
Deviation counter clear signal output time	–	Pr.55
Speed designation during OP shift	Pr.57	Pr.56
Dwell time during OPR retry	Pr.58	Pr.57
Speed-position function selection	–	Pr.150

Monitor data

Item	A1SD75	QD75
In test mode flag	Md.1	
Module name	Md.2	-
OS type	Md.3	-
OS version	Md.4	-
Clock data (hour: minute)	Md.5	-
Clock data (second: 100ms)	Md.6	-
Start axis (QD75: Md.3 Start information)	Md.7	Md.3
Operation type (QD75: Md.4 Start No.)	Md.8	Md.4
Start Hour: minute (QD75: Md.5 Start Hour)	Md.9	Md.5
Start Second: 100ms (QD75: Md.6 Start Minute: second)	Md.10	Md.6
Error judgment	Md.11	Md.7
Start history pointer	Md.12	Md.8
Start axis	Md.13	-
Operation type	Md.14	-
Start Hour: minute	Md.15	-
Start Second: 100ms	Md.16	-
Error judgment	Md.17	-
Start history storage during error	Md.18	-
Axis in which the error occurred	Md.19	Md.9
Axis error No.	Md.20	Md.10
Axis error occurrence Hour: minute (QD75: Md.11 Axis error occurrence (Hour))	Md.21	Md.11
Axis error occurrence Second: 100ms (QD75: Md.12 Axis error occurrence (Minute: second))	Md.22	Md.12
Pointer	Md.23	Md.13
Axis in which the warning occurred	Md.24	Md.14
Axis warning No.	Md.25	Md.15
Axis warning occurrence Hour: minute (QD75: Md.16 Axis warning occurrence (Hour))	Md.26	Md.16
Axis warning occurrence Second: 100ms (QD75: Md.17 Axis warning occurrence (Minute: second))	Md.27	Md.17
Pointer	Md.28	Md.18

Item	A1SD75	QD75
No. of write accesses to flash ROM	–	<a href="#">Md.19</a>
Current feed value	<a href="#">Md.29</a>	<a href="#">Md.20</a>
Machine feed value	<a href="#">Md.30</a>	<a href="#">Md.21</a>
Feedrate	<a href="#">Md.31</a>	<a href="#">Md.22</a>
Valid M code	<a href="#">Md.32</a>	<a href="#">Md.25</a>
Axis error No.	<a href="#">Md.33</a>	<a href="#">Md.23</a>
Axis warning No.	<a href="#">Md.34</a>	<a href="#">Md.24</a>
Axis operation status	<a href="#">Md.35</a>	<a href="#">Md.26</a>
Current speed	<a href="#">Md.36</a>	<a href="#">Md.27</a>
Axis feedrate	<a href="#">Md.37</a>	<a href="#">Md.28</a>
Speed-position switching control positioning amount	<a href="#">Md.38</a>	<a href="#">Md.29</a>
External input/output signal	<a href="#">Md.39</a>	<a href="#">Md.30</a>
Status	<a href="#">Md.40</a>	<a href="#">Md.31</a>
Target value	<a href="#">Md.41</a>	<a href="#">Md.32</a>
Target speed	<a href="#">Md.42</a>	<a href="#">Md.33</a>
OP absolute position	<a href="#">Md.43</a>	–
Movement amount after near-point dog ON	<a href="#">Md.44</a>	<a href="#">Md.34</a>
Torque limit stored value	<a href="#">Md.45</a>	<a href="#">Md.35</a>
Special start data instruction code setting value	<a href="#">Md.46</a>	<a href="#">Md.36</a>
Special start data instruction parameter setting value	<a href="#">Md.47</a>	<a href="#">Md.37</a>
Start positioning data No. setting value	<a href="#">Md.48</a>	<a href="#">Md.38</a>
In speed control flag	<a href="#">Md.49</a>	<a href="#">Md.39</a>
In speed change processing flag	<a href="#">Md.50</a>	<a href="#">Md.40</a>
Start data pointer being executed	<a href="#">Md.51</a>	<a href="#">Md.43</a>
Last executed positioning data No.	<a href="#">Md.52</a>	<a href="#">Md.46</a>
Repetition counter (QD75: <a href="#">Md.41</a> Special start repetition counter)	<a href="#">Md.53</a>	<a href="#">Md.41</a>
Control system repetition counter	–	<a href="#">Md.42</a>
Positioning data No. being executed	<a href="#">Md.54</a>	<a href="#">Md.44</a>
Block No. being executed	<a href="#">Md.55</a>	<a href="#">Md.45</a>
Positioning data being executed	<a href="#">Md.56</a>	<a href="#">Md.47</a>
Deceleration start flag	–	<a href="#">Md.48</a>

## Control data

Item	A1SD75	QD75
Clock data setting (hour)	Cd.1	–
Clock data setting (minute, second)	Cd.2	–
Clock data writing	Cd.3	–
Target axis	Cd.4	–
Positioning data No.	Cd.5	–
Write pattern	Cd.6	–
Read/write request	Cd.7	–
Read/write positioning data I/F	Cd.8	–
Flash ROM write request	Cd.9	Cd.1
Parameter initialization request	Cd.10	Cd.2
Positioning start No.	Cd.11	Cd.3
Axis error reset	Cd.12	Cd.5
Restart command	Cd.13	Cd.6
M code OFF request	Cd.14	Cd.7
New current value	Cd.15	Cd.9
New speed value	Cd.16	Cd.14
Speed change request	Cd.17	Cd.15
Positioning operation speed override	Cd.18	Cd.13
JOG speed	Cd.19	Cd.17
Inching movement amount	–	Cd.16
Speed-position switching enable flag	Cd.20	Cd.24
Speed-position switching control movement amount change register	Cd.21	Cd.23
Position-speed switching enable flag	–	Cd.26
Position-speed switching control speed change register	–	Cd.25
Target position change request flag	–	Cd.29
Target position change value (new address)	–	Cd.27
Target position change value (new speed)	–	Cd.28
ABS direction in degrees	–	Cd.40
Manual pulse generator enable flag	Cd.22	Cd.21
Manual pulse generator 1 pulse input magnification	Cd.23	Cd.20
OPR request flag OFF request	Cd.24	Cd.19
External start valid (QD75: Cd.8 External command valid)	Cd.25	Cd.8

Item	A1SD75	QD75
Step valid flag	Cd.26	Cd.35
Step mode	Cd.27	Cd.34
Step start information	Cd.28	Cd.36
Skip command	Cd.29	Cd.37
New torque value	Cd.30	Cd.22
Positioning starting point No.	Cd.31	Cd.4
Interrupt request during continuous operation	Cd.32	Cd.18
Simultaneous starting axis start data No. (Axis 1 start data No.)	–	Cd.30
Simultaneous starting axis start data No. (Axis 2 start data No.)	–	Cd.31
Simultaneous starting axis start data No. (Axis 3 start data No.)	–	Cd.32
Simultaneous starting axis start data No. (Axis 4 start data No.)	–	Cd.33
Teaching data selection	–	Cd.38
Teaching positioning data No.	–	Cd.39
New acceleration time value	Cd.33	Cd.10
New deceleration time value	Cd.34	Cd.11
Acceleration/deceleration time change during speed change, enable/disable selection	Cd.35	Cd.12
Stop command processing for deceleration stop selection	–	Cd.42
Deceleration start flag valid	–	Cd.41

## Positioning data, block start data, condition data

Item		A1SD75	QD75	
Positioning data	Operation pattern		Da.1	
	Control system		Da.2	
	Acceleration time No.		Da.3	
	Deceleration time No.		Da.4	
	Axis to be interpolated	-	Da.5	
	Positioning address/movement amount	Da.5	Da.6	
	Arc address	Da.6	Da.7	
	Command speed	Da.7	Da.8	
	Dwell time/JUMP destination positioning data No.	Da.8	Da.9	
	M code/condition data	Da.9	Da.10	
Positioning start information *	Start block data *	Shape	Da.10	Da.11
		Start data No.	Da.11	Da.12
		Special start instruction	Da.12	Da.13
		Parameter	Da.13	Da.14
	Condition data	Condition target	Da.14	Da.15
		Condition operator	Da.15	Da.16
		Address	Da.16	Da.17
		Parameter 1	Da.17	Da.18
		Parameter 2	Da.18	Da.19

\*: Called "block start data" with the QD75.

(6) Input/output signal comparisons

Input signal comparisons

Name	A1SD75		QD75	
	Logic (initial status)	Logic switch with parameters	Logic (initial status)	Logic switch with parameters
Drive unit READY	Negative logic	Not possible	Negative logic	Possible
In-position signal	Negative logic	Not possible	–	–
Zero signal	Negative logic	Not possible	Negative logic	Possible
Manual pulse generator A phase Manual pulse generator B phase *1	Negative logic (multiple of 4)	Not possible	Negative logic (multiple of 4)	Possible
Near-point dog signal	Negative logic	Not possible	Negative logic	Possible
Stop signal	Negative logic	Not possible	Negative logic	Possible
Upper limit	Negative logic	Not possible	Negative logic	Possible
Lower limit	Negative logic	Not possible	Negative logic	Possible
External start *2	Negative logic	Not possible	Negative logic	Possible
Speed-position switching signal *2	Negative logic	Not possible	Negative logic	Possible

Output signal comparisons

Name	A1SD75		QD75	
	Logic (initial status)	Logic switch with parameters	Logic (initial status)	Logic switch with parameters
Command pulse *3	Positive logic CW/CCW mode	Possible	Negative logic CW/CCW mode	Possible
Deviation counter clear	Negative logic	Not possible	Negative logic	Possible

\*1: Comparisons about manual pulse generator A phase/B phase

	A1SD75	QD75
No. of connectable manual pulse generators	1 generator/1 axis	1 generator/1 module
Mode selection (with parameter)	Not possible	Possible Multiple of 1 mode, multiple of 4 mode, PULSE/SIGN mode

\*2: With the QD75, the "external start signal" and "speed-position switching signal" are combined into the "external command signal".

\*3: Comparisons about command pulse

	A1SD75	QD75
Mode selection (with parameter)	Possible PULSE/SIGN mode, A phase/B phase (multiple of 4) mode, A phase/B phase (multiple of 1) mode, CW/CCW mode	
Max. command frequency	Open collector: 200kpps Differential driver: 400kpps	Open collector: 200kpps Differential driver: 4Mpps(QD75D□N) 1Mpps (QD75D□)

Appendix 10 When using GX Works2

The following shows the procedure for positioning operation when GX Works2 is used.

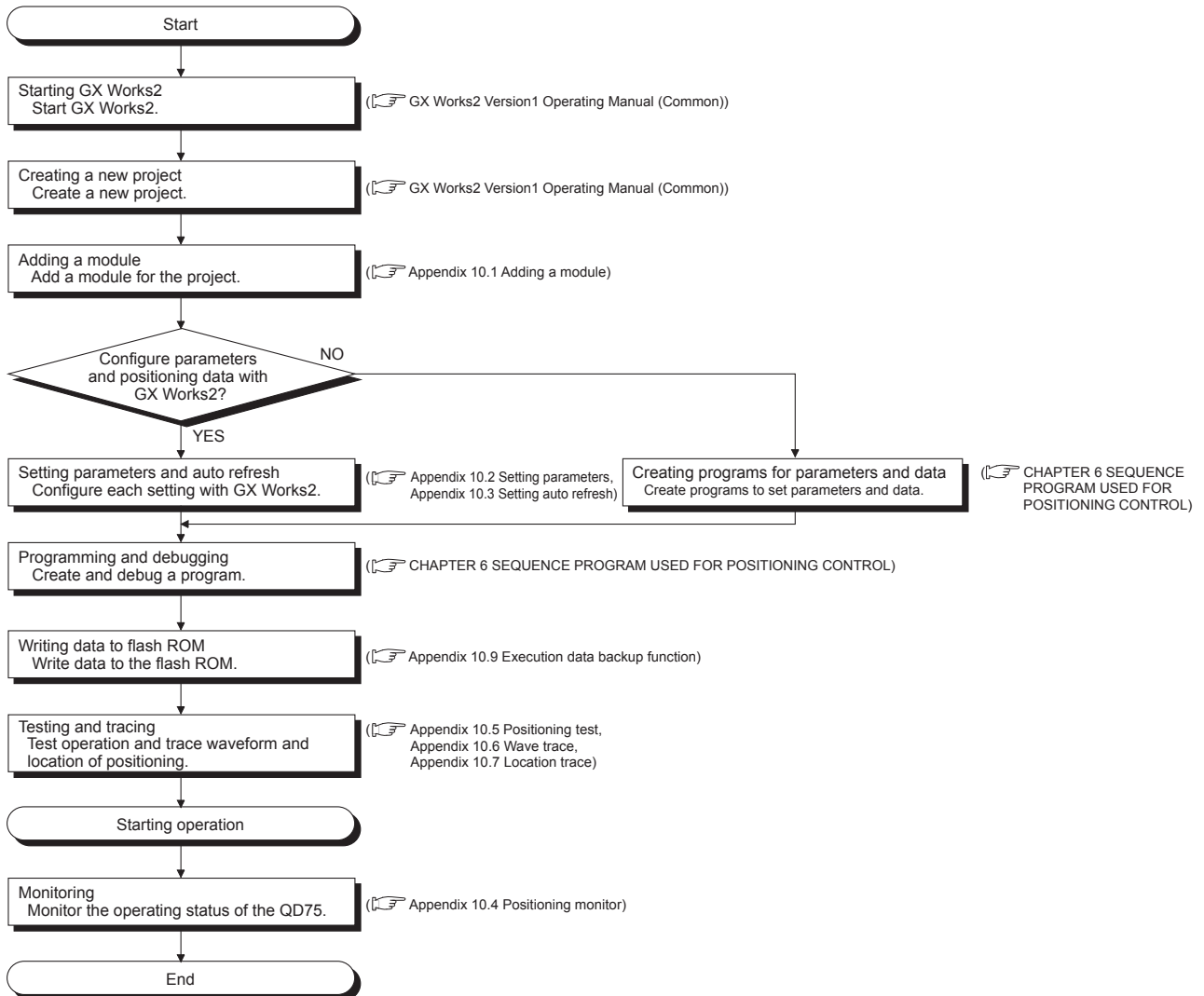

For details on the operation method of GX Works2, refer to the following.  
GX Works2 Version 1 Operating Manual (Common)

For details on operation in GX Works2 for the QD75, refer to the following.  
GX Works2 Version 1 Operating Manual (Intelligent Function Module)



Appendix 10.1 Adding a module

Add the model name of the positioning module to be used in the project.

(1) Operating procedure

1. Open the "New Module..." dialog box.

Project window → Right-click [Intelligent Function Module] → "New Module..."

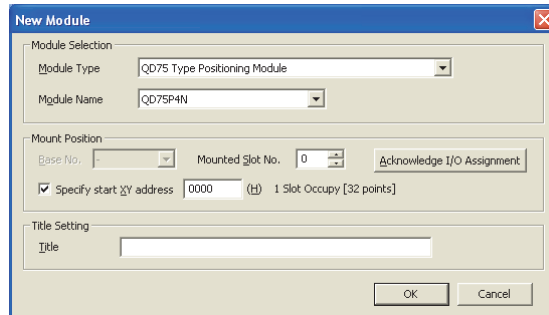

2. Configure settings

Set the following items.

Item		Contents
Module Selection	Module Type	Select "QD75 Type Positioning Module".
	Module Name	Select the model name of the module to be connected.
Mount Position	Mounted Slot No.	Select the number of the slot where the module is mounted.
	Specify start X/Y address	The start I/O number (hexadecimal) of the module to be mounted on the slot set in "Mounted Slot No." is displayed. The value can be changed.
Title Setting	Title	Enter a title.

Appendix 10.2 Setting parameters

Set parameters for the positioning module.  
 By setting parameters, the parameter setting by sequence program is not needed.

■ Parameter setting

(1) Operating procedure

1. Open the "Parameter" window.

Project window → [Intelligent Function Module] → Module name → "Parameter"

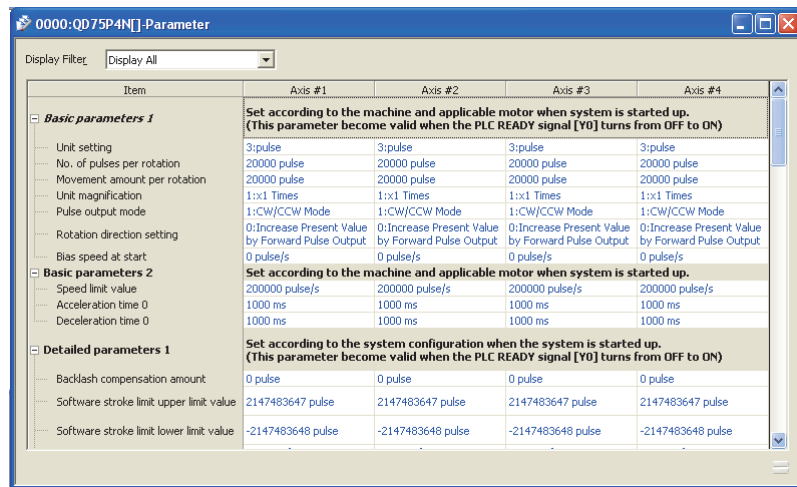

2. Configure settings

Double-click the setting-target item and select or enter a value.

- Items with a pull-down list  
Double-click the item and select an item in the displayed pull-down list.
- Items without a pull-down list  
Double-click the item and enter a value.

For details on the setting items, refer to the following.

Parameter	Reference
Basic parameters 1	Section 5.2.1
Basic parameters 2	Section 5.2.2
Detailed parameters 1	Section 5.2.3
Detailed parameters 2	Section 5.2.4
OPR basic parameters	Section 5.2.5
OPR detailed parameters	Section 5.2.6

■ Setting positioning data

(1) Operating procedure

1. Open the "Parameter" window.

Project window → [Intelligent Function Module] → Module name → "Positioning\_Axis\_#□\_Data"

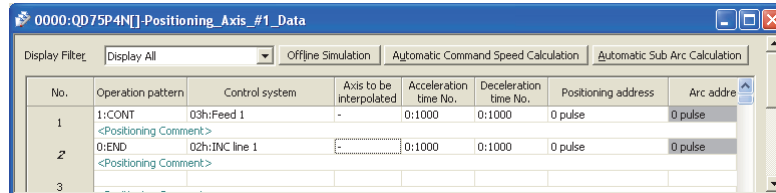

2. Configure settings.

Double-click the setting-target item and select or enter a value.

- Items with a pull-down list  
Double-click the item and select an item in the displayed pull-down list.
- Items without a pull-down list  
Double-click the item and enter a value.

**POINT**

In the default status, the data displayed on "Positioning\_Axis\_#□\_Data" are only No. 1 to No. 100 of positioning data. To display the data No. 101 and later, change the display range under "Display Specification of Positioning data".

[Tool] → [Options...] → [Intelligent Function Module] → "QD75/LD75 Type Positioning"

(Example) To display No.1 to No. 120 of positioning data

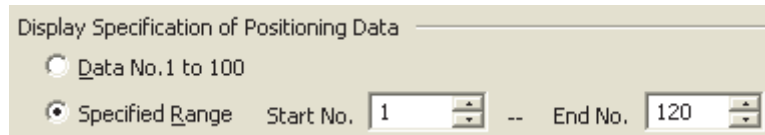

(2) Sub-function

- Offline Simulation

The locus and waveform of configured positioning data can be checked.

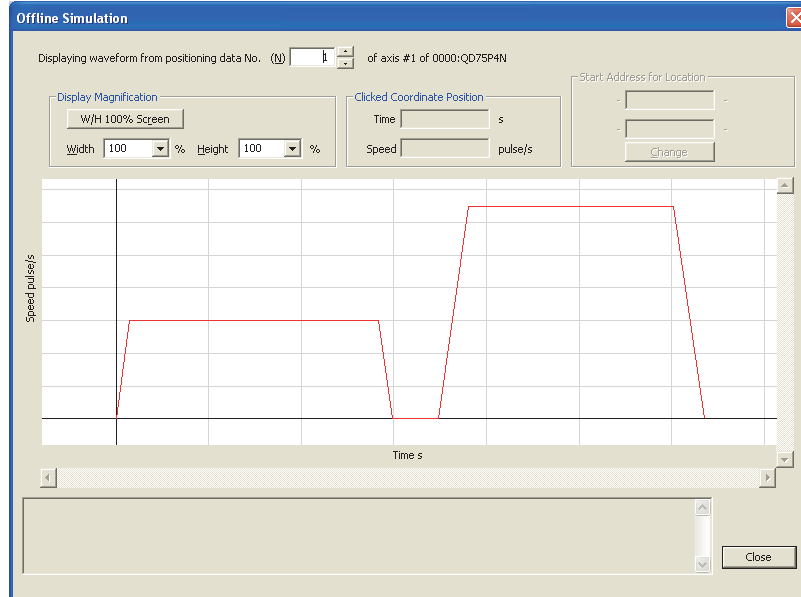

- Automatic Command Speed Calculation

Constant speed is automatically calculated by setting the time for positioning from the starting position to the target position.

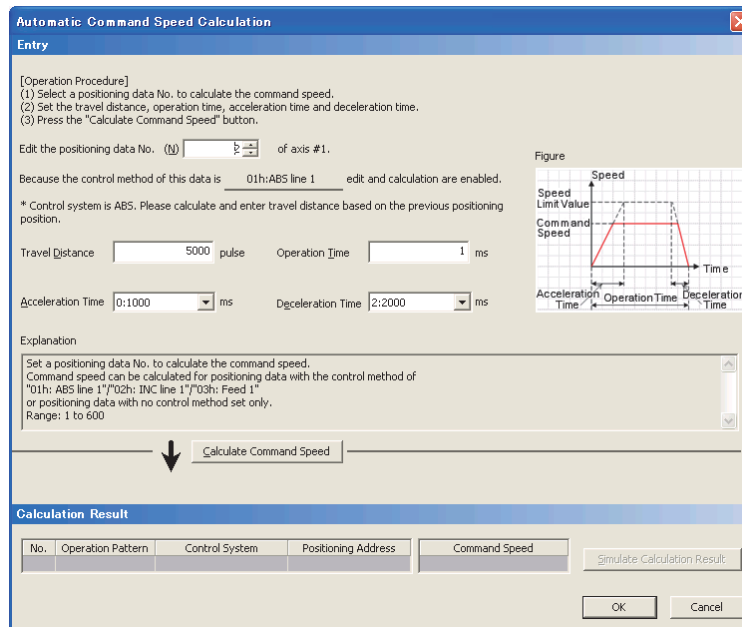

- Automatic Sub Arc Calculation

The circular interpolation control data for two positioning data interpolation is automatically created, by selecting two positioning data and setting the radius.

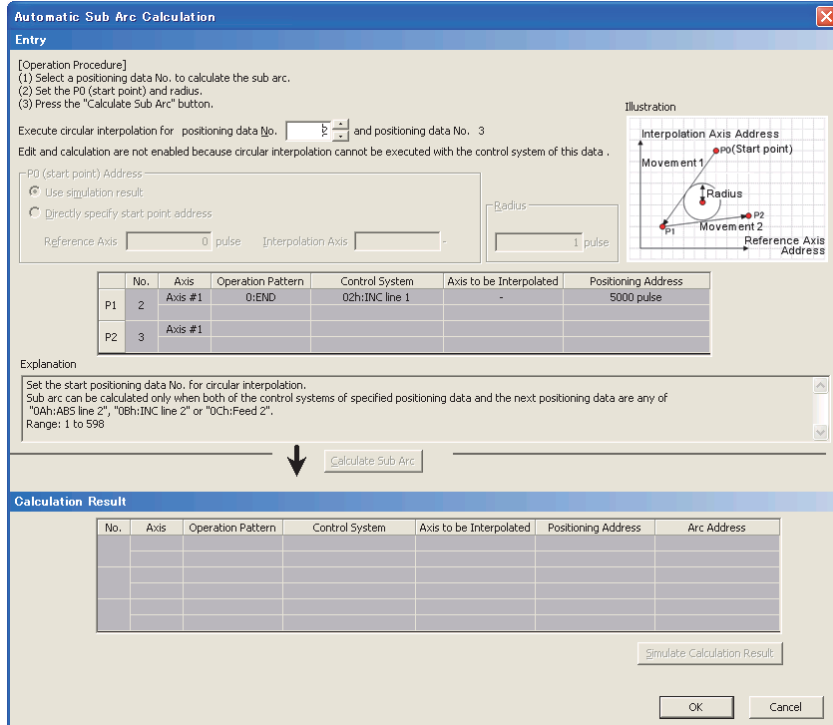

- M Code Comment Edit

Set and display M code comments of the positioning module.

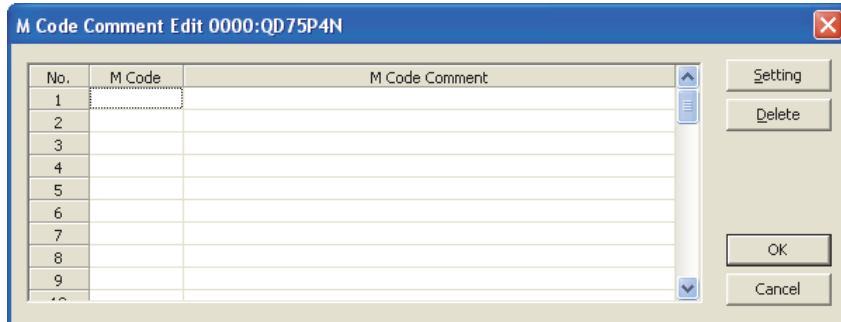

For details on each function, refer to the GX Works2 Version1 Operating Manual (Intelligent Function Module).

## ■ Setting block start data

### (1) Operating procedure

1. Open the "Parameter" window.

Project window → [Intelligent Function Module] → Module name → "Starting\_Axis\_#□\_Block\_Data"

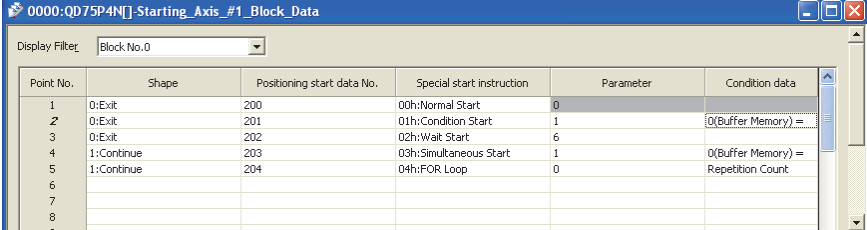

The screenshot shows a software window titled "0000:QD75P4N[]-Starting\_Axis\_#1\_Block\_Data". It contains a table with the following data:

Point No.	Shape	Positioning start data No.	Special start instruction	Parameter	Condition data
1	0:Exit	200	00h:Normal Start	0	
2	0:Exit	201	01h:Condition Start	1	0(Buffer Memory) =
3	0:Exit	202	02h:Wait Start	6	
4	1:Continue	203	03h:Simultaneous Start	1	0(Buffer Memory) =
5	1:Continue	204	04h:FOR Loop	0	Repetition Count
6					
7					
8					
>					

2. Configure settings.

Double-click the setting-target item and select or enter a value.

- Items with a pull-down list  
Double-click the item and select an item in the displayed pull-down list.
- Items without a pull-down list  
Double-click the item and enter a value.

For details on the setting items, refer to Section 5.4 "List of block start data".

### Appendix 10.3 Setting auto refresh

Transfer data in the buffer memory of the positioning module to specified devices in the CPU module.

By setting auto refresh, reading by sequence program is not needed.

#### (1) Operating procedure

1. Open the "Auto\_Refresh" window.

Project window → [Intelligent Function Module] → Module name → "Auto\_Refresh"

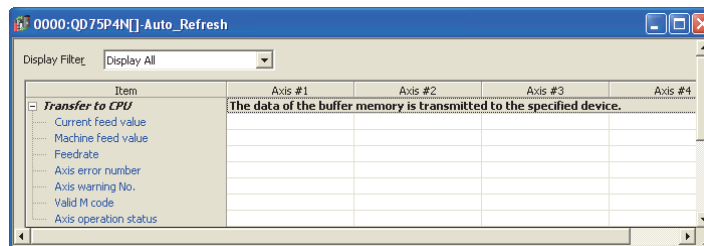

2. Enter devices.

Click the text box of the item to be set, and enter the auto refresh target device.

#### POINT

To validate the auto refresh data after writing them into the CPU module, power off and then on or reset the CPU module.

Appendix 10.4 Positioning monitor

With the positioning monitor function, the QD75 operating status can be confirmed, and debugging can be performed.

The following five types of monitors are available in this function:

- Axis Monitor : The actual status of each axis can be monitored.
- Starting History : 16 starting history logs of operations such as positioning operation, JOG operation, and manual pulse generator operation can be monitored.
- Error History : 16 error history logs can be monitored.
- Warning History : 16 warning history logs can be monitored.
- Module Information List : Signals and flag ON/OFF status of each axis can be monitored.

■ Axis Monitor

(1) Operating procedure

1. Starting the "Positioning Monitor" window

Display the "Positioning Monitor" window.

[Tool] → [Intelligent Function Module Tool] → [QD75/LD75 Positioning Module] → [Positioning Monitor...]

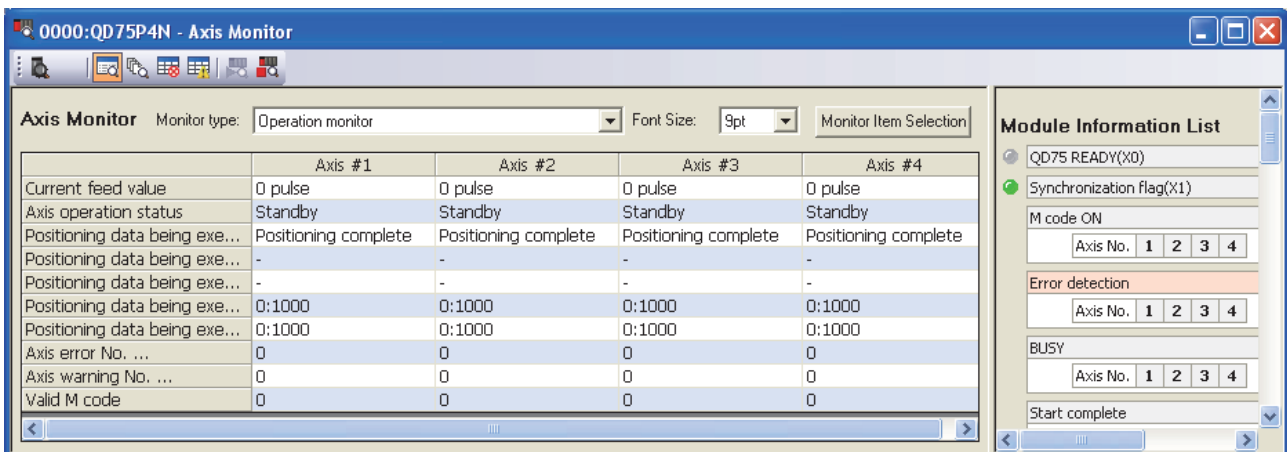

By default, the "Axis Monitor" window is displayed. When displaying the "Axis Monitor" window from the status which another window is selected, proceed according to the 2. below.



2. Switching to the "Axis Monitor" window

Click the "Axis Monitor" button (  ) on the toolbar.

The display switches to the "Axis Monitor" window.

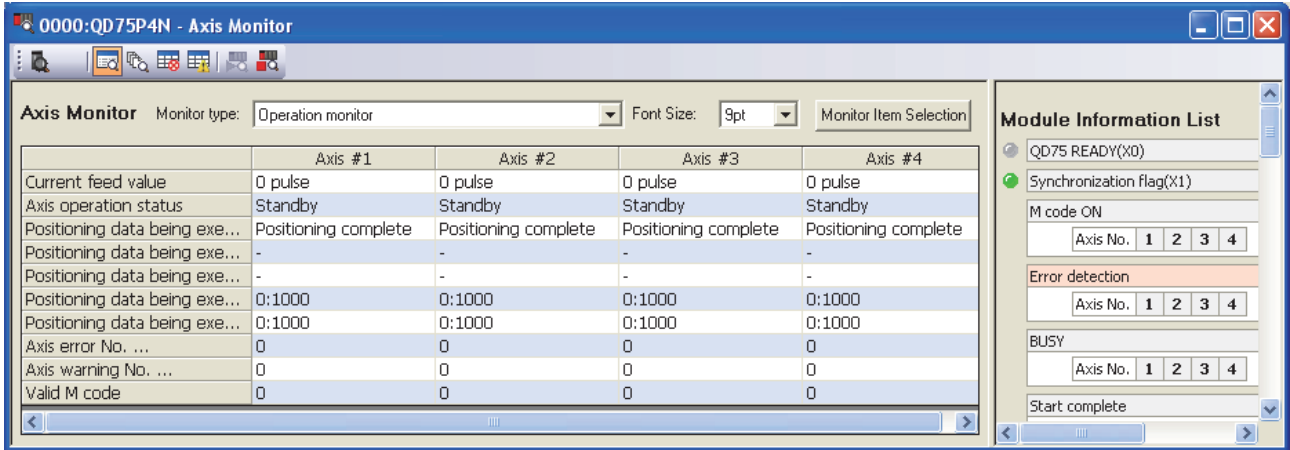

3. Selecting the monitor type

Select the monitor type from the pull-down menu of "Monitor type".

- "Operation monitor"
- "Operation monitor (Axis control)"
- "Operation monitor (Speed-position switching control)"
- "Operation monitor (Position-speed switching control)"
- "Operation monitor (OPR monitor)"
- "Operation monitor (JOG/manual pulse)"

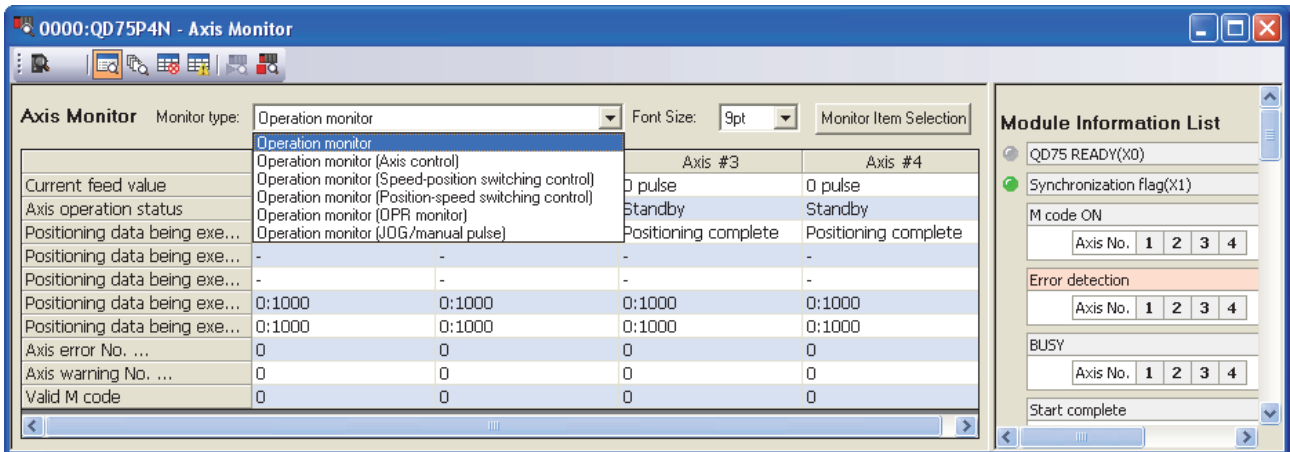

4. Selecting the monitor axis and monitor item

1) Click the **Monitor Item Selection** button.

The "Monitor Item Selection" window is displayed.

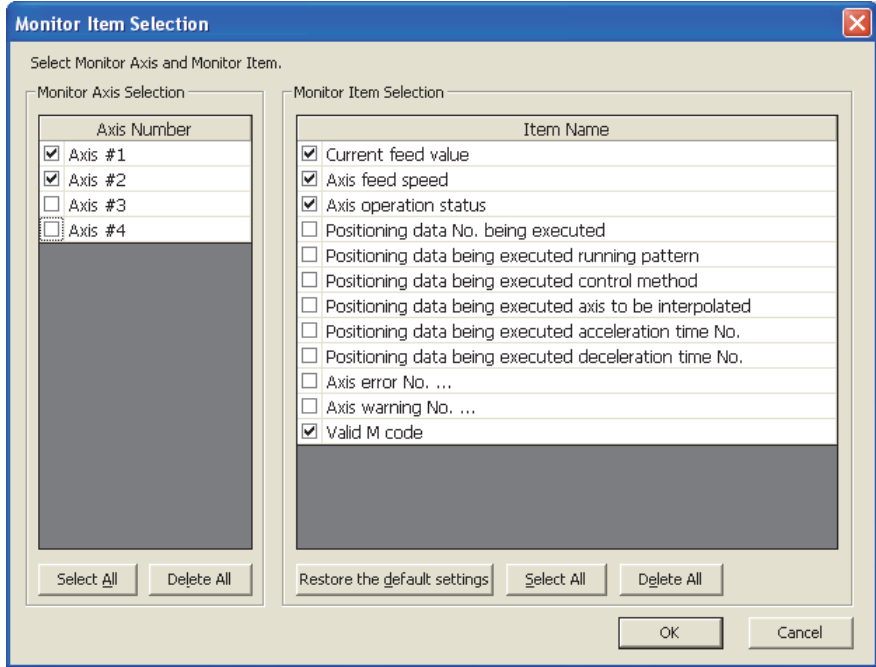

2) Select the  of the axes and items to be monitored.

The following shows the selectable monitor items for each monitor type.

• For "Operation monitor":

Monitor item	Symbol of reference buffer memory	Reference
Current feed value	Md.20	Section 5.6.2
Axis feed speed	Md.28	
Axis operation status	Md.26	
Positioning data No. being executed	Md.44	
Positioning data being executed running pattern	Md.47	
Positioning data being executed control method		
Positioning data being executed axis to be interpolated		
Positioning data being executed acceleration time No.		
Positioning data being executed deceleration time No.		
Axis error No. ...	Md.23	
Axis warning No. ...	Md.24	
Valid M code	Md.25	

• For "Operation monitor (Axis control)":

Monitor item	Symbol of reference buffer memory	Reference
Current feed value	Md.20	Section 5.6.2
Axis feed speed	Md.28	
Axis operation status	Md.26	
Target value	Md.32	
Machine feed value	Md.21	
New current value	Cd.9	Section 5.7.2
New speed value	Cd.14	
Positioning operation speed override	Cd.13	
Step mode	Cd.34	
Step valid flag	Cd.35	
Speed change being processed flag	Md.40	Section 5.6.2
Status speed change 0 flag	Md.31	
External command valid	Cd.8	Section 5.7.2
Skip command	Cd.37	

• For "Operation monitor (Speed-position switching control)":

Monitor item	Symbol of reference buffer memory	Reference
Current feed value	Md.20	Section 5.6.2
Axis feed speed	Md.28	
Axis operation status	Md.26	
Target speed	Md.33	
Feedrate	Md.22	
Current speed	Md.27	
Positioning amount of speed and position switch control	Md.29	Section 5.7.2
Speed-position switching control movement amount change register	Cd.23	
Status speed and position change latch flag	Md.31	Section 5.6.2
Speed-position switching enable flag	Cd.24	Section 5.7.2
Status speed controlling flag	Md.31	Section 5.6.2

• For "Operation monitor (Position-speed switching control)":

Monitor item	Symbol of reference buffer memory	Reference
Current feed value	Md.20	Section 5.6.2
Axis feed speed	Md.28	
Axis operation status	Md.26	
Target speed	Md.33	
Feedrate	Md.22	
Current speed	Md.27	
Position-speed switching control speed change register	Cd.25	Section 5.7.2
Status position and speed change latch flag	Md.31	Section 5.6.2
Position-speed switching enable flag	Cd.26	Section 5.7.2
Status speed controlling flag	Md.31	Section 5.6.2

• For "Operation monitor (OPR monitor)":

Monitor item	Symbol of reference buffer memory	Reference
Current feed value	Md.20	Section 5.6.2
Axis feed speed	Md.28	
Axis operation status	Md.26	
Movement amount after near-point dog ON	Md.34	
Torque limitation stored value	Md.35	
Status command in-position flag	Md.31	
Status OPR request flag		
Status OPR complete flag		
External I/O signal lower limit	Md.30	
External I/O signal upper limit		
External I/O signal zero signal		
External I/O signal near-point dog signal		
External I/O signal deviation counter clear		

• For "Operation monitor (JOG/manual pulse)":

Monitor item	Symbol of reference buffer memory or device No. of the output signal				Reference
	Axis 1	Axis 2	Axis 3	Axis 4	
Current feed value	Md.20				Section 5.6.2
Axis feed speed	Md.28				
Axis operation status	Md.26				
Forward JOG start	Y8	YA	YC	YE	Section 3.3.3
Reverse JOG start	Y9	YB	YD	YF	
JOG speed	Cd.17				Section 5.7.2
JOG speed limit value	Pr.31				Section 5.2.4
JOG acceleration time	Pr.32				
JOG deceleration time	Pr.33				
Manual pulse generator enable flag	Cd.21				Section 5.7.2
Manual pulse generator input selection	Pr.24				Section 5.2.3
Manual pulse generator 1 pulse input magnification	Cd.20				Section 5.7.2

3) Click the **OK** button to close the "Monitor Item Selection" window.  
The selected items are reflected to the "Axis Monitor" window.

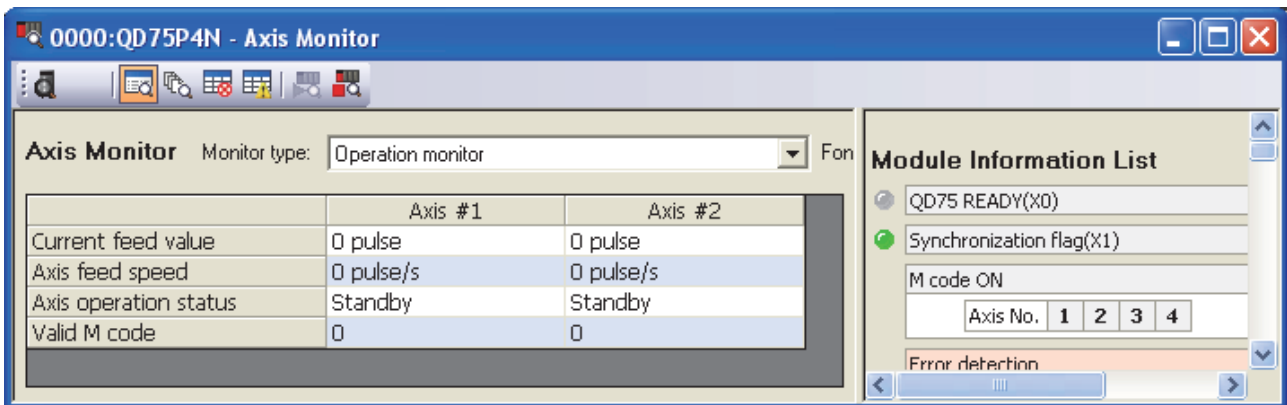

■ Starting History

(1) Operating procedure

1. Starting the "Positioning Monitor" window

Display the "Positioning Monitor" window.

[Tool] → [Intelligent Function Module Tool] → [QD75/LD75 Positioning Module] → [Positioning Monitor...]

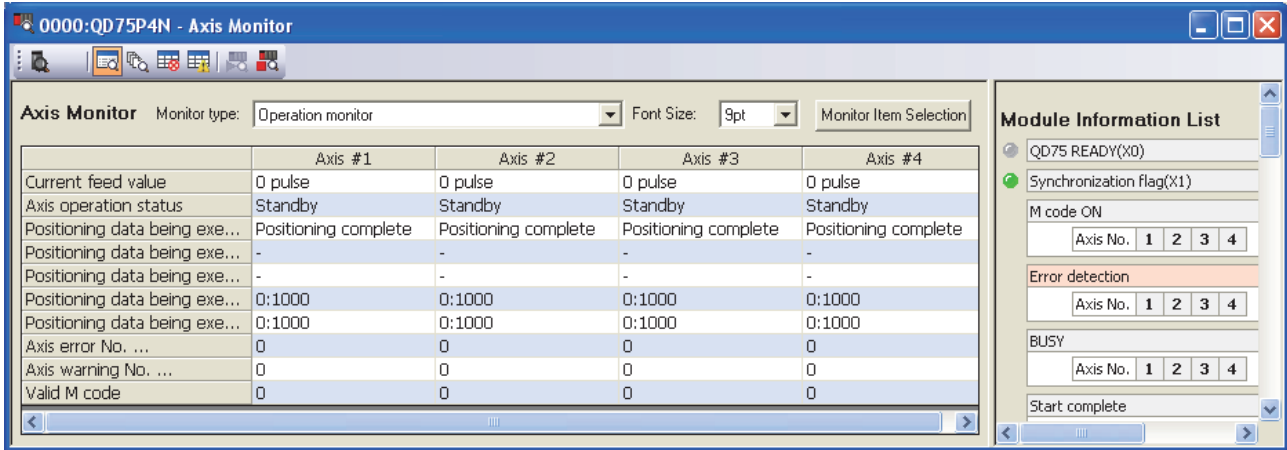

2. Switching to the "Starting History" window

Click the "Starting History" button (img) on the toolbar.

The display switches to the "Starting History" window.

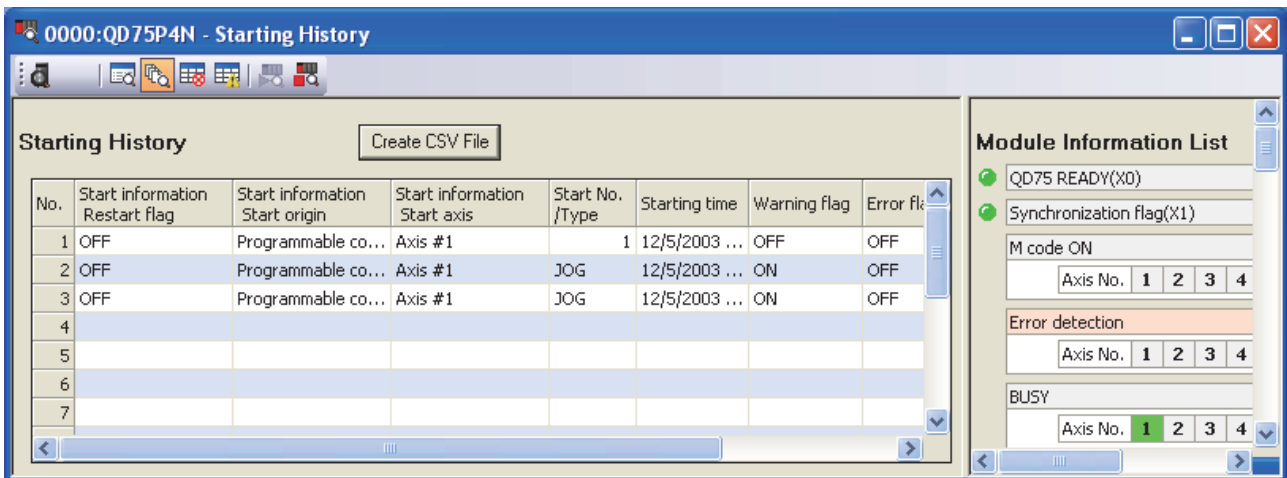

When the number of logs exceeds 16, the latest log overwrites the oldest log so that the latest 16 starting histories can be monitored all the time. Also, the error details can be confirmed by clicking the error number.

For details on the starting history, refer to Section 5.6.1.

■ Error History

(1) Operating procedure

1. Starting the "Positioning Monitor" window

Display the "Positioning Monitor" window.

[Tool] → [Intelligent Function Module Tool] → [QD75/LD75 Positioning Module] → [Positioning Monitor...]

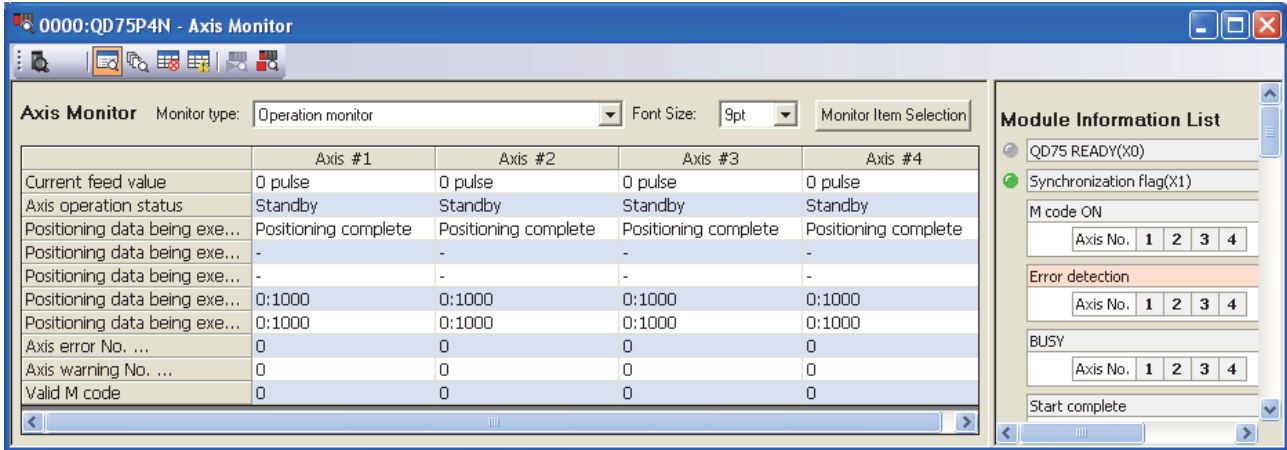

2. Switching to the "Error History" window

Click the "Error History" button ( ) on the toolbar.

The display switches to the "Error History" window.

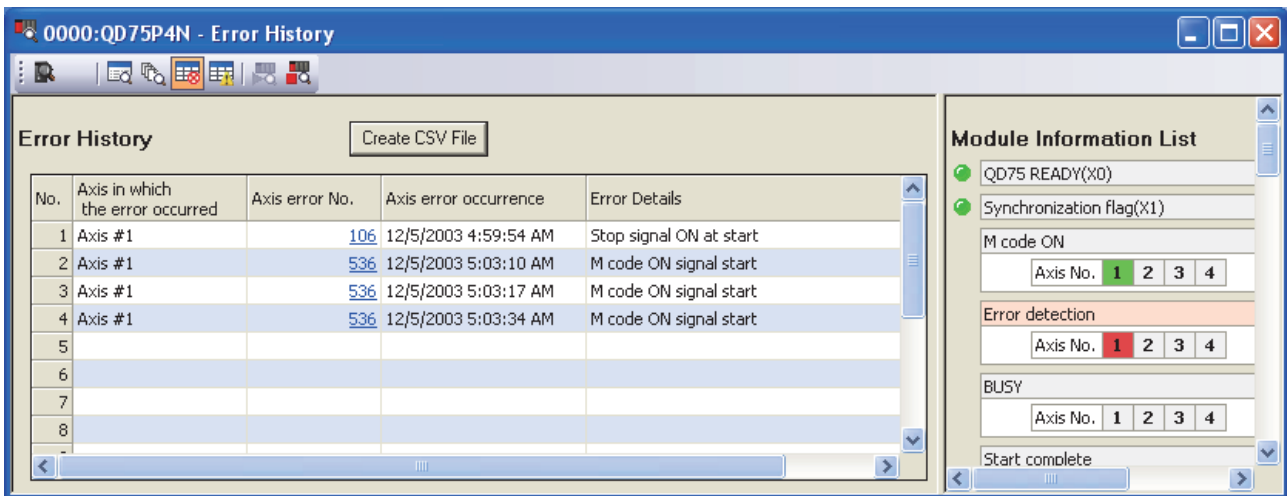

When the number of logs exceeds 16, the latest log overwrites the oldest log so that the latest 16 error histories can be monitored all the time.

Also, the error details can be confirmed by clicking the axis error No.

■ Warning History

(1) Operating procedure

1. Starting the "Positioning Monitor" window

Display the "Positioning Monitor" window.

[Tool] → [Intelligent Function Module Tool] → [QD75/LD75 Positioning Module] → [Positioning Monitor...]

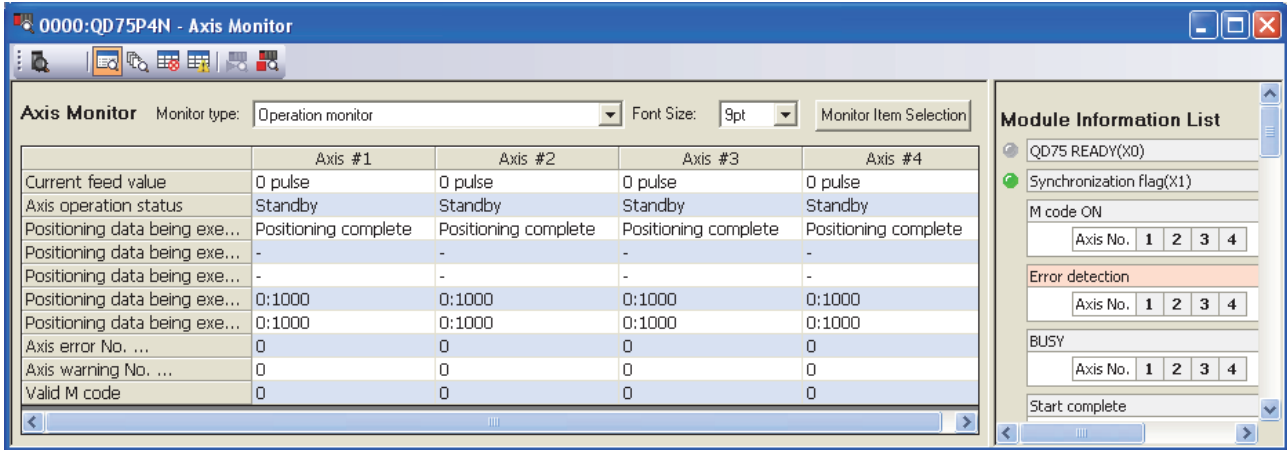

2. Switching to the "Warning History" window

Click the "Warning History" button (  ) on the toolbar.

The display switches to the "Warning History" window.

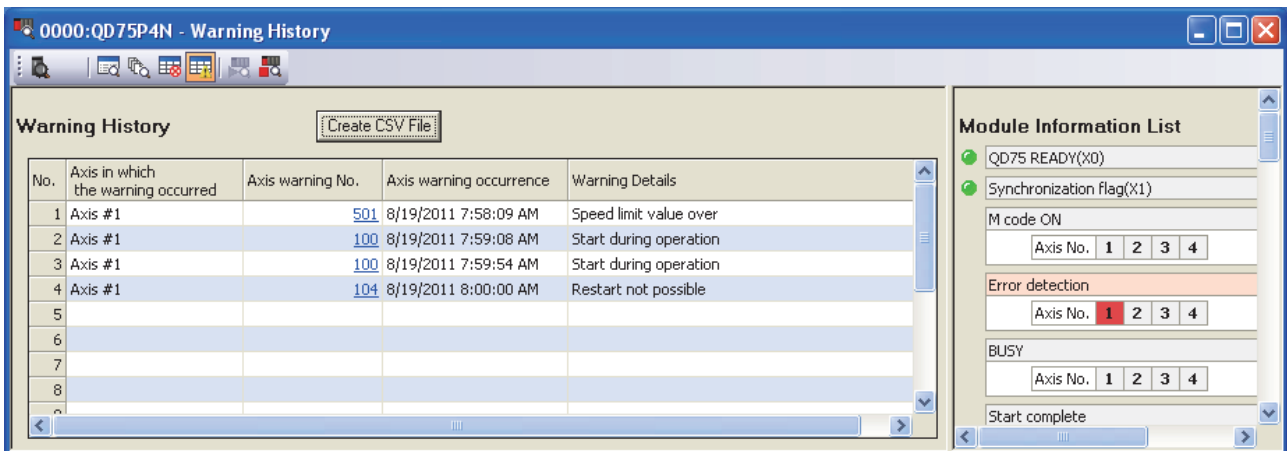

When the number of logs exceeds 16, the latest log overwrites the oldest log so that the latest 16 warning histories can be monitored all the time.

Also, the warning details can be confirmed by clicking the axis warning No.

■ Module Information List

(1) Operating procedure

1. Starting the "Positioning Monitor" window

Display the "Positioning Monitor" window.

[Tool] → [Intelligent Function Module Tool] → [QD75/LD75 Positioning Module] → [Positioning Monitor...]

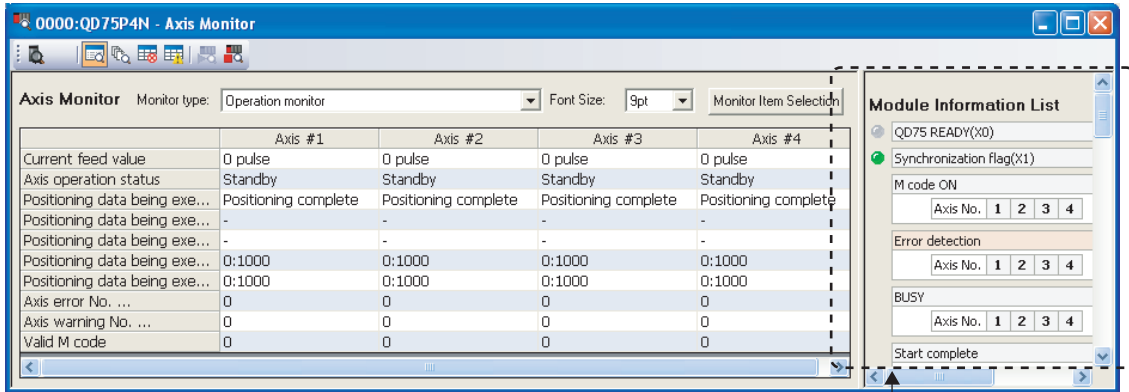

"Module Information List" window



The status by each axis of the following items is displayed in the "Module Information List" window.

Monitor item	Device No. of the I/O signal device or symbol of the buffer memory to be referred				Reference
	Axis 1	Axis 2	Axis 3	Axis 4	
QD75 READY (X0)	X0				Section 3.3.2
Synchronization flag (X1)	X1				
M code ON	X4	X5	X6	X7	
Error detection	X8	X9	XA	XB	
BUSY	XC	XD	XE	XF	
Start complete	X10	X11	X12	X13	
Positioning complete	X14	X15	X16	X17	
PLC READY (Y0)	Y0				Section 3.3.3
Axis stop	Y4	Y5	Y6	Y7	
Forward JOG start	Y8	YA	YC	YE	
Reverse JOG start	Y9	YB	YD	YF	
Positioning start	Y10	Y11	Y12	Y13	
Execution prohibition flag	Y14	Y15	Y16	Y17	
External I/O signal lower limit	Md.30				Section 5.6.2
External I/O signal upper limit					
External I/O signal drive unit ready					
External I/O signal stop signal					
External I/O signal external command					
External I/O signal zero signal					
External I/O signal near-point dog signal					
External I/O signal deviation counter clear	Cd.8				Section 5.7.2
External command valid	Md.31				Section 5.6.2
Status speed controlling flag					
Status speed and position change latch flag					
Status command in-position flag					
Status OPR request flag					
Status OPR complete flag					
Status position and speed change latch flag					
Status axis warning detection					
Status speed change 0 flag					

Statuses turned ON are displayed in green by each axis.

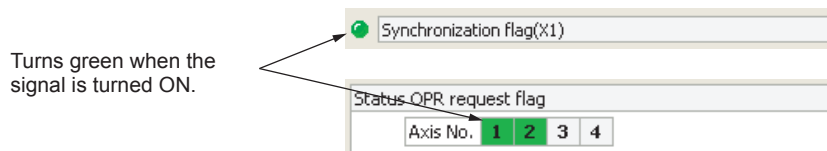

Also, at error occurrence, the axis in which the error occurred ("Error detection") is displayed in red.

At occurrence of warning, the axis in which the warning occurred ("Status axis warning detection") is displayed in orange.

Appendix 10.5 Positioning test

This function allows users to perform the following tests while monitoring the current status of the QD75.

- Positioning start test
- JOG/manual pulse generator/OPR test
- Speed change test
- Current value change test

■ Positioning start test

Test operation is performed by specifying the positioning data No. or point No. of the block start data.

(1) Operating procedure

1. Open the "Positioning Test" dialog box.

[Tool] → [Intelligent Function Module Tool] → [QD75/LD75 Positioning Module] → [Positioning Test...]

Monitor current values such as the current feed value and feedrate.

Test each function while checking current values with the monitor.

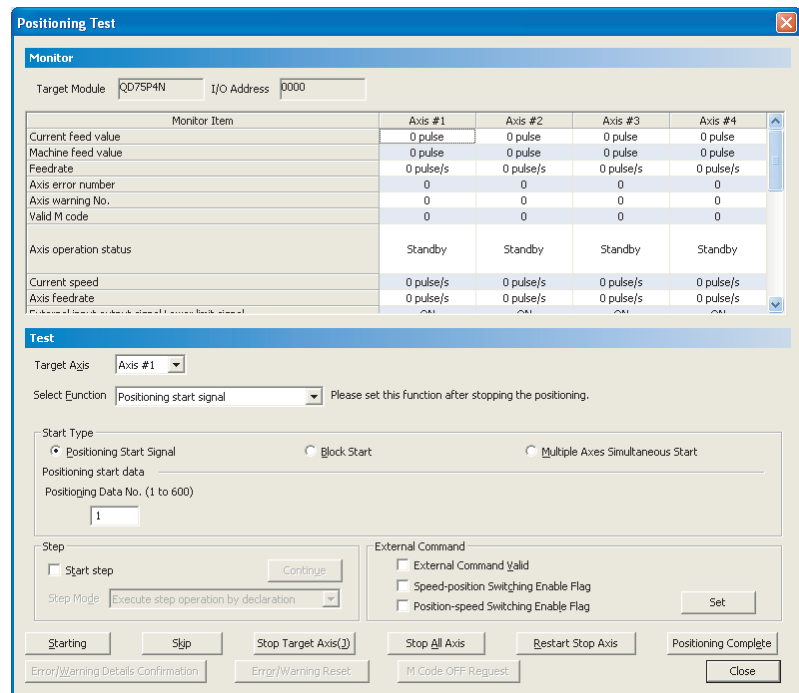

## 2. Select the test target axis.

Select the test target axis from the pull-down menu of "Target Axis".

## 3. Select the function.

Select "Positioning start signal" from the pull-down menu of "Select Function".

## 4. Perform positioning start test.

1) Select "Positioning Start Signal", "Block Start", or "Multiple Axes Simultaneous Start" for "Start Type".

2) Set positioning start data according to the setting for "Start Type".

- Positioning Start Signal: Set the positioning data No.
- Block Start: Set the block No. and point No.
- Multiple Axes Simultaneous Start: Set the multiple axes simultaneous start data No.

Set "Step" and "External Command" as needed.

## • Step

To perform test operation by step start, check the "Start step" checkbox, select a step mode from the pull-down list, and click the **Continue** button.

## • External Command

To enable external commands or control switch, select the corresponding item and click the **Set** button.

3) Click the **Starting** button to perform test operation.

■ JOG/manual pulse generator/OPR test

The following test can be performed when positioning control is debugged by the JOG operation test or manual pulse operation test.

- Direction check (forward run or reverse run)
- On/off status check of external input signals, such as upper/lower limit switches, zero signal, or near-point dog signal
- Operation test of speed and acceleration/deceleration
- Measurement of backlash compensation amount for forward/reverse rotation
- Accurate address check and movement amount measurement

In addition, the OP is established and the OPR basic and detailed parameters are corrected by the OPR test.

(1) Operating procedure

1. Open the "Positioning Test" dialog box.

[Tool] → [Intelligent Function Module Tool] → [QD75/LD75 Positioning Module] → [Positioning Test]

Monitor current values such as the current feed value and feedrate.

Test each function while checking current values with the monitor.

Monitor Item	Axis #1	Axis #2	Axis #3	Axis #4
Current feed value	0 pulse	0 pulse	0 pulse	0 pulse
Machine feed value	0 pulse	0 pulse	0 pulse	0 pulse
Feedrate	0 pulse/s	0 pulse/s	0 pulse/s	0 pulse/s
Axis error number	0	0	0	0
Axis warning No.	0	0	0	0
Valid M code	0	0	0	0
Axis operation status	Standby	Standby	Standby	Standby
Current speed	0 pulse/s	0 pulse/s	0 pulse/s	0 pulse/s
Axis feedrate	0 pulse/s	0 pulse/s	0 pulse/s	0 pulse/s

2. Select the test target axis.

Select the test target axis from the pull-down menu of "Target Axis".

## 3. Select the function.

Select "JOG/Manual Pulse Generator/OPR" from the pull-down menu of "Select Function".

The screenshot shows a control panel titled "Test". At the top, "Target Axis" is set to "Axis #1". Below that, "Select Function" is set to "JOG/Manual Pulse Generator/OPR" with a note: "Please set this function after stopping the positioning." The "JOG" section contains two input fields: "JOG Speed" (value: 1, unit: pulse/s (1 to 1000000)) and "Inching Movement Amount" (value: 0, unit: pulse (0 to 65535)). There are "Forward RUN" and "Reverse RUN" buttons. The "Manual Pulse Generator" section has a checked checkbox for "Manual pulse generator enable flag" and an input field for "Manual Pulse 1 Pulse Generator Input Magnification" (value: 1, unit: x (1 to 100)). The "OPR Operation" section has a dropdown for "OPR Method" set to "Machine OPR" and an "OPR" button. At the bottom, there are several control buttons: "Starting", "Stop", "Stop Target Axis", "Stop All Axis", "Restart Stop Axis", "Positioning Complete", "Error/Warning Details Confirmation", "Error/Warning Reset", "M Code OFF Request", and "Close".

## 1) Perform each operation.

## • JOG operation

Set "JOG speed" to "1" or more, "Inching Movement Amount" to "0" and click the **Forward RUN** or **Reverse RUN** button.

## • Manual Pulse Generator operation

Set "Manual pulse generator 1 pulse input magnification", select "Manual pulse generator enable flag" and use the manual pulse generator.

## • OPR operation

Select the OPR method from "Machine OPR" and "Fast OPR", and click the **OPR** button.

■ Speed change test

The appropriate speed and acceleration/deceleration time can be checked by changing speed or acceleration/deceleration time or by performing override to the axis where the positioning start test, OPR test, or JOG operation test is performed.

(1) Operating procedure

1. Open the "Positioning Test" dialog box.

Display the "Positioning Test" window.

[Tool] → [Intelligent Function Module Tool] → [QD75/LD75 Positioning Module] → [Positioning Test]

Monitor current values such as the current feed value and feedrate.

Monitor Item	Axis #1	Axis #2	Axis #3	Axis #4
Current feed value	0 pulse	0 pulse	0 pulse	0 pulse
Machine feed value	0 pulse	0 pulse	0 pulse	0 pulse
Feedrate	0 pulse/s	0 pulse/s	0 pulse/s	0 pulse/s
Axis error number	0	0	0	0
Axis warning No.	0	0	0	0
Valid M code	0	0	0	0
Axis operation status	Standby	Standby	Standby	Standby
Current speed	0 pulse/s	0 pulse/s	0 pulse/s	0 pulse/s
Axis feedrate	0 pulse/s	0 pulse/s	0 pulse/s	0 pulse/s

Test each function while checking current values with the monitor.

2. Select the test target axis.

Select the test target axis from the pull-down menu of "Target Axis".

## 3. Select the function.

Select "New Speed" from the pull-down menu of "Select Function".

The screenshot shows the 'Test' dialog box with the following settings:

- Target Axis: Axis #1
- Select Function: New Speed
- New Speed Value: 0 pulse/s (0 to 1000000)
- Speed Override: 100 % (1 to 300)
- Acceleration Time: 0 ms (0 to 8388608)
- Deceleration Time: 0 ms (0 to 8388608)
- Acceleration/deceleration time change enable:

## 4. Execute the speed change test.

## 1) Execute the speed change function.

## • New Speed

Enter the new speed value during the startup of positioning start test or OPR test, and click the **New Speed** button.

## • Override

Enter the speed override value and click the **Speed Override Change** button.

## • Acceleration/Deceleration Time Change

Check the "Acceleration/deceleration time change enable" checkbox, set the acceleration time and deceleration time values, and click the **New Speed** button.

■ Current value change test

The current feed value of the QD75 can be changed to the specified address.

(1) Operating procedure

1. Open the "Positioning Test" dialog box.

[Tool] → [Intelligent Function Module Tool] → [QD75/LD75 Positioning Module] → [Positioning Test]

Monitor current values such as the current feed value and feedrate.

Test each function while checking current values with the monitor.

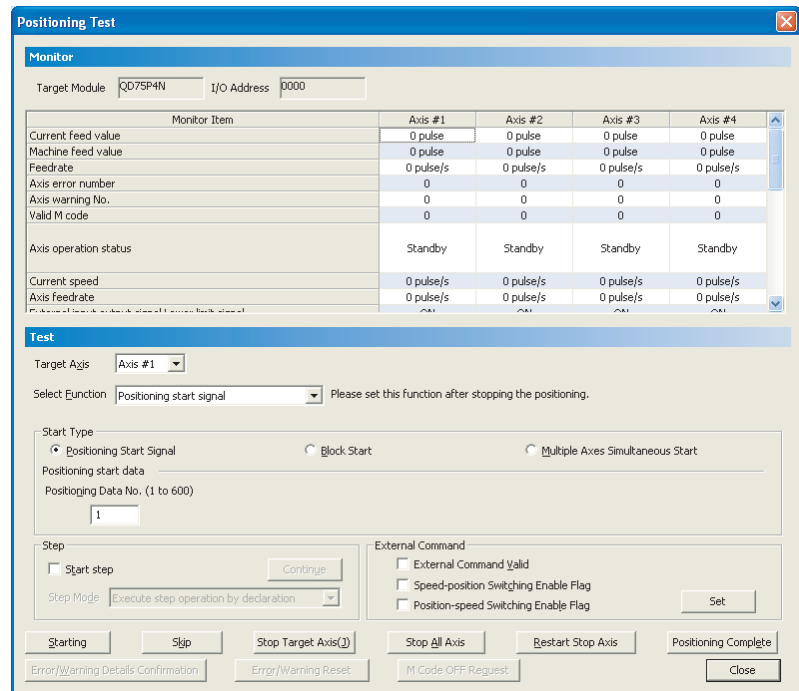

2. Select the test target axis.

Select the test target axis from the pull-down menu of "Target Axis".



## 3. Select the function.

Select "Current Value Changing" from the pull-down menu of "Select Function".

The screenshot shows a software interface titled "Test". At the top, "Target Axis" is set to "Axis #1". Below it, "Select Function" is set to "Current Value Changing" with a note: "Please set this function after stopping the positioning." Underneath, there is a section for "Current Value Changing" containing a "New Current Value" input field with the value "0" and a range indicator "pulse (-2147483648 to 2147483647)". A button labeled "Current Value Changing" is positioned to the right of the input field. At the bottom of the window, there is a row of buttons: "Starting", "Skip", "Stop Target Axis(D)", "Stop All Axis", "Restart Stop Axis", "Positioning Complete", "Error/Warning Details Confirmation", "Error/Warning Reset", "M Code OFF Request", and "Close".

1) Enter the new current value and click the **Current Value Changing** button.



2. Select the module.

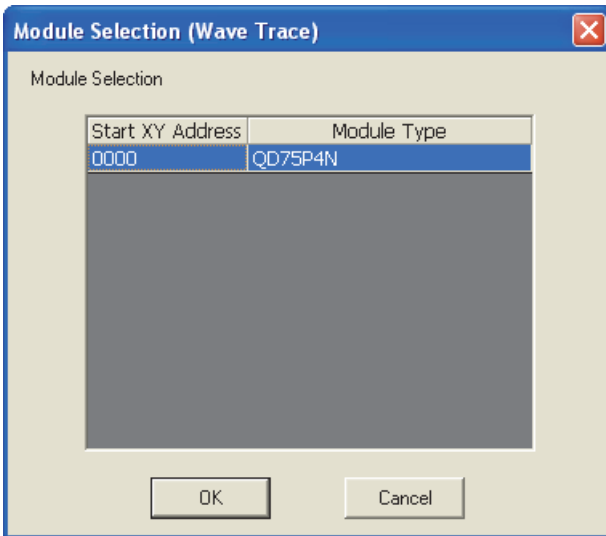

Click the **Module Selection** button.

Select the positioning module to trace waves and click the **OK** button.

3. Set conditions.

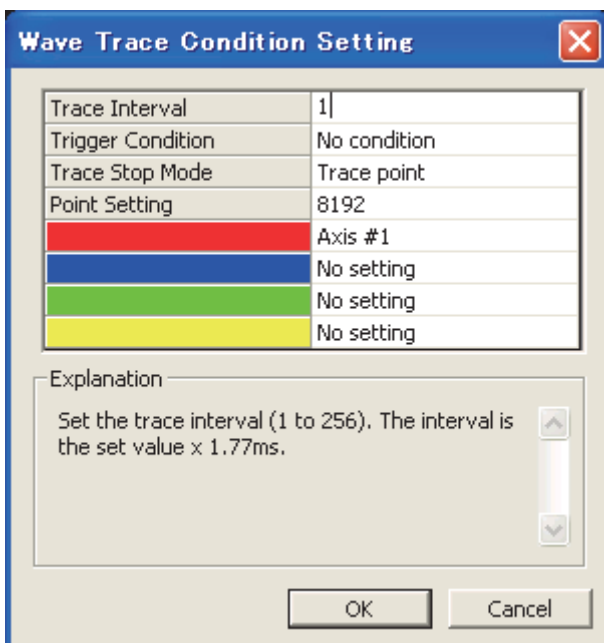

Click the **Condition Setting** button.

Read the displayed description, set each condition, and click the **OK** button.

4. Start trace and display trace results.

Click the **Start Trace** button to start trace.

The trace result at that point can be displayed by clicking the **Display Current Trace Result** button during trace, even if the trace completion conditions are not met.

When the completion conditions are met and the trace is completed, the trace result is displayed.

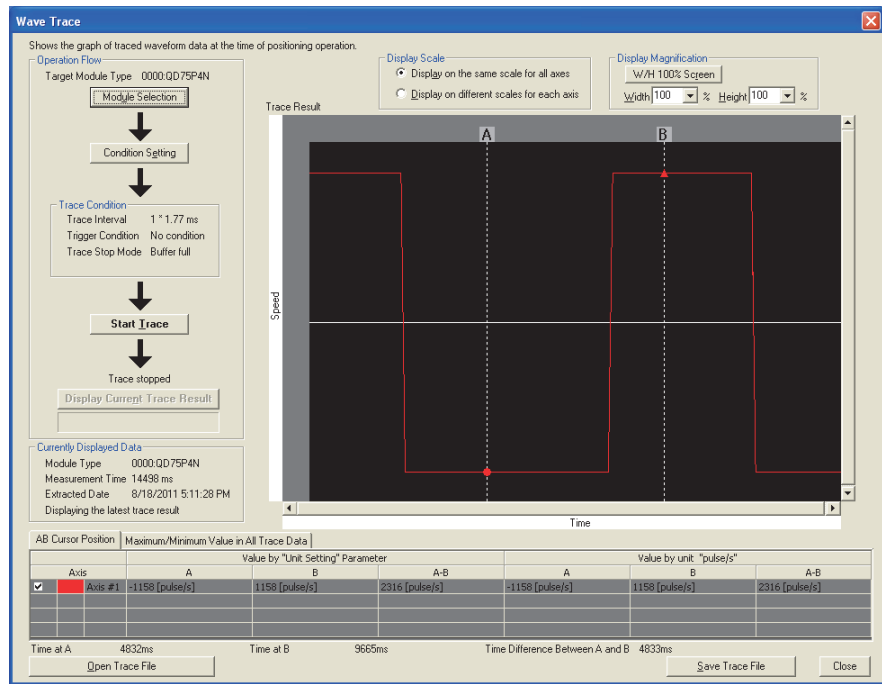

Appendix 10.7 Location trace

This function displays 2-axis interpolation control and simultaneous start (2-axes) in locus data.

(1) Operating procedure

1. Open the "Location Trace" dialog box.

[Tool] → [Intelligent Function Module Tool] → [QD75/LD75 Positioning Module] → [Location Trace]

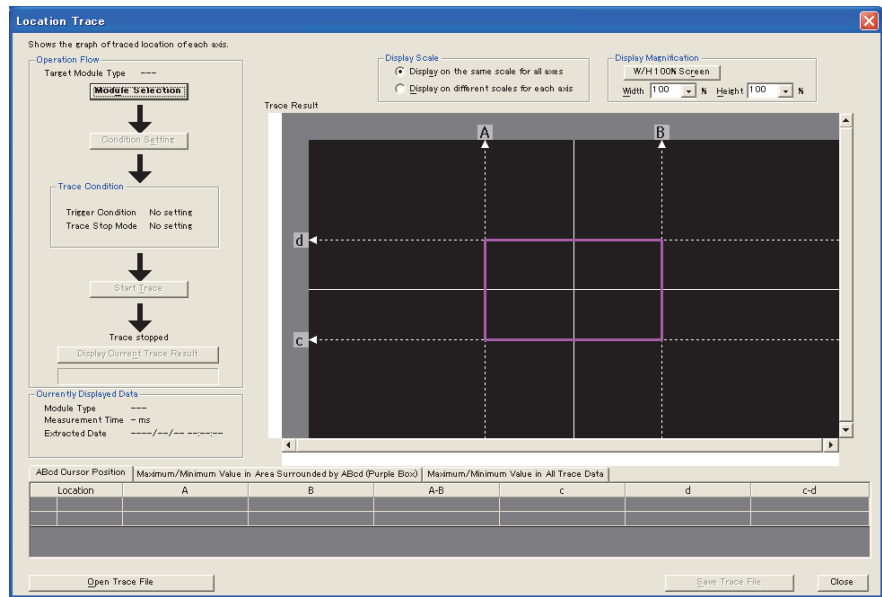

2. Select the module.

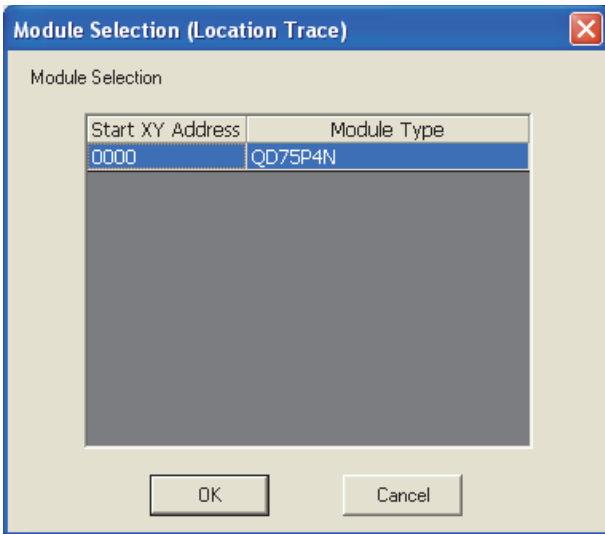

Click the **Module Selection** button.  
 Select the positioning module to trace locations and click the **OK** button.

3. Set conditions.

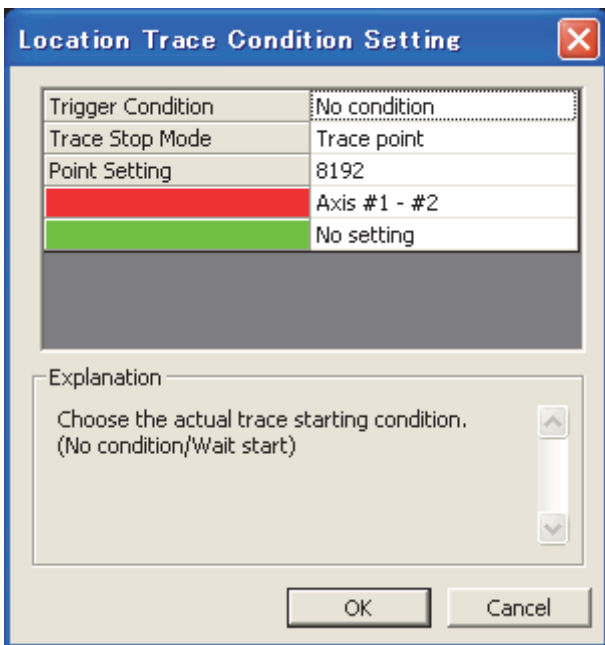

Click the **Condition Setting** button.  
 Read the displayed description, set each condition, and click the **OK** button.

4. Start trace and display trace results.

Click the **Start Trace** button to start trace.

The trace result at that point can be displayed by clicking the **Display Current Trace Result** button during trace, even if the trace completion conditions are not met.

When the completion conditions are met and the trace is completed, the trace result is displayed.

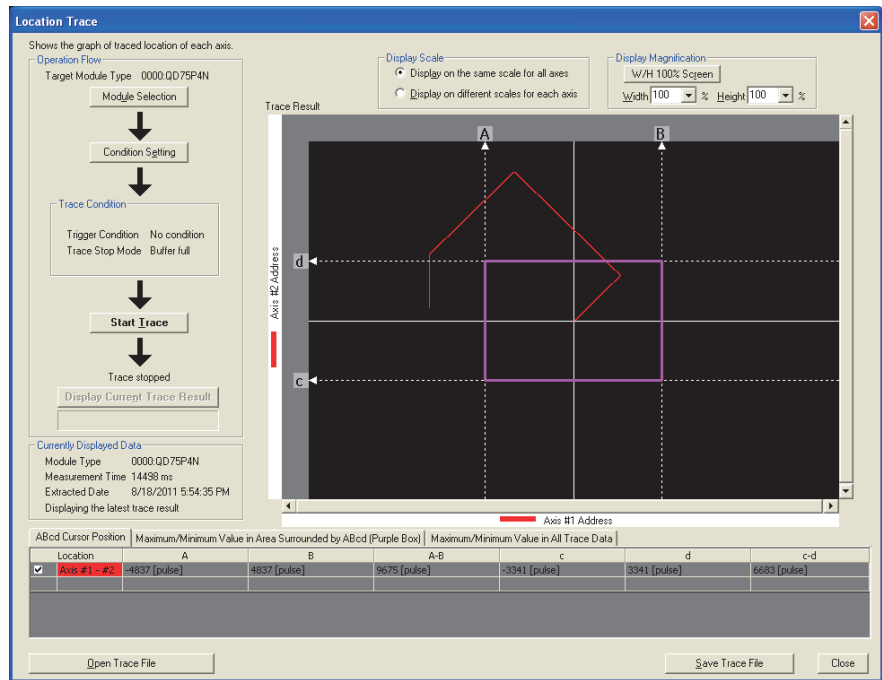

## Appendix 10.8 Parameter initialization function

The "parameter initialization function" is used to return the setting data set in the QD75 buffer memory and flash ROM to their factory-set initial values.

The details shown below explain about the "parameter initialization function".

- [1] Parameter initialization means
- [2] Control details
- [3] Control Precautions
- [4] Parameter initialization method

### [1] Parameter initialization means

- Initialization is executed with a program.
- Initialization is executed by GX Works2.

Refer to GX Works2 Version1 Operating Manual (Intelligent Function Module) for the execution method by GX Works2.

### [2] Control details

The following table shows the setting data initialized by the "parameter initialization function".

(The data initialized are "buffer memory" and "flash ROM" setting data.)

Setting data
Basic parameters (Pr.1 to Pr.10)
Detailed parameters (Pr.11 to Pr.42, Pr.70, Pr.150)
OPR basic parameters (Pr.43 to Pr.48)
OPR detailed parameters (Pr.49 to Pr.57)
Positioning data (No.1 to No.600)
Block start data (No.7000 to No.7004)

### [3] Control Precautions

- (1) Parameter initialization is only executed when the positioning control is not carried out (when the PLC READY signal (Y0) is OFF).  
The warning "In PLC READY" (warning code: 111) will occur if executed when the PLC READY [Y0] is ON.
- (2) Writing to the flash ROM can be executed up to 100,000 times.  
If writing to the flash ROM exceeds 100,000 times, the writing may become impossible, and an error "Flash ROM write error" (error code: 801) will occur.
- (3) A "CPU module reset" or "CPU module power restart" must be carried out after the parameters are initialized.
- (4) If an error occurs on the parameter set in the QD75 when the PLC READY signal [Y0] is turned ON, the QD75 READY signal [X0] will not be turned ON and the control cannot be carried out.

#### Important

Parameter initialization takes about 10 seconds. (Up to 30 seconds are sometimes required.)  
Do not turn the power ON/OFF; reset the CPU module, etc., during parameter initialization. If the power is turned OFF or the CPU module is reset to forcibly end the process, the data backed up in the flash ROM will be lost.



[4] Parameter initialization method

(1) Parameter initialization is carried out using the dedicated instruction "ZP.PINIT".  
 (Refer to CHAPTER 14 "DEDICATED INSTRUCTIONS" for details.)

(2) Parameter initialization can also be carried out by the writing of the data shown in the table below to the buffer memory using the TO instruction /intelligent function device.

The initialization of the parameter is executed at the time point the data is written to the QD75 buffer memory.

Setting item	Setting value	Setting details	Buffer memory address			
			Axis 1	Axis 2	Axis 3	Axis 4
Cd.2 Parameter initialization request	1	Set "1" (parameter initialization request).	1901			

Refer to Section 5.7 "List of control data" for details on the setting details.

When the initialization is complete, "0" will be set in " Cd.2 Parameter initialization request" by the QD75 automatically.

Appendix 10.9 Execution data backup function

When the QD75 buffer memory data is rewritten from the CPU module, "the data backed up in the QD75 flash ROM" may differ from "the data (buffer memory data) for which control is being executed". In cases like these, the data being executed will be lost when the programmable controller power is turned OFF.  
(Refer to CHAPTER 7.)

In cases like these, the "execution data backup function" backs up the data being executed by writing it to the flash ROM. The data that was backed up is then written to the buffer memory when the power is turned ON next.

The details shown below explain about the "execution data backup function".

- [1] Execution data backup means
- [2] Control details
- [3] Control Precautions
- [4] Execution data backup method

[1] Execution data backup (written to flash ROM) means

- The backup is executed with a program.
- The backup is executed by GX Works2.

Refer to GX Works2 Version1 Operating Manual (Common) for execution data backup method by GX Works2.

[2] Control details

The following shows the data that can be written to the flash ROM using the "execution data backup function".

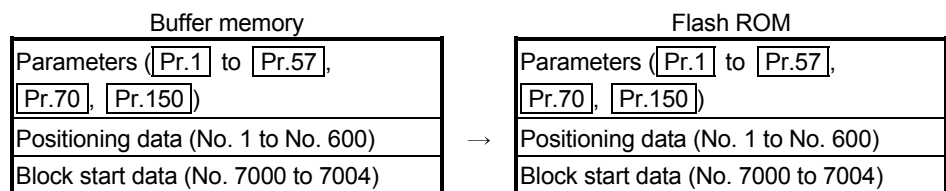

[3] Control Precautions

- (1) Parameter initialization is only executed when the positioning control is not carried out (when the PLC READY signal (Y0) is OFF). The warning "In PLC READY" (warning code: 111) will occur if executed when the PLC READY [Y0] is ON.
- (2) Writing to the flash ROM can be executed up to 100,000 times. If writing to the flash ROM exceeds 100,000 times, the writing may become impossible, and an error "Flash ROM write error" (error code: 801) will occur.
- (3) After one power ON/CPU module reset operation, writing to the flash ROM using a program is limited to up to 25 times. If the 26th writing is executed, an error "Flash ROM write number error" (error code: 801) will occur. If this error occurs, carry out the power OFF ON/CPU module reset operation again.  
Refer to Md.19 of Section 5.1.7 "Types and roles of monitor data" for details.

**Important**

Do not turn the power ON/OFF, reset the CPU module, during writing to the flash ROM. If the power is turned OFF or the CPU module is reset to forcibly end the process, the data backed up in the flash ROM will be lost.

[4] Execution data backup method

- (1) Execution data backup (writing to the flash ROM) is carried out using the dedicated instruction "ZP.PFWRT". (Refer to CHAPTER 14 "DEDICATED INSTRUCTIONS" for details.)
- (2) Refer to Section 7.2 "Data transmission process" for the data transmission processing at the backup of the execution data.
- (3) Execution data backup can also be carried out by the writing of the data shown in the table below to the QD75 buffer memory using the TO instruction /intelligent function device.

The writing to the flash ROM is executed at the time point the data is written to the QD75 buffer memory.

Setting item	Setting value	Setting details	Buffer memory address			
			Axis 1	Axis 2	Axis 3	Axis 4
Cd.1 Flash ROM write request	1	Set "1" (flash ROM write request).	1900			

Refer to Section 5.7 "List of control data" for details on the setting details.

When the writing to the flash ROM is complete, "0" will be set in " Cd.1 Flash ROM write request" by the QD75 automatically.

Appendix 10.10 External I/O signal logic switching function

This function switches the signal logic according to the external equipment connected to the QD75.

For the system in which drive unit READY with b-contact, upper limit switch, and lower limit switch are not used, the parameter logic setting can be controlled without wiring if it is changed to a "positive logic".

When the drive unit READY, upper limit switch, and lower limit switch are used, ensure to use them with b-contact.

The details shown below explain about the "external I/O signal logic switching function".

- [1] Parameter setting details
- [2] Precautions on parameter setting

[1] Parameter setting details

To use the "external I/O signal logic switching function", set the parameters shown in the following table.

Setting item		Setting details		Factory-set initial value	Buffer memory address					
					Axis 1	Axis 2	Axis 3	Axis 4		
Pr.22	Input signal logic selection	• Selection of logic of signals input from external source to QD75		0	31	181	331	481		
		b0	Lower limit						0: Negative logic, 1: Positive logic	
		b1	Upper limit							
		b2	Drive unit READY							
		b3	Stop signal							
		b4	External command signal							
		b5	Zero signal							
		b6	Near-point dog signal							
		b7	Unused							Set "0".
		b8	Manual pulse generator input							0: Negative logic, 1: Positive logic
b9 to b15	Unused	Set "0".								
Pr.23	Output signal logic selection	• Selection of logic of signals output from QD75 to external source		0	32	182	332	482		
		b0	Command pulse signal						0: Negative logic, 1: Positive logic	
		b1 to b3	Unused						Set "0".	
		b4	Deviation counter clear signal						0: Negative logic, 1: Positive logic	
		b5 to b15	Unused						Set "0".	

\* Refer to Section 5.2 "List of parameters" for the information on detail settings.

[2] Precautions on parameter setting

- (1) The external I/O signal logic switching parameters are validated when the PLC READY signal [Y0] is turned OFF to ON. (The logic is negative right after power-on.)
- (2) If each signal logic is set erroneously, the operation may not be carried out correctly.  
Before setting, check the specifications of the equipment to be used.

Appendix 10.11 External I/O signal monitor function

The "external I/O signal monitor function" monitors the module's information and external I/O signal statuses in the module's detailed information which can be displayed on the system monitor of GX Works2.

The information that can be monitored are the module's information (same as the QD75 front "RUN", "ERR" LED indicators) and the following external I/O signals. Set the logic of the external I/O signals in " Pr.22 Input signal logic selection" and " Pr.23 Output signal logic selection".

0: OFF, 1: ON

Axis-by-axis external I/O signals and module RUN, ERR. LEDs

indicates that drive unit ready of axis 1 is ON.

Item	Value
RUN	0001
ERR	0001
RLS-1	0001
FLS-1	0001
READY-1	0001
STOP-1	0000
CHG-1	0000
PGO-1	0000
DOG-1	0000
RLS-2	0001
FLS-2	0001
READY-2	0001
STOP-2	0000
CHG-2	0000
PGO-2	0000
DOG-2	0000

Item	Value
RLS-3	0001
FLS-3	0001
READY-3	0001
STOP-3	0000
CHG-3	0000
PGO-3	0000
DOG-3	0000
RLS-4	0001
FLS-4	0001
READY-4	0001
STOP-4	0000
CHG-4	0000
PGO-4	0000
DOG-4	0000

Refer to the following manual for the system monitor of GX Works2.  
GX Works2 Version1 Operating Manual (Common)

Appendix 10.12 History monitor function

This function monitors starting history, error history, and warning history stored in the buffer memory of the QD75 during operation.

[1] Starting history

Sixteen starting history logs of operations such as positioning operation, JOG operation, and manual pulse generator operation can be monitored. When the number of logs exceeds 16, the latest log overwrites the oldest log so that the latest 16 logs can be monitored all the time. This function allows users to check the operation sequence (whether the operations have been started in a predetermined sequence) at system start-up.

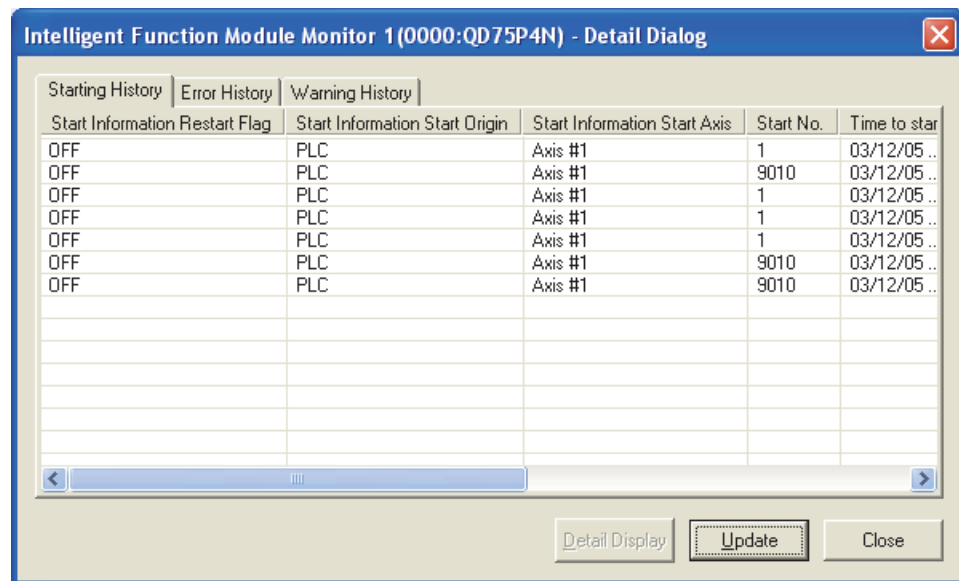

To monitor the starting history, register the QD75 to the "Intelligent Function Module Monitor Window".

For details on the registration method and monitoring method, refer to the following. GX Works2 Version1 Operating Manual (Intelligent Function Module)

[2] Error history, warning history

Sixteen error history logs and sixteen warning history logs can be monitored. When the number of logs exceeds 16, the latest log overwrites the oldest log so that the latest 16 logs can be monitored all the time.

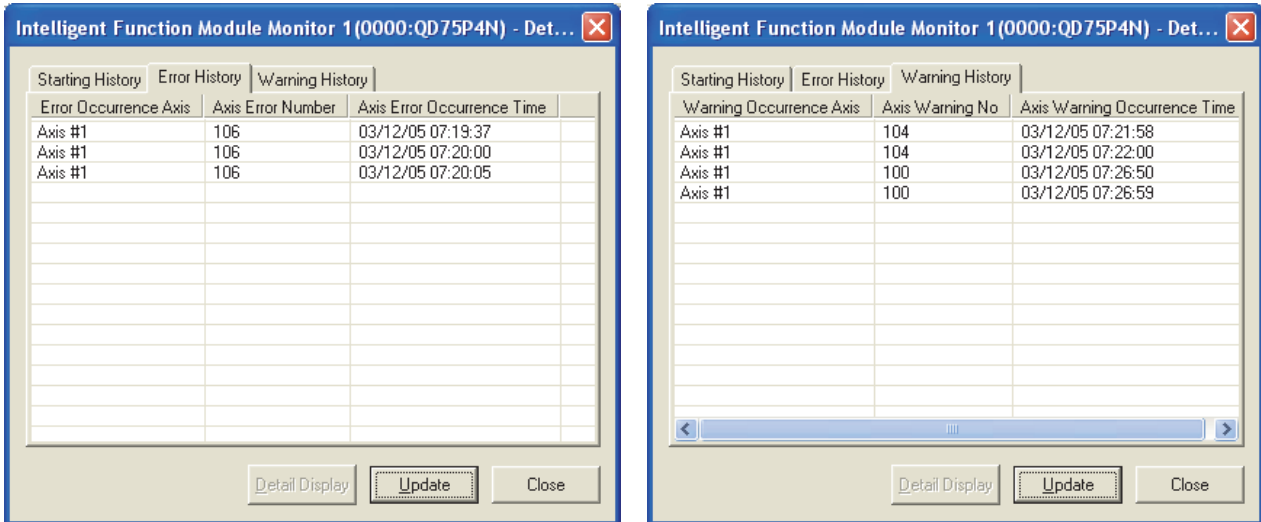

To monitor the error history and warning history, register the QD75 to the "Intelligent Function Module Monitor Window".

For details on the registration method and monitoring method, refer to the following. GX Works2 Version1 Operating Manual (Intelligent Function Module)

Appendix 10.13 Checking errors

Error codes corresponding to the errors occurred in the QD75 can be checked on the following screen of GX Works2.

Select the screen according to the purpose and usage.

- "Module's Detailed Information" screen
- "Error History" screen (for the QD75P□N/QD75D□N only)

(1) Checking errors on the "Module's Detailed Information" screen

Select [Diagnostics] → [System Monitor...] on GX Works2.

Select QD75 for "Main Base" and click the Detailed Information button.

The "Module's Detailed Information" screen for the QD75 appears and the error code, error details, and corrective actions can be checked.

The screenshot shows the 'Module's Detailed Information' window. On the left, there is a 'Monitor Status' section with a 'Monitoring' button and a red warning triangle. Below it is a 'Hardware Information' section. The main area is divided into several sections: 'Module' (Model Name: QD75P4N, I/O Address: 0000, Mount Position: Main Base 0 Slot, Product Information: 13081000000000-B, Production Number: ---), 'Module Information' (Module Access: Possible, Status of External Power Supply: ---, Fuse Blown Status: ---, Status of I/O Address Verify: Agree, I/O Clear / Hold Setting: ---, Noise Filter Setting: ---, Input Type: ---, Remote Password Setting Status: ---), 'Error Information' (Latest Error Code: 00CF, Error Clear, Display Format: HEX, Error History table), and 'Error and Solution' (Contents: M code ON signal start, \* The positioning start is carried out when an M code ON signal (X4 to X7) is turned ON. Solution: After turning OFF the M code ON signal, start the system.).

Annotations on the right side of the screenshot:

- Displays the latest error code.
- Displays error history.
- Displays description of the error code that is currently selected under Error history and corrective action for the error.



- (2) Checking errors on the "Error History" screen. (for the QD75P□N/QD75D□N only)

On the "Error History" screen, the error logs of the QD75 are displayed in a list together with the error logs of other modules. The logs can be output to a CSV format file. The error codes and the time of error occurrence can be checked even after the CPU module is powered off and then on or reset.

Select [Diagnostics] → [System Monitor...] → **System Error History** button on GX Works2.

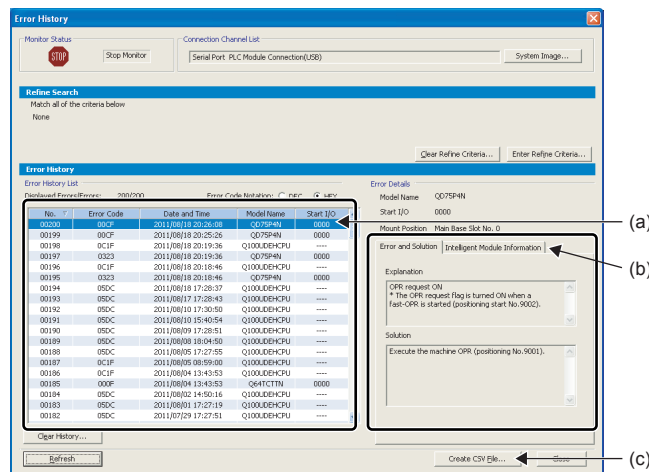

- (a) Error History List  
Module error logs are displayed in a list.

(b) Error and Solution, Intelligent Module Information

- Error and Solution  
Details of the selected in the "Error History List" and its corrective action are displayed.
- Intelligent Module Information  
The QD75P□N/QD75D□N status when the error selected in the "Error History List" occurred is displayed.

For the QD75P□N/QD75D□N, the following contents are displayed.

Item	Description
Start axis	The axis No. requested to start is stored.
Positioning start No.	The positioning start No. is stored.
Axis in which the error occurred	The axis No. in which the error occurred is stored.
Axis error occurrence (Data No.)	The data No. in which the error occurred is stored.
Current feed value	The current feed value (at the time of error) of the error axis is stored.
Input signals with PLC CPU(X0 -- XF)	The status of input signals (X0 to XF) (at the time of error) is stored (in hexadecimal).
Input signals with PLC CPU(X10 -- X1F)	The status of input signals (X10 to X1F) (at the time of error) is stored (in hexadecimal).
Output signals with PLC CPU(Y0 -- YF)	The status of output signals (Y0 to YF) (at the time of error) is stored (in hexadecimal).
Output signals with PLC CPU(Y10 -- Y1F)	The status of output signals (Y10 to Y1F) (at the time of error) is stored (in hexadecimal).
<ul style="list-style-type: none"> <li>• Axis 1 drive unit READY signal</li> <li>• Axis 1 upper limit signal</li> <li>• Axis 1 lower limit signal</li> <li>• Axis 1 stop signal</li> <li>• Axis 1 external command signal</li> <li>• Axis 1 near-point dog signal</li> <li>• Axis 1 zero signal</li> </ul>	The status of axis 1 external input signals (at the time of error) is stored.
<ul style="list-style-type: none"> <li>• Axis 2 drive unit READY signal</li> <li>• Axis 2 upper limit signal</li> <li>• Axis 2 lower limit signal</li> <li>• Axis 2 stop signal</li> <li>• Axis 2 external command signal</li> <li>• Axis 2 near-point dog signal</li> <li>• Axis 2 zero signal</li> </ul>	The status of axis 2 external input signals (at the time of error) is stored.
<ul style="list-style-type: none"> <li>• Axis 3 drive unit READY signal</li> <li>• Axis 3 upper limit signal</li> <li>• Axis 3 lower limit signal</li> <li>• Axis 3 stop signal</li> <li>• Axis 3 external command signal</li> <li>• Axis 3 near-point dog signal</li> <li>• Axis 3 zero signal</li> </ul>	The status of axis 3 external input signals (at the time of error) is stored.
<ul style="list-style-type: none"> <li>• Axis 4 drive unit READY signal</li> <li>• Axis 4 upper limit signal</li> <li>• Axis 4 lower limit signal</li> <li>• Axis 4 stop signal</li> <li>• Axis 4 external command signal</li> <li>• Axis 4 near-point dog signal</li> <li>• Axis 4 zero signal</li> </ul>	The status of axis 4 external input signals (at the time of error) is stored.

- (c) **Create CSV File** button

The module error logs are output to a CSV format file.

**POINT**

(1) If errors frequently occur in the QD75P□N/QD75D□N, **"\*HST.LOSS\*"** (instead of an actual error code) may be displayed in the Error Code column.

(Display example)

No. ▾	Error Code	Date and Time	Model Name	Start I/O	▲
00200	00CF	2011/06/28 02:52:50	QD75P4N	0000	
00199	020C	2011/06/28 02:51:24	QD75P4N	0000	
00198	<b>*HST.LOSS*</b>	2011/06/28 02:50:09	QD75P4N	0000	
00197	020C	2011/06/28 02:49:28	QD75P4N	0000	
00196	020C	2011/06/28 02:47:58	QD75P4N	0000	

If **"\*HST.LOSS\*"** is frequently displayed, set a larger value for the number of errors collected per scan in the PLC RAS tab of the PLC Parameter dialog box. For the setting, refer to the QnUCPU User's Manual (Function Explanation, Program Fundamentals).

(2) If the error occurred at the simultaneous start, the axis No. in which the error is detected is stored in the "Starting axis" in Error History.

Appendix 11 MELSEC Explanation of positioning terms

1-2 PHASE EXCITATION SYSTEM

This is one system for exciting each stepping motor coil in a determined order. In this system, one phase and two phases are alternately excited.

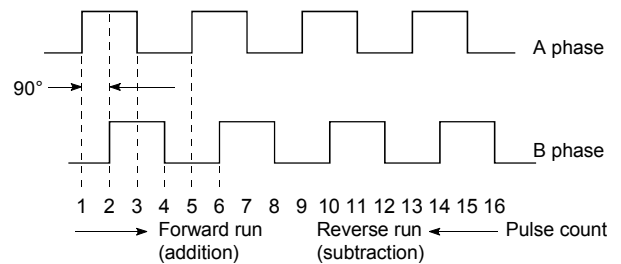
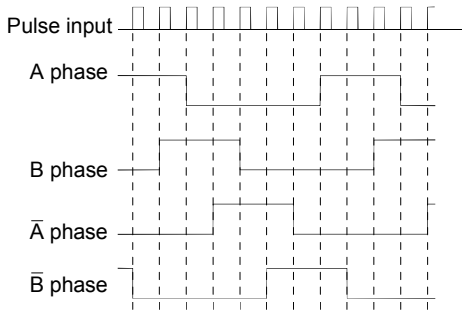

2-SPEED TRAPEZOIDAL CONTROL

In this positioning control method, the positioning pattern, positioning addresses (P1, P2), and positioning speeds (V1, V2) are set in the sequence program. Positioning is carried out to positioning address P1 by issuing the 1st positioning start command. When P1 is reached, the positioning then automatically changes to positioning at the V2 speed.

2-PHASE EXCITATION SYSTEM

This is one system for exciting each stepping motor coil in a determined order. In this system, a current constantly flows to 2 phases to carry out step feed.

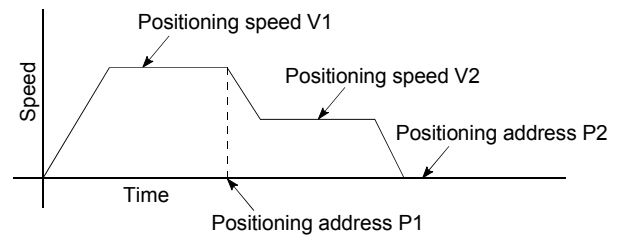
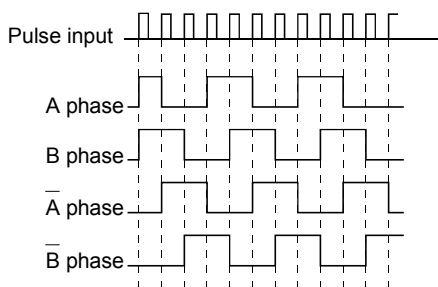

2-PHASE PULSE

An A phase and B phase double pulse. There is a phase difference between the two phases, so that difference can be automatically added and subtracted in the pulse count. The standard phase difference is a 90° electrical angle.

If the B phase were to lag behind the A phase in a forward run (B phase turns ON after the A phase), the A phase would lag behind the B phase in a reverse run (A phase turns ON after the B phase). In this way the forward and reverse run (addition and subtraction) can be automatically carried out.

**ABSOLUTE ENCODER**

This is a detector that enables the angle data within 1 motor rotation to be output to an external destination. Absolute encoders are generally able to output 360° in 8 to 12 bits. Incremental encoders have a disadvantage in that the axis position is lost when a power failure occurs. However, with absolute encoders, the axis position is not lost even when a power failure occurs. Various codes such as a binary code and BCD code can be output. Absolute encoders are more expensive, more accurate, and larger than incremental encoders. Refer to "ENCODER".

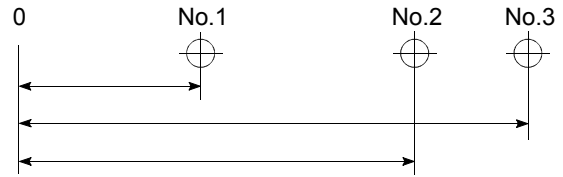
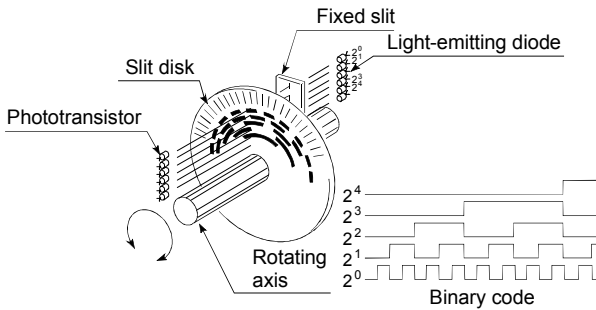

**ACCELERATION TIME**

The parameter acceleration time refers to the time from a stopped state to the time the speed limit value is reached, so it becomes proportionally shorter as the setting speed decreases. The acceleration time is determined by factors such as machine inertia, motor torque, and load resistance torque.

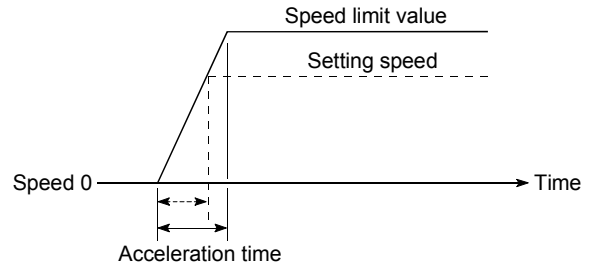

**ABSOLUTE POSITION DETECTION SYSTEM**

In the absolute position detection system, once an OPR is carried out at the system startup, the system stores the machine position in the memory and retains the current position even when the power is turned OFF. Mechanical deviation will be compensated, so that the OPR is not required after the power is turned ON next time. Configuring this system requires a motor with an absolute position detector and a servo amplifier and positioning module compatible with an absolute position detection system.

**ADDRESS**

- 1) This is a numerical value to express the positioning position, designated in mm, inch, angle, or No. of pulse units.
- 2) The memory address. Many addresses are stored in the memory. An address is read or written after it is designated.

**ABSOLUTE SYSTEM**

This is one system for expressing a positioning address. Absolute address system. This system uses 0 as a reference, and expresses the address as the distance from 0. The direction is automatically determined, even when it is not designated. The other address system is the increment system.

**AFTER mode**

This is the mode that outputs the M code after positioning is complete (after stopping). Clamping can be commanded, drilling dimensions can be selected, etc., with this mode.

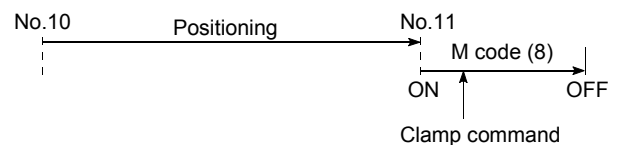

**AUTO TUNING (Automatic Tuning)**

Properties such as responsiveness and stability of machines driven with a servomotor are affected by changes in the inertia moment and rigidity due to changes in the machine load, etc.

This function automatically adjusts the speed loop gain and position loop gain to match the machine state, so the machine's performance can be maintained at its optimum state.

A real time automatic tuning function should be used for machines having large load fluctuations.

**BACKLASH COMPENSATION**

When a forward run operation changes to a reverse run operation, there is sometimes play (backlash) in the mesh of the toothed gears. This also occurs when using a worm gear. Because of this backlash, a left feed of 1m carried out after a right feed of 1m will not be sufficient to return the machine to its original position. The machine cannot be positioned to its original position without an extra feed equivalent to the backlash amount. This function compensates for that backlash amount.

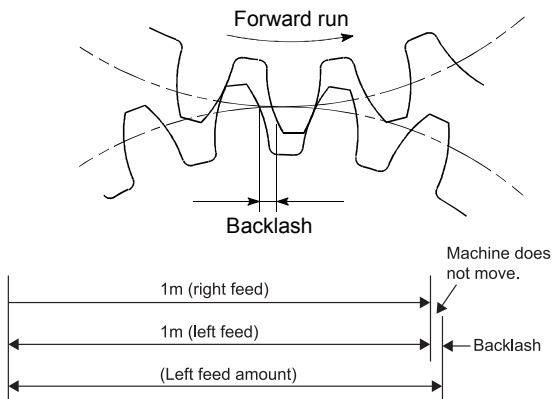

**BACKUP FUNCTION**

Backup functions consist of the following.

- 1) Functions for storing the sequence program and device statuses stored in the RAM memory of the CPU module, so that they are not lost during power failures, etc.
- 2) Functions for storing the current value in absolute position compatible systems so that it is not lost during power failures, etc.
- 3) Functions for reading the CPU module data (programmable controller programs, parameters, positioning data, etc.) by a peripheral device when the old CPU module is replaced, and then write it to the new CPU module after the replacement is completed.

**BALL SCREW**

This is a type of screw, with balls lined up in the threads like ball bearings. This reduces backlash, and enables rotation with little force.

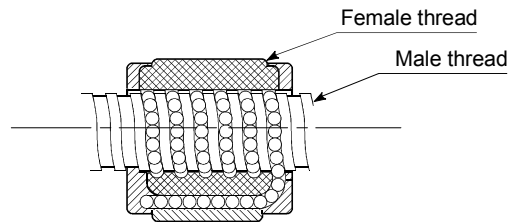

**BIAS SPEED AT START**

A large amount of torque is required when the machine starts moving, but the torque may be unstable at speed 0 with stepping motors. Therefore, movement can be smoothly carried out by starting the movement at a given speed from the beginning. The bias speed at start is the speed set at that start.

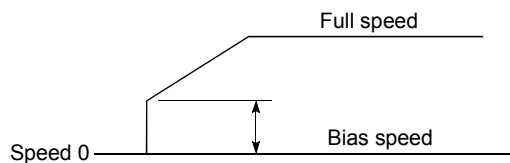

**BIPOLAR DRIVE CONSTANT-CURRENT SYSTEM**

This is one system for driving a stepping motor. In this method, the orientation of the excitation current flowing to the stator coil is reversed, and the excitation current direction is in both the positive and negative direction. This enables the motor coil to be used effectively, and a large output torque can be obtained at low speeds.

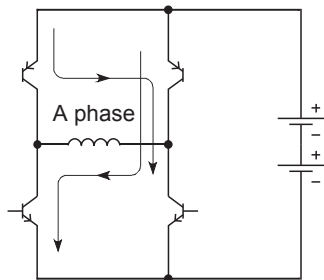

Bipolar drive basic circuit (bridge method)

**BUFFER MEMORY**

Memory used to temporarily store data. Before writing external data to the CPU module data memory, it is first temporarily stored in the buffer memory to be used for operation by the program. The buffer memory is used by the positioning module because the latest data can be read and written.

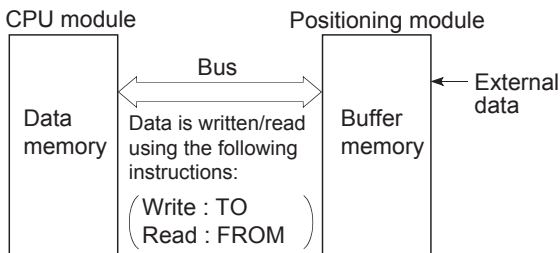

**BUSY**

The device is doing some other work. It is in a positioning operation or in dwell time.

**CCW (Counterclockwise)**

Rotation in the counterclockwise direction. In the motor, this is determined looking from the shaft end side. Also refer to "CW".

**CHANGE signal**

The CHANGE signal is an external signal used to switch the speed-position control from the speed control being executed to position control.

**CIRCULAR INTERPOLATION**

Automatic operation in which the machine path makes a circle when positioning is carried out by simultaneously operating both the longitudinal feed and latitudinal feed motors. The normal unit is 90°. Round shapes can be created with this type of interpolation, and obstacles in the machine path can also be avoided. Refer to the terms "INTERPOLATION OPERATION" and "LINEAR INTERPOLATION"

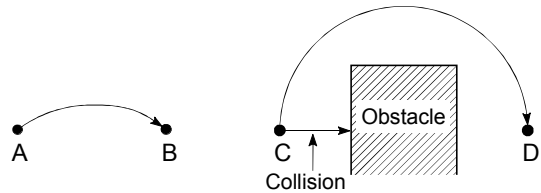

**COMMAND PULSE**

Refer to term "FEEDBACK PULSE".

**COMPOSITE SPEED**

The movement speed for the target control during interpolation operations.

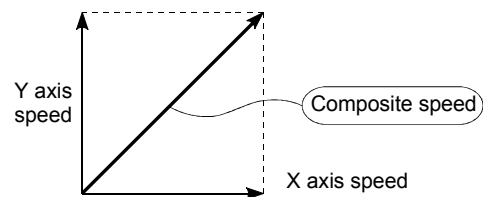

**CONTROL UNIT**

This is one type of positioning reference data. The unit to be used is designated as mm, inch, degree, or pulse.

**CP CONTROL (Continuous Path Control)**

Continuous path is a control method in which a path is followed without interrupting such as in uniform speed control.

**CREEP SPEED**

A speed at which the machine moves very slowly.  
 It is difficult for the machine to stop accurately when running at high speed, so the movement must first be changed to the creep speed before stopping.  
 Refer to the term "NEAR-POINT DOG".

**CURRENT FEED VALUE**

The OP address at the completion of the machine OPR is stored.  
 The position currently being executed is stored.  
 This value changes when the current value is changed.

**CURRENT LOOP MODE**

One of the servo control modes in positioning.  
 Mode which uses current for torque control.  
 Also called the torque loop mode.  
 Refer to the section of "position loop mode".

**CURRENT VALUE**

This is the current address (position) when stopped or during positioning.

**CW (Clockwise)**

Rotation in the clockwise direction. Rotation in the clockwise direction looking from the motor shaft end side.

**D/A CONVERTER (Digital-to-Analog converter)**

A device having a function to convert the digital value expressing the No. of pulses to an analog value expressing the voltage (or current).

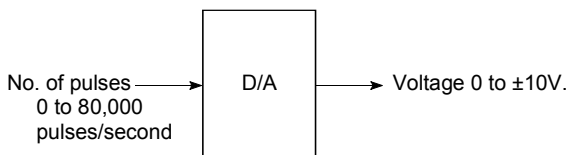

**DATA NO.**

To carry out positioning to 2 or more addresses, each position is assigned a sequence No. such as No. 1, No. 2, No. 3, etc. The positioning is then carried out following this sequence. The QD75 is capable of positioning up to No. 600.

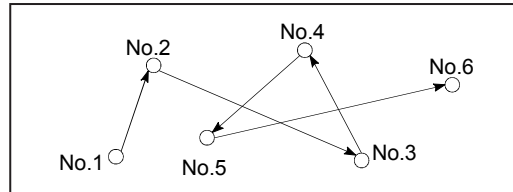

**DECELERATION RATIO**

A ratio used when the machine is decelerated using a toothed gear. This ratio is a numeral larger than 1.

$$\text{Deceleration ratio} = \frac{\text{Input gear speed}}{\text{Output gear speed}}$$

**DECELERATION TIME**

The parameter deceleration time is the same value as the acceleration time. Deceleration time refers to the time from the speed limit value to a stopped state, so it becomes proportionally shorter as the setting speed decreases.

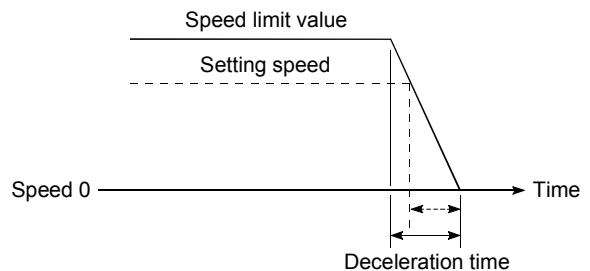



**DEVIATION COUNTER**

Deviation counters have the following two functions.

- 1) To count the command pulses issued from the QD75, and transmit the count value to the D/A converter.
- 2) To subtract the feedback pulses from the command pulses, and run the motor by the deviation value (droop pulse) of the command pulses and feedback pulses until the command pulses reaches 0.

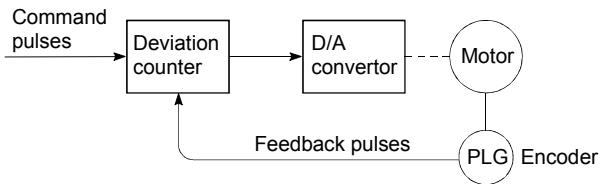

**DIFFERENTIAL OUTPUT TYPE**

This is one type of encoder feedback pulse output. When one signal is output with this method, a companion signal having the reverse polarity is simultaneously output. This method enables high-frequency transfer, and is resistant to noise, etc., so it is also used in high-speed signal transfer such as inputting and outputting of pulse trains. In general, the transmission side is called the driver, the reception side is called the receiver, and a dedicated IC is used.

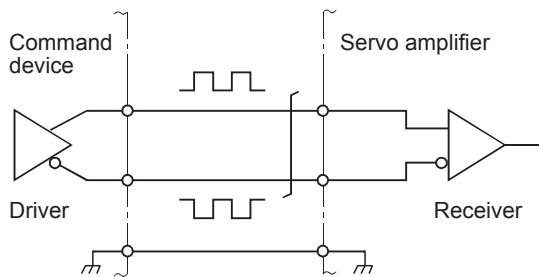

**DIGITAL BUS CONNECTION**

Commands are generally output from the positioning module to the servo amplifier as a pulse train. Recently, however, devices are being digitalized. Accompanying that, a connection method has appeared in which the bus lines of both the positioning module and the servo amplifier CPUs are connected. This has enabled the construction of higher-accuracy, higher-speed systems. The MELSEC A70D, AD774M, A171SCPU, A273UCPU etc., models employ this digital bus connection.

**DOG SIGNAL**

The near-point dog of the OPR.

**DRIVE UNIT**

The commands output from the positioning module are low-voltage, low-current commands with insufficient energy to run the motor.

The drive unit increases the width of these commands so the motor can be run. It is an accessory on servomotors and stepping motors. Also called a servo amplifier.

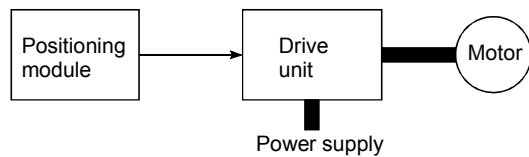

**DRIVE UNIT READY**

This signal is output when the drive unit for the motor is in a READY state.

This signal remains OFF when the drive unit power is OFF, or during faults, etc.

**DROOP PULSE**

Because of inertia ( $GD^2$ ) in the machine, it will lag behind and not be able to track if the positioning module speed commands are issued in their normal state.

Thus, for a servomotor, a method is used in which the speed command pulses are delayed by accumulation in a deviation counter. These accumulated pulses are called the droop pulse.

The deviation counter emits all pulses and returns to 0 when the machine stops.

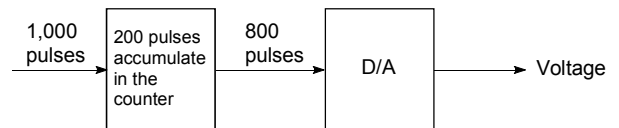

**DWELL TIME**

This is the time taken immediately after the positioning is completed to adjust for the droop pulses in the deviation counter. The positioning will not be accurate if this time is too short.

**DYNAMIC BRAKE**

When protection circuits operate due to power failures, emergency stops (EMG signal) etc., this function is used to short-circuit between servomotor terminals via a resistor, thermally consume the rotation energy, and cause a sudden stop without allowing coasting of the motor.

Braking power is generated by electromagnetic brakes only when running motors with which a large brake torque can be obtained. Because electromagnetic brakes have no holding power, they are used in combination with mechanical brakes to prevent dropping of the vertical axis.

**ELECTROMAGNETIC BRAKE**

This function is supplied on motors with electromagnetic brakes. Electromagnetic brakes are used to prevent slipping during power failures and faults when driving a vertical axis, or as a protective function when the machine is stopped.

These brakes are activated when not excited.

**ELECTRONIC GEAR**

This function electrically increases/decreases the command pulses from the pulse command module by 1/50 to 50-fold. Thus, the positioning speed and movement amount can be controlled by the electronic gear ratio magnification.

**EMERGENCY STOP**

Emergency stops cannot be carried out by the QD75, so a method of shutting OFF the servo side power supply from outside the programmable controller, etc., must be considered.

**ENCODER**

This device turns the input data into a binary code of 1 (ON) and 0 (OFF). A type of pulse generator.

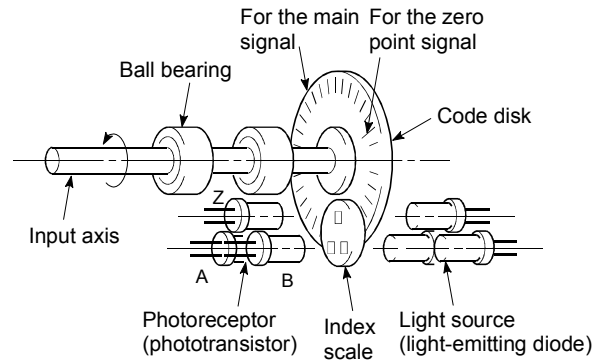

Rotary encoder

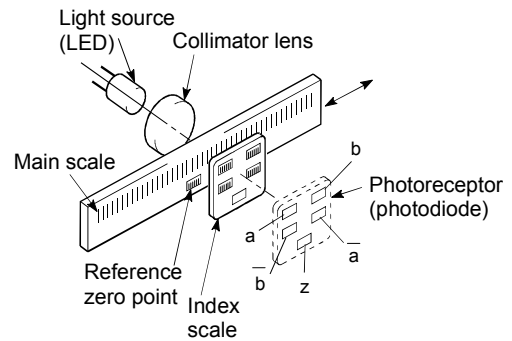

Linear encoder

**ERROR CORRECTION**

If a dimension error occurs in the machine, and that error is actually smaller or larger than 1m in spite of a 1m command being issued from the QD75, that error amount will be compensated. For example, when the error is actually smaller than 1m, the remaining distance to 1m is fed, and the correct 1m of positioning is carried out.

**ERROR RESET**

This resets error of axis. Note that if the cause of the error is not eliminated at that time, the error will occur again.

**EXTERNAL REGENERATIVE BRAKE RESISTOR**

This is also called the regenerative brake. When a machine is moved with a motor, power is normally supplied to the motor from an amplifier. However, the rotation energy in the motor and machine counterflows (regenerates) to the amplifier when the motor is decelerating or when driving a descending load. The external regenerative resistor consumes this regeneration energy with resistance, obtains the regenerative brake torque, and enables the full capacity of the regeneration system during stopping. It is used when carrying out highly repetitive acceleration/deceleration.

**F**

In the QD75, F is a status where the module itself has a fault.  
[HOLD]

**FAST OPR**

The axis returns to the machine OP at the OPR speed without detecting the near-point dog.  
(This is not validated unless a machine OPR has been carried out first.)

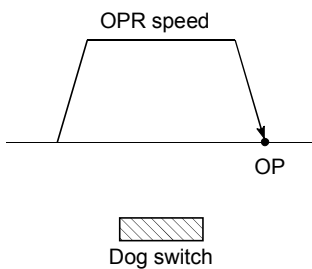

**FEED PULSE**

This is a pulse issued from the positioning module to a servomotor or stepping motor. Also called a command pulse.

**FEED SCREW**

This is the basic screw in mechanisms that position using screw rotation. Ball screws are often used to reduce backlash and dimension error.

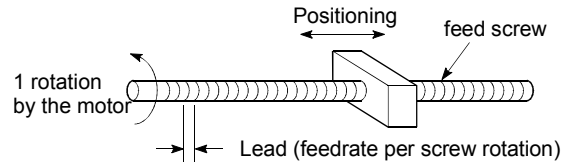

**FEEDBACK PULSE**

This is a method of using a returning pulse train to confirm whether the machine faithfully operated according to the commands issued in automatic control. If the machine did not faithfully operate according to the commands, a correction command is issued. For example, if a command is issued for 10,000 pulses, and a feedback pulse of 10,000 pulses is returned, then the balance becomes 0 and it can be judged that the command was faithfully followed. Refer to the term "DEVIATION COUNTER".

**FIXED-FEED**

This is the feeding of a set dimension for cutting sheet and bar workpieces into the designated dimensions. Incremental system positioning is often used. The current value is not incremented, even when the feed operation is repeated.

**FLASH MEMORY**

This battery-less memory can be used to store parameters and positioning data for backup. Because it is battery-less, battery maintenance is not required.

**FLAT TYPE MOTOR (PANCAKE MOTOR)**

About 100mm shorter in axial dimension than the standard motor. Used when the servomotor is installed in a small space.

**FLS SIGNAL (forward limit signal)**

This is the input signal that notifies the user that the limit switch (b contact configuration, normally ON) installed at the upper limit of the positioning control enabled range has been activated.

The positioning operation stops when the FLS signal turns OFF (non-continuity).

**G CODE**

These are standardized (coded) 2-digit numerical values (00 to 99) designating various control functions of the NC module. Also called G functions.

Example :

- G01 Linear interpolation
- G02 Circular interpolation CW (clockwise)
- G04 Dwell
- G28 OPR
- G50 Max. spindle speed setting

**GAIN**

The changing of the ratio between two values having a proportional relation. Seen on a graph, the changing of the incline of the characteristics.

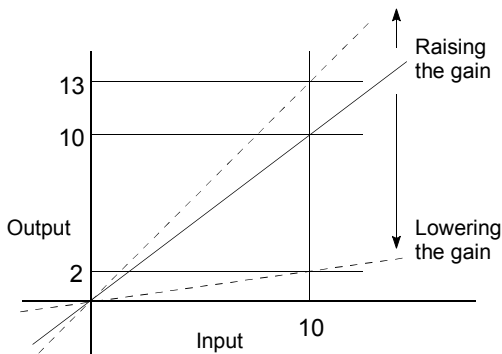

For example, when 10 is output for an input of 10, the output can be changed to 12, 5, etc., by changing the gain.

**GD<sup>2</sup>**

The inertia moment. The sum total of the mass (dm) of each small area configuring an object multiplied by the square of the distance (r) of each of those areas from a given straight line. The relation with  $I = \int r^2 dm$  GD<sup>2</sup> is given by 4gl, with "g" being gravitational acceleration.

**INCREMENTAL ENCODER**

A device that simply outputs ON/OFF pulses by the rotation of the axis. 1-phase types output only A pulses, and do not indicate the axis rotation direction. 2-phase types output both A and B pulse trains, and can judge the rotation direction. The direction is judged to be forward if the B pulse train turns ON when A is ON, and judged to be reverse if A turns ON when B is ON. There is also another type of incremental encoder with a zero signal. The most commonly used incremental encoders output between 100 and 10,000 pulses per axis rotation. Refer to "ENCODER".

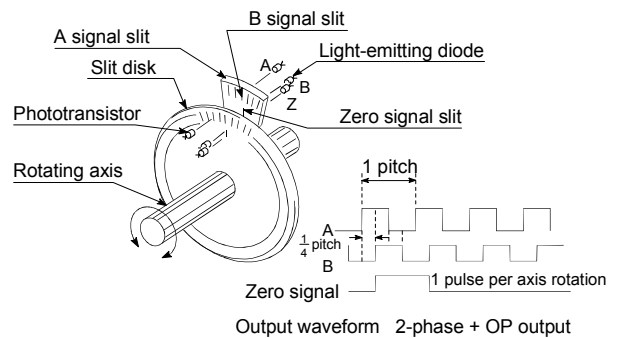

**INCREMENTAL SYSTEM**

The current value is 0 in this system. Positions are expressed by the designated direction and distance of travel. Also called the relative address system. This system is used in fixed-feed, etc. Compare ABSOLUTE SYSTEM.

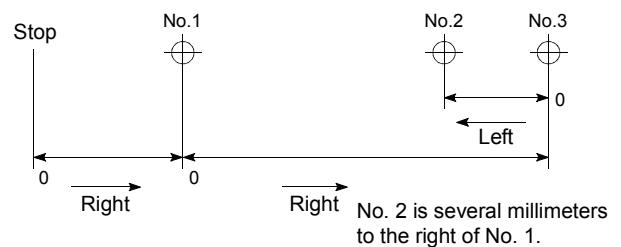

**INERTIA**

The property of an object, when not being affected by external forces, where it tries to maintain its current condition. The inertia moment.

**INPUT TERMINAL**

This is a pin connector wired by the user for inputting data to the QD75 from an external source. It is connected to the motor drive unit or machine side.

This terminal is used to output the following.

- DRIVE UNIT READY signal
- START signal
- STOP signal

, etc.

The input No. Xn is not directly related to the program, so it is not used.

**INTERLOCK**

In this condition, the machine is blocked from moving to the next operation until the operation in progress is complete. This function is used to prevent damage to devices and malfunctioning.

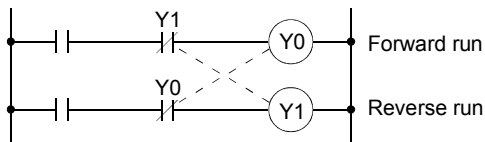

**INTERPOLATION OPERATION**

The simultaneous operation of multiple motors to carry out a composite operation. Each motor can be freely set with the positioning distance, acceleration/deceleration time, speed, and other factors, which are combined to move a target in a straight line, circle, etc. Linear interpolation and circular interpolation are available. (The circular interpolation uses two motors.)

**INVERTER**

This refers to a device to change a direct current (DC) to an alternating current (AC). The device actually changes the motor speed by changing 50Hz or 60Hz of commercial frequency to direct current once, then changing it again to a 5 to 120Hz alternating current and controlling the motor speed.

**JOG**

Jog. This refers to moving the tool little by little. Inching. Parameter setting is required to carry out JOG operation.

**kPPS**

This is the abbreviation for "kilopulses per second". 80kPPS equals 80,000 pulses per second.

**LIMIT SWITCH**

This is a switch set to stop a moving object at both ends, etc., of a movement device for safety reasons.

A circuit is created in which the moving body itself presses against the switch to activate the contact and forcibly shut the power OFF. For example, pressing on the actuator in the drawing below activates the internal microswitch. There are various other types.

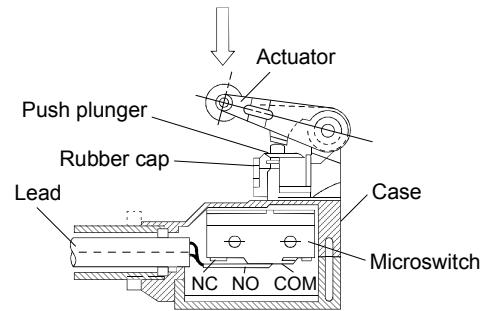

**LINEAR INTERPOLATION**

This automatic operation simultaneously operates two motors for the latitudinal (X) feed and longitudinal (Y) feed to move a target in a diagonal line for positioning. Three or four motors can also be operated simultaneously. The QD75 combines the operation of axis 1 through 4 for the linear interpolation. The same positioning data No. must be used for the setting. Refer to the term "INTERPOLATION OPERATION".

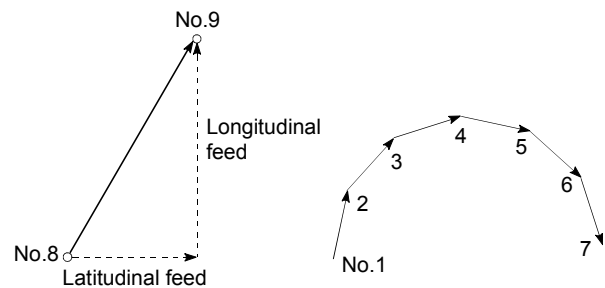

**LOAD INERTIA RATIO**

$$GDL^2/GDM^2$$

Refer to "GD<sup>2</sup>".

**LOW-INERTIA MOTOR**

This is a motor used when frequent acceleration/deceleration is repeated. Low-inertia motors are longitudinally longer, to decrease the rotor diameter and cover the torque. This enables their inertia moment to be reduced up to 1/3 that of standard motors. The ideal load inertia ratio is 1 or less.

**M CODE (Machine Code)**

These are sub functions that interlock with the positioning operation to replace drills, tighten and loosen clamps, raise and lower welding electrodes, display various data, etc. Either of two modes can be entered when the machine code turns ON: AFTER or WITH. The machine does not move to the next positioning when the machine code is ON. M codes are turned OFF by the programmable controller program. Code Nos. from 1 to 65535 assigned by the user and used (1: Clamp, 2: Loosen, etc.). Comments can be written after 50 of the M codes, and they can be monitored using a peripheral device or displayed on an external display. Refer to "AFTER MODE" and "WITH MODE".

**MACHINE FEED VALUE**

The OP address at the completion of the machine OPR is stored. The current position of the machine coordinates determined by a machine having the OP address as a reference. Even if the current value is changed, this value will not change.

**MANUAL PULSE GENERATOR**

The handle of this device is manually rotated to generate pulses. This device is used when manually carrying out accurate positioning.

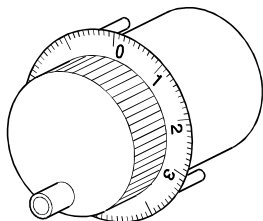

Made by Mitsubishi Electric Corp.  
(model: MR-HDP01)

**MASTER AXIS**

When carrying out interpolation operations, this is the side on which the positioning data is executed in priority. For example, when positioning with the X axis and Y axis, the side with the largest movement distance will become the master axis, and the speed will follow that axis. The slave axis speed will be ignored.

**MOVEMENT AMOUNT PER PULSE**

When using mm, inch, or degree units, the movement amount is calculated and output from the machine side showing how much the motor shaft moves per pulse. Positioning accuracy in smaller units is not possible. On the motor side, the movement amount per axis rotation is normally designed as a reference, so it is calculated as follows.

$$\frac{\text{P rate}}{\text{No. of pulses per encoder rotation}} \times \text{Movement amount per rotation} = \text{Movement amount per pulse}$$

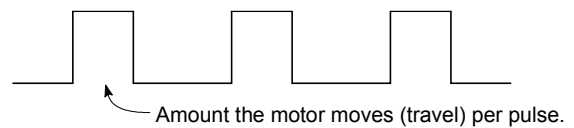

**MULTI-PHASE PULSE**

A combination of pulses in which 2 or more phases differ. 2-phase pulses, etc.

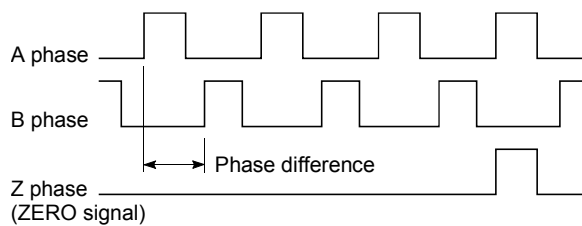

**MULTIPLYING RATE SETTING**

The P rate. Refer to the term "P RATE".

**NC LANGUAGE (Numerical Control Language)**

This is the language punched into the paper tape that instructs the machining to the NC module.  
 The NC language consists of EIA codes (EIA language), ISO codes (ISO standards), and JIS codes (JIS standards).

**NEAR-POINT DOG**

This is a switch placed before the OP. When this switch turns ON, the feedrate is changed to the creep speed. Because of that, the time that this switch is ON must be long enough to allow for the time required for deceleration from the feedrate to the creep speed.

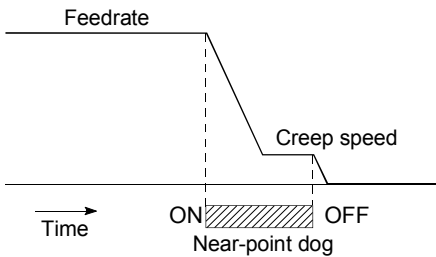

**NEW CURRENT VALUE (CURRENT VALUE CHANGING)**

The QD75 has no way of knowing the current value when the machine is assembled and the positioning module is connected, so this function is used to teach it a temporary approximate value as the current value. This function can also be used to write a temporary current value when the current value has been lost due to accidents, etc. If an OPR is carried out after that, the positioning module will recognize the zero point.  
 To prevent the accumulated value from exceeding the stroke limit in fixed-feed, etc., rewrite the current value to 0 after the fixed-feed. The current value can be changed during a positioning stop.

**OP**

This is the reference position for positioning. Positioning cannot start without a reference point. The OP is normally set to the upper or lower stroke limit.

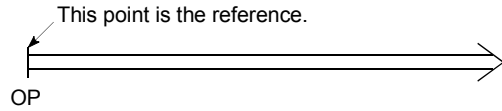

**OP SHIFT FUNCTION**

The OP position can be shifted in the positive or negative direction by executing a machine OPR and determining the shift amount from the machine OPR complete position. An OP can be set at a position besides the OP position, or outside the dog switch.

**OPERATION PATTERN**

The kind of operation to be carried out after executing the positioning data is determined.

- 1) If "POSITIONING COMPLETE" is selected, the operation will stop after the positioning is complete.
- 2) If "CONTINUOUS POSITIONING CONTROL" is selected, the next data No. will be automatically executed after the positioning is complete.
- 3) If "CONTINUOUS PATH CONTROL" is selected, the positioning will not be completed. Only the speed will be automatically changed, and the next data No. will be executed.

**OPR METHOD**

The OPR methods are shown below. The method used depends on the machine structure, stopping accuracy, etc. OPR can be carried out when the OPR parameters are written.

- 1) Near-point dog method
- 2) Stopper method
- 3) Count method

## OPR PARAMETER

This parameter is required when returning to the OP. It is determined by the machine side design, so subsequent changes of this parameter must be accompanied by changes in the machine design.

The OP is the reference for positioning operations, so if the OP is lost due to a power failure during positioning, or because the power is turned OFF and the machine is moved manually, etc., it can be restored by carrying out an OPR. When a machine OPR command is issued, the machine will move in search of the near-point dog regardless of the current value, and will stop at the OP. At this time, the current value will be rewritten to the OP address. Data cannot be written during positioning. With the QD75, data is always written for all axes (from 1 to 4 axes). Refer to the term "NEAR-POINT DOG".

## OPR REQUEST

This signal turns ON when there is an error with the QD75. It will turn ON in the following situations.

- 1) When the power is turned ON.
- 2) When the PLC READY signal turns from OFF to ON.
- 3) When the machine OPR starts.
- 4) When the drive unit READY signal turns from ON to OFF.

The user judges whether to carry out a machine OPR in the above situations.

## OUTPUT TERMINAL

This is a pin connector for outputting data from the QD75 to an external source. It is connected to the motor drive unit.

This terminal is used to output the following.

- Feedback pulses for both forward run and reverse run
- Start
- Deviation counter clear

The terminal Nos. are determined for each axis.

The output No. Yn is not directly related to the program, so it is not used.

## OVERRIDE FUNCTION

With this function, the speed during positioning operations (current speed) can be varied between 1 and 300%.

The speed can also be changed by the same variable rate for continuous positioning with differing designated speeds.

## P RATE (Pulse Rate)

A coefficient that magnifies the feedback pulses per motor shaft rotation by 2-fold, 3-fold, 1/2 or 1/3.

It is the ratio of the feed pulses and feedback pulses.

For example, when the No. of pulses per motor shaft rotation is set to 2400 pulses, and the P rate is set to 2, the result will be equivalent to 1200 pulses.

The rotation per pulse is  $0.15^\circ$  when 2400 pulses per rotation are set, but this becomes  $0.3^\circ$  when 1200 pulses. The positioning accuracy drops as the P rate is increased.

## PARAMETER

This is the basic data used in positioning.

Parameters are determined by the machine side design, so subsequent changes of parameters must be accompanied by changes in the machine design.

Data cannot be written during positioning. The initial parameter values are written by the maker.

## PG0 (Pulse Generator Zero)

Pronounced "pee-jee-zero". Refer to the term "ZERO SIGNAL".

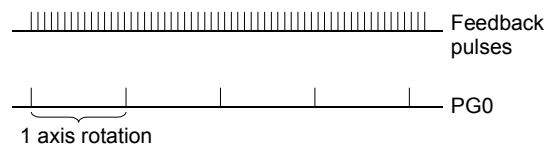

## POSITION CONTROL

This is mainly the control of position and dimension, such as in fixed-feed, positioning, numerical control, etc. This is always controlled with feed pulses. There is also speed control.

Drive units may differ, even when the same motor is used.



**POSITION DETECTION MODULE**

This is an abridged version of positioning. There are two types on MELSEC, the A1S62LS. This module has positioning and limit switch functions, and can use a total of 16 channels. The following drawing shows an example for 5 channels. A resolver is used in the positioning detection.

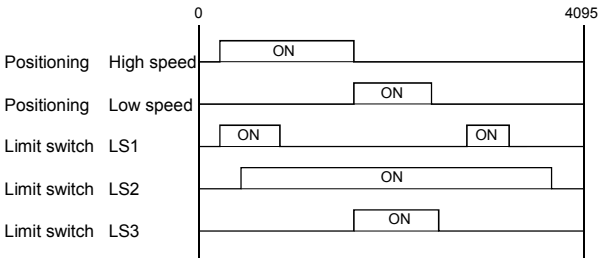

**POSITION LOOP GAIN**

This is the ratio of the deviation counter droop pulses to the command pulse frequency.

$$\text{Position loop gain} = \frac{\text{Command pulse frequency}}{\text{Droop pulses}} (1/s)$$

The position loop gain can be set with the drive unit. Raise the gain to improve the stopping accuracy. However, overshooting will occur if the position loop gain is raised too far, and the operation will become unstable. If the position loop gain is lowered too far, the machine will stop more smoothly but the stopping error will increase.

**POSITION LOOP MODE**

This is one servo control mode used in positioning. It is a mode for carrying out position control. The other servo control modes are the speed loop mode for carrying out speed control, and the torque loop mode for carrying out torque control (current control).

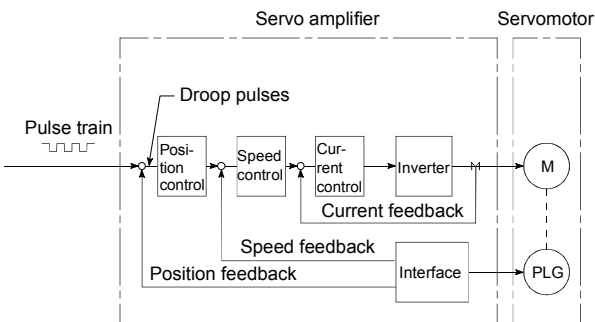

**POSITIONING**

Accurately moving the machine from a point to a determined point. The distance, direction, speed, etc., for that movement are designated by the user. Positioning is used in operations such as cutting sheets, drilling holes in plates, mounting parts on a PCB, and welding. Positioning is also used with robots.

**POSITIONING COMPLETE**

Refer to the term "OPERATION PATTERN".

**POSITIONING COMPLETE SIGNAL**

This is a signal that occurs when the positioning is complete. A timer set beforehand starts when this signal is output, and the machine movement stops for that time. When this signal turns ON, the positioning start signal turns OFF.

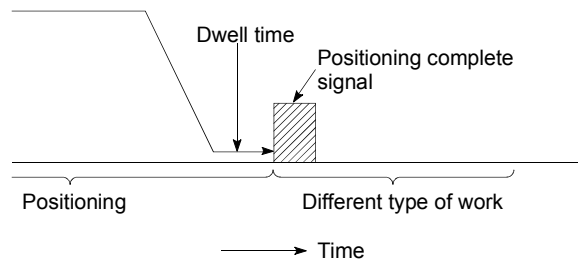

**POSITIONING CONTINUED**

Refer to the section of term "operation pattern".

**POSITIONING DATA**

This is data for the user to carry out positioning. The No. of points to which positioning is carried out (the No. of addresses) is designated by the user. In the QD75, these are 600 points. As a principle, positioning is executed in the order of the data Nos.

**POSITIONING PARAMETER**

This is basic data for carrying out positioning control. Types of data include control unit, movement amount per pulse, speed limit value, upper and lower stroke limit values, acceleration/deceleration time, positioning system, etc.

Parameters have an initial value, so that value is changed to match the control conditions.

**POSITIONING START**

This refers the act of designating a target data No. and starting the positioning.

The operation after the positioning is complete for that data No. is determined by the data No.'s positioning pattern.

**PTP Control (Point To Point Control)**

This is a type of positioning control. With this control method, the points to be passed are designated at random locations on the path. Movement only to a given target positioning is requested. Path control is not required during movement from a given point to the next value.

**PULSE**

The turning ON and OFF of the current (voltage) for short periods. A pulse train is a series of pulses. The QD75 is the module that generates the pulses.

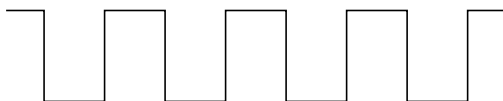

**PULSE GENERATOR**

This is a device that generates pulses.

Examples include devices installed on the motor shaft that create pulses when the shaft rotates, and digital devices.

1-phase types output one pulse train. 2-phase types output two pulse trains with a phase difference. From 600 to 1,000,000 pulses can be output per shaft rotation. Generators with a ZERO signal function to output 1 or 2 pulses per shaft rotation. Abbreviated as PLG. Refer to the term "ENCODER".

**PULSE OUTPUT MODE**

There are two methods used to issue forward run and reverse run commands to the servomotor. The type used differs according to the machine maker. In type A, the forward run pulses and reverse run pulses are output from separate terminals.

In type B, the forward run pulses and reverse run pulses are output from the same terminal, and a forward/reverse run identification signal is output from another terminal.

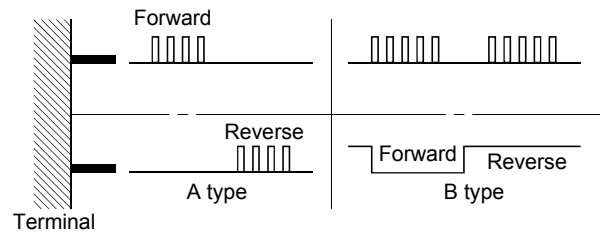

**READY**

This means that preparation is complete.

**REAL-TIME AUTO TUNING (Real-time Automatic Tuning)**

Refer to "AUTO TUNING".

**REFERENCE AXIS SPEED**

This is the speed of the reference axis during interpolation operations.

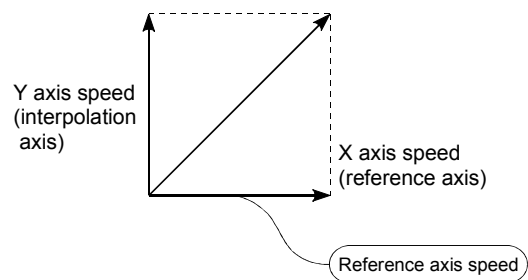

**REGENERATIVE BRAKE OPTION**

This function is an option. It is used when carrying out highly repetitive acceleration/deceleration. Refer to "EXTERNAL REGENERATIVE RESISTOR".

**RESOLVER**

This device detects the angle by resolving the two voltages of the analog input. Also called a 2-phase synchro. For a 1-phase voltage input, the axis rotation angle is converted into a perpendicular 2-phase voltage (analog voltage) and output.

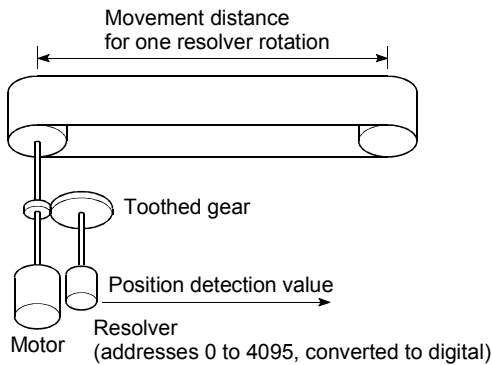

**RLS SIGNAL (reverse limit signal)**

This is the input signal that notifies the user that the limit switch (b contact configuration, normally ON) installed at the lower limit of the positioning control enabled range is activated. The positioning operation stops when the RLS signal turns OFF (non-continuity).

**ROTARY TABLE**

A round table on which the workpiece is placed. Positioning control is carried out while rotating the workpiece in a 360° range.

**S-CURVE ACCELERATION/DECELERATION**

In this pattern, the acceleration and deceleration follow a sine curve, and the movement is smooth. The S-curve ratio can be set from 1 to 100%.

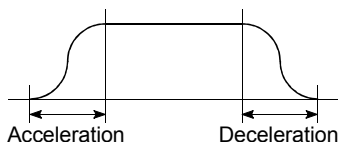

**SERVO AMPLIFIER**

Refer to the term "DRIVE UNIT".

**SERVO LOCK**

In positioning using a servomotor, stepping motor, etc., working power is required to hold the machine at the stop position. (The position will be lost if the machine is moved by external power.) This kind of state is called servo lock or servo lock torque.

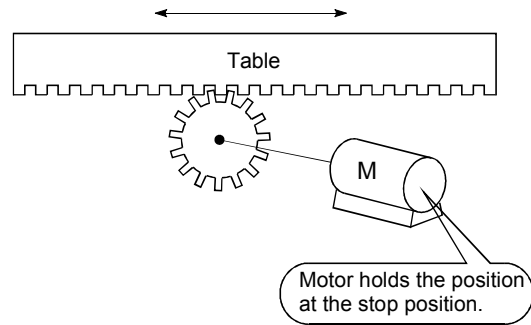

**SERVO ON**

The servo amplifier will not operate if the servo amplifier is in a normal state and this servo ON signal is OFF.

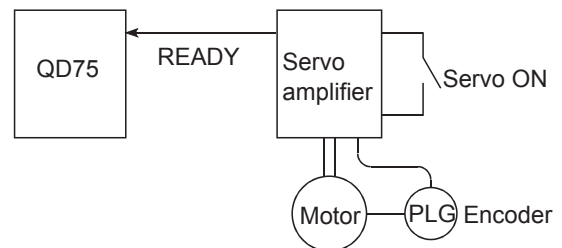

**SERVOMOTOR**

A motor that rotates true to the command. Servomotors are highly responsive, and can carry out frequent high-speed and high-accuracy starts and stops. DC and AC types are available, as well as large-capacity motors. A pulse generator accessory for speed detection is common, and feedback control is often carried out.

**SETTING UNIT**

This is one setting item of the positioning reference parameters. The unit to be used is designated as mm, inch, degree, or pulse.

### SFC (Sequential Function Chart)

A sequential function chart is a programming method optimally structured for running a machine's automatic control in sequence with the programmable controller.

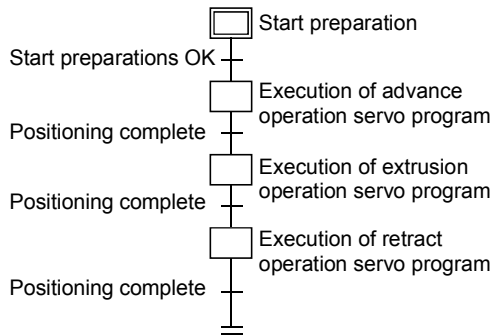

### SKIP FUNCTION

When a SKIP signal is input, the positioning being executed is interrupted, the motor is deceleration stopped, and the next positioning is automatically carried out.

### SLAVE AXIS

During interpolation operation, the positioning data is partially ignored on this side. This axis is moved by the master axis data.

### SPEED CONTROL

Speed control is mainly carried out with the servomotor. It is an application for grindstone rotation, welding speed, feedrate, etc. Speed control differs from position control in that the current position (address) is not controlled. Drive units may differ, even when the same motor is used.

### SPEED INTEGRAL COMPENSATION

This is one item in the parameters of the servo amplifier, and is used to raise the frequency response during speed control to improve transient characteristics.

When adjusting the speed loop gain, raising this value is effective if the overshooting during acceleration/deceleration remains large.

This compensation is set in ms units.

### SPEED LIMIT VALUE

This is the max. speed for positioning. Even if other data is mistakenly set to a higher speed than this, the positioning will be carried out at this speed limit value when it is set in the parameters. The acceleration time becomes the time to accelerate from a stopped state to the speed limit value, and the deceleration time becomes the time to decelerate from the speed limit value to a stopped state.

### SPEED LOOP GAIN

This is one item in the parameters of the servo amplifier, and expresses the speed of the control response during speed control. When the load inertia moment ratio increases, the control system speed response decreases and the operation may become unstable. If this happens, the operation can be improved by raising this setting value.

The overshoot will become larger if the speed loop gain is raised too far, and motor vibration noise will occur during operation and when stopped.

### SPEED LOOP MODE

This is one servo control mode used in positioning. It is a mode for carrying out speed control. Refer to "POSITION LOOP MODE".

### SPEED-POSITION SWITCHING CONTROL

With this control, positioning is carried out to the end point of the movement amount while changing the speed at the speed switching point during positioning control.

### SPEED-POSITION SWITCHING CONTROL MODE

This is one method used for positioning. It is an application for operations such as high-speed movement to a point unrelated to positioning, then set dimension movement from the switching signal activation point.

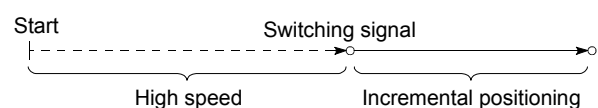

**START COMPLETE**

This signal gives an immediate response notifying the user that the QD75 that was started is now in a normal state and can start positioning.

**STARTING AXIS**

One of the QD75 axis system axes (axis 1, axis 2, axis 3, or axis 4) or the reference axis for the interpolation operation is designated as the starting axis.

**STATUS**

Data showing the state of the machine. Collectively refers to signals that turn ON when the battery voltage drops, during OPR requests, during dwell time, etc.

**STEP FUNCTION**

When the operation is designed so that several positioning data Nos. are consecutively run, this function can be used to carry out a test operation for 1 data item at a time.

**STEP OUT**

Stepping motors rotate in proportion to the No. of pulses (frequency), but the motor's rotation will deviate if the load is too large for the motor. This is called step out. If step out occurs, the motor must be replaced by one with a larger torque. Step out causes the positioning error to increase.

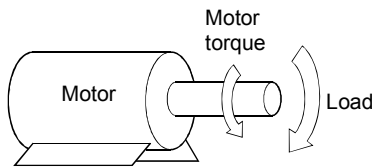

**STEPPING MOTOR**

A motor that rotates a given angle (example:  $0.15^\circ$ ) when 1 pulse is generated. For that reason, a rotation proportional to the No. of pulses can be obtained. 2-phase to 5-phase stepping motors are available. In the 3-phase type, the rotor rotates in order from A to C when a voltage is applied. Often found in compact motors, stepping motors rotate accurately without feedback. Be careful of step out when overloaded.

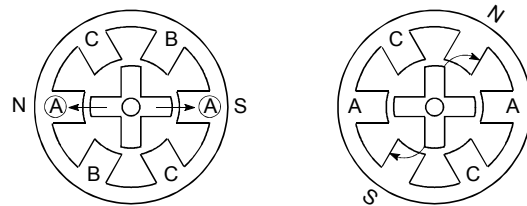

- 1) First, the A phase is excited by a pulse.
- 2) When the B phase is then excited, the force works in the direction shown by the arrows.

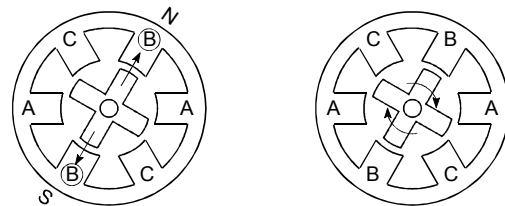

- 3) The nearest tooth to the B phase is attracted, and the rotation stops.
- 4) As the excitation phase is continuously changed, the rotor rotates in a clockwise direction.

**STOP SETTling TIME**

Refer to the term "Dwell Time".

**STOP SIGNAL**

In positioning control, this is the input signal that directly stops the operation from an external source.

The operation stops when the external stop signal (a-contact) turns ON (continuity).

**STOP WITH STOPPER**

This is one machine OPR method. With this method, a stopper is established at the OP, and the operation is stopped when the machine presses against it.

Motor burning would occur or the stopper would be damaged if the machine were left in that state. There are two methods to prevent this; a timer can be used to shut OFF the motor after a fixed time, or the motor can be stopped by limiting sudden increase in the motor torque when the machine presses against the stopper.

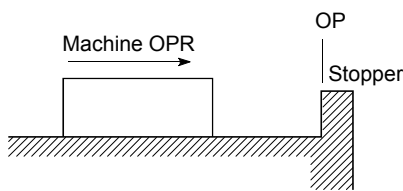

**STROKE**

The stroke is the variation in the operation by the distance from a stopped state to the next stopped state after a movement.

**STROKE LIMIT**

This is the range in which a positioning operation is possible, or the range in which the machine can be moved without damage occurring.

(Movement outside this range is possible in the manual operation.) For operations using a worm gear, the stroke limit is determined by the length of the screw. For operations using a fixed-feed, it is determined by the max. dimension to be cut.

The upper and lower limits are set in the parameters, but a separate limit switch should be established and an emergency stop circuit outside the programmable controller should be created. Refer to the term "LIMIT SWITCH".

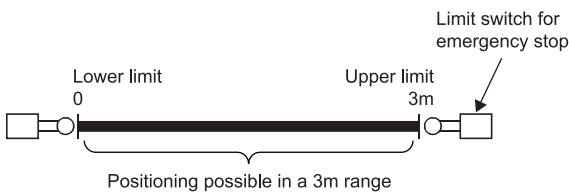

**SUDDEN STOP**

A stop carried out in a shorter time than the deceleration time designated in the parameters.

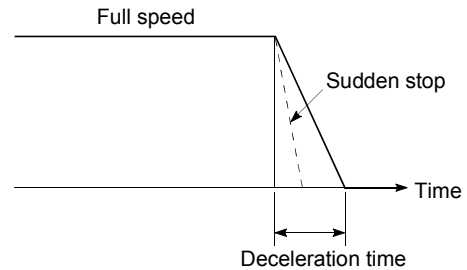

**TEACHING**

When the positioning address is uncertain, or gauging is required, this function is used by the user to search for and teach the position to the machine.

For example, complex addresses such as drawings can be taught by tracing a model, and the positioning operation can be reproduced.

**TORQUE CONTROL**

In this function, a limit is established for the resistance torque applied to the motor used for positioning. The power is turned OFF if torque exceeding that value is applied to the motor. When excessive torque is applied to a motor, it causes the current to suddenly increase. Motor burning and other stress on the motor occurs, and the life of the motor is shortened.

This function utilizes the sudden increase in the torque when the machine OPR to issue a command to stop the motor.

**TORQUE LOOP MODE**

Also called the current loop mode. Refer to "POSITIONING LOOP MODE".

**TORQUE RIPPLE**

Torque width variations, deviations in the torque.

**TRACKING FUNCTION**

In this function, positioning is carried out at a speed relative to a moving target object by inputting the movement amount from an external encoder and adding it to the servo command value.

**TRAPEZOIDAL ACCELERATION/DECELERATION**

An operation in which a graph of the time and speed takes a trapezoidal shape.

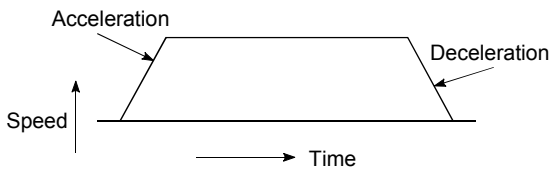

**TURNTABLE**

A rotating table, which is turned using power. The table is used divided from one 360° rotation into the required locations for work. The positioning control unit is "degree".

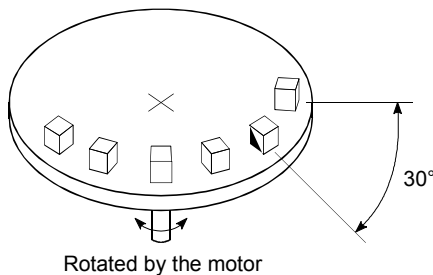

**UNIT SETTING**

This is the setting of the unit for the actual address to which positioning is required, or for the movement amount.

The following units can be set: mm, inch, degree and pulse. The initial value in the parameters is a pulse unit.

**WARNING**

A warning is output as a warning code in when an abnormality is detected that is not serious enough to require cancellation or stoppage of the positioning operation. Warnings are handled differently than errors.

**WINDOW**

These are the selection menus that appear on the screen when the QD75 is started.

- Menu selection window
- Mode function selection window
- Sub-function selection window
- Execution/setting selection window

**WITH MODE**

This is the mode that outputs the M code before the start of the positioning. This mode turns ON at the positioning start, enabling voltage to be applied to the welding electrodes, display of positioning speeds, etc. Refer to the term "AFTER MODE".

**XY TABLE**

This is a device that moves a table in the X (latitudinal) and Y (longitudinal) directions so that positioning can be carried out easily. There are also commercially available products.

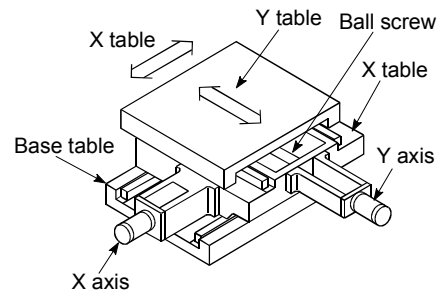

**Z PHASE**

Also called "PG zero". Refer to "ZERO SIGNAL".

**ZERO SIGNAL**

This refers to PG0 of the pulse generator (encoder) (one detection per shaft rotation). It also called "Z phase". Refer to the term "PULSE GENERATOR".

## Appendix 12 Positioning control troubleshooting

Trouble type	Questions/Trouble	Remedy	No.
Parameter	Display reads "FFFFH" when a parameter is read with GX Configurator-QP.	The CPU module power was turned OFF or the CPU module was reset, etc., during flash ROM writing, which deleted the data in the flash ROM. Initialize the parameters, and reset the required parameters. (Refer to Section 13.2 "Parameter initialization function" for details.)	1
	How can the parameters be returned to their initial values (default values)?	Set the " [Cd.2] Parameter initialization request" to "1". (Refer to Section 13.2 "Parameter initialization function" for details.)	2
	A parameter error occurred although the parameter was set correctly by GX Configurator-QP.	The parameter may have been overwritten in the sequence program. Review the sequence program.	3
Hardware stroke limit	The machine overruns if operating at high speeds when the hardware stroke limit range is exceeded.	In the QD75, deceleration stops are executed after the machine exceeds hardware stroke limit range. Because of this, more time is required for the deceleration stop as the speed increases, and the overrun becomes larger. (The deceleration time becomes shorter at lower speeds, so the overrun becomes smaller.)	4
	When the machine exceeded the hardware stroke limit range, positioning toward inside the range was started, but the machine did not start.	Use a "JOG operation", " Inching operation" or "Manual pulse generator operation" to return the machine to inside the hardware stroke limit range. (When the hardware stroke limit range is exceeded, positioning will not start toward inside the range even when so commanded. Once the range is exceeded, a return to inside the range can only be executed using a "JOG operation", "Inching operation" or "Manual pulse generator operation".)	5
Degree	Exactly one rotation is required, but the setting range for a "degree" unit setting is "0 to 359.999...". Won't the rotation deviate by "0.00...1"?	Designate "360.000" in the INC control. The motor will make exactly one rotation.	6
Movement amount per pulse	If the "movement amount per pulse" is calculated as written in the manual, settings smaller than the basic parameter setting range cannot be carried out.	Set "movement amount per pulse" in the QD75 using the three parameter values of [Pr.2] to [Pr.4]. Try setting the values following the explanations for each parameter.	7
Override	Will an override setting value written before starting be valid?	It will be valid.	8
	During path control, will the override still be valid after the point is passed?	It will still be valid.	9
	How can the override be canceled?	Set the " [Cd.13] Positioning operation speed override" to "100".	10



Trouble type	Questions/Trouble	Remedy	No.
Acceleration/ deceleration time	How can the deceleration stop time during stopping be shortened using the hardware stroke limit?	Set "1: Sudden stop" in the " <a href="#">Pr.37</a> Stop group 1 sudden stop selection", and reduce the setting value of " <a href="#">Pr.36</a> Sudden stop deceleration time".	11
	The motor does not operate at "60000ms" although the acceleration/deceleration time is set to "60000ms".	The value set for the acceleration/deceleration time is the time required for the machine to accelerate from speed "0" to the value set in " <a href="#">Pr.8</a> Speed limit value". Because of that, the acceleration/deceleration time will also be shorter than "60000ms" if the command speed value is smaller than the " <a href="#">Pr.8</a> Speed limit value". (Refer to the explanation for <a href="#">Pr.9</a> and <a href="#">Pr.10</a> for details.)	12
	Can each acceleration/ deceleration time be individually set to trapezoidal or S-curve acceleration/deceleration?	The trapezoidal and S-curve acceleration/deceleration processing is a common setting for all acceleration/deceleration times, so individual setting is not possible. (Refer to Section 12.7.6 "Acceleration/deceleration process function".)	13
	The machine starts and stops suddenly when carrying out JOG operations and positioning operations. (Using an MR-J2S servo amplifier.)	Review the parameter settings for acceleration/ deceleration time, speed limit value, JOG speed limit value, JOG acceleration/deceleration time, etc.	14
Simplified absolute position detection system	Are simplified absolute position detection system possible in the QD75 Positional deviation models?	They are possible if the models are used in combination with a Mitsubishi "AC Servo". (Refer to "AC servo User's Manual" for details.)	15
Positional deviation	The physical position position detection system from the commanded position, although the positioning is complete (and the monitored current position is correct).	If the deviation counter value is not "0", the servo side is still moving. Increase the torque.	16
Electronic gear	A setting of "1 $\mu$ m = 1pulse" is required in the following system. <ul style="list-style-type: none"> <li>• Ball screw pitch = 10mm</li> <li>• No. of feedback pulses = 8192pulse</li> </ul>	In this case, the following values will result. <ul style="list-style-type: none"> <li>• No. of pulses per rotation = 8192</li> <li>• Movement amount per rotation = 10000</li> <li>• Unit magnification = 10</li> </ul> Therefore, the "Movement amount per pulse" will become "1.2207 $\mu$ m". This value is fixed by the machine system, so it cannot be changed. Thus, the setting "1 $\mu$ m = 1pulse" cannot be achieved.	17

Trouble type	Questions/Trouble	Remedy	No.
Error compensation	<p>The machine only moves to "10081230", although positioning with a command value of "10081234" carried out.</p> <p>How can the error be compensated?</p> <p>The following values are currently set.</p> <ul style="list-style-type: none"> <li>• [Pr.2] No. of pulses per rotation = 8192</li> <li>• [Pr.3] Movement amount per rotation = 8000</li> </ul>	<p>Reset [Pr.3] and [Pr.2] in the following order.</p> <ol style="list-style-type: none"> <li>1) Calculate "8192/8000 × 10081230/10081234".</li> <li>2) Obtain the reduced value.</li> <li>3) Set the numerator in "[Pr.3] Movement amount per rotation", and the denominator in "[Pr.2] No. of pulses per rotation".</li> </ol>	18
OPR	<p>When carrying out a count method machine OPR, the message "Leave Sufficient Distance From The OP Position To The Near-Point Dog OFF." appears. Is there a problem if the distance is short?</p>	<p>The near-point dog must be set to turn OFF at a position after the OP is passed. (When the machine OPR is started on the near-point dog on in a count-method machine OPR, the machine enters a normal machine OPR operation after returning to the near-point dog OFF region.) (If the near-point dog is turned OFF before the OP, and the machine OPR is started between the near-point dog OFF position and the OP, the machine will mistakenly interpret that its current position is before the near-point dog ON position, and it will pass over the OP and continue moving.)</p>	19
	<p>In the near-point dog method machine OPR, the stop positions are not uniform.</p>	<p>Carry out the following measures.</p> <ol style="list-style-type: none"> <li>1) Separate the near-point dog signal and zero signal detection positions.</li> <li>2) Lower the values in "[Pr.46] OPR speed" and "[Pr.47] Creep speed".</li> <li>3) Confirm whether the zero signal and near-point dog signal turn ON normally.</li> <li>4) Check that there is no play (backlash) in the machine system.</li> </ol>	20
	<p>Can the machine OPR be carried out with the OPR retry function when it is started with the near-point dog ON and the upper/lower limit OFF?</p>	<p>A "Hardware stroke limit error" will occur and the operation will not be carried out. (The machine will interpret any position where the near-point dog is ON as being within the working range, and that the upper/lower limit is ON.)</p>	21
	<p>Are ABS and INC positioning possible without carrying out an OPR?</p>	<p>They are possible. In this case, the position where the power is turned ON is handled as the current feed value "0".</p>	22
	<p>After an OPR, the OPR request flag sometimes turns ON for no apparent reason.</p>	<p>The OPR request flag turns ON in the following cases.</p> <ol style="list-style-type: none"> <li>1) When the power is turned ON.</li> <li>2) When the PLC READY signal [YO] turns from OFF to ON.</li> <li>3) When an OPR is carried out.</li> <li>4) When the servo amplifier power is turned OFF.</li> </ol> <p>If no problem is found when the above are checked, then it is possible that the communication is being interrupted by "a fault in the bus cable", "noise influence", etc.</p>	23
	<p>The OPR complete flag ([Md.31] Status: b4) sometimes turns ON when it shouldn't be ON.</p>	<p>Check whether the drive unit READY signal is weak or the power supply is unstable.</p>	24

Trouble type	Questions/Trouble	Remedy	No.
Start	The positioning start signal [Y10] is kept ON until the BUSY signal is OFF, but is there any problem with turning it OFF before the BUSY signal turns OFF?	After the BUSY signal turns ON, there is no problem with turning [Y10] OFF before the BUSY signal turns OFF. (The QD75 detects the rising edge (OFF → ON) of the positioning start signal [Y10].)	25
	The operation will not start even when the start signal is turned ON.	Check the " [Md.26] Axis operation status" and " [Md.23] Axis error No.".	26
Stop	How many milliseconds should the axis stop signal [Y4] be turned ON for?	The signal should be turned ON at 4ms or more. (If possible, set the signal so it does not turn ON only momentarily, but instead stays ON until the BUSY signal turns OFF. This will keep the stop signal from skipping.)	27
	How can a sudden stop be selected?	Set "1: Sudden stop" in the parameter from [Pr.37] to [Pr.39] corresponding to the stop group, and reduce the setting value of " [Pr.36] Sudden stop deceleration time".	28
	"Normal deceleration stop" was selected in " [Pr.39] Stop group 3 sudden stop", and Y stop was turned ON. If the [Pr.39] setting is changed to "sudden stop" during a deceleration stop, and the Y stop signal turns from OFF to ON, will the operation change to a sudden stop from that point?	The operation will not change. Even if the same stop factor is input again during the deceleration stop, it will be ignored. The same deceleration stop process used when the stop signal was first input will be continued. (This also applies for [Pr.37] and [Pr.38].)	29
Circular interpolation	ABS system circular interpolation operates normally, but a vertically oblong circle results when INC system circular interpolation is carried out.	The address designation may be incorrect. When carrying out INC system circular interpolation, designate the relative addresses from the starting point of both the center point and end point.	30
Speed-position switching control	Can the speed be changed during speed control and position control by speed-position switching control?	No. The speed for the speed control and position control cannot be set differently.	31
JOG operation	Even if the JOG start signal is turned ON, the response until it turns ON is sometimes slow.	Either of the following is possible. 1) The sequence program may be incorrect. Check by creating a test program in which the JOG start signal is turned ON only. 2) If the machine is hitting something when the torque setting is low, it may be trying to move by JOG operation in the opposite direction. In this case, the machine will start moving only after the internal droop pulses have been reached 0 in the counter, even if the JOG start signal has been turned ON. This makes it seem that the response is slow.	32
	The operation is not carried out at the set JOG speed, although the speed limit value has not been reached.	Either of the following is possible. 1) The JOG start signal may be chattering. Monitor the JOG start signal to confirm whether it is chattering. (When using the "BUSY signal" in the JOG operation start circuit, check the position of the BUSY signal.) 2) The " [Pr.31] JOG speed limit value" may not be appropriate. Review the setting value and carry out the JOG operation again.	33

Trouble type	Questions/Trouble	Remedy	No.
JOG operation	When a JOG operation is attempted, an error results and the machine does not move.	The " [Pr.31] JOG speed limit value" may be larger than the " [Pr.8] Speed limit value". Review the parameters and carry out the JOG operation again.	34
	Why does the positioning complete signal turns ON during the JOG operation?	If a value other than "0" is set for " [Cd.16] Inching movement amount", the inching operation is carried out and the positioning complete signal turns ON. Confirm that the " [Cd.16] Inching movement amount" is set to "0".	35
Manual pulse generator operation	Is it possible to count the pulses when the B phase is set to "1", and only A phase pulses are input?	Not possible. (The QD75 counts 1, 0, 1, 0.)	36
	Can a manual pulse generator other than the Mitsubishi MR-HDP01 be used?	Other manual pulse generators can be used if they conform to Section 3.4 "Specifications for input/output interfaces with external devices."	37
	Can one manual pulse generator be operated connected to several QD75 modules?	This is possible if the system conforms to the electrical specifications.	38
Current value changing	The BUSY signal is not canceled by the current value changing. How can it be canceled?	The BUSY signal may remain if the scan time is long. Use a complete signal to check whether the current value changing has been executed.	39
QD75 READY signal	The QD75 READY signal does not turn ON even when the PLC READY signal [Y0] is turned ON.	"A parameter error" has occurred. Confirm the error No. in the error history, and correct the parameter.	40
M code ON signal	Is there any problem with setting an M code ON signal OFF request in the next scan after the M code ON signal ON?	The QD75 checks the M code ON signal OFF request every "0.9ms" (QD75P□N/QD75D□N) or "1.8ms" (QD75P□/QD75D□), so there is a possibility that the M code ON signal OFF may be delayed by a maximum of "0.9ms" (QD75P□N/QD75D□N) or "1.8ms" (QD75P□/QD75D□) after the M code ON signal ON, even if an M code ON signal OFF request is set.	41
Deviation counter clear	How long is the output time for the deviation counter clear signal?	The time set in " [Pr.55] Deviation counter clear signal output time". (Initial value: 11ms)	42
	Is a deviation counter clear signal output when the positioning is complete?	A signal is not output. The only time the QD75 outputs a deviation counter clear signal is for a machine OPR.	43
	How can a deviation counter clear signal be output?	The QD75 does not output a deviation counter clear signal except for machine OPR.	44
Module	An error "PLC READY OFF start" (error code: 537) occurs after the QD75 is replaced. (The sequence program is the same.)	The internal parameters of the QD75 may be different. Check if the QD75 READY signal [X0] turns ON when the PLC READY signal [Y0] turns ON. When the PLC READY signal is ON but the QD75 READY signal is OFF, the parameter error has occurred. Check the error code and modify the parameter with the error.	45
Motor	The motor only rotates in one direction.	The parameter settings on the QD75 side may not match those on the servo side. Check the parameter settings.	46
	Can the current motor speed be monitored?	The speed shown on the QD75 monitor is calculated from the number of pulses output from the module. Thus, the actual motor speed cannot be monitored. (" [Md.22] Feedrate" monitors the commanded speed. It does not show the actual motor speed.)	47

Trouble type	Questions/Trouble	Remedy	No.
Error/warning	An error "Backlash compensation amount error" (error code: 920) occurs even when the backlash compensation value is set to "1".	$0 \leq \frac{\text{Backlash compensation value}}{\text{Movement amount per pulse}} \leq 255$ Setting is not possible if the above equation is not satisfied. Adjust by setting " [Pr.4] Unit magnification" to 10-fold (or 100-fold, or 1000-fold), and setting " [Pr.2] Movement amount per rotation" to 1/10 (or 1/100, or 1/1000).	48
	When a JOG operation is attempted, errors such as "Hardware stroke limit (+)" or "Hardware stroke limit (-)" (error code: 104 or 105) occur and the machine does not move.	The hardware stroke limit wiring has probably not been carried out. Refer to Section 12.4.4 "Hardware stroke limit function" for details, and wire accordingly.	49
	An error "Speed designation during OP shift error" (error code: 997) appears when the PLC READY signal [Y0] turns from OFF to ON.	A value besides "0" or "1" may be set in the " [Pr.56] Speed designation during OP shift". Review the set sequence program, and reset the correct parameters.	50
	When the start signal was turned ON immediately after the stop signal ON, a warning "Start during operation" (warning code: 100) was detected, and the start was ignored.	The QD75 starts the deceleration stop process when the stop signal ON is detected. Thus, the machine interprets that "positioning is still being executed" immediately after the stop signal ON. Even if the start signal is turned ON at that time, the start request will be ignored and a warning "Start during operation" (warning code: 100) will occur.	51
	Does a warning "Deceleration/stop speed change" (warning code: 500) occur only during "stop deceleration" and "automatically deceleration"? Is there any problem if the operation is continued in that state without resetting the error?	The warning occurs only at those times mentioned at the left. Because this is a warning, there is no problem if the operation can be continued without resetting the error. (When the speed is changed using the override, the new value will not be reflected on the data being executed, but will be reflected from the next start.)	52
Positioning complete signal	Position control was executed but the positioning complete signal does not turn ON.	Depending on the stop occurrence factor, positioning may have not been completed normally. Check the axis monitor " [Md.26] Axis operation status" after the BUSY signal has turned OFF. Stop : The stop signal has turned ON during positioning. Check the condition under which the stop signal (Y stop, external stop) turns ON. Error : An error has occurred during positioning. Check the error occurrence factor from " [Md.23] Axis error No.".	53
		The setting value of the detailed parameter 2 "Positioning complete signal output time" is 0 or shorter than the scan time. Using the sequence program, set the time when the signal can be detected securely.	54

## Appendix 13 List of buffer memory addresses

The following shows the relation between the buffer memory addresses and the various items.

(Do not use any address other than listed below. If used, the system may not operate correctly.)

Buffer memory address				Item	Memory area	
Axis 1	Axis 2	Axis 3	Axis 4		Basic parameters 1	Positioning parameters
0	150	300	450	Pr.1 Unit setting		
1	151	301	451	Pr.2 No. of pulses per rotation (Ap)		
2	152	302	452	Pr.3 Movement amount per rotation (Al)		
3	153	303	453	Pr.4 Unit magnification (Am)		
4	154	304	454	Pr.5 Pulse output mode		
5	155	305	455	Pr.6 Rotation direction setting		
6	156	306	456	Pr.7 Bias speed at start		
7	157	307	457			
8	158	308	458	Not used	Basic parameters 2	
9	159	309	459			
10	160	310	460	Pr.8 Speed limit value		
11	161	311	461			
12	162	312	462	Pr.9 Acceleration time 0		
13	163	313	463			
14	164	314	464	Pr.10 Deceleration time 0	Detailed parameters 1	
15	165	315	465			
17	167	317	467	Pr.11 Backlash compensation amount		
18	168	318	468	Pr.12 Software stroke limit upper limit value		
19	169	319	469			
20	170	320	470	Pr.13 Software stroke limit lower limit value		
21	171	321	471			
22	172	322	472	Pr.14 Software stroke limit selection		
23	173	323	473	Pr.15 Software stroke limit valid/invalid setting		
24	174	324	474	Pr.16 Command in-position width		
25	175	325	475			
26	176	326	476	Pr.17 Torque limit setting value		
27	177	327	477	Pr.18 M code ON signal output timing		
28	178	328	478	Pr.19 Speed switching mode		
29	179	329	479	Pr.20 Interpolation speed designation method		
30	180	330	480	Pr.21 Current feed value during speed control		
31	181	331	481	Pr.22 Input signal logic selection		
32	182	332	482	Pr.23 Output signal logic selection		
33	—	—	—	Pr.24 Manual pulse generator input selection		
34	184	334	484	Pr.150 Speed-position function selection	Detailed parameters 2	
35	185	335	485	Not used		
36	186	336	486	Pr.25 Acceleration time 1		
37	187	337	487			
38	188	338	488	Pr.26 Acceleration time 2		
39	189	339	489			

Buffer memory address				Item	Memory area	
Axis 1	Axis 2	Axis 3	Axis 4		Detailed parameters 2	Positioning parameters
40	190	340	490	Pr.27		
41	191	341	491			
42	192	342	492	Pr.28	Deceleration time 1	
43	193	343	493			
44	194	344	494	Pr.29	Deceleration time 2	
45	195	345	495			
46	196	346	496	Pr.30	Deceleration time 3	
47	197	347	497			
48	198	348	498	Pr.31	JOG speed limit value	
49	199	349	499			
50	200	350	500	Pr.32	JOG operation acceleration time selection	
51	201	351	501	Pr.33	JOG operation deceleration time selection	
52	202	352	502	Pr.34	Acceleration/deceleration process selection	
53	203	353	503	Pr.35	S-curve ratio	
54	204	354	504	Pr.36	Sudden stop deceleration time	
55	205	355	505			
56	206	356	506	Pr.37	Stop group 1 sudden stop selection	
57	207	357	507	Pr.38	Stop group 2 sudden stop selection	
58	208	358	508	Pr.39	Stop group 3 sudden stop selection	
59	209	359	509	Pr.40	Positioning complete signal output time	
60	210	360	510	Pr.41	Allowable circular interpolation error width	
61	211	361	511			
62	212	362	512	Pr.42	External command function selection	
70	220	370	520	Pr.43	OPR method	OPR basic parameters
71	221	371	521	Pr.44	OPR direction	
72	222	372	522	Pr.45	OP address	
73	223	373	523			
74	224	374	524	Pr.46	OPR speed	
75	225	375	525			
76	226	376	526	Pr.47	Creep speed	
77	227	377	527			
78	228	378	528	Pr.48	OPR retry	OPR parameters
79	229	379	529	Pr.49	OPR dwell time	
80	230	380	530	Pr.50	Setting for the movement amount after near-point dog ON	
81	231	381	531			
82	232	382	532	Pr.51	OPR acceleration time selection	
83	233	383	533	Pr.52	OPR deceleration time selection	
84	234	384	534	Pr.53	OP shift amount	
85	235	385	535			
86	236	386	536	Pr.54	OPR torque limit value	
87	237	387	537	Pr.55	Deviation counter clear signal output time	
88	238	388	538	Pr.56	Speed designation during OP shift	
89	239	389	539	Pr.57	Dwell time during OPR retry	
140	—	—	—	Pr.70	Positioning option valid/invalid setting	Detailed parameters 1 Positioning parameters

Buffer memory address																Item	Memory area	
Common to axes 1, 2, 3, and 4																		
1200																Md.1	In test mode flag	Start History
1201																Not used		
1202																		
1203																		
1204																		
1205																		
1206																		
1207																		
1208																		
1209																		
1210																		
1211																		
(0)	(1)	(2)	(3)	(4)	(5)	(6)	(7)	(8)	(9)	(10)	(11)	(12)	(13)	(14)	(15)	(Pointer No.)		
1212	1217	1222	1227	1232	1237	1242	1247	1252	1257	1262	1267	1272	1277	1282	1287	Md.3	Start information	
1213	1218	1223	1228	1233	1238	1243	1248	1253	1258	1263	1268	1273	1278	1283	1288	Md.4	Start No.	
1440	1441	1442	1443	1444	1445	1446	1447	1448	1449	1450	1451	1452	1453	1454	1455	Md.50	Start (Year:month) (QD75P□N/QD75D□N)	
1214	1219	1224	1229	1234	1239	1244	1249	1254	1259	1264	1269	1274	1279	1284	1289	Md.5	Start (Day:hour)	
1215	1220	1225	1230	1235	1240	1245	1250	1255	1260	1265	1270	1275	1280	1285	1290	Md.6	Start (Minute: second)	
1216	1221	1226	1231	1236	1241	1246	1251	1256	1261	1266	1271	1276	1281	1286	1291	Md.7	Error judgment	
1292																Md.8	Start history pointer	
(0)	(1)	(2)	(3)	(4)	(5)	(6)	(7)	(8)	(9)	(10)	(11)	(12)	(13)	(14)	(15)	(Pointer No.)		
1293	1297	1301	1305	1309	1313	1317	1321	1325	1329	1333	1337	1341	1345	1349	1353	Md.9	Axis in which the error occurred	
1294	1298	1302	1306	1310	1314	1318	1322	1326	1330	1334	1338	1342	1346	1350	1354	Md.10	Axis error No.	
1456	1457	1458	1459	1460	1461	1462	1463	1464	1465	1466	1467	1468	1469	1470	1471	Md.51	Axis error occurrence (Year:month) (QD75P□N/QD75D□N)	
1295	1299	1303	1307	1311	1315	1319	1323	1327	1331	1335	1339	1343	1347	1351	1355	Md.11	Axis error occurrence (Day:hour)	
1296	1300	1304	1308	1312	1316	1320	1324	1328	1332	1336	1340	1344	1348	1352	1356	Md.12	Axis error occurrence (Minute: second)	
1357																Md.13	Error history pointer	
(0)	(1)	(2)	(3)	(4)	(5)	(6)	(7)	(8)	(9)	(10)	(11)	(12)	(13)	(14)	(15)	(Pointer No.)		
1358	1362	1366	1370	1374	1378	1382	1386	1390	1394	1398	1402	1406	1410	1414	1418	Md.14	Axis in which the warning occurred	
1359	1363	1367	1371	1375	1379	1383	1387	1391	1395	1399	1403	1407	1411	1415	1419	Md.15	Axis warning No.	
1472	1473	1474	1475	1476	1477	1478	1479	1480	1481	1482	1483	1484	1485	1486	1487	Md.52	Axis warning occurrence (Year:month) (QD75P□N/QD75D□N)	
1360	1364	1368	1372	1376	1380	1384	1388	1392	1396	1400	1404	1408	1412	1416	1420	Md.16	Axis warning occurrence (Day:hour)	
1361	1365	1369	1373	1377	1381	1385	1389	1393	1397	1401	1405	1409	1413	1417	1421	Md.17	Axis warning occurrence (Minute: second)	
1422																Md.18	Warning history pointer	
1424																Md.19		No. of write accesses to flash ROM
1425																		

System monitor data

Monitor data



Buffer memory address				Item	Memory area		
Axis 1	Axis 2	Axis 3	Axis 4				
800	900	1000	1100	Md.20	Current feed value	Axis monitor data	Monitor data
801	901	1001	1101				
802	902	1002	1102	Md.21	Machine feed value		
803	903	1003	1103				
804	904	1004	1104	Md.22	Feedrate		
805	905	1005	1105				
806	906	1006	1106	Md.23	Axis error No.		
807	907	1007	1107	Md.24	Axis warning No.		
808	908	1008	1108	Md.25	Valid M code		
809	909	1009	1109	Md.26	Axis operation status		
810	910	1010	1110	Md.27	Current speed		
811	911	1011	1111				
812	912	1012	1112	Md.28	Axis feedrate		
813	913	1013	1113				
814	914	1014	1114	Md.29	Speed-position switching control positioning amount		
815	915	1015	1115				
816	916	1016	1116	Md.30	External input/output signal		
817	917	1017	1117	Md.31	Status		
818	918	1018	1118	Md.32	Target value		
819	919	1019	1119				
820	920	1020	1120	Md.33	Target speed		
821	921	1021	1121				
824	924	1024	1124	Md.34	Movement amount after near-point dog ON		
825	925	1025	1125				
826	926	1026	1126	Md.35	Torque limit stored value		
827	927	1027	1127	Md.36	Special start data instruction parameter setting value		
828	928	1028	1128	Md.37	Special start data instruction parameter setting value		
829	929	1029	1129	Md.38	Start positioning data No. setting value.		
830	930	1030	1130	Md.39	In speed control flag		
831	931	1031	1131	Md.40	In speed change processing flag		
832	932	1032	1132	Md.41	Special start repetition counter		
833	933	1033	1133	Md.42	Control system repetition counter		
834	934	1034	1134	Md.43	Start data pointer being executed		
835	935	1035	1135	Md.44	Positioning data No. being executed		
836	936	1036	1136	Md.45	Block No. being executed		
837	937	1037	1137	Md.46	Last executed positioning data No.		
838 to 847	938 to 947	1038 to 1047	1138 to 1147	Md.47	Positioning data being executed		
899	999	1099	1199	Md.48	Deceleration start flag		

Buffer memory address				Item	Memory area	
Axis 1	Axis 2	Axis 3	Axis 4			
1500	1600	1700	1800	<u>Cd.3</u> Positioning start No.	Axis control data	Control data
1501	1601	1701	1801	<u>Cd.4</u> Positioning starting point No.		
1502	1602	1702	1802	<u>Cd.5</u> Axis error reset		
1503	1603	1703	1803	<u>Cd.6</u> Restart command		
1504	1604	1704	1804	<u>Cd.7</u> M code OFF request		
1505	1605	1705	1805	<u>Cd.8</u> External command valid		
1506	1606	1706	1806	<u>Cd.9</u> New current value		
1507	1607	1707	1807			
1508	1608	1708	1808	<u>Cd.10</u> New acceleration time value		
1509	1609	1709	1809			
1510	1610	1710	1810	<u>Cd.11</u> New deceleration time value		
1511	1611	1711	1811			
1512	1612	1712	1812	<u>Cd.12</u> Acceleration/deceleration time change during speed change, enable/disable selection		
1513	1613	1713	1813	<u>Cd.13</u> Positioning operation speed override		
1514	1614	1714	1814	<u>Cd.14</u> New speed value		
1515	1615	1715	1815			
1516	1616	1716	1816	<u>Cd.15</u> Speed change request		
1517	1617	1717	1817	<u>Cd.16</u> Inching movement amount		
1518	1618	1718	1818	<u>Cd.17</u> JOG speed		
1519	1619	1719	1819			
1520	1620	1720	1820	<u>Cd.18</u> Continuous operation interrupt request		
1521	1621	1721	1821	<u>Cd.19</u> OPR request flag OFF request		
1522	1622	1722	1822	<u>Cd.20</u> Manual pulse generator 1 pulse input magnification		
1523	1623	1723	1823			
1524	1624	1724	1824	<u>Cd.21</u> Manual pulse generator enable flag		
1525	1625	1725	1825	<u>Cd.22</u> New torque value		
1526	1626	1726	1826	<u>Cd.23</u> Speed-position switching control movement amount change register		
1527	1627	1727	1827			
1528	1628	1728	1828	<u>Cd.24</u> Speed-position switching enable flag		
1529	1629	1729	1829	Not used		
1530	1630	1730	1830	<u>Cd.25</u> Position-speed switching control speed change register		
1531	1631	1731	1831			
1532	1632	1732	1832	<u>Cd.26</u> Position-speed switching enable flag		
1533	1633	1733	1833	Not used		
1534	1634	1734	1834	<u>Cd.27</u> Target position change value (new address)		
1535	1635	1735	1835			
1536	1636	1736	1836	<u>Cd.28</u> Target position change value (new speed)		
1537	1637	1737	1837			
1538	1638	1738	1838	<u>Cd.29</u> Target position change request flag		
1539	1639	1739	1839	Not used		
1540	1640	1740	1840	<u>Cd.30</u> Simultaneous starting axis start data No. (axis 1 start data No.)		

Buffer memory address				Item	Memory area			
Axis 1	Axis 2	Axis 3	Axis 4		Axis control data	Control data		
1541	1641	1741	1841	Cd.31 Simultaneous starting axis start data No. (axis 2 start data No.)			Axis control data	Control data
1542	1642	1742	1842	Cd.32 Simultaneous starting axis start data No. (axis 3 start data No.)				
1543	1643	1743	1843	Cd.33 Simultaneous starting axis start data No. (axis 4 start data No.)				
1544	1644	1744	1844	Cd.34 Step mode				
1545	1645	1745	1845	Cd.35 Step valid flag				
1546	1646	1746	1846	Cd.36 Step start information				
1547	1647	1747	1847	Cd.37 Skip command				
1548	1648	1748	1848	Cd.38 Teaching data selection				
1549	1649	1749	1849	Cd.39 Teaching positioning data No.				
1550	1650	1750	1850	Cd.40 ABS direction in degrees				
1900				Cd.1 Flash ROM write request	System Control data	Control data		
1901				Cd.2 Parameter initialization request				
1905				Cd.41 Deceleration start flag valid				
1907				Cd.42 Stop command processing for deceleration stop selection				
1934				Cd.43 Output timing selection of near pass control				

Buffer memory address				Item	Memory area					
Axis 1	Axis 2	Axis 3	Axis 4		No.1	Positioning data	Positioning data			
2000	8000	14000	20000	Da.1 Operation pattern Da.2 Control system Da.3 Acceleration time No. Da.4 Deceleration time No. Da.5 Axis to be interpolated						
2001	8001	14001	20001	Da.10 M code/condition data No. /No. of LOOP to LEND repetitions						
2002	8002	14002	20002	Da.9 Dwell time (JUMP destination positioning data No.)						
2003	8003	14003	20003	Da.27 M code ON signal output timing Da.28 ABS direction in degrees Da.29 Interpolation speed designation method						
2004 2005	8004 8005	14004 14005	20004 20005	Da.8 Command speed						
2006 2007	8006 8007	14006 14007	20006 20007	Da.6 Positioning address/movement amount						
2008 2009	8008 8009	14008 14009	20008 20009	Da.7 Arc address						
2010 to 2019	8010 to 8019	14010 to 14019	20010 to 20019	No.2						
2020 to 2029	8020 to 8029	14020 to 14029	20020 to 20029	No.3						
to	to	to	to	to						
7990 to 7999	13990 to 13999	19990 to 19999	25990 to 25999	No.600						

Buffer memory address								Item	Memory area		
Axis 1		Axis 2		Axis 3		Axis 4			1st point	Block start data	Starting block 0
26000	26050	27000	27050	28000	28050	29000	29050	Da.11 Shape Da.12 Start data No. Da.13 Special start instruction Da.14 Parameter			
26001	26051	27001	27051	28001	28051	29001	29051	2nd point			
26002	26052	27002	27052	28002	28052	29002	29052	3rd point			
to	to	to	to	to	to	to	to	to			
26049	26099	27049	27099	28049	28099	29049	29099	50th point			
26100	27100	28100	29100	Da.15 Condition target Da.16 Condition operator	No. 1	Condition data	Starting block 0	Starting block 0			
26102 26103	27102 27103	28102 28103	29102 29103	Da.17 Address							
26104 26105	27104 27105	28104 28105	29104 29105	Da.18 Parameter 1							
26106 26107	27106 27107	28106 28107	29106 29107	Da.19 Parameter 2							
26110 to 26119	27110 to 27119	28110 to 28119	29110 to 29119	No. 2							
26120 to 26129	27120 to 27129	28120 to 28129	29120 to 29129	No. 3							
to	to	to	to	to							
26190 to 26199	27190 to 27199	28190 to 28199	29190 to 29199	No. 10							
26200 to 26299	27200 to 27299	28200 to 28299	29200 to 29299	Block start data	Starting block 1	Condition data	Starting block 1				
26300 to 26399	27300 to 27399	28300 to 28399	29300 to 29399	Condition data							
26400 to 26499	27400 to 27499	28400 to 28499	29400 to 29499	Block start data	Starting block 2	Condition data	Starting block 2				
26500 to 26599	27500 to 27599	28500 to 28599	29500 to 29599	Condition data							
26600 to 26699	27600 to 27699	28600 to 28699	29600 to 29699	Block start data	Starting block 3	Condition data	Starting block 3				
26700 to 26799	27700 to 27799	28700 to 28799	29700 to 29799	Condition data							
26800 to 26899	27800 to 27899	28800 to 28899	29800 to 29899	Block start data	Starting block 4	Condition data	Starting block 4				
26900 to 26999	27900 to 27999	28900 to 28999	29900 to 29999	Condition data							

Positioning data (Starting block data)

Buffer memory address				Item	Memory area			
Axis 1	Axis 2	Axis 3	Axis 4		PLC CPU memory area	Positioning data		
30000				Condition judgement target data of the condition data			PLC CPU memory area	Positioning data
to								
30099								

Appendix 14 External dimension drawing

[1] QD75P1N

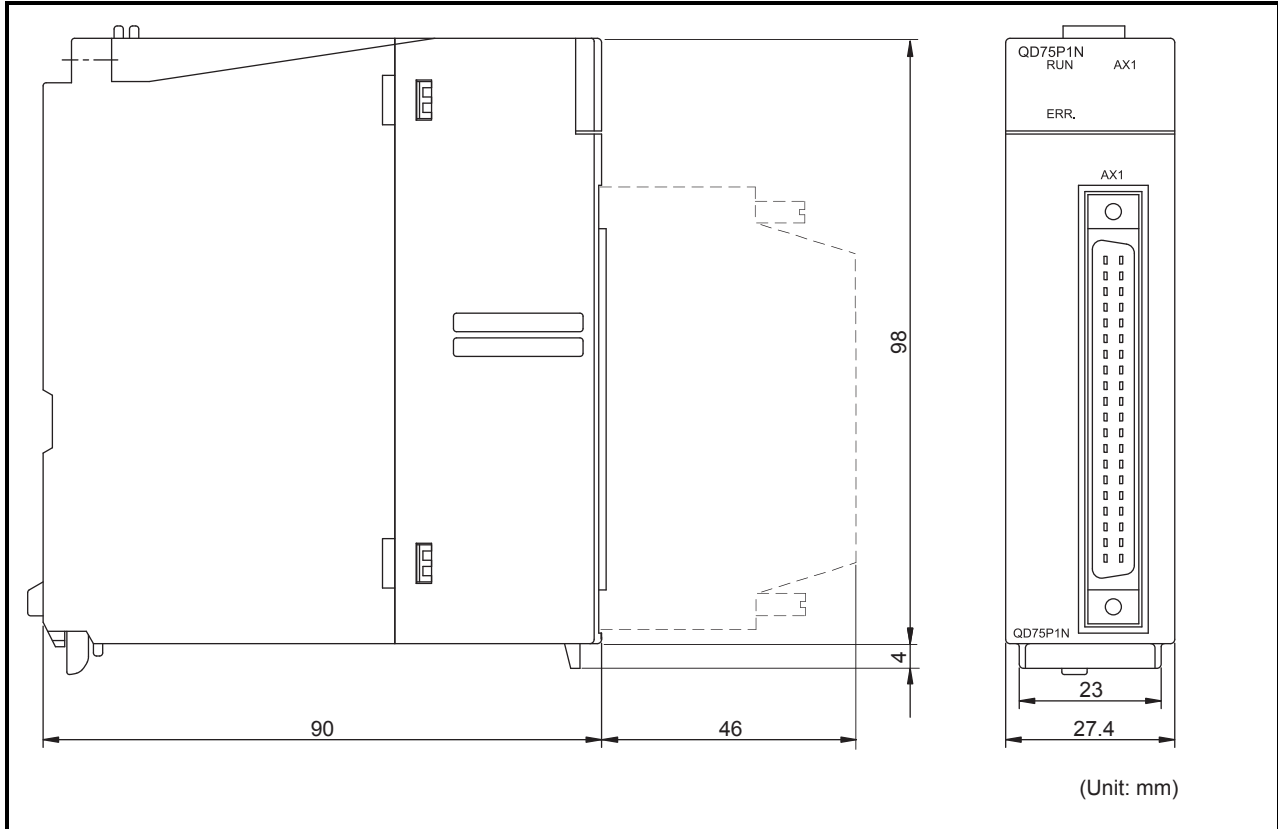

[2] QD75P2N

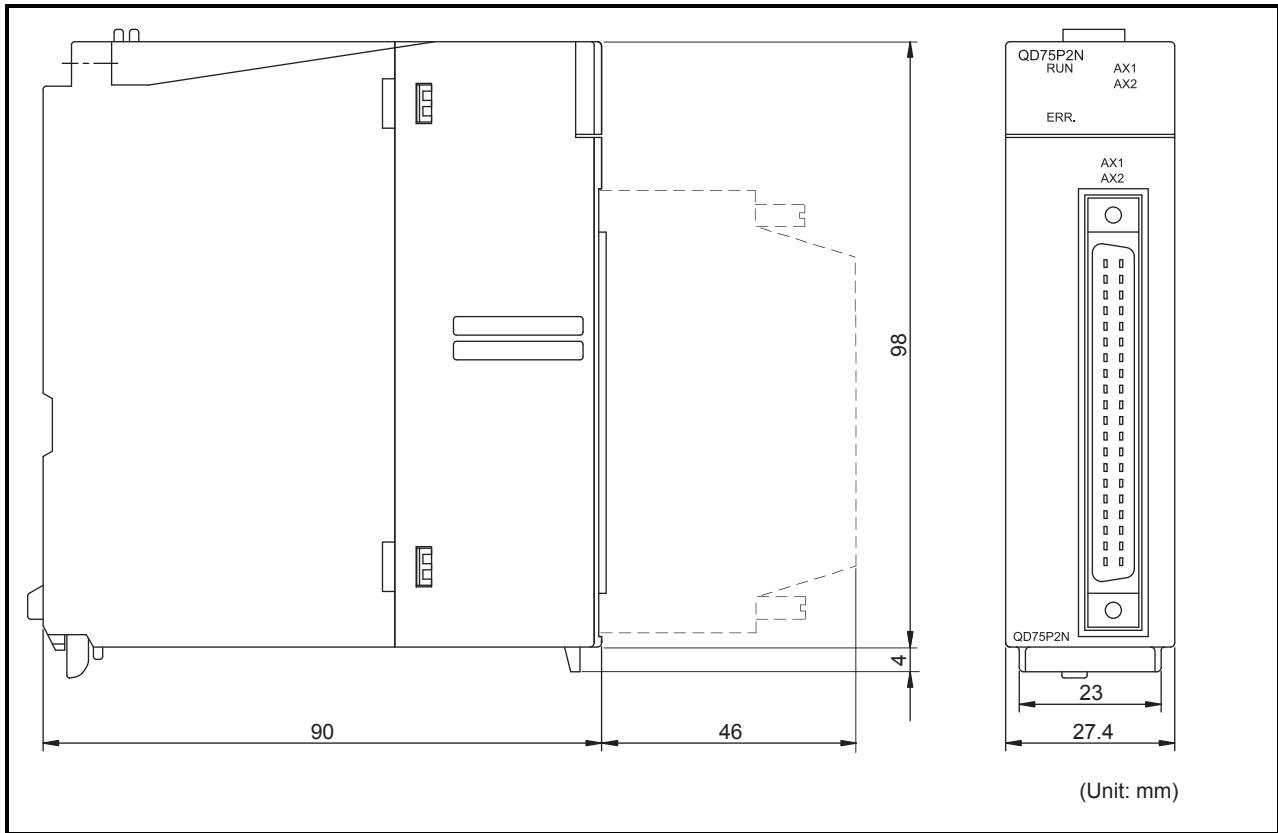

[3] QD75P4N

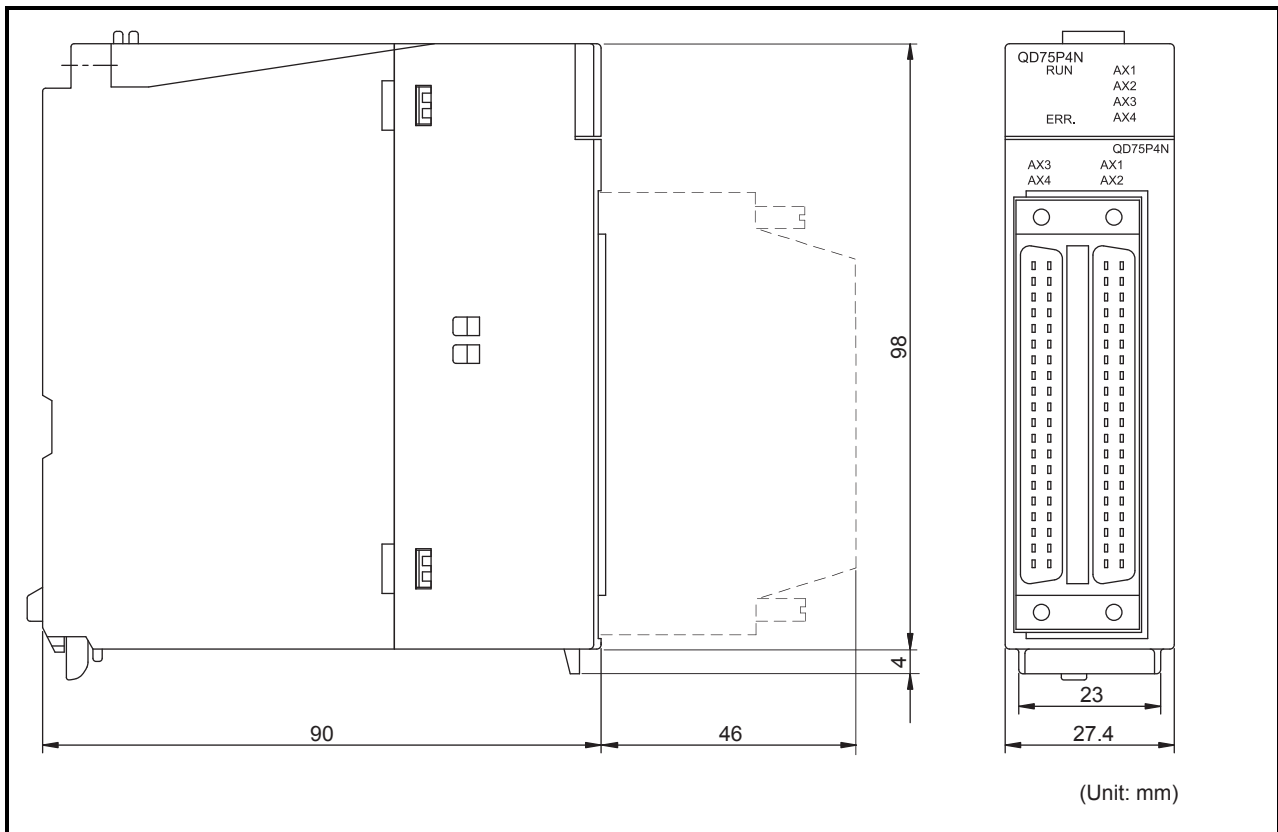



[4] QD75D1N

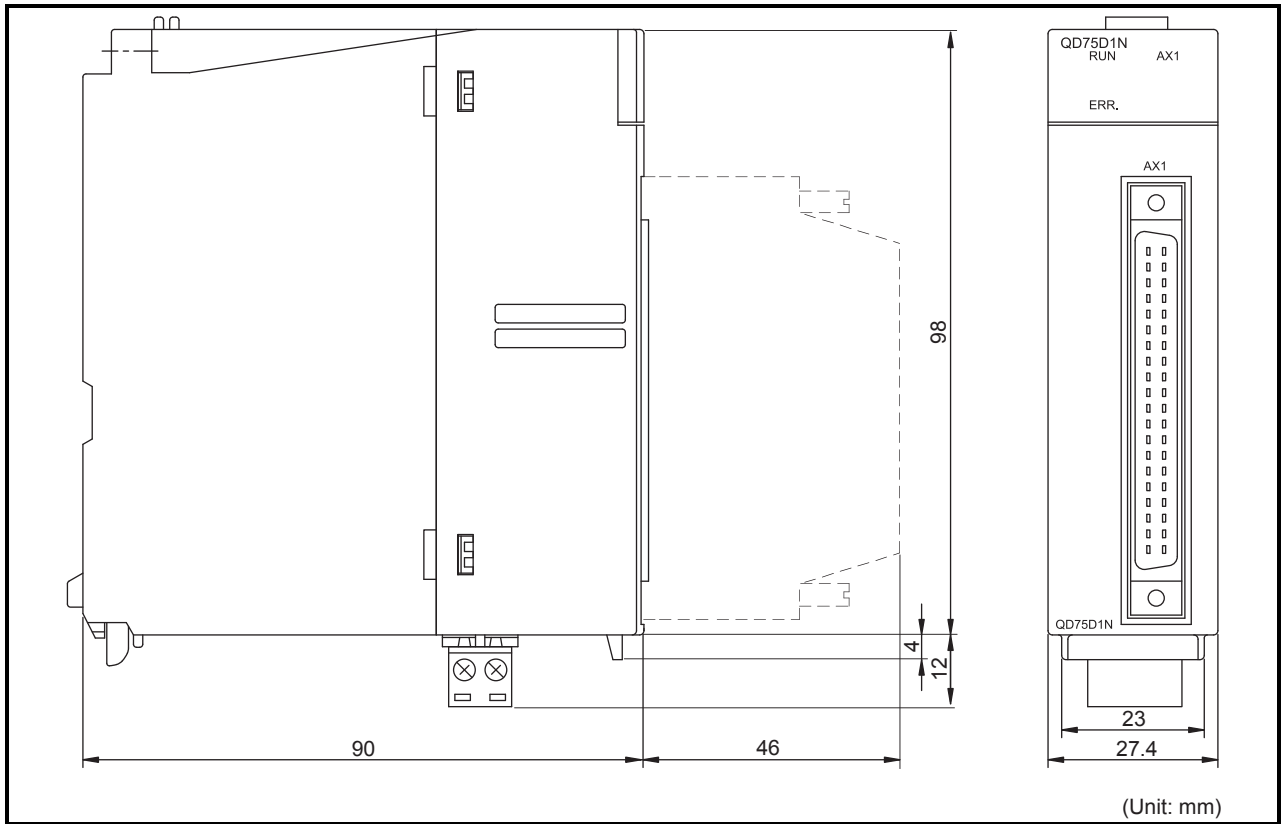

[5] QD75D2N

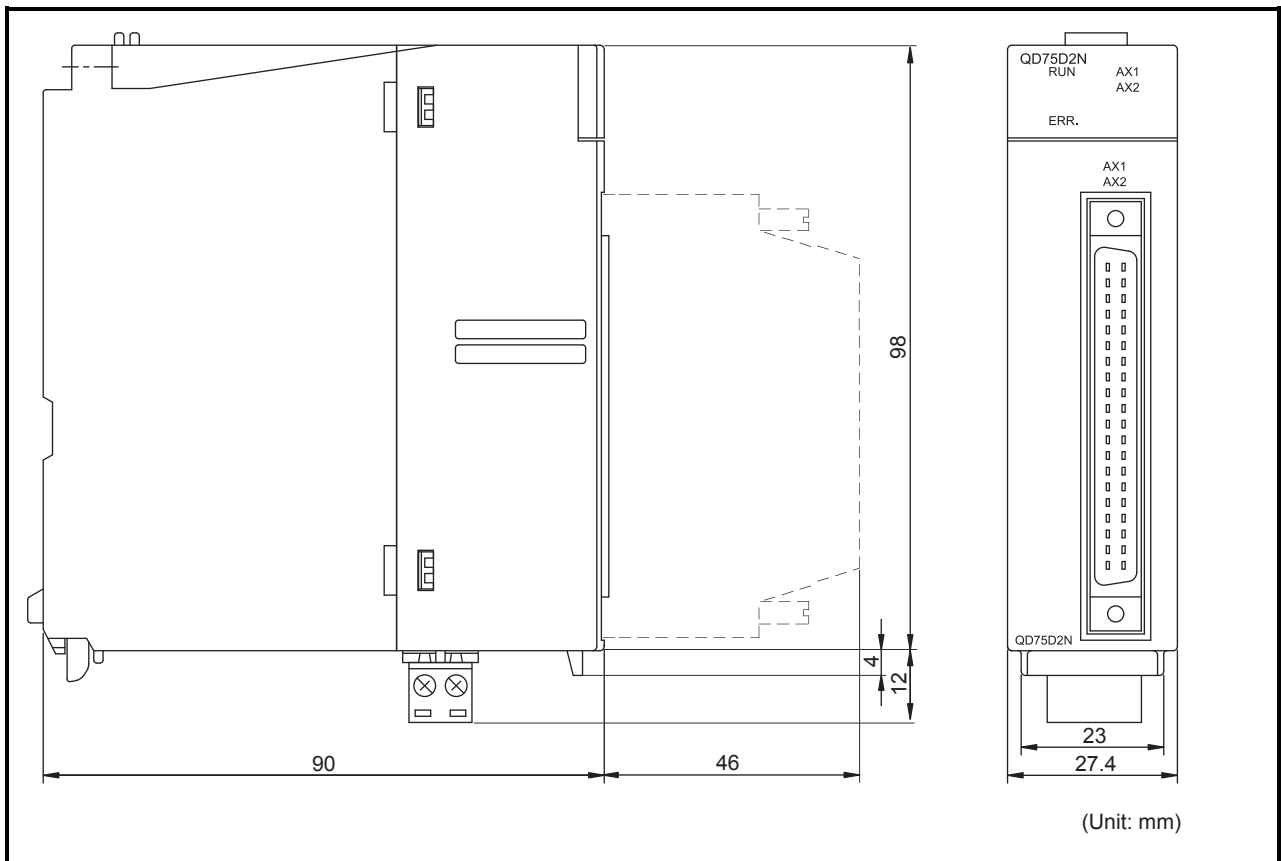

[6] QD75D4N

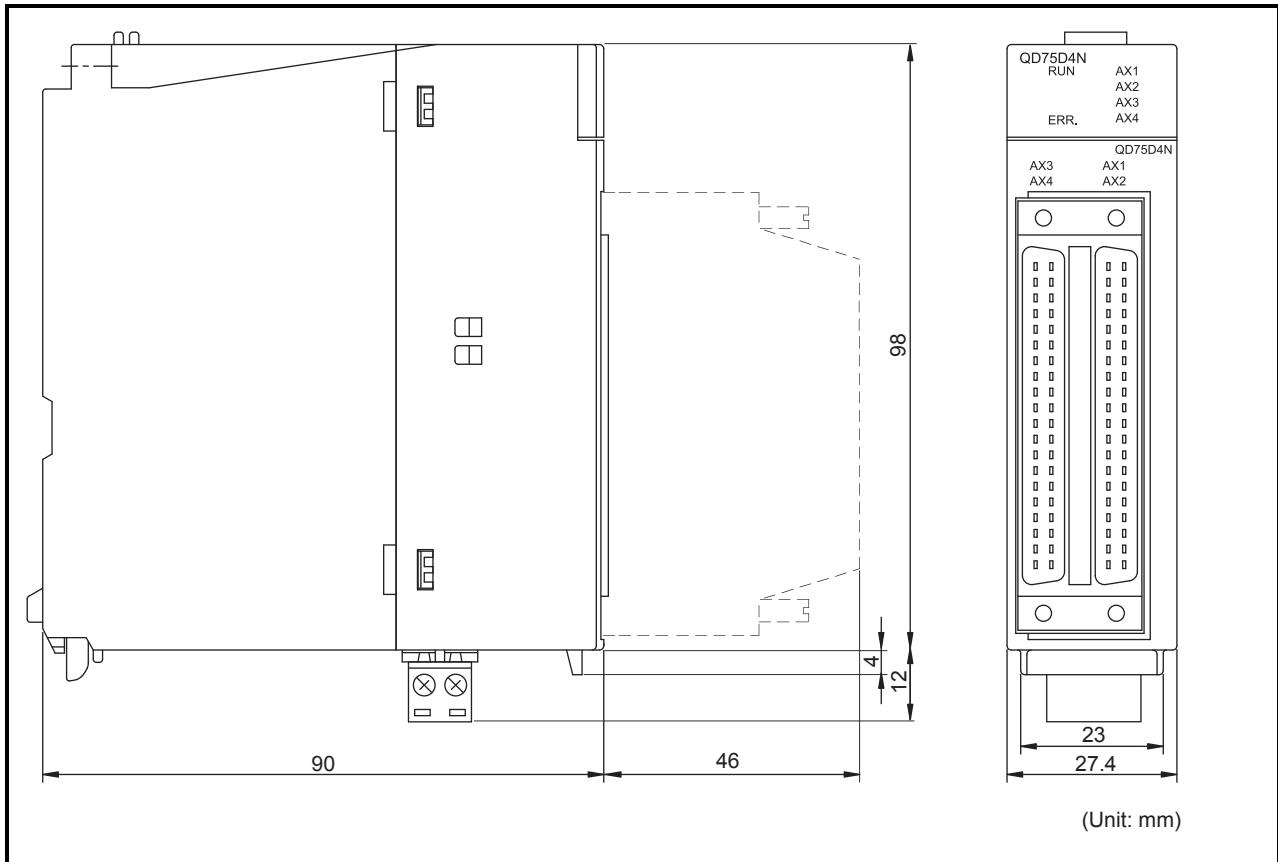

[7] QD75P1/QD75P2/QD75P4

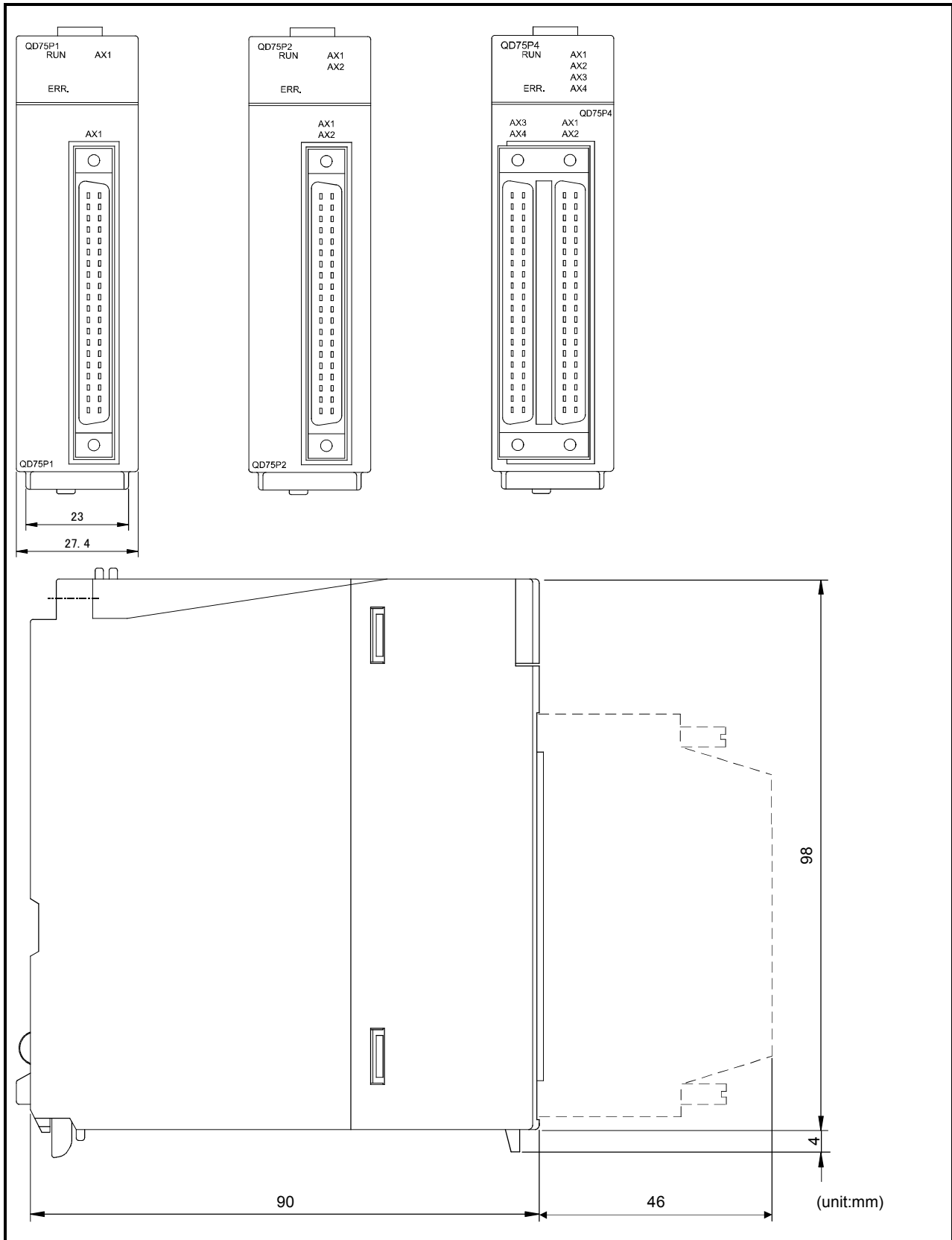

[8] QD75D1/QD75D2/QD75D4

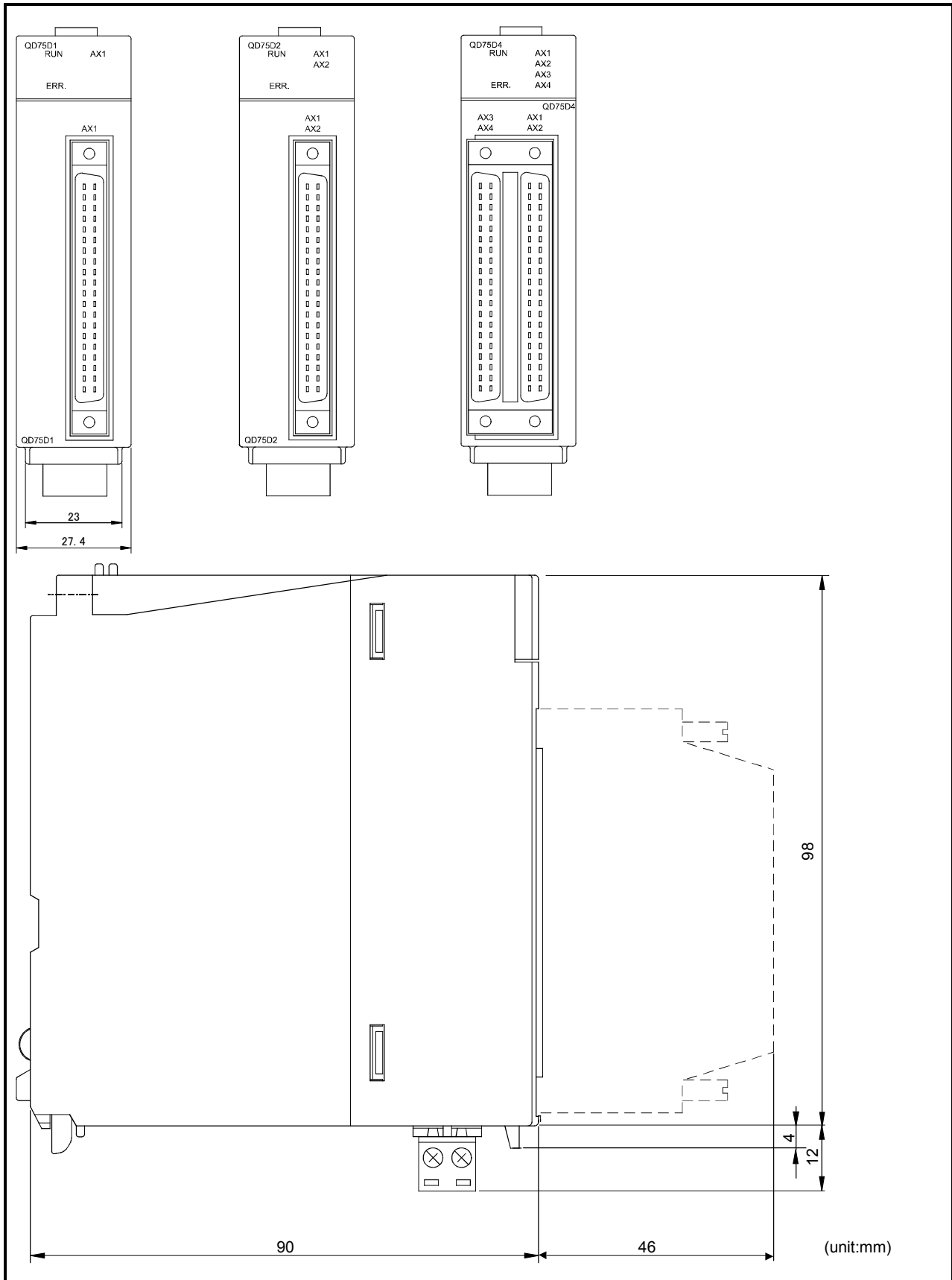

# INDEX

## [Number]

- 1-2 phase excitation system (Explanation of positioning terms) ..... Appendix-124
- 1-axis fixed-feed control ..... 9-47
- 1-axis linear control (ABS linear 1) ..... 9-31
- 1-axis linear control (INC linear 1) ..... 9-32
- 1-axis speed control ..... 9-91
- 2-axis circular interpolation control with center point designation (ABS circular right/ABS circular left) ..... 9-68
- 2-axis circular interpolation control with center point designation (INC circular right/INC circular left) ..... 9-71
- 2-axis circular interpolation control with sub point designation (ABS circular sub) ..... 9-60
- 2-axis circular interpolation control with sub point designation (INC circular sub) ..... 9-63
- 2-axis fixed-feed control (interpolation) ..... 9-49
- 2-axis linear interpolation control (ABS linear 2) ..... 9-33
- 2-axis linear interpolation control (INC linear 2) ..... 9-35
- 2-axis speed control ..... 9-94
- 2-phase excitation system (Explanation of positioning terms) ..... Appendix-124
- 2-phase pulse (Explanation of positioning terms) ..... Appendix-124
- 2-speed trapezoidal control (Explanation of positioning terms) ..... Appendix-124
- 3-axis fixed-feed control (interpolation) ..... 9-52
- 3-axis linear interpolation control (ABS linear 3) ..... 9-37
- 3-axis linear interpolation control (INC linear 3) ..... 9-40
- 3-axis speed control ..... 9-97
- 4-axis fixed-feed control (interpolation) ..... 9-57
- 4-axis linear interpolation control (ABS linear 4) ..... 9-43
- 4-axis linear interpolation control (INC linear 4) ..... 9-45
- 4-axis speed control ..... 9-101

## [A]

- A phase/B phase mode ..... 5-22
- ABS direction in degrees ( [Cd.40] ) ..... 5-132
- Absolute encoder (Explanation of positioning terms) ..... Appendix-125
- Absolute position detection system (Explanation of positioning terms) ..... Appendix-125
- Absolute position restoration function ..... 12-62
- Absolute system ..... 9-16
- Absolute system (Explanation of positioning terms) ..... Appendix-125
- Acceleration time (Explanation of positioning terms) ..... Appendix-125
- Acceleration time 0 ( [Pr.9] ) ..... 5-25
- Acceleration time 1 ( [Pr.25] ) ..... 5-36
- Acceleration time 2 ( [Pr.26] ) ..... 5-36
- Acceleration time 3 ( [Pr.27] ) ..... 5-36
- Acceleration time No. ( [Da.3] ) ..... 5-60
- Acceleration/deceleration process selection ( [Pr.34] ) ..... 5-38
- Acceleration/deceleration processing function ..... 12-96
- Acceleration/deceleration time change during speed change, enable/disable selection ( [Cd.12] ) ..... 5-118
- Acceleration/deceleration time change function ..... 12-51
- Actual acceleration/deceleration time ..... 5-25
- Adding a module ..... Appendix-81
- Address ( [Da.17] ) ..... 5-80
- Address (Explanation of positioning terms) ..... Appendix-125
- AFTER mode ..... 12-82
- AFTER mode (Explanation of positioning terms) ..... Appendix-125
- Allowable circular interpolation error width ( [Pr.41] ) ..... 5-43
- Applicable wire size ..... 3-3
- Arc address ( [Da.7] ) ..... 5-67
- Auto tuning (Explanation of positioning terms) ..... Appendix-126

Automatic command speed calculation	Appendix-84
Automatic sub arc calculation	Appendix-85
Axis error No. (Md.10, Md.23)	5-92, 96
Axis error occurrence (Day: hour) (Md.11)	5-92
Axis error occurrence (Minute: second) (Md.12)	5-92
Axis error reset (Cd.5)	5-114
Axis feedrate (Md.28)	5-100
Axis in which the error occurred (Md.9)	5-92
Axis in which the warning occurred (Md.14)	5-94
Axis monitor	Appendix-88
Axis monitor data	5-96
Axis operation status (Md.26)	5-98
Axis stop signal	3-18
Axis to be interpolated (Da.5)	5-61
Axis warning detection	5-103
Axis warning No. (Md.15, Md.24)	5-94, 98
Axis warning occurrence (Day: hour) (Md.16)	5-94
Axis warning occurrence (Minute: second) (Md.17)	5-94
<b>[B]</b>	
Backlash compensation (Explanation of positioning terms)	Appendix-126
Backlash compensation amount (Pr.11)	5-26
Backlash compensation function	12-12
Backup function (Explanation of positioning terms)	Appendix-126
Ball screw (Explanation of positioning terms)	Appendix-126
Basic parameters 1	5-18
Basic parameters 2	5-24
Bias speed at start (Pr.7)	5-24
Bias speed at start (Explanation of positioning terms)	Appendix-126
Bipolar drive constant-current system (Explanation of positioning terms)	Appendix-127
Block No. being executed (Md.45)	5-108
Block start data area (No. 7000 to 7004)	7-3
Buffer memory	7-2
Buffer memory (Explanation of positioning terms)	Appendix-127
Buffer memory area configuration	7-5

BUSY (Explanation of positioning terms)	Appendix-127
BUSY signal	3-18
<b>[C]</b>	
CCW (Explanation of positioning terms)	Appendix-127
CHANGE signal (Explanation of positioning terms)	Appendix-127
Circular interpolation (Explanation of positioning terms)	Appendix-127
Combination of functions	3-14
Combination of main functions and sub functions	3-14
Command in-position flag	5-102
Command in-position function	12-93
Command in-position width (Pr.16)	5-28
Command pulse (Explanation of positioning terms)	Appendix-127
Command pulse frequency	1-11
Command speed (Da.8)	5-70
Common functions	3-13, 13-6
Communicating signals between QD75 and each module	1-12
Composite speed	5-32
Composite speed (Explanation of positioning terms)	Appendix-127
Condition operator (Da.16)	5-84
Condition target (Da.15)	5-84
Conditional JUMP	9-136
Configuration and roles of QD75 memory	7-2
Confirming the current value	9-17
Continuous operation interrupt program	6-38
Continuous operation interrupt request (Cd.18)	5-122
Continuous path control	9-8
Continuous positioning control	9-7
Control data area	7-3
Control functions	3-6
Control system (Da.2)	5-60
Control system repetition counter (Md.42)	5-108
Control unit (Explanation of positioning terms)	Appendix-127
CP control (Explanation of positioning terms)	Appendix-127
Creep speed (Pr.47)	5-50
Creep speed (Explanation of positioning terms)	Appendix-128

Current feed value .....	9-17
Current feed value (Md.20) .....	5-96
Current feed value (Explanation of positioning terms).....	Appendix-128
Current feed value during speed control (Pr.21) .....	5-33
Current loop mode (Explanation of positioning terms).....	Appendix-128
Current speed (Md.27) .....	5-98
Current value (Explanation of positioning terms) .....	Appendix-128
Current value change test.....	Appendix-104
CW (Explanation of positioning terms) .....	Appendix-128
CW/CCW mode.....	5-21

[D]

D/A converter (Explanation of positioning terms) .....	Appendix-128
Data No. (Explanation of positioning terms) .....	Appendix-128
Data transmission process.....	7-6
Deceleration curve .....	12-108
Deceleration curve continuation .....	12-108
Deceleration curve re-processing.....	12-108
Deceleration ratio (Explanation of positioning terms).....	Appendix-128
Deceleration start flag (Md.48).....	5-108
Deceleration start flag valid (Cd.41).....	5-110
Deceleration stop .....	6-45
Deceleration time (Explanation of positioning terms).....	Appendix-128
Deceleration time 0 (Pr.10) .....	5-25
Deceleration time 1 (Pr.28) .....	5-36
Deceleration time 2 (Pr.29) .....	5-36
Deceleration time 3 (Pr.30) .....	5-36
Deceleration time No. (Da.4).....	5-60
Detailed parameters 1 .....	5-26
Detailed parameters 2.....	5-36
Details of input signals (QD75 → CPU module) .....	3-17
Details of output signals (CPU module → QD75) .....	3-18
Deviation counter (Explanation of positioning terms).....	Appendix-129
Deviation counter clear .....	3-27

Deviation counter clear signal output time (Pr.55) .....	5-55
Deviation counter droop pulse amount .....	1-11
Differential output type (Explanation of positioning terms) .....	Appendix-129
Digital bus connection (Explanation of positioning terms) .....	Appendix-129
DOG signal (Explanation of positioning terms) .....	Appendix-129
DOS/V personal computer .....	A-18
Drive unit (Explanation of positioning terms) .....	Appendix-129
Drive unit (Servo amplifier) .....	A-18
Drive unit READY .....	3-27
Drive unit READY (Explanation of positioning terms) .....	Appendix-129
Droop pulse (Explanation of positioning terms) .....	Appendix-129
Dwell time (Explanation of positioning terms) .....	Appendix-129
Dwell time (JUMP destination positioning data No.) (Da.9).....	5-72
Dwell time during OPR retry (Pr.57) .....	5-55
Dynamic brake (Explanation of positioning terms) .....	Appendix-130

[E]

Electrical specifications.....	3-19
Electromagnetic brake (Explanation of positioning terms) .....	Appendix-130
Electronic gear (Explanation of positioning terms) .....	Appendix-130
Electronic gear function .....	12-14
Emergency stop .....	6-44
Emergency stop (Explanation of positioning terms) .....	Appendix-130
Encoder (Explanation of positioning terms) .....	Appendix-130
Error and warning details.....	15-6
Error compensation method .....	12-17
Error correction (Explanation of positioning terms) .....	Appendix-130
Error history.....	5-92
Error history pointer (Md.13) .....	5-92
Error judgement (Md.7) .....	5-90
Error reset (Explanation of positioning terms) .....	Appendix-130

Execution data backup function.....	13-5
Execution prohibition flag.....	3-18
External command signal.....	3-27
External command function selection ( <u>Pr.42</u> ) .....	5-44
External command function valid setting program .....	6-25
External command valid ( <u>Cd.8</u> ).....	5-116
External dimension drawing.....	Appendix-159
External input/output signal ( <u>Md.30</u> ).....	5-100
External I/O signal logic switching function ..	13-7
External I/O signal monitor function.....	13-8
External regenerative brake resistor (Explanation of positioning terms).....	Appendix-131
<b>[F]</b>	
F (Explanation of positioning terms) .....	Appendix-131
Fast OPR (Explanation of positioning terms) .....	Appendix-131
Fatal stop.....	6-44
Features of QD75.....	1-2
Feed pulse (Explanation of positioning terms) .....	Appendix-131
Feed screw (Explanation of positioning terms) .....	Appendix-131
Feedback pulse (Explanation of positioning terms) .....	Appendix-131
Feedrate ( <u>Md.22</u> ).....	5-96
Fixed-feed (Explanation of positioning terms) .....	Appendix-131
Flash memory (Explanation of positioning terms) .....	Appendix-131
Flash ROM.....	7-2
Flash ROM write program.....	6-24
Flash ROM write request ( <u>Cd.1</u> ).....	5-110
Flat type motor (Pancake motor) (Explanation of positioning terms).....	Appendix-131
Flow of all processes.....	1-15
Flow of system operation.....	1-15
FLS signal (Explanation of positioning terms) .....	Appendix-132
Forced stop.....	6-44
Front-loading speed switching mode.....	9-14
Function version.....	1-23, Appendix-2
Functions for compensating the control .....	12-12
Functions to change the control details.....	12-41
Functions to limit the control.....	12-27

<b>[G]</b>	
G code (Explanation of positioning terms) .....	Appendix-132
Gain (Explanation of positioning terms) .....	Appendix-132
GD <sup>2</sup> (Explanation of positioning terms) .....	Appendix-132
General configuration of program.....	6-11
GX Configurator-QP.....	A-18, 2-4
GX Developer.....	A-18
GX Works2.....	A-18
<b>[H]</b>	
Hardware stroke limit function.....	12-39
History monitor function.....	Appendix-118
<b>[I]</b>	
Immediate stop.....	6-45
In speed change processing flag ( <u>Md.40</u> ) .....	5-106
In speed control flag.....	5-102
In speed limit flag ( <u>Md.39</u> ).....	5-106
In test mode flag ( <u>Md.1</u> ).....	5-86
Inching movement amount ( <u>Cd.16</u> ).....	5-122
Inching operation setting program.....	6-20
Incremental encoder (Explanation of positioning terms).....	Appendix-132
Incremental system.....	9-16
Incremental system (Explanation of positioning terms).....	Appendix-132
Independent positioning control.....	9-6
Inertia (Explanation of positioning terms) .....	Appendix-132
Initialization program.....	6-25
Input signal logic selection ( <u>Pr.22</u> ).....	5-33
Input terminal (Explanation of positioning terms) .....	Appendix-133
Input/output interface internal circuit.....	3-28
Intentional stop.....	6-44
Interlock (Explanation of positioning terms) .....	Appendix-133
Internal circuit.....	3-28
Internal current consumption.....	3-3
Interpolation axis.....	9-23
Interpolation control.....	9-23
Interpolation operation (Explanation of positioning terms).....	Appendix-133



Interpolation speed designation method (Pr.20)	5-32
Inverter (Explanation of positioning terms)	Appendix-133
<b>[J]</b>	
JOG (Explanation of positioning terms)	Appendix-133
JOG operation acceleration time selection (Pr.32)	5-37
JOG operation deceleration time selection (Pr.33)	5-37
JOG speed (Cd.17)	5-122
JOG speed limit value (Pr.31)	5-37
JOG start signal	3-18
JUMP instruction	9-136
<b>[K]</b>	
kPPS (Explanation of positioning terms)	Appendix-133
<b>[L]</b>	
Last executed positioning data No. (Md.46)	5-108
LEND	9-139
Limit switch (Explanation of positioning terms)	Appendix-133
Linear interpolation (Explanation of positioning terms)	Appendix-133
List of block start data	5-74
List of condition data	5-80
List of control data	5-110
List of devices used	6-5
List of errors	15-10
List of functions	3-6
List of input/output signal details	3-26
List of input/output signals	3-16
List of monitor data	5-86
List of parameters	5-18
List of positioning data	5-56
List of warnings	15-42
Load inertia ratio (Explanation of positioning terms)	Appendix-133
Location trace	Appendix-109
LOOP	9-138
Lower limit signal	3-26
Low-inertia motor (Explanation of positioning terms)	Appendix-134

<b>[M]</b>	
M code (Condition data No., No. of LOOP to LEND repetitions) (Da.10)	5-71
M code (Explanation of positioning terms)	Appendix-134
M code comment edit	Appendix-85
M code OFF request	12-82
M code OFF request (Cd.7)	5-114
M code ON signal	3-17
M code ON signal output timing	12-81
M code ON signal output timing (Pr.18)	5-30
M code output function	12-81
Machine feed value	9-17
Machine feed value (Md.21)	5-96
Machine feed value (Explanation of positioning terms)	Appendix-134
Main functions	3-8
Major positioning controls	9-2
Manual pulse generator	A-18, 2-4
Manual pulse generator (Explanation of positioning terms)	Appendix-134
Manual pulse generator 1 pulse input magnification (Cd.20)	5-124
Manual pulse generator enable flag (Cd.21)	5-124
Manual pulse generator input selection (Pr.24)	5-33
Master axis (Explanation of positioning terms)	Appendix-134
Max. connection distance	3-3
Max. output pulse	3-3
Mechanism of positioning control	1-7
Module's detailed information	Appendix-117
Monitor data area	7-3
Movement amount after near-point dog ON (Md.34)	5-104
Movement amount per pulse (Pr.2 to Pr.4)	5-19
Movement amount per pulse (Explanation of positioning terms)	Appendix-134
Movement amount per rotation (Pr.3)	5-19
Multi-phase pulse (Explanation of positioning terms)	Appendix-134
Multiplying rate setting (Explanation of positioning terms)	Appendix-134

## [N]

NC language (Explanation of positioning terms)	Appendix-135
Near pass function	12-21
Near-point dog (Explanation of positioning terms)	Appendix-135
Near-point dog signal	3-27
New acceleration time value (Cd.10)	5-118
New current value	9-130
New current value (Cd.9)	5-116
New current value (Explanation of positioning terms)	Appendix-135
New deceleration time value (Cd.11)	5-118
New speed value (Cd.14)	5-120
New torque value (Cd.22)	5-124
No. of control axes	3-2
No. of occupied I/O points	3-3
No. of pulses per rotation (Pr.2)	5-19
No. of write accesses to flash ROM (Md.19)	5-94
NOP instruction	9-135
Normal start	10-8

## [O]

Offline simulation	Appendix-84
OP (Explanation of positioning terms)	Appendix-135
OP address (Pr.45)	5-49
OP shift amount (Pr.53)	5-54
OP shift function	12-8
OP shift function (Explanation of positioning terms)	Appendix-135
Operation pattern (Da.1)	5-58
Operation pattern (Explanation of positioning terms)	Appendix-135
Operation patterns	9-5
Operation timing and processing time during position-speed switching control	9-110
Operation timing and processing time during speed-position switching control (ABS mode)	9-119
Operation timing and processing time during speed-position switching control (INC mode)	9-110
Operation timing and processing time of fast OPR	8-24
OPR acceleration time selection (Pr.51)	5-52

OPR basic parameters	5-45
OPR complete flag	5-102
OPR deceleration time selection (Pr.52)	5-52
OPR detailed parameters	5-52
OPR direction (Pr.44)	5-46
OPR dwell time (Pr.49)	5-52
OPR method	8-5
OPR method (Pr.43)	5-45
OPR method (1): Near-point dog method	8-7
OPR method (2): Stopper method 1	8-9
OPR method (3): Stopper method 2	8-12
OPR method (4): Stopper method 3	8-15
OPR method (5): Count method 1	8-17
OPR method (6): Count method 2	8-20
OPR method (Explanation of positioning terms)	Appendix-135
OPR parameter (Explanation of positioning terms)	Appendix-136
OPR request	8-2
OPR request (Explanation of positioning terms)	Appendix-136
OPR request flag	5-102
OPR request flag OFF request (Cd.19)	5-124
OPR request OFF program	6-25
OPR retry (Pr.48)	5-49
OPR retry function	12-4
OPR speed (Pr.46)	5-49
OPR torque limit value (Pr.54)	5-55
Order of priority for stop process	6-46
Outline design of positioning system	1-9
Outline of installation, wiring and maintenance	4-2
Outline of OPR control	8-2
Outline of restarting	1-22
Outline of starting	1-18
Outline of stopping	1-20
Output signal logic selection (Pr.23)	5-33
Output terminal (Explanation of positioning terms)	Appendix-136
Output timing selection of near pass control	12-23
Override function	12-48
Override function (Explanation of positioning terms)	Appendix-136
Override program	6-14

[P]	
P rate (Explanation of positioning terms)	
.....	Appendix-136
Parameter (Da.14)	5-73
Parameter (Explanation of positioning terms)	
.....	Appendix-136
Parameter 1 (Da.18)	5-80
Parameter 2 (Da.19)	5-80
Parameter area	7-3
Parameter initialization program	6-23
Parameter initialization request (Cd.2)	5-110
Parameter setting	Appendix-82
Performance specifications	3-2
Peripheral device	A-18
Personal computer	A-18
PG0 (Explanation of positioning terms)	
.....	Appendix-136
PLC CPU memo area	7-3
PLC READY signal	3-17
PLC READY signal [Y0] ON program	6-12
Position control (Explanation of positioning terms)	
.....	Appendix-136
Position detection module (Explanation of positioning terms)	
.....	Appendix-137
Position loop gain (Explanation of positioning terms)	
.....	Appendix-137
Position loop mode (Explanation of positioning terms)	
.....	Appendix-137
Position-speed switching control	9-123
Position-speed switching control enable flag (Cd.26)	5-128
Position-speed switching control speed change register (Cd.25)	5-126
Position-speed switching latch flag	5-102
Position-speed switching signal	3-8
Positioning (Explanation of positioning terms)	
.....	Appendix-137
Positioning address/movement amount (Da.6)	5-62
Positioning complete	9-6
Positioning complete (Explanation of positioning terms)	
.....	Appendix-137
Positioning complete signal	3-17
Positioning complete signal (Explanation of positioning terms)	
.....	Appendix-137
Positioning complete signal output time (Pr.40)	5-42
Positioning continued	Appendix-137
Positioning control operation program	6-12
Positioning data (Explanation of positioning terms)	
.....	Appendix-137
Positioning data area (No. 1 to 600)	7-3
Positioning data being executed (Md.47)	5-108
Positioning data No. being executed (Md.44)	5-108
Positioning monitor	Appendix-88
Positioning operation speed override (Cd.13)	5-120
Positioning parameter (Explanation of positioning terms)	
.....	Appendix-138
Positioning program examples	6-15
Positioning start (Explanation of positioning terms)	
.....	Appendix-138
Positioning start No. (Cd.3)	5-114
Positioning start No. setting program	6-13
Positioning start program	6-19
Positioning start signal	3-18
Positioning start test	Appendix-98
Positioning starting point No. (Cd.4)	5-114
Positioning test	Appendix-98
Pre-reading start function	12-99
Precautions	
• Disposal precautions	4-16
• Handling precautions	4-5
• Precautions for creating program	6-2
• Precautions for installation	4-7
• Precautions for maintenance	4-16
• Precautions for using stepping motor	1-23
• Precautions for wiring	4-8
Process time	
• Inching operation timing and processing time	11-18
• JOG operation timing and processing time	11-6
• Machine OPR operation timing and process time	6-35
• Manual pulse generator operation timing and processing times	11-28
• Operation timing and processing time during position-speed switching control	9-125

- Operation timing and processing time during speed-position switching control (ABS mode) ..... 9-119
- Operation timing and processing time during speed-position switching control (INC mode) ..... 9-110
- Operation timing and processing time of fast OPR ..... 8-24
- Position control operation timing and process time ..... 6-36
- Program details ..... 6-25
- Program examples
  - Absolute position restoration program.... 6-23
  - Acceleration/deceleration time change program ..... 6-14
  - Block start data setting program ..... 6-16
  - Continuous operation interrupt program 6-38
  - Error reset program ..... 6-24
  - External command function valid setting program ..... 6-25
  - Flash ROM write program ..... 6-24
  - Inching operation setting program ..... 6-20
  - JOG operation setting program ..... 6-20
  - JOG operation/inching operation execution program ..... 6-20
  - M code OFF program..... 6-20
  - Manual pulse generator operation program ..... 6-11
  - OPR request OFF program ..... 6-12
  - Override program ..... 6-14
  - Parameter initialization program ..... 6-14
  - Parameter setting program ..... 6-12
  - PLC READY signal [Y0] ON program .... 6-12
  - Positioning start No. setting program .... 6-13
  - Positioning start program ..... 6-13
  - Restart program ..... 6-14
  - Skip program ..... 6-14
  - Speed change program ..... 6-14
  - Step operation program ..... 6-14
  - Stop program..... 6-14
  - Target position change program..... 6-14
  - Teaching program ..... 6-14
- PTP control (Explanation of positioning terms) ..... Appendix-138
- Pulse (Explanation of positioning terms) ..... Appendix-138

- Pulse generator (Explanation of positioning terms) ..... Appendix-138
- Pulse output mode (**Pr.5**) ..... 5-21
- Pulse output mode (Explanation of positioning terms) ..... Appendix-138
- PULSE/SIGN mode ..... 5-21
- Purpose and applications of positioning control ..... 1-5

[Q]

- QD75 ..... A-18
- QD75 READY signal ..... 3-18

[R]

- READY (Explanation of positioning terms) ..... Appendix-138
- Real-time AUTO tuning (Explanation of positioning terms) ..... Appendix-138
- Reference axis ..... 9-23
- Reference axis speed ..... 5-31
- Reference axis speed (Explanation of positioning terms) ..... Appendix-138
- Regeneration brake option (Explanation of positioning terms)..... Appendix-138
- Relatively safe stop ..... 6-44
- Repeated start (FOR condition) ..... 10-15
- Repeated start (FOR loop) ..... 10-14
- Resolver (Explanation of positioning terms) ..... Appendix-139
- Restart command (**Cd.6**) ..... 5-114
- Restart operation ..... 6-40
- Restart program ..... 6-40
- RLS signal (Explanation of positioning terms) ..... Appendix-139
- Rotary table ..... Appendix-139
- Rotation direction setting (**Pr.6**) ..... 5-23

[S]

- S-curve acceleration/deceleration ..... Appendix-139
- S-curve acceleration/deceleration processing method ..... 12-97
- S-curve ratio (**Pr.35**) ..... 5-39
- SERIAL No. .... 1-23, Appendix-2
- Servo amplifier (Explanation of positioning terms) ..... Appendix-139

Servo lock (Explanation of positioning terms) .....Appendix-139	Skip function..... 12-78
Servo ON (Explanation of positioning terms) .....Appendix-139	Skip function (Explanation of positioning terms) ..... Appendix-140
Servomotor (Explanation of positioning terms) .....Appendix-139	Slave axis (Explanation of positioning terms) ..... Appendix-140
Setting auto refresh..... Appendix-87	Slot ..... 2-6
Setting block starting data..... Appendix-86	Software stroke limit lower limit value (Pr.13) .....5-27
Setting data ..... 5-2	Software stroke limit selection (Pr.14) .....5-28
Setting for the movement amount after near-point dog ON (Pr.50) ..... 5-52	Software stroke limit upper limit value (Pr.12) .....5-27
Setting items for block start data ..... 5-10	Software stroke limit valid/invalid setting (Pr.15) .....5-28
Setting items for condition data ..... 5-11	Special start data instruction code setting value (Md.36).....5-106
Setting items for OPR parameters..... 5-7	Special start data instruction parameter setting value (Md.37).....5-106
Setting items for positioning data..... 5-8	Special start instruction (Da.13).....5-78
Setting items for positioning parameters ..... 5-5	Special start repetition counter (Md.41).....5-108
Setting the positioning data..... 9-29	Specifications of input/output interfaces ..... 3-19
Setting unit (Explanation of positioning terms) .....Appendix-139	Specifications of input/output signals ..... 3-16
SFC (Explanation of positioning terms) .....Appendix-140	Speed change 0 flag..... 5-102
Shape (Da.11) ..... 5-74	Speed change function..... 12-41
Signal layout of connector..... 3-25	Speed change request (Cd.15) ..... 5-120
Signal name..... 3-16	Speed change test..... Appendix-102
Signals	Speed control (Explanation of positioning terms) ..... Appendix-140
• Axis stop signal ..... 3-18	Speed designation during OP shift (Pr.56) .....5-55
• BUSY signal ..... 3-18	Speed integral compensation (Explanation of positioning terms)..... Appendix-140
• Error detection signal ..... 3-17	Speed limit function ..... 12-27
• Execution prohibition flag signal ..... 3-18	Speed limit value (Pr.8).....5-25
• JOG start signal..... 3-18	Speed limit value (Explanation of positioning terms) ..... Appendix-140
• M code ON signal..... 3-17	Speed loop gain (Explanation of positioning terms) ..... Appendix-140
• PLC READY signal ..... 3-18	Speed loop mode (Explanation of positioning terms) ..... Appendix-140
• Positioning complete signal ..... 3-17	Speed switching mode (Pr.19).....5-32
• Positioning start signal ..... 3-17	Speed-position function selection (Pr.150) .....5-33
• QD75 READY signal ..... 3-17	Speed-position switching control (ABS mode) .....9-115
• Start complete signal..... 3-17	Speed-position switching control (INC mode) .....9-106
• Synchronization flag signal ..... 3-17	Speed-position switching control (Explanation of positioning terms)..... Appendix-140
Simultaneous start..... 10-12	
Simultaneous starting axis start data No. (Axis 1 start data No.)(Cd.30)..... 5-130	
Simultaneous starting axis start data No. (Axis 2 start data No.)(Cd.31)..... 5-130	
Simultaneous starting axis start data No. (Axis 3 start data No.)(Cd.32)..... 5-130	
Simultaneous starting axis start data No. (Axis 4 start data No.)(Cd.33)..... 5-130	
Skip command (Cd.37)..... 5-132	

Speed-position switching control mode (Explanation of positioning terms) .....	Appendix-140	Stop cause .....	6-44
Speed-position switching control movement amount change register (Cd.23) .....	5-126	Stop command processing for deceleration stop function .....	12-108
Speed-position switching control positioning amount (Md.29) .....	5-100	Stop command processing for deceleration stop selection ( Cd.42 ) .....	5-110
Speed-position switching enable flag (Cd.24) .....	5-126	Stop group 1 sudden stop selection (Pr.37) .....	5-38
Speed-position switching latch flag .....	5-102	Stop group 2 sudden stop selection (Pr.38) .....	5-38
Speed-position switching signal .....	3-8	Stop group 3 sudden stop selection (Pr.39) .....	5-38
Spiral interpolation .....	9-67	Stop process .....	6-44
Standard speed switching mode .....	9-13	Stop program .....	6-44
Start (Day: hour) (Md.5) .....	5-88	Stop settling time (Explanation of positioning terms) .....	Appendix-141
Start (Minute: second) (Md.6) .....	5-88	Stop signal .....	3-27
Start complete (Explanation of positioning terms) .....	Appendix-141	STOP signal (Explanation of positioning terms) .....	Appendix-141
Start complete signal .....	3-17	Stop with stopper (Explanation of positioning terms) .....	Appendix-142
Start data No. (Da.12) .....	5-77	Stopper method 1) machine OPR .....	8-9
Start data pointer being executed (Md.43) .....	5-112	Stopper method 2) machine OPR .....	8-12
Start details setting program .....	6-26	Stopper method 3) machine OPR .....	8-15
Start history pointer (Md.8) .....	5-90	Stroke (Explanation of positioning terms) .....	Appendix-142
Start information (Md.3) .....	5-88	Stroke limit (Explanation of positioning terms) .....	Appendix-142
Start No. (Md.4) .....	5-88	Sub functions .....	12-2
Start positioning data No. setting value (Md.38) .....	5-106	Sub functions specifically for machine OPR .....	12-4
Start program .....	6-28	Sudden stop .....	6-45
Start program for high-level positioning control .....	10-24	Sudden stop (Explanation of positioning terms) .....	Appendix-142
Starting axis (Explanation of positioning terms) .....	Appendix-141	Sudden stop deceleration time (Pr.36) .....	5-38
Status (Md.31) .....	5-102	Synchronization flag (X1) .....	3-17
Status (Explanation of positioning terms) .....	Appendix-141	System control data .....	5-110
Step function .....	12-73	System monitor data .....	5-86
Step function (Explanation of positioning terms) .....	Appendix-141		
Step mode .....	12-74	[T]	
Step mode (Cd.34) .....	5-130	Tact time .....	12-99
Step out (Explanation of positioning terms) .....	Appendix-141	Target position change function .....	12-58
Step start information .....	12-74	Target position change request flag (Cd.29) .....	5-128
Step start information (Cd.36) .....	5-132	Target position change value (new address) (Cd.27) .....	5-128
Step valid flag (Cd.35) .....	5-130	Target position change value (new speed) (Cd.28) .....	5-128
Stepping motor (Explanation of positioning terms) .....	Appendix-141		

Target speed (Md.33)	5-104
Target value (Md.32)	5-102
Teaching (Explanation of positioning terms)	Appendix-142
Teaching data selection (Cd.38)	5-132
Teaching function	12-86
Teaching positioning data No. (Cd.39)	5-132
Teaching program	6-14
Time chart	
• Inching operation start time chart	11-22
• JOG operation start time chart	11-11
• Time chart for changing the speed from the CPU module	12-44
• Time chart for changing the speed using an external command signal	12-46
• Time chart for changing the speed using the override function	12-50
• Time chart for restarting	6-43
• Time chart for starting "fast OPR"	6-32
• Time chart for starting "machine OPR"	6-31
• Time chart for starting "major positioning control"	6-33
• Time chart for starting "position-speed switching control"	6-34
• Time chart for starting "speed-position switching control"	6-33
• Time chart for starting with external command signal	6-37
Torque change function	12-56
Torque control (Explanation of positioning terms)	Appendix-142
Torque limit function	12-29
Torque limit setting value (Pr.17)	5-28
Torque limit stored value (Md.35)	5-104
Torque loop mode (Explanation of positioning terms)	Appendix-142
Torque ripple (Explanation of positioning terms)	Appendix-142
Tracking function (Explanation of positioning terms)	Appendix-143
Trapezoidal acceleration/deceleration (Explanation of positioning terms)	Appendix-143
Trapezoidal acceleration/deceleration processing method	12-97
Troubleshooting	15-2
Turntable (Explanation of positioning terms)	Appendix-143

Types and roles of control data	5-15
Types and roles of monitor data	5-12
Types of data	5-2
Types of errors	15-6
Types of stop processes	6-45
Types of warnings	15-7
[U]	
Unconditional JUMP	9-136
Unit magnification (Pr.4)	5-18
Unit setting (Pr.1)	5-18
Unit setting (Explanation of positioning terms)	Appendix-143
Upper limit signal	3-26
[V]	
Valid M code (Md.25)	5-98
[W]	
Wait start	10-11
Warning (Explanation of positioning terms)	Appendix-143
Warning history	5-94
Warning history pointer (Md.18)	5-94
Wave trace	Appendix-106
Window (Explanation of positioning terms)	Appendix-143
WITH mode	12-81
WITH mode (Explanation of positioning terms)	Appendix-143
Workpiece	A-18
Writing to the Flash ROM	13-5
[X]	
X0 (QD75 READY)	3-17
X1 (Synchronization flag)	3-17
XY table (Explanation of positioning terms)	Appendix-143
[Z]	
Z phase (Explanation of positioning terms)	Appendix-143
Z.ABRST1	14-3
Z.ABRST2	14-3
Z.ABRST3	14-3
Z.ABRST4	14-3
Zero signal (Explanation of positioning terms)	Appendix-143

ZP.PFWRT .....	14-16
ZP.PINIT .....	14-20
ZP.PSTRT1 .....	14-8
ZP.PSTRT2 .....	14-8
ZP.PSTRT3 .....	14-8
ZP.PSTRT4 .....	14-8
ZP.TEACH1 .....	14-12
ZP.TEACH2 .....	14-12
ZP.TEACH3 .....	14-12
ZP.TEACH4 .....	14-12



# WARRANTY

Please confirm the following product warranty details before using this product.

## **1. Gratis Warranty Term and Gratis Warranty Range**

If any faults or defects (hereinafter "Failure") found to be the responsibility of Mitsubishi occurs during use of the product within the gratis warranty term, the product shall be repaired at no cost via the sales representative or Mitsubishi Service Company.

However, if repairs are required onsite at domestic or overseas location, expenses to send an engineer will be solely at the customer's discretion. Mitsubishi shall not be held responsible for any re-commissioning, maintenance, or testing on-site that involves replacement of the failed module.

[Gratis Warranty Term]

The gratis warranty term of the product shall be for one year after the date of purchase or delivery to a designated place. Note that after manufacture and shipment from Mitsubishi, the maximum distribution period shall be six (6) months, and the longest gratis warranty term after manufacturing shall be eighteen (18) months. The gratis warranty term of repair parts shall not exceed the gratis warranty term before repairs.

[Gratis Warranty Range]

- (1) The range shall be limited to normal use within the usage state, usage methods and usage environment, etc., which follow the conditions and precautions, etc., given in the instruction manual, user's manual and caution labels on the product.
- (2) Even within the gratis warranty term, repairs shall be charged for in the following cases.
  1. Failure occurring from inappropriate storage or handling, carelessness or negligence by the user. Failure caused by the user's hardware or software design.
  2. Failure caused by unapproved modifications, etc., to the product by the user.
  3. When the Mitsubishi product is assembled into a user's device, Failure that could have been avoided if functions or structures, judged as necessary in the legal safety measures the user's device is subject to or as necessary by industry standards, had been provided.
  4. Failure that could have been avoided if consumable parts (battery, backlight, fuse, etc.) designated in the instruction manual had been correctly serviced or replaced.
  5. Failure caused by external irresistible forces such as fires or abnormal voltages, and Failure caused by force majeure such as earthquakes, lightning, wind and water damage.
  6. Failure caused by reasons unpredictable by scientific technology standards at time of shipment from Mitsubishi.
  7. Any other failure found not to be the responsibility of Mitsubishi or that admitted not to be so by the user.

## **2. Onerous repair term after discontinuation of production**

- (1) Mitsubishi shall accept onerous product repairs for seven (7) years after production of the product is discontinued. Discontinuation of production shall be notified with Mitsubishi Technical Bulletins, etc.
- (2) Product supply (including repair parts) is not available after production is discontinued.

## **3. Overseas service**

Overseas, repairs shall be accepted by Mitsubishi's local overseas FA Center. Note that the repair conditions at each FA Center may differ.

## **4. Exclusion of loss in opportunity and secondary loss from warranty liability**

Regardless of the gratis warranty term, Mitsubishi shall not be liable for compensation to:

- (1) Damages caused by any cause found not to be the responsibility of Mitsubishi.
- (2) Loss in opportunity, lost profits incurred to the user by Failures of Mitsubishi products.
- (3) Special damages and secondary damages whether foreseeable or not, compensation for accidents, and compensation for damages to products other than Mitsubishi products.
- (4) Replacement by the user, maintenance of on-site equipment, start-up test run and other tasks.

## **5. Changes in product specifications**

The specifications given in the catalogs, manuals or technical documents are subject to change without prior notice.

Microsoft and Windows are either registered trademarks or trademarks of Microsoft Corporation in the United States and/or other countries.

The company names, system names and product names mentioned in this manual are either registered trademarks or trademarks of their respective companies.

In some cases, trademark symbols such as <sup>TM</sup> or <sup>®</sup> are not specified in this manual.



SH(NA)-080058-S(1602)MEE

MODEL: QD75-U-S-E

MODEL CODE: 13JR09

## **MITSUBISHI ELECTRIC CORPORATION**

HEAD OFFICE : TOKYO BUILDING, 2-7-3 MARUNOUCHI, CHIYODA-KU, TOKYO 100-8310, JAPAN  
NAGOYA WORKS : 1-14, YADA-MINAMI 5-CHOME, HIGASHI-KU, NAGOYA, JAPAN

When exported from Japan, this manual does not require application to the  
Ministry of Economy, Trade and Industry for service transaction permission.

Specifications subject to change without notice.