

SIEMENS



Configuring Manual

SENTRON

Switching Devices

Edition

03/2022

[siemens.com/lowvoltage](https://www.siemens.com/lowvoltage)

SIEMENS

SENTRON

Switching devices



Configuration Manual

<u>Introduction</u>	1
<u>Introduction</u>	2
<u>5TE8 control switches</u>	3
<u>5TE48 pushbuttons</u>	4
<u>5TE58 light indicators</u>	5
<u>5TE8 On/Off switches</u>	6
<u>5TL1 On/Off switches</u>	7
<u>5TE25 DC safety disconnectors</u>	8
<u>5ST busbars for modular installation devices</u>	9
<u>5TT4 remote control switches</u>	10
<u>5TT4 switching relays</u>	11
<u>5TT5 Insta contactors</u>	12
<u>5TT3 soft-starting devices</u>	13
<u>Controls</u>	14
<u>7LF, 5TT3 timers</u>	15

Legal information

Warning notice system

This manual contains notices you have to observe in order to ensure your personal safety, as well as to prevent damage to property. The notices referring to your personal safety are highlighted in the manual by a safety alert symbol, notices referring only to property damage have no safety alert symbol. These notices shown below are graded according to the degree of danger.

 DANGER
indicates that death or severe personal injury will result if proper precautions are not taken.
 WARNING
indicates that death or severe personal injury may result if proper precautions are not taken.
 CAUTION
indicates that minor personal injury can result if proper precautions are not taken.
NOTICE
indicates that property damage can result if proper precautions are not taken.

If more than one degree of danger is present, the warning notice representing the highest degree of danger will be used. A notice warning of injury to persons with a safety alert symbol may also include a warning relating to property damage.

Qualified Personnel

The product/system described in this documentation may be operated only by **personnel qualified** for the specific task in accordance with the relevant documentation, in particular its warning notices and safety instructions. Qualified personnel are those who, based on their training and experience, are capable of identifying risks and avoiding potential hazards when working with these products/systems.

Proper use of Siemens products

Note the following:

 WARNING
Siemens products may only be used for the applications described in the catalog and in the relevant technical documentation. If products and components from other manufacturers are used, these must be recommended or approved by Siemens. Proper transport, storage, installation, assembly, commissioning, operation and maintenance are required to ensure that the products operate safely and without any problems. The permissible ambient conditions must be complied with. The information in the relevant documentation must be observed.

Trademarks

All names identified by ® are registered trademarks of Siemens AG. The remaining trademarks in this publication may be trademarks whose use by third parties for their own purposes could violate the rights of the owner.

Disclaimer of Liability

We have reviewed the contents of this publication to ensure consistency with the hardware and software described. Since variance cannot be precluded entirely, we cannot guarantee full consistency. However, the information in this publication is reviewed regularly and any necessary corrections are included in subsequent editions.

Table of contents

1	Introduction	7
1.1	Siemens Industry Online Support	7
1.2	Siemens Industry Online Support app.....	9
1.3	Support Request	10
1.4	Security information	11
1.5	Recycling and disposal	12
2	Introduction	13
2.1	Overview	13
3	5TE8 control switches	17
3.1	Overview	17
3.2	Technical specifications	18
3.3	Dimensional drawings	19
3.4	Circuit diagrams.....	21
4	5TE48 pushbuttons	23
4.1	Overview	23
4.2	Technical specifications	24
4.3	Dimensional drawings	26
4.4	Circuit diagrams.....	28
5	5TE58 light indicators	29
5.1	Overview	29
5.2	Technical specifications	30
5.3	Dimensional drawings	32
5.4	Circuit diagrams.....	33
6	5TE8 On/Off switches.....	35
6.1	Overview	35
6.2	Technical specifications	36
6.3	Dimensional drawings	38
6.4	Circuit diagrams.....	39

7	5TL1 On/Off switches	41
7.1	Overview.....	41
7.2	Technical specifications	42
7.3	Dimensional drawings	44
7.4	Circuit diagrams.....	46
8	5TE25 DC safety disconnectors	47
8.1	Overview.....	47
8.2	Technical specifications	48
8.3	Dimensional drawings	49
8.4	Circuit diagrams.....	50
8.5	Configuration	51
9	5ST busbars for modular installation devices	53
9.1	Overview.....	53
9.2	Dimensional drawings	54
10	5TT4 remote control switches	55
10.1	Overview.....	55
10.2	Technical specifications	56
10.3	Dimensional drawings	62
10.4	Circuit diagrams.....	65
10.5	More information	67
10.6	Typical circuits.....	69
10.7	Switching of lamps	73
11	5TT4 switching relays	93
11.1	Overview.....	93
11.2	Technical specifications	94
11.3	Dimensional drawings	96
11.4	Circuit diagrams.....	97
11.5	More information	98
12	5TT5 Insta contactors	101
12.1	5TT50 Insta contactors, AC/DC technology	101
12.1.1	Overview.....	101
12.1.2	Technical specifications	103
12.1.3	Dimensional drawings	105
12.1.4	Circuit diagrams.....	107
12.1.5	More information	108

12.2	5TT58 Insta contactors, AC technology.....	116
12.2.1	Overview	116
12.2.2	Technical specifications	117
12.2.3	Dimensional drawings	119
12.2.4	Circuit diagrams.....	121
12.2.5	More information	122
13	5TT3 soft-starting devices.....	131
13.1	Overview	131
13.2	Technical specifications	132
13.3	Dimensional drawings	133
13.4	Example circuits.....	134
14	Controls	137
14.1	Overview	137
15	7LF, 5TT3 timers.....	141
15.1	7LF4 digital time switches.....	141
15.1.1	Overview	141
15.1.2	Technical specifications	142
15.1.3	Dimensional drawings	144
15.1.4	Circuit diagrams.....	147
15.1.5	More information	148
15.2	7LF5 mechanical time switches.....	154
15.2.1	Overview	154
15.2.2	Technical specifications	155
15.2.3	Dimensional drawings	157
15.2.4	Circuit diagrams.....	158
15.2.5	More information	159
15.3	5TT3 timers for industrial applications.....	161
15.3.1	Overview	161
15.3.2	Technical specifications	162
15.3.3	Dimensional drawings	163
15.3.4	Circuit diagrams.....	163
15.3.5	More information	163
15.3.6	5TT3185 multifunction timers.....	165

Introduction

1.1 Siemens Industry Online Support

Information and service

At Siemens Industry Online Support you can obtain up-to-date information from our global support database:

- Product support
- Application examples
- Forum
- mySupport

Link: Siemens Industry Online Support (<https://support.industry.siemens.com/cs/de/en>)

Product support

You can find information and comprehensive know-how covering all aspects of your product here:

- **FAQs**
Answers to frequently asked questions
- **Manuals/operating instructions**
Read online or download, available as PDF or individually configurable.
- **Certificates**
Clearly sorted according to approving authority, type and country.
- **Characteristics**
For support in planning and configuring your system.
- **Product announcements**
The latest information and news concerning our products.
- **Downloads**
Here you will find updates, service packs, HSPs and much more for your product.
- **Application examples**
Function blocks, background and system descriptions, performance statements, demonstration systems, and application examples, clearly explained and represented.
- **Technical data**
Technical product data for support in planning and implementing your project

Link: Product support (<https://support.industry.siemens.com/cs/ww/en/ps>)

mySupport

The following functions are available in your personal work area "mySupport":

- **Support Request**
Search for request number, product or subject
- **My filters**
With filters, you limit the content of the online support to different focal points.
- **My favorites**
With favorites you bookmark articles and products that you need frequently.
- **My notifications**
Your personal mailbox for exchanging information and managing your contacts. You can compile your own individual newsletter in the "Notifications" section.
- **My products**
With product lists you can virtually map your control cabinet, your system or your entire automation project.
- **My documentation**
Configure your individual documentation from different manuals.
- **CAX data**
Easy access to CAX data, e.g. 3D models, 2D dimension drawings, EPLAN macros, device circuit diagrams
- **My IBase registrations**
Register your Siemens products, systems and software.

1.2 Siemens Industry Online Support app

Siemens Industry Online Support app

The Siemens Industry Online Support app provides you access to all the device-specific information available on the Siemens Industry Online Support portal for a particular article number, such as operating instructions, manuals, data sheets, FAQs etc.

The Siemens Industry Online Support app is available for Android and iOS:



Android



iOS

1.3 Support Request

After you have registered, you can use the Support Request form in the online support to send your question directly to Technical Support:

Support Request:	Internet (https://support.industry.siemens.com/My/ww/en/requests)
-------------------------	--

1.4 Security information

Siemens provides products and solutions with industrial security functions that support the secure operation of plants, systems, machines and networks.

In order to protect plants, systems, machines and networks against cyber threats, it is necessary to implement – and continuously maintain – a holistic, state-of-the-art industrial security concept. Siemens' products and solutions constitute one element of such a concept.

Customers are responsible for preventing unauthorized access to their plants, systems, machines and networks. Such systems, machines and components should only be connected to an enterprise network or the internet if and to the extent such a connection is necessary and only when appropriate security measures (e.g. firewalls and/or network segmentation) are in place.

For additional information on industrial security measures that may be implemented, please visit

<https://www.siemens.com/industrialsecurity>.

Siemens' products and solutions undergo continuous development to make them more secure. Siemens strongly recommends that product updates are applied as soon as they are available and that the latest product versions are used. Use of product versions that are no longer supported, and failure to apply the latest updates may increase customer's exposure to cyber threats.

To stay informed about product updates, subscribe to the Siemens Industrial Security RSS Feed under

<https://www.siemens.com/cert>.

1.5 Recycling and disposal

For environmentally friendly recycling and disposal of your old device, please contact a company certified for the disposal of old electrical and/or electronic devices and dispose of the device in accordance with the regulations in your country.

Introduction

2.1 Overview

Devices	Applications	Standards	Used in Non-residential buildings	Used in Residential buildings	Used in Industry	
	5TE8 control switches	For switching lighting, other electrical devices up to 20 A and 32 A. Used in control cabinets for the logical gating of functions.	IEC/EN 60947-3, (VDE 0660-107) GB 14048.3 CCC	✓	✓	✓
	5TE48 pushbuttons	For use as pushbuttons in control systems, e.g. to switch on seal-in circuits or as pushbuttons with maintained-contact function for manual use, as control switches or for switching of loads up to 20 A.	IEC/EN 60947-3, (VDE 0660-107) GB 14048.3 CCC	✓	-	✓
	5TE58 light indicators	Light indicators for signaling switching states or faults in systems.	EN 62094-1/A11	✓	-	✓
	5TE81/82 On/Off switches	For switching lighting, motors and other electrical devices 5TE81: 20 A 5TE82: 32 A	20 A / 32 A: IEC/EN 60947-3, (VDE 0660-107)	✓	✓	✓
	5TL1 On/Off switches	On/Off switches used for lighting control and for switching of motors and other electric loads, for example.	32 A ... 125 A: IEC/EN 60947-3, (VDE 0660-107)	✓	✓	✓





Devices	Applications	Standards	Used in Non-residential buildings	Used in Residential buildings	Used in Industry	
	5TE25 DC safety disconnectors	The DC safety disconnecter is a special switch disconnecter for switching DC loads.	IEC/EN 60947-3 GB 14018.3 CCC	✓	✓	✓
	5ST busbars for modular installation devices	For fast and safe connection.	IEC/EN 61439-1, (VDE 0660-600-1)	✓	-	✓
 	5TT41 remote control switches 5TT44 remote control switches	Remote control switches are used in residential and non-residential buildings, but also in the manufacture of panels. In addition to the 5TT41 remote control switches up to 16 A, the 5TT44 variants from 20 to 63 A (up to 32 A DC) are available.	EN 60669-1 (VDE 0632-1) / EN 60669-1/A1/A2 EN 60669-2-2 (VDE0632-2-2) / EN 60669-2-2 from 40 A types: EN 60947-11/A/A2 EN IEC 60947-4-1	✓	✓	✓
	5TT42 relays	For switching of small loads up to 16 A or as coupling devices in control systems.	EN 60947-5-1, (VDE 0660-200) EN 60947-1, (VDE 0660-100) GB 14048.4 CCC	✓	-	✓

Table 2-1 5TT5 Insta contactors



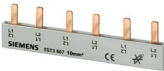



Devices		Applications	Standards	Used in Non-residential buildings	Used in Residential buildings	Used in Industry
	5TT50 Insta contactors, AC/DC technology	Insta contactors 20 A, 40 A and 63 A for switching heating, lighting, such as fluorescent lamps or incandescent lamps, resistive or inductive load.	IEC 60947-4-1 IEC 60947-5-1 IEC 61095 EN 60947-1/A1/A2 EN IEC 60947-4-1 EN 60947-5-1 EN 61095 UL 508 GB 14048.4 CCC	✓	✓	✓
	5TT58 Insta contactors, AC technology	Insta contactors 20 A, 25 A, 40 A and 63 A for switching heating, lighting, such as fluorescent lamps or incandescent lamps, resistive or inductive load.	IEC 60947-4-1 IEC 60947-5-1 IEC 61095 EN60947-1/A1/A2 EN IEC 60947-4-1 EN 60947-5-1 EN 61095 UL 508 GB 14048.4.CCC	✓	✓	✓
	5TT3 soft-starting devices	For protection of machines with gear, belt and chain drives, conveyor belts, fans, pumps, compressors, packaging machines or door drives.	EN 60947-4-2, (VDE 0660-117)	-	-	✓
<p>Controls</p> 		For switching loads on and off, contact selection for lighting systems, switching off direct currents and switching safety extra-low voltage. A wide range of options for practical use.	-	-	-	

Table 2- 2 7LF, 5TT3 timers

Devices		Applications	Standards	Used in Non-residential buildings	Used in Residential buildings	Used in Industry
	7LF4 digital time switches	Minute-precise switching of devices and system components in day, week and year programs. Unique due to the wide variety of functions offered by the Mini and Top versions; Astro, Profi and Expert for PC programming.	IEC 60730-1 and IEC 60730-2-7 EN 60730-1 and EN 60730-2-7 VDE 0631-1 and -2-7	✓	✓	✓
	7LF5 mechanical time switches	Accurate with precise switching in 15-minute steps. With automatic time setting during commissioning and automatic changeover to daylight saving time.	IEC 60730-1 and IEC 60730-2-7 EN 60730-1 und EN 60730-2-7 VDE 0631-1 and -2-7 UL 60730 UL 917	✓	✓	✓
	7LF6 timers for buildings	Lighting controls with stairwell lighting timers ensure the safe use of stairwells and save energy. Expanded applications for common rooms and garages, as well as the time switching of fans and fluorescent lamps.	EN/IEC 60669-1/AC EN/IEC 60669-2-3 EMC: EN 60669-2-1/A1/A12	✓	✓	-
	5TT3 timers for industrial applications	Multifunctional, delay, wiper, flashing and Off-delay timers in control circuits expand the use of distribution boards in both small and large systems.	EN 61812-1 EN 61812-1	-	-	✓

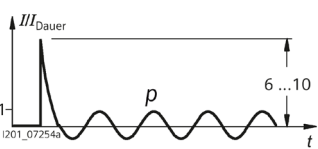
5TE8 control switches

3.1 Overview

Two-way switches are used in control cabinets and distribution boards for switching small loads on/off or over.

Group switches with center position permit the positions open/stop/closed, for example to control counter-clockwise rotation – Off – clockwise rotation.

Control switches in a range of contact versions have an integral control lamp for the On setting.

The auxiliary switch (AS) signals the contact position of the switch. It has the same design as the auxiliary switch used for the miniature circuit breakers.

3.2 Technical specifications

5TE81			
Standards	IEC/EN 60947-3 (VDE 0660-107)		
Approvals	GB 14048.3-2008 CCC		
Rated operational current I_e	Per conducting path	A	20
Rated operational voltage U_e	1-pole	V AC	230
	Multi-pole	V AC	400
Rated power loss P_v	Contact per pole	VA	0.7
Thermal rated current I_{th}	-	A	20
Rated breaking capacity	At $\cos \phi = 0.65$	A	60
Rated breaking capacity	At $\cos \phi = 0.65$	A	60
Short-circuit strength In conjunction with fuse of the same rated operational current	EN 60269 gL/gG	kA	10
Rated impulse withstand voltage U_{imp}	-	kV	> 5
Clearances	Open contacts between poles	mm	$2 \times > 2$
		mm	> 7
Creepage distances	-	mm	> 7
Mechanical endurance	Switching cycles	-	25000
Electrical endurance	Switching cycles	-	10000
Minimum contact load	-	V; mA	10; 300
Rated short-time currents Per conducting path at $\cos \phi = 0.7$ (Multiply by the factor 1.5 to obtain the corresponding rated surge current.)	Up to 0.2 s	A	650
	Up to 0.5 s	A	400
	Up to 1 s	A	200
	Up to 3 s	A	170
Connecting terminals	\pm screw (Pozidriv)		PZ1
	Max. tightening torque	Nm	0.8 ... 1.0
Conductor cross-sections	Rigid	mm ²	1 ... 6
	Flexible, with end sleeve	mm ²	1 ... 6
Permissible ambient temperature	-	°C	-5 ... +40
Resistance to climate At 95% relative humidity	Acc. to DIN 50015	°C	45

3.3 Dimensional drawings

Two-way switches, group switches with center position, 20 A

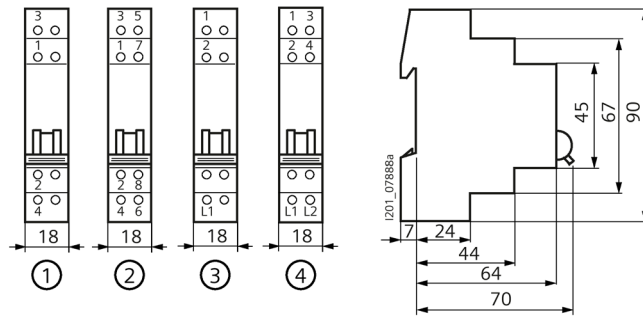

- ① 5TE8151
- ② 5TE8152, 5TE8153
- ③ 5TE8141, 5TE8161
- ④ 5TE8142, 5TE8162

5TE8 switches with pilot lamp, 20 A, with lamp

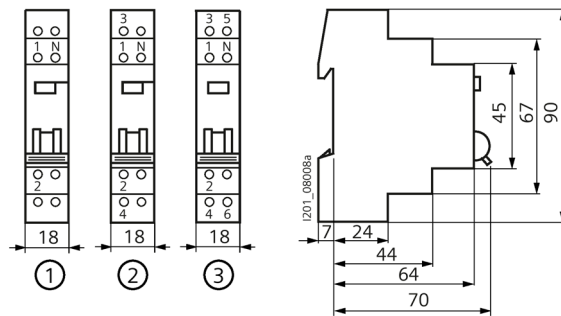

- ① 5TE8101, 5TE8101-3, 5TE8105
- ② 5TE8102
- ③ 5TE8103

5TE8 switches with pilot lamp, 20 A, with lamp and auxiliary switch

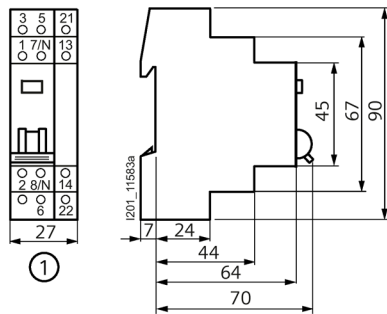

① 5TE8108

5ST3 auxiliary switches

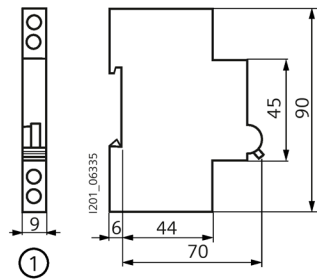

① 5ST3010, 5ST3011, 5ST3012

3.4 Circuit diagrams

Two-way switches, group switches with center position, 20 A



5TE8151



5TE8152

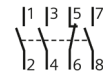

5TE8153



5TE8141



5TE8142



5TE8161

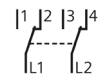

5TE8162

5TE8 switches with pilot lamp, 20 A, with lamp



5TE8101

5TE8101-03

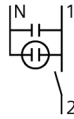

5TE8105



5TE8102

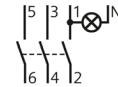

5TE8103

5TE8 switches with pilot lamp, 20 A, with lamp and auxiliary switch

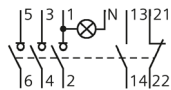

Figure 3-1 5TE8101

5ST3 auxiliary switches



5TE3010



5TE3011



5TE3012

5TE48 pushbuttons

4.1 Overview

The pushbuttons are used in control systems, e.g. to switch on seal-in circuits or as pushbuttons with maintained-contact function for manual use, as control switches, or for switching of loads up to 20 A.

4.2 Technical specifications

5TE48			
Standards	IEC/EN 60947-3 (VDE 0660-107)		
Approvals			
Rated operational current I_e	Per conducting path	A	20
Rated operational voltage U_e	1-pole	V AC	230
	Multi-pole	V AC	400
Rated power loss P_v	Contact per pole	VA	0.6
Thermal rated current I_{th}	-	A	20
Rated breaking capacity	At $\cos \phi = 0.65$	A	60
Rated breaking capacity	At $\cos \phi = 0.65$	A	60
Rated impulse withstand voltage U_{imp}	-	kV	> 5
Clearances	Open contacts	mm	$2 \times > 2$
	Between the poles	mm	> 7
Creepage distances	-	mm	> 7
Mechanical endurance	Switching cycles	-	25000
Minimum contact load	-	V; mA	10; 300
Rated short-time currents Per conducting path at $\cos \phi = 0.7$ (Multiply by the factor 1.5 to obtain the corresponding rated surge current.)	Up to 0.2 s	A	650
	Up to 0.5 s	A	400
	Up to 1 s	A	200
	Up to 3 s	A	170
Connecting terminals	\pm screw (Pozidriv)		PZ1
	Max. tightening torque	Nm	0.8 ... 1.0
Conductor cross-sections	Rigid	mm ²	1 ... 6
	Flexible, with end sleeve	mm ²	1 ... 6
Permissible ambient temperature	-	°C	-5 ... +40
Resistance to climate At 95% relative humidity	Acc. to DIN 50015	°C	45

Power loss of 5TG805 lamps		5TG8050	5TG8051	5TG8052	5TG8053	5TG8054	5TG8055
Rated operational voltage U_e	V A C	12	24	48	60	115	230
Rated power loss P_v	mW	70	160	350	420	70	170
Rated operational voltage U_e	V D C	12	24	48	60	110	220
Rated power loss P_v	mW	85	190	450	550	50	135

Power loss of 5TG805.-. LEDs	5TG805.-.
Rated power loss P_v Light-emitting diode	VA 0.4

Color coding according to IEC 60073	Meaning		
Color	Safety of people or environment	Process state	System state
Red	Danger	Emergency	Fault
Yellow	Warning/Caution	Abnormal	-
Green	Safe	Normal	-
Blue	Mandatory intervention required		
White, gray, black	No special significance assigned		

4.3 Dimensional drawings

5TE48 pushbuttons

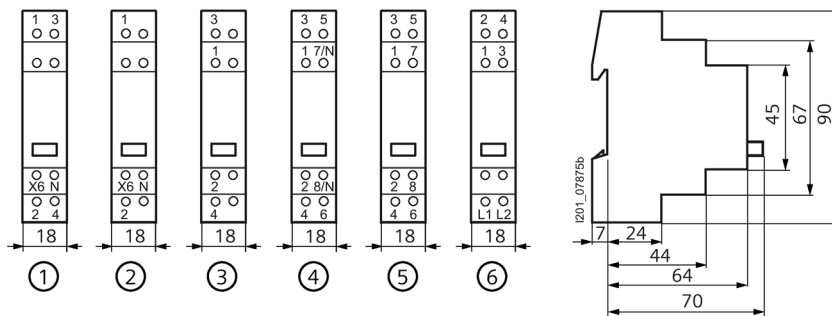

- ① 5TE4820, 5TE4823, 5TE4824
- ② 5TE4821, 5TE4822
- ③ 5TE4800, 5TE4805, 5TE4806, 5TE4807, 5TE4808, 5TE4809, 5TE4810, 5TE4811
- ④ 5TE4812
- ⑤ 5TE4813
- ⑥ 5TE4814

5TE4804 pushbuttons

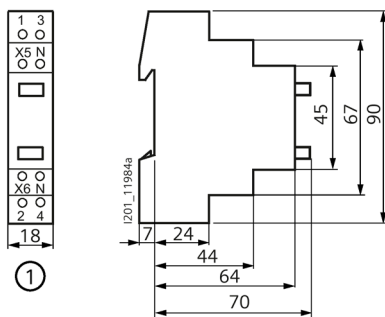

- ① 5TE4804

5TE48 double pushbuttons with maintained contact

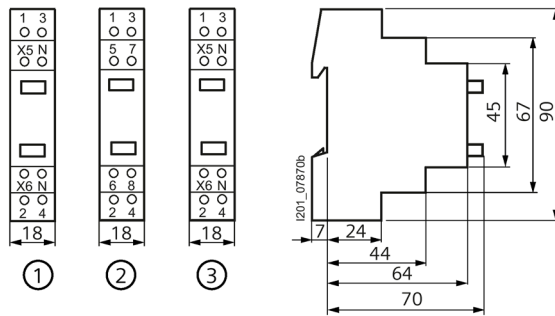

- ① 5TE4830
- ② 5TE4831
- ③ 5TE4840, 5TE4841

4.4 Circuit diagrams



5TE4800
5TE4805
5TE4806
5TE4807

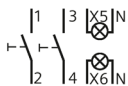

5TE4804



5TE4810

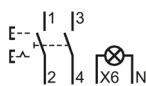

5TE4823

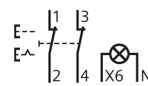

5TE4824

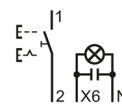

5TE4822



5TE4811

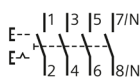

5TE4812

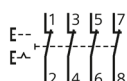

5TE4813

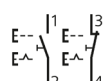

5TE4830

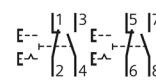

5TE4831

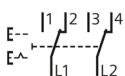

5TE4814

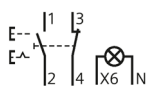

5TE4820

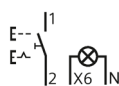

5TE4821

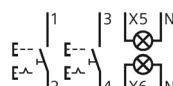

5TE4840

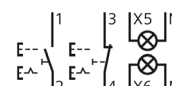

5TE4841

5TE58 light indicators

5.1 Overview

Light indicators are used to signal switching states or faults in systems. They are available as single, double or triple light indicators.

5.2 Technical specifications

5TE58			
Standards	EN 62094-1/A11		
Rated operational voltage U_e	Max.	V AC	230 (further voltages, see Lamps 5TG805)
Rated power loss P_v	-	VA	See Lamps 5TG8
Clearances	Between the terminals	mm	> 7
Minimum contact load	-	V; mA	10; 300
Rated short-time currents Per conducting path at $\cos \phi = 0.7$ (Multiply by the factor 1.5 to obtain the corresponding rated surge current.)	Up to 0.2 s Up to 0.5 s Up to 1 s Up to 3 s	A A A A	650 400 200 170
Connecting terminals Max. tightening torque	\pm screw (Pozidriv)	Nm	PZ1 0.8 ... 1.0
Conductor cross-sections	Rigid Flexible, with end sleeve	mm ² mm ²	1 ... 6 1 ... 6
Permissible ambient temperature	-	°C	-5 ... +40
Resistance to climate At 95% relative humidity	Acc. to DIN 50015	°C	45

Power loss of 5TG805 lamps		5TG8050	5TG8051	5TG8052	5TG8053	5TG8054	5TG8055
Rated operational voltage U_e	V AC	12	24	48	60	115	230
Rated power loss P_v	mW	70	160	350	420	70	170
Rated operational voltage U_e	V DC	12	24	48	60	110	220
Rated power loss P_v	mW	85	190	450	550	50	135

Power loss of 5TG805.-. LEDs	5TG805.-.	
Rated power loss P_v Light-emitting diode	VA	0.4

Color coding according to IEC 60073	Meaning		
Color	Safety of people or environment	Process state	System state
Red	Danger	Emergency	Fault
Yellow	Warning/Caution	Abnormal	-
Green	Safe	Normal	-
Blue	Mandatory intervention required		
White, gray, black	No special significance assigned		

5.3 Dimensional drawings

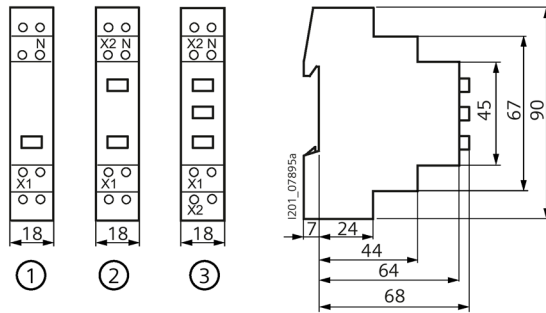

① 5TE5800, 5TE5804

② 5TE5801

③ 5TE5802, 5TE5803

5.4 Circuit diagrams



5TE5800



5TE5801

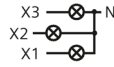

5TE5802, 5TE5803



5TE5804

5TE8 On/Off switches

6.1 Overview

The devices are used for switching of lighting, motors and other electrical devices.

For rated currents of 20 A and 32 A, a compact series in a space-saving design is available with up to 4 NO contacts in one MW. In addition, the 5TE2 device versions can be used as switch disconnectors according to EN 60947-1.

The devices can be used as main control switches for the disconnection or isolation of systems according to EN 60204-1.

6.2 Technical specifications

		5TE81	5TE82
Standards		IEC/EN 60947-3 (VDE 0660-107)	
Approvals		IEC/EN 60947-3 (VDE 0660-107)	
Rated operational current I_e Per conducting path	A	20	32
Rated operational voltage U_e 1-pole Multi-pole	V AC V AC	230 400	
Rated power loss P_v Per pole, max.	VA	0.7	
Thermal rated current I_{th}	A	20	32
Rated breaking capacity At $\cos \phi = 0.65$	A	60	96
Rated breaking capacity At $\cos \phi = 0.65$	A	60	96
Rated short-circuit making capacity I_{cm} In conjunction with fuse of the same rated operational current EN 60269 gL/gG	kA	10	
Rated impulse withstand voltage U_{imp}	kV	> 5	
Clearances Open contacts Between the poles	mm mm	2 x > 2 > 7	
Creepage distances	mm	> 7	
Mechanical endurance Switching cycles		25000	
Electrical endurance Switching cycles		10000	
Minimum contact load	V; mA	10; 300	
Rated short-time withstand current I_{cw} Per conducting path at $\cos \phi = 0.7$ (Multiply by the factor 1.5 to obtain the corresponding rated surge current.) Up to 0.2 s Up to 0.5 s Up to 1 s Up to 3 s	A A A A	650 400 290 170	1000 630 450 250
Connecting terminals ± screw (Pozidriv) Max. tightening torque	Nm	PZ1 0.8 ... 1.0	

		5TE81	5TE82
Conductor cross-sections			
Rigid	mm ²	1 ... 6	
Flexible, with end sleeve	mm ²	1 ... 6	
Permissible ambient temperature	°C	-5 ... +40	
Resistance to climate			
At 95% relative humidity	°C	45	
Acc. to DIN 50015			

6.3 Dimensional drawings

5ST3 auxiliary switches

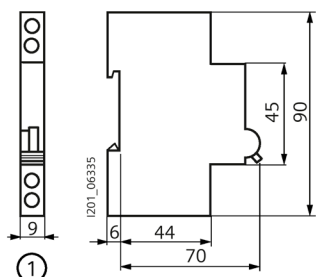

① 5ST3010, 5ST3011, 5ST3012

6.4 Circuit diagrams

5TE8 On/Off switches



5TE8111

5TE8211



5TE8112

5TE8212

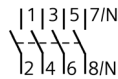

5TE8114

5TE8212

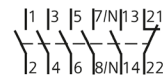

5TE8118

5TE8218

5ST3 auxiliary switches



5ST3010



5ST3011



5ST3012

5TL1 On/Off switches

7.1 Overview

The new 5TL1 On/Off switches are used for switching of lighting, motors and other electrical devices. The rated currents range from 32 A to 125 A. Thanks to its new design, the 5TL1 On/Off switch can be optically integrated perfectly into the range of residual current operated circuit breakers and miniature circuit breakers.

The 5TL1 device versions can also be used as switch disconnectors in accordance with EN 60947-1. The devices may be used as main switches in accordance with EN 60204-1 for disconnecting or isolating systems.

7.2 Technical specifications

		5TL1132	5TL1140	5TL1163	5TL1180	5TL1191	5TL1192
		5TL1232	5TL1240	STL1263	5TL1280	5TL1291	5TL1292
		5TL1332	5TL1340	STL1363	5TL1380	5TL1391	5TL1392
		5TL1432	5TL1440	STL1463	5TL1480	5TL1491	5TL1492
		5TL1630	5TL1640	STL1663	5TL1680	5TL1691	5TL1692
Standards		IEC/EN 60947-3 (VDE 0660-107)					
Rated operational current I_e Per conducting path	A	32	40	63	80	100	125
Rated operational voltage U_e 1-pole	V AC	250					
Multi-pole	V AC	440					
Rated power loss P_v Per pole, max.	VA	0.7	0.9	2.2	3.5	5.5	8.6
Thermal rated current I_{th}	A	32	40	63	80	100	125
Rated breaking capacity AC-22A At $\cos \phi = 0.65$	A	96	120	196	240	300	375
Rated breaking capacity AC-22A At $\cos \phi = 0.65$	A	96	120	196	240	300	375
Rated short-circuit making capacity I_{cm} In conjunction with fuse of the same rated operational current - EN 60269 gL/gG	kA	10					
Rated impulse withstand voltage U_{imp}	kV	6					
Clearances Open contacts	mm	> 7					
Between the poles	mm	> 7					
Creepage distances	mm	> 7					
Mechanical endurance Switching cycles		20000					
Electrical endurance Switching cycles		10000		5000	1000		
Minimum contact load	V; mA	24; 300					
Rated short-time withstand current I_{cw}							
Per conducting path at $\cos \phi = 0.7$ (Multiply by the factor 1.5 to obtain the corresponding rated surge current.)							
Up to 0.2 s	A	760	950	1500	2700	3400	3400
Up to 0.5 s	A	500	630	1000	1650	2100	2100
Up to 1 s	A	400	500	800	1350	1700	1700
Up to 3 s	A	280	350	560	800	1000	1000

		5TL1132	5TL1140	5TL1163	5TL1180	5TL1191	5TL1192
		5TL1232	5TL1240	5TL1263	5TL1280	5TL1291	5TL1292
		5TL1332	5TL1340	5TL1363	5TL1380	5TL1391	5TL1392
		5TL1432	5TL1440	5TL1463	5TL1480	5TL1491	5TL1492
		5TL1630	5TL1640	5TL1663	5TL1680	5TL1691	5TL1692
Connecting terminals ± screw (Pozidriv) Max. tightening torque	Nm	PZ2 3.5					
Conductor cross-sections Rigid Flexible, with end sleeve	mm ² mm ²	1 ... 35			2.5 ... 50		
Permissible ambient temperature	°C	-5 ... +40					
Resistance to climate At 95% relative humidity Acc. to DIN 50015	°C	45					

7.3 Dimensional drawings

5TL1 On/Off switches, 32 A to 125 A

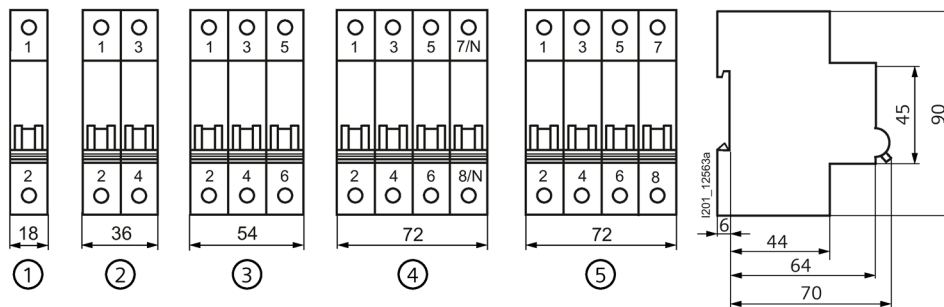

- ① 5TL1163-1, 5TL1191-1, 5TL1132-0, 5TL1140-0
5TL1163-0, 5TL1180-0, 5TL1191-0, 5TL1192-0
- ② 5TL1263-1, 5TL1291-1, 5TL1232-0, 5TL1240-0
5TL1263-0, 5TL1280-0, 5TL1291-0, 5TL1292-0
- ③ 5TL1363-1, 5TL1391-1, 5TL1332-0, 5TL1340-0
5TL1363-0, 5TL1380-0, 5TL1391-0, 5TL1392-0
- ④ 5TL1663-1, 5TL1691-1, 5TL1632-0, 5 TL1640-0
5TL1663-0, 5TL1680-0, 5TL1691-0, 5TL1692-0
- ⑤ 5TL1432-0, 5TL1140-0, 5TL1463-0, 5TL1480-0
5TL1491-0, 5TL1492-0

5ST3 auxiliary switches

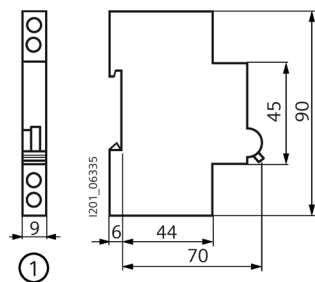

- ① 5ST3010, 5ST3011, 5ST3012, 5ST3013, 5ST3014, 5ST3015

Phase connector/N-conductor connector

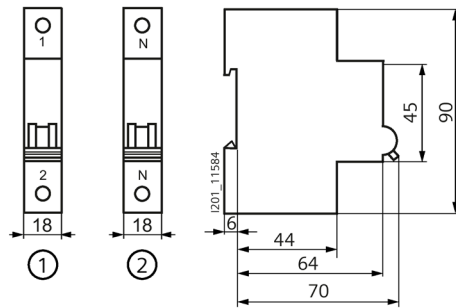

- ① 5TL1192-4
- ② 5TL1192-3

7.4 Circuit diagrams

5TL1 On/Off switches



5TL1163-1
5TL1191-1
5TL1132-0
5TL1140-0



5TL1263-1
5TL1291-1
5TL1232-0
5TL1240-0



5TL1363-1
5TL1391-1
5TL1392-0
5TL1340-0

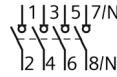

5TL1663-1
5TL1691-1
5TL1632-0
5TL1640-0



5TL1432-0
5TL1140-0
5TL1463-0
5TL1480-0

5TL1163-0
5TL1180-0
5TL1191-0
5TL1192-0

5TL1263-0
5TL1280-0
5TL1291-0
5TL1292-0

5TL1363-0
5TL1380-0
5TL1391-0
5TL1392-0

5TL1663-0
5TL1680-0
5TL1691-0
5TL1692-0

5TL1491-0
5TL1492-0

5ST3 auxiliary switches



5ST3010
5ST3013



5ST3011
5ST3014



5ST3012
5ST3015

5TE25 DC safety disconnectors

8.1 Overview

- Compact DIN rail device for applications up to 1000 V DC
- Separate switching position indicator for unambiguous indication of the switching state
- Compatible with all miniature circuit breaker accessories – reduced stock-keeping
- The effective touch protection when grasping the device considerably exceeds the requirements of BGV A3
- Manual snap-on fixing and release systems that require no tools enable fast assembly and disassembly of switch disconnectors
- Clear and visible conductor connection that can be easily checked in front of the busbar

8.2 Technical specifications

5TE2515-1		
Standards	IEC/EN 60947-3, GB14048.3-2017 (CCC)	
Rated operational current I_e	A	63
Rated operational voltage U_e For 4 poles in series	V DC	880
Rated power loss P_v Per pole, max.	W	4.4
Rated short-time withstand current I_{cw} 1000 V DC, 4-pole	A	700
Rated impulse withstand voltage U_{imp}	kV	> 4
Maximum operational voltage U_{max}	V DC	1000
Overvoltage category	-	II at U = 880 V ... 440 V I at U = 1000 V
Mechanical endurance	Switching cycles	10000
Electrical endurance	Switching cycles	5000
Utilization category	-	DC-21B
Minimum contact load	V; mA	24; 300
Connecting terminals Max. tightening torque \pm screw (Pozidriv)	Nm	PZ 2 2.5 ... 3
Conductor cross-sections Rigid Flexible, with end sleeve	mm ² mm ²	0.75 ... 35 0.75 ... 25
Permissible ambient temperature	°C	-25 ... +45
Resistance to climate At 95% relative humidity Acc. to DIN 50015	°C	45

8.3 Dimensional drawings

5TE2 DC safety disconnectors

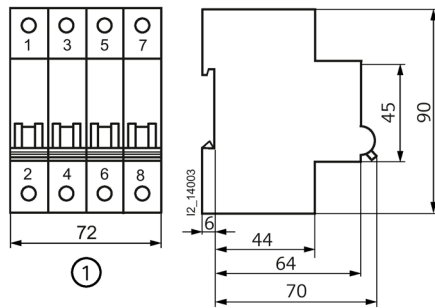

① 5TE2515-1

5ST3 auxiliary switches

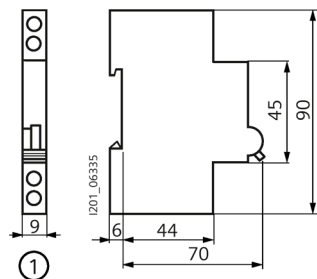

① 5ST3010, 5ST3011, 5ST3012

8.4 Circuit diagrams

5TE2 DC safety disconnectors



5TE2515-1

5ST3 auxiliary switches



5ST3010



5ST3011



5ST3012

8.5 Configuration

For DC voltages up to 1000 V, the four poles need to be connected in series. In contrast to normal flush-mounting switches, these devices are also fitted with arcing chambers and permanent solenoids to aid the positive quenching of the electric arc in direct currents.

For this reason it is essential to comply with the polarity specifications of the switches when connecting the conductors. Suitable precautions should be taken during system configuration to ensure there can be no polarity reversal in DC operation.

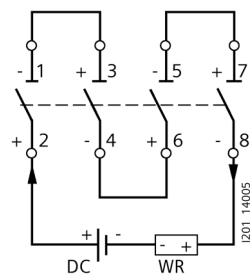

WR: Wechselrichter

INV Inverter

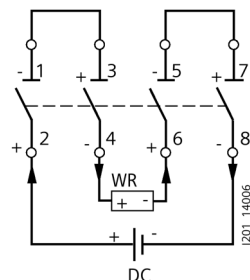

WR: Wechselrichter

INV Inverter

5ST busbars for modular installation devices

9.1 Overview

Siemens has developed a rail-mounting concept which makes the linking of switching devices just as easy as that of miniature circuit breakers.

The arrangement of the terminals on the devices is adapted to the bus mounting. With only two busbars, this saves considerable mounting time.

9.2 Dimensional drawings

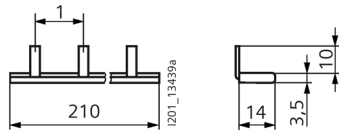

Figure 9-1 5TE9100

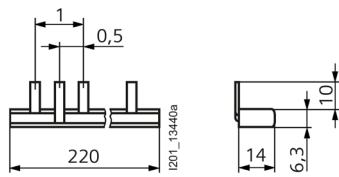

Figure 9-2 5TE9101

Note

Pin spacing in MW, dimensions in the print views are rounded in mm.

5TT4 remote control switches

10.1 Overview

Remote control switches are used in residential and non-residential buildings, as well as in power distribution systems. They trip in the event of "current inrushes", i.e. pulses, and then electromechanically save the switching position, even in the event of a power failure.

All the devices have the VDE mark and can also be equipped with an additional auxiliary switch. All devices have a switching position indicator and are operated manually. The switching noise is particularly quiet and meets the requirements of residential buildings.

Note

Busbars to match the 5TT41 remote control switches can be found in chapter 5ST busbars for modular installation devices (Page 55).

10.2 Technical specifications

		5TT41 remote control switches up to 16 A				Auxiliary switches for 5TT41	
		5TT4101 5TT4102 5TT4105 5TT4111 5TT4112 5TT4114 5TT4115	5TT4103 5TT4104	5TT412 5TT415	5TT413 5TT414	5TT4900	5TT4901
Standards		IEC 60669-1, IEC 60669-2, IEC 60669-3 EN 60669 (VDE 0632), EN 60669-2-2 EN 60669-2-2/A1				EN 60947-1 (VDE 0660 Part 100) EN 60947-5-1 (VDE 0660 Part 200)	
Approvals		VDE					
Contact types		1 NO 2 NO 1 NO 1 NC	3 NO 4 NO	1 NO 2 NO 3 NO 1 NO 1 NC	Series Shutter/blind	1 CO	1 CO
Manual operation		Yes				-	
Switch position indicator		Yes			-		
Rated control voltage U_c	V AC	8 ... 230				-	
	V DC	12 ... 110				-	
Operating range	x U_c	0.8 ... 1.1				-	
Rated frequency f_c (AC types)	Hz	50				-	
Rated impulse withstand voltage U_{imp}	kV	4				1	
Rated power loss P_v	W	-					
Solenoid coil, only pulse at 16 A	W/VA	4.5 / 7	9 / 13	4.5 / 7		-	
Per contact at 16 A	W	1.2				-	
Minimum contact load	V; mA	10; AC 100					AC / DC 5;1
Rated operational current I_e At $\cos \phi = 0.6 \dots 1$	A	16				5	0.1
Rated operational voltage U_e							
1 NO	V AC	250	-	250	-	250	30 AC / DC
2 NO	V AC	400	-	400	250	-	-
3 NO	V AC	-	400	400	-	-	-
4 NO	V AC	400	400	-	-	-	-
1 NO + 1 NC	V AC	250	-	250	-	-	-

		5TT41 remote control switches up to 16 A				Auxiliary switches for 5TT41	
		5TT4101 5TT4102 5TT4105 5TT4111 5TT4112 5TT4114 5TT4115	5TT4103 5TT4104	5TT412 5TT415	5TT413 5TT414	5TT4900	5TT4901
Orientation lamp load	mA	5				-	
At 230 V							
With 1x 5TT4 920 compensator	mA	25				-	
With 2x 5TT4 920 compensators	mA	45				-	
Incandescent lamp load¹⁾	W	1200				-	
At AC-5b (230V) switching of incandescent lamps							
LED lamp load	-	Limited to typical domestic application				-	
Different phases	-	Permissible				-	
Between solenoid coil and contact							
Rated operational power (AC-3)	kw						
1-phase, up to 230 V		n.a.				n.a.	
3-phase, at 230 V		n.a.				n.a.	
3-phase, at 400 V		n.a.				n.a.	
Contact gap	mm	> 1.2				> 1.2	
Protective separation	mm	> 6					
Creepage distances and clearances between solenoid coil/contact							
Pushbutton malfunction		Yes	PTC	Yes ²⁾	Yes	Yes	Yes
Safeguard against continuous voltage, safe by design							
Minimum pulse duration	ms	50					
Max. operating speed	h ⁻¹	450 cycles/h					
In operating cycles per hour							
Electrical endurance		50000				-	
At I_e/U_e , $\cos \phi = 0.6$; incandescent lamp load 600 W (operating cycles)							
Connecting terminals		PZ1					
\pm screw (Pozidriv)							
Torque	Nm	0.8 ... 1.0				Max. 0.5	
Conductor cross-sections							
Rigid	mm ²	1 ... 6			0.5 ... 2.5		
Flexible, with end sleeve	mm ²	1 ... 6			0.5 ... 2.5		

		5TT41 remote control switches up to 16 A				Auxiliary switches for 5TT41	
		5TT4101 5TT4102 5TT4105 5TT4111 5TT4112 5TT4114 5TT4115	5TT4103 5TT4104	5TT412 5TT415	5TT413 5TT414	5TT4900	5TT4901
Permissible ambient temperature	°C	-10 ... +40					
Resistance to climate At 95% relative air humidity according to DIN 50015	°C	35					
Degree of protection Acc. to EN 60529		IP20 with connected conductors					
Mounting position		Any					

1) For 15000 switching cycles

2) For 2.5 MW 5TT4123-0 devices with PTC

		5TT44 remote control switches From 20 to 63 A	Auxiliary switches for 5TT44		
			5TT4930	5TT4931	5TT4932
Standards		IEC/EN 60669-2-2, (up to 32 A) EN IEC 60947-4-1 (40 ... 63 A)	IEC/EN 60947-5-1		
Approvals		CE, CCC (only 20 A, 25 A)	CE, EAC		
Contact types		2 NO 4 NO 1 NO + 1 NC 2 NO + 2 NC 1 CO 2 CO	1 NO + 1 NC	Central	Group
Manual operation		Yes	No		
Switch position indicator		Yes	No		
Rated control voltage U_c	V AC	230, 24	250		
	V DC	24	-		
Operating range	x U_c	0.85 ... 1.1	n.a.		
Rated frequency f_c (AC types)	Hz	50 / 60	50 / 60		
Rated impulse withstand voltage U_{imp}	kV	3	1		
Rated power loss P_v	W	-	0.3 per pole		
Solenoid coil, only pulse at 16 A	W / VA	-	-	-	-
Solenoid coil, for pulse "on" at 20...25 A		13 / 18; DC: 9 / 9	-	-	-
Solenoid coil, for pulse "on" at 40...63 A		12 / 26	-	-	-
Per contact at 16 A	W	-	-	-	-
Per contact at 20 A		1.5	-	-	-
Per contact at 25 A		2	-	-	-
Per contact at 32 A		3	-	-	-
Per contact at 40 A		3	-	-	-
Per contact at 63 A		3.5	-	-	-
Minimum contact load	V; mA	AC 10; 100	12; 5	-	-
Rated operational current I_e At $\cos \phi = 0.6 \dots 1$	A	5TT440.../41...: 20 5TT442.../43...: 25 5TT445...: 32 5TT446...: 40 5TT447...: 63	4	-	-
Rated operational voltage U_e 1 NO 2 NO 3 NO 4 NO 1 NO + 1 NC	V AC	-	-	250	250
	V AC	440	-		
	V AC	440	-		
	V AC	440	-		
	V AC	440	250		

		5TT44 remote control	Auxiliary switches for 5TT44	
Incandescent lamp load at 230 V With 1x 5TT4 920 compensator With 2x 5TT4 920 compensators	mA	-	-	-
	mA	-	-	-
	mA	-	-	-
Incandescent lamp load At AC-5b (230V) switching of incandescent lamps For 15000 position changes	W	5TT440.../41...: 4400 5TT442.../43...: 5500 5TT445...: 7000 5TT446...: 8800 5TT447...: 13800	-	
Rated operational power (AC-3)				
1-phase, at 230 V	kW	5TT440.../41...: 0.5 5TT442.../43...: 0.75 5TT445...: 1.1 5TT446...: 2.2 5TT447...: 4	-	
3-phase, at 230 V	KW	5TT440.../41...: 1.5 5TT442.../43...: 2.2 5TT445...: 3 5TT446...: 5.5 5TT447...: 11	-	
3-phase, at 400 V	kW	5TT440.../41...: 3 5TT442.../43...: 4 5TT445...: 5.5 5TT446...: 11 5TT447...: 18.5	-	
Different phases Between solenoid coil and contact		Permissible	-	
Contact gap	mm	> 3		
Protective separation Creepage distances and clearances between solenoid coil/contact	mm	> 6	-	
Pushbutton malfunction Fused against continuous voltage		Yes	-	
Minimum pulse duration	ms	50	-	
Max. operating speed In operating cycles per hour	h ⁻¹	5TT440.../41...: 600 5TT442.../43...: 450 5TT445.../43...: 450 5TT446...: 360 5TT447...: 360	-	
Electrical endurance At I _e / U _e , cos φ = 0.6; incandescent lamp load 600 W (operating cycles)		50000	100000	-
Connecting terminals Max. tightening torque ± screw (Pozidriv)		Coil: 1 Contact: 2	1	

		5TT44 remote control	Auxiliary switches for 5TT44
Torque	Nm	See conductor cross-sections	0.8
Conductor cross-sections Rigid	mm ²	Coil: 1 ... 4 Torque: 0.6 Nm Contacts: 20 ... 32 A: 1 ... 10, Torque: 1.2 Nm 40 ... 63 A: 2.5 ... 25, Tightening torque: 2.0 Nm	1 ... 4
Flexible, with end sleeve	mm ²	Coil: 1 ... 4, Torque: 0.6 Nm Contacts: 20 ... 32 A: 1 ... 10 Torque: 1.2 Nm 40 ... 63 A: 2.5 ... 25 Torque: 2.0 Nm	1 ... 4
Resistance to climate At 95% relative air humidity according to DIN 50015	°C	55	55
Permissible ambient temperature Storage temperature Operating temperature	°C	-30 ... +80 -25 ... +55	-30 ... +80 -25 ... +70
Degree of protection Acc. to EN 60529		IP20	
Mounting position		Any (not overhead)	

¹⁾ For 2.5 MW devices 5TT4123-0 with PTC

10.3 Dimensional drawings

5TT41 remote control switches

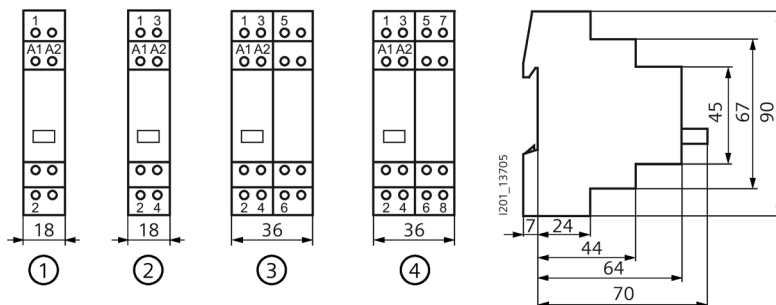

- ① 5TT4101, 5TT4111
- ② 5TT4102, 5TT4105, 5TT4112, 5TT4115
- ③ 5TT4103
- ④ 5TT4104, 5TT4114

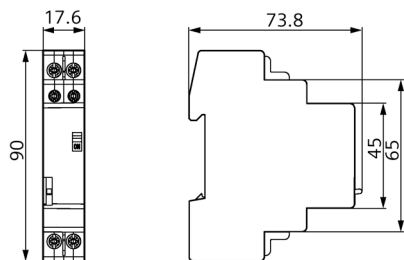

5TT4402-0, 5TT4402-2, 5TT4405-0, 5TT4405-2, 5TT4407-0, 5TT4407-2, 5TT4425-0, 5TT4425-2
 5TT4412-5, 5TT4422-0, 5TT4422-2, 5TT4432-5, 5TT4452-0, 5TT4452-2, 5TT4452-5, 5TT4415-5
 5TT4435-5, 5TT4455-5, 5TT4417-5, 5TT4437-5, 5TT4457-5, 5TT4411-5, 5TT4431-5, 5TT4451-5

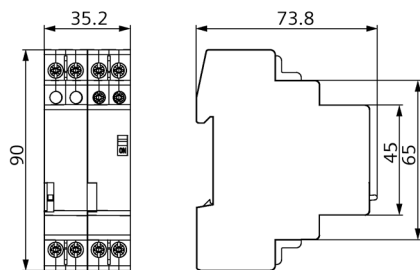

5TT4428-0, 5TT4428-2, 5TT4424-0, 5TT4424-2, 5TT4426-0, 5TT4426-2, 5TT4458-0, 5TT4458-2
 5TT4454-0, 5TT4454-2, 5TT4456-0, 5TT4456-2, 5TT4462-0, 5TT4462-2, 5TT4465-0, 5TT4465-2
 5TT4468-0, 5TT4468-2, 5TT4472-0, 5TT4472-2, 5TT4475-0, 5TT4475-2, 5TT4478-0, 5TT4478-2

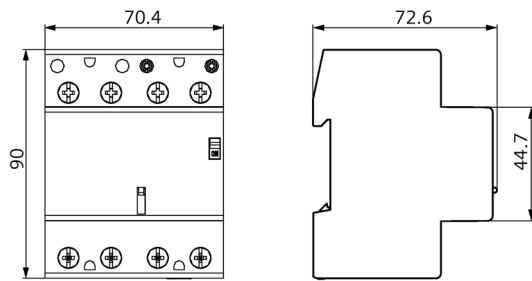

5TT4464-0, 5TT4464-2, 5TT4468-0, 5TT4468-2, 5TT4466-0
5TT4466-2, 5TT4474-0, 5TT4474-2, 5TT4476-0, 5TT4476-2

5TT412 remote control switches with central ON/OFF switching

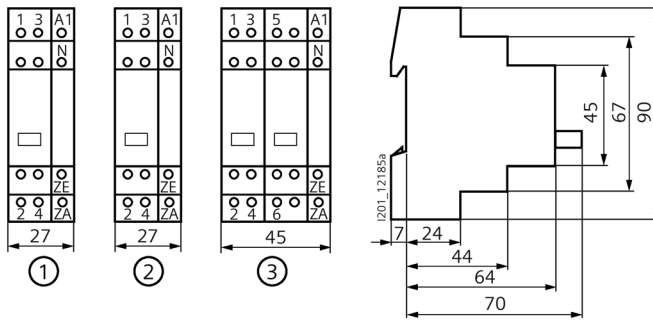

① 5TT5121-0, 5TT4121-2
② 5TT4122-0, 5TT4122-2, 5TT4125-0
① 5TT4123-0

5TT4132-0 series remote control switches and 5TT4142 shutter remote control switches

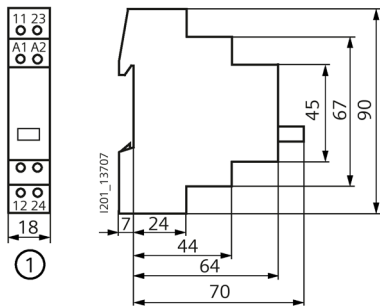

① 5TT4132, 5TT4142

Remote control switches with central and multiple series ON/OFF switching

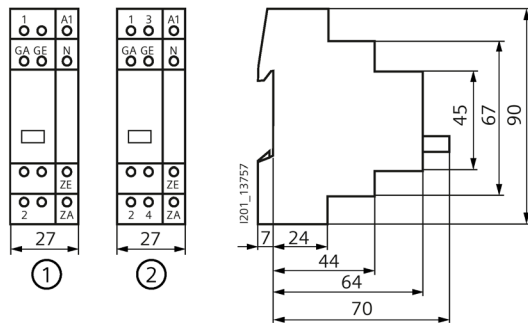

- ① 5TT4151
- ② 5TT4152

Auxiliary switches

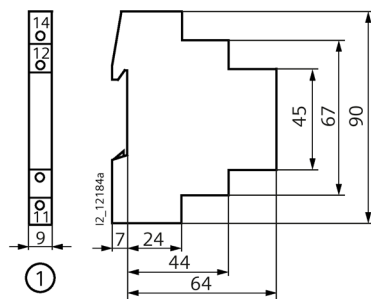

- ① 5TT49..

Compensator

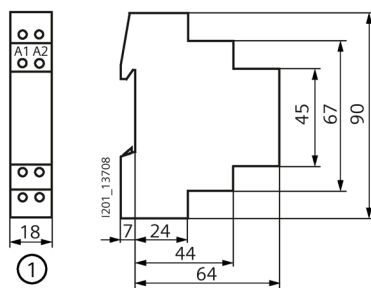

- ① 5TT4920

10.4 Circuit diagrams

Graphic symbols



5TT4101
5TT4111
5TT4411
5TT4431
5TT4451



5TT4102
5TT4112
5TT4402
5TT4422
5TT4452
5TT4462
5TT4472
5TT4412
5TT4432
5TT4452

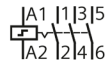

5TT4103

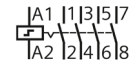

5TT4104
5TT4114
5TT4424
5TT4454
5TT4464
5TT4474

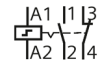

5TT4105
5TT4115
5TT4405
5TT4425
5TT4455
5TT4465
5TT4475

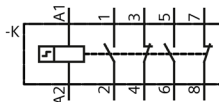

5TT4426-0
5TT4426-2
5TT4456-0
5TT4456-2
5TT4466-0
5TT4466-2
5TT4476-0

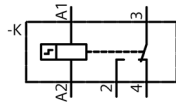

5TT4407-0
5TT4407-2
5TT4417-5
5TT4437-5
5TT4457-5

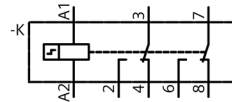

5TT4428-0
5TT4428-2
5TT4458-0
5TT4458-2
5TT4468-0
5TT4468-2
5TT4478-0
5TT4478-2



5TT4121-0
5TT4121-2

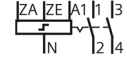

5TT4122-0
5TT4122-2

10.4 Circuit diagrams



5TT4123-0

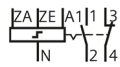

5TT4125-0

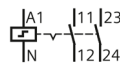

5TT4132
5TT4142



5TT4151

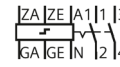

5TT4152



5TT490.



5TT4920

10.5 More information

Mechanical storage

Remote control switches are used to switch lighting through the use of several pushbuttons. This makes complex cross/two-way switching unnecessary. With each pushbutton pulse, the remote control switch changes its contact position from "OFF" to "ON", etc. In the event of a power failure, the last switching position is mechanically stored. Electromechanical remote control switches have no standby loss.

Pushbutton malfunction

Pushbuttons can jam, in which case they apply continuous voltage to the remote control switch. To prevent such malfunctions, the design of all remote control switches is such that they are protected by the design or by PTC resistors.

Central switching functions

Versions with central On/Off function allow the central switching of all connected remote control switches. This type of central switching can also be actuated using a time switch. All remote control switches can be switched to the ON or OFF switching state, regardless of their current switching state.

Contact sequences

1 – 2 – 1+2 – 0 or 1 – 0 – 2 – 0 means:

0: No contacts closed

1: Only contact 1 closed

2: Only contact 2 closed

1+2: Contact 1 and contact 2 are closed

The contact positions change continuously with each pushbutton pulse.

Note:

In parallel connections, it is not ensured that the contacts change positions synchronously. Products with central/group switching must be used for the mutual control of several remote control switches.

Bus mounting

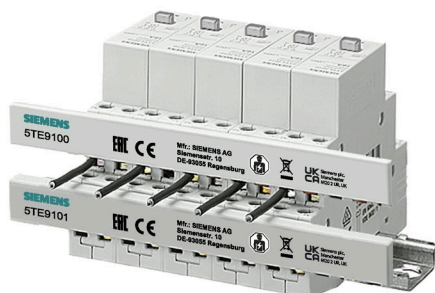

- All 5TT41 remote control switches can be bus-mounted with each other. This saves time and space.

Note

Busbars to match the 5TT41 remote control switches can be found in chapter Busbars for modular installation devices (Page 55).

10.6 Typical circuits

Typical circuit for 5TT4101-0

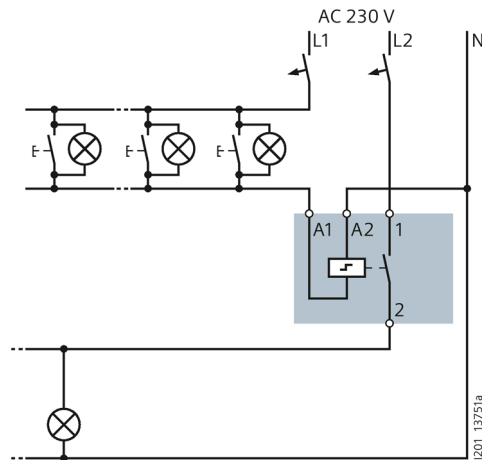

Figure 10-1 1-phase lighting connection with 230 V AC actuation, e.g. in office block

Typical circuit for 5TT4122-0 with central ON/OFF switching

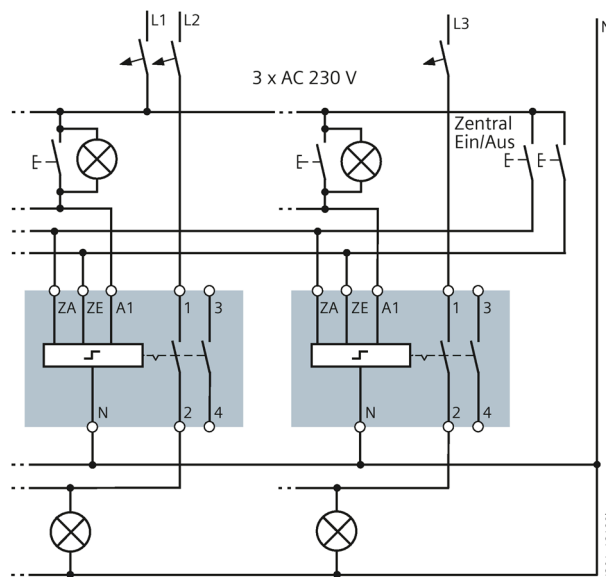

Figure 10-2 Typical circuit for 5TT4122-0 with central ON/OFF switching

10.6 Typical circuits

With the 2 pushbuttons central "ON" and "OFF", all remote control switches can be switched on or off from a central point, e.g. at the start and end of operation. A time switch with a one-second pulse (e.g. 7LF4444-0) can also be used if desired. Once a central on/off switching operation has been executed, the remote control switches can also be switched on and off locally at any time. Remote control switches with central ON/OFF switching can also be used to quickly and easily set up a panic circuit/panic lighting using conventional installation methods.

Typical circuit for 5TT4101-4

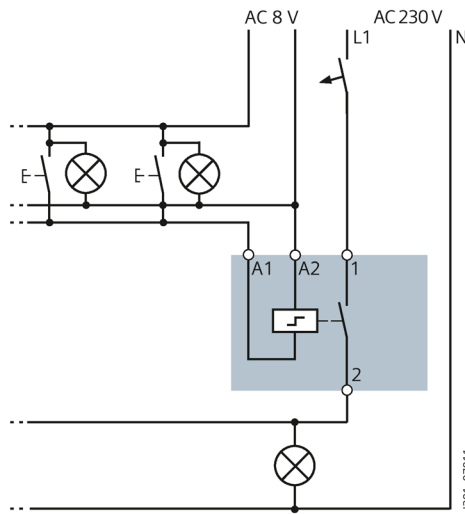

Figure 10-3 1-phase lighting circuit with safety extra-low voltage 8 V AC, illuminated pushbutton

Typical circuit for 5TT4121-0 with central ON/OFF switching and time switch

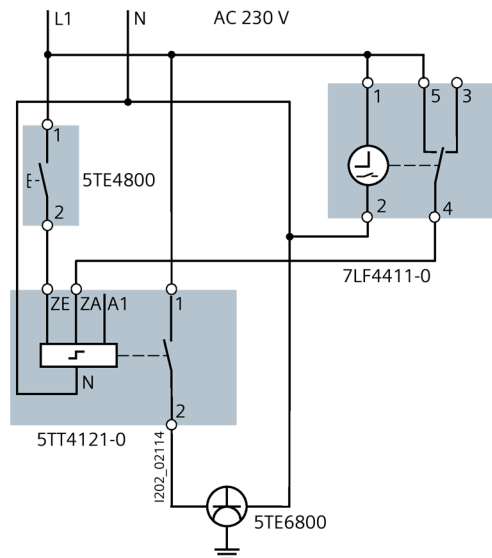

Figure 10-4 Typical circuit for 5TT4121-0 with central ON/OFF switching and time switch

Typical circuit: 5TT4920 orientation lamps and compensator

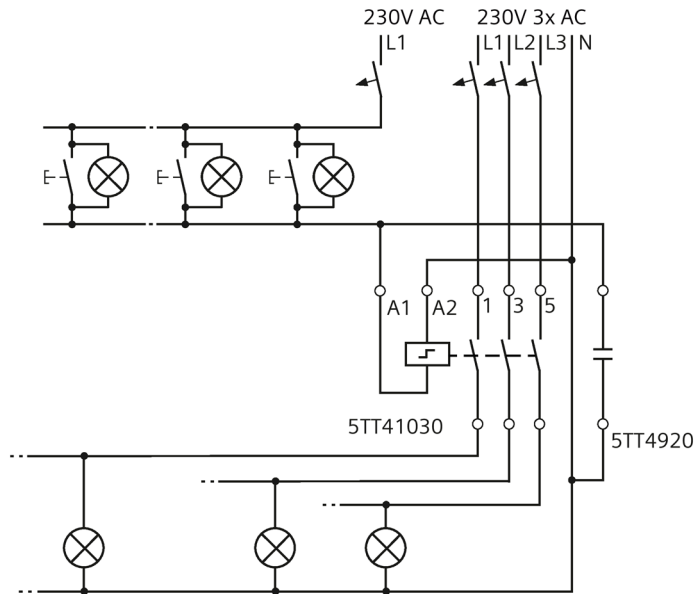

Figure 10-6 Typical circuit: 5TT4920 orientation lamps and compensator

When several illuminated pushbuttons are used, the current of the orientation lamps used, would cause remote control switches to be activated or no longer drop out when not wanted, especially at 230 V AC. This may also occur with high cable capacitance. Connecting a 5TT4920 compensator in parallel to the coil increases the glow lamp load of the remote control switch from 5 mA to 25 mA. Several compensators can be connected in parallel. The current consumption of 5TG8058-x 230 V LED inserts is 1.1 mA.

To reduce capacitive coupling due to long cable lengths, we recommend using shielded cables. In particular in systems with motors controlled by frequency converters or where cables are routed in parallel (e.g. cable tray systems), the induced current can impair the function of the devices.

10.7 Switching of lamps

			Remote control switches			
			5TT4101 5TT4102 5TT4105 5TT4115	5TT4103 5TT4104	5TT412 5TT415	5TT413 5TT414
Switching of transformers for halogen lamps	W		1200			
Fluorescent and compact lamps in ballast operation (CCG)						
Uncompensated	L18W	Units	35	30		
	L36W	Units	35	30		
	L58W	Units	25	20		
Parallel-compensated	L18W / 4.5 μ F	Units	40	50		
	L36W / 4.5 μ F	Units	40	50		
	L58W / 7 μ F	Units	28	30		
DUO connection, 2 lamps	L18W	Units	2 x 30	2 x 24		
	L36W	Units	2 x 30	2 x 24		
	L58W	Units	2 x 30	2 x 16		
Fluorescent and compact lamps with electronic ballast (ECG)						
AC operation, 1 lamp	L18W	Units	36	30		
	L36W	Units	36	30		
	L58W	Units	24	20		
AC operation, 2 lamps	L18W / 4.5 μ F	Units	2 x 22	2 x 18		
	L36W / 4.5 μ F	Units	2 x 22	2 x 18		
	L58W / 7 μ F	Units	2 x 15	2 x 12		
LED lamp load	-		Limited to typical domestic application			

For higher lamp loads, use 5TT44..- remote control switches.

The specified values are intended to serve as a guideline only. The max. number of light sources can vary depending on the manufacturer. The values specified here refer to Osram light sources and ballasts.

10.7 Switching of lamps

Table 10- 1 Incandescent lamps and halogen incandescent lamps

Incandescent lamps and halogen incandescent lamps								
Type	Power	Current	Capacitor	Maximum number of lamps per current path at 230 V, 50 Hz				
	P W	I A	C μF	5TT4 40x-x / 41x-x 20 A	5TT4 42x / 43x-x 25 A	5TT4 44x-x / 45x-x 32 A	5TT4 46x-x 40 A	5TT4 47x-x 63 A
	11	0.05	-	182	227	318	500	636
	15	0.07	-	183	167	233	367	467
	18	0.08	-	111	139	194	306	389
	20	0.09	-	100	125	175	275	350
	25	0.11	-	80	100	140	220	280
	28	0.12	-	71	89	125	196	250
	30	0.13	-	67	83	117	183	233
	33	0.14	-	61	76	106	167	212
	35	0.15	-	57	71	100	157	200
	40	0.17	-	50	63	88	138	175
	42	0.18	-	48	60	83	131	167
	46	0.2	-	43	54	76	120	152
	48	0.21	-	42	52	73	115	146
	50	0.22	-	40	50	70	110	140
	53	0.23	-	38	47	66	104	132
	57	0.25	-	35	44	61	96	123
	60	0.26	-	33	42	58	92	117
	70	0.3	-	29	36	50	79	100
	75	0.33	-	27	33	47	73	93
	77	0.34	-	26	32	45	71	91
	80	0.35	-	25	31	44	69	88
	100	0.44	-	20	25	35	55	70
	116	0.5	-	17	22	30	47	60
	120	0.52	-	17	21	29	46	58
	150	0.65	-	13	17	23	37	47
	160	0.7	-	13	16	22	34	44
	200	0.87	-	10	13	18	28	35
	205	0.89	-	10	12	17	27	34
	230	1	-	9	11	15	24	30
	300	1.3	-	7	8	12	18	23
	400	1.74	-	5	6	9	14	18
	500	2.17	-	4	5	7	11	14
	750	3.26	-	3	3	5	7	9
	1000	4.35	-	2	3	4	6	7
	1500	6.52	-	1	2	2	4	5
	2000	8.7	-	1	1	2	3	4

Table 10- 2 Transformers for low-voltage halogen incandescent lamps (electromagnetic and electronic)

Transformers for low-voltage halogen incandescent lamps (electromagnetic and electronic)								
Type	Power	Current	Capacitor	Maximum number of lamps per current path at 230 V, 50 Hz				
	P W	I A	C μF	5TT4 40x-x / 41x-x 20 A	5TT4 42x / 43x-x 25 A	5TT4 44x-x / 45x-x 32 A	5TT4 46x-x 40 A	5TT4 47x-x 63 A
	10	0.04	-	100	200	300	350	500
	20	0.09	-	75	100	150	175	250
	30	0.13	-	50	67	100	117	167
	40	0.17	-	38	50	75	88	125
	50	0.22	-	30	40	60	70	100
	60	0.26	-	25	33	50	58	83
	70	0.3	-	21	29	43	50	71
	80	0.35	-	19	25	38	44	63
	90	0.39	-	17	22	33	39	56
	100	0.44	-	15	20	30	35	50
	150	0.65	-	10	13	20	23	33
	200	0.87	-	8	10	15	18	25
	300	1.3	-	5	7	10	17	17
	400	1.74	-	4	5	8	9	13

10.7 Switching of lamps

Table 10-3 Compact fluorescent lamps with integrated ballasts

Compact fluorescent lamps with integrated ballasts								
Type	Power	Current	Capacitor	Maximum number of lamps per current path at 230 V, 50 Hz				
	P W	I A	C μF	5TT4 40x-x / 41x-x 20 A	5TT4 42x / 43x-x 25 A	5TT4 44x-x / 45x-x 32 A	5TT4 46x-x 40 A	5TT4 47x-x 63 A
	3	0.04	-	167	250	333	550	700
	5	0.06	-	100	150	200	330	420
	6	0.07	-	83	125	167	275	350
	7	0.08	-	71	107	143	236	300
	8	0.09	-	63	94	125	206	263
	9	0.1	-	56	83	111	183	233
	10	0.11	-	50	75	100	165	210
	11	0.12	-	45	68	91	150	191
	12	0.13	-	42	63	83	138	175
	13	0.14	-	38	58	77	127	162
	14	0.15	-	36	54	71	118	150
	15	0.16	-	33	50	67	110	140
	16	0.18	-	31	47	63	103	131
	17	0.19	-	29	44	59	97	124
	18	0.2	-	28	42	56	92	117
	20	0.21	-	25	38	50	83	105
	21	0.22	-	24	36	48	79	100
	22	0.23	-	23	34	45	75	95
	23	0.24	-	22	33	43	72	91
	24	0.25	-	21	31	42	69	88
	25	0.26	-	20	30	40	66	84
	26	0.27	-	19	29	38	63	81
	27	0.124	-	19	28	37	61	78
	30	0.15	-	17	25	33	55	70
	33	0.155	-	15	23	30	50	64
	35	0.164	-	14	21	29	47	60
	40	0.2	-	13	19	25	41	53
	50	0.24	-	10	15	20	33	42
	70	0.312	-	7	11	14	24	30

Table 10- 4 Compact fluorescent lamps with external electromagnetic ballasts - uncompensated

Compact fluorescent lamps with external electromagnetic ballasts - uncompensated								
Type	Power	Current	Capacitor	Maximum number of lamps per current path at 230 V, 50 Hz				
	P W	I A	C μF	5TT4 40x-x / 41x-x 20 A	5TT4 42x / 43x-x 25 A	5TT4 44x-x / 45x-x 32 A	5TT4 46x-x 40 A	5TT4 47x-x 63 A
	5	0.05		120	180	240	400	500
	2x5	0.07	-	86	129	171	286	357
	7	0.05	-	120	180	240	400	500
	2x7	0.07	-	86	129	171	286	357
	9	0.06	-	100	150	200	333	417
	2x9	0.08	-	75	113	150	250	313
	10	0.07	-	86	129	171	286	357
	11	0.08	-	75	113	150	250	313
	13	0.08	-	75	113	150	250	313
	16	0.1	-	60	90	120	200	250
	18	0.12	-	50	75	100	167	208
	2x18	0.21	-	29	43	57	95	119
	21	0.12	-	50	75	100	167	208
	22	0.2	-	30	45	60	100	125
	24	0.15	-	40	60	80	133	167
	26	0.15	-	40	60	80	133	167
	28	0.15	-	40	60	80	133	167
	32	0.22	-	27	41	55	91	114
	36	0.21	-	29	43	57	95	119
	38	0.21	-	29	43	57	95	119
	40	0.21	-	29	43	57	95	119
	58	0.32	-	19	28	38	63	78

10.7 Switching of lamps

Table 10- 5 Compact fluorescent lamps with external electromagnetic ballasts - with parallel compensation

Compact fluorescent lamps with external electromagnetic ballasts - with parallel compensation								
Type	Power	Current	Capacitor	Maximum number of lamps per current path at 230 V, 50 Hz				
	P W	I A	C μF	5TT4 40x-x / 41x-x 20 A	5TT4 42x / 43x-x 25 A	5TT4 44x-x / 45x-x 32 A	5TT4 46x-x 40 A	5TT4 47x-x 63 A
	5	0.05	2	50	60	75	110	150
	2x5	0.07	2	50	60	75	110	150
	7	0.05	2	50	60	75	110	150
	2x7	0.07	2	50	60	75	110	150
	9	0.06	2	50	60	75	110	150
	2x9	0.08	2	50	60	75	110	150
	10	0.07	2	50	60	75	110	150
	11	0.08	2	50	60	75	110	150
	13	0.08	2	50	60	75	110	150
	16	0.1	2	50	60	75	110	150
	18	0.12	4.5	22	27	33	49	67
	2x18	0.21	4	25	30	38	55	75
	21	0.12	3	33	40	50	73	100
	22	0.2	4.5	22	27	33	49	67
	24	0.15	4.5	22	27	33	49	67
	26	0.15	4.5	22	27	33	49	67
	28	0.15	3.5	29	34	43	63	86
	32	0.22	4	25	30	38	55	75
	36	0.21	4.5	22	27	33	49	67
	38	0.21	4.5	22	27	33	49	67
	40	0.21	4.5	22	27	33	49	67
	58	0.32	7	14	17	21	31	43

Table 10- 6 Compact fluorescent lamps with external electronic ballasts

Compact fluorescent lamps with external electronic ballasts								
Type	Power	Current	Capacitor	Maximum number of lamps per current path at 230 V, 50 Hz				
	P W	I A	C μF	5TT4 40x-x / 41x-x 20 A	5TT4 42x / 43x-x 25 A	5TT4 44x-x / 45x-x 32 A	5TT4 46x-x 40 A	5TT4 47x-x 63 A
	5	0.03	-	200	300	400	667	833
	7	0.04	-	150	225	300	500	625
	9	0.05	-	120	180	240	400	500
	2x9	0.09	-	67	100	133	222	278
	10	0.05	-	120	180	171	400	500
	2x10	0.09	-	67	100	100	222	278
	11	0.07	-	86	129	171	286	357
	2x11	0.12	-	50	75	100	167	208
	13	0.07	-	86	129	171	286	357
	2x13	0.12	-	50	75	100	167	208
	14	0.08	-	75	113	150	250	313
	2x14	0.15	-	40	60	80	133	167
	16	0.07	-	86	129	171	286	357
	17	0.1	-	60	90	120	200	250
	2x17	0.18	-	33	50	67	111	139
	18	0.09	-	67	100	133	222	278
	2x18	0.17	-	35	53	71	118	147
	22	0.13	-	46	69	92	154	192
	2x22	0.21	-	29	43	57	95	119
	24	0.12	-	50	75	100	167	208
	2x24	0.23	-	26	39	52	87	109
	3x24	0.32	-	19	28	38	63	78
	4x74	0.43	-	14	21	28	47	58
	26	0.12	-	50	75	100	167	208
	2x26	0.24	-	25	38	50	83	104
	28	0.14	-	43	64	86	143	179
	32	0.16	-	38	56	75	125	156
	2x32	0.31	-	19	29	39	65	81
	36	0.16	-	38	56	75	125	156
	2x36	0.31	-	19	29	39	65	81
	38	0.17	-	35	53	71	118	147
	2x38	0.35	-	17	26	34	57	71
	40	0.2	-	30	45	60	100	125
	2x40	0.39	-	15	23	31	51	64
	42	0.2	-	30	45	60	100	125
	2x42	0.41	-	15	22	29	49	61
	55	0.27	-	22	33	44	74	93
	2x55	0.52	-	12	17	23	38	48
	57	0.28	-	21	32	43	71	89
	2x57	0.57	-	11	16	21	35	44
	60	0.31	-	19	29	39	65	81

10.7 Switching of lamps

Compact fluorescent lamps with external electronic ballasts								
	2x60	0.61	-	10	15	20	33	41
	70	0.34	-	18	26	35	59	74
	80	0.38	-	16	24	32	53	66
	2x80	0.76	-	8	12	16	26	33
	85	0.42	-	14	21	29	48	60
	100	0.46	-	13	20	26	43	54
	120	0.58	-	10	16	21	34	43
	150	0.69	-	9	13	17	29	36

Table 10-7 Fluorescent lamps with external electromagnetic ballasts - uncompensated

Fluorescent lamps with external electromagnetic ballasts - uncompensated								
Type	Power	Current	Capacitor	Maximum number of lamps per current path at 230 V, 50 Hz				
	P W	I A	C μF	5TT4 40x-x / 41x-x 20 A	5TT4 42x / 43x-x 25 A	5TT4 44x-x / 45x-x 32 A	5TT4 46x-x 40 A	5TT4 47x-x 63 A
	4	0.17		94	94	94	147	188
	6	0.16	-	100	100	100	156	200
	8	0.15	-	107	107	107	167	213
	10	0.17	-	94	94	94	147	188
	11	0.16	-	100	100	000	156	200
	13	0.17	-	94	94	94	147	97
	14	0.04	-	40	40	40	63	160
	15	0.33	-	48	48	48	76	86
	16	0.2	-	80	80	80	125	84
	18	0.37	-	43	43	43	68	86
	20	0.38	-	42	42	142	66	110
	22	0.37	-	43	43	43	68	86
	25	0.29	-	55	55	55	86	110
	30	0.37	-	43	43	43	68	86
	32	0.43	-	37	37	37	58	74
	36	0.43	-	37	37	37	58	74
	38	0.43	-	37	37	37	58	74
	40	0.43	-	37	37	37	58	74
	58	0.67	-	24	24	24	37	48
	65	0.67	-	24	24	24	37	48
	75	0.67	-	24	24	24	37	48
	80	0.8	-	20	20	20	31	40
	85	0.8	-	20	20	20	31	40
	100	0.96	-	17	17	17	26	33
	125	0.94	-	17	17	17	27	34

Table 10- 8 Fluorescent lamps with external electromagnetic ballasts - with parallel compensation

Fluorescent lamps with external electromagnetic ballasts - with parallel compensation								
Type	Power	Current	Capacitor	Maximum number of lamps per current path at 230 V, 50 Hz				
	P W	I A	C μF	5TT4 40x-x / 41x-x 20 A	5TT4 42x / 43x-x 25 A	5TT4 44x-x / 45x-x 32 A	5TT4 46x-x 40 A	5TT4 47x-x 63 A
	4	0.09	2	50	60	75	110	165
	6	0.08	2	50	60	75	110	165
	8	0.08	2	50	60	75	110	165
	10	0.09	2	50	60	75	110	165
	11	0.08	2	50	60	75	110	165
	13	0.09	2	50	60	75	110	165
	14	0.2	4.5	22	27	33	49	73
	15	0.17	4.5	22	27	33	49	73
	16	0.1	2.5	40	48	60	88	132
	18	0.19	4.5	22	27	33	49	73
	20	0.19	4.5	22	27	33	49	73
	22	0.19	5	20	24	30	44	66
	25	0.15	3.5	29	34	43	63	94
	30	0.24	4.5	22	27	33	49	73
	32	0.29	5	20	24	30	44	66
	36	0.29	4.5	22	27	33	49	73
	38	0.29	4.5	22	27	33	49	73
	40	0.29	4.5	22	27	33	49	73
	58	0.46	7	14	17	21	31	47
	65	0.46	7	14	17	21	31	47
	75	0.46	6	17	20	25	37	55
	80	0.57	7	14	17	21	31	47
	85	0.57	8	13	15	19	28	41
	100	0.66	10	10	12	15	22	33
	125	0.65	18	6	7	8	12	18

10.7 Switching of lamps

Table 10-9 Tandem connection of fluorescent lamps with external electromagnetic ballasts - with parallel compensation

Tandem connection of fluorescent lamps with external electromagnetic ballasts - with parallel compensation								
Type	Power	Current	Capacitor	Maximum number of lamps per current path at 230 V, 50 Hz				
	P W	I A	C μF	5TT4 40x-x / 41x-x 20 A	5TT4 42x / 43x-x 25 A	5TT4 44x-x / 45x-x 32 A	5TT4 46x-x 40 A	5TT4 47x-x 63 A
	2x4	0.17	2	50	60	75	110	165
	2x6	0.16	2	50	60	75	110	165
	2x8	0.15	2	50	60	75	110	165
	2x10	0.17	2	50	60	75	110	165
	2x11	0.16	2	50	60	75	110	165
	2x13	0.17	2	50	60	75	110	165
	2x14	0.4	4.5	22	27	33	49	73
	2x15	0.33	4.5	22	27	33	49	73
	2x16	0.2	2.5	40	48	60	88	132
	2x18	0.37	4.5	22	27	33	49	73
	2x20	0.38	4.5	22	27	33	49	73
	2x22	0.37	5	20	24	30	44	66
	2x25	0.29	3.5	29	34	43	63	94
	2x30	0.37	4.5	22	27	33	49	73
	2x32	0.43	5	20	24	30	44	66
	2x36	0.43	4.5	22	27	33	49	73
	2x38	0.43	4.5	22	27	33	49	73
	2x40	0.43	4.5	22	27	33	49	73
	2x58	0.67	7	14	17	21	31	47
	2x65	0.67	7	14	17	21	31	47
	2x75	0.67	6	17	20	25	37	55
	2x80	0.8	7	14	17	21	31	47
	2x85	0.8	8	13	15	19	28	41
	2x100	0.96	10	10	12	15	22	33
	2x125	0.94	18	6	7	8	12	18

Table 10- 10 Duo connection of fluorescent lamps with external electromagnetic ballasts - with series compensation

Duo connection of fluorescent lamps with external electromagnetic ballasts - with series compensation								
Type	Power	Current	Capacitor	Maximum number of lamps per current path at 230 V, 50 Hz				
	P W	I A	C μF	5TT4 40x-x / 41x-x 20 A	5TT4 42x / 43x-x 25 A	5TT4 44x-x / 45x-x 32 A	5TT4 46x-x 40 A	5TT4 47x-x 63 A
	2x18	0.26	2.7	62	62	62	96	123
	2x36	0.48	2.5	33	33	33	52	67
	2x40	0.48	4.5	33	33	33	52	67
	2x58	0.78	7	21	21	21	32	41
	2x65	0.78	7	21	21	21	32	41
	2x80	0.96	9	17	17	17	26	33
	2x85	0.96	9	17	17	17	26	33
	2x125	1.2	18	13	13	13	21	27

10.7 Switching of lamps

Table 10- 11 Fluorescent lamps with external electronic ballasts

Fluorescent lamps with external electronic ballasts								
Type	Power	Current	Capacitor	Maximum number of lamps per current path at 230 V, 50 Hz				
	P W	I A	C μF	5TT4 40x-x / 41x-x 20 A	5TT4 42x / 43x-x 25 A	5TT4 44x-x / 45x-x 32 A	5TT4 46x-x 40 A	5TT4 47x-x 63 A
	4	0.03	-	200	300	400	667	833
	6	0.033	-	182	273	364	606	758
	2x6	0.06	-	100	150	200	333	417
	8	0.04	-	150	225	300	500	625
	2x8	0.08	-	75	113	150	250	313
	10	0.05	-	120	180	240	400	500
	2x10	0.09	-	67	100	133	222	278
	11	0.06	-	100	150	200	333	417
	13	0.07	-	86	129	171	286	357
	14	0.08	-	75	113	150	250	313
	2x14	0.15	-	40	60	80	133	167
	3x14	0.21	-	29	43	57	95	119
	4x14	0.28	-	21	32	43	71	89
	15	0.08	-	75	113	150	250	313
	2x15	0.13	-	46	69	92	154	192
	16	0.07	-	86	129	171	286	357
	2x16	0.14	-	43	64	86	143	179
	3x16	0.2	-	30	45	60	100	125
	4x16	0.28	-	21	32	43	71	89
	18	0.09	-	67	100	133	222	278
	2x18	0.17	-	35	53	71	118	147
	3x18	0.24	-	25	38	60	83	104
	4x18	0.31	-	19	29	39	65	81
	19	0.11	-	55	82	109	182	227
	2x19	0.22	-	27	41	55	91	114
	20	0.11	-	55	82	109	182	227
	2x20	0.22	-	27	41	55	91	114
	21	0.11	-	55	82	109	182	227
	2x21	0.22	-	27	41	55	91	114
	22	0.11	-	55	82	109	182	227
	2x22	0.23	-	26	39	52	87	109
	24	0.12	-	50	75	100	167	208
	2x24	0.22	-	27	41	55	91	114
	3x24	0.33	-	18	27	36	61	76
	4x24	0.43	-	14	21	28	47	58
	25	0.15	-	40	60	80	133	167
	2x25	0.28	-	21	32	43	71	89
	28	0.14	-	43	64	86	143	179
	2x28	0.27	-	22	33	44	74	93
	30	0.14	-	43	64	86	143	179
	2x30	0.27	-	22	33	44	74	93

Fluorescent lamps with external electronic ballasts								
32	0.17	-	35	53	71	118	147	
2x32	0.35	-	17	26	34	57	71	
34	0.17	-	35	53	71	118	147	
2x34	0.35	-	17	26	34	57	71	
35	0.17	-	35	53	71	118	147	
2x35	0.34	-	18	26	35	59	74	
36	0.16	-	38	56	75	125	156	
2x36	0.31	-	19	29	39	65	81	
2x36	0.46	-	13	20	26	43	54	
38	0.15	-	40	60	80	133	167	
2x38	0.31	-	19	29	39	65	81	
39	0.19	-	32	47	63	105	132	
2x39	0.36	-	17	25	33	56	69	
40	0.21	-	29	43	57	95	119	
2x40	0.42	-	14	21	29	48	60	
45	0.24	-	25	38	50	83	104	
2x45	0.46	-	13	20	26	43	54	
49	0.24	-	25	38	50	83	104	
2x49	0.46	-	13	20	26	43	54	
50	0.25	-	24	36	48	80	100	
2x50	0.48	-	13	19	25	42	52	
51	0.22	-	27	41	55	91	114	
2x51	0.42	-	14	21	29	48	60	
54	0.26	-	23	35	46	77	96	
2x54	0.52	-	12	17	23	38	48	
55	0.28	-	21	32	43	71	89	
2x55	0.55	-	11	16	22	36	45	
58	0.25	-	24	36	48	80	100	
2x58	0.48	-	13	19	25	42	52	
65	0.25	-	24	36	48	80	100	
2x65	0.48	-	13	19	25	42	52	
70	0.3	-	20	30	40	67	83	
2x70	0.57	-	11	16	21	35	44	
73	0.38	-	16	24	32	53	66	
2x73	0.7	-	9	13	17	29	36	
80	0.4	-	15	23	30	50	63	
2x80	0.76	-	8	12	16	26	33	

10.7 Switching of lamps

Table 10- 12 High-pressure mercury-vapor lamps with external electromagnetic ballasts - uncompensated

High-pressure mercury-vapor lamps with external electromagnetic ballasts - uncompensated								
Type	Power	Current	Capacitor	Maximum number of lamps per current path at 230 V, 50 Hz				
	P W	I A	C μF	5TT4 40x-x / 41x-x 20 A	5TT4 42x / 43x-x 25 A	5TT4 44x-x / 45x-x 32 A	5TT4 46x-x 40 A	5TT4 47x-x 63 A
	50	0.6	-	27	27	27	42	53
	80	0.8	-	20	20	20	31	40
	125	1.2	-	13	13	13	21	27
	250	2.2	-	7	7	7	11	15
	400	3.3	-	5	5	5	8	10
	700	5.4	-	3	3	3	5	6
	1000	7.5	-	2	2	2	3	4

Table 10- 13 High-pressure mercury-vapor lamps with external electromagnetic ballasts - with parallel compensation

High-pressure mercury-vapor lamps with external electromagnetic ballasts - with parallel compensation								
Type	Power	Current	Capacitor	Maximum number of lamps per current path at 230 V, 50 Hz				
	P W	I A	C μF	5TT4 40x-x / 41x-x 20 A	5TT4 42x / 43x-x 25 A	5TT4 44x-x / 45x-x 32 A	5TT4 46x-x 40 A	5TT4 47x-x 63 A
	50	0.3	7	14	17	21	31	47
	80	0.4	8	13	15	19	28	41
	125	0.6	10	10	12	15	22	33
	250	1.2	18	6	7	8	12	18
	400	1.8	25	4	5	6	9	13
	700	3.4	40	3	3	4	6	8
	1000	4.8	60	2	2	3	4	6

Table 10- 14 High-pressure mercury-vapor lamps

High-pressure mercury-vapor lamps (ballasts not required)								
Type	Power	Current	Capacitor	Maximum number of lamps per current path at 230 V, 50 Hz				
	P W	I A	C μF	5TT4 40x-x / 41x-x 20 A	5TT4 42x / 43x-x 25 A	5TT4 44x-x / 45x-x 32 A	5TT4 46x-x 40 A	5TT4 47x-x 63 A
	160	0.8	-	11	14	20	31	40
	250	1.2	-	7	9	13	21	27
	500	2.4	-	4	5	7	10	13

Table 10- 15 Metal halogen lamps with external electromagnetic ballasts - uncompensated

Metal halogen lamps with external electromagnetic ballasts - uncompensated								
Type	Power	Current	Capacitor	Maximum number of lamps per current path at 230 V, 50 Hz				
	P W	I A	C μF	5TT4 40x-x / 41x-x 20 A	5TT4 42x / 43x-x 25 A	5TT4 44x-x / 45x-x 32 A	5TT4 46x-x 40 A	5TT4 47x-x 63 A
	35	0.5	-	32	32	32	50	64
	70	1	-	16	16	16	25	32
	100	1.2	-	13	13	13	21	27
	150	1.8	-	9	9	9	14	18
	250	3	-	5	5	5	8	11
	400	4.6	-	3	3	3	5	7
	600	6.2	-	3	3	3	4	5
	1000	9.7	-	2	2	2	3	3
	2000	12.2	-	1	1	1	2	3

Table 10- 16 Metal halogen lamps with external electromagnetic ballasts - with parallel compensation

Metal halogen lamps with external electromagnetic ballasts - with parallel compensation								
Type	Power	Current	Capacitor	Maximum number of lamps per current path at 230 V, 50 Hz				
	P W	I A	C μF	5TT4 40x-x / 41x-x 20 A	5TT4 42x / 43x-x 25 A	5TT4 44x-x / 45x-x 32 A	5TT4 46x-x 40 A	5TT4 47x-x 63 A
	35	0.23	6	17	20	25	37	55
	70	0.42	12	8	10	13	18	28
	100	0.55	12	8	10	13	18	28
	150	0.77	20	5	6	8	11	17
	250	1.26	32	3	4	5	7	10
	400	2	45	2	3	3	5	7
	600	3	65	2	2	2	3	5
	1000	5	85	1	1	2	3	4
	2000	10.5	125	0	1	1	2	3

10.7 Switching of lamps

Table 10- 17 Metal halogen lamps with external electromagnetic ballasts

Metal halogen lamps with external electromagnetic ballasts								
Type	Power	Current	Capacitor	Maximum number of lamps per current path at 230 V, 50 Hz				
	P W	I A	C μF	5TT4 40x-x / 41x-x 20 A	5TT4 42x / 43x-x 25 A	5TT4 44x-x / 45x-x 32 A	5TT4 46x-x 40 A	5TT4 47x-x 63 A
	20	0.11	-	55	82	109	182	227
	35	0.21	-	29	43	57	95	119
	2x35	0.38	-	16	24	32	53	66
	50	0.29	-	21	31	41	69	86
	70	0.38	-	16	24	32	53	66
	2x70	0.71	-	8	13	17	28	35
	100	0.56	-	11	16	21	36	45
	150	0.72	-	8	13	17	28	35
	250	1.3	-	5	7	9	15	19
	400	2	-	3	5	6	10	13
	1000	5	-	1	2	2	4	5
	2000	6	-	1	2	2	3	4

Table 10- 18 High-pressure sodium lamps with external electromagnetic ballasts - uncompensated

High-pressure sodium lamps with external electromagnetic ballasts - uncompensated								
Type	Power	Current	Capacitor	Maximum number of lamps per current path at 230 V, 50 Hz				
	P W	I A	C μF	5TT4 40x-x / 41x-x 20 A	5TT4 42x / 43x-x 25 A	5TT4 44x-x / 45x-x 32 A	5TT4 46x-x 40 A	5TT4 47x-x 63 A
	35	0.53	-	30	30	30	47	60
	50	0.8	-	20	20	20	31	40
	70	1	-	16	16	16	25	32
	100	1.2	-	13	13	13	21	27
	150	1.8	-	9	9	9	14	18
	250	3	-	5	5	5	8	11
	400	4.4	-	4	4	4	6	7
	600	6.2	-	2	2	2	4	5
	1000	10.3	-	1	1	1	2	3

Table 10- 19 High-pressure sodium lamps with external electromagnetic ballasts - with parallel compensation

High-pressure sodium lamps with external electromagnetic ballasts - with parallel compensation								
Type	Power	Current	Capacitor	Maximum number of lamps per current path at 230 V, 50 Hz				
	P W	I A	C μF	5TT4 40x-x / 41x-x 20 A	5TT4 42x / 43x-x 25 A	5TT4 44x-x / 45x-x 32 A	5TT4 46x-x 40 A	5TT4 47x-x 63 A
	35	0.22	6	17	20	25	37	55
	50	0.3	8	13	15	19	28	41
	70	0.4	12	8	10	13	18	28
	100	0.55	12	8	10	13	18	28
	150	0.77	20	5	6	8	11	17
	250	1.26	32	3	4	5	7	10
	400	2	45	2	3	3	5	7
	600	2.9	65	1	2	2	3	5
	1000	5.1	100	0	1	1	2	3

Table 10- 20 High-pressure sodium lamps with external electromagnetic ballasts

High-pressure sodium lamps with external electromagnetic ballasts								
Type	Power	Current	Capacitor	Maximum number of lamps per current path at 230 V, 50 Hz				
	P W	I A	C μF	5TT4 40x-x / 41x-x 20 A	5TT4 42x / 43x-x 25 A	5TT4 44x-x / 45x-x 32 A	5TT4 46x-x 40 A	5TT4 47x-x 63 A
	35	0.21	-	29	43	57	95	119
	50	0.25	-	24	36	48	80	100
	70	0.38	-	16	24	32	53	66
	100	0.56	-	11	16	21	36	45
	150	0.72	-	8	13	17	28	35
	250	1.3	-	5	7	9	15	19
	400	2	-	3	5	6	10	13
	600	3.1	-	2	3	4	6	8
	1000	5	-	1	2	2	4	5

Table 10- 21 Low-pressure sodium-vapor lamps with external electromagnetic ballasts - uncompensated

Low-pressure sodium-vapor lamps with external electromagnetic ballasts - uncompensated								
Type	Power	Current	Capacitor	Maximum number of lamps per current path at 230 V, 50 Hz				
	P W	I A	C μF	5TT4 40x-x / 41x-x 20 A	5TT4 42x / 43x-x 25 A	5TT4 44x-x / 45x-x 32 A	5TT4 46x-x 40 A	5TT4 47x-x 63 A
	18	0.4	-	40	24	40	63	80
	35	0.6	-	27	6	27	42	53
	55	0.6	-	27	6	27	42	53
	90	0.9	-	18	5	18	28	36
	135	0.9	-	18	3	18	28	36
	180	0.9	-	18	3	18	28	36

10.7 Switching of lamps

Table 10- 22 Low-pressure sodium-vapor lamps with external electromagnetic ballasts - with parallel compensation

Low-pressure sodium-vapor lamps with external electromagnetic ballasts - with parallel compensation								
Type	Power	Current	Capacitor	Maximum number of lamps per current path at 230 V, 50 Hz				
	P W	I A	C μF	5TT4 40x-x / 41x-x 20 A	5TT4 42x / 43x-x 25 A	5TT4 44x-x / 45x-x 32 A	5TT4 46x-x 40 A	5TT4 47x-x 63 A
	18	0.35	5	20	24	30	44	66
	35	0.28	20	5	6	8	11	17
	55	0.35	20	5	6	8	11	17
	90	0.55	26	4	5	6	8	13
	135	0.8	40	3	3	4	6	8
	180	1	40	3	3	4	6	8

Table 10- 23 Low-pressure sodium-vapor lamps with electronic ballasts

Low-pressure sodium-vapor lamps with electronic ballasts								
Type	Power	Current	Capacitor	Maximum number of lamps per current path at 230 V, 50 Hz				
	P W	I A	C μF	5TT4 40x-x / 41x-x 20 A	5TT4 42x / 43x-x 25 A	5TT4 44x-x / 45x-x 32 A	5TT4 46x-x 40 A	5TT4 47x-x 63 A
	35	0.16	-	38	56	75	152	156
	35	0.25	-	24	36	48	80	100

Table 10- 24 Switching LED lamps

LED lamps								
Power supplies for LEDs	Power	Current	Capacitor	Maximum number of lamps per current path at 230 V, 50 Hz				
	P W	I A	C μF	5TT4 40x-x / 41x-x 20 A	5TT4 42x / 43x-x 25 A	5TT4 44x-x / 45x-x 32 A	5TT4 46x-x 40 A	5TT4 47x-x 63 A
Type	-	-	-	Max. 6 A per pole	Max. 9 A per pole	Max. 12 A per pole	Max. 20 A per pole	Max. 25 A per pole

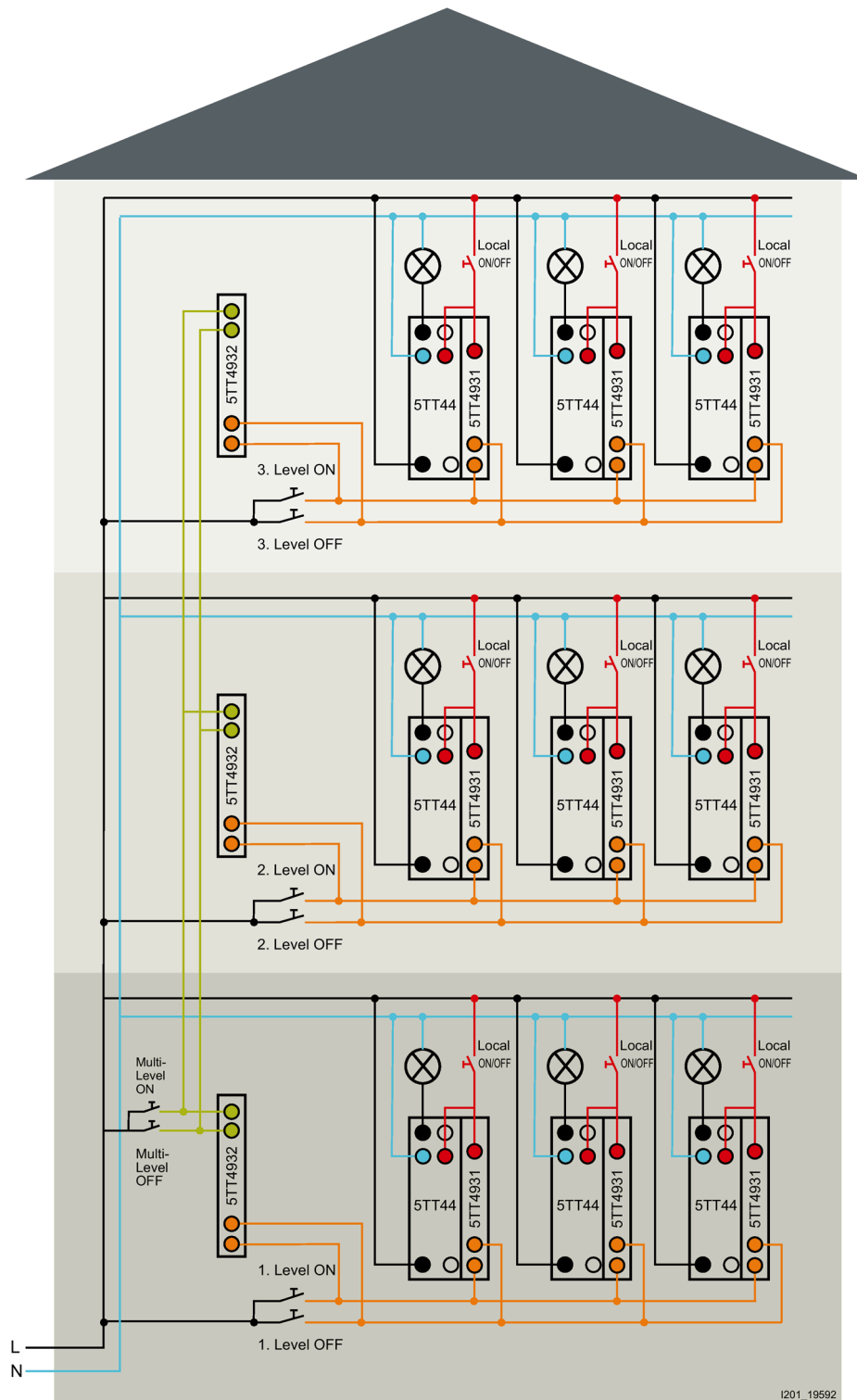

Figure 10-7 Example application for 5TT44 remote control switches

5TT4 switching relays

11.1 Overview

Switching relays are used in residential, non-residential and industrial buildings for the purpose of contact multiplication. They can be used with protective separation between coil voltage and contact.

With the 5TE9100 and 5TE9101 busbars, the switching relays can be mounted quickly and safely, e.g. by bus mounting the N conductor and/or infeed.

Note

Busbars to match the 5TT42 switching relays can be found in chapter 5ST busbars for modular installation devices (Page 55).

11.2 Technical specifications

		5TT4 201-.	5TT4202-.	5TT4204-.	5TT4 205-.	5TT4 206-.	5TT4 207-.	5TT4 217-.	
Standards		EN 60947-5-1 GB 14048.4 CCC							
Approvals		VDE, CCC							
Contact types		1 NO	2 NO	4 NO	1 NO + 1 NC	1 CO	2 CO	2 CO	
Manual operation		Yes				-		-	
Rated control voltage U_c	V AC	8 ... 230						-	
	V DC	-						12 ... 110	
Operating range	x U_c	0.8 ... 1.1							
Rated frequency f_c	Hz	50							
Rated impulse withstand voltage U_{imp}	kV	4							
Minimum contact load	AC V; mA	10; 100							
Rated operational current I_e At $\cos \phi = 0.6 \dots 1$	A	16							
Rated power loss P_v Solenoid coil, only pulse Per contact at 16 A	W / VA	2.4 / 3.0	2.4 / 3.0	4.8 / 6.0	2.4 / 3.0	2.4 / 3.0	2.4 / 3.0	1.7	
	W	1.0	1.0	1.0	1.0	1.0	1.0	1.0	
Rated operational voltage U_e		250	400	400	400	250	400	400	
Different phases Between solenoid coil and contact		Permissible							
Contact gap	mm	> 1.2				> 1.2			
Electrical endurance At I_e/U_e , $\cos \phi = 0.6$; incandescent lamp load 600 W (operating cycles)		50000							
Connecting terminals \pm screw (Pozidriv) Max. tightening torque	Nm	PZ1 0.8 ... 1.0							
Conductor cross-sections Rigid Flexible, with end sleeve	mm ²	1 ... 6							
	mm ²	1 ... 6							
Permissible ambient temperature	°C	-10 ... +40							

		5TT4 201-.	5TT4202-.	5TT4204-.	5TT4 205-.	5TT4 206-.	5TT4 207-.	5TT4 217-.
Resistance to climate At 95% relative humidity Acc. to DIN 50015	°C	35						
Degree of protection Acc. to EN 60529		IP20 with connected conductors						
Mounting position		Any						

11.3 Dimensional drawings

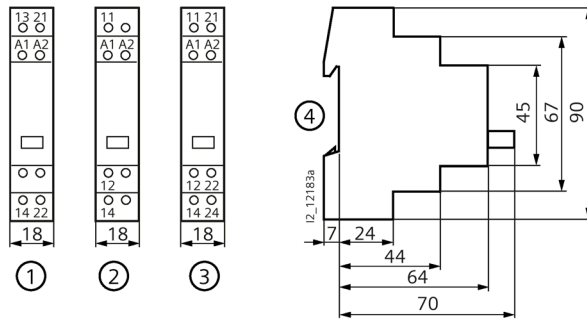

- ① 5TT4201
- ② 5TT4202
- ③ 5TT4204
- ④ 5TT4205, 5TT4206, 5TT4207, 5TT4217

11.4 Circuit diagrams

Graphic symbols



5TT4201

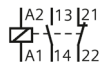

5TT4205

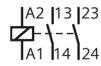

5TT4202



5TT4206

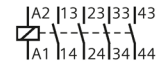

5TT4204

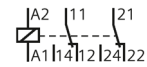

5TT4207

5TT4217

11.5 More information

			5TT42...-
Incandescent lamp load At I_e/U_e , $\cos \phi = 0.6$; incandescent lamp load 600 W		W	600
Switching of transformers for halogen lamps		W	1200
Fluorescent and compact lamps in ballast operation (CCG) Uncompensated	L18W	Units	27
	L36W	Units	24
	L58W	Units	15
Fluorescent and compact lamps with electronic ballast (ECG) AC operation, 1 lamp	L18W	Units	43
	L36W	Units	24
	L58W	Units	15
Metal-vapor and high-pressure mercury-vapor lamps (HQL) Uncompensated	50 W	Units	12
	80 W	Units	9
	125 W	Units	6
	250 W	Units	3
	400 W	Units	2
	700 W	Units	1
	1000 W	Units	1
Halogen metal-vapor lamps (HQI) Uncompensated	70 W	Units	8
	150 W	Units	4
	250 W	Units	2
	400 W	Units	1
High-pressure sodium-vapor lamps (NAV) Uncompensated	50 W	Units	10
	70 W	Units	8
	110 W	Units	6
	150 W	Units	4
	250 W	Units	1
LED lamp load		Limited to typical domestic application	

For higher lamp loads, use Insta contactors 5TT5...

The specified values are intended to serve as a guideline only. The max. number of light sources can vary depending on the manufacturer. The values specified here refer to Osram light sources and ballasts.

Bus mounting



- All 5TT42 switching relays can be bus-mounted with each other. This saves time and space.

Note

Busbars to match the 5TT42 switching relays can be found in chapter 5ST busbars for modular installation devices (Page 55).

5TT5 Insta contactors

12.1 5TT50 Insta contactors, AC/DC technology

12.1.1 Overview

The Insta contactors are the ideal switching devices for controlling AC/DC control voltage in industrial applications and infrastructure.

In addition to their basic function, they can also be used for the On/Off switching of 1-phase and 3-phase electrical motors. The 5TT50 Insta contactors meet the requirements of EN 60947 and are approved to UL 508.

The simultaneous switching of lamp loads at varying phases can be achieved with a single contactor. It is essential to aim for/ensure a symmetrical load of the phases. Upstream short-circuit detection devices must disconnect at all poles or must be equipped with phase failure detection. Violations of the specified capacitor load limits may cause excessive inrush peak currents. The level of inrush peak currents is also affected by the following factors:

- Length and cross-section of the installed supply lines
- Type of electronic ballasts
- Brand/make of lamp



- Insta contactors with O/I automatic function enable the testing of a system by manual switching without the need to apply a control voltage



- Switching position indicator for fast recognition of operating states offers greater safety during system checks

12.1.2 Technical specifications

		5TT500 2-pole	5TT503 4-pole	5TT504 4-pole	5TT505 4-pole
Standards		EN 60947-4-1 EN 60947-5-1 EN 61095			
Approvals		UL508 UL File No. E303328 CCC			
Rated frequency at AC f_n	Hz	50 / 60			
Rated control circuit voltage U_c	V AC	24, 230	24.115, 230	24, 230	
	V DC	24, 220	24, 110, 220	24, 230	
Operating range	x U_c	0.85 ... 1.1			
Rated operational voltage U_e	V	230	400		
Rated operational current I_e	At AC V	Acc. to UL 480, IEC 440			
AC-1 / AC-7a, NO contacts	A	20	25	40	63
AC-1 / AC-7a, NC contacts	A	20	25	40	63
AC-3 / AC-7b, NO contacts		9	8.5	22	30
AC-3 / AC-7b, NC contacts		6	8.5	22	30
Rated power loss P_v					
Pick-up power (without manual switching or with manual switching in "I" position)	VA/W	2.3 / 2.3	2.6 / 2.6	6 / 6	6 / 6
Pick-up power (with manual switching in "AUTO" position)	VA/W	2.3 / 2.3	2.6 / 2.6	6 / 6	6 / 6
Holding power	VA/W	2.3 / 2.3	2.6 / 2.6	6 / 6	6 / 6
Per contact AC-1 / AC-7a	VA	1.7	2.2	4	8
Switching times					
Closing (NO contacts)	ms	15-45	15-45	15-20	
Opening (NO contacts)	ms	20-50	20-70	35-45	
Rated impulse withstand voltage U_{imp}	kv	≤ 4			
Contact gap (NO contacts) min.	mm	3.6			
Electrical endurance					
At I_e and load					
AC-1 / AC-7a (in operating cycles)		200000		100000	
AC-3 / AC-7b (in operating cycles)		300000	500000		150000
Mechanical endurance					
In operating cycles					
Maximum switching frequency					
At load					
AC-1 / AC-7a	Switching operations / h	600			
AC-3 / AC-7b	Switching operations / h	600			

		5TT500 2-pole	5TT503 4-pole	5TT504 4-pole	5TT505 4-pole
Switching resistive load AC-1 At rated operational power P _s (NO contacts)	V AC	230	400		
1-phase	kW	4	5.4	8.7	13.3
3-phase	kW	-	16	26	40
Switching 3-phase asynchronous motors AC-3 At rated operational power P _s (NO contacts)	V AC	230	400		
1-phase	kW	1.3 / 0.75	1.3 / 1.3	3.7 / 3.7	5 / 5
3-phase	kW	-	4	11	15
Minimum switching capacity	V; mA	≥17; 50			
Overload withstand capability Per current path (only NO contacts) At 10 s	A	72	68	176	240
Short-circuit protection, according to type of coordination 1 Back-up fuse characteristic gL/gG	A	20	25	63	80
Connecting terminals Coil connection Main connection ± screw (Pozidriv)		PZ1 PZ1	PZ1 PZ2		
Tightening torques Coil connection Main connection	Nm Nm	0.6 1.2	0.6 3.5		
Conductor cross-sections Coil connection - Solid - Finely stranded with end sleeve - AWG cables Tightening torque Main connection - Solid - Finely stranded with end sleeve - AWG cables Tightening torque	mm ² mm ² AWG lb.in mm ² mm ² AWG lb.in	1.0 ... 2.5 1.0 ... 2.5 16 ... 10 8 1.0 ... 10 1.0 ... 6 16 ... 8 9	- - - - 1.5 ... 25 1.5 ... 16 16 ... 4 20	- - - - - - -	
Permissible ambient temperature For operation For storage	°C °C	-15 ... +55 ¹⁾ -50 ... +80			
Degree of protection EN 60529		IP 20, with connected conductors			

			5TT500 2-pole	5TT503 4-pole	5TT504 4-pole	5TT505 4-pole
According to UL 508	I _{rated}	A	20	25	40	63
UL 508 General Use 240 V / 780 V	FLA	A	20	25	40	63
UL 508 AC Discharge lamps		A	20	25	30	40
UL 508 motor load 240 V	Power	hp	1	3	7.5	10
UL 508 motor load 480 V	Power	hp	-	5	15	20
UL 508 short- circuit at 480 V	K-5 fuses	kA	5	5	5	5
		A	20	25	60	70

¹⁾ Contactors can be operated up to an ambient temperature of -25 °C and +70 °C, but under special conditions. For further details, contact Siemens Support (<https://support.industry.siemens.com/cs/de/en/>).

12.1.3 Dimensional drawings

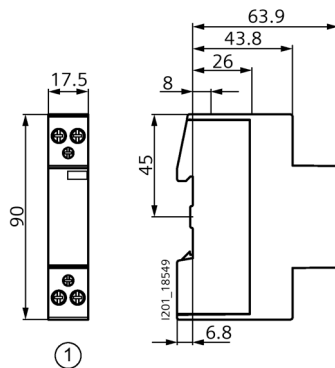

① 5TT5001-0, 5TT5001-2

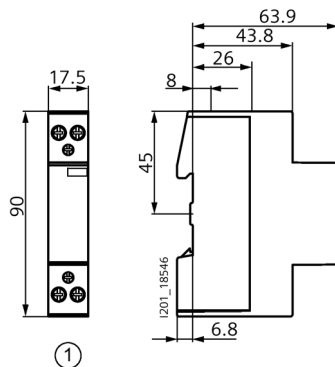

① 5TT5002-0, 5TT5002-2

12.1 5TT50 Insta contactors, AC/DC technology

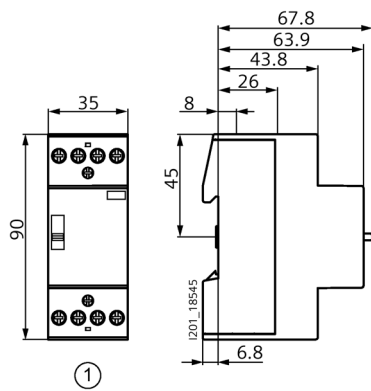

①

① 5TT5031-6, 5TT5031-8

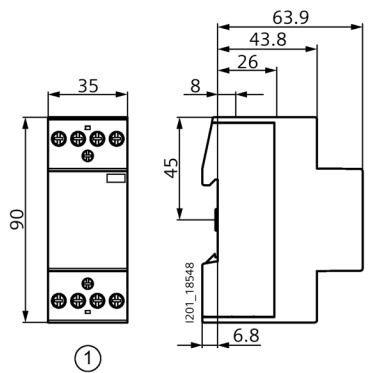

①

① 5TT5032-0, 5TT5032-2

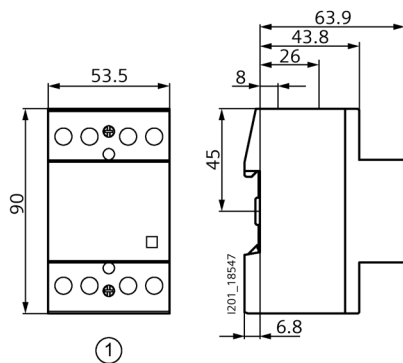

①

① 5TT5041-0, 5TT5041-2

12.1.4 Circuit diagrams

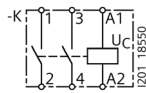

5TT5000

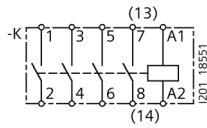

5TT5030

5TT5040

5TT5050

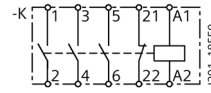

5TT5031

5TT5041

5TT5051

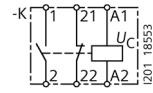

5TT5001

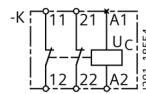

5TT5002

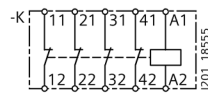

5TT5033

5TT5043

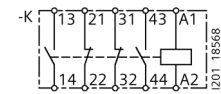

5TT5032

5TT5042

5TT5052

12.1.5 More information

Mounting position of Insta contactors, AC/DC technology

The installation of the devices is permissible in the positions shown in the following diagram (0° to 90°, 270° to 0°). There are no restrictions when the devices are installed in these normal mounting positions.

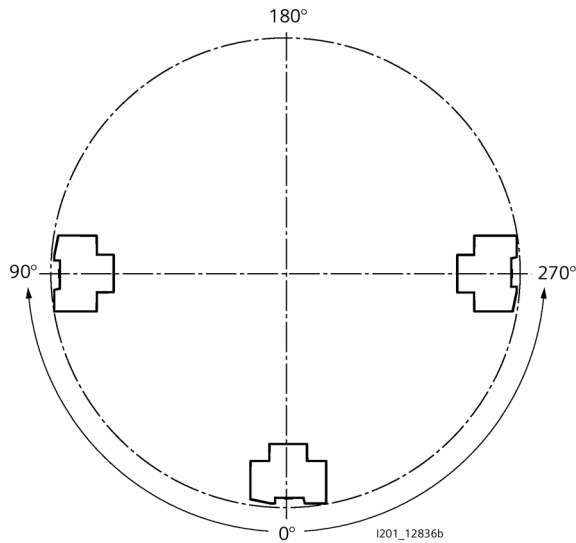

Heat dissipation

Spacers must be planned to ensure heat dissipation. In the Insta contactors with a width of 18 mm (1 width modules), a 5TG8240 spacer must be used in the temperature range up to 40 °C after every third Insta contactor, in the temperature range above 40 °C up to 55 °C after every second.

In continuous operation (100% OP), a spacer is recommended after every Insta contactor.

Manual switching with O//automatic function

The 5TT50... versions also offer manual switching. The knob allows preselection of 3 positions:

- Knob in the "AUTO" position

Automatic mode → normal contactor operation

- Knob in the "I" position

Continuous duty → switched on manually (without control signal; when a control signal is applied, manual switch-on is enabled again, i.e. the knob is automatically reset to the "AUTO" position)

- Knob in the "O" position

Off → switched off (coil circuit interrupted)



System test without applying a control voltage

Insta contactors with O//Automatic function enable system testing by manual switching without the need to apply a control voltage.

Automatic resetting through control signal

When a control signal is applied to terminals A1 and A2, the Insta contactors can be reset from continuous duty ("I" position) to automatic mode ("AUTO" position).

Table 12- 1 Switching DC currents

Permissible DC switching currents for NO contacts with resistive load in [A]				1 contact	2 contacts in series	3 contacts in series	4 contacts in series
5TT500 2-pole	20 A	I _{e at}	U _e = 24 V DC U _e = 110 V DC U _e = 220 V DC	20 6 0.6	20 10 6	- - -	- - -
5TT503 4-pole	25 A	I _{e at}	U _e = 24 V DC U _e = 110 V DC U _e = 220 V DC	25 6 0.6	25 10 6	25 20 15	25 20 15
5TT504 4-pole	40 A	I _{e at}	U _e = 24 V DC U _e = 110 V DC U _e = 220 V DC	40 4 1.2	40 10 8	40 30 20	40 40 40
5TT505 4-pole	63 A	I _{e at}	U _e = 24 V DC U _e = 110 V DC U _e = 220 V DC	63 4 1.2	63 10 8	63 35 30	63 63 63

Table 12- 2 Switching of lamps

LED lamps Type	Power P W	Current I A	Capacitor C μF	Maximum number of lamps per current path at 230 V, 50 Hz			
				5TT5 80x-x / 00x-x 20 A	5TT5 83x-x / 03x-x 25 A	5TT5 84x-x / 04x-x 40 A	5TT5 85x-x / 05x- x 63 A
Power supply for LEDs	-	-	-	Max. 2.4 A per pole	Max. 3.8 A per pole	Max. 11 A per pole	Max. 18 A per pole

Table 12- 3 Switching of lamps

Incandescent lamp load, lamp type			1000 W	500 W	200 W	100 W	60 W
5TT500 2-pole	20 A	Per NO contact / NC contact	1	3	10	20	33
5TT503 4-pole	25 A	Per NO contact / NC contact	1	3	10	20	33
5TT504 4-pole	40 A	Per NO contact / NC contact	4	8	20	40	65
5TT505 4-pole	63 A	Per NO contact / NC contact	5	10	25	50	85

Maximum number of lamps in units, per NO contact/NC contact at 230 V AC, 50 Hz.

Table 12- 4 Fluorescent and compact lamps in ballast operation (CCG)
(permissible number of lamps per NO contact / NC contact at 230 V AC, 50 Hz)

			Uncompensated			Parallel-compensated			DUO connection, 2 lamps			
Lamp type Capacitance			W μF	L18 -	L36 -	L58 -	L18 4.5	L36 4.5	L58 7.0	2 x L18 -	2 x L36 -	2 x L58 -
5TT500 2-pole	20 A	Per NO contact / NC contact	-	22	17	14	7	7	4	30	17	10
5TT503 4-pole	25 A	Per NO contact / NC contact	-	24	20	17	8	8	5	40	24	14
5TT504 4-pole	40 A	Per NO contact / NC contact	-	90	65	45	48	48	31	100	65	40
5TT505 4-pole	63 A	Per NO contact / NC contact	-	140	95	70	73	73	47	150	95	60

Table 12- 5 Fluorescent and compact lamps with electronic ballast (ECG)
(permissible number of lamps per NO contact / NC contact at 230 V AC, 50 Hz)

			W	1 lamp			2 lamps		
Lamp type			W	1 x L18	1 x L36	1 x L58	2 x L18	2 x L36	2 x L58
5TT500 2-pole	20 A	Per NO contact / NC contact	-	25	15	14	12	7	7
5TT503 4-pole	25 A	Per NO contact / NC contact	-	35	20	19	17	10	9
5TT504 4-pole	40 A	Per NO contact / NC contact	-	100	52	50	50	28	25
5TT505 4-pole	63 A	Per NO contact / NC contact	-	140	75	72	70	38	36

12.1 5TT50 Insta contactors, AC/DC technology

Table 12-6 High-pressure mercury-vapor lamps (HQL) (permissible number of lamps per NO contact/NC contact at 230 V AC, 50 Hz)

Lamp type Capacitance			W μF	Uncompensated							Parallel-compensated						
				50	80	125	250	400	700	1000	50	80	125	250	400	700	1000
5TT500 2-pole	20 A	Per NO contact / NC contact	-	14	10	7	4	2	1	1	4	4	3	1	1	0	0
5TT503 4-pole	25 A	Per NO contact / NC contact	-	18	13	9	5	3	2	1	5	5	4	2	1	0	0
5TT504 4-pole	40 A	Per NO contact / NC contact	-	38	29	20	10	7	4	3	31	48	27	12	9	5	4
5TT505 4-pole	63 A	Per NO contact / NC contact	-	55	42	29	15	10	6	4	47	73	41	18	13	7	5

Table 12-7 Metal-halide lamps (HQL) (permissible number of lamps per NO contact/NC contact at 230 V AC, 50 Hz)

Lamp type Capacitance			W μF	Uncompensated						Parallel-compensated						With electronic ballast PCI			
				70	150	250	400	1000	2000	70	150	250	400	1000	2000	20	35	70	150
5TT500 2-pole	20 A	Per NO contact / NC contact	-	10	5	3	3	1	0	2	1	0	0	0	0	9	6	5	4
5TT503 4-pole	25 A	Per NO contact / NC contact	-	12	7	4	3	1	0	3	1	1	0	0	0	9	6	5	4
5TT504 4-pole	40 A	Per NO contact / NC contact	-	23	12	7	6	2	1	18	11	6	6	2	1	18	11	10	8
5TT505 4-pole	63 A	Per NO contact / NC contact	-	32	18	10	9	3	1	25	15	9	8	3	2	20	13	12	10

Table 12- 8 High-pressure sodium-vapor lamps (HPS)
(permissible number of lamps per NO contact/NC contact at 230 V AC, 50 Hz)

			Uncompensated				Parallel-compensated				With electronic ballast PCI				
Lamp type Capacitance			W μF	150	250	400	1000	150	250	400	1000	20	35	70	150
			-	-	-	-	20	33	48	106	-	-	-	-	
5TT500 2-pole	20 A	Per NO contact / NC contact	-	5	3	2	0	0	0	0	0	9	6	5	4
5TT503 4-pole	25 A	Per NO contact / NC contact	-	6	4	2	1	1	1	0	0	9	6	5	4
5TT504 4-pole	40 A	Per NO contact / NC contact	-	17	10	6	3	11	6	4	2	18	11	10	8
5TT505 4-pole	63 A	Per NO contact / NC contact	-	22	13	8	3	16	9	6	3	20	13	12	10

Table 12- 9 Low-pressure sodium-vapor lamps (LPS)
(permissible number of lamps per NO contact/NC contact at 230 V AC, 50 Hz)

			Uncompensated						Parallel-compensated						
Lamp type Capacitance			W μF	18	35	55	90	135	190	18	35	55	90	135	180
			-	-	-	-	-	-	-	5	20	20	26	45	40
5TT500 2-pole	20 A	Per NO contact / NC contact	-	22	7	7	4	3	3	6	1	1	1	-	.
5TT503 4-pole	25 A	Per NO contact / NC contact	-	27	9	9	5	4	4	7	1	1	1	-	-
5TT504 4-pole	40 A	Per NO contact / NC contact	-	71	23	23	14	10	10	44	11	11	8	4	5
5TT505 4-pole	63 A	Per NO contact / NC contact	-	90	30	30	19	13	13	66	16	16	12	7	8

12.1 5TT50 Insta contactors, AC/DC technology

Table 12- 10 Fluorescent lamps Lumilux T5 type FC with electronic ballast (ECG)
(permissible number of lamps per NO contact/NC contact at 230 V AC, 50 Hz)

Lamp type					W	1 lamp			2 lamps		
						22	40	55	2 x 22	2 x 40	2 x 55
5TT500	2-pole	20 A	Per NO contact / NC contact	-	22	12	8	11	6	4	
5TT503	4-pole	25 A	Per NO contact / NC contact	-	30	15	12	15	7	6	
5TT504	4-pole	40 A	Per NO contact / NC contact	-	80	40	30	40	20	15	
5TT505	4-pole	63 A	Per NO contact / NC contact	-	110	60	45	55	30	22	

Table 12- 11 Fluorescent lamps Lumilux T5 type HE with electronic ballast (ECG)
(permissible number of lamps per NO contact/NC contact at 230 V AC, 50 Hz)

Lamp type					W	1 lamp				2 lamps			
						14	21	28	35	2 x 14	2 x 21	2 x 28	2 x 35
5TT500	2-pole	20 A	Per NO contact / NC contact	-	30	22	18	14	15	11	9	7	
5TT503	4-pole	25 A	Per NO contact / NC contact	-	40	30	22	18	20	15	11	9	
5TT504	4-pole	40 A	Per NO contact / NC contact	-	105	80	60	48	52	40	30	24	
5TT505	4-pole	63 A	Per NO contact / NC contact	-	150	115	90	70	75	57	45	35	

Table 12- 12 Fluorescent lamps Lumilux T5 type HO with electronic ballast (ECG)
(permissible number of lamps per NO contact/NC contact at 230 V AC, 50 Hz)

				1 lamp					2 lamps				
Lamp type			W	24	39	49	54	80	2 x 24	2 x 39	2 x 49	2 x 54	2 x 80
5TT500	20 A	Per NO contact / NC contact	-	20	12	10	9	6	10	6	5	4	3
5TT503	25 A	Per NO contact / NC contact	-	26	16	14	13	8	13	8	7	6	4
5TT504	40 A	Per NO contact / NC contact	-	70	42	35	32	22	35	21	17	16	11
5TT505	63 A	Per NO contact / NC contact	-	100	62	52	47	32	50	31	26	23	16

12.2 5TT58 Insta contactors, AC technology

12.2.1 Overview

The 5TT58 Insta contactors are equipped with an AC solenoid system and are ideal for use under harsh conditions. The auxiliary switches can be mounted without tools. When equipped with terminal covers, the devices can also be sealed.

Insta contactors without manual switching

Insta contactors are ideal for a wide range of uses in industry, such as for motors where distribution technology plays a major role, e.g. in installations for heat pumps and air conditioning technology. In addition to their basic function, they can also be used for the On/Off switching of 1-phase and 3-phase electrical motors.

Insta contactors with manual switching

Insta contactors with manual operation can be switched on and off by hand.



- Extremely long service life of 3 million operating cycles
- Safe cable entry through the cable entry funnel
- Insulated right through to the cable entry funnel
- Auxiliary switches can be retrofitted on all versions – even on the 20 A type
- Insta contactors with O/I / Automatic function enable system testing by manual switching without the need to apply a control voltage.
- Switching position indicator for fast recognition of operating states offers greater safety during system checks

12.2.2 Technical specifications

		Insta contactors						Auxiliary switches
		5TT580.	5TT58100	5TT58600	5TT582. 5TT583.	5TT584.	5TT585.	5TT5910
Standards		IEC 60947-4-1, IEC 60947-5-1, IEC 61095 EN 60947-4-1, EN 60947-5-1, EN 61095 VDE 0660						IEC 60947-5-1
Approvals		CCC						
Number of poles	-	2	2	2	4	4	4	2
Rated frequency at AC	Hz	50 / 60						
Rated control circuit voltage U_c	V AC	24, 230	230	230	24, 115, 230	24, 230	24, 230	-
Operating range	x U_c	0.85 ... 1.1						-
Rated operational voltage U_e	V AC	230	230	230	400			230 / 400
Rated operational current I_e	A	20	25	32	25	40	63	6 / 4 (230 / 400 V)
Rated power loss P_v								
Pick-up power (without manual switching or with manual switching in "I" position)	VA/W	6 / 3.8	12 / 10	12 / 10	10 / 5	15.4 / 6	15.4 / 6	-
Pick-up power (with manual switching in "AUTO" position)	VA/W	12 / 10	-	-	33 / 25	62 / 50	62 / 50	-
Holding power	VA/W	2.8 / 1.2			5.5 / 1.6	7.7 / 3	7.7 / 3	-
Per contact	VA	1.7	2.0	2.5	2.2	4	8	-
Switching times								
Closing (NO contacts)	ms	15 ... 25			10 ... 20	15 ... 20		-
Opening (NO contacts)	ms	20			20	10		-
Closing (NC contacts)	ms	20 ... 30			20 ... 30	5 ... 10		-
Opening (NC contacts)	ms	10			10	10 ... 15		-
Rated impulse withstand voltage U_{imp}	kV	4						
Rated insulation voltage U_i	V	440			500			500
Contact gap, minimum	mm	3.6				3.4		4
Electrical endurance								
At I_e and load								
AC-1 / AC-7a		200000		150000	200000	100000		-
AC-3 / AC-7b		300000		300000	500000	150000		-
In operating cycles								
Mechanical endurance		3 million						
In operating cycles								

		Insta contactors						Auxiliary switches
		5TT580.	5TT58100	5TT58600	5TT582. 5TT583.	5TT584.	5TT585.	5TT5910
Maximum switching frequency At load Switching operations / h		600						
Switching resistive load AC-1 / AC-7a at rated operational power P_s								
1-phase 230 V	kW	4	5.4	5.9	5.4	8.7	13.3	-
3-phase 400 V	kW	-			16	26	40	-
Switching 3-phase asynchronous motors AC-3 at rated operational power P_s								
1-phase 230 V	kW	1.3 ¹⁾			1.3	3.7	5	-
3-phase 400 V	kW	-			4	11	15	-
Minimum switching capacity	V; mA	17; 50						12; 5
Overload withstand capability Per current path (only NO contacts) At 10 s	A	72			68	176	240	-
Short-circuit protection, according to type of coordination 1 Back-up fuse characteristic gL/gG	A	20	25	32	25	63	80	6
Connecting terminals Coil connection Main connection ± screw (Pozidriv)		PZ1				PZ1 PZ2		- PZ1
Tightening torques Coil connection Main connection		Nm 0.6 Nm 1.2				0.6 3.5		- 0.8
Conductor cross-sections Coil connection - Rigid - Flexible, with end sleeve Main connection - Rigid - Flexible, with end sleeve		mm ² mm ² mm ² mm ²	1.0 ... 2.5 1.0 ... 2.5 1.0 ... 10 1.0 ... 6			1.0 ... 2.5 1.0 ... 2.5 1 ... 25 1 ... 16		- - 1 ... 2.5 1 ... 2.5
Permissible ambient temperature For operation For storage		°C °C	-5 ... +55 -30 ... +80					
Degree of protection Acc. to EN 60529		IP 20 with connected conductors						

¹⁾ Only for NO contacts.

12.2.3 Dimensional drawings

Insta contactors AC technology without manual control

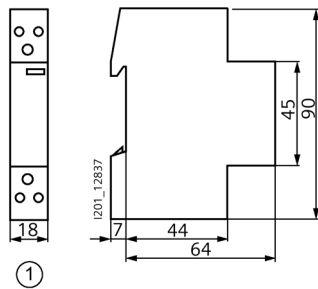

①

① 5TT580.-0, 5TT580.-2, 5TT58100, 5TT58600

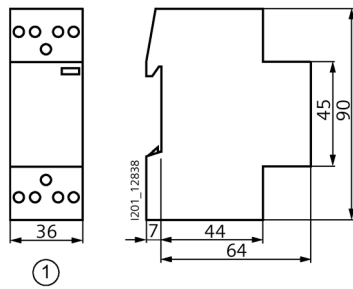

①

① 5TT820-0, 5TT583.-0, 5TT583.-2

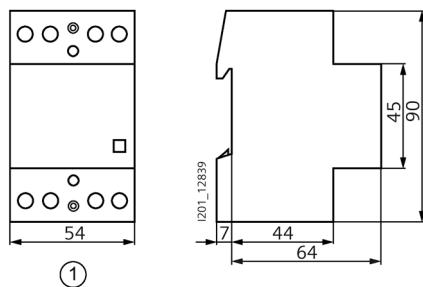

①

① 5TT584.-0, 5TT584.-2, 5TT585.-0, 5TT585.-2

Insta contactors AC technology without manual control

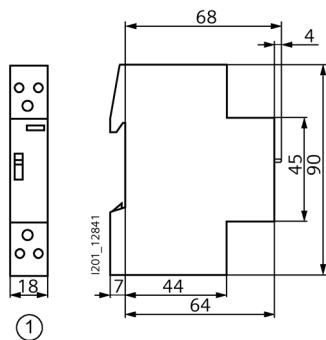

①

① 5TT580.-6, 5TT580-8

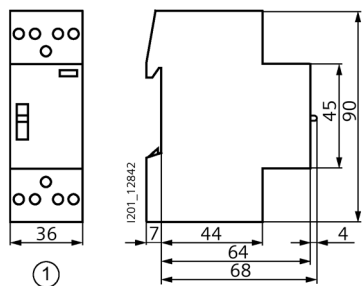

①

① 5TT583.-6, 5TT583.-8

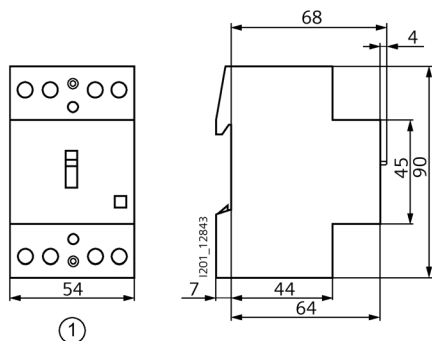

①

① 5TT584.-6, 5TT584.-8, 5TT585.-6

Auxiliary switches

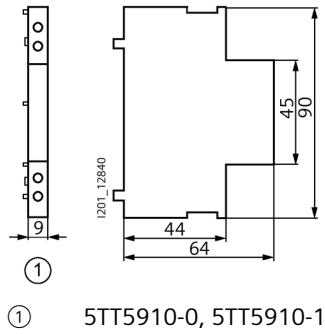

12.2.4 Circuit diagrams



5TT5800
5TT58100
5TT58600



5TT5801



5TT5802

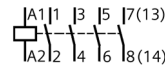

5TT5820
5TT5830
5TT5840
5TT5850

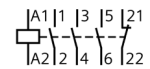

5TT5831
5TT5841
5TT5851

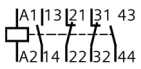

5TT5832
5TT5842
5TT5852

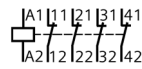

5TT5833
5TT5843
5TT5853



5TT5910-0



5TT5910-1

12.2.5 More information

Mounting position for Insta contactors AC technology

The installation of the devices is permissible in the positions shown in the following diagram (0° to 90°, 270° to 0°). There are no restrictions when the devices are installed in these normal mounting positions.

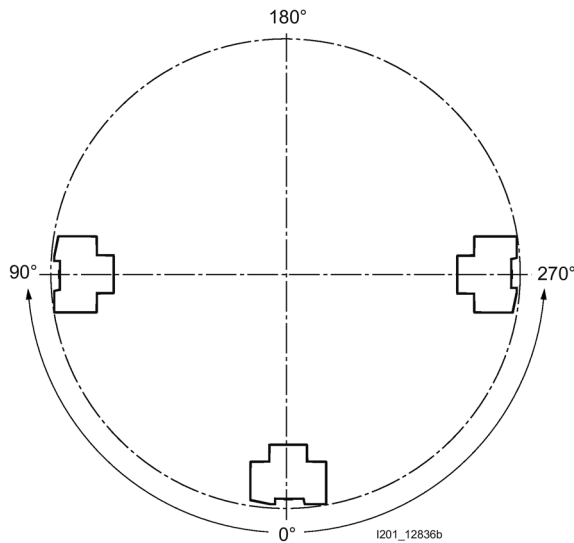

Heat dissipation

Spacers must be planned to ensure heat dissipation. In the Insta contactors with a width of 18 mm (1 width modules), a 5TG8240 spacer must be used in the temperature range up to 40 °C after every third Insta contactor, in the temperature range above 40 °C up to 55 °C after every second.

In continuous operation (100% OP), a spacer is recommended after every Insta contactor.

Manual switching with O//automatic function

The 5TT58...-6 and 5TT58...-8 versions also offer manual switching. The knob allows preselection of 3 positions:

- Knob in the "AUTO" position

Automatic mode → normal contactor operation

- Knob in the "I" position

Continuous duty → switched on manually (without control signal; when a control signal is applied, manual switch-on is enabled again, i.e. the knob is automatically reset to the "AUTO" position)

- Knob in the "O" position

Off → switched off (coil circuit interrupted)



System test without applying a control voltage

Insta contactors with O//Automatic function enable system testing by manual switching without the need to apply a control voltage.

Automatic resetting through control signal

When a control signal is applied to terminals A1 and A2, the Insta contactors can be reset from continuous duty ("I" position) to automatic mode ("AUTO" position).

Table 12- 13 Switching of DC-1 alternating voltages

Permissible DC switching currents for NO contacts with resistive load					1 contact	2 contacts in series	3 contacts in series	4 contacts in series
5TT580 5TT58100	2-pole	20 A	le at	U _e = 24 V DC U _e = 110 V DC U _e = 220 V DC	20 6 0.6	20 10 6	- - -	- - -
5TT582 5TT583	4-pole	25 A	le at	U _e = 24 V DC U _e = 110 V DC U _e = 220 V DC	25 6 0.6	25 10 6	25 20 15	25 20 15
5TT58600	2-pole							
5TT584	4-pole	40 A	le at	U _e = 24 V DC U _e = 110 V DC U _e = 220 V DC	40 4 1.2	40 10 8	40 30 20	40 40 40
5TT585	4-pole	63 A	le at	U _e = 24 V DC U _e = 110 V DC U _e = 220 V DC	63 4 1.2	63 10 8	63 35 30	63 63 63

Table 12- 14 Switching LED lamps

LED lamps Type	Power P W	Current I A	Capacitor C μF	Maximum number of lamps per current path at 230 V, 50 Hz			
				5TT5 80x-x / 00x-x / 8100 20 A	5TT5 83x-x / 03x-x / 8600 25 A, 32 A	5TT5 84x-x / 04x-x 40 A	5TT5 85x-x / 05x-x 63 A
Power supply for LEDs	-	-	-	Max. 2.4 A per pole	Max. 3.8 A per pole	Max. 11 A per pole	Max. 18 A per pole

Table 12- 15 Switching of lamps

Incandescent lamp load, lamp type				1000 W	500 W	200 W	100 W	60 W
5TT580 5TT58100	2-pole	20 A	Per NO contact / NC contact	1	3	10	20	33
5TT582 5TT58600	4-pole 2-pole	25 A	Per NO contact / NC contact	2	4	10	20	33
5TT583	4-pole							
5TT584	4-pole	40 A	Per NO contact / NC contact	4	8	20	40	65
5TT585	4-pole	63 A	Per NO contact / NC contact	5	10	25	50	85

Maximum number of lamps in units, per NO contact/NC contact at 230 V AC, 50 Hz.

Table 12- 16 Fluorescent and compact lamps in ballast operation (CCG)
(permissible number of lamps per NO contact / NC contact at 230 V AC, 50 Hz)

				Uncompensated			Parallel-compensated			DUO connection, 2 lamps			
Lamp type			W	L18	L36	L58	L18	L36	L58	2 x L18	2 x L36	2 x L58	
Capacitance			μF	-	-	-	4.5	4.5	7.0	-	-	-	
5TT580 5TT58100	20 A	2-pole	Per NO contact / NC contact	-	22	17	14	7	7	4	30	17	10
5TT582 5TT58600	25 A	4-pole 2-pole	Per NO contact / NC contact	-	41	41	28	33	33	21	54	36	19
5TT583	25 A	4-pole	Per NO contact / NC contact	-	24	20	17	8	8	5	40	24	14
5TT584	40 A	4-pole	Per NO contact / NC contact	-	90	65	45	48	48	31	100	65	40
5TT585	63 A	4-pole	Per NO contact / NC contact	-	140	95	70	73	73	47	150	95	60

Table 12- 17 Fluorescent and compact lamps with electronic ballast (ECG)
(permissible number of lamps per NO contact / NC contact at 230 V AC, 50 Hz)

				1 lamp			2 lamps			
Lamp type				W	1 x L18	1 x L36	1 x L58	2 x L18	2 x L36	2 x L58
5TT580 5TT58100	2-pole	20 A	Per NO contact / NC contact	-	25	15	14	12	7	7
5TT582 5TT58600	4-pole 2-pole	25 A	Per NO contact / NC contact	-	35	20	19	17	10	9
5TT583	4-pole	25 A	Per NO contact / NC contact	-	35	20	19	17	10	9
5TT584	4-pole	40 A	Per NO contact / NC contact	-	100	52	50	50	26	25
5TT585	4-pole	63 A	Per NO contact / NC contact	-	140	75	72	70	38	36

12.2 5TT58 Insta contactors, AC technology

Table 12- 18 High-pressure mercury-vapor lamps (HQL)
(permissible number of lamps per NO contact / NC contact at 230 V AC, 50 Hz)

Lamp type Capacitance			W μF	Uncompensated							Parallel-compensated						
				50	80	125	250	400	700	1000	50	80	125	250	400	700	1000
5TT580 5TT58100 2-pole	20 A	Per NO contact / NC contact	-	14	10	7	4	2	1	1	4	4	3	1	1	0	0
5TT582 4-pole	25 A	Per NO contact / NC contact	-	18	13	9	5	3	2	1	21	18	15	8	6	3	2
5TT58600 2-pole	25 A	Per NO contact / NC contact	-	18	13	9	5	3	2	1	21	18	15	8	6	3	2
5TT583 4-pole	25 A	Per NO contact / NC contact	-	18	13	9	5	3	2	1	5	5	4	2	1	0	0
5TT584 4-pole	40 A	Per NO contact / NC contact	-	38	29	20	10	7	4	3	31	27	22	12	9	5	4
5TT585 4-pole	63 A	Per NO contact / NC contact	-	55	42	29	15	10	6	4	41	41	33	18	13	7	5

Table 12- 19 Metal-halide lamps (HQL)

(permissible number of lamps per NO contact / NC contact at 230 V AC, 50 Hz)

			Uncompensated						Parallel-compensated						With electronic ballast PCI				
Lamp type			W	70	150	250	400	1000	2000	70	150	250	400	1000	2000	20	35	70	150
Capacitance			μF	-	-	-				12	20	33	35	95	148	-	-	-	-
5TT580 5TT58100 2-pole	20 A	Per NO contact / NC contact	-	10	5	3	3	1	0	2	1	0	0	0	0	9	6	5	4
5TT582 4-pole	25 A	Per NO contact / NC contact	-	12	7	4	3	1	0	12	7	4	4	1	1	9	6	5	4
5TT58600 2-pole																			
5TT583 4-pole	25 A	Per NO contact / NC contact	-	12	7	4	3	1	0	3	1	1	0	0	0	9	6	5	4
5TT584 4-pole	40 A	Per NO contact / NC contact	-	23	12	7	6	2	1	18	11	6	6	2	1	18	11	10	8
5TT585 4-pole	63 A	Per NO contact / NC contact	-	32	18	10	9	3	1	25	15	9	8	3	2	20	13	12	10

Table 12- 20 High-pressure sodium-vapor lamps (HPS)
(permissible number of lamps per NO contact / NC contact at 230 V AC, 50 Hz)

Lamp type Capacitance			W μF	Uncompensated				Parallel-compensated				With electronic ballast PCI			
				150	250	400	1000	150 20	250 33	400 48	1000 106	20 -	35 -	70 -	150 -
5TT580 5TT5810 2-pole	20 A	Per NO contact / NC contact	-	5	3	2	0	1	0	0	0	9	6	5	4
5TT582 4-pole	25 A	Per NO contact / NC contact	-	6	4	2	1	7	4	3	1	9	6	5	4
5TT58600 2-pole															
5TT583 4-pole	25 A	Per NO contact / NC contact	-	6	4	2	1	1	1	0	0	9	6	5	4
5TT584 4-pole	40 A	Per NO contact / NC contact	-	17	10	6	3	11	6	4	2	18	11	10	8
5TT585 4-pole	63 A	Per NO contact / NC contact	-	22	13	8	3	16	10	6	3	20	13	12	10

Table 12- 21 Low-pressure sodium-vapor lamps (LPS)
(permissible number of lamps per NO contact / NC contact at 230 V AC, 50 Hz)

Lamp type Capacitance			W μF	Uncompensated					Parallel-compensated						
				18	35	55	90	135	190	18 5	35 20	55 20	90 26	135 45	180 40
5TT580 5TT5810 2-pole	20 A	Per NO contact / NC contact	-	22	7	7	4	3	3	6	1	1	1	-	.
5TT582 4-pole	25 A	Per NO contact / NC contact	-	27	9	9	5	4	4	30	7	7	5	3	3
5TT5860 02-pole															
5TT583 4-pole	25 A	Per NO contact / NC contact	-	27	9	9	5	4	4	7	1	1	1	-	-
5TT584 4-pole	40 A	Per NO contact / NC contact	-	71	23	23	14	10	10	44	11	11	8	4	5
5TT585 4-pole	63 A	Per NO contact / NC contact	-	90	30	30	19	13	13	66	16	16	12	7	8

Table 12- 22 Fluorescent lamps Lumilux T5 type FC with electronic ballast (ECG)
(permissible number of lamps per NO contact / NC contact at 230 V AC, 50 Hz)

Lamp type					W	1 lamp			2 lamps		
						22	40	55	2 x 22	2 x 40	2 x 55
5TT580 5TT58100	2-pole	20 A	Per NO contact / NC contact	-	22	12	8	11	6	4	
5TT582 5TT58600	4-pole 2-pole	25 A	Per NO contact / NC contact	-	30	15	12	15	7	6	
5TT583	4-pole	25 A	Per NO contact / NC contact	-	30	15	12	15	7	6	
5TT584	4-pole	40 A	Per NO contact / NC contact	-	80	40	30	40	20	15	
5TT585	4-pole	63 A	Per NO contact / NC contact	-	110	60	45	55	30	22	

Table 12- 23 Fluorescent lamps Lumilux T5 type HE with electronic ballast (ECG)
(permissible number of lamps per NO contact / NC contact at 230 V AC, 50 Hz)

Lamp type					W	1 lamp				2 lamps			
						14	21	28	35	2 x 14	2 x 21	2 x 28	2 x 35
5TT580 5TT58100	2-pole	20 A	Per NO contact / NC contact	-	30	22	18	14	15	11	9	7	
5TT582 5TT58600	4-pole 2-pole	25 A	Per NO contact / NC contact	-	40	30	22	18	20	15	11	9	
5TT583	4-pole	25 A	Per NO contact / NC contact	-	40	30	22	18	20	15	11	9	
5TT584	4-pole	40 A	Per NO contact / NC contact	-	105	80	60	48	52	40	30	24	
5TT585	4-pole	63 A	Per NO contact / NC contact	-	150	115	90	70	75	57	45	35	

12.2 5TT58 Insta contactors, AC technology

Table 12- 24 Fluorescent lamps Lumilux T5 type HO with electronic ballast (ECG)
 (permissible number of lamps per NO contact / NC contact at 230 V AC, 50 Hz) in [A]

Lamp type			W	1 lamp					2 lamps				
				24	39	49	54	80	2 x 24	2 x 39	2 x 49	2 x 54	2 x 80
5TT580 5TT58100 2-pole	20 A	Per NO contact / NC contact	-	20	12	10	9	6	10	6	5	4	3
5TT582 4-pole	25 A	Per NO contact / NC contact	-	26	16	14	13	8	13	8	7	6	4
5TT58600 2-pole													
5TT582 4-pole	25 A	Per NO contact / NC contact	-	26	16	14	13	8	13	8	7	6	4
5TT584 4-pole	40 A	Per NO contact / NC contact	-	70	42	35	32	22	35	21	17	16	11
5TT585 4-pole	63 A	Per NO contact / NC contact	-	100	62	52	47	32	50	31	26	23	16

5TT3 soft-starting devices

13.1 Overview

Soft-starting devices are rugged electronic control devices for soft starting of 3-phase asynchronous machines. Two of the three motor phases are influenced by generalized phase control in such a way that the current rises continuously in these phases. The motor torque behaves in the same way during start-up. This ensures that the drive can start without jerk. This prevents the drive components from being damaged because the sudden starting torque that occurs with direct switch-on is eliminated. This characteristic permits a low-cost design of the actuator elements.

A clear reduction in starting noise can also be witnessed. On belt conveyor systems, sliding or tilting over of the goods conveyed is avoided. After starting, the power electronics is bypassed by means of an internal relay contact to minimize losses in the device.

13.2 Technical specifications

			5TT3440	5TT3441
Standards			EN 60947-4-2 (VDE 0660-117)	
Line/motor voltage		V AC	400	230
Operating range		x U _c	0.8 ... 1.1	
Rated power		VA	3.5	1.4
Rated frequency		Hz	50 / 60	
Rated power loss P_v	Coil/actuator	W	3.5	1.7
	Contact ¹⁾ per pole	W	4.6	0.7
Rated power of motor	- Max.	VA	5500	1500
	- Min.	VA	300	100
Startup voltage		%	30 ... 70	20 ... 70
Starting ramp		s	0.1 ... 10	
Recovery time		ms	100	200
Switching frequency				
3 × I _N , T _{AN} = 10 s, v _u = 20%		Operating cycles/h	36 (up to 3 kW)	10
3 × I _N , T _{AN} = 10 s, v _u = 20%		Operating cycles/h	20 (from 3 ... 5.5 kW)	10
Semiconductor fuse	Quick-acting	A	35	20
Conductor cross-sections	Rigid	max. mm ²	2 x 2.5	
	Flexible, with end sleeve	min. mm ²	1 x 0.5	
Permissible ambient temperature		°C	-20 ... +60	-20 ... +55
Resistance to climate	Acc. to EN 60068-1		20 / 60 / 4	20 / 55 / 4

¹⁾ For rated operational current.

13.3 Dimensional drawings

Soft starter 5TT344.

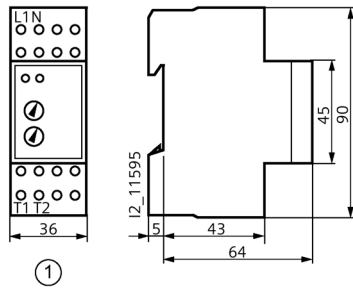

① 5TT3441

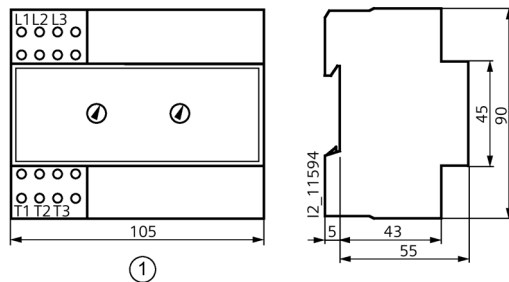

① 5TT3440

13.4 Example circuits

Typical circuit for 5TT3441

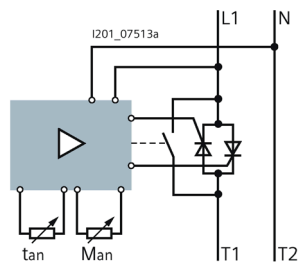
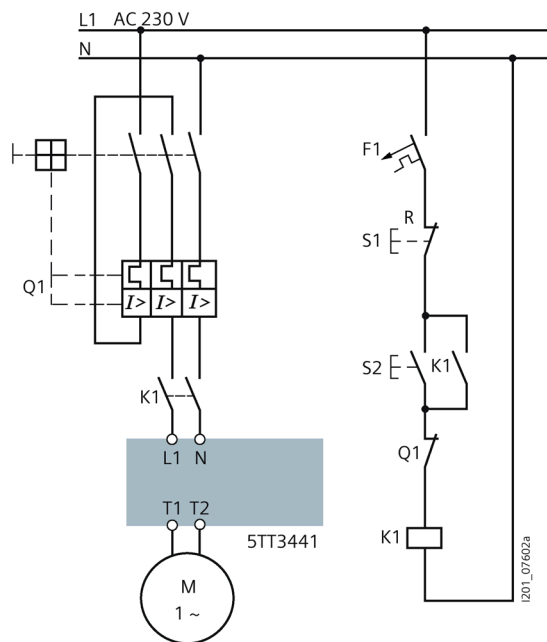

tan: Anlaufzeit
Man: Anlaufmoment

Figure 13-1 Typical circuit for 5TT3441

Typical circuit for 5TT3440

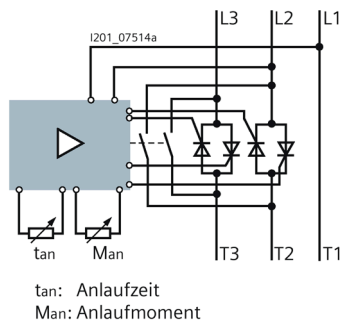
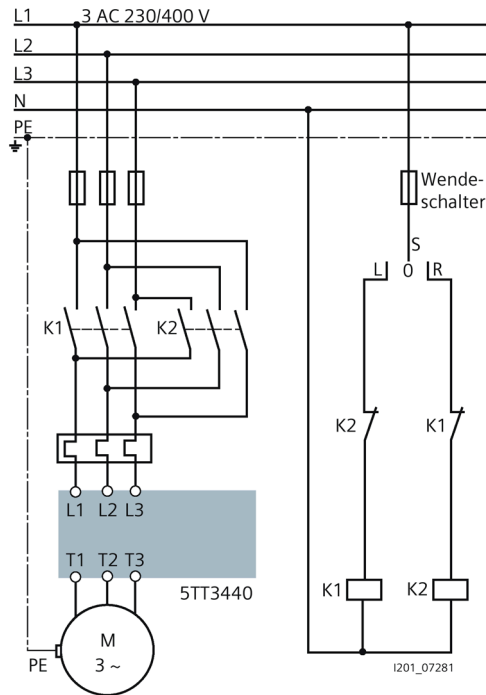

Figure 13-2 Typical circuit for 5TT3440

Controls

14.1 Overview

Switching on loads

The increased making currents of different loads and the consequent risk of contact welding are often underestimated.

Resistive load:

The resistive load, e.g. electric heating, does not increase the making current.

Incandescent lamps:

The cold coiled filament in incandescent lamps or halogen lamps causes a 6 to 10-fold making current for approx. 10 ms.

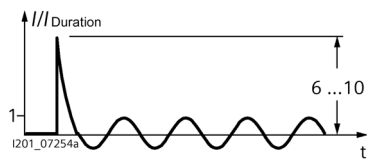

Uncompensated fluorescent lamps:

When switched on over several periods, the heating current of the coiled filament and the operational current produce a 2 to 2.5-fold inductive current.

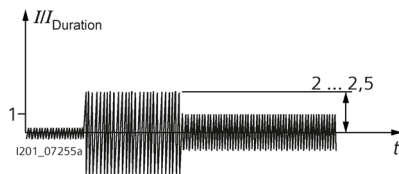

Fluorescent lamps with parallel compensation:

When switching on, the capacitor results in a high to 13-fold level of current for around 10 ms.

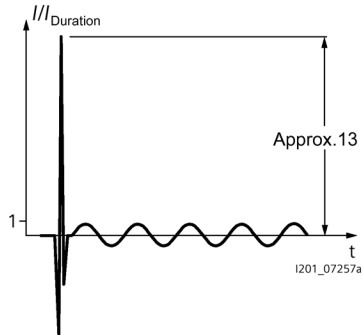

LED lamps

LED lamps cause a very high current for several μ s on switch-on (20 to 100 times).

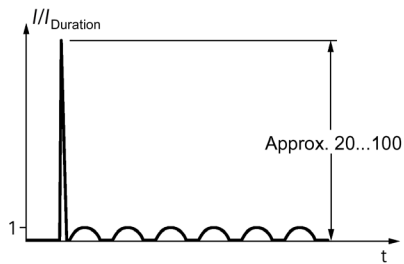

Fluorescent lamps in DUO connection:

The series capacitor results in compensation. In spite of this, an increased making current is produced over several periods, as with uncompensated fluorescent lamps.

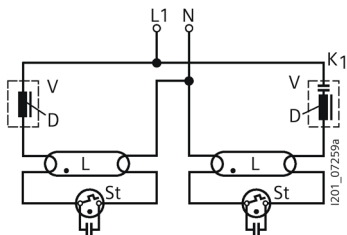

Selecting contacts for lighting systems

A wide range of different contacts are used for modular installation devices:

- Contactor contacts with contact gap > 3 mm, as for Insta contactors, AC technology
- Switching relay contacts with m contacts (contact gap > 1.2 mm but < 3 mm)
- Manually operated contacts with contact gap > 3 mm, as for 5TE8 switches
- Relay contacts with μ contacts (contact gap > 0.5 mm), as used on PCBs for electronic devices.

The selection tables in the Technical Specifications will help you to find the correct switching device for the different lighting installations.

Switching off loads

If a contact with current flowing through it opens, this always ignites an electric arc above 24 to 30 V. This arc depends on voltage, length of isolating distance, speed of contact, actuating angle and amperage. The principle of the so-called zero cutoff is that after no more than 1½ half-waves, the electric arc is quenched in the zero point. No additional quenching aids or current limitations are available, as with miniature circuit-breakers.

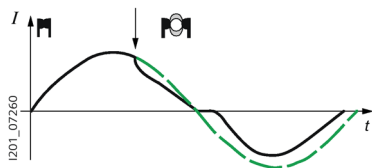

Switching off direct currents

When switching direct voltages, there is no zero passage of current for quenching of the arc. To be able to switch significant currents despite this, contacts are connected in series to increase the isolating distance. In some switchgears, planning data are specified for switching of direct currents. Compliance with these planning data is essential. If the data values are exceeded, the electric arc is not reliably quenched and there is a risk of fire.

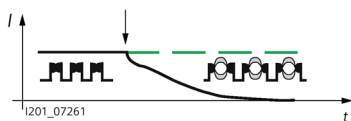

Protective separation

When operating 230 V and safety extra-low voltage SELV – voltage of bell transformers or transformers for permanent load – on a device, it is essential to ensure "protective separation". At least 8 mm of creepage distances and clearances and a withstand voltage of more than 4 kV is needed for this. If these conditions – 8 mm or 4 kV – are not fulfilled, the term "electrical separation" as "not SELV" is used instead of the term "protective separation".

7LF, 5TT3 timers

15.1 7LF4 digital time switches

15.1.1 Overview

Today, time switching has become the norm.

In fact, it is now hard to imagine many process sequences and energy saving processes without time switching. It could also be argued that time switching satisfies a basic need in the electrical installation sector.

New-generation digital time switches have a wider variety of functions than their predecessors and are easier to operate thanks to improved solution options.

They can be used to switch systems or system components, and for functions such as: Irrigation systems, greenhouses, public gardens, swimming pools, filtering installations, canopy controls, break signals, church bells, shop window lighting, advertising lighting, gym lighting, traffic signal controls, street lighting, illuminated signs, office lighting, lighting of stairwells and entrances, object illumination, preheating of industrial furnaces, spraying machines, ovens, heating systems, air-conditioning systems, fans and ventilation systems, heating and circulation pumps and sauna systems.

All devices feature the VDE mark of conformity and are UL-approved (except for 7LF4444).

15.1.2 Technical specifications

7LF4 digital time switches		Mini 7LF4401-5	Top 7LF4511 7LF4512	Profi 7LF4521 7LF4522	Astro 7LF4531 7LF4532	Expert 7LF4444	Expert GPS 7LF4541 7F4542	
Standards		EN 60730-1, -2-7; VDE 0631-1, -2-7						
Approvals		-			UL File No. E301698		-	UL File No. E301698
Supply								
Rated control supply voltage U_c	V AC V AC / DC	110 ... 240	230	230	230	120 / 230	230	
- Operating range	$x U_c$	0.85 ... 1.1	0.85 ... 1.1	0.85 ... 1.1 ¹⁾	0.85 ... 1.1	80 ... 253 V ¹⁾	0.85 ... 1.1	
- Frequency range	Hz	50 ... 60	50 ... 60	50 ... 60 ²⁾	50 ... 60	50 ... 60 ²⁾	50 ... 60	
Rated power loss P_v	VA	0.035	2	2	2	2.5 / 4 ³⁾	2	
Channels/contacts								
Switching channels		1	1 or 2		4		1 or 2	
Rated operational voltage U_e	V AC	250						
Rated operational current I_e at $\cos \phi = 1$	A	16						
At $\cos \phi = 0.6$	A	10						
Contact		1 CO	1 or 2 CO			4 CO	7LF4541: 1 CO 7LF4542: 1 CO + 1 NO	
- Mechanical operating cycles (in millions)	-	> 5	10					
- Electrical operating cycles at $\cos \phi = 1$	-	6000 (20 A)	100000					
Minimum contact load	V; mA	12; 100						
Incandescent lamp load	A	5	8					
Fluorescent lamp load Uncompensated	VA VA	58 1400	60 2300	600 2000		58 1400	600 2000	
Energy-saving lamp load	W	100	60 VA	1000		100	1000	
Safety								
Different phases, Actuator / contact permissible ⁷⁾		Yes						
Rated impulse withstand voltage U_{imp}	kV	4.0						
- EMC: Burst Acc. to IEC 61000-4-4	kV	> 4.4						
- EMC: Surge Acc. to IEC 61000-4-5	kV	> 2.0						
- Electrostatic discharge Acc. to IEC 61000-4-2	kV	> 8.0						
Power reserve storage Mains / battery	a	6 / 2	3	5				
- Battery type		Li primary cell						

7LF4 digital time switches	Mini 7LF4401-5	Top 7LF4511 7LF4512	Profi 7LF4521 7LF4522	Astro 7LF4531 7LF4532	Expert 7LF4444	Expert GPS 7LF4541 7F4542	
Program memory Non-volatile	-	No	Yes				
Overvoltage category Acc. to EN 61010-1	III						
Function							
Minimum operating sequence	1 min		1 s				
Switching step	1 min		1 s				
Clock error per day Typical	s / day	+ 0.3 ± 1	± 1.5	0.1	± 0.1	± 0.2	5)
Control input Terminal S	-	No		Yes (only in the case of 1K clock)		6)	
Memory locations - Programs ⁴⁾	28	28 (2 x 14)	56 (2 x 28)	56 (2 x 28)	4 x 3 x 28	84 (3 x 28)	
Connections							
Connecting terminals ± screw (Pozidriv)	PZ 1						
Conductor cross-sections of main conducting path							
- Rigid, max.	mm ²	4					
- Rigid, min.	mm ²	1.5					
- Flexible, with end sleeve Max.	mm ²	2.5					
Environmental conditions							
Permissible ambient temperature	°C	-10 ... +55	-20 ... +55				
Storage temperature	°C	-20 ... +60					
Resistance to climate Acc. to EN 60068-1		10 / 055 / 21	20 / 055 / 21				
Degree of protection Acc. to EN 60529		IP20, with connected conductors					
Protection class Acc. to EN 60730-1		II					

1) For 24 V devices (7LF4521-2, 7LF4522-2 and 7LF4444-2): Tolerance -10/+10%; operating range 0.9 ... 1.1 × U_c.

2) For 24 V devices (7LF4521-2, 7LF4522-2 and 7LF4444-2): Frequency range 0 ... 60 Hz.

3) For 24 V device (7LF4444-2): P_v = 4 VA.

4) A program consists of an ON time, an OFF time and assigned ON and OFF days or day blocks.

5) DCF/GPS atomic clock error, without antenna: +/-0.1 s/day

6) Control input for connection of the time signal + local coordinates (GPS) from the antenna power supply module

7) The combination of line voltage (230 V) and SELV is not admissible in conjunction with a 2K clock. This requirement is admissible in the case of 1K clocks and the Expert 4K however.

15.1.3 Dimensional drawings

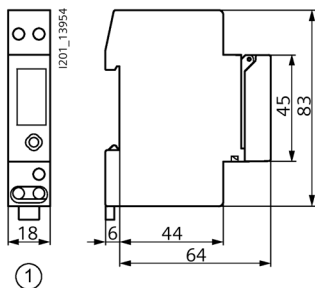

①
① 7LF4401-5

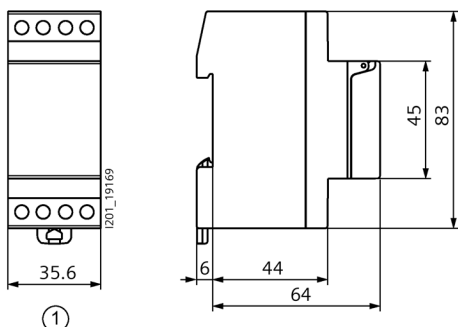

①
① 7LF451., 7LF452., 7LF453., 7LF454.

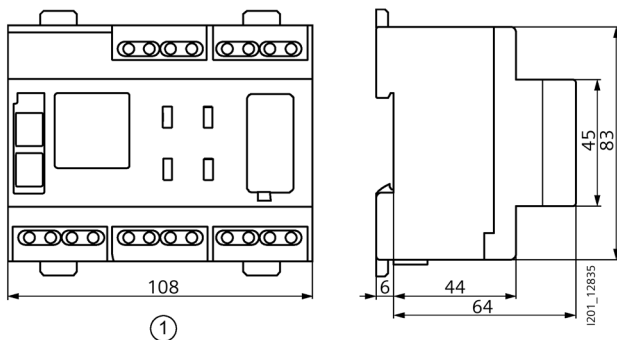

①
① 7LF4444

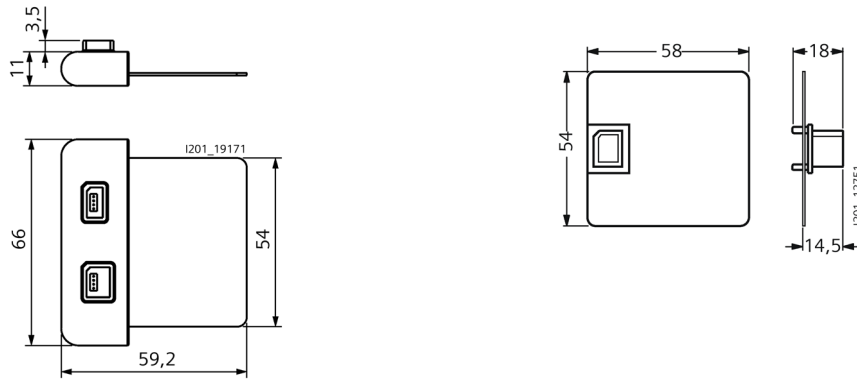

7LF4941-0, USB adapter_

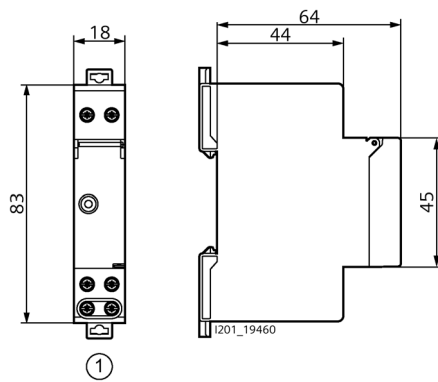

① 7LF4941-4
 Power supply unit for GPS antenna

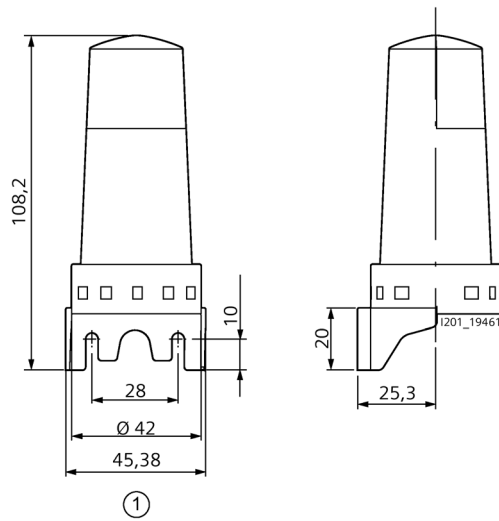

① 7LF4941-5
GPS antenna

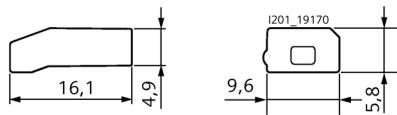

Figure 15-1 7LF4941-1

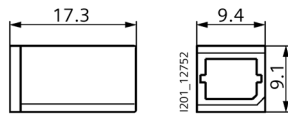

Figure 15-2 7LF4940-2

15.1.4 Circuit diagrams

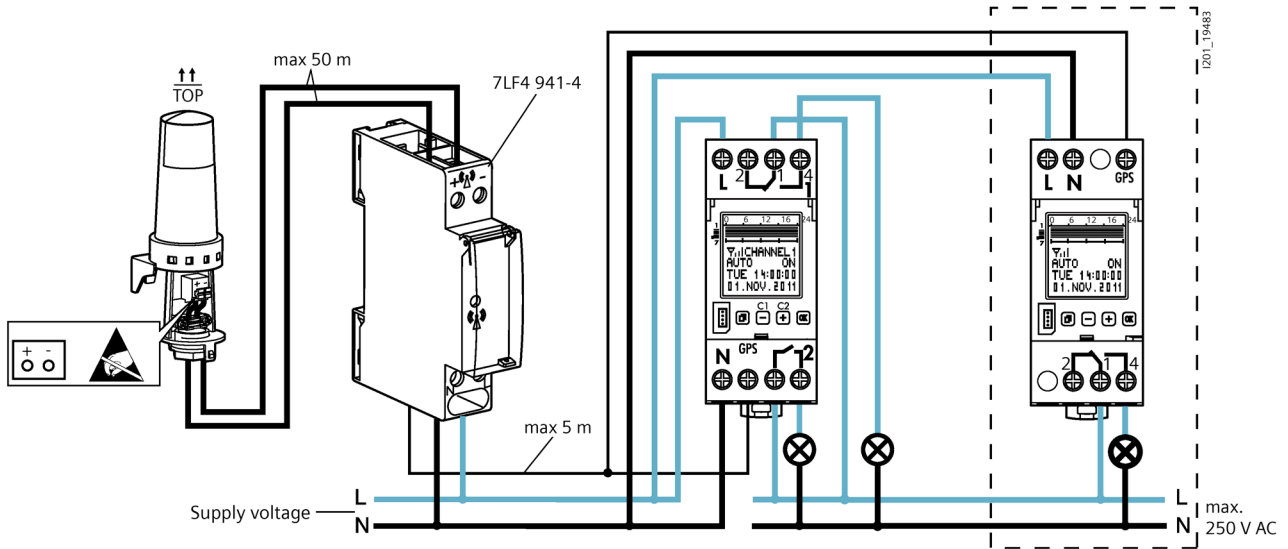
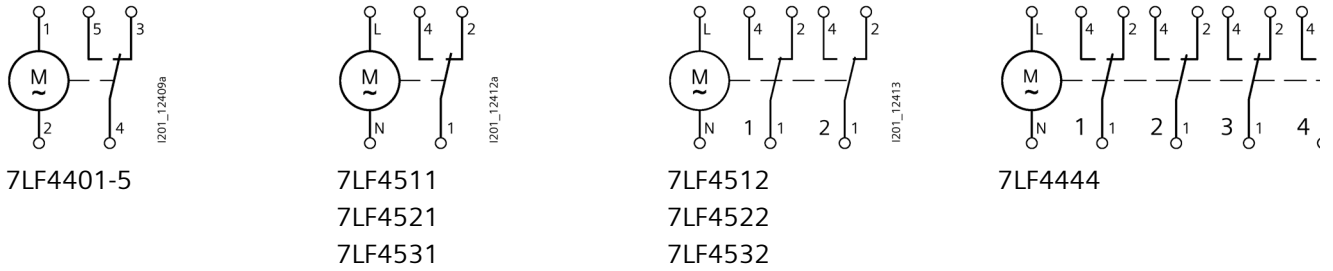

Figure 15-3 Digital time switch Expert GPS (7LF4541, 7LF4542) with GPS antenna (7LF4941-5) and power supply unit for GPS antenna (7LF4941-4)

15.1.5 More information

Mini digital time switch



The Mini digital time switch with a width of only 1 MW and its hour, day and week programs is ideal for replacement and installation in distribution boards with limited space.

The Mini digital time switch can be used flexibly as it can also be operated in battery mode with all its functionalities. Furthermore, the actuator of the clock can be removed from its enclosure for easy programming over the 5-way joystick prior to mounting.

Top, Profi, Astro and Expert digital time switches

Whether you are using text-assisted programming directly on the device or user-friendly programming on the PC, the Top, Profi, Astro and Expert digital time switches will make your work quicker and easier.

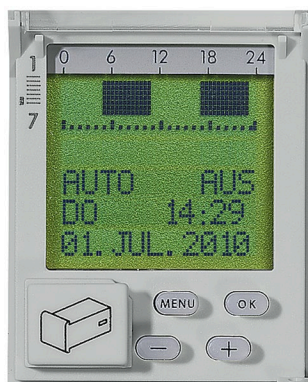

Simple operation:

Four programming pushbuttons offer user-friendly assistance with the text menu.

Easy-to-read display:

If you have to change the setting on the digital time switch inside a dark control cabinet, the integrated backlit display and illuminated control elements ensure that you retain an overview of what is what.

Straightforward commissioning:

You can start programming immediately. Profi, Astro and Expert are supplied with the time, date and automatic daylight saving for Central Europe already set.

Clear contrast:

In order to retain an overview even if lighting is poor and temperatures extreme, the display contrast can be adjusted, practically down to the finest detail.

User-friendly programming:

1-channel time switches allow input of up to 56 switching programs, 2-channel time switches allow up to 28 programs per channel and 4-channel time switches up to 84 programs per channel. This means that the Profi, Astro and Expert time switches are ideally equipped for even the most complex of tasks.

Each entry required is clearly indicated and no prolonged study of the operating instructions is necessary. A particularly practical feature: The digital time switch can be programmed even when it is not connected to a supply voltage.

The Profi, Astro and Expert digital time switches offer more than just reliable switching. Numerous integrated, easy-to-use functions ensure that these problem solvers are as simple to operate as they are versatile.

A data key enables easy programming of the Profi, Astro and Expert digital time switches at a PC, simplifies the setting of time switch programs and saves enormous amounts of time. This prevents human error and enables simple copying of complete time switch programs to different time switches.

Astro function: The Astro and Expert time switches have one key strength: the Astro function. In this way, the exact sunrise and sunset times are available for every location and every day of the year. For example, this means that connected exterior lighting only switches on when it gets dark - on short winter days as well as on summer days when it is light for much longer. The advantages are clear:

- Cost savings, because electricity is only used when the lighting is really needed, and because the service life of the light sources is extended. Particularly in the case of dusk-dependent lighting controls.
- Safety and convenience, because the light is always switched on when it is dark
- Ease of use, because the digital time switch does not have to be reprogrammed throughout the year
- Simplest possible installation, as the Astro digital time switch works in the distribution board. No further need for laborious cable laying to the light sensors. This means that it is not necessary to lay cables across the lightning protection zones. The compact 2 MW range is also ideally suited for subsequent installation or replacement.

Of course, the Astro and Expert digital time switches do more than just switch on and off at sunrise and sunset. More complex, combined programs are also possible. You always have the choice between astronomically calculated or individually set switching times, or a combination of both.

PC programming:



The Profi, Astro and Expert digital time switches support plug-in data keys. Thus providing you with even more security and convenience.

For example, you can read a program out from a digital time switch via the data key, copy the program to the PC and save and edit it there – or you could just transfer it to another clock. You can also work with several data keys. Programs can then be changed in a matter of seconds.

A backup copy ensures faster service. If the time switch has been manipulated, the data key can be used to retransfer the saved program to the clock without any problem.

Thanks to the standard operator interface based on MS Office, there is no need for laborious program training.

Pulse function on a 1-channel device:

Up to 84 start times and one pulse time can be programmed on the time switch using the pulse function. The pulse duration can be selected between 1 s and 59 min 59 s.

Random function:

If the random function is activated, the set switching times are shifted at random within a range of +/- 30 min.

Operating hours counter:

Particularly in commercial applications, it is often necessary to determine the operating life of the switched load, e.g. light sources. The operating hours counter displays the total ON duration per channel and the date of the last reset.

Holiday function:

The start and end dates of the holiday period are set in the holiday program. If the holiday program is activated, the digital time switch does not carry out any programmed switching commands during the relevant period. Depending on the input setting, it is either set to "CONTINUOUSLY OFF" or "CONTINUOUSLY ON". Once the holiday period is over, the digital time switch again begins to perform switching automatically in accordance with the programmed switching times.

Control input:

The follow-on time that can be set in the control input enables the relay to be switched in addition to and in parallel with the switching program. The follow-on time can be set within the range 0 min ... 23 h 59 min, and begins as soon as the voltage on the control input drops.

1 h test: The "1H TEST" function can be used for simulating switching. If "1H TEST" is activated, the switching outputs are switched for one hour. Once this period has elapsed, the digital time switch again begins to perform switching automatically in accordance with the programmed switching times.

PIN code: Input and programming can be disabled using a four-digit PIN code.

Week programs: Programs that are designed to be repeated regularly every week, e.g. light control, heating control. A week program comprises an ON/OFF time and assigned ON/OFF days.

Year programs: Programs that are only to be executed within a defined period of validity. They overlap with the weekly programs of the same channel combined with a logical OR function. The period of validity is specified by entering the start/end date. Validity from start date 00:00:00 to end date 24:00:00. The start date must be prior to the end date. Within their period of validity, these programs behave like week programs. Outside their period of validity, these programs have no influence on the switching behavior.

Exception programs: Have a higher priority than week and year programs. Weekly and annual programs of the same channel are no longer executed within the validity period of an exception program. However, other exception programs will be executed within the period of validity. The different exception programs overlap according to an OR operation.

Cycle function: On the year time switch, channel 1 has an additional option for "cyclic switching". The term "cyclic switching" means that within a specific period, the time switch is switched on for a specific duration (ON time). The cycle time can be set between 2 seconds and 2 hours. The ON time can be set between one second and one hour.

15.2 7LF5 mechanical time switches

15.2.1 Overview

Today, time switching has become the norm.

And making energy savings by means of time switching has also become a matter of course. Many process sequences are now inconceivable without time switching.

If the minimum switching interval is sufficient, mechanical time switches are always used. The press-down tabs can be set to a minimum interval of 15 minutes without the need for any tools. They can be used to switch systems or system components, or for functions such as: Irrigation systems, greenhouses, public gardens, swimming pools, filtering installations, canopy controls, church bells, shop window lighting, advertising lighting, gym lighting, traffic signal controls, street lighting, illuminated signs, office lighting, lighting of stairwells and entrances, object illumination, preheating of industrial furnaces, spraying machines, ovens, heating systems, air-conditioning systems, fans and ventilation systems, heating and circulation pumps and sauna systems.

All devices have the VDE mark and are UL-approved.

15.2.2 Technical specifications

		Synchronous time switches without power reserve				Quartz-clock time switches with power reserve					
7LF5 mechanical time switches		7LF5 300-1	7LF5 300-5	7LF5 300-6	7LF5 301-0	7LF5 301-1	7LF5 301-4	7LF5 301-5	7LF5 301-6	7LF5 301-7	7LF5 305-0
Standards		EN 60730-1, -2-7, UL 917, CSA C22.2 Nos. 14 and 177									
Approvals		VDE, UL file: E301698									
Supply											
Rated control supply voltage U_c	V AC	230				230					
- Operating range	x U_c	0.85 ... 1.1				0.85 ... 1.1					
Rated frequency	Hz	50				50					
- Frequency range	Hz	50				50 / 60					
Rated power loss P_v	VA					1	0.2	0.2	1	1	1
Channels/contacts											
Switching channels		1				1					
Rated operational voltage U_e	V AC	250				250					
Rated operational current I_e											
At $\cos \phi = 1$	A	16				16					
At $\cos \phi = 0.6$	A	4				4					
Contact		1 NO	1 CO	1 CO	1 CO	1 NO	1 CO	1 CO	1 CO	1 CO	1 CO
- Mechanical operating cycles (in millions)		20				20					
- Electrical operating cycles at $\cos \phi = 1$		100000				100000					
Minimum contact load	V; mA	4; 1				4; 1					
- Incandescent lamp load		A				5					
- Fluorescent lamps											
At 7 μ A	VA	60				60					
Uncompensated	VA	1400				1400					
Safety											
Different phases, actuator/contact permissible		Yes				Yes					
Electrical isolation, creepage distances and clearances, actuator/contact	mm	8 / 6				8 / 6					
Rated impulse withstand voltage U_{imp} drive/contact	kV	4				4					
- EMC: Burst Acc. to IEC 61000-4-4	kV	> 4.4				> 4.4					
- EMC: Surge Acc. to IEC 61000-4-5	kV	> 2.0				> 2.0					

		Synchronous time switches without power reserve				Quartz-clock time switches with power reserve					
7LF5 mechanical time switches		7LF5 300-1	7LF5 300-5	7LF5 300-6	7LF5 301-0	7LF5 301-1	7LF5 301-4	7LF5 301-5	7LF5 301-6	7LF5 301-7	7LF5 305-0
- Electrostatic discharge Acc. to IEC 61000-4-2	kV	> 8.0				> 8.0					
Power reserve storage	a	-				100 h	6		100 h		
- Minimum loading time	h	-				48	-		48		
- Battery type		-				NiMH cell	Li primary cell		NiMH cell		
- Service life of battery At 20 °C	a	-				6	10		6		
At 40 °C	a	-				5	5		5		
Overvoltage category Acc. to EN 61010-1		III				III					
Function											
Minimum operating sequence	min	30	240	30	30	240	30	240	30	240	30
Switching step	min	15	120	10	15	120	15	120	15	120	10
Switching accuracy	min	± 5	± 30	± 5	± 5	± 30	± 5	± 30	± 5	± 30	± 5
Clock error per day	-	System-synchronized				± 2.5 s	± 60 s / year		± 2.5 s		
Connections											
Connecting terminals ± screw (Pozidriv)		PZ 1				PZ 1					
- Conductor cross-sections of main current path											
- Rigid, max.	mm ²	4				4					
- Rigid, min.	mm ²	1.5				1.5					
- Flexible, with end sleeve	mm ²	2.5				2.5					
- Flexible, without end sleeve	mm ²	4				4					
Environmental conditions											
Permissible ambient temperature	°C	-10 ... +55				-10 ... +55					
Storage temperature	°C	-10 ... +60				-10 ... +60					
Resistance to climate Acc. to EN 60068-1		10 / 055 / 21				10 / 055 / 21					
Degree of protection Acc. to EN 60529		IP20, with connected conductors				IP20, with connected conductors					
Protection class Acc. to EN 61140		II				II					

15.2.3 Dimensional drawings

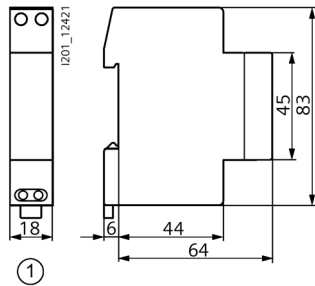

① 7LF5300-1, 7LF53007. 7LF5301-1

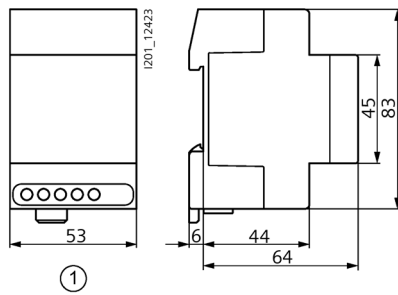

① 7LF5300-5, 7LF5300-6, 7LF5301-4, 7LF5301-5, 7LF5301-6, 7LF5301-7

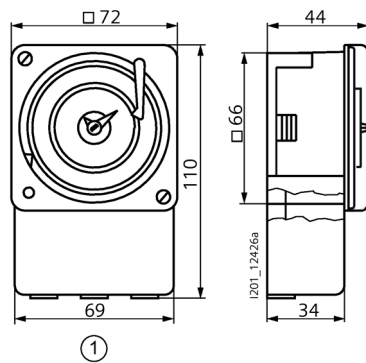

① 7LF5301-0, 7LF5305-0

15.2.4 Circuit diagrams

Graphic symbols

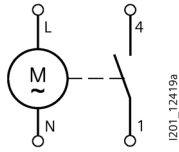

7LF5300-1
7LF5300-7
7LF5301-1

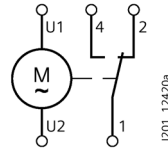

7LF5300-5
7LF5300-6
7LF5301-0
7LF5301-4
7LF5301-5
7LF5301-6
7LF5301-7
7LF5305-0

15.2.5 More information

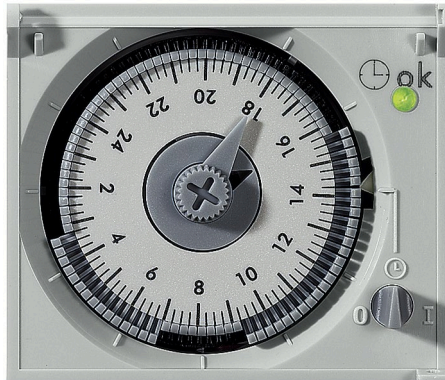

Figure 15-4 Mechanical time switch with day disk

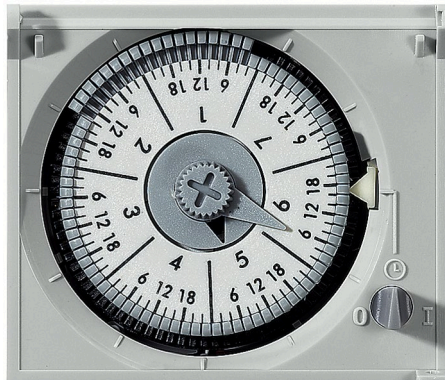

Figure 15-5 Mechanical time switch with week disk

Synchronous time switch without power reserve

The control gear is actuated by a synchronous motor, so it is dependent on the line frequency. If the line frequency is unstable, the devices cannot be used. In the event of a power failure, the time switch will stop.

Quartz time switch with power reserve

A quartz electronic circuit supplies the actuator with a stabilized frequency. The time switch is therefore not dependent on the line frequency. In the event of a power failure, the time switch continues to operate on its power reserve.

Automatic setting function

The automatic setting function makes installing the 7LF5301-4 and 7LF5301-5 time switches quick and easy. These time switches self-adjust during commissioning in fast mode to the correct time and correct day within the Central European zone. The relevant daylight-saving adjustment is also made automatically. Another advantage is that, once the supply voltage is reconnected following a power failure, the correct time and day are reset using quartz precision.

Precision quartz clockwork

The internal precision quartz clockwork has an accuracy of +/-1 min per year. Until now, this level of accuracy and automatic operational safety was only possible using digital time switches.

Optimization of power consumption through minimum switching steps of 15 minutes: It is possible to set the switching times in 15-minute increments with a switching interval of at least 30 minutes.

LED display

Adjustment data for Central Europe are stored in the switch and an LED display provides information about the current status. So, all you have to do is unpack, snap on, connect, and set the desired switching times, all without the need for tools. This saves time and money.

Clear design

The clear design makes it easy to understand. Switching times can be easily identified. With the week time switch, the switching step is only 120 minutes with a minimum switching interval of 240 minutes.

15.3 5TT3 timers for industrial applications

15.3.1 Overview

Time relays are primarily used in series applications where the use of PLC controls is too labor and cost-intensive. Multifunction relays with a range of functionalities are currently the market standard. Their operation is clear and intuitive.

15.3.2 Technical specifications

5TT3 timers for industrial applications		5TT3185	5TT3181 5TT3182 5TT3183	5TT3184
Standards		EN 60255; DIN VDE 0435-110		
Supply				
Rated control supply voltage U_c	V AC	12 ... 240	220 ... 240	110 ... 240
	V DC	12 ... 240	-	110 ... 240
- Operating range	x U_c	0.8 ... 1.1	0.8 ... 1.1	0.8 ... 1.1
Rated frequency f_n	Hz	45 ... 400	50 / 60	
Rated power loss P_v	VA	Approx. 1.5	Approx. 5	Approx. 1
Setting ranges		See setting ranges, timing intervals		
Recovery time	ms	15 ... 80	Approx. 40	Approx. 100
Contacts				
Switching channels				
- Rated operational voltage U_e	V AC	250		
- Rated operational current I_e	A	4	8	5
Contact gap	mm	μ contact		
Minimum contact load	V; mA	10; 300		
Rated impulse withstand voltage U_{imp} Input/output	kV	> 4		
Electrical endurance in switching cycles At AC-15	1 A	1.5 x 10 ⁵ -	- 1.5 x 10 ⁵	1.5 x 10 ⁵ -
Connections				
Connecting terminals ± screw (Pozidriv)	-	2		
- Conductor cross-sections of main current path				
- Rigid	mm ²	2 x 2.5		
- Flexible, with end sleeve, min.	mm ²	2 x 1.5		
Environmental conditions				
Resistance to climate Acc. to EN 60068-1	°C	40 / 60 / 4		
Permissible ambient temperature	°C	-40 ... +60		

15.3.3 Dimensional drawings

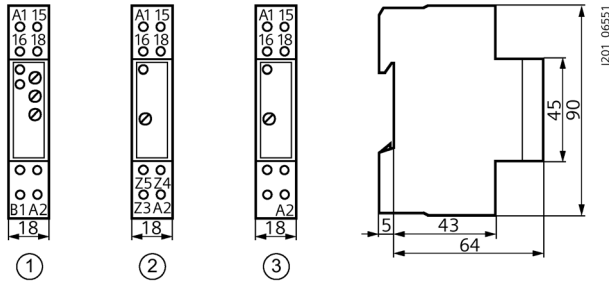

- ① 5TT3185
- ② 5TT3181
- ③ 5TT3182, 5TT3183, 5TT3184

15.3.4 Circuit diagrams

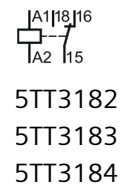
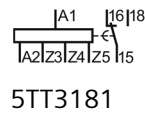

15.3.5 More information

5TT3181 delay timers

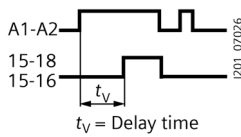

ON-delay

- Adjustable time ranges t_v
- 0.25 s ... 2.5 s
 - 1 s ... 10 s
 - 8 s ... 80 s
 - 64 s ... 300 s

5TT3182 wiper timers

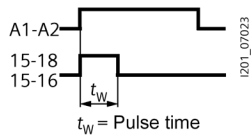

Pulse contact function

Adjustable time ranges t_v
1 s ... 10 s

5TT3183 flashing timers

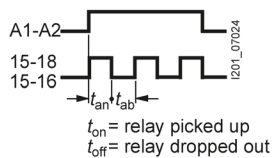

Flash function

Jointly adjustable time range of $t_{on}=t_{off}=t$
1 s ... 10 s

5TT3184 delay-off timers

	Adjustable time range t
<p>$t_1 < t$ $t = \text{OFF-delay}$</p> <p>OFF-delay</p>	<p>1 s ... 10 s</p> <p>$t_1 = \text{interruption}$</p>

15.3.6 5TT3185 multifunction timers

Setting aid

The flashing period of the green LED 1 during a timing interval is $1 \text{ s} \pm 4\%$; it can therefore be used as a setting aid. This is particularly useful in the lower time setting range and for long delay times because of the accuracy of the multiplication factors between the individual time ranges.

Example: Delay time to be set: 40 min. Using the fine setting, this delay time can be set within the setting range 3 ... 300 min. However, in this case it takes a long time to check the time and requires several operational sequences in real time. To speed up the setting process, the setting range is switched to 0.03 ... 3 min. In this case, the required value corresponds to a delay time 0.4 min (= 24 s). The timing interval is triggered and the potentiometer is set to 24 flashing periods of the yellow LED 2. The device is then set back to the setting range 3 ... 300 min and the setting process is completed.

Timing interval interruption/time addition

For the functions AV, EW, IE, BI, the timing interval can be interrupted at any time by activating B1 (+) and resumed by removing the control voltage (time addition).

Control input B1

The functions RV, IF, AW, AV/RV can be controlled using the control input B1 (+) with potential against terminal A2. The auxiliary voltage of terminal A1 – or any other voltage within the range 12 ... 240 V AC/DC – can be used for this purpose. The operation of parallel loads (e.g. contactors) from B1 (+) to A2 is also permissible.

If voltage is simultaneously applied to the control input B1 (+) and A1 for the IF function, an output pulse is triggered with the set time interval t_1 .

15.3 5TT3 timers for industrial applications

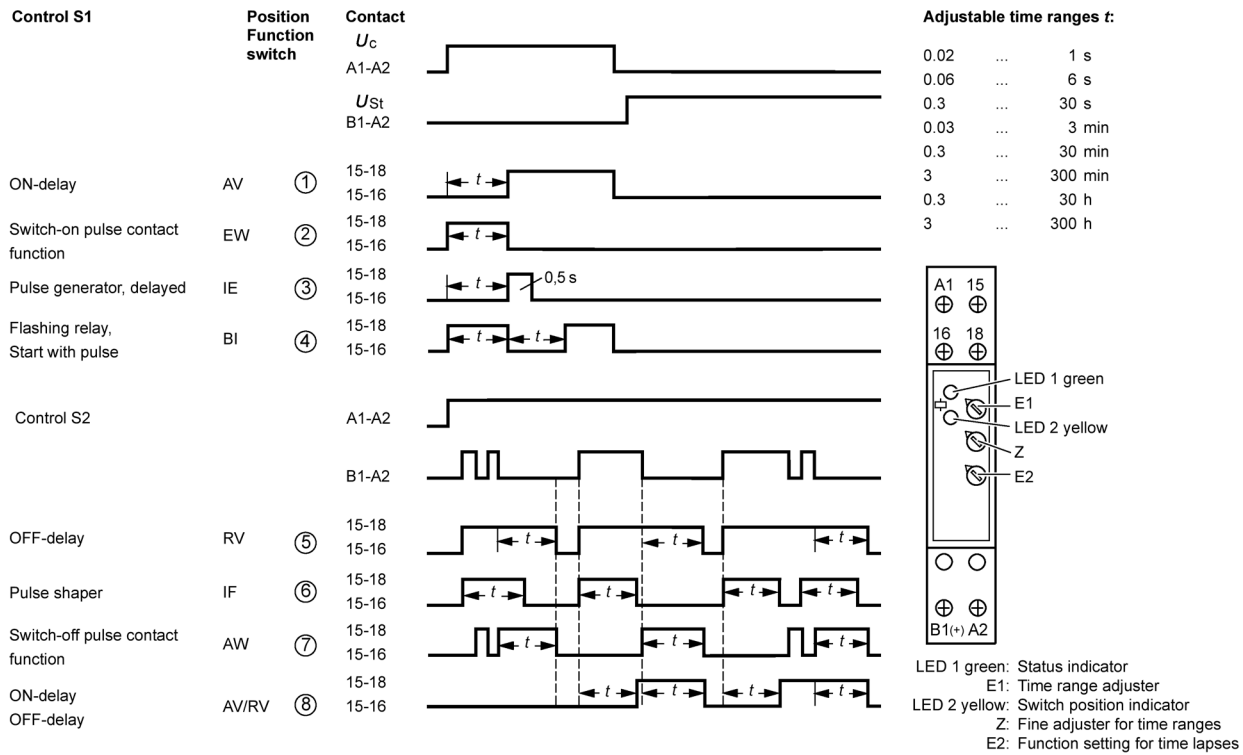

Control S1

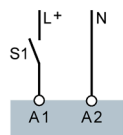

Contact S1
For the functions ON-delay, switch-on pulse contact function, pulse generator delayed, clock generator – (start with pulse) – the time lapse is triggered by closing the switch contact S1.

Control S2

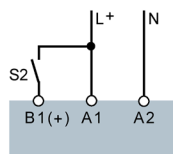

Contact S2
Functions OFF-delay, pulse shaper, switch-off pulse contact function, ON-delay and OFF-delay are triggered with continuous power supply via the control contact S2 between A1 and B1 (+).

User interface

- LED 1 Status indicator
- LED 2 Switch position indicator
- E1 Time range adjuster
- Z Fine adjuster for time ranges
- E2 Function setting for time lapses

Device indicators

- LED 1 Lamps up with applied operating voltage (green)
- LED 2 Shows the time lapse and status of the output relay (yellow)
 - Continuous light
 - Off Output relay not activated, no time lapse
 - On Output relay not activated, no time lapse
 - Flashing light
 - Short on, long off Output relay not activated, time lapse
 - Long on, short off Output relay activated, time lapse

Front view

- LED 1 green: Status indicator
- LED 2 yellow: Switch position indicator
- E1: Time range adjuster
- Z: Fine adjuster for time ranges
- E2: Function setting for time lapses

Further Information

Always at your disposal: our extensive support
www.siemens.com/online-support

Published by
Siemens AG

Smart Infrastructure
Electrical Products
Postfach 10 09 53
93009 REGENSBURG, Germany

For the U.S. published by
Siemens Industry Inc.

100 Technology Drive
Alpharetta, GA 30005
United States

Subject to change.

SI EP
Online

