

Rectangular Inductive Proximity Sensors

(□ 17/25/30/40 mm)



PS Series (DC 3-wire)

PRODUCT MANUAL

For your safety, read and follow the considerations written in the instruction manual, other manuals and Autonics website.

The specifications, dimensions, etc. are subject to change without notice for product improvement. Some models may be discontinued without notice.

Major Features

- Alternate frequency models allow adjacent installation of multiple sensors without interference (PSN17-□-F model)
- Operation indicator (red LED)
- IP67 protection structure (IEC standard)

Safety Considerations

- Observe all 'Safety Considerations' for safe and proper operation to avoid hazards.
- ⚠ symbol indicates caution due to special circumstances in which hazards may occur.

⚠ Warning Failure to follow instructions may result in serious injury or death.

- 01. Fail-safe device must be installed when using the unit with machinery that may cause serious injury or substantial economic loss. (e.g. nuclear power control, medical equipment, ships, vehicles, railways, aircraft, combustion apparatus, safety equipment, crime/disaster prevention devices, etc.)**
Failure to follow this instruction may result in personal injury, economic loss or fire.
- 02. Do not use the unit in the place where flammable/explosive/corrosive gas, high humidity, direct sunlight, radiant heat, vibration, impact, or salinity may be present.**
Failure to follow this instruction may result in explosion or fire.
- 03. Do not disassemble or modify the unit.**
Failure to follow this instruction may result in fire.
- 04. Do not connect, repair, or inspect the unit while connected to a power source.**
Failure to follow this instruction may result in fire.
- 05. Check 'Connections' before wiring.**
Failure to follow this instruction may result in fire.

⚠ Caution Failure to follow instructions may result in injury or product damage.

- 01. Use the unit within the rated specifications.**
Failure to follow this instruction may result in fire or product damage.
- 02. Use a dry cloth to clean the unit, and do not use water or organic solvent.**
Failure to follow this instruction may result in fire.

Cautions during Use

- Follow instructions in 'Cautions during Use'. Otherwise, it may cause unexpected accidents.
- 12-24 VDC \equiv power supply should be insulated and limited voltage/current or Class 2, SELV power supply device.
- Use the product, after 0.8 sec of supplying power.
- Wire as short as possible and keep away from high voltage lines or power lines, to prevent surge and inductive noise. Do not use near the equipment which generates strong magnetic force or high frequency noise (transceiver, etc.). In case installing the product near the equipment which generates strong surge (motor, welding machine, etc.), use diode or varistor to remove surge.
- This unit may be used in the following environments.
 - Indoors (in the environment condition rated in 'Specifications')
 - Altitude max. 2,000 m
 - Pollution degree 2
 - Installation category II

Cautions for Installation

- Install the unit correctly with the usage environment, location, and the designated specifications.
- Do NOT impacts with a hard object or excessive bending of the wire lead-out. It may cause damage the water resistance.
- Do NOT pull the \varnothing 4 mm cable with a tensile strength of 30 N or over. It may result in fire due to the broken wire.
- When extending wire, use AWG 22 cable or over within 200 m.
- Refer to the table below for the screw tightening torque when mounting the bracket.

	PSN17	PSN25	PSN30	PSN40
Tightening torque	0.49 N m	0.98 N m	0.98 N m	0.98 N m

Ordering Information

This is only for reference, the actual product does not support all combinations. For selecting the specified model, follow the Autonics website.

PSN ① - ② ③ ④ ⑤ - ⑥

① Sensing side length

Number: Side length of head (unit: mm)

② Sensing distance

Number: Sensing distance (unit: mm)

③ Power supply

D: 12 - 24 VDC≐

④ Control output

N: NPN Normally Open

N2: NPN Normally Closed

P: PNP Normally Open

P2: PNP Normally Closed

⑤ Sensing side

No-mark: Standard type

U: Upper side type

⑥ Frequency

No-mark: Standard type

F: Differential frequency type

Product Components

	PSN17	PSN25	PSN30	PSN40
Product	× 1	× 1	× 1	× 1
Instruction manual	× 1	× 1	× 1	× 1
Bracket	× 1	× 1	× 1	× 1
Bolt	M3 × 2	M4 × 2	M4 × 2	M5 × 2

Connections

■ Cable type

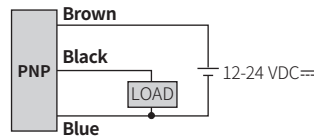
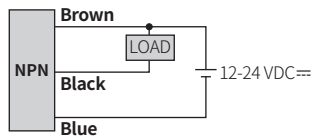

■ Inner circuit (NPN output)

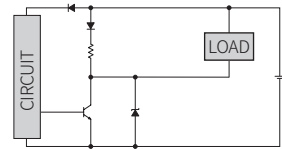

■ Inner circuit (PNP output)

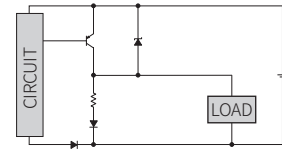

Operation Timing Chart

		Normally open	Normally closed
Sensing target	Presence		
	Nothing		
Load	Operation		
	Return		
Output voltage	NPN output		
	PNP output		
Operation indicator (red)			

Specifications

Installation	Standard type / Upper side type		Standard type			
	PSN17-5D□□-□	PSN17-8D□□-□	PSN25-5D□	PSN30-10D□	PSN30-15D□	PSN40-20D□
Model	18 mm	18 mm	25 mm	30 mm	30 mm	40 mm
Sensing side length	18 mm	18 mm	25 mm	30 mm	30 mm	40 mm
Sensing distance	5 mm	8 mm	5 mm	10 mm	15 mm	20 mm
Setting distance	0 to 3.5 mm	0 to 5 mm	0 to 3.5 mm	0 to 7 mm	0 to 10.5 mm	0 to 14 mm
Hysteresis	≤ 10 % of sensing distance					
Standard sensing target: iron	18 × 18 × 1 mm	25 × 25 × 1 mm	25 × 25 × 1 mm	30 × 30 × 1 mm	45 × 45 × 1 mm	60 × 60 × 1 mm
Response frequency (0.1)	700 Hz	200 Hz	300 Hz	250 Hz	200 Hz	100 Hz
Affection by temperature	± 10 % for sensing distance at ambient temperature 20 °C					
Indicator	Operation indicator (red)					
Approval	CE 标志 EAC	CE 标志 EAC	CE 标志 EAC	CE 标志 EAC	CE 标志 EAC	CE 标志 EAC
Unit weight (package)	≈ 62 g (≈ 83 g)	≈ 62 g (≈ 83 g)	≈ 71 g (≈ 103 g)	≈ 96 g (≈ 165 g)	≈ 96 g (≈ 165 g)	≈ 135 g (≈ 225 g)

01) The response frequency is the average value. The standard sensing target is used and the width is set as 2 times of the standard sensing target, 1/2 of the sensing distance for the distance.

Power supply	12 - 24 VDC≐ (ripple P-P: ≤ 10 %), operating voltage: 10 - 30 VDC≐
Current consumption	≤ 10 mA
Control output	≤ 200 mA
Residual voltage	≤ 1.5 V
Protection circuit	Surge protection circuit, output short over current protection circuit, reverse polarity protection
Insulation type	≥ 50 MΩ (500 VDC≐ megger)
Dielectric strength	Between the charging part and the case: 1,500 VAC~ 50/60 Hz for 1 min
Vibration	1 mm double amplitude at frequency 10 to 55 Hz in each X, Y, Z direction for 2 hours
Shock	500 m/s ² (≈ 50 G) in each X, Y, Z direction for 3 times
Ambient temp.	-25 to 70 °C, storage: -30 to 80 °C (no freezing or condensation)
Ambient humi.	35 to 95 %RH, storage: 35 to 95 %RH (no freezing or condensation)
Protection structure	IP67 (IEC standard)
Connection	Cable type model
Wire spec.	Ø 4 mm, 3-wire, 2 m
Connector spec.	AWG 22 (0.08 mm, 60-core), insulator diameter: Ø 1.25 mm
Material	Case: Heat-resistant ABS, standard type cable (black): polyvinyl chloride (PVC)

Dimensions

• Unit: mm, For the detailed dimensions of the product, follow the Autonics web site.

A Operation indicator (red) **B** Tap hole

■ PSN17

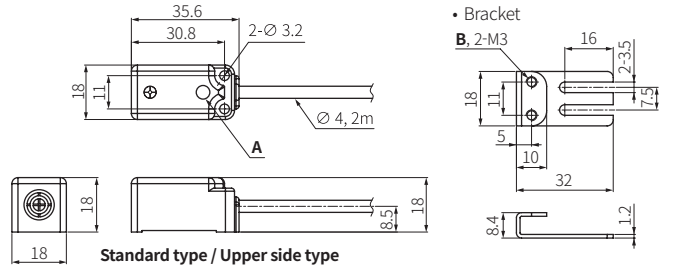

■ PSN25

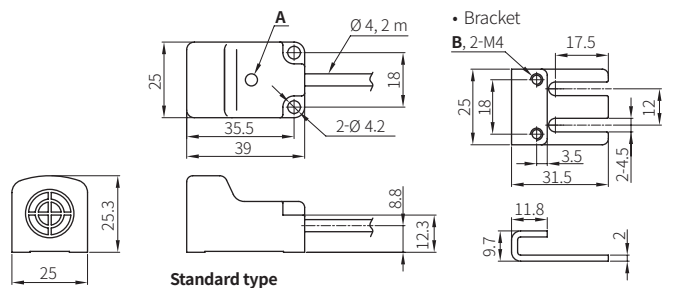

■ PSN30

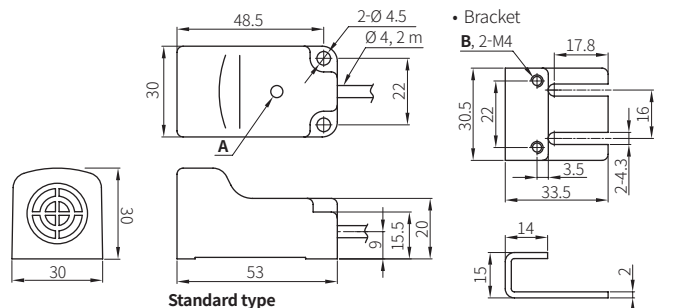

■ PSN40

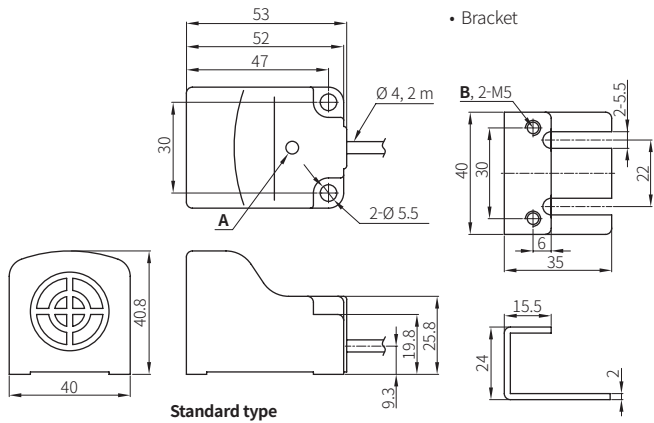

Sensing Distance Feature Data by Target Material and Size

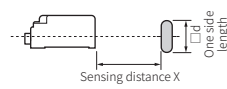

• PSN17-5

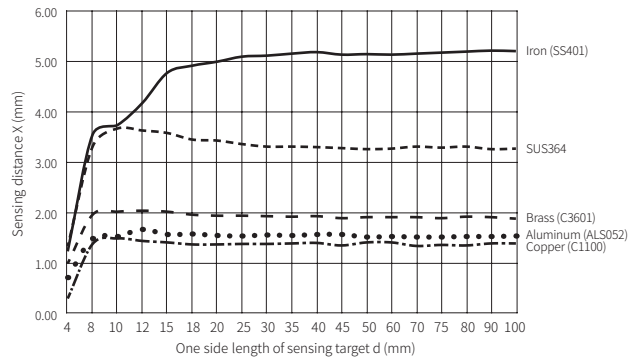

• PSN17-8

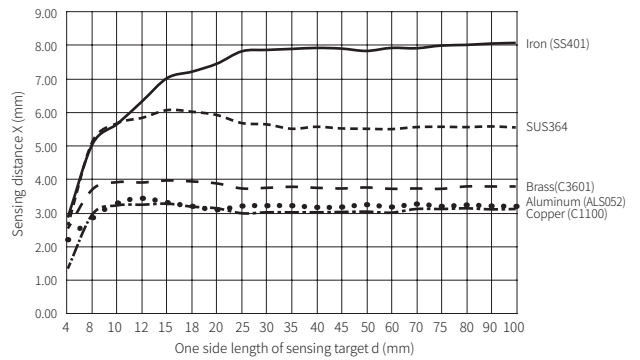

• PSN25

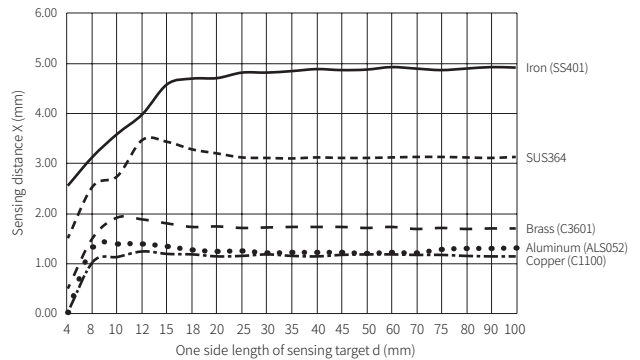

Setting Distance Formula

Detecting distance can be changed by the shape, size or material of the target.

For stable sensing, install the unit within the 70% of sensing distance.

Setting distance (Sa)
= Sensing distance (Sn) × 70%

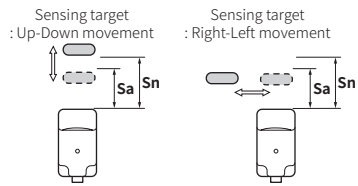

Mutual-interference & Influence by Surrounding Metals

■ Mutual-interference

When plural proximity sensors are mounted in a close row, malfunction of sensor may be caused due to mutual interference.

Therefore, be sure to provide a minimum distance between the two sensors, as below table.

[Face to Face]

[Parallel]



■ Differential frequency

When the several proximity sensors are installed closely each other, install standard type and differential frequency type sensors alternatively to prevent mutual interference due to frequency interference.

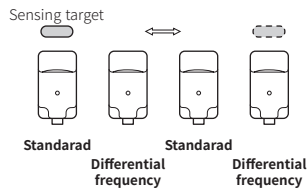

■ Influence by surrounding metals

When sensors are mounted on metallic panel, it must be prevented sensors from being affected by any metallic object except target. Therefore, be sure to provide a minimum distance as below chart.

• Standard type

• Upper side type

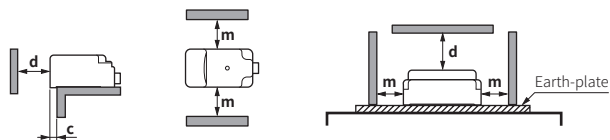

(unit: mm)

Model	PSN17-5	PSN17-8	PSN25	PSN30-10	PSN30-15	PSN40
A	30	48	30	60	90	120
B	36	40	40	50	65	70
c	4	4	4	5	5	5
d	15	24	15	30	45	60
m	18	20	20	25	35	35

• PSN30-10

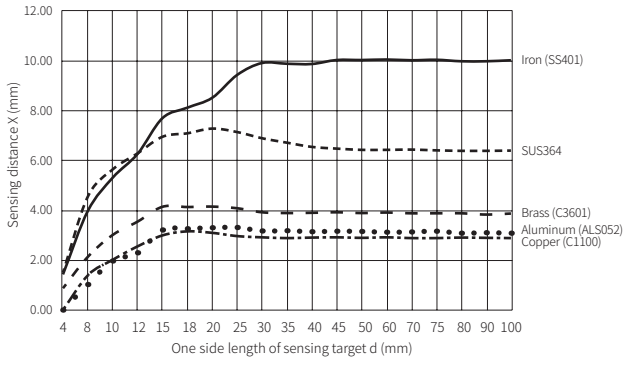

• PSN30-15

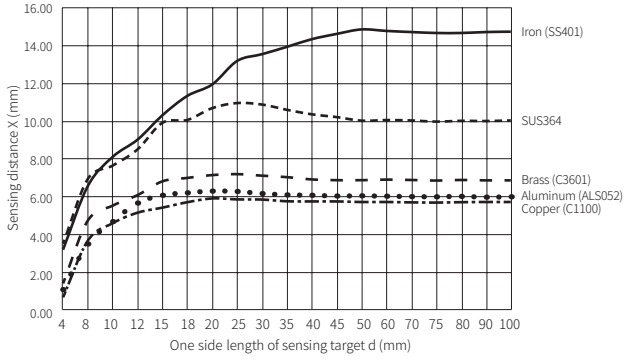

• PSN40

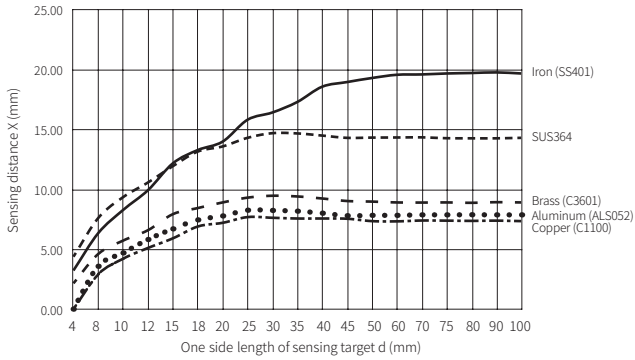

Sensing Distance Feature Data by Parallel (Left/Right) Movement

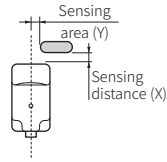

• PSN17

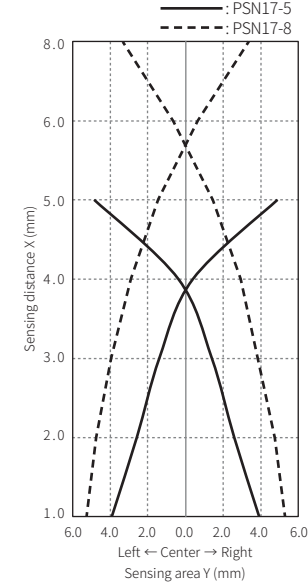

• PSN25

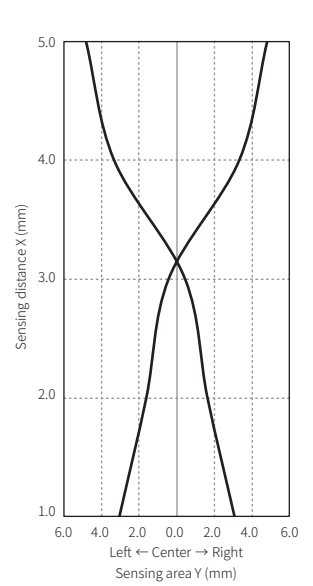

• PSN30

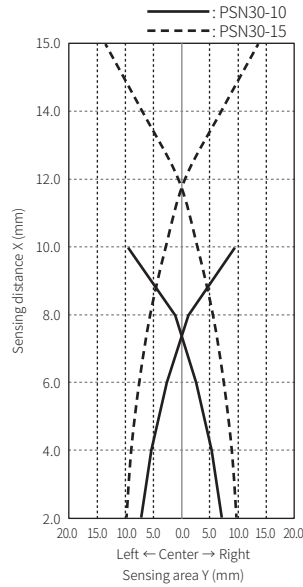

• PSN40

